

Draft

HAWTHORNE HIGH SCHOOL ATHLETIC FIELDS IMPROVEMENTS PROJECT

Initial Study/Mitigated Negative Declaration

Prepared for
Centinela Valley Union High School District

March 2022



Draft

HAWTHORNE HIGH SCHOOL ATHLETIC FIELDS IMPROVEMENTS PROJECT

Initial Study/Mitigated Negative Declaration

Prepared for
Centinela Valley Union High School District

March 2022

626 Wilshire Boulevard
Suite 1100
Los Angeles, CA 90017
213.599.4300
esassoc.com



Bend	Orlando	San Jose
Camarillo	Pasadena	Santa Monica
Delray Beach	Petaluma	Sarasota
Destin	Portland	Seattle
Irvine	Sacramento	Tampa
Los Angeles	San Diego	
Oakland	San Francisco	

OUR COMMITMENT TO SUSTAINABILITY | ESA helps a variety of public and private sector clients plan and prepare for climate change and emerging regulations that limit GHG emissions. ESA is a registered assessor with the California Climate Action Registry, a Climate Leader, and founding reporter for the Climate Registry. ESA is also a corporate member of the U.S. Green Building Council and the Business Council on Climate Change (BC3). Internally, ESA has adopted a Sustainability Vision and Policy Statement and a plan to reduce waste and energy within our operations. This document was produced using recycled paper.

TABLE OF CONTENTS

Initial Study/Mitigated Negative Declaration

	<u>Page</u>
Chapter 1, Introduction	1
Overview	1
CEQA Requirements	1
Initial Study/ Mitigated Negative Declaration Organization	2
Chapter 2, Project Description	3
Project Overview	3
Background.....	3
Environmental Setting	4
Project Location	4
Project Site Characteristics.....	4
Project Characteristics.....	10
Athletic Facilities	10
Hawthorne Aquatics Facility.....	15
Access, Parking, and Circulation	16
Operation.....	16
Construction Activities	17
Discretionary Approvals Required.....	18
Chapter 3, Initial Study/Environmental Checklist	19
Evaluation of Environmental Impacts.....	20
Environmental Checklist.....	23
Aesthetics.....	23
Agriculture and Forestry Resources	31
Air Quality.....	33
Biological Resources	46
Cultural Resources.....	50
Energy	54
Geology and Soils.....	58
Greenhouse Gas Emissions	65
Hazards and Hazardous Materials	70
Hydrology and Water Quality	75
Land Use and Planning.....	81
Mineral Resources	83
Noise	85
Population and Housing.....	98
Public Services.....	99
Recreation	102
Transportation	104
Tribal Cultural Resources	108
Utilities and Service Systems	111

	<u>Page</u>
Wildfire	114
Mandatory Findings of Significance	116
Chapter 4, Report Preparers.....	119
Lead Agency.....	119
Environmental Impact Report Preparation	119
Environmental Consultant.....	119
Architect	119
Geotechnical Engineers.....	120
Lighting Engineers	120
Chapter 5, References.....	121

Appendices

- A. Photometrics Plan
- B. Air Quality, GHG, and Energy Calculations
- C. Biological Resources Database Search
- D. Cultural Resources
- E1. Geotechnical Evaluation
- E2. Additional Geotechnical Design Recommendations
- F. Noise Calculations
- G. Tribal Cultural Resources

List of Figures

Figure 1 Regional Location	5
Figure 2 Project Location	6
Figure 3 Existing Site Plan	7
Figure 4 Project Site Plan.....	11
Figure 5 Lighting Equipment Layout	14
Figure 6 Musco Luminaire TLC-LED-1500	29
Figure 7 Musco Luminaire TLC-LED-1200	29
Figure 8 Noise Measurement Locations	89

List of Tables

Table 1 Existing Hawthorne Aquatics Facility Uses.....	8
Table 2 Proposed Lighting	12
Table 3 Proposed Aquatic Facility Uses	15
Table 4 Construction Schedule	17
Table 5 Lighting Equipment List.....	28
Table 6 Estimated Construction Schedule.....	36
Table 7 Maximum Regional Construction Emissions – Without Mitigation (pounds per day)	37
Table 8 Maximum Localized Construction Emissions – without mitigation (pounds per day)	41

	<u>Page</u>
Table 9 Summary of Energy Consumption During Project Construction	55
Table 10 Project Construction Greenhouse Gas Emissions	68
Table 11 Land Use Compatibility Matrix	88
Table 12 Summary of Ambient Noise Measurements	90
Table 13 Construction Equipment and Estimated Noise Levels.....	91
Table 14 Estimated Construction Noise Levels at Sensitive Receptors.....	92
Table 15 Vibration Source Levels for Construction Equipment	97
Table 16 Summary of AB 52 Consultation.....	109

This page intentionally left blank

CHAPTER 1

Introduction

Overview

The Centinela Valley Union High School District (District), as the lead agency under the California Environmental Quality Act (CEQA), has prepared this Draft Initial Study/Mitigated Negative Declaration (Draft IS/MND) to evaluate the potential environmental consequences associated with the Hawthorne High School Athletic Fields Improvement Project (Project). The Project includes the replacement of the existing athletic fields located on the grounds of the Hawthorne High School campus (Campus) as well as the redevelopment of the Hawthorne Aquatics Facility. The athletic fields and Hawthorne Aquatics Facility are hereafter referred to as the “Project site”. The athletic fields on the western and eastern portions of the Campus would be improved with new synthetic turf, existing field lighting would be replaced with high efficiency lighting, and existing public announcement systems would be replaced. Additionally, the Project would include the construction of a 5,400 square-foot (sf) team room/concessions stand on the central portion of the Campus, the updating of existing utilities, the addition of new site improvements, including bike racks, drinking fountains, and trash receptacles, and the Hawthorne Aquatics Facility redevelopment. As part of the District’s discretionary review process, the proposed Project is required to undergo environmental review in accordance with the CEQA.

CEQA Requirements

The CEQA was enacted in 1970 for the purpose of providing decision-makers and the public with information regarding environmental effects of proposed projects, identifying means of avoiding environmental damage, and disclosing to the public the reasons behind a project’s approval, even if it leads to environmental damage. The District has determined the proposed Project is subject to CEQA, and no exemptions apply. Therefore, the preparation of an Initial Study/Mitigated Negative Declaration is required. An Initial Study/Mitigated Negative Declaration is a preliminary analysis conducted by the lead agency, in consultation with other agencies (responsible or trustee agencies, as applicable), to determine whether there is substantial evidence that a project may have a significant effect on the environment. If the Initial Study/Mitigated Negative Declaration concludes that a project, with mitigation, may have a significant effect on the environment, an environmental impact report should be prepared; otherwise, the lead agency may adopt a negative declaration or mitigated negative declaration.

This Initial Study/Mitigated Negative Declaration has been prepared in accordance with CEQA (Public Resources Code Section 21000 et seq.), the State CEQA Guidelines (Title 14, California Code of Regulations, Section 15000 et seq.)

Initial Study/ Mitigated Negative Declaration Organization

The content and format of this report are designed to meet the requirements of CEQA. This Draft IS/MND identifies the potential environmental impacts of the proposed Project. The report contains the following sections.

Chapter 1, Introduction, identifies the purpose and scope of the Draft IS/MND.

Chapter 2, Project Description, identifies the location and environmental setting of the proposed Project and describes the proposed Project in detail.

Chapter 3, Initial Study/Environmental Checklist, presents the checklist responses for each resource topic. This section identifies the potential impacts of implementing the proposed Project, and identifies all references and individuals cited in this Draft IS/MND.

Chapter 4, Report Preparers, provides a list of key personnel involved in the preparation of this report and key personnel consulted.

Chapter 5, References, provides a list of reference materials used during the preparation of this Draft IS/MND.

CHAPTER 2

Project Description

Project Overview

The proposed Hawthorne High School Athletic Fields Improvements Project (Project) includes the replacement of the existing athletic fields located on the grounds of the Hawthorne High School campus (Campus) and the redevelopment of the Hawthorne Aquatics Facility located to the southeast of the athletic fields, hereafter the athletic fields and Hawthorne Aquatics Facility are referred to as the “Project site.” The athletic fields on the western and eastern grounds of the Campus would be improved with new synthetic turf, existing field lighting would be replaced with high efficiency lighting, and existing public announcement systems would be replaced. Additionally, the proposed Project would include the construction of a 5,400-sf team room/concessions stand on the central portion of the athletic fields, the updating of existing utilities, and the addition of new site improvements, including bike racks, drinking fountains, and trash receptacles. The Governing Board of the Centinela Valley Union High School District (District) is acquiring the City-owned Hawthorne Aquatics Facility. There are no current plans for the extent of the renovation or redevelopment of the Hawthorne Aquatics Facility as of right now. Therefore, for the purposes of this Draft IS/MND, the aquatic facilities being proposed are presented as a worst-case scenario, assuming complete demolition and redevelopment of the existing Hawthorne Aquatics Facility, like for like.

The proposed Project would not increase the student capacity on the Campus, would not increase operation or use of the athletic fields and Hawthorne Aquatics Facility, and would not involve any temporary relocation of students during construction. Construction of the athletic fields would be completed over 18 months and is scheduled to begin in December 2022. Although, there are no current plans for the renovation or redevelopment of the Hawthorne Aquatics Facility, the construction of the proposed aquatic facility would be completed over 11 months and would be scheduled to begin in October 2024.

Background

Hawthorne High School is part of the District. The District serves approximately 6,900 students in grades 9–12 from Lawndale, Hawthorne, Lennox, Del Aire, and El Camino Village, and is comprised of Hawthorne High School, Lawndale High School, R.K. Lloyd Continuation High School, Leuzinger High School, and Centinela Valley Independent Study (Ed Data 2021). The District is also the chartering authority for New Opportunities Charter School and Family First Charter School.

Environmental Setting

Project Location

The Project site is located within the City of Hawthorne in the Centinela Valley, which is a relatively flat alluvial plain stretching from the Baldwin Hills on the north to the Palos Verdes Hills on the south, and is approximately 13 miles south of the Santa Monica Mountains (City of Hawthorne 1989). The Project site is made up of the athletic fields located on the grounds of the Campus at 4859 West El Segundo Boulevard and the Hawthorne Aquatics Facility located at 12501 South Inglewood Avenue within the City of Hawthorne (**Figure 1, Regional Location**). The Campus is located entirely within Assessor's Parcel Number (APN) 4142-012-908 and the Hawthorne Aquatics Facility is located entirely within APN 4142-012-900. As shown in Figure 1, the Project site is located approximately 11 miles southwest of downtown Los Angeles and approximately 14 miles northwest of the City of Long Beach. The Project site is located approximately 2 miles northeast of Pacific Coast Highway, 0.2-mile east of Interstate (I-) 405, approximately 4.5 miles west of I-110, and approximately 0.8-mile south of I-105. Local access is provided by West El Segundo Boulevard to the south, South Inglewood Avenue to the east, and West 124th Street to the north. The athletic fields are located within the northern portion of the Campus, encompasses approximately 12 acres, and is bounded by West 124th Street on the north, South Inglewood Avenue on the east, single family residential residences on the west, and an existing railroad right-of-way, and the existing remaining portions of the Campus to the south. The Hawthorne Aquatics Facility encompasses approximately 1.26 acres and is bounded by the existing railroad right-of-way on the north, South Inglewood Avenue on the east, and the existing Hawthorne High School campus to the west and south. The location of the athletic fields and Project site are depicted on **Figure 2, Project Location**.

Project Site Characteristics

Existing Conditions

The Project site encompasses the athletic fields located on the grounds of the Campus, which is an operational high school serving students in grades 9 through 12, and the City-owned Hawthorne Aquatics Facility that serves the community of Hawthorne (**Figure 3, Existing Site Plan**). This Hawthorne Aquatics Facility provides two swimming pools (lap pool and baby pool), and men and women's locker rooms that include heated showers and private changing rooms. The Project site is currently occupied by the athletic facilities including a baseball/softball field, outdoor basketball courts, a football stadium with approximately 2,000 home bleacher seats and 550 visitor bleacher seats, as well as a track, three tennis courts, and six handball courts and the Hawthorne Aquatics Facility. Landscaping on the Project site is limited to grass fields, some mature trees and shrubs. The football field and track are located east of Felton Avenue, adjacent to existing single-family homes and west of the baseball/softball field. The outdoor basketball courts, tennis courts, and handball courts are located east of the football field along the southwest boundary of the Project site and north of the existing railroad right-of-way. There is a baseball field located east of the football field along the northwest boundary of the Project site, south of West 124th Street. The handball and tennis courts are located south of the baseball field and adjacent to the existing railroad right-of-way with existing campus facilities to the south.

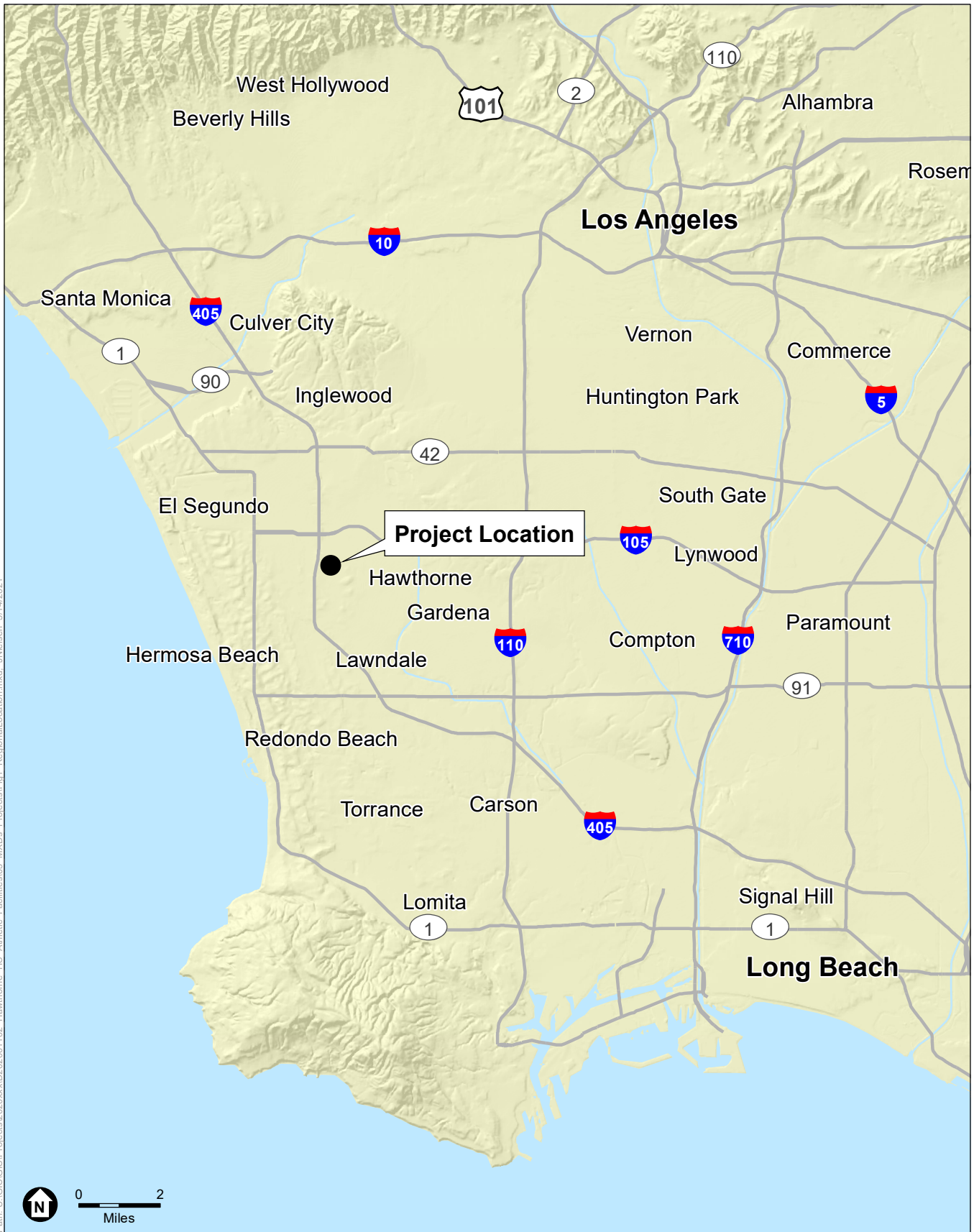

Path: U:\GIS\GIS\Projects\2020\Hawthorne_HS_Athletic_Facilities\03_MXD\Projects\Fig1_RegionalLocation.mxd; jNielsen; 5/14/2021

SOURCE: ESRI

Hawthorne High School Athletic Fields Improvements Project

Figure 1
Regional Location





SOURCE: ESRI

Hawthorne High School Athletic Fields Improvements Project

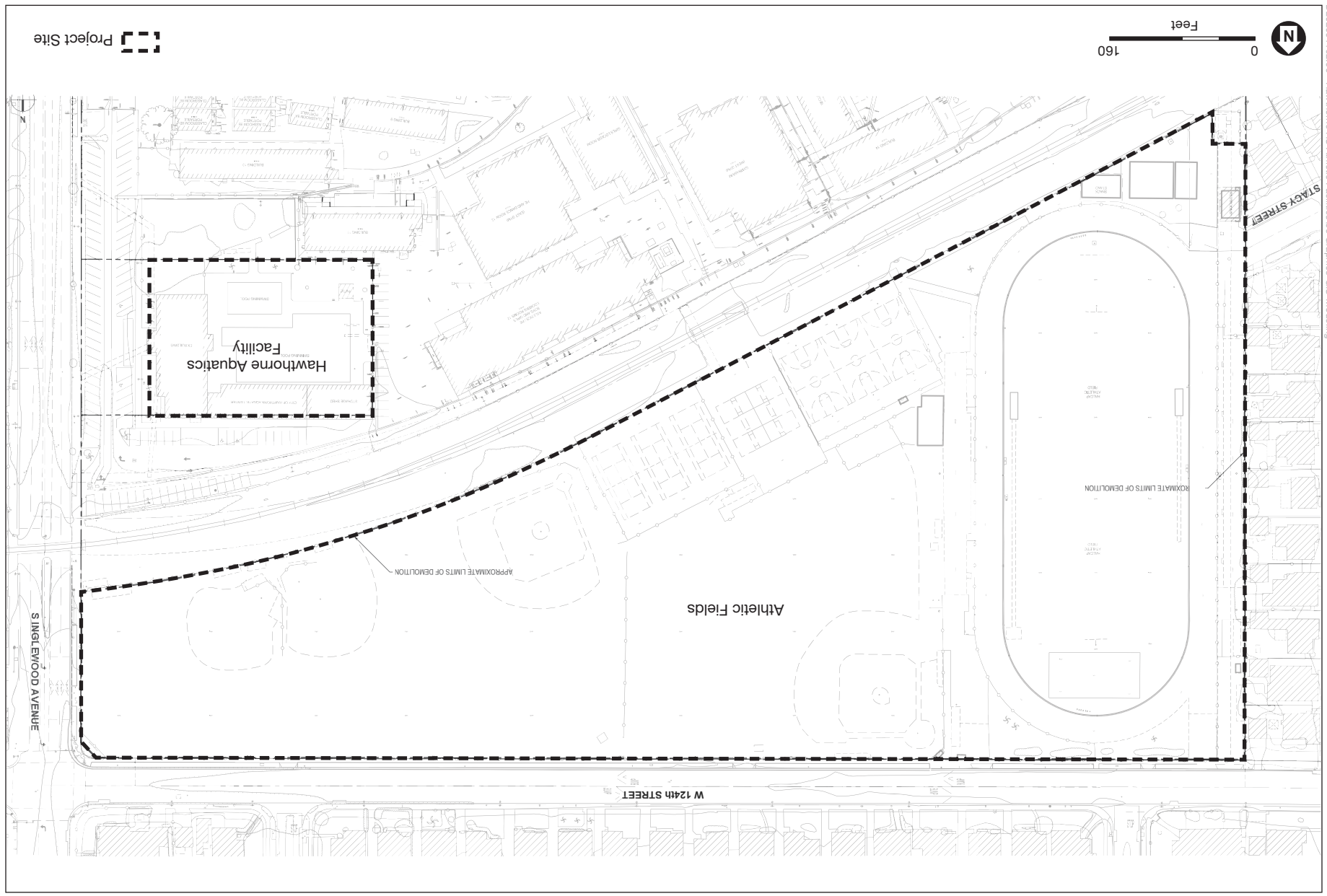

Figure 2
Project Location

Figure 3
Existing Site Plan

Hawthorne High School Athletic Fields Improvements Project

SOURCE: LPA, 2020



D202001102.00 - Hawthorne HS Athletic Facilities05 Graphics-CIS-Modeling

Additional baseball/softball fields are located east of the existing tennis courts and west of South Inglewood Avenue. Existing athletic field lighting includes tall pole mounted light fixtures that are used to illuminate the football and track fields in the stadium

The Hawthorne Aquatics Facility is located at 12501 S Inglewood Avenue in the City of Hawthorne. This City-owned recreation facility provides two swimming pools (lap pool and baby pool) seating and structures housing men and women's locker rooms with heated showers and private changing rooms. The Hawthorne Aquatics Facility includes two swimming pools at an approximate total of 11,200-sf (2,000-sf baby pool and 9,200-sf lap pool), 16,200-sf of structures, and 0.28-acre surface parking.¹ The pool is currently open from 7:00 a.m. to 5:00 p.m. on weekdays and 7:00 a.m. to 1:00 p.m. on Saturdays. During the week, the pool is open to the public from 1:00 p.m. to 3:00 p.m. and hosts swim classes, which require registration, between the hours of 7:00 a.m. to 10:00 a.m. (except Thursdays), 12:00 p.m. to 2:00 p.m., and 3:00 p.m. to 4:00 p.m. Additionally, the South Bay Swim Team uses the pool from 5:30 p.m. to 7:30 p.m. On the weekend, the pool is open to the public from 1:00 p.m. to 4:00 p.m. and hosts swimming classes between 9:00 a.m. to 12:00 p.m. In addition to the aforementioned schedule, the Hawthorne Aquatics Facility hosted approximately 15 events/swim meets during 2019 at various dates and times. As shown in **Table 1, Existing Hawthorne Aquatics Facility Uses**, in 2019, Hawthorne Aquatics Facility uses included recreational swim, swimming and diving lessons, lap swimming, water aerobics classes, a Junior Lifeguard Program, Sunday Classes for Adaptive Swimming, and uses by the local South Bay Swim Team.

**TABLE 1
EXISTING HAWTHORNE AQUATICS FACILITY USES**

Program	Use Type	# of Events	Season
Existing^a			
Recreational Swim	Swim	-	Summer/1 p.m. to 4 p.m.
Diving	Lessons	-	Summer/11 a.m.
Lap Swimming	Swim	-	Year Round/6 a.m. to 9 a.m., 12 p.m. to 1 p.m., 3 p.m. to 5 p.m. and 9 a.m. to 1 p.m. on Weekends
Water Aerobics	Lessons	-	Summer/8 a.m. to 9 a.m., 6 p.m. to 7 p.m., and 9 a.m. to 10 a.m. Saturdays
Community Swim Lessons	Lessons	-	Summer/7 a.m. to 10 a.m. (except Thursdays), 12 p.m. to 2 p.m., and 3 p.m. to 4 p.m. and 9 a.m. to 12 p.m. on weekends
South Bay Swim Team	Practice	-	Year Round/5:30 p.m. to 7:30 p.m.
Events/Swim Meets	Meets/Events	15	Year Round
Junior Lifeguard Program	Lessons	-	Summer/11 a.m. to 1 p.m.
Sunday Classes/Adaptive Swim for Special Needs	Lessons	-	Summer/9 a.m. to 11 a.m. on Sundays
Total Events:		15	

NOTES:

^a Existing use was derived from pool uses during 2019 as a worst-case-scenario.

SOURCE: City of Hawthorne, 2019.

¹ The totals presented are rough estimates based on measurements conducted on Google Earth.

The Project site is located within walking or biking distance from Metro Routes 211/215, 40, 126 and 740. Bus lines with a stop located within 1 mile of the Project site include the following:

- Metro Route 211/215 – nearest stop at West El Segundo Boulevard and Broadway, approximately 0.02 mile east of the Project site, runs north-south along South Inglewood Avenue.
- Metro Route 40 – nearest stop at Hawthorne Boulevard and West El Segundo Boulevard, approximately 0.5 mile southeast of the Project site, runs north-south along Hawthorne Boulevard.
- Metro Route 126 – nearest stop at 120th Street and Hawthorne Boulevard, approximately 0.6-mile northeast of the Project site, runs east-west along 120th Street.
- Metro Route 740 – nearest stop at Hawthorne Boulevard and West El Segundo Boulevard, approximately 0.5 mile southeast of the Project site, runs north-south along Hawthorne Boulevard.

Bus lines with a stop located within at least 0.25 mile of the Project site include the following:

- Metro Route 211/215 – nearest stop at West El Segundo Boulevard and Broadway, approximately 0.02 mile east of the Project site, runs north-south along South Inglewood Avenue.
- Metro Route 211/215 – stop at South Inglewood Avenue and West El Segundo Boulevard, approximately 0.25 mile southeast of the Project site, runs north-south along South Inglewood Avenue.

According to the City of Hawthorne’s (City) Zoning Ordinance, the Project site is zoned UOS-Urban Open Space (City of Hawthorne 2019). The City’s General Plan Land Use designation for the Campus is ‘Public Facilities.’ According to the City’s Land Use Element, the Public Facilities designation includes a variety of public uses, such as institutional uses (elementary, junior high, and high schools) and government facilities (city hall, police and fire stations, libraries, etc.). Allowable development on Public Facilities-designated areas may include a floor area ratio (FAR) ranging from 0.30 to 0.75. The Hawthorne Aquatics Facility has a Land Use designation of ‘Open Space’ which includes recreational uses and parklands, horticultural plots, railroad rights-of-way, flood control channels, Southern California Edison easements, and small lots. Development in this category is limited to recreational uses or other uses necessary in easements or flood control channels and includes a FAR ranging from 0.1 to 0.3 (City of Hawthorne 2016).

The Project site is located approximately 3 miles west of the Newport-Inglewood Fault Zone and 1 mile southeast of the Charnock Fault Zone (Department of Conservation 2021). Liquefaction is not considered a significant risk in Hawthorne, as the City is not located within an area identified as having the potential for liquefaction (City of Hawthorne 2014). The Project site is not within a designated hillside, airport hazard, coastal zone, farmland, fire hazard severity zone, hazardous waste site, landslide, liquefaction, fault rupture, or tsunami inundation zone (City of Hawthorne 1989). The Project site is located approximately 1 mile to the west of the Hawthorne Municipal Airport. According to the Los Angeles County Airport Land Use Commission’s Airport Influence Area, the Project site is not within any of the airport’s safety or influence areas and is not subject to Federal Aviation Administration restrictions (ALUC 2018).

Surrounding Uses

The Project site is located within an urban residential neighborhood comprised of a mix of commercial and residential uses consisting primarily of single- and multi-family (one- and two-story) homes. The Project site is bounded by West 124th Street and residential uses to the north, South Inglewood Avenue and commercial and residential uses the east, single-family residences and the I-405 to the west, and an existing railroad right-of-way followed by the existing Hawthorne High School campus and residential uses to the south.

Project Characteristics

As shown in **Figure 4, Project Site Plan**, the proposed Project would include upgrades to the athletic fields on Campus, including a new combined football/soccer field, upgraded track, and upgraded bleachers on the western portion of the athletic fields; a reconfigured baseball field, new basketball courts, and a 5,400 square-foot (sf) team room/concessions building on the central portion of the Campus; and a new softball field and a multi-use (soccer and football) field in the eastern portion of the athletic fields. The Hawthorne Aquatics Facility would include upgrades to the pool, pool deck, public seating, and locker rooms.

Athletic Facilities

The western portion of the athletic facilities would include upgrades to the existing football field and track, including new synthetic turf and striping on the football field to allow for a dual football/soccer use, a new track, a new scoreboard, existing field lighting would be replaced with high efficiency LED lighting, the existing public announcement systems would be replaced, and upgraded bleachers on the western portion of the athletic fields. A new digital scoreboard would be installed on the northern portion of the football/soccer field. Bleachers would be replaced on the west and east side of the football/soccer field and track and would be improved with aluminum decking. The “home side” eastern bleachers would contain 1,504 seats, 18 of which would be wheelchair spaces, 18 for companion seating, and 15 for semi-ambulant seating. The “visitor side” western bleachers would contain 1,102 seats, 12 of which would be wheelchair spaces, 12 for companion seating, and 12 for semi-ambulant seating. The new bleachers would decrease capacity by 496 seats for the home bleachers and increase seating capacity by 552 seats for the visitor bleachers. In addition, existing utilities would be upgraded and site improvements, such as bike racks, drinking fountains, and trash receptacles, would be installed.

On the central portion of the Campus, the existing baseball field and outdoor basketball, tennis, and handball courts would be replaced by a baseball field, outdoor basketball and handball courts, and 5,400-sf team room/concessions building. The new baseball field would include home and visitor’s dugouts, outfield fencing, a backstop wall with padding, a pitcher’s mound, a batting cage/bullpen with synthetic turf, a dugout, a foul pole, a new baseball scoreboard that would be located to the northeast portion of the field. Three basketball courts and three handball courts would be constructed to the south of the baseball field. The new 5,400-sf team room/concessions building would be constructed on the southwest of the basketball courts. The new building would include a 465-sf concessions stand, a 950-sf team room with 32 lockers, a 910-sf team room with 30 lockers, a 730-sf training room, 1,525-sf of restrooms, and electric and storage facilities.

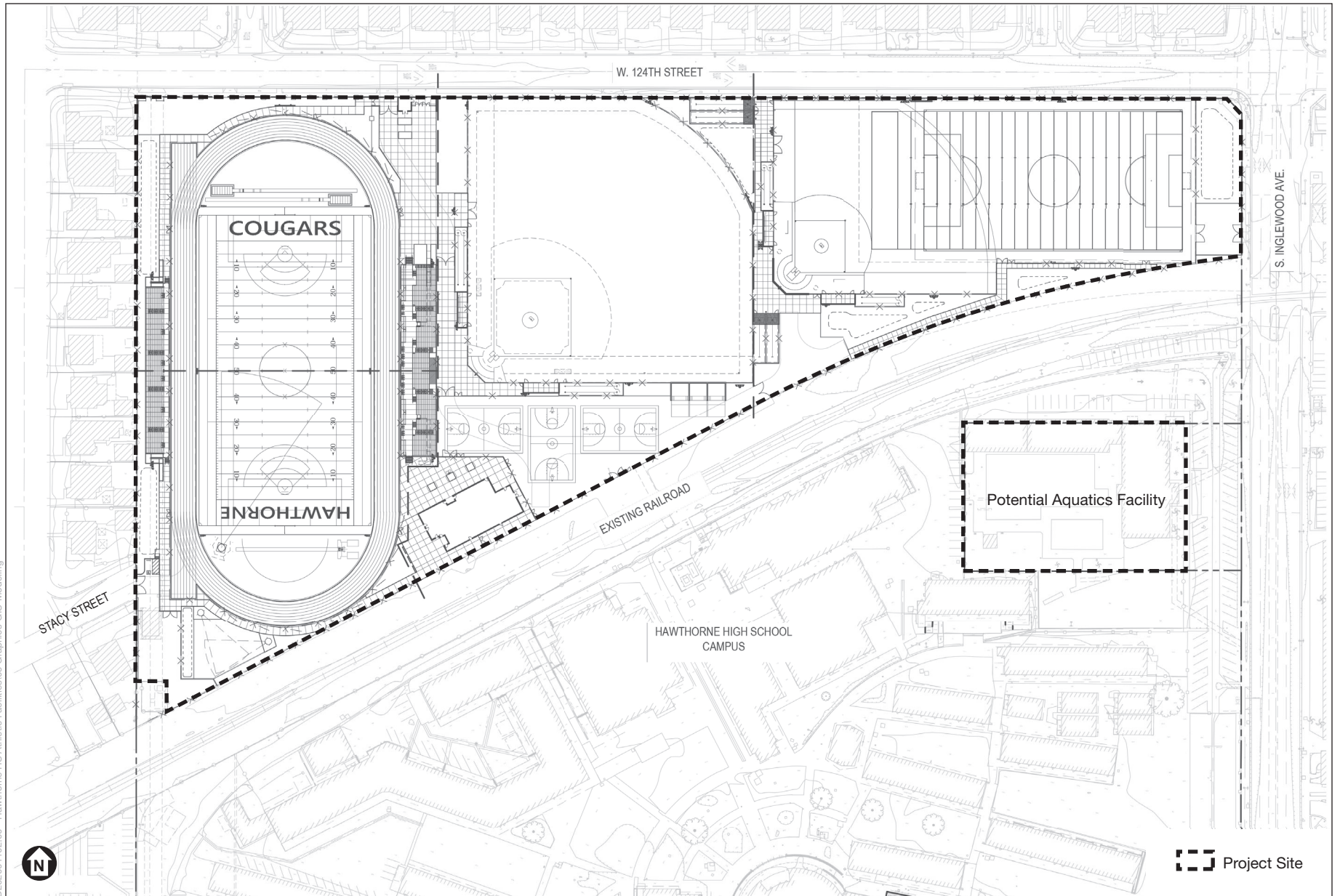

D:\2020\01102.00 - Hawthorne HS Athletic Facilities\05 Graphics-GIS-Modeling

SOURCE: LPA, 2020

Hawthorne High School Athletic Fields Improvements Project

Figure 4
Project Site Plan



On the eastern portion of the Campus, the existing athletic fields would be replaced with a new softball field and a multi-use (soccer and football) field. The new softball field would include synthetic turf, softball netting, a backstop wall with padding, a softball base, a bullpen, a batting cage, as well as a new softball scoreboard that would be located northeast of the pitcher’s mound. The multi-use field improvements would include synthetic turf, a soccer goal, and curb outside the southern and eastern edge of the field.

The field improvements at the baseball and softball fields would provide outfield fencing ranging from 4 feet to 14 feet in height and netting ranging from 20 feet to 40 feet in height. The proposed Project would provide upgrades to the storm drain system and existing utilities throughout the Project site. In addition, the proposed Project would include new benches, bike racks, drinking fountains, trash receptacles, recycling receptacles, a flagpole, tree grates, and benches.

New athletic field lighting would be installed throughout the athletic fields in place of and in addition to existing lighting as shown in **Figure 5, Lighting Equipment Layout**. The proposed new field lighting would be light-emitting diode (LED), pointed downward, and fully shielded. **Table 2, Proposed Lighting**, includes the quantity, location, and size of the poles and luminaires, which correspond to Figure 5, Lighting Equipment Layout. As shown in Table 2, 16 new light poles would be provided, which would range in height from 60 to 80 feet and contain a total of 135 light fixtures (i.e., luminaires) mounted on the poles at heights from 15.5 feet to 83 feet. The luminaires would be fully shielded to direct light onto the athletic fields to avoid or minimize spillover light, glare, and skyglow impacts. The additional field lighting would improve safety for those using the athletic facilities and it would provide the District with greater flexibility in scheduling athletic events and activities.

**TABLE 2
PROPOSED LIGHTING**

Pole			Luminaires	
Quantity	Location	Size (feet)	Mounting Height (feet)	Quantity Pole
1	A1	70	70	4
			70	1
			16	1
1	A2	70	70	4*
			70	1
			16	1
			70	4
1	A4	60	60	2
			60	1
			60	1
			16	1
1	B1	80	80	6
			16	1

Pole			Luminaires	
Quantity	Location	Size (feet)	Mounting Height (feet)	Quantity Pole
1	B2	80	80	6
			16	1
			80	3*
1	B3	70	70	5
			16	1
1	C1	70	70	4
			16	2
1	C2	70	70	2
			70	4
			70	1
			70	1
			16	2
			16	1
2	F1-F2	80	80	11
			16	2
			70	1
2	F3-F4	80	80	10
			20	2
			70	1
1	S1	60	60	4
			16	1
2	S2-S3	60	60	4
1	S4	70	70	6
			16	1
16	TOTALS			135

NOTE:

* This structure utilizes a back-to-back mounting configuration.

SOURCE: Musco Sports Lighting, LLC., Preliminary Photometrics Plans, 2021.

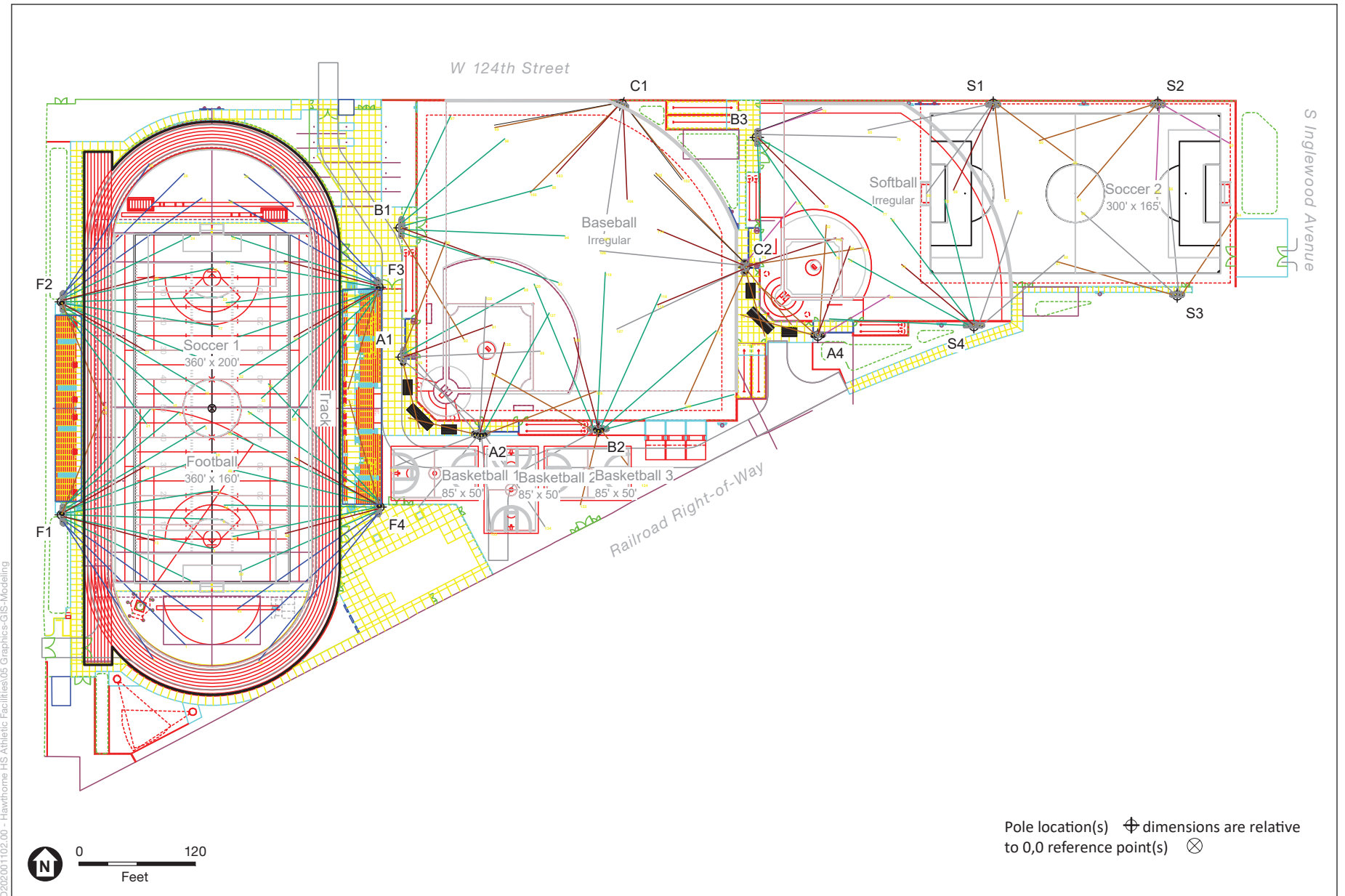

SOURCE: Musco Lighting, 2020

Hawthorne High School Athletic Fields Improvements Project

Figure 5
Lighting Equipment Layout

Hawthorne Aquatics Facility

The proposed aquatic facility would be open year-round, depending on the sports and groups that utilize the facility. Hawthorne High School does not currently have a formalized athletic calendar or program for aquatic sports; however, it is anticipated that new aquatic programs, such as water polo and swimming teams, could be started based the improvements being made to this facility. These sports would utilize the proposed aquatic facility year-round, with the water polo season taking place in the fall and the swimming season taking place in the spring. As shown in **Table 3, Proposed Aquatics Facility Uses**, the proposed aquatic facility would have a boys and girls swim team and potentially a water polo team that would practice at the facility and host approximately four and twelve events/meets, respectively. In addition, in accordance with the required Civic Center Act, the proposed aquatic facility could potentially be utilized by the South Bay Swim Team year-round and by Hawthorne residents in the summer season for recreational swim, swim and diving lessons, lap swimming, water aerobics classes, a Junior Lifeguard Program, and Sunday Classes for Adaptive Swimming for Special Needs.² The Hawthorne Aquatic Facility would likely operate from 6:00 a.m. to 7:00 p.m. on weekdays and 8:00 a.m. to 4:00 p.m. on weekend days; however, hours of operation are expected to change throughout the seasons.³

**TABLE 3
PROPOSED AQUATIC FACILITY USES**

Program	Use Type	# of Annual Events	Season
Proposed Uses^a			
Water Polo	Meets/Events	12	Fall
Swim Teams	Meets/Events	4	Spring
Community Teams (South Bay Swim Team)	Meets/Events	3	
Swim Teams	Practice	-	Spring
Water Polo	Practice	-	Fall
South Bay Swim Team	Practice	-	Year Round/5:30 p.m. to 7:30 p.m.
Community Recreational Swim	Swim	-	Summer/1 p.m. to 4 p.m.
Community Diving	Lessons	-	Summer/11 a.m.
Community Swim Lessons	Lessons	-	Summer/7 a.m. to 10 a.m. (except Thursdays), 12 p.m. to 2 p.m., and 3 p.m. to 4 p.m. and 9 a.m. to 12 p.m. on weekends
Community Lap Swimming	Swim	-	Summer/1 p.m. to 3 p.m. and 9 a.m. to 1 p.m. on Weekends
Community Water Aerobics	Lessons	-	Summer/8 a.m. to 9 a.m., 6 p.m. to 7 p.m., and 9 a.m. to 10 a.m. Saturdays

² The California Civic Center Act was enacted in 1917 (codified as Education Code Section 38130 et seq.), and it provided the legal basis for the provision of school facilities as civic centers. The Civic Center Act requires school districts to allow community groups to use district-owned facilities.

³ The aforementioned uses are based on the District's experience with similar facilities and includes both school and community use.

Junior Lifeguard Program	Lessons	-	Summer/11 a.m. to 1 p.m.
Sunday Classes/Adaptive Swim for Special Needs	Lessons	-	Summer/9 a.m. to 11 a.m. on Sundays
Total Annual Events:		19	

NOTES:

^a Assumptions included as a worst-case-scenario as Hawthorne High School does not currently have a water polo team. Event numbers were based off El Segundo High School aquatics program. El Segundo High School is in the Ocean League, same league as Hawthorne High School.

SOURCE: City of Hawthorne, 2019 and El Segundo High School, 2021a; 2021b.

While the Governing Board of the District is acquiring the City-owned Hawthorne Aquatic Facility, at this time there are no plans for the extent of the renovation or redevelopment of the Aquatic Facility. Therefore, for the purposes of this Draft IS/MND, the proposed aquatic facility is presented as a worst-case scenario, assuming complete demolition and redevelopment of the existing Hawthorne Aquatic Facility like for like.

Access, Parking, and Circulation

There are three parking areas that serve the Project site: the two parking lots south and southeast of the Project site, west of South Inglewood Avenue and a parking area in the southwestern corner of the Project site, east of Stacy Street (see Figure 3). The parking lots south of the athletic fields and east of the Hawthorne Aquatics Facility are located west of South Inglewood Avenue, serve both the school and existing Hawthorne Aquatics Facility, and can be accessed from two existing driveways off of South Inglewood Avenue. The parking area located east of Stacy Street that currently allows vehicular access and parking is located southwest of the football field.

The proposed Project assumes a worst-case scenario of demolishing and redeveloping the existing Hawthorne Aquatic Facility like for like, and as such, it is assumed that new surface parking would not be required. However, improvements to the parking area in the southwestern corner of the Project site, east of Stacy Street, would occur under the proposed Project. Additionally, improvements to the parking area in the southwest corner of the Project site would include designating one parking stall as an Americans with Disabilities Act (ADA) accessible parking space. Furthermore, parking and access/driveways to the Project site would be the same as existing conditions. Vehicular traffic would use West 124th Street, Fenton Avenue, or Stacy Street to access the entrance to the parking area on the southwest corner of the Project site and West 124th Street, West 120th Street, or West El Segundo Boulevard to reach South Inglewood Avenue to access the two existing driveways to the parking lots that would serve the proposed athletic fields and aquatics facility.

Operation

The proposed Project would increase the bleacher seating capacity in the football/track stadium by approximately 56 seats (an increase of 552 seats for the visitor bleachers and a decrease in the home bleachers by 496). Operationally, although the seating capacity would increase, it is anticipated that the type, number, and frequency of athletic events and activities upon completion of the proposed improvements would not be substantially different from what currently occurs. As mentioned above under *Project Characteristics*, the Hawthorne Aquatics Facility would continue to be open year-

round; however, it is anticipated that Hawthorne High School would utilize the facility during the school year, the South Bay Swim Team would utilize the facility year round, and the City of Hawthorne would utilize the facility during the summer months, as required under the Civic Center Act. Although Hawthorne High School does not currently have a formalized aquatics program, with the acquisition of the Hawthorne Aquatics Facility there is the potential to start both swimming and water polo programs. In order to present a realistic scenario for use of the Hawthorne Aquatics Facility, it is anticipated that the facility would be used by Hawthorne High School for swim team and water polo practices/events during the school year and by the South Bay Swim Team for swim practices/events year round, which would result in a total of approximately 19 on-site events/meets annually. These events could generate up to approximately 80 spectators for each event/meet.⁴ However, it should be noted that when these events occur, only one team (either Hawthorne High School or the South Bay Swim Team) would be able to use the facility and, thus, while there may be an increase in spectators, it would be a net increase since there would be a reduction in use by the other swim team. Given that the average number of events in 2019 was 15 events, it is not anticipated that the acquisition and redevelopment of the Hawthorne Aquatic Facility would result in a substantial increase in use over existing conditions.

Construction Activities

Compliant with the City of Hawthorne’s municipal code, construction would occur Monday through Friday between the hours of 7:00 a.m. and 4:00 p.m. Although it is not anticipated, construction could occur on Saturdays between the hours of 8:00 a.m. and 5:00 p.m. Construction of the proposed Project would require the demolition of the existing bleachers, and could require demolition of the Hawthorne Aquatics Facility. All other structures located on the Project site are portable and would be removed. Excavation depths would range from 5 feet to 18 feet. Total soil export would be approximately 16,000 cubic yards and total soil import would be approximately 16,000 cubic yards. There would be a maximum of 40 construction workers onsite at one time. Construction of the proposed Project is anticipated to begin in December 2022 and be completed in May 2024 for the athletic fields; and October 2024 through September 2025 for the pool redevelopment, as seen in **Table 4, Construction Schedule**.

**TABLE 4
CONSTRUCTION SCHEDULE**

Construction Phase	Start Date	End Date	Maximum Workers
Field Replacement			
Demolition	12/1/2022	1/31/2023	40
Grading/Site Preparation	2/1/2023	5/17/2023	40
Foundations/Concrete Pour #1	3/1/2023	3/3/2023	40
Drainage/Utilities/Trenching	4/1/2023	8/31/2023	40
Building Construction	5/18/2023	4/1/2024	40
Foundations/Concrete Pour #2	7/1/2023	7/5/2023	40
Paving Event #1	10/1/2023	10/6/2023	40

⁴ The spectator estimate is based on the estimated attendance at a nearby school with similar events/meets.

Construction Phase	Start Date	End Date	Maximum Workers
Foundations/Concrete Pour #3	2/1/2024	2/5/2024	40
Architectural Coatings	2/1/2024	4/1/2024	40
Paving Event #2	3/1/2024	3/7/2024	40
Synthetic Track	3/1/2024	5/30/2024	40
Field/Bleachers	11/1/2023	5/31/2024	40
Hawthorne Aquatics Facility Redevelopment			
Demolition	10/1/2024	10/28/2024	20
Site Preparation	10/29/2024	10/30/2024	2
Grading	10/31/2024	11/19/2024	14
Building Construction	11/20/2024	8/12/2025	190
Paving	8/13/2025	8/26/2025	10
Architectural Coating	8/27/2025	9/9/2025	10

Discretionary Approvals Required

The District is the lead agency under CEQA and is responsible for the approval and implementation of the proposed Project.

CHAPTER 3

Initial Study/Environmental Checklist

1. **Project Title:** Hawthorne High School Athletic Fields Improvements Project
2. **Lead Agency Name and Address:** Centinela Valley Union High School District
3. **Contact Person and Phone Number:** Ron Hacker, Assistant Superintendent, Business Services (310) 263-3230, hackerr@centinela.k12.ca.us
4. **Project Location:** 4859 West El Segundo Boulevard, Hawthorne, 90260
5. **Project Sponsor’s Name and Address:** Centinela Valley Union High School District
14901 South Inglewood Avenue
Lawndale, CA 90260
6. **General Plan Designation(s):** Public Facilities and Open Space
7. **Zoning:** UOS-Urban Open Space
8. **Description of Project:**

The proposed Hawthorne High School Athletic Fields Improvements Project (Project) includes the replacement of the existing athletic fields located on the grounds of the Hawthorne High School campus (Campus) and the redevelopment of the Hawthorne Aquatics Facility located to the southeast of the athletic fields. The athletic fields and Hawthorne Aquatics Facility are hereafter referred to as the “Project site.” The athletic fields on the western and eastern grounds of the Campus would be improved with new synthetic turf, existing field lighting would be replaced with high efficiency lighting, and existing public announcement systems would be replaced. Additionally, the proposed Project would include the construction of a 5,400-sf team room/concessions stand on the central portion of the athletic fields, the updating of existing utilities, and the addition of new site improvements, including bike racks, drinking fountains, and trash receptacles. The Governing Board of the District is acquiring the City-owned Hawthorne Aquatics Facility. There are no current plans for the extent of the renovation or redevelopment of the Hawthorne Aquatics Facility as of right now. Therefore, for the purposes of this Draft IS/MND, the aquatic facilities being proposed are presented as a worst-case scenario, assuming complete demolition and redevelopment of the existing Hawthorne Aquatics Facility with like for like uses.

9. Surrounding Land Uses and Setting.

The Project site is located within an urban residential neighborhood comprised of a mix of commercial and residential uses consisting primarily of single- and multi-family (one- and two-story) homes. The Project site is bounded by West 124th Street and residential uses to the north, South Inglewood Avenue and commercial and residential uses the east, single-family residences and the I-405 to the west, and an existing railroad right-of-way followed by the existing Hawthorne High School campus and residential uses to the south.

10. Other public agencies whose approval is required (e.g., permits, financing approval, or participation agreement.)

The District will be required to submit the proposed Project's construction plans to the Division of State Architect for structural safety, access compliance, and fire safety approvals.

11. Have California Native American tribes traditionally and culturally affiliated with the project area requested consultation pursuant to Public Resources Code section 21080.3.1? If so, is there a plan for consultation that includes, for example, the determination of significance of impacts to tribal cultural resources, procedures regarding confidentiality, etc.?

See Section XVIII., *Tribal Cultural Resources*, of this Draft IS/MND.

Evaluation of Environmental Impacts

1. A brief explanation is required for all answers except "No Impact" answers that are adequately supported by the information sources a lead agency cites in the parentheses following each question. A "No Impact" answer is adequately supported if the referenced information sources show that the impact simply does not apply to projects like the one involved (e.g., the project falls outside a fault rupture zone). A "No Impact" answer should be explained where it is based on project-specific factors as well as general standards (e.g., the project will not expose sensitive receptors to pollutants, based on a project-specific screening analysis).
2. All answers must take account of the whole action involved, including off-site as well as on-site, cumulative as well as project-level, indirect as well as direct, and construction as well as operational impacts.
3. Once the lead agency has determined that a particular physical impact may occur, then the checklist answers must indicate whether the impact is potentially significant, less than significant with mitigation, or less than significant. "Potentially Significant Impact" is appropriate if there is substantial evidence that an effect may be significant. If there are one or more "Potentially Significant Impact" entries when the determination is made, an EIR is required.
4. "Negative Declaration: Less Than Significant with Mitigation Incorporated" applies where the incorporation of mitigation measures has reduced an effect from "Potentially Significant Impact" to a "Less Than Significant Impact." The lead agency must describe the mitigation measures, and briefly explain how they reduce the effect to a less than significant level (mitigation measures from "Earlier Analyses," as described in (5) below, may be cross-referenced).

5. Earlier analyses may be used where, pursuant to the tiering, program EIR, or other CEQA process, an effect has been adequately analyzed in an earlier EIR or negative declaration. Section 15063(c)(3)(D). In this case, a brief discussion should identify the following:

Earlier Analyses Used. Identify and state where they are available for review.

Impacts Adequately Addressed. Identify which effects from the checklist were within the scope of and adequately analyzed in an earlier document pursuant to applicable legal standards, and state whether such effects were addressed by mitigation measures based on the earlier analysis.

Mitigation Measures. For effects that are “Less than Significant with Mitigation Measures Incorporated,” describe the mitigation measures that were incorporated or refined from the earlier document and the extent to which they address site-specific conditions for the project.

6. Lead agencies are encouraged to incorporate into the checklist references to information sources for potential impacts (e.g., general plans, zoning ordinances). Reference to a previously prepared or outside document should, where appropriate, include a reference to the page or pages where the statement is substantiated.
7. Supporting Information Sources: A source list should be attached, and other sources used or individuals contacted should be cited in the discussion.
8. This is only a suggested form, and lead agencies are free to use different formats; however, lead agencies should normally address the questions from this checklist that are relevant to a project’s environmental effects in whatever format is selected.
9. The explanation of each issue should identify:

The significance criteria or threshold, if any, used to evaluate each question; and

The mitigation measure identified, if any, to reduce the impact to less than significance.

DETERMINATION: (To be completed by the Lead Agency)

On the basis of this initial study:

- I find that the proposed project COULD NOT have a significant effect on the environment, and a NEGATIVE DECLARATION will be prepared.
- I find that although the proposed project could have a significant effect on the environment, there will not be a significant effect in this case because revisions in the project have been made by or agreed to by the project proponent. A MITIGATED NEGATIVE DECLARATION will be prepared.
- I find that the proposed project MAY have a significant effect on the environment, and an ENVIRONMENTAL IMPACT REPORT is required.
- I find that the proposed project MAY have a “potentially significant impact” or “potentially significant unless mitigated” impact on the environment, but at least one effect 1) has been adequately analyzed in an earlier document pursuant to applicable legal standards, and 2) has been addressed by mitigation measures based on the earlier analysis as described on attached sheets. An ENVIRONMENTAL IMPACT REPORT is required, but it must analyze only the effects that remain to be addressed.
- I find that although the proposed project could have a significant effect on the environment, because all potentially significant effects (a) have been analyzed adequately in an earlier EIR or NEGATIVE DECLARATION pursuant to applicable standards, and (b) have been avoided or mitigated pursuant to that earlier EIR or NEGATIVE DECLARATION, including revisions or mitigation measures that are imposed upon the proposed project, nothing further is required.

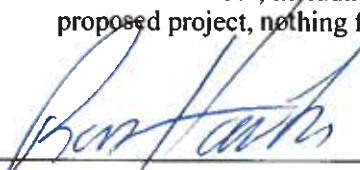

Signature

3/17/22

Date

Signature

Date

Environmental Checklist

Aesthetics

Issues (and Supporting Information Sources):	Potentially Significant Impact	Less Than Significant with Mitigation Incorporated	Less Than Significant Impact	No Impact
I. AESTHETICS — Except as provided in Public Resources Code Section 21099, would the project:				
a) Have a substantial adverse effect on a scenic vista?	<input type="checkbox"/>	<input type="checkbox"/>	<input type="checkbox"/>	<input checked="" type="checkbox"/>
b) Substantially damage scenic resources, including, but not limited to, trees, rock outcroppings, and historic buildings within a state scenic highway?	<input type="checkbox"/>	<input type="checkbox"/>	<input type="checkbox"/>	<input checked="" type="checkbox"/>
c) In non-urbanized areas, substantially degrade the existing visual character or quality of public views of the site and its surroundings? (Public views are those that are experienced from publicly accessible vantage point). If the project is in an urbanized area, would the project conflict with applicable zoning and other regulations governing scenic quality?	<input type="checkbox"/>	<input type="checkbox"/>	<input checked="" type="checkbox"/>	<input type="checkbox"/>
d) Create a new source of substantial light or glare which would adversely affect daytime or nighttime views in the area?	<input type="checkbox"/>	<input type="checkbox"/>	<input checked="" type="checkbox"/>	<input type="checkbox"/>

Discussion

- a) **No Impact.** The 1989 General Plan Conservation Element for the City of Hawthorne does not identify any scenic resources (Hawthorne 1989). As an urbanized and developed City, there are few scenic resources within the City and scenic viewpoints from the City are limited to views of the San Gabriel Mountains to the northeast, the Santa Monica Mountains to the north, and the hills of the Palos Verdes Peninsula to the southwest.

Eligible and/or officially designated state and/or county scenic highways in Los Angeles County, as defined by the California Department of Transportation (2018), include portions of Pacific Coast Highway (State Route [SR] 1), SR-2, Interstate (I) 110, I-5, SR-27, SR-39, SR-57, SR-91, US-101, SR-118, and I-210 (Caltrans 2018). Hawthorne has no City-, County- or State-designated scenic highways or corridors. Furthermore, due to the physical urban features of the local streets, highways and surrounding cityscapes, no potential exists within the foreseeable future for satisfying the criteria necessary for scenic highways. The nearest eligible scenic highway, a portion of SR-1, is located over 7 miles northwest of the Project site. Therefore, no impacts to scenic vistas would occur and no mitigation measures would be required.

- b) **No Impact.** As noted above, the nearest eligible state scenic highway is over 7 miles northwest of the Project site. No rock outcroppings or historic buildings would be removed from the Project site. The Project site contains some mature trees and vegetation, which would be removed during construction; however, they are not considered a scenic resource within a state scenic highway. None of the trees that could be removed are protected species. Any trees that would be removed would be marked by the construction contractor and approved for removal by the District or District's representative prior to removing or

cutting trees. Additionally, the proposed Project includes new landscaping and green space. Therefore, no impacts to scenic resources within a state scenic highway would occur and no mitigation measures would be required.

- c) **Less-than-Significant Impact.** The Project site is in an urbanized area within an existing school campus. The existing visual environment surrounding the Project site is characterized by a mix of commercial and urban residential neighborhood comprised primarily of single and multi-family (one- and two-story) homes. The Project site is bounded by West 124th Street and residential uses to the north, South Inglewood Avenue and commercial and residential uses the east, single-family residences and the I-405 to the west, and an existing railroad right-of-way followed by the existing Hawthorne High School campus and residential uses to the south. Single-family residences lie to the north and west. Multi-family residences lie to the southeast. To the east, across South Inglewood Avenue, are existing commercial uses, apartments and the U.S. Post Office. To the south is the existing Campus and multi- and single-family residences further. Directly south of the southwest boundary of the Project site is a railroad right-of-way followed by the existing Campus classrooms and administrative offices. The Project site is currently developed with Hawthorne High School athletic facilities and the Hawthorne Aquatics Facility. The athletic facilities include baseball and softball fields, outdoor basketball courts, a football and track field stadium, tennis courts, and surface parking. The Hawthorne Aquatics Facility includes two swimming pools (lap pool and baby pool) and men and women's locker rooms that include heated showers, and private changing rooms.

The Project site is zoned UOS-Urban Open Space. According to the Hawthorne Municipal Code, property classified in the UOS zone shall be utilized for recreational purposes, including but not limited to:

- Community gardens, and nursery stock uses;
- Golf courses or golf driving ranges;
- Historical buildings, sites, or landmarks;
- Libraries;
- Museums;
- Public parks, playfields, swimming pools;
- Schools, elementary, junior high and high schools, (public or nonprofit private), subject to the general provisions and conditions set forth in Section 17.14.020;
- Nonprofit recreation centers;
- Trails; hiking and bicycle;
- Other open space uses when interpreted by the planning commission as to performance standards as set forth in Chapter 17.10;

Accessory buildings, structures and uses including, but not limited to, the following:

- Recreational buildings and equipment,
- Restroom facilities,
- Concession stands (no alcoholic beverage sales, no separate enterprise),
- Maintenance buildings and equipment yards,
- Parking lots.

The proposed Project would include upgrades to the athletic fields, including a new combined football/soccer field, upgraded track, and upgraded bleachers on the western portion of the athletic fields; a reconfigured baseball field, new basketball courts, and a 5,400-sf team room/concessions building on the central portion of the Campus; and a new softball field and a multi-use (soccer and football) field in the eastern portion of the Campus. The Hawthorne Aquatics Facility would include upgrades to the pool, pool deck, public seating, and locker rooms. As such, the proposed Project, would be consistent with the UOS zoning designation.

Additionally, views from private residences surrounding the Project site are not protected under CEQA, and therefore are not further discussed. Construction of the proposed Project would include the presence and use of heavy machinery including, but not limited to, large trucks, bulldozers, and a construction staging area. Construction activities associated with the proposed Project are considered a temporary, short-term adverse but minor visual effect.

From a visual perspective, the proposed improvements and other Project elements would not be incongruent with the current land uses or the visual elements already present in the Project area. Though viewer exposure and sensitivity would be higher for more accustomed viewer groups (i.e., residences and frequent visitors), given the nature and quality of existing viewsheds and constrained lines of sight to the Project site, the proposed Project would not substantially diminish or alter the aesthetic value of the Project area. Overall, the Project area would remain fairly unified, and the proposed Project would not substantially compromise the visual coherence, line patterns, or overall scenery.

Given these considerations, Project construction and operation would not substantially degrade the existing visual character or quality of the site and its surroundings. Impacts would be less-than-significant, and no mitigation measures are required.

- d) **Less-than-Significant Impact.** The proposed Project would result in a significant impact if the proposed uses were to create a new source of substantial light or glare, which would adversely affect daytime or nighttime views in the area. Glare occurs when either the luminance is too high or the range of brightness in a visual field is too large. A bright light source, such as a flood light or streetlight, viewed against a dark sky may be uncomfortable to look at, and may create a temporary sensation of blindness, which is referred to as disability. Any source of luminance that is 50 times the adjacent background will be viewed as prominent and may be viewed as distracting. (IESNA 2015)

According to the Lighting Handbook prepared by the Illuminating Engineering Society of North America (IESNA), a significant impact would occur if the proposed Project results in:

1. Substantial spillover light at nearby residential properties inconsistent with California Energy Code and California Green Code standards and requirements. All urban areas in California are designated Lighting Zone 3 in the California Energy Code, which limits light trespass to 8 lux (0.74 footcandles).
10. Glare due to illuminance from light fixtures that:
- Creates a range of brightness, i.e., high contrast ratios greater than 50 to 1 in the field of view of residents at residential properties in the Project area, or
 - Impairs the vision of drivers pursuant to Division 11, Chapter 2, Article 3 of the California Vehicle Code.
11. Skyglow i.e., upright levels greater than 500 lumens.

The Project site is located in a developed, medium-density urban area with commercial and residential uses (predominantly single-family) that contains a variety of artificial lighting sources in the form of streetlights, security lights, and landscape lighting in addition to the existing on-campus athletic field and building lighting. Light-sensitive land uses in the immediate vicinity of the Project site include:

1. Single-family residences and a single-family residence on the north side of West 124th Street, which are approximately 60 feet from the northern Project site boundary;
12. Single-family residences east of Felon Avenue, immediately adjacent to the western boundary of the Project site;
13. Single-family residences on the north side of West 124th Street, which are located immediately north of the proposed baseball field and approximately 60 feet north of the proposed football/soccer field;

Based on streetlight design standards, ambient nighttime light (illuminance) levels would typically range from approximately 0.2 footcandles along local streets east and north of the campus to approximately 2 footcandles for a major arterial such as Hawthorne Boulevard that runs north-south approximately 0.5 miles east of the Project site (City of Los Angeles Bureau Department of Public Works 2007, Los Angeles County Department of Public Works 2012).

There are no light-sensitive natural areas or light-sensitive commercial or institutional uses in the immediate Project area.

Construction

Construction would run Monday through Friday between the hours of 7:00 a.m. and 4:00 a.m. Although it is not anticipated, construction could occur on Saturdays between the hours of 8:00 a.m. and 5:00 p.m. Any security lighting provided at night during construction would be directed downwards to reduce light-sourced impacts surrounding the Project site. As such, construction of the proposed Project would not introduce any substantial, new sources of nighttime lighting or glare.

Operation

The proposed Project would replace existing athletic field lighting (existing field lighting is limited to the tall pole mounted light fixtures that are used to illuminate the football and track field in the stadium) with new LED lighting that would illuminate all of the proposed athletic fields. Detailed plans showing the proposed light pole locations, number of fixtures, pole heights, luminaire types, wattages, and light levels are provided in Figure 5, Lighting Equipment Layout (Appendix A) to this Draft IS/MND. Figure 5 shows the proposed lighting equipment layout as depicted in the Photometrics Study and the lighting equipment locations shown in Figure 5 are listed in **Table 5, Lighting Equipment List**. As shown in Table 5, 16 new light poles would be provided, which would range in height from 60 to 80 feet and contain a total of 135 light fixtures (i.e., luminaires) mounted on the poles at heights from 15.5 feet to 83 feet. The luminaires would be fully shielded to direct light onto the athletic fields to avoid or minimize spillover light, glare, and skyglow impacts. **Figure 6, Musco Luminaire TLC-LED-1500**, and **Figure 7, Musco Luminaire TLC-LED-1200**, depict fully shielded luminaires similar to those identified in the Photometrics Study.

New athletic field lighting would be installed throughout the athletic fields in place of and in addition to existing lighting as shown in Figure 5. The lights in the football and track field stadium, would be used primarily to illuminate the 5 home football games each fall season, which would occur on Friday evenings at 7 p.m. The lighting on the other proposed athletic fields would be used as needed, i.e., during practices that extend to the late afternoon on the shorter winter days or during games scheduled in the late afternoon or early evening. Use of the fields would typically end at approximately 10 p.m. With a tie-breaker game or during play-offs or finals, a game may occasionally go to 11 p.m. No increase in the frequency of nighttime lighting is anticipated as a result of Project implementation.

According to the Photometrics Study, there is no spillover lighting impacts that would occur at the single-family residences located immediately west of the football field and north of the baseball, softball, and soccer field across West 124th Street. In addition, the California Code of Regulations, Title 24, Part 6, Section 140.7 (i.e., California Energy Code) exempts “lighting from sports and athletic fields, and children’s playgrounds” from the energy efficiency requirements of the code. Furthermore, the California Green Code, Title 24, Part 11, Chapter 5 (Nonresidential Mandatory Measures), Section 5.106.8 states that luminaires that qualify as exceptions in Section 140.7 of the California Energy Code are also excepted from the outdoor light pollution reduction requirements of Section 5.106.8. It should also be noted that the baseball fields would be illuminated infrequently for only a limited period of time, for the safety of participants during baseball practices and for baseball games that occur in the late afternoon or early evening hours. Currently, the varsity baseball team plays 7 home games per school year, which typically occur on Fridays at 3 p.m. The junior baseball team also plays three home games per year. For these reasons, the spillover lighting impacts would be less than significant.

**TABLE 5
LIGHTING EQUIPMENT LIST**

Pole				Luminaires		
Qty	Location	Size	Grade Elevation	Mounting Height	Luminaire Type	Qty/Pole
1	A1	70'	-	70'	TLC-LED-400	1
				15.5'	TLC-BT-575	1
				70'	TLC-LED-1500	4
1	A2	70'	-	70'	TLC-LED-400	1
				70'	TLC-LED-1200	4*
				15.5'	TLC-BT-575	1
				70'	TLC-LED-1500	4
1	A4	60'	-	60'	TLC-LED-1200	2
				60'	TLC-LED-900 TLC-BT-575	1
				15.5'		1
				60'	TLC-LED-400	1
1	B1	80'	-	15.5'	TLC-BT-575	1
				80'	TLC-LED-1500	6
1	B2	80'	3'	83'	TLC-LED-1200	3*
				18.5'	TLC-BT-575 TLC-LED-1500	1
				83'		6
1	B3	70'	-	15.5'	TLC-BT-575	1
				70'	TLC-LED-1500	5
1	C1	70'	-	15.5'	TLC-BT-575	2
				70'	TLC-LED-1500	4
1	C2	70'	-	70'	TLC-LED-400	1*
				70'	TLC-LED-1200	2*
				70'	TLC-LED-900	1*
				15.5'	TLC-BT-575	2/1*
				70'	TLC-LED-1500	4
2	F1-F2	80'	-	15.5'	TLC-BT-575	2
				70'	TLC-LED-400	1
				80'	TLC-LED-1500	11
2	F3-F4	80'	-	20'	TLC-BT-575	2
				70'	TLC-LED-400	1
				80'	TLC-LED-1500	10
1	S1	60'	-	15.5'	TLC-BT-575	1
				80'	TLC-LED-1500	4
2	S2-S3	60'	-	60'	TLC-LED-1500	4
1	S4	70'	-	15.5'	TLC-BT-575	1
				70'	TLC-LED-1500	6
16	TOTALS					135

NOTE:

* This structure utilizes a back-to-back mounting configuration.

SOURCE: Musco Sports Lighting, 2020.



Figure 6
Musco Luminaire TLC-LED-1500

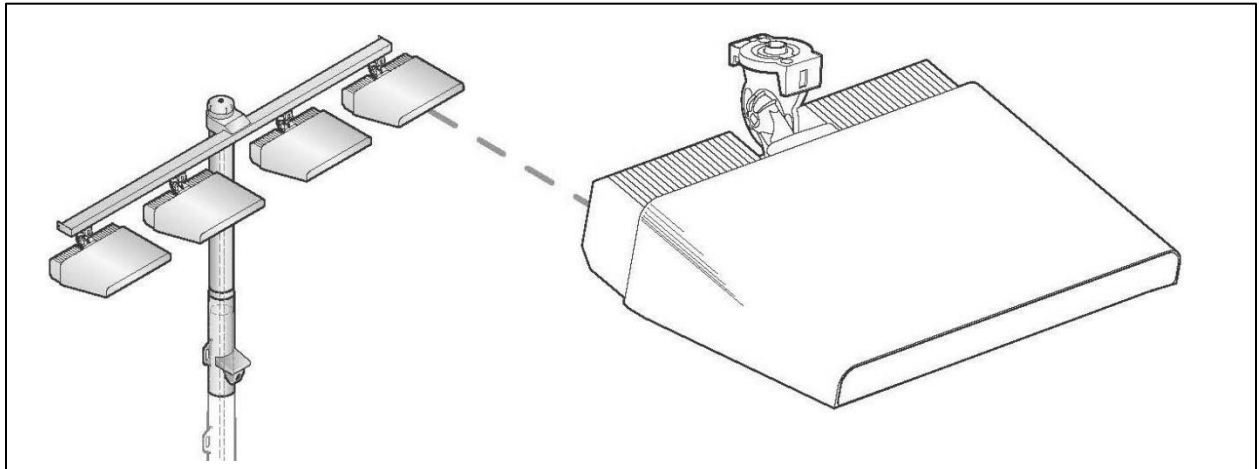

Figure 7
Musco Luminaire TLC-LED-1200

Glare

The proposed Project would not include new structures that would have highly reflective surfaces that would create glare impacts. However, glare due to new field lighting that could create high contrast lighting conditions could adversely affect motorists traveling on local streets and residences who have clear line-of-sight views of proposed field lighting. Specifically, the luminaires at location C1 at the northeastern corner of the baseball field as well as locations S1 and S2 (shown in Figure 5) on the northern boundary of the football/soccer field, would be within the field of view of drivers traveling west on West 124th Street. Drivers traveling south on Burl Avenue towards West 124th Street could also experience glare impacts from the luminaires at location S4 and S3 (shown in Figure 5) that would face north towards West 124th Street. The residence on the east side of Felton Avenue that borders the west of the existing football field could also be exposed to high contrast light levels from the proposed field lighting. However, as noted above, sports and athletic field lighting are exempted from light pollution reduction requirements of the California Green Code. Additionally, the athletic fields would be illuminated infrequently for only a limited period of time for the safety of participants during practices and for games that occur in the late afternoon or early evening hours; therefore, potential glare impacts are considered less than significant.

Skyglow

The proposed new and additional athletic field lighting could contribute to nighttime skyglow light levels in the Project area. However, as noted above, the proposed Project would use full-cutoff luminaires (see Figures 6 and 7), which would prevent the emittance of light upwards from the luminaires, thereby minimizing skyglow light impacts. Although light reflected from the field surfaces would still occur, proposed synthetic turf surfaces with their dark-rubber in-fill materials would have a lower surface reflectance than the natural grass fields that they would replace and, therefore, would result in less sky-glow (ANSI/IES 2020). Additionally, as described above, field lighting would be used for limited periods of time, i.e., for the 5 home football games that occur during the fall season at 7 p.m. on Fridays and to illuminate fields as needed, particularly during the shorter days in the winter, for afternoon practices and games. Also, it should be noted that the football stadium, which contains existing field lighting for the Friday evening football games, would be replaced with improved, energy efficient lights that would be designed to minimize skyglow impacts. Furthermore, the baseball fields would be illuminated infrequently for the safety of participants during baseball practices and for baseball games that occur in the late afternoon or early evening hours. Currently, the varsity baseball team plays 7 home games per school year, which typically occur on Fridays at 3 p.m. The junior baseball team also plays three home games per year. Therefore, potential impacts are considered less than significant.

Agriculture and Forestry Resources

<i>Issues (and Supporting Information Sources):</i>	<i>Potentially Significant Impact</i>	<i>Less Than Significant with Mitigation Incorporated</i>	<i>Less Than Significant Impact</i>	<i>No Impact</i>
II. AGRICULTURE AND FORESTRY RESOURCES —				
<p>In determining whether impacts to agricultural resources are significant environmental effects, lead agencies may refer to the California Agricultural Land Evaluation and Site Assessment Model (1997) prepared by the California Dept. of Conservation as an optional model to use in assessing impacts on agriculture and farmland. In determining whether impacts to forest resources, including timberland, are significant environmental effects, lead agencies may refer to information compiled by the California Department of Forestry and Fire Protection regarding the state's inventory of forest land, including the Forest and Range Assessment Project and the Forest Legacy Assessment project; and forest carbon measurement methodology provided in Forest Protocols adopted by the California Air Resources Board. Would the project:</p>				
a) Convert Prime Farmland, Unique Farmland, or Farmland of Statewide Importance (Farmland), as shown on the maps prepared pursuant to the Farmland Mapping and Monitoring Program of the California Resources Agency, to non-agricultural use?	<input type="checkbox"/>	<input type="checkbox"/>	<input type="checkbox"/>	<input checked="" type="checkbox"/>
b) Conflict with existing zoning for agricultural use, or a Williamson Act contract?	<input type="checkbox"/>	<input type="checkbox"/>	<input type="checkbox"/>	<input checked="" type="checkbox"/>
c) Conflict with existing zoning for, or cause rezoning of, forest land (as defined in Public Resources Code section 12220(g)), timberland (as defined by Public Resources Code section 4526), or timberland zoned Timberland Production (as defined by Government Code section 51104(g))?	<input type="checkbox"/>	<input type="checkbox"/>	<input type="checkbox"/>	<input checked="" type="checkbox"/>
d) Result in the loss of forest land or conversion of forest land to non-forest use?	<input type="checkbox"/>	<input type="checkbox"/>	<input type="checkbox"/>	<input checked="" type="checkbox"/>
e) Involve other changes in the existing environment which, due to their location or nature, could result in conversion of Farmland, to non-agricultural use or conversion of forest land to non-forest use?	<input type="checkbox"/>	<input type="checkbox"/>	<input type="checkbox"/>	<input checked="" type="checkbox"/>

Discussion

- a) **No Impact.** A significant impact may occur if a project were to result in the conversion of State- designated agricultural land from agricultural use to another nonagricultural use. The California Department of Conservation, Division of Land Protection, lists Prime Farmland, Unique Farmland, and Farmland of Statewide Importance under the general category of “Important Farmland” in California.

The Project site is located in an urbanized area of the City of Hawthorne within a fully developed high school campus and aquatic facility that is zoned as UOS, Urban Open Space (City of Hawthorne 2019). According to the California Department of Conservation, Division of Land Resource Protection, the soils at the Project site and in the surrounding area are not a candidate for listing as Prime Farmland, Unique Farmland, or Farmland of Statewide Importance (California State Department of Conservation 2016). Therefore, the proposed Project would have no impact on the conversion of farmland to nonagricultural uses.

- b) **No Impact.** A significant impact may occur if Project construction were to result in the conversion of land zoned for agricultural use or under a Williamson Act Contract from agricultural use to nonagricultural use. The Williamson Act of 1965 allows local

governments to enter into contract agreements with local landowners with the purpose of trying to limit specific parcels of land to agricultural or other related open space use.

The Project site is zoned, UOS, Urban Open Space. The UOS Zone permits recreational uses, including but not limited to: public parks, playfields, swimming pools, schools, elementary, junior high and high schools (public or nonprofit private) pursuant to Hawthorne Municipal Code Section 17.24.020. The Project site is not zoned for agricultural production, and no farmland activities exist on-site. Also, no Williamson Act Contracts are in effect for the Project site. Therefore, the proposed Project would have no impact with respect to land zoned for agricultural use or under a Williamson Act Contract.

- c) **No Impact.** The Project site is zoned UOS, Urban Open Space. The UOS Zone permits recreational uses, including but not limited to: public parks, playfields, swimming pools, schools, elementary, junior high and high schools (public or nonprofit private) pursuant to Hawthorne Municipal Code Section 17.24.020. The Project site is not zoned as forestland or timberland and there is no timberland production at the Project site (California State Department of Conservation 2016). Therefore, no impact related to forest land or timberland would occur.
- d) **No Impact.** The Project site is not zoned as forestland or timberland and there is no timberland production at the Project site (California State Department of Conservation 2016). As such, the proposed Project would not result in the loss of forest land or conservation of forest land to non- forest use. Therefore, the proposed Project would have no impact and would not result in the loss of forest land or conversion of forest land to non-forest use.
- e) **No Impact.** A significant impact may occur if a project involves changes to the existing environment that could result in the conversion of farmland to another nonagricultural use or conversion of forest land to non-forest use.

The Project site is in an area of the City that is urbanized. Neither the Project site nor surrounding parcels are utilized for agricultural uses or forest land and such uses are not in proximity to the Project site. The Project site is not classified in any “Farmland” category designated by the State of California. According to the California Department of Conservation, Division of Land Resource Protection, the soils at the Project site and in the surrounding area are not a candidate for listing as Prime Farmland, Unique Farmland, or Farmland of Statewide Importance (California State Department of Conservation 2016). Therefore, the proposed Project would have no impact related to conversion of farmland to a nonagricultural use or conversion of forest land to non-forest use, and no impact would occur.

Air Quality

<i>Issues (and Supporting Information Sources):</i>	<i>Potentially Significant Impact</i>	<i>Less Than Significant with Mitigation Incorporated</i>	<i>Less Than Significant Impact</i>	<i>No Impact</i>
III. AIR QUALITY —				
Where available, the significance criteria established by the applicable air quality management district or air pollution control district may be relied upon to make the following determinations. Would the project:				
a) Conflict with or obstruct implementation of the applicable air quality plan?	<input type="checkbox"/>	<input type="checkbox"/>	<input checked="" type="checkbox"/>	<input type="checkbox"/>
b) Result in a cumulatively considerable net increase of any criteria pollutant for which the project region is non-attainment under an applicable federal or state ambient air quality standard?	<input type="checkbox"/>	<input type="checkbox"/>	<input checked="" type="checkbox"/>	<input type="checkbox"/>
c) Expose sensitive receptors to substantial pollutant concentrations?	<input type="checkbox"/>	<input type="checkbox"/>	<input checked="" type="checkbox"/>	<input type="checkbox"/>
d) Result in other emissions (such as those leading to odors) adversely affecting a substantial number of people?	<input type="checkbox"/>	<input type="checkbox"/>	<input checked="" type="checkbox"/>	<input type="checkbox"/>

Discussion

Data presented in this Air Quality section includes information from the detailed assumptions, calculations, and modeling outputs included in Appendix B of this Draft IS/MND.

- a) **Less-than-Significant Impact.** The Project site is located within the South Coast Air Basin (Basin). Air quality planning for the Basin is under the jurisdiction of the South Coast Air Quality Management District (SCAQMD). The proposed Project would be subject to the SCAQMD's Air Quality Management Plan (AQMP), which contains a comprehensive list of pollution control strategies directed at reducing emissions and achieving ambient air quality standards. These strategies are developed, in part, based on regional population, housing, and employment projections prepared by the Southern California Association of Governments (SCAG). The 2016 AQMP was prepared to accommodate growth, reduce the high levels of pollutants within the areas under the jurisdiction of SCAQMD, return clean air to the region, and minimize the impact on the economy (SCAQMD, 2016). Projects that are consistent with the assumptions used in the AQMP do not interfere with attainment because the growth is included in the projections utilized in the formulation of the AQMP. Thus, projects, uses, and activities that are consistent with the applicable growth projections and control strategies used in the development of the AQMP would not jeopardize attainment of the air quality levels identified in the AQMP, even if it would individually exceed the SCAQMD's numeric indicators.

Construction

Construction activities associated with the proposed Project have the potential to generate temporary criteria pollutant emissions through the use of heavy-duty construction equipment, such as backhoes and excavators, and through vehicle trips generated from worker trips, vendor and haul trucks traveling to and from the Project area. In addition, fugitive dust emissions would result from grading/site preparation and drainage/utilities/trenching activities. Construction emissions can vary substantially from

day to day, depending on the level of activity, the specific type of construction activity, and prevailing weather conditions. The assessment of construction air quality impacts considers each of these potential sources.

Under this criterion, the SCAQMD recommends that lead agencies demonstrate that a project would not directly obstruct implementation of an applicable air quality plan and that a project be consistent with the assumptions (typically land-use related) upon which the air quality plan is based. The proposed Project would result in an increase in short-term employment compared to existing conditions. Being relatively small in number (maximally 40 workers per day per phase) and temporary in nature, construction jobs under the proposed Project would not conflict with the long-term employment projections upon which the AQMP is based. Control strategies in the AQMP, potentially applicable to control temporary emissions from construction activities, include ONRD-04 and OFFRD-01, which are intended to reduce emissions from on-road and off-road heavy-duty vehicles and equipment by accelerating the replacement of older, emissions-prone engines with newer engines that meet more stringent emission standards.

As described in sections below, this proposed Project would have less-than-significant construction emissions of criteria pollutants even without mitigation. Therefore, the proposed Project would be consistent with the AQMP. Additionally, the proposed Project would comply with California Air Resources Board (CARB) requirements to minimize short-term emissions from on-road and off-road diesel equipment. The proposed Project would also comply with SCAQMD regulations for controlling fugitive dust pursuant to SCAQMD Rule 403, for example, apply water spray/mists or similar suppressant (e.g., SoilSeal) at least 3 times per day on active areas of disturbance and unpaved roads. In addition all off-road diesel equipment greater than 50 horsepower would have Tier 3 compliant engines.

Compliance with these requirements is consistent with and meets or exceeds the AQMP requirements for control strategies intended to reduce emissions from construction equipment and activities. Because the proposed Project would not conflict with the control strategies intended to reduce emissions from construction equipment, the proposed Project would not conflict with or obstruct implementation of the AQMP, and impacts would be less than significant.

Operation

The proposed Project includes the replacement of existing sports fields and Hawthorne Aquatics Facility like-for-like as well as the addition of a 5,400 SF team room/concessions stand. Additionally, the proposed Project would replace the existing lighting with energy-efficient LED lighting and include new synthetic turf that would be installed on the softball/multi-use field, outdoor football field, and baseball field, which would reduce water consumption. The team room/concessions stand would meet the energy efficiency measures that are required by regulation, such as the current Title 24 standards, the California Green Building Standards (CALGreen) Code, and the City's Green Building Code. Implementation of the proposed Project would not result in an increase in vehicular traffic.

As discussed in CEQA Checklist Issue XVII, Transportation, the proposed Project would not have a significant impact on transportation. Overall, the proposed Project would not conflict with the growth projections identified in the AQMP and would not conflict with or obstruct implementation of the AQMP's or the City's strategies and policies intended to reduce criteria pollutant emissions. Therefore, impacts would be less than significant.

The Project site is located within the Basin, which is characterized by relatively poor air quality. State and federal air quality standards are often exceeded in many parts of the Basin. The proposed Project would contribute to local and regional air pollutant emissions during construction (short-term or temporary). However, based on the following analysis, construction and operation of the proposed Project would result in less-than-significant impacts relative to the daily significance thresholds for criteria air pollutant emissions established by the SCAQMD for construction and operational phases.

Construction Impacts Analysis

Project construction includes demolition, grading/site preparation, foundations/concrete pouring, drainage/utilities/trenching, building construction, architectural coating, paving, synthetic track installation, and field/bleachers installation activities. During the demolition phase, 14 haul trucks would be required to export approximately 2,500 tons of demolition debris from the Project site. During the grading/site preparation phase, 31 haul trucks would be required to export approximately 16,000 cubic yards of soil and import 16,000 cubic yards for soil from the Project site. During each of the three foundations/concrete pouring events, 25 concrete trucks would be required. During the building construction phase, 50 vendor trucks are required to deliver materials. During all other phases, 3 vendor trucks would be required. Haul trucks would travel west on West El Segundo Boulevard and travel north along Interstate 405 to a landfill within a 40-mile radius of the Project site.⁵

For the Hawthorne Aquatics Facility redevelopment, there would be 28 haul trucks to export 5,440 tons of demolition debris. During the building construction phase, 10 vendor trucks are required to deliver materials.

Based on criteria set forth in the SCAQMD CEQA Air Quality Handbook (SCAQMD, 1993), a project would have the potential to violate an air quality standard or contribute substantially to an existing violation and result in a significant impact with regard to construction emissions if regional emissions from both direct and indirect sources would exceed any of the following SCAQMD prescribed threshold levels: (1) 75 pounds a day for volatile organic compounds (VOCs), (2) 100 pounds per day for (NO_x), (3) 550 pounds per day for carbon monoxide (CO), (4) 150 pounds per day for sulfur oxides (SO_x), (5) 150 pounds per day for respirable particulate matter (PM₁₀), and (6) 55 pounds per day for fine particulate matter (PM_{2.5}).

⁵ The anticipated landfill has yet to be determined. A conservative distance of 40 miles for haul trucks was used instead of the CalEEMod default of 20 miles as provided by the applicant. Approved landfills include Sunrise Canyon Landfill in Sylmar and Azusa Landfill in Azusa.

Daily regional emissions during construction are forecasted by assuming a conservative estimate of construction activities (i.e., assuming all construction occurs at the earliest feasible date) and applying the mobile source and fugitive dust emissions factors. The emissions have been estimated using the CalEEMod software (version 2020.4.0) an emissions inventory software program recommended by the SCAQMD. CalEEMod is based on outputs from OFFROAD and EMFAC2017, which are emissions estimation models developed by CARB and used to calculate emissions from construction activities, including on- and off-road vehicles. The input values used in this analysis were adjusted to be project-specific based on equipment types and the construction schedule. These values were then applied to the construction phasing assumptions used in the criteria pollutant analysis to generate criteria pollutant emissions values for each construction activity. This emissions analysis for all construction activities includes compliance with mandatory SCAQMD Rule 403 measures regarding the control of fugitive dust.

Construction of the proposed Project is estimated to last approximately 18 months, tentatively scheduled to begin December 2022 and conclude May 2024. As stated in Chapter 2, *Project Description*, the Governing Board of the District is acquiring the City-owned Hawthorne Aquatics Facility. Although, there are no current plans for the renovation or redevelopment of the facility, the demolition and redevelopment of the aquatic facility is included as a worst-case scenario and included as a separate activity line item. Construction duration by phase and activity are provided in **Table 6, Estimated Construction Schedule**. The duration of construction activity and associated equipment represents a reasonable approximation of the expected construction fleet as required per CEQA guidelines. Site specific construction fleet may vary due to specific project needs at the time of construction. The duration of construction activity and associated construction equipment was estimated based on consultation with the District.

**TABLE 6
ESTIMATED CONSTRUCTION SCHEDULE**

Activity	Start Date	End Date	Duration (Days)
Field Replacement			
Demolition	12/1/2022	1/31/2023	44
Grading/Site Preparation	2/1/2023	5/17/2023	76
Foundations/Concrete Pour #1	3/1/2023	3/3/2023	3
Drainage/Utilities/Trenching	4/1/2023	8/31/2023	109
Building Construction	5/18/2023	4/1/2024	228
Foundations/Concrete Pour #2	7/1/2023	7/5/2023	3
Paving Event #1	10/1/2023	10/6/2023	5
Field/Bleachers	2/1/2024	2/5/2024	153
Foundations/Concrete Pour #3	2/1/2024	4/1/2024	3
Architectural Coatings	3/1/2024	3/7/2024	43
Paving Event #2	3/1/2024	5/30/2024	5
Synthetic Track	11/1/2023	5/31/2024	65

Activity	Start Date	End Date	Duration (Days)
Hawthorne Aquatics Facility Redevelopment			
Demolition	10/01/2024	10/28/2024	20
Site Preparation	10/29/2024	10/30/2024	2
Grading	10/31/2024	11/19/2024	14
Building Construction	11/20/2024	8/12/2025	190
Paving	8/13/2025	8/26/2025	10
Architectural Coating	8/27/2025	9/9/2025	10

SOURCE: ESA 2021

The maximum daily regional emissions from these activities are estimated by construction phase and compared to the SCAQMD significance thresholds. It is assumed that all construction equipment greater than 50 horsepower would meet Tier 3 diesel engine standards and that exposed soils would be watered three times daily to comply with SCAQMD Rule 403. Maximum daily emissions are calculated by taking the sum of the overlapping phases for each criteria pollutant. As shown in **Table 7, Maximum Regional Construction Emissions – Without Mitigation (Pounds Per Day)**, emissions resulting from Project construction would not exceed any criteria pollutant thresholds established by the SCAQMD. Therefore, impacts would be considered less than significant without mitigation.

**TABLE 7
MAXIMUM REGIONAL CONSTRUCTION EMISSIONS – WITHOUT MITIGATION (POUNDS PER DAY) ^A**

Source	VOC	NO _x	CO	SO ₂	PM10 ^b	PM2.5 ^b
Field Replacement						
Demolition (2022)	1.3	20.6	28.2	0.1	2.5	1.3
Demolition (2023)	1.2	20.1	27.9	0.1	2.5	1.3
Grading/Site Preparation (2023)	2.0	42.9	42.5	0.1	7.2	3.5
Foundations Concrete Pour #1 (2023)	0.9	14.6	20.4	0.0	2.1	1.2
Drainage/Utilities Trenching (2023)	1.2	20.1	28.2	0.0	2.0	1.3
Building Construction (2023)	1.2	18.9	23.5	0.1	2.5	1.4
Building Construction (2024)	1.2	18.9	23.3	0.1	2.5	1.4
Foundations Concrete Pour #2 (2023)	0.9	14.6	20.4	0.0	2.1	1.2
Paving Event #1 (2023)	1.9	11.7	20.2	0.0	1.5	0.9
Field Bleachers (2023)	1.1	15.4	22.2	0.0	1.9	1.2
Field Bleachers (2024)	1.1	15.3	22.0	0.0	1.8	1.2
Foundations Concrete Pour #3 (2024)	0.8	14.6	20.2	0.0	2.1	1.2
Architectural Coatings (2024)	1.5	2.2	5.1	0.0	1.1	0.4
Paving Event #2 (2024)	1.9	11.7	20.0	0.0	1.5	0.9
Synthetic Track (2024)	1.2	15.3	22.0	0.0	1.8	1.2

Source	VOC	NO _x	CO	SO ₂	PM10 ^b	PM2.5 ^b
Overlapping Phases						
2023						
Grading/Site Preparation + Foundations/Concrete Pour #1	2.8	57.5	62.8	0.2	9.3	4.7
Grading/Site Preparation + Drainage/Utilities/Trenching	3.2	63.0	70.6	0.2	9.2	4.8
Drainage/Utilities/Trenching + Building Construction	2.5	39.0	51.7	0.1	4.5	2.7
Drainage/Utilities/Trenching + Building Construction + Foundations/Concrete Pour #2	3.3	53.6	72.0	0.1	6.6	3.9
Building Construction + Paving Event #1	3.1	30.6	43.7	0.1	4.0	2.2
Building Construction + Field/Bleachers	2.4	34.3	45.7	0.1	4.3	2.5
2024						
Building Construction + Field/Bleachers	2.3	34.2	45.3	0.1	4.3	2.5
Building Construction + Foundations/Concrete Pour #3 + architectural Coatings + Field/Bleachers	4.7	51.0	70.6	0.1	7.5	4.1
Building Construction + Foundations/Concrete Pour #3 + architectural Coatings + Paving Event #2 + Synthetic Track + Field/Bleachers	7.8	78.0	112.5	0.2	10.9	6.1
Hawthorne Aquatics Facility						
Demolition (2024)	1.5	18.4	17.4	0.05	2.5	1.0
Site Preparation (2024)	1.1	11.9	6.9	0.02	3.0	1.6
Grading (2024)	0.9	9.8	5.8	0.01	1.1	0.7
Building Construction (2024)	1.4	11.8	14.0	0.03	0.8	0.5
Building Construction (2025)	1.3	11.1	13.9	0.03	0.7	0.5
Paving (2025)	0.7	5.4	9.2	0.01	0.4	0.3
Architectural Coating (2025)	16.1	1.2	2.0	0.00	0.1	0.1
Field Replacement Maximum Daily Emissions	7.8	78.0	112.5	0.2	10.9	6.1
SCAQMD Regional Significance Thresholds	75	100	550	150	150	55
Exceeds Threshold?	No	No	No	No	No	No
Hawthorne Aquatics Facility Maximum Daily Emissions	16.1	18.4	17.4	0.05	3.0	1.6
SCAQMD Regional Significance Thresholds	75	100	550	150	150	55
Exceeds Threshold?	No	No	No	No	No	No

^a Totals may not add up exactly due to rounding in the modeling calculations. Detailed emissions calculations are provided in Appendix B.

^b Emissions include fugitive dust control measures consistent with SCAQMD Rule 403.

SOURCE: ESA, 2021

Operational Impacts Analysis

Operation of the proposed Project has the potential to generate criteria pollutant emissions through vehicle trips traveling to and from the Project site. In addition, emissions would result from natural gas combustion for heating and area sources on-site such as landscaping equipment and use of consumer products. However, the proposed Project consists of replacing athletic fields like-for-like and as such the same number of trips were assumed. However, the number of events hosted at the existing Hawthorne Aquatics Facility was 15

during the 2019 calendar year, while the proposed school aquatic facility would host up to 19 annual events. As explained further in Section XVII, *Transportation* of this Draft IS/MND, school events at the proposed aquatic facility would result in regularly scheduled community use of the pool to be canceled thereby removing vehicle trips associated with community use and replacing them with school use, which would generate fewer vehicle trips due to the fact that many attendees (i.e., students and staff) would already be on campus. Therefore, the increase in the number of vehicle trips would be minimal due to Project implementation. The proposed Project would replace the existing field lighting with energy-efficient LED lighting and include new synthetic turf that would be installed on the softball/multi-use field, outdoor football field, and baseball field, which would reduce water consumption and emissions associated with landscaping. Therefore, it is not anticipated that implementation of the proposed Project would result in substantial increases in operational emissions. Impacts would be less than significant and no mitigation is required.

- b) **Less-than-Significant Impact.** The proposed Project would result in the emission of criteria pollutants during construction for which the Project area is in non-attainment. A significant impact may occur if a project would add a cumulatively considerable contribution of a federal or state non-attainment pollutant. The Air Basin is currently in non-attainment for ozone, PM10, and PM2.5.

The SCAQMD's approach for assessing cumulative impacts related to operations is based on attainment of ambient air quality standards in accordance with the requirements of the Federal and State Clean Air Acts. As discussed earlier, the SCAQMD has developed a comprehensive plan, the 2016 AQMP, which addresses the region's cumulative air quality condition.

A significant impact may occur if a project were to add a cumulatively considerable contribution of a federal or state non-attainment pollutant. The Basin is currently in non-attainment for ozone (federal and state standards), PM10 (state standards only) and PM2.5 (federal and state standards); therefore, related projects could cause ambient concentrations to exceed an air quality standard or contribute to an existing or projected air quality exceedance. Cumulative impacts to air quality are evaluated under two sets of thresholds for CEQA and SCAQMD.

In particular, CEQA Guidelines Section 15064(h)(3) provides guidance in determining the significance of cumulative impacts. Specifically, Section 15064(h)(3) states in part that:

“A lead agency may determine that a project’s incremental contribution to a cumulative effect is not cumulatively considerable if the project will comply with the requirements in a previously approved plan or mitigation program which provides specific requirements that will avoid or substantially lessen the cumulative problem (e.g., water quality control plan, air quality plan, integrated waste management plan) within the geographic area in which the project is located. Such plans or programs must be specified in law or adopted by the public agency with jurisdiction over the affected resources through a public review process to implement, interpret, or make specific the law enforced or administered by the public agency...”

For purposes of the cumulative air quality analysis with respect to CEQA Guidelines Section 15064(h)(3), the Project's incremental contribution to cumulative air quality impacts is determined based on compliance with the SCAQMD adopted 2016 AQMP. As previously stated, the proposed Project would comply with and incorporate measures to reduce criteria pollutant emissions during construction and operations. Also, construction jobs would be temporary would be within SCAG's employment growth forecast for the City of Hawthorne. No permanent increase in employment would occur as a result of the proposed Project.

Nonetheless, SCAQMD no longer recommends relying solely upon consistency with the AQMP as an appropriate methodology for assessing cumulative air quality impacts. The SCAQMD recommends that project-specific air quality impacts be used to determine the potential cumulative impacts to regional air quality (SCAQMD 2003).

As displayed in Tables 7 and 8, regional emissions calculated for Project construction would be less than the applicable SCAQMD daily significance thresholds, which are designed to assist the region in attaining the applicable State and national ambient air quality standards. These standards apply to both primary (criteria and precursor) and secondary pollutants (ozone). Although the Project site is located in a region that is in non-attainment for ozone, PM10, and PM2.5, the emissions associated with the proposed Project would not be cumulatively considerable as the emissions would fall below SCAQMD daily significance thresholds. In addition, the proposed Project would be consistent with the AQMP, which is intended to bring the Basin into attainment for all criteria pollutants.

With respect to health impacts, Project construction health risks would be less-than-significant and related projects would also be required to implement similarly stringent measures, as necessary under CEQA, to mitigate impacts to less-than-significant. Compliance with applicable SCAQMD rules would ensure Project operational health risks would be less-than-significant and related projects would also be required to comply with applicable rules as well as implement mitigation measures, as necessary under CEQA, to mitigate impacts to less-than-significant. As a result, the proposed Project would not result in cumulatively considerable health impacts.

- c) **Less-than-Significant Impact.** Certain population groups are especially sensitive to air pollution and should be given special consideration when evaluating potential air quality impacts. These population groups include children, the elderly, persons with pre-existing respiratory or cardiovascular illness, and athletes and others who engage in frequent exercise. As defined in the SCAQMD CEQA Air Quality Handbook, a sensitive receptor to air quality is defined as any of the following land use categories: (1) long-term health care facilities; (2) rehabilitation centers; (3) convalescent centers; (4) retirement homes; (5) residences; (6) schools; (7) parks and playgrounds; (8) child care centers; and (9) athletic fields. Sensitive receptors within a quarter-mile radius of the Project boundary include adjacent residential land uses, Hawthorne High School (where the proposed Project

is located), residential uses along Eucalyptus Avenue north of Broadway, and Eucalyptus Park located on Inglewood Avenue.

The localized air quality analysis was conducted using the methodology described in the SCAQMD *Localized Significance Threshold Methodology* (June 2003, revised July 2008), which relies on on-site mass emission rate screening tables and project-specific dispersion modeling typically for sites greater than 5 acres, as appropriate (SCAQMD 2008). The localized significance thresholds are applicable to NO_x, CO, PM10, and PM2.5. For NO_x and CO, the thresholds are based on the ambient air quality standards. For PM10 and PM2.5, the thresholds are based on requirements in SCAQMD Rule 403 (Fugitive Dust) for construction and Rule 1303 (New Source Review Requirements) for operations. The SCAQMD has established screening criteria that can be used to determine the maximum allowable daily emissions that would satisfy the localized significance thresholds and therefore not cause or contribute to an exceedance of the applicable ambient air quality standards without project-specific dispersion modeling. The screening criteria depend on: (1) the area in which the project is located, (2) the size of the project area, and (3) the distance between the project area and the nearest sensitive receptor.

SCAQMD's Methodology clearly states that "off-site mobile emissions from the project should not be included in the emissions compared to LSTs." Therefore, for purposes of the LST analysis, only emissions included in the CalEEMod "on-site" emissions outputs were considered, including truck idling emissions (e.g., haul trucks and vendor trucks) heavy-heavy-duty (HHD) vehicles. The closest existing sensitive receptors to the proposed Project are single-family residential uses to the immediate west and north, as well as the existing Hawthorne High School classrooms to the south of the Project site. The localized significance threshold (LST) used for the localized significance impact analysis were based on a 5-acre site in the Southwest Coastal Los Angeles Source-Receptor Area with sensitive receptors located adjacent to the Project site (i.e., 25 meters).

Construction Emissions

Table 8, Maximum Localized Construction Emissions – Without Mitigation (pounds per day), identifies the localized impacts at the nearest receptor location in the vicinity of the Project area without mitigation. The localized emissions during construction activity would not exceed SCAQMD's localized significance thresholds. Therefore, impacts would be less-than-significant and no mitigation is required.

**TABLE 8
MAXIMUM LOCALIZED CONSTRUCTION EMISSIONS – WITHOUT MITIGATION (POUNDS PER DAY)^A**

Source	NO _x	CO	PM10 ^b	PM2.5 ^B
Field Replacement				
Demolition (2022)	18.3	24.7	1.3	0.9
Demolition (2023)	18.3	24.7	1.3	0.9
Grading/Site Preparation (2023)	30.0	36.7	4.3	2.7
Foundations Concrete Pour #1 (2023)	12.5	16.9	0.9	0.9

Source	NO _x	CO	PM10 ^b	PM2.5 ^B
Drainage/Utilities Trenching (2023)	19.7	25.3	1.1	1.1
Building Construction (2023)	14.9	19.3	0.9	0.9
Building Construction (2024)	14.9	19.3	0.9	0.9
Foundations Concrete Pour #2 (2023)	12.5	16.9	0.9	0.9
Paving Event #1 (2023)	11.3	17.3	0.6	0.6
Field Bleachers (2023)	14.9	19.3	0.9	0.9
Field Bleachers (2024)	14.9	19.3	0.9	0.9
Foundations Concrete Pour #3 (2024)	12.5	16.9	0.9	0.9
Architectural Coatings (2024)	1.8	2.4	0.1	0.1
Paving Event #2 (2024)	11.3	17.3	0.6	0.6
Synthetic Track (2024)	14.9	19.3	0.9	0.9
Overlapping Phases				
2023				
Grading/Site Preparation + Foundations/Concrete Pour #1	42.5	53.6	5.2	3.5
Grading/Site Preparation + Drainage/Utilities/Trenching	49.6	62.0	5.4	3.7
Drainage/Utilities/Trenching + Building Construction	34.6	44.6	2.0	2.0
Drainage/Utilities/Trenching + Building Construction + Foundations/Concrete Pour #2	47.1	61.5	2.9	2.9
Building Construction + Paving Event #1	26.2	36.6	1.5	1.5
Building Construction + Field/Bleachers	29.9	38.6	1.8	1.8
2024				
Building Construction + Field/Bleachers	29.8	38.6	1.8	1.8
Building Construction + Foundations/Concrete Pour #3 + architectural Coatings + Field/Bleachers	44.1	57.9	2.8	2.8
Building Construction + Foundations/Concrete Pour #3 + architectural Coatings + Paving Event #2 + Synthetic Track + Field/Bleachers	70.3	94.5	4.3	4.3
Field Development Maximum Daily Emissions	70.3	94.5	5.4	4.3
SCAQMD Localized Significance Thresholds^c	197	1,796	15	8
Exceeds Threshold?	No	No	No	No
Hawthorne Aquatics Facility				
Demolition (2024)	13.89	13.49	1.78	0.76
Site Preparation (2024)	11.84	6.63	2.93	1.62
Grading (2024)	9.73	5.55	0.99	0.65
Building Construction (2024)	11.06	12.52	0.45	0.43
Building Construction (2025)	10.41	12.44	0.39	0.38
Paving (2025)	5.33	8.80	0.25	0.23
Architectural Coating (2025)	1.15	1.81	0.05	0.05
Hawthorne Aquatics Facility Maximum Daily Emissions	13.9	13.5	2.9	1.6
SCAQMD Localized Significance Thresholds^c	91	664	5	3
Exceeds Threshold?	No	No	No	No

Source	NO _x	CO	PM10 ^b	PM2.5 ^B
^a Totals may not add up exactly due to rounding in the modeling calculations. Detailed emissions calculations are provided in Appendix B.				
^b Emissions include fugitive dust control measures consistent with SCAQMD Rule 403, and Tier 3 engines for construction equipment greater than 50 hp.				
^c Localized Significance Thresholds (LST) were for a 5-acre project site with a 25-meter receptor distance.				
SOURCE: ESA, 2021				

Operational Emissions

As discussed above, it is not anticipated that implementation of the proposed Project would result in substantial increases in operational emissions. Therefore, impacts would be less than significant and no mitigation is required.

Carbon Monoxide Hotspot

A carbon monoxide (CO) hotspot is an area of localized CO pollution that is caused by severe vehicle congestion on major roadways, typically near intersections. Projects may worsen air quality if they increase the percentage of vehicles in cold start modes by two percent or more; significantly increase traffic volumes (by 5 percent or more) over existing volumes; or worsen traffic flow, defined for signalized intersections as increasing average delay at intersections operating at Level of Service (LOS) E or F or causing an intersection that would operate at LOS D or better without the proposed Project, to operate at LOS E or F.

CO decreased dramatically in the Basin with the introduction of the automobile catalytic converter in 1975. No exceedances of CO have been recorded at monitoring stations in the Basin in recent years and the Basin is currently designated as a CO attainment area for both the CAAQS and NAAQS. As discussed below, it is not expected that CO levels at Project-impacted intersections would rise to such a degree as to cause an exceedance of these standards.

Construction

While construction-related traffic on the local roadways would occur during construction, the net increase of construction worker vehicle trips to the existing daily traffic volumes on local roadways would be relatively small and would not result in CO hotspots. Additionally, construction-related vehicle trips would only occur in the short-term and would cease once construction activities have been completed. Impacts would be less than significant and no mitigation is required.

Operation

As discussed above, Project implementation would not result in an increase in events or an increase in the number of spectators at each event over existing conditions. As described in Chapter 2 *Project Description*, the Hawthorne Aquatics Facility would continue to be open year-round; however, it is anticipated that Hawthorne High School would utilize the facility during the school year, the South Bay Swim Team would utilize the facility year

round, and the City of Hawthorne would utilize the facility during the summer months, as required under the Civic Center Act. As such, the school would occupy the vast majority of the available operational hours of the facility. Therefore, the majority of the trips to the aquatic facility would be captured internally from students and staff who would already be onsite in other school buildings, and therefore would not generate a substantial number of vehicle trips. Additionally, the proposed aquatic facility would likely result in trips outside of the school's peak morning and afternoon commute times because swim team practice times would typically be scheduled before and after the normal school bell schedule. This would result in vehicle trips associated with the proposed aquatic facility occurring early in the morning (i.e., before 6:00 a.m.) and later in the early evening after school (i.e., after 6:30 p.m.) on weekdays, which would be outside of the school's peak commuting hours. Therefore, the proposed Project would not result in a substantial increase in vehicular trips that would contribute to or result in CO hotspots. Impacts would be less than significant and no mitigation is required.

Toxic Air Contaminants

Concentrations of toxic air contaminants (TACs), or in federal parlance, hazardous air pollutants (HAPs), are also used as indicators of ambient air quality conditions. A TAC is defined as an air pollutant that may cause or contribute to an increase in mortality or in serious illness, or that may pose a hazard to human health. TACs are usually present in minute quantities in the ambient air; however, their high toxicity or health risk may pose a threat to public health even at low concentrations.

Sensitive receptors are located adjacent to the Project site. SCAQMD recommends that construction health risk assessments be conducted for substantial sources of diesel particulate matter (DPM) emissions (e.g., earth-moving construction activities) in proximity to sensitive receptors and has provided guidance for analyzing mobile source diesel emissions. However, localized DPM emissions (strongly correlated with PM_{2.5} emissions) are less than significant (as shown in Table 8, above). Although the localized analysis does not directly measure health risk impacts, it does provide data that can be used to evaluate the potential to cause health risk impacts. The very low level of PM_{2.5} emissions coupled with the short-term duration of construction activity results in an overall low level of DPM concentrations in the Project area. Furthermore, compliance with the CARB Airborne Toxic Control Measures (ATCM) anti-idling measure, which limits idling to no more than five minutes at any location for diesel-fueled commercial vehicles, further minimized DPM emissions in the Project area. Sensitive receptors would be exposed to emissions below thresholds, and construction TAC impacts are less than significant.

SCAQMD recommends that operational health risk assessments be conducted for substantial sources of DPM emissions (e.g., truck stops and warehouse distribution facilities) in proximity to sensitive receptors and has provided guidance for analyzing mobile source diesel emissions. The proposed Project is not anticipated to generate a substantial number of daily truck trips. Therefore, based on the limited activity of TAC sources TAC concentrations at off-site sensitive receptors, the proposed Project would not

warrant the need for a health risk assessment associated with on-site operational activities, and potential TAC impacts are expected to be less than significant.

- d) **Less-than-Significant Impact.** Potential activities that may emit odors during construction activities include the use of architectural coatings and solvents and the combustion of diesel fuel in on- and off-road equipment. SCAQMD Rule 1113 would limit the amount of VOCs in architectural coatings and solvents. In addition, the proposed Project would comply with the applicable provisions of the CARB Air Toxics Control Measure regarding idling limitations for diesel trucks. Further, construction odor emissions would be temporary, short-term, and intermittent in nature and would cease upon completion of construction. Through adherence with mandatory compliance with SCAQMD Rules, no construction activities or materials are expected to create objectionable odors affecting a substantial number of people. Therefore, construction of the proposed Project would result in less than significant impacts.

According to the SCAQMD CEQA Air Quality Handbook, land uses associated with odor complaints typically include agricultural uses, wastewater treatment plants, food processing plants, chemical plants, composting, refineries, landfills, dairies, and fiberglass molding. The proposed Project does not include any uses identified by SCAQMD as being associated with substantial odors. As a result, the proposed Project is not expected to discharge contaminants into the air in quantities that would cause a nuisance, injury, or annoyance to the public or property pursuant to SCAQMD Rule 402. Therefore, the proposed Project would not create adverse odors affecting a substantial number of people and impacts would be less than significant.

Biological Resources

<i>Issues (and Supporting Information Sources):</i>	<i>Potentially Significant Impact</i>	<i>Less Than Significant with Mitigation Incorporated</i>	<i>Less Than Significant Impact</i>	<i>No Impact</i>
IV. BIOLOGICAL RESOURCES — Would the project:				
a) Have a substantial adverse effect, either directly or through habitat modifications, on any species identified as a candidate, sensitive, or special-status species in local or regional plans, policies, or regulations, or by the California Department of Fish and Game or U.S. Fish and Wildlife Service?	<input type="checkbox"/>	<input type="checkbox"/>	<input type="checkbox"/>	<input checked="" type="checkbox"/>
b) Have a substantial adverse effect on any riparian habitat or other sensitive natural community identified in local or regional plans, policies, regulations, or by the California Department of Fish and Game or U.S. Fish and Wildlife Service?	<input type="checkbox"/>	<input type="checkbox"/>	<input type="checkbox"/>	<input checked="" type="checkbox"/>
c) Have a substantial adverse effect on state or federally protected wetlands (including, but not limited to, marsh, vernal pool, coastal, etc.) through direct removal, filling, hydrological interruption, or other means?	<input type="checkbox"/>	<input type="checkbox"/>	<input type="checkbox"/>	<input checked="" type="checkbox"/>
d) Interfere substantially with the movement of any native resident or migratory fish or wildlife species or with established native resident or migratory wildlife corridors, or impede the use of native wildlife nursery sites?	<input type="checkbox"/>	<input checked="" type="checkbox"/>	<input type="checkbox"/>	<input type="checkbox"/>
e) Conflict with any local policies or ordinances protecting biological resources, such as a tree preservation policy or ordinance?	<input type="checkbox"/>	<input type="checkbox"/>	<input type="checkbox"/>	<input checked="" type="checkbox"/>
f) Conflict with the provisions of an adopted Habitat Conservation Plan, Natural Community Conservation Plan, or other approved local, regional, or state habitat conservation plan?	<input type="checkbox"/>	<input type="checkbox"/>	<input type="checkbox"/>	<input checked="" type="checkbox"/>

Discussion

a) **No Impact.**

Special-Status Species

A significant impact would occur if the proposed Project directly resulted in take or removed or modified habitat for any species identified as a candidate, sensitive, or special-status species in local or regional plans, policies, or regulations, or by the California Department of Fish and Wildlife (CDFW) or U.S. Fish and Wildlife Service (USFWS).

A search of the California Natural Diversity Database (CNDDDB); California Native Plant Society (CNPS) Inventory of Rare, Threatened, and Endangered Plants of California (CNPS Inventory); and USFWS Information for Planning and Consultation (IPaC) database was conducted in June 2021 to identify special-status plants and animals with the potential to occur in the proposed Project area (Appendix C; CDFW 2021; CNPS 2021; USFWS 2021b). Due to the highly developed nature of the Project site and vicinity and the lack of any natural vegetation communities in the surrounding area, the search was restricted to the USGS quadrangle that the proposed Project occurs in, the Inglewood 7.5-

minute topographic quadrangle. For the purpose of this assessment, “special-status species” is defined as those species that meet one or more of the following criteria:

- Listed as threatened or endangered, or proposed or a candidate for listing, under the federal and/or California Endangered Species Act;
- California species of special concern or fully protected species;
- USFWS bird of conservation concern;
- Plants listed as rare under the California Native Plant Protection Act, or ranked as rare, threatened, or endangered in California (California Rare Plant Rank [CRPR] of 1A, 1B, 2A, and 2B).

Species that were in the record search results but do not meet these criteria were not included in the analysis below.

Plant Species

A total of nine special-status plant species meeting the criteria above is reported to occur within the USGS Inglewood 7.5-minute topographic quadrangle based on the record search (Appendix C). Four of these species are federally and/or State listed: coastal dunes milk-vetch (*Astragalus tener* var. *titi*), San Diego button-celery (*Eryngium aristulatum* var. *parishii*), spreading navarretia (*Navarretia fossalis*), and California Orcutt grass (*Orcuttia californica*).

All nine special-status plant species are considered absent due to lack of suitable habitat on and around the Project site. Because no special-status plant species are expected to occur on the site, there would be no impacts on special-status plant species, and therefore, no avoidance and minimization or compensatory mitigation measures would be required.

Wildlife Species

A total of 13 special-status wildlife species meeting the criteria above is reported to occur within the USGS Inglewood 7.5-minute topographic quadrangle based on the record search (Appendix C). Five of these species are federally and/or State listed or candidate species: Crotch bumble bee (*Bombus crotchii*), tricolored blackbird (*Agelaius tricolor*), least Bell’s vireo (*Vireo bellii pusillus*), southwestern willow flycatcher (*Empidonax traillii extimus*), and coastal California gnatcatcher (*Polioptila californica californica*).

All 13 special-status wildlife species were determined to be absent from the Project site due to lack of suitable habitat. The study area is composed entirely of developed areas and regularly maintained athletic fields and is devoid of any vegetation or land cover types that would support any special-status wildlife species. As such, there would be no impacts on special-status wildlife species and no avoidance and minimization or compensatory mitigation measures would be required.

- b) **No Impact.** A significant impact would occur if the proposed Project substantially removed or modified any riparian habitat or other sensitive natural communities as defined by CDFW, USFWS, or local or regional plans, policies, or regulations.

The study area for the proposed Project consists of the existing Hawthorne High School athletic fields and the Hawthorne Aquatics Facility. Project development would consist of upgrades and reconfiguring of the existing athletic fields, updating the existing utilities, new site improvements including the installation of bike racks, drinking fountains, trash receptacles, and redevelopment of the Hawthorne Aquatics Facility. The land cover in the study area is composed of developed areas (i.e., existing buildings, walkways, parking lots, and basketball courts) and landscaped areas (i.e., athletic playing fields).

Since the study area is developed and contains only ornamental vegetation within landscaped areas, the study area does not support sensitive natural communities. Based on an analysis of aerial photographs of the study area, no riparian habitats or other special-status natural communities are present on the Project site. Because there are no riparian habitats or other sensitive natural communities in the study area, there would be no impacts on them as a result of the proposed Project and, therefore, no avoidance and minimization or compensatory mitigation measures would be required.

- c) **No Impact.** A significant impact would occur if federally protected wetlands or non-wetland Waters of the U.S. as defined by Section 404 of the Clean Water Act, or vegetated or unvegetated Waters of the State as defined by Section 1602 et seq. of the California Fish and Game Code, were removed or substantially modified.

There are no federally protected wetlands, non-wetland waters, or vegetated or unvegetated State streambeds within the study area, and therefore, there would be no impacts on any protected aquatic resource. No avoidance and minimization measures or compensatory mitigation measures would be required.

- d) **Less-than-Significant Impact with Mitigation Incorporated.** A significant impact would occur if the proposed Project interfered with the movement of any native wildlife species through a migratory wildlife corridor, or impede the use of a native wildlife nursery site.

There are no wildlife movement corridors on or near the study area and implementation of the proposed Project would not adversely affect the movements of fish or other wildlife. However, there are a few trees and shrubs onsite near existing buildings that could provide suitable habitat for nesting birds protected by the federal Migratory Bird Treaty Act or California Fish and Game Code sections. The proposed Project has the potential to affect active native resident and/or migratory bird nests if, and to the extent that, those trees are removed or trimmed during the avian nesting season and they contain nests or should construction work occur adjacent to active nests. Mitigation Measure **MM- BIO-1** below would avoid or minimize any potential impacts on nesting birds. Thus, the impact would be less-than-significant. No compensatory mitigation would be required.

MM-BIO-1: If construction commences during the bird breeding season (approximately February 1 – August 31), a preconstruction survey for nesting birds shall occur within seven days prior to construction activities by an experienced avian biologist. The survey shall occur within all suitable nesting habitat within the Project impact area and a 100-foot buffer. If nesting birds are

found, an avoidance area shall be established as appropriate by a qualified biologist around the nest until a qualified avian biologist has determined that young have fledged or nesting activities have ceased. The Project site shall be re-surveyed if there is a lapse in construction activities for more than seven days during the bird breeding season.

- e) **No Impact.** A significant impact would occur if the proposed Project conflicted with any local policies or ordinances protecting biological resources.

The City of Hawthorne does not have any tree protection guidelines, or other local policies or ordinances that pertain to the study area. Therefore, the proposed Project would not conflict with any local policies or ordinances protecting biological resources.

- f) **No Impact.** A significant impact would occur if the proposed Project were inconsistent with the provisions of an adopted Habitat Conservation Plan, Natural Community Conservation Plan, or other approved local, regional, or State habitat conservation plan.

There are no Habitat Conservation Plans, Natural Community Conservation Plans, or other approved local, regional, or State habitat conservation plans that cover the study area (CDFW 2019; USFWA 2021). The proposed Project would not be in conflict with any conservation plans, and therefore, there would be no impact.

Cultural Resources

<i>Issues (and Supporting Information Sources):</i>	<i>Potentially Significant Impact</i>	<i>Less Than Significant with Mitigation Incorporated</i>	<i>Less Than Significant Impact</i>	<i>No Impact</i>
V. CULTURAL RESOURCES — Would the project:				
a) Cause a substantial adverse change in the significance of a historical resource pursuant to §15064.5?	<input type="checkbox"/>	<input type="checkbox"/>	<input type="checkbox"/>	<input checked="" type="checkbox"/>
b) Cause a substantial adverse change in the significance of an archaeological resource pursuant to §15064.5?	<input type="checkbox"/>	<input checked="" type="checkbox"/>	<input type="checkbox"/>	<input type="checkbox"/>
c) Disturb any human remains, including those interred outside of dedicated cemeteries?	<input type="checkbox"/>	<input checked="" type="checkbox"/>	<input type="checkbox"/>	<input type="checkbox"/>

Discussion

- a) **No Impact.** A cultural resources records search was conducted on July 1, 2021 through the California Historical Resources Information System – South Central Coastal Information Center (CHRIS-SCCIC). Search results indicate that one historic architectural resource (P-19-188895/Hawthorne High School) has been recorded within the athletic fields (McKenna 2010). The resource was constructed in the mid-1950s and includes athletic fields (within the Project site), as well as classrooms, an administration building, gyms, locker rooms, and a teachers’ lounge south of the Project site. Hawthorne High School was recommended ineligible for listing in the California Register of Historical Resources and, therefore, does not qualify as a historical resource under CEQA (McKenna 2010). No impacts to historic architectural resources qualifying as historical resources are anticipated.
- b) **Less-than-Significant Impact with Mitigation Incorporated.** The records search conducted with the CHRIS-SCCIC did not identify any previously recorded archaeological resources within the Project site or within the 0.50-mile records search radius. Additionally, a Sacred Lands File search conducted by the Native American Heritage Commission (NAHC) on May 26, 2021 returned negative results within the Project site (Green2021).

Historic topographic map and aerial photograph review (TopoView 2021; historicaerials.com 2021) indicate that the Project site was undeveloped prior to the turn of the 19th century with the nearest water, Aguaje de la Centinela, located approximately 3.25 miles north. By 1924, a Pacific Electric railroad line is depicted bisecting the undeveloped site. By 1930, the northern portion of the Project site is identified as within “Kelly’s Airport” and includes one structure. By 1938, Kelly’s airport was no longer shown, rather a grouping of domestic structures is depicted north of the railroad tracks and southwest of the current intersection of West 124th Street and South Inglewood Avenue, while the remainder of the Project site appears to have been agricultural fields. By 1941, additional structures appear north of the railroad tracks. The structures appear to have been removed by 1952 at which time the development of the high school buildings had already begun. By 1963 the Hawthorne High School facilities appear as they are today. Given historic development on portions of the Project site prior to construction of the high school

facilities, there is the potential for ground disturbing activities to encounter buried historic-period archaeological materials including building foundations and refuse deposits.

Geologic map review indicates the surface of the Project site is mapped as Qoa, which is described as older alluvium (Dibblee and Minch 2007). Older alluvial sediments predate human habitation of the area and as such the sensitivity of these sediments for prehistoric archaeological materials is considered low.

No known previously-recorded archaeological resources have been identified; however, there is the potential, albeit unlikely, for the proposed Project to encounter unknown historic and prehistoric archaeological resources as a result of ground disturbing activities. Such archaeological resources could qualify as historical resources or unique archaeological resources under CEQA. However, with the implementation of Mitigation Measures **MM-CUL-1** and **MM-CUL-2** impacts to archaeological resources qualifying as historical resources or unique archaeological resources would be less than significant.

MM-CUL-1: The District/Construction Contractor shall retain an archaeologist who meets the Secretary of the Interior's Professional Qualifications Standards for Archaeology (Qualified Archaeologist) to carry out all mitigation related to archaeological resources. Prior to start of ground-disturbing activities, the Qualified Archaeologist or their designee shall conduct cultural resources sensitivity training for all construction personnel. Construction personnel shall be informed of the types of archaeological resources that may be encountered, the proper procedures to be enacted in the event of an inadvertent discovery of archaeological resources or human remains, and safety precautions to be taken when working with archaeological monitors. The District shall ensure that construction personnel are made available for and attend the training and retain documentation demonstrating attendance.

MM-CUL-2: In the event of the unanticipated discovery of archaeological materials, the Centinela Valley Union High School District (District) shall immediately cease all work activities in the area (within approximately 100 feet) of the discovery until it can be evaluated by the Qualified Archaeologist. Construction shall not resume until the Qualified Archaeologist has conferred with the District on the significance of the resource. If it is determined that the discovered archaeological resource constitutes a historical resource or unique archaeological resource pursuant to CEQA, avoidance and preservation in place shall be the preferred manner of mitigation. Preservation in place maintains the important relationship between artifacts and their archaeological context and also serves to avoid conflict with traditional and religious values of groups who may ascribe meaning to the resource. Preservation in place may be accomplished by, but is not limited to, avoidance, incorporating the resource into open space, capping, or deeding the site into a permanent conservation easement. In the event that preservation in place is determined to be infeasible and data recovery through excavation is the only feasible mitigation available, an Archaeological Resources Treatment Plan shall be prepared and implemented by the Qualified Archaeologist that provides for the adequate

recovery of the scientifically consequential information contained in the archaeological resource. The District shall consult with appropriate Native American tribal representatives in determining treatment for prehistoric or Native American resources to ensure cultural values ascribed to the resources, beyond those that are scientifically important, are considered. The treatment plan shall include provisions for the final disposition of the recovered resources, which may include onsite reburial, curation at a public, non-profit institution, or donation to a local Native American Tribe, school, or historical society.

- c) **Less-than-Significant Impact with Mitigation Incorporated.** No formal or informal cemeteries or other burial places are known to exist within the Project site. However, since the proposed Project would involve ground-disturbing activities, it is possible that such actions could unearth, expose, or disturb previously unknown human remains. Should ground disturbance encounter human remains, disturbance of those remains could result in a significant effect on the environment. However, with the implementation of Mitigation Measure **MM-CUL-3**, which requires following State laws in the event of a discovery, impacts to human remains would be less than significant.

MM-CUL-3: If human remains are encountered, the District or its contractor shall halt work in the vicinity (within 100 feet) of the discovery and contact the Los Angeles County Coroner in accordance with Public Resources Code Section 5097.98 and Health and Safety Code Section 7050.5, which requires that no further disturbance shall occur until the County Coroner has made the necessary findings as to origin and disposition pursuant to Public Resources Code Section 5097.98. If the remains are determined to be of Native American descent, the Coroner has 24 hours to notify the Native American Heritage Commission (NAHC). The NAHC shall then identify the person(s) thought to be the Most Likely Descendent (MLD). The MLD may, with the permission of the landowner, or his or her authorized representative, inspect the site of the discovery of the Native American remains and may recommend to the owner or the person responsible for the excavation work means for treating or disposing, with appropriate dignity, the human remains and any associated grave goods. The MLD shall complete their inspection and make their recommendation within 48 hours of being granted access by the landowner to inspect the discovery. The recommendation may include the scientific removal and nondestructive analysis of human remains and items associated with Native American burials. Upon the discovery of the Native American remains, the landowner shall ensure that the immediate vicinity, according to generally accepted cultural or archaeological standards or practices, where the Native American human remains are located, is not damaged or disturbed by further development activity until the landowner has discussed and conferred, as prescribed in this mitigation measure, with the MLD regarding their recommendations, if applicable, taking into account the possibility of multiple human remains. The landowner shall discuss and confer with the MLD on all reasonable options regarding their preferences for treatment.

If the NAHC is unable to identify an MLD, or the MLD identified fails to make a recommendation, or the landowner rejects the recommendation of the MLD and the mediation provided for in Subdivision (k) of Section 5097.94, if invoked, fails to provide measures acceptable to the landowner, the landowner or his or her authorized representative shall inter the human remains and items associated with Native American human remains with appropriate dignity on the facility property in a location not subject to further and future subsurface disturbance.

Energy

<i>Issues (and Supporting Information Sources):</i>	<i>Potentially Significant Impact</i>	<i>Less Than Significant with Mitigation Incorporated</i>	<i>Less Than Significant Impact</i>	<i>No Impact</i>
VI. ENERGY — Would the project:				
a) Result in potentially significant environmental impact due to wasteful, inefficient, or unnecessary consumption of energy resources, during project construction or operation?	<input type="checkbox"/>	<input type="checkbox"/>	<input checked="" type="checkbox"/>	<input type="checkbox"/>
b) Conflict with or obstruct a state or local plan for renewable energy or energy efficiency?	<input type="checkbox"/>	<input type="checkbox"/>	<input checked="" type="checkbox"/>	<input type="checkbox"/>

Discussion

- a) **Less-than-Significant Impact.** The proposed Project would consume energy during construction activities primarily from on- and off-road vehicle fuel consumption in the form of diesel, gasoline, and electricity from water conveyance for dust control. Project operation would not result in substantial increases in the consumption of energy compared to existing conditions. The analysis below includes the Project’s energy requirements and energy use efficiencies by energy type for each stage of the proposed Project (construction and operations).

Construction

The proposed Project would consume energy during construction activities, primarily from on- and off-road vehicle fuel consumption in the form of diesel, gasoline, and electricity from water conveyance for dust control. The analysis below includes the Project’s energy requirements and energy use efficiencies by energy type for each stage of the Project.

The estimated fuel usage for off-road equipment is based on the number and type of equipment that would be used during construction activities, hour usage estimates, the total duration of construction activities, and hourly equipment fuel consumption factors from the CARB OFFROAD model, which was used in the Project’s air quality analysis. On-road vehicles would include trucks to haul material to and from the Project site, vendor trucks to deliver supplies necessary for Project construction, and fuel used for employee commute trips. Energy for lighting, and other processes associated with grid electricity, would be available onsite. Electricity used from water conveyance for dust control was calculated using assumptions for gallons used per acre per and CalEEMod water conveyance intensity factors were applied to calculate total construction electricity consumption. Construction activities typically do not involve the consumption of natural gas. **Table 9, Summary of Energy Consumption During Project Construction**, summarizes the Project’s total fuel and electricity consumption from construction activities.

**TABLE 9
SUMMARY OF ENERGY CONSUMPTION DURING PROJECT CONSTRUCTION**

Field Replacement	
Fuel Type	Quantity
Gasoline	gallons
On-Road Construction Trips	30,552
Off-Road Construction Equipment	0
Total Gasoline	30,552
Diesel	gallons
On-Road Construction Trips	24,421
Off-Road Construction Equipment	113,690
Total Diesel	138,111
Construction Length	18 months
Hawthorne Aquatics Facility	
Fuel Type	Quantity
Gasoline	gallons
On-Road Construction Trips	2,759
Off-Road Construction Trips	0
Total Gasoline	2,759
Diesel	gallons
On-Road Construction Trips	3,656
Off-Road Construction Equipment	22,572
Total Diesel	26,228
Construction Length	12 months

SOURCE: ESA, 2021

The energy use summary provided above in Table 9 represents the amount of energy that could potentially be consumed during Project construction based on a conservative set of assumptions, provided in Appendix B, of this Draft IS/MND. As shown, on- and off-road vehicles would consume an estimated 30,552 gallons of gasoline and approximately 138,111 gallons of diesel fuel for the field replacement and 2,759 gallons of gasoline and approximately 26,228 gallons of diesel fuel for the Hawthorne Aquatics Facility. For comparison purposes, the fuel usage during Project construction would represent approximately 0.0006 percent of the 2019 annual gasoline sales and 0.016 percent of the 2019 annual diesel sales in Los Angeles County for the field replacement and would be significantly less for the aquatic facility should it be developed. Detailed calculations are shown in Appendix B, of this Draft IS/MND.

The Project's construction contractors would comply with applicable CARB regulations governing the accelerated retrofitting, repowering, or replacement of heavy duty diesel on- and off-road equipment. CARB adopted an Airborne Toxic Control Measure to limit

heavy-duty diesel motor vehicle idling time in order to reduce public exposure to diesel particulate matter and other toxic air contaminants. CARB approved the Truck and Bus regulation to reduce NO_x, PM₁₀, and PM_{2.5} emissions from existing diesel vehicles operating in California. In addition to limiting exhaust from idling trucks, CARB recently promulgated emission standards for off-road diesel construction equipment of greater than 25 horsepower to reduce emissions by requiring the installation of diesel soot filters and encouraging the retirement, replacement, or repower of older, dirtier engines with newer emission-controlled models.

While intended to reduce construction criteria pollutant emissions, compliance with the above listed anti-idling and emissions regulations would also result in efficient use of construction-related energy and the minimization or elimination of wasteful and unnecessary consumption of energy. According to the CARB staff report that was prepared at the time the anti-idling ATCM was being proposed for adoption in late 2004/early 2005, the regulation was estimated to reduce non-essential idling and associated emissions of diesel particulate matter and NO_x emissions by 64 and 78 percent respectively in analysis year 2009.

These reductions in emissions are directly attributable to overall reduced idling times and fuel combustion as a result of compliance with the regulation. Heavy-duty engines continue to become more efficient and reduction amounts may lessen in the future due to this. Although the energy savings cannot be accurately quantified, the proposed Project would still reduce consumption of diesel fuel under the anti-idling measure. Construction electricity use would be temporary, sporadic, and would cease upon completion of the proposed Project. Electricity for water conveyance would only be used to prevent fugitive dust and would decrease after completion of excavation and field installation phases when the site has less dust to control. Thus, construction of the proposed Project would use energy necessary to build the proposed Project, but would not result in the wasteful, inefficient, and unnecessary use of energy and impacts would be less than significant.

Operation

The proposed Project consists of replacing athletic fields like-for-like and the redevelopment of the Hawthorne Aquatics Facility with minimal increase in the number of events and the number of vehicle trips from nearby spectators in attendance. Therefore, vehicle trips and fuel usage would not increase due to Project implementation. The proposed Project would replace the existing lighting with energy-efficient LED lighting that would reduce the fields' current consumption of electricity. New synthetic turf that would be installed on the softball/multi-use field, outdoor football field, and baseball field would reduce water consumption and associated energy consumption requirements related to supplying and treating water.

The Proposed team building/concessions stand would comply with the applicable provisions of Title 24, City of Hawthorne's Climate Action Plan (CAP), and the CALGreen Code in effect at the time of construction. As such, the proposed Project would minimize energy demand. Therefore, with the incorporation of these features, operation of the

proposed Project would not result in the wasteful, inefficient, and unnecessary consumption of electricity.

As discussed in CEQA Checklist Issue III, *Air Quality*, the proposed Project would not result in the generation of permanent employees. As discussed in CEQA Checklist Section XVII, *Transportation*, this proposed Project does not have a significant impact on transportation or traffic in the project vicinity. Furthermore, the proposed Project is within walking distance from Metro Routes 211/215, 40, 126, and 740. Therefore, Since the proposed Project is consistent with SCAG' growth projections, is connected to a transit network, and has less-than-significant traffic impacts based on no anticipated increase in operational trips, the Project's fuel consumption would not result in the wasteful, inefficient, and unnecessary consumption of fuel and impacts would be less than significant.

- b) **Less-than-Significant Impact.** Construction of the proposed Project would result in a temporary increase in demand for electricity, gasoline, and diesel. The Project's energy consumption primarily would result from on- and off-road fuel use from construction related vehicles and electricity from water conveyance for dust control. Natural gas would not be used during Project construction. These activities make up small percentages of total energy supplies and would cease after the 18-month construction period. Thus, construction would not cause a permanent increase in demand and impacts would be less than significant.

Project operation would not result in substantial increases the demand for electricity resources including for water supply, conveyance, distribution, and treatment. The proposed Project consists of replacing athletic fields like-for-like and the redevelopment of the Hawthorne Aquatics Facility with no anticipated increase in the number of events or the number of spectators in attendance. Therefore, vehicle trips and fuel usage would not increase due to Project implementation. The proposed Project would replace the existing field lighting with energy-efficient LED lighting that would reduce the fields' current consumption of electricity. New synthetic turf that would be installed on the softball/multi-use field, outdoor football field, and baseball field would reduce water consumption and associated energy consumption requirements related to supplying and treating water. Thus, the proposed Project would not cause a permanent increase in demand and impacts would be less than significant.

Geology and Soils

<i>Issues (and Supporting Information Sources):</i>	<i>Potentially Significant Impact</i>	<i>Less Than Significant with Mitigation Incorporated</i>	<i>Less Than Significant Impact</i>	<i>No Impact</i>
VII. GEOLOGY AND SOILS — Would the project:				
a) Directly or indirectly cause potential substantial adverse effects, including the risk of loss, injury, or death involving:				
i) Rupture of a known earthquake fault, as delineated on the most recent Alquist-Priolo Earthquake Fault Zoning Map issued by the State Geologist for the area or based on other substantial evidence of a known fault? Refer to Division of Mines and Geology Special Publication 42.	<input type="checkbox"/>	<input type="checkbox"/>	<input type="checkbox"/>	<input checked="" type="checkbox"/>
ii) Strong seismic ground shaking?	<input type="checkbox"/>	<input type="checkbox"/>	<input checked="" type="checkbox"/>	<input type="checkbox"/>
iii) Seismic-related ground failure, including liquefaction?	<input type="checkbox"/>	<input type="checkbox"/>	<input type="checkbox"/>	<input checked="" type="checkbox"/>
iv) Landslides?	<input type="checkbox"/>	<input type="checkbox"/>	<input type="checkbox"/>	<input checked="" type="checkbox"/>
b) Result in substantial soil erosion or the loss of topsoil?	<input type="checkbox"/>	<input type="checkbox"/>	<input checked="" type="checkbox"/>	<input type="checkbox"/>
c) Be located on a geologic unit or soil that is unstable, or that would become unstable as a result of the project, and potentially result in on- or off-site landslide, lateral spreading, subsidence, liquefaction, or collapse?	<input type="checkbox"/>	<input type="checkbox"/>	<input checked="" type="checkbox"/>	<input type="checkbox"/>
d) Be located on expansive soil, as defined in Table 18-1-B of the Uniform Building Code (1994), creating substantial direct or indirect risks to life or property?	<input type="checkbox"/>	<input type="checkbox"/>	<input checked="" type="checkbox"/>	<input type="checkbox"/>
e) Have soils incapable of adequately supporting the use of septic tanks or alternative waste water disposal systems where sewers are not available for the disposal of waste water?	<input type="checkbox"/>	<input type="checkbox"/>	<input type="checkbox"/>	<input checked="" type="checkbox"/>
f) Directly or indirectly destroy a unique paleontological resource or site or unique geologic feature?	<input type="checkbox"/>	<input checked="" type="checkbox"/>	<input type="checkbox"/>	<input type="checkbox"/>

Discussion

- a.i) **No Impact.** The proposed Project site is not located within an Alquist-Priolo Earthquake Fault Zone (EFZ). The nearest EFZ is the Newport-Inglewood Fault Zone with its closest segment located approximately 2.7 miles northeast of the Project site (Geo-Advantec Inc. 2017). As no active faults intersect the Project site, surface rupture in a fault zone would not occur. As such, the proposed Project would not be exposed to substantial adverse effects from a rupture of a known earthquake fault and there would be no impact.
- a.ii) **Less-than-Significant Impact.** A number of faults recognized as active by the State and the California Building Code (CBC) are located within the southern California area. A moderate to major event on any of these faults could result in strong ground shaking at the Project site. The intensity of the ground shaking would depend on the distance to the epicenter and the geology of the areas between the epicenter and the Project site. This risk exists throughout the southern California region and could pose a risk by exposing people, property and infrastructure to potentially damaging ground shaking.

As with all of southern California, the Project site is located in a seismically active region. The principal source of seismic activity in the area is movement along the northwest-trending regional faults such as the San Andreas, San Jacinto, Newport-Inglewood, and Whittier-Elsinore fault zones. According to the *Geotechnical Evaluation Report* prepared for the proposed Project, the most significant faults to the Project site (as it relates to seismic ground shaking) are the northwest-trending Newport-Inglewood Fault located approximately 2.7 miles northeast of the Project site and the Palos Verdes Fault located approximately 5.8 miles, to the southwest.

The *Geotechnical Evaluation Report* estimates that magnitude 7.5 and 7.3 earthquakes could be produced by the Newport- Inglewood and Palos Verdes faults, respectively. As a result, the proposed Project could be subject to future seismic shaking and strong ground motion resulting from seismic activity, and damage could occur. As discussed in the City's General Plan, *Safety Element*, design and construction of the proposed Project would be consistent with the recommendations contained in the *Geotechnical Evaluation Report* and the CBC, along with applicable federal, State, and local codes. In addition, Project plans and specifications must adhere to the seismic requirements of the Earthquake Design Regulations of Chapter 16A, Section 1613A of the CBC 2016. Further, as stated in the recommendations contained in the *Geotechnical Evaluation Report*, construction of the proposed Project would be overseen by a licensed Structural Engineer who is required to ensure that the proposed Project is constructed in accordance with the requirements of the most current and applicable building code. These recommendations, requirements, and approvals would reduce anticipated impacts by requiring the proposed Project to be built to withstand significant seismic ground shaking beyond that of typical construction. Impacts would be less than significant.

- a.iii) **No Impact.** Liquefaction is a seismic phenomenon in which loose unconsolidated soil or sediment materials lose cohesion and behave as a liquid due to earthquake shaking. Liquefaction occurs when saturated, loose materials (e.g., sand or silty sand) are weakened and transformed from a solid to a near-liquid state as a result of increased pore water pressure. The increase in pressure is caused by strong ground motion from an earthquake. A site's susceptibility to liquefaction is a function of depth, density, groundwater level, and magnitude of an earthquake. Liquefaction-related phenomena can include lateral spreading, ground oscillation, flow failure, loss of bearing strength, subsidence, and buoyancy effects. For liquefaction to occur, the soil must be saturated (i.e., shallow groundwater) and be relatively loose. Liquefaction more often occurs in areas where groundwater level is at or above the level of the susceptible soils during the ground shaking. According to the *Geotechnical Evaluation Report* and the California Department of Conservation, the Project site is not located in a seismic hazard zone of liquefaction and is therefore not considered a potential hazard at the site (CGS 2021). No impact would occur.
- a.iv) **No Impact.** The topography of the Project site and the surrounding area is relatively flat and does not contain any distinctive landforms. In addition, according to the California Department of Conservation, the Project site is not located in an earthquake induced landslide zone (CGS 2021). According to the *Geotechnical Evaluation Report*, no evidence

of landslides has been observed on or in the immediate vicinity of the Project site. In addition, the California Department of Conservation, Geological Survey does not show the Project site as being within an area of landslide or liquefaction (CGS 2021). As such, landslides are not considered a potential hazard at the site and no impact would occur.

- b) **Less-than-Significant Impact.** The Project site is currently developed by Hawthorne High School athletic facilities and the Hawthorne Aquatics Facility. The athletic facilities include a baseball/softball field, outdoor basketball courts, a football stadium as well as a track, three tennis courts, and six handball courts. Development of the Project site would include removal of the existing facilities and paving, as well as limited grading of the site during construction. These activities are not likely to result in a substantial loss in topsoil since the site is currently developed and has previously been graded and disturbed. Therefore, implementation of the proposed Project would have a less-than-significant impact in regard to the loss of top soil.

Construction activities may result in wind and water driven erosion of soils due to grading activities if soil is stockpiled or exposed during construction. This impact is considered short-term in nature because the site would expose small amounts of soil only during construction activities. Any potential erosion impacts would be reduced by implementation of erosion controls imposed by the City through grading and building code requirements. The developer would also be required to adhere to SCAQMD Rule 403 (Fugitive Dust), which would further reduce the impact related to soil erosion to less than significant.

As the Project site is greater than 1 acre in size, the proposed Project would be required to implement a Stormwater Pollution Prevention Plan (SWPPP) in accordance with the National Pollutant Discharge Elimination System (NPDES) General Permit for Construction Activities. The SWPPP requires the implementation of Best Management Practices (BMPs) during construction to ensure that potential water quality impacts from water-driven erosion, as well as discharge of other construction-related pollutants would be less than significant. Temporary BMPs could include installation of berms, plastic sheeting, silt fences, straw wattles, sediment traps, gravel sandbag barriers etc. and would be implemented to control runoff and erosion during construction activities.

Implementation of erosion and sediment control BMPs would prevent substantial soil erosion and sedimentation from exposed soils. In addition, post-construction measures, such as surface drainage design provisions and site maintenance practices would reduce potential soil erosion during operation of the proposed Project improvements. Therefore, potential impacts related to soil erosion or loss of topsoil would be less than significant.

- c) **Less-than-Significant Impact.** As previously mentioned under threshold a), onsite liquefaction and landslide potential are considered negligible. Due to the relatively flat topography of the Project site and surrounding area, and the analysis within the City's General Plan, the Project site would not expose people or structures to potential landslides (City of Hawthorne 1989). Impacts would be less than significant.

Lateral spreading results from liquefaction or plastic deformation of soil that commonly occur on gentle slopes and has a rapid fluid-like flow movement. The conditions occur when blocks of mostly intact surficial soil are displaced laterally as a result of liquefaction in a subsurface layer. The Project site is not located within an area of significant lateral spreading and is not susceptible to liquefaction. No impact would occur.

Subsidence involves the settling or sinking of a body of rock or sediment. Subsidence is a type of mass wasting, or mass movement-transport of large volumes of earth material primarily by gravity but may occur as the result of either natural or human-caused events, such as groundwater withdrawal. The Project site is not located within an area of significant subsidence activity. Impacts would be less than significant.

Collapsible soil involves the rapid settling or collapsing of certain types of geologically recent, unconsolidated sediments. Ground settlement can damage man-made structures such as foundations, pavements, concrete slabs, and utilities. Those portions of the City that may be susceptible to seismically induced settlement are the alluvial surfaces and larger drainages that are underlain by alluvial sediments, and do not include the Project site. In addition, a dry settlement analysis was conducted as part of the geotechnical investigation. Results of the analysis indicated that a maximum total earthquake-induced dry settlement would be less than 0.1 inch. Recommendations related to potential settlement are included in the *Geotechnical Evaluation Report* under Sections 9.1 *Earthwork*, 9.1.3 *Treatment of Near-Surface Soils*, 9.1.5 *Fill Material*, 9.4 *Foundations* and 9.4.1 *Square and Continuous Foundations*. In addition, the *Additional Geotechnical Design Recommendations* includes recommendations on light pole foundations, modulus of subgrade reaction, and retaining walls. As mentioned previously, design and construction of the proposed Project would be consistent with the recommendations contained in the *Geotechnical Evaluation Report* and the latest CBC, along with any other applicable federal, State, and local codes, which would reduce anticipated impacts by requiring the proposed Project to be built to withstand seismic hazards. Impacts would be less than significant.

- d) **Less-than-Significant Impact.** Expansive soils are fine-grained soils (generally high-plasticity clays) that can undergo a significant increase in volume with an increase in water content as well as a significant decrease in volume with a decrease in water content. Changes in the water content of highly expansive soils can result in severe distress for structures constructed on or against the soils.

Expansion Index testing was performed on onsite soils as part of the *Geotechnical Evaluation Report*. Results on the samples obtained from within the proposed Project footprint indicate that onsite soils have a high to very high expansion potential. Construction of the proposed Project would be subject to applicable ordinances of the 2019 CBC and recommendations contained in the Project-specific *Geotechnical Evaluation Report* (recommendations associated with expansive soils are discussed under Sections 9.1 *Earthwork*, 9.2 *Underground Utilities*, and 9.4 *Foundations*), the recommendations contained in the *Additional Geotechnical Design Recommendations* (recommendations

- associated with retaining walls) and include using imported materials for backfilling purposes and that a sample of the potential backfill/import material is to be submitted to the Geotechnical Consultant at least 72 hours prior to fill operations. Therefore, impacts would be less than significant.
- e) **No Impact.** Hawthorne High School is served by an existing City sewer system and no septic tanks or alternative wastewater disposal systems are proposed as part of the proposed Project. Implementation of the proposed Project would continue to utilize the existing sanitary sewer infrastructure and would not use septic tanks or alternative wastewater disposal systems. As such, no impact would occur.
- f) **Less-than-Significant Impact with Mitigation Incorporated.** Archival research was conducted and consisted of geologic map review, geologic literature review, and a paleontological resources database search conducted by the Natural History Museum of Los Angeles County (LACM).

Review of the geologic map indicates that the Project site is underlain by Quaternary older alluvium (Qoa) sediments, described as “gray to light brown pebble-gravel, sand, and silt-clay” from the late Pleistocene (Dibblee and Minch 2007). Pleistocene alluvium contains a rich repository of Ice Age mammals and other animals in the Los Angeles area including mammoth, bison, horse, lion, cheetah, wolf, camel, antelope, peccary, mastodon, capybara, and giant ground sloth, as well as small animals such as rodents and lizards (Brattstrom and Sturn 1959; Graham and Lundelius 1994; Steadman 1980). As such, older Pleistocene alluvium deposits are assigned a high paleontological potential.

The LACM indicates that no fossil localities lie directly within the Project site, but that fossil localities (LACM VP 1225, 3264-3266, 3789, 4942, and 7332) exist nearby (approximately between 2 and 5 miles away from the Project site) and from the same sedimentary deposits that occur in the Project site. These localities were found within Pleistocene deposits that yielded fossil specimens of mammoth, bison, hare, uncatalogued vertebrates, and elephant family (Proboscidea); some at unknown depths and others at depths between 14 and 40 feet below ground surface (Bell 2021).

Based on the fossiliferous geologic formations that have been mapped within the Project site and the abundance of fossil localities in same geologic formations in the vicinity of the Project site and elsewhere in the Los Angeles Basin, the potential to encounter fossiliferous deposits within the Project site is considered high. Should paleontological resources be encountered, the proposed Project could directly or indirectly destroy a unique paleontological resource or site or unique geologic feature. However, with the implementation of Mitigation Measures **MM-PALEO-1** through **MM-PALEO-4**, impacts to unique paleontological resources or sites or unique geologic feature would be less than significant.

MM-PALEO-1: The District/Construction Contractor shall retain a paleontologist who meets the Society of Vertebrate Paleontology’s (SVP 2010) definition for qualified profession paleontologist (Qualified Paleontologist) to carry out all mitigation related to paleontological resources. Prior to the

start of ground-disturbing activities, the Qualified Paleontologist or their designee shall conduct construction worker paleontological resources sensitivity training for all construction personnel. Construction personnel shall be informed on how to identify the types of paleontological resources that may be encountered, the proper procedures to be enacted in the event of an inadvertent discovery of paleontological resources, and safety precautions to be taken when working with paleontological monitors. The District shall ensure that construction personnel are made available for and attend the training and retain documentation demonstrating attendance.

MM-PALEO-2: Paleontological monitoring shall be conducted during ground-disturbing activities below 10 feet in Quaternary alluvium. Monitoring shall be conducted by a qualified paleontological monitor (SVP 2010) working under the direct supervision of the Qualified Paleontologist. Monitoring shall consist of visually inspecting fresh exposures of rock for larger fossil remains and, where appropriate, collecting sediment samples to wet or dry screen to test promising horizons for smaller fossil remains. If the Qualified Paleontologist determines that full-time monitoring is no longer warranted, based on the specific geologic conditions at the surface or at depth, the Qualified Paleontologist may recommend that monitoring be reduced to periodic spot-checking or cease entirely.

MM-PALEO-3: If a potential fossil is found, the paleontological monitor shall be allowed to temporarily divert or redirect grading and excavation activities in the area of the exposed fossil to facilitate evaluation of the discovery. An appropriate buffer area shall be established around the find where construction activities shall not be allowed to continue. Work shall be allowed to continue outside of the buffer area. At the monitor's discretion, and to reduce any construction delay, the grading and excavation contractor shall assist in removing rock/sediment samples for initial processing and evaluation. If a fossil is determined to be significant, the Qualified Paleontologist shall implement a paleontological salvage program to remove the resources from their location, following the guidelines of the SVP (2010). Any fossils encountered and recovered shall be prepared to the point of identification, catalogued, and curated at a public, non-profit institution with a research interest in the material and with retrievable storage, such as the Natural History Museum of Los Angeles County, if such an institution agrees to accept the fossils. If no institution accepts the fossil collection, they shall be donated to a local school in the area for educational purposes. Accompanying notes, maps, and photographs shall also be filed at the repository and/or school.

If construction personnel discover any potential fossils during construction while the paleontological monitor is not present, regardless of the depth of work or location, work at the discovery location shall cease in a 50-foot radius of the discovery until the Qualified Paleontologist has assessed the discovery and recommended and implemented appropriate treatment as described earlier in this measure.

MM-PALEO-4: At the conclusion of paleontological monitoring and prior to the release of the grading bond, the Qualified Paleontologist shall prepare a report summarizing the results of the monitoring and salvage efforts, the methodology used in these efforts, as well as a description of the fossils collected and their significance. The report shall be submitted to the District, the Natural History Museum of Los Angeles County, and representatives of other appropriate or concerned agencies to signify the satisfactory completion of the project and required mitigation measures.

Greenhouse Gas Emissions

<i>Issues (and Supporting Information Sources):</i>	<i>Potentially Significant Impact</i>	<i>Less Than Significant with Mitigation Incorporated</i>	<i>Less Than Significant Impact</i>	<i>No Impact</i>
VIII. GREENHOUSE GAS EMISSIONS —				
Would the project:				
a) Generate greenhouse gas emissions, either directly or indirectly, that may have a significant impact on the environment?	<input type="checkbox"/>	<input type="checkbox"/>	<input checked="" type="checkbox"/>	<input type="checkbox"/>
b) Conflict with an applicable plan, policy or regulation adopted for the purpose of reducing the emissions of greenhouse gases?	<input type="checkbox"/>	<input type="checkbox"/>	<input checked="" type="checkbox"/>	<input type="checkbox"/>

Discussion

- a) **Less-than-Significant Impact.** Gases that trap heat in the atmosphere are called greenhouse gases (GHGs). The major concern with GHGs is that increases in their concentrations are causing global climate change. Global climate change is a change in the average weather on Earth that can be measured by wind patterns, storms, precipitation, and temperature. Although there is disagreement as to the rate of global climate change and the extent of the impacts attributable to human activities, most in the scientific community agree that there is a direct link between increased emissions of GHGs and long-term global temperature increases.

The State of California defines GHGs as carbon dioxide (CO₂), methane (CH₄), nitrous oxide (N₂O), sulfur hexafluoride (SF₆), perfluorocarbons (PFCs), and hydrofluorocarbons (HFCs). Because different GHGs have different global warming potentials (GWPs) and CO₂ is the most common reference gas for climate change, GHG emissions are often quantified and reported as CO₂ equivalents (CO₂e). For example, CH₄ has a GWP of 25 (over a 100-year period); therefore, 1 metric ton (MT) of CH₄ is equivalent to 25 MT of CO₂ equivalents (MTCO₂e). The State uses the GWP ratios available from the United Nations Intergovernmental Panel on Climate Change (IPCC) and published in the *Fourth Assessment Report (AR4)*. By applying the GWP ratios, project-related CO₂e emissions can be tabulated in metric tons (MT) per year. Large emission sources are reported in million metric tons (MMT) of CO₂e.

Some of the potential effects of global warming in California may include loss in snow pack, sea level rise, more extreme heat days per year, more high ozone days, more forest fires, and more drought years (CARB 2008). Globally, climate change has the potential to impact numerous environmental resources through potential, though uncertain, impacts related to future air temperatures and precipitation patterns. The projected effects of global warming on weather and climate are likely to vary regionally, but are expected to include the following direct effects (IPCC 2001):

- Higher maximum temperatures and more hot days over nearly all land areas;
- Higher minimum temperatures, fewer cold days and frost days over nearly all land areas;
- Reduced diurnal temperature range over most land areas;

- Increase of heat index over land areas; and
- More intense precipitation events.

Also, there are many secondary effects that are projected to result from global warming, including global rise in sea level, impacts to agriculture, changes in disease vectors, and changes in habitat and biodiversity. While the possible outcomes and the feedback mechanisms involved are not fully understood and much research remains to be done, the potential for substantial environmental, social, and economic consequences over the long term may be great.

California generated 429.4 MMTCO₂e in 2016, the most recent year data are available. Combustion of fossil fuel in the transportation sector was the single largest source of California's GHG emissions in 2016, accounting for approximately 39 percent of total GHG emissions in the State. This sector was followed by the industrial sector (21 percent) and the electric power sector (including both in-state and out-of-state sources) (16 percent) (CARB 2018).

Impacts of GHGs are borne globally, as opposed to localized air quality effects of criteria air pollutants and toxic air contaminants. The quantity of GHGs that it takes to ultimately result in climate change is not precisely known; however, it is clear that the quantity is enormous, and no single project would measurably contribute to a noticeable incremental change in the global average temperature, or to global, local, or microclimates. From the standpoint of CEQA, GHG impacts to global climate change are inherently cumulative.

The City of Hawthorne has not adopted a threshold of significance for GHG emissions that would be applicable to this proposed Project. Currently, there is no Statewide GHG emissions threshold that has been used to determine the potential GHG emissions impacts of a project. Threshold methodology and thresholds are still being developed and revised by air districts in the State. To provide guidance to local lead agencies on determining significance for GHG emissions in their CEQA documents, SCAQMD convened a GHG CEQA Significance Threshold Stakeholder Working Group (Working Group). Based on the last Working Group meeting (Meeting No. 15) held in September 2010, SCAQMD proposed an analysis methodology using a tiered approach for the evaluation of GHG emissions for development projects where SCAQMD is not the lead agency (SCAQMD, 2010). SCAQMD developed GHG thresholds for both stationary sources as well as for land use development projects under Tier 3 of the GHG guidance. If a project's GHG emissions are below the proposed thresholds, then a project's GHG impacts would be considered less than significant.

The SCAQMD has formally adopted a 10,000 metric ton (MT) CO₂e threshold for industrial (permitted) facilities where SCAQMD is the lead agency. This industrial source threshold is not appropriate for use on commercial or school projects, such as the proposed Project, since the proposed Project is not associated with industrial processes. For land

development projects, such as the proposed Project, the SCAQMD proposed two different approaches to be taken by lead agencies when analyzing GHG emissions:

- Option #1 includes using separate numerical thresholds for residential projects (3,500 MTCO_{2e}/year), commercial projects (1,400 MTCO_{2e}/project), and mixed use projects (3,000 MTCO_{2e}/year).
- Option #2 is use of a single numerical threshold for all non-industrial projects of 3,000 MTCO_{2e}/year. SCAQMD's most recent recommendation per its September 2010 meeting minutes is to use option #2.

Since the proposed Project is non-industrial and is a land development project, the appropriate GHG threshold for the proposed Project would be 3,000 MTCO_{2e} per year. If the Project's GHG emissions are less than 3,000 MTCO_{2e} per year, project-level and cumulative GHG emissions would be less than significant.

CEQA Guidelines 15064.4 (b)(1) states that a lead agency may use a model or methodology to quantify GHGs associated with a project. In September 2016, the SCAQMD in conjunction with CAPCOA released the latest version of the CalEEMod (Version 2020.4.0). The purpose of this model is to estimate construction-source and operational-source emissions from direct and indirect sources. Accordingly, the latest version of CalEEMod has been used for this proposed Project to estimate the Project's emission impacts.

Construction Emissions

Construction activities associated with the proposed Project would result in emissions of CO₂ and to a lesser extent methane (CH₄) and nitrous oxide (N₂O). Construction-period GHG emissions were quantified based on the same construction schedule, activities, and equipment list as described in Issue 3 (b). To amortize the emissions over the life of the proposed Project, the SCAQMD recommends calculating the total GHG emissions attributable to construction activities, dividing it by a 30-year project life, and then adding that number to a project's annual operational-phase GHG emissions. As such, construction emissions were amortized over a 30-year period and included in the Project's annual operational-phase GHG emissions.

Operational Emissions

The proposed Project consists of replacing athletic fields and the redevelopment of the Hawthorne Aquatics Facility like-for-like with minimal increases in the number of events and the number of vehicle trips from nearby spectators in attendance. Therefore, vehicle trips and fuel usage would not increase due to Project implementation. The proposed Project would replace the existing lighting with energy-efficient LED lighting that would reduce the fields' current consumption of electricity. New synthetic turf that would be installed on the softball/multi-use field, outdoor football field, and baseball field would reduce water consumption and associated energy consumption requirements related to supplying and treating water. The Proposed team building/concessions stand would comply with the applicable provisions of Title 24, City of Hawthorne's CAP, and the CALGreen Code in effect at the time of construction. As such, the proposed Project would

minimize energy demand. It is not anticipated that Project implementation would result in substantial increases in operational GHG emissions and therefore, operational emissions have not been quantified.

Emissions Summary

The Project's annual GHG emissions are shown in **Table 10, Project Construction Greenhouse Gas Emissions**. As shown, the Project's total GHG emissions would be below the SCAQMD's proposed screening level of 3,000 MTCO_{2e}, as would the construction of the proposed aquatic facility. The proposed Project would result in a less-than-significant impact with respect to GHG emissions.

**TABLE 10
PROJECT CONSTRUCTION GREENHOUSE GAS EMISSIONS**

Emissions Sources	CO_{2e} (Metric Tons per Year) ^a
Facility Redevelopment	
Demolition (2022)	54.59
Demolition (2023)	53.89
Grading/Site Preparation (2023)	476.21
Foundations Concrete Pour #1 (2023)	5.82
Drainage/Utilities Trenching (2023)	230.66
Building Construction (2023)	408.65
Building Construction (2024)	165.13
Foundations Concrete Pour #2 (2023)	5.82
Paving Event #1 (2023)	7.08
Field Bleachers (2023)	71.21
Field Bleachers (2024)	181.26
Foundations Concrete Pour #3 (2024)	5.78
Architectural Coatings (2024)	24.44
Paving Event #2 (2024)	7.04
Synthetic Track (2024)	107.11
Water Conveyance	1.71
Project Total	1,806.41
Amortized Project Total ^b	60
SCAQMD GHG Significance Threshold	3,000
Exceeds Threshold?	No
Hawthorne Aquatics Facility	
Demolition (2024)	45.04
Site Preparation (2024)	1.60
Grading (2024)	9.25
Building Construction (2024)	35.24
Building Construction (2025)	185.53
Building Construction (2025)	6.52

Emissions Sources	CO₂e (Metric Tons per Year) ^a
Architectural Coating (2025)	1.50
Water Conveyance	0.23
Project Total	284.92
Amortized Project Total	9.50
SCAQMD GHG Significance Threshold	3,000
Exceeds Threshold?	No

^a Totals may not add up exactly due to rounding in the modeling calculations.

^b Construction emissions are amortized over 30 years.

SOURCE: ESA 2021

- b) **Less-than-Significant Impact.** The City of Hawthorne developed a CAP in 2017. The CAP identifies community-wide strategies for the reduction of GHG emissions. The proposed Project would comply with all applicable energy efficiency measures included in the City's CAP. Therefore, the proposed Project would not conflict with any of the strategies set forth in the City's CAP.

The proposed Project would not conflict with plans, policies, and regulations adopted for reducing emissions of GHGs including Assembly Bill 32 Scoping Plan, which includes goals such as energy conservation and energy efficiency. The proposed Project would replace the existing lighting with energy-efficient LED lighting and include new synthetic turf that would be installed on the softball/multi-use field, outdoor football field, and baseball field, which would reduce water consumption and associate GHG emissions related to supplying and treating water. In addition, the Project site is also located in close proximity to bus lines, including Metro Routes 211/215, 40, 126, and 740. These bus routes would provide convenient connection to the regional transit system. The proposed Project would be consistent with the mobility and transit accessibility objectives of the southern California Association of Government's *Regional Transportation Plan and Sustainable Communities Strategies*.

Overall, as the proposed Project would be consistent with the City's CAP and SCAG's mobility and transit accessibility objectives, the proposed Project would not conflict with an applicable plan, policy, or regulation to reduce GHG emissions. As such, impacts would be considered less than significant and no mitigation is required.

Hazards and Hazardous Materials

<i>Issues (and Supporting Information Sources):</i>	<i>Potentially Significant Impact</i>	<i>Less Than Significant with Mitigation Incorporated</i>	<i>Less Than Significant Impact</i>	<i>No Impact</i>
IX. HAZARDS AND HAZARDOUS MATERIALS — Would the project:				
a) Create a significant hazard to the public or the environment through the routine transport, use, or disposal of hazardous materials?	<input type="checkbox"/>	<input type="checkbox"/>	<input checked="" type="checkbox"/>	<input type="checkbox"/>
b) Create a significant hazard to the public or the environment through reasonably foreseeable upset and accident conditions involving the release of hazardous materials into the environment?	<input type="checkbox"/>	<input type="checkbox"/>	<input checked="" type="checkbox"/>	<input type="checkbox"/>
c) Emit hazardous emissions or handle hazardous or acutely hazardous materials, substances, or waste within one-quarter mile of an existing or proposed school?	<input type="checkbox"/>	<input type="checkbox"/>	<input checked="" type="checkbox"/>	<input type="checkbox"/>
d) Be located on a site which is included on a list of hazardous materials sites compiled pursuant to Government Code Section 65962.5 and, as a result, would it create a significant hazard to the public or the environment?	<input type="checkbox"/>	<input type="checkbox"/>	<input type="checkbox"/>	<input checked="" type="checkbox"/>
e) For a project located within an airport land use plan or, where such a plan has not been adopted, within two miles of a public airport or public use airport, would the project result in a safety hazard or excessive noise for people residing or working in the project area?	<input type="checkbox"/>	<input type="checkbox"/>	<input checked="" type="checkbox"/>	<input type="checkbox"/>
f) Impair implementation of or physically interfere with an adopted emergency response plan or emergency evacuation plan?	<input type="checkbox"/>	<input type="checkbox"/>	<input checked="" type="checkbox"/>	<input type="checkbox"/>
g) Expose people or structures, either directly or indirectly, to a significant risk of loss, injury, or death involving wildland fires?	<input type="checkbox"/>	<input type="checkbox"/>	<input type="checkbox"/>	<input checked="" type="checkbox"/>

Discussion

- a) **Less-than-Significant Impact.** Construction of the proposed Project would also involve the temporary use of potentially hazardous materials, including vehicle fuels, paints, oils, transmission fluids, solvents, and other acidic and alkaline solutions that would require special handling, transport, and disposal. The transport, use, and disposal of hazardous materials during construction would be required to comply with applicable federal, State, and local regulations. Additionally, the Los Angeles County Fire Department (LACFD) would have the authority to perform inspections and enforce federal and State laws governing the storage, use, transport, and disposal of hazardous materials and wastes (City of Hawthorne 1989). Although these materials would be transported, used, and disposed of during construction, they are commonly used in construction projects and would not represent the transport, use, or disposal of acutely hazardous materials.

In addition, construction activity disturbing 1 acre or more must obtain coverage under the State’s General Permit for Discharges of Storm Water Associated with Construction Activity (Construction General Permit Order 2009-0009-DWQ). Construction General Permit applicants are required to prepare a SWPPP and implement and maintain BMPs to

avoid adverse construction-related effects on receiving water quality, including releases of hazardous materials, which would potentially wash off from the Project site and into storm drains. Because the proposed action would result in the disturbance of an area greater than 1 acre, the applicant would be required to obtain coverage under the Construction General Permit prior to construction. Short term construction impacts would be less than significant.

The proposed Project would include upgrades to the athletic fields, including a new combined football/soccer field, upgraded track, and upgraded bleachers on the western portion of the athletic fields; a reconfigured baseball field, new basketball courts, and a 5,400-sf team room/concessions building on the central portion of the Campus; and a new softball field and a multi-use (soccer and football) field in the eastern portion of the Campus. The Hawthorne Aquatics Facility would include upgrades to the pool, pool deck, public seating, and locker rooms. The types and amounts of hazardous materials that would be used in connection with the proposed Project would be typical of those used for similar institutional uses and aquatics facilities (such as cleaning solutions, solvents, pesticides for landscaping, painting supplies, and petroleum products). Chemicals to be used during operations could include common materials such as toners, paints, lubricants, cleaners, chlorine and other maintenance materials. Due to the nature of the proposed Project operations, these materials are expected to be used in small quantities and any spills would be localized and cleaned up as they occur. Additionally, once the proposed improvements are completed and operational, the use of these materials is not expected to substantially increase beyond pre-Project levels. As such, potential impacts associated with the routine transport, use, or disposal of hazardous materials during proposed Project operations would be less than significant.

- b) **Less-than-Significant Impact.** As described in the response to question a) above, typical construction-related hazardous materials would be used during construction of the proposed Project, including fuel, solvents, paints, oils, grease, and caulking. It is possible that any of these substances could be released during construction activities. However, compliance with federal, State, and local regulations in combination with BMPs implemented from a SWPPP would ensure that all hazardous materials are used, stored, and disposed of properly, which would minimize potential impacts related to a hazardous materials release during construction activities.

According to the State Water Resource Control Board's GeoTracker site, there are four Leaking Underground Storage Tank sites located within 0.25 mile of the Project site (GeoTracker 2021). They are the following:

- Thrifty Oil #253 (Case number T0603704735). The site is located at 5038 El Segundo Boulevard and is listed with a prior gasoline release to groundwater. The site is currently in Open Remediation status but as of 2019 has been placed on a Path to Closure Plan by the Los Angeles Regional Water Quality Control Board (RWQCB). Remediation activities included groundwater monitoring.

- ARCO #0123 (Case number T0603703899). The site is located at 4773 El Segundo Boulevard West and is listed with a prior gasoline release to soil. The site was granted Case Closed status in prior September of 1996 by the Los Angeles RWQCB.
- Chevron #9-1796 (Case number T0603702742). The site is located at 12801 Inglewood Avenue and is listed with a prior gasoline release to soil. The site was granted Case Closed status in July of 1993 by the Los Angeles RWQCB.
- Chevron #9-1796 (Case number T0603702743). The site is located at 12801 Inglewood Avenue S and is listed with a prior solvent or non-petroleum hydrocarbon release to groundwater, particularly an aquifer used for drinking water supply. The site was granted Case Closed status in April of 2013 by the Los Angeles RWQCB. Remediation activities included groundwater monitoring. Similar to Thrifty Oil above, remediation activities included groundwater monitoring and groundwater pump and treat.

Sites within a 0.25-mile radius are presented above as they are the most likely to present a potential deleterious effect to the Project site. The Thrifty Oil #253 (Case number T0603704735) is listed with a prior gasoline release to groundwater but as of 2019 has been placed on a Path to Closure Plan by the LARWQCB. All other gas stations listed above have been remediated to the satisfaction of the oversight agency. As all gas stations have been remediated to the satisfaction of the oversight agency or are on the path to closure, the risk of adverse impacts due to implementation of the proposed Project is considered low.

The proposed Project would result in the demolition of existing bleachers, hardscape, and landscape features, thus significant amounts of asbestos, lead, and other hazardous building materials are not expected to be encountered during these activities. Thus, impacts associated with reasonably foreseeable upset and accident conditions involving the release of hazardous materials would be less than significant.

- c) **Less-than-Significant Impact.** The proposed Project is within a school site. Other nearby schools include Hawthorne Math and Science Academy located approximately 0.40 mile to the east, Eucalyptus Elementary School located approximately 0.23 mile to the northeast, and Juan De Anza Elementary School located approximately 0.32 mile to the northwest.

Routine transport, use, and disposal of hazardous materials such as fuel, solvents, paints, oils, grease, and caulking would occur during construction of the proposed Project. Such transport, use, and disposal would be compliant with applicable regulations previously mentioned. In addition, the proposed Project would implement site-specific BMPs as part of a SWPPP to minimize the potential of a release of these materials into the environment. Although small amounts of hazardous materials would be transported, used, and disposed during construction, these materials are typically used in construction projects and would not represent the transport, use, and disposal of acutely hazardous materials.

Demolition activities to be conducted as part of the proposed Project would only involve existing bleachers, hardscape, and landscape features, thus, no significant amounts of hazardous building materials would be handled and are not expected to pose a risk to the proposed Project or any nearby site, including schools within 0.25 mile.

- Due to the nature of the proposed Project, hazardous materials used in operations would include common hazardous materials such as paints, lubricants, cleaners, etc. These materials are expected to be used in small quantities and any spills would be localized and cleaned up as they occur. As such, impacts related to hazardous materials within a quarter mile of an existing or proposed school would be less than significant.
- d) **No Impact.** The Project site is not listed in any of the CalEPA Cortese List Data Resources (CalEPA 2021). The Cortese List Data Resources include Hazardous Waste and Substances sites from DTSC’s EnviroStor database, Leaking Underground Storage Tank (LUST) Sites from the State Water Board’s GeoTracker database, solid waste disposal sites identified (by the State Water Board) with waste constituents above hazardous waste levels, “active” Cease and Desist Order (CDO) and Cleanup and Abatement Order (CAO) sites, and hazardous waste facilities subject to corrective action as identified by the DTSC. As the Project site was not identified in any Cortese List Data Resources, no impacts associated with the Project site being included on a list of hazardous materials sites compiled pursuant to Government Code Section 65962.5 would occur.
- e) **Less-than-Significant Impact.** The Project site is located approximately 1.4 miles to the west of the Hawthorne Municipal Airport. According to the Los Angeles County Airport Land Use Commission’s Airport Influence Area, the Project site is not within any of the airport’s safety or influence areas and is not subject to Federal Aviation Administration restrictions (ALUC 2018). Thus, implementation of the proposed Project would not result in a safety hazard for people residing or working in the Project area nor would it expose people to excessive noise levels (see Section XIII, *Noise* of this document). Potential impacts would be less than significant.
- f) **Less-than-Significant Impact.** The City does not have any defined emergency routes; however, the Los Angeles County Department of Public Works identifies the I-405 as a primary disaster route and Hawthorne Boulevard as a secondary disaster route (Los Angeles County Department of Public Works 2012). Implementation of the proposed Project would not impair implementation of or physically interfere with an adopted emergency response plan or emergency evacuation plan. The proposed Project would not allow any construction vehicles or equipment to park or remain stationary for extensive periods of time within any of the main roadways (i.e., West El Segundo Boulevard, South Inglewood Avenue) leading into the Project site. In addition, large construction vehicles entering and exiting the Project site would be guided by the use of personnel using signs and flags to direct traffic. Moreover, the proposed Project does not include any characteristics (e.g., permanent road closures, long-term blocking of road access) that would physically impair or otherwise interfere with emergency response or evacuation in the Project vicinity.

Project features such as not allowing construction vehicles and equipment to park or stop for extended amounts of time along main arterial roadways, the use of flag personnel to ensure the continued flow of traffic, and compliance with programs, rules, and regulations for emergency response would ensure that the proposed Project would not impair or

interfere with implementation of an adopted emergency response plan or emergency evacuation plan. Impacts would be less than significant.

- g) **No Impact.** Implementation of the proposed Project would not expose people or structures to a significant risk of loss, injury, or death involving wildland fires, including where wildlands are adjacent to urbanized areas or where residences are intermixed with wildlands. According to the California Department of Forestry and Fire Protection (CAL FIRE), Fire Hazard Severity Zone Viewer, the Project site does not exist within a CAL FIRE Very High Fire Hazard Severity Zones (CAL FIRE 2021). The Project site is located in a heavily urbanized area within the County of Los Angeles. No impact would occur.
-

Hydrology and Water Quality

<i>Issues (and Supporting Information Sources):</i>	<i>Potentially Significant Impact</i>	<i>Less Than Significant with Mitigation Incorporated</i>	<i>Less Than Significant Impact</i>	<i>No Impact</i>
X. HYDROLOGY AND WATER QUALITY —				
Would the project:				
a) Violate any water quality standards or waste discharge requirements or otherwise substantially degrade surface or ground water quality?	<input type="checkbox"/>	<input type="checkbox"/>	<input checked="" type="checkbox"/>	<input type="checkbox"/>
b) Substantially decrease groundwater supplies or interfere substantially with groundwater recharge such that the project may impede sustainable groundwater management of the basin?	<input type="checkbox"/>	<input type="checkbox"/>	<input checked="" type="checkbox"/>	<input type="checkbox"/>
c) Substantially alter the existing drainage pattern of the site or area, including through the alteration of the course of a stream or river or through the addition of impervious surfaces, in a manner which would:				
i) result in substantial erosion or siltation on- or off-site;	<input type="checkbox"/>	<input type="checkbox"/>	<input checked="" type="checkbox"/>	<input type="checkbox"/>
ii) substantially increase the rate or amount of surface runoff in a manner which would result in flooding on- or offsite;	<input type="checkbox"/>	<input type="checkbox"/>	<input checked="" type="checkbox"/>	<input type="checkbox"/>
iii) create or contribute runoff water which would exceed the capacity of existing or planned stormwater drainage systems or provide substantial additional sources of polluted runoff; or	<input type="checkbox"/>	<input type="checkbox"/>	<input checked="" type="checkbox"/>	<input type="checkbox"/>
iv) impede or redirect flood flows?	<input type="checkbox"/>	<input type="checkbox"/>	<input checked="" type="checkbox"/>	<input type="checkbox"/>
d) In flood hazard, tsunami, or seiche zones, risk release of pollutants due to project inundation?	<input type="checkbox"/>	<input type="checkbox"/>	<input checked="" type="checkbox"/>	<input type="checkbox"/>
e) Conflict with or obstruct implementation of a water quality control plan or sustainable groundwater management plan?	<input type="checkbox"/>	<input type="checkbox"/>	<input checked="" type="checkbox"/>	<input type="checkbox"/>

Discussion

- a) **Less-than-Significant Impact.** A significant impact would occur if the proposed Project discharged water that does not meet the quality standards of agencies that regulate surface water quality and water discharge into stormwater drainage systems such as the Los Angeles RWQCB. These regulations include compliance with the Standard Urban Storm Water Mitigation Plan (SUSMP) requirements to reduce potential water quality impacts. Project construction activities include demolition, site preparation, grading/excavation, drainage/utilities/subgrade, foundations/concrete pour, and paving/landscaping which could lead to ground disturbance and polluted runoff.

Since the proposed Project is anticipated to disturb greater than 1 acre of land (including laydown and stockpile areas), Project construction activities would be carried out in accordance with applicable City standard erosion control practices required pursuant to the current CBC and the requirements of the NPDES Construction General Permit issued by the Los Angeles RWQCB, as applicable. Consistent with these requirements, a SWPPP would be prepared that incorporates BMPs to control water erosion during the Project's

construction period. Pursuant to the Construction General Permit, prior to terminating permit coverage, the Project site must be stabilized and not pose any additional sediment discharge risk than it did prior to the commencement of construction activity.

As described in Chapter 2, *Project Description*, of this Draft IS/MND, construction of the proposed Project would require the demolition of the existing, bleachers, hardscape, and landscape and replaced with similar surfaces. The proposed Project would replace existing impervious and pervious surfaces with synthetic turf. Therefore, impervious surface is anticipated to decrease as compared to existing conditions. On-site use, storage of fuels, lubricants, and other hydrocarbon fluids during construction, would all carry the potential risk of affecting water quality through accidental release. Storm events during construction also have the potential to carry disturbed sediments and spilled substances from construction activities off-site to nearby receiving waters. The proposed Project would be required to comply with NPDES Construction General Permit requirements issued by the Los Angeles RWQCB, which would identify structural and nonstructural BMPs to be implemented during the construction phase. With implementation of the Construction General Permit and BMPs, the proposed Project would not violate any water quality standards or waste discharge requirements.

Operation of the proposed Project would have similar intensity as the current and existing activities on the Project site. As such the proposed Project would result in similar, typical urban pollutants generated by motor vehicle use on roadways and parking areas adjacent to the Project site, the maintenance and operation of landscaped areas. Stormwater quality is generally impacted by the length of time since the last rainfall, rainfall intensity, urban uses of the area and quantity of transported sediment. Typical urban water quality pollutants are typically associated with motor vehicle operations, oil and grease residues, fertilizer/pesticide uses, human/animal littering, careless material storage, and poor handling and property management. The majority of pollutant loads are usually washed away during the first flush of the storm occurring after the dry-season period. The proposed Project would incorporate design features per the recommendations provided in the *Geotechnical Evaluation Report*. The report prepared for the proposed Project included recommendations applicable to the proposed Project to allow water to drain away from structures and foundations. The proposed Project would include areas for biofiltration on the west, northwest and southwest of the football field, northwest of the softball field, southwest and northeast of the combined football/soccer field. Additionally, an expanded storm drain system would be installed and would connect to the existing storm drain system in order to accommodate the additional runoff.

Given these considerations, construction and operation of the proposed Project would not cause a violation of State water quality standards or otherwise substantially degrade water quality, and impacts would be less than significant.

- b) **Less-than-Significant Impact.** A significant impact may occur if the proposed Project results in substantial depletion of groundwater supplies during construction or operation of the proposed Project. According to the Conservation Element of the City General Plan,

freshwater-bearing sediments extend from a depth of about 300 feet to a depth of approximately 1,500 feet below the surface of the City.

The *Geotechnical Evaluation Report* prepared for the proposed Project identified a historic groundwater depth at the Project site of approximately 30 feet below ground surface (bgs) (Appendix E1). Depth to groundwater can be expected to fluctuate both seasonally and from year to year. Fluctuations in the groundwater level may occur due to variations in precipitation, irrigation practices at the site and in the surrounding areas, climatic conditions, and pumping from wells. Construction activities would not require excavation beyond 5 feet for the proposed 5,400-sf building and 18 feet for all proposed field areas. The proposed Project would result in the consumption of water as a result of construction and operational activities and the sources of that water could include local groundwater supplies provided by the local water purveyor, the West Coast Basin Municipal Water District. However, given the temporary nature of construction activities, while some dewatering could be necessary during construction activities, such dewatering activities would not be of an extent that would substantially alter groundwater supplies due to the depth of excavation needed and the lower groundwater levels, and the treatment and disposal of the dewatered water would occur in accordance with the requirements of LARWQCB's Waste Discharge Requirements for Discharges of Groundwater from Construction and Project Dewatering to Surface Waters in Coastal Watersheds of Los Angeles and Ventura Counties. In addition, given the relatively small size of the proposed Project and the fact that it includes sustainable design principals, including synthetic turf, drought-resistant landscaping, biofiltration areas, consumption of significant amounts of groundwater that would lower groundwater levels or deplete local supplies is not anticipated. Although the proposed Project would increase water consumption on the site due to the home and visitor concession buildings that include restroom facilities, the minor incremental impact on City water supplies would not require new or expanded entitlements. Therefore, the proposed Project would not substantially deplete groundwater supplies or interfere substantially with groundwater recharge such that the proposed Project may impede sustainable groundwater management of the basin. Impacts would be less than significant.

- c.i) **Less-than-Significant Impact.** A significant impact would occur if the proposed Project resulted in a substantial alteration of drainage patterns and an increase in erosion or siltation during construction or operation of the proposed Project.

No natural drainage or riparian areas remain within the Project site or the surrounding area. In addition, no streams or rivers are located within the immediate vicinity of the proposed Project. The Project site is located in an urban area and is currently developed with pervious and impervious surfaces including basketball and handball courts, swimming pools, and surface parking, and pervious areas including athletic fields and landscaped areas. Surface runoff from the Project site is currently directed to the existing stormwater infrastructure (e.g., gutters, storm drains). While the proposed Project would not increase the amount of impervious surfaces and landscaping, as compared to prior uses, as discussed above, during construction the proposed Project would still be required to comply with

BMP's identified in the RWQCB issued SWPPP, which would reduce the potential for erosion or siltation to occur. During Project operation, the Project site would be fully developed and would not contain exposed soils. Therefore, compliance with BMPs would ensure that the proposed Project would not substantially alter the drainage pattern of the Project site in a manner that would result in the substantial erosion or siltation on- or off-site and impacts would be less than significant.

- c.ii) **Less-than-Significant Impact.** A significant impact may occur if the proposed Project were to impede or redirect flood flows contributing to flooding on- or off-site.

There are no lakes, rivers, or streams within the immediate vicinity of the Project site. The Project site is located in an urban area and is currently developed with athletic fields and an aquatic facility, including both impervious and pervious areas. Surface runoff is currently directed to the existing stormwater infrastructure (e.g., gutters, storm drains) and would continue to be conveyed to City stormwater infrastructure. Storm water surface runoff is not anticipated to increase as a result of the proposed Project as it would increase pervious surfaces through implementation of synthetic turf and would include a biofiltration basin to reduce to decrease the rate or amount of surface runoff (LPA 2021). In addition, the existing underground storm drain system would remain and continue to operate for the duration of Project construction and operation. Furthermore, according to Los Angeles County Low Impact Development (LID) Standards, "Stormwater quality control measures are required to augment site design principles and source control measures to reduce the volume of stormwater runoff and potential pollution loads in stormwater runoff to the maximum extent practicable." The Los Angeles County LID also states that "In general, all proposed projects must maximize on-site retention of the stormwater quality design volume through infiltration and/or bioretention." The proposed Project would include a biofiltration basin consistent with County LID standards. As such, the proposed Project would not substantially increase the rate of runoff and drainage patterns on the Project site would be maintained. Therefore, a less-than-significant impact resulting from flooding would occur.

- c.iii) **Less-than-Significant Impact.** A significant impact would occur if the volume of runoff increased to the point where it exceeds the capacity of the storm drain system serving the Project site or substantially increases the probability that polluted runoff would reach the storm drain system.

The Project site is located in an urban area and is currently developed with athletic fields and an aquatic facility, including both impervious and pervious areas. Surface runoff is currently directed to the existing stormwater infrastructure, which adequately serves the Project site. As discussed above, the District/Construction Contractor would be required to comply with the standard BMPs in the SWPPP, as identified by the RWQCB. Additionally, the proposed Project would be required to comply with the Los Angeles County LID Standards, including stormwater quality control measures. Furthermore, the existing drainage pattern would remain largely the same under the proposed Project, and thus, the proposed Project would be adequately served by the existing stormwater infrastructure at

the site during Project operations. Therefore, the proposed Project would not exceed the capacity of existing or planned storm drain systems and impacts would be less than significant.

- c.iv) **Less-than-Significant Impact.** During construction of the proposed Project, stormwater BMPs would be implemented, as required by federal, State, county, and local policies to minimize degradation of water quality associated with stormwater runoff or construction-related pollutants. In addition, construction activities and operation would comply with local stormwater ordinances, stormwater requirements established by the Los Angeles County MS4 Permit and regional waste discharge requirements. As required by law, the proposed Project would involve the construction of diversion structures, pre-treatment systems, and infiltration wells to improve water quality. In addition, features including native and drought-tolerant landscaping, planter pockets, and LID features such as porous concrete walkways, permeable pavers, and rock cobble bioswale would provide water quality benefits through stormwater treatment to reduce the risk of release of pollutants due to Project inundation. The Project site is not within 100-year flood hazard area as indicated by the Federal Emergency Management Agency (FEMA 2021). Because the Project site is not subject to flooding due to flood hazard, tsunami, or seiche inundation, no adverse effects from these types of events would occur. Therefore, the impact of risk of release of pollutants as a result of Project inundation is less than significant.
- d) **Less-than-Significant Impact.** The Project site is outside of the 100-year floodplain, within FEMA Zone X (unshaded), areas of minimal flood hazard (FEMA 2008). According to California Department of Conservation tsunami mapping, the Project site is not subject to inundation by a tsunami (DOC 2021). No large waterbodies exist in close proximity to the Project site; therefore, the proposed Project would not be prone to inundation by a seiche. Because the proposed Project site is not subject to flooding due to flood hazard, tsunami, or seiche inundation, no adverse effects from these types of events would occur. Therefore, the impact of risk of release of pollutants as a result of Project inundation is less than significant.
- e) **Less-than-Significant Impact.** During construction of the proposed Project, stormwater control BMPs would be implemented, as required by the NPDES Construction General Permit, to reduce the discharge of pollutants and the potential for adverse impacts to water quality. These stormwater BMPs would be implemented to control construction site runoff and to reduce the discharge of pollutants to storm drain systems from stormwater and other nonpoint-source runoff. As part of compliance with permit requirements during ground disturbing or construction activities, implementation of water quality control measures and BMPs would ensure that water quality standards would be achieved, including the water quality objectives that protect designated beneficial uses of surface water and groundwater. Construction runoff would also have to comply with the appropriate water quality objectives for the region. The NPDES Construction General Permit also requires stormwater discharges not to contain pollutants that cause or contribute to an exceedance of any applicable water quality objectives or water quality standards, including designated surface and groundwater beneficial uses. Operation of the proposed Project would not

increase demands for groundwater. The proposed Project includes athletic field improvements such as synthetic turf and surface landscaping would utilize native and drought-tolerant landscaping. Additionally, the implementation of the biofiltration basin treatment system, polluted runoff would be minimized under the Project site and would provide an improvement in the surface water quality runoff compared to existing conditions. Therefore, the proposed Project would not conflict with or obstruct implementation of a water quality control plan or sustainable groundwater management plan. Impacts would be less than significant.

Land Use and Planning

<i>Issues (and Supporting Information Sources):</i>	<i>Potentially Significant Impact</i>	<i>Less Than Significant with Mitigation Incorporated</i>	<i>Less Than Significant Impact</i>	<i>No Impact</i>
XI. LAND USE AND PLANNING — Would the project:				
a) Physically divide an established community?	<input type="checkbox"/>	<input type="checkbox"/>	<input type="checkbox"/>	<input checked="" type="checkbox"/>
b) Cause a significant environmental impact due to a conflict with any land use plan, policy, or regulation adopted for the purpose of avoiding or mitigating an environmental effect?	<input type="checkbox"/>	<input type="checkbox"/>	<input type="checkbox"/>	<input checked="" type="checkbox"/>

Discussion

- a) **No Impact.** A significant impact would occur if the proposed Project would be sufficiently large or configured in such a way so as to create a physical barrier within an established community. A physical division of an established community is caused by an impediment to through travel or a physical barrier, such as a new freeway with limited access between neighborhoods on either side of the freeway, or major street closures.

The Project site is located in an urbanized area of the City of Hawthorne within a fully developed high school campus and aquatics facility. The proposed Project would not involve any street vacation or closure or result in development of new thoroughfares or highways. The proposed Project would replace existing athletic and aquatic facilities with like-for-like uses within the Project site and would be developed in the same footprint that it currently exists in. Therefore, the proposed Project would not physically divide an established community and no impact would occur.

- b) **No Impact.** A significant impact could occur if the proposed Project would result in environmental impacts that conflict with local plans, City of Hawthorne zoning designations, or other environmental regulations applicable to the Project site that are intended to avoid or mitigate an environmental effect.

The local land use plan that is most relevant and applicable to the Project site is the City of Hawthorne General Plan, which was adopted in December 1989 with revisions made in 2014, 2015, and 2018 (the reader is also referred to other impact sections in this Draft IS/MND for a discussion of other plans that are applicable to the Project site, such as the South Coast Air Quality Management District Air Quality Management Plan). The General Plan includes the following elements, each of which contain specific goals and policies: Land Use, Circulation, Conservation (Climate, Air Quality, Groundwater, Gage Aquifer, Silverado Aquifer, Sunnyside Aquifer, Landform, Soils, Hydrology, Groundwater Volume, City Water Needs, southern California Water Company, Future Water Demands, Water Pollution Control, Drainage and Flooding, Plant Life, Wildlife, Electrical Energy, Natural Gas, and Transportation), Economic Development, Housing, Noise, Open Space, and Safety (Seismic, Newport-Inglewood Structural Zone, Charnock. Fault, San Andreas Fault, Liquefaction, Ground Failure, Fire Hazards, Response Time and Water Availability, Fire Hazard Reduction, Hazardous Materials, Disclosure and Regulatory Procedures, Transportation of Hazardous Materials, Sites and Facilities, Critical Facilities,

Preparedness Plans, Alternative Power Sources, Alternative Water Sources, Evaluation Plans). As discussed in other impact sections of this Draft IS/MND, the proposed Project would not result in significant impacts in any of the environmental categories addressed by the elements of the General Plan. Consequently, it would not conflict with any of the goals and policies of the General Plan adopted for the purpose of avoiding or mitigating an environmental effect.

Additionally, the Project site is zoned as Urban Open Space (UOS) in the City of Hawthorne Zoning Map (City of Hawthorne 2019). Pursuant to Hawthorne Municipal Code Section 17.24.020, the Urban Open Space Zone permits recreational uses, including but not limited to: public parks, playfields, swimming pools, Schools, elementary, junior high and high schools (public or nonprofit private). The proposed Project does not propose uses that would conflict with the City of Hawthorne Municipal Code.

Therefore, no significant land use plan or policy conflict impacts would occur as a result of construction and operation of the proposed Project.

Mineral Resources

<i>Issues (and Supporting Information Sources):</i>	<i>Potentially Significant Impact</i>	<i>Less Than Significant with Mitigation Incorporated</i>	<i>Less Than Significant Impact</i>	<i>No Impact</i>
XII. MINERAL RESOURCES — Would the project:				
a) Result in the loss of availability of a known mineral resource that would be of value to the region and the residents of the state?	<input type="checkbox"/>	<input type="checkbox"/>	<input type="checkbox"/>	<input checked="" type="checkbox"/>
b) Result in the loss of availability of a locally-important mineral resource recovery site delineated on a local general plan, specific plan, or other land use plan?	<input type="checkbox"/>	<input type="checkbox"/>	<input type="checkbox"/>	<input checked="" type="checkbox"/>

Discussion

- a) **No Impact.** A significant impact could occur if the Project site were located in an area used or available for extraction of a regionally important mineral resource, or if proposed Project development would convert an existing or future regionally important mineral extraction use to another use, or if proposed Project development would affect access to a site used or potentially available for regionally important mineral resource extraction.

According to the Conservation Element of the City of Hawthorne General Plan, the City has been a highly urbanized community since 1922 and as a consequence native plants and animals, minerals and natural water courses, are practically non-existent as soils have been highly disturbed as a result of development (City of Hawthorne 1989).

The Project site is not located in an area designated a Mineral Resource Zone (MRZ-2) by the Los Angeles Department of Regional Planning (Los Angeles County 2021), which means that the Project site does not contain potentially significant sand and gravel deposits identified for preservation.

The Project site is not used for mineral extraction. No mineral extraction activities would be disrupted or removed under the proposed Project. The proposed Project would replace existing athletic facilities, i.e., replace the existing softball field, outdoor basketball courts, football field and track, baseball field, and tennis courts with like-for-like uses including a new combined football/soccer field and striping, upgraded track, upgraded bleachers, reconfigured ball field with synthetic turf, and new football/soccer field with synthetic turf in the eastern portion of the athletic area. All of the proposed new and improved facilities would be located within the existing boundaries of the high school campus.

As such, construction and operation of the proposed Project would not result in the loss of availability of a known mineral resource that would be of value to the region and the residents of the State and no impacts would result.

- b) **No Impact.** The Project site is not located within a Mineral Resource Zone 2 (MRZ-2) Area (County of Los Angeles, 2021). The Project site is not designated as a locally important mineral resource recovery site delineated on a local general plan, specific plan, or other land use plan (City of Hawthorne 1989). Thus, there would be no impacts from

construction or operation of the proposed Project to the loss of availability of a locally important mineral resource recovery site delineated on a local general plan, specific plan, or other land use plan and no impacts would result.

Noise

<i>Issues (and Supporting Information Sources):</i>	<i>Potentially Significant Impact</i>	<i>Less Than Significant with Mitigation Incorporated</i>	<i>Less Than Significant Impact</i>	<i>No Impact</i>
XIII. NOISE — Would the project result in:				
a) Generation of a substantial temporary or permanent increase in ambient noise levels in the vicinity of the project in excess of standards established in the local general plan or noise ordinance, or applicable standards of other agencies?	<input type="checkbox"/>	<input checked="" type="checkbox"/>	<input type="checkbox"/>	<input type="checkbox"/>
b) Generation of excessive groundborne vibration or groundborne noise levels?	<input type="checkbox"/>	<input type="checkbox"/>	<input checked="" type="checkbox"/>	<input type="checkbox"/>
c) For a project located within the vicinity of a private airstrip or an airport land use plan or, where such a plan has not been adopted, within two miles of a public airport or public use airport, would the project expose people residing or working in the project area to excessive noise levels?	<input type="checkbox"/>	<input type="checkbox"/>	<input type="checkbox"/>	<input checked="" type="checkbox"/>

Discussion

Noise is defined as unwanted sound; however, not all unwanted sound rises to the level of a potentially significant noise impact. The following analysis evaluates the potential noise impacts at nearby noise-sensitive land uses resulting from construction and operation of the proposed Project. Details of the noise analysis are located in Appendix F of this Draft IS/MND.

Noise Principles and Descriptors

Sound can be described as the mechanical energy of a vibrating object transmitted by pressure waves through a liquid or gaseous medium (e.g., air). Noise is generally defined as unwanted sound (i.e., loud, unexpected, or annoying sound). Acoustics is defined as the physics of sound and addresses its propagation and control (Caltrans 2013). In acoustics, the fundamental scientific model consists of a sound (or noise) source, a receiver, and the propagation path between the two. The loudness of the noise source and obstructions or atmospheric factors affecting the propagation path to the receiver determines the sound level and characteristics of the noise perceived by the receiver. Acoustics addresses primarily the propagation and control of sound.

Sound, traveling in the form of waves from a source, exerts a sound pressure level (referred to as sound level) that is measured in decibels (dB), which is the standard unit of sound amplitude measurement. The dB scale is a logarithmic scale (i.e., not linear) that describes the physical intensity of the pressure vibrations that make up any sound, with 0 dB corresponding roughly to the threshold of human hearing and 120 to 140 dB corresponding to the threshold of feeling and pain, respectively. Pressure waves traveling through air exert a force registered by the human ear as sound (Caltrans 2013).

The typical human ear is not equally sensitive to all frequencies of the audible sound spectrum. As a consequence, when assessing potential noise impacts, sound is measured using an electronic filter that deemphasizes the frequencies below 1,000 hertz (Hz) and above 5,000 Hz in a manner corresponding to the human ear's decreased sensitivity to extremely low and extremely high frequencies. This method of frequency weighting is referred to as A-weighting and is expressed in

units of A-weighted decibels (dBA). A-weighting follows an international standard methodology of frequency de-emphasis and is typically applied to community noise measurements (Caltrans 2013).

An individual's noise exposure is a measure of noise over a period of time, whereas a noise level is a measure of noise at a given instant in time. Community noise varies continuously over a period of time with respect to the contributing sound sources of the community noise environment. Community noise is primarily the product of many distant noise sources, which constitute a relatively stable background noise exposure, with the individual contributors unidentifiable. The background noise level changes throughout a typical day, but does so gradually, corresponding with the addition and subtraction of distant noise sources such as traffic. What makes community noise variable throughout a day, besides the slowly changing background noise, is the addition of short-duration, single-event noise sources (e.g., aircraft flyovers, motor vehicles, sirens), which are readily identifiable to the individual (Caltrans 2013). These successive additions of sound to the community noise environment change the community noise level from instant to instant, requiring the measurement of noise exposure over a period of time to legitimately characterize a community noise environment and evaluate cumulative noise impacts. The time-varying characteristic of environmental noise over specified periods of time is described using statistical noise descriptors in terms of a single numerical value, expressed as dBA (Caltrans 2013). The most frequently used noise descriptors are summarized below:

- L_{eq} : The L_{eq} , or equivalent sound level, is used to describe the noise level over a specified period of time, typically 1-hour, i.e., $L_{eq(1)}$, expressed as L_{eq} . The L_{eq} may also be referred to as the "average" sound level.
- L_{max} : The maximum, instantaneous noise level.
- L_{min} : The minimum, instantaneous noise level.
- L_x : The noise level exceeded for specified percentage (x) over a specified time period; i.e., L_{50} and L_{90} represent the noise levels that are exceeded 50 90 percent of the time specified, respectively.
- L_{dn} : The L_{dn} is the average noise level over a 24-hour day, including an addition of 10 dBA to the measured hourly noise levels between the hours of 10:00 p.m. to 7:00 a.m. to account nighttime noise sensitivity. L_{dn} is also termed the day-night average noise level or DNL,
- CNEL: Community Noise Equivalent Level (CNEL), is the average noise level over a 24-hour day that includes an addition of 5 dBA to the measured hourly noise levels between the evening hours of 7:00 p.m. to 10:00 p.m. and an addition of 10 dBA to the measured hourly noise levels between the nighttime hours of 10:00 p.m. to 7:00 a.m. to account for noise sensitivity during the evening and nighttime hours, respectively.

City of Hawthorne Municipal Code

The City of Hawthorne Municipal Code regulations with respect to noise are included in Municipal Code Chapter 9.34, Noise Ordinance. Pursuant to Section 9.34.060 subsection B, construction activity is prohibited between the hours of 6:00 p.m. and 7:00 a.m. Monday through Friday and between 5:00 p.m. and 8:00 a.m. on Saturdays. Construction activity including demolition,

excavation, grading, spray painting, construction, maintenance, and/or repair of buildings occurring outside of prohibited hours is allowed.

City of Hawthorne General Plan Noise Element (2018)

The City has established noise guidelines in the Noise Element of the City's General Plan that are used for planning purposes. These guidelines are based, in part, on the community noise compatibility guidelines established by the California State Governor's Office of Planning and Research and are intended for use in assessing the compatibility of various land use types with a range of noise levels. **Table 11, Land Use Compatibility Matrix**, provides the guidelines for land use compatibility for community noise sources. The CNEL noise levels for specific land uses are classified into four categories: (A) "clearly compatible" (B) "normally compatible" (C) "normally incompatible" and (D) "clearly incompatible." A CNEL value of 70 dBA is considered the dividing line between a "normally compatible" and "normally incompatible" noise environment for single-family and multiple-family residential uses.

Existing Conditions

The Project site is bounded by residential uses to the west and north, the Hawthorne High School campus to the south, and commercial uses to the east. The Project site is in a suburban area characterized by residential uses, commercial uses, institutional, and school facilities. **Figure 8, Noise Measurement Locations**, shows the noise sensitive receptor locations in the vicinity of the Project site.

To quantify the existing noise environment of the Project site, short-term (15-minute) noise measurements were conducted at locations R1 through R3. Ambient sound measurements were conducted on June 8, 2021, to characterize the existing noise environment in the Project site vicinity, as shown on Figure 8.

The ambient noise measurements were conducted using a Larson-Davis Model LxT Sound Level Meter (SLM). The Larson-Davis LxT SLM is a Type 1 standard instrument, as defined in the American National Standard Institute (ANSI) S1.4. The SLMs were calibrated and operated according to manufacturer specifications. The SLM microphone was placed at a height of 5 feet above ground level.

**TABLE 11
LAND USE COMPATIBILITY MATRIX**

LAND USE CATEGORIES		COMMUNITY NOISE EQUIVALENT LEVEL (CNEL)					
		≤55	60	65	70	75	80>
CATEGORIES	USES						
RESIDENTIAL	Single Family, Duplex, Multiple Family	A	A	B	B	C	D
RESIDENTIAL	Mobile Home	A	A	B	C	C	D
COMMERCIAL (Regional, District)	Hotel, Motel, Transient Lodging	A	A	B	B	C	C
COMMERCIAL (Regional, Village, District, Special)	Commercial Retail, Bank, Restaurant, Movie Theater	A	A	A	A	B	B
COMMERCIAL INDUSTRIAL INSTITUTIONAL	Office Building, Research and Development, Professional Offices, City Office Building	A	A	A	B	B	C
COMMERCIAL (Recreation) INSTITUTIONAL (Civic Center)	Amphitheater, Concert Hall Auditorium, Meeting Hall	B	B	C	C	D	D
COMMERCIAL (Recreation)	Children's Amusement Park, Miniature Golf Course, Go-Cart Track, Equestrian Center, Sports Club	A	A	A	B	B	D
COMMERCIAL (General, Special) INDUSTRIAL, INSTITUTIONAL	Automobile Service Station, Auto Dealership, Manufacturing, Warehousing, Wholesale, Utilities	A	A	A	A	B	B
INSTITUTIONAL (General)	Hospital, Church, Library, School Classroom	A	A	B	C	C	D
OPEN SPACE	Parks	A	A	A	B	C	D
OPEN SPACE	Golf Course, Cemetery, Nature Center, Wildlife Reserve, Wildlife Habitat	A	A	A	A	B	C
AGRICULTURE	Agriculture	A	A	A	A	A	A

INTERPRETATION**ZONE A**

CLEARLY COMPATIBLE

Specified land use is satisfactory, based upon the assumption that any buildings involved are of normal conventional construction without any special noise insulation requirements.

ZONE B

NORMALLY COMPATIBLE

New construction or development should be undertaken only after detailed analysis of noise reduction requirements are made and needed noise insulation features in the design are determined. Conventional construction, with closed windows and fresh air supply systems or air conditioning, will normally suffice.

ZONE C

NORMALLY INCOMPATIBLE

New construction or development should generally be discouraged. If new construction or development does not proceed, a details analysis of noise reduction requirements must be made and needed noise insulation features included in the design.

ZONE D

CLEARLY INCOMPATIBLE

New construction or development should generally not be undertaken.



SOURCE: ESRI, ESA 2021

Hawthorne High School Athletic Fields Improvements Project

Figure 8
 Noise Measurement Locations

These monitoring locations provide a representative characterization of the existing noise conditions within the vicinity of the Project site. The results of the ambient noise measurement data are summarized in **Table 12, Summary of Ambient Noise Measurements**. As shown in Table 10, the measured L_{eq} ranged from 54.3 to 68.3 dBA.

**TABLE 12
SUMMARY OF AMBIENT NOISE MEASUREMENTS**

Site ID	Monitoring Date(s)	Start Time	End Time	L_{eq}
R1 Felton and Stacy Street	6/8/2021	8:23	8:38	60.0
R2 124 th and Sundale	6/8/2021	8:41	8:56	54.3
R3 Inglewood Avenue	6/8/2021	9:00	9:15	68.3

SOURCE: ESA, 2021.

It should be noted that ambient measurements were taken during the COVID-19 pandemic. Due to ongoing restrictions on non-essential uses, traffic volumes under pandemic conditions are lower when compared to pre-pandemic conditions and activity at the existing high school was limited.

- a) **Less-than-Significant Impact with Mitigation Incorporated.** A significant impact would occur if the proposed Project exposed persons to or generated noise levels in an exceedance of standards established in the City of Hawthorne’s General Plan or would result in an exceedance in any established standard in the noise ordinance.

Construction Noise

Construction of the proposed Project is anticipated to occur over a duration of 18 months. Project construction activities would be subject to the City’s Municipal Code Section 9.34.060, which limits noise-generating construction activity to between the hours of 7:00 a.m. and 6:00 p.m., Monday through Friday, and between 8:00 a.m. and 5:00 p.m. on Saturdays. Construction of the proposed Project would require the use of heavy equipment at the Project site. During each stage of Project construction, there would be a different number of mix of equipment operating. As such, construction activity noise levels at and near the Project site would fluctuate depending on the particular type, number, and duration of use of the various pieces of construction equipment. Individual pieces of construction equipment anticipated to be used during Project construction could produce maximum noise levels (L_{max}) of 73 dBA to 85 dBA at a reference distance of 50 feet from the noise source, as shown in **Table 13, Construction Equipment and Estimated Noise Levels**. These maximum noise levels would occur when equipment is operating under full power conditions. The estimated usage factor for the equipment is also shown in Table 11. The usage factors are based on the Federal Highway Administration (FHWA) Roadway Construction Noise Model User’s Guide (FHWA 2006).

TABLE 13
CONSTRUCTION EQUIPMENT AND ESTIMATED NOISE LEVELS

Type of Equipment	Estimated Usage Factor (%)	Reference Noise Level at 50 feet (dBA, L _{max})
Welder	40%	73
Air Compressor	50%	78
Cement and Mortar Mixer	40%	79
Crane	16%	85
Dozer	40%	85
Forklift	20%	85
Other Equipment	50%	85
Rubber Tired Dozers	40%	85
Graders	40%	85
Tractor / Loader / Backhoe	20%	85

SOURCE: FHWA 2006; ESA 2021.

To more accurately characterize construction-period noise levels, the average (hourly Leq) noise level associated with each construction phase is estimated based on the quantity, type, and usage factors for each type of equipment used during each construction phase and are typically attributable to multiple pieces of equipment operating simultaneously.

Over the course of a construction day, the highest noise levels would be generated when multiple pieces of construction equipment are operated concurrently. The Project's estimated construction noise levels were calculated for a scenario in which a reasonable number of construction equipment was assumed to be operating simultaneously and with the loudest equipment located at the construction area nearest to the affected sensitive receptors to present a conservative impact analysis. This is considered a worst-case evaluation as the proposed Project would typically use fewer overall equipment simultaneously at any given time, and as such would likely generate lower noise levels than reported herein. **Table 14, Estimated Construction Noise Levels at Sensitive Receptors,** presents the estimated total noise level for the combined Project construction equipment.

TABLE 14
ESTIMATED CONSTRUCTION NOISE LEVELS AT SENSITIVE RECEPTORS

Construction Phase	Noise Levels (dBA L _{eq})			
	R1	R2	R3	Classrooms
Demolition	89	83	69	76
Grading/Site Preparation	88	81	68	76
Foundations/Concrete Pour	84	77	63	71
Drainage/Utilities/Trenching	88	81	67	75
Building Construction	84	78	66	73
Paving	88	82	68	75
Architectural Coating	82	74	58	66
Synthetic Track	84	78	66	73
Field/Bleachers	84	78	66	73
Hawthorne Aquatics Facility	65	73	83	93
Overlapping Phases				
Grading/Site Preparation + Foundations/Concrete Pour	89	83	70	77
Grading/Site Preparation + Drainage/Utilities/Trenching	91	84	71	78
Drainage/Utilities/Trenching + Building Construction	90	83	70	77
Drainage/Utilities/Trenching + Building Construction + Foundations/Concrete Pour	91	84	71	78
Building Construction + Paving	90	83	70	77
Building Construction + Field/Bleachers	87	81	69	76
Building Construction + Foundations/Concrete Pour + Architectural Coatings + Field/Bleachers	89	83	70	77
Building Construction + Foundations/Concrete Pour + Architectural Coatings + Paving + Synthetic Track + Field/Bleachers	93	86	73	80

SOURCE: ESA, 2021.

The estimated noise levels represent a conservative worst-case noise scenario where the construction activities are analyzed with the loudest piece of construction equipment in use along the perimeter of the construction area, the second loudest piece of equipment set back a reasonable distance, and the rest at the center of the Project site. Construction typically would involve equipment in use throughout the Project site maintaining safe equipment operating distances, and resulting in most equipment in use further away from noise-sensitive receptors. As shown in Table 14, construction noise would result in temporary noise level in excess of ambient conditions for all phases of construction at receptor locations R1, R2, R3, and Hawthorne High School classrooms. The school classrooms to the south are considered noise-sensitive uses. Normal school buildings would provide an exterior-to-interior noise attenuation of 24 dBA when windows are closed (Protective Noise Levels, Condensed Version of EPA Levels Document, 1974). Because schools are in sessions during the daytime hours only, noise level thresholds are discussed in terms of hourly average noise levels (L_{eq}). In order for classrooms to be

adequate for teaching purposes, a noise level of 55 dBA Leq, is desired. As shown in Table 14, the maximum construction noise level outside the classrooms would reach 93 dBA Leq without any mitigation.

The proposed Project would implement Mitigation Measure **MM-NOISE-1**, which requires all feasible noise reduction measures such as temporary noise barriers providing a minimum 25 dBA noise attenuation and installation of silences and mufflers on construction equipment to minimize construction noise. The maximum construction noise level of 93 dBA Leq would be reduced by the implementation of Mitigation Measure **MM-NOISE-1** to 68 dBA Leq. This maximum noise level of 68 dBA Leq outside of the classrooms would be reduced by the building shell to 44 dBA Leq and would be considered to be adequate for teaching purposes. Therefore, with implementation of Mitigation Measure **MM-NOISE-1**, temporary increases in ambient noise due to construction would be less than significant.

Under worst case conditions, there would be approximately 52 one-way haul truck trips (26 haul trucks) and 80 one-way workers' trips (40 passenger vehicles) per day between the hours of 7:00 a.m. and 7:00 p.m. from Monday through Friday during the grading phase. Assuming that all 40 construction workers would arrive during the morning peak hour and that the haul trucks would be evenly distributed over an eight-hour work day, peak hour construction traffic would consist of 40 worker trips and approximately 7 haul trucks. Due to the location of the Project site, construction traffic may travel through the surrounding single-family residential neighborhood to access the regional roadway network. Noise associated with construction truck trips were estimated using the FHWA Traffic Noise Model (TNM) Version 2.5 method described in FHWA Traffic Noise Model Technical Manual (FHWA 1998) and based on the maximum number of truck and passenger trips in a day. The results of the analysis indicate that the Project construction trips would generate noise levels of approximately 54.5 dBA Leq (54.8 dBA CNEL) along residential roadways. When combined with existing ambient noise levels, the construction traffic noise would generate levels of 61.1 dBA Leq at R1, 57.4 dBA Leq at R2, and 68.5 dBA Leq at R3. Project construction traffic would add less than 3 dBA to the existing ambient noise levels in the Project vicinity. This range of noise levels is consistent with ambient conditions and would be within the "clearly compatible" land use compatibility category for single family residential uses. Additionally, the construction truck trips are temporary in nature and hauling during grading would only take place for 76 days after which the proposed Project would cease to have any significant lasting noise impact on the surrounding areas. Therefore, off-site construction traffic noise impacts would be less-than-significant.

Project construction would comply with the hours required by the City's municipal code. In addition, Mitigation Measure **MM-NOI-1** would ensure that construction noise is minimized and reduced by 25 dBA. **MM-NOI-2** would further reduce construction noise at nearby sensitive receivers by the use of mufflers and strategic placement of equipment staging area away from adjacent sensitive receivers. Construction activities associated with the proposed Project would not expose persons to, or generate noise levels in excess of standards established in the local general plan or noise ordinance, or applicable standards of other

agencies. Therefore, onsite and offsite construction impacts would be less than significant with incorporation of Mitigation Measures **MM-NOI-1** and **MM-NOI-2**.

MM-NOI-1: Temporary noise barriers shall be used along the western, northern, southern, and eastern property boundaries to block the line-of-sight between the construction equipment and the adjacent noise sensitive uses.

The noise barrier shall provide minimum 25-dBA noise reduction (minimum 16 feet high) at the residences adjacent to the Project site to the west, north, and east and to the classrooms directly south of the Hawthorne pool construction area.

These noise barriers shall be in-place during early Project construction phases (remain up to the start of building framing) and during paving when heavy equipment is used. Temporary barriers shall provide acoustically sealed gate access as needed for construction activities, deliveries, and site access by construction personnel.

MM-NOI-2: Construction Site Noise Control: The following methods shall be considered and implemented by the construction contractor as part of the Project to reduce noise to the greatest extent practical.

- a) Use low-noise-generating construction equipment, in lieu of large pieces of equipment;
- b) Properly maintain all construction equipment, including mufflers and ancillary noise abatement equipment;
- c) Ensure that all mobile and stationary noise-producing construction equipment used on the Project site that is regulated for noise output by a local, state, or federal agency complies with such regulation while in the course of Project activity;
- d) Schedule high noise-producing activities during periods that are least sensitive;
- e) Switch off construction equipment when not in use;
- f) Position stationary construction equipment, such as generators and compressors, as far away as practical from noise-sensitive receptors;
- g) Restrict the use of noise-producing signals, including horns, whistles, alarms, and bells, to safety warning purposes only;
- h) Route construction-related truck traffic away from noise-sensitive areas; and
- i) Reduce construction vehicle speeds.

Operational Noise

The existing noise environment in the Project site vicinity is dominated by traffic noise from nearby roadways and residential activities, as well as by noise generated by the existing school uses at Hawthorne High School. Currently the school has activities on the Project site when school is in session.

The proposed Project consists of replacing sports fields and the redevelopment of the Hawthorne Aquatics Facility like-for-like with no anticipated increase in the number of events or the number of spectators in attendance. An existing PA system is currently in use at the existing football stadium. The proposed Project would include the design and operation of a Public Address (PA) system located at each of the sports fields. Based on the Project design and the anticipated speaker type, the maximum output rated for each speaker is 120 dB.⁶ Project specifications require that the PA noise level should be 98 dB at all seats. Pole-mounted speakers would be directionally focused on the field and stands to reduce noise levels at adjacent sensitive-receptors.

The residential uses to the north and west of the Project site are considered noise-sensitive uses, with a noise level above 70 dBA CNEL considered to be incompatible. As shown in Table 12, at these off-site noise-sensitive residences, the measured L_{eq} ranged from 54.3 to 68.3 dBA. If Project-related operational noise levels would exceed 70 dBA CNEL standard, or exceed the prevailing ambient noise levels by 5 dBA or more, potential noise impacts would occur.

It should be noted that noise from the PA systems would only occur while an announcement is being made and would cease once the announcement has been made by the speaker. In addition, noise levels from the new PA systems would be similar to the existing PA system output during games at nearby residences. Because no increases in the number of events is expected and PA system noise would be similar to existing conditions, event-related noise is not expected to increase compared to existing conditions. Impacts would be less than significant.

Off-Site Operational Traffic Noise

The proposed Project consists of replacing sports fields and the redevelopment of the Hawthorne Aquatics Facility like-for-like with no anticipated increase in the number of events or the number of spectators in attendance. Therefore, vehicle trips would not increase due to Project implementation. Impacts related to traffic noise would be less than significant.

Parking Noise

The Project consists of replacing sports fields and the redevelopment of the Hawthorne Aquatics Facility like-for-like with no anticipated increase in the number of events or the number of spectators in attendance. The proposed Project includes a parking area in the southwestern corner of the Project site, east of Stacy Street, with six parking spaces in an area that currently allows vehicular access and parking. Because no increase in operational activity is anticipated and parking activity currently exists in this location, the proposed Project would not result in an increase in parking-related noise. Impacts would be less than significant.

- b) **Less-than-Significant Impact.** The proposed Project would be constructed using typical construction techniques. As such, it is anticipated that the equipment to be used during construction would not expose persons to or generate excessive groundborne vibration.

⁶ The maximum noise level of each speaker is based on the spec sheet included in Appendix F.

Post-construction on-site activities would be limited to athletic use and events that would not generate excessive groundborne vibration.

Groundborne vibration from development is primarily generated from the operation of construction equipment and from vehicle traffic. Groundborne vibration propagates from the source through the ground to adjacent buildings by surface waves. Vibration energy dissipates as it travels through the ground, causing the vibration amplitude to decrease with distance away from the source. Vibration in buildings is typically perceived as rattling of windows, shaking of loose items, or the motion of building surfaces. The vibration of building surfaces also can be radiated as sound and heard as a low-frequency rumbling noise, known as groundborne noise. Vibration levels for potential structural damage is described in terms of the peak particle velocity (PPV) measured in inches per second (in/sec) (FTA 2018).

Groundborne vibration is generally limited to areas within a few hundred feet of certain types of industrial operations and construction/demolition activities such as pile driving. Road vehicles rarely create enough groundborne vibration amplitude to be perceptible to humans unless the receiver is in immediate proximity to the source or the road surface is poorly maintained and has potholes or bumps. If traffic, typically heavy trucks, does induce perceptible building vibration, it is most likely an effect of low-frequency airborne noise or ground characteristics (FTA 2018). Typically, groundborne vibration generated by man-made activities attenuates rapidly with distance from the source of the vibration. Heavy trucks would generate 0.076 in/sec PPV at 25 feet. The vibration velocity of 0.076 in/sec PPV at 25 feet attenuates to 0.027 in/sec PPV at 50 feet (FTA 2018).

Building structural components also can be stressed by high levels of low-frequency airborne noise (typically less than 100 Hz). The many structural components of a building, stressed by low-frequency noise, can be coupled together to create complex vibrating systems. The low-frequency vibration of the structural components can cause smaller items such as ornaments, pictures, and shelves to rattle, which can cause annoyance to building occupants (FTA 2018).

As discussed above, the rumbling noise caused by the vibration of room surfaces is called groundborne noise. The annoyance potential of groundborne noise is usually characterized with the A-weighted sound level. Although the A-weighted level is almost the only metric used to characterize community noise, there are potential problems when characterizing low-frequency noise using A-weighting. This is because of the non-linearity of human hearing which causes sounds dominated by low-frequency components to seem louder than broadband sounds that have the same A-weighted level. The result is that groundborne noise with a level of 40 dBA sounds louder than 40 dBA broadband noise. This is accounted for by setting the limits for groundborne noise lower than would be the case for broadband noise (FTA 2018).

Construction activities on the Project site could generate ground-borne vibration from the operation of excavators, graders, and loaders. The nearest residential structures are located

approximately 10 feet to the west of the Project boundary. Vibration levels generated by typically heavy equipment, measured at 10 feet and 25 feet, are identified in **Table 15, Vibration Source Levels for Construction Equipment**, in terms of peak particle velocity (PPV), and expressed in inches per second (in/sec).

TABLE 15
VIBRATION SOURCE LEVELS FOR CONSTRUCTION EQUIPMENT

Equipment	Approximate PPV (in/sec) at 10 feet	Approximate PPV (in/sec) at 25 feet
Excavator/Grader	0.352	0.089
Loaded Trucks	0.300	0.076
Small Bulldozer	0.012	0.003

SOURCE: FTA 2018.

Caltrans' vibration threshold for potential structural damage for off-site residential buildings is 0.5 in/sec PPV (Caltrans 2013). At 10 feet from the Project construction area, the operation of heavy construction equipment would generate vibration levels of up to 0.352 in/sec PPV, which is less than the Caltrans threshold for structural damage. Furthermore, construction would only occur during the permitted weekday construction hours and would be temporary. Therefore, impacts would be less than significant.

Project operation would not include equipment or activities that would generate perceptible operational vibration levels. Therefore, there would be no impact during Project operation.

- c) **No Impact.** As discussed in Section IX, *Hazards and Hazardous Materials*, of this Draft IS/MND, the Project site is located approximately 1.4 miles to the west of the Hawthorne Municipal Airport. However, according to the Los Angeles County Airport Land Use Commission's Airport Influence Area, the Project site is not within any of the airport's safety or influence areas and is not subject to Federal Aviation Administration restrictions (ALUC 2018).

In addition, the Project site is not located within an airport land use plan or within the vicinity of a private airstrip. Therefore, construction or operation of the proposed Project would not expose people to excessive airport related noise levels. No impacts would occur in this regard and no mitigation measures would be required.

Population and Housing

<i>Issues (and Supporting Information Sources):</i>	<i>Potentially Significant Impact</i>	<i>Less Than Significant with Mitigation Incorporated</i>	<i>Less Than Significant Impact</i>	<i>No Impact</i>
XIV. POPULATION AND HOUSING — Would the project:				
a) Induce substantial unplanned population growth in an area, either directly (for example, by proposing new homes and businesses) or indirectly (for example, through extension of roads or other infrastructure)?	<input type="checkbox"/>	<input type="checkbox"/>	<input type="checkbox"/>	<input checked="" type="checkbox"/>
b) Displace substantial numbers of existing people or housing, necessitating the construction of replacement housing elsewhere?	<input type="checkbox"/>	<input type="checkbox"/>	<input type="checkbox"/>	<input checked="" type="checkbox"/>

Discussion

- a) **No Impact.** A significant impact may occur if the proposed Project would locate new development, such as homes or employment generators businesses, or infrastructure, with the effect of substantially inducing growth in the proposed area that would otherwise not have occurred as rapidly or in as great a magnitude.

The proposed Project would develop/redevelop athletic and aquatic facilities in place of the existing facilities on the Project site, and does not include the construction of any residential uses. Thus, the proposed Project would not directly induce unplanned population growth. Although short-term construction jobs would be generated, no long-term increases in employment would occur as a result of the proposed Project improvements. Additionally, the proposed Project would not result in any new expanded infrastructure to accommodate additional growth in the area, such as improved utilities, roadways, and expanded public services. As a consequence, no indirect growth inducing impacts would occur as a result of the proposed Project.

- b) **No Impact.** The proposed Project would develop/redevelop athletic and aquatic facilities in place of the existing facilities on the Project site. No residential dwelling units currently exist on the Project site; therefore, no existing people or housing would be displaced by development of the proposed Project, and the construction of replacement housing elsewhere would not be necessary. Therefore, there would be no impact.

Public Services

<i>Issues (and Supporting Information Sources):</i>	<i>Potentially Significant Impact</i>	<i>Less Than Significant with Mitigation Incorporated</i>	<i>Less Than Significant Impact</i>	<i>No Impact</i>
XV. PUBLIC SERVICES —				
a) Would the project result in substantial adverse physical impacts associated with the provision of new or physically altered governmental facilities, need for new or physically altered governmental facilities, the construction of which could cause significant environmental impacts, in order to maintain acceptable service ratios, response times or other performance objectives for any of the following public services:				
i) Fire protection?	<input type="checkbox"/>	<input type="checkbox"/>	<input checked="" type="checkbox"/>	<input type="checkbox"/>
ii) Police protection?	<input type="checkbox"/>	<input type="checkbox"/>	<input checked="" type="checkbox"/>	<input type="checkbox"/>
iii) Schools?	<input type="checkbox"/>	<input type="checkbox"/>	<input type="checkbox"/>	<input checked="" type="checkbox"/>
iv) Parks?	<input type="checkbox"/>	<input type="checkbox"/>	<input type="checkbox"/>	<input checked="" type="checkbox"/>
v) Other public facilities?	<input type="checkbox"/>	<input type="checkbox"/>	<input type="checkbox"/>	<input checked="" type="checkbox"/>

Discussion

a.i) **Less-than-Significant Impact.** The Los Angeles County Fire Department (LACoFD) provides full fire protection services, including air and wildland fire support, emergency medical, and fire prevention for the City of Hawthorne. The LACoFD has one facility in the City, Fire Station #160, which serves the Project site and is located at 5323 West Rosecrans Avenue, approximately 1.2 miles southwest of the campus (County of Los Angeles Fire Department 2021). The next closest LACoFD facility is Fire Station #21, located approximately 1.6 miles southwest of the Project site. Other stations would respond to emergencies at the Project site as needed.

The proposed Project would replace existing athletic facilities on the athletic fields and Hawthorne Aquatics Facility with new and improved facilities. Construction activities associated with the proposed Project may temporarily increase demand for fire protection and emergency medical services. Construction workers performing activities associated with the construction of the proposed Project could be exposed to risks that could require fire protection and emergency medical services. Construction worker accidents could result from the occasional exposure to combustible materials such as wood, plastics, sawdust, coverings and coatings, heat sources including machinery and equipment sparking, exposed electrical lines, welding activities, and chemical reactions in combustible materials and coatings. Given the nature of construction activities in the work requirements of construction personnel, in compliance with the California Division of Occupational Safety and Health Administration (Cal/OSHA) and Fire Code requirements, construction managers and personnel would be trained in fire prevention and emergency response and fire suppression equipment specific to construction would be maintained on-site. As such, construction impacts on fire protection services and facilities would be less than significant.

The proposed Project would increase the bleacher seating capacity in the football/track stadium by approximately 56 seats (an increase of 552 seats for the visitor bleachers and a decrease in the home bleachers by 496). Operationally, although the seating capacity would increase, it is anticipated that the type, number, and frequency of athletic events and activities upon completion of the proposed improvements would not be substantially different from what currently occurs. As shown in Table 1 and Table 3, the number of events hosted at the existing Hawthorne Aquatics Facility was 15 during the 2019 calendar year and the proposed school aquatic facility would host up to 19 annual events, respectively. However, it should be noted that when these events occur, only one team (either Hawthorne High School or the South Bay Swim Team) would be able to use the facility and, thus, while there may be an increase in spectators, it would be a net increase since there would be a reduction in use by the other swim team. Given that the average number of events in 2019 was 15 events, it is not anticipated that the acquisition and redevelopment of the Hawthorne Aquatic Facility would result in a substantial increase in use over existing conditions. For that reason, the proposed Project would not substantially increase the demand for fire protection services and would not require the construction of new or altered fire protection facilities to serve the proposed Project. In addition, the LACoFD would review the proposed Project plans to confirm that existing resources are sufficient to service the proposed Project. Because the proposed Project is in the LACoFD's existing service area and would not require new or expanded fire protection facilities, the proposed Project's impact on fire protection services and facilities would be less than significant.

- a.ii) **Less-than-Significant Impact.** Law enforcement services are provided to the City by the Hawthorne Police Department. The Hawthorne Police Department maintains the Police Station located at 12501 Hawthorne Boulevard, approximately 0.45 miles east of the Project site (Hawthorne Police Department 2021).

The proposed Project would replace existing athletic and aquatic facilities on the athletic fields and Hawthorne Aquatics Facility with new and improved facilities. During construction of future development of the Project site, equipment and building materials could be temporarily stored on-site, which could result in theft, graffiti, and vandalism. However,

the Project site is located in an area with high vehicular activity from the I-405, West El Segundo Boulevard and South Inglewood Avenue. Given the visibility of the Project site from the I-405 and adjacent roadways, surrounding properties, and construction fencing, construction of the proposed Project is not expected to increase demand on existing police services to a meaningful extent. As noted above, the proposed Project would increase the bleacher seating capacity in the football/track stadium by approximately 56 seats and new aquatic facilities. However, during operation of the Project, it is anticipated that the type, number, and frequency of athletic events and activities upon completion of the proposed improvements would not be substantially different from what currently occurs. For that reason, the proposed Project would not substantially increase the demand for police protection services and would not require the construction of new or altered police

protection facilities to serve the proposed Project. Therefore, impacts to police protection services and facilities would be less than significant.

- a.iii) **No Impact.** The proposed Project would provide new and improved athletic and aquatic facilities on the athletic fields and Hawthorne Aquatics Facility. Construction of future development of the proposed Project would require the participation of construction employees who would be hired from a mobile regional construction work force that moves from project to project. Typically, construction workers pass through various development projects on an intermittent basis as their particular trades are required. Given the mobility and short durations of work at a particular site, and a large construction labor pool that can be drawn upon in the region, construction employees would not be expected to relocate their families or their residences within this region or from other regions as a result of their work on future development of the proposed Project. Accordingly, construction of the future development of the proposed Project would not result in a notable increase in the resident population or generate new students needing to attend local schools.

The proposed Project does not include a residential development component and would not create any new jobs that would result in persons relocating to the area. Therefore, the proposed Project would not directly or indirectly increase local school student enrollment and would not require the construction or expansion of other schools in the Project area. No impacts to schools would occur.

- a.iv) **No Impact.** The closest park to the to the Project Site is Eucalyptus Park, located at 12100 South Inglewood Avenue, approximately 0.5 miles northeast of the eastern boundary of the Project site. The proposed Project would provide new and improved athletic and aquatic facilities on the athletic fields and Hawthorne Aquatics Facility. Construction of the proposed Project would result in a temporary increase in the number of construction workers at the Project site. Due to the employment patterns of construction workers in southern California, and the operation of the market for construction labor, the likelihood that construction workers would relocate their households as a consequence of working on future development of the proposed Project is negligible. Additionally, because the proposed Project does not include a residential component and would not create permanent new jobs, it would not increase the use of off-campus recreational facilities. As such, the proposed Project would not require the construction of new or altered off- campus parks or other recreational spaces that could cause significant environmental impacts. No park impacts would occur.
- a.v) **No Impact.** As noted above, the proposed Project does not include a residential component and would not create new permanent jobs. Therefore, it would not increase the number of residents or permanent employees in the Project area and consequently would not require the construction or expansion of other public facilities, such as libraries. No impacts would occur.

Recreation

<i>Issues (and Supporting Information Sources):</i>	<i>Potentially Significant Impact</i>	<i>Less Than Significant with Mitigation Incorporated</i>	<i>Less Than Significant Impact</i>	<i>No Impact</i>
XVI. RECREATION —				
a) Would the project increase the use of existing neighborhood and regional parks or other recreational facilities such that substantial physical deterioration of the facility would occur or be accelerated?	<input type="checkbox"/>	<input type="checkbox"/>	<input type="checkbox"/>	<input checked="" type="checkbox"/>
b) Does the project include recreational facilities or require the construction or expansion of recreational facilities which might have an adverse physical effect on the environment?	<input type="checkbox"/>	<input type="checkbox"/>	<input checked="" type="checkbox"/>	<input type="checkbox"/>

Discussion

- a) **No Impact.** The proposed Project would include upgrades to the athletic fields, including a new combined football/soccer field, upgraded track, and upgraded bleachers on the western portion of the athletic fields; a reconfigured baseball field, new basketball courts, and a 5,400-sf team room/concessions building on the central portion of the Campus; and a new softball field and a multi-use (soccer and football) field in the eastern portion of the Campus. The Hawthorne Aquatics Facility would include upgrades to the pool, pool deck, public seating, and locker rooms. Improvements include upgrades to the athletic fields including a new combined football/soccer field and striping, upgraded track, upgraded bleachers, reconfigured ball field with synthetic turf, and new football/soccer field with synthetic turf in the eastern portion of the athletic area. As such, the proposed Project would provide a public recreation benefit to the community high school as it would be updating outdated and older facilities. As noted in Section XV, *Public Services*, of this Draft IS/MND the proposed Project would increase the bleacher seating capacity in the football/track stadium by approximately 56 seats; however, it is anticipated that the type, number, and frequency of athletic events and activities that would occur after completion of the proposed Project improvements would be similar to what currently occurs. Similarly, for the proposed redevelopment of the Hawthorne Aquatics Facility, there would be approximately 19 events/meets annually with the proposed aquatic facility versus the approximately 15 events/swim meets that occurred at the Hawthorne Aquatics Facility during 2019. However, it should be noted that when these events occur, only one team (either Hawthorne High School or the South Bay Swim Team) would be able to use the facility and, thus, while there may be an increase in spectators, it would be a net increase since there would be a reduction in use by the other swim team. Given that the average number of events in 2019 was 15 events, it is not anticipated that the acquisition and redevelopment of the Hawthorne Aquatic Facility would result in a substantial increase in use over existing conditions.

Additionally, the proposed Project does not include a residential development component that could increase the population and result in increased use of campus athletic facilities or off-site parks and/or recreational facilities. Therefore, the proposed Project would provide a public recreation benefit to the Campus and would not increase the use of and

result in deterioration of existing neighborhood and regional parks and recreational facilities. No parks or recreational facilities impacts would occur.

- b) **Less-than-Significant Impact.** The proposed Project in and of itself is a recreational facility improvements project and the construction and operation of the proposed improvements could result in impacts to the environment. However, those impacts are expected to be less than significant (please see discussions of other impacts in this Draft IS/MND).

The proposed Project does not include a residential development component that could increase the population; therefore, it would not result in increased demand for or use of off-site parks or recreational facilities. Consequently, it would not require the construction of any new or expanded off-site parks or recreational facilities. Therefore, impacts to parks or recreational facilities would be less than significant.

Transportation

<i>Issues (and Supporting Information Sources):</i>	<i>Potentially Significant Impact</i>	<i>Less Than Significant with Mitigation Incorporated</i>	<i>Less Than Significant Impact</i>	<i>No Impact</i>
XVII. TRANSPORTATION — Would the project:				
a) Conflict with a program plan, ordinance or policy addressing the circulation system, including transit, roadway, bicycle and pedestrian facilities?	<input type="checkbox"/>	<input type="checkbox"/>	<input checked="" type="checkbox"/>	<input type="checkbox"/>
b) Would the project conflict or be inconsistent with CEQA Guidelines section 15064.3, subdivision (b)?	<input type="checkbox"/>	<input type="checkbox"/>	<input checked="" type="checkbox"/>	<input type="checkbox"/>
c) Substantially increase hazards due to a geometric design feature (e.g., sharp curves or dangerous intersections) or incompatible uses (e.g., farm equipment)?	<input type="checkbox"/>	<input type="checkbox"/>	<input checked="" type="checkbox"/>	<input type="checkbox"/>
d) Result in inadequate emergency access?	<input type="checkbox"/>	<input type="checkbox"/>	<input checked="" type="checkbox"/>	<input type="checkbox"/>

Discussion

This evaluation was conducted by reviewing City documents such as the City of Hawthorne General Plan and the Centinela Valley Union High School District Local Control and Accountability Plan (LCAP).

- a) **Less-than-Significant Impact.** The purpose of this section is to determine whether the proposed Project conflicts with a transportation-related City or District plan, program, ordinance, or policy that was adopted to protect the environment. A project would not be shown to result in an impact merely based on whether a project would not implement an adopted plan, program, ordinance, or policy. Rather, it is the intention of this threshold test to ensure that proposed development does not conflict with nor preclude the City or District from implementing adopted plans, programs, ordinances, or policies. Furthermore, under CEQA, a project is considered consistent with an applicable plan if it is consistent with the overall intent of the plan and would not preclude the attainment of its primary goals. A project does not need to be in perfect conformity with each and every policy. Finally, any inconsistency with an applicable policy, plan, or regulation is only a significant impact under CEQA if the policy, plan, or regulation was adopted for the purpose of avoiding or mitigating an environmental effect and if the inconsistency itself would result in a direct physical impact on the environment.

City of Hawthorne General Plan

The City of Hawthorne General Plan is a broad planning guideline to the City’s future development goals and provides policy statements to achieve those development goals for land use, circulation, housing, and economic development. It lays out the overall goals and policies of the circulation element, which aim to provide for the safe and efficient movement of people, goods, and services throughout the City. The Project’s proposed land use and operations design features were reviewed and compared to existing and future conditions resulting from the proposed Project, including site access, pedestrian, bicycle and transit accessibility and loading.

As discussed in Chapter 2, *Project Description*, all proposed Project improvements would be constructed onsite, and would not increase the student capacity on the Campus or increase operation or use of the athletic fields. While the proposed demolition of the Hawthorne Aquatics Facility and construction of a new aquatic facility in its place to serve Hawthorne High School would represent a new use for the school, it does not represent a new use to the Project site. As required by the Civic Center Act, the proposed aquatic facility could potentially be utilized by Hawthorne residents year-round when not hosting school activities such as practices and events.

In terms of school use of the proposed new aquatic facility, the majority of students and staff would already be onsite in other school buildings, and therefore would not generate a substantial number of vehicle trips. This is in contrast to the existing Hawthorne Aquatics Facility, which is open to the public year-round and draws visitors from throughout the local area requiring travel by vehicle and, to a lesser extent, by transit, bicycle, and walking. Furthermore, the new aquatic facility would likely decrease the number of vehicles traveling to/from the school during the morning and afternoon peak commute times because swim team practice times would be scheduled before and after the normal school bell schedule, resulting in a shifting of vehicle trips associated with students or staff to early in the morning (i.e., before 6:00 a.m.) and later in the evening (i.e., after 6:30 p.m.) on weekdays.

As shown in Table 1 and Table 3, events (i.e., swim meets, water polo games), which would could generate vehicle trips during other times of the day or on weekends, would be more frequent with the proposed school aquatic facility versus the existing Hawthorne Aquatics Facility. The number of events hosted at the existing Hawthorne Aquatics Facility was 15 during the 2019 calendar year, while the proposed school aquatic facility would host up to 19 annual events. However, school events at the proposed aquatic facility would cause regularly scheduled community use of the pool to be cancelled, thereby removing vehicle trips associated with community use and replacing them with school use which, as described above, would generate fewer vehicle trips due to the fact that many attendees (i.e., students and staff) would already be on campus.

In summary, the proposed Project would not include any modifications to public facilities (i.e., sidewalks, roadways, street parking), nor would it increase traffic, bicycle and pedestrian activity, or transit demand. Therefore, the proposed Project is consistent with the reviewed policies of the circulation element in the General Plan.

Centinela Valley Union High School District Local Control and Accountability Plan

Centinela Valley Union High School District Local Control and Accountability Plan (LCAP) has an ultimate vision to prepare their students for graduation, college, a career, and healthy life (Centinela Valley Union High School District 2019). To that end, one of the goals of the LCAP (Goal 2, page 11) is to actively engage students, families, and the school community in promoting students' academic and behavioral health. This includes a provision of increased athletics funding. Enhancing District athletic programs is a means

of subsequently increasing students' attendance and academic engagement, according to the Plan (Action 2004, page 12). The proposed Project is consistent with the goals set forth in the LCAP. Two of the three goals in the LCAP are exclusively focused on academics and college readiness. The proposed improvements to Hawthorne High School's athletic fields and the creation of a new swim program is consistent with the broader Goal #2 of the LCAP ("Provide varied supports to actively engage students, families, and the school community in promoting students' academic and behavioral health," page 21) and Action 2004 ("Enhance District athletic programs as a means of subsequently increasing students' attendance and academic engagement.") since it enhances District athletic programs with the athletic facilities improvements and additions. Moreover, the proposed Project is consistent with Action 2002 ("Improve school climate and student engagement through enhanced provision of safe and drug-free schools," page 21) and Action 2003 ("Expand family engagement efforts by increasing meaningful family engagement opportunities and providing parent education to support student success," page 21) under Goal #2 since it enables and expands student and family engagement through improvements and additions to the athletic facilities.

The proposed Project features, location, and design generally support multi-modal transportation options and would be consistent with policies, plans, and programs that support alternative transportation, including the City of Hawthorne General Plan and the Centinela Valley Union High School District Local Control and Accountability Plan. The proposed Project proposes to upgrade the athletic facilities at Hawthorne High School and replace the existing Hawthorne Aquatics Facility with a new aquatic facility, which would not require modifications to the public right-of-way or changes to the existing transportation system in Hawthorne immediately surrounding the school. Therefore, the proposed Project would not conflict with a program, plan, ordinance, or policy addressing the vehicular circulation system and impacts would be less than significant.

See below for the proposed Project's conflict/consistency analysis with SCAG's Regional Transportation Plan/Sustainable Communities Strategy (RTP/SCS).

- b) **Less-than-Significant Impact.** In accordance with Senate Bill (SB) 743, the CEQA Guidelines Section 15064.3, subdivision (b) was adopted in December 2018 by the California Natural Resources Agency. These revisions to the CEQA Guidelines criteria for determining the significance of transportation impacts are primarily focused on projects within transit priority areas, and shifts the focus from driver delay to reduction of greenhouse gas emissions, creation of multimodal networks, and promotion of a mix of land uses. Vehicle miles traveled, or VMT, is a measure of the total number of miles driven to or from a development and is sometimes expressed as an average per trip or per person. As of July 1, 2020, the provisions of this section applies Statewide.

The City has not yet updated its thresholds related to the significance of transportation impacts as required by SB 743. In June 2020, the City Council requested a two-year delay in the implementation of SB 743 from Governor Newsom and the California State legislature. Since the regulations of SB 743 have not been finalized or adopted by the City,

Statewide guidance, as documented in the Governor’s Office of Planning and Research’s (OPR) *Technical Advisory on Evaluating Transportation Impacts in CEQA* (Technical Advisory), was used to determine the significance of transportation impacts.

The Technical Advisory provides a screening criterion that could be used to determine if VMT analysis is warranted for small projects, which are defined as projects that would generate fewer than 110 trips per day and may generally be assumed to cause a less-than-significant transportation impacts. As discussed in Chapter 2, *Project Description*, of this Draft IS/MND, and above for Issue a), the proposed Project would not increase the student capacity on the Campus or increase operation or use of the athletic fields, and the replacement of the existing Hawthorne Aquatics Facility with a new aquatic facility that serves Hawthorne High School would represent a less-intensive use with respect to trip generation. Therefore, no significant new vehicle trips would be generated, and the proposed Project would meet the small project criterion. Therefore, the proposed Project would result in a less-than-significant impact related to CEQA Guidelines Section 15064.3.

- c) **Less-than-Significant Impact.** This section discusses impacts regarding the potential increase in hazards due to a geometric design feature that generally relates to the design of access points to and from the proposed Project site and may include safety, operational, or capacity impacts. Impacts can be related to vehicle/vehicle, vehicle/bicycle, or vehicle/pedestrian conflicts as well as to operational delays caused by vehicles slowing and/or queuing to access a proposed Project site. As discussed in Chapter 2, *Project Description*, there are three parking areas that serve the Project site: the parking lots south and southwest of the Project site, which could be accessed from two driveways off South Inglewood Avenue and a parking area in the southwestern corner of the Project site that currently allows vehicular access and parking (see Figure 3). The proposed Project would not include any new surface parking, and driveway access to the Project site would be the same as existing conditions. Driveway access and surface parking capacity at the proposed new aquatic facility would also be the same as existing conditions. Furthermore, implementation of the proposed Project would not introduce incompatible uses into the surrounding roadway network. Therefore, impacts would be less than significant and vehicular, bicycle, and pedestrian access would remain the same as existing conditions related to roadway hazards.
- d) **Less-than-Significant Impact.** A significant impact would occur if the design of the proposed Project would not satisfy local emergency access requirements. The proposed Project would not include any alterations of existing roadway features (e.g., road realignment) that would create a permanent change to access for emergency vehicles. During construction of the proposed Project, heavy construction-related vehicles could interfere with emergency response to the site (e.g., slowing vehicles traveling behind the truck). However, such delays would be infrequent and brief (drivers are required to pull over to allow an emergency vehicle on-call to pass), and contract specifications for the proposed Project would ensure that emergency vehicle access on area roadways would be maintained at all times. As such, inadequate emergency access would not occur as a result of implementation of the proposed Project, and impacts would be less than significant.

Tribal Cultural Resources

<i>Issues (and Supporting Information Sources):</i>	<i>Potentially Significant Impact</i>	<i>Less Than Significant with Mitigation Incorporated</i>	<i>Less Than Significant Impact</i>	<i>No Impact</i>
XVIII. TRIBAL CULTURAL RESOURCES —				
a) Would the project cause a substantial adverse change in the significance of a tribal cultural resource, defined in Public Resources Code section 21074 as either a site, feature, place, cultural landscape that is geographically defined in terms of the size and scope of the landscape, sacred place, or object with cultural value to a California Native American tribe, and that is:				
i) Listed or eligible for listing in the California Register of Historical Resources, or in a local register of historical resources as defined in Public Resources Code Section 5020.1(k), or	<input type="checkbox"/>	<input checked="" type="checkbox"/>	<input type="checkbox"/>	<input type="checkbox"/>
ii) A resource determined by the lead agency, in its discretion and supported by substantial evidence, to be significant pursuant to criteria set forth in subdivision (c) of Public Resources Code Section 5024.1. In applying the criteria set forth in subdivision (c) of Public Resources Code Section 5024.1, the lead agency shall consider the significance of the resource to a California Native American tribe.	<input type="checkbox"/>	<input type="checkbox"/>	<input checked="" type="checkbox"/>	<input type="checkbox"/>

Discussion

a.i) **Less-than-Significant Impact with Mitigation Incorporated.** As previously mentioned in Section V, *Cultural Resources*, a cultural resources records search was conducted on July 1, 2021 through the California Historical Resources Information System – South Central Coastal Information Center (CHRIS-SCCIC). The records search conducted with the CHRIS-SCCIC did not identify any previously recorded cultural resources eligible for listing in the California Register of Historical Resources. Additionally, the Native American Heritage Commission (NAHC) performed a Sacred Lands File (SLF) search on May 26, 2021 (see Appendix D). The SLF search through the NAHC yielded negative results. The District conducted consultation with California Native American tribes pursuant to AB 52 to identify tribal cultural resources in or near the proposed Project site (see Appendix G).

On October, 28, 2021, the District sent notification letters via certified mail with return receipt requested and email to the designated representatives of 7 California Native American tribes, as listed in **Table 16, Summary of AB 52 Consultation**. The letters provide brief descriptions of the proposed Project and its location, with maps, the District’s contact information, and a notification that the tribe has 30 days to request consultation pursuant to Public Resources Code section 21080.3.1. The 30-day review period ended on Friday, November 26, 2021. As of November 30, 2021 no responses have been received from the tribes listed in Table 16.

TABLE 16
SUMMARY OF AB 52 CONSULTATION

Tribe	Contact/Title	Date Letter Sent	Response
Gabrieleño/Tongva San Gabriel Band of Mission Indians	Anthony Morales, Chairperson	10/28/2021	No response
Gabrielino/Tongva Nation	Sandonne Goad, Chairperson	10/28/2021	No response
Gabrielino Tongva Indians of California Tribal Council	Robert Dorame, Chairperson	10/28/2021	No response
Gabrielino-Tongva Tribe	Charles Alvarez	10/28/2021	No response
Gabrieleño Band of Mission Indians-Kizh Nation	Andrew Salas, Chairperson	10/28/2001	No response
Santa Rosa Band of Cahuilla Indians	Lovina Redner, Tribal Chair	10/28/2021	No response
Soboba Band of Luiseno Indians	Scott Cozart, Chairperson	10/28/2021	No response

The proposed Project is on a previously disturbed site in a developed suburban environment, where no prior records of archeological resources have been encountered. As such, the potential for the proposed Project to encounter either prehistoric or historical archaeological resources is considered low. Archaeological materials may include prehistoric resources such as flaked and ground stone tools and debris, shell, bone, ceramics, and fire-affected rock as well as historical resources such as glass, metal, wood, brick, or structural remnants. If prehistoric archaeological resources are encountered during construction activities, they must have the following characteristics to be considered TCRs:

- Sites, features, places, cultural landscapes (must be geographically defined), sacred places, and objects with cultural value to a California Native American tribe that are either included or determined to be eligible for inclusion in the CRHR or included in a local register of historical resources (PRC Section 21074[a][1]); and
- The lead agency, supported by substantial evidence, chooses to treat the resource as a TCR (PRC Section 21074[a][2]).

As previously mentioned, the potential for the proposed Project to encounter either prehistoric or historical archaeological resources is considered low. However, with the implementation of Mitigation Measure **MM-TCR-1**, impacts to tribal cultural resources would be less-than-significant.

MM-TCR-1: The District shall retain the services of a qualified Native American monitor(s) if unanticipated TCRs are encountered during construction activities. The determination of what constitutes a potential TCR shall be the responsibility of the District. Selection of the appropriate Native American monitor shall be based on ongoing consultation under AB 52. If evidence of any prehistoric subsurface archaeological features or deposits (e.g., lithic scatters, midden soils) is discovered during construction-related earthmoving activities, all ground-disturbing activity in the area and within 50 feet of the find shall be halted until a

qualified archaeologist and Native American representative can assess the significance of the find. If, after evaluation, a resource is considered significant or a TCR, all preservation options shall be considered, as required by CEQA (see PRC Section 21084.3), including possible data recovery, mapping, capping, or avoidance of the resource. Upon discovery of any TCR, if the District determines that the Project may cause a substantial adverse change to a TCR, the District shall work with the consulting tribe(s) to employ measures that treat the resource with culturally appropriate dignity, taking into account the tribal cultural values and meaning of the resource.

- a.ii) **Less-than-Significant Impact.** The District solicited consultation with potentially affected Native American tribes (as applicable) regarding the proposed Project in accordance with AB 52. The District drafted and mailed the letters via certified mail on October 28, 2021 (see Appendix G). The consultation period allows 30 days for responses, and as of November 30, 2021 no responses have been received. Impacts to tribal cultural resources would be less-than-significant.
-

Utilities and Service Systems

<i>Issues (and Supporting Information Sources):</i>	<i>Potentially Significant Impact</i>	<i>Less Than Significant with Mitigation Incorporated</i>	<i>Less Than Significant Impact</i>	<i>No Impact</i>
XIX. UTILITIES AND SERVICE SYSTEMS —				
Would the project:				
a) Require or result in the relocation or construction of new or expanded water, wastewater treatment or storm water drainage, electric power, natural gas, or telecommunications facilities, the construction or relocation of which could cause significant environmental effects?	<input type="checkbox"/>	<input type="checkbox"/>	<input type="checkbox"/>	<input checked="" type="checkbox"/>
b) Have sufficient water supplies available to serve the project and reasonably foreseeable future development during normal, dry and multiple dry years?	<input type="checkbox"/>	<input type="checkbox"/>	<input type="checkbox"/>	<input checked="" type="checkbox"/>
c) Result in a determination by the wastewater treatment provider which serves or may serve the project that it has adequate capacity to serve the project's projected demand in addition to the provider's existing commitments?	<input type="checkbox"/>	<input type="checkbox"/>	<input checked="" type="checkbox"/>	<input type="checkbox"/>
d) Generate solid waste in excess of State or local standards, or in excess of the capacity of local infrastructure, or otherwise impair the attainment of solid waste reduction goals?	<input type="checkbox"/>	<input type="checkbox"/>	<input checked="" type="checkbox"/>	<input type="checkbox"/>
e) Comply with federal, state, and local management and reduction statutes and regulations related to solid waste?	<input type="checkbox"/>	<input type="checkbox"/>	<input type="checkbox"/>	<input checked="" type="checkbox"/>

Discussion

- a) **No Impact.** Construction activities are limited and temporary and would not require or result in the relocation or construction of new or expanded water, wastewater treatment, stormwater drainage, electric power, natural gas, and telecommunications facilities. Once the proposed improvements are completed and operational, the proposed Project would not require or result in the relocation or construction of new or expanded water, wastewater treatment, stormwater drainage, electric power, natural gas, and telecommunications facilities beyond what is currently generated at the Project site. Additionally, grass on the softball, football, and baseball fields would be removed and replaced with synthetic turf, which would result in a reduction in the amount of water consumed at the Project site. While the proposed demolition of the Hawthorne Aquatics Facility and construction of a new facility in its place to serve Hawthorne High School would represent a new use for the school, it does not represent a new use to the Project site and would not require or result in the relocation or construction of new or expanded water, wastewater treatment, stormwater drainage, electric power, natural gas, and telecommunications facilities beyond what is currently generated. Therefore, the proposed Project would have no impact and would not require or result in the relocation or construction of new or expanded water, wastewater treatment, stormwater drainage, electric power, natural gas, and telecommunications facilities.
- b) **No Impact.** The proposed Project would include upgrades to the athletic fields, including a new combined football/soccer field, upgraded track, and upgraded bleachers on the western portion of the athletic fields; a reconfigured baseball field, new basketball courts,

and a 5,400-sf team room/concessions building on the central portion of the Campus; and a new softball field and a multi-use (soccer and football) field in the eastern portion of the Campus. The Hawthorne Aquatics Facility would include upgrades to the pool, pool deck, public seating, and locker rooms. Those improvements would increase the capacity of the bleachers in the football and track field stadium by approximately 56 seats. However, given the number of athletic events on the campus are anticipated to be similar to what currently occurs and natural grass fields would be replaced with synthetic field turf, which would reduce irrigation needs. Additionally, while the proposed demolition of the Hawthorne Aquatics Facility and construction of a new facility in its place to serve Hawthorne High School would represent a new use for the school, it does not represent a new use to the Project site and would not require or result in water consumption beyond what is currently generated. As such, the proposed Project would likely result in a net decrease in water consumption. Consequently, new or expanded entitlements would not be required and no impact to water supplies would occur.

- c) **Less-than-Significant Impact.** A significant impact would occur if the volume of stormwater runoff from the proposed Project required the construction of new stormwater drainage facilities or expansion of existing facilities that would cause significant environmental effects.

Modifications to on-site stormwater and drainage infrastructure would be required to accommodate the proposed Project improvements. Minor adverse impacts, e.g., temporary air quality and noise impacts, may occur during construction of these improvements; however, construction or expansion of off-site storm drain facilities, outside the boundaries of the high school campus, would not be required. Once the proposed Project improvements are completed and operational, replacement of natural grass fields with synthetic turf would reduce the amount of water percolating into soils on the site and increase wastewater flows into existing storm drains. However, the increases are not expected to be significant and no off-site improvements to existing storm drains would be required. As such, construction and operation of the proposed Project would result in less-than-significant impacts to the existing stormwater drainage system.

- d) **Less-than-Significant Impact.** Construction of the proposed Project would generate minor amounts of solid waste. Given debris and solid waste generated by construction activities would be limited to the construction period, existing landfills have sufficient long-term permitted capacity to accommodate construction generated solid waste.

The number of athletic events on the athletic fields and the aquatic facility after completion of the proposed Project would be similar to existing; however, the proposed Project would result in a minor increase in football and track field stadium seating capacity. As a consequence, the increase in solid waste due to operation of the proposed Project facilities would be minor. Of the Class III solid waste disposal facilities in Los Angeles County, Chiquita Canyon and Sunshine Canyon have the largest remaining capacity at 56.98 million tons and 55.15 million tons, respectively (Los Angeles County Department of Public Works 2020). The estimated remaining life of Chiquita Canyon is 28 years and

Sunshine Canyon is 18 years. Adequate landfill capacity exists to accommodate Project-generated waste. If disposal would occur at an off-site location, it would be disposed of in accordance with County of Los Angeles regulations. Therefore, the level of impact pertaining to generation of solid waste by Project development and operation would be less than significant.

- e) **No Impact.** A significant impact would occur if the proposed Project generated solid waste that was in excess of or was not disposed of in accordance with any applicable regulations.

As stated in the County of Los Angeles Countywide Integrated Waste Management Plan, the County has established a goal to divert 80-percent of solid waste generated in the unincorporated County areas from landfills by 2025, 90-percent by 2035, and 95-percent or more by 2045 (Los Angeles County Department of Public Works 2020).

As discussed, the proposed Project would generate minor amounts of solid waste, and waste would be disposed of by City of Hawthorne's solid waste collection services, managed by Republic Services, to regulated landfills with adequate capacity to accommodate the waste (City of Hawthorne 2021). Waste generated by the proposed Project, both during construction and operation, would comply with federal, State, and local regulations related to solid waste. As such, there would be no impact.

Wildfire

<i>Issues (and Supporting Information Sources):</i>	<i>Potentially Significant Impact</i>	<i>Less Than Significant with Mitigation Incorporated</i>	<i>Less Than Significant Impact</i>	<i>No Impact</i>
XX. WILDFIRE — If located in or near state responsibility areas or lands classified as very high fire hazard severity zones, would the project:				
a) Substantially impair an adopted emergency response plan or emergency evacuation plan?	<input type="checkbox"/>	<input type="checkbox"/>	<input checked="" type="checkbox"/>	<input type="checkbox"/>
b) Due to slope, prevailing winds, and other factors, exacerbate wildfire risks, and thereby expose project occupants to, pollutant concentrations from a wildfire or the uncontrolled spread of a wildfire?	<input type="checkbox"/>	<input type="checkbox"/>	<input type="checkbox"/>	<input checked="" type="checkbox"/>
c) Require the installation or maintenance of associated infrastructure (such as roads, fuel breaks, emergency water sources, power lines or other utilities) that may exacerbate fire risk or that may result in temporary or ongoing impacts to the environment?	<input type="checkbox"/>	<input type="checkbox"/>	<input type="checkbox"/>	<input checked="" type="checkbox"/>
d) Expose people or structures to significant risks, including downslope or downstream flooding or landslides, as a result of runoff, post-fire slope instability, or drainage changes?	<input type="checkbox"/>	<input type="checkbox"/>	<input type="checkbox"/>	<input checked="" type="checkbox"/>

Discussion

- a) **Less-than-Significant Impact.** The Project site is located within a developed urban area that has not been identified as a wildland fire hazard area. According to the California Department of Forestry and Fire Protection (CAL FIRE) Very High Fire Hazard Severity Zone (VHFHSZ) in Local Responsibility Area Map, the Project site is not located within a fire hazard severity zone (CAL FIRE 2011). As stated under Threshold f in Section IX, *Hazards and Hazardous Materials*, while the City does not have any defined emergency routes, Hawthorne Boulevard and the I-405 are considered emergency routes as they both traverse the City and provide regional access to the greater Los Angeles area (Los Angeles County Department of Public Works 2012). Additionally, all proposed Project activities would occur within the already developed school property and the proposed Project would not allow any construction vehicles or equipment to park or remain stationary for extensive periods of time within any of the main roadways (i.e., West El Segundo Boulevard, South Inglewood Avenue) leading into the Project site.

Construction activities, however, could potentially temporarily obstruct emergency vehicle access to school facilities within the boundaries of the campus. However, it is the contractor’s responsibility to provide a fire watch specialist service for the duration of time that emergency/fire access vehicles may be blocked and/or obstructed during construction unless equivalent alternate measures are taken to ensure continuous access for emergency/fire access vehicles.

After construction of the proposed Project, emergency access would not be substantially changed or impaired compared to existing conditions. As a result, implementation of the proposed Project would not substantially impair an adopted emergency response plan or emergency evacuation plan, and impacts would be less than significant.

- b) **No Impact.** As discussed above, the Project site is within a developed urban area and the Project site is not located within a VHFHSZ (CAL FIRE 2021). While construction activities typically require materials that are considered flammable, such as fuels and chemical cleaners, the handling and storage of such materials would be conducted in accordance with applicable regulations. In addition, the proposed Project would be designed and constructed in accordance with the California Fire Code. After completion of construction, the proposed Project would not substantially change the ongoing operations of the Hawthorne High School athletic facilities and Hawthorne Aquatics Facility. Given the proposed Project would occur on an existing developed school site and aquatic facility, it would not exacerbate wildfire risks, and would not expose people to pollutant concentrations from a wildfire or the uncontrolled spread of a wildfire, as such there would be no impact.
- c) **No Impact.** As discussed in Threshold b above, the Project site is not located within a VHFHSZ, but it is already developed with the Hawthorne High School campus and Hawthorne Aquatics Facility that is served by roads, power lines, water sources, and other utilities. Construction of the proposed Project would utilize existing infrastructure, including roads, water lines, and power lines serving the Project site and surrounding area. Given no new offsite infrastructure would be required to serve the proposed Project and because the Project site is not located in a wildland fire hazard area, the proposed Project would not exacerbate fire risk at the Project site. Thus, no impacts would occur.
- d) **No Impact.** As stated above, the Project site is not located within a VHFHSZ or wildland fire hazard area and is already fully developed with the Hawthorne High School campus and Hawthorne Aquatics Facility that is bordered by residential uses to the north and west, roadway to the east and an existing railroad right-of-way following by the existing Hawthorne High School campus to the south. Additionally, the topography of the Project site and immediately surrounding area is relatively flat and vegetation on the Project site is limited to landscaped areas and there are no natural biological communities in the surrounding Project area. As discussed throughout Section VII, *Geology and Soils*, the Project site is not located within an area identified as having a potential for flooding, landslides, or slope instability. Additionally, as described in Section X, *Hydrology and Water Quality*, the proposed Project would not result in a change to the drainage patterns. For those reasons and because the proposed Project would not substantially change drainage patterns on the Project site or stormwater flows from the site, no post wildland fire hazards such as downstream flooding or slope instability, i.e., landslides, would occur.
-

Mandatory Findings of Significance

<i>Issues (and Supporting Information Sources):</i>	<i>Potentially Significant Impact</i>	<i>Less Than Significant with Mitigation Incorporated</i>	<i>Less Than Significant Impact</i>	<i>No Impact</i>
XXI. MANDATORY FINDINGS OF SIGNIFICANCE —				
a) Does the project have the potential to substantially degrade the quality of the environment, substantially reduce the habitat of a fish or wildlife species, cause a fish or wildlife population to drop below self-sustaining levels, threaten to eliminate a plant or animal community, substantially reduce the number or restrict the range of a rare or endangered plant or animal or eliminate important examples of the major periods of California history or prehistory?	<input type="checkbox"/>	<input checked="" type="checkbox"/>	<input type="checkbox"/>	<input type="checkbox"/>
b) The project has the potential to achieve short-term environmental goals to the disadvantage of long-term environmental goals.	<input type="checkbox"/>	<input checked="" type="checkbox"/>	<input type="checkbox"/>	<input type="checkbox"/>
c) Does the project have impacts that are individually limited, but cumulatively considerable? ("Cumulatively considerable" means that the incremental effects of a project are considerable when viewed in connection with the effects of past projects, the effects of other current projects, and the effects of probable future projects)?	<input type="checkbox"/>	<input checked="" type="checkbox"/>	<input type="checkbox"/>	<input type="checkbox"/>
d) Does the project have environmental effects which will cause substantial adverse effects on human beings, either directly or indirectly?	<input type="checkbox"/>	<input checked="" type="checkbox"/>	<input type="checkbox"/>	<input type="checkbox"/>

Discussion

- a) **Less-than-Significant Impact with Mitigation Incorporated.** Project implementation could lead to development that adversely affects the environment in terms of impacts to various CEQA issue topics, as A significant impact may occur only if the Project would have an identified potentially significant impact on fish or wildlife species, including habitat and population, on a plant or animal community, including elimination of such communities or reduction or restriction of the range of a rare or endangered plant or animal, or historical, archeological or paleontological resources.

As discussed in **Section IV, Biological Resources**, there are no wildlife movement corridors on or near the study area and implementation of the proposed Project would not adversely affect the movements of fish or other wildlife. However, there are a few trees and shrubs onsite near existing buildings that could provide suitable habitat for nesting birds protected by the federal Migratory Bird Treaty Act or California Fish and Game Code sections. The proposed Project has the potential to affect active native resident and/or migratory bird nests if, and to the extent that, those trees are removed or trimmed during the avian nesting season and they contain nests or should construction work occur adjacent to active nests. Mitigation Measure **MM-BIO-1** would avoid or minimize any potential impacts on nesting birds. Thus, the impact would be less than significant after implementation of the proposed Mitigation Measure **MM-BIO-1**.

The proposed Project would not degrade the quality of the environment, reduce or threaten any fish or wildlife species (endangered or otherwise), or eliminate important examples of

the major periods of California history or pre-history. Therefore, impacts from the proposed Project would be less than significant with mitigation incorporated.

- b) **Less-than-Significant Impact with Mitigation Incorporated.** The proposed Project does not include any features that would achieve short-term environmental goals to the disadvantage of long-term environmental goals. The proposed Project incorporates the use of LED lighting, artificial turf in place of natural grass, and compliance with LID standards, which would have long-term beneficial environmental effects while the adverse effects are limited to short-term construction impacts. Appropriate mitigation measures, where necessary, have been identified for both the construction (short-term) and operation (long-term) of the proposed Project, in order to address the short-term and long-term effects of the proposed Project. Feasible mitigation measures are incorporated in **Sections IV, Biological Resources; V, Cultural Resources; VII, Geology and Soils; XIII, Noise; and XVIII, Tribal Cultural Resources**, of this Draft IS/MND, to reduce impacts to less-than-significant levels. None of the mitigation measures are anticipated to achieve short-term environmental goals to the disadvantage of long-term environmental goals. Impacts would therefore be less than significant with mitigation incorporated.
- c) **Less-than-Significant Impact with Mitigation Incorporated.** The proposed Project would result in potentially significant project-level biological resources and cultural resources impacts prior to mitigation.

However, mitigation measures are proposed that would reduce the proposed Project's contribution to any significant cumulative impacts to less than significant. Additionally, the air quality, GHG, and transportation analyses presented in **Section III, Section VIII, and Section XVII**, respectively, of this Draft IS/MND consider cumulative impacts and have determined that cumulative air quality, GHG, and traffic impacts would be less than significant. Furthermore, all reasonably foreseeable future development in the City would be subject to the same land use and environmental regulations that have been described throughout this document. All development projects are guided by the policies identified in the City's General Plan and by the regulations established in the City's Municipal Code. Compliance with applicable land use and environmental regulations and implementation of proposed mitigation measures would ensure that environmental effects associated with the proposed Project would not combine with effects from reasonably foreseeable future development in the City to cause cumulatively considerable significant impacts. Cumulative impacts would therefore be less than significant with mitigation incorporated.

- d) **Less-than-Significant Impact with Mitigation Incorporated.** The proposed Project is not anticipated to result in increased use of the proposed improved athletic and aquatic facilities. While human beings could be affected by a variety of impacts described in this Draft IS/MND, the proposed Project would not have environmental effects that would cause substantial adverse effects on human beings, either directly or indirectly. Construction of the proposed Project could result in temporary increases in ambient noise in the Project area. However, as discussed in **Section XIII, Noise** of this Draft IS/MND, mitigation measures would be implemented that would reduce potential impacts to less

than significant. As such, the proposed Project would not directly or indirectly expose people to substantial adverse effects caused by environmental effects of the Project. As such, impacts would be less than significant with mitigation incorporated.

CHAPTER 4

Report Preparers

Lead Agency

Centinela Valley Union High School District
4859 West El Segundo Boulevard,
Hawthorne, 90260

- Ron Hacker, Assistant Superintendent

Environmental Impact Report Preparation

Environmental Consultant

ESA
626 Wilshire Boulevard, Suite 100
Los Angeles, CA 90017

- Ruta K. Thomas, Project Director
- Olivia Chan, Project Manager
- Sylvia Palomera, Deputy Project Manager
- Anitra Rice, Managing Associate (Air Quality, Greenhouse Gas, Energy, Noise)
- Jonathan Chen, Associate (Air Quality, Greenhouse Gas, Energy)
- Tim Witwer, Associate (Noise)
- Fatima Clark, Senior Associate (Cultural Resources – Archaeological Resources, Paleontological Resources, Tribal Cultural Resources)
- Shadde Rosenblum, Senior Managing Associate (Traffic)
- Denise Kaneshiro, Senior Graphic Designer
- Aaron Guzman, Senior Publications Specialist

Architect

LPA Design Studios
5301 California Avenue, Suite 100
Irvine, CA 92617

Geotechnical Engineers

Ninyo and Moore
475 Goddard, Suite 200
Irvine, CA 92618

- Morteza Mirshekari, PhD, PE Project Engineer
- Ronald Hallum, PG, CEG Principal Geologist
- Soumitra Guha, PhD, PE, GE Principal Engineer

Lighting Engineers

Musco Sports Lighting LLC
100 1st Avenue West
P.O. Box 808
Oskaloosa, IA 52577

- Alexander Vashon, Engineer

CHAPTER 5

References

- American National Standards Institute/Illuminating Engineering Society (ANSI/IES), 2020. RP-6-20: Sports and Recreational Area Lighting.
- Brattstrom, B. H., and A. Sturn. 1959. A new species of fossil turtle from the Pliocene of Oregon, with notes on other fossil Clemmys from western North America. *Bull. South. Calif. Acad. Sci.* 58:65-71.
- CAL FIRE, 2021. California Fire Hazard Severity Zone Viewer. Available at: <https://egis.fire.ca.gov/FHSZ/>. Accessed June 2, 2021.
- California Air Resources Board (CARB), 2008. *Climate Change Scoping Plan*. December 2008. Available: https://www.arb.ca.gov/cc/scopingplan/document/adopted_scoping_plan.pdf. Accessed June 2021.
- _____, Mobile Source Emissions Inventory, <https://www.arb.ca.gov/emfac/2017/>. Accessed July 2020.
- California Building Standards Commission, 2010. California Green Building Standards Code, (2010).
- California Department of Conservation (DOC), 2021. Los Angeles County Tsunami Hazard Area Maps. Available at: <https://www.conservation.ca.gov/cgs/tsunami/maps/los-angeles>. Accessed June 4, 2021.
- California Department of Fish and Wildlife (CDFW), 2019. California Natural Community Conservation Plans. Available at: <https://nrm.dfg.ca.gov/FileHandler.ashx?DocumentID=68626&inline>. Accessed June 4, 2021.
- _____, 2020. *California Natural Diversity Database (CNDDDB) Rarefind 5*. Electronic database, Sacramento, California. Accessed at: <https://wildlife.ca.gov/Data/CNDDDB/Maps-and-Data>. Accessed on June 9, 2021.
- California Department of Forestry and Fire Protection (CAL FIRE), 2011. CALFIRE's Very High Fire Hazard Severity Zones in LRA, Map of Los Angeles. Available at: https://osfm.fire.ca.gov/media/5830/los_angeles.pdf. Accessed June 3, 2021.
- California Department of Forestry and Fire Protection (CAL FIRE), 2021. California Fire Hazard Severity Zone Viewer. Available at: <https://egis.fire.ca.gov/FHSZ/>. Accessed June 2, 2021.
- California Department of Transportation (Caltrans), 2018. California State Scenic Highway System Map, search for 4859 West El Segundo Boulevard, Hawthorne, 90260. Available at: <https://caltrans.maps.arcgis.com/apps/webappviewer/index.html?id=465dfd3d807c46cc8e8057116f1aaca>. Accessed June 9, 2021.

California Department of Transportation, 2013. *Technical Noise Supplement to the Traffic Noise Analysis Protocol*. September 2013

California Department of Transportation, 2013. *Transportation and Construction Vibration Guidance Manual*. September 2013

California Energy Commission, 2018. Gas Consumption by Entity. Available at: <http://www.ecdms.energy.ca.gov/gasbyutil.aspx>. Accessed December 2020

California Energy Commission, 2019 California Annual Retail Fuel Outlet Report Results (CEC-A15) Energy Assessments Division, 2019. Available at <https://www.energy.ca.gov/data-reports/energy-almanac/transportation-energy/california-retail-fuel-outlet-annual-reporting>. Accessed December 2020.

California Environmental Protection Agency (CalEPA), 2021. Cortese List Data Resources. Available at: <https://calepa.ca.gov/SiteCleanup/CorteseList/>. Accessed June 2, 2021.

California Gas and Electric Utilities, 2019 California Gas Report Supplement. Available: https://www.socalgas.com/regulatory/documents/cgr/2019_CGR_Supplement_7-1-19.pdf Accessed July 2020.

California Native Plant Society (CNPS). 2021. *Inventory of Rare and Endangered Plants (online edition, v8-01a)*. Sacramento, CA. <https://rareplants.cnps.org/>. Accessed on June 9, 2021.

California State Department of Conservation, 2016. California Important Farmland Finder. Available at: <https://maps.conservation.ca.gov/DLRP/CIFF/>. Accessed June 1, 2021.

California Vehicle Code, Division 11, Chapter 3, Article 3, Overtaking and Passing [21750 - 21761]. Available at: https://leginfo.legislature.ca.gov/faces/codes_displayText.xhtml?lawCode=VEH&division=11.&title=&part=&chapter=3.&article=3. Accessed June 11, 2021.

CARB, 2017. The 2017 Climate Change Scoping Plan Update – The Proposed Strategy for Achieving California’s 2030 Greenhouse Gas Target. January 2017. Available: https://www.arb.ca.gov/cc/scopingplan/2030sp_pp_final.pdf. Accessed June 2021.

CARB, 2018. California Greenhouse Gas Emission Inventory 2018 Edition. Available: <https://www.arb.ca.gov/cc/inventory/data/data.htm>. Accessed June 2021.

CARB, Proposed Regulation Order: Airborne Toxic Control Measure to Limit Diesel-Fueled Commercial Motor Vehicle Idling, Appendix A, 2004. Available at <https://www.arb.ca.gov/regact/idling/isorappf.pdf> Accessed July 2020.

Centinela Valley Union High School District, 2019. Local Control & Accountability Plan 2019-2020. Available at: <https://4.files.edl.io/3462/04/02/20/170443-42732267-b53e-4e11-84cc-23997eeea505.pdf>. Accessed June 2, 2021.

CGS, 2021. Earthquake Zones of Required Investigation, Mapping System, 4859 West El Segundo Blvd, Hawthorne, CA, 90250, USA. Available at: <https://maps.conservation.ca.gov/cgs/EQZApp/app/>. Accessed June 2, 2021.

- City of Hawthorne, 1989. General Plan Conservation Element, p. 5. Available at:
<https://static1.squarespace.com/static/52ec83cee4b032691e28b3ce/t/55368c28e4b0ce6f220a59eb/1429638184847/1989+GP-Conservation.pdf>. Accessed May 13, 2021.
- _____, 1989. General Plan Safety Element, pp. 4, 11, and 12. Available at:
<https://static1.squarespace.com/static/52ec83cee4b032691e28b3ce/t/55368c6de4b0ce6f220a5bb5/1429638253214/1989+GP-Safety.pdf>. Accessed May 13, 2021
- _____, 2014. General Plan, 2013-2021 Housing Element, p. 54. Available at:
https://static1.squarespace.com/static/52ec83cee4b032691e28b3ce/t/57bf1590f7e0aba6bba36a11/1472140689474/plan_notices-HousingElement2013-2021Final.pdf. Accessed May 13, 2021.
- _____, 2015. General Plan Circulation Element, adopted April 1990, last revised December 4, 2015. Available at:
<https://static1.squarespace.com/static/52ec83cee4b032691e28b3ce/t/568c12e557eb8d622b874954/1452020453389/CIRCULATION+ELEMENT.pdf>. Accessed June 2, 2021.
- _____, 2016. General Plan Land Use Element, pp. 11-12. Available at:
https://static1.squarespace.com/static/52ec83cee4b032691e28b3ce/t/56e0be8222482e207bc8953c/1457569425897/plan_gen-LAND+USE+ELEMENT2016.pdf. Accessed May 13, 2021.
- _____, 2017. Climate Action Plan. November 2017. Available:
https://static1.squarespace.com/static/52ec83cee4b032691e28b3ce/t/5b230139352f530edd02798b/1529020747620/pwks_green-Climate+Action+Plan.pdf. June 2021.
- _____, 2018. General Plan Noise Element.
- _____, 2019. City of Hawthorne Zoning Map. Available at:
https://static1.squarespace.com/static/52ec83cee4b032691e28b3ce/t/5cb616aa9140b726269758a1/1555437245233/plan_Zoning+Map+040119.pdf. Accessed June 2, 2021.
- _____, 2019. City of Hawthorne Summer 2019 Brochure, *Hawthorne Pool*, page 10. Available at:
https://issuu.com/qpress/docs/hawthorne_summer_19. Accessed November 2021.
- _____, 2020. Minutes of a Special Meeting of the City Council – SB 743 Implementation, June 23, 2020. Available at:
https://static1.squarespace.com/static/52ec83cee4b032691e28b3ce/t/5f199c1e5057772fdd212d63/1595513886513/cc_min-062320spcl.pdf. Accessed June 2, 2021.
- _____, 2021. Waste Disposal: Republic Services. Available at:
<https://www.cityofhawthorne.org/trash-pickup>. Accessed June 3, 2021.
- City of Los Angeles Bureau Department of Public Works, 2007. Bureau of Street Lighting Design Standards and Guidelines.
- County of Los Angeles, 2021. *GIS-NET*. Available at:
http://rpgis.isd.lacounty.gov/Html5Viewer/index.html?viewer=GISNET_Public.GIS-NET_Public. Accessed June 1, 2021.

- County of Los Angeles Fire Department, 2021. Los Angeles County Fire Department - Station 160. Available at: <https://locator.lacounty.gov/fire/Location/3034641/los-angeles-county-fire-department---station-160>. Accessed June 2, 2021.
- Data Basin, 2021. Habitat Conservation Plan (HCP), California, 4859 W El Segundo Blvd, Hawthorne, 90250. Available at: <https://databasin.org/maps/new/#datasets=c116dd0d32df408cb44ece185d98731c>. Accessed June 4, 2021.
- Department of Conservation, California Geological Survey. 2021. Fault Activity Map of California. Available at: <https://maps.conservation.ca.gov/cgs/fam/app/>. Accessed May 13, 2021.
- Dibblee, T.W. and Minch, J.A. 2007. Geologic map of the Venice and Inglewood quadrangles, Los Angeles County, California, Dibblee Geological Foundation, Dibblee Foundation Map DF-322, 1: 24,000.
- Ed Data Education Data Partnership, 2021. *Centinela Valley Union High School District*. Available: <http://www.ed-data.org/district/Los-Angeles/Centinela-Valley-Union-High>
- El Segundo High School, 2021a. El Segundo High School 2020/2021 Water Polo Boys Schedule. Available at: https://www.elsegundohigh.org/apps/pages/index.jsp?uREC_ID=50490&type=d&pREC_ID=267944. Accessed November 2021.
- El Segundo High School, 2021b. El Segundo Coed Varsity Swimming, 2020/2021 Schedule. Available at: <https://elsegundoathletics.com/teams/2900489/coed/swimming/varsity/schedule>. Accessed November 2021.
- Federal Emergency Management Agency (FEMA), 2008. FEMA's National Flood Hazard Layer (NFHL) Viewer with Web AppBuilder for ArcGIS. Available at: <https://hazards-fema.maps.arcgis.com/apps/webappviewer/index.html?id=8b0adb51996444d4879338b5529aa9cd>. Accessed June 4, 2021.
- Federal Highway Administration, 2006. *Roadway Construction Noise Model User's Guide*. January 2006
- Federal Transit Administration, 2018. *Transit Noise and Vibration Impact Assessment*. September 2018.
- FEMA, 2021. FEMA Flood Map Service Center, 4859 West El Segundo, Hawthorne, <https://msc.fema.gov/portal/search#searchresultsanchor>. Accessed November 2021.
- Geo-Advantec Inc., 2017. Geotechnical Engineering Evaluation Report for the Proposed Phase 2B/C Developments one-story and two-story buildings and parking lots at: Hawthorne High School 4859 West El Segundo Boulevard Hawthorne, CA 90250. March 27, 2017.
- Graham, R.W., and E.L. Lundelius. 1994. FAUNMAP: A database documenting the late Quaternary distributions of mammal species in the United States. *Illinois State Museum Scientific Papers XXV* (1).

- Green, Andrew. 2021. Sacred Lands File search results from the Native American Heritage Commission, Re: Hawthorne High School Athletic Fields Improvement Project, Los Angeles County. Dated May 26, 2021. Results on file at ESA.
- Hawthorne Municipal Code Section 17.24.020, Permitted uses. Available at: <http://www.qcode.us/codes/hawthorne/index.php?topic=17>. Accessed June 1, 2021.
- Hawthorne Police Department, 2021. Webpage. Available at: <https://hawthornepolice.com/home>. Accessed June 2, 2021.
- Historicaerials.com. 2021. Historic aerial photographs for the years 1952 and 1963. Accessed at <https://www.historicaerials.com/viewer>, July 2021.
- Illuminating Engineering Society of North America (IESNA), 2015. 10th Edition Lighting Handbook, Table 25.5.
- Intergovernmental Panel on Climate Change (IPCC), 2001. *Climate Change 2001: Working Group I: The Scientific Basis*. Available: <http://www.ipcc.ch/ipccreports/tar/wg1/index.php?idp=0>. Accessed June 2021.
- Kott, Isabela. 2021. Records Search Results for Hawthorne High School. Results received from the South Central Coastal Information Center. Results on file at ESA.
- Los Angeles County Airport Land Use Commission (ALUC), 2018. Airports and Airport Influence Areas Map. Available at: https://planning.lacounty.gov/assets/upl/project/ALUC_Airports_Aug2018_rev3.pdf. Accessed June 2, 2021.
- Los Angeles County Department of Public Works, 2012. Disaster Routes with Road Districts for South Los Angeles County, Map. Available at: https://dpw.lacounty.gov/dsg/DisasterRoutes/map/disaster_rdm-South.pdf. Accessed June 3, 2021.
- _____, 2020. Los Angeles County Countywide Integrated Waste Management Plan, 2019 Annual Report. Available at: <https://dpw.lacounty.gov/epd/swims/ShowDoc.aspx?id=14372&hp=yes&type=PDF>. Accessed June 3, 2021.
- LPA, 2021. Hawthorne High School Athletic Fields Improvements Project, C3.01 Storm Drain Plan. November 13, 2020.
- McKenna, Jeanette. 2010. *A Cultural Resources Overview and Architectural Evaluation of the Hawthorne High School Campus, 4859 W. El Segundo Boulevard, Hawthorne, Los Angeles, Co., California*. Report on file at McKenna et al.
- National Wetlands Inventory, 2021. National Wetlands Inventory, Surface Waters and Wetlands, 4859 W El Segundo Blvd, Hawthorne, 90250. Available at: <https://www.fws.gov/wetlands/data/mapper.html>. Accessed June 4, 2021.

- SCAG, 2016. *2016-2040 RTP/SCS*, Available:
http://rtpscs.scag.ca.gov/Documents/2012/final/SR/2012fRTP_GrowthForecast.pdf.
Accessed October 2018.
- South Coast Air Quality Management District (SCAQMD), 2008. *Localized Significance Thresholds*, (2003, revised 2008). Available:
<http://www.aqmd.gov/home/regulations/ceqa/air-quality-analysis-handbook/localized-significance-thresholds>. Accessed December 2020.
- _____, 2019. *South Coast AQMD Air Quality Significance Thresholds*, Revised April 2019. Available: <http://www.aqmd.gov/docs/default-source/ceqa/handbook/scaqmd-air-quality-significance-thresholds.pdf>. Accessed December 2020.
- _____, 2013. *CEQA Air Quality Handbook*, April 1993, p. 12-1.
- _____, 2010. *Minutes for the GHG CEQA Significance Threshold Stakeholder Working Group #15*. Available: [http://www.aqmd.gov/docs/default-source/ceqa/handbook/greenhouse-gases-\(ghg\)-ceqa-significance-thresholds/year-2008-2009/ghg-meeting-15/ghg-meeting-15-minutes.pdf](http://www.aqmd.gov/docs/default-source/ceqa/handbook/greenhouse-gases-(ghg)-ceqa-significance-thresholds/year-2008-2009/ghg-meeting-15/ghg-meeting-15-minutes.pdf). Accessed June 2021
- Bell, Alyssa. 2021. Results of a paleontological resources records search conducted by the Natural History Museum of Los Angeles County; Re: Paleontological resources for the Hawthorne High School Athletic Fields Improvement Project (D202001102.00).
- Southern California Edison (SCE), 2019 *Financial and Statistical Report*.
<https://www.edison.com/content/dam/eix/documents/investors/corporate-governance/eix-sce-2019-annual-report.pdf>. Accessed July 2020.
- State of California Governor's Office of Planning and Research, 2018. *Technical Advisory on Evaluating Transportation Impacts in CEQA*, December 2018. Available at:
https://opr.ca.gov/docs/20190122-743_Technical_Advisory.pdf. Accessed June 2, 2021.
- State Water Resources Control Board, 2021. *GeoTracker Database search for 4859 West El Segundo Boulevard, Hawthorne, 90260*. Available at:
<https://geotracker.waterboards.ca.gov/map/?CMD=runreport&myaddress=4859+West+El+Segundo+Boulevard%2C+Hawthorne%2C+90260>. Accessed June 2, 2021.
- Steadman, D. W. 1980. A Review of the osteology and paleontology of turkeys (Aves: Meleagridinae). *Contributions in Science, Natural History Museum of Los Angeles County* 330:131-207.
- TopoView. 2021. *Historic topographic maps from 1896 and 1924*. Accessed at
<https://ngmdb.usgs.gov/topoview/viewer/#15/33.9173/-118.3631>, July 2021.
- United States Fish and Wildlife Service (USFWS), 2021a. *Information for Planning and Consultation*. Accessible online at: <https://ecos.fws.gov/ipac/>. Accessed on June 9, 2021.
- USFWS, 2021b. *Critical Habitat for Threatened & Endangered Species, 4859 W El Segundo Blvd, Hawthorne, 90250*. Available at:
<https://fws.maps.arcgis.com/home/webmap/viewer.html?webmap=9d8de5e265ad4fe09893cf75b8dbfb77>. Accessed June 4, 2021.

Appendix A

Photometrics Plan

Hawthorne High School Athletic Complex

Hawthorne, CA

Lighting System

Pole / Fixture Summary						
Pole ID	Pole Height	Mtg Height	Fixture Qty	Luminaire Type	Load	Circuit
A1	70'	70'	4	TLC-LED-1500	5.72 kW	C
		70'	1	TLC-LED-400	0.40 kW	D
		16'	1	TLC-BT-575	0.58 kW	C
A2	70'	70'	4	TLC-LED-1500	5.72 kW	C
		70'	1	TLC-LED-400	0.40 kW	D
		16'	1	TLC-BT-575	0.58 kW	C
		70'	4	TLC-LED-1200	4.68 kW	I
A4	60'	60'	2	TLC-LED-1200	2.34 kW	E
		60'	1	TLC-LED-400	0.40 kW	H
		60'	1	TLC-LED-900	0.89 kW	E
		16'	1	TLC-BT-575	0.58 kW	E
B1	80'	80'	6	TLC-LED-1500	8.58 kW	C
		16'	1	TLC-BT-575	0.58 kW	C
B2	80'	80'	6	TLC-LED-1500	8.58 kW	C
		16'	1	TLC-BT-575	0.58 kW	C
		80'	3	TLC-LED-1200	3.51 kW	I
B3	70'	70'	5	TLC-LED-1500	7.15 kW	E
		16'	1	TLC-BT-575	0.58 kW	E
C1	70'	70'	4	TLC-LED-1500	5.72 kW	C
		16'	2	TLC-BT-575	1.15 kW	C
C2	70'	70'	2	TLC-LED-1200	2.34 kW	E
		70'	4	TLC-LED-1500	5.72 kW	C
		70'	1	TLC-LED-400	0.40 kW	H
		70'	1	TLC-LED-900	0.89 kW	E
		16'	2	TLC-BT-575	1.15 kW	C
F1-F2	80'	80'	11	TLC-LED-1500	15.73 kW	A
		16'	2	TLC-BT-575	1.15 kW	A
		70'	1	TLC-LED-400	0.40 kW	B
F3-F4	80'	80'	10	TLC-LED-1500	14.30 kW	A
		20'	2	TLC-BT-575	1.15 kW	A
		70'	1	TLC-LED-400	0.40 kW	B
S1	60'	60'	4	TLC-LED-1500	5.72 kW	F
		16'	1	TLC-BT-575	0.58 kW	F
S2-S3	60'	60'	4	TLC-LED-1500	5.72 kW	G
S4	70'	70'	6	TLC-LED-1500	8.58 kW	F
		16'	1	TLC-BT-575	0.58 kW	F
16			135		162.92 kW	

Circuit Summary			
Circuit	Description	Load	Fixture Qty
A	Football	64.66 kW	50
B	Stadium Egress	1.6 kW	4
C	Baseball	44.64 kW	36
D	Baseball Egress	0.8 kW	2
E	Softball	15.34 kW	14
F	Softball/Soccer 2	15.45 kW	12
G	Soccer 2	11.44 kW	8
H	Softball Egress	0.8 kW	2
I	Basketball	8.19 kW	7

From Hometown to Professional

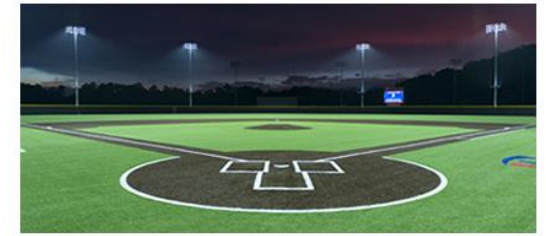

We Make It Happen.

Not to be reproduced in whole or part without the written consent of Musco Sports Lighting, LLC. ©1981, 2020 Musco Sports Lighting, LLC.

Hawthorne High School Athletic Complex

Hawthorne, CA

Fixture Type Summary							
Type	Source	Wattage	Lumens	L90	L80	L70	Quantity
TLC-LED-1500	LED 5700K - 75 CRI	1430W	160,000	>120,000	>120,000	>120,000	93
TLC-BT-575	LED 5700K - 75 CRI	575W	52,000	>120,000	>120,000	>120,000	21
TLC-LED-400	LED 5700K - 75 CRI	400W	46,500	>120,000	>120,000	>120,000	8
TLC-LED-1200	LED 5700K - 75 CRI	1170W	136,000	>120,000	>120,000	>120,000	11
TLC-LED-900	LED 5700K - 75 CRI	890W	89,600	>120,000	>120,000	>120,000	2

Light Level Summary

Calculation Grid Summary								
Grid Name	Calculation Metric	Illumination					Circuits	Fixture Qty
		Ave	Min	Max	Max/Min	Ave/Min		
BB LF Bull Pen	Horizontal	32.3	26	35	1.34	1.24	C	36
BB RF Bull Pen	Horizontal	30.3	22	35	1.64	1.38	C	36
Baseball Egress	Horizontal	12.1	5	18	3.93	2.41	D	2
Baseball (Infield)	Horizontal Illuminance	51.2	37	63	1.71	1.38	C	36
Baseball (Outfield)	Horizontal Illuminance	30.4	19	40	2.11	1.60	C	36
Basketball 1	Horizontal Illuminance	32.6	22	40	1.86	1.48	I	7
Basketball 2	Horizontal Illuminance	36.2	24	44	1.83	1.51	I	7
Basketball 3	Horizontal Illuminance	33	28	38	1.35	1.18	I	7
Football	Horizontal Illuminance	51.5	40	65	1.63	1.29	A	50
Home Bleacher	Horizontal	6.14	2	10	6.82	3.07	B	4
Property Line	Horizontal	1.64	0.02	7.36	478.85	81.94	A,B,C,D,E, F,G,H	128
Property Line	Max Candela (by Fixture)	29029	2712	54598	20.13	10.70	A,B,C,D,E, F,G,H	128
Property Line	Max Vertical Illuminance Metric	2.39	0.06	8.01	128.03	39.81	A,B,C,D,E, F,G,H	128
SB LF Bull Pen	Horizontal	32.4	25	36	1.41	1.30	E,F	26
SB RF Bull Pen	Horizontal	32.4	27	36	1.30	1.20	E,F	26
Soccer 1	Horizontal Illuminance	51.3	40	63	1.56	1.28	A	50
Soccer 2	Horizontal Illuminance	32.3	20	44	2.15	1.62	F,G	20
Softball Egress	Horizontal	13.4	4	20	5.34	3.35	H	2
Softball (Infield)	Horizontal Illuminance	52.9	39	61	1.59	1.36	E,F	26
Softball (Outfield)	Horizontal Illuminance	32	20	48	2.38	1.60	E,F	26
Track	Horizontal Illuminance	26.9	12	45	3.84	2.24	A	50
Visitor Bleacher	Horizontal	5.69	3	7	2.38	1.90	B	4

From Hometown to Professional

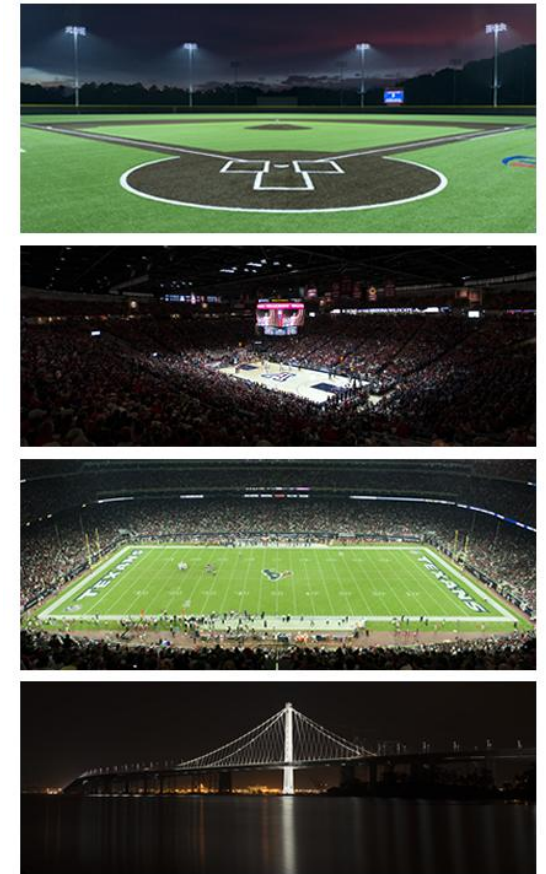

We Make It Happen.

Not to be reproduced in whole or part without the written consent of Musco Sports Lighting, LLC. ©1981, 2020 Musco Sports Lighting, LLC.

EQUIPMENT LIST FOR AREAS SHOWN

Pole		Luminaires						
QTY	LOCATION	SIZE	GRADE ELEVATION	MOUNTING HEIGHT	LUMINAIRE TYPE	QTY / POLE	THIS GRID	OTHER GRIDS
2	F1-F2	80'	-	15.5'	TLC-BT-575	2	2	0
				70'	TLC-LED-400	1	0	1
				80'	TLC-LED-1500	11	11	0
2	F3-F4	80'	-	20'	TLC-BT-575	2	2	0
				70'	TLC-LED-400	1	0	1
				80'	TLC-LED-1500	10	10	0
4	TOTALS					54	50	4

Hawthorne High School Athletic Complex
Hawthorne, CA

GRID SUMMARY

Name: **Football**
Size: 360' x 160'
Spacing: 30.0' x 30.0'
Height: 3.0' above grade

ILLUMINATION SUMMARY

MAINTAINED HORIZONTAL FOOTCANDLES

Entire Grid	
Guaranteed Average:	50
Scan Average:	51.49
Maximum:	65
Minimum:	40
Avg / Min:	1.29
Guaranteed Max / Min:	2
Max / Min:	1.63
UG (adjacent pts):	1.19
CU:	0.48
No. of Points:	72

LUMINAIRE INFORMATION

Applied Circuits: A
No. of Luminaires: **50**
Total Load: 64.66 kW

Guaranteed Performance: The ILLUMINATION described above is guaranteed per your Musco Warranty document and includes a 0.95 dirt depreciation factor.

Field Measurements: Individual field measurements may vary from computer-calculated predictions and should be taken in accordance with IESNA RP-6-15.

Electrical System Requirements: Refer to Amperage Draw Chart and/or the "Musco Control System Summary" for electrical sizing.

Installation Requirements: Results assume ± 3% nominal voltage at line side of the driver and structures located within 3 feet (1m) of design locations.

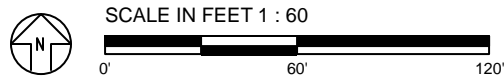
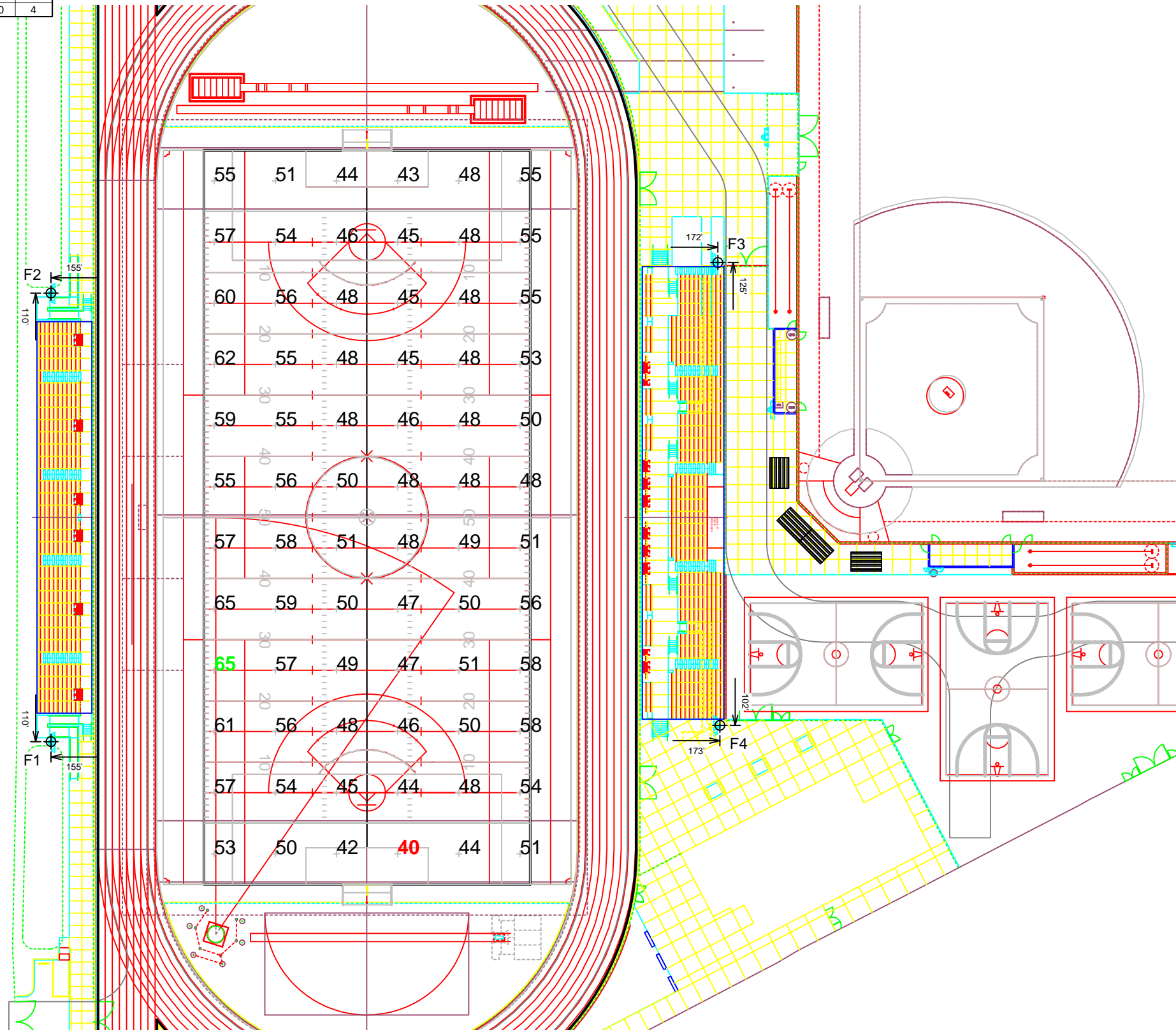

Pole location(s) ⚡ dimensions are relative to 0,0 reference point(s) ⊗



EQUIPMENT LIST FOR AREAS SHOWN

Pole		Luminaires						
QTY	LOCATION	SIZE	GRADE ELEVATION	MOUNTING HEIGHT	LUMINAIRE TYPE	QTY / POLE	THIS GRID	OTHER GRIDS
2	F1-F2	80'	-	15.5'	TLC-BT-575	2	2	0
				70'	TLC-LED-400	1	0	1
				80'	TLC-LED-1500	11	11	0
2	F3-F4	80'	-	20'	TLC-BT-575	2	2	0
				70'	TLC-LED-400	1	0	1
				80'	TLC-LED-1500	10	10	0
4	TOTALS					54	50	4

Hawthorne High School Athletic Complex
Hawthorne, CA

GRID SUMMARY

Name: **Soccer 1**
Size: 360' x 200'
Spacing: 30.0' x 30.0'
Height: 3.0' above grade

ILLUMINATION SUMMARY

MAINTAINED HORIZONTAL FOOTCANDLES

Entire Grid	
Guaranteed Average:	50
Scan Average:	51.29
Maximum:	63
Minimum:	40
Avg / Min:	1.28
Guaranteed Max / Min:	2
Max / Min:	1.56
UG (adjacent pts):	1.25
CU:	0.55
No. of Points:	84

LUMINAIRE INFORMATION

Applied Circuits: A
No. of Luminaires: 50
Total Load: 64.66 kW

Guaranteed Performance: The ILLUMINATION described above is guaranteed per your Musco Warranty document and includes a 0.95 dirt depreciation factor.

Field Measurements: Individual field measurements may vary from computer-calculated predictions and should be taken in accordance with IESNA RP-6-15.

Electrical System Requirements: Refer to Amperage Draw Chart and/or the "Musco Control System Summary" for electrical sizing.

Installation Requirements: Results assume ± 3% nominal voltage at line side of the driver and structures located within 3 feet (1m) of design locations.

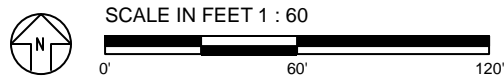
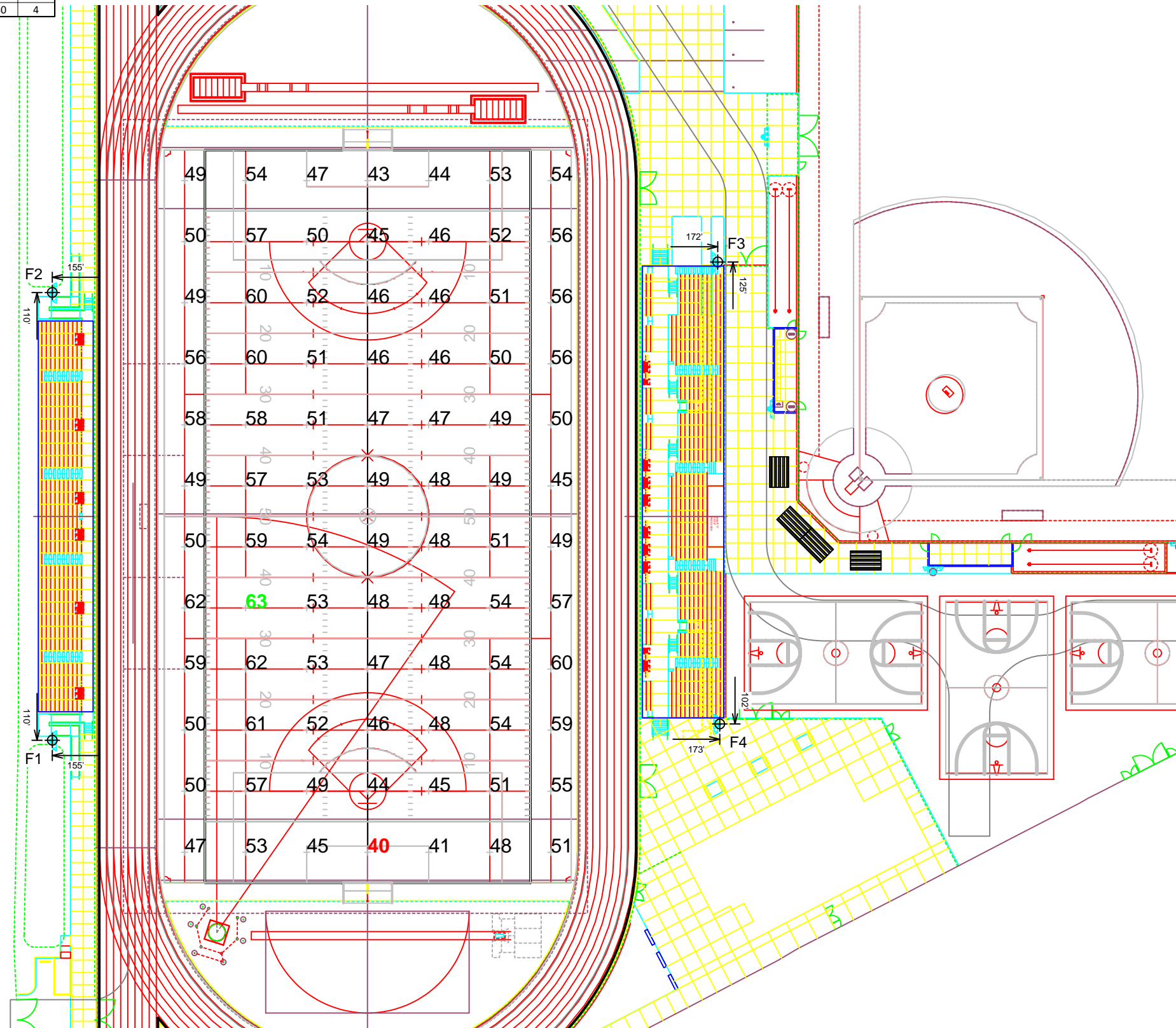

Pole location(s) ⚡ dimensions are relative to 0,0 reference point(s) ⊗



EQUIPMENT LIST FOR AREAS SHOWN

Pole		Luminaires						
QTY	LOCATION	SIZE	GRADE ELEVATION	MOUNTING HEIGHT	LUMINAIRE TYPE	QTY / POLE	THIS GRID	OTHER GRIDS
2	F1-F2	80'	-	15.5'	TLC-BT-575	2	2	0
				70'	TLC-LED-400	1	0	1
				80'	TLC-LED-1500	11	11	0
2	F3-F4	80'	-	20'	TLC-BT-575	2	2	0
				70'	TLC-LED-400	1	0	1
				80'	TLC-LED-1500	10	10	0
4	TOTALS					54	50	4

Hawthorne High School Athletic Complex
Hawthorne, CA

GRID SUMMARY

Name: Track
Size: Irregular
Spacing: 30.0' x 30.0'
Height: 3.0' above grade

ILLUMINATION SUMMARY

MAINTAINED HORIZONTAL FOOTCANDLES

Entire Grid	
Guaranteed Average:	25
Scan Average:	26.89
Maximum:	45
Minimum:	12
Avg / Min:	2.30
Guaranteed Max / Min:	4
Max / Min:	3.84
UG (adjacent pts):	0.00
CU:	0.16
No. of Points:	46

LUMINAIRE INFORMATION

Applied Circuits: A
No. of Luminaires: 50
Total Load: 64.66 kW

Guaranteed Performance: The ILLUMINATION described above is guaranteed per your Musco Warranty document and includes a 0.95 dirt depreciation factor.

Field Measurements: Individual field measurements may vary from computer-calculated predictions and should be taken in accordance with IESNA RP-6-15.

Electrical System Requirements: Refer to Amperage Draw Chart and/or the "Musco Control System Summary" for electrical sizing.

Installation Requirements: Results assume ± 3% nominal voltage at line side of the driver and structures located within 3 feet (1m) of design locations.

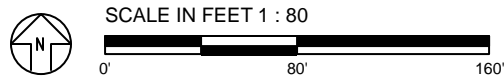
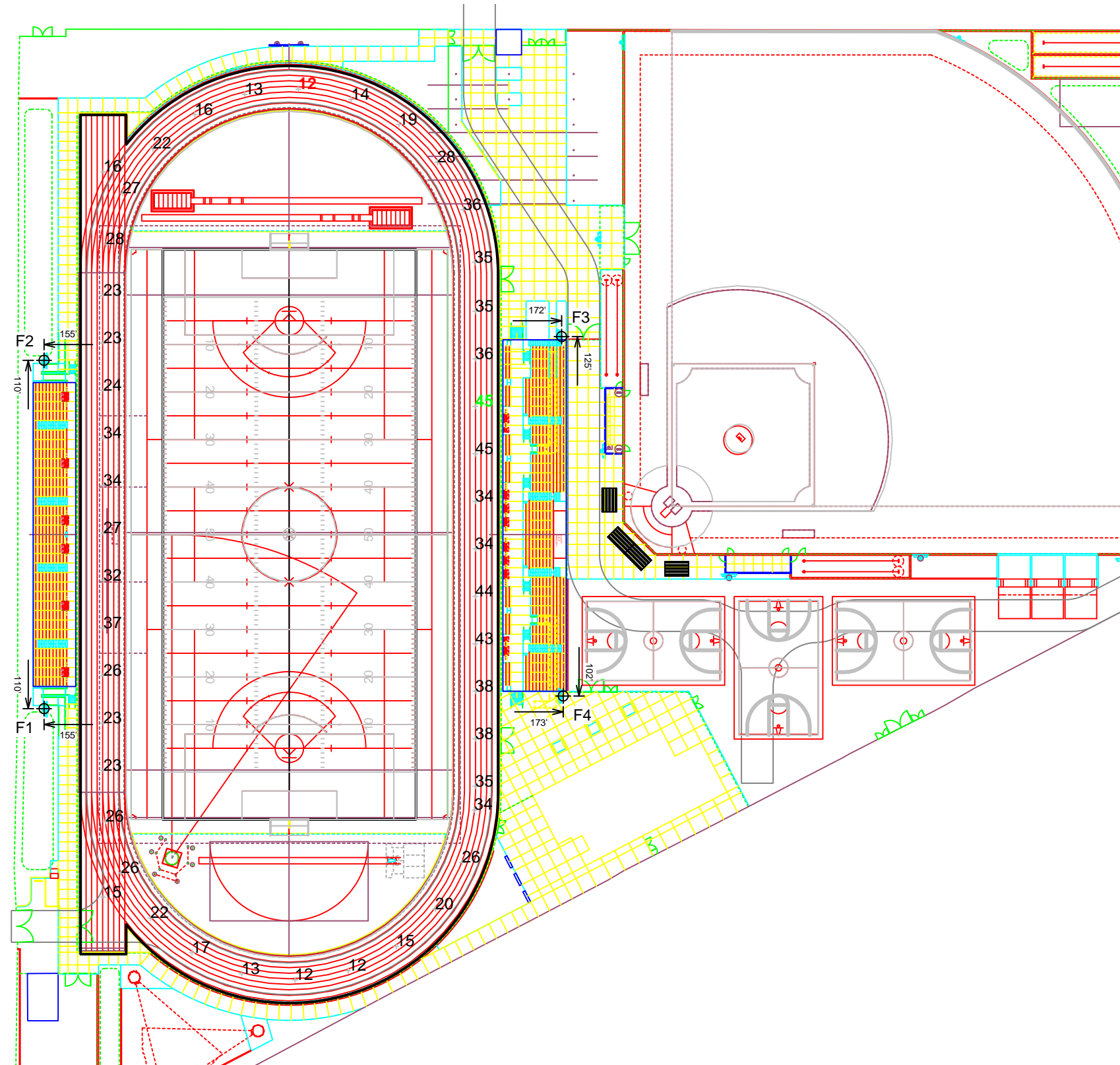

Pole location(s) Ⓢ dimensions are relative to 0,0 reference point(s) ⊗



EQUIPMENT LIST FOR AREAS SHOWN									
Pole				Luminaires					
QTY	LOCATION	SIZE	GRADE ELEVATION	MOUNTING HEIGHT	LUMINAIRE TYPE	QTY / POLE	THIS GRID	OTHER GRIDS	
2	F1-F2	80'	-	15.5'	TLC-BT-575	2	0	2	
				70'	TLC-LED-400	1	1	0	
				80'	TLC-LED-1500	11	0	11	
2	F3-F4	80'	-	20'	TLC-BT-575	2	0	2	
				70'	TLC-LED-400	1	1	0	
				80'	TLC-LED-1500	10	0	10	
4	TOTALS					54	4	50	

GRID SUMMARY	
Name:	Home Bleacher
Size:	Irregular
Spacing:	10.0' x 10.0'

ILLUMINATION SUMMARY	
MAINTAINED HORIZONTAL FOOTCANDLES	
Entire Grid	
Scan Average:	6.14
Maximum:	10
Minimum:	2
Avg / Min:	4.06
Max / Min:	6.82
UG (adjacent pts):	2.08
CU:	0.27
No. of Points:	88
LUMINAIRE INFORMATION	
Applied Circuits:	B
No. of Luminaires:	4
Total Load:	1.6 kW

Guaranteed Performance: The ILLUMINATION described above is guaranteed per your Musco Warranty document and includes a 0.95 dirt depreciation factor.

Field Measurements: Individual field measurements may vary from computer-calculated predictions and should be taken in accordance with IESNA RP-6-15.

Electrical System Requirements: Refer to Amperage Draw Chart and/or the "Musco Control System Summary" for electrical sizing.

Installation Requirements: Results assume ± 3% nominal voltage at line side of the driver and structures located within 3 feet (1m) of design locations.

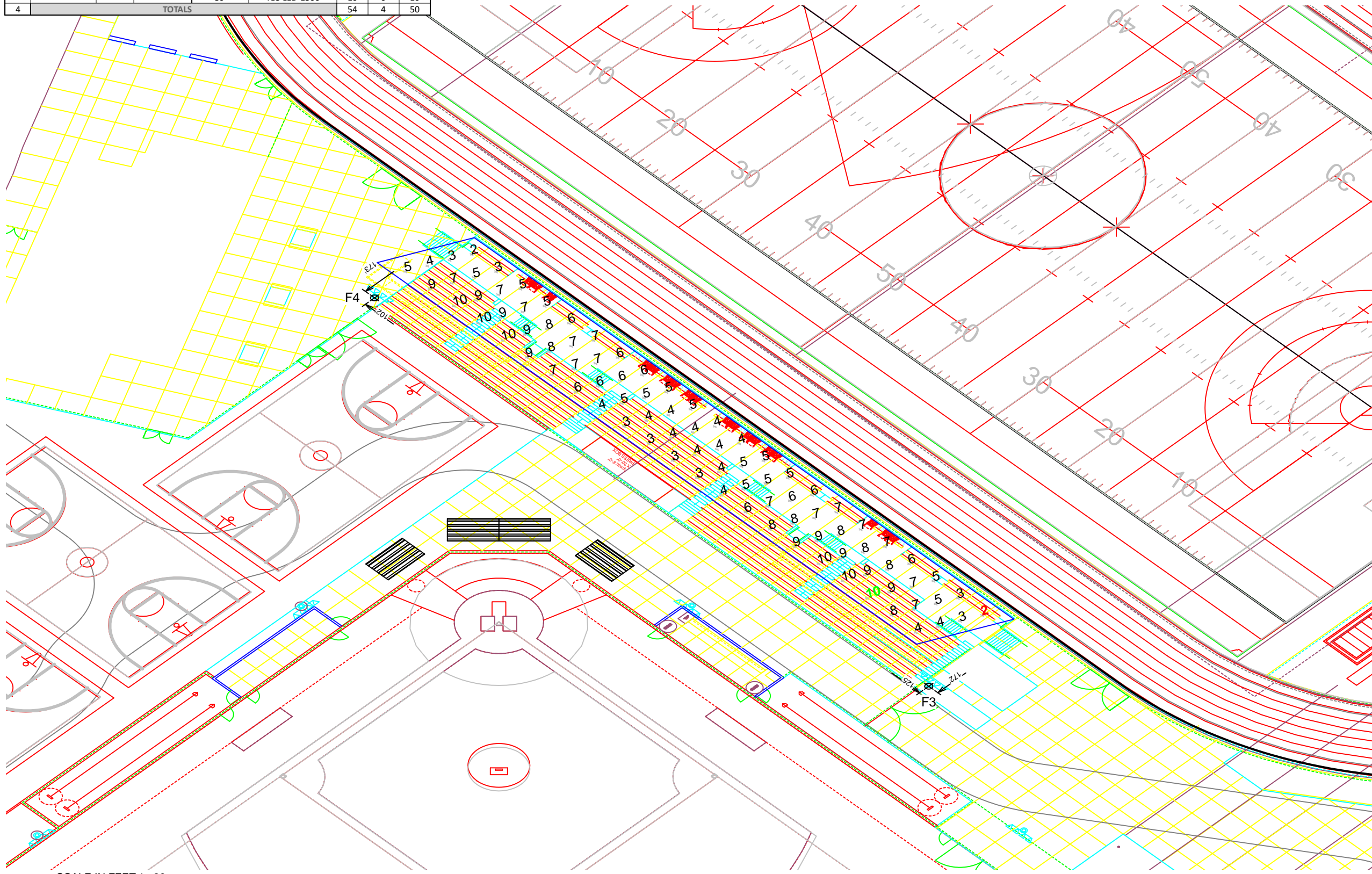

Pole location(s) ⚡ dimensions are relative to 0,0 reference point(s) ⊗



EQUIPMENT LIST FOR AREAS SHOWN								
Pole				Luminaires				
QTY	LOCATION	SIZE	GRADE ELEVATION	MOUNTING HEIGHT	LUMINAIRE TYPE	QTY / POLE	THIS GRID	OTHER GRIDS
2	F1-F2	80'	-	15.5'	TLC-BT-575	2	0	2
				70'	TLC-LED-400	1	1	0
				80'	TLC-LED-1500	11	0	11
2	F3-F4	80'	-	20'	TLC-BT-575	2	0	2
				70'	TLC-LED-400	1	1	0
				80'	TLC-LED-1500	10	0	10
4	TOTALS					54	4	50

GRID SUMMARY	
Name:	Visitor Bleacher
Size:	Irregular
Spacing:	10.0' x 10.0'

ILLUMINATION SUMMARY	
MAINTAINED HORIZONTAL FOOTCANDLES	
Entire Grid	
Scan Average:	5.69
Maximum:	7
Minimum:	3
Avg / Min:	1.86
Max / Min:	2.38
UG (adjacent pts):	1.42
CU:	0.00
No. of Points:	57
LUMINAIRE INFORMATION	
Applied Circuits:	B
No. of Luminaires:	4
Total Load:	1.6 kW

Guaranteed Performance: The ILLUMINATION described above is guaranteed per your Musco Warranty document and includes a 0.95 dirt depreciation factor.

Field Measurements: Individual field measurements may vary from computer-calculated predictions and should be taken in accordance with IESNA RP-6-15.

Electrical System Requirements: Refer to Amperage Draw Chart and/or the "Musco Control System Summary" for electrical sizing.

Installation Requirements: Results assume ± 3% nominal voltage at line side of the driver and structures located within 3 feet (1m) of design locations.

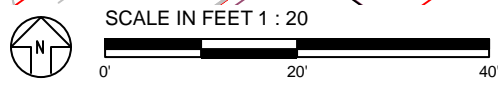
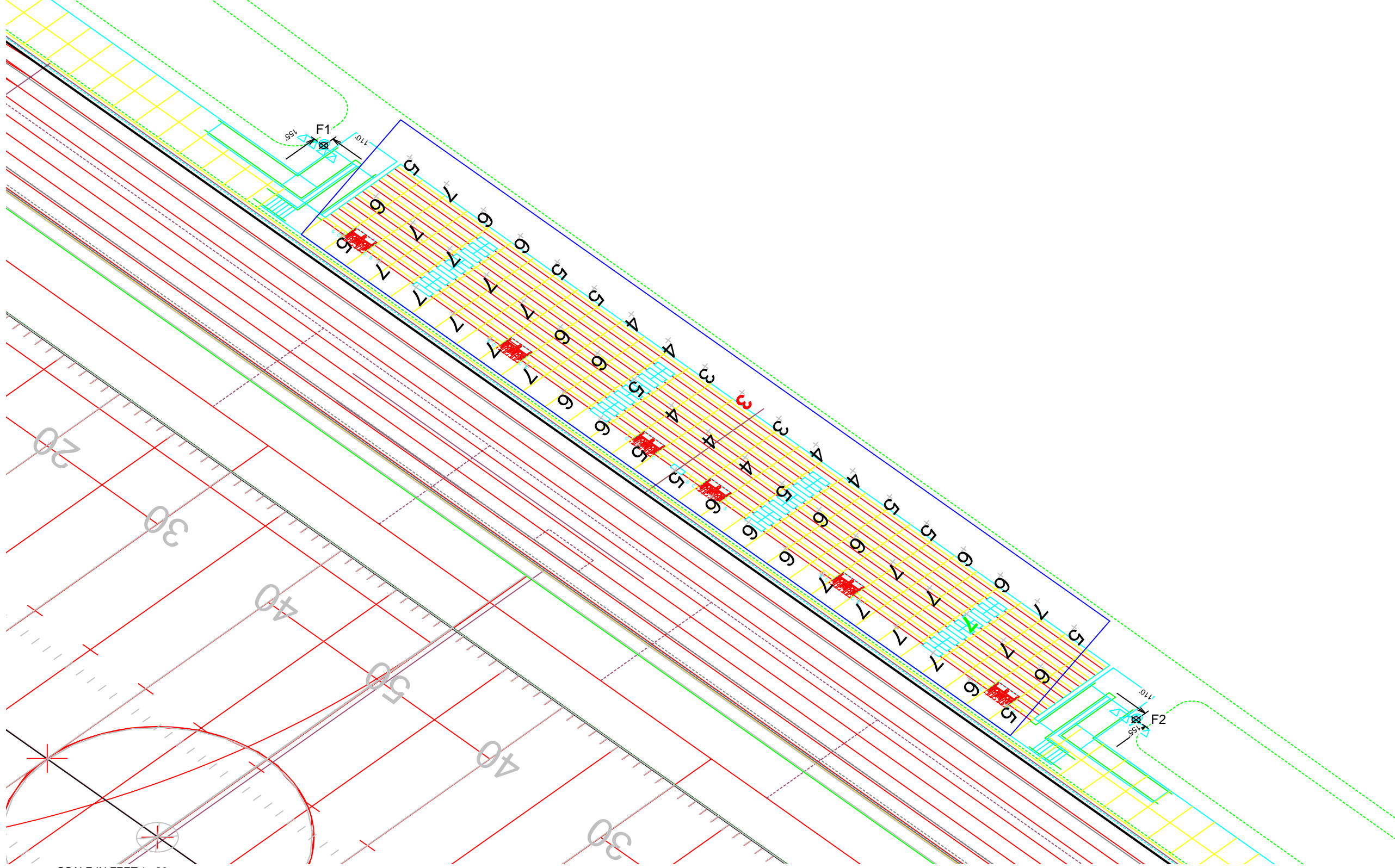

Pole location(s) Ⓢ dimensions are relative to 0,0 reference point(s) ⊗



EQUIPMENT LIST FOR AREAS SHOWN									
Pole			Luminaires						
QTY	LOCATION	SIZE	GRADE ELEVATION	MOUNTING HEIGHT	LUMINAIRE TYPE	QTY / POLE	THIS GRID	OTHER GRIDS	
1	A1	70'	-	70'	TLC-LED-400	1	0	1	
				15.5'	TLC-BT-575	1	1	0	
				70'	TLC-LED-1500	4	4	0	
1	A2	70'	-	70'	TLC-LED-400	1	0	1	
				70'	TLC-LED-1200	4*	0	4	
				15.5'	TLC-BT-575	1	1	0	
				70'	TLC-LED-1500	4	4	0	
				70'	TLC-LED-1500	4	4	0	
1	B1	80'	-	15.5'	TLC-BT-575	1	1	0	
				80'	TLC-LED-1500	6	6	0	
1	B2	80'	3'	83'	TLC-LED-1200	3*	0	3	
				18.5'	TLC-BT-575	1	1	0	
				83'	TLC-LED-1500	6	6	0	
1	C1	70'	-	15.5'	TLC-BT-575	2	2	0	
				70'	TLC-LED-1500	4	4	0	
1	C2	70'	-	70'	TLC-LED-400	1*	0	1	
				70'	TLC-LED-1200	2*	0	2	
				70'	TLC-LED-900	1*	0	1	
				15.5'	TLC-BT-575	2/1*	2	1	
				70'	TLC-LED-1500	4	4	0	
6	TOTALS					50	36	14	

* This structure utilizes a back-to-back mounting configuration

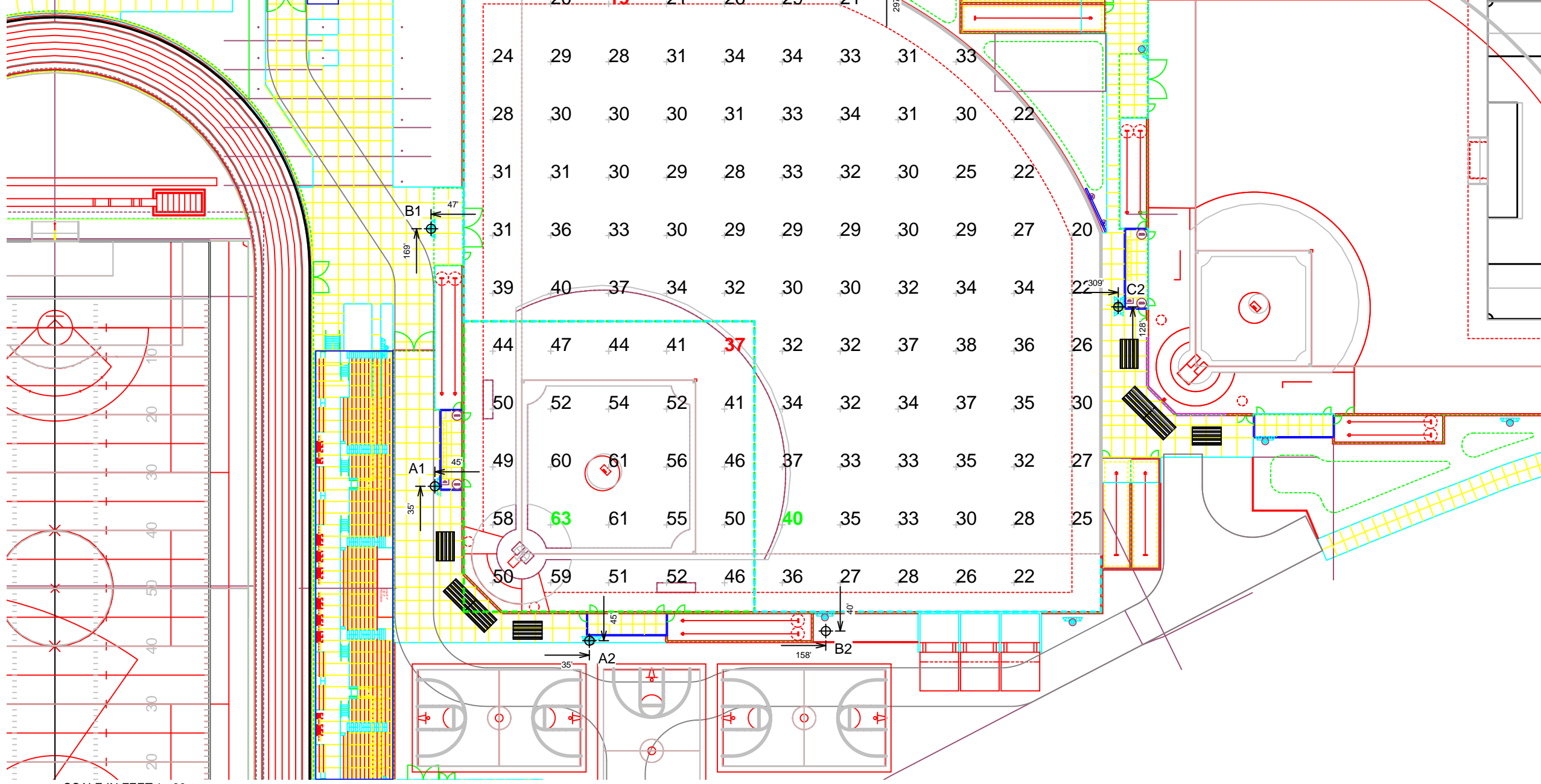

GRID SUMMARY	
Name:	Baseball
Size:	Irregular 300' / 350' / 300'
Spacing:	30.0' x 30.0'
Height:	3.0' above grade

ILLUMINATION SUMMARY		
MAINTAINED HORIZONTAL FOOTCANDLES		
	Infield	Outfield
Guaranteed Average:	50	30
Scan Average:	51.23	30.39
Maximum:	63	40
Minimum:	37	19
Avg / Min:	1.38	1.61
Guaranteed Max / Min:	2	2.5
Max / Min:	1.71	2.11
UG (adjacent pts):	1.26	1.58
CU:	0.75	
No. of Points:	25	86
LUMINAIRE INFORMATION		
Applied Circuits:	C	
No. of Luminaires:	36	
Total Load:	44.64 kW	

Guaranteed Performance: The ILLUMINATION described above is guaranteed per your Musco Warranty document and includes a 0.95 dirt depreciation factor.

Field Measurements: Individual field measurements may vary from computer-calculated predictions and should be taken in accordance with IESNA RP-6-15.

Electrical System Requirements: Refer to Amperage Draw Chart and/or the "Musco Control System Summary" for electrical sizing.

Installation Requirements: Results assume ± 3% nominal voltage at line side of the driver and structures located within 3 feet (1m) of design locations.

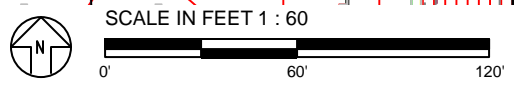

Pole location(s) Ⓧ dimensions are relative to 0,0 reference point(s) ⊗



EQUIPMENT LIST FOR AREAS SHOWN									
Pole				Luminaires					
QTY	LOCATION	SIZE	GRADE ELEVATION	MOUNTING HEIGHT	LUMINAIRE TYPE	QTY / POLE	THIS GRID	OTHER GRIDS	
1	A1	70'	-	70'	TLC-LED-400	1	0	1	
				15.5'	TLC-BT-575	1	1	0	
				70'	TLC-LED-1500	4	4	0	
1	A2	70'	-	70'	TLC-LED-400	1	0	1	
				70'	TLC-LED-1200	4*	0	4	
				15.5'	TLC-BT-575	1	1	0	
				70'	TLC-LED-1500	4	4	0	
1	B1	80'	-	15.5'	TLC-BT-575	1	1	0	
				80'	TLC-LED-1500	6	6	0	
1	B2	80'	3'	83'	TLC-LED-1200	3*	0	3	
				18.5'	TLC-BT-575	1	1	0	
				83'	TLC-LED-1500	6	6	0	
1	C1	70'	-	15.5'	TLC-BT-575	2	2	0	
				70'	TLC-LED-1500	4	4	0	
1	C2	70'	-	70'	TLC-LED-400	1*	0	1	
				70'	TLC-LED-1200	2*	0	2	
				70'	TLC-LED-900	1*	0	1	
				15.5'	TLC-BT-575	2/1*	2	1	
				70'	TLC-LED-1500	4	4	0	
6	TOTALS					50	36	14	

* This structure utilizes a back-to-back mounting configuration

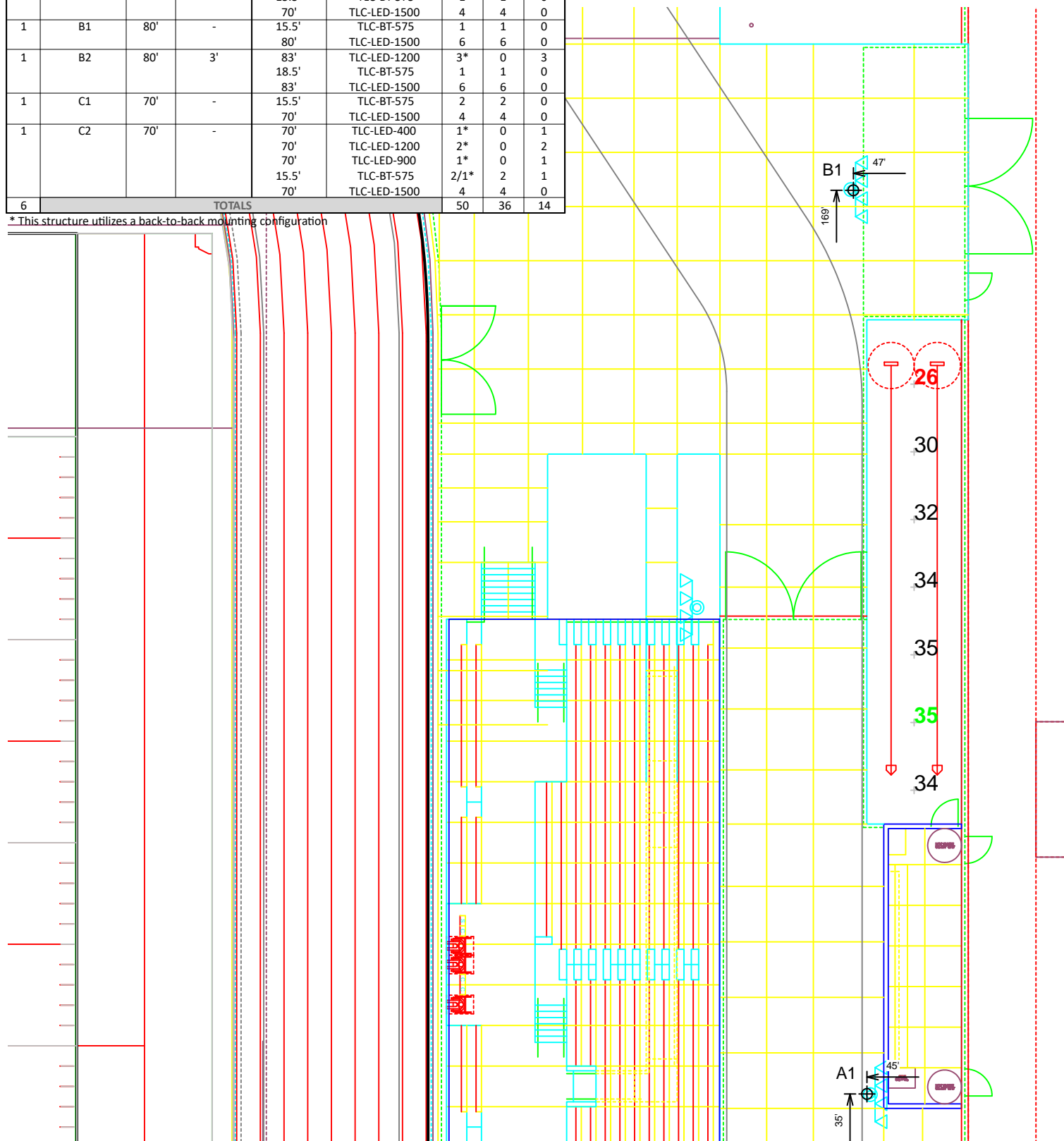

GRID SUMMARY	
Name:	BB LF Bull Pen
Size:	Irregular 300' / 350' / 300'
Spacing:	10.0' x 10.0'
Height:	3.0' above grade

ILLUMINATION SUMMARY	
MAINTAINED HORIZONTAL FOOTCANDLES	
Entire Grid	
Scan Average:	32.31
Maximum:	35
Minimum:	26
Avg / Min:	1.23
Max / Min:	1.34
UG (adjacent pts):	1.14
CU:	0.00
No. of Points:	7
LUMINAIRE INFORMATION	
Applied Circuits:	C
No. of Luminaires:	36
Total Load:	44.64 kW

Guaranteed Performance: The ILLUMINATION described above is guaranteed per your Musco Warranty document and includes a 0.95 dirt depreciation factor.

Field Measurements: Individual field measurements may vary from computer-calculated predictions and should be taken in accordance with IESNA RP-6-15.

Electrical System Requirements: Refer to Amperage Draw Chart and/or the "Musco Control System Summary" for electrical sizing.

Installation Requirements: Results assume ± 3% nominal voltage at line side of the driver and structures located within 3 feet (1m) of design locations.

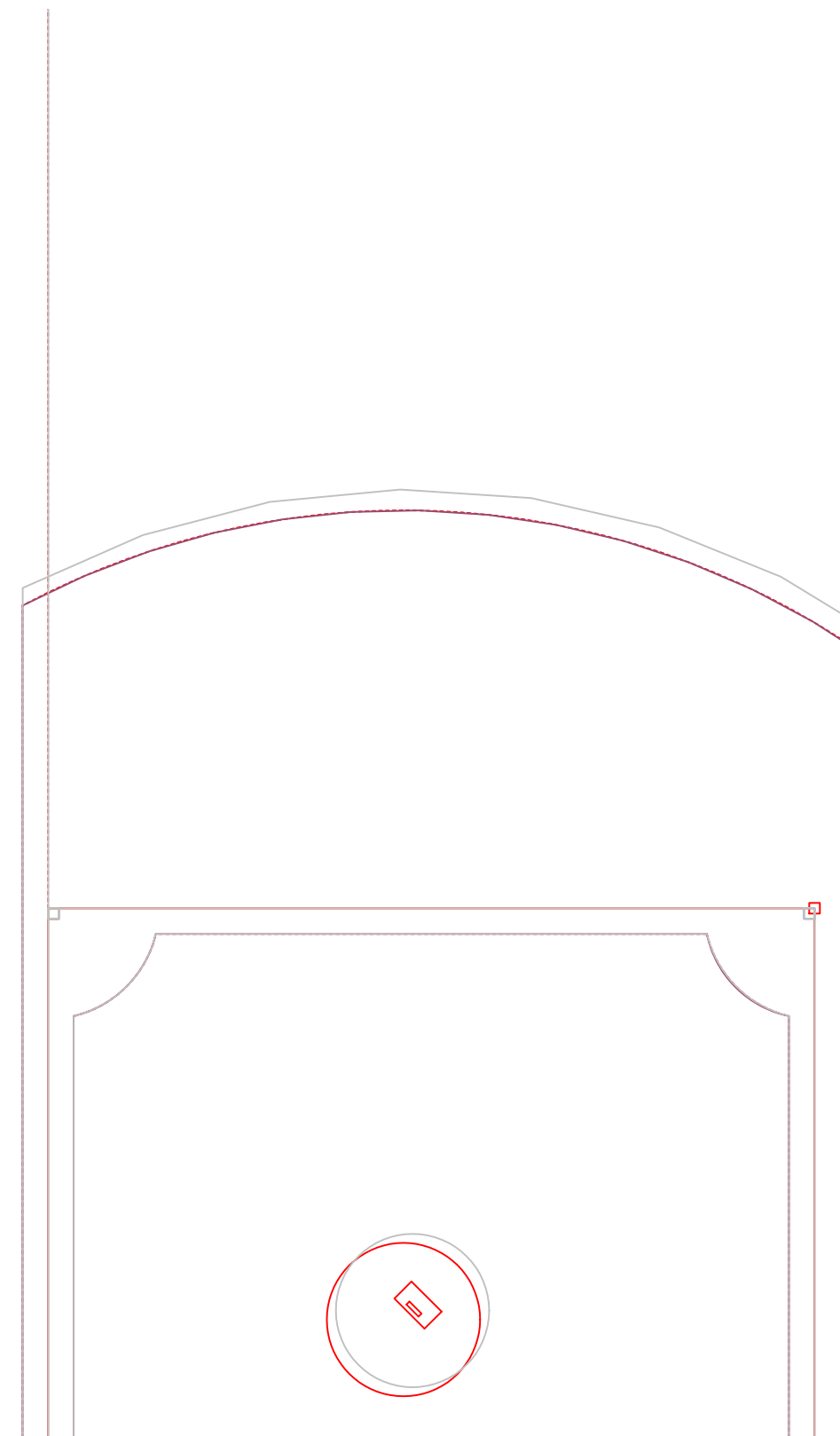
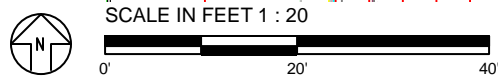

Pole location(s) ⊕ dimensions are relative to 0,0 reference point(s) ⊗



We Make It Happen.

EQUIPMENT LIST FOR AREAS SHOWN							
Pole				Luminaires			
QTY	LOCATION	SIZE	GRADE ELEVATION	MOUNTING HEIGHT	LUMINAIRE TYPE	QTY / POLE	THIS GRID / OTHER GRIDS
1	A1	70'	-	70'	TLC-LED-400	1	0 / 1
				15.5'	TLC-BT-575	1	1 / 0
				70'	TLC-LED-1500	4	4 / 0
1	A2	70'	-	70'	TLC-LED-400	1	0 / 1
				70'	TLC-LED-1200	4*	0 / 4
				15.5'	TLC-BT-575	1	1 / 0
				70'	TLC-LED-1500	4	4 / 0
1	B1	80'	-	15.5'	TLC-BT-575	1	1 / 0
1	B2	80'	3'	80'	TLC-LED-1500	6	6 / 0
				83'	TLC-LED-1200	3*	0 / 3
1	C1	70'	-	18.5'	TLC-BT-575	1	1 / 0
				83'	TLC-LED-1500	6	6 / 0
1	C2	70'	-	15.5'	TLC-BT-575	2	2 / 0
				70'	TLC-LED-1500	4	4 / 0
1		70'	-	70'	TLC-LED-400	1*	0 / 1
				70'	TLC-LED-1200	2*	0 / 2
				70'	TLC-LED-900	1*	0 / 1
				15.5'	TLC-BT-575	2/1*	2 / 1
				70'	TLC-LED-1500	4	4 / 0
6	TOTALS					50	36 / 14

* This structure utilizes a back-to-back mounting configuration

GRID SUMMARY	
Name:	BB RF Bull Pen
Size:	Irregular 300' / 350' / 300'
Spacing:	10.0' x 10.0'
Height:	3.0' above grade

ILLUMINATION SUMMARY	
MAINTAINED HORIZONTAL FOOTCANDLES	
	Entire Grid
Scan Average:	30.31
Maximum:	35
Minimum:	22
Avg / Min:	1.41
Max / Min:	1.64
UG (adjacent pts):	1.19
CU:	0.00
No. of Points:	7

LUMINAIRE INFORMATION	
Applied Circuits:	C
No. of Luminaires:	36
Total Load:	44.64 kW

Guaranteed Performance: The ILLUMINATION described above is guaranteed per your Musco Warranty document and includes a 0.95 dirt depreciation factor.

Field Measurements: Individual field measurements may vary from computer-calculated predictions and should be taken in accordance with IESNA RP-6-15.

Electrical System Requirements: Refer to Amperage Draw Chart and/or the "Musco Control System Summary" for electrical sizing.

Installation Requirements: Results assume ± 3% nominal voltage at line side of the driver and structures located within 3 feet (1m) of design locations.

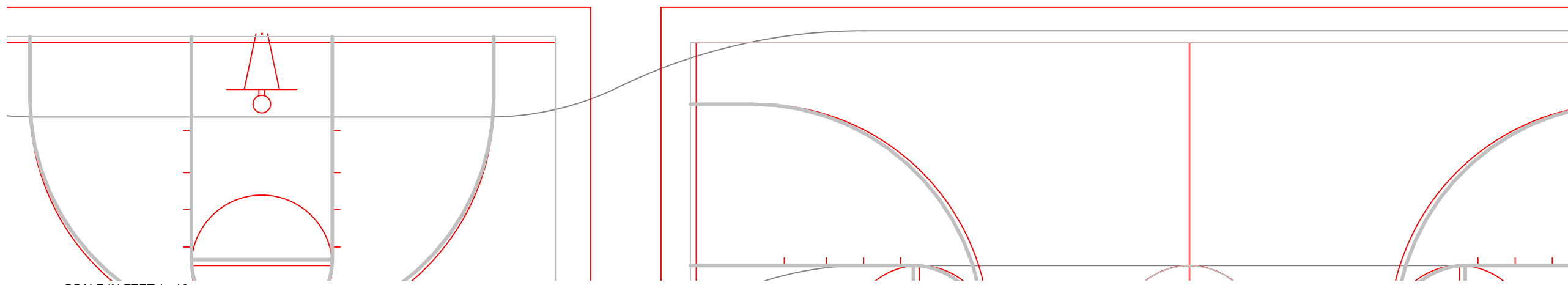
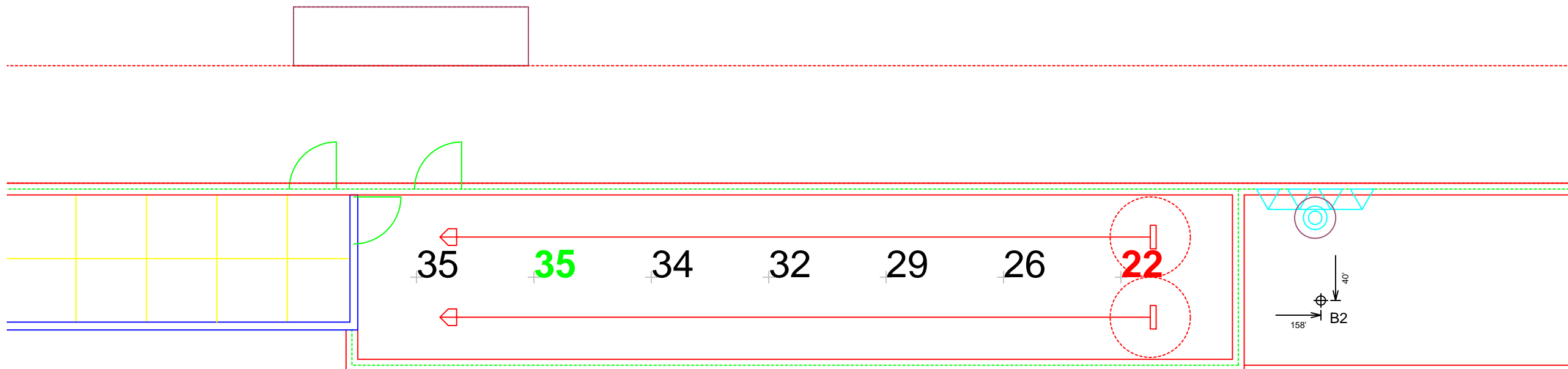

Pole location(s) Ⓢ dimensions are relative to 0,0 reference point(s) ⊗



Not to be reproduced in whole or part without the written consent of Musco Sports Lighting, LLC. ©1981, 2020 Musco Sports Lighting, LLC.

EQUIPMENT LIST FOR AREAS SHOWN							
Pole				Luminaires			
QTY	LOCATION	SIZE	GRADE ELEVATION	MOUNTING HEIGHT	LUMINAIRE TYPE	QTY / POLE	THIS GRID / OTHER GRIDS
1	A1	70'	-	70'	TLC-LED-400	1	1 0
				15.5'	TLC-BT-575	1	0 1
				70'	TLC-LED-1500	4	0 4
1	A2	70'	-	70'	TLC-LED-400	1	1 0
				70'	TLC-LED-1200	4*	0 4
				15.5'	TLC-BT-575	1	0 1
				70'	TLC-LED-1500	4	0 4
2	TOTALS					16	2 14

* This structure utilizes a back-to-back mounting configuration

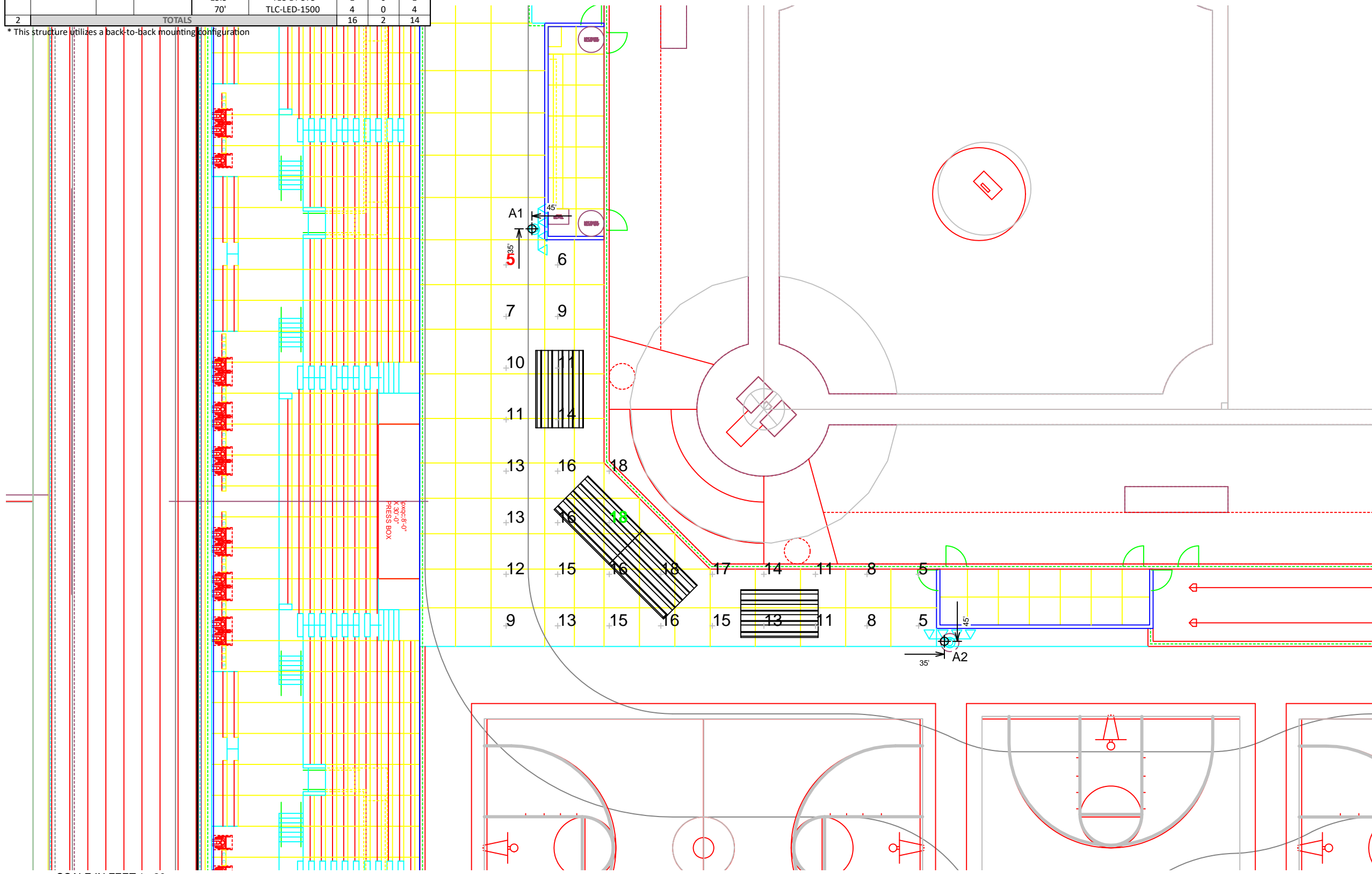

GRID SUMMARY	
Name:	Baseball Egress
Size:	Irregular 300' / 350' / 300'
Spacing:	10.0' x 10.0'
Height:	3.0' above grade

ILLUMINATION SUMMARY	
MAINTAINED HORIZONTAL FOOTCANDLES	
Entire Grid	
Scan Average:	12.06
Maximum:	18
Minimum:	5
Avg / Min:	2.64
Max / Min:	3.93
UG (adjacent pts):	1.77
CU:	0.42
No. of Points:	32
LUMINAIRE INFORMATION	
Applied Circuits:	D
No. of Luminaires:	2
Total Load:	0.8 kW

Guaranteed Performance: The ILLUMINATION described above is guaranteed per your Musco Warranty document and includes a 0.95 dirt depreciation factor.

Field Measurements: Individual field measurements may vary from computer-calculated predictions and should be taken in accordance with IESNA RP-6-15.

Electrical System Requirements: Refer to Amperage Draw Chart and/or the "Musco Control System Summary" for electrical sizing.

Installation Requirements: Results assume ± 3% nominal voltage at line side of the driver and structures located within 3 feet (1m) of design locations.

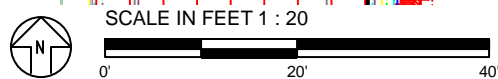

Pole location(s) Ⓢ dimensions are relative to 0,0 reference point(s) ⊗



We Make It Happen.

EQUIPMENT LIST FOR AREAS SHOWN

Pole		Luminaires						
QTY	LOCATION	SIZE	GRADE ELEVATION	MOUNTING HEIGHT	LUMINAIRE TYPE	QTY / POLE	THIS GRID	OTHER GRIDS
1	A4	60'	-	60'	TLC-LED-1200	2	2	0
				60'	TLC-LED-900	1	1	0
				15.5'	TLC-BT-575	1	1	0
				60'	TLC-LED-400	1	0	1
1	B3	70'	-	15.5'	TLC-BT-575	1	1	0
				70'	TLC-LED-1500	5	5	0
1	C2	70'	-	70'	TLC-LED-400	1*	0	1
				70'	TLC-LED-1200	2*	2	0
				70'	TLC-LED-900	1*	1	0
				15.5'	TLC-BT-575	2/1*	1	2
				70'	TLC-LED-1500	4	0	4
1	S1	60'	-	15.5'	TLC-BT-575	1	1	0
1	S4	70'	-	60'	TLC-LED-1500	4	4	0
				15.5'	TLC-BT-575	1	1	0
5	TOTALS					34	26	8

* This structure utilizes a back-to-back mounting configuration

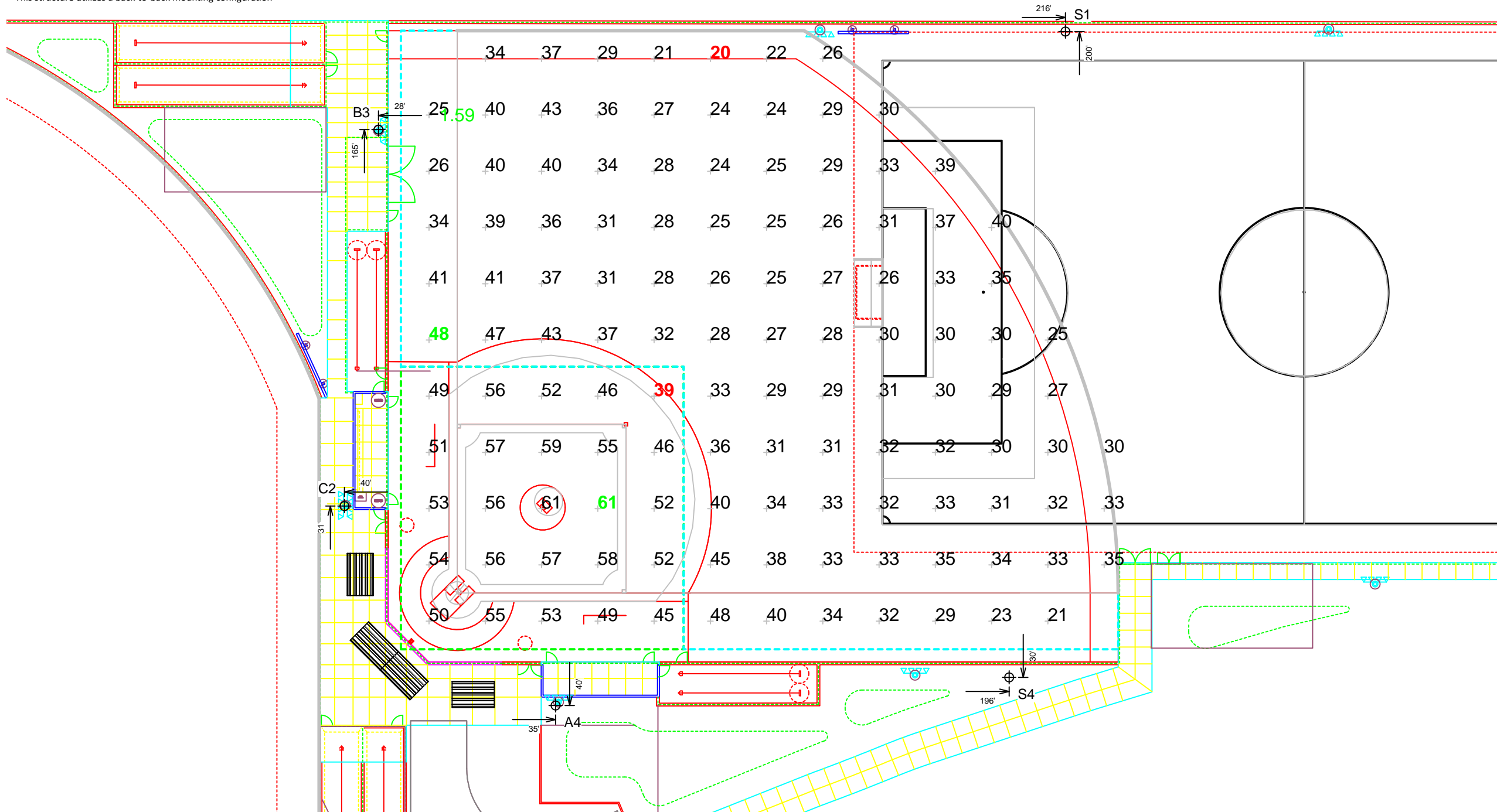

Hawthorne High School Athletic Complex
Hawthorne, CA

GRID SUMMARY		
Name:	Softball	
Size:	Irregular 200' / 235' / 235'	
Spacing:	20.0' x 20.0'	
Height:	3.0' above grade	

ILLUMINATION SUMMARY		
MAINTAINED HORIZONTAL FOOTCANDLES		
	Infield	Outfield
Guaranteed Average:	50	30
Scan Average:	52.87	32.00
Maximum:	61	48
Minimum:	39	20
Avg / Min:	1.37	1.58
Guaranteed Max / Min:	2	2.5
Max / Min:	1.59	2.38
UG (adjacent pts):	1.20	1.59
CU:	0.55	
No. of Points:	25	98

LUMINAIRE INFORMATION		
Applied Circuits:	E, F	
No. of Luminaires:	26	
Total Load:	30.79 kW	

Guaranteed Performance: The ILLUMINATION described above is guaranteed per your Musco Warranty document and includes a 0.95 dirt depreciation factor.

Field Measurements: Individual field measurements may vary from computer-calculated predictions and should be taken in accordance with IESNA RP-6-15.

Electrical System Requirements: Refer to Amperage Draw Chart and/or the "Musco Control System Summary" for electrical sizing.

Installation Requirements: Results assume ± 3% nominal voltage at line side of the driver and structures located within 3 feet (1m) of design locations.

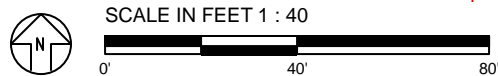

ENGINEERED DESIGN By: Vashon Alexander · File #207400A · 03-Sep-20

Pole location(s) Ⓢ dimensions are relative to 0,0 reference point(s) ⊗



Not to be reproduced in whole or part without the written consent of Musco Sports Lighting, LLC. ©1981, 2020 Musco Sports Lighting, LLC.

ILLUMINATION SUMMARY

EQUIPMENT LIST FOR AREAS SHOWN							
Pole				Luminaires			
QTY	LOCATION	SIZE	GRADE ELEVATION	MOUNTING HEIGHT	LUMINAIRE TYPE	QTY / POLE	THIS GRID / OTHER GRIDS
1	A4	60'	-	60'	TLC-LED-1200	2	2 0
				60'	TLC-LED-900	1	1 0
				15.5'	TLC-BT-575	1	1 0
				60'	TLC-LED-400	1	0 1
1	B3	70'	-	15.5'	TLC-BT-575	1	1 0
				70'	TLC-LED-1500	5	5 0
1	C2	70'	-	70'	TLC-LED-400	1*	0 1
				70'	TLC-LED-1200	2*	2 0
				70'	TLC-LED-900	1*	1 0
				15.5'	TLC-BT-575	2/1*	1 2
				70'	TLC-LED-1500	4	0 4
1	S1	60'	-	15.5'	TLC-BT-575	1	1 0
				60'	TLC-LED-1500	4	4 0
1	S4	70'	-	15.5'	TLC-BT-575	1	1 0
				70'	TLC-LED-1500	6	6 0
5	TOTALS					34	26 8

* This structure utilizes a back-to-back mounting configuration

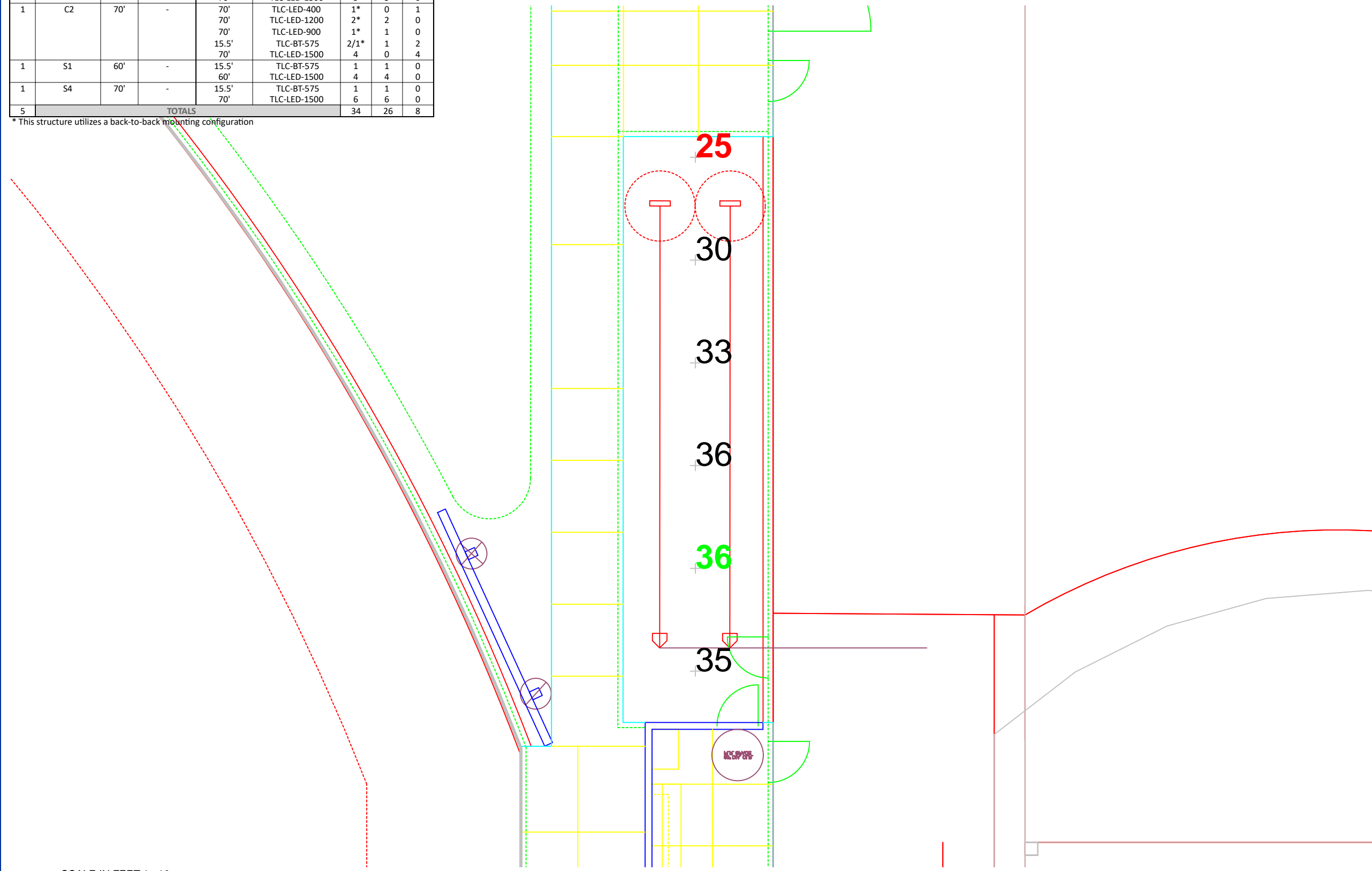

Hawthorne High School Athletic Complex
Hawthorne, CA

GRID SUMMARY	
Name:	SB LF Bull Pen
Size:	Irregular 200' / 235' / 235'
Spacing:	10.0' x 10.0'
Height:	3.0' above grade

ILLUMINATION SUMMARY	
MAINTAINED HORIZONTAL FOOTCANDLES	
Entire Grid	
Scan Average:	32.43
Maximum:	36
Minimum:	25
Avg / Min:	1.28
Max / Min:	1.41
UG (adjacent pts):	1.17
CU:	0.01
No. of Points:	6
LUMINAIRE INFORMATION	
Applied Circuits:	E, F
No. of Luminaires:	26
Total Load:	30.79 kW

Guaranteed Performance: The ILLUMINATION described above is guaranteed per your Musco Warranty document and includes a 0.95 dirt depreciation factor.

Field Measurements: Individual field measurements may vary from computer-calculated predictions and should be taken in accordance with IESNA RP-6-15.

Electrical System Requirements: Refer to Amperage Draw Chart and/or the "Musco Control System Summary" for electrical sizing.

Installation Requirements: Results assume ± 3% nominal voltage at line side of the driver and structures located within 3 feet (1m) of design locations.



SCALE IN FEET 1 : 10

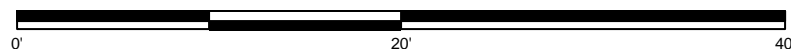

ENGINEERED DESIGN By: Vashon Alexander · File #207400A · 03-Sep-20

Pole location(s) ⊕ dimensions are relative to 0,0 reference point(s) ⊗



We Make It Happen.

Not to be reproduced in whole or part without the written consent of Musco Sports Lighting, LLC. ©1981, 2020 Musco Sports Lighting, LLC.

ILLUMINATION SUMMARY

EQUIPMENT LIST FOR AREAS SHOWN								
Pole			Luminaires					
QTY	LOCATION	SIZE	GRADE ELEVATION	MOUNTING HEIGHT	LUMINAIRE TYPE	QTY / POLE	THIS GRID	OTHER GRIDS
1	A4	60'	-	60'	TLC-LED-1200	2	2	0
				60'	TLC-LED-900	1	1	0
				15.5'	TLC-BT-575	1	1	0
				60'	TLC-LED-400	1	0	1
1	B3	70'	-	15.5'	TLC-BT-575	1	1	0
				70'	TLC-LED-1500	5	5	0
1	C2	70'	-	70'	TLC-LED-400	1*	0	1
				70'	TLC-LED-1200	2*	2	0
				70'	TLC-LED-900	1*	1	0
				15.5'	TLC-BT-575	2/1*	1	2
				70'	TLC-LED-1500	4	0	4
1	S1	60'	-	15.5'	TLC-BT-575	1	1	0
				60'	TLC-LED-1500	4	4	0
1	S4	70'	-	15.5'	TLC-BT-575	1	1	0
				70'	TLC-LED-1500	6	6	0
5	TOTALS					34	26	8

* This structure utilizes a back-to-back mounting configuration

GRID SUMMARY	
Name:	SB RF Bull Pen
Size:	Irregular 200' / 235' / 235'
Spacing:	10.0' x 10.0'
Height:	3.0' above grade

ILLUMINATION SUMMARY	
MAINTAINED HORIZONTAL FOOTCANDLES	
	Entire Grid
Scan Average:	32.44
Maximum:	36
Minimum:	27
Avg / Min:	1.18
Max / Min:	1.30
UG (adjacent pts):	1.10
CU:	0.01
No. of Points:	6
LUMINAIRE INFORMATION	
Applied Circuits:	E, F
No. of Luminaires:	26
Total Load:	30.79 kW

Guaranteed Performance: The ILLUMINATION described above is guaranteed per your Musco Warranty document and includes a 0.95 dirt depreciation factor.

Field Measurements: Individual field measurements may vary from computer-calculated predictions and should be taken in accordance with IESNA RP-6-15.

Electrical System Requirements: Refer to Amperage Draw Chart and/or the "Musco Control System Summary" for electrical sizing.

Installation Requirements: Results assume ± 3% nominal voltage at line side of the driver and structures located within 3 feet (1m) of design locations.

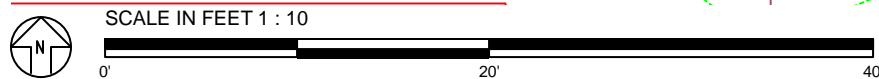
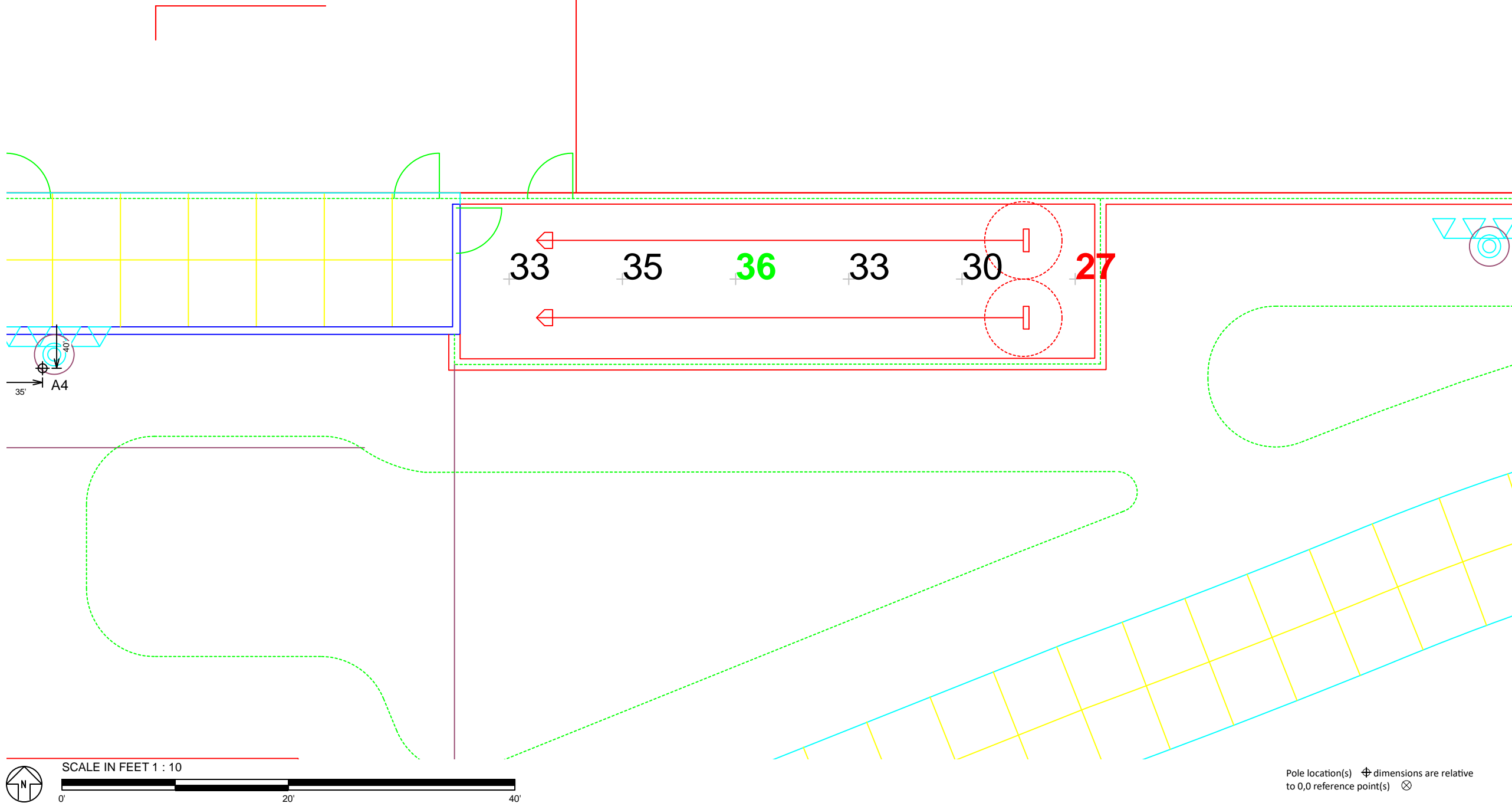

Pole location(s) ⊗ dimensions are relative to 0,0 reference point(s) ⊗

EQUIPMENT LIST FOR AREAS SHOWN

Pole				Luminaires				
QTY	LOCATION	SIZE	GRADE ELEVATION	MOUNTING HEIGHT	LUMINAIRE TYPE	QTY / POLE	THIS GRID	OTHER GRIDS
1	A4	60'	-	60'	TLC-LED-1200	2	0	2
				60'	TLC-LED-900	1	0	1
				15.5'	TLC-BT-575	1	0	1
				60'	TLC-LED-400	1	1	0
1	C2	70'	-	70'	TLC-LED-400	1*	1	0
				70'	TLC-LED-1200	2*	0	2
				70'	TLC-LED-900	1*	0	1
				15.5'	TLC-BT-575	2/1*	0	3
				70'	TLC-LED-1500	4	0	4
2	TOTALS					16	2	14

* This structure utilizes a back-to-back mounting configuration

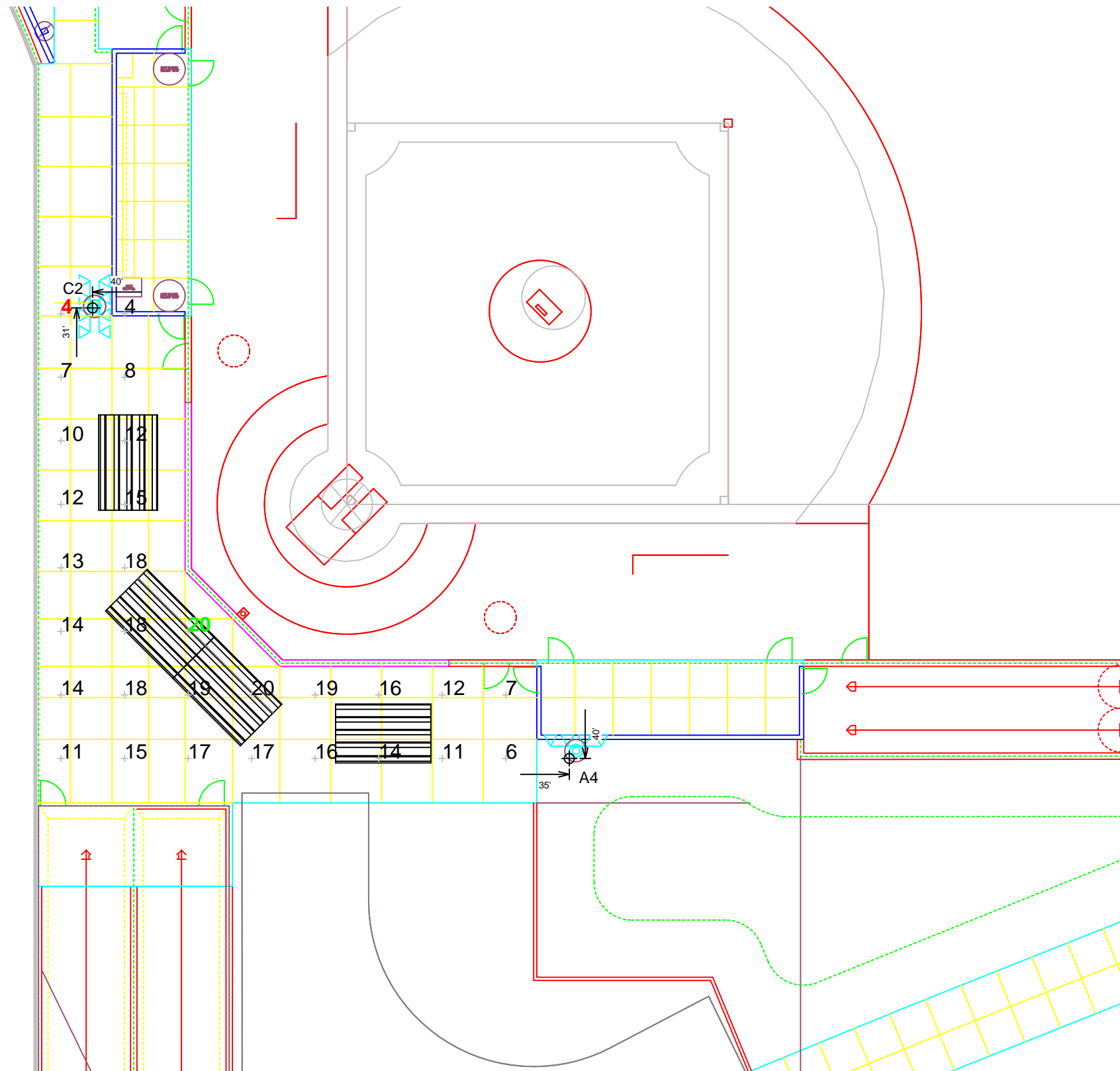

Pole location(s) ⊕ dimensions are relative to 0,0 reference point(s) ⊗

Hawthorne High School Athletic Complex
Hawthorne, CA

GRID SUMMARY

Name: Softball Egress
Size: Irregular 200' / 235' / 235'
Spacing: 10.0' x 10.0'
Height: 3.0' above grade

ILLUMINATION SUMMARY

MAINTAINED HORIZONTAL FOOTCANDLES

Entire Grid

Scan Average: 13.38
Maximum: 20
Minimum: 4
Avg / Min: 3.56
Max / Min: 5.34
UG (adjacent pts): 1.89
CU: 0.43
No. of Points: 29

LUMINAIRE INFORMATION

Applied Circuits: H
No. of Luminaires: 2
Total Load: 0.8 kW

Guaranteed Performance: The ILLUMINATION described above is guaranteed per your Musco Warranty document and includes a 0.95 dirt depreciation factor.

Field Measurements: Individual field measurements may vary from computer-calculated predictions and should be taken in accordance with IESNA RP-6-15.

Electrical System Requirements: Refer to Amperage Draw Chart and/or the "Musco Control System Summary" for electrical sizing.

Installation Requirements: Results assume ± 3% nominal voltage at line side of the driver and structures located within 3 feet (1m) of design locations.

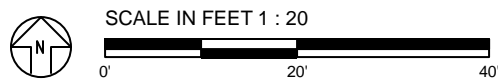

EQUIPMENT LIST FOR AREAS SHOWN								
Pole				Luminaires				
QTY	LOCATION	SIZE	GRADE ELEVATION	MOUNTING HEIGHT	LUMINAIRE TYPE	QTY / POLE	THIS GRID	OTHER GRIDS
1	S1	60'	-	15.5'	TLC-BT-575	1	1	0
				60'	TLC-LED-1500	4	4	0
2	S2-S3	60'	-	60'	TLC-LED-1500	4	4	0
1	S4	70'	-	15.5'	TLC-BT-575	1	1	0
				70'	TLC-LED-1500	6	6	0
4	TOTALS					20	20	0

Hawthorne High School Athletic Complex
Hawthorne, CA

GRID SUMMARY	
Name:	Soccer 2
Size:	300' x 165'
Spacing:	30.0' x 30.0'
Height:	3.0' above grade

ILLUMINATION SUMMARY	
MAINTAINED HORIZONTAL FOOTCANDLES	
	Entire Grid
Guaranteed Average:	30
Scan Average:	32.32
Maximum:	44
Minimum:	20
Avg / Min:	1.58
Guaranteed Max / Min:	2.5
Max / Min:	2.15
UG (adjacent pts):	1.53
CU:	0.60
No. of Points:	60
LUMINAIRE INFORMATION	
Applied Circuits:	F, G
No. of Luminaires:	20
Total Load:	26.89 kW

Guaranteed Performance: The ILLUMINATION described above is guaranteed per your Musco Warranty document and includes a 0.95 dirt depreciation factor.

Field Measurements: Individual field measurements may vary from computer-calculated predictions and should be taken in accordance with IESNA RP-6-15.

Electrical System Requirements: Refer to Amperage Draw Chart and/or the "Musco Control System Summary" for electrical sizing.

Installation Requirements: Results assume ± 3% nominal voltage at line side of the driver and structures located within 3 feet (1m) of design locations.

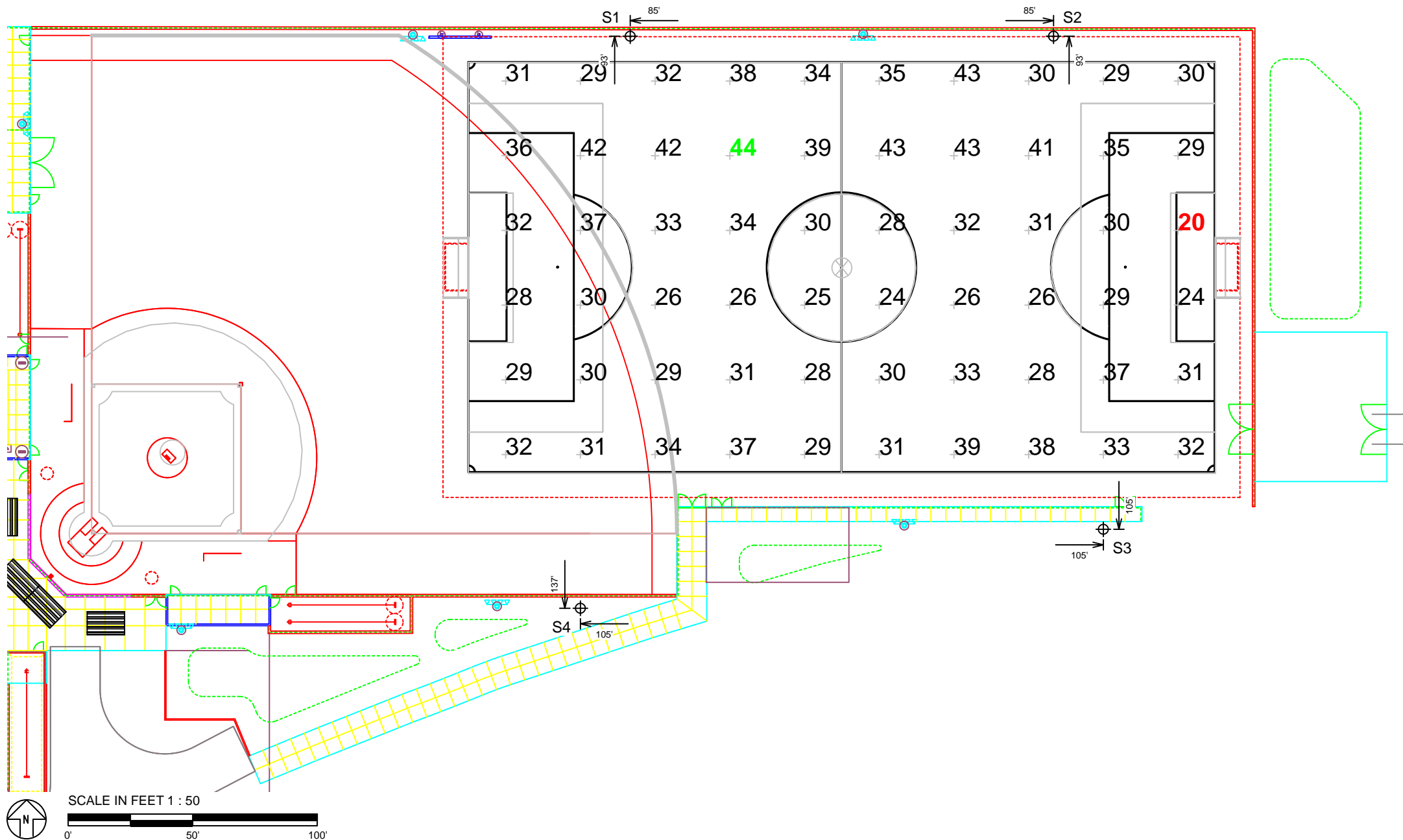

Pole location(s) Ⓢ dimensions are relative to 0,0 reference point(s) ⊗



Not to be reproduced in whole or part without the written consent of Musco Sports Lighting, LLC. ©1981, 2020 Musco Sports Lighting, LLC.

EQUIPMENT LIST FOR AREAS SHOWN							
Pole				Luminaires			
QTY	LOCATION	SIZE	GRADE ELEVATION	MOUNTING HEIGHT	LUMINAIRE TYPE	QTY / POLE	THIS GRID / OTHER GRIDS
1	A2	70'	-	70'	TLC-LED-400	1	0 1
				70'	TLC-LED-1200	4*	4 0
				15.5'	TLC-BT-575	1	0 1
				70'	TLC-LED-1500	4	0 4
1	B2	80'	3'	83'	TLC-LED-1200	3*	3 0
				18.5'	TLC-BT-575	1	0 1
				83'	TLC-LED-1500	6	0 6
2	TOTALS					20	7 13

* This structure utilizes a back-to-back mounting configuration

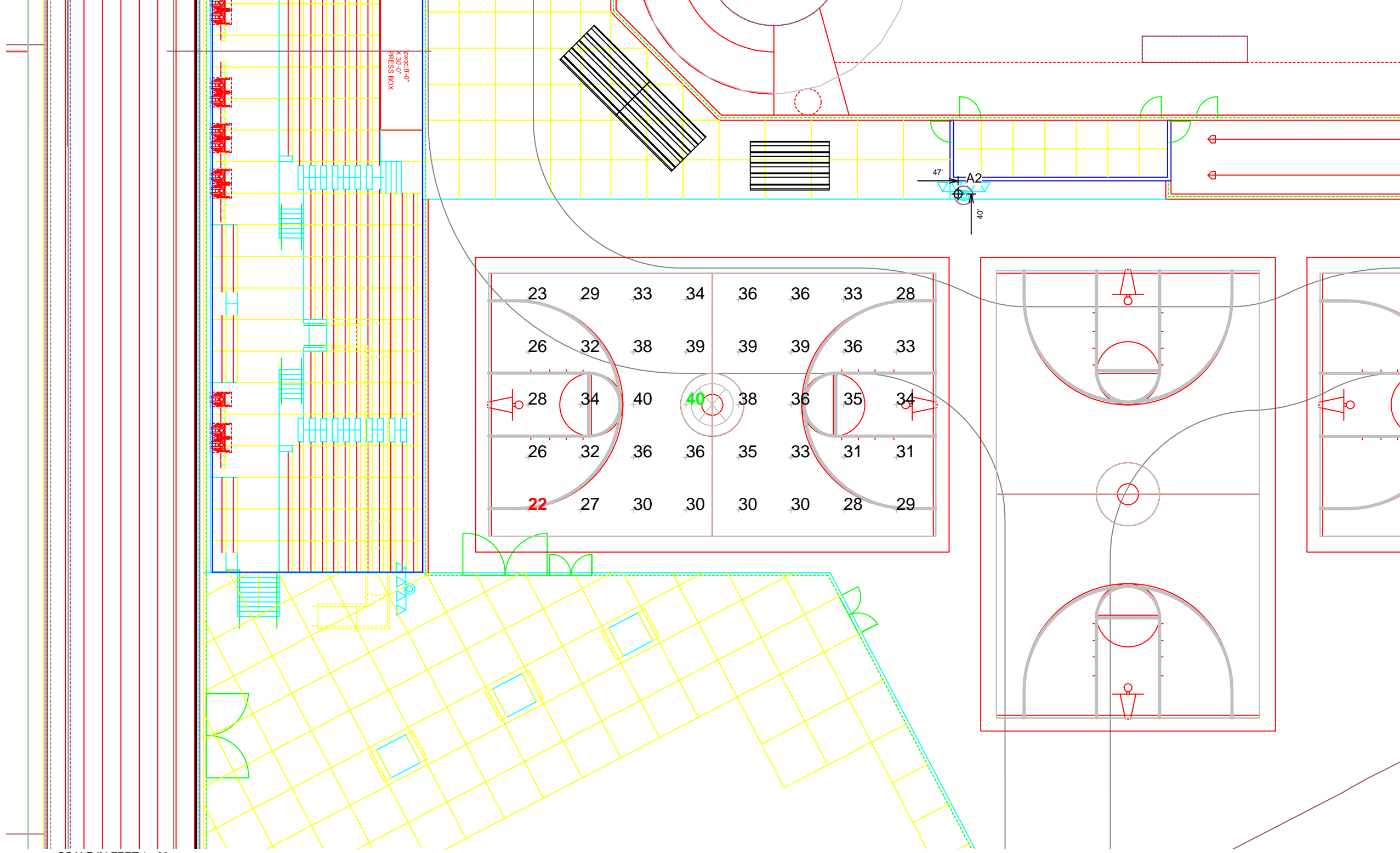

23	29	33	34	36	36	33	28
26	32	38	39	39	39	36	33
28	34	40	40	38	36	35	34
26	32	36	36	35	33	31	31
22	27	30	30	30	30	28	29

GRID SUMMARY	
Name:	Basketball 1
Size:	85' x 50'
Spacing:	10.0' x 10.0'
Height:	3.0' above grade

ILLUMINATION SUMMARY	
MAINTAINED HORIZONTAL FOOTCANDLES	
Entire Grid	
Guaranteed Average:	30
Scan Average:	32.61
Maximum:	40
Minimum:	22
Avg / Min:	1.50
Guaranteed Max / Min:	2.5
Max / Min:	1.86
UG (adjacent pts):	1.24
CU:	0.14
No. of Points:	40
LUMINAIRE INFORMATION	
Applied Circuits:	1
No. of Luminaires:	7
Total Load:	8.19 kW

Guaranteed Performance: The ILLUMINATION described above is guaranteed per your Musco Warranty document and includes a 0.95 dirt depreciation factor.

Field Measurements: Individual field measurements may vary from computer-calculated predictions and should be taken in accordance with IESNA RP-6-15.

Electrical System Requirements: Refer to Amperage Draw Chart and/or the "Musco Control System Summary" for electrical sizing.

Installation Requirements: Results assume ± 3% nominal voltage at line side of the driver and structures located within 3 feet (1m) of design locations.



Pole location(s) ⚡ dimensions are relative to 0,0 reference point(s) ⊗



EQUIPMENT LIST FOR AREAS SHOWN								
Pole				Luminaires				
QTY	LOCATION	SIZE	GRADE ELEVATION	MOUNTING HEIGHT	LUMINAIRE TYPE	QTY / POLE	THIS GRID	OTHER GRIDS
1	A2	70'	-	70'	TLC-LED-400	1	0	1
				70'	TLC-LED-1200	4*	4	0
				15.5'	TLC-BT-575	1	0	1
				70'	TLC-LED-1500	4	0	4
1	B2	80'	3'	83'	TLC-LED-1200	3*	3	0
				18.5'	TLC-BT-575	1	0	1
				83'	TLC-LED-1500	6	0	6
2	TOTALS					20	7	13

*This structure utilizes a back-to-back mounting configuration

GRID SUMMARY	
Name:	Basketball 2
Size:	85' x 50'
Spacing:	10.0' x 10.0'
Height:	3.0' above grade

ILLUMINATION SUMMARY	
MAINTAINED HORIZONTAL FOOTCANDLES	
Entire Grid	
Guaranteed Average:	30
Scan Average:	36.18
Maximum:	44
Minimum:	24
Avg / Min:	1.52
Guaranteed Max / Min:	2.5
Max / Min:	1.83
UG (adjacent pts):	1.26
CU:	0.15
No. of Points:	40
LUMINAIRE INFORMATION	
Applied Circuits:	1
No. of Luminaires:	7
Total Load:	8.19 kW

Guaranteed Performance: The ILLUMINATION described above is guaranteed per your Musco Warranty document and includes a 0.95 dirt depreciation factor.

Field Measurements: Individual field measurements may vary from computer-calculated predictions and should be taken in accordance with IESNA RP-6-15.

Electrical System Requirements: Refer to Amperage Draw Chart and/or the "Musco Control System Summary" for electrical sizing.

Installation Requirements: Results assume ± 3% nominal voltage at line side of the driver and structures located within 3 feet (1m) of design locations.

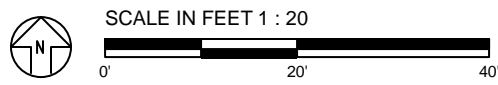
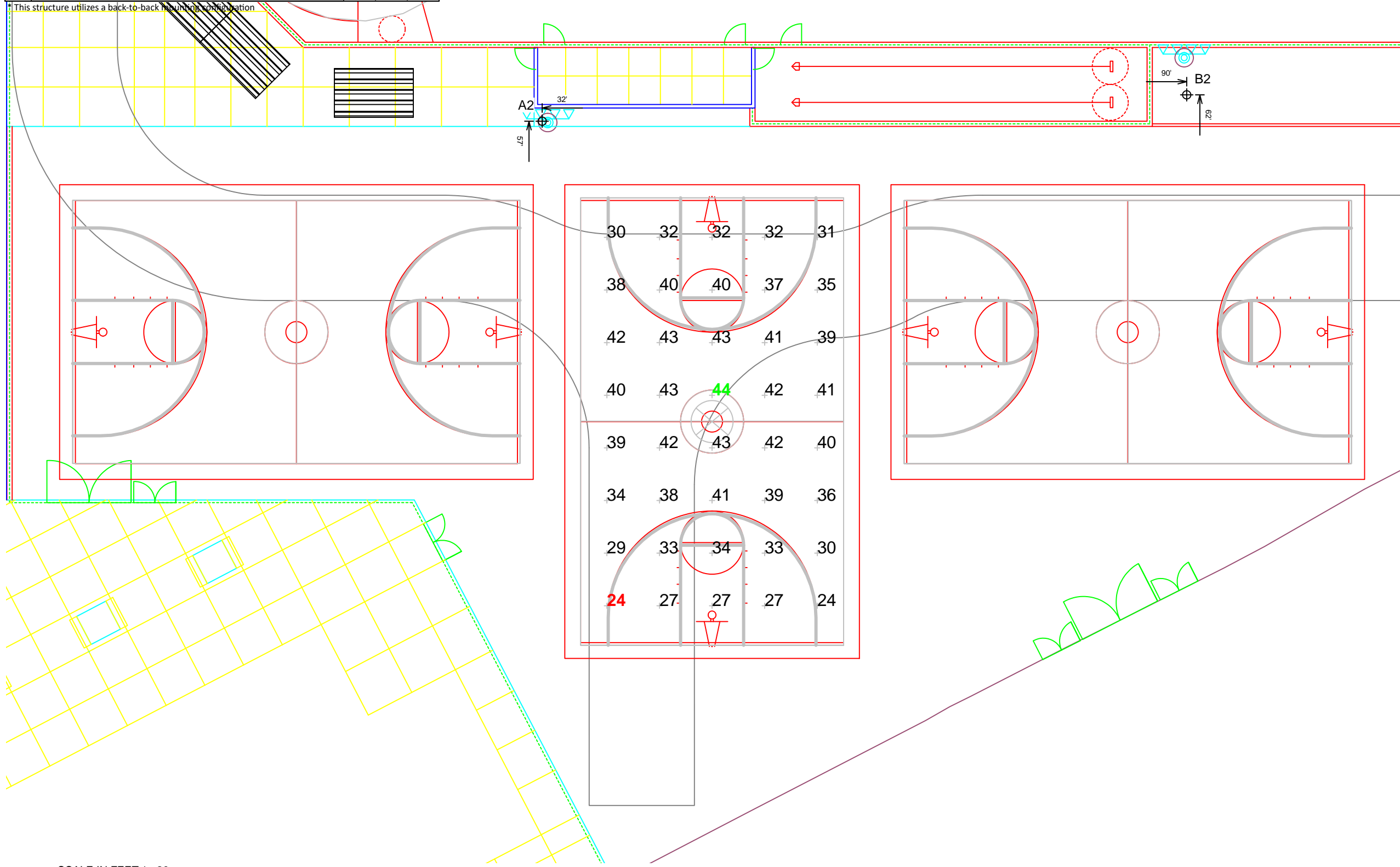

Pole location(s) ⊕ dimensions are relative to 0,0 reference point(s) ⊗



EQUIPMENT LIST FOR AREAS SHOWN								
Pole				Luminaires				
QTY	LOCATION	SIZE	GRADE ELEVATION	MOUNTING HEIGHT	LUMINAIRE TYPE	QTY / POLE	THIS GRID	OTHER GRIDS
1	A2	70'	-	70'	TLC-LED-400	1	0	1
				70'	TLC-LED-1200	4*	4	0
				15.5'	TLC-BT-575	1	0	1
				70'	TLC-LED-1500	4	0	4
1	B2	80'	3'	83'	TLC-LED-1200	3*	3	0
				18.5'	TLC-BT-575	1	0	1
				83'	TLC-LED-1500	6	0	6
2	TOTALS					20	7	13

* This structure utilizes a back-to-back mounting configuration

GRID SUMMARY	
Name:	Basketball 3
Size:	85' x 50'
Spacing:	10.0' x 10.0'
Height:	3.0' above grade

ILLUMINATION SUMMARY	
MAINTAINED HORIZONTAL FOOTCANDLES	
Entire Grid	
Guaranteed Average:	30
Scan Average:	32.98
Maximum:	38
Minimum:	28
Avg / Min:	1.16
Guaranteed Max / Min:	2.5
Max / Min:	1.35
UG (adjacent pts):	1.17
CU:	0.14
No. of Points:	40
LUMINAIRE INFORMATION	
Applied Circuits:	1
No. of Luminaires:	7
Total Load:	8.19 kW

Guaranteed Performance: The ILLUMINATION described above is guaranteed per your Musco Warranty document and includes a 0.95 dirt depreciation factor.

Field Measurements: Individual field measurements may vary from computer-calculated predictions and should be taken in accordance with IESNA RP-6-15.

Electrical System Requirements: Refer to Amperage Draw Chart and/or the "Musco Control System Summary" for electrical sizing.

Installation Requirements: Results assume ± 3% nominal voltage at line side of the driver and structures located within 3 feet (1m) of design locations.

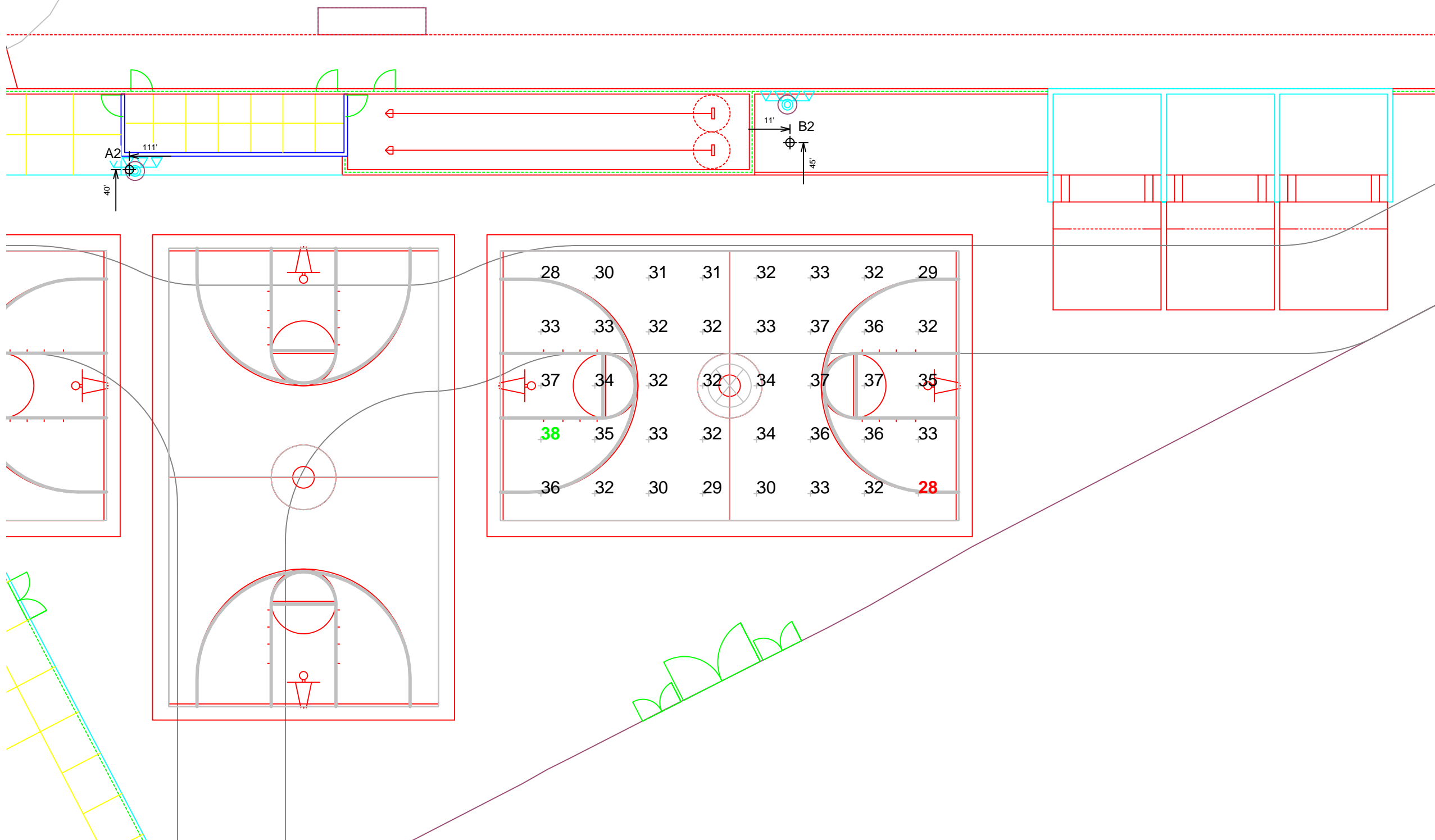

Pole location(s) ⊕ dimensions are relative to 0,0 reference point(s) ⊗



GRID SUMMARY	
Name:	Property Line
Spacing:	30.0'
Height:	3.0' above grade

ILLUMINATION SUMMARY	
HORIZONTAL FOOTCANDLES	
Scan Average:	Entire Grid 1.6387
Maximum:	7.36
Minimum:	0.02
No. of Points:	69
LUMINAIRE INFORMATION	
Applied Circuits:	A, B, C, D, E, F, G, H
No. of Luminaires:	128
Total Load:	154.72 kW

Guaranteed Performance: The ILLUMINATION described above is guaranteed per your Musco Warranty document.

Field Measurements: Individual field measurements may vary from computer-calculated predictions and should be taken in accordance with IESNA RP-6-15.

Electrical System Requirements: Refer to Amperage Draw Chart and/or the "Musco Control System Summary" for electrical sizing.

Installation Requirements: Results assume $\pm 3\%$ nominal voltage at line side of the driver and structures located within 3 feet (1m) of design locations.

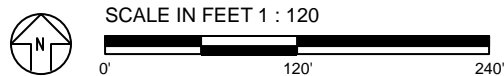
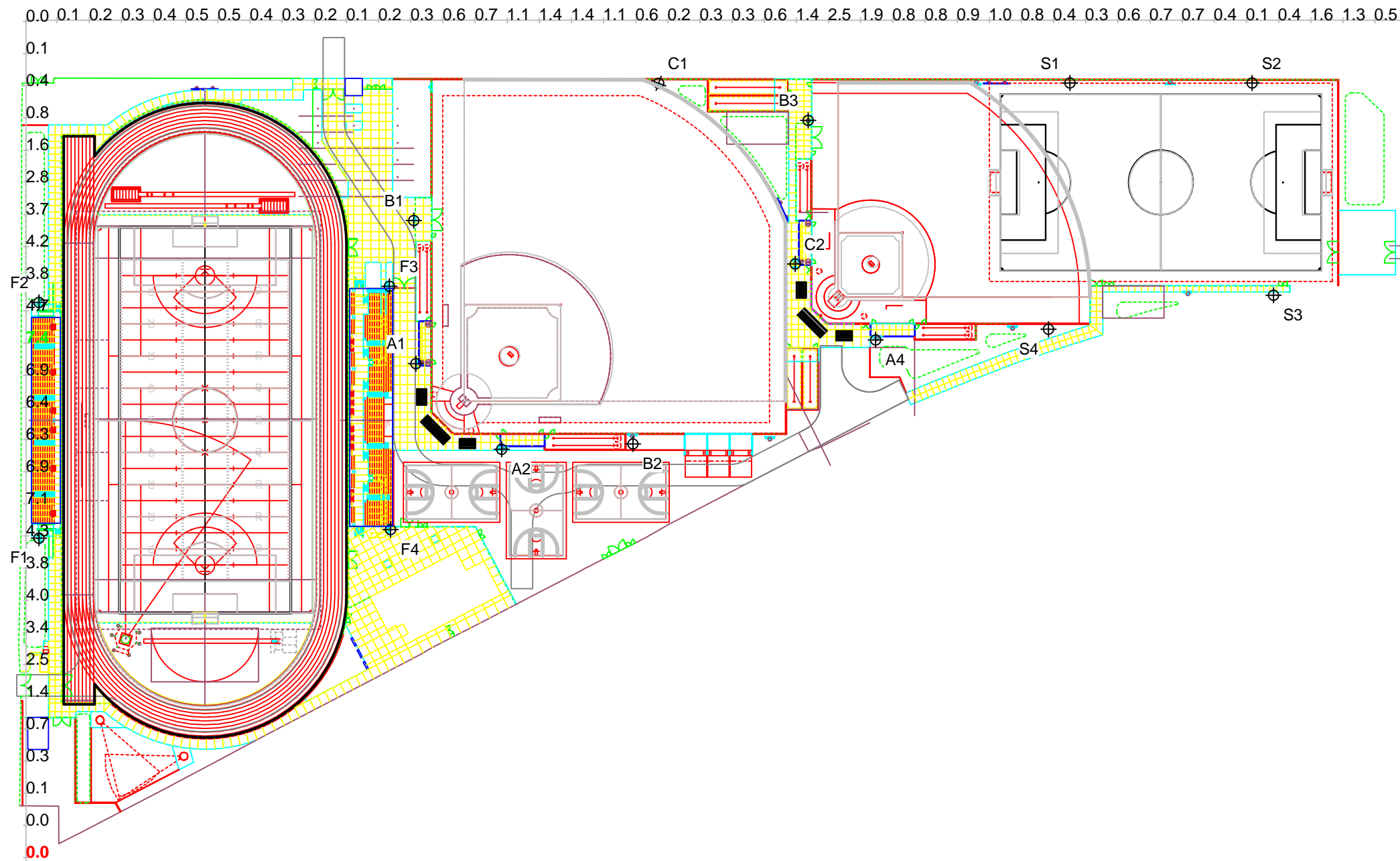

Pole location(s) \oplus dimensions are relative to 0,0 reference point(s) \otimes



GRID SUMMARY	
Name:	Property Line
Spacing:	30.0'
Height:	3.0' above grade

ILLUMINATION SUMMARY	
MAX VERTICAL FOOTCANDLES	
Scan Average:	Entire Grid 2.3886
Maximum:	8.01
Minimum:	0.06
No. of Points:	69
LUMINAIRE INFORMATION	
Applied Circuits:	A, B, C, D, E, F, G, H
No. of Luminaires:	128
Total Load:	154.72 kW

Guaranteed Performance: The ILLUMINATION described above is guaranteed per your Musco Warranty document.

Field Measurements: Individual field measurements may vary from computer-calculated predictions and should be taken in accordance with IESNA RP-6-15.

Electrical System Requirements: Refer to Amperage Draw Chart and/or the "Musco Control System Summary" for electrical sizing.

Installation Requirements: Results assume $\pm 3\%$ nominal voltage at line side of the driver and structures located within 3 feet (1m) of design locations.

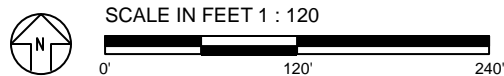
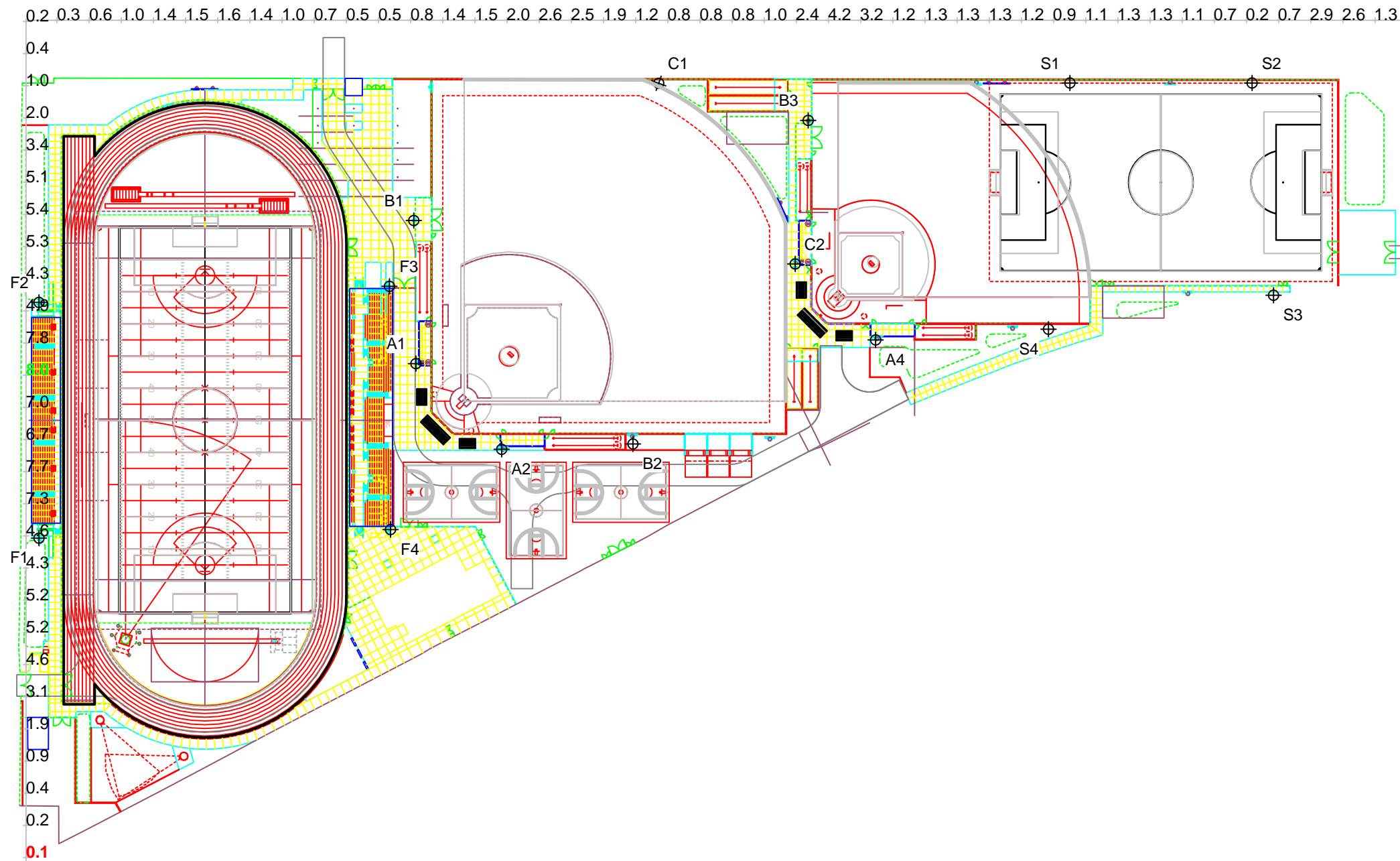

Pole location(s) \oplus dimensions are relative to 0,0 reference point(s) \otimes



GRID SUMMARY	
Name:	Property Line
Spacing:	30.0'
Height:	3.0' above grade

ILLUMINATION SUMMARY	
CANDELA (PER FIXTURE)	
Scan Average:	Entire Grid 29028.6816
Maximum:	54598.39
Minimum:	2711.96
No. of Points:	69
LUMINAIRE INFORMATION	
Applied Circuits:	A, B, C, D, E, F, G, H
No. of Luminaires:	128
Total Load:	154.72 kW

Guaranteed Performance: The ILLUMINATION described above is guaranteed per your Musco Warranty document.

Field Measurements: Individual field measurements may vary from computer-calculated predictions and should be taken in accordance with IESNA RP-6-15.

Electrical System Requirements: Refer to Amperage Draw Chart and/or the "Musco Control System Summary" for electrical sizing.

Installation Requirements: Results assume ± 3% nominal voltage at line side of the driver and structures located within 3 feet (1m) of design locations.

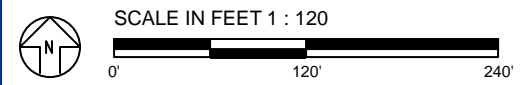
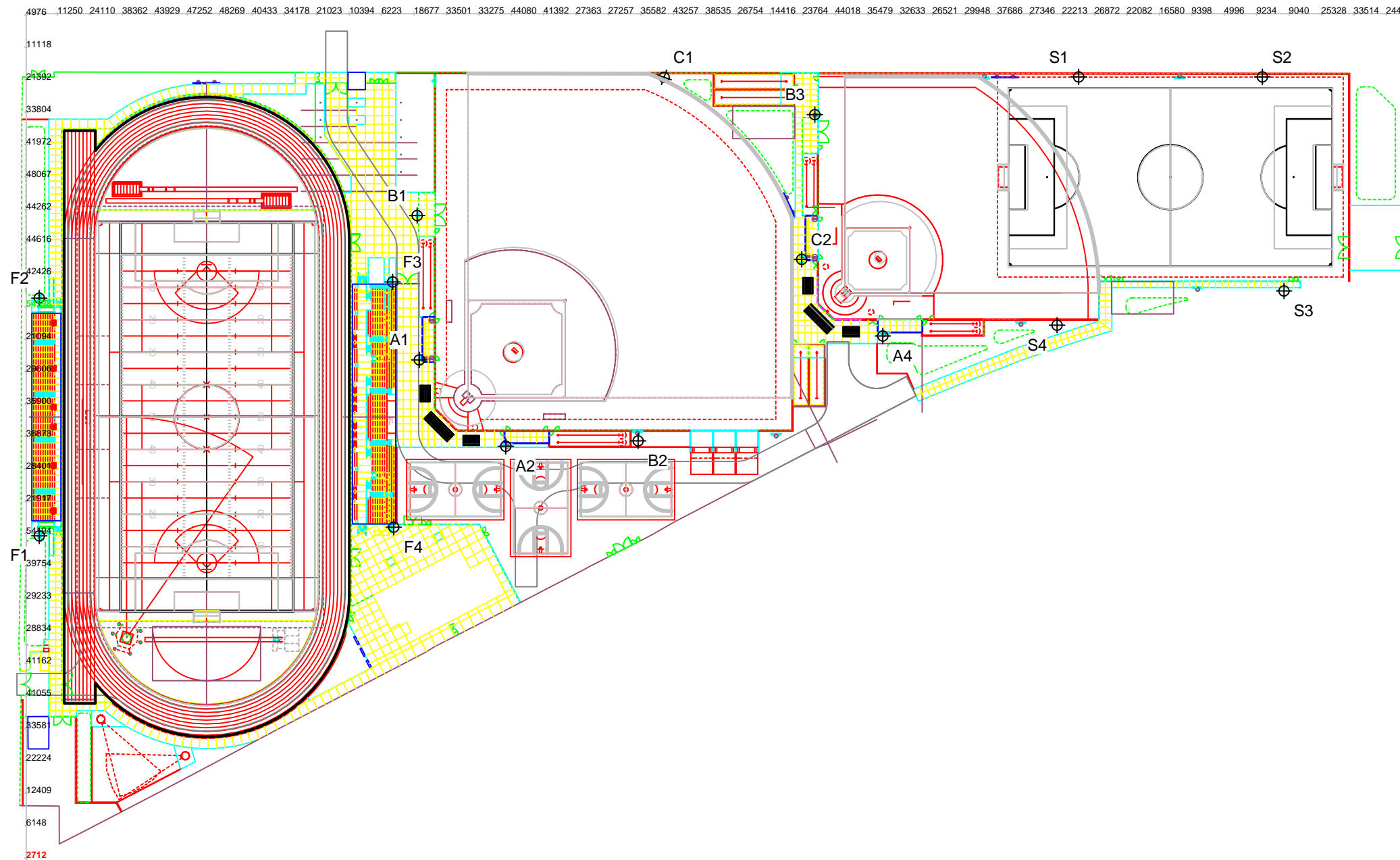

Pole location(s) Ⓢ dimensions are relative to 0,0 reference point(s) ⊗



EQUIPMENT LAYOUT

INCLUDES:

- Baseball
- Basketball 1
- Basketball 2
- Basketball 3
- Football
- Soccer 1
- Soccer 2
- Softball
- Track

Electrical System Requirements: Refer to Amperage Draw Chart and/or the "Musco Control System Summary" for electrical sizing.

Installation Requirements: Results assume ± 3% nominal voltage at line side of the driver and structures located within 3 feet (1m) of design locations.

EQUIPMENT LIST FOR AREAS SHOWN

QTY	Pole			Luminaires		
	LOCATION	SIZE	GRADE ELEVATION	MOUNTING HEIGHT	LUMINAIRE TYPE	QTY / POLE
1	A1	70'	-	70'	TLC-LED-400	1
				15.5'	TLC-BT-575	1
				70'	TLC-LED-1500	4
1	A2	70'	-	70'	TLC-LED-400	1
				70'	TLC-LED-1200	4*
				15.5'	TLC-BT-575	1
				70'	TLC-LED-1500	4
				70'	TLC-LED-1500	4
1	A4	60'	-	60'	TLC-LED-1200	2
				60'	TLC-LED-900	1
				15.5'	TLC-BT-575	1
				60'	TLC-LED-400	1
				60'	TLC-LED-1500	6
1	B1	80'	-	15.5'	TLC-BT-575	1
				80'	TLC-LED-1500	6
				83'	TLC-LED-1200	3*
1	B2	80'	3'	18.5'	TLC-BT-575	1
				83'	TLC-LED-1500	6
				83'	TLC-LED-1500	6
1	B3	70'	-	15.5'	TLC-BT-575	1
				70'	TLC-LED-1500	5
1	C1	70'	-	15.5'	TLC-BT-575	2
				70'	TLC-LED-1500	4
1	C2	70'	-	70'	TLC-LED-400	1*
				70'	TLC-LED-1200	2*
				70'	TLC-LED-900	1*
				15.5'	TLC-BT-575	2/1*
				70'	TLC-LED-1500	4
2	F1-F2	80'	-	15.5'	TLC-BT-575	2
				70'	TLC-LED-400	1
				80'	TLC-LED-1500	11
2	F3-F4	80'	-	20'	TLC-BT-575	2
				70'	TLC-LED-400	1
				80'	TLC-LED-1500	10
				80'	TLC-LED-1500	10
1	S1	60'	-	15.5'	TLC-BT-575	1
				60'	TLC-LED-1500	4
2	S2-S3	60'	-	60'	TLC-LED-1500	4
				60'	TLC-LED-1500	4
1	S4	70'	-	15.5'	TLC-BT-575	1
				70'	TLC-LED-1500	6
16	TOTALS					135

* This structure utilizes a back-to-back mounting configuration

SINGLE LUMINAIRE AMPERAGE DRAW CHART

Ballast Specifications (.90 min power factor)	Line Amperage Per Luminaire (max draw)						
	208 (60)	220 (60)	240 (60)	277 (60)	347 (60)	380 (60)	480 (60)
Single Phase Voltage	208 (60)	220 (60)	240 (60)	277 (60)	347 (60)	380 (60)	480 (60)
TLC-LED-1500	8.5	8.1	7.4	6.4	5.1	4.7	3.7
TLC-BT-575	3.4	3.2	2.9	2.5	2.0	1.8	1.5
TLC-LED-400	2.3	2.2	2.0	1.7	1.4	1.3	1.0
TLC-LED-1200	7.0	6.6	6.1	5.2	4.2	4.0	3.0
TLC-LED-900	5.3	5.0	4.6	4.0	3.2	2.9	2.3



We Make It Happen.

Not to be reproduced in whole or part without the written consent of Musco Sports Lighting, LLC. ©1981, 2020 Musco Sports Lighting, LLC.

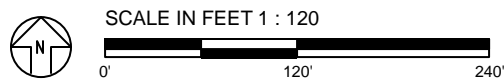
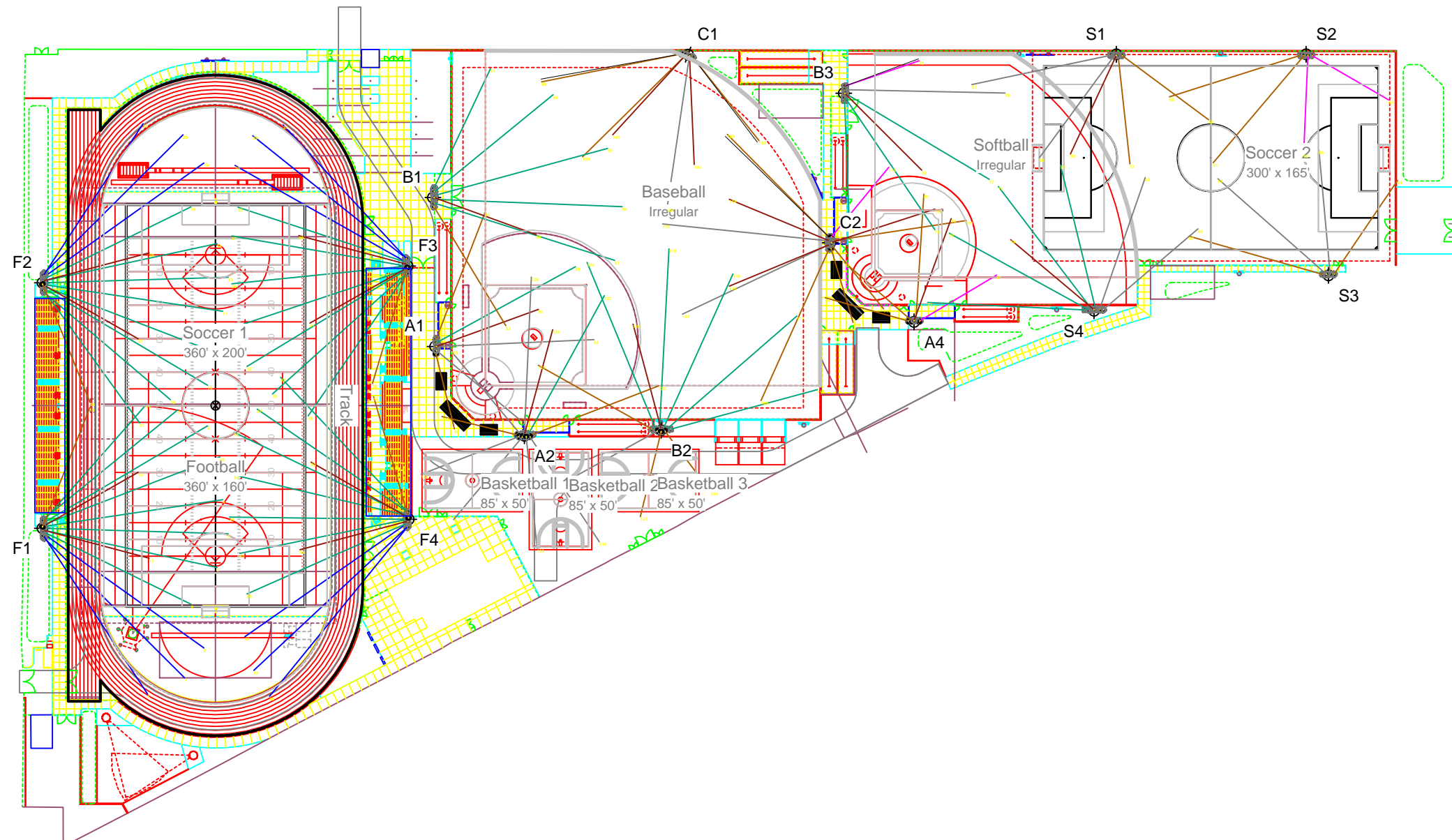

Pole location(s) ⚡ dimensions are relative to 0,0 reference point(s) ⊗

Appendix B

Air Quality, GHG, and Energy Calculations

Hawthorne High School Field Modification

Project Land Uses

Land Use Type	CalEEMod LandUse Type	CalEEMod LandUse Subtype	Amount	Unit	Building SF
<i>Field Modification</i>					
	Educational	High School	12.8	acre	555,390

	<i>Pool</i>				
Pool	Recreational	Recreational Swimming Pool	0.26		11,200
Structures	Commercial	User Defined	0.37		16,200
Parking	Parking	Other Asphalt Surfaces	0.28	acre	0
Landscape/Hardscape	Parking	Other Non-Asphalt Surfaces	0.47	acre	0

Assumptions:

Grading - 16,000 CY of Export and 16,000 CY of Import

Demolition material approximately 2500 tons

Use standard mitigation for 2x/day watering to reduce dust.

Operational Data

Solid waste, electricity, natural gas, water consumption defaults from CalEEMod

No increase in operational trips anticipated for field replacement

CalEEMod defaults assumed for pool component. Assume all net new to be conservative.

Phase	Hawthorne Start	Hawthorne End	Leuzinger Start	Leuzinger End	Total Days
Demolition	12/1/2022	1/31/2023	7/1/2021	8/31/2021	44
Grading/Site Preparation	2/1/2023	5/17/2023	9/1/2021	12/15/2021	76
Foundations/Concrete Pour #1	3/1/2023	3/3/2023	10/1/2021	10/5/2021	3
Drainage/Utilities/Trenching	4/1/2023	8/31/2023	11/1/2021	3/31/2022	109
Building Construction	5/18/2023	4/1/2024	12/16/2021	10/31/2022	228
Foundations/Concrete Pour #2	7/1/2023	7/5/2023	2/1/2022	2/3/2022	3
Paving Event #1	10/1/2023	10/6/2023	5/1/2022	5/7/2022	5
Foundations/Concrete Pour #3	2/1/2024	2/5/2024	9/1/2022	9/5/2022	3
Architectural Coatings	2/1/2024	4/1/2024	9/1/2022	10/31/2022	43
Paving Event #2	3/1/2024	3/7/2024	10/1/2022	10/7/2022	5
Synthetic Track	3/1/2024	5/30/2024	10/1/2022	12/31/2022	65
Field/Bleachers	11/1/2023	5/31/2024	6/1/2022	12/31/2022	153

Phase	Equipment Type	# of Equipment	hours/day	HP	LF
Demolition	Concrete/Industrial	1	8	81	0.73
	Excavators	3	8	158	0.38
Grading/Site Preparation	Rubber Tired Dozer	2	8	247	0.4
	Excavators	2	8	158	0.38
	Graders	1	8	187	0.41
	Rubber Tired Dozer	1	9	247	0.4
	Scrapers	2	8	367	0.48
	Tractors/Loaders/	2	8	97	0.37
Foundations/Concrete Pour #1	Pumps	3	8	84	0.74
	Tractors/Loaders/	2	8	97	0.37
Drainage/Utilities/Trenching	Trenchers	3	8	78	0.5025
	Tractors/Loaders/	2	8	97	0.37
	Rubber Tired Dozer	1	9	247	0.4
	Excavators	1	8	158	0.38
Building Construction	Cranes	1	8	231	0.29
	Forklifts	3	8	89	0.2
	Generator Sets	1	8	84	0.74
	Tractors/Loaders/	3	8	97	0.37
	Welders	1	8	46	0.45
	Foundations/Concrete Pour #2	Pumps	3	8	84
Tractors/Loaders/		2	8	97	0.37
Paving Event #1	Pavers	2	8	130	0.42
	Paving Equipment	2	8	132	0.36
	Rollers	2	8	80	0.38
Foundations/Concrete Pour #3	Pumps	3	8	84	0.74
	Tractors/Loaders/	2	8	97	0.37
Architectural Coatings	Air Compressors	1	8	78	0.48
Paving Event #2	Pavers	2	8	130	0.42
	Paving Equipment	2	8	132	0.36
	Rollers	2	8	80	0.38
Synthetic Track	Cranes	1	8	231	0.29
	Forklifts	3	8	89	0.2
	Generator Sets	1	8	84	0.74
	Tractors/Loaders/	3	8	97	0.37
	Welders	1	8	46	0.45
Field/Bleachers	Cranes	1	8	231	0.29
	Forklifts	3	8	89	0.2
	Generator Sets	1	8	84	0.74
	Tractors/Loaders/	3	8	97	0.37
	Welders	1	8	46	0.45

Phase	One-Way	One-Way	One-Way	Worker	Vendor	Vendor	Haul Trip	Haul Trip
	Worker Trips (In/Out)	Trips (In/Out)	Haul Trips (In/Out)	Trip Length	Trip Length OnSite	Trip Length OffSite	Length OnSite	Length OffSite
Demolition	80	6	28	14.7	0.19	6.9	0.19	40
Grading/Site Preparation	80	6	62	14.7	0.19	6.9	0.19	40
Foundations/Concrete Pour #1	80	50	0	14.7	0.19	6.9	0.19	40
Drainage/Utilities/Trenching	80	6	0	14.7	0.19	6.9	0.19	40
Building Construction	80	99	0	14.7	0.19	6.9	0.19	40
Foundations/Concrete Pour #2	80	50	0	14.7	0.19	6.9	0.19	40
Paving Event #1	80	6	0	14.7	0.19	6.9	0.19	40
Foundations/Concrete Pour #3	80	50	0	14.7	0.19	6.9	0.19	40
Architectural Coatings	80	6	0	14.7	0.19	6.9	0.19	40
Paving Event #2	80	6	0	14.7	0.19	6.9	0.19	40
Synthetic Track	80	6	0	14.7	0.19	6.9	0.19	40
Field/Bleachers	80	6	0	14.7	0.19	6.9	0.19	40

AQ Construction Summary

Air Quality Construction Analysis

Unmitigated Construction Scenario

Regional		lbs/day					
	ROG	NOX	CO	SO2	PM10 Total	Total PM2.5	
Demolition (2022)	1.3	20.6	28.2	0.1	2.5	1.3	
Demolition (2023)	1.2	20.1	27.9	0.1	2.5	1.3	
Grading/Site Preparation (2023)	2.0	42.9	42.5	0.1	7.2	3.5	
Foundations Concrete Pour #1 (2023)	0.9	14.6	20.4	0.0	2.1	1.2	
Drainage/Utilities Trenching (2023)	1.2	20.1	28.2	0.0	2.0	1.3	
Building Construction (2023)	1.2	18.9	23.5	0.1	2.5	1.4	
Building Construction (2024)	1.2	18.9	23.3	0.1	2.5	1.4	
Foundations Concrete Pour #2 (2023)	0.9	14.6	20.4	0.0	2.1	1.2	
Paving Event #1 (2023)	1.9	11.7	20.2	0.0	1.5	0.9	
Field Bleachers (2023)	1.1	15.4	22.2	0.0	1.9	1.2	
Field Bleachers (2024)	1.1	15.3	22.0	0.0	1.8	1.2	
Foundations Concrete Pour #3 (2024)	0.8	14.6	20.2	0.0	2.1	1.2	
Architectural Coatings (2024)	1.5	2.2	5.1	0.0	1.1	0.4	
Paving Event #2 (2024)	1.9	11.7	20.0	0.0	1.5	0.9	
Synthetic Track (2024)	1.2	15.3	22.0	0.0	1.8	1.2	
Overlapping Phases - Regional Emissions							
2023	ROG	NOX	CO	SO2	PM10 Total	Total PM2.5	
Grading/Site Preparation + Foundations/Concrete Pour #1	2.8	57.5	62.8	0.2	9.3	4.7	
Grading/Site Preparation + Drainage/Utilities/Trenching	3.2	63.0	70.6	0.2	9.2	4.8	
Drainage/Utilities/Trenching + Building Construction	2.5	39.0	51.7	0.1	4.5	2.7	
Drainage/Utilities/Trenching + Building Construction + Foundations/Concrete Pour #2	3.3	53.6	72.0	0.1	6.6	3.9	
Building Construction + Paving Event #1	3.1	30.6	43.7	0.1	4.0	2.2	
Building Construction + Field/Bleachers	2.4	34.3	45.7	0.1	4.3	2.5	
2024	ROG	NOX	CO	SO2	PM10 Total	Total PM2.5	
Building Construction + Field/Bleachers	2.3	34.2	45.3	0.1	4.3	2.5	
Field/Bleachers	4.7	51.0	70.6	0.1	7.5	4.1	
Event #2 + Synthetic Track + Field/Bleachers	7.8	78.0	112.5	0.2	10.9	6.1	
Daily Maximum Emissions	7.8	78.0	112.5	0.2	10.9	6.1	
SCAQMD Regional Threshold	75	100	550	150	150	55	
Exceeds Threshold?	No	No	No	No	No	No	

Air Quality Construction Analysis

Unmitigated Construction Scenario

Localized Emissions Summary	lbs/day				
	NOX	CO	PM10 Total	Total PM2.5	
Demolition (2022)	18.3	24.7	1.3	0.9	
Demolition (2023)	18.3	24.7	1.3	0.9	
Grading/Site Preparation (2023)	30.0	36.7	4.3	2.7	
Foundations Concrete Pour #1 (2023)	12.5	16.9	0.9	0.9	
Drainage/Utilities Trenching (2023)	19.7	25.3	1.1	1.1	
Building Construction (2023)	14.9	19.3	0.9	0.9	
Building Construction (2024)	14.9	19.3	0.9	0.9	
Foundations Concrete Pour #2 (2023)	12.5	16.9	0.9	0.9	
Paving Event #1 (2023)	11.3	17.3	0.6	0.6	
Field Bleachers (2023)	14.9	19.3	0.9	0.9	
Field Bleachers (2024)	14.9	19.3	0.9	0.9	
Foundations Concrete Pour #3 (2024)	12.5	16.9	0.9	0.9	
Architectural Coatings (2024)	1.8	2.4	0.1	0.1	
Paving Event #2 (2024)	11.3	17.3	0.6	0.6	
Synthetic Track (2024)	14.9	19.3	0.9	0.9	
	Overlapping Phases - Localized				
	2023	NOX	CO	PM10 Total	Total PM2.5
Grading/Site Preparation + Foundations/Concrete Pour #1		42.5	53.6	5.2	3.5
Grading/Site Preparation + Drainage/Utilities/Trenching		49.6	62.0	5.4	3.7
Drainage/Utilities/Trenching + Building Construction		34.6	44.6	2.0	2.0
Drainage/Utilities/Trenching + Building Construction + Foundations/Concrete Pour #2		47.1	61.5	2.9	2.9
Building Construction + Paving Event #1		26.2	36.6	1.5	1.5
Building Construction + Field/Bleachers		29.9	38.6	1.8	1.8
	2024	NOX	CO	PM10 Total	Total PM2.5
Building Construction + Field/Bleachers		29.8	38.6	1.8	1.8
Building Construction + Foundations/Concrete Pour #3 + architectural Coatings + Field/Blea		44.1	57.9	2.8	2.8
Building Construction + Foundations/Concrete Pour #3 + architectural Coatings + Paving Ev		70.3	94.5	4.3	4.3
Daily Maximum Emissions		70.3	94.5	5.4	4.3
SCAQMD Localized Threshold		197	1796	15	8
Exceeds Threshold?		No	No	No	No

Air Quality Construction Analysis

Summer	Onsite Construction Emissions (CalEEMod)									
	ROG	NOX	CO	SO2	Fugitive PM10	Exhaust PM10	PM10 Total	Fugitive PM2.5	Exhaust PM2.5	Total PM2.5
Demolition (2022)	0.92	18.31	24.67	0.04	0.47	0.86	1.34	0.07	0.86	0.93
Demolition (2023)	0.92	18.31	24.67	0.04	0.47	0.86	1.34	0.07	0.86	0.93
Grading/Site Preparation (2023)	1.52	29.98	36.72	0.06	3.05	1.30	4.35	1.37	1.30	2.67
Foundations Concrete Pour #1 (2023)	0.55	12.48	16.85	0.03	0.00	0.87	0.87	0.00	0.87	0.87
Drainage/Utilities Trenching (2023)	0.94	19.66	25.30	0.04	0.00	1.06	1.06	0.00	1.06	1.06
Building Construction (2023)	0.87	14.95	19.32	0.03	0.00	0.92	0.92	0.00	0.92	0.92
Building Construction (2024)	0.85	14.91	19.30	0.03	0.00	0.91	0.91	0.00	0.91	0.91
Foundations Concrete Pour #2 (2023)	0.55	12.48	16.85	0.03	0.00	0.87	0.87	0.00	0.87	0.87
Paving Event #1 (2023)	1.61	11.30	17.30	0.02	0.00	0.61	0.61	0.00	0.61	0.61
Field Bleachers (2023)	0.87	14.95	19.32	0.03	0.00	0.92	0.92	0.00	0.92	0.92
Field Bleachers (2024)	0.85	14.91	19.30	0.03	0.00	0.91	0.91	0.00	0.91	0.91
Foundations Concrete Pour #3 (2024)	0.55	12.48	16.85	0.03	0.00	0.87	0.87	0.00	0.87	0.87
Architectural Coatings (2024)	1.29	1.81	2.44	0.00	0.00	0.13	0.13	0.00	0.13	0.13
Paving Event #2 (2024)	1.61	11.30	17.30	0.02	0.00	0.61	0.61	0.00	0.61	0.61
Synthetic Track (2024)	0.93	14.91	19.30	0.03	0.00	0.91	0.91	0.00	0.91	0.91
Overlapping Phases - Regional Emissions (Onsite Construction) - from CalEEMod										
	ROG	NOX	CO	SO2	Fugitive PM10	Exhaust PM10	PM10 Total	Fugitive PM2.5	Exhaust PM2.5	Total PM2.5
2023										
Grading/Site Preparation + Foundations/Concrete Pour #1	2.07	42.46	53.58	0.09	3.05	2.17	5.22	1.37	2.17	3.54
Grading/Site Preparation + Drainage/Utilities/Trenching	2.47	49.64	62.02	0.10	3.05	2.36	5.41	1.37	2.36	3.73
Drainage/Utilities/Trenching + Building Construction	1.81	34.61	44.62	0.07	0.00	1.98	1.98	0.00	1.98	1.98
Drainage/Utilities/Trenching + Building Construction + Foundations/Concrete Pour #2	2.36	47.09	61.47	0.09	0.00	2.85	2.85	0.00	2.85	2.85
Building Construction + Paving Event #1	2.48	26.24	36.61	0.05	0.00	1.52	1.52	0.00	1.52	1.52
Building Construction + Field/Bleachers	1.74	29.90	38.63	0.06	0.00	1.83	1.83	0.00	1.83	1.83
2024										
Building Construction + Field/Bleachers	1.70	29.82	38.61	0.06	0.00	1.81	1.81	0.00	1.81	1.81
Building Construction + Foundations/Concrete Pour #3 + architectural Coatings + Field/Bleachers	3.53	44.11	57.90	0.09	0.00	2.82	2.82	0.00	2.82	2.82
Building Construction + Foundations/Concrete Pour #3 + architectural Coatings + Paving Event #2 + Synthetic Track + Field/Bleachers	6.07	70.31	94.50	0.14	0.00	4.33	4.33	0.00	4.33	4.33
	6.07	70.31	94.50	0.14	3.05	4.33	5.41	1.37	4.33	4.33

Air Quality Construction Analysis

Summer	Offsite Construction Emissions (CalEEMod)									
	ROG	NOX	CO	SO2	Fugitive PM10	Exhaust PM10	PM10 Total	Fugitive PM2.5	Exhaust PM2.5	Total PM2.5
	lb/day									
Demolition (2022)	0.33	2.18	3.48	0.02	1.13	0.02	1.15	0.30	0.02	0.32
Demolition (2023)	0.28	1.67	3.19	0.02	1.13	0.02	1.14	0.30	0.02	0.32
Grading/Site Preparation (2023)	0.43	12.42	5.74	0.07	2.77	0.10	2.87	0.75	0.09	0.84
Foundations Concrete Pour #1 (2023)	0.31	2.00	3.50	0.02	1.21	0.02	1.23	0.33	0.01	0.34
Drainage/Utilities Trenching (2023)	0.26	0.39	2.88	0.01	0.93	0.01	0.94	0.25	0.01	0.25
Building Construction (2023)	0.36	3.79	4.19	0.03	1.53	0.03	1.55	0.42	0.02	0.44
Building Construction (2024)	0.34	3.79	3.98	0.03	1.53	0.03	1.55	0.42	0.02	0.44
Foundations Concrete Pour #2 (2023)	0.31	2.00	3.50	0.02	1.21	0.02	1.23	0.33	0.01	0.34
Paving Event #1 (2023)	0.26	0.39	2.88	0.01	0.93	0.01	0.94	0.25	0.01	0.25
Field Bleachers (2023)	0.26	0.39	2.88	0.01	0.93	0.01	0.94	0.25	0.01	0.25
Field Bleachers (2024)	0.24	0.37	2.69	0.01	0.93	0.01	0.94	0.25	0.01	0.25
Foundations Concrete Pour #3 (2024)	0.29	1.99	3.30	0.02	1.21	0.02	1.23	0.33	0.01	0.34
Architectural Coatings (2024)	0.24	0.37	2.69	0.01	0.93	0.01	0.94	0.25	0.01	0.25
Paving Event #2 (2024)	0.24	0.37	2.69	0.01	0.93	0.01	0.94	0.25	0.01	0.25
Synthetic Track (2024)	0.24	0.37	2.69	0.01	0.93	0.01	0.94	0.25	0.01	0.25
Overlapping Phases - Regional Emissions (Offsite Construction) - from CalEEMod										
	ROG	NOX	CO	SO2	Fugitive PM10	Exhaust PM10	PM10 Total	Fugitive PM2.5	Exhaust PM2.5	Total PM2.5
2023										
Grading/Site Preparation + Foundations/Concrete Pour #1	0.73	14.42	9.24	0.09	3.99	0.11	4.10	1.08	0.11	1.19
Grading/Site Preparation + Drainage/Utilities/Trenching	0.69	12.81	8.63	0.08	3.70	0.10	3.81	1.00	0.10	1.10
Drainage/Utilities/Trenching + Building Construction	0.62	4.18	7.07	0.03	2.46	0.03	2.49	0.67	0.03	0.70
Drainage/Utilities/Trenching + Building Construction + Foundations/Concrete Pour #2	0.93	6.18	10.57	0.05	3.67	0.05	3.72	1.00	0.04	1.04
Building Construction + Paving Event #1	0.62	4.18	7.07	0.03	2.46	0.03	2.49	0.67	0.03	0.70
Building Construction + Field/Bleachers	0.62	4.18	7.07	0.03	2.46	0.03	2.49	0.67	0.03	0.70
2024										
Building Construction + Field/Bleachers	0.58	4.16	6.67	0.03	2.46	0.03	2.49	0.67	0.03	0.70
Building Construction + Foundations/Concrete Pour #3 + architectural Coatings + Field/Bleachers	1.11	6.53	12.66	0.06	4.61	0.05	4.66	1.25	0.05	1.29
Building Construction + Foundations/Concrete Pour #3 + architectural Coatings + Paving Event #2 + Synthetic Track + Field/Bleachers	1.60	7.27	18.04	0.08	6.47	0.06	6.54	1.74	0.06	1.80
	1.60	14.42	18.04	0.09	6.47	0.11	6.54	1.74	0.11	1.80

Air Quality Construction Analysis

Winter	Onsite Construction Emissions (CalEEMod)									
	ROG	NOX	CO	SO2	Fugitive PM10	Exhaust PM10	PM10 Total	Fugitive PM2.5	Exhaust PM2.5	Total PM2.5
	lb/day									
Demolition (2022)	0.92	18.31	24.67	0.04	0.47	0.86	1.34	0.07	0.86	0.93
Demolition (2023)	0.92	18.31	24.67	0.04	0.47	0.86	1.34	0.07	0.86	0.93
Grading/Site Preparation (2023)	1.52	29.98	36.72	0.06	3.05	1.30	4.35	1.37	1.30	2.67
Foundations Concrete Pour #1 (2023)	0.55	12.48	16.85	0.03	0.00	0.87	0.87	0.00	0.87	0.87
Drainage/Utilities Trenching (2023)	0.94	19.66	25.30	0.04	0.00	1.06	1.06	0.00	1.06	1.06
Building Construction (2023)	0.87	14.95	19.32	0.03	0.00	0.92	0.92	0.00	0.92	0.92
Building Construction (2024)	0.85	14.91	19.30	0.03	0.00	0.91	0.91	0.00	0.91	0.91
Foundations Concrete Pour #2 (2023)	0.55	12.48	16.85	0.03	0.00	0.87	0.87	0.00	0.87	0.87
Paving Event #1 (2023)	1.61	11.30	17.30	0.02	0.00	0.61	0.61	0.00	0.61	0.61
Field Bleachers (2023)	0.87	14.95	19.32	0.03	0.00	0.92	0.92	0.00	0.92	0.92
Field Bleachers (2024)	0.85	14.91	19.30	0.03	0.00	0.91	0.91	0.00	0.91	0.91
Foundations Concrete Pour #3 (2024)	0.55	12.48	16.85	0.03	0.00	0.87	0.87	0.00	0.87	0.87
Architectural Coatings (2024)	1.29	1.81	2.44	0.00	0.00	0.13	0.13	0.00	0.13	0.13
Paving Event #2 (2024)	1.61	11.30	17.30	0.02	0.00	0.61	0.61	0.00	0.61	0.61
Synthetic Track (2024)	0.93	14.91	19.30	0.03	0.00	0.91	0.91	0.00	0.91	0.91
Overlapping Phases - Regional Emissions (Onsite Construction) - from CalEEMod										
	ROG	NOX	CO	SO2	Fugitive PM10	Exhaust PM10	PM10 Total	Fugitive PM2.5	Exhaust PM2.5	Total PM2.5
2023										
Grading/Site Preparation + Foundations/Concrete Pour #1	2.07	42.46	53.58	0.09	3.05	2.17	5.22	1.37	2.17	3.54
Grading/Site Preparation + Drainage/Utilities/Trenching	2.47	49.64	62.02	0.10	3.05	2.36	5.41	1.37	2.36	3.73
Drainage/Utilities/Trenching + Building Construction	1.81	34.61	44.62	0.07	0.00	1.98	1.98	0.00	1.98	1.98
Drainage/Utilities/Trenching + Building Construction + Foundations/Concrete Pour #2	2.36	47.09	61.47	0.09	0.00	2.85	2.85	0.00	2.85	2.85
Building Construction + Paving Event #1	2.48	26.24	36.61	0.05	0.00	1.52	1.52	0.00	1.52	1.52
Building Construction + Field/Bleachers	1.74	29.90	38.63	0.06	0.00	1.83	1.83	0.00	1.83	1.83
2024										
Building Construction + Field/Bleachers	1.70	29.82	38.61	0.06	0.00	1.81	1.81	0.00	1.81	1.81
Building Construction + Foundations/Concrete Pour #3 + architectural Coatings + Field/Bleachers	3.53	44.11	57.90	0.09	0.00	2.82	2.82	0.00	2.82	2.82
Building Construction + Foundations/Concrete Pour #3 + architectural Coatings + Paving Event #2 + Synthetic Track + Field/Bleachers	6.07	70.31	94.50	0.14	0.00	4.33	4.33	0.00	4.33	4.33
	6.07	70.31	94.50	0.14	3.05	4.33	5.41	1.37	4.33	4.33

Air Quality Construction Analysis

Winter	Offsite Construction Emissions (CalEEMod)									
	ROG	NOX	CO	SO2	Fugitive PM10	Exhaust PM10	PM10 Total	Fugitive PM2.5	Exhaust PM2.5	Total PM2.5
	lb/day									
Demolition (2022)	0.34	2.28	3.22	0.02	1.13	0.02	1.15	0.30	0.02	0.32
Demolition (2023)	0.29	1.76	2.94	0.01	1.13	0.02	1.14	0.30	0.02	0.32
Grading/Site Preparation (2023)	0.44	12.96	5.52	0.07	2.77	0.10	2.87	0.75	0.09	0.84
Foundations Concrete Pour #1 (2023)	0.32	2.10	3.27	0.02	1.21	0.02	1.23	0.33	0.01	0.34
Drainage/Utilities Trenching (2023)	0.28	0.42	2.64	0.01	0.93	0.01	0.94	0.25	0.01	0.25
Building Construction (2023)	0.37	3.98	3.98	0.03	1.53	0.03	1.55	0.42	0.02	0.44
Building Construction (2024)	0.35	3.98	3.79	0.03	1.53	0.03	1.55	0.42	0.02	0.44
Foundations Concrete Pour #2 (2023)	0.32	2.10	3.27	0.02	1.21	0.02	1.23	0.33	0.01	0.34
Paving Event #1 (2023)	0.28	0.42	2.64	0.01	0.93	0.01	0.94	0.25	0.01	0.25
Field Bleachers (2023)	0.28	0.42	2.64	0.01	0.93	0.01	0.94	0.25	0.01	0.25
Field Bleachers (2024)	0.26	0.40	2.46	0.01	0.93	0.01	0.94	0.25	0.01	0.25
Foundations Concrete Pour #3 (2024)	0.30	2.09	3.09	0.02	1.21	0.02	1.23	0.33	0.01	0.34
Architectural Coatings (2024)	0.26	0.40	2.46	0.01	0.93	0.01	0.94	0.25	0.01	0.25
Paving Event #2 (2024)	0.26	0.40	2.46	0.01	0.93	0.01	0.94	0.25	0.01	0.25
Synthetic Track (2024)	0.26	0.40	2.46	0.01	0.93	0.01	0.94	0.25	0.01	0.25
Overlapping Phases - Regional Emissions (Offsite Construction) - from CalEEMod										
	ROG	NOX	CO	SO2	Fugitive PM10	Exhaust PM10	PM10 Total	Fugitive PM2.5	Exhaust PM2.5	Total PM2.5
2023										
Grading/Site Preparation + Foundations/Concrete Pour #1	0.76	15.07	8.80	0.08	3.99	0.11	4.10	1.08	0.11	1.19
Grading/Site Preparation + Drainage/Utilities/Trenching	0.71	13.38	8.16	0.08	3.70	0.10	3.81	1.00	0.10	1.10
Drainage/Utilities/Trenching + Building Construction	0.65	4.40	6.62	0.03	2.46	0.03	2.49	0.67	0.03	0.70
Drainage/Utilities/Trenching + Building Construction + Foundations/Concrete Pour #2	0.97	6.50	9.90	0.05	3.67	0.05	3.72	1.00	0.04	1.04
Building Construction + Paving Event #1	0.65	4.40	6.62	0.03	2.46	0.03	2.49	0.67	0.03	0.70
Building Construction + Field/Bleachers	0.65	4.40	6.62	0.03	2.46	0.03	2.49	0.67	0.03	0.70
2024										
Building Construction + Field/Bleachers	0.61	4.38	6.25	0.03	2.46	0.03	2.49	0.67	0.03	0.70
Building Construction + Foundations/Concrete Pour #3 + architectural Coatings + Field/Bleachers	1.17	6.86	11.81	0.06	4.61	0.05	4.66	1.25	0.05	1.29
Building Construction + Foundations/Concrete Pour #3 + architectural Coatings + Paving Event #2 + Synthetic Track + Field/Bleachers	1.69	7.66	16.74	0.07	6.47	0.06	6.54	1.74	0.06	1.80
	1.69	15.07	16.74	0.08	6.47	0.11	6.54	1.74	0.11	1.80

Hawthorne HS Field Improvement Project - Construction Only - South Coast Air Basin, Annual

EMFAC Off-Model Adjustment Factors for Gasoline Light Duty Vehicle to Account for the SAFE Vehicle Rule Applied

Hawthorne HS Field Improvement Project - Construction Only

South Coast Air Basin, Annual

1.0 Project Characteristics

1.1 Land Usage

Land Uses	Size	Metric	Lot Acreage	Floor Surface Area	Population
High School	555.39	1000sqft	12.75	555,390.00	0

1.2 Other Project Characteristics

Urbanization	Urban	Wind Speed (m/s)	2.2	Precipitation Freq (Days)	31
Climate Zone	8			Operational Year	2025
Utility Company	Southern California Edison				
CO2 Intensity (lb/MWhr)	531.98	CH4 Intensity (lb/MWhr)	0.033	N2O Intensity (lb/MWhr)	0.004

1.3 User Entered Comments & Non-Default Data

Project Characteristics - co2

Land Use -

Construction Phase - Consistent with previous District HS Field Improvement Projects

Off-road Equipment - Project-Specific Equipment

Off-road Equipment - Project-Specific Equipment

Off-road Equipment - Project-Specific Construction Equipment

Off-road Equipment - Project-Specific Equipment

Off-road Equipment - Project-Specific Equipment

Off-road Equipment - Project-Specific Equipment

Off-road Equipment - Project-Specific Equipment

Off-road Equipment - Project-Specific Equipment

Off-road Equipment -

Hawthorne HS Field Improvement Project - Construction Only - South Coast Air Basin, Annual

EMFAC Off-Model Adjustment Factors for Gasoline Light Duty Vehicle to Account for the SAFE Vehicle Rule Applied

Off-road Equipment -

Off-road Equipment -

Off-road Equipment - Project-Specific Equipment

Trips and VMT - Project-Specific Construction Program

Demolition - 2,500 tons of debris

Grading - 16,000 CY exported, 16,000 CY imported

Architectural Coating - 5,400 SF Team building, approx 400 SF parking lot

Vehicle Trips - Construction emissions only.

Energy Use - Construction emissions only

Water And Wastewater - Construction emissions only

Solid Waste - Construction emissions only

Construction Off-road Equipment Mitigation - Equipment >50 HP tier 3, water exposed area 3 times daily

Table Name	Column Name	Default Value	New Value
tblArchitecturalCoating	ConstArea_Nonresidential_Exterior	277,695.00	2,700.00
tblArchitecturalCoating	ConstArea_Nonresidential_Interior	833,085.00	8,100.00
tblArchitecturalCoating	ConstArea_Parking	0.00	400.00
tblConstEquipMitigation	NumberOfEquipmentMitigated	0.00	1.00
tblConstEquipMitigation	NumberOfEquipmentMitigated	0.00	1.00
tblConstEquipMitigation	NumberOfEquipmentMitigated	0.00	3.00
tblConstEquipMitigation	NumberOfEquipmentMitigated	0.00	6.00
tblConstEquipMitigation	NumberOfEquipmentMitigated	0.00	9.00
tblConstEquipMitigation	NumberOfEquipmentMitigated	0.00	3.00
tblConstEquipMitigation	NumberOfEquipmentMitigated	0.00	1.00
tblConstEquipMitigation	NumberOfEquipmentMitigated	0.00	4.00
tblConstEquipMitigation	NumberOfEquipmentMitigated	0.00	4.00
tblConstEquipMitigation	NumberOfEquipmentMitigated	0.00	9.00
tblConstEquipMitigation	NumberOfEquipmentMitigated	0.00	4.00
tblConstEquipMitigation	NumberOfEquipmentMitigated	0.00	5.00

Hawthorne HS Field Improvement Project - Construction Only - South Coast Air Basin, Annual

EMFAC Off-Model Adjustment Factors for Gasoline Light Duty Vehicle to Account for the SAFE Vehicle Rule Applied

tblConstEquipMitigation	NumberOfEquipmentMitigated	0.00	2.00
tblConstEquipMitigation	NumberOfEquipmentMitigated	0.00	19.00
tblConstEquipMitigation	NumberOfEquipmentMitigated	0.00	3.00
tblConstEquipMitigation	Tier	No Change	Tier 3
tblConstEquipMitigation	Tier	No Change	Tier 3
tblConstEquipMitigation	Tier	No Change	Tier 3
tblConstEquipMitigation	Tier	No Change	Tier 3
tblConstEquipMitigation	Tier	No Change	Tier 3
tblConstEquipMitigation	Tier	No Change	Tier 3
tblConstEquipMitigation	Tier	No Change	Tier 3
tblConstEquipMitigation	Tier	No Change	Tier 3
tblConstEquipMitigation	Tier	No Change	Tier 3
tblConstEquipMitigation	Tier	No Change	Tier 3
tblConstEquipMitigation	Tier	No Change	Tier 3
tblConstEquipMitigation	Tier	No Change	Tier 3
tblConstEquipMitigation	Tier	No Change	Tier 3
tblConstEquipMitigation	Tier	No Change	Tier 3
tblConstEquipMitigation	Tier	No Change	Tier 3
tblConstEquipMitigation	Tier	No Change	Tier 3
tblConstructionPhase	NumDays	20.00	43.00
tblConstructionPhase	NumDays	300.00	65.00
tblConstructionPhase	NumDays	300.00	3.00
tblConstructionPhase	NumDays	300.00	228.00
tblConstructionPhase	NumDays	300.00	3.00
tblConstructionPhase	NumDays	300.00	153.00
tblConstructionPhase	NumDays	300.00	3.00
tblConstructionPhase	NumDays	20.00	44.00
tblConstructionPhase	NumDays	30.00	76.00
tblConstructionPhase	NumDays	20.00	5.00
tblConstructionPhase	NumDays	20.00	5.00

Hawthorne HS Field Improvement Project - Construction Only - South Coast Air Basin, Annual

EMFAC Off-Model Adjustment Factors for Gasoline Light Duty Vehicle to Account for the SAFE Vehicle Rule Applied

tblEnergyUse	LightingElect	2.68	0.00
tblEnergyUse	NT24E	1.51	0.00
tblEnergyUse	NT24NG	1.03	0.00
tblEnergyUse	T24E	1.69	0.00
tblEnergyUse	T24NG	10.71	0.00
tblGrading	AcresOfGrading	228.00	125.00
tblGrading	MaterialExported	0.00	16,000.00
tblGrading	MaterialImported	0.00	16,000.00
tblOffRoadEquipment	HorsePower	231.00	78.00
tblOffRoadEquipment	LoadFactor	0.29	0.50
tblOffRoadEquipment	OffRoadEquipmentUnitAmount	1.00	0.00
tblOffRoadEquipment	OffRoadEquipmentUnitAmount	1.00	0.00
tblOffRoadEquipment	OffRoadEquipmentUnitAmount	1.00	0.00
tblOffRoadEquipment	OffRoadEquipmentUnitAmount	3.00	0.00
tblOffRoadEquipment	OffRoadEquipmentUnitAmount	3.00	0.00
tblOffRoadEquipment	OffRoadEquipmentUnitAmount	3.00	0.00
tblOffRoadEquipment	OffRoadEquipmentUnitAmount	1.00	0.00
tblOffRoadEquipment	OffRoadEquipmentUnitAmount	1.00	0.00
tblOffRoadEquipment	OffRoadEquipmentUnitAmount	1.00	0.00
tblOffRoadEquipment	OffRoadEquipmentUnitAmount	3.00	2.00
tblOffRoadEquipment	OffRoadEquipmentUnitAmount	3.00	2.00
tblOffRoadEquipment	OffRoadEquipmentUnitAmount	3.00	2.00
tblOffRoadEquipment	OffRoadEquipmentUnitAmount	1.00	0.00
tblOffRoadEquipment	OffRoadEquipmentUnitAmount	1.00	0.00
tblOffRoadEquipment	OffRoadEquipmentUnitAmount	1.00	0.00
tblOffRoadEquipment	UsageHours	6.00	8.00
tblOffRoadEquipment	UsageHours	7.00	8.00
tblOffRoadEquipment	UsageHours	7.00	8.00
tblOffRoadEquipment	UsageHours	7.00	8.00

Hawthorne HS Field Improvement Project - Construction Only - South Coast Air Basin, Annual

EMFAC Off-Model Adjustment Factors for Gasoline Light Duty Vehicle to Account for the SAFE Vehicle Rule Applied

tblOffRoadEquipment	UsageHours	7.00	8.00
tblOffRoadEquipment	UsageHours	7.00	8.00
tblOffRoadEquipment	UsageHours	7.00	8.00
tblOffRoadEquipment	UsageHours	7.00	8.00
tblOffRoadEquipment	UsageHours	7.00	8.00
tblOffRoadEquipment	UsageHours	7.00	8.00
tblProjectCharacteristics	CO2IntensityFactor	390.98	531.98
tblSolidWaste	SolidWasteGenerationRate	722.01	0.00
tblTripsAndVMT	HaulingTripLength	20.00	40.00
tblTripsAndVMT	HaulingTripLength	20.00	40.00
tblTripsAndVMT	VendorTripNumber	0.00	6.00
tblTripsAndVMT	VendorTripNumber	0.00	6.00
tblTripsAndVMT	VendorTripNumber	91.00	6.00
tblTripsAndVMT	VendorTripNumber	0.00	6.00
tblTripsAndVMT	VendorTripNumber	0.00	6.00
tblTripsAndVMT	VendorTripNumber	91.00	50.00
tblTripsAndVMT	VendorTripNumber	0.00	6.00
tblTripsAndVMT	VendorTripNumber	91.00	99.00
tblTripsAndVMT	VendorTripNumber	91.00	50.00
tblTripsAndVMT	VendorTripNumber	0.00	6.00
tblTripsAndVMT	VendorTripNumber	91.00	6.00
tblTripsAndVMT	VendorTripNumber	91.00	50.00
tblTripsAndVMT	WorkerTripNumber	15.00	80.00
tblTripsAndVMT	WorkerTripNumber	47.00	80.00
tblTripsAndVMT	WorkerTripNumber	233.00	80.00
tblTripsAndVMT	WorkerTripNumber	15.00	80.00
tblTripsAndVMT	WorkerTripNumber	20.00	80.00
tblTripsAndVMT	WorkerTripNumber	233.00	80.00
tblTripsAndVMT	WorkerTripNumber	20.00	80.00

Hawthorne HS Field Improvement Project - Construction Only - South Coast Air Basin, Annual

EMFAC Off-Model Adjustment Factors for Gasoline Light Duty Vehicle to Account for the SAFE Vehicle Rule Applied

tblTripsAndVMT	WorkerTripNumber	233.00	80.00
tblTripsAndVMT	WorkerTripNumber	233.00	80.00
tblTripsAndVMT	WorkerTripNumber	15.00	80.00
tblTripsAndVMT	WorkerTripNumber	233.00	80.00
tblTripsAndVMT	WorkerTripNumber	233.00	80.00
tblVehicleTrips	ST_TR	3.98	0.00
tblVehicleTrips	SU_TR	1.71	0.00
tblVehicleTrips	WD_TR	14.07	0.00
tblWater	IndoorWaterUseRate	18,441,525.01	0.00
tblWater	OutdoorWaterUseRate	47,421,064.31	0.00

2.0 Emissions Summary

Hawthorne HS Field Improvement Project - Construction Only - South Coast Air Basin, Annual

EMFAC Off-Model Adjustment Factors for Gasoline Light Duty Vehicle to Account for the SAFE Vehicle Rule Applied

2.1 Overall Construction

Unmitigated Construction

	ROG	NOx	CO	SO2	Fugitive PM10	Exhaust PM10	PM10 Total	Fugitive PM2.5	Exhaust PM2.5	PM2.5 Total	Bio- CO2	NBio- CO2	Total CO2	CH4	N2O	CO2e
Year	tons/yr										MT/yr					
2022	0.0326	0.3083	0.2627	6.0000e-004	0.0256	0.0139	0.0395	5.2900e-003	0.0129	0.0182	0.0000	53.8484	53.8484	0.0112	1.5600e-003	54.5936
2023	0.5557	5.6281	5.1156	0.0135	0.6232	0.2352	0.8584	0.2203	0.2183	0.4386	0.0000	1,234.6825	1,234.6825	0.2257	0.0638	1,259.3493
2024	0.2623	1.9926	2.6001	5.4400e-003	0.1534	0.0843	0.2377	0.0413	0.0793	0.1206	0.0000	484.9867	484.9867	0.0799	0.0127	490.7569
Maximum	0.5557	5.6281	5.1156	0.0135	0.6232	0.2352	0.8584	0.2203	0.2183	0.4386	0.0000	1,234.6825	1,234.6825	0.2257	0.0638	1,259.3493

Mitigated Construction

	ROG	NOx	CO	SO2	Fugitive PM10	Exhaust PM10	PM10 Total	Fugitive PM2.5	Exhaust PM2.5	PM2.5 Total	Bio- CO2	NBio- CO2	Total CO2	CH4	N2O	CO2e
Year	tons/yr										MT/yr					
2022	0.0137	0.2268	0.3076	6.0000e-004	0.0174	9.7400e-003	0.0272	4.0600e-003	9.7300e-003	0.0138	0.0000	53.8483	53.8483	0.0112	1.5600e-003	54.5936
2023	0.2800	4.8914	5.9122	0.0135	0.4339	0.2212	0.6551	0.1378	0.2209	0.3587	0.0000	1,234.6816	1,234.6816	0.2257	0.0638	1,259.3485
2024	0.1704	2.0621	2.8594	5.4400e-003	0.1534	0.1164	0.2699	0.0413	0.1163	0.1577	0.0000	484.9863	484.9863	0.0799	0.0127	490.7565
Maximum	0.2800	4.8914	5.9122	0.0135	0.4339	0.2212	0.6551	0.1378	0.2209	0.3587	0.0000	1,234.6816	1,234.6816	0.2257	0.0638	1,259.3485

Hawthorne HS Field Improvement Project - Construction Only - South Coast Air Basin, Annual

EMFAC Off-Model Adjustment Factors for Gasoline Light Duty Vehicle to Account for the SAFE Vehicle Rule Applied

	ROG	NOx	CO	SO2	Fugitive PM10	Exhaust PM10	PM10 Total	Fugitive PM2.5	Exhaust PM2.5	PM2.5 Total	Bio- CO2	NBio-CO2	Total CO2	CH4	N2O	CO2e
Percent Reduction	45.43	9.44	-13.80	0.00	24.61	-4.20	16.15	31.37	-11.75	8.19	0.00	0.00	0.00	0.00	0.00	0.00

Quarter	Start Date	End Date	Maximum Unmitigated ROG + NOX (tons/quarter)	Maximum Mitigated ROG + NOX (tons/quarter)
1	12-1-2022	2-28-2023	1.1410	0.9267
2	3-1-2023	5-31-2023	2.2404	1.8211
3	6-1-2023	8-31-2023	1.7808	1.3821
4	9-1-2023	11-30-2023	0.9117	0.8572
5	12-1-2023	2-29-2024	1.2910	1.2548
6	3-1-2024	5-31-2024	1.3890	1.3748
		Highest	2.2404	1.8211

Hawthorne HS Field Improvement Project - Construction Only - South Coast Air Basin, Annual

EMFAC Off-Model Adjustment Factors for Gasoline Light Duty Vehicle to Account for the SAFE Vehicle Rule Applied

2.2 Overall Operational

Unmitigated Operational

	ROG	NOx	CO	SO2	Fugitive PM10	Exhaust PM10	PM10 Total	Fugitive PM2.5	Exhaust PM2.5	PM2.5 Total	Bio- CO2	NBio- CO2	Total CO2	CH4	N2O	CO2e
Category	tons/yr										MT/yr					
Area	2.2650	6.0000e-005	7.0700e-003	0.0000		3.0000e-005	3.0000e-005		3.0000e-005	3.0000e-005	0.0000	0.0138	0.0138	4.0000e-005	0.0000	0.0147
Energy	0.0000	0.0000	0.0000	0.0000		0.0000	0.0000		0.0000	0.0000	0.0000	0.0000	0.0000	0.0000	0.0000	0.0000
Mobile	0.0000	0.0000	0.0000	0.0000	0.0000	0.0000	0.0000	0.0000	0.0000	0.0000	0.0000	0.0000	0.0000	0.0000	0.0000	0.0000
Waste						0.0000	0.0000		0.0000	0.0000	0.0000	0.0000	0.0000	0.0000	0.0000	0.0000
Water						0.0000	0.0000		0.0000	0.0000	0.0000	0.0000	0.0000	0.0000	0.0000	0.0000
Total	2.2650	6.0000e-005	7.0700e-003	0.0000	0.0000	3.0000e-005	3.0000e-005	0.0000	3.0000e-005	3.0000e-005	0.0000	0.0138	0.0138	4.0000e-005	0.0000	0.0147

Hawthorne HS Field Improvement Project - Construction Only - South Coast Air Basin, Annual

EMFAC Off-Model Adjustment Factors for Gasoline Light Duty Vehicle to Account for the SAFE Vehicle Rule Applied

2.2 Overall Operational

Mitigated Operational

	ROG	NOx	CO	SO2	Fugitive PM10	Exhaust PM10	PM10 Total	Fugitive PM2.5	Exhaust PM2.5	PM2.5 Total	Bio- CO2	NBio- CO2	Total CO2	CH4	N2O	CO2e
Category	tons/yr										MT/yr					
Area	2.2650	6.0000e-005	7.0700e-003	0.0000		3.0000e-005	3.0000e-005		3.0000e-005	3.0000e-005	0.0000	0.0138	0.0138	4.0000e-005	0.0000	0.0147
Energy	0.0000	0.0000	0.0000	0.0000		0.0000	0.0000		0.0000	0.0000	0.0000	0.0000	0.0000	0.0000	0.0000	0.0000
Mobile	0.0000	0.0000	0.0000	0.0000	0.0000	0.0000	0.0000	0.0000	0.0000	0.0000	0.0000	0.0000	0.0000	0.0000	0.0000	0.0000
Waste						0.0000	0.0000		0.0000	0.0000	0.0000	0.0000	0.0000	0.0000	0.0000	0.0000
Water						0.0000	0.0000		0.0000	0.0000	0.0000	0.0000	0.0000	0.0000	0.0000	0.0000
Total	2.2650	6.0000e-005	7.0700e-003	0.0000	0.0000	3.0000e-005	3.0000e-005	0.0000	3.0000e-005	3.0000e-005	0.0000	0.0138	0.0138	4.0000e-005	0.0000	0.0147

	ROG	NOx	CO	SO2	Fugitive PM10	Exhaust PM10	PM10 Total	Fugitive PM2.5	Exhaust PM2.5	PM2.5 Total	Bio- CO2	NBio- CO2	Total CO2	CH4	N2O	CO2e
Percent Reduction	0.00	0.00	0.00	0.00	0.00	0.00	0.00	0.00	0.00	0.00	0.00	0.00	0.00	0.00	0.00	0.00

3.0 Construction Detail

Construction Phase

Phase Number	Phase Name	Phase Type	Start Date	End Date	Num Days Week	Num Days	Phase Description
1	Demolition	Demolition	12/1/2022	1/31/2023	5	44	
2	Grading/Site Preparation	Grading	2/1/2023	5/17/2023	5	76	
3	Foundations/Concrete Pour #1	Building Construction	3/1/2023	3/3/2023	5	3	

Hawthorne HS Field Improvement Project - Construction Only - South Coast Air Basin, Annual

EMFAC Off-Model Adjustment Factors for Gasoline Light Duty Vehicle to Account for the SAFE Vehicle Rule Applied

4	Drainage/Utilities/Trenching	Trenching	4/1/2023	8/31/2023	5	109
5	Building Construction	Building Construction	5/18/2023	4/1/2024	5	228
6	Foundations/Concrete Pour #2	Building Construction	7/1/2023	7/5/2023	5	3
7	Paving Event #1	Paving	10/1/2023	10/6/2023	5	5
8	Field/Bleachers	Building Construction	11/1/2023	5/31/2024	5	153
9	Foundations/Concrete Pour #3	Building Construction	2/1/2024	2/5/2024	5	3
10	Architectural Coatings	Architectural Coating	2/1/2024	4/1/2024	5	43
11	Synthetic Track	Building Construction	3/1/2024	5/30/2024	5	65
12	Paving Event #2	Paving	3/1/2024	3/7/2024	5	5

Acres of Grading (Site Preparation Phase): 0

Acres of Grading (Grading Phase): 125

Acres of Paving: 0

Residential Indoor: 0; Residential Outdoor: 0; Non-Residential Indoor: 8,100; Non-Residential Outdoor: 2,700; Striped Parking Area: 400 (Architectural Coating – sqft)

OffRoad Equipment

Phase Name	Offroad Equipment Type	Amount	Usage Hours	Horse Power	Load Factor
Demolition	Concrete/Industrial Saws	1	8.00	81	0.73
Demolition	Excavators	3	8.00	158	0.38
Demolition	Rubber Tired Dozers	2	8.00	247	0.40
Grading/Site Preparation	Excavators	2	8.00	158	0.38
Grading/Site Preparation	Graders	1	8.00	187	0.41
Grading/Site Preparation	Rubber Tired Dozers	1	8.00	247	0.40
Grading/Site Preparation	Scrapers	2	8.00	367	0.48
Grading/Site Preparation	Tractors/Loaders/Backhoes	2	8.00	97	0.37
Foundations/Concrete Pour #1	Cranes	0	7.00	231	0.29
Foundations/Concrete Pour #1	Excavators	0		158	0.38
Foundations/Concrete Pour #1	Forklifts	0	8.00	89	0.20

Hawthorne HS Field Improvement Project - Construction Only - South Coast Air Basin, Annual

EMFAC Off-Model Adjustment Factors for Gasoline Light Duty Vehicle to Account for the SAFE Vehicle Rule Applied

Foundations/Concrete Pour #1	Generator Sets	0	8.00	84	0.74
Foundations/Concrete Pour #1	Graders	0		187	0.41
Foundations/Concrete Pour #1	Pumps	3	8.00	84	0.74
Foundations/Concrete Pour #1	Rubber Tired Dozers	0		247	0.40
Foundations/Concrete Pour #1	Scrapers	0		367	0.48
Foundations/Concrete Pour #1	Tractors/Loaders/Backhoes	2	8.00	97	0.37
Foundations/Concrete Pour #1	Welders	0	8.00	46	0.45
Drainage/Utilities/Trenching	Cranes			78	0.50
Drainage/Utilities/Trenching	Excavators	1	8.00	158	0.38
Drainage/Utilities/Trenching	Forklifts	0		89	0.20
Drainage/Utilities/Trenching	Generator Sets	0		84	0.74
Drainage/Utilities/Trenching	Rubber Tired Dozers	2	8.00	247	0.40
Drainage/Utilities/Trenching	Tractors/Loaders/Backhoes	2	8.00	97	0.37
Drainage/Utilities/Trenching	Trenchers	3	8.00	78	0.50
Drainage/Utilities/Trenching	Welders	0		46	0.45
Building Construction	Cranes	1	8.00	231	0.29
Building Construction	Forklifts	3	8.00	89	0.20
Building Construction	Generator Sets	1	8.00	84	0.74
Building Construction	Pavers	0		130	0.42
Building Construction	Paving Equipment	0		132	0.36
Building Construction	Rollers	0		80	0.38
Building Construction	Tractors/Loaders/Backhoes	3	8.00	97	0.37
Building Construction	Welders	1	8.00	46	0.45
Foundations/Concrete Pour #2	Air Compressors	0		78	0.48
Foundations/Concrete Pour #2	Cranes	0	7.00	231	0.29
Foundations/Concrete Pour #2	Forklifts	0	8.00	89	0.20
Foundations/Concrete Pour #2	Generator Sets	0	8.00	84	0.74
Foundations/Concrete Pour #2	Pumps	3	8.00	84	0.74
Foundations/Concrete Pour #2	Tractors/Loaders/Backhoes	2	8.00	97	0.37

Hawthorne HS Field Improvement Project - Construction Only - South Coast Air Basin, Annual

EMFAC Off-Model Adjustment Factors for Gasoline Light Duty Vehicle to Account for the SAFE Vehicle Rule Applied

Foundations/Concrete Pour #2	Welders	0	8.00	46	0.45
Paving Event #1	Pavers	2	8.00	130	0.42
Paving Event #1	Paving Equipment	2	8.00	132	0.36
Paving Event #1	Rollers	2	8.00	80	0.38
Field/Bleachers	Cranes	1	8.00	231	0.29
Field/Bleachers	Forklifts	3	8.00	89	0.20
Field/Bleachers	Generator Sets	1	8.00	84	0.74
Field/Bleachers	Tractors/Loaders/Backhoes	3	8.00	97	0.37
Field/Bleachers	Welders	1	8.00	46	0.45
Foundations/Concrete Pour #3	Cranes	0	7.00	231	0.29
Foundations/Concrete Pour #3	Forklifts	0	8.00	89	0.20
Foundations/Concrete Pour #3	Generator Sets	0	8.00	84	0.74
Foundations/Concrete Pour #3	Pumps	3	8.00	84	0.74
Foundations/Concrete Pour #3	Tractors/Loaders/Backhoes	2	8.00	97	0.37
Foundations/Concrete Pour #3	Welders	0	8.00	46	0.45
Architectural Coatings	Air Compressors	1	8.00	78	0.48
Synthetic Track	Cranes	1	8.00	231	0.29
Synthetic Track	Forklifts	3	8.00	89	0.20
Synthetic Track	Generator Sets	1	8.00	84	0.74
Synthetic Track	Tractors/Loaders/Backhoes	3	8.00	97	0.37
Synthetic Track	Welders	1	8.00	46	0.45
Paving Event #2	Pavers	2	8.00	130	0.42
Paving Event #2	Paving Equipment	2	8.00	132	0.36
Paving Event #2	Rollers	2	8.00	80	0.38

Trips and VMT

Hawthorne HS Field Improvement Project - Construction Only - South Coast Air Basin, Annual

EMFAC Off-Model Adjustment Factors for Gasoline Light Duty Vehicle to Account for the SAFE Vehicle Rule Applied

Phase Name	Offroad Equipment Count	Worker Trip Number	Vendor Trip Number	Hauling Trip Number	Worker Trip Length	Vendor Trip Length	Hauling Trip Length	Worker Vehicle Class	Vendor Vehicle Class	Hauling Vehicle Class
Demolition	6	80.00	6.00	247.00	14.70	6.90	40.00	LD_Mix	HDT_Mix	HHDT
Grading/Site Preparation	8	80.00	6.00	4,000.00	14.70	6.90	40.00	LD_Mix	HDT_Mix	HHDT
Foundations/Concrete Pour #1	5	80.00	50.00	0.00	14.70	6.90	20.00	LD_Mix	HDT_Mix	HHDT
Drainage/Utilities/Trenching	8	80.00	6.00	0.00	14.70	6.90	20.00	LD_Mix	HDT_Mix	HHDT
Building Construction	9	80.00	99.00	0.00	14.70	6.90	20.00	LD_Mix	HDT_Mix	HHDT
Foundations/Concrete Pour #2	5	80.00	50.00	0.00	14.70	6.90	20.00	LD_Mix	HDT_Mix	HHDT
Paving Event #1	6	80.00	6.00	0.00	14.70	6.90	20.00	LD_Mix	HDT_Mix	HHDT
Field/Bleachers	9	80.00	6.00	0.00	14.70	6.90	20.00	LD_Mix	HDT_Mix	HHDT
Foundations/Concrete Pour #2	5	80.00	50.00	0.00	14.70	6.90	20.00	LD_Mix	HDT_Mix	HHDT
Architectural Coatings	1	80.00	6.00	0.00	14.70	6.90	20.00	LD_Mix	HDT_Mix	HHDT
Synthetic Track	9	80.00	6.00	0.00	14.70	6.90	20.00	LD_Mix	HDT_Mix	HHDT
Paving Event #2	6	80.00	6.00	0.00	14.70	6.90	20.00	LD_Mix	HDT_Mix	HHDT

3.1 Mitigation Measures Construction

Use Cleaner Engines for Construction Equipment

Water Exposed Area

Hawthorne HS Field Improvement Project - Construction Only - South Coast Air Basin, Annual

EMFAC Off-Model Adjustment Factors for Gasoline Light Duty Vehicle to Account for the SAFE Vehicle Rule Applied

3.2 Demolition - 2022

Unmitigated Construction On-Site

	ROG	NOx	CO	SO2	Fugitive PM10	Exhaust PM10	PM10 Total	Fugitive PM2.5	Exhaust PM2.5	PM2.5 Total	Bio- CO2	NBio- CO2	Total CO2	CH4	N2O	CO2e
Category	tons/yr										MT/yr					
Fugitive Dust					0.0134	0.0000	0.0134	2.0300e-003	0.0000	2.0300e-003	0.0000	0.0000	0.0000	0.0000	0.0000	0.0000
Off-Road	0.0290	0.2829	0.2265	4.3000e-004		0.0137	0.0137		0.0127	0.0127	0.0000	37.3893	37.3893	0.0105	0.0000	37.6518
Total	0.0290	0.2829	0.2265	4.3000e-004	0.0134	0.0137	0.0270	2.0300e-003	0.0127	0.0147	0.0000	37.3893	37.3893	0.0105	0.0000	37.6518

Unmitigated Construction Off-Site

	ROG	NOx	CO	SO2	Fugitive PM10	Exhaust PM10	PM10 Total	Fugitive PM2.5	Exhaust PM2.5	PM2.5 Total	Bio- CO2	NBio- CO2	Total CO2	CH4	N2O	CO2e
Category	tons/yr										MT/yr					
Hauling	4.7000e-004	0.0197	3.9200e-003	7.0000e-005	2.1200e-003	1.6000e-004	2.2800e-003	5.8000e-004	1.5000e-004	7.3000e-004	0.0000	7.3659	7.3659	4.4000e-004	1.1700e-003	7.7258
Vendor	1.2000e-004	3.2700e-003	1.0600e-003	1.0000e-005	4.2000e-004	3.0000e-005	4.5000e-004	1.2000e-004	3.0000e-005	1.5000e-004	0.0000	1.2369	1.2369	5.0000e-005	1.8000e-004	1.2916
Worker	2.9500e-003	2.3800e-003	0.0312	9.0000e-005	9.6500e-003	6.0000e-005	9.7100e-003	2.5600e-003	5.0000e-005	2.6200e-003	0.0000	7.8564	7.8564	2.2000e-004	2.1000e-004	7.9245
Total	3.5400e-003	0.0254	0.0362	1.7000e-004	0.0122	2.5000e-004	0.0124	3.2600e-003	2.3000e-004	3.5000e-003	0.0000	16.4591	16.4591	7.1000e-004	1.5600e-003	16.9418

Hawthorne HS Field Improvement Project - Construction Only - South Coast Air Basin, Annual

EMFAC Off-Model Adjustment Factors for Gasoline Light Duty Vehicle to Account for the SAFE Vehicle Rule Applied

3.2 Demolition - 2022

Mitigated Construction On-Site

	ROG	NOx	CO	SO2	Fugitive PM10	Exhaust PM10	PM10 Total	Fugitive PM2.5	Exhaust PM2.5	PM2.5 Total	Bio- CO2	NBio- CO2	Total CO2	CH4	N2O	CO2e
Category	tons/yr										MT/yr					
Fugitive Dust					5.2200e-003	0.0000	5.2200e-003	7.9000e-004	0.0000	7.9000e-004	0.0000	0.0000	0.0000	0.0000	0.0000	0.0000
Off-Road	0.0102	0.2014	0.2714	4.3000e-004		9.4900e-003	9.4900e-003		9.4900e-003	9.4900e-003	0.0000	37.3892	37.3892	0.0105	0.0000	37.6518
Total	0.0102	0.2014	0.2714	4.3000e-004	5.2200e-003	9.4900e-003	0.0147	7.9000e-004	9.4900e-003	0.0103	0.0000	37.3892	37.3892	0.0105	0.0000	37.6518

Mitigated Construction Off-Site

	ROG	NOx	CO	SO2	Fugitive PM10	Exhaust PM10	PM10 Total	Fugitive PM2.5	Exhaust PM2.5	PM2.5 Total	Bio- CO2	NBio- CO2	Total CO2	CH4	N2O	CO2e
Category	tons/yr										MT/yr					
Hauling	4.7000e-004	0.0197	3.9200e-003	7.0000e-005	2.1200e-003	1.6000e-004	2.2800e-003	5.8000e-004	1.5000e-004	7.3000e-004	0.0000	7.3659	7.3659	4.4000e-004	1.1700e-003	7.7258
Vendor	1.2000e-004	3.2700e-003	1.0600e-003	1.0000e-005	4.2000e-004	3.0000e-005	4.5000e-004	1.2000e-004	3.0000e-005	1.5000e-004	0.0000	1.2369	1.2369	5.0000e-005	1.8000e-004	1.2916
Worker	2.9500e-003	2.3800e-003	0.0312	9.0000e-005	9.6500e-003	6.0000e-005	9.7100e-003	2.5600e-003	5.0000e-005	2.6200e-003	0.0000	7.8564	7.8564	2.2000e-004	2.1000e-004	7.9245
Total	3.5400e-003	0.0254	0.0362	1.7000e-004	0.0122	2.5000e-004	0.0124	3.2600e-003	2.3000e-004	3.5000e-003	0.0000	16.4591	16.4591	7.1000e-004	1.5600e-003	16.9418

Hawthorne HS Field Improvement Project - Construction Only - South Coast Air Basin, Annual

EMFAC Off-Model Adjustment Factors for Gasoline Light Duty Vehicle to Account for the SAFE Vehicle Rule Applied

3.2 Demolition - 2023

Unmitigated Construction On-Site

	ROG	NOx	CO	SO2	Fugitive PM10	Exhaust PM10	PM10 Total	Fugitive PM2.5	Exhaust PM2.5	PM2.5 Total	Bio- CO2	NBio- CO2	Total CO2	CH4	N2O	CO2e
Category	tons/yr										MT/yr					
Fugitive Dust					0.0134	0.0000	0.0134	2.0300e-003	0.0000	2.0300e-003	0.0000	0.0000	0.0000	0.0000	0.0000	0.0000
Off-Road	0.0250	0.2363	0.2161	4.3000e-004		0.0110	0.0110		0.0102	0.0102	0.0000	37.3913	37.3913	0.0105	0.0000	37.6531
Total	0.0250	0.2363	0.2161	4.3000e-004	0.0134	0.0110	0.0243	2.0300e-003	0.0102	0.0122	0.0000	37.3913	37.3913	0.0105	0.0000	37.6531

Unmitigated Construction Off-Site

	ROG	NOx	CO	SO2	Fugitive PM10	Exhaust PM10	PM10 Total	Fugitive PM2.5	Exhaust PM2.5	PM2.5 Total	Bio- CO2	NBio- CO2	Total CO2	CH4	N2O	CO2e
Category	tons/yr										MT/yr					
Hauling	1.9000e-004	0.0149	3.3700e-003	7.0000e-005	2.1200e-003	1.1000e-004	2.2300e-003	5.8000e-004	1.0000e-004	6.8000e-004	0.0000	6.9585	6.9585	4.3000e-004	1.1100e-003	7.2992
Vendor	7.0000e-005	2.5300e-003	9.4000e-004	1.0000e-005	4.2000e-004	1.0000e-005	4.3000e-004	1.2000e-004	1.0000e-005	1.3000e-004	0.0000	1.1778	1.1778	4.0000e-005	1.7000e-004	1.2299
Worker	2.7300e-003	2.1100e-003	0.0288	8.0000e-005	9.6500e-003	6.0000e-005	9.7100e-003	2.5600e-003	5.0000e-005	2.6200e-003	0.0000	7.6498	7.6498	1.9000e-004	1.9000e-004	7.7125
Total	2.9900e-003	0.0195	0.0331	1.6000e-004	0.0122	1.8000e-004	0.0124	3.2600e-003	1.6000e-004	3.4300e-003	0.0000	15.7861	15.7861	6.6000e-004	1.4700e-003	16.2416

Hawthorne HS Field Improvement Project - Construction Only - South Coast Air Basin, Annual

EMFAC Off-Model Adjustment Factors for Gasoline Light Duty Vehicle to Account for the SAFE Vehicle Rule Applied

3.2 Demolition - 2023

Mitigated Construction On-Site

	ROG	NOx	CO	SO2	Fugitive PM10	Exhaust PM10	PM10 Total	Fugitive PM2.5	Exhaust PM2.5	PM2.5 Total	Bio- CO2	NBio- CO2	Total CO2	CH4	N2O	CO2e
Category	tons/yr										MT/yr					
Fugitive Dust					5.2200e-003	0.0000	5.2200e-003	7.9000e-004	0.0000	7.9000e-004	0.0000	0.0000	0.0000	0.0000	0.0000	0.0000
Off-Road	0.0102	0.2014	0.2714	4.3000e-004		9.4900e-003	9.4900e-003		9.4900e-003	9.4900e-003	0.0000	37.3912	37.3912	0.0105	0.0000	37.6530
Total	0.0102	0.2014	0.2714	4.3000e-004	5.2200e-003	9.4900e-003	0.0147	7.9000e-004	9.4900e-003	0.0103	0.0000	37.3912	37.3912	0.0105	0.0000	37.6530

Mitigated Construction Off-Site

	ROG	NOx	CO	SO2	Fugitive PM10	Exhaust PM10	PM10 Total	Fugitive PM2.5	Exhaust PM2.5	PM2.5 Total	Bio- CO2	NBio- CO2	Total CO2	CH4	N2O	CO2e
Category	tons/yr										MT/yr					
Hauling	1.9000e-004	0.0149	3.3700e-003	7.0000e-005	2.1200e-003	1.1000e-004	2.2300e-003	5.8000e-004	1.0000e-004	6.8000e-004	0.0000	6.9585	6.9585	4.3000e-004	1.1100e-003	7.2992
Vendor	7.0000e-005	2.5300e-003	9.4000e-004	1.0000e-005	4.2000e-004	1.0000e-005	4.3000e-004	1.2000e-004	1.0000e-005	1.3000e-004	0.0000	1.1778	1.1778	4.0000e-005	1.7000e-004	1.2299
Worker	2.7300e-003	2.1100e-003	0.0288	8.0000e-005	9.6500e-003	6.0000e-005	9.7100e-003	2.5600e-003	5.0000e-005	2.6200e-003	0.0000	7.6498	7.6498	1.9000e-004	1.9000e-004	7.7125
Total	2.9900e-003	0.0195	0.0331	1.6000e-004	0.0122	1.8000e-004	0.0124	3.2600e-003	1.6000e-004	3.4300e-003	0.0000	15.7861	15.7861	6.6000e-004	1.4700e-003	16.2416

Hawthorne HS Field Improvement Project - Construction Only - South Coast Air Basin, Annual

EMFAC Off-Model Adjustment Factors for Gasoline Light Duty Vehicle to Account for the SAFE Vehicle Rule Applied

3.3 Grading/Site Preparation - 2023

Unmitigated Construction On-Site

	ROG	NOx	CO	SO2	Fugitive PM10	Exhaust PM10	PM10 Total	Fugitive PM2.5	Exhaust PM2.5	PM2.5 Total	Bio- CO2	NBio- CO2	Total CO2	CH4	N2O	CO2e
Category	tons/yr										MT/yr					
Fugitive Dust					0.2969	0.0000	0.2969	0.1332	0.0000	0.1332	0.0000	0.0000	0.0000	0.0000	0.0000	0.0000
Off-Road	0.1262	1.3116	1.0659	2.3600e-003		0.0541	0.0541		0.0498	0.0498	0.0000	207.2338	207.2338	0.0670	0.0000	208.9094
Total	0.1262	1.3116	1.0659	2.3600e-003	0.2969	0.0541	0.3511	0.1332	0.0498	0.1830	0.0000	207.2338	207.2338	0.0670	0.0000	208.9094

Unmitigated Construction Off-Site

	ROG	NOx	CO	SO2	Fugitive PM10	Exhaust PM10	PM10 Total	Fugitive PM2.5	Exhaust PM2.5	PM2.5 Total	Bio- CO2	NBio- CO2	Total CO2	CH4	N2O	CO2e
Category	tons/yr										MT/yr					
Hauling	6.2500e-003	0.4826	0.1091	2.2500e-003	0.0688	3.4400e-003	0.0722	0.0189	3.2900e-003	0.0222	0.0000	225.3778	225.3778	0.0140	0.0359	236.4114
Vendor	2.4000e-004	8.7600e-003	3.2500e-003	4.0000e-005	1.4400e-003	5.0000e-005	1.4800e-003	4.1000e-004	4.0000e-005	4.6000e-004	0.0000	4.0689	4.0689	1.5000e-004	5.9000e-004	4.2486
Worker	9.4500e-003	7.2800e-003	0.0994	2.8000e-004	0.0334	1.9000e-004	0.0335	8.8600e-003	1.8000e-004	9.0300e-003	0.0000	26.4265	26.4265	6.7000e-004	6.7000e-004	26.6433
Total	0.0159	0.4986	0.2117	2.5700e-003	0.1036	3.6800e-003	0.1072	0.0282	3.5100e-003	0.0317	0.0000	255.8731	255.8731	0.0148	0.0371	267.3033

Hawthorne HS Field Improvement Project - Construction Only - South Coast Air Basin, Annual

EMFAC Off-Model Adjustment Factors for Gasoline Light Duty Vehicle to Account for the SAFE Vehicle Rule Applied

3.3 Grading/Site Preparation - 2023

Mitigated Construction On-Site

	ROG	NOx	CO	SO2	Fugitive PM10	Exhaust PM10	PM10 Total	Fugitive PM2.5	Exhaust PM2.5	PM2.5 Total	Bio- CO2	NBio- CO2	Total CO2	CH4	N2O	CO2e
Category	tons/yr										MT/yr					
Fugitive Dust					0.1158	0.0000	0.1158	0.0520	0.0000	0.0520	0.0000	0.0000	0.0000	0.0000	0.0000	0.0000
Off-Road	0.0579	1.1392	1.3955	2.3600e-003		0.0494	0.0494		0.0494	0.0494	0.0000	207.2336	207.2336	0.0670	0.0000	208.9091
Total	0.0579	1.1392	1.3955	2.3600e-003	0.1158	0.0494	0.1652	0.0520	0.0494	0.1013	0.0000	207.2336	207.2336	0.0670	0.0000	208.9091

Mitigated Construction Off-Site

	ROG	NOx	CO	SO2	Fugitive PM10	Exhaust PM10	PM10 Total	Fugitive PM2.5	Exhaust PM2.5	PM2.5 Total	Bio- CO2	NBio- CO2	Total CO2	CH4	N2O	CO2e
Category	tons/yr										MT/yr					
Hauling	6.2500e-003	0.4826	0.1091	2.2500e-003	0.0688	3.4400e-003	0.0722	0.0189	3.2900e-003	0.0222	0.0000	225.3778	225.3778	0.0140	0.0359	236.4114
Vendor	2.4000e-004	8.7600e-003	3.2500e-003	4.0000e-005	1.4400e-003	5.0000e-005	1.4800e-003	4.1000e-004	4.0000e-005	4.6000e-004	0.0000	4.0689	4.0689	1.5000e-004	5.9000e-004	4.2486
Worker	9.4500e-003	7.2800e-003	0.0994	2.8000e-004	0.0334	1.9000e-004	0.0335	8.8600e-003	1.8000e-004	9.0300e-003	0.0000	26.4265	26.4265	6.7000e-004	6.7000e-004	26.6433
Total	0.0159	0.4986	0.2117	2.5700e-003	0.1036	3.6800e-003	0.1072	0.0282	3.5100e-003	0.0317	0.0000	255.8731	255.8731	0.0148	0.0371	267.3033

Hawthorne HS Field Improvement Project - Construction Only - South Coast Air Basin, Annual

EMFAC Off-Model Adjustment Factors for Gasoline Light Duty Vehicle to Account for the SAFE Vehicle Rule Applied

3.4 Foundations/Concrete Pour #1 - 2023

Unmitigated Construction On-Site

	ROG	NOx	CO	SO2	Fugitive PM10	Exhaust PM10	PM10 Total	Fugitive PM2.5	Exhaust PM2.5	PM2.5 Total	Bio- CO2	NBio- CO2	Total CO2	CH4	N2O	CO2e
Category	tons/yr										MT/yr					
Off-Road	1.9300e-003	0.0170	0.0235	4.0000e-005		8.3000e-004	8.3000e-004		8.2000e-004	8.2000e-004	0.0000	3.3642	3.3642	3.8000e-004	0.0000	3.3737
Total	1.9300e-003	0.0170	0.0235	4.0000e-005		8.3000e-004	8.3000e-004		8.2000e-004	8.2000e-004	0.0000	3.3642	3.3642	3.8000e-004	0.0000	3.3737

Unmitigated Construction Off-Site

	ROG	NOx	CO	SO2	Fugitive PM10	Exhaust PM10	PM10 Total	Fugitive PM2.5	Exhaust PM2.5	PM2.5 Total	Bio- CO2	NBio- CO2	Total CO2	CH4	N2O	CO2e
Category	tons/yr										MT/yr					
Hauling	0.0000	0.0000	0.0000	0.0000	0.0000	0.0000	0.0000	0.0000	0.0000	0.0000	0.0000	0.0000	0.0000	0.0000	0.0000	0.0000
Vendor	8.0000e-005	2.8800e-003	1.0700e-003	1.0000e-005	4.7000e-004	2.0000e-005	4.9000e-004	1.4000e-004	1.0000e-005	1.5000e-004	0.0000	1.3385	1.3385	5.0000e-005	1.9000e-004	1.3976
Worker	3.7000e-004	2.9000e-004	3.9200e-003	1.0000e-005	1.3200e-003	1.0000e-005	1.3200e-003	3.5000e-004	1.0000e-005	3.6000e-004	0.0000	1.0432	1.0432	3.0000e-005	3.0000e-005	1.0517
Total	4.5000e-004	3.1700e-003	4.9900e-003	2.0000e-005	1.7900e-003	3.0000e-005	1.8100e-003	4.9000e-004	2.0000e-005	5.1000e-004	0.0000	2.3816	2.3816	8.0000e-005	2.2000e-004	2.4493

Hawthorne HS Field Improvement Project - Construction Only - South Coast Air Basin, Annual

EMFAC Off-Model Adjustment Factors for Gasoline Light Duty Vehicle to Account for the SAFE Vehicle Rule Applied

3.4 Foundations/Concrete Pour #1 - 2023

Mitigated Construction On-Site

	ROG	NOx	CO	SO2	Fugitive PM10	Exhaust PM10	PM10 Total	Fugitive PM2.5	Exhaust PM2.5	PM2.5 Total	Bio- CO2	NBio- CO2	Total CO2	CH4	N2O	CO2e
Category	tons/yr										MT/yr					
Off-Road	8.2000e-004	0.0187	0.0253	4.0000e-005		1.3100e-003	1.3100e-003		1.3100e-003	1.3100e-003	0.0000	3.3642	3.3642	3.8000e-004	0.0000	3.3737
Total	8.2000e-004	0.0187	0.0253	4.0000e-005		1.3100e-003	1.3100e-003		1.3100e-003	1.3100e-003	0.0000	3.3642	3.3642	3.8000e-004	0.0000	3.3737

Mitigated Construction Off-Site

	ROG	NOx	CO	SO2	Fugitive PM10	Exhaust PM10	PM10 Total	Fugitive PM2.5	Exhaust PM2.5	PM2.5 Total	Bio- CO2	NBio- CO2	Total CO2	CH4	N2O	CO2e
Category	tons/yr										MT/yr					
Hauling	0.0000	0.0000	0.0000	0.0000	0.0000	0.0000	0.0000	0.0000	0.0000	0.0000	0.0000	0.0000	0.0000	0.0000	0.0000	0.0000
Vendor	8.0000e-005	2.8800e-003	1.0700e-003	1.0000e-005	4.7000e-004	2.0000e-005	4.9000e-004	1.4000e-004	1.0000e-005	1.5000e-004	0.0000	1.3385	1.3385	5.0000e-005	1.9000e-004	1.3976
Worker	3.7000e-004	2.9000e-004	3.9200e-003	1.0000e-005	1.3200e-003	1.0000e-005	1.3200e-003	3.5000e-004	1.0000e-005	3.6000e-004	0.0000	1.0432	1.0432	3.0000e-005	3.0000e-005	1.0517
Total	4.5000e-004	3.1700e-003	4.9900e-003	2.0000e-005	1.7900e-003	3.0000e-005	1.8100e-003	4.9000e-004	2.0000e-005	5.1000e-004	0.0000	2.3816	2.3816	8.0000e-005	2.2000e-004	2.4493

Hawthorne HS Field Improvement Project - Construction Only - South Coast Air Basin, Annual

EMFAC Off-Model Adjustment Factors for Gasoline Light Duty Vehicle to Account for the SAFE Vehicle Rule Applied

3.5 Drainage/Utilities/Trenching - 2023

Unmitigated Construction On-Site

	ROG	NOx	CO	SO2	Fugitive PM10	Exhaust PM10	PM10 Total	Fugitive PM2.5	Exhaust PM2.5	PM2.5 Total	Bio- CO2	NBio- CO2	Total CO2	CH4	N2O	CO2e
Category	tons/yr										MT/yr					
Off-Road	0.1581	1.5573	1.1832	2.1000e-003		0.0841	0.0841		0.0773	0.0773	0.0000	184.8551	184.8551	0.0598	0.0000	186.3497
Total	0.1581	1.5573	1.1832	2.1000e-003		0.0841	0.0841		0.0773	0.0773	0.0000	184.8551	184.8551	0.0598	0.0000	186.3497

Unmitigated Construction Off-Site

	ROG	NOx	CO	SO2	Fugitive PM10	Exhaust PM10	PM10 Total	Fugitive PM2.5	Exhaust PM2.5	PM2.5 Total	Bio- CO2	NBio- CO2	Total CO2	CH4	N2O	CO2e
Category	tons/yr										MT/yr					
Hauling	0.0000	0.0000	0.0000	0.0000	0.0000	0.0000	0.0000	0.0000	0.0000	0.0000	0.0000	0.0000	0.0000	0.0000	0.0000	0.0000
Vendor	3.4000e-004	0.0126	4.6600e-003	6.0000e-005	2.0600e-003	7.0000e-005	2.1300e-003	5.9000e-004	6.0000e-005	6.6000e-004	0.0000	5.8356	5.8356	2.2000e-004	8.5000e-004	6.0934
Worker	0.0136	0.0104	0.1425	4.1000e-004	0.0478	2.8000e-004	0.0481	0.0127	2.5000e-004	0.0130	0.0000	37.9011	37.9011	9.6000e-004	9.6000e-004	38.2120
Total	0.0139	0.0230	0.1472	4.7000e-004	0.0499	3.5000e-004	0.0502	0.0133	3.1000e-004	0.0136	0.0000	43.7367	43.7367	1.1800e-003	1.8100e-003	44.3055

Hawthorne HS Field Improvement Project - Construction Only - South Coast Air Basin, Annual

EMFAC Off-Model Adjustment Factors for Gasoline Light Duty Vehicle to Account for the SAFE Vehicle Rule Applied

3.5 Drainage/Utilities/Trenching - 2023

Mitigated Construction On-Site

	ROG	NOx	CO	SO2	Fugitive PM10	Exhaust PM10	PM10 Total	Fugitive PM2.5	Exhaust PM2.5	PM2.5 Total	Bio- CO2	NBio- CO2	Total CO2	CH4	N2O	CO2e
Category	tons/yr										MT/yr					
Off-Road	0.0515	1.0717	1.3788	2.1000e-003		0.0580	0.0580		0.0580	0.0580	0.0000	184.8549	184.8549	0.0598	0.0000	186.3495
Total	0.0515	1.0717	1.3788	2.1000e-003		0.0580	0.0580		0.0580	0.0580	0.0000	184.8549	184.8549	0.0598	0.0000	186.3495

Mitigated Construction Off-Site

	ROG	NOx	CO	SO2	Fugitive PM10	Exhaust PM10	PM10 Total	Fugitive PM2.5	Exhaust PM2.5	PM2.5 Total	Bio- CO2	NBio- CO2	Total CO2	CH4	N2O	CO2e
Category	tons/yr										MT/yr					
Hauling	0.0000	0.0000	0.0000	0.0000	0.0000	0.0000	0.0000	0.0000	0.0000	0.0000	0.0000	0.0000	0.0000	0.0000	0.0000	0.0000
Vendor	3.4000e-004	0.0126	4.6600e-003	6.0000e-005	2.0600e-003	7.0000e-005	2.1300e-003	5.9000e-004	6.0000e-005	6.6000e-004	0.0000	5.8356	5.8356	2.2000e-004	8.5000e-004	6.0934
Worker	0.0136	0.0104	0.1425	4.1000e-004	0.0478	2.8000e-004	0.0481	0.0127	2.5000e-004	0.0130	0.0000	37.9011	37.9011	9.6000e-004	9.6000e-004	38.2120
Total	0.0139	0.0230	0.1472	4.7000e-004	0.0499	3.5000e-004	0.0502	0.0133	3.1000e-004	0.0136	0.0000	43.7367	43.7367	1.1800e-003	1.8100e-003	44.3055

Hawthorne HS Field Improvement Project - Construction Only - South Coast Air Basin, Annual

EMFAC Off-Model Adjustment Factors for Gasoline Light Duty Vehicle to Account for the SAFE Vehicle Rule Applied

3.6 Building Construction - 2023

Unmitigated Construction On-Site

	ROG	NOx	CO	SO2	Fugitive PM10	Exhaust PM10	PM10 Total	Fugitive PM2.5	Exhaust PM2.5	PM2.5 Total	Bio- CO2	NBio- CO2	Total CO2	CH4	N2O	CO2e
Category	tons/yr										MT/yr					
Off-Road	0.1356	1.2505	1.4021	2.3400e-003		0.0606	0.0606		0.0569	0.0569	0.0000	201.2049	201.2049	0.0490	0.0000	202.4302
Total	0.1356	1.2505	1.4021	2.3400e-003		0.0606	0.0606		0.0569	0.0569	0.0000	201.2049	201.2049	0.0490	0.0000	202.4302

Unmitigated Construction Off-Site

	ROG	NOx	CO	SO2	Fugitive PM10	Exhaust PM10	PM10 Total	Fugitive PM2.5	Exhaust PM2.5	PM2.5 Total	Bio- CO2	NBio- CO2	Total CO2	CH4	N2O	CO2e
Category	tons/yr										MT/yr					
Hauling	0.0000	0.0000	0.0000	0.0000	0.0000	0.0000	0.0000	0.0000	0.0000	0.0000	0.0000	0.0000	0.0000	0.0000	0.0000	0.0000
Vendor	8.4200e-003	0.3079	0.1143	1.4600e-003	0.0506	1.6300e-003	0.0522	0.0146	1.5500e-003	0.0161	0.0000	143.1066	143.1066	5.2900e-003	0.0208	149.4290
Worker	0.0201	0.0155	0.2118	6.1000e-004	0.0711	4.1000e-004	0.0715	0.0189	3.8000e-004	0.0193	0.0000	56.3301	56.3301	1.4300e-003	1.4300e-003	56.7922
Total	0.0286	0.3234	0.3261	2.0700e-003	0.1217	2.0400e-003	0.1237	0.0335	1.9300e-003	0.0354	0.0000	199.4367	199.4367	6.7200e-003	0.0222	206.2212

Hawthorne HS Field Improvement Project - Construction Only - South Coast Air Basin, Annual

EMFAC Off-Model Adjustment Factors for Gasoline Light Duty Vehicle to Account for the SAFE Vehicle Rule Applied

3.6 Building Construction - 2023

Mitigated Construction On-Site

	ROG	NOx	CO	SO2	Fugitive PM10	Exhaust PM10	PM10 Total	Fugitive PM2.5	Exhaust PM2.5	PM2.5 Total	Bio- CO2	NBio- CO2	Total CO2	CH4	N2O	CO2e
Category	tons/yr										MT/yr					
Off-Road	0.0704	1.2109	1.5647	2.3400e-003		0.0741	0.0741		0.0741	0.0741	0.0000	201.2047	201.2047	0.0490	0.0000	202.4300
Total	0.0704	1.2109	1.5647	2.3400e-003		0.0741	0.0741		0.0741	0.0741	0.0000	201.2047	201.2047	0.0490	0.0000	202.4300

Mitigated Construction Off-Site

	ROG	NOx	CO	SO2	Fugitive PM10	Exhaust PM10	PM10 Total	Fugitive PM2.5	Exhaust PM2.5	PM2.5 Total	Bio- CO2	NBio- CO2	Total CO2	CH4	N2O	CO2e
Category	tons/yr										MT/yr					
Hauling	0.0000	0.0000	0.0000	0.0000	0.0000	0.0000	0.0000	0.0000	0.0000	0.0000	0.0000	0.0000	0.0000	0.0000	0.0000	0.0000
Vendor	8.4200e-003	0.3079	0.1143	1.4600e-003	0.0506	1.6300e-003	0.0522	0.0146	1.5500e-003	0.0161	0.0000	143.1066	143.1066	5.2900e-003	0.0208	149.4290
Worker	0.0201	0.0155	0.2118	6.1000e-004	0.0711	4.1000e-004	0.0715	0.0189	3.8000e-004	0.0193	0.0000	56.3301	56.3301	1.4300e-003	1.4300e-003	56.7922
Total	0.0286	0.3234	0.3261	2.0700e-003	0.1217	2.0400e-003	0.1237	0.0335	1.9300e-003	0.0354	0.0000	199.4367	199.4367	6.7200e-003	0.0222	206.2212

Hawthorne HS Field Improvement Project - Construction Only - South Coast Air Basin, Annual

EMFAC Off-Model Adjustment Factors for Gasoline Light Duty Vehicle to Account for the SAFE Vehicle Rule Applied

3.6 Building Construction - 2024

Unmitigated Construction On-Site

	ROG	NOx	CO	SO2	Fugitive PM10	Exhaust PM10	PM10 Total	Fugitive PM2.5	Exhaust PM2.5	PM2.5 Total	Bio- CO2	NBio- CO2	Total CO2	CH4	N2O	CO2e
Category	tons/yr										MT/yr					
Off-Road	0.0517	0.4760	0.5685	9.5000e-004		0.0217	0.0217		0.0204	0.0204	0.0000	81.9891	81.9891	0.0199	0.0000	82.4857
Total	0.0517	0.4760	0.5685	9.5000e-004		0.0217	0.0217		0.0204	0.0204	0.0000	81.9891	81.9891	0.0199	0.0000	82.4857

Unmitigated Construction Off-Site

	ROG	NOx	CO	SO2	Fugitive PM10	Exhaust PM10	PM10 Total	Fugitive PM2.5	Exhaust PM2.5	PM2.5 Total	Bio- CO2	NBio- CO2	Total CO2	CH4	N2O	CO2e
Category	tons/yr										MT/yr					
Hauling	0.0000	0.0000	0.0000	0.0000	0.0000	0.0000	0.0000	0.0000	0.0000	0.0000	0.0000	0.0000	0.0000	0.0000	0.0000	0.0000
Vendor	3.3500e-003	0.1260	0.0458	5.9000e-004	0.0206	6.7000e-004	0.0213	5.9400e-003	6.4000e-004	6.5800e-003	0.0000	57.4738	57.4738	2.1500e-003	8.3600e-003	60.0177
Worker	7.6700e-003	5.6500e-003	0.0805	2.4000e-004	0.0290	1.6000e-004	0.0291	7.6900e-003	1.5000e-004	7.8400e-003	0.0000	22.4556	22.4556	5.3000e-004	5.4000e-004	22.6305
Total	0.0110	0.1316	0.1263	8.3000e-004	0.0496	8.3000e-004	0.0504	0.0136	7.9000e-004	0.0144	0.0000	79.9294	79.9294	2.6800e-003	8.9000e-003	82.6481

Hawthorne HS Field Improvement Project - Construction Only - South Coast Air Basin, Annual

EMFAC Off-Model Adjustment Factors for Gasoline Light Duty Vehicle to Account for the SAFE Vehicle Rule Applied

3.6 Building Construction - 2024

Mitigated Construction On-Site

	ROG	NOx	CO	SO2	Fugitive PM10	Exhaust PM10	PM10 Total	Fugitive PM2.5	Exhaust PM2.5	PM2.5 Total	Bio- CO2	NBio- CO2	Total CO2	CH4	N2O	CO2e
Category	tons/yr										MT/yr					
Off-Road	0.0281	0.4920	0.6370	9.5000e-004		0.0299	0.0299		0.0299	0.0299	0.0000	81.9890	81.9890	0.0199	0.0000	82.4856
Total	0.0281	0.4920	0.6370	9.5000e-004		0.0299	0.0299		0.0299	0.0299	0.0000	81.9890	81.9890	0.0199	0.0000	82.4856

Mitigated Construction Off-Site

	ROG	NOx	CO	SO2	Fugitive PM10	Exhaust PM10	PM10 Total	Fugitive PM2.5	Exhaust PM2.5	PM2.5 Total	Bio- CO2	NBio- CO2	Total CO2	CH4	N2O	CO2e
Category	tons/yr										MT/yr					
Hauling	0.0000	0.0000	0.0000	0.0000	0.0000	0.0000	0.0000	0.0000	0.0000	0.0000	0.0000	0.0000	0.0000	0.0000	0.0000	0.0000
Vendor	3.3500e-003	0.1260	0.0458	5.9000e-004	0.0206	6.7000e-004	0.0213	5.9400e-003	6.4000e-004	6.5800e-003	0.0000	57.4738	57.4738	2.1500e-003	8.3600e-003	60.0177
Worker	7.6700e-003	5.6500e-003	0.0805	2.4000e-004	0.0290	1.6000e-004	0.0291	7.6900e-003	1.5000e-004	7.8400e-003	0.0000	22.4556	22.4556	5.3000e-004	5.4000e-004	22.6305
Total	0.0110	0.1316	0.1263	8.3000e-004	0.0496	8.3000e-004	0.0504	0.0136	7.9000e-004	0.0144	0.0000	79.9294	79.9294	2.6800e-003	8.9000e-003	82.6481

Hawthorne HS Field Improvement Project - Construction Only - South Coast Air Basin, Annual

EMFAC Off-Model Adjustment Factors for Gasoline Light Duty Vehicle to Account for the SAFE Vehicle Rule Applied

3.7 Foundations/Concrete Pour #2 - 2023

Unmitigated Construction On-Site

	ROG	NOx	CO	SO2	Fugitive PM10	Exhaust PM10	PM10 Total	Fugitive PM2.5	Exhaust PM2.5	PM2.5 Total	Bio- CO2	NBio- CO2	Total CO2	CH4	N2O	CO2e
Category	tons/yr										MT/yr					
Off-Road	1.9300e-003	0.0170	0.0235	4.0000e-005		8.3000e-004	8.3000e-004		8.2000e-004	8.2000e-004	0.0000	3.3642	3.3642	3.8000e-004	0.0000	3.3737
Total	1.9300e-003	0.0170	0.0235	4.0000e-005		8.3000e-004	8.3000e-004		8.2000e-004	8.2000e-004	0.0000	3.3642	3.3642	3.8000e-004	0.0000	3.3737

Unmitigated Construction Off-Site

	ROG	NOx	CO	SO2	Fugitive PM10	Exhaust PM10	PM10 Total	Fugitive PM2.5	Exhaust PM2.5	PM2.5 Total	Bio- CO2	NBio- CO2	Total CO2	CH4	N2O	CO2e
Category	tons/yr										MT/yr					
Hauling	0.0000	0.0000	0.0000	0.0000	0.0000	0.0000	0.0000	0.0000	0.0000	0.0000	0.0000	0.0000	0.0000	0.0000	0.0000	0.0000
Vendor	8.0000e-005	2.8800e-003	1.0700e-003	1.0000e-005	4.7000e-004	2.0000e-005	4.9000e-004	1.4000e-004	1.0000e-005	1.5000e-004	0.0000	1.3385	1.3385	5.0000e-005	1.9000e-004	1.3976
Worker	3.7000e-004	2.9000e-004	3.9200e-003	1.0000e-005	1.3200e-003	1.0000e-005	1.3200e-003	3.5000e-004	1.0000e-005	3.6000e-004	0.0000	1.0432	1.0432	3.0000e-005	3.0000e-005	1.0517
Total	4.5000e-004	3.1700e-003	4.9900e-003	2.0000e-005	1.7900e-003	3.0000e-005	1.8100e-003	4.9000e-004	2.0000e-005	5.1000e-004	0.0000	2.3816	2.3816	8.0000e-005	2.2000e-004	2.4493

Hawthorne HS Field Improvement Project - Construction Only - South Coast Air Basin, Annual

EMFAC Off-Model Adjustment Factors for Gasoline Light Duty Vehicle to Account for the SAFE Vehicle Rule Applied

3.7 Foundations/Concrete Pour #2 - 2023

Mitigated Construction On-Site

	ROG	NOx	CO	SO2	Fugitive PM10	Exhaust PM10	PM10 Total	Fugitive PM2.5	Exhaust PM2.5	PM2.5 Total	Bio- CO2	NBio- CO2	Total CO2	CH4	N2O	CO2e
Category	tons/yr										MT/yr					
Off-Road	8.2000e-004	0.0187	0.0253	4.0000e-005		1.3100e-003	1.3100e-003		1.3100e-003	1.3100e-003	0.0000	3.3642	3.3642	3.8000e-004	0.0000	3.3737
Total	8.2000e-004	0.0187	0.0253	4.0000e-005		1.3100e-003	1.3100e-003		1.3100e-003	1.3100e-003	0.0000	3.3642	3.3642	3.8000e-004	0.0000	3.3737

Mitigated Construction Off-Site

	ROG	NOx	CO	SO2	Fugitive PM10	Exhaust PM10	PM10 Total	Fugitive PM2.5	Exhaust PM2.5	PM2.5 Total	Bio- CO2	NBio- CO2	Total CO2	CH4	N2O	CO2e
Category	tons/yr										MT/yr					
Hauling	0.0000	0.0000	0.0000	0.0000	0.0000	0.0000	0.0000	0.0000	0.0000	0.0000	0.0000	0.0000	0.0000	0.0000	0.0000	0.0000
Vendor	8.0000e-005	2.8800e-003	1.0700e-003	1.0000e-005	4.7000e-004	2.0000e-005	4.9000e-004	1.4000e-004	1.0000e-005	1.5000e-004	0.0000	1.3385	1.3385	5.0000e-005	1.9000e-004	1.3976
Worker	3.7000e-004	2.9000e-004	3.9200e-003	1.0000e-005	1.3200e-003	1.0000e-005	1.3200e-003	3.5000e-004	1.0000e-005	3.6000e-004	0.0000	1.0432	1.0432	3.0000e-005	3.0000e-005	1.0517
Total	4.5000e-004	3.1700e-003	4.9900e-003	2.0000e-005	1.7900e-003	3.0000e-005	1.8100e-003	4.9000e-004	2.0000e-005	5.1000e-004	0.0000	2.3816	2.3816	8.0000e-005	2.2000e-004	2.4493

Hawthorne HS Field Improvement Project - Construction Only - South Coast Air Basin, Annual

EMFAC Off-Model Adjustment Factors for Gasoline Light Duty Vehicle to Account for the SAFE Vehicle Rule Applied

3.8 Paving Event #1 - 2023

Unmitigated Construction On-Site

	ROG	NOx	CO	SO2	Fugitive PM10	Exhaust PM10	PM10 Total	Fugitive PM2.5	Exhaust PM2.5	PM2.5 Total	Bio- CO2	NBio- CO2	Total CO2	CH4	N2O	CO2e
Category	tons/yr										MT/yr					
Off-Road	2.5800e-003	0.0255	0.0365	6.0000e-005		1.2800e-003	1.2800e-003		1.1700e-003	1.1700e-003	0.0000	5.0067	5.0067	1.6200e-003	0.0000	5.0472
Paving	0.0000					0.0000	0.0000		0.0000	0.0000	0.0000	0.0000	0.0000	0.0000	0.0000	0.0000
Total	2.5800e-003	0.0255	0.0365	6.0000e-005		1.2800e-003	1.2800e-003		1.1700e-003	1.1700e-003	0.0000	5.0067	5.0067	1.6200e-003	0.0000	5.0472

Unmitigated Construction Off-Site

	ROG	NOx	CO	SO2	Fugitive PM10	Exhaust PM10	PM10 Total	Fugitive PM2.5	Exhaust PM2.5	PM2.5 Total	Bio- CO2	NBio- CO2	Total CO2	CH4	N2O	CO2e
Category	tons/yr										MT/yr					
Hauling	0.0000	0.0000	0.0000	0.0000	0.0000	0.0000	0.0000	0.0000	0.0000	0.0000	0.0000	0.0000	0.0000	0.0000	0.0000	0.0000
Vendor	2.0000e-005	5.8000e-004	2.1000e-004	0.0000	9.0000e-005	0.0000	1.0000e-004	3.0000e-005	0.0000	3.0000e-005	0.0000	0.2677	0.2677	1.0000e-005	4.0000e-005	0.2795
Worker	6.2000e-004	4.8000e-004	6.5400e-003	2.0000e-005	2.1900e-003	1.0000e-005	2.2100e-003	5.8000e-004	1.0000e-005	5.9000e-004	0.0000	1.7386	1.7386	4.0000e-005	4.0000e-005	1.7529
Total	6.4000e-004	1.0600e-003	6.7500e-003	2.0000e-005	2.2800e-003	1.0000e-005	2.3100e-003	6.1000e-004	1.0000e-005	6.2000e-004	0.0000	2.0063	2.0063	5.0000e-005	8.0000e-005	2.0324

Hawthorne HS Field Improvement Project - Construction Only - South Coast Air Basin, Annual

EMFAC Off-Model Adjustment Factors for Gasoline Light Duty Vehicle to Account for the SAFE Vehicle Rule Applied

3.8 Paving Event #1 - 2023

Mitigated Construction On-Site

	ROG	NOx	CO	SO2	Fugitive PM10	Exhaust PM10	PM10 Total	Fugitive PM2.5	Exhaust PM2.5	PM2.5 Total	Bio- CO2	NBio- CO2	Total CO2	CH4	N2O	CO2e
Category	tons/yr										MT/yr					
Off-Road	1.4000e-003	0.0282	0.0432	6.0000e-005		1.5200e-003	1.5200e-003		1.5200e-003	1.5200e-003	0.0000	5.0067	5.0067	1.6200e-003	0.0000	5.0472
Paving	0.0000					0.0000	0.0000		0.0000	0.0000	0.0000	0.0000	0.0000	0.0000	0.0000	0.0000
Total	1.4000e-003	0.0282	0.0432	6.0000e-005		1.5200e-003	1.5200e-003		1.5200e-003	1.5200e-003	0.0000	5.0067	5.0067	1.6200e-003	0.0000	5.0472

Mitigated Construction Off-Site

	ROG	NOx	CO	SO2	Fugitive PM10	Exhaust PM10	PM10 Total	Fugitive PM2.5	Exhaust PM2.5	PM2.5 Total	Bio- CO2	NBio- CO2	Total CO2	CH4	N2O	CO2e
Category	tons/yr										MT/yr					
Hauling	0.0000	0.0000	0.0000	0.0000	0.0000	0.0000	0.0000	0.0000	0.0000	0.0000	0.0000	0.0000	0.0000	0.0000	0.0000	0.0000
Vendor	2.0000e-005	5.8000e-004	2.1000e-004	0.0000	9.0000e-005	0.0000	1.0000e-004	3.0000e-005	0.0000	3.0000e-005	0.0000	0.2677	0.2677	1.0000e-005	4.0000e-005	0.2795
Worker	6.2000e-004	4.8000e-004	6.5400e-003	2.0000e-005	2.1900e-003	1.0000e-005	2.2100e-003	5.8000e-004	1.0000e-005	5.9000e-004	0.0000	1.7386	1.7386	4.0000e-005	4.0000e-005	1.7529
Total	6.4000e-004	1.0600e-003	6.7500e-003	2.0000e-005	2.2800e-003	1.0000e-005	2.3100e-003	6.1000e-004	1.0000e-005	6.2000e-004	0.0000	2.0063	2.0063	5.0000e-005	8.0000e-005	2.0324

Hawthorne HS Field Improvement Project - Construction Only - South Coast Air Basin, Annual

EMFAC Off-Model Adjustment Factors for Gasoline Light Duty Vehicle to Account for the SAFE Vehicle Rule Applied

3.9 Field/Bleachers - 2023

Unmitigated Construction On-Site

	ROG	NOx	CO	SO2	Fugitive PM10	Exhaust PM10	PM10 Total	Fugitive PM2.5	Exhaust PM2.5	PM2.5 Total	Bio- CO2	NBio- CO2	Total CO2	CH4	N2O	CO2e
Category	tons/yr										MT/yr					
Off-Road	0.0360	0.3319	0.3722	6.2000e-004		0.0161	0.0161		0.0151	0.0151	0.0000	53.4062	53.4062	0.0130	0.0000	53.7315
Total	0.0360	0.3319	0.3722	6.2000e-004		0.0161	0.0161		0.0151	0.0151	0.0000	53.4062	53.4062	0.0130	0.0000	53.7315

Unmitigated Construction Off-Site

	ROG	NOx	CO	SO2	Fugitive PM10	Exhaust PM10	PM10 Total	Fugitive PM2.5	Exhaust PM2.5	PM2.5 Total	Bio- CO2	NBio- CO2	Total CO2	CH4	N2O	CO2e
Category	tons/yr										MT/yr					
Hauling	0.0000	0.0000	0.0000	0.0000	0.0000	0.0000	0.0000	0.0000	0.0000	0.0000	0.0000	0.0000	0.0000	0.0000	0.0000	0.0000
Vendor	1.4000e-004	4.9500e-003	1.8400e-003	2.0000e-005	8.1000e-004	3.0000e-005	8.4000e-004	2.3000e-004	3.0000e-005	2.6000e-004	0.0000	2.3021	2.3021	9.0000e-005	3.3000e-004	2.4038
Worker	5.3500e-003	4.1200e-003	0.0562	1.6000e-004	0.0189	1.1000e-004	0.0190	5.0100e-003	1.0000e-004	5.1100e-003	0.0000	14.9518	14.9518	3.8000e-004	3.8000e-004	15.0745
Total	5.4900e-003	9.0700e-003	0.0581	1.8000e-004	0.0197	1.4000e-004	0.0198	5.2400e-003	1.3000e-004	5.3700e-003	0.0000	17.2540	17.2540	4.7000e-004	7.1000e-004	17.4783

Hawthorne HS Field Improvement Project - Construction Only - South Coast Air Basin, Annual

EMFAC Off-Model Adjustment Factors for Gasoline Light Duty Vehicle to Account for the SAFE Vehicle Rule Applied

3.9 Field/Bleachers - 2023

Mitigated Construction On-Site

	ROG	NOx	CO	SO2	Fugitive PM10	Exhaust PM10	PM10 Total	Fugitive PM2.5	Exhaust PM2.5	PM2.5 Total	Bio- CO2	NBio- CO2	Total CO2	CH4	N2O	CO2e
Category	tons/yr										MT/yr					
Off-Road	0.0187	0.3214	0.4153	6.2000e-004		0.0197	0.0197		0.0197	0.0197	0.0000	53.4062	53.4062	0.0130	0.0000	53.7314
Total	0.0187	0.3214	0.4153	6.2000e-004		0.0197	0.0197		0.0197	0.0197	0.0000	53.4062	53.4062	0.0130	0.0000	53.7314

Mitigated Construction Off-Site

	ROG	NOx	CO	SO2	Fugitive PM10	Exhaust PM10	PM10 Total	Fugitive PM2.5	Exhaust PM2.5	PM2.5 Total	Bio- CO2	NBio- CO2	Total CO2	CH4	N2O	CO2e
Category	tons/yr										MT/yr					
Hauling	0.0000	0.0000	0.0000	0.0000	0.0000	0.0000	0.0000	0.0000	0.0000	0.0000	0.0000	0.0000	0.0000	0.0000	0.0000	0.0000
Vendor	1.4000e-004	4.9500e-003	1.8400e-003	2.0000e-005	8.1000e-004	3.0000e-005	8.4000e-004	2.3000e-004	3.0000e-005	2.6000e-004	0.0000	2.3021	2.3021	9.0000e-005	3.3000e-004	2.4038
Worker	5.3500e-003	4.1200e-003	0.0562	1.6000e-004	0.0189	1.1000e-004	0.0190	5.0100e-003	1.0000e-004	5.1100e-003	0.0000	14.9518	14.9518	3.8000e-004	3.8000e-004	15.0745
Total	5.4900e-003	9.0700e-003	0.0581	1.8000e-004	0.0197	1.4000e-004	0.0198	5.2400e-003	1.3000e-004	5.3700e-003	0.0000	17.2540	17.2540	4.7000e-004	7.1000e-004	17.4783

Hawthorne HS Field Improvement Project - Construction Only - South Coast Air Basin, Annual

EMFAC Off-Model Adjustment Factors for Gasoline Light Duty Vehicle to Account for the SAFE Vehicle Rule Applied

3.9 Field/Bleachers - 2024

Unmitigated Construction On-Site

	ROG	NOx	CO	SO2	Fugitive PM10	Exhaust PM10	PM10 Total	Fugitive PM2.5	Exhaust PM2.5	PM2.5 Total	Bio- CO2	NBio- CO2	Total CO2	CH4	N2O	CO2e
Category	tons/yr										MT/yr					
Off-Road	0.0862	0.7934	0.9475	1.5900e-003		0.0361	0.0361		0.0339	0.0339	0.0000	136.6485	136.6485	0.0331	0.0000	137.4762
Total	0.0862	0.7934	0.9475	1.5900e-003		0.0361	0.0361		0.0339	0.0339	0.0000	136.6485	136.6485	0.0331	0.0000	137.4762

Unmitigated Construction Off-Site

	ROG	NOx	CO	SO2	Fugitive PM10	Exhaust PM10	PM10 Total	Fugitive PM2.5	Exhaust PM2.5	PM2.5 Total	Bio- CO2	NBio- CO2	Total CO2	CH4	N2O	CO2e
Category	tons/yr										MT/yr					
Hauling	0.0000	0.0000	0.0000	0.0000	0.0000	0.0000	0.0000	0.0000	0.0000	0.0000	0.0000	0.0000	0.0000	0.0000	0.0000	0.0000
Vendor	3.4000e-004	0.0127	4.6300e-003	6.0000e-005	2.0800e-003	7.0000e-005	2.1500e-003	6.0000e-004	6.0000e-005	6.6000e-004	0.0000	5.8054	5.8054	2.2000e-004	8.4000e-004	6.0624
Worker	0.0128	9.4100e-003	0.1342	4.0000e-004	0.0483	2.7000e-004	0.0485	0.0128	2.5000e-004	0.0131	0.0000	37.4261	37.4261	8.8000e-004	9.0000e-004	37.7174
Total	0.0131	0.0221	0.1388	4.6000e-004	0.0504	3.4000e-004	0.0507	0.0134	3.1000e-004	0.0137	0.0000	43.2315	43.2315	1.1000e-003	1.7400e-003	43.7798

Hawthorne HS Field Improvement Project - Construction Only - South Coast Air Basin, Annual

EMFAC Off-Model Adjustment Factors for Gasoline Light Duty Vehicle to Account for the SAFE Vehicle Rule Applied

3.9 Field/Bleachers - 2024

Mitigated Construction On-Site

	ROG	NOx	CO	SO2	Fugitive PM10	Exhaust PM10	PM10 Total	Fugitive PM2.5	Exhaust PM2.5	PM2.5 Total	Bio- CO2	NBio- CO2	Total CO2	CH4	N2O	CO2e
Category	tons/yr										MT/yr					
Off-Road	0.0468	0.8200	1.0617	1.5900e-003		0.0499	0.0499		0.0499	0.0499	0.0000	136.6483	136.6483	0.0331	0.0000	137.4760
Total	0.0468	0.8200	1.0617	1.5900e-003		0.0499	0.0499		0.0499	0.0499	0.0000	136.6483	136.6483	0.0331	0.0000	137.4760

Mitigated Construction Off-Site

	ROG	NOx	CO	SO2	Fugitive PM10	Exhaust PM10	PM10 Total	Fugitive PM2.5	Exhaust PM2.5	PM2.5 Total	Bio- CO2	NBio- CO2	Total CO2	CH4	N2O	CO2e
Category	tons/yr										MT/yr					
Hauling	0.0000	0.0000	0.0000	0.0000	0.0000	0.0000	0.0000	0.0000	0.0000	0.0000	0.0000	0.0000	0.0000	0.0000	0.0000	0.0000
Vendor	3.4000e-004	0.0127	4.6300e-003	6.0000e-005	2.0800e-003	7.0000e-005	2.1500e-003	6.0000e-004	6.0000e-005	6.6000e-004	0.0000	5.8054	5.8054	2.2000e-004	8.4000e-004	6.0624
Worker	0.0128	9.4100e-003	0.1342	4.0000e-004	0.0483	2.7000e-004	0.0485	0.0128	2.5000e-004	0.0131	0.0000	37.4261	37.4261	8.8000e-004	9.0000e-004	37.7174
Total	0.0131	0.0221	0.1388	4.6000e-004	0.0504	3.4000e-004	0.0507	0.0134	3.1000e-004	0.0137	0.0000	43.2315	43.2315	1.1000e-003	1.7400e-003	43.7798

Hawthorne HS Field Improvement Project - Construction Only - South Coast Air Basin, Annual

EMFAC Off-Model Adjustment Factors for Gasoline Light Duty Vehicle to Account for the SAFE Vehicle Rule Applied

3.10 Foundations/Concrete Pour #3 - 2024

Unmitigated Construction On-Site

	ROG	NOx	CO	SO2	Fugitive PM10	Exhaust PM10	PM10 Total	Fugitive PM2.5	Exhaust PM2.5	PM2.5 Total	Bio- CO2	NBio- CO2	Total CO2	CH4	N2O	CO2e
Category	tons/yr										MT/yr					
Off-Road	1.8100e-003	0.0160	0.0235	4.0000e-005		7.3000e-004	7.3000e-004		7.1000e-004	7.1000e-004	0.0000	3.3647	3.3647	3.8000e-004	0.0000	3.3742
Total	1.8100e-003	0.0160	0.0235	4.0000e-005		7.3000e-004	7.3000e-004		7.1000e-004	7.1000e-004	0.0000	3.3647	3.3647	3.8000e-004	0.0000	3.3742

Unmitigated Construction Off-Site

	ROG	NOx	CO	SO2	Fugitive PM10	Exhaust PM10	PM10 Total	Fugitive PM2.5	Exhaust PM2.5	PM2.5 Total	Bio- CO2	NBio- CO2	Total CO2	CH4	N2O	CO2e
Category	tons/yr										MT/yr					
Hauling	0.0000	0.0000	0.0000	0.0000	0.0000	0.0000	0.0000	0.0000	0.0000	0.0000	0.0000	0.0000	0.0000	0.0000	0.0000	0.0000
Vendor	8.0000e-005	2.8900e-003	1.0500e-003	1.0000e-005	4.7000e-004	2.0000e-005	4.9000e-004	1.4000e-004	1.0000e-005	1.5000e-004	0.0000	1.3194	1.3194	5.0000e-005	1.9000e-004	1.3778
Worker	3.5000e-004	2.6000e-004	3.6600e-003	1.0000e-005	1.3200e-003	1.0000e-005	1.3200e-003	3.5000e-004	1.0000e-005	3.6000e-004	0.0000	1.0207	1.0207	2.0000e-005	2.0000e-005	1.0287
Total	4.3000e-004	3.1500e-003	4.7100e-003	2.0000e-005	1.7900e-003	3.0000e-005	1.8100e-003	4.9000e-004	2.0000e-005	5.1000e-004	0.0000	2.3401	2.3401	7.0000e-005	2.1000e-004	2.4065

Hawthorne HS Field Improvement Project - Construction Only - South Coast Air Basin, Annual

EMFAC Off-Model Adjustment Factors for Gasoline Light Duty Vehicle to Account for the SAFE Vehicle Rule Applied

3.10 Foundations/Concrete Pour #3 - 2024

Mitigated Construction On-Site

	ROG	NOx	CO	SO2	Fugitive PM10	Exhaust PM10	PM10 Total	Fugitive PM2.5	Exhaust PM2.5	PM2.5 Total	Bio- CO2	NBio- CO2	Total CO2	CH4	N2O	CO2e
Category	tons/yr										MT/yr					
Off-Road	8.2000e-004	0.0187	0.0253	4.0000e-005		1.3100e-003	1.3100e-003		1.3100e-003	1.3100e-003	0.0000	3.3647	3.3647	3.8000e-004	0.0000	3.3741
Total	8.2000e-004	0.0187	0.0253	4.0000e-005		1.3100e-003	1.3100e-003		1.3100e-003	1.3100e-003	0.0000	3.3647	3.3647	3.8000e-004	0.0000	3.3741

Mitigated Construction Off-Site

	ROG	NOx	CO	SO2	Fugitive PM10	Exhaust PM10	PM10 Total	Fugitive PM2.5	Exhaust PM2.5	PM2.5 Total	Bio- CO2	NBio- CO2	Total CO2	CH4	N2O	CO2e
Category	tons/yr										MT/yr					
Hauling	0.0000	0.0000	0.0000	0.0000	0.0000	0.0000	0.0000	0.0000	0.0000	0.0000	0.0000	0.0000	0.0000	0.0000	0.0000	0.0000
Vendor	8.0000e-005	2.8900e-003	1.0500e-003	1.0000e-005	4.7000e-004	2.0000e-005	4.9000e-004	1.4000e-004	1.0000e-005	1.5000e-004	0.0000	1.3194	1.3194	5.0000e-005	1.9000e-004	1.3778
Worker	3.5000e-004	2.6000e-004	3.6600e-003	1.0000e-005	1.3200e-003	1.0000e-005	1.3200e-003	3.5000e-004	1.0000e-005	3.6000e-004	0.0000	1.0207	1.0207	2.0000e-005	2.0000e-005	1.0287
Total	4.3000e-004	3.1500e-003	4.7100e-003	2.0000e-005	1.7900e-003	3.0000e-005	1.8100e-003	4.9000e-004	2.0000e-005	5.1000e-004	0.0000	2.3401	2.3401	7.0000e-005	2.1000e-004	2.4065

Hawthorne HS Field Improvement Project - Construction Only - South Coast Air Basin, Annual

EMFAC Off-Model Adjustment Factors for Gasoline Light Duty Vehicle to Account for the SAFE Vehicle Rule Applied

3.11 Architectural Coatings - 2024

Unmitigated Construction On-Site

	ROG	NOx	CO	SO2	Fugitive PM10	Exhaust PM10	PM10 Total	Fugitive PM2.5	Exhaust PM2.5	PM2.5 Total	Bio- CO2	NBio- CO2	Total CO2	CH4	N2O	CO2e
Category	tons/yr										MT/yr					
Archit. Coating	0.0260					0.0000	0.0000		0.0000	0.0000	0.0000	0.0000	0.0000	0.0000	0.0000	0.0000
Off-Road	5.1800e-003	0.0349	0.0519	9.0000e-005		1.7500e-003	1.7500e-003		1.7500e-003	1.7500e-003	0.0000	7.3193	7.3193	4.1000e-004	0.0000	7.3296
Total	0.0311	0.0349	0.0519	9.0000e-005		1.7500e-003	1.7500e-003		1.7500e-003	1.7500e-003	0.0000	7.3193	7.3193	4.1000e-004	0.0000	7.3296

Unmitigated Construction Off-Site

	ROG	NOx	CO	SO2	Fugitive PM10	Exhaust PM10	PM10 Total	Fugitive PM2.5	Exhaust PM2.5	PM2.5 Total	Bio- CO2	NBio- CO2	Total CO2	CH4	N2O	CO2e
Category	tons/yr										MT/yr					
Hauling	0.0000	0.0000	0.0000	0.0000	0.0000	0.0000	0.0000	0.0000	0.0000	0.0000	0.0000	0.0000	0.0000	0.0000	0.0000	0.0000
Vendor	1.3000e-004	4.9700e-003	1.8100e-003	2.0000e-005	8.1000e-004	3.0000e-005	8.4000e-004	2.3000e-004	3.0000e-005	2.6000e-004	0.0000	2.2694	2.2694	9.0000e-005	3.3000e-004	2.3698
Worker	5.0000e-003	3.6800e-003	0.0524	1.6000e-004	0.0189	1.0000e-004	0.0190	5.0100e-003	1.0000e-004	5.1100e-003	0.0000	14.6302	14.6302	3.4000e-004	3.5000e-004	14.7441
Total	5.1300e-003	8.6500e-003	0.0543	1.8000e-004	0.0197	1.3000e-004	0.0198	5.2400e-003	1.3000e-004	5.3700e-003	0.0000	16.8996	16.8996	4.3000e-004	6.8000e-004	17.1139

Hawthorne HS Field Improvement Project - Construction Only - South Coast Air Basin, Annual

EMFAC Off-Model Adjustment Factors for Gasoline Light Duty Vehicle to Account for the SAFE Vehicle Rule Applied

3.11 Architectural Coatings - 2024

Mitigated Construction On-Site

	ROG	NOx	CO	SO2	Fugitive PM10	Exhaust PM10	PM10 Total	Fugitive PM2.5	Exhaust PM2.5	PM2.5 Total	Bio- CO2	NBio- CO2	Total CO2	CH4	N2O	CO2e
Category	tons/yr										MT/yr					
Archit. Coating	0.0260					0.0000	0.0000		0.0000	0.0000	0.0000	0.0000	0.0000	0.0000	0.0000	0.0000
Off-Road	1.7000e-003	0.0389	0.0525	9.0000e-005		2.7300e-003	2.7300e-003		2.7300e-003	2.7300e-003	0.0000	7.3193	7.3193	4.1000e-004	0.0000	7.3296
Total	0.0277	0.0389	0.0525	9.0000e-005		2.7300e-003	2.7300e-003		2.7300e-003	2.7300e-003	0.0000	7.3193	7.3193	4.1000e-004	0.0000	7.3296

Mitigated Construction Off-Site

	ROG	NOx	CO	SO2	Fugitive PM10	Exhaust PM10	PM10 Total	Fugitive PM2.5	Exhaust PM2.5	PM2.5 Total	Bio- CO2	NBio- CO2	Total CO2	CH4	N2O	CO2e
Category	tons/yr										MT/yr					
Hauling	0.0000	0.0000	0.0000	0.0000	0.0000	0.0000	0.0000	0.0000	0.0000	0.0000	0.0000	0.0000	0.0000	0.0000	0.0000	0.0000
Vendor	1.3000e-004	4.9700e-003	1.8100e-003	2.0000e-005	8.1000e-004	3.0000e-005	8.4000e-004	2.3000e-004	3.0000e-005	2.6000e-004	0.0000	2.2694	2.2694	9.0000e-005	3.3000e-004	2.3698
Worker	5.0000e-003	3.6800e-003	0.0524	1.6000e-004	0.0189	1.0000e-004	0.0190	5.0100e-003	1.0000e-004	5.1100e-003	0.0000	14.6302	14.6302	3.4000e-004	3.5000e-004	14.7441
Total	5.1300e-003	8.6500e-003	0.0543	1.8000e-004	0.0197	1.3000e-004	0.0198	5.2400e-003	1.3000e-004	5.3700e-003	0.0000	16.8996	16.8996	4.3000e-004	6.8000e-004	17.1139

Hawthorne HS Field Improvement Project - Construction Only - South Coast Air Basin, Annual

EMFAC Off-Model Adjustment Factors for Gasoline Light Duty Vehicle to Account for the SAFE Vehicle Rule Applied

3.12 Synthetic Track - 2024

Unmitigated Construction On-Site

	ROG	NOx	CO	SO2	Fugitive PM10	Exhaust PM10	PM10 Total	Fugitive PM2.5	Exhaust PM2.5	PM2.5 Total	Bio- CO2	NBio- CO2	Total CO2	CH4	N2O	CO2e
Category	tons/yr										MT/yr					
Off-Road	0.0509	0.4688	0.5599	9.4000e-004		0.0213	0.0213		0.0200	0.0200	0.0000	80.7468	80.7468	0.0196	0.0000	81.2359
Total	0.0509	0.4688	0.5599	9.4000e-004		0.0213	0.0213		0.0200	0.0200	0.0000	80.7468	80.7468	0.0196	0.0000	81.2359

Unmitigated Construction Off-Site

	ROG	NOx	CO	SO2	Fugitive PM10	Exhaust PM10	PM10 Total	Fugitive PM2.5	Exhaust PM2.5	PM2.5 Total	Bio- CO2	NBio- CO2	Total CO2	CH4	N2O	CO2e
Category	tons/yr										MT/yr					
Hauling	0.0000	0.0000	0.0000	0.0000	0.0000	0.0000	0.0000	0.0000	0.0000	0.0000	0.0000	0.0000	0.0000	0.0000	0.0000	0.0000
Vendor	2.0000e-004	7.5200e-003	2.7300e-003	3.0000e-005	1.2300e-003	4.0000e-005	1.2700e-003	3.5000e-004	4.0000e-005	3.9000e-004	0.0000	3.4305	3.4305	1.3000e-004	5.0000e-004	3.5823
Worker	7.5500e-003	5.5600e-003	0.0793	2.4000e-004	0.0285	1.6000e-004	0.0287	7.5800e-003	1.4000e-004	7.7200e-003	0.0000	22.1154	22.1154	5.2000e-004	5.3000e-004	22.2876
Total	7.7500e-003	0.0131	0.0820	2.7000e-004	0.0298	2.0000e-004	0.0300	7.9300e-003	1.8000e-004	8.1100e-003	0.0000	25.5459	25.5459	6.5000e-004	1.0300e-003	25.8699

Hawthorne HS Field Improvement Project - Construction Only - South Coast Air Basin, Annual

EMFAC Off-Model Adjustment Factors for Gasoline Light Duty Vehicle to Account for the SAFE Vehicle Rule Applied

3.12 Synthetic Track - 2024

Mitigated Construction On-Site

	ROG	NOx	CO	SO2	Fugitive PM10	Exhaust PM10	PM10 Total	Fugitive PM2.5	Exhaust PM2.5	PM2.5 Total	Bio- CO2	NBio- CO2	Total CO2	CH4	N2O	CO2e
Category	tons/yr										MT/yr					
Off-Road	0.0276	0.4846	0.6273	9.4000e-004		0.0295	0.0295		0.0295	0.0295	0.0000	80.7467	80.7467	0.0196	0.0000	81.2358
Total	0.0276	0.4846	0.6273	9.4000e-004		0.0295	0.0295		0.0295	0.0295	0.0000	80.7467	80.7467	0.0196	0.0000	81.2358

Mitigated Construction Off-Site

	ROG	NOx	CO	SO2	Fugitive PM10	Exhaust PM10	PM10 Total	Fugitive PM2.5	Exhaust PM2.5	PM2.5 Total	Bio- CO2	NBio- CO2	Total CO2	CH4	N2O	CO2e
Category	tons/yr										MT/yr					
Hauling	0.0000	0.0000	0.0000	0.0000	0.0000	0.0000	0.0000	0.0000	0.0000	0.0000	0.0000	0.0000	0.0000	0.0000	0.0000	0.0000
Vendor	2.0000e-004	7.5200e-003	2.7300e-003	3.0000e-005	1.2300e-003	4.0000e-005	1.2700e-003	3.5000e-004	4.0000e-005	3.9000e-004	0.0000	3.4305	3.4305	1.3000e-004	5.0000e-004	3.5823
Worker	7.5500e-003	5.5600e-003	0.0793	2.4000e-004	0.0285	1.6000e-004	0.0287	7.5800e-003	1.4000e-004	7.7200e-003	0.0000	22.1154	22.1154	5.2000e-004	5.3000e-004	22.2876
Total	7.7500e-003	0.0131	0.0820	2.7000e-004	0.0298	2.0000e-004	0.0300	7.9300e-003	1.8000e-004	8.1100e-003	0.0000	25.5459	25.5459	6.5000e-004	1.0300e-003	25.8699

Hawthorne HS Field Improvement Project - Construction Only - South Coast Air Basin, Annual

EMFAC Off-Model Adjustment Factors for Gasoline Light Duty Vehicle to Account for the SAFE Vehicle Rule Applied

3.13 Paving Event #2 - 2024

Unmitigated Construction On-Site

	ROG	NOx	CO	SO2	Fugitive PM10	Exhaust PM10	PM10 Total	Fugitive PM2.5	Exhaust PM2.5	PM2.5 Total	Bio- CO2	NBio- CO2	Total CO2	CH4	N2O	CO2e
Category	tons/yr										MT/yr					
Off-Road	2.4700e-003	0.0238	0.0366	6.0000e-005		1.1700e-003	1.1700e-003		1.0800e-003	1.0800e-003	0.0000	5.0066	5.0066	1.6200e-003	0.0000	5.0471
Paving	0.0000					0.0000	0.0000		0.0000	0.0000	0.0000	0.0000	0.0000	0.0000	0.0000	0.0000
Total	2.4700e-003	0.0238	0.0366	6.0000e-005		1.1700e-003	1.1700e-003		1.0800e-003	1.0800e-003	0.0000	5.0066	5.0066	1.6200e-003	0.0000	5.0471

Unmitigated Construction Off-Site

	ROG	NOx	CO	SO2	Fugitive PM10	Exhaust PM10	PM10 Total	Fugitive PM2.5	Exhaust PM2.5	PM2.5 Total	Bio- CO2	NBio- CO2	Total CO2	CH4	N2O	CO2e
Category	tons/yr										MT/yr					
Hauling	0.0000	0.0000	0.0000	0.0000	0.0000	0.0000	0.0000	0.0000	0.0000	0.0000	0.0000	0.0000	0.0000	0.0000	0.0000	0.0000
Vendor	2.0000e-005	5.8000e-004	2.1000e-004	0.0000	9.0000e-005	0.0000	1.0000e-004	3.0000e-005	0.0000	3.0000e-005	0.0000	0.2639	0.2639	1.0000e-005	4.0000e-005	0.2756
Worker	5.8000e-004	4.3000e-004	6.1000e-003	2.0000e-005	2.1900e-003	1.0000e-005	2.2100e-003	5.8000e-004	1.0000e-005	5.9000e-004	0.0000	1.7012	1.7012	4.0000e-005	4.0000e-005	1.7144
Total	6.0000e-004	1.0100e-003	6.3100e-003	2.0000e-005	2.2800e-003	1.0000e-005	2.3100e-003	6.1000e-004	1.0000e-005	6.2000e-004	0.0000	1.9651	1.9651	5.0000e-005	8.0000e-005	1.9900

Hawthorne HS Field Improvement Project - Construction Only - South Coast Air Basin, Annual

EMFAC Off-Model Adjustment Factors for Gasoline Light Duty Vehicle to Account for the SAFE Vehicle Rule Applied

3.13 Paving Event #2 - 2024

Mitigated Construction On-Site

	ROG	NOx	CO	SO2	Fugitive PM10	Exhaust PM10	PM10 Total	Fugitive PM2.5	Exhaust PM2.5	PM2.5 Total	Bio- CO2	NBio- CO2	Total CO2	CH4	N2O	CO2e
Category	tons/yr										MT/yr					
Off-Road	1.4000e-003	0.0282	0.0432	6.0000e-005		1.5200e-003	1.5200e-003		1.5200e-003	1.5200e-003	0.0000	5.0066	5.0066	1.6200e-003	0.0000	5.0471
Paving	0.0000					0.0000	0.0000		0.0000	0.0000	0.0000	0.0000	0.0000	0.0000	0.0000	0.0000
Total	1.4000e-003	0.0282	0.0432	6.0000e-005		1.5200e-003	1.5200e-003		1.5200e-003	1.5200e-003	0.0000	5.0066	5.0066	1.6200e-003	0.0000	5.0471

Mitigated Construction Off-Site

	ROG	NOx	CO	SO2	Fugitive PM10	Exhaust PM10	PM10 Total	Fugitive PM2.5	Exhaust PM2.5	PM2.5 Total	Bio- CO2	NBio- CO2	Total CO2	CH4	N2O	CO2e
Category	tons/yr										MT/yr					
Hauling	0.0000	0.0000	0.0000	0.0000	0.0000	0.0000	0.0000	0.0000	0.0000	0.0000	0.0000	0.0000	0.0000	0.0000	0.0000	0.0000
Vendor	2.0000e-005	5.8000e-004	2.1000e-004	0.0000	9.0000e-005	0.0000	1.0000e-004	3.0000e-005	0.0000	3.0000e-005	0.0000	0.2639	0.2639	1.0000e-005	4.0000e-005	0.2756
Worker	5.8000e-004	4.3000e-004	6.1000e-003	2.0000e-005	2.1900e-003	1.0000e-005	2.2100e-003	5.8000e-004	1.0000e-005	5.9000e-004	0.0000	1.7012	1.7012	4.0000e-005	4.0000e-005	1.7144
Total	6.0000e-004	1.0100e-003	6.3100e-003	2.0000e-005	2.2800e-003	1.0000e-005	2.3100e-003	6.1000e-004	1.0000e-005	6.2000e-004	0.0000	1.9651	1.9651	5.0000e-005	8.0000e-005	1.9900

Hawthorne HS Field Improvement Project - Construction Only - South Coast Air Basin, Annual

EMFAC Off-Model Adjustment Factors for Gasoline Light Duty Vehicle to Account for the SAFE Vehicle Rule Applied

4.0 Operational Detail - Mobile

4.1 Mitigation Measures Mobile

	ROG	NOx	CO	SO2	Fugitive PM10	Exhaust PM10	PM10 Total	Fugitive PM2.5	Exhaust PM2.5	PM2.5 Total	Bio- CO2	NBio- CO2	Total CO2	CH4	N2O	CO2e
Category	tons/yr										MT/yr					
Mitigated	0.0000	0.0000	0.0000	0.0000	0.0000	0.0000	0.0000	0.0000	0.0000	0.0000	0.0000	0.0000	0.0000	0.0000	0.0000	0.0000
Unmitigated	0.0000	0.0000	0.0000	0.0000	0.0000	0.0000	0.0000	0.0000	0.0000	0.0000	0.0000	0.0000	0.0000	0.0000	0.0000	0.0000

4.2 Trip Summary Information

Land Use	Average Daily Trip Rate			Unmitigated	Mitigated
	Weekday	Saturday	Sunday	Annual VMT	Annual VMT
High School	0.00	0.00	0.00		
Total	0.00	0.00	0.00		

4.3 Trip Type Information

Land Use	Miles			Trip %			Trip Purpose %		
	H-W or C-W	H-S or C-C	H-O or C-NW	H-W or C-W	H-S or C-C	H-O or C-NW	Primary	Diverted	Pass-by
High School	16.60	8.40	6.90	77.80	17.20	5.00	75	19	6

4.4 Fleet Mix

Land Use	LDA	LDT1	LDT2	MDV	LHD1	LHD2	MHD	HHD	OBUS	UBUS	MCY	SBUS	MH
High School	0.542639	0.062168	0.185423	0.128137	0.023809	0.006526	0.012163	0.008660	0.000816	0.000502	0.024766	0.000746	0.003644

Hawthorne HS Field Improvement Project - Construction Only - South Coast Air Basin, Annual

EMFAC Off-Model Adjustment Factors for Gasoline Light Duty Vehicle to Account for the SAFE Vehicle Rule Applied

5.3 Energy by Land Use - Electricity

Unmitigated

	Electricity Use	Total CO2	CH4	N2O	CO2e
Land Use	kWh/yr	MT/yr			
High School	0	0.0000	0.0000	0.0000	0.0000
Total		0.0000	0.0000	0.0000	0.0000

Mitigated

	Electricity Use	Total CO2	CH4	N2O	CO2e
Land Use	kWh/yr	MT/yr			
High School	0	0.0000	0.0000	0.0000	0.0000
Total		0.0000	0.0000	0.0000	0.0000

6.0 Area Detail

6.1 Mitigation Measures Area

Hawthorne HS Field Improvement Project - Construction Only - South Coast Air Basin, Annual

EMFAC Off-Model Adjustment Factors for Gasoline Light Duty Vehicle to Account for the SAFE Vehicle Rule Applied

	ROG	NOx	CO	SO2	Fugitive PM10	Exhaust PM10	PM10 Total	Fugitive PM2.5	Exhaust PM2.5	PM2.5 Total	Bio- CO2	NBio- CO2	Total CO2	CH4	N2O	CO2e
Category	tons/yr										MT/yr					
Mitigated	2.2650	6.0000e-005	7.0700e-003	0.0000		3.0000e-005	3.0000e-005		3.0000e-005	3.0000e-005	0.0000	0.0138	0.0138	4.0000e-005	0.0000	0.0147
Unmitigated	2.2650	6.0000e-005	7.0700e-003	0.0000		3.0000e-005	3.0000e-005		3.0000e-005	3.0000e-005	0.0000	0.0138	0.0138	4.0000e-005	0.0000	0.0147

6.2 Area by SubCategory

Unmitigated

	ROG	NOx	CO	SO2	Fugitive PM10	Exhaust PM10	PM10 Total	Fugitive PM2.5	Exhaust PM2.5	PM2.5 Total	Bio- CO2	NBio- CO2	Total CO2	CH4	N2O	CO2e
SubCategory	tons/yr										MT/yr					
Architectural Coating	0.2574					0.0000	0.0000		0.0000	0.0000	0.0000	0.0000	0.0000	0.0000	0.0000	0.0000
Consumer Products	2.0069					0.0000	0.0000		0.0000	0.0000	0.0000	0.0000	0.0000	0.0000	0.0000	0.0000
Landscaping	6.5000e-004	6.0000e-005	7.0700e-003	0.0000		3.0000e-005	3.0000e-005		3.0000e-005	3.0000e-005	0.0000	0.0138	0.0138	4.0000e-005	0.0000	0.0147
Total	2.2650	6.0000e-005	7.0700e-003	0.0000		3.0000e-005	3.0000e-005		3.0000e-005	3.0000e-005	0.0000	0.0138	0.0138	4.0000e-005	0.0000	0.0147

Hawthorne HS Field Improvement Project - Construction Only - South Coast Air Basin, Annual

EMFAC Off-Model Adjustment Factors for Gasoline Light Duty Vehicle to Account for the SAFE Vehicle Rule Applied

6.2 Area by SubCategory

Mitigated

	ROG	NOx	CO	SO2	Fugitive PM10	Exhaust PM10	PM10 Total	Fugitive PM2.5	Exhaust PM2.5	PM2.5 Total	Bio- CO2	NBio- CO2	Total CO2	CH4	N2O	CO2e
SubCategory	tons/yr										MT/yr					
Architectural Coating	0.2574					0.0000	0.0000		0.0000	0.0000	0.0000	0.0000	0.0000	0.0000	0.0000	0.0000
Consumer Products	2.0069					0.0000	0.0000		0.0000	0.0000	0.0000	0.0000	0.0000	0.0000	0.0000	0.0000
Landscaping	6.5000e-004	6.0000e-005	7.0700e-003	0.0000		3.0000e-005	3.0000e-005		3.0000e-005	3.0000e-005	0.0000	0.0138	0.0138	4.0000e-005	0.0000	0.0147
Total	2.2650	6.0000e-005	7.0700e-003	0.0000		3.0000e-005	3.0000e-005		3.0000e-005	3.0000e-005	0.0000	0.0138	0.0138	4.0000e-005	0.0000	0.0147

7.0 Water Detail

7.1 Mitigation Measures Water

Hawthorne HS Field Improvement Project - Construction Only - South Coast Air Basin, Annual

EMFAC Off-Model Adjustment Factors for Gasoline Light Duty Vehicle to Account for the SAFE Vehicle Rule Applied

	Total CO2	CH4	N2O	CO2e
Category	MT/yr			
Mitigated	0.0000	0.0000	0.0000	0.0000
Unmitigated	0.0000	0.0000	0.0000	0.0000

7.2 Water by Land Use

Unmitigated

	Indoor/Outdoor Use	Total CO2	CH4	N2O	CO2e
Land Use	Mgal	MT/yr			
High School	0 / 0	0.0000	0.0000	0.0000	0.0000
Total		0.0000	0.0000	0.0000	0.0000

Hawthorne HS Field Improvement Project - Construction Only - South Coast Air Basin, Annual

EMFAC Off-Model Adjustment Factors for Gasoline Light Duty Vehicle to Account for the SAFE Vehicle Rule Applied

7.2 Water by Land Use

Mitigated

	Indoor/Outdoor Use	Total CO2	CH4	N2O	CO2e
Land Use	Mgal	MT/yr			
High School	0 / 0	0.0000	0.0000	0.0000	0.0000
Total		0.0000	0.0000	0.0000	0.0000

8.0 Waste Detail

8.1 Mitigation Measures Waste

Category/Year

	Total CO2	CH4	N2O	CO2e
	MT/yr			
Mitigated	0.0000	0.0000	0.0000	0.0000
Unmitigated	0.0000	0.0000	0.0000	0.0000

Hawthorne HS Field Improvement Project - Construction Only - South Coast Air Basin, Annual

EMFAC Off-Model Adjustment Factors for Gasoline Light Duty Vehicle to Account for the SAFE Vehicle Rule Applied

8.2 Waste by Land Use

Unmitigated

	Waste Disposed	Total CO2	CH4	N2O	CO2e
Land Use	tons	MT/yr			
High School	0	0.0000	0.0000	0.0000	0.0000
Total		0.0000	0.0000	0.0000	0.0000

Mitigated

	Waste Disposed	Total CO2	CH4	N2O	CO2e
Land Use	tons	MT/yr			
High School	0	0.0000	0.0000	0.0000	0.0000
Total		0.0000	0.0000	0.0000	0.0000

9.0 Operational Offroad

Equipment Type	Number	Hours/Day	Days/Year	Horse Power	Load Factor	Fuel Type
----------------	--------	-----------	-----------	-------------	-------------	-----------

Hawthorne HS Field Improvement Project - Construction Only - South Coast Air Basin, Annual

EMFAC Off-Model Adjustment Factors for Gasoline Light Duty Vehicle to Account for the SAFE Vehicle Rule Applied

10.0 Stationary Equipment

Fire Pumps and Emergency Generators

Equipment Type	Number	Hours/Day	Hours/Year	Horse Power	Load Factor	Fuel Type
----------------	--------	-----------	------------	-------------	-------------	-----------

Boilers

Equipment Type	Number	Heat Input/Day	Heat Input/Year	Boiler Rating	Fuel Type
----------------	--------	----------------	-----------------	---------------	-----------

User Defined Equipment

Equipment Type	Number
----------------	--------

11.0 Vegetation

Hawthorne HS Field Improvement Project - Construction Only - South Coast Air Basin, Summer

EMFAC Off-Model Adjustment Factors for Gasoline Light Duty Vehicle to Account for the SAFE Vehicle Rule Applied

Hawthorne HS Field Improvement Project - Construction Only
South Coast Air Basin, Summer

1.0 Project Characteristics

1.1 Land Usage

Land Uses	Size	Metric	Lot Acreage	Floor Surface Area	Population
High School	555.39	1000sqft	12.75	555,390.00	0

1.2 Other Project Characteristics

Urbanization	Urban	Wind Speed (m/s)	2.2	Precipitation Freq (Days)	31
Climate Zone	8			Operational Year	2025
Utility Company	Southern California Edison				
CO2 Intensity (lb/MWhr)	531.98	CH4 Intensity (lb/MWhr)	0.033	N2O Intensity (lb/MWhr)	0.004

1.3 User Entered Comments & Non-Default Data

Project Characteristics - co2

Land Use -

Construction Phase - Consistent with previous District HS Field Improvement Projects

Off-road Equipment - Project-Specific Equipment

Off-road Equipment - Project-Specific Equipment

Off-road Equipment - Project-Specific Construction Equipment

Off-road Equipment - Project-Specific Equipment

Off-road Equipment - Project-Specific Equipment

Off-road Equipment - Project-Specific Equipment

Off-road Equipment - Project-Specific Equipment

Off-road Equipment - Project-Specific Equipment

Off-road Equipment -

Hawthorne HS Field Improvement Project - Construction Only - South Coast Air Basin, Summer

EMFAC Off-Model Adjustment Factors for Gasoline Light Duty Vehicle to Account for the SAFE Vehicle Rule Applied

Off-road Equipment -

Off-road Equipment -

Off-road Equipment - Project-Specific Equipment

Trips and VMT - Project-Specific Construction Program

Demolition - 2,500 tons of debris

Grading - 16,000 CY exported, 16,000 CY imported

Architectural Coating - 5,400 SF Team building, approx 400 SF parking lot

Vehicle Trips - Construction emissions only.

Energy Use - Construction emissions only

Water And Wastewater - Construction emissions only

Solid Waste - Construction emissions only

Construction Off-road Equipment Mitigation - Equipment >50 HP tier 3, water exposed area 3 times daily

Table Name	Column Name	Default Value	New Value
tblArchitecturalCoating	ConstArea_Nonresidential_Exterior	277,695.00	2,700.00
tblArchitecturalCoating	ConstArea_Nonresidential_Interior	833,085.00	8,100.00
tblArchitecturalCoating	ConstArea_Parking	0.00	400.00
tblConstEquipMitigation	NumberOfEquipmentMitigated	0.00	1.00
tblConstEquipMitigation	NumberOfEquipmentMitigated	0.00	1.00
tblConstEquipMitigation	NumberOfEquipmentMitigated	0.00	3.00
tblConstEquipMitigation	NumberOfEquipmentMitigated	0.00	6.00
tblConstEquipMitigation	NumberOfEquipmentMitigated	0.00	9.00
tblConstEquipMitigation	NumberOfEquipmentMitigated	0.00	3.00
tblConstEquipMitigation	NumberOfEquipmentMitigated	0.00	1.00
tblConstEquipMitigation	NumberOfEquipmentMitigated	0.00	4.00
tblConstEquipMitigation	NumberOfEquipmentMitigated	0.00	4.00
tblConstEquipMitigation	NumberOfEquipmentMitigated	0.00	9.00
tblConstEquipMitigation	NumberOfEquipmentMitigated	0.00	4.00
tblConstEquipMitigation	NumberOfEquipmentMitigated	0.00	5.00

Hawthorne HS Field Improvement Project - Construction Only - South Coast Air Basin, Summer

EMFAC Off-Model Adjustment Factors for Gasoline Light Duty Vehicle to Account for the SAFE Vehicle Rule Applied

tblConstEquipMitigation	NumberOfEquipmentMitigated	0.00	2.00
tblConstEquipMitigation	NumberOfEquipmentMitigated	0.00	19.00
tblConstEquipMitigation	NumberOfEquipmentMitigated	0.00	3.00
tblConstEquipMitigation	Tier	No Change	Tier 3
tblConstEquipMitigation	Tier	No Change	Tier 3
tblConstEquipMitigation	Tier	No Change	Tier 3
tblConstEquipMitigation	Tier	No Change	Tier 3
tblConstEquipMitigation	Tier	No Change	Tier 3
tblConstEquipMitigation	Tier	No Change	Tier 3
tblConstEquipMitigation	Tier	No Change	Tier 3
tblConstEquipMitigation	Tier	No Change	Tier 3
tblConstEquipMitigation	Tier	No Change	Tier 3
tblConstEquipMitigation	Tier	No Change	Tier 3
tblConstEquipMitigation	Tier	No Change	Tier 3
tblConstEquipMitigation	Tier	No Change	Tier 3
tblConstEquipMitigation	Tier	No Change	Tier 3
tblConstEquipMitigation	Tier	No Change	Tier 3
tblConstEquipMitigation	Tier	No Change	Tier 3
tblConstEquipMitigation	Tier	No Change	Tier 3
tblConstructionPhase	NumDays	20.00	43.00
tblConstructionPhase	NumDays	300.00	65.00
tblConstructionPhase	NumDays	300.00	3.00
tblConstructionPhase	NumDays	300.00	228.00
tblConstructionPhase	NumDays	300.00	3.00
tblConstructionPhase	NumDays	300.00	153.00
tblConstructionPhase	NumDays	300.00	3.00
tblConstructionPhase	NumDays	20.00	44.00
tblConstructionPhase	NumDays	30.00	76.00
tblConstructionPhase	NumDays	20.00	5.00
tblConstructionPhase	NumDays	20.00	5.00

Hawthorne HS Field Improvement Project - Construction Only - South Coast Air Basin, Summer

EMFAC Off-Model Adjustment Factors for Gasoline Light Duty Vehicle to Account for the SAFE Vehicle Rule Applied

tblEnergyUse	LightingElect	2.68	0.00
tblEnergyUse	NT24E	1.51	0.00
tblEnergyUse	NT24NG	1.03	0.00
tblEnergyUse	T24E	1.69	0.00
tblEnergyUse	T24NG	10.71	0.00
tblGrading	AcresOfGrading	228.00	125.00
tblGrading	MaterialExported	0.00	16,000.00
tblGrading	MaterialImported	0.00	16,000.00
tblOffRoadEquipment	HorsePower	231.00	78.00
tblOffRoadEquipment	LoadFactor	0.29	0.50
tblOffRoadEquipment	OffRoadEquipmentUnitAmount	1.00	0.00
tblOffRoadEquipment	OffRoadEquipmentUnitAmount	1.00	0.00
tblOffRoadEquipment	OffRoadEquipmentUnitAmount	1.00	0.00
tblOffRoadEquipment	OffRoadEquipmentUnitAmount	3.00	0.00
tblOffRoadEquipment	OffRoadEquipmentUnitAmount	3.00	0.00
tblOffRoadEquipment	OffRoadEquipmentUnitAmount	3.00	0.00
tblOffRoadEquipment	OffRoadEquipmentUnitAmount	1.00	0.00
tblOffRoadEquipment	OffRoadEquipmentUnitAmount	1.00	0.00
tblOffRoadEquipment	OffRoadEquipmentUnitAmount	1.00	0.00
tblOffRoadEquipment	OffRoadEquipmentUnitAmount	3.00	2.00
tblOffRoadEquipment	OffRoadEquipmentUnitAmount	3.00	2.00
tblOffRoadEquipment	OffRoadEquipmentUnitAmount	3.00	2.00
tblOffRoadEquipment	OffRoadEquipmentUnitAmount	1.00	0.00
tblOffRoadEquipment	OffRoadEquipmentUnitAmount	1.00	0.00
tblOffRoadEquipment	OffRoadEquipmentUnitAmount	1.00	0.00
tblOffRoadEquipment	UsageHours	6.00	8.00
tblOffRoadEquipment	UsageHours	7.00	8.00
tblOffRoadEquipment	UsageHours	7.00	8.00
tblOffRoadEquipment	UsageHours	7.00	8.00

Hawthorne HS Field Improvement Project - Construction Only - South Coast Air Basin, Summer

EMFAC Off-Model Adjustment Factors for Gasoline Light Duty Vehicle to Account for the SAFE Vehicle Rule Applied

tblOffRoadEquipment	UsageHours	7.00	8.00
tblOffRoadEquipment	UsageHours	7.00	8.00
tblOffRoadEquipment	UsageHours	7.00	8.00
tblOffRoadEquipment	UsageHours	7.00	8.00
tblOffRoadEquipment	UsageHours	7.00	8.00
tblOffRoadEquipment	UsageHours	7.00	8.00
tblProjectCharacteristics	CO2IntensityFactor	390.98	531.98
tblSolidWaste	SolidWasteGenerationRate	722.01	0.00
tblTripsAndVMT	HaulingTripLength	20.00	40.00
tblTripsAndVMT	HaulingTripLength	20.00	40.00
tblTripsAndVMT	VendorTripNumber	0.00	6.00
tblTripsAndVMT	VendorTripNumber	0.00	6.00
tblTripsAndVMT	VendorTripNumber	91.00	6.00
tblTripsAndVMT	VendorTripNumber	0.00	6.00
tblTripsAndVMT	VendorTripNumber	0.00	6.00
tblTripsAndVMT	VendorTripNumber	91.00	50.00
tblTripsAndVMT	VendorTripNumber	0.00	6.00
tblTripsAndVMT	VendorTripNumber	91.00	99.00
tblTripsAndVMT	VendorTripNumber	91.00	50.00
tblTripsAndVMT	VendorTripNumber	0.00	6.00
tblTripsAndVMT	VendorTripNumber	91.00	6.00
tblTripsAndVMT	VendorTripNumber	91.00	50.00
tblTripsAndVMT	WorkerTripNumber	15.00	80.00
tblTripsAndVMT	WorkerTripNumber	47.00	80.00
tblTripsAndVMT	WorkerTripNumber	233.00	80.00
tblTripsAndVMT	WorkerTripNumber	15.00	80.00
tblTripsAndVMT	WorkerTripNumber	20.00	80.00
tblTripsAndVMT	WorkerTripNumber	233.00	80.00
tblTripsAndVMT	WorkerTripNumber	20.00	80.00

Hawthorne HS Field Improvement Project - Construction Only - South Coast Air Basin, Summer

EMFAC Off-Model Adjustment Factors for Gasoline Light Duty Vehicle to Account for the SAFE Vehicle Rule Applied

tblTripsAndVMT	WorkerTripNumber	233.00	80.00
tblTripsAndVMT	WorkerTripNumber	233.00	80.00
tblTripsAndVMT	WorkerTripNumber	15.00	80.00
tblTripsAndVMT	WorkerTripNumber	233.00	80.00
tblTripsAndVMT	WorkerTripNumber	233.00	80.00
tblVehicleTrips	ST_TR	3.98	0.00
tblVehicleTrips	SU_TR	1.71	0.00
tblVehicleTrips	WD_TR	14.07	0.00
tblWater	IndoorWaterUseRate	18,441,525.01	0.00
tblWater	OutdoorWaterUseRate	47,421,064.31	0.00

2.0 Emissions Summary

Hawthorne HS Field Improvement Project - Construction Only - South Coast Air Basin, Summer

EMFAC Off-Model Adjustment Factors for Gasoline Light Duty Vehicle to Account for the SAFE Vehicle Rule Applied

2.1 Overall Construction (Maximum Daily Emission)

Unmitigated Construction

	ROG	NOx	CO	SO2	Fugitive PM10	Exhaust PM10	PM10 Total	Fugitive PM2.5	Exhaust PM2.5	PM2.5 Total	Bio- CO2	NBio- CO2	Total CO2	CH4	N2O	CO2e
Year	lb/day										lb/day					
2022	2.9664	27.8961	24.0786	0.0548	2.3447	1.2652	3.6099	0.4861	1.1767	1.6627	0.0000	5,431.0006	5,431.0006	1.1225	0.1548	5,505.1968
2023	6.9094	75.9019	65.2256	0.1776	11.8003	3.0696	14.5882	4.5873	2.8274	7.3336	0.0000	18,123.6223	18,123.6223	3.6061	1.2355	18,544.5610
2024	8.4481	59.7068	83.4600	0.1733	5.2585	2.5683	7.8268	1.4125	2.4083	3.8208	0.0000	17,098.8250	17,098.8250	2.9021	0.5204	17,299.5609
Maximum	8.4481	75.9019	83.4600	0.1776	11.8003	3.0696	14.5882	4.5873	2.8274	7.3336	0.0000	18,123.6223	18,123.6223	3.6061	1.2355	18,544.5610

Mitigated Construction

	ROG	NOx	CO	SO2	Fugitive PM10	Exhaust PM10	PM10 Total	Fugitive PM2.5	Exhaust PM2.5	PM2.5 Total	Bio- CO2	NBio- CO2	Total CO2	CH4	N2O	CO2e
Year	lb/day										lb/day					
2022	1.2518	20.4896	28.1584	0.0548	1.6030	0.8853	2.4883	0.3738	0.8841	1.2579	0.0000	5,431.0006	5,431.0006	1.1225	0.1548	5,505.1968
2023	3.2860	62.4557	72.0365	0.1776	7.0338	2.9006	9.3196	2.4488	2.8981	4.8298	0.0000	18,123.6223	18,123.6223	3.6061	1.2355	18,544.5610
2024	5.7083	63.1155	92.3872	0.1733	5.2585	3.5074	8.7659	1.4125	3.5044	4.9169	0.0000	17,098.8250	17,098.8250	2.9021	0.5204	17,299.5609
Maximum	5.7083	63.1155	92.3872	0.1776	7.0338	3.5074	9.3196	2.4488	3.5044	4.9169	0.0000	18,123.6223	18,123.6223	3.6061	1.2355	18,544.5610

Hawthorne HS Field Improvement Project - Construction Only - South Coast Air Basin, Summer

EMFAC Off-Model Adjustment Factors for Gasoline Light Duty Vehicle to Account for the SAFE Vehicle Rule Applied

	ROG	NOx	CO	SO2	Fugitive PM10	Exhaust PM10	PM10 Total	Fugitive PM2.5	Exhaust PM2.5	PM2.5 Total	Bio- CO2	NBio-CO2	Total CO2	CH4	N2O	CO2e
Percent Reduction	44.08	10.67	-11.47	0.00	28.39	-5.65	20.95	34.70	-13.63	14.14	0.00	0.00	0.00	0.00	0.00	0.00

Hawthorne HS Field Improvement Project - Construction Only - South Coast Air Basin, Summer

EMFAC Off-Model Adjustment Factors for Gasoline Light Duty Vehicle to Account for the SAFE Vehicle Rule Applied

2.2 Overall Operational

Unmitigated Operational

	ROG	NOx	CO	SO2	Fugitive PM10	Exhaust PM10	PM10 Total	Fugitive PM2.5	Exhaust PM2.5	PM2.5 Total	Bio- CO2	NBio- CO2	Total CO2	CH4	N2O	CO2e
Category	lb/day										lb/day					
Area	12.4125	5.1000e-004	0.0566	0.0000		2.0000e-004	2.0000e-004		2.0000e-004	2.0000e-004		0.1216	0.1216	3.2000e-004		0.1295
Energy	0.0000	0.0000	0.0000	0.0000		0.0000	0.0000		0.0000	0.0000		0.0000	0.0000	0.0000	0.0000	0.0000
Mobile	0.0000	0.0000	0.0000	0.0000	0.0000	0.0000	0.0000	0.0000	0.0000	0.0000		0.0000	0.0000	0.0000	0.0000	0.0000
Total	12.4125	5.1000e-004	0.0566	0.0000	0.0000	2.0000e-004	2.0000e-004	0.0000	2.0000e-004	2.0000e-004		0.1216	0.1216	3.2000e-004	0.0000	0.1295

Mitigated Operational

	ROG	NOx	CO	SO2	Fugitive PM10	Exhaust PM10	PM10 Total	Fugitive PM2.5	Exhaust PM2.5	PM2.5 Total	Bio- CO2	NBio- CO2	Total CO2	CH4	N2O	CO2e
Category	lb/day										lb/day					
Area	12.4125	5.1000e-004	0.0566	0.0000		2.0000e-004	2.0000e-004		2.0000e-004	2.0000e-004		0.1216	0.1216	3.2000e-004		0.1295
Energy	0.0000	0.0000	0.0000	0.0000		0.0000	0.0000		0.0000	0.0000		0.0000	0.0000	0.0000	0.0000	0.0000
Mobile	0.0000	0.0000	0.0000	0.0000	0.0000	0.0000	0.0000	0.0000	0.0000	0.0000		0.0000	0.0000	0.0000	0.0000	0.0000
Total	12.4125	5.1000e-004	0.0566	0.0000	0.0000	2.0000e-004	2.0000e-004	0.0000	2.0000e-004	2.0000e-004		0.1216	0.1216	3.2000e-004	0.0000	0.1295

Hawthorne HS Field Improvement Project - Construction Only - South Coast Air Basin, Summer

EMFAC Off-Model Adjustment Factors for Gasoline Light Duty Vehicle to Account for the SAFE Vehicle Rule Applied

	ROG	NOx	CO	SO2	Fugitive PM10	Exhaust PM10	PM10 Total	Fugitive PM2.5	Exhaust PM2.5	PM2.5 Total	Bio- CO2	NBio-CO2	Total CO2	CH4	N2O	CO2e
Percent Reduction	0.00	0.00	0.00	0.00	0.00	0.00	0.00	0.00	0.00	0.00	0.00	0.00	0.00	0.00	0.00	0.00

3.0 Construction Detail

Construction Phase

Phase Number	Phase Name	Phase Type	Start Date	End Date	Num Days Week	Num Days	Phase Description
1	Demolition	Demolition	12/1/2022	1/31/2023	5	44	
2	Grading/Site Preparation	Grading	2/1/2023	5/17/2023	5	76	
3	Foundations/Concrete Pour #1	Building Construction	3/1/2023	3/3/2023	5	3	
4	Drainage/Utilities/Trenching	Trenching	4/1/2023	8/31/2023	5	109	
5	Building Construction	Building Construction	5/18/2023	4/1/2024	5	228	
6	Foundations/Concrete Pour #2	Building Construction	7/1/2023	7/5/2023	5	3	
7	Paving Event #1	Paving	10/1/2023	10/6/2023	5	5	
8	Field/Bleachers	Building Construction	11/1/2023	5/31/2024	5	153	
9	Foundations/Concrete Pour #3	Building Construction	2/1/2024	2/5/2024	5	3	
10	Architectural Coatings	Architectural Coating	2/1/2024	4/1/2024	5	43	
11	Synthetic Track	Building Construction	3/1/2024	5/30/2024	5	65	
12	Paving Event #2	Paving	3/1/2024	3/7/2024	5	5	

Acres of Grading (Site Preparation Phase): 0

Acres of Grading (Grading Phase): 125

Acres of Paving: 0

Residential Indoor: 0; Residential Outdoor: 0; Non-Residential Indoor: 8,100; Non-Residential Outdoor: 2,700; Striped Parking Area: 400 (Architectural Coating – sqft)

OffRoad Equipment

Hawthorne HS Field Improvement Project - Construction Only - South Coast Air Basin, Summer

EMFAC Off-Model Adjustment Factors for Gasoline Light Duty Vehicle to Account for the SAFE Vehicle Rule Applied

Phase Name	Offroad Equipment Type	Amount	Usage Hours	Horse Power	Load Factor
Demolition	Concrete/Industrial Saws	1	8.00	81	0.73
Demolition	Excavators	3	8.00	158	0.38
Demolition	Rubber Tired Dozers	2	8.00	247	0.40
Grading/Site Preparation	Excavators	2	8.00	158	0.38
Grading/Site Preparation	Graders	1	8.00	187	0.41
Grading/Site Preparation	Rubber Tired Dozers	1	8.00	247	0.40
Grading/Site Preparation	Scrapers	2	8.00	367	0.48
Grading/Site Preparation	Tractors/Loaders/Backhoes	2	8.00	97	0.37
Foundations/Concrete Pour #1	Cranes	0	7.00	231	0.29
Foundations/Concrete Pour #1	Excavators	0		158	0.38
Foundations/Concrete Pour #1	Forklifts	0	8.00	89	0.20
Foundations/Concrete Pour #1	Generator Sets	0	8.00	84	0.74
Foundations/Concrete Pour #1	Graders	0		187	0.41
Foundations/Concrete Pour #1	Pumps	3	8.00	84	0.74
Foundations/Concrete Pour #1	Rubber Tired Dozers	0		247	0.40
Foundations/Concrete Pour #1	Scrapers	0		367	0.48
Foundations/Concrete Pour #1	Tractors/Loaders/Backhoes	2	8.00	97	0.37
Foundations/Concrete Pour #1	Welders	0	8.00	46	0.45
Drainage/Utilities/Trenching	Cranes			78	0.50
Drainage/Utilities/Trenching	Excavators	1	8.00	158	0.38
Drainage/Utilities/Trenching	Forklifts	0		89	0.20
Drainage/Utilities/Trenching	Generator Sets	0		84	0.74
Drainage/Utilities/Trenching	Rubber Tired Dozers	2	8.00	247	0.40
Drainage/Utilities/Trenching	Tractors/Loaders/Backhoes	2	8.00	97	0.37
Drainage/Utilities/Trenching	Trenchers	3	8.00	78	0.50
Drainage/Utilities/Trenching	Welders	0		46	0.45
Building Construction	Cranes	1	8.00	231	0.29
Building Construction	Forklifts	3	8.00	89	0.20

Hawthorne HS Field Improvement Project - Construction Only - South Coast Air Basin, Summer

EMFAC Off-Model Adjustment Factors for Gasoline Light Duty Vehicle to Account for the SAFE Vehicle Rule Applied

Building Construction	Generator Sets	1	8.00	84	0.74
Building Construction	Pavers	0		130	0.42
Building Construction	Paving Equipment	0		132	0.36
Building Construction	Rollers	0		80	0.38
Building Construction	Tractors/Loaders/Backhoes	3	8.00	97	0.37
Building Construction	Welders	1	8.00	46	0.45
Foundations/Concrete Pour #2	Air Compressors	0		78	0.48
Foundations/Concrete Pour #2	Cranes	0	7.00	231	0.29
Foundations/Concrete Pour #2	Forklifts	0	8.00	89	0.20
Foundations/Concrete Pour #2	Generator Sets	0	8.00	84	0.74
Foundations/Concrete Pour #2	Pumps	3	8.00	84	0.74
Foundations/Concrete Pour #2	Tractors/Loaders/Backhoes	2	8.00	97	0.37
Foundations/Concrete Pour #2	Welders	0	8.00	46	0.45
Paving Event #1	Pavers	2	8.00	130	0.42
Paving Event #1	Paving Equipment	2	8.00	132	0.36
Paving Event #1	Rollers	2	8.00	80	0.38
Field/Bleachers	Cranes	1	8.00	231	0.29
Field/Bleachers	Forklifts	3	8.00	89	0.20
Field/Bleachers	Generator Sets	1	8.00	84	0.74
Field/Bleachers	Tractors/Loaders/Backhoes	3	8.00	97	0.37
Field/Bleachers	Welders	1	8.00	46	0.45
Foundations/Concrete Pour #3	Cranes	0	7.00	231	0.29
Foundations/Concrete Pour #3	Forklifts	0	8.00	89	0.20
Foundations/Concrete Pour #3	Generator Sets	0	8.00	84	0.74
Foundations/Concrete Pour #3	Pumps	3	8.00	84	0.74
Foundations/Concrete Pour #3	Tractors/Loaders/Backhoes	2	8.00	97	0.37
Foundations/Concrete Pour #3	Welders	0	8.00	46	0.45
Architectural Coatings	Air Compressors	1	8.00	78	0.48
Synthetic Track	Cranes	1	8.00	231	0.29

Hawthorne HS Field Improvement Project - Construction Only - South Coast Air Basin, Summer

EMFAC Off-Model Adjustment Factors for Gasoline Light Duty Vehicle to Account for the SAFE Vehicle Rule Applied

Synthetic Track	Forklifts	3	8.00	89	0.20
Synthetic Track	Generator Sets	1	8.00	84	0.74
Synthetic Track	Tractors/Loaders/Backhoes	3	8.00	97	0.37
Synthetic Track	Welders	1	8.00	46	0.45
Paving Event #2	Pavers	2	8.00	130	0.42
Paving Event #2	Paving Equipment	2	8.00	132	0.36
Paving Event #2	Rollers	2	8.00	80	0.38

Trips and VMT

Phase Name	Offroad Equipment Count	Worker Trip Number	Vendor Trip Number	Hauling Trip Number	Worker Trip Length	Vendor Trip Length	Hauling Trip Length	Worker Vehicle Class	Vendor Vehicle Class	Hauling Vehicle Class
Demolition	6	80.00	6.00	247.00	14.70	6.90	40.00	LD_Mix	HDT_Mix	HHDT
Grading/Site Preparation	8	80.00	6.00	4,000.00	14.70	6.90	40.00	LD_Mix	HDT_Mix	HHDT
Foundations/Concrete Pour #1	5	80.00	50.00	0.00	14.70	6.90	20.00	LD_Mix	HDT_Mix	HHDT
Drainage/Utilities/Trenching	8	80.00	6.00	0.00	14.70	6.90	20.00	LD_Mix	HDT_Mix	HHDT
Building Construction	9	80.00	99.00	0.00	14.70	6.90	20.00	LD_Mix	HDT_Mix	HHDT
Foundations/Concrete Pour #2	5	80.00	50.00	0.00	14.70	6.90	20.00	LD_Mix	HDT_Mix	HHDT
Paving Event #1	6	80.00	6.00	0.00	14.70	6.90	20.00	LD_Mix	HDT_Mix	HHDT
Field/Bleachers	9	80.00	6.00	0.00	14.70	6.90	20.00	LD_Mix	HDT_Mix	HHDT
Foundations/Concrete Pour #3	5	80.00	50.00	0.00	14.70	6.90	20.00	LD_Mix	HDT_Mix	HHDT
Architectural Coatings	1	80.00	6.00	0.00	14.70	6.90	20.00	LD_Mix	HDT_Mix	HHDT
Synthetic Track	9	80.00	6.00	0.00	14.70	6.90	20.00	LD_Mix	HDT_Mix	HHDT
Paving Event #2	6	80.00	6.00	0.00	14.70	6.90	20.00	LD_Mix	HDT_Mix	HHDT

3.1 Mitigation Measures Construction

Use Cleaner Engines for Construction Equipment

Water Exposed Area

Hawthorne HS Field Improvement Project - Construction Only - South Coast Air Basin, Summer

EMFAC Off-Model Adjustment Factors for Gasoline Light Duty Vehicle to Account for the SAFE Vehicle Rule Applied

3.2 Demolition - 2022

Unmitigated Construction On-Site

	ROG	NOx	CO	SO2	Fugitive PM10	Exhaust PM10	PM10 Total	Fugitive PM2.5	Exhaust PM2.5	PM2.5 Total	Bio- CO2	NBio- CO2	Total CO2	CH4	N2O	CO2e
Category	lb/day										lb/day					
Fugitive Dust					1.2159	0.0000	1.2159	0.1841	0.0000	0.1841			0.0000			0.0000
Off-Road	2.6392	25.7194	20.5941	0.0388		1.2427	1.2427		1.1553	1.1553		3,746.781 2	3,746.781 2	1.0524		3,773.092 0
Total	2.6392	25.7194	20.5941	0.0388	1.2159	1.2427	2.4585	0.1841	1.1553	1.3394		3,746.781 2	3,746.781 2	1.0524		3,773.092 0

Unmitigated Construction Off-Site

	ROG	NOx	CO	SO2	Fugitive PM10	Exhaust PM10	PM10 Total	Fugitive PM2.5	Exhaust PM2.5	PM2.5 Total	Bio- CO2	NBio- CO2	Total CO2	CH4	N2O	CO2e
Category	lb/day										lb/day					
Hauling	0.0433	1.7008	0.3546	6.7000e-003	0.1962	0.0143	0.2105	0.0538	0.0137	0.0675		738.0911	738.0911	0.0442	0.1173	774.1528
Vendor	0.0110	0.2831	0.0947	1.1500e-003	0.0384	2.8900e-003	0.0413	0.0111	2.7600e-003	0.0138		123.9280	123.9280	4.5600e-003	0.0180	129.4053
Worker	0.2730	0.1928	3.0352	8.0800e-003	0.8942	5.3600e-003	0.8996	0.2372	4.9400e-003	0.2421		822.2003	822.2003	0.0214	0.0195	828.5467
Total	0.3272	2.1767	3.4845	0.0159	1.1288	0.0226	1.1514	0.3020	0.0214	0.3234		1,684.219 4	1,684.219 4	0.0701	0.1548	1,732.104 7

Hawthorne HS Field Improvement Project - Construction Only - South Coast Air Basin, Summer

EMFAC Off-Model Adjustment Factors for Gasoline Light Duty Vehicle to Account for the SAFE Vehicle Rule Applied

3.2 Demolition - 2022

Mitigated Construction On-Site

	ROG	NOx	CO	SO2	Fugitive PM10	Exhaust PM10	PM10 Total	Fugitive PM2.5	Exhaust PM2.5	PM2.5 Total	Bio- CO2	NBio- CO2	Total CO2	CH4	N2O	CO2e
Category	lb/day										lb/day					
Fugitive Dust					0.4742	0.0000	0.4742	0.0718	0.0000	0.0718			0.0000			0.0000
Off-Road	0.9246	18.3130	24.6739	0.0388		0.8627	0.8627		0.8627	0.8627	0.0000	3,746.781 2	3,746.781 2	1.0524		3,773.092 0
Total	0.9246	18.3130	24.6739	0.0388	0.4742	0.8627	1.3369	0.0718	0.8627	0.9345	0.0000	3,746.781 2	3,746.781 2	1.0524		3,773.092 0

Mitigated Construction Off-Site

	ROG	NOx	CO	SO2	Fugitive PM10	Exhaust PM10	PM10 Total	Fugitive PM2.5	Exhaust PM2.5	PM2.5 Total	Bio- CO2	NBio- CO2	Total CO2	CH4	N2O	CO2e
Category	lb/day										lb/day					
Hauling	0.0433	1.7008	0.3546	6.7000e-003	0.1962	0.0143	0.2105	0.0538	0.0137	0.0675		738.0911	738.0911	0.0442	0.1173	774.1528
Vendor	0.0110	0.2831	0.0947	1.1500e-003	0.0384	2.8900e-003	0.0413	0.0111	2.7600e-003	0.0138		123.9280	123.9280	4.5600e-003	0.0180	129.4053
Worker	0.2730	0.1928	3.0352	8.0800e-003	0.8942	5.3600e-003	0.8996	0.2372	4.9400e-003	0.2421		822.2003	822.2003	0.0214	0.0195	828.5467
Total	0.3272	2.1767	3.4845	0.0159	1.1288	0.0226	1.1514	0.3020	0.0214	0.3234		1,684.219 4	1,684.219 4	0.0701	0.1548	1,732.104 7

Hawthorne HS Field Improvement Project - Construction Only - South Coast Air Basin, Summer

EMFAC Off-Model Adjustment Factors for Gasoline Light Duty Vehicle to Account for the SAFE Vehicle Rule Applied

3.2 Demolition - 2023

Unmitigated Construction On-Site

	ROG	NOx	CO	SO2	Fugitive PM10	Exhaust PM10	PM10 Total	Fugitive PM2.5	Exhaust PM2.5	PM2.5 Total	Bio- CO2	NBio- CO2	Total CO2	CH4	N2O	CO2e
Category	lb/day										lb/day					
Fugitive Dust					1.2159	0.0000	1.2159	0.1841	0.0000	0.1841			0.0000			0.0000
Off-Road	2.2691	21.4844	19.6434	0.0388		0.9975	0.9975		0.9280	0.9280		3,746.9840	3,746.9840	1.0494		3,773.2183
Total	2.2691	21.4844	19.6434	0.0388	1.2159	0.9975	2.2134	0.1841	0.9280	1.1121		3,746.9840	3,746.9840	1.0494		3,773.2183

Unmitigated Construction Off-Site

	ROG	NOx	CO	SO2	Fugitive PM10	Exhaust PM10	PM10 Total	Fugitive PM2.5	Exhaust PM2.5	PM2.5 Total	Bio- CO2	NBio- CO2	Total CO2	CH4	N2O	CO2e
Category	lb/day										lb/day					
Hauling	0.0179	1.2834	0.3054	6.3100e-003	0.1962	9.6400e-003	0.2058	0.0538	9.2200e-003	0.0630		697.1625	697.1625	0.0433	0.1109	731.2923
Vendor	6.4400e-003	0.2196	0.0843	1.0900e-003	0.0384	1.2100e-003	0.0396	0.0111	1.1600e-003	0.0122		117.9481	117.9481	4.3700e-003	0.0171	123.1550
Worker	0.2532	0.1706	2.7970	7.8200e-003	0.8942	5.0600e-003	0.8993	0.2372	4.6500e-003	0.2418		800.5129	800.5129	0.0192	0.0180	806.3623
Total	0.2775	1.6735	3.1866	0.0152	1.1288	0.0159	1.1447	0.3020	0.0150	0.3170		1,615.6235	1,615.6235	0.0668	0.1460	1,660.8097

Hawthorne HS Field Improvement Project - Construction Only - South Coast Air Basin, Summer

EMFAC Off-Model Adjustment Factors for Gasoline Light Duty Vehicle to Account for the SAFE Vehicle Rule Applied

3.2 Demolition - 2023

Mitigated Construction On-Site

	ROG	NOx	CO	SO2	Fugitive PM10	Exhaust PM10	PM10 Total	Fugitive PM2.5	Exhaust PM2.5	PM2.5 Total	Bio- CO2	NBio- CO2	Total CO2	CH4	N2O	CO2e
Category	lb/day										lb/day					
Fugitive Dust					0.4742	0.0000	0.4742	0.0718	0.0000	0.0718			0.0000			0.0000
Off-Road	0.9246	18.3130	24.6739	0.0388		0.8627	0.8627		0.8627	0.8627	0.0000	3,746.9840	3,746.9840	1.0494		3,773.2183
Total	0.9246	18.3130	24.6739	0.0388	0.4742	0.8627	1.3369	0.0718	0.8627	0.9345	0.0000	3,746.9840	3,746.9840	1.0494		3,773.2183

Mitigated Construction Off-Site

	ROG	NOx	CO	SO2	Fugitive PM10	Exhaust PM10	PM10 Total	Fugitive PM2.5	Exhaust PM2.5	PM2.5 Total	Bio- CO2	NBio- CO2	Total CO2	CH4	N2O	CO2e
Category	lb/day										lb/day					
Hauling	0.0179	1.2834	0.3054	6.3100e-003	0.1962	9.6400e-003	0.2058	0.0538	9.2200e-003	0.0630		697.1625	697.1625	0.0433	0.1109	731.2923
Vendor	6.4400e-003	0.2196	0.0843	1.0900e-003	0.0384	1.2100e-003	0.0396	0.0111	1.1600e-003	0.0122		117.9481	117.9481	4.3700e-003	0.0171	123.1550
Worker	0.2532	0.1706	2.7970	7.8200e-003	0.8942	5.0600e-003	0.8993	0.2372	4.6500e-003	0.2418		800.5129	800.5129	0.0192	0.0180	806.3623
Total	0.2775	1.6735	3.1866	0.0152	1.1288	0.0159	1.1447	0.3020	0.0150	0.3170		1,615.6235	1,615.6235	0.0668	0.1460	1,660.8097

Hawthorne HS Field Improvement Project - Construction Only - South Coast Air Basin, Summer

EMFAC Off-Model Adjustment Factors for Gasoline Light Duty Vehicle to Account for the SAFE Vehicle Rule Applied

3.3 Grading/Site Preparation - 2023

Unmitigated Construction On-Site

	ROG	NOx	CO	SO2	Fugitive PM10	Exhaust PM10	PM10 Total	Fugitive PM2.5	Exhaust PM2.5	PM2.5 Total	Bio- CO2	NBio- CO2	Total CO2	CH4	N2O	CO2e
Category	lb/day										lb/day					
Fugitive Dust					7.8140	0.0000	7.8140	3.5058	0.0000	3.5058			0.0000			0.0000
Off-Road	3.3217	34.5156	28.0512	0.0621		1.4245	1.4245		1.3105	1.3105		6,011.4777	6,011.4777	1.9442		6,060.0836
Total	3.3217	34.5156	28.0512	0.0621	7.8140	1.4245	9.2384	3.5058	1.3105	4.8163		6,011.4777	6,011.4777	1.9442		6,060.0836

Unmitigated Construction Off-Site

	ROG	NOx	CO	SO2	Fugitive PM10	Exhaust PM10	PM10 Total	Fugitive PM2.5	Exhaust PM2.5	PM2.5 Total	Bio- CO2	NBio- CO2	Total CO2	CH4	N2O	CO2e
Category	lb/day										lb/day					
Hauling	0.1676	12.0323	2.8629	0.0591	1.8394	0.0904	1.9298	0.5040	0.0865	0.5905		6,536.3630	6,536.3630	0.4056	1.0398	6,856.3525
Vendor	6.4400e-003	0.2196	0.0843	1.0900e-003	0.0384	1.2100e-003	0.0396	0.0111	1.1600e-003	0.0122		117.9481	117.9481	4.3700e-003	0.0171	123.1550
Worker	0.2532	0.1706	2.7970	7.8200e-003	0.8942	5.0600e-003	0.8993	0.2372	4.6500e-003	0.2418		800.5129	800.5129	0.0192	0.0180	806.3623
Total	0.4272	12.4224	5.7442	0.0681	2.7720	0.0966	2.8687	0.7522	0.0923	0.8445		7,454.8240	7,454.8240	0.4291	1.0749	7,785.8699

Hawthorne HS Field Improvement Project - Construction Only - South Coast Air Basin, Summer

EMFAC Off-Model Adjustment Factors for Gasoline Light Duty Vehicle to Account for the SAFE Vehicle Rule Applied

3.3 Grading/Site Preparation - 2023

Mitigated Construction On-Site

	ROG	NOx	CO	SO2	Fugitive PM10	Exhaust PM10	PM10 Total	Fugitive PM2.5	Exhaust PM2.5	PM2.5 Total	Bio- CO2	NBio- CO2	Total CO2	CH4	N2O	CO2e
Category	lb/day										lb/day					
Fugitive Dust					3.0474	0.0000	3.0474	1.3673	0.0000	1.3673			0.0000			0.0000
Off-Road	1.5231	29.9782	36.7226	0.0621		1.2994	1.2994		1.2994	1.2994	0.0000	6,011.4777	6,011.4777	1.9442		6,060.0836
Total	1.5231	29.9782	36.7226	0.0621	3.0474	1.2994	4.3469	1.3673	1.2994	2.6667	0.0000	6,011.4777	6,011.4777	1.9442		6,060.0836

Mitigated Construction Off-Site

	ROG	NOx	CO	SO2	Fugitive PM10	Exhaust PM10	PM10 Total	Fugitive PM2.5	Exhaust PM2.5	PM2.5 Total	Bio- CO2	NBio- CO2	Total CO2	CH4	N2O	CO2e
Category	lb/day										lb/day					
Hauling	0.1676	12.0323	2.8629	0.0591	1.8394	0.0904	1.9298	0.5040	0.0865	0.5905		6,536.3630	6,536.3630	0.4056	1.0398	6,856.3525
Vendor	6.4400e-003	0.2196	0.0843	1.0900e-003	0.0384	1.2100e-003	0.0396	0.0111	1.1600e-003	0.0122		117.9481	117.9481	4.3700e-003	0.0171	123.1550
Worker	0.2532	0.1706	2.7970	7.8200e-003	0.8942	5.0600e-003	0.8993	0.2372	4.6500e-003	0.2418		800.5129	800.5129	0.0192	0.0180	806.3623
Total	0.4272	12.4224	5.7442	0.0681	2.7720	0.0966	2.8687	0.7522	0.0923	0.8445		7,454.8240	7,454.8240	0.4291	1.0749	7,785.8699

Hawthorne HS Field Improvement Project - Construction Only - South Coast Air Basin, Summer

EMFAC Off-Model Adjustment Factors for Gasoline Light Duty Vehicle to Account for the SAFE Vehicle Rule Applied

3.4 Foundations/Concrete Pour #1 - 2023

Unmitigated Construction On-Site

	ROG	NOx	CO	SO2	Fugitive PM10	Exhaust PM10	PM10 Total	Fugitive PM2.5	Exhaust PM2.5	PM2.5 Total	Bio- CO2	NBio- CO2	Total CO2	CH4	N2O	CO2e
Category	lb/day										lb/day					
Off-Road	1.2861	11.3299	15.6385	0.0260		0.5562	0.5562		0.5440	0.5440		2,472.2567	2,472.2567	0.2806		2,479.2713
Total	1.2861	11.3299	15.6385	0.0260		0.5562	0.5562		0.5440	0.5440		2,472.2567	2,472.2567	0.2806		2,479.2713

Unmitigated Construction Off-Site

	ROG	NOx	CO	SO2	Fugitive PM10	Exhaust PM10	PM10 Total	Fugitive PM2.5	Exhaust PM2.5	PM2.5 Total	Bio- CO2	NBio- CO2	Total CO2	CH4	N2O	CO2e
Category	lb/day										lb/day					
Hauling	0.0000	0.0000	0.0000	0.0000	0.0000	0.0000	0.0000	0.0000	0.0000	0.0000		0.0000	0.0000	0.0000	0.0000	0.0000
Vendor	0.0536	1.8297	0.7022	9.1000e-003	0.3201	0.0101	0.3302	0.0922	9.6700e-003	0.1018		982.9008	982.9008	0.0364	0.1426	1,026.2920
Worker	0.2532	0.1706	2.7970	7.8200e-003	0.8942	5.0600e-003	0.8993	0.2372	4.6500e-003	0.2418		800.5129	800.5129	0.0192	0.0180	806.3623
Total	0.3068	2.0003	3.4992	0.0169	1.2143	0.0152	1.2295	0.3293	0.0143	0.3436		1,783.4137	1,783.4137	0.0556	0.1606	1,832.6543

Hawthorne HS Field Improvement Project - Construction Only - South Coast Air Basin, Summer

EMFAC Off-Model Adjustment Factors for Gasoline Light Duty Vehicle to Account for the SAFE Vehicle Rule Applied

3.4 Foundations/Concrete Pour #1 - 2023

Mitigated Construction On-Site

	ROG	NOx	CO	SO2	Fugitive PM10	Exhaust PM10	PM10 Total	Fugitive PM2.5	Exhaust PM2.5	PM2.5 Total	Bio- CO2	NBio- CO2	Total CO2	CH4	N2O	CO2e
Category	lb/day										lb/day					
Off-Road	0.5466	12.4805	16.8532	0.0260		0.8746	0.8746		0.8746	0.8746	0.0000	2,472.2567	2,472.2567	0.2806		2,479.2713
Total	0.5466	12.4805	16.8532	0.0260		0.8746	0.8746		0.8746	0.8746	0.0000	2,472.2567	2,472.2567	0.2806		2,479.2713

Mitigated Construction Off-Site

	ROG	NOx	CO	SO2	Fugitive PM10	Exhaust PM10	PM10 Total	Fugitive PM2.5	Exhaust PM2.5	PM2.5 Total	Bio- CO2	NBio- CO2	Total CO2	CH4	N2O	CO2e
Category	lb/day										lb/day					
Hauling	0.0000	0.0000	0.0000	0.0000	0.0000	0.0000	0.0000	0.0000	0.0000	0.0000		0.0000	0.0000	0.0000	0.0000	0.0000
Vendor	0.0536	1.8297	0.7022	9.1000e-003	0.3201	0.0101	0.3302	0.0922	9.6700e-003	0.1018		982.9008	982.9008	0.0364	0.1426	1,026.2920
Worker	0.2532	0.1706	2.7970	7.8200e-003	0.8942	5.0600e-003	0.8993	0.2372	4.6500e-003	0.2418		800.5129	800.5129	0.0192	0.0180	806.3623
Total	0.3068	2.0003	3.4992	0.0169	1.2143	0.0152	1.2295	0.3293	0.0143	0.3436		1,783.4137	1,783.4137	0.0556	0.1606	1,832.6543

Hawthorne HS Field Improvement Project - Construction Only - South Coast Air Basin, Summer

EMFAC Off-Model Adjustment Factors for Gasoline Light Duty Vehicle to Account for the SAFE Vehicle Rule Applied

3.5 Drainage/Utilities/Trenching - 2023

Unmitigated Construction On-Site

	ROG	NOx	CO	SO2	Fugitive PM10	Exhaust PM10	PM10 Total	Fugitive PM2.5	Exhaust PM2.5	PM2.5 Total	Bio- CO2	NBio- CO2	Total CO2	CH4	N2O	CO2e
Category	lb/day										lb/day					
Off-Road	2.9008	28.5738	21.7093	0.0386		1.5422	1.5422		1.4188	1.4188		3,738.8596	3,738.8596	1.2092		3,769.0902
Total	2.9008	28.5738	21.7093	0.0386		1.5422	1.5422		1.4188	1.4188		3,738.8596	3,738.8596	1.2092		3,769.0902

Unmitigated Construction Off-Site

	ROG	NOx	CO	SO2	Fugitive PM10	Exhaust PM10	PM10 Total	Fugitive PM2.5	Exhaust PM2.5	PM2.5 Total	Bio- CO2	NBio- CO2	Total CO2	CH4	N2O	CO2e
Category	lb/day										lb/day					
Hauling	0.0000	0.0000	0.0000	0.0000	0.0000	0.0000	0.0000	0.0000	0.0000	0.0000		0.0000	0.0000	0.0000	0.0000	0.0000
Vendor	6.4400e-003	0.2196	0.0843	1.0900e-003	0.0384	1.2100e-003	0.0396	0.0111	1.1600e-003	0.0122		117.9481	117.9481	4.3700e-003	0.0171	123.1550
Worker	0.2532	0.1706	2.7970	7.8200e-003	0.8942	5.0600e-003	0.8993	0.2372	4.6500e-003	0.2418		800.5129	800.5129	0.0192	0.0180	806.3623
Total	0.2596	0.3901	2.8812	8.9100e-003	0.9326	6.2700e-003	0.9389	0.2482	5.8100e-003	0.2540		918.4610	918.4610	0.0236	0.0351	929.5173

Hawthorne HS Field Improvement Project - Construction Only - South Coast Air Basin, Summer

EMFAC Off-Model Adjustment Factors for Gasoline Light Duty Vehicle to Account for the SAFE Vehicle Rule Applied

3.5 Drainage/Utilities/Trenching - 2023

Mitigated Construction On-Site

	ROG	NOx	CO	SO2	Fugitive PM10	Exhaust PM10	PM10 Total	Fugitive PM2.5	Exhaust PM2.5	PM2.5 Total	Bio- CO2	NBio- CO2	Total CO2	CH4	N2O	CO2e
Category	lb/day										lb/day					
Off-Road	0.9448	19.6649	25.2984	0.0386		1.0646	1.0646		1.0646	1.0646	0.0000	3,738.8596	3,738.8596	1.2092		3,769.0902
Total	0.9448	19.6649	25.2984	0.0386		1.0646	1.0646		1.0646	1.0646	0.0000	3,738.8596	3,738.8596	1.2092		3,769.0902

Mitigated Construction Off-Site

	ROG	NOx	CO	SO2	Fugitive PM10	Exhaust PM10	PM10 Total	Fugitive PM2.5	Exhaust PM2.5	PM2.5 Total	Bio- CO2	NBio- CO2	Total CO2	CH4	N2O	CO2e
Category	lb/day										lb/day					
Hauling	0.0000	0.0000	0.0000	0.0000	0.0000	0.0000	0.0000	0.0000	0.0000	0.0000		0.0000	0.0000	0.0000	0.0000	0.0000
Vendor	6.4400e-003	0.2196	0.0843	1.0900e-003	0.0384	1.2100e-003	0.0396	0.0111	1.1600e-003	0.0122		117.9481	117.9481	4.3700e-003	0.0171	123.1550
Worker	0.2532	0.1706	2.7970	7.8200e-003	0.8942	5.0600e-003	0.8993	0.2372	4.6500e-003	0.2418		800.5129	800.5129	0.0192	0.0180	806.3623
Total	0.2596	0.3901	2.8812	8.9100e-003	0.9326	6.2700e-003	0.9389	0.2482	5.8100e-003	0.2540		918.4610	918.4610	0.0236	0.0351	929.5173

Hawthorne HS Field Improvement Project - Construction Only - South Coast Air Basin, Summer

EMFAC Off-Model Adjustment Factors for Gasoline Light Duty Vehicle to Account for the SAFE Vehicle Rule Applied

3.6 Building Construction - 2023

Unmitigated Construction On-Site

	ROG	NOx	CO	SO2	Fugitive PM10	Exhaust PM10	PM10 Total	Fugitive PM2.5	Exhaust PM2.5	PM2.5 Total	Bio- CO2	NBio- CO2	Total CO2	CH4	N2O	CO2e
Category	lb/day										lb/day					
Off-Road	1.6735	15.4377	17.3101	0.0288		0.7481	0.7481		0.7029	0.7029		2,738.1535	2,738.1535	0.6670		2,754.8288
Total	1.6735	15.4377	17.3101	0.0288		0.7481	0.7481		0.7029	0.7029		2,738.1535	2,738.1535	0.6670		2,754.8288

Unmitigated Construction Off-Site

	ROG	NOx	CO	SO2	Fugitive PM10	Exhaust PM10	PM10 Total	Fugitive PM2.5	Exhaust PM2.5	PM2.5 Total	Bio- CO2	NBio- CO2	Total CO2	CH4	N2O	CO2e
Category	lb/day										lb/day					
Hauling	0.0000	0.0000	0.0000	0.0000	0.0000	0.0000	0.0000	0.0000	0.0000	0.0000		0.0000	0.0000	0.0000	0.0000	0.0000
Vendor	0.1062	3.6228	1.3904	0.0180	0.6338	0.0200	0.6538	0.1825	0.0192	0.2016		1,946.1436	1,946.1436	0.0720	0.2823	2,032.0582
Worker	0.2532	0.1706	2.7970	7.8200e-003	0.8942	5.0600e-003	0.8993	0.2372	4.6500e-003	0.2418		800.5129	800.5129	0.0192	0.0180	806.3623
Total	0.3594	3.7934	4.1873	0.0258	1.5280	0.0251	1.5531	0.4196	0.0238	0.4434		2,746.6564	2,746.6564	0.0912	0.3003	2,838.4205

Hawthorne HS Field Improvement Project - Construction Only - South Coast Air Basin, Summer

EMFAC Off-Model Adjustment Factors for Gasoline Light Duty Vehicle to Account for the SAFE Vehicle Rule Applied

3.6 Building Construction - 2023

Mitigated Construction On-Site

	ROG	NOx	CO	SO2	Fugitive PM10	Exhaust PM10	PM10 Total	Fugitive PM2.5	Exhaust PM2.5	PM2.5 Total	Bio- CO2	NBio- CO2	Total CO2	CH4	N2O	CO2e
Category	lb/day										lb/day					
Off-Road	0.8687	14.9493	19.3171	0.0288		0.9150	0.9150		0.9150	0.9150	0.0000	2,738.1535	2,738.1535	0.6670		2,754.8288
Total	0.8687	14.9493	19.3171	0.0288		0.9150	0.9150		0.9150	0.9150	0.0000	2,738.1535	2,738.1535	0.6670		2,754.8288

Mitigated Construction Off-Site

	ROG	NOx	CO	SO2	Fugitive PM10	Exhaust PM10	PM10 Total	Fugitive PM2.5	Exhaust PM2.5	PM2.5 Total	Bio- CO2	NBio- CO2	Total CO2	CH4	N2O	CO2e
Category	lb/day										lb/day					
Hauling	0.0000	0.0000	0.0000	0.0000	0.0000	0.0000	0.0000	0.0000	0.0000	0.0000		0.0000	0.0000	0.0000	0.0000	0.0000
Vendor	0.1062	3.6228	1.3904	0.0180	0.6338	0.0200	0.6538	0.1825	0.0192	0.2016		1,946.1436	1,946.1436	0.0720	0.2823	2,032.0582
Worker	0.2532	0.1706	2.7970	7.8200e-003	0.8942	5.0600e-003	0.8993	0.2372	4.6500e-003	0.2418		800.5129	800.5129	0.0192	0.0180	806.3623
Total	0.3594	3.7934	4.1873	0.0258	1.5280	0.0251	1.5531	0.4196	0.0238	0.4434		2,746.6564	2,746.6564	0.0912	0.3003	2,838.4205

Hawthorne HS Field Improvement Project - Construction Only - South Coast Air Basin, Summer

EMFAC Off-Model Adjustment Factors for Gasoline Light Duty Vehicle to Account for the SAFE Vehicle Rule Applied

3.6 Building Construction - 2024

Unmitigated Construction On-Site

	ROG	NOx	CO	SO2	Fugitive PM10	Exhaust PM10	PM10 Total	Fugitive PM2.5	Exhaust PM2.5	PM2.5 Total	Bio- CO2	NBio- CO2	Total CO2	CH4	N2O	CO2e
Category	lb/day										lb/day					
Off-Road	1.5670	14.4249	17.2270	0.0288		0.6565	0.6565		0.6166	0.6166		2,738.7124	2,738.7124	0.6635		2,755.3009
Total	1.5670	14.4249	17.2270	0.0288		0.6565	0.6565		0.6166	0.6166		2,738.7124	2,738.7124	0.6635		2,755.3009

Unmitigated Construction Off-Site

	ROG	NOx	CO	SO2	Fugitive PM10	Exhaust PM10	PM10 Total	Fugitive PM2.5	Exhaust PM2.5	PM2.5 Total	Bio- CO2	NBio- CO2	Total CO2	CH4	N2O	CO2e
Category	lb/day										lb/day					
Hauling	0.0000	0.0000	0.0000	0.0000	0.0000	0.0000	0.0000	0.0000	0.0000	0.0000		0.0000	0.0000	0.0000	0.0000	0.0000
Vendor	0.1036	3.6382	1.3677	0.0178	0.6338	0.0201	0.6539	0.1825	0.0193	0.2017		1,918.4505	1,918.4505	0.0720	0.2787	2,003.3047
Worker	0.2364	0.1524	2.6081	7.5900e-003	0.8942	4.8400e-003	0.8991	0.2372	4.4600e-003	0.2416		783.2695	783.2695	0.0174	0.0168	788.7031
Total	0.3400	3.7907	3.9758	0.0253	1.5280	0.0250	1.5530	0.4196	0.0237	0.4433		2,701.7199	2,701.7199	0.0894	0.2955	2,792.0078

Hawthorne HS Field Improvement Project - Construction Only - South Coast Air Basin, Summer

EMFAC Off-Model Adjustment Factors for Gasoline Light Duty Vehicle to Account for the SAFE Vehicle Rule Applied

3.6 Building Construction - 2024

Mitigated Construction On-Site

	ROG	NOx	CO	SO2	Fugitive PM10	Exhaust PM10	PM10 Total	Fugitive PM2.5	Exhaust PM2.5	PM2.5 Total	Bio- CO2	NBio- CO2	Total CO2	CH4	N2O	CO2e
Category	lb/day										lb/day					
Off-Road	0.8501	14.9095	19.3029	0.0288		0.9074	0.9074		0.9074	0.9074	0.0000	2,738.7123	2,738.7123	0.6635		2,755.3009
Total	0.8501	14.9095	19.3029	0.0288		0.9074	0.9074		0.9074	0.9074	0.0000	2,738.7123	2,738.7123	0.6635		2,755.3009

Mitigated Construction Off-Site

	ROG	NOx	CO	SO2	Fugitive PM10	Exhaust PM10	PM10 Total	Fugitive PM2.5	Exhaust PM2.5	PM2.5 Total	Bio- CO2	NBio- CO2	Total CO2	CH4	N2O	CO2e
Category	lb/day										lb/day					
Hauling	0.0000	0.0000	0.0000	0.0000	0.0000	0.0000	0.0000	0.0000	0.0000	0.0000		0.0000	0.0000	0.0000	0.0000	0.0000
Vendor	0.1036	3.6382	1.3677	0.0178	0.6338	0.0201	0.6539	0.1825	0.0193	0.2017		1,918.4505	1,918.4505	0.0720	0.2787	2,003.3047
Worker	0.2364	0.1524	2.6081	7.5900e-003	0.8942	4.8400e-003	0.8991	0.2372	4.4600e-003	0.2416		783.2695	783.2695	0.0174	0.0168	788.7031
Total	0.3400	3.7907	3.9758	0.0253	1.5280	0.0250	1.5530	0.4196	0.0237	0.4433		2,701.7199	2,701.7199	0.0894	0.2955	2,792.0078

Hawthorne HS Field Improvement Project - Construction Only - South Coast Air Basin, Summer

EMFAC Off-Model Adjustment Factors for Gasoline Light Duty Vehicle to Account for the SAFE Vehicle Rule Applied

3.7 Foundations/Concrete Pour #2 - 2023

Unmitigated Construction On-Site

	ROG	NOx	CO	SO2	Fugitive PM10	Exhaust PM10	PM10 Total	Fugitive PM2.5	Exhaust PM2.5	PM2.5 Total	Bio- CO2	NBio- CO2	Total CO2	CH4	N2O	CO2e
Category	lb/day										lb/day					
Off-Road	1.2861	11.3299	15.6385	0.0260		0.5562	0.5562		0.5440	0.5440		2,472.2567	2,472.2567	0.2806		2,479.2713
Total	1.2861	11.3299	15.6385	0.0260		0.5562	0.5562		0.5440	0.5440		2,472.2567	2,472.2567	0.2806		2,479.2713

Unmitigated Construction Off-Site

	ROG	NOx	CO	SO2	Fugitive PM10	Exhaust PM10	PM10 Total	Fugitive PM2.5	Exhaust PM2.5	PM2.5 Total	Bio- CO2	NBio- CO2	Total CO2	CH4	N2O	CO2e
Category	lb/day										lb/day					
Hauling	0.0000	0.0000	0.0000	0.0000	0.0000	0.0000	0.0000	0.0000	0.0000	0.0000		0.0000	0.0000	0.0000	0.0000	0.0000
Vendor	0.0536	1.8297	0.7022	9.1000e-003	0.3201	0.0101	0.3302	0.0922	9.6700e-003	0.1018		982.9008	982.9008	0.0364	0.1426	1,026.2920
Worker	0.2532	0.1706	2.7970	7.8200e-003	0.8942	5.0600e-003	0.8993	0.2372	4.6500e-003	0.2418		800.5129	800.5129	0.0192	0.0180	806.3623
Total	0.3068	2.0003	3.4992	0.0169	1.2143	0.0152	1.2295	0.3293	0.0143	0.3436		1,783.4137	1,783.4137	0.0556	0.1606	1,832.6543

Hawthorne HS Field Improvement Project - Construction Only - South Coast Air Basin, Summer

EMFAC Off-Model Adjustment Factors for Gasoline Light Duty Vehicle to Account for the SAFE Vehicle Rule Applied

3.7 Foundations/Concrete Pour #2 - 2023

Mitigated Construction On-Site

	ROG	NOx	CO	SO2	Fugitive PM10	Exhaust PM10	PM10 Total	Fugitive PM2.5	Exhaust PM2.5	PM2.5 Total	Bio- CO2	NBio- CO2	Total CO2	CH4	N2O	CO2e
Category	lb/day										lb/day					
Off-Road	0.5466	12.4805	16.8532	0.0260		0.8746	0.8746		0.8746	0.8746	0.0000	2,472.2567	2,472.2567	0.2806		2,479.2713
Total	0.5466	12.4805	16.8532	0.0260		0.8746	0.8746		0.8746	0.8746	0.0000	2,472.2567	2,472.2567	0.2806		2,479.2713

Mitigated Construction Off-Site

	ROG	NOx	CO	SO2	Fugitive PM10	Exhaust PM10	PM10 Total	Fugitive PM2.5	Exhaust PM2.5	PM2.5 Total	Bio- CO2	NBio- CO2	Total CO2	CH4	N2O	CO2e
Category	lb/day										lb/day					
Hauling	0.0000	0.0000	0.0000	0.0000	0.0000	0.0000	0.0000	0.0000	0.0000	0.0000		0.0000	0.0000	0.0000	0.0000	0.0000
Vendor	0.0536	1.8297	0.7022	9.1000e-003	0.3201	0.0101	0.3302	0.0922	9.6700e-003	0.1018		982.9008	982.9008	0.0364	0.1426	1,026.2920
Worker	0.2532	0.1706	2.7970	7.8200e-003	0.8942	5.0600e-003	0.8993	0.2372	4.6500e-003	0.2418		800.5129	800.5129	0.0192	0.0180	806.3623
Total	0.3068	2.0003	3.4992	0.0169	1.2143	0.0152	1.2295	0.3293	0.0143	0.3436		1,783.4137	1,783.4137	0.0556	0.1606	1,832.6543

Hawthorne HS Field Improvement Project - Construction Only - South Coast Air Basin, Summer

EMFAC Off-Model Adjustment Factors for Gasoline Light Duty Vehicle to Account for the SAFE Vehicle Rule Applied

3.8 Paving Event #1 - 2023

Unmitigated Construction On-Site

	ROG	NOx	CO	SO2	Fugitive PM10	Exhaust PM10	PM10 Total	Fugitive PM2.5	Exhaust PM2.5	PM2.5 Total	Bio- CO2	NBio- CO2	Total CO2	CH4	N2O	CO2e
Category	lb/day										lb/day					
Off-Road	1.0327	10.1917	14.5842	0.0228		0.5102	0.5102		0.4694	0.4694		2,207.5841	2,207.5841	0.7140		2,225.4336
Paving	0.0000					0.0000	0.0000		0.0000	0.0000			0.0000			0.0000
Total	1.0327	10.1917	14.5842	0.0228		0.5102	0.5102		0.4694	0.4694		2,207.5841	2,207.5841	0.7140		2,225.4336

Unmitigated Construction Off-Site

	ROG	NOx	CO	SO2	Fugitive PM10	Exhaust PM10	PM10 Total	Fugitive PM2.5	Exhaust PM2.5	PM2.5 Total	Bio- CO2	NBio- CO2	Total CO2	CH4	N2O	CO2e
Category	lb/day										lb/day					
Hauling	0.0000	0.0000	0.0000	0.0000	0.0000	0.0000	0.0000	0.0000	0.0000	0.0000		0.0000	0.0000	0.0000	0.0000	0.0000
Vendor	6.4400e-003	0.2196	0.0843	1.0900e-003	0.0384	1.2100e-003	0.0396	0.0111	1.1600e-003	0.0122		117.9481	117.9481	4.3700e-003	0.0171	123.1550
Worker	0.2532	0.1706	2.7970	7.8200e-003	0.8942	5.0600e-003	0.8993	0.2372	4.6500e-003	0.2418		800.5129	800.5129	0.0192	0.0180	806.3623
Total	0.2596	0.3901	2.8812	8.9100e-003	0.9326	6.2700e-003	0.9389	0.2482	5.8100e-003	0.2540		918.4610	918.4610	0.0236	0.0351	929.5173

Hawthorne HS Field Improvement Project - Construction Only - South Coast Air Basin, Summer

EMFAC Off-Model Adjustment Factors for Gasoline Light Duty Vehicle to Account for the SAFE Vehicle Rule Applied

3.8 Paving Event #1 - 2023

Mitigated Construction On-Site

	ROG	NOx	CO	SO2	Fugitive PM10	Exhaust PM10	PM10 Total	Fugitive PM2.5	Exhaust PM2.5	PM2.5 Total	Bio- CO2	NBio- CO2	Total CO2	CH4	N2O	CO2e
Category	lb/day										lb/day					
Off-Road	0.5609	11.2952	17.2957	0.0228		0.6093	0.6093		0.6093	0.6093	0.0000	2,207.584 1	2,207.584 1	0.7140		2,225.433 6
Paving	0.0000					0.0000	0.0000		0.0000	0.0000			0.0000			0.0000
Total	0.5609	11.2952	17.2957	0.0228		0.6093	0.6093		0.6093	0.6093	0.0000	2,207.584 1	2,207.584 1	0.7140		2,225.433 6

Mitigated Construction Off-Site

	ROG	NOx	CO	SO2	Fugitive PM10	Exhaust PM10	PM10 Total	Fugitive PM2.5	Exhaust PM2.5	PM2.5 Total	Bio- CO2	NBio- CO2	Total CO2	CH4	N2O	CO2e
Category	lb/day										lb/day					
Hauling	0.0000	0.0000	0.0000	0.0000	0.0000	0.0000	0.0000	0.0000	0.0000	0.0000		0.0000	0.0000	0.0000	0.0000	0.0000
Vendor	6.4400e-003	0.2196	0.0843	1.0900e-003	0.0384	1.2100e-003	0.0396	0.0111	1.1600e-003	0.0122		117.9481	117.9481	4.3700e-003	0.0171	123.1550
Worker	0.2532	0.1706	2.7970	7.8200e-003	0.8942	5.0600e-003	0.8993	0.2372	4.6500e-003	0.2418		800.5129	800.5129	0.0192	0.0180	806.3623
Total	0.2596	0.3901	2.8812	8.9100e-003	0.9326	6.2700e-003	0.9389	0.2482	5.8100e-003	0.2540		918.4610	918.4610	0.0236	0.0351	929.5173

Hawthorne HS Field Improvement Project - Construction Only - South Coast Air Basin, Summer

EMFAC Off-Model Adjustment Factors for Gasoline Light Duty Vehicle to Account for the SAFE Vehicle Rule Applied

3.9 Field/Bleachers - 2023

Unmitigated Construction On-Site

	ROG	NOx	CO	SO2	Fugitive PM10	Exhaust PM10	PM10 Total	Fugitive PM2.5	Exhaust PM2.5	PM2.5 Total	Bio- CO2	NBio- CO2	Total CO2	CH4	N2O	CO2e
Category	lb/day										lb/day					
Off-Road	1.6735	15.4377	17.3101	0.0288		0.7481	0.7481		0.7029	0.7029		2,738.1535	2,738.1535	0.6670		2,754.8288
Total	1.6735	15.4377	17.3101	0.0288		0.7481	0.7481		0.7029	0.7029		2,738.1535	2,738.1535	0.6670		2,754.8288

Unmitigated Construction Off-Site

	ROG	NOx	CO	SO2	Fugitive PM10	Exhaust PM10	PM10 Total	Fugitive PM2.5	Exhaust PM2.5	PM2.5 Total	Bio- CO2	NBio- CO2	Total CO2	CH4	N2O	CO2e
Category	lb/day										lb/day					
Hauling	0.0000	0.0000	0.0000	0.0000	0.0000	0.0000	0.0000	0.0000	0.0000	0.0000		0.0000	0.0000	0.0000	0.0000	0.0000
Vendor	6.4400e-003	0.2196	0.0843	1.0900e-003	0.0384	1.2100e-003	0.0396	0.0111	1.1600e-003	0.0122		117.9481	117.9481	4.3700e-003	0.0171	123.1550
Worker	0.2532	0.1706	2.7970	7.8200e-003	0.8942	5.0600e-003	0.8993	0.2372	4.6500e-003	0.2418		800.5129	800.5129	0.0192	0.0180	806.3623
Total	0.2596	0.3901	2.8812	8.9100e-003	0.9326	6.2700e-003	0.9389	0.2482	5.8100e-003	0.2540		918.4610	918.4610	0.0236	0.0351	929.5173

Hawthorne HS Field Improvement Project - Construction Only - South Coast Air Basin, Summer

EMFAC Off-Model Adjustment Factors for Gasoline Light Duty Vehicle to Account for the SAFE Vehicle Rule Applied

3.9 Field/Bleachers - 2023

Mitigated Construction On-Site

	ROG	NOx	CO	SO2	Fugitive PM10	Exhaust PM10	PM10 Total	Fugitive PM2.5	Exhaust PM2.5	PM2.5 Total	Bio- CO2	NBio- CO2	Total CO2	CH4	N2O	CO2e
Category	lb/day										lb/day					
Off-Road	0.8687	14.9493	19.3171	0.0288		0.9150	0.9150		0.9150	0.9150	0.0000	2,738.1535	2,738.1535	0.6670		2,754.8288
Total	0.8687	14.9493	19.3171	0.0288		0.9150	0.9150		0.9150	0.9150	0.0000	2,738.1535	2,738.1535	0.6670		2,754.8288

Mitigated Construction Off-Site

	ROG	NOx	CO	SO2	Fugitive PM10	Exhaust PM10	PM10 Total	Fugitive PM2.5	Exhaust PM2.5	PM2.5 Total	Bio- CO2	NBio- CO2	Total CO2	CH4	N2O	CO2e
Category	lb/day										lb/day					
Hauling	0.0000	0.0000	0.0000	0.0000	0.0000	0.0000	0.0000	0.0000	0.0000	0.0000		0.0000	0.0000	0.0000	0.0000	0.0000
Vendor	6.4400e-003	0.2196	0.0843	1.0900e-003	0.0384	1.2100e-003	0.0396	0.0111	1.1600e-003	0.0122		117.9481	117.9481	4.3700e-003	0.0171	123.1550
Worker	0.2532	0.1706	2.7970	7.8200e-003	0.8942	5.0600e-003	0.8993	0.2372	4.6500e-003	0.2418		800.5129	800.5129	0.0192	0.0180	806.3623
Total	0.2596	0.3901	2.8812	8.9100e-003	0.9326	6.2700e-003	0.9389	0.2482	5.8100e-003	0.2540		918.4610	918.4610	0.0236	0.0351	929.5173

Hawthorne HS Field Improvement Project - Construction Only - South Coast Air Basin, Summer

EMFAC Off-Model Adjustment Factors for Gasoline Light Duty Vehicle to Account for the SAFE Vehicle Rule Applied

3.9 Field/Bleachers - 2024

Unmitigated Construction On-Site

	ROG	NOx	CO	SO2	Fugitive PM10	Exhaust PM10	PM10 Total	Fugitive PM2.5	Exhaust PM2.5	PM2.5 Total	Bio- CO2	NBio- CO2	Total CO2	CH4	N2O	CO2e
Category	lb/day										lb/day					
Off-Road	1.5670	14.4249	17.2270	0.0288		0.6565	0.6565		0.6166	0.6166		2,738.7124	2,738.7124	0.6635		2,755.3009
Total	1.5670	14.4249	17.2270	0.0288		0.6565	0.6565		0.6166	0.6166		2,738.7124	2,738.7124	0.6635		2,755.3009

Unmitigated Construction Off-Site

	ROG	NOx	CO	SO2	Fugitive PM10	Exhaust PM10	PM10 Total	Fugitive PM2.5	Exhaust PM2.5	PM2.5 Total	Bio- CO2	NBio- CO2	Total CO2	CH4	N2O	CO2e
Category	lb/day										lb/day					
Hauling	0.0000	0.0000	0.0000	0.0000	0.0000	0.0000	0.0000	0.0000	0.0000	0.0000		0.0000	0.0000	0.0000	0.0000	0.0000
Vendor	6.2800e-003	0.2205	0.0829	1.0800e-003	0.0384	1.2200e-003	0.0396	0.0111	1.1700e-003	0.0122		116.2697	116.2697	4.3700e-003	0.0169	121.4124
Worker	0.2364	0.1524	2.6081	7.5900e-003	0.8942	4.8400e-003	0.8991	0.2372	4.4600e-003	0.2416		783.2695	783.2695	0.0174	0.0168	788.7031
Total	0.2427	0.3729	2.6910	8.6700e-003	0.9326	6.0600e-003	0.9387	0.2482	5.6300e-003	0.2538		899.5392	899.5392	0.0217	0.0337	910.1155

Hawthorne HS Field Improvement Project - Construction Only - South Coast Air Basin, Summer

EMFAC Off-Model Adjustment Factors for Gasoline Light Duty Vehicle to Account for the SAFE Vehicle Rule Applied

3.9 Field/Bleachers - 2024

Mitigated Construction On-Site

	ROG	NOx	CO	SO2	Fugitive PM10	Exhaust PM10	PM10 Total	Fugitive PM2.5	Exhaust PM2.5	PM2.5 Total	Bio- CO2	NBio- CO2	Total CO2	CH4	N2O	CO2e
Category	lb/day										lb/day					
Off-Road	0.8501	14.9095	19.3029	0.0288		0.9074	0.9074		0.9074	0.9074	0.0000	2,738.7123	2,738.7123	0.6635		2,755.3009
Total	0.8501	14.9095	19.3029	0.0288		0.9074	0.9074		0.9074	0.9074	0.0000	2,738.7123	2,738.7123	0.6635		2,755.3009

Mitigated Construction Off-Site

	ROG	NOx	CO	SO2	Fugitive PM10	Exhaust PM10	PM10 Total	Fugitive PM2.5	Exhaust PM2.5	PM2.5 Total	Bio- CO2	NBio- CO2	Total CO2	CH4	N2O	CO2e
Category	lb/day										lb/day					
Hauling	0.0000	0.0000	0.0000	0.0000	0.0000	0.0000	0.0000	0.0000	0.0000	0.0000		0.0000	0.0000	0.0000	0.0000	0.0000
Vendor	6.2800e-003	0.2205	0.0829	1.0800e-003	0.0384	1.2200e-003	0.0396	0.0111	1.1700e-003	0.0122		116.2697	116.2697	4.3700e-003	0.0169	121.4124
Worker	0.2364	0.1524	2.6081	7.5900e-003	0.8942	4.8400e-003	0.8991	0.2372	4.4600e-003	0.2416		783.2695	783.2695	0.0174	0.0168	788.7031
Total	0.2427	0.3729	2.6910	8.6700e-003	0.9326	6.0600e-003	0.9387	0.2482	5.6300e-003	0.2538		899.5392	899.5392	0.0217	0.0337	910.1155

Hawthorne HS Field Improvement Project - Construction Only - South Coast Air Basin, Summer

EMFAC Off-Model Adjustment Factors for Gasoline Light Duty Vehicle to Account for the SAFE Vehicle Rule Applied

3.10 Foundations/Concrete Pour #3 - 2024

Unmitigated Construction On-Site

	ROG	NOx	CO	SO2	Fugitive PM10	Exhaust PM10	PM10 Total	Fugitive PM2.5	Exhaust PM2.5	PM2.5 Total	Bio- CO2	NBio- CO2	Total CO2	CH4	N2O	CO2e
Category	lb/day										lb/day					
Off-Road	1.2055	10.6321	15.6306	0.0260		0.4849	0.4849		0.4742	0.4742		2,472.637 2	2,472.637 2	0.2774		2,479.572 7
Total	1.2055	10.6321	15.6306	0.0260		0.4849	0.4849		0.4742	0.4742		2,472.637 2	2,472.637 2	0.2774		2,479.572 7

Unmitigated Construction Off-Site

	ROG	NOx	CO	SO2	Fugitive PM10	Exhaust PM10	PM10 Total	Fugitive PM2.5	Exhaust PM2.5	PM2.5 Total	Bio- CO2	NBio- CO2	Total CO2	CH4	N2O	CO2e
Category	lb/day										lb/day					
Hauling	0.0000	0.0000	0.0000	0.0000	0.0000	0.0000	0.0000	0.0000	0.0000	0.0000		0.0000	0.0000	0.0000	0.0000	0.0000
Vendor	0.0523	1.8375	0.6908	8.9700e-003	0.3201	0.0102	0.3303	0.0922	9.7200e-003	0.1019		968.9144	968.9144	0.0364	0.1408	1,011.770 0
Worker	0.2364	0.1524	2.6081	7.5900e-003	0.8942	4.8400e-003	0.8991	0.2372	4.4600e-003	0.2416		783.2695	783.2695	0.0174	0.0168	788.7031
Total	0.2887	1.9899	3.2989	0.0166	1.2143	0.0150	1.2293	0.3293	0.0142	0.3435		1,752.183 8	1,752.183 8	0.0538	0.1575	1,800.473 1

Hawthorne HS Field Improvement Project - Construction Only - South Coast Air Basin, Summer

EMFAC Off-Model Adjustment Factors for Gasoline Light Duty Vehicle to Account for the SAFE Vehicle Rule Applied

3.10 Foundations/Concrete Pour #3 - 2024

Mitigated Construction On-Site

	ROG	NOx	CO	SO2	Fugitive PM10	Exhaust PM10	PM10 Total	Fugitive PM2.5	Exhaust PM2.5	PM2.5 Total	Bio- CO2	NBio- CO2	Total CO2	CH4	N2O	CO2e
Category	lb/day										lb/day					
Off-Road	0.5466	12.4805	16.8532	0.0260		0.8746	0.8746		0.8746	0.8746	0.0000	2,472.637 2	2,472.637 2	0.2774		2,479.572 7
Total	0.5466	12.4805	16.8532	0.0260		0.8746	0.8746		0.8746	0.8746	0.0000	2,472.637 2	2,472.637 2	0.2774		2,479.572 7

Mitigated Construction Off-Site

	ROG	NOx	CO	SO2	Fugitive PM10	Exhaust PM10	PM10 Total	Fugitive PM2.5	Exhaust PM2.5	PM2.5 Total	Bio- CO2	NBio- CO2	Total CO2	CH4	N2O	CO2e
Category	lb/day										lb/day					
Hauling	0.0000	0.0000	0.0000	0.0000	0.0000	0.0000	0.0000	0.0000	0.0000	0.0000		0.0000	0.0000	0.0000	0.0000	0.0000
Vendor	0.0523	1.8375	0.6908	8.9700e-003	0.3201	0.0102	0.3303	0.0922	9.7200e-003	0.1019		968.9144	968.9144	0.0364	0.1408	1,011.770 0
Worker	0.2364	0.1524	2.6081	7.5900e-003	0.8942	4.8400e-003	0.8991	0.2372	4.4600e-003	0.2416		783.2695	783.2695	0.0174	0.0168	788.7031
Total	0.2887	1.9899	3.2989	0.0166	1.2143	0.0150	1.2293	0.3293	0.0142	0.3435		1,752.183 8	1,752.183 8	0.0538	0.1575	1,800.473 1

Hawthorne HS Field Improvement Project - Construction Only - South Coast Air Basin, Summer

EMFAC Off-Model Adjustment Factors for Gasoline Light Duty Vehicle to Account for the SAFE Vehicle Rule Applied

3.11 Architectural Coatings - 2024

Unmitigated Construction On-Site

	ROG	NOx	CO	SO2	Fugitive PM10	Exhaust PM10	PM10 Total	Fugitive PM2.5	Exhaust PM2.5	PM2.5 Total	Bio- CO2	NBio- CO2	Total CO2	CH4	N2O	CO2e
Category	lb/day										lb/day					
Archit. Coating	1.2073					0.0000	0.0000		0.0000	0.0000			0.0000			0.0000
Off-Road	0.2410	1.6251	2.4135	3.9600e-003		0.0812	0.0812		0.0812	0.0812		375.2641	375.2641	0.0211		375.7923
Total	1.4483	1.6251	2.4135	3.9600e-003		0.0812	0.0812		0.0812	0.0812		375.2641	375.2641	0.0211		375.7923

Unmitigated Construction Off-Site

	ROG	NOx	CO	SO2	Fugitive PM10	Exhaust PM10	PM10 Total	Fugitive PM2.5	Exhaust PM2.5	PM2.5 Total	Bio- CO2	NBio- CO2	Total CO2	CH4	N2O	CO2e
Category	lb/day										lb/day					
Hauling	0.0000	0.0000	0.0000	0.0000	0.0000	0.0000	0.0000	0.0000	0.0000	0.0000		0.0000	0.0000	0.0000	0.0000	0.0000
Vendor	6.2800e-003	0.2205	0.0829	1.0800e-003	0.0384	1.2200e-003	0.0396	0.0111	1.1700e-003	0.0122		116.2697	116.2697	4.3700e-003	0.0169	121.4124
Worker	0.2364	0.1524	2.6081	7.5900e-003	0.8942	4.8400e-003	0.8991	0.2372	4.4600e-003	0.2416		783.2695	783.2695	0.0174	0.0168	788.7031
Total	0.2427	0.3729	2.6910	8.6700e-003	0.9326	6.0600e-003	0.9387	0.2482	5.6300e-003	0.2538		899.5392	899.5392	0.0217	0.0337	910.1155

Hawthorne HS Field Improvement Project - Construction Only - South Coast Air Basin, Summer

EMFAC Off-Model Adjustment Factors for Gasoline Light Duty Vehicle to Account for the SAFE Vehicle Rule Applied

3.11 Architectural Coatings - 2024

Mitigated Construction On-Site

	ROG	NOx	CO	SO2	Fugitive PM10	Exhaust PM10	PM10 Total	Fugitive PM2.5	Exhaust PM2.5	PM2.5 Total	Bio- CO2	NBio- CO2	Total CO2	CH4	N2O	CO2e
Category	lb/day										lb/day					
Archit. Coating	1.2073					0.0000	0.0000		0.0000	0.0000			0.0000			0.0000
Off-Road	0.0792	1.8093	2.4432	3.9600e-003		0.1268	0.1268		0.1268	0.1268	0.0000	375.2641	375.2641	0.0211		375.7923
Total	1.2865	1.8093	2.4432	3.9600e-003		0.1268	0.1268		0.1268	0.1268	0.0000	375.2641	375.2641	0.0211		375.7923

Mitigated Construction Off-Site

	ROG	NOx	CO	SO2	Fugitive PM10	Exhaust PM10	PM10 Total	Fugitive PM2.5	Exhaust PM2.5	PM2.5 Total	Bio- CO2	NBio- CO2	Total CO2	CH4	N2O	CO2e
Category	lb/day										lb/day					
Hauling	0.0000	0.0000	0.0000	0.0000	0.0000	0.0000	0.0000	0.0000	0.0000	0.0000		0.0000	0.0000	0.0000	0.0000	0.0000
Vendor	6.2800e-003	0.2205	0.0829	1.0800e-003	0.0384	1.2200e-003	0.0396	0.0111	1.1700e-003	0.0122		116.2697	116.2697	4.3700e-003	0.0169	121.4124
Worker	0.2364	0.1524	2.6081	7.5900e-003	0.8942	4.8400e-003	0.8991	0.2372	4.4600e-003	0.2416		783.2695	783.2695	0.0174	0.0168	788.7031
Total	0.2427	0.3729	2.6910	8.6700e-003	0.9326	6.0600e-003	0.9387	0.2482	5.6300e-003	0.2538		899.5392	899.5392	0.0217	0.0337	910.1155

Hawthorne HS Field Improvement Project - Construction Only - South Coast Air Basin, Summer

EMFAC Off-Model Adjustment Factors for Gasoline Light Duty Vehicle to Account for the SAFE Vehicle Rule Applied

3.12 Synthetic Track - 2024

Unmitigated Construction On-Site

	ROG	NOx	CO	SO2	Fugitive PM10	Exhaust PM10	PM10 Total	Fugitive PM2.5	Exhaust PM2.5	PM2.5 Total	Bio- CO2	NBio- CO2	Total CO2	CH4	N2O	CO2e
Category	lb/day										lb/day					
Off-Road	1.5670	14.4249	17.2270	0.0288		0.6565	0.6565		0.6166	0.6166		2,738.7124	2,738.7124	0.6635		2,755.3009
Total	1.5670	14.4249	17.2270	0.0288		0.6565	0.6565		0.6166	0.6166		2,738.7124	2,738.7124	0.6635		2,755.3009

Unmitigated Construction Off-Site

	ROG	NOx	CO	SO2	Fugitive PM10	Exhaust PM10	PM10 Total	Fugitive PM2.5	Exhaust PM2.5	PM2.5 Total	Bio- CO2	NBio- CO2	Total CO2	CH4	N2O	CO2e
Category	lb/day										lb/day					
Hauling	0.0000	0.0000	0.0000	0.0000	0.0000	0.0000	0.0000	0.0000	0.0000	0.0000		0.0000	0.0000	0.0000	0.0000	0.0000
Vendor	6.2800e-003	0.2205	0.0829	1.0800e-003	0.0384	1.2200e-003	0.0396	0.0111	1.1700e-003	0.0122		116.2697	116.2697	4.3700e-003	0.0169	121.4124
Worker	0.2364	0.1524	2.6081	7.5900e-003	0.8942	4.8400e-003	0.8991	0.2372	4.4600e-003	0.2416		783.2695	783.2695	0.0174	0.0168	788.7031
Total	0.2427	0.3729	2.6910	8.6700e-003	0.9326	6.0600e-003	0.9387	0.2482	5.6300e-003	0.2538		899.5392	899.5392	0.0217	0.0337	910.1155

Hawthorne HS Field Improvement Project - Construction Only - South Coast Air Basin, Summer

EMFAC Off-Model Adjustment Factors for Gasoline Light Duty Vehicle to Account for the SAFE Vehicle Rule Applied

3.12 Synthetic Track - 2024

Mitigated Construction On-Site

	ROG	NOx	CO	SO2	Fugitive PM10	Exhaust PM10	PM10 Total	Fugitive PM2.5	Exhaust PM2.5	PM2.5 Total	Bio- CO2	NBio- CO2	Total CO2	CH4	N2O	CO2e
Category	lb/day										lb/day					
Off-Road	0.8501	14.9095	19.3029	0.0288		0.9074	0.9074		0.9074	0.9074	0.0000	2,738.7123	2,738.7123	0.6635		2,755.3009
Total	0.8501	14.9095	19.3029	0.0288		0.9074	0.9074		0.9074	0.9074	0.0000	2,738.7123	2,738.7123	0.6635		2,755.3009

Mitigated Construction Off-Site

	ROG	NOx	CO	SO2	Fugitive PM10	Exhaust PM10	PM10 Total	Fugitive PM2.5	Exhaust PM2.5	PM2.5 Total	Bio- CO2	NBio- CO2	Total CO2	CH4	N2O	CO2e
Category	lb/day										lb/day					
Hauling	0.0000	0.0000	0.0000	0.0000	0.0000	0.0000	0.0000	0.0000	0.0000	0.0000		0.0000	0.0000	0.0000	0.0000	0.0000
Vendor	6.2800e-003	0.2205	0.0829	1.0800e-003	0.0384	1.2200e-003	0.0396	0.0111	1.1700e-003	0.0122		116.2697	116.2697	4.3700e-003	0.0169	121.4124
Worker	0.2364	0.1524	2.6081	7.5900e-003	0.8942	4.8400e-003	0.8991	0.2372	4.4600e-003	0.2416		783.2695	783.2695	0.0174	0.0168	788.7031
Total	0.2427	0.3729	2.6910	8.6700e-003	0.9326	6.0600e-003	0.9387	0.2482	5.6300e-003	0.2538		899.5392	899.5392	0.0217	0.0337	910.1155

Hawthorne HS Field Improvement Project - Construction Only - South Coast Air Basin, Summer

EMFAC Off-Model Adjustment Factors for Gasoline Light Duty Vehicle to Account for the SAFE Vehicle Rule Applied

3.13 Paving Event #2 - 2024

Unmitigated Construction On-Site

	ROG	NOx	CO	SO2	Fugitive PM10	Exhaust PM10	PM10 Total	Fugitive PM2.5	Exhaust PM2.5	PM2.5 Total	Bio- CO2	NBio- CO2	Total CO2	CH4	N2O	CO2e
Category	lb/day										lb/day					
Off-Road	0.9882	9.5246	14.6258	0.0228		0.4685	0.4685		0.4310	0.4310		2,207.547 2	2,207.547 2	0.7140		2,225.396 3
Paving	0.0000					0.0000	0.0000		0.0000	0.0000			0.0000			0.0000
Total	0.9882	9.5246	14.6258	0.0228		0.4685	0.4685		0.4310	0.4310		2,207.547 2	2,207.547 2	0.7140		2,225.396 3

Unmitigated Construction Off-Site

	ROG	NOx	CO	SO2	Fugitive PM10	Exhaust PM10	PM10 Total	Fugitive PM2.5	Exhaust PM2.5	PM2.5 Total	Bio- CO2	NBio- CO2	Total CO2	CH4	N2O	CO2e
Category	lb/day										lb/day					
Hauling	0.0000	0.0000	0.0000	0.0000	0.0000	0.0000	0.0000	0.0000	0.0000	0.0000		0.0000	0.0000	0.0000	0.0000	0.0000
Vendor	6.2800e-003	0.2205	0.0829	1.0800e-003	0.0384	1.2200e-003	0.0396	0.0111	1.1700e-003	0.0122		116.2697	116.2697	4.3700e-003	0.0169	121.4124
Worker	0.2364	0.1524	2.6081	7.5900e-003	0.8942	4.8400e-003	0.8991	0.2372	4.4600e-003	0.2416		783.2695	783.2695	0.0174	0.0168	788.7031
Total	0.2427	0.3729	2.6910	8.6700e-003	0.9326	6.0600e-003	0.9387	0.2482	5.6300e-003	0.2538		899.5392	899.5392	0.0217	0.0337	910.1155

Hawthorne HS Field Improvement Project - Construction Only - South Coast Air Basin, Summer

EMFAC Off-Model Adjustment Factors for Gasoline Light Duty Vehicle to Account for the SAFE Vehicle Rule Applied

3.13 Paving Event #2 - 2024

Mitigated Construction On-Site

	ROG	NOx	CO	SO2	Fugitive PM10	Exhaust PM10	PM10 Total	Fugitive PM2.5	Exhaust PM2.5	PM2.5 Total	Bio- CO2	NBio- CO2	Total CO2	CH4	N2O	CO2e
Category	lb/day										lb/day					
Off-Road	0.5609	11.2952	17.2957	0.0228		0.6093	0.6093		0.6093	0.6093	0.0000	2,207.547 2	2,207.547 2	0.7140		2,225.396 3
Paving	0.0000					0.0000	0.0000		0.0000	0.0000			0.0000			0.0000
Total	0.5609	11.2952	17.2957	0.0228		0.6093	0.6093		0.6093	0.6093	0.0000	2,207.547 2	2,207.547 2	0.7140		2,225.396 3

Mitigated Construction Off-Site

	ROG	NOx	CO	SO2	Fugitive PM10	Exhaust PM10	PM10 Total	Fugitive PM2.5	Exhaust PM2.5	PM2.5 Total	Bio- CO2	NBio- CO2	Total CO2	CH4	N2O	CO2e
Category	lb/day										lb/day					
Hauling	0.0000	0.0000	0.0000	0.0000	0.0000	0.0000	0.0000	0.0000	0.0000	0.0000		0.0000	0.0000	0.0000	0.0000	0.0000
Vendor	6.2800e-003	0.2205	0.0829	1.0800e-003	0.0384	1.2200e-003	0.0396	0.0111	1.1700e-003	0.0122		116.2697	116.2697	4.3700e-003	0.0169	121.4124
Worker	0.2364	0.1524	2.6081	7.5900e-003	0.8942	4.8400e-003	0.8991	0.2372	4.4600e-003	0.2416		783.2695	783.2695	0.0174	0.0168	788.7031
Total	0.2427	0.3729	2.6910	8.6700e-003	0.9326	6.0600e-003	0.9387	0.2482	5.6300e-003	0.2538		899.5392	899.5392	0.0217	0.0337	910.1155

Hawthorne HS Field Improvement Project - Construction Only - South Coast Air Basin, Summer

EMFAC Off-Model Adjustment Factors for Gasoline Light Duty Vehicle to Account for the SAFE Vehicle Rule Applied

4.0 Operational Detail - Mobile

4.1 Mitigation Measures Mobile

	ROG	NOx	CO	SO2	Fugitive PM10	Exhaust PM10	PM10 Total	Fugitive PM2.5	Exhaust PM2.5	PM2.5 Total	Bio- CO2	NBio- CO2	Total CO2	CH4	N2O	CO2e
Category	lb/day										lb/day					
Mitigated	0.0000	0.0000	0.0000	0.0000	0.0000	0.0000	0.0000	0.0000	0.0000	0.0000		0.0000	0.0000	0.0000	0.0000	0.0000
Unmitigated	0.0000	0.0000	0.0000	0.0000	0.0000	0.0000	0.0000	0.0000	0.0000	0.0000		0.0000	0.0000	0.0000	0.0000	0.0000

4.2 Trip Summary Information

Land Use	Average Daily Trip Rate			Unmitigated	Mitigated
	Weekday	Saturday	Sunday	Annual VMT	Annual VMT
High School	0.00	0.00	0.00		
Total	0.00	0.00	0.00		

4.3 Trip Type Information

Land Use	Miles			Trip %			Trip Purpose %		
	H-W or C-W	H-S or C-C	H-O or C-NW	H-W or C-W	H-S or C-C	H-O or C-NW	Primary	Diverted	Pass-by
High School	16.60	8.40	6.90	77.80	17.20	5.00	75	19	6

4.4 Fleet Mix

Land Use	LDA	LDT1	LDT2	MDV	LHD1	LHD2	MHD	HHD	OBUS	UBUS	MCY	SBUS	MH
High School	0.542639	0.062168	0.185423	0.128137	0.023809	0.006526	0.012163	0.008660	0.000816	0.000502	0.024766	0.000746	0.003644

Hawthorne HS Field Improvement Project - Construction Only - South Coast Air Basin, Summer

EMFAC Off-Model Adjustment Factors for Gasoline Light Duty Vehicle to Account for the SAFE Vehicle Rule Applied

5.0 Energy Detail

Historical Energy Use: N

5.1 Mitigation Measures Energy

	ROG	NOx	CO	SO2	Fugitive PM10	Exhaust PM10	PM10 Total	Fugitive PM2.5	Exhaust PM2.5	PM2.5 Total	Bio- CO2	NBio- CO2	Total CO2	CH4	N2O	CO2e
Category	lb/day										lb/day					
NaturalGas Mitigated	0.0000	0.0000	0.0000	0.0000		0.0000	0.0000		0.0000	0.0000		0.0000	0.0000	0.0000	0.0000	0.0000
NaturalGas Unmitigated	0.0000	0.0000	0.0000	0.0000		0.0000	0.0000		0.0000	0.0000		0.0000	0.0000	0.0000	0.0000	0.0000

5.2 Energy by Land Use - NaturalGas

Unmitigated

	NaturalGas Use	ROG	NOx	CO	SO2	Fugitive PM10	Exhaust PM10	PM10 Total	Fugitive PM2.5	Exhaust PM2.5	PM2.5 Total	Bio- CO2	NBio- CO2	Total CO2	CH4	N2O	CO2e
Land Use	kBTU/yr	lb/day										lb/day					
High School	0	0.0000	0.0000	0.0000	0.0000		0.0000	0.0000		0.0000	0.0000		0.0000	0.0000	0.0000	0.0000	0.0000
Total		0.0000	0.0000	0.0000	0.0000		0.0000	0.0000		0.0000	0.0000		0.0000	0.0000	0.0000	0.0000	0.0000

Hawthorne HS Field Improvement Project - Construction Only - South Coast Air Basin, Summer

EMFAC Off-Model Adjustment Factors for Gasoline Light Duty Vehicle to Account for the SAFE Vehicle Rule Applied

5.2 Energy by Land Use - NaturalGas

Mitigated

	NaturalGas Use	ROG	NOx	CO	SO2	Fugitive PM10	Exhaust PM10	PM10 Total	Fugitive PM2.5	Exhaust PM2.5	PM2.5 Total	Bio- CO2	NBio- CO2	Total CO2	CH4	N2O	CO2e	
Land Use	kBTU/yr	lb/day										lb/day						
High School	0	0.0000	0.0000	0.0000	0.0000		0.0000	0.0000		0.0000	0.0000		0.0000	0.0000	0.0000	0.0000	0.0000	0.0000
Total		0.0000	0.0000	0.0000	0.0000		0.0000	0.0000		0.0000	0.0000		0.0000	0.0000	0.0000	0.0000	0.0000	0.0000

6.0 Area Detail

6.1 Mitigation Measures Area

	ROG	NOx	CO	SO2	Fugitive PM10	Exhaust PM10	PM10 Total	Fugitive PM2.5	Exhaust PM2.5	PM2.5 Total	Bio- CO2	NBio- CO2	Total CO2	CH4	N2O	CO2e
Category	lb/day										lb/day					
Mitigated	12.4125	5.1000e-004	0.0566	0.0000		2.0000e-004	2.0000e-004		2.0000e-004	2.0000e-004		0.1216	0.1216	3.2000e-004		0.1295
Unmitigated	12.4125	5.1000e-004	0.0566	0.0000		2.0000e-004	2.0000e-004		2.0000e-004	2.0000e-004		0.1216	0.1216	3.2000e-004		0.1295

Hawthorne HS Field Improvement Project - Construction Only - South Coast Air Basin, Summer

EMFAC Off-Model Adjustment Factors for Gasoline Light Duty Vehicle to Account for the SAFE Vehicle Rule Applied

6.2 Area by SubCategory

Unmitigated

	ROG	NOx	CO	SO2	Fugitive PM10	Exhaust PM10	PM10 Total	Fugitive PM2.5	Exhaust PM2.5	PM2.5 Total	Bio- CO2	NBio- CO2	Total CO2	CH4	N2O	CO2e
SubCategory	lb/day										lb/day					
Architectural Coating	1.4105					0.0000	0.0000		0.0000	0.0000			0.0000			0.0000
Consumer Products	10.9967					0.0000	0.0000		0.0000	0.0000			0.0000			0.0000
Landscaping	5.2100e-003	5.1000e-004	0.0566	0.0000		2.0000e-004	2.0000e-004		2.0000e-004	2.0000e-004		0.1216	0.1216	3.2000e-004		0.1295
Total	12.4125	5.1000e-004	0.0566	0.0000		2.0000e-004	2.0000e-004		2.0000e-004	2.0000e-004		0.1216	0.1216	3.2000e-004		0.1295

Hawthorne HS Field Improvement Project - Construction Only - South Coast Air Basin, Summer

EMFAC Off-Model Adjustment Factors for Gasoline Light Duty Vehicle to Account for the SAFE Vehicle Rule Applied

6.2 Area by SubCategory

Mitigated

	ROG	NOx	CO	SO2	Fugitive PM10	Exhaust PM10	PM10 Total	Fugitive PM2.5	Exhaust PM2.5	PM2.5 Total	Bio- CO2	NBio- CO2	Total CO2	CH4	N2O	CO2e
SubCategory	lb/day										lb/day					
Architectural Coating	1.4105					0.0000	0.0000		0.0000	0.0000			0.0000			0.0000
Consumer Products	10.9967					0.0000	0.0000		0.0000	0.0000			0.0000			0.0000
Landscaping	5.2100e-003	5.1000e-004	0.0566	0.0000		2.0000e-004	2.0000e-004		2.0000e-004	2.0000e-004		0.1216	0.1216	3.2000e-004		0.1295
Total	12.4125	5.1000e-004	0.0566	0.0000		2.0000e-004	2.0000e-004		2.0000e-004	2.0000e-004		0.1216	0.1216	3.2000e-004		0.1295

7.0 Water Detail

7.1 Mitigation Measures Water

Hawthorne HS Field Improvement Project - Construction Only - South Coast Air Basin, Summer

EMFAC Off-Model Adjustment Factors for Gasoline Light Duty Vehicle to Account for the SAFE Vehicle Rule Applied

8.0 Waste Detail

8.1 Mitigation Measures Waste

9.0 Operational Offroad

Equipment Type	Number	Hours/Day	Days/Year	Horse Power	Load Factor	Fuel Type
----------------	--------	-----------	-----------	-------------	-------------	-----------

10.0 Stationary Equipment

Fire Pumps and Emergency Generators

Equipment Type	Number	Hours/Day	Hours/Year	Horse Power	Load Factor	Fuel Type
----------------	--------	-----------	------------	-------------	-------------	-----------

Boilers

Equipment Type	Number	Heat Input/Day	Heat Input/Year	Boiler Rating	Fuel Type
----------------	--------	----------------	-----------------	---------------	-----------

User Defined Equipment

Equipment Type	Number
----------------	--------

11.0 Vegetation

Hawthorne HS Field Improvement Project - Construction Only - South Coast Air Basin, Winter

EMFAC Off-Model Adjustment Factors for Gasoline Light Duty Vehicle to Account for the SAFE Vehicle Rule Applied

Hawthorne HS Field Improvement Project - Construction Only

South Coast Air Basin, Winter

1.0 Project Characteristics

1.1 Land Usage

Land Uses	Size	Metric	Lot Acreage	Floor Surface Area	Population
High School	555.39	1000sqft	12.75	555,390.00	0

1.2 Other Project Characteristics

Urbanization	Urban	Wind Speed (m/s)	2.2	Precipitation Freq (Days)	31
Climate Zone	8			Operational Year	2025
Utility Company	Southern California Edison				
CO2 Intensity (lb/MWhr)	531.98	CH4 Intensity (lb/MWhr)	0.033	N2O Intensity (lb/MWhr)	0.004

1.3 User Entered Comments & Non-Default Data

Project Characteristics - co2

Land Use -

Construction Phase - Consistent with previous District HS Field Improvement Projects

Off-road Equipment - Project-Specific Equipment

Off-road Equipment - Project-Specific Equipment

Off-road Equipment - Project-Specific Construction Equipment

Off-road Equipment - Project-Specific Equipment

Off-road Equipment - Project-Specific Equipment

Off-road Equipment - Project-Specific Equipment

Off-road Equipment - Project-Specific Equipment

Off-road Equipment - Project-Specific Equipment

Off-road Equipment -

Hawthorne HS Field Improvement Project - Construction Only - South Coast Air Basin, Winter

EMFAC Off-Model Adjustment Factors for Gasoline Light Duty Vehicle to Account for the SAFE Vehicle Rule Applied

Off-road Equipment -

Off-road Equipment -

Off-road Equipment - Project-Specific Equipment

Trips and VMT - Project-Specific Construction Program

Demolition - 2,500 tons of debris

Grading - 16,000 CY exported, 16,000 CY imported

Architectural Coating - 5,400 SF Team building, approx 400 SF parking lot

Vehicle Trips - Construction emissions only.

Energy Use - Construction emissions only

Water And Wastewater - Construction emissions only

Solid Waste - Construction emissions only

Construction Off-road Equipment Mitigation - Equipment >50 HP tier 3, water exposed area 3 times daily

Table Name	Column Name	Default Value	New Value
tblArchitecturalCoating	ConstArea_Nonresidential_Exterior	277,695.00	2,700.00
tblArchitecturalCoating	ConstArea_Nonresidential_Interior	833,085.00	8,100.00
tblArchitecturalCoating	ConstArea_Parking	0.00	400.00
tblConstEquipMitigation	NumberOfEquipmentMitigated	0.00	1.00
tblConstEquipMitigation	NumberOfEquipmentMitigated	0.00	1.00
tblConstEquipMitigation	NumberOfEquipmentMitigated	0.00	3.00
tblConstEquipMitigation	NumberOfEquipmentMitigated	0.00	6.00
tblConstEquipMitigation	NumberOfEquipmentMitigated	0.00	9.00
tblConstEquipMitigation	NumberOfEquipmentMitigated	0.00	3.00
tblConstEquipMitigation	NumberOfEquipmentMitigated	0.00	1.00
tblConstEquipMitigation	NumberOfEquipmentMitigated	0.00	4.00
tblConstEquipMitigation	NumberOfEquipmentMitigated	0.00	4.00
tblConstEquipMitigation	NumberOfEquipmentMitigated	0.00	9.00
tblConstEquipMitigation	NumberOfEquipmentMitigated	0.00	4.00
tblConstEquipMitigation	NumberOfEquipmentMitigated	0.00	5.00

Hawthorne HS Field Improvement Project - Construction Only - South Coast Air Basin, Winter

EMFAC Off-Model Adjustment Factors for Gasoline Light Duty Vehicle to Account for the SAFE Vehicle Rule Applied

tblConstEquipMitigation	NumberOfEquipmentMitigated	0.00	2.00
tblConstEquipMitigation	NumberOfEquipmentMitigated	0.00	19.00
tblConstEquipMitigation	NumberOfEquipmentMitigated	0.00	3.00
tblConstEquipMitigation	Tier	No Change	Tier 3
tblConstEquipMitigation	Tier	No Change	Tier 3
tblConstEquipMitigation	Tier	No Change	Tier 3
tblConstEquipMitigation	Tier	No Change	Tier 3
tblConstEquipMitigation	Tier	No Change	Tier 3
tblConstEquipMitigation	Tier	No Change	Tier 3
tblConstEquipMitigation	Tier	No Change	Tier 3
tblConstEquipMitigation	Tier	No Change	Tier 3
tblConstEquipMitigation	Tier	No Change	Tier 3
tblConstEquipMitigation	Tier	No Change	Tier 3
tblConstEquipMitigation	Tier	No Change	Tier 3
tblConstEquipMitigation	Tier	No Change	Tier 3
tblConstEquipMitigation	Tier	No Change	Tier 3
tblConstEquipMitigation	Tier	No Change	Tier 3
tblConstEquipMitigation	Tier	No Change	Tier 3
tblConstEquipMitigation	Tier	No Change	Tier 3
tblConstructionPhase	NumDays	20.00	43.00
tblConstructionPhase	NumDays	300.00	65.00
tblConstructionPhase	NumDays	300.00	3.00
tblConstructionPhase	NumDays	300.00	228.00
tblConstructionPhase	NumDays	300.00	3.00
tblConstructionPhase	NumDays	300.00	153.00
tblConstructionPhase	NumDays	300.00	3.00
tblConstructionPhase	NumDays	20.00	44.00
tblConstructionPhase	NumDays	30.00	76.00
tblConstructionPhase	NumDays	20.00	5.00
tblConstructionPhase	NumDays	20.00	5.00

Hawthorne HS Field Improvement Project - Construction Only - South Coast Air Basin, Winter

EMFAC Off-Model Adjustment Factors for Gasoline Light Duty Vehicle to Account for the SAFE Vehicle Rule Applied

tblEnergyUse	LightingElect	2.68	0.00
tblEnergyUse	NT24E	1.51	0.00
tblEnergyUse	NT24NG	1.03	0.00
tblEnergyUse	T24E	1.69	0.00
tblEnergyUse	T24NG	10.71	0.00
tblGrading	AcresOfGrading	228.00	125.00
tblGrading	MaterialExported	0.00	16,000.00
tblGrading	MaterialImported	0.00	16,000.00
tblOffRoadEquipment	HorsePower	231.00	78.00
tblOffRoadEquipment	LoadFactor	0.29	0.50
tblOffRoadEquipment	OffRoadEquipmentUnitAmount	1.00	0.00
tblOffRoadEquipment	OffRoadEquipmentUnitAmount	1.00	0.00
tblOffRoadEquipment	OffRoadEquipmentUnitAmount	1.00	0.00
tblOffRoadEquipment	OffRoadEquipmentUnitAmount	3.00	0.00
tblOffRoadEquipment	OffRoadEquipmentUnitAmount	3.00	0.00
tblOffRoadEquipment	OffRoadEquipmentUnitAmount	3.00	0.00
tblOffRoadEquipment	OffRoadEquipmentUnitAmount	1.00	0.00
tblOffRoadEquipment	OffRoadEquipmentUnitAmount	1.00	0.00
tblOffRoadEquipment	OffRoadEquipmentUnitAmount	1.00	0.00
tblOffRoadEquipment	OffRoadEquipmentUnitAmount	3.00	2.00
tblOffRoadEquipment	OffRoadEquipmentUnitAmount	3.00	2.00
tblOffRoadEquipment	OffRoadEquipmentUnitAmount	3.00	2.00
tblOffRoadEquipment	OffRoadEquipmentUnitAmount	1.00	0.00
tblOffRoadEquipment	OffRoadEquipmentUnitAmount	1.00	0.00
tblOffRoadEquipment	OffRoadEquipmentUnitAmount	1.00	0.00
tblOffRoadEquipment	UsageHours	6.00	8.00
tblOffRoadEquipment	UsageHours	7.00	8.00
tblOffRoadEquipment	UsageHours	7.00	8.00
tblOffRoadEquipment	UsageHours	7.00	8.00

Hawthorne HS Field Improvement Project - Construction Only - South Coast Air Basin, Winter

EMFAC Off-Model Adjustment Factors for Gasoline Light Duty Vehicle to Account for the SAFE Vehicle Rule Applied

tblOffRoadEquipment	UsageHours	7.00	8.00
tblOffRoadEquipment	UsageHours	7.00	8.00
tblOffRoadEquipment	UsageHours	7.00	8.00
tblOffRoadEquipment	UsageHours	7.00	8.00
tblOffRoadEquipment	UsageHours	7.00	8.00
tblOffRoadEquipment	UsageHours	7.00	8.00
tblProjectCharacteristics	CO2IntensityFactor	390.98	531.98
tblSolidWaste	SolidWasteGenerationRate	722.01	0.00
tblTripsAndVMT	HaulingTripLength	20.00	40.00
tblTripsAndVMT	HaulingTripLength	20.00	40.00
tblTripsAndVMT	VendorTripNumber	0.00	6.00
tblTripsAndVMT	VendorTripNumber	0.00	6.00
tblTripsAndVMT	VendorTripNumber	91.00	6.00
tblTripsAndVMT	VendorTripNumber	0.00	6.00
tblTripsAndVMT	VendorTripNumber	0.00	6.00
tblTripsAndVMT	VendorTripNumber	91.00	50.00
tblTripsAndVMT	VendorTripNumber	0.00	6.00
tblTripsAndVMT	VendorTripNumber	91.00	99.00
tblTripsAndVMT	VendorTripNumber	91.00	50.00
tblTripsAndVMT	VendorTripNumber	0.00	6.00
tblTripsAndVMT	VendorTripNumber	91.00	6.00
tblTripsAndVMT	VendorTripNumber	91.00	50.00
tblTripsAndVMT	WorkerTripNumber	15.00	80.00
tblTripsAndVMT	WorkerTripNumber	47.00	80.00
tblTripsAndVMT	WorkerTripNumber	233.00	80.00
tblTripsAndVMT	WorkerTripNumber	15.00	80.00
tblTripsAndVMT	WorkerTripNumber	20.00	80.00
tblTripsAndVMT	WorkerTripNumber	233.00	80.00
tblTripsAndVMT	WorkerTripNumber	20.00	80.00

Hawthorne HS Field Improvement Project - Construction Only - South Coast Air Basin, Winter

EMFAC Off-Model Adjustment Factors for Gasoline Light Duty Vehicle to Account for the SAFE Vehicle Rule Applied

tblTripsAndVMT	WorkerTripNumber	233.00	80.00
tblTripsAndVMT	WorkerTripNumber	233.00	80.00
tblTripsAndVMT	WorkerTripNumber	15.00	80.00
tblTripsAndVMT	WorkerTripNumber	233.00	80.00
tblTripsAndVMT	WorkerTripNumber	233.00	80.00
tblVehicleTrips	ST_TR	3.98	0.00
tblVehicleTrips	SU_TR	1.71	0.00
tblVehicleTrips	WD_TR	14.07	0.00
tblWater	IndoorWaterUseRate	18,441,525.01	0.00
tblWater	OutdoorWaterUseRate	47,421,064.31	0.00

2.0 Emissions Summary

Hawthorne HS Field Improvement Project - Construction Only - South Coast Air Basin, Winter

EMFAC Off-Model Adjustment Factors for Gasoline Light Duty Vehicle to Account for the SAFE Vehicle Rule Applied

2.1 Overall Construction (Maximum Daily Emission)

Unmitigated Construction

	ROG	NOx	CO	SO2	Fugitive PM10	Exhaust PM10	PM10 Total	Fugitive PM2.5	Exhaust PM2.5	PM2.5 Total	Bio- CO2	NBio- CO2	Total CO2	CH4	N2O	CO2e
Year	lb/day										lb/day					
2022	2.9824	27.9959	23.8141	0.0543	2.3447	1.2652	3.6099	0.4861	1.1767	1.6627	0.0000	5,385.2287	5,385.2287	1.1228	0.1561	5,459.8103
2023	6.9347	76.4696	64.5528	0.1768	11.8003	3.0697	14.5883	4.5873	2.8275	7.3338	0.0000	18,038.2188	18,038.2188	3.6063	1.2387	18,460.0316
2024	8.5234	59.9937	82.3678	0.1712	5.2585	2.5685	7.8270	1.4125	2.4084	3.8209	0.0000	16,884.7885	16,884.7885	2.9031	0.5256	17,087.3642
Maximum	8.5234	76.4696	82.3678	0.1768	11.8003	3.0697	14.5883	4.5873	2.8275	7.3338	0.0000	18,038.2188	18,038.2188	3.6063	1.2387	18,460.0316

Mitigated Construction

	ROG	NOx	CO	SO2	Fugitive PM10	Exhaust PM10	PM10 Total	Fugitive PM2.5	Exhaust PM2.5	PM2.5 Total	Bio- CO2	NBio- CO2	Total CO2	CH4	N2O	CO2e
Year	lb/day										lb/day					
2022	1.2678	20.5895	27.8939	0.0543	1.6030	0.8853	2.4883	0.3738	0.8841	1.2579	0.0000	5,385.2287	5,385.2287	1.1228	0.1561	5,459.8103
2023	3.3288	63.0233	71.3637	0.1768	7.0338	2.9008	9.3197	2.4488	2.8982	4.8299	0.0000	18,038.2188	18,038.2188	3.6063	1.2387	18,460.0316
2024	5.7836	63.4024	91.2950	0.1712	5.2585	3.5075	8.7660	1.4125	3.5045	4.9170	0.0000	16,884.7884	16,884.7884	2.9031	0.5256	17,087.3641
Maximum	5.7836	63.4024	91.2950	0.1768	7.0338	3.5075	9.3197	2.4488	3.5045	4.9170	0.0000	18,038.2188	18,038.2188	3.6063	1.2387	18,460.0316

Hawthorne HS Field Improvement Project - Construction Only - South Coast Air Basin, Winter

EMFAC Off-Model Adjustment Factors for Gasoline Light Duty Vehicle to Account for the SAFE Vehicle Rule Applied

	ROG	NOx	CO	SO2	Fugitive PM10	Exhaust PM10	PM10 Total	Fugitive PM2.5	Exhaust PM2.5	PM2.5 Total	Bio- CO2	NBio-CO2	Total CO2	CH4	N2O	CO2e
Percent Reduction	43.71	10.61	-11.61	0.00	28.39	-5.65	20.95	34.70	-13.63	14.14	0.00	0.00	0.00	0.00	0.00	0.00

Hawthorne HS Field Improvement Project - Construction Only - South Coast Air Basin, Winter

EMFAC Off-Model Adjustment Factors for Gasoline Light Duty Vehicle to Account for the SAFE Vehicle Rule Applied

2.2 Overall Operational

Unmitigated Operational

	ROG	NOx	CO	SO2	Fugitive PM10	Exhaust PM10	PM10 Total	Fugitive PM2.5	Exhaust PM2.5	PM2.5 Total	Bio- CO2	NBio- CO2	Total CO2	CH4	N2O	CO2e
Category	lb/day										lb/day					
Area	12.4125	5.1000e-004	0.0566	0.0000		2.0000e-004	2.0000e-004		2.0000e-004	2.0000e-004		0.1216	0.1216	3.2000e-004		0.1295
Energy	0.0000	0.0000	0.0000	0.0000		0.0000	0.0000		0.0000	0.0000		0.0000	0.0000	0.0000	0.0000	0.0000
Mobile	0.0000	0.0000	0.0000	0.0000	0.0000	0.0000	0.0000	0.0000	0.0000	0.0000		0.0000	0.0000	0.0000	0.0000	0.0000
Total	12.4125	5.1000e-004	0.0566	0.0000	0.0000	2.0000e-004	2.0000e-004	0.0000	2.0000e-004	2.0000e-004		0.1216	0.1216	3.2000e-004	0.0000	0.1295

Mitigated Operational

	ROG	NOx	CO	SO2	Fugitive PM10	Exhaust PM10	PM10 Total	Fugitive PM2.5	Exhaust PM2.5	PM2.5 Total	Bio- CO2	NBio- CO2	Total CO2	CH4	N2O	CO2e
Category	lb/day										lb/day					
Area	12.4125	5.1000e-004	0.0566	0.0000		2.0000e-004	2.0000e-004		2.0000e-004	2.0000e-004		0.1216	0.1216	3.2000e-004		0.1295
Energy	0.0000	0.0000	0.0000	0.0000		0.0000	0.0000		0.0000	0.0000		0.0000	0.0000	0.0000	0.0000	0.0000
Mobile	0.0000	0.0000	0.0000	0.0000	0.0000	0.0000	0.0000	0.0000	0.0000	0.0000		0.0000	0.0000	0.0000	0.0000	0.0000
Total	12.4125	5.1000e-004	0.0566	0.0000	0.0000	2.0000e-004	2.0000e-004	0.0000	2.0000e-004	2.0000e-004		0.1216	0.1216	3.2000e-004	0.0000	0.1295

Hawthorne HS Field Improvement Project - Construction Only - South Coast Air Basin, Winter

EMFAC Off-Model Adjustment Factors for Gasoline Light Duty Vehicle to Account for the SAFE Vehicle Rule Applied

	ROG	NOx	CO	SO2	Fugitive PM10	Exhaust PM10	PM10 Total	Fugitive PM2.5	Exhaust PM2.5	PM2.5 Total	Bio- CO2	NBio-CO2	Total CO2	CH4	N2O	CO2e
Percent Reduction	0.00	0.00	0.00	0.00	0.00	0.00	0.00	0.00	0.00	0.00	0.00	0.00	0.00	0.00	0.00	0.00

3.0 Construction Detail

Construction Phase

Phase Number	Phase Name	Phase Type	Start Date	End Date	Num Days Week	Num Days	Phase Description
1	Demolition	Demolition	12/1/2022	1/31/2023	5	44	
2	Grading/Site Preparation	Grading	2/1/2023	5/17/2023	5	76	
3	Foundations/Concrete Pour #1	Building Construction	3/1/2023	3/3/2023	5	3	
4	Drainage/Utilities/Trenching	Trenching	4/1/2023	8/31/2023	5	109	
5	Building Construction	Building Construction	5/18/2023	4/1/2024	5	228	
6	Foundations/Concrete Pour #2	Building Construction	7/1/2023	7/5/2023	5	3	
7	Paving Event #1	Paving	10/1/2023	10/6/2023	5	5	
8	Field/Bleachers	Building Construction	11/1/2023	5/31/2024	5	153	
9	Foundations/Concrete Pour #3	Building Construction	2/1/2024	2/5/2024	5	3	
10	Architectural Coatings	Architectural Coating	2/1/2024	4/1/2024	5	43	
11	Synthetic Track	Building Construction	3/1/2024	5/30/2024	5	65	
12	Paving Event #2	Paving	3/1/2024	3/7/2024	5	5	

Acres of Grading (Site Preparation Phase): 0

Acres of Grading (Grading Phase): 125

Acres of Paving: 0

Residential Indoor: 0; Residential Outdoor: 0; Non-Residential Indoor: 8,100; Non-Residential Outdoor: 2,700; Striped Parking Area: 400 (Architectural Coating – sqft)

OffRoad Equipment

Hawthorne HS Field Improvement Project - Construction Only - South Coast Air Basin, Winter

EMFAC Off-Model Adjustment Factors for Gasoline Light Duty Vehicle to Account for the SAFE Vehicle Rule Applied

Phase Name	Offroad Equipment Type	Amount	Usage Hours	Horse Power	Load Factor
Demolition	Concrete/Industrial Saws	1	8.00	81	0.73
Demolition	Excavators	3	8.00	158	0.38
Demolition	Rubber Tired Dozers	2	8.00	247	0.40
Grading/Site Preparation	Excavators	2	8.00	158	0.38
Grading/Site Preparation	Graders	1	8.00	187	0.41
Grading/Site Preparation	Rubber Tired Dozers	1	8.00	247	0.40
Grading/Site Preparation	Scrapers	2	8.00	367	0.48
Grading/Site Preparation	Tractors/Loaders/Backhoes	2	8.00	97	0.37
Foundations/Concrete Pour #1	Cranes	0	7.00	231	0.29
Foundations/Concrete Pour #1	Excavators	0		158	0.38
Foundations/Concrete Pour #1	Forklifts	0	8.00	89	0.20
Foundations/Concrete Pour #1	Generator Sets	0	8.00	84	0.74
Foundations/Concrete Pour #1	Graders	0		187	0.41
Foundations/Concrete Pour #1	Pumps	3	8.00	84	0.74
Foundations/Concrete Pour #1	Rubber Tired Dozers	0		247	0.40
Foundations/Concrete Pour #1	Scrapers	0		367	0.48
Foundations/Concrete Pour #1	Tractors/Loaders/Backhoes	2	8.00	97	0.37
Foundations/Concrete Pour #1	Welders	0	8.00	46	0.45
Drainage/Utilities/Trenching	Cranes			78	0.50
Drainage/Utilities/Trenching	Excavators	1	8.00	158	0.38
Drainage/Utilities/Trenching	Forklifts	0		89	0.20
Drainage/Utilities/Trenching	Generator Sets	0		84	0.74
Drainage/Utilities/Trenching	Rubber Tired Dozers	2	8.00	247	0.40
Drainage/Utilities/Trenching	Tractors/Loaders/Backhoes	2	8.00	97	0.37
Drainage/Utilities/Trenching	Trenchers	3	8.00	78	0.50
Drainage/Utilities/Trenching	Welders	0		46	0.45
Building Construction	Cranes	1	8.00	231	0.29
Building Construction	Forklifts	3	8.00	89	0.20

Hawthorne HS Field Improvement Project - Construction Only - South Coast Air Basin, Winter

EMFAC Off-Model Adjustment Factors for Gasoline Light Duty Vehicle to Account for the SAFE Vehicle Rule Applied

Building Construction	Generator Sets	1	8.00	84	0.74
Building Construction	Pavers	0		130	0.42
Building Construction	Paving Equipment	0		132	0.36
Building Construction	Rollers	0		80	0.38
Building Construction	Tractors/Loaders/Backhoes	3	8.00	97	0.37
Building Construction	Welders	1	8.00	46	0.45
Foundations/Concrete Pour #2	Air Compressors	0		78	0.48
Foundations/Concrete Pour #2	Cranes	0	7.00	231	0.29
Foundations/Concrete Pour #2	Forklifts	0	8.00	89	0.20
Foundations/Concrete Pour #2	Generator Sets	0	8.00	84	0.74
Foundations/Concrete Pour #2	Pumps	3	8.00	84	0.74
Foundations/Concrete Pour #2	Tractors/Loaders/Backhoes	2	8.00	97	0.37
Foundations/Concrete Pour #2	Welders	0	8.00	46	0.45
Paving Event #1	Pavers	2	8.00	130	0.42
Paving Event #1	Paving Equipment	2	8.00	132	0.36
Paving Event #1	Rollers	2	8.00	80	0.38
Field/Bleachers	Cranes	1	8.00	231	0.29
Field/Bleachers	Forklifts	3	8.00	89	0.20
Field/Bleachers	Generator Sets	1	8.00	84	0.74
Field/Bleachers	Tractors/Loaders/Backhoes	3	8.00	97	0.37
Field/Bleachers	Welders	1	8.00	46	0.45
Foundations/Concrete Pour #3	Cranes	0	7.00	231	0.29
Foundations/Concrete Pour #3	Forklifts	0	8.00	89	0.20
Foundations/Concrete Pour #3	Generator Sets	0	8.00	84	0.74
Foundations/Concrete Pour #3	Pumps	3	8.00	84	0.74
Foundations/Concrete Pour #3	Tractors/Loaders/Backhoes	2	8.00	97	0.37
Foundations/Concrete Pour #3	Welders	0	8.00	46	0.45
Architectural Coatings	Air Compressors	1	8.00	78	0.48
Synthetic Track	Cranes	1	8.00	231	0.29

Hawthorne HS Field Improvement Project - Construction Only - South Coast Air Basin, Winter

EMFAC Off-Model Adjustment Factors for Gasoline Light Duty Vehicle to Account for the SAFE Vehicle Rule Applied

Synthetic Track	Forklifts	3	8.00	89	0.20
Synthetic Track	Generator Sets	1	8.00	84	0.74
Synthetic Track	Tractors/Loaders/Backhoes	3	8.00	97	0.37
Synthetic Track	Welders	1	8.00	46	0.45
Paving Event #2	Pavers	2	8.00	130	0.42
Paving Event #2	Paving Equipment	2	8.00	132	0.36
Paving Event #2	Rollers	2	8.00	80	0.38

Trips and VMT

Phase Name	Offroad Equipment Count	Worker Trip Number	Vendor Trip Number	Hauling Trip Number	Worker Trip Length	Vendor Trip Length	Hauling Trip Length	Worker Vehicle Class	Vendor Vehicle Class	Hauling Vehicle Class
Demolition	6	80.00	6.00	247.00	14.70	6.90	40.00	LD_Mix	HDT_Mix	HHDT
Grading/Site Preparation	8	80.00	6.00	4,000.00	14.70	6.90	40.00	LD_Mix	HDT_Mix	HHDT
Foundations/Concrete Pour #1	5	80.00	50.00	0.00	14.70	6.90	20.00	LD_Mix	HDT_Mix	HHDT
Drainage/Utilities/Trenching	8	80.00	6.00	0.00	14.70	6.90	20.00	LD_Mix	HDT_Mix	HHDT
Building Construction	9	80.00	99.00	0.00	14.70	6.90	20.00	LD_Mix	HDT_Mix	HHDT
Foundations/Concrete Pour #2	5	80.00	50.00	0.00	14.70	6.90	20.00	LD_Mix	HDT_Mix	HHDT
Paving Event #1	6	80.00	6.00	0.00	14.70	6.90	20.00	LD_Mix	HDT_Mix	HHDT
Field/Bleachers	9	80.00	6.00	0.00	14.70	6.90	20.00	LD_Mix	HDT_Mix	HHDT
Foundations/Concrete Pour #3	5	80.00	50.00	0.00	14.70	6.90	20.00	LD_Mix	HDT_Mix	HHDT
Architectural Coatings	1	80.00	6.00	0.00	14.70	6.90	20.00	LD_Mix	HDT_Mix	HHDT
Synthetic Track	9	80.00	6.00	0.00	14.70	6.90	20.00	LD_Mix	HDT_Mix	HHDT
Paving Event #2	6	80.00	6.00	0.00	14.70	6.90	20.00	LD_Mix	HDT_Mix	HHDT

3.1 Mitigation Measures Construction

Use Cleaner Engines for Construction Equipment

Water Exposed Area

Hawthorne HS Field Improvement Project - Construction Only - South Coast Air Basin, Winter

EMFAC Off-Model Adjustment Factors for Gasoline Light Duty Vehicle to Account for the SAFE Vehicle Rule Applied

3.2 Demolition - 2022

Unmitigated Construction On-Site

	ROG	NOx	CO	SO2	Fugitive PM10	Exhaust PM10	PM10 Total	Fugitive PM2.5	Exhaust PM2.5	PM2.5 Total	Bio- CO2	NBio- CO2	Total CO2	CH4	N2O	CO2e
Category	lb/day										lb/day					
Fugitive Dust					1.2159	0.0000	1.2159	0.1841	0.0000	0.1841			0.0000			0.0000
Off-Road	2.6392	25.7194	20.5941	0.0388		1.2427	1.2427		1.1553	1.1553		3,746.781 2	3,746.781 2	1.0524		3,773.092 0
Total	2.6392	25.7194	20.5941	0.0388	1.2159	1.2427	2.4585	0.1841	1.1553	1.3394		3,746.781 2	3,746.781 2	1.0524		3,773.092 0

Unmitigated Construction Off-Site

	ROG	NOx	CO	SO2	Fugitive PM10	Exhaust PM10	PM10 Total	Fugitive PM2.5	Exhaust PM2.5	PM2.5 Total	Bio- CO2	NBio- CO2	Total CO2	CH4	N2O	CO2e
Category	lb/day										lb/day					
Hauling	0.0427	1.7702	0.3582	6.7000e-003	0.1962	0.0143	0.2105	0.0538	0.0137	0.0675		738.1964	738.1964	0.0441	0.1173	774.2633
Vendor	0.0108	0.2948	0.0981	1.1500e-003	0.0384	2.9000e-003	0.0413	0.0111	2.7700e-003	0.0138		123.9730	123.9730	4.5500e-003	0.0180	129.4559
Worker	0.2898	0.2115	2.7637	7.6300e-003	0.8942	5.3600e-003	0.8996	0.2372	4.9400e-003	0.2421		776.2782	776.2782	0.0217	0.0207	782.9991
Total	0.3432	2.2765	3.2200	0.0155	1.1288	0.0226	1.1514	0.3020	0.0214	0.3234		1,638.447 6	1,638.447 6	0.0704	0.1561	1,686.718 3

Hawthorne HS Field Improvement Project - Construction Only - South Coast Air Basin, Winter

EMFAC Off-Model Adjustment Factors for Gasoline Light Duty Vehicle to Account for the SAFE Vehicle Rule Applied

3.2 Demolition - 2022

Mitigated Construction On-Site

	ROG	NOx	CO	SO2	Fugitive PM10	Exhaust PM10	PM10 Total	Fugitive PM2.5	Exhaust PM2.5	PM2.5 Total	Bio- CO2	NBio- CO2	Total CO2	CH4	N2O	CO2e
Category	lb/day										lb/day					
Fugitive Dust					0.4742	0.0000	0.4742	0.0718	0.0000	0.0718			0.0000			0.0000
Off-Road	0.9246	18.3130	24.6739	0.0388		0.8627	0.8627		0.8627	0.8627	0.0000	3,746.781 2	3,746.781 2	1.0524		3,773.092 0
Total	0.9246	18.3130	24.6739	0.0388	0.4742	0.8627	1.3369	0.0718	0.8627	0.9345	0.0000	3,746.781 2	3,746.781 2	1.0524		3,773.092 0

Mitigated Construction Off-Site

	ROG	NOx	CO	SO2	Fugitive PM10	Exhaust PM10	PM10 Total	Fugitive PM2.5	Exhaust PM2.5	PM2.5 Total	Bio- CO2	NBio- CO2	Total CO2	CH4	N2O	CO2e
Category	lb/day										lb/day					
Hauling	0.0427	1.7702	0.3582	6.7000e-003	0.1962	0.0143	0.2105	0.0538	0.0137	0.0675		738.1964	738.1964	0.0441	0.1173	774.2633
Vendor	0.0108	0.2948	0.0981	1.1500e-003	0.0384	2.9000e-003	0.0413	0.0111	2.7700e-003	0.0138		123.9730	123.9730	4.5500e-003	0.0180	129.4559
Worker	0.2898	0.2115	2.7637	7.6300e-003	0.8942	5.3600e-003	0.8996	0.2372	4.9400e-003	0.2421		776.2782	776.2782	0.0217	0.0207	782.9991
Total	0.3432	2.2765	3.2200	0.0155	1.1288	0.0226	1.1514	0.3020	0.0214	0.3234		1,638.447 6	1,638.447 6	0.0704	0.1561	1,686.718 3

Hawthorne HS Field Improvement Project - Construction Only - South Coast Air Basin, Winter

EMFAC Off-Model Adjustment Factors for Gasoline Light Duty Vehicle to Account for the SAFE Vehicle Rule Applied

3.2 Demolition - 2023

Unmitigated Construction On-Site

	ROG	NOx	CO	SO2	Fugitive PM10	Exhaust PM10	PM10 Total	Fugitive PM2.5	Exhaust PM2.5	PM2.5 Total	Bio- CO2	NBio- CO2	Total CO2	CH4	N2O	CO2e
Category	lb/day										lb/day					
Fugitive Dust					1.2159	0.0000	1.2159	0.1841	0.0000	0.1841			0.0000			0.0000
Off-Road	2.2691	21.4844	19.6434	0.0388		0.9975	0.9975		0.9280	0.9280		3,746.9840	3,746.9840	1.0494		3,773.2183
Total	2.2691	21.4844	19.6434	0.0388	1.2159	0.9975	2.2134	0.1841	0.9280	1.1121		3,746.9840	3,746.9840	1.0494		3,773.2183

Unmitigated Construction Off-Site

	ROG	NOx	CO	SO2	Fugitive PM10	Exhaust PM10	PM10 Total	Fugitive PM2.5	Exhaust PM2.5	PM2.5 Total	Bio- CO2	NBio- CO2	Total CO2	CH4	N2O	CO2e
Category	lb/day										lb/day					
Hauling	0.0171	1.3382	0.3078	6.3100e-003	0.1962	9.6500e-003	0.2058	0.0538	9.2300e-003	0.0630		697.5286	697.5286	0.0432	0.1110	731.6755
Vendor	6.1900e-003	0.2299	0.0870	1.0900e-003	0.0384	1.2200e-003	0.0396	0.0111	1.1700e-003	0.0122		118.1442	118.1442	4.3500e-003	0.0172	123.3633
Worker	0.2696	0.1871	2.5496	7.3900e-003	0.8942	5.0600e-003	0.8993	0.2372	4.6500e-003	0.2418		755.8991	755.8991	0.0195	0.0192	762.0932
Total	0.2930	1.7552	2.9443	0.0148	1.1288	0.0159	1.1447	0.3020	0.0151	0.3170		1,571.5719	1,571.5719	0.0670	0.1473	1,617.1320

Hawthorne HS Field Improvement Project - Construction Only - South Coast Air Basin, Winter

EMFAC Off-Model Adjustment Factors for Gasoline Light Duty Vehicle to Account for the SAFE Vehicle Rule Applied

3.2 Demolition - 2023

Mitigated Construction On-Site

	ROG	NOx	CO	SO2	Fugitive PM10	Exhaust PM10	PM10 Total	Fugitive PM2.5	Exhaust PM2.5	PM2.5 Total	Bio- CO2	NBio- CO2	Total CO2	CH4	N2O	CO2e
Category	lb/day										lb/day					
Fugitive Dust					0.4742	0.0000	0.4742	0.0718	0.0000	0.0718			0.0000			0.0000
Off-Road	0.9246	18.3130	24.6739	0.0388		0.8627	0.8627		0.8627	0.8627	0.0000	3,746.9840	3,746.9840	1.0494		3,773.2183
Total	0.9246	18.3130	24.6739	0.0388	0.4742	0.8627	1.3369	0.0718	0.8627	0.9345	0.0000	3,746.9840	3,746.9840	1.0494		3,773.2183

Mitigated Construction Off-Site

	ROG	NOx	CO	SO2	Fugitive PM10	Exhaust PM10	PM10 Total	Fugitive PM2.5	Exhaust PM2.5	PM2.5 Total	Bio- CO2	NBio- CO2	Total CO2	CH4	N2O	CO2e
Category	lb/day										lb/day					
Hauling	0.0171	1.3382	0.3078	6.3100e-003	0.1962	9.6500e-003	0.2058	0.0538	9.2300e-003	0.0630		697.5286	697.5286	0.0432	0.1110	731.6755
Vendor	6.1900e-003	0.2299	0.0870	1.0900e-003	0.0384	1.2200e-003	0.0396	0.0111	1.1700e-003	0.0122		118.1442	118.1442	4.3500e-003	0.0172	123.3633
Worker	0.2696	0.1871	2.5496	7.3900e-003	0.8942	5.0600e-003	0.8993	0.2372	4.6500e-003	0.2418		755.8991	755.8991	0.0195	0.0192	762.0932
Total	0.2930	1.7552	2.9443	0.0148	1.1288	0.0159	1.1447	0.3020	0.0151	0.3170		1,571.5719	1,571.5719	0.0670	0.1473	1,617.1320

Hawthorne HS Field Improvement Project - Construction Only - South Coast Air Basin, Winter

EMFAC Off-Model Adjustment Factors for Gasoline Light Duty Vehicle to Account for the SAFE Vehicle Rule Applied

3.3 Grading/Site Preparation - 2023

Unmitigated Construction On-Site

	ROG	NOx	CO	SO2	Fugitive PM10	Exhaust PM10	PM10 Total	Fugitive PM2.5	Exhaust PM2.5	PM2.5 Total	Bio- CO2	NBio- CO2	Total CO2	CH4	N2O	CO2e
Category	lb/day										lb/day					
Fugitive Dust					7.8140	0.0000	7.8140	3.5058	0.0000	3.5058			0.0000			0.0000
Off-Road	3.3217	34.5156	28.0512	0.0621		1.4245	1.4245		1.3105	1.3105		6,011.4777	6,011.4777	1.9442		6,060.0836
Total	3.3217	34.5156	28.0512	0.0621	7.8140	1.4245	9.2384	3.5058	1.3105	4.8163		6,011.4777	6,011.4777	1.9442		6,060.0836

Unmitigated Construction Off-Site

	ROG	NOx	CO	SO2	Fugitive PM10	Exhaust PM10	PM10 Total	Fugitive PM2.5	Exhaust PM2.5	PM2.5 Total	Bio- CO2	NBio- CO2	Total CO2	CH4	N2O	CO2e
Category	lb/day										lb/day					
Hauling	0.1605	12.5462	2.8862	0.0592	1.8394	0.0905	1.9299	0.5040	0.0866	0.5906		6,539.7949	6,539.7949	0.4052	1.0403	6,859.9448
Vendor	6.1900e-003	0.2299	0.0870	1.0900e-003	0.0384	1.2200e-003	0.0396	0.0111	1.1700e-003	0.0122		118.1442	118.1442	4.3500e-003	0.0172	123.3633
Worker	0.2696	0.1871	2.5496	7.3900e-003	0.8942	5.0600e-003	0.8993	0.2372	4.6500e-003	0.2418		755.8991	755.8991	0.0195	0.0192	762.0932
Total	0.4364	12.9632	5.5227	0.0677	2.7720	0.0968	2.8688	0.7522	0.0924	0.8446		7,413.8382	7,413.8382	0.4290	1.0766	7,745.4014

Hawthorne HS Field Improvement Project - Construction Only - South Coast Air Basin, Winter

EMFAC Off-Model Adjustment Factors for Gasoline Light Duty Vehicle to Account for the SAFE Vehicle Rule Applied

3.3 Grading/Site Preparation - 2023

Mitigated Construction On-Site

	ROG	NOx	CO	SO2	Fugitive PM10	Exhaust PM10	PM10 Total	Fugitive PM2.5	Exhaust PM2.5	PM2.5 Total	Bio- CO2	NBio- CO2	Total CO2	CH4	N2O	CO2e
Category	lb/day										lb/day					
Fugitive Dust					3.0474	0.0000	3.0474	1.3673	0.0000	1.3673			0.0000			0.0000
Off-Road	1.5231	29.9782	36.7226	0.0621		1.2994	1.2994		1.2994	1.2994	0.0000	6,011.4777	6,011.4777	1.9442		6,060.0836
Total	1.5231	29.9782	36.7226	0.0621	3.0474	1.2994	4.3469	1.3673	1.2994	2.6667	0.0000	6,011.4777	6,011.4777	1.9442		6,060.0836

Mitigated Construction Off-Site

	ROG	NOx	CO	SO2	Fugitive PM10	Exhaust PM10	PM10 Total	Fugitive PM2.5	Exhaust PM2.5	PM2.5 Total	Bio- CO2	NBio- CO2	Total CO2	CH4	N2O	CO2e
Category	lb/day										lb/day					
Hauling	0.1605	12.5462	2.8862	0.0592	1.8394	0.0905	1.9299	0.5040	0.0866	0.5906		6,539.7949	6,539.7949	0.4052	1.0403	6,859.9448
Vendor	6.1900e-003	0.2299	0.0870	1.0900e-003	0.0384	1.2200e-003	0.0396	0.0111	1.1700e-003	0.0122		118.1442	118.1442	4.3500e-003	0.0172	123.3633
Worker	0.2696	0.1871	2.5496	7.3900e-003	0.8942	5.0600e-003	0.8993	0.2372	4.6500e-003	0.2418		755.8991	755.8991	0.0195	0.0192	762.0932
Total	0.4364	12.9632	5.5227	0.0677	2.7720	0.0968	2.8688	0.7522	0.0924	0.8446		7,413.8382	7,413.8382	0.4290	1.0766	7,745.4014

Hawthorne HS Field Improvement Project - Construction Only - South Coast Air Basin, Winter

EMFAC Off-Model Adjustment Factors for Gasoline Light Duty Vehicle to Account for the SAFE Vehicle Rule Applied

3.4 Foundations/Concrete Pour #1 - 2023

Unmitigated Construction On-Site

	ROG	NOx	CO	SO2	Fugitive PM10	Exhaust PM10	PM10 Total	Fugitive PM2.5	Exhaust PM2.5	PM2.5 Total	Bio- CO2	NBio- CO2	Total CO2	CH4	N2O	CO2e
Category	lb/day										lb/day					
Off-Road	1.2861	11.3299	15.6385	0.0260		0.5562	0.5562		0.5440	0.5440		2,472.2567	2,472.2567	0.2806		2,479.2713
Total	1.2861	11.3299	15.6385	0.0260		0.5562	0.5562		0.5440	0.5440		2,472.2567	2,472.2567	0.2806		2,479.2713

Unmitigated Construction Off-Site

	ROG	NOx	CO	SO2	Fugitive PM10	Exhaust PM10	PM10 Total	Fugitive PM2.5	Exhaust PM2.5	PM2.5 Total	Bio- CO2	NBio- CO2	Total CO2	CH4	N2O	CO2e
Category	lb/day										lb/day					
Hauling	0.0000	0.0000	0.0000	0.0000	0.0000	0.0000	0.0000	0.0000	0.0000	0.0000		0.0000	0.0000	0.0000	0.0000	0.0000
Vendor	0.0516	1.9160	0.7246	9.1200e-003	0.3201	0.0102	0.3303	0.0922	9.7300e-003	0.1019		984.5345	984.5345	0.0362	0.1429	1,028.0277
Worker	0.2696	0.1871	2.5496	7.3900e-003	0.8942	5.0600e-003	0.8993	0.2372	4.6500e-003	0.2418		755.8991	755.8991	0.0195	0.0192	762.0932
Total	0.3212	2.1031	3.2742	0.0165	1.2143	0.0152	1.2295	0.3293	0.0144	0.3437		1,740.4337	1,740.4337	0.0557	0.1621	1,790.1209

Hawthorne HS Field Improvement Project - Construction Only - South Coast Air Basin, Winter

EMFAC Off-Model Adjustment Factors for Gasoline Light Duty Vehicle to Account for the SAFE Vehicle Rule Applied

3.4 Foundations/Concrete Pour #1 - 2023

Mitigated Construction On-Site

	ROG	NOx	CO	SO2	Fugitive PM10	Exhaust PM10	PM10 Total	Fugitive PM2.5	Exhaust PM2.5	PM2.5 Total	Bio- CO2	NBio- CO2	Total CO2	CH4	N2O	CO2e
Category	lb/day										lb/day					
Off-Road	0.5466	12.4805	16.8532	0.0260		0.8746	0.8746		0.8746	0.8746	0.0000	2,472.2567	2,472.2567	0.2806		2,479.2713
Total	0.5466	12.4805	16.8532	0.0260		0.8746	0.8746		0.8746	0.8746	0.0000	2,472.2567	2,472.2567	0.2806		2,479.2713

Mitigated Construction Off-Site

	ROG	NOx	CO	SO2	Fugitive PM10	Exhaust PM10	PM10 Total	Fugitive PM2.5	Exhaust PM2.5	PM2.5 Total	Bio- CO2	NBio- CO2	Total CO2	CH4	N2O	CO2e
Category	lb/day										lb/day					
Hauling	0.0000	0.0000	0.0000	0.0000	0.0000	0.0000	0.0000	0.0000	0.0000	0.0000		0.0000	0.0000	0.0000	0.0000	0.0000
Vendor	0.0516	1.9160	0.7246	9.1200e-003	0.3201	0.0102	0.3303	0.0922	9.7300e-003	0.1019		984.5345	984.5345	0.0362	0.1429	1,028.0277
Worker	0.2696	0.1871	2.5496	7.3900e-003	0.8942	5.0600e-003	0.8993	0.2372	4.6500e-003	0.2418		755.8991	755.8991	0.0195	0.0192	762.0932
Total	0.3212	2.1031	3.2742	0.0165	1.2143	0.0152	1.2295	0.3293	0.0144	0.3437		1,740.4337	1,740.4337	0.0557	0.1621	1,790.1209

Hawthorne HS Field Improvement Project - Construction Only - South Coast Air Basin, Winter

EMFAC Off-Model Adjustment Factors for Gasoline Light Duty Vehicle to Account for the SAFE Vehicle Rule Applied

3.5 Drainage/Utilities/Trenching - 2023

Unmitigated Construction On-Site

	ROG	NOx	CO	SO2	Fugitive PM10	Exhaust PM10	PM10 Total	Fugitive PM2.5	Exhaust PM2.5	PM2.5 Total	Bio- CO2	NBio- CO2	Total CO2	CH4	N2O	CO2e
Category	lb/day										lb/day					
Off-Road	2.9008	28.5738	21.7093	0.0386		1.5422	1.5422		1.4188	1.4188		3,738.8596	3,738.8596	1.2092		3,769.0902
Total	2.9008	28.5738	21.7093	0.0386		1.5422	1.5422		1.4188	1.4188		3,738.8596	3,738.8596	1.2092		3,769.0902

Unmitigated Construction Off-Site

	ROG	NOx	CO	SO2	Fugitive PM10	Exhaust PM10	PM10 Total	Fugitive PM2.5	Exhaust PM2.5	PM2.5 Total	Bio- CO2	NBio- CO2	Total CO2	CH4	N2O	CO2e
Category	lb/day										lb/day					
Hauling	0.0000	0.0000	0.0000	0.0000	0.0000	0.0000	0.0000	0.0000	0.0000	0.0000		0.0000	0.0000	0.0000	0.0000	0.0000
Vendor	6.1900e-003	0.2299	0.0870	1.0900e-003	0.0384	1.2200e-003	0.0396	0.0111	1.1700e-003	0.0122		118.1442	118.1442	4.3500e-003	0.0172	123.3633
Worker	0.2696	0.1871	2.5496	7.3900e-003	0.8942	5.0600e-003	0.8993	0.2372	4.6500e-003	0.2418		755.8991	755.8991	0.0195	0.0192	762.0932
Total	0.2758	0.4170	2.6365	8.4800e-003	0.9326	6.2800e-003	0.9389	0.2482	5.8200e-003	0.2540		874.0433	874.0433	0.0238	0.0363	885.4565

Hawthorne HS Field Improvement Project - Construction Only - South Coast Air Basin, Winter

EMFAC Off-Model Adjustment Factors for Gasoline Light Duty Vehicle to Account for the SAFE Vehicle Rule Applied

3.5 Drainage/Utilities/Trenching - 2023

Mitigated Construction On-Site

	ROG	NOx	CO	SO2	Fugitive PM10	Exhaust PM10	PM10 Total	Fugitive PM2.5	Exhaust PM2.5	PM2.5 Total	Bio- CO2	NBio- CO2	Total CO2	CH4	N2O	CO2e
Category	lb/day										lb/day					
Off-Road	0.9448	19.6649	25.2984	0.0386		1.0646	1.0646		1.0646	1.0646	0.0000	3,738.8596	3,738.8596	1.2092		3,769.0902
Total	0.9448	19.6649	25.2984	0.0386		1.0646	1.0646		1.0646	1.0646	0.0000	3,738.8596	3,738.8596	1.2092		3,769.0902

Mitigated Construction Off-Site

	ROG	NOx	CO	SO2	Fugitive PM10	Exhaust PM10	PM10 Total	Fugitive PM2.5	Exhaust PM2.5	PM2.5 Total	Bio- CO2	NBio- CO2	Total CO2	CH4	N2O	CO2e
Category	lb/day										lb/day					
Hauling	0.0000	0.0000	0.0000	0.0000	0.0000	0.0000	0.0000	0.0000	0.0000	0.0000		0.0000	0.0000	0.0000	0.0000	0.0000
Vendor	6.1900e-003	0.2299	0.0870	1.0900e-003	0.0384	1.2200e-003	0.0396	0.0111	1.1700e-003	0.0122		118.1442	118.1442	4.3500e-003	0.0172	123.3633
Worker	0.2696	0.1871	2.5496	7.3900e-003	0.8942	5.0600e-003	0.8993	0.2372	4.6500e-003	0.2418		755.8991	755.8991	0.0195	0.0192	762.0932
Total	0.2758	0.4170	2.6365	8.4800e-003	0.9326	6.2800e-003	0.9389	0.2482	5.8200e-003	0.2540		874.0433	874.0433	0.0238	0.0363	885.4565

Hawthorne HS Field Improvement Project - Construction Only - South Coast Air Basin, Winter

EMFAC Off-Model Adjustment Factors for Gasoline Light Duty Vehicle to Account for the SAFE Vehicle Rule Applied

3.6 Building Construction - 2023

Unmitigated Construction On-Site

	ROG	NOx	CO	SO2	Fugitive PM10	Exhaust PM10	PM10 Total	Fugitive PM2.5	Exhaust PM2.5	PM2.5 Total	Bio- CO2	NBio- CO2	Total CO2	CH4	N2O	CO2e
Category	lb/day										lb/day					
Off-Road	1.6735	15.4377	17.3101	0.0288		0.7481	0.7481		0.7029	0.7029		2,738.1535	2,738.1535	0.6670		2,754.8288
Total	1.6735	15.4377	17.3101	0.0288		0.7481	0.7481		0.7029	0.7029		2,738.1535	2,738.1535	0.6670		2,754.8288

Unmitigated Construction Off-Site

	ROG	NOx	CO	SO2	Fugitive PM10	Exhaust PM10	PM10 Total	Fugitive PM2.5	Exhaust PM2.5	PM2.5 Total	Bio- CO2	NBio- CO2	Total CO2	CH4	N2O	CO2e
Category	lb/day										lb/day					
Hauling	0.0000	0.0000	0.0000	0.0000	0.0000	0.0000	0.0000	0.0000	0.0000	0.0000		0.0000	0.0000	0.0000	0.0000	0.0000
Vendor	0.1021	3.7937	1.4347	0.0181	0.6338	0.0201	0.6539	0.1825	0.0193	0.2017		1,949.3784	1,949.3784	0.0718	0.2830	2,035.4948
Worker	0.2696	0.1871	2.5496	7.3900e-003	0.8942	5.0600e-003	0.8993	0.2372	4.6500e-003	0.2418		755.8991	755.8991	0.0195	0.0192	762.0932
Total	0.3717	3.9808	3.9843	0.0254	1.5280	0.0252	1.5532	0.4196	0.0239	0.4435		2,705.2775	2,705.2775	0.0912	0.3021	2,797.5880

Hawthorne HS Field Improvement Project - Construction Only - South Coast Air Basin, Winter

EMFAC Off-Model Adjustment Factors for Gasoline Light Duty Vehicle to Account for the SAFE Vehicle Rule Applied

3.6 Building Construction - 2023

Mitigated Construction On-Site

	ROG	NOx	CO	SO2	Fugitive PM10	Exhaust PM10	PM10 Total	Fugitive PM2.5	Exhaust PM2.5	PM2.5 Total	Bio- CO2	NBio- CO2	Total CO2	CH4	N2O	CO2e
Category	lb/day										lb/day					
Off-Road	0.8687	14.9493	19.3171	0.0288		0.9150	0.9150		0.9150	0.9150	0.0000	2,738.1535	2,738.1535	0.6670		2,754.8288
Total	0.8687	14.9493	19.3171	0.0288		0.9150	0.9150		0.9150	0.9150	0.0000	2,738.1535	2,738.1535	0.6670		2,754.8288

Mitigated Construction Off-Site

	ROG	NOx	CO	SO2	Fugitive PM10	Exhaust PM10	PM10 Total	Fugitive PM2.5	Exhaust PM2.5	PM2.5 Total	Bio- CO2	NBio- CO2	Total CO2	CH4	N2O	CO2e
Category	lb/day										lb/day					
Hauling	0.0000	0.0000	0.0000	0.0000	0.0000	0.0000	0.0000	0.0000	0.0000	0.0000		0.0000	0.0000	0.0000	0.0000	0.0000
Vendor	0.1021	3.7937	1.4347	0.0181	0.6338	0.0201	0.6539	0.1825	0.0193	0.2017		1,949.3784	1,949.3784	0.0718	0.2830	2,035.4948
Worker	0.2696	0.1871	2.5496	7.3900e-003	0.8942	5.0600e-003	0.8993	0.2372	4.6500e-003	0.2418		755.8991	755.8991	0.0195	0.0192	762.0932
Total	0.3717	3.9808	3.9843	0.0254	1.5280	0.0252	1.5532	0.4196	0.0239	0.4435		2,705.2775	2,705.2775	0.0912	0.3021	2,797.5880

Hawthorne HS Field Improvement Project - Construction Only - South Coast Air Basin, Winter

EMFAC Off-Model Adjustment Factors for Gasoline Light Duty Vehicle to Account for the SAFE Vehicle Rule Applied

3.6 Building Construction - 2024

Unmitigated Construction On-Site

	ROG	NOx	CO	SO2	Fugitive PM10	Exhaust PM10	PM10 Total	Fugitive PM2.5	Exhaust PM2.5	PM2.5 Total	Bio- CO2	NBio- CO2	Total CO2	CH4	N2O	CO2e
Category	lb/day										lb/day					
Off-Road	1.5670	14.4249	17.2270	0.0288		0.6565	0.6565		0.6166	0.6166		2,738.7124	2,738.7124	0.6635		2,755.3009
Total	1.5670	14.4249	17.2270	0.0288		0.6565	0.6565		0.6166	0.6166		2,738.7124	2,738.7124	0.6635		2,755.3009

Unmitigated Construction Off-Site

	ROG	NOx	CO	SO2	Fugitive PM10	Exhaust PM10	PM10 Total	Fugitive PM2.5	Exhaust PM2.5	PM2.5 Total	Bio- CO2	NBio- CO2	Total CO2	CH4	N2O	CO2e
Category	lb/day										lb/day					
Hauling	0.0000	0.0000	0.0000	0.0000	0.0000	0.0000	0.0000	0.0000	0.0000	0.0000		0.0000	0.0000	0.0000	0.0000	0.0000
Vendor	0.0993	3.8100	1.4114	0.0178	0.6338	0.0202	0.6540	0.1825	0.0194	0.2018		1,921.7001	1,921.7001	0.0717	0.2794	2,006.7510
Worker	0.2525	0.1672	2.3788	7.1700e-003	0.8942	4.8400e-003	0.8991	0.2372	4.4600e-003	0.2416		739.6547	739.6547	0.0177	0.0178	745.4074
Total	0.3518	3.9771	3.7902	0.0250	1.5280	0.0251	1.5531	0.4196	0.0238	0.4434		2,661.3548	2,661.3548	0.0894	0.2972	2,752.1583

Hawthorne HS Field Improvement Project - Construction Only - South Coast Air Basin, Winter

EMFAC Off-Model Adjustment Factors for Gasoline Light Duty Vehicle to Account for the SAFE Vehicle Rule Applied

3.6 Building Construction - 2024

Mitigated Construction On-Site

	ROG	NOx	CO	SO2	Fugitive PM10	Exhaust PM10	PM10 Total	Fugitive PM2.5	Exhaust PM2.5	PM2.5 Total	Bio- CO2	NBio- CO2	Total CO2	CH4	N2O	CO2e
Category	lb/day										lb/day					
Off-Road	0.8501	14.9095	19.3029	0.0288		0.9074	0.9074		0.9074	0.9074	0.0000	2,738.7123	2,738.7123	0.6635		2,755.3009
Total	0.8501	14.9095	19.3029	0.0288		0.9074	0.9074		0.9074	0.9074	0.0000	2,738.7123	2,738.7123	0.6635		2,755.3009

Mitigated Construction Off-Site

	ROG	NOx	CO	SO2	Fugitive PM10	Exhaust PM10	PM10 Total	Fugitive PM2.5	Exhaust PM2.5	PM2.5 Total	Bio- CO2	NBio- CO2	Total CO2	CH4	N2O	CO2e
Category	lb/day										lb/day					
Hauling	0.0000	0.0000	0.0000	0.0000	0.0000	0.0000	0.0000	0.0000	0.0000	0.0000		0.0000	0.0000	0.0000	0.0000	0.0000
Vendor	0.0993	3.8100	1.4114	0.0178	0.6338	0.0202	0.6540	0.1825	0.0194	0.2018		1,921.7001	1,921.7001	0.0717	0.2794	2,006.7510
Worker	0.2525	0.1672	2.3788	7.1700e-003	0.8942	4.8400e-003	0.8991	0.2372	4.4600e-003	0.2416		739.6547	739.6547	0.0177	0.0178	745.4074
Total	0.3518	3.9771	3.7902	0.0250	1.5280	0.0251	1.5531	0.4196	0.0238	0.4434		2,661.3548	2,661.3548	0.0894	0.2972	2,752.1583

Hawthorne HS Field Improvement Project - Construction Only - South Coast Air Basin, Winter

EMFAC Off-Model Adjustment Factors for Gasoline Light Duty Vehicle to Account for the SAFE Vehicle Rule Applied

3.7 Foundations/Concrete Pour #2 - 2023

Unmitigated Construction On-Site

	ROG	NOx	CO	SO2	Fugitive PM10	Exhaust PM10	PM10 Total	Fugitive PM2.5	Exhaust PM2.5	PM2.5 Total	Bio- CO2	NBio- CO2	Total CO2	CH4	N2O	CO2e
Category	lb/day										lb/day					
Off-Road	1.2861	11.3299	15.6385	0.0260		0.5562	0.5562		0.5440	0.5440		2,472.2567	2,472.2567	0.2806		2,479.2713
Total	1.2861	11.3299	15.6385	0.0260		0.5562	0.5562		0.5440	0.5440		2,472.2567	2,472.2567	0.2806		2,479.2713

Unmitigated Construction Off-Site

	ROG	NOx	CO	SO2	Fugitive PM10	Exhaust PM10	PM10 Total	Fugitive PM2.5	Exhaust PM2.5	PM2.5 Total	Bio- CO2	NBio- CO2	Total CO2	CH4	N2O	CO2e
Category	lb/day										lb/day					
Hauling	0.0000	0.0000	0.0000	0.0000	0.0000	0.0000	0.0000	0.0000	0.0000	0.0000		0.0000	0.0000	0.0000	0.0000	0.0000
Vendor	0.0516	1.9160	0.7246	9.1200e-003	0.3201	0.0102	0.3303	0.0922	9.7300e-003	0.1019		984.5345	984.5345	0.0362	0.1429	1,028.0277
Worker	0.2696	0.1871	2.5496	7.3900e-003	0.8942	5.0600e-003	0.8993	0.2372	4.6500e-003	0.2418		755.8991	755.8991	0.0195	0.0192	762.0932
Total	0.3212	2.1031	3.2742	0.0165	1.2143	0.0152	1.2295	0.3293	0.0144	0.3437		1,740.4337	1,740.4337	0.0557	0.1621	1,790.1209

Hawthorne HS Field Improvement Project - Construction Only - South Coast Air Basin, Winter

EMFAC Off-Model Adjustment Factors for Gasoline Light Duty Vehicle to Account for the SAFE Vehicle Rule Applied

3.7 Foundations/Concrete Pour #2 - 2023

Mitigated Construction On-Site

	ROG	NOx	CO	SO2	Fugitive PM10	Exhaust PM10	PM10 Total	Fugitive PM2.5	Exhaust PM2.5	PM2.5 Total	Bio- CO2	NBio- CO2	Total CO2	CH4	N2O	CO2e
Category	lb/day										lb/day					
Off-Road	0.5466	12.4805	16.8532	0.0260		0.8746	0.8746		0.8746	0.8746	0.0000	2,472.2567	2,472.2567	0.2806		2,479.2713
Total	0.5466	12.4805	16.8532	0.0260		0.8746	0.8746		0.8746	0.8746	0.0000	2,472.2567	2,472.2567	0.2806		2,479.2713

Mitigated Construction Off-Site

	ROG	NOx	CO	SO2	Fugitive PM10	Exhaust PM10	PM10 Total	Fugitive PM2.5	Exhaust PM2.5	PM2.5 Total	Bio- CO2	NBio- CO2	Total CO2	CH4	N2O	CO2e
Category	lb/day										lb/day					
Hauling	0.0000	0.0000	0.0000	0.0000	0.0000	0.0000	0.0000	0.0000	0.0000	0.0000		0.0000	0.0000	0.0000	0.0000	0.0000
Vendor	0.0516	1.9160	0.7246	9.1200e-003	0.3201	0.0102	0.3303	0.0922	9.7300e-003	0.1019		984.5345	984.5345	0.0362	0.1429	1,028.0277
Worker	0.2696	0.1871	2.5496	7.3900e-003	0.8942	5.0600e-003	0.8993	0.2372	4.6500e-003	0.2418		755.8991	755.8991	0.0195	0.0192	762.0932
Total	0.3212	2.1031	3.2742	0.0165	1.2143	0.0152	1.2295	0.3293	0.0144	0.3437		1,740.4337	1,740.4337	0.0557	0.1621	1,790.1209

Hawthorne HS Field Improvement Project - Construction Only - South Coast Air Basin, Winter

EMFAC Off-Model Adjustment Factors for Gasoline Light Duty Vehicle to Account for the SAFE Vehicle Rule Applied

3.8 Paving Event #1 - 2023

Unmitigated Construction On-Site

	ROG	NOx	CO	SO2	Fugitive PM10	Exhaust PM10	PM10 Total	Fugitive PM2.5	Exhaust PM2.5	PM2.5 Total	Bio- CO2	NBio- CO2	Total CO2	CH4	N2O	CO2e
Category	lb/day										lb/day					
Off-Road	1.0327	10.1917	14.5842	0.0228		0.5102	0.5102		0.4694	0.4694		2,207.5841	2,207.5841	0.7140		2,225.4336
Paving	0.0000					0.0000	0.0000		0.0000	0.0000			0.0000			0.0000
Total	1.0327	10.1917	14.5842	0.0228		0.5102	0.5102		0.4694	0.4694		2,207.5841	2,207.5841	0.7140		2,225.4336

Unmitigated Construction Off-Site

	ROG	NOx	CO	SO2	Fugitive PM10	Exhaust PM10	PM10 Total	Fugitive PM2.5	Exhaust PM2.5	PM2.5 Total	Bio- CO2	NBio- CO2	Total CO2	CH4	N2O	CO2e
Category	lb/day										lb/day					
Hauling	0.0000	0.0000	0.0000	0.0000	0.0000	0.0000	0.0000	0.0000	0.0000	0.0000		0.0000	0.0000	0.0000	0.0000	0.0000
Vendor	6.1900e-003	0.2299	0.0870	1.0900e-003	0.0384	1.2200e-003	0.0396	0.0111	1.1700e-003	0.0122		118.1442	118.1442	4.3500e-003	0.0172	123.3633
Worker	0.2696	0.1871	2.5496	7.3900e-003	0.8942	5.0600e-003	0.8993	0.2372	4.6500e-003	0.2418		755.8991	755.8991	0.0195	0.0192	762.0932
Total	0.2758	0.4170	2.6365	8.4800e-003	0.9326	6.2800e-003	0.9389	0.2482	5.8200e-003	0.2540		874.0433	874.0433	0.0238	0.0363	885.4565

Hawthorne HS Field Improvement Project - Construction Only - South Coast Air Basin, Winter

EMFAC Off-Model Adjustment Factors for Gasoline Light Duty Vehicle to Account for the SAFE Vehicle Rule Applied

3.8 Paving Event #1 - 2023

Mitigated Construction On-Site

	ROG	NOx	CO	SO2	Fugitive PM10	Exhaust PM10	PM10 Total	Fugitive PM2.5	Exhaust PM2.5	PM2.5 Total	Bio- CO2	NBio- CO2	Total CO2	CH4	N2O	CO2e
Category	lb/day										lb/day					
Off-Road	0.5609	11.2952	17.2957	0.0228		0.6093	0.6093		0.6093	0.6093	0.0000	2,207.584 1	2,207.584 1	0.7140		2,225.433 6
Paving	0.0000					0.0000	0.0000		0.0000	0.0000			0.0000			0.0000
Total	0.5609	11.2952	17.2957	0.0228		0.6093	0.6093		0.6093	0.6093	0.0000	2,207.584 1	2,207.584 1	0.7140		2,225.433 6

Mitigated Construction Off-Site

	ROG	NOx	CO	SO2	Fugitive PM10	Exhaust PM10	PM10 Total	Fugitive PM2.5	Exhaust PM2.5	PM2.5 Total	Bio- CO2	NBio- CO2	Total CO2	CH4	N2O	CO2e
Category	lb/day										lb/day					
Hauling	0.0000	0.0000	0.0000	0.0000	0.0000	0.0000	0.0000	0.0000	0.0000	0.0000		0.0000	0.0000	0.0000	0.0000	0.0000
Vendor	6.1900e-003	0.2299	0.0870	1.0900e-003	0.0384	1.2200e-003	0.0396	0.0111	1.1700e-003	0.0122		118.1442	118.1442	4.3500e-003	0.0172	123.3633
Worker	0.2696	0.1871	2.5496	7.3900e-003	0.8942	5.0600e-003	0.8993	0.2372	4.6500e-003	0.2418		755.8991	755.8991	0.0195	0.0192	762.0932
Total	0.2758	0.4170	2.6365	8.4800e-003	0.9326	6.2800e-003	0.9389	0.2482	5.8200e-003	0.2540		874.0433	874.0433	0.0238	0.0363	885.4565

Hawthorne HS Field Improvement Project - Construction Only - South Coast Air Basin, Winter

EMFAC Off-Model Adjustment Factors for Gasoline Light Duty Vehicle to Account for the SAFE Vehicle Rule Applied

3.9 Field/Bleachers - 2023

Unmitigated Construction On-Site

	ROG	NOx	CO	SO2	Fugitive PM10	Exhaust PM10	PM10 Total	Fugitive PM2.5	Exhaust PM2.5	PM2.5 Total	Bio- CO2	NBio- CO2	Total CO2	CH4	N2O	CO2e
Category	lb/day										lb/day					
Off-Road	1.6735	15.4377	17.3101	0.0288		0.7481	0.7481		0.7029	0.7029		2,738.1535	2,738.1535	0.6670		2,754.8288
Total	1.6735	15.4377	17.3101	0.0288		0.7481	0.7481		0.7029	0.7029		2,738.1535	2,738.1535	0.6670		2,754.8288

Unmitigated Construction Off-Site

	ROG	NOx	CO	SO2	Fugitive PM10	Exhaust PM10	PM10 Total	Fugitive PM2.5	Exhaust PM2.5	PM2.5 Total	Bio- CO2	NBio- CO2	Total CO2	CH4	N2O	CO2e
Category	lb/day										lb/day					
Hauling	0.0000	0.0000	0.0000	0.0000	0.0000	0.0000	0.0000	0.0000	0.0000	0.0000		0.0000	0.0000	0.0000	0.0000	0.0000
Vendor	6.1900e-003	0.2299	0.0870	1.0900e-003	0.0384	1.2200e-003	0.0396	0.0111	1.1700e-003	0.0122		118.1442	118.1442	4.3500e-003	0.0172	123.3633
Worker	0.2696	0.1871	2.5496	7.3900e-003	0.8942	5.0600e-003	0.8993	0.2372	4.6500e-003	0.2418		755.8991	755.8991	0.0195	0.0192	762.0932
Total	0.2758	0.4170	2.6365	8.4800e-003	0.9326	6.2800e-003	0.9389	0.2482	5.8200e-003	0.2540		874.0433	874.0433	0.0238	0.0363	885.4565

Hawthorne HS Field Improvement Project - Construction Only - South Coast Air Basin, Winter

EMFAC Off-Model Adjustment Factors for Gasoline Light Duty Vehicle to Account for the SAFE Vehicle Rule Applied

3.9 Field/Bleachers - 2023

Mitigated Construction On-Site

	ROG	NOx	CO	SO2	Fugitive PM10	Exhaust PM10	PM10 Total	Fugitive PM2.5	Exhaust PM2.5	PM2.5 Total	Bio- CO2	NBio- CO2	Total CO2	CH4	N2O	CO2e
Category	lb/day										lb/day					
Off-Road	0.8687	14.9493	19.3171	0.0288		0.9150	0.9150		0.9150	0.9150	0.0000	2,738.1535	2,738.1535	0.6670		2,754.8288
Total	0.8687	14.9493	19.3171	0.0288		0.9150	0.9150		0.9150	0.9150	0.0000	2,738.1535	2,738.1535	0.6670		2,754.8288

Mitigated Construction Off-Site

	ROG	NOx	CO	SO2	Fugitive PM10	Exhaust PM10	PM10 Total	Fugitive PM2.5	Exhaust PM2.5	PM2.5 Total	Bio- CO2	NBio- CO2	Total CO2	CH4	N2O	CO2e
Category	lb/day										lb/day					
Hauling	0.0000	0.0000	0.0000	0.0000	0.0000	0.0000	0.0000	0.0000	0.0000	0.0000		0.0000	0.0000	0.0000	0.0000	0.0000
Vendor	6.1900e-003	0.2299	0.0870	1.0900e-003	0.0384	1.2200e-003	0.0396	0.0111	1.1700e-003	0.0122		118.1442	118.1442	4.3500e-003	0.0172	123.3633
Worker	0.2696	0.1871	2.5496	7.3900e-003	0.8942	5.0600e-003	0.8993	0.2372	4.6500e-003	0.2418		755.8991	755.8991	0.0195	0.0192	762.0932
Total	0.2758	0.4170	2.6365	8.4800e-003	0.9326	6.2800e-003	0.9389	0.2482	5.8200e-003	0.2540		874.0433	874.0433	0.0238	0.0363	885.4565

Hawthorne HS Field Improvement Project - Construction Only - South Coast Air Basin, Winter

EMFAC Off-Model Adjustment Factors for Gasoline Light Duty Vehicle to Account for the SAFE Vehicle Rule Applied

3.9 Field/Bleachers - 2024

Unmitigated Construction On-Site

	ROG	NOx	CO	SO2	Fugitive PM10	Exhaust PM10	PM10 Total	Fugitive PM2.5	Exhaust PM2.5	PM2.5 Total	Bio- CO2	NBio- CO2	Total CO2	CH4	N2O	CO2e
Category	lb/day										lb/day					
Off-Road	1.5670	14.4249	17.2270	0.0288		0.6565	0.6565		0.6166	0.6166		2,738.7124	2,738.7124	0.6635		2,755.3009
Total	1.5670	14.4249	17.2270	0.0288		0.6565	0.6565		0.6166	0.6166		2,738.7124	2,738.7124	0.6635		2,755.3009

Unmitigated Construction Off-Site

	ROG	NOx	CO	SO2	Fugitive PM10	Exhaust PM10	PM10 Total	Fugitive PM2.5	Exhaust PM2.5	PM2.5 Total	Bio- CO2	NBio- CO2	Total CO2	CH4	N2O	CO2e
Category	lb/day										lb/day					
Hauling	0.0000	0.0000	0.0000	0.0000	0.0000	0.0000	0.0000	0.0000	0.0000	0.0000		0.0000	0.0000	0.0000	0.0000	0.0000
Vendor	6.0200e-003	0.2309	0.0855	1.0800e-003	0.0384	1.2300e-003	0.0396	0.0111	1.1700e-003	0.0122		116.4667	116.4667	4.3500e-003	0.0169	121.6213
Worker	0.2525	0.1672	2.3788	7.1700e-003	0.8942	4.8400e-003	0.8991	0.2372	4.4600e-003	0.2416		739.6547	739.6547	0.0177	0.0178	745.4074
Total	0.2585	0.3981	2.4643	8.2500e-003	0.9326	6.0700e-003	0.9387	0.2482	5.6300e-003	0.2538		856.1213	856.1213	0.0220	0.0348	867.0286

Hawthorne HS Field Improvement Project - Construction Only - South Coast Air Basin, Winter

EMFAC Off-Model Adjustment Factors for Gasoline Light Duty Vehicle to Account for the SAFE Vehicle Rule Applied

3.9 Field/Bleachers - 2024

Mitigated Construction On-Site

	ROG	NOx	CO	SO2	Fugitive PM10	Exhaust PM10	PM10 Total	Fugitive PM2.5	Exhaust PM2.5	PM2.5 Total	Bio- CO2	NBio- CO2	Total CO2	CH4	N2O	CO2e
Category	lb/day										lb/day					
Off-Road	0.8501	14.9095	19.3029	0.0288		0.9074	0.9074		0.9074	0.9074	0.0000	2,738.7123	2,738.7123	0.6635		2,755.3009
Total	0.8501	14.9095	19.3029	0.0288		0.9074	0.9074		0.9074	0.9074	0.0000	2,738.7123	2,738.7123	0.6635		2,755.3009

Mitigated Construction Off-Site

	ROG	NOx	CO	SO2	Fugitive PM10	Exhaust PM10	PM10 Total	Fugitive PM2.5	Exhaust PM2.5	PM2.5 Total	Bio- CO2	NBio- CO2	Total CO2	CH4	N2O	CO2e
Category	lb/day										lb/day					
Hauling	0.0000	0.0000	0.0000	0.0000	0.0000	0.0000	0.0000	0.0000	0.0000	0.0000		0.0000	0.0000	0.0000	0.0000	0.0000
Vendor	6.0200e-003	0.2309	0.0855	1.0800e-003	0.0384	1.2300e-003	0.0396	0.0111	1.1700e-003	0.0122		116.4667	116.4667	4.3500e-003	0.0169	121.6213
Worker	0.2525	0.1672	2.3788	7.1700e-003	0.8942	4.8400e-003	0.8991	0.2372	4.4600e-003	0.2416		739.6547	739.6547	0.0177	0.0178	745.4074
Total	0.2585	0.3981	2.4643	8.2500e-003	0.9326	6.0700e-003	0.9387	0.2482	5.6300e-003	0.2538		856.1213	856.1213	0.0220	0.0348	867.0286

Hawthorne HS Field Improvement Project - Construction Only - South Coast Air Basin, Winter

EMFAC Off-Model Adjustment Factors for Gasoline Light Duty Vehicle to Account for the SAFE Vehicle Rule Applied

3.10 Foundations/Concrete Pour #3 - 2024

Unmitigated Construction On-Site

	ROG	NOx	CO	SO2	Fugitive PM10	Exhaust PM10	PM10 Total	Fugitive PM2.5	Exhaust PM2.5	PM2.5 Total	Bio- CO2	NBio- CO2	Total CO2	CH4	N2O	CO2e
Category	lb/day										lb/day					
Off-Road	1.2055	10.6321	15.6306	0.0260		0.4849	0.4849		0.4742	0.4742		2,472.637 2	2,472.637 2	0.2774		2,479.572 7
Total	1.2055	10.6321	15.6306	0.0260		0.4849	0.4849		0.4742	0.4742		2,472.637 2	2,472.637 2	0.2774		2,479.572 7

Unmitigated Construction Off-Site

	ROG	NOx	CO	SO2	Fugitive PM10	Exhaust PM10	PM10 Total	Fugitive PM2.5	Exhaust PM2.5	PM2.5 Total	Bio- CO2	NBio- CO2	Total CO2	CH4	N2O	CO2e
Category	lb/day										lb/day					
Hauling	0.0000	0.0000	0.0000	0.0000	0.0000	0.0000	0.0000	0.0000	0.0000	0.0000		0.0000	0.0000	0.0000	0.0000	0.0000
Vendor	0.0502	1.9242	0.7128	8.9800e-003	0.3201	0.0102	0.3303	0.0922	9.7700e-003	0.1019		970.5556	970.5556	0.0362	0.1411	1,013.510 6
Worker	0.2525	0.1672	2.3788	7.1700e-003	0.8942	4.8400e-003	0.8991	0.2372	4.4600e-003	0.2416		739.6547	739.6547	0.0177	0.0178	745.4074
Total	0.3027	2.0914	3.0916	0.0162	1.2143	0.0151	1.2294	0.3293	0.0142	0.3435		1,710.210 3	1,710.210 3	0.0539	0.1589	1,758.918 0

Hawthorne HS Field Improvement Project - Construction Only - South Coast Air Basin, Winter

EMFAC Off-Model Adjustment Factors for Gasoline Light Duty Vehicle to Account for the SAFE Vehicle Rule Applied

3.10 Foundations/Concrete Pour #3 - 2024

Mitigated Construction On-Site

	ROG	NOx	CO	SO2	Fugitive PM10	Exhaust PM10	PM10 Total	Fugitive PM2.5	Exhaust PM2.5	PM2.5 Total	Bio- CO2	NBio- CO2	Total CO2	CH4	N2O	CO2e
Category	lb/day										lb/day					
Off-Road	0.5466	12.4805	16.8532	0.0260		0.8746	0.8746		0.8746	0.8746	0.0000	2,472.637 2	2,472.637 2	0.2774		2,479.572 7
Total	0.5466	12.4805	16.8532	0.0260		0.8746	0.8746		0.8746	0.8746	0.0000	2,472.637 2	2,472.637 2	0.2774		2,479.572 7

Mitigated Construction Off-Site

	ROG	NOx	CO	SO2	Fugitive PM10	Exhaust PM10	PM10 Total	Fugitive PM2.5	Exhaust PM2.5	PM2.5 Total	Bio- CO2	NBio- CO2	Total CO2	CH4	N2O	CO2e
Category	lb/day										lb/day					
Hauling	0.0000	0.0000	0.0000	0.0000	0.0000	0.0000	0.0000	0.0000	0.0000	0.0000		0.0000	0.0000	0.0000	0.0000	0.0000
Vendor	0.0502	1.9242	0.7128	8.9800e-003	0.3201	0.0102	0.3303	0.0922	9.7700e-003	0.1019		970.5556	970.5556	0.0362	0.1411	1,013.510 6
Worker	0.2525	0.1672	2.3788	7.1700e-003	0.8942	4.8400e-003	0.8991	0.2372	4.4600e-003	0.2416		739.6547	739.6547	0.0177	0.0178	745.4074
Total	0.3027	2.0914	3.0916	0.0162	1.2143	0.0151	1.2294	0.3293	0.0142	0.3435		1,710.210 3	1,710.210 3	0.0539	0.1589	1,758.918 0

Hawthorne HS Field Improvement Project - Construction Only - South Coast Air Basin, Winter

EMFAC Off-Model Adjustment Factors for Gasoline Light Duty Vehicle to Account for the SAFE Vehicle Rule Applied

3.11 Architectural Coatings - 2024

Unmitigated Construction On-Site

	ROG	NOx	CO	SO2	Fugitive PM10	Exhaust PM10	PM10 Total	Fugitive PM2.5	Exhaust PM2.5	PM2.5 Total	Bio- CO2	NBio- CO2	Total CO2	CH4	N2O	CO2e
Category	lb/day										lb/day					
Archit. Coating	1.2073					0.0000	0.0000		0.0000	0.0000			0.0000			0.0000
Off-Road	0.2410	1.6251	2.4135	3.9600e-003		0.0812	0.0812		0.0812	0.0812		375.2641	375.2641	0.0211		375.7923
Total	1.4483	1.6251	2.4135	3.9600e-003		0.0812	0.0812		0.0812	0.0812		375.2641	375.2641	0.0211		375.7923

Unmitigated Construction Off-Site

	ROG	NOx	CO	SO2	Fugitive PM10	Exhaust PM10	PM10 Total	Fugitive PM2.5	Exhaust PM2.5	PM2.5 Total	Bio- CO2	NBio- CO2	Total CO2	CH4	N2O	CO2e
Category	lb/day										lb/day					
Hauling	0.0000	0.0000	0.0000	0.0000	0.0000	0.0000	0.0000	0.0000	0.0000	0.0000		0.0000	0.0000	0.0000	0.0000	0.0000
Vendor	6.0200e-003	0.2309	0.0855	1.0800e-003	0.0384	1.2300e-003	0.0396	0.0111	1.1700e-003	0.0122		116.4667	116.4667	4.3500e-003	0.0169	121.6213
Worker	0.2525	0.1672	2.3788	7.1700e-003	0.8942	4.8400e-003	0.8991	0.2372	4.4600e-003	0.2416		739.6547	739.6547	0.0177	0.0178	745.4074
Total	0.2585	0.3981	2.4643	8.2500e-003	0.9326	6.0700e-003	0.9387	0.2482	5.6300e-003	0.2538		856.1213	856.1213	0.0220	0.0348	867.0286

Hawthorne HS Field Improvement Project - Construction Only - South Coast Air Basin, Winter

EMFAC Off-Model Adjustment Factors for Gasoline Light Duty Vehicle to Account for the SAFE Vehicle Rule Applied

3.11 Architectural Coatings - 2024

Mitigated Construction On-Site

	ROG	NOx	CO	SO2	Fugitive PM10	Exhaust PM10	PM10 Total	Fugitive PM2.5	Exhaust PM2.5	PM2.5 Total	Bio- CO2	NBio- CO2	Total CO2	CH4	N2O	CO2e
Category	lb/day										lb/day					
Archit. Coating	1.2073					0.0000	0.0000		0.0000	0.0000			0.0000			0.0000
Off-Road	0.0792	1.8093	2.4432	3.9600e-003		0.1268	0.1268		0.1268	0.1268	0.0000	375.2641	375.2641	0.0211		375.7923
Total	1.2865	1.8093	2.4432	3.9600e-003		0.1268	0.1268		0.1268	0.1268	0.0000	375.2641	375.2641	0.0211		375.7923

Mitigated Construction Off-Site

	ROG	NOx	CO	SO2	Fugitive PM10	Exhaust PM10	PM10 Total	Fugitive PM2.5	Exhaust PM2.5	PM2.5 Total	Bio- CO2	NBio- CO2	Total CO2	CH4	N2O	CO2e
Category	lb/day										lb/day					
Hauling	0.0000	0.0000	0.0000	0.0000	0.0000	0.0000	0.0000	0.0000	0.0000	0.0000		0.0000	0.0000	0.0000	0.0000	0.0000
Vendor	6.0200e-003	0.2309	0.0855	1.0800e-003	0.0384	1.2300e-003	0.0396	0.0111	1.1700e-003	0.0122		116.4667	116.4667	4.3500e-003	0.0169	121.6213
Worker	0.2525	0.1672	2.3788	7.1700e-003	0.8942	4.8400e-003	0.8991	0.2372	4.4600e-003	0.2416		739.6547	739.6547	0.0177	0.0178	745.4074
Total	0.2585	0.3981	2.4643	8.2500e-003	0.9326	6.0700e-003	0.9387	0.2482	5.6300e-003	0.2538		856.1213	856.1213	0.0220	0.0348	867.0286

Hawthorne HS Field Improvement Project - Construction Only - South Coast Air Basin, Winter

EMFAC Off-Model Adjustment Factors for Gasoline Light Duty Vehicle to Account for the SAFE Vehicle Rule Applied

3.12 Synthetic Track - 2024

Unmitigated Construction On-Site

	ROG	NOx	CO	SO2	Fugitive PM10	Exhaust PM10	PM10 Total	Fugitive PM2.5	Exhaust PM2.5	PM2.5 Total	Bio- CO2	NBio- CO2	Total CO2	CH4	N2O	CO2e
Category	lb/day										lb/day					
Off-Road	1.5670	14.4249	17.2270	0.0288		0.6565	0.6565		0.6166	0.6166		2,738.7124	2,738.7124	0.6635		2,755.3009
Total	1.5670	14.4249	17.2270	0.0288		0.6565	0.6565		0.6166	0.6166		2,738.7124	2,738.7124	0.6635		2,755.3009

Unmitigated Construction Off-Site

	ROG	NOx	CO	SO2	Fugitive PM10	Exhaust PM10	PM10 Total	Fugitive PM2.5	Exhaust PM2.5	PM2.5 Total	Bio- CO2	NBio- CO2	Total CO2	CH4	N2O	CO2e
Category	lb/day										lb/day					
Hauling	0.0000	0.0000	0.0000	0.0000	0.0000	0.0000	0.0000	0.0000	0.0000	0.0000		0.0000	0.0000	0.0000	0.0000	0.0000
Vendor	6.0200e-003	0.2309	0.0855	1.0800e-003	0.0384	1.2300e-003	0.0396	0.0111	1.1700e-003	0.0122		116.4667	116.4667	4.3500e-003	0.0169	121.6213
Worker	0.2525	0.1672	2.3788	7.1700e-003	0.8942	4.8400e-003	0.8991	0.2372	4.4600e-003	0.2416		739.6547	739.6547	0.0177	0.0178	745.4074
Total	0.2585	0.3981	2.4643	8.2500e-003	0.9326	6.0700e-003	0.9387	0.2482	5.6300e-003	0.2538		856.1213	856.1213	0.0220	0.0348	867.0286

Hawthorne HS Field Improvement Project - Construction Only - South Coast Air Basin, Winter

EMFAC Off-Model Adjustment Factors for Gasoline Light Duty Vehicle to Account for the SAFE Vehicle Rule Applied

3.12 Synthetic Track - 2024

Mitigated Construction On-Site

	ROG	NOx	CO	SO2	Fugitive PM10	Exhaust PM10	PM10 Total	Fugitive PM2.5	Exhaust PM2.5	PM2.5 Total	Bio- CO2	NBio- CO2	Total CO2	CH4	N2O	CO2e
Category	lb/day										lb/day					
Off-Road	0.8501	14.9095	19.3029	0.0288		0.9074	0.9074		0.9074	0.9074	0.0000	2,738.7123	2,738.7123	0.6635		2,755.3009
Total	0.8501	14.9095	19.3029	0.0288		0.9074	0.9074		0.9074	0.9074	0.0000	2,738.7123	2,738.7123	0.6635		2,755.3009

Mitigated Construction Off-Site

	ROG	NOx	CO	SO2	Fugitive PM10	Exhaust PM10	PM10 Total	Fugitive PM2.5	Exhaust PM2.5	PM2.5 Total	Bio- CO2	NBio- CO2	Total CO2	CH4	N2O	CO2e
Category	lb/day										lb/day					
Hauling	0.0000	0.0000	0.0000	0.0000	0.0000	0.0000	0.0000	0.0000	0.0000	0.0000		0.0000	0.0000	0.0000	0.0000	0.0000
Vendor	6.0200e-003	0.2309	0.0855	1.0800e-003	0.0384	1.2300e-003	0.0396	0.0111	1.1700e-003	0.0122		116.4667	116.4667	4.3500e-003	0.0169	121.6213
Worker	0.2525	0.1672	2.3788	7.1700e-003	0.8942	4.8400e-003	0.8991	0.2372	4.4600e-003	0.2416		739.6547	739.6547	0.0177	0.0178	745.4074
Total	0.2585	0.3981	2.4643	8.2500e-003	0.9326	6.0700e-003	0.9387	0.2482	5.6300e-003	0.2538		856.1213	856.1213	0.0220	0.0348	867.0286

Hawthorne HS Field Improvement Project - Construction Only - South Coast Air Basin, Winter

EMFAC Off-Model Adjustment Factors for Gasoline Light Duty Vehicle to Account for the SAFE Vehicle Rule Applied

3.13 Paving Event #2 - 2024

Unmitigated Construction On-Site

	ROG	NOx	CO	SO2	Fugitive PM10	Exhaust PM10	PM10 Total	Fugitive PM2.5	Exhaust PM2.5	PM2.5 Total	Bio- CO2	NBio- CO2	Total CO2	CH4	N2O	CO2e
Category	lb/day										lb/day					
Off-Road	0.9882	9.5246	14.6258	0.0228		0.4685	0.4685		0.4310	0.4310		2,207.547 2	2,207.547 2	0.7140		2,225.396 3
Paving	0.0000					0.0000	0.0000		0.0000	0.0000			0.0000			0.0000
Total	0.9882	9.5246	14.6258	0.0228		0.4685	0.4685		0.4310	0.4310		2,207.547 2	2,207.547 2	0.7140		2,225.396 3

Unmitigated Construction Off-Site

	ROG	NOx	CO	SO2	Fugitive PM10	Exhaust PM10	PM10 Total	Fugitive PM2.5	Exhaust PM2.5	PM2.5 Total	Bio- CO2	NBio- CO2	Total CO2	CH4	N2O	CO2e
Category	lb/day										lb/day					
Hauling	0.0000	0.0000	0.0000	0.0000	0.0000	0.0000	0.0000	0.0000	0.0000	0.0000		0.0000	0.0000	0.0000	0.0000	0.0000
Vendor	6.0200e-003	0.2309	0.0855	1.0800e-003	0.0384	1.2300e-003	0.0396	0.0111	1.1700e-003	0.0122		116.4667	116.4667	4.3500e-003	0.0169	121.6213
Worker	0.2525	0.1672	2.3788	7.1700e-003	0.8942	4.8400e-003	0.8991	0.2372	4.4600e-003	0.2416		739.6547	739.6547	0.0177	0.0178	745.4074
Total	0.2585	0.3981	2.4643	8.2500e-003	0.9326	6.0700e-003	0.9387	0.2482	5.6300e-003	0.2538		856.1213	856.1213	0.0220	0.0348	867.0286

Hawthorne HS Field Improvement Project - Construction Only - South Coast Air Basin, Winter

EMFAC Off-Model Adjustment Factors for Gasoline Light Duty Vehicle to Account for the SAFE Vehicle Rule Applied

3.13 Paving Event #2 - 2024

Mitigated Construction On-Site

	ROG	NOx	CO	SO2	Fugitive PM10	Exhaust PM10	PM10 Total	Fugitive PM2.5	Exhaust PM2.5	PM2.5 Total	Bio- CO2	NBio- CO2	Total CO2	CH4	N2O	CO2e
Category	lb/day										lb/day					
Off-Road	0.5609	11.2952	17.2957	0.0228		0.6093	0.6093		0.6093	0.6093	0.0000	2,207.547 2	2,207.547 2	0.7140		2,225.396 3
Paving	0.0000					0.0000	0.0000		0.0000	0.0000			0.0000			0.0000
Total	0.5609	11.2952	17.2957	0.0228		0.6093	0.6093		0.6093	0.6093	0.0000	2,207.547 2	2,207.547 2	0.7140		2,225.396 3

Mitigated Construction Off-Site

	ROG	NOx	CO	SO2	Fugitive PM10	Exhaust PM10	PM10 Total	Fugitive PM2.5	Exhaust PM2.5	PM2.5 Total	Bio- CO2	NBio- CO2	Total CO2	CH4	N2O	CO2e
Category	lb/day										lb/day					
Hauling	0.0000	0.0000	0.0000	0.0000	0.0000	0.0000	0.0000	0.0000	0.0000	0.0000		0.0000	0.0000	0.0000	0.0000	0.0000
Vendor	6.0200e-003	0.2309	0.0855	1.0800e-003	0.0384	1.2300e-003	0.0396	0.0111	1.1700e-003	0.0122		116.4667	116.4667	4.3500e-003	0.0169	121.6213
Worker	0.2525	0.1672	2.3788	7.1700e-003	0.8942	4.8400e-003	0.8991	0.2372	4.4600e-003	0.2416		739.6547	739.6547	0.0177	0.0178	745.4074
Total	0.2585	0.3981	2.4643	8.2500e-003	0.9326	6.0700e-003	0.9387	0.2482	5.6300e-003	0.2538		856.1213	856.1213	0.0220	0.0348	867.0286

Hawthorne HS Field Improvement Project - Construction Only - South Coast Air Basin, Winter

EMFAC Off-Model Adjustment Factors for Gasoline Light Duty Vehicle to Account for the SAFE Vehicle Rule Applied

4.0 Operational Detail - Mobile

4.1 Mitigation Measures Mobile

	ROG	NOx	CO	SO2	Fugitive PM10	Exhaust PM10	PM10 Total	Fugitive PM2.5	Exhaust PM2.5	PM2.5 Total	Bio- CO2	NBio- CO2	Total CO2	CH4	N2O	CO2e
Category	lb/day										lb/day					
Mitigated	0.0000	0.0000	0.0000	0.0000	0.0000	0.0000	0.0000	0.0000	0.0000	0.0000		0.0000	0.0000	0.0000	0.0000	0.0000
Unmitigated	0.0000	0.0000	0.0000	0.0000	0.0000	0.0000	0.0000	0.0000	0.0000	0.0000		0.0000	0.0000	0.0000	0.0000	0.0000

4.2 Trip Summary Information

Land Use	Average Daily Trip Rate			Unmitigated	Mitigated
	Weekday	Saturday	Sunday	Annual VMT	Annual VMT
High School	0.00	0.00	0.00		
Total	0.00	0.00	0.00		

4.3 Trip Type Information

Land Use	Miles			Trip %			Trip Purpose %		
	H-W or C-W	H-S or C-C	H-O or C-NW	H-W or C-W	H-S or C-C	H-O or C-NW	Primary	Diverted	Pass-by
High School	16.60	8.40	6.90	77.80	17.20	5.00	75	19	6

4.4 Fleet Mix

Land Use	LDA	LDT1	LDT2	MDV	LHD1	LHD2	MHD	HHD	OBUS	UBUS	MCY	SBUS	MH
High School	0.542639	0.062168	0.185423	0.128137	0.023809	0.006526	0.012163	0.008660	0.000816	0.000502	0.024766	0.000746	0.003644

Hawthorne HS Field Improvement Project - Construction Only - South Coast Air Basin, Winter

EMFAC Off-Model Adjustment Factors for Gasoline Light Duty Vehicle to Account for the SAFE Vehicle Rule Applied

5.0 Energy Detail

Historical Energy Use: N

5.1 Mitigation Measures Energy

	ROG	NOx	CO	SO2	Fugitive PM10	Exhaust PM10	PM10 Total	Fugitive PM2.5	Exhaust PM2.5	PM2.5 Total	Bio- CO2	NBio- CO2	Total CO2	CH4	N2O	CO2e
Category	lb/day										lb/day					
NaturalGas Mitigated	0.0000	0.0000	0.0000	0.0000		0.0000	0.0000		0.0000	0.0000		0.0000	0.0000	0.0000	0.0000	0.0000
NaturalGas Unmitigated	0.0000	0.0000	0.0000	0.0000		0.0000	0.0000		0.0000	0.0000		0.0000	0.0000	0.0000	0.0000	0.0000

5.2 Energy by Land Use - NaturalGas

Unmitigated

	NaturalGas Use	ROG	NOx	CO	SO2	Fugitive PM10	Exhaust PM10	PM10 Total	Fugitive PM2.5	Exhaust PM2.5	PM2.5 Total	Bio- CO2	NBio- CO2	Total CO2	CH4	N2O	CO2e
Land Use	kBTU/yr	lb/day										lb/day					
High School	0	0.0000	0.0000	0.0000	0.0000		0.0000	0.0000		0.0000	0.0000		0.0000	0.0000	0.0000	0.0000	0.0000
Total		0.0000	0.0000	0.0000	0.0000		0.0000	0.0000		0.0000	0.0000		0.0000	0.0000	0.0000	0.0000	0.0000

Hawthorne HS Field Improvement Project - Construction Only - South Coast Air Basin, Winter

EMFAC Off-Model Adjustment Factors for Gasoline Light Duty Vehicle to Account for the SAFE Vehicle Rule Applied

5.2 Energy by Land Use - NaturalGas

Mitigated

	NaturalGas Use	ROG	NOx	CO	SO2	Fugitive PM10	Exhaust PM10	PM10 Total	Fugitive PM2.5	Exhaust PM2.5	PM2.5 Total	Bio- CO2	NBio- CO2	Total CO2	CH4	N2O	CO2e	
Land Use	kBTU/yr	lb/day										lb/day						
High School	0	0.0000	0.0000	0.0000	0.0000		0.0000	0.0000		0.0000	0.0000		0.0000	0.0000	0.0000	0.0000	0.0000	0.0000
Total		0.0000	0.0000	0.0000	0.0000		0.0000	0.0000		0.0000	0.0000		0.0000	0.0000	0.0000	0.0000	0.0000	0.0000

6.0 Area Detail

6.1 Mitigation Measures Area

	ROG	NOx	CO	SO2	Fugitive PM10	Exhaust PM10	PM10 Total	Fugitive PM2.5	Exhaust PM2.5	PM2.5 Total	Bio- CO2	NBio- CO2	Total CO2	CH4	N2O	CO2e
Category	lb/day										lb/day					
Mitigated	12.4125	5.1000e-004	0.0566	0.0000		2.0000e-004	2.0000e-004		2.0000e-004	2.0000e-004		0.1216	0.1216	3.2000e-004		0.1295
Unmitigated	12.4125	5.1000e-004	0.0566	0.0000		2.0000e-004	2.0000e-004		2.0000e-004	2.0000e-004		0.1216	0.1216	3.2000e-004		0.1295

Hawthorne HS Field Improvement Project - Construction Only - South Coast Air Basin, Winter

EMFAC Off-Model Adjustment Factors for Gasoline Light Duty Vehicle to Account for the SAFE Vehicle Rule Applied

6.2 Area by SubCategory

Unmitigated

	ROG	NOx	CO	SO2	Fugitive PM10	Exhaust PM10	PM10 Total	Fugitive PM2.5	Exhaust PM2.5	PM2.5 Total	Bio- CO2	NBio- CO2	Total CO2	CH4	N2O	CO2e
SubCategory	lb/day										lb/day					
Architectural Coating	1.4105					0.0000	0.0000		0.0000	0.0000			0.0000			0.0000
Consumer Products	10.9967					0.0000	0.0000		0.0000	0.0000			0.0000			0.0000
Landscaping	5.2100e-003	5.1000e-004	0.0566	0.0000		2.0000e-004	2.0000e-004		2.0000e-004	2.0000e-004		0.1216	0.1216	3.2000e-004		0.1295
Total	12.4125	5.1000e-004	0.0566	0.0000		2.0000e-004	2.0000e-004		2.0000e-004	2.0000e-004		0.1216	0.1216	3.2000e-004		0.1295

Hawthorne HS Field Improvement Project - Construction Only - South Coast Air Basin, Winter

EMFAC Off-Model Adjustment Factors for Gasoline Light Duty Vehicle to Account for the SAFE Vehicle Rule Applied

6.2 Area by SubCategory

Mitigated

	ROG	NOx	CO	SO2	Fugitive PM10	Exhaust PM10	PM10 Total	Fugitive PM2.5	Exhaust PM2.5	PM2.5 Total	Bio- CO2	NBio- CO2	Total CO2	CH4	N2O	CO2e
SubCategory	lb/day										lb/day					
Architectural Coating	1.4105					0.0000	0.0000		0.0000	0.0000			0.0000			0.0000
Consumer Products	10.9967					0.0000	0.0000		0.0000	0.0000			0.0000			0.0000
Landscaping	5.2100e-003	5.1000e-004	0.0566	0.0000		2.0000e-004	2.0000e-004		2.0000e-004	2.0000e-004		0.1216	0.1216	3.2000e-004		0.1295
Total	12.4125	5.1000e-004	0.0566	0.0000		2.0000e-004	2.0000e-004		2.0000e-004	2.0000e-004		0.1216	0.1216	3.2000e-004		0.1295

7.0 Water Detail

7.1 Mitigation Measures Water

Hawthorne HS Field Improvement Project - Construction Only - South Coast Air Basin, Winter

EMFAC Off-Model Adjustment Factors for Gasoline Light Duty Vehicle to Account for the SAFE Vehicle Rule Applied

8.0 Waste Detail

8.1 Mitigation Measures Waste

9.0 Operational Offroad

Equipment Type	Number	Hours/Day	Days/Year	Horse Power	Load Factor	Fuel Type
----------------	--------	-----------	-----------	-------------	-------------	-----------

10.0 Stationary Equipment

Fire Pumps and Emergency Generators

Equipment Type	Number	Hours/Day	Hours/Year	Horse Power	Load Factor	Fuel Type
----------------	--------	-----------	------------	-------------	-------------	-----------

Boilers

Equipment Type	Number	Heat Input/Day	Heat Input/Year	Boiler Rating	Fuel Type
----------------	--------	----------------	-----------------	---------------	-----------

User Defined Equipment

Equipment Type	Number
----------------	--------

11.0 Vegetation

CalEEMod LandUse Type	CalEEMod LandUse Subtype	Amount	Unit	Building SF
<i>Pool</i>				
Recreational	Recreational Swimming Pool	0.26		11,200
Commercial	User Defined	0.37		16,200
Parking	Other Asphalt Surfaces	0.28	acre	12000
Parking	Other Non-Asphalt Surfaces	0.47	acre	20473.2

Construction Schedule

PhaseName	PhaseType	PhaseStartDate	PhaseEndDate	NumDaysWeek	NumDays
Demolition	Demolition	10/1/2024	10/28/2024	5	20
Site Preparation	Site Preparation	10/29/2024	10/30/2024	5	2
Grading	Grading	10/31/2024	11/19/2024	5	14
Building Construction	Building Construction	11/20/2024	8/12/2025	5	190
Paving	Paving	8/13/2025	8/26/2025	5	10
Architectural Coating	Architectural Coating	8/27/2025	9/9/2025	5	10

Construction Equipment

PhaseName	OffRoadEquipmentType	OffRoadEquipmentUsageHours	HorsePower	LoadFactor
Demolition	Concrete/Industrial Saws	1	8	0.73
Demolition	Rubber Tired Dozers	1	8	0.4
Demolition	Tractors/Loaders/Backhoes	3	8	0.37
Site Preparation	Graders	1	8	0.41
Site Preparation	Rubber Tired Dozers	1	7	0.4
Site Preparation	Tractors/Loaders/Backhoes	1	8	0.37
Grading	Graders	1	6	0.41
Grading	Rubber Tired Dozers	1	6	0.4
Grading	Tractors/Loaders/Backhoes	1	7	0.37
Building Construction	Cranes	1	6	0.29
Building Construction	Forklifts	1	6	0.2
Building Construction	Generator Sets	1	8	0.74
Building Construction	Tractors/Loaders/Backhoes	1	6	0.37
Building Construction	Welders	3	8	0.45
Paving	Cement and Mortar Mixers	1	6	0.56
Paving	Pavers	1	6	0.42
Paving	Paving Equipment	1	8	0.36
Paving	Rollers	1	7	0.38
Paving	Tractors/Loaders/Backhoes	1	8	0.37
Architectural Coating	Air Compressors	1	6	0.48

Hawthorne Pool
 Winter
 Air Quality Construction Analysis

Winter Regional Emissions Source	Onsite Emissions						Offsite Emissions					
	ROG	NOX	CO	SO2	Total PM10	Total PM2.5	ROG	NOX	CO	SO2	Total PM10	Total PM2.5
	lb/day						lb/day					
3.2 Demolition - 2024	1.44	13.89	13.49	0.024	1.78	0.76	0.03	4.47	3.95	0.023	0.68	0.20
3.3 Site Preparation - 2024	1.11	11.84	6.63	0.017	2.93	1.62	0.01	0.02	0.29	0.001	0.08	0.02
3.4 Grading - 2024	0.91	9.73	5.55	0.014	0.99	0.65	0.01	0.02	0.29	0.001	0.08	0.02
3.5 Building Construction - 2024	1.42	11.06	12.52	0.022	0.45	0.43	0.02	0.74	1.51	0.005	0.31	0.08
3.5 Building Construction - 2025	1.32	10.41	12.44	0.022	0.39	0.38	0.02	0.71	1.43	0.005	0.31	0.08
3.6 Paving - 2025	0.65	5.33	8.80	0.014	0.247	0.23	0.01	0.03	0.43	0.001	0.134	0.03
3.7 Architectural Coating - 2025	16.09	1.15	1.81	0.003	0.052	0.05	0.00	0.01	0.17	0.000	0.052	0.01
Regional Emissions	ROG	NOX	CO	SO2	Total PM10	Total PM2.5						
3.2 Demolition - 2024	1.5	18.4	17.4	0.0	2.5	1.0						
3.3 Site Preparation - 2024	1.1	11.9	6.9	0.0	3.0	1.6						
3.4 Grading - 2024	0.9	9.8	5.8	0.0	1.1	0.7						
3.5 Building Construction - 2024	1.4	11.8	14.0	0.0	0.8	0.5						
3.5 Building Construction - 2025	1.3	11.1	13.9	0.0	0.7	0.5						
3.6 Paving - 2025	0.7	5.4	9.2	0.0	0.4	0.3						
3.7 Architectural Coating - 2025	16.1	1.2	2.0	0.0	0.1	0.1						
Project Daily Maximum Emissions	16.09	18.36	17.44	0.05	3.01	1.64						

Hawthorne Pool	Hawthorne Pool
Total On-Road Emissions	Total On-Road Emissions

Construction Phase	179 Max construction days per year		Work Hours per Day (hours/day)	One-Way Trip Distance per Day (miles)	Idling per Day (minutes)	Regional Emissions (pounds/day)											(MT/yr)	
	Daily One-Way Trips	Haul Days per Phase (days)				ROG	NOX	CO	SO2	PM10 Dust	PM10 Exh	Total PM10	PM2.5 Dust	PM2.5 Exh	Total PM2.5	Total CO2e		
Demolition																		
	2024																	
Total Haul Trips	544																	
Hauling	28	20	8	20	15	0.02	4.43	3.48	0.02	0.52	0.03	0.55	0.14	0.03	0.17	22.63		
Vendor	0	20	8	6.9	15	0.00	0.00	0.00	0.00	0.00	0.00	0.00	0.00	0.00	0.00	0.00		
Worker	13	20	8	14.7	0	0.01	0.04	0.47	0.00	0.13	0.00	0.13	0.03	0.00	0.03	1.19		
					Total:	0.03	4.47	3.95	0.02	0.65	0.03	0.68	0.17	0.03	0.20	23.82		
Site Preparation																		
	2024																	
Total Haul Trips	0																	
Hauling	0	2	8	20	15	0.00	0.00	0.00	0.00	0.00	0.00	0.00	0.00	0.00	0.00	0.00		
Vendor	0	2	8	6.9	15	0.00	0.00	0.00	0.00	0.00	0.00	0.00	0.00	0.00	0.00	0.00		
Worker	8	2	8	14.7	0	0.01	0.02	0.29	0.00	0.08	0.00	0.08	0.02	0.00	0.02	0.07		
					Total:	0.01	0.02	0.29	0.00	0.08	0.00	0.08	0.02	0.00	0.02	0.07		
Grading																		
	2024																	
Total Haul Trips	0																	
Hauling	0	14	8	20	15	0.00	0.00	0.00	0.00	0.00	0.00	0.00	0.00	0.00	0.00	0.00		
Vendor	0	14	8	6.9	15	0.00	0.00	0.00	0.00	0.00	0.00	0.00	0.00	0.00	0.00	0.00		
Worker	8	14	8	14.7	0	0.01	0.02	0.29	0.00	0.08	0.00	0.08	0.02	0.00	0.02	0.51		
					Total:	0.01	0.02	0.29	0.00	0.08	0.00	0.08	0.02	0.00	0.02	0.51		
Building Construction																		
	2024																	
Total Haul Trips	0																	
Hauling	0	31	8	20	15	0.00	0.00	0.00	0.00	0.00	0.00	0.00	0.00	0.00	0.00	0.00		
Vendor	10	31	8	6.9	15	0.01	0.67	0.64	0.00	0.06	0.00	0.06	0.02	0.00	0.02	4.47		
Worker	24	31	8	14.7	0	0.02	0.07	0.86	0.00	0.25	0.00	0.25	0.06	0.00	0.06	3.41		
					Total:	0.02	0.74	1.51	0.01	0.31	0.00	0.31	0.08	0.00	0.08	7.89		
Building Construction																		
	2025																	
Total Haul Trips	0																	
Hauling	0	159	8	20	15	0.00	0.00	0.00	0.00	0.00	0.00	0.00	0.00	0.00	0.00	0.00		
Vendor	10	159	8	6.9	15	0.01	0.66	0.63	0.00	0.06	0.00	0.06	0.02	0.00	0.02	22.55		
Worker	24	159	8	14.7	0	0.01	0.06	0.80	0.00	0.25	0.00	0.25	0.06	0.00	0.06	17.09		
					Total:	0.02	0.71	1.43	0.01	0.31	0.00	0.31	0.08	0.00	0.08	39.63		
Paving																		
	2025																	
Total Haul Trips	0																	
Hauling	0	10	8	20	15	0.00	0.00	0.00	0.00	0.00	0.00	0.00	0.00	0.00	0.00	0.00		
Vendor	0	10	8	6.9	15	0.00	0.00	0.00	0.00	0.00	0.00	0.00	0.00	0.00	0.00	0.00		
Worker	13	10	8	14.7	0	0.01	0.03	0.43	0.00	0.13	0.00	0.13	0.03	0.00	0.03	0.58		
					Total:	0.01	0.03	0.43	0.00	0.13	0.00	0.13	0.03	0.00	0.03	0.58		
Architectural Coating																		
	2025																	
Total Haul Trips	0																	
Hauling	0	10	8	20	15	0.00	0.00	0.00	0.00	0.00	0.00	0.00	0.00	0.00	0.00	0.00		
Vendor	0	10	8	6.9	15	0.00	0.00	0.00	0.00	0.00	0.00	0.00	0.00	0.00	0.00	0.00		
Worker	5	10	8	14.7	0	0.00	0.01	0.17	0.00	0.05	0.00	0.05	0.01	0.00	0.01	0.22		
					Total:	0.00	0.01	0.17	0.00	0.05	0.00	0.05	0.01	0.00	0.01	0.22		

**Hawthorne Pool
Running Emissions**

Running Emissions Factor (grams/mile)	Running Emissions Factor (grams/mile)
--	--

	ROG	NOX	CO	SO2	PM10	PM2.5	CO2	CH4	N2O
2024Hauling Hauling	0.01500166	1.757966945	0.5097505	0.01416696	0.02319781	0.02218961	1557.21286	0.07114403	0.24811684
2024Vendor Vendor	0.02221033	1.324663487	0.47751009	0.01284951	0.01640294	0.01568629	1384.23319	0.03949423	0.19181212
2024Worker Worker	0.01996092	0.084125691	1.11121797	0.00306134	0.00178709	0.00164482	309.685005	0.0047538	0.0069466
2025Hauling Hauling	0.01431182	1.682904108	0.49345533	0.01390961	0.02282737	0.02183543	1529.97223	0.06799383	0.24382581
2025Vendor Vendor	0.01962764	1.243630697	0.43346534	0.01262634	0.01566747	0.01498289	1361.14553	0.03768321	0.189104
2025Worker Worker	0.01787186	0.075802473	1.03210504	0.00299115	0.00169862	0.00156324	302.584557	0.00430196	0.00645241
2026Hauling Hauling	0.01368221	1.614053992	0.47684787	0.01364538	0.0226378	0.02165426	1501.9816	0.06476403	0.23941148
2026Vendor Vendor	0.01750743	1.169214075	0.39765668	0.0123973	0.01509905	0.01443925	1337.37545	0.03590634	0.1862605
2026Worker Worker	0.01606854	0.068748951	0.96388598	0.00292729	0.0016094	0.00148096	296.123967	0.00390838	0.00603404
2027Hauling Hauling	0.0131128	1.553518611	0.45473657	0.01336714	0.02273486	0.02174732	1471.80075	0.0608523	0.23462364
2027Vendor Vendor	0.01570588	1.102331968	0.36327753	0.01214871	0.01475662	0.01411185	1311.1435	0.03381904	0.18307889
2027Worker Worker	0.01447264	0.062492418	0.90230685	0.0028686	0.00150729	0.0013867	290.185649	0.00356123	0.00566307
GWP	N/A	N/A	N/A	N/A	N/A	N/A	1	25	298

Construction Phase	Daily One-Way Trips	Haul Days per Phase (days)	Work Hours per Day (hours/day)	One-Way Trip Distance per Day (miles)	Regional Emissions (pounds/day)						Regional Emissions (MT/year)			
					ROG	NOX	CO	SO2	PM10	PM2.5	CO2	CH4	N2O	CO2e
Demolition														
Total Haul Trips	544													
Hauling	28	20	8	20	0.02	2.17	0.63	0.02	0.03	0.03	17.44	0.02	0.83	18.29
Vendor	0	20	8	6.9	0.00	0.00	0.00	0.00	0.00	0.00	0.00	0.00	0.00	0.00
Worker	13	20	8	14.7	0.01	0.04	0.47	0.00	0.00	0.00	1.18	0.00	0.01	1.19
Site Preparation														
Total Haul Trips	0													
Hauling	0	2	8	20	0.00	0.00	0.00	0.00	0.00	0.00	0.00	0.00	0.00	0.00
Vendor	0	2	8	6.9	0.00	0.00	0.00	0.00	0.00	0.00	0.00	0.00	0.00	0.00
Worker	8	2	8	14.7	0.01	0.02	0.29	0.00	0.00	0.00	0.07	0.00	0.00	0.07
Grading														
Total Haul Trips	0													
Hauling	0	14	8	20	0.00	0.00	0.00	0.00	0.00	0.00	0.00	0.00	0.00	0.00
Vendor	0	14	8	6.9	0.00	0.00	0.00	0.00	0.00	0.00	0.00	0.00	0.00	0.00
Worker	8	14	8	14.7	0.01	0.02	0.29	0.00	0.00	0.00	0.51	0.00	0.00	0.51
Building Construction														
Total Haul Trips	0													
Hauling	0	31	8	20	0.00	0.00	0.00	0.00	0.00	0.00	0.00	0.00	0.00	0.00
Vendor	10	31	8	6.9	0.00	0.20	0.07	0.00	0.00	0.00	2.96	0.00	0.12	3.09
Worker	24	31	8	14.7	0.02	0.07	0.86	0.00	0.00	0.00	3.39	0.00	0.02	3.41
Building Construction														
Total Haul Trips	0													
Hauling	0	159	8	20	0.00	0.00	0.00	0.00	0.00	0.00	0.00	0.00	0.00	0.00
Vendor	10	159	8	6.9	0.00	0.19	0.07	0.00	0.00	0.00	14.93	0.01	0.62	15.56
Worker	24	159	8	14.7	0.01	0.06	0.80	0.00	0.00	0.00	16.97	0.01	0.11	17.09
Paving														
Total Haul Trips	0													
Hauling	0	10	8	20	0.00	0.00	0.00	0.00	0.00	0.00	0.00	0.00	0.00	0.00
Vendor	0	10	8	6.9	0.00	0.00	0.00	0.00	0.00	0.00	0.00	0.00	0.00	0.00
Worker	13	10	8	14.7	0.01	0.03	0.43	0.00	0.00	0.00	0.58	0.00	0.00	0.58
Architectural Coating														
Total Haul Trips	0													
Hauling	0	10	8	20	0.00	0.00	0.00	0.00	0.00	0.00	0.00	0.00	0.00	0.00
Vendor	0	10	8	6.9	0.00	0.00	0.00	0.00	0.00	0.00	0.00	0.00	0.00	0.00
Worker	5	10	8	14.7	0.00	0.01	0.17	0.00	0.00	0.00	0.22	0.00	0.00	0.22

Hawthorne Pool
Road Dust, Break Wear, and Tire wear Emissions

		Emission Factors (grams/mile)					
		PM10			PM2.5		
		RD	BW	TW	RD	BW	TW
2024	Hauling Hauling	3.00E-01	0.08427948	0.03543928	7.36E-02	0.02949782	0.00885982
2024	Vendor Vendor	3.00E-01	0.063890978	0.02371964	7.36E-02	0.02236184	0.00592991
2024	Worker Worker	3.00E-01	0.009419633	0.008	7.36E-02	0.00329687	0.002
2025	Hauling Hauling	3.00E-01	0.084162962	0.03544313	7.36E-02	0.02945704	0.00886078
2025	Vendor Vendor	3.00E-01	0.063767774	0.02372157	7.36E-02	0.02231872	0.00593039
2025	Worker Worker	3.00E-01	0.009385513	0.008	7.36E-02	0.00328493	0.002
2026	Hauling Hauling	3.00E-01	0.084352575	0.03544711	7.36E-02	0.0295234	0.00886178
2026	Vendor Vendor	3.00E-01	0.063787152	0.02372356	7.36E-02	0.0223255	0.00593089
2026	Worker Worker	3.00E-01	0.009353635	0.008	7.36E-02	0.00327377	0.002
2027	Hauling Hauling	3.00E-01	0.084297987	0.03545106	7.36E-02	0.0295043	0.00886277
2027	Vendor Vendor	3.00E-01	0.063623189	0.02372553	7.36E-02	0.02226812	0.00593138
2027	Worker Worker	3.00E-01	0.009305649	0.008	7.36E-02	0.00325698	0.002

Construction Phase	Daily One-Way Trips	Haul Days per Phase (days)	Work Hours per Day (hours/day)	One-Way Trip Distance per Day (miles)	Regional Emissions (pounds/day)					
					RD	PM10 BW	TW	RD	PM2.5 BW	TW
Demolition										
Total Haul Trips	544									
Hauling	28	20	8	20	0.37	0.10	0.04	0.09	0.04	0.01
Vendor	0	20	8	6.9	0.00	0.00	0.00	0.00	0.00	0.00
Worker	13	20	8	14.7	0.13	0.00	0.00	0.03	0.00	0.00
Site Preparation										
Total Haul Trips	0									
Hauling	0	2	8	20	0.00	0.00	0.00	0.00	0.00	0.00
Vendor	0	2	8	6.9	0.00	0.00	0.00	0.00	0.00	0.00
Worker	8	2	8	14.7	0.08	0.00	0.00	0.02	0.00	0.00
Grading										
Total Haul Trips	0									
Hauling	0	14	8	20	0.00	0.00	0.00	0.00	0.00	0.00
Vendor	0	14	8	6.9	0.00	0.00	0.00	0.00	0.00	0.00
Worker	8	14	8	14.7	0.08	0.00	0.00	0.02	0.00	0.00
Building Construction										
Total Haul Trips	0									
Hauling	0	31	8	20	0.00	0.00	0.00	0.00	0.00	0.00
Vendor	10	31	8	6.9	0.05	0.01	0.00	0.01	0.00	0.00
Worker	24	31	8	14.7	0.23	0.01	0.01	0.06	0.00	0.00
Building Construction										
Total Haul Trips	0									
Hauling	0	159	8	20	0.00	0.00	0.00	0.00	0.00	0.00
Vendor	10	159	8	6.9	0.05	0.01	0.00	0.01	0.00	0.00
Worker	24	159	8	14.7	0.23	0.01	0.01	0.06	0.00	0.00
Paving										
Total Haul Trips	0									
Hauling	0	10	8	20	0.00	0.00	0.00	0.00	0.00	0.00
Vendor	0	10	8	6.9	0.00	0.00	0.00	0.00	0.00	0.00
Worker	13	10	8	14.7	0.13	0.00	0.00	0.03	0.00	0.00
Architectural Coating										
Total Haul Trips	0									
Hauling	0	10	8	20	0.00	0.00	0.00	0.00	0.00	0.00
Vendor	0	10	8	6.9	0.00	0.00	0.00	0.00	0.00	0.00
Worker	5	10	8	14.7	0.05	0.00	0.00	0.01	0.00	0.00

Hawthorne Pool	Hawthorne Pool
Total On-Road Fuel Consumption	Total On-Road Fuel Consumption

	gal/mile	gal/min
2024Hauling Hauling	0.16534457	1.98496E-07
2024Vendor Vendor	0.13876713	6.53915E-07
2024Worker Worker	0.03843741	8.66366E-07
2025Hauling Hauling	0.16305171	1.95685E-07
2025Vendor Vendor	0.13736272	6.50149E-07
2025Worker Worker	0.0377809	8.51473E-07
2026Hauling Hauling	0.00028353	3.5284E-10
2026Vendor Vendor	0.00023979	1.15112E-09
2026Worker Worker	1.1175E-05	2.51628E-10
2027Hauling Hauling	0.00027945	3.17148E-10
2027Vendor Vendor	0.00023737	1.26476E-09
2027Worker Worker	1.0686E-05	2.25058E-10

Source	Fuel Type	Total Fuel Use (gal)
Hauling	Diesel	1,852
Vendor	Diesel	1,804
Worker	Gasoline	2,759

Fuel Type	Total Fuel Use	Annual Fuel Use
Diesel	3,656	3,890
Gasoline	2,759	2,936

Duration of Construction
0.9 years

Construction Phase	Daily One-Way Trips	Haul Days per Phase (days)	Work Hours per Day (hours/day)	One-Way Trip Distance per Day (miles)	Idling per Day (minutes)	Regional Emissions				
						gal/mile	gal/min	gal/day	Total Gallons/yr	
Demolition										
2024										
Total Haul Trips	544									
Hauling	28	20	8	20	15	0.17	1.98E-07	93	1,852	
Vendor	0	20	8	6.9	15	0.14	6.54E-07	0	0	
Worker	13	20	8	14.7	0	0.04	8.66E-07	7	147	
Site Preparation										
2024										
Total Haul Trips	0									
Hauling	0	2	8	20	15	0.17	1.98E-07	0	0	
Vendor	0	2	8	6.9	15	0.14	6.54E-07	0	0	
Worker	8	2	8	14.7	0	0.04	8.66E-07	5	9	
Grading										
2024										
Total Haul Trips	0									
Hauling	0	14	8	20	15	0.17	1.98E-07	0	0	
Vendor	0	14	8	6.9	15	0.14	6.54E-07	0	0	
Worker	8	14	8	14.7	0	0.04	8.66E-07	5	63	
Building Construction										
2024										
Total Haul Trips	0									
Hauling	0	31	8	20	15	0.17	1.98E-07	0	0	
Vendor	10	31	8	6.9	15	0.14	6.54E-07	10	297	
Worker	24	31	8	14.7	0	0.04	8.66E-07	14	420	
Building Construction										
2025										
Total Haul Trips	0									
Hauling	0	159	8	20	15	0.16	1.96E-07	0	0	
Vendor	10	159	8	6.9	15	0.14	6.50E-07	9	1,507	
Worker	24	159	8	14.7	0	0.04	8.51E-07	13	2,119	
Paving										
2025										
Total Haul Trips	0									
Hauling	0	10	8	20	15	0.16	1.96E-07	0	0	
Vendor	0	10	8	6.9	15	0.14	6.50E-07	0	0	
Worker	13	10	8	14.7	0	0.04	8.51E-07	7	72	
Architectural Coating										
2025										
Total Haul Trips	0									
Hauling	0	10	8	20	15	0.16	1.96E-07	0	0	
Vendor	0	10	8	6.9	15	0.14	6.50E-07	0	0	
Worker	5	10	8	14.7	0	0.04	8.51E-07	3	28	

Hawthorne Pool

Road Dust

Paved Road Dust Emission Factors (Assumes No Precipitation)

Formula: $EF_{Dust,P} = (k (sL)^{0.91} \times (W)^{1.02})$

Where:

$EF_{Dust,P}$ = Paved Road Dust Emission Factor (having the same units as k)
 k = particle size multiplier
 sL = road surface silt loading (g/m^2)
 W = average fleet vehicle weight (tons) (CARB uses 2.4 tons as a fleet average vehicle weight factor)

Emission Factor (grams per VMT)		
	PM10	PM2.5
k	0.9979	0.2449
sL	0.1	0.1
W	2.4	2.4
$EF_{Dust,P}$	3.00E-01	7.36E-02

Unpaved Road Dust Emission Factors (Assumes No Precipitation)

Formula: $EF_{Dust,U} = (k (s / 12)^1 \times (Sp / 30)^{0.5} / (M / 0.5)^{0.2}) - C$

Where:

$EF_{Dust,U}$ = Unpaved Road Dust Emission Factor (having the same units as k)
 k = particle size multiplier
 s = surface material silt content (%)
 Sp = mean vehicle speed (mph)
 M = surface material moisture content (%)
 C = Emission Factor for 1980s vehicle fleet exhaust, brake wear, and tire wear

Emission Factor (grams per VMT)		
	PM10	PM2.5
k	816.47	81.65
s	4.3%	4.3%
Sp	15	15
M	0.5%	0.5%
C	0.00047	0.00036
$EF_{Dust,U}$	5.20E+00	5.19E-01

Sources:

SCAQMD, CalEEMod, Version 2011.1.

CARB, *Entrained Dust from Paved Road Travel: Emission Estimation Methodology Background Document*, (1997).

USEPA, *AP-42*, Fifth Edition, Volume I, Chapter 13.2.1 - Paved Roads, (2011).

PCR Services Corporation, 2013.

Hawthorne High School Pool - South Coast Air Basin, Annual

EMFAC Off-Model Adjustment Factors for Gasoline Light Duty Vehicle to Account for the SAFE Vehicle Rule Not Applied

Hawthorne High School Pool

South Coast Air Basin, Annual

1.0 Project Characteristics

1.1 Land Usage

Land Uses	Size	Metric	Lot Acreage	Floor Surface Area	Population
User Defined Commercial	0.37	User Defined Unit	0.37	16,200.00	0
Other Asphalt Surfaces	12.00	1000sqft	0.28	12,000.00	0
Other Non-Asphalt Surfaces	0.47	Acre	0.47	20,473.20	0
Recreational Swimming Pool	11.20	1000sqft	0.26	11,200.00	0

1.2 Other Project Characteristics

Urbanization	Urban	Wind Speed (m/s)	2.2	Precipitation Freq (Days)	31
Climate Zone	8			Operational Year	2026
Utility Company	Southern California Edison				
CO2 Intensity (lb/MWhr)	390.98	CH4 Intensity (lb/MWhr)	0.033	N2O Intensity (lb/MWhr)	0.004

1.3 User Entered Comments & Non-Default Data

- Project Characteristics -
- Land Use - User Defined Commercial - structures
- Construction Phase - See Construction Assumptions Default
- Off-road Equipment - See Assumption Defaults
- Trips and VMT -
- Demolition - Demolition of Pool, Recreational Area, Asphalt surfaces
- Grading -
- Vehicle Trips -
- Vehicle Emission Factors -

Hawthorne High School Pool - South Coast Air Basin, Annual

EMFAC Off-Model Adjustment Factors for Gasoline Light Duty Vehicle to Account for the SAFE Vehicle Rule Not Applied

Vehicle Emission Factors -

Vehicle Emission Factors -

Construction Off-road Equipment Mitigation -

Fleet Mix -

Table Name	Column Name	Default Value	New Value
tblConstructionPhase	NumDays	200.00	190.00
tblConstructionPhase	NumDays	4.00	14.00
tblLandUse	LandUseSquareFeet	0.00	16,200.00
tblLandUse	LotAcreage	0.00	0.37
tblOffRoadEquipment	OffRoadEquipmentUnitAmount	2.00	1.00
tblOffRoadEquipment	UsageHours	8.00	6.00
tblOffRoadEquipment	UsageHours	8.00	6.00

2.0 Emissions Summary

Hawthorne High School Pool - South Coast Air Basin, Annual

EMFAC Off-Model Adjustment Factors for Gasoline Light Duty Vehicle to Account for the SAFE Vehicle Rule Not Applied

2.1 Overall Construction

Unmitigated Construction

	ROG	NOx	CO	SO2	Fugitive PM10	Exhaust PM10	PM10 Total	Fugitive PM2.5	Exhaust PM2.5	PM2.5 Total	Bio- CO2	NBio- CO2	Total CO2	CH4	N2O	CO2e
Year	tons/yr										MT/yr					
2024	0.0452	0.4095	0.3918	8.4000e-004	0.0823	0.0165	0.0988	0.0280	0.0156	0.0436	0.0000	73.4922	73.4922	0.0139	1.7300e-003	74.3532
2025	0.1959	0.9000	1.1161	2.1600e-003	0.0271	0.0332	0.0603	7.3100e-003	0.0319	0.0393	0.0000	182.4724	182.4724	0.0266	2.4000e-003	183.8508
Maximum	0.1959	0.9000	1.1161	2.1600e-003	0.0823	0.0332	0.0988	0.0280	0.0319	0.0436	0.0000	182.4724	182.4724	0.0266	2.4000e-003	183.8508

Mitigated Construction

	ROG	NOx	CO	SO2	Fugitive PM10	Exhaust PM10	PM10 Total	Fugitive PM2.5	Exhaust PM2.5	PM2.5 Total	Bio- CO2	NBio- CO2	Total CO2	CH4	N2O	CO2e
Year	tons/yr										MT/yr					
2024	0.0452	0.4095	0.3918	8.4000e-004	0.0378	0.0165	0.0543	0.0125	0.0156	0.0281	0.0000	73.4921	73.4921	0.0139	1.7300e-003	74.3531
2025	0.1959	0.9000	1.1161	2.1600e-003	0.0271	0.0332	0.0603	7.3100e-003	0.0319	0.0393	0.0000	182.4722	182.4722	0.0266	2.4000e-003	183.8506
Maximum	0.1959	0.9000	1.1161	2.1600e-003	0.0378	0.0332	0.0603	0.0125	0.0319	0.0393	0.0000	182.4722	182.4722	0.0266	2.4000e-003	183.8506

Hawthorne High School Pool - South Coast Air Basin, Annual

EMFAC Off-Model Adjustment Factors for Gasoline Light Duty Vehicle to Account for the SAFE Vehicle Rule Not Applied

	ROG	NOx	CO	SO2	Fugitive PM10	Exhaust PM10	PM10 Total	Fugitive PM2.5	Exhaust PM2.5	PM2.5 Total	Bio- CO2	NBio-CO2	Total CO2	CH4	N2O	CO2e
Percent Reduction	0.00	0.00	0.00	0.00	40.67	0.00	27.96	44.01	0.00	18.74	0.00	0.00	0.00	0.00	0.00	0.00

Quarter	Start Date	End Date	Maximum Unmitigated ROG + NOX (tons/quarter)	Maximum Mitigated ROG + NOX (tons/quarter)
1	10-1-2024	12-31-2024	0.4524	0.4524
2	1-1-2025	3-31-2025	0.3936	0.3936
3	4-1-2025	6-30-2025	0.3972	0.3972
4	7-1-2025	9-30-2025	0.3041	0.3041
		Highest	0.4524	0.4524

2.2 Overall Operational

Unmitigated Operational

	ROG	NOx	CO	SO2	Fugitive PM10	Exhaust PM10	PM10 Total	Fugitive PM2.5	Exhaust PM2.5	PM2.5 Total	Bio- CO2	NBio- CO2	Total CO2	CH4	N2O	CO2e
Category	tons/yr										MT/yr					
Area	0.0686	0.0000	3.1000e-004	0.0000		0.0000	0.0000		0.0000	0.0000	0.0000	6.0000e-004	6.0000e-004	0.0000	0.0000	6.4000e-004
Energy	0.0000	0.0000	0.0000	0.0000		0.0000	0.0000		0.0000	0.0000	0.0000	0.0000	0.0000	0.0000	0.0000	0.0000
Mobile	0.1077	0.1148	1.0061	2.1700e-003	0.2447	1.5900e-003	0.2463	0.0653	1.4800e-003	0.0668	0.0000	200.4215	200.4215	0.0141	9.3800e-003	203.5687
Waste						0.0000	0.0000		0.0000	0.0000	12.9589	0.0000	12.9589	0.7659	0.0000	32.1052
Water						0.0000	0.0000		0.0000	0.0000	0.2102	2.3296	2.5397	0.0218	5.3000e-004	3.2432
Total	0.1763	0.1148	1.0065	2.1700e-003	0.2447	1.5900e-003	0.2463	0.0653	1.4800e-003	0.0668	13.1691	202.7516	215.9207	0.8018	9.9100e-003	238.9178

Hawthorne High School Pool - South Coast Air Basin, Annual

EMFAC Off-Model Adjustment Factors for Gasoline Light Duty Vehicle to Account for the SAFE Vehicle Rule Not Applied

2.2 Overall Operational

Mitigated Operational

	ROG	NOx	CO	SO2	Fugitive PM10	Exhaust PM10	PM10 Total	Fugitive PM2.5	Exhaust PM2.5	PM2.5 Total	Bio- CO2	NBio- CO2	Total CO2	CH4	N2O	CO2e
Category	tons/yr										MT/yr					
Area	0.0686	0.0000	3.1000e-004	0.0000		0.0000	0.0000		0.0000	0.0000	0.0000	6.0000e-004	6.0000e-004	0.0000	0.0000	6.4000e-004
Energy	0.0000	0.0000	0.0000	0.0000		0.0000	0.0000		0.0000	0.0000	0.0000	0.0000	0.0000	0.0000	0.0000	0.0000
Mobile	0.1077	0.1148	1.0061	2.1700e-003	0.2447	1.5900e-003	0.2463	0.0653	1.4800e-003	0.0668	0.0000	200.4215	200.4215	0.0141	9.3800e-003	203.5687
Waste						0.0000	0.0000		0.0000	0.0000	12.9589	0.0000	12.9589	0.7659	0.0000	32.1052
Water						0.0000	0.0000		0.0000	0.0000	0.2102	2.3296	2.5397	0.0218	5.3000e-004	3.2432
Total	0.1763	0.1148	1.0065	2.1700e-003	0.2447	1.5900e-003	0.2463	0.0653	1.4800e-003	0.0668	13.1691	202.7516	215.9207	0.8018	9.9100e-003	238.9178

	ROG	NOx	CO	SO2	Fugitive PM10	Exhaust PM10	PM10 Total	Fugitive PM2.5	Exhaust PM2.5	PM2.5 Total	Bio- CO2	NBio- CO2	Total CO2	CH4	N2O	CO2e
Percent Reduction	0.00	0.00	0.00	0.00	0.00	0.00	0.00	0.00	0.00	0.00	0.00	0.00	0.00	0.00	0.00	0.00

3.0 Construction Detail

Construction Phase

Phase Number	Phase Name	Phase Type	Start Date	End Date	Num Days Week	Num Days	Phase Description
1	Demolition	Demolition	10/1/2024	10/28/2024	5	20	
2	Site Preparation	Site Preparation	10/29/2024	10/30/2024	5	2	
3	Grading	Grading	10/31/2024	11/19/2024	5	14	

Hawthorne High School Pool - South Coast Air Basin, Annual

EMFAC Off-Model Adjustment Factors for Gasoline Light Duty Vehicle to Account for the SAFE Vehicle Rule Not Applied

4	Building Construction	Building Construction	11/20/2024	8/12/2025	5	190
5	Paving	Paving	8/13/2025	8/26/2025	5	10
6	Architectural Coating	Architectural Coating	8/27/2025	9/9/2025	5	10

Acres of Grading (Site Preparation Phase): 1.88

Acres of Grading (Grading Phase): 10.5

Acres of Paving: 0.75

Residential Indoor: 0; Residential Outdoor: 0; Non-Residential Indoor: 24,300; Non-Residential Outdoor: 8,100; Striped Parking Area: 1,948 (Architectural Coating – sqft)

OffRoad Equipment

Phase Name	Offroad Equipment Type	Amount	Usage Hours	Horse Power	Load Factor
Demolition	Concrete/Industrial Saws	1	8.00	81	0.73
Demolition	Rubber Tired Dozers	1	8.00	247	0.40
Demolition	Tractors/Loaders/Backhoes	3	8.00	97	0.37
Site Preparation	Graders	1	8.00	187	0.41
Site Preparation	Rubber Tired Dozers	1	7.00	247	0.40
Site Preparation	Tractors/Loaders/Backhoes	1	8.00	97	0.37
Grading	Graders	1	6.00	187	0.41
Grading	Rubber Tired Dozers	1	6.00	247	0.40
Grading	Tractors/Loaders/Backhoes	1	7.00	97	0.37
Building Construction	Cranes	1	6.00	231	0.29
Building Construction	Forklifts	1	6.00	89	0.20
Building Construction	Generator Sets	1	8.00	84	0.74
Building Construction	Tractors/Loaders/Backhoes	1	6.00	97	0.37
Building Construction	Welders	3	8.00	46	0.45
Paving	Cement and Mortar Mixers	1	6.00	9	0.56
Paving	Pavers	1	6.00	130	0.42
Paving	Paving Equipment	1	8.00	132	0.36

Hawthorne High School Pool - South Coast Air Basin, Annual

EMFAC Off-Model Adjustment Factors for Gasoline Light Duty Vehicle to Account for the SAFE Vehicle Rule Not Applied

Paving	Rollers	1	7.00	80	0.38
Paving	Tractors/Loaders/Backhoes	1	8.00	97	0.37
Architectural Coating	Air Compressors	1	6.00	78	0.48

Trips and VMT

Phase Name	Offroad Equipment Count	Worker Trip Number	Vendor Trip Number	Hauling Trip Number	Worker Trip Length	Vendor Trip Length	Hauling Trip Length	Worker Vehicle Class	Vendor Vehicle Class	Hauling Vehicle Class
Demolition	5	13.00	0.00	272.00	14.70	6.90	20.00	LD_Mix	HDT_Mix	HHDT
Site Preparation	3	8.00	0.00	0.00	14.70	6.90	20.00	LD_Mix	HDT_Mix	HHDT
Grading	3	8.00	0.00	0.00	14.70	6.90	20.00	LD_Mix	HDT_Mix	HHDT
Building Construction	7	24.00	10.00	0.00	14.70	6.90	20.00	LD_Mix	HDT_Mix	HHDT
Paving	5	13.00	0.00	0.00	14.70	6.90	20.00	LD_Mix	HDT_Mix	HHDT
Architectural Coating	1	5.00	0.00	0.00	14.70	6.90	20.00	LD_Mix	HDT_Mix	HHDT

3.1 Mitigation Measures Construction

Water Exposed Area

Hawthorne High School Pool - South Coast Air Basin, Annual

EMFAC Off-Model Adjustment Factors for Gasoline Light Duty Vehicle to Account for the SAFE Vehicle Rule Not Applied

3.2 Demolition - 2024

Unmitigated Construction On-Site

	ROG	NOx	CO	SO2	Fugitive PM10	Exhaust PM10	PM10 Total	Fugitive PM2.5	Exhaust PM2.5	PM2.5 Total	Bio- CO2	NBio- CO2	Total CO2	CH4	N2O	CO2e
Category	tons/yr										MT/yr					
Fugitive Dust					0.0295	0.0000	0.0295	4.4600e-003	0.0000	4.4600e-003	0.0000	0.0000	0.0000	0.0000	0.0000	0.0000
Off-Road	0.0144	0.1389	0.1349	2.4000e-004		6.3100e-003	6.3100e-003		5.8900e-003	5.8900e-003	0.0000	21.0916	21.0916	5.3400e-003	0.0000	21.2250
Total	0.0144	0.1389	0.1349	2.4000e-004	0.0295	6.3100e-003	0.0358	4.4600e-003	5.8900e-003	0.0104	0.0000	21.0916	21.0916	5.3400e-003	0.0000	21.2250

Unmitigated Construction Off-Site

	ROG	NOx	CO	SO2	Fugitive PM10	Exhaust PM10	PM10 Total	Fugitive PM2.5	Exhaust PM2.5	PM2.5 Total	Bio- CO2	NBio- CO2	Total CO2	CH4	N2O	CO2e
Category	tons/yr										MT/yr					
Hauling	2.8000e-004	0.0177	4.7800e-003	8.0000e-005	2.3400e-003	1.2000e-004	2.4600e-003	6.4000e-004	1.1000e-004	7.6000e-004	0.0000	7.7256	7.7256	4.8000e-004	1.2300e-003	8.1040
Vendor	0.0000	0.0000	0.0000	0.0000	0.0000	0.0000	0.0000	0.0000	0.0000	0.0000	0.0000	0.0000	0.0000	0.0000	0.0000	0.0000
Worker	3.8000e-004	2.8000e-004	3.9500e-003	1.0000e-005	1.4300e-003	1.0000e-005	1.4300e-003	3.8000e-004	1.0000e-005	3.9000e-004	0.0000	1.0835	1.0835	3.0000e-005	3.0000e-005	1.0921
Total	6.6000e-004	0.0180	8.7300e-003	9.0000e-005	3.7700e-003	1.3000e-004	3.8900e-003	1.0200e-003	1.2000e-004	1.1500e-003	0.0000	8.8091	8.8091	5.1000e-004	1.2600e-003	9.1960

Hawthorne High School Pool - South Coast Air Basin, Annual

EMFAC Off-Model Adjustment Factors for Gasoline Light Duty Vehicle to Account for the SAFE Vehicle Rule Not Applied

3.2 Demolition - 2024

Mitigated Construction On-Site

	ROG	NOx	CO	SO2	Fugitive PM10	Exhaust PM10	PM10 Total	Fugitive PM2.5	Exhaust PM2.5	PM2.5 Total	Bio- CO2	NBio- CO2	Total CO2	CH4	N2O	CO2e
Category	tons/yr										MT/yr					
Fugitive Dust					0.0115	0.0000	0.0115	1.7400e-003	0.0000	1.7400e-003	0.0000	0.0000	0.0000	0.0000	0.0000	0.0000
Off-Road	0.0144	0.1389	0.1349	2.4000e-004		6.3100e-003	6.3100e-003		5.8900e-003	5.8900e-003	0.0000	21.0915	21.0915	5.3400e-003	0.0000	21.2250
Total	0.0144	0.1389	0.1349	2.4000e-004	0.0115	6.3100e-003	0.0178	1.7400e-003	5.8900e-003	7.6300e-003	0.0000	21.0915	21.0915	5.3400e-003	0.0000	21.2250

Mitigated Construction Off-Site

	ROG	NOx	CO	SO2	Fugitive PM10	Exhaust PM10	PM10 Total	Fugitive PM2.5	Exhaust PM2.5	PM2.5 Total	Bio- CO2	NBio- CO2	Total CO2	CH4	N2O	CO2e
Category	tons/yr										MT/yr					
Hauling	2.8000e-004	0.0177	4.7800e-003	8.0000e-005	2.3400e-003	1.2000e-004	2.4600e-003	6.4000e-004	1.1000e-004	7.6000e-004	0.0000	7.7256	7.7256	4.8000e-004	1.2300e-003	8.1040
Vendor	0.0000	0.0000	0.0000	0.0000	0.0000	0.0000	0.0000	0.0000	0.0000	0.0000	0.0000	0.0000	0.0000	0.0000	0.0000	0.0000
Worker	3.8000e-004	2.8000e-004	3.9500e-003	1.0000e-005	1.4300e-003	1.0000e-005	1.4300e-003	3.8000e-004	1.0000e-005	3.9000e-004	0.0000	1.0835	1.0835	3.0000e-005	3.0000e-005	1.0921
Total	6.6000e-004	0.0180	8.7300e-003	9.0000e-005	3.7700e-003	1.3000e-004	3.8900e-003	1.0200e-003	1.2000e-004	1.1500e-003	0.0000	8.8091	8.8091	5.1000e-004	1.2600e-003	9.1960

Hawthorne High School Pool - South Coast Air Basin, Annual

EMFAC Off-Model Adjustment Factors for Gasoline Light Duty Vehicle to Account for the SAFE Vehicle Rule Not Applied

3.3 Site Preparation - 2024

Unmitigated Construction On-Site

	ROG	NOx	CO	SO2	Fugitive PM10	Exhaust PM10	PM10 Total	Fugitive PM2.5	Exhaust PM2.5	PM2.5 Total	Bio- CO2	NBio- CO2	Total CO2	CH4	N2O	CO2e
Category	tons/yr										MT/yr					
Fugitive Dust					6.2700e-003	0.0000	6.2700e-003	3.0000e-003	0.0000	3.0000e-003	0.0000	0.0000	0.0000	0.0000	0.0000	0.0000
Off-Road	1.1100e-003	0.0118	6.6300e-003	2.0000e-005		4.8000e-004	4.8000e-004		4.4000e-004	4.4000e-004	0.0000	1.5113	1.5113	4.9000e-004	0.0000	1.5235
Total	1.1100e-003	0.0118	6.6300e-003	2.0000e-005	6.2700e-003	4.8000e-004	6.7500e-003	3.0000e-003	4.4000e-004	3.4400e-003	0.0000	1.5113	1.5113	4.9000e-004	0.0000	1.5235

Unmitigated Construction Off-Site

	ROG	NOx	CO	SO2	Fugitive PM10	Exhaust PM10	PM10 Total	Fugitive PM2.5	Exhaust PM2.5	PM2.5 Total	Bio- CO2	NBio- CO2	Total CO2	CH4	N2O	CO2e
Category	tons/yr										MT/yr					
Hauling	0.0000	0.0000	0.0000	0.0000	0.0000	0.0000	0.0000	0.0000	0.0000	0.0000	0.0000	0.0000	0.0000	0.0000	0.0000	0.0000
Vendor	0.0000	0.0000	0.0000	0.0000	0.0000	0.0000	0.0000	0.0000	0.0000	0.0000	0.0000	0.0000	0.0000	0.0000	0.0000	0.0000
Worker	2.0000e-005	2.0000e-005	2.4000e-004	0.0000	9.0000e-005	0.0000	9.0000e-005	2.0000e-005	0.0000	2.0000e-005	0.0000	0.0667	0.0667	0.0000	0.0000	0.0672
Total	2.0000e-005	2.0000e-005	2.4000e-004	0.0000	9.0000e-005	0.0000	9.0000e-005	2.0000e-005	0.0000	2.0000e-005	0.0000	0.0667	0.0667	0.0000	0.0000	0.0672

Hawthorne High School Pool - South Coast Air Basin, Annual

EMFAC Off-Model Adjustment Factors for Gasoline Light Duty Vehicle to Account for the SAFE Vehicle Rule Not Applied

3.3 Site Preparation - 2024

Mitigated Construction On-Site

	ROG	NOx	CO	SO2	Fugitive PM10	Exhaust PM10	PM10 Total	Fugitive PM2.5	Exhaust PM2.5	PM2.5 Total	Bio- CO2	NBio- CO2	Total CO2	CH4	N2O	CO2e
Category	tons/yr										MT/yr					
Fugitive Dust					2.4400e-003	0.0000	2.4400e-003	1.1700e-003	0.0000	1.1700e-003	0.0000	0.0000	0.0000	0.0000	0.0000	0.0000
Off-Road	1.1100e-003	0.0118	6.6300e-003	2.0000e-005		4.8000e-004	4.8000e-004		4.4000e-004	4.4000e-004	0.0000	1.5113	1.5113	4.9000e-004	0.0000	1.5235
Total	1.1100e-003	0.0118	6.6300e-003	2.0000e-005	2.4400e-003	4.8000e-004	2.9200e-003	1.1700e-003	4.4000e-004	1.6100e-003	0.0000	1.5113	1.5113	4.9000e-004	0.0000	1.5235

Mitigated Construction Off-Site

	ROG	NOx	CO	SO2	Fugitive PM10	Exhaust PM10	PM10 Total	Fugitive PM2.5	Exhaust PM2.5	PM2.5 Total	Bio- CO2	NBio- CO2	Total CO2	CH4	N2O	CO2e
Category	tons/yr										MT/yr					
Hauling	0.0000	0.0000	0.0000	0.0000	0.0000	0.0000	0.0000	0.0000	0.0000	0.0000	0.0000	0.0000	0.0000	0.0000	0.0000	0.0000
Vendor	0.0000	0.0000	0.0000	0.0000	0.0000	0.0000	0.0000	0.0000	0.0000	0.0000	0.0000	0.0000	0.0000	0.0000	0.0000	0.0000
Worker	2.0000e-005	2.0000e-005	2.4000e-004	0.0000	9.0000e-005	0.0000	9.0000e-005	2.0000e-005	0.0000	2.0000e-005	0.0000	0.0667	0.0667	0.0000	0.0000	0.0672
Total	2.0000e-005	2.0000e-005	2.4000e-004	0.0000	9.0000e-005	0.0000	9.0000e-005	2.0000e-005	0.0000	2.0000e-005	0.0000	0.0667	0.0667	0.0000	0.0000	0.0672

Hawthorne High School Pool - South Coast Air Basin, Annual

EMFAC Off-Model Adjustment Factors for Gasoline Light Duty Vehicle to Account for the SAFE Vehicle Rule Not Applied

3.4 Grading - 2024

Unmitigated Construction On-Site

	ROG	NOx	CO	SO2	Fugitive PM10	Exhaust PM10	PM10 Total	Fugitive PM2.5	Exhaust PM2.5	PM2.5 Total	Bio- CO2	NBio- CO2	Total CO2	CH4	N2O	CO2e
Category	tons/yr										MT/yr					
Fugitive Dust					0.0372	0.0000	0.0372	0.0180	0.0000	0.0180	0.0000	0.0000	0.0000	0.0000	0.0000	0.0000
Off-Road	6.3900e-003	0.0681	0.0388	1.0000e-004		2.8000e-003	2.8000e-003		2.5800e-003	2.5800e-003	0.0000	8.6660	8.6660	2.8000e-003	0.0000	8.7361
Total	6.3900e-003	0.0681	0.0388	1.0000e-004	0.0372	2.8000e-003	0.0400	0.0180	2.5800e-003	0.0206	0.0000	8.6660	8.6660	2.8000e-003	0.0000	8.7361

Unmitigated Construction Off-Site

	ROG	NOx	CO	SO2	Fugitive PM10	Exhaust PM10	PM10 Total	Fugitive PM2.5	Exhaust PM2.5	PM2.5 Total	Bio- CO2	NBio- CO2	Total CO2	CH4	N2O	CO2e
Category	tons/yr										MT/yr					
Hauling	0.0000	0.0000	0.0000	0.0000	0.0000	0.0000	0.0000	0.0000	0.0000	0.0000	0.0000	0.0000	0.0000	0.0000	0.0000	0.0000
Vendor	0.0000	0.0000	0.0000	0.0000	0.0000	0.0000	0.0000	0.0000	0.0000	0.0000	0.0000	0.0000	0.0000	0.0000	0.0000	0.0000
Worker	1.6000e-004	1.2000e-004	1.7000e-003	1.0000e-005	6.1000e-004	0.0000	6.2000e-004	1.6000e-004	0.0000	1.7000e-004	0.0000	0.4667	0.4667	1.0000e-005	1.0000e-005	0.4704
Total	1.6000e-004	1.2000e-004	1.7000e-003	1.0000e-005	6.1000e-004	0.0000	6.2000e-004	1.6000e-004	0.0000	1.7000e-004	0.0000	0.4667	0.4667	1.0000e-005	1.0000e-005	0.4704

Hawthorne High School Pool - South Coast Air Basin, Annual

EMFAC Off-Model Adjustment Factors for Gasoline Light Duty Vehicle to Account for the SAFE Vehicle Rule Not Applied

3.4 Grading - 2024

Mitigated Construction On-Site

	ROG	NOx	CO	SO2	Fugitive PM10	Exhaust PM10	PM10 Total	Fugitive PM2.5	Exhaust PM2.5	PM2.5 Total	Bio- CO2	NBio- CO2	Total CO2	CH4	N2O	CO2e
Category	tons/yr										MT/yr					
Fugitive Dust					0.0145	0.0000	0.0145	7.0100e-003	0.0000	7.0100e-003	0.0000	0.0000	0.0000	0.0000	0.0000	0.0000
Off-Road	6.3900e-003	0.0681	0.0388	1.0000e-004		2.8000e-003	2.8000e-003		2.5800e-003	2.5800e-003	0.0000	8.6660	8.6660	2.8000e-003	0.0000	8.7361
Total	6.3900e-003	0.0681	0.0388	1.0000e-004	0.0145	2.8000e-003	0.0173	7.0100e-003	2.5800e-003	9.5900e-003	0.0000	8.6660	8.6660	2.8000e-003	0.0000	8.7361

Mitigated Construction Off-Site

	ROG	NOx	CO	SO2	Fugitive PM10	Exhaust PM10	PM10 Total	Fugitive PM2.5	Exhaust PM2.5	PM2.5 Total	Bio- CO2	NBio- CO2	Total CO2	CH4	N2O	CO2e
Category	tons/yr										MT/yr					
Hauling	0.0000	0.0000	0.0000	0.0000	0.0000	0.0000	0.0000	0.0000	0.0000	0.0000	0.0000	0.0000	0.0000	0.0000	0.0000	0.0000
Vendor	0.0000	0.0000	0.0000	0.0000	0.0000	0.0000	0.0000	0.0000	0.0000	0.0000	0.0000	0.0000	0.0000	0.0000	0.0000	0.0000
Worker	1.6000e-004	1.2000e-004	1.7000e-003	1.0000e-005	6.1000e-004	0.0000	6.2000e-004	1.6000e-004	0.0000	1.7000e-004	0.0000	0.4667	0.4667	1.0000e-005	1.0000e-005	0.4704
Total	1.6000e-004	1.2000e-004	1.7000e-003	1.0000e-005	6.1000e-004	0.0000	6.2000e-004	1.6000e-004	0.0000	1.7000e-004	0.0000	0.4667	0.4667	1.0000e-005	1.0000e-005	0.4704

Hawthorne High School Pool - South Coast Air Basin, Annual

EMFAC Off-Model Adjustment Factors for Gasoline Light Duty Vehicle to Account for the SAFE Vehicle Rule Not Applied

3.5 Building Construction - 2024

Unmitigated Construction On-Site

	ROG	NOx	CO	SO2	Fugitive PM10	Exhaust PM10	PM10 Total	Fugitive PM2.5	Exhaust PM2.5	PM2.5 Total	Bio- CO2	NBio- CO2	Total CO2	CH4	N2O	CO2e
Category	tons/yr										MT/yr					
Off-Road	0.0213	0.1660	0.1878	3.3000e-004		6.7600e-003	6.7600e-003		6.5200e-003	6.5200e-003	0.0000	27.2417	27.2417	4.5400e-003	0.0000	27.3551
Total	0.0213	0.1660	0.1878	3.3000e-004		6.7600e-003	6.7600e-003		6.5200e-003	6.5200e-003	0.0000	27.2417	27.2417	4.5400e-003	0.0000	27.3551

Unmitigated Construction Off-Site

	ROG	NOx	CO	SO2	Fugitive PM10	Exhaust PM10	PM10 Total	Fugitive PM2.5	Exhaust PM2.5	PM2.5 Total	Bio- CO2	NBio- CO2	Total CO2	CH4	N2O	CO2e
Category	tons/yr										MT/yr					
Hauling	0.0000	0.0000	0.0000	0.0000	0.0000	0.0000	0.0000	0.0000	0.0000	0.0000	0.0000	0.0000	0.0000	0.0000	0.0000	0.0000
Vendor	1.5000e-004	5.7800e-003	2.1000e-003	3.0000e-005	9.5000e-004	3.0000e-005	9.8000e-004	2.7000e-004	3.0000e-005	3.0000e-004	0.0000	2.6388	2.6388	1.0000e-004	3.8000e-004	2.7556
Worker	1.0400e-003	7.7000e-004	0.0109	3.0000e-005	3.9500e-003	2.0000e-005	3.9700e-003	1.0500e-003	2.0000e-005	1.0700e-003	0.0000	3.0004	3.0004	7.0000e-005	7.0000e-005	3.0242
Total	1.1900e-003	6.5500e-003	0.0130	6.0000e-005	4.9000e-003	5.0000e-005	4.9500e-003	1.3200e-003	5.0000e-005	1.3700e-003	0.0000	5.6392	5.6392	1.7000e-004	4.5000e-004	5.7798

Hawthorne High School Pool - South Coast Air Basin, Annual

EMFAC Off-Model Adjustment Factors for Gasoline Light Duty Vehicle to Account for the SAFE Vehicle Rule Not Applied

3.5 Building Construction - 2024

Mitigated Construction On-Site

	ROG	NOx	CO	SO2	Fugitive PM10	Exhaust PM10	PM10 Total	Fugitive PM2.5	Exhaust PM2.5	PM2.5 Total	Bio- CO2	NBio- CO2	Total CO2	CH4	N2O	CO2e
Category	tons/yr										MT/yr					
Off-Road	0.0213	0.1660	0.1878	3.3000e-004		6.7600e-003	6.7600e-003		6.5200e-003	6.5200e-003	0.0000	27.2417	27.2417	4.5400e-003	0.0000	27.3551
Total	0.0213	0.1660	0.1878	3.3000e-004		6.7600e-003	6.7600e-003		6.5200e-003	6.5200e-003	0.0000	27.2417	27.2417	4.5400e-003	0.0000	27.3551

Mitigated Construction Off-Site

	ROG	NOx	CO	SO2	Fugitive PM10	Exhaust PM10	PM10 Total	Fugitive PM2.5	Exhaust PM2.5	PM2.5 Total	Bio- CO2	NBio- CO2	Total CO2	CH4	N2O	CO2e
Category	tons/yr										MT/yr					
Hauling	0.0000	0.0000	0.0000	0.0000	0.0000	0.0000	0.0000	0.0000	0.0000	0.0000	0.0000	0.0000	0.0000	0.0000	0.0000	0.0000
Vendor	1.5000e-004	5.7800e-003	2.1000e-003	3.0000e-005	9.5000e-004	3.0000e-005	9.8000e-004	2.7000e-004	3.0000e-005	3.0000e-004	0.0000	2.6388	2.6388	1.0000e-004	3.8000e-004	2.7556
Worker	1.0400e-003	7.7000e-004	0.0109	3.0000e-005	3.9500e-003	2.0000e-005	3.9700e-003	1.0500e-003	2.0000e-005	1.0700e-003	0.0000	3.0004	3.0004	7.0000e-005	7.0000e-005	3.0242
Total	1.1900e-003	6.5500e-003	0.0130	6.0000e-005	4.9000e-003	5.0000e-005	4.9500e-003	1.3200e-003	5.0000e-005	1.3700e-003	0.0000	5.6392	5.6392	1.7000e-004	4.5000e-004	5.7798

Hawthorne High School Pool - South Coast Air Basin, Annual

EMFAC Off-Model Adjustment Factors for Gasoline Light Duty Vehicle to Account for the SAFE Vehicle Rule Not Applied

3.5 Building Construction - 2025

Unmitigated Construction On-Site

	ROG	NOx	CO	SO2	Fugitive PM10	Exhaust PM10	PM10 Total	Fugitive PM2.5	Exhaust PM2.5	PM2.5 Total	Bio- CO2	NBio- CO2	Total CO2	CH4	N2O	CO2e
Category	tons/yr										MT/yr					
Off-Road	0.1060	0.8330	0.9952	1.7600e-003		0.0314	0.0314		0.0303	0.0303	0.0000	145.3058	145.3058	0.0237	0.0000	145.8989
Total	0.1060	0.8330	0.9952	1.7600e-003		0.0314	0.0314		0.0303	0.0303	0.0000	145.3058	145.3058	0.0237	0.0000	145.8989

Unmitigated Construction Off-Site

	ROG	NOx	CO	SO2	Fugitive PM10	Exhaust PM10	PM10 Total	Fugitive PM2.5	Exhaust PM2.5	PM2.5 Total	Bio- CO2	NBio- CO2	Total CO2	CH4	N2O	CO2e
Category	tons/yr										MT/yr					
Hauling	0.0000	0.0000	0.0000	0.0000	0.0000	0.0000	0.0000	0.0000	0.0000	0.0000	0.0000	0.0000	0.0000	0.0000	0.0000	0.0000
Vendor	8.0000e-004	0.0307	0.0111	1.4000e-004	5.0400e-003	1.6000e-004	5.2100e-003	1.4600e-003	1.6000e-004	1.6100e-003	0.0000	13.8211	13.8211	5.3000e-004	2.0100e-003	14.4339
Worker	5.2200e-003	3.6900e-003	0.0543	1.7000e-004	0.0211	1.1000e-004	0.0212	5.5900e-003	1.0000e-004	5.7000e-003	0.0000	15.4575	15.4575	3.5000e-004	3.7000e-004	15.5761
Total	6.0200e-003	0.0344	0.0654	3.1000e-004	0.0261	2.7000e-004	0.0264	7.0500e-003	2.6000e-004	7.3100e-003	0.0000	29.2787	29.2787	8.8000e-004	2.3800e-003	30.0100

Hawthorne High School Pool - South Coast Air Basin, Annual

EMFAC Off-Model Adjustment Factors for Gasoline Light Duty Vehicle to Account for the SAFE Vehicle Rule Not Applied

3.5 Building Construction - 2025

Mitigated Construction On-Site

	ROG	NOx	CO	SO2	Fugitive PM10	Exhaust PM10	PM10 Total	Fugitive PM2.5	Exhaust PM2.5	PM2.5 Total	Bio- CO2	NBio- CO2	Total CO2	CH4	N2O	CO2e
Category	tons/yr										MT/yr					
Off-Road	0.1060	0.8330	0.9952	1.7600e-003		0.0314	0.0314		0.0303	0.0303	0.0000	145.3056	145.3056	0.0237	0.0000	145.8987
Total	0.1060	0.8330	0.9952	1.7600e-003		0.0314	0.0314		0.0303	0.0303	0.0000	145.3056	145.3056	0.0237	0.0000	145.8987

Mitigated Construction Off-Site

	ROG	NOx	CO	SO2	Fugitive PM10	Exhaust PM10	PM10 Total	Fugitive PM2.5	Exhaust PM2.5	PM2.5 Total	Bio- CO2	NBio- CO2	Total CO2	CH4	N2O	CO2e
Category	tons/yr										MT/yr					
Hauling	0.0000	0.0000	0.0000	0.0000	0.0000	0.0000	0.0000	0.0000	0.0000	0.0000	0.0000	0.0000	0.0000	0.0000	0.0000	0.0000
Vendor	8.0000e-004	0.0307	0.0111	1.4000e-004	5.0400e-003	1.6000e-004	5.2100e-003	1.4600e-003	1.6000e-004	1.6100e-003	0.0000	13.8211	13.8211	5.3000e-004	2.0100e-003	14.4339
Worker	5.2200e-003	3.6900e-003	0.0543	1.7000e-004	0.0211	1.1000e-004	0.0212	5.5900e-003	1.0000e-004	5.7000e-003	0.0000	15.4575	15.4575	3.5000e-004	3.7000e-004	15.5761
Total	6.0200e-003	0.0344	0.0654	3.1000e-004	0.0261	2.7000e-004	0.0264	7.0500e-003	2.6000e-004	7.3100e-003	0.0000	29.2787	29.2787	8.8000e-004	2.3800e-003	30.0100

Hawthorne High School Pool - South Coast Air Basin, Annual

EMFAC Off-Model Adjustment Factors for Gasoline Light Duty Vehicle to Account for the SAFE Vehicle Rule Not Applied

3.6 Paving - 2025

Unmitigated Construction On-Site

	ROG	NOx	CO	SO2	Fugitive PM10	Exhaust PM10	PM10 Total	Fugitive PM2.5	Exhaust PM2.5	PM2.5 Total	Bio- CO2	NBio- CO2	Total CO2	CH4	N2O	CO2e
Category	tons/yr										MT/yr					
Off-Road	2.8700e-003	0.0266	0.0440	7.0000e-005		1.2300e-003	1.2300e-003		1.1400e-003	1.1400e-003	0.0000	5.8868	5.8868	1.8700e-003	0.0000	5.9334
Paving	3.7000e-004					0.0000	0.0000		0.0000	0.0000	0.0000	0.0000	0.0000	0.0000	0.0000	0.0000
Total	3.2400e-003	0.0266	0.0440	7.0000e-005		1.2300e-003	1.2300e-003		1.1400e-003	1.1400e-003	0.0000	5.8868	5.8868	1.8700e-003	0.0000	5.9334

Unmitigated Construction Off-Site

	ROG	NOx	CO	SO2	Fugitive PM10	Exhaust PM10	PM10 Total	Fugitive PM2.5	Exhaust PM2.5	PM2.5 Total	Bio- CO2	NBio- CO2	Total CO2	CH4	N2O	CO2e
Category	tons/yr										MT/yr					
Hauling	0.0000	0.0000	0.0000	0.0000	0.0000	0.0000	0.0000	0.0000	0.0000	0.0000	0.0000	0.0000	0.0000	0.0000	0.0000	0.0000
Vendor	0.0000	0.0000	0.0000	0.0000	0.0000	0.0000	0.0000	0.0000	0.0000	0.0000	0.0000	0.0000	0.0000	0.0000	0.0000	0.0000
Worker	1.8000e-004	1.2000e-004	1.8400e-003	1.0000e-005	7.1000e-004	0.0000	7.2000e-004	1.9000e-004	0.0000	1.9000e-004	0.0000	0.5233	0.5233	1.0000e-005	1.0000e-005	0.5273
Total	1.8000e-004	1.2000e-004	1.8400e-003	1.0000e-005	7.1000e-004	0.0000	7.2000e-004	1.9000e-004	0.0000	1.9000e-004	0.0000	0.5233	0.5233	1.0000e-005	1.0000e-005	0.5273

Hawthorne High School Pool - South Coast Air Basin, Annual

EMFAC Off-Model Adjustment Factors for Gasoline Light Duty Vehicle to Account for the SAFE Vehicle Rule Not Applied

3.6 Paving - 2025

Mitigated Construction On-Site

	ROG	NOx	CO	SO2	Fugitive PM10	Exhaust PM10	PM10 Total	Fugitive PM2.5	Exhaust PM2.5	PM2.5 Total	Bio- CO2	NBio- CO2	Total CO2	CH4	N2O	CO2e
Category	tons/yr										MT/yr					
Off-Road	2.8700e-003	0.0266	0.0440	7.0000e-005		1.2300e-003	1.2300e-003		1.1400e-003	1.1400e-003	0.0000	5.8868	5.8868	1.8700e-003	0.0000	5.9334
Paving	3.7000e-004					0.0000	0.0000		0.0000	0.0000	0.0000	0.0000	0.0000	0.0000	0.0000	0.0000
Total	3.2400e-003	0.0266	0.0440	7.0000e-005		1.2300e-003	1.2300e-003		1.1400e-003	1.1400e-003	0.0000	5.8868	5.8868	1.8700e-003	0.0000	5.9334

Mitigated Construction Off-Site

	ROG	NOx	CO	SO2	Fugitive PM10	Exhaust PM10	PM10 Total	Fugitive PM2.5	Exhaust PM2.5	PM2.5 Total	Bio- CO2	NBio- CO2	Total CO2	CH4	N2O	CO2e
Category	tons/yr										MT/yr					
Hauling	0.0000	0.0000	0.0000	0.0000	0.0000	0.0000	0.0000	0.0000	0.0000	0.0000	0.0000	0.0000	0.0000	0.0000	0.0000	0.0000
Vendor	0.0000	0.0000	0.0000	0.0000	0.0000	0.0000	0.0000	0.0000	0.0000	0.0000	0.0000	0.0000	0.0000	0.0000	0.0000	0.0000
Worker	1.8000e-004	1.2000e-004	1.8400e-003	1.0000e-005	7.1000e-004	0.0000	7.2000e-004	1.9000e-004	0.0000	1.9000e-004	0.0000	0.5233	0.5233	1.0000e-005	1.0000e-005	0.5273
Total	1.8000e-004	1.2000e-004	1.8400e-003	1.0000e-005	7.1000e-004	0.0000	7.2000e-004	1.9000e-004	0.0000	1.9000e-004	0.0000	0.5233	0.5233	1.0000e-005	1.0000e-005	0.5273

Hawthorne High School Pool - South Coast Air Basin, Annual

EMFAC Off-Model Adjustment Factors for Gasoline Light Duty Vehicle to Account for the SAFE Vehicle Rule Not Applied

3.7 Architectural Coating - 2025

Unmitigated Construction On-Site

	ROG	NOx	CO	SO2	Fugitive PM10	Exhaust PM10	PM10 Total	Fugitive PM2.5	Exhaust PM2.5	PM2.5 Total	Bio- CO2	NBio- CO2	Total CO2	CH4	N2O	CO2e
Category	tons/yr										MT/yr					
Archit. Coating	0.0796					0.0000	0.0000		0.0000	0.0000	0.0000	0.0000	0.0000	0.0000	0.0000	0.0000
Off-Road	8.5000e-004	5.7300e-003	9.0500e-003	1.0000e-005		2.6000e-004	2.6000e-004		2.6000e-004	2.6000e-004	0.0000	1.2766	1.2766	7.0000e-005	0.0000	1.2784
Total	0.0805	5.7300e-003	9.0500e-003	1.0000e-005		2.6000e-004	2.6000e-004		2.6000e-004	2.6000e-004	0.0000	1.2766	1.2766	7.0000e-005	0.0000	1.2784

Unmitigated Construction Off-Site

	ROG	NOx	CO	SO2	Fugitive PM10	Exhaust PM10	PM10 Total	Fugitive PM2.5	Exhaust PM2.5	PM2.5 Total	Bio- CO2	NBio- CO2	Total CO2	CH4	N2O	CO2e
Category	tons/yr										MT/yr					
Hauling	0.0000	0.0000	0.0000	0.0000	0.0000	0.0000	0.0000	0.0000	0.0000	0.0000	0.0000	0.0000	0.0000	0.0000	0.0000	0.0000
Vendor	0.0000	0.0000	0.0000	0.0000	0.0000	0.0000	0.0000	0.0000	0.0000	0.0000	0.0000	0.0000	0.0000	0.0000	0.0000	0.0000
Worker	7.0000e-005	5.0000e-005	7.1000e-004	0.0000	2.7000e-004	0.0000	2.8000e-004	7.0000e-005	0.0000	7.0000e-005	0.0000	0.2013	0.2013	0.0000	0.0000	0.2028
Total	7.0000e-005	5.0000e-005	7.1000e-004	0.0000	2.7000e-004	0.0000	2.8000e-004	7.0000e-005	0.0000	7.0000e-005	0.0000	0.2013	0.2013	0.0000	0.0000	0.2028

Hawthorne High School Pool - South Coast Air Basin, Annual

EMFAC Off-Model Adjustment Factors for Gasoline Light Duty Vehicle to Account for the SAFE Vehicle Rule Not Applied

3.7 Architectural Coating - 2025

Mitigated Construction On-Site

	ROG	NOx	CO	SO2	Fugitive PM10	Exhaust PM10	PM10 Total	Fugitive PM2.5	Exhaust PM2.5	PM2.5 Total	Bio- CO2	NBio- CO2	Total CO2	CH4	N2O	CO2e
Category	tons/yr										MT/yr					
Archit. Coating	0.0796					0.0000	0.0000		0.0000	0.0000	0.0000	0.0000	0.0000	0.0000	0.0000	0.0000
Off-Road	8.5000e-004	5.7300e-003	9.0500e-003	1.0000e-005		2.6000e-004	2.6000e-004		2.6000e-004	2.6000e-004	0.0000	1.2766	1.2766	7.0000e-005	0.0000	1.2784
Total	0.0805	5.7300e-003	9.0500e-003	1.0000e-005		2.6000e-004	2.6000e-004		2.6000e-004	2.6000e-004	0.0000	1.2766	1.2766	7.0000e-005	0.0000	1.2784

Mitigated Construction Off-Site

	ROG	NOx	CO	SO2	Fugitive PM10	Exhaust PM10	PM10 Total	Fugitive PM2.5	Exhaust PM2.5	PM2.5 Total	Bio- CO2	NBio- CO2	Total CO2	CH4	N2O	CO2e
Category	tons/yr										MT/yr					
Hauling	0.0000	0.0000	0.0000	0.0000	0.0000	0.0000	0.0000	0.0000	0.0000	0.0000	0.0000	0.0000	0.0000	0.0000	0.0000	0.0000
Vendor	0.0000	0.0000	0.0000	0.0000	0.0000	0.0000	0.0000	0.0000	0.0000	0.0000	0.0000	0.0000	0.0000	0.0000	0.0000	0.0000
Worker	7.0000e-005	5.0000e-005	7.1000e-004	0.0000	2.7000e-004	0.0000	2.8000e-004	7.0000e-005	0.0000	7.0000e-005	0.0000	0.2013	0.2013	0.0000	0.0000	0.2028
Total	7.0000e-005	5.0000e-005	7.1000e-004	0.0000	2.7000e-004	0.0000	2.8000e-004	7.0000e-005	0.0000	7.0000e-005	0.0000	0.2013	0.2013	0.0000	0.0000	0.2028

Hawthorne High School Pool - South Coast Air Basin, Annual

EMFAC Off-Model Adjustment Factors for Gasoline Light Duty Vehicle to Account for the SAFE Vehicle Rule Not Applied

4.0 Operational Detail - Mobile

4.1 Mitigation Measures Mobile

	ROG	NOx	CO	SO2	Fugitive PM10	Exhaust PM10	PM10 Total	Fugitive PM2.5	Exhaust PM2.5	PM2.5 Total	Bio- CO2	NBio- CO2	Total CO2	CH4	N2O	CO2e
Category	tons/yr										MT/yr					
Mitigated	0.1077	0.1148	1.0061	2.1700e-003	0.2447	1.5900e-003	0.2463	0.0653	1.4800e-003	0.0668	0.0000	200.4215	200.4215	0.0141	9.3800e-003	203.5687
Unmitigated	0.1077	0.1148	1.0061	2.1700e-003	0.2447	1.5900e-003	0.2463	0.0653	1.4800e-003	0.0668	0.0000	200.4215	200.4215	0.0141	9.3800e-003	203.5687

4.2 Trip Summary Information

Land Use	Average Daily Trip Rate			Unmitigated	Mitigated
	Weekday	Saturday	Sunday	Annual VMT	Annual VMT
Other Asphalt Surfaces	0.00	0.00	0.00		
Other Non-Asphalt Surfaces	0.00	0.00	0.00		
Recreational Swimming Pool	322.78	101.92	152.32	649,989	649,989
User Defined Commercial	0.00	0.00	0.00		
Total	322.78	101.92	152.32	649,989	649,989

4.3 Trip Type Information

Land Use	Miles			Trip %			Trip Purpose %		
	H-W or C-W	H-S or C-C	H-O or C-NW	H-W or C-W	H-S or C-C	H-O or C-NW	Primary	Diverted	Pass-by
Other Asphalt Surfaces	16.60	8.40	6.90	0.00	0.00	0.00	0	0	0
Other Non-Asphalt Surfaces	16.60	8.40	6.90	0.00	0.00	0.00	0	0	0
Recreational Swimming Pool	16.60	8.40	6.90	33.00	48.00	19.00	52	39	9

Hawthorne High School Pool - South Coast Air Basin, Annual

EMFAC Off-Model Adjustment Factors for Gasoline Light Duty Vehicle to Account for the SAFE Vehicle Rule Not Applied

Land Use	Miles			Trip %			Trip Purpose %		
	H-W or C-W	H-S or C-C	H-O or C-NW	H-W or C-W	H-S or C-C	H-O or C-NW	Primary	Diverted	Pass-by
User Defined Commercial	16.60	8.40	6.90	0.00	0.00	0.00	0	0	0

4.4 Fleet Mix

Land Use	LDA	LDT1	LDT2	MDV	LHD1	LHD2	MHD	HHD	OBUS	UBUS	MCY	SBUS	MH
Other Asphalt Surfaces	0.541801	0.062785	0.185964	0.127448	0.023798	0.006607	0.012341	0.008651	0.000818	0.000497	0.024959	0.000748	0.003583
Other Non-Asphalt Surfaces	0.541801	0.062785	0.185964	0.127448	0.023798	0.006607	0.012341	0.008651	0.000818	0.000497	0.024959	0.000748	0.003583
Recreational Swimming Pool	0.541801	0.062785	0.185964	0.127448	0.023798	0.006607	0.012341	0.008651	0.000818	0.000497	0.024959	0.000748	0.003583
User Defined Commercial	0.541801	0.062785	0.185964	0.127448	0.023798	0.006607	0.012341	0.008651	0.000818	0.000497	0.024959	0.000748	0.003583

5.0 Energy Detail

Historical Energy Use: N

5.1 Mitigation Measures Energy

Hawthorne High School Pool - South Coast Air Basin, Annual

EMFAC Off-Model Adjustment Factors for Gasoline Light Duty Vehicle to Account for the SAFE Vehicle Rule Not Applied

5.3 Energy by Land Use - Electricity

Unmitigated

	Electricity Use	Total CO2	CH4	N2O	CO2e
Land Use	kWh/yr	MT/yr			
Other Asphalt Surfaces	0	0.0000	0.0000	0.0000	0.0000
Other Non-Asphalt Surfaces	0	0.0000	0.0000	0.0000	0.0000
Recreational Swimming Pool	0	0.0000	0.0000	0.0000	0.0000
User Defined Commercial	0	0.0000	0.0000	0.0000	0.0000
Total		0.0000	0.0000	0.0000	0.0000

Hawthorne High School Pool - South Coast Air Basin, Annual

EMFAC Off-Model Adjustment Factors for Gasoline Light Duty Vehicle to Account for the SAFE Vehicle Rule Not Applied

5.3 Energy by Land Use - Electricity

Mitigated

	Electricity Use	Total CO2	CH4	N2O	CO2e
Land Use	kWh/yr	MT/yr			
Other Asphalt Surfaces	0	0.0000	0.0000	0.0000	0.0000
Other Non-Asphalt Surfaces	0	0.0000	0.0000	0.0000	0.0000
Recreational Swimming Pool	0	0.0000	0.0000	0.0000	0.0000
User Defined Commercial	0	0.0000	0.0000	0.0000	0.0000
Total		0.0000	0.0000	0.0000	0.0000

6.0 Area Detail

6.1 Mitigation Measures Area

Hawthorne High School Pool - South Coast Air Basin, Annual

EMFAC Off-Model Adjustment Factors for Gasoline Light Duty Vehicle to Account for the SAFE Vehicle Rule Not Applied

	ROG	NOx	CO	SO2	Fugitive PM10	Exhaust PM10	PM10 Total	Fugitive PM2.5	Exhaust PM2.5	PM2.5 Total	Bio- CO2	NBio- CO2	Total CO2	CH4	N2O	CO2e
Category	tons/yr										MT/yr					
Mitigated	0.0686	0.0000	3.1000e-004	0.0000		0.0000	0.0000		0.0000	0.0000	0.0000	6.0000e-004	6.0000e-004	0.0000	0.0000	6.4000e-004
Unmitigated	0.0686	0.0000	3.1000e-004	0.0000		0.0000	0.0000		0.0000	0.0000	0.0000	6.0000e-004	6.0000e-004	0.0000	0.0000	6.4000e-004

6.2 Area by SubCategory

Unmitigated

	ROG	NOx	CO	SO2	Fugitive PM10	Exhaust PM10	PM10 Total	Fugitive PM2.5	Exhaust PM2.5	PM2.5 Total	Bio- CO2	NBio- CO2	Total CO2	CH4	N2O	CO2e
SubCategory	tons/yr										MT/yr					
Architectural Coating	7.9600e-003					0.0000	0.0000		0.0000	0.0000	0.0000	0.0000	0.0000	0.0000	0.0000	0.0000
Consumer Products	0.0606					0.0000	0.0000		0.0000	0.0000	0.0000	0.0000	0.0000	0.0000	0.0000	0.0000
Landscaping	3.0000e-005	0.0000	3.1000e-004	0.0000		0.0000	0.0000		0.0000	0.0000	0.0000	6.0000e-004	6.0000e-004	0.0000	0.0000	6.4000e-004
Total	0.0686	0.0000	3.1000e-004	0.0000		0.0000	0.0000		0.0000	0.0000	0.0000	6.0000e-004	6.0000e-004	0.0000	0.0000	6.4000e-004

Hawthorne High School Pool - South Coast Air Basin, Annual

EMFAC Off-Model Adjustment Factors for Gasoline Light Duty Vehicle to Account for the SAFE Vehicle Rule Not Applied

6.2 Area by SubCategory

Mitigated

	ROG	NOx	CO	SO2	Fugitive PM10	Exhaust PM10	PM10 Total	Fugitive PM2.5	Exhaust PM2.5	PM2.5 Total	Bio- CO2	NBio- CO2	Total CO2	CH4	N2O	CO2e
SubCategory	tons/yr										MT/yr					
Architectural Coating	7.9600e-003					0.0000	0.0000		0.0000	0.0000	0.0000	0.0000	0.0000	0.0000	0.0000	0.0000
Consumer Products	0.0606					0.0000	0.0000		0.0000	0.0000	0.0000	0.0000	0.0000	0.0000	0.0000	0.0000
Landscaping	3.0000e-005	0.0000	3.1000e-004	0.0000		0.0000	0.0000		0.0000	0.0000	0.0000	6.0000e-004	6.0000e-004	0.0000	0.0000	6.4000e-004
Total	0.0686	0.0000	3.1000e-004	0.0000		0.0000	0.0000		0.0000	0.0000	0.0000	6.0000e-004	6.0000e-004	0.0000	0.0000	6.4000e-004

7.0 Water Detail

7.1 Mitigation Measures Water

Hawthorne High School Pool - South Coast Air Basin, Annual

EMFAC Off-Model Adjustment Factors for Gasoline Light Duty Vehicle to Account for the SAFE Vehicle Rule Not Applied

	Total CO2	CH4	N2O	CO2e
Category	MT/yr			
Mitigated	2.5397	0.0218	5.3000e-004	3.2432
Unmitigated	2.5397	0.0218	5.3000e-004	3.2432

7.2 Water by Land Use

Unmitigated

	Indoor/Outdoor Use	Total CO2	CH4	N2O	CO2e
Land Use	Mgal	MT/yr			
Other Asphalt Surfaces	0 / 0	0.0000	0.0000	0.0000	0.0000
Other Non-Asphalt Surfaces	0 / 0	0.0000	0.0000	0.0000	0.0000
Recreational Swimming Pool	0.662403 / 0.405989	2.5397	0.0218	5.3000e-004	3.2432
User Defined Commercial	0 / 0	0.0000	0.0000	0.0000	0.0000
Total		2.5397	0.0218	5.3000e-004	3.2432

Hawthorne High School Pool - South Coast Air Basin, Annual

EMFAC Off-Model Adjustment Factors for Gasoline Light Duty Vehicle to Account for the SAFE Vehicle Rule Not Applied

7.2 Water by Land Use

Mitigated

	Indoor/Outdoor Use	Total CO2	CH4	N2O	CO2e
Land Use	Mgal	MT/yr			
Other Asphalt Surfaces	0 / 0	0.0000	0.0000	0.0000	0.0000
Other Non-Asphalt Surfaces	0 / 0	0.0000	0.0000	0.0000	0.0000
Recreational Swimming Pool	0.662403 / 0.405989	2.5397	0.0218	5.3000e-004	3.2432
User Defined Commercial	0 / 0	0.0000	0.0000	0.0000	0.0000
Total		2.5397	0.0218	5.3000e-004	3.2432

8.0 Waste Detail

8.1 Mitigation Measures Waste

Hawthorne High School Pool - South Coast Air Basin, Annual

EMFAC Off-Model Adjustment Factors for Gasoline Light Duty Vehicle to Account for the SAFE Vehicle Rule Not Applied

Category/Year

	Total CO2	CH4	N2O	CO2e
	MT/yr			
Mitigated	12.9589	0.7659	0.0000	32.1052
Unmitigated	12.9589	0.7659	0.0000	32.1052

8.2 Waste by Land Use

Unmitigated

	Waste Disposed	Total CO2	CH4	N2O	CO2e
Land Use	tons	MT/yr			
Other Asphalt Surfaces	0	0.0000	0.0000	0.0000	0.0000
Other Non-Asphalt Surfaces	0	0.0000	0.0000	0.0000	0.0000
Recreational Swimming Pool	63.84	12.9589	0.7659	0.0000	32.1052
User Defined Commercial	0	0.0000	0.0000	0.0000	0.0000
Total		12.9589	0.7659	0.0000	32.1052

Hawthorne High School Pool - South Coast Air Basin, Annual

EMFAC Off-Model Adjustment Factors for Gasoline Light Duty Vehicle to Account for the SAFE Vehicle Rule Not Applied

8.2 Waste by Land Use

Mitigated

	Waste Disposed	Total CO2	CH4	N2O	CO2e
Land Use	tons	MT/yr			
Other Asphalt Surfaces	0	0.0000	0.0000	0.0000	0.0000
Other Non-Asphalt Surfaces	0	0.0000	0.0000	0.0000	0.0000
Recreational Swimming Pool	63.84	12.9589	0.7659	0.0000	32.1052
User Defined Commercial	0	0.0000	0.0000	0.0000	0.0000
Total		12.9589	0.7659	0.0000	32.1052

9.0 Operational Offroad

Equipment Type	Number	Hours/Day	Days/Year	Horse Power	Load Factor	Fuel Type
----------------	--------	-----------	-----------	-------------	-------------	-----------

10.0 Stationary Equipment

Fire Pumps and Emergency Generators

Equipment Type	Number	Hours/Day	Hours/Year	Horse Power	Load Factor	Fuel Type
----------------	--------	-----------	------------	-------------	-------------	-----------

Boilers

Equipment Type	Number	Heat Input/Day	Heat Input/Year	Boiler Rating	Fuel Type
----------------	--------	----------------	-----------------	---------------	-----------

User Defined Equipment

Hawthorne High School Pool - South Coast Air Basin, Annual

EMFAC Off-Model Adjustment Factors for Gasoline Light Duty Vehicle to Account for the SAFE Vehicle Rule Not Applied

Equipment Type	Number
----------------	--------

11.0 Vegetation

Hawthorne High School Pool - South Coast Air Basin, Summer

EMFAC Off-Model Adjustment Factors for Gasoline Light Duty Vehicle to Account for the SAFE Vehicle Rule Not Applied

**Hawthorne High School Pool
South Coast Air Basin, Summer**

1.0 Project Characteristics

1.1 Land Usage

Land Uses	Size	Metric	Lot Acreage	Floor Surface Area	Population
User Defined Commercial	0.37	User Defined Unit	0.37	16,200.00	0
Other Asphalt Surfaces	12.00	1000sqft	0.28	12,000.00	0
Other Non-Asphalt Surfaces	0.47	Acre	0.47	20,473.20	0
Recreational Swimming Pool	11.20	1000sqft	0.26	11,200.00	0

1.2 Other Project Characteristics

Urbanization	Urban	Wind Speed (m/s)	2.2	Precipitation Freq (Days)	31
Climate Zone	8			Operational Year	2026
Utility Company	Southern California Edison				
CO2 Intensity (lb/MWhr)	390.98	CH4 Intensity (lb/MWhr)	0.033	N2O Intensity (lb/MWhr)	0.004

1.3 User Entered Comments & Non-Default Data

- Project Characteristics -
- Land Use - User Defined Commercial - structures
- Construction Phase - See Construction Assumptions Default
- Off-road Equipment - See Assumption Defaults
- Trips and VMT -
- Demolition - Demolition of Pool, Recreational Area, Asphalt surfaces
- Grading -
- Vehicle Trips -
- Vehicle Emission Factors -

Hawthorne High School Pool - South Coast Air Basin, Summer

EMFAC Off-Model Adjustment Factors for Gasoline Light Duty Vehicle to Account for the SAFE Vehicle Rule Not Applied

Vehicle Emission Factors -

Vehicle Emission Factors -

Construction Off-road Equipment Mitigation -

Fleet Mix -

Table Name	Column Name	Default Value	New Value
tblConstructionPhase	NumDays	200.00	190.00
tblConstructionPhase	NumDays	4.00	14.00
tblLandUse	LandUseSquareFeet	0.00	16,200.00
tblLandUse	LotAcreage	0.00	0.37
tblOffRoadEquipment	OffRoadEquipmentUnitAmount	2.00	1.00
tblOffRoadEquipment	UsageHours	8.00	6.00
tblOffRoadEquipment	UsageHours	8.00	6.00

2.0 Emissions Summary

Hawthorne High School Pool - South Coast Air Basin, Summer

EMFAC Off-Model Adjustment Factors for Gasoline Light Duty Vehicle to Account for the SAFE Vehicle Rule Not Applied

2.1 Overall Construction (Maximum Daily Emission)

Unmitigated Construction

	ROG	NOx	CO	SO2	Fugitive PM10	Exhaust PM10	PM10 Total	Fugitive PM2.5	Exhaust PM2.5	PM2.5 Total	Bio- CO2	NBio- CO2	Total CO2	CH4	N2O	CO2e
Year	lb/day										lb/day					
2024	1.5066	15.5925	14.3854	0.0331	6.3556	0.6437	6.8384	3.0278	0.6015	3.4719	0.0000	3,300.889 5	3,300.889 5	0.6444	0.1382	3,358.171 0
2025	16.1050	10.8197	13.3012	0.0260	0.3323	0.3959	0.7282	0.0896	0.3818	0.4713	0.0000	2,414.848 4	2,414.848 4	0.4140	0.0324	2,432.973 1
Maximum	16.1050	15.5925	14.3854	0.0331	6.3556	0.6437	6.8384	3.0278	0.6015	3.4719	0.0000	3,300.889 5	3,300.889 5	0.6444	0.1382	3,358.171 0

Mitigated Construction

	ROG	NOx	CO	SO2	Fugitive PM10	Exhaust PM10	PM10 Total	Fugitive PM2.5	Exhaust PM2.5	PM2.5 Total	Bio- CO2	NBio- CO2	Total CO2	CH4	N2O	CO2e
Year	lb/day										lb/day					
2024	1.5066	15.5925	14.3854	0.0331	2.5332	0.6437	3.0160	1.1953	0.6015	1.6394	0.0000	3,300.889 5	3,300.889 5	0.6444	0.1382	3,358.171 0
2025	16.1050	10.8197	13.3012	0.0260	0.3323	0.3959	0.7282	0.0896	0.3818	0.4713	0.0000	2,414.848 4	2,414.848 4	0.4140	0.0324	2,432.973 1
Maximum	16.1050	15.5925	14.3854	0.0331	2.5332	0.6437	3.0160	1.1953	0.6015	1.6394	0.0000	3,300.889 5	3,300.889 5	0.6444	0.1382	3,358.171 0

Hawthorne High School Pool - South Coast Air Basin, Summer

EMFAC Off-Model Adjustment Factors for Gasoline Light Duty Vehicle to Account for the SAFE Vehicle Rule Not Applied

	ROG	NOx	CO	SO2	Fugitive PM10	Exhaust PM10	PM10 Total	Fugitive PM2.5	Exhaust PM2.5	PM2.5 Total	Bio- CO2	NBio-CO2	Total CO2	CH4	N2O	CO2e
Percent Reduction	0.00	0.00	0.00	0.00	57.15	0.00	50.52	58.78	0.00	46.47	0.00	0.00	0.00	0.00	0.00	0.00

Hawthorne High School Pool - South Coast Air Basin, Summer

EMFAC Off-Model Adjustment Factors for Gasoline Light Duty Vehicle to Account for the SAFE Vehicle Rule Not Applied

2.2 Overall Operational

Unmitigated Operational

	ROG	NOx	CO	SO2	Fugitive PM10	Exhaust PM10	PM10 Total	Fugitive PM2.5	Exhaust PM2.5	PM2.5 Total	Bio- CO2	NBio- CO2	Total CO2	CH4	N2O	CO2e
Category	lb/day										lb/day					
Area	0.3761	2.0000e-005	2.4500e-003	0.0000		1.0000e-005	1.0000e-005		1.0000e-005	1.0000e-005		5.2600e-003	5.2600e-003	1.0000e-005		5.6000e-003
Energy	0.0000	0.0000	0.0000	0.0000		0.0000	0.0000		0.0000	0.0000		0.0000	0.0000	0.0000	0.0000	0.0000
Mobile	0.7560	0.7019	6.7342	0.0149	1.6564	0.0106	1.6669	0.4414	9.8200e-003	0.4512		1,520.4010	1,520.4010	0.1005	0.0657	1,542.4982
Total	1.1321	0.7019	6.7367	0.0149	1.6564	0.0106	1.6669	0.4414	9.8300e-003	0.4512		1,520.4063	1,520.4063	0.1006	0.0657	1,542.5038

Mitigated Operational

	ROG	NOx	CO	SO2	Fugitive PM10	Exhaust PM10	PM10 Total	Fugitive PM2.5	Exhaust PM2.5	PM2.5 Total	Bio- CO2	NBio- CO2	Total CO2	CH4	N2O	CO2e
Category	lb/day										lb/day					
Area	0.3761	2.0000e-005	2.4500e-003	0.0000		1.0000e-005	1.0000e-005		1.0000e-005	1.0000e-005		5.2600e-003	5.2600e-003	1.0000e-005		5.6000e-003
Energy	0.0000	0.0000	0.0000	0.0000		0.0000	0.0000		0.0000	0.0000		0.0000	0.0000	0.0000	0.0000	0.0000
Mobile	0.7560	0.7019	6.7342	0.0149	1.6564	0.0106	1.6669	0.4414	9.8200e-003	0.4512		1,520.4010	1,520.4010	0.1005	0.0657	1,542.4982
Total	1.1321	0.7019	6.7367	0.0149	1.6564	0.0106	1.6669	0.4414	9.8300e-003	0.4512		1,520.4063	1,520.4063	0.1006	0.0657	1,542.5038

Hawthorne High School Pool - South Coast Air Basin, Summer

EMFAC Off-Model Adjustment Factors for Gasoline Light Duty Vehicle to Account for the SAFE Vehicle Rule Not Applied

	ROG	NOx	CO	SO2	Fugitive PM10	Exhaust PM10	PM10 Total	Fugitive PM2.5	Exhaust PM2.5	PM2.5 Total	Bio- CO2	NBio-CO2	Total CO2	CH4	N2O	CO2e
Percent Reduction	0.00	0.00	0.00	0.00	0.00	0.00	0.00	0.00	0.00	0.00	0.00	0.00	0.00	0.00	0.00	0.00

3.0 Construction Detail

Construction Phase

Phase Number	Phase Name	Phase Type	Start Date	End Date	Num Days Week	Num Days	Phase Description
1	Demolition	Demolition	10/1/2024	10/28/2024	5	20	
2	Site Preparation	Site Preparation	10/29/2024	10/30/2024	5	2	
3	Grading	Grading	10/31/2024	11/19/2024	5	14	
4	Building Construction	Building Construction	11/20/2024	8/12/2025	5	190	
5	Paving	Paving	8/13/2025	8/26/2025	5	10	
6	Architectural Coating	Architectural Coating	8/27/2025	9/9/2025	5	10	

Acres of Grading (Site Preparation Phase): 1.88

Acres of Grading (Grading Phase): 10.5

Acres of Paving: 0.75

Residential Indoor: 0; Residential Outdoor: 0; Non-Residential Indoor: 24,300; Non-Residential Outdoor: 8,100; Striped Parking Area: 1,948 (Architectural Coating – sqft)

OffRoad Equipment

Phase Name	Offroad Equipment Type	Amount	Usage Hours	Horse Power	Load Factor
Demolition	Concrete/Industrial Saws	1	8.00	81	0.73
Demolition	Rubber Tired Dozers	1	8.00	247	0.40
Demolition	Tractors/Loaders/Backhoes	3	8.00	97	0.37
Site Preparation	Graders	1	8.00	187	0.41
Site Preparation	Rubber Tired Dozers	1	7.00	247	0.40

Hawthorne High School Pool - South Coast Air Basin, Summer

EMFAC Off-Model Adjustment Factors for Gasoline Light Duty Vehicle to Account for the SAFE Vehicle Rule Not Applied

Site Preparation	Tractors/Loaders/Backhoes	1	8.00	97	0.37
Grading	Graders	1	6.00	187	0.41
Grading	Rubber Tired Dozers	1	6.00	247	0.40
Grading	Tractors/Loaders/Backhoes	1	7.00	97	0.37
Building Construction	Cranes	1	6.00	231	0.29
Building Construction	Forklifts	1	6.00	89	0.20
Building Construction	Generator Sets	1	8.00	84	0.74
Building Construction	Tractors/Loaders/Backhoes	1	6.00	97	0.37
Building Construction	Welders	3	8.00	46	0.45
Paving	Cement and Mortar Mixers	1	6.00	9	0.56
Paving	Pavers	1	6.00	130	0.42
Paving	Paving Equipment	1	8.00	132	0.36
Paving	Rollers	1	7.00	80	0.38
Paving	Tractors/Loaders/Backhoes	1	8.00	97	0.37
Architectural Coating	Air Compressors	1	6.00	78	0.48

Trips and VMT

Phase Name	Offroad Equipment Count	Worker Trip Number	Vendor Trip Number	Hauling Trip Number	Worker Trip Length	Vendor Trip Length	Hauling Trip Length	Worker Vehicle Class	Vendor Vehicle Class	Hauling Vehicle Class
Demolition	5	13.00	0.00	272.00	14.70	6.90	20.00	LD_Mix	HDT_Mix	HHDT
Site Preparation	3	8.00	0.00	0.00	14.70	6.90	20.00	LD_Mix	HDT_Mix	HHDT
Grading	3	8.00	0.00	0.00	14.70	6.90	20.00	LD_Mix	HDT_Mix	HHDT
Building Construction	7	24.00	10.00	0.00	14.70	6.90	20.00	LD_Mix	HDT_Mix	HHDT
Paving	5	13.00	0.00	0.00	14.70	6.90	20.00	LD_Mix	HDT_Mix	HHDT
Architectural Coating	1	5.00	0.00	0.00	14.70	6.90	20.00	LD_Mix	HDT_Mix	HHDT

3.1 Mitigation Measures Construction

Water Exposed Area

Hawthorne High School Pool - South Coast Air Basin, Summer

EMFAC Off-Model Adjustment Factors for Gasoline Light Duty Vehicle to Account for the SAFE Vehicle Rule Not Applied

3.2 Demolition - 2024

Unmitigated Construction On-Site

	ROG	NOx	CO	SO2	Fugitive PM10	Exhaust PM10	PM10 Total	Fugitive PM2.5	Exhaust PM2.5	PM2.5 Total	Bio- CO2	NBio- CO2	Total CO2	CH4	N2O	CO2e
Category	lb/day										lb/day					
Fugitive Dust					2.9468	0.0000	2.9468	0.4462	0.0000	0.4462			0.0000			0.0000
Off-Road	1.4397	13.8867	13.4879	0.0241		0.6311	0.6311		0.5895	0.5895		2,324.9459	2,324.9459	0.5884		2,339.6562
Total	1.4397	13.8867	13.4879	0.0241	2.9468	0.6311	3.5779	0.4462	0.5895	1.0356		2,324.9459	2,324.9459	0.5884		2,339.6562

Unmitigated Construction Off-Site

	ROG	NOx	CO	SO2	Fugitive PM10	Exhaust PM10	PM10 Total	Fugitive PM2.5	Exhaust PM2.5	PM2.5 Total	Bio- CO2	NBio- CO2	Total CO2	CH4	N2O	CO2e
Category	lb/day										lb/day					
Hauling	0.0285	1.6811	0.4755	7.7000e-003	0.2378	0.0118	0.2496	0.0652	0.0113	0.0765		851.2304	851.2304	0.0531	0.1354	892.9187
Vendor	0.0000	0.0000	0.0000	0.0000	0.0000	0.0000	0.0000	0.0000	0.0000	0.0000		0.0000	0.0000	0.0000	0.0000	0.0000
Worker	0.0384	0.0247	0.4220	1.2300e-003	0.1453	7.8000e-004	0.1461	0.0385	7.2000e-004	0.0393		124.7132	124.7132	2.8200e-003	2.7300e-003	125.5962
Total	0.0669	1.7058	0.8974	8.9300e-003	0.3831	0.0126	0.3957	0.1037	0.0120	0.1157		975.9436	975.9436	0.0560	0.1382	1,018.5148

Hawthorne High School Pool - South Coast Air Basin, Summer

EMFAC Off-Model Adjustment Factors for Gasoline Light Duty Vehicle to Account for the SAFE Vehicle Rule Not Applied

3.2 Demolition - 2024

Mitigated Construction On-Site

	ROG	NOx	CO	SO2	Fugitive PM10	Exhaust PM10	PM10 Total	Fugitive PM2.5	Exhaust PM2.5	PM2.5 Total	Bio- CO2	NBio- CO2	Total CO2	CH4	N2O	CO2e
Category	lb/day										lb/day					
Fugitive Dust					1.1493	0.0000	1.1493	0.1740	0.0000	0.1740			0.0000			0.0000
Off-Road	1.4397	13.8867	13.4879	0.0241		0.6311	0.6311		0.5895	0.5895	0.0000	2,324.9459	2,324.9459	0.5884		2,339.6562
Total	1.4397	13.8867	13.4879	0.0241	1.1493	0.6311	1.7804	0.1740	0.5895	0.7635	0.0000	2,324.9459	2,324.9459	0.5884		2,339.6562

Mitigated Construction Off-Site

	ROG	NOx	CO	SO2	Fugitive PM10	Exhaust PM10	PM10 Total	Fugitive PM2.5	Exhaust PM2.5	PM2.5 Total	Bio- CO2	NBio- CO2	Total CO2	CH4	N2O	CO2e
Category	lb/day										lb/day					
Hauling	0.0285	1.6811	0.4755	7.7000e-003	0.2378	0.0118	0.2496	0.0652	0.0113	0.0765		851.2304	851.2304	0.0531	0.1354	892.9187
Vendor	0.0000	0.0000	0.0000	0.0000	0.0000	0.0000	0.0000	0.0000	0.0000	0.0000		0.0000	0.0000	0.0000	0.0000	0.0000
Worker	0.0384	0.0247	0.4220	1.2300e-003	0.1453	7.8000e-004	0.1461	0.0385	7.2000e-004	0.0393		124.7132	124.7132	2.8200e-003	2.7300e-003	125.5962
Total	0.0669	1.7058	0.8974	8.9300e-003	0.3831	0.0126	0.3957	0.1037	0.0120	0.1157		975.9436	975.9436	0.0560	0.1382	1,018.5148

Hawthorne High School Pool - South Coast Air Basin, Summer

EMFAC Off-Model Adjustment Factors for Gasoline Light Duty Vehicle to Account for the SAFE Vehicle Rule Not Applied

3.3 Site Preparation - 2024

Unmitigated Construction On-Site

	ROG	NOx	CO	SO2	Fugitive PM10	Exhaust PM10	PM10 Total	Fugitive PM2.5	Exhaust PM2.5	PM2.5 Total	Bio- CO2	NBio- CO2	Total CO2	CH4	N2O	CO2e
Category	lb/day										lb/day					
Fugitive Dust					6.2662	0.0000	6.2662	3.0041	0.0000	3.0041			0.0000			0.0000
Off-Road	1.1067	11.8407	6.6317	0.0172		0.4823	0.4823		0.4437	0.4437		1,665.8826	1,665.8826	0.5388		1,679.3521
Total	1.1067	11.8407	6.6317	0.0172	6.2662	0.4823	6.7485	3.0041	0.4437	3.4478		1,665.8826	1,665.8826	0.5388		1,679.3521

Unmitigated Construction Off-Site

	ROG	NOx	CO	SO2	Fugitive PM10	Exhaust PM10	PM10 Total	Fugitive PM2.5	Exhaust PM2.5	PM2.5 Total	Bio- CO2	NBio- CO2	Total CO2	CH4	N2O	CO2e
Category	lb/day										lb/day					
Hauling	0.0000	0.0000	0.0000	0.0000	0.0000	0.0000	0.0000	0.0000	0.0000	0.0000		0.0000	0.0000	0.0000	0.0000	0.0000
Vendor	0.0000	0.0000	0.0000	0.0000	0.0000	0.0000	0.0000	0.0000	0.0000	0.0000		0.0000	0.0000	0.0000	0.0000	0.0000
Worker	0.0236	0.0152	0.2597	7.6000e-004	0.0894	4.8000e-004	0.0899	0.0237	4.4000e-004	0.0242		76.7466	76.7466	1.7400e-003	1.6800e-003	77.2900
Total	0.0236	0.0152	0.2597	7.6000e-004	0.0894	4.8000e-004	0.0899	0.0237	4.4000e-004	0.0242		76.7466	76.7466	1.7400e-003	1.6800e-003	77.2900

Hawthorne High School Pool - South Coast Air Basin, Summer

EMFAC Off-Model Adjustment Factors for Gasoline Light Duty Vehicle to Account for the SAFE Vehicle Rule Not Applied

3.3 Site Preparation - 2024

Mitigated Construction On-Site

	ROG	NOx	CO	SO2	Fugitive PM10	Exhaust PM10	PM10 Total	Fugitive PM2.5	Exhaust PM2.5	PM2.5 Total	Bio- CO2	NBio- CO2	Total CO2	CH4	N2O	CO2e
Category	lb/day										lb/day					
Fugitive Dust					2.4438	0.0000	2.4438	1.1716	0.0000	1.1716			0.0000			0.0000
Off-Road	1.1067	11.8407	6.6317	0.0172		0.4823	0.4823		0.4437	0.4437	0.0000	1,665.8826	1,665.8826	0.5388		1,679.3521
Total	1.1067	11.8407	6.6317	0.0172	2.4438	0.4823	2.9261	1.1716	0.4437	1.6153	0.0000	1,665.8826	1,665.8826	0.5388		1,679.3521

Mitigated Construction Off-Site

	ROG	NOx	CO	SO2	Fugitive PM10	Exhaust PM10	PM10 Total	Fugitive PM2.5	Exhaust PM2.5	PM2.5 Total	Bio- CO2	NBio- CO2	Total CO2	CH4	N2O	CO2e
Category	lb/day										lb/day					
Hauling	0.0000	0.0000	0.0000	0.0000	0.0000	0.0000	0.0000	0.0000	0.0000	0.0000		0.0000	0.0000	0.0000	0.0000	0.0000
Vendor	0.0000	0.0000	0.0000	0.0000	0.0000	0.0000	0.0000	0.0000	0.0000	0.0000		0.0000	0.0000	0.0000	0.0000	0.0000
Worker	0.0236	0.0152	0.2597	7.6000e-004	0.0894	4.8000e-004	0.0899	0.0237	4.4000e-004	0.0242		76.7466	76.7466	1.7400e-003	1.6800e-003	77.2900
Total	0.0236	0.0152	0.2597	7.6000e-004	0.0894	4.8000e-004	0.0899	0.0237	4.4000e-004	0.0242		76.7466	76.7466	1.7400e-003	1.6800e-003	77.2900

Hawthorne High School Pool - South Coast Air Basin, Summer

EMFAC Off-Model Adjustment Factors for Gasoline Light Duty Vehicle to Account for the SAFE Vehicle Rule Not Applied

3.4 Grading - 2024

Unmitigated Construction On-Site

	ROG	NOx	CO	SO2	Fugitive PM10	Exhaust PM10	PM10 Total	Fugitive PM2.5	Exhaust PM2.5	PM2.5 Total	Bio- CO2	NBio- CO2	Total CO2	CH4	N2O	CO2e
Category	lb/day										lb/day					
Fugitive Dust					5.3119	0.0000	5.3119	2.5686	0.0000	2.5686			0.0000			0.0000
Off-Road	0.9132	9.7297	5.5468	0.0141		0.4001	0.4001		0.3681	0.3681		1,364.662 3	1,364.662 3	0.4414		1,375.696 2
Total	0.9132	9.7297	5.5468	0.0141	5.3119	0.4001	5.7120	2.5686	0.3681	2.9367		1,364.662 3	1,364.662 3	0.4414		1,375.696 2

Unmitigated Construction Off-Site

	ROG	NOx	CO	SO2	Fugitive PM10	Exhaust PM10	PM10 Total	Fugitive PM2.5	Exhaust PM2.5	PM2.5 Total	Bio- CO2	NBio- CO2	Total CO2	CH4	N2O	CO2e
Category	lb/day										lb/day					
Hauling	0.0000	0.0000	0.0000	0.0000	0.0000	0.0000	0.0000	0.0000	0.0000	0.0000		0.0000	0.0000	0.0000	0.0000	0.0000
Vendor	0.0000	0.0000	0.0000	0.0000	0.0000	0.0000	0.0000	0.0000	0.0000	0.0000		0.0000	0.0000	0.0000	0.0000	0.0000
Worker	0.0236	0.0152	0.2597	7.6000e-004	0.0894	4.8000e-004	0.0899	0.0237	4.4000e-004	0.0242		76.7466	76.7466	1.7400e-003	1.6800e-003	77.2900
Total	0.0236	0.0152	0.2597	7.6000e-004	0.0894	4.8000e-004	0.0899	0.0237	4.4000e-004	0.0242		76.7466	76.7466	1.7400e-003	1.6800e-003	77.2900

Hawthorne High School Pool - South Coast Air Basin, Summer

EMFAC Off-Model Adjustment Factors for Gasoline Light Duty Vehicle to Account for the SAFE Vehicle Rule Not Applied

3.4 Grading - 2024

Mitigated Construction On-Site

	ROG	NOx	CO	SO2	Fugitive PM10	Exhaust PM10	PM10 Total	Fugitive PM2.5	Exhaust PM2.5	PM2.5 Total	Bio- CO2	NBio- CO2	Total CO2	CH4	N2O	CO2e
Category	lb/day										lb/day					
Fugitive Dust					2.0717	0.0000	2.0717	1.0017	0.0000	1.0017			0.0000			0.0000
Off-Road	0.9132	9.7297	5.5468	0.0141		0.4001	0.4001		0.3681	0.3681	0.0000	1,364.662 3	1,364.662 3	0.4414		1,375.696 2
Total	0.9132	9.7297	5.5468	0.0141	2.0717	0.4001	2.4718	1.0017	0.3681	1.3698	0.0000	1,364.662 3	1,364.662 3	0.4414		1,375.696 2

Mitigated Construction Off-Site

	ROG	NOx	CO	SO2	Fugitive PM10	Exhaust PM10	PM10 Total	Fugitive PM2.5	Exhaust PM2.5	PM2.5 Total	Bio- CO2	NBio- CO2	Total CO2	CH4	N2O	CO2e
Category	lb/day										lb/day					
Hauling	0.0000	0.0000	0.0000	0.0000	0.0000	0.0000	0.0000	0.0000	0.0000	0.0000		0.0000	0.0000	0.0000	0.0000	0.0000
Vendor	0.0000	0.0000	0.0000	0.0000	0.0000	0.0000	0.0000	0.0000	0.0000	0.0000		0.0000	0.0000	0.0000	0.0000	0.0000
Worker	0.0236	0.0152	0.2597	7.6000e-004	0.0894	4.8000e-004	0.0899	0.0237	4.4000e-004	0.0242		76.7466	76.7466	1.7400e-003	1.6800e-003	77.2900
Total	0.0236	0.0152	0.2597	7.6000e-004	0.0894	4.8000e-004	0.0899	0.0237	4.4000e-004	0.0242		76.7466	76.7466	1.7400e-003	1.6800e-003	77.2900

Hawthorne High School Pool - South Coast Air Basin, Summer

EMFAC Off-Model Adjustment Factors for Gasoline Light Duty Vehicle to Account for the SAFE Vehicle Rule Not Applied

3.5 Building Construction - 2024

Unmitigated Construction On-Site

	ROG	NOx	CO	SO2	Fugitive PM10	Exhaust PM10	PM10 Total	Fugitive PM2.5	Exhaust PM2.5	PM2.5 Total	Bio- CO2	NBio- CO2	Total CO2	CH4	N2O	CO2e
Category	lb/day										lb/day					
Off-Road	1.4200	11.0639	12.5172	0.0221		0.4506	0.4506		0.4348	0.4348		2,001.9214	2,001.9214	0.3334		2,010.2563
Total	1.4200	11.0639	12.5172	0.0221		0.4506	0.4506		0.4348	0.4348		2,001.9214	2,001.9214	0.3334		2,010.2563

Unmitigated Construction Off-Site

	ROG	NOx	CO	SO2	Fugitive PM10	Exhaust PM10	PM10 Total	Fugitive PM2.5	Exhaust PM2.5	PM2.5 Total	Bio- CO2	NBio- CO2	Total CO2	CH4	N2O	CO2e
Category	lb/day										lb/day					
Hauling	0.0000	0.0000	0.0000	0.0000	0.0000	0.0000	0.0000	0.0000	0.0000	0.0000		0.0000	0.0000	0.0000	0.0000	0.0000
Vendor	0.0105	0.3675	0.1382	1.7900e-003	0.0640	2.0300e-003	0.0661	0.0184	1.9400e-003	0.0204		193.7829	193.7829	7.2800e-003	0.0282	202.3540
Worker	0.0708	0.0457	0.7790	2.2800e-003	0.2683	1.4500e-003	0.2697	0.0711	1.3300e-003	0.0725		230.2398	230.2398	5.2100e-003	5.0300e-003	231.8699
Total	0.0813	0.4132	0.9172	4.0700e-003	0.3323	3.4800e-003	0.3358	0.0896	3.2700e-003	0.0929		424.0227	424.0227	0.0125	0.0332	434.2239

Hawthorne High School Pool - South Coast Air Basin, Summer

EMFAC Off-Model Adjustment Factors for Gasoline Light Duty Vehicle to Account for the SAFE Vehicle Rule Not Applied

3.5 Building Construction - 2024

Mitigated Construction On-Site

	ROG	NOx	CO	SO2	Fugitive PM10	Exhaust PM10	PM10 Total	Fugitive PM2.5	Exhaust PM2.5	PM2.5 Total	Bio- CO2	NBio- CO2	Total CO2	CH4	N2O	CO2e
Category	lb/day										lb/day					
Off-Road	1.4200	11.0639	12.5172	0.0221		0.4506	0.4506		0.4348	0.4348	0.0000	2,001.9214	2,001.9214	0.3334		2,010.2563
Total	1.4200	11.0639	12.5172	0.0221		0.4506	0.4506		0.4348	0.4348	0.0000	2,001.9214	2,001.9214	0.3334		2,010.2563

Mitigated Construction Off-Site

	ROG	NOx	CO	SO2	Fugitive PM10	Exhaust PM10	PM10 Total	Fugitive PM2.5	Exhaust PM2.5	PM2.5 Total	Bio- CO2	NBio- CO2	Total CO2	CH4	N2O	CO2e
Category	lb/day										lb/day					
Hauling	0.0000	0.0000	0.0000	0.0000	0.0000	0.0000	0.0000	0.0000	0.0000	0.0000		0.0000	0.0000	0.0000	0.0000	0.0000
Vendor	0.0105	0.3675	0.1382	1.7900e-003	0.0640	2.0300e-003	0.0661	0.0184	1.9400e-003	0.0204		193.7829	193.7829	7.2800e-003	0.0282	202.3540
Worker	0.0708	0.0457	0.7790	2.2800e-003	0.2683	1.4500e-003	0.2697	0.0711	1.3300e-003	0.0725		230.2398	230.2398	5.2100e-003	5.0300e-003	231.8699
Total	0.0813	0.4132	0.9172	4.0700e-003	0.3323	3.4800e-003	0.3358	0.0896	3.2700e-003	0.0929		424.0227	424.0227	0.0125	0.0332	434.2239

Hawthorne High School Pool - South Coast Air Basin, Summer

EMFAC Off-Model Adjustment Factors for Gasoline Light Duty Vehicle to Account for the SAFE Vehicle Rule Not Applied

3.5 Building Construction - 2025

Unmitigated Construction On-Site

	ROG	NOx	CO	SO2	Fugitive PM10	Exhaust PM10	PM10 Total	Fugitive PM2.5	Exhaust PM2.5	PM2.5 Total	Bio- CO2	NBio- CO2	Total CO2	CH4	N2O	CO2e
Category	lb/day										lb/day					
Off-Road	1.3246	10.4128	12.4393	0.0221		0.3925	0.3925		0.3785	0.3785		2,002.1524	2,002.1524	0.3269		2,010.3248
Total	1.3246	10.4128	12.4393	0.0221		0.3925	0.3925		0.3785	0.3785		2,002.1524	2,002.1524	0.3269		2,010.3248

Unmitigated Construction Off-Site

	ROG	NOx	CO	SO2	Fugitive PM10	Exhaust PM10	PM10 Total	Fugitive PM2.5	Exhaust PM2.5	PM2.5 Total	Bio- CO2	NBio- CO2	Total CO2	CH4	N2O	CO2e
Category	lb/day										lb/day					
Hauling	0.0000	0.0000	0.0000	0.0000	0.0000	0.0000	0.0000	0.0000	0.0000	0.0000		0.0000	0.0000	0.0000	0.0000	0.0000
Vendor	0.0102	0.3658	0.1361	1.7600e-003	0.0640	2.0400e-003	0.0661	0.0184	1.9500e-003	0.0204		190.3019	190.3019	7.3000e-003	0.0277	198.7341
Worker	0.0663	0.0411	0.7257	2.2000e-003	0.2683	1.3800e-003	0.2696	0.0711	1.2700e-003	0.0724		222.3940	222.3940	4.7000e-003	4.7100e-003	223.9142
Total	0.0765	0.4069	0.8619	3.9600e-003	0.3323	3.4200e-003	0.3357	0.0896	3.2200e-003	0.0928		412.6960	412.6960	0.0120	0.0324	422.6483

Hawthorne High School Pool - South Coast Air Basin, Summer

EMFAC Off-Model Adjustment Factors for Gasoline Light Duty Vehicle to Account for the SAFE Vehicle Rule Not Applied

3.5 Building Construction - 2025

Mitigated Construction On-Site

	ROG	NOx	CO	SO2	Fugitive PM10	Exhaust PM10	PM10 Total	Fugitive PM2.5	Exhaust PM2.5	PM2.5 Total	Bio- CO2	NBio- CO2	Total CO2	CH4	N2O	CO2e
Category	lb/day										lb/day					
Off-Road	1.3246	10.4128	12.4393	0.0221		0.3925	0.3925		0.3785	0.3785	0.0000	2,002.1524	2,002.1524	0.3269		2,010.3248
Total	1.3246	10.4128	12.4393	0.0221		0.3925	0.3925		0.3785	0.3785	0.0000	2,002.1524	2,002.1524	0.3269		2,010.3248

Mitigated Construction Off-Site

	ROG	NOx	CO	SO2	Fugitive PM10	Exhaust PM10	PM10 Total	Fugitive PM2.5	Exhaust PM2.5	PM2.5 Total	Bio- CO2	NBio- CO2	Total CO2	CH4	N2O	CO2e
Category	lb/day										lb/day					
Hauling	0.0000	0.0000	0.0000	0.0000	0.0000	0.0000	0.0000	0.0000	0.0000	0.0000		0.0000	0.0000	0.0000	0.0000	0.0000
Vendor	0.0102	0.3658	0.1361	1.7600e-003	0.0640	2.0400e-003	0.0661	0.0184	1.9500e-003	0.0204		190.3019	190.3019	7.3000e-003	0.0277	198.7341
Worker	0.0663	0.0411	0.7257	2.2000e-003	0.2683	1.3800e-003	0.2696	0.0711	1.2700e-003	0.0724		222.3940	222.3940	4.7000e-003	4.7100e-003	223.9142
Total	0.0765	0.4069	0.8619	3.9600e-003	0.3323	3.4200e-003	0.3357	0.0896	3.2200e-003	0.0928		412.6960	412.6960	0.0120	0.0324	422.6483

Hawthorne High School Pool - South Coast Air Basin, Summer

EMFAC Off-Model Adjustment Factors for Gasoline Light Duty Vehicle to Account for the SAFE Vehicle Rule Not Applied

3.6 Paving - 2025

Unmitigated Construction On-Site

	ROG	NOx	CO	SO2	Fugitive PM10	Exhaust PM10	PM10 Total	Fugitive PM2.5	Exhaust PM2.5	PM2.5 Total	Bio- CO2	NBio- CO2	Total CO2	CH4	N2O	CO2e
Category	lb/day										lb/day					
Off-Road	0.5732	5.3259	8.7951	0.0136		0.2465	0.2465		0.2276	0.2276		1,297.8096	1,297.8096	0.4114		1,308.0951
Paving	0.0734					0.0000	0.0000		0.0000	0.0000			0.0000			0.0000
Total	0.6466	5.3259	8.7951	0.0136		0.2465	0.2465		0.2276	0.2276		1,297.8096	1,297.8096	0.4114		1,308.0951

Unmitigated Construction Off-Site

	ROG	NOx	CO	SO2	Fugitive PM10	Exhaust PM10	PM10 Total	Fugitive PM2.5	Exhaust PM2.5	PM2.5 Total	Bio- CO2	NBio- CO2	Total CO2	CH4	N2O	CO2e
Category	lb/day										lb/day					
Hauling	0.0000	0.0000	0.0000	0.0000	0.0000	0.0000	0.0000	0.0000	0.0000	0.0000		0.0000	0.0000	0.0000	0.0000	0.0000
Vendor	0.0000	0.0000	0.0000	0.0000	0.0000	0.0000	0.0000	0.0000	0.0000	0.0000		0.0000	0.0000	0.0000	0.0000	0.0000
Worker	0.0359	0.0222	0.3931	1.1900e-003	0.1453	7.5000e-004	0.1461	0.0385	6.9000e-004	0.0392		120.4634	120.4634	2.5500e-003	2.5500e-003	121.2869
Total	0.0359	0.0222	0.3931	1.1900e-003	0.1453	7.5000e-004	0.1461	0.0385	6.9000e-004	0.0392		120.4634	120.4634	2.5500e-003	2.5500e-003	121.2869

Hawthorne High School Pool - South Coast Air Basin, Summer

EMFAC Off-Model Adjustment Factors for Gasoline Light Duty Vehicle to Account for the SAFE Vehicle Rule Not Applied

3.6 Paving - 2025

Mitigated Construction On-Site

	ROG	NOx	CO	SO2	Fugitive PM10	Exhaust PM10	PM10 Total	Fugitive PM2.5	Exhaust PM2.5	PM2.5 Total	Bio- CO2	NBio- CO2	Total CO2	CH4	N2O	CO2e
Category	lb/day										lb/day					
Off-Road	0.5732	5.3259	8.7951	0.0136		0.2465	0.2465		0.2276	0.2276	0.0000	1,297.8096	1,297.8096	0.4114		1,308.0951
Paving	0.0734					0.0000	0.0000		0.0000	0.0000			0.0000			0.0000
Total	0.6466	5.3259	8.7951	0.0136		0.2465	0.2465		0.2276	0.2276	0.0000	1,297.8096	1,297.8096	0.4114		1,308.0951

Mitigated Construction Off-Site

	ROG	NOx	CO	SO2	Fugitive PM10	Exhaust PM10	PM10 Total	Fugitive PM2.5	Exhaust PM2.5	PM2.5 Total	Bio- CO2	NBio- CO2	Total CO2	CH4	N2O	CO2e
Category	lb/day										lb/day					
Hauling	0.0000	0.0000	0.0000	0.0000	0.0000	0.0000	0.0000	0.0000	0.0000	0.0000		0.0000	0.0000	0.0000	0.0000	0.0000
Vendor	0.0000	0.0000	0.0000	0.0000	0.0000	0.0000	0.0000	0.0000	0.0000	0.0000		0.0000	0.0000	0.0000	0.0000	0.0000
Worker	0.0359	0.0222	0.3931	1.1900e-003	0.1453	7.5000e-004	0.1461	0.0385	6.9000e-004	0.0392		120.4634	120.4634	2.5500e-003	2.5500e-003	121.2869
Total	0.0359	0.0222	0.3931	1.1900e-003	0.1453	7.5000e-004	0.1461	0.0385	6.9000e-004	0.0392		120.4634	120.4634	2.5500e-003	2.5500e-003	121.2869

Hawthorne High School Pool - South Coast Air Basin, Summer

EMFAC Off-Model Adjustment Factors for Gasoline Light Duty Vehicle to Account for the SAFE Vehicle Rule Not Applied

3.7 Architectural Coating - 2025

Unmitigated Construction On-Site

	ROG	NOx	CO	SO2	Fugitive PM10	Exhaust PM10	PM10 Total	Fugitive PM2.5	Exhaust PM2.5	PM2.5 Total	Bio- CO2	NBio- CO2	Total CO2	CH4	N2O	CO2e
Category	lb/day										lb/day					
Archit. Coating	15.9203					0.0000	0.0000		0.0000	0.0000			0.0000			0.0000
Off-Road	0.1709	1.1455	1.8091	2.9700e-003		0.0515	0.0515		0.0515	0.0515		281.4481	281.4481	0.0154		281.8319
Total	16.0912	1.1455	1.8091	2.9700e-003		0.0515	0.0515		0.0515	0.0515		281.4481	281.4481	0.0154		281.8319

Unmitigated Construction Off-Site

	ROG	NOx	CO	SO2	Fugitive PM10	Exhaust PM10	PM10 Total	Fugitive PM2.5	Exhaust PM2.5	PM2.5 Total	Bio- CO2	NBio- CO2	Total CO2	CH4	N2O	CO2e
Category	lb/day										lb/day					
Hauling	0.0000	0.0000	0.0000	0.0000	0.0000	0.0000	0.0000	0.0000	0.0000	0.0000		0.0000	0.0000	0.0000	0.0000	0.0000
Vendor	0.0000	0.0000	0.0000	0.0000	0.0000	0.0000	0.0000	0.0000	0.0000	0.0000		0.0000	0.0000	0.0000	0.0000	0.0000
Worker	0.0138	8.5500e-003	0.1512	4.6000e-004	0.0559	2.9000e-004	0.0562	0.0148	2.6000e-004	0.0151		46.3321	46.3321	9.8000e-004	9.8000e-004	46.6488
Total	0.0138	8.5500e-003	0.1512	4.6000e-004	0.0559	2.9000e-004	0.0562	0.0148	2.6000e-004	0.0151		46.3321	46.3321	9.8000e-004	9.8000e-004	46.6488

Hawthorne High School Pool - South Coast Air Basin, Summer

EMFAC Off-Model Adjustment Factors for Gasoline Light Duty Vehicle to Account for the SAFE Vehicle Rule Not Applied

3.7 Architectural Coating - 2025

Mitigated Construction On-Site

	ROG	NOx	CO	SO2	Fugitive PM10	Exhaust PM10	PM10 Total	Fugitive PM2.5	Exhaust PM2.5	PM2.5 Total	Bio- CO2	NBio- CO2	Total CO2	CH4	N2O	CO2e
Category	lb/day										lb/day					
Archit. Coating	15.9203					0.0000	0.0000		0.0000	0.0000			0.0000			0.0000
Off-Road	0.1709	1.1455	1.8091	2.9700e-003		0.0515	0.0515		0.0515	0.0515	0.0000	281.4481	281.4481	0.0154		281.8319
Total	16.0912	1.1455	1.8091	2.9700e-003		0.0515	0.0515		0.0515	0.0515	0.0000	281.4481	281.4481	0.0154		281.8319

Mitigated Construction Off-Site

	ROG	NOx	CO	SO2	Fugitive PM10	Exhaust PM10	PM10 Total	Fugitive PM2.5	Exhaust PM2.5	PM2.5 Total	Bio- CO2	NBio- CO2	Total CO2	CH4	N2O	CO2e
Category	lb/day										lb/day					
Hauling	0.0000	0.0000	0.0000	0.0000	0.0000	0.0000	0.0000	0.0000	0.0000	0.0000		0.0000	0.0000	0.0000	0.0000	0.0000
Vendor	0.0000	0.0000	0.0000	0.0000	0.0000	0.0000	0.0000	0.0000	0.0000	0.0000		0.0000	0.0000	0.0000	0.0000	0.0000
Worker	0.0138	8.5500e-003	0.1512	4.6000e-004	0.0559	2.9000e-004	0.0562	0.0148	2.6000e-004	0.0151		46.3321	46.3321	9.8000e-004	9.8000e-004	46.6488
Total	0.0138	8.5500e-003	0.1512	4.6000e-004	0.0559	2.9000e-004	0.0562	0.0148	2.6000e-004	0.0151		46.3321	46.3321	9.8000e-004	9.8000e-004	46.6488

Hawthorne High School Pool - South Coast Air Basin, Summer

EMFAC Off-Model Adjustment Factors for Gasoline Light Duty Vehicle to Account for the SAFE Vehicle Rule Not Applied

4.0 Operational Detail - Mobile

4.1 Mitigation Measures Mobile

	ROG	NOx	CO	SO2	Fugitive PM10	Exhaust PM10	PM10 Total	Fugitive PM2.5	Exhaust PM2.5	PM2.5 Total	Bio- CO2	NBio- CO2	Total CO2	CH4	N2O	CO2e
Category	lb/day										lb/day					
Mitigated	0.7560	0.7019	6.7342	0.0149	1.6564	0.0106	1.6669	0.4414	9.8200e-003	0.4512		1,520.4010	1,520.4010	0.1005	0.0657	1,542.4982
Unmitigated	0.7560	0.7019	6.7342	0.0149	1.6564	0.0106	1.6669	0.4414	9.8200e-003	0.4512		1,520.4010	1,520.4010	0.1005	0.0657	1,542.4982

4.2 Trip Summary Information

Land Use	Average Daily Trip Rate			Unmitigated	Mitigated
	Weekday	Saturday	Sunday	Annual VMT	Annual VMT
Other Asphalt Surfaces	0.00	0.00	0.00		
Other Non-Asphalt Surfaces	0.00	0.00	0.00		
Recreational Swimming Pool	322.78	101.92	152.32	649,989	649,989
User Defined Commercial	0.00	0.00	0.00		
Total	322.78	101.92	152.32	649,989	649,989

4.3 Trip Type Information

Land Use	Miles			Trip %			Trip Purpose %		
	H-W or C-W	H-S or C-C	H-O or C-NW	H-W or C-W	H-S or C-C	H-O or C-NW	Primary	Diverted	Pass-by
Other Asphalt Surfaces	16.60	8.40	6.90	0.00	0.00	0.00	0	0	0
Other Non-Asphalt Surfaces	16.60	8.40	6.90	0.00	0.00	0.00	0	0	0
Recreational Swimming Pool	16.60	8.40	6.90	33.00	48.00	19.00	52	39	9

Hawthorne High School Pool - South Coast Air Basin, Summer

EMFAC Off-Model Adjustment Factors for Gasoline Light Duty Vehicle to Account for the SAFE Vehicle Rule Not Applied

Land Use	Miles			Trip %			Trip Purpose %		
	H-W or C-W	H-S or C-C	H-O or C-NW	H-W or C-W	H-S or C-C	H-O or C-NW	Primary	Diverted	Pass-by
User Defined Commercial	16.60	8.40	6.90	0.00	0.00	0.00	0	0	0

4.4 Fleet Mix

Land Use	LDA	LDT1	LDT2	MDV	LHD1	LHD2	MHD	HHD	OBUS	UBUS	MCY	SBUS	MH
Other Asphalt Surfaces	0.541801	0.062785	0.185964	0.127448	0.023798	0.006607	0.012341	0.008651	0.000818	0.000497	0.024959	0.000748	0.003583
Other Non-Asphalt Surfaces	0.541801	0.062785	0.185964	0.127448	0.023798	0.006607	0.012341	0.008651	0.000818	0.000497	0.024959	0.000748	0.003583
Recreational Swimming Pool	0.541801	0.062785	0.185964	0.127448	0.023798	0.006607	0.012341	0.008651	0.000818	0.000497	0.024959	0.000748	0.003583
User Defined Commercial	0.541801	0.062785	0.185964	0.127448	0.023798	0.006607	0.012341	0.008651	0.000818	0.000497	0.024959	0.000748	0.003583

5.0 Energy Detail

Historical Energy Use: N

5.1 Mitigation Measures Energy

Category	ROG	NOx	CO	SO2	Fugitive PM10	Exhaust PM10	PM10 Total	Fugitive PM2.5	Exhaust PM2.5	PM2.5 Total	Bio- CO2	NBio- CO2	Total CO2	CH4	N2O	CO2e
lb/day											lb/day					
NaturalGas Mitigated	0.0000	0.0000	0.0000	0.0000		0.0000	0.0000		0.0000	0.0000		0.0000	0.0000	0.0000	0.0000	0.0000
NaturalGas Unmitigated	0.0000	0.0000	0.0000	0.0000		0.0000	0.0000		0.0000	0.0000		0.0000	0.0000	0.0000	0.0000	0.0000

Hawthorne High School Pool - South Coast Air Basin, Summer

EMFAC Off-Model Adjustment Factors for Gasoline Light Duty Vehicle to Account for the SAFE Vehicle Rule Not Applied

5.2 Energy by Land Use - NaturalGas

Unmitigated

	NaturalGas Use	ROG	NOx	CO	SO2	Fugitive PM10	Exhaust PM10	PM10 Total	Fugitive PM2.5	Exhaust PM2.5	PM2.5 Total	Bio- CO2	NBio- CO2	Total CO2	CH4	N2O	CO2e
Land Use	kBTU/yr	lb/day										lb/day					
Other Asphalt Surfaces	0	0.0000	0.0000	0.0000	0.0000		0.0000	0.0000		0.0000	0.0000		0.0000	0.0000	0.0000	0.0000	0.0000
Other Non-Asphalt Surfaces	0	0.0000	0.0000	0.0000	0.0000		0.0000	0.0000		0.0000	0.0000		0.0000	0.0000	0.0000	0.0000	0.0000
Recreational Swimming Pool	0	0.0000	0.0000	0.0000	0.0000		0.0000	0.0000		0.0000	0.0000		0.0000	0.0000	0.0000	0.0000	0.0000
User Defined Commercial	0	0.0000	0.0000	0.0000	0.0000		0.0000	0.0000		0.0000	0.0000		0.0000	0.0000	0.0000	0.0000	0.0000
Total		0.0000	0.0000	0.0000	0.0000		0.0000	0.0000		0.0000	0.0000		0.0000	0.0000	0.0000	0.0000	0.0000

Hawthorne High School Pool - South Coast Air Basin, Summer

EMFAC Off-Model Adjustment Factors for Gasoline Light Duty Vehicle to Account for the SAFE Vehicle Rule Not Applied

5.2 Energy by Land Use - NaturalGas

Mitigated

	NaturalGas Use	ROG	NOx	CO	SO2	Fugitive PM10	Exhaust PM10	PM10 Total	Fugitive PM2.5	Exhaust PM2.5	PM2.5 Total	Bio- CO2	NBio- CO2	Total CO2	CH4	N2O	CO2e
Land Use	kBTU/yr	lb/day										lb/day					
Other Asphalt Surfaces	0	0.0000	0.0000	0.0000	0.0000		0.0000	0.0000		0.0000	0.0000		0.0000	0.0000	0.0000	0.0000	0.0000
Other Non-Asphalt Surfaces	0	0.0000	0.0000	0.0000	0.0000		0.0000	0.0000		0.0000	0.0000		0.0000	0.0000	0.0000	0.0000	0.0000
Recreational Swimming Pool	0	0.0000	0.0000	0.0000	0.0000		0.0000	0.0000		0.0000	0.0000		0.0000	0.0000	0.0000	0.0000	0.0000
User Defined Commercial	0	0.0000	0.0000	0.0000	0.0000		0.0000	0.0000		0.0000	0.0000		0.0000	0.0000	0.0000	0.0000	0.0000
Total		0.0000	0.0000	0.0000	0.0000		0.0000	0.0000		0.0000	0.0000		0.0000	0.0000	0.0000	0.0000	0.0000

6.0 Area Detail

6.1 Mitigation Measures Area

Hawthorne High School Pool - South Coast Air Basin, Summer

EMFAC Off-Model Adjustment Factors for Gasoline Light Duty Vehicle to Account for the SAFE Vehicle Rule Not Applied

	ROG	NOx	CO	SO2	Fugitive PM10	Exhaust PM10	PM10 Total	Fugitive PM2.5	Exhaust PM2.5	PM2.5 Total	Bio- CO2	NBio- CO2	Total CO2	CH4	N2O	CO2e
Category	lb/day										lb/day					
Mitigated	0.3761	2.0000e-005	2.4500e-003	0.0000		1.0000e-005	1.0000e-005		1.0000e-005	1.0000e-005		5.2600e-003	5.2600e-003	1.0000e-005		5.6000e-003
Unmitigated	0.3761	2.0000e-005	2.4500e-003	0.0000		1.0000e-005	1.0000e-005		1.0000e-005	1.0000e-005		5.2600e-003	5.2600e-003	1.0000e-005		5.6000e-003

6.2 Area by SubCategory

Unmitigated

	ROG	NOx	CO	SO2	Fugitive PM10	Exhaust PM10	PM10 Total	Fugitive PM2.5	Exhaust PM2.5	PM2.5 Total	Bio- CO2	NBio- CO2	Total CO2	CH4	N2O	CO2e
SubCategory	lb/day										lb/day					
Architectural Coating	0.0436					0.0000	0.0000		0.0000	0.0000			0.0000			0.0000
Consumer Products	0.3323					0.0000	0.0000		0.0000	0.0000			0.0000			0.0000
Landscaping	2.3000e-004	2.0000e-005	2.4500e-003	0.0000		1.0000e-005	1.0000e-005		1.0000e-005	1.0000e-005		5.2600e-003	5.2600e-003	1.0000e-005		5.6000e-003
Total	0.3761	2.0000e-005	2.4500e-003	0.0000		1.0000e-005	1.0000e-005		1.0000e-005	1.0000e-005		5.2600e-003	5.2600e-003	1.0000e-005		5.6000e-003

Hawthorne High School Pool - South Coast Air Basin, Summer

EMFAC Off-Model Adjustment Factors for Gasoline Light Duty Vehicle to Account for the SAFE Vehicle Rule Not Applied

6.2 Area by SubCategory

Mitigated

	ROG	NOx	CO	SO2	Fugitive PM10	Exhaust PM10	PM10 Total	Fugitive PM2.5	Exhaust PM2.5	PM2.5 Total	Bio- CO2	NBio- CO2	Total CO2	CH4	N2O	CO2e
SubCategory	lb/day										lb/day					
Architectural Coating	0.0436					0.0000	0.0000		0.0000	0.0000			0.0000			0.0000
Consumer Products	0.3323					0.0000	0.0000		0.0000	0.0000			0.0000			0.0000
Landscaping	2.3000e-004	2.0000e-005	2.4500e-003	0.0000		1.0000e-005	1.0000e-005		1.0000e-005	1.0000e-005		5.2600e-003	5.2600e-003	1.0000e-005		5.6000e-003
Total	0.3761	2.0000e-005	2.4500e-003	0.0000		1.0000e-005	1.0000e-005		1.0000e-005	1.0000e-005		5.2600e-003	5.2600e-003	1.0000e-005		5.6000e-003

7.0 Water Detail

7.1 Mitigation Measures Water

Hawthorne High School Pool - South Coast Air Basin, Summer

EMFAC Off-Model Adjustment Factors for Gasoline Light Duty Vehicle to Account for the SAFE Vehicle Rule Not Applied

8.0 Waste Detail

8.1 Mitigation Measures Waste

9.0 Operational Offroad

Equipment Type	Number	Hours/Day	Days/Year	Horse Power	Load Factor	Fuel Type
----------------	--------	-----------	-----------	-------------	-------------	-----------

10.0 Stationary Equipment

Fire Pumps and Emergency Generators

Equipment Type	Number	Hours/Day	Hours/Year	Horse Power	Load Factor	Fuel Type
----------------	--------	-----------	------------	-------------	-------------	-----------

Boilers

Equipment Type	Number	Heat Input/Day	Heat Input/Year	Boiler Rating	Fuel Type
----------------	--------	----------------	-----------------	---------------	-----------

User Defined Equipment

Equipment Type	Number
----------------	--------

11.0 Vegetation

Hawthorne High School Pool - South Coast Air Basin, Winter

EMFAC Off-Model Adjustment Factors for Gasoline Light Duty Vehicle to Account for the SAFE Vehicle Rule Not Applied

Hawthorne High School Pool

South Coast Air Basin, Winter

1.0 Project Characteristics

1.1 Land Usage

Land Uses	Size	Metric	Lot Acreage	Floor Surface Area	Population
User Defined Commercial	0.37	User Defined Unit	0.37	16,200.00	0
Other Asphalt Surfaces	12.00	1000sqft	0.28	12,000.00	0
Other Non-Asphalt Surfaces	0.47	Acre	0.47	20,473.20	0
Recreational Swimming Pool	11.20	1000sqft	0.26	11,200.00	0

1.2 Other Project Characteristics

Urbanization	Urban	Wind Speed (m/s)	2.2	Precipitation Freq (Days)	31
Climate Zone	8			Operational Year	2026
Utility Company	Southern California Edison				
CO2 Intensity (lb/MWhr)	390.98	CH4 Intensity (lb/MWhr)	0.033	N2O Intensity (lb/MWhr)	0.004

1.3 User Entered Comments & Non-Default Data

- Project Characteristics -
- Land Use - User Defined Commercial - structures
- Construction Phase - See Construction Assumptions Default
- Off-road Equipment - See Assumption Defaults
- Trips and VMT -
- Demolition - Demolition of Pool, Recreational Area, Asphalt surfaces
- Grading -
- Vehicle Trips -
- Vehicle Emission Factors -

Hawthorne High School Pool - South Coast Air Basin, Winter

EMFAC Off-Model Adjustment Factors for Gasoline Light Duty Vehicle to Account for the SAFE Vehicle Rule Not Applied

Vehicle Emission Factors -

Vehicle Emission Factors -

Construction Off-road Equipment Mitigation -

Fleet Mix -

Table Name	Column Name	Default Value	New Value
tblConstructionPhase	NumDays	200.00	190.00
tblConstructionPhase	NumDays	4.00	14.00
tblLandUse	LandUseSquareFeet	0.00	16,200.00
tblLandUse	LotAcreage	0.00	0.37
tblOffRoadEquipment	OffRoadEquipmentUnitAmount	2.00	1.00
tblOffRoadEquipment	UsageHours	8.00	6.00
tblOffRoadEquipment	UsageHours	8.00	6.00

2.0 Emissions Summary

Hawthorne High School Pool - South Coast Air Basin, Winter

EMFAC Off-Model Adjustment Factors for Gasoline Light Duty Vehicle to Account for the SAFE Vehicle Rule Not Applied

2.1 Overall Construction (Maximum Daily Emission)

Unmitigated Construction

	ROG	NOx	CO	SO2	Fugitive PM10	Exhaust PM10	PM10 Total	Fugitive PM2.5	Exhaust PM2.5	PM2.5 Total	Bio- CO2	NBio- CO2	Total CO2	CH4	N2O	CO2e
Year	lb/day										lb/day					
2024	1.5074	15.6706	14.3546	0.0330	6.3556	0.6437	6.8384	3.0278	0.6015	3.4719	0.0000	3,294.832 3	3,294.832 3	0.6443	0.1385	3,352.205 9
2025	16.1060	10.8409	13.2422	0.0259	0.3323	0.3959	0.7282	0.0896	0.3818	0.4713	0.0000	2,402.813 4	2,402.813 4	0.4140	0.0328	2,421.046 7
Maximum	16.1060	15.6706	14.3546	0.0330	6.3556	0.6437	6.8384	3.0278	0.6015	3.4719	0.0000	3,294.832 3	3,294.832 3	0.6443	0.1385	3,352.205 9

Mitigated Construction

	ROG	NOx	CO	SO2	Fugitive PM10	Exhaust PM10	PM10 Total	Fugitive PM2.5	Exhaust PM2.5	PM2.5 Total	Bio- CO2	NBio- CO2	Total CO2	CH4	N2O	CO2e
Year	lb/day										lb/day					
2024	1.5074	15.6706	14.3546	0.0330	2.5332	0.6437	3.0160	1.1953	0.6015	1.6394	0.0000	3,294.832 3	3,294.832 3	0.6443	0.1385	3,352.205 9
2025	16.1060	10.8409	13.2422	0.0259	0.3323	0.3959	0.7282	0.0896	0.3818	0.4713	0.0000	2,402.813 4	2,402.813 4	0.4140	0.0328	2,421.046 7
Maximum	16.1060	15.6706	14.3546	0.0330	2.5332	0.6437	3.0160	1.1953	0.6015	1.6394	0.0000	3,294.832 3	3,294.832 3	0.6443	0.1385	3,352.205 9

Hawthorne High School Pool - South Coast Air Basin, Winter

EMFAC Off-Model Adjustment Factors for Gasoline Light Duty Vehicle to Account for the SAFE Vehicle Rule Not Applied

	ROG	NOx	CO	SO2	Fugitive PM10	Exhaust PM10	PM10 Total	Fugitive PM2.5	Exhaust PM2.5	PM2.5 Total	Bio- CO2	NBio-CO2	Total CO2	CH4	N2O	CO2e
Percent Reduction	0.00	0.00	0.00	0.00	57.15	0.00	50.52	58.78	0.00	46.47	0.00	0.00	0.00	0.00	0.00	0.00

Hawthorne High School Pool - South Coast Air Basin, Winter

EMFAC Off-Model Adjustment Factors for Gasoline Light Duty Vehicle to Account for the SAFE Vehicle Rule Not Applied

2.2 Overall Operational

Unmitigated Operational

	ROG	NOx	CO	SO2	Fugitive PM10	Exhaust PM10	PM10 Total	Fugitive PM2.5	Exhaust PM2.5	PM2.5 Total	Bio- CO2	NBio- CO2	Total CO2	CH4	N2O	CO2e
Category	lb/day										lb/day					
Area	0.3761	2.0000e-005	2.4500e-003	0.0000		1.0000e-005	1.0000e-005		1.0000e-005	1.0000e-005		5.2600e-003	5.2600e-003	1.0000e-005		5.6000e-003
Energy	0.0000	0.0000	0.0000	0.0000		0.0000	0.0000		0.0000	0.0000		0.0000	0.0000	0.0000	0.0000	0.0000
Mobile	0.7302	0.7539	6.6377	0.0143	1.6564	0.0106	1.6669	0.4414	9.8200e-003	0.4512		1,454.1730	1,454.1730	0.1041	0.0684	1,477.1440
Total	1.1063	0.7539	6.6401	0.0143	1.6564	0.0106	1.6670	0.4414	9.8300e-003	0.4512		1,454.1783	1,454.1783	0.1042	0.0684	1,477.1496

Mitigated Operational

	ROG	NOx	CO	SO2	Fugitive PM10	Exhaust PM10	PM10 Total	Fugitive PM2.5	Exhaust PM2.5	PM2.5 Total	Bio- CO2	NBio- CO2	Total CO2	CH4	N2O	CO2e
Category	lb/day										lb/day					
Area	0.3761	2.0000e-005	2.4500e-003	0.0000		1.0000e-005	1.0000e-005		1.0000e-005	1.0000e-005		5.2600e-003	5.2600e-003	1.0000e-005		5.6000e-003
Energy	0.0000	0.0000	0.0000	0.0000		0.0000	0.0000		0.0000	0.0000		0.0000	0.0000	0.0000	0.0000	0.0000
Mobile	0.7302	0.7539	6.6377	0.0143	1.6564	0.0106	1.6669	0.4414	9.8200e-003	0.4512		1,454.1730	1,454.1730	0.1041	0.0684	1,477.1440
Total	1.1063	0.7539	6.6401	0.0143	1.6564	0.0106	1.6670	0.4414	9.8300e-003	0.4512		1,454.1783	1,454.1783	0.1042	0.0684	1,477.1496

Hawthorne High School Pool - South Coast Air Basin, Winter

EMFAC Off-Model Adjustment Factors for Gasoline Light Duty Vehicle to Account for the SAFE Vehicle Rule Not Applied

	ROG	NOx	CO	SO2	Fugitive PM10	Exhaust PM10	PM10 Total	Fugitive PM2.5	Exhaust PM2.5	PM2.5 Total	Bio- CO2	NBio-CO2	Total CO2	CH4	N2O	CO2e
Percent Reduction	0.00	0.00	0.00	0.00	0.00	0.00	0.00	0.00	0.00	0.00	0.00	0.00	0.00	0.00	0.00	0.00

3.0 Construction Detail

Construction Phase

Phase Number	Phase Name	Phase Type	Start Date	End Date	Num Days Week	Num Days	Phase Description
1	Demolition	Demolition	10/1/2024	10/28/2024	5	20	
2	Site Preparation	Site Preparation	10/29/2024	10/30/2024	5	2	
3	Grading	Grading	10/31/2024	11/19/2024	5	14	
4	Building Construction	Building Construction	11/20/2024	8/12/2025	5	190	
5	Paving	Paving	8/13/2025	8/26/2025	5	10	
6	Architectural Coating	Architectural Coating	8/27/2025	9/9/2025	5	10	

Acres of Grading (Site Preparation Phase): 1.88

Acres of Grading (Grading Phase): 10.5

Acres of Paving: 0.75

Residential Indoor: 0; Residential Outdoor: 0; Non-Residential Indoor: 24,300; Non-Residential Outdoor: 8,100; Striped Parking Area: 1,948 (Architectural Coating – sqft)

OffRoad Equipment

Phase Name	Offroad Equipment Type	Amount	Usage Hours	Horse Power	Load Factor
Demolition	Concrete/Industrial Saws	1	8.00	81	0.73
Demolition	Rubber Tired Dozers	1	8.00	247	0.40
Demolition	Tractors/Loaders/Backhoes	3	8.00	97	0.37
Site Preparation	Graders	1	8.00	187	0.41
Site Preparation	Rubber Tired Dozers	1	7.00	247	0.40

Hawthorne High School Pool - South Coast Air Basin, Winter

EMFAC Off-Model Adjustment Factors for Gasoline Light Duty Vehicle to Account for the SAFE Vehicle Rule Not Applied

Site Preparation	Tractors/Loaders/Backhoes	1	8.00	97	0.37
Grading	Graders	1	6.00	187	0.41
Grading	Rubber Tired Dozers	1	6.00	247	0.40
Grading	Tractors/Loaders/Backhoes	1	7.00	97	0.37
Building Construction	Cranes	1	6.00	231	0.29
Building Construction	Forklifts	1	6.00	89	0.20
Building Construction	Generator Sets	1	8.00	84	0.74
Building Construction	Tractors/Loaders/Backhoes	1	6.00	97	0.37
Building Construction	Welders	3	8.00	46	0.45
Paving	Cement and Mortar Mixers	1	6.00	9	0.56
Paving	Pavers	1	6.00	130	0.42
Paving	Paving Equipment	1	8.00	132	0.36
Paving	Rollers	1	7.00	80	0.38
Paving	Tractors/Loaders/Backhoes	1	8.00	97	0.37
Architectural Coating	Air Compressors	1	6.00	78	0.48

Trips and VMT

Phase Name	Offroad Equipment Count	Worker Trip Number	Vendor Trip Number	Hauling Trip Number	Worker Trip Length	Vendor Trip Length	Hauling Trip Length	Worker Vehicle Class	Vendor Vehicle Class	Hauling Vehicle Class
Demolition	5	13.00	0.00	272.00	14.70	6.90	20.00	LD_Mix	HDT_Mix	HHDT
Site Preparation	3	8.00	0.00	0.00	14.70	6.90	20.00	LD_Mix	HDT_Mix	HHDT
Grading	3	8.00	0.00	0.00	14.70	6.90	20.00	LD_Mix	HDT_Mix	HHDT
Building Construction	7	24.00	10.00	0.00	14.70	6.90	20.00	LD_Mix	HDT_Mix	HHDT
Paving	5	13.00	0.00	0.00	14.70	6.90	20.00	LD_Mix	HDT_Mix	HHDT
Architectural Coating	1	5.00	0.00	0.00	14.70	6.90	20.00	LD_Mix	HDT_Mix	HHDT

3.1 Mitigation Measures Construction

Water Exposed Area

Hawthorne High School Pool - South Coast Air Basin, Winter

EMFAC Off-Model Adjustment Factors for Gasoline Light Duty Vehicle to Account for the SAFE Vehicle Rule Not Applied

3.2 Demolition - 2024

Unmitigated Construction On-Site

	ROG	NOx	CO	SO2	Fugitive PM10	Exhaust PM10	PM10 Total	Fugitive PM2.5	Exhaust PM2.5	PM2.5 Total	Bio- CO2	NBio- CO2	Total CO2	CH4	N2O	CO2e
Category	lb/day										lb/day					
Fugitive Dust					2.9468	0.0000	2.9468	0.4462	0.0000	0.4462			0.0000			0.0000
Off-Road	1.4397	13.8867	13.4879	0.0241		0.6311	0.6311		0.5895	0.5895		2,324.9459	2,324.9459	0.5884		2,339.6562
Total	1.4397	13.8867	13.4879	0.0241	2.9468	0.6311	3.5779	0.4462	0.5895	1.0356		2,324.9459	2,324.9459	0.5884		2,339.6562

Unmitigated Construction Off-Site

	ROG	NOx	CO	SO2	Fugitive PM10	Exhaust PM10	PM10 Total	Fugitive PM2.5	Exhaust PM2.5	PM2.5 Total	Bio- CO2	NBio- CO2	Total CO2	CH4	N2O	CO2e
Category	lb/day										lb/day					
Hauling	0.0267	1.7568	0.4818	7.7100e-003	0.2378	0.0118	0.2496	0.0652	0.0113	0.0765		852.1169	852.1169	0.0530	0.1356	893.8454
Vendor	0.0000	0.0000	0.0000	0.0000	0.0000	0.0000	0.0000	0.0000	0.0000	0.0000		0.0000	0.0000	0.0000	0.0000	0.0000
Worker	0.0410	0.0271	0.3849	1.1700e-003	0.1453	7.8000e-004	0.1461	0.0385	7.2000e-004	0.0393		117.7696	117.7696	2.8700e-003	2.9000e-003	118.7044
Total	0.0677	1.7839	0.8666	8.8800e-003	0.3831	0.0126	0.3957	0.1037	0.0120	0.1157		969.8865	969.8865	0.0559	0.1385	1,012.5497

Hawthorne High School Pool - South Coast Air Basin, Winter

EMFAC Off-Model Adjustment Factors for Gasoline Light Duty Vehicle to Account for the SAFE Vehicle Rule Not Applied

3.2 Demolition - 2024

Mitigated Construction On-Site

	ROG	NOx	CO	SO2	Fugitive PM10	Exhaust PM10	PM10 Total	Fugitive PM2.5	Exhaust PM2.5	PM2.5 Total	Bio- CO2	NBio- CO2	Total CO2	CH4	N2O	CO2e
Category	lb/day										lb/day					
Fugitive Dust					1.1493	0.0000	1.1493	0.1740	0.0000	0.1740			0.0000			0.0000
Off-Road	1.4397	13.8867	13.4879	0.0241		0.6311	0.6311		0.5895	0.5895	0.0000	2,324.9459	2,324.9459	0.5884		2,339.6562
Total	1.4397	13.8867	13.4879	0.0241	1.1493	0.6311	1.7804	0.1740	0.5895	0.7635	0.0000	2,324.9459	2,324.9459	0.5884		2,339.6562

Mitigated Construction Off-Site

	ROG	NOx	CO	SO2	Fugitive PM10	Exhaust PM10	PM10 Total	Fugitive PM2.5	Exhaust PM2.5	PM2.5 Total	Bio- CO2	NBio- CO2	Total CO2	CH4	N2O	CO2e
Category	lb/day										lb/day					
Hauling	0.0267	1.7568	0.4818	7.7100e-003	0.2378	0.0118	0.2496	0.0652	0.0113	0.0765		852.1169	852.1169	0.0530	0.1356	893.8454
Vendor	0.0000	0.0000	0.0000	0.0000	0.0000	0.0000	0.0000	0.0000	0.0000	0.0000		0.0000	0.0000	0.0000	0.0000	0.0000
Worker	0.0410	0.0271	0.3849	1.1700e-003	0.1453	7.8000e-004	0.1461	0.0385	7.2000e-004	0.0393		117.7696	117.7696	2.8700e-003	2.9000e-003	118.7044
Total	0.0677	1.7839	0.8666	8.8800e-003	0.3831	0.0126	0.3957	0.1037	0.0120	0.1157		969.8865	969.8865	0.0559	0.1385	1,012.5497

Hawthorne High School Pool - South Coast Air Basin, Winter

EMFAC Off-Model Adjustment Factors for Gasoline Light Duty Vehicle to Account for the SAFE Vehicle Rule Not Applied

3.3 Site Preparation - 2024

Unmitigated Construction On-Site

	ROG	NOx	CO	SO2	Fugitive PM10	Exhaust PM10	PM10 Total	Fugitive PM2.5	Exhaust PM2.5	PM2.5 Total	Bio- CO2	NBio- CO2	Total CO2	CH4	N2O	CO2e
Category	lb/day										lb/day					
Fugitive Dust					6.2662	0.0000	6.2662	3.0041	0.0000	3.0041			0.0000			0.0000
Off-Road	1.1067	11.8407	6.6317	0.0172		0.4823	0.4823		0.4437	0.4437		1,665.8826	1,665.8826	0.5388		1,679.3521
Total	1.1067	11.8407	6.6317	0.0172	6.2662	0.4823	6.7485	3.0041	0.4437	3.4478		1,665.8826	1,665.8826	0.5388		1,679.3521

Unmitigated Construction Off-Site

	ROG	NOx	CO	SO2	Fugitive PM10	Exhaust PM10	PM10 Total	Fugitive PM2.5	Exhaust PM2.5	PM2.5 Total	Bio- CO2	NBio- CO2	Total CO2	CH4	N2O	CO2e
Category	lb/day										lb/day					
Hauling	0.0000	0.0000	0.0000	0.0000	0.0000	0.0000	0.0000	0.0000	0.0000	0.0000		0.0000	0.0000	0.0000	0.0000	0.0000
Vendor	0.0000	0.0000	0.0000	0.0000	0.0000	0.0000	0.0000	0.0000	0.0000	0.0000		0.0000	0.0000	0.0000	0.0000	0.0000
Worker	0.0252	0.0167	0.2368	7.2000e-004	0.0894	4.8000e-004	0.0899	0.0237	4.4000e-004	0.0242		72.4736	72.4736	1.7700e-003	1.7800e-003	73.0488
Total	0.0252	0.0167	0.2368	7.2000e-004	0.0894	4.8000e-004	0.0899	0.0237	4.4000e-004	0.0242		72.4736	72.4736	1.7700e-003	1.7800e-003	73.0488

Hawthorne High School Pool - South Coast Air Basin, Winter

EMFAC Off-Model Adjustment Factors for Gasoline Light Duty Vehicle to Account for the SAFE Vehicle Rule Not Applied

3.3 Site Preparation - 2024

Mitigated Construction On-Site

	ROG	NOx	CO	SO2	Fugitive PM10	Exhaust PM10	PM10 Total	Fugitive PM2.5	Exhaust PM2.5	PM2.5 Total	Bio- CO2	NBio- CO2	Total CO2	CH4	N2O	CO2e
Category	lb/day										lb/day					
Fugitive Dust					2.4438	0.0000	2.4438	1.1716	0.0000	1.1716			0.0000			0.0000
Off-Road	1.1067	11.8407	6.6317	0.0172		0.4823	0.4823		0.4437	0.4437	0.0000	1,665.8826	1,665.8826	0.5388		1,679.3521
Total	1.1067	11.8407	6.6317	0.0172	2.4438	0.4823	2.9261	1.1716	0.4437	1.6153	0.0000	1,665.8826	1,665.8826	0.5388		1,679.3521

Mitigated Construction Off-Site

	ROG	NOx	CO	SO2	Fugitive PM10	Exhaust PM10	PM10 Total	Fugitive PM2.5	Exhaust PM2.5	PM2.5 Total	Bio- CO2	NBio- CO2	Total CO2	CH4	N2O	CO2e
Category	lb/day										lb/day					
Hauling	0.0000	0.0000	0.0000	0.0000	0.0000	0.0000	0.0000	0.0000	0.0000	0.0000		0.0000	0.0000	0.0000	0.0000	0.0000
Vendor	0.0000	0.0000	0.0000	0.0000	0.0000	0.0000	0.0000	0.0000	0.0000	0.0000		0.0000	0.0000	0.0000	0.0000	0.0000
Worker	0.0252	0.0167	0.2368	7.2000e-004	0.0894	4.8000e-004	0.0899	0.0237	4.4000e-004	0.0242		72.4736	72.4736	1.7700e-003	1.7800e-003	73.0488
Total	0.0252	0.0167	0.2368	7.2000e-004	0.0894	4.8000e-004	0.0899	0.0237	4.4000e-004	0.0242		72.4736	72.4736	1.7700e-003	1.7800e-003	73.0488

Hawthorne High School Pool - South Coast Air Basin, Winter

EMFAC Off-Model Adjustment Factors for Gasoline Light Duty Vehicle to Account for the SAFE Vehicle Rule Not Applied

3.4 Grading - 2024

Unmitigated Construction On-Site

	ROG	NOx	CO	SO2	Fugitive PM10	Exhaust PM10	PM10 Total	Fugitive PM2.5	Exhaust PM2.5	PM2.5 Total	Bio- CO2	NBio- CO2	Total CO2	CH4	N2O	CO2e
Category	lb/day										lb/day					
Fugitive Dust					5.3119	0.0000	5.3119	2.5686	0.0000	2.5686			0.0000			0.0000
Off-Road	0.9132	9.7297	5.5468	0.0141		0.4001	0.4001		0.3681	0.3681		1,364.662 3	1,364.662 3	0.4414		1,375.696 2
Total	0.9132	9.7297	5.5468	0.0141	5.3119	0.4001	5.7120	2.5686	0.3681	2.9367		1,364.662 3	1,364.662 3	0.4414		1,375.696 2

Unmitigated Construction Off-Site

	ROG	NOx	CO	SO2	Fugitive PM10	Exhaust PM10	PM10 Total	Fugitive PM2.5	Exhaust PM2.5	PM2.5 Total	Bio- CO2	NBio- CO2	Total CO2	CH4	N2O	CO2e
Category	lb/day										lb/day					
Hauling	0.0000	0.0000	0.0000	0.0000	0.0000	0.0000	0.0000	0.0000	0.0000	0.0000		0.0000	0.0000	0.0000	0.0000	0.0000
Vendor	0.0000	0.0000	0.0000	0.0000	0.0000	0.0000	0.0000	0.0000	0.0000	0.0000		0.0000	0.0000	0.0000	0.0000	0.0000
Worker	0.0252	0.0167	0.2368	7.2000e-004	0.0894	4.8000e-004	0.0899	0.0237	4.4000e-004	0.0242		72.4736	72.4736	1.7700e-003	1.7800e-003	73.0488
Total	0.0252	0.0167	0.2368	7.2000e-004	0.0894	4.8000e-004	0.0899	0.0237	4.4000e-004	0.0242		72.4736	72.4736	1.7700e-003	1.7800e-003	73.0488

Hawthorne High School Pool - South Coast Air Basin, Winter

EMFAC Off-Model Adjustment Factors for Gasoline Light Duty Vehicle to Account for the SAFE Vehicle Rule Not Applied

3.4 Grading - 2024

Mitigated Construction On-Site

	ROG	NOx	CO	SO2	Fugitive PM10	Exhaust PM10	PM10 Total	Fugitive PM2.5	Exhaust PM2.5	PM2.5 Total	Bio- CO2	NBio- CO2	Total CO2	CH4	N2O	CO2e
Category	lb/day										lb/day					
Fugitive Dust					2.0717	0.0000	2.0717	1.0017	0.0000	1.0017			0.0000			0.0000
Off-Road	0.9132	9.7297	5.5468	0.0141		0.4001	0.4001		0.3681	0.3681	0.0000	1,364.662 3	1,364.662 3	0.4414		1,375.696 2
Total	0.9132	9.7297	5.5468	0.0141	2.0717	0.4001	2.4718	1.0017	0.3681	1.3698	0.0000	1,364.662 3	1,364.662 3	0.4414		1,375.696 2

Mitigated Construction Off-Site

	ROG	NOx	CO	SO2	Fugitive PM10	Exhaust PM10	PM10 Total	Fugitive PM2.5	Exhaust PM2.5	PM2.5 Total	Bio- CO2	NBio- CO2	Total CO2	CH4	N2O	CO2e
Category	lb/day										lb/day					
Hauling	0.0000	0.0000	0.0000	0.0000	0.0000	0.0000	0.0000	0.0000	0.0000	0.0000		0.0000	0.0000	0.0000	0.0000	0.0000
Vendor	0.0000	0.0000	0.0000	0.0000	0.0000	0.0000	0.0000	0.0000	0.0000	0.0000		0.0000	0.0000	0.0000	0.0000	0.0000
Worker	0.0252	0.0167	0.2368	7.2000e-004	0.0894	4.8000e-004	0.0899	0.0237	4.4000e-004	0.0242		72.4736	72.4736	1.7700e-003	1.7800e-003	73.0488
Total	0.0252	0.0167	0.2368	7.2000e-004	0.0894	4.8000e-004	0.0899	0.0237	4.4000e-004	0.0242		72.4736	72.4736	1.7700e-003	1.7800e-003	73.0488

Hawthorne High School Pool - South Coast Air Basin, Winter

EMFAC Off-Model Adjustment Factors for Gasoline Light Duty Vehicle to Account for the SAFE Vehicle Rule Not Applied

3.5 Building Construction - 2024

Unmitigated Construction On-Site

	ROG	NOx	CO	SO2	Fugitive PM10	Exhaust PM10	PM10 Total	Fugitive PM2.5	Exhaust PM2.5	PM2.5 Total	Bio- CO2	NBio- CO2	Total CO2	CH4	N2O	CO2e
Category	lb/day										lb/day					
Off-Road	1.4200	11.0639	12.5172	0.0221		0.4506	0.4506		0.4348	0.4348		2,001.9214	2,001.9214	0.3334		2,010.2563
Total	1.4200	11.0639	12.5172	0.0221		0.4506	0.4506		0.4348	0.4348		2,001.9214	2,001.9214	0.3334		2,010.2563

Unmitigated Construction Off-Site

	ROG	NOx	CO	SO2	Fugitive PM10	Exhaust PM10	PM10 Total	Fugitive PM2.5	Exhaust PM2.5	PM2.5 Total	Bio- CO2	NBio- CO2	Total CO2	CH4	N2O	CO2e
Category	lb/day										lb/day					
Hauling	0.0000	0.0000	0.0000	0.0000	0.0000	0.0000	0.0000	0.0000	0.0000	0.0000		0.0000	0.0000	0.0000	0.0000	0.0000
Vendor	0.0100	0.3849	0.1426	1.8000e-003	0.0640	2.0400e-003	0.0661	0.0184	1.9500e-003	0.0204		194.1111	194.1111	7.2500e-003	0.0282	202.7021
Worker	0.0757	0.0501	0.7105	2.1500e-003	0.2683	1.4500e-003	0.2697	0.0711	1.3300e-003	0.0725		217.4207	217.4207	5.3000e-003	5.3500e-003	219.1465
Total	0.0857	0.4349	0.8531	3.9500e-003	0.3323	3.4900e-003	0.3358	0.0896	3.2800e-003	0.0929		411.5318	411.5318	0.0126	0.0336	421.8487

Hawthorne High School Pool - South Coast Air Basin, Winter

EMFAC Off-Model Adjustment Factors for Gasoline Light Duty Vehicle to Account for the SAFE Vehicle Rule Not Applied

3.5 Building Construction - 2024

Mitigated Construction On-Site

	ROG	NOx	CO	SO2	Fugitive PM10	Exhaust PM10	PM10 Total	Fugitive PM2.5	Exhaust PM2.5	PM2.5 Total	Bio- CO2	NBio- CO2	Total CO2	CH4	N2O	CO2e
Category	lb/day										lb/day					
Off-Road	1.4200	11.0639	12.5172	0.0221		0.4506	0.4506		0.4348	0.4348	0.0000	2,001.9214	2,001.9214	0.3334		2,010.2563
Total	1.4200	11.0639	12.5172	0.0221		0.4506	0.4506		0.4348	0.4348	0.0000	2,001.9214	2,001.9214	0.3334		2,010.2563

Mitigated Construction Off-Site

	ROG	NOx	CO	SO2	Fugitive PM10	Exhaust PM10	PM10 Total	Fugitive PM2.5	Exhaust PM2.5	PM2.5 Total	Bio- CO2	NBio- CO2	Total CO2	CH4	N2O	CO2e
Category	lb/day										lb/day					
Hauling	0.0000	0.0000	0.0000	0.0000	0.0000	0.0000	0.0000	0.0000	0.0000	0.0000		0.0000	0.0000	0.0000	0.0000	0.0000
Vendor	0.0100	0.3849	0.1426	1.8000e-003	0.0640	2.0400e-003	0.0661	0.0184	1.9500e-003	0.0204		194.1111	194.1111	7.2500e-003	0.0282	202.7021
Worker	0.0757	0.0501	0.7105	2.1500e-003	0.2683	1.4500e-003	0.2697	0.0711	1.3300e-003	0.0725		217.4207	217.4207	5.3000e-003	5.3500e-003	219.1465
Total	0.0857	0.4349	0.8531	3.9500e-003	0.3323	3.4900e-003	0.3358	0.0896	3.2800e-003	0.0929		411.5318	411.5318	0.0126	0.0336	421.8487

Hawthorne High School Pool - South Coast Air Basin, Winter

EMFAC Off-Model Adjustment Factors for Gasoline Light Duty Vehicle to Account for the SAFE Vehicle Rule Not Applied

3.5 Building Construction - 2025

Unmitigated Construction On-Site

	ROG	NOx	CO	SO2	Fugitive PM10	Exhaust PM10	PM10 Total	Fugitive PM2.5	Exhaust PM2.5	PM2.5 Total	Bio- CO2	NBio- CO2	Total CO2	CH4	N2O	CO2e
Category	lb/day										lb/day					
Off-Road	1.3246	10.4128	12.4393	0.0221		0.3925	0.3925		0.3785	0.3785		2,002.1524	2,002.1524	0.3269		2,010.3248
Total	1.3246	10.4128	12.4393	0.0221		0.3925	0.3925		0.3785	0.3785		2,002.1524	2,002.1524	0.3269		2,010.3248

Unmitigated Construction Off-Site

	ROG	NOx	CO	SO2	Fugitive PM10	Exhaust PM10	PM10 Total	Fugitive PM2.5	Exhaust PM2.5	PM2.5 Total	Bio- CO2	NBio- CO2	Total CO2	CH4	N2O	CO2e
Category	lb/day										lb/day					
Hauling	0.0000	0.0000	0.0000	0.0000	0.0000	0.0000	0.0000	0.0000	0.0000	0.0000		0.0000	0.0000	0.0000	0.0000	0.0000
Vendor	9.7800e-003	0.3831	0.1405	1.7600e-003	0.0640	2.0500e-003	0.0661	0.0184	1.9600e-003	0.0204		190.6298	190.6298	7.2700e-003	0.0278	199.0813
Worker	0.0711	0.0450	0.6624	2.0800e-003	0.2683	1.3800e-003	0.2696	0.0711	1.2700e-003	0.0724		210.0312	210.0312	4.7900e-003	5.0000e-003	211.6406
Total	0.0809	0.4282	0.8029	3.8400e-003	0.3323	3.4300e-003	0.3357	0.0896	3.2300e-003	0.0928		400.6610	400.6610	0.0121	0.0328	410.7219

Hawthorne High School Pool - South Coast Air Basin, Winter

EMFAC Off-Model Adjustment Factors for Gasoline Light Duty Vehicle to Account for the SAFE Vehicle Rule Not Applied

3.5 Building Construction - 2025

Mitigated Construction On-Site

	ROG	NOx	CO	SO2	Fugitive PM10	Exhaust PM10	PM10 Total	Fugitive PM2.5	Exhaust PM2.5	PM2.5 Total	Bio- CO2	NBio- CO2	Total CO2	CH4	N2O	CO2e
Category	lb/day										lb/day					
Off-Road	1.3246	10.4128	12.4393	0.0221		0.3925	0.3925		0.3785	0.3785	0.0000	2,002.1524	2,002.1524	0.3269		2,010.3248
Total	1.3246	10.4128	12.4393	0.0221		0.3925	0.3925		0.3785	0.3785	0.0000	2,002.1524	2,002.1524	0.3269		2,010.3248

Mitigated Construction Off-Site

	ROG	NOx	CO	SO2	Fugitive PM10	Exhaust PM10	PM10 Total	Fugitive PM2.5	Exhaust PM2.5	PM2.5 Total	Bio- CO2	NBio- CO2	Total CO2	CH4	N2O	CO2e
Category	lb/day										lb/day					
Hauling	0.0000	0.0000	0.0000	0.0000	0.0000	0.0000	0.0000	0.0000	0.0000	0.0000		0.0000	0.0000	0.0000	0.0000	0.0000
Vendor	9.7800e-003	0.3831	0.1405	1.7600e-003	0.0640	2.0500e-003	0.0661	0.0184	1.9600e-003	0.0204		190.6298	190.6298	7.2700e-003	0.0278	199.0813
Worker	0.0711	0.0450	0.6624	2.0800e-003	0.2683	1.3800e-003	0.2696	0.0711	1.2700e-003	0.0724		210.0312	210.0312	4.7900e-003	5.0000e-003	211.6406
Total	0.0809	0.4282	0.8029	3.8400e-003	0.3323	3.4300e-003	0.3357	0.0896	3.2300e-003	0.0928		400.6610	400.6610	0.0121	0.0328	410.7219

Hawthorne High School Pool - South Coast Air Basin, Winter

EMFAC Off-Model Adjustment Factors for Gasoline Light Duty Vehicle to Account for the SAFE Vehicle Rule Not Applied

3.6 Paving - 2025

Unmitigated Construction On-Site

	ROG	NOx	CO	SO2	Fugitive PM10	Exhaust PM10	PM10 Total	Fugitive PM2.5	Exhaust PM2.5	PM2.5 Total	Bio- CO2	NBio- CO2	Total CO2	CH4	N2O	CO2e
Category	lb/day										lb/day					
Off-Road	0.5732	5.3259	8.7951	0.0136		0.2465	0.2465		0.2276	0.2276		1,297.8096	1,297.8096	0.4114		1,308.0951
Paving	0.0734					0.0000	0.0000		0.0000	0.0000			0.0000			0.0000
Total	0.6466	5.3259	8.7951	0.0136		0.2465	0.2465		0.2276	0.2276		1,297.8096	1,297.8096	0.4114		1,308.0951

Unmitigated Construction Off-Site

	ROG	NOx	CO	SO2	Fugitive PM10	Exhaust PM10	PM10 Total	Fugitive PM2.5	Exhaust PM2.5	PM2.5 Total	Bio- CO2	NBio- CO2	Total CO2	CH4	N2O	CO2e
Category	lb/day										lb/day					
Hauling	0.0000	0.0000	0.0000	0.0000	0.0000	0.0000	0.0000	0.0000	0.0000	0.0000		0.0000	0.0000	0.0000	0.0000	0.0000
Vendor	0.0000	0.0000	0.0000	0.0000	0.0000	0.0000	0.0000	0.0000	0.0000	0.0000		0.0000	0.0000	0.0000	0.0000	0.0000
Worker	0.0385	0.0244	0.3588	1.1300e-003	0.1453	7.5000e-004	0.1461	0.0385	6.9000e-004	0.0392		113.7669	113.7669	2.5900e-003	2.7100e-003	114.6386
Total	0.0385	0.0244	0.3588	1.1300e-003	0.1453	7.5000e-004	0.1461	0.0385	6.9000e-004	0.0392		113.7669	113.7669	2.5900e-003	2.7100e-003	114.6386

Hawthorne High School Pool - South Coast Air Basin, Winter

EMFAC Off-Model Adjustment Factors for Gasoline Light Duty Vehicle to Account for the SAFE Vehicle Rule Not Applied

3.6 Paving - 2025

Mitigated Construction On-Site

	ROG	NOx	CO	SO2	Fugitive PM10	Exhaust PM10	PM10 Total	Fugitive PM2.5	Exhaust PM2.5	PM2.5 Total	Bio- CO2	NBio- CO2	Total CO2	CH4	N2O	CO2e
Category	lb/day										lb/day					
Off-Road	0.5732	5.3259	8.7951	0.0136		0.2465	0.2465		0.2276	0.2276	0.0000	1,297.8096	1,297.8096	0.4114		1,308.0951
Paving	0.0734					0.0000	0.0000		0.0000	0.0000			0.0000			0.0000
Total	0.6466	5.3259	8.7951	0.0136		0.2465	0.2465		0.2276	0.2276	0.0000	1,297.8096	1,297.8096	0.4114		1,308.0951

Mitigated Construction Off-Site

	ROG	NOx	CO	SO2	Fugitive PM10	Exhaust PM10	PM10 Total	Fugitive PM2.5	Exhaust PM2.5	PM2.5 Total	Bio- CO2	NBio- CO2	Total CO2	CH4	N2O	CO2e
Category	lb/day										lb/day					
Hauling	0.0000	0.0000	0.0000	0.0000	0.0000	0.0000	0.0000	0.0000	0.0000	0.0000		0.0000	0.0000	0.0000	0.0000	0.0000
Vendor	0.0000	0.0000	0.0000	0.0000	0.0000	0.0000	0.0000	0.0000	0.0000	0.0000		0.0000	0.0000	0.0000	0.0000	0.0000
Worker	0.0385	0.0244	0.3588	1.1300e-003	0.1453	7.5000e-004	0.1461	0.0385	6.9000e-004	0.0392		113.7669	113.7669	2.5900e-003	2.7100e-003	114.6386
Total	0.0385	0.0244	0.3588	1.1300e-003	0.1453	7.5000e-004	0.1461	0.0385	6.9000e-004	0.0392		113.7669	113.7669	2.5900e-003	2.7100e-003	114.6386

Hawthorne High School Pool - South Coast Air Basin, Winter

EMFAC Off-Model Adjustment Factors for Gasoline Light Duty Vehicle to Account for the SAFE Vehicle Rule Not Applied

3.7 Architectural Coating - 2025

Unmitigated Construction On-Site

	ROG	NOx	CO	SO2	Fugitive PM10	Exhaust PM10	PM10 Total	Fugitive PM2.5	Exhaust PM2.5	PM2.5 Total	Bio- CO2	NBio- CO2	Total CO2	CH4	N2O	CO2e
Category	lb/day										lb/day					
Archit. Coating	15.9203					0.0000	0.0000		0.0000	0.0000			0.0000			0.0000
Off-Road	0.1709	1.1455	1.8091	2.9700e-003		0.0515	0.0515		0.0515	0.0515		281.4481	281.4481	0.0154		281.8319
Total	16.0912	1.1455	1.8091	2.9700e-003		0.0515	0.0515		0.0515	0.0515		281.4481	281.4481	0.0154		281.8319

Unmitigated Construction Off-Site

	ROG	NOx	CO	SO2	Fugitive PM10	Exhaust PM10	PM10 Total	Fugitive PM2.5	Exhaust PM2.5	PM2.5 Total	Bio- CO2	NBio- CO2	Total CO2	CH4	N2O	CO2e
Category	lb/day										lb/day					
Hauling	0.0000	0.0000	0.0000	0.0000	0.0000	0.0000	0.0000	0.0000	0.0000	0.0000		0.0000	0.0000	0.0000	0.0000	0.0000
Vendor	0.0000	0.0000	0.0000	0.0000	0.0000	0.0000	0.0000	0.0000	0.0000	0.0000		0.0000	0.0000	0.0000	0.0000	0.0000
Worker	0.0148	9.3800e-003	0.1380	4.3000e-004	0.0559	2.9000e-004	0.0562	0.0148	2.6000e-004	0.0151		43.7565	43.7565	1.0000e-003	1.0400e-003	44.0918
Total	0.0148	9.3800e-003	0.1380	4.3000e-004	0.0559	2.9000e-004	0.0562	0.0148	2.6000e-004	0.0151		43.7565	43.7565	1.0000e-003	1.0400e-003	44.0918

Hawthorne High School Pool - South Coast Air Basin, Winter

EMFAC Off-Model Adjustment Factors for Gasoline Light Duty Vehicle to Account for the SAFE Vehicle Rule Not Applied

3.7 Architectural Coating - 2025

Mitigated Construction On-Site

	ROG	NOx	CO	SO2	Fugitive PM10	Exhaust PM10	PM10 Total	Fugitive PM2.5	Exhaust PM2.5	PM2.5 Total	Bio- CO2	NBio- CO2	Total CO2	CH4	N2O	CO2e
Category	lb/day										lb/day					
Archit. Coating	15.9203					0.0000	0.0000		0.0000	0.0000			0.0000			0.0000
Off-Road	0.1709	1.1455	1.8091	2.9700e-003		0.0515	0.0515		0.0515	0.0515	0.0000	281.4481	281.4481	0.0154		281.8319
Total	16.0912	1.1455	1.8091	2.9700e-003		0.0515	0.0515		0.0515	0.0515	0.0000	281.4481	281.4481	0.0154		281.8319

Mitigated Construction Off-Site

	ROG	NOx	CO	SO2	Fugitive PM10	Exhaust PM10	PM10 Total	Fugitive PM2.5	Exhaust PM2.5	PM2.5 Total	Bio- CO2	NBio- CO2	Total CO2	CH4	N2O	CO2e
Category	lb/day										lb/day					
Hauling	0.0000	0.0000	0.0000	0.0000	0.0000	0.0000	0.0000	0.0000	0.0000	0.0000		0.0000	0.0000	0.0000	0.0000	0.0000
Vendor	0.0000	0.0000	0.0000	0.0000	0.0000	0.0000	0.0000	0.0000	0.0000	0.0000		0.0000	0.0000	0.0000	0.0000	0.0000
Worker	0.0148	9.3800e-003	0.1380	4.3000e-004	0.0559	2.9000e-004	0.0562	0.0148	2.6000e-004	0.0151		43.7565	43.7565	1.0000e-003	1.0400e-003	44.0918
Total	0.0148	9.3800e-003	0.1380	4.3000e-004	0.0559	2.9000e-004	0.0562	0.0148	2.6000e-004	0.0151		43.7565	43.7565	1.0000e-003	1.0400e-003	44.0918

Hawthorne High School Pool - South Coast Air Basin, Winter

EMFAC Off-Model Adjustment Factors for Gasoline Light Duty Vehicle to Account for the SAFE Vehicle Rule Not Applied

4.0 Operational Detail - Mobile

4.1 Mitigation Measures Mobile

	ROG	NOx	CO	SO2	Fugitive PM10	Exhaust PM10	PM10 Total	Fugitive PM2.5	Exhaust PM2.5	PM2.5 Total	Bio- CO2	NBio- CO2	Total CO2	CH4	N2O	CO2e
Category	lb/day										lb/day					
Mitigated	0.7302	0.7539	6.6377	0.0143	1.6564	0.0106	1.6669	0.4414	9.8200e-003	0.4512		1,454.1730	1,454.1730	0.1041	0.0684	1,477.1440
Unmitigated	0.7302	0.7539	6.6377	0.0143	1.6564	0.0106	1.6669	0.4414	9.8200e-003	0.4512		1,454.1730	1,454.1730	0.1041	0.0684	1,477.1440

4.2 Trip Summary Information

Land Use	Average Daily Trip Rate			Unmitigated	Mitigated
	Weekday	Saturday	Sunday	Annual VMT	Annual VMT
Other Asphalt Surfaces	0.00	0.00	0.00		
Other Non-Asphalt Surfaces	0.00	0.00	0.00		
Recreational Swimming Pool	322.78	101.92	152.32	649,989	649,989
User Defined Commercial	0.00	0.00	0.00		
Total	322.78	101.92	152.32	649,989	649,989

4.3 Trip Type Information

Land Use	Miles			Trip %			Trip Purpose %		
	H-W or C-W	H-S or C-C	H-O or C-NW	H-W or C-W	H-S or C-C	H-O or C-NW	Primary	Diverted	Pass-by
Other Asphalt Surfaces	16.60	8.40	6.90	0.00	0.00	0.00	0	0	0
Other Non-Asphalt Surfaces	16.60	8.40	6.90	0.00	0.00	0.00	0	0	0
Recreational Swimming Pool	16.60	8.40	6.90	33.00	48.00	19.00	52	39	9

Hawthorne High School Pool - South Coast Air Basin, Winter

EMFAC Off-Model Adjustment Factors for Gasoline Light Duty Vehicle to Account for the SAFE Vehicle Rule Not Applied

Land Use	Miles			Trip %			Trip Purpose %		
	H-W or C-W	H-S or C-C	H-O or C-NW	H-W or C-W	H-S or C-C	H-O or C-NW	Primary	Diverted	Pass-by
User Defined Commercial	16.60	8.40	6.90	0.00	0.00	0.00	0	0	0

4.4 Fleet Mix

Land Use	LDA	LDT1	LDT2	MDV	LHD1	LHD2	MHD	HHD	OBUS	UBUS	MCY	SBUS	MH
Other Asphalt Surfaces	0.541801	0.062785	0.185964	0.127448	0.023798	0.006607	0.012341	0.008651	0.000818	0.000497	0.024959	0.000748	0.003583
Other Non-Asphalt Surfaces	0.541801	0.062785	0.185964	0.127448	0.023798	0.006607	0.012341	0.008651	0.000818	0.000497	0.024959	0.000748	0.003583
Recreational Swimming Pool	0.541801	0.062785	0.185964	0.127448	0.023798	0.006607	0.012341	0.008651	0.000818	0.000497	0.024959	0.000748	0.003583
User Defined Commercial	0.541801	0.062785	0.185964	0.127448	0.023798	0.006607	0.012341	0.008651	0.000818	0.000497	0.024959	0.000748	0.003583

5.0 Energy Detail

Historical Energy Use: N

5.1 Mitigation Measures Energy

Category	ROG	NOx	CO	SO2	Fugitive PM10	Exhaust PM10	PM10 Total	Fugitive PM2.5	Exhaust PM2.5	PM2.5 Total	Bio- CO2	NBio- CO2	Total CO2	CH4	N2O	CO2e
lb/day											lb/day					
NaturalGas Mitigated	0.0000	0.0000	0.0000	0.0000		0.0000	0.0000		0.0000	0.0000		0.0000	0.0000	0.0000	0.0000	0.0000
NaturalGas Unmitigated	0.0000	0.0000	0.0000	0.0000		0.0000	0.0000		0.0000	0.0000		0.0000	0.0000	0.0000	0.0000	0.0000

Hawthorne High School Pool - South Coast Air Basin, Winter

EMFAC Off-Model Adjustment Factors for Gasoline Light Duty Vehicle to Account for the SAFE Vehicle Rule Not Applied

5.2 Energy by Land Use - NaturalGas

Unmitigated

	NaturalGas Use	ROG	NOx	CO	SO2	Fugitive PM10	Exhaust PM10	PM10 Total	Fugitive PM2.5	Exhaust PM2.5	PM2.5 Total	Bio- CO2	NBio- CO2	Total CO2	CH4	N2O	CO2e
Land Use	kBTU/yr	lb/day										lb/day					
Other Asphalt Surfaces	0	0.0000	0.0000	0.0000	0.0000		0.0000	0.0000		0.0000	0.0000		0.0000	0.0000	0.0000	0.0000	0.0000
Other Non-Asphalt Surfaces	0	0.0000	0.0000	0.0000	0.0000		0.0000	0.0000		0.0000	0.0000		0.0000	0.0000	0.0000	0.0000	0.0000
Recreational Swimming Pool	0	0.0000	0.0000	0.0000	0.0000		0.0000	0.0000		0.0000	0.0000		0.0000	0.0000	0.0000	0.0000	0.0000
User Defined Commercial	0	0.0000	0.0000	0.0000	0.0000		0.0000	0.0000		0.0000	0.0000		0.0000	0.0000	0.0000	0.0000	0.0000
Total		0.0000	0.0000	0.0000	0.0000		0.0000	0.0000		0.0000	0.0000		0.0000	0.0000	0.0000	0.0000	0.0000

Hawthorne High School Pool - South Coast Air Basin, Winter

EMFAC Off-Model Adjustment Factors for Gasoline Light Duty Vehicle to Account for the SAFE Vehicle Rule Not Applied

5.2 Energy by Land Use - NaturalGas

Mitigated

	NaturalGas s Use	ROG	NOx	CO	SO2	Fugitive PM10	Exhaust PM10	PM10 Total	Fugitive PM2.5	Exhaust PM2.5	PM2.5 Total	Bio- CO2	NBio- CO2	Total CO2	CH4	N2O	CO2e
Land Use	kBTU/yr	lb/day										lb/day					
Other Asphalt Surfaces	0	0.0000	0.0000	0.0000	0.0000		0.0000	0.0000		0.0000	0.0000		0.0000	0.0000	0.0000	0.0000	0.0000
Other Non-Asphalt Surfaces	0	0.0000	0.0000	0.0000	0.0000		0.0000	0.0000		0.0000	0.0000		0.0000	0.0000	0.0000	0.0000	0.0000
Recreational Swimming Pool	0	0.0000	0.0000	0.0000	0.0000		0.0000	0.0000		0.0000	0.0000		0.0000	0.0000	0.0000	0.0000	0.0000
User Defined Commercial	0	0.0000	0.0000	0.0000	0.0000		0.0000	0.0000		0.0000	0.0000		0.0000	0.0000	0.0000	0.0000	0.0000
Total		0.0000	0.0000	0.0000	0.0000		0.0000	0.0000		0.0000	0.0000		0.0000	0.0000	0.0000	0.0000	0.0000

6.0 Area Detail

6.1 Mitigation Measures Area

Hawthorne High School Pool - South Coast Air Basin, Winter

EMFAC Off-Model Adjustment Factors for Gasoline Light Duty Vehicle to Account for the SAFE Vehicle Rule Not Applied

	ROG	NOx	CO	SO2	Fugitive PM10	Exhaust PM10	PM10 Total	Fugitive PM2.5	Exhaust PM2.5	PM2.5 Total	Bio- CO2	NBio- CO2	Total CO2	CH4	N2O	CO2e
Category	lb/day										lb/day					
Mitigated	0.3761	2.0000e-005	2.4500e-003	0.0000		1.0000e-005	1.0000e-005		1.0000e-005	1.0000e-005		5.2600e-003	5.2600e-003	1.0000e-005		5.6000e-003
Unmitigated	0.3761	2.0000e-005	2.4500e-003	0.0000		1.0000e-005	1.0000e-005		1.0000e-005	1.0000e-005		5.2600e-003	5.2600e-003	1.0000e-005		5.6000e-003

6.2 Area by SubCategory

Unmitigated

	ROG	NOx	CO	SO2	Fugitive PM10	Exhaust PM10	PM10 Total	Fugitive PM2.5	Exhaust PM2.5	PM2.5 Total	Bio- CO2	NBio- CO2	Total CO2	CH4	N2O	CO2e
SubCategory	lb/day										lb/day					
Architectural Coating	0.0436					0.0000	0.0000		0.0000	0.0000			0.0000			0.0000
Consumer Products	0.3323					0.0000	0.0000		0.0000	0.0000			0.0000			0.0000
Landscaping	2.3000e-004	2.0000e-005	2.4500e-003	0.0000		1.0000e-005	1.0000e-005		1.0000e-005	1.0000e-005		5.2600e-003	5.2600e-003	1.0000e-005		5.6000e-003
Total	0.3761	2.0000e-005	2.4500e-003	0.0000		1.0000e-005	1.0000e-005		1.0000e-005	1.0000e-005		5.2600e-003	5.2600e-003	1.0000e-005		5.6000e-003

Hawthorne High School Pool - South Coast Air Basin, Winter

EMFAC Off-Model Adjustment Factors for Gasoline Light Duty Vehicle to Account for the SAFE Vehicle Rule Not Applied

6.2 Area by SubCategory

Mitigated

	ROG	NOx	CO	SO2	Fugitive PM10	Exhaust PM10	PM10 Total	Fugitive PM2.5	Exhaust PM2.5	PM2.5 Total	Bio- CO2	NBio- CO2	Total CO2	CH4	N2O	CO2e
SubCategory	lb/day										lb/day					
Architectural Coating	0.0436					0.0000	0.0000		0.0000	0.0000			0.0000			0.0000
Consumer Products	0.3323					0.0000	0.0000		0.0000	0.0000			0.0000			0.0000
Landscaping	2.3000e-004	2.0000e-005	2.4500e-003	0.0000		1.0000e-005	1.0000e-005		1.0000e-005	1.0000e-005		5.2600e-003	5.2600e-003	1.0000e-005		5.6000e-003
Total	0.3761	2.0000e-005	2.4500e-003	0.0000		1.0000e-005	1.0000e-005		1.0000e-005	1.0000e-005		5.2600e-003	5.2600e-003	1.0000e-005		5.6000e-003

7.0 Water Detail

7.1 Mitigation Measures Water

Hawthorne High School Pool - South Coast Air Basin, Winter

EMFAC Off-Model Adjustment Factors for Gasoline Light Duty Vehicle to Account for the SAFE Vehicle Rule Not Applied

8.0 Waste Detail

8.1 Mitigation Measures Waste

9.0 Operational Offroad

Equipment Type	Number	Hours/Day	Days/Year	Horse Power	Load Factor	Fuel Type
----------------	--------	-----------	-----------	-------------	-------------	-----------

10.0 Stationary Equipment

Fire Pumps and Emergency Generators

Equipment Type	Number	Hours/Day	Hours/Year	Horse Power	Load Factor	Fuel Type
----------------	--------	-----------	------------	-------------	-------------	-----------

Boilers

Equipment Type	Number	Heat Input/Day	Heat Input/Year	Boiler Rating	Fuel Type
----------------	--------	----------------	-----------------	---------------	-----------

User Defined Equipment

Equipment Type	Number
----------------	--------

11.0 Vegetation

**Hawthorne Pool
Construction Energy**

Construction Water Energy Estimates					
Source	Acreage/Day	Number of Days	Total Construction Water Use (Mgal)	Electricity Demand from Water Conveyance (MWh)	Annual Electricity Demand from Water Conveyance (MWh)
Demolition	0.5	20	0.030	0.4	0.4
Site Preparation	1.0	2	0.006	0.1	0.1
Grading	1.0	14	0.042	0.5	0.6
Total			0.078	1.0	1.1

CalEEMod Water Electricity Factors	Electricity Intensity Factor To Supply (kWh/Mgal)	Electricity Intensity Factor To Treat (kWh/Mgal)	Electricity Intensity Factor To Distribute (kWh/Mgal)	Electricity Intensity Factor For Wastewater Treatment (kWh/Mgal)
		9727	111	1272

Construction Water GHG	Electricity Emission (MT CO2e/MWh)	Electricity Emission (lbs CO2e/MWh)
0.23	0.23	508.97
	(MT CH4/MWh)	(lbs CH4/MWh)
	1.50E-05	0.033
	(MT N2O/MWh)	(lbs N2O/MWh)
	1.81E-06	0.004

Sources and Assumptions:

CalEEMod Appendix A, Pg. 8, based on given piece of equipment can pass over in an 8-hour workday

-Electricity Intensity Factors - California Emissions Estimator Model (CalEEMod).

-Estimated construction water use assumed to be generally equivalent to landscape irrigation, based on a factor of 20.94 gallons per year per square foot of landscaped area within the Los Angeles area (Mediterranean climate), which assumes high water demand landscaping materials and an irrigation system efficiency of 85%. Factor is therefore (20.94 GAL/SF/year) x (43,560 SF/acre) / (365 days/year) / (0.85) = 2,940 gallons/acre/day, rounded up to 3,000 gallons/acre/day.

(U.S. Department of Energy, Energy Efficiency & Renewable Energy, Federal Energy Management Program. "Guidelines for Estimating Unmetered Landscaping Water Use." July 2010. Page 12, Table 4 - Annual Irrigation Factor – Landscaped Areas with High Water Requirements).

GHG Emissions Summary

	Onsite Emissions (CO2e)	Offsite Emissions (CO2e)	Total CO2e
Demolition (2022)	37.65	16.94	54.59
Demolition (2023)	37.65	16.24	53.89
Grading/Site Preparation (2023)	208.91	267.30	476.21
Foundations Concrete Pour #1 (2023)	3.37	2.45	5.82
Drainage/Utilities Trenching (2023)	186.35	44.31	230.66
Building Construction (2023)	202.43	206.22	408.65
Building Construction (2024)	82.49	82.65	165.13
Foundations Concrete Pour #2 (2023)	3.37	2.45	5.82
Paving Event #1 (2023)	5.05	2.03	7.08
Field Bleachers (2023)	53.73	17.48	71.21
Field Bleachers (2024)	137.48	43.78	181.26
Foundations Concrete Pour #3 (2024)	3.37	2.41	5.78
Architectural Coatings (2024)	7.33	17.11	24.44
Paving Event #2 (2024)	5.05	1.99	7.04
Synthetic Track (2024)	81.24	25.87	107.11
Water Conveyance			1.71
Total GHG Emissions			1,806.41

GHG Emissions Summary

	Onsite Emissions (CO2e)	Offsite Emissions (CO2e)	Total CO2e
3.2 Demolition - 2024	21.23	23.82	45.04
3.3 Site Preparation - 2024	1.52	0.07	1.60
3.4 Grading - 2024	8.74	0.51	9.25
3.5 Building Construction - 2024	27.36	7.89	35.24
3.5 Building Construction - 2025	145.90	39.63	185.53
3.6 Paving - 2025	5.93	0.58	6.52
3.7 Architectural Coating - 2025	1.28	0.22	1.50
Water Conveyance			0.23
Total GHG Emissions			284.92

**Hawthorne
Construction Energy Analysis**

Annual Fuel Summary

Heavy-Duty Construction Equipment	
113,690	Total Project Consumption
75,793	Annual Consumption
Haul Trucks	
3,413	Total Project Consumption
2,275	Annual Consumption
Vendor Trucks	
21,008	Total Project Consumption
14,005	Annual Consumption
Workers	
30,552	Total Project Consumption
20,368	Annual Consumption
24,421	Project Consumption of diesel for Haul Trucks and Vendors
16,281	Annual Consumption
138,111	Total Gallons Diesel
30,552	Total Gallons Gasoline

1.5	Estimated Project Construction Duration (years)
-----	---

92,074	Annual Average Gallons Diesel
20,368	Annual Average Gallons Gasoline

Los Angeles County			Percent of Annual Project Compared to Los Angeles County	
Source	Fuel Type	Gallons		
Workers	Gasoline	3,559,000,000		0.0006%
Off-Road/Vendor/Haul Trucks	Diesel	584,745,763		0.016%

Notes:

1 Gasoline and diesel amounts from CEC, 2019. Available: <https://www.energy.ca.gov/data-reports/energy-almanac/transportation-energy/california-retail-fuel-outlet-annual-reporting>

Annual Electricity Summary

Water Conveyance for Dust Control	4,948 kWh/year
Total	4,948 kWh/year

84,654,000 Total SCE, 2019
0.01% Project percentage of SCE

Hawthorne
Construction Energy Analysis

Off-Road Equipment

<u>Equipment ≤ 100 hp</u>	
pounds diesel fuel/hp-hr (lb/hp-hr): ¹	0.408 lb/hp-hr
diesel density (lb/gal): ¹	7.11 lb/gal
diesel gallons/hp-hr:	0.0574 gal/hp-hr
Total <100	1,136,263 hp-hr
Total diesel gallons:	65,213 gal

<u>Equipment > 100 hp</u>	
pounds diesel fuel/hp-hr (lb/hp-hr): ¹	0.367 lb/hp-hr
diesel density (lb/gal): ¹	7.11 lb/gal
diesel gallons/hp-hr:	0.0516 gal/hp-hr
Total >100	939,008 hp-hr
Total diesel gallons:	48,477 gal

Total diesel gallons (off-road equipment): 113,690 gal

[1. OFFROAD2017 Emission Factor Documentation](#)

Construction Phase	Equipment	Number	Hours/Day	HP	Load	Days	Total hp-hr
Demolition	Concrete/Industrial Saws	1	8	81	0.73	44	20,814
	Excavators	3	8	158	0.38	44	63,402
	Rubber Tired Dozers	2	8	247	0.4	44	69,555
Grading/Site Preparation	Excavators	2	8	158	0.38	76	73,009
	Graders	1	8	187	0.41	76	46,615
	Rubber Tired Dozers	1	9	247	0.4	76	67,579
	Scrapers	2	8	367	0.48	76	214,211
	Tractors/Loaders/Backhoes	2	8	97	0.37	76	43,642
	Pumps	3	8	84	0.74	3	4,476
Foundations/Concrete Pour #1	Tractors/Loaders/Backhoes	2	8	97	0.37	3	1,723
	Trenchers	3	8	78	0.5025	109	102,534
Drainage/Utilities/Trenching	Tractors/Loaders/Backhoes	2	8	97	0.37	109	62,592
	Rubber Tired Dozers	1	9	247	0.4	109	96,923
	Excavators	1	8	158	0.38	109	52,355
Building Construction	Cranes	1	8	231	0.29	228	122,190
	Forklifts	3	8	89	0.2	228	97,402
	Generator Sets	1	8	84	0.74	228	113,380
	Tractors/Loaders/Backhoes	3	8	97	0.37	228	196,390
	Welders	1	8	46	0.45	228	37,757
Foundations/Concrete Pour #2	Pumps	3	8	84	0.74	3	4,476
	Tractors/Loaders/Backhoes	2	8	97	0.37	3	1,723
Paving Event #1	Pavers	2	8	130	0.42	5	4,368
	Paving Equipment	2	8	132	0.36	5	3,802
	Rollers	2	8	80	0.38	5	2,432
Foundations/Concrete Pour #3	Pumps	3	8	84	0.74	3	4,476
	Tractors/Loaders/Backhoes	2	8	97	0.37	3	1,723
Architectural Coatings	Air Compressors	1	8	78	0.48	43	12,879
Paving Event #2	Pavers	2	8	130	0.42	5	4,368
	Paving Equipment	2	8	132	0.36	5	3,802
	Rollers	2	8	80	0.38	5	2,432
Synthetic Track	Cranes	1	8	231	0.29	65	34,835
	Forklifts	3	8	89	0.2	65	27,768
	Generator Sets	1	8	84	0.74	65	32,323
	Tractors/Loaders/Backhoes	3	8	97	0.37	65	55,988
	Welders	1	8	46	0.45	65	10,764
Field/Bleachers	Cranes	1	8	231	0.29	153	81,996
	Forklifts	3	8	89	0.2	153	65,362
	Generator Sets	1	8	84	0.74	153	76,084
	Tractors/Loaders/Backhoes	3	8	97	0.37	153	131,788
	Welders	1	8	46	0.45	153	25,337
						Total >100	939,008
						Total <100	1,136,263

**Hawthorne
Construction Energy**

Construction Water Energy Estimates

Source	Acreage/Day	Number of Days	Total Construction Water Use (Mgal)	Electricity Demand from Water Conveyance (MWh)	Annual Electricity Demand from Water Conveyance (MWh)
Grading/Site Preparation	2.5	76	0.570	7.4	4.9
Total			0.570	7.4	4.9

CalEEMod Water Electricity Factors	Electricity Intensity Factor To Supply (kWh/Mgal)	Electricity Intensity Factor To Treat (kWh/Mgal)	Electricity Intensity Factor To Distribute (kWh/Mgal)	Electricity Intensity Factor For Wastewater Treatment (kWh/Mgal)
	9727	111	1272	1911

Construction Water GHG Emissions Total	Electricity Emission Factor (MT CO2e/MWh)	Electricity Emission Factor (lbs CO2e/MWh)
1.71	0.23	508.97

Sources and Assumptions:

CalEEMod Appendix A, Pg. 8, based on given piece of equipment can pass over in an 8-hour workday

-Electricity Intensity Factors - California Emissions Estimator Model (CalEEMod).

-Estimated construction water use assumed to be generally equivalent to landscape irrigation, based on a factor of 20.94 gallons per year per square foot of landscaped area within the Los Angeles area (Mediterranean climate), which assumes high water demand landscaping materials and an irrigation system efficiency of 85%. Factor is therefore $(20.94 \text{ GAL/SF/year}) \times (43,560 \text{ SF/acre}) / (365 \text{ days/year}) / (0.85) = 2,940 \text{ gallons/acre/day}$, rounded up to 3,000 gallons/acre/day.

(U.S. Department of Energy, Energy Efficiency & Renewable Energy, Federal Energy Management Program. "Guidelines for Estimating Unmetered Landscaping Water Use." July 2010. Page 12, Table 4 - Annual Irrigation Factor – Landscaped Areas with High Water Requirements).

-Demolition areage is an estimate from Google Earth based on the existing structures to be removed on-site

Accounts for both pump stations

**Hawthorne Pool
Construction Energy Analysis**

Annual Fuel Summary

Maximum Heavy-Duty Construction Equipment	
22,572	Total Project Consumption
24,020	Annual Consumption
On-Road Diesel	
3,656	Total Project Consumption
3,890	Annual Consumption
On-Road Gasoline	
2,759	Total Project Consumption
2,936	Annual Consumption
26,228	Total Gallons Diesel
2,759	Total Gallons Gasoline
27,910	Average Annual Gallons Diesel
2,936	Average Annual Gallons Gasoline
0.9	Estimated Project Construction Duration (years)

Los Angeles County			Percent of Annual Project Compared to Los Angeles County
Source	Fuel Type	Gallons	
Workers	Gasoline	3,559,000,000	0.0001%
Off-Road/Vendor/Haul Trucks	Diesel	584,745,763	0.004%

Notes:

- 1 Gasoline and diesel amounts from CEC, 2019. Available: <https://www.energy.ca.gov/data-reports/energy-almanac/transportation-energy/california-retail-fuel-outlet-annual-reporting>

Annual Electricity Summary

Electricity Demand from Water Conveyance	1,081 kWh/year
Total	1,081 kWh/year

**Hawthorne Pool
Construction Energy Analysis**

Off-Road Equipment

Equipment ≤ 100 hp
 pounds diesel fuel/hp-hr (lb/hp-hr):¹ 0.408 lb/hp-hr
 diesel density (lb/gal):¹ 7.11 lb/gal
 diesel gallons/hp-hr: 0.0574 gal/hp-hr
 Total <100 288,409 hp-hr
 Total diesel gallons: 16,553 gal

Equipment > 100 hp
 pounds diesel fuel/hp-hr (lb/hp-hr):¹ 0.367 lb/hp-hr
 diesel density (lb/gal):¹ 7.11 lb/gal
 diesel gallons/hp-hr: 0.0516 gal/hp-hr
 Total >100 116,604 hp-hr
 Total diesel gallons: 6,020 gal

Total diesel gallons (off-road equipment): 22,572 gal

[1. OFFROAD2017 Emission Factor Documentation](#)

Construction Phase	Equipment	Number	Hours/Day	HP	Load	Days	Total hp-hr
Demolition	Concrete/Industrial Saws	1	8	81	0.73	20	9,461
Demolition	Rubber Tired Dozers	1	8	247	0.4	20	15,808
Demolition	Tractors/Loaders/Backhoes	3	8	97	0.37	20	17,227
Site Preparation	Graders	1	8	187	0.41	2	1,227
Site Preparation	Rubber Tired Dozers	1	7	247	0.4	2	1,383
Site Preparation	Tractors/Loaders/Backhoes	1	8	97	0.37	2	574
Grading	Graders	1	6	187	0.41	14	6,440
Grading	Rubber Tired Dozers	1	6	247	0.4	14	8,299
Grading	Tractors/Loaders/Backhoes	1	7	97	0.37	14	3,517
Building Construction	Cranes	1	6	231	0.29	190	76,369
Building Construction	Forklifts	1	6	89	0.2	190	20,292
Building Construction	Generator Sets	1	8	84	0.74	190	94,483
Building Construction	Tractors/Loaders/Backhoes	1	6	97	0.37	190	40,915
Building Construction	Welders	3	8	46	0.45	190	94,392
Paving	Cement and Mortar Mixers	1	6	9	0.56	10	302
Paving	Pavers	1	6	130	0.42	10	3,276
Paving	Paving Equipment	1	8	132	0.36	10	3,802
Paving	Rollers	1	7	80	0.38	10	2,128
Paving	Tractors/Loaders/Backhoes	1	8	97	0.37	10	2,871
Architectural Coating	Air Compressors	1	6	78	0.48	10	2,246
						Total >100	116,604
						Total <100	288,409

**Hawthorne Pool
Construction Energy**

Construction Water Energy Estimates

Source	Acreage/Day	Number of Days	Total Construction Water Use (Mgal)	Electricity Demand from Water Conveyance (MWh)	Annual Electricity Demand from Water Conveyance (MWh)
Demolition	0.5	20	0.030	0.4	0.4
Site Preparation	1.0	2	0.006	0.1	0.1
Grading	1.0	14	0.042	0.5	0.6
Total			0.078	1.0	1.1

CalEEMod Water Electricity Factors	Electricity Intensity Factor To Supply (kWh/Mgal)	Electricity Intensity Factor To Treat (kWh/Mgal)	Electricity Intensity Factor To Distribute (kWh/Mgal)	Electricity Intensity Factor For Wastewater Treatment (kWh/Mgal)
	9727	111	1272	1911

Construction Water GHG	Electricity Emission (MT CO2e/MWh)	Electricity Emission (lbs CO2e/MWh)
0.23	0.23	508.97

Sources and Assumptions:

CalEEMod Appendix A, Pg. 8, based on given piece of equipment can pass over in an 8-hour workday

-Electricity Intensity Factors - California Emissions Estimator Model (CalEEMod).

-Estimated construction water use assumed to be generally equivalent to landscape irrigation, based on a factor of 20.94 gallons per year per square foot of landscaped area within the Los Angeles area (Mediterranean climate), which assumes high water demand landscaping materials and an irrigation system efficiency of 85%. Factor is therefore $(20.94 \text{ GAL/SF/year}) \times (43,560 \text{ SF/acre}) / (365 \text{ days/year}) / (0.85) = 2,940 \text{ gallons/acre/day}$, rounded up to 3,000 gallons/acre/day.

(U.S. Department of Energy, Energy Efficiency & Renewable Energy, Federal Energy Management Program. "Guidelines for Estimating Unmetered Landscaping Water Use." July 2010. Page 12, Table 4 - Annual Irrigation Factor – Landscaped Areas with High Water Requirements).

Total On-Road Fuel Consumption

	gal/mile	gal/min
2022Hauling Hauling	0.15194685	1.49226E-05
2022Vendor Vendor	0.12346263	8.98135E-06
2022Worker Worker	0.03636982	2.00421E-06
2023Hauling Hauling	0.14312318	1.42709E-05
2023Vendor Vendor	0.11698571	8.58941E-06
2023Worker Worker	0.03532451	1.94677E-06
2024Hauling Hauling	0.14107785	1.41309E-05
2024Vendor Vendor	0.11532828	8.40578E-06
2024Worker Worker	0.03445725	1.96264E-06

Construction Phase	Daily One-Way Trips	Haul Days per Phase (days)	Work Hours per Day (hours/day)	One-Way Trip Distance per Day (miles)	Idling per Day (minutes)
<u>Demolition</u>	2022				
Total Haul Trips	28				
Hauling	3	44	8	40	5
Vendor	6	44	8	6.9	5
Worker	80	44	8	14.7	0
<u>Grading/Site Preparation</u>	2023				
Total Haul Trips	62				
Hauling	6	76	8	40	5
Vendor	6	76	8	6.9	5
Worker	80	76	8	14.7	0
<u>Foundations/Concrete Pour #1</u>	2023				
Total Haul Trips	0				
Hauling	0	3	8	40	5
Vendor	50	3	8	6.9	5
Worker	80	3	8	14.7	0
<u>Drainage/Utilities/Trenching</u>	2023				
Total Haul Trips	0				
Hauling	0	109	8	40	5
Vendor	6	109	8	6.9	5
Worker	80	109	8	14.7	0
<u>Building Construction</u>	2023				
Total Haul Trips	0				
Hauling	0	228	8	40	5
Vendor	99	228	8	6.9	5
Worker	80	228	8	14.7	0
<u>Foundations/Concrete Pour #2</u>	2023				
Total Haul Trips	0				
Hauling	0	3	8	40	5
Vendor	50	3	8	6.9	5
Worker	80	3	8	14.7	0

Total On-Road Fuel Consumption

	gal/mile	gal/min
2022Hauling Hauling	0.15194685	1.49226E-05
2022Vendor Vendor	0.12346263	8.98135E-06
2022Worker Worker	0.03636982	2.00421E-06
2023Hauling Hauling	0.14312318	1.42709E-05
2023Vendor Vendor	0.11698571	8.58941E-06
2023Worker Worker	0.03532451	1.94677E-06
2024Hauling Hauling	0.14107785	1.41309E-05
2024Vendor Vendor	0.11532828	8.40578E-06
2024Worker Worker	0.03445725	1.96264E-06

Construction Phase	Daily One-Way Trips	Haul Days per Phase (days)	Work Hours per Day (hours/day)	One-Way Trip Distance per Day (miles)	Idling per Day (minutes)
<u>Paving Event #1</u>	2023				
Total Haul Trips	0				
Hauling	0	5	8	40	5
Vendor	6	5	8	6.9	5
Worker	80	5	8	14.7	0
<u>Foundations/Concrete Pour #3</u>	2024				
Total Haul Trips	0				
Hauling	0	3	8	40	5
Vendor	50	3	8	6.9	5
Worker	80	3	8	14.7	0
<u>Architectural Coatings</u>	2024				
Total Haul Trips	0				
Hauling	0	43	8	40	5
Vendor	6	43	8	6.9	5
Worker	80	43	8	14.7	0
<u>Paving Event #2</u>	2024				
Total Haul Trips	0				
Hauling	0	5	8	40	5
Vendor	6	5	8	6.9	5
Worker	80	5	8	14.7	0
<u>Synthetic Track</u>	2024				
Total Haul Trips	0				
Hauling	0	65	8	40	5
Vendor	6	65	8	6.9	5
Worker	80	65	8	14.7	0
<u>Field/Bleachers</u>	2023				
Total Haul Trips	0				
Hauling	0	153	8	40	5
Vendor	6	153	8	6.9	5
Worker	80	153	8	14.7	0

Total On-Road Fuel Consumption

Construction Phase	Regional Emissions (gallons)			
	gal/mile	gal/min	gal/day	Total Gallons/yr
<u>Demolition</u>				
Total Haul Trips				
Hauling	0.15	1.49E-05	18	802
Vendor	0.12	8.98E-06	5	225
Worker	0.04	2.00E-06	43	1,882
<u>Grading/Site Preparation</u>				
Total Haul Trips				
Hauling	0.14	1.43E-05	34	2,611
Vendor	0.12	8.59E-06	5	368
Worker	0.04	1.95E-06	42	3,157
<u>Foundations/Concrete Pour #1</u>				
Total Haul Trips				
Hauling	0.14	1.43E-05	0	0
Vendor	0.12	8.59E-06	40	121
Worker	0.04	1.95E-06	42	125
<u>Drainage/Utilities/Trenching</u>				
Total Haul Trips				
Hauling	0.14	1.43E-05	0	0
Vendor	0.12	8.59E-06	5	528
Worker	0.04	1.95E-06	42	4,528
<u>Building Construction</u>				
Total Haul Trips				
Hauling	0.14	1.43E-05	0	0
Vendor	0.12	8.59E-06	80	18,221
Worker	0.04	1.95E-06	42	9,471
<u>Foundations/Concrete Pour #2</u>				
Total Haul Trips				
Hauling	0.14	1.43E-05	0	0
Vendor	0.12	8.59E-06	40	121
Worker	0.04	1.95E-06	42	125

Total On-Road Fuel Consumption

Construction Phase	Regional Emissions (gallons)			
	gal/mile	gal/min	gal/day	Total Gallons/yr
<u>Paving Event #1</u>				
Total Haul Trips				
Hauling	0.14	1.43E-05	0	0
Vendor	0.12	8.59E-06	5	24
Worker	0.04	1.95E-06	42	208
<u>Foundations/Concrete Pour #3</u>				
Total Haul Trips				
Hauling	0.14	1.41E-05	0	0
Vendor	0.12	8.41E-06	40	119
Worker	0.03	1.96E-06	41	122
<u>Architectural Coatings</u>				
Total Haul Trips				
Hauling	0.14	1.41E-05	0	0
Vendor	0.12	8.41E-06	5	205
Worker	0.03	1.96E-06	41	1,742
<u>Paving Event #2</u>				
Total Haul Trips				
Hauling	0.14	1.41E-05	0	0
Vendor	0.12	8.41E-06	5	24
Worker	0.03	1.96E-06	41	203
<u>Synthetic Track</u>				
Total Haul Trips				
Hauling	0.14	1.41E-05	0	0
Vendor	0.12	8.41E-06	5	310
Worker	0.03	1.96E-06	41	2,634
<u>Field/Bleachers</u>				
Total Haul Trips				
Hauling	0.14	1.43E-05	0	0
Vendor	0.12	8.59E-06	5	741
Worker	0.04	1.95E-06	42	6,356

Appendix C

Biological Resources Database Search



Selected Elements by Scientific Name
California Department of Fish and Wildlife
California Natural Diversity Database



Query Criteria: QuadIS (Inglewood (3311883))

Species	Element Code	Federal Status	State Status	Global Rank	State Rank	Rare Plant Rank/CDFW SSC or FP
<i>Agelaius tricolor</i> tricolored blackbird	ABPBXB0020	None	Threatened	G1G2	S1S2	SSC
<i>Anniella stebbinsi</i> Southern California legless lizard	ARACC01060	None	None	G3	S3	SSC
<i>Astragalus tener var. titi</i> coastal dunes milk-vetch	PDFAB0F8R2	Endangered	Endangered	G2T1	S1	1B.1
<i>Athene cunicularia</i> burrowing owl	ABNSB10010	None	None	G4	S3	SSC
<i>Atriplex coulteri</i> Coulter's saltbush	PDCHE040E0	None	None	G3	S1S2	1B.2
<i>Bombus crotchii</i> Crotch bumble bee	IIHYM24480	None	Candidate Endangered	G3G4	S1S2	
<i>Centromadia parryi ssp. australis</i> southern tarplant	PDAST4R0P4	None	None	G3T2	S2	1B.1
<i>Empidonax traillii extimus</i> southwestern willow flycatcher	ABPAE33043	Endangered	Endangered	G5T2	S1	
<i>Eryngium aristulatum var. parishii</i> San Diego button-celery	PDAP10Z042	Endangered	Endangered	G5T1	S1	1B.1
<i>Eumops perotis californicus</i> western mastiff bat	AMACD02011	None	None	G4G5T4	S3S4	SSC
<i>Lasthenia glabrata ssp. coulteri</i> Coulter's goldfields	PDAST5L0A1	None	None	G4T2	S2	1B.1
<i>Microtus californicus stephensi</i> south coast marsh vole	AMAFF11035	None	None	G5T2T3	S1S2	SSC
<i>Navarretia fossalis</i> spreading navarretia	PDPLM0C080	Threatened	None	G2	S2	1B.1
<i>Navarretia prostrata</i> prostrate vernal pool navarretia	PDPLM0C0Q0	None	None	G2	S2	1B.2
<i>Nyctinomops femorosaccus</i> pocketed free-tailed bat	AMACD04010	None	None	G5	S3	SSC
<i>Orcuttia californica</i> California Orcutt grass	PMPOA4G010	Endangered	Endangered	G1	S1	1B.1
<i>Phrynosoma blainvillii</i> coast horned lizard	ARACF12100	None	None	G3G4	S3S4	SSC
<i>Polioptila californica californica</i> coastal California gnatcatcher	ABPBJ08081	Threatened	None	G4G5T3Q	S2	SSC
<i>Sidalcea neomexicana</i> salt spring checkerbloom	PDMAL110J0	None	None	G4	S2	2B.2
<i>Spea hammondi</i> western spadefoot	AAABF02020	None	None	G2G3	S3	SSC



Selected Elements by Scientific Name
California Department of Fish and Wildlife
California Natural Diversity Database



Species	Element Code	Federal Status	State Status	Global Rank	State Rank	Rare Plant Rank/CDFW SSC or FP
<i>Taxidea taxus</i> American badger	AMAJF04010	None	None	G5	S3	SSC
<i>Vireo bellii pusillus</i> least Bell's vireo	ABPBW01114	Endangered	Endangered	G5T2	S2	

Record Count: 22

Search:

Simple

Advanced

Search for species and

Go

Search Results

Back

Export Results

11 matches found. Click on scientific name for details

Search Criteria: Quad is one of [3311883]

[Scientific Name](#)
[Common Name](#)
[Family](#)
[Lifeform](#)
[Blooming Period](#)
[Fed List](#)
[State List](#)
[Global Rank](#)
[State Rank](#)

[CA Rare Plant Rank](#)
[General Habitats](#)
[Micro Habitats](#)
[Lowest Elevation](#)
[Highest Elevation](#)
[CA Endemic](#)
[Date Added](#)
[Photo](#)

Search:

▲ SCIENTIFIC NAME	COMMON NAME	FAMILY	LIFEFORM	BLOOMING PERIOD	FED LIST	STATE LIST	GLOBAL RANK	STATE RANK	CA RARE PLANT RANK	PHOTO
Astragalus tener var. titi	coastal dunes milk-vetch	Fabaceae	annual herb	Mar-May	FE	CE	G2T1	S1	1B.1	No Photo Available
Atriplex coulteri	Coulter's saltbush	Chenopodiaceae	perennial herb	Mar-Oct	None	None	G3	S1S2	1B.2	No Photo Available
Camissoniopsis lewisii	Lewis' evening- primrose	Onagraceae	annual herb	Mar- May(Jun)	None	None	G4	S4	3	No Photo Available
Centromadia parryi ssp. australis	southern tarplant	Asteraceae	annual herb	May-Nov	None	None	G3T2	S2	1B.1	No Photo Available
Eryngium aristulatum parishii	San Diego button-celery	Apiaceae	annual/perennial herb	Apr-Jun	FE	CE	G5T1	S1	1B.1	No Photo Available
Hordeum intercedens	vernal barley	Poaceae	annual herb	Mar-Jun	None	None	G3G4	S3S4	3.2	No Photo Available
Lasthenia glabrata ssp. coulteri	Coulter's goldfields	Asteraceae	annual herb	Feb-Jun	None	None	G4T2	S2	1B.1	No Photo Available
Navarretia fossalis	spreading navarretia	Polemoniaceae	annual herb	Apr-Jun	FT	None	G2	S2	1B.1	No Photo Available
Navarretia prostrata	prostrate vernal pool navarretia	Polemoniaceae	annual herb	Apr-Jul	None	None	G2	S2	1B.2	No Photo Available
Orcuttia californica	California Orcutt grass	Poaceae	annual herb	Apr-Aug	FE	CE	G1	S1	1B.1	No Photo Available

<u>Sidalcea</u>	salt spring	Malvaceae	perennial herb	Mar-Jun	None	None	G4	S2	0 BARE	
<u>neomexicana</u>	checkerbloom			BLOOMING	FED	STATE	GLOBAL	STATE	PLANT	No Photo
SCIENTIFIC NAME	COMMON NAME	FAMILY	LIFEFORM	PERIOD	LIST	LIST	RANK	RANK	RANK	PHOTO Available

Showing 1 to 11 of 11 entries

CONTACT US

Send questions and comments to rareplants@cnps.org.



Developed by
Rincon Consultants, Inc.

ABOUT THIS WEBSITE

[About the Inventory](#)
[Release Notes](#)
[Advanced Search](#)
[Glossary](#)

ABOUT CNPS

[About the Rare Plant Program](#)
[CNPS Home Page](#)
[About CNPS](#)
[Join CNPS](#)

CONTRIBUTORS

[The Calflora Database](#)
[The California Lichen Society](#)
[California Natural Diversity Database](#)
[The Jepson Flora Project](#)
[The Consortium of California Herbaria](#)
[CalPhotos](#)

[Log in](#)

Copyright © 2010-2021 [California Native Plant Society](#). All rights reserved.

IPaC resource list

This report is an automatically generated list of species and other resources such as critical habitat (collectively referred to as *trust resources*) under the U.S. Fish and Wildlife Service's (USFWS) jurisdiction that are known or expected to be on or near the project area referenced below. The list may also include trust resources that occur outside of the project area, but that could potentially be directly or indirectly affected by activities in the project area. However, determining the likelihood and extent of effects a project may have on trust resources typically requires gathering additional



Local office

Carlsbad Fish And Wildlife Office

☎ (760) 431-9440

📅 (760) 431-5901

2177 Salk Avenue - Suite 250
Carlsbad, CA 92008-7385

<http://www.fws.gov/carlsbad/>

Endangered species

This resource list is for informational purposes only and does not constitute an analysis of project level impacts.

The primary information used to generate this list is the known or expected range of each species. Additional areas of influence (AOI) for species are also considered. An AOI includes areas outside of the species range if the species could be indirectly affected by activities in that area (e.g., placing a dam upstream of a fish population even if that fish does not occur at the dam site, may indirectly impact the species by reducing or eliminating water flow downstream). Because species can move, and site conditions can change, the species on this list are not guaranteed to be found on or near the project area. To fully determine any potential effects to species, additional site-specific and project-specific information is often required.

Section 7 of the Endangered Species Act **requires** Federal agencies to "request of the Secretary information whether any species which is listed or proposed to be listed may be present in the area of such proposed action" for any project that is conducted, permitted, funded, or licensed by any Federal agency. A letter from the local office and a species list which fulfills this requirement can **only** be obtained by requesting an official species list from either the Regulatory Review section in IPaC (see directions below) or from the local field office directly.

For project evaluations that require USFWS concurrence/review, please return to the IPaC website and request an official species list by doing the following:

1. Draw the project location and click CONTINUE.
2. Click DEFINE PROJECT.
3. Log in (if directed to do so).
4. Provide a name and description for your project.
5. Click REQUEST SPECIES LIST.

Listed species¹ and their critical habitats are managed by the [Ecological Services Program](#) of the U.S. Fish and Wildlife Service (USFWS) and the fisheries division of the National Oceanic and Atmospheric Administration (NOAA Fisheries²).

Species and critical habitats under the sole responsibility of NOAA Fisheries are **not** shown on this list. Please contact [NOAA Fisheries](#) for [species under their jurisdiction](#).

1. Species listed under the [Endangered Species Act](#) are threatened or endangered; IPaC also shows species that are candidates, or proposed, for listing. See the [listing status page](#) for more information. IPaC only shows species that are regulated by USFWS (see FAQ).
2. [NOAA Fisheries](#), also known as the National Marine Fisheries Service (NMFS), is an office of the National Oceanic and Atmospheric Administration within the Department of Commerce.

The following species are potentially affected by activities in this location:

Birds

NAME

STATUS

Coastal California Gnatcatcher *Polioptila californica californica* Threatened

Wherever found

There is **final** critical habitat for this species. The location of the critical habitat is not available.

<https://ecos.fws.gov/ecp/species/8178>

Western Snowy Plover *Charadrius nivosus nivosus* Threatened

There is **final** critical habitat for this species. The location of the critical habitat is not available.

<https://ecos.fws.gov/ecp/species/8035>

Critical habitats

Potential effects to critical habitat(s) in this location must be analyzed along with the endangered species themselves.

THERE ARE NO CRITICAL HABITATS AT THIS LOCATION.

Migratory birds

Certain birds are protected under the Migratory Bird Treaty Act¹ and the Bald and Golden Eagle Protection Act².

Any person or organization who plans or conducts activities that may result in impacts to migratory birds, eagles, and their habitats should follow appropriate regulations and consider implementing appropriate conservation measures, as described [below](#).

1. The [Migratory Birds Treaty Act](#) of 1918.
2. The [Bald and Golden Eagle Protection Act](#) of 1940.

Additional information can be found using the following links:

- Birds of Conservation Concern <http://www.fws.gov/birds/management/managed-species/birds-of-conservation-concern.php>
- Measures for avoiding and minimizing impacts to birds <http://www.fws.gov/birds/management/project-assessment-tools-and-guidance/conservation-measures.php>
- Nationwide conservation measures for birds <http://www.fws.gov/migratorybirds/pdf/management/nationwidestandardconservationmeasures.pdf>

The birds listed below are birds of particular concern either because they occur on the [USFWS Birds of Conservation Concern](#) (BCC) list or warrant special attention in your project location. To learn more about the levels of concern for birds on your list and how this list is generated, see the FAQ [below](#). This is not a list of every bird you may find in this location, nor a guarantee that every bird on this list will be found in your project area. To see exact locations of where birders and the general

public have sighted birds in and around your project area, visit the [E-bird data mapping tool](#) (Tip: enter your location, desired date range and a species on your list). For projects that occur off the Atlantic Coast, additional maps and models detailing the relative occurrence and abundance of bird species on your list are available. Links to additional information about Atlantic Coast birds, and other important information about your migratory bird list, including how to properly interpret and use your migratory bird report, can be found [below](#).

For guidance on when to schedule activities or implement avoidance and minimization measures to reduce impacts to migratory birds on your list, click on the PROBABILITY OF PRESENCE SUMMARY at the top of your list to see when these birds are most likely to be present and breeding in your project area.

NAME

BREEDING SEASON (IF A

.....
.....
.....
.....
.....
.....
.....
.....
.....
.....
.....

NOT FOR CONSULTATION

Marbled Godwit *Limosa fedoa*

Breeds elsewhere

This is a Bird of Conservation Concern (BCC) throughout its range in the continental USA and Alaska.

<https://ecos.fws.gov/ecp/species/9481>

Nuttall's Woodpecker *Picoides nuttallii*

Breeds Apr 1 to Jul 20

This is a Bird of Conservation Concern (BCC) only in particular Bird Conservation Regions (BCRs) in the continental USA

<https://ecos.fws.gov/ecp/species/9410>

Rufous Hummingbird *selasphorus rufus*

Breeds elsewhere

This is a Bird of Conservation Concern (BCC) throughout its range in the continental USA and Alaska.

<https://ecos.fws.gov/ecp/species/8002>

Song Sparrow *Melospiza melodia*

Breeds Feb 20 to Sep 5

This is a Bird of Conservation Concern (BCC) only in particular Bird Conservation Regions (BCRs) in the continental USA

Spotted Towhee *Pipilo maculatus clementae*

Breeds Apr 15 to Jul 20

This is a Bird of Conservation Concern (BCC) only in particular Bird Conservation Regions (BCRs) in the continental USA

<https://ecos.fws.gov/ecp/species/4243>

Tricolored Blackbird *Agelaius tricolor*

Breeds Mar 15 to Aug 10

This is a Bird of Conservation Concern (BCC) throughout its range in the continental USA and Alaska.

<https://ecos.fws.gov/ecp/species/3910>

Probability of Presence Summary

The graphs below provide our best understanding of when birds of concern are most likely to be present in your project area. This information can be used to tailor and schedule your project activities to avoid or minimize impacts to birds. Please make sure you read and understand the FAQ "Proper Interpretation and Use of Your Migratory Bird Report" before using or attempting to interpret this report.

Probability of Presence (■)

Each green bar represents the bird's relative probability of presence in the 10km grid cell(s) your project overlaps during a particular week of the year. (A year is represented as 12 4-week months.) A taller bar indicates a higher probability of species presence. The survey effort (see below) can be used to establish a level of confidence in the presence score. One can have higher confidence in the presence score if the corresponding survey effort is also high.

How is the probability of presence score calculated? The calculation is done in three steps:

1. The probability of presence for each week is calculated as the number of survey events in the week where the species was detected divided by the total number of survey events for that week. For example, if in week 12 there were 20 survey events and the Spotted Towhee was found in 5 of them, the probability of presence of the Spotted Towhee in week 12 is 0.25.
2. To properly present the pattern of presence across the year, the relative probability of presence is calculated. This is the probability of presence divided by the maximum probability of presence across all weeks. For example, imagine the probability of presence in week 20 for the Spotted Towhee is 0.05, and that the probability of presence at week 12 (0.25) is the maximum of any week of the year. The relative probability of presence on week 12 is $0.25/0.25 = 1$; at week 20 it is $0.05/0.25 = 0.2$.
3. The relative probability of presence calculated in the previous step undergoes a statistical conversion so that all possible values fall between 0 and 10, inclusive. This is the probability of

Marbled Godwit
 BCC Rangewide
 (CON) (This is a
 Bird of
 Conservation
 Concern (BCC)
 throughout its
 range in the
 continental USA
 and Alaska.)



Nuttall's
 Woodpecker
 BCC - BCR (This is a
 Bird of
 Conservation
 Concern (BCC) only
 in particular Bird
 Conservation
 Regions (BCRs) in
 the continental
 USA)



Rufous
 Hummingbird
 BCC Rangewide
 (CON) (This is a
 Bird of
 Conservation
 Concern (BCC)
 throughout its
 range in the
 continental USA
 and Alaska.)



Song Sparrow
 BCC - BCR (This is a
 Bird of
 Conservation
 Concern (BCC) only
 in particular Bird
 Conservation
 Regions (BCRs) in
 the continental
 USA)



Spotted Towhee
 BCC - BCR (This is a
 Bird of
 Conservation
 Concern (BCC) only
 in particular Bird
 Conservation
 Regions (BCRs) in
 the continental
 USA)



DRAFT FOR CONSULTATION

Tricolored
Blackbird
BCC Rangewide
(CON) (This is a
Bird of
Conservation
Concern (BCC)
throughout its
range in the
continental USA
and Alaska.)

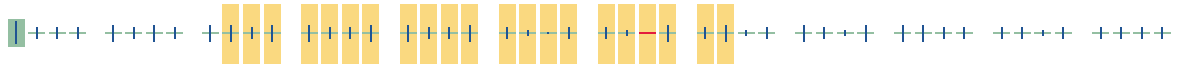

Tell me more about conservation measures I can implement to avoid or minimize impacts to migratory birds.

[Nationwide Conservation Measures](#) describes measures that can help avoid and minimize impacts to all birds at



[Avian Knowledge Network \(AKN\)](#). This data is derived from a growing collection of [survey, banding, and citizen science datasets](#).

Probability of presence data is continuously being updated as new and better information becomes available. To learn more about how the probability of presence graphs are produced and how to interpret them, go the Probability of Presence Summary and then click on the "Tell me about these graphs" link.

How do I know if a bird is breeding, wintering, migrating or present year-round in my project area?

To see what part of a particular bird's range your project area falls within (i.e. breeding, wintering, migrating or year-round), you may refer to the following resources: [The Cornell Lab of Ornithology All About Birds Bird Guide](#), or (if you are unsuccessful in locating the bird of interest there), the [Cornell Lab of Ornithology Neotropical Birds guide](#). If a bird on your migratory bird species list has a breeding season associated with it, if that bird does occur in your project area, there may be nests present at some point within the timeframe specified. If "Breeds elsewhere" is indicated, then the bird likely does not breed in your project area.

What are the levels of concern for migratory birds?

Migratory birds delivered through IPaC fall into the following distinct categories of concern:

1. "BCC Rangewide" birds are [Birds of Conservation Concern](#) (BCC) that are of concern throughout their range anywhere within the USA (including Hawaii, the Pacific Islands, Puerto Rico, and the Virgin Islands);
2. "BCC - BCR" birds are BCCs that are of concern only in particular Bird Conservation Regions (BCRs) in the continental USA; and
3. "Non-BCC - Vulnerable" birds are not BCC species in your project area, but appear on your list either because of the [Eagle Act](#) requirements (for eagles) or (for non-eagles) potential susceptibilities in offshore areas from certain types of development or activities (e.g. offshore energy development or longline fishing).

Although it is important to try to avoid and minimize impacts to all birds, efforts should be made, in particular, to avoid and minimize impacts to the birds on this list, especially eagles and BCC species of rangewide concern. For more information on conservation measures you can implement to help avoid and minimize migratory bird impacts and requirements for eagles, please see the FAQs for these topics.

Details about birds that are potentially affected by offshore projects

For additional details about the relative occurrence and abundance of both individual bird species and groups of bird species within your project area off the Atlantic Coast, please visit the [Northeast Ocean Data Portal](#). The Portal also offers data and information about other taxa besides birds that may be helpful to you in your project review. Alternately, you may download the bird model results files underlying the portal maps through the [NOAA NCCOS Integrative Statistical Modeling and Predictive Mapping of Marine Bird Distributions and Abundance on the Atlantic Outer Continental Shelf](#) project webpage.

Bird tracking data can also provide additional details about occurrence and habitat use throughout the year, including migration. Models relying on survey data may not include this information. For additional information on marine bird tracking data, see the [Diving Bird Study](#) and the [nanotag studies](#) or contact [Caleb Spiegel](#) or [Pam Loring](#).

What if I have eagles on my list?

If your project has the potential to disturb or kill eagles, you may need to [obtain a permit](#) to avoid violating the Eagle Act should such impacts occur.

Proper Interpretation and Use of Your Migratory Bird Report

The migratory bird list generated is not a list of all birds in your project area, only a subset of birds of priority concern. To learn more about how your list is generated, and see options for identifying what other birds may be in your project area, please see the FAQ "What does IPaC use to generate the migratory birds potentially occurring in my specified location". Please be aware this report provides the "probability of presence" of birds within the 10 km grid cell(s) that overlap your project; not your exact project footprint. On the graphs provided, please also look carefully at the survey effort (indicated by the black vertical bar) and for the existence of the "no data" indicator (a red horizontal bar). A high survey effort is the key component. If the survey effort is high, then the probability of presence score can be viewed as more dependable. In contrast, a low survey effort bar or no data bar means a lack of data and, therefore, a lack of certainty about presence of the species. This list is not perfect; it is simply a starting point for identifying what birds of concern have the potential to be in your project area, when they might be there, and if they might be breeding (which means nests might be present). The list helps you know what to look for to confirm presence, and helps guide you in knowing when to implement conservation measures to avoid or minimize potential impacts from your project activities, should presence be confirmed. To learn more about conservation measures, visit the FAQ "Tell me about conservation measures I can implement to avoid or minimize impacts to migratory birds" at the bottom of your migratory bird trust resources page.

Facilities

National Wildlife Refuge lands

Any activity proposed on lands managed by the [National Wildlife Refuge](#) system must undergo a 'Compatibility Determination' conducted by the Refuge. Please contact the individual Refuges to discuss any questions or concerns.

THERE ARE NO REFUGE LANDS AT THIS LOCATION.

Fish hatcheries

THERE ARE NO FISH HATCHERIES AT THIS LOCATION.

Wetlands in the National Wetlands Inventory

Impacts to [NWI wetlands](#) and other aquatic habitats may be subject to regulation under Section 404 of the Clean Water Act, or other State/Federal statutes.

For more information please contact the Regulatory Program of the local [U.S. Army Corps of Engineers District](#).

THERE ARE NO KNOWN WETLANDS AT THIS LOCATION.

Data limitations

The Service's objective of mapping wetlands and deepwater habitats is to produce reconnaissance level information on the location, type and size of these resources. The maps are prepared from the analysis of high altitude imagery. Wetlands are identified based on vegetation, visible hydrology and geography. A margin of error is inherent in the use of imagery; thus, detailed on-the-ground inspection of any particular site may result in revision of the wetland boundaries or classification established through image analysis.

The accuracy of image interpretation depends on the quality of the imagery, the experience of the image analysts, the amount and quality of the collateral data and the amount of ground truth verification work conducted. Metadata should be consulted to determine the date of the source imagery used and any mapping problems.

Wetlands or other mapped features may have changed since the date of the imagery or field work. There may be occasional differences in polygon boundaries or classifications between the information depicted on the map and the actual conditions on site.

Data exclusions

Certain wetland habitats are excluded from the National mapping program because of the limitations of aerial imagery as the primary data source used to detect wetlands. These habitats include seagrasses or submerged aquatic vegetation that are found in the intertidal and subtidal zones of estuaries and nearshore coastal waters.

Some deepwater reef communities (coral or tubercid worm reefs) have also been excluded from the inventory. These habitats, because of their depth, go undetected by aerial imagery.

Data precautions

Federal, state, and local regulatory agencies with jurisdiction over wetlands may define and describe wetlands in a different manner than that used in this inventory. There is no attempt, in either the design or products of this inventory, to define the limits of proprietary jurisdiction of any Federal, state, or local government or to establish the geographical scope of the regulatory programs of government agencies. Persons intending to engage in activities involving modifications within or adjacent to wetland areas should seek the advice of appropriate federal, state, or local agencies concerning specified agency regulatory programs and proprietary jurisdictions that may affect such activities.

NOT FOR CONSULTATION

Appendix D
Cultural Resources

NATIVE AMERICAN HERITAGE COMMISSION

May 26, 2021

Fatima Clark
ESAVia Email to: fclark@esassoc.com

Re: Hawthorne High School Athletic Fields Improvement Project, Los Angeles County

Dear Ms. Clark:

A record search of the Native American Heritage Commission (NAHC) Sacred Lands File (SLF) was completed for the information you have submitted for the above referenced project. The results were negative. However, the absence of specific site information in the SLF does not indicate the absence of cultural resources in any project area. Other sources of cultural resources should also be contacted for information regarding known and recorded sites.

Attached is a list of Native American tribes who may also have knowledge of cultural resources in the project area. This list should provide a starting place in locating areas of potential adverse impact within the proposed project area. I suggest you contact all of those indicated; if they cannot supply information, they might recommend others with specific knowledge. By contacting all those listed, your organization will be better able to respond to claims of failure to consult with the appropriate tribe. If a response has not been received within two weeks of notification, the Commission requests that you follow-up with a telephone call or email to ensure that the project information has been received.

If you receive notification of change of addresses and phone numbers from tribes, please notify me. With your assistance, we can assure that our lists contain current information.

If you have any questions or need additional information, please contact me at my email address: Andrew.Green@nahc.ca.gov.

Sincerely,

Andrew Green
Cultural Resources Analyst

Attachment

CHAIRPERSON
Laura Miranda
LuiseñoVICE CHAIRPERSON
Reginald Pagaling
ChumashSECRETARY
Merri Lopez-Keifer
LuiseñoPARLIAMENTARIAN
Russell Attebery
KarukCOMMISSIONER
William Mungary
Paiute/White Mountain
ApacheCOMMISSIONER
Julie Tumamait-
Stenslie
ChumashCOMMISSIONER
[Vacant]COMMISSIONER
[Vacant]COMMISSIONER
[Vacant]EXECUTIVE SECRETARY
Christina Snider
PomoNAHC HEADQUARTERS
1550 Harbor Boulevard
Suite 100
West Sacramento,
California 95691
(916) 373-3710
nahc@nahc.ca.gov
NAHC.ca.gov

**Native American Heritage Commission
Native American Contact List
Los Angeles County
5/26/2021**

**Gabrieleno Band of Mission
Indians - Kizh Nation**

Andrew Salas, Chairperson
P.O. Box 393 Gabrieleno
Covina, CA, 91723
Phone: (626) 926 - 4131
admin@gabrielenoindians.org

**Santa Rosa Band of Cahuilla
Indians**

Lovina Redner, Tribal Chair
P.O. Box 391820 Cahuilla
Anza, CA, 92539
Phone: (951) 659 - 2700
Fax: (951) 659-2228
Isaul@santarosa-nsn.gov

**Gabrieleno/Tongva San Gabriel
Band of Mission Indians**

Anthony Morales, Chairperson
P.O. Box 693 Gabrieleno
San Gabriel, CA, 91778
Phone: (626) 483 - 3564
Fax: (626) 286-1262
GTTribalcouncil@aol.com

**Soboba Band of Luiseno
Indians**

Joseph Ontiveros, Cultural
Resource Department
P.O. BOX 487 Cahuilla
San Jacinto, CA, 92581 Luiseno
Phone: (951) 663 - 5279
Fax: (951) 654-4198
jontiveros@soboba-nsn.gov

Gabrielino /Tongva Nation

Sandonne Goad, Chairperson
106 1/2 Judge John Aiso St., Gabrielino
#231
Los Angeles, CA, 90012
Phone: (951) 807 - 0479
sgoad@gabrielino-tongva.com

**Soboba Band of Luiseno
Indians**

Isaiah Vivanco, Chairperson
P. O. Box 487 Cahuilla
San Jacinto, CA, 92581 Luiseno
Phone: (951) 654 - 5544
Fax: (951) 654-4198
ivivanco@soboba-nsn.gov

**Gabrielino Tongva Indians of
California Tribal Council**

Christina Conley,
739 Verdemont Circle Gabrielino
Simi Valley, CA, 93065
Phone: (626) 407 - 8761
christina.marsden@alumni.usc.edu

**Gabrielino Tongva Indians of
California Tribal Council**

Robert Dorame, Chairperson
P.O. Box 490 Gabrielino
Bellflower, CA, 90707
Phone: (562) 761 - 6417
Fax: (562) 761-6417
gtongva@gmail.com

Gabrielino-Tongva Tribe

Charles Alvarez,
23454 Vanowen Street Gabrielino
West Hills, CA, 91307
Phone: (310) 403 - 6048
roadkingcharles@aol.com

This list is current only as of the date of this document. Distribution of this list does not relieve any person of statutory responsibility as defined in Section 7050.5 of the Health and Safety Code, Section 5097.94 of the Public Resource Section 5097.98 of the Public Resources Code.

This list is only applicable for contacting local Native Americans with regard to cultural resources assessment for the proposed Hawthorne High School Athletic Fields Improvement Project, Los Angeles County.

Natural History Museum
of Los Angeles County
900 Exposition Boulevard
Los Angeles, CA 90007

tel 213.763.DINO
www.nhm.org

Research & Collections

e-mail: paleorecords@nhm.org

May 19, 2021

Environmental Science Associates
Attn: Fatima Clark

re: Paleontological resources for the Hawthorne High School Athletic Fields Improvement Project
(D202001102.00)

Dear Fatima:

I have conducted a thorough search of our paleontology collection records for the locality and specimen data for proposed development at the Hawthorne High School Athletic Fields Improvement project area as outlined on the portion of the Ingelwood USGS topographic quadrangle map that you sent to me via e-mail on May 14, 2021. We do not have any fossil localities that lie directly within the proposed project area, but we do have fossil localities nearby from the same sedimentary deposits that occur in the proposed project area, either at the surface or at depth.

The following table shows the closest known localities in the collection of the Natural History Museum of Los Angeles County.

Locality Number	Location	Formation	Taxa	Depth
LACM VP 7332	Westchester, NW of intersection of West Century Blvd & Bellanca Ave	Unknown formation (Pleistocene; silty sand)	Mammoth (<i>Mammuthus</i>)	40 ft bgs
LACM VP 3264	Los Angeles International Airport	Unknown formation (Pleistocene sands)	Elephant family (Proboscidea)	25 ft bgs
LACM VP 3266	W Athens Blvd & Menlo Ave	Unnamed formation (Pleistocene, calcareous siltstone)	Uncatalogued vertebrates	15-18 ft bgs
LACM VP 1225	354 W 99th St., Los Angeles	Unknown formation (Pleistocene)	Mammoth (<i>Mammuthus</i>)	15-20 ft bgs
LACM VP 3365	Athens on the Hill, Los Angeles (more precise information not available)	Unnamed formation (Pleistocene)	Mammoth (<i>Mammuthus</i>)	Unknown
LACM VP 3789	8734 Bellanca Avenue,	Unknown (Pleistocene;	Mammoth (<i>Mammuthus</i>)	14 ft bgs

	Westchester	pebbly gray-green to brown mud that directly overlies a gray-green fine sand)		
		Unknown formation (Pleistocene, massive sandy mudstone w scattered pieces of gravel)	Mammoth (<i>Mammuthus</i>); bison (<i>Bison</i>); hare (<i>Lepus</i>)	16 ft bgs
LACM VP 4942	SE corner of Airport Blvd. & Manchester Ave			

VP, Vertebrate Paleontology; IP, Invertebrate Paleontology; bgs, below ground surface

This records search covers only the records of the Natural History Museum of Los Angeles County (“NHMLA”). It is not intended as a paleontological assessment of the project area for the purposes of CEQA or NEPA. Potentially fossil-bearing units are present in the project area, either at the surface or in the subsurface. As such, NHMLA recommends that a full paleontological assessment of the project area be conducted by a paleontologist meeting Bureau of Land Management or Society of Vertebrate Paleontology standards.

Sincerely,



Alyssa Bell, Ph.D.
Natural History Museum of Los Angeles County

enclosure: invoice

Appendix E1

Geotechnical Evaluation

Geotechnical Evaluation Hawthorne High School - Athletic Facilities Improvements 4859 West El Segundo Boulevard Hawthorne, California

TELACU Construction Management
604 North Eckhoff Street | Orange, California 92868

April 9, 2021 | Project No. 211602001



Geotechnical | Environmental | Construction Inspection & Testing | Forensic Engineering & Expert Witness

Geophysics | Engineering Geology | Laboratory Testing | Industrial Hygiene | Occupational Safety | Air Quality | GIS

Ninyo & Moore
Geotechnical & Environmental Sciences Consultants

Geotechnical Evaluation
Hawthorne High School -
Athletic Facilities Improvements
4859 West El Segundo Boulevard
Hawthorne, California

Mr. Blaine Yoder
TELACU Construction Management
604 North Eckhoff Street | Orange, California 92868

April 9, 2021 | Project No. 211602001



Morteza Mirshekari, PhD, PE
Project Engineer

Ronald Hallum, PG, CEG
Principal Geologist

Soumitra Guha, PhD, PE, GE
Principal Engineer

ECH/GM/MRM/RDH/SG/mlc



CONTENTS

1	INTRODUCTION	1
2	SCOPE OF SERVICES	1
3	SITE DESCRIPTION AND PROPOSED CONSTRUCTION	2
4	SUBSURFACE EVALUATION AND LABORATORY TESTING	2
5	GEOLOGY AND SUBSURFACE CONDITIONS	3
5.1	Regional Geology	3
5.2	Site Geology	3
5.3	Groundwater	4
6	FIELD PERCOLATION TESTING	4
7	FAULTING AND SEISMICITY, AND GEOLOGIC HAZARDS	5
7.1	Surface Fault Rupture	6
7.2	Site-Specific Ground Motion	6
7.3	Liquefaction Evaluation	8
7.4	Tsunamis and Seiches	8
8	CONCLUSIONS	8
9	RECOMMENDATIONS	9
9.1	Earthwork	9
9.1.1	Construction Plan Review and Pre-Construction Conference	10
9.1.2	Clearing and Site Preparation	10
9.1.3	Treatment of Near-Surface Soils	10
9.1.4	Temporary Excavations and Shoring	11
9.1.5	Fill Material	11
9.1.6	Fill Placement and Compaction	12
9.2	Underground Utilities	12
9.2.1	Pipe Bedding	12
9.2.2	Trench Backfill	12
9.2.3	Modulus of Soil Reaction	13
9.3	Seismic Design Considerations	13
9.4	Foundations	13
9.4.1	Square and Continuous Foundations	14
9.4.2	Slab-On-Grade	14

9.4.3	Exterior Sidewalks	15
9.5	Preliminary Pavement Design	15
9.6	Corrosivity	16
9.7	Concrete	17
9.8	Drainage	17
10	CONSTRUCTION OBSERVATION	18
11	LIMITATIONS	18
12	REFERENCES	20

TABLES

1 – Percolation Test Results	5
2 – Historical Earthquakes	6
3 – 2019 California Building Code Seismic Design Criteria	13
4 – Preliminary Flexible Pavement Structural Sections	16
5 – Preliminary Rigid Pavement Structural Sections	16

FIGURES

1 – Site Location
2 – Boring Locations
3 – Regional Geology
4 – Fault Locations
5 – Acceleration Response Spectra

APPENDICES

A – Boring Logs
B – Laboratory Testing

1 INTRODUCTION

In accordance with your request and authorization, we have performed a geotechnical evaluation for the Athletic Facilities Improvements project located at Hawthorne High School, 4859 West El Segundo Boulevard in Hawthorne, California (Figure 1). We understand that the project will involve demolishing the existing athletic facilities and constructing new facilities including the improvement and construction of track, baseball, soccer, and basketball fields, home/visitor dugouts, a ticket booth, and a small field building. The purpose of our study was to evaluate the soil and geologic conditions at the site in order to provide geotechnical recommendations for the design and construction of the proposed improvements. This report presents the findings from our background review and subsurface exploration, results of our laboratory testing, conclusions regarding the subsurface conditions at the site, and geotechnical recommendations for design and construction of this project.

2 SCOPE OF SERVICES

Our scope of services included the following:

- Project coordination, planning, and scheduling the subsurface exploration with Centinela Valley Union High School District and TELACU personnel.
- Review of readily available background material, including published geologic maps, fault and seismic hazards maps, groundwater data, topographic maps, stereoscopic aerial photographs, and previous geotechnical reports.
- Obtain boring permits from the County of Los Angeles Department of Environmental Health.
- A site reconnaissance, performed on February 10, 2021, to observe the general site conditions, mark-out the proposed boring locations, and coordination with Underground Service Alert for utility clearance.
- Subsurface exploration consisting of the drilling, logging, and sampling of twelve hollow-stem auger exploratory borings to depths of approximately 18 to 31½ feet below ground surface. The borings were logged by a representative of our firm and bulk and relatively undisturbed soil samples were collected at selected intervals for laboratory testing.
- Performance of three infiltration tests in general accordance with the County of Los Angeles percolation guidelines.
- Laboratory testing on selected soil samples, including evaluation of in-situ moisture content and density, percentage of soil particles finer than the No. 200 sieve, Atterberg limits, direct shear strength, Expansion Index, R-value, and soil corrosivity characteristics (including pH, resistivity, and water soluble sulfates and chlorides).
- Data compilation and engineering analysis of the information from our background review, subsurface exploration, and laboratory testing.

- Preparation of this report presenting our findings, conclusions, and recommendations pertaining to the geotechnical aspects of the design and construction of the proposed improvements.

3 SITE DESCRIPTION AND PROPOSED CONSTRUCTION

The site has been developed to house the different athletic facilities at Hawthorne high school since 1951. The high school is bounded to the north by West 124th Street, to the east by South Inglewood Avenue, to the south by West El Segundo Boulevard, and to the west by residential and commercial properties (Figure 1). Union Pacific Rail Road (UPRR) tracks bisect the school with the majority of the school to the south of the tracks and the athletic fields to the north of the tracks. Review of historical aerial photographs suggests that a majority of the buildings on campus were constructed by 1963, with newer buildings such as the cafeteria and administration buildings being constructed more recently. Topography in the vicinity of the project area is relatively level with an approximate site elevation in the vicinity of the project area of 85 to 90 feet above mean sea level (MSL).

Based on the 100% Schematic Design Plans, received from TELACU construction management and dated September 15, 2020 (LPA, 2020), we understand that the proposed development will include demolishing all or part of the existing athletic facilities at the high school, to the north of UPRR tracks, and improvement of some of the existing facilities and constructing some brand new sport facilities. The proposed plans include track, baseball, soccer, and basketball fields, home/visitor dugouts, a ticket booth, and a small field building. In addition, paved sections are to be designed and constructed between the proposed baseball and football fields, which will primarily be used as fire lane and will provide access path to emergency vehicles.

4 SUBSURFACE EVALUATION AND LABORATORY TESTING

Our subsurface exploration was performed on February 23 and 24, 2021, and consisted of drilling, logging, and sampling of twelve hollow-stem auger borings to depths ranging from approximately 18 feet to 31½ feet. The borings were drilled using a truck-mounted drill rig utilizing 8-inch-diameter hollow stem augers. The approximate locations of the exploratory borings were provided by LPA, Inc. (LPA, Inc. 2020) and are shown on Figure 2. The borings were logged by a representative from our firm, and bulk and relatively undisturbed soil samples were obtained at selected depths for laboratory testing. The logs of the exploratory borings are presented in Appendix A.

Laboratory testing was performed on representative samples to evaluate in-situ moisture content and density, percentage of soil particles finer than the No. 200 sieve, Atterberg limits, direct shear strength, Expansion Index, R-value, and soil corrosivity characteristics (including pH, resistivity,

and water soluble sulfates and chlorides). The results of the in-situ moisture content and dry density tests are presented on the boring logs in Appendix A. The remaining laboratory testing results are presented in Appendix B.

5 GEOLOGY AND SUBSURFACE CONDITIONS

5.1 Regional Geology

The subject site is located within the southwestern portion of the Los Angeles Basin, which is included in the Peninsular Ranges Geomorphic Province (Norris and Webb, 1990). The Los Angeles Basin has been divided into four structural blocks by Norris and Webb (1990), which are generally bounded by prominent fault systems, and includes the Northwestern Block, the Southwestern Block, the Central Block, and the Northeastern Block. The site is located in the southwestern block, which is bounded by the Newport-Inglewood fault to the northeast and the Palos Verdes Hills fault to the southwest, the Santa Monica-Hollywood-Raymond fault system to the northwest, and the Pacific Ocean to the south. The block is underlain by up to approximately 20,500 feet of Miocene to Pleistocene age marine sedimentary rock over basement rock consisting of the Mesozoic age Catalina Schist. Variable thicknesses of late Pleistocene to Holocene age alluvial deposits associated with the ancestral Los Angeles and San Gabriel Rivers overlie the sedimentary rock.

5.2 Site Geology

Based on our review, the site is underlain by middle Pleistocene-age old alluvial-fan deposits (Figure 3) consisting of well consolidated, poorly sorted, permeable, slightly dissected gravel, sand, silt, and clay (Saucedo, et al., 2016).

Materials encountered during our subsurface exploration generally consisted of fill and alluvial soils. Fill was encountered at the surface to depths ranging from approximately 5 to 11 feet and consisted of moist, stiff to hard, lean clay, and fat clay with different sand/gravel content, and loose to medium dense, silty and clayey sand with different gravel content, and clayey gravel with sand. Alluvial soils were encountered beneath the fill to the total depths explored of up to approximately 31½ feet and consisted of moist, stiff to hard, lean and fat clay with different sand/gravel content, and dense to very dense, silty sand, clayey sand, and poorly-graded sand with different gravel content. Detailed descriptions of the subsurface materials encountered during our exploration are presented on the boring logs in Appendix A.

5.3 Groundwater

Groundwater was not encountered during our subsurface exploration. The historic high groundwater depth for the project area is mapped at approximately 30 feet below the ground surface (California Department of Conservation, Division of Mines and Geology, State of California [CDMG], 1998). Fluctuations in groundwater levels will occur due to variations in precipitation, ground surface topography, subsurface stratification, irrigation, groundwater pumping, and other factors that may not have been evident at the time of our field evaluation.

6 FIELD PERCOLATION TESTING

Percolation testing was performed in percolation borings, P-1 through P-3 (Figure 2), in general accordance with the County of Los Angeles Guidelines for Geotechnical Investigation and Reporting Low Impact Development Stormwater Infiltration (COLA, 2017). The percolation tests at P-1 through P-3 were performed adjacent to the borings B-4, B-2, and B-3, respectively, per the direction provided by LPA, Inc. (LPA, Inc. 2020).

Borings P-1 through P-3 were drilled to depths of approximately 10 feet. Preparation of each boring for percolation testing included installing a slotted 2-inch-diameter polyvinyl chloride (PVC) pipe in the borings and backfilling the annular space between the borehole wall and pipe with clean gravel. The infiltration zones were pre-soaked with water for at least one hour prior to performing percolation testing. After the borings were pre-soaked, falling-head percolation testing was performed in all borings.

The falling-head test method involved placing clean water into the PVC pipe to establish a head of water and measuring the rate at which the water level dropped in the pipe at consecutive time intervals (30 minutes). The time interval for recording the water drop was determined by recording the duration for percolation of 12 inches of water, which was recorded longer than 30 minutes in all borings, thereby suggesting that the time interval between readings should be 30 minutes. The test was repeated until three consecutive tests provided similar results and a stabilized rate was obtained. The field percolation rate was calculated by measuring the total volume of water infiltrated during the time interval and dividing by the surface area of the tested zone of the boring. The field percolation rates are presented in Table 1.

The County of Los Angeles Low Impact Development Stormwater Infiltration Guidelines (COLA, 2017) indicate that the measured field percolation rates should be reduced to account for the long-term performance of the proposed facilities by dividing the rates by the "Total Reduction Factor (RF)." The RF is defined as the product of the "test-specific" reduction factor (RF_t), the "site

variability" reduction factor (RF_v), and the "long-term siltation, plugging, and maintenance" reduction factor (RF_s) (i.e., $RF = RF_t \times RF_v \times RF_s$).

The adjusted percolation rates in Table 1 consider a test-specific reduction factor of 2, recommended for boring percolation tests in the COLA Guidelines (2017). Given the inherent variability of subsurface materials at the site, the recommended percolation rate also incorporates a site-variability reduction factor of 2 into the average percolation rate (COLA, 2017). Additional reduction factors for the long-term siltation, plugging, and maintenance should be implemented, if required by the manufacturer.

Test Boring	Field Percolation Rate (inches/hour)	Reduction Factor				Adjusted Percolation Rate (inches/hour)
		RF_t	RF_v	RF_s	RF	
P-1	0.0086	2	2	N/A	4	0.002
P-2	0.0085	2	2	N/A	4	0.002
P-3	0.0565	2	2	N/A	4	0.014
Average Adjusted and Design Percolation Rate (inches/hour)						0.006

Notes:

RF_t – Test Specific Reduction Factor

RF_v – Site Variability Reduction Factor

RF_s – Long-Term Siltation, Plugging, and Maintenance Reduction Factor (To be adjusted by the BMP designer as needed)

RF – Total Reduction Factor

7 FAULTING AND SEISMICITY, AND GEOLOGIC HAZARDS

Based on our review of pertinent readily available geologic literature, geologic maps, stereoscopic aerial photographs, and our geologic field reconnaissance, no active faults are known to cross the subject site and the site is not located within a State of California Earthquake Fault Zone (EFZ) formerly known as an Alquist-Priolo Special Studies Zone (Hart and Bryant, 2007). However, the site is located in a seismically active area, as is the majority of southern California, and the potential for strong ground motion in the project area is considered significant during the design life of the proposed project. Figure 4 shows the approximate site location relative to the major faults in the region.

In addition to the mapped faults shown on Figure 4, the Los Angeles segment of the Puente Hills blind thrust fault is located within approximately 7.5 miles from the site, and the Santa Fe Springs segment of the Puente Hills blind thrust fault is located approximately 12.9 miles from the site (USGS, 2008). Blind thrust faults are low-angle faults at depth that do not break the surface and are, therefore, not shown on Figure 4. Although blind thrust faults do not have a surface trace, they can be capable of generating damaging earthquakes.

Historical earthquakes with a magnitude of 6.5 or more, or earthquakes that have caused significant loss of life and property within approximately 62 miles (100 kilometers) of the subject site were obtained from the CGS Regional Geologic Hazards and Mapping Program website (CGS, 2015) and are presented in Table 2.

Date	Name, Location, or Region Affected	Approximate Earthquake Epicenter to Site Distance in miles (km)	Earthquake Magnitude
October 1, 1987	Whittier Narrows	19.5 (31.4)	6.0
March 11, 1933	Long Beach	25.5 (41.0)	6.4
January 17, 1994	Northridge	22.8 (36.7)	6.7
February 9, 1971	San Fernando	34.4 (55.4)	6.6
December 8, 1812	Wrightwood	52.0 (83.7)	7.3
July 22, 1899	Wrightwood	56.4 (90.8)	6.4
December 21, 1812	Los Angeles, Ventura, Santa Barbara	59.4 (95.6)	7.1
December 25, 1899	San Jacinto and Hemet	79.1 (127.3)	6.7

In general, seismic hazards that could impact the project include ground surface rupture, strong ground motion, liquefaction, and dynamic compaction of dry soils. These potential hazards are discussed in the following sections.

7.1 Surface Fault Rupture

Based on our review of the referenced literature and our site reconnaissance, no active faults are known to cross the project site. Therefore, the probability of damage from surface fault rupture is considered to be low. However, lurching or cracking of the ground surface as a result of nearby seismic events is possible.

7.2 Site-Specific Ground Motion

Considering the proximity of the sites to active faults capable of producing a maximum moment magnitude of 6.0 or more, the project area has a high potential for experiencing strong ground motion. The 2019 CBC requires the risk-targeted maximum considered earthquake (MCE_R) ground motion response accelerations to evaluate seismic loads for design of buildings and other structures. Per the 2019 CBC, site-specific ground motion hazard analysis needs to be performed following the guidelines presented in Sections 21.2 and 21.3 of American Society of Civil Engineers (ASCE) Publication 7-16 for soil deposits classified as Site Class D with mapped S₁ (spectral response acceleration at a period of 1 second) greater than or equal to 0.2g. Since the S₁ is 0.649g at the site (per ASCE 7-16, using the 2019 Structural Engineers Association of California [SEAOC]/Office of Statewide Health Planning and Development [OSHPD] web-based

seismic design tool), site-specific ground motion hazard analysis was performed to evaluate the ground motion characteristics at the site.

The site-specific ground motion hazard analysis consisted of the review of available seismologic information for nearby faults and performance of probabilistic seismic hazard analysis (PSHA) and deterministic seismic hazard analysis (DSHA) to develop 5-percent-damped acceleration response spectrum (ARS) curves corresponding to the MCE_R . Prior to the site-specific ground motion hazard analysis, we obtained the mapped seismic ground motion values and developed the general MCE_R response spectrum for 5 percent damping in accordance with Section 11.4 of ASCE 7-16 (SEAOC/OSHPD, 2019).

The 2014 next generation attenuation (NGA) West-2 relationships were used to evaluate the site-specific ground motions. The NGA relationships used for developing the probabilistic and deterministic response spectra were those by Chiou and Youngs (2014), Campbell and Bozorgnia (2014), Boore, Stewart, Seyhan, and Atkinson (2014), and Abrahamson, Silva, and Kamai (2014). The Open Seismic Hazard Analysis software developed by USGS (Field et al. 2003) was used for performing the PSHA. The Calculation of Weighted Average 2014 NGA Models spreadsheet developed by the Pacific Earthquake Engineering Research Center (PEER) was used for performing the DSHA (Seyhan, 2014).

PSHA was performed for earthquake hazards having a 2 percent probability of being exceeded in 50 years adjusted for the risk factors per ASCE 7-16. The maximum rotated components of 5-percent-damped ground motions were considered in PSHA. The DSHA considers accelerations from characteristic earthquakes on active faults within the region using the hazard curves and deaggregation plots at the site using the USGS Unified Hazard Tool application (USGS, 2020b). A magnitude 7.5 event on the Newport-Inglewood fault was deemed to be the controlling earthquake. The DSHA was performed for the site using this event and corrections were applied to spectral accelerations for the 84th percentile of the maximum rotated component of ground motion with 5 percent damping.

The site-specific MCE_R response spectrum was considered as the lesser of the PSHA and DSHA spectral response acceleration at any period, and the site-specific design response spectrum was determined by taking two-thirds of the MCE_R response spectrum with some conditions in accordance with Section 21.3 of ASCE 7-16. Figure 5 presents the site-specific MCE_R and design response spectra as well as the general mapped design response spectra calculated in accordance with Section 11.4 of ASCE 7-16. The site-specific spectral acceleration parameters, obtained from ground motion hazard analysis, are presented in Section 9.3 for evaluation of

seismic loads on buildings and other structures. The site-specific MCE_G (maximum considered earthquake geometric mean) peak ground acceleration, PGA_M , was calculated as 0.813g.

In addition, the mapped spectral response acceleration parameters, in accordance with ASCE 7-16 Section 11.4, are provided in Section 9.3 for the evaluation of seismic loads on buildings and other structures should the structural design be performed in accordance with the Exception 2 of ASCE 7-16 Section 11.4.8.

7.3 Liquefaction Evaluation

Liquefaction is a phenomenon in which loosely deposited granular soils and non-plastic silts located below the water table undergo rapid loss of shear strength when subjected to strong earthquake-induced ground shaking. Ground shaking of sufficient duration results in the loss of grain-to-grain contact due to a rapid rise in pore water pressure, and causes the soil to behave as a fluid for a short period of time. Liquefaction is known generally to occur in saturated or near-saturated cohesionless soils at depths shallower than 50 feet below the ground surface. Factors known to influence liquefaction potential include composition and thickness of soil layers, grain size, relative density, groundwater level, degree of saturation, and both intensity and duration of ground shaking.

According to the State of California Seismic Hazard Zones Map (CDMG, 1999), the site is not mapped in an area susceptible to seismically-induced liquefaction. Based on the depth of groundwater level in the vicinity of the site, and the relatively dense native soils, liquefaction is not a design consideration for the project.

7.4 Tsunamis and Seiches

Tsunamis are long wavelength, seismic, sea waves (long compared to ocean depth) generated by the sudden movements of the ocean floor during submarine earthquakes, landslides, or volcanic activity. Seiches are waves generated in a large, enclosed body of water. The project area is not mapped within an area considered susceptible to tsunamis or seiche inundation. Therefore, damage due to tsunamis or seiches is not a design consideration.

8 CONCLUSIONS

Based on the results of our evaluation, it is our opinion that the improvement/construction of the proposed athletic facilities is feasible from a geotechnical perspective, provided the recommendations presented in this report are incorporated into the design and construction of the project. In general, the following conclusions were made:

- The site is underlain by fill and alluvial deposits. Fill was encountered at the surface to depths ranging from approximately 5 to 11 feet and consisted of moist, stiff to hard, lean clay and fat clay with different sand/gravel content, and loose to medium dense, silty and clayey sand with different gravel content, and clayey gravel with sand. Alluvial soils were encountered beneath the fill to the total depths explored of up to approximately 31½ feet and consisted of moist, stiff to hard, lean and fat clay with different sand/gravel content, and dense to very dense, silty sand, clayey sand, and poorly-graded sand with different gravel content.
- The near-surface soils encountered at the site are typically lean or fat clay, with the exception of clayey sand encountered at B-4 and P-1. The results of our laboratory program indicate that the surficial fat clay exhibits medium to high expansion potential.
- The surficial soils should be considered as Type B in accordance with the Occupational Safety and Health Administration (OSHA) soil classifications.
- Groundwater was not encountered during our subsurface exploration. Historic high groundwater at the site is approximately 30 feet below the ground surface.
- Surficial soils at the project site are significantly comprised of fine-grained, low-permeability materials. The percolation rate recommended for this project is 0.006 inches per hour.
- The site is not mapped in an area susceptible to seismically-induced liquefaction (CDMG, 1998).
- The subject site is not located within a State of California EFZ (CGS, 2018), and based on our review of published geologic maps, there are no known active faults underlying the site. Therefore, the potential for surface fault rupture at the site is considered to be low.
- The horizontal PGA that corresponds to the MCE_R for the site was calculated as 0.813g.
- Based on our laboratory test results, the near-surface site soils are classified as corrosive based on California Department of Transportation (Caltrans, 2018) corrosion guidelines.

9 RECOMMENDATIONS

The recommendations presented in the following sections provide geotechnical criteria regarding the design and construction of the proposed site improvements. The recommendations are based on the results of our subsurface evaluation, geotechnical analysis, and project understanding. The proposed work should be performed in conformance with the recommendations presented in this report, project specifications, and requirements of applicable governing agencies.

9.1 Earthwork

Earthwork at the site is anticipated to consist of site clearing, remedial grading for foundation support, trenching, and foundation excavation. Earthwork operations should be performed in accordance with the requirements of applicable governing agencies and the recommendations presented in the following sections of this report.

9.1.1 Construction Plan Review and Pre-Construction Conference

We recommend that the construction plans be submitted to Ninyo & Moore for review to evaluate conformance to the geotechnical recommendations provided in this report. We further recommend that a pre-construction conference be held. The owner and/or their representative, the governing agencies' representatives, the civil engineer, Ninyo & Moore, and the contractor should attend to discuss the work plan, project schedule, and earthwork requirements.

9.1.2 Clearing and Site Preparation

Prior to performing excavations or other earthwork, the area should be cleared of existing improvements, including concrete, rubble and debris, abandoned utilities, surface obstructions, and other deleterious materials. Existing utilities within the project limits should be re-routed or protected from damage by construction activities. Materials generated from the clearing operations should be removed from the project site and disposed at a legal dumpsite.

9.1.3 Treatment of Near-Surface Soils

After the site has been cleared of surface improvements, vegetation, and subsurface obstructions, remedial grading operations should be performed to support the construction of the proposed improvements. Due to the soils with high expansion potential encountered at the site, we recommend either of the following two mitigation measures for soils underlying both shallow foundations and pavements:

(1) Minimum of 3 feet over-excavation for shallow spread footing and 1.5 feet of over-excavation for pavements and exterior slabs, replacement with granular materials having a low expansion potential per ASTM International (ASTM) test method D 4829, and compaction to a relative compaction of 90 percent as evaluated per ASTM D 1557. The limits of the excavations should extend laterally so that the bottoms of the excavations are approximately 3 feet beyond the outside edges of the spread footing and 1.5 feet beyond the edges of the pavement section or exterior slab. The excavation bottom should be evaluated by a Ninyo & Moore representative during the excavation work. Additional over-excavation of loose, soft, and/or wet areas may be appropriate, depending on our observations during construction. Prior to placing newly compacted fill, the exposed bottoms should be scarified, moisture-conditioned, and re-compacted to a depth of approximately 8 inches.

(2) Treatment with quick lime to a depth of 3 feet for shallow spread footing and 1.5 feet for pavements and exterior slabs. Based on our previous experience, we recommend a

preliminary lime content of 4 percent (by weight). Additional study may need to be performed by Ninyo & Moore upon request to identify the optimum lime content for the site. Lime treatment usually requires at least two hydration phases followed by compaction of the subgrade materials blended with lime. The lime-treated soil, following hydration, should be compacted to a relative compaction of 90 percent as evaluated by ASTM D 1557. The stabilized subgrade should extend approximately 3 feet and 1.5 feet laterally beyond the outside edges of the spread footing and pavement section, respectively.

9.1.4 Temporary Excavations and Shoring

We recommend that trenches and excavations be designed and constructed in accordance with OSHA regulations. These regulations provide trench sloping and shoring design parameters for trenches up to 20 feet deep based on the soil types encountered. Trenches/excavations over 20 feet deep should be designed by the contractor's engineer based on site-specific geotechnical analyses. For planning purposes, we recommend that the materials on site be considered as OSHA soil Type B.

Temporary excavations should be constructed in accordance with OSHA recommendations. For trench or other excavations, OSHA requirements regarding personnel safety should be met by using appropriate shoring (including trench boxes) or by laying back the slopes no steeper than 1.5:1 (horizontal to vertical). Temporary excavations that encounter seepage may need shoring or may be mitigated by placing sandbags or gravel along the base of the seepage zone. Excavations encountering seepage should be evaluated on a case-by-case basis. On-site safety of personnel is the responsibility of the contractor. Recommendations for temporary shoring can be provided, if requested.

9.1.5 Fill Material

In general, the on-site soils are not suitable for re-use as fill. Imported materials should consist of clean, non-expansive, granular material, which conforms to the "Greenbook" for structure backfill. "Non-expansive" can be defined as soils having an expansion index of 20 or less in accordance with ASTM D 4829. The imported materials should also meet the Caltrans (2018) criteria for non-corrosive soils (i.e., soils having a chloride concentration of 500 parts per million [ppm] or less, a soluble sulfate content of approximately 0.15 percent (1,500 ppm) or less, a pH value of 5.5 or higher and a minimum resistivity of 1,100 ohm-centimeters [ohm-cm] or higher). Import materials for use as fill should be evaluated by the geotechnical consultant prior to importing. The contractor should be responsible for the uniformity of import materials brought to the site.

9.1.6 Fill Placement and Compaction

Fill placed for support of the improvements and as trench backfill should be compacted in horizontal lifts to a relative compaction of 90 percent or more as evaluated by ASTM D 1557. Fill soils should be moisture-conditioned to two percent or more above the optimum moisture content. The optimum lift thickness of fill will depend on the type of compaction equipment used but generally should not exceed 8 inches in loose thickness. Special care should be taken to avoid pipe damage when compacting trench backfill above pipes. Placement and compaction of the fill soils should be in general accordance with appropriate governing agency standards and good construction practice.

9.2 Underground Utilities

We anticipate that utility pipelines will be supported on future compacted fill or deeper native alluvial soils. The depths of the pipelines are not known; however, we anticipate that the pipe invert depths will not exceed 10 feet.

9.2.1 Pipe Bedding

We recommend that bedding material be placed around pipe zones 1 foot or more above the top of the pipe. The bedding material should be classified as sand, should be free of organic material, and have a sand equivalent of 30 or more. Because of the clayey subgrade encountered, we do not recommend gravel to be used for bedding material. It has been our experience that the voids within gravel material are sufficiently large to allow fines to migrate into the voids, thereby creating the potential for sinkholes and depressions to develop at the ground surface. Where soft, wet soil conditions are encountered the trench excavation should be excavated approximately 1 foot or more below the pipe invert and should be backfilled with gravel wrapped in filter fabric.

Special care should be taken not to allow voids beneath and around the pipe. Compaction of the bedding material and backfill should proceed uniformly up both sides of the pipe. Trench backfill, including bedding material, should be placed in accordance with the recommendations presented in the preceding section.

9.2.2 Trench Backfill

Based on our subsurface evaluation, the on-site soils are not suitable for re-use as trench backfill. Trench backfill has to be performed using import materials, as specified in the “Earthwork” section of this report. We recommend that trench backfilling be in general conformance with the Standard Specifications for Public Works Construction (“Greenbook”) for structure backfill. Fill should be moisture-conditioned to at or slightly above the laboratory

optimum. Wet soils should be allowed to dry to a moisture content near the optimum prior to their placement as trench backfill. Trench backfill should be compacted to a relative compaction of 90 percent as evaluated by ASTM D 1557. Lift thickness for backfill will depend on the type of compaction equipment utilized, but fill should generally be placed in horizontal lifts not exceeding 8 inches in loose thickness. Special care should be exercised to avoid damaging the pipe during compaction of the backfill.

9.2.3 Modulus of Soil Reaction

The modulus of soil reaction is used to characterize the stiffness of soil backfill placed on the sides of buried flexible pipelines for the purpose of evaluating lateral deflection caused by the weight of the backfill above the pipe. We recommend that a modulus of soil reaction of 1,000 pounds per square inch be used for design, provided that granular bedding material is placed adjacent to the pipe, as recommended in this report.

9.3 Seismic Design Considerations

Design of the proposed improvements should be performed in accordance with the requirements of governing jurisdictions and applicable building codes. Table 3 presents the spectral response acceleration parameters in accordance with the 2019 CBC guidelines.

Table 3 – 2019 California Building Code Seismic Design Criteria	
Site Coefficients and Spectral Response Acceleration Parameters	Values
Site Class	D
Mapped Spectral Response Acceleration at 0.2-second Period, S_s	1.845g
Mapped Spectral Response Acceleration at 1.0-second Period, S_1	0.649g
Site-modified Spectral Response Acceleration at 0.2-second Period, S_{MS}	1.983g
Site-modified Spectral Response Acceleration at 1.0-second Period, S_{M1}	1.655g
Design Spectral Response Acceleration at 0.2-second Period, S_{DS}	1.322g
Design Spectral Response Acceleration at 1.0-second Period, S_{D1}	1.104g
Site-modified Peak Ground Acceleration, PGA_M	0.813g

9.4 Foundations

The proposed buildings can be supported on shallow foundations including square and continuous footings bearing on compacted import fill material or lime-treated subgrade soil prepared in accordance with the recommendations presented in the Earthwork section of this report. Foundations should be designed in accordance with structural considerations and the following recommendations. In addition, requirements of the appropriate governing jurisdictions and applicable building codes should be considered in the design of the structures.

9.4.1 Square and Continuous Foundations

Footings should be at least 24 inches wide and extend 24 inches or more below the adjacent finished grade. Further details should be in accordance with the recommendations of the structural engineer.

Spread footings may be designed using an allowable bearing capacity of 2,500 pounds per square foot (psf). The allowable bearing capacity may be increased by one-third when considering loads of short duration such as wind or seismic forces. Please note that the allowable bearing capacity cannot be increased for footings of different size and/or embedment depth. Total and differential settlements for footings designed and constructed in accordance with the above recommendations are estimated to be approximately 1 and ½ inch over a horizontal span of 40 feet, respectively, under the static loading condition.

Footings bearing on compacted fill may be designed using a coefficient of friction of 0.35, where the total frictional resistance equals the coefficient of friction times the dead load. Footings may be designed using a passive resistance of 300 psf per foot of depth for a level ground condition up to a value of 3,000 psf. The allowable lateral resistance can be taken as the sum of the frictional resistance and passive resistance, provided the passive resistance does not exceed one-half of the total allowable resistance. The passive resistance may be increased by one-third when considering loads of short duration such as wind or seismic forces.

Concrete should be placed soon after subgrade compaction to reduce bearing soil disturbance. Should the soils at bearing level become excessively dry, disturbed, or saturated, the affected soil should be moisture-conditioned and compacted. Ninyo & Moore should review the building layout and grading plans once available to evaluate if modifications to our recommendations are needed. It is recommended that Ninyo & Moore be retained to observe, test, and evaluate the foundation bearing materials.

9.4.2 Slab-On-Grade

Building floor slabs should be designed by the project structural engineer based on the anticipated loading conditions. Building floor slabs may be supported on compacted fill prepared in accordance with the recommendations presented in the Earthwork section. At a minimum, we recommend that floor slabs have a thickness of 5 inches or more and be reinforced with No. 4 steel reinforcing bars placed 18 inches on-center (each way) in the middle one-third of the slab height. The placement of the reinforcement in the slab is vital for

its satisfactory performance. The floor slab and foundations should be tied together by extending the slab reinforcement into the footings.

The slab should be underlain by a 4-inch-thick layer of clean sand overlain by a polyethylene vapor retarder, 10-mil or thicker. The vapor retarder is recommended in areas where moisture-sensitive floor coverings are anticipated. Soils underlying the slabs should be moisture-conditioned and compacted in accordance with the recommendations presented in this report prior to concrete placement. Joints should be constructed at intervals designed by the structural engineer to help reduce random cracking of the slab.

9.4.3 Exterior Sidewalks

Due to the presence of near-surface soils with high expansion potential at the site, we recommend that the upper 18 inches of the surficial soils below the exterior flatwork be treated following the recommendations presented in Section 9.1.3. Exterior slabs-on-grade may be 4 inches thick and reinforced with No. 3 reinforcing bars at a spacing of 18 inches and doweled to curbs. In areas abutting landscape areas, the edge of the slab should be deepened to approximately 8 inches below the adjacent finish subgrade. The vapor retarder and 4 inches of sand may be excluded from beneath the exterior slabs unless tile, paint, or other potentially moisture-sensitive surface treatments are used.

9.5 Preliminary Pavement Design

We anticipate that future new pavement may include new flexible pavement (AC) or rigid pavement (PCC) for the anticipated traffic including fire trucks. Traffic loading information was not available for our design at the time of preparation of this report; however, based on the direction from TELACU Construction Management, we understand that the pavements designed at this stage will be used as fire lanes (email correspondence from Mr. Blaine Yoder to Mr. Morteza Mirshekari, dated March 31, 2021). Accordingly, a traffic index (TI) value of 6.0 was used for the preliminary design of pavement sections. The TI of 6.0 is generally used for designing pavements for driveway areas that are subjected to heavy equipment/truck traffic.

Due to the occurrence of significant expansive, fat clay at surface, use of hot-mixed asphalt pavement is only possible after the ground improvement has been performed, following the instructions in the Earthwork section of this report. For planning purposes, an R-value of 40 was used for the subgrade soil in the design of the preliminary flexible pavement sections. Portland Cement Concrete (PCC) pavement may also be used over the on-site soil, provided that 18 inches of the subgrade soil be scarified, moisture-conditioned to four percent or more above the optimum,

and compacted to a relative compaction of 90 percent per ASTM D 1557. An R-value of 5 was used for the preliminary design of PCC pavement sections.

Based on the abovementioned assumptions and guidelines of the Caltrans Highway Design Manual (Caltrans, 2019), we have developed the following preliminary pavement sections for the project (Tables 4 and 5). We recommend that these pavement sections be re-evaluated once project-specific traffic indices are developed and the as-graded near-surface earth materials are further tested for R-value.

Table 4 – Preliminary Flexible Pavement Structural Sections			
Traffic Index	R-Value	AC over CAB or AC over CMB (inches)	Full Depth AC (inches)
6.0	40	4 over 5	7

Notes:
 AC – Asphalt Concrete
 CAB – Crushed Aggregate Base
 CMB – Crushed Miscellaneous Base

Table 5 – Preliminary Rigid Pavement Structural Sections		
Traffic Index	R Value	Full Depth PCC (inches)
6.0	5	8

Notes:
 PCC – Portland Cement Concrete

Subgrade soils in areas to be paved should be prepared as recommended in the Earthwork section of this report. Crushed aggregate base (CAB) or crushed miscellaneous base (CMB) material should conform to the latest edition of the Standard Specifications for Public Works Construction “Greenbook,” Section 200. The CAB/CMB should be compacted to a relative compaction of 95 percent as evaluated by ASTM D 1557. CAB/CMB should be placed at slightly above the optimum moisture content as evaluated by ASTM D 1557. AC should conform to Section 203 of the Greenbook and should be compacted to a relative compaction of 95 percent. Final pavement sections should be selected based on actual anticipated traffic loading conditions and evaluation of the subgrade materials at the time of construction.

9.6 Corrosivity

Laboratory testing was performed on a representative sample of near-surface soil at B-11 to evaluate pH, electrical resistivity, water-soluble chloride content, and water-soluble sulfate content. The soil pH and electrical resistivity tests were performed in general accordance with California Test Method (CT) 643. Chloride content test was performed in general accordance with CT 422. Sulfate testing was performed in general accordance with CT 417. The laboratory test results are presented in Appendix B.

The soil pH of the sample tested was measured to be 7.0, and the electrical resistivity was measured to be 206 ohm-cm. The chloride content of the sample was measured to be 2,550 ppm. The sulfate content of the tested sample was 0.036 percent (360 ppm). Based on the laboratory test results and Caltrans criteria (2018), the project site can be classified as a corrosive site, which is defined as having earth materials with chloride content higher than 500 ppm, sulfate content higher than 0.15 percent, a pH of less than 5.5, and an electrical resistivity of less than 1,100 ohm-cm. If corrosion susceptible improvements are planned on site, we recommend that a corrosion engineer be consulted for further evaluation and recommendations.

9.7 Concrete

Concrete in contact with soil or water that contains high concentrations of water-soluble sulfates can be subject to premature chemical and/or physical deterioration. Based on the American Concrete Institute (ACI) criteria (2016), the potential for sulfate attack is negligible for water-soluble sulfate contents in soil ranging from 0.00 to 0.10 percent by weight and moderate for water-soluble sulfate contents ranging from 0.10 to 0.20 percent by weight. The potential for sulfate attack is severe for water-soluble sulfate contents ranging from 0.20 to 2.00 percent by weight and very severe for water-soluble sulfate contents over 2.00 percent by weight. The soil sample tested for this evaluation, using Caltrans Test Method 417, indicates a water-soluble sulfate content of 0.036 percent by weight (i.e., 360 ppm). Accordingly, the on-site soils are considered to have a negligible potential for sulfate attack. However, the site is classified as corrosive, and per the ACI 318-14 criteria (ACI, 2016), Type II cement is considered to be appropriate for the project. Due to the potential variability in soil conditions across the site, Type II/V cement with a water/cement ratio of 0.45 or less should be considered for the project.

In order to reduce the potential for shrinkage cracks in the concrete during curing, we recommend that the concrete for the proposed structures be placed with a slump of 4 inches based on ASTM C 143. The slump should be checked periodically at the site prior to concrete placement. We also recommend that crack control joints be provided in sidewalks and exterior hardscape in accordance with the recommendations of the structural engineer to reduce the potential for distress due to minor soil movement and concrete shrinkage. The structural engineer should be consulted for additional concrete specifications.

9.8 Drainage

Good surface drainage is imperative for satisfactory site performance. Positive drainage should be provided and maintained to channel surface water off the pavement, away from foundations and off-site. Positive drainage is defined as a slope of 2 percent or more for a distance of 5 feet or more away from foundations and tops of slopes. Runoff should then be transported by the use

of swales or pipes into a collective drainage system and discharged to suitable facilities. Surface waters should not be allowed to pond adjacent to footings or on pavements. Concentrated runoff should not be allowed to flow over asphalt pavement as this can result in early deterioration of the pavement. Area drains for landscaped and paved areas are recommended.

10 CONSTRUCTION OBSERVATION

The recommendations provided in this report are based on our understanding of the proposed project and our evaluation of the data collected based on subsurface conditions observed in our exploratory borings. It is imperative that Ninyo & Moore checks the subsurface conditions during construction.

During construction, we recommend that Ninyo & Moore duties include, but not be limited to:

- Observing clearing, grubbing, and removals.
- Observing remedial grading bottoms.
- Observe the placement and compaction of fill and trench backfill.
- Evaluating imported materials prior to their use as fill.
- Performing field tests to evaluate fill compaction.
- Observing foundation excavations for bearing materials and cleaning prior to placement of reinforcing steel or concrete.
- Performing material testing services including concrete compressive strength and steel tensile strength tests and inspections.

The recommendations provided in this report are based on the assumption that Ninyo & Moore will provide geotechnical observation and testing services during construction. In the event that the services of Ninyo & Moore are not utilized during construction, we request that the selected consultant provide the owner with a letter (with a copy to Ninyo & Moore) indicating that they fully understand Ninyo & Moore's recommendations, and that they are in full agreement with the design parameters and recommendations contained in this report.

11 LIMITATIONS

The field evaluation, laboratory testing, and geotechnical analyses presented in this geotechnical report have been conducted in general accordance with current practice and the standard of care exercised by geotechnical consultants performing similar tasks in the project area. No warranty, expressed or implied, is made regarding the conclusions, recommendations, and opinions presented in this report. There is no evaluation detailed enough to reveal every subsurface condition. Variations may exist and conditions not observed or described in this report may be

encountered during construction. Uncertainties relative to subsurface conditions can be reduced through additional subsurface exploration. Additional subsurface evaluation will be performed upon request. Please also note that our evaluation was limited to assessment of the geotechnical aspects of the project, and did not include evaluation of structural issues, environmental concerns, or the presence of hazardous materials.

This document is intended to be used only in its entirety. No portion of the document, by itself, is designed to completely represent any aspect of the project described herein. Ninyo & Moore should be contacted if the reader requires additional information or has questions regarding the content, interpretations presented, or completeness of this document.

This report is intended for design purposes only. It does not provide sufficient data to prepare an accurate bid by contractors. It is suggested that the bidders and their geotechnical consultant perform an independent evaluation of the subsurface conditions in the project areas. The independent evaluations may include, but not be limited to, review of other geotechnical reports prepared for the adjacent areas, site reconnaissance, and additional exploration and laboratory testing.

Our conclusions, recommendations, and opinions are based on an analysis of the observed site conditions. If geotechnical conditions different from those described in this report are encountered, our office should be notified, and additional recommendations, if warranted, will be provided upon request. It should be understood that the conditions of a site could change with time as a result of natural processes or the activities of man at the subject site or nearby sites. In addition, changes to the applicable laws, regulations, codes, and standards of practice may occur due to government action or the broadening of knowledge. The findings of this report may, therefore, be invalidated over time, in part or in whole, by changes over which Ninyo & Moore has no control.

This report is intended exclusively for use by the client. Any use or reuse of the findings, conclusions, and/or recommendations of this report by parties other than the client is undertaken at said parties' sole risk.

12 REFERENCES

- Abrahamson, N.A., Silva, W.J. and Kamai, R., 2014, Summary of the ASK14 Ground Motion Relation for Active Crustal Regions, *Earthquake Spectra*: Vol. 30, No. 3, pp. 1025-1055, dated August.
- American Concrete Institute, 2016, *Building Code Requirements for Structural Concrete (ACI 318-14) and Commentary (ACI 318-14)*.
- American Society of Civil Engineers, 2016, *Minimum Design Loads for Buildings and Other Structures*, Standard ASCE/SEI 7-16.
- ASTM International (ASTM), 2018, *Annual Book of ASTM Standards*, West Conshohocken, Pennsylvania.
- Boore, D.M., Stewart, J.P., Seyhan, E., and Atkinson, G.M., 2014, NGA-West2 Equations for Predicting PGA, PGV, and 5% Damped PSA for Shallow Crustal Earthquakes, *Earthquake Spectra*, Vol. 30, No. 3, pp. 1057-1085, dated August.
- California Building Standards Commission, 2019, *California Building Code: California Code: California Code of Regulations, Title 24, Part 2, Volumes 1 and 2*, based on the 2018 international Building Code.
- California Department of Transportation, 2018, *Corrosion Guidelines, Version 3.0*, Division of Engineering Services, Materials Engineering and Testing Services, Corrosion Technology Branch, dated March.
- California Department of Transportation, 2019, *Highway Design Manual Sixth Edition, U.S. Customary Units*.
- California Geological Survey, *Regional Geologic Hazards and Mapping Program*, 2015. Significant California Earthquakes (M > 6.5 or That Caused Loss of Life or More than \$200,000 in Damage).
- California Geological Survey, State of California, 1998, *Seismic Hazard Zone Report for the Inglewood 7.5-Minute Quadrangle, Los Angeles County, California: Seismic Hazard Zone Report 027*.
- California Geological Survey, State of California, 1999, *Earthquake Zones of Required Investigation, Inglewood Quadrangle, 7.5-Minute Series: Scale 1:24,000*, dated March 25.
- Campbell, K.W., and Bozorgnia, Y., 2014, NGA-West2 Ground Motion Model for the Average Horizontal Components of PGA, PGV, and 5% Damped Linear Acceleration Response Spectra, *Earthquake Spectra*, Vol. 30, No. 3, pp. 1087-1115, dated August.
- Chiou, B. S.-J., and Youngs, R.R., 2014, Update of the Chiou and Youngs NGA Model for the Average Horizontal Component of Peak Ground Motion and Response Spectra, *Earthquake Spectra*, August 2014, Vol. 30, No. 3, dated August.
- County of Los Angeles, Department of Public Works, Geotechnical and Materials Engineering Division, 2017. *Guidelines for Geotechnical Investigation and Reporting. Low Impact Stormwater Infiltration*, dated June 30.
- Field, E.H., T.H. Jordan, and C.A. Cornell, 2003. OpenSHA: A Developing Community-Modeling Environment for Seismic Hazard Analysis. *Seismological Research Letters*, 74, no. 4, p. 406-419.

- Hart, E.W., and Bryant, W.A., 2007, Fault-Rupture Hazard Zones in California, Alquist-Priolo Earthquake Fault Zoning Act with Index to Earthquake Fault Zones Maps: California Department of Conservation, California Geological Survey, Special Publication 42, with Supplement 1 added in 2012, Supplement 2 added in 2014, Supplement 3 added in 2015, and Supplement 4 added in 2016.
- Historical Aerials, 2021, Website for Viewing Aerial Photographs, www.historicaerials.com.
- Jennings, C.W., and Bryant, W.A., 2010, Fault Activity Map: California Geological Survey, California Geologic Data Map Series, Map No. 6, Scale 1: 750,000.
- LPA, Incorporated, 2020, 100% Schematic Design. dated September 15, 2020.
- LPA, Incorporated, 2020, Preliminary Survey & Geotechnical Boring Diagram, dated August 21, 2020.
- Ninyo & Moore, 2020, Proposal for Geotechnical Consulting Services, Centinela Valley Union High School District Hawthorne High School - Athletic Fields Improvements, Proposal No. 04-02296B, dated August 27, 2020.
- Norris, R.M., and Webb, R.W., 1990, Geology of California, Second Edition: John Wiley & Sons.
- Public Works Standard, Inc., 2018, The "Greenbook": Standard Specifications for Public Works Construction, with Errata No. 1, dated 2019: BNI Building News, Vista, California.
- Saucedo, G.J., Greene, H.G., Kennedy, M.P., and Bezore, S.P., 2016, Geologic Map of the Long Beach 30' x 60' Quadrangle, California, version 2.0.
- Structural Engineers Association of California (SEAOC) and California Office of Statewide Health Planning and Development (OSHPD), 2019, Web Based Seismic Design Map Tool; <https://seismicmaps.org>.
- Seyhan, E., 2014, Weighted Average 2014 NGA West-2 GMPE, Pacific Earthquake Engineering Research Center.
- United States Geological Survey, 2008, National Seismic Hazard Maps - Fault Parameters, http://geohazards.usgs.gov/cfusion/hazfaults_search/hf_search_main.cfm.
- United States Geological Survey, 2018, Inglewood Quadrangle, California, 7.5 Minute Series: Scale 1:24,000.
- United States Geological Survey, 2020b, Unified Hazard Tool; <https://earthquake.usgs.gov/hazards/interactive/>.
- United States Geological Survey and Southern California Earthquake Center, 2020a, Open Seismic Hazard Analysis, <http://www.opensha.org/>.
- USDA, Aerial Photograph, Date 11-4-52, Flight AXJ-4K, Number 172 and 173, Scale 1: 20,000.



FIGURES

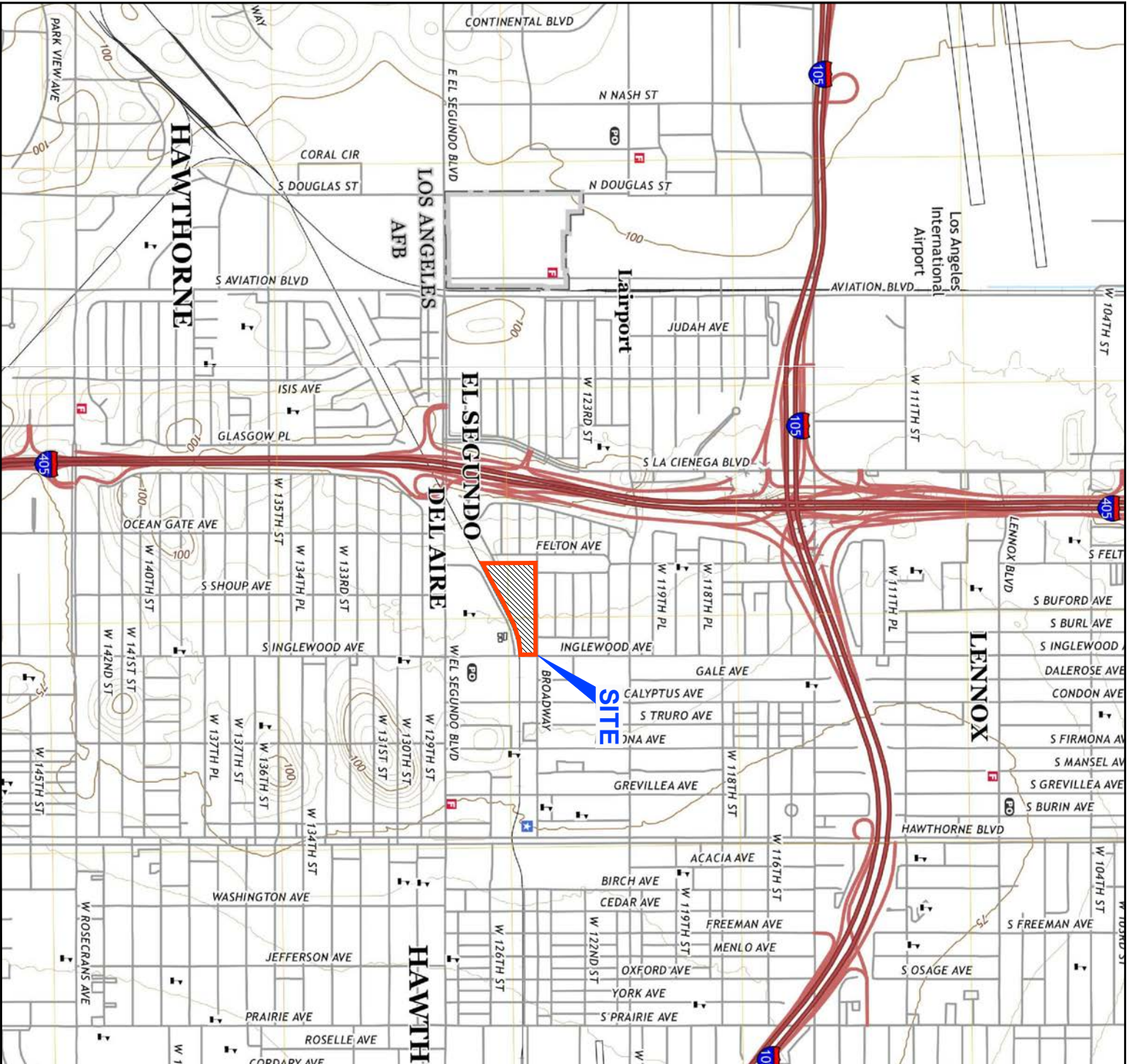

NOTE: DIMENSIONS, DIRECTIONS AND LOCATIONS ARE APPROXIMATE. | REFERENCE: USGS, 2018.



FIGURE 1

Ningo & Moore



Geotechnical & Environmental Sciences Consultants

HAWTHORNE HIGH SCHOOL - ATHLETIC FACILITIES IMPROVEMENTS 4859 WEST EL SEGUNDO BOULEVARD, HAWTHORNE, CALIFORNIA

SITE LOCATION

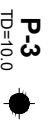

LEGEND

-  LIMIT OF DETAILED SURVEY/ UTILITY SURVEY
-  **B-12**
TD=18.0 EXPLORATORY BORING:
TD=TOTAL DEPTH IN FEET
-  **P-3**
TD=10.0 PERCOLATION BORING:
TD=TOTAL DEPTH IN FEET

NOTE: DIMENSIONS, DIRECTIONS AND LOCATIONS ARE APPROXIMATE. | REFERENCE:





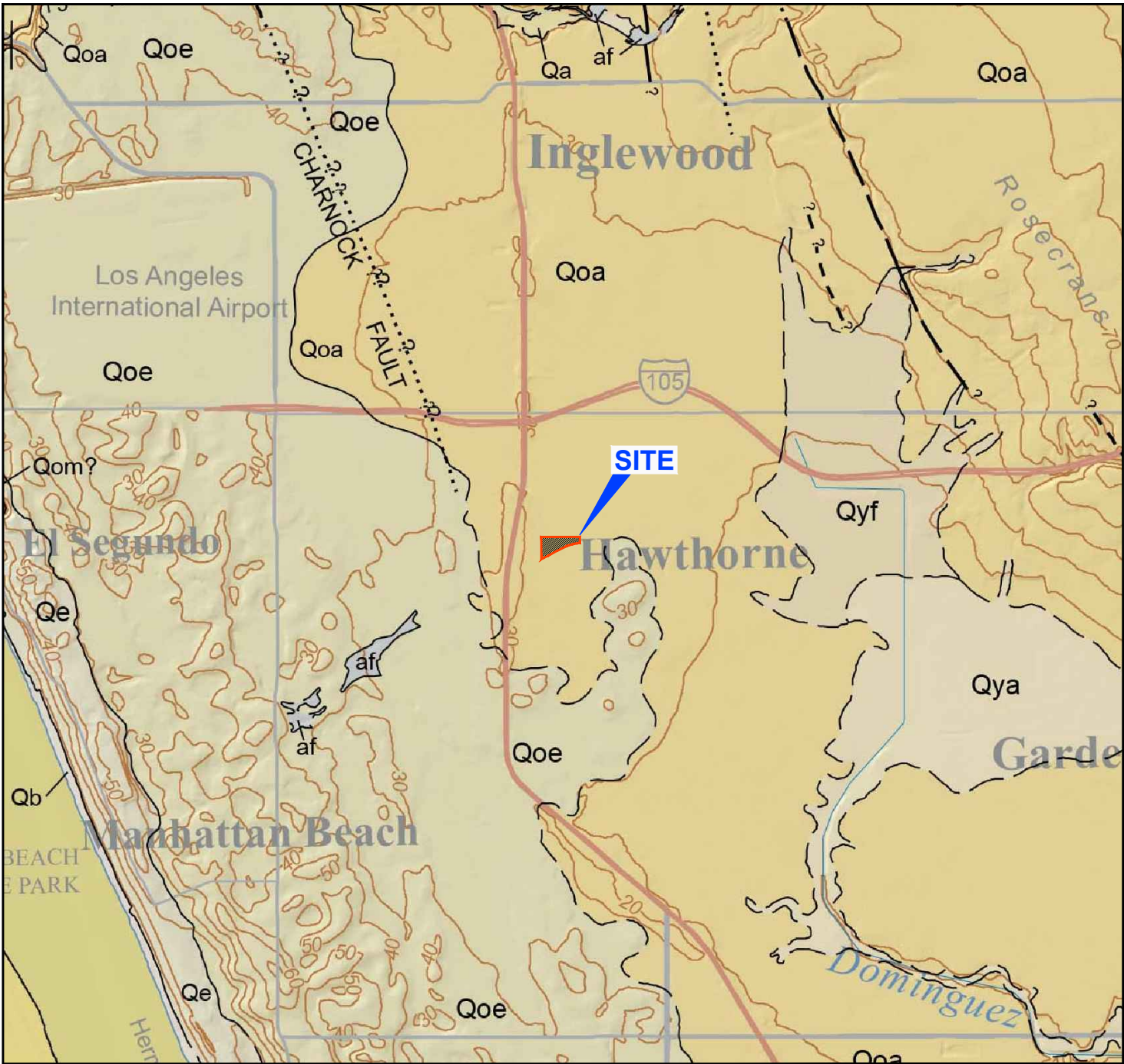



FIGURE 2



REFERENCE: GEORGE J. SAUCEDO, H. GARY GREENE, MICHAEL P. KENNEDY AND STEPHEN P. BEZORE, 2016.

LEGEND

 Qe	TOUNG EOLIAN DEPOSITS	 Qoa	OLDER ALLUVIUM
 Qya	ALLUVIUM	 Qoe	OLDER EOLIAN DEPOSITS
 Qyf	ALLUVIAL FAN DEPOSITS		FAULT
			GEOLOGIC CONTACT

NOTE: DIMENSIONS, DIRECTIONS AND LOCATIONS ARE APPROXIMATE.

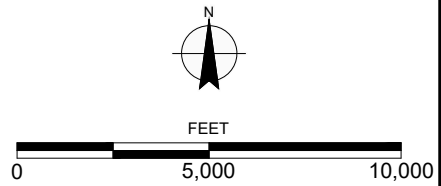

211602001_RG.dwg 03/04/2021 GK

FIGURE 3

REGIONAL GEOLOGY

HAWTHORNE HIGH SCHOOL - ATHLETIC FACILITIES IMPROVEMENTS
 4859 WEST EL SEGUNDO BOULEVARD, HAWTHORNE, CALIFORNIA





LEGEND

QUATERNARY FAULTS
 BASED ON TIME OF MOST RECENT SURFACE DEFORMATION
 HISTORICAL (<150 YEARS)

- WELL CONSTRAINED
- - - MODERATELY CONSTRAINED
- INFERRED

LATEST QUATERNARY (<15,000 YEARS)

- WELL CONSTRAINED
- - - MODERATELY CONSTRAINED
- INFERRED

LATE QUATERNARY (<130,000 YEARS)

- WELL CONSTRAINED
- - - MODERATELY CONSTRAINED
- INFERRED

UNDIFFERENTIATED QUATERNARY (<1.6 MILLION YEARS)

- WELL CONSTRAINED
- - - MODERATELY CONSTRAINED
- INFERRED

SOURCES: U.S. GEOLOGICAL SURVEY AND UTAH GEOLOGICAL SURVEY, QUATERNARY FAULT AND FOLD DATABASE FOR THE UNITED STATES, ACCESSED DECEMBER 10, 2020, AT: <https://www.usgs.gov/natural-hazards/earthquake-hazards/faults/>; ESRI, 2021,

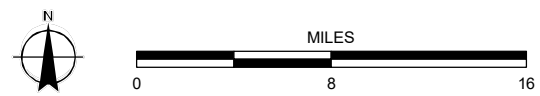

NOTE: DIRECTIONS, DIMENSIONS AND LOCATIONS ARE APPROXIMATE.

FIGURE 4

FAULT LOCATIONS

HAWTHORNE HIGH SCHOOL - ATHLETIC FACILITIES IMPROVEMENTS
 4859 WEST EL SEGUNDO BOULEVARD, HAWTHORNE, CALIFORNIA
 211602001 | 4/21

211602001_FL.mxd 3/4/2021

PERIOD (seconds)	SITE-SPECIFIC MCE _R RESPONSE SPECTRUM Sa (g)	SITE-SPECIFIC DESIGN RESPONSE SPECTRUM Sa (g)
0.010	0.865	0.576
0.020	0.869	0.579
0.030	0.899	0.600
0.050	1.006	0.671
0.075	1.189	0.792
0.100	1.372	0.915
0.150	1.663	1.109
0.200	1.876	1.251
0.250	2.087	1.391
0.300	2.203	1.469
0.400	2.202	1.468

PERIOD (seconds)	SITE-SPECIFIC MCE _R RESPONSE SPECTRUM Sa (g)	SITE-SPECIFIC DESIGN RESPONSE SPECTRUM Sa (g)
0.500	2.141	1.427
0.750	1.819	1.212
1.000	1.562	1.041
1.500	1.092	0.728
2.000	0.828	0.552
3.000	0.543	0.362
4.000	0.385	0.257
5.000	0.289	0.193
7.500	0.173	0.115
10.000	0.104	0.069

S_{DS} = 1.322 g S_{D1} = 1.104 g S_{MS} = 1.983 g S_{M1} = 1.655 g PGA_M = 0.813 g

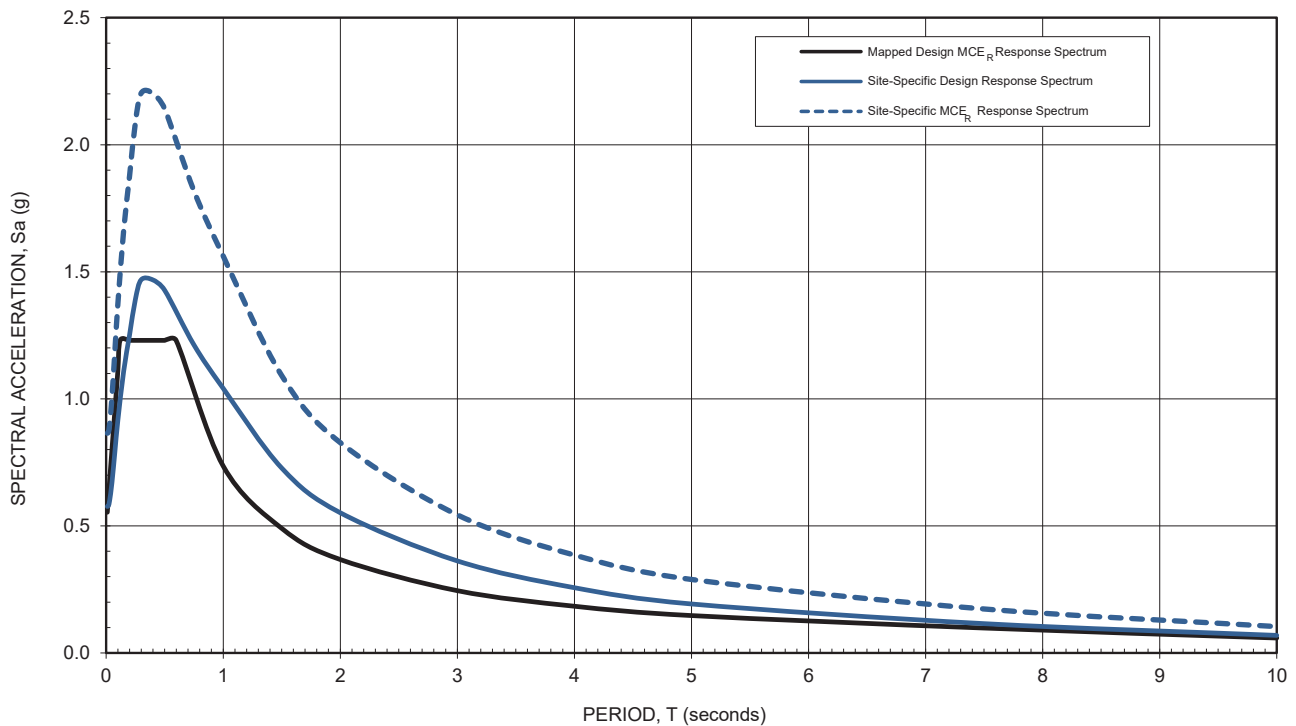

NOTES:

- 1 The probabilistic ground motion spectral response accelerations are based on the risk-targeted Maximum Considered Earthquake (MCE_R) having a 2% probability of exceedance in 50 years in the maximum direction using the Chiou & Youngs (2014), Campbell & Bozorgnia (2014), Boore et al. (2014), and Abrahamson et al. (2014) attenuation relationships and the risk coefficients.
- 2 The deterministic ground motion spectral response accelerations are for the 84th percentile of the geometric mean values in the maximum direction using the Chiou & Youngs (2014), Campbell & Bozorgnia (2014), Boore et al. (2014), and Abrahamson et al. (2014) attenuation relationships for deep soil sites considering a Mw 7.5 event on the Newport-Inglewood fault zone located 4.4 kilometer from the site. It conforms with the lower bound limit per ASCE 7-16 Section 21.2.2.
- 3 The Site-Specific MCE_R Response Spectrum is the lesser of spectral ordinates of deterministic and probabilistic accelerations at each period per ASCE 7-16 Section 21.2.3. The Site-Specific Design Response Spectrum conforms with lower bound limit per ASCE 7-16 Section 21.3.
- 4 The Mapped Design MCE_R Response Spectrum is computed from mapped spectral ordinates modified for Site Class D (stiff soil profile) per ASCE 7-16 Section 11.4. It is presented for the sake of comparison.

FIGURE 5

ACCELERATION RESPONSE SPECTRA



Geotechnical & Environmental Sciences Consultants

HAWTHORNE HIGH SCHOOL - ATHLETIC FACILITIES IMPROVEMENTS
4859 WEST EL SEGUNDO BOULEVARD, HAWTHORNE, CALIFORNIA



APPENDIX A

Boring Logs

APPENDIX A

BORING LOGS

Field Procedure for the Collection of Disturbed Samples

Disturbed soil samples were obtained in the field using the following methods.

Bulk Samples

Bulk samples of representative earth materials were obtained from the exploratory borings. The samples were bagged and transported to the laboratory for testing.

The Standard Penetration Test (SPT) Sampler

Disturbed drive samples of earth materials were obtained by means of a Standard Penetration Test sampler. The sampler is composed of a split barrel with an external diameter of 2 inches and an unlined internal diameter of $1\frac{3}{8}$ inches. The sampler was driven into the ground 18 inches with a 140-pound hammer falling freely from a height of 30 inches in general accordance with ASTM D 1586. The blow counts were recorded for every 6 inches of penetration; the blow counts reported on the logs are those for the last 12 inches of penetration. Soil samples were observed and removed from the sampler, bagged, sealed, and transported to the laboratory for testing.

Field Procedure for the Collection of Relatively Undisturbed Samples

Relatively undisturbed soil samples were obtained in the field using the following method.

The Modified Split-Barrel Drive Sampler

The sampler, with an external diameter of 3 inches, was lined with 1-inch long, thin brass rings with inside diameters of approximately 2.4 inches. The sampler barrel was driven into the ground with the weight of a hammer in general accordance with ASTM D 3550. The driving weight was permitted to fall freely. The approximate length of the fall, the weight of the hammer, and the number of blows per foot of driving are presented on the boring logs as an index to the relative resistance of the materials sampled. The samples were removed from the sampler barrel in the brass rings, sealed, and transported to the laboratory for testing.

Soil Classification Chart Per ASTM D 2488

Primary Divisions		Secondary Divisions			
		Group Symbol	Group Name		
COARSE-GRAINED SOILS more than 50% retained on No. 200 sieve	GRAVEL more than 50% of coarse fraction retained on No. 4 sieve	CLEAN GRAVEL less than 5% fines	GW	well-graded GRAVEL	
			GP	poorly graded GRAVEL	
		GRAVEL with DUAL CLASSIFICATIONS 5% to 12% fines	GW-GM	well-graded GRAVEL with silt	
			GP-GM	poorly graded GRAVEL with silt	
			GW-GC	well-graded GRAVEL with clay	
			GP-GC	poorly graded GRAVEL with clay	
			GM	silty GRAVEL	
		GRAVEL with FINES more than 12% fines	GC	clayey GRAVEL	
			GC-GM	silty, clayey GRAVEL	
	SW		well-graded SAND		
	SP		poorly graded SAND		
	SAND 50% or more of coarse fraction passes No. 4 sieve	CLEAN SAND less than 5% fines	SW	well-graded SAND	
			SP	poorly graded SAND	
		SAND with DUAL CLASSIFICATIONS 5% to 12% fines	SW-SM	well-graded SAND with silt	
			SP-SM	poorly graded SAND with silt	
			SW-SC	well-graded SAND with clay	
			SP-SC	poorly graded SAND with clay	
			SM	silty SAND	
SAND with FINES more than 12% fines		SC	clayey SAND		
		SC-SM	silty, clayey SAND		
	CL	lean CLAY			
FINE-GRAINED SOILS 50% or more passes No. 200 sieve	SILT and CLAY liquid limit less than 50%	INORGANIC	ML	SILT	
			CL-ML	silty CLAY	
			OL (PI > 4)	organic CLAY	
		ORGANIC	OL (PI < 4)	organic SILT	
			CH	fat CLAY	
			MH	elastic SILT	
	SILT and CLAY liquid limit 50% or more	INORGANIC	OH (plots on or above "A"-line)	organic CLAY	
			OH (plots below "A"-line)	organic SILT	
			PT	Peat	
		Highly Organic Soils			

Grain Size

Description	Sieve Size	Grain Size	Approximate Size
Boulders	> 12"	> 12"	Larger than basketball-sized
Cobbles	3 - 12"	3 - 12"	Fist-sized to basketball-sized
Gravel	Coarse	3/4 - 3"	Thumb-sized to fist-sized
	Fine	#4 - 3/4"	Pea-sized to thumb-sized
Sand	Coarse	#10 - #4	Rock-salt-sized to pea-sized
	Medium	#40 - #10	Sugar-sized to rock-salt-sized
	Fine	#200 - #40	Flour-sized to sugar-sized
Fines	Passing #200	< 0.0029"	Flour-sized and smaller

Plasticity Chart

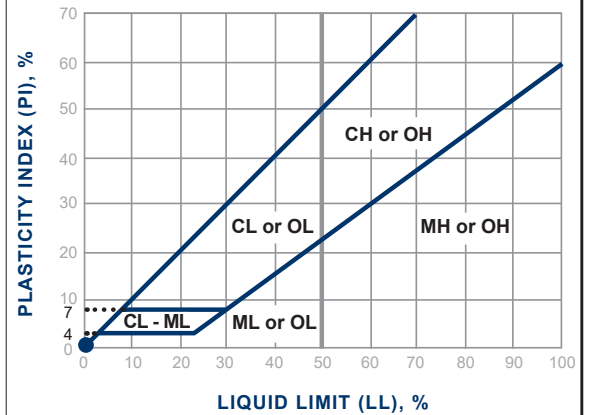

Apparent Density - Coarse-Grained Soil

Apparent Density	Spooling Cable or Cathead		Automatic Trip Hammer	
	SPT (blows/foot)	Modified Split Barrel (blows/foot)	SPT (blows/foot)	Modified Split Barrel (blows/foot)
Very Loose	≤ 4	≤ 8	≤ 3	≤ 5
Loose	5 - 10	9 - 21	4 - 7	6 - 14
Medium Dense	11 - 30	22 - 63	8 - 20	15 - 42
Dense	31 - 50	64 - 105	21 - 33	43 - 70
Very Dense	> 50	> 105	> 33	> 70

Consistency - Fine-Grained Soil

Consistency	Spooling Cable or Cathead		Automatic Trip Hammer	
	SPT (blows/foot)	Modified Split Barrel (blows/foot)	SPT (blows/foot)	Modified Split Barrel (blows/foot)
Very Soft	< 2	< 3	< 1	< 2
Soft	2 - 4	3 - 5	1 - 3	2 - 3
Firm	5 - 8	6 - 10	4 - 5	4 - 6
Stiff	9 - 15	11 - 20	6 - 10	7 - 13
Very Stiff	16 - 30	21 - 39	11 - 20	14 - 26
Hard	> 30	> 39	> 20	> 26

BORING LOG EXPLANATION SHEET

DEPTH (feet)	Bulk Driven SAMPLES	BLOWS/FOOT	MOISTURE (%)	DRY DENSITY (PCF)	SYMBOL	CLASSIFICATION U.S.C.S.	
0	█						Bulk sample. Modified split-barrel drive sampler. No recovery with modified split-barrel drive sampler. Sample retained by others. Standard Penetration Test (SPT). No recovery with a SPT. Shelby tube sample. Distance pushed in inches/length of sample recovered in inches. No recovery with Shelby tube sampler. Continuous Push Sample. Seepage. Groundwater encountered during drilling. Groundwater measured after drilling.
5	XX/XX		∅				
10			∅				
15					█	SM	MAJOR MATERIAL TYPE (SOIL): Solid line denotes unit change.
15					█	CL	Dashed line denotes material change. Attitudes: Strike/Dip b: Bedding c: Contact j: Joint f: Fracture F: Fault cs: Clay Seam s: Shear bss: Basal Slide Surface sf: Shear Fracture sz: Shear Zone sbs: Shear Bedding Surface
20							The total depth line is a solid line that is drawn at the bottom of the boring.

DEPTH (feet)	BULK SAMPLES Driven	BLOWS/FOOT	MOISTURE (%)	DRY DENSITY (PCF)	SYMBOL	CLASSIFICATION U.S.C.S.	DATE DRILLED	BORING NO.	
							2/24/21	B-1	
							GROUND ELEVATION	SHEET	OF
							86' ± (MSL)	1	1
							METHOD OF DRILLING 8" Hollow-Stem Auger (Baja Exploration)		
							DRIVE WEIGHT	DROP	
							140 lbs. (Auto. Trip Hammer)	30"	
							SAMPLED BY	LOGGED BY	REVIEWED BY
							GM	GM	MRM
							DESCRIPTION/INTERPRETATION		
0						CH	FILL: Dark gray, moist, hard, fat CLAY with sand; few rootlets.		
		37	20.3	108.1					
10						CL	ALLUVIUM: Olive brown, moist, very stiff, sandy lean CLAY.		
		19							
							Hard.		
		43							
		27							
20							Total Depth = 18.0 feet. Groundwater not encountered during drilling. Backfilled with cement-bentonite grout on 2/24/21.		
							<u>Notes:</u> Groundwater, though not encountered at the time of drilling, may rise to a higher level due to seasonal variations in precipitation and several other factors as discussed in the report.		
							The ground elevation shown above is an estimation only. It is based on our interpretations of published maps and other documents reviewed for the purposes of this evaluation. It is not sufficiently accurate for preparing construction bids and design documents.		
30									
40									

FIGURE A- 1

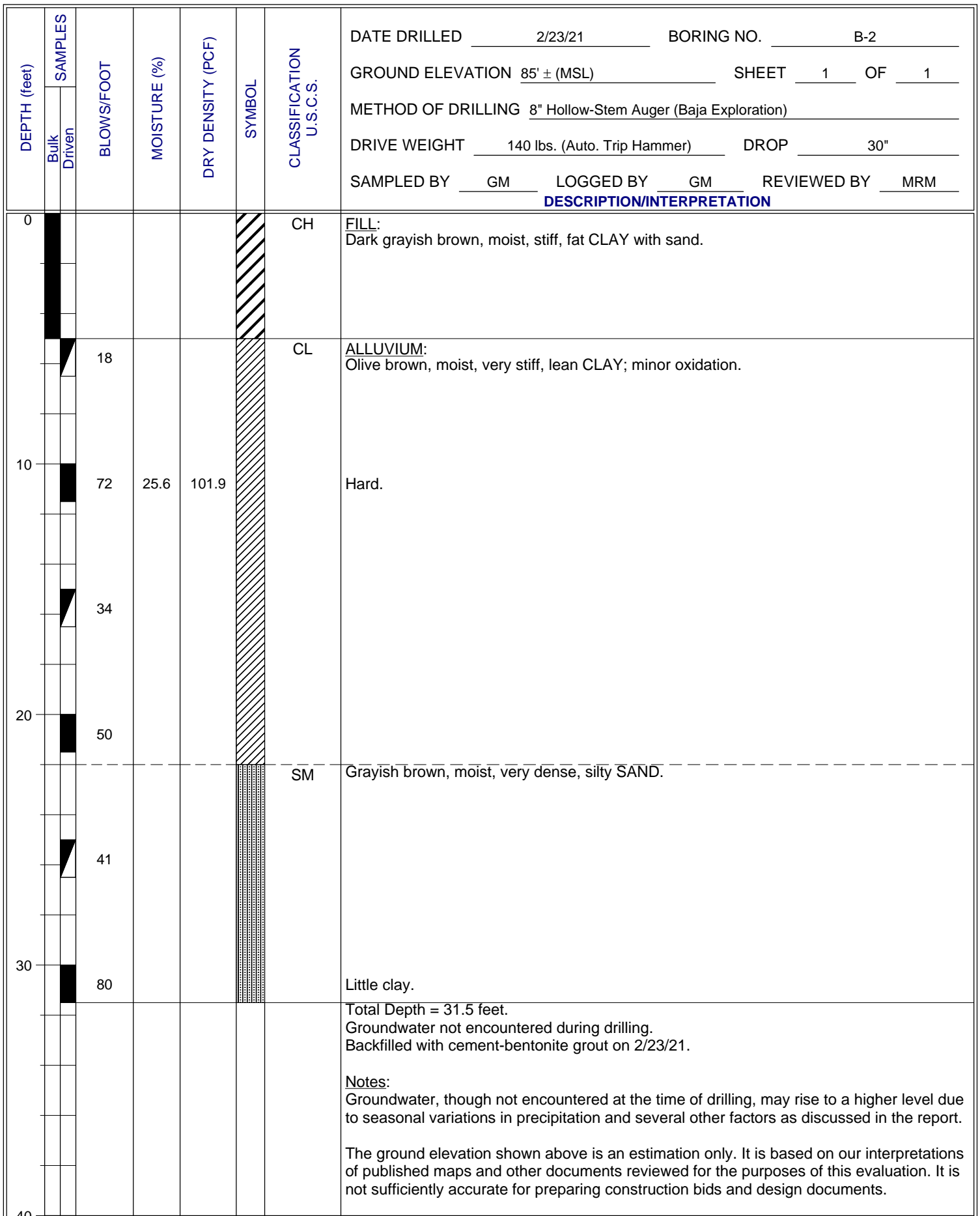

FIGURE A- 2

DEPTH (feet)	SAMPLES Bulk Driven	BLOWS/FOOT	MOISTURE (%)	DRY DENSITY (PCF)	SYMBOL	CLASSIFICATION U.S.C.S.	DATE DRILLED <u>2/23/21</u> BORING NO. <u>B-3</u>
							GROUND ELEVATION <u>83' ± (MSL)</u> SHEET <u>1</u> OF <u>1</u>
							METHOD OF DRILLING <u>8" Hollow-Stem Auger (Baja Exploration)</u>
							DRIVE WEIGHT <u>140 lbs. (Auto. Trip Hammer)</u> DROP <u>30"</u>
							SAMPLED BY <u>GM</u> LOGGED BY <u>GM</u> REVIEWED BY <u>MRM</u>
							DESCRIPTION/INTERPRETATION
0						CL	FILL: Reddish brown, moist, stiff, lean CLAY with sand; grayish brown mottling; trace rootlets.
		48	20.5	109.0			Hard.
10		27				SC	ALLUVIUM: Yellowish brown, moist, dense, clayey SAND.
						SP	Yellowish brown, moist, very dense, poorly graded SAND.
		72/10"					
20		42					
		92/11"					
30		37				CL	Olive brown, moist, hard, lean CLAY; few to little sand.
40							Total Depth = 31.5 feet. Groundwater not encountered during drilling. Backfilled with cement-bentonite grout on 2/23/21. Notes: Groundwater, though not encountered at the time of drilling, may rise to a higher level due to seasonal variations in precipitation and several other factors as discussed in the report. The ground elevation shown above is an estimation only. It is based on our interpretations of published maps and other documents reviewed for the purposes of this evaluation. It is not sufficiently accurate for preparing construction bids and design documents.

FIGURE A-3

DEPTH (feet)	BULK SAMPLES Driven	BLOWS/FOOT	MOISTURE (%)	DRY DENSITY (PCF)	SYMBOL	CLASSIFICATION U.S.C.S.	DATE DRILLED <u>2/23/21</u> BORING NO. <u>B-4</u>
							GROUND ELEVATION <u>89' ± (MSL)</u> SHEET <u>1</u> OF <u>1</u>
							METHOD OF DRILLING <u>8" Hollow-Stem Auger (Baja Exploration)</u>
							DRIVE WEIGHT <u>140 lbs. (Auto. Trip Hammer)</u> DROP <u>30"</u>
							SAMPLED BY <u>GM</u> LOGGED BY <u>GM</u> REVIEWED BY <u>MRM</u>
							DESCRIPTION/INTERPRETATION
0						SC	<p>FILL: Dark yellowish brown, moist, medium dense, clayey SAND with gravel.</p> <p>Loose; scattered gravel; angular to sub-angular.</p>
5							
9		9	18.4	111.6		CL	<p>ALLUVIUM: Olive brown, moist, stiff, lean CLAY with sand.</p> <p>Very stiff.</p> <p>Hard.</p>
14							
20		42					
24							
30		31					
							<p>Total Depth = 31.5 feet. Groundwater not encountered during drilling. Backfilled with cement-bentonite grout on 2/23/21.</p> <p>Notes: Groundwater, though not encountered at the time of drilling, may rise to a higher level due to seasonal variations in precipitation and several other factors as discussed in the report.</p> <p>The ground elevation shown above is an estimation only. It is based on our interpretations of published maps and other documents reviewed for the purposes of this evaluation. It is not sufficiently accurate for preparing construction bids and design documents.</p>
40							

FIGURE A- 4



DEPTH (feet)	BULK SAMPLES Driven	BLOWS/FOOT	MOISTURE (%)	DRY DENSITY (PCF)	SYMBOL	CLASSIFICATION U.S.C.S.	DATE DRILLED <u>2/24/21</u> BORING NO. <u>B-5</u>
							GROUND ELEVATION <u>89' ± (MSL)</u> SHEET <u>1</u> OF <u>1</u>
							METHOD OF DRILLING <u>8" Hollow-Stem Auger (Baja Exploration)</u>
							DRIVE WEIGHT <u>140 lbs. (Auto. Trip Hammer)</u> DROP <u>30"</u>
							SAMPLED BY <u>GM</u> LOGGED BY <u>GM</u> REVIEWED BY <u>MRM</u>
							DESCRIPTION/INTERPRETATION
0						GC	FILL: Reddish brown, moist, medium dense, clayey GRAVEL with sand. Dark grayish brown, moist, very stiff, lean CLAY; trace gravel.
		16	22.8	102.1		CL	
10		23				CL	ALLUVIUM: Yellowish brown, moist, hard, lean CLAY with sand.
40		24					Sandy.
20							Total Depth = 18.0 feet. Groundwater not encountered during drilling. Backfilled with cement-bentonite grout on 2/24/21. Notes: Groundwater, though not encountered at the time of drilling, may rise to a higher level due to seasonal variations in precipitation and several other factors as discussed in the report. The ground elevation shown above is an estimation only. It is based on our interpretations of published maps and other documents reviewed for the purposes of this evaluation. It is not sufficiently accurate for preparing construction bids and design documents.
30							
40							

FIGURE A- 5

DEPTH (feet)	Bulk Driven SAMPLES	BLOWS/FOOT	MOISTURE (%)	DRY DENSITY (PCF)	SYMBOL	CLASSIFICATION U.S.C.S.	DATE DRILLED <u>2/24/21</u> BORING NO. <u>B-6</u>
							GROUND ELEVATION <u>87' ± (MSL)</u> SHEET <u>1</u> OF <u>1</u>
							METHOD OF DRILLING <u>8" Hollow-Stem Auger (Baja Exploration)</u>
							DRIVE WEIGHT <u>140 lbs. (Auto. Trip Hammer)</u> DROP <u>30"</u>
							SAMPLED BY <u>GM</u> LOGGED BY <u>GM</u> REVIEWED BY <u>MRM</u>
							DESCRIPTION/INTERPRETATION
0						CL	FILL: Grayish to reddish brown, moist, stiff, lean CLAY with sand; trace to few gravel.
		32					Hard; increase in sand.
10		54	25.8	100.7		CL	ALLUVIUM: Olive brown, moist, hard, sandy lean CLAY.
		32				SC	Olive brown, moist, dense, clayey SAND.
		56				CL	Olive brown, moist, hard, sandy lean CLAY.
20							Total Depth = 18.0 feet. Groundwater not encountered during drilling. Backfilled with cement-bentonite grout on 2/24/21.
							Notes: Groundwater, though not encountered at the time of drilling, may rise to a higher level due to seasonal variations in precipitation and several other factors as discussed in the report.
							The ground elevation shown above is an estimation only. It is based on our interpretations of published maps and other documents reviewed for the purposes of this evaluation. It is not sufficiently accurate for preparing construction bids and design documents.
30							
40							

FIGURE A- 6

DEPTH (feet)	BULK SAMPLES Driven	BLOWS/FOOT	MOISTURE (%)	DRY DENSITY (PCF)	SYMBOL	CLASSIFICATION U.S.C.S.	DATE DRILLED <u>2/24/21</u> BORING NO. <u>B-7</u>
							GROUND ELEVATION <u>86' ± (MSL)</u> SHEET <u>1</u> OF <u>1</u>
METHOD OF DRILLING <u>8" Hollow-Stem Auger (Baja Exploration)</u>							
DRIVE WEIGHT <u>140 lbs. (Auto. Trip Hammer)</u> DROP <u>30"</u>							
SAMPLED BY <u>GM</u> LOGGED BY <u>GM</u> REVIEWED BY <u>MRM</u>							
DESCRIPTION/INTERPRETATION							
0						CL	FILL: Dark grayish brown, moist, stiff, lean CLAY; trace gravel; trace cobbles/boulders.
		22	26.2	99.1		CL	ALLUVIUM: Olive brown, moist, very stiff, sandy lean CLAY; trace caliche.
10		9					Stiff.
		44					Hard.
		26					
20							Total Depth = 18.0 feet Groundwater not encountered during drilling. Backfilled with cement-bentonite grout on 2/24/21.
							Notes: Groundwater, though not encountered at the time of drilling, may rise to a higher level due to seasonal variations in precipitation and several other factors as discussed in the report.
							The ground elevation shown above is an estimation only. It is based on our interpretations of published maps and other documents reviewed for the purposes of this evaluation. It is not sufficiently accurate for preparing construction bids and design documents.
30							
40							

FIGURE A- 7

DEPTH (feet)	BULK SAMPLES Driven	BLOWS/FOOT	MOISTURE (%)	DRY DENSITY (PCF)	SYMBOL	CLASSIFICATION U.S.C.S.	DATE DRILLED <u>2/23/21</u> BORING NO. <u>B-8</u>
							GROUND ELEVATION <u>85' ± (MSL)</u> SHEET <u>1</u> OF <u>1</u>
METHOD OF DRILLING <u>8" Hollow-Stem Auger (Baja Exploration)</u>							
DRIVE WEIGHT <u>140 lbs. (Auto. Trip Hammer)</u> DROP <u>30"</u>							
SAMPLED BY <u>GM</u> LOGGED BY <u>GM</u> REVIEWED BY <u>MRM</u>							
DESCRIPTION/INTERPRETATION							
0						CL	<p><u>FILL:</u> Dark grayish brown, moist, stiff, lean CLAY; mottled reddish brown; trace gravel.</p> <p>Very stiff.</p>
10		14					
		56	13.8	110.9		SM	<p><u>ALLUVIUM:</u> Yellowish brown, moist, dense, silty SAND.</p> <p>Very dense.</p> <p>Dense.</p>
		39					
		68					
20							<p>Total Depth = 18.0 feet. Groundwater not encountered during drilling. Backfilled with cement-bentonite grout on 2/23/21.</p> <p><u>Notes:</u> Groundwater, though not encountered at the time of drilling, may rise to a higher level due to seasonal variations in precipitation and several other factors as discussed in the report.</p> <p>The ground elevation shown above is an estimation only. It is based on our interpretations of published maps and other documents reviewed for the purposes of this evaluation. It is not sufficiently accurate for preparing construction bids and design documents.</p>
30							
40							

FIGURE A- 8

DEPTH (feet)	BULK SAMPLES Driven	BLOWS/FOOT	MOISTURE (%)	DRY DENSITY (PCF)	SYMBOL	CLASSIFICATION U.S.C.S.	DATE DRILLED <u>2/23/21</u> BORING NO. <u>B-9</u>
							GROUND ELEVATION <u>85' ± (MSL)</u> SHEET <u>1</u> OF <u>1</u>
							METHOD OF DRILLING <u>8" Hollow-Stem Auger (Baja Exploration)</u>
							DRIVE WEIGHT <u>140 lbs. (Auto. Trip Hammer)</u> DROP <u>30"</u>
							SAMPLED BY <u>GM</u> LOGGED BY <u>GM</u> REVIEWED BY <u>MRM</u>
							DESCRIPTION/INTERPRETATION
0						CL	FILL: Dark grayish brown, moist, stiff, lean CLAY; mottled reddish brown.
		58					Hard.
10		36				SC	ALLUVIUM: Yellowish brown, moist, very dense, clayey SAND.
		52					Dense.
		56					Very dense.
20							Total Depth = 18.0 feet. Groundwater not encountered during drilling. Backfilled with cement-bentonite grout on 2/23/21.
							Notes: Groundwater, though not encountered at the time of drilling, may rise to a higher level due to seasonal variations in precipitation and several other factors as discussed in the report.
							The ground elevation shown above is an estimation only. It is based on our interpretations of published maps and other documents reviewed for the purposes of this evaluation. It is not sufficiently accurate for preparing construction bids and design documents.
30							
40							

FIGURE A- 9

DEPTH (feet)	BULK SAMPLES Driven	BLOWS/FOOT	MOISTURE (%)	DRY DENSITY (PCF)	SYMBOL	CLASSIFICATION U.S.C.S.	DATE DRILLED	BORING NO.	
							2/24/21	B-10	
							GROUND ELEVATION	SHEET	OF
							88' ± (MSL)	1	1
							METHOD OF DRILLING 8" Hollow-Stem Auger (Baja Exploration)		
							DRIVE WEIGHT	DROP	
							140 lbs. (Auto. Trip Hammer)	30"	
							SAMPLED BY	LOGGED BY	REVIEWED BY
							GM	GM	MRM
DESCRIPTION/INTERPRETATION									
0						CL	FILL: Dark grayish brown, moist, stiff, lean CLAY; trace sand and gravel.		
		39					Hard.		
10						CL	ALLUVIUM: Olive brown, moist, hard, sandy lean CLAY; trace caliche.		
		25							
						ML	Olive brown, moist, very stiff, clayey SILT.		
		53							
		16							
20							Total Depth = 18.0 feet. Groundwater not encountered during drilling. Backfilled with cement-bentonite grout on 2/24/21.		
							Notes: Groundwater, though not encountered at the time of drilling, may rise to a higher level due to seasonal variations in precipitation and several other factors as discussed in the report.		
							The ground elevation shown above is an estimation only. It is based on our interpretations of published maps and other documents reviewed for the purposes of this evaluation. It is not sufficiently accurate for preparing construction bids and design documents.		
30									
40									

FIGURE A- 10

DEPTH (feet)	BULK SAMPLES Driven	BLOWS/FOOT	MOISTURE (%)	DRY DENSITY (PCF)	SYMBOL	CLASSIFICATION U.S.C.S.	DATE DRILLED <u>2/24/21</u> BORING NO. <u>B-11</u>
							GROUND ELEVATION <u>88' ± (MSL)</u> SHEET <u>1</u> OF <u>1</u>
							METHOD OF DRILLING <u>8" Hollow-Stem Auger (Baja Exploration)</u>
							DRIVE WEIGHT <u>140 lbs. (Auto. Trip Hammer)</u> DROP <u>30"</u>
							SAMPLED BY <u>GM</u> LOGGED BY <u>GM</u> REVIEWED BY <u>MRM</u>
							DESCRIPTION/INTERPRETATION
0		20				CH	FILL: Dark grayish brown, moist, stiff, sandy fat CLAY; few rootlets. Very stiff.
10		22	24.8	100.6		CH	ALLUVIUM: Olive brown, moist, very stiff, fat CLAY with sand. Hard.
20							Total Depth = 18.0 feet. Groundwater not encountered during drilling. Backfilled with cement-bentonite grout on 2/24/21. Notes: Groundwater, though not encountered at the time of drilling, may rise to a higher level due to seasonal variations in precipitation and several other factors as discussed in the report. The ground elevation shown above is an estimation only. It is based on our interpretations of published maps and other documents reviewed for the purposes of this evaluation. It is not sufficiently accurate for preparing construction bids and design documents.
30							
40							

FIGURE A- 11

DEPTH (feet)	Bulk Samples Driven	BLOWS/FOOT	MOISTURE (%)	DRY DENSITY (PCF)	SYMBOL	CLASSIFICATION U.S.C.S.	DATE DRILLED <u>2/24/21</u> BORING NO. <u>B-12</u>
							GROUND ELEVATION <u>88' ± (MSL)</u> SHEET <u>1</u> OF <u>1</u>
							METHOD OF DRILLING <u>8" Hollow-Stem Auger (Baja Exploration)</u>
							DRIVE WEIGHT <u>140 lbs. (Auto. Trip Hammer)</u> DROP <u>30"</u>
							SAMPLED BY <u>GM</u> LOGGED BY <u>GM</u> REVIEWED BY <u>MRM</u>
							DESCRIPTION/INTERPRETATION
0						SM CH	FILL: Reddish brown, moist, medium dense, silty SAND. Dark grayish brown, moist, stiff, fat CLAY; few to little sand.
		21	24.1	102.1		CL	Very stiff. ALLUVIUM: Yellowish brown, moist, very stiff, lean CLAY with sand.
10		22					Hard; with caliche.
		85				SC	Yellowish brown, moist, dense, clayey SAND.
20		31					Total Depth = 18.0 feet. Groundwater not encountered during drilling. Backfilled with cement-bentonite grout on 2/24/21.
							<u>Notes:</u> Groundwater, though not encountered at the time of drilling, may rise to a higher level due to seasonal variations in precipitation and several other factors as discussed in the report.
							The ground elevation shown above is an estimation only. It is based on our interpretations of published maps and other documents reviewed for the purposes of this evaluation. It is not sufficiently accurate for preparing construction bids and design documents.
30							
40							

FIGURE A- 12

DEPTH (feet)	SAMPLES		BLOWS/FOOT	MOISTURE (%)	DRY DENSITY (PCF)	SYMBOL	CLASSIFICATION U.S.C.S.	DATE DRILLED <u>2/23/21</u> BORING NO. <u>P-1</u> GROUND ELEVATION <u>87' ± (MSL)</u> SHEET <u>1</u> OF <u>1</u> METHOD OF DRILLING <u>8" Hollow-Stem Auger (Baja Exploration)</u> DRIVE WEIGHT <u>140 lbs. (Auto. Trip Hammer)</u> DROP <u>30"</u> SAMPLED BY <u>GM</u> LOGGED BY <u>GM</u> REVIEWED BY <u>MRM</u>		
	Bulk	Driven						DESCRIPTION/INTERPRETATION		
0						SC	SC	FILL: Dark yellowish brown, moist, loose to medium dense, clayey SAND with gravel.		
10								Total Depth = 10.0 feet. Groundwater not encountered during drilling. Backfilled with on-site soil on 2/24/21. <u>Notes:</u> Groundwater, though not encountered at the time of drilling, may rise to a higher level due to seasonal variations in precipitation and several other factors as discussed in the report. The ground elevation shown above is an estimation only. It is based on our interpretations of published maps and other documents reviewed for the purposes of this evaluation. It is not sufficiently accurate for preparing construction bids and design documents.		
20										
30										
40										

FIGURE A- 13

DEPTH (feet)	SAMPLES		BLOWS/FOOT	MOISTURE (%)	DRY DENSITY (PCF)	SYMBOL	CLASSIFICATION U.S.C.S.	DATE DRILLED <u>2/23/21</u> BORING NO. <u>P-2</u>	
	Bulk	Driven						GROUND ELEVATION <u>82' ± (MSL)</u>	SHEET <u>1</u> OF <u>1</u>
								METHOD OF DRILLING <u>8" Hollow-Stem Auger (Baja Exploration)</u>	
								DRIVE WEIGHT <u>140 lbs. (Auto. Trip Hammer)</u> DROP <u>30"</u>	
								SAMPLED BY <u>GM</u> LOGGED BY <u>GM</u> REVIEWED BY <u>MRM</u>	
DESCRIPTION/INTERPRETATION									
0						[Diagonal Hatching]	CH	FILL: Dark grayish brown, moist, stiff, fat CLAY with sand.	
						[Diagonal Hatching]	CL	ALLUVIUM: Olive brown, moist, very stiff to hard, lean CLAY; minor oxidation.	
10								Total Depth = 10.0 feet. Groundwater not encountered during drilling. Backfilled with on-site soil on 2/24/21. Notes: Groundwater, though not encountered at the time of drilling, may rise to a higher level due to seasonal variations in precipitation and several other factors as discussed in the report. The ground elevation shown above is an estimation only. It is based on our interpretations of published maps and other documents reviewed for the purposes of this evaluation. It is not sufficiently accurate for preparing construction bids and design documents.	
20									
30									
40									

FIGURE A- 14

DEPTH (feet)	SAMPLES		BLOWS/FOOT	MOISTURE (%)	DRY DENSITY (PCF)	SYMBOL	CLASSIFICATION U.S.C.S.	DATE DRILLED <u>2/23/21</u> BORING NO. <u>P-3</u> GROUND ELEVATION <u>81' ± (MSL)</u> SHEET <u>1</u> OF <u>1</u> METHOD OF DRILLING <u>8" Hollow-Stem Auger (Baja Exploration)</u> DRIVE WEIGHT <u>140 lbs. (Auto. Trip Hammer)</u> DROP <u>30"</u> SAMPLED BY <u>GM</u> LOGGED BY <u>GM</u> REVIEWED BY <u>MRM</u>	
	Bulk	Driven						DESCRIPTION/INTERPRETATION	
0							CL	FILL: Reddish brown, moist, stiff, lean CLAY with sand; grayish brown mottling; trace rootlets. Hard.	
							SC	ALLUVIUM: Yellowish brown, moist, dense, clayey SAND.	
10								Total Depth = 10.0 feet. Groundwater not encountered during drilling. Backfilled with on-site soil on 2/24/21. Notes: Groundwater, though not encountered at the time of drilling, may rise to a higher level due to seasonal variations in precipitation and several other factors as discussed in the report. The ground elevation shown above is an estimation only. It is based on our interpretations of published maps and other documents reviewed for the purposes of this evaluation. It is not sufficiently accurate for preparing construction bids and design documents.	
20									
30									
40									

FIGURE A- 15



APPENDIX B

Laboratory Testing

APPENDIX B

LABORATORY TESTING

Classification

Soils were visually and texturally classified in accordance with the Unified Soil Classification System (USCS) in general accordance with ASTM D 2488. Soil classifications are indicated on the logs of the exploratory borings in Appendix A.

In-Place Moisture and Density Tests

The moisture content and dry density of relatively undisturbed samples obtained from the exploratory borings were evaluated in general accordance with ASTM D 2937. The test results are presented on the logs of the exploratory borings in Appendix A.

Percent Finer than No. 200 Sieve

An evaluation of the percentage of particles finer than the No. 200 sieve on selected soil samples was performed in general accordance with ASTM D 1140. The results of the tests are presented on Figure B-1.

Atterberg Limits

Tests were performed on selected representative fine-grained soil samples to evaluate the liquid limit, plastic limit, and plasticity index in general accordance with ASTM D 4318. These test results were utilized to evaluate the soil classification in accordance with the USCS. The test results and classifications are shown on Figure B-2.

Direct Shear Test

A direct shear test was performed on a relatively undisturbed sample in general accordance with ASTM D 3080 to evaluate the shear strength characteristics of the selected material. The sample was inundated during shearing to represent the adverse field conditions. The results are shown on Figure B-3.

R-Value

The resistance value, or R-value, for site soil was evaluated in general accordance with California Test (CT) 301. The sample was prepared and evaluated for exudation pressure and expansion pressure. The equilibrium R-value is reported as the lesser or more conservative of the two calculated results. The test result is shown on Figure B-4.

Expansion Index Tests

The expansion index of selected materials was evaluated in general accordance with ASTM D 4829. Samples were molded under a specified compactive energy at approximately 50 percent saturation (plus or minus 1 percent). The prepared 1-inch thick by 4-inch diameter specimens were loaded with a surcharge of 144 pounds per square foot and were inundated with tap water. Readings of volumetric swell were made for a period of 24 hours. The results of these tests are presented on Figure B-5.

Soil Corrosivity Tests

Soil pH and resistivity tests were performed on a representative sample in general accordance with California Test (CT) 643. The soluble sulfate and chloride content of the selected sample were evaluated in general accordance with CT 417 and CT 422, respectively. The test results are presented on Figure B-6.

SAMPLE LOCATION	SAMPLE DEPTH (ft)	DESCRIPTION	PERCENT PASSING NO. 4	PERCENT PASSING NO. 200	USCS (TOTAL SAMPLE)
B-1	0.0-5.0	Fat CLAY with Sand	100	85	CH
B-2	0.0-5.0	Fat CLAY with Sand	100	82	CH
B-3	5.0-6.5	Lean CLAY with Sand	100	75	CL
B-4	5.0-6.5	Clayey SAND with Gravel	84	27	SC
B-5	0.0-1.0	Clayey GRAVEL with Sand	57	27	GC
B-11	0.0-5.0	Sandy Fat CLAY	99	70	CH
B-11	10.0-11.5	Fat CLAY with Sand	100	84	CH
B-12	0.0-5.0	Fat CLAY	100	86	CH

PERFORMED IN GENERAL ACCORDANCE WITH ASTM D 1140

FIGURE B-1

SYMBOL	LOCATION	DEPTH (ft)	LIQUID LIMIT	PLASTIC LIMIT	PLASTICITY INDEX	USCS CLASSIFICATION (Fraction Finer Than No. 40 Sieve)	USCS
●	B-9	0.0-5.0	46	13	33	CL	CL
■	B-11	0.0-5.0	56	14	42	CH	CH

NP - INDICATES NON-PLASTIC

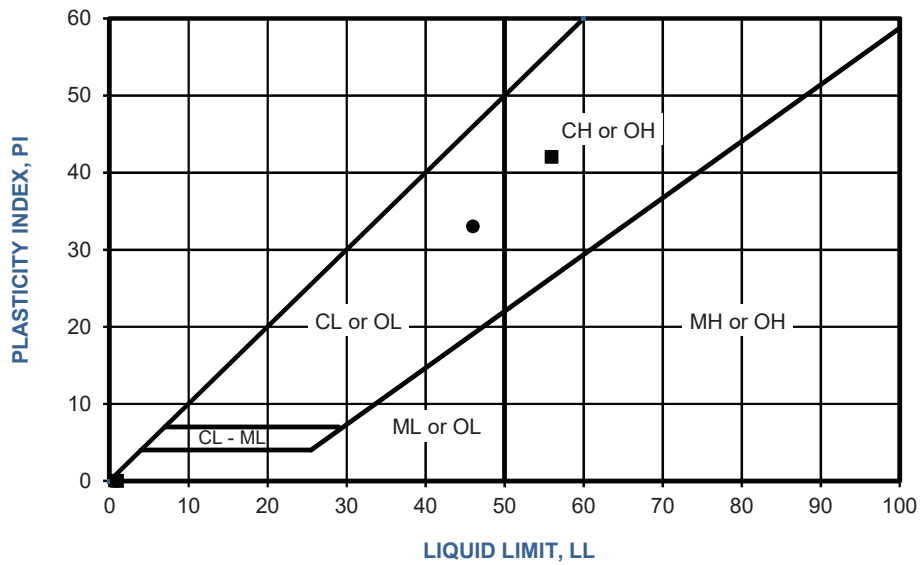

PERFORMED IN GENERAL ACCORDANCE WITH ASTM D 4318

FIGURE B-2

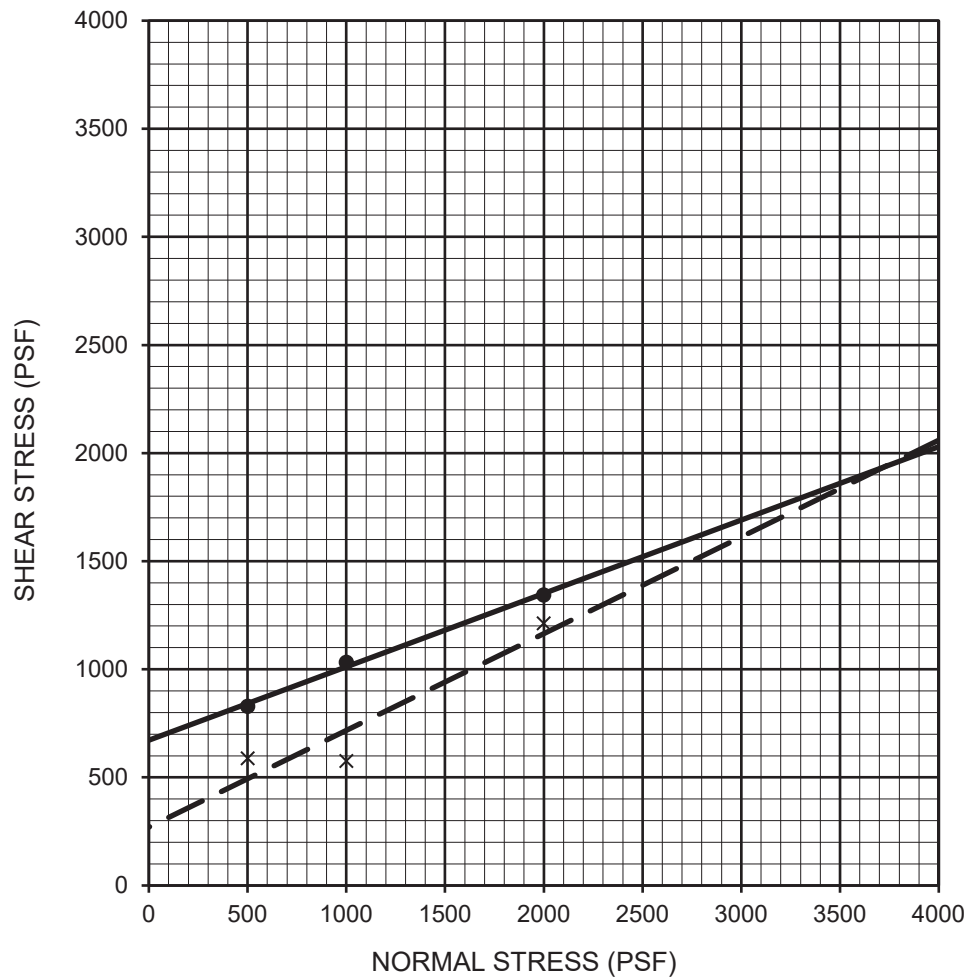

Description	Symbol	Sample Location	Depth (ft)	Shear Strength	Cohesion (psf)	Friction Angle (degrees)	Soil Type
FAT CLAY WITH SAND	—●—	B-11	10.0-11.5	Peak	672	19	CH
FAT CLAY WITH SAND	- - X - -	B-11	10.0-11.5	Ultimate	270	24	CH

PERFORMED IN GENERAL ACCORDANCE WITH ASTM D 3080

FIGURE B-3

DIRECT SHEAR TEST RESULTS



HAWTHORNE HIGH SCHOOL - ATHLETIC FACILITIES IMPROVEMENTS
4859 WEST EL SEGUNDO BOULEVARD, HAWTHORNE, CALIFORNIA

SAMPLE LOCATION	SAMPLE DEPTH (ft)	SOIL TYPE	R-VALUE
B-1	0.0-5.0	FAT CLAY WITH SAND	less than 5

PERFORMED IN GENERAL ACCORDANCE WITH ASTM D 2844/CT 301

FIGURE B-4

R-VALUE TEST RESULTS



Geotechnical & Environmental Sciences Consultants

HAWTHORNE HIGH SCHOOL - ATHLETIC FACILITIES IMPROVEMENTS
4859 WEST EL SEGUNDO BOULEVARD, HAWTHORNE, CALIFORNIA

211602001 | 4/21

SAMPLE LOCATION	SAMPLE DEPTH (ft)	INITIAL MOISTURE (percent)	COMPACTED DRY DENSITY (pcf)	FINAL MOISTURE (percent)	VOLUMETRIC SWELL (in)	EXPANSION INDEX	POTENTIAL EXPANSION
B-1	0.0-5.0	14.9	93.4	34.0	0.102	102	High
B-11	0.0-5.0	15.0	92.6	32.0	0.064	64	Medium

PERFORMED IN GENERAL ACCORDANCE WITH

UBC STANDARD 18-2

ASTM D 4829

FIGURE B-5

EXPANSION INDEX TEST RESULTS

HAWTHORNE HIGH SCHOOL - ATHLETIC FACILITIES IMPROVEMENTS
4859 WEST EL SEGUNDO BOULEVARD, HAWTHORNE, CALIFORNIA

SAMPLE LOCATION	SAMPLE DEPTH (ft)	pH ¹	RESISTIVITY ¹ (ohm-cm)	SULFATE CONTENT ²		CHLORIDE CONTENT ³ (ppm)
				(ppm)	(%)	
B-11	0.0-5.0	7.0	206	360	0.036	2,550

¹ PERFORMED IN GENERAL ACCORDANCE WITH CALIFORNIA TEST METHOD 643

² PERFORMED IN GENERAL ACCORDANCE WITH CALIFORNIA TEST METHOD 417

³ PERFORMED IN GENERAL ACCORDANCE WITH CALIFORNIA TEST METHOD 422

FIGURE B-6



CORROSIVITY TEST RESULTS

HAWTHORNE HIGH SCHOOL - ATHLETIC FACILITIES IMPROVEMENTS
4859 WEST EL SEGUNDO BOULEVARD, HAWTHORNE, CALIFORNIA

211602001 | 4/21

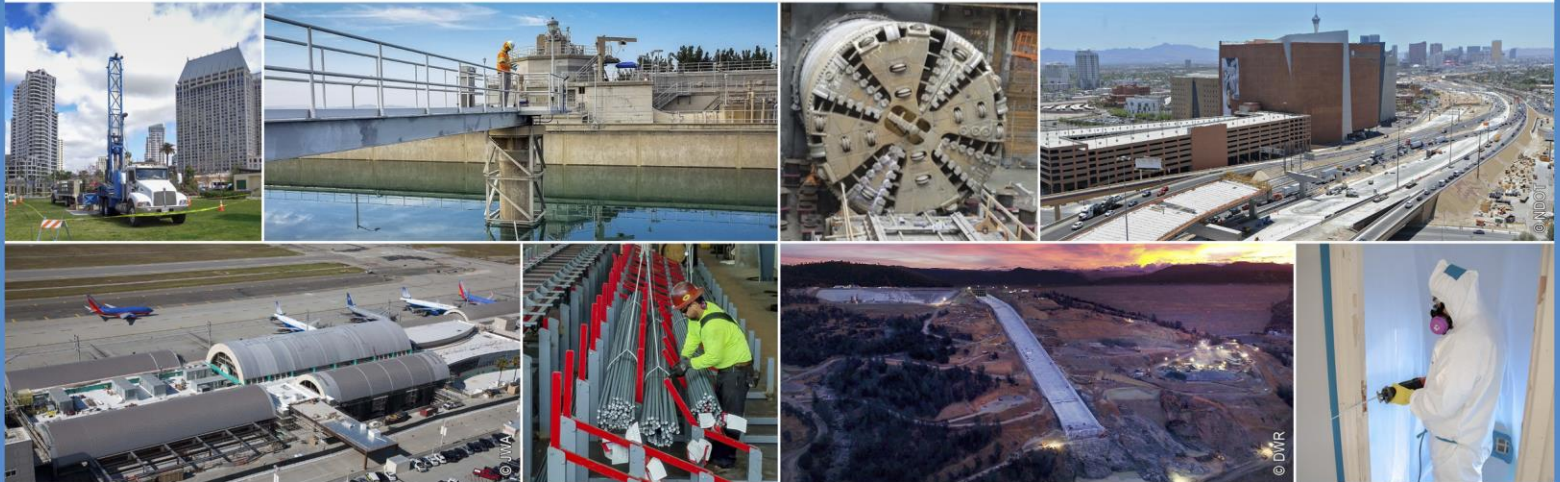

475 Goddard, Suite 200 | Irvine, California 92618 | p. 949.753.7070

ARIZONA | CALIFORNIA | COLORADO | NEVADA | TEXAS | UTAH

ninyoandmoore.com

Ninyo & Moore
Geotechnical & Environmental Sciences Consultants

Appendix E2

Additional Geotechnical Design Recommendations



April 30, 2021
Project No. 211602001

Mr. Blaine Yoder
TELACU Construction Management
604 North Eckhoff Street
Orange, California 92868

Subject: Additional Geotechnical Design Recommendations
Athletic Facilities Improvements
Hawthorne High School
Hawthorne, California

Reference: Ninyo & Moore, 2021, Geotechnical Evaluation, Hawthorne High School – Athletic Facilities Improvements, 4859 West El Segundo Boulevard, Hawthorne, California, dated April 9.

Dear Mr. Yoder:

Ninyo & Moore prepared the referenced geotechnical evaluation report dated April 9, 2021, for the Athletic Facilities Improvements project located at Hawthorne High School, 4859 West El Segundo Boulevard in Hawthorne, California. At your request, we have prepared this letter to provide additional geotechnical recommendations for light pole foundations, modulus of subgrade reaction, and lateral earth pressure for retaining wall design.

LIGHT POLE FOUNDATIONS

We understand that sports lighting, scoreboards, football goalposts, and flags will be supported on light pole foundations. The depth of pole foundations should be evaluated on a case-by-case basis. Pole foundations should have a minimum diameter of 24 inches. We recommend that the embedded posts and poles be designed in accordance with Section 1807.3 of the 2019 California Building Code.

The drilled piers may be designed using an allowable side friction value of 25 pounds per square foot (psf) under static loading conditions starting at a depth of 1 foot below the ground surface. In addition, an allowable resistance of 15 psf for uplift can also be used for design. The lateral capacity of the drilled piers may be evaluated using a lateral bearing pressure of 250 psf per foot of depth, up to a value of 2,500 psf per foot of depth. Provided that isolated poles are not adversely affected by a ½-inch of deflection at the ground surface due to short-term lateral loads, a lateral bearing pressure of two times the indicated value can be used. The passive resistance may be considered to act on an area equal to the product of the effective width (two times the pier diameter) and the embedded length of the pier. These calculations assume that the poles have a minimum spacing of three times the pole diameter.

MODULUS OF SUBGRADE REACTION

A design modulus of subgrade reaction of 30 kips per cubic feet (kcf) can be used for continuous footings, if these are used to support the structures. The design modulus of subgrade reaction may be increased to 150 kcf for continuous footings bearing on compacted import fill material or lime-treated subgrade soil.

RETAINING WALLS

Retaining walls may be supported by spread footings designed in accordance with the recommendations presented in Section 9.4 of our referenced report. Lateral earth pressures recommended for the design of yielding retaining walls are provided on Figure 1. Passive pressures may be increased by one-third when considering loads of short duration, including wind and seismic loads. For sliding resistance, a friction coefficient of 0.35 may be used for the concrete and soil interface. The allowable resistance may be taken as the sum of the frictional and passive resistance, provided that the passive portion does not exceed one-half of the total allowable resistance.

Retaining walls should be backfilled with free-draining, granular, non-expansive material (expansion index [EI] of 20 or less). Measures should be taken to reduce the potential for build-up of moisture behind the retaining walls. Drainage design should include free-draining backfill materials and perforated drains as described on Figure 2. For pipe penetrating into the structures, standard “water-tight” penetration design shall be utilized. To reduce the potential for pipe-to-wall differential settlement, which could cause pipe distress, we recommend that a flexible pipe joint be located close to the exterior of the wall. The type of joint should be such that minor, relative movement can be accommodated without distress on the pipe.

We appreciate the opportunity to be of service on this project.

Respectfully submitted,
NINYO & MOORE



Morteza Mirshekari, PhD, PE
Project Engineer



Soumitra Guha, PhD, PE, GE
Principal Engineer

MRM/RDH/SG/sc



Ronald Hallum, PG, CEG
Principal Geologist



Attachments: Figure 1 – Lateral Earth Pressures for Yielding Retaining Walls
Figure 2 – Retaining Wall Drainage Detail

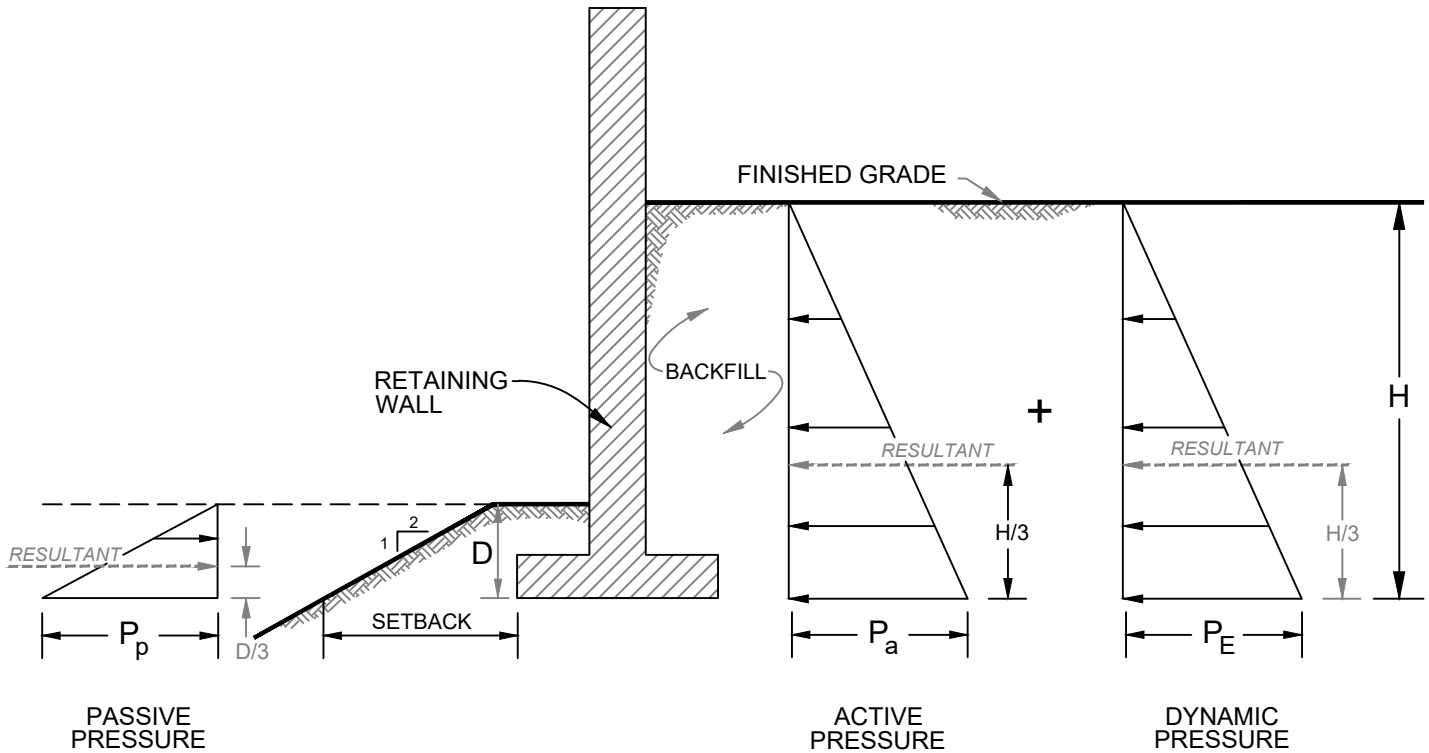

NOTES:

1. ASSUMES NO HYDROSTATIC PRESSURE BUILD-UP BEHIND THE RETAINING WALL
2. STRUCTURAL GRANULAR BACKFILL MATERIALS AS SPECIFIED IN GREENBOOK SHOULD BE USED FOR RETAINING WALL BACKFILL
3. DRAINS AS RECOMMENDED IN THE RETAINING WALL DRAINAGE DETAIL SHOULD BE INSTALLED BEHIND THE RETAINING WALL
4. DYNAMIC LATERAL EARTH PRESSURE IS BASED ON A MAPPED DESIGN PEAK GROUND ACCELERATION OF 0.81 g
5. P_E IS CALCULATED IN ACCORDANCE WITH THE RECOMMENDATIONS OF MONONOBÉ AND MATSUO (1929), AND ATIK AND SITAR (2010)
6. SURCHARGE PRESSURES CAUSED BY VEHICLES OR NEARBY STRUCTURES ARE NOT INCLUDED
7. H AND D ARE IN FEET
8. SETBACK SHOULD BE IN ACCORDANCE WITH FIGURE 1808.7.1 OF THE CBC (2016)

RECOMMENDED GEOTECHNICAL DESIGN PARAMETERS

Lateral Earth Pressure	Equivalent Fluid Pressure (lb/ft ² /ft) ⁽¹⁾	
	Level Backfill with Granular Soils ⁽²⁾	2H:1V Sloping Backfill with Granular Soils ⁽²⁾
P_a	37H	57H
P_E	20H	25H
P_p	Level Ground	2H:1V Descending Ground
	360D	135D

NOT TO SCALE

FIGURE 1

LATERAL EARTH PRESSURES FOR YIELDING RETAINING WALLS

211602001_RWDD.dwg 04/20/2021 GK

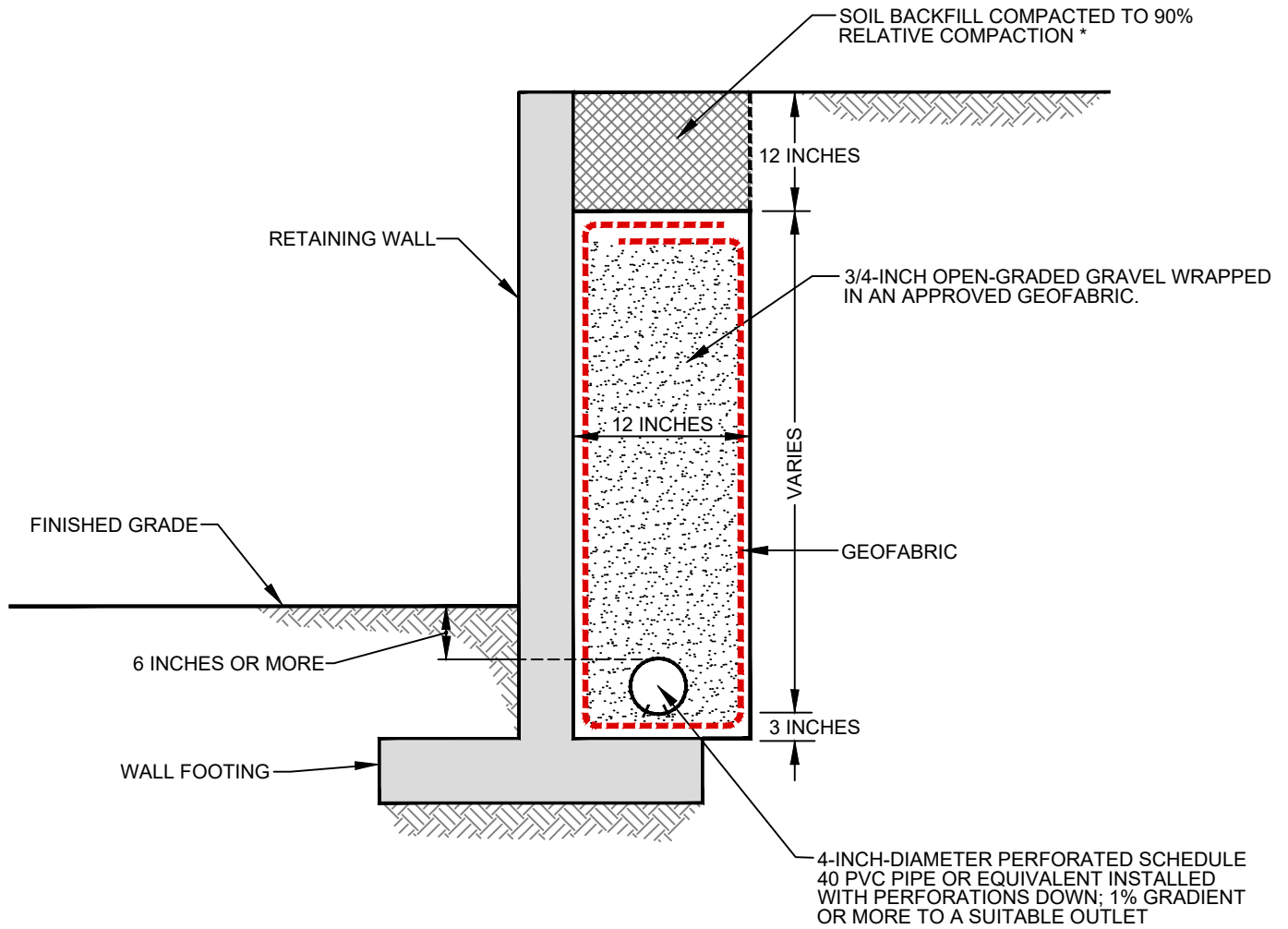

*BASED ON ASTM D1557

NOT TO SCALE

FIGURE 2

Appendix F

Noise Calculations

Summary

File Name on Meter R1
 File Name on PC SLM_0004161_LxT_Data_169.00.ldbin
 Serial Number 0004161
 Model SoundTrack LxT®
 Firmware Version 2.402
 User
 Location
 Job Description
 Note

Measurement

Description
 Start 2021-06-08 08:23:42
 Stop 2021-06-08 08:38:42
 Duration 00:15:00.0
 Run Time 00:15:00.0
 Pause 00:00:00.0

 Pre Calibration 2021-06-08 08:21:35
 Post Calibration None
 Calibration Deviation ---

Overall Settings

RMS Weight A Weighting
 Peak Weight A Weighting
 Detector Slow
 Preamp PRMLxT1
 Microphone Correction Off
 Integration Method Exponential
 Overload 144.8 dB

	A	C	Z
Under Range Peak	100.7	97.7	102.7 dB
Under Range Limit	37.9	37.6	44.6 dB
Noise Floor	28.8	28.5	35.5 dB

Results

LAseq 60.0 dB
 LASE 89.6 dB
 EAS 100.224 µPa²h
 EAS8 3.207 mPa²h
 EAS40 16.036 mPa²h
 LApeak (max) 2021-06-08 08:34:16 95.6 dB
 LASmax 2021-06-08 08:34:17 82.5 dB
 LASmin 2021-06-08 08:24:24 46.1 dB
 SEA -99.9 dB

 LAS > 85.0 dB (Exceedance Counts / Duration) 0 0.0 s
 LAS > 115.0 dB (Exceedance Counts / Duration) 0 0.0 s
 LApeak > 135.0 dB (Exceedance Counts / Duration) 0 0.0 s
 LApeak > 137.0 dB (Exceedance Counts / Duration) 0 0.0 s
 LApeak > 140.0 dB (Exceedance Counts / Duration) 0 0.0 s

LCseq 69.5 dB
 LAseq 60.0 dB
 LCseq - LAseq 9.5 dB
 LAleq 63.4 dB
 LAeq 60.0 dB
 LAleq - LAeq 3.4 dB

Leq
 LS(max)
 LS(min)
 LPeak(max)

	A		C		Z	
	dB	Time Stamp	dB	Time Stamp	dB	Time Stamp
Leq	60.0					
LS(max)	82.5	2021/06/08 8:34:17				
LS(min)	46.1	2021/06/08 8:24:24				
LPeak(max)	95.6	2021/06/08 8:34:16				

Overloads 0
 Overload Duration 0.0 s

Summary

File Name on Meter R2
 File Name on PC SLM_0004161_LxT_Data_170.00.ldbin
 Serial Number 0004161
 Model SoundTrack LxT®
 Firmware Version 2.402
 User
 Location
 Job Description
 Note

Measurement

Description
 Start 2021-06-08 08:41:32
 Stop 2021-06-08 08:56:32
 Duration 00:15:00.0
 Run Time 00:15:00.0
 Pause 00:00:00.0

 Pre Calibration 2021-06-08 08:21:34
 Post Calibration None
 Calibration Deviation ---

Overall Settings

RMS Weight A Weighting
 Peak Weight A Weighting
 Detector Slow
 Preamp PRMLxT1
 Microphone Correction Off
 Integration Method Exponential
 Overload 144.8 dB

	A	C	Z
Under Range Peak	100.7	97.7	102.7 dB
Under Range Limit	37.9	37.6	44.6 dB
Noise Floor	28.8	28.5	35.5 dB

Results

LASeq 54.3 dB
 LASE 83.8 dB
 EAS 26.748 µPa²h
 EAS8 855.950 µPa²h
 EAS40 4.280 mPa²h
 LApeak (max) 2021-06-08 08:49:08 88.5 dB
 LASmax 2021-06-08 08:49:08 75.1 dB
 LASmin 2021-06-08 08:48:02 47.4 dB
 SEA -99.9 dB

 LAS > 85.0 dB (Exceedance Counts / Duration) 0 0.0 s
 LAS > 115.0 dB (Exceedance Counts / Duration) 0 0.0 s
 LApeak > 135.0 dB (Exceedance Counts / Duration) 0 0.0 s
 LApeak > 137.0 dB (Exceedance Counts / Duration) 0 0.0 s
 LApeak > 140.0 dB (Exceedance Counts / Duration) 0 0.0 s

LCSeq 66.7 dB
 LASeq 54.3 dB
 LCSeq - LASeq 12.5 dB
 LAleq 57.1 dB
 LAeq 54.3 dB
 LAleq - LAeq 2.8 dB

Leq
 LS(max)
 LS(min)
 LPeak(max)

	A		C		Z	
	dB	Time Stamp	dB	Time Stamp	dB	Time Stamp
Leq	54.3					
LS(max)	75.1	2021/06/08 8:49:08				
LS(min)	47.4	2021/06/08 8:48:02				
LPeak(max)	88.5	2021/06/08 8:49:08				

Overloads 0
 Overload Duration 0.0 s

Summary

File Name on Meter R3
 File Name on PC SLM_0004161_LxT_Data_171.00.ldbin
 Serial Number 0004161
 Model SoundTrack LxT®
 Firmware Version 2.402
 User
 Location
 Job Description
 Note

Measurement

Description
 Start 2021-06-08 09:00:40
 Stop 2021-06-08 09:15:40
 Duration 00:15:00.0
 Run Time 00:15:00.0
 Pause 00:00:00.0

 Pre Calibration 2021-06-08 08:21:34
 Post Calibration None
 Calibration Deviation ---

Overall Settings

RMS Weight A Weighting
 Peak Weight A Weighting
 Detector Slow
 Preamp PRMLxT1
 Microphone Correction Off
 Integration Method Exponential
 Overload 144.8 dB

	A	C	Z
Under Range Peak	100.7	97.7	102.7 dB
Under Range Limit	37.9	37.6	44.6 dB
Noise Floor	28.8	28.5	35.5 dB

Results

LASeq 68.3 dB
 LASE 97.9 dB
 EAS 681.144 µPa²h
 EAS8 21.797 mPa²h
 EAS40 108.983 mPa²h
 LApeak (max) 2021-06-08 09:10:58 102.1 dB
 LASmax 2021-06-08 09:10:59 84.2 dB
 LASmin 2021-06-08 09:02:17 48.3 dB
 SEA -99.9 dB

 LAS > 85.0 dB (Exceedance Counts / Duration) 0 0.0 s
 LAS > 115.0 dB (Exceedance Counts / Duration) 0 0.0 s
 LApeak > 135.0 dB (Exceedance Counts / Duration) 0 0.0 s
 LApeak > 137.0 dB (Exceedance Counts / Duration) 0 0.0 s
 LApeak > 140.0 dB (Exceedance Counts / Duration) 0 0.0 s

LCSeq 74.5 dB
 LASeq 68.3 dB
 LCSeq - LASeq 6.2 dB
 LAleq 70.1 dB
 LAeq 68.3 dB
 LAleq - LAeq 1.8 dB

Leq
 LS(max)
 LS(min)
 LPeak(max)

	A		C		Z	
	dB	Time Stamp	dB	Time Stamp	dB	Time Stamp
Leq	68.3					
LS(max)	84.2	2021/06/08 9:10:59				
LS(min)	48.3	2021/06/08 9:02:17				
LPeak(max)	102.1	2021/06/08 9:10:58				

Overloads 0
 Overload Duration 0.0 s

Project: Hawthorne

Construction Noise Impact on Sensitive Receptors

Building Construction + Field/Bleachers	81	84	69	76
Building Construction + Foundations/Concrete Pour #3 + architectural Coatings + Field/Bleachers	83	88	70	77
Building Construction + Foundations/Concrete Pour #3 + architectural Coatings + Paving Event #2 + Synthetic Track + Field/Bleachers	86	91	73	80
Maximum Noise Level	86	91	73	80

Source for Ref. Noise Levels: FHWA RCNM, 2005

TRAFFIC NOISE ANALYSIS TOOL



Project Name: Hawthorne HS Field Replacement Project
 Analysis Scenario: Construction

Roadway Segment	Ground Type	Distance from Roadway to Receiver (feet)	Speed (mph)			Peak Hour Volume			Peak Hour Noise Level (Leq(h) dBA)	Noise Level dBA CNEL
			Auto	MT	HT	Auto	MT	HT		
Off-site Construction Noise	Hard	50	25	25	25	40	0	7	54.5	54.8

Model Notes:

The calculation is based on the methodology described in FHWA Traffic Noise Model Technical Manual (1998).
 The peak hour noise level at 50 feet was validated with the results from FHWA Traffic Noise Model Version 2.5.
 Accuracy of the calculation is within ±0.1 dB when comparing to TNM results.
 Noise propagation greater than 50 feet is based on the following assumptions:
 For hard ground, the propagation rate is 3 dB per doubling the distance.
 For soft ground, the propagation rate is 4.5 dB per doubling the distance.
 Vehicles are assumed to be on a long straight roadway with cruise speed.
 Roadway grade is less than 1.5%.
 CNEL levels were obtained based on Figure 2-19, on page 2-58 Caltran's TeNS 2013.

Hawthorne HS Field Replacement Project

Vibration Level Calculations

Based on Federal Transit Administration, Office of Planning and Environment

N =	1.5
-----	-----

Construction Equipment	Project Equipment	Equipment Peak Particle Velocity @ 25 Feet* (inches/second)	Distance to Receptor for < 0.5 PPV (Feet)	Estimated Velocity Decibels @ Distance** (VdB)	Estimated Peak Particle Velocity @ Distance*** (inches/second)
Unmitigated Vibration Levels					
Excavator	Yes	0.089	10	98.9	0.352
Loaded Trucks	Yes	0.076	10	97.5	0.300
Small Bulldozer	Yes	0.003	10	69.4	0.012

Source:

Federal Transit Administration, *Transit Noise and Vibration Impact Assessment Manual*, 2018.

Notes:

* Values taken from Table 7-4.

** Based on the formula $VdB = 20 \times \text{LOG}_{10} (v/v_{ref})$, where v_{ref} is equal to 1×10^{-6} in/sec (see page 111).

The approximate rms vibration velocity level (v) is calculated from PPV using a crest factor of 4 (see page 184).

*** Based on the formula $PPV(D) = PPV(25 \text{ ft}) \times (25/D)^N$, where D is equal to the distance (see page 185).

N = soil type classification factor (typically ranges from 1 to 1.5)

Appendix G
Tribal Cultural Resources



Centinela Valley Union High School District

Business Services Division

14901 Inglewood Avenue, Lawndale, CA 90260
(310) 263-3220; (310) 644-7218 fax
www.centinela.k12.ca.us

October 28, 2021

BOARD OF EDUCATION

Gloria A. Ramos
President

Hugo M. Rojas II
Vice-President

Marisela Ruiz
Clerk

Estefany A. Castañeda
Member

Dr. Daniel D. Urrutia
Member

SUPERINTENDENT

Dr. Stephen W. Nellman

Business Services

Ron Hacker
Assistant Superintendent
(310) 263-3220
(310) 644-7218 fax

Educational Services

Dr. Kelly Santos
Assistant Superintendent
(310) 263-3170
(310) 973-8318 fax

Diversity, Equity & Inclusion

Dr. Pamela Brown
Assistant Superintendent
(310) 263-3210
(310) 973-7983 fax

Hawthorne High School

Grace Yang
Principal
(310) 263-4400
(310) 675-7017 fax

Lawndale High School

Dr. Paula Hart Rodas
Principal
(310) 263-3100
(310) 675-8174 fax

Leuzinger High School

Dr. Howard Ho
Principal
(310) 263-2200
(310) 675-7023 fax

Lloyd High School / CV Adult School / CV Independent Study School

Ben Wardrop
Principal
(310) 263-3263
(310) 679-2632 fax

Gabrieleno / Tongva San Gabriel Band of Mission Indians
Anthony Morales, Chairperson
P.O. Box 693
San Gabriel, CA 91778

Subject: Hawthorne High School Athletic Facilities Improvements Project

Dear Tribal Representative:

In conformance with the tribal consultation requirements of Assembly Bill (AB) 52, this letter is to inform you that the Centinela Valley Union High School District is reviewing the proposed project described below. Per AB 52, the tribe has the right to consult on a proposed public or private project prior to the release of a negative declaration, mitigated negative declaration or environmental impact report. The project description is as follows:

The proposed Hawthorne Athletic Facilities Improvements Project (proposed Project) is located on the grounds of the Hawthorne High School campus (Campus) located at 4859 West El Segundo Boulevard and the Hawthorne Pool located at 12501 South Inglewood Avenue within the City of Hawthorne in southwest Los Angeles County. The Campus is located entirely within Assessor's Parcel Number (APN) 4142-012-908 and the Hawthorne Pool is located within APN 4142-012-900. The proposed Project includes the replacement of the existing athletic fields located on the grounds of the Campus and the potential redevelopment of the Hawthorne Pool. The fields would be furnished with new synthetic turf, existing field lighting would be replaced with high efficiency lighting, and existing public announcement systems would be replaced. Additionally, the proposed Project would include the construction of a 5,400-square-foot team room / concessions stand, the updating of existing utilities, the addition of new site furnishings, including bike racks, drinking fountains, and trash receptacles as well as potential redevelopment of the existing Hawthorne Pool like for like. The Project is located within an unsectioned portion of Township 3 South, Range 14 West on the Inglewood, CA U.S. Geological Survey (USGS) 7.5-minute topographic quadrangle (as shown on attached map).

The NAHC completed a search of the Sacred Lands File, which indicated no presence of Native American sacred lands within the project area. The NAHC identify you as a person who may have concerns or knowledge of cultural resources in the project area. Any information you might be able to share about the project area would greatly enhance the study and would be most appreciated.

You have 30 calendar days from receipt of this letter to notify us in writing that you want to consult on this project. Please provide the lead contact person's contact information. Please mail or email your request to: Ron Hacker. I can be reached at 310-263-3220 (office), or by email at hackerr@cvuhsd.org.

Sincerely,

Ron Hacker
Assistant Superintendent,
Business Services Centinela Valley Union High School District



Centinela Valley Union High School District

Business Services Division

14901 Inglewood Avenue, Lawndale, CA 90260
(310) 263-3220; (310) 644-7218 fax
www.centinela.k12.ca.us

October 28, 2021

Gabrielino / Tongva Nation
Sandonne Goad, Chairperson
106 ½ Judge John Aiso St., #231
Los Angeles, CA 90012

Subject: Hawthorne High School Athletic Facilities Improvements Project

Dear Tribal Representative:

In conformance with the tribal consultation requirements of Assembly Bill (AB) 52, this letter is to inform you that the Centinela Valley Union High School District is reviewing the proposed project described below. Per AB 52, the tribe has the right to consult on a proposed public or private project prior to the release of a negative declaration, mitigated negative declaration or environmental impact report. The project description is as follows:

The proposed Hawthorne Athletic Facilities Improvements Project (proposed Project) is located on the grounds of the Hawthorne High School campus (Campus) located at 4859 West El Segundo Boulevard and the Hawthorne Pool located at 12501 South Inglewood Avenue within the City of Hawthorne in southwest Los Angeles County. The Campus is located entirely within Assessor's Parcel Number (APN) 4142-012-908 and the Hawthorne Pool is located within APN 4142-012-900. The proposed Project includes the replacement of the existing athletic fields located on the grounds of the Campus and the potential redevelopment of the Hawthorne Pool. The fields would be furnished with new synthetic turf, existing field lighting would be replaced with high efficiency lighting, and existing public announcement systems would be replaced. Additionally, the proposed Project would include the construction of a 5,400-square-foot team room / concessions stand, the updating of existing utilities, the addition of new site furnishings, including bike racks, drinking fountains, and trash receptacles as well as potential redevelopment of the existing Hawthorne Pool like for like. The Project is located within an unsectioned portion of Township 3 South, Range 14 West on the Inglewood, CA U.S. Geological Survey (USGS) 7.5-minute topographic quadrangle (as shown on attached map).

The NAHC completed a search of the Sacred Lands File, which indicated no presence of Native American sacred lands within the project area. The NAHC identify you as a person who may have concerns or knowledge of cultural resources in the project area. Any information you might be able to share about the project area would greatly enhance the study and would be most appreciated.

You have 30 calendar days from receipt of this letter to notify us in writing that you want to consult on this project. Please provide the lead contact person's contact information. Please mail or email your request to: Ron Hacker. I can be reached at 310-263-3220 (office), or by email at hackerr@cvuhsd.org.

Sincerely,

Ron Hacker
Assistant Superintendent,
Business Services Centinela Valley Union High School District

BOARD OF EDUCATION

Gloria A. Ramos
President

Hugo M. Rojas II
Vice-President

Marisela Ruiz
Clerk

Estefany A. Castañeda
Member

Dr. Daniel D. Urrutia
Member

SUPERINTENDENT

Dr. Stephen W. Nellman

Business Services

Ron Hacker
Assistant Superintendent
(310) 263-3220
(310) 644-7218 fax

Educational Services

Dr. Kelly Santos
Assistant Superintendent
(310) 263-3170
(310) 973-8318 fax

Diversity, Equity & Inclusion

Dr. Pamela Brown
Assistant Superintendent
(310) 263-3210
(310) 973-7983 fax

Hawthorne High School

Grace Yang
Principal
(310) 263-4400
(310) 675-7017 fax

Lawndale High School

Dr. Paula Hart Rodas
Principal
(310) 263-3100
(310) 675-8174 fax

Leuzinger High School

Dr. Howard Ho
Principal
(310) 263-2200
(310) 675-7023 fax

Lloyde High School / CV Adult School / CV Independent Study School

Ben Wardrop
Principal
(310) 263-3263
(310) 679-2632 fax



Centinela Valley Union High School District

Business Services Division

14901 Inglewood Avenue, Lawndale, CA 90260
(310) 263-3220; (310) 644-7218 fax
www.centinela.k12.ca.us

October 28, 2021

Gabrielino Tongva Indians of California Tribal Council
Robert Dorame, Chairperson
P.O. Box 490
Bellflower, CA 90707

Subject: Hawthorne High School Athletic Facilities Improvements Project

Dear Tribal Representative:

In conformance with the tribal consultation requirements of Assembly Bill (AB) 52, this letter is to inform you that the Centinela Valley Union High School District is reviewing the proposed project described below. Per AB 52, the tribe has the right to consult on a proposed public or private project prior to the release of a negative declaration, mitigated negative declaration or environmental impact report. The project description is as follows:

The proposed Hawthorne Athletic Facilities Improvements Project (proposed Project) is located on the grounds of the Hawthorne High School campus (Campus) located at 4859 West El Segundo Boulevard and the Hawthorne Pool located at 12501 South Inglewood Avenue within the City of Hawthorne in southwest Los Angeles County. The Campus is located entirely within Assessor's Parcel Number (APN) 4142-012-908 and the Hawthorne Pool is located within APN 4142-012-900. The proposed Project includes the replacement of the existing athletic fields located on the grounds of the Campus and the potential redevelopment of the Hawthorne Pool. The fields would be furnished with new synthetic turf, existing field lighting would be replaced with high efficiency lighting, and existing public announcement systems would be replaced. Additionally, the proposed Project would include the construction of a 5,400-square-foot team room / concessions stand, the updating of existing utilities, the addition of new site furnishings, including bike racks, drinking fountains, and trash receptacles as well as potential redevelopment of the existing Hawthorne Pool like for like. The Project is located within an unsectioned portion of Township 3 South, Range 14 West on the Inglewood, CA U.S. Geological Survey (USGS) 7.5-minute topographic quadrangle (as shown on attached map).

The NAHC completed a search of the Sacred Lands File, which indicated no presence of Native American sacred lands within the project area. The NAHC identify you as a person who may have concerns or knowledge of cultural resources in the project area. Any information you might be able to share about the project area would greatly enhance the study and would be most appreciated.

You have 30 calendar days from receipt of this letter to notify us in writing that you want to consult on this project. Please provide the lead contact person's contact information. Please mail or email your request to: Ron Hacker. I can be reached at 310-263-3220 (office), or by email at hackerr@cvuhd.org.

Sincerely,

Ron Hacker
Assistant Superintendent,
Business Services Centinela Valley Union High School District

BOARD OF EDUCATION

Gloria A. Ramos
President

Hugo M. Rojas II
Vice-President

Marisela Ruiz
Clerk

Estefany A. Castañeda
Member

Dr. Daniel D. Urrutia
Member

SUPERINTENDENT

Dr. Stephen W. Nellman

Business Services

Ron Hacker
Assistant Superintendent
(310) 263-3220
(310) 644-7218 fax

Educational Services

Dr. Kelly Santos
Assistant Superintendent
(310) 263-3170
(310) 973-8318 fax

Diversity, Equity & Inclusion

Dr. Pamela Brown
Assistant Superintendent
(310) 263-3210
(310) 973-7983 fax

Hawthorne High School

Grace Yang
Principal
(310) 263-4400
(310) 675-7017 fax

Lawndale High School

Dr. Paula Hart Rodas
Principal
(310) 263-3100
(310) 675-8174 fax

Leuzinger High School

Dr. Howard Ho
Principal
(310) 263-2200
(310) 675-7023 fax

Lloyde High School / CV Adult School / CV Independent Study School

Ben Wardrop
Principal
(310) 263-3263
(310) 679-2632 fax



Centinela Valley Union High School District

Business Services Division

14901 Inglewood Avenue, Lawndale, CA 90260
(310) 263-3220; (310) 644-7218 fax
www.centinela.k12.ca.us

October 28, 2021

BOARD OF EDUCATION

Gloria A. Ramos
President

Hugo M. Rojas II
Vice-President

Marisela Ruiz
Clerk

Estefany A. Castañeda
Member

Dr. Daniel D. Urrutia
Member

SUPERINTENDENT

Dr. Stephen W. Nellman

Business Services

Ron Hacker
Assistant Superintendent
(310) 263-3220
(310) 644-7218 fax

Educational Services

Dr. Kelly Santos
Assistant Superintendent
(310) 263-3170
(310) 973-8318 fax

Diversity, Equity & Inclusion

Dr. Pamela Brown
Assistant Superintendent
(310) 263-3210
(310) 973-7983 fax

Hawthorne High School

Grace Yang
Principal
(310) 263-4400
(310) 675-7017 fax

Lawndale High School

Dr. Paula Hart Rodas
Principal
(310) 263-3100
(310) 675-8174 fax

Leuzinger High School

Dr. Howard Ho
Principal
(310) 263-2200
(310) 675-7023 fax

Lloyde High School / CV Adult School / CV Independent Study School

Ben Wardrop
Principal
(310) 263-3263
(310) 679-2632 fax

Gabrielino-Tongva Tribe
Charles Alvarez
23454 Vanowen Street
West Hills, CA 91307

Subject: Hawthorne High School Athletic Facilities Improvements Project

Dear Tribal Representative:

In conformance with the tribal consultation requirements of Assembly Bill (AB) 52, this letter is to inform you that the Centinela Valley Union High School District is reviewing the proposed project described below. Per AB 52, the tribe has the right to consult on a proposed public or private project prior to the release of a negative declaration, mitigated negative declaration or environmental impact report. The project description is as follows:

The proposed Hawthorne Athletic Facilities Improvements Project (proposed Project) is located on the grounds of the Hawthorne High School campus (Campus) located at 4859 West El Segundo Boulevard and the Hawthorne Pool located at 12501 South Inglewood Avenue within the City of Hawthorne in southwest Los Angeles County. The Campus is located entirely within Assessor's Parcel Number (APN) 4142-012-908 and the Hawthorne Pool is located within APN 4142-012-900. The proposed Project includes the replacement of the existing athletic fields located on the grounds of the Campus and the potential redevelopment of the Hawthorne Pool. The fields would be furnished with new synthetic turf, existing field lighting would be replaced with high efficiency lighting, and existing public announcement systems would be replaced. Additionally, the proposed Project would include the construction of a 5,400-square-foot team room / concessions stand, the updating of existing utilities, the addition of new site furnishings, including bike racks, drinking fountains, and trash receptacles as well as potential redevelopment of the existing Hawthorne Pool like for like. The Project is located within an unsectioned portion of Township 3 South, Range 14 West on the Inglewood, CA U.S. Geological Survey (USGS) 7.5-minute topographic quadrangle (as shown on attached map).

The NAHC completed a search of the Sacred Lands File, which indicated no presence of Native American sacred lands within the project area. The NAHC identify you as a person who may have concerns or knowledge of cultural resources in the project area. Any information you might be able to share about the project area would greatly enhance the study and would be most appreciated.

You have 30 calendar days from receipt of this letter to notify us in writing that you want to consult on this project. Please provide the lead contact person's contact information. Please mail or email your request to: Ron Hacker. I can be reached at 310-263-3220 (office), or by email at hackerr@cvuhsd.org.

Sincerely,

Ron Hacker
Assistant Superintendent,
Business Services Centinela Valley Union High School District



Centinela Valley Union High School District

Business Services Division

14901 Inglewood Avenue, Lawndale, CA 90260
(310) 263-3220; (310) 644-7218 fax
www.centinela.k12.ca.us

October 28, 2021

Santa Rosa Band of Cahuilla Indians
Lovina Redner, Tribal Chair
P.O. Box 391820
Anza, CA 92539

Subject: Hawthorne High School Athletic Facilities Improvements Project

Dear Tribal Representative:

In conformance with the tribal consultation requirements of Assembly Bill (AB) 52, this letter is to inform you that the Centinela Valley Union High School District is reviewing the proposed project described below. Per AB 52, the tribe has the right to consult on a proposed public or private project prior to the release of a negative declaration, mitigated negative declaration or environmental impact report. The project description is as follows:

The proposed Hawthorne Athletic Facilities Improvements Project (proposed Project) is located on the grounds of the Hawthorne High School campus (Campus) located at 4859 West El Segundo Boulevard and the Hawthorne Pool located at 12501 South Inglewood Avenue within the City of Hawthorne in southwest Los Angeles County. The Campus is located entirely within Assessor's Parcel Number (APN) 4142-012-908 and the Hawthorne Pool is located within APN 4142-012-900. The proposed Project includes the replacement of the existing athletic fields located on the grounds of the Campus and the potential redevelopment of the Hawthorne Pool. The fields would be furnished with new synthetic turf, existing field lighting would be replaced with high efficiency lighting, and existing public announcement systems would be replaced. Additionally, the proposed Project would include the construction of a 5,400-square-foot team room / concessions stand, the updating of existing utilities, the addition of new site furnishings, including bike racks, drinking fountains, and trash receptacles as well as potential redevelopment of the existing Hawthorne Pool like for like. The Project is located within an unsectioned portion of Township 3 South, Range 14 West on the Inglewood, CA U.S. Geological Survey (USGS) 7.5-minute topographic quadrangle (as shown on attached map).

The NAHC completed a search of the Sacred Lands File, which indicated no presence of Native American sacred lands within the project area. The NAHC identify you as a person who may have concerns or knowledge of cultural resources in the project area. Any information you might be able to share about the project area would greatly enhance the study and would be most appreciated.

You have 30 calendar days from receipt of this letter to notify us in writing that you want to consult on this project. Please provide the lead contact person's contact information. Please mail or email your request to: Ron Hacker. I can be reached at 310-263-3220 (office), or by email at hackerr@cvuhd.org.

Sincerely,

Ron Hacker
Assistant Superintendent,
Business Services Centinela Valley Union High School District

BOARD OF EDUCATION

Gloria A. Ramos
President

Hugo M. Rojas II
Vice-President

Marisela Ruiz
Clerk

Estefany A. Castañeda
Member

Dr. Daniel D. Urrutia
Member

SUPERINTENDENT

Dr. Stephen W. Nellman

Business Services

Ron Hacker
Assistant Superintendent
(310) 263-3220
(310) 644-7218 fax

Educational Services

Dr. Kelly Santos
Assistant Superintendent
(310) 263-3170
(310) 973-8318 fax

Diversity, Equity & Inclusion

Dr. Pamela Brown
Assistant Superintendent
(310) 263-3210
(310) 973-7983 fax

Hawthorne High School

Grace Yang
Principal
(310) 263-4400
(310) 675-7017 fax

Lawndale High School

Dr. Paula Hart Rodas
Principal
(310) 263-3100
(310) 675-8174 fax

Leuzinger High School

Dr. Howard Ho
Principal
(310) 263-2200
(310) 675-7023 fax

Loyde High School / CV Adult School / CV Independent Study School

Ben Wardrop
Principal
(310) 263-3263
(310) 679-2632 fax



Centinela Valley Union High School District

Business Services Division

14901 Inglewood Avenue, Lawndale, CA 90260
(310) 263-3220; (310) 644-7218 fax
www.centinela.k12.ca.us

October 28, 2021

BOARD OF EDUCATION

Gloria A. Ramos
President

Hugo M. Rojas II
Vice-President

Marisela Ruiz
Clerk

Estefany A. Castañeda
Member

Dr. Daniel D. Urrutia
Member

SUPERINTENDENT

Dr. Stephen W. Nellman

Business Services

Ron Hacker
Assistant Superintendent
(310) 263-3220
(310) 644-7218 fax

Educational Services

Dr. Kelly Santos
Assistant Superintendent
(310) 263-3170
(310) 973-8318 fax

Diversity, Equity & Inclusion

Dr. Pamela Brown
Assistant Superintendent
(310) 263-3210
(310) 973-7983 fax

Hawthorne High School

Grace Yang
Principal
(310) 263-4400
(310) 675-7017 fax

Lawndale High School

Dr. Paula Hart Rodas
Principal
(310) 263-3100
(310) 675-8174 fax

Leuzinger High School

Dr. Howard Ho
Principal
(310) 263-2200
(310) 675-7023 fax

Loyde High School / CV Adult School / CV Independent Study School

Ben Wardrop
Principal
(310) 263-3263
(310) 679-2632 fax

Soboba Band of Luiseno Indians
Scott Cozart, Chairperson
P. O. Box 487
San Jacinto, CA 92583

Subject: Hawthorne High School Athletic Facilities Improvements Project

Dear Tribal Representative:

In conformance with the tribal consultation requirements of Assembly Bill (AB) 52, this letter is to inform you that the Centinela Valley Union High School District is reviewing the proposed project described below. Per AB 52, the tribe has the right to consult on a proposed public or private project prior to the release of a negative declaration, mitigated negative declaration or environmental impact report. The project description is as follows:

The proposed Hawthorne Athletic Facilities Improvements Project (proposed Project) is located on the grounds of the Hawthorne High School campus (Campus) located at 4859 West El Segundo Boulevard and the Hawthorne Pool located at 12501 South Inglewood Avenue within the City of Hawthorne in southwest Los Angeles County. The Campus is located entirely within Assessor's Parcel Number (APN) 4142-012-908 and the Hawthorne Pool is located within APN 4142-012-900. The proposed Project includes the replacement of the existing athletic fields located on the grounds of the Campus and the potential redevelopment of the Hawthorne Pool. The fields would be furnished with new synthetic turf, existing field lighting would be replaced with high efficiency lighting, and existing public announcement systems would be replaced. Additionally, the proposed Project would include the construction of a 5,400-square-foot team room / concessions stand, the updating of existing utilities, the addition of new site furnishings, including bike racks, drinking fountains, and trash receptacles as well as potential redevelopment of the existing Hawthorne Pool like for like. The Project is located within an unsectioned portion of Township 3 South, Range 14 West on the Inglewood, CA U.S. Geological Survey (USGS) 7.5-minute topographic quadrangle (as shown on attached map).

The NAHC completed a search of the Sacred Lands File, which indicated no presence of Native American sacred lands within the project area. The NAHC identify you as a person who may have concerns or knowledge of cultural resources in the project area. Any information you might be able to share about the project area would greatly enhance the study and would be most appreciated.

You have 30 calendar days from receipt of this letter to notify us in writing that you want to consult on this project. Please provide the lead contact person's contact information. Please mail or email your request to: Ron Hacker. I can be reached at 310-263-3220 (office), or by email at hackerr@cvuhsd.org.

Sincerely,

Ron Hacker
Assistant Superintendent,
Business Services Centinela Valley Union High School District



Centinela Valley Union High School District

Business Services Division

14901 Inglewood Avenue, Lawndale, CA 90260
(310) 263-3220; (310) 644-7218 fax
www.centinela.k12.ca.us

October 28, 2021

Gabrieleno Band of Mission Indians - Kizh Nation
Andrew Salas, Chairperson
P.O. Box 393
Covina, CA 91723

Subject: Hawthorne High School Athletic Facilities Improvements Project

Dear Tribal Representative:

In conformance with the tribal consultation requirements of Assembly Bill (AB) 52, this letter is to inform you that the Centinela Valley Union High School District is reviewing the proposed project described below. Per AB 52, the tribe has the right to consult on a proposed public or private project prior to the release of a negative declaration, mitigated negative declaration or environmental impact report. The project description is as follows:

The proposed Hawthorne Athletic Facilities Improvements Project (proposed Project) is located on the grounds of the Hawthorne High School campus (Campus) located at 4859 West El Segundo Boulevard and the Hawthorne Pool located at 12501 South Inglewood Avenue within the City of Hawthorne in southwest Los Angeles County. The Campus is located entirely within Assessor's Parcel Number (APN) 4142-012-908 and the Hawthorne Pool is located within APN 4142-012-900. The proposed Project includes the replacement of the existing athletic fields located on the grounds of the Campus and the potential redevelopment of the Hawthorne Pool. The fields would be furnished with new synthetic turf, existing field lighting would be replaced with high efficiency lighting, and existing public announcement systems would be replaced. Additionally, the proposed Project would include the construction of a 5,400-square-foot team room / concessions stand, the updating of existing utilities, the addition of new site furnishings, including bike racks, drinking fountains, and trash receptacles as well as potential redevelopment of the existing Hawthorne Pool like for like. The Project is located within an unsectioned portion of Township 3 South, Range 14 West on the Inglewood, CA U.S. Geological Survey (USGS) 7.5-minute topographic quadrangle (as shown on attached map).

The NAHC completed a search of the Sacred Lands File, which indicated no presence of Native American sacred lands within the project area. The NAHC identify you as a person who may have concerns or knowledge of cultural resources in the project area. Any information you might be able to share about the project area would greatly enhance the study and would be most appreciated.

You have 30 calendar days from receipt of this letter to notify us in writing that you want to consult on this project. Please provide the lead contact person's contact information. Please mail or email your request to: Ron Hacker. I can be reached at 310-263-3220 (office), or by email at hackerr@cvuhsd.org.

Sincerely,

Ron Hacker
Assistant Superintendent,
Business Services Centinela Valley Union High School District

BOARD OF EDUCATION

Gloria A. Ramos
President

Hugo M. Rojas II
Vice-President

Marisela Ruiz
Clerk

Estefany A. Castañeda
Member

Dr. Daniel D. Urrutia
Member

SUPERINTENDENT

Dr. Stephen W. Nellman

Business Services

Ron Hacker
Assistant Superintendent
(310) 263-3220
(310) 644-7218 fax

Educational Services

Dr. Kelly Santos
Assistant Superintendent
(310) 263-3170
(310) 973-8318 fax

Diversity, Equity & Inclusion

Dr. Pamela Brown
Assistant Superintendent
(310) 263-3210
(310) 973-7983 fax

Hawthorne High School

Grace Yang
Principal
(310) 263-4400
(310) 675-7017 fax

Lawndale High School

Dr. Paula Hart Rodas
Principal
(310) 263-3100
(310) 675-8174 fax

Leuzinger High School

Dr. Howard Ho
Principal
(310) 263-2200
(310) 675-7023 fax

Lloyd High School / CV Adult School / CV Independent Study School

Ben Wardrop
Principal
(310) 263-3263
(310) 679-2632 fax