

## Appendix E

### 1. DHS Light Industrial with Cannabis Overlay Traffic Analysis

City of Desert Hot Springs,

Prepared by  
Urban Crossroads  
April 11, 2022

And

DHS Light Industrial with Cannabis Overlay

### 2. Vehicle Miles Traveled (VMT) Screening Evaluation

Prepared by  
Urban Crossroads  
April 7, 2022





---

# **DHS LIGHT INDUSTRIAL WITH CANNABIS OVERLAY TRAFFIC ANALYSIS CITY OF DESERT HOT SPRINGS**

PREPARED BY:

John Kain, AICP  
jkain@urbanxroads.com  
(949) 375-2435

Marlie Whiteman, P.E.  
mwhiteman@urbanxroads.com  
(714) 585-0574

Janette Cachola  
jcatchola@urbanxroads.com

APRIL 11, 2022



## TABLE OF CONTENTS

<b>TABLE OF CONTENTS</b> .....	<b>I</b>
<b>APPENDICES</b> .....	<b>III</b>
<b>LIST OF EXHIBITS</b> .....	<b>V</b>
<b>LIST OF TABLES</b> .....	<b>VII</b>
<b>LIST OF ABBREVIATED TERMS</b> .....	<b>IX</b>
<b>1 INTRODUCTION</b> .....	<b>1</b>
1.1 Summary of Findings.....	1
1.2 Project Overview.....	1
1.3 Analysis Scenarios .....	3
1.4 Study Area.....	3
1.5 Analysis Findings .....	5
1.6 Circulation System Deficiencies and Recommended Improvements .....	7
1.7 On-Site Roadway and Site Access Improvements .....	7
<b>2 METHODOLOGIES</b> .....	<b>11</b>
2.1 Level of Service .....	11
2.2 Intersection Capacity Analysis .....	11
2.3 Traffic Signal Warrant Analysis Methodology.....	13
2.4 Minimum Level of Service (LOS) .....	14
2.5 Deficiency Criteria .....	14
2.6 Project Fair Share Calculation Methodology .....	14
<b>3 EXISTING CONDITIONS</b> .....	<b>15</b>
3.1 Existing Circulation Network.....	15
3.2 City of Desert Hot Springs General Plan Circulation Element.....	15
3.3 Transit Service .....	15
3.4 Pedestrian and Bicycle Facilities .....	15
3.5 Existing Traffic Volumes .....	15
3.6 Existing Conditions Intersection Operations Analysis.....	20
3.7 Existing Conditions Traffic Signal Warrants Analysis .....	20
<b>4 PROJECTED FUTURE TRAFFIC</b> .....	<b>23</b>
4.1 Project Trip Generation.....	23
4.2 Project Trip Distribution.....	23
4.3 Modal Split .....	23
4.4 Trip Assignment .....	23
4.5 Cumulative Growth Traffic.....	27
<b>5 EAP (2024) TRAFFIC CONDITIONS</b> .....	<b>31</b>
5.1 Roadway Improvements .....	31
5.2 EAP (2024) Traffic Volume Forecasts .....	31
5.3 EAP (2024) Intersection Operations Analysis.....	31
5.4 EAP (2024) Traffic Signal Warrants Analysis .....	31
5.5 Recommended Improvements .....	32



**6 EAPC (2024) TRAFFIC CONDITIONS ..... 35**

6.1 Roadway Improvements ..... 35

6.2 EAPC (2024) Traffic Volume Forecasts ..... 35

6.3 EAPC (2024) Intersection Operations Analysis ..... 35

6.4 EAPC (2024) Traffic Signal Warrants Analysis ..... 35

6.5 Recommended Improvements ..... 36

**7 REFERENCES ..... 39**

## **APPENDICES**

**APPENDIX 1.1: APPROVED TRAFFIC STUDY SCOPING AGREEMENT**

**APPENDIX 3.1: EXISTING TRAFFIC COUNTS – (2022)**

**APPENDIX 3.2: EXISTING (2022) CONDITIONS INTERSECTION OPERATIONS ANALYSIS WORKSHEETS**

**APPENDIX 3.3: TRAFFIC SIGNAL WARRANT ANALYSIS WORKSHEETS**

**APPENDIX 5.1: EAP (2024) CONDITIONS INTERSECTION OPERATIONS ANALYSIS WORKSHEETS**

**APPENDIX 6.1: EAPC (2024) CONDITIONS INTERSECTION OPERATIONS ANALYSIS WORKSHEETS**

This Page Intentionally Left Blank

**LIST OF EXHIBITS**

**EXHIBIT 1-1: PRELIMINARY SITE PLAN ..... 2**  
**EXHIBIT 1-2: TRAFFIC ANALYSIS STUDY AREA ..... 4**  
**EXHIBIT 1-3: SUMMARY OF INTERSECTION LOS BY ANALYSIS SCENARIO ..... 6**  
**EXHIBIT 1-4: SITE ACCESS RECOMMENDATIONS ..... 9**  
**EXHIBIT 3-1: EXISTING NUMBER OF THROUGH LANES AND INTERSECTION CONTROLS ..... 16**  
**EXHIBIT 3-2: CITY OF DESERT HOT SPRINGS GENERAL PLAN CIRCULATION ELEMENT ..... 17**  
**EXHIBIT 3-3: CITY OF DESERT HOT SPRINGS GENERAL PLAN ROADWAY CROSS-SECTIONS ..... 18**  
**EXHIBIT 3-4: EXISTING PEDESTRIAN FACILITIES ..... 19**  
**EXHIBIT 3-5: EXISTING (2022) TRAFFIC VOLUMES ..... 21**  
**EXHIBIT 4-1: PROJECT TRIP DISTRIBUTION ..... 25**  
**EXHIBIT 4-2: PROJECT ONLY TRAFFIC VOLUMES ..... 26**  
**EXHIBIT 4-3: CUMULATIVE DEVELOPMENT LOCATION MAP ..... 28**  
**EXHIBIT 5-1: EAP (2024) TRAFFIC VOLUMES ..... 33**  
**EXHIBIT 6-1: EAPC (2024) TRAFFIC VOLUMES ..... 37**

This Page Intentionally Left Blank

## **LIST OF TABLES**

<b>TABLE 1-1: INTERSECTION ANALYSIS LOCATIONS .....</b>	<b>5</b>
<b>TABLE 1-2: PROJECT FAIR SHARE CALCULATIONS.....</b>	<b>8</b>
<b>TABLE 2-1: SIGNALIZED INTERSECTION DESCRIPTION OF LOS .....</b>	<b>12</b>
<b>TABLE 2-2: UNSIGNALIZED INTERSECTION DESCRIPTION OF LOS .....</b>	<b>12</b>
<b>TABLE 2-3: UNSIGNALIZED INTERSECTION LOCATIONS .....</b>	<b>13</b>
<b>TABLE 3-1: INTERSECTION ANALYSIS FOR EXISTING (2022) CONDITIONS .....</b>	<b>22</b>
<b>TABLE 4-1: PROJECT TRIP GENERATION SUMMARY .....</b>	<b>24</b>
<b>TABLE 4-2: CUMULATIVE DEVELOPMENT LAND USE SUMMARY .....</b>	<b>29</b>
<b>TABLE 5-1: INTERSECTION ANALYSIS FOR EAP (2024) CONDITIONS .....</b>	<b>34</b>
<b>TABLE 6-1: INTERSECTION ANALYSIS FOR EAPC (2024) CONDITIONS.....</b>	<b>38</b>

This Page Intentionally Left Blank

## **LIST OF ABBREVIATED TERMS**

(1)	Reference
ADT	Average Daily Traffic
Caltrans	California Department of Transportation
CMP	Congestion Management Program
DU	Dwelling Unit
EAP	Existing Plus Ambient Growth Plus Project
EAPC	Existing Plus Ambient Growth Plus Project Plus Cumulative
HCM	Highway Capacity Manual
ITE	Institute of Transportation Engineers
LOS	Level of Service
MUTCD	Manual on Uniform Traffic Control Devices
N/A	Not Applicable
NP	Without Project
PHF	Peak Hour Factor
Project	DHS Light Industrial with Cannabis Overlay
TA	Traffic Analysis



This Page Intentionally Left Blank

# 1 INTRODUCTION

This report presents the results of the traffic analysis (TA) for the proposed DHS Light Industrial with Cannabis Overlay (“Project”), which is located east side of Little Morongo Road, north of Dillon Road in the City of Desert Hot Springs.

The purpose of this TA is to evaluate the potential circulation system deficiencies that may result from the development of the proposed Project, and recommend improvements to achieve acceptable circulation system operational conditions. This TA has been prepared based in accordance with the County of Riverside’s Transportation Analysis Guidelines for Level of Service & Vehicle Miles Traveled (December 2020), as the City of Desert Hot Springs utilizes the County LOS/VMT analysis guidelines. (1) To ensure that this TA satisfies the City of Desert Hot Springs’s traffic study requirements, Urban Crossroads, Inc. prepared a traffic study scoping package for review by City staff prior to the preparation of this report. The Agreement provides an outline of the Project study area, trip generation, trip distribution, and analysis methodology. The Agreement approved by the City is included in Appendix 1.1.

## 1.1 SUMMARY OF FINDINGS

For Existing and Interim Year Cumulative (2024) traffic conditions, the Project contributes to off-site study area intersections (Little Morongo Road / Dillon Road - #3 and Indian Canyon Drive / 19<sup>th</sup> Avenue - #7) which require traffic signal improvements to achieve acceptable intersection operations.

The Project applicant shall participate in relevant City and subregional (CVAG’s TUMF program) fees; and in addition pay the Project’s fair share towards the installation of off-site traffic signals as agreed to by the City and Project Applicant.

## 1.2 PROJECT OVERVIEW

The Project is proposed to consist of approximately 116,000 square feet of light industrial buildings for the research, development, and cultivation of medical-grade cannabis. It is anticipated that the Project would be fully developed by year 2024. A preliminary site plan of the proposed Project is shown in Exhibit 1-1. Project will have two gated full-access driveways along the Little Morongo Road. Regional access to the project site is provided via the I-10 Freeway at Indian Canyon Drive.

Trips generated by the Project’s proposed land uses have been estimated based on trip generation rates collected by the Institute of Transportation Engineers (ITE) Trip Generation Manual, 11<sup>th</sup> Edition, 2021. (2) The Project is anticipated to generate a total of 705 trip-ends per day with 80 AM peak hour trips and 74 PM peak hour trips.

### EXHIBIT 1-1: PRELIMINARY SITE PLAN

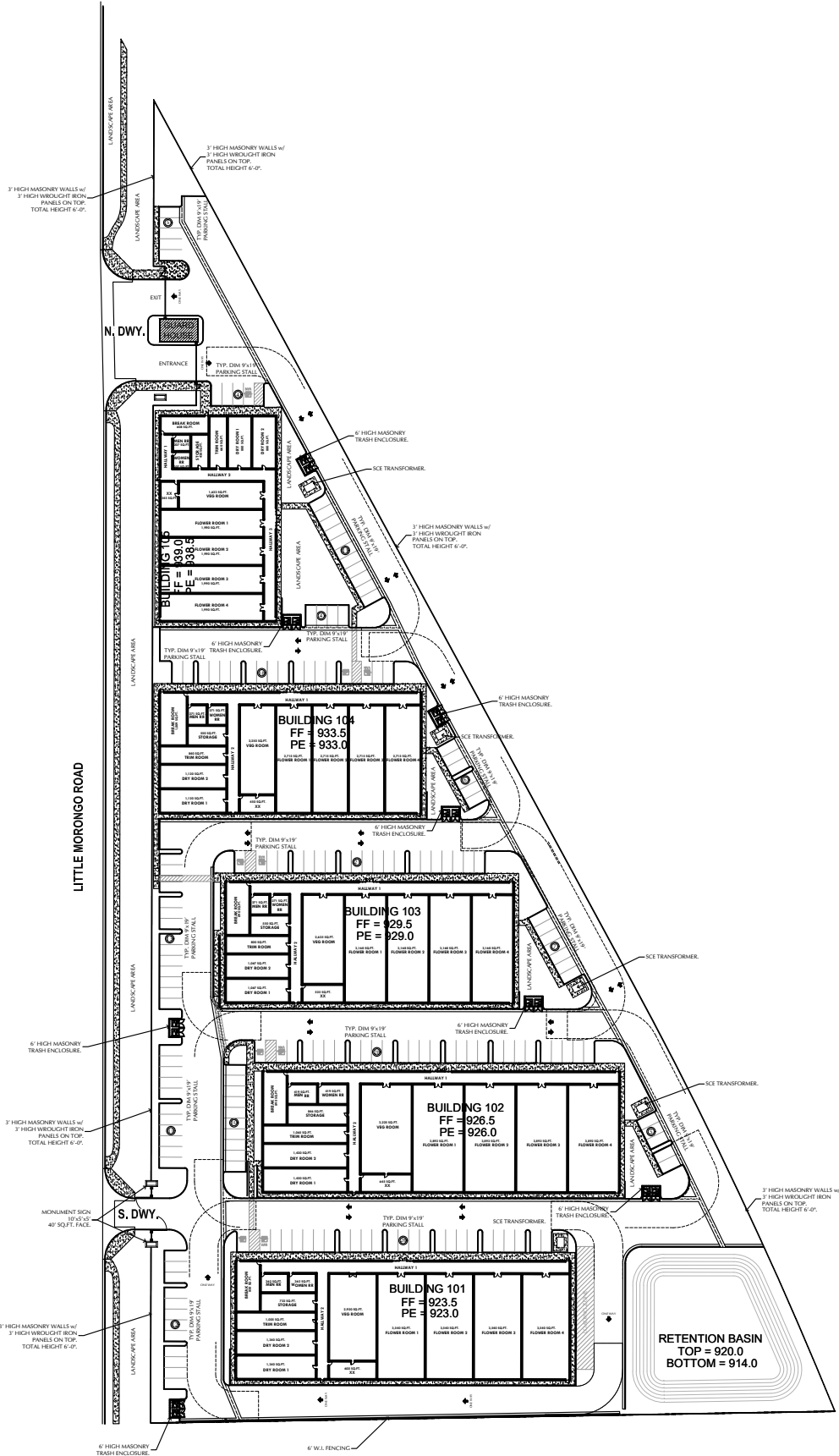

The assumptions and methods used to estimate the Project's trip generation characteristics are discussed in greater detail in Section 4.1 *Project Trip Generation* of this report.

### **1.3 ANALYSIS SCENARIOS**

For the purposes of this traffic study, potential impacts to traffic and circulation have been evaluated for each of the following conditions:

- Existing (2022) Conditions
- Existing plus Ambient Growth plus Project (EAP) (2024) Conditions
- Existing plus Ambient Growth plus Project Plus Cumulative (EAPC) (2024) Conditions

All study area intersections are evaluated using the Highway Capacity Manual (HCM) 6<sup>th</sup> Edition analysis methodology.

#### **1.3.1 EXISTING CONDITIONS**

Existing physical conditions have been disclosed to represent the baseline traffic conditions as they existed at the time this report was prepared.

#### **1.3.2 EAP CONDITIONS**

The EAP (2024) traffic conditions analyses determine potential traffic impacts based on a comparison of the EAP traffic conditions to Existing conditions. To account for background traffic growth, an ambient growth factor from Existing conditions of 4.04% (2 percent per year over 2 years, compounded annually) for 2024 conditions is included for EAP traffic conditions. Consistent with County of Riverside traffic study guidelines, the EAP analysis is intended to identify "Opening Year" deficiencies associated with the development of the proposed Project based on the expected background growth within the study area.

#### **1.3.3 EAPC CONDITIONS**

The EAPC (2024) traffic conditions analyses determine the potential near-term cumulative circulation system deficiencies. Background traffic for these analysis scenarios follow the same ambient growth methodology described above for EAP traffic conditions. However, EAPC traffic conditions also include the addition of cumulative development traffic. The comprehensive list of cumulative development projects was compiled from information provided by the City of Desert Hot Springs.

### **1.4 STUDY AREA**

The Project study area was defined in coordination with the City of Desert Hot Springs. Consistent with County of Riverside traffic study guidelines, the study area includes any intersection of "Collector" or higher classification street, with "Collector" or higher classification streets, at which the proposed project will add 50 or more peak hour trips. Exhibit 1-2 presents the study area and intersection analysis locations.

**EXHIBIT 1-2: TRAFFIC ANALYSIS STUDY AREA**

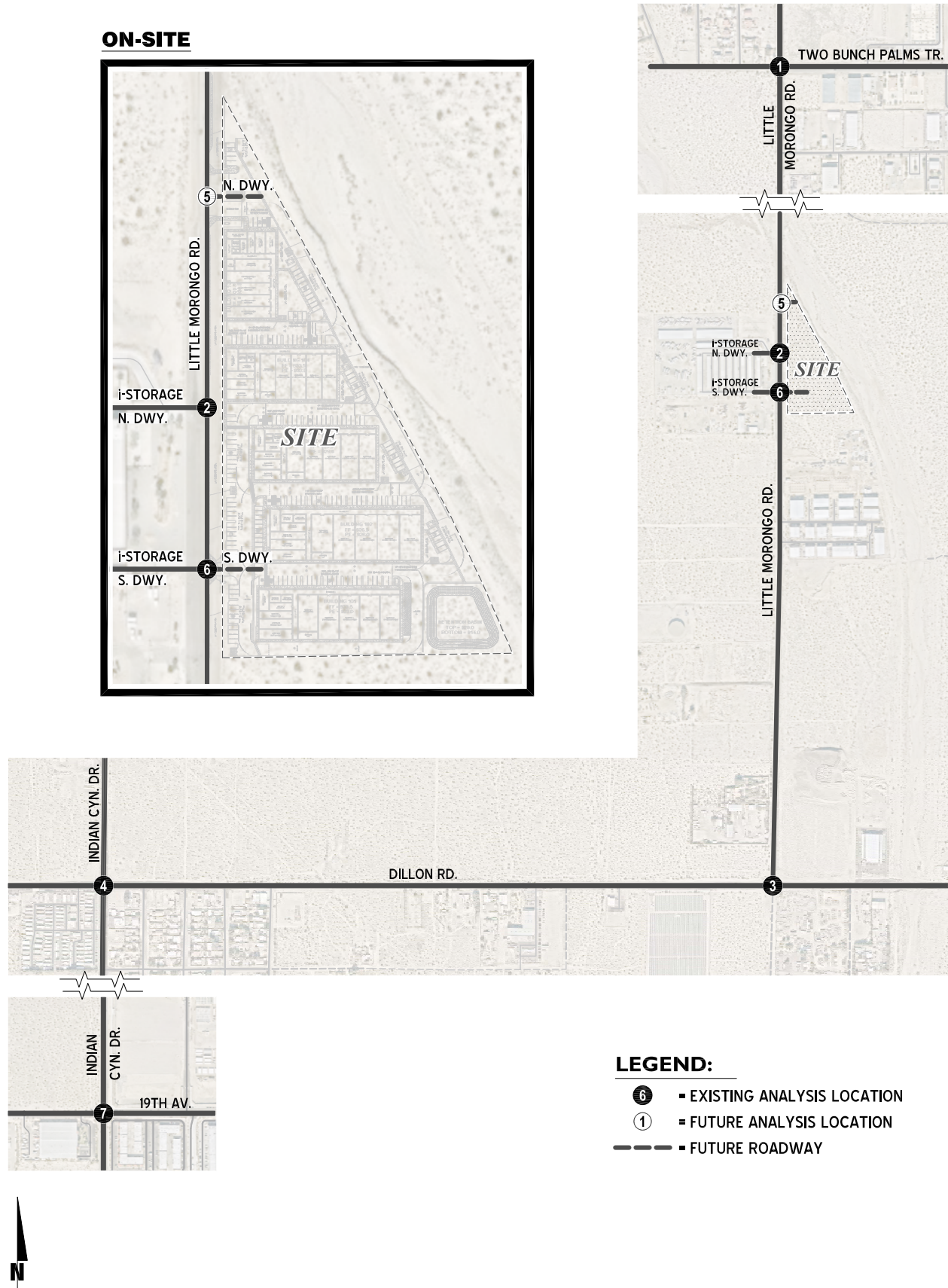

The “50 peak hour trip” criteria generally represents a minimum number of trips at which a typical intersection would have the potential to be substantively impacted by a given development proposal. Although each intersection may have unique operating characteristics, this traffic engineering rule of thumb is a widely utilized tool for estimating a potential area of impact (i.e., study area).

**1.4.1 INTERSECTIONS**

The following 7 study area intersections shown on Exhibit 1-2 and listed in Table 1-1 were selected for this TA based on consultation with City of Desert Hot Springs staff.

**TABLE 1-1: INTERSECTION ANALYSIS LOCATIONS**

ID	Intersection Location
1	Little Morongo Road / Two Bunch Palms Trail
2	Little Morongo Road / i-Storage N. Dwy.
3	Little Morongo Road / Dillon Road
4	Indian Canyon Dr. / Dillon Road.
5	Little Morongo Road / Project N. Dwy.
6	Little Morongo Road / i-Storage S. Dwy. - Project S. Dwy.
7	Indian Canyon Dr. / 19th Avenue

**1.5 ANALYSIS FINDINGS**

This section provides a summary of the analysis results for Existing (2022), EAP (2024), and EAPC (2024) conditions. The LOS results are summarized in Exhibit 1-3.

**Existing (2022) Conditions**

The intersection of Indian Canyon Drive / 19<sup>th</sup> Avenue (#7) is currently operating at an unacceptable LOS (LOS “E” or worse) during the PM peak hour.

The intersections of Little Morongo Road / Two Bunch Palms Trail (#1), Little Morongo Road / Dillon Road (#3), and Indian Canyon Drive / 19<sup>th</sup> Avenue (#7) currently meets the volume warrants for installation of a traffic signal.

**Opening Year (2024) Conditions**

For EAP (2024) and EAPC (2024) traffic conditions, the intersection of Little Morongo Road / Dillon Road (#3) is projected to operate at an unacceptable LOS (LOS “E” or worse) during the peak hours, with or without the addition of Project traffic.

**EXHIBIT 1-3: SUMMARY OF DEFICIENT INTERSECTIONS BY ANALYSIS SCENARIO**

#	Intersection	Existing (2022)	EAP (2024)	EAPC (2024)
1	Little Morongo Rd. / Two Bunch Palms Tr.			
2	Little Morongo Rd. / i-Storage N. Dwy.			
3	Little Morongo Rd. / Dillon Rd.			
4	Indian Cyn. Dr. / Dillon Rd.			
5	Little Morongo Rd. / N. Dwy.	NA		
6	Little Morongo Rd. / i-Storage S. Dwy. - S. Dwy.			
7	Indian Cyn. Dr. / 19th Av.			

**LEGEND:**

- = AM PEAK HOUR
- = PM PEAK HOUR
- = LOS A-D
- = LOS E
- = LOS F

## 1.6 CIRCULATION SYSTEM DEFICIENCIES AND RECOMMENDED IMPROVEMENTS

A summary of the operationally deficient study area intersections and recommended improvements required to achieve acceptable circulation system performance are described in detail within Section 5 *EAP (2024) Traffic Analysis*, and Section 6 *EAPC (2024) Traffic Analysis* of this report.

Installation of off-site traffic signals at the off-site intersections of Little Morongo Road / Dillon Road (#3) and Indian Canyon Drive / 19<sup>th</sup> Avenue (#7) address intersection operational deficiencies for opening year (2024) conditions. Fair share financial contribution based on the Project's estimated peak hour volumes at this location may be imposed at the discretion of the City of Desert Hot Springs.

Detailed fair share calculations, for each peak hour, are provided in Table 1-2 for the off-site study area intersections.

## 1.7 SITE ACCESS IMPROVEMENTS

The Project is proposed to have two gated full-access driveways along the Little Morongo Road. Regional access to the project site is provided via the I-10 Freeway at Indian Canyon Drive, as indicated on Exhibit 1-4. Roadway improvements necessary to provide site access and on-site circulation are assumed to be constructed in conjunction with site development.

These improvements should be in place prior to occupancy:

***Little Morongo Road*** – Construct Little Morongo Road from the Project's northerly boundary to the Project's southerly boundary at its ultimate half-section width as a 4-lane Secondary II undivided roadway.

***Little Morongo Road / North Project Driveway (#5)*** – Cross-street stop control on the westbound approach provides acceptable peak hour service levels.

***Little Morongo Road / i-Storage South Driveway – South Project Driveway (#6)*** – Cross-street stop control on the westbound approach provides acceptable peak hour service levels.

On-site traffic signing and striping should be implemented in conjunction with detailed construction plans for the Project site.

Sight distance at the project access points should be reviewed with respect to standard Caltrans and City of Desert Hot Springs sight distance standards at the time of preparation of final grading, landscape and street improvement plans.



**TABLE 1-2: FAIR SHARE CALCULATIONS**

ID	Intersection	Existing (2021) Traffic	EAPC (2024) Traffic	Project Only Traffic	Total New Traffic <sup>1</sup>	Project Fair Share (%) <sup>2</sup>
3	Little Morongo Rd. / Dillon Rd.					
	• AM Peak Hour	1,183	1,569	69	386	17.9%
	• PM Peak Hour	1,268	1,790	63	522	12.1%
7	Indian Cyn. Dr. / 19th Av.					
	• AM Peak Hour	1,497	2,610	48	1,113	4.3%
	• PM Peak Hour	1,480	2,889	46	1,409	3.3%

<sup>1</sup> Total New Traffic = (EAPC - Existing Traffic)

<sup>2</sup> Project Fair Share % = (Project Only Traffic / Total New Traffic)

F:\UXRjobs\\_14100-14500\14398\Excel\[14398 - Report.xlsx]FS

**EXHIBIT 1-4: SITE ACCESS RECOMMENDATIONS**

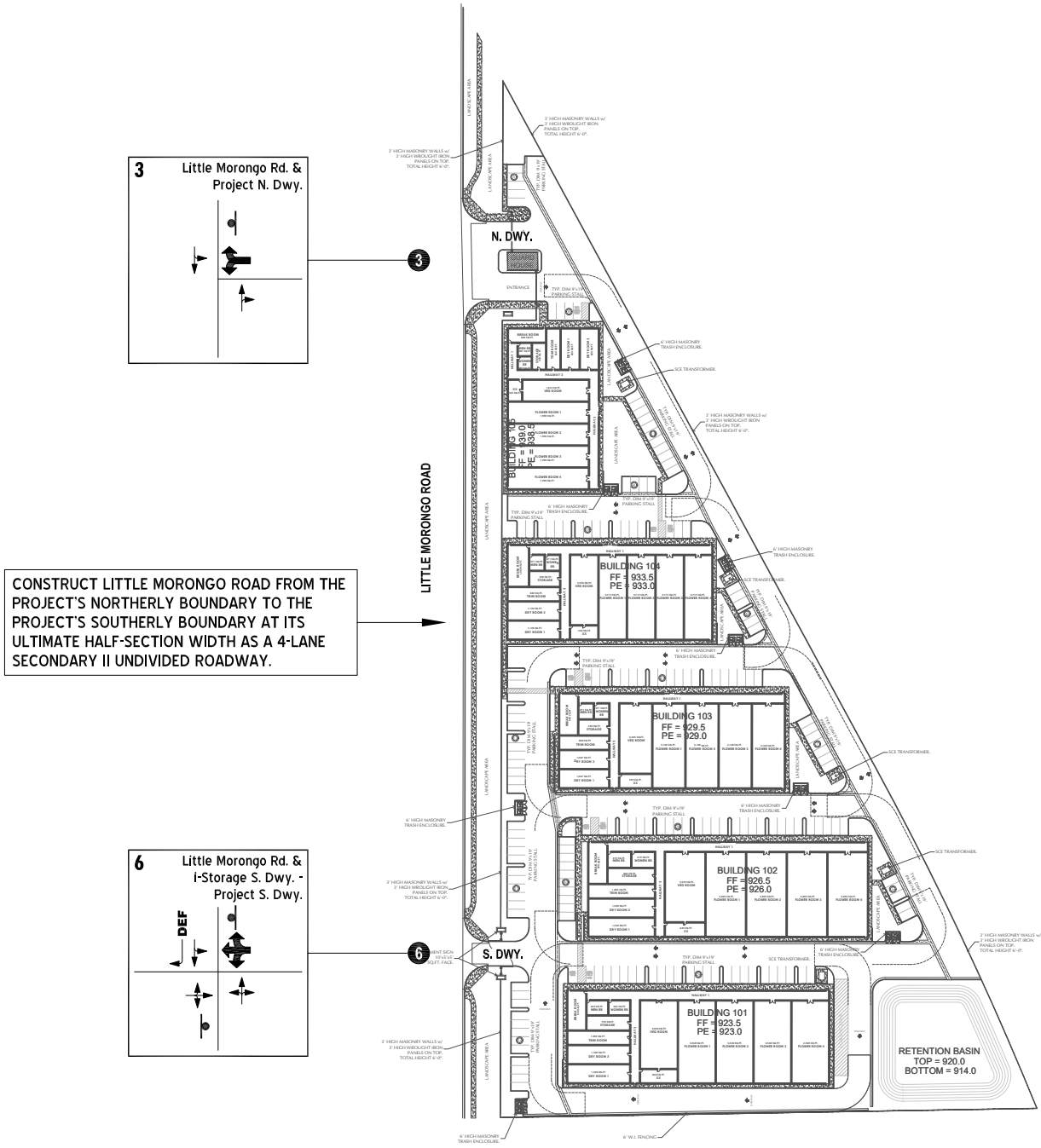

ON-SITE TRAFFIC SIGNING AND STRIPING SHOULD BE IMPLEMENTED IN CONJUNCTION WITH DETAILED CONSTRUCTION PLANS FOR THE PROJECT SITE.

SIGHT DISTANCE AT THE PROJECT ACCESS POINTS SHOULD BE REVIEWED WITH RESPECT TO STANDARD CALTRANS AND CITY OF DESERT HOT SPRINGS SIGHT DISTANCE STANDARDS AT THE TIME OF PREPARATION OF FINAL GRADING, LANDSCAPE AND STREET IMPROVEMENT PLANS.

**LEGEND:**

- INTERSECTION ID
- STOP SIGN
- EXISTING LANE
- LANE IMPROVEMENT
- DEFACTO RIGHT TURN LANE



This Page Intentionally Left Blank

## 2 METHODOLOGIES

This section documents the methodologies and assumptions used to perform this traffic assessment.

### 2.1 LEVEL OF SERVICE

Traffic operations of roadway facilities are described using the term "Level of Service" (LOS). LOS is a qualitative description of traffic flow based on several factors such as speed, travel time, delay, and freedom to maneuver. Six levels are typically defined ranging from LOS A, representing completely free-flow conditions, to LOS F, representing breakdown in flow resulting in stop-and-go conditions. LOS E represents operations at or near capacity, an unstable level where vehicles are operating with the minimum spacing for maintaining uniform flow.

### 2.2 INTERSECTION CAPACITY ANALYSIS

The definitions of LOS for interrupted traffic flow (flow restrained by the existence of traffic signals and other traffic control devices) differ slightly depending on the type of traffic control. The LOS is typically dependent on the quality of traffic flow at the intersections along a roadway. The *Highway Capacity Manual* (HCM) methodology expresses the LOS at an intersection in terms of delay time for the various intersection approaches. (3) The HCM uses different procedures depending on the type of intersection control.

#### 2.2.1 SIGNALIZED INTERSECTIONS

The City of Desert Hot Springs require signalized intersection operations analysis based on the methodology described in the HCM 6<sup>th</sup> Edition (3). Intersection LOS operations are based on an intersection's average control delay. Control delay includes initial deceleration delay, queue move-up time, stopped delay, and final acceleration delay. For signalized intersections LOS is directly related to the average control delay per vehicle and is correlated to a LOS designation as described in Table 2-1. Study area intersections have been evaluated using the Synchro (Version 11) analysis software package.

Synchro is a macroscopic traffic software program that is based on the signalized intersection capacity analysis as specified in the HCM. Macroscopic level models represent traffic in terms of aggregate measures for each movement at the study intersections. Equations are used to determine measures of effectiveness in addressing such parameters as delay and queue length. The level of service and capacity analysis performed by Synchro takes into consideration optimization and coordination of signalized intersections within a network.

**TABLE 2-1: SIGNALIZED INTERSECTION DESCRIPTION OF LOS**

Description	Average Control Delay (Seconds), V/C ≤ 1.0	Level of Service, V/C ≤ 1.0	Level of Service, V/C > 1.0
Operations with very low delay occurring with favorable progression and/or short cycle length.	0 to 10.00	A	F
Operations with low delay occurring with good progression and/or short cycle lengths.	10.01 to 20.00	B	F
Operations with average delays resulting from fair progression and/or longer cycle lengths. Individual cycle failures begin to appear.	20.01 to 35.00	C	F
Operations with longer delays due to a combination of unfavorable progression, long cycle lengths, or high V/C ratios. Many vehicles stop and individual cycle failures are noticeable.	35.01 to 55.00	D	F
Operations with high delay values indicating poor progression, long cycle lengths, and high V/C ratios. Individual cycle failures are frequent occurrences. This is considered to be the limit of acceptable delay.	55.01 to 80.00	E	F
Operation with delays unacceptable to most drivers occurring due to over saturation, poor progression, or very long cycle lengths	80.01 and up	F	F

Source: HCM 6<sup>th</sup> Edition (3)

### 2.2.2 UNSIGNALIZED INTERSECTIONS

The City of Desert Hot Springs require the operations of unsignalized intersections be evaluated using the methodology described in the HCM 6<sup>th</sup> Edition. (3) The LOS rating is based on the weighted average control delay expressed in seconds per vehicle (see Table 2-2).

**TABLE 2-2: UNSIGNALIZED INTERSECTION DESCRIPTION OF LOS**

Description	Average Control Delay Per Vehicle (Seconds)	Level of Service, V/C ≤ 1.0	Level of Service, V/C > 1.0
Little or no delays.	0 to 10.00	A	F
Short traffic delays.	10.01 to 15.00	B	F
Average traffic delays.	15.01 to 25.00	C	F
Long traffic delays.	25.01 to 35.00	D	F
Very long traffic delays.	35.01 to 50.00	E	F
Extreme traffic delays with intersection capacity exceeded.	> 50.00	F	F

Source: HCM 6<sup>th</sup> Edition

At two-way or side-street stop-controlled intersections, LOS is calculated for each controlled movement and for the left turn movement from the major street, as well as for the intersection as a whole. For approaches composed of a single lane, the delay is computed as the average of all movements in that lane. For all-way stop controlled intersections, LOS is computed for the intersection as a whole.

### 2.3 TRAFFIC SIGNAL WARRANT ANALYSIS METHODOLOGY

The term "signal warrants" refers to the list of established criteria used by Caltrans and other public agencies to quantitatively justify or ascertain the potential need for installation of a traffic signal at an otherwise unsignalized intersection. This TA uses the signal warrant criteria presented in the latest edition of the Caltrans California Manual on Uniform Traffic Control Devices (CA MUTCD), for all study area intersections. (4)

The signal warrant criteria for Existing conditions are based upon several factors, including volume of vehicular and pedestrian traffic, frequency of accidents, and location of school areas. The CAMUTCD indicates that the installation of a traffic signal should be considered if one or more of the signal warrants are met. (4) Specifically, this TA utilizes the Peak Hour Volume-based Warrant 3 as the appropriate representative traffic signal warrant analysis for existing study area intersections for all analysis scenarios. Warrant 3 is appropriate to use for this TA because it provides specialized warrant criteria for intersections with rural characteristics (e.g. located in communities with populations of less than 10,000 persons or with adjacent major streets operating above 40 miles per hour). For the purposes of this study, the speed limit was the basis for determining whether Urban or Rural warrants were used for a given intersection.

Future intersections that do not currently exist have been assessed regarding the potential need for new traffic signals based on future average daily traffic (ADT) volumes, using the Caltrans planning level ADT-based signal warrant analysis worksheets.

Traffic signal warrant analyses were performed for all the unsignalized study area intersections, as listed below:

**TABLE 2-3: UNSIGNALIZED INTERSECTION LOCATIONS**

ID	Intersection Location	ID	Intersection Location
1	Little Morongo Road / Two Bunch Palms Trail	5	Little Morongo Road / Project N. Dwy.
2	Little Morongo Road / i-Storage N. Dwy.	6	Little Morongo Road / i-Storage S. Dwy. - Project S. Dwy.
3	Little Morongo Road / Dillon Road	7	Indian Canyon Dr. / 19th Avenue

The Existing conditions traffic signal warrant analysis is presented in the subsequent section, Section 3 *Existing Conditions* of this report. The traffic signal warrant analysis for future conditions is presented Section 5 *EAP (2024) Traffic Analysis and Section 6 EAPC (2024)* of this report.

It is important to note that a signal warrant defines the minimum condition under which the installation of a traffic signal might be warranted. Meeting this condition does not require that a traffic control signal be installed at a particular location, but rather, that other traffic factors and conditions be evaluated in order to determine whether the signal is truly justified. It should also be noted that signal warrants do not necessarily correlate with LOS. An intersection may satisfy a signal warrant condition and operate at or above acceptable LOS or operate below acceptable LOS and not meet a signal warrant.

## 2.4 MINIMUM LEVEL OF SERVICE (LOS)

Per the City of Desert Hot Springs's General Plan, LOS D as the threshold for acceptable traffic conditions on the circulation network.

## 2.5 DEFICIENCY CRITERIA

This section outlines the methodology used in this analysis related to identifying circulation system deficiencies.

To determine whether the addition of project traffic at a study intersection would result in a deficiency, the following will be utilized:

- A deficiency occurs at study area intersections if the pre-Project condition is at or better than LOS D (i.e., acceptable LOS), and the addition of project trips causes the peak hour LOS of the study area intersection to operate at unacceptable LOS (i.e., LOS E or F). Per the County of Riverside traffic study guidelines, for intersections currently operating at unacceptable LOS (LOS E or F), a deficiency would occur if the Project contributes 50 or more peak hour trips to pre-project traffic conditions.

## 2.6 PROJECT FAIR SHARE CALCULATION METHODOLOGY

In cases where this TA identifies that the Project would contribute additional traffic volumes to cumulative traffic deficiencies, Project fair share costs of improvements necessary to address deficiencies have been identified. The Project's fair share cost of improvements is determined based on the following equation, which is the ratio of Project traffic to total future traffic:

$$\text{Project Fair Share \%} = \text{Project Traffic} / (\text{EAPC Total Traffic} - \text{Existing Traffic})$$

The Project fair share contribution calculations are presented in Section 1.6 *Circulation System Deficiencies and Recommended Improvements* of this TA.

### **3 EXISTING CONDITIONS**

This section provides a summary of the existing circulation network, the City of Desert Hot Springs General Plan Circulation Network, and a review of existing peak hour intersection operations, and traffic signal warrant analyses.

#### **3.1 EXISTING CIRCULATION NETWORK**

Pursuant to the agreement with City of Desert Hot Springs staff (Appendix 1.1), the study area includes a total of 7 existing and future intersections as shown on Exhibit 1-2. Exhibit 3-1 illustrates the study area intersections located near the proposed Project and identifies the number of through traffic lanes for existing roadways and intersection traffic controls.

#### **3.2 CITY OF DESERT HOT SPRINGS GENERAL PLAN CIRCULATION ELEMENT**

Exhibit 3-2 shows the adopted City of Desert Hot Springs General Plan Circulation Element, and Exhibit 3-3 illustrates the adopted City of Desert Hot Springs General Plan roadway cross-sections.

#### **3.3 TRANSIT SERVICE**

The City of Desert Hot Springs is currently served by the SunLine Transit Agency, but current bus services are not located within the Project study area. Transit service is reviewed and updated by Sunline periodically to address ridership, budget and community demand needs. Changes in land use can affect these periodic adjustments which may lead to either enhanced or reduced service where appropriate.

#### **3.4 PEDESTRIAN AND BICYCLE FACILITIES**

The existing pedestrian facilities within the study area are shown on Exhibit 3-4.

As shown on Exhibit 3-4, existing on-street bike lanes are located along Indian Canyon Drive, and a portion of Little Morongo Road, north Dillon Road.

Sidewalks also exist on some portions of Little Morongo Road, Dillon Road, and Indian Canyon Drive.

#### **3.5 EXISTING TRAFFIC VOLUMES**

The intersection LOS analysis is based on the traffic volumes observed during the peak hour conditions using traffic count data collected in March 2022. The following peak hours were selected for analysis:

- Weekday AM Peak Hour (peak hour between 7:00 AM and 9:00 AM)
- Weekday PM Peak Hour (peak hour between 4:00 PM and 6:00 PM)

The raw manual peak hour turning movement traffic count data sheets are included in Appendix 3.1.



**EXHIBIT 3-1: EXISTING NUMBER OF THROUGH LANES AND INTERSECTION CONTROLS**

**ON-SITE**

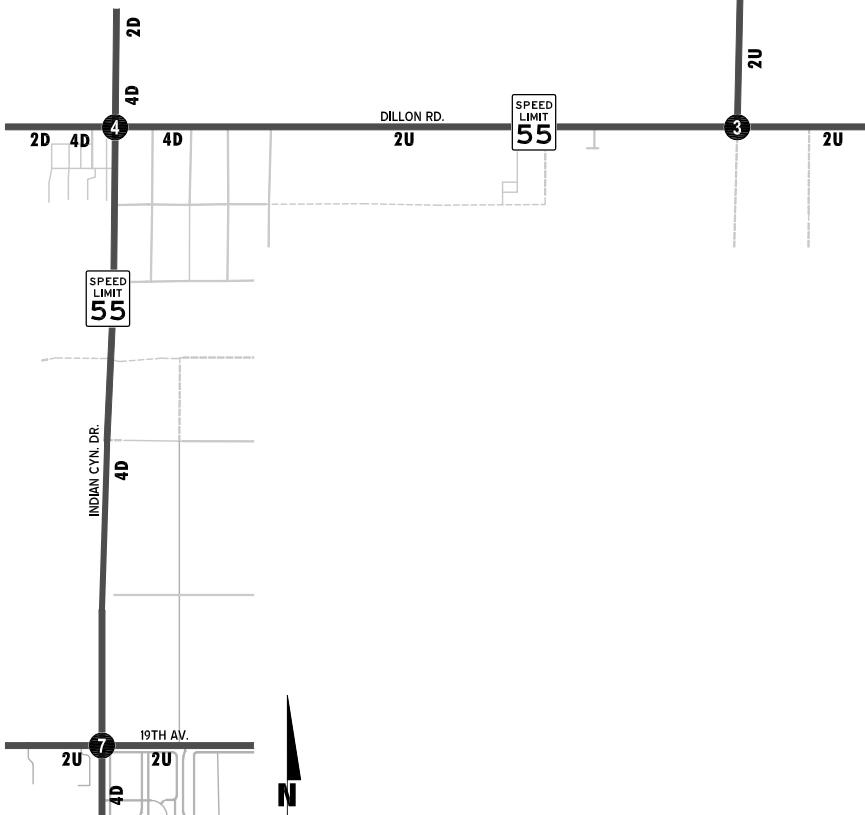
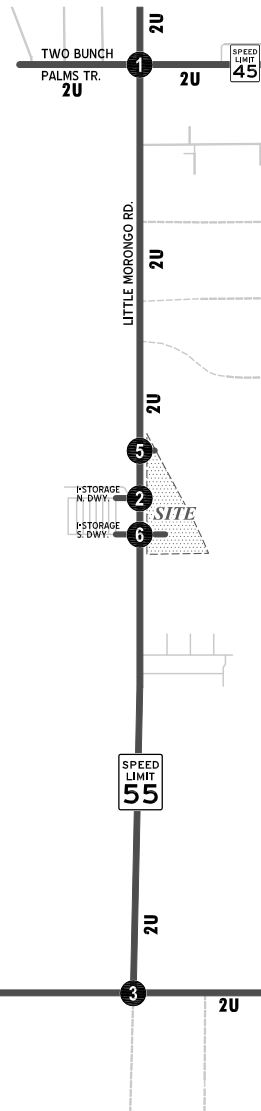
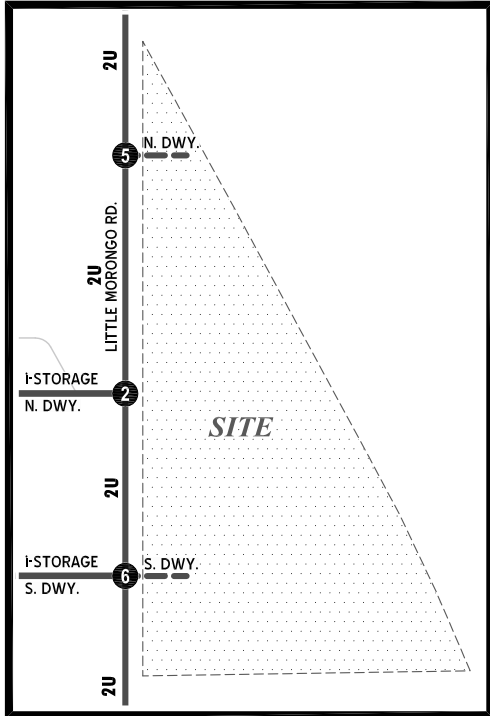

<p><b>1</b> Little Morongo Rd. &amp; Two Bunch Palms Tr.</p>	<p><b>2</b> Little Morongo Rd. &amp; I-Storage N. Dwy.</p>
<p><b>3</b> Little Morongo Rd. &amp; Dillon Rd.</p>	<p><b>4</b> Indian Cyn. Dr. &amp; Dillon Rd.</p>
<p><b>5</b> Little Morongo Rd. &amp; Project N. Dwy.</p> <p><b>FUTURE INTERSECTION</b></p>	<p><b>6</b> Little Morongo Rd. &amp; I-Storage S. Dwy. - Project S. Dwy.</p>
<p><b>7</b> Indian Cyn. Dr. &amp; 19th Av.</p>	

**LEGEND:**

- = INTERSECTION ID
- = TRAFFIC SIGNAL
- = STOP SIGN
- 4** = NUMBER OF LANES
- D** = DIVIDED
- U** = UNDIVIDED
- DEF** = DEFACTO RIGHT TURN LANE
- \*** = LEFT TURN LANE ACCOMMODATED WITHIN TWO-WAY LEFT TURN LANE (TWLTL) MEDIAN

**EXHIBIT 3-2: CITY OF DESERT HOT SPRINGS ROADWAYS PLAN**

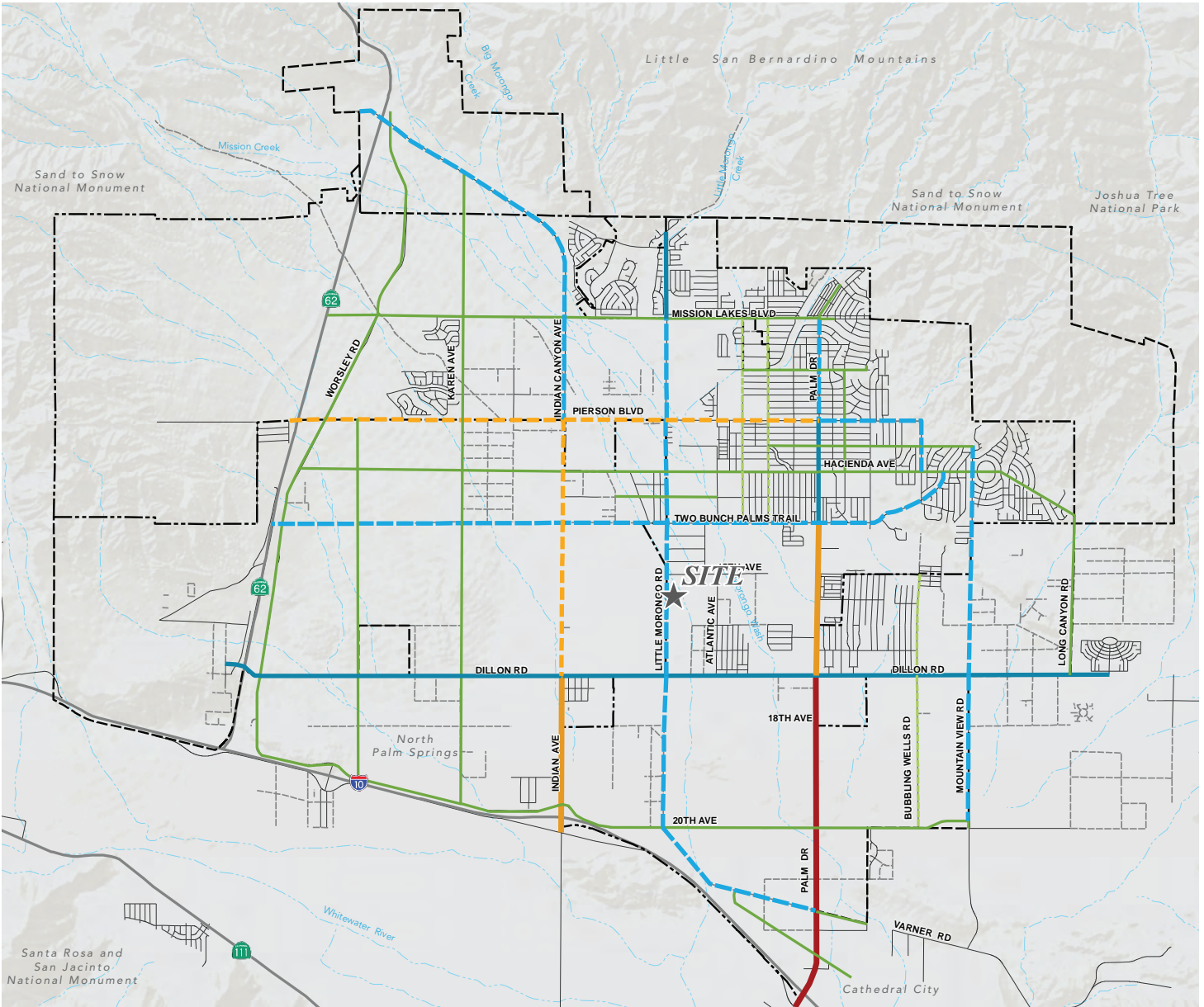

SOURCE: CITY OF DESERT HOT SPRINGS GENERAL PLAN (MAY 2020)

**Road Classifications**

- Urban Arterial
- Primary I
- - - Primary II
- Secondary I
- - - Secondary II
- Collector
- - - Local Collector

**Base Map Features**

- City Boundary
- Sphere of Influence
- - - Water Courses



**EXHIBIT 3-3: CITY OF DESERT HOT SPRINGS GENERAL PLAN ROADWAY CROSS-SECTIONS**

**Urban Arterial**

8-Lanes Divided  
No Parking  
With Protected Bike Lane

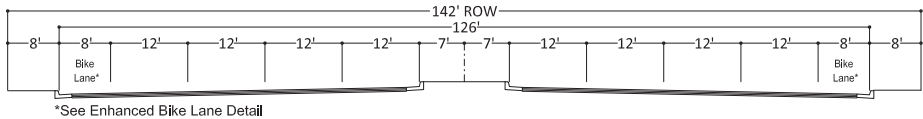

\*See Enhanced Bike Lane Detail

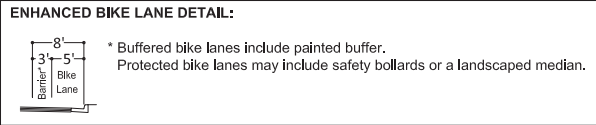

**Primary I**

6-Lanes Divided  
No Parking  
With or Without Protected Bike Lane

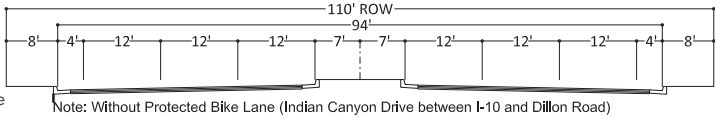

Note: Without Protected Bike Lane (Indian Canyon Drive between I-10 and Dillon Road)

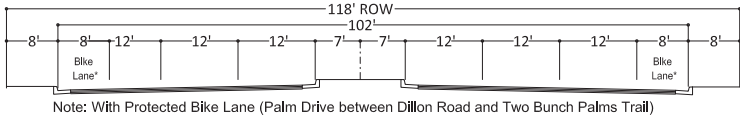

Note: With Protected Bike Lane (Palm Drive between Dillon Road and Two Bunch Palms Trail)  
\*See Enhanced Bike Lane Detail

**Primary II**

4-Lanes Divided  
No Parking  
With or Without Protected Bike Lane

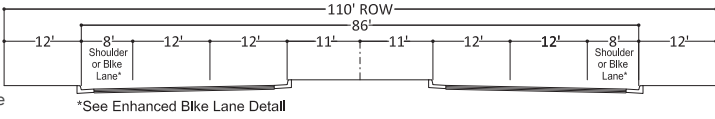

\*See Enhanced Bike Lane Detail

**Secondary I**

4-Lanes Divided  
No Parking  
With Protected Bike Lane

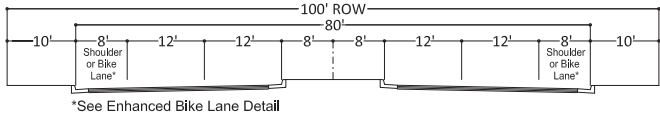

\*See Enhanced Bike Lane Detail

**Secondary II**

4-Lanes Undivided  
On-Street Parking  
With or Without Dedicated Bike Lane

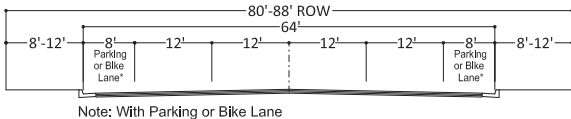

Note: With Parking or Bike Lane  
\*See Enhanced Bike Lane Detail

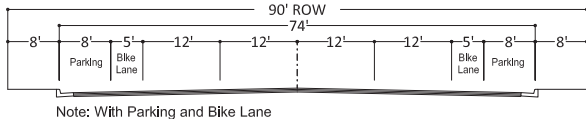

Note: With Parking and Bike Lane

**Collector**

2-Lanes Undivided  
On-Street Parking  
With or Without Dedicated Bike Lane

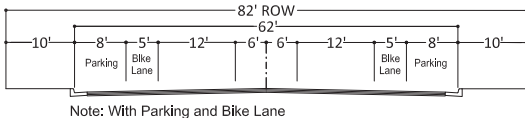
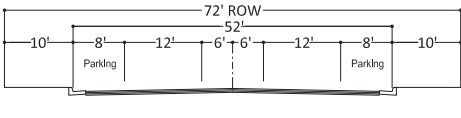

Note: With Parking and Bike Lane

**Local Collector**

2-Lanes Undivided  
On-Street Parking  
With or Without Dedicated Bike Lane

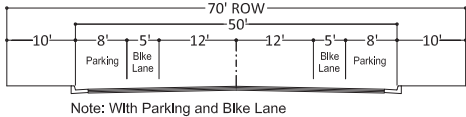
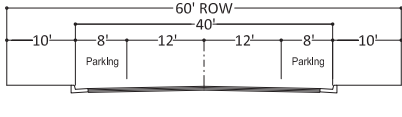

Note: With Parking and Bike Lane

SOURCE: CITY OF DESERT HOT SPRINGS GENERAL PLAN (MAY 2020)

**EXHIBIT 3-4: EXISTING PEDESTRIAN AND BIKE FACILITIES**

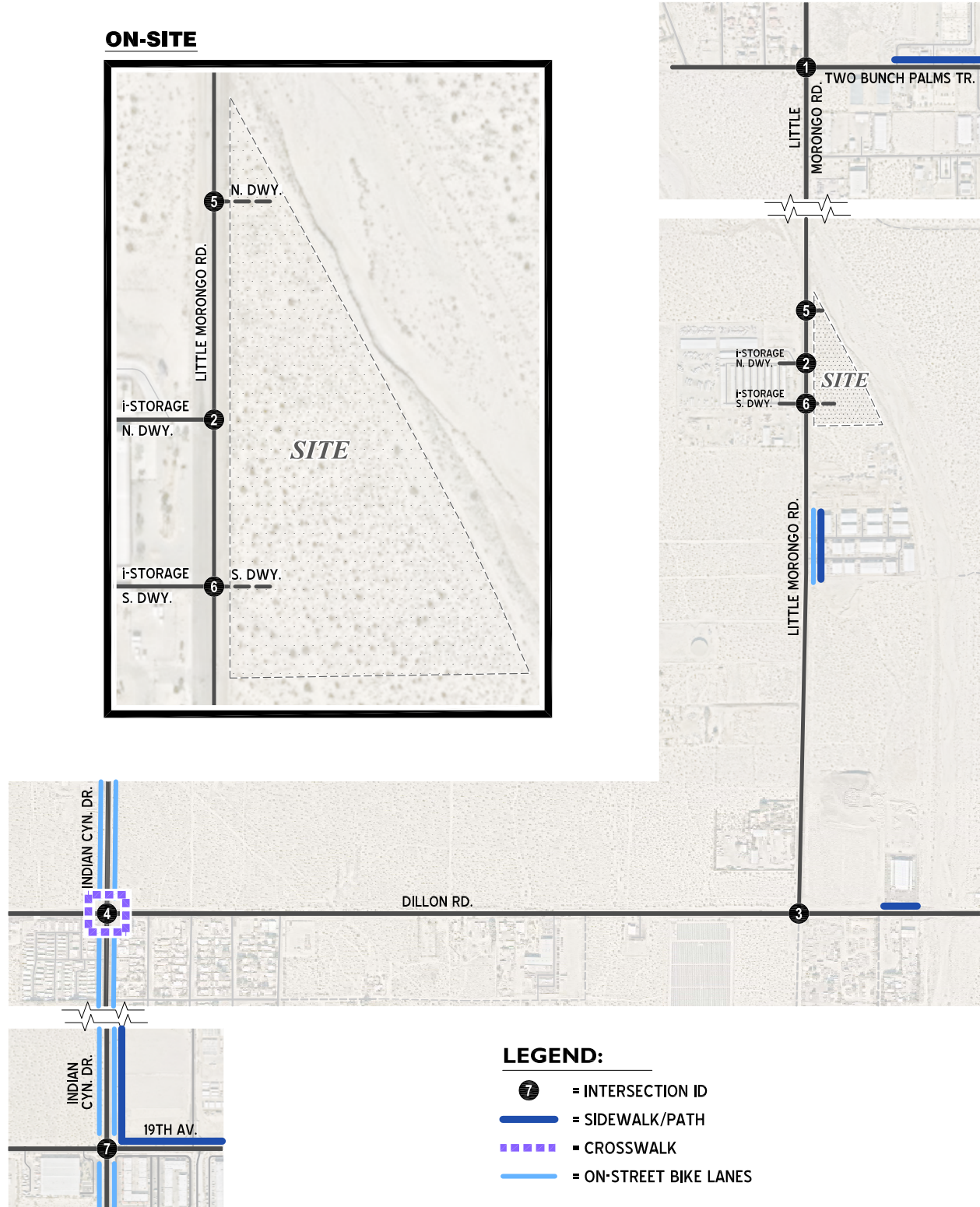



The weekday AM and PM peak hour count data are representative of typical peak hour traffic conditions in the study area. There were no observations made in the field that would indicate atypical traffic conditions on the count dates, such as construction activity that would prevent or limit roadway access and detour routes. These raw turning volumes have been flow conserved between intersections with limited access, no access and where there are currently no uses generating traffic.

Existing weekday average daily traffic (ADT) volumes on arterial highways throughout the study area are shown on Exhibit 3-5. Existing ADT volumes are based upon factored intersection peak hour counts collected by Urban Crossroads, Inc. using the following formula for each intersection leg where daily counts are unavailable:

$$\text{Weekday PM Peak Hour (Approach Volume + Exit Volume)} \times 12.821 = \text{Leg Volume}$$

For those roadway segments which have 24-hour tube count data available in close proximity to the study area, a comparison between the PM peak hour and daily traffic volumes indicated that the peak-to-daily relationship of approximately 7.80 percent would sufficiently estimate ADT volumes for planning-level analyses. As such, the above equation utilizing a factor of 12.821 estimates the ADT volumes on the study area roadway segments assuming a peak-to-daily relationship of approximately 7.80 percent (i.e.,  $1/0.0780 = 12.821$ ). Existing weekday AM and PM peak hour intersection volumes are also shown on Exhibit 3-5.

### **3.6 EXISTING CONDITIONS INTERSECTION OPERATIONS ANALYSIS**

Existing peak hour traffic operations have been evaluated for the study area intersections based on the analysis methodologies presented in Section 2.2 *Intersection Capacity Analysis* of this report. The intersection operations analysis results are summarized in Table 3-1 which indicates that the study area intersections are currently operating at acceptable LOS (LOS “D” or better) during the peak hours, with the exception of Indian Canyon Drive / 19<sup>th</sup> Avenue (#7) that operates at LOS “F” during the during the PM peak hour.

### **3.7 EXISTING CONDITIONS TRAFFIC SIGNAL WARRANTS ANALYSIS**

Traffic signal warrants for Existing traffic conditions are based on 2022 peak hour intersection turning volumes (see Appendix 3.3). For Existing (2022) traffic conditions, the unsignalized intersections of Little Morongo Road / Two Bunch Palms Trail (#1), Little Morongo Road / Dillon Road (#3), and Indian Canyon Drive / 19<sup>th</sup> Avenue (#7) currently meets volume warrants for installation of a traffic signal.

As mentioned previously, a signal warrant defines the minimum condition under which the installation of a traffic signal might be warranted. Meeting this condition does not require that a traffic control signal be installed at a particular location, but rather, that other traffic factors and conditions be evaluated in order to determine whether the signal is truly justified. It should also be noted that signal warrants do not necessarily correlate with LOS. An intersection may satisfy a signal warrant condition and operate at or above acceptable LOS or operate below acceptable LOS and not meet a signal warrant.

EXHIBIT 3-5: EXISTING (2022) TRAFFIC VOLUMES

ON-SITE

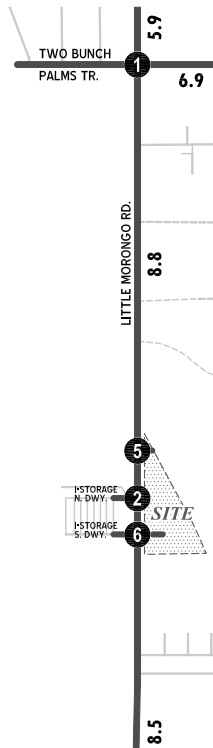
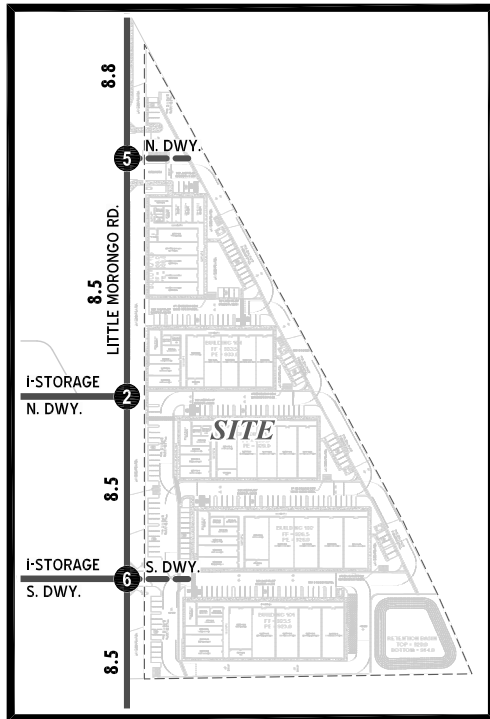

AM PEAK HOUR

1 Little Morongo Rd. & Two Bunch Palms Tr.	2 Little Morongo Rd. & i-Storage N. Dwy.	3 Little Morongo Rd. & Dillon Rd.
4 Indian Cyn. Dr. & Dillon Rd.	5 Little Morongo Rd. & Project N. Dwy.	6 Little Morongo Rd. & i-Storage S. Dwy. - Project S. Dwy.
7 Indian Cyn. Dr. & 19th Av.	<b>FUTURE INTERSECTION</b>	

PM PEAK HOUR

1 Little Morongo Rd. & Two Bunch Palms Tr.	2 Little Morongo Rd. & i-Storage N. Dwy.	3 Little Morongo Rd. & Dillon Rd.
4 Indian Cyn. Dr. & Dillon Rd.	5 Little Morongo Rd. & Project N. Dwy.	6 Little Morongo Rd. & i-Storage S. Dwy. - Project S. Dwy.
7 Indian Cyn. Dr. & 19th Av.	<b>FUTURE INTERSECTION</b>	

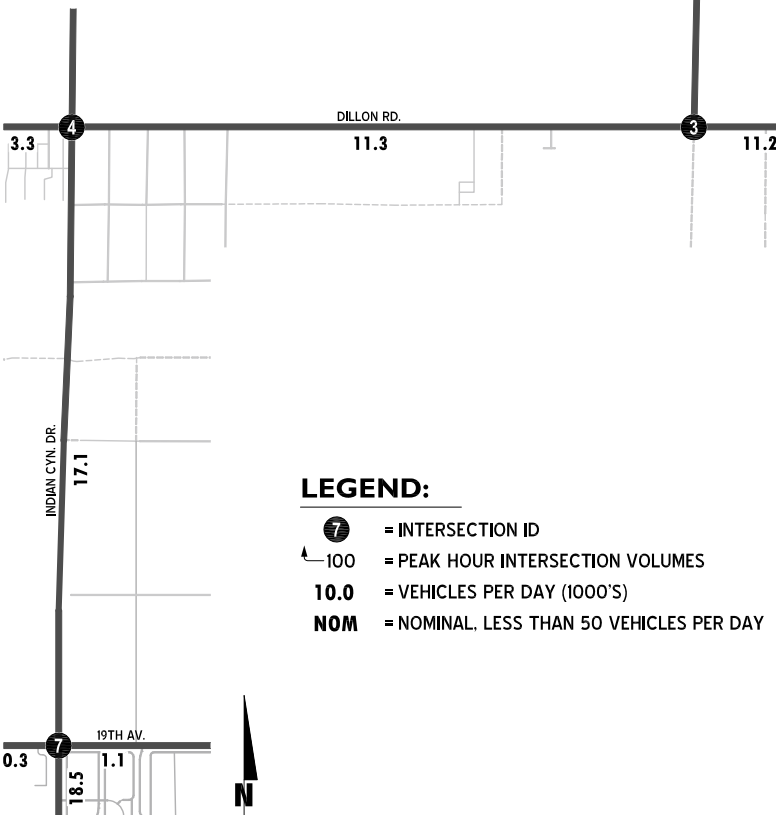

LEGEND:

- = INTERSECTION ID
- = PEAK HOUR INTERSECTION VOLUMES
- 10.0** = VEHICLES PER DAY (1000'S)
- NOM** = NOMINAL, LESS THAN 50 VEHICLES PER DAY

**TABLE 3-1: INTERSECTION ANALYSIS FOR EXISTING (2022) CONDITIONS**

#	Intersection	Traffic Control <sup>3</sup>	Intersection Approach Lanes <sup>1</sup>												Delay <sup>2</sup> (Secs)		Level of Service <sup>2</sup>	
			Northbound			Southbound			Eastbound			Westbound			AM	PM	AM	PM
			L	T	R	L	T	R	L	T	R	L	T	R				
1	Little Morongo Rd. / Two Bunch Palms Tr.	AWS	0	1!	0	0.5	0.5	d	0	1!	0	0.5	0.5	d	15.3	15.1	C	C
2	Little Morongo Rd. / i-Storage N. Dwy.	CSS	0.5	0.5	0	0	1	d	1	0	d	0	0	0	15.6	15.5	C	C
3	Little Morongo Rd. / Dillon Rd.	AWS	0	0	0	0	1!	0	1	1	0	1	1	0	33.2	26.0	D	D
4	Indian Cyn. Dr. / Dillon Rd.	TS	1	2	0	1	2	0	1	2	0	1	2	1	29.3	21.8	C	C
5	Little Morongo Rd. / N. Dwy.		Intersection Does Not Exist												-	-	-	-
6	Little Morongo Rd. / i-Storage Dwy. - S. Dwy.	CSS	0.5	0.5	0	0	1	d	0	1!	0	0	0	0	13.6	12.7	B	B
7	Indian Cyn. Dr. / 19th Av.	CSS	1	2	0	1*	2	0	0	1!	0	0	1!	0	32.5	<b>69.3</b>	D	<b>F</b>

<sup>1</sup> When a right turn is designated, the lane can either be striped or unstriped. To function as a right turn lane there must be sufficient width for right turning vehicles to travel outside the through lanes.

L = Left; T = Through; R = Right; 1! = Shared Left/Through/Right Lane; 0.5 = Shared Lane; d = Defacto Right Turn Lane;

\* = Turn lane accommodated within two-way left-turn lane (TWLTL)

<sup>2</sup> Per the Highway Capacity Manual 6th Edition (HCM6), overall average intersection delay and level of service are shown for intersections with a traffic signal or all way stop control.

For intersections with cross street stop control, the delay and level of service for the worst individual movement (or movements sharing a single lane) are shown.

Delay and level of service is calculated using Synchro 11 analysis software.

**BOLD** = LOS does not meet the applicable jurisdictional requirements (i.e., unacceptable LOS).

<sup>3</sup> AWS = All Way Stop; CSS = Cross-Street Stop; TS = Traffic Signal

## 4 PROJECTED FUTURE TRAFFIC

This section presents the traffic volumes estimated to be generated by the Project, as well as the Project's trip assignment onto the study area roadway network.

The Project is proposed to consist of approximately 116,000 square feet of light industrial buildings for the research, development, and cultivation of medical-grade cannabis. For the purposes of this analysis, it is assumed that the Project will be constructed within a single phase of development with a projected Opening Year of 2024. Project will have two gated full-access driveways along the Little Morongo Road. Regional access to the project site is provided via the I-10 Freeway at Indian Canyon Drive.

### 4.1 PROJECT TRIP GENERATION

Trip generation represents the amount of traffic which is both attracted to and produced by a development. Determining traffic generation for a specific project is therefore based upon forecasting the amount of traffic that is expected to be both attracted to and produced by the specific land uses being proposed for a given development.

Trip generation rates used to estimate Project traffic and a summary of the Project's trip generation are shown in Table 4-1. The trip generation rates are based upon data collected by the Institute of Transportation Engineers (ITE) for Marijuana Cultivation and Processing Facility (ITE Land Use Code 190) land use in their published Trip Generation Manual, 11<sup>th</sup> Edition, 2021. (2) As shown on Table 4-1, the proposed Project is anticipated to generate a total of 705 trip-ends per day with 80 AM peak hour trips and 74 PM peak hour trips.

### 4.2 PROJECT TRIP DISTRIBUTION

The trip distribution pattern for the proposed Project is depicted on Exhibit 4-1. The trip distribution has been developed based on past work experience in the vicinity of the Project site and refined to reflect the roadway network and the surrounding uses in the vicinity of the proposed Project as they exist today.

### 4.3 MODAL SPLIT

Although the use of public transit, walking, and/or bicycling have the potential to reduce Project-related traffic, such reductions have not been taken into considerations in this traffic study in order to provide a conservative analysis of the Project's potential to contribute to circulation system deficiencies.

### 4.4 TRIP ASSIGNMENT

The assignment of traffic from the Project area to the adjoining roadway system is based upon the Project trip generation, trip distribution, and the arterial highway and local street system improvements that would be in place by the time of initial occupancy of the Project. Based on the identified Project traffic generation and trip distribution patterns, Project weekday ADT, AM peak hour, and PM peak hour peak hour intersection turning movement volumes are shown on Exhibit 4-2.



**TABLE 4-1: PROJECT TRIP GENERATION SUMMARY**

Trip Generation Rates <sup>1</sup>									
Land Use	ITE LU Code	Quantity <sup>2</sup>	AM Peak Hour			PM Peak Hour			Daily
			In	Out	Total	In	Out	Total	
Marijuana Cultivation and Processing Facility	190	116 TSF	0.64	0.05	0.69	0.18	0.46	0.64	6.08

Trip Generation Results									
Land Use	ITE LU Code	Quantity <sup>2</sup>	AM Peak Hour			PM Peak Hour			Daily
			In	Out	Total	In	Out	Total	
Marijuana Cultivation and Processing Facility	190	116 TSF	74	6	80	21	53	74	705

<sup>1</sup> Trip Generation Source: Institute of Transportation Engineers (ITE), Trip Generation Manual, 11th Edition (2021).

<sup>2</sup> TSF = Thousand Square Feet

F:\UXRjobs\_14100-14500\14398\Excel\14398 - Report.xlsx\Trip Gen

**EXHIBIT 4-1: PROJECT TRIP DISTRIBUTION**

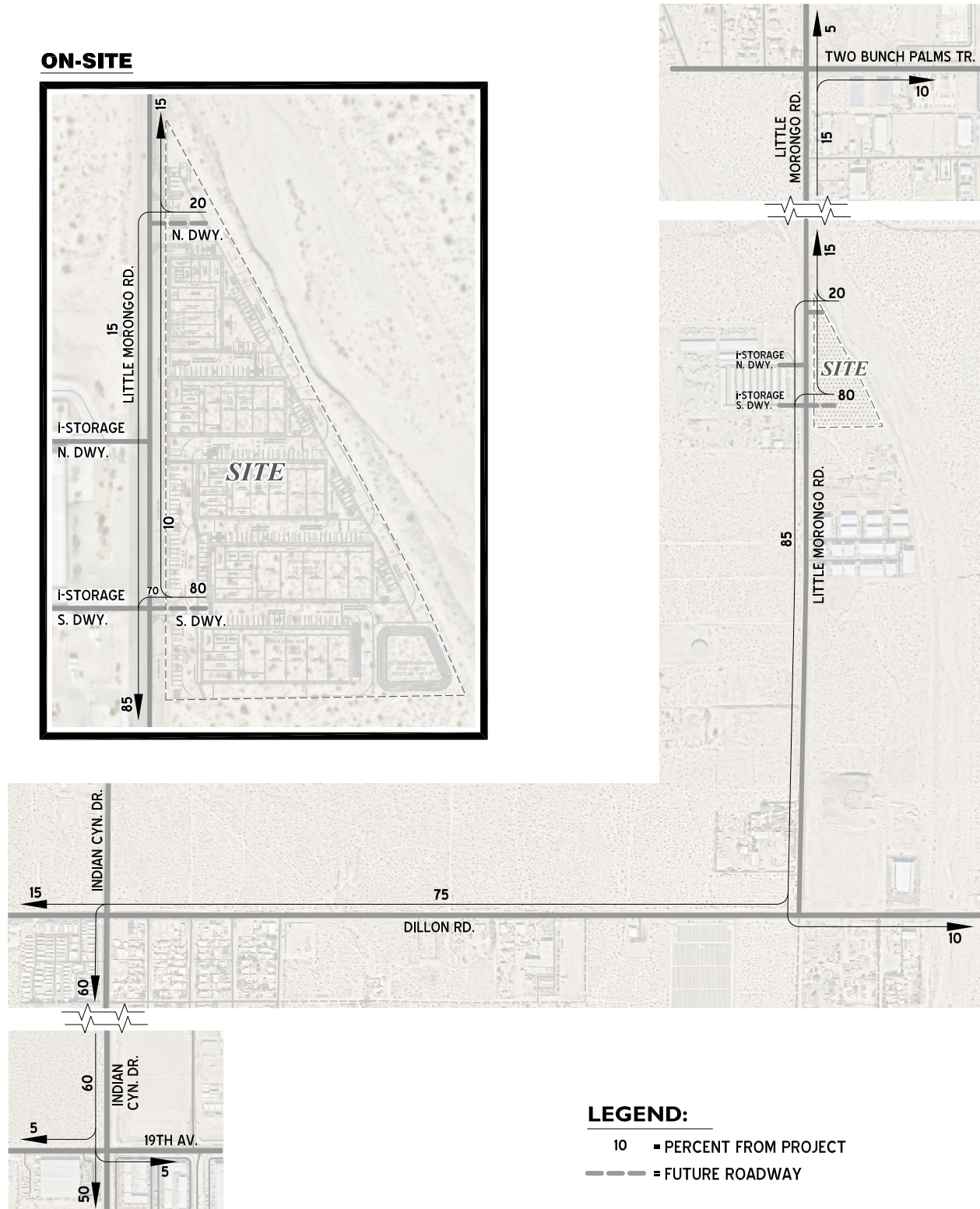
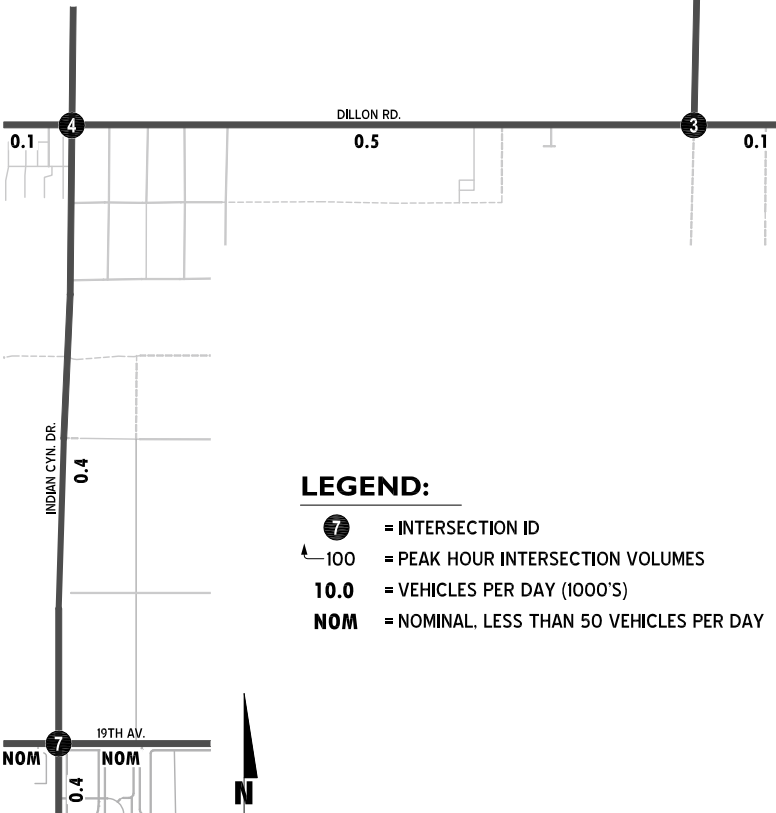
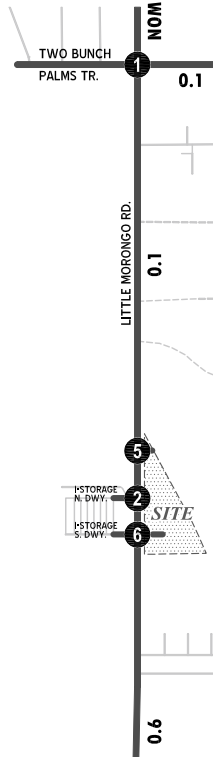
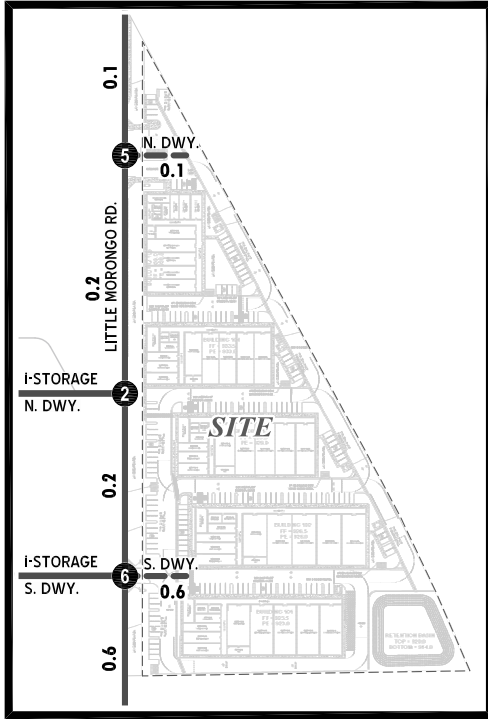

EXHIBIT 4-2: PROJECT ONLY TRAFFIC VOLUMES

ON-SITE



LEGEND:

- = INTERSECTION ID
- = PEAK HOUR INTERSECTION VOLUMES
- 10.0** = VEHICLES PER DAY (1000'S)
- NOM** = NOMINAL, LESS THAN 50 VEHICLES PER DAY

AM PEAK HOUR

<p><b>1</b> Little Morongo Rd. &amp; Two Bunch Palms Tr.</p>	<p><b>2</b> Little Morongo Rd. &amp; i-Storage N. Dwy.</p>	<p><b>3</b> Little Morongo Rd. &amp; Dillon Rd.</p>
<p><b>4</b> Indian Cyn. Dr. &amp; Dillon Rd.</p>	<p><b>5</b> Little Morongo Rd. &amp; Project N. Dwy.</p>	<p><b>6</b> Little Morongo Rd. &amp; i-Storage S. Dwy. - Project S. Dwy.</p>
<p><b>7</b> Indian Cyn. Dr. &amp; 19th Av.</p>		

PM PEAK HOUR

<p><b>1</b> Little Morongo Rd. &amp; Two Bunch Palms Tr.</p>	<p><b>2</b> Little Morongo Rd. &amp; i-Storage N. Dwy.</p>	<p><b>3</b> Little Morongo Rd. &amp; Dillon Rd.</p>
<p><b>4</b> Indian Cyn. Dr. &amp; Dillon Rd.</p>	<p><b>5</b> Little Morongo Rd. &amp; Project N. Dwy.</p>	<p><b>6</b> Little Morongo Rd. &amp; i-Storage S. Dwy. - Project S. Dwy.</p>
<p><b>7</b> Indian Cyn. Dr. &amp; 19th Av.</p>		

## 4.5 CUMULATIVE GROWTH TRAFFIC

### 4.5.1 AMBIENT GROWTH RATE

Future year traffic forecasts have been based upon background (ambient) growth at 4.04 percent (2 percent per year over 2 years) for EAP and EAPC traffic conditions. The ambient growth factor is intended to approximate regional traffic growth. This ambient growth rate is added to existing traffic volumes to account for area-wide growth not reflected by cumulative development projects. Ambient growth has been added to daily and peak hour traffic volumes on surrounding roadways, in addition to traffic generated by the development of future projects that have been approved but not yet built and/or for which development applications have been filed and are under consideration by governing agencies, for EAPC traffic conditions.

### 4.5.2 CUMULATIVE DEVELOPMENT TRAFFIC

A cumulative project list was developed for the purposes of this analysis through consultation with planning and engineering staff from the City of Desert Hot Springs.

Exhibit 4-3 illustrates the cumulative development location map. A summary of cumulative development projects and their proposed land uses are shown on Table 4-2. If applicable, the traffic generated by individual cumulative projects was manually added to the Opening Year Cumulative forecasts to ensure that traffic generated by the listed cumulative development projects in Table 4-2 are reflected as part of the background traffic.

### 4.5.3 NEAR-TERM TRAFFIC FORECASTS

The “buildup” approach combines existing traffic counts with a background ambient growth factor to forecast EAP (2024) and EAPC (2024) traffic conditions. An ambient growth factor of 2% per year accounts for background (area-wide) traffic increases that occur over time up to the year 2024 from the year 2022 (compounded 2% per year growth over a 2-year period). Project traffic is added to assess both forecast EAP (2024) and EAPC (2024) traffic conditions. Traffic volumes generated by cumulative development projects are not included in the EAP (2024) traffic conditions. The near-term traffic analysis includes the following traffic conditions, with the various traffic components:

- EAP (2024)
  - Existing 2022 volumes
  - Ambient growth traffic (4.04%)
  - Project Traffic
- EAPC (2024)
  - Existing 2022 volumes
  - Ambient growth traffic (4.04%)
  - Cumulative Development traffic
  - Project Traffic

### EXHIBIT 4-3: CUMULATIVE DEVELOPMENT LOCATION MAP

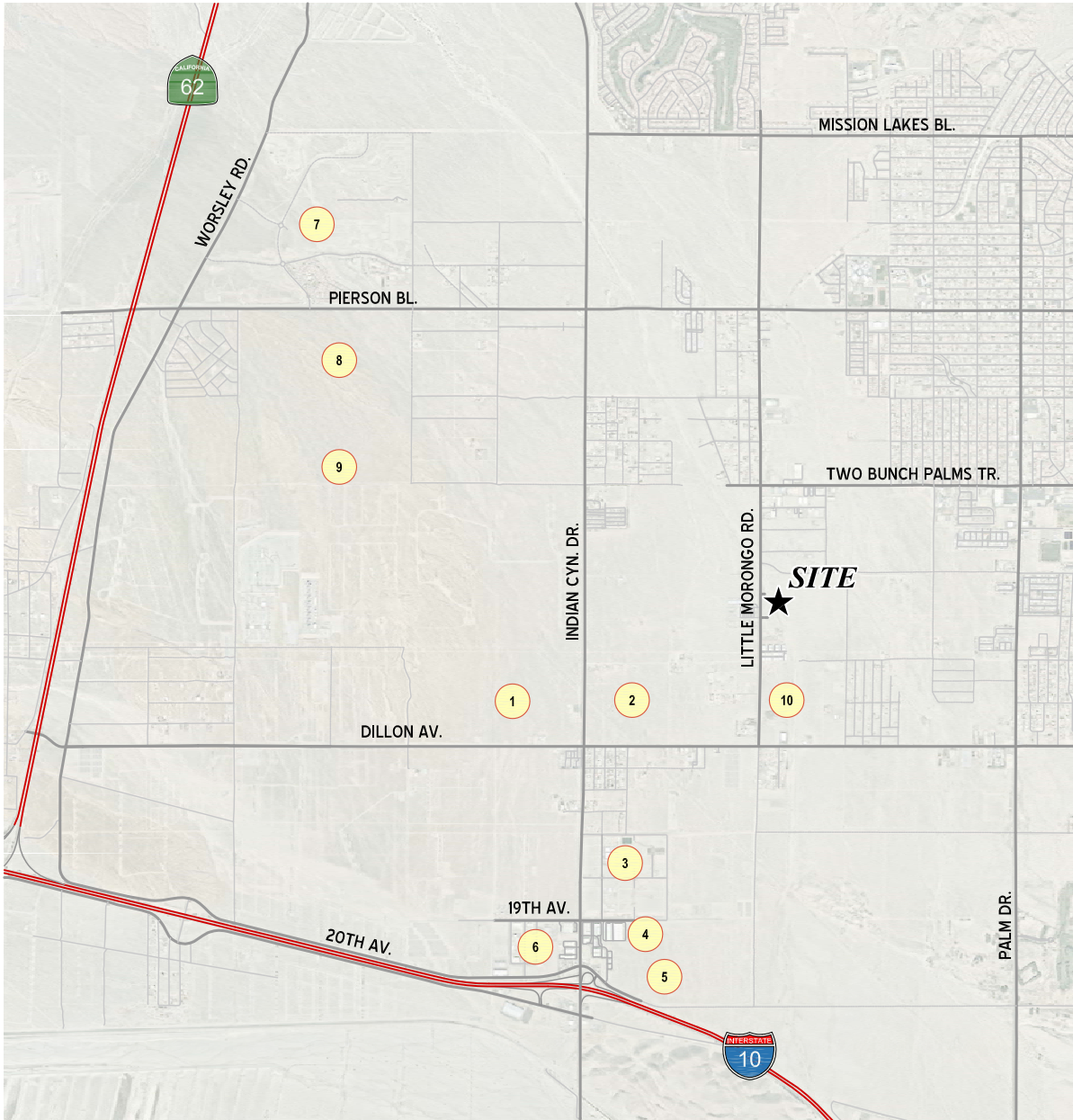

**LEGEND:**

# = CUMULATIVE DEVELOPMENT ID



**TABLE 4-2: CUMULATIVE DEVELOPMENT LAND USE SUMMARY**

ID	Project Name	Land Use <sup>1</sup>	Quantity	Units <sup>2</sup>
1	Angel View Salvage & Recycling Facility	Gen. Light Industrial	13.650	TSF
		Factory Outlet Center	9.000	TSF
		General Office	3.600	TSF
2	Cultivation Center	Nursery (Wholesale)	38.00	AC
3	The Desert Commerce Center	High-Cube Warehouse	2,952.00	TSF
4	Blackstar Industrial Properties	Business Park	621.920	TSF
5	20th/Calle De Los Romos Distribution Center	High-Cube Warehouse	1,059.24	TSF
		Commercial	36.0	TSF
6	Palm Springs Business Park	Business Park	37.874	TSF
7	Skyborne Active Adult Community at Stoneridge	Senior Adult Housing - Detached	1,141	DU
		SFDR	801	DU
		Clubhouse	5.0	TSF
8	Vista Rosa Residential (Phase 1)	Senior Adult Housing - Detached	702	DU
		Passive Parks	21.78	AC
9	PM32692	SFDR	3	DU
10	Oxford Properties Cultivation Center	Nursery (Wholesale)	70.26	AC

<sup>1</sup> SFDR = Single Family Detached Residential

<sup>2</sup> DU = Dwelling Unit; RM = Room; TSF = Thousand Square Feet; AC = Acre

F:\UXRjobs\\_14100-14500\14398\Excel\14398 - Report.xlsx\14398-Cumulative List

This Page Intentionally Left Blank



## 5 EAP (2024) TRAFFIC CONDITIONS

This section discusses the methods used to develop Existing plus Ambient Growth plus Project (EAP) (2024) traffic conditions and the resulting peak hour intersection operations and traffic signal warrant analyses.

### 5.1 ROADWAY IMPROVEMENTS

The lane configurations and traffic controls assumed to be in place for EAP conditions are consistent with those shown previously on Exhibit 3-1, with the exception of the following:

- Project driveways and those facilities assumed to be constructed by the Project to provide site access are also assumed to be in place for EAP conditions only (e.g., intersection and roadway improvements at the Project's frontage and driveways).

### 5.2 EAP (2024) TRAFFIC VOLUME FORECASTS

To account for background traffic growth, an ambient growth from Existing conditions of 4.04% (2 percent per year over 2 years, compounded annually) is included for EAP traffic conditions. Cumulative development projects are not included as part of the EAP analysis. EAP weekday ADT, weekday PM, and weekend peak hour intersection turning movement volumes are shown on Exhibit 5-1.

### 5.3 EAP (2024) INTERSECTION OPERATIONS ANALYSIS

EAP peak hour traffic operations have been evaluated for the study area intersections based on the analysis methodologies presented in Section 2 *Methodologies* of this TA. The intersection analysis results are summarized in Table 5-1, which indicate that the intersection of Little Morongo Road / Dillon Road (#3) and Indian Canyon Drive / 19<sup>th</sup> Avenue (#7) operate at an unacceptable LOS (LOS "E" or worse) for opening year (2024) conditions, with or without the addition of Project traffic. The intersection operations analysis worksheets for EAP traffic conditions is included in Appendix 5.1 of this TA.

### 5.4 EAP (2024) TRAFFIC SIGNAL WARRANTS ANALYSIS

Traffic signal warrants for EAP (2024) traffic conditions are based on estimated peak hour intersection turning volumes for existing intersections and average daily traffic (ADT) volumes for future intersections (see Appendix 3.3). For EAP (2024) traffic conditions, the remaining unsignalized intersections are not anticipated warrant a traffic signal.



## 5.5 RECOMMENDED IMPROVEMENTS

Installation of traffic signals at the off-site deficient locations (Little Morongo Road / Dillon Road - #3 and Indian Canyon Drive / 19th Avenue - #7) address intersection operational deficiencies for opening year (2024) conditions, with or without the addition of Project traffic. The effectiveness of the recommended traffic signal at these locations are presented in Table 5-1 for EAP (2024) traffic conditions. The intersection operations analysis worksheets for EAP (2024) traffic conditions, with traffic signal improvements, are included in Appendix 5.1 of this TA.

### EXHIBIT 5-1: EXISTING PLUS AMBIENT PLUS PROJECT (2024) TRAFFIC VOLUMES

**ON-SITE**

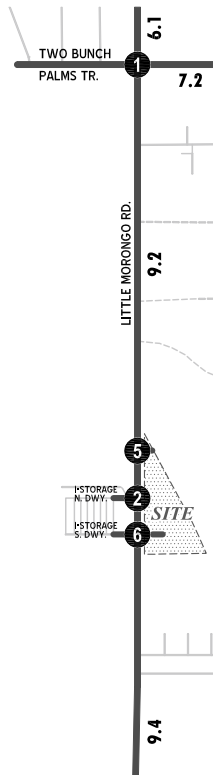
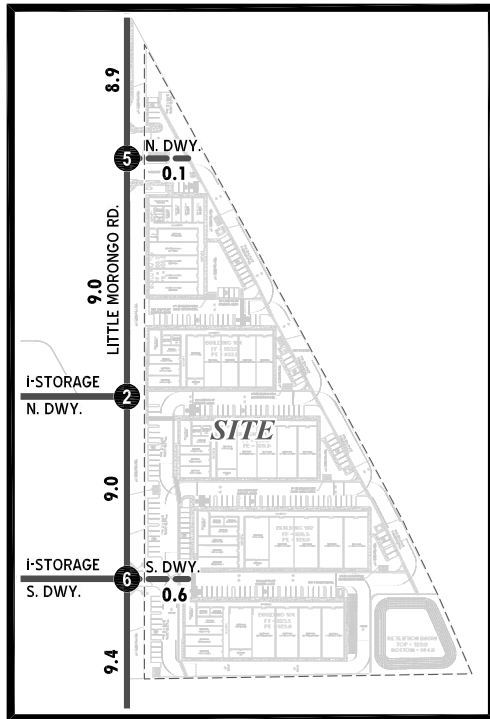

**AM PEAK HOUR**

<p><b>1</b> Little Morongo Rd. &amp; Two Bunch Palms Tr.</p>	<p><b>2</b> Little Morongo Rd. &amp; i-Storage N. Dwy.</p>	<p><b>3</b> Little Morongo Rd. &amp; Dillon Rd.</p>
<p><b>4</b> Indian Cyn. Dr. &amp; Dillon Rd.</p>	<p><b>5</b> Little Morongo Rd. &amp; Project N. Dwy.</p>	<p><b>6</b> Little Morongo Rd. &amp; i-Storage S. Dwy. - Project S. Dwy.</p>
<p><b>7</b> Indian Cyn. Dr. &amp; 19th Av.</p>		

**PM PEAK HOUR**

<p><b>1</b> Little Morongo Rd. &amp; Two Bunch Palms Tr.</p>	<p><b>2</b> Little Morongo Rd. &amp; i-Storage N. Dwy.</p>	<p><b>3</b> Little Morongo Rd. &amp; Dillon Rd.</p>
<p><b>4</b> Indian Cyn. Dr. &amp; Dillon Rd.</p>	<p><b>5</b> Little Morongo Rd. &amp; Project N. Dwy.</p>	<p><b>6</b> Little Morongo Rd. &amp; i-Storage S. Dwy. - Project S. Dwy.</p>
<p><b>7</b> Indian Cyn. Dr. &amp; 19th Av.</p>		

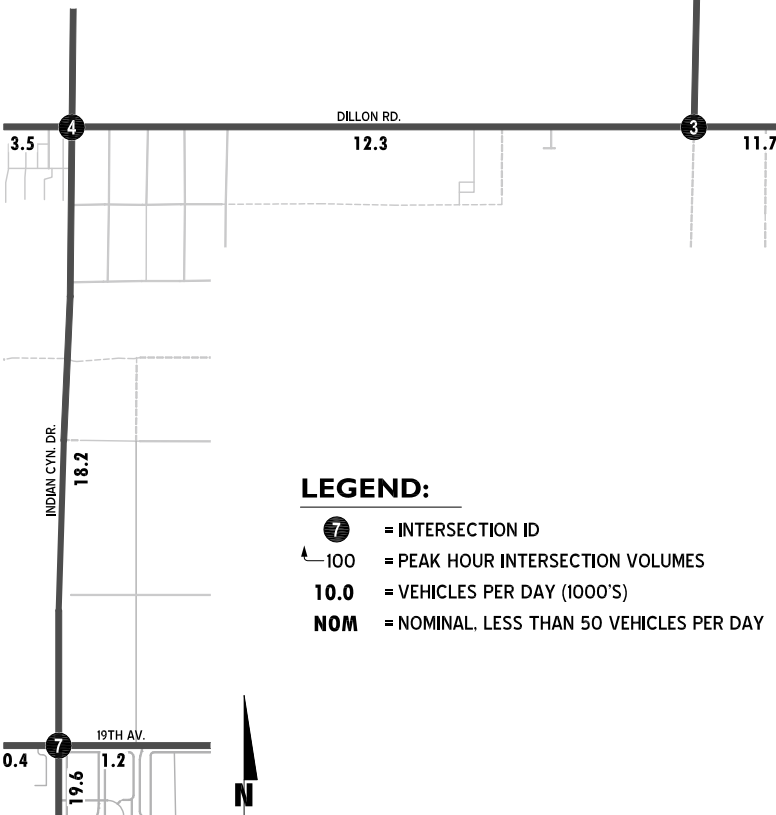

**LEGEND:**

- = INTERSECTION ID
- = PEAK HOUR INTERSECTION VOLUMES
- 10.0** = VEHICLES PER DAY (1000'S)
- NOM** = NOMINAL, LESS THAN 50 VEHICLES PER DAY

**TABLE 5-1: INTERSECTION ANALYSIS FOR EAP (2024) CONDITIONS**

#	Intersection	Traffic Control <sup>3</sup>	Intersection Approach Lanes <sup>1</sup>												Delay <sup>2</sup> (Secs)		Level of Service <sup>2</sup>	
			Northbound			Southbound			Eastbound			Westbound			AM	PM	AM	PM
			L	T	R	L	T	R	L	T	R	L	T	R				
1	Little Morongo Rd. / Two Bunch Palms Tr.	AWS	0	1!	0	0.5	0.5	d	0	1!	0	0.5	0.5	d	16.6	16.6	C	C
2	Little Morongo Rd. / i-Storage N. Dwy.	CSS	0.5	0.5	0	0.5	0.5	d	0.5	0.5	d	0	<u>1!</u>	0	16.4	16.2	C	C
3	Little Morongo Rd. / Dillon Rd. - With Improvements	AWS	0	0	0	0	1!	0	1	1	0	1	1	0	<b>47.3</b>	<b>37.0</b>	<b>E</b>	<b>E</b>
		<u>TS</u>	0	0	0	0	1!	0	1	1	0	1	1	0	23.6	20.8	C	C
4	Indian Cyn. Dr. / Dillon Rd.	TS	1	2	0	1	2	0	1	2	0	1	2	1	30.0	23.4	C	C
5	Little Morongo Rd. / N. Dwy.	<u>CSS</u>	0	1	0	0.5	0.5	0	0	0	0	0	<u>1!</u>	0	16.1	14.8	C	B
6	Little Morongo Rd. / i-Storage Dwy. - S. Dwy.	CSS	0	1!	0	0.5	0.5	d	0	1!	0	0	<u>1!</u>	0	17.6	19.5	C	C
7	Indian Cyn. Dr. / 19th Av. - With Improvements	CSS	1	2	0	1*	2	0	0	1!	0	0	1!	0	<b>38.1</b>	<b>&gt;80</b>	<b>E</b>	<b>F</b>
		<u>TS</u>	1	2	0	1	2	0	0	1!	0	0	1!	0	3.1	4.4	A	A

<sup>1</sup> When a right turn is designated, the lane can either be striped or unstriped. To function as a right turn lane there must be sufficient width for right turning vehicles to travel outside the through lanes.

L = Left; T = Through; R = Right; 1! = Shared Left/Through/Right Lane; 0.5 = Shared Lane; d = Defacto Right Turn Lane;

\* = Turn lane accommodated within two-way left-turn lane (TWLTL); 1 = Improvement

<sup>2</sup> Per the Highway Capacity Manual 6th Edition (HCM6), overall average intersection delay and level of service are shown for intersections with a traffic signal or all way stop control. For intersections with cross street stop control, the delay and level of service for the worst individual movement (or movements sharing a single lane) are shown.

Delay and level of service is calculated using Synchro 11 analysis software.

**BOLD** = LOS does not meet the applicable jurisdictional requirements (i.e., unacceptable LOS).

<sup>3</sup> AWS = All Way Stop; CSS = Cross-Street Stop; TS = Traffic Signal

## 6 EAPC (2024) TRAFFIC CONDITIONS

This section discusses the methods used to develop Existing plus Ambient Growth plus Project plus Cumulative (EAPC) (2024) traffic conditions and the resulting peak hour intersection operations and traffic signal warrant analyses.

### 6.1 ROADWAY IMPROVEMENTS

The lane configurations and traffic controls assumed to be in place for EAPC conditions are consistent with those shown previously on Exhibit 3-1, with the exception of the following:

- Project driveways and those facilities assumed to be constructed by the Project to provide site access are also assumed to be in place for EAPC conditions only (e.g., intersection and roadway improvements at the Project's frontage and driveways).
- Driveways and those facilities assumed to be constructed by cumulative developments to provide site access are also assumed to be in place for EAPC conditions only (e.g., intersection and roadway improvements along the cumulative development's frontages and driveways).

### 6.2 EAPC (2024) TRAFFIC VOLUME FORECASTS

To account for background traffic, other known cumulative development projects in the study area were included in addition to 4.04% of ambient growth for EAPC traffic conditions in conjunction with traffic associated with the proposed Project. EAPC weekday ADT, weekday PM, and weekend peak hour intersection turning movement volumes are shown on Exhibit 6-1.

### 6.3 EAPC (2024) INTERSECTION OPERATIONS ANALYSIS

EAPC peak hour traffic operations have been evaluated for the study area intersections based on the analysis methodologies presented in Section 2 *Methodologies* of this TA. The intersection analysis results are summarized in Table 6-1, which indicate that the study area intersections of Little Morongo Road / Dillon Road (#3) and Indian Canyon Drive / 19th Avenue (#7) operate at an unacceptable LOS (LOS "E" or worse) under EAPC conditions. The intersection operations analysis worksheets for EAPC traffic conditions is included in Appendix 6.1 of this TA.

### 6.4 EAPC (2024) TRAFFIC SIGNAL WARRANTS ANALYSIS

Traffic signal warrants for EAPC (2024) traffic conditions are based on estimated peak hour intersection turning volumes for existing intersections and average daily traffic (ADT) volumes for future intersections (see Appendix 3.3). For EAPC (2024) traffic conditions, the remaining unsignalized intersections are not anticipated warrant a traffic signal.

## 6.5 RECOMMENDED IMPROVEMENTS

Installation of traffic signals at the off-site deficient locations (Little Morongo Road / Dillon Road - #3 and Indian Canyon Drive / 19th Avenue - #7) address intersection operational deficiencies for opening year (2024) conditions, with or without the addition of Project traffic. The effectiveness of the traffic signal at these locations are presented in Table 6-1 for EAPC (2024) traffic conditions. The intersection operations analysis worksheets for EAPC (2024) traffic conditions, with traffic signal improvements, are included in Appendix 6.1 of this TA.

Fair share financial contribution based on the Project's estimated peak hour volumes (as shown previously in Table 1-2) at these locations may be imposed at the discretion of the City of Desert Hot Springs:

### ***#3 – Little Morongo Road / Dillon Road***

- Improvement: Install traffic signal
- Fair Share: 17.9%.

### ***#7 – Indian Canyon Drive / 19th Avenue***

- Improvement: Install traffic signal
- Fair Share: 4.3%.

## EXHIBIT 6-1: EXISTING PLUS AMBIENT PLUS PROJECT PLUS CUMULATIVE (2024) TRAFFIC VOLUMES

### ON-SITE

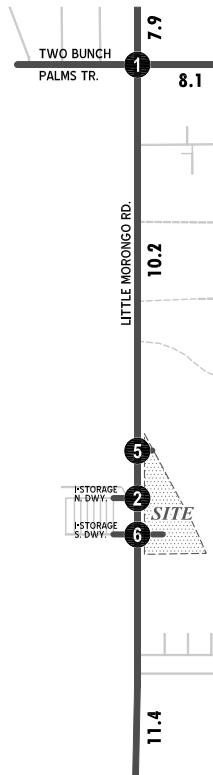
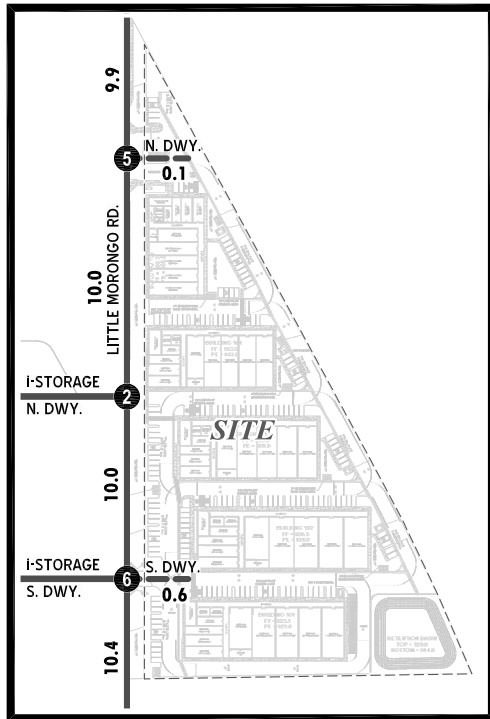

### AM PEAK HOUR

1 Little Morongo Rd. & Two Bunch Palms Tr.	2 Little Morongo Rd. & i-Storage N. Dwy.	3 Little Morongo Rd. & Dillon Rd.
4 Indian Cyn. Dr. & Dillon Rd.	5 Little Morongo Rd. & Project N. Dwy.	6 Little Morongo Rd. & i-Storage S. Dwy. - Project S. Dwy.
7 Indian Cyn. Dr. & 19th Av.		

### PM PEAK HOUR

1 Little Morongo Rd. & Two Bunch Palms Tr.	2 Little Morongo Rd. & i-Storage N. Dwy.	3 Little Morongo Rd. & Dillon Rd.
4 Indian Cyn. Dr. & Dillon Rd.	5 Little Morongo Rd. & Project N. Dwy.	6 Little Morongo Rd. & i-Storage S. Dwy. - Project S. Dwy.
7 Indian Cyn. Dr. & 19th Av.		

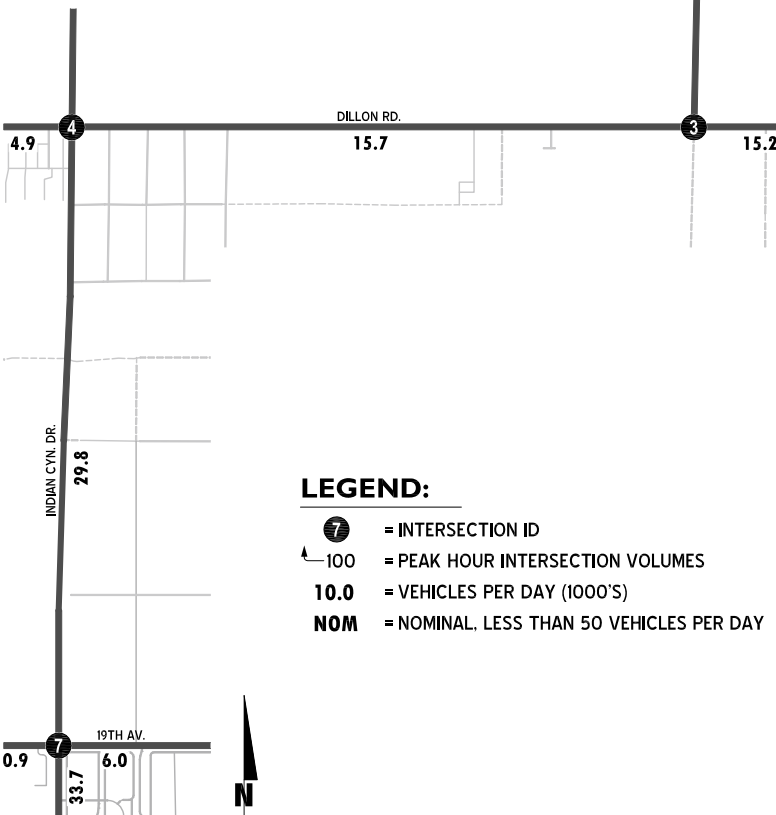

### LEGEND:

- = INTERSECTION ID
- = PEAK HOUR INTERSECTION VOLUMES
- 10.0** = VEHICLES PER DAY (1000'S)
- NOM** = NOMINAL, LESS THAN 50 VEHICLES PER DAY

**TABLE 6-1: INTERSECTION ANALYSIS FOR EAPC (2024) CONDITIONS**

#	Intersection	Traffic Control <sup>3</sup>	Intersection Approach Lanes <sup>1</sup>												Delay <sup>2</sup> (Secs)		Level of Service <sup>2</sup>	
			Northbound			Southbound			Eastbound			Westbound			AM	PM	AM	PM
			L	T	R	L	T	R	L	T	R	L	T	R				
1	Little Morongo Rd. / Two Bunch Palms Tr.	AWS	0	1!	0	0.5	0.5	d	0	1!	0	0.5	0.5	d	22.5	23.0	C	C
2	Little Morongo Rd. / i-Storage N. Dwy.	CSS	0.5	0.5	0	0.5	0.5	d	0.5	0.5	d	0	<u>1!</u>	0	17.5	17.9	C	C
3	Little Morongo Rd. / Dillon Rd. - With Improvements	AWS	0	0	0	0	1!	0	1	1	0	1	1	0	>80	>80	F	F
		<u>TS</u>	0	0	0	0	1!	0	1	1	0	1	1	0	46.2	50.0	D	D
4	Indian Cyn. Dr. / Dillon Rd.	TS	1	2	0	1	2	0	1	2	0	1	2	1	37.4	31.4	D	C
5	Little Morongo Rd. / N. Dwy.	<u>CSS</u>	0	1	0	0.5	0.5	0	0	0	0	0	<u>1!</u>	0	17.2	16.2	C	C
6	Little Morongo Rd. / i-Storage Dwy. - S. Dwy.	CSS	0	1!	0	0.5	0.5	d	0	1!	0	0	<u>1!</u>	0	18.9	22.4	C	C
7	Indian Cyn. Dr. / 19th Av. - With Improvements	CSS	1	2	0	1*	2	0	0	1!	0	0	1!	0	>80	>80	F	F
		<u>TS</u>	1	2	0	1	2	0	0	1!	0	0	1!	0	5.5	15.2	A	B

<sup>1</sup> When a right turn is designated, the lane can either be striped or unstriped. To function as a right turn lane there must be sufficient width for right turning vehicles to travel outside the through lanes.

L = Left; T = Through; R = Right; 1! = Shared Left/Through/Right Lane; 0.5 = Shared Lane; d = Defacto Right Turn Lane;

\* = Turn lane accommodated within two-way left-turn lane (TWLTL); 1 = Improvement

<sup>2</sup> Per the Highway Capacity Manual 6th Edition (HCM6), overall average intersection delay and level of service are shown for intersections with a traffic signal or all way stop control.

For intersections with cross street stop control, the delay and level of service for the worst individual movement (or movements sharing a single lane) are shown.

Delay and level of service is calculated using Synchro 11 analysis software.

**BOLD** = LOS does not meet the applicable jurisdictional requirements (i.e., unacceptable LOS).

<sup>3</sup> AWS = All Way Stop; CSS = Cross-Street Stop; TS = Traffic Signal

## 7 REFERENCES

1. **Riverside County Transportation Department.** *Transportation Analysis Guidelines for Level of Service & Vehicle Miles Traveled.* County of Riverside : s.n., December 2020.
2. **Institute of Transportation Engineers.** *Trip Generation Manual.* 11th Edition, 2021.
3. **Transportation Research Board.** *Highway Capacity Manual (HCM), 6th Edition.* s.l. : National Academy of Sciences, 2016.
4. **California Department of Transportation.** *California Manual on Uniform Traffic Control Devices (MUTCD).* [book auth.] California Department of Transportation. *California Manual on Uniform Traffic Control Devices (CAMUTCD).* 2014.



This Page Intentionally Left Blank

**APPENDIX 1.1:**

**APPROVED TRAFFIC STUDY SCOPING AGREEMENT**

*This Page Intentionally Left Blank*

March 17, 2022

Jilleen Ferris  
City of Desert Hot Springs  
65-950 Pierson Blvd.  
Desert Hot Springs, CA 92240

**SUBJECT: DHS LIGHT INDUSTRIAL WITH CANNABIS OVERLAY, LOS ANALYSIS AND VMT SCREENING  
SCOPING AGREEMENT**

Dear Jilleen Ferris:

Urban Crossroads, Inc. is pleased to resubmit this scoping letter to City of Desert Hot Springs regarding the Level of Service (LOS) Analysis and VMT Screening for the proposed DHS Light Industrial with Cannabis Overlay development (“Project”), which is located east side of Little Morongo Road, north of Dillon Road in the City of Desert Hot Springs. It is our understanding that the Project is to consist of approximately 116,000 square feet of light industrial buildings for the research, development, and cultivation of medical-grade cannabis.

The remainder of this letter describes the proposed analysis methodology, Project trip generation, trip distribution, and Project traffic assignment/project trips on the surrounding roadway network. The following scoping assumptions have been prepared in accordance with the County of Riverside’s Transportation Analysis Guidelines for Level of Service & Vehicle Miles Traveled (December 2020) as the City of Desert Hot Springs utilizes the County guidelines.

A preliminary site plan for the proposed Project is shown on Exhibit 1. Exhibit 2 depicts the location of the proposed project in relation to the existing roadway network. It is anticipated that the Project would be fully developed by year 2024. Project will have two gated full-access driveways along the Little Morongo Road.

## **TRIP GENERATION**

In order to develop the traffic characteristics of the proposed project, trip-generation statistics published in the Institute of Transportation Engineers (ITE) *Trip Generation* (11<sup>th</sup> Edition, 2021) manual for the proposed land use (190 - Marijuana Cultivation and Processing Facility) is used. Table 1 presents the trip generation rates and the resulting trip generation summary for the proposed Project. As shown in Table 1, the Project is anticipated to generate a total of 705 trip-ends per day with 80 AM peak hour trips and 74 PM peak hour trips.

**TABLE 1: PROJECT TRIP GENERATION SUMMARY**

Trip Generation Rates <sup>1</sup>									
Land Use	ITE LU Code	Quantity <sup>2</sup>	AM Peak Hour			PM Peak Hour			Daily
			In	Out	Total	In	Out	Total	
Marijuana Cultivation and Processing Facility	190	116 TSF	0.64	0.05	0.69	0.18	0.46	0.64	6.08

Trip Generation Results									
Land Use	ITE LU Code	Quantity <sup>2</sup>	AM Peak Hour			PM Peak Hour			Daily
			In	Out	Total	In	Out	Total	
Marijuana Cultivation and Processing Facility	190	116 TSF	74	6	80	21	53	74	705

<sup>1</sup> Trip Generation Source: Institute of Transportation Engineers (ITE), Trip Generation Manual, 11th Edition (2021).

<sup>2</sup> TSF = Thousand Square Feet

## TRIP DISTRIBUTION AND TRIP ASSIGNMENT

The trip distribution pattern is heavily influenced by the geographical location of the site, the location of surrounding uses, and the proximity to the regional freeway system. Exhibit 3 presents the Project distribution patterns. Based on the identified Project traffic generation and trip distribution patterns, Project ADT and peak hour intersection turning movement volumes are shown on Exhibit 4.

## ANALYSIS SCENARIOS

Consistent with the County’s LOS guidelines, intersection analysis will be provided for the following analysis scenarios:

- Existing (2022) Conditions
- Existing plus Ambient plus Project (EAP) (2024)
- Existing plus Ambient plus Project plus Cumulative (EAPC) (2024)

The City of Desert Hot Springs General Plan Circulation Element is depicted on Exhibit 5, while the accompanying roadway cross-sections are presented on Exhibit 6.

## STUDY AREA

The traffic impact study area was defined in conformance with the requirements of County of Riverside’s Transportation Analysis Guidelines for Level of Service & Vehicle Miles Traveled. Consistent with the County’s LOS guidelines, study area intersections have been identified for the Project based on the contribution of 50 or more peak hour trips. Based on this criterion, anticipated trip generation and trip distribution, the following intersections will be evaluated:

ID	Intersection Location	ID	Intersection Location
1	Little Morongo Road / Two Bunch Palms Trail	5	Little Morongo Road / Project N. Dwy.
2	Little Morongo Road / i-Storage N. Dwy.	6	Little Morongo Road / i-Storage S. Dwy. - Project S. Dwy.
3	Little Morongo Road / Dillon Road	7	Indian Canyon Dr. / 19th Avenue
4	Indian Canyon Dr. / Dillon Road.		

Exhibit 2 identifies the proposed study area intersection analysis locations.

### **LEVEL OF SERVICE (LOS) CRITERIA**

Per the City of Desert Hot Springs’s General Plan, LOS D as the threshold for acceptable traffic conditions on the circulation network.

### **PREFERRED ANALYSIS METHODOLOGY**

For the purposes of this analysis, signalized intersection operations analysis will be based on the methodology described in the Highway Capacity Manual (6<sup>th</sup> Edition). Intersection LOS operations are based on an intersection’s average control delay. Unsignalized intersections will be evaluated using the methodology described in the HCM 6<sup>th</sup> Edition. At two-way or side-street stop-controlled intersections, LOS is calculated for each controlled movement and for the left turn movement from the major street, as well as for the intersection as a whole. For approaches composed of a single lane, the delay is computed as the average of all movements in that lane.

### **TRAFFIC COUNTS**

Traffic count data will be collected in March during the AM peak period of 7:00 AM to 9:00 AM and PM peak period of 4:00 PM to 6:00 PM.

### **CUMULATIVE DEVELOPMENT TRAFFIC**

It is requested that City staff review the list of cumulative development projects (shown on Exhibit 7 and listed on Table 2) for inclusion in the traffic study. Consistent with other studies performed in the area, an ambient growth rate of 2% per year will be utilized as a minimum if necessary. The rate will be compounded over a 2-year period (i.e.,  $1.02^{2\text{years}} = 1.0404$  or 4.04%) for Interim Year (2024) conditions.

### **VEHICLE MILES TRAVELED (VMT) SCREENING**

The VMT screening assessment will be prepared under separate cover. The California Environmental Quality Act (CEQA) procedures for determination of transportation impacts have recently changed to an evaluation of Vehicle Miles Traveled (VMT) rather than vehicle delay or level of service, due to Senate Bill 743 (SB 743). County of Riverside VMT screening guidelines will be applied to the project.

Jilleen Ferris  
City of Desert Hot Springs  
March 17, 2022  
Page 4

Please review this scoping agreement let us know if it is acceptable, or if the City requests any changes to this proposed scope of work. If you have any questions, please contact John Kain at (949) 375-2435 or Marlie Whiteman (714) 585-0574.

Respectfully submitted,

URBAN CROSSROADS, INC.



John Kain, AICP  
Principal



Marlie Whiteman, PE  
Senior Associate

### EXHIBIT 1: PRELIMINARY SITE PLAN

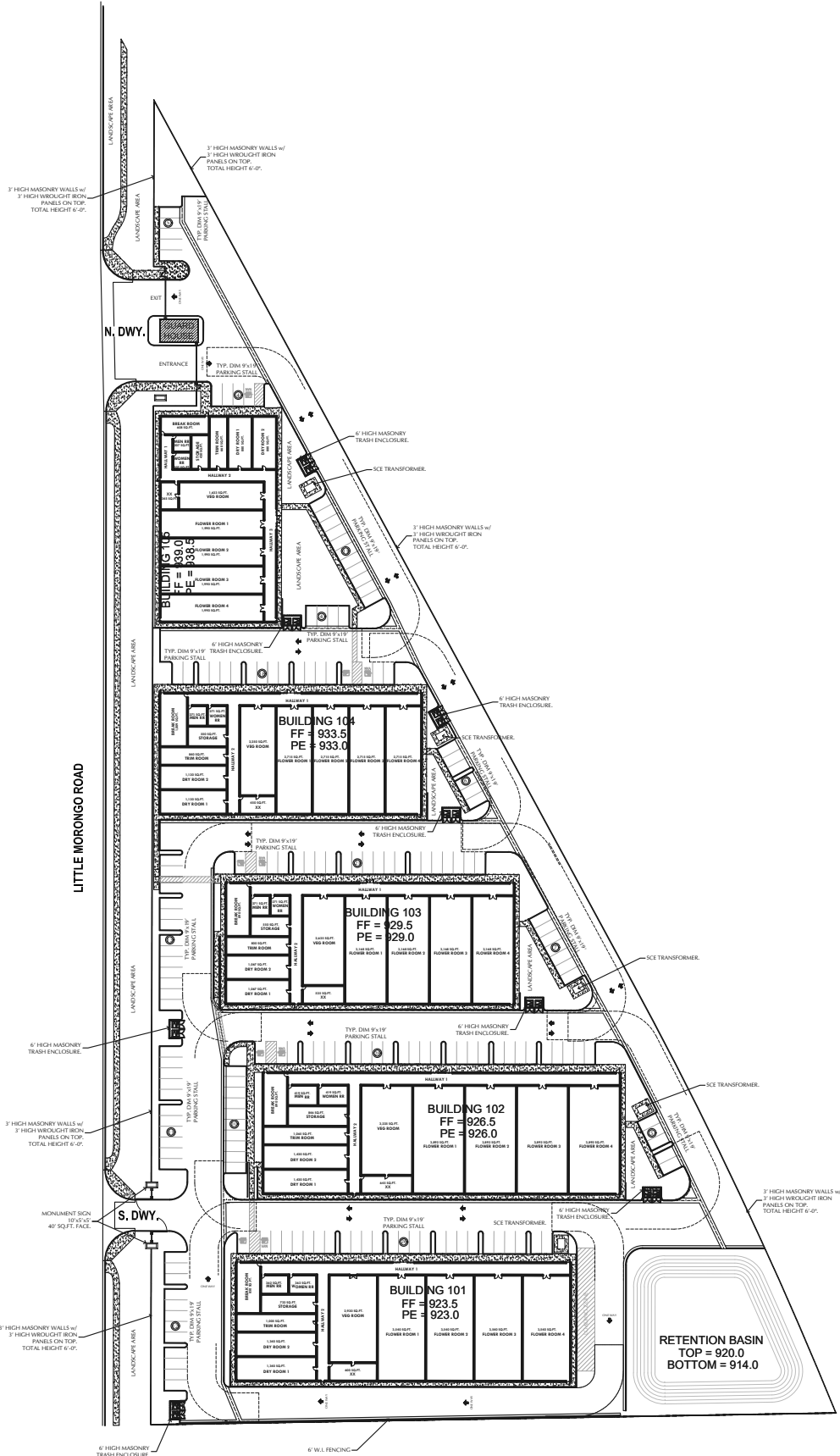



**EXHIBIT 2: TRAFFIC ANALYSIS STUDY AREA**

**ON-SITE**

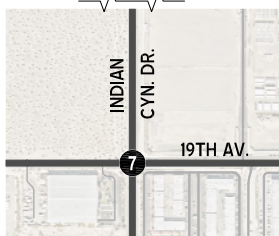
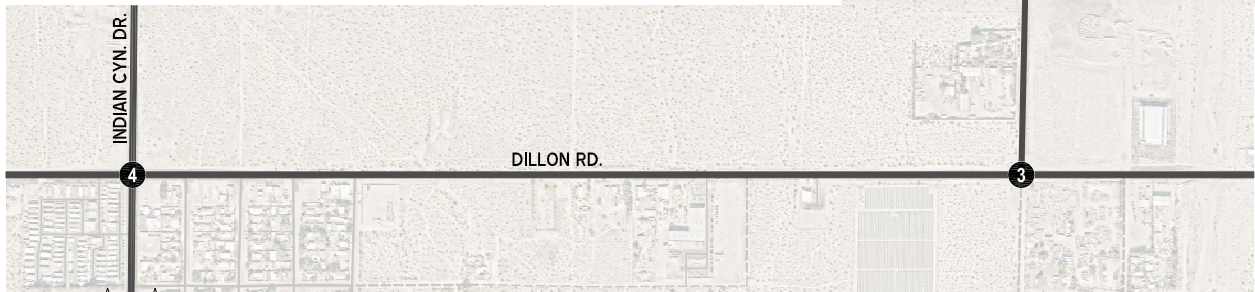
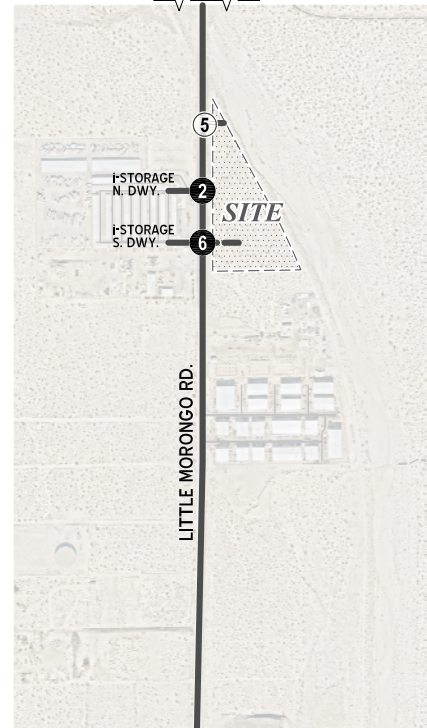
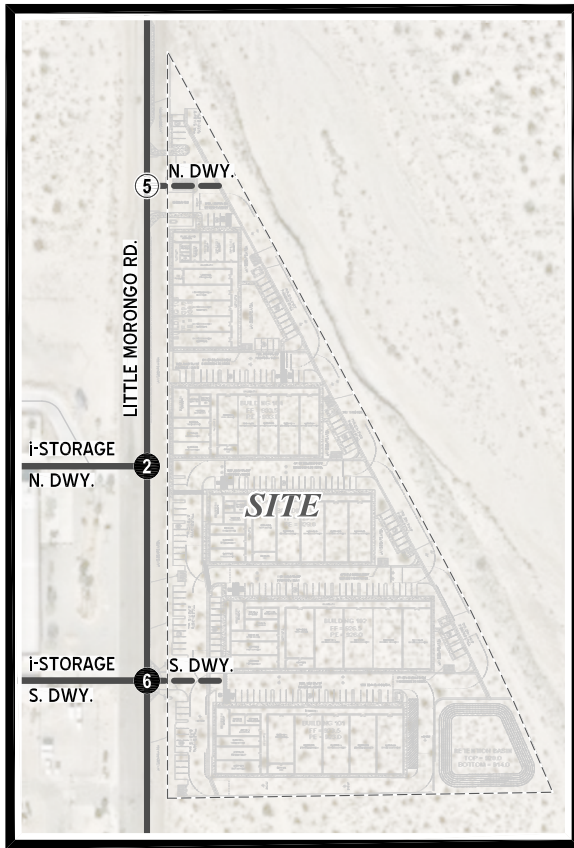

**LEGEND:**

- ⑥ = EXISTING ANALYSIS LOCATION
- ① = FUTURE ANALYSIS LOCATION
- = FUTURE ROADWAY



**EXHIBIT 3: PROJECT TRIP DISTRIBUTION (OUTBOUND)**

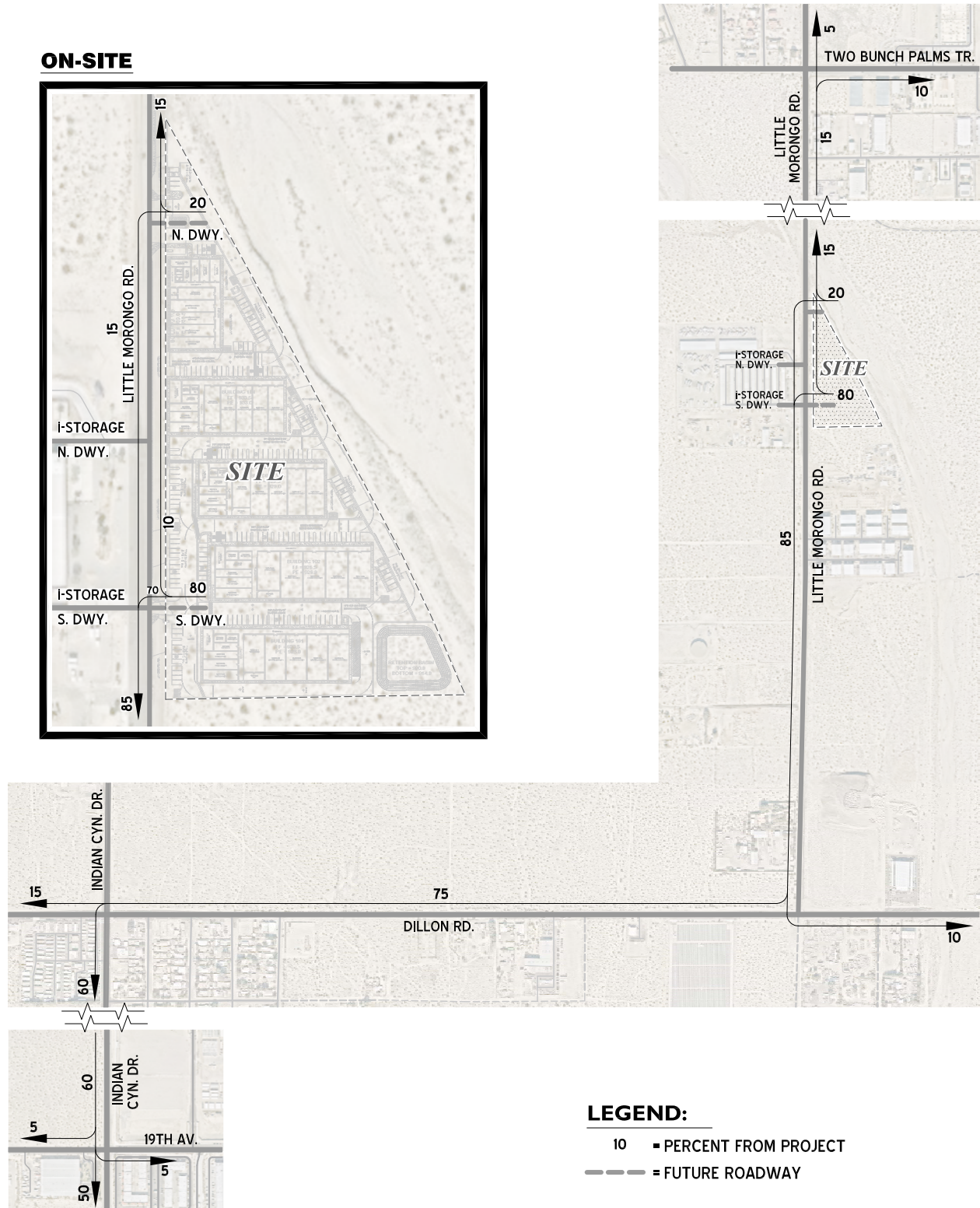
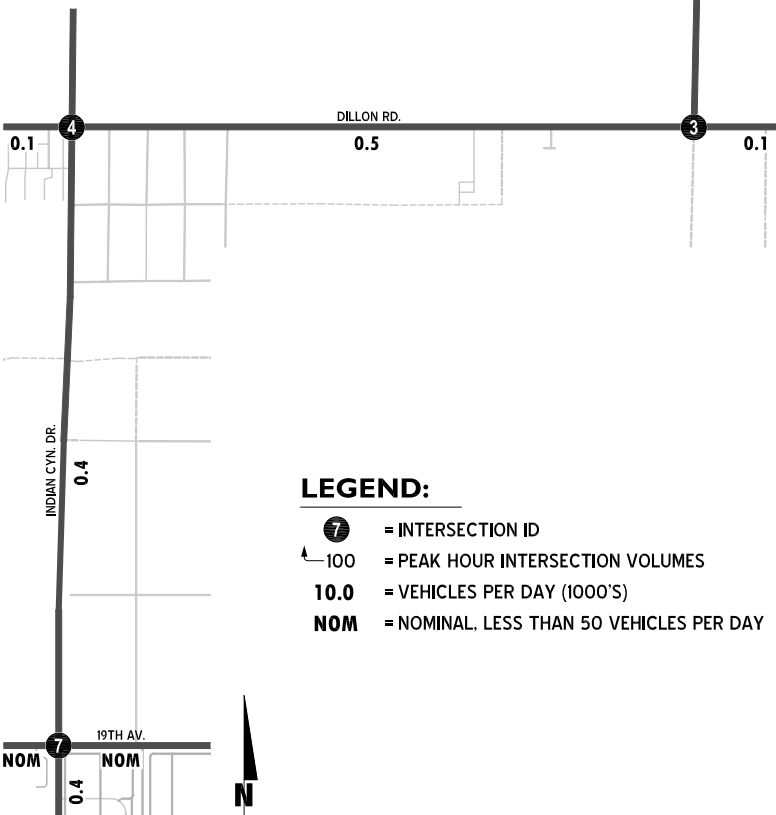
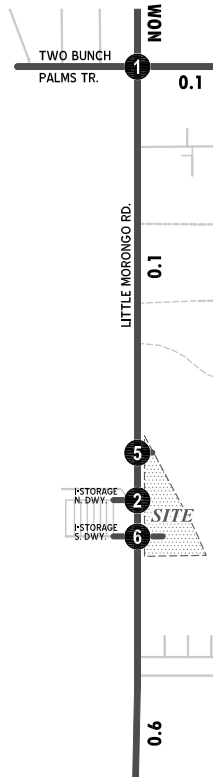
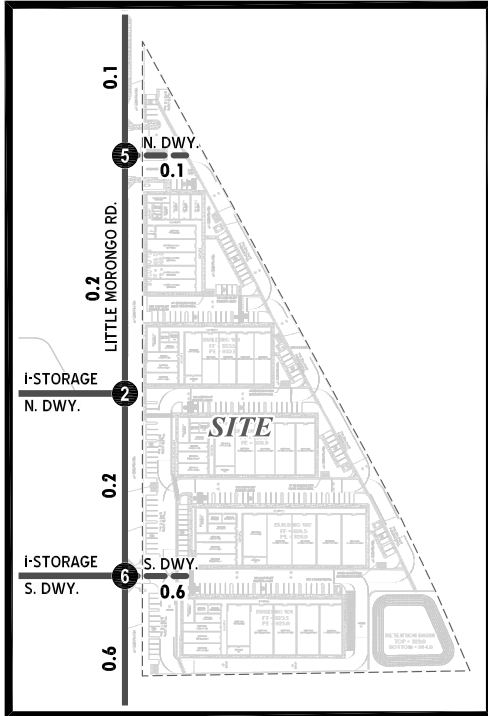

EXHIBIT 4: PROJECT ONLY TRAFFIC VOLUMES

ON-SITE



LEGEND:

- 7** = INTERSECTION ID
- 100** = PEAK HOUR INTERSECTION VOLUMES
- 10.0** = VEHICLES PER DAY (1000'S)
- NOM** = NOMINAL, LESS THAN 50 VEHICLES PER DAY

AM PEAK HOUR

<p><b>1</b> Little Morongo Rd. &amp; Two Bunch Palms Tr.</p>	<p><b>2</b> Little Morongo Rd. &amp; I-Storage N. Dwy.</p>	<p><b>3</b> Little Morongo Rd. &amp; Dillon Rd.</p>
<p><b>4</b> Indian Cyn. Dr. &amp; Dillon Rd.</p>	<p><b>5</b> Little Morongo Rd. &amp; Project N. Dwy.</p>	<p><b>6</b> Little Morongo Rd. &amp; I-Storage S. Dwy. - Project S. Dwy.</p>
<p><b>7</b> Indian Cyn. Dr. &amp; 19th Av.</p>		

PM PEAK HOUR

<p><b>1</b> Little Morongo Rd. &amp; Two Bunch Palms Tr.</p>	<p><b>2</b> Little Morongo Rd. &amp; I-Storage N. Dwy.</p>	<p><b>3</b> Little Morongo Rd. &amp; Dillon Rd.</p>
<p><b>4</b> Indian Cyn. Dr. &amp; Dillon Rd.</p>	<p><b>5</b> Little Morongo Rd. &amp; Project N. Dwy.</p>	<p><b>6</b> Little Morongo Rd. &amp; I-Storage S. Dwy. - Project S. Dwy.</p>
<p><b>7</b> Indian Cyn. Dr. &amp; 19th Av.</p>		



### EXHIBIT 5: CITY OF DESERT HOT SPRINGS ROADWAYS PLAN

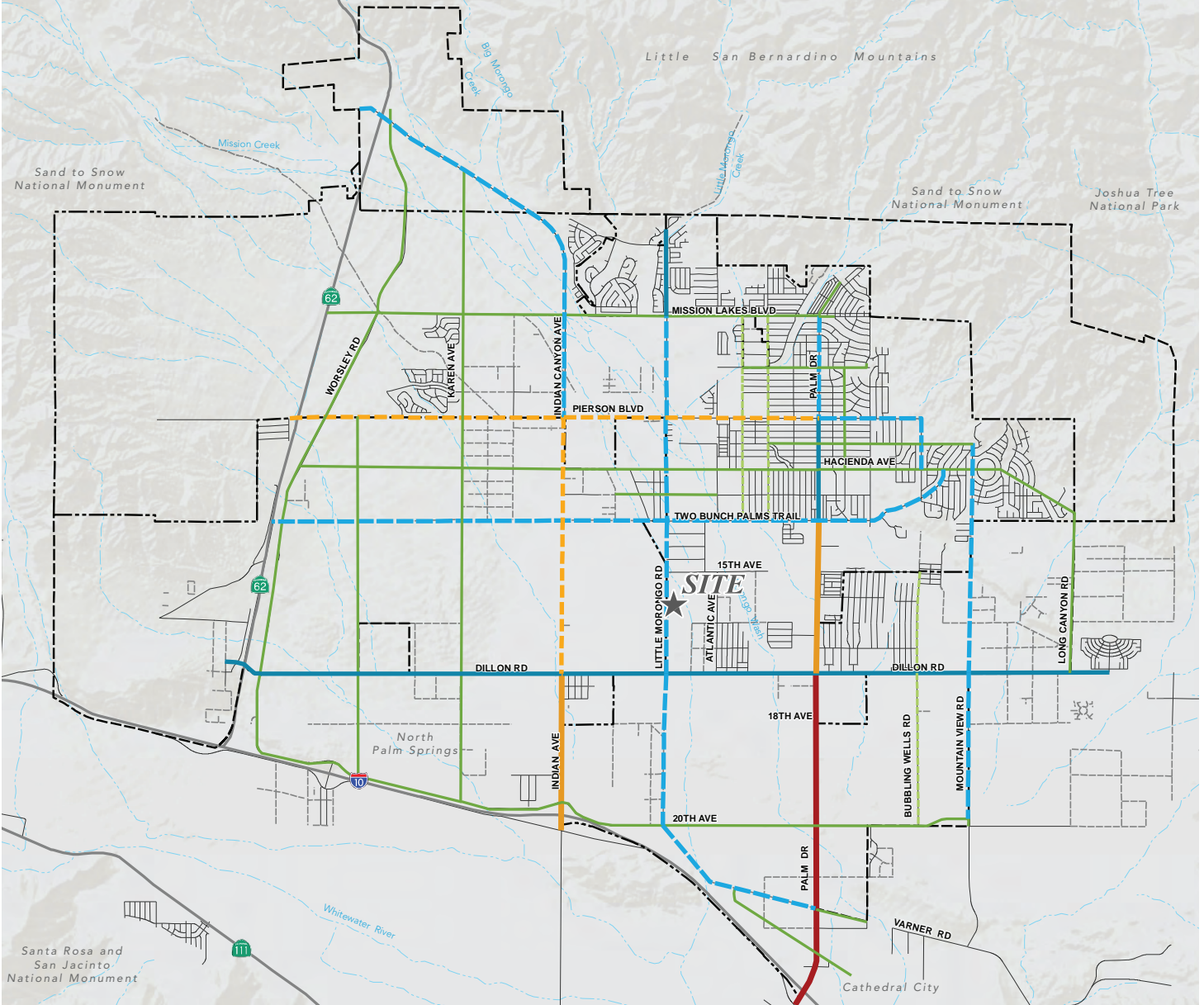

SOURCE: CITY OF DESERT HOT SPRINGS GENERAL PLAN (MAY 2020)

**Road Classifications**

- Urban Arterial
- Primary I
- - - Primary II
- Secondary I
- - - Secondary II
- Collector
- - - Local Collector

**Base Map Features**

- City Boundary
- Sphere of Influence
- Water Courses



### EXHIBIT 6: CITY OF DESERT HOT SPRINGS GENERAL PLAN ROADWAY CROSS-SECTIONS

**Urban Arterial**

8-Lanes Divided  
No Parking  
With Protected Bike Lane

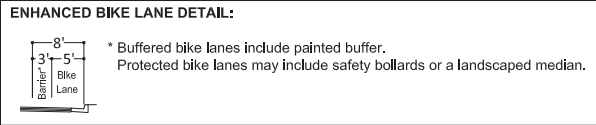
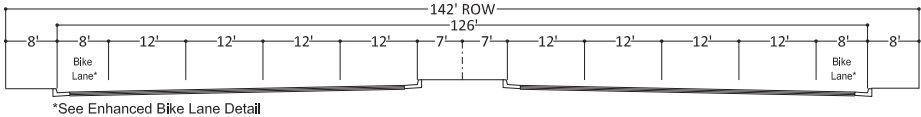

**Primary I**

6-Lanes Divided  
No Parking  
With or Without Protected Bike Lane

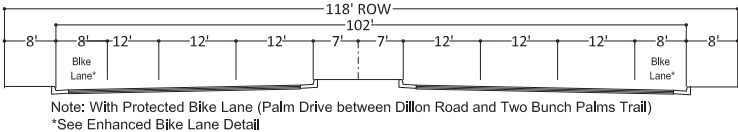
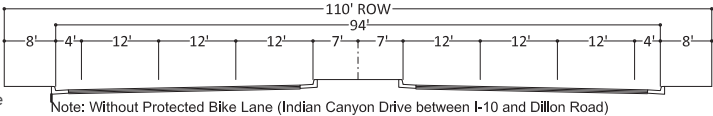

**Primary II**

4-Lanes Divided  
No Parking  
With or Without Protected Bike Lane

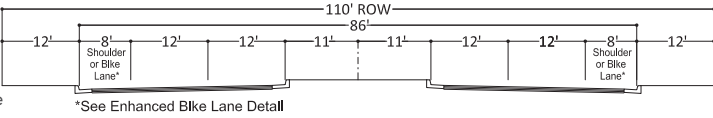

**Secondary I**

4-Lanes Divided  
No Parking  
With Protected Bike Lane

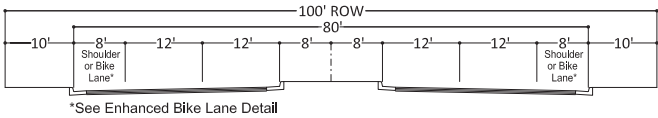

**Secondary II**

4-Lanes Undivided  
On-Street Parking  
With or Without Dedicated Bike Lane

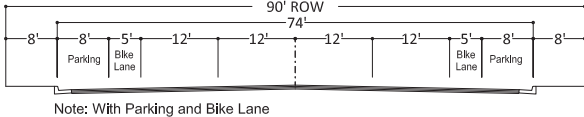
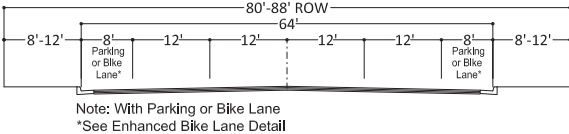

**Collector**

2-Lanes Undivided  
On-Street Parking  
With or Without Dedicated Bike Lane

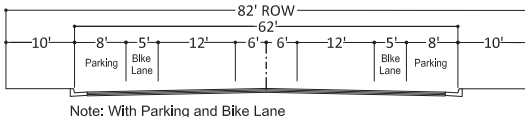
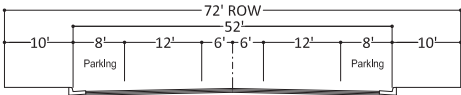

**Local Collector**

2-Lanes Undivided  
On-Street Parking  
With or Without Dedicated Bike Lane

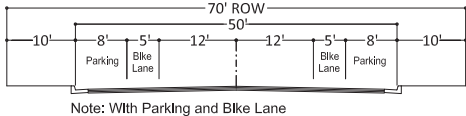
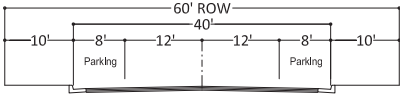

SOURCE: CITY OF DESERT HOT SPRINGS GENERAL PLAN (MAY 2020)



### EXHIBIT 7: CUMULATIVE DEVELOPMENT LOCATION MAP

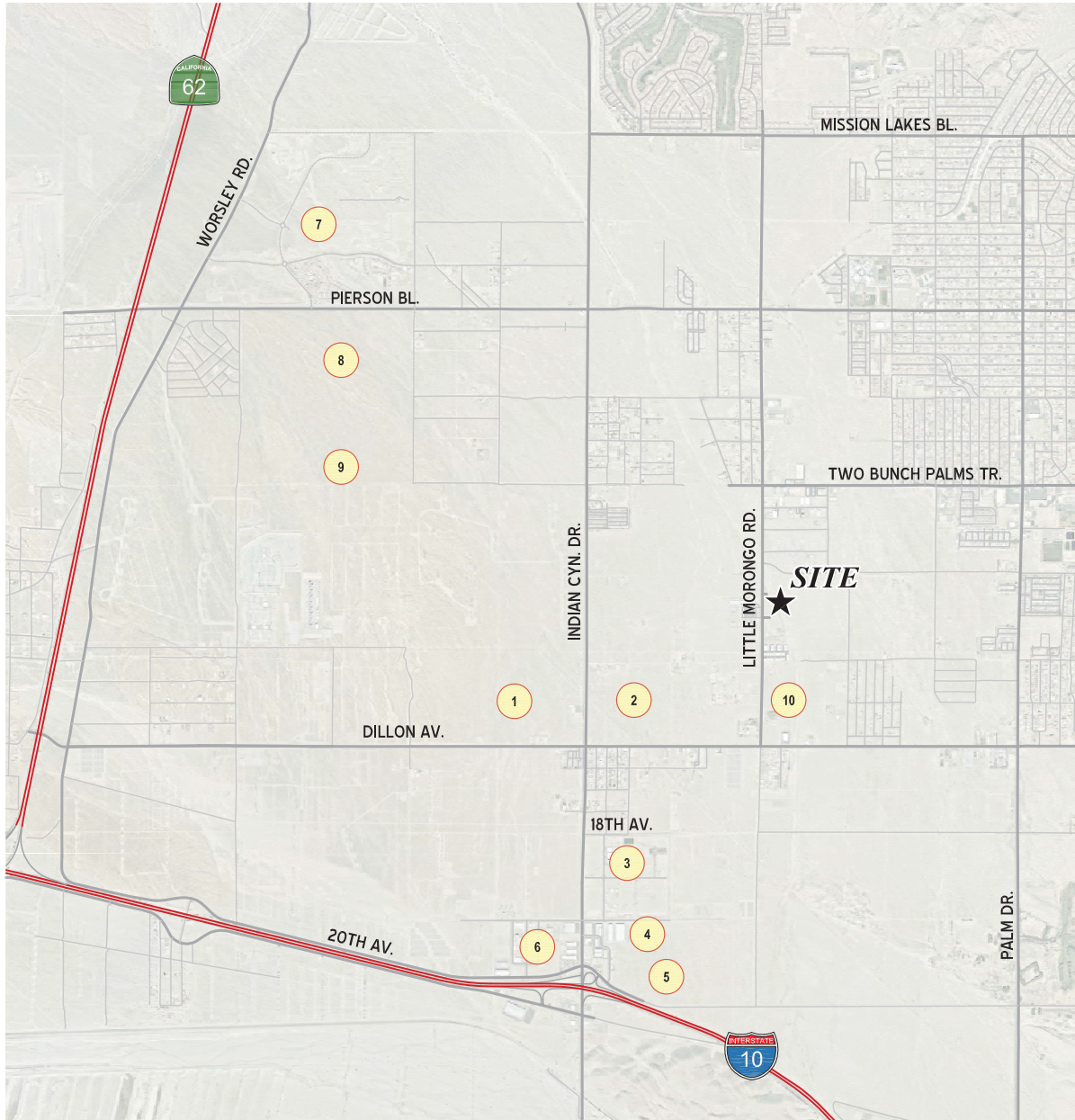

**LEGEND:**

# = CUMULATIVE DEVELOPMENT ID



**TABLE 2: CUMULATIVE DEVELOPMENT LAND USE SUMMARY**

ID	Project Name	Land Use <sup>1</sup>	Quantity	Units <sup>2</sup>
1	Angel View Salvage & Recycling Facility	Gen. Light Industrial	13.650	TSF
		Factory Outlet Center	9.000	TSF
		General Office	3.600	TSF
2	Cultivation Center	Nursery (Wholesale)	38.00	AC
3	The Desert Commerce Center	High-Cube Warehouse	2,952.000	TSF
4	Blackstar Industrial Properties	Business Park	621.920	TSF
5	Indian Cyn. Dr. / I-10 Retail & Cultivation	Nursery (Cultivation/Greenhouse)	57.100	AC
		Specialty Retail Center	59.000	TSF
		Dispensary w/Drive-Thru window	9.000	TSF
6	Palm Springs Business Park	Business Park	37.874	TSF
7	Skyborne Active Adult Community at Stoneridge	Senior Adult Housing - Detached	1,141	DU
		SFDR	801	DU
		Clubhouse	5.000	TSF
8	Vista Rosa Residential (Phase 1)	Senior Adult Housing - Detached	702	DU
		Passive Parks	21.78	AC
9	PM32692	SFDR	3	DU
10	Oxford Properties Cultivation Center	Nursery (Wholesale)	70.26	AC

<sup>1</sup> SFDR = Single Family Detached Residential

<sup>2</sup> DU = Dwelling Unit; RM = Room; TSF = Thousand Square Feet; AC = Acre

F:\UXRjobs\14100-14500\14398\Excel\14398 - Scope.xlsx\14398-Cumulative List

**APPENDIX 3.1:**  
**EXISTING TRAFFIC COUNTS – (2022)**



*This Page Intentionally Left Blank*

City of Desert Hot Springs  
 N/S: Little Morongo Road  
 E/W: Two Bunch Palms Trail  
 Weather: Clear

File Name : 01\_DHS\_LM\_TBP AM  
 Site Code : 05122266  
 Start Date : 3/29/2022  
 Page No : 1

Groups Printed- Total Volume

Start Time	Little Morongo Road Southbound				Two Bunch Palms Trail Westbound				Little Morongo Road Northbound				Two Bunch Palms Trail Eastbound				Int. Total
	Left	Thru	Right	App. Total	Left	Thru	Right	App. Total	Left	Thru	Right	App. Total	Left	Thru	Right	App. Total	
07:00 AM	12	51	0	63	57	3	8	68	0	18	23	41	1	1	2	4	176
07:15 AM	20	75	0	95	67	0	10	77	2	21	17	40	1	4	5	10	222
07:30 AM	16	42	0	58	57	3	10	70	0	34	29	63	0	1	3	4	195
07:45 AM	28	56	0	84	47	1	16	64	1	47	37	85	1	0	1	2	235
Total	76	224	0	300	228	7	44	279	3	120	106	229	3	6	11	20	828
08:00 AM	22	43	1	66	43	0	10	53	0	24	28	52	1	4	2	7	178
08:15 AM	17	37	0	54	45	3	14	62	0	12	33	45	0	3	2	5	166
08:30 AM	20	36	1	57	63	3	12	78	1	25	33	59	1	2	3	6	200
08:45 AM	13	27	1	41	28	0	13	41	0	15	26	41	1	0	0	1	124
Total	72	143	3	218	179	6	49	234	1	76	120	197	3	9	7	19	668
Grand Total	148	367	3	518	407	13	93	513	4	196	226	426	6	15	18	39	1496
Apprch %	28.6	70.8	0.6		79.3	2.5	18.1		0.9	46	53.1		15.4	38.5	46.2		
Total %	9.9	24.5	0.2	34.6	27.2	0.9	6.2	34.3	0.3	13.1	15.1	28.5	0.4	1	1.2	2.6	

Start Time	Little Morongo Road Southbound				Two Bunch Palms Trail Westbound				Little Morongo Road Northbound				Two Bunch Palms Trail Eastbound				Int. Total
	Left	Thru	Right	App. Total	Left	Thru	Right	App. Total	Left	Thru	Right	App. Total	Left	Thru	Right	App. Total	
07:15 AM	20	<b>75</b>	0	<b>95</b>	<b>67</b>	0	10	<b>77</b>	<b>2</b>	21	17	40	<b>1</b>	<b>4</b>	<b>5</b>	<b>10</b>	222
07:30 AM	16	42	0	58	57	<b>3</b>	10	70	0	34	29	63	0	1	3	4	195
07:45 AM	<b>28</b>	56	0	84	47	1	<b>16</b>	64	1	<b>47</b>	<b>37</b>	<b>85</b>	1	0	1	2	<b>235</b>
08:00 AM	22	43	<b>1</b>	66	43	0	10	53	0	24	28	52	1	4	2	7	178
Total Volume	86	216	1	303	214	4	46	264	3	126	111	240	3	9	11	23	830
% App. Total	28.4	71.3	0.3		81.1	1.5	17.4		1.2	52.5	46.2		13	39.1	47.8		
PHF	.768	.720	.250	.797	.799	.333	.719	.857	.375	.670	.750	.706	.750	.563	.550	.575	.883

Peak Hour Analysis From 07:00 AM to 08:45 AM - Peak 1 of 1  
 Peak Hour for Entire Intersection Begins at 07:15 AM

City of Desert Hot Springs  
 N/S: Little Morongo Road  
 E/W: Two Bunch Palms Trail  
 Weather: Clear

File Name : 01\_DHS\_LM\_TBP AM  
 Site Code : 05122266  
 Start Date : 3/29/2022  
 Page No : 2

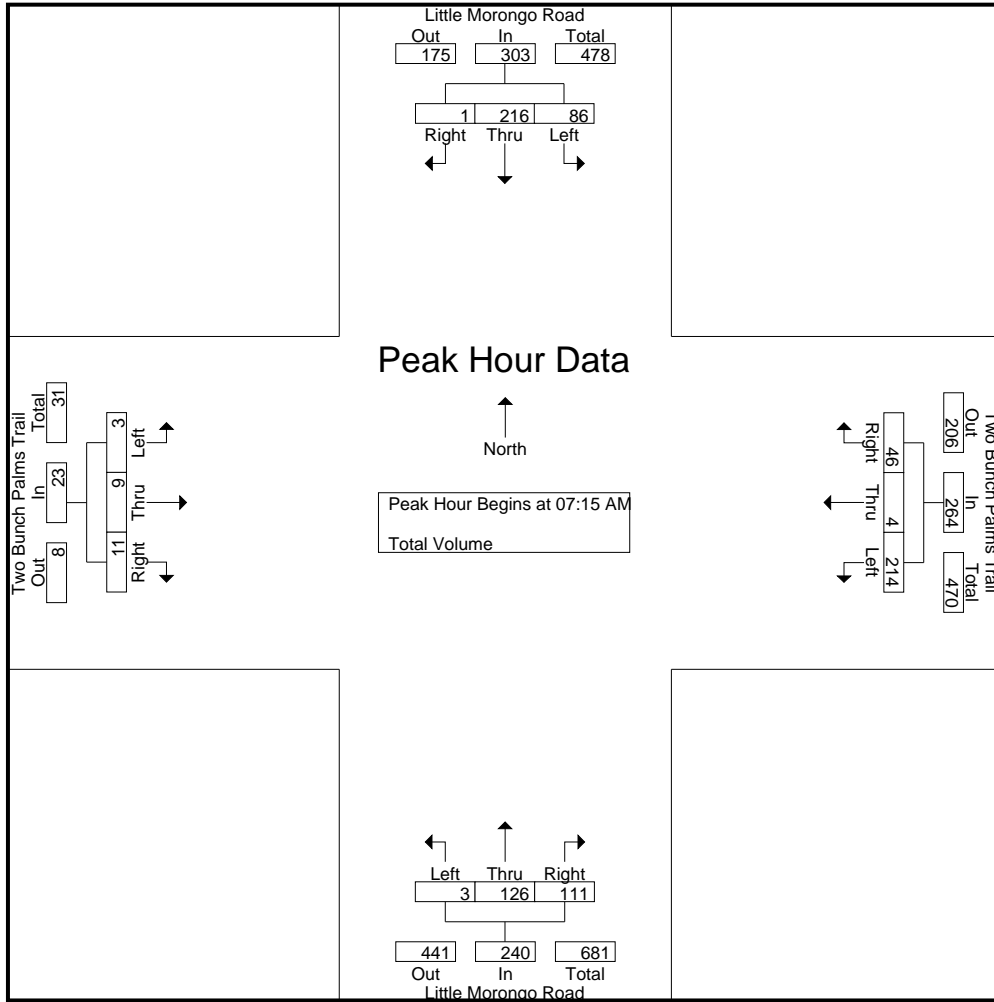

Peak Hour Analysis From 07:00 AM to 08:45 AM - Peak 1 of 1  
 Peak Hour for Each Approach Begins at:

	07:15 AM				07:00 AM				07:30 AM				07:15 AM			
+0 mins.	20	<b>75</b>	0	<b>95</b>	57	<b>3</b>	8	68	0	34	29	63	<b>1</b>	<b>4</b>	<b>5</b>	<b>10</b>
+15 mins.	16	42	0	58	<b>67</b>	0	10	<b>77</b>	<b>1</b>	<b>47</b>	<b>37</b>	<b>85</b>	0	1	3	4
+30 mins.	<b>28</b>	56	0	84	57	3	10	70	0	24	28	52	1	0	1	2
+45 mins.	22	43	<b>1</b>	66	47	<b>1</b>	<b>16</b>	64	0	12	33	45	1	4	2	7
Total Volume	86	216	1	303	228	7	44	279	1	117	127	245	3	9	11	23
% App. Total	28.4	71.3	0.3		81.7	2.5	15.8		0.4	47.8	51.8		13	39.1	47.8	
PHF	.768	.720	.250	.797	.851	.583	.688	.906	.250	.622	.858	.721	.750	.563	.550	.575

City of Desert Hot Springs  
 N/S: Little Morongo Road  
 E/W: Two Bunch Palms Trail  
 Weather: Clear

File Name : 01\_DHS\_LM\_TBP PM  
 Site Code : 05122266  
 Start Date : 3/29/2022  
 Page No : 1

Groups Printed- Total Volume

Start Time	Little Morongo Road Southbound				Two Bunch Palms Trail Westbound				Little Morongo Road Northbound				Two Bunch Palms Trail Eastbound				Int. Total
	Left	Thru	Right	App. Total	Left	Thru	Right	App. Total	Left	Thru	Right	App. Total	Left	Thru	Right	App. Total	
04:00 PM	21	51	1	73	41	4	19	64	3	31	45	79	0	3	3	6	222
04:15 PM	19	34	0	53	27	4	21	52	3	44	55	102	0	1	1	2	209
04:30 PM	22	33	2	57	47	4	13	64	2	44	47	93	0	1	0	1	215
04:45 PM	19	27	0	46	37	4	16	57	4	44	50	98	0	3	0	3	204
Total	81	145	3	229	152	16	69	237	12	163	197	372	0	8	4	12	850
05:00 PM	18	21	0	39	38	1	22	61	2	59	64	125	0	2	1	3	228
05:15 PM	14	22	0	36	19	2	20	41	5	42	61	108	0	0	1	1	186
05:30 PM	23	37	0	60	25	1	16	42	1	53	56	110	0	1	2	3	215
05:45 PM	12	19	0	31	31	1	14	46	4	27	50	81	0	2	1	3	161
Total	67	99	0	166	113	5	72	190	12	181	231	424	0	5	5	10	790
Grand Total	148	244	3	395	265	21	141	427	24	344	428	796	0	13	9	22	1640
Apprch %	37.5	61.8	0.8		62.1	4.9	33		3	43.2	53.8		0	59.1	40.9		
Total %	9	14.9	0.2	24.1	16.2	1.3	8.6	26	1.5	21	26.1	48.5	0	0.8	0.5	1.3	

Start Time	Little Morongo Road Southbound				Two Bunch Palms Trail Westbound				Little Morongo Road Northbound				Two Bunch Palms Trail Eastbound				Int. Total
	Left	Thru	Right	App. Total	Left	Thru	Right	App. Total	Left	Thru	Right	App. Total	Left	Thru	Right	App. Total	
04:15 PM	19	<b>34</b>	0	53	27	<b>4</b>	21	52	3	44	55	102	0	1	<b>1</b>	2	209
04:30 PM	<b>22</b>	33	<b>2</b>	<b>57</b>	<b>47</b>	4	13	<b>64</b>	2	44	47	93	0	1	0	<b>1</b>	215
04:45 PM	19	27	0	46	37	4	16	57	<b>4</b>	44	50	98	0	<b>3</b>	0	<b>3</b>	204
05:00 PM	18	21	0	39	38	1	<b>22</b>	61	2	<b>59</b>	<b>64</b>	<b>125</b>	0	2	1	3	<b>228</b>
Total Volume	78	115	2	195	149	13	72	234	11	191	216	418	0	7	2	9	856
% App. Total	40	59	1		63.7	5.6	30.8		2.6	45.7	51.7		0	77.8	22.2		
PHF	.886	.846	.250	.855	.793	.813	.818	.914	.688	.809	.844	.836	.000	.583	.500	.750	.939

Peak Hour Analysis From 04:00 PM to 05:45 PM - Peak 1 of 1  
 Peak Hour for Entire Intersection Begins at 04:15 PM

City of Desert Hot Springs  
 N/S: Little Morongo Road  
 E/W: Two Bunch Palms Trail  
 Weather: Clear

File Name : 01\_DHS\_LM\_TBP PM  
 Site Code : 05122266  
 Start Date : 3/29/2022  
 Page No : 2

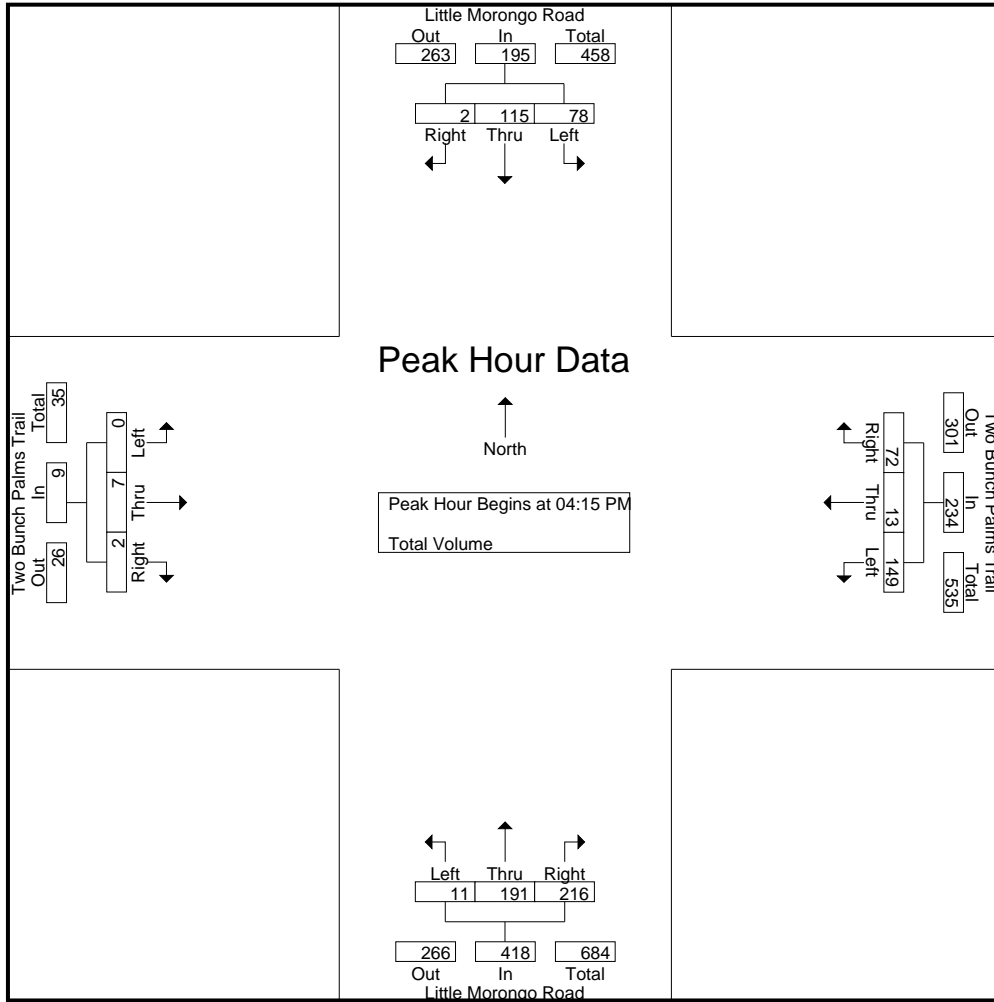

Peak Hour Analysis From 04:00 PM to 05:45 PM - Peak 1 of 1  
 Peak Hour for Each Approach Begins at:

	04:00 PM				04:00 PM				04:45 PM				04:00 PM			
+0 mins.	21	51	1	73	41	4	19	64	4	44	50	98	0	3	3	6
+15 mins.	19	34	0	53	27	4	21	52	2	59	64	125	0	1	1	2
+30 mins.	22	33	2	57	47	4	13	64	5	42	61	108	0	1	0	1
+45 mins.	19	27	0	46	37	4	16	57	1	53	56	110	0	3	0	3
Total Volume	81	145	3	229	152	16	69	237	12	198	231	441	0	8	4	12
% App. Total	35.4	63.3	1.3		64.1	6.8	29.1		2.7	44.9	52.4		0	66.7	33.3	
PHF	.920	.711	.375	.784	.809	1.000	.821	.926	.600	.839	.902	.882	.000	.667	.333	.500

City of Desert Hot Springs  
 N/S: Little Morongo Road  
 E/W: iStorage North Driveway  
 Weather: Clear

File Name : 02\_DHS\_LM\_N DW AM  
 Site Code : 05122266  
 Start Date : 3/29/2022  
 Page No : 1

Groups Printed- Total Volume

Start Time	Little Morongo Road Southbound			Little Morongo Road Northbound			iStorage North Driveway Eastbound			Int. Total
	Thru	Right	App. Total	Left	Thru	App. Total	Left	Right	App. Total	
07:00 AM	113	0	113	0	46	46	0	1	1	160
07:15 AM	152	0	152	0	48	48	0	1	1	201
07:30 AM	98	0	98	0	65	65	0	2	2	165
07:45 AM	112	0	112	0	87	87	0	0	0	199
Total	475	0	475	0	246	246	0	4	4	725
08:00 AM	87	1	88	0	50	50	0	0	0	138
08:15 AM	87	0	87	1	54	55	0	1	1	143
08:30 AM	101	2	103	1	63	64	1	2	3	170
08:45 AM	54	2	56	0	48	48	0	1	1	105
Total	329	5	334	2	215	217	1	4	5	556
Grand Total	804	5	809	2	461	463	1	8	9	1281
Apprch %	99.4	0.6		0.4	99.6		11.1	88.9		
Total %	62.8	0.4	63.2	0.2	36	36.1	0.1	0.6	0.7	

Start Time	Little Morongo Road Southbound			Little Morongo Road Northbound			iStorage North Driveway Eastbound			Int. Total
	Thru	Right	App. Total	Left	Thru	App. Total	Left	Right	App. Total	
07:00 AM	113	0	113	0	46	46	0	1	1	160
07:15 AM	<b>152</b>	0	<b>152</b>	0	48	48	0	1	1	<b>201</b>
07:30 AM	98	0	98	0	65	65	0	2	2	165
07:45 AM	112	0	112	0	<b>87</b>	<b>87</b>	0	0	0	199
Total Volume	475	0	475	0	246	246	0	4	4	725
% App. Total	100	0		0	100		0	100		
PHF	.781	.000	.781	.000	.707	.707	.000	.500	.500	.902

Peak Hour Analysis From 07:00 AM to 08:45 AM - Peak 1 of 1  
 Peak Hour for Entire Intersection Begins at 07:00 AM

City of Desert Hot Springs  
 N/S: Little Morongo Road  
 E/W: iStorage North Driveway  
 Weather: Clear

File Name : 02\_DHS\_LM\_N DW AM  
 Site Code : 05122266  
 Start Date : 3/29/2022  
 Page No : 2

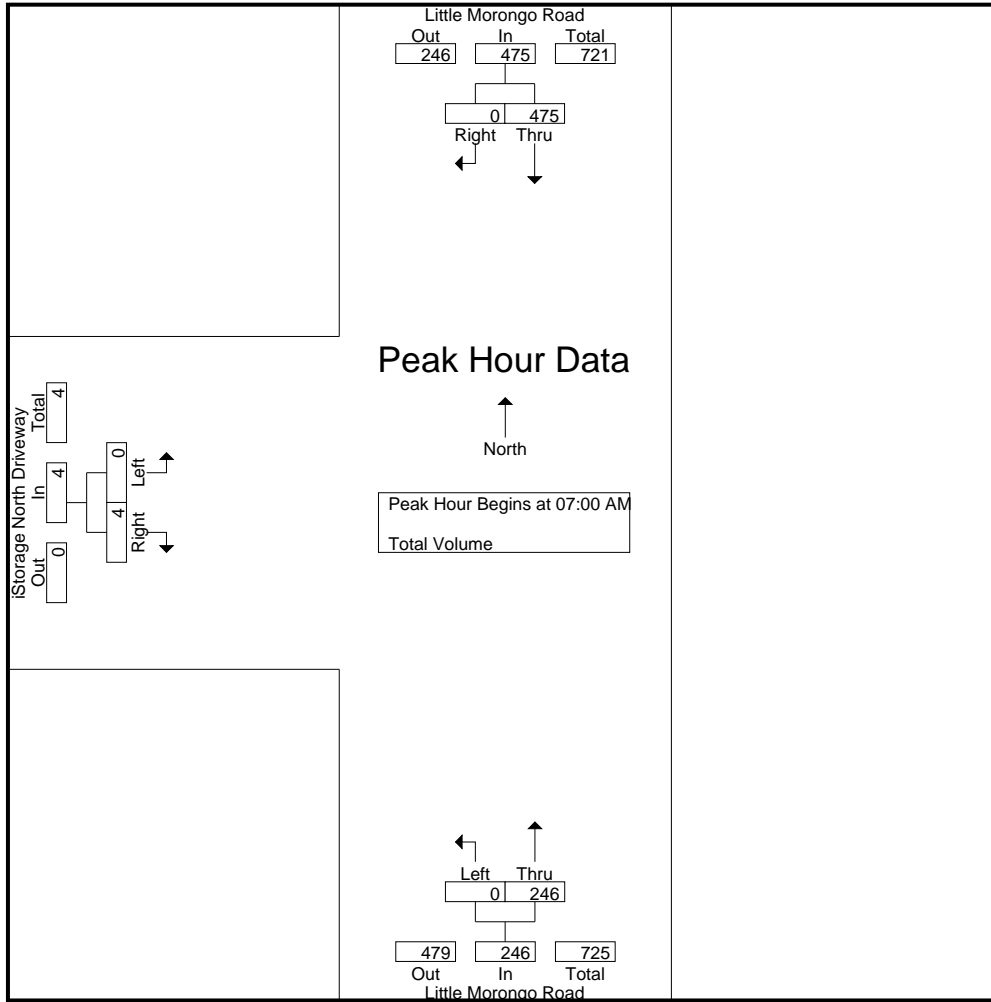

Peak Hour Analysis From 07:00 AM to 08:45 AM - Peak 1 of 1  
 Peak Hour for Each Approach Begins at:

	07:00 AM			07:30 AM			08:00 AM		
+0 mins.	113	0	113	0	65	65	0	0	0
+15 mins.	<b>152</b>	0	<b>152</b>	0	<b>87</b>	<b>87</b>	0	1	1
+30 mins.	98	0	98	0	50	50	1	2	3
+45 mins.	112	0	112	1	54	55	0	1	1
Total Volume	475	0	475	1	256	257	1	4	5
% App. Total	100	0		0.4	99.6		20	80	
PHF	.781	.000	.781	.250	.736	.739	.250	.500	.417

City of Desert Hot Springs  
 N/S: Little Morongo Road  
 E/W: iStorage North Driveway  
 Weather: Clear

File Name : 02\_DHS\_LM\_N DW PM  
 Site Code : 05122266  
 Start Date : 3/29/2022  
 Page No : 1

Groups Printed- Total Volume

Start Time	Little Morongo Road Southbound			Little Morongo Road Northbound			iStorage North Driveway Eastbound			Int. Total
	Thru	Right	App. Total	Left	Thru	App. Total	Left	Right	App. Total	
04:00 PM	105	2	107	5	82	87	0	0	0	194
04:15 PM	61	0	61	4	91	95	3	1	4	160
04:30 PM	81	2	83	3	98	101	3	7	10	194
04:45 PM	55	2	57	3	99	102	1	4	5	164
Total	302	6	308	15	370	385	7	12	19	712
05:00 PM	73	1	74	4	117	121	1	0	1	196
05:15 PM	47	0	47	0	118	118	1	0	1	166
05:30 PM	66	1	67	0	100	100	3	1	4	171
05:45 PM	57	0	57	1	78	79	0	1	1	137
Total	243	2	245	5	413	418	5	2	7	670
Grand Total	545	8	553	20	783	803	12	14	26	1382
Apprch %	98.6	1.4		2.5	97.5		46.2	53.8		
Total %	39.4	0.6	40	1.4	56.7	58.1	0.9	1	1.9	

Start Time	Little Morongo Road Southbound			Little Morongo Road Northbound			iStorage North Driveway Eastbound			Int. Total
	Thru	Right	App. Total	Left	Thru	App. Total	Left	Right	App. Total	
04:30 PM	<b>81</b>	<b>2</b>	<b>83</b>	3	98	101	<b>3</b>	<b>7</b>	<b>10</b>	194
04:45 PM	55	2	57	3	99	102	1	4	5	164
05:00 PM	73	1	74	<b>4</b>	117	<b>121</b>	1	0	1	<b>196</b>
05:15 PM	47	0	47	0	<b>118</b>	118	1	0	1	166
Total Volume	256	5	261	10	432	442	6	11	17	720
% App. Total	98.1	1.9		2.3	97.7		35.3	64.7		
PHF	.790	.625	.786	.625	.915	.913	.500	.393	.425	.918

Peak Hour Analysis From 04:00 PM to 05:45 PM - Peak 1 of 1  
 Peak Hour for Entire Intersection Begins at 04:30 PM



City of Desert Hot Springs  
 N/S: Little Morongo Road  
 E/W: iStorage North Driveway  
 Weather: Clear

File Name : 02\_DHS\_LM\_N DW PM  
 Site Code : 05122266  
 Start Date : 3/29/2022  
 Page No : 2

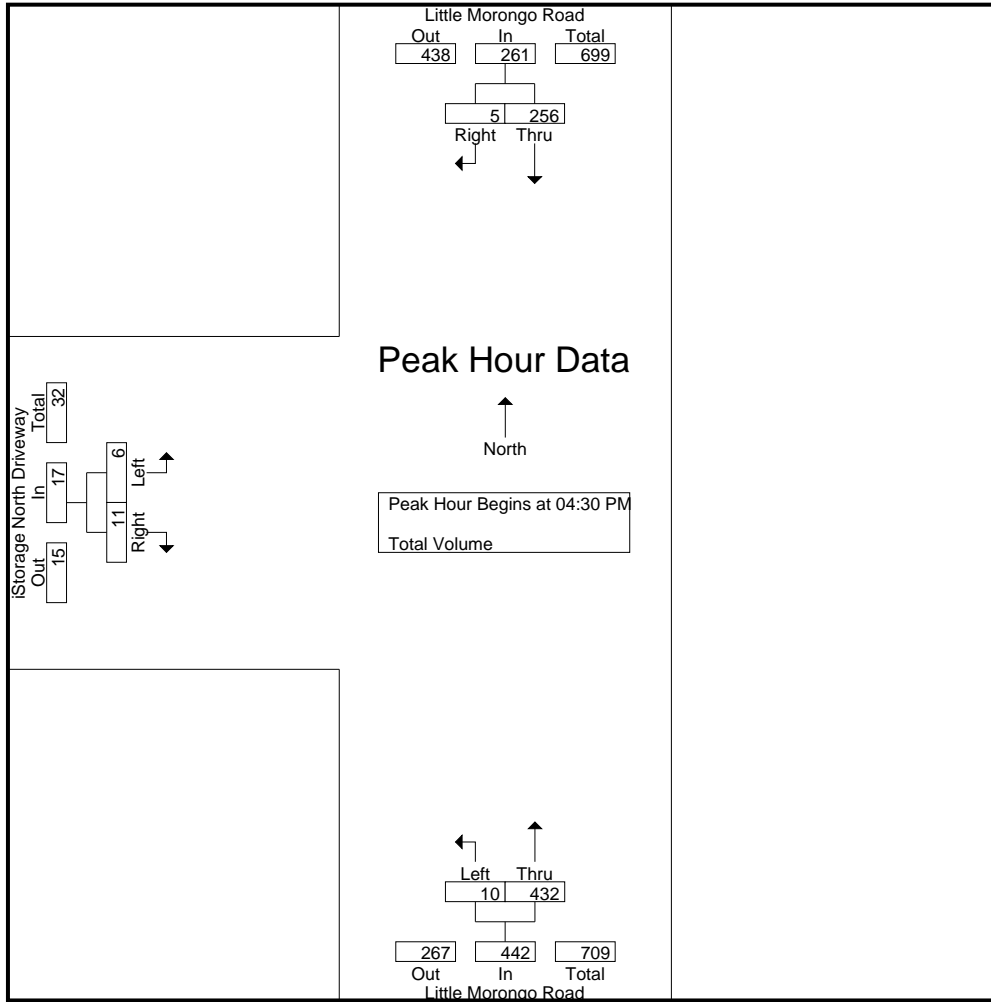

Peak Hour Analysis From 04:00 PM to 05:45 PM - Peak 1 of 1  
 Peak Hour for Each Approach Begins at:

	04:00 PM			04:30 PM			04:15 PM		
+0 mins.	<b>105</b>	<b>2</b>	<b>107</b>	3	98	101	<b>3</b>	1	4
+15 mins.	61	0	61	3	99	102	3	<b>7</b>	<b>10</b>
+30 mins.	81	2	83	<b>4</b>	117	<b>121</b>	1	4	5
+45 mins.	55	2	57	0	<b>118</b>	118	1	0	1
Total Volume	302	6	308	10	432	442	8	12	20
% App. Total	98.1	1.9		2.3	97.7		40	60	
PHF	.719	.750	.720	.625	.915	.913	.667	.429	.500

City of Desert Hot Springs  
 N/S: Little Morongo Road  
 E/W: Dillon Road  
 Weather: Clear

File Name : 03\_DHS\_LM\_Dillon AM  
 Site Code : 05122266  
 Start Date : 3/29/2022  
 Page No : 1

Groups Printed- Total Volume

Start Time	Little Morongo Road Southbound				Dillon Road Westbound				Little Morongo Road Northbound				Dillon Road Eastbound				Int. Total
	Left	Thru	Right	App. Total	Left	Thru	Right	App. Total	Left	Thru	Right	App. Total	Left	Thru	Right	App. Total	
07:00 AM	50	0	60	110	0	78	27	105	0	0	0	0	28	28	0	56	271
07:15 AM	65	0	80	145	0	66	28	94	0	0	0	0	28	24	0	52	291
07:30 AM	58	0	61	119	0	82	53	135	0	0	0	0	26	34	0	60	314
07:45 AM	61	0	58	119	0	73	42	115	0	0	0	0	49	24	0	73	307
Total	234	0	259	493	0	299	150	449	0	0	0	0	131	110	0	241	1183
08:00 AM	43	0	48	91	0	55	27	82	0	0	0	0	35	35	0	70	243
08:15 AM	38	0	53	91	0	59	30	89	0	0	0	0	37	39	0	76	256
08:30 AM	42	1	62	105	0	59	42	101	0	1	0	1	34	48	0	82	289
08:45 AM	25	0	35	60	0	60	19	79	0	0	1	1	30	41	0	71	211
Total	148	1	198	347	0	233	118	351	0	1	1	2	136	163	0	299	999
Grand Total	382	1	457	840	0	532	268	800	0	1	1	2	267	273	0	540	2182
Apprch %	45.5	0.1	54.4		0	66.5	33.5		0	50	50		49.4	50.6	0		
Total %	17.5	0	20.9	38.5	0	24.4	12.3	36.7	0	0	0	0.1	12.2	12.5	0	24.7	

Start Time	Little Morongo Road Southbound				Dillon Road Westbound				Little Morongo Road Northbound				Dillon Road Eastbound				Int. Total
	Left	Thru	Right	App. Total	Left	Thru	Right	App. Total	Left	Thru	Right	App. Total	Left	Thru	Right	App. Total	
07:00 AM	50	0	60	110	0	78	27	105	0	0	0	0	28	28	0	56	271
07:15 AM	<b>65</b>	0	<b>80</b>	<b>145</b>	0	66	28	94	0	0	0	0	28	24	0	52	291
07:30 AM	58	0	61	119	0	<b>82</b>	<b>53</b>	<b>135</b>	0	0	0	0	26	<b>34</b>	0	60	<b>314</b>
07:45 AM	61	0	58	119	0	73	42	115	0	0	0	0	<b>49</b>	24	0	<b>73</b>	307
Total Volume	234	0	259	493	0	299	150	449	0	0	0	0	131	110	0	241	1183
% App. Total	47.5	0	52.5		0	66.6	33.4		0	0	0		54.4	45.6	0		
PHF	.900	.000	.809	.850	.000	.912	.708	.831	.000	.000	.000	.000	.668	.809	.000	.825	.942

Peak Hour Analysis From 07:00 AM to 08:45 AM - Peak 1 of 1  
 Peak Hour for Entire Intersection Begins at 07:00 AM

City of Desert Hot Springs  
 N/S: Little Morongo Road  
 E/W: Dillon Road  
 Weather: Clear

File Name : 03\_DHS\_LM\_Dillon AM  
 Site Code : 05122266  
 Start Date : 3/29/2022  
 Page No : 2

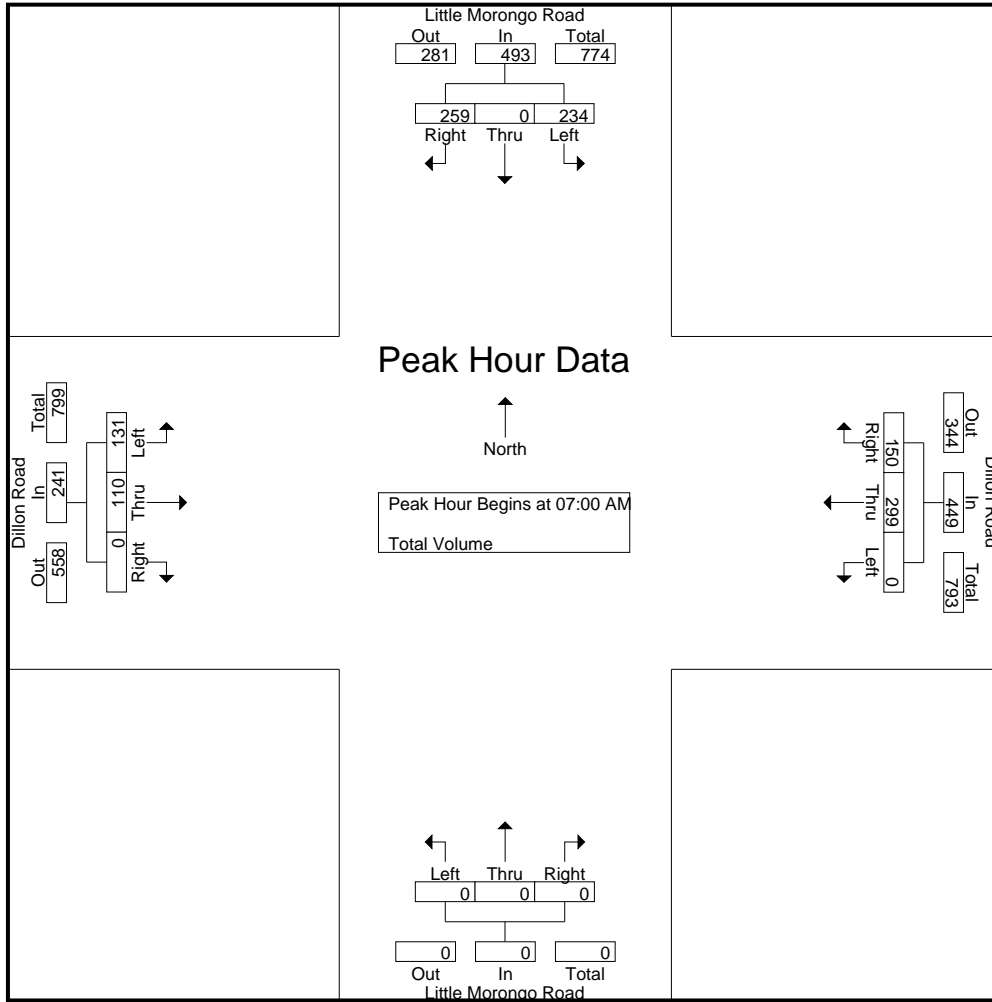

Peak Hour Analysis From 07:00 AM to 08:45 AM - Peak 1 of 1  
 Peak Hour for Each Approach Begins at:

	07:00 AM				07:00 AM				08:00 AM				07:45 AM			
+0 mins.	50	0	60	110	0	78	27	105	0	0	0	0	<b>49</b>	24	0	73
+15 mins.	<b>65</b>	0	<b>80</b>	<b>145</b>	0	66	28	94	0	0	0	0	35	35	0	70
+30 mins.	58	0	61	119	0	<b>82</b>	<b>53</b>	<b>135</b>	0	<b>1</b>	0	<b>1</b>	37	39	0	76
+45 mins.	61	0	58	119	0	73	42	115	0	0	<b>1</b>	<b>1</b>	34	<b>48</b>	0	<b>82</b>
Total Volume	234	0	259	493	0	299	150	449	0	1	1	2	155	146	0	301
% App. Total	47.5	0	52.5		0	66.6	33.4		0	50	50		51.5	48.5	0	
PHF	.900	.000	.809	.850	.000	.912	.708	.831	.000	.250	.250	.500	.791	.760	.000	.918

City of Desert Hot Springs  
 N/S: Little Morongo Road  
 E/W: Dillon Road  
 Weather: Clear

File Name : 03\_DHS\_LM\_Dillon PM  
 Site Code : 05122266  
 Start Date : 3/29/2022  
 Page No : 1

Groups Printed- Total Volume

Start Time	Little Morongo Road Southbound				Dillon Road Westbound				Little Morongo Road Northbound				Dillon Road Eastbound				Int. Total
	Left	Thru	Right	App. Total	Left	Thru	Right	App. Total	Left	Thru	Right	App. Total	Left	Thru	Right	App. Total	
04:00 PM	59	0	57	116	0	74	37	111	0	0	0	0	54	83	0	137	364
04:15 PM	44	1	32	77	0	55	39	94	0	0	0	0	53	72	0	125	296
04:30 PM	38	0	44	82	1	40	46	87	0	1	0	1	51	80	1	132	302
04:45 PM	34	0	43	77	1	52	44	97	0	0	0	0	64	70	0	134	308
Total	175	1	176	352	2	221	166	389	0	1	0	1	222	305	1	528	1270
05:00 PM	40	0	39	79	0	57	43	100	0	1	0	1	74	52	0	126	306
05:15 PM	23	0	27	50	1	53	42	96	0	0	0	0	72	60	0	132	278
05:30 PM	35	0	33	68	0	37	43	80	0	0	0	0	53	68	0	121	269
05:45 PM	25	0	40	65	0	27	31	58	0	1	1	2	46	54	0	100	225
Total	123	0	139	262	1	174	159	334	0	2	1	3	245	234	0	479	1078
Grand Total	298	1	315	614	3	395	325	723	0	3	1	4	467	539	1	1007	2348
Apprch %	48.5	0.2	51.3		0.4	54.6	45		0	75	25		46.4	53.5	0.1		
Total %	12.7	0	13.4	26.1	0.1	16.8	13.8	30.8	0	0.1	0	0.2	19.9	23	0	42.9	

Start Time	Little Morongo Road Southbound				Dillon Road Westbound				Little Morongo Road Northbound				Dillon Road Eastbound				Int. Total
	Left	Thru	Right	App. Total	Left	Thru	Right	App. Total	Left	Thru	Right	App. Total	Left	Thru	Right	App. Total	
04:00 PM	<b>59</b>	0	<b>57</b>	<b>116</b>	0	<b>74</b>	37	<b>111</b>	0	0	0	0	54	<b>83</b>	0	<b>137</b>	<b>364</b>
04:15 PM	44	<b>1</b>	32	77	0	55	39	94	0	0	0	0	53	72	0	125	296
04:30 PM	38	0	44	82	<b>1</b>	40	<b>46</b>	87	0	<b>1</b>	0	<b>1</b>	51	80	<b>1</b>	132	302
04:45 PM	34	0	43	77	1	52	44	97	0	0	0	0	<b>64</b>	70	0	134	308
Total Volume	175	1	176	352	2	221	166	389	0	1	0	1	222	305	1	528	1270
% App. Total	49.7	0.3	50		0.5	56.8	42.7		0	100	0		42	57.8	0.2		
PHF	.742	.250	.772	.759	.500	.747	.902	.876	.000	.250	.000	.250	.867	.919	.250	.964	.872

Peak Hour Analysis From 04:00 PM to 05:45 PM - Peak 1 of 1  
 Peak Hour for Entire Intersection Begins at 04:00 PM

City of Desert Hot Springs  
 N/S: Little Morongo Road  
 E/W: Dillon Road  
 Weather: Clear

File Name : 03\_DHS\_LM\_Dillon PM  
 Site Code : 05122266  
 Start Date : 3/29/2022  
 Page No : 2

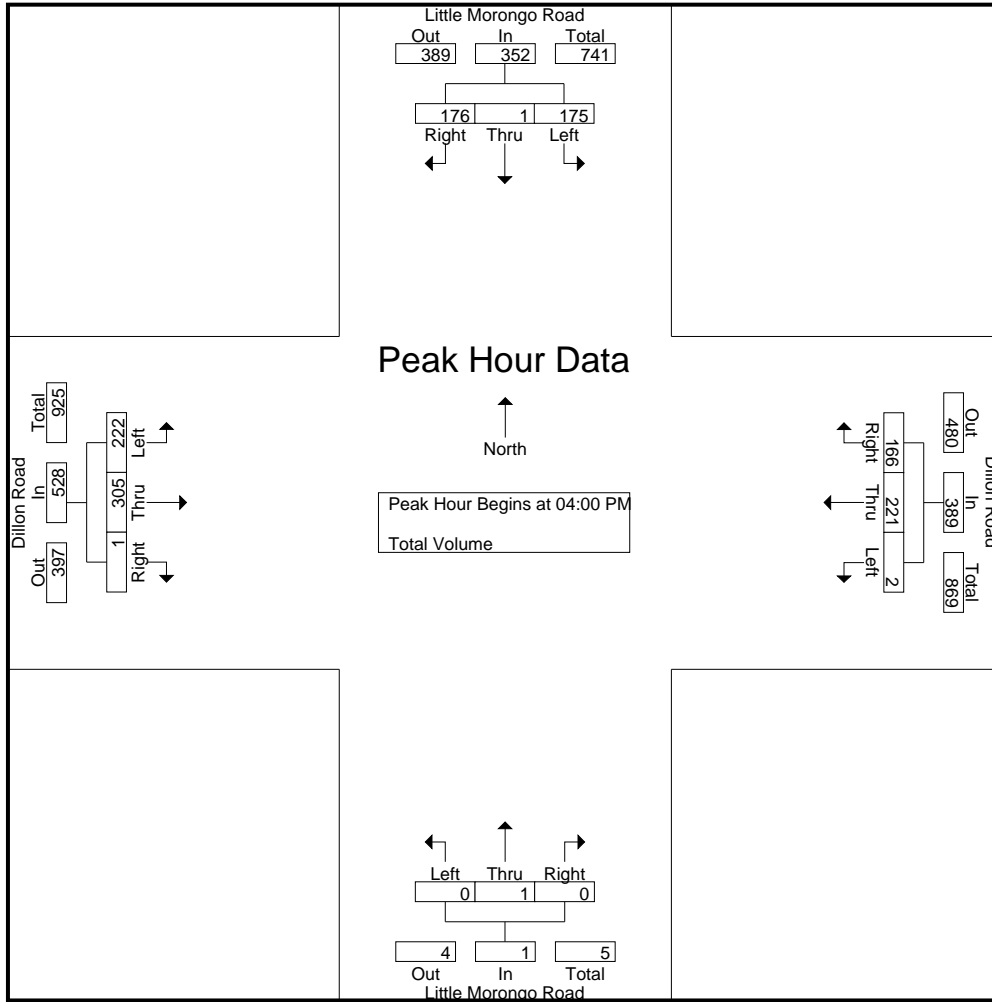

Peak Hour Analysis From 04:00 PM to 05:45 PM - Peak 1 of 1  
 Peak Hour for Each Approach Begins at:

	04:00 PM				04:00 PM				05:00 PM				04:00 PM			
+0 mins.	59	0	57	116	0	74	37	111	0	1	0	1	54	83	0	137
+15 mins.	44	1	32	77	0	55	39	94	0	0	0	0	53	72	0	125
+30 mins.	38	0	44	82	1	40	46	87	0	0	0	0	51	80	1	132
+45 mins.	34	0	43	77	1	52	44	97	0	1	1	2	64	70	0	134
Total Volume	175	1	176	352	2	221	166	389	0	2	1	3	222	305	1	528
% App. Total	49.7	0.3	50		0.5	56.8	42.7		0	66.7	33.3		42	57.8	0.2	
PHF	.742	.250	.772	.759	.500	.747	.902	.876	.000	.500	.250	.375	.867	.919	.250	.964

City of Desert Hot Springs  
 N/S: Indian Canyon Drive  
 E/W: Dillon Road  
 Weather: Clear

File Name : 04\_DHS\_IC\_Dillon AM  
 Site Code : 05122266  
 Start Date : 3/29/2022  
 Page No : 1

Groups Printed- Total Volume

Start Time	Indian Canyon Drive Southbound				Dillon Road Westbound				Indian Canyon Drive Northbound				Dillon Road Eastbound				Int. Total
	Left	Thru	Right	App. Total	Left	Thru	Right	App. Total	Left	Thru	Right	App. Total	Left	Thru	Right	App. Total	
07:00 AM	6	107	1	114	85	33	13	131	4	48	24	76	1	14	7	22	343
07:15 AM	6	151	0	157	111	18	4	133	2	56	21	79	0	19	7	26	395
07:30 AM	9	168	1	178	104	23	4	131	3	74	28	105	1	26	10	37	451
07:45 AM	3	115	1	119	108	23	3	134	6	57	35	98	1	24	4	29	380
Total	24	541	3	568	408	97	24	529	15	235	108	358	3	83	28	114	1569
08:00 AM	4	108	2	114	60	25	5	90	1	50	34	85	1	32	11	44	333
08:15 AM	7	135	0	142	72	28	8	108	2	67	41	110	0	26	4	30	390
08:30 AM	6	104	1	111	82	31	7	120	3	62	41	106	0	32	7	39	376
08:45 AM	6	76	1	83	67	19	3	89	0	66	33	99	1	23	2	26	297
Total	23	423	4	450	281	103	23	407	6	245	149	400	2	113	24	139	1396
Grand Total	47	964	7	1018	689	200	47	936	21	480	257	758	5	196	52	253	2965
Apprch %	4.6	94.7	0.7		73.6	21.4	5		2.8	63.3	33.9		2	77.5	20.6		
Total %	1.6	32.5	0.2	34.3	23.2	6.7	1.6	31.6	0.7	16.2	8.7	25.6	0.2	6.6	1.8	8.5	

Start Time	Indian Canyon Drive Southbound				Dillon Road Westbound				Indian Canyon Drive Northbound				Dillon Road Eastbound				Int. Total
	Left	Thru	Right	App. Total	Left	Thru	Right	App. Total	Left	Thru	Right	App. Total	Left	Thru	Right	App. Total	
07:00 AM	6	107	<b>1</b>	114	85	<b>33</b>	<b>13</b>	131	4	48	24	76	<b>1</b>	14	7	22	343
07:15 AM	6	151	0	157	<b>111</b>	18	4	133	2	56	21	79	0	19	7	26	395
07:30 AM	<b>9</b>	<b>168</b>	1	<b>178</b>	104	23	4	131	3	<b>74</b>	28	<b>105</b>	1	<b>26</b>	<b>10</b>	<b>37</b>	<b>451</b>
07:45 AM	3	115	1	119	108	23	3	<b>134</b>	<b>6</b>	57	<b>35</b>	98	1	24	4	29	380
Total Volume	24	541	3	568	408	97	24	529	15	235	108	358	3	83	28	114	1569
% App. Total	4.2	95.2	0.5		77.1	18.3	4.5		4.2	65.6	30.2		2.6	72.8	24.6		
PHF	.667	.805	.750	.798	.919	.735	.462	.987	.625	.794	.771	.852	.750	.798	.700	.770	.870

Peak Hour Analysis From 07:00 AM to 08:45 AM - Peak 1 of 1  
 Peak Hour for Entire Intersection Begins at 07:00 AM

City of Desert Hot Springs  
 N/S: Indian Canyon Drive  
 E/W: Dillon Road  
 Weather: Clear

File Name : 04\_DHS\_IC\_Dillon AM  
 Site Code : 05122266  
 Start Date : 3/29/2022  
 Page No : 2

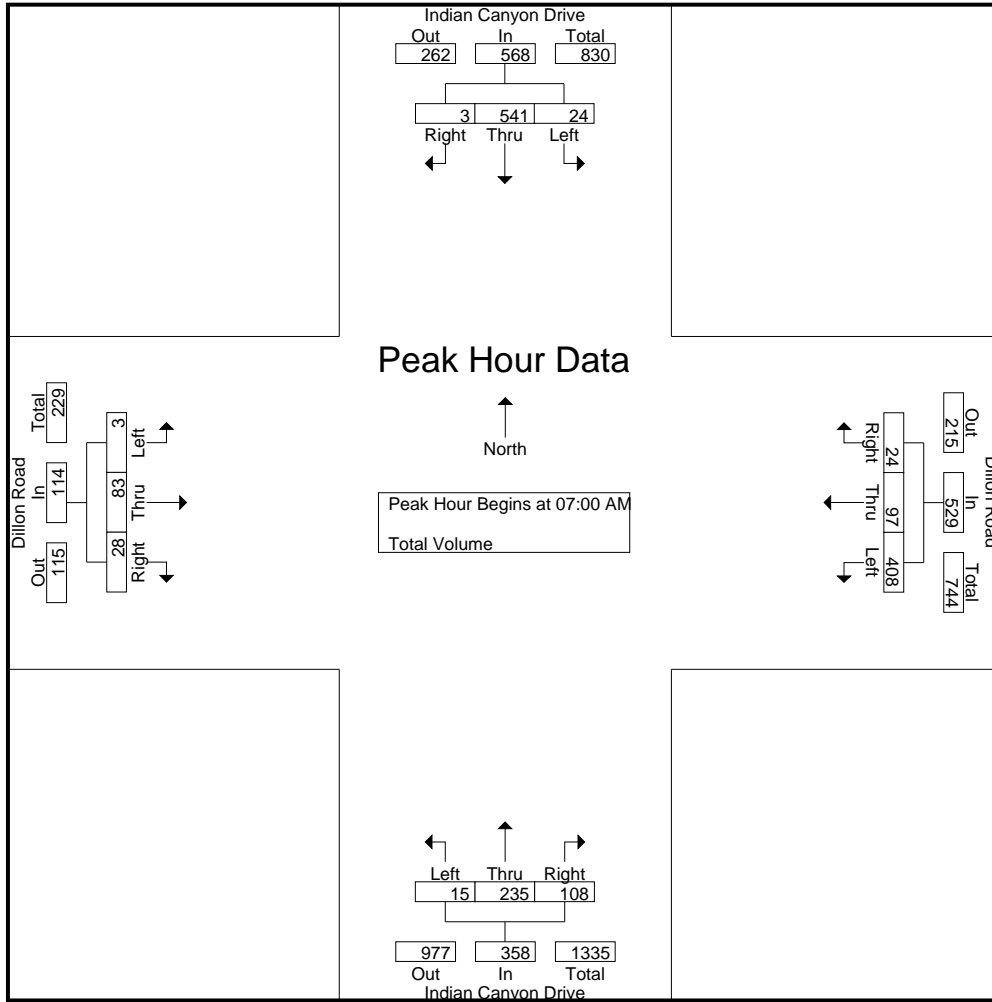

Peak Hour Analysis From 07:00 AM to 08:45 AM - Peak 1 of 1  
 Peak Hour for Each Approach Begins at:

	07:00 AM				07:00 AM				08:00 AM				07:45 AM			
+0 mins.	6	107	1	114	85	<b>33</b>	<b>13</b>	131	1	50	34	85	1	24	4	29
+15 mins.	6	151	0	157	<b>111</b>	18	4	133	2	<b>67</b>	<b>41</b>	<b>110</b>	1	<b>32</b>	<b>11</b>	<b>44</b>
+30 mins.	<b>9</b>	<b>168</b>	1	<b>178</b>	104	23	4	131	<b>3</b>	62	41	106	0	26	4	30
+45 mins.	3	115	1	119	108	23	3	<b>134</b>	0	66	33	99	0	32	7	39
Total Volume	24	541	3	568	408	97	24	529	6	245	149	400	2	114	26	142
% App. Total	4.2	95.2	0.5		77.1	18.3	4.5		1.5	61.2	37.2		1.4	80.3	18.3	
PHF	.667	.805	.750	.798	.919	.735	.462	.987	.500	.914	.909	.909	.500	.891	.591	.807

City of Desert Hot Springs  
 N/S: Indian Canyon Drive  
 E/W: Dillon Road  
 Weather: Clear

File Name : 04\_DHS\_IC\_Dillon PM  
 Site Code : 05122266  
 Start Date : 3/29/2022  
 Page No : 1

Groups Printed- Total Volume

Start Time	Indian Canyon Drive Southbound				Dillon Road Westbound				Indian Canyon Drive Northbound				Dillon Road Eastbound				Int. Total
	Left	Thru	Right	App. Total	Left	Thru	Right	App. Total	Left	Thru	Right	App. Total	Left	Thru	Right	App. Total	
04:00 PM	9	67	1	77	62	36	13	111	5	151	81	237	1	22	3	26	451
04:15 PM	12	46	1	59	43	33	9	85	1	147	73	221	0	22	2	24	389
04:30 PM	7	60	0	67	55	26	8	89	2	111	76	189	2	23	7	32	377
04:45 PM	6	53	0	59	46	36	13	95	3	156	72	231	1	26	3	30	415
Total	34	226	2	262	206	131	43	380	11	565	302	878	4	93	15	112	1632
05:00 PM	10	71	0	81	51	29	14	94	4	120	77	201	0	18	5	23	399
05:15 PM	10	45	2	57	35	33	6	74	1	122	63	186	3	32	2	37	354
05:30 PM	9	55	1	65	31	20	8	59	0	123	64	187	3	37	2	42	353
05:45 PM	10	35	0	45	41	20	3	64	2	87	52	141	3	29	3	35	285
Total	39	206	3	248	158	102	31	291	7	452	256	715	9	116	12	137	1391
Grand Total	73	432	5	510	364	233	74	671	18	1017	558	1593	13	209	27	249	3023
Apprch %	14.3	84.7	1		54.2	34.7	11		1.1	63.8	35		5.2	83.9	10.8		
Total %	2.4	14.3	0.2	16.9	12	7.7	2.4	22.2	0.6	33.6	18.5	52.7	0.4	6.9	0.9	8.2	

Start Time	Indian Canyon Drive Southbound				Dillon Road Westbound				Indian Canyon Drive Northbound				Dillon Road Eastbound				Int. Total
	Left	Thru	Right	App. Total	Left	Thru	Right	App. Total	Left	Thru	Right	App. Total	Left	Thru	Right	App. Total	
04:00 PM	9	67	1	77	62	36	13	111	5	151	81	237	1	22	3	26	451
04:15 PM	12	46	1	59	43	33	9	85	1	147	73	221	0	22	2	24	389
04:30 PM	7	60	0	67	55	26	8	89	2	111	76	189	2	23	7	32	377
04:45 PM	6	53	0	59	46	36	13	95	3	156	72	231	1	26	3	30	415
Total Volume	34	226	2	262	206	131	43	380	11	565	302	878	4	93	15	112	1632
% App. Total	13	86.3	0.8		54.2	34.5	11.3		1.3	64.4	34.4		3.6	83	13.4		
PHF	.708	.843	.500	.851	.831	.910	.827	.856	.550	.905	.932	.926	.500	.894	.536	.875	.905

Peak Hour Analysis From 04:00 PM to 05:45 PM - Peak 1 of 1  
 Peak Hour for Entire Intersection Begins at 04:00 PM



City of Desert Hot Springs  
 N/S: Indian Canyon Drive  
 E/W: Dillon Road  
 Weather: Clear

File Name : 04\_DHS\_IC\_Dillon PM  
 Site Code : 05122266  
 Start Date : 3/29/2022  
 Page No : 2

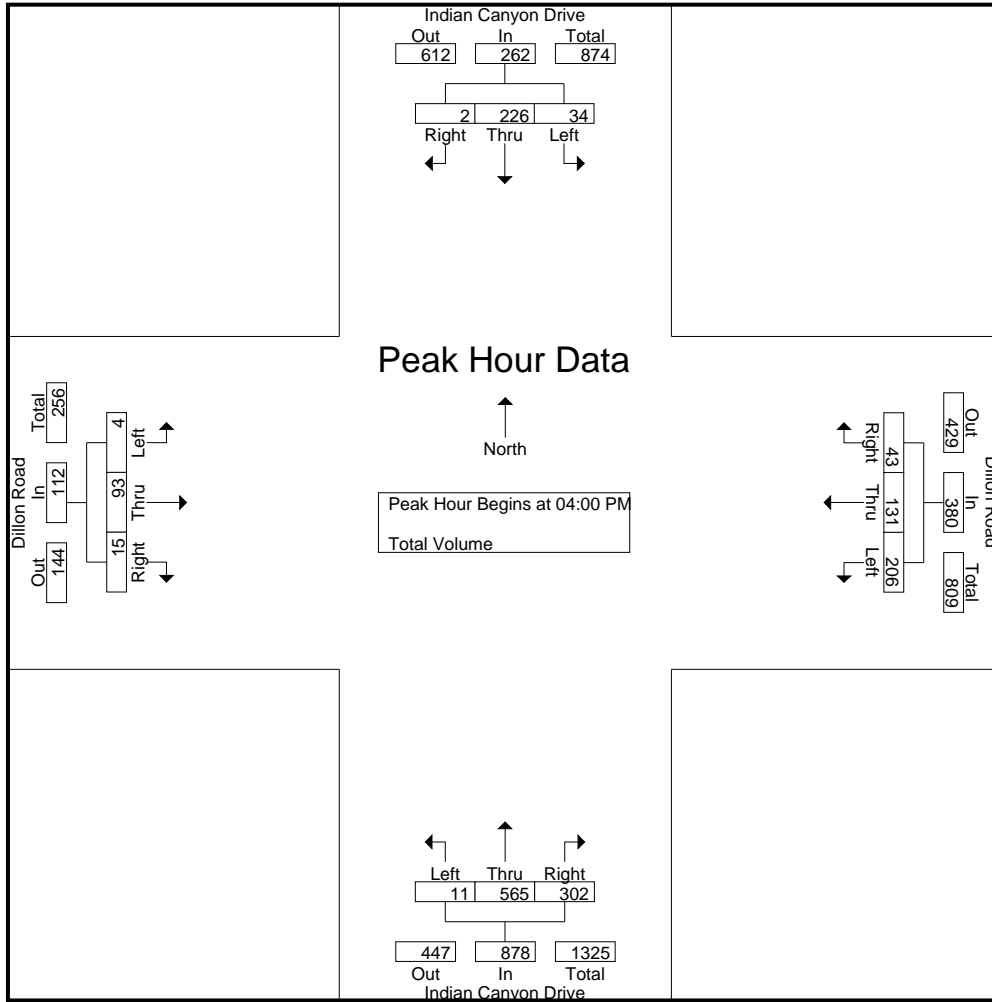

Peak Hour Analysis From 04:00 PM to 05:45 PM - Peak 1 of 1  
 Peak Hour for Each Approach Begins at:

	04:15 PM				04:00 PM				04:00 PM				05:00 PM			
+0 mins.	12	46	1	59	62	36	13	111	5	151	81	237	0	18	5	23
+15 mins.	7	60	0	67	43	33	9	85	1	147	73	221	3	32	2	37
+30 mins.	6	53	0	59	55	26	8	89	2	111	76	189	3	37	2	42
+45 mins.	10	71	0	81	46	36	13	95	3	156	72	231	3	29	3	35
Total Volume	35	230	1	266	206	131	43	380	11	565	302	878	9	116	12	137
% App. Total	13.2	86.5	0.4		54.2	34.5	11.3		1.3	64.4	34.4		6.6	84.7	8.8	
PHF	.729	.810	.250	.821	.831	.910	.827	.856	.550	.905	.932	.926	.750	.784	.600	.815

City of Desert Hot Springs  
 N/S: Little Morongo Road  
 E/W: iStorage South DW/Project South DW  
 Weather: Clear

File Name : 06\_DHS\_LM\_S DW AM  
 Site Code : 05122266  
 Start Date : 3/29/2022  
 Page No : 1

Groups Printed- Total Volume

Start Time	Little Morongo Road Southbound				Project South Driveway Westbound				Little Morongo Road Northbound				iStorage South Driveway Eastbound				Int. Total
	Left	Thru	Right	App. Total	Left	Thru	Right	App. Total	Left	Thru	Right	App. Total	Left	Thru	Right	App. Total	
07:00 AM	0	115	0	115	0	0	0	0	0	46	0	46	0	0	0	0	161
07:15 AM	0	153	0	153	0	0	0	0	0	47	0	47	0	0	0	0	200
07:30 AM	0	103	0	103	0	0	0	0	0	66	0	66	0	0	0	0	169
07:45 AM	0	111	0	111	0	0	0	0	0	89	0	89	0	0	0	0	200
Total	0	482	0	482	0	0	0	0	0	248	0	248	0	0	0	0	730
08:00 AM	0	85	0	85	0	0	0	0	0	50	0	50	0	0	0	0	135
08:15 AM	0	90	0	90	0	0	0	0	0	56	0	56	0	0	0	0	146
08:30 AM	0	104	0	104	0	0	0	0	0	67	0	67	0	0	0	0	171
08:45 AM	0	52	0	52	0	0	0	0	0	46	0	46	0	0	0	0	98
Total	0	331	0	331	0	0	0	0	0	219	0	219	0	0	0	0	550
Grand Total	0	813	0	813	0	0	0	0	0	467	0	467	0	0	0	0	1280
Apprch %	0	100	0		0	0	0		0	100	0		0	0	0		
Total %	0	63.5	0	63.5	0	0	0	0	0	36.5	0	36.5	0	0	0	0	

Start Time	Little Morongo Road Southbound				Project South Driveway Westbound				Little Morongo Road Northbound				iStorage South Driveway Eastbound				Int. Total
	Left	Thru	Right	App. Total	Left	Thru	Right	App. Total	Left	Thru	Right	App. Total	Left	Thru	Right	App. Total	
07:00 AM	0	115	0	115	0	0	0	0	0	46	0	46	0	0	0	0	161
07:15 AM	0	<b>153</b>	0	<b>153</b>	0	0	0	0	0	47	0	47	0	0	0	0	<b>200</b>
07:30 AM	0	103	0	103	0	0	0	0	0	66	0	66	0	0	0	0	169
07:45 AM	0	111	0	111	0	0	0	0	0	<b>89</b>	0	<b>89</b>	0	0	0	0	200
Total Volume	0	482	0	482	0	0	0	0	0	248	0	248	0	0	0	0	730
% App. Total	0	100	0		0	0	0		0	100	0		0	0	0		
PHF	.000	.788	.000	.788	.000	.000	.000	.000	.000	.697	.000	.697	.000	.000	.000	.000	.913

Peak Hour Analysis From 07:00 AM to 08:45 AM - Peak 1 of 1  
 Peak Hour for Entire Intersection Begins at 07:00 AM

City of Desert Hot Springs  
 N/S: Little Morongo Road  
 E/W: iStorage South DW/Project South DW  
 Weather: Clear

File Name : 06\_DHS\_LM\_S DW AM  
 Site Code : 05122266  
 Start Date : 3/29/2022  
 Page No : 2

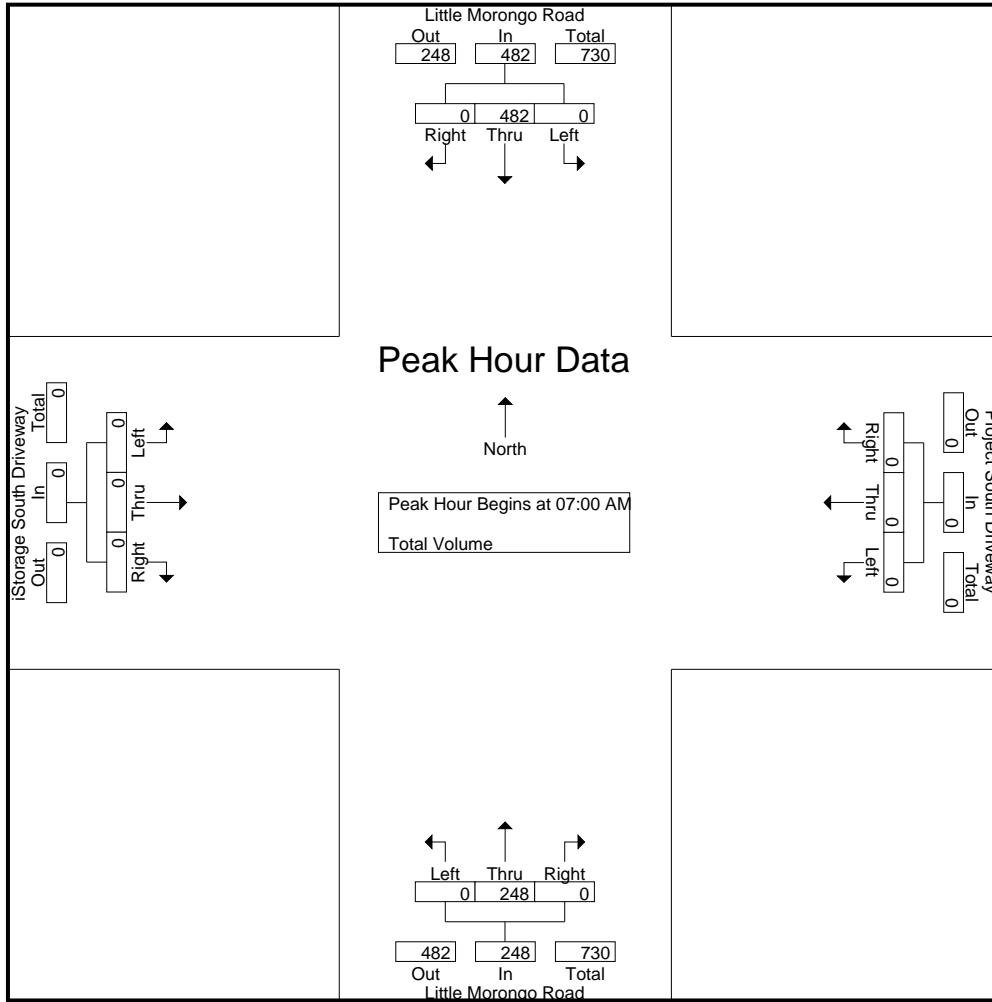

Peak Hour Analysis From 07:00 AM to 08:45 AM - Peak 1 of 1  
 Peak Hour for Each Approach Begins at:

	07:00 AM				07:00 AM				07:45 AM				07:00 AM			
+0 mins.	0	115	0	115	0	0	0	0	0	<b>89</b>	0	<b>89</b>	0	0	0	0
+15 mins.	0	<b>153</b>	0	<b>153</b>	0	0	0	0	0	50	0	50	0	0	0	0
+30 mins.	0	103	0	103	0	0	0	0	0	56	0	56	0	0	0	0
+45 mins.	0	111	0	111	0	0	0	0	0	67	0	67	0	0	0	0
Total Volume	0	482	0	482	0	0	0	0	0	262	0	262	0	0	0	0
% App. Total	0	100	0		0	0	0		0	100	0		0	0	0	
PHF	.000	.788	.000	.788	.000	.000	.000	.000	.000	.736	.000	.736	.000	.000	.000	.000

City of Desert Hot Springs  
 N/S: Little Morongo Road  
 E/W: iStorage South DW/Project South DW  
 Weather: Clear

File Name : 06\_DHS\_LM\_S DW PM  
 Site Code : 05122266  
 Start Date : 3/29/2022  
 Page No : 1

Groups Printed- Total Volume

Start Time	Little Morongo Road Southbound				Project South Driveway Westbound				Little Morongo Road Northbound				iStorage South Driveway Eastbound				Int. Total
	Left	Thru	Right	App. Total	Left	Thru	Right	App. Total	Left	Thru	Right	App. Total	Left	Thru	Right	App. Total	
04:00 PM	0	105	0	105	0	0	0	0	0	91	0	91	0	0	0	0	196
04:15 PM	0	62	0	62	0	0	0	0	0	93	0	93	0	0	0	0	155
04:30 PM	0	86	0	86	0	0	0	0	0	100	0	100	0	0	0	0	186
04:45 PM	0	64	0	64	0	0	0	0	0	105	0	105	0	0	0	0	169
Total	0	317	0	317	0	0	0	0	0	389	0	389	0	0	0	0	706
05:00 PM	0	74	1	75	0	0	0	0	0	122	0	122	0	0	0	0	197
05:15 PM	0	47	0	47	0	0	0	0	0	119	0	119	0	0	0	0	166
05:30 PM	0	66	0	66	0	0	0	0	0	97	0	97	0	0	0	0	163
05:45 PM	0	57	0	57	0	0	0	0	0	80	0	80	0	0	0	0	137
Total	0	244	1	245	0	0	0	0	0	418	0	418	0	0	0	0	663
Grand Total	0	561	1	562	0	0	0	0	0	807	0	807	0	0	0	0	1369
Apprch %	0	99.8	0.2		0	0	0		0	100	0		0	0	0		
Total %	0	41	0.1	41.1	0	0	0		0	58.9	0	58.9	0	0	0		

Start Time	Little Morongo Road Southbound				Project South Driveway Westbound				Little Morongo Road Northbound				iStorage South Driveway Eastbound				Int. Total
	Left	Thru	Right	App. Total	Left	Thru	Right	App. Total	Left	Thru	Right	App. Total	Left	Thru	Right	App. Total	
04:30 PM	0	<b>86</b>	0	<b>86</b>	0	0	0	0	0	100	0	100	0	0	0	0	186
04:45 PM	0	64	0	64	0	0	0	0	0	105	0	105	0	0	0	0	169
05:00 PM	0	74	<b>1</b>	75	0	0	0	0	0	<b>122</b>	0	<b>122</b>	0	0	0	0	<b>197</b>
05:15 PM	0	47	0	47	0	0	0	0	0	119	0	119	0	0	0	0	166
Total Volume	0	271	1	272	0	0	0	0	0	446	0	446	0	0	0	0	718
% App. Total	0	99.6	0.4		0	0	0		0	100	0		0	0	0		
PHF	.000	.788	.250	.791	.000	.000	.000	.000	.000	.914	.000	.914	.000	.000	.000	.000	.911

Peak Hour Analysis From 04:00 PM to 05:45 PM - Peak 1 of 1  
 Peak Hour for Entire Intersection Begins at 04:30 PM

City of Desert Hot Springs  
 N/S: Little Morongo Road  
 E/W: iStorage South DW/Project South DW  
 Weather: Clear

File Name : 06\_DHS\_LM\_S DW PM  
 Site Code : 05122266  
 Start Date : 3/29/2022  
 Page No : 2

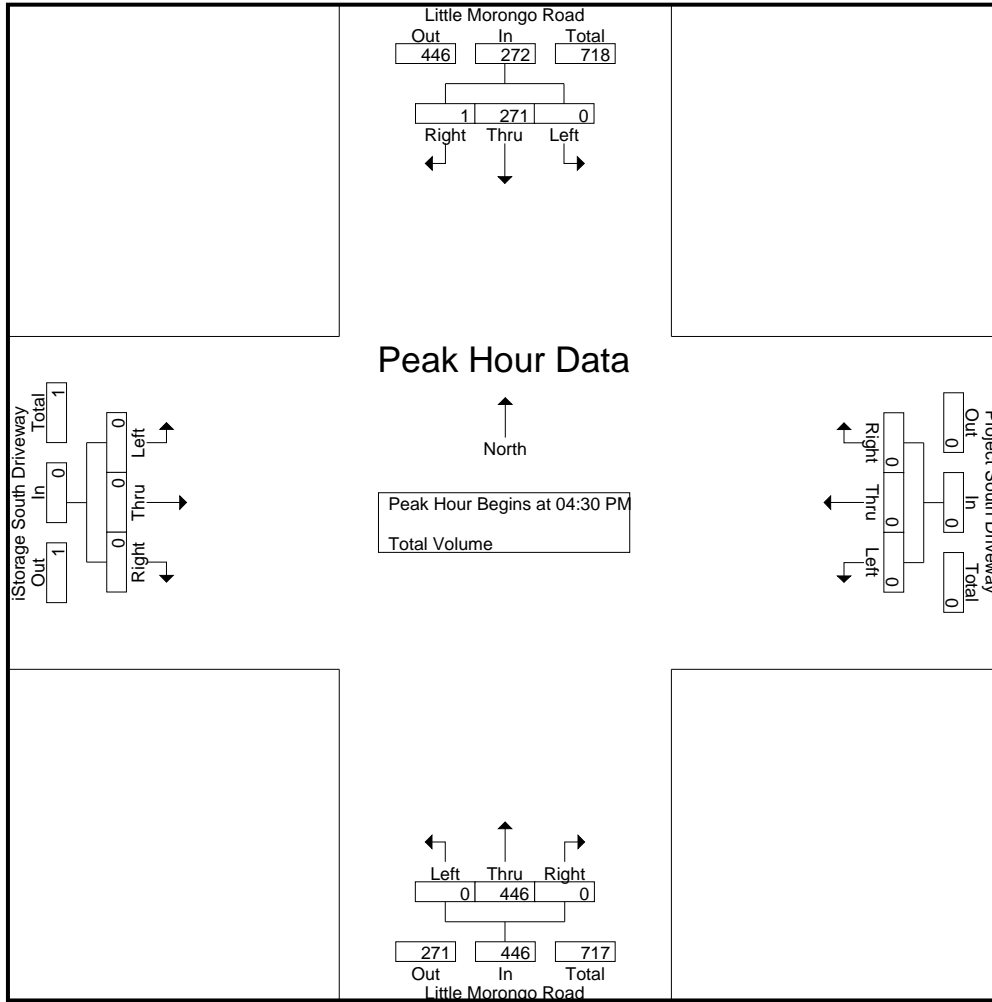

Peak Hour Analysis From 04:00 PM to 05:45 PM - Peak 1 of 1  
 Peak Hour for Each Approach Begins at:

	04:00 PM				04:00 PM				04:30 PM				04:00 PM			
+0 mins.	0	105	0	105	0	0	0	0	0	100	0	100	0	0	0	0
+15 mins.	0	62	0	62	0	0	0	0	0	105	0	105	0	0	0	0
+30 mins.	0	86	0	86	0	0	0	0	0	122	0	122	0	0	0	0
+45 mins.	0	64	0	64	0	0	0	0	0	119	0	119	0	0	0	0
Total Volume	0	317	0	317	0	0	0	0	0	446	0	446	0	0	0	0
% App. Total	0	100	0		0	0	0		0	100	0		0	0	0	
PHF	.000	.755	.000	.755	.000	.000	.000	.000	.000	.914	.000	.914	.000	.000	.000	.000

City of Desert Hot Springs  
 N/S: Indian Canyon Drive  
 E/W: 19th Avenue  
 Weather: Clear

File Name : 07\_DHS\_IC\_19th AM  
 Site Code : 05122266  
 Start Date : 3/29/2022  
 Page No : 1

Groups Printed- Total Volume

Start Time	Indian Canyon Drive Southbound				19th Avenue Westbound				Indian Canyon Drive Northbound				19th Avenue Eastbound				Int. Total
	Left	Thru	Right	App. Total	Left	Thru	Right	App. Total	Left	Thru	Right	App. Total	Left	Thru	Right	App. Total	
07:00 AM	15	200	1	216	3	0	1	4	5	77	21	103	0	0	1	1	324
07:15 AM	10	268	3	281	8	0	1	9	7	80	13	100	1	0	2	3	393
07:30 AM	7	282	1	290	0	0	3	3	2	102	11	115	0	0	2	2	410
07:45 AM	4	245	2	251	2	0	1	3	5	97	9	111	1	0	1	2	367
Total	36	995	7	1038	13	0	6	19	19	356	54	429	2	0	6	8	1494
08:00 AM	1	199	0	200	1	0	0	1	3	98	11	112	2	0	1	3	316
08:15 AM	3	204	3	210	6	0	0	6	2	102	10	114	2	0	2	4	334
08:30 AM	1	186	1	188	2	0	1	3	3	111	17	131	0	0	2	2	324
08:45 AM	0	159	5	164	2	0	0	2	7	102	7	116	0	0	0	0	282
Total	5	748	9	762	11	0	1	12	15	413	45	473	4	0	5	9	1256
Grand Total	41	1743	16	1800	24	0	7	31	34	769	99	902	6	0	11	17	2750
Apprch %	2.3	96.8	0.9		77.4	0	22.6		3.8	85.3	11		35.3	0	64.7		
Total %	1.5	63.4	0.6	65.5	0.9	0	0.3	1.1	1.2	28	3.6	32.8	0.2	0	0.4	0.6	

Start Time	Indian Canyon Drive Southbound				19th Avenue Westbound				Indian Canyon Drive Northbound				19th Avenue Eastbound				Int. Total
	Left	Thru	Right	App. Total	Left	Thru	Right	App. Total	Left	Thru	Right	App. Total	Left	Thru	Right	App. Total	
07:00 AM	<b>15</b>	200	1	216	3	0	1	4	5	77	<b>21</b>	103	0	0	1	1	324
07:15 AM	10	268	<b>3</b>	281	<b>8</b>	0	1	<b>9</b>	<b>7</b>	80	13	100	<b>1</b>	0	<b>2</b>	<b>3</b>	393
07:30 AM	7	<b>282</b>	1	<b>290</b>	0	0	<b>3</b>	3	2	<b>102</b>	11	<b>115</b>	0	0	2	2	<b>410</b>
07:45 AM	4	245	2	251	2	0	1	3	5	97	9	111	1	0	1	2	367
Total Volume	36	995	7	1038	13	0	6	19	19	356	54	429	2	0	6	8	1494
% App. Total	3.5	95.9	0.7		68.4	0	31.6		4.4	83	12.6		25	0	75		
PHF	.600	.882	.583	.895	.406	.000	.500	.528	.679	.873	.643	.933	.500	.000	.750	.667	.911

Peak Hour Analysis From 07:00 AM to 08:45 AM - Peak 1 of 1  
 Peak Hour for Entire Intersection Begins at 07:00 AM

City of Desert Hot Springs  
 N/S: Indian Canyon Drive  
 E/W: 19th Avenue  
 Weather: Clear

File Name : 07\_DHS\_IC\_19th AM  
 Site Code : 05122266  
 Start Date : 3/29/2022  
 Page No : 2

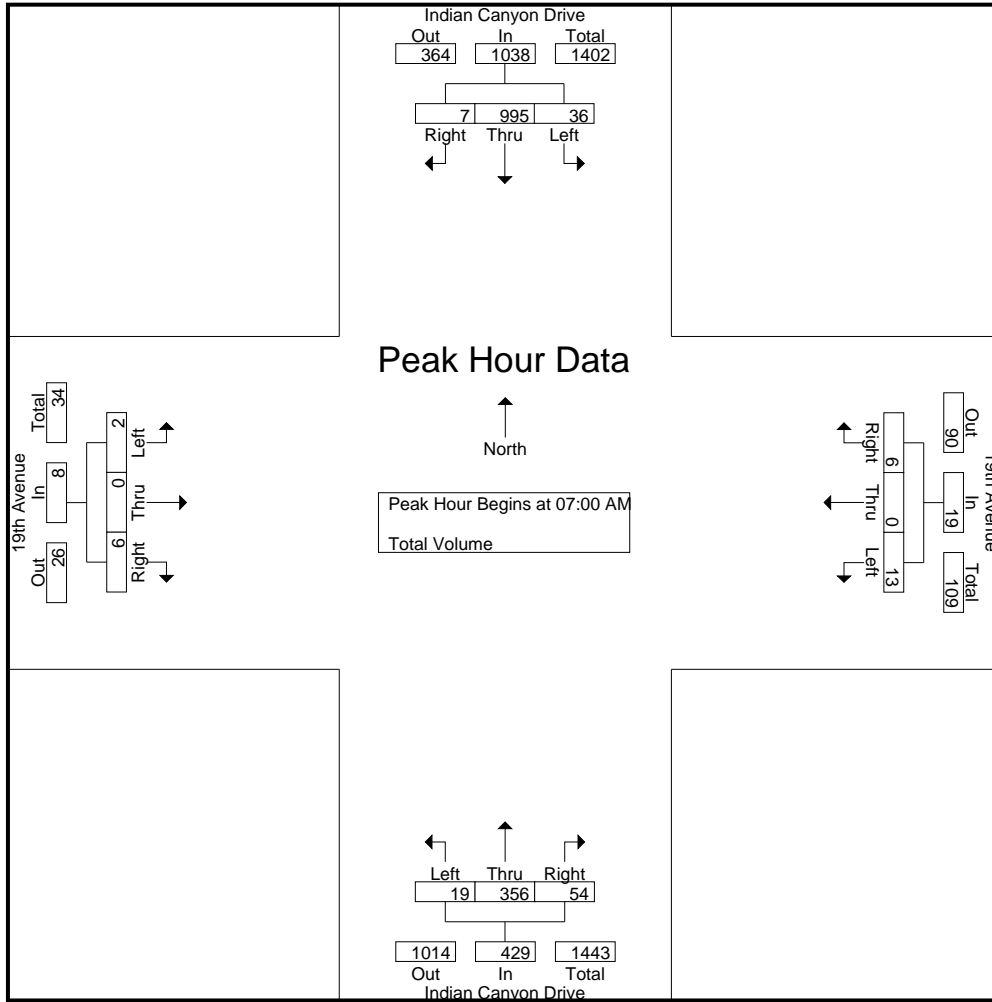

Peak Hour Analysis From 07:00 AM to 08:45 AM - Peak 1 of 1  
 Peak Hour for Each Approach Begins at:

	07:00 AM				07:00 AM				08:00 AM				07:30 AM			
+0 mins.	15	200	1	216	3	0	1	4	3	98	11	112	0	0	2	2
+15 mins.	10	268	3	281	8	0	1	9	2	102	10	114	1	0	1	2
+30 mins.	7	282	1	290	0	0	3	3	3	111	17	131	2	0	1	3
+45 mins.	4	245	2	251	2	0	1	3	7	102	7	116	2	0	2	4
Total Volume	36	995	7	1038	13	0	6	19	15	413	45	473	5	0	6	11
% App. Total	3.5	95.9	0.7		68.4	0	31.6		3.2	87.3	9.5		45.5	0	54.5	
PHF	.600	.882	.583	.895	.406	.000	.500	.528	.536	.930	.662	.903	.625	.000	.750	.688

City of Desert Hot Springs  
 N/S: Indian Canyon Drive  
 E/W: 19th Avenue  
 Weather: Clear

File Name : 07\_DHS\_IC\_19th PM  
 Site Code : 05122266  
 Start Date : 3/29/2022  
 Page No : 1

Groups Printed- Total Volume

Start Time	Indian Canyon Drive Southbound				19th Avenue Westbound				Indian Canyon Drive Northbound				19th Avenue Eastbound				Int. Total
	Left	Thru	Right	App. Total	Left	Thru	Right	App. Total	Left	Thru	Right	App. Total	Left	Thru	Right	App. Total	
04:00 PM	0	123	0	123	17	0	9	26	1	254	2	257	1	0	2	3	409
04:15 PM	0	98	1	99	11	0	5	16	1	219	2	222	1	0	0	1	338
04:30 PM	0	114	0	114	8	0	1	9	1	229	2	232	3	0	4	7	362
04:45 PM	0	105	2	107	15	0	0	15	0	232	0	232	2	0	3	5	359
Total	0	440	3	443	51	0	15	66	3	934	6	943	7	0	9	16	1468
05:00 PM	0	124	0	124	7	0	2	9	1	227	2	230	2	0	5	7	370
05:15 PM	0	88	0	88	5	0	1	6	0	201	2	203	0	0	3	3	300
05:30 PM	1	87	0	88	4	1	1	6	0	202	2	204	4	0	1	5	303
05:45 PM	0	90	3	93	5	0	0	5	1	156	4	161	2	0	2	4	263
Total	1	389	3	393	21	1	4	26	2	786	10	798	8	0	11	19	1236
Grand Total	1	829	6	836	72	1	19	92	5	1720	16	1741	15	0	20	35	2704
Apprch %	0.1	99.2	0.7		78.3	1.1	20.7		0.3	98.8	0.9		42.9	0	57.1		
Total %	0	30.7	0.2	30.9	2.7	0	0.7	3.4	0.2	63.6	0.6	64.4	0.6	0	0.7	1.3	

Start Time	Indian Canyon Drive Southbound				19th Avenue Westbound				Indian Canyon Drive Northbound				19th Avenue Eastbound				Int. Total
	Left	Thru	Right	App. Total	Left	Thru	Right	App. Total	Left	Thru	Right	App. Total	Left	Thru	Right	App. Total	
04:00 PM	0	<b>123</b>	0	<b>123</b>	<b>17</b>	0	<b>9</b>	<b>26</b>	<b>1</b>	<b>254</b>	<b>2</b>	<b>257</b>	1	0	2	3	<b>409</b>
04:15 PM	0	98	1	99	11	0	5	16	1	219	2	222	1	0	0	1	338
04:30 PM	0	114	0	114	8	0	1	9	1	229	2	232	<b>3</b>	0	<b>4</b>	<b>7</b>	362
04:45 PM	0	105	<b>2</b>	107	15	0	0	15	0	232	0	232	2	0	3	5	359
Total Volume	0	440	3	443	51	0	15	66	3	934	6	943	7	0	9	16	1468
% App. Total	0	99.3	0.7		77.3	0	22.7		0.3	99	0.6		43.8	0	56.2		
PHF	.000	.894	.375	.900	.750	.000	.417	.635	.750	.919	.750	.917	.583	.000	.563	.571	.897

Peak Hour Analysis From 04:00 PM to 05:45 PM - Peak 1 of 1  
 Peak Hour for Entire Intersection Begins at 04:00 PM



City of Desert Hot Springs  
 N/S: Indian Canyon Drive  
 E/W: 19th Avenue  
 Weather: Clear

File Name : 07\_DHS\_IC\_19th PM  
 Site Code : 05122266  
 Start Date : 3/29/2022  
 Page No : 2

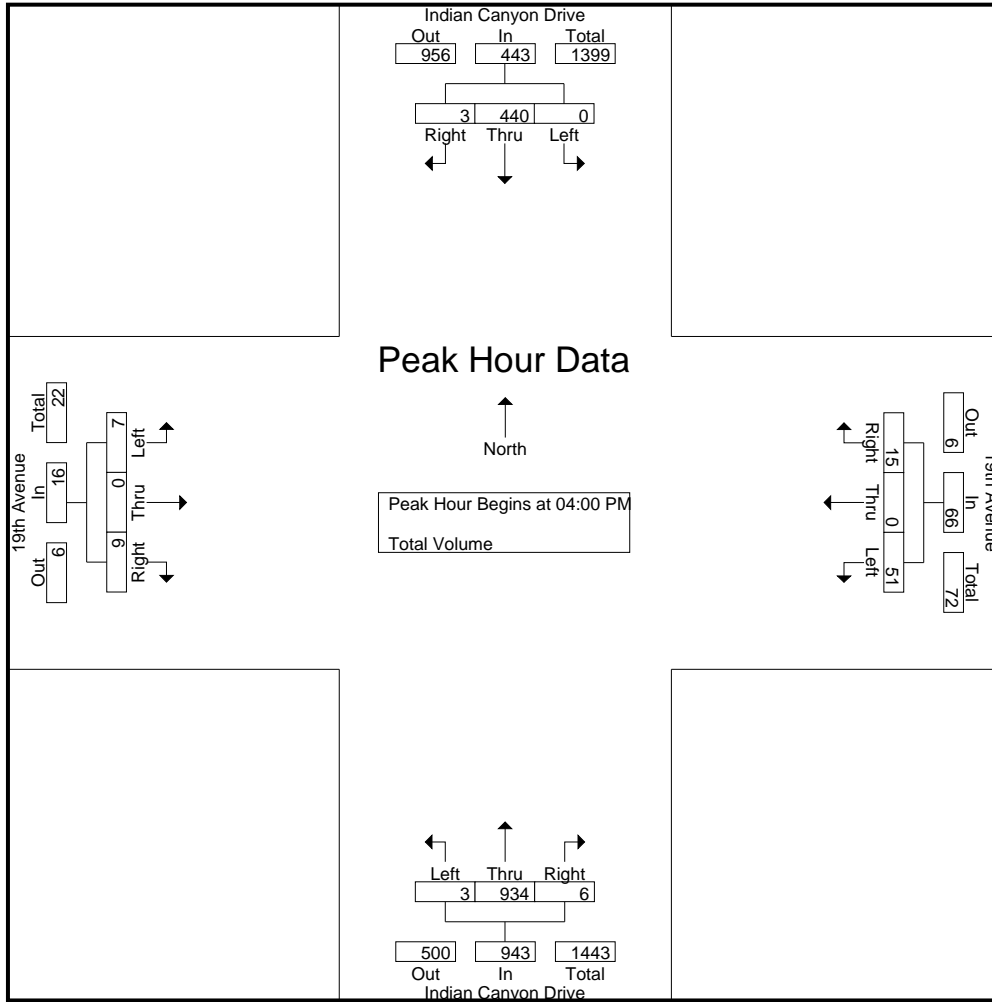

Peak Hour Analysis From 04:00 PM to 05:45 PM - Peak 1 of 1  
 Peak Hour for Each Approach Begins at:

	04:15 PM				04:00 PM				04:00 PM				04:30 PM			
+0 mins.	0	98	1	99	17	0	9	26	1	254	2	257	3	0	4	7
+15 mins.	0	114	0	114	11	0	5	16	1	219	2	222	2	0	3	5
+30 mins.	0	105	2	107	8	0	1	9	1	229	2	232	2	0	5	7
+45 mins.	0	124	0	124	15	0	0	15	0	232	0	232	0	0	3	3
Total Volume	0	441	3	444	51	0	15	66	3	934	6	943	7	0	15	22
% App. Total	0	99.3	0.7		77.3	0	22.7		0.3	99	0.6		31.8	0	68.2	
PHF	.000	.889	.375	.895	.750	.000	.417	.635	.750	.919	.750	.917	.583	.000	.750	.786

# Counts Unlimited, Inc.

City of Desert Hot Springs  
 Dillon Road  
 E/ Indian Canyon Drive  
 24 Hour Directional Volume Count

PO Box 1178  
 Corona, CA 92878  
 Phone: (951) 268-6268  
 email: counts@countsunlimited.com

DHS002  
 Site Code: 051-22266

Start Time	29-Mar-22 Tue	Eastbound		Hour Totals		Westbound		Hour Totals		Combined Totals	
		Morning	Afternoon	Morning	Afternoon	Morning	Afternoon	Morning	Afternoon	Morning	Afternoon
12:00		16	64			6	87				
12:15		17	70			11	80				
12:30		12	69			7	70				
12:45		17	83	62	286	6	83	30	320	92	606
01:00		17	67			2	72				
01:15		10	77			3	82				
01:30		6	81			9	72				
01:45		10	101	43	326	6	74	20	300	63	626
02:00		6	107			3	94				
02:15		6	100			4	72				
02:30		13	116			5	85				
02:45		12	106	37	429	8	93	20	344	57	773
03:00		15	<b>138</b>			5	79				
03:15		12	<b>132</b>			7	<b>92</b>				
03:30		7	<b>159</b>			8	<b>97</b>				
03:45		8	<b>139</b>	42	568	17	<b>110</b>	37	378	79	946
04:00		7	134			17	<b>125</b>				
04:15		6	125			14	91				
04:30		8	121			27	91				
04:45		6	130	27	510	26	99	84	406	111	916
05:00		8	120			36	97				
05:15		16	124			35	82				
05:30		21	116			57	72				
05:45		43	105	88	465	70	70	198	321	286	786
06:00		47	92			74	67				
06:15		48	87			81	60				
06:30		55	80			109	64				
06:45		63	90	213	349	110	49	374	240	587	589
07:00		52	78			<b>136</b>	57				
07:15		51	75			<b>133</b>	50				
07:30		64	55			<b>157</b>	39				
07:45		78	45	245	253	<b>130</b>	47	556	193	801	446
08:00		70	45			97	35				
08:15		<b>81</b>	58			112	37				
08:30		<b>89</b>	56			126	36				
08:45		<b>74</b>	43	314	202	83	32	418	140	732	342
09:00		<b>83</b>	42			98	25				
09:15		47	43			89	28				
09:30		60	36			98	32				
09:45		66	53	256	174	78	26	363	111	619	285
10:00		74	39			81	12				
10:15		85	35			73	17				
10:30		56	30			98	14				
10:45		80	36	295	140	80	24	332	67	627	207
11:00		77	32			65	24				
11:15		83	28			82	13				
11:30		71	19			84	7				
11:45		82	20	313	99	77	8	308	52	621	151
<b>Total</b>		1935	3801	1935	3801	2740	2872	2740	2872	4675	6673
<b>Combined Total</b>		5736		5736		5612		5612		11348	
AM Peak	-	08:15	-	-	-	07:00	-	-	-	-	-
Vol.	-	327	-	-	-	556	-	-	-	-	-
P.H.F.	-	0.919	-	-	-	0.885	-	-	-	-	-
PM Peak	-	-	03:00	-	-	-	03:15	-	-	-	-
Vol.	-	-	568	-	-	-	424	-	-	-	-
P.H.F.	-	-	0.893	-	-	-	0.848	-	-	-	-
Percentage		33.7%	66.3%			48.8%	51.2%				
ADT/AADT		ADT 11,348		AADT 11,348							

# Counts Unlimited, Inc.

City of Desert Hot Springs  
 Indian Canyon Drive  
 S/ Dillon Road  
 24 Hour Directional Volume Count

PO Box 1178  
 Corona, CA 92878  
 Phone: (951) 268-6268  
 email: counts@countsunlimited.com

DHS003  
 Site Code: 051-22266

Start Time	29-Mar-22 Tue	Northbound		Hour Totals		Southbound		Hour Totals		Combined Totals	
		Morning	Afternoon	Morning	Afternoon	Morning	Afternoon	Morning	Afternoon	Morning	Afternoon
12:00		24	112			11	107				
12:15		26	112			10	105				
12:30		15	119			6	105				
12:45		17	132	82	475	6	112	33	429	115	904
01:00		10	115			7	91				
01:15		17	120			4	98				
01:30		17	134			12	120				
01:45		16	140	60	509	7	107	30	416	90	925
02:00		14	154			4	108				
02:15		17	159			3	129				
02:30		17	172			7	132				
02:45		11	195	59	680	6	116	20	485	79	1165
03:00		13	209			8	115				
03:15		11	231			9	111				
03:30		8	248			18	121				
03:45		13	214	45	902	24	138	59	485	104	1387
04:00		13	252			28	135				
04:15		12	237			12	83				
04:30		15	212			34	120				
04:45		9	235	49	936	29	98	103	436	152	1372
05:00		22	238			35	120				
05:15		20	191			49	86				
05:30		28	202			81	87				
05:45		43	153	113	784	96	87	261	380	374	1164
06:00		41	165			84	93				
06:15		56	147			98	89				
06:30		53	120			180	96				
06:45		84	136	234	568	213	69	575	347	809	915
07:00		75	98			211	70				
07:15		86	103			277	72				
07:30		100	104			281	62				
07:45		106	84	367	389	231	61	1000	265	1367	654
08:00		97	89			195	49				
08:15		100	81			199	41				
08:30		114	78			187	55				
08:45		102	89	413	337	140	40	721	185	1134	522
09:00		98	72			154	42				
09:15		92	77			122	33				
09:30		111	75			143	37				
09:45		94	83	395	307	127	34	546	146	941	453
10:00		111	68			115	19				
10:15		138	63			116	25				
10:30		127	60			126	44				
10:45		104	67	480	258	132	27	489	115	969	373
11:00		115	49			99	26				
11:15		105	58			122	15				
11:30		113	42			123	9				
11:45		127	28	460	177	94	13	438	63	898	240
<b>Total</b>		<b>2757</b>	<b>6322</b>	<b>2757</b>	<b>6322</b>	<b>4275</b>	<b>3752</b>	<b>4275</b>	<b>3752</b>	<b>7032</b>	<b>10074</b>
<b>Combined Total</b>		<b>9079</b>		<b>9079</b>		<b>8027</b>		<b>8027</b>		<b>17106</b>	
AM Peak	-	10:15	-	-	-	07:00	-	-	-	-	-
Vol.	-	484	-	-	-	1000	-	-	-	-	-
P.H.F.		0.877				0.890					
PM Peak	-	-	03:30	-	-	-	03:15	-	-	-	-
Vol.	-	-	951	-	-	-	505	-	-	-	-
P.H.F.			0.943				0.915				
Percentage		30.4%	69.6%			53.3%	46.7%				
ADT/AADT		ADT 17,106	AADT 17,106								

# Counts Unlimited, Inc.

City of Desert Hot Springs  
 Little Morongo Road  
 N/ Dillon Road  
 24 Hour Directional Volume Count

PO Box 1178  
 Corona, CA 92878  
 Phone: (951) 268-6268  
 email: counts@countsunlimited.com

DHS001  
 Site Code: 051-22266

Start Time	29-Mar-22 Tue	Northbound		Hour Totals		Southbound		Hour Totals		Combined Totals	
		Morning	Afternoon	Morning	Afternoon	Morning	Afternoon	Morning	Afternoon	Morning	Afternoon
12:00		10	51			1	54				
12:15		4	61			2	47				
12:30		6	54			5	58				
12:45		7	66	27	232	3	54	11	213	38	445
01:00		8	54			1	58				
01:15		5	68			2	61				
01:30		7	70			4	49				
01:45		7	77	27	269	1	48	8	216	35	485
02:00		1	86			1	71				
02:15		4	100			1	74				
02:30		6	89			2	92				
02:45		8	90	19	365	2	78	6	315	25	680
03:00		8	106			1	67				
03:15		6	112			4	90				
03:30		5	122			3	99				
03:45		2	118	21	458	10	95	18	351	39	809
04:00		5	92			5	94				
04:15		5	90			5	67				
04:30		4	97			15	77				
04:45		10	112	24	391	7	71	32	309	56	700
05:00		14	112			12	69				
05:15		20	122			22	43				
05:30		42	96			38	69				
05:45		57	79	133	409	47	53	119	234	252	643
06:00		40	66			27	48				
06:15		48	52			54	26				
06:30		70	63			70	33				
06:45		77	55	235	236	70	34	221	141	456	377
07:00		53	59			98	25				
07:15		54	56			74	14				
07:30		78	44			75	6				
07:45		92	42	277	201	111	9	358	54	635	255
08:00		61	31			81	8				
08:15		72	39			85	13				
08:30		74	40			96	16				
08:45		49	31	256	141	50	18	312	55	568	196
09:00		57	35			63	24				
09:15		37	28			60	15				
09:30		43	23			73	19				
09:45		50	27	187	113	50	15	246	73	433	186
10:00		49	35			50	3				
10:15		55	32			44	12				
10:30		45	32			59	15				
10:45		54	23	203	122	56	27	209	57	412	179
11:00		52	24			51	21				
11:15		58	22			57	6				
11:30		59	15			72	1				
11:45		61	6	230	67	78	2	258	30	488	97
<b>Total</b>		<b>1639</b>	<b>3004</b>	<b>1639</b>	<b>3004</b>	<b>1798</b>	<b>2048</b>	<b>1798</b>	<b>2048</b>	<b>3437</b>	<b>5052</b>
<b>Combined Total</b>		<b>4643</b>		<b>4643</b>		<b>3846</b>		<b>3846</b>		<b>8489</b>	
AM Peak	-	07:30	-	-	-	07:45	-	-	-	-	-
Vol.	-	303	-	-	-	373	-	-	-	-	-
P.H.F.	-	0.823	-	-	-	0.840	-	-	-	-	-
PM Peak	-	-	03:00	-	-	-	03:15	-	-	-	-
Vol.	-	-	458	-	-	-	378	-	-	-	-
P.H.F.	-	-	0.939	-	-	-	0.955	-	-	-	-
Percentage		35.3%	64.7%			46.7%	53.3%				
ADT/AADT		ADT 8,489	AADT 8,489								

*This Page Intentionally Left Blank*



















**APPENDIX 3.2:**

**EXISTING (2022) CONDITIONS INTERSECTION OPERATIONS ANALYSIS WORKSHEETS**

*This Page Intentionally Left Blank*

Lanes, Volumes, Timings  
 1: Little Morongo Rd. & Two Bunch Palms Tr.

Existing (2022) AM Peak Hour

												
Lane Group	EBL	EBT	EBR	WBL	WBT	WBR	NBL	NBT	NBR	SBL	SBT	SBR
Lane Configurations												
Traffic Volume (vph)	3	9	11	214	4	46	3	126	111	86	216	1
Future Volume (vph)	3	9	11	214	4	46	3	126	111	86	216	1
Ideal Flow (vphpl)	1900	1900	1900	1900	1900	1900	1900	1900	1900	1900	1900	1900
Storage Length (ft)	0		0	0		50	150		150	150		50
Storage Lanes	0		0	0		1	0		0	0		1
Taper Length (ft)	90			90			90			90		
Link Speed (mph)		45			45			55			55	
Link Distance (ft)		1073			1443			3240			728	
Travel Time (s)		16.3			21.9			40.2			9.0	
Confl. Peds. (#/hr)	5		5	5		5	5		5	5		5
Peak Hour Factor	0.88	0.88	0.88	0.88	0.88	0.88	0.88	0.88	0.88	0.88	0.88	0.88
Shared Lane Traffic (%)												
Sign Control		Stop			Stop			Stop			Stop	

Intersection Summary

Area Type: Other  
 Control Type: Unsignalized



Intersection	
Intersection Delay, s/veh	15.3
Intersection LOS	C

Movement	EBL	EBT	EBR	WBL	WBT	WBR	NBL	NBT	NBR	SBL	SBT	SBR
Lane Configurations		↕			↕	↕		↕			↕	↕
Traffic Vol, veh/h	3	9	11	214	4	46	3	126	111	86	216	1
Future Vol, veh/h	3	9	11	214	4	46	3	126	111	86	216	1
Peak Hour Factor	0.88	0.88	0.88	0.88	0.88	0.88	0.88	0.88	0.88	0.88	0.88	0.88
Heavy Vehicles, %	2	2	2	2	2	2	2	2	2	2	2	2
Mvmt Flow	3	10	13	243	5	52	3	143	126	98	245	1
Number of Lanes	0	1	0	0	1	1	0	1	0	0	1	1

Approach	EB	WB	NB	SB
Opposing Approach	WB	EB	SB	NB
Opposing Lanes	2	1	2	1
Conflicting Approach Left	SB	NB	EB	WB
Conflicting Lanes Left	2	1	1	2
Conflicting Approach Right	NB	SB	WB	EB
Conflicting Lanes Right	1	2	2	1
HCM Control Delay	10.3	14.6	13.9	17.5
HCM LOS	B	B	B	C

Lane	NBLn1	EBLn1	WBLn1	WBLn2	SBLn1	SBLn2
Vol Left, %	1%	13%	98%	0%	28%	0%
Vol Thru, %	52%	39%	2%	0%	72%	0%
Vol Right, %	46%	48%	0%	100%	0%	100%
Sign Control	Stop	Stop	Stop	Stop	Stop	Stop
Traffic Vol by Lane	240	23	218	46	302	1
LT Vol	3	3	214	0	86	0
Through Vol	126	9	4	0	216	0
RT Vol	111	11	0	46	0	1
Lane Flow Rate	273	26	248	52	343	1
Geometry Grp	6	6	7	7	7	7
Degree of Util (X)	0.451	0.05	0.475	0.083	0.589	0.002
Departure Headway (Hd)	5.957	6.858	6.902	5.693	6.179	5.325
Convergence, Y/N	Yes	Yes	Yes	Yes	Yes	Yes
Cap	603	519	523	628	583	670
Service Time	4.009	4.94	4.653	3.443	3.927	3.072
HCM Lane V/C Ratio	0.453	0.05	0.474	0.083	0.588	0.001
HCM Control Delay	13.9	10.3	15.8	9	17.5	8.1
HCM Lane LOS	B	B	C	A	C	A
HCM 95th-tile Q	2.3	0.2	2.5	0.3	3.8	0

Lanes, Volumes, Timings  
 2: Little Morongo Rd. & i-Storage N. Dwy

Existing (2022) AM Peak Hour



Lane Group	EBL	EBR	NBL	NBT	SBT	SBR
Lane Configurations						
Traffic Volume (vph)	1	4	1	248	478	1
Future Volume (vph)	1	4	1	248	478	1
Ideal Flow (vphpl)	1900	1900	1900	1900	1900	1900
Storage Length (ft)	150	50	150			50
Storage Lanes	0	1	0			1
Taper Length (ft)	90		90			
Link Speed (mph)	30			55	55	
Link Distance (ft)	557			342	421	
Travel Time (s)	12.7			4.2	5.2	
Confl. Peds. (#/hr)	5	5	5			5
Peak Hour Factor	0.90	0.90	0.90	0.90	0.90	0.90
Shared Lane Traffic (%)						
Sign Control	Stop			Free	Free	

Intersection Summary

Area Type: Other  
 Control Type: Unsignalized

HCM 6th TWSC  
 2: Little Morongo Rd. & i-Storage N. Dwy

Existing (2022) AM Peak Hour

Intersection						
Int Delay, s/veh	0.1					
Movement	EBL	EBR	NBL	NBT	SBT	SBR
Lane Configurations						
Traffic Vol, veh/h	1	4	1	248	478	1
Future Vol, veh/h	1	4	1	248	478	1
Conflicting Peds, #/hr	5	5	5	0	0	5
Sign Control	Stop	Stop	Free	Free	Free	Free
RT Channelized	-	None	-	None	-	None
Storage Length	-	50	-	-	-	50
Veh in Median Storage, #	0	-	-	0	0	-
Grade, %	0	-	-	0	0	-
Peak Hour Factor	90	90	90	90	90	90
Heavy Vehicles, %	2	2	2	2	2	2
Mvmt Flow	1	4	1	276	531	1



















Major/Minor	Minor2	Major1	Major2			
Conflicting Flow All	819	541	537	0	-	0
Stage 1	536	-	-	-	-	-
Stage 2	283	-	-	-	-	-
Critical Hdwy	6.42	6.22	4.12	-	-	-
Critical Hdwy Stg 1	5.42	-	-	-	-	-
Critical Hdwy Stg 2	5.42	-	-	-	-	-
Follow-up Hdwy	3.518	3.318	2.218	-	-	-
Pot Cap-1 Maneuver	345	541	1031	-	-	-
Stage 1	587	-	-	-	-	-
Stage 2	765	-	-	-	-	-
Platoon blocked, %				-	-	-
Mov Cap-1 Maneuver	341	536	1026	-	-	-
Mov Cap-2 Maneuver	341	-	-	-	-	-
Stage 1	583	-	-	-	-	-
Stage 2	761	-	-	-	-	-

Approach	EB	NB	SB
HCM Control Delay, s	12.6	0	0
HCM LOS	B		

Minor Lane/Major Mvmt	NBL	NBT	EBLn1	EBLn2	SBT	SBR
Capacity (veh/h)	1026	-	341	536	-	-
HCM Lane V/C Ratio	0.001	-	0.003	0.008	-	-
HCM Control Delay (s)	8.5	0	15.6	11.8	-	-
HCM Lane LOS	A	A	C	B	-	-
HCM 95th %tile Q(veh)	0	-	0	0	-	-

Lanes, Volumes, Timings  
3: Little Morongo Rd. & Dillon Rd.

Existing (2022) AM Peak Hour

												
Lane Group	EBL	EBT	EBR	WBL	WBT	WBR	NBL	NBT	NBR	SBL	SBT	SBR
Lane Configurations												
Traffic Volume (vph)	131	110	0	0	299	150	0	0	0	234	0	259
Future Volume (vph)	131	110	0	0	299	150	0	0	0	234	0	259
Ideal Flow (vphpl)	1900	1900	1900	1900	1900	1900	1900	1900	1900	1900	1900	1900
Storage Length (ft)	205		150	145		150	0		0	150		150
Storage Lanes	1		0	1		0	0		0	0		0
Taper Length (ft)	90			90			90			90		
Link Speed (mph)		55			55			55			55	
Link Distance (ft)		4457			1492			286			3985	
Travel Time (s)		55.3			18.5			3.5			49.4	
Confl. Peds. (#/hr)	5		5	5		5	5		5	5		5
Peak Hour Factor	0.94	0.94	0.94	0.94	0.94	0.94	0.94	0.94	0.94	0.94	0.94	0.94
Shared Lane Traffic (%)												
Sign Control		Stop			Stop			Stop			Stop	

Intersection Summary

Area Type: Other

Control Type: Unsignalized

HCM 6th AWSC  
3: Little Morongo Rd. & Dillon Rd.

Existing (2022) AM Peak Hour

Intersection	
Intersection Delay, s/veh	33.2
Intersection LOS	D

Movement	EBL	EBT	EBR	WBL	WBT	WBR	NBL	NBT	NBR	SBL	SBT	SBR
Lane Configurations	↶	↑		↶	↷						↷	
Traffic Vol, veh/h	131	110	0	0	299	150	0	0	0	234	0	259
Future Vol, veh/h	131	110	0	0	299	150	0	0	0	234	0	259
Peak Hour Factor	0.94	0.94	0.94	0.94	0.94	0.94	0.94	0.94	0.94	0.94	0.94	0.94
Heavy Vehicles, %	2	2	2	2	2	2	2	2	2	2	2	2
Mvmt Flow	139	117	0	0	318	160	0	0	0	249	0	276
Number of Lanes	1	1	0	1	1	0	0	0	0	0	1	0

Approach	EB	WB	SB
Opposing Approach	WB	EB	
Opposing Lanes	2	2	0
Conflicting Approach Left	SB		WB
Conflicting Lanes Left	1	0	2
Conflicting Approach Right		SB	EB
Conflicting Lanes Right	0	1	2
HCM Control Delay	13.1	39.1	37.7
HCM LOS	B	E	E

Lane	EBLn1	EBLn2	WBLn1	WBLn2	SBLn1
Vol Left, %	100%	0%	0%	0%	47%
Vol Thru, %	0%	100%	100%	67%	0%
Vol Right, %	0%	0%	0%	33%	53%
Sign Control	Stop	Stop	Stop	Stop	Stop
Traffic Vol by Lane	131	110	0	449	493
LT Vol	131	0	0	0	234
Through Vol	0	110	0	299	0
RT Vol	0	0	0	150	259
Lane Flow Rate	139	117	0	478	524
Geometry Grp	7	7	7	7	2
Degree of Util (X)	0.3	0.235	0	0.872	0.879
Departure Headway (Hd)	7.754	7.24	6.814	6.574	6.032
Convergence, Y/N	Yes	Yes	Yes	Yes	Yes
Cap	463	495	0	549	603
Service Time	5.521	5.007	4.566	4.326	4.032
HCM Lane V/C Ratio	0.3	0.236	0	0.871	0.869
HCM Control Delay	13.8	12.2	9.6	39.1	37.7
HCM Lane LOS	B	B	N	E	E
HCM 95th-tile Q	1.2	0.9	0	9.7	10.2

Lanes, Volumes, Timings  
4: Indian Cyn. Dr. & Dillon Rd.

Existing (2022) AM Peak Hour

Lane Group	EBL	EBT	EBR	WBL	WBT	WBR	NBL	NBT	NBR	SBL	SBT	SBR
Lane Configurations												
Traffic Volume (vph)	3	83	28	408	97	24	15	235	108	24	541	3
Future Volume (vph)	3	83	28	408	97	24	15	235	108	24	541	3
Ideal Flow (vphpl)	1900	1900	1900	1900	1900	1900	1900	1900	1900	1900	1900	1900
Storage Length (ft)	150		195	100		100	100		150	120		150
Storage Lanes	1		0	1		1	1		0	1		0
Taper Length (ft)	90			90			90			90		
Right Turn on Red			Yes			Yes			Yes			Yes
Link Speed (mph)		55			55			55			55	
Link Distance (ft)		780			957			919			547	
Travel Time (s)		9.7			11.9			11.4			6.8	
Confl. Peds. (#/hr)	5		5	5		5	5		5	5		5
Peak Hour Factor	0.87	0.87	0.87	0.87	0.87	0.87	0.87	0.87	0.87	0.87	0.87	0.87
Shared Lane Traffic (%)												
Turn Type	Prot	NA		Prot	NA	Perm	Perm	NA		Perm	NA	
Protected Phases	7	4		3	8			2			6	
Permitted Phases						8	2			6		
Detector Phase	7	4		3	8	8	2	2		6	6	
Switch Phase												
Minimum Initial (s)	5.0	4.0		5.0	4.0	4.0	4.0	4.0		4.0	4.0	
Minimum Split (s)	9.5	20.0		9.5	20.0	20.0	20.0	20.0		20.0	20.0	
Total Split (s)	10.0	20.0		59.0	69.0	69.0	41.0	41.0		41.0	41.0	
Total Split (%)	8.3%	16.7%		49.2%	57.5%	57.5%	34.2%	34.2%		34.2%	34.2%	
Yellow Time (s)	3.5	3.5		3.5	3.5	3.5	3.5	3.5		3.5	3.5	
All-Red Time (s)	1.0	0.5		1.0	0.5	0.5	0.5	0.5		0.5	0.5	
Lost Time Adjust (s)	0.0	0.0		0.0	0.0	0.0	0.0	0.0		0.0	0.0	
Total Lost Time (s)	4.5	4.0		4.5	4.0	4.0	4.0	4.0		4.0	4.0	
Lead/Lag	Lead	Lag		Lead	Lag	Lag						
Lead-Lag Optimize?	Yes	Yes		Yes	Yes	Yes						
Recall Mode	None	None		None	None	None	C-Max	C-Max		C-Max	C-Max	

Intersection Summary





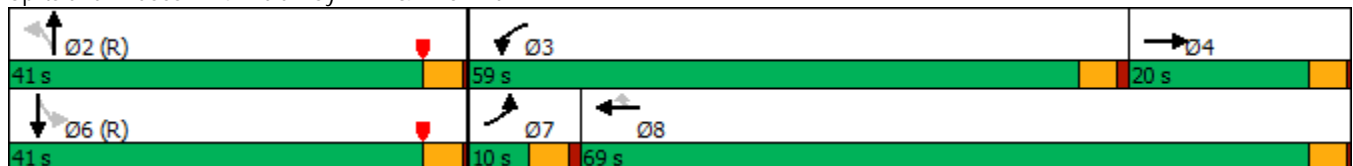

















Area Type: Other  
 Cycle Length: 120  
 Actuated Cycle Length: 120  
 Offset: 0 (0%), Referenced to phase 2:NBTL and 6:SBTL, Start of Yellow  
 Natural Cycle: 65  
 Control Type: Actuated-Coordinated

Splits and Phases: 4: Indian Cyn. Dr. & Dillon Rd.



HCM 6th Signalized Intersection Summary  
4: Indian Cyn. Dr. & Dillon Rd.

Existing (2022) AM Peak Hour

												
Movement	EBL	EBT	EBR	WBL	WBT	WBR	NBL	NBT	NBR	SBL	SBT	SBR
Lane Configurations												
Traffic Volume (veh/h)	3	83	28	408	97	24	15	235	108	24	541	3
Future Volume (veh/h)	3	83	28	408	97	24	15	235	108	24	541	3
Initial Q (Qb), veh	0	0	0	0	0	0	0	0	0	0	0	0
Ped-Bike Adj(A_pbT)	1.00		0.98	1.00		1.00	1.00		1.00	1.00		1.00
Parking Bus, Adj	1.00	1.00	1.00	1.00	1.00	1.00	1.00	1.00	1.00	1.00	1.00	1.00
Work Zone On Approach		No			No			No			No	
Adj Sat Flow, veh/h/ln	1870	1870	1870	1870	1870	1870	1870	1870	1870	1870	1870	1870
Adj Flow Rate, veh/h	3	95	32	469	111	28	17	270	124	28	622	3
Peak Hour Factor	0.87	0.87	0.87	0.87	0.87	0.87	0.87	0.87	0.87	0.87	0.87	0.87
Percent Heavy Veh, %	2	2	2	2	2	2	2	2	2	2	2	2
Cap, veh/h	7	179	57	506	1237	549	419	1298	580	539	1972	10
Arrive On Green	0.00	0.07	0.07	0.28	0.35	0.35	0.54	0.54	0.54	0.54	0.54	0.54
Sat Flow, veh/h	1781	2629	844	1781	3554	1578	800	2386	1066	989	3627	17
Grp Volume(v), veh/h	3	63	64	469	111	28	17	199	195	28	305	320
Grp Sat Flow(s),veh/h/ln	1781	1777	1696	1781	1777	1578	800	1777	1675	989	1777	1867
Q Serve(g_s), s	0.2	4.1	4.4	30.7	2.5	1.4	1.4	6.9	7.2	1.8	11.3	11.3
Cycle Q Clear(g_c), s	0.2	4.1	4.4	30.7	2.5	1.4	12.8	6.9	7.2	9.0	11.3	11.3
Prop In Lane	1.00		0.50	1.00		1.00	1.00		0.64	1.00		0.01
Lane Grp Cap(c), veh/h	7	121	116	506	1237	549	419	966	911	539	966	1016
V/C Ratio(X)	0.42	0.52	0.56	0.93	0.09	0.05	0.04	0.21	0.21	0.05	0.32	0.32
Avail Cap(c_a), veh/h	82	237	226	809	1925	855	419	966	911	539	966	1016
HCM Platoon Ratio	1.00	1.00	1.00	1.00	1.00	1.00	1.00	1.00	1.00	1.00	1.00	1.00
Upstream Filter(I)	1.00	1.00	1.00	1.00	1.00	1.00	1.00	1.00	1.00	1.00	1.00	1.00
Uniform Delay (d), s/veh	59.6	54.0	54.2	41.8	26.3	26.0	18.6	14.1	14.1	16.5	15.1	15.1
Incr Delay (d2), s/veh	35.7	3.4	4.1	11.5	0.0	0.0	0.2	0.5	0.5	0.2	0.9	0.8
Initial Q Delay(d3),s/veh	0.0	0.0	0.0	0.0	0.0	0.0	0.0	0.0	0.0	0.0	0.0	0.0
%ile BackOfQ(50%),veh/ln	0.2	1.9	1.9	14.3	1.0	0.5	0.3	2.6	2.6	0.4	4.4	4.6
Unsig. Movement Delay, s/veh												
LnGrp Delay(d),s/veh	95.4	57.4	58.3	53.3	26.4	26.0	18.8	14.5	14.7	16.6	15.9	15.9
LnGrp LOS	F	E	E	D	C	C	B	B	B	B	B	B
Approach Vol, veh/h		130			608			411			653	
Approach Delay, s/veh		58.7			47.1			14.8			15.9	
Approach LOS		E			D			B			B	
Timer - Assigned Phs		2	3	4		6	7	8				
Phs Duration (G+Y+Rc), s		69.3	38.6	12.2		69.3	5.0	45.8				
Change Period (Y+Rc), s		4.0	4.5	4.0		4.0	4.5	4.0				
Max Green Setting (Gmax), s		37.0	54.5	16.0		37.0	5.5	65.0				
Max Q Clear Time (g_c+I1), s		14.8	32.7	6.4		13.3	2.2	4.5				
Green Ext Time (p_c), s		2.0	1.3	0.3		3.3	0.0	0.7				
<b>Intersection Summary</b>												
HCM 6th Ctrl Delay				29.3								
HCM 6th LOS				C								
<b>Notes</b>												
User approved pedestrian interval to be less than phase max green.												

Lanes, Volumes, Timings  
 6: Little Morongo Rd. & i-Storage S. Dwy

Existing (2022) AM Peak Hour



Lane Group	EBL	EBR	NBL	NBT	SBT	SBR
Lane Configurations						
Traffic Volume (vph)	1	1	1	248	482	1
Future Volume (vph)	1	1	1	248	482	1
Ideal Flow (vphpl)	1900	1900	1900	1900	1900	1900
Storage Length (ft)	150	150	150			50
Storage Lanes	0	0	0			1
Taper Length (ft)	90		90			
Link Speed (mph)	30			55	55	
Link Distance (ft)	528			3985	342	
Travel Time (s)	12.0			49.4	4.2	
Confl. Peds. (#/hr)	5	5	5			5
Peak Hour Factor	0.91	0.91	0.91	0.91	0.91	0.91
Shared Lane Traffic (%)						
Sign Control	Stop			Free	Free	

Intersection Summary

Area Type: Other  
 Control Type: Unsignalized



HCM 6th TWSC  
6: Little Morongo Rd. & i-Storage S. Dwy

Existing (2022) AM Peak Hour

Intersection						
Int Delay, s/veh	0					
Movement	EBL	EBR	NBL	NBT	SBT	SBR
Lane Configurations						
Traffic Vol, veh/h	1	1	1	248	482	1
Future Vol, veh/h	1	1	1	248	482	1
Conflicting Peds, #/hr	5	5	5	0	0	5
Sign Control	Stop	Stop	Free	Free	Free	Free
RT Channelized	-	None	-	None	-	None
Storage Length	-	-	-	-	-	50
Veh in Median Storage, #	0	-	-	0	0	-
Grade, %	0	-	-	0	0	-
Peak Hour Factor	91	91	91	91	91	91
Heavy Vehicles, %	2	2	2	2	2	2
Mvmt Flow	1	1	1	273	530	1





















Major/Minor	Minor2	Major1	Major2			
Conflicting Flow All	815	540	536	0	-	0
Stage 1	535	-	-	-	-	-
Stage 2	280	-	-	-	-	-
Critical Hdwy	6.42	6.22	4.12	-	-	-
Critical Hdwy Stg 1	5.42	-	-	-	-	-
Critical Hdwy Stg 2	5.42	-	-	-	-	-
Follow-up Hdwy	3.518	3.318	2.218	-	-	-
Pot Cap-1 Maneuver	347	542	1032	-	-	-
Stage 1	587	-	-	-	-	-
Stage 2	767	-	-	-	-	-
Platoon blocked, %				-	-	-
Mov Cap-1 Maneuver	343	537	1027	-	-	-
Mov Cap-2 Maneuver	343	-	-	-	-	-
Stage 1	583	-	-	-	-	-
Stage 2	763	-	-	-	-	-

Approach	EB	NB	SB
HCM Control Delay, s	13.6	0	0
HCM LOS	B		

Minor Lane/Major Mvmt	NBL	NBT	EBLn1	SBT	SBR
Capacity (veh/h)	1027	-	419	-	-
HCM Lane V/C Ratio	0.001	-	0.005	-	-
HCM Control Delay (s)	8.5	0	13.6	-	-
HCM Lane LOS	A	A	B	-	-
HCM 95th %tile Q(veh)	0	-	0	-	-

Lanes, Volumes, Timings  
7: Indian Cyn. Dr. & 19th Av.

Existing (2022) AM Peak Hour

												
Lane Group	EBL	EBT	EBR	WBL	WBT	WBR	NBL	NBT	NBR	SBL	SBT	SBR
Lane Configurations												
Traffic Volume (vph)	2	1	6	13	1	7	19	356	54	36	995	7
Future Volume (vph)	2	1	6	13	1	7	19	356	54	36	995	7
Ideal Flow (vphpl)	1900	1900	1900	1900	1900	1900	1900	1900	1900	1900	1900	1900
Storage Length (ft)	0		0	0		50	200		0	100		0
Storage Lanes	0		0	0		1	1		0	1		0
Taper Length (ft)	90			90			90			90		
Link Speed (mph)		30			30			55			55	
Link Distance (ft)		938			936			640			4458	
Travel Time (s)		21.3			21.3			7.9			55.3	
Confl. Peds. (#/hr)	5		5	5		5	5		5	5		5
Peak Hour Factor	0.91	0.91	0.91	0.91	0.91	0.91	0.91	0.91	0.91	0.91	0.91	0.91
Shared Lane Traffic (%)												
Sign Control		Stop			Stop			Free			Free	

Intersection Summary

Area Type: Other

Control Type: Unsignalized

Intersection												
Int Delay, s/veh	0.9											
Movement	EBL	EBT	EBR	WBL	WBT	WBR	NBL	NBT	NBR	SBL	SBT	SBR
Lane Configurations		↕			↕	↕	↕	↕		↕	↕	
Traffic Vol, veh/h	2	1	6	13	1	7	19	356	54	36	995	7
Future Vol, veh/h	2	1	6	13	1	7	19	356	54	36	995	7
Conflicting Peds, #/hr	5	0	5	5	0	5	5	0	5	5	0	5
Sign Control	Stop	Stop	Stop	Stop	Stop	Stop	Free	Free	Free	Free	Free	Free
RT Channelized	-	-	None	-	-	None	-	-	None	-	-	None
Storage Length	-	-	-	-	-	50	200	-	-	100	-	-
Veh in Median Storage, #	-	0	-	-	0	-	-	0	-	-	0	-
Grade, %	-	0	-	-	0	-	-	0	-	-	0	-
Peak Hour Factor	91	91	91	91	91	91	91	91	91	91	91	91
Heavy Vehicles, %	2	2	2	2	2	2	2	2	2	2	2	2
Mvmt Flow	2	1	7	14	1	8	21	391	59	40	1093	8



















Major/Minor	Minor2		Minor1		Major1		Major2					
Conflicting Flow All	1425	1679	561	1100	1654	235	1106	0	0	455	0	0
Stage 1	1182	1182	-	468	468	-	-	-	-	-	-	-
Stage 2	243	497	-	632	1186	-	-	-	-	-	-	-
Critical Hdwy	7.54	6.54	6.94	7.54	6.54	6.94	4.14	-	-	4.14	-	-
Critical Hdwy Stg 1	6.54	5.54	-	6.54	5.54	-	-	-	-	-	-	-
Critical Hdwy Stg 2	6.54	5.54	-	6.54	5.54	-	-	-	-	-	-	-
Follow-up Hdwy	3.52	4.02	3.32	3.52	4.02	3.32	2.22	-	-	2.22	-	-
Pot Cap-1 Maneuver	96	94	471	167	97	767	627	-	-	1102	-	-
Stage 1	201	262	-	545	560	-	-	-	-	-	-	-
Stage 2	739	543	-	435	260	-	-	-	-	-	-	-
Platoon blocked, %								-	-	-	-	-
Mov Cap-1 Maneuver	88	87	467	153	89	760	624	-	-	1097	-	-
Mov Cap-2 Maneuver	88	87	-	153	89	-	-	-	-	-	-	-
Stage 1	193	251	-	524	538	-	-	-	-	-	-	-
Stage 2	702	522	-	409	249	-	-	-	-	-	-	-

Approach	EB		WB		NB		SB	
HCM Control Delay, s	24.9		24.9		0.5		0.3	
HCM LOS	C		C					

Minor Lane/Major Mvmt	NBL	NBT	NBR	EBLn1	WBLn1	WBLn2	SBL	SBT	SBR
Capacity (veh/h)	624	-	-	191	146	760	1097	-	-
HCM Lane V/C Ratio	0.033	-	-	0.052	0.105	0.01	0.036	-	-
HCM Control Delay (s)	11	-	-	24.9	32.5	9.8	8.4	-	-
HCM Lane LOS	B	-	-	C	D	A	A	-	-
HCM 95th %tile Q(veh)	0.1	-	-	0.2	0.3	0	0.1	-	-

Lanes, Volumes, Timings  
 1: Little Morongo Rd. & Two Bunch Palms Tr.

Existing (2022) PM Peak Hour

												
Lane Group	EBL	EBT	EBR	WBL	WBT	WBR	NBL	NBT	NBR	SBL	SBT	SBR
Lane Configurations												
Traffic Volume (vph)	0	7	2	149	13	72	11	191	216	78	115	2
Future Volume (vph)	0	7	2	149	13	72	11	191	216	78	115	2
Ideal Flow (vphpl)	1900	1900	1900	1900	1900	1900	1900	1900	1900	1900	1900	1900
Storage Length (ft)	0		0	0		50	150		150	150		50
Storage Lanes	0		0	0		1	0		0	0		1
Taper Length (ft)	90			90			90			90		
Link Speed (mph)		45			45			55			55	
Link Distance (ft)		1073			1443			3240			728	
Travel Time (s)		16.3			21.9			40.2			9.0	
Confl. Peds. (#/hr)	5		5	5		5	5		5	5		5
Peak Hour Factor	0.94	0.94	0.94	0.94	0.94	0.94	0.94	0.94	0.94	0.94	0.94	0.94
Shared Lane Traffic (%)												
Sign Control		Stop			Stop			Stop			Stop	

Intersection Summary

Area Type: Other  
 Control Type: Unsignalized

HCM 6th AWSC  
 1: Little Morongo Rd. & Two Bunch Palms Tr.

Existing (2022) PM Peak Hour

Intersection	
Intersection Delay, s/veh	15.1
Intersection LOS	C

Movement	EBL	EBT	EBR	WBL	WBT	WBR	NBL	NBT	NBR	SBL	SBT	SBR
Lane Configurations		↕			↕	↕		↕			↕	↕
Traffic Vol, veh/h	0	7	2	149	13	72	11	191	216	78	115	2
Future Vol, veh/h	0	7	2	149	13	72	11	191	216	78	115	2
Peak Hour Factor	0.94	0.94	0.94	0.94	0.94	0.94	0.94	0.94	0.94	0.94	0.94	0.94
Heavy Vehicles, %	2	2	2	2	2	2	2	2	2	2	2	2
Mvmt Flow	0	7	2	159	14	77	12	203	230	83	122	2
Number of Lanes	0	1	0	0	1	1	0	1	0	0	1	1

Approach	EB	WB	NB	SB
Opposing Approach	WB	EB	SB	NB
Opposing Lanes	2	1	2	1
Conflicting Approach Left	SB	NB	EB	WB
Conflicting Lanes Left	2	1	1	2
Conflicting Approach Right	NB	SB	WB	EB
Conflicting Lanes Right	1	2	2	1
HCM Control Delay	10	11.7	18.5	12.1
HCM LOS	A	B	C	B

Lane	NBLn1	EBLn1	WBLn1	WBLn2	SBLn1	SBLn2
Vol Left, %	3%	0%	92%	0%	40%	0%
Vol Thru, %	46%	78%	8%	0%	60%	0%
Vol Right, %	52%	22%	0%	100%	0%	100%
Sign Control	Stop	Stop	Stop	Stop	Stop	Stop
Traffic Vol by Lane	418	9	162	72	193	2
LT Vol	11	0	149	0	78	0
Through Vol	191	7	13	0	115	0
RT Vol	216	2	0	72	0	2
Lane Flow Rate	445	10	172	77	205	2
Geometry Grp	6	6	7	7	7	7
Degree of Util (X)	0.665	0.018	0.326	0.12	0.349	0.003
Departure Headway (Hd)	5.387	6.8	6.815	5.638	6.117	5.202
Convergence, Y/N	Yes	Yes	Yes	Yes	Yes	Yes
Cap	671	526	527	636	589	688
Service Time	3.415	4.852	4.549	3.372	3.85	2.935
HCM Lane V/C Ratio	0.663	0.019	0.326	0.121	0.348	0.003
HCM Control Delay	18.5	10	12.8	9.1	12.1	8
HCM Lane LOS	C	A	B	A	B	A
HCM 95th-tile Q	5	0.1	1.4	0.4	1.6	0

Lanes, Volumes, Timings  
 2: Little Morongo Rd. & i-Storage N. Dwy

Existing (2022) PM Peak Hour



Lane Group	EBL	EBR	NBL	NBT	SBT	SBR
Lane Configurations						
Traffic Volume (vph)	6	11	10	436	261	5
Future Volume (vph)	6	11	10	436	261	5
Ideal Flow (vphpl)	1900	1900	1900	1900	1900	1900
Storage Length (ft)	150	50	150			50
Storage Lanes	0	1	0			1
Taper Length (ft)	90		90			
Link Speed (mph)	30			55	55	
Link Distance (ft)	557			342	421	
Travel Time (s)	12.7			4.2	5.2	
Confl. Peds. (#/hr)	5	5	5			5
Peak Hour Factor	0.92	0.92	0.92	0.92	0.92	0.92
Shared Lane Traffic (%)						
Sign Control	Stop			Free	Free	

Intersection Summary

Area Type: Other

Control Type: Unsignalized

HCM 6th TWSC  
 2: Little Morongo Rd. & i-Storage N. Dwy

Existing (2022) PM Peak Hour

Intersection						
Int Delay, s/veh	0.4					
Movement	EBL	EBR	NBL	NBT	SBT	SBR
Lane Configurations						
Traffic Vol, veh/h	6	11	10	436	261	5
Future Vol, veh/h	6	11	10	436	261	5
Conflicting Peds, #/hr	5	5	5	0	0	5
Sign Control	Stop	Stop	Free	Free	Free	Free
RT Channelized	-	None	-	None	-	None
Storage Length	-	50	-	-	-	50
Veh in Median Storage, #	0	-	-	0	0	-
Grade, %	0	-	-	0	0	-
Peak Hour Factor	92	92	92	92	92	92
Heavy Vehicles, %	2	2	2	2	2	2
Mvmt Flow	7	12	11	474	284	5

















Major/Minor	Minor2	Major1	Major2			
Conflicting Flow All	790	294	294	0	-	0
Stage 1	289	-	-	-	-	-
Stage 2	501	-	-	-	-	-
Critical Hdwy	6.42	6.22	4.12	-	-	-
Critical Hdwy Stg 1	5.42	-	-	-	-	-
Critical Hdwy Stg 2	5.42	-	-	-	-	-
Follow-up Hdwy	3.518	3.318	2.218	-	-	-
Pot Cap-1 Maneuver	359	745	1268	-	-	-
Stage 1	760	-	-	-	-	-
Stage 2	609	-	-	-	-	-
Platoon blocked, %				-	-	-
Mov Cap-1 Maneuver	351	738	1262	-	-	-
Mov Cap-2 Maneuver	351	-	-	-	-	-
Stage 1	747	-	-	-	-	-
Stage 2	606	-	-	-	-	-

Approach	EB	NB	SB
HCM Control Delay, s	11.9	0.2	0
HCM LOS	B		

Minor Lane/Major Mvmt	NBL	NBT	EBLn1	EBLn2	SBT	SBR
Capacity (veh/h)	1262	-	351	738	-	-
HCM Lane V/C Ratio	0.009	-	0.019	0.016	-	-
HCM Control Delay (s)	7.9	0	15.5	10	-	-
HCM Lane LOS	A	A	C	B	-	-
HCM 95th %tile Q(veh)	0	-	0.1	0	-	-

Lanes, Volumes, Timings  
3: Little Morongo Rd. & Dillon Rd.

Existing (2022) PM Peak Hour

												
Lane Group	EBL	EBT	EBR	WBL	WBT	WBR	NBL	NBT	NBR	SBL	SBT	SBR
Lane Configurations												
Traffic Volume (vph)	222	306	0	0	221	167	0	0	0	176	0	176
Future Volume (vph)	222	306	0	0	221	167	0	0	0	176	0	176
Ideal Flow (vphpl)	1900	1900	1900	1900	1900	1900	1900	1900	1900	1900	1900	1900
Storage Length (ft)	205		150	145		150	0		0	150		150
Storage Lanes	1		0	1		0	0		0	0		0
Taper Length (ft)	90			90			90			90		
Link Speed (mph)		55			55			55			55	
Link Distance (ft)		4457			1492			286			3985	
Travel Time (s)		55.3			18.5			3.5			49.4	
Confl. Peds. (#/hr)	5		5	5		5	5		5	5		5
Peak Hour Factor	0.87	0.87	0.87	0.87	0.87	0.87	0.87	0.87	0.87	0.87	0.87	0.87
Shared Lane Traffic (%)												
Sign Control		Stop			Stop			Stop			Stop	

Intersection Summary

Area Type: Other

Control Type: Unsignalized



HCM 6th AWSC  
3: Little Morongo Rd. & Dillon Rd.

Existing (2022) PM Peak Hour

Intersection	
Intersection Delay, s/veh	26
Intersection LOS	D

Movement	EBL	EBT	EBR	WBL	WBT	WBR	NBL	NBT	NBR	SBL	SBT	SBR
Lane Configurations	↶	↑		↶	↷						↷	
Traffic Vol, veh/h	222	306	0	0	221	167	0	0	0	176	0	176
Future Vol, veh/h	222	306	0	0	221	167	0	0	0	176	0	176
Peak Hour Factor	0.87	0.87	0.87	0.87	0.87	0.87	0.87	0.87	0.87	0.87	0.87	0.87
Heavy Vehicles, %	2	2	2	2	2	2	2	2	2	2	2	2
Mvmt Flow	255	352	0	0	254	192	0	0	0	202	0	202
Number of Lanes	1	1	0	1	1	0	0	0	0	0	1	0

Approach	EB	WB	SB
Opposing Approach	WB	EB	
Opposing Lanes	2	2	0
Conflicting Approach Left	SB		WB
Conflicting Lanes Left	1	0	2
Conflicting Approach Right		SB	EB
Conflicting Lanes Right	0	1	2
HCM Control Delay	20.4	34.4	25.2
HCM LOS	C	D	D

Lane	EBLn1	EBLn2	WBLn1	WBLn2	SBLn1
Vol Left, %	100%	0%	0%	0%	50%
Vol Thru, %	0%	100%	100%	57%	0%
Vol Right, %	0%	0%	0%	43%	50%
Sign Control	Stop	Stop	Stop	Stop	Stop
Traffic Vol by Lane	222	306	0	388	352
LT Vol	222	0	0	0	176
Through Vol	0	306	0	221	0
RT Vol	0	0	0	167	176
Lane Flow Rate	255	352	0	446	405
Geometry Grp	7	7	7	7	2
Degree of Util (X)	0.52	0.667	0	0.831	0.732
Departure Headway (Hd)	7.338	6.826	7.018	6.708	6.511
Convergence, Y/N	Yes	Yes	Yes	Yes	Yes
Cap	490	528	0	540	558
Service Time	5.09	4.577	4.764	4.454	4.511
HCM Lane V/C Ratio	0.52	0.667	0	0.826	0.726
HCM Control Delay	17.8	22.3	9.8	34.4	25.2
HCM Lane LOS	C	C	N	D	D
HCM 95th-tile Q	3	4.9	0	8.4	6.2

Lanes, Volumes, Timings  
4: Indian Cyn. Dr. & Dillon Rd.

Existing (2022) PM Peak Hour

Lane Group	EBL	EBT	EBR	WBL	WBT	WBR	NBL	NBT	NBR	SBL	SBT	SBR
Lane Configurations												
Traffic Volume (vph)	4	93	15	206	131	43	11	565	302	34	226	2
Future Volume (vph)	4	93	15	206	131	43	11	565	302	34	226	2
Ideal Flow (vphpl)	1900	1900	1900	1900	1900	1900	1900	1900	1900	1900	1900	1900
Storage Length (ft)	150		195	100		100	100		150	120		150
Storage Lanes	1		0	1		1	1		0	1		0
Taper Length (ft)	90			90			90			90		
Right Turn on Red			Yes			Yes			Yes			Yes
Link Speed (mph)		55			55			55			55	
Link Distance (ft)		780			957			919			547	
Travel Time (s)		9.7			11.9			11.4			6.8	
Confl. Peds. (#/hr)	5		5	5		5	5		5	5		5
Peak Hour Factor	0.91	0.91	0.91	0.91	0.91	0.91	0.91	0.91	0.91	0.91	0.91	0.91
Shared Lane Traffic (%)												
Turn Type	Prot	NA		Prot	NA	Perm	Perm	NA		Perm	NA	
Protected Phases	7	4		3	8			2			6	
Permitted Phases						8	2			6		
Detector Phase	7	4		3	8	8	2	2		6	6	
Switch Phase												
Minimum Initial (s)	5.0	4.0		5.0	4.0	4.0	4.0	4.0		4.0	4.0	
Minimum Split (s)	9.5	20.0		9.5	20.0	20.0	20.0	20.0		20.0	20.0	
Total Split (s)	11.0	22.0		38.0	49.0	49.0	60.0	60.0		60.0	60.0	
Total Split (%)	9.2%	18.3%		31.7%	40.8%	40.8%	50.0%	50.0%		50.0%	50.0%	
Yellow Time (s)	3.5	3.5		3.5	3.5	3.5	3.5	3.5		3.5	3.5	
All-Red Time (s)	1.0	0.5		1.0	0.5	0.5	0.5	0.5		0.5	0.5	
Lost Time Adjust (s)	0.0	0.0		0.0	0.0	0.0	0.0	0.0		0.0	0.0	
Total Lost Time (s)	4.5	4.0		4.5	4.0	4.0	4.0	4.0		4.0	4.0	
Lead/Lag	Lead	Lag		Lead	Lag	Lag						
Lead-Lag Optimize?	Yes	Yes		Yes	Yes	Yes						
Recall Mode	None	None		None	None	None	C-Max	C-Max		C-Max	C-Max	

Intersection Summary





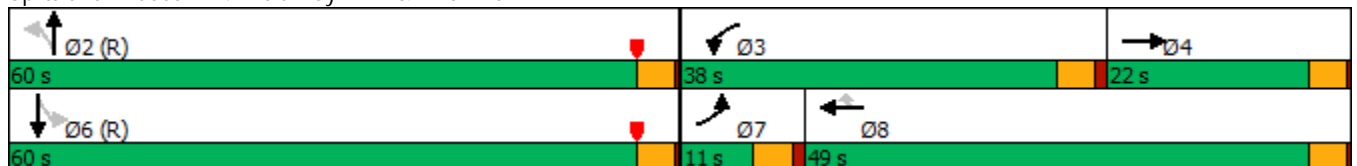

















Area Type: Other  
 Cycle Length: 120  
 Actuated Cycle Length: 120  
 Offset: 0 (0%), Referenced to phase 2:NBTL and 6:SBTL, Start of Yellow  
 Natural Cycle: 60  
 Control Type: Actuated-Coordinated

Splits and Phases: 4: Indian Cyn. Dr. & Dillon Rd.



HCM 6th Signalized Intersection Summary  
4: Indian Cyn. Dr. & Dillon Rd.

Existing (2022) PM Peak Hour

												
Movement	EBL	EBT	EBR	WBL	WBT	WBR	NBL	NBT	NBR	SBL	SBT	SBR
Lane Configurations												
Traffic Volume (veh/h)	4	93	15	206	131	43	11	565	302	34	226	2
Future Volume (veh/h)	4	93	15	206	131	43	11	565	302	34	226	2
Initial Q (Qb), veh	0	0	0	0	0	0	0	0	0	0	0	0
Ped-Bike Adj(A_pbT)	1.00		0.98	1.00		0.99	1.00		1.00	1.00		1.00
Parking Bus, Adj	1.00	1.00	1.00	1.00	1.00	1.00	1.00	1.00	1.00	1.00	1.00	1.00
Work Zone On Approach		No			No			No			No	
Adj Sat Flow, veh/h/ln	1870	1870	1870	1870	1870	1870	1870	1870	1870	1870	1870	1870
Adj Flow Rate, veh/h	4	102	16	226	144	47	12	621	332	37	248	2
Peak Hour Factor	0.91	0.91	0.91	0.91	0.91	0.91	0.91	0.91	0.91	0.91	0.91	0.91
Percent Heavy Veh, %	2	2	2	2	2	2	2	2	2	2	2	2
Cap, veh/h	9	200	31	259	728	322	808	1532	819	393	2478	20
Arrive On Green	0.01	0.06	0.06	0.15	0.20	0.20	0.69	0.69	0.69	0.69	0.69	0.69
Sat Flow, veh/h	1781	3078	471	1781	3554	1573	1128	2235	1195	589	3613	29
Grp Volume(v), veh/h	4	58	60	226	144	47	12	494	459	37	122	128
Grp Sat Flow(s),veh/h/ln	1781	1777	1772	1781	1777	1573	1128	1777	1652	589	1777	1865
Q Serve(g_s), s	0.3	3.8	3.9	14.9	4.0	2.9	0.4	14.5	14.5	3.5	2.8	2.8
Cycle Q Clear(g_c), s	0.3	3.8	3.9	14.9	4.0	2.9	3.2	14.5	14.5	18.0	2.8	2.8
Prop In Lane	1.00		0.27	1.00		1.00	1.00		0.72	1.00		0.02
Lane Grp Cap(c), veh/h	9	115	115	259	728	322	808	1219	1133	393	1219	1279
V/C Ratio(X)	0.43	0.50	0.52	0.87	0.20	0.15	0.01	0.41	0.41	0.09	0.10	0.10
Avail Cap(c_a), veh/h	96	267	266	497	1333	590	808	1219	1133	393	1219	1279
HCM Platoon Ratio	1.00	1.00	1.00	1.00	1.00	1.00	1.00	1.00	1.00	1.00	1.00	1.00
Upstream Filter(I)	1.00	1.00	1.00	1.00	1.00	1.00	1.00	1.00	1.00	1.00	1.00	1.00
Uniform Delay (d), s/veh	59.5	54.2	54.3	50.2	39.5	39.1	6.9	8.2	8.2	12.1	6.4	6.4
Incr Delay (d2), s/veh	28.7	3.3	3.6	9.0	0.1	0.2	0.0	1.0	1.1	0.5	0.2	0.2
Initial Q Delay(d3),s/veh	0.0	0.0	0.0	0.0	0.0	0.0	0.0	0.0	0.0	0.0	0.0	0.0
%ile BackOfQ(50%),veh/ln	0.2	1.7	1.8	7.0	1.7	1.1	0.1	4.8	4.5	0.5	0.9	0.9
Unsig. Movement Delay, s/veh												
LnGrp Delay(d),s/veh	88.2	57.6	58.0	59.2	39.7	39.3	6.9	9.2	9.3	12.6	6.5	6.5
LnGrp LOS	F	E	E	E	D	D	A	A	A	B	A	A
Approach Vol, veh/h		122			417			965			287	
Approach Delay, s/veh		58.8			50.2			9.2			7.3	
Approach LOS		E			D			A			A	
Timer - Assigned Phs		2	3	4		6	7	8				
Phs Duration (G+Y+Rc), s		86.3	21.9	11.8		86.3	5.1	28.6				
Change Period (Y+Rc), s		4.0	4.5	4.0		4.0	4.5	4.0				
Max Green Setting (Gmax), s		56.0	33.5	18.0		56.0	6.5	45.0				
Max Q Clear Time (g_c+I1), s		16.5	16.9	5.9		20.0	2.3	6.0				
Green Ext Time (p_c), s		6.3	0.5	0.3		1.6	0.0	0.9				
<b>Intersection Summary</b>												
HCM 6th Ctrl Delay				21.8								
HCM 6th LOS				C								
<b>Notes</b>												
User approved pedestrian interval to be less than phase max green.												

Lanes, Volumes, Timings  
 6: Little Morongo Rd. & i-Storage S. Dwy

Existing (2022) PM Peak Hour



Lane Group	EBL	EBR	NBL	NBT	SBT	SBR
Lane Configurations						
Traffic Volume (vph)	1	1	1	446	271	1
Future Volume (vph)	1	1	1	446	271	1
Ideal Flow (vphpl)	1900	1900	1900	1900	1900	1900
Storage Length (ft)	150	150	150			50
Storage Lanes	0	0	0			1
Taper Length (ft)	90		90			
Link Speed (mph)	30			55	55	
Link Distance (ft)	528			3985	342	
Travel Time (s)	12.0			49.4	4.2	
Confl. Peds. (#/hr)	5	5	5			5
Peak Hour Factor	0.91	0.91	0.91	0.91	0.91	0.91
Shared Lane Traffic (%)						
Sign Control	Stop			Free	Free	

Intersection Summary

Area Type: Other  
 Control Type: Unsignalized

HCM 6th TWSC  
6: Little Morongo Rd. & i-Storage S. Dwy

Existing (2022) PM Peak Hour

Intersection						
Int Delay, s/veh	0					
Movement	EBL	EBR	NBL	NBT	SBT	SBR
Lane Configurations						
Traffic Vol, veh/h	1	1	1	446	271	1
Future Vol, veh/h	1	1	1	446	271	1
Conflicting Peds, #/hr	5	5	5	0	0	5
Sign Control	Stop	Stop	Free	Free	Free	Free
RT Channelized	-	None	-	None	-	None
Storage Length	-	-	-	-	-	50
Veh in Median Storage, #	0	-	-	0	0	-
Grade, %	0	-	-	0	0	-
Peak Hour Factor	91	91	91	91	91	91
Heavy Vehicles, %	2	2	2	2	2	2
Mvmt Flow	1	1	1	490	298	1



















Major/Minor	Minor2	Major1	Major2			
Conflicting Flow All	800	308	304	0	-	0
Stage 1	303	-	-	-	-	-
Stage 2	497	-	-	-	-	-
Critical Hdwy	6.42	6.22	4.12	-	-	-
Critical Hdwy Stg 1	5.42	-	-	-	-	-
Critical Hdwy Stg 2	5.42	-	-	-	-	-
Follow-up Hdwy	3.518	3.318	2.218	-	-	-
Pot Cap-1 Maneuver	354	732	1257	-	-	-
Stage 1	749	-	-	-	-	-
Stage 2	611	-	-	-	-	-
Platoon blocked, %				-	-	-
Mov Cap-1 Maneuver	350	725	1251	-	-	-
Mov Cap-2 Maneuver	350	-	-	-	-	-
Stage 1	745	-	-	-	-	-
Stage 2	608	-	-	-	-	-

Approach	EB	NB	SB
HCM Control Delay, s	12.7	0	0
HCM LOS	B		

Minor Lane/Major Mvmt	NBL	NBT	EBLn1	SBT	SBR
Capacity (veh/h)	1251	-	472	-	-
HCM Lane V/C Ratio	0.001	-	0.005	-	-
HCM Control Delay (s)	7.9	0	12.7	-	-
HCM Lane LOS	A	A	B	-	-
HCM 95th %tile Q(veh)	0	-	0	-	-

Lanes, Volumes, Timings  
7: Indian Cyn. Dr. & 19th Av.

Existing (2022) PM Peak Hour

												
Lane Group	EBL	EBT	EBR	WBL	WBT	WBR	NBL	NBT	NBR	SBL	SBT	SBR
Lane Configurations												
Traffic Volume (vph)	7	1	9	53	3	20	3	934	6	1	440	3
Future Volume (vph)	7	1	9	53	3	20	3	934	6	1	440	3
Ideal Flow (vphpl)	1900	1900	1900	1900	1900	1900	1900	1900	1900	1900	1900	1900
Storage Length (ft)	0		0	0		50	200		0	100		0
Storage Lanes	0		0	0		1	1		0	1		0
Taper Length (ft)	90			90			90			90		
Link Speed (mph)		30			30			55			55	
Link Distance (ft)		938			936			640			4458	
Travel Time (s)		21.3			21.3			7.9			55.3	
Confl. Peds. (#/hr)	5		5	5		5	5		5	5		5
Peak Hour Factor	0.90	0.90	0.90	0.90	0.90	0.90	0.90	0.90	0.90	0.90	0.90	0.90
Shared Lane Traffic (%)												
Sign Control		Stop			Stop			Free			Free	

Intersection Summary

Area Type: Other  
Control Type: Unsignalized

Intersection												
Int Delay, s/veh	3											
Movement	EBL	EBT	EBR	WBL	WBT	WBR	NBL	NBT	NBR	SBL	SBT	SBR
Lane Configurations		↕			↕	↕	↕	↕		↕	↕	
Traffic Vol, veh/h	7	1	9	53	3	20	3	934	6	1	440	3
Future Vol, veh/h	7	1	9	53	3	20	3	934	6	1	440	3
Conflicting Peds, #/hr	5	0	5	5	0	5	5	0	5	5	0	5
Sign Control	Stop	Stop	Stop	Stop	Stop	Stop	Free	Free	Free	Free	Free	Free
RT Channelized	-	-	None	-	-	None	-	-	None	-	-	None
Storage Length	-	-	-	-	-	50	200	-	-	100	-	-
Veh in Median Storage, #	-	0	-	-	0	-	-	0	-	-	0	-
Grade, %	-	0	-	-	0	-	-	0	-	-	0	-
Peak Hour Factor	90	90	90	90	90	90	90	90	90	90	90	90
Heavy Vehicles, %	2	2	2	2	2	2	2	2	2	2	2	2
Mvmt Flow	8	1	10	59	3	22	3	1038	7	1	489	3

Major/Minor	Minor2		Minor1		Major1		Major2					
Conflicting Flow All	1030	1554	256	1305	1552	533	497	0	0	1050	0	0
Stage 1	498	498	-	1053	1053	-	-	-	-	-	-	-
Stage 2	532	1056	-	252	499	-	-	-	-	-	-	-
Critical Hdwy	7.54	6.54	6.94	7.54	6.54	6.94	4.14	-	-	4.14	-	-
Critical Hdwy Stg 1	6.54	5.54	-	6.54	5.54	-	-	-	-	-	-	-
Critical Hdwy Stg 2	6.54	5.54	-	6.54	5.54	-	-	-	-	-	-	-
Follow-up Hdwy	3.52	4.02	3.32	3.52	4.02	3.32	2.22	-	-	2.22	-	-
Pot Cap-1 Maneuver	188	112	743	118	112	491	1063	-	-	659	-	-
Stage 1	523	543	-	242	301	-	-	-	-	-	-	-
Stage 2	499	300	-	730	542	-	-	-	-	-	-	-
Platoon blocked, %								-	-	-	-	-
Mov Cap-1 Maneuver	173	110	736	114	110	486	1058	-	-	656	-	-
Mov Cap-2 Maneuver	173	110	-	114	110	-	-	-	-	-	-	-
Stage 1	519	539	-	240	299	-	-	-	-	-	-	-
Stage 2	467	298	-	714	538	-	-	-	-	-	-	-

Approach	EB	WB	NB	SB
HCM Control Delay, s	19.1	54.4	0	0
HCM LOS	C	F		

Minor Lane/Major Mvmt	NBL	NBT	NBR	EBLn1	WBLn1	WBLn2	SBL	SBT	SBR
Capacity (veh/h)	1058	-	-	275	114	486	656	-	-
HCM Lane V/C Ratio	0.003	-	-	0.069	0.546	0.046	0.002	-	-
HCM Control Delay (s)	8.4	-	-	19.1	69.3	12.8	10.5	-	-
HCM Lane LOS	A	-	-	C	F	B	B	-	-
HCM 95th %tile Q(veh)	0	-	-	0.2	2.6	0.1	0	-	-

**APPENDIX 3.3:**

**TRAFFIC SIGNAL WARRANT ANALYSIS WORKSHEETS**



*This Page Intentionally Left Blank*

**Figure 4C-4. Warrant 3, Peak Hour (70% Factor)**

(COMMUNITY LESS THAN 10,000 POPULATION OR ABOVE 64 km/h OR ABOVE 40 mph ON MAJOR STREET)

Traffic Conditions = **EXISTING (2022) AM PEAK HOUR WARRANTS**

Major Street Name = **Little Morongo Rd.** Total of Both Approaches (VPH) = **543**  
 Number of Approach Lanes Major Street = **1**

Minor Street Name = **Two Bunch Palms Tr.** High Volume Approach (VPH) = **264**  
 Number of Approach Lanes Minor Street = **1**

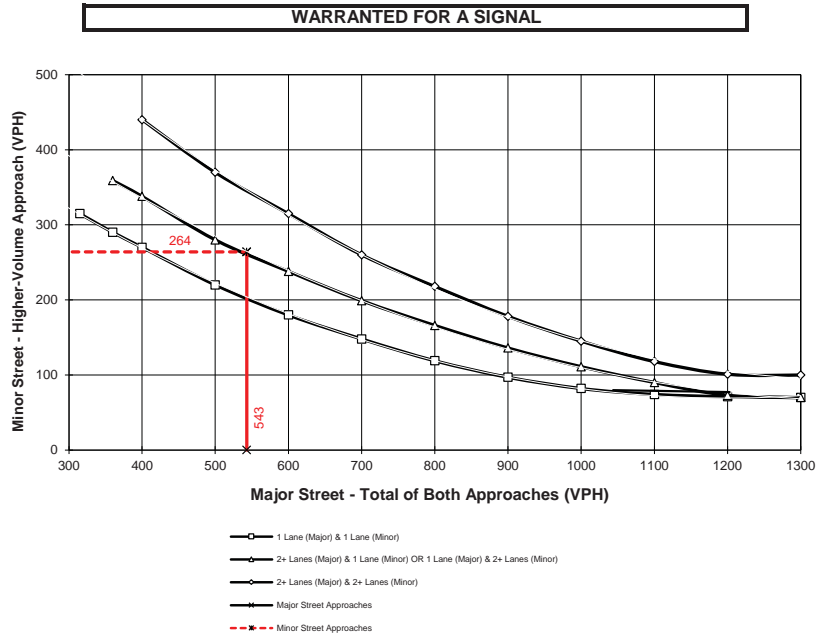

\*Note: 100 vph applies as the lower threshold for a minor-street approach with two or more lanes and 75 vph applies as the lower threshold for a minor-street approach with one lane

Intersection ID: #1

**Figure 4C-4. Warrant 3, Peak Hour (70% Factor)**

(COMMUNITY LESS THAN 10,000 POPULATION OR ABOVE 64 km/h OR ABOVE 40 mph ON MAJOR STREET)

Traffic Conditions = **EXISTING (2022) PM PEAK HOUR WARRANTS**

Major Street Name = **Little Morongo Rd.** Total of Both Approaches (VPH) = **613**  
 Number of Approach Lanes Major Street = **1**

Minor Street Name = **Two Bunch Palms Tr.** High Volume Approach (VPH) = **234**  
 Number of Approach Lanes Minor Street = **1**

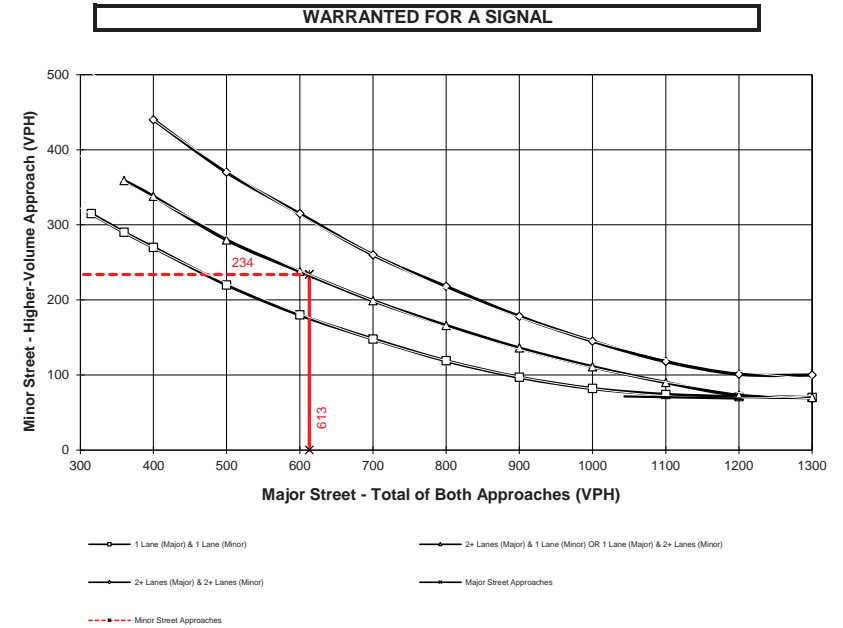

\*Note: 100 vph applies as the lower threshold for a minor-street approach with two or more lanes and 75 vph applies as the lower threshold for a minor-street approach with one lane

Intersection ID: #1

**Figure 4C-3. Warrant 3, Peak Hour**

Traffic Conditions = **EXISTING (2022) AM PEAK HOUR WARRANTS**

Major Street Name = **Little Morongo Rd.** Total of Both Approaches (VPH) = **543**  
Number of Approach Lanes on Major Street = **1**

Minor Street Name = **Two Bunch Palms Tr.** High Volume Approach (VPH) = **264**  
Number of Approach Lanes On Minor Street = **1**

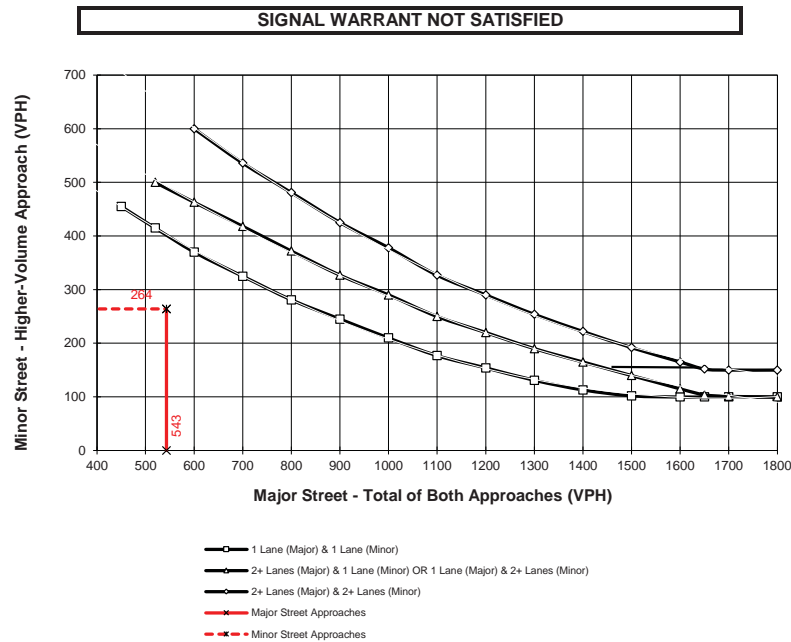

\*Note: 150 vph applies as the lower threshold for a minor-street approach with two or more lanes and 100 vph applies as the lower threshold for a minor-street approach with one lane

Intersection ID: #1

**Figure 4C-3. Warrant 3, Peak Hour**

Traffic Conditions = **EXISTING (2022) PM PEAK HOUR WARRANTS**

Major Street Name = **Little Morongo Rd.** Total of Both Approaches (VPH) = **613**  
Number of Approach Lanes on Major Street = **1**

Minor Street Name = **Two Bunch Palms Tr.** High Volume Approach (VPH) = **234**  
Number of Approach Lanes On Minor Street = **1**

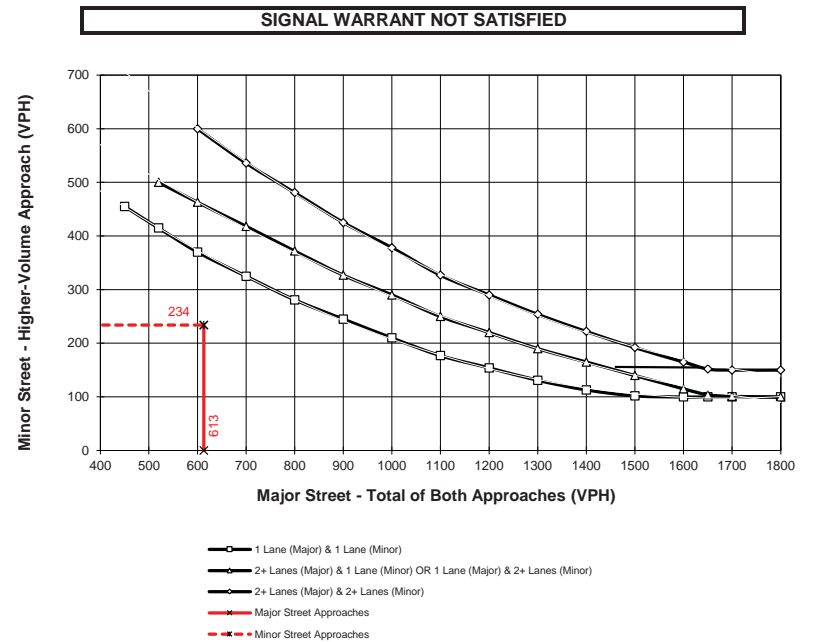

\*Note: 150 vph applies as the lower threshold for a minor-street approach with two or more lanes and 100 vph applies as the lower threshold for a minor-street approach with one lane

Intersection ID: #1

**Figure 4C-4. Warrant 3, Peak Hour (70% Factor)**

(COMMUNITY LESS THAN 10,000 POPULATION OR ABOVE 64 km/h OR ABOVE 40 mph ON MAJOR STREET)

Traffic Conditions = **EXISTING (2022) AM PEAK HOUR WARRANTS**

Major Street Name = **Little Morongo Rd.** Total of Both Approaches (VPH) = **728**  
Number of Approach Lanes Major Street = **1**

Minor Street Name = **i-Strange N. Dwy.** High Volume Approach (VPH) = **5**  
Number of Approach Lanes Minor Street = **1**

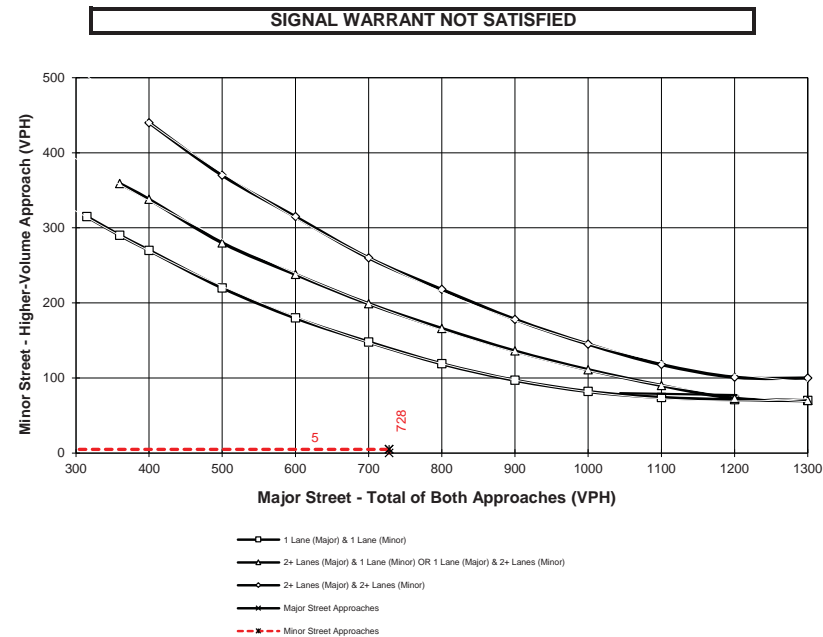

\*Note: 100 vph applies as the lower threshold for a minor-street approach with two or more lanes and 75 vph applies as the lower threshold for a minor-street approach with one lane

Intersection ID: #2

**Figure 4C-4. Warrant 3, Peak Hour (70% Factor)**

(COMMUNITY LESS THAN 10,000 POPULATION OR ABOVE 64 km/h OR ABOVE 40 mph ON MAJOR STREET)

Traffic Conditions = **EXISTING (2022) PM PEAK HOUR WARRANTS**

Major Street Name = **Little Morongo Rd.** Total of Both Approaches (VPH) = **712**  
Number of Approach Lanes Major Street = **1**

Minor Street Name = **i-Strange N. Dwy.** High Volume Approach (VPH) = **17**  
Number of Approach Lanes Minor Street = **1**

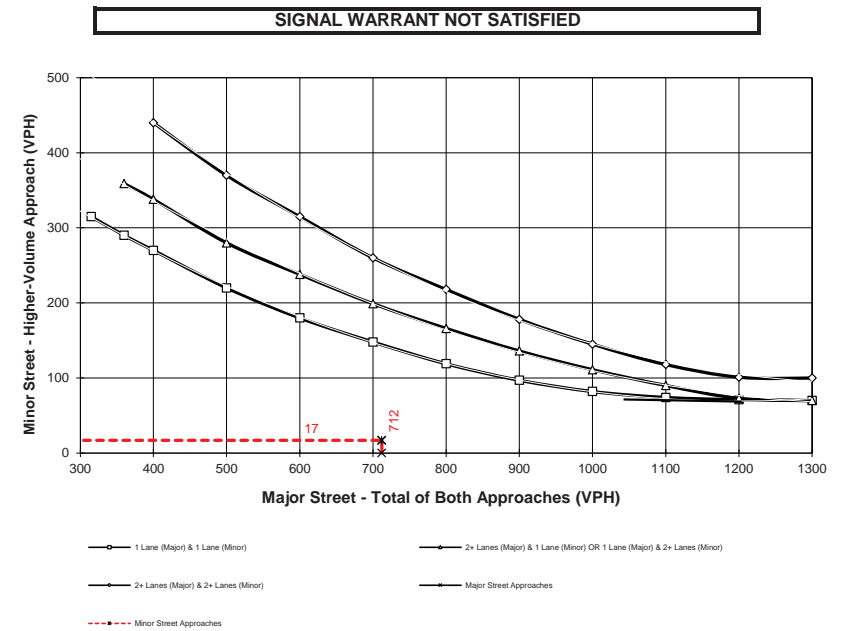

\*Note: 100 vph applies as the lower threshold for a minor-street approach with two or more lanes and 75 vph applies as the lower threshold for a minor-street approach with one lane

Intersection ID: #2

**Figure 4C-4. Warrant 3, Peak Hour (70% Factor)**

(COMMUNITY LESS THAN 10,000 POPULATION OR ABOVE 64 km/h OR ABOVE 40 mph ON MAJOR STREET)

Traffic Conditions = **EXISTING (2022) AM PEAK HOUR WARRANTS**

Major Street Name = **Dillon Rd.** Total of Both Approaches (VPH) = **690**  
Number of Approach Lanes Major Street = **1**

Minor Street Name = **Little Morongo Rd.** High Volume Approach (VPH) = **493**  
Number of Approach Lanes Minor Street = **1**

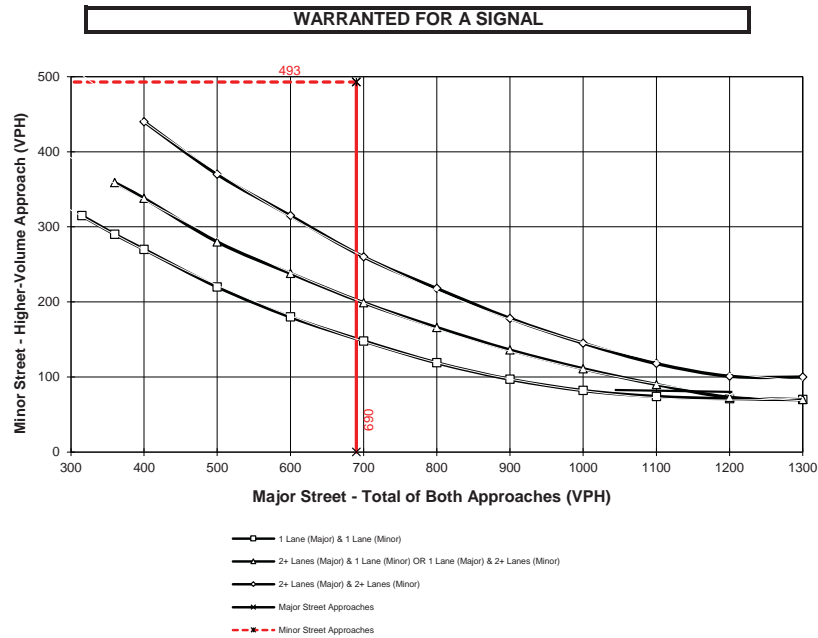

\*Note: 100 vph applies as the lower threshold for a minor-street approach with two or more lanes and 75 vph applies as the lower threshold for a minor-street approach with one lane

Intersection ID: #3

**Figure 4C-4. Warrant 3, Peak Hour (70% Factor)**

(COMMUNITY LESS THAN 10,000 POPULATION OR ABOVE 64 km/h OR ABOVE 40 mph ON MAJOR STREET)

Traffic Conditions = **EXISTING (2022) PM PEAK HOUR WARRANTS**

Major Street Name = **Dillon Rd.** Total of Both Approaches (VPH) = **916**  
Number of Approach Lanes Major Street = **1**

Minor Street Name = **Little Morongo Rd.** High Volume Approach (VPH) = **352**  
Number of Approach Lanes Minor Street = **1**

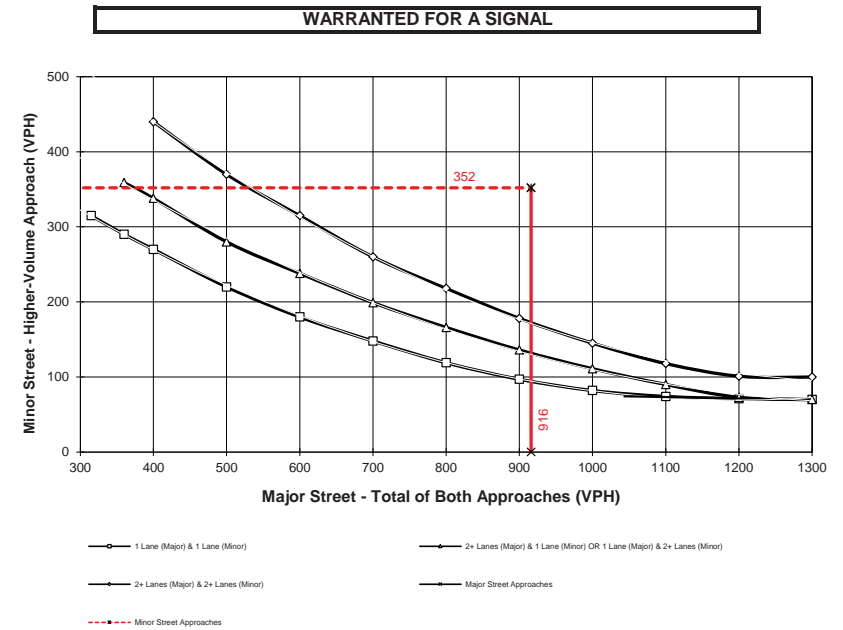

\*Note: 100 vph applies as the lower threshold for a minor-street approach with two or more lanes and 75 vph applies as the lower threshold for a minor-street approach with one lane

Intersection ID: #3

**Figure 4C-4. Warrant 3, Peak Hour (70% Factor)**

(COMMUNITY LESS THAN 10,000 POPULATION OR ABOVE 64 km/h OR ABOVE 40 mph ON MAJOR STREET)

Traffic Conditions = **EXISTING (2022) AM PEAK HOUR WARRANTS**

Major Street Name = **Little Morongo Rd.** Total of Both Approaches (VPH) = **732**  
 Number of Approach Lanes Major Street = **1**

Minor Street Name = **i-Storage S. Dwy. - Project S. Dwy.** High Volume Approach (VPH) = **2**  
 Number of Approach Lanes Minor Street = **1**

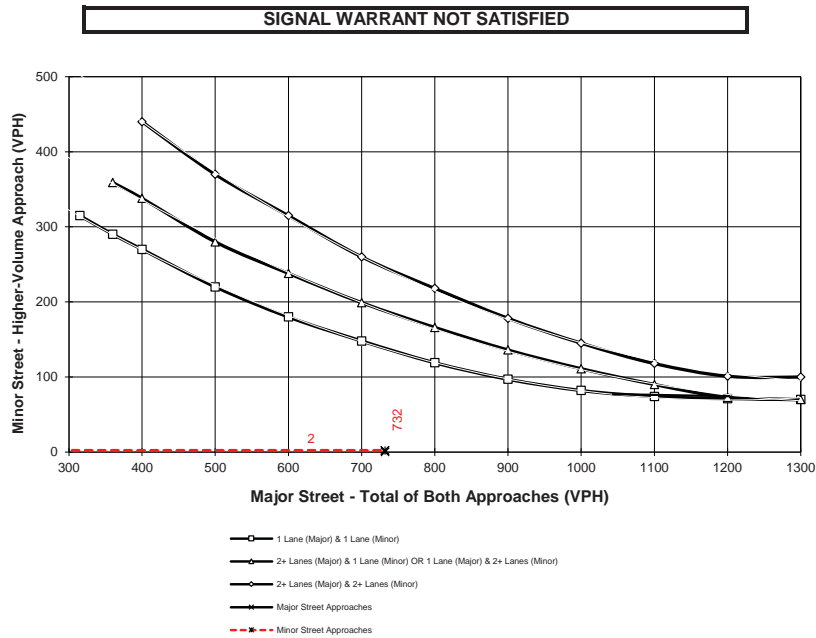

\*Note: 100 vph applies as the lower threshold for a minor-street approach with two or more lanes and 75 vph applies as the lower threshold for a minor-street approach with one lane

Intersection ID: #6

**Figure 4C-4. Warrant 3, Peak Hour (70% Factor)**

(COMMUNITY LESS THAN 10,000 POPULATION OR ABOVE 64 km/h OR ABOVE 40 mph ON MAJOR STREET)

Traffic Conditions = **EXISTING (2022) PM PEAK HOUR WARRANTS**

Major Street Name = **Little Morongo Rd.** Total of Both Approaches (VPH) = **719**  
 Number of Approach Lanes Major Street = **1**

Minor Street Name = **i-Storage S. Dwy. - Project S. Dwy.** High Volume Approach (VPH) = **2**  
 Number of Approach Lanes Minor Street = **1**

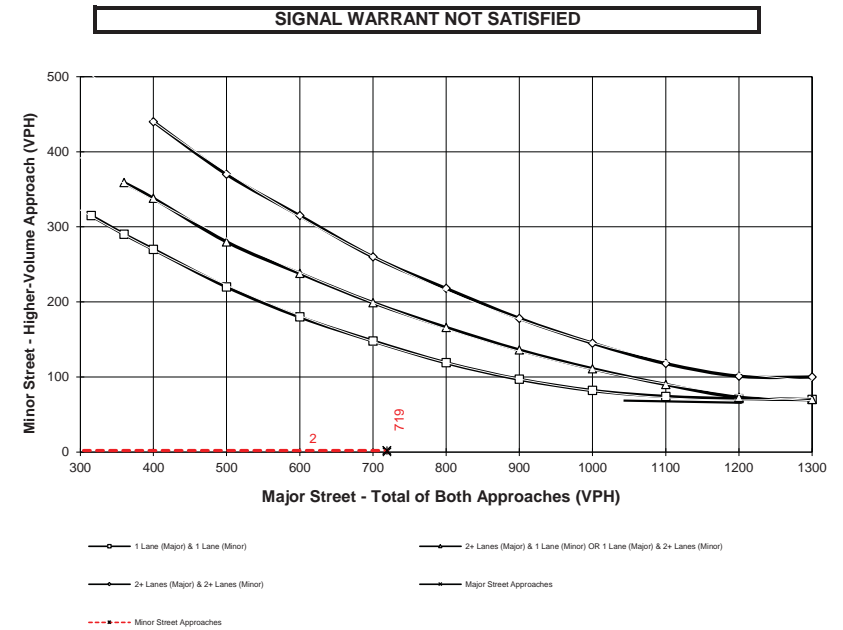

\*Note: 100 vph applies as the lower threshold for a minor-street approach with two or more lanes and 75 vph applies as the lower threshold for a minor-street approach with one lane

Intersection ID: #6

**Figure 4C-4. Warrant 3, Peak Hour (70% Factor)**

(COMMUNITY LESS THAN 10,000 POPULATION OR ABOVE 64 km/h OR ABOVE 40 mph ON MAJOR STREET)

Traffic Conditions = **EXISTING (2022) AM PEAK HOUR WARRANTS**

Major Street Name = **Indian Cyn. Dr.** Total of Both Approaches (VPH) = **1,467**  
 Number of Approach Lanes Major Street = **2**

Minor Street Name = **19th Av.** High Volume Approach (VPH) = **21**  
 Number of Approach Lanes Minor Street = **1**

**SIGNAL WARRANT NOT SATISFIED**

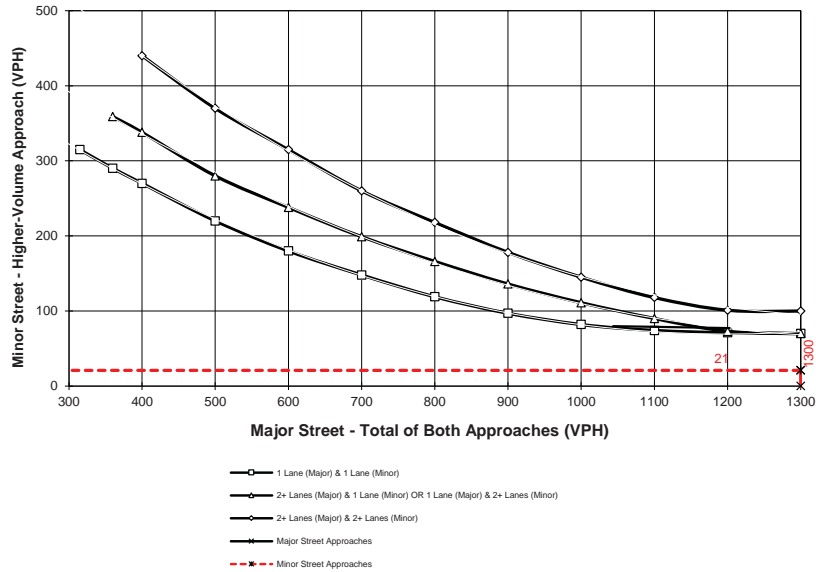

\*Note: 100 vph applies as the lower threshold for a minor-street approach with two or more lanes and 75 vph applies as the lower threshold for a minor-street approach with one lane

Intersection ID: #7

**Figure 4C-4. Warrant 3, Peak Hour (70% Factor)**

(COMMUNITY LESS THAN 10,000 POPULATION OR ABOVE 64 km/h OR ABOVE 40 mph ON MAJOR STREET)

Traffic Conditions = **EXISTING (2022) PM PEAK HOUR WARRANTS**

Major Street Name = **Indian Cyn. Dr.** Total of Both Approaches (VPH) = **1,387**  
 Number of Approach Lanes Major Street = **2**

Minor Street Name = **19th Av.** High Volume Approach (VPH) = **76**  
 Number of Approach Lanes Minor Street = **1**

**WARRANTED FOR A SIGNAL**

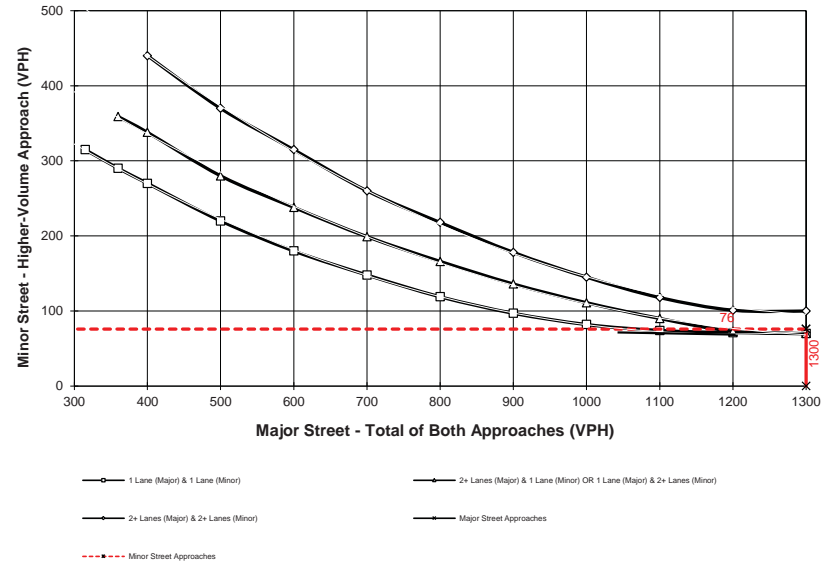

\*Note: 100 vph applies as the lower threshold for a minor-street approach with two or more lanes and 75 vph applies as the lower threshold for a minor-street approach with one lane

Intersection ID: #7

**Figure 4C-4. Warrant 3, Peak Hour (70% Factor)**

(COMMUNITY LESS THAN 10,000 POPULATION OR ABOVE 64 km/h OR ABOVE 40 mph ON MAJOR STREET)

Traffic Conditions = **EAP AM PEAK HOUR WARRANTS**

Major Street Name = **Little Morongo Rd.** Total of Both Approaches (VPH) = **779**  
Number of Approach Lanes Major Street = **1**

Minor Street Name = **i-Strange N. Dwy.** High Volume Approach (VPH) = **6**  
Number of Approach Lanes Minor Street = **1**

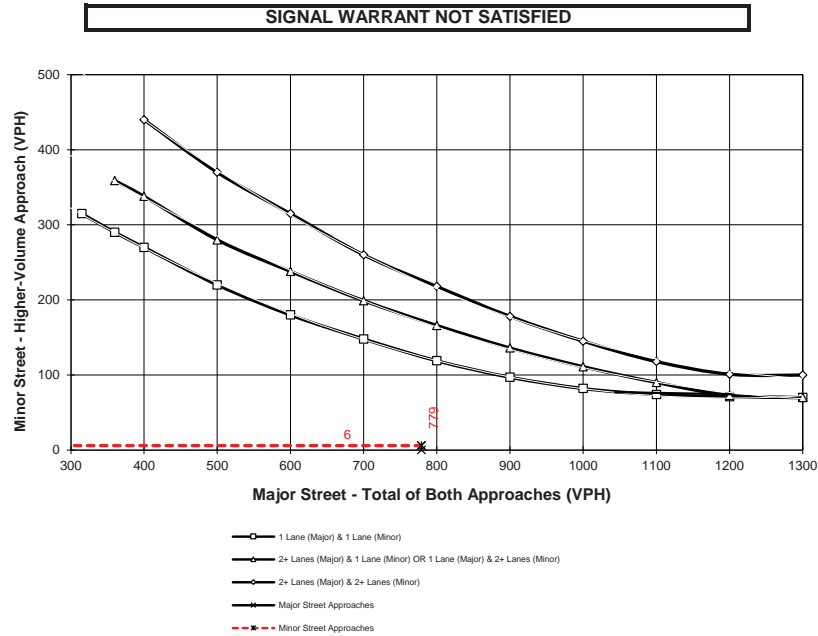

\*Note: 100 vph applies as the lower threshold for a minor-street approach with two or more lanes and 75 vph applies as the lower threshold for a minor-street approach with one lane

Intersection ID: #2

**Figure 4C-4. Warrant 3, Peak Hour (70% Factor)**

(COMMUNITY LESS THAN 10,000 POPULATION OR ABOVE 64 km/h OR ABOVE 40 mph ON MAJOR STREET)

Traffic Conditions = **EAP PM PEAK HOUR WARRANTS**

Major Street Name = **Little Morongo Rd.** Total of Both Approaches (VPH) = **759**  
Number of Approach Lanes Major Street = **1**

Minor Street Name = **i-Strange N. Dwy.** High Volume Approach (VPH) = **17**  
Number of Approach Lanes Minor Street = **1**

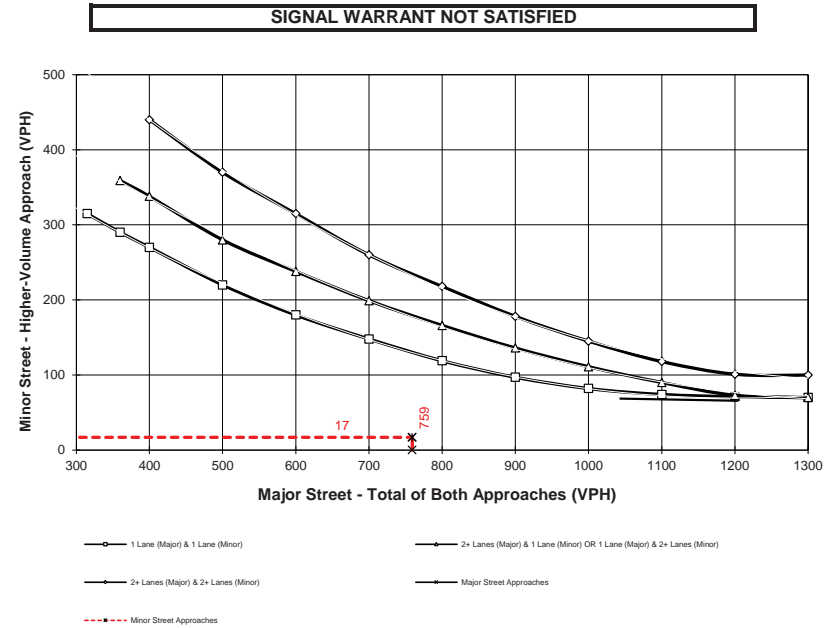

\*Note: 100 vph applies as the lower threshold for a minor-street approach with two or more lanes and 75 vph applies as the lower threshold for a minor-street approach with one lane

Intersection ID: #2



California MUTCD 2014 Edition  
 (FHWA's MUTCD 2009, as amended for use in California)

**Figure 4C-4. Warrant 3, Peak Hour (70% Factor)**

(COMMUNITY LESS THAN 10,000 POPULATION OR ABOVE 64 km/h OR ABOVE 40 mph ON MAJOR STREET)

Traffic Conditions = **EAP AM PEAK HOUR WARRANTS**

Major Street Name = **Little Morongo Rd.** Total of Both Approaches (VPH) = **832**  
 Number of Approach Lanes Major Street = **1**

Minor Street Name = **i-Storage S. Dwy. - Project S. Dwy.** High Volume Approach (VPH) = **5**  
 Number of Approach Lanes Minor Street = **1**

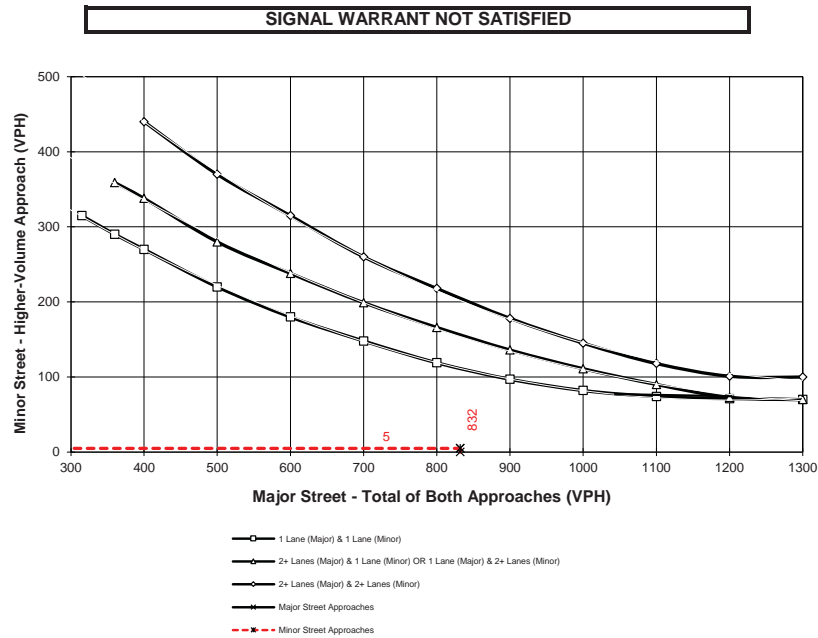

\*Note: 100 vph applies as the lower threshold for a minor-street approach with two or more lanes and 75 vph applies as the lower threshold for a minor-street approach with one lane

Intersection ID: #6

F:\UXR\jobs\_14100-1450014398\Warrants\02 - EAP\06R\_AM.xls\Fig 4C-4 (Rural Peak)

California MUTCD 2014 Edition  
 (FHWA's MUTCD 2009, as amended for use in California)

**Figure 4C-4. Warrant 3, Peak Hour (70% Factor)**

(COMMUNITY LESS THAN 10,000 POPULATION OR ABOVE 64 km/h OR ABOVE 40 mph ON MAJOR STREET)

Traffic Conditions = **EAP PM PEAK HOUR WARRANTS**

Major Street Name = **Little Morongo Rd.** Total of Both Approaches (VPH) = **776**  
 Number of Approach Lanes Major Street = **1**

Minor Street Name = **i-Storage S. Dwy. - Project S. Dwy.** High Volume Approach (VPH) = **42**  
 Number of Approach Lanes Minor Street = **1**

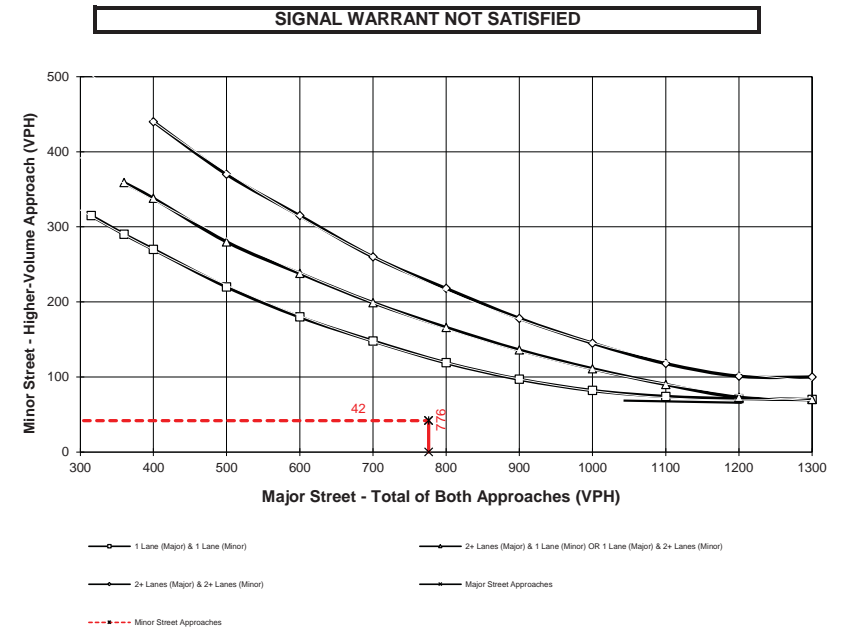

\*Note: 100 vph applies as the lower threshold for a minor-street approach with two or more lanes and 75 vph applies as the lower threshold for a minor-street approach with one lane

Intersection ID: #6

F:\UXR\jobs\_14100-1450014398\Warrants\02 - EAP\06R\_PM.xls\Fig 4C-4 (Rural Peak)

California MUTCD 2014 Edition  
(FHWA's MUTCD 2009, as amended for use in California)

**Figure 4C-4. Warrant 3, Peak Hour (70% Factor)**

(COMMUNITY LESS THAN 10,000 POPULATION OR ABOVE 64 km/h OR ABOVE 40 mph ON MAJOR STREET)

Traffic Conditions = **EAPC AM PEAK HOUR WARRANTS**

Major Street Name = **Little Morongo Rd.** Total of Both Approaches (VPH) = **842**  
Number of Approach Lanes Major Street = **1**

Minor Street Name = **i-Strange N. Dwy.** High Volume Approach (VPH) = **6**  
Number of Approach Lanes Minor Street = **1**

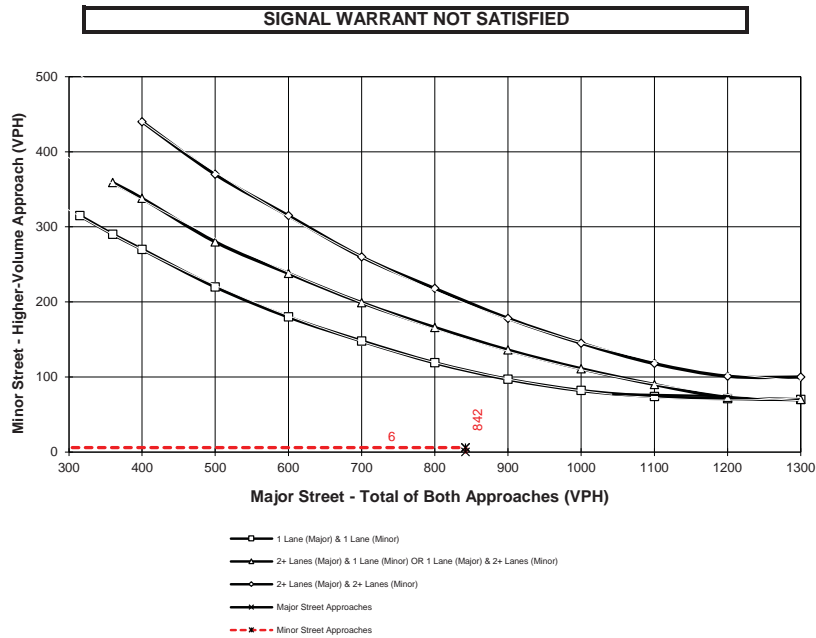

\*Note: 100 vph applies as the lower threshold for a minor-street approach with two or more lanes and 75 vph applies as the lower threshold for a minor-street approach with one lane

Intersection ID: #2

F:\UXR\jobs\_14100-14500114398\Warrants\03 - EAPC\02R\_AM.xls\Fig 4C-4 (Rural Peak)

California MUTCD 2014 Edition  
(FHWA's MUTCD 2009, as amended for use in California)

**Figure 4C-4. Warrant 3, Peak Hour (70% Factor)**

(COMMUNITY LESS THAN 10,000 POPULATION OR ABOVE 64 km/h OR ABOVE 40 mph ON MAJOR STREET)

Traffic Conditions = **EAPC PM PEAK HOUR WARRANTS**

Major Street Name = **Little Morongo Rd.** Total of Both Approaches (VPH) = **851**  
Number of Approach Lanes Major Street = **1**

Minor Street Name = **i-Strange N. Dwy.** High Volume Approach (VPH) = **17**  
Number of Approach Lanes Minor Street = **1**

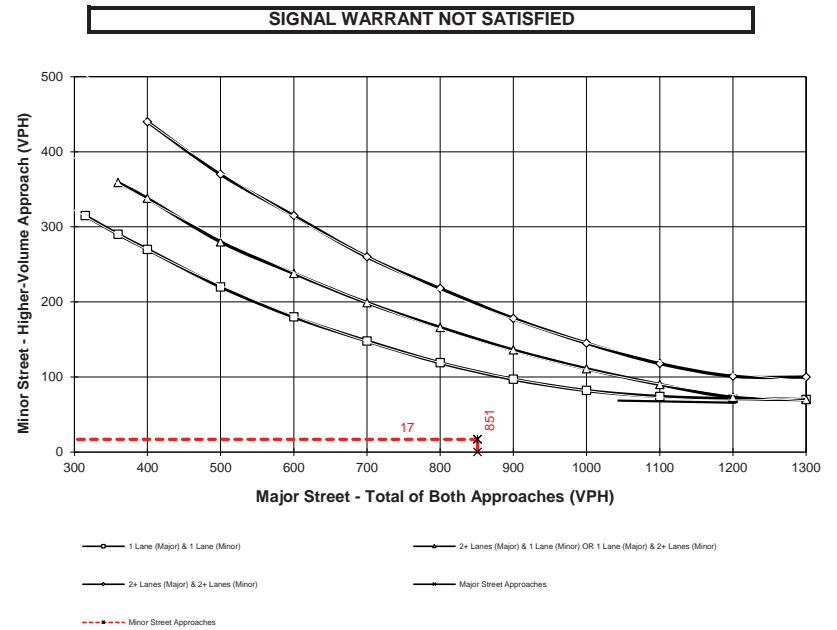

\*Note: 100 vph applies as the lower threshold for a minor-street approach with two or more lanes and 75 vph applies as the lower threshold for a minor-street approach with one lane

Intersection ID: #2

F:\UXR\jobs\_14100-14500114398\Warrants\03 - EAPC\02R\_PM.xls\Fig 4C-4 (Rural Peak)

California MUTCD 2014 Edition  
 (FHWA's MUTCD 2009, as amended for use in California)

**Figure 4C-4. Warrant 3, Peak Hour (70% Factor)**

(COMMUNITY LESS THAN 10,000 POPULATION OR ABOVE 64 km/h OR ABOVE 40 mph ON MAJOR STREET)

Traffic Conditions = **EAPC AM PEAK HOUR WARRANTS**

Major Street Name = **Little Morongo Rd.** Total of Both Approaches (VPH) = **895**  
 Number of Approach Lanes Major Street = **1**

Minor Street Name = **i-Storage S. Dwy. - Project S. Dwy.** High Volume Approach (VPH) = **5**  
 Number of Approach Lanes Minor Street = **1**

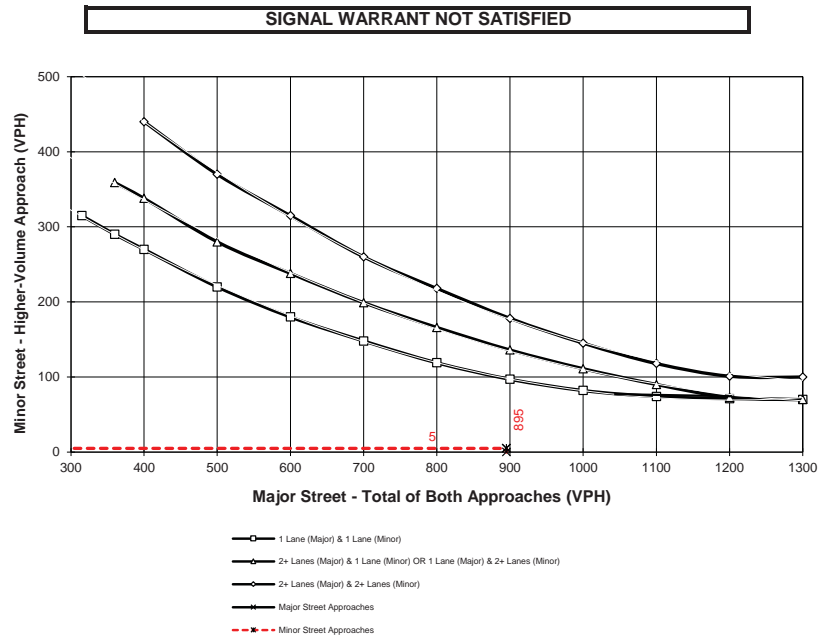

\*Note: 100 vph applies as the lower threshold for a minor-street approach with two or more lanes and 75 vph applies as the lower threshold for a minor-street approach with one lane

Intersection ID: #6

California MUTCD 2014 Edition  
 (FHWA's MUTCD 2009, as amended for use in California)

**Figure 4C-4. Warrant 3, Peak Hour (70% Factor)**

(COMMUNITY LESS THAN 10,000 POPULATION OR ABOVE 64 km/h OR ABOVE 40 mph ON MAJOR STREET)

Traffic Conditions = **EAPC PM PEAK HOUR WARRANTS**

Major Street Name = **Little Morongo Rd.** Total of Both Approaches (VPH) = **868**  
 Number of Approach Lanes Major Street = **1**

Minor Street Name = **i-Storage S. Dwy. - Project S. Dwy.** High Volume Approach (VPH) = **42**  
 Number of Approach Lanes Minor Street = **1**

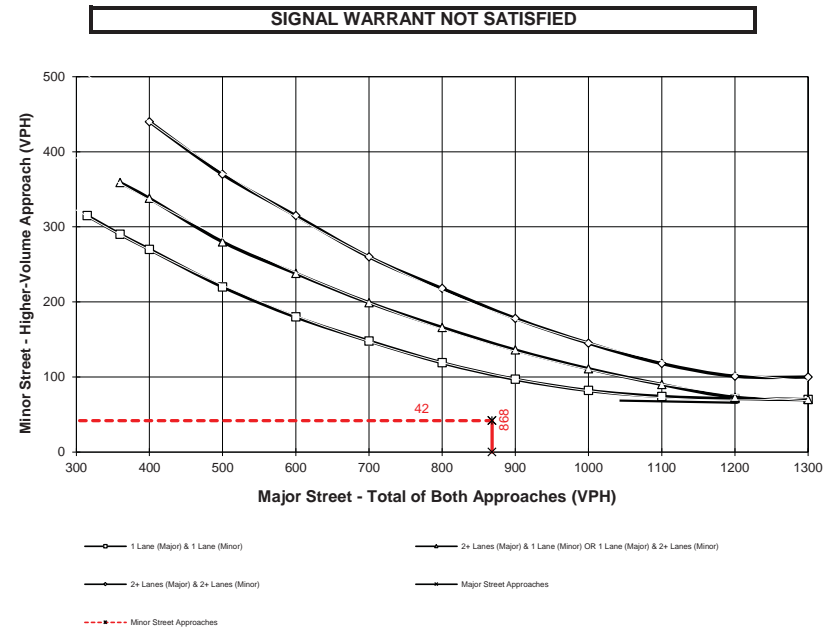

\*Note: 100 vph applies as the lower threshold for a minor-street approach with two or more lanes and 75 vph applies as the lower threshold for a minor-street approach with one lane

Intersection ID: #6

### Figure 4C-103 (CA). Traffic Signal Warrants Worksheet (Average Traffic Estimate Form)

<u>DIST</u>	<u>CO</u>	<u>RTE</u>	<u>PM</u>	<u>CALC</u> <u>JC</u>	<u>TRAFFIC CONDITIONS</u>	<u>EAP</u>
Jurisdiction: <u>City of Desert Hot Springs Rd.</u>				<u>CHK</u>	<u>DATE</u> <u>04/05/22</u>	
Major Street: <u>Little Morongo Rd.</u>					Critical Approach Speed (Major) <u>55</u> mph	
Minor Street: <u>Project N. Dwy.</u>					Critical Approach Speed (Minor) <u>30</u> mph	
Major Street Approach Lanes = <u>1</u> lane					Minor Street Approach Lanes: <u>1</u> lane	
Major Street Future ADT = <u>8,973</u> vpd					Minor Street Future ADT = <u>71</u> vpd	
Speed limit or critical speed on major street traffic > 64 km/h (40 mph); .....					<input checked="" type="checkbox"/>	
					or	<b>RURAL (R)</b>
In built up area of isolated community of < 10,000 population .....					<input type="checkbox"/>	

**(Based on Estimated Average Daily Traffic - See Note)**

<u>URBAN</u>	<u>RURAL</u>	<u>Minimum Requirements</u>			
<b>CONDITION A - Minimum Vehicular Volume</b> <u>Satisfied</u> <u>Not Satisfied</u> <span style="color: red; font-weight: bold;">XX</span>		<u>ADT</u>			
		<u>Vehicles Per Day on Major Street</u> (Total of Both Approaches)		<u>Vehicles Per Day on Higher-Volume Minor Street Approach</u> (One Direction Only)	
Number of lanes for moving traffic on each approach <u>Major Street</u> <u>Minor Street</u>		<u>Urban</u>	<u>Rural</u>	<u>Urban</u>	<u>Rural</u>
1 <b>8,973</b> 1 <b>71</b>		8,000	5,600 *	2,400	1,680
2 +                                      1		9,600	6,720	2,400	1,680
2 +                                      2 +		9,600	6,720	3,200	2,240
1    2 +		8,000	5,600	3,200	2,240
<b>CONDITION B - Interruption of Continuous Traffic</b> <u>Satisfied</u> <u>Not Satisfied</u> <span style="color: red; font-weight: bold;">XX</span>		<u>Vehicles Per Day on Major Street</u> (Total of Both Approaches)		<u>Vehicles Per Day on Higher-Volume Minor Street Approach</u> (One Direction Only)	
		<u>Urban</u>	<u>Rural</u>	<u>Urban</u>	<u>Rural</u>
Number of lanes for moving traffic on each approach <u>Major Street</u> <u>Minor Street</u>		12,000	8,400 *	1,200	850
1 <b>8,973</b> 1 <b>71</b>		14,400	10,080	1,200	850
2 +                                      1		14,400	10,080	1,600	1,120
2 +                                      2 +		14,400	10,080	1,600	1,120
1    2 +		12,000	8,400	1,600	1,120
<b>Combination of CONDITIONS A + B</b> <u>Satisfied</u> <u>Not Satisfied</u> <span style="color: red; font-weight: bold;">XX</span>		2 CONDITIONS 80%		2 CONDITIONS 80%	
No one condition satisfied, but following conditions fulfilled 80% of more .....					
				<u>A</u>	<u>B</u>
				<span style="color: red; font-weight: bold;">4%</span>	<span style="color: red; font-weight: bold;">8%</span>

**Note: To be used only for NEW INTERSECTIONS or other locations where it is not reasonable to count actual traffic volumes.**

The satisfaction of a traffic signal warrant or warrants shall not in itself require the installation of a traffic control signal.

### Figure 4C-103 (CA). Traffic Signal Warrants Worksheet (Average Traffic Estimate Form)

<u>DIST</u>	<u>CO</u>	<u>RTE</u>	<u>PM</u>	<u>CALC</u> <u>JC</u>	<u>TRAFFIC CONDITIONS</u>	<u>EAPC</u>
Jurisdiction: <u>City of Desert Hot Springs Rd.</u>				<u>CHK</u>	<u>DATE</u> <u>04/05/22</u>	
Major Street: <u>Little Morongo Rd.</u>					Critical Approach Speed (Major) <u>55</u> mph	
Minor Street: <u>Project N. Dwy.</u>					Critical Approach Speed (Minor) <u>30</u> mph	

Major Street Approach Lanes = <u>1</u> lane	Minor Street Approach Lanes: <u>1</u> lane
Major Street Future ADT = <u>9,963</u> vpd	Minor Street Future ADT = <u>71</u> vpd

Speed limit or critical speed on major street traffic > 64 km/h (40 mph); .....  or  **RURAL (R)**

In built up area of isolated community of < 10,000 population .....

**(Based on Estimated Average Daily Traffic - See Note)**

<u>URBAN</u>	<u>RURAL</u>	Minimum Requirements ADT			
<b>CONDITION A - Minimum Vehicular Volume</b>		Vehicles Per Day on Major Street (Total of Both Approaches)		Vehicles Per Day on Higher-Volume Minor Street Approach (One Direction Only)	
<u>Satisfied</u>	<u>Not Satisfied</u>	<u>Urban</u>	<u>Rural</u>	<u>Urban</u>	<u>Rural</u>
	<b>XX</b>				
Number of lanes for moving traffic on each approach					
<u>Major Street</u>	<u>Minor Street</u>				
1 <b>9,963</b>	1 <b>71</b>	8,000	5,600 *	2,400	1,680
2 +	1	9,600	6,720	2,400	1,680
2 +	2 +	9,600	6,720	3,200	2,240
1	2 +	8,000	5,600	3,200	2,240
<b>CONDITION B - Interruption of Continuous Traffic</b>		Vehicles Per Day on Major Street (Total of Both Approaches)		Vehicles Per Day on Higher-Volume Minor Street Approach (One Direction Only)	
<u>Satisfied</u>	<u>Not Satisfied</u>	<u>Urban</u>	<u>Rural</u>	<u>Urban</u>	<u>Rural</u>
	<b>XX</b>				
Number of lanes for moving traffic on each approach					
<u>Major Street</u>	<u>Minor Street</u>				
1 <b>9,963</b>	1 <b>71</b>	12,000	8,400 *	1,200	850
2 +	1	14,400	10,080	1,200	850
2 +	2 +	14,400	10,080	1,600	1,120
1	2 +	12,000	8,400	1,600	1,120
<b>Combination of CONDITIONS A + B</b>		2 CONDITIONS 80%		2 CONDITIONS 80%	
<u>Satisfied</u>	<u>Not Satisfied</u>				
	<b>XX</b>				
No one condition satisfied, but following conditions fulfilled 80% of more .....					
	<b>A</b>				
	<b>4%</b>				
	<b>B</b>				
	<b>8%</b>				

**Note: To be used only for NEW INTERSECTIONS or other locations where it is not reasonable to count actual traffic volumes.**

The satisfaction of a traffic signal warrant or warrants shall not in itself require the installation of a traffic control signal.



















**APPENDIX 5.1:**

**EAP (2024) CONDITIONS INTERSECTION OPERATIONS ANALYSIS WORKSHEETS**

*This Page Intentionally Left Blank*

Lanes, Volumes, Timings  
 1: Little Morongo Rd. & Two Bunch Palms Tr.

EAP (2024) AM Peak Hour

												
Lane Group	EBL	EBT	EBR	WBL	WBT	WBR	NBL	NBT	NBR	SBL	SBT	SBR
Lane Configurations												
Traffic Volume (vph)	3	9	11	230	4	48	3	131	116	89	229	1
Future Volume (vph)	3	9	11	230	4	48	3	131	116	89	229	1
Ideal Flow (vphpl)	1900	1900	1900	1900	1900	1900	1900	1900	1900	1900	1900	1900
Storage Length (ft)	0		0	0		50	150		150	150		50
Storage Lanes	0		0	0		1	0		0	0		1
Taper Length (ft)	90			90			90			90		
Link Speed (mph)		45			45			55			55	
Link Distance (ft)		1073			1443			3240			728	
Travel Time (s)		16.3			21.9			40.2			9.0	
Confl. Peds. (#/hr)	5		5	5		5	5		5	5		5
Peak Hour Factor	0.88	0.88	0.88	0.88	0.88	0.88	0.88	0.88	0.88	0.88	0.88	0.88
Shared Lane Traffic (%)												
Sign Control		Stop			Stop			Stop			Stop	

**Intersection Summary**  
 Area Type: Other  
 Control Type: Unsignalized



Intersection	
Intersection Delay, s/veh	16.6
Intersection LOS	C

Movement	EBL	EBT	EBR	WBL	WBT	WBR	NBL	NBT	NBR	SBL	SBT	SBR
Lane Configurations		↕			↕	↕		↕			↕	↕
Traffic Vol, veh/h	3	9	11	230	4	48	3	131	116	89	229	1
Future Vol, veh/h	3	9	11	230	4	48	3	131	116	89	229	1
Peak Hour Factor	0.88	0.88	0.88	0.88	0.88	0.88	0.88	0.88	0.88	0.88	0.88	0.88
Heavy Vehicles, %	2	2	2	2	2	2	2	2	2	2	2	2
Mvmt Flow	3	10	13	261	5	55	3	149	132	101	260	1
Number of Lanes	0	1	0	0	1	1	0	1	0	0	1	1

Approach	EB	WB	NB	SB
Opposing Approach	WB	EB	SB	NB
Opposing Lanes	2	1	2	1
Conflicting Approach Left	SB	NB	EB	WB
Conflicting Lanes Left	2	1	1	2
Conflicting Approach Right	NB	SB	WB	EB
Conflicting Lanes Right	1	2	2	1
HCM Control Delay	10.6	15.7	14.7	19.3
HCM LOS	B	C	B	C

Lane	NBLn1	EBLn1	WBLn1	WBLn2	SBLn1	SBLn2
Vol Left, %	1%	13%	98%	0%	28%	0%
Vol Thru, %	52%	39%	2%	0%	72%	0%
Vol Right, %	46%	48%	0%	100%	0%	100%
Sign Control	Stop	Stop	Stop	Stop	Stop	Stop
Traffic Vol by Lane	250	23	234	48	318	1
LT Vol	3	3	230	0	89	0
Through Vol	131	9	4	0	229	0
RT Vol	116	11	0	48	0	1
Lane Flow Rate	284	26	266	55	361	1
Geometry Grp	6	6	7	7	7	7
Degree of Util (X)	0.481	0.052	0.518	0.088	0.632	0.002
Departure Headway (Hd)	6.09	7.162	7.014	5.803	6.295	5.442
Convergence, Y/N	Yes	Yes	Yes	Yes	Yes	Yes
Cap	588	503	513	615	571	654
Service Time	4.154	5.162	4.778	3.565	4.055	3.203
HCM Lane V/C Ratio	0.483	0.052	0.519	0.089	0.632	0.002
HCM Control Delay	14.7	10.6	17.1	9.1	19.3	8.2
HCM Lane LOS	B	B	C	A	C	A
HCM 95th-tile Q	2.6	0.2	2.9	0.3	4.4	0

Lanes, Volumes, Timings  
 2: Little Morongo Rd. & i-Storage N. Dwy

EAP (2024) AM Peak Hour



Lane Group	EBL	EBR	NBL	NBT	SBT	SBR
Lane Configurations						
Traffic Volume (vph)	1	4	1	270	505	1
Future Volume (vph)	1	4	1	270	505	1
Ideal Flow (vphpl)	1900	1900	1900	1900	1900	1900
Storage Length (ft)	150	50	150			50
Storage Lanes	0	1	0			1
Taper Length (ft)	90		90			
Link Speed (mph)	30			55	55	
Link Distance (ft)	557			342	421	
Travel Time (s)	12.7			4.2	5.2	
Confl. Peds. (#/hr)	5	5	5			5
Peak Hour Factor	0.90	0.90	0.90	0.90	0.90	0.90
Shared Lane Traffic (%)						
Sign Control	Stop			Free	Free	

Intersection Summary

Area Type: Other  
 Control Type: Unsignalized

Intersection						
Int Delay, s/veh	0.1					
Movement	EBL	EBR	NBL	NBT	SBT	SBR
Lane Configurations	↖	↗		↖	↗	↗
Traffic Vol, veh/h	1	4	1	270	505	1
Future Vol, veh/h	1	4	1	270	505	1
Conflicting Peds, #/hr	5	5	5	0	0	5
Sign Control	Stop	Stop	Free	Free	Free	Free
RT Channelized	-	None	-	None	-	None
Storage Length	-	50	-	-	-	50
Veh in Median Storage, #	0	-	-	0	0	-
Grade, %	0	-	-	0	0	-
Peak Hour Factor	90	90	90	90	90	90
Heavy Vehicles, %	2	2	2	2	2	2
Mvmt Flow	1	4	1	300	561	1

















Major/Minor	Minor2	Major1	Major2			
Conflicting Flow All	873	571	567	0	-	0
Stage 1	566	-	-	-	-	-
Stage 2	307	-	-	-	-	-
Critical Hdwy	6.42	6.22	4.12	-	-	-
Critical Hdwy Stg 1	5.42	-	-	-	-	-
Critical Hdwy Stg 2	5.42	-	-	-	-	-
Follow-up Hdwy	3.518	3.318	2.218	-	-	-
Pot Cap-1 Maneuver	321	520	1005	-	-	-
Stage 1	568	-	-	-	-	-
Stage 2	746	-	-	-	-	-
Platoon blocked, %				-	-	-
Mov Cap-1 Maneuver	317	515	1000	-	-	-
Mov Cap-2 Maneuver	317	-	-	-	-	-
Stage 1	565	-	-	-	-	-
Stage 2	742	-	-	-	-	-

Approach	EB	NB	SB
HCM Control Delay, s	13	0	0
HCM LOS	B		

Minor Lane/Major Mvmt	NBL	NBT	EBLn1	EBLn2	SBT	SBR
Capacity (veh/h)	1000	-	317	515	-	-
HCM Lane V/C Ratio	0.001	-	0.004	0.009	-	-
HCM Control Delay (s)	8.6	0	16.4	12.1	-	-
HCM Lane LOS	A	A	C	B	-	-
HCM 95th %tile Q(veh)	0	-	0	0	-	-

Lanes, Volumes, Timings  
 3: Little Morongo Rd. & Dillon Rd.

EAP (2024) AM Peak Hour

												
Lane Group	EBL	EBT	EBR	WBL	WBT	WBR	NBL	NBT	NBR	SBL	SBT	SBR
Lane Configurations												
Traffic Volume (vph)	192	114	0	0	311	163	0	0	0	244	0	274
Future Volume (vph)	192	114	0	0	311	163	0	0	0	244	0	274
Ideal Flow (vphpl)	1900	1900	1900	1900	1900	1900	1900	1900	1900	1900	1900	1900
Storage Length (ft)	205		150	145		150	0		0	150		150
Storage Lanes	1		0	1		0	0		0	0		0
Taper Length (ft)	90			90			90			90		
Link Speed (mph)		55			55			55			55	
Link Distance (ft)		4457			1492			286			3985	
Travel Time (s)		55.3			18.5			3.5			49.4	
Confl. Peds. (#/hr)	5		5	5		5	5		5	5		5
Peak Hour Factor	0.94	0.94	0.94	0.94	0.94	0.94	0.94	0.94	0.94	0.94	0.94	0.94
Shared Lane Traffic (%)												
Sign Control		Stop			Stop			Stop			Stop	

Intersection Summary

Area Type: Other  
 Control Type: Unsignalized

Intersection	
Intersection Delay, s/veh	47.3
Intersection LOS	E

Movement	EBL	EBT	EBR	WBL	WBT	WBR	NBL	NBT	NBR	SBL	SBT	SBR
Lane Configurations	↶	↑		↶	↷						↷	
Traffic Vol, veh/h	192	114	0	0	311	163	0	0	0	244	0	274
Future Vol, veh/h	192	114	0	0	311	163	0	0	0	244	0	274
Peak Hour Factor	0.94	0.94	0.94	0.94	0.94	0.94	0.94	0.94	0.94	0.94	0.94	0.94
Heavy Vehicles, %	2	2	2	2	2	2	2	2	2	2	2	2
Mvmt Flow	204	121	0	0	331	173	0	0	0	260	0	291
Number of Lanes	1	1	0	1	1	0	0	0	0	0	1	0

Approach	EB	WB	SB
Opposing Approach	WB	EB	
Opposing Lanes	2	2	0
Conflicting Approach Left	SB		WB
Conflicting Lanes Left	1	0	2
Conflicting Approach Right		SB	EB
Conflicting Lanes Right	0	1	2
HCM Control Delay	15.9	59.1	55.1
HCM LOS	C	F	F

Lane	EBLn1	EBLn2	WBLn1	WBLn2	SBLn1
Vol Left, %	100%	0%	0%	0%	47%
Vol Thru, %	0%	100%	100%	66%	0%
Vol Right, %	0%	0%	0%	34%	53%
Sign Control	Stop	Stop	Stop	Stop	Stop
Traffic Vol by Lane	192	114	0	474	518
LT Vol	192	0	0	0	244
Through Vol	0	114	0	311	0
RT Vol	0	0	0	163	274
Lane Flow Rate	204	121	0	504	551
Geometry Grp	7	7	7	7	2
Degree of Util (X)	0.46	0.256	0	0.972	0.967
Departure Headway (Hd)	8.101	7.586	7.184	6.936	6.32
Convergence, Y/N	Yes	Yes	Yes	Yes	Yes
Cap	443	472	0	524	573
Service Time	5.877	5.362	4.945	4.697	4.367
HCM Lane V/C Ratio	0.46	0.256	0	0.962	0.962
HCM Control Delay	17.7	13	9.9	59.1	55.1
HCM Lane LOS	C	B	N	F	F
HCM 95th-tile Q	2.4	1	0	12.8	13.2

Lanes, Volumes, Timings  
3: Little Morongo Rd. & Dillon Rd.

EAP (2024) AM Peak Hour  
With Improvements

Lane Group	EBL	EBT	EBR	WBL	WBT	WBR	NBL	NBT	NBR	SBL	SBT	SBR
Lane Configurations												
Traffic Volume (vph)	192	114	0	0	311	163	0	0	0	244	0	274
Future Volume (vph)	192	114	0	0	311	163	0	0	0	244	0	274
Ideal Flow (vphpl)	1900	1900	1900	1900	1900	1900	1900	1900	1900	1900	1900	1900
Storage Length (ft)	205		150	145		150	0		0	150		150
Storage Lanes	1		0	1		0	0		0	0		0
Taper Length (ft)	90			90			90			90		
Right Turn on Red			Yes			Yes			Yes			Yes
Link Speed (mph)		55			55			55			55	
Link Distance (ft)		4457			1492			286			3985	
Travel Time (s)		55.3			18.5			3.5			49.4	
Confl. Peds. (#/hr)	5		5	5		5	5		5	5		5
Peak Hour Factor	0.94	0.94	0.94	0.94	0.94	0.94	0.94	0.94	0.94	0.94	0.94	0.94
Shared Lane Traffic (%)												
Turn Type	Perm	NA		Perm	NA					Perm	NA	
Protected Phases		2			6							4
Permitted Phases	2			6						4		
Detector Phase	2	2		6	6					4	4	
Switch Phase												
Minimum Initial (s)	5.0	5.0		5.0	5.0					5.0	5.0	
Minimum Split (s)	22.5	22.5		22.5	22.5					22.5	22.5	
Total Split (s)	32.8	32.8		32.8	32.8					27.2	27.2	
Total Split (%)	54.7%	54.7%		54.7%	54.7%					45.3%	45.3%	
Yellow Time (s)	3.5	3.5		3.5	3.5					3.5	3.5	
All-Red Time (s)	1.0	1.0		1.0	1.0					1.0	1.0	
Lost Time Adjust (s)	0.0	0.0		0.0	0.0							0.0
Total Lost Time (s)	4.5	4.5		4.5	4.5							4.5
Lead/Lag												
Lead-Lag Optimize?												
Recall Mode	C-Max	C-Max		C-Max	C-Max					Max	Max	





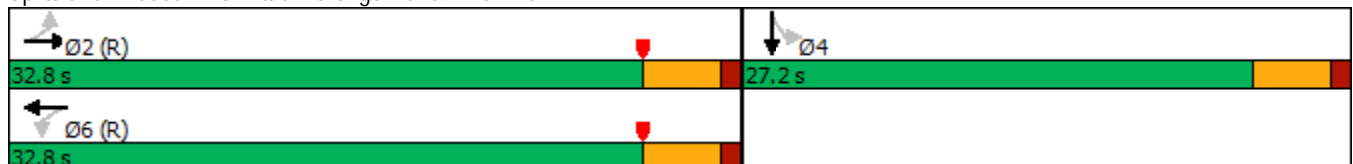













**Intersection Summary**  
 Area Type: Other  
 Cycle Length: 60  
 Actuated Cycle Length: 60  
 Offset: 31.4 (52%), Referenced to phase 2:EBTL and 6:WBTL, Start of Yellow  
 Natural Cycle: 50  
 Control Type: Actuated-Coordinated

Splits and Phases: 3: Little Morongo Rd. & Dillon Rd.



HCM 6th Signalized Intersection Summary  
3: Little Morongo Rd. & Dillon Rd.

EAP (2024) AM Peak Hour  
With Improvements

												
Movement	EBL	EBT	EBR	WBL	WBT	WBR	NBL	NBT	NBR	SBL	SBT	SBR
Lane Configurations												
Traffic Volume (veh/h)	192	114	0	0	311	163	0	0	0	244	0	274
Future Volume (veh/h)	192	114	0	0	311	163	0	0	0	244	0	274
Initial Q (Qb), veh	0	0	0	0	0	0				0	0	0
Ped-Bike Adj(A_pbT)	1.00		1.00	1.00		0.99				1.00		0.99
Parking Bus, Adj	1.00	1.00	1.00	1.00	1.00	1.00				1.00	1.00	1.00
Work Zone On Approach		No			No						No	
Adj Sat Flow, veh/h/ln	1870	1870	0	1870	1870	1870				1870	1870	1870
Adj Flow Rate, veh/h	204	121	0	0	331	173				260	0	291
Peak Hour Factor	0.94	0.94	0.94	0.94	0.94	0.94				0.94	0.94	0.94
Percent Heavy Veh, %	2	2	0	2	2	2				2	2	2
Cap, veh/h	352	882	0	120	545	285				297	0	333
Arrive On Green	0.47	0.47	0.00	0.00	0.47	0.47				0.38	0.00	0.38
Sat Flow, veh/h	894	1870	0	1270	1155	603				786	0	880
Grp Volume(v), veh/h	204	121	0	0	0	504				551	0	0
Grp Sat Flow(s),veh/h/ln	894	1870	0	1270	0	1758				1666	0	0
Q Serve(g_s), s	13.1	2.2	0.0	0.0	0.0	12.7				18.4	0.0	0.0
Cycle Q Clear(g_c), s	25.9	2.2	0.0	0.0	0.0	12.7				18.4	0.0	0.0
Prop In Lane	1.00		0.00	1.00		0.34				0.47		0.53
Lane Grp Cap(c), veh/h	352	882	0	120	0	829				630	0	0
V/C Ratio(X)	0.58	0.14	0.00	0.00	0.00	0.61				0.87	0.00	0.00
Avail Cap(c_a), veh/h	352	882	0	120	0	829				630	0	0
HCM Platoon Ratio	1.00	1.00	1.00	1.00	1.00	1.00				1.00	1.00	1.00
Upstream Filter(I)	1.00	1.00	0.00	0.00	0.00	1.00				1.00	0.00	0.00
Uniform Delay (d), s/veh	21.3	9.0	0.0	0.0	0.0	11.7				17.3	0.0	0.0
Incr Delay (d2), s/veh	6.8	0.3	0.0	0.0	0.0	3.3				15.6	0.0	0.0
Initial Q Delay(d3),s/veh	0.0	0.0	0.0	0.0	0.0	0.0				0.0	0.0	0.0
%ile BackOfQ(50%),veh/ln	2.9	0.7	0.0	0.0	0.0	4.1				7.9	0.0	0.0
Unsig. Movement Delay, s/veh												
LnGrp Delay(d),s/veh	28.1	9.3	0.0	0.0	0.0	15.0				32.9	0.0	0.0
LnGrp LOS	C	A	A	A	A	B				C	A	A
Approach Vol, veh/h		325			504						551	
Approach Delay, s/veh		21.1			15.0						32.9	
Approach LOS		C			B						C	
Timer - Assigned Phs		2		4		6						
Phs Duration (G+Y+Rc), s		32.8		27.2		32.8						
Change Period (Y+Rc), s		4.5		4.5		4.5						
Max Green Setting (Gmax), s		28.3		22.7		28.3						
Max Q Clear Time (g_c+I1), s		27.9		20.4		14.7						
Green Ext Time (p_c), s		0.1		0.7		2.4						
<b>Intersection Summary</b>												
HCM 6th Ctrl Delay				23.6								
HCM 6th LOS				C								

Lanes, Volumes, Timings  
4: Indian Cyn. Dr. & Dillon Rd.

EAP (2024) AM Peak Hour

Lane Group	EBL	EBT	EBR	WBL	WBT	WBR	NBL	NBT	NBR	SBL	SBT	SBR
Lane Configurations												
Traffic Volume (vph)	3	97	29	428	102	25	16	244	156	25	563	3
Future Volume (vph)	3	97	29	428	102	25	16	244	156	25	563	3
Ideal Flow (vphpl)	1900	1900	1900	1900	1900	1900	1900	1900	1900	1900	1900	1900
Storage Length (ft)	150		195	100		100	100		150	120		150
Storage Lanes	1		0	1		1	1		0	1		0
Taper Length (ft)	90			90			90			90		
Right Turn on Red			Yes			Yes			Yes			Yes
Link Speed (mph)		55			55			55			55	
Link Distance (ft)		780			957			919			547	
Travel Time (s)		9.7			11.9			11.4			6.8	
Confl. Peds. (#/hr)	5		5	5		5	5		5	5		5
Peak Hour Factor	0.87	0.87	0.87	0.87	0.87	0.87	0.87	0.87	0.87	0.87	0.87	0.87
Shared Lane Traffic (%)												
Turn Type	Prot	NA		Prot	NA	Perm	Perm	NA		Perm	NA	
Protected Phases	7	4		3	8			2			6	
Permitted Phases						8	2			6		
Detector Phase	7	4		3	8	8	2	2		6	6	
Switch Phase												
Minimum Initial (s)	5.0	4.0		5.0	4.0	4.0	4.0	4.0		4.0	4.0	
Minimum Split (s)	9.5	20.0		9.5	20.0	20.0	20.0	20.0		20.0	20.0	
Total Split (s)	10.0	20.0		59.0	69.0	69.0	41.0	41.0		41.0	41.0	
Total Split (%)	8.3%	16.7%		49.2%	57.5%	57.5%	34.2%	34.2%		34.2%	34.2%	
Yellow Time (s)	3.5	3.5		3.5	3.5	3.5	3.5	3.5		3.5	3.5	
All-Red Time (s)	1.0	0.5		1.0	0.5	0.5	0.5	0.5		0.5	0.5	
Lost Time Adjust (s)	0.0	0.0		0.0	0.0	0.0	0.0	0.0		0.0	0.0	
Total Lost Time (s)	4.5	4.0		4.5	4.0	4.0	4.0	4.0		4.0	4.0	
Lead/Lag	Lead	Lag		Lead	Lag	Lag						
Lead-Lag Optimize?	Yes	Yes		Yes	Yes	Yes						
Recall Mode	None	None		None	None	None	C-Max	C-Max		C-Max	C-Max	

Intersection Summary

Area Type: Other  
 Cycle Length: 120  
 Actuated Cycle Length: 120  
 Offset: 0 (0%), Referenced to phase 2:NBTL and 6:SBTL, Start of Yellow  
 Natural Cycle: 65  
 Control Type: Actuated-Coordinated



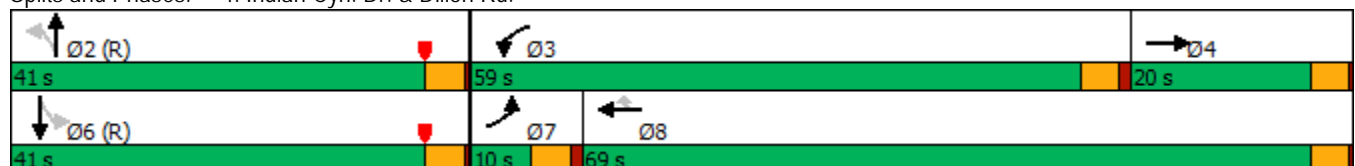



















Splits and Phases: 4: Indian Cyn. Dr. & Dillon Rd.





HCM 6th Signalized Intersection Summary  
4: Indian Cyn. Dr. & Dillon Rd.

EAP (2024) AM Peak Hour

												
Movement	EBL	EBT	EBR	WBL	WBT	WBR	NBL	NBT	NBR	SBL	SBT	SBR
Lane Configurations												
Traffic Volume (veh/h)	3	97	29	428	102	25	16	244	156	25	563	3
Future Volume (veh/h)	3	97	29	428	102	25	16	244	156	25	563	3
Initial Q (Qb), veh	0	0	0	0	0	0	0	0	0	0	0	0
Ped-Bike Adj(A_pbT)	1.00		0.98	1.00		1.00	1.00		1.00	1.00		1.00
Parking Bus, Adj	1.00	1.00	1.00	1.00	1.00	1.00	1.00	1.00	1.00	1.00	1.00	1.00
Work Zone On Approach		No			No			No			No	
Adj Sat Flow, veh/h/ln	1870	1870	1870	1870	1870	1870	1870	1870	1870	1870	1870	1870
Adj Flow Rate, veh/h	3	111	33	492	117	29	18	280	179	29	647	3
Peak Hour Factor	0.87	0.87	0.87	0.87	0.87	0.87	0.87	0.87	0.87	0.87	0.87	0.87
Percent Heavy Veh, %	2	2	2	2	2	2	2	2	2	2	2	2
Cap, veh/h	7	196	56	529	1297	576	391	1108	687	481	1911	9
Arrive On Green	0.00	0.07	0.07	0.30	0.37	0.37	0.53	0.53	0.53	0.53	0.53	0.53
Sat Flow, veh/h	1781	2714	774	1781	3554	1579	781	2104	1304	932	3627	17
Grp Volume(v), veh/h	3	71	73	492	117	29	18	235	224	29	317	333
Grp Sat Flow(s),veh/h/ln	1781	1777	1712	1781	1777	1579	781	1777	1631	932	1777	1867
Q Serve(g_s), s	0.2	4.6	5.0	32.2	2.6	1.4	1.6	8.7	9.0	2.1	12.3	12.3
Cycle Q Clear(g_c), s	0.2	4.6	5.0	32.2	2.6	1.4	14.0	8.7	9.0	11.1	12.3	12.3
Prop In Lane	1.00		0.45	1.00		1.00	1.00		0.80	1.00		0.01
Lane Grp Cap(c), veh/h	7	128	124	529	1297	576	391	936	859	481	936	984
V/C Ratio(X)	0.42	0.55	0.59	0.93	0.09	0.05	0.05	0.25	0.26	0.06	0.34	0.34
Avail Cap(c_a), veh/h	82	237	228	809	1925	855	391	936	859	481	936	984
HCM Platoon Ratio	1.00	1.00	1.00	1.00	1.00	1.00	1.00	1.00	1.00	1.00	1.00	1.00
Upstream Filter(I)	1.00	1.00	1.00	1.00	1.00	1.00	1.00	1.00	1.00	1.00	1.00	1.00
Uniform Delay (d), s/veh	59.6	53.8	53.9	41.0	25.0	24.6	20.4	15.5	15.6	18.6	16.4	16.4
Incr Delay (d2), s/veh	35.7	3.7	4.4	12.6	0.0	0.0	0.2	0.6	0.7	0.2	1.0	0.9
Initial Q Delay(d3),s/veh	0.0	0.0	0.0	0.0	0.0	0.0	0.0	0.0	0.0	0.0	0.0	0.0
%ile BackOfQ(50%),veh/ln	0.2	2.1	2.2	15.1	1.0	0.5	0.3	3.3	3.2	0.5	4.8	5.0
Unsig. Movement Delay, s/veh												
LnGrp Delay(d),s/veh	95.4	57.5	58.4	53.6	25.0	24.7	20.6	16.1	16.3	18.9	17.3	17.3
LnGrp LOS	F	E	E	D	C	C	C	B	B	B	B	B
Approach Vol, veh/h		147			638			477			679	
Approach Delay, s/veh		58.7			47.0			16.4			17.4	
Approach LOS		E			D			B			B	
Timer - Assigned Phs		2	3	4		6	7	8				
Phs Duration (G+Y+Rc), s		67.2	40.1	12.7		67.2	5.0	47.8				
Change Period (Y+Rc), s		4.0	4.5	4.0		4.0	4.5	4.0				
Max Green Setting (Gmax), s		37.0	54.5	16.0		37.0	5.5	65.0				
Max Q Clear Time (g_c+I1), s		16.0	34.2	7.0		14.3	2.2	4.6				
Green Ext Time (p_c), s		2.4	1.4	0.4		3.4	0.0	0.7				
<b>Intersection Summary</b>												
HCM 6th Ctrl Delay			30.0									
HCM 6th LOS			C									
<b>Notes</b>												
User approved pedestrian interval to be less than phase max green.												

Lanes, Volumes, Timings  
 5: Little Morongo Rd. & N. Dwy.

EAP (2024) AM Peak Hour



Lane Group	WBL	WBR	NBT	NBR	SBL	SBT
Lane Configurations						
Traffic Volume (vph)	1	0	259	11	4	504
Future Volume (vph)	1	0	259	11	4	504
Ideal Flow (vphpl)	1900	1900	1900	1900	1900	1900
Storage Length (ft)	150	150		150	150	
Storage Lanes	0	0		0	0	
Taper Length (ft)	90				90	
Link Speed (mph)	30		55			55
Link Distance (ft)	298		421			3240
Travel Time (s)	6.8		5.2			40.2
Confl. Peds. (#/hr)	5	5		5	5	
Peak Hour Factor	0.92	0.92	0.92	0.92	0.92	0.92
Shared Lane Traffic (%)						
Sign Control	Stop		Free			Free

Intersection Summary

Area Type: Other

Control Type: Unsignalized

Intersection						
Int Delay, s/veh	0.1					
Movement	WBL	WBR	NBT	NBR	SBL	SBT
Lane Configurations						
Traffic Vol, veh/h	1	0	259	11	4	504
Future Vol, veh/h	1	0	259	11	4	504
Conflicting Peds, #/hr	5	5	0	5	5	0
Sign Control	Stop	Stop	Free	Free	Free	Free
RT Channelized	-	None	-	None	-	None
Storage Length	-	-	-	-	-	-
Veh in Median Storage, #	0	-	0	-	-	0
Grade, %	0	-	0	-	-	0
Peak Hour Factor	92	92	92	92	92	92
Heavy Vehicles, %	2	2	2	2	2	2
Mvmt Flow	1	0	282	12	4	548

















Major/Minor	Minor1	Major1	Major2			
Conflicting Flow All	854	298	0	0	299	0
Stage 1	293	-	-	-	-	-
Stage 2	561	-	-	-	-	-
Critical Hdwy	6.42	6.22	-	-	4.12	-
Critical Hdwy Stg 1	5.42	-	-	-	-	-
Critical Hdwy Stg 2	5.42	-	-	-	-	-
Follow-up Hdwy	3.518	3.318	-	-	2.218	-
Pot Cap-1 Maneuver	329	741	-	-	1262	-
Stage 1	757	-	-	-	-	-
Stage 2	571	-	-	-	-	-
Platoon blocked, %			-	-	-	-
Mov Cap-1 Maneuver	324	734	-	-	1256	-
Mov Cap-2 Maneuver	324	-	-	-	-	-
Stage 1	753	-	-	-	-	-
Stage 2	565	-	-	-	-	-

Approach	WB	NB	SB
HCM Control Delay, s	16.1	0	0.1
HCM LOS	C		

Minor Lane/Major Mvmt	NBT	NBRWBLn1	SBL	SBT
Capacity (veh/h)	-	-	324	1256
HCM Lane V/C Ratio	-	-	0.003	0.003
HCM Control Delay (s)	-	-	16.1	7.9
HCM Lane LOS	-	-	C	A
HCM 95th %tile Q(veh)	-	-	0	0

Lanes, Volumes, Timings  
 6: Little Morongo Rd. & i-Storage S. Dwy

EAP (2024) AM Peak Hour

												
Lane Group	EBL	EBT	EBR	WBL	WBT	WBR	NBL	NBT	NBR	SBL	SBT	SBR
Lane Configurations												
Traffic Volume (vph)	1	0	1	4	0	1	1	269	52	7	502	1
Future Volume (vph)	1	0	1	4	0	1	1	269	52	7	502	1
Ideal Flow (vphpl)	1900	1900	1900	1900	1900	1900	1900	1900	1900	1900	1900	1900
Storage Length (ft)	150		150	0		0	150		150	150		50
Storage Lanes	0		0	0		0	0		0	0		1
Taper Length (ft)	90			90			90			90		
Link Speed (mph)		30			30			55			55	
Link Distance (ft)		528			365			3985			342	
Travel Time (s)		12.0			8.3			49.4			4.2	
Confl. Peds. (#/hr)	5		5				5					5
Peak Hour Factor	0.91	0.91	0.91	0.91	0.91	0.91	0.91	0.91	0.91	0.91	0.91	0.91
Shared Lane Traffic (%)												
Sign Control		Stop			Stop			Free			Free	

Intersection Summary

Area Type: Other  
 Control Type: Unsignalized

HCM 6th TWSC  
6: Little Morongo Rd. & i-Storage S. Dwy

EAP (2024) AM Peak Hour

Intersection												
Int Delay, s/veh	0.2											
Movement	EBL	EBT	EBR	WBL	WBT	WBR	NBL	NBT	NBR	SBL	SBT	SBR
Lane Configurations		↕			↕			↕			↑	↗
Traffic Vol, veh/h	1	0	1	4	0	1	1	269	52	7	502	1
Future Vol, veh/h	1	0	1	4	0	1	1	269	52	7	502	1
Conflicting Peds, #/hr	5	0	5	0	0	0	5	0	0	0	0	5
Sign Control	Stop	Stop	Stop	Stop	Stop	Stop	Free	Free	Free	Free	Free	Free
RT Channelized	-	-	None	-	-	None	-	-	None	-	-	None
Storage Length	-	-	-	-	-	-	-	-	-	-	-	50
Veh in Median Storage, #	-	0	-	-	0	-	-	0	-	-	0	-
Grade, %	-	0	-	-	0	-	-	0	-	-	0	-
Peak Hour Factor	91	91	91	91	91	91	91	91	91	91	91	91
Heavy Vehicles, %	2	2	2	2	2	2	2	2	2	2	2	2
Mvmt Flow	1	0	1	4	0	1	1	296	57	8	552	1



















Major/Minor	Minor2		Minor1		Major1		Major2					
Conflicting Flow All	905	928	562	901	901	330	558	0	0	353	0	0
Stage 1	573	573	-	327	327	-	-	-	-	-	-	-
Stage 2	332	355	-	574	574	-	-	-	-	-	-	-
Critical Hdwy	7.12	6.52	6.22	7.12	6.52	6.22	4.12	-	-	4.12	-	-
Critical Hdwy Stg 1	6.12	5.52	-	6.12	5.52	-	-	-	-	-	-	-
Critical Hdwy Stg 2	6.12	5.52	-	6.12	5.52	-	-	-	-	-	-	-
Follow-up Hdwy	3.518	4.018	3.318	3.518	4.018	3.318	2.218	-	-	2.218	-	-
Pot Cap-1 Maneuver	257	268	526	259	278	712	1013	-	-	1206	-	-
Stage 1	505	504	-	686	648	-	-	-	-	-	-	-
Stage 2	681	630	-	504	503	-	-	-	-	-	-	-
Platoon blocked, %								-	-	-	-	-
Mov Cap-1 Maneuver	252	264	521	255	274	709	1008	-	-	1206	-	-
Mov Cap-2 Maneuver	252	264	-	255	274	-	-	-	-	-	-	-
Stage 1	502	496	-	685	647	-	-	-	-	-	-	-
Stage 2	676	629	-	496	495	-	-	-	-	-	-	-

Approach	EB		WB		NB		SB			
HCM Control Delay, s	15.7		17.6		0		0.1			
HCM LOS	C		C							

Minor Lane/Major Mvmt	NBL	NBT	NBR	EBLn1WBLn1	SBL	SBT	SBR
Capacity (veh/h)	1008	-	-	340	292	1206	-
HCM Lane V/C Ratio	0.001	-	-	0.006	0.019	0.006	-
HCM Control Delay (s)	8.6	0	-	15.7	17.6	8	-
HCM Lane LOS	A	A	-	C	C	A	-
HCM 95th %tile Q(veh)	0	-	-	0	0.1	0	-

Lanes, Volumes, Timings  
7: Indian Cyn. Dr. & 19th Av.

EAP (2024) AM Peak Hour

												
Lane Group	EBL	EBT	EBR	WBL	WBT	WBR	NBL	NBT	NBR	SBL	SBT	SBR
Lane Configurations												
Traffic Volume (vph)	6	1	6	14	1	11	20	407	56	37	1038	7
Future Volume (vph)	6	1	6	14	1	11	20	407	56	37	1038	7
Ideal Flow (vphpl)	1900	1900	1900	1900	1900	1900	1900	1900	1900	1900	1900	1900
Storage Length (ft)	0		0	0		50	200		0	100		0
Storage Lanes	0		0	0		1	1		0	1		0
Taper Length (ft)	90			90			90			90		
Link Speed (mph)		30			30			55			55	
Link Distance (ft)		938			936			640			4458	
Travel Time (s)		21.3			21.3			7.9			55.3	
Confl. Peds. (#/hr)	5		5	5		5	5		5	5		5
Peak Hour Factor	0.91	0.91	0.91	0.91	0.91	0.91	0.91	0.91	0.91	0.91	0.91	0.91
Shared Lane Traffic (%)												
Sign Control		Stop			Stop			Free			Free	

Intersection Summary

Area Type: Other  
Control Type: Unsignalized

Intersection												
Int Delay, s/veh	1.1											
Movement	EBL	EBT	EBR	WBL	WBT	WBR	NBL	NBT	NBR	SBL	SBT	SBR
Lane Configurations		↕			↕	↕	↕	↕		↕	↕	
Traffic Vol, veh/h	6	1	6	14	1	11	20	407	56	37	1038	7
Future Vol, veh/h	6	1	6	14	1	11	20	407	56	37	1038	7
Conflicting Peds, #/hr	5	0	5	5	0	5	5	0	5	5	0	5
Sign Control	Stop	Stop	Stop	Stop	Stop	Stop	Free	Free	Free	Free	Free	Free
RT Channelized	-	-	None	-	-	None	-	-	None	-	-	None
Storage Length	-	-	-	-	-	50	200	-	-	100	-	-
Veh in Median Storage, #	-	0	-	-	0	-	-	0	-	-	0	-
Grade, %	-	0	-	-	0	-	-	0	-	-	0	-
Peak Hour Factor	91	91	91	91	91	91	91	91	91	91	91	91
Heavy Vehicles, %	2	2	2	2	2	2	2	2	2	2	2	2
Mvmt Flow	7	1	7	15	1	12	22	447	62	41	1141	8

Major/Minor	Minor2		Minor1		Major1			Major2				
Conflicting Flow All	1505	1790	585	1185	1763	265	1154	0	0	514	0	0
Stage 1	1232	1232	-	527	527	-	-	-	-	-	-	-
Stage 2	273	558	-	658	1236	-	-	-	-	-	-	-
Critical Hdwy	7.54	6.54	6.94	7.54	6.54	6.94	4.14	-	-	4.14	-	-
Critical Hdwy Stg 1	6.54	5.54	-	6.54	5.54	-	-	-	-	-	-	-
Critical Hdwy Stg 2	6.54	5.54	-	6.54	5.54	-	-	-	-	-	-	-
Follow-up Hdwy	3.52	4.02	3.32	3.52	4.02	3.32	2.22	-	-	2.22	-	-
Pot Cap-1 Maneuver	84	80	454	144	83	733	601	-	-	1048	-	-
Stage 1	188	248	-	502	527	-	-	-	-	-	-	-
Stage 2	710	510	-	420	246	-	-	-	-	-	-	-
Platoon blocked, %								-	-	-	-	-
Mov Cap-1 Maneuver	76	73	450	131	76	726	598	-	-	1043	-	-
Mov Cap-2 Maneuver	76	73	-	131	76	-	-	-	-	-	-	-
Stage 1	180	237	-	481	505	-	-	-	-	-	-	-
Stage 2	668	489	-	394	235	-	-	-	-	-	-	-

Approach	EB		WB		NB		SB	
HCM Control Delay, s	38.1		26.2		0.5		0.3	
HCM LOS	E		D					

Minor Lane/Major Mvmt	NBL	NBT	NBR	EBLn1	WBLn1	WBLn2	SBL	SBT	SBR
Capacity (veh/h)	598	-	-	123	125	726	1043	-	-
HCM Lane V/C Ratio	0.037	-	-	0.116	0.132	0.017	0.039	-	-
HCM Control Delay (s)	11.2	-	-	38.1	38.1	10	8.6	-	-
HCM Lane LOS	B	-	-	E	E	B	A	-	-
HCM 95th %tile Q(veh)	0.1	-	-	0.4	0.4	0.1	0.1	-	-

Lanes, Volumes, Timings  
7: Indian Cyn. Dr. & 19th Av.

EAP (2024) AM Peak Hour  
With Improvements

Lane Group	EBL	EBT	EBR	WBL	WBT	WBR	NBL	NBT	NBR	SBL	SBT	SBR
Lane Configurations												
Traffic Volume (vph)	6	1	6	14	1	11	20	407	56	37	1038	7
Future Volume (vph)	6	1	6	14	1	11	20	407	56	37	1038	7
Ideal Flow (vphpl)	1900	1900	1900	1900	1900	1900	1900	1900	1900	1900	1900	1900
Storage Length (ft)	0		0	0		50	200		0	100		0
Storage Lanes	0		0	0		1	1		0	1		0
Taper Length (ft)	90			90			90			90		
Right Turn on Red			Yes			Yes			Yes			Yes
Link Speed (mph)		30			30			55			55	
Link Distance (ft)		938			936			640			4458	
Travel Time (s)		21.3			21.3			7.9			55.3	
Confl. Peds. (#/hr)	5		5	5		5	5		5	5		5
Peak Hour Factor	0.91	0.91	0.91	0.91	0.91	0.91	0.91	0.91	0.91	0.91	0.91	0.91
Shared Lane Traffic (%)												
Turn Type	Perm	NA		Perm	NA	Perm	Perm	NA		Perm	NA	
Protected Phases		4			8			2			6	
Permitted Phases	4			8		8	2			6		
Detector Phase	4	4		8	8	8	2	2		6	6	
Switch Phase												
Minimum Initial (s)	5.0	5.0		5.0	5.0	5.0	5.0	5.0		5.0	5.0	
Minimum Split (s)	22.5	22.5		22.5	22.5	22.5	22.5	22.5		22.5	22.5	
Total Split (s)	23.0	23.0		23.0	23.0	23.0	37.0	37.0		37.0	37.0	
Total Split (%)	38.3%	38.3%		38.3%	38.3%	38.3%	61.7%	61.7%		61.7%	61.7%	
Yellow Time (s)	3.5	3.5		3.5	3.5	3.5	3.5	3.5		3.5	3.5	
All-Red Time (s)	1.0	1.0		1.0	1.0	1.0	1.0	1.0		1.0	1.0	
Lost Time Adjust (s)		0.0			0.0	0.0	0.0	0.0		0.0	0.0	
Total Lost Time (s)		4.5			4.5	4.5	4.5	4.5		4.5	4.5	
Lead/Lag												
Lead-Lag Optimize?												
Recall Mode	None	None		None	None	None	C-Max	C-Max		C-Max	C-Max	

Intersection Summary

Area Type: Other  
 Cycle Length: 60  
 Actuated Cycle Length: 60  
 Offset: 0 (0%), Referenced to phase 2:NBTL and 6:SBTL, Start of Yellow  
 Natural Cycle: 50  
 Control Type: Actuated-Coordinated



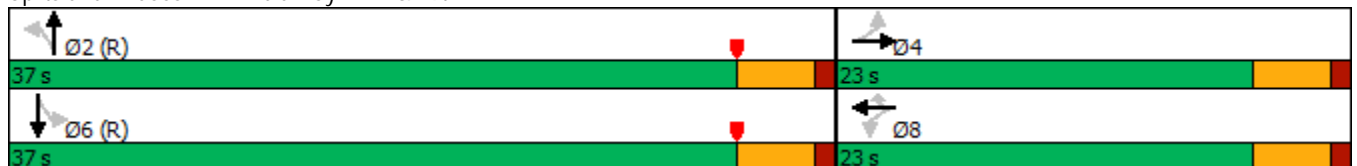

















Splits and Phases: 7: Indian Cyn. Dr. & 19th Av.























HCM 6th Signalized Intersection Summary  
7: Indian Cyn. Dr. & 19th Av.

EAP (2024) AM Peak Hour  
With Improvements

												
Movement	EBL	EBT	EBR	WBL	WBT	WBR	NBL	NBT	NBR	SBL	SBT	SBR
Lane Configurations												
Traffic Volume (veh/h)	6	1	6	14	1	11	20	407	56	37	1038	7
Future Volume (veh/h)	6	1	6	14	1	11	20	407	56	37	1038	7
Initial Q (Qb), veh	0	0	0	0	0	0	0	0	0	0	0	0
Ped-Bike Adj(A_pbT)	0.98		0.98	0.98		0.98	1.00		1.00	1.00		1.00
Parking Bus, Adj	1.00	1.00	1.00	1.00	1.00	1.00	1.00	1.00	1.00	1.00	1.00	1.00
Work Zone On Approach		No			No			No			No	
Adj Sat Flow, veh/h/ln	1870	1870	1870	1870	1870	1870	1870	1870	1870	1870	1870	1870
Adj Flow Rate, veh/h	7	1	7	15	1	12	22	447	62	41	1141	8
Peak Hour Factor	0.91	0.91	0.91	0.91	0.91	0.91	0.91	0.91	0.91	0.91	0.91	0.91
Percent Heavy Veh, %	2	2	2	2	2	2	2	2	2	2	2	2
Cap, veh/h	120	21	46	199	10	99	456	2466	340	788	2845	20
Arrive On Green	0.06	0.06	0.06	0.06	0.06	0.06	0.79	0.79	0.79	0.79	0.79	0.79
Sat Flow, veh/h	500	323	720	1298	152	1557	489	3135	432	889	3617	25
Grp Volume(v), veh/h	15	0	0	16	0	12	22	252	257	41	560	589
Grp Sat Flow(s),veh/h/ln	1543	0	0	1450	0	1557	489	1777	1791	889	1777	1866
Q Serve(g_s), s	0.0	0.0	0.0	0.0	0.0	0.4	0.9	2.1	2.1	0.7	5.9	5.9
Cycle Q Clear(g_c), s	0.5	0.0	0.0	0.5	0.0	0.4	6.8	2.1	2.1	2.9	5.9	5.9
Prop In Lane	0.47		0.47	0.94		1.00	1.00		0.24	1.00		0.01
Lane Grp Cap(c), veh/h	186	0	0	208	0	99	456	1397	1408	788	1397	1467
V/C Ratio(X)	0.08	0.00	0.00	0.08	0.00	0.12	0.05	0.18	0.18	0.05	0.40	0.40
Avail Cap(c_a), veh/h	548	0	0	551	0	480	456	1397	1408	788	1397	1467
HCM Platoon Ratio	1.00	1.00	1.00	1.00	1.00	1.00	1.00	1.00	1.00	1.00	1.00	1.00
Upstream Filter(I)	1.00	0.00	0.00	1.00	0.00	1.00	1.00	1.00	1.00	1.00	1.00	1.00
Uniform Delay (d), s/veh	26.5	0.0	0.0	26.5	0.0	26.5	3.1	1.6	1.6	2.0	2.0	2.0
Incr Delay (d2), s/veh	0.2	0.0	0.0	0.2	0.0	0.5	0.2	0.3	0.3	0.1	0.9	0.8
Initial Q Delay(d3),s/veh	0.0	0.0	0.0	0.0	0.0	0.0	0.0	0.0	0.0	0.0	0.0	0.0
%ile BackOfQ(50%),veh/ln	0.2	0.0	0.0	0.2	0.0	0.2	0.1	0.1	0.1	0.0	0.3	0.3
Unsig. Movement Delay, s/veh												
LnGrp Delay(d),s/veh	26.7	0.0	0.0	26.7	0.0	27.1	3.3	1.9	1.9	2.1	2.9	2.8
LnGrp LOS	C	A	A	C	A	C	A	A	A	A	A	A
Approach Vol, veh/h		15			28			531			1190	
Approach Delay, s/veh		26.7			26.8			1.9			2.8	
Approach LOS		C			C			A			A	
Timer - Assigned Phs		2		4		6		8				
Phs Duration (G+Y+Rc), s		51.7		8.3		51.7		8.3				
Change Period (Y+Rc), s		4.5		4.5		4.5		4.5				
Max Green Setting (Gmax), s		32.5		18.5		32.5		18.5				
Max Q Clear Time (g_c+I1), s		8.8		2.5		7.9		2.5				
Green Ext Time (p_c), s		2.8		0.0		7.2		0.0				
<b>Intersection Summary</b>												
HCM 6th Ctrl Delay				3.1								
HCM 6th LOS				A								

Lanes, Volumes, Timings  
 1: Little Morongo Rd. & Two Bunch Palms Tr.

EAP (2024) PM Peak Hour

												
Lane Group	EBL	EBT	EBR	WBL	WBT	WBR	NBL	NBT	NBR	SBL	SBT	SBR
Lane Configurations												
Traffic Volume (vph)	1	7	2	157	14	75	11	202	230	81	121	2
Future Volume (vph)	1	7	2	157	14	75	11	202	230	81	121	2
Ideal Flow (vphpl)	1900	1900	1900	1900	1900	1900	1900	1900	1900	1900	1900	1900
Storage Length (ft)	0		0	0		50	150		150	150		50
Storage Lanes	0		0	0		1	0		0	0		1
Taper Length (ft)	90			90			90			90		
Link Speed (mph)		45			45			55			55	
Link Distance (ft)		1073			1443			3240			728	
Travel Time (s)		16.3			21.9			40.2			9.0	
Confl. Peds. (#/hr)	5		5	5		5	5		5	5		5
Peak Hour Factor	0.94	0.94	0.94	0.94	0.94	0.94	0.94	0.94	0.94	0.94	0.94	0.94
Shared Lane Traffic (%)												
Sign Control		Stop			Stop			Stop			Stop	

**Intersection Summary**  
 Area Type: Other  
 Control Type: Unsignalized

Intersection	
Intersection Delay, s/veh	16.6
Intersection LOS	C

Movement	EBL	EBT	EBR	WBL	WBT	WBR	NBL	NBT	NBR	SBL	SBT	SBR
Lane Configurations		↕			↕	↕		↕			↕	↕
Traffic Vol, veh/h	1	7	2	157	14	75	11	202	230	81	121	2
Future Vol, veh/h	1	7	2	157	14	75	11	202	230	81	121	2
Peak Hour Factor	0.94	0.94	0.94	0.94	0.94	0.94	0.94	0.94	0.94	0.94	0.94	0.94
Heavy Vehicles, %	2	2	2	2	2	2	2	2	2	2	2	2
Mvmt Flow	1	7	2	167	15	80	12	215	245	86	129	2
Number of Lanes	0	1	0	0	1	1	0	1	0	0	1	1

Approach	EB	WB	NB	SB
Opposing Approach	WB	EB	SB	NB
Opposing Lanes	2	1	2	1
Conflicting Approach Left	SB	NB	EB	WB
Conflicting Lanes Left	2	1	1	2
Conflicting Approach Right	NB	SB	WB	EB
Conflicting Lanes Right	1	2	2	1
HCM Control Delay	10.2	12.2	21.1	12.6
HCM LOS	B	B	C	B

Lane	NBLn1	EBLn1	WBLn1	WBLn2	SBLn1	SBLn2
Vol Left, %	2%	10%	92%	0%	40%	0%
Vol Thru, %	46%	70%	8%	0%	60%	0%
Vol Right, %	52%	20%	0%	100%	0%	100%
Sign Control	Stop	Stop	Stop	Stop	Stop	Stop
Traffic Vol by Lane	443	10	171	75	202	2
LT Vol	11	1	157	0	81	0
Through Vol	202	7	14	0	121	0
RT Vol	230	2	0	75	0	2
Lane Flow Rate	471	11	182	80	215	2
Geometry Grp	6	6	7	7	7	7
Degree of Util (X)	0.716	0.021	0.35	0.128	0.372	0.003
Departure Headway (Hd)	5.466	7.01	6.932	5.754	6.225	5.311
Convergence, Y/N	Yes	Yes	Yes	Yes	Yes	Yes
Cap	660	509	518	622	578	673
Service Time	3.498	5.077	4.676	3.498	3.966	3.051
HCM Lane V/C Ratio	0.714	0.022	0.351	0.129	0.372	0.003
HCM Control Delay	21.1	10.2	13.4	9.3	12.6	8.1
HCM Lane LOS	C	B	B	A	B	A
HCM 95th-tile Q	6	0.1	1.6	0.4	1.7	0

Lanes, Volumes, Timings  
 2: Little Morongo Rd. & i-Storage N. Dwy

EAP (2024) PM Peak Hour



Lane Group	EBL	EBR	NBL	NBT	SBT	SBR
Lane Configurations						
Traffic Volume (vph)	6	11	10	462	282	5
Future Volume (vph)	6	11	10	462	282	5
Ideal Flow (vphpl)	1900	1900	1900	1900	1900	1900
Storage Length (ft)	150	50	150			50
Storage Lanes	0	1	0			1
Taper Length (ft)	90		90			
Link Speed (mph)	30			55	55	
Link Distance (ft)	557			342	421	
Travel Time (s)	12.7			4.2	5.2	
Confl. Peds. (#/hr)	5	5	5			5
Peak Hour Factor	0.92	0.92	0.92	0.92	0.92	0.92
Shared Lane Traffic (%)						
Sign Control	Stop			Free	Free	

Intersection Summary

Area Type: Other  
 Control Type: Unsignalized

Intersection						
Int Delay, s/veh	0.4					
Movement	EBL	EBR	NBL	NBT	SBT	SBR
Lane Configurations						
Traffic Vol, veh/h	6	11	10	462	282	5
Future Vol, veh/h	6	11	10	462	282	5
Conflicting Peds, #/hr	5	5	5	0	0	5
Sign Control	Stop	Stop	Free	Free	Free	Free
RT Channelized	-	None	-	None	-	None
Storage Length	-	50	-	-	-	50
Veh in Median Storage, #	0	-	-	0	0	-
Grade, %	0	-	-	0	0	-
Peak Hour Factor	92	92	92	92	92	92
Heavy Vehicles, %	2	2	2	2	2	2
Mvmt Flow	7	12	11	502	307	5



















Major/Minor	Minor2	Major1	Major2			
Conflicting Flow All	841	317	317	0	-	0
Stage 1	312	-	-	-	-	-
Stage 2	529	-	-	-	-	-
Critical Hdwy	6.42	6.22	4.12	-	-	-
Critical Hdwy Stg 1	5.42	-	-	-	-	-
Critical Hdwy Stg 2	5.42	-	-	-	-	-
Follow-up Hdwy	3.518	3.318	2.218	-	-	-
Pot Cap-1 Maneuver	335	724	1243	-	-	-
Stage 1	742	-	-	-	-	-
Stage 2	591	-	-	-	-	-
Platoon blocked, %				-	-	-
Mov Cap-1 Maneuver	328	717	1237	-	-	-
Mov Cap-2 Maneuver	328	-	-	-	-	-
Stage 1	729	-	-	-	-	-
Stage 2	588	-	-	-	-	-

Approach	EB	NB	SB
HCM Control Delay, s	12.3	0.2	0
HCM LOS	B		

Minor Lane/Major Mvmt	NBL	NBT	EBLn1	EBLn2	SBT	SBR
Capacity (veh/h)	1237	-	328	717	-	-
HCM Lane V/C Ratio	0.009	-	0.02	0.017	-	-
HCM Control Delay (s)	7.9	0	16.2	10.1	-	-
HCM Lane LOS	A	A	C	B	-	-
HCM 95th %tile Q(veh)	0	-	0.1	0.1	-	-

Lanes, Volumes, Timings  
 3: Little Morongo Rd. & Dillon Rd.

EAP (2024) PM Peak Hour

												
Lane Group	EBL	EBT	EBR	WBL	WBT	WBR	NBL	NBT	NBR	SBL	SBT	SBR
Lane Configurations												
Traffic Volume (vph)	247	318	0	0	230	176	0	0	0	188	0	223
Future Volume (vph)	247	318	0	0	230	176	0	0	0	188	0	223
Ideal Flow (vphpl)	1900	1900	1900	1900	1900	1900	1900	1900	1900	1900	1900	1900
Storage Length (ft)	205		150	145		150	0		0	150		150
Storage Lanes	1		0	1		0	0		0	0		0
Taper Length (ft)	90			90			90			90		
Link Speed (mph)		55			55			55				55
Link Distance (ft)		4457			1492			286			3985	
Travel Time (s)		55.3			18.5			3.5			49.4	
Confl. Peds. (#/hr)	5		5	5		5	5		5	5		5
Peak Hour Factor	0.87	0.87	0.87	0.87	0.87	0.87	0.87	0.87	0.87	0.87	0.87	0.87
Shared Lane Traffic (%)												
Sign Control		Stop			Stop			Stop			Stop	

Intersection Summary

Area Type: Other  
 Control Type: Unsignalized

Intersection	
Intersection Delay, s/veh	37
Intersection LOS	E

Movement	EBL	EBT	EBR	WBL	WBT	WBR	NBL	NBT	NBR	SBL	SBT	SBR
Lane Configurations	↙	↑		↙	↘						↕	
Traffic Vol, veh/h	247	318	0	0	230	176	0	0	0	188	0	223
Future Vol, veh/h	247	318	0	0	230	176	0	0	0	188	0	223
Peak Hour Factor	0.87	0.87	0.87	0.87	0.87	0.87	0.87	0.87	0.87	0.87	0.87	0.87
Heavy Vehicles, %	2	2	2	2	2	2	2	2	2	2	2	2
Mvmt Flow	284	366	0	0	264	202	0	0	0	216	0	256
Number of Lanes	1	1	0	1	1	0	0	0	0	0	1	0

Approach	EB	WB	SB
Opposing Approach	WB	EB	
Opposing Lanes	2	2	0
Conflicting Approach Left	SB		WB
Conflicting Lanes Left	1	0	2
Conflicting Approach Right		SB	EB
Conflicting Lanes Right	0	1	2
HCM Control Delay	25.7	50	39.8
HCM LOS	D	E	E

Lane	EBLn1	EBLn2	WBLn1	WBLn2	SBLn1
Vol Left, %	100%	0%	0%	0%	46%
Vol Thru, %	0%	100%	100%	57%	0%
Vol Right, %	0%	0%	0%	43%	54%
Sign Control	Stop	Stop	Stop	Stop	Stop
Traffic Vol by Lane	247	318	0	406	411
LT Vol	247	0	0	0	188
Through Vol	0	318	0	230	0
RT Vol	0	0	0	176	223
Lane Flow Rate	284	366	0	467	472
Geometry Grp	7	7	7	7	2
Degree of Util (X)	0.616	0.74	0	0.924	0.873
Departure Headway (Hd)	7.805	7.291	7.442	7.128	6.649
Convergence, Y/N	Yes	Yes	Yes	Yes	Yes
Cap	463	493	0	509	543
Service Time	5.566	5.052	5.193	4.88	4.686
HCM Lane V/C Ratio	0.613	0.742	0	0.917	0.869
HCM Control Delay	22.4	28.2	10.2	50	39.8
HCM Lane LOS	C	D	N	E	E
HCM 95th-tile Q	4.1	6.2	0	11	9.7

Lanes, Volumes, Timings  
3: Little Morongo Rd. & Dillon Rd.

EAP (2024) PM Peak Hour  
With Improvements

Lane Group	EBL	EBT	EBR	WBL	WBT	WBR	NBL	NBT	NBR	SBL	SBT	SBR
Lane Configurations												
Traffic Volume (vph)	247	318	0	0	230	176	0	0	0	188	0	223
Future Volume (vph)	247	318	0	0	230	176	0	0	0	188	0	223
Ideal Flow (vphpl)	1900	1900	1900	1900	1900	1900	1900	1900	1900	1900	1900	1900
Storage Length (ft)	205		150	145		150	0		0	150		150
Storage Lanes	1		0	1		0	0		0	0		0
Taper Length (ft)	90			90			90			90		
Right Turn on Red			Yes			Yes			Yes			Yes
Link Speed (mph)		55			55			55			55	
Link Distance (ft)		4457			1492			286			3985	
Travel Time (s)		55.3			18.5			3.5			49.4	
Confl. Peds. (#/hr)	5		5	5		5	5		5	5		5
Peak Hour Factor	0.87	0.87	0.87	0.87	0.87	0.87	0.87	0.87	0.87	0.87	0.87	0.87
Shared Lane Traffic (%)												
Turn Type	Perm	NA		Perm	NA					Perm	NA	
Protected Phases		2			6							4
Permitted Phases	2			6						4		
Detector Phase	2	2		6	6					4	4	
Switch Phase												
Minimum Initial (s)	5.0	5.0		5.0	5.0					5.0	5.0	
Minimum Split (s)	22.5	22.5		22.5	22.5					22.5	22.5	
Total Split (s)	35.9	35.9		35.9	35.9					24.1	24.1	
Total Split (%)	59.8%	59.8%		59.8%	59.8%					40.2%	40.2%	
Yellow Time (s)	3.5	3.5		3.5	3.5					3.5	3.5	
All-Red Time (s)	1.0	1.0		1.0	1.0					1.0	1.0	
Lost Time Adjust (s)	0.0	0.0		0.0	0.0							0.0
Total Lost Time (s)	4.5	4.5		4.5	4.5							4.5
Lead/Lag												
Lead-Lag Optimize?												
Recall Mode	C-Max	C-Max		C-Max	C-Max					Max	Max	

Intersection Summary

Area Type: Other  
 Cycle Length: 60  
 Actuated Cycle Length: 60  
 Offset: 35 (58%), Referenced to phase 2:EBTL and 6:WBTL, Start of Yellow  
 Natural Cycle: 55  
 Control Type: Actuated-Coordinated



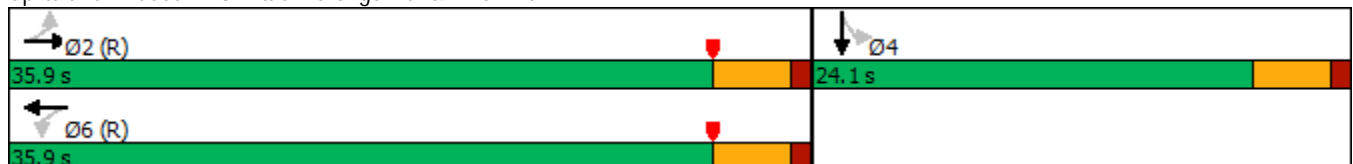















Splits and Phases: 3: Little Morongo Rd. & Dillon Rd.





HCM 6th Signalized Intersection Summary  
3: Little Morongo Rd. & Dillon Rd.

EAP (2024) PM Peak Hour  
With Improvements

												
Movement	EBL	EBT	EBR	WBL	WBT	WBR	NBL	NBT	NBR	SBL	SBT	SBR
Lane Configurations												
Traffic Volume (veh/h)	247	318	0	0	230	176	0	0	0	188	0	223
Future Volume (veh/h)	247	318	0	0	230	176	0	0	0	188	0	223
Initial Q (Qb), veh	0	0	0	0	0	0				0	0	0
Ped-Bike Adj(A_pbT)	1.00		1.00	1.00		1.00				1.00		0.99
Parking Bus, Adj	1.00	1.00	1.00	1.00	1.00	1.00				1.00	1.00	1.00
Work Zone On Approach		No			No						No	
Adj Sat Flow, veh/h/ln	1870	1870	0	1870	1870	1870				1870	1870	1870
Adj Flow Rate, veh/h	284	366	0	0	264	202				216	0	256
Peak Hour Factor	0.87	0.87	0.87	0.87	0.87	0.87				0.87	0.87	0.87
Percent Heavy Veh, %	2	2	0	2	2	2				2	2	2
Cap, veh/h	442	979	0	120	513	393				248	0	294
Arrive On Green	0.52	0.52	0.00	0.00	0.52	0.52				0.33	0.00	0.33
Sat Flow, veh/h	926	1870	0	1016	981	750				761	0	901
Grp Volume(v), veh/h	284	366	0	0	0	466				472	0	0
Grp Sat Flow(s),veh/h/ln	926	1870	0	1016	0	1731				1662	0	0
Q Serve(g_s), s	17.3	7.0	0.0	0.0	0.0	10.5				16.0	0.0	0.0
Cycle Q Clear(g_c), s	27.9	7.0	0.0	0.0	0.0	10.5				16.0	0.0	0.0
Prop In Lane	1.00		0.00	1.00		0.43				0.46		0.54
Lane Grp Cap(c), veh/h	442	979	0	120	0	906				543	0	0
V/C Ratio(X)	0.64	0.37	0.00	0.00	0.00	0.51				0.87	0.00	0.00
Avail Cap(c_a), veh/h	442	979	0	120	0	906				543	0	0
HCM Platoon Ratio	1.00	1.00	1.00	1.00	1.00	1.00				1.00	1.00	1.00
Upstream Filter(I)	1.00	1.00	0.00	0.00	0.00	1.00				1.00	0.00	0.00
Uniform Delay (d), s/veh	18.4	8.5	0.0	0.0	0.0	9.3				19.0	0.0	0.0
Incr Delay (d2), s/veh	7.0	1.1	0.0	0.0	0.0	2.1				17.1	0.0	0.0
Initial Q Delay(d3),s/veh	0.0	0.0	0.0	0.0	0.0	0.0				0.0	0.0	0.0
%ile BackOfQ(50%),veh/ln	3.7	2.1	0.0	0.0	0.0	3.0				7.3	0.0	0.0
Unsig. Movement Delay, s/veh												
LnGrp Delay(d),s/veh	25.4	9.6	0.0	0.0	0.0	11.4				36.1	0.0	0.0
LnGrp LOS	C	A	A	A	A	B				D	A	A
Approach Vol, veh/h		650			466						472	
Approach Delay, s/veh		16.5			11.4						36.1	
Approach LOS		B			B						D	
Timer - Assigned Phs		2		4		6						
Phs Duration (G+Y+Rc), s		35.9		24.1		35.9						
Change Period (Y+Rc), s		4.5		4.5		4.5						
Max Green Setting (Gmax), s		31.4		19.6		31.4						
Max Q Clear Time (g_c+I1), s		29.9		18.0		12.5						
Green Ext Time (p_c), s		0.6		0.4		2.5						
<b>Intersection Summary</b>												
HCM 6th Ctrl Delay				20.8								
HCM 6th LOS				C								

Lanes, Volumes, Timings  
4: Indian Cyn. Dr. & Dillon Rd.

EAP (2024) PM Peak Hour

Lane Group	EBL	EBT	EBR	WBL	WBT	WBR	NBL	NBT	NBR	SBL	SBT	SBR
Lane Configurations												
Traffic Volume (vph)	4	100	16	246	144	45	11	588	327	35	235	2
Future Volume (vph)	4	100	16	246	144	45	11	588	327	35	235	2
Ideal Flow (vphpl)	1900	1900	1900	1900	1900	1900	1900	1900	1900	1900	1900	1900
Storage Length (ft)	150		195	100		100	100		150	120		150
Storage Lanes	1		0	1		1	1		0	1		0
Taper Length (ft)	90			90			90			90		
Right Turn on Red			Yes			Yes			Yes			Yes
Link Speed (mph)		55			55			55			55	
Link Distance (ft)		780			957			919			547	
Travel Time (s)		9.7			11.9			11.4			6.8	
Confl. Peds. (#/hr)	5		5	5		5	5		5	5		5
Peak Hour Factor	0.91	0.91	0.91	0.91	0.91	0.91	0.91	0.91	0.91	0.91	0.91	0.91
Shared Lane Traffic (%)												
Turn Type	Prot	NA		Prot	NA	Perm	Perm	NA		Perm	NA	
Protected Phases	7	4		3	8			2			6	
Permitted Phases						8	2			6		
Detector Phase	7	4		3	8	8	2	2		6	6	
Switch Phase												
Minimum Initial (s)	5.0	4.0		5.0	4.0	4.0	4.0	4.0		4.0	4.0	
Minimum Split (s)	9.5	20.0		9.5	20.0	20.0	20.0	20.0		20.0	20.0	
Total Split (s)	10.0	20.0		40.0	50.0	50.0	60.0	60.0		60.0	60.0	
Total Split (%)	8.3%	16.7%		33.3%	41.7%	41.7%	50.0%	50.0%		50.0%	50.0%	
Yellow Time (s)	3.5	3.5		3.5	3.5	3.5	3.5	3.5		3.5	3.5	
All-Red Time (s)	1.0	0.5		1.0	0.5	0.5	0.5	0.5		0.5	0.5	
Lost Time Adjust (s)	0.0	0.0		0.0	0.0	0.0	0.0	0.0		0.0	0.0	
Total Lost Time (s)	4.5	4.0		4.5	4.0	4.0	4.0	4.0		4.0	4.0	
Lead/Lag	Lead	Lag		Lead	Lag	Lag						
Lead-Lag Optimize?	Yes	Yes		Yes	Yes	Yes						
Recall Mode	None	None		None	None	None	C-Max	C-Max		C-Max	C-Max	

Intersection Summary





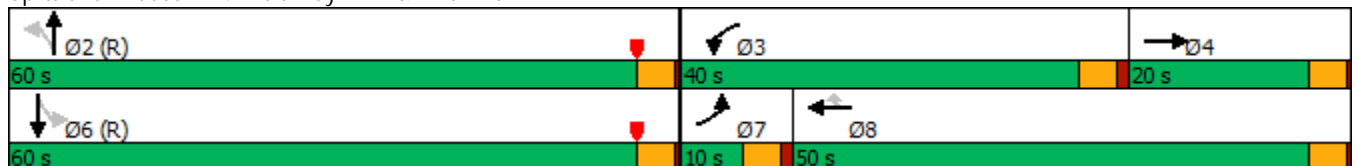















Area Type: Other  
 Cycle Length: 120  
 Actuated Cycle Length: 120  
 Offset: 0 (0%), Referenced to phase 2:NBTL and 6:SBTL, Start of Yellow  
 Natural Cycle: 60  
 Control Type: Actuated-Coordinated

Splits and Phases: 4: Indian Cyn. Dr. & Dillon Rd.



HCM 6th Signalized Intersection Summary  
4: Indian Cyn. Dr. & Dillon Rd.

EAP (2024) PM Peak Hour

												
Movement	EBL	EBT	EBR	WBL	WBT	WBR	NBL	NBT	NBR	SBL	SBT	SBR
Lane Configurations												
Traffic Volume (veh/h)	4	100	16	246	144	45	11	588	327	35	235	2
Future Volume (veh/h)	4	100	16	246	144	45	11	588	327	35	235	2
Initial Q (Qb), veh	0	0	0	0	0	0	0	0	0	0	0	0
Ped-Bike Adj(A_pbT)	1.00		0.98	1.00		0.99	1.00		1.00	1.00		1.00
Parking Bus, Adj	1.00	1.00	1.00	1.00	1.00	1.00	1.00	1.00	1.00	1.00	1.00	1.00
Work Zone On Approach		No			No			No			No	
Adj Sat Flow, veh/h/ln	1870	1870	1870	1870	1870	1870	1870	1870	1870	1870	1870	1870
Adj Flow Rate, veh/h	4	110	18	270	158	49	12	646	359	38	258	2
Peak Hour Factor	0.91	0.91	0.91	0.91	0.91	0.91	0.91	0.91	0.91	0.91	0.91	0.91
Percent Heavy Veh, %	2	2	2	2	2	2	2	2	2	2	2	2
Cap, veh/h	9	206	33	303	825	366	767	1449	805	350	2380	18
Arrive On Green	0.01	0.07	0.07	0.17	0.23	0.23	0.66	0.66	0.66	0.66	0.66	0.66
Sat Flow, veh/h	1781	3058	488	1781	3554	1575	1118	2201	1223	561	3614	28
Grp Volume(v), veh/h	4	63	65	270	158	49	12	522	483	38	127	133
Grp Sat Flow(s),veh/h/ln	1781	1777	1769	1781	1777	1575	1118	1777	1647	561	1777	1865
Q Serve(g_s), s	0.3	4.1	4.3	17.8	4.3	3.0	0.5	17.0	17.0	4.2	3.1	3.2
Cycle Q Clear(g_c), s	0.3	4.1	4.3	17.8	4.3	3.0	3.6	17.0	17.0	21.2	3.1	3.2
Prop In Lane	1.00		0.28	1.00		1.00	1.00		0.74	1.00		0.02
Lane Grp Cap(c), veh/h	9	119	119	303	825	366	767	1170	1084	350	1170	1228
V/C Ratio(X)	0.43	0.53	0.55	0.89	0.19	0.13	0.02	0.45	0.45	0.11	0.11	0.11
Avail Cap(c_a), veh/h	82	237	236	527	1362	604	767	1170	1084	350	1170	1228
HCM Platoon Ratio	1.00	1.00	1.00	1.00	1.00	1.00	1.00	1.00	1.00	1.00	1.00	1.00
Upstream Filter(I)	1.00	1.00	1.00	1.00	1.00	1.00	1.00	1.00	1.00	1.00	1.00	1.00
Uniform Delay (d), s/veh	59.5	54.1	54.2	48.7	37.0	36.5	8.2	9.9	9.9	15.0	7.5	7.5
Incr Delay (d2), s/veh	28.7	3.6	3.9	9.5	0.1	0.2	0.0	1.2	1.3	0.6	0.2	0.2
Initial Q Delay(d3),s/veh	0.0	0.0	0.0	0.0	0.0	0.0	0.0	0.0	0.0	0.0	0.0	0.0
%ile BackOfQ(50%),veh/ln	0.2	1.9	2.0	8.3	1.8	1.1	0.1	5.8	5.4	0.6	1.1	1.1
Unsig. Movement Delay, s/veh												
LnGrp Delay(d),s/veh	88.2	57.7	58.1	58.2	37.1	36.7	8.2	11.1	11.2	15.7	7.7	7.7
LnGrp LOS	F	E	E	E	D	D	A	B	B	B	A	A
Approach Vol, veh/h		132			477			1017			298	
Approach Delay, s/veh		58.8			49.0			11.2			8.7	
Approach LOS		E			D			B			A	
Timer - Assigned Phs		2	3	4		6	7	8				
Phs Duration (G+Y+Rc), s		83.0	24.9	12.1		83.0	5.1	31.9				
Change Period (Y+Rc), s		4.0	4.5	4.0		4.0	4.5	4.0				
Max Green Setting (Gmax), s		56.0	35.5	16.0		56.0	5.5	46.0				
Max Q Clear Time (g_c+I1), s		19.0	19.8	6.3		23.2	2.3	6.3				
Green Ext Time (p_c), s		6.7	0.6	0.3		1.7	0.0	1.0				
<b>Intersection Summary</b>												
HCM 6th Ctrl Delay				23.4								
HCM 6th LOS				C								
<b>Notes</b>												
User approved pedestrian interval to be less than phase max green.												

Lanes, Volumes, Timings  
 5: Little Morongo Rd. & N. Dwy.

EAP (2024) PM Peak Hour



Lane Group	WBL	WBR	NBT	NBR	SBL	SBT
Lane Configurations						
Traffic Volume (vph)	8	3	465	3	1	279
Future Volume (vph)	8	3	465	3	1	279
Ideal Flow (vphpl)	1900	1900	1900	1900	1900	1900
Storage Length (ft)	150	150		150	150	
Storage Lanes	0	0		0	0	
Taper Length (ft)	90				90	
Link Speed (mph)	30		55			55
Link Distance (ft)	298		421			3240
Travel Time (s)	6.8		5.2			40.2
Confl. Peds. (#/hr)	5	5		5	5	
Peak Hour Factor	0.92	0.92	0.92	0.92	0.92	0.92
Shared Lane Traffic (%)						
Sign Control	Stop		Free			Free

Intersection Summary

Area Type: Other

Control Type: Unsignalized

Intersection						
Int Delay, s/veh	0.2					
Movement	WBL	WBR	NBT	NBR	SBL	SBT
Lane Configurations	W	W	T	T	T	T
Traffic Vol, veh/h	8	3	465	3	1	279
Future Vol, veh/h	8	3	465	3	1	279
Conflicting Peds, #/hr	5	5	0	5	5	0
Sign Control	Stop	Stop	Free	Free	Free	Free
RT Channelized	-	None	-	None	-	None
Storage Length	-	-	-	-	-	-
Veh in Median Storage, #	0	-	0	-	-	0
Grade, %	0	-	0	-	-	0
Peak Hour Factor	92	92	92	92	92	92
Heavy Vehicles, %	2	2	2	2	2	2
Mvmt Flow	9	3	505	3	1	303

















Major/Minor	Minor1	Major1	Major2			
Conflicting Flow All	822	517	0	0	513	0
Stage 1	512	-	-	-	-	-
Stage 2	310	-	-	-	-	-
Critical Hdwy	6.42	6.22	-	-	4.12	-
Critical Hdwy Stg 1	5.42	-	-	-	-	-
Critical Hdwy Stg 2	5.42	-	-	-	-	-
Follow-up Hdwy	3.518	3.318	-	-	2.218	-
Pot Cap-1 Maneuver	344	558	-	-	1052	-
Stage 1	602	-	-	-	-	-
Stage 2	744	-	-	-	-	-
Platoon blocked, %			-	-	-	-
Mov Cap-1 Maneuver	340	553	-	-	1047	-
Mov Cap-2 Maneuver	340	-	-	-	-	-
Stage 1	599	-	-	-	-	-
Stage 2	740	-	-	-	-	-

Approach	WB	NB	SB
HCM Control Delay, s	14.8	0	0
HCM LOS	B		

Minor Lane/Major Mvmt	NBT	NBRWBLn1	SBL	SBT
Capacity (veh/h)	-	-	380	1047
HCM Lane V/C Ratio	-	-	0.031	0.001
HCM Control Delay (s)	-	-	14.8	8.4
HCM Lane LOS	-	-	B	A
HCM 95th %tile Q(veh)	-	-	0.1	0

Lanes, Volumes, Timings  
 6: Little Morongo Rd. & i-Storage S. Dwy

EAP (2024) PM Peak Hour

												
Lane Group	EBL	EBT	EBR	WBL	WBT	WBR	NBL	NBT	NBR	SBL	SBT	SBR
Lane Configurations												
Traffic Volume (vph)	1	0	1	37	0	5	1	467	15	2	290	1
Future Volume (vph)	1	0	1	37	0	5	1	467	15	2	290	1
Ideal Flow (vphpl)	1900	1900	1900	1900	1900	1900	1900	1900	1900	1900	1900	1900
Storage Length (ft)	150		150	0		0	150		150	150		50
Storage Lanes	0		0	0		0	0		0	0		1
Taper Length (ft)	90			90			90			90		
Link Speed (mph)		30			30			55			55	
Link Distance (ft)		528			365			3985			342	
Travel Time (s)		12.0			8.3			49.4			4.2	
Confl. Peds. (#/hr)	5		5				5					5
Peak Hour Factor	0.91	0.91	0.91	0.91	0.91	0.91	0.91	0.91	0.91	0.91	0.91	0.91
Shared Lane Traffic (%)												
Sign Control		Stop			Stop			Free			Free	

Intersection Summary

Area Type: Other  
 Control Type: Unsignalized

HCM 6th TWSC  
6: Little Morongo Rd. & i-Storage S. Dwy

EAP (2024) PM Peak Hour

Intersection												
Int Delay, s/veh	1.1											
Movement	EBL	EBT	EBR	WBL	WBT	WBR	NBL	NBT	NBR	SBL	SBT	SBR
Lane Configurations		↕			↕			↕			↑	↗
Traffic Vol, veh/h	1	0	1	37	0	5	1	467	15	2	290	1
Future Vol, veh/h	1	0	1	37	0	5	1	467	15	2	290	1
Conflicting Peds, #/hr	5	0	5	0	0	0	5	0	0	0	0	5
Sign Control	Stop	Stop	Stop	Stop	Stop	Stop	Free	Free	Free	Free	Free	Free
RT Channelized	-	-	None	-	-	None	-	-	None	-	-	None
Storage Length	-	-	-	-	-	-	-	-	-	-	-	50
Veh in Median Storage, #	-	0	-	-	0	-	-	0	-	-	0	-
Grade, %	-	0	-	-	0	-	-	0	-	-	0	-
Peak Hour Factor	91	91	91	91	91	91	91	91	91	91	91	91
Heavy Vehicles, %	2	2	2	2	2	2	2	2	2	2	2	2
Mvmt Flow	1	0	1	41	0	5	1	513	16	2	319	1



















Major/Minor	Minor2		Minor1		Major1		Major2					
Conflicting Flow All	859	859	329	852	852	526	325	0	0	529	0	0
Stage 1	328	328	-	523	523	-	-	-	-	-	-	-
Stage 2	531	531	-	329	329	-	-	-	-	-	-	-
Critical Hdwy	7.12	6.52	6.22	7.12	6.52	6.22	4.12	-	-	4.12	-	-
Critical Hdwy Stg 1	6.12	5.52	-	6.12	5.52	-	-	-	-	-	-	-
Critical Hdwy Stg 2	6.12	5.52	-	6.12	5.52	-	-	-	-	-	-	-
Follow-up Hdwy	3.518	4.018	3.318	3.518	4.018	3.318	2.218	-	-	2.218	-	-
Pot Cap-1 Maneuver	277	294	712	280	297	552	1235	-	-	1038	-	-
Stage 1	685	647	-	537	530	-	-	-	-	-	-	-
Stage 2	532	526	-	684	646	-	-	-	-	-	-	-
Platoon blocked, %								-	-	-	-	-
Mov Cap-1 Maneuver	271	292	705	277	295	549	1229	-	-	1038	-	-
Mov Cap-2 Maneuver	271	292	-	277	295	-	-	-	-	-	-	-
Stage 1	681	642	-	536	529	-	-	-	-	-	-	-
Stage 2	524	525	-	678	641	-	-	-	-	-	-	-

Approach	EB		WB		NB		SB		
HCM Control Delay, s	14.2		19.5		0		0.1		
HCM LOS	B		C						

Minor Lane/Major Mvmt	NBL	NBT	NBR	EBLn1WBLn1	SBL	SBT	SBR
Capacity (veh/h)	1229	-	-	392	294	1038	-
HCM Lane V/C Ratio	0.001	-	-	0.006	0.157	0.002	-
HCM Control Delay (s)	7.9	0	-	14.2	19.5	8.5	-
HCM Lane LOS	A	A	-	B	C	A	-
HCM 95th %tile Q(veh)	0	-	-	0	0.5	0	-

Lanes, Volumes, Timings  
7: Indian Cyn. Dr. & 19th Av.

EAP (2024) PM Peak Hour

												
Lane Group	EBL	EBT	EBR	WBL	WBT	WBR	NBL	NBT	NBR	SBL	SBT	SBR
Lane Configurations												
Traffic Volume (vph)	8	1	9	55	3	22	3	983	6	4	485	6
Future Volume (vph)	8	1	9	55	3	22	3	983	6	4	485	6
Ideal Flow (vphpl)	1900	1900	1900	1900	1900	1900	1900	1900	1900	1900	1900	1900
Storage Length (ft)	0		0	0		50	200		0	100		0
Storage Lanes	0		0	0		1	1		0	1		0
Taper Length (ft)	90			90			90			90		
Link Speed (mph)		30			30			55			55	
Link Distance (ft)		938			936			640			4458	
Travel Time (s)		21.3			21.3			7.9			55.3	
Confl. Peds. (#/hr)	5		5	5		5	5		5	5		5
Peak Hour Factor	0.90	0.90	0.90	0.90	0.90	0.90	0.90	0.90	0.90	0.90	0.90	0.90
Shared Lane Traffic (%)												
Sign Control		Stop			Stop			Free			Free	

Intersection Summary

Area Type: Other  
Control Type: Unsignalized



Intersection												
Int Delay, s/veh	3.9											
Movement	EBL	EBT	EBR	WBL	WBT	WBR	NBL	NBT	NBR	SBL	SBT	SBR
Lane Configurations		↕			↕	↕	↕	↕		↕	↕	
Traffic Vol, veh/h	8	1	9	55	3	22	3	983	6	4	485	6
Future Vol, veh/h	8	1	9	55	3	22	3	983	6	4	485	6
Conflicting Peds, #/hr	5	0	5	5	0	5	5	0	5	5	0	5
Sign Control	Stop	Stop	Stop	Stop	Stop	Stop	Free	Free	Free	Free	Free	Free
RT Channelized	-	-	None	-	-	None	-	-	None	-	-	None
Storage Length	-	-	-	-	-	50	200	-	-	100	-	-
Veh in Median Storage, #	-	0	-	-	0	-	-	0	-	-	0	-
Grade, %	-	0	-	-	0	-	-	0	-	-	0	-
Peak Hour Factor	90	90	90	90	90	90	90	90	90	90	90	90
Heavy Vehicles, %	2	2	2	2	2	2	2	2	2	2	2	2
Mvmt Flow	9	1	10	61	3	24	3	1092	7	4	539	7

Major/Minor	Minor2		Minor1		Major1		Major2					
Conflicting Flow All	1115	1666	283	1390	1666	560	551	0	0	1104	0	0
Stage 1	556	556	-	1107	1107	-	-	-	-	-	-	-
Stage 2	559	1110	-	283	559	-	-	-	-	-	-	-
Critical Hdwy	7.54	6.54	6.94	7.54	6.54	6.94	4.14	-	-	4.14	-	-
Critical Hdwy Stg 1	6.54	5.54	-	6.54	5.54	-	-	-	-	-	-	-
Critical Hdwy Stg 2	6.54	5.54	-	6.54	5.54	-	-	-	-	-	-	-
Follow-up Hdwy	3.52	4.02	3.32	3.52	4.02	3.32	2.22	-	-	2.22	-	-
Pot Cap-1 Maneuver	163	96	714	102	96	472	1015	-	-	628	-	-
Stage 1	483	511	-	224	284	-	-	-	-	-	-	-
Stage 2	481	283	-	700	509	-	-	-	-	-	-	-
Platoon blocked, %								-	-	-	-	-
Mov Cap-1 Maneuver	148	94	707	98	94	468	1010	-	-	625	-	-
Mov Cap-2 Maneuver	148	94	-	98	94	-	-	-	-	-	-	-
Stage 1	479	505	-	222	282	-	-	-	-	-	-	-
Stage 2	447	281	-	681	503	-	-	-	-	-	-	-

Approach	EB		WB		NB		SB	
HCM Control Delay, s	22		72		0		0.1	
HCM LOS	C		F					

Minor Lane/Major Mvmt	NBL	NBT	NBR	EBLn1	WBLn1	WBLn2	SBL	SBT	SBR
Capacity (veh/h)	1010	-	-	232	98	468	625	-	-
HCM Lane V/C Ratio	0.003	-	-	0.086	0.658	0.052	0.007	-	-
HCM Control Delay (s)	8.6	-	-	22	94.3	13.1	10.8	-	-
HCM Lane LOS	A	-	-	C	F	B	B	-	-
HCM 95th %tile Q(veh)	0	-	-	0.3	3.2	0.2	0	-	-

Lanes, Volumes, Timings  
7: Indian Cyn. Dr. & 19th Av.

EAP (2024) PM Peak Hour  
With Improvements

Lane Group	EBL	EBT	EBR	WBL	WBT	WBR	NBL	NBT	NBR	SBL	SBT	SBR
Lane Configurations												
Traffic Volume (vph)	8	1	9	55	3	22	3	983	6	4	485	6
Future Volume (vph)	8	1	9	55	3	22	3	983	6	4	485	6
Ideal Flow (vphpl)	1900	1900	1900	1900	1900	1900	1900	1900	1900	1900	1900	1900
Storage Length (ft)	0		0	0		50	200		0	100		0
Storage Lanes	0		0	0		1	1		0	1		0
Taper Length (ft)	90			90			90			90		
Right Turn on Red			Yes			Yes			Yes			Yes
Link Speed (mph)		30			30			55				55
Link Distance (ft)		938			936			640				4458
Travel Time (s)		21.3			21.3			7.9				55.3
Confl. Peds. (#/hr)	5		5	5		5	5		5	5		5
Peak Hour Factor	0.90	0.90	0.90	0.90	0.90	0.90	0.90	0.90	0.90	0.90	0.90	0.90
Shared Lane Traffic (%)												
Turn Type	Perm	NA		Perm	NA	Perm	Perm	NA		Perm	NA	
Protected Phases		4			8			2			6	
Permitted Phases	4			8		8	2			6		
Detector Phase	4	4		8	8	8	2	2		6	6	
Switch Phase												
Minimum Initial (s)	5.0	5.0		5.0	5.0	5.0	5.0	5.0		5.0	5.0	
Minimum Split (s)	22.5	22.5		22.5	22.5	22.5	22.5	22.5		22.5	22.5	
Total Split (s)	23.0	23.0		23.0	23.0	23.0	37.0	37.0		37.0	37.0	
Total Split (%)	38.3%	38.3%		38.3%	38.3%	38.3%	61.7%	61.7%		61.7%	61.7%	
Yellow Time (s)	3.5	3.5		3.5	3.5	3.5	3.5	3.5		3.5	3.5	
All-Red Time (s)	1.0	1.0		1.0	1.0	1.0	1.0	1.0		1.0	1.0	
Lost Time Adjust (s)		0.0			0.0	0.0	0.0	0.0		0.0	0.0	
Total Lost Time (s)		4.5			4.5	4.5	4.5	4.5		4.5	4.5	
Lead/Lag												
Lead-Lag Optimize?												
Recall Mode	None	None		None	None	None	C-Max	C-Max		C-Max	C-Max	

Intersection Summary





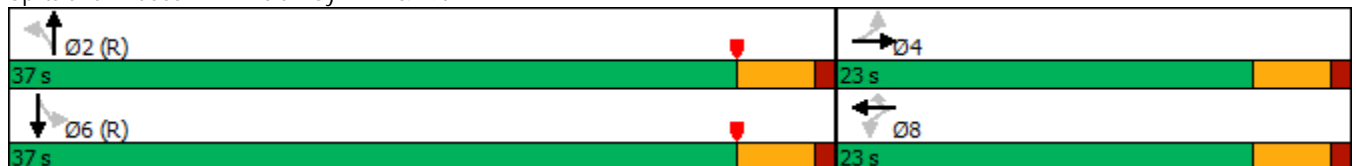













Area Type: Other  
 Cycle Length: 60  
 Actuated Cycle Length: 60  
 Offset: 0 (0%), Referenced to phase 2:NBTL and 6:SBTL, Start of Yellow  
 Natural Cycle: 45  
 Control Type: Actuated-Coordinated

Splits and Phases: 7: Indian Cyn. Dr. & 19th Av.



HCM 6th Signalized Intersection Summary  
7: Indian Cyn. Dr. & 19th Av.

EAP (2024) PM Peak Hour  
With Improvements

												
Movement	EBL	EBT	EBR	WBL	WBT	WBR	NBL	NBT	NBR	SBL	SBT	SBR
Lane Configurations												
Traffic Volume (veh/h)	8	1	9	55	3	22	3	983	6	4	485	6
Future Volume (veh/h)	8	1	9	55	3	22	3	983	6	4	485	6
Initial Q (Qb), veh	0	0	0	0	0	0	0	0	0	0	0	0
Ped-Bike Adj(A_pbT)	0.99		0.98	0.99		0.98	1.00		1.00	1.00		1.00
Parking Bus, Adj	1.00	1.00	1.00	1.00	1.00	1.00	1.00	1.00	1.00	1.00	1.00	1.00
Work Zone On Approach		No			No			No			No	
Adj Sat Flow, veh/h/ln	1870	1870	1870	1870	1870	1870	1870	1870	1870	1870	1870	1870
Adj Flow Rate, veh/h	9	1	10	61	3	24	3	1092	7	4	539	7
Peak Hour Factor	0.90	0.90	0.90	0.90	0.90	0.90	0.90	0.90	0.90	0.90	0.90	0.90
Percent Heavy Veh, %	2	2	2	2	2	2	2	2	2	2	2	2
Cap, veh/h	123	32	67	244	9	138	739	2757	18	458	2736	36
Arrive On Green	0.09	0.09	0.09	0.09	0.09	0.09	0.76	0.76	0.76	0.76	0.76	0.76
Sat Flow, veh/h	407	357	764	1438	105	1558	860	3620	23	513	3592	47
Grp Volume(v), veh/h	20	0	0	64	0	24	3	536	563	4	267	279
Grp Sat Flow(s),veh/h/ln	1527	0	0	1544	0	1558	860	1777	1866	513	1777	1862
Q Serve(g_s), s	0.0	0.0	0.0	0.0	0.0	0.9	0.1	6.2	6.2	0.2	2.5	2.5
Cycle Q Clear(g_c), s	2.1	0.0	0.0	2.1	0.0	0.9	2.6	6.2	6.2	6.3	2.5	2.5
Prop In Lane	0.45		0.50	0.95		1.00	1.00		0.01	1.00		0.03
Lane Grp Cap(c), veh/h	222	0	0	254	0	138	739	1353	1421	458	1353	1418
V/C Ratio(X)	0.09	0.00	0.00	0.25	0.00	0.17	0.00	0.40	0.40	0.01	0.20	0.20
Avail Cap(c_a), veh/h	547	0	0	562	0	480	739	1353	1421	458	1353	1418
HCM Platoon Ratio	1.00	1.00	1.00	1.00	1.00	1.00	1.00	1.00	1.00	1.00	1.00	1.00
Upstream Filter(I)	1.00	0.00	0.00	1.00	0.00	1.00	1.00	1.00	1.00	1.00	1.00	1.00
Uniform Delay (d), s/veh	25.2	0.0	0.0	25.9	0.0	25.3	2.4	2.4	2.4	3.5	2.0	2.0
Incr Delay (d2), s/veh	0.2	0.0	0.0	0.5	0.0	0.6	0.0	0.9	0.8	0.0	0.3	0.3
Initial Q Delay(d3),s/veh	0.0	0.0	0.0	0.0	0.0	0.0	0.0	0.0	0.0	0.0	0.0	0.0
%ile BackOfQ(50%),veh/ln	0.3	0.0	0.0	0.9	0.0	0.3	0.0	0.3	0.3	0.0	0.1	0.1
Unsig. Movement Delay, s/veh												
LnGrp Delay(d),s/veh	25.4	0.0	0.0	26.4	0.0	25.9	2.4	3.3	3.3	3.6	2.3	2.3
LnGrp LOS	C	A	A	C	A	C	A	A	A	A	A	A
Approach Vol, veh/h		20			88			1102			550	
Approach Delay, s/veh		25.4			26.3			3.3			2.3	
Approach LOS		C			C			A			A	
Timer - Assigned Phs		2		4		6		8				
Phs Duration (G+Y+Rc), s		50.2		9.8		50.2		9.8				
Change Period (Y+Rc), s		4.5		4.5		4.5		4.5				
Max Green Setting (Gmax), s		32.5		18.5		32.5		18.5				
Max Q Clear Time (g_c+I1), s		8.2		4.1		8.3		4.1				
Green Ext Time (p_c), s		6.6		0.0		2.8		0.3				
<b>Intersection Summary</b>												
HCM 6th Ctrl Delay				4.4								
HCM 6th LOS				A								



















**APPENDIX 6.1:**

**EAPC (2024) CONDITIONS INTERSECTION OPERATIONS ANALYSIS WORKSHEETS**

*This Page Intentionally Left Blank*

Lanes, Volumes, Timings  
 1: Little Morongo Rd. & Two Bunch Palms Tr.

EAPC (2024) AM Peak Hour

												
Lane Group	EBL	EBT	EBR	WBL	WBT	WBR	NBL	NBT	NBR	SBL	SBT	SBR
Lane Configurations												
Traffic Volume (vph)	3	9	11	232	4	63	3	150	118	125	269	1
Future Volume (vph)	3	9	11	232	4	63	3	150	118	125	269	1
Ideal Flow (vphpl)	1900	1900	1900	1900	1900	1900	1900	1900	1900	1900	1900	1900
Storage Length (ft)	0		0	0		50	150		150	150		50
Storage Lanes	0		0	0		1	0		0	0		1
Taper Length (ft)	90			90			90			90		
Link Speed (mph)		45			45			55			55	
Link Distance (ft)		1073			1443			3240			728	
Travel Time (s)		16.3			21.9			40.2			9.0	
Confl. Peds. (#/hr)	5		5	5		5	5		5	5		5
Peak Hour Factor	0.88	0.88	0.88	0.88	0.88	0.88	0.88	0.88	0.88	0.88	0.88	0.88
Shared Lane Traffic (%)												
Sign Control		Stop			Stop			Stop			Stop	

Intersection Summary

Area Type: Other  
 Control Type: Unsignalized

Intersection	
Intersection Delay, s/veh	22.5
Intersection LOS	C

Movement	EBL	EBT	EBR	WBL	WBT	WBR	NBL	NBT	NBR	SBL	SBT	SBR
Lane Configurations		↕			↕	↕		↕			↕	↕
Traffic Vol, veh/h	3	9	11	232	4	63	3	150	118	125	269	1
Future Vol, veh/h	3	9	11	232	4	63	3	150	118	125	269	1
Peak Hour Factor	0.88	0.88	0.88	0.88	0.88	0.88	0.88	0.88	0.88	0.88	0.88	0.88
Heavy Vehicles, %	2	2	2	2	2	2	2	2	2	2	2	2
Mvmt Flow	3	10	13	264	5	72	3	170	134	142	306	1
Number of Lanes	0	1	0	0	1	1	0	1	0	0	1	1

Approach	EB	WB	NB	SB
Opposing Approach	WB	EB	SB	NB
Opposing Lanes	2	1	2	1
Conflicting Approach Left	SB	NB	EB	WB
Conflicting Lanes Left	2	1	1	2
Conflicting Approach Right	NB	SB	WB	EB
Conflicting Lanes Right	1	2	2	1
HCM Control Delay	11.2	17	17	31
HCM LOS	B	C	C	D

Lane	NBLn1	EBLn1	WBLn1	WBLn2	SBLn1	SBLn2
Vol Left, %	1%	13%	98%	0%	32%	0%
Vol Thru, %	55%	39%	2%	0%	68%	0%
Vol Right, %	44%	48%	0%	100%	0%	100%
Sign Control	Stop	Stop	Stop	Stop	Stop	Stop
Traffic Vol by Lane	271	23	236	63	394	1
LT Vol	3	3	232	0	125	0
Through Vol	150	9	4	0	269	0
RT Vol	118	11	0	63	0	1
Lane Flow Rate	308	26	268	72	448	1
Geometry Grp	6	6	7	7	7	7
Degree of Util (X)	0.547	0.056	0.55	0.123	0.806	0.002
Departure Headway (Hd)	6.389	7.76	7.385	6.169	6.479	5.607
Convergence, Y/N	Yes	Yes	Yes	Yes	Yes	Yes
Cap	560	464	485	576	555	633
Service Time	4.483	5.76	5.175	3.958	4.262	3.389
HCM Lane V/C Ratio	0.55	0.056	0.553	0.125	0.807	0.002
HCM Control Delay	17	11.2	18.9	9.8	31.1	8.4
HCM Lane LOS	C	B	C	A	D	A
HCM 95th-tile Q	3.3	0.2	3.3	0.4	7.8	0

Lanes, Volumes, Timings  
 2: Little Morongo Rd. & i-Storage N. Dwy

EAPC (2024) AM Peak Hour



Lane Group	EBL	EBR	NBL	NBT	SBT	SBR
Lane Configurations						
Traffic Volume (vph)	1	4	1	291	547	1
Future Volume (vph)	1	4	1	291	547	1
Ideal Flow (vphpl)	1900	1900	1900	1900	1900	1900
Storage Length (ft)	150	50	150			50
Storage Lanes	0	1	0			1
Taper Length (ft)	90		90			
Link Speed (mph)	30			55	55	
Link Distance (ft)	557			342	421	
Travel Time (s)	12.7			4.2	5.2	
Confl. Peds. (#/hr)	5	5	5			5
Peak Hour Factor	0.90	0.90	0.90	0.90	0.90	0.90
Shared Lane Traffic (%)						
Sign Control	Stop			Free	Free	

Intersection Summary

Area Type: Other  
 Control Type: Unsignalized



HCM 6th TWSC  
 2: Little Morongo Rd. & i-Storage N. Dwy

EAPC (2024) AM Peak Hour

Intersection						
Int Delay, s/veh	0.1					
Movement	EBL	EBR	NBL	NBT	SBT	SBR
Lane Configurations						
Traffic Vol, veh/h	1	4	1	291	547	1
Future Vol, veh/h	1	4	1	291	547	1
Conflicting Peds, #/hr	5	5	5	0	0	5
Sign Control	Stop	Stop	Free	Free	Free	Free
RT Channelized	-	None	-	None	-	None
Storage Length	-	50	-	-	-	50
Veh in Median Storage, #	0	-	-	0	0	-
Grade, %	0	-	-	0	0	-
Peak Hour Factor	90	90	90	90	90	90
Heavy Vehicles, %	2	2	2	2	2	2
Mvmt Flow	1	4	1	323	608	1

















Major/Minor	Minor2	Major1	Major2			
Conflicting Flow All	943	618	614	0	-	0
Stage 1	613	-	-	-	-	-
Stage 2	330	-	-	-	-	-
Critical Hdwy	6.42	6.22	4.12	-	-	-
Critical Hdwy Stg 1	5.42	-	-	-	-	-
Critical Hdwy Stg 2	5.42	-	-	-	-	-
Follow-up Hdwy	3.518	3.318	2.218	-	-	-
Pot Cap-1 Maneuver	291	489	965	-	-	-
Stage 1	541	-	-	-	-	-
Stage 2	728	-	-	-	-	-
Platoon blocked, %				-	-	-
Mov Cap-1 Maneuver	288	484	960	-	-	-
Mov Cap-2 Maneuver	288	-	-	-	-	-
Stage 1	538	-	-	-	-	-
Stage 2	724	-	-	-	-	-

Approach	EB	NB	SB
HCM Control Delay, s	13.5	0	0
HCM LOS	B		

Minor Lane/Major Mvmt	NBL	NBT	EBLn1	EBLn2	SBT	SBR
Capacity (veh/h)	960	-	288	484	-	-
HCM Lane V/C Ratio	0.001	-	0.004	0.009	-	-
HCM Control Delay (s)	8.8	0	17.5	12.5	-	-
HCM Lane LOS	A	A	C	B	-	-
HCM 95th %tile Q(veh)	0	-	0	0	-	-

Lanes, Volumes, Timings  
3: Little Morongo Rd. & Dillon Rd.

EAPC (2024) AM Peak Hour

												
Lane Group	EBL	EBT	EBR	WBL	WBT	WBR	NBL	NBT	NBR	SBL	SBT	SBR
Lane Configurations												
Traffic Volume (vph)	219	150	0	0	425	186	0	0	0	288	0	301
Future Volume (vph)	219	150	0	0	425	186	0	0	0	288	0	301
Ideal Flow (vphpl)	1900	1900	1900	1900	1900	1900	1900	1900	1900	1900	1900	1900
Storage Length (ft)	205		150	145		150	0		0	150		150
Storage Lanes	1		0	1		0	0		0	0		0
Taper Length (ft)	90			90			90			90		
Link Speed (mph)		55			55			55			55	
Link Distance (ft)		4457			1492			286			3985	
Travel Time (s)		55.3			18.5			3.5			49.4	
Confl. Peds. (#/hr)	5		5	5		5	5		5	5		5
Peak Hour Factor	0.94	0.94	0.94	0.94	0.94	0.94	0.94	0.94	0.94	0.94	0.94	0.94
Shared Lane Traffic (%)												
Sign Control		Stop			Stop			Stop			Stop	

Intersection Summary

Area Type: Other

Control Type: Unsignalized

Intersection	
Intersection Delay, s/veh	105.7
Intersection LOS	F

Movement	EBL	EBT	EBR	WBL	WBT	WBR	NBL	NBT	NBR	SBL	SBT	SBR
Lane Configurations	↶	↷		↶	↷						↷	
Traffic Vol, veh/h	219	150	0	0	425	186	0	0	0	288	0	301
Future Vol, veh/h	219	150	0	0	425	186	0	0	0	288	0	301
Peak Hour Factor	0.94	0.94	0.94	0.94	0.94	0.94	0.94	0.94	0.94	0.94	0.94	0.94
Heavy Vehicles, %	2	2	2	2	2	2	2	2	2	2	2	2
Mvmt Flow	233	160	0	0	452	198	0	0	0	306	0	320
Number of Lanes	1	1	0	1	1	0	0	0	0	0	1	0

Approach	EB	WB	SB
Opposing Approach	WB	EB	
Opposing Lanes	2	2	0
Conflicting Approach Left	SB		WB
Conflicting Lanes Left	1	0	2
Conflicting Approach Right		SB	EB
Conflicting Lanes Right	0	1	2
HCM Control Delay	18.9	161.9	101.7
HCM LOS	C	F	F

Lane	EBLn1	EBLn2	WBLn1	WBLn2	SBLn1
Vol Left, %	100%	0%	0%	0%	49%
Vol Thru, %	0%	100%	100%	70%	0%
Vol Right, %	0%	0%	0%	30%	51%
Sign Control	Stop	Stop	Stop	Stop	Stop
Traffic Vol by Lane	219	150	0	611	589
LT Vol	219	0	0	0	288
Through Vol	0	150	0	425	0
RT Vol	0	0	0	186	301
Lane Flow Rate	233	160	0	650	627
Geometry Grp	7	7	7	7	2
Degree of Util (X)	0.526	0.338	0	1.274	1.119
Departure Headway (Hd)	9	8.48	7.725	7.504	6.948
Convergence, Y/N	Yes	Yes	Yes	Yes	Yes
Cap	403	428	0	488	526
Service Time	6.7	6.18	5.425	5.204	4.948
HCM Lane V/C Ratio	0.578	0.374	0	1.332	1.192
HCM Control Delay	21.3	15.4	10.4	161.9	101.7
HCM Lane LOS	C	C	N	F	F
HCM 95th-tile Q	3	1.5	0	25.4	19.1

Lanes, Volumes, Timings  
3: Little Morongo Rd. & Dillon Rd.

EAPC (2024) AM Peak Hour  
With Improvements

Lane Group	EBL	EBT	EBR	WBL	WBT	WBR	NBL	NBT	NBR	SBL	SBT	SBR
Lane Configurations												
Traffic Volume (vph)	219	150	0	0	425	186	0	0	0	288	0	301
Future Volume (vph)	219	150	0	0	425	186	0	0	0	288	0	301
Ideal Flow (vphpl)	1900	1900	1900	1900	1900	1900	1900	1900	1900	1900	1900	1900
Storage Length (ft)	205		150	145		150	0			0	150	150
Storage Lanes	1		0	1		0	0			0	0	0
Taper Length (ft)	90			90			90				90	
Right Turn on Red			Yes			Yes			Yes			Yes
Link Speed (mph)		55			55			55				55
Link Distance (ft)		4457			1492			286			3985	
Travel Time (s)		55.3			18.5			3.5			49.4	
Confl. Peds. (#/hr)	5		5	5		5	5		5	5		5
Peak Hour Factor	0.94	0.94	0.94	0.94	0.94	0.94	0.94	0.94	0.94	0.94	0.94	0.94
Shared Lane Traffic (%)												
Turn Type	Perm	NA		Perm	NA					Perm	NA	
Protected Phases		2			6							4
Permitted Phases	2			6						4		
Detector Phase	2	2		6	6					4	4	
Switch Phase												
Minimum Initial (s)	5.0	5.0		5.0	5.0					5.0	5.0	
Minimum Split (s)	22.5	22.5		22.5	22.5					22.5	22.5	
Total Split (s)	70.0	70.0		70.0	70.0					50.0	50.0	
Total Split (%)	58.3%	58.3%		58.3%	58.3%					41.7%	41.7%	
Yellow Time (s)	3.5	3.5		3.5	3.5					3.5	3.5	
All-Red Time (s)	1.0	1.0		1.0	1.0					1.0	1.0	
Lost Time Adjust (s)	0.0	0.0		0.0	0.0							0.0
Total Lost Time (s)	4.5	4.5		4.5	4.5							4.5
Lead/Lag												
Lead-Lag Optimize?												
Recall Mode	C-Max	C-Max		C-Max	C-Max					Max	Max	





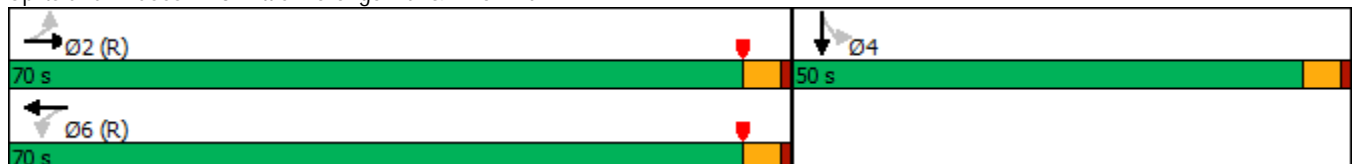













**Intersection Summary**  
 Area Type: Other  
 Cycle Length: 120  
 Actuated Cycle Length: 120  
 Offset: 0 (0%), Referenced to phase 2:EBTL and 6:WBTL, Start of Yellow  
 Natural Cycle: 75  
 Control Type: Actuated-Coordinated

Splits and Phases: 3: Little Morongo Rd. & Dillon Rd.



HCM 6th Signalized Intersection Summary  
 3: Little Morongo Rd. & Dillon Rd.

EAPC (2024) AM Peak Hour  
 With Improvements

												
Movement	EBL	EBT	EBR	WBL	WBT	WBR	NBL	NBT	NBR	SBL	SBT	SBR
Lane Configurations												
Traffic Volume (veh/h)	219	150	0	0	425	186	0	0	0	288	0	301
Future Volume (veh/h)	219	150	0	0	425	186	0	0	0	288	0	301
Initial Q (Qb), veh	0	0	0	0	0	0				0	0	0
Ped-Bike Adj(A_pbT)	1.00		1.00	1.00		1.00				1.00		0.99
Parking Bus, Adj	1.00	1.00	1.00	1.00	1.00	1.00				1.00	1.00	1.00
Work Zone On Approach		No			No						No	
Adj Sat Flow, veh/h/ln	1870	1870	0	1870	1870	1870				1870	1870	1870
Adj Flow Rate, veh/h	233	160	0	0	452	198				306	0	320
Peak Hour Factor	0.94	0.94	0.94	0.94	0.94	0.94				0.94	0.94	0.94
Percent Heavy Veh, %	2	2	0	2	2	2				2	2	2
Cap, veh/h	281	1021	0	60	672	294				309	0	324
Arrive On Green	0.55	0.55	0.00	0.00	0.55	0.55				0.38	0.00	0.38
Sat Flow, veh/h	782	1870	0	1226	1231	539				816	0	853
Grp Volume(v), veh/h	233	160	0	0	0	650				626	0	0
Grp Sat Flow(s),veh/h/ln	782	1870	0	1226	0	1770				1669	0	0
Q Serve(g_s), s	33.9	5.1	0.0	0.0	0.0	31.6				44.7	0.0	0.0
Cycle Q Clear(g_c), s	65.5	5.1	0.0	0.0	0.0	31.6				44.7	0.0	0.0
Prop In Lane	1.00		0.00	1.00		0.30				0.49		0.51
Lane Grp Cap(c), veh/h	281	1021	0	60	0	966				633	0	0
V/C Ratio(X)	0.83	0.16	0.00	0.00	0.00	0.67				0.99	0.00	0.00
Avail Cap(c_a), veh/h	281	1021	0	60	0	966				633	0	0
HCM Platoon Ratio	1.00	1.00	1.00	1.00	1.00	1.00				1.00	1.00	1.00
Upstream Filter(I)	1.00	1.00	0.00	0.00	0.00	1.00				1.00	0.00	0.00
Uniform Delay (d), s/veh	44.0	13.5	0.0	0.0	0.0	19.6				37.0	0.0	0.0
Incr Delay (d2), s/veh	23.9	0.3	0.0	0.0	0.0	3.7				33.2	0.0	0.0
Initial Q Delay(d3),s/veh	0.0	0.0	0.0	0.0	0.0	0.0				0.0	0.0	0.0
%ile BackOfQ(50%),veh/ln	8.5	2.0	0.0	0.0	0.0	12.4				22.5	0.0	0.0
Unsig. Movement Delay, s/veh												
LnGrp Delay(d),s/veh	67.8	13.9	0.0	0.0	0.0	23.3				70.2	0.0	0.0
LnGrp LOS	E	B	A	A	A	C				E	A	A
Approach Vol, veh/h		393			650						626	
Approach Delay, s/veh		45.9			23.3						70.2	
Approach LOS		D			C						E	
Timer - Assigned Phs		2		4		6						
Phs Duration (G+Y+Rc), s		70.0		50.0		70.0						
Change Period (Y+Rc), s		4.5		4.5		4.5						
Max Green Setting (Gmax), s		65.5		45.5		65.5						
Max Q Clear Time (g_c+I1), s		67.5		46.7		33.6						
Green Ext Time (p_c), s		0.0		0.0		4.2						
<b>Intersection Summary</b>												
HCM 6th Ctrl Delay				46.2								
HCM 6th LOS				D								

Lanes, Volumes, Timings  
4: Indian Cyn. Dr. & Dillon Rd.

EAPC (2024) AM Peak Hour

Lane Group	EBL	EBT	EBR	WBL	WBT	WBR	NBL	NBT	NBR	SBL	SBT	SBR
Lane Configurations												
Traffic Volume (vph)	6	104	67	557	112	27	37	374	210	27	866	6
Future Volume (vph)	6	104	67	557	112	27	37	374	210	27	866	6
Ideal Flow (vphpl)	1900	1900	1900	1900	1900	1900	1900	1900	1900	1900	1900	1900
Storage Length (ft)	150		195	100		100	100		150	120		150
Storage Lanes	1		0	1		1	1		0	1		0
Taper Length (ft)	90			90			90			90		
Right Turn on Red			Yes			Yes			Yes			Yes
Link Speed (mph)		55			55			55			55	
Link Distance (ft)		780			957			919			547	
Travel Time (s)		9.7			11.9			11.4			6.8	
Confl. Peds. (#/hr)	5		5	5		5	5		5	5		5
Peak Hour Factor	0.87	0.87	0.87	0.87	0.87	0.87	0.87	0.87	0.87	0.87	0.87	0.87
Shared Lane Traffic (%)												
Turn Type	Prot	NA		Prot	NA	Perm	Perm	NA		Perm	NA	
Protected Phases	7	4		3	8			2			6	
Permitted Phases						8	2			6		
Detector Phase	7	4		3	8	8	2	2		6	6	
Switch Phase												
Minimum Initial (s)	5.0	4.0		5.0	4.0	4.0	4.0	4.0		4.0	4.0	
Minimum Split (s)	9.5	20.0		9.5	20.0	20.0	20.0	20.0		20.0	20.0	
Total Split (s)	9.5	20.0		55.0	65.5	65.5	45.0	45.0		45.0	45.0	
Total Split (%)	7.9%	16.7%		45.8%	54.6%	54.6%	37.5%	37.5%		37.5%	37.5%	
Yellow Time (s)	3.5	3.5		3.5	3.5	3.5	3.5	3.5		3.5	3.5	
All-Red Time (s)	1.0	0.5		1.0	0.5	0.5	0.5	0.5		0.5	0.5	
Lost Time Adjust (s)	0.0	0.0		0.0	0.0	0.0	0.0	0.0		0.0	0.0	
Total Lost Time (s)	4.5	4.0		4.5	4.0	4.0	4.0	4.0		4.0	4.0	
Lead/Lag	Lead	Lag		Lead	Lag	Lag						
Lead-Lag Optimize?	Yes	Yes		Yes	Yes	Yes						
Recall Mode	None	None		None	None	None	C-Max	C-Max		C-Max	C-Max	

Intersection Summary





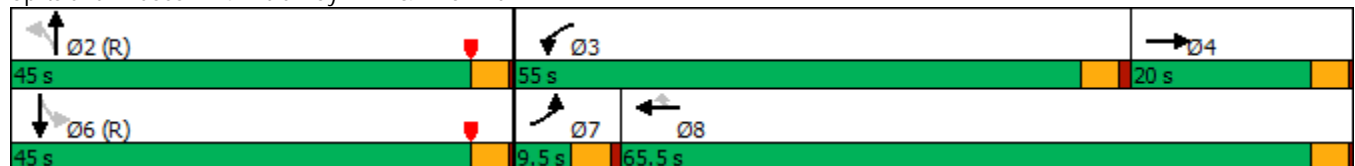



















Area Type: Other  
 Cycle Length: 120  
 Actuated Cycle Length: 120  
 Offset: 0 (0%), Referenced to phase 2:NBTL and 6:SBTL, Start of Yellow  
 Natural Cycle: 90  
 Control Type: Actuated-Coordinated

Splits and Phases: 4: Indian Cyn. Dr. & Dillon Rd.



HCM 6th Signalized Intersection Summary  
4: Indian Cyn. Dr. & Dillon Rd.

EAPC (2024) AM Peak Hour

												
Movement	EBL	EBT	EBR	WBL	WBT	WBR	NBL	NBT	NBR	SBL	SBT	SBR
Lane Configurations		 			 			 			 	
Traffic Volume (veh/h)	6	104	67	557	112	27	37	374	210	27	866	6
Future Volume (veh/h)	6	104	67	557	112	27	37	374	210	27	866	6
Initial Q (Qb), veh	0	0	0	0	0	0	0	0	0	0	0	0
Ped-Bike Adj(A_pbT)	1.00		0.98	1.00		1.00	1.00		1.00	1.00		1.00
Parking Bus, Adj	1.00	1.00	1.00	1.00	1.00	1.00	1.00	1.00	1.00	1.00	1.00	1.00
Work Zone On Approach		No			No			No			No	
Adj Sat Flow, veh/h/ln	1870	1870	1870	1870	1870	1870	1870	1870	1870	1870	1870	1870
Adj Flow Rate, veh/h	7	120	77	640	129	31	43	430	241	31	995	7
Peak Hour Factor	0.87	0.87	0.87	0.87	0.87	0.87	0.87	0.87	0.87	0.87	0.87	0.87
Percent Heavy Veh, %	2	2	2	2	2	2	2	2	2	2	2	2
Cap, veh/h	15	187	111	671	1621	720	181	949	527	283	1559	11
Arrive On Green	0.01	0.09	0.09	0.38	0.46	0.46	0.43	0.43	0.43	0.43	0.43	0.43
Sat Flow, veh/h	1781	2127	1266	1781	3554	1580	562	2200	1222	767	3617	25
Grp Volume(v), veh/h	7	99	98	640	129	31	43	346	325	31	489	513
Grp Sat Flow(s),veh/h/ln	1781	1777	1616	1781	1777	1580	562	1777	1645	767	1777	1866
Q Serve(g_s), s	0.5	6.4	7.1	41.9	2.5	1.3	7.8	16.5	16.8	3.6	25.9	25.9
Cycle Q Clear(g_c), s	0.5	6.4	7.1	41.9	2.5	1.3	33.7	16.5	16.8	20.4	25.9	25.9
Prop In Lane	1.00		0.78	1.00		1.00	1.00		0.74	1.00		0.01
Lane Grp Cap(c), veh/h	15	156	142	671	1621	720	181	766	709	283	766	804
V/C Ratio(X)	0.45	0.63	0.69	0.95	0.08	0.04	0.24	0.45	0.46	0.11	0.64	0.64
Avail Cap(c_a), veh/h	74	237	216	750	1821	810	181	766	709	283	766	804
HCM Platoon Ratio	1.00	1.00	1.00	1.00	1.00	1.00	1.00	1.00	1.00	1.00	1.00	1.00
Upstream Filter(I)	1.00	1.00	1.00	1.00	1.00	1.00	1.00	1.00	1.00	1.00	1.00	1.00
Uniform Delay (d), s/veh	59.2	52.8	53.1	36.4	18.4	18.1	40.0	24.1	24.2	31.4	26.8	26.8
Incr Delay (d2), s/veh	19.3	4.2	5.9	21.1	0.0	0.0	3.1	1.9	2.1	0.8	4.0	3.9
Initial Q Delay(d3),s/veh	0.0	0.0	0.0	0.0	0.0	0.0	0.0	0.0	0.0	0.0	0.0	0.0
%ile BackOfQ(50%),veh/ln	0.3	2.9	3.0	20.7	1.0	0.5	1.2	6.8	6.5	0.7	10.9	11.5
Unsig. Movement Delay, s/veh												
LnGrp Delay(d),s/veh	78.5	57.0	59.0	57.5	18.4	18.1	43.1	26.0	26.3	32.2	30.8	30.6
LnGrp LOS	E	E	E	E	B	B	D	C	C	C	C	C
Approach Vol, veh/h		204			800			714			1033	
Approach Delay, s/veh		58.7			49.7			27.2			30.8	
Approach LOS		E			D			C			C	
Timer - Assigned Phs		2	3	4		6	7	8				
Phs Duration (G+Y+Rc), s		55.7	49.7	14.6		55.7	5.5	58.7				
Change Period (Y+Rc), s		4.0	4.5	4.0		4.0	4.5	4.0				
Max Green Setting (Gmax), s		41.0	50.5	16.0		41.0	5.0	61.5				
Max Q Clear Time (g_c+I1), s		35.7	43.9	9.1		27.9	2.5	4.5				
Green Ext Time (p_c), s		1.9	1.3	0.5		4.7	0.0	0.8				
<b>Intersection Summary</b>												
HCM 6th Ctrl Delay				37.4								
HCM 6th LOS				D								
<b>Notes</b>												
User approved pedestrian interval to be less than phase max green.												

Lanes, Volumes, Timings  
 5: Little Morongo Rd. & N. Dwy.

EAPC (2024) AM Peak Hour



Lane Group	WBL	WBR	NBT	NBR	SBL	SBT
Lane Configurations						
Traffic Volume (vph)	1	0	280	11	4	546
Future Volume (vph)	1	0	280	11	4	546
Ideal Flow (vphpl)	1900	1900	1900	1900	1900	1900
Storage Length (ft)	150	150		150	150	
Storage Lanes	0	0		0	0	
Taper Length (ft)	90				90	
Link Speed (mph)	30		55			55
Link Distance (ft)	298		421			3240
Travel Time (s)	6.8		5.2			40.2
Confl. Peds. (#/hr)	5	5		5	5	
Peak Hour Factor	0.92	0.92	0.92	0.92	0.92	0.92
Shared Lane Traffic (%)						
Sign Control	Stop		Free			Free

Intersection Summary

Area Type: Other

Control Type: Unsignalized



HCM 6th TWSC  
5: Little Morongo Rd. & N. Dwy.

EAPC (2024) AM Peak Hour

Intersection						
Int Delay, s/veh	0.1					
Movement	WBL	WBR	NBT	NBR	SBL	SBT
Lane Configurations	W		T			T
Traffic Vol, veh/h	1	0	280	11	4	546
Future Vol, veh/h	1	0	280	11	4	546
Conflicting Peds, #/hr	5	5	0	5	5	0
Sign Control	Stop	Stop	Free	Free	Free	Free
RT Channelized	-	None	-	None	-	None
Storage Length	-	-	-	-	-	-
Veh in Median Storage, #	0	-	0	-	-	0
Grade, %	0	-	0	-	-	0
Peak Hour Factor	92	92	92	92	92	92
Heavy Vehicles, %	2	2	2	2	2	2
Mvmt Flow	1	0	304	12	4	593

















Major/Minor	Minor1	Major1	Major2			
Conflicting Flow All	921	320	0	0	321	0
Stage 1	315	-	-	-	-	-
Stage 2	606	-	-	-	-	-
Critical Hdwy	6.42	6.22	-	-	4.12	-
Critical Hdwy Stg 1	5.42	-	-	-	-	-
Critical Hdwy Stg 2	5.42	-	-	-	-	-
Follow-up Hdwy	3.518	3.318	-	-	2.218	-
Pot Cap-1 Maneuver	300	721	-	-	1239	-
Stage 1	740	-	-	-	-	-
Stage 2	545	-	-	-	-	-
Platoon blocked, %			-	-		
Mov Cap-1 Maneuver	296	714	-	-	1233	-
Mov Cap-2 Maneuver	296	-	-	-	-	-
Stage 1	736	-	-	-	-	-
Stage 2	540	-	-	-	-	-

Approach	WB	NB	SB
HCM Control Delay, s	17.2	0	0.1
HCM LOS	C		

Minor Lane/Major Mvmt	NBT	NBRWBLn1	SBL	SBT
Capacity (veh/h)	-	-	296	1233
HCM Lane V/C Ratio	-	-	0.004	0.004
HCM Control Delay (s)	-	-	17.2	7.9
HCM Lane LOS	-	-	C	A
HCM 95th %tile Q(veh)	-	-	0	0

Lanes, Volumes, Timings  
6: Little Morongo Rd. & i-Storage S. Dwy

EAPC (2024) AM Peak Hour

												
Lane Group	EBL	EBT	EBR	WBL	WBT	WBR	NBL	NBT	NBR	SBL	SBT	SBR
Lane Configurations												
Traffic Volume (vph)	1	0	1	4	0	1	1	290	52	7	544	1
Future Volume (vph)	1	0	1	4	0	1	1	290	52	7	544	1
Ideal Flow (vphpl)	1900	1900	1900	1900	1900	1900	1900	1900	1900	1900	1900	1900
Storage Length (ft)	150		150	0		0	150		150	150		50
Storage Lanes	0		0	0		0	0		0	0		1
Taper Length (ft)	90			90			90			90		
Link Speed (mph)		30			30			55			55	
Link Distance (ft)		528			365			3985			342	
Travel Time (s)		12.0			8.3			49.4			4.2	
Confl. Peds. (#/hr)	5		5				5					5
Peak Hour Factor	0.91	0.91	0.91	0.91	0.91	0.91	0.91	0.91	0.91	0.91	0.91	0.91
Shared Lane Traffic (%)												
Sign Control		Stop			Stop			Free			Free	

Intersection Summary

Area Type: Other

Control Type: Unsignalized

HCM 6th TWSC  
6: Little Morongo Rd. & i-Storage S. Dwy

EAPC (2024) AM Peak Hour

Intersection												
Int Delay, s/veh	0.2											
Movement	EBL	EBT	EBR	WBL	WBT	WBR	NBL	NBT	NBR	SBL	SBT	SBR
Lane Configurations		↕			↕			↕			↑	↗
Traffic Vol, veh/h	1	0	1	4	0	1	1	290	52	7	544	1
Future Vol, veh/h	1	0	1	4	0	1	1	290	52	7	544	1
Conflicting Peds, #/hr	5	0	5	0	0	0	5	0	0	0	0	5
Sign Control	Stop	Stop	Stop	Stop	Stop	Stop	Free	Free	Free	Free	Free	Free
RT Channelized	-	-	None	-	-	None	-	-	None	-	-	None
Storage Length	-	-	-	-	-	-	-	-	-	-	-	50
Veh in Median Storage, #	-	0	-	-	0	-	-	0	-	-	0	-
Grade, %	-	0	-	-	0	-	-	0	-	-	0	-
Peak Hour Factor	91	91	91	91	91	91	91	91	91	91	91	91
Heavy Vehicles, %	2	2	2	2	2	2	2	2	2	2	2	2
Mvmt Flow	1	0	1	4	0	1	1	319	57	8	598	1



















Major/Minor	Minor2		Minor1		Major1		Major2					
Conflicting Flow All	974	997	608	970	970	353	604	0	0	376	0	0
Stage 1	619	619	-	350	350	-	-	-	-	-	-	-
Stage 2	355	378	-	620	620	-	-	-	-	-	-	-
Critical Hdwy	7.12	6.52	6.22	7.12	6.52	6.22	4.12	-	-	4.12	-	-
Critical Hdwy Stg 1	6.12	5.52	-	6.12	5.52	-	-	-	-	-	-	-
Critical Hdwy Stg 2	6.12	5.52	-	6.12	5.52	-	-	-	-	-	-	-
Follow-up Hdwy	3.518	4.018	3.318	3.518	4.018	3.318	2.218	-	-	2.218	-	-
Pot Cap-1 Maneuver	231	244	496	233	253	691	974	-	-	1182	-	-
Stage 1	476	480	-	666	633	-	-	-	-	-	-	-
Stage 2	662	615	-	476	480	-	-	-	-	-	-	-
Platoon blocked, %								-	-	-	-	-
Mov Cap-1 Maneuver	227	240	491	230	249	688	969	-	-	1182	-	-
Mov Cap-2 Maneuver	227	240	-	230	249	-	-	-	-	-	-	-
Stage 1	473	473	-	665	632	-	-	-	-	-	-	-
Stage 2	657	614	-	468	473	-	-	-	-	-	-	-

Approach	EB		WB		NB		SB	
HCM Control Delay, s	16.7		18.9		0		0.1	
HCM LOS	C		C					

Minor Lane/Major Mvmt	NBL	NBT	NBR	EBLn1	WBLn1	SBL	SBT	SBR
Capacity (veh/h)	969	-	-	310	265	1182	-	-
HCM Lane V/C Ratio	0.001	-	-	0.007	0.021	0.007	-	-
HCM Control Delay (s)	8.7	0	-	16.7	18.9	8.1	-	-
HCM Lane LOS	A	A	-	C	C	A	-	-
HCM 95th %tile Q(veh)	0	-	-	0	0.1	0	-	-

Lanes, Volumes, Timings  
7: Indian Cyn. Dr. & 19th Av.

EAPC (2024) AM Peak Hour

												
Lane Group	EBL	EBT	EBR	WBL	WBT	WBR	NBL	NBT	NBR	SBL	SBT	SBR
Lane Configurations												
Traffic Volume (vph)	14	3	8	75	3	29	23	693	270	94	1363	35
Future Volume (vph)	14	3	8	75	3	29	23	693	270	94	1363	35
Ideal Flow (vphpl)	1900	1900	1900	1900	1900	1900	1900	1900	1900	1900	1900	1900
Storage Length (ft)	0		0	0		50	200		0	100		0
Storage Lanes	0		0	0		1	1		0	1		0
Taper Length (ft)	90			90			90			90		
Link Speed (mph)		30			30			55			55	
Link Distance (ft)		938			936			640			4458	
Travel Time (s)		21.3			21.3			7.9			55.3	
Confl. Peds. (#/hr)	5		5	5		5	5		5	5		5
Peak Hour Factor	0.91	0.91	0.91	0.91	0.91	0.91	0.91	0.91	0.91	0.91	0.91	0.91
Shared Lane Traffic (%)												
Sign Control		Stop			Stop			Free			Free	
<b>Intersection Summary</b>												
Area Type:	Other											
Control Type:	Unsignalized											

Intersection												
Int Delay, s/veh	47.8											
Movement	EBL	EBT	EBR	WBL	WBT	WBR	NBL	NBT	NBR	SBL	SBT	SBR
Lane Configurations		↕			↕	↕	↕	↕		↕	↕	
Traffic Vol, veh/h	14	3	8	75	3	29	23	693	270	94	1363	35
Future Vol, veh/h	14	3	8	75	3	29	23	693	270	94	1363	35
Conflicting Peds, #/hr	5	0	5	5	0	5	5	0	5	5	0	5
Sign Control	Stop	Stop	Stop	Stop	Stop	Stop	Free	Free	Free	Free	Free	Free
RT Channelized	-	-	None	-	-	None	-	-	None	-	-	None
Storage Length	-	-	-	-	-	50	200	-	-	100	-	-
Veh in Median Storage, #	-	0	-	-	0	-	-	0	-	-	0	-
Grade, %	-	0	-	-	0	-	-	0	-	-	0	-
Peak Hour Factor	91	91	91	91	91	91	91	91	91	91	91	91
Heavy Vehicles, %	2	2	2	2	2	2	2	2	2	2	2	2
Mvmt Flow	15	3	9	82	3	32	25	762	297	103	1498	38

Major/Minor	Minor2		Minor1		Major1		Major2					
Conflicting Flow All	2166	2842	778	1928	2713	540	1541	0	0	1064	0	0
Stage 1	1728	1728	-	966	966	-	-	-	-	-	-	-
Stage 2	438	1114	-	962	1747	-	-	-	-	-	-	-
Critical Hdwy	7.54	6.54	6.94	7.54	6.54	6.94	4.14	-	-	4.14	-	-
Critical Hdwy Stg 1	6.54	5.54	-	6.54	5.54	-	-	-	-	-	-	-
Critical Hdwy Stg 2	6.54	5.54	-	6.54	5.54	-	-	-	-	-	-	-
Follow-up Hdwy	3.52	4.02	3.32	3.52	4.02	3.32	2.22	-	-	2.22	-	-
Pot Cap-1 Maneuver	26	17	339	~ 40	21	486	427	-	-	651	-	-
Stage 1	92	142	-	273	331	-	-	-	-	-	-	-
Stage 2	567	282	-	275	138	-	-	-	-	-	-	-
Platoon blocked, %								-	-	-	-	-
Mov Cap-1 Maneuver	17	13	336	~ 26	16	481	425	-	-	648	-	-
Mov Cap-2 Maneuver	17	13	-	~ 26	16	-	-	-	-	-	-	-
Stage 1	86	119	-	256	310	-	-	-	-	-	-	-
Stage 2	491	264	-	218	116	-	-	-	-	-	-	-

Approach	EB		WB		NB		SB	
HCM Control Delay, s/\$	498.6		1036.5		0.3		0.7	
HCM LOS	F		F					

Minor Lane/Major Mvmt	NBL	NBT	NBR	EBLn1	WBLn1	WBLn2	SBL	SBT	SBR
Capacity (veh/h)	425	-	-	23	25	481	648	-	-
HCM Lane V/C Ratio	0.059	-	-	1.194	3.429	0.066	0.159	-	-
HCM Control Delay (s)	14	-	-	498.6	1417.1	13	11.6	-	-
HCM Lane LOS	B	-	-	F	F	B	B	-	-
HCM 95th %tile Q(veh)	0.2	-	-	3.5	10.6	0.2	0.6	-	-

Notes  
 -: Volume exceeds capacity    \$: Delay exceeds 300s    +: Computation Not Defined    \*: All major volume in platoon

Lanes, Volumes, Timings  
7: Indian Cyn. Dr. & 19th Av.

EAPC (2024) AM Peak Hour  
With Improvements

Lane Group	EBL	EBT	EBR	WBL	WBT	WBR	NBL	NBT	NBR	SBL	SBT	SBR
Lane Configurations												
Traffic Volume (vph)	14	3	8	75	3	29	23	693	270	94	1363	35
Future Volume (vph)	14	3	8	75	3	29	23	693	270	94	1363	35
Ideal Flow (vphpl)	1900	1900	1900	1900	1900	1900	1900	1900	1900	1900	1900	1900
Storage Length (ft)	0		0	0		50	200		0	100		0
Storage Lanes	0		0	0		1	1		0	1		0
Taper Length (ft)	90			90			90			90		
Right Turn on Red			Yes			Yes			Yes			Yes
Link Speed (mph)		30			30			55			55	
Link Distance (ft)		938			936			640			4458	
Travel Time (s)		21.3			21.3			7.9			55.3	
Confl. Peds. (#/hr)	5		5	5		5	5		5	5		5
Peak Hour Factor	0.91	0.91	0.91	0.91	0.91	0.91	0.91	0.91	0.91	0.91	0.91	0.91
Shared Lane Traffic (%)												
Turn Type	Perm	NA		Perm	NA	Perm	Perm	NA		Perm	NA	
Protected Phases		4			8			2			6	
Permitted Phases	4			8		8	2			6		
Detector Phase	4	4		8	8	8	2	2		6	6	
Switch Phase												
Minimum Initial (s)	5.0	5.0		5.0	5.0	5.0	5.0	5.0		5.0	5.0	
Minimum Split (s)	22.5	22.5		22.5	22.5	22.5	22.5	22.5		22.5	22.5	
Total Split (s)	22.5	22.5		22.5	22.5	22.5	37.5	37.5		37.5	37.5	
Total Split (%)	37.5%	37.5%		37.5%	37.5%	37.5%	62.5%	62.5%		62.5%	62.5%	
Yellow Time (s)	3.5	3.5		3.5	3.5	3.5	3.5	3.5		3.5	3.5	
All-Red Time (s)	1.0	1.0		1.0	1.0	1.0	1.0	1.0		1.0	1.0	
Lost Time Adjust (s)		0.0			0.0	0.0	0.0	0.0		0.0	0.0	
Total Lost Time (s)		4.5			4.5	4.5	4.5	4.5		4.5	4.5	
Lead/Lag												
Lead-Lag Optimize?												
Recall Mode	None	None		None	None	None	C-Max	C-Max		C-Max	C-Max	

Intersection Summary





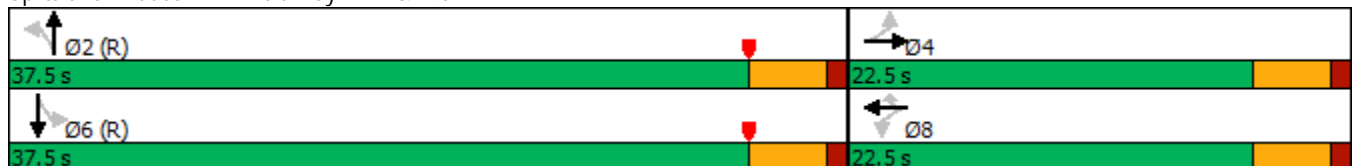















Area Type: Other  
 Cycle Length: 60  
 Actuated Cycle Length: 60  
 Offset: 0 (0%), Referenced to phase 2:NBTL and 6:SBTL, Start of Yellow  
 Natural Cycle: 60  
 Control Type: Actuated-Coordinated

Splits and Phases: 7: Indian Cyn. Dr. & 19th Av.





















HCM 6th Signalized Intersection Summary  
7: Indian Cyn. Dr. & 19th Av.

EAPC (2024) AM Peak Hour  
With Improvements

												
Movement	EBL	EBT	EBR	WBL	WBT	WBR	NBL	NBT	NBR	SBL	SBT	SBR
Lane Configurations												
Traffic Volume (veh/h)	14	3	8	75	3	29	23	693	270	94	1363	35
Future Volume (veh/h)	14	3	8	75	3	29	23	693	270	94	1363	35
Initial Q (Qb), veh	0	0	0	0	0	0	0	0	0	0	0	0
Ped-Bike Adj(A_pbT)	0.99		0.98	0.99		0.98	1.00		1.00	1.00		1.00
Parking Bus, Adj	1.00	1.00	1.00	1.00	1.00	1.00	1.00	1.00	1.00	1.00	1.00	1.00
Work Zone On Approach		No			No			No			No	
Adj Sat Flow, veh/h/ln	1870	1870	1870	1870	1870	1870	1870	1870	1870	1870	1870	1870
Adj Flow Rate, veh/h	15	3	9	82	3	32	25	762	297	103	1498	38
Peak Hour Factor	0.91	0.91	0.91	0.91	0.91	0.91	0.91	0.91	0.91	0.91	0.91	0.91
Percent Heavy Veh, %	2	2	2	2	2	2	2	2	2	2	2	2
Cap, veh/h	134	36	38	263	5	149	314	1883	734	464	2671	68
Arrive On Green	0.10	0.10	0.10	0.10	0.10	0.10	0.75	0.75	0.75	0.75	0.75	0.75
Sat Flow, veh/h	425	379	402	1520	56	1560	338	2496	972	533	3541	90
Grp Volume(v), veh/h	27	0	0	85	0	32	25	542	517	103	751	785
Grp Sat Flow(s),veh/h/ln	1205	0	0	1575	0	1560	338	1777	1692	533	1777	1854
Q Serve(g_s), s	0.0	0.0	0.0	0.0	0.0	1.1	2.0	6.5	6.5	5.1	10.8	10.8
Cycle Q Clear(g_c), s	2.8	0.0	0.0	2.7	0.0	1.1	12.9	6.5	6.5	11.6	10.8	10.8
Prop In Lane	0.56		0.33	0.96		1.00	1.00		0.57	1.00		0.05
Lane Grp Cap(c), veh/h	209	0	0	269	0	149	314	1340	1276	464	1340	1398
V/C Ratio(X)	0.13	0.00	0.00	0.32	0.00	0.21	0.08	0.40	0.40	0.22	0.56	0.56
Avail Cap(c_a), veh/h	508	0	0	554	0	468	314	1340	1276	464	1340	1398
HCM Platoon Ratio	1.00	1.00	1.00	1.00	1.00	1.00	1.00	1.00	1.00	1.00	1.00	1.00
Upstream Filter(I)	1.00	0.00	0.00	1.00	0.00	1.00	1.00	1.00	1.00	1.00	1.00	1.00
Uniform Delay (d), s/veh	24.9	0.0	0.0	25.8	0.0	25.1	5.9	2.6	2.6	4.7	3.1	3.1
Incr Delay (d2), s/veh	0.3	0.0	0.0	0.7	0.0	0.7	0.5	0.9	1.0	1.1	1.7	1.6
Initial Q Delay(d3),s/veh	0.0	0.0	0.0	0.0	0.0	0.0	0.0	0.0	0.0	0.0	0.0	0.0
%ile BackOfQ(50%),veh/ln	0.3	0.0	0.0	1.1	0.0	0.4	0.1	0.4	0.4	0.4	0.7	0.7
Unsig. Movement Delay, s/veh												
LnGrp Delay(d),s/veh	25.2	0.0	0.0	26.4	0.0	25.8	6.4	3.5	3.6	5.8	4.8	4.8
LnGrp LOS	C	A	A	C	A	C	A	A	A	A	A	A
Approach Vol, veh/h		27			117			1084			1639	
Approach Delay, s/veh		25.2			26.3			3.6			4.9	
Approach LOS		C			C			A			A	
Timer - Assigned Phs		2		4		6		8				
Phs Duration (G+Y+Rc), s		49.8		10.2		49.8		10.2				
Change Period (Y+Rc), s		4.5		4.5		4.5		4.5				
Max Green Setting (Gmax), s		33.0		18.0		33.0		18.0				
Max Q Clear Time (g_c+I1), s		14.9		4.8		13.6		4.7				
Green Ext Time (p_c), s		6.3		0.0		10.6		0.4				
<b>Intersection Summary</b>												
HCM 6th Ctrl Delay				5.5								
HCM 6th LOS				A								

Lanes, Volumes, Timings  
 1: Little Morongo Rd. & Two Bunch Palms Tr.

EAPC (2024) PM Peak Hour

												
Lane Group	EBL	EBT	EBR	WBL	WBT	WBR	NBL	NBT	NBR	SBL	SBT	SBR
Lane Configurations												
Traffic Volume (vph)	1	7	2	161	14	116	11	252	234	106	155	2
Future Volume (vph)	1	7	2	161	14	116	11	252	234	106	155	2
Ideal Flow (vphpl)	1900	1900	1900	1900	1900	1900	1900	1900	1900	1900	1900	1900
Storage Length (ft)	0		0	0		50	150		150	150		50
Storage Lanes	0		0	0		1	0		0	0		1
Taper Length (ft)	90			90			90			90		
Link Speed (mph)		45			45			55			55	
Link Distance (ft)		1073			1443			3240			728	
Travel Time (s)		16.3			21.9			40.2			9.0	
Confl. Peds. (#/hr)	5		5	5		5	5		5	5		5
Peak Hour Factor	0.94	0.94	0.94	0.94	0.94	0.94	0.94	0.94	0.94	0.94	0.94	0.94
Shared Lane Traffic (%)												
Sign Control		Stop			Stop			Stop			Stop	

Intersection Summary

Area Type: Other  
 Control Type: Unsignalized



Intersection	
Intersection Delay, s/veh	23
Intersection LOS	C

Movement	EBL	EBT	EBR	WBL	WBT	WBR	NBL	NBT	NBR	SBL	SBT	SBR
Lane Configurations		↕			↕	↕		↕			↕	↕
Traffic Vol, veh/h	1	7	2	161	14	116	11	252	234	106	155	2
Future Vol, veh/h	1	7	2	161	14	116	11	252	234	106	155	2
Peak Hour Factor	0.94	0.94	0.94	0.94	0.94	0.94	0.94	0.94	0.94	0.94	0.94	0.94
Heavy Vehicles, %	2	2	2	2	2	2	2	2	2	2	2	2
Mvmt Flow	1	7	2	171	15	123	12	268	249	113	165	2
Number of Lanes	0	1	0	0	1	1	0	1	0	0	1	1

Approach	EB	WB	NB	SB
Opposing Approach	WB	EB	SB	NB
Opposing Lanes	2	1	2	1
Conflicting Approach Left	SB	NB	EB	WB
Conflicting Lanes Left	2	1	1	2
Conflicting Approach Right	NB	SB	WB	EB
Conflicting Lanes Right	1	2	2	1
HCM Control Delay	10.9	12.9	33	15.7
HCM LOS	B	B	D	C

Lane	NBLn1	EBLn1	WBLn1	WBLn2	SBLn1	SBLn2
Vol Left, %	2%	10%	92%	0%	41%	0%
Vol Thru, %	51%	70%	8%	0%	59%	0%
Vol Right, %	47%	20%	0%	100%	0%	100%
Sign Control	Stop	Stop	Stop	Stop	Stop	Stop
Traffic Vol by Lane	497	10	175	116	261	2
LT Vol	11	1	161	0	106	0
Through Vol	252	7	14	0	155	0
RT Vol	234	2	0	116	0	2
Lane Flow Rate	529	11	186	123	278	2
Geometry Grp	6	6	7	7	7	7
Degree of Util (X)	0.849	0.023	0.379	0.211	0.504	0.003
Departure Headway (Hd)	5.782	7.752	7.329	6.146	6.53	5.611
Convergence, Y/N	Yes	Yes	Yes	Yes	Yes	Yes
Cap	624	465	490	581	550	634
Service Time	3.837	5.752	5.098	3.914	4.297	3.376
HCM Lane V/C Ratio	0.848	0.024	0.38	0.212	0.505	0.003
HCM Control Delay	33	10.9	14.5	10.6	15.8	8.4
HCM Lane LOS	D	B	B	B	C	A
HCM 95th-tile Q	9.4	0.1	1.7	0.8	2.8	0

Lanes, Volumes, Timings  
 2: Little Morongo Rd. & i-Storage N. Dwy

EAPC (2024) PM Peak Hour



Lane Group	EBL	EBR	NBL	NBT	SBT	SBR
Lane Configurations						
Traffic Volume (vph)	6	11	10	516	320	5
Future Volume (vph)	6	11	10	516	320	5
Ideal Flow (vphpl)	1900	1900	1900	1900	1900	1900
Storage Length (ft)	150	50	150			50
Storage Lanes	0	1	0			1
Taper Length (ft)	90		90			
Link Speed (mph)	30			55	55	
Link Distance (ft)	557			342	421	
Travel Time (s)	12.7			4.2	5.2	
Confl. Peds. (#/hr)	5	5	5			5
Peak Hour Factor	0.92	0.92	0.92	0.92	0.92	0.92
Shared Lane Traffic (%)						
Sign Control	Stop			Free	Free	

Intersection Summary

Area Type: Other  
 Control Type: Unsignalized

Intersection						
Int Delay, s/veh	0.4					
Movement	EBL	EBR	NBL	NBT	SBT	SBR
Lane Configurations						
Traffic Vol, veh/h	6	11	10	516	320	5
Future Vol, veh/h	6	11	10	516	320	5
Conflicting Peds, #/hr	5	5	5	0	0	5
Sign Control	Stop	Stop	Free	Free	Free	Free
RT Channelized	-	None	-	None	-	None
Storage Length	-	50	-	-	-	50
Veh in Median Storage, #	0	-	-	0	0	-
Grade, %	0	-	-	0	0	-
Peak Hour Factor	92	92	92	92	92	92
Heavy Vehicles, %	2	2	2	2	2	2
Mvmt Flow	7	12	11	561	348	5

















Major/Minor	Minor2	Major1	Major2			
Conflicting Flow All	941	358	358	0	-	0
Stage 1	353	-	-	-	-	-
Stage 2	588	-	-	-	-	-
Critical Hdwy	6.42	6.22	4.12	-	-	-
Critical Hdwy Stg 1	5.42	-	-	-	-	-
Critical Hdwy Stg 2	5.42	-	-	-	-	-
Follow-up Hdwy	3.518	3.318	2.218	-	-	-
Pot Cap-1 Maneuver	292	686	1201	-	-	-
Stage 1	711	-	-	-	-	-
Stage 2	555	-	-	-	-	-
Platoon blocked, %				-	-	-
Mov Cap-1 Maneuver	285	679	1195	-	-	-
Mov Cap-2 Maneuver	285	-	-	-	-	-
Stage 1	698	-	-	-	-	-
Stage 2	552	-	-	-	-	-

Approach	EB	NB	SB
HCM Control Delay, s	13	0.2	0
HCM LOS	B		

Minor Lane/Major Mvmt	NBL	NBT	EBLn1	EBLn2	SBT	SBR
Capacity (veh/h)	1195	-	285	679	-	-
HCM Lane V/C Ratio	0.009	-	0.023	0.018	-	-
HCM Control Delay (s)	8	0	17.9	10.4	-	-
HCM Lane LOS	A	A	C	B	-	-
HCM 95th %tile Q(veh)	0	-	0.1	0.1	-	-

Lanes, Volumes, Timings  
3: Little Morongo Rd. & Dillon Rd.

EAPC (2024) PM Peak Hour

												
Lane Group	EBL	EBT	EBR	WBL	WBT	WBR	NBL	NBT	NBR	SBL	SBT	SBR
Lane Configurations												
Traffic Volume (vph)	304	453	0	0	288	234	0	0	0	231	0	280
Future Volume (vph)	304	453	0	0	288	234	0	0	0	231	0	280
Ideal Flow (vphpl)	1900	1900	1900	1900	1900	1900	1900	1900	1900	1900	1900	1900
Storage Length (ft)	205		150	145		150	0		0	150		150
Storage Lanes	1		0	1		0	0		0	0		0
Taper Length (ft)	90			90			90			90		
Link Speed (mph)		55			55			55				55
Link Distance (ft)		4457			1492			286				3985
Travel Time (s)		55.3			18.5			3.5				49.4
Confl. Peds. (#/hr)	5		5	5		5	5		5	5		5
Peak Hour Factor	0.87	0.87	0.87	0.87	0.87	0.87	0.87	0.87	0.87	0.87	0.87	0.87
Shared Lane Traffic (%)												
Sign Control		Stop			Stop			Stop				Stop

Intersection Summary

Area Type: Other

Control Type: Unsignalized

Intersection	
Intersection Delay, s/veh	104.1
Intersection LOS	F

Movement	EBL	EBT	EBR	WBL	WBT	WBR	NBL	NBT	NBR	SBL	SBT	SBR
Lane Configurations	↙	↑		↙	↘						↕	
Traffic Vol, veh/h	304	453	0	0	288	234	0	0	0	231	0	280
Future Vol, veh/h	304	453	0	0	288	234	0	0	0	231	0	280
Peak Hour Factor	0.87	0.87	0.87	0.87	0.87	0.87	0.87	0.87	0.87	0.87	0.87	0.87
Heavy Vehicles, %	2	2	2	2	2	2	2	2	2	2	2	2
Mvmt Flow	349	521	0	0	331	269	0	0	0	266	0	322
Number of Lanes	1	1	0	1	1	0	0	0	0	0	1	0

Approach	EB	WB	SB
Opposing Approach	WB	EB	
Opposing Lanes	2	2	0
Conflicting Approach Left	SB		WB
Conflicting Lanes Left	1	0	2
Conflicting Approach Right		SB	EB
Conflicting Lanes Right	0	1	2
HCM Control Delay	75.7	147.5	102
HCM LOS	F	F	F

Lane	EBLn1	EBLn2	WBLn1	WBLn2	SBLn1
Vol Left, %	100%	0%	0%	0%	45%
Vol Thru, %	0%	100%	100%	55%	0%
Vol Right, %	0%	0%	0%	45%	55%
Sign Control	Stop	Stop	Stop	Stop	Stop
Traffic Vol by Lane	304	453	0	522	511
LT Vol	304	0	0	0	231
Through Vol	0	453	0	288	0
RT Vol	0	0	0	234	280
Lane Flow Rate	349	521	0	600	587
Geometry Grp	7	7	7	7	2
Degree of Util (X)	0.787	1.098	0	1.233	1.116
Departure Headway (Hd)	8.935	8.416	8.233	7.905	7.239
Convergence, Y/N	Yes	Yes	Yes	Yes	Yes
Cap	409	437	0	462	505
Service Time	6.635	6.116	5.933	5.605	5.239
HCM Lane V/C Ratio	0.853	1.192	0	1.299	1.162
HCM Control Delay	37.6	101.3	10.9	147.5	102
HCM Lane LOS	E	F	N	F	F
HCM 95th-tile Q	6.8	16.1	0	22.6	18.5

Lanes, Volumes, Timings  
3: Little Morongo Rd. & Dillon Rd.

EAPC (2024) PM Peak Hour  
With Improvements

Lane Group	EBL	EBT	EBR	WBL	WBT	WBR	NBL	NBT	NBR	SBL	SBT	SBR
Lane Configurations												
Traffic Volume (vph)	304	453	0	0	288	234	0	0	0	231	0	280
Future Volume (vph)	304	453	0	0	288	234	0	0	0	231	0	280
Ideal Flow (vphpl)	1900	1900	1900	1900	1900	1900	1900	1900	1900	1900	1900	1900
Storage Length (ft)	205		150	145		150	0		0	150		150
Storage Lanes	1		0	1		0	0		0	0		0
Taper Length (ft)	90			90			90			90		
Right Turn on Red			Yes			Yes			Yes			Yes
Link Speed (mph)		55			55			55			55	
Link Distance (ft)		4457			1492			286			3985	
Travel Time (s)		55.3			18.5			3.5			49.4	
Confl. Peds. (#/hr)	5		5	5		5	5		5	5		5
Peak Hour Factor	0.87	0.87	0.87	0.87	0.87	0.87	0.87	0.87	0.87	0.87	0.87	0.87
Shared Lane Traffic (%)												
Turn Type	Perm	NA		Perm	NA					Perm	NA	
Protected Phases		2			6							4
Permitted Phases	2			6						4		
Detector Phase	2	2		6	6					4	4	
Switch Phase												
Minimum Initial (s)	5.0	5.0		5.0	5.0					5.0	5.0	
Minimum Split (s)	22.5	22.5		22.5	22.5					22.5	22.5	
Total Split (s)	76.0	76.0		76.0	76.0					44.0	44.0	
Total Split (%)	63.3%	63.3%		63.3%	63.3%					36.7%	36.7%	
Yellow Time (s)	3.5	3.5		3.5	3.5					3.5	3.5	
All-Red Time (s)	1.0	1.0		1.0	1.0					1.0	1.0	
Lost Time Adjust (s)	0.0	0.0		0.0	0.0							0.0
Total Lost Time (s)	4.5	4.5		4.5	4.5							4.5
Lead/Lag												
Lead-Lag Optimize?												
Recall Mode	C-Max	C-Max		C-Max	C-Max					Max	Max	

Intersection Summary



















Area Type: Other  
 Cycle Length: 120  
 Actuated Cycle Length: 120  
 Offset: 0 (0%), Referenced to phase 2:EBTL and 6:WBTL, Start of Yellow  
 Natural Cycle: 70  
 Control Type: Actuated-Coordinated

Splits and Phases: 3: Little Morongo Rd. & Dillon Rd.



HCM 6th Signalized Intersection Summary  
3: Little Morongo Rd. & Dillon Rd.

EAPC (2024) PM Peak Hour  
With Improvements

												
Movement	EBL	EBT	EBR	WBL	WBT	WBR	NBL	NBT	NBR	SBL	SBT	SBR
Lane Configurations												
Traffic Volume (veh/h)	304	453	0	0	288	234	0	0	0	231	0	280
Future Volume (veh/h)	304	453	0	0	288	234	0	0	0	231	0	280
Initial Q (Qb), veh	0	0	0	0	0	0				0	0	0
Ped-Bike Adj(A_pbT)	1.00		1.00	1.00		1.00				1.00		0.99
Parking Bus, Adj	1.00	1.00	1.00	1.00	1.00	1.00				1.00	1.00	1.00
Work Zone On Approach		No			No						No	
Adj Sat Flow, veh/h/ln	1870	1870	0	1870	1870	1870				1870	1870	1870
Adj Flow Rate, veh/h	349	521	0	0	331	269				266	0	322
Peak Hour Factor	0.87	0.87	0.87	0.87	0.87	0.87				0.87	0.87	0.87
Percent Heavy Veh, %	2	2	0	2	2	2				2	2	2
Cap, veh/h	372	1114	0	60	568	461				247	0	299
Arrive On Green	0.60	0.60	0.00	0.00	0.60	0.60				0.33	0.00	0.33
Sat Flow, veh/h	819	1870	0	881	953	774				751	0	910
Grp Volume(v), veh/h	349	521	0	0	0	600				588	0	0
Grp Sat Flow(s),veh/h/ln	819	1870	0	881	0	1727				1661	0	0
Q Serve(g_s), s	45.7	18.7	0.0	0.0	0.0	25.8				39.5	0.0	0.0
Cycle Q Clear(g_c), s	71.5	18.7	0.0	0.0	0.0	25.8				39.5	0.0	0.0
Prop In Lane	1.00		0.00	1.00		0.45				0.45		0.55
Lane Grp Cap(c), veh/h	372	1114	0	60	0	1029				547	0	0
V/C Ratio(X)	0.94	0.47	0.00	0.00	0.00	0.58				1.08	0.00	0.00
Avail Cap(c_a), veh/h	372	1114	0	60	0	1029				547	0	0
HCM Platoon Ratio	1.00	1.00	1.00	1.00	1.00	1.00				1.00	1.00	1.00
Upstream Filter(I)	1.00	1.00	0.00	0.00	0.00	1.00				1.00	0.00	0.00
Uniform Delay (d), s/veh	39.6	13.6	0.0	0.0	0.0	15.0				40.3	0.0	0.0
Incr Delay (d2), s/veh	33.5	1.4	0.0	0.0	0.0	2.4				60.4	0.0	0.0
Initial Q Delay(d3),s/veh	0.0	0.0	0.0	0.0	0.0	0.0				0.0	0.0	0.0
%ile BackOfQ(50%),veh/ln	13.6	7.3	0.0	0.0	0.0	9.4				24.1	0.0	0.0
Unsig. Movement Delay, s/veh												
LnGrp Delay(d),s/veh	73.1	15.0	0.0	0.0	0.0	17.4				100.6	0.0	0.0
LnGrp LOS	E	B	A	A	A	B				F	A	A
Approach Vol, veh/h		870			600						588	
Approach Delay, s/veh		38.3			17.4						100.6	
Approach LOS		D			B						F	
Timer - Assigned Phs		2		4		6						
Phs Duration (G+Y+Rc), s		76.0		44.0		76.0						
Change Period (Y+Rc), s		4.5		4.5		4.5						
Max Green Setting (Gmax), s		71.5		39.5		71.5						
Max Q Clear Time (g_c+I1), s		73.5		41.5		27.8						
Green Ext Time (p_c), s		0.0		0.0		4.0						
<b>Intersection Summary</b>												
HCM 6th Ctrl Delay				50.0								
HCM 6th LOS				D								

Lanes, Volumes, Timings  
4: Indian Cyn. Dr. & Dillon Rd.

EAPC (2024) PM Peak Hour

Lane Group	EBL	EBT	EBR	WBL	WBT	WBR	NBL	NBT	NBR	SBL	SBT	SBR
Lane Configurations												
Traffic Volume (vph)	11	118	48	341	160	50	61	947	497	40	460	9
Future Volume (vph)	11	118	48	341	160	50	61	947	497	40	460	9
Ideal Flow (vphpl)	1900	1900	1900	1900	1900	1900	1900	1900	1900	1900	1900	1900
Storage Length (ft)	150		195	100		100	100		150	120		150
Storage Lanes	1		0	1		1	1		0	1		0
Taper Length (ft)	90			90			90			90		
Right Turn on Red			Yes			Yes			Yes			Yes
Link Speed (mph)		55			55			55			55	
Link Distance (ft)		780			957			919			547	
Travel Time (s)		9.7			11.9			11.4			6.8	
Confl. Peds. (#/hr)	5		5	5		5	5		5	5		5
Peak Hour Factor	0.91	0.91	0.91	0.91	0.91	0.91	0.91	0.91	0.91	0.91	0.91	0.91
Shared Lane Traffic (%)												
Turn Type	Prot	NA		Prot	NA	Perm	Perm	NA		Perm	NA	
Protected Phases	7	4		3	8			2			6	
Permitted Phases						8	2			6		
Detector Phase	7	4		3	8	8	2	2		6	6	
Switch Phase												
Minimum Initial (s)	5.0	4.0		5.0	4.0	4.0	4.0	4.0		4.0	4.0	
Minimum Split (s)	9.5	20.0		9.5	20.0	20.0	20.0	20.0		20.0	20.0	
Total Split (s)	9.6	20.0		36.0	46.4	46.4	64.0	64.0		64.0	64.0	
Total Split (%)	8.0%	16.7%		30.0%	38.7%	38.7%	53.3%	53.3%		53.3%	53.3%	
Yellow Time (s)	3.5	3.5		3.5	3.5	3.5	3.5	3.5		3.5	3.5	
All-Red Time (s)	1.0	0.5		1.0	0.5	0.5	0.5	0.5		0.5	0.5	
Lost Time Adjust (s)	0.0	0.0		0.0	0.0	0.0	0.0	0.0		0.0	0.0	
Total Lost Time (s)	4.5	4.0		4.5	4.0	4.0	4.0	4.0		4.0	4.0	
Lead/Lag	Lead	Lag		Lead	Lag	Lag						
Lead-Lag Optimize?	Yes	Yes		Yes	Yes	Yes						
Recall Mode	None	None		None	None	None	C-Max	C-Max		C-Max	C-Max	

Intersection Summary

Area Type: Other  
 Cycle Length: 120  
 Actuated Cycle Length: 120  
 Offset: 0 (0%), Referenced to phase 2:NBTL and 6:SBTL, Start of Yellow  
 Natural Cycle: 90  
 Control Type: Actuated-Coordinated

Splits and Phases: 4: Indian Cyn. Dr. & Dillon Rd.

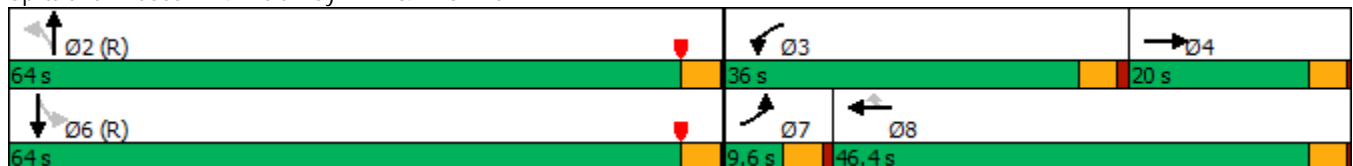



HCM 6th Signalized Intersection Summary  
4: Indian Cyn. Dr. & Dillon Rd.

EAPC (2024) PM Peak Hour

Movement	EBL	EBT	EBR	WBL	WBT	WBR	NBL	NBT	NBR	SBL	SBT	SBR
Lane Configurations												
Traffic Volume (veh/h)	11	118	48	341	160	50	61	947	497	40	460	9
Future Volume (veh/h)	11	118	48	341	160	50	61	947	497	40	460	9
Initial Q (Qb), veh	0	0	0	0	0	0	0	0	0	0	0	0
Ped-Bike Adj(A_pbT)	1.00		0.98	1.00		0.99	1.00		1.00	1.00		1.00
Parking Bus, Adj	1.00	1.00	1.00	1.00	1.00	1.00	1.00	1.00	1.00	1.00	1.00	1.00
Work Zone On Approach		No			No			No			No	
Adj Sat Flow, veh/h/ln	1870	1870	1870	1870	1870	1870	1870	1870	1870	1870	1870	1870
Adj Flow Rate, veh/h	12	130	53	375	176	55	67	1041	546	44	505	10
Peak Hour Factor	0.91	0.91	0.91	0.91	0.91	0.91	0.91	0.91	0.91	0.91	0.91	0.91
Percent Heavy Veh, %	2	2	2	2	2	2	2	2	2	2	2	2
Cap, veh/h	24	206	80	404	1053	467	518	1337	676	129	2088	41
Arrive On Green	0.01	0.08	0.08	0.23	0.30	0.30	0.59	0.59	0.59	0.59	0.59	0.59
Sat Flow, veh/h	1781	2488	965	1781	3554	1577	885	2281	1155	322	3564	71
Grp Volume(v), veh/h	12	91	92	375	176	55	67	802	785	44	252	263
Grp Sat Flow(s),veh/h/ln	1781	1777	1676	1781	1777	1577	885	1777	1659	322	1777	1857
Q Serve(g_s), s	0.8	5.9	6.4	24.7	4.4	3.1	4.7	40.9	44.6	14.9	8.2	8.2
Cycle Q Clear(g_c), s	0.8	5.9	6.4	24.7	4.4	3.1	13.0	40.9	44.6	59.5	8.2	8.2
Prop In Lane	1.00		0.58	1.00		1.00	1.00		0.70	1.00		0.04
Lane Grp Cap(c), veh/h	24	147	139	404	1053	467	518	1041	972	129	1041	1088
V/C Ratio(X)	0.49	0.62	0.66	0.93	0.17	0.12	0.13	0.77	0.81	0.34	0.24	0.24
Avail Cap(c_a), veh/h	76	237	223	468	1256	557	518	1041	972	129	1041	1088
HCM Platoon Ratio	1.00	1.00	1.00	1.00	1.00	1.00	1.00	1.00	1.00	1.00	1.00	1.00
Upstream Filter(I)	1.00	1.00	1.00	1.00	1.00	1.00	1.00	1.00	1.00	1.00	1.00	1.00
Uniform Delay (d), s/veh	58.8	53.2	53.4	45.4	31.3	30.8	15.1	18.8	19.5	42.9	12.0	12.0
Incr Delay (d2), s/veh	14.4	4.1	5.3	23.0	0.1	0.1	0.5	5.5	7.2	7.1	0.6	0.5
Initial Q Delay(d3),s/veh	0.0	0.0	0.0	0.0	0.0	0.0	0.0	0.0	0.0	0.0	0.0	0.0
%ile BackOfQ(50%),veh/ln	0.4	2.7	2.8	12.9	1.8	1.1	0.9	15.9	16.5	1.4	3.0	3.2
Unsig. Movement Delay, s/veh												
LnGrp Delay(d),s/veh	73.2	57.3	58.7	68.4	31.3	30.9	15.6	24.3	26.7	50.0	12.5	12.5
LnGrp LOS	E	E	E	E	C	C	B	C	C	D	B	B
Approach Vol, veh/h		195			606			1654			559	
Approach Delay, s/veh		58.9			54.2			25.1			15.5	
Approach LOS		E			D			C			B	
Timer - Assigned Phs		2	3	4		6	7	8				
Phs Duration (G+Y+Rc), s		74.3	31.7	14.0		74.3	6.1	39.5				
Change Period (Y+Rc), s		4.0	4.5	4.0		4.0	4.5	4.0				
Max Green Setting (Gmax), s		60.0	31.5	16.0		60.0	5.1	42.4				
Max Q Clear Time (g_c+I1), s		46.6	26.7	8.4		61.5	2.8	6.4				
Green Ext Time (p_c), s		8.4	0.5	0.4		0.0	0.0	1.1				
<b>Intersection Summary</b>												
HCM 6th Ctrl Delay				31.4								
HCM 6th LOS				C								
<b>Notes</b>												
User approved pedestrian interval to be less than phase max green.												

Lanes, Volumes, Timings  
5: Little Morongo Rd. & N. Dwy.

EAPC (2024) PM Peak Hour



Lane Group	WBL	WBR	NBT	NBR	SBL	SBT
Lane Configurations						
Traffic Volume (vph)	8	3	519	3	1	317
Future Volume (vph)	8	3	519	3	1	317
Ideal Flow (vphpl)	1900	1900	1900	1900	1900	1900
Storage Length (ft)	150	150		150	150	
Storage Lanes	0	0		0	0	
Taper Length (ft)	90				90	
Link Speed (mph)	30		55			55
Link Distance (ft)	298		421			3240
Travel Time (s)	6.8		5.2			40.2
Confl. Peds. (#/hr)	5	5		5	5	
Peak Hour Factor	0.92	0.92	0.92	0.92	0.92	0.92
Shared Lane Traffic (%)						
Sign Control	Stop		Free			Free

Intersection Summary

Area Type: Other

Control Type: Unsignalized

Intersection						
Int Delay, s/veh	0.2					
Movement	WBL	WBR	NBT	NBR	SBL	SBT
Lane Configurations	TT		TT			TT
Traffic Vol, veh/h	8	3	519	3	1	317
Future Vol, veh/h	8	3	519	3	1	317
Conflicting Peds, #/hr	5	5	0	5	5	0
Sign Control	Stop	Stop	Free	Free	Free	Free
RT Channelized	-	None	-	None	-	None
Storage Length	-	-	-	-	-	-
Veh in Median Storage, #	0	-	0	-	-	0
Grade, %	0	-	0	-	-	0
Peak Hour Factor	92	92	92	92	92	92
Heavy Vehicles, %	2	2	2	2	2	2
Mvmt Flow	9	3	564	3	1	345

















Major/Minor	Minor1	Major1	Major2			
Conflicting Flow All	923	576	0	0	572	0
Stage 1	571	-	-	-	-	-
Stage 2	352	-	-	-	-	-
Critical Hdwy	6.42	6.22	-	-	4.12	-
Critical Hdwy Stg 1	5.42	-	-	-	-	-
Critical Hdwy Stg 2	5.42	-	-	-	-	-
Follow-up Hdwy	3.518	3.318	-	-	2.218	-
Pot Cap-1 Maneuver	299	517	-	-	1001	-
Stage 1	565	-	-	-	-	-
Stage 2	712	-	-	-	-	-
Platoon blocked, %			-	-	-	-
Mov Cap-1 Maneuver	296	512	-	-	996	-
Mov Cap-2 Maneuver	296	-	-	-	-	-
Stage 1	562	-	-	-	-	-
Stage 2	708	-	-	-	-	-

Approach	WB	NB	SB
HCM Control Delay, s	16.2	0	0
HCM LOS	C		

Minor Lane/Major Mvmt	NBT	NBRWBLn1	SBL	SBT
Capacity (veh/h)	-	-	334	996
HCM Lane V/C Ratio	-	-	0.036	0.001
HCM Control Delay (s)	-	-	16.2	8.6
HCM Lane LOS	-	-	C	A
HCM 95th %tile Q(veh)	-	-	0.1	0

Lanes, Volumes, Timings  
 6: Little Morongo Rd. & i-Storage S. Dwy

EAPC (2024) PM Peak Hour

												
Lane Group	EBL	EBT	EBR	WBL	WBT	WBR	NBL	NBT	NBR	SBL	SBT	SBR
Lane Configurations												
Traffic Volume (vph)	1	0	1	37	0	5	1	521	15	2	328	1
Future Volume (vph)	1	0	1	37	0	5	1	521	15	2	328	1
Ideal Flow (vphpl)	1900	1900	1900	1900	1900	1900	1900	1900	1900	1900	1900	1900
Storage Length (ft)	150		150	0		0	150		150	150		50
Storage Lanes	0		0	0		0	0		0	0		1
Taper Length (ft)	90			90			90			90		
Link Speed (mph)		30			30			55			55	
Link Distance (ft)		528			365			3985			342	
Travel Time (s)		12.0			8.3			49.4			4.2	
Confl. Peds. (#/hr)	5		5				5					5
Peak Hour Factor	0.91	0.91	0.91	0.91	0.91	0.91	0.91	0.91	0.91	0.91	0.91	0.91
Shared Lane Traffic (%)												
Sign Control		Stop			Stop			Free			Free	

Intersection Summary

Area Type: Other  
 Control Type: Unsignalized

HCM 6th TWSC  
6: Little Morongo Rd. & i-Storage S. Dwy

EAPC (2024) PM Peak Hour

Intersection												
Int Delay, s/veh	1.1											
Movement	EBL	EBT	EBR	WBL	WBT	WBR	NBL	NBT	NBR	SBL	SBT	SBR
Lane Configurations		↕			↕			↕			↑	↗
Traffic Vol, veh/h	1	0	1	37	0	5	1	521	15	2	328	1
Future Vol, veh/h	1	0	1	37	0	5	1	521	15	2	328	1
Conflicting Peds, #/hr	5	0	5	0	0	0	5	0	0	0	0	5
Sign Control	Stop	Stop	Stop	Stop	Stop	Stop	Free	Free	Free	Free	Free	Free
RT Channelized	-	-	None	-	-	None	-	-	None	-	-	None
Storage Length	-	-	-	-	-	-	-	-	-	-	-	50
Veh in Median Storage, #	-	0	-	-	0	-	-	0	-	-	0	-
Grade, %	-	0	-	-	0	-	-	0	-	-	0	-
Peak Hour Factor	91	91	91	91	91	91	91	91	91	91	91	91
Heavy Vehicles, %	2	2	2	2	2	2	2	2	2	2	2	2
Mvmt Flow	1	0	1	41	0	5	1	573	16	2	360	1



















Major/Minor	Minor2		Minor1		Major1		Major2					
Conflicting Flow All	960	960	370	953	953	586	366	0	0	589	0	0
Stage 1	369	369	-	583	583	-	-	-	-	-	-	-
Stage 2	591	591	-	370	370	-	-	-	-	-	-	-
Critical Hdwy	7.12	6.52	6.22	7.12	6.52	6.22	4.12	-	-	4.12	-	-
Critical Hdwy Stg 1	6.12	5.52	-	6.12	5.52	-	-	-	-	-	-	-
Critical Hdwy Stg 2	6.12	5.52	-	6.12	5.52	-	-	-	-	-	-	-
Follow-up Hdwy	3.518	4.018	3.318	3.518	4.018	3.318	2.218	-	-	2.218	-	-
Pot Cap-1 Maneuver	236	257	676	239	259	510	1193	-	-	986	-	-
Stage 1	651	621	-	498	499	-	-	-	-	-	-	-
Stage 2	493	494	-	650	620	-	-	-	-	-	-	-
Platoon blocked, %								-	-	-	-	-
Mov Cap-1 Maneuver	231	255	670	237	257	508	1187	-	-	986	-	-
Mov Cap-2 Maneuver	231	255	-	237	257	-	-	-	-	-	-	-
Stage 1	647	616	-	498	499	-	-	-	-	-	-	-
Stage 2	485	494	-	644	615	-	-	-	-	-	-	-

Approach	EB		WB		NB		SB			
HCM Control Delay, s	15.5		22.4		0		0.1			
HCM LOS	C		C							

Minor Lane/Major Mvmt	NBL	NBT	NBR	EBLn1WBLn1	SBL	SBT	SBR
Capacity (veh/h)	1187	-	-	344	253	986	-
HCM Lane V/C Ratio	0.001	-	-	0.006	0.182	0.002	-
HCM Control Delay (s)	8	0	-	15.5	22.4	8.7	-
HCM Lane LOS	A	A	-	C	C	A	-
HCM 95th %tile Q(veh)	0	-	-	0	0.7	0	-

Lanes, Volumes, Timings  
7: Indian Cyn. Dr. & 19th Av.

EAPC (2024) PM Peak Hour

												
Lane Group	EBL	EBT	EBR	WBL	WBT	WBR	NBL	NBT	NBR	SBL	SBT	SBR
Lane Configurations												
Traffic Volume (vph)	34	3	11	282	5	78	5	1416	84	28	923	20
Future Volume (vph)	34	3	11	282	5	78	5	1416	84	28	923	20
Ideal Flow (vphpl)	1900	1900	1900	1900	1900	1900	1900	1900	1900	1900	1900	1900
Storage Length (ft)	0		0	0		50	200		0	100		0
Storage Lanes	0		0	0		1	1		0	1		0
Taper Length (ft)	90			90			90			90		
Link Speed (mph)		30			30			55			55	
Link Distance (ft)		938			936			640			4458	
Travel Time (s)		21.3			21.3			7.9			55.3	
Confl. Peds. (#/hr)	5		5	5		5	5		5	5		5
Peak Hour Factor	0.90	0.90	0.90	0.90	0.90	0.90	0.90	0.90	0.90	0.90	0.90	0.90
Shared Lane Traffic (%)												
Sign Control		Stop			Stop			Free			Free	

Intersection Summary

Area Type: Other  
Control Type: Unsignalized

Intersection												
Int Delay, s/veh	803											
Movement	EBL	EBT	EBR	WBL	WBT	WBR	NBL	NBT	NBR	SBL	SBT	SBR
Lane Configurations		↕			↕	↕	↕	↕		↕	↕	
Traffic Vol, veh/h	34	3	11	282	5	78	5	1416	84	28	923	20
Future Vol, veh/h	34	3	11	282	5	78	5	1416	84	28	923	20
Conflicting Peds, #/hr	5	0	5	5	0	5	5	0	5	5	0	5
Sign Control	Stop	Stop	Stop	Stop	Stop	Stop	Free	Free	Free	Free	Free	Free
RT Channelized	-	-	None	-	-	None	-	-	None	-	-	None
Storage Length	-	-	-	-	-	50	200	-	-	100	-	-
Veh in Median Storage, #	-	0	-	-	0	-	-	0	-	-	0	-
Grade, %	-	0	-	-	0	-	-	0	-	-	0	-
Peak Hour Factor	90	90	90	90	90	90	90	90	90	90	90	90
Heavy Vehicles, %	2	2	2	2	2	2	2	2	2	2	2	2
Mvmt Flow	38	3	12	313	6	87	6	1573	93	31	1026	22

Major/Minor	Minor2		Minor1		Major1			Major2				
Conflicting Flow All	1911	2787	534	2219	2752	843	1053	0	0	1671	0	0
Stage 1	1104	1104	-	1637	1637	-	-	-	-	-	-	-
Stage 2	807	1683	-	582	1115	-	-	-	-	-	-	-
Critical Hdwy	7.54	6.54	6.94	7.54	6.54	6.94	4.14	-	-	4.14	-	-
Critical Hdwy Stg 1	6.54	5.54	-	6.54	5.54	-	-	-	-	-	-	-
Critical Hdwy Stg 2	6.54	5.54	-	6.54	5.54	-	-	-	-	-	-	-
Follow-up Hdwy	3.52	4.02	3.32	3.52	4.02	3.32	2.22	-	-	2.22	-	-
Pot Cap-1 Maneuver	41	18	491	~ 24	19	307	657	-	-	380	-	-
Stage 1	225	285	-	~ 105	157	-	-	-	-	-	-	-
Stage 2	341	149	-	466	282	-	-	-	-	-	-	-
Platoon blocked, %								-	-	-	-	-
Mov Cap-1 Maneuver	~ 20	16	486	~ 18	17	304	654	-	-	378	-	-
Mov Cap-2 Maneuver	~ 20	16	-	~ 18	17	-	-	-	-	-	-	-
Stage 1	222	260	-	~ 104	155	-	-	-	-	-	-	-
Stage 2	232	147	-	410	257	-	-	-	-	-	-	-

Approach	EB	WB	NB	SB
HCM Control Delay, s/\$	854.8	\$ 6242.7	0	0.4
HCM LOS	F	F		

Minor Lane/Major Mvmt	NBL	NBT	NBR	EBLn1	WBLn1	WBLn2	SBL	SBT	SBR
Capacity (veh/h)	654	-	-	25	18	304	378	-	-
HCM Lane V/C Ratio	0.008	-	-	2.133	17.716	0.285	0.082	-	-
HCM Control Delay (s)	10.6	-	-	\$ 854.8	\$ 7933.5	21.5	15.4	-	-
HCM Lane LOS	B	-	-	F	F	C	C	-	-
HCM 95th %tile Q(veh)	0	-	-	6.6	40.6	1.1	0.3	-	-

Notes  
 -: Volume exceeds capacity    \$: Delay exceeds 300s    +: Computation Not Defined    \*: All major volume in platoon

Lanes, Volumes, Timings  
7: Indian Cyn. Dr. & 19th Av.

EAPC (2024) PM Peak Hour  
With Improvements

Lane Group	EBL	EBT	EBR	WBL	WBT	WBR	NBL	NBT	NBR	SBL	SBT	SBR
Lane Configurations												
Traffic Volume (vph)	34	3	11	282	5	78	5	1416	84	28	923	20
Future Volume (vph)	34	3	11	282	5	78	5	1416	84	28	923	20
Ideal Flow (vphpl)	1900	1900	1900	1900	1900	1900	1900	1900	1900	1900	1900	1900
Storage Length (ft)	0		0	0		50	200		0	100		0
Storage Lanes	0		0	0		1	1		0	1		0
Taper Length (ft)	90			90			90			90		
Right Turn on Red			Yes			Yes			Yes			Yes
Link Speed (mph)		30			30			55			55	
Link Distance (ft)		938			936			640			4458	
Travel Time (s)		21.3			21.3			7.9			55.3	
Confl. Peds. (#/hr)	5		5	5		5	5		5	5		5
Peak Hour Factor	0.90	0.90	0.90	0.90	0.90	0.90	0.90	0.90	0.90	0.90	0.90	0.90
Shared Lane Traffic (%)												
Turn Type	Perm	NA		Perm	NA	Perm	Perm	NA		Perm	NA	
Protected Phases		4			8			2			6	
Permitted Phases	4			8		8	2			6		
Detector Phase	4	4		8	8	8	2	2		6	6	
Switch Phase												
Minimum Initial (s)	5.0	5.0		5.0	5.0	5.0	5.0	5.0		5.0	5.0	
Minimum Split (s)	22.5	22.5		22.5	22.5	22.5	22.5	22.5		22.5	22.5	
Total Split (s)	23.0	23.0		23.0	23.0	23.0	37.0	37.0		37.0	37.0	
Total Split (%)	38.3%	38.3%		38.3%	38.3%	38.3%	61.7%	61.7%		61.7%	61.7%	
Yellow Time (s)	3.5	3.5		3.5	3.5	3.5	3.5	3.5		3.5	3.5	
All-Red Time (s)	1.0	1.0		1.0	1.0	1.0	1.0	1.0		1.0	1.0	
Lost Time Adjust (s)		0.0			0.0	0.0	0.0	0.0		0.0	0.0	
Total Lost Time (s)		4.5			4.5	4.5	4.5	4.5		4.5	4.5	
Lead/Lag												
Lead-Lag Optimize?												
Recall Mode	None	None		None	None	None	C-Max	C-Max		C-Max	C-Max	

Intersection Summary

Area Type: Other  
 Cycle Length: 60  
 Actuated Cycle Length: 60  
 Offset: 0 (0%), Referenced to phase 2:NBTL and 6:SBTL, Start of Yellow  
 Natural Cycle: 60  
 Control Type: Actuated-Coordinated



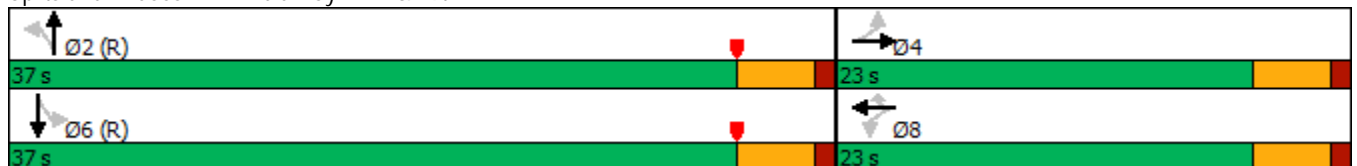

















Splits and Phases: 7: Indian Cyn. Dr. & 19th Av.





HCM 6th Signalized Intersection Summary  
7: Indian Cyn. Dr. & 19th Av.

EAPC (2024) PM Peak Hour  
With Improvements

												
Movement	EBL	EBT	EBR	WBL	WBT	WBR	NBL	NBT	NBR	SBL	SBT	SBR
Lane Configurations												
Traffic Volume (veh/h)	34	3	11	282	5	78	5	1416	84	28	923	20
Future Volume (veh/h)	34	3	11	282	5	78	5	1416	84	28	923	20
Initial Q (Qb), veh	0	0	0	0	0	0	0	0	0	0	0	0
Ped-Bike Adj(A_pbT)	1.00		0.99	1.00		0.99	1.00		1.00	1.00		1.00
Parking Bus, Adj	1.00	1.00	1.00	1.00	1.00	1.00	1.00	1.00	1.00	1.00	1.00	1.00
Work Zone On Approach		No			No			No			No	
Adj Sat Flow, veh/h/ln	1870	1870	1870	1870	1870	1870	1870	1870	1870	1870	1870	1870
Adj Flow Rate, veh/h	38	3	12	313	6	87	6	1573	93	31	1026	22
Peak Hour Factor	0.90	0.90	0.90	0.90	0.90	0.90	0.90	0.90	0.90	0.90	0.90	0.90
Percent Heavy Veh, %	2	2	2	2	2	2	2	2	2	2	2	2
Cap, veh/h	158	23	23	490	7	439	334	1949	115	180	2033	44
Arrive On Green	0.28	0.28	0.28	0.28	0.28	0.28	0.57	0.57	0.57	0.57	0.57	0.57
Sat Flow, veh/h	197	81	81	1333	26	1577	538	3410	201	298	3557	76
Grp Volume(v), veh/h	53	0	0	319	0	87	6	816	850	31	513	535
Grp Sat Flow(s),veh/h/ln	360	0	0	1359	0	1577	538	1777	1833	298	1777	1856
Q Serve(g_s), s	1.2	0.0	0.0	0.0	0.0	2.5	0.4	21.8	22.2	5.6	10.4	10.4
Cycle Q Clear(g_c), s	14.6	0.0	0.0	13.4	0.0	2.5	10.8	21.8	22.2	27.8	10.4	10.4
Prop In Lane	0.72		0.23	0.98		1.00	1.00		0.11	1.00		0.04
Lane Grp Cap(c), veh/h	203	0	0	497	0	439	334	1016	1048	180	1016	1061
V/C Ratio(X)	0.26	0.00	0.00	0.64	0.00	0.20	0.02	0.80	0.81	0.17	0.50	0.50
Avail Cap(c_a), veh/h	245	0	0	539	0	486	334	1016	1048	180	1016	1061
HCM Platoon Ratio	1.00	1.00	1.00	1.00	1.00	1.00	1.00	1.00	1.00	1.00	1.00	1.00
Upstream Filter(I)	1.00	0.00	0.00	1.00	0.00	1.00	1.00	1.00	1.00	1.00	1.00	1.00
Uniform Delay (d), s/veh	21.3	0.0	0.0	20.4	0.0	16.5	11.0	10.2	10.3	21.4	7.7	7.7
Incr Delay (d2), s/veh	0.7	0.0	0.0	2.3	0.0	0.2	0.1	6.7	6.8	2.1	1.8	1.7
Initial Q Delay(d3),s/veh	0.0	0.0	0.0	0.0	0.0	0.0	0.0	0.0	0.0	0.0	0.0	0.0
%ile BackOfQ(50%),veh/ln	0.7	0.0	0.0	4.1	0.0	0.9	0.0	6.6	6.9	0.4	2.7	2.8
Unsig. Movement Delay, s/veh												
LnGrp Delay(d),s/veh	22.0	0.0	0.0	22.8	0.0	16.8	11.1	16.9	17.1	23.4	9.5	9.4
LnGrp LOS	C	A	A	C	A	B	B	B	B	C	A	A
Approach Vol, veh/h		53			406			1672			1079	
Approach Delay, s/veh		22.0			21.5			17.0			9.9	
Approach LOS		C			C			B			A	
Timer - Assigned Phs		2		4		6		8				
Phs Duration (G+Y+Rc), s		38.8		21.2		38.8		21.2				
Change Period (Y+Rc), s		4.5		4.5		4.5		4.5				
Max Green Setting (Gmax), s		32.5		18.5		32.5		18.5				
Max Q Clear Time (g_c+I1), s		24.2		16.6		29.8		15.4				
Green Ext Time (p_c), s		5.8		0.0		1.6		0.7				
<b>Intersection Summary</b>												
HCM 6th Ctrl Delay				15.2								
HCM 6th LOS				B								

April 7, 2022

Jilleen Ferris  
City of Desert Hot Springs  
65-950 Pierson Blvd.  
Desert Hot Springs, CA 92240

**SUBJECT: DHS LIGHT INDUSTRIAL WITH CANNABIS OVERLAY, VEHICLE MILES TRAVELED (VMT)  
SCREENING EVALUATION**

Dear Jilleen Ferris:

Urban Crossroads, Inc. is pleased to provide the following Vehicle Miles Traveled (VMT) Screening for the DHS Light Industrial with Cannabis Overlay development (**Project**) located at the east side of Little Morongo Road, north of Dillon Road in the City of Desert Hot Springs.

## **PROJECT OVERVIEW**

It is our understanding that the Project is to consist of approximately 116,000 square feet of light industrial buildings for the research, development, and cultivation of medical-grade cannabis.

## **BACKGROUND**

Changes to California Environmental Quality Act (CEQA) Guidelines were adopted in December 2018, which require all lead agencies to adopt VMT as a replacement for automobile delay-based level of service (LOS) as the measure for identifying transportation impacts for land use projects. This statewide mandate went into effect July 1, 2020. To aid in this transition, the Governor's Office of Planning and Research (OPR) released a Technical Advisory on Evaluating Transportation Impacts in CEQA (December of 2018) (**Technical Advisory**) (1). Based on the Technical Advisory, the County of Riverside has developed and adopted the Transportation Analysis Guidelines for Level of Service, Vehicle Miles Traveled (December 2020) (**County Guidelines**) (2). This VMT analysis has been developed based on the adopted County Guidelines.

## **VMT SCREENING**

County Guidelines identify Projects that meet certain VMT screening criteria may be presumed to result in a less than significant transportation impact. The County Guidelines lists the following VMT screening criteria that would be appropriate for light industrial/warehousing/R&D Projects:

- Small Projects
- Projects Near High Quality Transit

A land use project need only meet one of the above screening criteria to result in a less than significant impact.

### **SMALL PROJECTS SCREENING**

The County Guidelines define General Light Industrial small projects as less than or equal to 179,000 square feet. The Project is proposing 116,000 square feet of light industrial buildings for the research, development, and cultivation of medical-grade cannabis.

**The Small Projects screening threshold is met and no further analysis is necessary.**

### **PROJECTS NEAR HIGH QUALITY TRANSIT SCREENING**

Consistent with guidance identified in the County Guidelines, projects located within an area with high quality transit (i.e., within ½ mile of an existing “major transit stop”<sup>1</sup> and maintains a service interval frequency of 15 minutes or less during the morning and afternoon peak commute periods.

**Projects Near high Quality Transit screening criteria is not met.**

### **CONCLUSION**

Based on our review of applicable VMT screening thresholds for light industrial/warehousing/R&D uses, the Project meets the Small Projects criteria. Because the screening criteria is met, the Project is presumed to have a less-than-significant transportation impact. No additional VMT analysis is required.

If you have any questions, please contact us at [jkain@urbanxroads.com](mailto:jkain@urbanxroads.com) for John Kain or [mwhiteman@urbanxroads.com](mailto:mwhiteman@urbanxroads.com) for Marlie Whiteman.

Respectfully submitted,

URBAN CROSSROADS, INC.



John Kain, AICP  
Principal



Marlie Whiteman, PE  
Senior Associate

---

<sup>1</sup> Pub. Resources Code, § 21064.3 (“Major transit stop’ means a site containing an existing rail transit station, a ferry terminal served by either a bus or rail transit service, or the intersection of two or more major bus routes with a frequency of service interval of 15 minutes or less during the morning and afternoon peak commute periods.”).