

GEOTECHNICAL INVESTIGATION

**BELLA MAR
408 HOLLISTER STREET
SAN DIEGO, CALIFORNIA**



GEOCON
INCORPORATED

**GEOTECHNICAL
ENVIRONMENTAL
MATERIALS**

**PREPARED FOR
RED TAIL ACQUISITIONS, LLC
IRVINE, CALIFORNIA**

**APRIL 24, 2019
PROJECT NO. G2129-52-03**



Project No. G2129-52-03
April 24, 2019

Red Tail Acquisitions, LLC
2082 Michelson Drive, 4th Floor
Irvine, California 92612

Attention: Mr. Tim Kihm

Subject: GEOTECHNICAL INVESTIGATION
BELLA MAR
408 HOLLISTER STREET
SAN DIEGO, CALIFORNIA

Dear Mr. Kihm:

In accordance with your request and authorization of our Proposal No. LG-16466 dated April 10, 2017, we herein submit the results of our geotechnical investigation for the subject project. We performed our investigation to evaluate the underlying soil/geologic conditions and potential geologic hazards. This report can assist in the design of the proposed buildings and associated improvements.

The accompanying report presents the results of our study and conclusions and recommendations pertaining to geotechnical aspects of the proposed project. The site is suitable for the proposed buildings and improvements provided the recommendations of this report are incorporated into the design and construction of the planned project.

Should you have questions regarding this report, or if we may be of further service, please contact the undersigned at your convenience.

Very truly yours,

GEOCON INCORPORATED

Lilian E. Rodriguez
RCE 83227

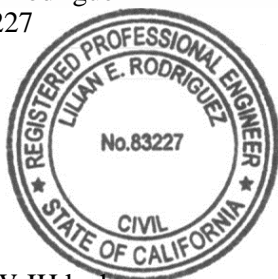

Shawn Foy Weedon
GE 2714



John Hoobs
CEG 1524



LER:SFW:JH:kcd

(email) Addressee

TABLE OF CONTENTS

1.	PURPOSE AND SCOPE	1
2.	SITE AND PROJECT DESCRIPTION.....	1
3.	GEOLOGIC SETTING	2
4.	SOIL AND GEOLOGIC CONDITIONS	3
4.1	Undocumented Fill (Qudf)	3
4.2	Topsoil (unmapped).....	3
4.3	Alluvium (Qal)	3
4.4	Old Paralic Deposits (Qop)	4
4.5	San Diego Formation (Tsd).....	4
5.	GROUNDWATER	4
6.	GEOLOGIC HAZARDS	5
6.1	Geologic Hazard Category	5
6.2	Faulting and Seismicity	5
6.3	Ground Rupture	7
6.4	Liquefaction Potential and Seismically Induced Settlement	7
6.5	Storm Surge, Tsunamis and Seiches	9
6.6	Landslides.....	10
7.	CONCLUSIONS AND RECOMMENDATIONS	11
7.1	General	11
7.2	Soil Characteristics	12
7.3	Grading.....	13
7.4	Temporary Excavations.....	15
7.5	Seismic Design Criteria – California Building Code	15
7.6	Post-Tensioned Foundation Recommendations	17
7.7	Mat Foundations.....	19
7.8	Settlement Considerations	20
7.9	Mitigation of Liquefaction and Settlement.....	23
7.10	Exterior Concrete Flatwork	24
7.11	Retaining Walls	25
7.12	Lateral Loading	27
7.13	Pool/Spa Recommendations.....	28
7.14	Preliminary Pavement Recommendations.....	29
7.15	Site Drainage and Moisture Protection.....	32
7.16	Grading and Foundation Plan Review.....	33

LIMITATIONS AND UNIFORMITY OF CONDITIONS

TABLE OF CONTENTS (Concluded)

MAPS AND ILLUSTRATIONS

- Figure 1, Vicinity Map
- Figure 2, Geologic Map
- Figure 3, Geologic Cross Section
- Figure 4, Plate Settlement Monument
- Figure 5, Surface Settlement Monument
- Figure 6, Retaining Wall Loading Diagram
- Figure 7, Typical Retaining Wall Drain Detail

APPENDIX A

FIELD INVESTIGATION

- Figures A-1 – A-2, Logs of Borings
- Cone Penetrometer (CPT) Logs

APPENDIX B

LABORATORY TESTING

- Table B-I, Summary of Laboratory Maximum Dry Density and Optimum Moisture Content Test Results
- Table B-II, Summary of Laboratory Direct Shear Test Results
- Table B-III, Summary of Laboratory Expansion Index Test Results
- Table B-IV, Summary of Laboratory Water-Soluble Sulfate Test Results
- Table B-V, Summary of Laboratory Resistance Value (R-Value) Test Results
- Table B-VI, Summary of Laboratory Plasticity Index Test Results
- Figure B-1 –B-3, Consolidation Test Curves
- Figures B-4 – B-5, Gradation Curves

APPENDIX C

BORING AND TRENCH LOGS, AND LABORATORY TESTING FROM PREVIOUS INVESTIGATION (CHRISTIAN WHEELER, 2005)

APPENDIX D

LIQUEFACTION ANALYSIS

APPENDIX E

STORM WATER MANAGEMENT INVESTIGATION

APPENDIX F

RECOMMENDED GRADING SPECIFICATIONS

LIST OF REFERENCES

GEOTECHNICAL INVESTIGATION

1. PURPOSE AND SCOPE

This report presents the results of our geotechnical investigation for the proposed residential development in the Otay Mesa-Nestor Community Planning Area in San Diego, California (see Vicinity Map, Figure 1). The purpose of the geotechnical investigation is to evaluate the surface and subsurface soil conditions and general site geology, and to identify geotechnical constraints that may affect development of the property including faulting, liquefaction and seismic shaking based on the 2016 CBC seismic design criteria. In addition, we provided recommendations for remedial grading, shallow foundations, concrete slab-on-grade, concrete flatwork, pavement, and retaining walls.

We reviewed the following plans and reports in preparation of this report:

1. *Report of Preliminary Geotechnical Investigation, Proposed Bella Mar RV Park, 408 Hollister Street, San Diego, California*, prepared by Christian Wheeler Engineering, dated December 22, 2005 (Project No. 2050832.01).
2. *Preliminary Geotechnical Investigation, 408 Hollister Street, San Diego, California*, prepared by Geocon Incorporated, dated February 25, 2019.
3. *Tentative Parcel Map, Bella Mar, Conceptual Grading and Utilities, San Diego, California*, prepared by Geocon Incorporated, dated May 7, 2013 (Project No. G1580-11-01).

The scope of this investigation included reviewing readily available published and unpublished geologic literature (see List of References); performing engineering analyses; and preparing this report. We also advanced 2 exploratory borings to a maximum depth of about 51 feet, performed 6 percolation/infiltration tests, sampled soil and performed laboratory testing. Appendix A presents the exploratory boring logs and details of the field investigation for the current study. The details of the laboratory tests and a summary of the test results are shown in Appendix B and on the boring logs in Appendix A. Appendix C presents the boring and trench logs and the laboratory test results from the previous geotechnical investigation (Christian Wheeler Engineering, 2005). Appendix D presents the results of our liquefaction analysis, and Appendix E presents a summary of our storm water management investigation.

2. SITE AND PROJECT DESCRIPTION

The subject property is located east of Interstate 5, west of Hollister Street and about 725 feet north of Conifer Avenue in the Otay Mesa – Nestor Community Planning Area in San Diego, California. The site slopes gently to the northwest with existing elevations ranging from approximately 16 feet to 22 feet above Mean Sea Level (MSL). The property is covered with seasonal shrubs and grasses, and appears to have been previously used for agriculture purposes. Several structures were located on the northeast corner of the property that appear to have been demolished between 2006 and 2009.

Remnants of former asphalt concrete pavement remain on the northeast portion of the site. An approximately 10 foot high slope descends along the northern property line with inclinations of about 2:1 (horizontal to vertical) to the Otay River.

We understand the planned development will consist of the construction of approximately 16 residential buildings on two parcels with associated driveways, retaining walls, utilities and landscaping. We understand maximum cuts and fills of approximately 5 and 8 feet, respectively, will be required to achieve planned on-site and off-site grades.

The locations, site descriptions and proposed development herein are based on our site reconnaissance, review of published geologic literature, field investigations, and discussions with project personnel. If development plans differ from those described herein, Geocon Incorporated should be contacted for review of the plans and possible revisions to this report.

3. GEOLOGIC SETTING

The site is located in the coastal plain within the southern portion of the Peninsular Ranges Geomorphic Province of southern California. The Peninsular Ranges is a geologic and geomorphic province that extends from the Imperial Valley to the Pacific Ocean and from the Transverse Ranges to the north and into Baja California to the south. The coastal plain of San Diego County is underlain by a thick sequence of relatively undisturbed and non-conformable sedimentary rocks that thicken to the west and range in age from Upper Cretaceous through the Pleistocene with intermittent deposition. The sedimentary units are deposited on bedrock Cretaceous to Jurassic age igneous and metavolcanic rocks. Geomorphically, the coastal plain is characterized by a series of twenty-one, stair-stepped marine terraces (younger to the west) that have been dissected by west flowing rivers. The coastal plain is a relatively stable block that is dissected by relatively few faults consisting of the potentially active La Nacion Fault Zone and the active Rose Canyon Fault Zone. The Peninsular Ranges Province is also dissected by the Elsinore Fault Zone that is associated with and sub-parallel to the San Andreas Fault Zone, which is the plate boundary between the Pacific and North American Plates.

The site is located on the western portion of the coastal plain at the western portion of the Otay River drainage and the southern end of the San Diego Bay. Localized shallow undocumented fill and topsoil overlie alluvial soils deposits likely placed during the formation of the San Diego Bay and deposition from the Otay River. The site has Late Pleistocene-age Old Paralic Deposits (Unit 6 Nestor Terrace) and the Pliocene-age San Diego Formation underlying the alluvial soils at depths of approximately 35 feet.

4. SOIL AND GEOLOGIC CONDITIONS

Our field investigation and previous field investigations performed by Christian Wheeler Engineering (CWE) indicates the site is underlain by three surficial soil consisting of undocumented fill (Qudf), topsoil (unmapped) and alluvium (Qal). The Old Paralic Deposits (Qop) and the San Diego Formation (Tsd) exist below the alluvium. The occurrence, distribution, and description of the units encountered is shown on the Geologic Map, Figure 2 and on the boring logs in Appendices A and C. The Geologic Cross-Section, Figure 3, shows the approximate subsurface relationship between the surficial and geologic units. The surficial soils and geologic unit are described herein in order of increasing age.

4.1 Undocumented Fill (Qudf)

Undocumented fill associated with the previous land use was encountered in Boring B-1 by CWE (2005) to a depth of approximately 3 feet. The fill is reported to consist of gray, loose, silty sand with gravel. We expect fill is present on the northeast portion of the property from previously existing structures. Undocumented fill is also present on the western property boundary associated with the construction and support of existing Interstate 5 freeway. These materials are unsuitable in their present condition and will require removal and recompaction in the areas proposed to be graded and/or where settlement sensitive improvements are planned. The undocumented fill can be reused for the proposed compacted fill during grading operations provided it is free of roots and debris.

4.2 Topsoil (unmapped)

Holocene-age topsoil is present as a relatively thin veneer locally overlying alluvium materials across the site. The topsoil ranges in thickness from about 1 to 2 feet and can be characterized as soft and very loose to loose, dark brown to grayish brown, silty clay to silty sand. Removal of the topsoil will be necessary in areas to support proposed fill or structures. Due to the relatively thin thickness and discontinuity of these deposits, topsoil is not shown on the Geologic Map.

4.3 Alluvium (Qal)

The Quaternary-age alluvial deposits exist below the fill and topsoil across the site. We encountered alluvium in the current borings to a depth of approximately 34 feet below existing grade. The alluvium typically possesses a “very low” to “low” expansion potential (expansion index of 50 or less). The alluvium within the upper approximately 10 to 20 feet below grade encountered in the current and previous exploratory excavations at the site generally consists of loose to medium dense, moist to saturated, dark brown to reddish brown, silty to clayey sand. This material is compressible and the upper portions will require remedial grading.

The alluvium materials below a depth of approximately 10 to 20 feet to a depth of approximately 35 feet generally consists of very dense, saturated, dark brown sands with some gravels and cobbles.

The underlying dense to very dense alluvium is considered suitable for support of additional fill and/or structural load. We expect up to approximately 10 feet of compressible alluvium will be left in place due to the presence of the groundwater table. The alluvium is suitable for use as compacted fill soil; however, special soil handling will likely be required due to the saturated soil conditions.

4.4 Old Paralic Deposits (Qop)

We encountered the late Pleistocene-age Old Paralic Deposits underlying the alluvial deposits to depths of approximately 49 and 44 feet below existing grade in Borings B-1 and B-2, respectively. The Old Paralic Deposits encountered consist of interbedded layers of dense to very dense, silty sand to very stiff to hard silt. This geologic unit generally has a “low” to “medium” expansion potential (expansion index of 21 to 90) and adequate shear strengths. The Old Paralic Deposits are considered suitable for support of additional fill and/or structural loads.

4.5 San Diego Formation (Tsd)

The San Diego Formation is present underlying the Old Paralic Deposits at an elevation of about -30 to -25 feet MSL. The San Diego Formation encountered generally consists of weakly to well-cemented, micaceous, saturated, light brown, fine- to medium-grained sandstone. The San Diego Formation typically possesses a “very low” to “low” expansion potential (expansion index of 50 or less). The San Diego Formation is considered suitable for support of additional fill and/or structural loads.

5. GROUNDWATER

We encountered groundwater at depths of 13.5 and 16 feet in current Borings B-1 and B-2 (elevations of about 6.5 and 4 feet above Mean Sea Level). In addition, CWE reported that groundwater was encountered at depths ranging from 8 to 13 feet (elevations of about 7 to 12 feet above Mean Sea Level). We also encountered saturated soils at depths of approximately 5 feet in current Borings B-1 and B-2 (elevation of approximately 15 feet above MSL). The project should be designed with a groundwater elevation of 10 feet MSL, and saturated conditions should be expected at an elevations of approximately 15 feet MSL. Due to the relatively close vicinity of the San Diego Bay, the groundwater should be considered brackish. We expect groundwater and saturated soil will be a factor during site development, especially for liquefaction mitigation/ground improvements (if required), grading operations and utility installation. The use of dewatering techniques should be considered to facilitate site grading and improvements, where necessary. It is not uncommon for groundwater or seepage conditions to develop where none previously existed. Groundwater and seepage is dependent on seasonal precipitation, irrigation, land use, among other factors, and varies as a result. Proper surface drainage will be important to future performance of the project.

According to the *Water Quality Control Plan for the San Diego Basin* prepared by the California Regional Water Quality Control Board, the site is located within Hydrologic Unit Basin Number 10.20 (the Otay Valley hydrologic area). The subject site is classified as having beneficial use for municipal, agricultural and industrial uses according to Table 2-5, Beneficial Uses of Ground Waters.

6. GEOLOGIC HAZARDS

6.1 Geologic Hazard Category

The City of San Diego Seismic Safety Study, Geologic Hazards and Faults, Map Sheet 6 defines the site with *Hazard Category 31: High Liquefaction Potential – shallow groundwater, major drainages, hydraulic fills*. Based on a review of the map, a fault does not traverse or project toward the planned development area.

6.2 Faulting and Seismicity

Based on our site investigation and a review of published geologic maps and reports, the site is not located in a State of California Earthquake Fault Zone and does not possess known active, potentially active or inactive fault traces as defined by the California Geological Survey (CGS). The CGS considers a fault seismically active when evidence suggests seismic activity within roughly the last 11,000 years.

According to the computer program *EZ-FRISK* (Version 7.65), 6 known active faults are located within a search radius of 50 miles from the property. We used the 2008 USGS fault database that provides several models and combinations of fault data to evaluate the fault information. The Rose Canyon Fault zone and the Newport-Inglewood Fault are the closest known active faults, located approximately 4 miles northwest of the site. Earthquakes that might occur on the Newport-Inglewood or Rose Canyon Fault Zones or other faults within the southern California and northern Baja California area are potential generators of significant ground motion at the site. The estimated deterministic maximum earthquake magnitude and peak ground acceleration for the Newport-Inglewood Fault are 7.5 and 0.32g, respectively. Table 6.2.1 lists the estimated maximum earthquake magnitude and peak ground acceleration for the most dominant faults in relationship to the site location. We calculated peak ground acceleration (PGA) using Boore-Atkinson (2008) NGA USGS 2008, Campbell-Bozorgnia (2008) NGA USGS 2008, and Chiou-Youngs (2007) NGA USGS 2008 acceleration-attenuation relationships.

**TABLE 6.2.1
DETERMINISTIC SPECTRA SITE PARAMETERS**

Fault Name	Distance from Site (miles)	Maximum Earthquake Magnitude (Mw)	Peak Ground Acceleration		
			Boore-Atkinson 2008 (g)	Campbell-Bozorgnia 2008 (g)	Chiou-Youngs 2007 (g)
Newport-Inglewood	4	7.50	0.32	0.22	0.27
Rose Canyon	4	6.90	0.30	0.22	0.26
Palos Verdes	12	7.70	0.27	0.16	0.22
Coronado Bank	12	7.40	0.26	0.16	0.20
Elsinore	45	7.85	0.20	0.09	0.12
Earthquake Valley	50	6.80	0.13	0.06	0.06

We used the computer program *EZ-FRISK* to perform a probabilistic seismic hazard analysis. The computer program *EZ-FRISK* operates under the assumption that the occurrence rate of earthquakes on each mappable Quaternary fault is proportional to the faults slip rate. The program accounts for fault rupture length as a function of earthquake magnitude, and site acceleration estimates are made using the earthquake magnitude and distance from the site to the rupture zone. The program also accounts for uncertainty in each of following: (1) earthquake magnitude, (2) rupture length for a given magnitude, (3) location of the rupture zone, (4) maximum possible magnitude of a given earthquake, and (5) acceleration at the site from a given earthquake along each fault. By calculating the expected accelerations from considered earthquake sources, the program calculates the total average annual expected number of occurrences of site acceleration greater than a specified value. We utilized acceleration-attenuation relationships suggested by Boore-Atkinson (2008) NGA USGS 2008, Campbell-Bozorgnia (2008) NGA USGS 2008, and Chiou-Youngs (2007) NGA USGS 2008 in the analysis. Table 6.2.2 presents the site-specific probabilistic seismic hazard parameters including acceleration-attenuation relationships and the probability of exceedence.

**TABLE 6.2.2
PROBABILISTIC SEISMIC HAZARD PARAMETERS**

Probability of Exceedence	Peak Ground Acceleration		
	Boore-Atkinson, 2008 (g)	Campbell-Bozorgnia, 2008 (g)	Chiou-Youngs, 2007 (g)
2% in a 50 Year Period	0.59	0.32	0.37
5% in a 50 Year Period	0.45	0.25	0.29
10% in a 50 Year Period	0.35	0.20	0.23

While listing peak accelerations is useful for comparison of potential effects of fault activity in a region, other considerations are important in seismic design, including the frequency and duration of motion and the soil conditions underlying the site. Seismic design of the structures should be evaluated in accordance with the 2016 California Building Code (CBC) guidelines currently adopted by the City of San Diego.

The site could be subjected to moderate to severe ground shaking in the event of a major earthquake on any of the referenced faults or other faults in Southern California. With respect to seismic shaking, the site is considered comparable to the surrounding developed area.

6.3 Ground Rupture

Ground surface rupture occurs when movement along a fault is sufficient to cause a gap or rupture where the upper edge of the fault zone intersects the earth surface. The potential for ground rupture is considered to be negligible due to the absence of active faults at the subject site.

6.4 Liquefaction Potential and Seismically Induced Settlement

Liquefaction typically occurs when a site is located in a zone with seismic activity, onsite soils are cohesionless or silt/clay with low plasticity, groundwater is encountered within 50 feet of the surface, and soil densities are less than about 70 percent of the maximum dry densities. If the four previous criteria are met, a seismic event could result in a rapid pore water pressure increase from the earthquake-generated ground accelerations.

The County of San Diego Hazard Mitigation Plan (2017) maps the site in an area with a high liquefaction risk. In addition, the *City of San Diego Seismic Safety Study, Geologic Hazards and Faults, Sheet 6* defines the site with a geologic hazard Category 31: *Liquefaction: High Potential – Shallow Groundwater, major drainages, hydraulic fills*. The current standard of practice, as outlined in the *Recommended Procedures for Implementation of DMG Special Publication 117A, Guidelines for Analyzing and Mitigating Liquefaction in California* requires liquefaction analysis to a depth of 50 feet below the lowest portion of the proposed structure. Liquefaction typically occurs in areas where the soils below the water table are composed of poorly consolidated, fine to medium-grained, primarily sandy soil. In addition to the requisite soil conditions, the ground acceleration and duration of the earthquake must also be of a sufficient level to induce liquefaction.

We performed liquefaction analysis of our CPT soundings using the program CLiq (Version 1.7). This program utilizes the 2001 NCEER method of analysis. In addition, we performed liquefaction analyses using the data from current Borings B-1 and B-2. We used methods following the methodology of NCEER (2001 and 2008) to perform a liquefaction evaluation using the data from the borings. We used a static groundwater depth of 10 feet, a modal magnitude of 6.12 earthquake (attributed to the

Newport-Inglewood Fault), and a peak horizontal site acceleration, PGA_M , of 0.39g calculated from ASCE 7-10 Section 11.8.3. This semi-empirical method is based on correlations with the data collected from the borings and CPT soundings and field performance data.

The liquefaction analyses (included in Appendix D) indicate the soils to depths from generally 10 and 15 feet below the existing grade could be prone to between 0 and 0.9 inches using CPT data. We estimate the differential settlement of $\frac{2}{3}$ the total settlement ranging from 0 to $\frac{2}{3}$ inches. The estimated liquefaction settlement potential using the data from Borings B-1 and B-2 ranges from approximately 1 and 2 inches (average of 1.5 inches), with differential settlement ranging from approximately $\frac{2}{3}$ and $1\frac{1}{3}$ inches (average of 1 inch). We used a groundwater depth of approximately 10 feet for our liquefaction analyses based on the groundwater elevations encountered in the previous borings and trenches by CWE and the saturated conditions of the alluvial soils encountered above the groundwater table in the current borings. Our analyses indicate that liquefaction could at depths between 10 to 15 feet in the areas of CPT-1 through CPT-9 and Borings B-1 and 2 for the levels of ground shaking assumed. We do not expect liquefaction to occur within the underlying dense, gravelly alluvium, Old Paralic Deposits and San Diego Formation. Recommendations presented in this report are intended to reduce the effects of seismically-induced settlement on the proposed structures.

Sand boils occur where liquefiable soil is extruded upward through the soil deposit to the ground surface. Providing an increase in overburden pressure and a compacted fill mat can mitigate surface manifestation. Research presented by Ishihara (1985) indicates that the presence of a non-liquefiable surface layer typically results in the effects of at-depth liquefaction from reaching the surface. Modifications to Ishihara's chart have been made to include higher ground accelerations (Ishihara's 1985 chart was based on a 0.25g ground acceleration) by Youd and Garris (1995). Based on Youd's modified curves and the thickness of the non-liquefiable soil layer (layer above the assumed groundwater table), the potential for surface manifestation is possible unless ground improvements are performed.

Lateral spreading occurs when liquefiable soil is in the immediate vicinity of a free face such as a slope. Factors controlling lateral displacement include earthquake magnitude, distance from the earthquake epicenter, thickness of liquefiable soil layer, grain size characteristics, fines content of the soil and SPT blow counts. Bartlett and Youd (1995) have concluded that lateral spreading is restricted to sediments with corrected SPT blow counts of 15 or less for earthquake magnitudes less than or equal to 8.0. The potential of lateral spreading in the liquefiable soil below the groundwater table is not considered an adverse impact to the proposed development due to the limited amount of liquefaction potential and the distance between the Otay River face of slope located to the north of the site and the proposed buildings.

The mitigation of potential hazards due to liquefaction can be accomplished by the densification of the potentially liquefiable soil through ground improvements or the use of foundation systems that still provide acceptable structural support should liquefaction occur. Soil densification can be accomplished by compaction grouting, vibrocompaction, soil mixing, and deep dynamic compaction (among others). Soil densification is generally used to increase the density and provide liquefaction mitigation of sensitive soil to relatively shallow depths over large areas. Deep foundation systems may be used to transmit structural loads to bearing depths below the liquefiable zones and may consist of driven piles or drilled piles. Deep foundations are designed to mitigate damage to the structures supported on the piles; however, they do not generally reduce the potential for damage to underground utilities and peripheral site improvements. The effects of differential settlement between ridged structures and attached settlement-sensitive surface improvements can be mitigated by designing the utilities to accommodate differential movement at the connections.

6.5 Storm Surge, Tsunamis and Seiches

Storm surges are large ocean waves that sweep across coastal areas when storms make landfall. Storm surges can cause inundation, severe erosion and backwater flooding along the water front. The site is located approximately ½ miles from the San Diego Bay and is at an elevation of about 15 feet or greater above MSL. Based on historic and predicated wave heights and runout lengths, we opine that the proposed site elevation is sufficient to mitigate the risk; therefore, the potential of storm surges affecting the site is considered low.

A tsunami is a series of long period waves generated in the ocean by a sudden displacement of large volumes of water. Causes of tsunamis include underwater earthquakes, volcanic eruptions, or offshore slope failures. The first-order driving force for locally generated tsunamis offshore southern California is expected to be tectonic deformation from large earthquakes (Legg, *et al.*, 2002). Historically, tsunami wave heights have ranged up to 3.7 feet in the San Diego area. According to the County of San Diego Hazard Mitigation Plan (2010), the largest tsunami effect recorded in San Diego since 1950 was May 22, 1960 which had maximum run-up amplitudes of 2.1 feet (0.7 meters). Wave heights and run-up elevations from tsunamis along the San Diego Coast have historically fallen within the normal range of the tides. The California Geologic Survey (CGS) *Tsunami Inundation Map for Emergency Planning Imperial Beach Quadrangle* maps tsunami inundation areas. The subject site is not included within a tsunami inundation area.

A seiche is a run-up of water within a lake or embayment triggered by fault- or landslide-induced ground displacement. The site is located adjacent to the Otay River at an elevation of about 15 feet or greater above Mean Sea Level (MSL). Based on historic and predicated wave heights and runout lengths, it is our opinion that the proposed site elevation is sufficient to mitigate the risk; therefore, we consider the potential for seiches to impact the site low.

6.6 Landslides

We did not observe evidence of previous or incipient slope instability at the site during our study as the property is relatively flat. Published geologic mapping indicates landslides are not present on or adjacent to the site. Therefore, in our professional opinion, the potential for a landslide is not a significant concern for this project.

7. CONCLUSIONS AND RECOMMENDATIONS

7.1 General

- 7.1.1 We did not encounter soil or geologic conditions during our exploration that would preclude the proposed development, provided the recommendations presented herein are followed and implemented during the design and construction of the planned development. We will provide supplemental recommendations if we observe variable or undesirable conditions during construction, or if the proposed construction will differ from that anticipated herein.
- 7.1.2 The site may be subject to geologic hazards, including moderate to strong seismic shaking, liquefaction, seismically induced settlement and consolidation settlement. We included recommendations for the mitigation of these geologic hazards herein.
- 7.1.3 Our field investigation and the previous investigation performed by CWE indicates the site is underlain by undocumented fill and/or topsoil overlying alluvium, Old Paralac Deposits and the San Diego Formation. The undocumented fill, topsoil and upper portion of the alluvium is not considered suitable for the support of additional fill and/or settlement-sensitive building structures in its current state and will require remedial grading. The Old Paralac Deposits and Santiago Formation are considered suitable for the support of compacted fill and settlement-sensitive structures.
- 7.1.4 We encountered groundwater at depths of 13.5 and 16 feet in current Borings B-1 and B-2 (elevations of about 6.5 and 4 feet MSL). In addition, CWE reported that groundwater was encountered at depths ranging from 8 to 13 feet (elevations of about 7 to 12 feet MSL). We also encountered saturated alluvial soils at depths of approximately 5 feet in current Borings B-1 and B-2 (elevation of about 15 feet MSL). Groundwater and saturated soils will likely have a significant influence on construction of deep utilities and subterranean structures (if proposed) and during remedial grading. Dewatering will likely be required for excavations below the fluctuating groundwater elevation and preliminary recommendations are provided herein. The project should be designed with a groundwater elevation of 10 feet MSL, and saturated conditions should be estimated at an elevation of approximately 15 feet MSL.
- 7.1.5 Excavation of the undocumented fill, topsoil and alluvium should generally be possible with moderate to heavy effort using conventional, heavy-duty equipment during grading and trenching operations. We do not expect Old Paralac Deposits or the San Diego Formation will be encountered during the grading operations.

- 7.1.6 The upper portion of the alluvium is considered compressible and has a potential for liquefaction and seismically induced settlement. Removal and recompaction of the upper portions of these materials will be required in areas intended to support structural improvements. Because of the presence of groundwater, complete removal of the alluvium will likely not be possible. Remedial grading recommendations are provided hereinafter for areas where groundwater is encountered. We expect up to approximately 10 to 15 feet of compressible and liquefaction prone alluvium will be left in place during grading operations due to groundwater considerations. We expect the alluvium left in place and new compacted fills will settle up to 1¾ inches. We estimate the differential settlement would be 1 inch in 40 feet. We expect the settlement would occur within roughly 90 to 120 days after fill placement.
- 7.1.7 The proposed structures can be founded on mat foundations or post-tensioned shallow foundations designed to resist total and differential settlement. Recommendations for foundation systems are presented herein.
- 7.1.8 Proper drainage should be maintained in order to preserve the engineering properties of the fill in both the building pads and slope areas. Recommendations for site drainage are provided herein.
- 7.1.9 We performed a storm water management investigation to help evaluate the potential for infiltration on the property. Based on the results of our field infiltration testing and laboratory testing, we opine full or partial infiltration on the property should be considered infeasible as discussed in Appendix E.
- 7.1.10 Based on our review of the project plans, we opine the planned development can be constructed in accordance with our recommendations provided herein. We do not expect the planned development will destabilize or result in settlement of adjacent properties.
- 7.1.11 Canyon subdrains will not be required on this project.

7.2 Soil Characteristics

- 7.2.1 The soil encountered in the field investigation is considered to be “expansive” (expansion index [EI] of greater than 20) as defined by 2016 California Building Code (CBC) Section 1803.5.3. Table 7.2 presents soil classifications based on the expansion index. We expect a majority of the soil encountered possess a “very low” to “low” expansion potential (EI of 50 or less) in accordance with ASTM D 4829.

**TABLE 7.2
EXPANSION CLASSIFICATION BASED ON EXPANSION INDEX**

Expansion Index (EI)	ASTM D 4829 Expansion Classification	2016 CBC Expansion Classification
0 – 20	Very Low	Non-Expansive
21 – 50	Low	Expansive
51 – 90	Medium	
91 – 130	High	
Greater Than 130	Very High	

7.2.2 We performed laboratory tests on samples of the site materials to evaluate the percentage of water-soluble sulfate content. Appendix B presents results of the laboratory water-soluble sulfate content tests. The test results indicate the on-site materials at the locations tested possess “S0” sulfate exposure to concrete structures as defined by 2016 CBC Section 1904 and ACI 318-14 Chapter 19. The presence of water-soluble sulfates is not a visually discernible characteristic; therefore, other soil samples from the site could yield different concentrations. Additionally, over time landscaping activities (i.e., addition of fertilizers and other soil nutrients) may affect the concentration.

7.2.3 Geocon Incorporated does not practice in the field of corrosion engineering. Therefore, further evaluation by a corrosion engineer may be performed if improvements susceptible to corrosion are planned.

7.3 Grading

7.3.1 Grading should be performed in accordance with the recommendations provided in this report, the Recommended Grading Specifications contained in Appendix F and the City of San Diego Grading Ordinance. Geocon Incorporated should observe the grading operations on a full-time basis and provide testing during the fill placement.

7.3.2 Prior to commencing grading, a preconstruction conference should be held at the site with the county inspector, developer, grading and underground contractors, civil engineer, and geotechnical engineer in attendance. Special soil handling and/or the grading plans can be discussed at that time.

7.3.3 Site preparation should begin with the removal of deleterious material, debris, and vegetation. The depth of vegetation removal should be such that material exposed in cut areas or soil to be used as fill is relatively free of organic matter. Material generated during

stripping and/or site demolition should be exported from the site. Asphalt and concrete should not be mixed with the fill soil unless approved by the Geotechnical Engineer.

- 7.3.4 Abandoned foundations and buried utilities (if encountered) should be removed and the resultant depressions and/or trenches should be backfilled with properly compacted material as part of the remedial grading.
- 7.3.5 The upper 2 to 3 feet of surficial materials (undocumented fill, topsoil and alluvium) should be removed and replaced with compacted fill within the limits of grading. Deeper removals may be required if soft materials are encountered. Geocon Incorporated should be on-site during the removal process/grading operations to evaluate removal depths.
- 7.3.6 The bottom of swimming pool/spa areas, if proposed, should not be supported by different types of materials. A layer of common bearing material is needed to provide uniform support for the pool/spa. The pool/spa excavation should be overexcavated to a depth of approximately 2 to 3 feet above groundwater (elevation of approximately 9 feet above MSL) or 3 feet below the bottom of the swimming pool/spa, whichever is shallower, and recompacted up to rough grade. We expect stabilization with rock and/or reinforcement will be required for the pool grading operations.
- 7.3.7 Some areas of overly wet and saturated soil will be encountered during removals due to the variable groundwater elevation and existing saturated soil. The saturated soil would require considerable drying and mixing effort prior to placement as compacted fill. Special equipment such as swamp cats, excavators and top loading operations may be required to excavate wet alluvium. Stabilization of the soil would include scarifying and air-drying, removing, mixing with drier soils, and replacement with drier soil, use of stabilization fabric (e.g. Tensar TX7, Mirafi HP370 or other approved fabric), or chemical treating (i.e. cement treatment).
- 7.3.8 The contractor should be careful during the remedial grading operations to avoid a “pumping” condition at the base of the removals. Where recompaction of the excavated bottom will result in a “pumping” condition, the bottom of the excavation should be tracked with low ground pressure earthmoving equipment prior to placing fill to achieve a suitable bottom. If needed to improve the stability of the excavation bottoms, reinforcing fabric or 2- to 3-inch crushed rock can be placed prior to placement of compacted fill.
- 7.3.9 The site should then be brought to final subgrade elevations with structural fill compacted in layers. In general, soil native to the site is suitable for use as fill if relatively free from vegetation, debris and other deleterious material. Layers of fill should be no thicker than

will allow for adequate bonding and compaction. Fill, including backfill and scarified ground surfaces, should be compacted to a dry density of at least 90 percent of the laboratory maximum dry density near to slightly above optimum moisture content, as determined in accordance with ASTM D 1557. Fill materials placed below optimum moisture content may require additional moisture conditioning prior to placing additional fill.

- 7.3.10 Finish elevations across the majority of the site that will have surficial soils left in place will experience significant settlements in the first 90 days. Therefore, fine pad grading should be performed after the 90-day primary consolidation period has completed such that finish grade elevations are maintained and construction of the planned structures can begin.

7.4 Temporary Excavations

- 7.4.1 The recommendations included herein are provided for stable excavations. It is the responsibility of the contractor to provide a safe excavation during the construction of the proposed project.

- 7.4.2 Temporary slopes should be made in conformance with OSHA requirements and as directed by the assigned competent person in the field (contractor). Stable undocumented fill, topsoil and alluvium can be considered a Type C soil, and properly compacted fill should be considered a Type B soil (Type C if seepage is encountered) in accordance with OSHA requirements. In general, special shoring requirements will not be necessary if temporary excavations will be less than 4 feet in height. Temporary excavations greater than 4 feet in height, however, should be sloped back at an appropriate inclination. These excavations should not be allowed to become saturated or to dry out. Surcharge loads should not be permitted to a distance equal to the height of the excavation from the top of the excavation. The top of the excavation should be a minimum of 15 feet from the edge of existing improvements. Excavations steeper than those recommended or closer than 15 feet from an existing surface improvement should be shored in accordance with applicable OSHA codes and regulations.

7.5 Seismic Design Criteria – California Building Code

- 7.5.1 We used the Structural Engineers Association of California (SEAOC) and Office of Statewide Health Planning and Development (OSHPD) web application *Seismic Design Maps* (<https://seismicmaps.org/>) to evaluate site-specific seismic design parameters in accordance with the 2016 CBC/ASCE 7-10. Table 7.7.1 summarizes site-specific design criteria obtained from the 2016 California Building Code (CBC; Based on the 2015 International Building Code [IBC] and ASCE 7-10), Chapter 16 Structural Design, Section

1613 Earthquake Loads. The short spectral response uses a period of 0.2 second. The Site Class can be designated as a Site Class F due to the potential of liquefaction in the upper 15 feet; however, the building structure and improvements can be designed using a Site Class E because we expect the planned structures will possess a structural period of less than 0.5 seconds. A site specific seismic analysis will be required if the structural periods of the planned structures are greater than 0.5 seconds. We evaluated the Site Class based on the discussion in Section 1613.3.2 of the 2016 CBC and Table 20.3-1 of ASCE 7-10. The Site Class designation could change based on the results of additional field explorations at the site. The values presented in Table 7.7.1 are for the risk-targeted maximum considered earthquake (MCE_R).

**TABLE 7.7.1
2016 CBC SEISMIC DESIGN PARAMETERS**

Parameter	Value	2016 CBC Reference
Site Class	E	Section 1613.3.2
MCE _R Ground Motion Spectral Response Acceleration – Class B (short), S _S	1.015g	Figure 1613.3.1(1)
MCE _R Ground Motion Spectral Response Acceleration – Class B (1 sec), S ₁	0.383g	Figure 1613.3.1(2)
Site Coefficient, F _A	0.900	Table 1613.3.3(1)
Site Coefficient, F _V	2.467	Table 1613.3.3(2)
Site Class Modified MCE _R Spectral Response Acceleration (short), S _{MS}	0.913g	Section 1613.3.3 (Eqn 16-37)
Site Class Modified MCE _R Spectral Response Acceleration (1 sec), S _{M1}	0.946g	Section 1613.3.3 (Eqn 16-38)
5% Damped Design Spectral Response Acceleration (short), S _{DS}	0.609g	Section 1613.3.4 (Eqn 16-39)
5% Damped Design Spectral Response Acceleration (1 sec), S _{D1}	0.630g	Section 1613.3.4 (Eqn 16-40)

7.5.2 Table 7.7.2 presents additional seismic design parameters for projects located in Seismic Design Categories of D through F in accordance with ASCE 7-10 for the mapped maximum considered geometric mean (MCE_G).

**TABLE 7.7.2
2016 CBC SITE ACCELERATION DESIGN PARAMETERS**

Parameter	Value	ASCE 7-10 Reference
Mapped MCE_G Peak Ground Acceleration, PGA	0.430g	Figure 22-7
Site Coefficient, F_{PGA}	0.900	Table 11.8-1
Site Class Modified MCE_G Peak Ground Acceleration, PGA_M	0.387g	Section 11.8.3 (Eqn 11.8-1)

7.5.3 Conformance to the criteria in Tables 7.7.1 and 7.7.2 for seismic design does not constitute any kind of guarantee or assurance that significant structural damage or ground failure will not occur if a large earthquake occurs. The primary goal of seismic design is to protect life, not to avoid all damage, since such design may be economically prohibitive.

7.6 Post-Tensioned Foundation Recommendations

7.6.1 The proposed buildings can be supported on a post-tensioned concrete slab and foundation systems founded in properly compacted fill subsequent to approximately 90 to 120 days after fill placement, or subsequent to soil mitigation. The post-tensioned systems should be designed by a structural engineer experienced in post-tensioned slab design and design criteria of the Post-Tensioning Institute (PTI) DC 10.5-12 *Standard Requirements for Design and Analysis of Shallow Post-Tensioned Concrete Foundations on Expansive Soils* or *WRI/CRSI Design of Slab-on-Ground Foundations*, as required by the 2016 California Building Code (CBC Section 1808.6.2). Although this procedure was developed for expansive soil conditions, it can also be used to reduce the potential for foundation distress due to differential fill settlement. The post-tensioned design should incorporate the geotechnical parameters presented in Table 7.9.1. The parameters presented in Table 7.9.1 are based on the guidelines presented in the PTI DC 10.5 design manual.

**TABLE 7.9.1
POST-TENSIONED FOUNDATION SYSTEM DESIGN PARAMETERS**

Post-Tensioning Institute (PTI) DC10.5 Design Parameters	Value
Thornthwaite Index	-20
Equilibrium Suction	3.9
Edge Lift Moisture Variation Distance, e_M (feet)	5.3
Edge Lift, y_M (inches)	0.61
Center Lift Moisture Variation Distance, e_M (feet)	9.0
Center Lift, y_M (inches)	0.30

- 7.6.2 The parameters presented in Table 7.9.1 are based on soil characteristics only (EI of 50 or less). We can provide final post-tensioned foundation system design parameters for each building or lot after finish pad grades have been achieved and we perform laboratory testing of the subgrade soil.
- 7.6.3 The foundations for the post-tensioned slabs should be embedded in accordance with the recommendations of the structural engineer. If a post-tensioned mat foundation system is planned, the slab should possess a thickened edge with a minimum width of 12 inches and extend below the clean sand or crushed rock layer.
- 7.6.4 If the structural engineer proposes a post-tensioned foundation design method other than PTI, DC 10.5:
- The deflection criteria presented in Table 7.9.1 are still applicable.
 - Interior stiffener beams should be used for Foundation Categories II and III.
 - The width of the perimeter foundations should be at least 12 inches.
 - The perimeter footing embedment depths should be at least 12 inches, 18 inches and 24 inches for foundation categories I, II, and III, respectively. The embedment depths should be measured from the lowest adjacent pad grade.
- 7.6.5 Foundation systems for the buildings that possess a foundation Category I and a “very low” expansion potential (expansion index of 20 or less) can be designed using the method described in Section 1808 of the 2016 CBC. If post-tensioned foundations are planned, an alternative, commonly accepted design method (other than PTI) can be used. However, the post-tensioned foundation system should be designed with a total and differential deflection of 1 inch. Geocon Incorporated should be contacted to review the plans and provide additional information, if necessary.
- 7.6.6 If an alternate design method is contemplated, Geocon Incorporated should be contacted to evaluate if additional expansion index testing should be performed to identify the lots that possess a “very low” expansion potential (expansion index of 20 or less).
- 7.6.7 Our experience indicates post-tensioned slabs may be susceptible to excessive edge lift from tensioning, regardless of the underlying soil conditions. Placing reinforcing steel at the bottom of the perimeter footings and the interior stiffener beams may mitigate this potential. The structural engineer should design the foundation system to reduce the potential of edge lift occurring for the proposed structures.
- 7.6.8 During the construction of the post-tension foundation system, the concrete should be placed monolithically. Under no circumstances should cold joints form between the

footings/grade beams and the slab during the construction of the post-tension foundation system unless designed by the structural engineer.

- 7.6.9 The foundations may be designed for an allowable soil bearing pressure of 2,000 pounds per square foot (psf) (dead plus live load). This bearing pressure may be increased by one-third for transient loads due to wind or seismic forces. The estimated maximum total and differential settlement for the planned structures due to foundation loads is ½ inch.
- 7.6.10 We should observe the foundation excavations prior to the placement of reinforcing steel to check that the exposed soil conditions are similar to those expected and that they have been extended to the appropriate bearing strata. If unexpected soil conditions are encountered, foundation modifications may be required.

7.7 Mat Foundations

- 7.7.1 The planned buildings can be supported on a mat foundation. A mat foundation consists of a thick, rigid concrete mat that allows the entire footprint of the structure to carry building loads. In addition, the mat can tolerate significantly greater differential movements such as those associated with expansive soils or differential settlement.
- 7.7.2 The allowable bearing capacity can be taken as 500 pounds per square foot (psf). The modulus of subgrade reaction for design of the mat can range from 75 to 100 pounds per cubic inch (pci) for the compacted fill. These values should be modified as necessary using standard equations for mat size as required by the structural engineer. We expect total and differential settlements to be 1½ and ¾ inches in 40 feet, respectively, under static loads for these buildings.
- 7.7.3 The modulus of subgrade reaction can range from 100 to 150 pounds per cubic inch (pci) for the proposed compacted fill. These values should be modified as necessary using standard equations for mat size as required by the structural engineer. This value is a unit value for use with a 1-foot square footing. The modulus should be reduced in accordance with the following equation when used with larger foundations:

$$K_R = K \left[\frac{B+1}{2B} \right]^2$$

where: K_R = reduced subgrade modulus

K = unit subgrade modulus

B = foundation width (in feet)

- 7.7.4 A mat foundation system will allow the structure to settle with the ground and should have sufficient rigidity to allow the structure to move as a single unit. Re-leveling of the mat foundation could be necessary with the use of mud jacking, compaction grouting or other similar techniques if excessive differential settlement occurs.
- 7.7.5 Slabs that may receive moisture-sensitive floor coverings or may be used to store moisture-sensitive materials should be underlain by a vapor retarder. The vapor retarder design should be consistent with the guidelines presented in the American Concrete Institute's (ACI) *Guide for Concrete Slabs that Receive Moisture-Sensitive Flooring Materials* (ACI 302.2R-06). In addition, the membrane should be installed in accordance with manufacturer's recommendations and ASTM requirements and installed in a manner that prevents puncture. The vapor retarder used should be specified by the project architect or developer based on the type of floor covering that will be installed and if the structure will possess a humidity controlled environment.
- 7.7.6 The bedding sand thickness should be determined by the project foundation engineer, architect, and/or developer. However, we should be contacted to provide recommendations if the bedding sand is thicker than 6 inches. The foundation design engineer should provide appropriate concrete mix design criteria and curing measures to assure proper curing of the slab by reducing the potential for rapid moisture loss and subsequent cracking and/or slab curl. We suggest that the foundation design engineer present the concrete mix design and proper curing methods on the foundation plans. It is critical that the foundation contractor understands and follows the recommendations presented on the foundation plans.

7.8 Settlement Considerations

- 7.8.1 The undocumented fill, topsoil and upper portion of the alluvial deposits are compressible when subjected to increased vertical stress (placement of fill soils and building loads) and will require special foundation design, grading and construction phasing measures to reduce the potential for adverse settlement. We expect up to approximately 10 to 15 feet of compressible alluvium will be left in place subsequent to grading operations. We recommend that construction of buildings and improvements in areas where compressible alluvium is left in place be delayed until periodic settlement monitoring indicates that primary consolidation of the underlying saturated alluvial deposits is essentially complete. This will require finish grade elevations be achieved to fully load the compressible surficial soils left in place and create the required settlements. Based on the current plans, we expect fills of approximately 5 to 7 feet will be required to achieve grade within the building areas.
- 7.8.2 Estimates of potential settlement are generally based on the thickness of compressible alluvium left-in-place, the thickness of additional fill placed to achieve finish grade, and the

compressibility characteristics of the alluvial materials. The rate of settlement is generally based on the compressibility characteristics of the materials, and the drainage path thickness to allow for pore water pressure dissipation.

- 7.8.3 Laboratory test results, engineering analyses, and our experience indicate that up to 1¾ inches of total consolidation settlement could occur below the planned buildings after finish grades have been established. This is assuming the upper 3 feet of surficial soils are removed and replaced with properly compacted fill soils and up to approximately 15 feet of undocumented fill, topsoil and compressible alluvium will be left in-place.
- 7.8.4 The magnitude of the total settlement and the associated time rate of consolidation will not be uniform throughout the site due to the variable thickness and compressibility characteristics of the underlying compressible materials and the variable thickness of additional fills to achieve finish grade.
- 7.8.5 As discussed, we expect the consolidation settlement due to the placement of the planned new fill to take 90 to 120 days. This time could be reduced through the use of surcharge fill loading or the installation of wick drains, if possible. The use of surcharge fill may be advantageous for the proposed buildings supported on shallow foundations, while surcharging the portions of the site planned for non-structural improvements may not be necessary. Surcharge fill is additional fill material placed on above finish grade (in building pad areas) to decrease the settlement time for consolidation prior to construction of improvements. The use of surcharge fill requires double handling of the surcharge soil and is generally 5 to 10 feet thick plus the thickness of the proposed fill extending slightly outside the building footprint. Surcharging does not generally provide mitigation of liquefaction potential but does reduce the potential for surface manifestation.
- 7.8.6 Surficial soil with a potential for settlement will be left in-place beneath the planned improvements. Therefore, settlement monitoring using plate and surface settlement monuments will be required as discussed herein to evaluate when the settlement has stabilized and further improvements may proceed. We will evaluate the number, locations and type of settlement monuments during grading operations based on the final limits or removals performed.
- 7.8.7 Settlement plates should be installed within the bottom of the over-excavated areas where compressible surficial materials will be left in place. At the designated locations, a 4-foot-square, ½-inch-thick steel plate should be placed at 2 feet below the bottom elevation and leveled with a layer of gravel. After surveying the plate (horizontal and vertical), the plate should be covered with 2 feet of gravel and at least 2 feet of fill soil placed before heavy

equipment is allowed to run over the plate location. The steel plate, gravel, and equipment for installation should be provided by the grading contractor. Figure 4 presents a typical plate settlement monument detail.

7.8.8 Subsequent to placement of planned fill, Geocon will drill and “tag” the steel plate. The civil engineer will then survey the plate to determine settlement which occurred during grading. At that time a surface settlement monument will be installed at finished grade at the location of the plate monument to monitor settlement movement of the underlying fill and surficial materials thereafter. Figure 5 presents a typical surface settlement monument detail.

7.8.9 The project surveyor should record the movements of the plate and surface settlement monuments every two weeks until data indicates that the rate of primary fill and left in place surficial material soil compression is essentially non-detrimental (settlement monument data with a relatively level plateau) to proposed improvements. When we receive two to three data points of settlement values that show a relatively level settlement slope on the graphs, the construction of the buildings and surrounding utility improvements can begin. Based on our experience, we expect the monuments will require monitoring for roughly 90 to 120 days. At that time, we expect development can begin for settlement-sensitive underground utilities with less than one percent gradient along with construction of the buildings. Underground utilities with a gradient of one percent or greater will not have a waiting period and can start construction after finish grade is achieved. Underground wet utilities should not be installed until finish grade is achieved, as excessive settlements will occur with the placement of compacted fills. We will evaluate the location of the settlement monuments subsequent to the grading operations.

7.8.10 The planned buildings should be designed with the appropriate settlement. Table 7.10.1 provides a summary of the estimated static and seismic settlements for the project.

**TABLE 7.10.2
SUMMARY OF ESTIMATED SETTLEMENT DUE TO STATIC AND SEISMIC LOADING**

Building Foundation Type	Estimated Total Seismic Settlement (inches)	Estimated Total Static Settlement Due to Placement of Planned Fill (inches)	Estimated Static Settlement Due to Building Loads (inches)
Post-Tension Foundation	1	1¾	½
Mat Foundation	1	1¾	½

7.9 Mitigation of Liquefaction and Settlement

- 7.9.1 Based on our analysis discussed herein, we estimate a potential for up to 1 inch of total liquefaction settlement using CPT data.. In addition, we estimate up to approximately 1¾ inches of static settlement can occur within the existing compressible soils that will be left in-place subsequent to grading. Mitigation of liquefiable and compressible soil may be necessary for settlement-sensitive structures. Several alternatives are generally available for mitigation including deep foundations, ground improvements and structural mitigation.
- 7.9.2 The proposed buildings can be supported on a mat foundation or post-tensioned foundation provided the estimated seismic and static settlements due to liquefaction discussed herein are within the settlement tolerance for the foundation type selected. The recommendations for a mat foundation system and shallow post-tensioned foundation are presented herein.
- 7.9.3 Ground improvement techniques mitigate liquefaction by densifying existing soil through the use of stone columns, deep dynamic compaction, compaction grouting, soil mixing or other densification method. We do not recommend that deep dynamic compaction be used for densification due to the proximity of adjacent facilities and the limited influence depth of the method in fine grained materials. In addition, compaction grouting may not be economical due to the expected depth and the area of the required improvements.
- 7.9.4 Ground improvement using stone columns may be used from a geotechnical engineering standpoint that consist of densifying existing soils with a vibrating probe and placing crushed rock.. However, the amount of fine-grained material may limit the effectiveness of the stone columns. The pattern and depth of ground improvements may vary depending on the purposes of mitigation and stratigraphic conditions but the depths of improvement would be approximately 30 feet with spacing of approximately 8 to 10 feet and a diameter of 30 inches. The specialty contractor should determine the final spacing and diameter to obtain the necessary densification as outlined below. Following stone column construction, CPTs should be performed to check if the soil mitigation is successful. The post-production CPTs should show a maximum of 1 inch of total (static and seismic) settlements using generally accepted calculation parameters, unless noted otherwise by the structural engineer
- 7.9.5 Soil/cement mixing is a soil improvement technique of mechanically blending a cementitious binder into existing unsuitable soils to create load bearing columns. As the soil mixing tool is advanced into the ground, cement-based slurry is pumped through the hollow stem of the shaft and injected into the soil through jets located on the backside of the leading rotating mixing blades. The mixing blades on the tool mix the soil with the slurry. Injection and mixing will continue to design depth. When design depth is reached, the mixing tool is withdrawn, leaving behind stabilized soil mix columns. Soil mix piles are typically designed

and installed by a specialty geotechnical contractor. Soil mix piles should derive support in the competent Old Paralac Deposit materials found at or below an approximate depth of 15 to 20 feet below the existing ground surface.

- 7.9.6 Following soil modification construction, the upper 3 to 4 feet of the upper soils will be disturbed and should be removed and recompacted as discussed herein.
- 7.9.7 The mitigation should extend at least 15 feet laterally outside the edge of planned building structures, where practical. Mitigation within non-structure areas will be limited to that improvement obtained by nearby remediation within structure areas. We can provide additional recommendations for the ground improvement techniques when the improvement has been selected.
- 7.9.8 The mitigation should extend at least 15 feet laterally outside the edge of planned building structures, where practical. Mitigation within non-structure areas will be limited to that improvement obtained by nearby remediation within structure areas. We can provide additional recommendations or the ground improvement techniques when the improvement has been selected.

7.10 Exterior Concrete Flatwork

- 7.10.1 Exterior concrete flatwork not subject to vehicular traffic should be constructed in accordance with the recommendations herein assuming the subgrade materials possess an expansion index of 90 or less. Slab panels should be a minimum of 4 inches thick and when in excess of 8 feet square should be reinforced with 6x6-W2.9/W2.9 (6x6-6/6) welded wire mesh or No. 3 reinforcing bars spaced 18 inches center-to-center in both directions to reduce the potential for cracking. In addition, concrete flatwork should be provided with crack control joints to reduce and/or control shrinkage cracking. Crack control spacing should be determined by the project structural engineer based upon the slab thickness and intended usage. Criteria of the American Concrete Institute (ACI) should be taken into consideration when establishing crack control spacing. Subgrade soil for exterior slabs not subjected to vehicle loads should be compacted in accordance with criteria presented in the grading section prior to concrete placement. Subgrade soil should be properly compacted and the moisture content of subgrade soil should be verified prior to placing concrete. Base materials will not be required below concrete improvements.
- 7.10.2 Even with the incorporation of the recommendations of this report, the exterior concrete flatwork has a potential to experience some uplift due to expansive soil beneath grade. The steel reinforcement should overlap continuously in flatwork to reduce the potential for vertical offsets within flatwork. Additionally, flatwork should be structurally connected to

the curbs, where possible, to reduce the potential for offsets between the curbs and the flatwork.

- 7.10.3 Where exterior flatwork abuts the structure at entrant or exit points, the exterior slab should be dowelled into the structure's foundation stemwall. This recommendation is intended to reduce the potential for differential elevations that could result from differential settlement or minor heave of the flatwork. Dowelling details should be designed by the project structural engineer.
- 7.10.4 The recommendations presented herein are intended to reduce the potential for cracking of exterior slabs as a result of differential movement. However, even with the incorporation of the recommendations presented herein, slabs-on-grade will still crack. The occurrence of concrete shrinkage cracks is independent of the soil supporting characteristics. Their occurrence may be reduced and/or controlled by limiting the slump of the concrete, the use of crack control joints and proper concrete placement and curing. Crack control joints should be spaced at intervals no greater than 12 feet. Literature provided by the Portland Concrete Association (PCA) and American Concrete Institute (ACI) present recommendations for proper concrete mix, construction, and curing practices, and should be incorporated into project construction.
- 7.10.5 The subgrade soil for flatwork not subjected to vehicle loads should be compacted to a dry density of at least 90 percent of the laboratory maximum dry density near to slightly above optimum moisture content in accordance with ASTM D 1557. Flatwork that will experience vehicular loading (e.g. driveways) should be compacted to a dry density of at least 95 percent of the laboratory maximum dry density near to slightly above optimum moisture content. We should check the subgrade soil prior to concrete and steel placement.

7.11 Retaining Walls

- 7.11.1 Retaining walls not restrained at the top and having a level backfill surface should be designed for an active soil pressure equivalent to the pressure exerted by a fluid density of 35 pounds per cubic foot (pcf). Where the backfill will be inclined at 2:1 (horizontal:vertical), we recommend an active soil pressure of 50 pcf. Soil with an expansion index (EI) of greater than 50 should not be used as backfill material behind retaining walls.
- 7.11.2 Retaining walls should be designed to ensure stability against overturning sliding, and excessive foundation pressure. Where a keyway is extended below the wall base with the intent to engage passive pressure and enhance sliding stability, it is not necessary to consider active pressure on the keyway.

- 7.11.3 Unrestrained walls are those that are allowed to rotate more than $0.001H$ (where H equals the height of the retaining portion of the wall) at the top of the wall. Where walls are restrained from movement at the top (at-rest condition), an additional uniform pressure of $7H$ psf should be added to the active soil pressure for walls 8 feet or less. For walls greater than 8 feet tall, an additional uniform pressure of $13H$ psf should be applied to the wall starting at 8 feet from the top of the wall to the base of the wall. For retaining walls subject to vehicular loads within a horizontal distance equal to two-thirds the wall height, a surcharge equivalent to 2 feet of fill soil should be added.
- 7.11.4 The structural engineer should determine the Seismic Design Category for the project in accordance with Section 1613.3.5 of the 2016 CBC or Section 11.6 of ASCE 7-10. For structures assigned to Seismic Design Category of D, E, or F, retaining walls that support more than 6 feet of backfill should be designed with seismic lateral pressure in accordance with Section 1803.5.12 of the 2016 CBC. The seismic load is dependent on the retained height where H is the height of the wall, in feet, and the calculated loads result in pounds per square foot (psf) exerted at the base of the wall and zero at the top of the wall. A seismic load of $13H$ should be used for design. We used the peak ground acceleration adjusted for Site Class effects, PGA_M , of $0.39g$ calculated from ASCE 7-10 Section 11.8.3 and applied a pseudo-static coefficient of 0.3. Figure 6 presents a retaining wall loading diagram.
- 7.11.5 The retaining walls may be designed using either the active and restrained (at-rest) loading condition or the active and seismic loading condition as suggested by the structural engineer. Typically, it appears the design of the restrained condition for retaining wall loading may be adequate for the seismic design of the retaining walls. However, the active earth pressure combined with the seismic design load should be reviewed and also considered in the design of the retaining walls.
- 7.11.6 In general, wall foundations having a minimum depth and width of 1 foot may be designed for an allowable soil bearing pressure of 2,000 psf. The allowable soil bearing pressure may be increased by an additional 300 psf for each additional foot of depth and width, to a maximum allowable bearing capacity of 3,000 psf. The proximity of the foundation to the top of a slope steeper than 3:1 could impact the allowable soil bearing pressure. Therefore, retaining wall foundations should be deepened such that the bottom outside edge of the footing is at least 7 feet horizontally from the face of the slope.
- 7.11.7 Drainage openings through the base of the wall (weep holes) should not be used where the seepage could be a nuisance or otherwise adversely affect the property adjacent to the base of the wall. The recommendations herein assume a properly compacted granular (EI of 50 or less) free-draining backfill material with no hydrostatic forces or imposed surcharge load.

Figure 7 presents a typical retaining wall drainage detail. If conditions different than those described are expected, or if specific drainage details are desired, Geocon Incorporated should be contacted for additional recommendations.

- 7.11.8 The recommendations presented herein are generally applicable to the design of rigid concrete or masonry retaining walls. In the event that other types of walls (such as mechanically stabilized earth [MSE] walls, soil nail walls, or soldier pile walls) are planned, Geocon Incorporated should be consulted for additional recommendations.
- 7.11.9 Unrestrained walls will move laterally when backfilled and loading is applied. The amount of lateral deflection is dependent on the wall height, the type of soil used for backfill, and loads acting on the wall. The retaining walls and improvements above the retaining walls should be designed to incorporate an appropriate amount of lateral deflection as determined by the structural engineer.
- 7.11.10 Soil contemplated for use as retaining wall backfill, including import materials, should be identified in the field prior to backfill. At that time, Geocon Incorporated should obtain samples for laboratory testing to evaluate its suitability. Modified lateral earth pressures may be necessary if the backfill soil does not meet the required expansion index or shear strength. City or regional standard wall designs, if used, are based on a specific active lateral earth pressure and/or soil friction angle. In this regard, on-site soil to be used as backfill may or may not meet the values for standard wall designs. Geocon Incorporated should be consulted to assess the suitability of the on-site soil for use as wall backfill if standard wall designs will be used.

7.12 Lateral Loading

- 7.12.1 To resist lateral loads, a passive pressure exerted by an equivalent fluid density of 350 pounds per cubic foot (pcf) should be used for the design of footings or shear keys. The allowable passive pressure assumes a horizontal surface extending at least 5 feet, or three times the surface generating the passive pressure, whichever is greater. The upper 12 inches of material in areas not protected by floor slabs or pavement should not be included in design for passive resistance.
- 7.12.2 If friction is to be used to resist lateral loads, an allowable coefficient of friction between soil and concrete of 0.35 should be used for design. The friction coefficient may be reduced depending on the vapor barrier or waterproofing material used for construction in accordance with the manufacturer's recommendations.

- 7.12.3 The passive and frictional resistant loads can be combined for design purposes. The lateral passive pressures may be increased by one-third when considering transient loads due to wind or seismic forces.

7.13 Pool/Spa Recommendations

- 7.13.1 If a swimming pool/spa is proposed, it should be reinforced and designed by a structural engineer. The existing soil possesses a “very low” to “low” expansion potential (expansion index [EI] of 50 or less). The corresponding lateral pressures used for the design should be equivalent to a fluid pressure of at least 40 pcf, if drained. The swimming pool/spa also should be designed for possible surcharge loading if such nearby loading is a lateral distance from the top of the pool equal to the depth of the pool and hydrostatic loading if the walls are not drained. The walls should be designed with an equivalent to a fluid pressure of at least 100 pcf if not drained.
- 7.13.2 The bottom of the swimming pool/spa should not be supported by different types of materials. A layer of common bearing material is needed to provide uniform support for the pool/spa. The pool/spa excavation should be overexcavated to a depth of approximately 2 to 3 feet above groundwater (elevation of approximately 9 feet above MSL) or 4 feet below the bottom of the swimming pool/spa, whichever is shallower, and recompact up to rough grade. We expect stabilization with rock and/or reinforcement will be required for the pool grading operations. The bottom of the excavation should be scarified, moisture conditioned as necessary, and compacted in accordance with the “Grading” section of this report.
- 7.13.3 Surface drainage around the pool/spa should be designed to prevent water from ponding and seeping into the ground. Surface water should be collected and conducted through non-erosive devices to the street, storm drain or other approved water course or disposal area. Leakage from the proposed pool/spa could create an artificial groundwater condition that will likely create instability problems. Therefore, all plumbing and the pool/spa should be leak free.
- 7.13.4 The deck for the swimming pool/spa should be cast separately of the swimming pool/spa, and water stops should be provided between the bond beam and the deck. Jointing for concrete flatwork should be provided in accordance with the recommendations of the American Concrete Institute. The joints should be sealed with an approved flexible sealant to reduce the potential for introduction of surface water into the underlying soil.
- 7.13.5 The flatwork can be underlain by a minimum of 12 inches of clean sand compacted to a dry density of at least 90 percent of the laboratory maximum dry density near to slightly above

optimum moisture content. This would help with reducing the potential for expansion of the underlying soil and lifting of the concrete flatwork.

- 7.13.6 Consideration should be given to installing a subdrain system for the pool area. The subgrade surface should be graded to slope a minimum of 1 percent away from the pool. An impermeable liner (e.g. High-density polyethylene, HDPE, with a thickness of about 30 mil or equivalent PVC liner) could be placed over the subgrade soil. The liner, if installed, should overlap by at least 12 inches and sealed in accordance with manufacturer's recommendations.
- 7.13.7 To mitigate the potential for moisture infiltration into the subgrade soils beneath the pool deck, we recommend the construction of a deepened footing along the outside edge of the pool deck flatwork.
- 7.13.8 A subdrain consisting of 4-inch diameter perforated PVC pipe should be installed inside the deepened footing and sloped to drain into an approved outlet. The pipe should be surrounded by $\frac{3}{4}$ inch open-graded gravel and wrapped with filter fabric.
- 7.13.9 Our recommendations will not eliminate the potential for pavement and hardscape distress due to expansive soil. Concrete pavements are lightweight when compared to swell pressures exerted by highly expansive soil. Therefore, movement of the concrete could still occur if the clayey subgrade soils fluctuate in moisture content due to desiccation or water infiltration.

7.14 Preliminary Pavement Recommendations

- 7.14.1 We calculated the flexible pavement sections in general conformance with the *Caltrans Method of Flexible Pavement Design* (Highway Design Manual, Section 608.4) using an estimated Traffic Index (TI) of 5.0, 5.5, 6.0, and 7.0 for parking stalls, driveways, medium truck traffic areas, and heavy truck traffic areas, respectively. The project civil engineer and owner should review the pavement designations to determine appropriate locations for pavement thickness. The final pavement sections for the parking lot should be based on the R-Value of the subgrade soil encountered at final subgrade elevation. We have assumed an R-Value of 25 and 78 for the subgrade soil and base materials, respectively, for the purposes of this preliminary analysis. Table 7.15.1 presents the preliminary flexible pavement sections.

**TABLE 7.15.1
PRELIMINARY FLEXIBLE PAVEMENT SECTION**

Location	Assumed Traffic Index	Assumed Subgrade R-Value	Asphalt Concrete Thickness (inches)		
			3	3½	4
			Class 2 Aggregate Base (inches)		
Parking stalls for automobiles and light-duty vehicles	5.0	25	7	5	4
Driveways for automobiles and light-duty vehicles	5.5	25	8	7	6
Medium truck traffic areas	6.0	25	---	9	8
Driveways for heavy truck traffic	7.0	25	---	---	11

7.14.2 Prior to placing base materials, the upper 12 inches of the subgrade soil should be scarified, moisture conditioned as necessary, and recompacted to a dry density of at least 95 percent of the laboratory maximum dry density near to slightly above optimum moisture content as determined by ASTM D 1557. Similarly, the base material should be compacted to a dry density of at least 95 percent of the laboratory maximum dry density near to slightly above optimum moisture content. Asphalt concrete should be compacted to a density of at least 95 percent of the laboratory Hveem density in accordance with ASTM D 2726.

7.14.3 A rigid Portland cement concrete (PCC) pavement section should be placed in roadway aprons and cross gutters. We calculated the rigid pavement section in general conformance with the procedure recommended by the American Concrete Institute report ACI 330R-08 Guide for Design and Construction of Concrete Parking Lots using the parameters presented in Table 7.15.2.

**TABLE 7.15.2
RIGID PAVEMENT DESIGN PARAMETERS**

Design Parameter	Design Value
Modulus of subgrade reaction, k	100 pci
Modulus of rupture for concrete, M _R	500 psi
Traffic Category, TC	A and C
Average daily truck traffic, ADTT	10 and 100

7.14.4 Based on the criteria presented herein, the PCC pavement sections should have a minimum thickness as presented in Table 7.15.3.

**TABLE 7.15.3
RIGID VEHICULAR PAVEMENT RECOMMENDATIONS**

Location	Portland Cement Concrete (inches)
Automobile Parking Stalls (TC=A)	5.5
Driveways (TC=C)	7.0

7.14.5 The PCC vehicular pavement should be placed over subgrade soil that is compacted to a dry density of at least 95 percent of the laboratory maximum dry density near to slightly above optimum moisture content. This pavement section is based on a minimum concrete compressive strength of approximately 3,000 psi (pounds per square inch).

7.14.6 A thickened edge or integral curb should be constructed on the outside of concrete slabs subjected to wheel loads. The thickened edge should be 1.2 times the slab thickness or a minimum thickness of 2 inches, whichever results in a thicker edge, and taper back to the recommended slab thickness 4 feet behind the face of the slab (e.g., 5.5-inch and 7.0-inch-thick slabs would have a 7.5- and 9.0-inch-thick edge, respectively). Reinforcing steel will not be necessary within the concrete for geotechnical purposes with the possible exception of dowels at construction joints as discussed herein.

7.14.7 To control the location and spread of concrete shrinkage cracks, crack-control joints (weakened plane joints) should be included in the design of the concrete pavement slab. Crack-control joints should not exceed 30 times the slab thickness with a maximum spacing of 12 feet for 5.5-inch-thick and 15 feet for the 6.0-inch and thicker slabs and should be sealed with an appropriate sealant to prevent the migration of water through the control joint to the subgrade materials. The depth of the crack-control joints should be determined by the referenced ACI report. The depth of the crack-control joints should be at least ¼ of the slab thickness when using a conventional saw, or at least 1 inch when using early-entry saws on slabs 9 inches or less in thickness, as determined by the referenced ACI report discussed in the pavement section herein. Cuts at least ¼ inch wide are required for sealed joints, and a ⅜ inch wide cut is commonly recommended. A narrow joint width of 1/10- to 1/8-inch wide is common for unsealed joints.

7.14.8 To provide load transfer between adjacent pavement slab sections, a butt-type construction joint should be constructed. The butt-type joint should be thickened by at least 20 percent at the edge and taper back at least 4 feet from the face of the slab. As an alternative to the butt-

type construction joint, dowelling can be used between construction joints for pavements of 7 inches or thicker. As discussed in the referenced ACI guide, dowels should consist of smooth, 1-inch-diameter reinforcing steel 14 inches long embedded a minimum of 6 inches into the slab on either side of the construction joint. Dowels should be located at the midpoint of the slab, spaced at 12 inches on center and lubricated to allow joint movement while still transferring loads. In addition, tie bars should be installed at the as recommended in Section 3.8.3 of the referenced ACI guide. The structural engineer should provide other alternative recommendations for load transfer.

- 7.14.9 Concrete curb/gutter should be placed on soil subgrade compacted to a dry density of at least 90 percent of the laboratory maximum dry density near to slightly above optimum moisture content. Cross-gutters that receives vehicular should be placed on subgrade soil compacted to a dry density of at least 95 percent of the laboratory maximum dry density near to slightly above optimum moisture content. Base materials should not be placed below the curb/gutter, or cross-gutters so water is not able to migrate from the adjacent parkways to the pavement sections. Where flatwork is located directly adjacent to the curb/gutter, the concrete flatwork should be structurally connected to the curbs to help reduce the potential for offsets between the curbs and the flatwork.

7.15 Site Drainage and Moisture Protection

- 7.15.1 Adequate site drainage is critical to reduce the potential for differential soil movement, erosion and subsurface seepage. Under no circumstances should water be allowed to pond adjacent to footings. The site should be graded and maintained such that surface drainage is directed away from structures in accordance with 2016 CBC 1804.4 or other applicable standards. In addition, surface drainage should be directed away from the top of slopes into swales or other controlled drainage devices. Roof and pavement drainage should be directed into conduits that carry runoff away from the proposed structure.
- 7.15.2 Underground utilities should be leak free. Utility and irrigation lines should be checked periodically for leaks, and detected leaks should be repaired promptly. Detrimental soil movement could occur if water is allowed to infiltrate the soil for prolonged periods of time.
- 7.15.3 Landscaping planters adjacent to paved areas are not recommended due to the potential for surface or irrigation water to infiltrate the pavement's subgrade and base course. Area drains to collect excess irrigation water and transmit it to drainage structures or impervious above-grade planter boxes can be used. In addition, where landscaping is planned adjacent to the pavement, construction of a cutoff wall along the edge of the pavement that extends at least 6 inches below the bottom of the base material should be considered.

7.15.4 We understand storm water management devices are planned for the proposed development and biofiltration basins are planned along the west and east perimeters of the site. Appendix E presents recommendations regarding storm water management.

7.15.5 Liners and subdrains should be incorporated into the design and construction of the planned storm water devices. The liners should be installed on the sides and bottoms of the planned basins and should be impermeable (e.g. High-density polyethylene, HDPE, with a thickness of about 40 mil or equivalent Polyvinyl Chloride, PVC) to prevent water migration. The subdrains should be perforated within the liner area, installed at the base and above the liner, be at least 3 inches in diameter and consist of Schedule 40 PVC pipe. The subdrains outside of the liner should consist of solid pipe. The penetration of the liners at the subdrains should be properly waterproofed. The subdrains should be connected to a proper outlet. The devices should also be installed in accordance with the manufacturer's recommendations.

7.16 Grading and Foundation Plan Review

7.16.1 Geocon Incorporated should review the grading and building foundation plans for the project prior to final design submittal to evaluate if additional analyses and/or recommendations are required.

LIMITATIONS AND UNIFORMITY OF CONDITIONS

1. The firm that performed the geotechnical investigation for the project should be retained to provide testing and observation services during construction to provide continuity of geotechnical interpretation and to check that the recommendations presented for geotechnical aspects of site development are incorporated during site grading, construction of improvements, and excavation of foundations. If another geotechnical firm is selected to perform the testing and observation services during construction operations, that firm should prepare a letter indicating their intent to assume the responsibilities of project geotechnical engineer of record. A copy of the letter should be provided to the regulatory agency for their records. In addition, that firm should provide revised recommendations concerning the geotechnical aspects of the proposed development, or a written acknowledgement of their concurrence with the recommendations presented in our report. They should also perform additional analyses deemed necessary to assume the role of Geotechnical Engineer of Record.
2. The recommendations of this report pertain only to the site investigated and are based upon the assumption that the soil conditions do not deviate from those disclosed in the investigation. If any variations or undesirable conditions are encountered during construction, or if the proposed construction will differ from that anticipated herein, Geocon Incorporated should be notified so that supplemental recommendations can be given. The evaluation or identification of the potential presence of hazardous or corrosive materials was not part of the scope of services provided by Geocon Incorporated.
3. This report is issued with the understanding that it is the responsibility of the owner or his representative to ensure that the information and recommendations contained herein are brought to the attention of the architect and engineer for the project and incorporated into the plans, and the necessary steps are taken to see that the contractor and subcontractors carry out such recommendations in the field.
4. The findings of this report are valid as of the present date. However, changes in the conditions of a property can occur with the passage of time, whether they be due to natural processes or the works of man on this or adjacent properties. In addition, changes in applicable or appropriate standards may occur, whether they result from legislation or the broadening of knowledge. Accordingly, the findings of this report may be invalidated wholly or partially by changes outside our control. Therefore, this report is subject to review and should not be relied upon after a period of three years.



THE GEOGRAPHICAL INFORMATION MADE AVAILABLE FOR DISPLAY WAS PROVIDED BY GOOGLE EARTH, SUBJECT TO A LICENSING AGREEMENT. THE INFORMATION IS FOR ILLUSTRATIVE PURPOSES ONLY; IT IS NOT INTENDED FOR CLIENT'S USE OR RELIANCE AND SHALL NOT BE REPRODUCED BY CLIENT. CLIENT SHALL INDEMNIFY, DEFEND AND HOLD HARMLESS GEOCON FROM ANY LIABILITY INCURRED AS A RESULT OF SUCH USE OR RELIANCE BY CLIENT.



NO SCALE

VICINITY MAP

GEOCON
INCORPORATED



GEOTECHNICAL ■ ENVIRONMENTAL ■ MATERIALS
6960 FLANDERS DRIVE - SAN DIEGO, CALIFORNIA 92121 - 2974
PHONE 858 558-6900 - FAX 858 558-6159

BELLA MAR
408 HOLLISTER STREET
SAN DIEGO, CALIFORNIA

LR / CW	DSK/GTYPD	DATE 04 - 24 - 2019	PROJECT NO. G2129 - 52 - 03	FIG. 1
---------	-----------	---------------------	-----------------------------	--------

BELLA MAR - 408 HOLLISTER STREET
SAN DIEGO, CALIFORNIA

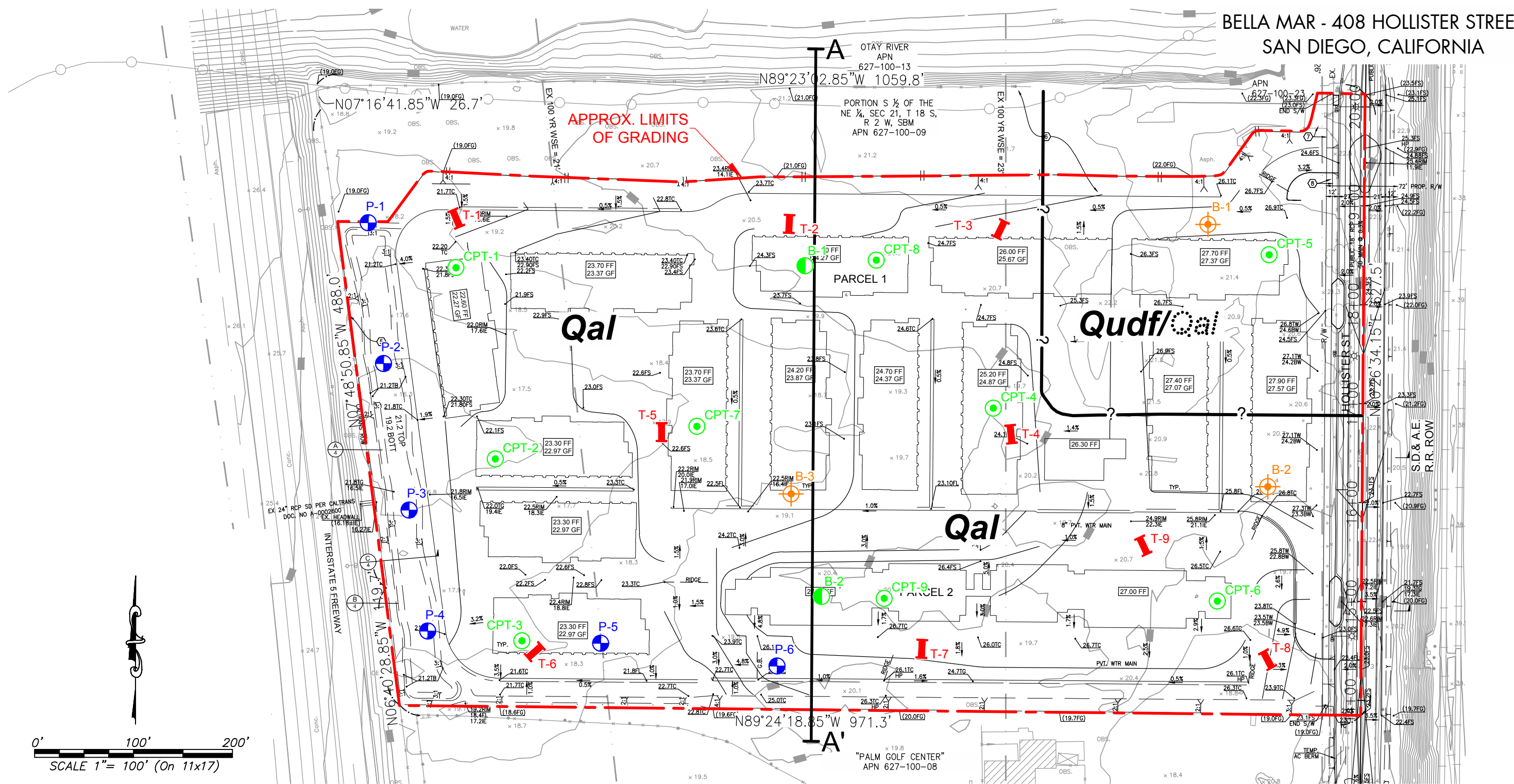

GEOCON LEGEND

- Qudf** UNDOCUMENTED FILL
- Qal** ALLUVIUM (Dotted Where Buried)
- B-2** APPROX. LOCATION OF GEOTECHNICAL BORING (Current Study)
- CPT-9** APPROX. LOCATION OF CONE PENETROMETER TEST (Current Study)

- P-6** APPROX. LOCATION OF INFILTRATION TEST (Geocon, 2017)
- B-3** APPROX. LOCATION OF GEOTECHNICAL BORING (CWE, 2005)
- T-9** APPROX. LOCATION OF TRENCH (CWE, 2005)
- A-A'** APPROX. LOCATION OF CROSS-SECTION
- ?** APPROX. LOCATION OF GEOLOGIC CONTACT (Queried Where Uncertain)

GEOCON
INCORPORATED
GEOTECHNICAL ■ ENVIRONMENTAL ■ MATERIALS
6960 FLANDERS DRIVE - SAN DIEGO, CALIFORNIA 92121 - 2974
PHONE 858 558-6900 - FAX 858 558-6159
PROJECT NO. G2129 - 52 - 03

GEOLOGIC MAP
FIGURE 2
DATE 04 - 24 - 2019

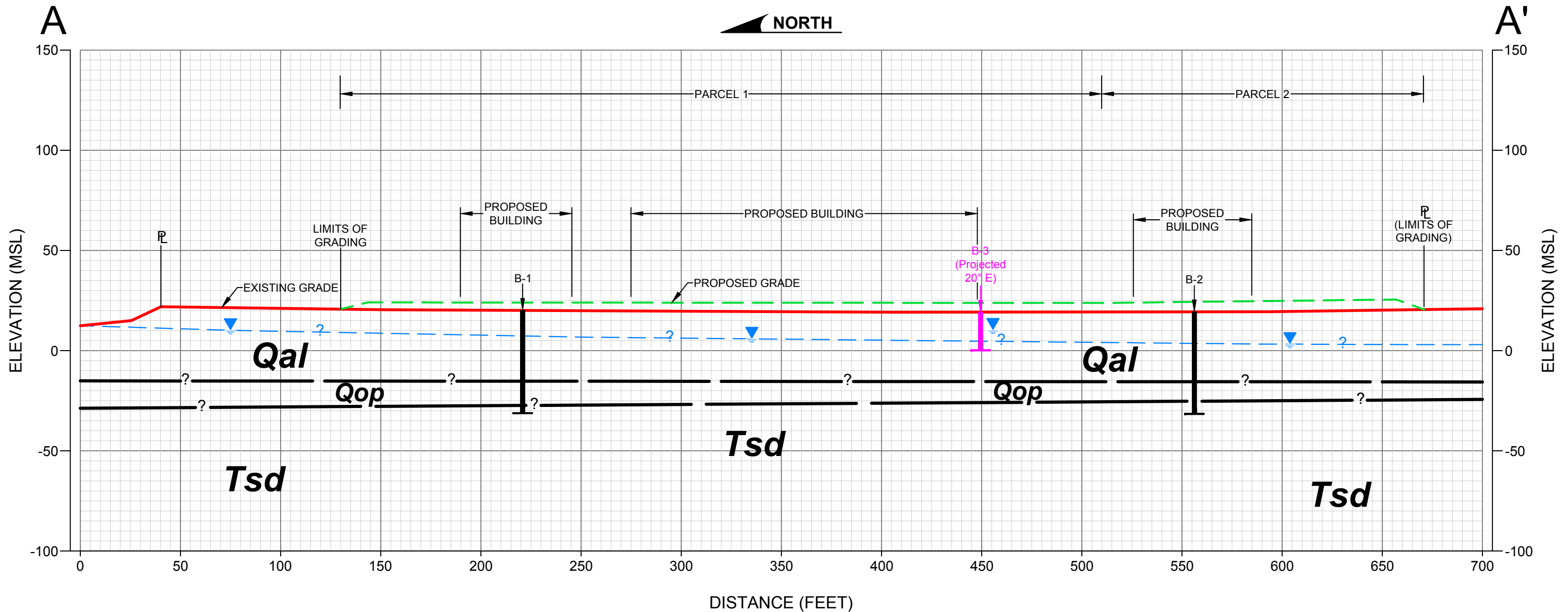

GEOLOGIC CROSS-SECTION A-A'

SCALE: 1" = 50' (Vert. = Horiz.)

GEOCON LEGEND

- Qal**ALLUVIUM
- Qop**OLD PARALIC DEPOSITS
- Tsd**SAN DIEGO FORMATION
- B-2**
|APPROX. LOCATION OF BORING (Current Study)
- B-3**
|APPROX. LOCATION OF BORING (CWE, 2005)
- ?---ESTIMATED GROUNDWATER ELEVATION (Queried Where Uncertain)
- ~?~APPROX. LOCATION OF GEOLOGIC CONTACT (Queried Where Uncertain)

GEOCON
INCORPORATED

GEOTECHNICAL ■ ENVIRONMENTAL ■ MATERIALS
6960 FLANDERS DRIVE - SAN DIEGO, CALIFORNIA 92121 - 297.4
PHONE 858 558-6900 - FAX 858 558-6159
PROJECT NO. G2129 - 52 - 03
FIGURE 3
DATE 04 - 24 - 2019

GEOLOGIC CROSS-SECTION

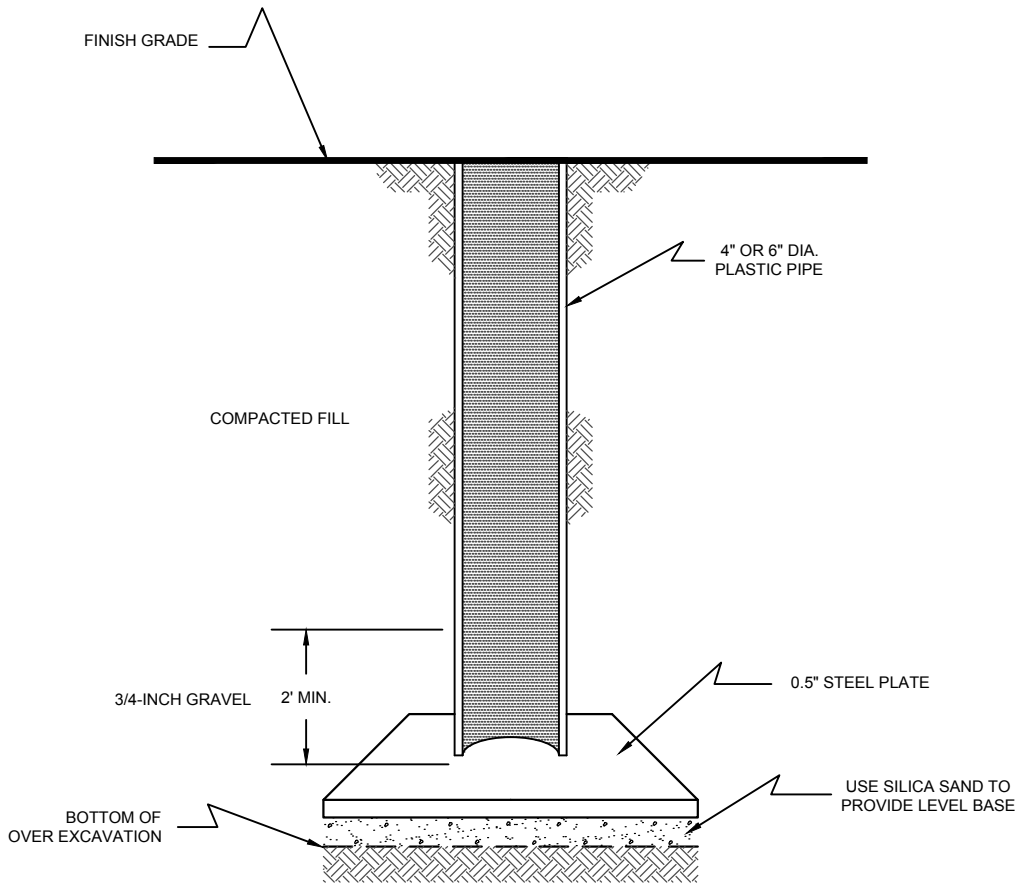

NOTES:

- 1.....STEEL PLATE SHOULD BE 4-FEET SQUARED. LOCATION OF SETTLEMENT PLATES SHALL BE SURVEYED AND VISIBLE (RED FLAG) TO EQUIPMENT OPERATORS.
- 2.....CONTRACTOR SHALL INSTALL SETTLEMENT PLATES. THERE SHOULD BE 2 FEET OF GRAVEL OVER THE SETTLEMENT PLATE. THERE SHOULD BE 2 FEET OF FILL OVER THE GRAVEL BEFORE HEAVY EQUIPMENT CAN OPERATE OVER THE PLATE.
- 3.....MULTIPLE READING CAN BE PERFORMED ON THE SETTLEMENT PLATE. A 4-INCH DIAMETER PVC PIPE SHOULD BE INSTALLED IF MULTIPLE READINGS ARE REQUIRED.
- 4.....THE EXCAVATION SHOULD BE PROPERLY BACKFILLED AFTER THE SETTLEMENT MONITORING PROGRAM IS COMPLETE.

NO SCALE

PLATE SETTLEMENT MONUMENT

GEOCON
INCORPORATED



GEOTECHNICAL ■ ENVIRONMENTAL ■ MATERIALS
6960 FLANDERS DRIVE - SAN DIEGO, CALIFORNIA 92121 - 2974
PHONE 858 558-6900 - FAX 858 558-6159

BELLA MAR
408 HOLLISTER STREET
SAN DIEGO, CALIFORNIA

LR / CW

DSK/GTYPD

DATE 04 - 24 - 2019

PROJECT NO. G2129 - 52 - 03

FIG. 4

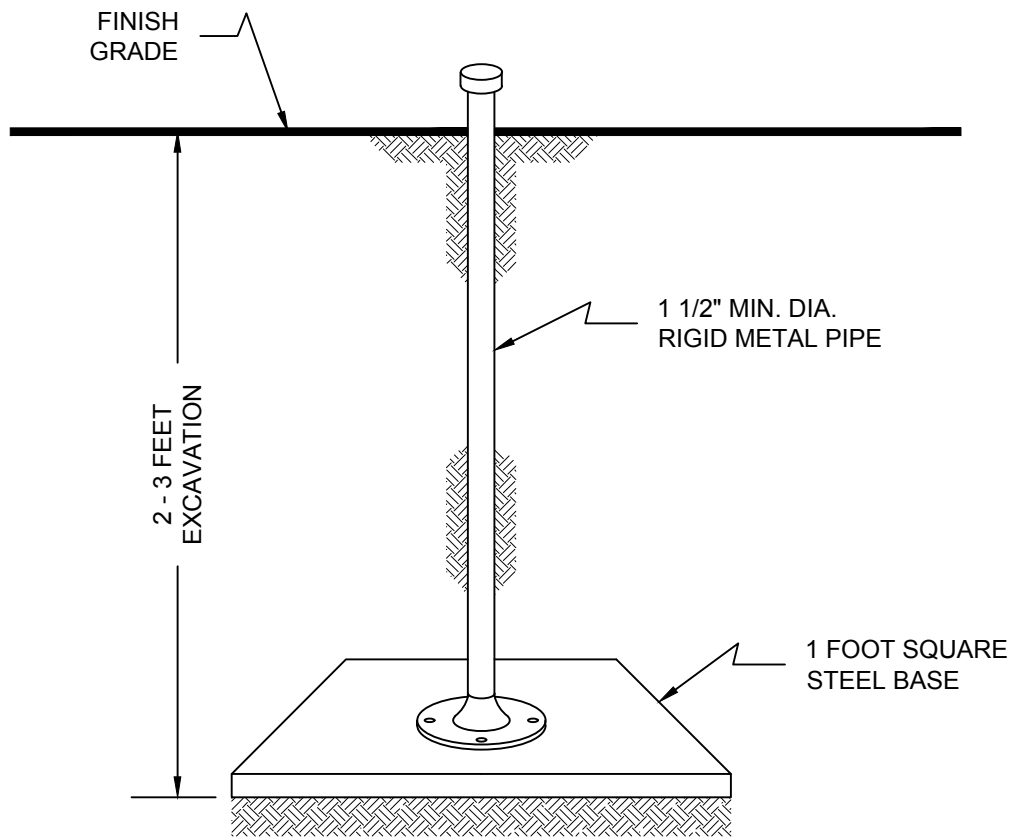

NOTES:

- 1.....LOCATION OF SETTLEMENT MONUMENTS SHALL BE CLEARLY MARKED AND READILY VISIBLE (RED FLAG) TO EQUIPMENT OPERATORS.
- 2.....CONTRACTOR SHALL MAINTAIN 10-FOOT HORIZONTAL CLEARANCE FOR HEAVY EQUIPMENT WITHIN 5 FEET (VERTICAL) OF PLATE BASE. FILL WITHIN CLEARANCE AREA SHALL BE HAND COMPACTED TO PROJECT SPECIFICATIONS OR COMPACTED BY ALTERNATIVE APPROVED SOILS ENGINEER.
- 3.....IN THE EVENT OF DAMAGE TO SETTLEMENT PLATE OR EXTENSION RESULTING FROM EQUIPMENT OPERATING WITHIN PRESCRIBED CLEARANCE AREA, CONTRACTORS SHALL IMMEDIATELY NOTIFY SOILS ENGINEER AND SHALL BE RESPONSIBLE FOR RESTORING THE SETTLEMENT PLATES TO WORKING ORDER.

NO SCALE

SURFACE SETTLEMENT MONUMENT

GEOCON
INCORPORATED



GEOTECHNICAL ■ ENVIRONMENTAL ■ MATERIALS
6960 FLANDERS DRIVE - SAN DIEGO, CALIFORNIA 92121 - 2974
PHONE 858 558-6900 - FAX 858 558-6159

BELLA MAR
408 HOLLISTER STREET
SAN DIEGO, CALIFORNIA

LR / CW

DSK/GTYPD

DATE 04 - 24 - 2019

PROJECT NO. G2129 - 52 - 03

FIG. 5

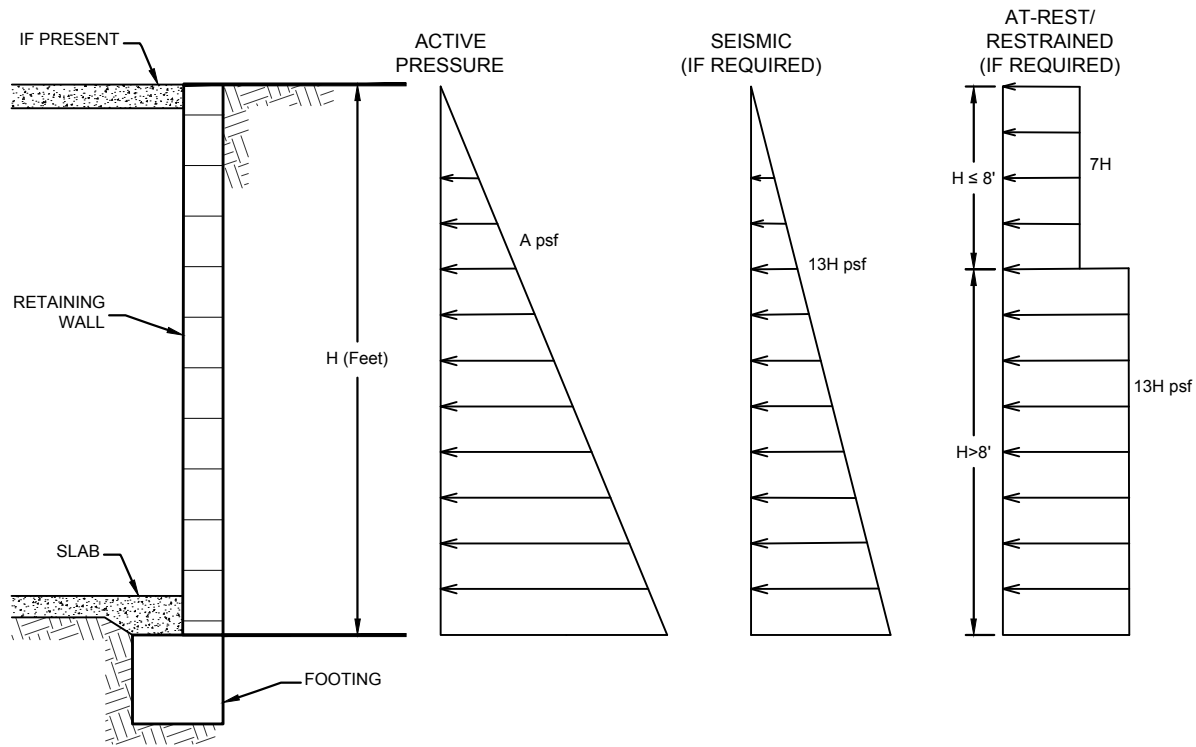

ACTIVE PRESSURE, A (psf)		
EXPANSION INDEX, EI	LEVEL BACKFILL	2:1 SLOPING BACKFILL
EI ≤ 50	35	50
EI ≤ 90	40	55

NOTES:

- 1..... A SURCHARGE OF 2 FEET OF SOIL (250 PSF VERTICAL LOAD) SHOULD BE ADDED TO THE DESIGN OF THE WALL WHERE TRAFFIC LOADS ARE WITHIN A HORIZONTAL DISTANCE EQUAL TO $\frac{2}{3}$ THE WALL HEIGHT. OTHER SURCHARGES SHOULD BE APPLIED, AS APPLICABLE.
- 2..... EXPANSION INDEX GREATER THAN 50/90 SHOULD NOT BE USED FOR WALL BACKFILL PER REPORT.
- 3..... RETAINING WALLS SHOULD BE PROPERLY DRAINED AND WATER PROOFED.
- 4..... THE PROJECT STRUCTURAL ENGINEER SHOULD EVALUATE THE WALLS LOADING COMBINATIONS.

NO SCALE

RETAINING WALL LOADING DIAGRAM

GEOCON
INCORPORATED



GEOTECHNICAL ■ ENVIRONMENTAL ■ MATERIALS
6960 FLANDERS DRIVE - SAN DIEGO, CALIFORNIA 92121 - 2974
PHONE 858 558-6900 - FAX 858 558-6159

BELLA MAR
408 HOLLISTER STREET
SAN DIEGO, CALIFORNIA

LR / CW

DSK/GTYPD

DATE 04 - 24 - 2019

PROJECT NO. G2129 - 52 - 03

FIG. 6

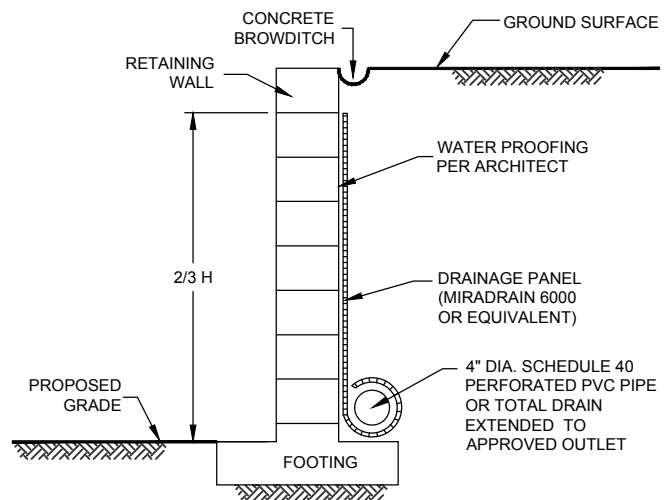
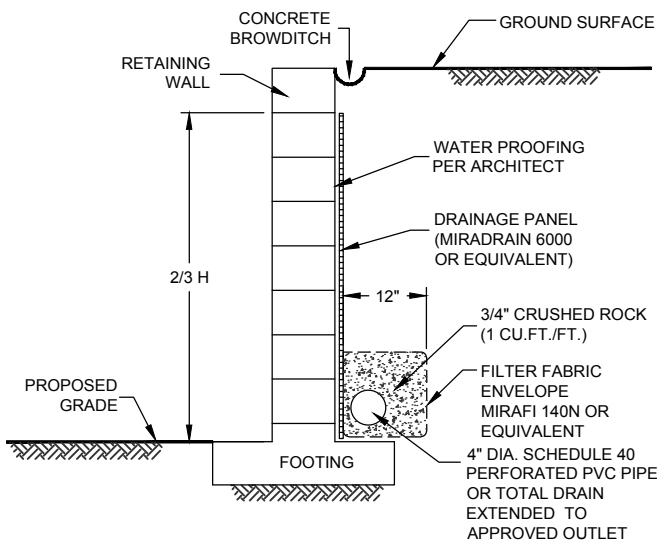
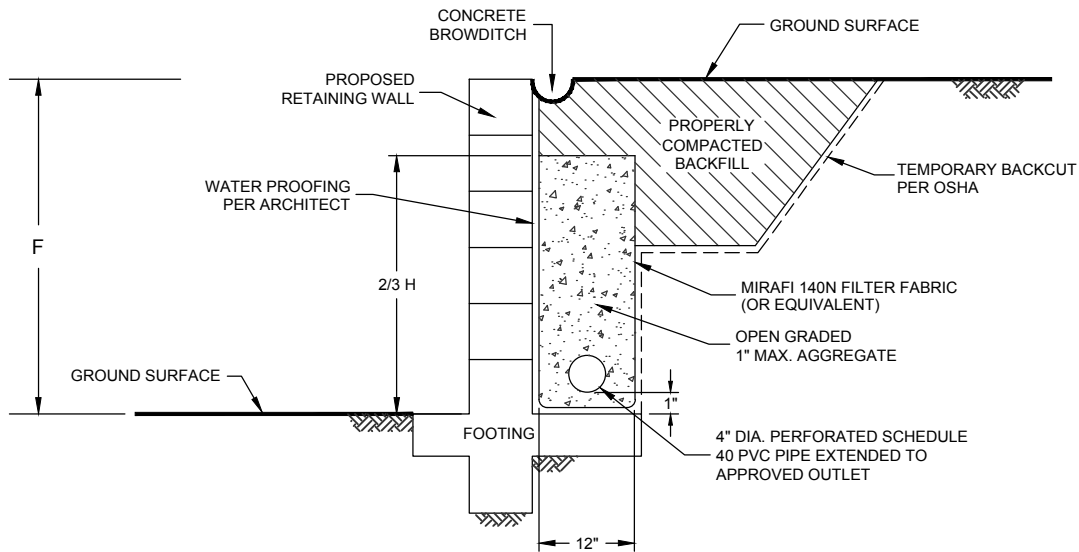

NOTE :

DRAIN SHOULD BE UNIFORMLY SLOPED TO GRAVITY OUTLET OR TO A SUMP WHERE WATER CAN BE REMOVED BY PUMPING

NO SCALE

TYPICAL RETAINING WALL DRAIN DETAIL

GEOCON
INCORPORATED



GEOTECHNICAL ■ ENVIRONMENTAL ■ MATERIALS
6960 FLANDERS DRIVE - SAN DIEGO, CALIFORNIA 92121 - 297 4
PHONE 858 558-6900 - FAX 858 558-6159

BELLA MAR
408 HOLLISTER STREET
SAN DIEGO, CALIFORNIA

LR / CW

DSK/GTYPD

DATE 04 - 24 - 2019

PROJECT NO. G2129 - 52 - 03

FIG. 7

APPENDIX

A

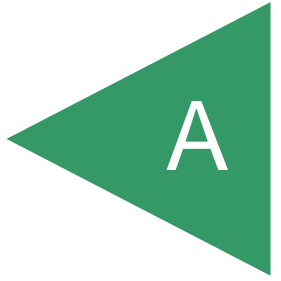

APPENDIX A

FIELD INVESTIGATION

We performed our field investigation on April 26, 2017 and March 11 and 14, 2019 that consisted of excavating 2 exploratory borings, conducting 6 infiltration tests, and 9 CPTs. The borings and CPTs extended to a maximum depth of approximately 51 feet. The locations of the exploratory borings and CPTs are shown on the Geologic Map, Figure 2 (map pocket). The boring logs and CPTs are presented in this Appendix. We located the borings and CPTs in the field using a measuring tape and existing reference points; therefore, actual locations may deviate slightly.

The geotechnical borings were drilled to a depth of approximately 51 feet below existing grade using a CME 75 drill rig equipped with hollow-stem augers. The infiltration-test borings were excavated with hand digging equipment to depths of approximately 4.5 to 5 feet.

We obtained samples during our subsurface exploration in the borings using a California sampler. The sampler is composed of steel and is driven to obtain ring samples. The California sampler has an inside diameter of 2.5 inches and an outside diameter of 3 inches. Up to 18 rings are placed inside the sampler that is 2.4 inches in diameter and 1 inch in height. We obtained ring samples at appropriate intervals, placed them in moisture-tight containers, and transported them to the laboratory for testing. The type of sample is noted on the exploratory boring logs.

The samplers were driven 12 inches. The sampler is connected to A rods and driven into the bottom of the excavation using a 140-pound hammer with a 30-inch drop. Blow counts are recorded for every 6 inches the sampler is driven. The penetration resistances shown on the boring logs are shown in terms of blows per foot. The values indicated on the boring logs are the sum of the last 12 inches of the sampler. If the sampler was not driven for 12 inches, an approximate value is calculated in term of blows per foot or the final 6-inch interval is reported. These values are not to be taken as N-values as adjustments have not been applied. We estimated elevations shown on the boring logs either from a topographic map or by using a benchmark. Each excavation was backfilled as noted on the boring logs.

We visually examined, classified, and logged the soil encountered in the borings in general accordance with American Society for Testing and Materials (ASTM) practice for Description and Identification of Soils (Visual-Manual Procedure D 2488). The logs depict the soil and geologic conditions observed and the depth at which samples were obtained.

Kehoe Testing & Engineering performed the CPT soundings. The soil conditions encountered during the field investigation were automatically logged in a nearly continuous profile of penetration resistance as each CPT sounding was being conducted. The recorded tip stress, sleeve stress, and pore pressure of the soil is used to develop a stratigraphic interpretation of the soil profile.

DEPTH IN FEET	SAMPLE NO.	LITHOLOGY	GROUNDWATER	SOIL CLASS (USCS)	BORING B 1		PENETRATION RESISTANCE (BLOWS/FT.)	DRY DENSITY (P.C.F.)	MOISTURE CONTENT (%)
					ELEV. (MSL.) <u>20'</u>	DATE COMPLETED <u>03-11-2019</u>			
					EQUIPMENT <u>CME 75</u>		BY: <u>K. HAASE</u>		
MATERIAL DESCRIPTION									
0	B1-1			SM	TOPSOIL Loose, moist, dark brown, Silty, fine to medium SAND				
2				SC	ALLUVIUM (Qal) Loose, moist, dark brown, Clayey, fine to medium SAND				
4				SM	Loose, moist, dark brown, Silty, fine SAND				
6	B1-2				-Becomes saturated	15	105.4	22.7	
10	B1-3				-Becomes dark reddish brown	7	105.4	25.0	
14									
16	B1-4					8	99.0	30.8	
18				GP	-Gravel Very dense, saturated, brown to yellowish brown, fine to coarse Sandy GRAVEL; cobble up to 4 inches in diameter				
20	B1-5					83/10"	121.7	15.8	
26	B1-6					82/10"		11.4	

Figure A-7,
Log of Boring B 1, Page 1 of 2

G2129-52-03.GPJ

SAMPLE SYMBOLS		... SAMPLING UNSUCCESSFUL		... STANDARD PENETRATION TEST		... DRIVE SAMPLE (UNDISTURBED)
		... DISTURBED OR BAG SAMPLE		... CHUNK SAMPLE		... WATER TABLE OR SEEPAGE

NOTE: THE LOG OF SUBSURFACE CONDITIONS SHOWN HEREON APPLIES ONLY AT THE SPECIFIC BORING OR TRENCH LOCATION AND AT THE DATE INDICATED. IT IS NOT WARRANTED TO BE REPRESENTATIVE OF SUBSURFACE CONDITIONS AT OTHER LOCATIONS AND TIMES.

DEPTH IN FEET	SAMPLE NO.	LITHOLOGY	GROUNDWATER	SOIL CLASS (USCS)	BORING B 1		PENETRATION RESISTANCE (BLOWS/FT.)	DRY DENSITY (P.C.F.)	MOISTURE CONTENT (%)
					ELEV. (MSL.) <u>20'</u>	DATE COMPLETED <u>03-11-2019</u>			
					EQUIPMENT <u>CME 75</u>		BY: <u>K. HAASE</u>		
MATERIAL DESCRIPTION									
30				GP					
32				SP	Medium dense, saturated, brown, fine to medium SAND				
34									
36	B1-7			SM	OLD PARALIC DEPOSITS (Qop) Dense, saturated, light reddish brown, Silty, fine to coarse SAND	52	105.5	23.0	
38									
40	B1-8				-Becomes yellowish brown	66	98.6	25.1	
42									
44					-Becomes medium dense, brown				
46	B1-9			MH	Hard, wet, light reddish brown, fine Sandy SILT; micaceous	74			
48									
50	B1-10			SP	SAN DIEGO FORMATION (Tsd) Very dense, saturated, light brown, fine to medium SAND	90/11"	106.6	27.3	
					BORING TERMINATED AT 51 FEET Groundwater encountered at 13.5 feet Backfilled with 58 cu. ft. of Portland I, II, V cement				

Figure A-7,
Log of Boring B 1, Page 2 of 2

G2129-52-03.GPJ

SAMPLE SYMBOLS	... SAMPLING UNSUCCESSFUL	... STANDARD PENETRATION TEST	... DRIVE SAMPLE (UNDISTURBED)
	... DISTURBED OR BAG SAMPLE	... CHUNK SAMPLE	... WATER TABLE OR SEEPAGE

NOTE: THE LOG OF SUBSURFACE CONDITIONS SHOWN HEREON APPLIES ONLY AT THE SPECIFIC BORING OR TRENCH LOCATION AND AT THE DATE INDICATED. IT IS NOT WARRANTED TO BE REPRESENTATIVE OF SUBSURFACE CONDITIONS AT OTHER LOCATIONS AND TIMES.

DEPTH IN FEET	SAMPLE NO.	LITHOLOGY	GROUNDWATER	SOIL CLASS (USCS)	BORING B 2		PENETRATION RESISTANCE (BLOWS/FT.)	DRY DENSITY (P.C.F.)	MOISTURE CONTENT (%)
					ELEV. (MSL.) <u>20'</u>	DATE COMPLETED <u>03-11-2019</u>			
					EQUIPMENT <u>CME 75</u> BY: <u>K. HAASE</u>				
					MATERIAL DESCRIPTION				
0	B2-1			SM	TOPSOIL Loose, moist, dark brown, Silty, fine to medium SAND				
2				SC	ALLUVIUM (Qal) Loose, moist, dark brown, Clayey, fine to medium SAND				
4				SM	Loose, wet to saturated, brown, Silty, fine SAND; trace gravel				
6	B2-2					16	112.6	20.1	
8									
10	B2-3				-No recovery	12			
12									
14									
16	B2-4		▼	SM	Dense, saturated, brown, fine to coarse SAND; some silt, little gravel	89			
18	B2-5					33		21.1	
20									
22				SW-SM	Very dense, saturated, brown, fine to coarse Silty SAND; some gravel				
24									
26	B2-7				-Becomes dark yellowish brown	90/11"	135.3	9.9	
28									

Figure A-8,
Log of Boring B 2, Page 1 of 2

G2129-52-03.GPJ

SAMPLE SYMBOLS		... SAMPLING UNSUCCESSFUL		... STANDARD PENETRATION TEST		... DRIVE SAMPLE (UNDISTURBED)
		... DISTURBED OR BAG SAMPLE		... CHUNK SAMPLE		... WATER TABLE OR SEEPAGE

NOTE: THE LOG OF SUBSURFACE CONDITIONS SHOWN HEREON APPLIES ONLY AT THE SPECIFIC BORING OR TRENCH LOCATION AND AT THE DATE INDICATED. IT IS NOT WARRANTED TO BE REPRESENTATIVE OF SUBSURFACE CONDITIONS AT OTHER LOCATIONS AND TIMES.

DEPTH IN FEET	SAMPLE NO.	LITHOLOGY	GROUNDWATER	SOIL CLASS (USCS)	BORING B 2		PENETRATION RESISTANCE (BLOWS/FT.)	DRY DENSITY (P.C.F.)	MOISTURE CONTENT (%)
					ELEV. (MSL.) <u>20'</u>	DATE COMPLETED <u>03-11-2019</u>			
					EQUIPMENT <u>CME 75</u> BY: <u>K. HAASE</u>				
					MATERIAL DESCRIPTION				
30	B2-8			SW-SM	-No recovery		50/1"		
32				SM	Medium dense, moist to wet, light olive brown, Silty, fine SAND; little gravel				
34				SM	OLD PARALIC DEPOSITS (Qop) Very dense, wet to saturated, brown, Silty, fine to coarse SAND		83		
36	B2-9								
38									
40	B2-10			ML	Very stiff, brown, moist to wet, fine Sandy SILT		25		
42									
44	B2-11			CL	SAN DIEGO FORMATION (Tsd) Hard, moist to wet, light brown, Sandy CLAY; micaceous		58		
46									
48				SP	Very dense, saturated, dark grayish brown, fine to medium SAND; micaceous				
50	B2-12						70/11"	98.2	25.8
					BORING TERMINATED AT 51 FEET Groundwater encountered at 16 feet Backfilled with 58 cu. ft. of Portland I, II, V cement				

Figure A-8,
Log of Boring B 2, Page 2 of 2

G2129-52-03.GPJ

SAMPLE SYMBOLS	... SAMPLING UNSUCCESSFUL	... STANDARD PENETRATION TEST	... DRIVE SAMPLE (UNDISTURBED)
	... DISTURBED OR BAG SAMPLE	... CHUNK SAMPLE	... WATER TABLE OR SEEPAGE

NOTE: THE LOG OF SUBSURFACE CONDITIONS SHOWN HEREON APPLIES ONLY AT THE SPECIFIC BORING OR TRENCH LOCATION AND AT THE DATE INDICATED. IT IS NOT WARRANTED TO BE REPRESENTATIVE OF SUBSURFACE CONDITIONS AT OTHER LOCATIONS AND TIMES.

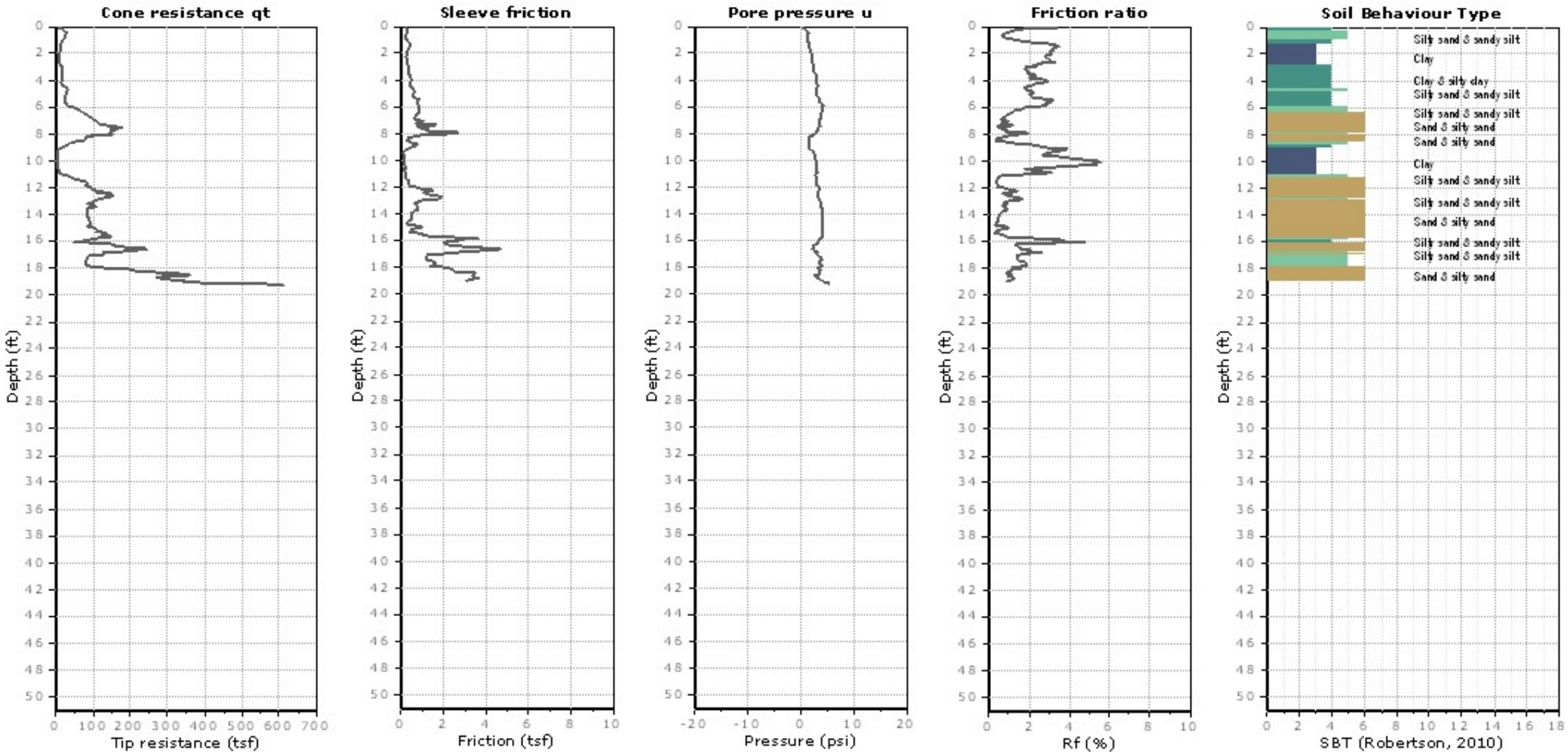

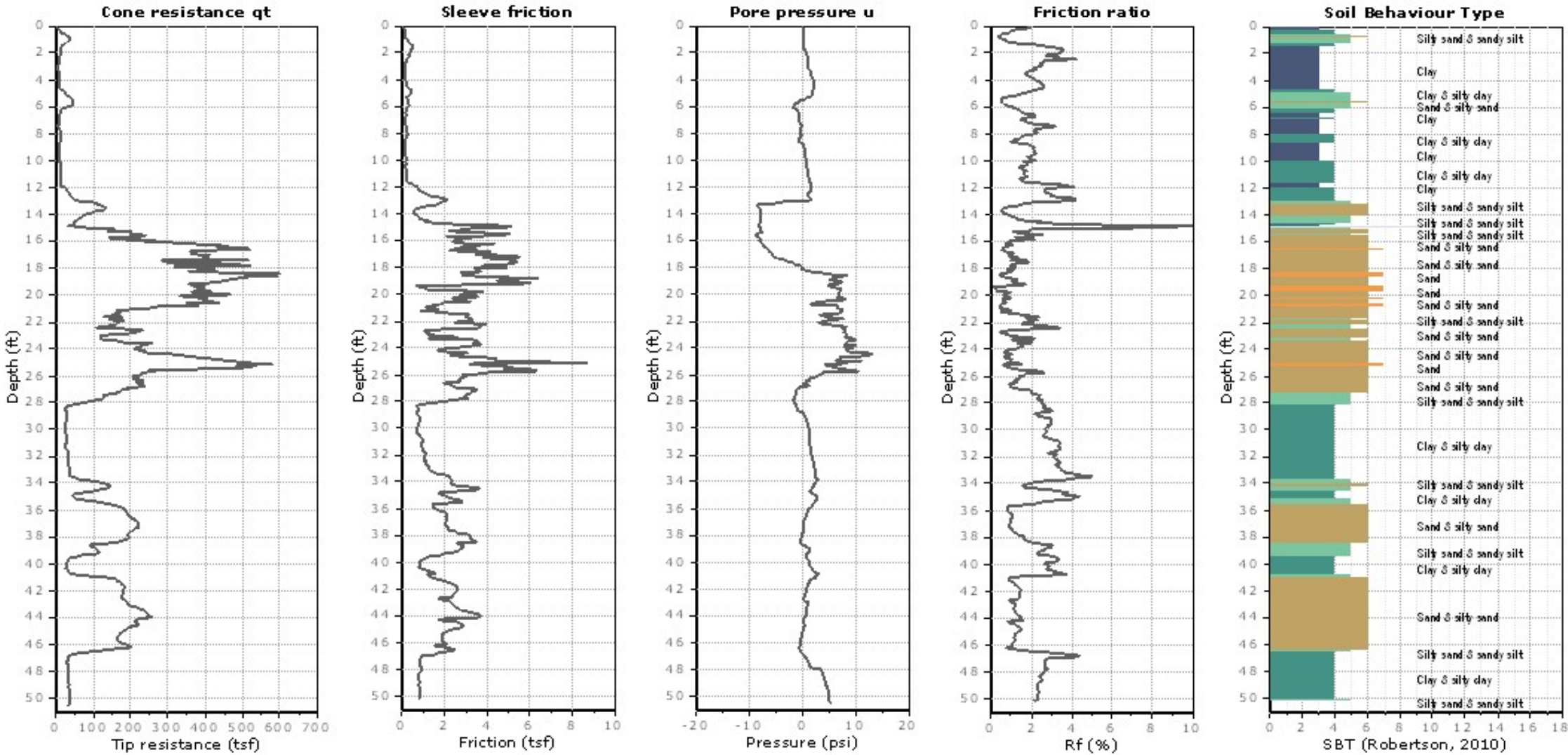

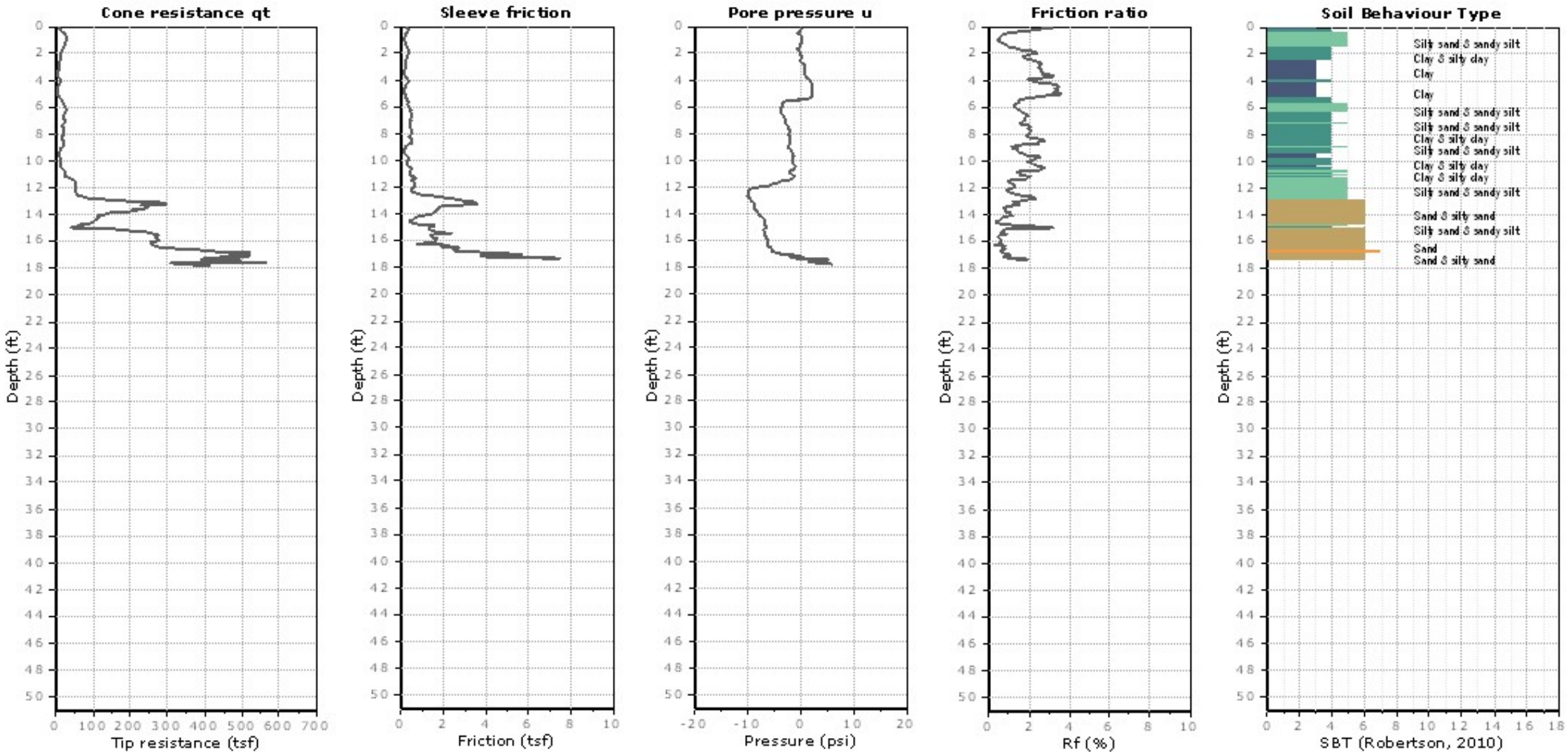

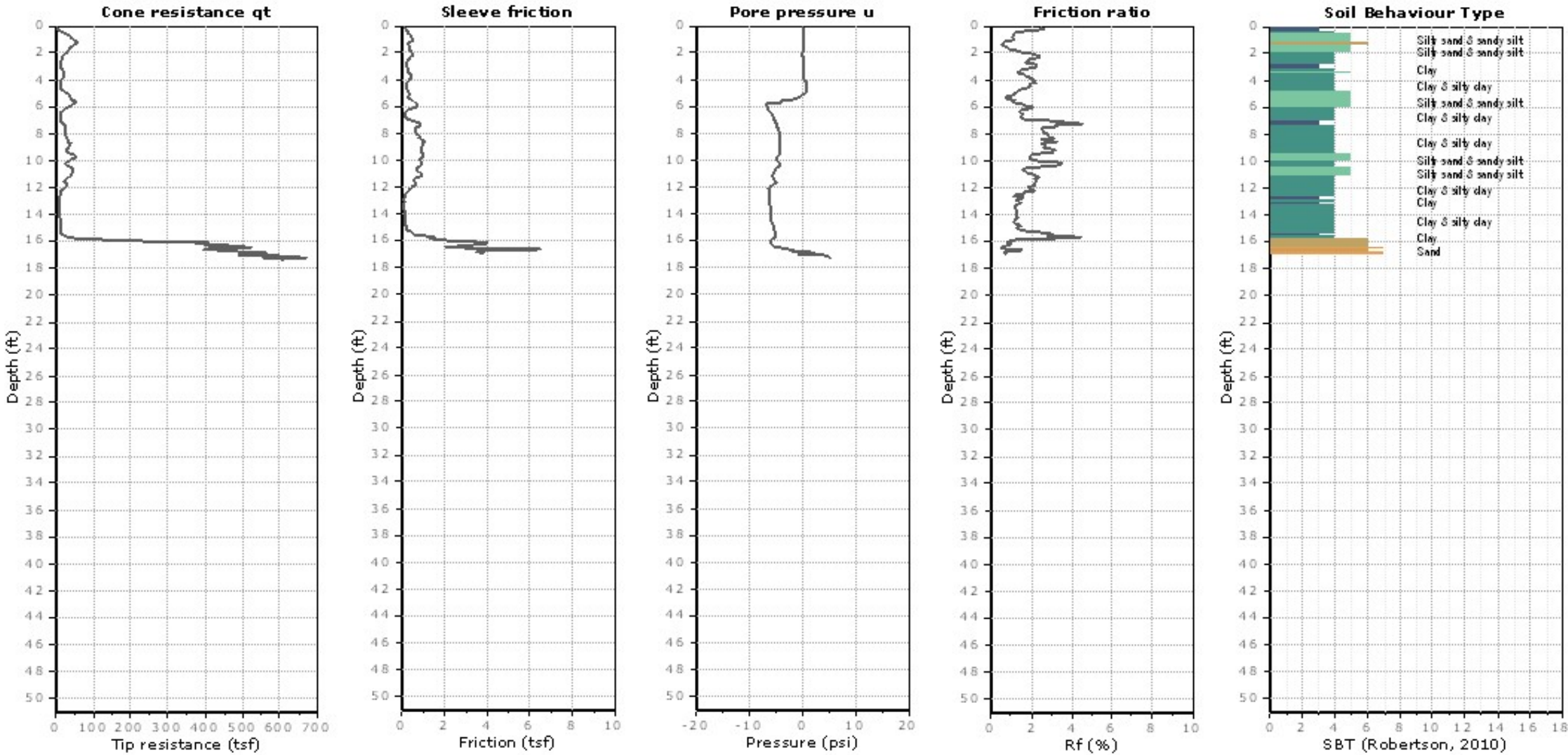

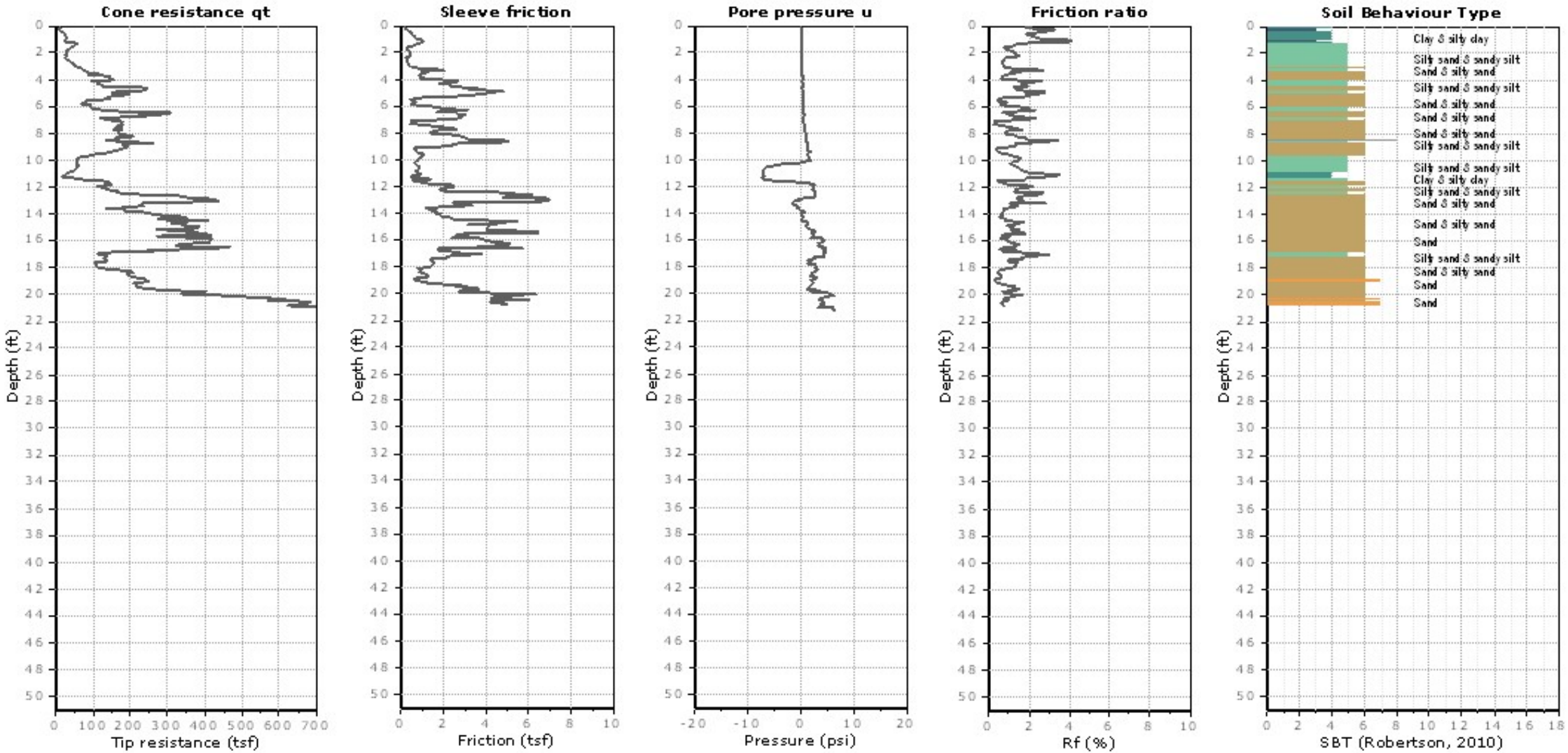

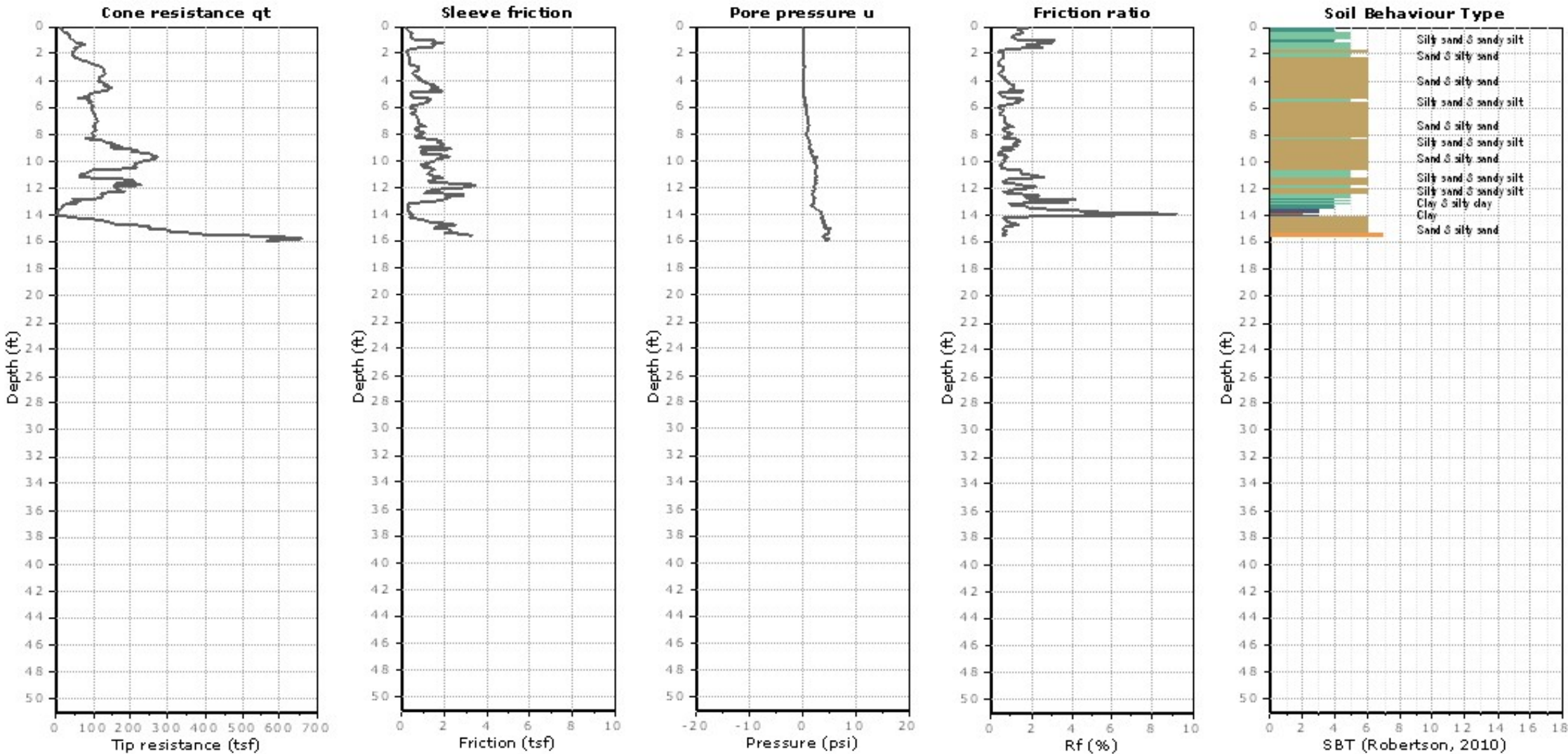

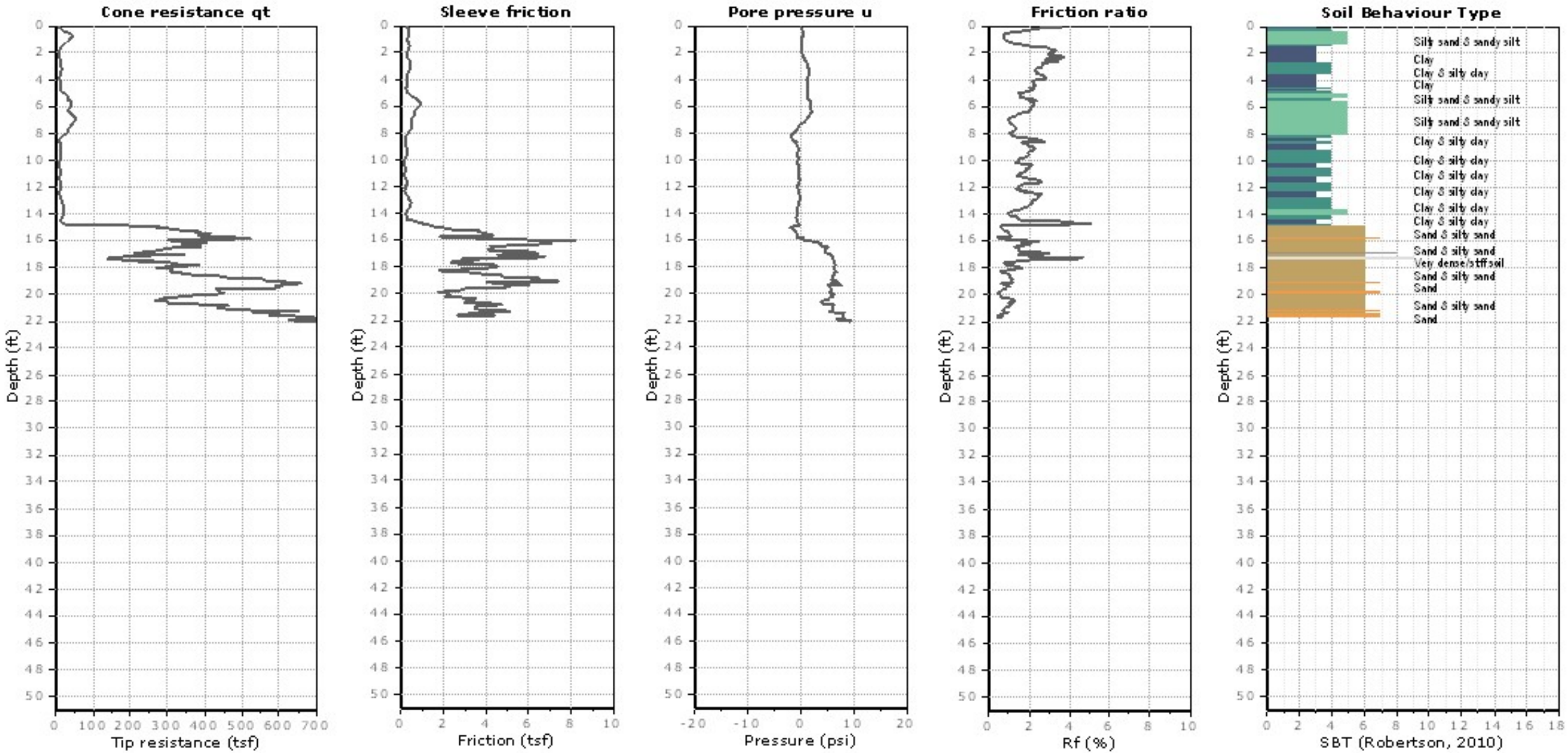

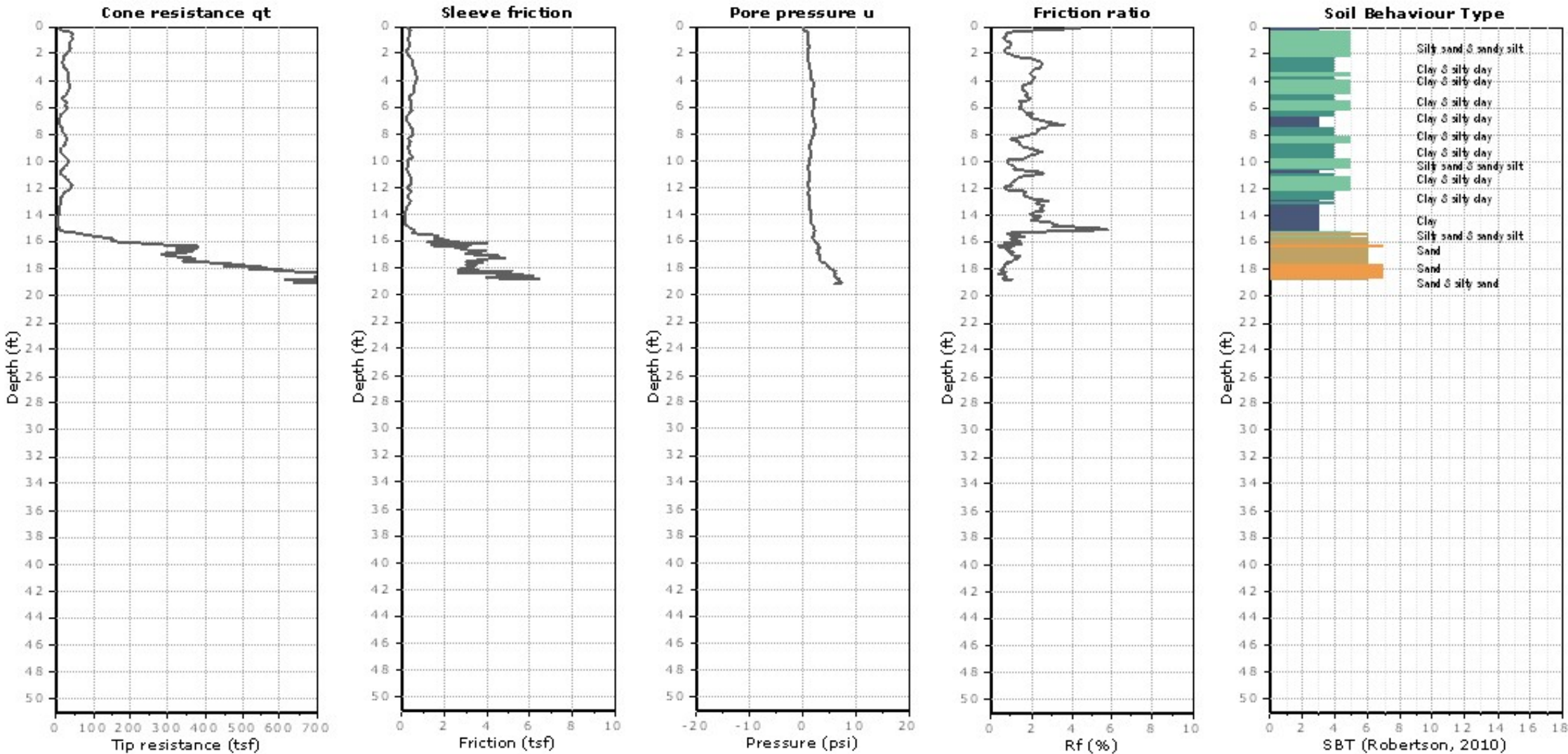

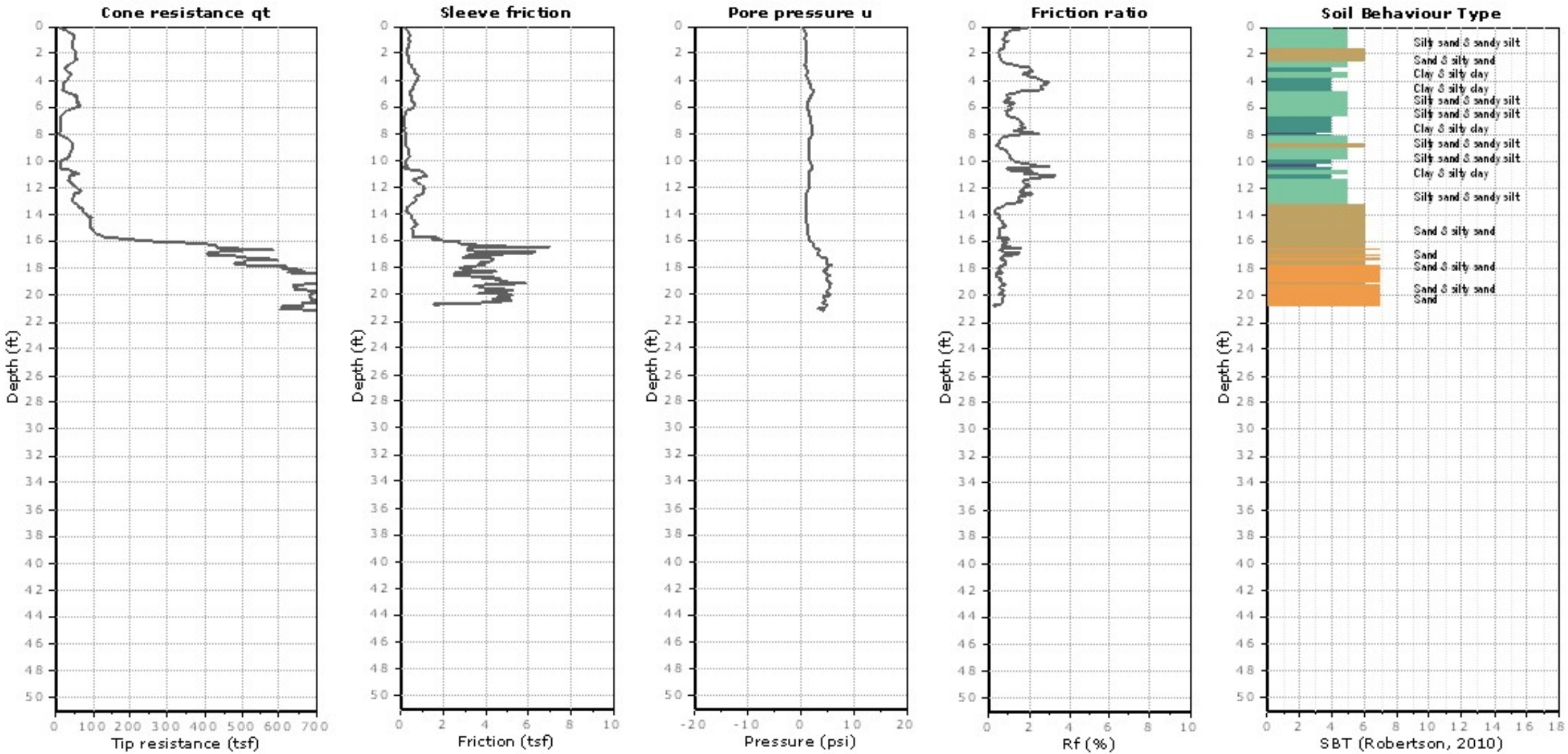

APPENDIX

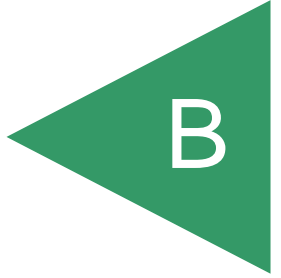

APPENDIX B

LABORATORY TESTING

The laboratory test results performed on representative materials are presented on the following tables. We performed laboratory tests in accordance with generally accepted test methods of the American Society for Testing and Materials (ASTM) or other suggested procedures. Selected soil samples were tested for in-place dry density and moisture content, maximum density/optimum moisture content, direct shear strength, expansion index, water-soluble sulfate, plasticity index, R-Value, unconfined compressive strength, gradation and consolidation characteristics. The results of our laboratory tests are presented in Tables B-I through B-VI and on Figures B-1 through B-5. The in-place dry density and moisture content of the samples tested are presented on the boring logs in Appendix A.

**TABLE B-I
SUMMARY OF LABORATORY MAXIMUM DRY DENSITY
AND OPTIMUM MOISTURE CONTENT TEST RESULTS
ASTM D 1557**

Sample No.	Description	Maximum Dry Density (pcf)	Optimum Moisture Content (% dry wt.)
B1-1	Dark brown, Clayey fine to medium SAND; trace gravel	127.8	10.6
B2-1	Dark brown, Clayey fine to medium SAND	126.9	11.3

**TABLE B-II
SUMMARY OF LABORATORY DIRECT SHEAR TEST RESULTS
ASTM D 3080**

Sample No.	Depth (feet)	Geologic Unit	Dry Density (pcf)	Moisture Content (%)		Peak [Ultimate ¹] Cohesion (psf)	Peak [Ultimate ¹] Angle of Shear Resistance (degrees)
				Initial	Final		
B1-2	5	Qal	105.4	22.7	22.8	400 [400]	31 [31]
B1-8	40	Qal	98.6	25.1	25.2	600 [425]	34 [32]

¹ Ultimate at end of test at 0.2 inch deflection.

**TABLE B-III
SUMMARY OF LABORATORY EXPANSION INDEX TEST RESULTS
ASTM D 4829**

Sample No.	Moisture Content (%)		Dry Density (pcf)	Expansion Index	2016 CBC Expansion Classification	ASTM Soil Expansion Classification
	Before Test	After Test				
B1-1	10.3	20.1	110.0	39	Expansive	Low
B2-1	9.5	18.2	111.7	24	Expansive	Low

**TABLE B-IV
SUMMARY OF LABORATORY WATER-SOLUBLE SULFATE TEST RESULTS
CALIFORNIA TEST NO. 417**

Sample No.	Water-Soluble Sulfate (%)	ACI 318 Sulfate Exposure
B1-1	0.034	S0
B2-1	0.024	S0

**TABLE B-V
SUMMARY OF LABORATORY RESISTANCE VALUE (R-VALUE) TEST RESULTS
ASTM D 2844-01**

Sample No.	R-Value
B1-1	25
B2-1	40

**TABLE B-VI
SUMMARY OF LABORATORY PLASTICITY INDEX TEST RESULTS
ASTM D 4318**

Sample No.	Liquid Limit	Plastic Limit	Plasticity Index
B1-9	35	27	8

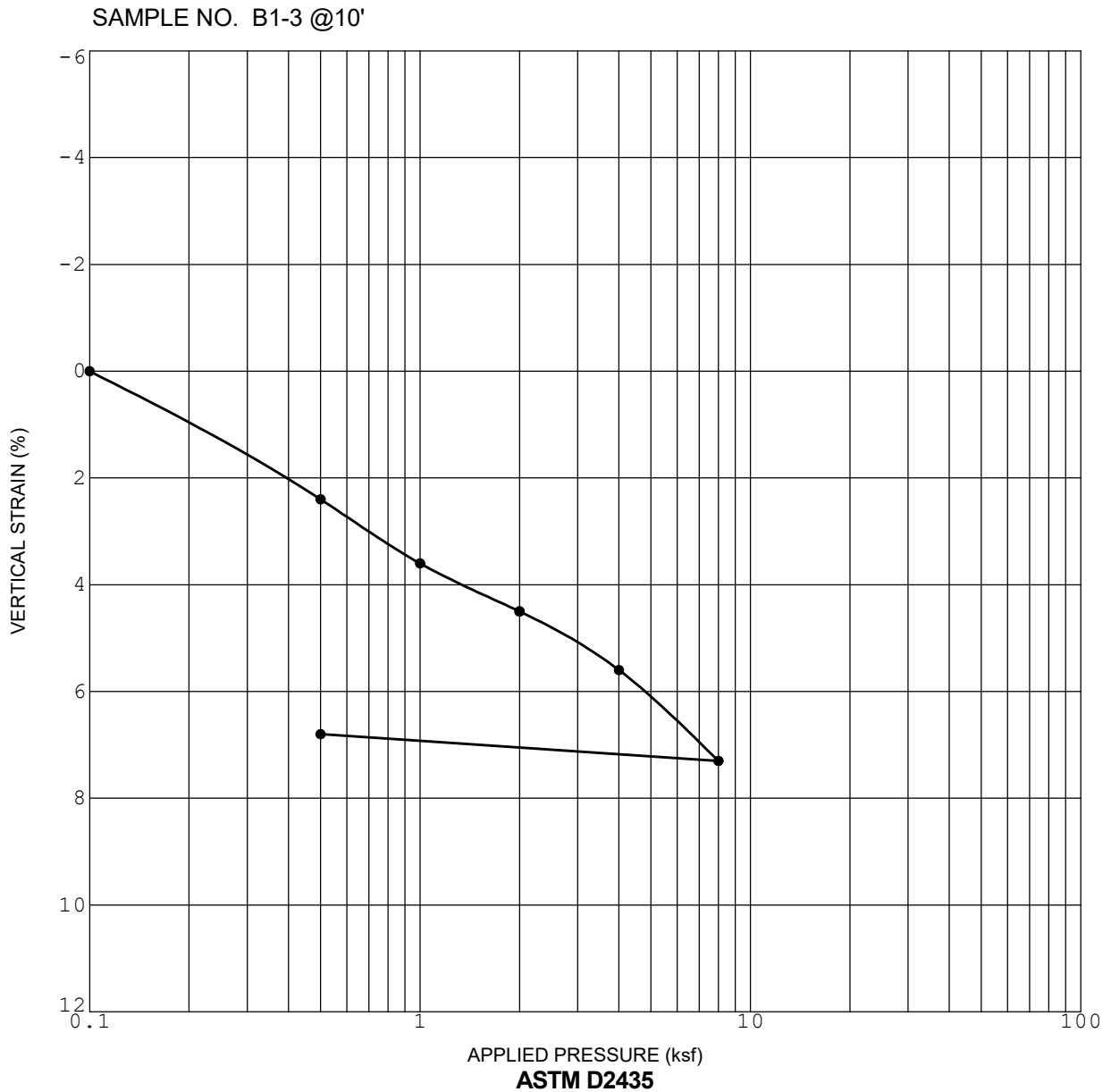

Initial Dry Density (pcf)	105.4
Initial Water Content (%)	25.0

Initial Saturation (%)	100+
Sample Saturated at (ksf)	2.0

CONSOLIDATION CURVE

BELLA MAR
408 HOLLISTER STREET
SAN DIEGO, CALIFORNIA

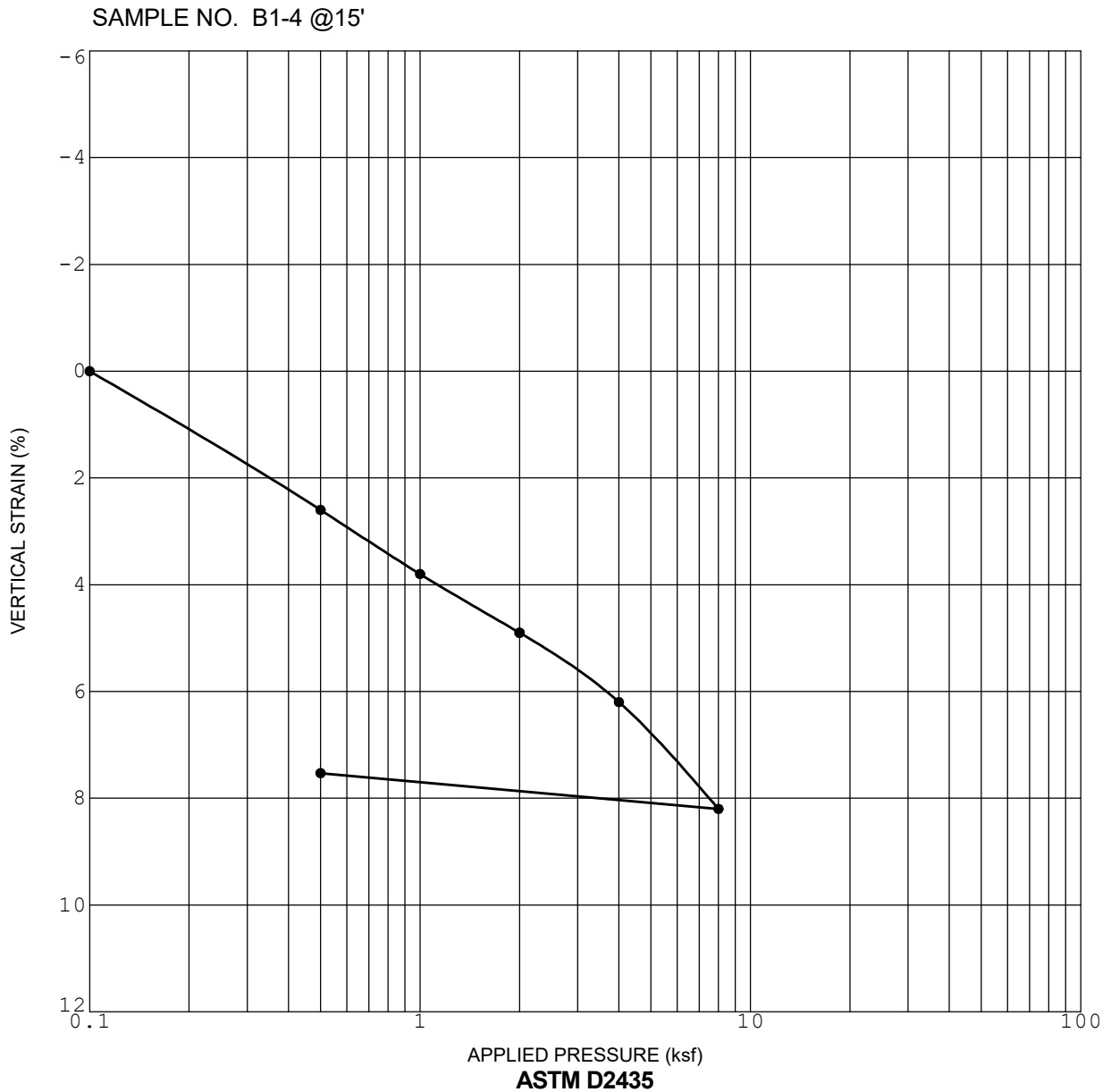

Initial Dry Density (pcf)	99.0
Initial Water Content (%)	30.8

Initial Saturation (%)	100+
Sample Saturated at (ksf)	2.0

CONSOLIDATION CURVE

BELLA MAR
408 HOLLISTER STREET
SAN DIEGO, CALIFORNIA

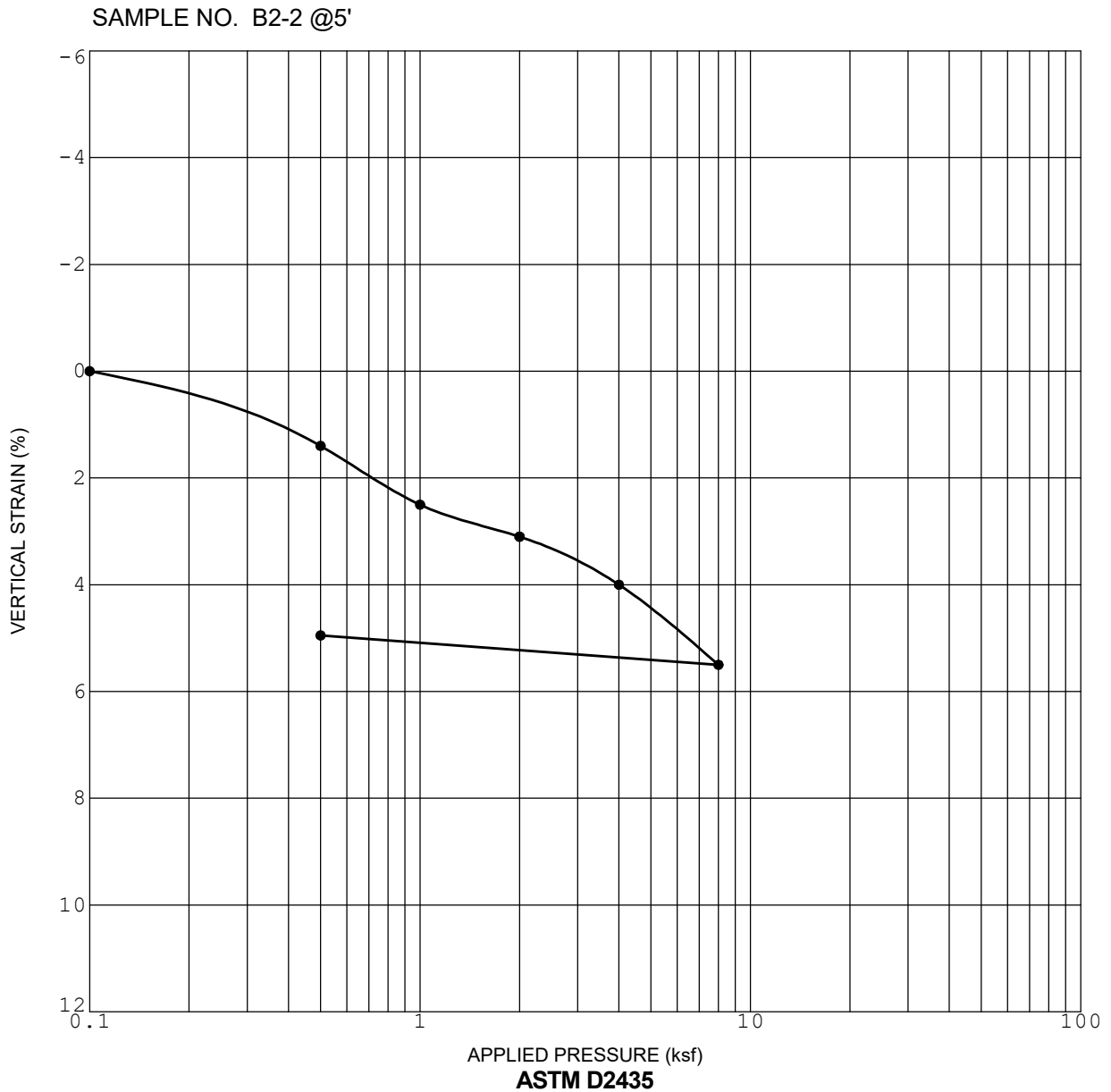

Initial Dry Density (pcf)	112.6
Initial Water Content (%)	20.1

Initial Saturation (%)	100+
Sample Saturated at (ksf)	2.0

CONSOLIDATION CURVE

BELLA MAR
408 HOLLISTER STREET
SAN DIEGO, CALIFORNIA

GRAVEL		SAND			SILT OR CLAY
COARSE	FINE	COARSE	MEDIUM	FINE	

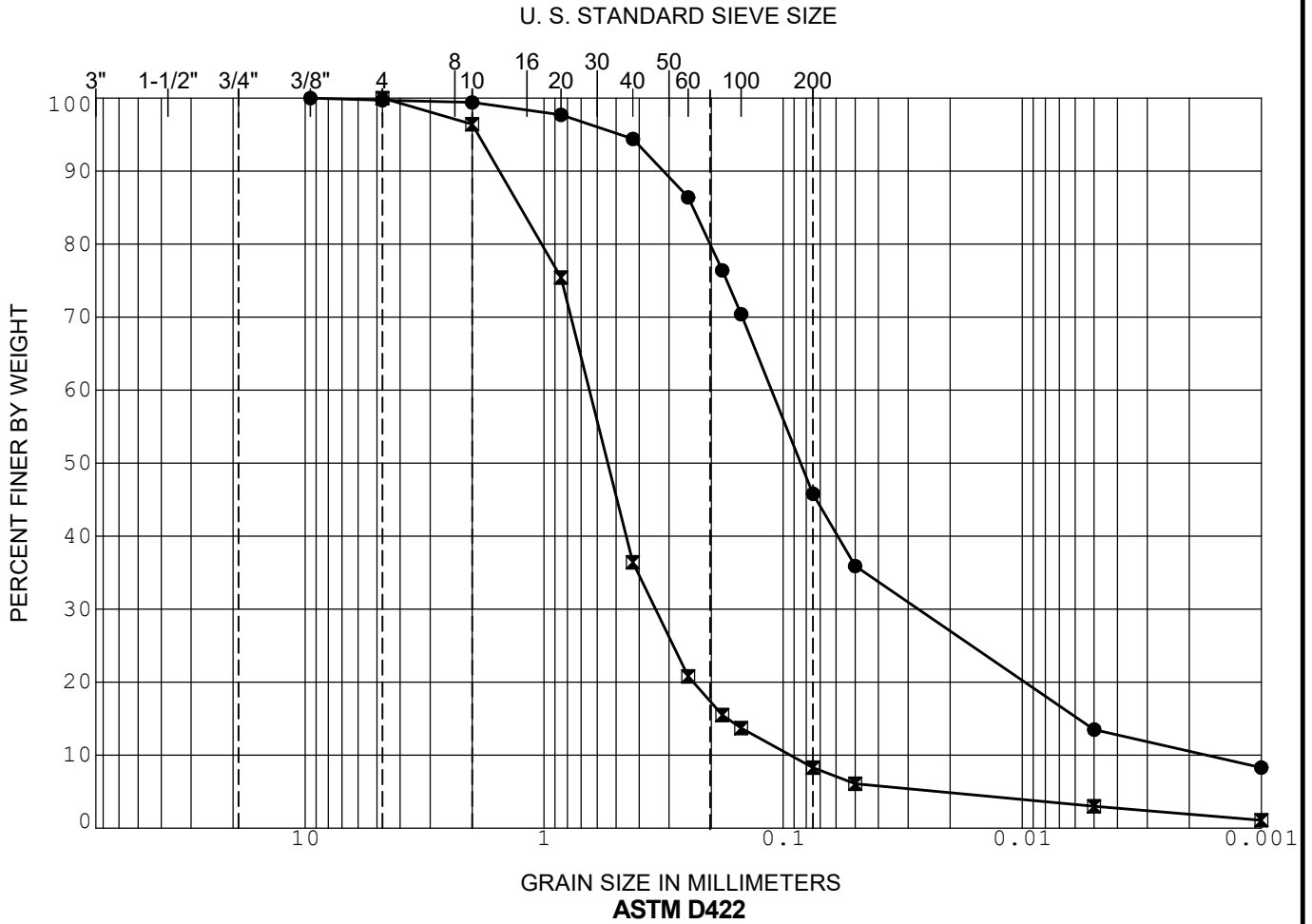

	SAMPLE	DEPTH (ft)	CLASSIFICATION	NAT WC	LL	PL	PI
●	B2-2	5.0	SM - Silty SAND				
☒	B2-6	20.0	SW-SM - Well-graded SAND to Silty SAND				
▲							

GRADATION CURVE

BELLA MAR
408 HOLLISTER STREET
SAN DIEGO, CALIFORNIA

GRAVEL		SAND			SILT OR CLAY
COARSE	FINE	COARSE	MEDIUM	FINE	

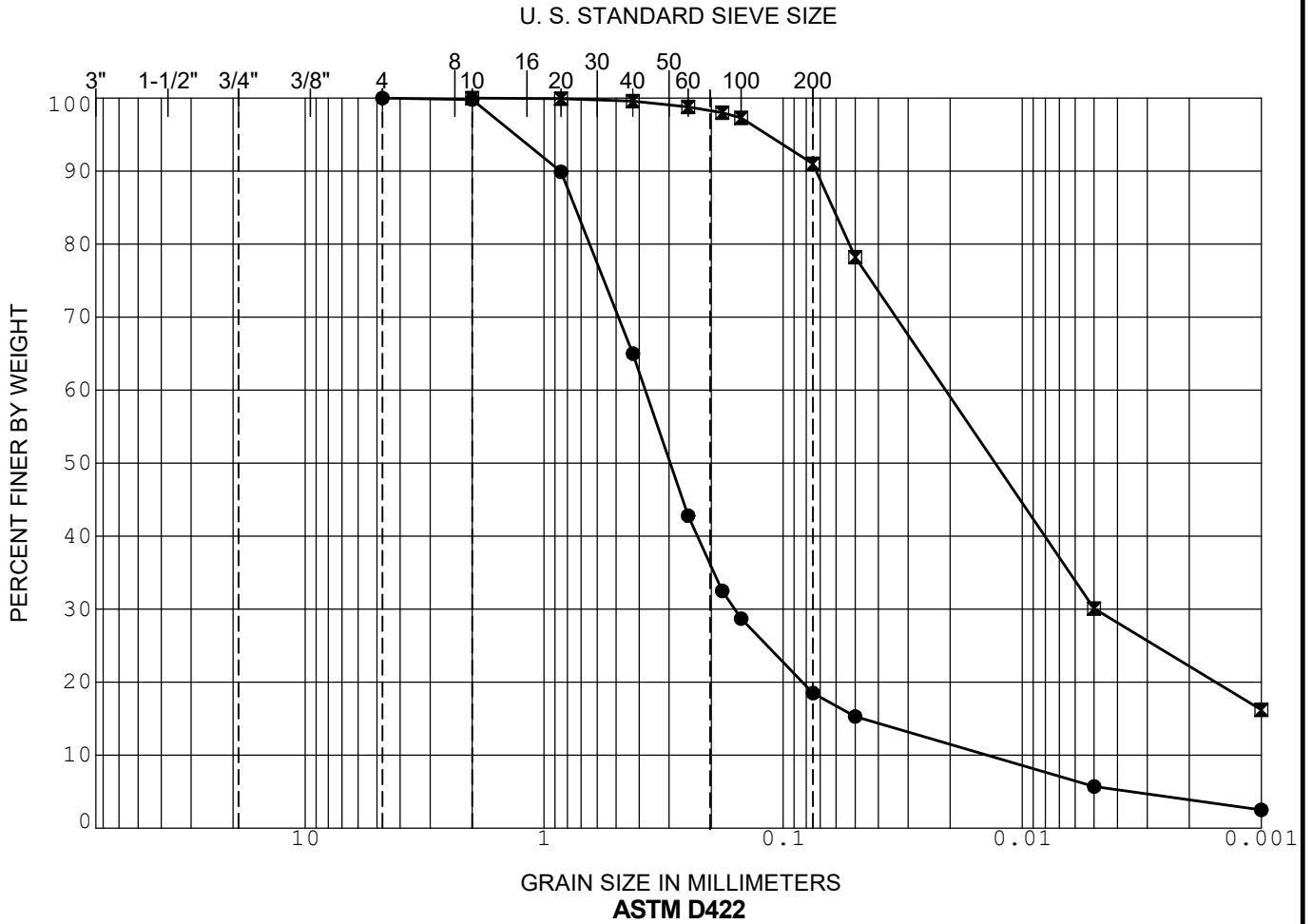

	SAMPLE	DEPTH (ft)	CLASSIFICATION	NAT WC	LL	PL	PI
●	B2-9	35.0	SM - Silty SAND				
☒	B2-11	45.0	CL - Lean CLAY				
▲							

GRADATION CURVE

BELLA MAR
408 HOLLISTER STREET
SAN DIEGO, CALIFORNIA

APPENDIX

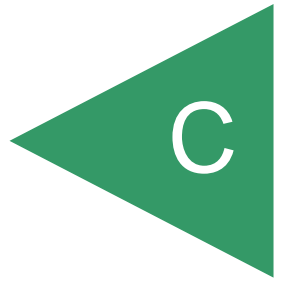

APPENDIX C

**BORING AND TRENCH LOGS, AND LABORATORY TESTING FROM
PREVIOUS INVESTIGATION (CHRISTIAN WHEELER)**

FOR

**BELLA MAR
408 HOLLISTER STREET
SAN DIEGO, CALIFORNIA**

PROJECT NO. G2129-52-03

LOG OF TEST BORING NUMBER B-1

Date Excavated: 10/3/2005
 Equipment: CME 55
 Existing Elevation: 13.0 feet
 Finish Elevation:

Logged by: AKN
 Project Manager: CHC
 Depth to Water: 13 feet
 Drive Weight: 140 lbs./30"

DEPTH (feet)	GRAPHIC LOG	SUMMARY OF SUBSURFACE CONDITIONS					SAMPLES		PENETRATION (blows/foot)	MOISTURE (%)	DRY UNIT WT. (pcf)	LABORATORY TESTS
		SAMPLE TYPE	BULK									
		2" layer of A.C.										
2		Artificial Fill (Oaf): Light to medium gray, damp to moist, loose, SILTY SAND (SM), with minor gravels and trace glas and A.C. debris.					Cal		8	2.5	97.8	
4		Alluvium (Oal): Light to medium grayish-brown, moist, loose, SILTY SAND (SM), with minor gravels.					SPT*		4			MD, DS, SA, SO ₄
6							Cal		5	2.5	98.9	
8							SPT		24			
10		Light to medium grayish-brown, moist, medium dense, POORLY GRADED SAND-SILTY SAND (SP-SM), coarse to very coarse-grained, with gravels and cobbles.					Cal		28	11.9	97.3	
12		At 11 feet becomes very moist.					SPT		43			SA
14		At 13 feet becomes saturated.					Cal*		50/5½'			
16							SPT		55			
18							SPT		55			
20							SPT		55			

Boring continued on Plate No. 3.

* No sample recovery.



CHRISTIAN WHEELER
Engineering

PROPOSED BELLA MAR R.V. PARK
 408 Hollister Road, San Diego, California

BY: HF	DATE: December 2005
JOB NO.: 2050832	PLATE NO.: 2

LOG OF TEST BORING NUMBER B-1 (Continued)

Date Excavated: 10/3/2005
 Equipment: CME 55
 Existing Elevation: 13.0 feet
 Finish Elevation:

Logged by: AKN
 Project Manager: CHC
 Depth to Water: 13 feet
 Drive Weight: 140 lbs./30"

DEPTH (feet)	GRAPHIC LOG	SUMMARY OF SUBSURFACE CONDITIONS					SAMPLES		MOISTURE (%)	DRY UNIT WT. (pcf)	LABORATORY TESTS
		SAMPLE TYPE	BULK	PENETRATION (blows/foot)							
22		<p>Alluvium (Qal): Light to medium grayish-brown, saturated, medium dense, POORLY GRADED SAND-SILTY SAND (SP-SM), coarse to very coarse-grained, with gravels and cobbles.</p> <p>Practical refusal at 27 feet on abundant cobbles.</p>					Cal*	50/5"			
24											
26											
28											
30											
32											
34											
36											
38											
40											

* No sample recovery.

CHRISTIAN WHEELER
 Engineering

PROPOSED BELLA MAR R.V. PARK
 408 Hollister Road, San Diego, California

BY: HF	DATE: December 2005
JOB NO.: 2050832	PLATE NO.: 3

LOG OF TEST BORING NUMBER B-2

Date Excavated: 10/3/2005
 Equipment: CME 55
 Existing Elevation: 12.0 feet
 Finish Elevation:

Logged by: AKN
 Project Manager: CHC
 Depth to Water: 12 feet
 Drive Weight: 140 lbs./30"

DEPTH (feet)	GRAPHIC LOG	SUMMARY OF SUBSURFACE CONDITIONS					SAMPLES		MOISTURE (%)	DRY UNIT WT. (pcf)	LABORATORY TESTS
		SAMPLE TYPE	BULK	PENETRATION (blows/foot)							
2		Residual Soil: Light to medium brown, damp, loose, SILTY SAND (SM), with minor gravels.									
4		Alluvium (Qa): Light to medium grayish-brown, damp to moist, medium dense, POORLY GRADED SAND (SP), medium-grained, poorly sorted, with minor gravels. At 4½ feet becomes moist, well sorted.					Cal		30	1.0	99.4
6							Cal		19		SA
8											
10		Medium grayish-brown, moist, medium dense, SILTY SAND-CLAYEY SAND (SM-SC), mottled.					Cal		28		
12		Light to medium grayish-brown, very moist, medium dense, POORLY GRADED SAND (SP), with gravels and cobbles. At 12 feet becomes saturated.									
14							SPT		13		
16							Cal		19		
18											
20							SPT		50/5"		SA

Boring continued on Plate No. 5.

CHRISTIAN WHEELER
 Engineering

PROPOSED BELLA MAR R.V. PARK
 408 Hollister Road, San Diego, California

BY: HF	DATE: December 2005
JOB NO.: 2050832	PLATE NO.: 4

LOG OF TEST BORING NUMBER B-2 (Continued)

Date Excavated: 10/3/2005
 Equipment: CME 55
 Existing Elevation: 12.0 feet
 Finish Elevation:

Logged by: AKN
 Project Manager: CHC
 Depth to Water: 12 feet
 Drive Weight: 140 lbs./30"

DEPTH (feet)	GRAPHIC LOG	SUMMARY OF SUBSURFACE CONDITIONS					SAMPLES		MOISTURE (%)	DRY UNIT WT. (pcf)	LABORATORY TESTS	
		SAMPLE TYPE	BULK	PENETRATION (blows/foot)								
22		Alluvium (Qa1): Light to medium grayish-brown, saturated, medium dense, POORLY GRADED SAND (SP), with gravels and cobbles.					Cal*		50/5"			
24							SPT		50/5½"			
26		Practical refusal at 27 feet on abundant cobbles.										
28												
30												
32												
34												
36												
38												
40												

* No sample recovery.



CHRISTIAN WHEELER
Engineering

PROPOSED BELLA MAR R.V. PARK
408 Hollister Road, San Diego, California

BY: HF	DATE: December 2005
JOB NO.: 2050832	PLATE NO.: 5

LOG OF TEST BORING NUMBER B-3

Date Excavated: 10/3/2005
 Equipment: CME 55
 Existing Elevation: 8.0 feet
 Finish Elevation:

Logged by: AKN
 Project Manager: CHC
 Depth to Water: 8 feet
 Drive Weight: 140 lbs./30"

DEPTH (feet)	GRAPHIC LOG	SUMMARY OF SUBSURFACE CONDITIONS					SAMPLES		PENETRATION (blows/foot)	MOISTURE (%)	DRY UNIT WT. (pcf)	LABORATORY TESTS
		SAMPLE TYPE	BULK									
		Residual Soil: Light to medium brown, damp, loose, SILTY SAND (SM), with trace gravels.										
2		Alluvium (Qa): Medium grayish-brown, moist, medium dense/stiff, SILTY SAND-SANDY SILT (SM-ML), fine-grained, with white mineral precipitate deposits and trace clay.					Cal	21	11.1	117.1	MD, DS, SA, SO ₄	
4							Cal	27	11.8	116.4		
6		Becomes saturated at 8 feet.										
8												
10		Cal	6	21.4	110.0							
12												
14		Light to medium brownish-gray, saturated, medium dense, POORLY GRADED SAND-SILTY SAND (SP-SM), very coarse-grained, with gravels and cobbles.					Cal	50/6"				
16												
18												
20		Cal	59									

Boring terminated at 20 feet.

CHRISTIAN WHEELER
 Engineering











PROPOSED BELLA MAR R.V. PARK
 408 Hollister Road, San Diego, California

BY: HF	DATE: December 2005
JOB NO.: 2050832	PLATE NO.: 6

LOG OF TEST TRENCH NUMBER T-1

Date Excavated: 9/29/2005
 Equipment: 580L with 18" bucket
 Existing Elevation: 9.0 feet
 Finish Elevation:

Logged by: AKN
 Project Manager: CHC
 Depth to Water: 9 feet
 Drive Weight: N/A

DEPTH (feet)	GRAPHIC LOG	SUMMARY OF SUBSURFACE CONDITIONS					SAMPLES		LABORATORY TESTS
		SAMPLE TYPE	BULK	PENETRATION (blows/foot)	MOISTURE (%)	DRY UNIT WT. (pcf)			
		4" layer of Residual Soil.	CK			7.8	109.4		
2		Alluvium (Qa1): Light to medium grayish-brown, damp to moist, loose to medium dense, SILTY SAND (SM), with trace clay. At 2 feet becomes moist.	CK			7.8	100.8	MD, DS, SA, SO ₄	
4		Medium grayish-brown, moist, stiff to very stiff, CLAYEY SILT-SILTY CLAY (ML-CL).	CK			23.9	93.7	HA, EI	
6		Light to medium brown, very moist, loose to medium dense, POORLY GRADED GRAVELLY SAND (SP), coarse-grained, friable. Becomes saturated at 9 feet.							
8		Practical refusal at 11 feet.							
10									
12									
14									
16									
18									
20									

CHRISTIAN WHEELER
 Engineering

PROPOSED BELLA MAR R.V. PARK
 408 Hollister Road, San Diego, California

BY: HF	DATE: December 2005
JOB NO.: 2050832	PLATE NO.: 7

LOG OF TEST TRENCH NUMBER T-2

Date Excavated: 9/29/2005
 Equipment: 580L with 18" bucket
 Existing Elevation: 11.0 feet
 Finish Elevation:

Logged by: AKN
 Project Manager: CHC
 Depth to Water: 11 feet
 Drive Weight: N/A

DEPTH (feet)	GRAPHIC LOG	SUMMARY OF SUBSURFACE CONDITIONS					SAMPLES		PENETRATION (blows/foot)	MOISTURE (%)	DRY UNIT WT. (pcf)	LABORATORY TESTS	
		SAMPLE TYPE	BULK										
		4" layer of Residual Soil.					CK			3.0	118.4		
2	2 4 6 8 10 12 14 16 18 20	<p>Alluvium (Qal): Light to medium grayish-brown, damp to moist, loose to medium dense, SILTY SAND (SM), with trace clay.</p> <p>At 2 feet becomes moist.</p>					CK			15.4	88.2		
4							CK				15.7	98.0	
8							CK						
10	▽	<p>Light to medium brown, very moist, loose to medium dense, POORLY GRADED GRAVELLY SAND (SP), medium-grained, friable.</p>											
12		Practical refusal at 12 feet.											

CHRISTIAN WHEELER
 Engineering

PROPOSED BELLA MAR R.V. PARK
 408 Hollister Road, San Diego, California

BY: HF	DATE: December 2005
JOB NO.: 2050832	PLATE NO.: 8

LOG OF TEST TRENCH NUMBER T-3

Date Excavated: 9/29/2005
 Equipment: 580L with 18" bucket
 Existing Elevation: 12.0 feet
 Finish Elevation:

Logged by: AKN
 Project Manager: CHC
 Depth to Water: 12 feet
 Drive Weight: N/A

DEPTH (feet)	GRAPHIC LOG	SUMMARY OF SUBSURFACE CONDITIONS					SAMPLES		MOISTURE (%)	DRY UNIT WT. (pcf)	LABORATORY TESTS
		SAMPLE TYPE	BULK	PENETRATION (blows/foot)	SAMPLE TYPE	BULK					
2		Residual Soil: Light to medium grayish-brown, damp, loose, SILTY SAND (SM), with minor gravels.					CK		7.5	94.1	
4		Alluvium (Qal): Light to medium grayish-brown, moist, loose to medium dense, SILTY SAND (SM), porous.					CK		11.7	95.1	
8		Light to medium brown, moist, loose to medium dense, POORLY GRADED GRAVELLY SAND-GRAVELLY SILTY SAND (SP-SM), friable.					CK		13.1	95.8	
10											
12		At 12 feet becomes saturated.									
14		Practical refusal at 13 feet.									
16											
18											
20											



CHRISTIAN WHEELER
Engineering

PROPOSED BELLA MAR R.V. PARK
 408 Hollister Road, San Diego, California

BY: HF	DATE: December 2005
JOB NO.: 2050832	PLATE NO.: 9

LOG OF TEST TRENCH NUMBER T-4

Date Excavated: 9/29/2005
 Equipment: 580L with 18" bucket
 Existing Elevation: 11.0 feet
 Finish Elevation:

Logged by: AKN
 Project Manager: CHC
 Depth to Water: 11 feet
 Drive Weight: N/A

DEPTH (feet)	GRAPHIC LOG	SUMMARY OF SUBSURFACE CONDITIONS					SAMPLES		MOISTURE (%)	DRY UNIT WT. (pcf)	LABORATORY TESTS	
		SAMPLE TYPE	BULK	PENETRATION (blows/foot)								
2		Residual Soil: Light to medium grayish-brown, damp, loose, SILTY SAND (SM), with minor gravels.					CK			1.1	109.7	
4		Alluvium (Qa): Light to medium grayish-brown, moist, loose to medium dense, SILTY SAND (SM), porous, with trace clay.					CK			16.9	101.1	
6												
8							CK			11.6	102.5	
10		Medium brown, very moist, loose to medium dense, SILTY SAND-SANDY SILT (SM-ML), very fine-grained, with trace clay.										
12		At 11 feet becomes saturated.										
14		Practical refusal at 12 feet.										
16												
18												
20												



CHRISTIAN WHEELER
Engineering

PROPOSED BELLA MAR R.V. PARK
 408 Hollister Road, San Diego, California

BY: HF	DATE: December 2005
JOB NO.: 2050832	PLATE NO.: 10

LOG OF TEST TRENCH NUMBER T-5

Date Excavated: 9/29/2005
 Equipment: 580L with 18" bucket
 Existing Elevation: 9.0 feet
 Finish Elevation:

Logged by: AKN
 Project Manager: CHC
 Depth to Water: 9 feet
 Drive Weight: N/A

DEPTH (feet)	GRAPHIC LOG	SUMMARY OF SUBSURFACE CONDITIONS				
		SAMPLES	PENETRATION (blows/foot)	MOISTURE (%)	DRY UNIT WT. (pcf)	LABORATORY TESTS
		SAMPLE TYPE	BULK			
	4" layer of Residual Soil.	CK		3.2	110.9	
2	<u>Alluvium (Qa)</u> : Light to medium grayish-brown, moist, loose to medium dense, SILTY SAND (SM), porous, with trace clay.					
4		CK		17.2	103.5	
6						
8	Medium brown, very moist, loose/medium stiff, SILTY SAND-SANDY SILT (SM-ML), very fine-grained, with trace clay.					
10	At 9 feet becomes saturated.					
12						
14	Practical refusal at 13 feet.					
16						
18						
20						



CHRISTIAN WHEELER
 Engineering

PROPOSED BELLA MAR R.V. PARK
 408 Hollister Road, San Diego, California

BY:	HF	DATE:	December 2005
JOB NO.:	2050832	PLATE NO.:	11

LOG OF TEST TRENCH NUMBER T-6

Date Excavated: 9/29/2005
 Equipment: 580L with 18" bucket
 Existing Elevation: 11.0 feet
 Finish Elevation:

Logged by: AKN
 Project Manager: CHC
 Depth to Water: 11 feet
 Drive Weight: N/A

DEPTH (feet)	GRAPHIC LOG	SUMMARY OF SUBSURFACE CONDITIONS				
		SAMPLE TYPE	BULK	PENETRATION (blows/foot)	MOISTURE (%)	DRY UNIT WT. (pcf)
		4" layer of Residual Soil.				
2		Alluvium (Qa): Light to medium grayish-brown, moist, loose to medium dense, SILTY SAND (SM), porous, with trace clay.				
4						
6		CK			3.4	104.5
8		Medium brown, very moist, loose/medium stiff, SILTY SAND-SANDY SILT (SM-ML), very fine-grained. At 11 feet becomes saturated.				
10						
12		CK			24.4	102.0
14		Practical refusal at 12 feet.				
16						
18						
20						



CHRISTIAN WHEELER
Engineering

PROPOSED BELLA MAR R.V. PARK
 408 Hollister Road, San Diego, California

BY:	HF	DATE:	December 2005
JOB NO.:	2050832	PLATE NO.:	12

LOG OF TEST TRENCH NUMBER T-7

Date Excavated: 9/29/2005
 Equipment: 580L with 18" bucket
 Existing Elevation: 10.0 feet
 Finish Elevation:

Logged by: AKN
 Project Manager: CHC
 Depth to Water: 10 feet
 Drive Weight: N/A

DEPTH (feet)	GRAPHIC LOG	SUMMARY OF SUBSURFACE CONDITIONS				
		SAMPLE TYPE	BULK PENETRATION (blows/foot)	MOISTURE (%)	DRY UNIT WT. (pcf)	LABORATORY TESTS
	4" layer of Residual Soil.	CK		2.2	100.9	
2						
4		<u>Alluvium (Qa)</u> : Light to medium grayish-brown, moist, loose to medium dense, SILTY SAND (SM), porous, with trace clay.	CK		13.0	100.5
6						
8						
10	At 10 feet becomes medium brown, saturated, loose, with minor gravels and cobbles.					
12	Practical refusal at 11 feet.					
14						
16						
18						
20						



CHRISTIAN WHEELER
Engineering

PROPOSED BELLA MAR R.V. PARK
 408 Hollister Road, San Diego, California

BY: HF	DATE: December 2005
JOB NO.: 2050832	PLATE NO.: 13

LOG OF TEST TRENCH NUMBER T-8

Date Excavated: 9/29/2005
 Equipment: 580L with 18" bucket
 Existing Elevation: 10.0 feet
 Finish Elevation:

Logged by: AKN
 Project Manager: CHC
 Depth to Water: N/A
 Drive Weight: N/A

DEPTH (feet)	GRAPHIC LOG	SUMMARY OF SUBSURFACE CONDITIONS					SAMPLES		MOISTURE (%)	DRY UNIT WT. (pcf)	LABORATORY TESTS			
		SAMPLE TYPE	BULK	PENETRATION (blows/foot)	MOISTURE (%)	DRY UNIT WT. (pcf)	LABORATORY TESTS							
2		<p>Residual Soil: Light to medium grayish-brown, damp, loose to medium dense, SILTY SAND (SM).</p> <p>Alluvium (Qal): Light to medium brown, damp to moist, loose to medium dense, SILTY SAND-POORLY GRADED SAND (SM-SP), friable, with minor cobbles throughout.</p> <p>At 2½ feet becomes moist.</p>												
4														
6														
8		<p>Practical refusal at 8 feet.</p>												
10														
12														
14														
16														
18														
20														



CHRISTIAN WHEELER
Engineering

PROPOSED BELLA MAR R.V. PARK
 408 Hollister Road, San Diego, California

BY: HF	DATE: December 2005
JOB NO.: 2050832	PLATE NO.: 14

LOG OF TEST TRENCH NUMBER T-9

Date Excavated: 9/29/2005
 Equipment: 580L with 18" bucket
 Existing Elevation: 12.0 feet
 Finish Elevation:

Logged by: AKN
 Project Manager: CHC
 Depth to Water: N/A
 Drive Weight: N/A

DEPTH (feet)	GRAPHIC LOG	SUMMARY OF SUBSURFACE CONDITIONS	SAMPLES					
			SAMPLE TYPE	BULK	PENETRATION (blows/foot)	MOISTURE (%)	DRY UNIT WT. (pcf)	LABORATORY TESTS
		6" layer of Residual Soil.	CK					
2		Alluvium (Qal): Light to medium grayish-brown, damp to moist, loose to medium dense, SILTY SAND (SM), slightly porous, with trace gravels. Light to medium brown, moist, loose to medium dense, SILTY SAND-POORLY GRADED SAND (SM-SP), with minor cobbles throughout.						
4								
6								
8		Practical refusal at 8 feet.						
10								
12								
14								
16								
18								
20								



CHRISTIAN WHEELER
Engineering

PROPOSED BELLA MAR R.V. PARK
 408 Hollister Road, San Diego, California

BY: HF	DATE: December 2005
JOB NO.: 2050832	PLATE NO.: 15

LABORATORY TEST RESULTS

PROPOSED BELLA MAR RV PARK

408 HOLLISTER STREET

SAN DIEGO, CALIFORNIA

MAXIMUM DRY DENSITY AND OPTIMUM MOISTURE CONTENT (ASTM D1557)

Sample Location	Boring B-1 @ 3'-8½'	Boring B-3 @ 1'-5'	Trench T-1 @ 0-4½'
Sample Description	Grayish-brown, SP-SM	Grayish-brown, ML	Grayish-brown, SM
Maximum Density	116.0 pcf	122.9 pcf	121.8 pcf
Optimum Moisture	10.7 %	11.2 %	11.8 %

DIRECT SHEAR (ASTM D3080)

Sample Location	Boring B-1 @ 3'-8½'	Boring B-3 @ 1'-5'	Trench T-1 @ 0-4½'
Sample Type	Remolded to 90 %	Remolded to 90 %	Remolded to 90 %
Friction Angle	27°	26°	28°
Cohesion	125 psf	100 psf	250 psf

GRAIN SIZE DISTRIBUTION (ASTM D422)

Sample Location	Boring B-1 @ 3'-8½'	Boring B-1 @ 14'-15'	Boring B-2 @ 2'-5'	Boring B-2 @ 19'-20'
Sieve Size	Percent Passing		Percent Passing	
2"			100	
1½"	100	100	99	100
1"	99	91	99	83
¾"	98	87	93	77
½"	96	83	85	66
⅜"	94	79	82	58
#4	91	71	75	46
#8	87	62	71	36
#16	82	49	65	29
#30	65	34	53	23
#50	30	19	26	16
#100	14	9	13	10
#200	8	5	8	7

Sample Location	Boring B-3 @ 1'-5'	Trench T-1 @ 0-4½'	Trench T-1 @ 4½'-8'
Sieve Size	Percent Passing		Percent Passing
#4			
#8	100	100	
#16	99	99	100
#30	97	97	99
#50	92	86	97
#100	73	61	85
#200	54	43	61
0.05 mm	--	--	50
0.005 mm	--	--	18
0.001 mm	--	--	15

LABORATORY TEST RESULTS (Continued)

EXPANSION INDEX (ASTM D4829)

Sample Location	Trench T-1 @ 4½'-8'
Initial Moisture	10.3 %
Initial Dry Density	97.1 pcf
Final Moisture	29.0 %
Expansion Index	42 (low)

SOLUBLE SULFATE CONTENT (CALTEST 417)

Sample Location	Boring B-1 @ 3'-8½'	Boring B-3 @ 1'-5'	Trench T-1 @ 0-4½'
Sulfate Content	0.005 %	0.024 %	0.050 %

REFERENCES

- Anderson, J.G.; Rockwell, R.K. and Agnew, D.C., 1989, Past and Possible Future Earthquakes of Significance to the San Diego Region, Earthquake Spectra, Volume 5, No. 2, 1989.
- Blake, T.F., 2000, EQFAULT, A Computer Program for the Estimation of Peak Horizontal Acceleration from 3-D Fault Sources, Version 3.0, Thomas F. Blake Computer Services and Software, Thousand Oaks, California.
- Boore, David M., Joyner, William B., and Fumal, Thomas E., 1997, "Empirical Near-Source Attenuation Relationships for Horizontal and Vertical Components of Peak Ground Acceleration, Peak Ground Velocity, and Pseudo-Absolute Acceleration Response Spectra", in *Seismological Research Letters*, Volume 68, Number 1, January/February 1997.
- California Division of Mines and Geology, 1997, "Guidelines for Evaluating and mitigating Seismic Hazards in California", CDMG Special Publication 117.
- California Division of Mines and Geology, 1998, Maps of Known Active Fault Near-Source Zones in California and Adjacent Portions of Nevada
- Countywide Flood Insurance Rate Map, Map No. 06073C1883F (panel 2154 of 2375), prepared by the Federal Emergency Management Agency, effective date June 19, 1997.
- Jennings, C.W., 1975, Fault Map of California, California Division of Mines and Geology, Map No. 1, Scale 1:750,000.
- Kennedy, M.P., 1975, Geology of the San Diego Metropolitan Area, California; California Division of Mines and Geology, Bulletin 200
- Kern, P., 1989, Earthquakes and Faults in San Diego County, Pickle Press, 73 pp.
- Wesnousky, S.G., 1986, "Earthquakes, Quaternary Faults, and Seismic Hazards in California," in *Journal of Geophysical Research*, Volume 91, No. B12, pp 12,587 to 12,631, November 1986.

APPENDIX

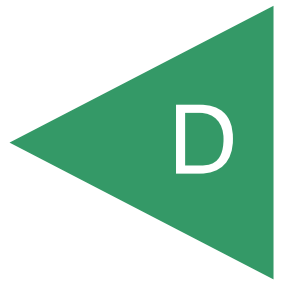

APPENDIX D

LIQUEFACTION ANALYSIS

FOR

BELLA MAR
408 HOLLISTER STREET
SAN DIEGO, CALIFORNIA

PROJECT NO. G2129-52-03



LIQUEFACTION ANALYSIS REPORT

Project title : Bella Mar

Location : 408 Hollister Street

CPT file : CPT-1

Input parameters and analysis data

Analysis method:	NCEER (1998)	G.W.T. (in-situ):	10.00 ft	Use fill:	No	Clay like behavior	
Fines correction method:	NCEER (1998)	G.W.T. (earthq.):	10.00 ft	Fill height:	N/A	applied:	Sands only
Points to test:	Based on Ic value	Average results interval:	3	Fill weight:	N/A	Limit depth applied:	No
Earthquake magnitude M_w :	6.12	Ic cut-off value:	2.60	Trans. detect. applied:	No	Limit depth:	N/A
Peak ground acceleration:	0.39	Unit weight calculation:	Based on SBT	K_0 applied:	Yes	MSF method:	Method based

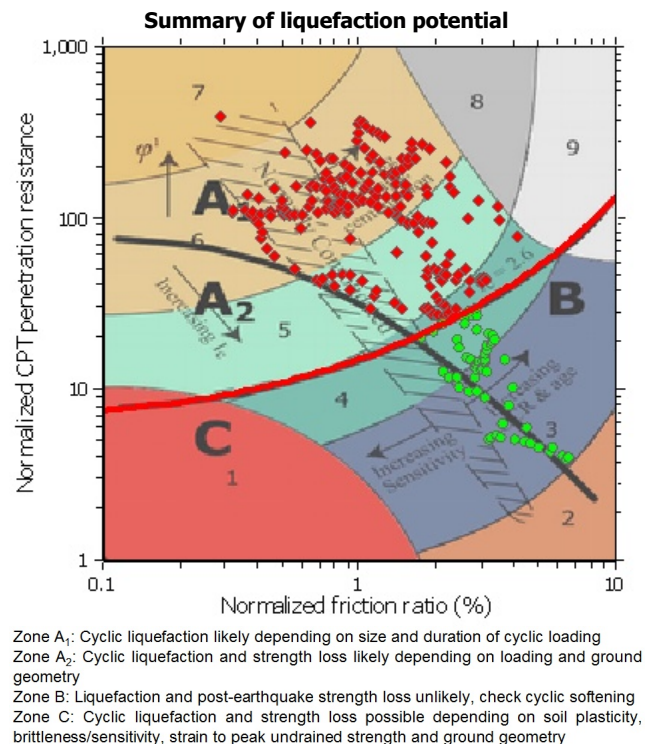
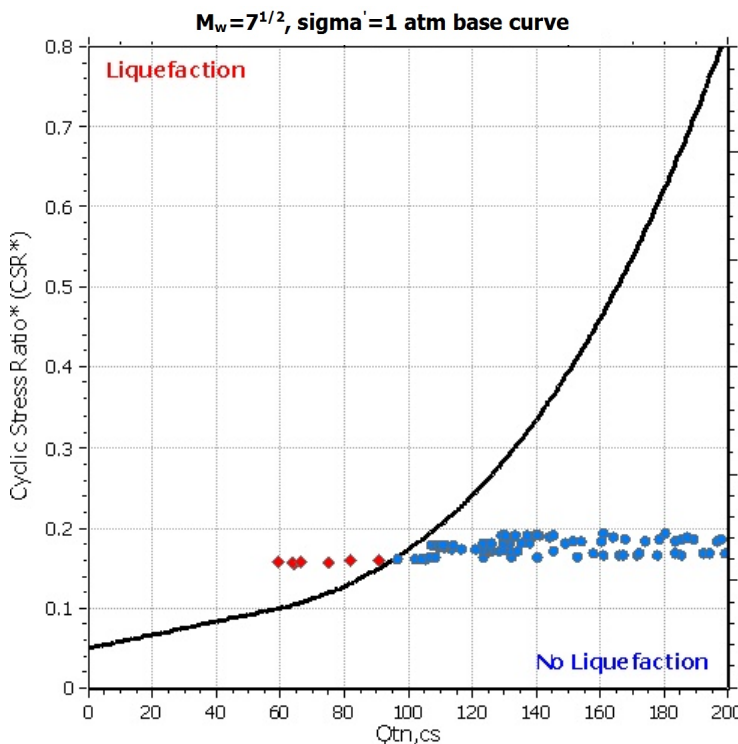
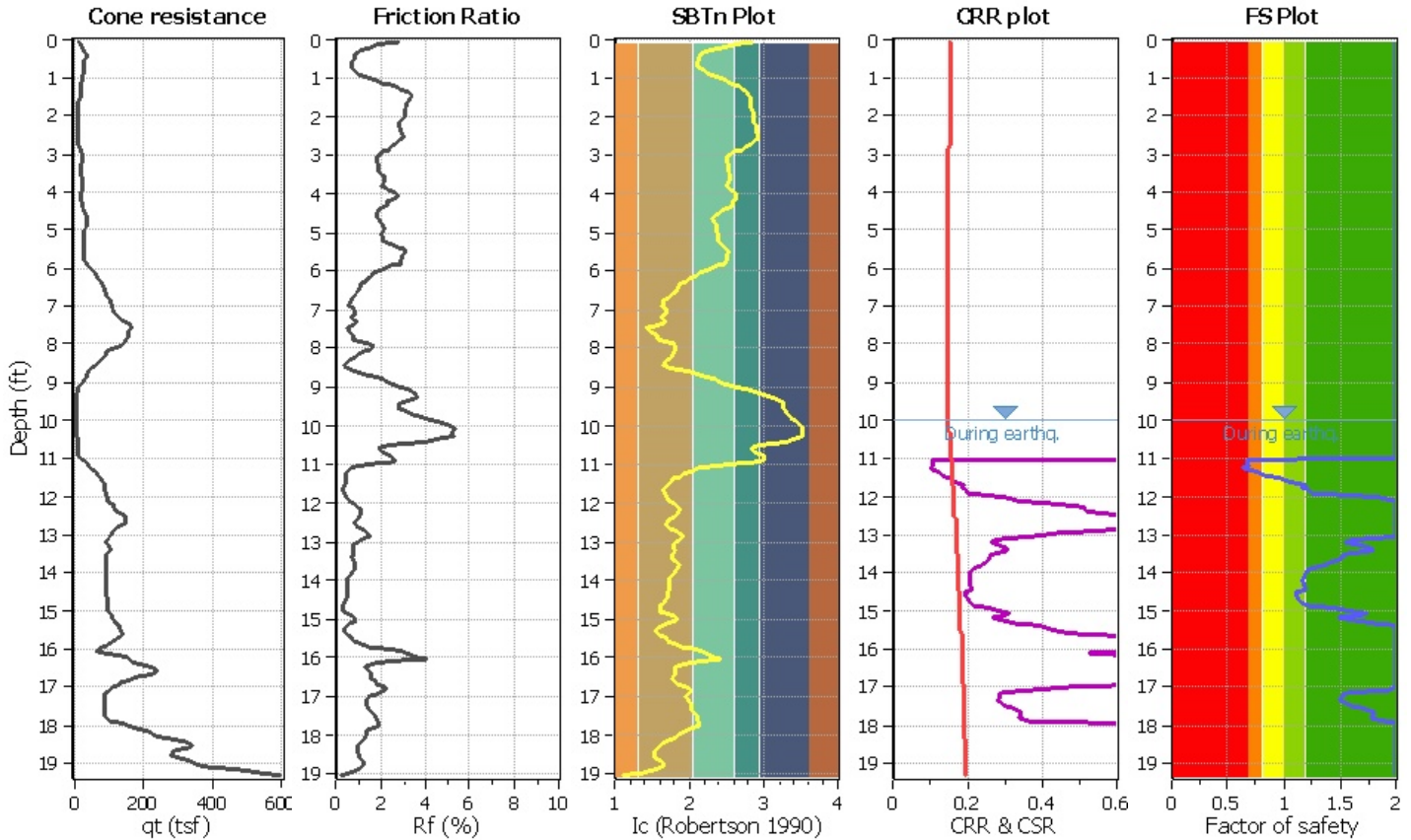

Liquefaction analysis overall plot

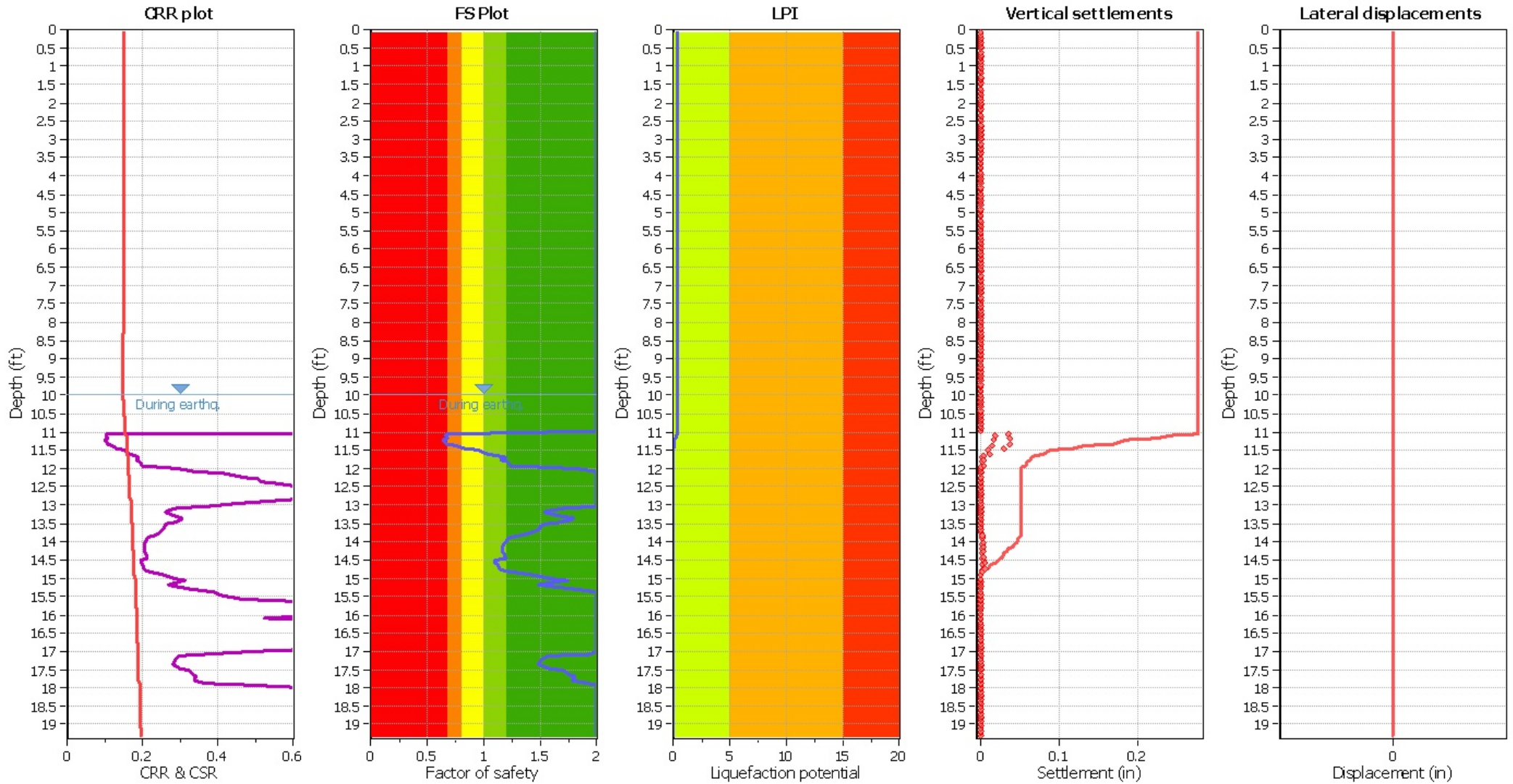

Input parameters and analysis data

Analysis method:	NCEER (1998)	Depth to water table (earthq.):	10.00 ft	Fill weight:	N/A
Fines correction method:	NCEER (1998)	Average results interval:	3	Transition detect. applied:	No
Points to test:	Based on Ic value	Ic cut-off value:	2.60	K_0 applied:	Yes
Earthquake magnitude M_w :	6.12	Unit weight calculation:	Based on SBT	Clay like behavior applied:	Sands only
Peak ground acceleration:	0.39	Use fill:	No	Limit depth applied:	No
Depth to water table (insitu):	10.00 ft	Fill height:	N/A	Limit depth:	N/A

F.S. color scheme

- Almost certain it will liquefy
- Very likely to liquefy
- Liquefaction and no liq. are equally likely
- Unlike to liquefy
- Almost certain it will not liquefy

LPI color scheme

- Very high risk
- High risk
- Low risk

Liquefaction analysis summary plo

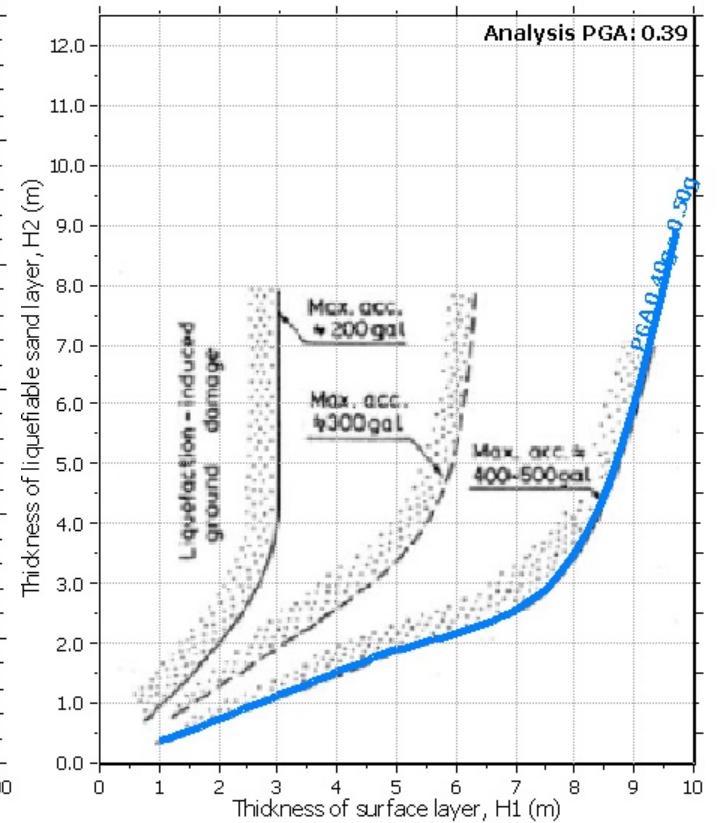
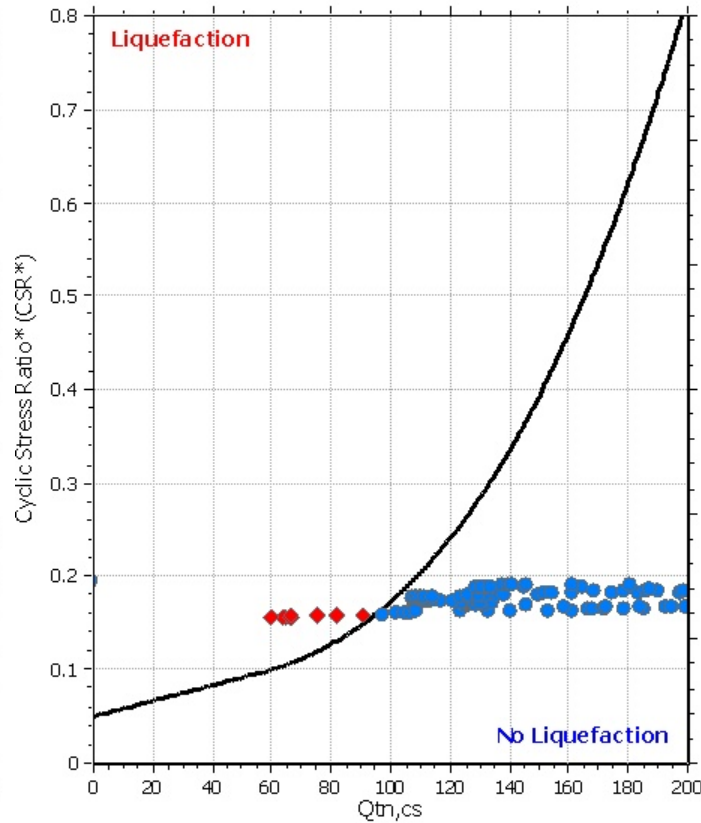
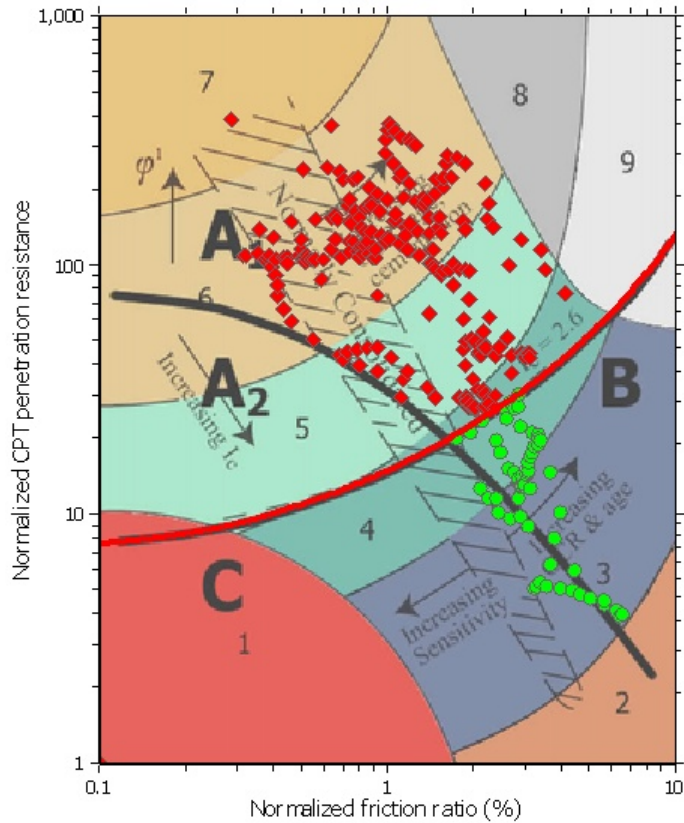

Input parameters and analysis data

Analysis method:	NCEER (1998)	Depth to water table (erthq.):	10.00 ft	Fill weight:	N/A
Fines correction method:	NCEER (1998)	Average results interval:	3	Transition detect. applied:	No
Points to test:	Based on Ic value	Ic cut-off value:	2.60	K_0 applied:	Yes
Earthquake magnitude M_w :	6.12	Unit weight calculation:	Based on SBT	Clay like behavior applied:	Sands only
Peak ground acceleration:	0.39	Use fill:	No	Limit depth applied:	No
Depth to water table (insitu):	10.00 ft	Fill height:	N/A	Limit depth:	N/A

LIQUEFACTION ANALYSIS REPORT

Project title : Bella Mar

Location : 408 Hollister Street

CPT file : CPT-2

Input parameters and analysis data

Analysis method:	NCEER (1998)	G.W.T. (in-situ):	10.00 ft	Use fill:	No	Clay like behavior	
Fines correction method:	NCEER (1998)	G.W.T. (earthq.):	10.00 ft	Fill height:	N/A	applied:	Sands only
Points to test:	Based on Ic value	Average results interval:	3	Fill weight:	N/A	Limit depth applied:	No
Earthquake magnitude M_w :	6.12	Ic cut-off value:	2.60	Trans. detect. applied:	No	Limit depth:	N/A
Peak ground acceleration:	0.39	Unit weight calculation:	Based on SBT	K_0 applied:	Yes	MSF method:	Method based

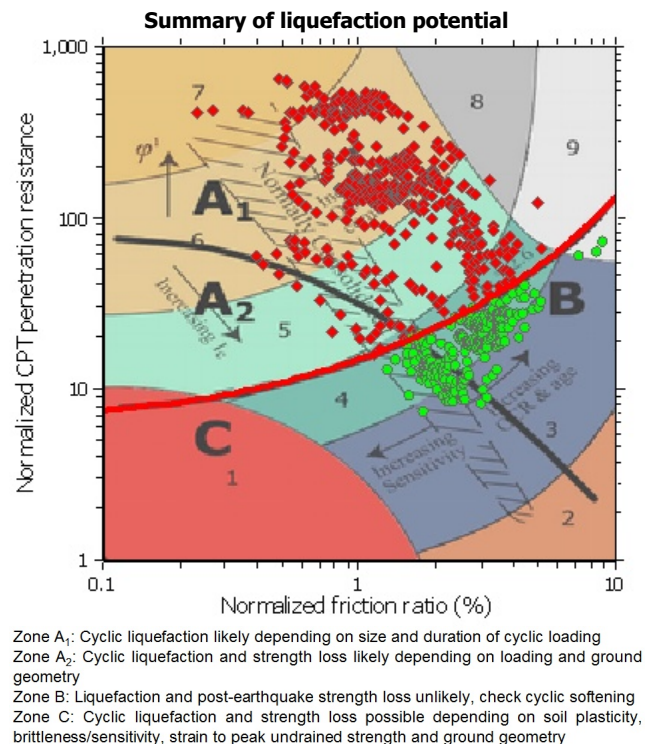
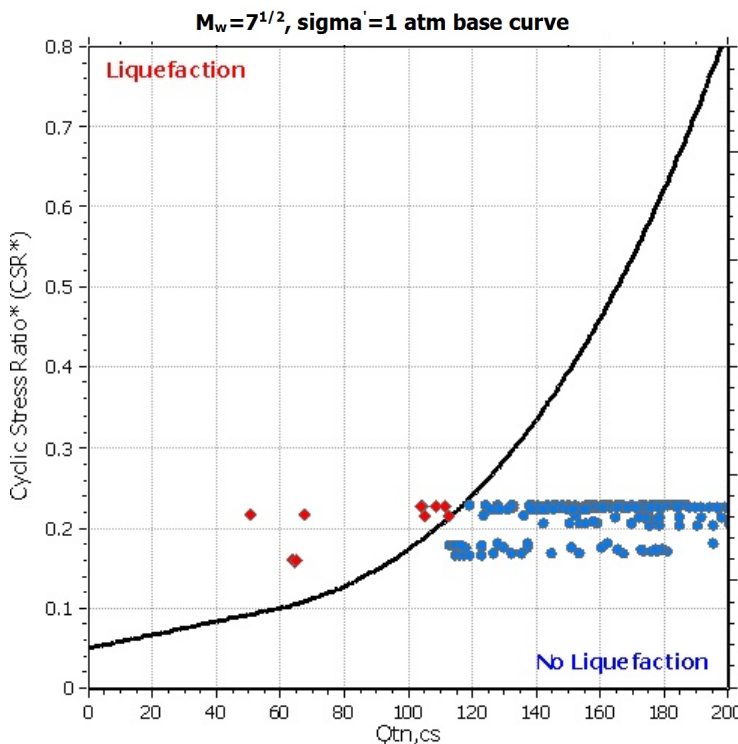
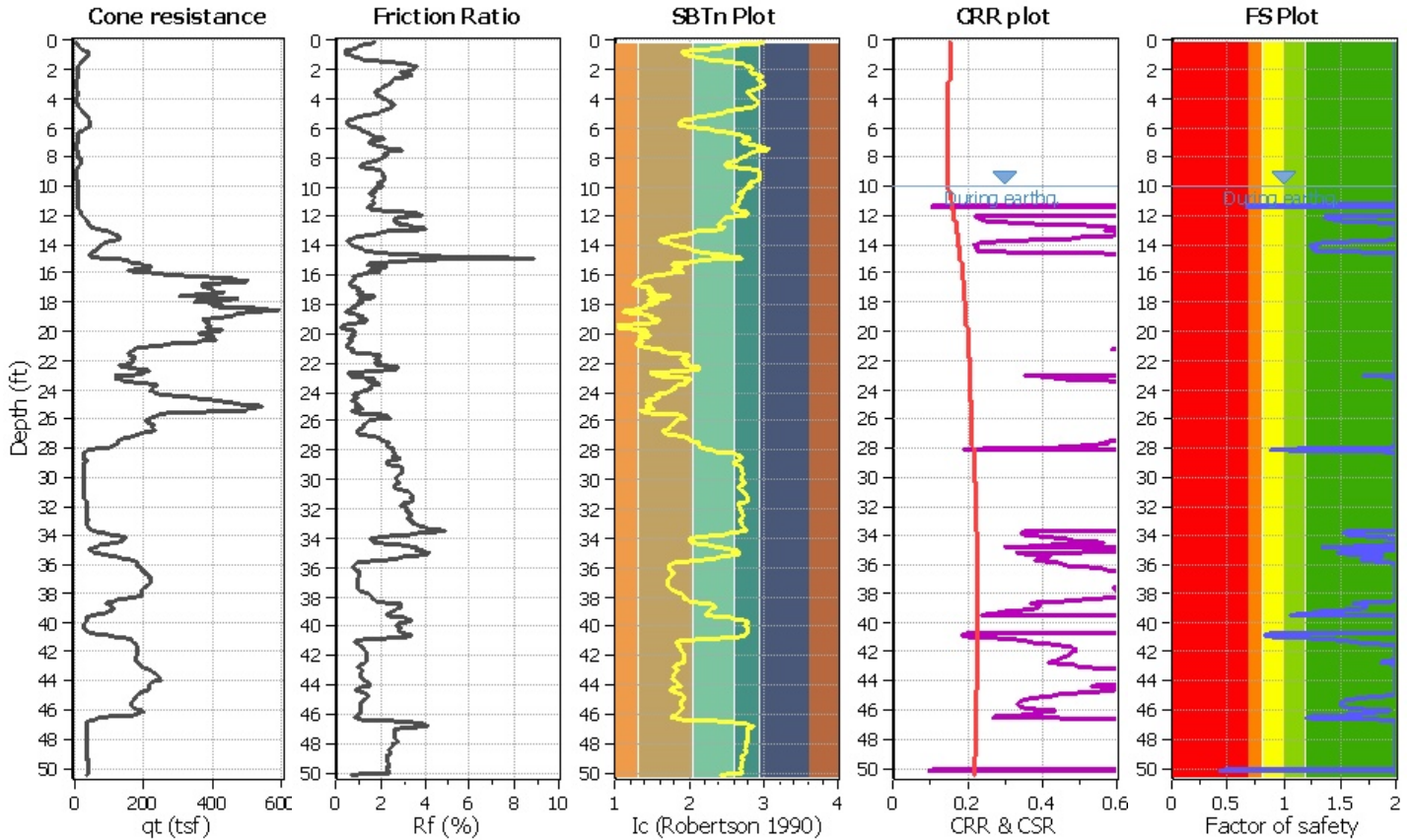

Liquefaction analysis overall plot

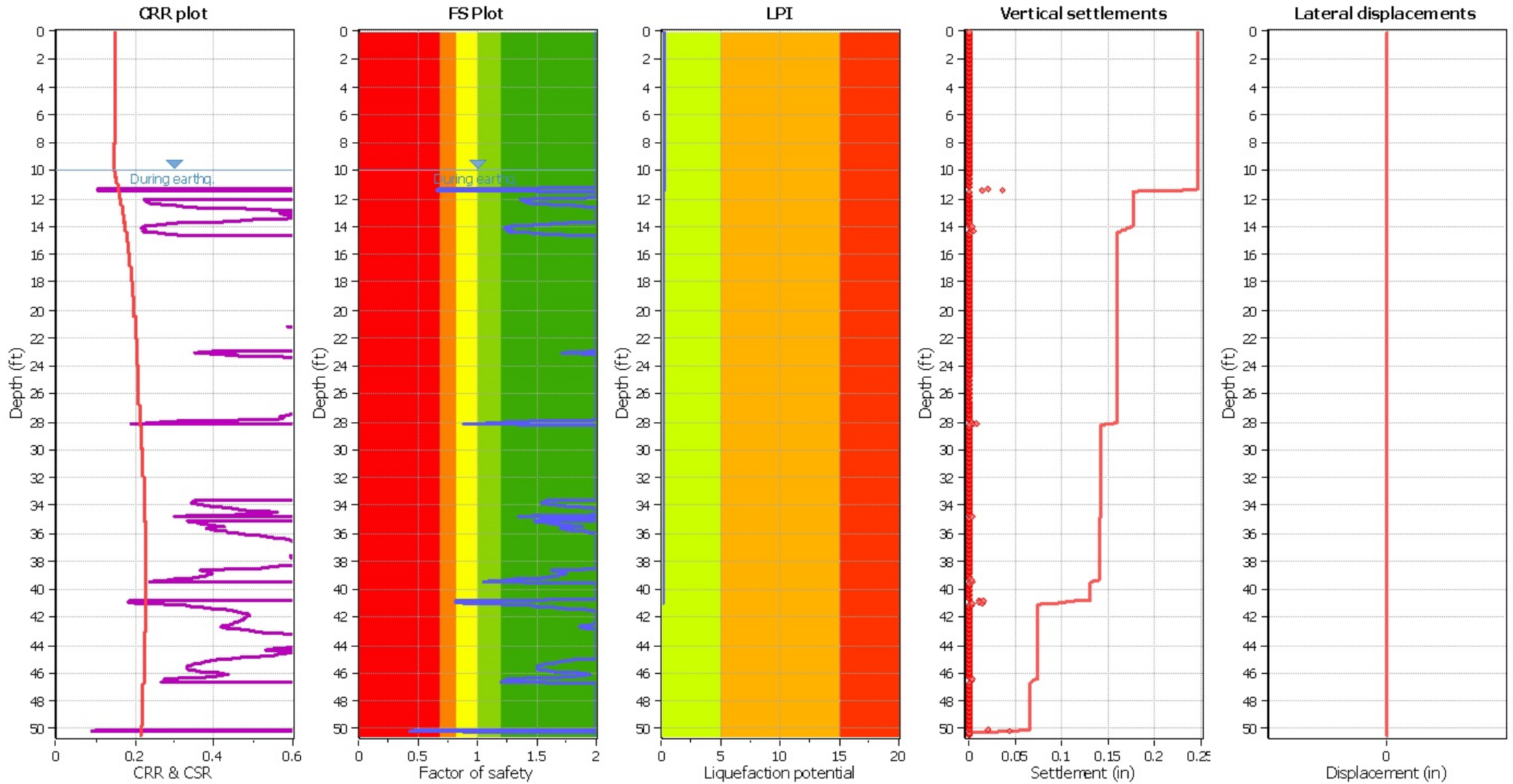

Input parameters and analysis data

Analysis method:	NCEER (1998)	Depth to water table (earthq.):	10.00 ft	Fill weight:	N/A
Fines correction method:	NCEER (1998)	Average results interval:	3	Transition detect. applied:	No
Points to test:	Based on Ic value	Ic cut-off value:	2.60	K_0 applied:	Yes
Earthquake magnitude M_w :	6.12	Unit weight calculation:	Based on SBT	Clay like behavior applied:	Sands only
Peak ground acceleration:	0.39	Use fill:	No	Limit depth applied:	No
Depth to water table (insitu):	10.00 ft	Fill height:	N/A	Limit depth:	N/A

F.S. color scheme

- Almost certain it will liquefy
- Very likely to liquefy
- Liquefaction and no liq. are equally likely
- Unlike to liquefy
- Almost certain it will not liquefy

LPI color scheme

- Very high risk
- High risk
- Low risk

Liquefaction analysis summary plo

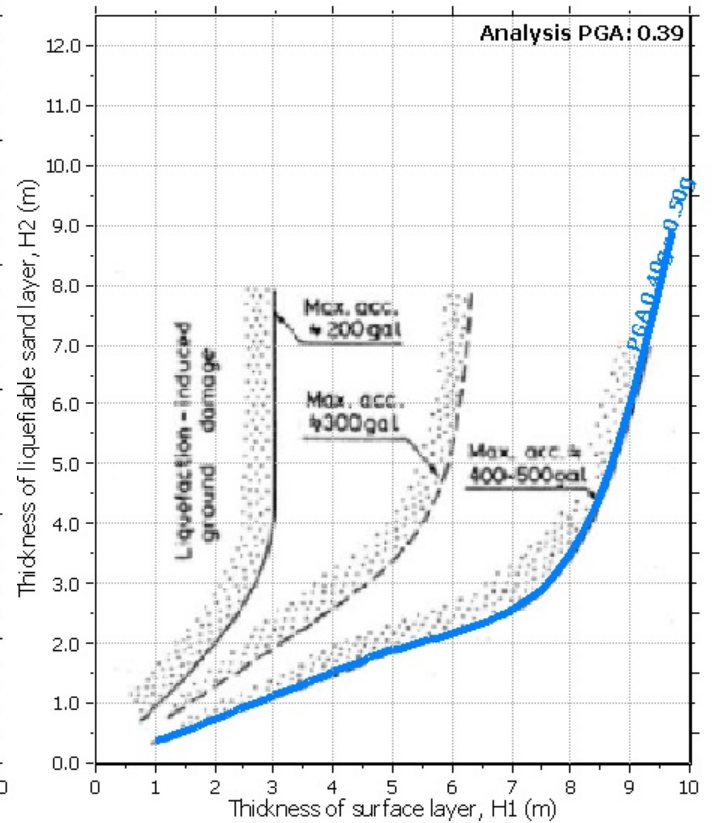
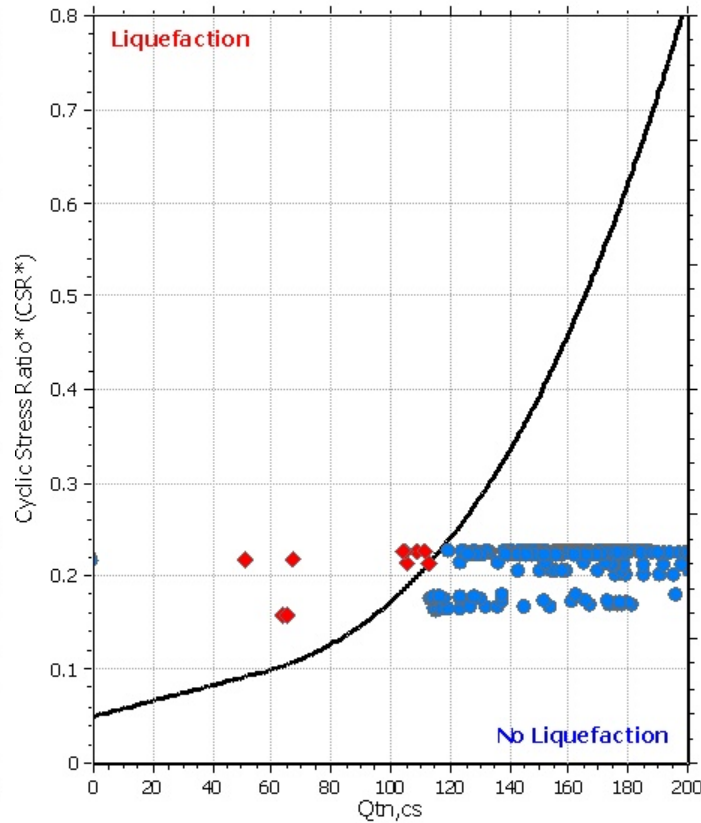
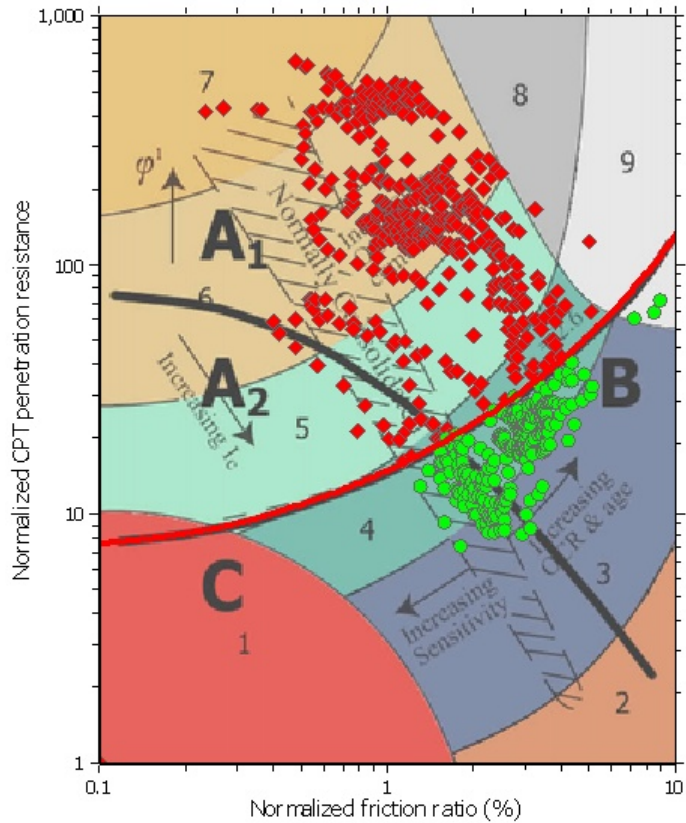

Input parameters and analysis data

Analysis method:	NCEER (1998)	Depth to water table (erthq.):	10.00 ft	Fill weight:	N/A
Fines correction method:	NCEER (1998)	Average results interval:	3	Transition detect. applied:	No
Points to test:	Based on Ic value	Ic cut-off value:	2.60	K_0 applied:	Yes
Earthquake magnitude M_w :	6.12	Unit weight calculation:	Based on SBT	Clay like behavior applied:	Sands only
Peak ground acceleration:	0.39	Use fill:	No	Limit depth applied:	No
Depth to water table (insitu):	10.00 ft	Fill height:	N/A	Limit depth:	N/A

LIQUEFACTION ANALYSIS REPORT

Project title : Bella Mar

Location : 408 Hollister Street

CPT file : CPT-3

Input parameters and analysis data

Analysis method:	NCEER (1998)	G.W.T. (in-situ):	10.00 ft	Use fill:	No	Clay like behavior	
Fines correction method:	NCEER (1998)	G.W.T. (earthq.):	10.00 ft	Fill height:	N/A	applied:	Sands only
Points to test:	Based on Ic value	Average results interval:	3	Fill weight:	N/A	Limit depth applied:	No
Earthquake magnitude M_w :	6.12	Ic cut-off value:	2.60	Trans. detect. applied:	No	Limit depth:	N/A
Peak ground acceleration:	0.39	Unit weight calculation:	Based on SBT	K_0 applied:	Yes	MSF method:	Method based

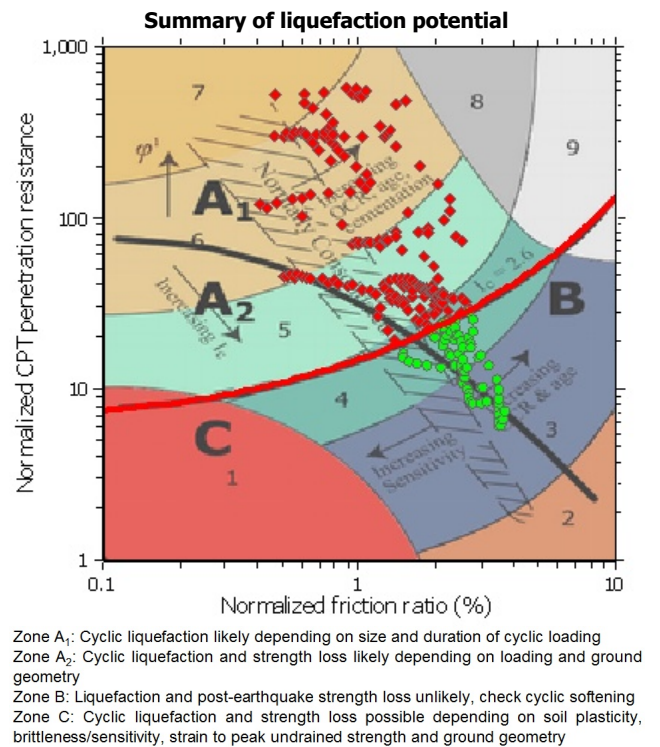
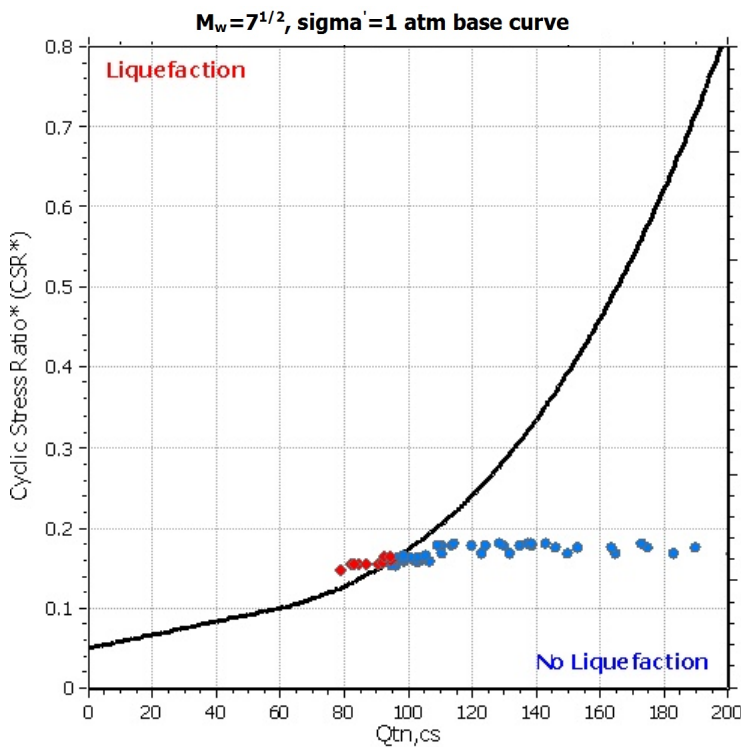
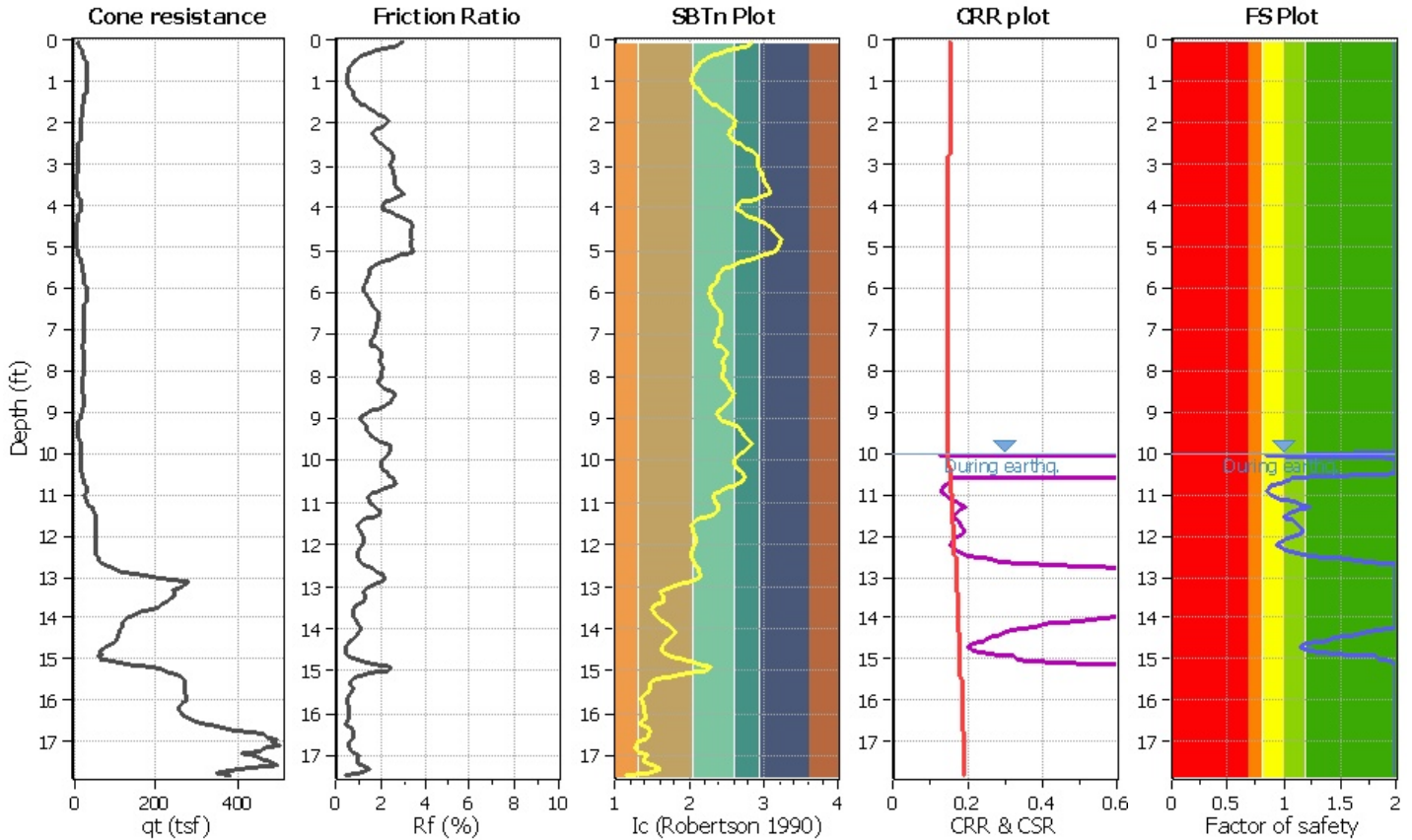

Liquefaction analysis overall plot

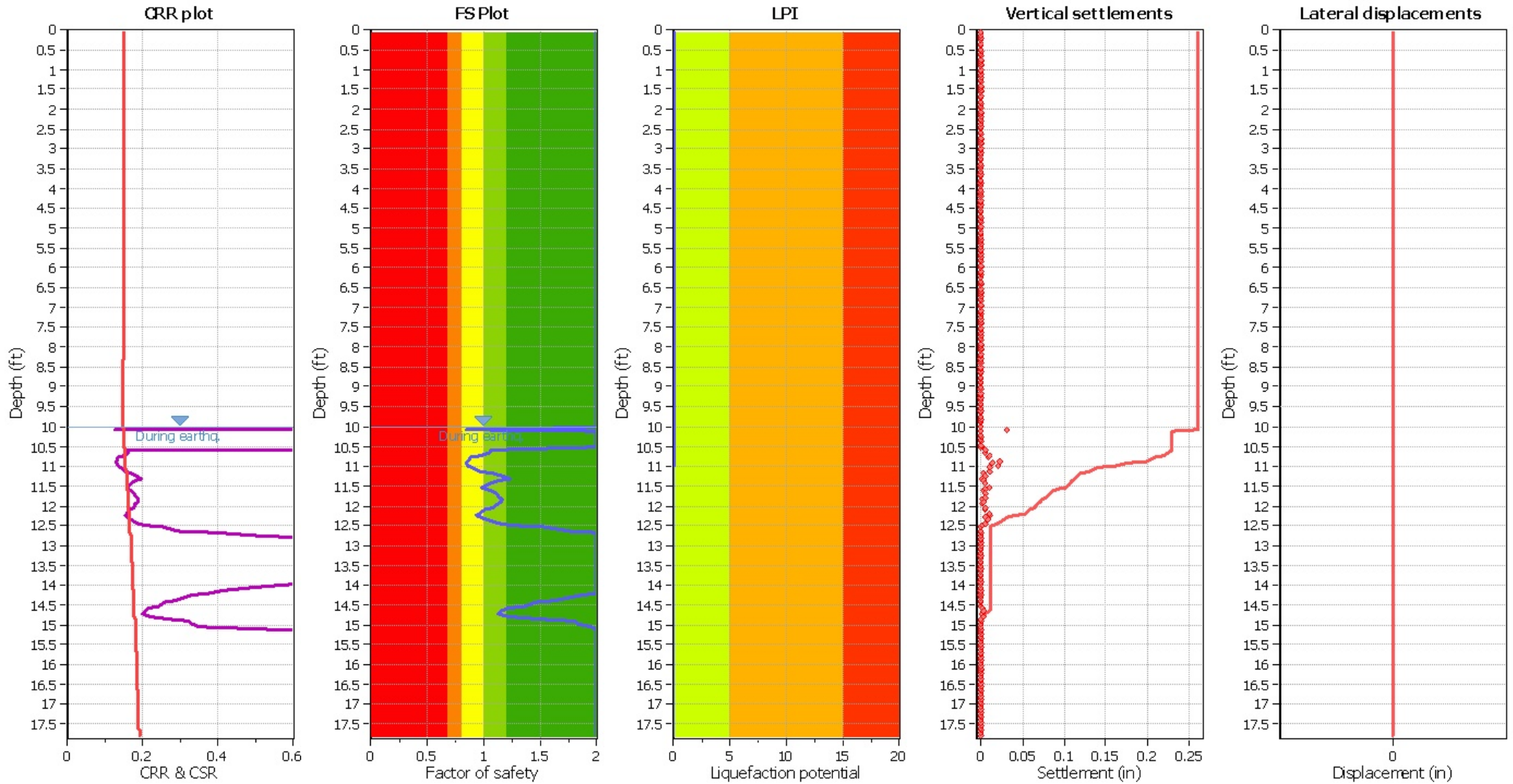

Input parameters and analysis data

Analysis method:	NCEER (1998)	Depth to water table (earthq.):	10.00 ft	Fill weight:	N/A
Fines correction method:	NCEER (1998)	Average results interval:	3	Transition detect. applied:	No
Points to test:	Based on Ic value	Ic cut-off value:	2.60	K_0 applied:	Yes
Earthquake magnitude M_w :	6.12	Unit weight calculation:	Based on SBT	Clay like behavior applied:	Sands only
Peak ground acceleration:	0.39	Use fill:	No	Limit depth applied:	No
Depth to water table (insitu):	10.00 ft	Fill height:	N/A	Limit depth:	N/A

F.S. color scheme

- Almost certain it will liquefy
- Very likely to liquefy
- Liquefaction and no liq. are equally likely
- Unlike to liquefy
- Almost certain it will not liquefy

LPI color scheme

- Very high risk
- High risk
- Low risk

Liquefaction analysis summary plo

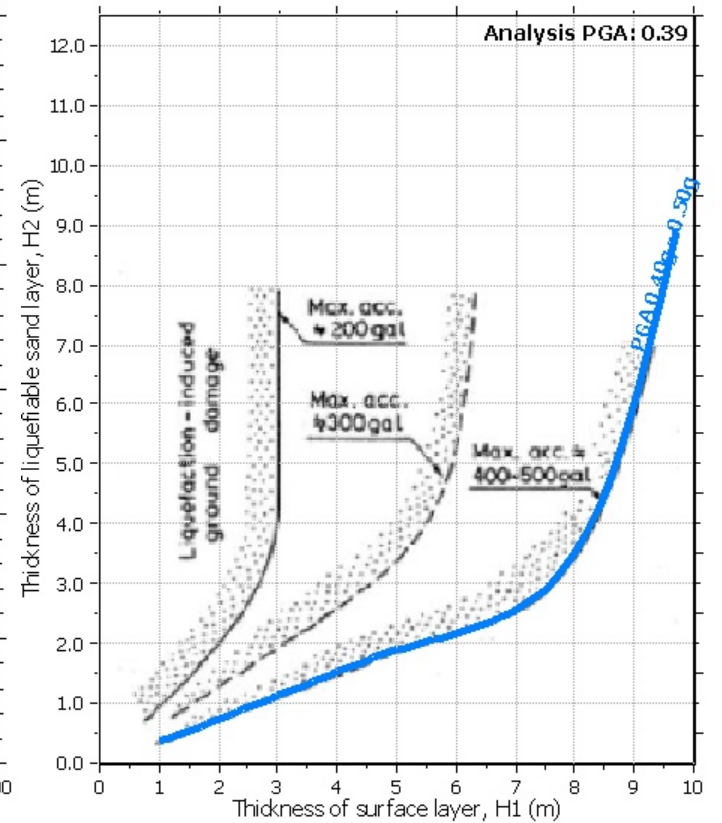
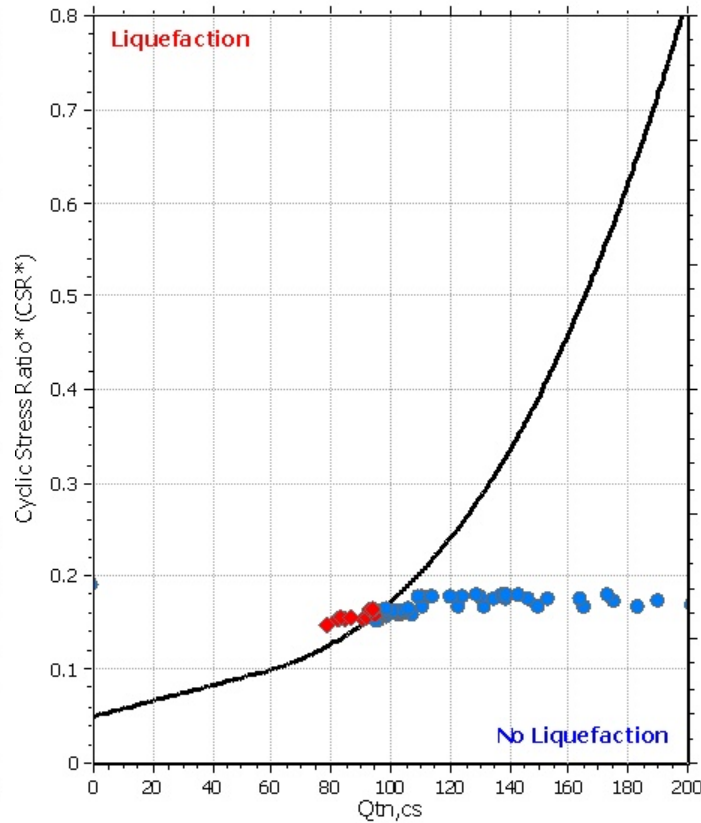
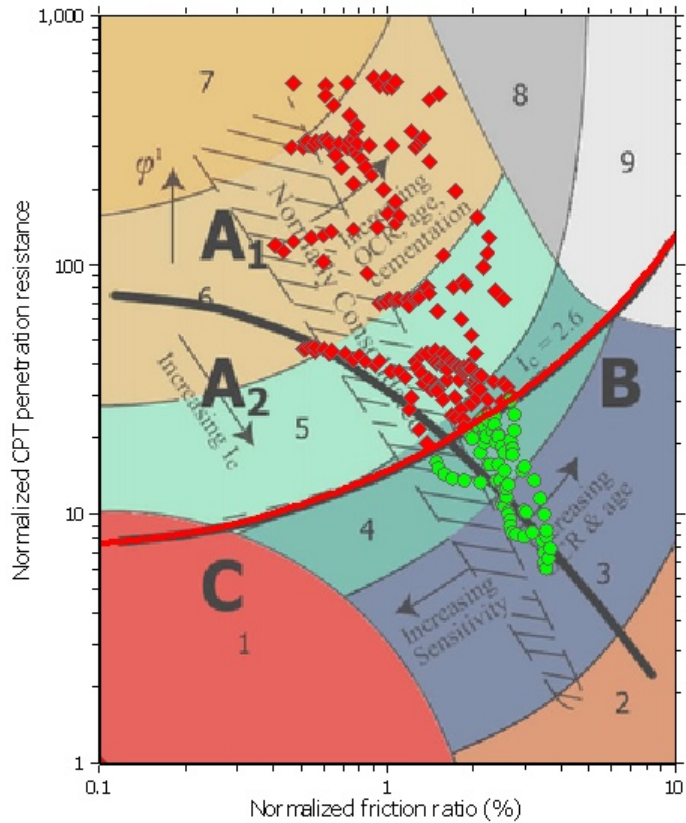

Input parameters and analysis data

Analysis method:	NCEER (1998)	Depth to water table (erthq.):	10.00 ft	Fill weight:	N/A
Fines correction method:	NCEER (1998)	Average results interval:	3	Transition detect. applied:	No
Points to test:	Based on I_c value	I_c cut-off value:	2.60	K_0 applied:	Yes
Earthquake magnitude M_w :	6.12	Unit weight calculation:	Based on SBT	Clay like behavior applied:	Sands only
Peak ground acceleration:	0.39	Use fill:	No	Limit depth applied:	No
Depth to water table (insitu):	10.00 ft	Fill height:	N/A	Limit depth:	N/A



LIQUEFACTION ANALYSIS REPORT

Project title : Bella Mar

Location : 408 Hollister Street

CPT file : CPT-4

Input parameters and analysis data

Analysis method:	NCEER (1998)	G.W.T. (in-situ):	10.00 ft	Use fill:	No	Clay like behavior applied:	Sands only
Fines correction method:	NCEER (1998)	G.W.T. (earthq.):	10.00 ft	Fill height:	N/A	Limit depth applied:	No
Points to test:	Based on Ic value	Average results interval:	3	Fill weight:	N/A	Limit depth:	N/A
Earthquake magnitude M_w :	6.12	Ic cut-off value:	2.60	Trans. detect. applied:	No	MSF method:	Method based
Peak ground acceleration:	0.39	Unit weight calculation:	Based on SBT	K_0 applied:	Yes		

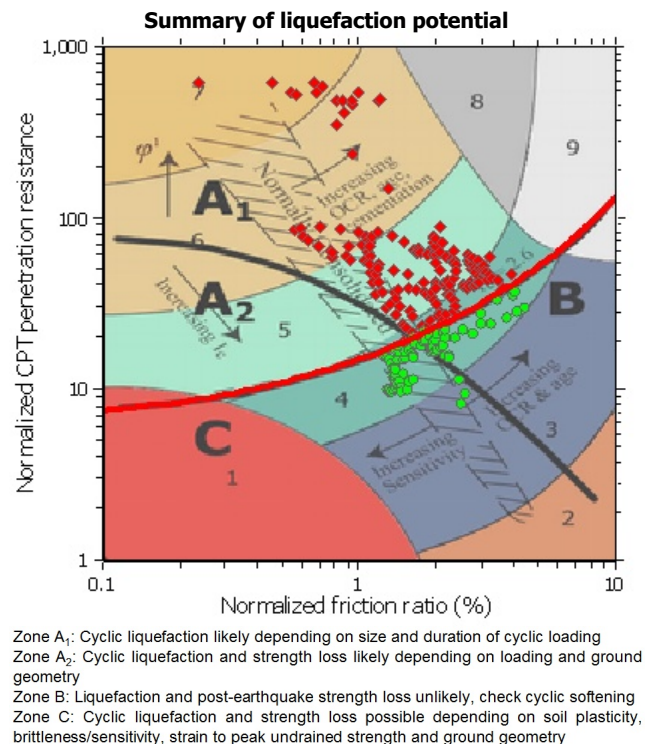
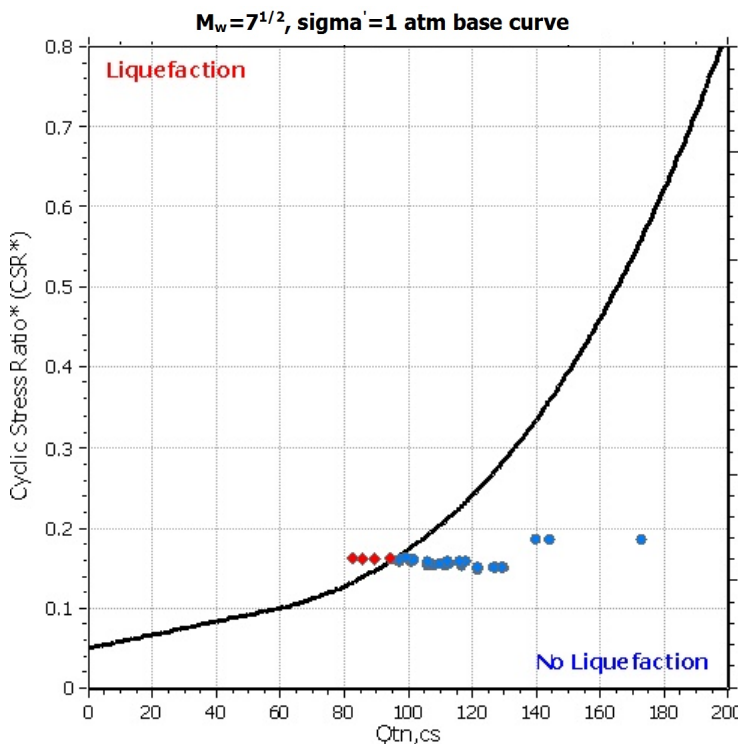
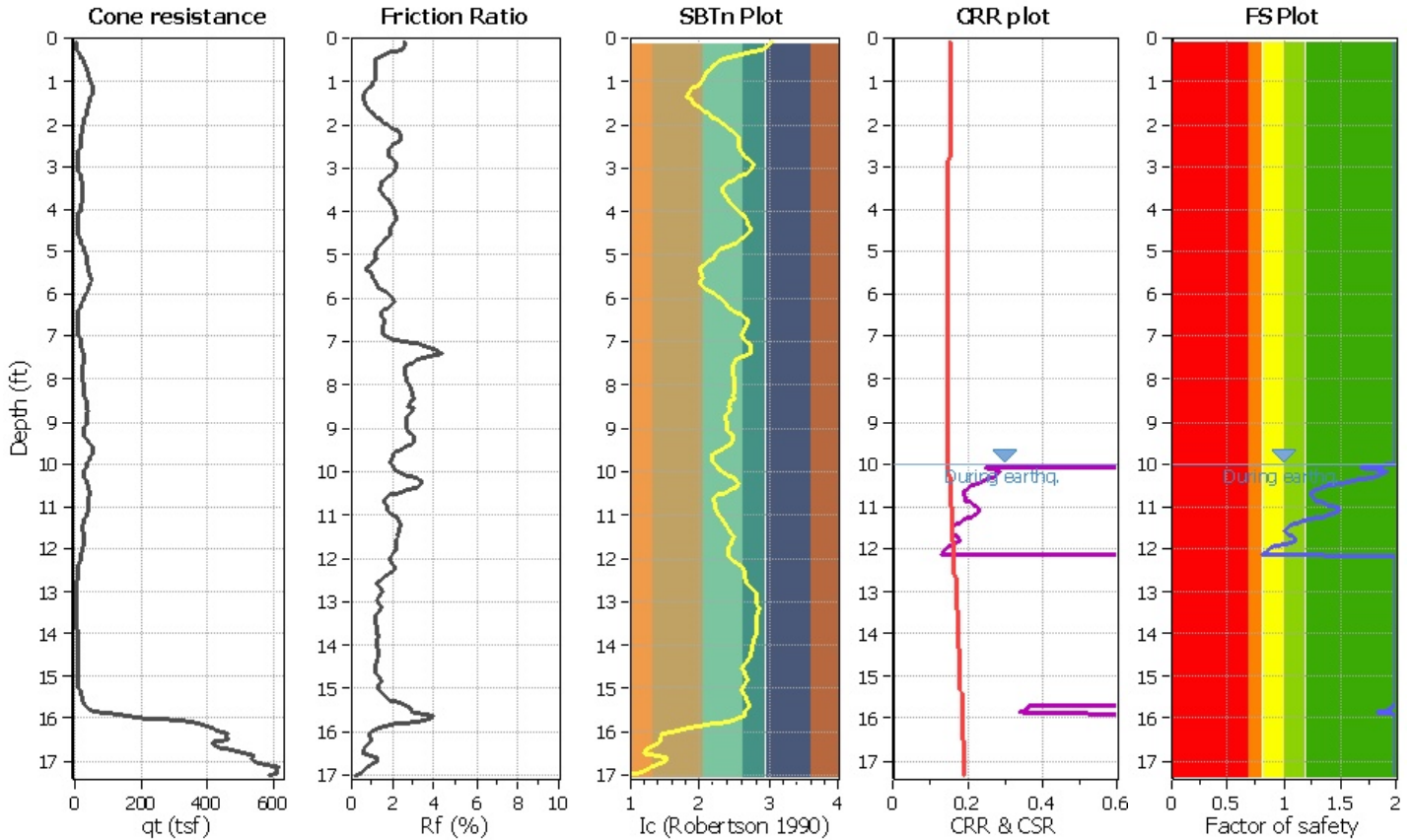

Liquefaction analysis overall plot

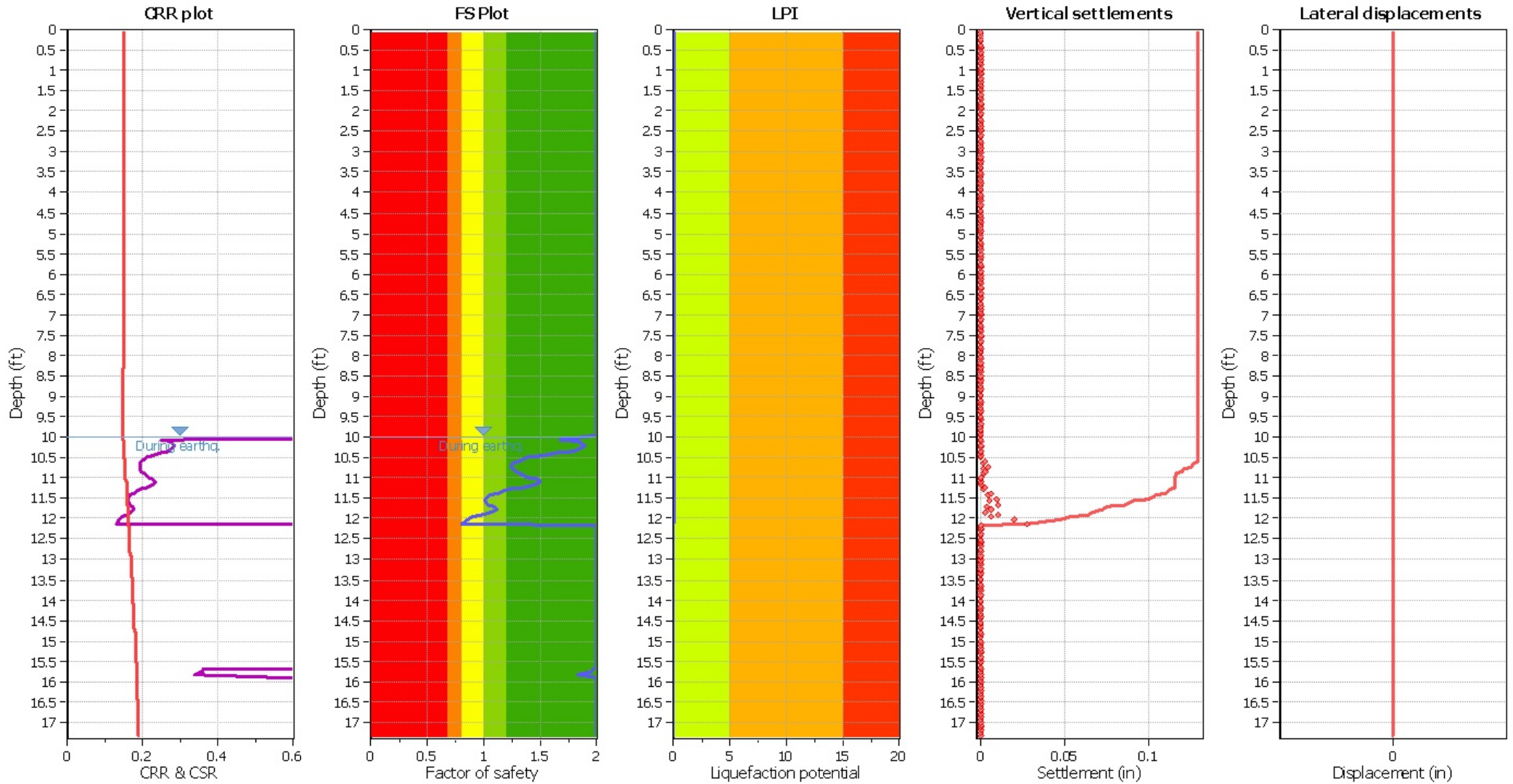

Input parameters and analysis data

Analysis method:	NCEER (1998)	Depth to water table (earthq.):	10.00 ft	Fill weight:	N/A
Fines correction method:	NCEER (1998)	Average results interval:	3	Transition detect. applied:	No
Points to test:	Based on Ic value	Ic cut-off value:	2.60	K_0 applied:	Yes
Earthquake magnitude M_w :	6.12	Unit weight calculation:	Based on SBT	Clay like behavior applied:	Sands only
Peak ground acceleration:	0.39	Use fill:	No	Limit depth applied:	No
Depth to water table (insitu):	10.00 ft	Fill height:	N/A	Limit depth:	N/A

F.S. color scheme

- Almost certain it will liquefy
- Very likely to liquefy
- Liquefaction and no liq. are equally likely
- Unlike to liquefy
- Almost certain it will not liquefy

LPI color scheme

- Very high risk
- High risk
- Low risk

Liquefaction analysis summary plo

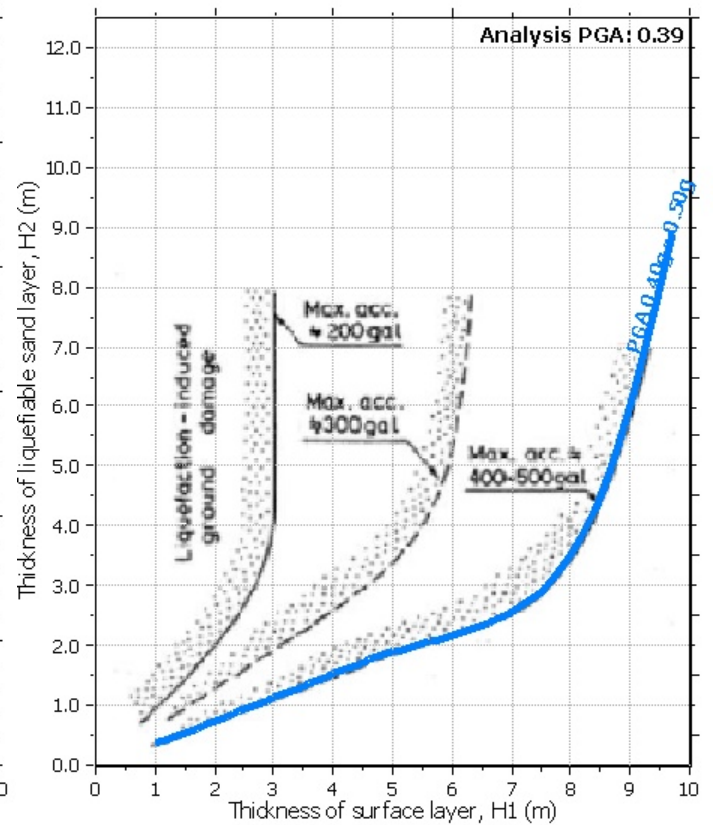
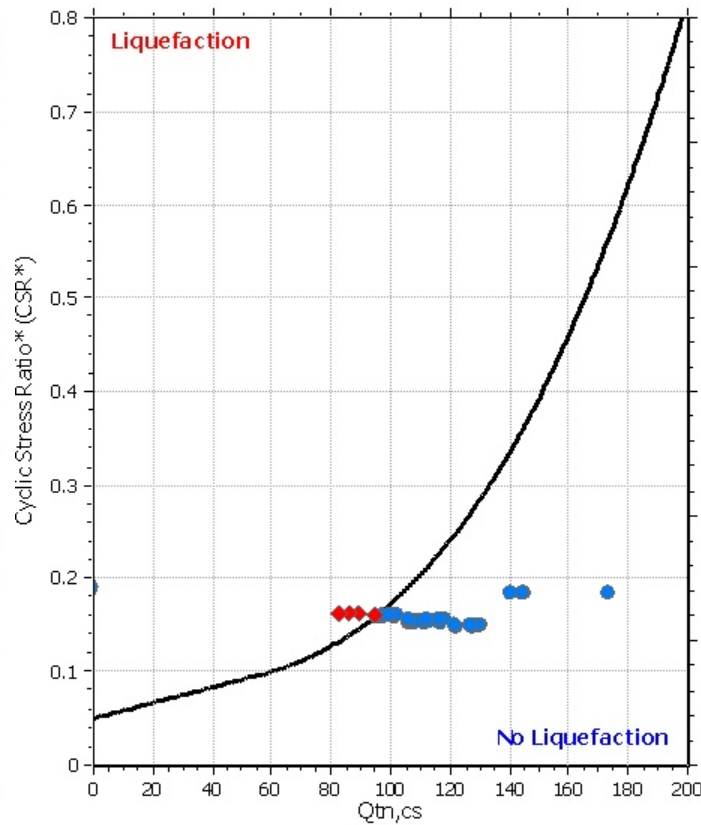
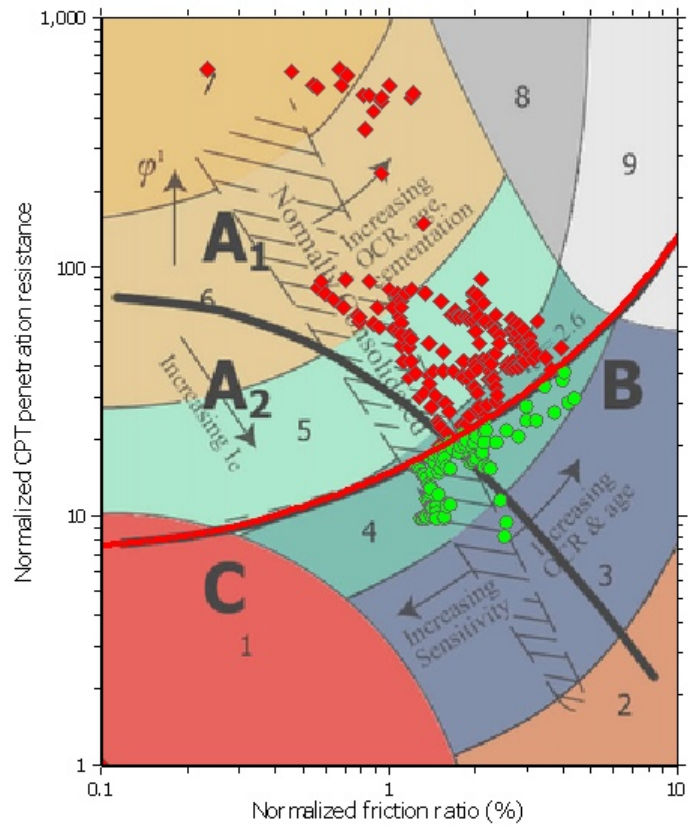

Input parameters and analysis data

Analysis method:	NCEER (1998)	Depth to water table (erthq.):	10.00 ft	Fill weight:	N/A
Fines correction method:	NCEER (1998)	Average results interval:	3	Transition detect. applied:	No
Points to test:	Based on Ic value	Ic cut-off value:	2.60	K_0 applied:	Yes
Earthquake magnitude M_w :	6.12	Unit weight calculation:	Based on SBT	Clay like behavior applied:	Sands only
Peak ground acceleration:	0.39	Use fill:	No	Limit depth applied:	No
Depth to water table (insitu):	10.00 ft	Fill height:	N/A	Limit depth:	N/A

LIQUEFACTION ANALYSIS REPORT

Project title : Bella Mar

Location : 408 Hollister Street

CPT file : CPT-5

Input parameters and analysis data

Analysis method:	NCEER (1998)	G.W.T. (in-situ):	10.00 ft	Use fill:	No	Clay like behavior applied:	Sands only
Fines correction method:	NCEER (1998)	G.W.T. (earthq.):	10.00 ft	Fill height:	N/A	Limit depth applied:	No
Points to test:	Based on Ic value	Average results interval:	3	Fill weight:	N/A	Limit depth:	N/A
Earthquake magnitude M_w :	6.12	Ic cut-off value:	2.60	Trans. detect. applied:	No	MSF method:	Method based
Peak ground acceleration:	0.39	Unit weight calculation:	Based on SBT	K_0 applied:	Yes		

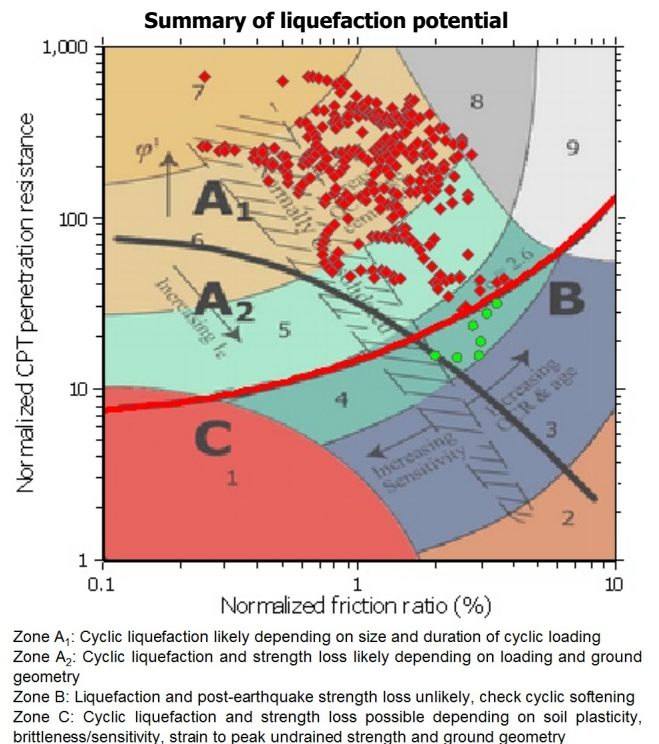
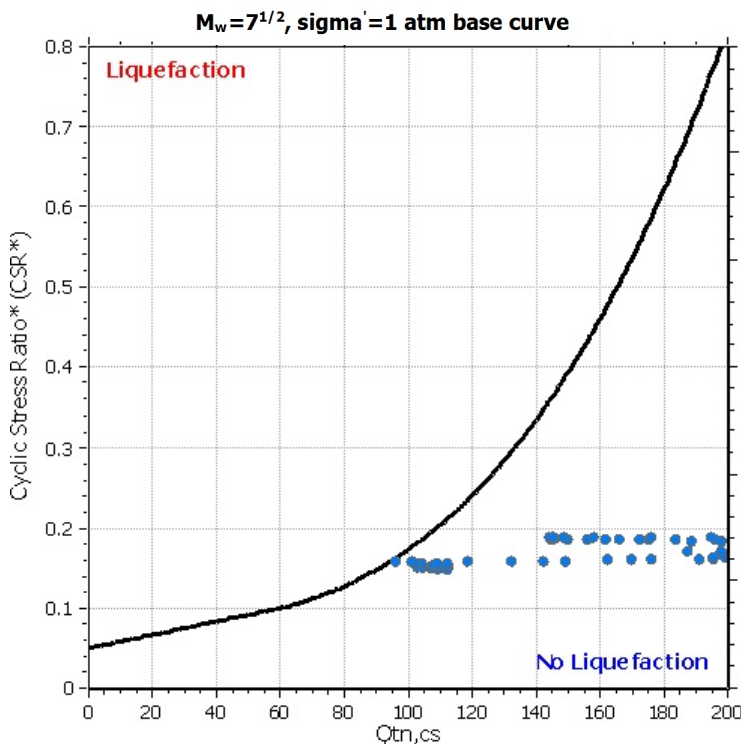
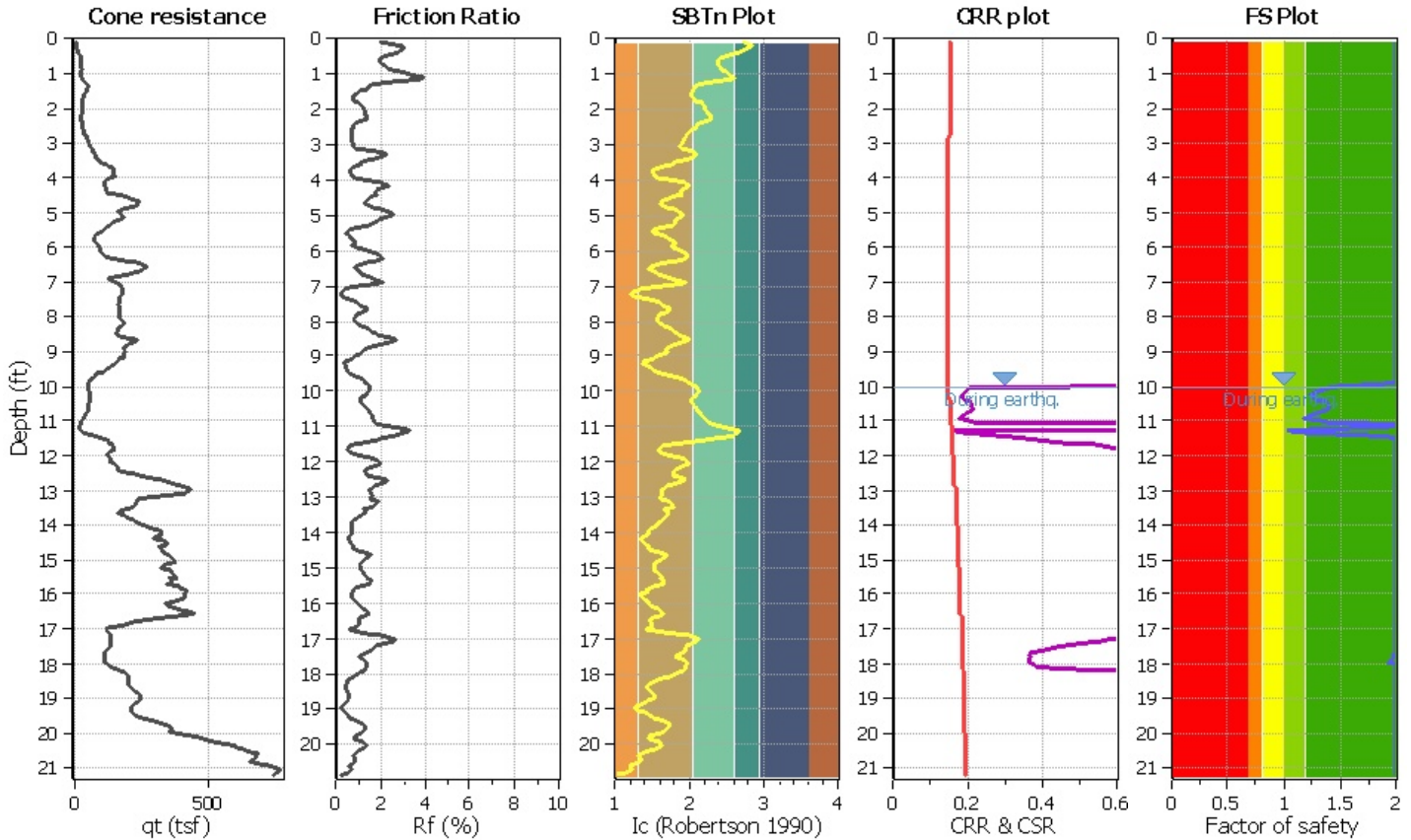

Liquefaction analysis overall plot

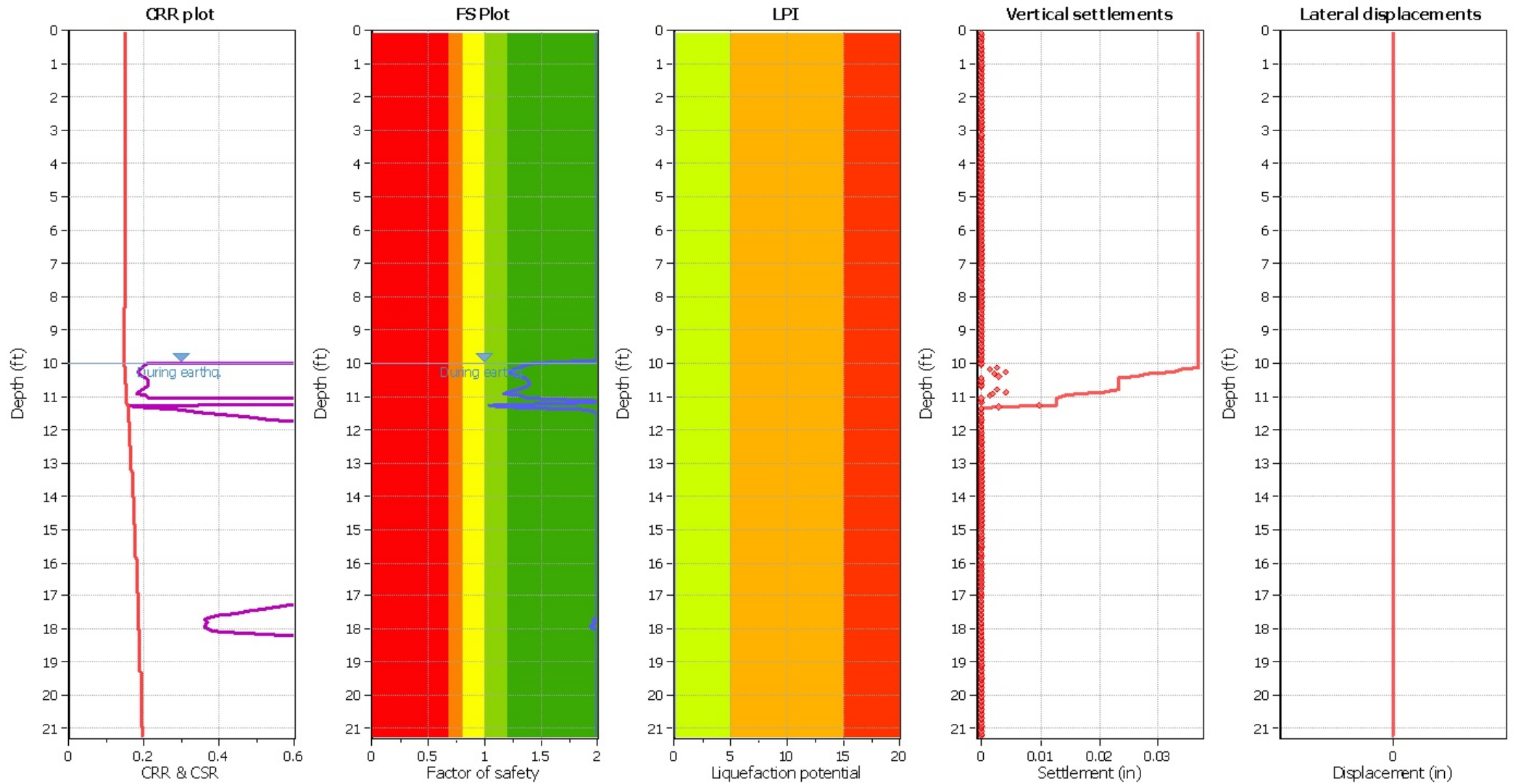

Input parameters and analysis data

Analysis method:	NCEER (1998)	Depth to water table (earthq.):	10.00 ft	Fill weight:	N/A
Fines correction method:	NCEER (1998)	Average results interval:	3	Transition detect. applied:	No
Points to test:	Based on Ic value	Ic cut-off value:	2.60	K_0 applied:	Yes
Earthquake magnitude M_w :	6.12	Unit weight calculation:	Based on SBT	Clay like behavior applied:	Sands only
Peak ground acceleration:	0.39	Use fill:	No	Limit depth applied:	No
Depth to water table (insitu):	10.00 ft	Fill height:	N/A	Limit depth:	N/A

F.S. color scheme

- Almost certain it will liquefy
- Very likely to liquefy
- Liquefaction and no liq. are equally likely
- Unlike to liquefy
- Almost certain it will not liquefy

LPI color scheme

- Very high risk
- High risk
- Low risk

Liquefaction analysis summary plo

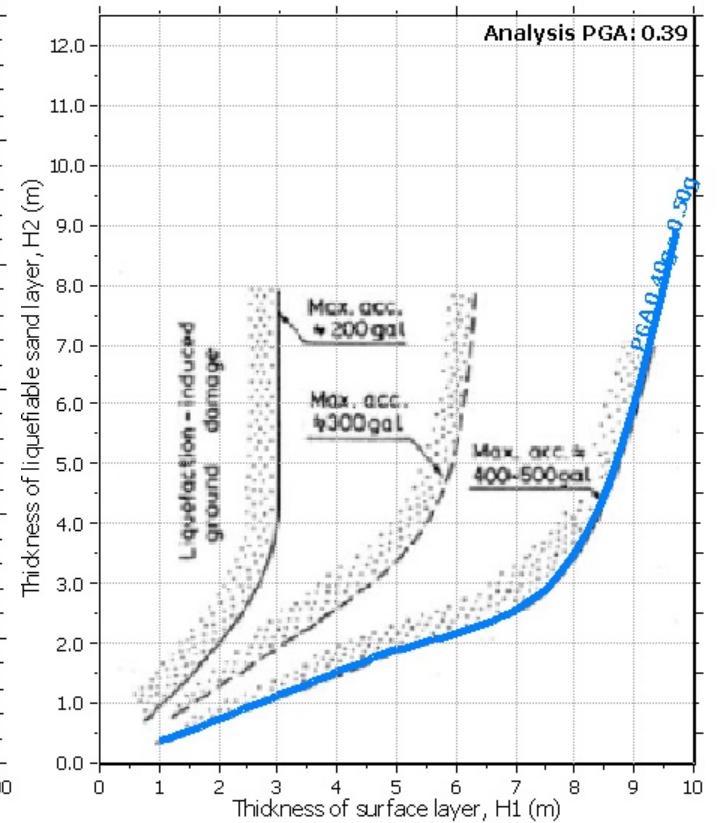
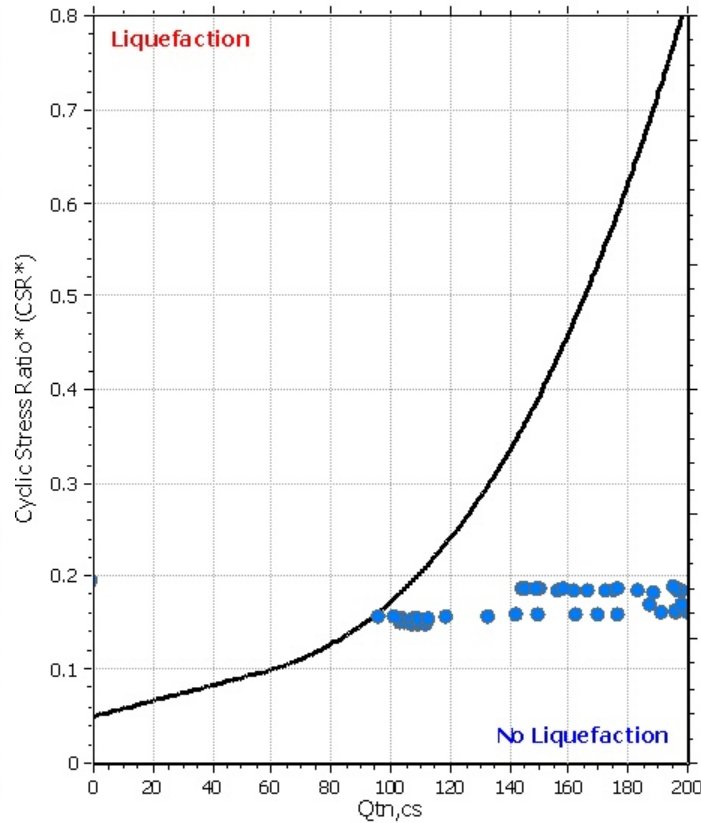
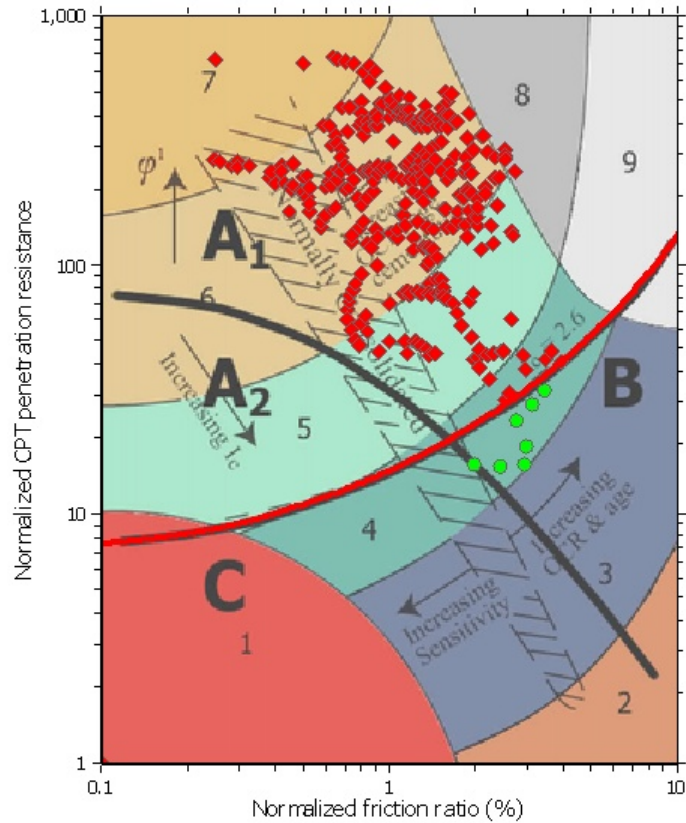

Input parameters and analysis data

Analysis method:	NCEER (1998)	Depth to water table (erthq.):	10.00 ft	Fill weight:	N/A
Fines correction method:	NCEER (1998)	Average results interval:	3	Transition detect. applied:	No
Points to test:	Based on Ic value	Ic cut-off value:	2.60	K_0 applied:	Yes
Earthquake magnitude M_w :	6.12	Unit weight calculation:	Based on SBT	Clay like behavior applied:	Sands only
Peak ground acceleration:	0.39	Use fill:	No	Limit depth applied:	No
Depth to water table (insitu):	10.00 ft	Fill height:	N/A	Limit depth:	N/A

LIQUEFACTION ANALYSIS REPORT

Project title : Bella Mar

Location : 408 Hollister Street

CPT file : CPT-6

Input parameters and analysis data

Analysis method:	NCEER (1998)	G.W.T. (in-situ):	10.00 ft	Use fill:	No	Clay like behavior applied:	Sands only
Fines correction method:	NCEER (1998)	G.W.T. (earthq.):	10.00 ft	Fill height:	N/A	Limit depth applied:	No
Points to test:	Based on Ic value	Average results interval:	3	Fill weight:	N/A	Limit depth:	N/A
Earthquake magnitude M_w :	6.12	Ic cut-off value:	2.60	Trans. detect. applied:	No	MSF method:	Method based
Peak ground acceleration:	0.39	Unit weight calculation:	Based on SBT	K_0 applied:	Yes		

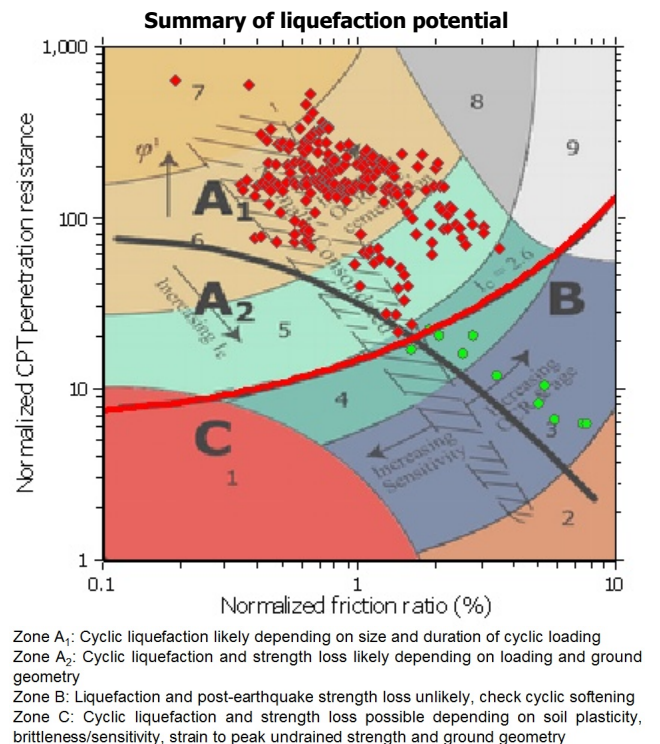
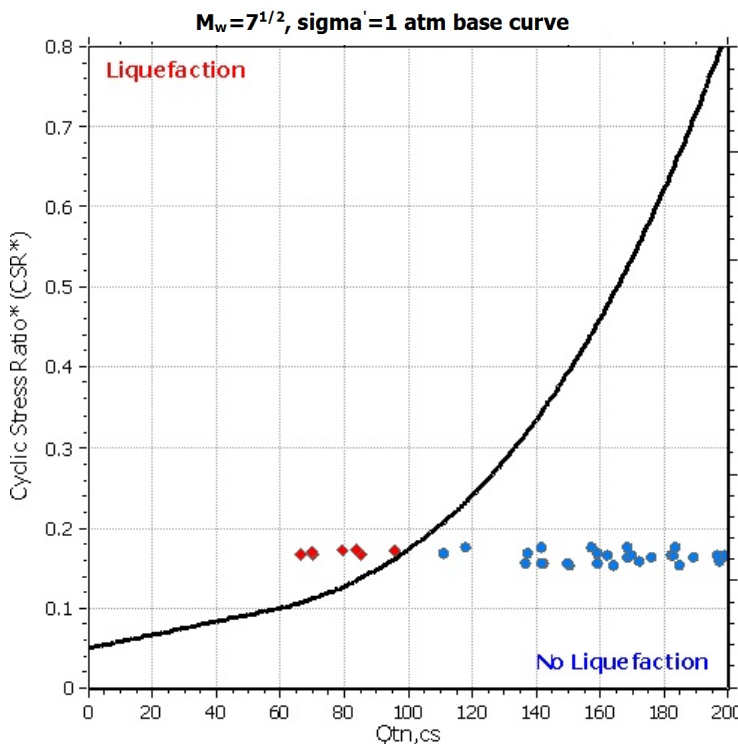
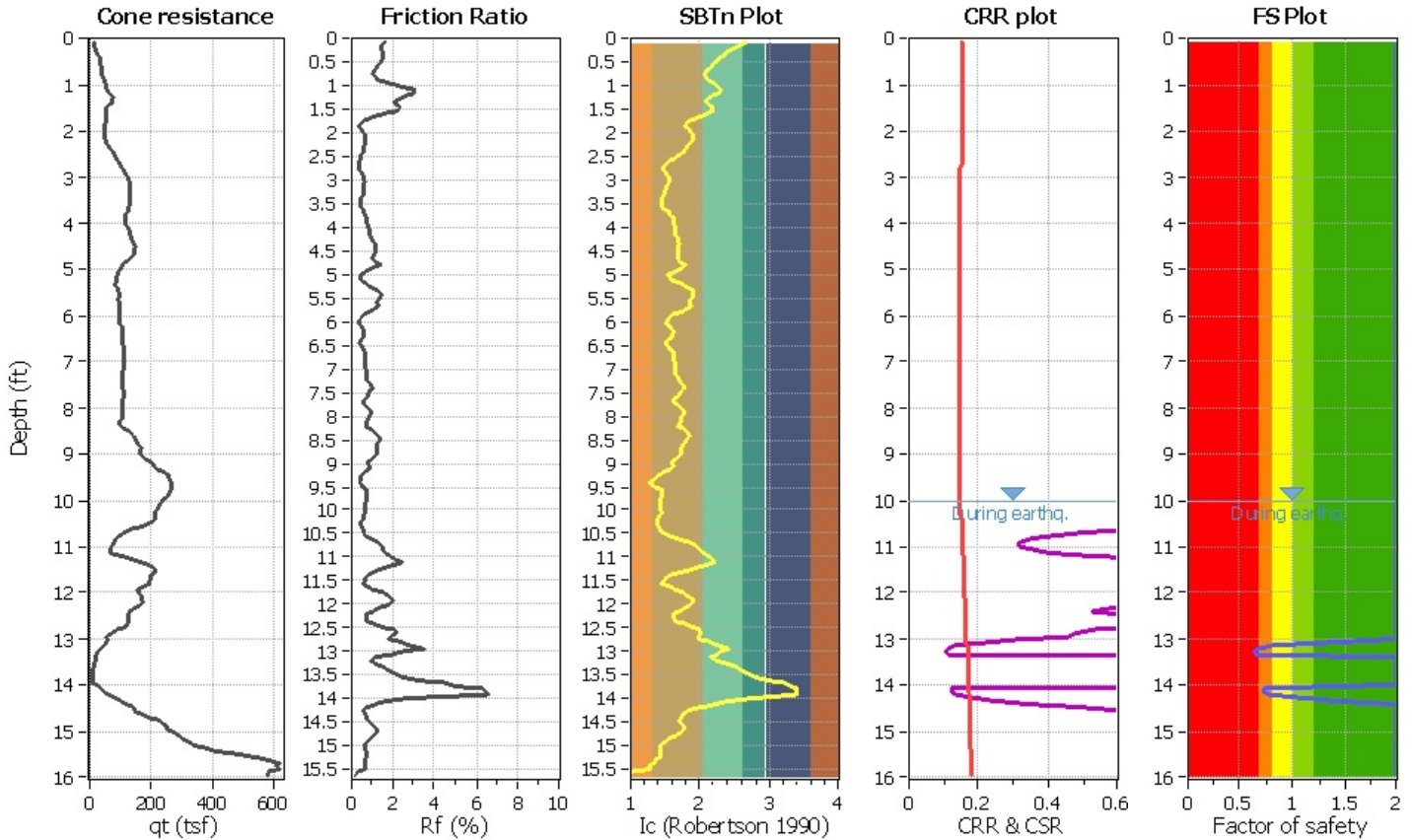

Liquefaction analysis overall plot

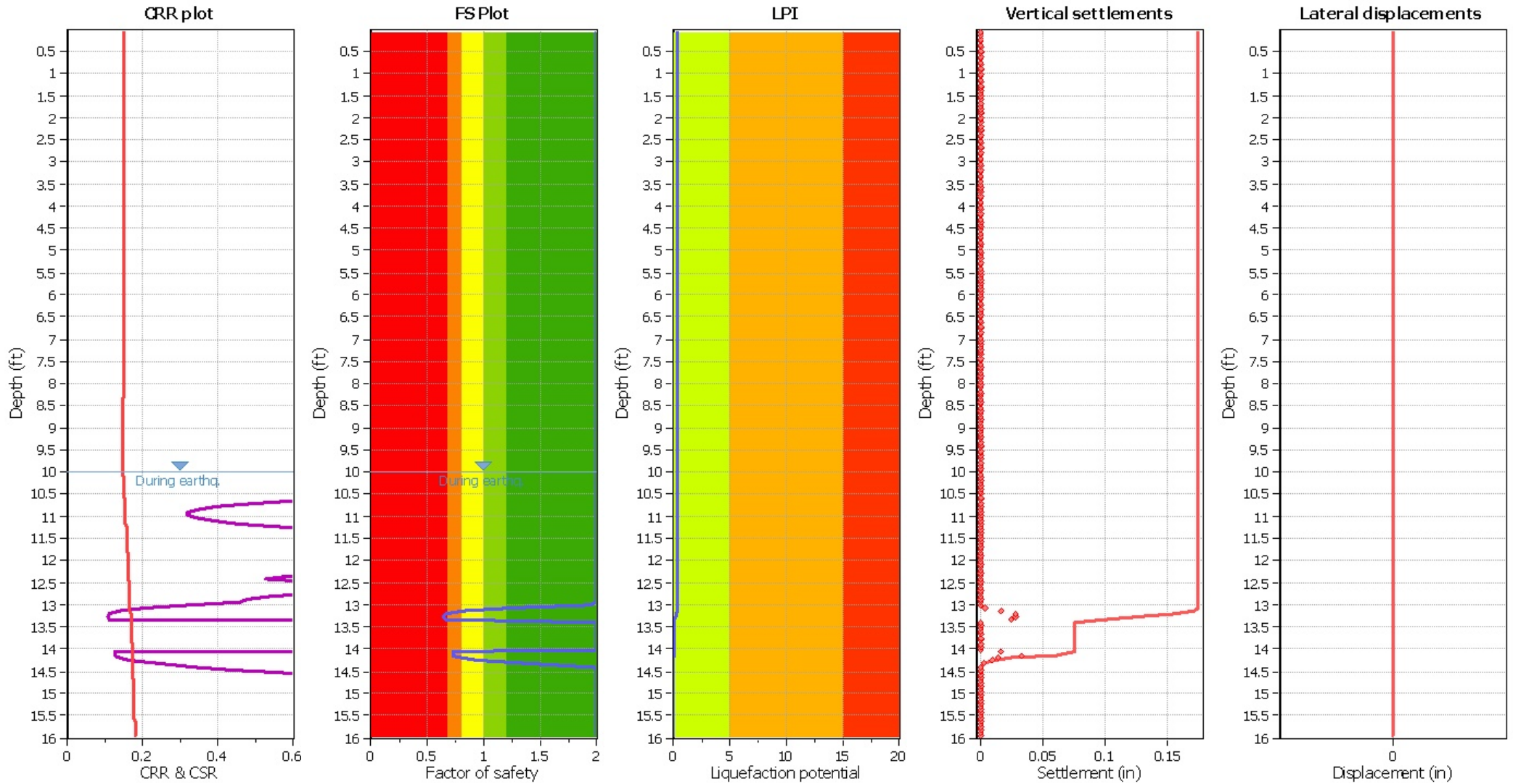

Input parameters and analysis data

Analysis method:	NCEER (1998)	Depth to water table (earthq.):	10.00 ft	Fill weight:	N/A
Fines correction method:	NCEER (1998)	Average results interval:	3	Transition detect. applied:	No
Points to test:	Based on Ic value	Ic cut-off value:	2.60	K_0 applied:	Yes
Earthquake magnitude M_w :	6.12	Unit weight calculation:	Based on SBT	Clay like behavior applied:	Sands only
Peak ground acceleration:	0.39	Use fill:	No	Limit depth applied:	No
Depth to water table (insitu):	10.00 ft	Fill height:	N/A	Limit depth:	N/A

F.S. color scheme

- Almost certain it will liquefy
- Very likely to liquefy
- Liquefaction and no liq. are equally likely
- Unlike to liquefy
- Almost certain it will not liquefy

LPI color scheme

- Very high risk
- High risk
- Low risk

Liquefaction analysis summary plo

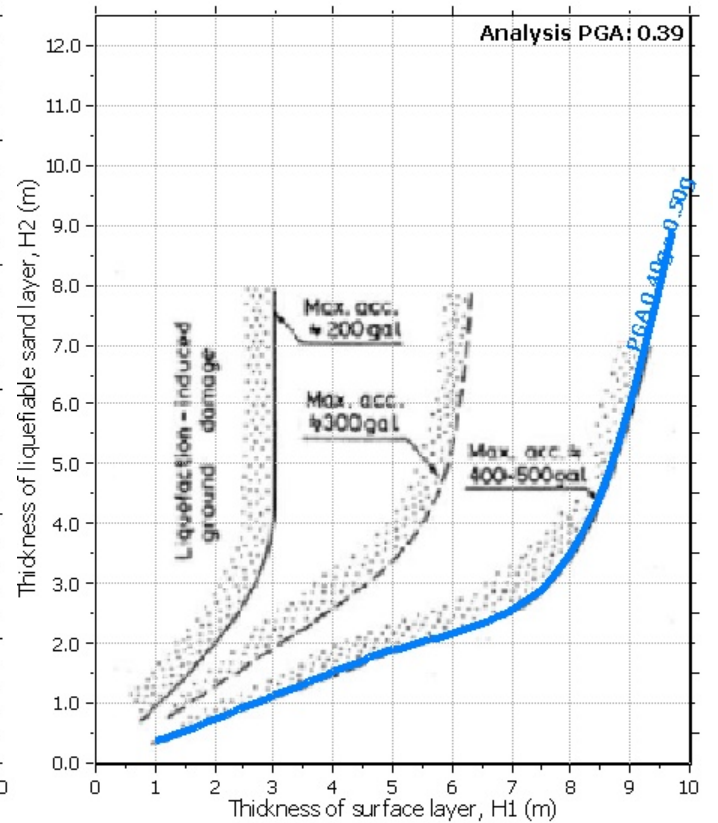
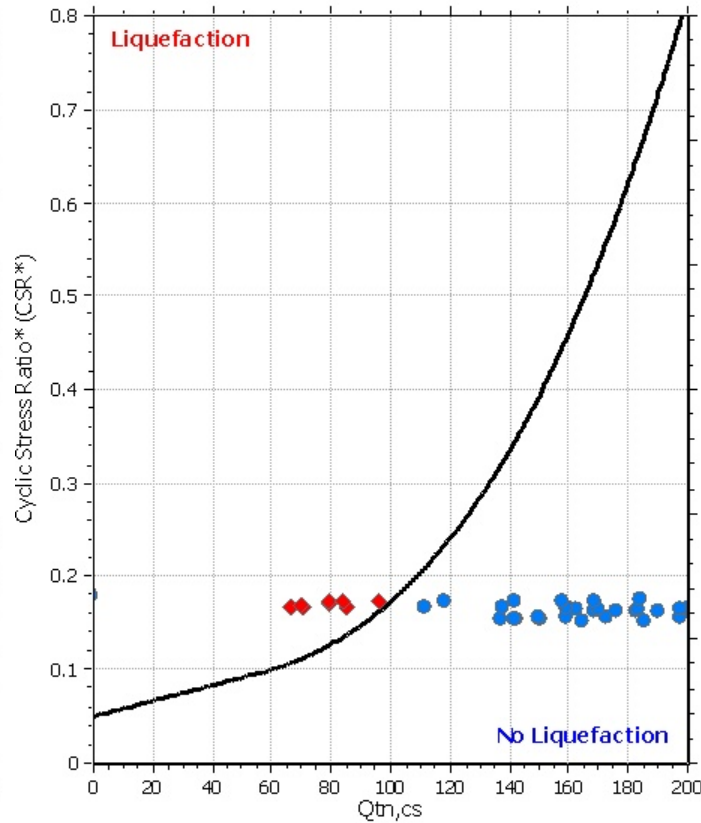
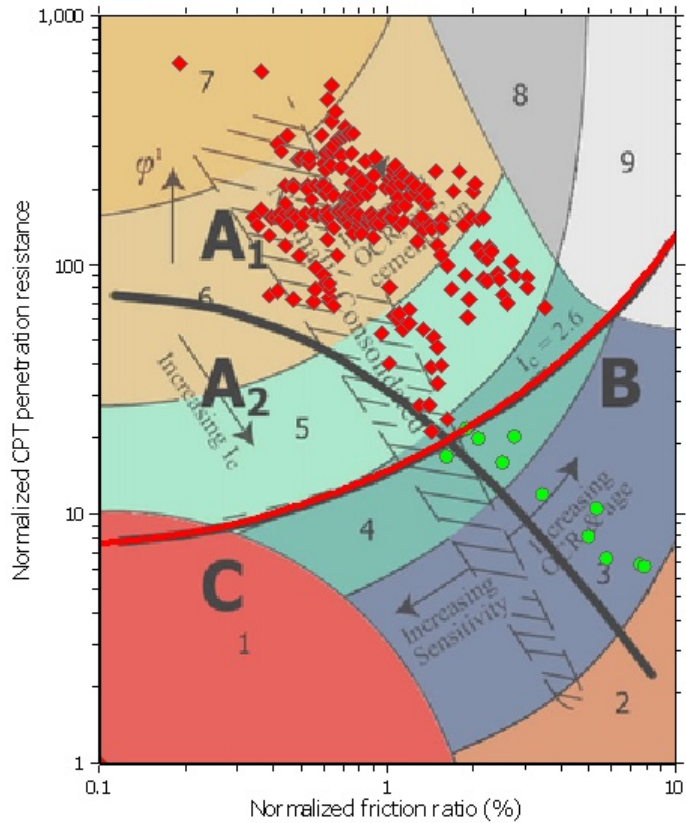

Input parameters and analysis data

Analysis method:	NCEER (1998)	Depth to water table (erthq.):	10.00 ft	Fill weight:	N/A
Fines correction method:	NCEER (1998)	Average results interval:	3	Transition detect. applied:	No
Points to test:	Based on Ic value	Ic cut-off value:	2.60	K ₀ applied:	Yes
Earthquake magnitude M _w :	6.12	Unit weight calculation:	Based on SBT	Clay like behavior applied:	Sands only
Peak ground acceleration:	0.39	Use fill:	No	Limit depth applied:	No
Depth to water table (insitu):	10.00 ft	Fill height:	N/A	Limit depth:	N/A

LIQUEFACTION ANALYSIS REPORT

Project title : Bella Mar

Location : 408 Hollister Street

CPT file : CPT-7

Input parameters and analysis data

Analysis method:	NCEER (1998)	G.W.T. (in-situ):	10.00 ft	Use fill:	No	Clay like behavior applied:	Sands only
Fines correction method:	NCEER (1998)	G.W.T. (earthq.):	10.00 ft	Fill height:	N/A	Limit depth applied:	No
Points to test:	Based on Ic value	Average results interval:	3	Fill weight:	N/A	Limit depth:	N/A
Earthquake magnitude M_w :	6.12	Ic cut-off value:	2.60	Trans. detect. applied:	No	MSF method:	Method based
Peak ground acceleration:	0.39	Unit weight calculation:	Based on SBT	K_0 applied:	Yes		

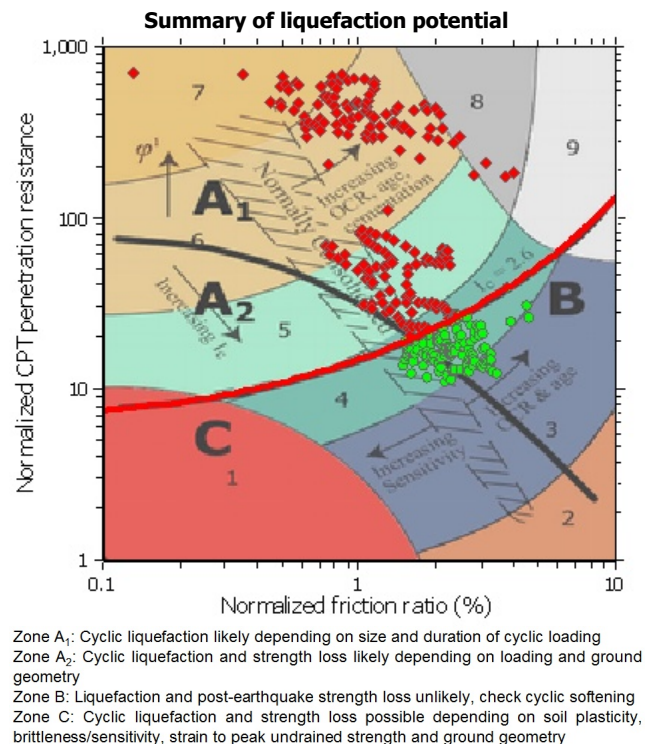
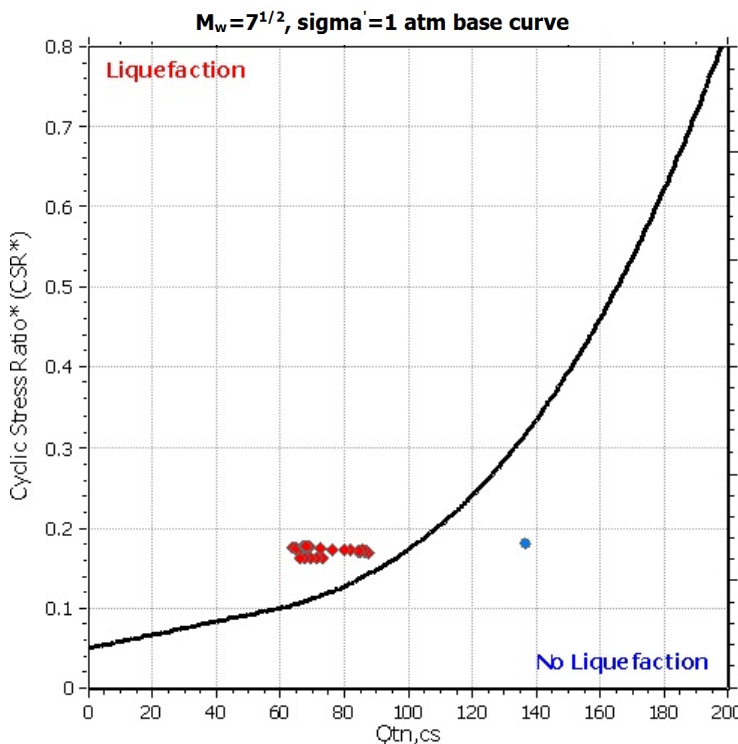
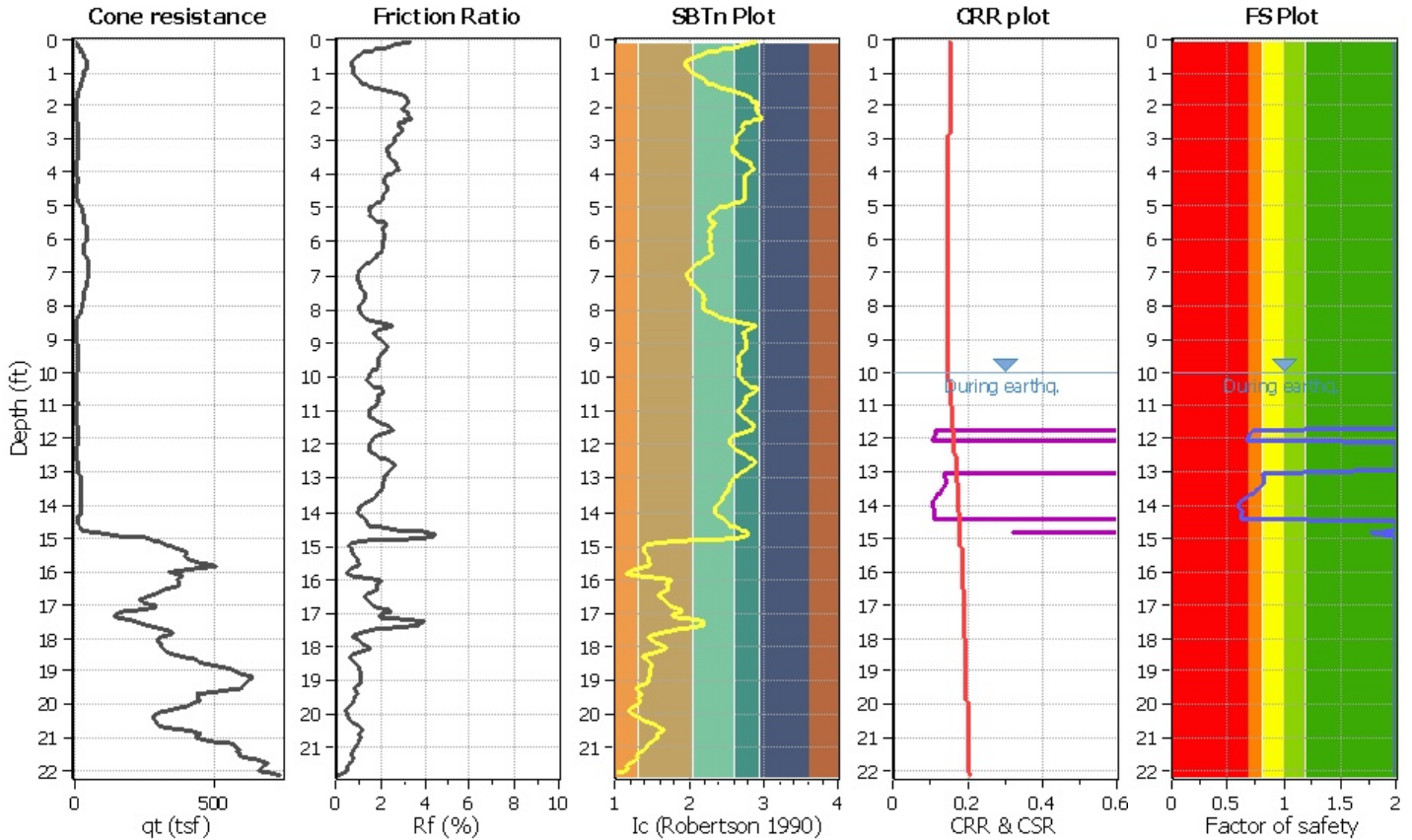

Liquefaction analysis overall plot

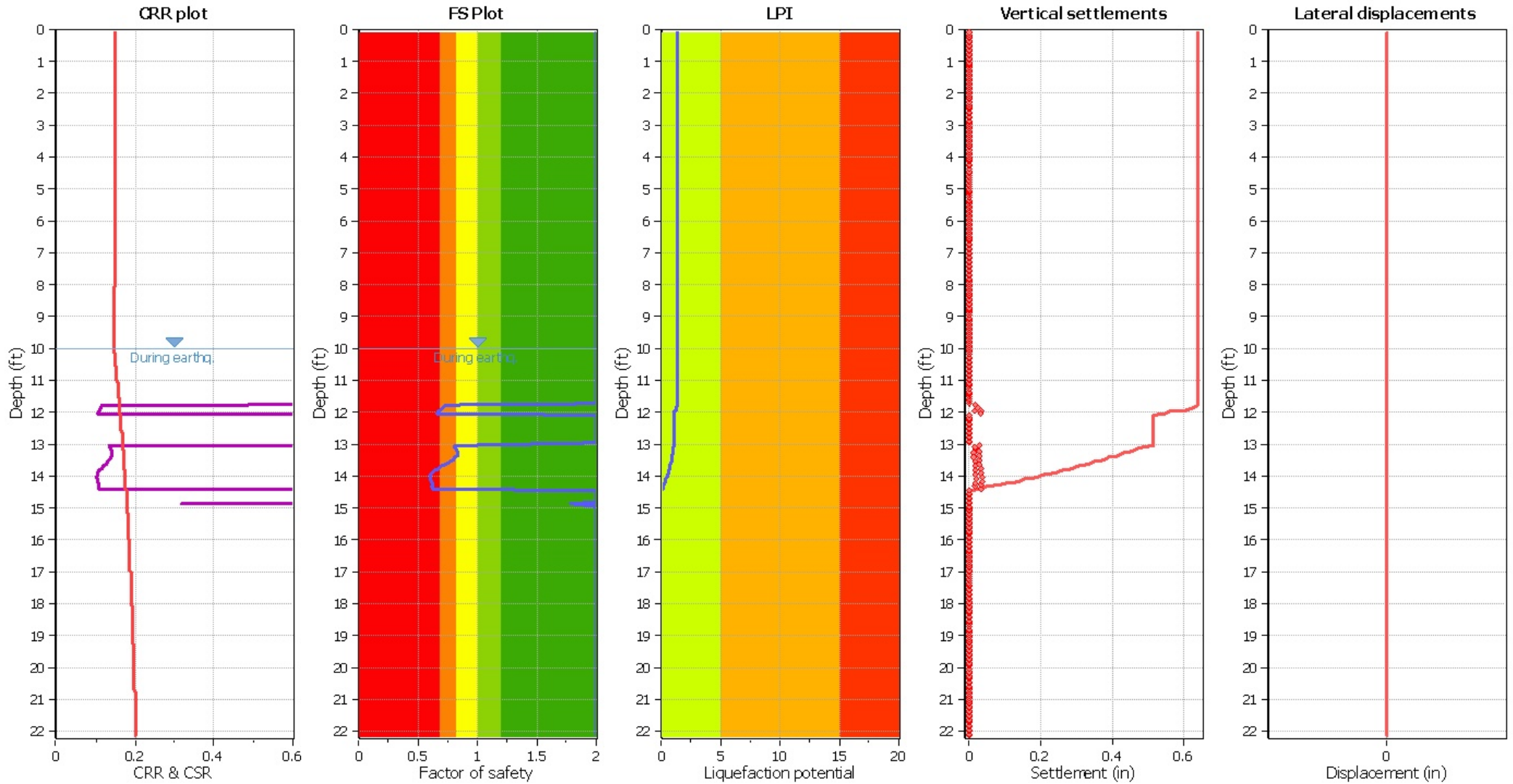

Input parameters and analysis data

Analysis method:	NCEER (1998)	Depth to water table (earthq.):	10.00 ft	Fill weight:	N/A
Fines correction method:	NCEER (1998)	Average results interval:	3	Transition detect. applied:	No
Points to test:	Based on Ic value	Ic cut-off value:	2.60	K_{σ} applied:	Yes
Earthquake magnitude M_w :	6.12	Unit weight calculation:	Based on SBT	Clay like behavior applied:	Sands only
Peak ground acceleration:	0.39	Use fill:	No	Limit depth applied:	No
Depth to water table (insitu):	10.00 ft	Fill height:	N/A	Limit depth:	N/A

F.S. color scheme

- Almost certain it will liquefy
- Very likely to liquefy
- Liquefaction and no liq. are equally likely
- Unlike to liquefy
- Almost certain it will not liquefy

LPI color scheme

- Very high risk
- High risk
- Low risk

Liquefaction analysis summary plo

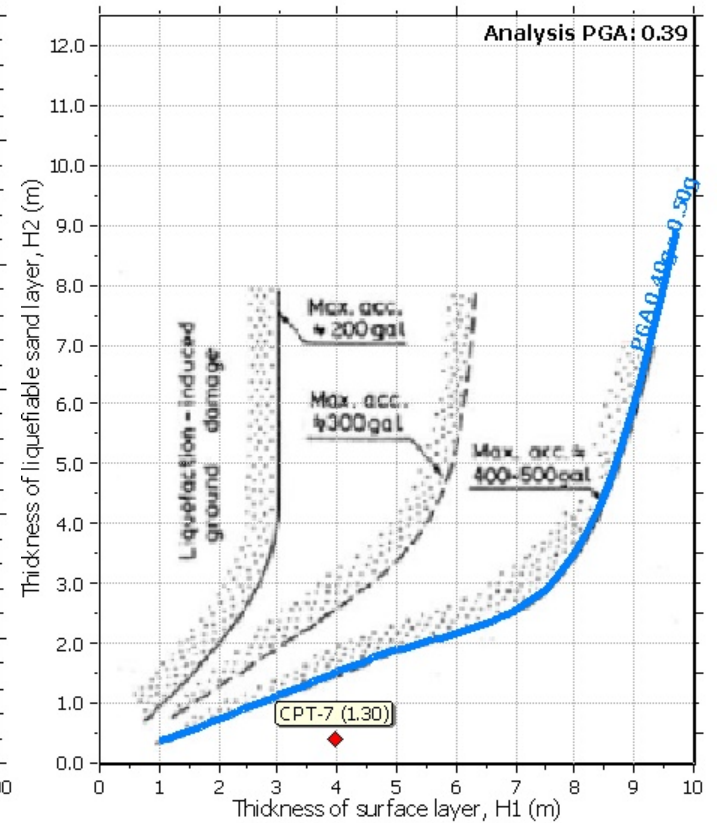
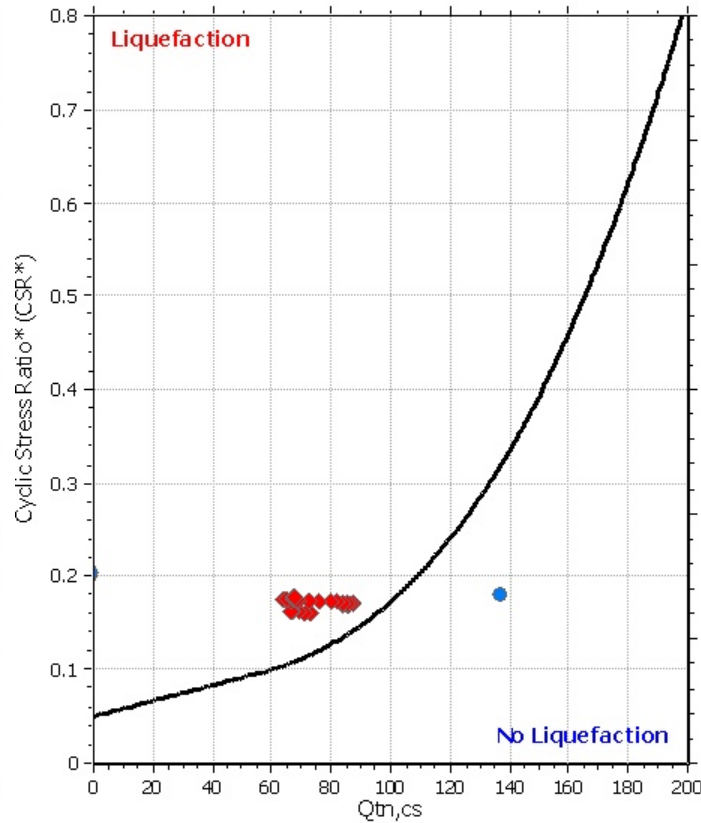
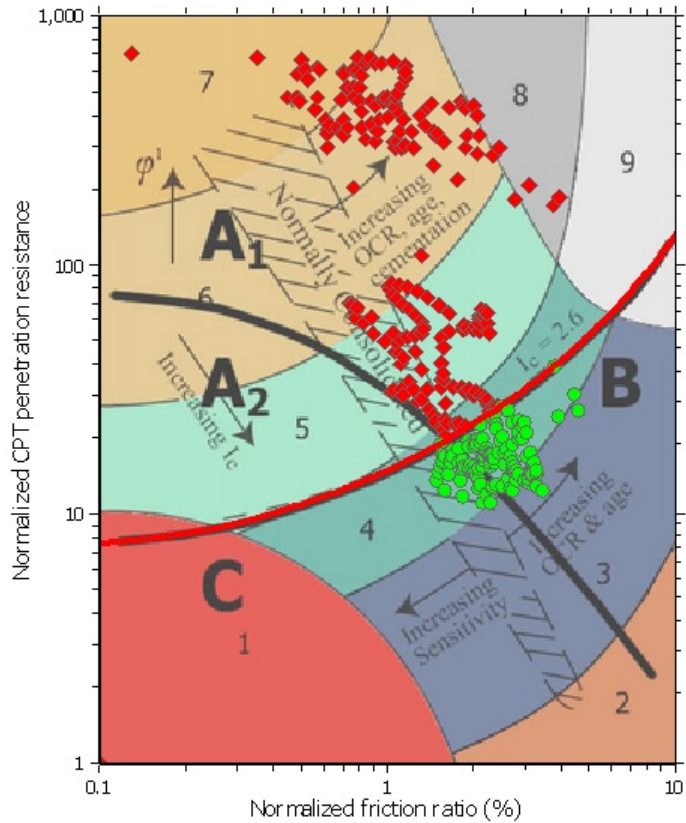

Input parameters and analysis data

Analysis method:	NCEER (1998)	Depth to water table (erthq.):	10.00 ft	Fill weight:	N/A
Fines correction method:	NCEER (1998)	Average results interval:	3	Transition detect. applied:	No
Points to test:	Based on Ic value	Ic cut-off value:	2.60	K_0 applied:	Yes
Earthquake magnitude M_w :	6.12	Unit weight calculation:	Based on SBT	Clay like behavior applied:	Sands only
Peak ground acceleration:	0.39	Use fill:	No	Limit depth applied:	No
Depth to water table (insitu):	10.00 ft	Fill height:	N/A	Limit depth:	N/A

LIQUEFACTION ANALYSIS REPORT

Project title : Bella Mar

Location : 408 Hollister Street

CPT file : CPT-8

Input parameters and analysis data

Analysis method:	NCEER (1998)	G.W.T. (in-situ):	10.00 ft	Use fill:	No	Clay like behavior	
Fines correction method:	NCEER (1998)	G.W.T. (earthq.):	10.00 ft	Fill height:	N/A	applied:	Sands only
Points to test:	Based on Ic value	Average results interval:	3	Fill weight:	N/A	Limit depth applied:	No
Earthquake magnitude M_w :	6.12	Ic cut-off value:	2.60	Trans. detect. applied:	No	Limit depth:	N/A
Peak ground acceleration:	0.39	Unit weight calculation:	Based on SBT	K_0 applied:	Yes	MSF method:	Method based

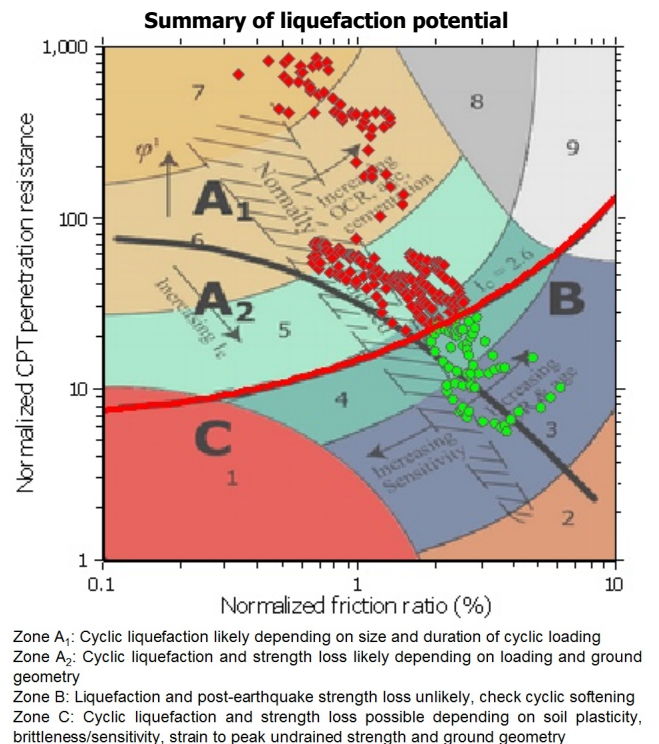
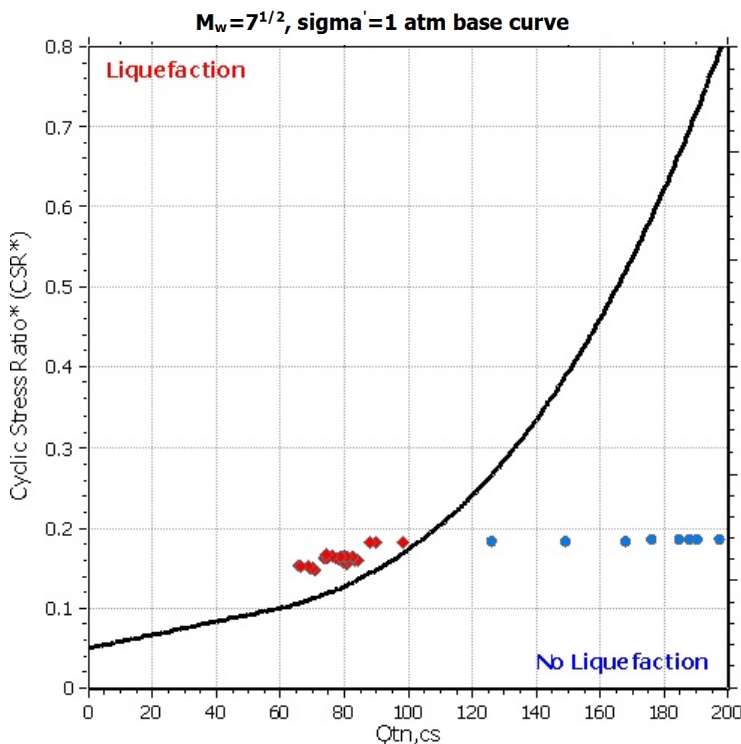
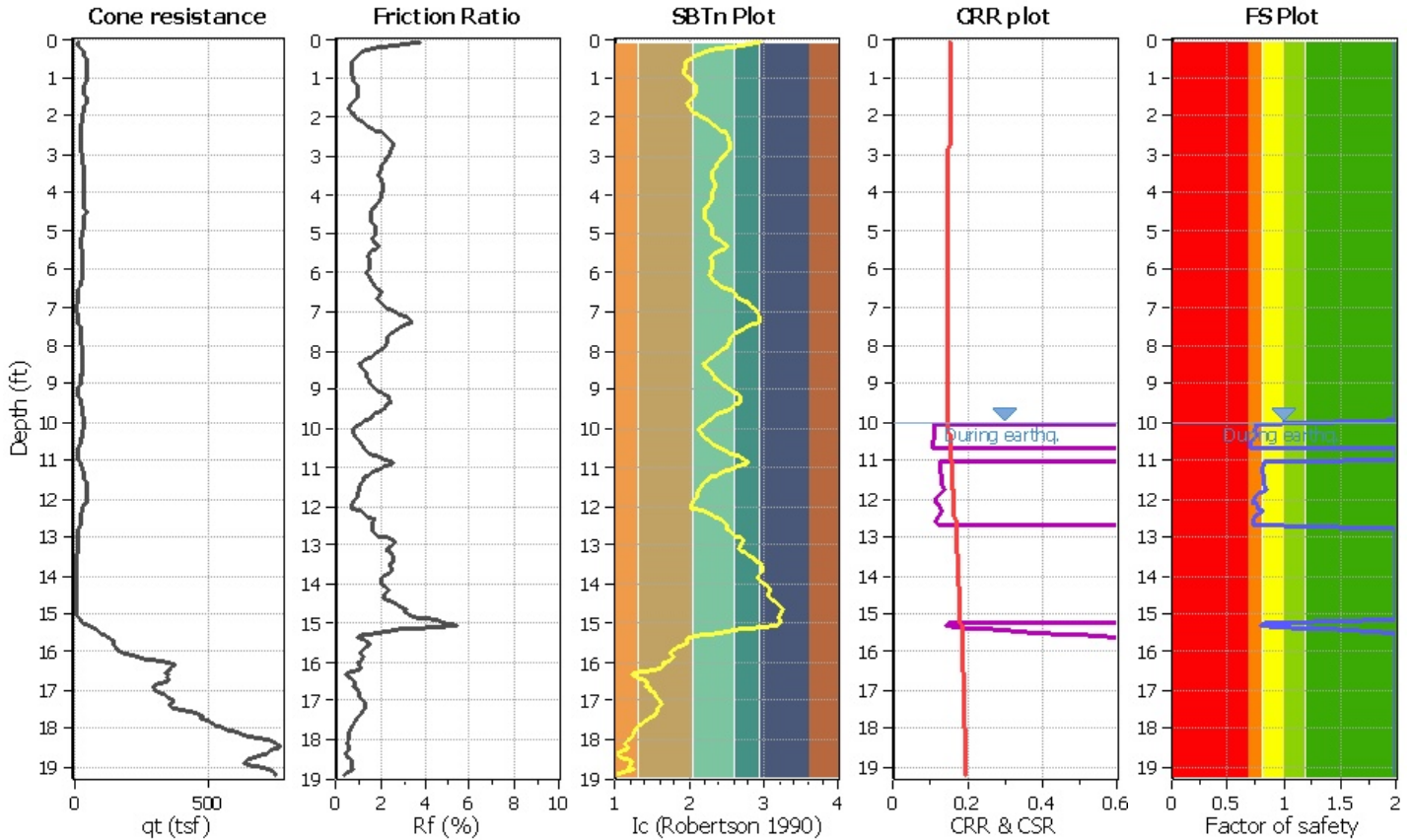

Liquefaction analysis overall plot

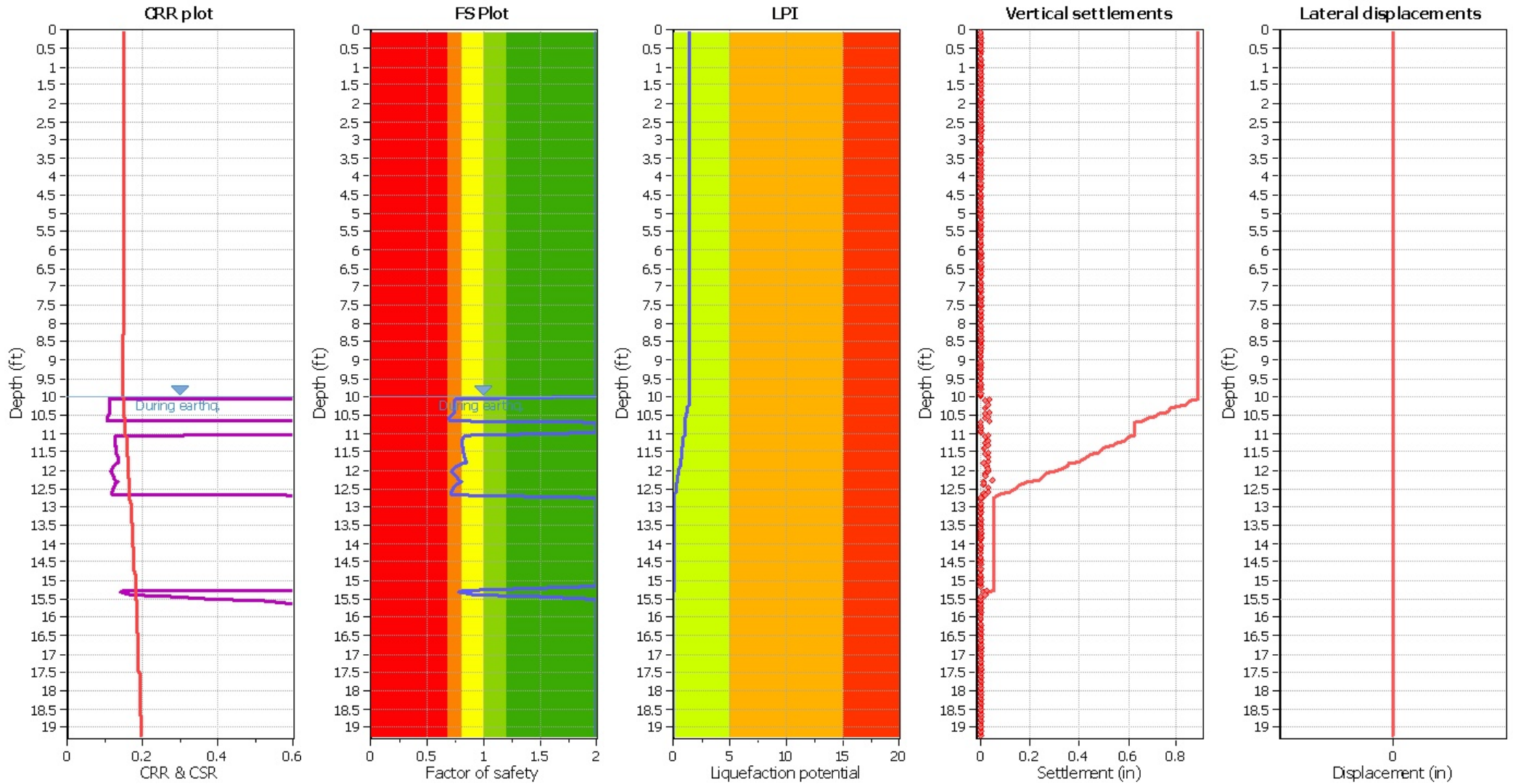

Input parameters and analysis data

Analysis method:	NCEER (1998)	Depth to water table (earthq.):	10.00 ft	Fill weight:	N/A
Fines correction method:	NCEER (1998)	Average results interval:	3	Transition detect. applied:	No
Points to test:	Based on Ic value	Ic cut-off value:	2.60	K_0 applied:	Yes
Earthquake magnitude M_w :	6.12	Unit weight calculation:	Based on SBT	Clay like behavior applied:	Sands only
Peak ground acceleration:	0.39	Use fill:	No	Limit depth applied:	No
Depth to water table (insitu):	10.00 ft	Fill height:	N/A	Limit depth:	N/A

F.S. color scheme

- Almost certain it will liquefy
- Very likely to liquefy
- Liquefaction and no liq. are equally likely
- Unlike to liquefy
- Almost certain it will not liquefy

LPI color scheme

- Very high risk
- High risk
- Low risk

Liquefaction analysis summary plo

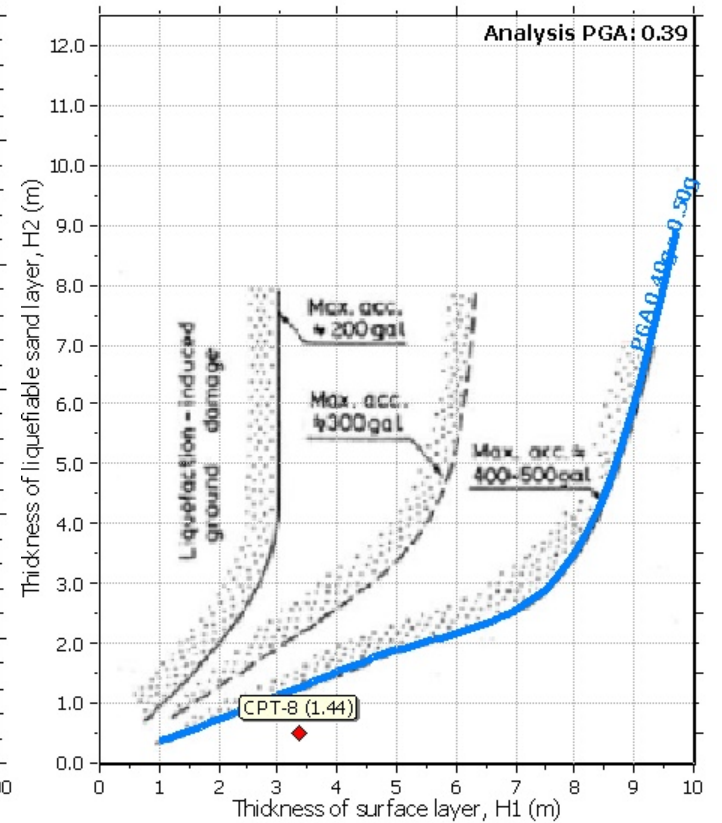
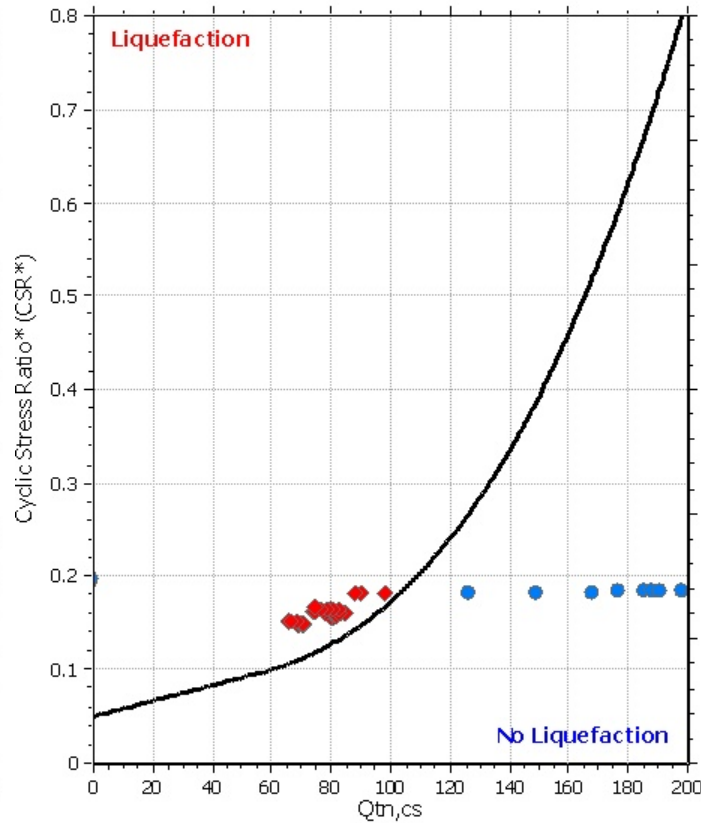
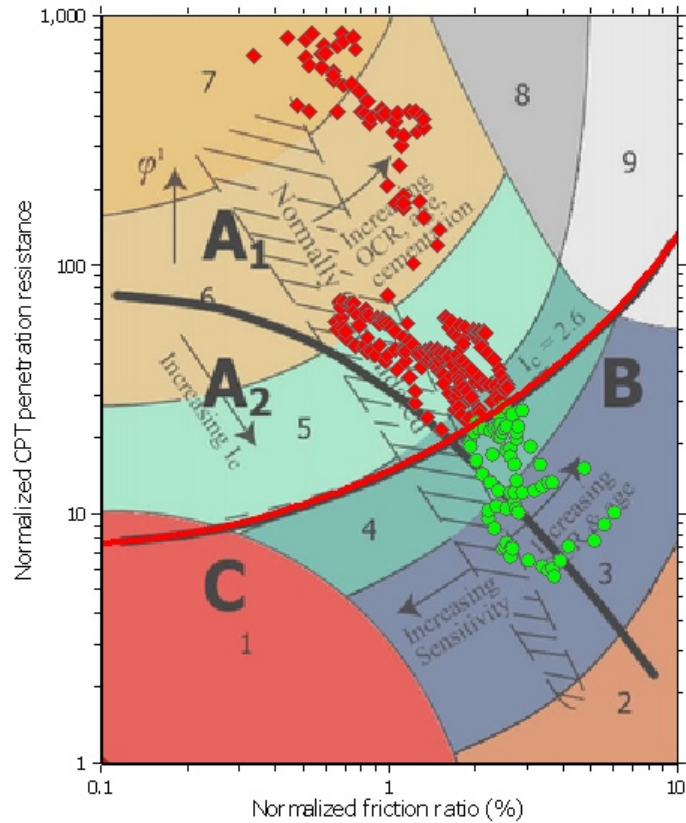

Input parameters and analysis data

Analysis method:	NCEER (1998)	Depth to water table (erthq.):	10.00 ft	Fill weight:	N/A
Fines correction method:	NCEER (1998)	Average results interval:	3	Transition detect. applied:	No
Points to test:	Based on Ic value	Ic cut-off value:	2.60	K ₀ applied:	Yes
Earthquake magnitude M _w :	6.12	Unit weight calculation:	Based on SBT	Clay like behavior applied:	Sands only
Peak ground acceleration:	0.39	Use fill:	No	Limit depth applied:	No
Depth to water table (insitu):	10.00 ft	Fill height:	N/A	Limit depth:	N/A

LIQUEFACTION ANALYSIS REPORT

Project title : Bella Mar

Location : 408 Hollister Street

CPT file : CPT-9

Input parameters and analysis data

Analysis method:	NCEER (1998)	G.W.T. (in-situ):	10.00 ft	Use fill:	No	Clay like behavior	
Fines correction method:	NCEER (1998)	G.W.T. (earthq.):	10.00 ft	Fill height:	N/A	applied:	Sands only
Points to test:	Based on Ic value	Average results interval:	3	Fill weight:	N/A	Limit depth applied:	No
Earthquake magnitude M_w :	6.12	Ic cut-off value:	2.60	Trans. detect. applied:	No	Limit depth:	N/A
Peak ground acceleration:	0.39	Unit weight calculation:	Based on SBT	K_0 applied:	Yes	MSF method:	Method based

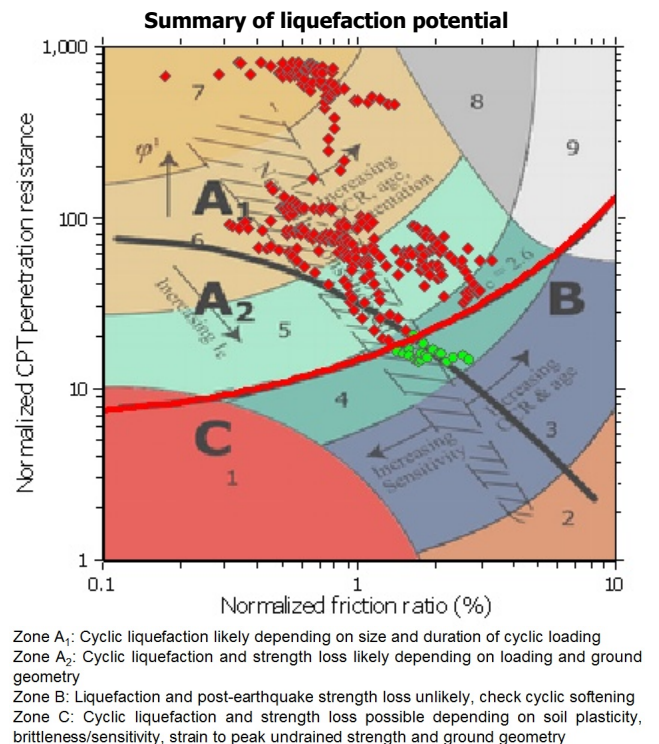
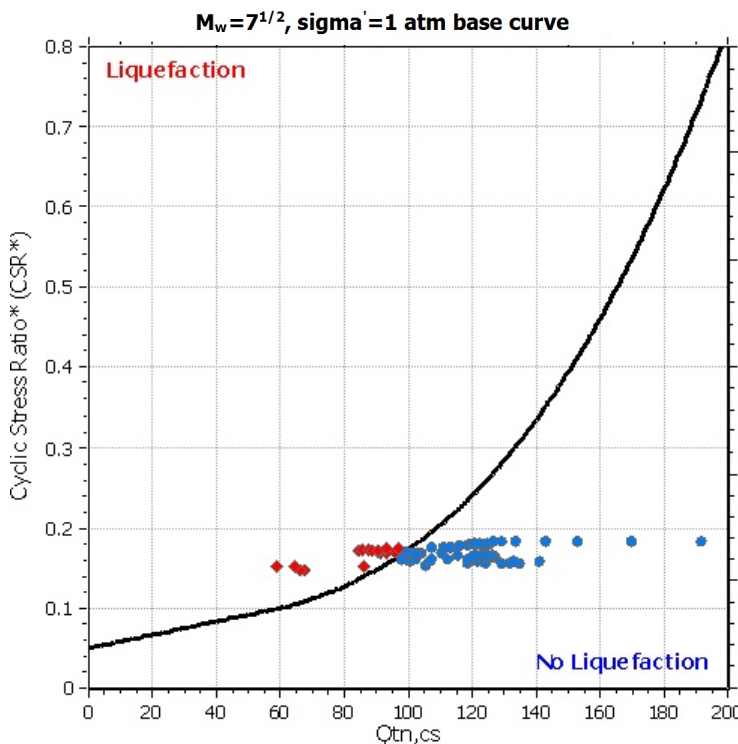
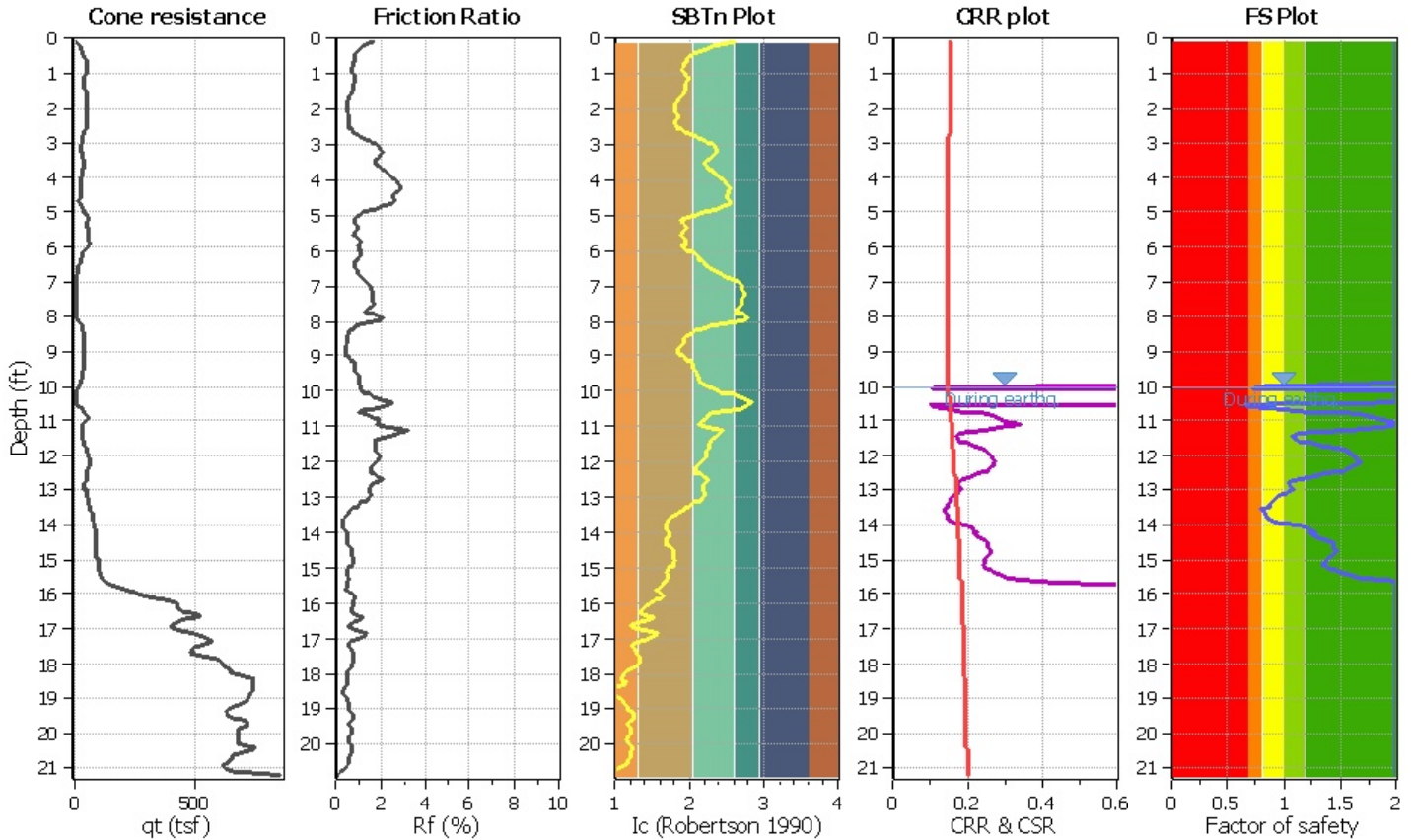

Liquefaction analysis overall plot

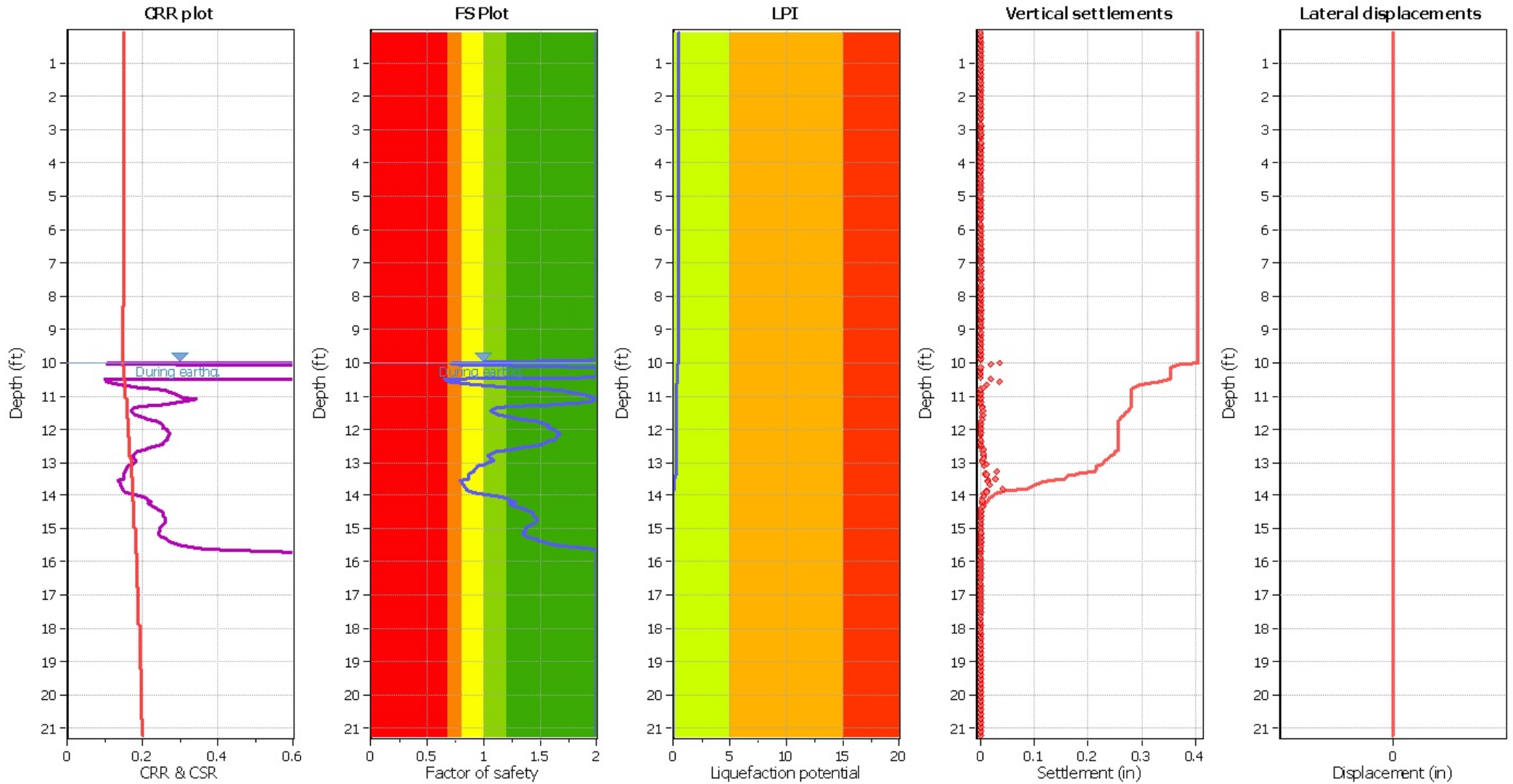

Input parameters and analysis data

Analysis method:	NCEER (1998)	Depth to water table (earthq.):	10.00 ft	Fill weight:	N/A
Fines correction method:	NCEER (1998)	Average results interval:	3	Transition detect. applied:	No
Points to test:	Based on Ic value	Ic cut-off value:	2.60	K_0 applied:	Yes
Earthquake magnitude M_w :	6.12	Unit weight calculation:	Based on SBT	Clay like behavior applied:	Sands only
Peak ground acceleration:	0.39	Use fill:	No	Limit depth applied:	No
Depth to water table (insitu):	10.00 ft	Fill height:	N/A	Limit depth:	N/A

F.S. color scheme

- Almost certain it will liquefy
- Very likely to liquefy
- Liquefaction and no liq. are equally likely
- Unlike to liquefy
- Almost certain it will not liquefy

LPI color scheme

- Very high risk
- High risk
- Low risk

Liquefaction analysis summary plo

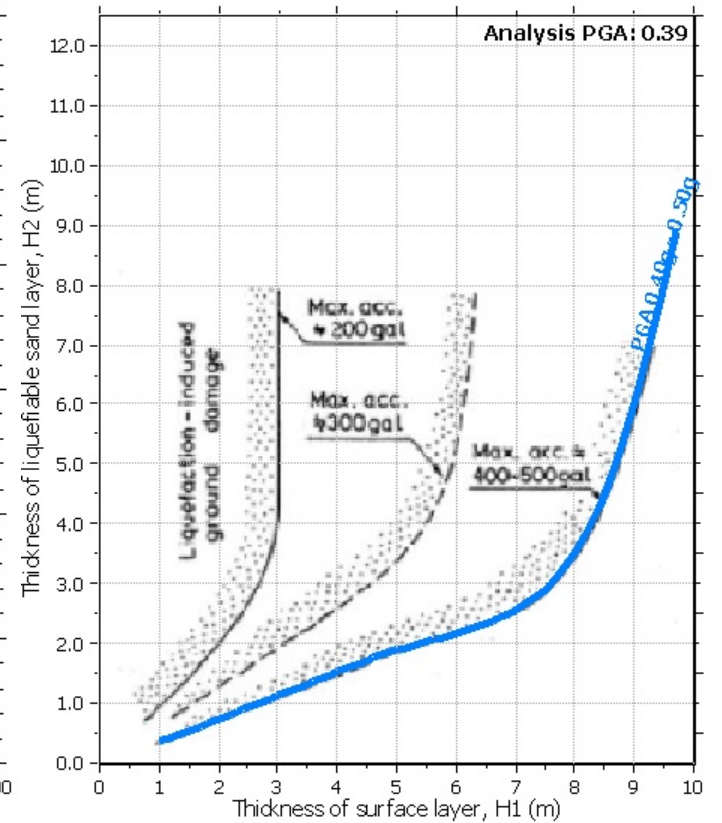
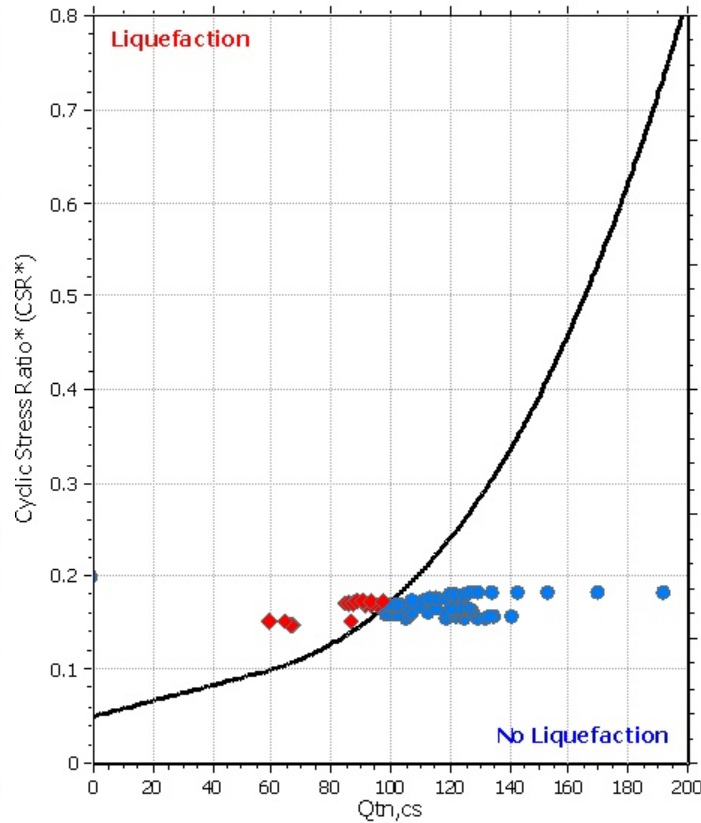
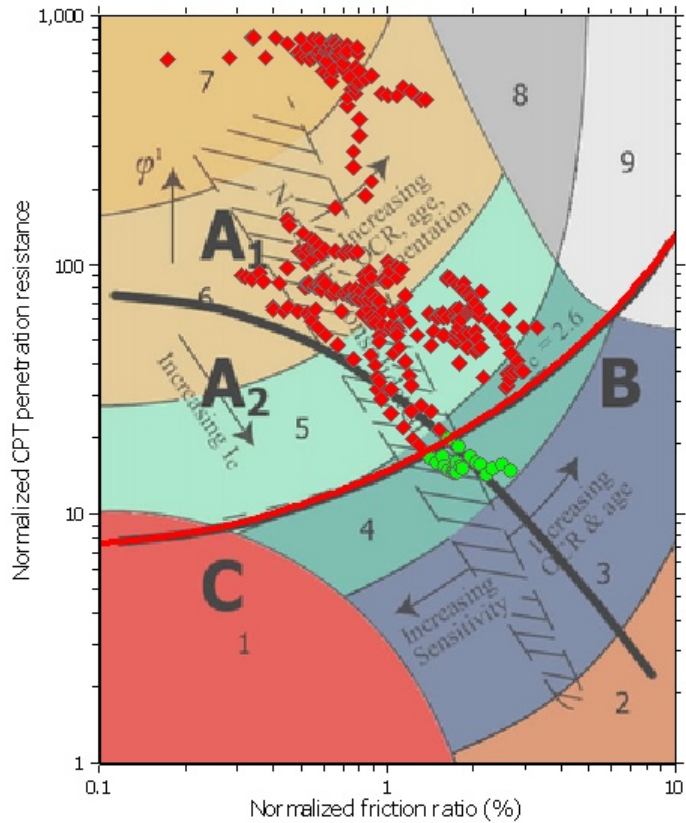

Input parameters and analysis data

Analysis method:	NCEER (1998)	Depth to water table (erthq.):	10.00 ft	Fill weight:	N/A
Fines correction method:	NCEER (1998)	Average results interval:	3	Transition detect. applied:	No
Points to test:	Based on Ic value	Ic cut-off value:	2.60	K_0 applied:	Yes
Earthquake magnitude M_w :	6.12	Unit weight calculation:	Based on SBT	Clay like behavior applied:	Sands only
Peak ground acceleration:	0.39	Use fill:	No	Limit depth applied:	No
Depth to water table (insitu):	10.00 ft	Fill height:	N/A	Limit depth:	N/A



Hammer Energy Correction Factors

Reference: Youd, et al, Liquefaction Resistance of Soils: Summary Report from the 1996 NCEER/NSF Workshops on Evaluation of Liquefaction Resistance of Soils, Journal of Geotechnical and Environmental Engineering, October, 2001, Vol. 127, No. 10

Project Name: 408 Hollister Street
 Project Number: G2129-52-03

Date: 4/4/2019

Hole Diameter, Inches: 8 Hole Diameter Correction, C_D : 1.15
 Average Unit Weight, γ (pcf): 120
 Adjustment Factor for 350 LB Hammer Above Groundwater: 1.00 <-- Enter 1.0 if an adjustment is not required; Applied to "MC" Samples
 Adjustment Factor for 350 LB Hammer Below Groundwater: 1.00 <-- Enter 1.0 if an adjustment is not required; Applied to "MC" Samples
 Approximate Depth to Groundwater in Boring B-1 and B-2: 10 *Auto, Cathead, or Downhole Hammer

Adjust for each GWT Level Energy Correction, C_E (1.0 Safe-T-Driver/Cathead, 1.3 Automatic)

Sample	Depth, Feet	Field Blow Count (per Foot)	Type of Sampler (MC or SPT)	Hammer Type* (A/C/D)	Equiv. SPT Blow Count, N	$\sigma'_{v,}$ psf	Overburden Pressure Correction, C_N	Energy Ratio Correction, C_E	Rod Length Correction, C_R	Sampling Correction, C_S	N1 60 Blowcounts (Prior to Fines)
B1-2	5.0	15	MC	A	10.0	600.0	1.70	1.3	0.75	1.00	19.06
B1-3	10.0	7	MC	A	4.7	1200.0	1.29	1.3	0.80	1.00	7.21
B1-4	15.0	8	MC	A	5.3	1488.0	1.16	1.3	0.85	1.00	7.86
B1-5	20.0	100	MC	A	66.7	1776.0	1.06	1.3	0.95	1.00	100.00
B1-6	25.0	100	MC	A	66.7	2064.0	0.98	1.3	0.95	1.00	93.20
B1-7	35.0	52	MC	A	34.7	2640.0	0.87	1.3	1.00	1.00	45.11
B1-8	40.0	66	MC	A	44.0	2928.0	0.83	1.3	1.00	1.00	54.37
B1-9	45.0	74	MC	A	49.3	3216.0	0.79	1.3	1.00	1.00	58.16
B1-10	50.0	100	MC	A	66.7	3504.0	0.76	1.3	1.00	1.00	75.30
B2-2	5.0	16	MC	A	10.7	600.0	1.70	1.3	0.75	1.00	20.33
B2-3	10.0	12	MC	A	8.0	1200.0	1.29	1.3	0.80	1.00	12.35
B2-4	15.0	89	MC	A	59.3	1488.0	1.16	1.3	0.85	1.00	87.41
B2-5	16.0	33	MC	A	22.0	1545.6	1.14	1.3	0.85	1.00	31.80
B2-6	20.0	100	MC	A	66.7	1776.0	1.06	1.3	0.95	1.00	100.00
B2-7	25.0	100	MC	A	66.7	2064.0	0.98	1.3	0.95	1.00	93.20
B2-8	30.0	100	MC	A	66.7	2352.0	0.92	1.3	1.00	1.00	91.91
B2-9	35.0	83	MC	A	55.3	2640.0	0.87	1.3	1.00	1.00	72.00
B2-10	40.0	25	MC	A	16.7	2928.0	0.83	1.3	1.00	1.00	20.59
B2-11	45.0	58	MC	A	38.7	3216.0	0.79	1.3	1.00	1.00	45.59
B2-12	50.0	100	MC	A	66.7	3504.0	0.76	1.3	1.00	1.00	75.30

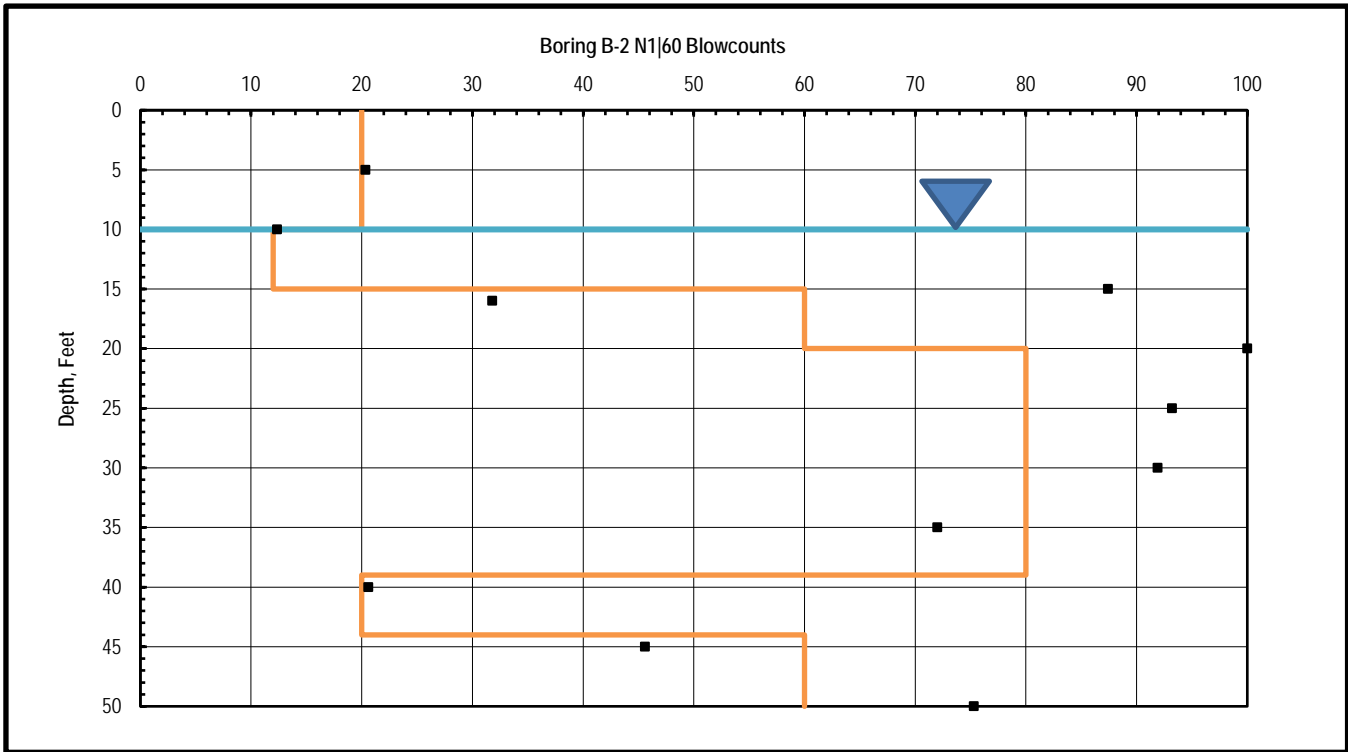
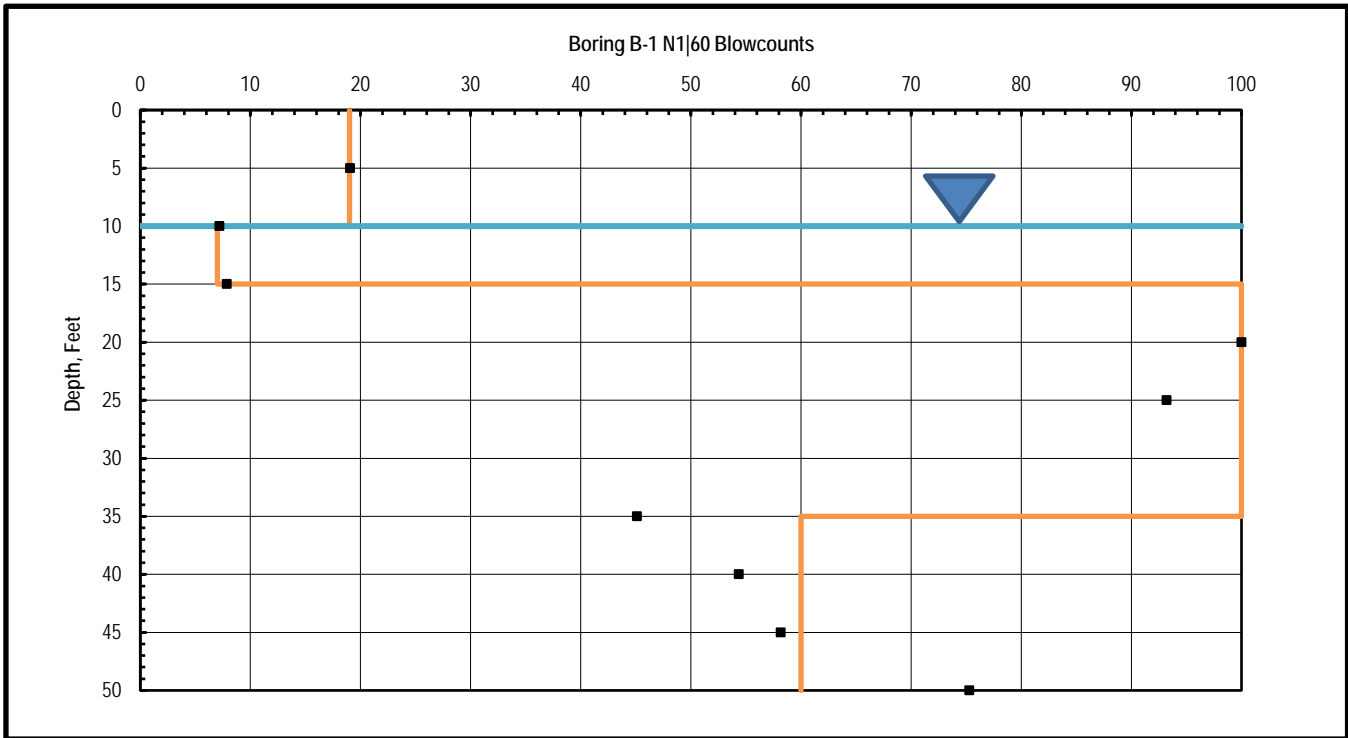

GEOCON
INCORPORATED
 GEOTECHNICAL CONSULTANTS
 6960 FLANDERS DRIVE - SAN DIEGO, CALIFORNIA 92121-2974
 PHONE 858 558-6900 - FAX 858 558-6159



LR / SW		
---------	--	--

HAMMER ENERGY CORRECTIONS

BELLA MAR
 408 HOLLISTER STREET
 SAN DIEGO, CALIFORNIA

	PROJECT NO. G2129-52-03
--	-------------------------



Liquefaction Analysis Using SPT

- References
1. Youd, et al, *Liquefaction Resistance of Soils: Summary Report from the 1996 NCEER/NSF Workshops on Evaluation of Liquefaction Resistance of Soils*, Journal of Geotechnical and Environmental Engineering, October, 2001, Vol. 127, No. 10
 2. Seed, et al, *Recent Advances in Soil Liquefaction Engineering: A Unified and Consistent Framework*, 2003.

Project Name: 408 Hollister Street
 Project Number: G2129-52-03
 Boring: B-1
 a_{max} /g: 0.39
 Magnitude: 6.1
 Groundwater Depth, Ft: 10.0
 Reference Pressure, p_a : 2000
 Unit Weight of Water: 62.4
 Soil Unit Weight, pcf: 120

Include K_σ (Y/N) N
 Use NCEER CRR7.5 (1) or Rauch CRR7.5 (2) 1
 Minimum Factor of Safety for Liquefaction 1

Depth, ft	Enter for Fine-Grained Materials							Old							New							MWF Idriss(1997) = $(M)^{2.56}/10^{2.24}$							From Graph	
	N_{160}	Fines Content, FC (%)	Water Content, w_c (%)	Liquid Limit	Plastic Limit	Plasticity Index	N_{160} Adj. for Fines	N_{160} Adj. for Fines	σ_v , psf	σ'_v , psf	r_d	K_σ	NCEER CRR7.5	RAUCH CRR7.5	CSR M=7.5	Fines Liquefiable (Y/N)	Liquefaction Potential	Factor of Safety	Volumetric Strain, %	Settlement, in.										
1	19	20	25.0	--	--	--	24.1	21.5	120.0	120.0	1.00	1.00	0.272	0.276	0.151	--	Above GWT	1.803												
2	19	20	25.0	--	--	--	24.1	21.5	240.0	240.0	1.00	1.00	0.272	0.276	0.150	--	Above GWT	1.807												
3	19	20	25.0	--	--	--	24.1	21.5	360.0	360.0	0.99	1.00	0.272	0.276	0.150	--	Above GWT	1.811												
4	19	20	25.0	--	--	--	24.1	21.5	480.0	480.0	0.99	1.00	0.272	0.276	0.150	--	Above GWT	1.816												
5	19	20	25.0	--	--	--	24.1	21.5	600.0	600.0	0.99	1.00	0.272	0.276	0.149	--	Above GWT	1.820												
6	19	20	25.0	--	--	--	24.1	21.5	720.0	720.0	0.99	1.00	0.272	0.276	0.149	--	Above GWT	1.824												
7	19	20	25.0	--	--	--	24.1	21.5	840.0	840.0	0.99	1.00	0.272	0.276	0.149	--	Above GWT	1.828												
8	19	20	25.0	--	--	--	24.1	21.5	960.0	960.0	0.98	1.00	0.272	0.276	0.148	--	Above GWT	1.832												
9	19	20	25.0	--	--	--	24.1	21.5	1080.0	1080.0	0.98	1.00	0.272	0.276	0.148	--	Above GWT	1.837												
10	7	14	25.0	--	--	--	9.5	8.1	1200.0	1200.0	0.98	1.00	0.104	0.109	0.148	--	LIQUEFIABLE	0.708	3.1	0.372										
11	7	14	25.0	--	--	--	9.5	8.1	1320.0	1257.6	0.98	1.00	0.104	0.109	0.155	--	LIQUEFIABLE	0.676	3.1	0.372										
12	7	14	25.0	--	--	--	9.5	8.1	1440.0	1315.2	0.97	1.00	0.104	0.109	0.161	--	LIQUEFIABLE	0.649	3.1	0.372										
13	7	14	25.0	--	--	--	9.5	8.1	1560.0	1372.8	0.97	1.00	0.104	0.109	0.167	--	LIQUEFIABLE	0.627	3.1	0.372										
14	7	14	25.0	--	--	--	9.5	8.1	1680.0	1430.4	0.97	1.00	0.104	0.109	0.172	--	LIQUEFIABLE	0.608	3.1	0.372										
15	100	14	30.0	--	--	--	106.4	106.3	1800.0	1488.0	0.97	1.00	0.800	0.800	0.177	--	NL	4.532												
16	100	14	30.0	--	--	--	106.4	106.3	1920.0	1545.6	0.97	1.00	0.800	0.800	0.181	--	NL	4.423												
17	100	14	16.0	--	--	--	106.4	106.3	2040.0	1603.2	0.96	1.00	0.800	0.800	0.185	--	NL	4.328												
18	100	14	16.0	--	--	--	106.4	106.3	2160.0	1660.8	0.96	1.00	0.800	0.800	0.188	--	NL	4.244												
19	100	14	16.0	--	--	--	106.4	106.3	2280.0	1718.4	0.96	1.00	0.800	0.800	0.192	--	NL	4.171												
20	100	14	16.0	--	--	--	106.4	106.3	2400.0	1776.0	0.96	1.00	0.800	0.800	0.195	--	NL	4.106												
21	100	14	16.0	--	--	--	106.4	106.3	2520.0	1833.6	0.95	1.00	0.800	0.800	0.198	--	NL	4.048												
22	100	14	16.0	--	--	--	106.4	106.3	2640.0	1891.2	0.95	1.00	0.800	0.800	0.200	--	NL	3.998												
23	100	14	16.0	--	--	--	106.4	106.3	2760.0	1948.8	0.95	1.00	0.800	0.800	0.202	--	NL	3.953												
24	100	14	16.0	--	--	--	106.4	106.3	2880.0	2006.4	0.95	1.00	0.800	0.800	0.204	--	NL	3.913												
25	100	14	16.0	--	--	--	106.4	106.3	3000.0	2064.0	0.94	1.00	0.800	0.800	0.206	--	NL	3.879												
26	100	14	16.0	--	--	--	106.4	106.3	3120.0	2121.6	0.94	1.00	0.800	0.800	0.208	--	NL	3.848												
27	100	14	16.0	--	--	--	106.4	106.3	3240.0	2179.2	0.93	1.00	0.800	0.800	0.209	--	NL	3.823												
28	100	14	16.0	--	--	--	106.4	106.3	3360.0	2236.8	0.93	1.00	0.800	0.800	0.210	--	NL	3.801												
29	100	14	16.0	--	--	--	106.4	106.3	3480.0	2294.4	0.93	1.00	0.800	0.800	0.211	--	NL	3.783												
30	100	14	16.0	--	--	--	106.4	106.3	3600.0	2352.0	0.92	1.00	0.800	0.800	0.212	--	NL	3.768												
31	100	14	16.0	--	--	--	106.4	106.3	3720.0	2409.6	0.92	1.00	0.800	0.800	0.213	--	NL	3.757												
32	100	14	16.0	--	--	--	106.4	106.3	3840.0	2467.2	0.91	1.00	0.800	0.800	0.213	--	NL	3.750												
33	100	14	16.0	--	--	--	106.4	106.3	3960.0	2524.8	0.90	1.00	0.800	0.800	0.214	--	NL	3.746												
34	100	14	16.0	--	--	--	106.4	106.3	4080.0	2582.4	0.90	1.00	0.800	0.800	0.214	--	NL	3.745												
35	60	14	25.0	--	--	--	64.7	64.1	4200.0	2640.0	0.89	1.00	0.800	0.800	0.213	--	NL	3.748												
36	60	14	25.0	--	--	--	64.7	64.1	4320.0	2697.6	0.88	1.00	0.800	0.800	0.213	--	NL	3.753												
37	60	14	25.0	--	--	--	64.7	64.1	4440.0	2755.2	0.88	1.00	0.800	0.800	0.213	--	NL	3.762												
38	60	14	25.0	--	--	--	64.7	64.1	4560.0	2812.8	0.87	1.00	0.800	0.800	0.212	--	NL	3.774												
39	60	14	25.0	--	--	--	64.7	64.1	4680.0	2870.4	0.86	1.00	0.800	0.800	0.211	--	NL	3.789												
40	60	14	25.0	--	--	--	64.7	64.1	4800.0	2928.0	0.85	1.00	0.800	0.800	0.210	--	NL	3.807												
41	60	14	25.0	--	--	--	64.7	64.1	4920.0	2985.6	0.84	1.00	0.800	0.800	0.209	--	NL	3.827												
42	60	14	25.0	--	--	--	64.7	64.1	5040.0	3043.2	0.83	1.00	0.800	0.800	0.208	--	NL	3.850												
43	60	14	25.0	--	--	--	64.7	64.1	5160.0	3100.8	0.82	1.00	0.800	0.800	0.206	--	NL	3.877												
44	60	14	25.0	--	--	--	64.7	64.1	5280.0	3158.4	0.81	1.00	0.800	0.800	0.205	--	NL	3.905												
45	60	70	25.0	--	--	--	77.0	66.0	5400.0	3216.0	0.80	1.00	0.800	0.800	0.203	--	NL	3.936												
46	60	70	25.0	--	--	--	77.0	66.0	5520.0	3273.6	0.79	1.00	0.800	0.800	0.202	--	NL	3.969												
47	60	70	25.0	--	--	--	77.0	66.0	5640.0	3331.2	0.78	1.00	0.800	0.800	0.200	--	NL	4.004												
48	60	70	25.0	--	--	--	77.0	66.0	5760.0	3388.8	0.77	1.00	0.800	0.800	0.198	--	NL	4.042												
49	60	10	25.0	--	--	--	62.2	62.9	5880.0	3446.4	0.76	1.00	0.800	0.800	0.196	--	NL	4.081												
50	60	10	25.0	--	--	--	62.2	62.9	6000.0	3504.0	0.75	1.00	0.800	0.800	0.194	--	NL	4.121												
51	60	10	25.0	--	--	--	62.2	62.9	6120.0	3561.6	0.74	1.00	0.800	0.800	0.192	--	NL	4.163												

Total Settlement, S_{LID} (in.) = 1.86
 Total Liquefiable Layers = 5



Liquefaction Analysis Using SPT

- References
1. Youd, et al, *Liquefaction Resistance of Soils: Summary Report from the 1996 NCEE/NSF Workshops on Evaluation of Liquefaction Resistance of Soils*, Journal of Geotechnical and Environmental Engineering, October, 2001, Vol. 127, No. 10
 2. Seed, et al, *Recent Advances in Soil Liquefaction Engineering: A Unified and Consistent Framework*, 2003.

Project Name: 408 Hollister Street
 Project Number: G2129-52-03
 Boring: B-2
 a_{max} /g: 0.39
 Magnitude: 6.1
 Groundwater Depth, Ft: 10.0
 Reference Pressure, p_a : 2000
 Unit Weight of Water: 62.4
 Soil Unit Weight, pcf: 120

Include K_σ (Y/N) N
 Use NCEE CRR7.5 (1) or Rauch CRR7.5 (2) 1
 Minimum Factor of Safety for Liquefaction 1

Depth, ft	Enter for Fine-Grained Materials						Old New										MWF Idriss(1997) = $(M)^{2.56}/10^{2.24}$				From Graph	
	N_{160}	Fines Content, FC (%)	Water Content, w_c (%)	Liquid Limit	Plastic Limit	Plasticity Index	N_{160} Adj. for Fines	N_{160} Adj. for Fines	σ , psf	σ' , psf	r_d	K_σ	NCEE CRR7.5	RAUCH CRR7.5	CSR M=7.5	Fines Liquefiable (Y/N)	Liquefaction Potential	Factor of Safety	Volumetric Strain, %	Settlement, in.		
1	20	30	25.0	--	--	--	27.8	23.9	120.0	120.0	1.00	1.00	0.344	0.362	0.151	--	Above GWT	2.281				
2	20	30	25.0	--	--	--	27.8	23.9	240.0	240.0	1.00	1.00	0.344	0.362	0.150	--	Above GWT	2.286				
3	20	30	25.0	--	--	--	27.8	23.9	360.0	360.0	0.99	1.00	0.344	0.362	0.150	--	Above GWT	2.292				
4	20	30	25.0	--	--	--	27.8	23.9	480.0	480.0	0.99	1.00	0.344	0.362	0.150	--	Above GWT	2.297				
5	20	30	25.0	--	--	--	27.8	23.9	600.0	600.0	0.99	1.00	0.344	0.362	0.149	--	Above GWT	2.303				
6	20	30	25.0	--	--	--	27.8	23.9	720.0	720.0	0.99	1.00	0.344	0.362	0.149	--	Above GWT	2.308				
7	20	30	25.0	--	--	--	27.8	23.9	840.0	840.0	0.99	1.00	0.344	0.362	0.149	--	Above GWT	2.313				
8	20	30	25.0	--	--	--	27.8	23.9	960.0	960.0	0.98	1.00	0.344	0.362	0.148	--	Above GWT	2.318				
9	20	30	25.0	--	--	--	27.8	23.9	1080.0	1080.0	0.98	1.00	0.344	0.362	0.148	--	Above GWT	2.324				
10	12	14	25.0	--	--	--	14.7	13.4	1200.0	1200.0	0.98	1.00	0.160	0.157	0.148	--	NL	1.087				
11	12	14	25.0	--	--	--	14.7	13.4	1320.0	1257.6	0.98	1.00	0.160	0.157	0.155	--	NL	1.038				
12	12	14	25.0	--	--	--	14.7	13.4	1440.0	1315.2	0.97	1.00	0.160	0.157	0.161	--	LIQUEFIABLE	0.997	2.2	0.264		
13	12	14	25.0	--	--	--	14.7	13.4	1560.0	1372.8	0.97	1.00	0.160	0.157	0.167	--	LIQUEFIABLE	0.963	2.2	0.264		
14	12	14	25.0	--	--	--	14.7	13.4	1680.0	1430.4	0.97	1.00	0.160	0.157	0.172	--	LIQUEFIABLE	0.934	2.2	0.264		
15	60	14	20.0	--	--	--	64.7	64.1	1800.0	1488.0	0.97	1.00	0.800	0.800	0.177	--	NL	4.532				
16	60	14	20.0	--	--	--	64.7	64.1	1920.0	1545.6	0.97	1.00	0.800	0.800	0.181	--	NL	4.423				
17	60	14	20.0	--	--	--	64.7	64.1	2040.0	1603.2	0.96	1.00	0.800	0.800	0.185	--	NL	4.328				
18	60	14	20.0	--	--	--	64.7	64.1	2160.0	1660.8	0.96	1.00	0.800	0.800	0.188	--	NL	4.244				
19	60	8	20.0	--	--	--	61.1	62.3	2280.0	1718.4	0.96	1.00	0.800	0.800	0.192	--	NL	4.171				
20	80	8	20.0	--	--	--	81.3	83.0	2400.0	1776.0	0.96	1.00	0.800	0.800	0.195	--	NL	4.106				
21	80	8	20.0	--	--	--	81.3	83.0	2520.0	1833.6	0.95	1.00	0.800	0.800	0.198	--	NL	4.048				
22	80	8	20.0	--	--	--	81.3	83.0	2640.0	1891.2	0.95	1.00	0.800	0.800	0.200	--	NL	3.998				
23	80	8	20.0	--	--	--	81.3	83.0	2760.0	1948.8	0.95	1.00	0.800	0.800	0.202	--	NL	3.953				
24	80	8	20.0	--	--	--	81.3	83.0	2880.0	2006.4	0.95	1.00	0.800	0.800	0.204	--	NL	3.913				
25	80	8	10.0	--	--	--	81.3	83.0	3000.0	2064.0	0.94	1.00	0.800	0.800	0.206	--	NL	3.879				
26	80	8	10.0	--	--	--	81.3	83.0	3120.0	2121.6	0.94	1.00	0.800	0.800	0.208	--	NL	3.848				
27	80	8	10.0	--	--	--	81.3	83.0	3240.0	2179.2	0.93	1.00	0.800	0.800	0.209	--	NL	3.823				
28	80	8	10.0	--	--	--	81.3	83.0	3360.0	2236.8	0.93	1.00	0.800	0.800	0.210	--	NL	3.801				
29	80	8	10.0	--	--	--	81.3	83.0	3480.0	2294.4	0.93	1.00	0.800	0.800	0.211	--	NL	3.783				
30	80	8	25.0	--	--	--	81.3	83.0	3600.0	2352.0	0.92	1.00	0.800	0.800	0.212	--	NL	3.768				
31	80	8	25.0	--	--	--	81.3	83.0	3720.0	2409.6	0.92	1.00	0.800	0.800	0.213	--	NL	3.757				
32	80	8	25.0	--	--	--	81.3	83.0	3840.0	2467.2	0.91	1.00	0.800	0.800	0.213	--	NL	3.750				
33	80	8	25.0	--	--	--	81.3	83.0	3960.0	2524.8	0.90	1.00	0.800	0.800	0.214	--	NL	3.746				
34	80	8	25.0	--	--	--	81.3	83.0	4080.0	2582.4	0.90	1.00	0.800	0.800	0.214	--	NL	3.745				
35	80	8	25.0	--	--	--	81.3	83.0	4200.0	2640.0	0.89	1.00	0.800	0.800	0.213	--	NL	3.748				
36	80	8	25.0	--	--	--	81.3	83.0	4320.0	2697.6	0.88	1.00	0.800	0.800	0.213	--	NL	3.753				
37	80	8	25.0	--	--	--	81.3	83.0	4440.0	2755.2	0.88	1.00	0.800	0.800	0.213	--	NL	3.762				
38	80	8	25.0	--	--	--	81.3	83.0	4560.0	2812.8	0.87	1.00	0.800	0.800	0.212	--	NL	3.774				
39	20	75	25.0	--	--	--	29.0	26.0	4680.0	2870.4	0.86	1.00	0.386	0.410	0.211	--	NL	1.828				
40	20	75	25.0	--	--	--	29.0	26.0	4800.0	2928.0	0.85	1.00	0.386	0.410	0.210	--	NL	1.836				
41	20	75	25.0	--	--	--	29.0	26.0	4920.0	2985.6	0.84	1.00	0.386	0.410	0.209	--	NL	1.846				
42	20	75	25.0	--	--	--	29.0	26.0	5040.0	3043.2	0.83	1.00	0.386	0.410	0.208	--	NL	1.858				
43	20	75	25.0	--	--	--	29.0	26.0	5160.0	3100.8	0.82	1.00	0.386	0.410	0.206	--	NL	1.870				
44	60	20	25.0	--	--	--	68.4	65.8	5280.0	3158.4	0.81	1.00	0.800	0.800	0.205	--	NL	3.905				
45	60	20	25.0	--	--	--	68.4	65.8	5400.0	3216.0	0.80	1.00	0.800	0.800	0.203	--	NL	3.936				
46	60	20	25.0	--	--	--	68.4	65.8	5520.0	3273.6	0.79	1.00	0.800	0.800	0.202	--	NL	3.969				
47	60	8	25.0	--	--	--	61.1	62.3	5640.0	3331.2	0.78	1.00	0.800	0.800	0.200	--	NL	4.004				
48	60	8	25.0	--	--	--	61.1	62.3	5760.0	3388.8	0.77	1.00	0.800	0.800	0.198	--	NL	4.042				
49	60	8	25.0	--	--	--	61.1	62.3	5880.0	3446.4	0.76	1.00	0.800	0.800	0.196	--	NL	4.081				
50	60	8	25.0	--	--	--	61.1	62.3	6000.0	3504.0	0.75	1.00	0.800	0.800	0.194	--	NL	4.121				
51	60	8	25.0	--	--	--	61.1	62.3	6120.0	3561.6	0.74	1.00	0.800	0.800	0.192	--	NL	4.163				

Total Settlement, S_{LID} (in.) = 0.79
 Total Liquefiable Layers = 3

Volumetric Strain, %

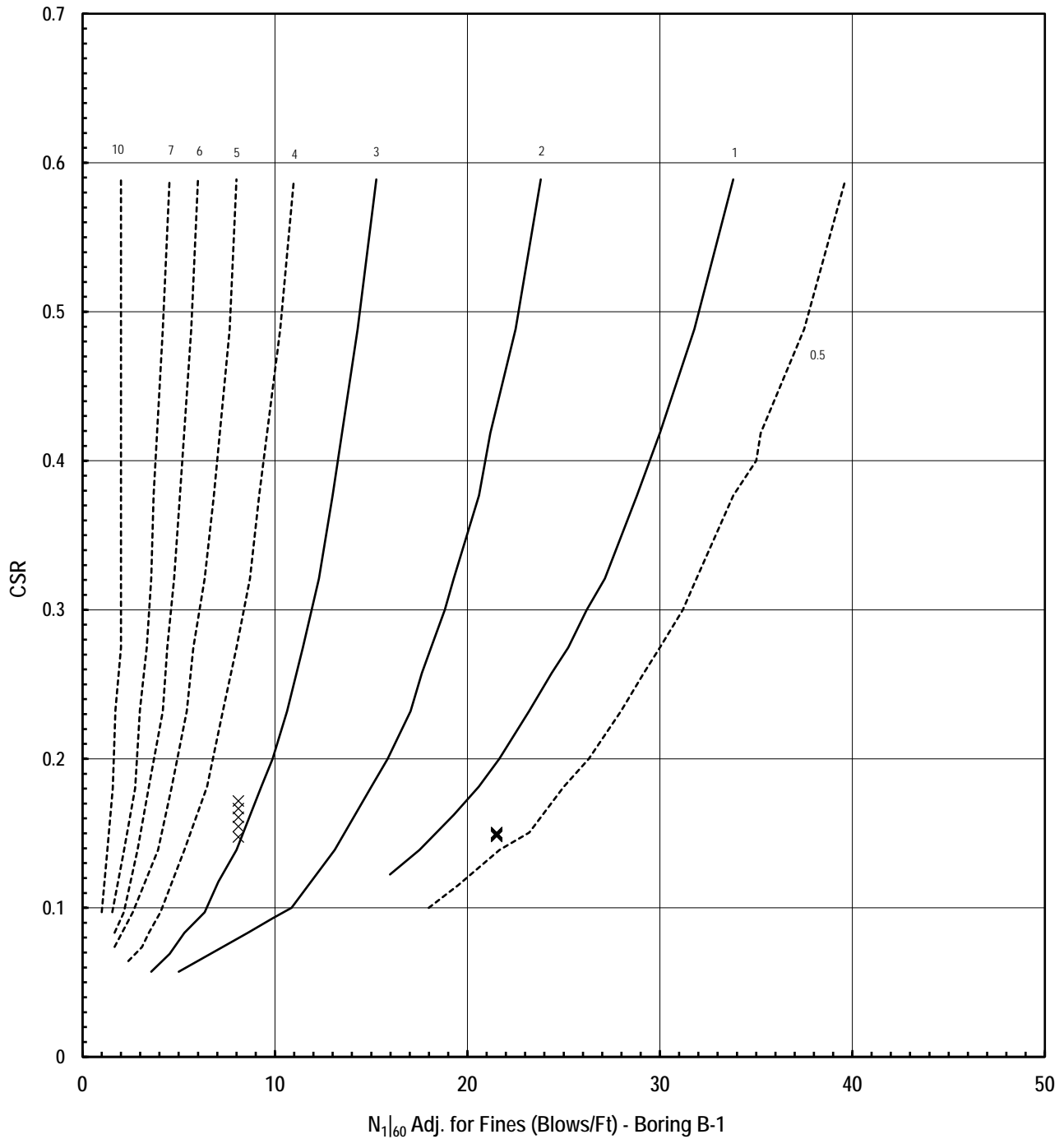

GEOCON
INCORPORATED



GEOTECHNICAL CONSULTANTS
6960 FLANDERS DRIVE - SAN DIEGO, CALIFORNIA 92121-2974
PHONE 858 558-6900 - FAX 858 558-6159

LR / SW

LIQUEFACTION - VOLUMETRIC STRAIN

BELLA MAR
408 HOLLISTER STREET
SAN DIEGO, CALIFORNIA

PROJECT NO. G2129-52-03

Volumetric Strain, %

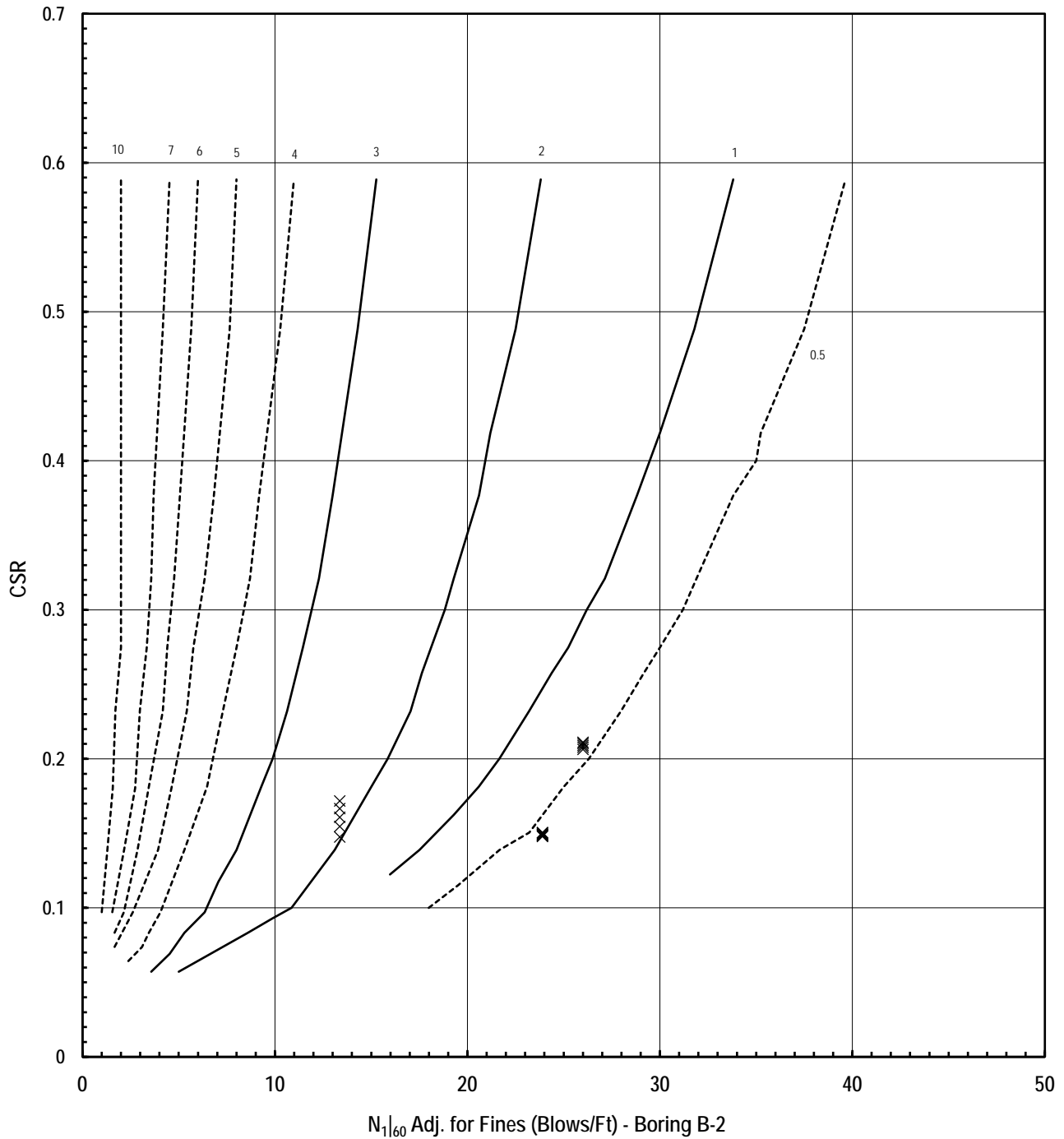

GEOCON
INCORPORATED



GEOTECHNICAL CONSULTANTS
6960 FLANDERS DRIVE - SAN DIEGO, CALIFORNIA 92121-2974
PHONE 858 558-6900 - FAX 858 558-6159

LR / SW

LIQUEFACTION - VOLUMETRIC STRAIN

BELLA MAR
408 HOLLISTER STREET
SAN DIEGO, CALIFORNIA

PROJECT NO. G2129-52-03

APPENDIX

A solid green triangle pointing to the left, containing the letter 'E' in white.

E

APPENDIX E

STORM WATER MANAGEMENT INVESTIGATION

We understand storm water management devices are being proposed in accordance with the *2018 City of San Diego Storm Water Standards* (SWS). If not properly constructed, there is a potential for distress to improvements and properties located hydrologically down gradient or adjacent to these devices. Factors such as the amount of water to be detained, its residence time, and soil permeability have an important effect on seepage transmission and the potential adverse impacts that may occur if the storm water management features are not properly designed and constructed. We have not performed a hydrogeological study at the site. If infiltration of storm water runoff occurs, downstream properties may be subjected to seeps, springs, slope instability, raised groundwater, movement of foundations and slabs, or other undesirable impacts as a result of water infiltration.

Hydrologic Soil Group

The United States Department of Agriculture (USDA), Natural Resources Conservation Services, possesses general information regarding the existing soil conditions for areas within the United States. The USDA website also provides the Hydrologic Soil Group. Table E-I presents the descriptions of the hydrologic soil groups. If a soil is assigned to a dual hydrologic group (A/D, B/D, or C/D), the first letter is for drained areas and the second is for undrained areas. In addition, the USDA website also provides an estimated saturated hydraulic conductivity for the existing soil.

**TABLE E-I
HYDROLOGIC SOIL GROUP DEFINITIONS**

Soil Group	Soil Group Definition
A	Soils having a high infiltration rate (low runoff potential) when thoroughly wet. These consist mainly of deep, well drained to excessively drained sands or gravelly sands. These soils have a high rate of water transmission.
B	Soils having a moderate infiltration rate when thoroughly wet. These consist chiefly of moderately deep or deep, moderately well drained or well drained soils that have moderately fine texture to moderately coarse texture. These soils have a moderate rate of water transmission.
C	Soils having a slow infiltration rate when thoroughly wet. These consist chiefly of soils having a layer that impedes the downward movement of water or soils of moderately fine texture or fine texture. These soils have a slow rate of water transmission.
D	Soils having a very slow infiltration rate (high runoff potential) when thoroughly wet. These consist chiefly of clays that have a high shrink-swell potential, soils that have a high water table, soils that have a claypan or clay layer at or near the surface, and soils that are shallow over nearly impervious material. These soils have a very slow rate of water transmission.

The property is designated as Tujunga Sand (TuB) and Visalia Gravelly Sandy Laom (VbB) which are classified as Soil Group A with a saturated hydraulic conductivity rate of greater than 1.42 inches per hour.

In Situ Testing

The infiltration rate, percolation rates and saturated hydraulic conductivity are different and have different meanings. Percolation rates tend to overestimate infiltration rates and saturated hydraulic conductivities by a factor of 10 or more. Table E-II describes the differences in the definitions.

**TABLE E-II
SOIL PERMEABILITY DEFINITIONS**

Term	Definition
Infiltration Rate	The observation of the flow of water through a material into the ground downward into a given soil structure under long term conditions. This is a function of layering of soil, density, pore space, discontinuities and initial moisture content.
Percolation Rate	The observation of the flow of water through a material into the ground downward and laterally into a given soil structure under long term conditions. This is a function of layering of soil, density, pore space, discontinuities and initial moisture content.
Saturated Hydraulic Conductivity (k_{SAT} , Permeability)	The volume of water that will move in a porous medium under a hydraulic gradient through a unit area. This is a function of density, structure, stratification, fines content and discontinuities. It is also a function of the properties of the liquid as well as of the porous medium.

The degree of soil compaction or in-situ density has a significant impact on soil permeability and infiltration. Based on our experience and other studies we performed an increase in compaction results in a decrease in soil permeability.

We performed 6 Aardvark Permeameter tests at on the property. The results of the tests provide parameters regarding the saturated hydraulic conductivity and infiltration characteristics of on-site soil and geologic units. Table E-III presents the results of the estimated field saturated hydraulic conductivity and estimated infiltration rates obtained from the Aardvark Permeameter tests. The field sheets are also attached herein. Based on a discussion in the SWS, the infiltration rate should be considered equal to the saturated hydraulic conductivity rate. We applied a feasibility factor of safety of 2.0 to our estimated infiltration rates to provide input on Worksheet C.4-1. Soil infiltration rates from in-situ tests can vary significantly from one location to another due to the heterogeneous characteristics inherent to most soil. The Geologic Map, Figure 2 presents the locations of the permeability tests.

**TABLE E-III
FIELD PERMEAMETER INFILTRATION TEST RESULTS**

Test No.	Geologic Unit	Test Elevation (feet, MSL)	Field-Saturated Hydraulic Conductivity/Infiltration Rate, k_{sat} (inch/hour)	Worksheet Infiltration Rate ¹ (inch/hour)
P-1	Qal	15	0.30	0.15
P-2	Qal	13	0.25	0.13
P-3	Qal	13	0.14	0.07
P-4	Qal	14	0.13	0.07
P-5	Qal	14	0.20	0.10
P-6	Qal	16	0.12	0.06
Average			0.19	0.10

¹ Using a factor of safety of 2.

Infiltration categories include full infiltration, partial infiltration and no infiltration. Table E-IV presents the commonly accepted definitions of the potential infiltration categories based on the infiltration rates.

**TABLE E-IV
INFILTRATION CATEGORIES**

Infiltration Category	Field Infiltration Rate, I (Inches/Hour)	Factored Infiltration Rate*, I (Inches/Hour)
Full Infiltration	$I > 1.0$	$I > 0.5$
Partial Infiltration	$0.10 < I \leq 1.0$	$0.05 < I \leq 0.5$
No Infiltration (Infeasible)	$I < 0.10$	$I < 0.05$

*Using a Factor of Safety of 2.

Based on our observations and test results, the infiltration rates for the alluvium are less than 0.5 inches per hour. Therefore, full infiltration on the property should be considered infeasible based on the calculated infiltrations rates. However, partial infiltration may be considered feasible within the alluvium based on the infiltration rates (greater than 0.05 inches per hour including a factor of safety of 2). Vertical cutoff walls or liners should be installed on the sides and a drain should be installed at the base of the basin.

Soil Types

Undocumented Fill and Topsoil – Undocumented fill and topsoil exists on the property to depths of up to 3 feet. The undocumented fill was not tested or observed during placement and should be considered to be highly variable on the property and within adjacent properties and right-of-ways. The

undocumented fill and topsoil materials should be considered to possess relatively high hydroconsolidation characteristics. Water that is allowed to migrate within the undocumented fill and topsoil materials soil cannot be controlled, would destabilize support for the existing improvements, and would shrink and swell. Therefore, full and partial infiltration should not be allowed within the undocumented fill or topsoil materials. The planned storm water devices should be extended to expose alluvium at the base and liners should be installed on the sides of the devices to prevent lateral water migration into the fill and topsoil.

Alluvium – The alluvium generally consists of loose to very dense, dark brown to grayish-brown, mixed sands, silts and clays with trace gravels and cobbles. Based on the results of our in-situ testing, the infiltration rates within the alluvium ranges from 0.12 to 0.30 inches/hour (0.06 to 0.15 including a factor of safety of 2). Based on our conversations with the City of San Diego, we expect a partial infiltration condition exists on the property.

Compacted Fill – The proposed compacted fill will be comprised of on-site materials that will consist predominantly of sand, silt and clay. The fill is compacted to a dry density of at least 90 percent of the laboratory maximum dry density. Based on our limited investigation and background research, sufficient materials do not exist on-site to perform select grading to allow infiltration within fill materials. In our experience, compacted fill using the on-site materials does not possess infiltration rates appropriate with infiltration and the water would destabilize the existing fill causing distress to existing and proposed improvements. Therefore, full and partial infiltration should be considered infeasible. Mitigation measures would include extending the infiltration devices into the alluvial materials and lining the storm water devices.

Groundwater Elevations

The SWS indicates that the depth to the groundwater table beneath an infiltration BMP must be greater than 10 feet for infiltration to be allowed. We encountered groundwater at depths of 13.5 and 16 feet in current Borings B-1 and B-2 (elevations of about 6.5 and 4 feet above Mean Sea Level). In addition, CWE reported that groundwater was encountered at depths ranging from 8 to 13 feet (elevations of about 7 to 12 feet above Mean Sea Level). We also encountered saturated soils at depths of approximately 5 feet in current Borings B-1 and B-2 (elevation of approximately 15 feet above MSL). The project should be designed with a groundwater elevation of 10 feet MSL.

There is likely not enough vertical space between planned bottom of basin elevations and 10 feet above the groundwater elevation; therefore, full and partial infiltration should be considered infeasible. Mitigation measures to lower the groundwater elevation are not feasible or reasonable for the planned development.

New or Existing Utilities

Utilities are located adjacent to the property on the eastern property boundaries and existing streets. Therefore, full infiltration within the areas near these utilities should be considered infeasible. Setbacks for infiltration should be incorporated. The setback for infiltration devices should be a minimum of 10 feet and a 1:1 plane of 1 foot below the closest edge of the deepest adjacent utility. Partial infiltration may be feasible if liners or cut-off walls will be installed on the sidewalls of the proposed devices.

Existing or Planned Structures

Structures exist on the southern property line of the subject project. Water should not be allowed to infiltrate in areas where it could affect the neighboring properties and adjacent structures. Infiltration should be considered infeasible due to the lateral migration characteristics of the soil. Mitigation for existing structures consists of not allowing water infiltration within 10 feet of the existing foundations.

Soil or Groundwater Contamination

We are unaware of contaminated soil or groundwater on the property. Therefore, infiltration associated with this risk is considered feasible.

Slopes and Other Geologic Hazards

As previously discussed, an existing slope associated with the Otay River is located adjacent to the northern property line. Water migration and the resulting seepage forces negatively affects the stability of slopes and causes erosion. The SWS recommends a minimum setback of 50 feet from the top of existing sensitive slopes. Due to the potential for lateral water migration within the existing soil, full or partial infiltration should be considered infeasible within this setback zone from the existing slopes.

The County of San Diego Hazard Mitigation Plan (2017) maps the site in a liquefiable area. The liquefaction analysis (included in Appendix D of this report) indicates the onsite soils to depths of approximately 20 feet below proposed grade could be prone to up to approximately 2 inches of total liquefaction settlement during PGA_M ground motion. Table C.5-1 of the 2018 Storm Water Standards (SWS) states BMPs (particularly infiltration BMPs) must not be sited in areas with high potential for liquefaction or landslides to minimize earthquake/landslide risks. Therefore, full and partial infiltration devices should be considered infeasible for the property. We expect the planned mitigation measures for liquefaction would include supporting the planned structures on post-tensioned or mat foundations.

Storm Water Evaluation Narrative

The site is underlain by fill soils, topsoil and alluvium to depths of approximately 35 feet overlying Old Paralac Deposits and San Diego Formation. We performed 6 infiltration tests within the alluvium and the results indicate rates less than 0.5 inches per hour (with an applied factor of safety of 2). Therefore, full infiltration is considered infeasible within the alluvium.

The project area is mapped within a liquefaction zone. In addition, our calculations show a potential for liquefaction exists within the alluvium underlying the property. Therefore, infiltration should be considered infeasible to help prevent an increased thickness of liquefiable soil. In addition, groundwater exists at depths ranging from approximately 8 and 16 feet below the existing ground surface (approximate elevations ranging from 4 and 12 feet MSL). The elevation where infiltration is feasible is limited to the required 10 feet above the groundwater elevation. There is likely not enough vertical space between planned bottom of basin elevations and 10 feet above the groundwater elevation. Therefore, full and partial infiltration devices should be considered infeasible for the property.

Storm Water Evaluation Conclusion

Due to the liquefaction potential at the site and the depth of the groundwater relative to the bottom of planned storm water devices, infiltration should be considered infeasible and planned storm water device should be lined.

Storm Water Management Devices

Liners and subdrains should be incorporated into the design and construction of the planned storm water devices. The liners should be impermeable (e.g. High-density polyethylene, HDPE, with a thickness of about 30 mil or equivalent Polyvinyl Chloride, PVC) to prevent water migration. The subdrains should be perforated within the liner area, installed at the base and above the liner, be at least 3 inches in diameter and consist of Schedule 40 PVC pipe. The subdrains outside of the liner should consist of solid pipe. The penetration of the liners at the subdrains should be properly waterproofed. The subdrains should be connected to a proper outlet. The devices should also be installed in accordance with the manufacturer's recommendations.

Storm Water Standard Worksheets

The SWS requests the geotechnical engineer complete the *Categorization of Infiltration Feasibility Condition* (Worksheet C.4-1 or I-8) worksheet information to help evaluate the potential for infiltration on the property. Worksheet C.4-1 presents the completed information for the submittal process and is attached herein.

The regional storm water standards also have a worksheet (Worksheet D.5-1 or Form I-9) that helps the project civil engineer estimate the factor of safety based on several factors. Table E-V describes the suitability assessment input parameters related to the geotechnical engineering aspects for the factor of safety determination.

**TABLE E-V
SUITABILITY ASSESSMENT RELATED CONSIDERATIONS FOR INFILTRATION FACILITY
SAFETY FACTORS**

Consideration	High Concern – 3 Points	Medium Concern – 2 Points	Low Concern – 1 Point
Assessment Methods	Use of soil survey maps or simple texture analysis to estimate short-term infiltration rates. Use of well permeameter or borehole methods without accompanying continuous boring log. Relatively sparse testing with direct infiltration methods	Use of well permeameter or borehole methods with accompanying continuous boring log. Direct measurement of infiltration area with localized infiltration measurement methods (e.g., Infiltrometer). Moderate spatial resolution	Direct measurement with localized (i.e. small-scale) infiltration testing methods at relatively high resolution or use of extensive test pit infiltration measurement methods.
Predominant Soil Texture	Silty and clayey soils with significant fines	Loamy soils	Granular to slightly loamy soils
Site Soil Variability	Highly variable soils indicated from site assessment or unknown variability	Soil boring/test pits indicate moderately homogenous soils	Soil boring/test pits indicate relatively homogenous soils
Depth to Groundwater/ Impervious Layer	<5 feet below facility bottom	5-15 feet below facility bottom	>15 feet below facility bottom

Based on our geotechnical investigation and the previous table, Table E-VI presents the estimated factor values for the evaluation of the factor of safety. This table only presents the suitability assessment safety factor (Part A) of the worksheet. The project civil engineer should evaluate the safety factor for design (Part B) and use the combined safety factor for the design infiltration rate.

**TABLE E-VI
FACTOR OF SAFETY WORKSHEET DESIGN VALUES – PART A¹**

Suitability Assessment Factor Category	Assigned Weight (w)	Factor Value (v)	Product (p = w x v)
Assessment Methods	0.25	2	0.50
Predominant Soil Texture	0.25	2	0.50
Site Soil Variability	0.25	3	0.75
Depth to Groundwater/ Impervious Layer	0.25	2	0.50
Suitability Assessment Safety Factor, $S_A = \sum p$			2.25

1. The project civil engineer should complete Worksheet D.5-1 or Form I-9 using the data on this table. Additional information is required to evaluate the design factor of safety.

Categorization of Infiltration Feasibility Condition based on Geotechnical Conditions		Worksheet C.4-1: Form I- 8A ¹⁰
Part 1 - Full Infiltration Feasibility Screening Criteria		
DMA(s) Being Analyzed:		Project Phase:
Bella Mar – 408 Hollister Street		Design
Criteria 1: Infiltration Rate Screening		
1A	<p>Is the mapped hydrologic soil group according to the NRCS Web Soil Survey or UC Davis Soil Web Mapper Type A or B and corroborated by available site soil data¹¹?</p> <p><input checked="" type="checkbox"/> Yes; the DMA may feasibly support full infiltration. Answer “Yes” to Criteria 1 Result or continue to Step 1B if the applicant elects to perform infiltration testing.</p> <p><input type="checkbox"/> No; the mapped soil types are A or B but is not corroborated by available site soil data (continue to Step 1B).</p> <p><input type="checkbox"/> No; the mapped soil types are C, D, or “urban/unclassified” and is corroborated by available site soil data. Answer “No” to Criteria 1 Result.</p> <p><input type="checkbox"/> No; the mapped soil types are C, D, or “urban/unclassified” but is not corroborated by available site soil data (continue to Step 1B).</p>	
1B	<p>Is the reliable infiltration rate calculated using planning phase methods from Table D.3-1?</p> <p><input checked="" type="checkbox"/> Yes; Continue to Step 1C.</p> <p><input type="checkbox"/> No; Skip to Step 1D.</p>	
1C	<p>Is the reliable infiltration rate calculated using planning phase methods from Table D.3-1 greater than 0.5 inches per hour?</p> <p><input type="checkbox"/> Yes; the DMA may feasibly support full infiltration. Answer “Yes” to Criteria 1 Result.</p> <p><input checked="" type="checkbox"/> No; full infiltration is not required. Answer “No” to Criteria 1 Result.</p>	
1D	<p>Infiltration Testing Method. Is the selected infiltration testing method suitable during the design phase (see Appendix D.3)? Note: Alternative testing standards may be allowed with appropriate rationales and documentation.</p> <p><input type="checkbox"/> Yes; continue to Step 1E.</p> <p><input type="checkbox"/> No; select an appropriate infiltration testing method.</p>	

Note that it is not required to investigate each and every criterion in the worksheet, a single “no” answer in Part 1, Part 2, Part 3, or Part 4 determines a full, partial, or no infiltration condition.

¹⁰ This form must be completed each time there is a change to the site layout that would affect the infiltration feasibility condition. Previously completed forms shall be retained to document the evolution of the site storm water design.

¹¹ Available data include site-specific sampling or observation of soil types or texture classes, such as obtained from borings or test pits necessary to support other design elements.



Categorization of Infiltration Feasibility Condition based on Geotechnical Conditions		Worksheet C.4-1: Form I- 8A ¹⁰
1E	<p>Number of Percolation/Infiltration Tests. Does the infiltration testing method performed satisfy the minimum number of tests specified in Table D.3-2?</p> <input type="checkbox"/> Yes; continue to Step 1F. <input type="checkbox"/> No; conduct appropriate number of tests.	
1F	<p>Factor of Safety. Is the suitable Factor of Safety selected for full infiltration design? See guidance in D.5; Tables D.5-1 and D.5-2; and Worksheet D.5-1 (Form I-9).</p> <input type="checkbox"/> Yes; continue to Step 1G. <input type="checkbox"/> No; select appropriate factor of safety.	
1G	<p>Full Infiltration Feasibility. Is the average measured infiltration rate divided by the Factor of Safety greater than 0.5 inches per hour?</p> <input type="checkbox"/> Yes; answer "Yes" to Criteria 1 Result. <input type="checkbox"/> No; answer "No" to Criteria 1 Result.	
Criteria 1 Result	<p>Is the estimated reliable infiltration rate greater than 0.5 inches per hour within the DMA where runoff can reasonably be routed to a BMP?</p> <input type="checkbox"/> Yes; the DMA may feasibly support full infiltration. Continue to Criteria 2. <input checked="" type="checkbox"/> No; full infiltration is not required. Skip to Part 1 Result.	
<p>Summarize infiltration testing methods, testing locations, replicates, and results and summarize estimates of reliable infiltration rates according to procedures outlined in D.5. Documentation should be included in project geotechnical report.</p> <p>Based on the USGS Soil Survey, the property possesses a Hydrologic Soil Group A classification. In addition, we encountered field infiltration rates of:</p> <ul style="list-style-type: none"> P-1: 0.30 inches/hour (0.15 with a FOS of 2.0) P-2: 0.25 inches/hour (0.13 with a FOS of 2.0) P-3: 0.14 inches/hour (0.07 with a FOS of 2.0) P-4: 0.13 inches/hour (0.07 with a FOS of 2.0) P-5: 0.20 inches/hour (0.10 with a FOS of 2.0) P-6: 0.12 inches/hour (0.06 with a FOS of 2.0) <p>This results in an average infiltration rate of 0.19 inches/hour (0.10 with a FOS of 2.0).</p>		



Criteria 2: Geologic/Geotechnical Screening

2A	<p>If all questions in Step 2A are answered “Yes,” continue to Step 2B.</p> <p>For any “No” answer in Step 2A answer “No” to Criteria 2, and submit an “Infiltration Feasibility Condition Letter” that meets the requirements in Appendix C.1.1. The geologic/geotechnical analyses listed in Appendix C.2.1 do not apply to the DMA because one of the following setbacks cannot be avoided and therefore result in the DMA being in a no infiltration condition. The setbacks must be the closest horizontal radial distance from the surface edge (at the overflow elevation) of the BMP.</p>		
2A-1	Can the proposed full infiltration BMP(s) avoid areas with existing fill materials greater than 5 feet thick below the infiltrating surface?	<input checked="" type="checkbox"/> Yes	<input type="checkbox"/> No
2A-2	Can the proposed full infiltration BMP(s) avoid placement within 10 feet of existing underground utilities, structures, or retaining walls?	<input checked="" type="checkbox"/> Yes	<input type="checkbox"/> No
2A-3	Can the proposed full infiltration BMP(s) avoid placement within 50 feet of a natural slope (>25%) or within a distance of 1.5H from fill slopes where H is the height of the fill slope?	<input checked="" type="checkbox"/> Yes	<input type="checkbox"/> No
2B	<p>When full infiltration is determined to be feasible, a geotechnical investigation report must be prepared that considers the relevant factors identified in Appendix C.2.1.</p> <p>If all questions in Step 2B are answered “Yes,” then answer “Yes” to Criteria 2 Result. If there are “No” answers continue to Step 2C.</p>		
2B-1	<p>Hydroconsolidation. Analyze hydroconsolidation potential per approved ASTM standard due to a proposed full infiltration BMP.</p> <p>Can full infiltration BMPs be proposed within the DMA without increasing hydroconsolidation risks?</p>	<input checked="" type="checkbox"/> Yes	<input type="checkbox"/> No
2B-2	<p>Expansive Soils. Identify expansive soils (soils with an expansion index greater than 20) and the extent of such soils due to proposed full infiltration BMPs.</p> <p>Can full infiltration BMPs be proposed within the DMA without increasing expansive soil risks?</p>	<input checked="" type="checkbox"/> Yes	<input type="checkbox"/> No



Categorization of Infiltration Feasibility Condition based on Geotechnical Conditions		Worksheet C.4-1: Form I- 8A ¹⁰	
2B-3	<p>Liquefaction. If applicable, identify mapped liquefaction areas. Evaluate liquefaction hazards in accordance with Section 6.4.2 of the City of San Diego's Guidelines for Geotechnical Reports (2011 or most recent edition). Liquefaction hazard assessment shall take into account any increase in groundwater elevation or groundwater mounding that could occur as a result of proposed infiltration or percolation facilities.</p> <p>Can full infiltration BMPs be proposed within the DMA without increasing liquefaction risks?</p>	<input type="checkbox"/> Yes	<input checked="" type="checkbox"/> No
2B-4	<p>Slope Stability. If applicable, perform a slope stability analysis in accordance with the ASCE and Southern California Earthquake Center (2002) Recommended Procedures for Implementation of DMG Special Publication 117, Guidelines for Analyzing and Mitigating Landslide Hazards in California to determine minimum slope setbacks for full infiltration BMPs. See the City of San Diego's Guidelines for Geotechnical Reports (2011) to determine which type of slope stability analysis is required.</p> <p>Can full infiltration BMPs be proposed within the DMA without increasing slope stability risks?</p>	<input checked="" type="checkbox"/> Yes	<input type="checkbox"/> No
2B-5	<p>Other Geotechnical Hazards. Identify site-specific geotechnical hazards not already mentioned (refer to Appendix C.2.1).</p> <p>Can full infiltration BMPs be proposed within the DMA without increasing risk of geologic or geotechnical hazards not already mentioned?</p>	<input checked="" type="checkbox"/> Yes	<input type="checkbox"/> No
2B-6	<p>Setbacks. Establish setbacks from underground utilities, structures, and/or retaining walls. Reference applicable ASTM or other recognized standard in the geotechnical report.</p> <p>Can full infiltration BMPs be proposed within the DMA using established setbacks from underground utilities, structures, and/or retaining walls?</p>	<input checked="" type="checkbox"/> Yes	<input type="checkbox"/> No

Categorization of Infiltration Feasibility Condition based on Geotechnical Conditions		Worksheet C.4-1: Form I- 8A ¹⁰	
2C	<p>Mitigation Measures. Propose mitigation measures for each geologic/geotechnical hazard identified in Step 2B. Provide a discussion of geologic/geotechnical hazards that would prevent full infiltration BMPs that cannot be reasonably mitigated in the geotechnical report. See Appendix C.2.1.8 for a list of typically reasonable and typically unreasonable mitigation measures.</p> <p>Can mitigation measures be proposed to allow for full infiltration BMPs? If the question in Step 2 is answered "Yes," then answer "Yes" to Criteria 2 Result.</p> <p>If the question in Step 2C is answered "No," then answer "No" to Criteria 2 Result.</p>	<input type="checkbox"/> Yes	<input checked="" type="checkbox"/> No
Criteria 2 Result	Can infiltration greater than 0.5 inches per hour be allowed without increasing risk of geologic or geotechnical hazards that cannot be reasonably mitigated to an acceptable level?	<input type="checkbox"/> Yes	<input checked="" type="checkbox"/> No
<p>Summarize findings and basis; provide references to related reports or exhibits.</p> <p>The site is underlain by fill soils, topsoil and alluvium to depths of approximately 35 feet overlying Old Paralic Deposits and San Diego Formation. We performed 6 infiltration tests within the alluvium and the results indicate rates less than 0.5 inches per hour (with an applied factor of safety of 2). Therefore, full infiltration is considered infeasible within the alluvium.</p> <p>The project area is mapped within a liquefaction zone. In addition, our calculations show a potential for liquefaction exists within the alluvium underlying the property. Therefore, infiltration should be considered infeasible to help prevent an increased thickness of liquefiable soil. In addition, groundwater exists at depths ranging from approximately 8 and 16 feet below the existing ground surface (approximate elevations ranging from 4 and 12 feet MSL). The elevation where infiltration is feasible is limited to the required 10 feet above the groundwater elevation. There is likely not enough vertical space between planned bottom of basin elevations and 10 feet above the groundwater elevation. Therefore, full and partial infiltration devices should be considered infeasible for the property.</p>			
Part 1 Result – Full Infiltration Geotechnical Screening¹²		Result	
<p>If answers to both Criteria 1 and Criteria 2 are "Yes", a full infiltration design is potentially feasible based on Geotechnical conditions only.</p> <p>If either answer to Criteria 1 or Criteria 2 is "No", a full infiltration design is not required.</p>		<input type="checkbox"/> Full infiltration Condition <input checked="" type="checkbox"/> Complete Part 2	

¹² To be completed using gathered site information and best professional judgement considering the definition of MEP in the MS4 Permit. Additional testing and/or studies may be required by City Engineer to substantiate findings.



Categorization of Infiltration Feasibility Condition based on Geotechnical Conditions		Worksheet C.4-1: Form I- 8A ¹⁰
Part 2 – Partial vs. No Infiltration Feasibility Screening Criteria		
DMA(s) Being Analyzed:		Project Phase:
Bella Mar – 408 Hollister Street		Design
Criteria 3: Infiltration Rate Screening		
3A	<p>NRCS Type C, D, or “urban/unclassified”: Is the mapped hydrologic soil group according to the NRCS Web Soil Survey or UC Davis Soil Web Mapper is Type C, D, or “urban/unclassified” and corroborated by available site soil data?</p> <p><input type="checkbox"/> Yes; the site is mapped as C soils and a reliable infiltration rate of 0.15 in/hr. is used to size partial infiltration BMPs. Answer “Yes” to Criteria 3 Result.</p> <p><input type="checkbox"/> Yes; the site is mapped as D soils or “urban/unclassified” and a reliable infiltration rate of 0.05 in/hr. is used to size partial infiltration BMPs. Answer “Yes” to Criteria 3 Result.</p> <p><input checked="" type="checkbox"/> No; infiltration testing is conducted (refer to Table D.3-1), continue to Step 3B.</p>	
3B	<p>Infiltration Testing Result: Is the reliable infiltration rate (i.e. average measured infiltration rate/2) greater than 0.05 in/hr. and less than or equal to 0.5 in/hr?</p> <p><input checked="" type="checkbox"/> Yes; the site may support partial infiltration. Answer “Yes” to Criteria 3 Result.</p> <p><input type="checkbox"/> No; the reliable infiltration rate (i.e. average measured rate/2) is less than 0.05 in/hr., partial infiltration is not required. Answer “No” to Criteria 3 Result.</p>	
Criteria 3 Result	<p>Is the estimated reliable infiltration rate (i.e., average measured infiltration rate/2) greater than or equal to 0.05 inches/hour and less than or equal to 0.5 inches/hour at any location within each DMA where runoff can reasonably be routed to a BMP?</p> <p><input checked="" type="checkbox"/> Yes; Continue to Criteria 4.</p> <p><input type="checkbox"/> No: Skip to Part 2 Result.</p>	
<p>Summarize infiltration testing and/or mapping results (i.e. soil maps and series description used for infiltration rate).</p> <p>Based on the USGS Soil Survey, the property possesses a Hydrologic Soil Group A classification. In addition, we encountered field infiltration rates of:</p> <ul style="list-style-type: none"> P-1: 0.30 inches/hour (0.15 with a FOS of 2.0) P-2: 0.25 inches/hour (0.13 with a FOS of 2.0) P-3: 0.14 inches/hour (0.07 with a FOS of 2.0) P-4: 0.13 inches/hour (0.07 with a FOS of 2.0) P-5: 0.20 inches/hour (0.10 with a FOS of 2.0) P-6: 0.12 inches/hour (0.06 with a FOS of 2.0) <p>This results in an average infiltration rate of 0.19 inches/hour (0.10 with a FOS of 2.0).</p>		

Criteria 4: Geologic/Geotechnical Screening

4A	<p>If all questions in Step 4A are answered “Yes,” continue to Step 4B.</p> <p>For any “No” answer in Step 4A answer “No” to Criteria 4 Result, and submit an “Infiltration Feasibility Condition Letter” that meets the requirements in Appendix C.1.1. The geologic/geotechnical analyses listed in Appendix C.2.1 do not apply to the DMA because one of the following setbacks cannot be avoided and therefore result in the DMA being in a no infiltration condition. The setbacks must be the closest horizontal radial distance from the surface edge (at the overflow elevation) of the BMP.</p>		
4A-1	Can the proposed partial infiltration BMP(s) avoid areas with existing fill materials greater than 5 feet thick?	<input checked="" type="checkbox"/> Yes	<input type="checkbox"/> No
4A-2	Can the proposed partial infiltration BMP(s) avoid placement within 10 feet of existing underground utilities, structures, or retaining walls?	<input checked="" type="checkbox"/> Yes	<input type="checkbox"/> No
4A-3	Can the proposed partial infiltration BMP(s) avoid placement within 50 feet of a natural slope (>25%) or within a distance of 1.5H from fill slopes where H is the height of the fill slope?	<input checked="" type="checkbox"/> Yes	<input type="checkbox"/> No
4B	<p>When full infiltration is determined to be feasible, a geotechnical investigation report must be prepared that considers the relevant factors identified in Appendix C.2.1</p> <p>If all questions in Step 4B are answered “Yes,” then answer “Yes” to Criteria 4 Result. If there are any “No” answers continue to Step 4C.</p>		
4B-1	<p>Hydroconsolidation. Analyze hydroconsolidation potential per approved ASTM standard due to a proposed full infiltration BMP.</p> <p>Can partial infiltration BMPs be proposed within the DMA without increasing hydroconsolidation risks?</p>	<input checked="" type="checkbox"/> Yes	<input type="checkbox"/> No
4B-2	<p>Expansive Soils. Identify expansive soils (soils with an expansion index greater than 20) and the extent of such soils due to proposed full infiltration BMPs.</p> <p>Can partial infiltration BMPs be proposed within the DMA without increasing expansive soil risks?</p>	<input checked="" type="checkbox"/> Yes	<input type="checkbox"/> No

Categorization of Infiltration Feasibility Condition based on Geotechnical Conditions		Worksheet C.4-1: Form I- 8A ¹⁰	
4B-3	<p>Liquefaction. If applicable, identify mapped liquefaction areas. Evaluate liquefaction hazards in accordance with Section 6.4.2 of the City of San Diego's Guidelines for Geotechnical Reports (2011). Liquefaction hazard assessment shall take into account any increase in groundwater elevation or groundwater mounding that could occur as a result of proposed infiltration or percolation facilities.</p> <p>Can partial infiltration BMPs be proposed within the DMA without increasing liquefaction risks?</p>	<input type="checkbox"/> Yes	<input checked="" type="checkbox"/> No
4B-4	<p>Slope Stability. If applicable, perform a slope stability analysis in accordance with the ASCE and Southern California Earthquake Center (2002) Recommended Procedures for Implementation of DMG Special Publication 117, Guidelines for Analyzing and Mitigating Landslide Hazards in California to determine minimum slope setbacks for full infiltration BMPs. See the City of San Diego's Guidelines for Geotechnical Reports (2011) to determine which type of slope stability analysis is required.</p> <p>Can partial infiltration BMPs be proposed within the DMA without increasing slope stability risks?</p>	<input checked="" type="checkbox"/> Yes	<input type="checkbox"/> No
4B-5	<p>Other Geotechnical Hazards. Identify site-specific geotechnical hazards not already mentioned (refer to Appendix C.2.1).</p> <p>Can partial infiltration BMPs be proposed within the DMA without increasing risk of geologic or geotechnical hazards not already mentioned?</p>	<input checked="" type="checkbox"/> Yes	<input type="checkbox"/> No
4B-6	<p>Setbacks. Establish setbacks from underground utilities, structures, and/or retaining walls. Reference applicable ASTM or other recognized standard in the geotechnical report.</p> <p>Can partial infiltration BMPs be proposed within the DMA using recommended setbacks from underground utilities, structures, and/or retaining walls?</p>	<input checked="" type="checkbox"/> Yes	<input type="checkbox"/> No
4C	<p>Mitigation Measures. Propose mitigation measures for each geologic/geotechnical hazard identified in Step 4B. Provide a discussion on geologic/geotechnical hazards that would prevent partial infiltration BMPs that cannot be reasonably mitigated in the geotechnical report. See Appendix C.2.1.8 for a list of typically reasonable and typically unreasonable mitigation measures.</p> <p>Can mitigation measures be proposed to allow for partial infiltration BMPs? If the question in Step 4C is answered "Yes," then answer "Yes" to Criteria 4 Result.</p> <p>If the question in Step 4C is answered "No," then answer "No" to Criteria 4 Result.</p>	<input checked="" type="checkbox"/> Yes	<input type="checkbox"/> No

Categorization of Infiltration Feasibility Condition based on Geotechnical Conditions		Worksheet C.4-1: Form I- 8A ¹⁰	
Criteria 4 Result	Can infiltration of greater than or equal to 0.05 inches/hour and less than or equal to 0.5 inches/hour be allowed without increasing the risk of geologic or geotechnical hazards that cannot be reasonably mitigated to an acceptable level?	<input type="checkbox"/> Yes	<input checked="" type="checkbox"/> No
<p>Summarize findings and basis; provide references to related reports or exhibits.</p> <p>The site is underlain by fill soils, topsoil and alluvium to depths of approximately 35 feet overlying Old Paralic Deposits and San Diego Formation. We performed 6 infiltration tests within the alluvium and the results indicate rates less than 0.5 inches per hour (with an applied factor of safety of 2). Therefore, full infiltration is considered infeasible within the alluvium.</p> <p>The project area is mapped within a liquefaction zone. In addition, our calculations show a potential for liquefaction exists within the alluvium underlying the property. Therefore, infiltration should be considered infeasible to help prevent an increased thickness of liquefiable soil. In addition, groundwater exists at depths ranging from approximately 8 and 16 feet below the existing ground surface (approximate elevations ranging from 4 and 12 feet MSL). The elevation where infiltration is feasible is limited to the required 10 feet above the groundwater elevation. There is likely not enough vertical space between planned bottom of basin elevations and 10 feet above the groundwater elevation. Therefore, full and partial infiltration devices should be considered infeasible for the property.</p>			
Part 2 – Partial Infiltration Geotechnical Screening Result ¹³		Result	
If answers to both Criteria 3 and Criteria 4 are “Yes”, a partial infiltration design is potentially feasible based on geotechnical conditions only.		<input type="checkbox"/> Partial Infiltration Condition	
If answers to either Criteria 3 or Criteria 4 is “No”, then infiltration of any volume is considered to be infeasible within the site.		<input checked="" type="checkbox"/> No Infiltration Condition	

¹³ To be completed using gathered site information and best professional judgement considering the definition of MEP in the MS4 Permit. Additional testing and/or studies may be required by City Engineer to substantiate findings.



Aardvark Permeameter Data Analysis

Project Name: 408 Hollister Street
 Project Number: G2129-52-01
 Borehole Location: P-1

Date: 4/26/2017
 By: JML
 Ref. EL (feet, MSL): 19.0
 Bottom EL (feet, MSL): 15.0

Borehole Diameter, d (in.): 4.50
 Borehole Depth, H (feet): 4.00
 Distance Between Reservoir & Top of Borehole (in.): 30.00
 Depth to Water Table, s (feet): 10.00
 Height APM Raised from Bottom (in.): 1.00
 Pressure Reducer Used: No

Wetted Area, A (in²): 86.59

Distance Between Reservoir and APM Float, D (in.): 72.25
 Head Height Calculated, h (in.): 4.74
 Head Height Recorded, h (in.): 5.00
 Distance Between Constant Head and Water Table, L (in.): 76.74

Reading	Time (min)	Time Elapsed (min)	Reservoir Water Weight (g)	Reservoir Water Weight (lbs)	Interval Water Consumption (lbs)	Total Water Consumption (lbs)	*Water Consumption Rate (in ³ /min)
1	0			17.305			
2	5	5.00		17.130	0.175	0.175	0.969
3	10	5.00		16.840	0.290	0.465	1.605
4	15	5.00		16.650	0.190	0.655	1.052
5	20	5.00		16.480	0.170	0.825	0.941
6	25	5.00		16.295	0.185	1.010	1.024
7	30	5.00		16.115	0.180	1.190	0.996
8	35	5.00		15.835	0.280	1.470	1.550
9	40	5.00		15.680	0.155	1.625	0.858
10	45	5.00		15.520	0.160	1.785	0.886
11	50	5.00		15.360	0.160	1.945	0.886
12							
13							
14							
15							
16							
17							
18							
19							
20							
21							
22							
23							
24							
25							
26							
27							
28							

Steady Flow Rate, Q (in³/min): 0.886

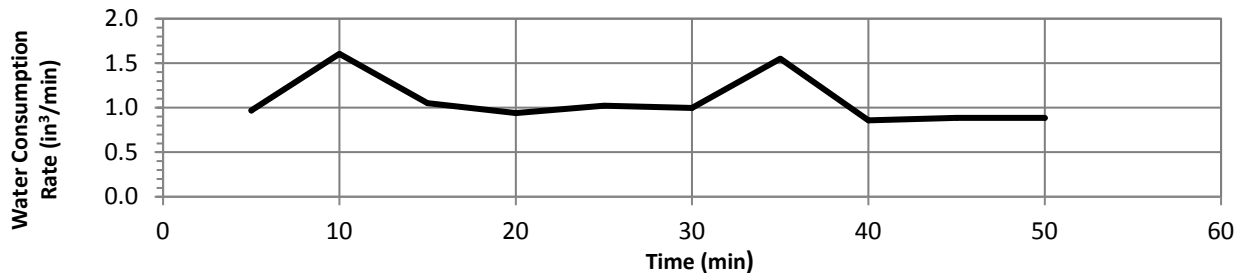

Field-Saturated Hydraulic Conductivity (Infiltration Rate)

Case 1: L/h > 3

$K_{sat} =$ 5.03E-03 in/min

0.302 in/hr



Aardvark Permeameter Data Analysis

Project Name: 408 Hollister Street
 Project Number: G2129-52-01
 Borehole Location: P-2

Date: 4/26/2017
 By: JML
 Ref. EL (feet, MSL): 17.0
 Bottom EL (feet, MSL): 13.0

Borehole Diameter, d (in.): 4.50
 Borehole Depth, H (feet): 4.00
 Distance Between Reservoir & Top of Borehole (in.): 30.00
 Depth to Water Table, s (feet): 10.00
 Height APM Raised from Bottom (in.): 1.00
 Pressure Reducer Used: No

Wetted Area, A (in²): 86.59

Distance Between Reservoir and APM Float, D (in.): 72.25
 Head Height Calculated, h (in.): 4.74
 Head Height Recorded, h (in.): 5.00
 Distance Between Constant Head and Water Table, L (in.): 76.74

Reading	Time (min)	Time Elapsed (min)	Reservoir Water Weight (g)	Reservoir Water Weight (lbs)	Interval Water Consumption (lbs)	Total Water Consumption (lbs)	*Water Consumption Rate (in ³ /min)
1	0			21.135			
2	5	5.00		20.890	0.245	0.245	1.356
3	10	5.00		20.685	0.205	0.450	1.135
4	15	5.00		20.480	0.205	0.655	1.135
5	20	5.00		20.285	0.195	0.850	1.079
6	25	5.00		20.120	0.165	1.015	0.913
7	30	5.00		19.965	0.155	1.170	0.858
8	35	5.00		19.925	0.040	1.210	0.221
9	40	5.00		19.865	0.060	1.270	0.332
10	45	5.00		19.750	0.115	1.385	0.637
11	50	5.00		19.620	0.130	1.515	0.720
12	55	5.00		19.490	0.130	1.645	0.720
13							
14							
15							
16							
17							
18							
19							
20							
21							
22							
23							
24							
25							
26							
27							
28							

Steady Flow Rate, Q (in³/min): 0.720

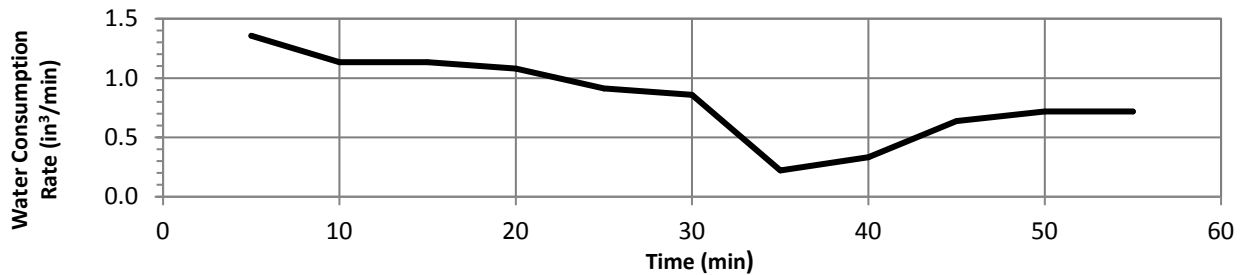

Field-Saturated Hydraulic Conductivity (Infiltration Rate)

Case 1: L/h > 3

$K_{sat} =$ 4.09E-03 in/min

0.245 in/hr



Aardvark Permeameter Data Analysis

Project Name: 408 Hollister Street
 Project Number: G2129-52-01
 Borehole Location: P-3

Date: 4/26/2017
 By: JML
 Ref. EL (feet, MSL): 17.0
 Bottom EL (feet, MSL): 13.0

Borehole Diameter, d (in.): 4.50
 Borehole Depth, H (feet): 4.00
 Distance Between Reservoir & Top of Borehole (in.): 30.00
 Depth to Water Table, s (feet): 10.00
 Height APM Raised from Bottom (in.): 1.00
 Pressure Reducer Used: No

Wetted Area, A (in²): 86.59

Distance Between Reservoir and APM Float, D (in.): 72.25
 Head Height Calculated, h (in.): 4.74
 Head Height Recorded, h (in.): 5.00
 Distance Between Constant Head and Water Table, L (in.): 76.74

Reading	Time (min)	Time Elapsed (min)	Reservoir Water Weight (g)	Reservoir Water Weight (lbs)	Interval Water Consumption (lbs)	Total Water Consumption (lbs)	*Water Consumption Rate (in ³ /min)
1	0			18.215			
2	5	5.00		18.060	0.155	0.155	0.858
3	10	5.00		17.930	0.130	0.285	0.720
4	15	5.00		17.855	0.075	0.360	0.415
5	20	5.00		17.780	0.075	0.435	0.415
6	25	5.00		17.715	0.065	0.500	0.360
7	30	5.00		17.630	0.085	0.585	0.471
8	35	5.00		17.555	0.075	0.660	0.415
9	40	5.00		17.480	0.075	0.735	0.415
10							
11							
12							
13							
14							
15							
16							
17							
18							
19							
20							
21							
22							
23							
24							
25							
26							
27							
28							

Steady Flow Rate, Q (in³/min): 0.415

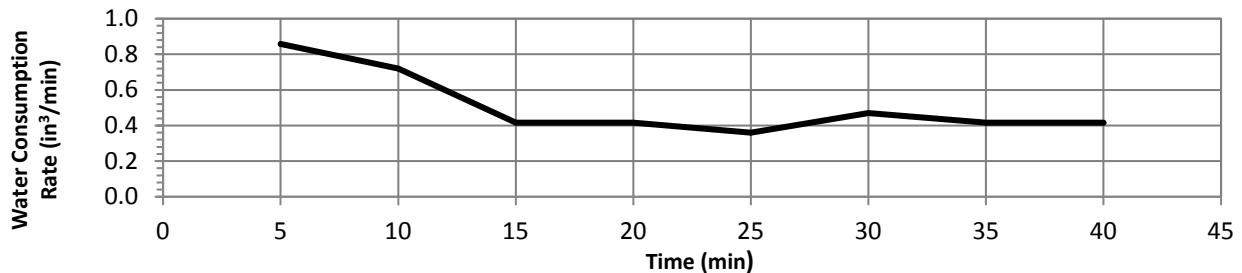

Field-Saturated Hydraulic Conductivity (Infiltration Rate)

Case 1: L/h > 3

$K_{sat} =$ 2.36E-03 in/min

0.142 in/hr



Aardvark Permeameter Data Analysis

Project Name: 408 Hollister Street
 Project Number: G2129-52-01
 Borehole Location: P-4

Date: 4/26/2017
 By: JML
 Ref. EL (feet, MSL): 18.0
 Bottom EL (feet, MSL): 14.0

Borehole Diameter, d (in.): 4.50
 Borehole Depth, H (feet): 4.00
 Distance Between Reservoir & Top of Borehole (in.): 30.00
 Depth to Water Table, s (feet): 10.00
 Height APM Raised from Bottom (in.): 1.00
 Pressure Reducer Used: No

Wetted Area, A (in²): 86.59

Distance Between Reservoir and APM Float, D (in.): 72.25
 Head Height Calculated, h (in.): 4.74
 Head Height Recorded, h (in.): 5.00
 Distance Between Constant Head and Water Table, L (in.): 76.74

Reading	Time (min)	Time Elapsed (min)	Reservoir Water Weight (g)	Reservoir Water Weight (lbs)	Interval Water Consumption (lbs)	Total Water Consumption (lbs)	*Water Consumption Rate (in ³ /min)
1	0			20.620			
2	5	5.00		20.515	0.105	0.105	0.581
3	10	5.00		20.440	0.075	0.180	0.415
4	15	5.00		20.365	0.075	0.255	0.415
5	20	5.00		20.290	0.075	0.330	0.415
6	25	5.00		20.270	0.020	0.350	0.111
7	30	5.00		20.245	0.025	0.375	0.138
8	35	5.00		20.170	0.075	0.450	0.415
9	40	5.00		20.100	0.070	0.520	0.388
10							
11							
12							
13							
14							
15							
16							
17							
18							
19							
20							
21							
22							
23							
24							
25							
26							
27							
28							

Steady Flow Rate, Q (in³/min): 0.388

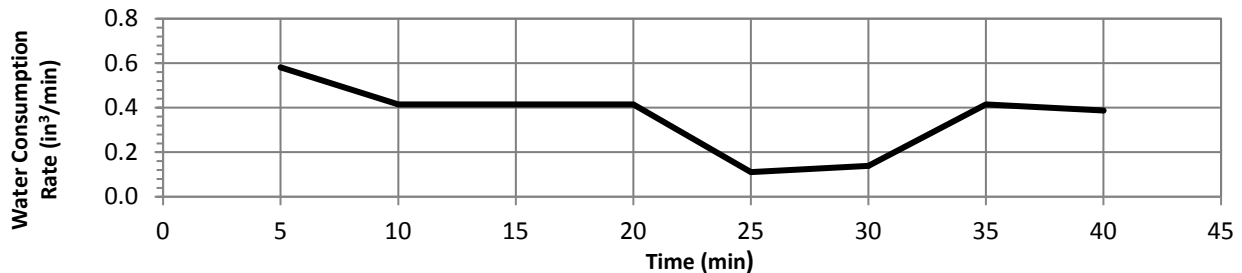

Field-Saturated Hydraulic Conductivity (Infiltration Rate)

Case 1: L/h > 3

$K_{sat} =$ 2.20E-03 in/min

0.132 in/hr



Aardvark Permeameter Data Analysis

Project Name: 408 Hollister Street
 Project Number: G2129-52-01
 Borehole Location: P-5

Date: 4/26/2017
 By: JML
 Ref. EL (feet, MSL): 18.0
 Bottom EL (feet, MSL): 14.0

Borehole Diameter, d (in.): 4.50
 Borehole Depth, H (feet): 4.00
 Distance Between Reservoir & Top of Borehole (in.): 30.00
 Depth to Water Table, s (feet): 10.00
 Height APM Raised from Bottom (in.): 1.00
 Pressure Reducer Used: No

Wetted Area, A (in²): 86.59

Distance Between Reservoir and APM Float, D (in.): 72.25
 Head Height Calculated, h (in.): 4.74
 Head Height Recorded, h (in.): 5.00
 Distance Between Constant Head and Water Table, L (in.): 76.74

Reading	Time (min)	Time Elapsed (min)	Reservoir Water Weight (g)	Reservoir Water Weight (lbs)	Interval Water Consumption (lbs)	Total Water Consumption (lbs)	*Water Consumption Rate (in ³ /min)
1	0			19.590			
2	5	5.00		19.355	0.235	0.235	1.301
3	10	5.00		19.235	0.120	0.355	0.664
4	15	5.00		19.110	0.125	0.480	0.692
5	20	5.00		19.020	0.090	0.570	0.498
6	25	5.00		18.905	0.115	0.685	0.637
7	30	5.00		18.835	0.070	0.755	0.388
8	35	5.00		18.730	0.105	0.860	0.581
9	40	5.00		18.625	0.105	0.965	0.581
10							
11							
12							
13							
14							
15							
16							
17							
18							
19							
20							
21							
22							
23							
24							
25							
26							
27							
28							

Steady Flow Rate, Q (in³/min): 0.581

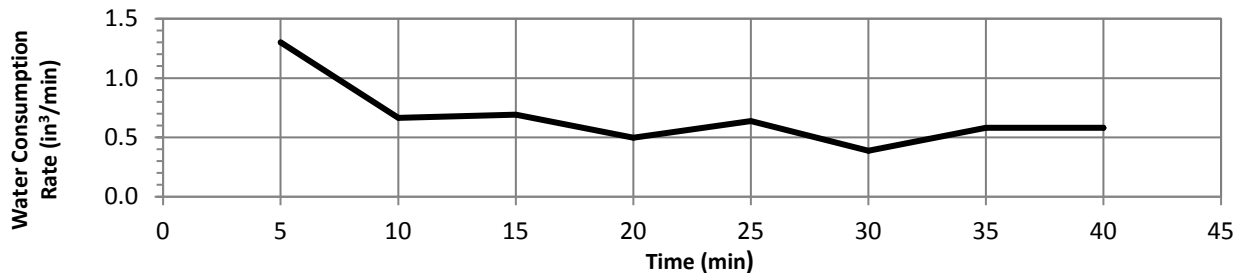

Field-Saturated Hydraulic Conductivity (Infiltration Rate)

Case 1: L/h > 3

$K_{sat} =$ 3.30E-03 in/min

0.198 in/hr



Aardvark Permeameter Data Analysis

Project Name: 408 Hollister Street
 Project Number: G2129-52-01
 Borehole Location: P-6

Date: 4/26/2017
 By: JML
 Ref. EL (feet, MSL): 20.0
 Bottom EL (feet, MSL): 16.0

Borehole Diameter, d (in.): 4.50
 Borehole Depth, H (feet): 4.00
 Distance Between Reservoir & Top of Borehole (in.): 30.00
 Depth to Water Table, s (feet): 10.00
 Height APM Raised from Bottom (in.): 1.00
 Pressure Reducer Used: No

Wetted Area, A (in²): 86.59

Distance Between Reservoir and APM Float, D (in.): 72.25
 Head Height Calculated, h (in.): 4.74
 Head Height Recorded, h (in.): 5.00
 Distance Between Constant Head and Water Table, L (in.): 76.74

Reading	Time (min)	Time Elapsed (min)	Reservoir Water Weight (g)	Reservoir Water Weight (lbs)	Interval Water Consumption (lbs)	Total Water Consumption (lbs)	*Water Consumption Rate (in ³ /min)
1	0			20.995			
2	5	5.00		20.930	0.065	0.065	0.360
3	10	5.00		20.845	0.085	0.150	0.471
4	15	5.00		20.770	0.075	0.225	0.415
5	20	5.00		20.690	0.080	0.305	0.443
6	25	5.00		20.615	0.075	0.380	0.415
7	30	5.00		20.550	0.065	0.445	0.360
8							
9							
10							
11							
12							
13							
14							
15							
16							
17							
18							
19							
20							
21							
22							
23							
24							
25							
26							
27							
28							

Steady Flow Rate, Q (in³/min): 0.360

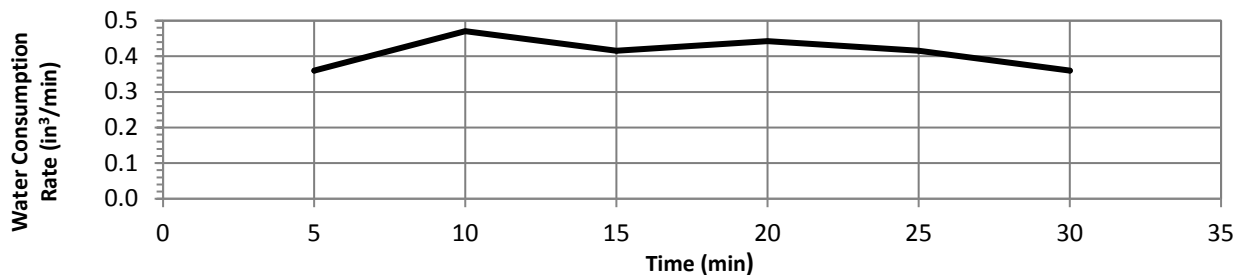

Field-Saturated Hydraulic Conductivity (Infiltration Rate)

Case 1: L/h > 3

$K_{sat} =$ 2.04E-03 in/min

0.123 in/hr

APPENDIX



APPENDIX F

RECOMMENDED GRADING SPECIFICATIONS

FOR

BELLA MAR
408 HOLLISTER STREET
SAN DIEGO, CALIFORNIA

PROJECT NO. G2129-52-03

RECOMMENDED GRADING SPECIFICATIONS

1. GENERAL

- 1.1 These Recommended Grading Specifications shall be used in conjunction with the Geotechnical Report for the project prepared by Geocon. The recommendations contained in the text of the Geotechnical Report are a part of the earthwork and grading specifications and shall supersede the provisions contained hereinafter in the case of conflict.
- 1.2 Prior to the commencement of grading, a geotechnical consultant (Consultant) shall be employed for the purpose of observing earthwork procedures and testing the fills for substantial conformance with the recommendations of the Geotechnical Report and these specifications. The Consultant should provide adequate testing and observation services so that they may assess whether, in their opinion, the work was performed in substantial conformance with these specifications. It shall be the responsibility of the Contractor to assist the Consultant and keep them apprised of work schedules and changes so that personnel may be scheduled accordingly.
- 1.3 It shall be the sole responsibility of the Contractor to provide adequate equipment and methods to accomplish the work in accordance with applicable grading codes or agency ordinances, these specifications and the approved grading plans. If, in the opinion of the Consultant, unsatisfactory conditions such as questionable soil materials, poor moisture condition, inadequate compaction, and/or adverse weather result in a quality of work not in conformance with these specifications, the Consultant will be empowered to reject the work and recommend to the Owner that grading be stopped until the unacceptable conditions are corrected.

2. DEFINITIONS

- 2.1 **Owner** shall refer to the owner of the property or the entity on whose behalf the grading work is being performed and who has contracted with the Contractor to have grading performed.
- 2.2 **Contractor** shall refer to the Contractor performing the site grading work.
- 2.3 **Civil Engineer** or **Engineer of Work** shall refer to the California licensed Civil Engineer or consulting firm responsible for preparation of the grading plans, surveying and verifying as-graded topography.
- 2.4 **Consultant** shall refer to the soil engineering and engineering geology consulting firm retained to provide geotechnical services for the project.

- 2.5 **Soil Engineer** shall refer to a California licensed Civil Engineer retained by the Owner, who is experienced in the practice of geotechnical engineering. The Soil Engineer shall be responsible for having qualified representatives on-site to observe and test the Contractor's work for conformance with these specifications.
- 2.6 **Engineering Geologist** shall refer to a California licensed Engineering Geologist retained by the Owner to provide geologic observations and recommendations during the site grading.
- 2.7 **Geotechnical Report** shall refer to a soil report (including all addenda) which may include a geologic reconnaissance or geologic investigation that was prepared specifically for the development of the project for which these Recommended Grading Specifications are intended to apply.

3. MATERIALS

- 3.1 Materials for compacted fill shall consist of any soil excavated from the cut areas or imported to the site that, in the opinion of the Consultant, is suitable for use in construction of fills. In general, fill materials can be classified as *soil* fills, *soil-rock* fills or *rock* fills, as defined below.
- 3.1.1 **Soil fills** are defined as fills containing no rocks or hard lumps greater than 12 inches in maximum dimension and containing at least 40 percent by weight of material smaller than $\frac{3}{4}$ inch in size.
- 3.1.2 **Soil-rock fills** are defined as fills containing no rocks or hard lumps larger than 4 feet in maximum dimension and containing a sufficient matrix of soil fill to allow for proper compaction of soil fill around the rock fragments or hard lumps as specified in Paragraph 6.2. **Oversize rock** is defined as material greater than 12 inches.
- 3.1.3 **Rock fills** are defined as fills containing no rocks or hard lumps larger than 3 feet in maximum dimension and containing little or no fines. Fines are defined as material smaller than $\frac{3}{4}$ inch in maximum dimension. The quantity of fines shall be less than approximately 20 percent of the rock fill quantity.
- 3.2 Material of a perishable, spongy, or otherwise unsuitable nature as determined by the Consultant shall not be used in fills.
- 3.3 Materials used for fill, either imported or on-site, shall not contain hazardous materials as defined by the California Code of Regulations, Title 22, Division 4, Chapter 30, Articles 9

and 10; 40CFR; and any other applicable local, state or federal laws. The Consultant shall not be responsible for the identification or analysis of the potential presence of hazardous materials. However, if observations, odors or soil discoloration cause Consultant to suspect the presence of hazardous materials, the Consultant may request from the Owner the termination of grading operations within the affected area. Prior to resuming grading operations, the Owner shall provide a written report to the Consultant indicating that the suspected materials are not hazardous as defined by applicable laws and regulations.

- 3.4 The outer 15 feet of *soil-rock* fill slopes, measured horizontally, should be composed of properly compacted *soil* fill materials approved by the Consultant. *Rock* fill may extend to the slope face, provided that the slope is not steeper than 2:1 (horizontal:vertical) and a soil layer no thicker than 12 inches is track-walked onto the face for landscaping purposes. This procedure may be utilized provided it is acceptable to the governing agency, Owner and Consultant.
- 3.5 Samples of soil materials to be used for fill should be tested in the laboratory by the Consultant to determine the maximum density, optimum moisture content, and, where appropriate, shear strength, expansion, and gradation characteristics of the soil.
- 3.6 During grading, soil or groundwater conditions other than those identified in the Geotechnical Report may be encountered by the Contractor. The Consultant shall be notified immediately to evaluate the significance of the unanticipated condition.

4. CLEARING AND PREPARING AREAS TO BE FILLED

- 4.1 Areas to be excavated and filled shall be cleared and grubbed. Clearing shall consist of complete removal above the ground surface of trees, stumps, brush, vegetation, man-made structures, and similar debris. Grubbing shall consist of removal of stumps, roots, buried logs and other unsuitable material and shall be performed in areas to be graded. Roots and other projections exceeding 1½ inches in diameter shall be removed to a depth of 3 feet below the surface of the ground. Borrow areas shall be grubbed to the extent necessary to provide suitable fill materials.
- 4.2 Asphalt pavement material removed during clearing operations should be properly disposed at an approved off-site facility or in an acceptable area of the project evaluated by Geocon and the property owner. Concrete fragments that are free of reinforcing steel may be placed in fills, provided they are placed in accordance with Section 6.2 or 6.3 of this document.

4.3 After clearing and grubbing of organic matter and other unsuitable material, loose or porous soils shall be removed to the depth recommended in the Geotechnical Report. The depth of removal and compaction should be observed and approved by a representative of the Consultant. The exposed surface shall then be plowed or scarified to a minimum depth of 6 inches and until the surface is free from uneven features that would tend to prevent uniform compaction by the equipment to be used.

4.4 Where the slope ratio of the original ground is steeper than 5:1 (horizontal:vertical), or where recommended by the Consultant, the original ground should be benched in accordance with the following illustration.

TYPICAL BENCHING DETAIL

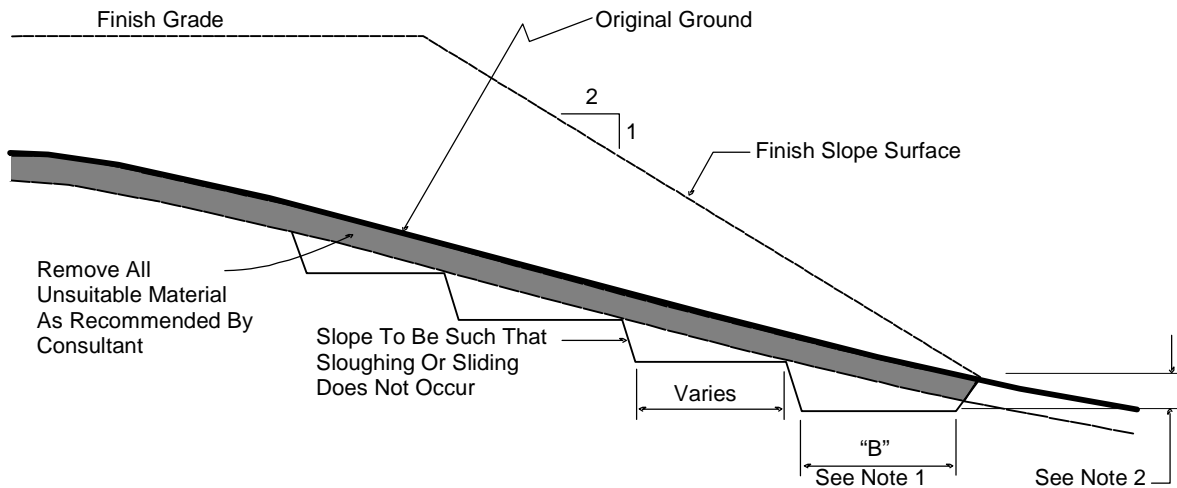

No Scale

- DETAIL NOTES:
- (1) Key width "B" should be a minimum of 10 feet, or sufficiently wide to permit complete coverage with the compaction equipment used. The base of the key should be graded horizontal, or inclined slightly into the natural slope.
 - (2) The outside of the key should be below the topsoil or unsuitable surficial material and at least 2 feet into dense formational material. Where hard rock is exposed in the bottom of the key, the depth and configuration of the key may be modified as approved by the Consultant.

4.5 After areas to receive fill have been cleared and scarified, the surface should be moisture conditioned to achieve the proper moisture content, and compacted as recommended in Section 6 of these specifications.

5. COMPACTION EQUIPMENT

- 5.1 Compaction of *soil* or *soil-rock* fill shall be accomplished by sheepsfoot or segmented-steel wheeled rollers, vibratory rollers, multiple-wheel pneumatic-tired rollers, or other types of acceptable compaction equipment. Equipment shall be of such a design that it will be capable of compacting the *soil* or *soil-rock* fill to the specified relative compaction at the specified moisture content.
- 5.2 Compaction of *rock* fills shall be performed in accordance with Section 6.3.

6. PLACING, SPREADING AND COMPACTION OF FILL MATERIAL

- 6.1 *Soil* fill, as defined in Paragraph 3.1.1, shall be placed by the Contractor in accordance with the following recommendations:
- 6.1.1 *Soil* fill shall be placed by the Contractor in layers that, when compacted, should generally not exceed 8 inches. Each layer shall be spread evenly and shall be thoroughly mixed during spreading to obtain uniformity of material and moisture in each layer. The entire fill shall be constructed as a unit in nearly level lifts. Rock materials greater than 12 inches in maximum dimension shall be placed in accordance with Section 6.2 or 6.3 of these specifications.
- 6.1.2 In general, the *soil* fill shall be compacted at a moisture content at or above the optimum moisture content as determined by ASTM D 1557.
- 6.1.3 When the moisture content of *soil* fill is below that specified by the Consultant, water shall be added by the Contractor until the moisture content is in the range specified.
- 6.1.4 When the moisture content of the *soil* fill is above the range specified by the Consultant or too wet to achieve proper compaction, the *soil* fill shall be aerated by the Contractor by blading/mixing, or other satisfactory methods until the moisture content is within the range specified.
- 6.1.5 After each layer has been placed, mixed, and spread evenly, it shall be thoroughly compacted by the Contractor to a relative compaction of at least 90 percent. Relative compaction is defined as the ratio (expressed in percent) of the in-place dry density of the compacted fill to the maximum laboratory dry density as determined in accordance with ASTM D 1557. Compaction shall be continuous over the entire area, and compaction equipment shall make sufficient passes so that the specified minimum relative compaction has been achieved throughout the entire fill.

- 6.1.6 Where practical, soils having an Expansion Index greater than 50 should be placed at least 3 feet below finish pad grade and should be compacted at a moisture content generally 2 to 4 percent greater than the optimum moisture content for the material.
 - 6.1.7 Properly compacted *soil* fill shall extend to the design surface of fill slopes. To achieve proper compaction, it is recommended that fill slopes be over-built by at least 3 feet and then cut to the design grade. This procedure is considered preferable to track-walking of slopes, as described in the following paragraph.
 - 6.1.8 As an alternative to over-building of slopes, slope faces may be back-rolled with a heavy-duty loaded sheepsfoot or vibratory roller at maximum 4-foot fill height intervals. Upon completion, slopes should then be track-walked with a D-8 dozer or similar equipment, such that a dozer track covers all slope surfaces at least twice.
- 6.2 *Soil-rock* fill, as defined in Paragraph 3.1.2, shall be placed by the Contractor in accordance with the following recommendations:
- 6.2.1 Rocks larger than 12 inches but less than 4 feet in maximum dimension may be incorporated into the compacted *soil* fill, but shall be limited to the area measured 15 feet minimum horizontally from the slope face and 5 feet below finish grade or 3 feet below the deepest utility, whichever is deeper.
 - 6.2.2 Rocks or rock fragments up to 4 feet in maximum dimension may either be individually placed or placed in windrows. Under certain conditions, rocks or rock fragments up to 10 feet in maximum dimension may be placed using similar methods. The acceptability of placing rock materials greater than 4 feet in maximum dimension shall be evaluated during grading as specific cases arise and shall be approved by the Consultant prior to placement.
 - 6.2.3 For individual placement, sufficient space shall be provided between rocks to allow for passage of compaction equipment.
 - 6.2.4 For windrow placement, the rocks should be placed in trenches excavated in properly compacted *soil* fill. Trenches should be approximately 5 feet wide and 4 feet deep in maximum dimension. The voids around and beneath rocks should be filled with approved granular soil having a Sand Equivalent of 30 or greater and should be compacted by flooding. Windrows may also be placed utilizing an "open-face" method in lieu of the trench procedure, however, this method should first be approved by the Consultant.

- 6.2.5 Windrows should generally be parallel to each other and may be placed either parallel to or perpendicular to the face of the slope depending on the site geometry. The minimum horizontal spacing for windrows shall be 12 feet center-to-center with a 5-foot stagger or offset from lower courses to next overlying course. The minimum vertical spacing between windrow courses shall be 2 feet from the top of a lower windrow to the bottom of the next higher windrow.
- 6.2.6 Rock placement, fill placement and flooding of approved granular soil in the windrows should be continuously observed by the Consultant.
- 6.3 *Rock* fills, as defined in Section 3.1.3, shall be placed by the Contractor in accordance with the following recommendations:
- 6.3.1 The base of the *rock* fill shall be placed on a sloping surface (minimum slope of 2 percent). The surface shall slope toward suitable subdrainage outlet facilities. The *rock* fills shall be provided with subdrains during construction so that a hydrostatic pressure buildup does not develop. The subdrains shall be permanently connected to controlled drainage facilities to control post-construction infiltration of water.
- 6.3.2 *Rock* fills shall be placed in lifts not exceeding 3 feet. Placement shall be by rock trucks traversing previously placed lifts and dumping at the edge of the currently placed lift. Spreading of the *rock* fill shall be by dozer to facilitate *seating* of the rock. The *rock* fill shall be watered heavily during placement. Watering shall consist of water trucks traversing in front of the current rock lift face and spraying water continuously during rock placement. Compaction equipment with compactive energy comparable to or greater than that of a 20-ton steel vibratory roller or other compaction equipment providing suitable energy to achieve the required compaction or deflection as recommended in Paragraph 6.3.3 shall be utilized. The number of passes to be made should be determined as described in Paragraph 6.3.3. Once a *rock* fill lift has been covered with *soil* fill, no additional *rock* fill lifts will be permitted over the *soil* fill.
- 6.3.3 Plate bearing tests, in accordance with ASTM D 1196, may be performed in both the compacted *soil* fill and in the *rock* fill to aid in determining the required minimum number of passes of the compaction equipment. If performed, a minimum of three plate bearing tests should be performed in the properly compacted *soil* fill (minimum relative compaction of 90 percent). Plate bearing tests shall then be performed on areas of *rock* fill having two passes, four passes and six passes of the compaction equipment, respectively. The number of passes required for the *rock* fill shall be determined by comparing the results of the plate bearing tests for the *soil* fill and the *rock* fill and by evaluating the deflection

variation with number of passes. The required number of passes of the compaction equipment will be performed as necessary until the plate bearing deflections are equal to or less than that determined for the properly compacted *soil* fill. In no case will the required number of passes be less than two.

- 6.3.4 A representative of the Consultant should be present during *rock* fill operations to observe that the minimum number of “passes” have been obtained, that water is being properly applied and that specified procedures are being followed. The actual number of plate bearing tests will be determined by the Consultant during grading.
- 6.3.5 Test pits shall be excavated by the Contractor so that the Consultant can state that, in their opinion, sufficient water is present and that voids between large rocks are properly filled with smaller rock material. In-place density testing will not be required in the *rock* fills.
- 6.3.6 To reduce the potential for “piping” of fines into the *rock* fill from overlying *soil* fill material, a 2-foot layer of graded filter material shall be placed above the uppermost lift of *rock* fill. The need to place graded filter material below the *rock* should be determined by the Consultant prior to commencing grading. The gradation of the graded filter material will be determined at the time the *rock* fill is being excavated. Materials typical of the *rock* fill should be submitted to the Consultant in a timely manner, to allow design of the graded filter prior to the commencement of *rock* fill placement.
- 6.3.7 *Rock* fill placement should be continuously observed during placement by the Consultant.

7. SUBDRAINS

- 7.1 The geologic units on the site may have permeability characteristics and/or fracture systems that could be susceptible under certain conditions to seepage. The use of canyon subdrains may be necessary to mitigate the potential for adverse impacts associated with seepage conditions. Canyon subdrains with lengths in excess of 500 feet or extensions of existing offsite subdrains should use 8-inch-diameter pipes. Canyon subdrains less than 500 feet in length should use 6-inch-diameter pipes.

TYPICAL CANYON DRAIN DETAIL

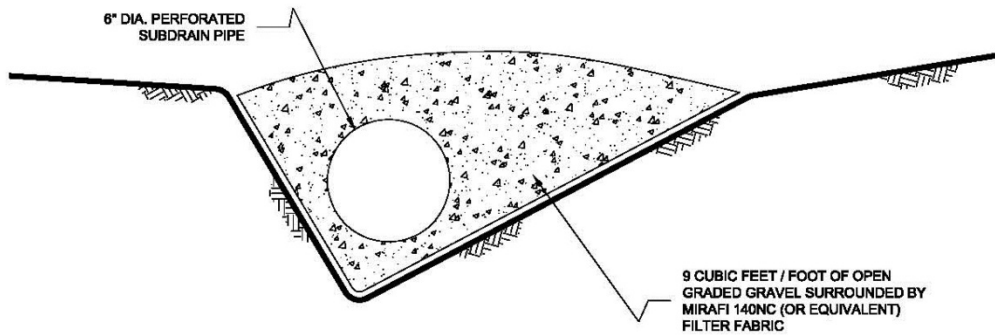
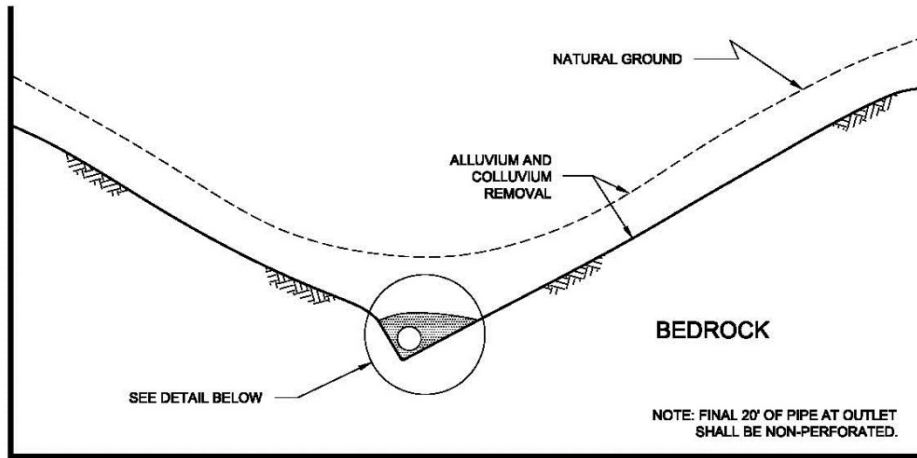

NOTES:

- 1.....8-INCH DIAMETER, SCHEDULE 80 PVC PERFORATED PIPE FOR FILLS IN EXCESS OF 100-FEET IN DEPTH OR A PIPE LENGTH OF LONGER THAN 500 FEET.
- 2.....6-INCH DIAMETER, SCHEDULE 40 PVC PERFORATED PIPE FOR FILLS LESS THAN 100-FEET IN DEPTH OR A PIPE LENGTH SHORTER THAN 500 FEET.

NO SCALE

7.2 Slope drains within stability fill keyways should use 4-inch-diameter (or larger) pipes.

TYPICAL STABILITY FILL DETAIL

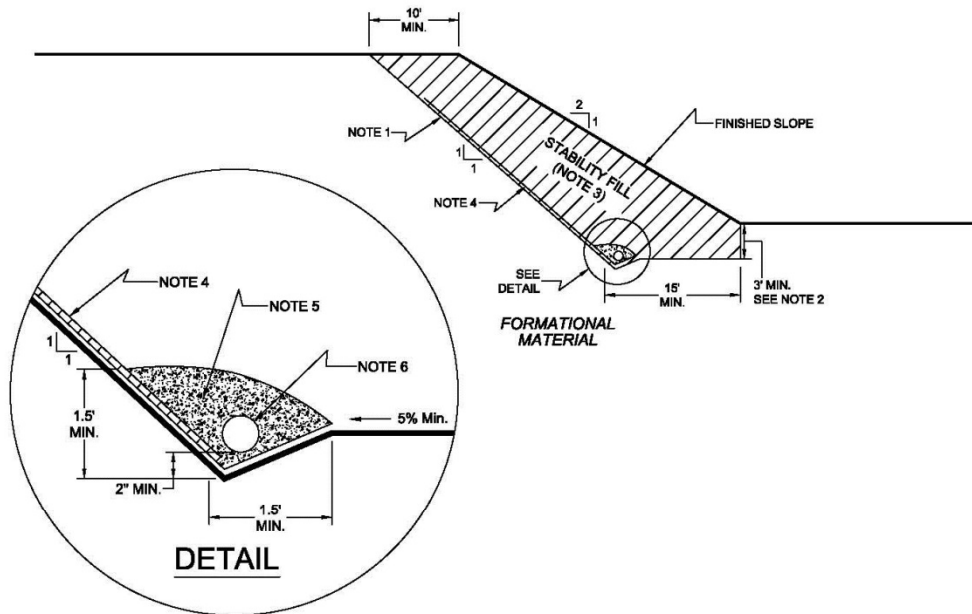

NOTES:

- 1.....EXCAVATE BACKCUT AT 1:1 INCLINATION (UNLESS OTHERWISE NOTED).
- 2.....BASE OF STABILITY FILL TO BE 3 FEET INTO FORMATIONAL MATERIAL, SLOPING A MINIMUM 5% INTO SLOPE.
- 3.....STABILITY FILL TO BE COMPOSED OF PROPERLY COMPACTED GRANULAR SOIL.
- 4.....CHIMNEY DRAINS TO BE APPROVED PREFABRICATED CHIMNEY DRAIN PANELS (MIRADRAIN G200N OR EQUIVALENT) SPACED APPROXIMATELY 20 FEET CENTER TO CENTER AND 4 FEET WIDE. CLOSER SPACING MAY BE REQUIRED IF SEEPAGE IS ENCOUNTERED.
- 5.....FILTER MATERIAL TO BE 3/4-INCH, OPEN-GRADED CRUSHED ROCK ENCLOSED IN APPROVED FILTER FABRIC (MIRAFI 140NC).
- 6.....COLLECTOR PIPE TO BE 4-INCH MINIMUM DIAMETER, PERFORATED, THICK-WALLED PVC SCHEDULE 40 OR EQUIVALENT, AND SLOPED TO DRAIN AT 1 PERCENT MINIMUM TO APPROVED OUTLET.

NO SCALE

7.3 The actual subdrain locations will be evaluated in the field during the remedial grading operations. Additional drains may be necessary depending on the conditions observed and the requirements of the local regulatory agencies. Appropriate subdrain outlets should be evaluated prior to finalizing 40-scale grading plans.

7.4 *Rock fill* or *soil-rock fill* areas may require subdrains along their down-slope perimeters to mitigate the potential for buildup of water from construction or landscape irrigation. The subdrains should be at least 6-inch-diameter pipes encapsulated in gravel and filter fabric. *Rock fill* drains should be constructed using the same requirements as canyon subdrains.

7.5 Prior to outletting, the final 20-foot segment of a subdrain that will not be extended during future development should consist of non-perforated drainpipe. At the non-perforated/perforated interface, a seepage cutoff wall should be constructed on the downslope side of the pipe.

TYPICAL CUT OFF WALL DETAIL

FRONT VIEW

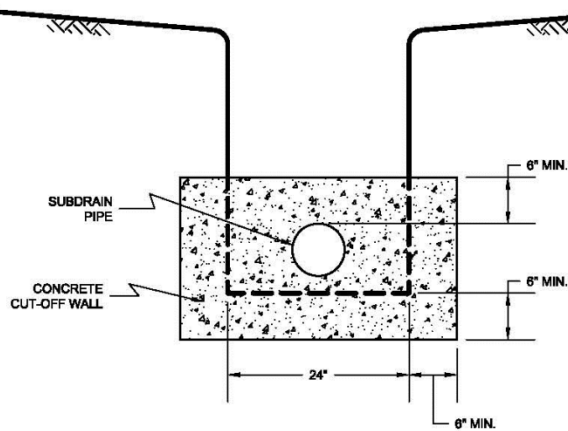

NO SCALE

SIDE VIEW

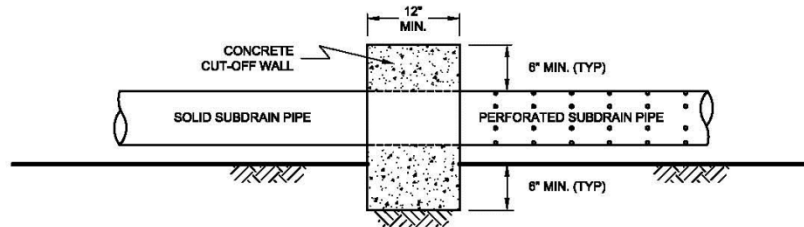

NO SCALE

7.6 Subdrains that discharge into a natural drainage course or open space area should be provided with a permanent headwall structure.

TYPICAL HEADWALL DETAIL

FRONT VIEW

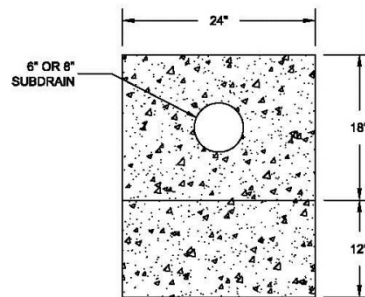

NO SCALE

SIDE VIEW

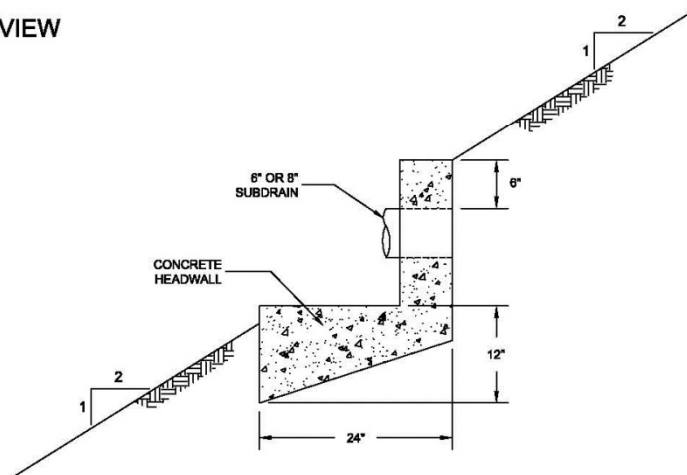

NOTE: HEADWALL SHOULD OUTLET AT TOE OF FILL SLOPE
OR INTO CONTROLLED SURFACE DRAINAGE

NO SCALE

- 7.7 The final grading plans should show the location of the proposed subdrains. After completion of remedial excavations and subdrain installation, the project civil engineer should survey the drain locations and prepare an “as-built” map showing the drain locations. The final outlet and connection locations should be determined during grading operations. Subdrains that will be extended on adjacent projects after grading can be placed on formational material and a vertical riser should be placed at the end of the subdrain. The grading contractor should consider videoing the subdrains shortly after burial to check proper installation and functionality. The contractor is responsible for the performance of the drains.

8. OBSERVATION AND TESTING

- 8.1 The Consultant shall be the Owner's representative to observe and perform tests during clearing, grubbing, filling, and compaction operations. In general, no more than 2 feet in vertical elevation of *soil* or *soil-rock* fill should be placed without at least one field density test being performed within that interval. In addition, a minimum of one field density test should be performed for every 2,000 cubic yards of *soil* or *soil-rock* fill placed and compacted.
- 8.2 The Consultant should perform a sufficient distribution of field density tests of the compacted *soil* or *soil-rock* fill to provide a basis for expressing an opinion whether the fill material is compacted as specified. Density tests shall be performed in the compacted materials below any disturbed surface. When these tests indicate that the density of any layer of fill or portion thereof is below that specified, the particular layer or areas represented by the test shall be reworked until the specified density has been achieved.
- 8.3 During placement of *rock* fill, the Consultant should observe that the minimum number of passes have been obtained per the criteria discussed in Section 6.3.3. The Consultant should request the excavation of observation pits and may perform plate bearing tests on the placed *rock* fills. The observation pits will be excavated to provide a basis for expressing an opinion as to whether the *rock* fill is properly seated and sufficient moisture has been applied to the material. When observations indicate that a layer of *rock* fill or any portion thereof is below that specified, the affected layer or area shall be reworked until the *rock* fill has been adequately seated and sufficient moisture applied.
- 8.4 A settlement monitoring program designed by the Consultant may be conducted in areas of *rock* fill placement. The specific design of the monitoring program shall be as recommended in the Conclusions and Recommendations section of the project Geotechnical Report or in the final report of testing and observation services performed during grading.
- 8.5 We should observe the placement of subdrains, to check that the drainage devices have been placed and constructed in substantial conformance with project specifications.
- 8.6 Testing procedures shall conform to the following Standards as appropriate:

8.6.1 Soil and Soil-Rock Fills:

- 8.6.1.1 Field Density Test, ASTM D 1556, *Density of Soil In-Place By the Sand-Cone Method.*

- 8.6.1.2 Field Density Test, Nuclear Method, ASTM D 6938, *Density of Soil and Soil-Aggregate In-Place by Nuclear Methods (Shallow Depth)*.
- 8.6.1.3 Laboratory Compaction Test, ASTM D 1557, *Moisture-Density Relations of Soils and Soil-Aggregate Mixtures Using 10-Pound Hammer and 18-Inch Drop*.
- 8.6.1.4 Expansion Index Test, ASTM D 4829, *Expansion Index Test*.

9. PROTECTION OF WORK

- 9.1 During construction, the Contractor shall properly grade all excavated surfaces to provide positive drainage and prevent ponding of water. Drainage of surface water shall be controlled to avoid damage to adjoining properties or to finished work on the site. The Contractor shall take remedial measures to prevent erosion of freshly graded areas until such time as permanent drainage and erosion control features have been installed. Areas subjected to erosion or sedimentation shall be properly prepared in accordance with the Specifications prior to placing additional fill or structures.
- 9.2 After completion of grading as observed and tested by the Consultant, no further excavation or filling shall be conducted except in conjunction with the services of the Consultant.

10. CERTIFICATIONS AND FINAL REPORTS

- 10.1 Upon completion of the work, Contractor shall furnish Owner a certification by the Civil Engineer stating that the lots and/or building pads are graded to within 0.1 foot vertically of elevations shown on the grading plan and that all tops and toes of slopes are within 0.5 foot horizontally of the positions shown on the grading plans. After installation of a section of subdrain, the project Civil Engineer should survey its location and prepare an *as-built* plan of the subdrain location. The project Civil Engineer should verify the proper outlet for the subdrains and the Contractor should ensure that the drain system is free of obstructions.
- 10.2 The Owner is responsible for furnishing a final as-graded soil and geologic report satisfactory to the appropriate governing or accepting agencies. The as-graded report should be prepared and signed by a California licensed Civil Engineer experienced in geotechnical engineering and by a California Certified Engineering Geologist, indicating that the geotechnical aspects of the grading were performed in substantial conformance with the Specifications or approved changes to the Specifications.

LIST OF REFERENCES

1. *2016 California Building Code, California Code of Regulations, Title 24, Part 2, based on the 2015 International Building Code*, prepared by California Building Standards Commission, dated July, 2016.
2. American Concrete Institute, *ACI 318-11, Building Code Requirements for Structural Concrete and Commentary*, dated August, 2011.
3. American Concrete Institute, *ACI 330-08, Guide for the Design and Construction of Concrete Parking Lots*, dated June, 2008.
4. American Society of Civil Engineers (ASCE), *ASCE 7-10, Minimum Design Loads for Buildings and Other Structures*, Second Printing, April 6, 2011.
5. Boore, D. M., and G. M Atkinson (2006), *Ground Motion Prediction Equations for the Average Horizontal Component of PGA, PVG, and 5%-Ramped PSA at Spectral Periods Between 0.01s and 10.0s*, Earthquake Spectra, Vol. 24, Issue I, February 2008.
6. California Department of Conservation, Division of Mines and Geology, *Probabilistic Seismic Hazard Assessment for the State of California*, Open File Report 96-08, 1996.
7. California Geological Survey, *Seismic Shaking Hazards in California*, Based on the USGS/CGS Probabilistic Seismic Hazards Assessment (PSHA) Model, 2002 (revised April 2003). 10% probability of being exceeded in 50 years.
<http://redirect.conservation.ca.gov/cgs/rghm/pshamap/pshamain.html>
8. Campbell, K. W., Y. Bozorgnia, *NGA Ground Motion Model for the Geometric Mean Horizontal Component of PGA, PGV, PGD and 5% Damped Linear Elastic Response Spectra for Periods Ranging from 0.01 to 10 s*, Preprint of version submitted for publication in the NGA Special Volume of Earthquake Spectra, Volume 24, Issue 1, pages 139-171, February 2008.
9. Chiou, Brian and Robert R. Youngs, *A NGA Model for the Average Horizontal Component of Peak Ground Motion and Response Spectra*, preprint for article to be published in NGA Special Edition for Earthquake Spectra, Spring 2008.
10. County of San Diego, *San Diego County Multi Jurisdiction Hazard Mitigation Plan, San Diego, California – Final Draft*, dated July, 2010.
11. Historical Aerial Photos. <http://www.historicaerials.com>
12. Jennings, C. W., 1994, California Division of Mines and Geology, *Fault Activity Map of California and Adjacent Areas*, California Geologic Data Map Series Map No. 6.
13. Kennedy, M. P. and S. S. Tan, 2008, *Geologic Map of the San Diego 30'x60' Quadrangle, California*, USGS Regional Map Series Map No. 3, Scale 1:100,000.
14. Legg, M. R., J. C. Borrero, and C. E. Synolakis (2002), *Evaluation of Tsunami Risk to Southern California Coastal Cities*, 2002 NEHRP Professional Fellowship Report, dated January.

15. Risk Engineering, *EZ-FRISK*, 2016.
16. Special Publication 117A, *Guidelines For Evaluating and Mitigating Seismic Hazards in California 2008*, California Geological Survey, Revised and Re-adopted September 11, 2008.
17. Structural Engineers Association of California (SEAOC) and Office of Statewide Health Planning and Development (OSHDP), *Seismic Design Maps*, <https://seismicmaps.org/>, accessed January 11, 2019.
18. Unpublished reports, aerial photographs, and maps on file with Geocon Incorporated.