APPENDIX G-1.
GEOTECHNICAL INVESTIGATION

This page intentionally left blank.

GEOTECHNICAL INVESTIGATION

PIRAEUS POINT ENCINITAS, CALIFORNIA



GEOCON
INCORPORATED

GEOTECHNICAL
ENVIRONMENTAL
MATERIALS

PREPARED FOR

**LENNAR
SAN DIEGO, CALIFORNIA**

**JANUARY 31, 2022
PROJECT NO. G2307-32-05**



Project No. G2307-32-05
January 31, 2022

Lennar
16465 Via Esprillo, Suite 150
San Diego, California 92127

Attention: Mr. David Shepherd

Subject: GEOTECHNICAL INVESTIGATION
PIRAEUS POINT
ENCINITAS, CALIFORNIA

Dear Mr. Shepherd:

In accordance with your request, we have performed a geotechnical investigation on the subject property located in Encinitas, California. The accompanying report presents our findings, conclusions and recommendations relative to the geotechnical aspects of developing the property as presently proposed.

The results of our study indicate that the site can be developed as planned, provided the recommendations of this report are incorporated into the design and construction of the project. If there are any questions regarding this report, or if we may be of further service, please contact the undersigned at your convenience.

Very truly yours,

GEOCON INCORPORATED

Troy K. Reist

Troy K. Reist
CEG 2408

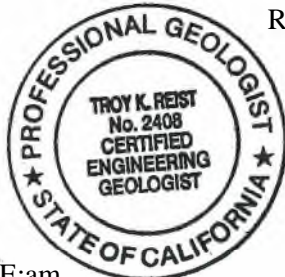

Trevor E. Myers

Trevor E. Myers
RCE 63773



David B. Evans

David B. Evans
CEG 1860

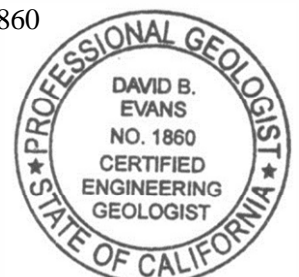

TKR:TEM:DBE:am

(e-mail) Addressee
(e-mail) Pasco Laret Suiter & Associates
Attention: Mr. Tadd Dolfo

TABLE OF CONTENTS

1.	PURPOSE AND SCOPE	1
2.	SITE AND PROJECT DESCRIPTION	1
3.	SOIL AND GEOLOGIC CONDITIONS	2
3.1	Previously-Placed Fill (Qpf).....	2
3.2	Landslide Debris (Qls).....	3
3.3	Alluvium (Qal)	3
3.4	Very Old Paralic Deposits (Qvop ₁₃)	3
3.5	Santiago Formation (Tsa)	3
4.	GROUNDWATER/SEEPAGE.....	4
5.	SLOPE STABILITY EVALUATION	4
6.	GEOLOGIC HAZARDS	7
6.1	Faulting and Seismicity	7
6.2	Seismicity	7
6.3	Liquefaction and Seismically Induced Settlement.....	7
6.4	Landslides.....	8
6.5	Settlement Considerations	8
7.	CONCLUSIONS AND RECOMMENDATIONS.....	9
7.1	General.....	9
7.2	Excavation and Soil Characteristics	10
7.3	Soil Nail Wall	11
7.4	Buttresses.....	13
7.5	Grading	13
7.6	Settlement Monitoring.....	14
7.7	Seismic Design Criteria.....	15
7.8	Slope Stability.....	17
7.9	Foundation Recommendations - General	18
7.10	Shallow Foundation and Concrete Slabs-On-Grade Recommendations	18
7.11	Mat Foundation.....	25
7.12	Drilled Pier Recommendations.....	26
7.13	Concrete Flatwork	28
7.14	Retaining Walls	29
7.15	Lateral Loading.....	32
7.16	Mechanically Stabilized Earth (MSE) Retaining Walls	33
7.17	Preliminary Pavement Recommendations	35
7.18	Site Drainage and Moisture Protection.....	38
7.19	Grading and Foundation Plan Review	38

LIMITATIONS AND UNIFORMITY OF CONDITIONS

TABLE OF CONTENTS (Concluded)

MAPS AND ILLUSTRATIONS

Figure 1, Vicinity Map

Figure 2, Geologic Map (Map Pocket)

Figures 3 – 5, Geologic Cross Sections A-A' through G-G' (Map Pocket)

Figure 6, Typical Buttress Fill Detail

APPENDIX A

FIELD INVESTIGATION

Figures A-1 – A-3, Logs of Borings (Geocon 2021)

Figures A-3 – A-10, Logs of Borings (Geocon 2019)

APPENDIX B

LABORATORY TESTING

Table B-I, Summary of Laboratory Maximum Dry Density and Optimum Moisture Content Test Results

Table B-II, Summary of Laboratory Direct Shear Test Results

Table B-III, Summary of Laboratory Expansion Index Test Results

Table B-IV, Summary of Laboratory Water-Soluble Sulfate Test Results

Table B-V, Summary of Laboratory Plasticity Index Test Results

Table B-VI, Summary of Laboratory Resistance Value (R-Value) Test Results

Gradation Curves

Consolidation Curves

APPENDIX C

SLOPE STABILITY ANALYSES

APPENDIX D

LIQUEFACTION ANALYSES

APPENDIX E

RECOMMENDED GRADING SPECIFICATIONS

LIST OF REFERENCES

GEOTECHNICAL INVESTIGATION

1. PURPOSE AND SCOPE

The purpose of this study was to evaluate the proposed grading for a residential development in Encinitas, California (see *Vicinity Map*, Figure 1). This report provides recommendations relative to the geotechnical engineering aspects of developing the property as presently proposed based on the conditions encountered during two field investigations.

The scope of our previous and recent studies consisted of the following:

- Reviewing aerial photographs and readily available published and unpublished geologic literature.
- Reviewing the digital plans prepared by Pasco Laret Suiter & Associates.
- Down-hole logging and sampling of four large-diameter borings (see Appendix A).
- Logging and sampling of six hollow-stem auger borings (see Appendix A).
- Performing laboratory tests on selected soil samples to evaluate their physical characteristics for engineering analysis (see Appendix B).
- Performing slope stability analyses along representative geologic cross sections (see Appendix C).
- Performing liquefaction analyses (see Appendix D).
- Preparing this report, geologic cross sections and a geologic map presenting our exploratory information and our conclusions and recommendations regarding the geotechnical aspects of developing the property as presently proposed.

The approximate locations of the exploratory borings are shown on the *Geologic Map*, Figure 2. *Geologic Cross-Sections A-A'* through *G-G'* (Figures 3 through 5) represent our interpretation of the geologic conditions across the site and served as the basis for our slope stability analysis.

2. SITE AND PROJECT DESCRIPTION

The roughly 7-acre property is primarily in a natural condition and consists of a rectangular-shaped parcel that slopes westward with elevations ranging from 180 feet Mean Sea Level (MSL) along the northeast property boundary to 80 feet MSL at the northwest corner of the site. A generally west-flowing drainage is located along the northern portion of the property and has created localized steep topography. A residential development is located to the east, Plato Place to the south and Piraeus Street to the west.

The site is essentially undeveloped other than a slope excavation along the western property margin presumed to be associated with grading of Piraeus Street. In 2001, a landslide occurred on the site that closed adjacent Piraeus Street. We understand that the City of Encinitas removed portions of the slide and installed two groundwater observation wells and two horizontal drains. The excavated soil was placed within a depression on the southern portion of the property. The western property margin currently contains the landslide remnant with an upper scarp area that has down dropped approximately 5 to 10 feet. The lower portion of the slope face adjacent to Piraeus Street was track walked with a bull dozer during repair operations.

It is our understanding that the property will be developed to create a residential development with approximately 15 building pads to support 149, 3-story condominium homes with parking garages, including 15 affordable homes, a pool house and swimming pool. In addition, associated infrastructure improvements consisting of wet and dry utilities, roadways, off-street parking, retaining walls and sidewalks are planned throughout the project.

Maximum cut and fill thicknesses not considering remedial grading will be on the order of 30 feet. Fill slopes are designed at 2:1 (horizontal:vertical) or flatter, with maximum heights of approximately 20 feet. Retaining walls are planned with a maximum height of approximately 30 feet. We understand cantilevered micropile and soil nail walls are proposed along the eastern property boundary with mechanically-stabilized earth (MSE) retaining walls along the western and northern property lines.

The site location, descriptions, and proposed development discussed above are based on site investigations, review of the project plans, and our discussions with you. Once project grading plans are prepared, Geocon Incorporated should be contacted to update this geotechnical report.

3. SOIL AND GEOLOGIC CONDITIONS

During our field investigations, we encountered three surficial soil deposits (previously-placed fill, landslide debris and alluvium) and two geologic units (Quaternary-age Very Old Paralic Deposits and Eocene-age Santiago Formation). The estimated lateral extent of these units is shown on the Geologic Map, Figure 2. Figures 3 through 5 present Geologic Cross-Sections providing our interpretation of the subsurface geologic conditions. The descriptions of the soil and geologic conditions are presented on the boring logs located in Appendix A and described herein in order of increasing age.

3.1 Previously-Placed Fill (Qpf)

Previously-placed fill exists within the southern portion of the site. This material was likely placed during construction of Plato Place and during the landslide removal in 2001. We encountered approximately 15 feet of previously placed fill in our borings. The material generally consists of loose to very dense, moist, yellowish to grayish brown, clayey, fine to coarse sand with trace gravel and

some organics. The upper approximately 5 feet of this soil has a variable moisture content and density, and is considered unsuitable for support of additional fill and/or structural loads in its present condition and will require remedial grading. The lower portion of the fill was evaluated for its density, moisture content, and compression characteristics, and was found to be generally suitable for support of additional fill and/or structural loads in its present condition.

3.2 Landslide Debris (QIs)

Landslide debris is present on the western approximately one-third of the site as shown on Figure 2. During our review of the 1953 stereo photographs of the property, the landslide was not distinguishable. Later aerial photographs suggest the first movement of the landslide occurred in 2001. The landslide extends from Piraeus Street at its toe roughly 140 feet into the property to the east. The landslide debris is unsuitable to be left in place and complete removal will be required during remedial grading operations. The complete removal will result in a buttress fill which will mitigate potential future instabilities.

3.3 Alluvium (Qal)

Alluvium exists below the previously-placed fill on the southern portion of the site to depths up to 55 feet below existing grades. The alluvium is generally composed of medium dense, damp to wet, dark yellowish brown, clayey to silty, fine to coarse sand. Perched groundwater was encountered within the alluvium at depths varying from 38 to 49 feet below the ground surface. The alluvium is considered generally suitable in its current condition for support of additional fill and/or structural loads based on laboratory analysis, as discussed herein.

3.4 Very Old Paralic Deposits (Qvop₁₃)

Very Old Paralic Deposits are exposed across the majority of the site above elevations of approximately 138 feet MSL. These deposits lie unconformably on the older Santiago Formation with a slightly undulating contact. The Very Old Paralic Deposits consist of medium dense to dense, damp to moist, reddish to yellowish brown, silty, fine to coarse sand with some cobble layers and cohesionless sand layers. The Very Old Paralic Deposits have adequate strength characteristics for support of the proposed improvements.

3.5 Santiago Formation (Tsa)

We encountered the Santiago Formation in our large diameter borings at depths ranging from approximately 14 feet to 32 feet below existing grades; and in our small diameter borings below the alluvium at depths ranging from 50 feet to 55 feet below existing ground. In addition, the Santiago Formation is exposed in the natural slopes within the drainage to the north of proposed development and in the adjacent to Piraeus Street. The Santiago Formation consists of dense to very dense, moist,

olive to yellowish brown, massive to weakly laminated, silty, fine to coarse sandstone. In addition, the Santiago Formation contains interbeds of hard, moist, grayish olive, claystone. Discrete seepage zones were encountered within this unit as shown on the boring logs.

Our study revealed a continuous 1- to 1.5-foot-thick bedding plane shear zone (BPS) at a depth varying from 43 to 63 feet below the existing ground. The orientation of this zone appears to be westerly dipping with elevations varying from 110 feet to 117 feet MSL. A second BPS zone was encountered roughly 15 feet above the lower BPS. The sheared material consists of soft, remolded plastic clay gouge. The lower BPS appears to be the causative feature that resulted in landsliding in the western portion of the site.

4. GROUNDWATER/SEEPAGE

We encountered seepage within the alluvial soils located below the previously placed fill in the southern portion of the site. The seepage elevations varied from approximately 38 to 49 feet below the existing ground surface and the seepage appeared to be perched within the lower 12 feet of the alluvium. Some perched seepage was also observed within the Santiago Formation. Groundwater/seepage conditions are dependent on seasonal precipitation, irrigation, and land use, among other factors, and vary as a result. Proper surface drainage will be important for future performance of the project.

A static groundwater table was not observed in the excavations performed during this study. The existing seepage elevations in buried alluvial areas, however, may fluctuate seasonally. It should be noted that areas where perched water or seepage was not encountered may exhibit groundwater during rainy periods.

5. SLOPE STABILITY EVALUATION

Six geologic cross-sections, A-A' through C-C' and E-E' through G-G' (Figures 3 through 5), were prepared to aid in evaluating the stability of the proposed slopes and retaining walls. Shear strength parameters for the soil and geologic materials encountered were determined from laboratory direct shear tests. Residual shear strengths were used for bedding plane shear features determined from laboratory test results, using the *Journal of Geotechnical and Geoenvironmental Engineering, Drained Shear Strength Parameters for Analysis of Landslides (Stark, Choi, McCone, 2005)* and engineering judgment.

Table 5.1 presents the soil strength parameters that were utilized in the slope stability analyses. The values were derived from laboratory test results and experience with similar soil and geologic conditions.

TABLE 5.1
SOIL STRENGTH PARAMETERS

Soil Condition	Angle of Internal Friction ϕ (degrees)	Cohesion c (psf)
Compacted Fill	28	300
Very Old Paralic Deposits	28	350
Santiago Formation (ML/CL)	23	500
Santiago Formation (SM/SP)	33	750
Alluvium	28	200
Bedding Plane Shear (BPS)	8	100

In accordance with Special Publication 117 guidelines, site-specific seismic slope stability analyses are required for sites located within mapped hazard zones. Seismic Hazard Zone maps published by CDMG, including landslide hazard zones, have not been published for San Diego County due to the relatively low seismic risk compared with other jurisdictions in Southern California. Therefore, it is our opinion that seismic slope stability analyses are not required in San Diego County. However, to satisfy City of Encinitas requirements, seismic slope stability analyses on the most critical failure surfaces have been performed in accordance with *Recommended Procedures for Implementation of DMG Special Publication 117: Guidelines for Analyzing and Mitigating Landslide Hazards in California*, prepared by the Southern California Earthquake Center (SCEC), dated June 2002.

The seismic slope stability analysis was performed using an acceleration of 0.23g, corresponding to a 10 percent probability of exceedance in 50 years, based on a deaggregation analysis for the site. A modal magnitude and modal distance of 6.9 and 6.3 kilometers, respectively, was used in the analysis. A plot of the hazard contribution from the deaggregation analysis is presented as Figure C-42.

Using the parameters discussed herein, an equivalent site acceleration, k_{EQ} , of 0.132g was calculated to perform the screening analysis. The screening analysis was performed using an acceleration of 0.132g resulting in factors of safety ranging between 1.0 and 2.7. A slope is considered acceptable by the screening analysis if the calculated factor of safety is greater than 1.0 using k_{EQ} ; therefore, the most critical failure surfaces depicted on Cross-sections A-A' through C-C' and E-E' through G-G', pass the screening analysis for the seismic slope stability, as shown on Figure C-43.

The output files and calculated factor of safety for the cross sections used for the stability analyses are presented in Appendix C and summarized in Table 5.2.

**TABLE 5.2
SLOPE STABILITY SUMMARY**

Cross Section	Figure Number	Condition Analyzed	Factor of Safety	
			Static	Pseudo-Static
A-A'	C-1/C-2	Block type failure on BPS thru fill (west portion)	4.4	2.7
	C-3/C-4	Circular type failure behind MSE wall	1.7	1.5
	C-5/C-6	Block type failure on BPS (east portion)	2.2	1.2
	C-7/C-8	Circular type failure behind shoring wall	1.5	1.2
	C-9/C-10	Circular type failure behind soil nail wall	3.0	2.2
B-B'	C-11/C-12	Circular type failure behind MSE wall	2.0	1.7
	C-13/C-14	Block type failure on upper BPS	1.5	1.0
	C-15/C-16	Circular type failure behind shoring walls	1.5	1.2
	C-17/C-18	Block type failure on lower BPS	1.8	1.0
	C-19/C-20	Block type failure on upper BPS	1.6	1.0
C-C'	C-21/C-22	Circular type failure behind MSE wall	3.1	2.3
	C-23/C-24	Block type failure on lower BPS	2.7	1.1
	C-25/C-26	Block type failure on upper BPS	1.8	1.5
	C-27/C-28	Circular type failure behind shoring walls	1.8	1.3
E-E'	C-29/C-30	Block type failure on BPS	1.6	1.2
	C-31/C-32	Circular type failure behind MSE wall	1.5	1.2
F-F'	C-33/C-34	Block type failure on BPS	2.0	1.3
	C-35/C-36	Circular type failure behind MSE wall	1.8	1.4
G-G'	C-37/C-38	Block type failure on BPS	2.3	1.4
	C-39/C-40	Circular type failure behind MSE wall	1.6	1.2

Note – Groundwater was incorporated into the analysis and generally placed at the first occurrence of seepage as encountered in our borings.

The results of the analyses indicate that full removal of the existing landslide and replacement with compacted fill will result in a static factor of safety of at least 1.5. The approximate limits of remedial grading are shown on the *Geologic Map* and depicted on the *Geologic Cross-Sections* (red landslide area). The depth and extent of remedial grading of these areas may need to be modified depending on the conditions observed during grading.

6. GEOLOGIC HAZARDS

6.1 Faulting and Seismicity

Based on our recent exploratory borings and a review of published geologic maps and reports, the site is not located on any known “active,” “potentially active” or “inactive” fault traces as defined by the California Geological Survey (CGS).

The Newport-Inglewood Fault and Rose Canyon Fault Zone, located approximately 13 miles west of the site, are the closest known active faults. The CGS considers a fault seismically active when evidence suggests seismic activity within roughly the last 11,000 years. The CGS has included portions of the Rose Canyon Fault zone within an Alquist-Priolo Earthquake Fault Zone. Based upon a review of available geologic data and published reports, the site is not located within a State of California Earthquake Fault Zone.

6.2 Seismicity

Considerations important in seismic design include the frequency and duration of motion and the soil conditions underlying the site. Seismic design of structures should be evaluated in accordance with the California Building Code (CBC) guidelines currently adopted by the local agency. The risk associated with strong ground motion due to earthquake at the site is high; however, the risk is no greater than that for the region.

6.3 Liquefaction and Seismically Induced Settlement

Liquefaction typically occurs when a site is located in a zone with seismic activity, onsite soils are cohesionless, groundwater is encountered within 50 feet of the surface, and soil densities are less than about 70 percent of the maximum dry densities. If the four previous criteria are met, a seismic event could result in a rapid pore water pressure increase from the earthquake-generated ground accelerations. We performed liquefaction analyses and the results indicate a low potential for liquefaction and seismically-induced settlement. Our analysis assumed that the first occurrence of perched seepage in the borings represents a “water table”. The results of the analyses are presented in Appendix D.

The site is not located within a state-designated liquefaction hazard zone. The County of San Diego Hazard Mitigation Plan (2017) maps the site within a zone with a low liquefiable risk. The current standard of practice, as outlined in the *Recommended Procedures for Implementation of DMG Special Publication 117A, Guidelines for Analyzing and Mitigating Liquefaction in California* requires liquefaction analysis to a depth of 50 feet below the lowest portion of the proposed structures. We analyzed our recent Borings B-1 through B-3 located within the southern area of the site where deep alluvium and perched seepage was encountered. We explored to a maximum depth of approximately 52-1/2 feet in this area. We do not expect there is a liquefaction potential within areas of the site

mapped as Very Old Paralic Deposits or Santiago Formation due to the dense nature of the materials and lack of groundwater.

We used the methods following the methodology of NCEER (2001 and 2008) to perform a liquefaction evaluation. We used a computed site acceleration of 0.56g (based on ASCE 7-16) and a modal magnitude of 6.9 as evaluated from the NSHM 2014 Dynamic edition using a recurrence interval of 2,475 years (2% in 50 years) on the United States Geological Survey web site.

We used the blow counts for the liquefaction analysis based on the driven samplers in the field. In addition, we adjusted blow counts using a California sampler by two-thirds to obtain equivalent Standard Penetration Test (SPT) values. The blow counts were also adjusted for boring diameter, sampling method, rod length, overburden pressure, and energy delivered to the sampler corresponding to a driving-energy of 60 percent (N_{160}). We further adjusted the blow counts for estimated fines content and calculated a factor of safety. A site is considered to be susceptible to liquefaction when the computed factor of safety is less than 1.0. The results of our liquefaction analysis indicate factors of safety greater than 1.0 within the alluvial soil below the assumed groundwater table and the liquefaction potential is considered low.

6.4 Landslides

A landslide was encountered on the site as described in Section 2. This deposit will be completely removed during remedial grading for the proposed development.

6.5 Settlement Considerations

Estimates of potential settlement are generally based on the thickness of alluvium left-in-place, the thickness of additional fill to achieve finish grade, and the compressibility characteristics of the alluvial materials. The rate of settlement is generally based on the drainage path that would allow for pore water pressure dissipation.

The alluvial deposits beneath the southern portion of the site were found to be slightly to moderately compressible when subjected to increased vertical stress. Laboratory consolidation tests were performed on samples of the alluvium to aid in evaluating the magnitude and time rate of settlement that could occur from the proposed fill and building loads presently planned. We have conservatively assumed a groundwater elevation at first occurrence of seepage for the analysis. Based on the test results and analysis, it is estimated that approximately 4 to 5 inches of settlement could occur and take approximately 2 months without geotechnical mitigation. Construction of improvements in the area where alluvium is left in place should be delayed until primary consolidation is essentially complete. It should be noted that the magnitude of the total settlement and the associated time rate of consolidation may not be uniform throughout the site. Settlement monitoring during grading will verify when primary compression has occurred, and improvement construction may commence.

7. CONCLUSIONS AND RECOMMENDATIONS

7.1 General

- 7.1.1 From a geotechnical engineering standpoint, it is our opinion that the site is suitable for development provided the recommendations presented herein are implemented in design and construction of the project.
- 7.1.2 The site is underlain by surficial soil consisting of previously-placed fill, landslide debris, and alluvium. Two geologic units consisting of Very Old Paralic Deposits and the Santiago Formation are also present on the site. Remedial grading of the upper portion of previously-placed fill and complete removal of the landslide debris will be required. The Very Old Paralic Deposits and the Santiago Formation are considered adequate for the support of compacted fill and/or structural loads.
- 7.1.3 Removal of the landslide in the western approximately one-third of the property will provide adequate slope stability for the central portion of the site. A buttress will be necessary along the northwest development margin to mitigate naturally occurring bedrock shear zones and provide acceptable slope stability. Details of these mitigation features are provided in Sections 7.4 and 7.8 and on Figures 2 through 5. This information should be updated once detailed grading plans are prepared.
- 7.1.4 The alluvium encountered beneath the previously placed fill in the southern portion of the site is considered slightly to moderately compressible when subjected to increased vertical stress due to fill or structural loads. Our settlement analysis indicates approximately 4 to 5 inches of settlement may occur as a result of placing approximately 10 feet of additional fill. As a consequence, construction of the proposed improvements, including underground utilities should be delayed until the primary consolidation of the alluvial deposits is essentially complete. Surcharge loading of this area may be considered to reduce the amount of time to achieve primary consolidation.
- 7.1.5 We encountered seepage within the alluvium in the southern portion of the site at depths ranging from approximately 38 to 49 feet below the existing ground surface. We also encountered seepage conditions within the formational materials in large-diameter Borings LB-1, 2 and 4 at depths of approximately 40½, 44 and 40 feet below existing grade, respectively.
- 7.1.6 We expect the proposed structures in areas underlain by Very Old Paralic Deposits, Santiago Formation, or properly compacted fill overlying these formations can be founded on conventional shallow foundations. The proposed structures in areas underlain by

significant differential fill thickness or previously placed fill and alluvium left in place should be founded on mat slabs or post-tensioned foundations designed to accommodate the anticipated settlement. Any proposed buildings within the influence of the reinforced zones of MSE retaining walls should be supported on deep foundations.

7.1.7 Soil nail wall construction may encounter flowing cohesionless sand within the Very Old Paralic Deposits. This condition was encountered in Boring LB-2 from 22.5 to 28 feet. Special drilling/construction techniques may be necessary if these conditions are encountered during project development.

7.2 Excavation and Soil Characteristics

7.2.1 Excavation of the surficial soil should generally be possible with moderate to heavy effort using conventional, heavy-duty equipment during grading and trenching operations. Excavation of the Very Old Paralic Deposits and the Santiago Formation should generally be possible with heavy to very heavy effort using conventional, heavy-duty equipment during grading and trenching operations.

7.2.2 We performed laboratory tests on samples of the site materials to evaluate the expansion potential of the site soils. Appendix B presents results of the laboratory expansion index tests. The soil encountered in the field investigation is considered to be “non-expansive” and “expansive” (expansion index [EI] of 20 or less and greater than 20, respectively) as defined by 2019 California Building Code [CBC] Section 1803.5.3. Table 7.2.1 presents soil classifications based on the expansion index. We expect a majority of the soil encountered possess a “very low” to “low” expansion potential (EI of 50 or less) in accordance with ASTM D 4829. However, the claystone and siltstone layers within the Santiago Formation would likely consist of “medium” to “high” expansive soils EI of 51 to 130).

**TABLE 7.2.1
EXPANSION CLASSIFICATION BASED ON EXPANSION INDEX**

Expansion Index (EI)	ASTM D 4829 Expansion Classification	2019 CBC Expansion Classification
0 – 20	Very Low	Non-Expansive
21 – 50	Low	Expansive
51 – 90	Medium	
91 – 130	High	
Greater Than 130	Very High	

7.2.3 The laboratory test results indicate that the near-surface on-site materials at the locations tested possess *Not Applicable* sulfate severity and *S0* exposure to concrete structures as defined by 2019 CBC Section 1904 and ACI 318-14 Chapter 19. Table 7.2.2 presents a summary of concrete requirements set forth by 2019 CBC Section 1904 and ACI 318. ACI guidelines should be followed when determining the type of concrete to be used. The presence of water-soluble sulfates is not a visually discernible characteristic; therefore, other soil samples from the site could yield different concentrations. Additionally, over time landscaping activities (i.e., addition of fertilizers and other soil nutrients) may affect the concentration.

**TABLE 7.2.2
REQUIREMENTS FOR CONCRETE EXPOSED TO
SULFATE-CONTAINING SOLUTIONS**

Exposure Class		Water-Soluble Sulfate (SO ₄) Percent by Weight	Cement Type (ASTM C 150)	Maximum Water to Cement Ratio by Weight ¹	Minimum Compressive Strength (psi)
S0		SO ₄ <0.10	No Type Restriction	n/a	2,500
S1		0.10≤SO ₄ <0.20	II	0.50	4,000
S2		0.20≤SO ₄ ≤2.00	V	0.45	4,500
S3	Option 1	SO ₄ >2.00	V+Pozzolan or Slag	0.45	4,500
	Option 2		V	0.40	5,000

¹ Maximum water to cement ratio limits do not apply to lightweight concrete

7.2.4 Geocon Incorporated does not practice in the field of corrosion engineering; therefore, further evaluation by a corrosion engineer may be needed to incorporate the necessary precautions to avoid premature corrosion of underground pipes and buried metal in direct contact with the soils.

7.3 Soil Nail Wall

7.3.1 In general, ground conditions are moderately suited to soil nail wall construction techniques. However, relatively cohesionless sands were encountered in Boring LB-2 indicating the potential for raveling or caving of the unsupported excavation. Casing or specialized drilling techniques may be required where low cohesion sands are encountered.

7.3.2 Testing of the soil nails should be performed in accordance with the guidelines of the Federal Highway Administration or similar guidelines. At least two verification tests should be performed to confirm design assumptions for each soil/rock type encountered. Verification tests nails should be sacrificial and should not be used to support the proposed wall. The bond length should be adjusted to allow for pullout testing of the verification nails

to evaluate the ultimate bond stress. A minimum of 5 percent of the production nails should also be proof tested and a minimum of 4 sacrificial nails should be tested at the discretion of Geocon Incorporated. Consideration should be given to testing sacrificial nails with an adjusted bond length rather than testing production nails. Geocon Incorporated should observe the nail installation and perform the nail testing.

7.3.3 The soil strength parameters listed in Table 7.3.1 can be used in design of the soil nails. The bond stress is dependent on drilling method, diameter, and construction method. Therefore, the designer should evaluate the bond stress based on the existing soil conditions and the construction method.

**TABLE 7.3.1
SOIL STRENGTH PARAMETERS FOR SOIL NAIL WALLS**

Description	Cohesion (psf)	Friction Angle (degrees)	Estimated Ultimate Bond Stress (psi)*
Previously Placed Fill	300	28	10
Very Old Paralic Deposits	350	28	10
Santiago Formation	750	33	20

*Assuming gravity fed, open hole drilling techniques.

7.3.4 A drain system should be incorporated into the design of the soil nail wall as shown herein. Corrosion protection should also be provided if the wall is intended to be a permanent structure.

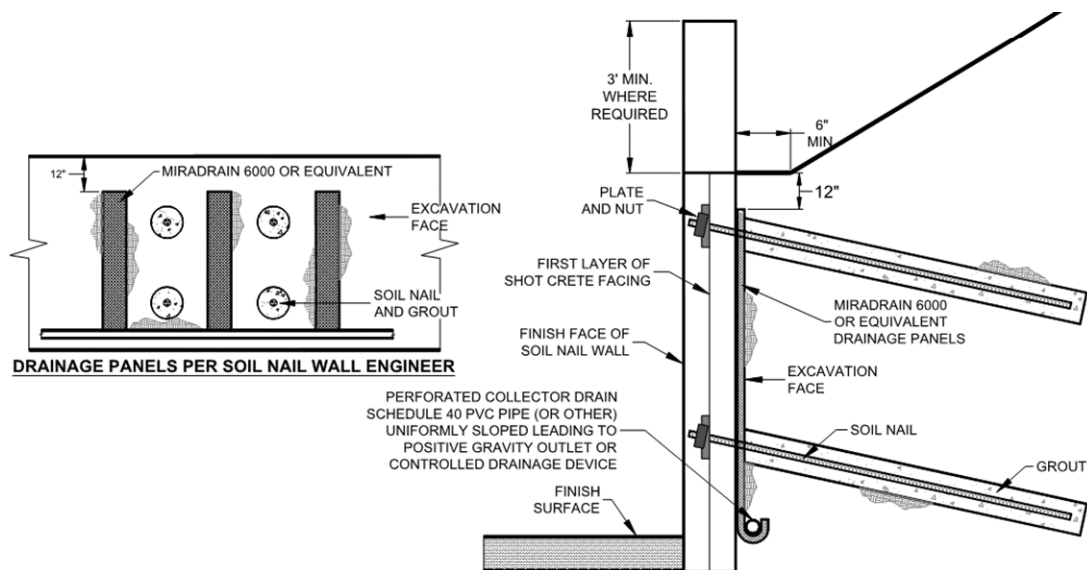

7.4 Buttresses

- 7.4.1 A drained buttress will be required on the north and northwest portion of the property to provide an acceptable factor of safety for the proposed MSE wall and slope. In addition, removal of the landslide debris in the western approximately one-third of the property will effectively provide adequate buttressing of the hillside in this area.
- 7.4.2 A typical buttress detail is shown on Figure 6. *Section 7* in Appendix E provides cut off wall and headwall details for the heel drains. Depending on the geologic conditions exposed, deeper and/or wider keyways may be necessary. The actual recommended keyway dimensions, as well as backdrain geometry and drain connection points should be determined as grading plans progress.

7.5 Grading

- 7.5.1 All grading should be performed in accordance with the attached *Recommended Grading Specifications* (Appendix E). Where the recommendations of this section conflict with Appendix E, the recommendations of this section take precedence. All earthwork should be observed and all fills tested for proper compaction by Geocon Incorporated.
- 7.5.2 Site preparation should begin with the removal of all deleterious material and vegetation. The depth of removal should be such that material exposed in cut areas or soils to be used as fill are relatively free of organic matter. Material generated during stripping and/or site demolition should be exported from the site.
- 7.5.3 All potentially compressible surficial soils within areas where structural improvements are planned, or where discussed herein, should be removed to firm natural ground and properly compacted prior to placing additional fill and/or structural load (i.e. the upper 5 feet of previously-placed fill, landslide debris, and other surficial deposits). Deeper than normal benching and/or stripping operations for sloping ground surfaces will be required where the thickness of potentially compressible surficial deposits exceeds 3 feet. The actual extent of unsuitable soil removals will be determined in the field during grading by the engineering geologist and/or geotechnical engineer.
- 7.5.4 A pre-construction meeting with a city inspector, owner, grading contractor, civil engineer, and a representative of Geocon Incorporated should be held prior to the beginning of grading and development operations. Grading requirements and construction methods can be discussed at that time.

- 7.5.5 Grading of the site should commence with the removal of vegetation and debris within the limits of development. Existing underground improvements should be removed and the resulting depressions properly backfilled in accordance with the procedures described herein.
- 7.5.6 To reduce the potential for differential settlement, it is recommended that the cut portion of cut/fill transition building pads be undercut at least 3 feet and replaced with properly compacted “very low” to “low” expansive fill soils. Where the thickness of the fill below the building pad exceeds 15 feet, the depth of the undercut should be increased to one-fifth of the maximum fill thickness.
- 7.5.7 Sharp fill differentials may result from removal of the landslide. Where these conditions occur beneath proposed buildings, additional undercutting or special foundation design considerations may be necessary.
- 7.5.8 The site should be brought to final subgrade elevations with structural fill compacted in layers. In general, soil native to the site is suitable for use as fill if relatively free from vegetation, debris and other deleterious material. Layers of fill should be no thicker than will allow for adequate bonding and compaction. Fill, including backfill and scarified ground surfaces, should be compacted to a dry density of at least 90 percent of the laboratory maximum dry density near to slightly above optimum moisture content, as determined in accordance with ASTM D 1557. Fill materials placed below optimum moisture content may require additional moisture conditioning prior to placing additional fill.
- 7.5.9 Import fill, if necessary, should consist of granular materials with a “very low” to “low” expansion potential (EI of 50 or less) free of deleterious material or rock larger than 3 inches and should be compacted as recommended above. Geocon Incorporated should be notified of the import soil source and should perform laboratory testing of import soil prior to its arrival at the site to determine its suitability as fill material.
- 7.5.10 It is the responsibility of the contractor and their competent person to ensure that all excavations, temporary slopes and trenches are properly constructed and maintained in accordance with applicable OSHA regulations in order to maintain safety and the stability of adjacent existing improvements.

7.6 Settlement Monitoring

- 7.6.1 The proposed structural areas underlain by previously-placed fill and alluvium should be monitored for settlement after the additional fill is placed to achieve finish grades. In general,

surface settlement plates should be placed at several locations within the southern development footprint and read periodically until primary consolidation has essentially ceased. Survey readings should be performed regularly following placement of the proposed fill. Specific details regarding the location and type of monitoring device as well as monitoring frequency will be provided once the development plans have been finalized. The possibility of surcharge loading to accelerate the magnitude of settlement should be considered as grading plans progress.

7.7 Seismic Design Criteria

7.7.1 Table 7.7.1 summarizes site-specific design criteria obtained from the 2019 California Building Code (CBC; Based on the 2018 International Building Code [IBC] and ASCE 7-16), Chapter 16 Structural Design, Section 1613 Earthquake Loads. We used the computer program *U.S. Seismic Design Maps*, provided by the Structural Engineers Association (SEA) to calculate the seismic design parameters. The short spectral response uses a period of 0.2 second. We evaluated the Site Class based on the discussion in Section 1613.2.2 of the 2019 CBC and Table 20.3-1 of ASCE 7-16. The values presented herein are for the risk-targeted maximum considered earthquake (MCE_R). Sites designated as Site Class D, E and F may require additional analyses if requested by the project structural engineer and client.

**TABLE 7.7.1
2019 CBC SEISMIC DESIGN PARAMETERS**

Parameter	Value	2019 CBC Reference
Site Class	D	Section 1613.2.2
MCE_R Ground Motion Spectral Response Acceleration – Class B (short), S_S	1.134g	Figure 1613.2.1(1)
MCE_R Ground Motion Spectral Response Acceleration – Class B (1 sec), S_1	0.406g	Figure 1613.2.1(2)
Site Coefficient, F_A	1.046	Table 1613.2.3(1)
Site Coefficient, F_V	1.894	Table 1613.2.3(2)
Site Class Modified MCE_R Spectral Response Acceleration (short), S_{MS}	1.187g	Section 1613.2.3 (Eqn 16-36)
Site Class Modified MCE_R Spectral Response Acceleration – (1 sec), S_{M1}	0.769g	Section 1613.2.3 (Eqn 16-37)
5% Damped Design Spectral Response Acceleration (short), S_{DS}	0.791g	Section 1613.2.4 (Eqn 16-38)
5% Damped Design Spectral Response Acceleration (1 sec), S_{D1}	0.512g	Section 1613.2.4 (Eqn 16-39)

***Note:** Using the code-based values presented in this table, in lieu of a performing a ground motion hazard analysis, requires the exceptions outlined in ASCE 7-16 Section 11.4.8 be followed by the project structural engineer. Per Section 11.4.8 of ASCE/SEI 7-16, a ground motion hazard analysis should be performed for projects for Site Class “E” sites with S_S greater than or equal to 1.0g and for Site Class “D” and “E” sites with S_1 greater than 0.2g. Section 11.4.8 also provides exceptions which indicates that the ground motion hazard analysis may be waived provided the exceptions are followed.

7.7.2 Table 7.7.2 presents the mapped maximum considered geometric mean (MCE_G) seismic design parameters for projects located in Seismic Design Categories of D through F in accordance with ASCE 7-16.

**TABLE 7.7.2
ASCE 7-16 PEAK GROUND ACCELERATION**

Parameter	Value	ASCE 7-16 Reference
Mapped MCE_G Peak Ground Acceleration, PGA	0.505g	Figure 22-9
Site Coefficient, F_{PGA}	1.1	Table 11.8-1
Site Class Modified MCE_G Peak Ground Acceleration, PGA_M	0.556g	Section 11.8.3 (Eqn 11.8-1)

7.7.3 Conformance to the criteria in Tables 7.7.1 and 7.7.2 for seismic design does not constitute any kind of guarantee or assurance that significant structural damage or ground failure will not occur in the event of a large earthquake. The primary goal of seismic design is to protect life, not to avoid all damage, since such design may be economically prohibitive.

7.7.4 The project structural engineer and architect should evaluate the appropriate Risk Category and Seismic Design Category for the planned structures. The values presented herein assume a Risk Category of I and resulting in a Seismic Design Category D. Table 7.7.3 presents a summary of the risk categories in accordance with ASCE 7-16.

**TABLE 7.7.3
ASCE 7-16 RISK CATEGORIES**

Risk Category	Building Use	Examples
I	Low risk to Human Life at Failure	Barn, Storage Shelter
II	Nominal Risk to Human Life at Failure (Buildings Not Designated as I, III or IV)	Residential, Commercial and Industrial Buildings
III	Substantial Risk to Human Life at Failure	Theaters, Lecture Halls, Dining Halls, Schools, Prisons, Small Healthcare Facilities, Infrastructure Plants, Storage for Explosives/Toxins
IV	Essential Facilities	Hazardous Material Facilities, Hospitals, Fire and Rescue, Emergency Shelters, Police Stations, Power Stations, Aviation Control Facilities, National Defense, Water Storage

7.8 Slope Stability

- 7.8.1 We performed slope stability analyses using the two-dimensional computer program GeoStudio 2018 created by Geo-Slope International Ltd. We calculated the factor of safety for the planned slopes for rotational-mode and block-mode analyses using the Spencer's method. Output of the computer program including the calculated factor of safety and the failure surfaces are presented in Appendix C.
- 7.8.2 We used average drained direct shear strength parameters based on laboratory tests and our experience with similar soil types in nearby areas for the slope stability analyses. Our calculations indicate the proposed slopes, constructed of on-site materials, should have calculated factors of safety (FOS) of at least 1.5 and 1.0 under static and pseudo-static conditions, respectively, for deep-seated failure when the recommendations of this report are followed.
- 7.8.3 We selected Cross-Sections A-A' through C-C' and E-E' through G-G' to perform the slope stability analyses.
- 7.8.4 The results of the slope stability analyses are presented as Figures C-1 through C-43. The results of the surficial slope stability analyses are presented in Figure C-41. A plot of the seismic deaggregation hazard contribution is shown as Figure C-42. The seismic slope stability screening analysis results are presented as Figure C-43.
- 7.8.5 Based on the compression characteristics of the landslide debris and results of the slope stability analyses, complete removal of landslide materials is required. In addition, a buttress will be required within the Bedding Plane Shear (BPS) zone shown on Cross-Sections E-E' through G-G' is recommended. A buttress with an approximately 15-foot wide keyway is required to achieve an acceptable factor of safety. The buttress design has assumed a 1:1 (horizontal to vertical) backcut extending down to intercept the critical bedding plane shear zones. Figure 6 provides a general buttress detail for use in design and construction.
- 7.8.6 The planned buttress keyway and heel drains should be surveyed during construction. We based the buttress width and depth presented on the Geologic Map on the results of the slope stability analysis. The buttress and landslide removal will require drains located at the heel of the excavations as shown on Figure 6 and should be as-built and surveyed by the project civil engineer. Prior to outletting, the final 20-foot segment of the buttress subdrain should consist of non-perforated drainpipe. At the non-perforated/perforated interface, a seepage cutoff wall should be constructed on the downslope side of the junction. Subdrains that

discharge into a natural drainage course or open space area should be provided with a permanent headwall structure, as presented in Appendix E.

- 7.8.7 Excavations, including buttress fills, should be observed during grading by an engineering geologist with Geocon to evaluate whether soil and geologic conditions do not differ significantly from those expected or identified in this report.
- 7.8.8 We performed the slope stability analyses based on the interpretation of geologic conditions encountered during our field investigation. We should evaluate the geologic conditions during the grading operations to check if the conditions observed during grading are consistent with our interpretations. Additional slope stability analyses and modifications to the proposed buttress may be required during the grading operations as conditions warrant.
- 7.8.9 Slopes should be landscaped with drought-tolerant vegetation having variable root depths and requiring minimal landscape irrigation. In addition, slopes should be drained and properly maintained to reduce erosion.

7.9 Foundation Recommendations - General

- 7.9.1 Proposed structures supported on compacted fill over Very Old Paralic Deposits or Santiago Formation may be designed using conventional shallow foundations. Proposed structures supported on compacted fill over previously-placed fill and alluvium, should be designed using mat slabs or post-tensioned slabs with 2-inches of total settlement or drilled pier foundations. Proposed structures supported on MSE retaining wall backfill should be designed using drilled pier foundations.

7.10 Shallow Foundation and Concrete Slabs-On-Grade Recommendations

- 7.10.1 Proposed structures supported on compacted fill over Very Old Paralic Deposits or Santiago Formation may be designed using conventional shallow foundations. Proposed structures supported on compacted fill over previously-placed fill and alluvium, should be designed using mat slabs or post-tensioned slabs with 2-inches of total settlement or drilled pier foundations. Proposed structures supported on MSE retaining wall backfill should be design using drilled pier foundations.
- 7.10.2 The foundation recommendations herein are for proposed one- to three-story residential structures. The foundation recommendations have been separated into three categories based on either the maximum and differential fill thickness or Expansion Index. The foundation category criteria are presented in Table 7.10.1.

**TABLE 7.10.1
FOUNDATION CATEGORY CRITERIA**

Foundation Category	Maximum Fill Thickness, T (Feet)	Differential Fill Thickness, D (Feet)	Expansion Index (EI)
I	$T < 20$	--	$EI \leq 50$
II	$20 \leq T < 50$	$10 \leq D < 20$	$50 < EI \leq 90$
III	$T \geq 50$	$D \geq 20$	$90 < EI \leq 130$

7.10.3 We will provide final foundation categories for each building or lot after finish pad grades have been achieved, the underlying underlying fill-bedrock geometry is evaluated and we perform laboratory testing of the subgrade soil. However, any structures supported on previously-placed fill and alluvium should be designed using Foundation Category III parameters and consider the total settlement due to additional structural loads and additional settlement due to the potential for hydrocollapse.

7.10.4 Table 7.10.2 presents minimum foundation and interior concrete slab design criteria for conventional foundation systems.

**TABLE 7.10.2
CONVENTIONAL FOUNDATION RECOMMENDATIONS BY CATEGORY**

Foundation Category	Minimum Footing Embedment Depth, D (inches)	Minimum Continuous Footing Reinforcement	Minimum Footing Width (Inches)
I	12	Two No. 4 bars, one top and one bottom	12 – Continuous, W_C 24 – Isolated, W_I
II	18	Four No. 4 bars, two top and two bottom	
III	24	Four No. 5 bars, two top and two bottom	

7.10.5 The foundations should be embedded in accordance with the recommendations herein and the Wall/Column Footing Dimension Detail. The embedment depths should be measured from the lowest adjacent pad grade for both interior and exterior footings. Footings should be deepened such that the bottom outside edge of the footing is at least 7 feet horizontally from the face of the slope (unless designed with a post-tensioned foundation system as discussed herein).

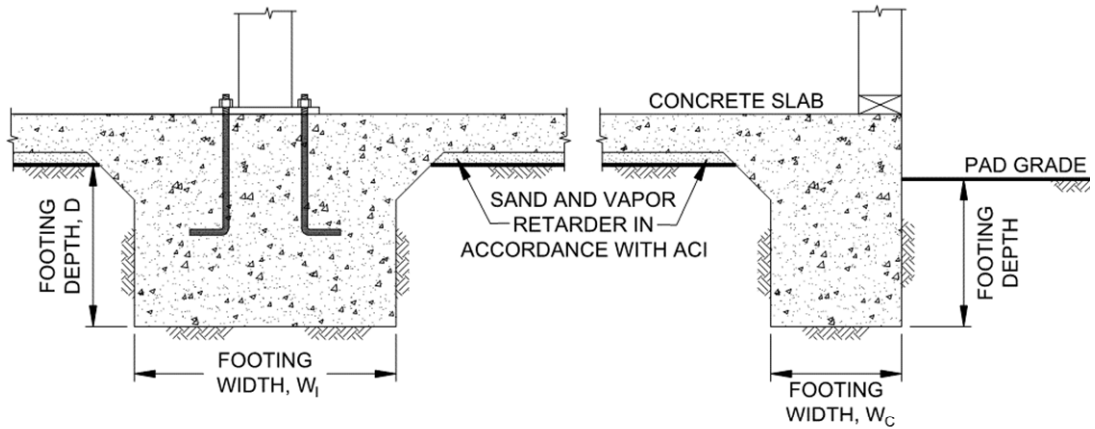

Wall/Column Footing Dimension Detail

7.10.6 The proposed structures can be supported on a shallow foundation system founded in the compacted fill/formational materials. Table 7.10.3 provides a summary of the foundation design recommendations.

**TABLE 7.10.3
SUMMARY OF FOUNDATION RECOMMENDATIONS**

Parameter	Value
Allowable Bearing Capacity	2,000 psf
Bearing Capacity Increase	500 psf per Foot of Depth
	300 psf per Foot of Width
Maximum Allowable Bearing Capacity	3,500 psf
Estimated Total Settlement*	1 Inch
Estimated Differential Settlement	½ Inch in 40 Feet

(*) The estimated total settlement is 2-inches with 1-inch differential in 40 feet beneath structures supported by previously-placed fill and alluvium

7.10.7 The bearing capacity values presented herein are for dead plus live loads and may be increased by one-third when considering transient loads due to wind or seismic forces.

7.10.8 The concrete slab-on-grades should be a designed in accordance with Table 7.10.4.

**TABLE 7.10.4
CONVENTIONAL SLAB-ON-GRADE RECOMMENDATIONS BY CATEGORY**

Foundation Category	Minimum Concrete Slab Thickness (inches)	Interior Slab Reinforcement	Typical Slab Underlayment
I	4	6 x 6 - 10/10 welded wire mesh at slab mid-point	3 to 4 Inches of Sand/Gravel/Base
II	4	No. 3 bars at 24 inches on center, both directions	
III	5	No. 3 bars at 18 inches on center, both directions	

7.10.9 Slabs that may receive moisture-sensitive floor coverings or may be used to store moisture-sensitive materials should be underlain by a vapor retarder. The vapor retarder design should be consistent with the guidelines presented in the American Concrete Institute’s (ACI) *Guide for Concrete Slabs that Receive Moisture-Sensitive Flooring Materials* (ACI 302.2R-06). The vapor retarder used should be specified by the project architect or developer based on the type of floor covering that will be installed and if the structure will possess a humidity controlled environment.

7.10.10 The bedding sand thickness should be determined by the project foundation engineer, architect, and/or developer. However, we should be contacted to provide recommendations if the bedding sand is thicker than 6 inches. It is common to see 3 inches and 4 inches of sand below the concrete slab-on-grade for 5-inch and 4-inch thick slabs, respectively, in the southern California area. The foundation design engineer should provide appropriate concrete mix design criteria and curing measures to assure proper curing of the slab by reducing the potential for rapid moisture loss and subsequent cracking and/or slab curl. We suggest that the foundation design engineer present the concrete mix design and proper curing methods on the foundation plans. It is critical that the foundation contractor understands and follows the recommendations presented on the foundation plans.

7.10.11 As an alternative to the conventional foundation recommendations, consideration should be given to the use of post-tensioned concrete slab and foundation systems for the support of the proposed structures. The post-tensioned systems (foundation dimensions and embedment depths, slab thickness and steel placement) should be designed by a structural engineer experienced in post-tensioned slab design and design criteria of the Post-Tensioning Institute (PTI) DC 10.5-12 *Standard Requirements for Design and Analysis of Shallow Post-Tensioned Concrete Foundations on Expansive Soils* or *WRI/CRSI Design of Slab-on-Ground Foundations*, as required by the 2019 California Building Code (CBC Section 1808.6.2). Although this procedure was developed for expansive soil conditions, it can

also be used to reduce the potential for foundation distress due to differential fill settlement. The post-tensioned design should incorporate the geotechnical parameters presented in Table 7.10.5 for the particular Foundation Category designated. The parameters presented in Table 7.10.5 are based on the guidelines presented in the PTI DC 10.5 design manual.

**TABLE 7.10.5
POST-TENSIONED FOUNDATION SYSTEM DESIGN PARAMETERS**

Post-Tensioning Institute (PTI) DC10.5 Design Parameters	Foundation Category		
	I	II	III
Thornthwaite Index	-20	-20	-20
Equilibrium Suction	3.9	3.9	3.9
Edge Lift Moisture Variation Distance, e_M (Feet)	5.3	5.1	4.9
Edge Lift, y_M (Inches)	0.61	1.10	1.58
Center Lift Moisture Variation Distance, e_M (Feet)	9.0	9.0	9.0
Center Lift, y_M (Inches)	0.30	0.47	0.66

7.10.12 The foundations for the post-tensioned slabs should be embedded in accordance with the recommendations of the structural engineer. If a post-tensioned mat foundation system is planned, the slab should possess a thickened edge with a minimum width of 12 inches and extend below the clean sand or crushed rock layer.

7.10.13 If the structural engineer proposes a post-tensioned foundation design method other than PTI, DC 10.5:

- The deflection criteria presented in Table 7.10.5 are still applicable.
- Interior stiffener beams should be used for Foundation Categories II and III.
- The width of the perimeter foundations should be at least 12 inches.
- The perimeter footing embedment depths should be at least 12 inches, 18 inches and 24 inches for foundation categories I, II, and III, respectively. The embedment depths should be measured from the lowest adjacent pad grade.

7.10.14 Foundation systems for the lots that possess a foundation Category I and a “very low” expansion potential (expansion index of 20 or less) can be designed using the method described in Section 1808 of the 2019 CBC. If post-tensioned foundations are planned, an alternative, commonly accepted design method (other than PTI) can be used. However, the post-tensioned foundation system should be designed with a total and differential deflection of 1 inch. Geocon Incorporated should be contacted to review the plans and provide additional information, if necessary.

- 7.10.15 If an alternate design method is contemplated, Geocon Incorporated should be contacted to evaluate if additional expansion index testing should be performed to identify the lots that possess a “very low” expansion potential (expansion index of 20 or less).
- 7.10.16 Our experience indicates post-tensioned slabs may be susceptible to excessive edge lift from tensioning, regardless of the underlying soil conditions. Placing reinforcing steel at the bottom of the perimeter footings and the interior stiffener beams may mitigate this potential. The structural engineer should design the foundation system to reduce the potential of edge lift occurring for the proposed structures.
- 7.10.17 During the construction of the post-tension foundation system, the concrete should be placed monolithically. Under no circumstances should cold joints form between the footings/grade beams and the slab during the construction of the post-tension foundation system unless designed by the structural engineer.
- 7.10.18 Isolated footings outside of the slab area, if present, should have the minimum embedment depth and width recommended for conventional foundations for a particular Foundation Category. The use of isolated footings, which are located beyond the perimeter of the building and support structural elements connected to the building, are not recommended for Category III. Where this condition cannot be avoided, the isolated footings should be connected to the building foundation system with grade beams in both directions. In addition, consideration should be given to connecting patio slabs, which exceed 5 feet in width, to the building foundation to reduce the potential for future separation to occur.
- 7.10.19 Interior stiffening beams should be incorporated into the design of the foundation system in accordance with the PTI design procedures.
- 7.10.20 Special subgrade presaturation is not deemed necessary prior to placing concrete; however, the exposed foundation and slab subgrade soil should be moisture conditioned, as necessary, to maintain a moist condition as would be expected in any such concrete placement.
- 7.10.21 Where buildings or other improvements are planned near the top of a slope 3:1 (horizontal:vertical) or steeper, special foundation and/or design considerations are recommended due to the tendency for lateral soil movement to occur.
- For fill slopes less than 20 feet high or cut slopes regardless of height, footings should be deepened such that the bottom outside edge of the footing is at least 7 feet horizontally from the face of the slope.

- When located next to a descending 3:1 (horizontal:vertical) fill slope or steeper, the foundations should be extended to a depth where the minimum horizontal distance is equal to H/3 (where H equals the vertical distance from the top of the fill slope to the base of the fill soil) with a minimum of 7 feet but need not exceed 40 feet. The horizontal distance is measured from the outer, deepest edge of the footing to the face of the slope. A post-tensioned slab and foundation system or mat foundation system can be used to reduce the potential for distress in the structures associated with strain softening and lateral fill extension. Specific design parameters or recommendations for either of these alternatives can be provided once the building location and fill slope geometry have been determined.
- If swimming pools are planned, Geocon Incorporated should be contacted for a review of specific site conditions.
- Swimming pools located within 7 feet of the top of cut or fill slopes are not recommended. Where such a condition cannot be avoided, the portion of the swimming pool wall within 7 feet of the slope face be designed assuming that the adjacent soil provides no lateral support. This recommendation applies to fill slopes up to 30 feet in height, and cut slopes regardless of height. For swimming pools located near the top of fill slopes greater than 30 feet in height, additional recommendations may be required and Geocon Incorporated should be contacted for a review of specific site conditions.
- Although other improvements, which are relatively rigid or brittle, such as concrete flatwork or masonry walls, may experience some distress if located near the top of a slope, it is generally not economical to mitigate this potential. It may be possible, however, to incorporate design measures which would permit some lateral soil movement without causing extensive distress. Geocon Incorporated should be consulted for specific recommendations.

7.10.22 The recommendations of this report are intended to reduce the potential for cracking of slabs and foundations due to expansive soil (if present), differential settlement of fill soil with varying thicknesses. However, even with the incorporation of the recommendations presented herein, foundations, stucco walls, and slabs-on-grade placed on such conditions may still exhibit some cracking due to soil movement and/or shrinkage. The occurrence of concrete shrinkage cracks is independent of the supporting soil characteristics. Their occurrence may be reduced by limiting the slump of the concrete, proper concrete placement and curing, and by the placement of crack control joints at periodic intervals, in particular, where re-entrant slab corners occur.

7.10.23 Concrete slabs should be provided with adequate crack-control joints, construction joints and/or expansion joints to reduce unsightly shrinkage cracking. The design of joints should consider criteria of the American Concrete Institute when establishing crack-control spacing. Additional steel reinforcing, concrete admixtures and/or closer crack control joint spacing should be considered where concrete-exposed finished floors are planned.

7.10.24 Geocon Incorporated should be consulted to provide additional design parameters as required by the structural engineer.

7.10.25 We should observe the foundation excavations prior to the placement of reinforcing steel to check that the exposed soil conditions are similar to those expected and that they have been extended to the appropriate bearing strata. If unexpected soil conditions are encountered, foundation modifications may be required.

7.11 Mat Foundation

7.11.1 We understand the proposed structures underlain by compacted fill over previously-placed fill and alluvium may be supported on a mat foundation. A mat foundation consists of a thick, rigid concrete mat that allows the entire footprint of the structure to carry building loads. In addition, the mat can tolerate significantly greater differential movements such as those associated with expansive soils or differential settlement. In this case, the mat foundation may be used below the water table if adequately waterproofed to reduce the potential for seepage. Table 7.11 provides a summary of the foundation design recommendations.

**TABLE 7.11
SUMMARY OF MAT FOUNDATION RECOMMENDATIONS**

Parameter	Value
Design Perimeter Foundation Width	12 inches
Minimum Foundation Depth	Extend Below Slab Underlayment
Minimum Steel Reinforcement	Per Structural Engineer
Bearing Capacity	500 psf
Estimated Total Settlement	2 Inches
Estimated Differential Settlement	1 Inch in 40 Feet
Modulus of Subgrade Reaction	125 pci
Design Expansion Index	50 or less

7.11.2 The modulus of subgrade reaction values should be modified as necessary using standard equations for mat size as required by the structural engineer. This value is a unit value for use with a 1-foot square footing. The modulus should be reduced in accordance with the following equation when used with larger foundations:

$$K_R = K \left[\frac{B+1}{2B} \right]^2$$

where: K_R = reduced subgrade modulus
 K = unit subgrade modulus
 B = foundation width (in feet)

- 7.11.3 A mat foundation system will allow the structure to settle with the ground and should have sufficient rigidity to allow the structure to move as a single unit. Re-leveling of the mat foundation could be necessary through the use of mud jacking, compaction grouting or other similar techniques if differential settlement occurs
- 7.11.4 Slabs that may receive moisture-sensitive floor coverings or may be used to store moisture-sensitive materials should be underlain by a vapor retarder. The vapor retarder design should be consistent with the guidelines presented in the American Concrete Institute's (ACI) *Guide for Concrete Slabs that Receive Moisture-Sensitive Flooring Materials* (ACI 302.2R-06). In addition, the membrane should be installed in accordance with manufacturer's recommendations and ASTM requirements and installed in a manner that prevents puncture. The vapor retarder used should be specified by the project architect or developer based on the type of floor covering that will be installed and if the structure will possess a humidity controlled environment.
- 7.11.5 The bedding sand thickness should be determined by the project foundation engineer, architect, and/or developer. However, we should be contacted to provide recommendations if the bedding sand is thicker than 6 inches. The foundation design engineer should provide appropriate concrete mix design criteria and curing measures to assure proper curing of the slab by reducing the potential for rapid moisture loss and subsequent cracking and/or slab curl. We suggest that the foundation design engineer present the concrete mix design and proper curing methods on the foundation plans. It is critical that the foundation contractor understands and follows the recommendations presented on the foundation plans.

7.12 Drilled Pier Recommendations

- 7.12.1 Drilled piers should be used for foundation support for structures supported within the influence of MSE wall backfill or structures supported on compacted fill over previously-placed fill and alluvium if the 2-inches of total settlement is prohibitive for mat or post-tensioned slabs. The foundation recommendations herein assume that the piers will extend through the fill into the Santiago Formation. The piers should be embedded at least 5 feet within the formational materials. For design purposes, a fill thickness of 25 feet was used to compute the allowable bearing capacities shown below. Once actual foundation types and locations are determined, revised allowable capacities may be provided based on actual site conditions.
- 7.12.2 Piers can be designed to develop support by end bearing within the formational materials and skin friction within the formational materials and portions of the fill soil. The end bearing capacity can be determined by the End Bearing Capacity Chart. These allowable values possess a factor of safety of 2 and 3 for skin friction and end bearing, respectively.

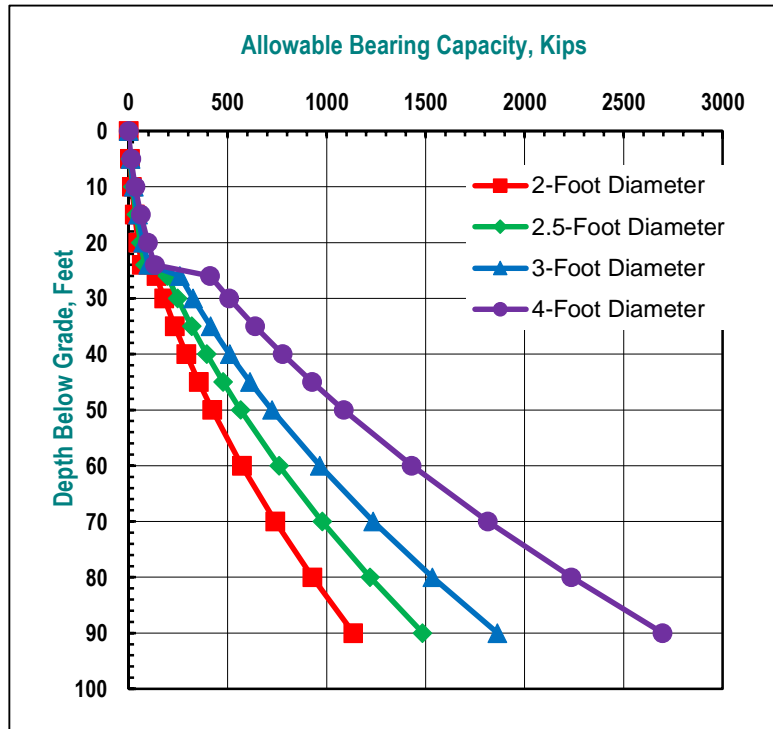

Allowable Bearing Capacity Chart

7.12.3 Piers can be designed to develop support by end bearing within the formational materials and skin friction within the formational materials and portions of the fill soil using the design parameters presented in Table 7.12.

**TABLE 7.12
SUMMARY OF DRILLED PIER RECOMMENDATIONS**

Parameter	Value
Minimum Pile Diameter	2 Feet
Minimum Pile Spacing	3 Times Pile Diameter
Minimum Foundation Embedment Depth	10 Feet
	5 Feet in Formational Materials
Allowable End Bearing Capacity	Per Chart
Allowable Skin Friction Capacity	300 psf (Fill Materials)
	750 psf (Santiago Formation)
Estimated Total Settlement	½ Inch
Estimated Differential Settlement	½ Inch in 40 Feet

- 7.12.4 The design length of the drilled piers should be determined by the designer based on the elevation of the pile cap or grade beam and the elevation of the top of the formational materials obtained from the Geologic Map and Geologic Cross-Sections presented herein. It is difficult to evaluate the exact length of the proposed drilled piers due to the variable thickness of the existing fill; therefore, some variation should be expected during drilling operations.
- 7.12.5 If pier spacing is at least three times the maximum dimension of the pier, no reduction in axial capacity for group effects is considered necessary. If piles are spaced between 2 and 3 pile diameters (center to center), the single pile axial capacity should be reduced by 25 percent. Geocon Incorporated should be contacted to provide single-pile capacity if piers are spaced closer than 2 diameters.
- 7.12.6 The allowable downward capacity may be increased by one-third when considering transient wind or seismic loads.
- 7.12.7 The existing materials may contain gravel and cobble and may possess very dense zones; therefore, the drilling contractor should expect difficult drilling conditions during excavations for the piers. Because a significant portion of the piers capacity will be developed by end bearing, the bottom of the borehole should be cleaned of loose cuttings prior to the placement of steel and concrete. Experience indicates that backspinning the auger does not remove loose material and a flat cleanout plate is necessary. We expect localized seepage may be encountered during the drilling operations and casing may be required to maintain the integrity of the pier excavation, particularly if seepage or sidewall instability is encountered. Concrete should be placed within the excavation as soon as possible after the auger/cleanout plate is withdrawn to reduce the potential for discontinuities or caving.
- 7.12.8 Pile settlement of production piers is expected to be on the order of ½ inch if the piers are loaded to their allowable capacities. Geocon should provide updated settlement estimates once the foundation plans are available. Settlements should be essentially complete shortly after completion of the building superstructure.

7.13 Concrete Flatwork

- 7.13.1 Exterior concrete flatwork not subject to vehicular traffic should be constructed in accordance with the recommendations herein. Slab panels should be a minimum of 4 inches thick and, when in excess of 8 feet square, should be reinforced with 6 x 6 - W2.9/W2.9 (6 x 6 - 6/6) welded wire mesh or No. 3 reinforcing bars spaced at least

18 inches center-to-center in both directions to reduce the potential for cracking. In addition, concrete flatwork should be provided with crack control joints to reduce and/or control shrinkage cracking. Crack control spacing should be determined by the project structural engineer based upon the slab thickness and intended usage. Criteria of the American Concrete Institute (ACI) should be taken into consideration when establishing crack control spacing. Subgrade soil for exterior slabs not subjected to vehicle loads should be compacted in accordance with criteria presented in the grading section prior to concrete placement. Subgrade soil should be properly compacted and the moisture content of subgrade soil should be checked prior to placing concrete. The recommendations herein assume the upper 3 feet of subgrade soil will possess a “very low” to “medium” expansion potential (expansion index of 90 or less).

- 7.13.2 Even with the incorporation of the recommendations within this report, the exterior concrete flatwork has a likelihood of experiencing some uplift due to expansive soil beneath grade; therefore, the steel reinforcement should overlap continuously in flatwork to reduce the potential for vertical offsets within flatwork. Additionally, flatwork should be structurally connected to the curbs, where possible, to reduce the potential for offsets between the curbs and the flatwork.
- 7.13.3 Where exterior flatwork abuts the structure at entrant or exit points, the exterior slab should be dowelled into the structure’s foundation stemwall. This recommendation is intended to reduce the potential for differential elevations that could result from differential settlement or minor heave of the flatwork. Dowelling details should be designed by the project structural engineer.
- 7.13.4 The recommendations presented herein are intended to reduce the potential for cracking of slabs and foundations as a result of differential movement. However, even with the incorporation of the recommendations presented herein, foundations and slabs-on-grade will still crack. The occurrence of concrete shrinkage cracks is independent of the soil supporting characteristics. Their occurrence may be reduced and/or controlled by limiting the slump of the concrete, the use of crack control joints and proper concrete placement and curing. Literature provided by the Portland Concrete Association (PCA) and American Concrete Institute (ACI) present recommendations for proper concrete mix, construction, and curing practices, and should be incorporated into project construction.

7.14 Retaining Walls

- 7.14.1 Retaining walls should be designed using the values presented in Table 7.14.1. Soil with an expansion index (EI) of greater than 50 should not be used as backfill material behind retaining walls.

**TABLE 7.14.1
RETAINING WALL DESIGN RECOMMENDATIONS**

Parameter	Value
Active Soil Pressure, A (Fluid Density, Level Backfill)	35 pcf
Active Soil Pressure, A (Fluid Density, 2:1 Sloping Backfill)	50 pcf
Seismic Pressure, S	21H psf
At-Rest/Restrained Walls Additional Uniform Pressure, R_U (0 to 8 Feet High)	7H psf
At-Rest/Restrained Walls Additional Uniform Pressure, R_L (8+ Feet High)	13H psf
Expected Expansion Index for the Subject Property	$EI \leq 50$

H equals the height of the retaining portion of the wall.

7.14.2 The project retaining walls should be designed as shown in the Retaining Wall Loading Diagram.

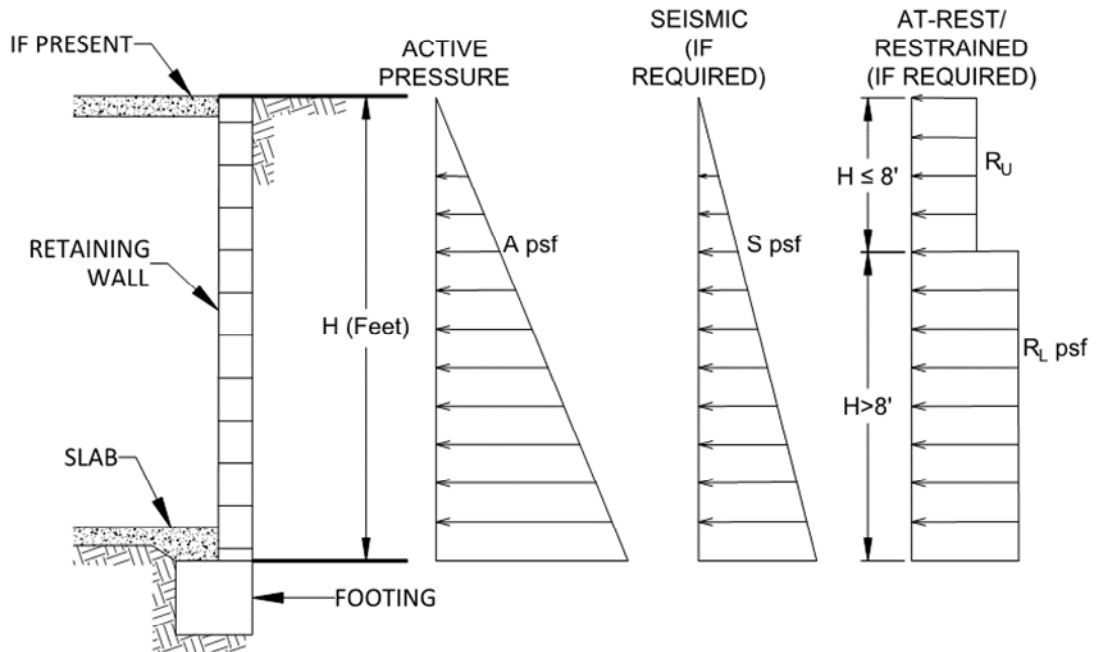

Retaining Wall Loading Diagram

7.14.3 Unrestrained walls are those that are allowed to rotate more than $0.001H$ (where H equals the height of the retaining portion of the wall) at the top of the wall. Where walls are restrained from movement at the top (at-rest condition), an additional uniform pressure should be applied to the wall. For retaining walls subject to vehicular loads within a horizontal distance equal to two-thirds the wall height, a surcharge equivalent to 2 feet of fill soil should be added.

- 7.14.4 The structural engineer should determine the Seismic Design Category for the project in accordance with Section 1613.3.5 of the 2019 CBC or Section 11.6 of ASCE 7-16. For structures assigned to Seismic Design Category of D, E, or F, retaining walls that support more than 6 feet of backfill should be designed with seismic lateral pressure in accordance with Section 1803.5.12 of the 2019 CBC. The seismic load is dependent on the retained height where H is the height of the wall, in feet, and the calculated loads result in pounds per square foot (psf) exerted at the base of the wall and zero at the top of the wall.
- 7.14.5 Retaining walls should be designed to ensure stability against overturning sliding, and excessive foundation pressure. Where a keyway is extended below the wall base with the intent to engage passive pressure and enhance sliding stability, it is not necessary to consider active pressure on the keyway.
- 7.14.6 Drainage openings through the base of the wall (weep holes) should not be used where the seepage could be a nuisance or otherwise adversely affect the property adjacent to the base of the wall. The recommendations herein assume a properly compacted granular (EI of 90 or less) free-draining backfill material with no hydrostatic forces or imposed surcharge load. The retaining wall should be properly drained as shown in the Typical Retaining Wall Drainage Detail. If conditions different than those described are expected, or if specific drainage details are desired, Geocon Incorporated should be contacted for additional recommendations.

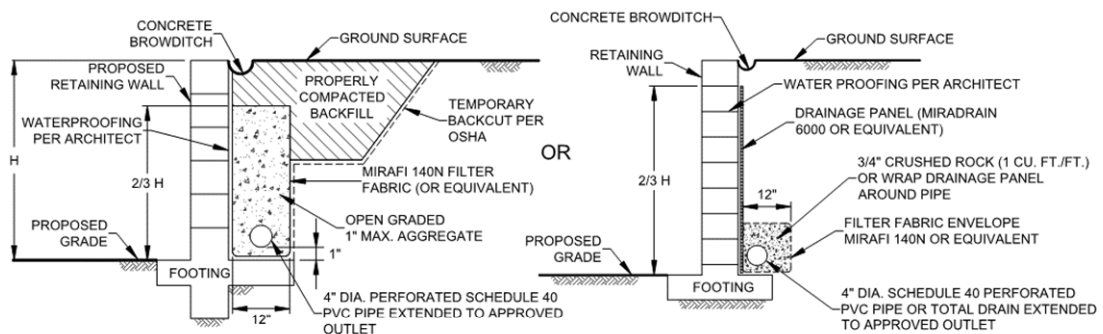

Typical Retaining Wall Drainage Detail

- 7.14.7 The retaining walls may be designed using either the active and restrained (at-rest) loading condition or the active and seismic loading condition as suggested by the structural engineer. Typically, it appears the design of the restrained condition for retaining wall loading may be adequate for the seismic design of the retaining walls. However, the active earth pressure combined with the seismic design load should be reviewed and also considered in the design of the retaining walls.

7.14.8 In general, wall foundations should be designed in accordance with Table 7.14.2. The proximity of the foundation to the top of a slope steeper than 3:1 could impact the allowable soil bearing pressure. Therefore, retaining wall foundations should be deepened such that the bottom outside edge of the footing is at least 7 feet horizontally from the face of the slope.

**TABLE 7.14.2
SUMMARY OF RETAINING WALL FOUNDATION RECOMMENDATIONS**

Parameter	Value
Minimum Retaining Wall Foundation Width	12 inches
Minimum Retaining Wall Foundation Depth	12 Inches
Minimum Steel Reinforcement	Per Structural Engineer
Allowable Bearing Capacity	2,000 psf
Estimated Total Settlement	½ Inch
Estimated Differential Settlement	½ Inch in 40 Feet

7.14.9 The recommendations presented herein are generally applicable to the design of rigid concrete or masonry retaining walls. In the event that other types of walls (such as mechanically stabilized earth [MSE] walls, soil nail walls, or soldier pile walls) are planned, Geocon Incorporated should be consulted for additional recommendations.

7.14.10 Unrestrained walls will move laterally when backfilled and loading is applied. The amount of lateral deflection is dependent on the wall height, the type of soil used for backfill, and loads acting on the wall. The retaining walls and improvements above the retaining walls should be designed to incorporate an appropriate amount of lateral deflection as determined by the structural engineer.

7.14.11 Soil contemplated for use as retaining wall backfill, including import materials, should be identified in the field prior to backfill. At that time, Geocon Incorporated should obtain samples for laboratory testing to evaluate its suitability. Modified lateral earth pressures may be necessary if the backfill soil does not meet the required expansion index or shear strength. City or regional standard wall designs, if used, are based on a specific active lateral earth pressure and/or soil friction angle. In this regard, on-site soil to be used as backfill may or may not meet the values for standard wall designs. Geocon Incorporated should be consulted to assess the suitability of the on-site soil for use as wall backfill if standard wall designs will be used.

7.15 Lateral Loading

7.15.1 To resist lateral loads, a passive pressure exerted by an equivalent fluid density of 300 pounds per cubic foot (pcf) should be used for the design of footings or shear keys. The allowable passive pressure assumes a horizontal surface extending at least 5 feet, or three

times the surface generating the passive pressure, whichever is greater. The upper 12 inches of material in areas not protected by floor slabs or pavement should not be included in design for passive resistance.

7.15.2 If friction is to be used to resist lateral loads, an allowable coefficient of friction between soil and concrete of 0.35 should be used for design. The friction coefficient may be reduced depending on the vapor barrier or waterproofing material used for construction in accordance with the manufacturer’s recommendations.

7.15.3 The passive and frictional resistant loads can be combined for design purposes. The lateral passive pressures may be increased by one-third when considering transient loads due to wind or seismic forces.

7.16 Mechanically Stabilized Earth (MSE) Retaining Walls

7.16.1 Mechanized stabilized earth (MSE) retaining walls can be used on the property. MSE retaining walls are alternative walls that consist of modular block facing units with geogrid reinforced earth behind the block. The reinforcement grid attaches to the block units and is typically placed at specified vertical intervals and embedment lengths. The grid length and spacing will be determined by the wall designer.

7.16.2 The geotechnical parameters listed in Table 7.16 can be used for preliminary design of the MSE walls. Soil with an expansion index (EI) of greater than 50 should not be used as backfill material behind retaining walls. In addition, some wall designers request soil with a plasticity index greater than 20, a liquid limit greater than 40 and a fines content greater than 35 percent should not be used for soil within the reinforcing zone. This may require import of select materials for the wall backfilling operations or selectively stockpiling of granular soils. Once the backfill source has been determined, laboratory testing should be performed to check that the shear strength parameters used in the design of the MSE walls meet or exceed the required strength within the reinforced zone.

**TABLE 7.16
GEOTECHNICAL PARAMETERS FOR MSE WALLS**

Parameter	Reinforced Zone	Retained Zone	Foundation Zone
Angle of Internal Friction	28 degrees	28 degrees	28 degrees
Cohesion	0 psf	0 psf	0 psf
Wet Unit Density	125 pcf	125 pcf	125 pcf

- 7.16.3 The soil parameters presented in Table 7.16 are based on our experience with MSE wall contractors on previous projects. The wet unit density values presented in Table 7.16 can be used for design but actual in-place densities may range from approximately 110 to 135 pounds per cubic foot. Geocon has no way of knowing which materials will actually be used as backfill behind the wall during construction. It is up to the wall designers to use their judgment in selection of the design parameters. As such, once backfill materials have been selected and/or stockpiled, sufficient shear tests should be conducted on samples of the proposed backfill materials to check that they conform to actual design values. Results should be provided to the designer to re-evaluate stability of the walls. Dependent upon test results, the designer may require modifications to the original wall design (e.g., longer reinforcement embedment lengths and/or steel reinforcement).
- 7.16.4 The foundation zone is the area where the footing is embedded, the reinforced zone is the area of the backfill that possesses the reinforcing fabric, and the retained zone is the area behind the reinforced zone.
- 7.16.5 Wall foundations having a minimum depth and width of one foot may be designed for an allowable soil bearing pressure of 2,000 psf. The MSE walls should be designed for a total and differential settlement of 1-inch and ½-inch in 40 feet, respectively. The planned MSE walls should be designed to accommodate the anticipated settlement.
- 7.16.6 Backfill materials within the reinforced zone should be compacted to a dry density of at least 90 percent of the laboratory maximum dry density near to slightly above optimum moisture content in accordance with ASTM D 1557. This is applicable to the entire embedment width of the reinforcement. Typically, wall designers specify no heavy compaction equipment within 3 feet of the face of the wall. However, smaller equipment (e.g., walk-behind, self-driven compactors or hand whackers) can be used to compact the materials without causing deformation of the wall. If the designer specifies no compactive effort for this zone, the materials are essentially not properly compacted and the reinforcement grid within the uncompacted zone should not be relied upon for reinforcement, and overall embedment lengths will have to be increased to account for the difference.
- 7.16.7 The wall should be provided with a drainage system sufficient to prevent excessive seepage through the wall and the base of the wall, thus preventing hydrostatic pressures behind the wall.
- 7.16.8 Geosynthetic reinforcement must elongate to develop full tensile resistance. This elongation generally results in movement at the top of the wall. The amount of movement is dependent upon the height of the wall (e.g., higher walls rotate more) and the type of reinforcing grid used. In addition, over time the reinforcement grid has been known to exhibit creep

(sometimes as much as 5 percent) and can undergo additional movement. Given this condition, the owner should be aware that structures and pavement placed within the reinforced and retained zones of the wall may undergo movement.

7.16.9 The MSE wall contractor should provide the estimated deformation of wall and adjacent ground in associated with wall construction. The calculated horizontal and vertical deformations should be determined by the wall designer. The estimated movements should be provided to the project structural engineer to determine if the planned improvements can tolerate the expected movements.

7.16.10 The MSE wall designer/contractor should review this report, including the slope stability requirements, and incorporate our recommendations as presented herein. We should be provided the plans for the MSE walls to check if they are in conformance with our recommendations prior to issuance of a permit and construction.

7.17 Preliminary Pavement Recommendations

7.17.1 We calculated the flexible pavement sections in general conformance with the *Caltrans Method of Flexible Pavement Design* (Highway Design Manual, Section 608.4) using estimated Traffic Indices (TI's) of 5.0, 6.0 and 7.0 for the interior roadways. The project civil engineer and owner should review the pavement designations to determine appropriate locations for pavement thickness. We have assumed an R-Value of 15 and 78 for the subgrade soil and base materials, respectively, based on laboratory test results for the purposes of this preliminary analysis. The final pavement sections should be based on the R-Value of the subgrade soil encountered at final subgrade elevation once site grading and utility trench backfill is completed. Table 7.17.1 presents the preliminary flexible pavement sections.

**TABLE 7.17.1
PRELIMINARY FLEXIBLE PAVEMENT SECTION**

Location	Assumed Traffic Index	Assumed Subgrade R-Value	Asphalt Concrete (inches)	Class 2 Aggregate Base (inches)
Interior Roadways (light-duty)	5.0	15	3	8
Interior Roadways (medium duty)	6.0	15	4	10
Interior Roadways (heavy duty)	7.0	15	4	13

7.17.2 Prior to placing base materials, the upper 12 inches of the subgrade soil should be scarified, moisture conditioned as necessary, and recompacted to a dry density of at least 95 percent of

the laboratory maximum dry density near to slightly above optimum moisture content as determined by ASTM D 1557. Similarly, the base material should be compacted to a dry density of at least 95 percent of the laboratory maximum dry density near to slightly above optimum moisture content. Asphalt concrete should be compacted to a density of at least 95 percent of the laboratory Hveem density in accordance with ASTM D 2726.

7.17.3 Base materials should conform to Section 26-1.02B of the *Standard Specifications for The State of California Department of Transportation (Caltrans)* with a ¾-inch maximum size aggregate. The asphalt concrete should conform to Section 203-6 of the *Standard Specifications for Public Works Construction (Greenbook)*.

7.17.4 The base thickness can be reduced if a reinforcement geogrid is used during the installation of the pavement. Geocon should be contact for additional recommendations, if required.

7.17.5 A rigid Portland cement concrete (PCC) pavement section should be placed in driveway entrance aprons, cross-gutters and trash bin loading/storage areas. The concrete pad for trash truck areas should be large enough such that the truck wheels will be positioned on the concrete during loading. We calculated the rigid pavement section in general conformance with the procedure recommended by the American Concrete Institute report ACI 330R-08 *Guide for Design and Construction of Concrete Parking Lots* using the parameters presented in Table 7.17.2.

**TABLE 7.17.2
RIGID PAVEMENT DESIGN PARAMETERS**

Design Parameter	Design Value
Modulus of subgrade reaction, k	100 pci
Modulus of rupture for concrete, M _R	500 psi
Traffic Category, TC	B and C
Average daily truck traffic, ADTT	25 and 100

7.17.6 Based on the criteria presented herein, the PCC pavement sections should have a minimum thickness as presented in Table 7.17.3.

**TABLE 7.17.3
RIGID PAVEMENT RECOMMENDATIONS**

Location	Portland Cement Concrete (inches)
Medium Duty Areas (TC=B)	6.0
Heavy Duty Areas (TC=C)	7.0

- 7.17.7 The PCC pavement should be placed over subgrade soil that is compacted to a dry density of at least 95 percent of the laboratory maximum dry density near to slightly above optimum moisture content. This pavement section is based on a minimum concrete compressive strength of approximately 3,000 psi (pounds per square inch). Base materials will not be required beneath concrete improvements including cross-gutters, curb and gutters, and sidewalks.
- 7.17.8 A thickened edge or integral curb should be constructed on the outside of concrete slabs subjected to wheel loads. The thickened edge should be 1.2 times the slab thickness or a minimum thickness of 2 inches, whichever results in a thicker edge, and taper back to the recommended slab thickness 4 feet behind the face of the slab (e.g., a 7.5-inch-thick slab would have a 9.5-inch-thick edge). Reinforcing steel will not be necessary within the concrete for geotechnical purposes with the possible exception of dowels at construction joints as discussed herein.
- 7.17.9 To control the location and spread of concrete shrinkage cracks, crack-control joints (weakened plane joints) should be included in the design of the concrete pavement slab. Crack-control joints should not exceed 30 times the slab thickness with a maximum spacing of 15 feet for slabs 6 inches and thicker and should be sealed with an appropriate sealant to prevent the migration of water through the control joint to the subgrade materials. The depth of the crack-control joints should be determined by the referenced ACI report. The depth of the crack-control joints should be at least $\frac{1}{4}$ of the slab thickness when using a conventional saw, or at least 1 inch when using early-entry saws on slabs 9 inches or less in thickness, as determined by the referenced ACI report discussed in the pavement section herein. Cuts at least $\frac{1}{4}$ inch wide are required for sealed joints, and a $\frac{3}{8}$ inch wide cut is commonly recommended. A narrow joint width of $\frac{1}{10}$ to $\frac{1}{8}$ -inch wide is common for unsealed joints.
- 7.17.10 Concrete curb/gutter should be placed on soil subgrade compacted to a dry density of at least 90 percent of the laboratory maximum dry density near to slightly above optimum moisture content. Cross-gutters should be placed on subgrade soil compacted to a dry density of at least 95 percent of the laboratory maximum dry density near to slightly above optimum moisture content. Base materials should not be placed below the curb/gutter, cross-gutters, or sidewalk so water is not able to migrate from the adjacent parkways to the pavement sections.
- 7.17.11 The performance of pavement is highly dependent on providing positive surface drainage away from the edge of the pavement. Ponding of water on or adjacent to the pavement and subgrade will likely result in pavement distress and subgrade failure. Drainage from landscaped areas should be directed to controlled drainage structures. Landscape areas

adjacent to the edge of asphalt pavements are not recommended due to the potential for surface or irrigation water to infiltrate the underlying permeable aggregate base and cause distress. Where such a condition cannot be avoided, consideration should be given to incorporating measures that will significantly reduce the potential for subsurface water migration into the aggregate base. If planter islands are planned, the perimeter curb should extend at least 6 inches below the level of the base materials.

7.18 Site Drainage and Moisture Protection

7.18.1 Adequate site drainage is critical to reduce the potential for differential soil movement, erosion and subsurface seepage. Under no circumstances should water be allowed to pond adjacent to footings. The site should be graded and maintained such that surface drainage is directed away from structures in accordance with 2019 CBC 1804.4 or other applicable standards. In addition, surface drainage should be directed away from the top of slopes into swales or other controlled drainage devices. Roof and pavement drainage should be directed into conduits that carry runoff away from the proposed structure.

7.18.2 Underground utilities should be leak free. Utility and irrigation lines should be checked periodically for leaks, and detected leaks should be repaired promptly. Detrimental soil movement could occur if water is allowed to infiltrate the soil for prolonged periods of time.

7.18.3 Landscaping planters adjacent to paved areas are not recommended due to the potential for surface or irrigation water to infiltrate the pavement's subgrade and base course. Area drains to collect excess irrigation water and transmit it to drainage structures or impervious above-grade planter boxes can be used. In addition, where landscaping is planned adjacent to the pavement, construction of a cutoff wall along the edge of the pavement that extends at least 6 inches below the bottom of the base material should be considered.

7.18.4 We should perform a storm water management study when grading plans have been prepared detailing the type and location of the proposed BMPs.

7.19 Grading and Foundation Plan Review

7.19.1 Geocon Incorporated should review the grading plans and foundation plans for the project prior to final design submittal to evaluate whether additional analyses and/or recommendations are required.

LIMITATIONS AND UNIFORMITY OF CONDITIONS

1. The firm that performed the geotechnical investigation for the project should be retained to provide testing and observation services during construction to provide continuity of geotechnical interpretation and to check that the recommendations presented for geotechnical aspects of site development are incorporated during site grading, construction of improvements, and excavation of foundations. If another geotechnical firm is selected to perform the testing and observation services during construction operations, that firm should prepare a letter indicating their intent to assume the responsibilities of project geotechnical engineer of record. A copy of the letter should be provided to the regulatory agency for their records. In addition, that firm should provide revised recommendations concerning the geotechnical aspects of the proposed development, or a written acknowledgement of their concurrence with the recommendations presented in our report. They should also perform additional analyses deemed necessary to assume the role of Geotechnical Engineer of Record.
2. The recommendations of this report pertain only to the site investigated and are based upon the assumption that the soil conditions do not deviate from those disclosed in the investigation. If any variations or undesirable conditions are encountered during construction, or if the proposed construction will differ from that anticipated herein, Geocon Incorporated should be notified so that supplemental recommendations can be given. The evaluation or identification of the potential presence of hazardous or corrosive materials was not part of the scope of services provided by Geocon Incorporated.
3. This report is issued with the understanding that it is the responsibility of the owner, or of his representative, to ensure that the information and recommendations contained herein are brought to the attention of the architect and engineer for the project and incorporated into the plans, and that the necessary steps are taken to see that the contractor and subcontractors carry out such recommendations in the field.
4. The findings of this report are valid as of the present date. However, changes in the conditions of a property can occur with the passage of time, whether they are due to natural processes or the works of man on this or adjacent properties. In addition, changes in applicable or appropriate standards may occur, whether they result from legislation or the broadening of knowledge. Accordingly, the findings of this report may be invalidated wholly or partially by changes outside our control. Therefore, this report is subject to review and should not be relied upon after a period of three years.

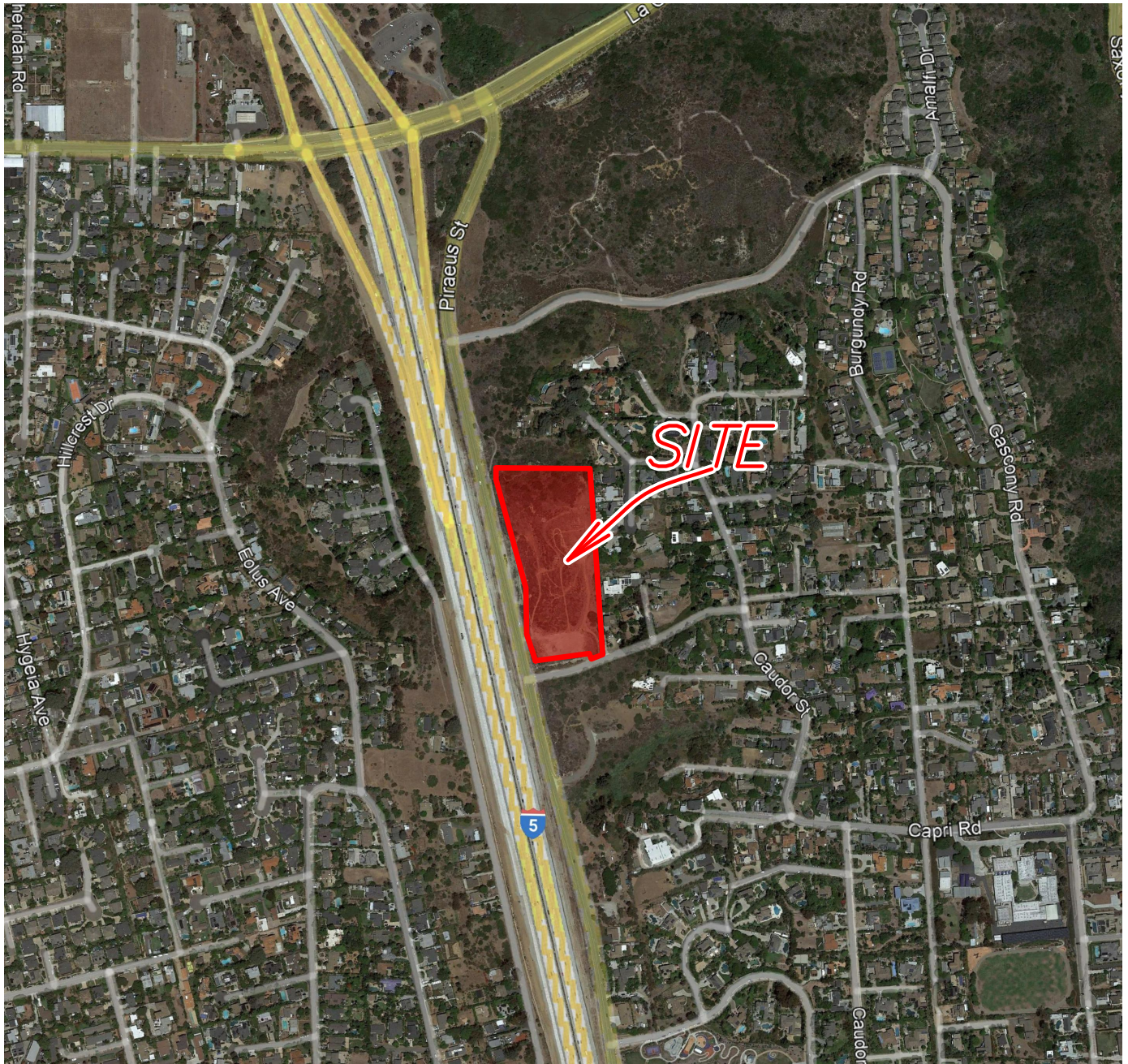

THE GEOGRAPHICAL INFORMATION MADE AVAILABLE FOR DISPLAY WAS PROVIDED BY GOOGLE EARTH, SUBJECT TO A LICENSING AGREEMENT. THE INFORMATION IS FOR ILLUSTRATIVE PURPOSES ONLY; IT IS NOT INTENDED FOR CLIENT'S USE OR RELIANCE AND SHALL NOT BE REPRODUCED BY CLIENT. CLIENT SHALL INDEMNIFY, DEFEND AND HOLD HARMLESS GEOCON FROM ANY LIABILITY INCURRED AS A RESULT OF SUCH USE OR RELIANCE BY CLIENT.



NO SCALE

VICINITY MAP

GEOCON
INCORPORATED



GEOTECHNICAL ■ ENVIRONMENTAL ■ MATERIALS
6960 FLANDERS DRIVE - SAN DIEGO, CALIFORNIA 92121 - 2974
PHONE 858 558-6900 - FAX 858 558-6159

PIRAEUS POINT ENCINITAS, CALIFORNIA

TM / RA

DSK/GTYPD

DATE 01 - 31 - 2022

PROJECT NO. G2307 - 32 - 05

FIG. 1

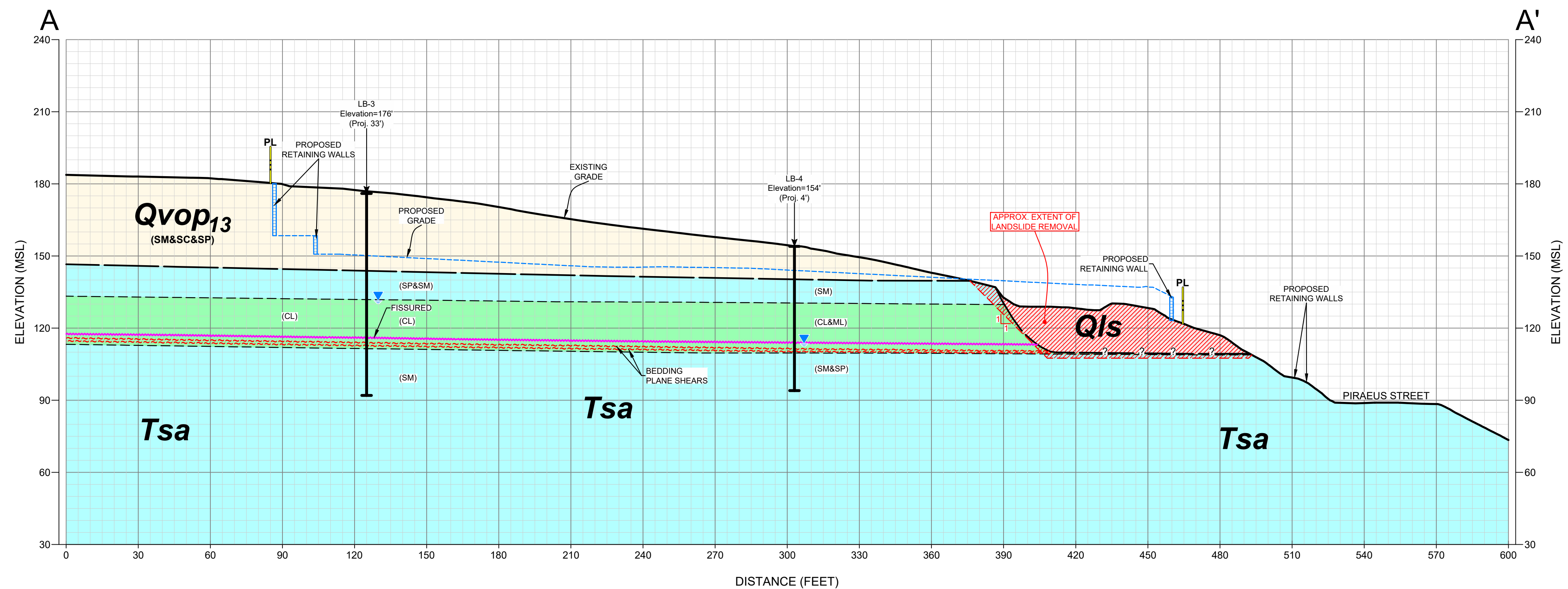

GEOLOGIC CROSS-SECTION A-A'
SCALE: 1" = 30' (Vert. = Horiz.)

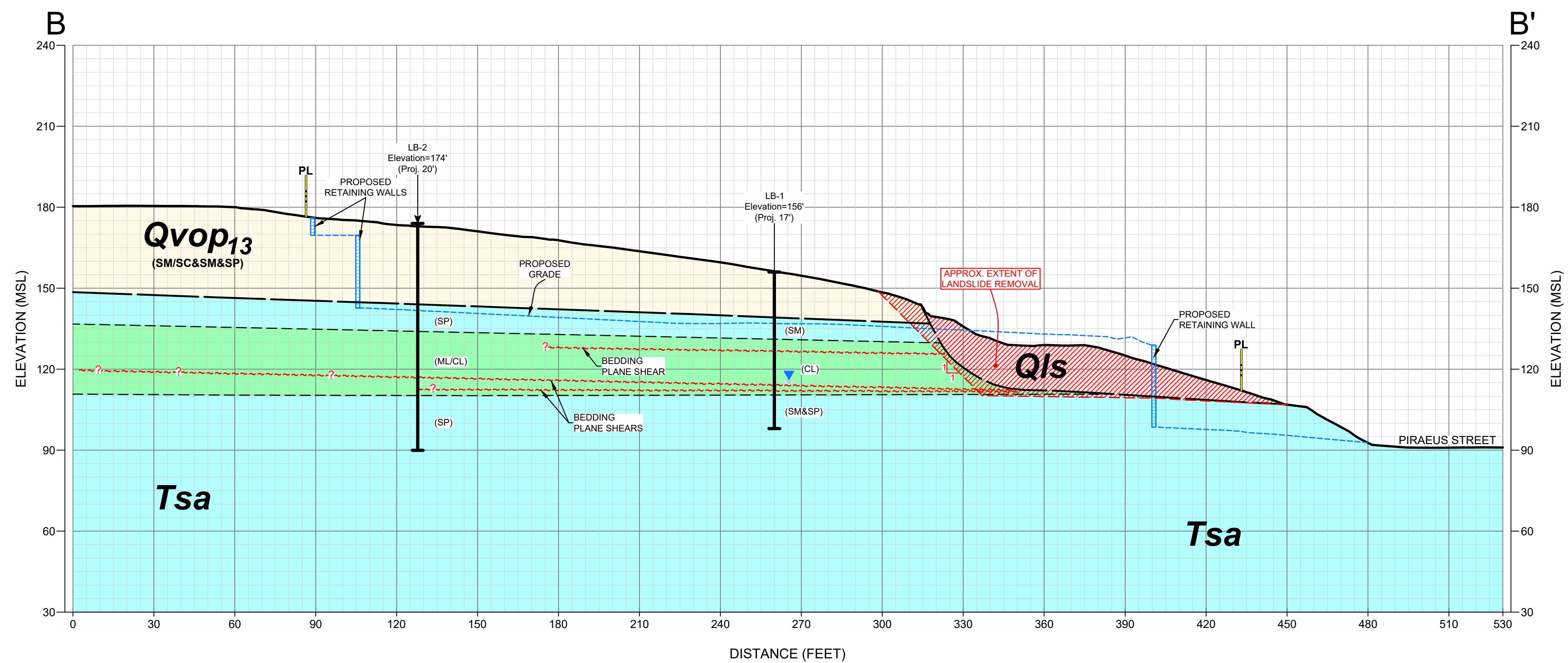

GEOLOGIC CROSS-SECTION B-B'
SCALE: 1" = 30' (Vert. = Horiz.)

- GEOCON LEGEND**
- Qpf**PREVIOUSLY PLACED FILL
 - Qal**ALLUVIUM
 - Qls**LANDSLIDE DEBRIS
 - Qvop₁₃**VERY OLD PARALIC DEPOSITS
 - Tsa**SANTIAGO FORMATION
 -APPROX. LOCATION OF GEOLOGIC CONTACT
 -APPROX. LOCATION OF INTRAFORMATIONAL CONTACT
 -APPROX. LOCATION OF BORING
 -APPROX. LOCATION OF BEDDING PLANE SHEAR

GEOLOGIC CROSS - SECTIONS

PIRAEUS POINT
ENCINITAS, CALIFORNIA

GEOCON
INCORPORATED
GEO TECHNICAL ■ ENVIRONMENTAL ■ MATERIALS
6940 FLANDERS DRIVE - SAN DIEGO, CALIFORNIA 92121 - 2974
PHONE 658-558-6900 - FAX 658-558-6159

SCALE 1" = 30' DATE 01 - 31 - 2022
PROJECT NO. G2307 - 32 - 05 FIGURE 3
SHEET 1 OF 1

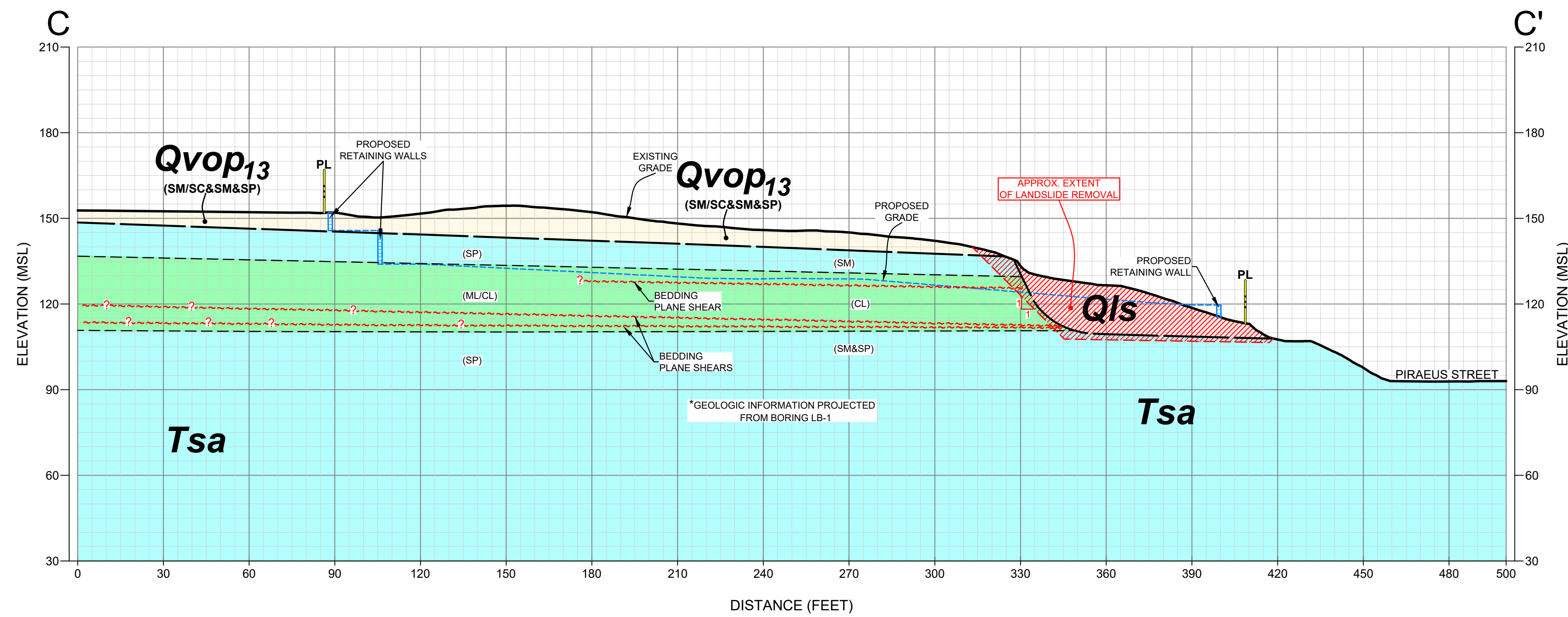

GEOLOGIC CROSS-SECTION C-C'

SCALE: 1" = 30' (Vert. = Horiz.)

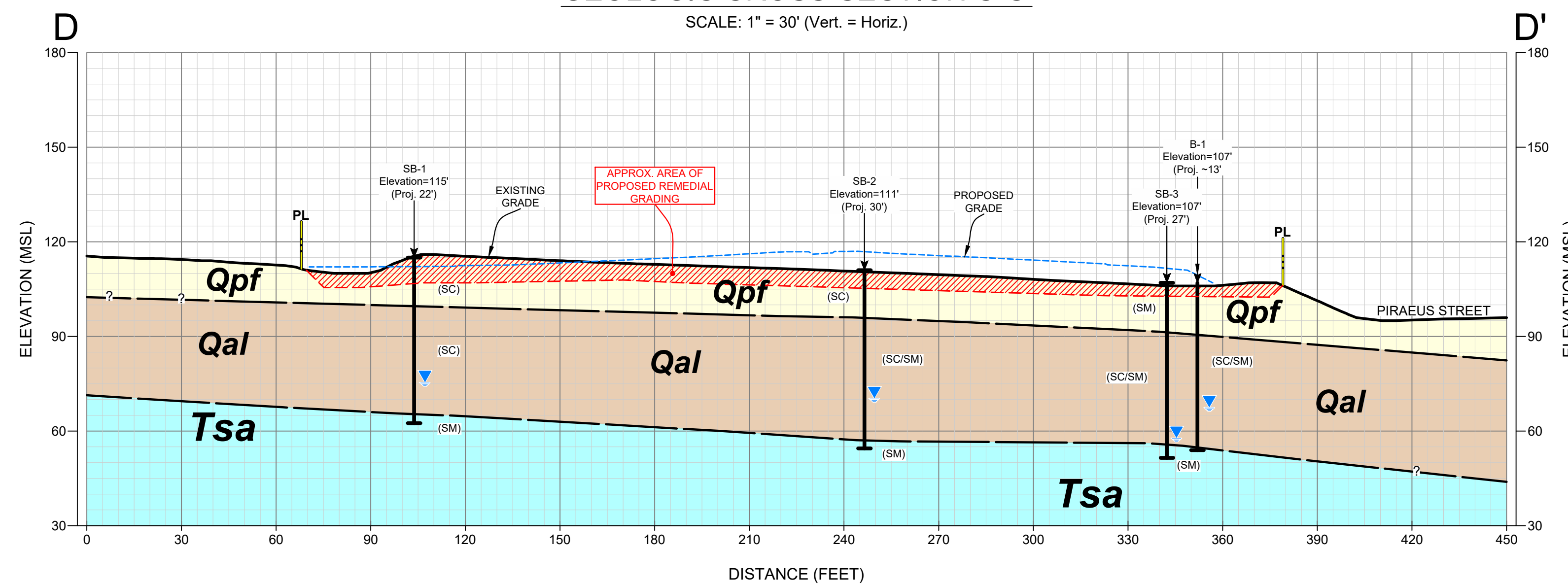

GEOLOGIC CROSS-SECTION D-D'

SCALE: 1" = 30' (Vert. = Horiz.)

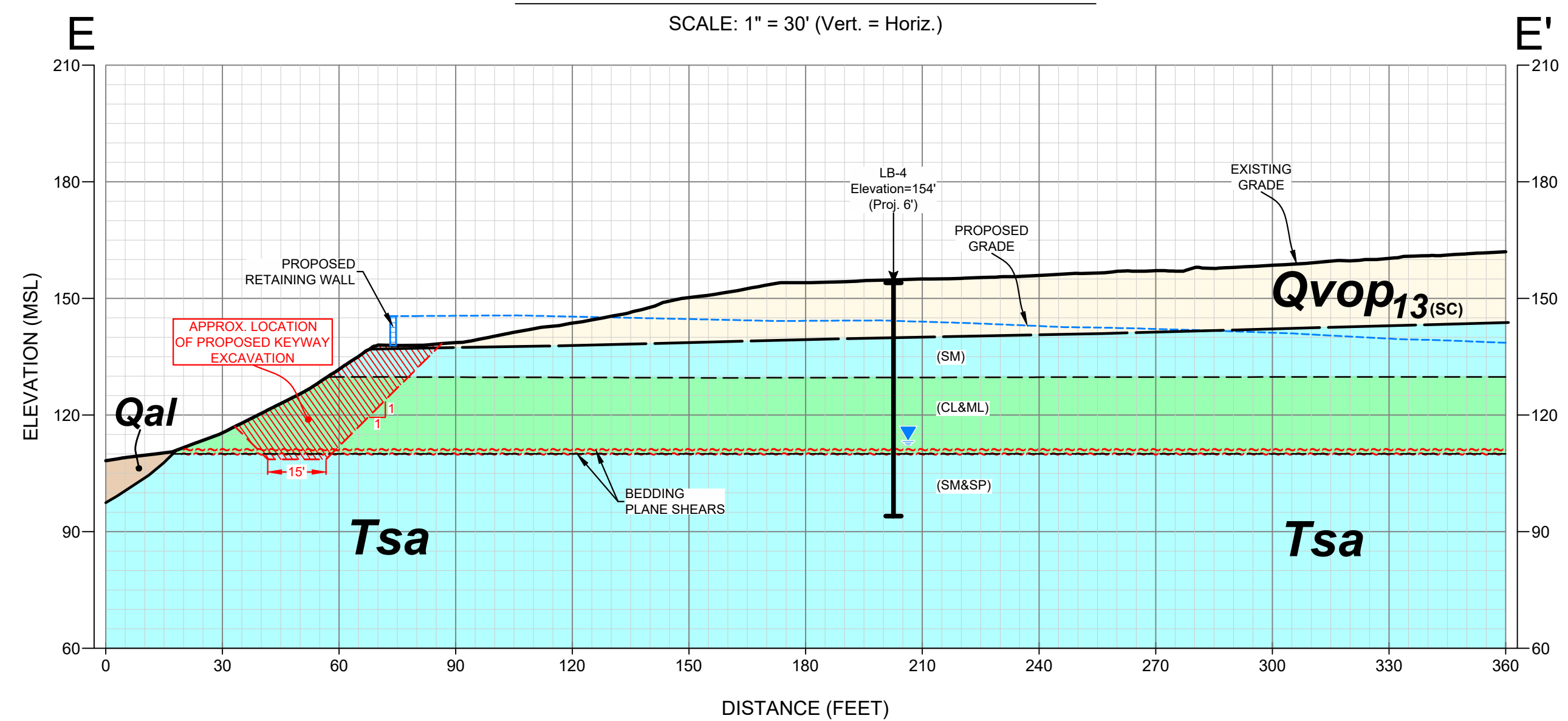

GEOLOGIC CROSS-SECTION E-E'

SCALE: 1" = 30' (Vert. = Horiz.)

- GEOCON LEGEND**
- Qpf**PREVIOUSLY PLACED FILL
 - Qal**ALLUVIUM
 - Qls**LANDSLIDE DEBRIS
 - Qvop13**VERY OLD PARALIC DEPOSITS
 - Tsa**SANTIAGO FORMATION
 -APPROX. LOCATION OF GEOLOGIC CONTACT
 -APPROX. LOCATION OF INTRAFORMATIONAL CONTACT
 -APPROX. LOCATION OF BORING
 -APPROX. LOCATION OF BEDDING PLANE SHEAR

GEOLOGIC CROSS - SECTIONS							
PIRAEUS POINT ENCINITAS, CALIFORNIA							
GEOCON INCORPORATED GEO TECHNICAL ■ ENVIRONMENTAL ■ MATERIALS 6940 FLANDERS DRIVE - SAN DIEGO, CALIFORNIA 92121 - 2974 PHONE 658-558-6900 - FAX 658-558-6159	<table border="1"> <tr> <td>SCALE 1" = 30'</td> <td>DATE 01 - 31 - 2022</td> </tr> <tr> <td>PROJECT NO. G2307 - 32 - 05</td> <td>FIGURE 4</td> </tr> <tr> <td>SHEET 1 OF 1</td> <td></td> </tr> </table>	SCALE 1" = 30'	DATE 01 - 31 - 2022	PROJECT NO. G2307 - 32 - 05	FIGURE 4	SHEET 1 OF 1	
SCALE 1" = 30'	DATE 01 - 31 - 2022						
PROJECT NO. G2307 - 32 - 05	FIGURE 4						
SHEET 1 OF 1							

Plotter: 02/01/2022 1:42PM | By: RUBEN AGUILAR | File Location: Y:\PROJECTS\G2307-32-05 Piraeus Street\SOURCE\SECTION\G2307-32-05 Profile_2022-01-12.dwg

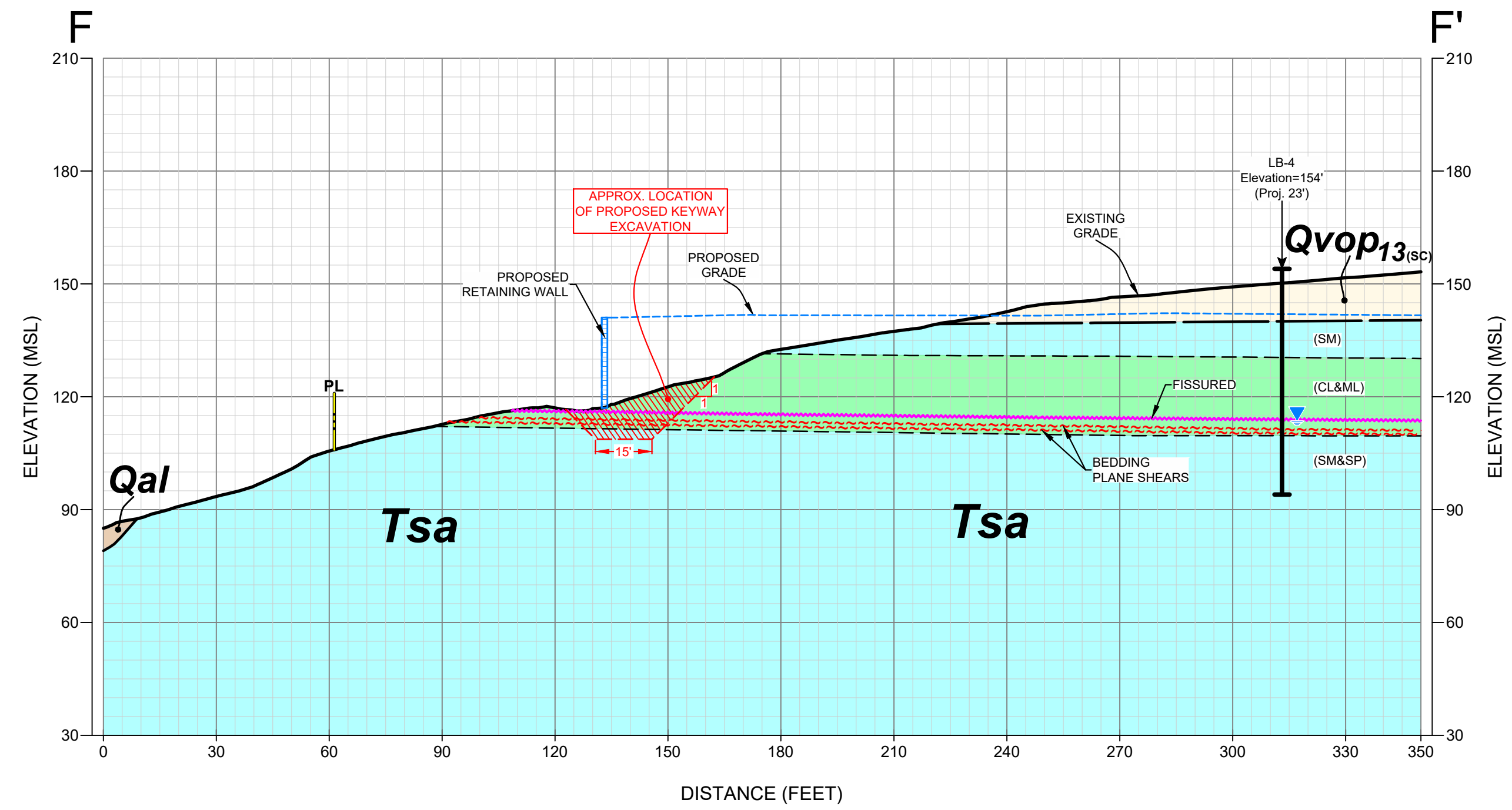

GEOLOGIC CROSS-SECTION F-F'

SCALE: 1" = 30' (Vert. = Horiz.)

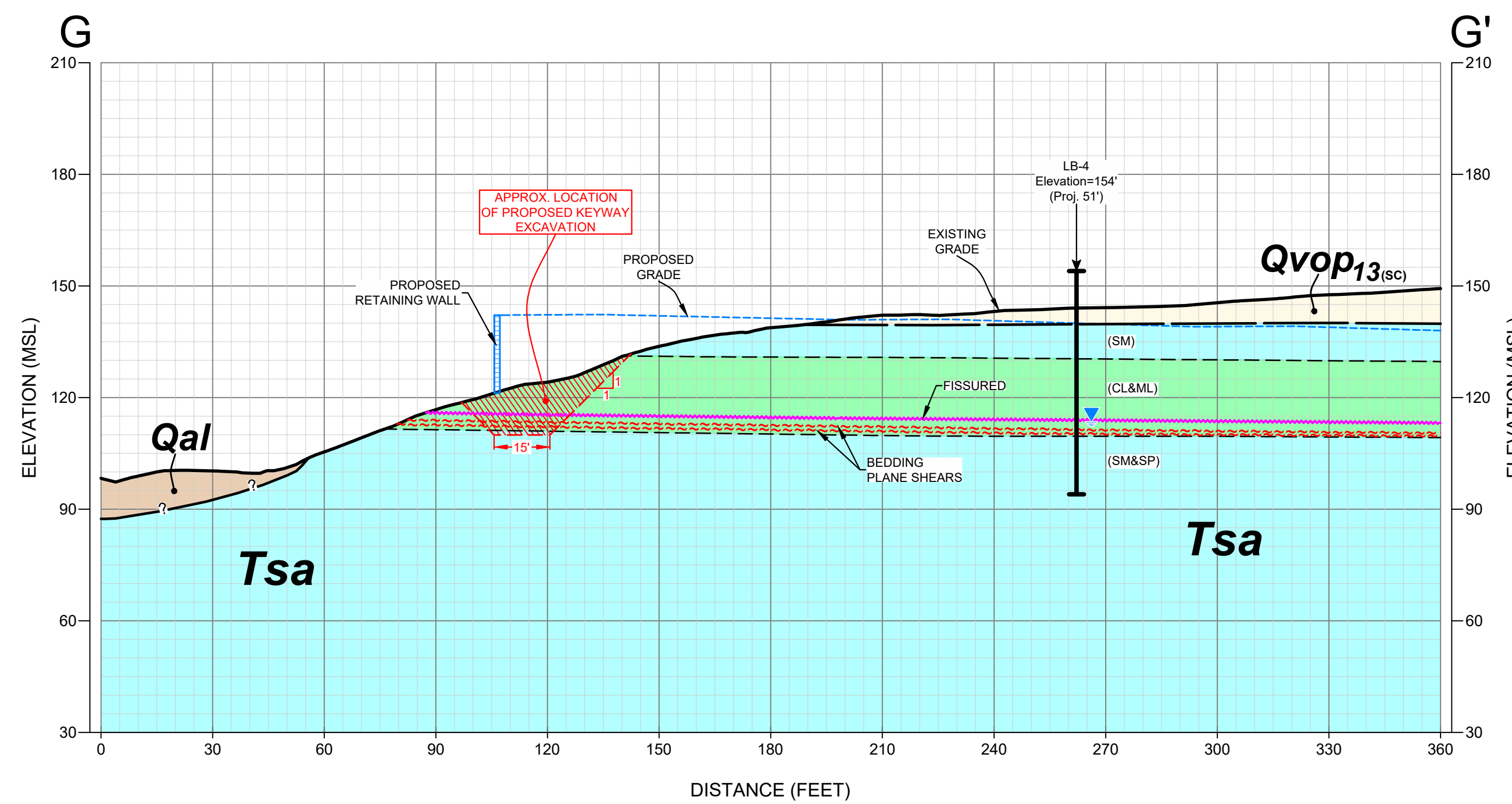

GEOLOGIC CROSS-SECTION G-G'

SCALE: 1" = 30' (Vert. = Horiz.)

- GEOCON LEGEND**
- Qpf**.....PREVIOUSLY PLACED FILL
 - Qal**.....ALLUVIUM
 - Qls**.....LANDSLIDE DEBRIS
 - Qvop₁₃**.....VERY OLD PARALIC DEPOSITS
 - Tsa**.....SANTIAGO FORMATION
 -APPROX. LOCATION OF GEOLOGIC CONTACT
 -APPROX. LOCATION OF INTRAFORMATIONAL CONTACT
 -APPROX. LOCATION OF BORING
 -APPROX. LOCATION OF BEDDING PLANE SHEAR

GEOLOGIC CROSS - SECTIONS

PIRAEUS POINT
ENCINITAS, CALIFORNIA

GEOCON
INCORPORATED
GEO TECHNICAL ■ ENVIRONMENTAL ■ MATERIALS
6940 FLANDERS DRIVE - SAN DIEGO, CALIFORNIA 92121 - 2974
PHONE 619-538-6900 - FAX 619-538-6159

SCALE	1" = 30'	DATE	01 - 31 - 2022
PROJECT NO.	G2307 - 32 - 05	FIGURE	5
SHEET	1 OF 1		

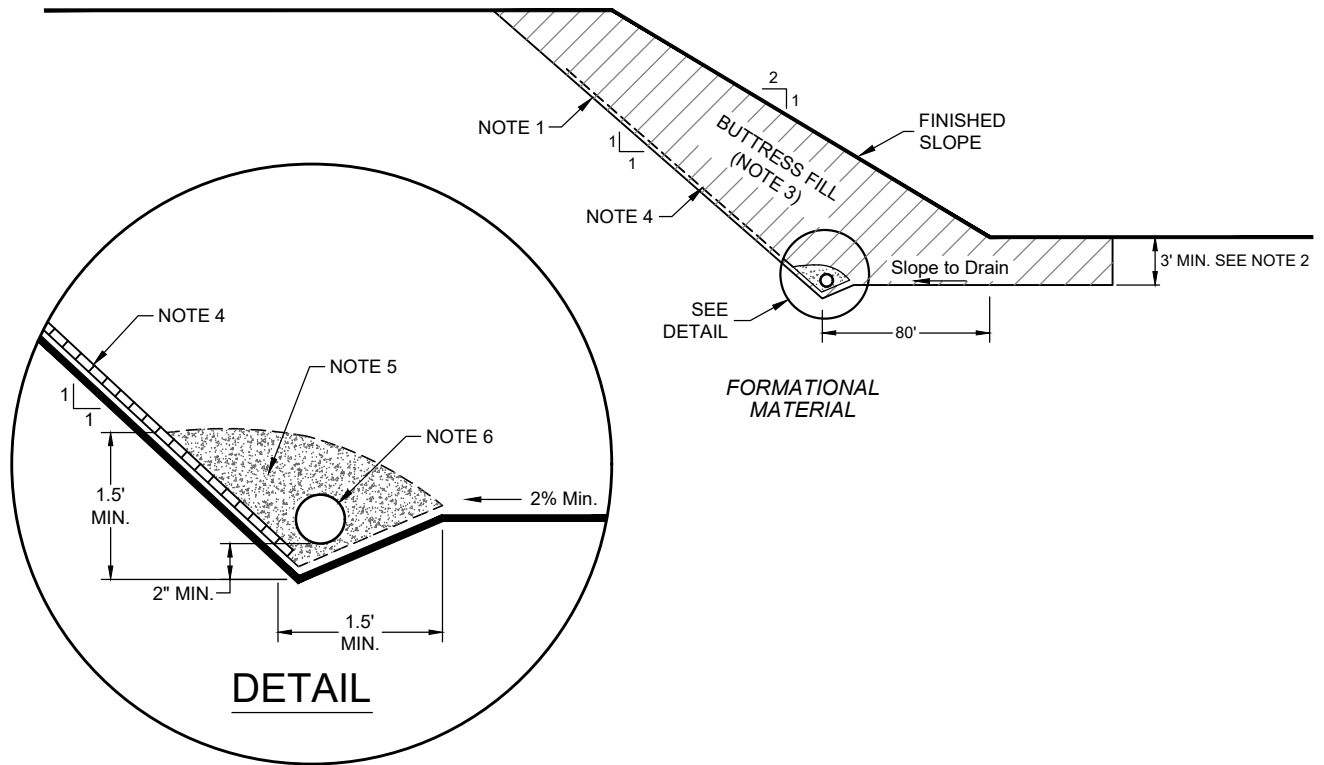

NOTES:

- 1....EXCAVATE BACKCUT AT 1:1 INCLINATION (UNLESS OTHERWISE NOTED).
- 2....BASE OF BUTTRESS TO BE 3 FEET INTO FORMATIONAL MATERIAL, SLOPING A MINIMUM 5% INTO SLOPE.
- 3....BUTTRESS FILL TO BE COMPOSED OF PROPERLY COMPACTED GRANULAR SOIL.
- 4....CHIMNEY DRAINS TO BE APPROVED PREFABRICATED CHIMNEY DRAIN PANELS (MIRADRAIN G200N OR EQUIVALENT) SPACED APPROXIMATELY 10 FEET CENTER TO CENTER AND 4 FEET WIDE. CLOSER SPACING MAY BE REQUIRED IF SEEPAGE IS ENCOUNTERED.
- 5....FILTER MATERIAL TO BE 3/4-INCH, OPEN-GRADED CRUSHED ROCK ENCLOSED IN APPROVED FILTER FABRIC (MIRAFI 140NC).
- 6....COLLECTOR PIPE TO BE 4-INCH MINIMUM DIAMETER, PERFORATED, THICK-WALLED PVC SCHEDULE 40 OR EQUIVALENT, AND SLOPED TO DRAIN AT 1 PERCENT MINIMUM TO APPROVED OUTLET.

TYPICAL BUTTRESS FILL DETAIL

GEOCON
INCORPORATED



GEOTECHNICAL ■ ENVIRONMENTAL ■ MATERIALS
6960 FLANDERS DRIVE - SAN DIEGO, CALIFORNIA 92121 - 2974
PHONE 858 558-6900 - FAX 858 558-6159

PIRAEUS POINT
ENCINITAS, CALIFORNIA

TM / RA

DSK/GTYPD

DATE 01 - 31 - 2022

PROJECT NO. G2307 - 32 - 05

FIG. 6

APPENDIX

A

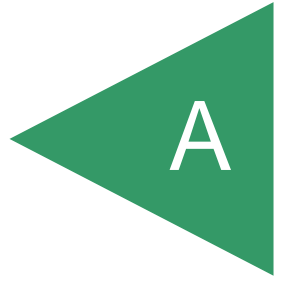

APPENDIX A

FIELD INVESTIGATION

We performed a preliminary field investigation on May 6 through 9, 2019. The preliminary investigation consisted of the excavation of three small-diameter borings drilled by Baja Exploration and four large-diameter borings by Dave's Drilling. The small diameter borings were excavated to a maximum depth of 56½ feet using a CME 75 rubber-tire drill rig equipped with 8-inch diameter hollow stem augers. The large diameter borings were excavated to a maximum depth of 84 feet with a truck-mounted drill rig equipped with a 30-inch diameter bucket-auger.

Our recent field investigation on December 17, 2021, consisted of excavating three additional borings by North County Drilling using an Ingersoll Rand A-300 truck-mounted drill rig equipped with 8-inch-diameter hollow-stem augers. The approximate locations of the excavations are shown on the Geologic Map, Figure 2. We located the exploratory borings in the field using a measuring tape and/or existing landmarks; therefore, actual boring locations may vary slightly.

We obtained samples during our boring excavations using either a California sampler or a Standard Penetration Test (SPT) sampler. Both samplers are composed of steel and driven to obtain relatively undisturbed soil samples. The California sampler has an inside diameter of 2.5 inches and an outside diameter of 2.875 inches. Up to 18 rings are placed inside the sampler that is 2.4 inches in diameter and 1 inch in height. The SPT sampler has an inside diameter of 1.5 inches and an outside diameter of 2 inches. We obtained ring samples at appropriate intervals were retained in moisture-tight containers and transported to the laboratory for testing. The type of sample is noted on the exploratory boring logs.

The samplers were driven 12 inches and 18 inches for California sampler and SPT sampler, respectively, with the use of an automatic hammer and the use of A rods. The sampler is connected to the A rods and driven into the bottom of the excavation using a 140-pound hammer with a 30-inch drop. Blow counts are recorded for every 6 inches the sampler is driven. The penetration resistances shown on the boring logs are shown in terms of blows per foot. The values indicated on the boring logs are the sum of the last 12 inches of the sampler if driven 12 inches. If the sampler was not driven for 12 inches, an approximate value is calculated in term of blows per foot or the final 6-inch interval is reported. These values are not to be taken as N-values, adjustments have not been applied.

The large-diameter boring sampler was driven up to 12 inches into the bottom of the excavation with the use of a telescoping Kelly bar. The weight of the Kelly bar (4,500 pounds maximum) drives the sampler and varies in weight with depth. The height of drop is usually 12 inches. Blow counts are recorded for every 12 inches the sampler is driven. The penetration resistance values on the boring

logs are shown in terms of blows per foot. These values are not to be taken as N-values and adjustments have not been applied.

We visually examined, classified and logged the soil conditions encountered in the excavations in general accordance with the Unified Soil Classification System (USCS). Logs of the exploratory borings are presented on Figures A-1 through A-10. The logs depict the general soil and geologic conditions encountered and the depth at which samples were obtained.

DEPTH IN FEET	SAMPLE NO.	LITHOLOGY	GROUNDWATER	SOIL CLASS (USCS)	BORING B 1		PENETRATION RESISTANCE (BLOWS/FT.)	DRY DENSITY (P.C.F.)	MOISTURE CONTENT (%)	
					ELEV. (MSL.) <u>107'</u>	DATE COMPLETED <u>12/17/2021</u>				
					EQUIPMENT <u>IR A-300</u>		BY: <u>D. GITHENS</u>			
MATERIAL DESCRIPTION										
0				SM	PREVIOUSLY PLACED FILL (Qpf) Medium dense, moist, brown, Silty, fine to coarse SAND -Becomes damp					
2	B1-1						80/11"	116.1	3.8	
4										
6										
8										
10	B1-2				-Chunks of gray siltstone present	33	109.0	12.2		
12										
14										
16	B1-3				-Becomes very dense	52	115.0	5.4		
18				SC/SM	ALLUVIUM (Qal) Medium dense, moist, dark brown/reddish brown, Clayey to Silty, fine to coarse SAND					
20	B1-4						18	113.5	14.7	
22										
24										
26	B1-5						33	114.2	14.8	
28										
30	B1-6					82/11.5"	111.0	8.7		
32	B1-7					30				
34										

Figure A-1,
Log of Boring B 1, Page 1 of 2

G2307-32-05.GPJ

SAMPLE SYMBOLS		... SAMPLING UNSUCCESSFUL		... STANDARD PENETRATION TEST		... DRIVE SAMPLE (UNDISTURBED)
		... DISTURBED OR BAG SAMPLE		... CHUNK SAMPLE		... WATER TABLE OR ... SEEPAGE

NOTE: THE LOG OF SUBSURFACE CONDITIONS SHOWN HEREON APPLIES ONLY AT THE SPECIFIC BORING OR TRENCH LOCATION AND AT THE DATE INDICATED. IT IS NOT WARRANTED TO BE REPRESENTATIVE OF SUBSURFACE CONDITIONS AT OTHER LOCATIONS AND TIMES.

DEPTH IN FEET	SAMPLE NO.	LITHOLOGY	GROUNDWATER	SOIL CLASS (USCS)	BORING B 1		PENETRATION RESISTANCE (BLOWS/FT.)	DRY DENSITY (P.C.F.)	MOISTURE CONTENT (%)				
					ELEV. (MSL.) <u>107'</u>	DATE COMPLETED <u>12/17/2021</u>							
					EQUIPMENT <u>IR A-300</u>		BY: <u>D. GITHENS</u>						
MATERIAL DESCRIPTION													
36	B1-8 B1-9				-Seepage encountered at 39 feet		35	104.3	20.6				
38										26			
40	B1-10 B1-11									49	108.8	5.4	
42										36			
44													
46	B1-12 B1-13									50	113.3	15.3	
48										31			
50	B1-14 B1-15									31	107.1	20.0	
52										28			
						BORING TERMINATED AT 52.5 FEET Backfilled with bentonite Seepage encountered at 39 feet							

Figure A-1,
Log of Boring B 1, Page 2 of 2

G2307-32-05.GPJ







SAMPLE SYMBOLS	... SAMPLING UNSUCCESSFUL	... STANDARD PENETRATION TEST	... DRIVE SAMPLE (UNDISTURBED)
	... DISTURBED OR BAG SAMPLE	... CHUNK SAMPLE	... WATER TABLE OR ... SEEPAGE

NOTE: THE LOG OF SUBSURFACE CONDITIONS SHOWN HEREON APPLIES ONLY AT THE SPECIFIC BORING OR TRENCH LOCATION AND AT THE DATE INDICATED. IT IS NOT WARRANTED TO BE REPRESENTATIVE OF SUBSURFACE CONDITIONS AT OTHER LOCATIONS AND TIMES.

DEPTH IN FEET	SAMPLE NO.	LITHOLOGY	GROUNDWATER	SOIL CLASS (USCS)	BORING B 2		PENETRATION RESISTANCE (BLOWS/FT.)	DRY DENSITY (P.C.F.)	MOISTURE CONTENT (%)
					ELEV. (MSL.) <u>109'</u>	DATE COMPLETED <u>12/17/2021</u>			
					EQUIPMENT <u>IR A-300</u>		BY: <u>D. GITHENS</u>		
MATERIAL DESCRIPTION									
0				SM	PREVIOUSLY PLACED FILL (Qpf) Loose to medium dense, moist, yellow to brown, Clayey, fine to coarse SAND; trace gravel				
2									
4									
6	B2-1				-Becomes damp with chunks of gray siltstone	50/5.5"	114.1	9.8	
8									
10	B2-2				-Siltstone chunk in shoe	82	108.2	4.2	
12									
14									
16	B2-3				-Becomes moist	63	112.7	15.2	
18				SC/SM	-Contact at 17 feet based on drilling efficiency				
20	B2-4				ALLUVIUM (Qal) Medium dense, moist, dark brown, Clayey to Silty, fine to medium SAND; mottled white	42	112.9	9.6	
22									
24									
26	B2-5				-Medium dense, dark brown, fine to medium sand; trace fines	44	107.3	4.7	
28									
30	B2-6				-Becomes dense	63	120.0	12.5	
32	B2-7					39			
34									

Figure A-2,
Log of Boring B 2, Page 1 of 2

G2307-32-05.GPJ

SAMPLE SYMBOLS	 ... SAMPLING UNSUCCESSFUL	 ... STANDARD PENETRATION TEST	 ... DRIVE SAMPLE (UNDISTURBED)
	 ... DISTURBED OR BAG SAMPLE	 ... CHUNK SAMPLE	 ... WATER TABLE OR  ... SEEPAGE

NOTE: THE LOG OF SUBSURFACE CONDITIONS SHOWN HEREON APPLIES ONLY AT THE SPECIFIC BORING OR TRENCH LOCATION AND AT THE DATE INDICATED. IT IS NOT WARRANTED TO BE REPRESENTATIVE OF SUBSURFACE CONDITIONS AT OTHER LOCATIONS AND TIMES.

DEPTH IN FEET	SAMPLE NO.	LITHOLOGY	GROUNDWATER	SOIL CLASS (USCS)	BORING B 2		PENETRATION RESISTANCE (BLOWS/FT.)	DRY DENSITY (P.C.F.)	MOISTURE CONTENT (%)
					ELEV. (MSL.) <u>109'</u>	DATE COMPLETED <u>12/17/2021</u>			
					EQUIPMENT <u>IR A-300</u>		BY: <u>D. GITHENS</u>		
MATERIAL DESCRIPTION									
36	B2-8 B2-9						71/10"	122.1	12.6
38							39		
40	B2-10 B2-11					-Becomes medium dense	36	115.3	15.4
42							29		
44			▽			-Seepage encountered at 43 feet			
46	B2-12 B2-13						34	118.4	14.5
48							16		
50	B2-14						41	106.2	19.5
52	B2-15			SM		SANTIAGO FORMATION (Tsa) Very dense, saturated, light yellow to gray brown, Silty, fine grained SANDSTONE	71/11"		
					BORING TERMINATED AT 52.5 FEET Backfilled with bentonite Seepage encountered at 43 feet				

Figure A-2,
Log of Boring B 2, Page 2 of 2

G2307-32-05.GPJ







SAMPLE SYMBOLS		
	... SAMPLING UNSUCCESSFUL	
	... DISTURBED OR BAG SAMPLE	
	... STANDARD PENETRATION TEST	
	... CHUNK SAMPLE	
		... WATER TABLE OR ... SEEPAGE

NOTE: THE LOG OF SUBSURFACE CONDITIONS SHOWN HEREON APPLIES ONLY AT THE SPECIFIC BORING OR TRENCH LOCATION AND AT THE DATE INDICATED. IT IS NOT WARRANTED TO BE REPRESENTATIVE OF SUBSURFACE CONDITIONS AT OTHER LOCATIONS AND TIMES.

DEPTH IN FEET	SAMPLE NO.	LITHOLOGY	GROUNDWATER	SOIL CLASS (USCS)	BORING B 3		PENETRATION RESISTANCE (BLOWS/FT.)	DRY DENSITY (P.C.F.)	MOISTURE CONTENT (%)
					ELEV. (MSL.) <u>113'</u>	DATE COMPLETED <u>12/17/2021</u>			
					EQUIPMENT <u>IR A-300</u>		BY: <u>D. GITHENS</u>		
MATERIAL DESCRIPTION									
0				SC	PREVIOUSLY PLACED FILL (Qpf) Medium dense, moist, yellow to gray brown, Clayey, fine to coarse SAND with trace gravel				
2									
4	B3-1						50/5.5"	117.2	10.1
6									
8									
10	B3-2				-Chunks of gray siltstone present		63	114.1	11.1
12									
14									
16	B3-3			SC	ALLUVIUM (Qal) Medium dense, damp, dark brown, Clayey, fine to medium SAND		36	119.5	10.9
18									
20	B3-4						38	112.9	10.7
22									
24									
26	B3-5				-Becomes moist below 26 feet		35	117.6	10.2
28									
30	B3-6						45	112.5	17.3
32	B3-7						27		
34									

Figure A-3,
Log of Boring B 3, Page 1 of 2

G2307-32-05.GPJ

SAMPLE SYMBOLS	 ... SAMPLING UNSUCCESSFUL	 ... STANDARD PENETRATION TEST	 ... DRIVE SAMPLE (UNDISTURBED)
	 ... DISTURBED OR BAG SAMPLE	 ... CHUNK SAMPLE	 ... WATER TABLE OR  ... SEEPAGE

NOTE: THE LOG OF SUBSURFACE CONDITIONS SHOWN HEREON APPLIES ONLY AT THE SPECIFIC BORING OR TRENCH LOCATION AND AT THE DATE INDICATED. IT IS NOT WARRANTED TO BE REPRESENTATIVE OF SUBSURFACE CONDITIONS AT OTHER LOCATIONS AND TIMES.









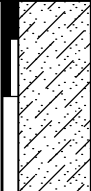

DEPTH IN FEET	SAMPLE NO.	LITHOLOGY	GROUNDWATER	SOIL CLASS (USCS)	BORING B 3		PENETRATION RESISTANCE (BLOWS/FT.)	DRY DENSITY (P.C.F.)	MOISTURE CONTENT (%)
					ELEV. (MSL.) <u>113'</u>	DATE COMPLETED <u>12/17/2021</u>			
					EQUIPMENT <u>IR A-300</u>		BY: <u>D. GITHENS</u>		
MATERIAL DESCRIPTION									
36	B3-8 B3-9			SC	-Becomes wet		35 26	114.5	14.6
38					-Seepage encountered at 38 feet				
40	B3-10 B3-11			SM	SANTIAGO FORMATION (Tsa) Dense, wet, yellow brown, Silty, fine grained SANDSTONE		39 53	105.9	20.1
44									
46	B3-12						50/6"	113.3	15.7
					BORING TERMINATED AT 46 FEET Backfilled with bentonite Seepage encountered at 38 feet				

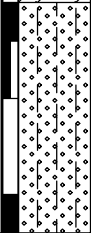
Figure A-3,
Log of Boring B 3, Page 2 of 2

G2307-32-05.GPJ







SAMPLE SYMBOLS	 ... SAMPLING UNSUCCESSFUL	 ... STANDARD PENETRATION TEST	 ... DRIVE SAMPLE (UNDISTURBED)
	 ... DISTURBED OR BAG SAMPLE	 ... CHUNK SAMPLE	 ... WATER TABLE OR  ... SEEPAGE

NOTE: THE LOG OF SUBSURFACE CONDITIONS SHOWN HEREON APPLIES ONLY AT THE SPECIFIC BORING OR TRENCH LOCATION AND AT THE DATE INDICATED. IT IS NOT WARRANTED TO BE REPRESENTATIVE OF SUBSURFACE CONDITIONS AT OTHER LOCATIONS AND TIMES.

DEPTH IN FEET	SAMPLE NO.	LITHOLOGY	GROUNDWATER	SOIL CLASS (USCS)	BORING LB 1		PENETRATION RESISTANCE (BLOWS/FT.)	DRY DENSITY (P.C.F.)	MOISTURE CONTENT (%)
					ELEV. (MSL.) <u>156'</u>	DATE COMPLETED <u>05-06-2019</u>			
					EQUIPMENT <u>EZ BORE E-120</u> BY: <u>K. HAASE</u>				
					MATERIAL DESCRIPTION				
0				SM	VERY OLD PARALIC DEPOSITS (Qvop₁₃) Medium dense, damp to moist, reddish brown, Silty, fine to coarse SAND				
2					-Upper 3 feet weathered				
4					-Becomes very dense		10/8"	124.9	5.4
6	LB1-1				-Becomes fine- to medium-grained				
8	LB1-2								
10	LB1-3				-Becomes moist		6	117.7	8.6
12					-Cobble up to 5 inches				
14									
16	LB1-4			SM	Dense, moist, brown to yellowish brown, Silty, fine to coarse SAND		8/8"	116.3	10.1
18	LB1-5				-Cobble up to 8 inches				
20	LB1-6			SM	-Erosional, undulatory contact				
22	LB1-7				SANTIAGO FORMATION (Tsa) Dense to very dense, moist, olive to yellowish brown, Silty, fine- to coarse-grained SANDSTONE; massive and very weakly laminated single undulatory sub vertical sand filled fracture 1/8"-1/4" wide, fracture is completely filled, trace claystone rip up clasts; rounded less than 3/4"		5		
24					-Oxidation				
26	LB1-8			CL	-Bioturbated contact Hard, moist, grayish olive, CLAYSTONE; oxidation				
28									
30	LB1-9				- BEDDING PLANE SHEAR at 30' ; 1/4" thick soft plastic clay gouge remolded, flat, moderately polished bounding surface with weak strike continuous around hole 1° at N30W DDD		8	107.5	20.3
32					-Few, close, iron stained fractures, sub vertical with N_S strike with 1/16" gypsum filling				
34					-Few gypsum veins sub-parallel to bedding				

Figure A-4,
Log of Boring LB 1, Page 1 of 2

G2307-32-05.GPJ

SAMPLE SYMBOLS		... SAMPLING UNSUCCESSFUL		... STANDARD PENETRATION TEST		... DRIVE SAMPLE (UNDISTURBED)
		... DISTURBED OR BAG SAMPLE		... CHUNK SAMPLE		... WATER TABLE OR  ... SEEPAGE

NOTE: THE LOG OF SUBSURFACE CONDITIONS SHOWN HEREON APPLIES ONLY AT THE SPECIFIC BORING OR TRENCH LOCATION AND AT THE DATE INDICATED. IT IS NOT WARRANTED TO BE REPRESENTATIVE OF SUBSURFACE CONDITIONS AT OTHER LOCATIONS AND TIMES.

DEPTH IN FEET	SAMPLE NO.	LITHOLOGY	GROUNDWATER	SOIL CLASS (USCS)	BORING LB 1		PENETRATION RESISTANCE (BLOWS/FT.)	DRY DENSITY (P.C.F.)	MOISTURE CONTENT (%)
					ELEV. (MSL.) <u>156'</u>	DATE COMPLETED <u>05-06-2019</u>			
					EQUIPMENT <u>EZ BORE E-120</u>		BY: <u>K. HAASE</u>		
MATERIAL DESCRIPTION									
36	LB1-10						10/10"	100.8	23.1
38	LB1-11								
40	LB1-12					-Open fractures 1/8"-1/4", moderate to heavy seepage	8/10"		
42									
44						-BEDDING PLANE SHEAR at 43'; 1/4"-1/2" thick, bluish-gray remolded clay gouge, soft plastic, continuous around hole			
46	LB1-13 LB1-14			SM		-BEDDING PLANE SHEAR at 44.5'; 1/2"-2" thick, bluish-gray and brown, fully remolded plastic clay gouge; soft, internally sheared with numerous polished parting surfaces	15/6"		
48				SP		Dense to very dense, wet, bluish-gray, Silty, fine- to medium-grained SANDSTONE; laminated			
50						Very dense, wet, reddish brown and gray, fine- to coarse-grained SANDSTONE; cross bedded, gunbarrel			
52									
54									
56						-End of log due to standing water			
58						BORING TERMINATED AT 58 FEET Seepage encountered at 40.5 feet Backfilled with bentonite chips and soil			

Figure A-4,
Log of Boring LB 1, Page 2 of 2

G2307-32-05.GPJ

SAMPLE SYMBOLS		... SAMPLING UNSUCCESSFUL		... STANDARD PENETRATION TEST		... DRIVE SAMPLE (UNDISTURBED)
		... DISTURBED OR BAG SAMPLE		... CHUNK SAMPLE		... WATER TABLE OR ... SEEPAGE

NOTE: THE LOG OF SUBSURFACE CONDITIONS SHOWN HEREON APPLIES ONLY AT THE SPECIFIC BORING OR TRENCH LOCATION AND AT THE DATE INDICATED. IT IS NOT WARRANTED TO BE REPRESENTATIVE OF SUBSURFACE CONDITIONS AT OTHER LOCATIONS AND TIMES.

DEPTH IN FEET	SAMPLE NO.	LITHOLOGY	GROUNDWATER	SOIL CLASS (USCS)	BORING LB 2		PENETRATION RESISTANCE (BLOWS/FT.)	DRY DENSITY (P.C.F.)	MOISTURE CONTENT (%)	
					ELEV. (MSL.) <u>174'</u>	DATE COMPLETED <u>05-07-2019</u>				
					EQUIPMENT <u>EZ BORE E-120</u>		BY: <u>K. HAASE</u>			
MATERIAL DESCRIPTION										
0				SM/SC	VERY OLD PARALIC DEPOSITS (Qvop₁₃) Medium dense to dense, moist, Silty to Clayey, fine to coarse SAND					
2										
4						-Upper 3 feet weathered				
6						-Vertical fractions, 1/4"-3" wide; completely sand filled with roots				
8										
10										
12										
14					SM	Dense, moist, brown to yellowish brown, Silty, fine to coarse SAND				
16						-Lenses of yellowish brown, fine to coarse sand				
18										
20						-Less cohesion				
22										
24					SP	Dense, damp, light brown, fine- to medium-grained SANDSTONE; oxidized and micaceous planer laminate				
26						-Belling of hole, logged cuttings only below				
28										
30					SM	Medium dense, damp, yellowish brown, Silty, fine to coarse SANDSTONE; cobble up to 8"				
32				SP	SANTIAGO FORMATION (Tsa) Dense to very dense, moist, yellowish brown, fine- to coarse-grained SANDSTONE					
34										

Figure A-5,
Log of Boring LB 2, Page 1 of 3

G2307-32-05.GPJ

SAMPLE SYMBOLS		... SAMPLING UNSUCCESSFUL		... STANDARD PENETRATION TEST		... DRIVE SAMPLE (UNDISTURBED)
		... DISTURBED OR BAG SAMPLE		... CHUNK SAMPLE		... WATER TABLE OR ... SEEPAGE

NOTE: THE LOG OF SUBSURFACE CONDITIONS SHOWN HEREON APPLIES ONLY AT THE SPECIFIC BORING OR TRENCH LOCATION AND AT THE DATE INDICATED. IT IS NOT WARRANTED TO BE REPRESENTATIVE OF SUBSURFACE CONDITIONS AT OTHER LOCATIONS AND TIMES.

DEPTH IN FEET	SAMPLE NO.	LITHOLOGY	GROUNDWATER	SOIL CLASS (USCS)	BORING LB 2		PENETRATION RESISTANCE (BLOWS/FT.)	DRY DENSITY (P.C.F.)	MOISTURE CONTENT (%)
					ELEV. (MSL.) <u>174'</u>	DATE COMPLETED <u>05-07-2019</u>			
					EQUIPMENT <u>EZ BORE E-120</u>		BY: <u>K. HAASE</u>		
MATERIAL DESCRIPTION									
36									
38									
40				ML/CL	Very stiff to hard, moist, bluish gray, SILTSTONE to CLAYSTONE; oxidized in areas				
42									
44									
46									
48									
50									
52									
54									
56	LB2-1				-BEDDING PLANE SHEAR observed in cuttings at 57'				
58									
60									
62									
64				SP	Very dense, damp to moist, light yellowish brown, fine- to coarse-grained SANDSTONE; cobble up to 6 inches				
66									
68									

Figure A-5,
Log of Boring LB 2, Page 2 of 3

G2307-32-05.GPJ







SAMPLE SYMBOLS		... SAMPLING UNSUCCESSFUL		... STANDARD PENETRATION TEST		... DRIVE SAMPLE (UNDISTURBED)
		... DISTURBED OR BAG SAMPLE		... CHUNK SAMPLE		... WATER TABLE OR ... SEEPAGE

NOTE: THE LOG OF SUBSURFACE CONDITIONS SHOWN HEREON APPLIES ONLY AT THE SPECIFIC BORING OR TRENCH LOCATION AND AT THE DATE INDICATED. IT IS NOT WARRANTED TO BE REPRESENTATIVE OF SUBSURFACE CONDITIONS AT OTHER LOCATIONS AND TIMES.

DEPTH IN FEET	SAMPLE NO.	LITHOLOGY	GROUNDWATER	SOIL CLASS (USCS)	BORING LB 2		PENETRATION RESISTANCE (BLOWS/FT.)	DRY DENSITY (P.C.F.)	MOISTURE CONTENT (%)
					ELEV. (MSL.) <u>174'</u>	DATE COMPLETED <u>05-07-2019</u>			
					EQUIPMENT <u>EZ BORE E-120</u>		BY: <u>K. HAASE</u>		
MATERIAL DESCRIPTION									
70		[Patterned Box]							
72									
74									
76									
78									
80									
82									
84					BORING TERMINATED AT 84 FEET Groundwater/seepage not encountered Backfilled with bentonite chips and soil				

Figure A-5,
Log of Boring LB 2, Page 3 of 3

G2307-32-05.GPJ







SAMPLE SYMBOLS	 ... SAMPLING UNSUCCESSFUL	 ... STANDARD PENETRATION TEST	 ... DRIVE SAMPLE (UNDISTURBED)
	 ... DISTURBED OR BAG SAMPLE	 ... CHUNK SAMPLE	 ... WATER TABLE OR  ... SEEPAGE

NOTE: THE LOG OF SUBSURFACE CONDITIONS SHOWN HEREON APPLIES ONLY AT THE SPECIFIC BORING OR TRENCH LOCATION AND AT THE DATE INDICATED. IT IS NOT WARRANTED TO BE REPRESENTATIVE OF SUBSURFACE CONDITIONS AT OTHER LOCATIONS AND TIMES.

DEPTH IN FEET	SAMPLE NO.	LITHOLOGY	GROUNDWATER	SOIL CLASS (USCS)	BORING LB 3		PENETRATION RESISTANCE (BLOWS/FT.)	DRY DENSITY (P.C.F.)	MOISTURE CONTENT (%)
					ELEV. (MSL.) <u>176'</u>	DATE COMPLETED <u>05-08-2019</u>			
					EQUIPMENT <u>EZ BORE E-120</u>		BY: <u>K. HAASE</u>		
MATERIAL DESCRIPTION									
0				SM	VERY OLD PARALIC DEPOSITS (Q_{vop13}) Loose to medium dense, dry to damp, Silty, fine- to medium-grained SAND				
2									
4	LB3-1			SC	-Upper 3 feet weathered -Vertical fractures, 1/2" to 3" wide, sand infilled Medium dense, moist, reddish brown, Clayey, fine to medium SAND		3		
6									
8					Vertical fractures, 1/4" to 2 1/2" wide, sand infilled				
10					-Less fractures				
12					-Becomes dense				
14									
16	LB3-2			SP	Dense, moist, brown, fine to medium SAND		5	116.1	5.9
18									
20					-Yellowish brown, fine to coarse SAND lenses				
22									
24				SC	Dense, moist, reddish brown, Clayey, fine to coarse SAND				
26					-Dark brown, sandy clay rip-up clasts				
28									
30	LB3-3				-Cobble lag up to 8"		8	101.5	7.5
32				SP	SANTIAGO FORMATION (T_{sa}) Dense, moist, yellowish brown, fine- to coarse-grained SANDSTONE				
34					-Lamination, fine to coarse cross-bedding				

Figure A-6,
Log of Boring LB 3, Page 1 of 3

G2307-32-05.GPJ

SAMPLE SYMBOLS	 ... SAMPLING UNSUCCESSFUL	 ... STANDARD PENETRATION TEST	 ... DRIVE SAMPLE (UNDISTURBED)
	 ... DISTURBED OR BAG SAMPLE	 ... CHUNK SAMPLE	 ... WATER TABLE OR  ... SEEPAGE

NOTE: THE LOG OF SUBSURFACE CONDITIONS SHOWN HEREON APPLIES ONLY AT THE SPECIFIC BORING OR TRENCH LOCATION AND AT THE DATE INDICATED. IT IS NOT WARRANTED TO BE REPRESENTATIVE OF SUBSURFACE CONDITIONS AT OTHER LOCATIONS AND TIMES.

DEPTH IN FEET	SAMPLE NO.	LITHOLOGY	GROUNDWATER	SOIL CLASS (USCS)	BORING LB 3		PENETRATION RESISTANCE (BLOWS/FT.)	DRY DENSITY (P.C.F.)	MOISTURE CONTENT (%)
					ELEV. (MSL.) <u>176'</u>	DATE COMPLETED <u>05-08-2019</u>			
					EQUIPMENT <u>EZ BORE E-120</u>		BY: <u>K. HAASE</u>		
MATERIAL DESCRIPTION									
36	LB3-4			SM	Dense, moist, olive gray, Silty, fine- to coarse-grained SANDSTONE		8/10"	117.1	9.1
38									
40				SM	Very dense, moist, dark gray, Silty, fine- to coarse-grained SANDSTONE; mottled yellowish brown oxidation				
42									
44			▽	CL	-Low seepage along contact				
46	LB3-5				Hard, damp to moist, light bluish gray, CLAYSTONE		10		
48					-Vertical and horizontal fracturing, oxidized with gypsum in fill				
50	LB3-6						10/8"		
52					-Sub-vertical fractures controlled seepage				
54									
56									
58					-Weakly fissured claystone beds with discontinuous, poorly developed clay gouge; fissile polished parting surfaces in some areas (58'-59.5')				
60	LB3-7						10/8"	101.5	19.4
62	LB3-8								
64				SM	-BEDDING PLANE SHEAR at 62.5'; 1/2" to 1" thick, soft and stiff, gray, fully developed, plastic clay bed 2° at N10W DDD				
66					-BEDDING PLANE SHEAR at 63.3'; 1" to 1 1/4" thick, soft and stiff, gray, fully developed, moderately to fully remolded, plastic clay bed; numerous polished internal parting surfaces, 1° at N10W DDD				
68				SM	Very dense, moist, bluish gray, fine- to medium-grained SANDSTONE				
				SM	-Contact interbedded				
					Very dense, moist, olive to yellowish brown, Silty, fine- to medium-grained SANDSTONE				

Figure A-6,
Log of Boring LB 3, Page 2 of 3

G2307-32-05.GPJ

SAMPLE SYMBOLS		
	... SAMPLING UNSUCCESSFUL	
	... DISTURBED OR BAG SAMPLE	
	... STANDARD PENETRATION TEST	
	... CHUNK SAMPLE	
	... WATER TABLE OR	
	... SEEPAGE	

NOTE: THE LOG OF SUBSURFACE CONDITIONS SHOWN HEREON APPLIES ONLY AT THE SPECIFIC BORING OR TRENCH LOCATION AND AT THE DATE INDICATED. IT IS NOT WARRANTED TO BE REPRESENTATIVE OF SUBSURFACE CONDITIONS AT OTHER LOCATIONS AND TIMES.

DEPTH IN FEET	SAMPLE NO.	LITHOLOGY	GROUNDWATER	SOIL CLASS (USCS)	BORING LB 3		PENETRATION RESISTANCE (BLOWS/FT.)	DRY DENSITY (P.C.F.)	MOISTURE CONTENT (%)
					ELEV. (MSL.) <u>176'</u>	DATE COMPLETED <u>05-08-2019</u>			
					EQUIPMENT <u>EZ BORE E-120</u> BY: <u>K. HAASE</u>				
					MATERIAL DESCRIPTION				
70	LB3-9						10/4"		
72									
74						-Concretion			
76									
78									
80					-Becomes finer grained				
82									
84									
					BORING TERMINATED AT 84 FEET Seepage encountered at 44 feet Backfilled with bentonite chips and soil				

Figure A-6,
Log of Boring LB 3, Page 3 of 3

G2307-32-05.GPJ

SAMPLE SYMBOLS	... SAMPLING UNSUCCESSFUL	... STANDARD PENETRATION TEST	... DRIVE SAMPLE (UNDISTURBED)
	... DISTURBED OR BAG SAMPLE	... CHUNK SAMPLE	... WATER TABLE OR ... SEEPAGE

NOTE: THE LOG OF SUBSURFACE CONDITIONS SHOWN HEREON APPLIES ONLY AT THE SPECIFIC BORING OR TRENCH LOCATION AND AT THE DATE INDICATED. IT IS NOT WARRANTED TO BE REPRESENTATIVE OF SUBSURFACE CONDITIONS AT OTHER LOCATIONS AND TIMES.









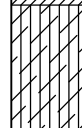

DEPTH IN FEET	SAMPLE NO.	LITHOLOGY	GROUNDWATER	SOIL CLASS (USCS)	BORING LB 4		PENETRATION RESISTANCE (BLOWS/FT.)	DRY DENSITY (P.C.F.)	MOISTURE CONTENT (%)	
					ELEV. (MSL.) <u>154'</u>	DATE COMPLETED <u>05-09-2019</u>				
					EQUIPMENT <u>EZ BORE E-120</u>		BY: <u>R. ADAMS</u>			
MATERIAL DESCRIPTION										
0				SC	<p>VERY OLD PARALIC DEPOSITS (Qvop₁₃) Dense, damp to moist, reddish brown to dark brown, Clayey, fine to coarse SAND; massive to very weakly bedded, few brown paleosol horizons</p> <p>-Upper 3 feet weathered</p>					
2										
4										
6										
8										
10										
12					SC	<p>-Paleosol, 2"-6" thick, reddish to dark brown sand with trace silt</p> <p>Medium dense to dense, moist, brown to reddish brown, Clayey, fine to coarse SAND; gravel and cobble up to 6 inches</p>				
14					SM	<p>SANTIAGO FORMATION (Tsa) Dense to very dense, damp, grayish to yellowish brown, Silty, fine- to coarse-grained SANDSTONE; massive to very weakly laminated, some cross bedding, few sand filled fractures extending down from contact, narrowing with increasing depth</p> <p>-Coarse grained</p> <p>-Mottled</p>				
16										
18										
20										
22										
24										
26					CL	<p>-Sharp, bioturbated contact</p> <p>Stiff to very stiff, damp, bluish gray to mottled orangish gray, CLAYSTONE; interbedded siltstone, oxidated laminae, short closed fractures</p>				
28										
30										
32					ML	<p>Stiff to hard, damp, gray to grayish brown, Clayey, SILTSTONE; massive, occasional closed fracture</p>				
34										

Figure A-7,
Log of Boring LB 4, Page 1 of 2

G2307-32-05.GPJ







SAMPLE SYMBOLS		... SAMPLING UNSUCCESSFUL		... STANDARD PENETRATION TEST		... DRIVE SAMPLE (UNDISTURBED)
		... DISTURBED OR BAG SAMPLE		... CHUNK SAMPLE		... WATER TABLE OR  ... SEEPAGE

NOTE: THE LOG OF SUBSURFACE CONDITIONS SHOWN HEREON APPLIES ONLY AT THE SPECIFIC BORING OR TRENCH LOCATION AND AT THE DATE INDICATED. IT IS NOT WARRANTED TO BE REPRESENTATIVE OF SUBSURFACE CONDITIONS AT OTHER LOCATIONS AND TIMES.

DEPTH IN FEET	SAMPLE NO.	LITHOLOGY	GROUNDWATER	SOIL CLASS (USCS)	BORING LB 4		PENETRATION RESISTANCE (BLOWS/FT.)	DRY DENSITY (P.C.F.)	MOISTURE CONTENT (%)
					ELEV. (MSL.) <u>154'</u>	DATE COMPLETED <u>05-09-2019</u>			
					EQUIPMENT <u>EZ BORE E-120</u>		BY: <u>R. ADAMS</u>		
MATERIAL DESCRIPTION									
36									
38				CL	-Transitional contact Stiff to hard, moist, bluish gray, CLAYSTONE; very weakly fissured, oxidized laminae, little seepage, few closed fractures, few thin, 1/8" thick, gypsum veins parallel to bedding				
40			▽						
42									
44				SM	-BEDDING PLANE SHEAR at 42.9'; 3/4" to 1" thick, gray, weak to moderately remolded, soft to very soft, plastic clay gouge; increase fissuring above shear				
46					-BEDDING PLANE SHEAR at 43.9'; 1 1/2" thick, grayish brown, weakly remolded, fully developed, soft plastic, clay bed, internally sheared with numerous parting surfaces, 1° N63W DDD				
48				SP	Very dense, damp, bluish gray, Silty, medium- to coarse-grained SANDSTONE				
50					-1/4" TO 1/2" sub-horizontal fractures with seepage; 40% TO 60% gypsum filled				
52					Very dense, damp, yellowish gray, medium- to coarse-grained SANDSTONE; very weakly laminated				
54					-Concretion bed				
56									
58									
60					BORING TERMINATED AT 60 FEET Seepage encountered at 40 feet Backfilled with bentonite chips and soil				

Figure A-7,
Log of Boring LB 4, Page 2 of 2

G2307-32-05.GPJ

SAMPLE SYMBOLS	 ... SAMPLING UNSUCCESSFUL	 ... STANDARD PENETRATION TEST	 ... DRIVE SAMPLE (UNDISTURBED)
	 ... DISTURBED OR BAG SAMPLE	 ... CHUNK SAMPLE	 ... WATER TABLE OR  ... SEEPAGE

NOTE: THE LOG OF SUBSURFACE CONDITIONS SHOWN HEREON APPLIES ONLY AT THE SPECIFIC BORING OR TRENCH LOCATION AND AT THE DATE INDICATED. IT IS NOT WARRANTED TO BE REPRESENTATIVE OF SUBSURFACE CONDITIONS AT OTHER LOCATIONS AND TIMES.

DEPTH IN FEET	SAMPLE NO.	LITHOLOGY	GROUNDWATER	SOIL CLASS (USCS)	BORING SB 1		PENETRATION RESISTANCE (BLOWS/FT.)	DRY DENSITY (P.C.F.)	MOISTURE CONTENT (%)	
					ELEV. (MSL.) <u>115'</u>	DATE COMPLETED <u>05-08-2019</u>				
					EQUIPMENT <u>CME 75</u> BY: <u>L. RODRIGUEZ</u>					
					MATERIAL DESCRIPTION					
0	SB1-1			SC	PREVIOUSLY PLACED FILL (Qpf) Loose to medium dense, moist, yellowish to grayish brown, Clayey, fine to coarse SAND; trace gravel					
2						-Becomes medium dense				
4										
6	SB1-2							46	113.3	8.1
8							-Becomes damp; chunks of gray siltstone			
10	SB1-3									
12							-Becomes moist, dark brown			
14										
16	SB1-4			SC	ALLUVIUM (Qal) Loose, damp, dark yellowish brown, Clayey, fine to coarse SAND		16	123.0	6.5	
18										
20	SB1-5					Becomes medium dense; finer-grained				
22	SB1-6						18	106.1	5.3	
24										
26	SB1-7					-Becomes moist; clay content increases				
28										
30	SB1-8									
32										
34										

Figure A-8,
Log of Boring SB 1, Page 1 of 2

G2307-32-05.GPJ

SAMPLE SYMBOLS		... SAMPLING UNSUCCESSFUL		... STANDARD PENETRATION TEST		... DRIVE SAMPLE (UNDISTURBED)
		... DISTURBED OR BAG SAMPLE		... CHUNK SAMPLE		... WATER TABLE OR ... SEEPAGE

NOTE: THE LOG OF SUBSURFACE CONDITIONS SHOWN HEREON APPLIES ONLY AT THE SPECIFIC BORING OR TRENCH LOCATION AND AT THE DATE INDICATED. IT IS NOT WARRANTED TO BE REPRESENTATIVE OF SUBSURFACE CONDITIONS AT OTHER LOCATIONS AND TIMES.

DEPTH IN FEET	SAMPLE NO.	LITHOLOGY	GROUNDWATER	SOIL CLASS (USCS)	BORING SB 1		PENETRATION RESISTANCE (BLOWS/FT.)	DRY DENSITY (P.C.F.)	MOISTURE CONTENT (%)	
					ELEV. (MSL.) <u>115'</u>	DATE COMPLETED <u>05-08-2019</u>				
					EQUIPMENT <u>CME 75</u> BY: <u>L. RODRIGUEZ</u>					
					MATERIAL DESCRIPTION					
36	SB1-9		▽		Becomes loose, wet -Seepage encountered -Measured after leaving hole open for 15 min.		15	110.2	15.0	
38										
40	SB1-10							17		
42										
44										
46	SB1-11					16	109.6	20.5		
48										
50	SB1-12			SM	SANTIAGO FORMATION (Tsa) Very dense, damp, light yellowish to grayish brown, Silty, fine-grained SANDSTONE	80/10"				
52	SB1-13						50/5"			
					BORING TERMINATED AT 52.5 FEET Seepage encountered at 38 feet Backfilled with 18.3 ft ³ of bentonite grout					

Figure A-8,
Log of Boring SB 1, Page 2 of 2

G2307-32-05.GPJ

SAMPLE SYMBOLS	... SAMPLING UNSUCCESSFUL	... STANDARD PENETRATION TEST	... DRIVE SAMPLE (UNDISTURBED)
	... DISTURBED OR BAG SAMPLE	... CHUNK SAMPLE	... WATER TABLE OR ... SEEPAGE

NOTE: THE LOG OF SUBSURFACE CONDITIONS SHOWN HEREON APPLIES ONLY AT THE SPECIFIC BORING OR TRENCH LOCATION AND AT THE DATE INDICATED. IT IS NOT WARRANTED TO BE REPRESENTATIVE OF SUBSURFACE CONDITIONS AT OTHER LOCATIONS AND TIMES.

DEPTH IN FEET	SAMPLE NO.	LITHOLOGY	GROUNDWATER	SOIL CLASS (USCS)	BORING SB 2		PENETRATION RESISTANCE (BLOWS/FT.)	DRY DENSITY (P.C.F.)	MOISTURE CONTENT (%)	
					ELEV. (MSL.) <u>111'</u>	DATE COMPLETED <u>05-08-2019</u>				
					EQUIPMENT <u>CME 75</u> BY: <u>L. RODRIGUEZ</u>					
					MATERIAL DESCRIPTION					
0	SB2-1			SC	PREVIOUSLY PLACED FILL (Qpf) Loose to medium dense, moist, yellowish to grayish brown, Clayey, fine to coarse SAND; trace organics, trace gravel					
2										
4										
6	SB2-2					-Becomes dense; chunks of gray siltstone and sandstone		61	120.2	11.4
8										
10	SB2-3					-Becomes medium dense		32	112.4	16.4
12										
14										
16	SB2-4			SC/SW	ALLUVIUM (Qal) Medium dense, moist, dark yellowish brown, Clayey, fine to medium SAND to well-graded, fine to medium SAND		19	115.0	9.1	
18										
20	SB2-5			SC	Medium dense, moist, dark yellowish brown, Clayey, fine to medium SAND		22	115.2	10.0	
22										
24										
26	SB2-6						18	107.1	6.5	
28										
30	SB2-7						16	110.8	12.2	
32										
34										

Figure A-9,
Log of Boring SB 2, Page 1 of 2

G2307-32-05.GPJ

SAMPLE SYMBOLS		... SAMPLING UNSUCCESSFUL		... STANDARD PENETRATION TEST		... DRIVE SAMPLE (UNDISTURBED)
		... DISTURBED OR BAG SAMPLE		... CHUNK SAMPLE		... WATER TABLE OR ... SEEPAGE

NOTE: THE LOG OF SUBSURFACE CONDITIONS SHOWN HEREON APPLIES ONLY AT THE SPECIFIC BORING OR TRENCH LOCATION AND AT THE DATE INDICATED. IT IS NOT WARRANTED TO BE REPRESENTATIVE OF SUBSURFACE CONDITIONS AT OTHER LOCATIONS AND TIMES.

DEPTH IN FEET	SAMPLE NO.	LITHOLOGY	GROUNDWATER	SOIL CLASS (USCS)	BORING SB 2		PENETRATION RESISTANCE (BLOWS/FT.)	DRY DENSITY (P.C.F.)	MOISTURE CONTENT (%)
					ELEV. (MSL.) <u>111'</u>	DATE COMPLETED <u>05-08-2019</u>			
					EQUIPMENT <u>CME 75</u> BY: <u>L. RODRIGUEZ</u>				
					MATERIAL DESCRIPTION				
36	SB2-8			SM/SP	Medium dense, moist, dark yellowish brown, Silty, fine SAND to poorly-graded fine SAND		19	112.4	9.6
38									
40	SB2-9		▽	SC	Medium dense, saturated, yellowish brown, Clayey, fine SAND		18	115.4	17.0
42									
44									
46	SB2-10						18		
48									
50	SB2-11				-Becomes light reddish brown		24	114.5	19.5
52									
54									
56	SB2-12 SB2-13			SM	SANTIAGO FORMATION (Tsa) Very dense, damp, light yellowish brown to gray, Silty, fine-grained SANDSTONE		82/8" 50/6"		
					BORING TERMINATED AT 56.5 FEET Seepage encountered at 40 feet Backfilled with 19.7 ft³ of bentonite grout				

Figure A-9,
Log of Boring SB 2, Page 2 of 2

G2307-32-05.GPJ

SAMPLE SYMBOLS		... SAMPLING UNSUCCESSFUL		... STANDARD PENETRATION TEST		... DRIVE SAMPLE (UNDISTURBED)
		... DISTURBED OR BAG SAMPLE		... CHUNK SAMPLE		... WATER TABLE OR ... SEEPAGE

NOTE: THE LOG OF SUBSURFACE CONDITIONS SHOWN HEREON APPLIES ONLY AT THE SPECIFIC BORING OR TRENCH LOCATION AND AT THE DATE INDICATED. IT IS NOT WARRANTED TO BE REPRESENTATIVE OF SUBSURFACE CONDITIONS AT OTHER LOCATIONS AND TIMES.

DEPTH IN FEET	SAMPLE NO.	LITHOLOGY	GROUNDWATER	SOIL CLASS (USCS)	BORING SB 3		PENETRATION RESISTANCE (BLOWS/FT.)	DRY DENSITY (P.C.F.)	MOISTURE CONTENT (%)	
					ELEV. (MSL.) <u>107'</u>	DATE COMPLETED <u>05-08-2019</u>				
					EQUIPMENT <u>CME 75</u> BY: <u>L. RODRIGUEZ</u>					
					MATERIAL DESCRIPTION					
0	SB3-1			SM	<p>PREVIOUSLY PLACED FILL (Qpf) Loose to medium dense, damp, yellowish brown, Silty, fine to coarse SAND; trace organics; trace gravel -Becomes medium dense</p> <p>-Becomes dense, dark yellowish brown</p> <p>-Becomes medium dense, yellowish brown to gray</p>					
2										
4										
6	SB3-2							56	120.9	3.7
8										
10	SB3-3							25	110.8	9.3
12										
14										
16	SB3-4			SC/CL	<p>ALLUVIUM (Qal) Loose, moist, dark brown to yellowish brown, Clayey, fine to medium SAND to Sandy CLAY</p>	16	121.1	11.5		
18										
20	SB3-5			SC	<p>Loose, moist, dark brown, Clayey, fine to medium SAND</p> <p>-Becomes light yellowish brown; clay content increases</p>	14	116.1	9.4		
22										
24										
26										
28										
30	SB3-6					15	112.6	11.8		
32										
34										

Figure A-10,
Log of Boring SB 3, Page 1 of 2

G2307-32-05.GPJ

SAMPLE SYMBOLS	... SAMPLING UNSUCCESSFUL	... STANDARD PENETRATION TEST	... DRIVE SAMPLE (UNDISTURBED)
	... DISTURBED OR BAG SAMPLE	... CHUNK SAMPLE	... WATER TABLE OR ... SEEPAGE

NOTE: THE LOG OF SUBSURFACE CONDITIONS SHOWN HEREON APPLIES ONLY AT THE SPECIFIC BORING OR TRENCH LOCATION AND AT THE DATE INDICATED. IT IS NOT WARRANTED TO BE REPRESENTATIVE OF SUBSURFACE CONDITIONS AT OTHER LOCATIONS AND TIMES.

DEPTH IN FEET	SAMPLE NO.	LITHOLOGY	GROUNDWATER	SOIL CLASS (USCS)	BORING SB 3		PENETRATION RESISTANCE (BLOWS/FT.)	DRY DENSITY (P.C.F.)	MOISTURE CONTENT (%)	
					ELEV. (MSL.) <u>107'</u>	DATE COMPLETED <u>05-08-2019</u>				
					EQUIPMENT <u>CME 75</u>		BY: <u>L. RODRIGUEZ</u>			
MATERIAL DESCRIPTION										
36	SB3-7						17	109.8	14.4	
38										
40	SB3-8			SM	Loose, damp, light yellowish to grayish brown, Silty, fine SAND		14	97.8	5.7	
42										
44										
46	SB3-9			SC	Loose, moist, light yellowish to grayish brown, Clayey, fine SAND		13	96.0	14.4	
48										
50	SB3-10				-Seepage encountered -Becomes saturated		30			
52				SM	SANTIAGO FORMATION (Tsa) Very dense, moist, light yellowish to grayish brown, Silty, fine-grained SANDSTONE					
54										
	SB3-11						50/6"			
					BORING TERMINATED AT 55.5 FEET Seepage encountered at 49 feet Backfilled with 19.4 ft ³ of bentonite grout					

Figure A-10,
Log of Boring SB 3, Page 2 of 2

G2307-32-05.GPJ

SAMPLE SYMBOLS	... SAMPLING UNSUCCESSFUL	... STANDARD PENETRATION TEST	... DRIVE SAMPLE (UNDISTURBED)
	... DISTURBED OR BAG SAMPLE	... CHUNK SAMPLE	... WATER TABLE OR ... SEEPAGE

NOTE: THE LOG OF SUBSURFACE CONDITIONS SHOWN HEREON APPLIES ONLY AT THE SPECIFIC BORING OR TRENCH LOCATION AND AT THE DATE INDICATED. IT IS NOT WARRANTED TO BE REPRESENTATIVE OF SUBSURFACE CONDITIONS AT OTHER LOCATIONS AND TIMES.

APPENDIX

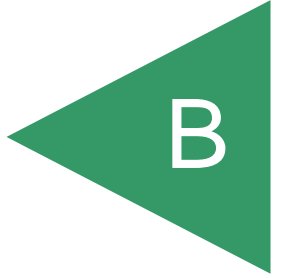

APPENDIX B

LABORATORY TESTING

We performed laboratory tests in accordance with generally accepted test methods of the American Society for Testing and Materials (ASTM) or other suggested procedures. We selected soil samples and tested them for their in-place dry density and moisture content, maximum dry density and optimum moisture content, shear strength, expansion index, water-soluble sulfate, Atterberg limits, resistance value (R-Value), consolidation and grain size characteristics. The results of our laboratory tests from both phases of study are presented on Tables B-I through B-VI and the following figures.

**TABLE B-I
SUMMARY OF LABORATORY MAXIMUM DRY DENSITY AND
OPTIMUM MOISTURE CONTENT TEST RESULTS
ASTM D 1557**

Sample No. (Geologic Unit)	Description	Maximum Dry Density (pcf)	Optimum Moisture Content (% dry wt.)
LB1-2 (Qvop)	Reddish brown, Silty, fine to coarse SAND	127.5	10.9
LB1-6 (Tsa)	Olive brown, Silty, fine to coarse SAND	120.0	12.0
SB2-1 (Qpf)	Yellowish brown, Clayey, fine SAND	127.5	10.3

**TABLE B-II
SUMMARY OF LABORATORY DIRECT SHEAR TEST RESULTS
ASTM D 3080**

Sample No. (Geologic Unit)	Dry Density (pcf)	Moisture Content (%)		Peak [Ultimate] Cohesion (psf)	Peak [Ultimate] Angle of Shear Resistance (degrees)
		Initial	After Test		
LB1-3 (Qvop)	117.7	8.6	14.4	725 [475]	29 [29]
LB1-9 (Tsa, CL)	107.5	20.3	23.2	1,300 [600]	32 [32]
LB1-13 ² (BPS)	--	--	--	200 [100]	10 [8]
LB3-2 (Qvop)	116.1	5.9	14.0	480 [375]	34 [34]
LB3-3 (Qvop)	101.5	7.5	21.0	340 [330]	36 [32]
LB3-8 ² (BPS)	--	--	--	240 [180]	11 [11]
SB2-1 ¹ (Qpf)	114.8	10.7	17.7	430 [430]	29 [29]

¹ Sample remolded to a dry density of approximately 90 percent of the laboratory maximum dry density near optimum moisture content.

² Remolded Paste Shear Test.

**TABLE B-III
SUMMARY OF LABORATORY EXPANSION INDEX TEST RESULTS
ASTM D 4829**

Sample No.	Depth (feet)	Geologic Unit	Moisture Content (%)		Dry Density (pcf)	Expansion Index	2016 CBC Expansion Classification	ASTM Soil Expansion Classification
			Before Test	After Test				
LB1-2	7.5 – 10	Qvop	9.6	18.8	109.6	0	Non-Expansive	Very Low
LB1-6	18 – 20	Tsa	9.8	17.4	110.5	0	Non-Expansive	Very Low
SB2-1	0 – 5	Qpf	9.6	19.2	112.1	40	Expansive	Low

**TABLE B-IV
SUMMARY OF LABORATORY WATER-SOLUBLE SULFATE TEST RESULTS
CALIFORNIA TEST NO. 417**

Sample No.	Depth (feet)	Geologic Unit	Water-Soluble Sulfate (%)	Sulfate Class
LB1-2	7.5 – 10	Qvop	0.034	S0
LB1-6	18 – 20	Tsa	0.028	S0
SB2-1	0 – 5	Qpf	0.030	S0

**TABLE B-V
SUMMARY OF LABORATORY PLASTICITY INDEX TEST RESULTS
ASTM D 4318**

Sample No.	Depth (feet)	Geologic Unit	Liquid Limit	Plastic Limit	Plasticity Index	Soil Classification
LB1-13	45	BPS	103	34	69	CH
LB3-8	62.5	BPS	89	34	55	CH
SB1-10	40	Qal	32	16	16	CL
SB2-10	45	Qal	33	16	17	CL
B1-11	41	Qal	-	-	-	NP
B1-13	46	Qal	32	14	18	CL
B2-13	46	Qal	28	17	11	CL
B3-9	36	Qal	30	15	15	CL

**TABLE B-VI
SUMMARY OF LABORATORY RESISTANCE VALUE (R-VALUE) TEST RESULTS
ASTM D 2844**

Sample No.	Depth (feet)	Description (Geologic Unit)	R-Value
LB1-2	7.5 – 10	Reddish brown, Silty, fine to coarse SAND (Qvop)	36
SB2-1	0 – 5	Yellowish brown, Clayey, fine SAND (Qpf)	13

SAMPLE NO.: **BI-11**
 SAMPLE DEPTH (FT.): **41'**

GEOLOGIC UNIT: **Qal**

GRAVEL		SAND			SILT OR CLAY
COARSE	FINE	COARSE	MEDIUM	FINE	

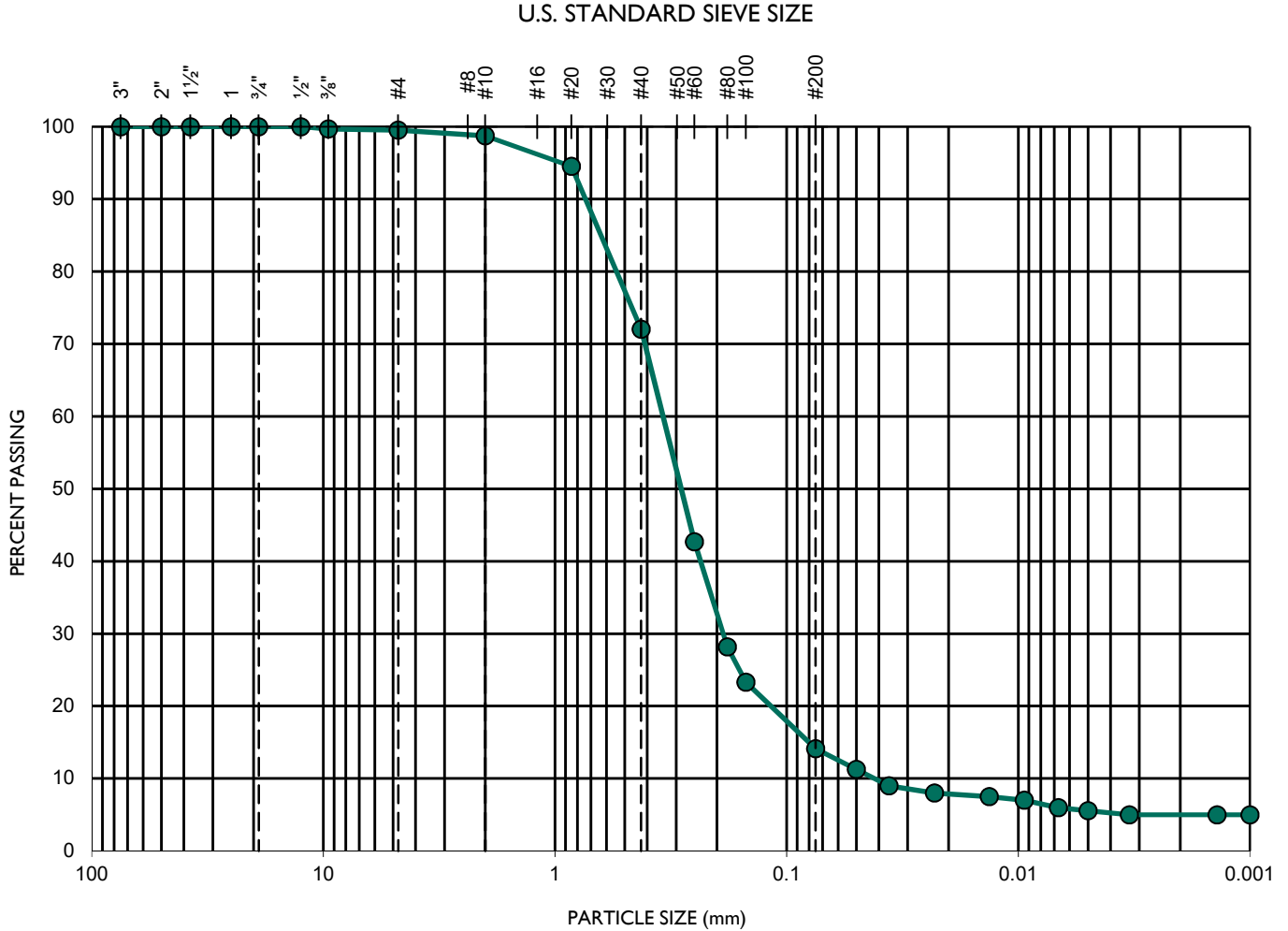

TEST DATA					
D ₁₀ (mm)	D ₃₀ (mm)	D ₆₀ (mm)	C _c	C _u	SOIL DESCRIPTION
0.04238	0.18887	0.35326	2.4	8.3	Silty SAND

GEOCON
INCORPORATED



GEOTECHNICAL CONSULTANTS
 6960 FLANDERS DRIVE - SAN DIEGO, CALIFORNIA 92121 - 2974
 PHONE 858 558-6900 - FAX 858 558-6159

SIEVE ANALYSES - ASTM D 6913

PIRAEUS POINT

PROJECT NO.: G2307-32-05

SAMPLE NO.: **B1-13**
 SAMPLE DEPTH (FT.): **46'**

GEOLOGIC UNIT: **Qal**

GRAVEL		SAND			SILT OR CLAY
COARSE	FINE	COARSE	MEDIUM	FINE	

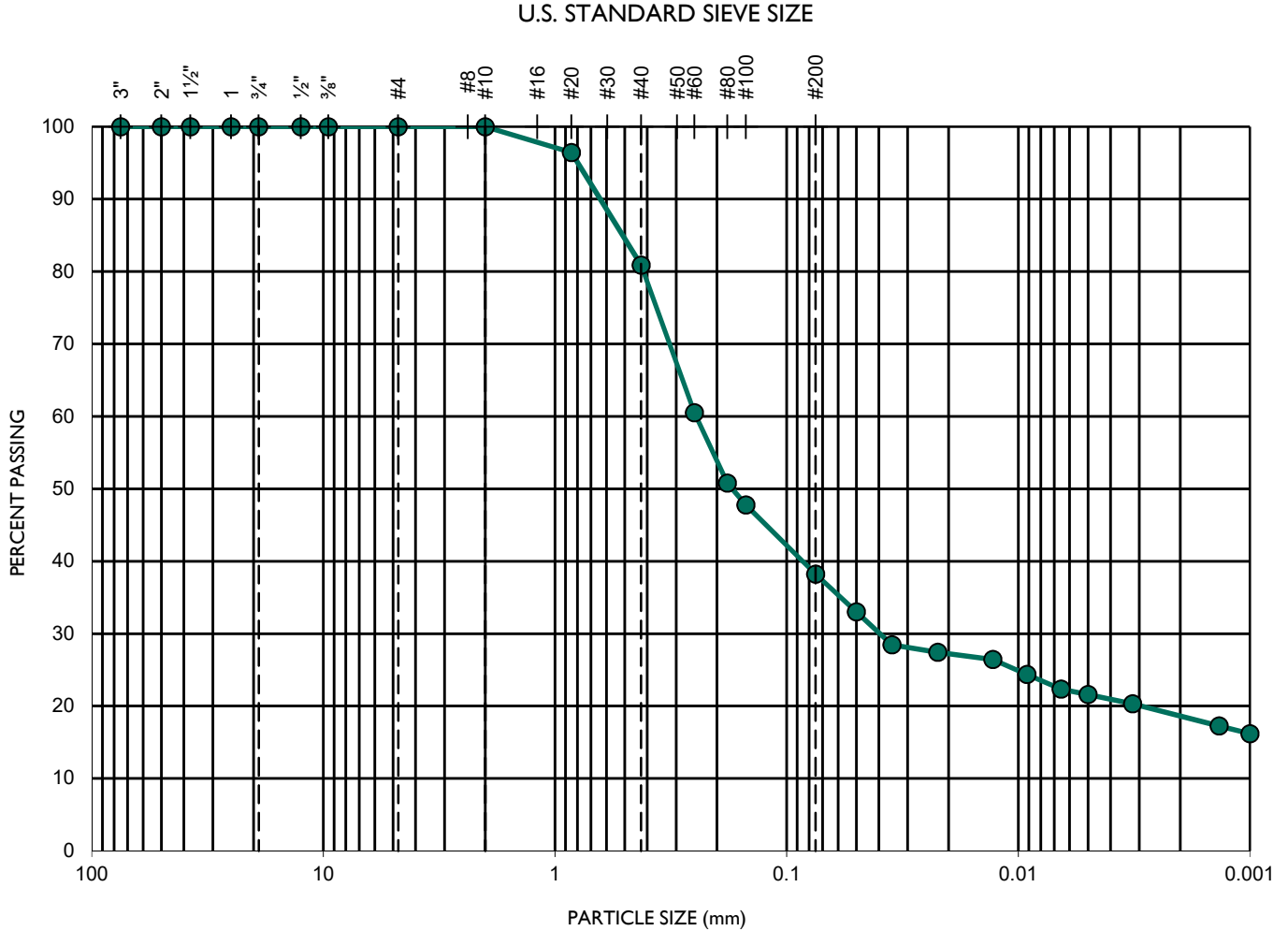

TEST DATA					
D ₁₀ (mm)	D ₃₀ (mm)	D ₆₀ (mm)	C _c	C _u	SOIL DESCRIPTION
--	0.04016	0.24651	--	--	Clayey SAND

GEOCON
INCORPORATED



GEOTECHNICAL CONSULTANTS
 6960 FLANDERS DRIVE - SAN DIEGO, CALIFORNIA 92121 - 2974
 PHONE 858 558-6900 - FAX 858 558-6159

SIEVE ANALYSES - ASTM D 6913

PIRAEUS POINT

PROJECT NO.: G2307-32-05

SAMPLE NO.: **B2-13**
 SAMPLE DEPTH (FT.): **46'**

GEOLOGIC UNIT: **Qal**

GRAVEL		SAND			SILT OR CLAY
COARSE	FINE	COARSE	MEDIUM	FINE	

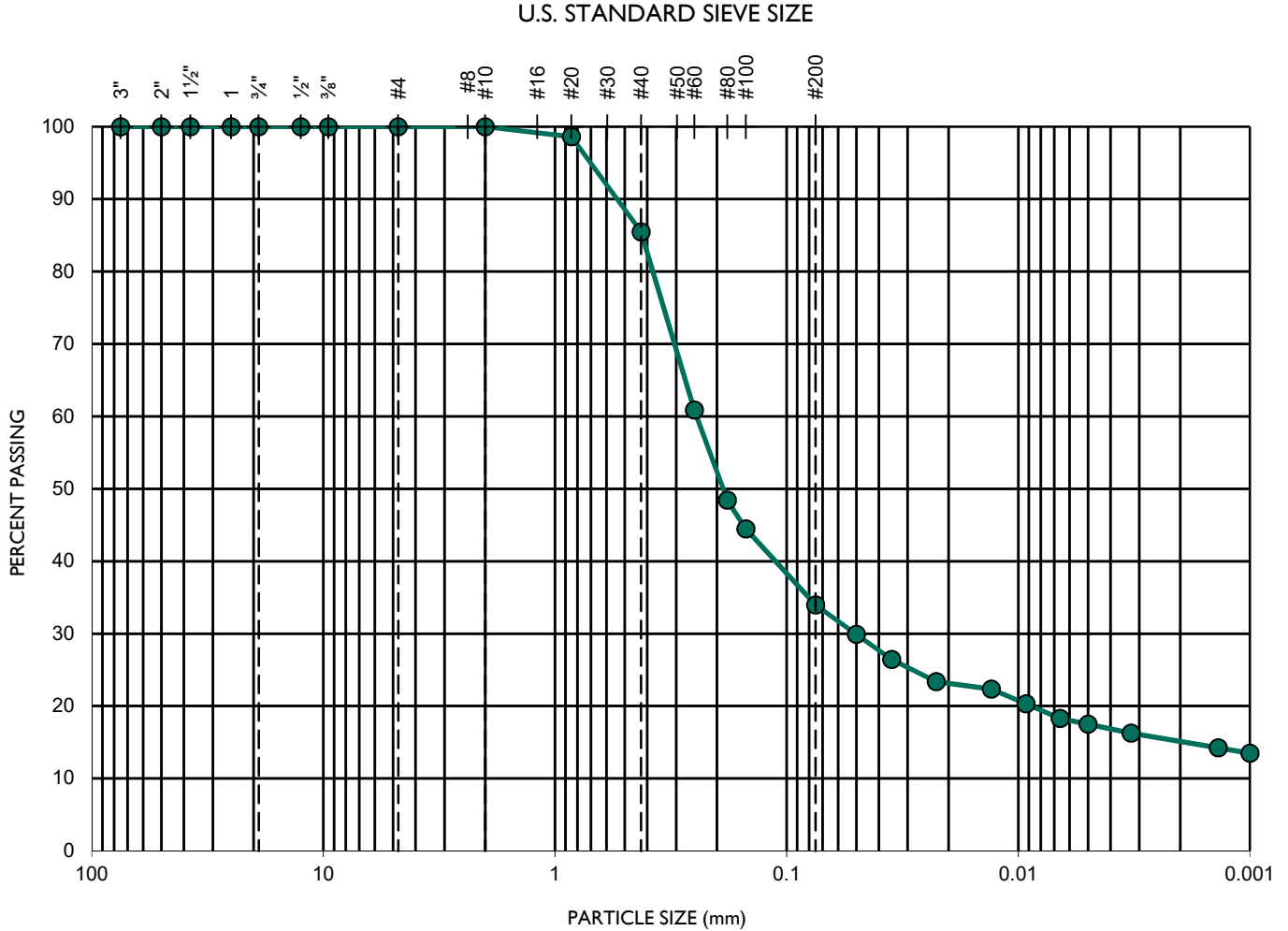

TEST DATA					
D ₁₀ (mm)	D ₃₀ (mm)	D ₆₀ (mm)	C _c	C _u	SOIL DESCRIPTION
--	0.05058	0.24515	--	--	Silty Clayey SAND

GEOCON
INCORPORATED



GEOTECHNICAL CONSULTANTS
 6960 FLANDERS DRIVE - SAN DIEGO, CALIFORNIA 92121 - 2974
 PHONE 858 558-6900 - FAX 858 558-6159

SIEVE ANALYSES - ASTM D 6913

PIRAEUS POINT

PROJECT NO.: G2307-32-05

SAMPLE NO.: **B3-9**
 SAMPLE DEPTH (FT.): **36'**

GEOLOGIC UNIT: **Qal**

GRAVEL		SAND			SILT OR CLAY
COARSE	FINE	COARSE	MEDIUM	FINE	

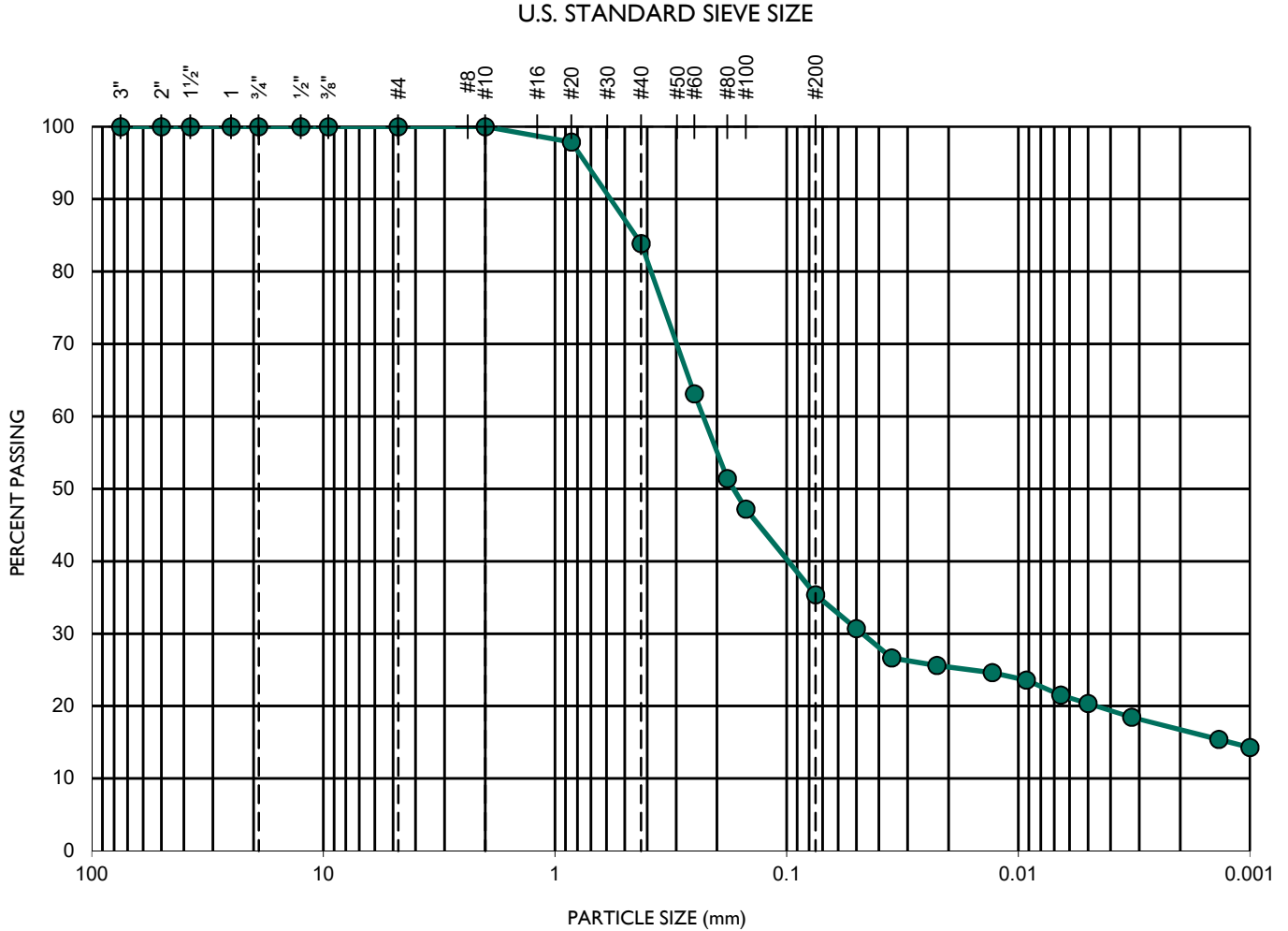

TEST DATA					
D ₁₀ (mm)	D ₃₀ (mm)	D ₆₀ (mm)	C _c	C _u	SOIL DESCRIPTION
--	0.04749	0.23151	--	--	Silty Clayey SAND

GEOCON
INCORPORATED



GEOTECHNICAL CONSULTANTS
 6960 FLANDERS DRIVE - SAN DIEGO, CALIFORNIA 92121 - 2974
 PHONE 858 558-6900 - FAX 858 558-6159

SIEVE ANALYSES - ASTM D 6913

PIRAEUS POINT

PROJECT NO.: G2307-32-05

GRAVEL		SAND			SILT OR CLAY
COARSE	FINE	COARSE	MEDIUM	FINE	

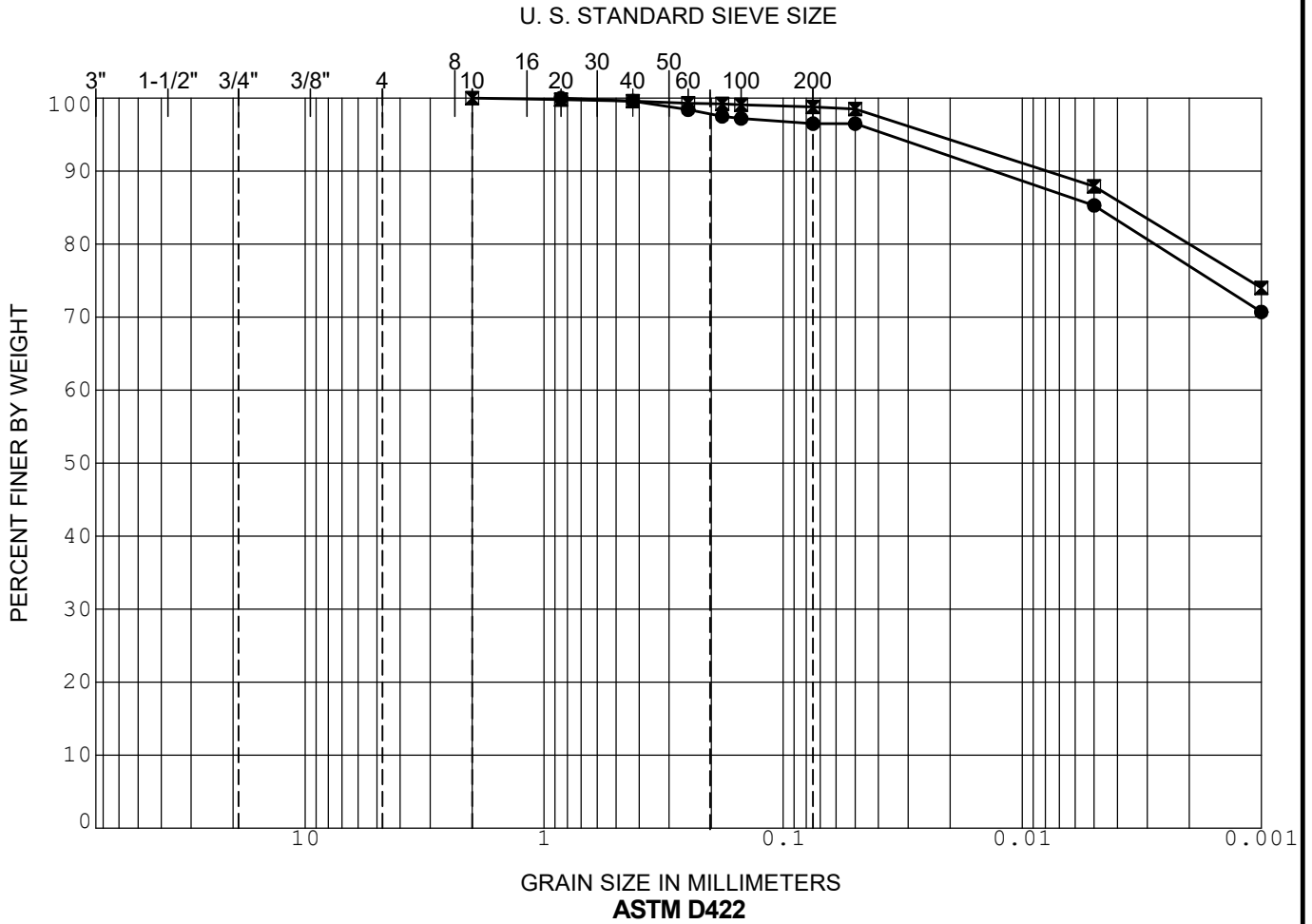

	SAMPLE	DEPTH (ft)	CLASSIFICATION	NAT WC	LL	PL	PI
●	LB1-13	44.5	CH - Fat CLAY		103	34	69
■	LB3-8	62.5	CH - Fat CLAY		89	34	55
▲							

GRADATION CURVE

PIRAEUS POINT

ENCINITAS, CALIFORNIA

GRAVEL		SAND			SILT OR CLAY
COARSE	FINE	COARSE	MEDIUM	FINE	

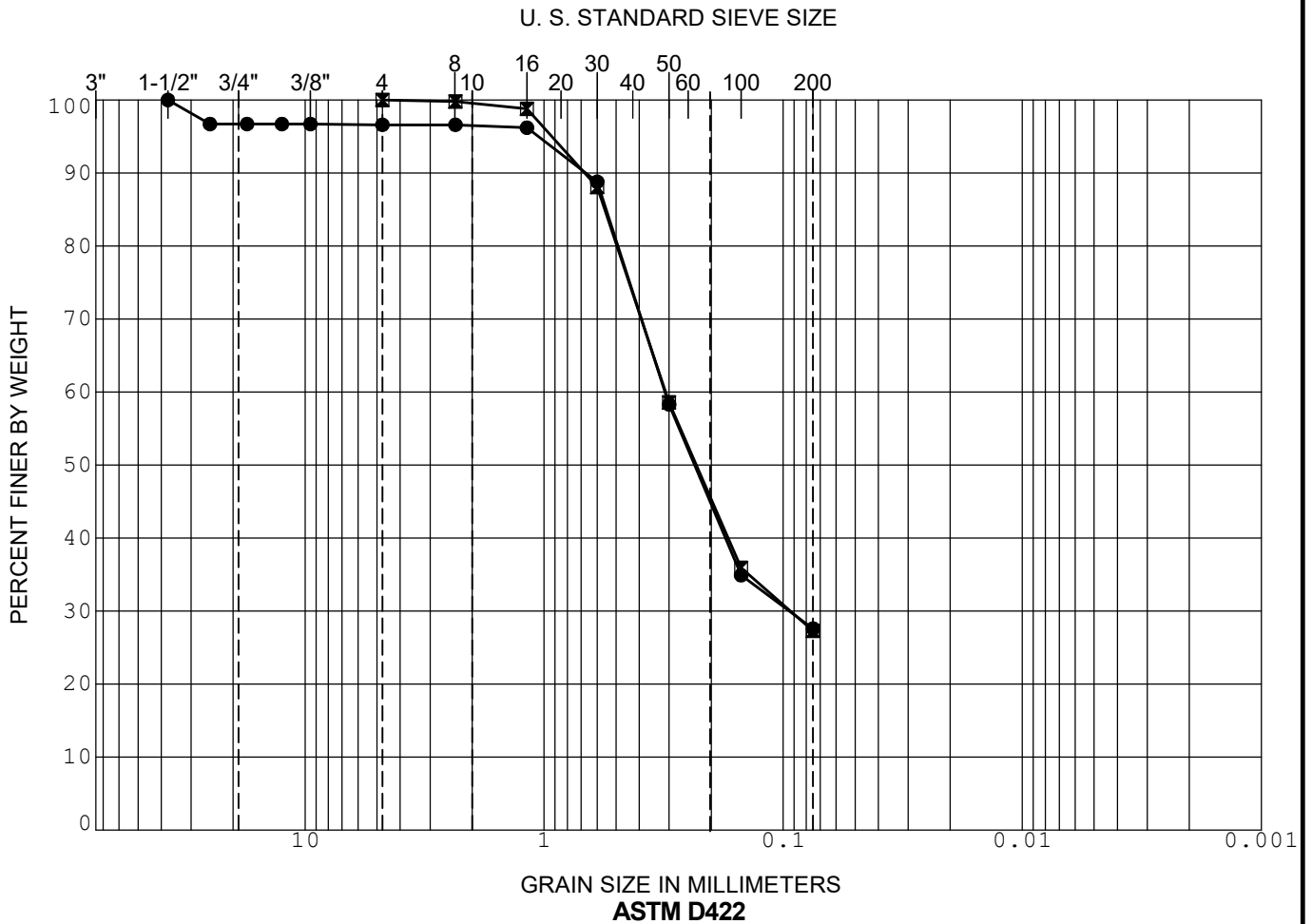

	SAMPLE	DEPTH (ft)	CLASSIFICATION	NAT WC	LL	PL	PI
●	SB1-10	40.0	SC - Clayey SAND		32	16	16
■	SB2-10	45.0	SC - Clayey SAND		33	16	17
▲							

GRADATION CURVE

PIRAEUS POINT

ENCINITAS, CALIFORNIA

SAMPLE NO.: **B1-2**
 SAMPLE DEPTH (FT): **10'**

GEOLOGIC UNIT: **Qpf**

TEST INFORMATION	
INITIAL DRY DENSITY (PCF):	109.0
INITIAL WATER CONTENT (%):	12.2%
SAMPLE SATURATED AT (KSF):	2.0
INITIAL SATURATION (%):	62.0%

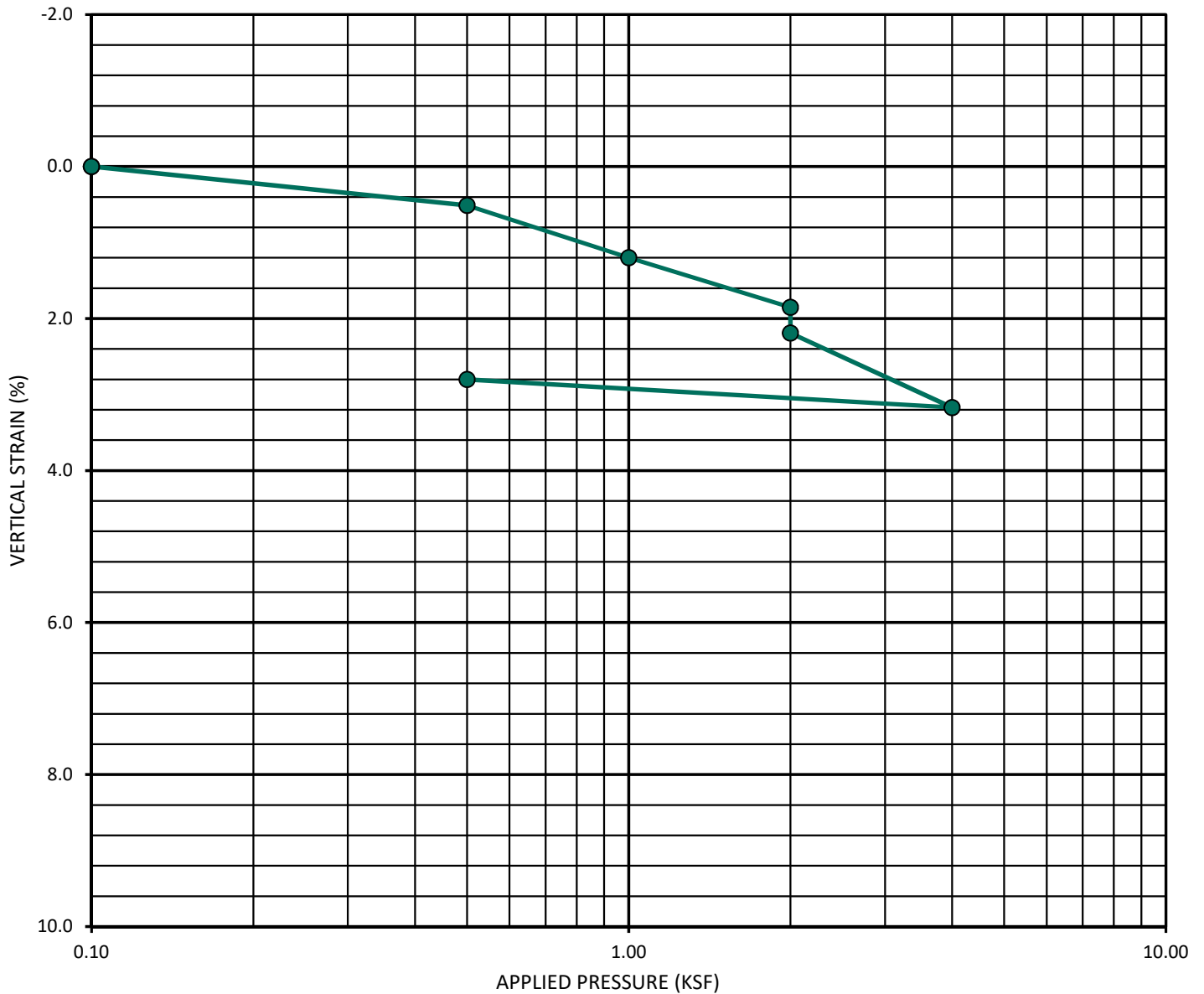

CONSOLIDATION CURVE - ASTM D 2435

GEOCON
 INCORPORATED



GEOTECHNICAL CONSULTANTS
 6960 FLANDERS DRIVE - SAN DIEGO, CALIFORNIA 92121 - 2974
 PHONE 858 558-6900 - FAX 858 558-6159

PIRAEUS POINT

PROJECT NO.: G2307-32-05

SAMPLE NO.: **B1-4**
 SAMPLE DEPTH (FT): **20'**

GEOLOGIC UNIT: **Qal**

TEST INFORMATION	
INITIAL DRY DENSITY (PCF):	113.5
INITIAL WATER CONTENT (%):	14.7%
SAMPLE SATURATED AT (KSF):	2.0
INITIAL SATURATION (%):	84.4%

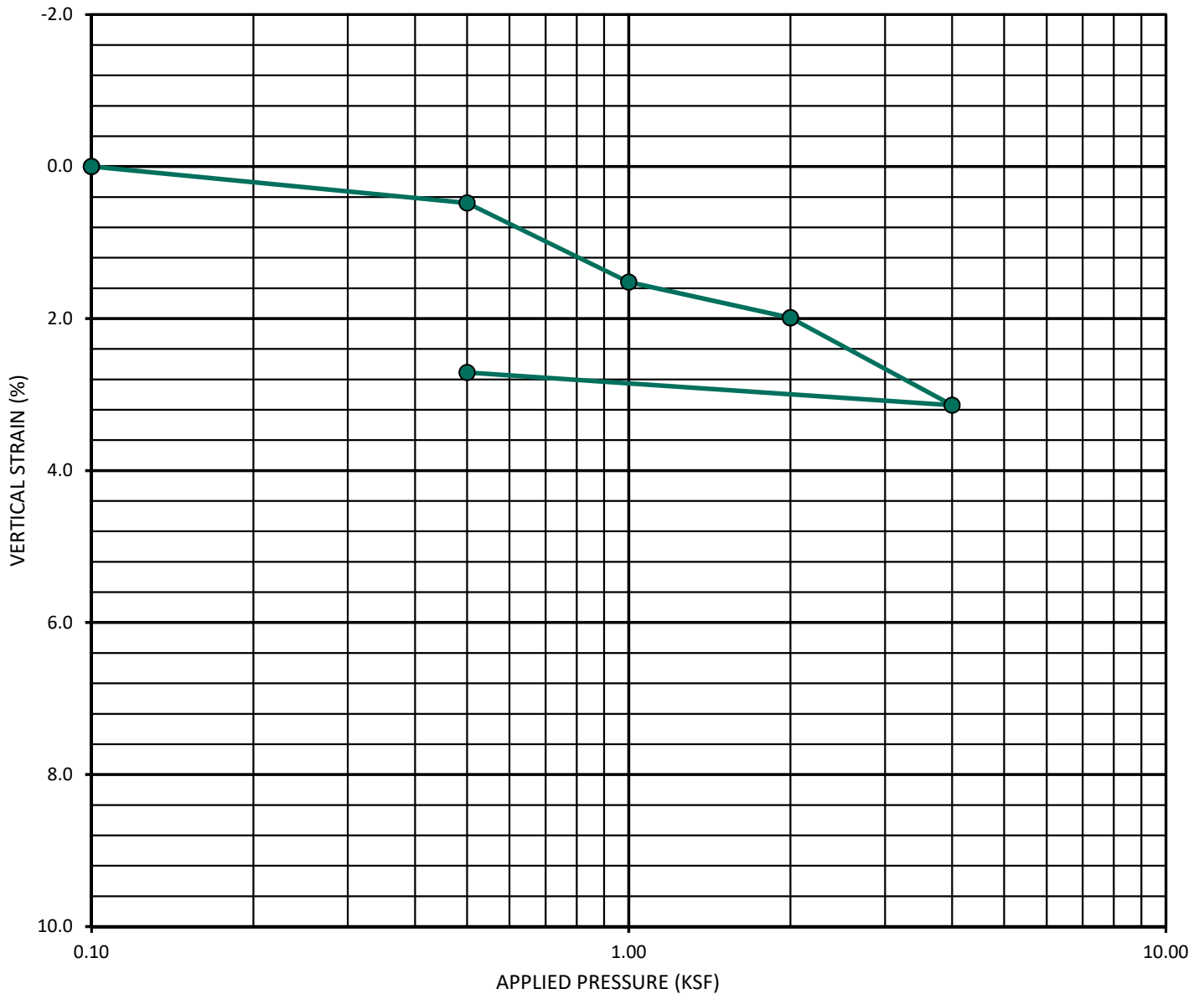

CONSOLIDATION CURVE - ASTM D 2435

GEOCON
 INCORPORATED



GEOTECHNICAL CONSULTANTS
 6960 FLANDERS DRIVE - SAN DIEGO, CALIFORNIA 92121 - 2974
 PHONE 858 558-6900 - FAX 858 558-6159

PIRAEUS POINT

PROJECT NO.: G2307-32-05

SAMPLE NO.: **B1-8**
 SAMPLE DEPTH (FT): **35'**

GEOLOGIC UNIT: **Qal**

TEST INFORMATION	
INITIAL DRY DENSITY (PCF):	104.3
INITIAL WATER CONTENT (%):	20.6%
SAMPLE SATURATED AT (KSF):	4.0
INITIAL SATURATION (%):	92.5%

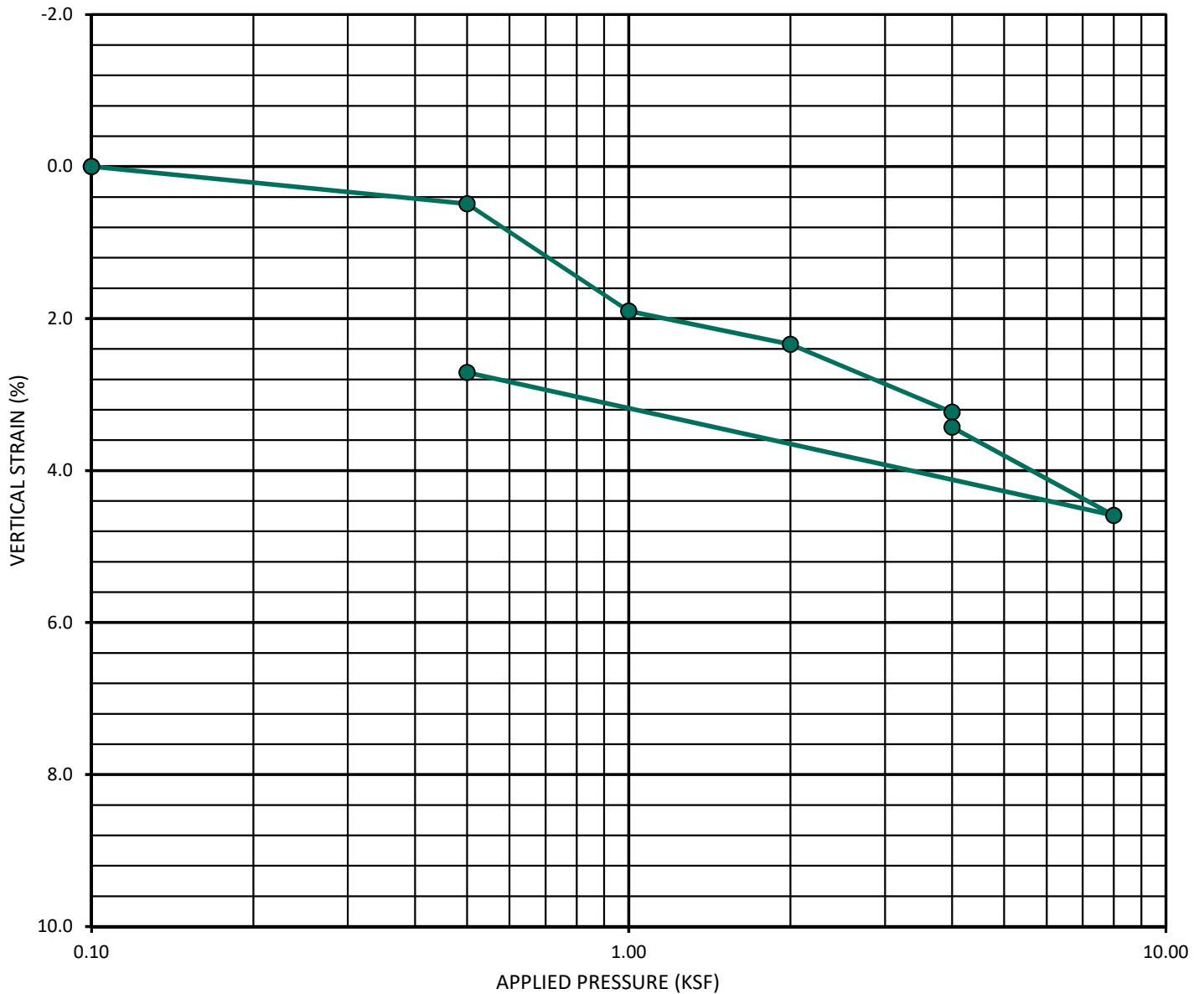

CONSOLIDATION CURVE - ASTM D 2435

GEOCON
 INCORPORATED



GEOTECHNICAL CONSULTANTS
 6960 FLANDERS DRIVE - SAN DIEGO, CALIFORNIA 92121 - 2974
 PHONE 858 558-6900 - FAX 858 558-6159

PIRAEUS POINT

PROJECT NO.: G2307-32-05

SAMPLE NO.: **B2-1**
 SAMPLE DEPTH (FT): **5'**

GEOLOGIC UNIT: **Qpf**

TEST INFORMATION	
INITIAL DRY DENSITY (PCF):	114.1
INITIAL WATER CONTENT (%):	9.8%
SAMPLE SATURATED AT (KSF):	2.0
INITIAL SATURATION (%):	57.5%

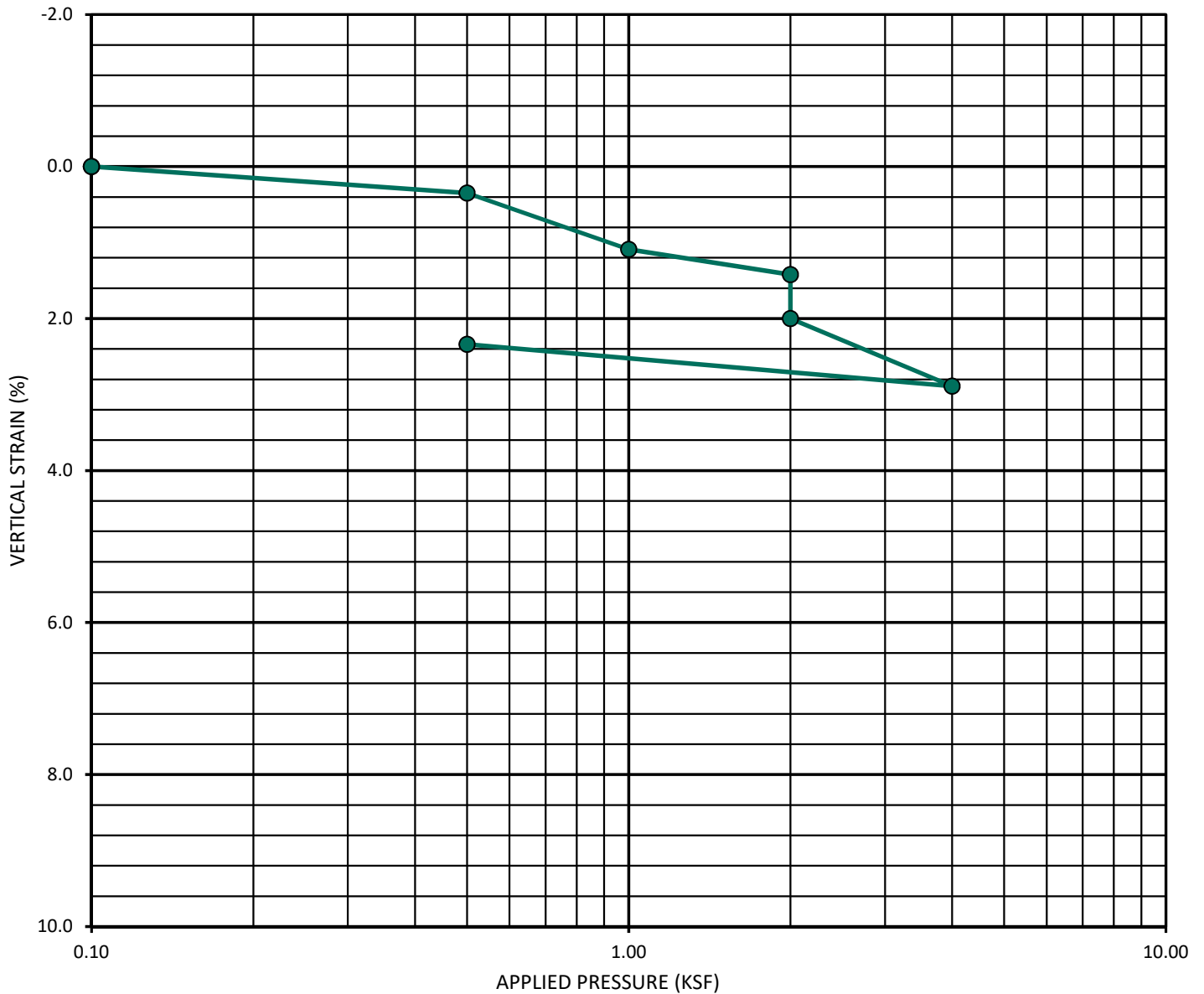

CONSOLIDATION CURVE - ASTM D 2435

GEOCON
 INCORPORATED



GEOTECHNICAL CONSULTANTS
 6960 FLANDERS DRIVE - SAN DIEGO, CALIFORNIA 92121 - 2974
 PHONE 858 558-6900 - FAX 858 558-6159

PIRAEUS POINT

PROJECT NO.: G2307-32-05

SAMPLE NO.: **B2-5**
 SAMPLE DEPTH (FT): **25'**

GEOLOGIC UNIT: **Qal**

TEST INFORMATION	
INITIAL DRY DENSITY (PCF):	107.3
INITIAL WATER CONTENT (%):	4.7%
SAMPLE SATURATED AT (KSF):	4.0
INITIAL SATURATION (%):	23.1%

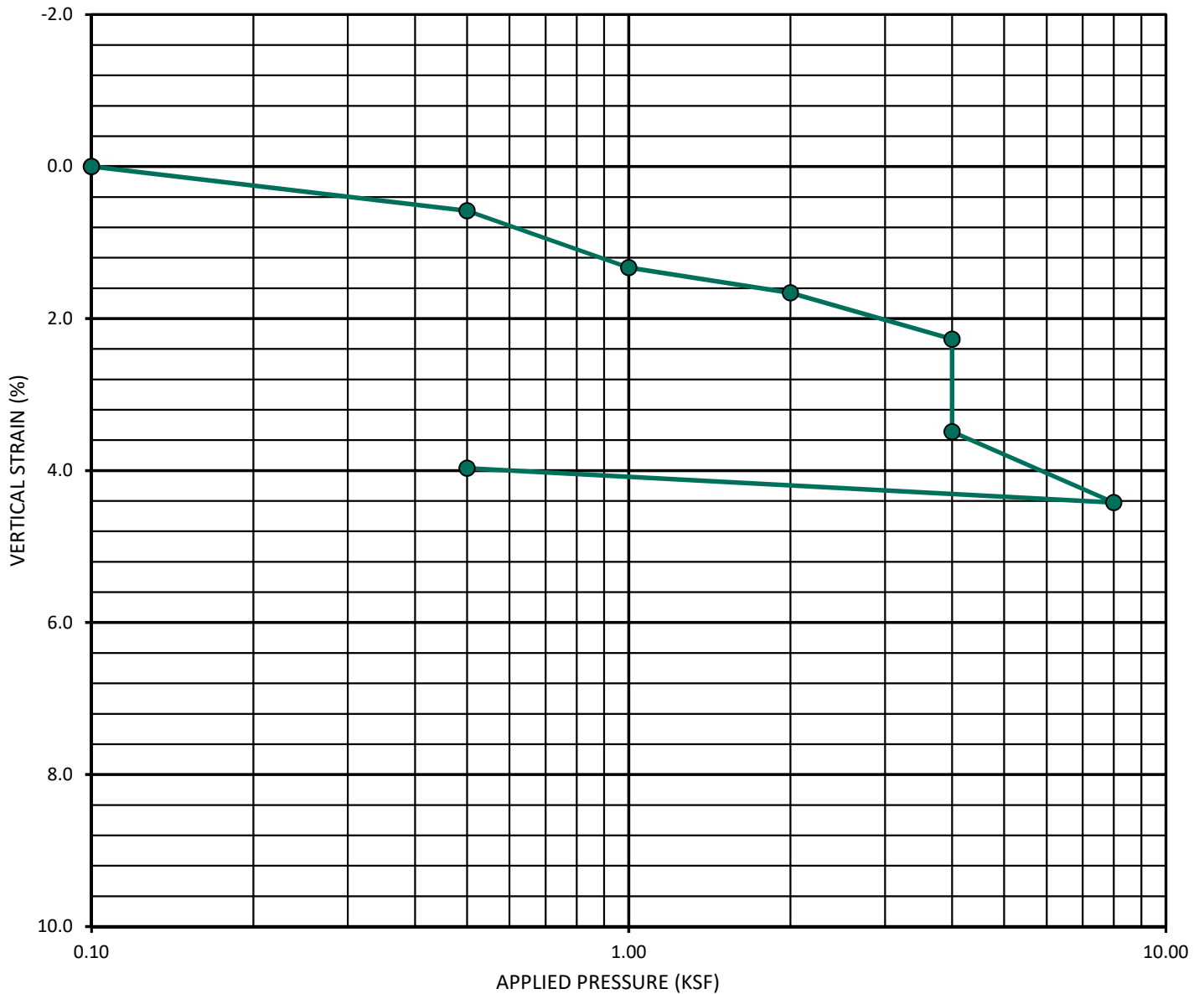

CONSOLIDATION CURVE - ASTM D 2435

GEOCON
 INCORPORATED



GEOTECHNICAL CONSULTANTS
 6960 FLANDERS DRIVE - SAN DIEGO, CALIFORNIA 92121 - 2974
 PHONE 858 558-6900 - FAX 858 558-6159

PIRAEUS POINT

PROJECT NO.: G2307-32-05

SAMPLE NO.: **B2-12**
 SAMPLE DEPTH (FT): **45'**

GEOLOGIC UNIT: **Qal**

TEST INFORMATION	
INITIAL DRY DENSITY (PCF):	118.4
INITIAL WATER CONTENT (%):	14.5%
SAMPLE SATURATED AT (KSF):	4.0
INITIAL SATURATION (%):	96.1%

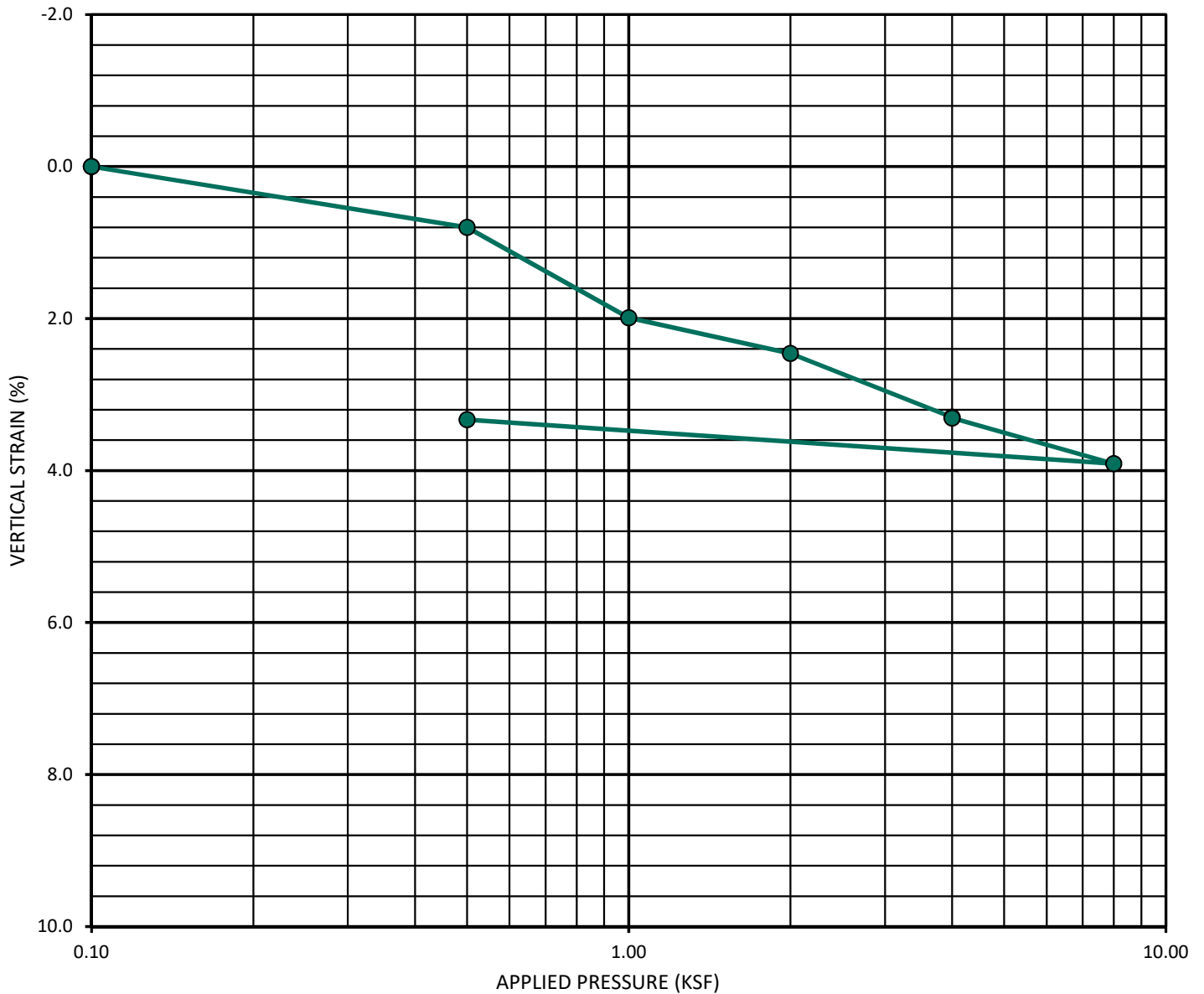

CONSOLIDATION CURVE - ASTM D 2435

GEOCON
 INCORPORATED



GEOTECHNICAL CONSULTANTS
 6960 FLANDERS DRIVE - SAN DIEGO, CALIFORNIA 92121 - 2974
 PHONE 858 558-6900 - FAX 858 558-6159

PIRAEUS POINT

PROJECT NO.: G2307-32-05

SAMPLE NO.: **B3-1**
 SAMPLE DEPTH (FT): **5'**

GEOLOGIC UNIT: **Qpf**

TEST INFORMATION	
INITIAL DRY DENSITY (PCF):	117.2
INITIAL WATER CONTENT (%):	10.1%
SAMPLE SATURATED AT (KSF):	2.0
INITIAL SATURATION (%):	65.0%

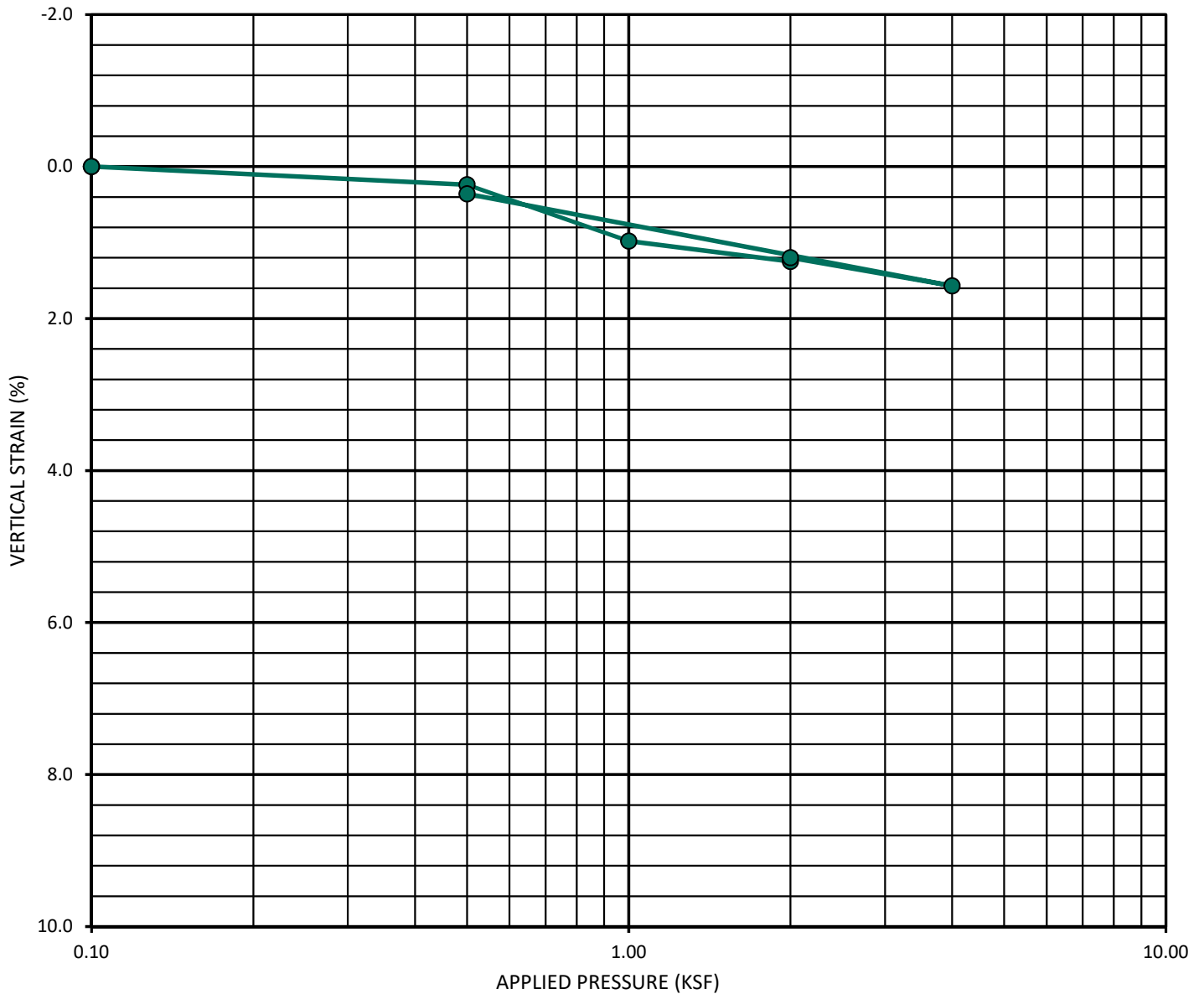

CONSOLIDATION CURVE - ASTM D 2435

GEOCON
 INCORPORATED



GEOTECHNICAL CONSULTANTS
 6960 FLANDERS DRIVE - SAN DIEGO, CALIFORNIA 92121 - 2974
 PHONE 858 558-6900 - FAX 858 558-6159

PIRAEUS POINT

PROJECT NO.: G2307-32-05

SAMPLE NO.: **B3-4**
 SAMPLE DEPTH (FT): **20'**

GEOLOGIC UNIT: **Qal**

TEST INFORMATION	
INITIAL DRY DENSITY (PCF):	112.9
INITIAL WATER CONTENT (%):	10.7%
SAMPLE SATURATED AT (KSF):	2.0
INITIAL SATURATION (%):	60.5%

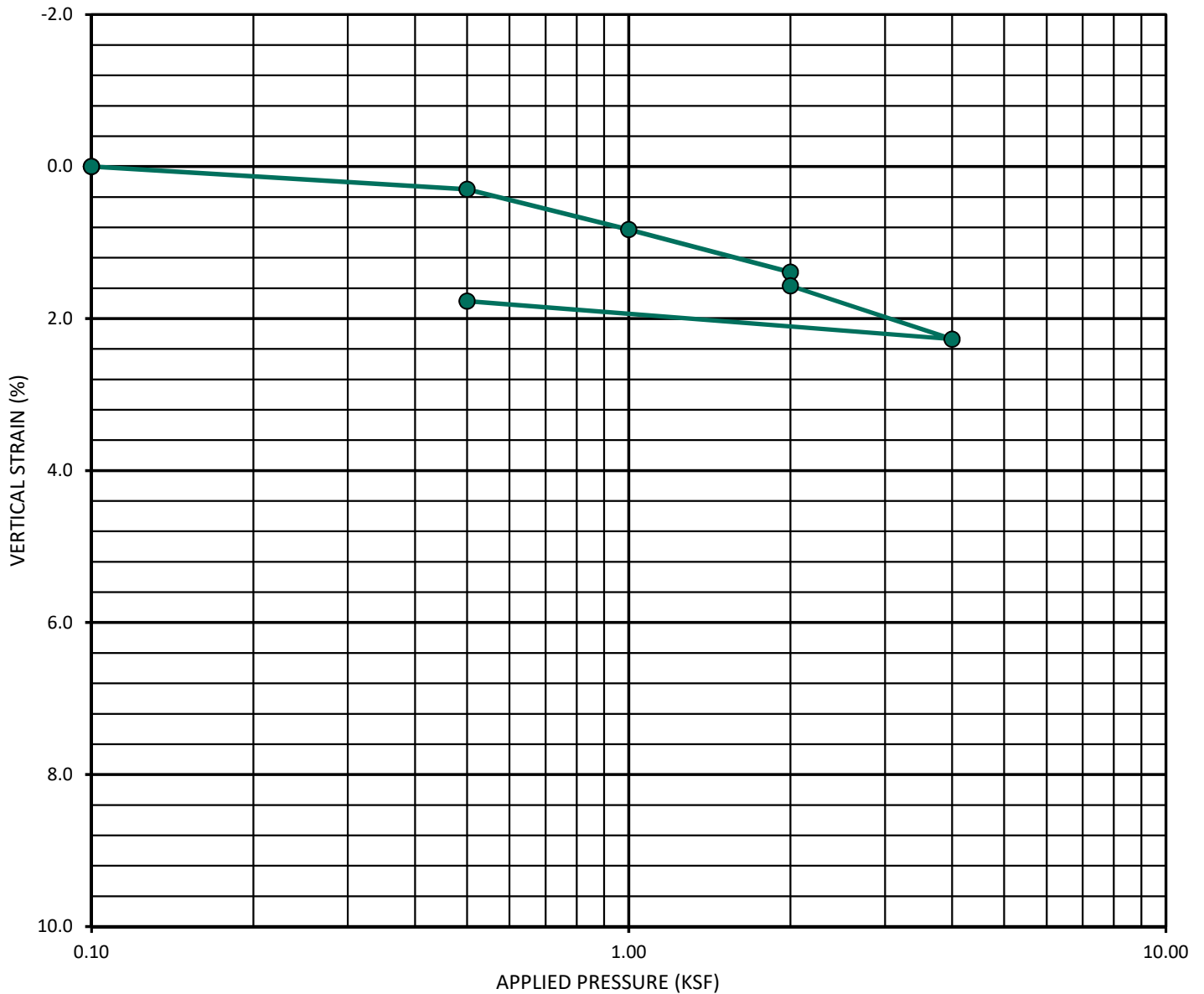

CONSOLIDATION CURVE - ASTM D 2435

GEOCON
 INCORPORATED



GEOTECHNICAL CONSULTANTS
 6960 FLANDERS DRIVE - SAN DIEGO, CALIFORNIA 92121 - 2974
 PHONE 858 558-6900 - FAX 858 558-6159

PIRAEUS POINT

PROJECT NO.: G2307-32-05

SAMPLE NO.: **B3-8**
 SAMPLE DEPTH (FT): **35'**

GEOLOGIC UNIT: **Qal**

TEST INFORMATION	
INITIAL DRY DENSITY (PCF):	114.5
INITIAL WATER CONTENT (%):	14.6%
SAMPLE SATURATED AT (KSF):	4.0
INITIAL SATURATION (%):	86.4%

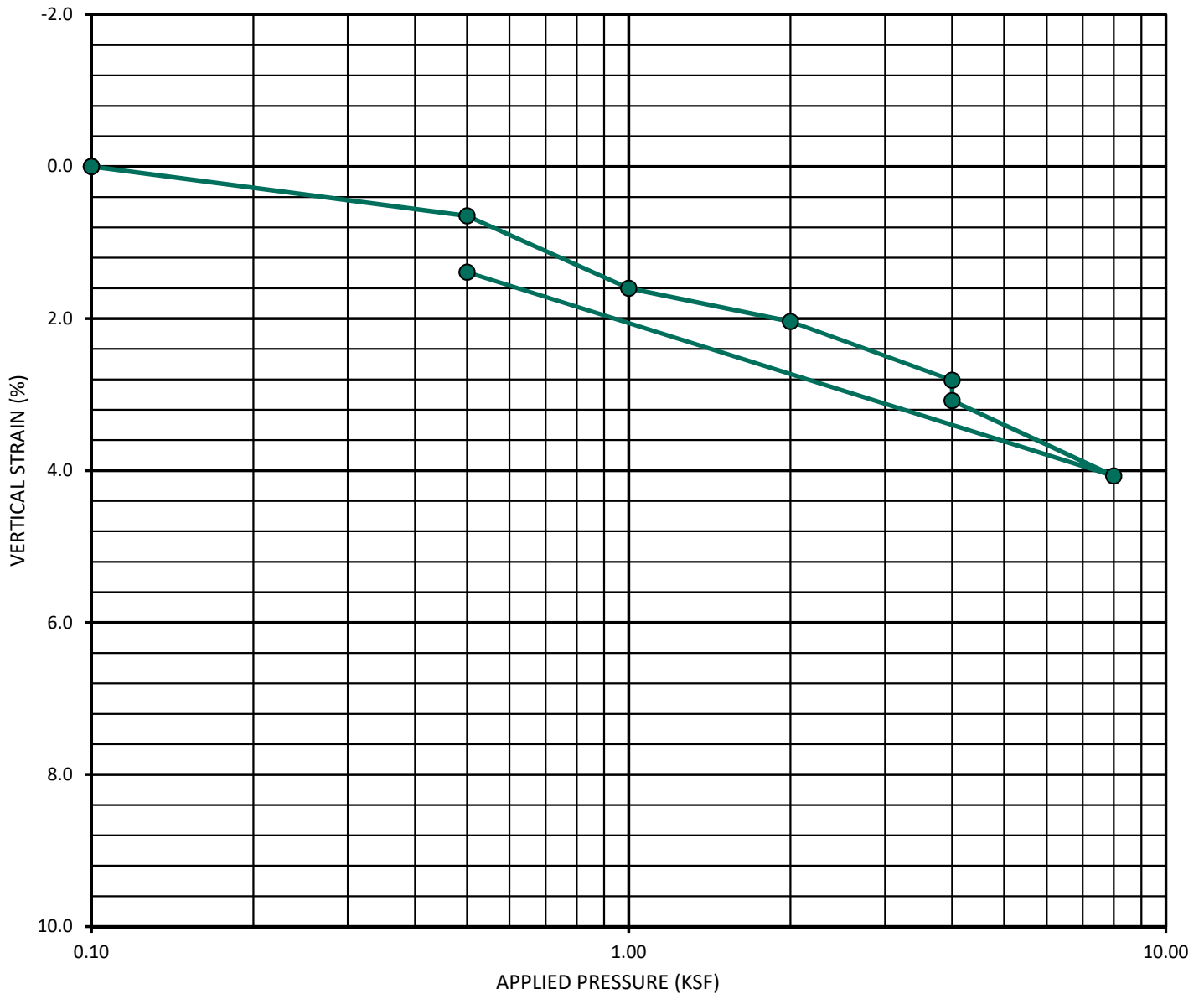

CONSOLIDATION CURVE - ASTM D 2435

GEOCON
 INCORPORATED



GEOTECHNICAL CONSULTANTS
 6960 FLANDERS DRIVE - SAN DIEGO, CALIFORNIA 92121 - 2974
 PHONE 858 558-6900 - FAX 858 558-6159

PIRAEUS POINT

PROJECT NO.: G2307-32-05

SAMPLE NO. SB1-2

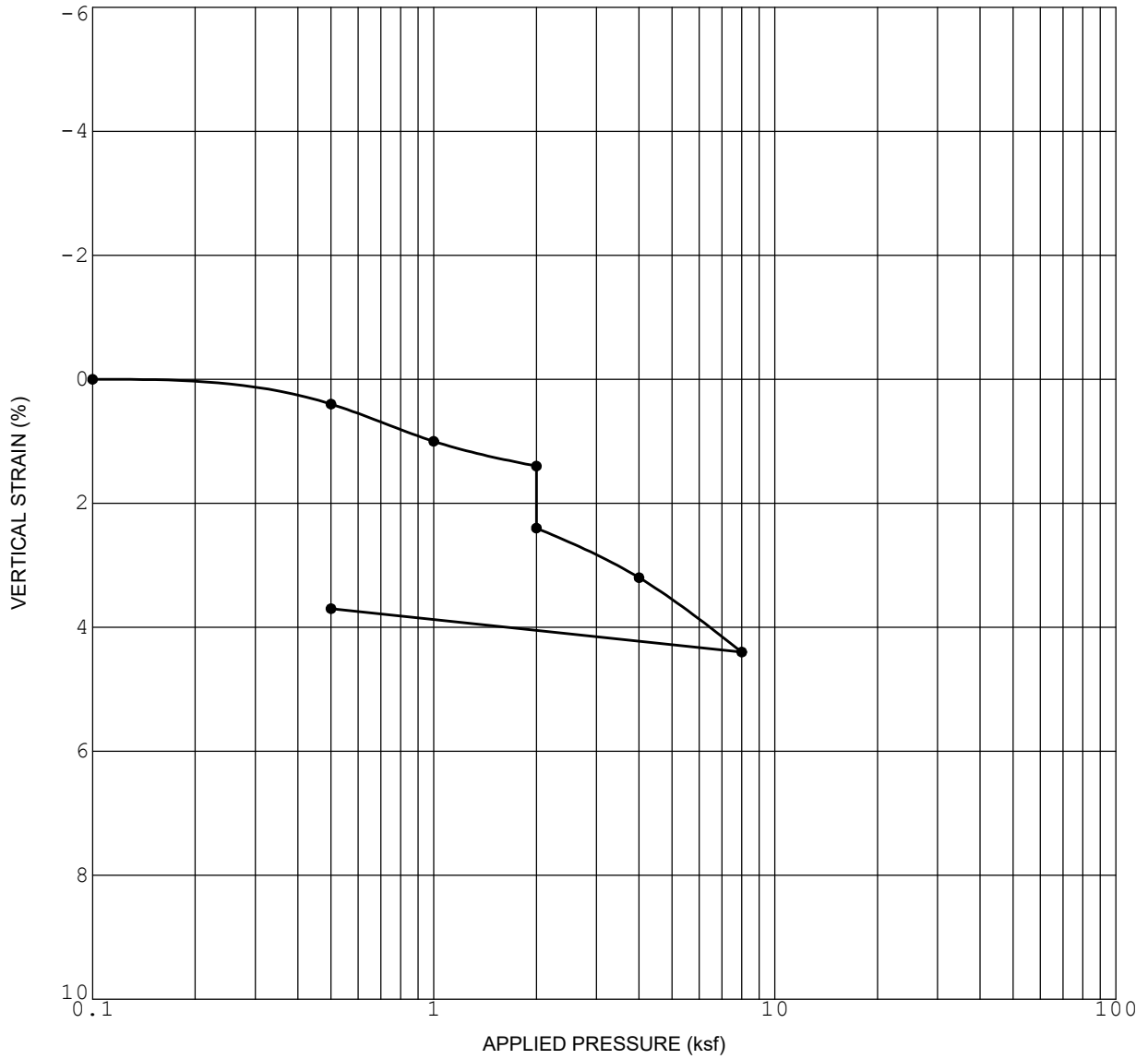

ASTM D2435

Initial Dry Density (pcf)	113.3
Initial Water Content (%)	8.1

Initial Saturation (%)	52.1
Sample Saturated at (ksf)	2.0

CONSOLIDATION CURVE

PIRAEUS POINT

ENCINITAS, CALIFORNIA

SAMPLE NO. SB2-5

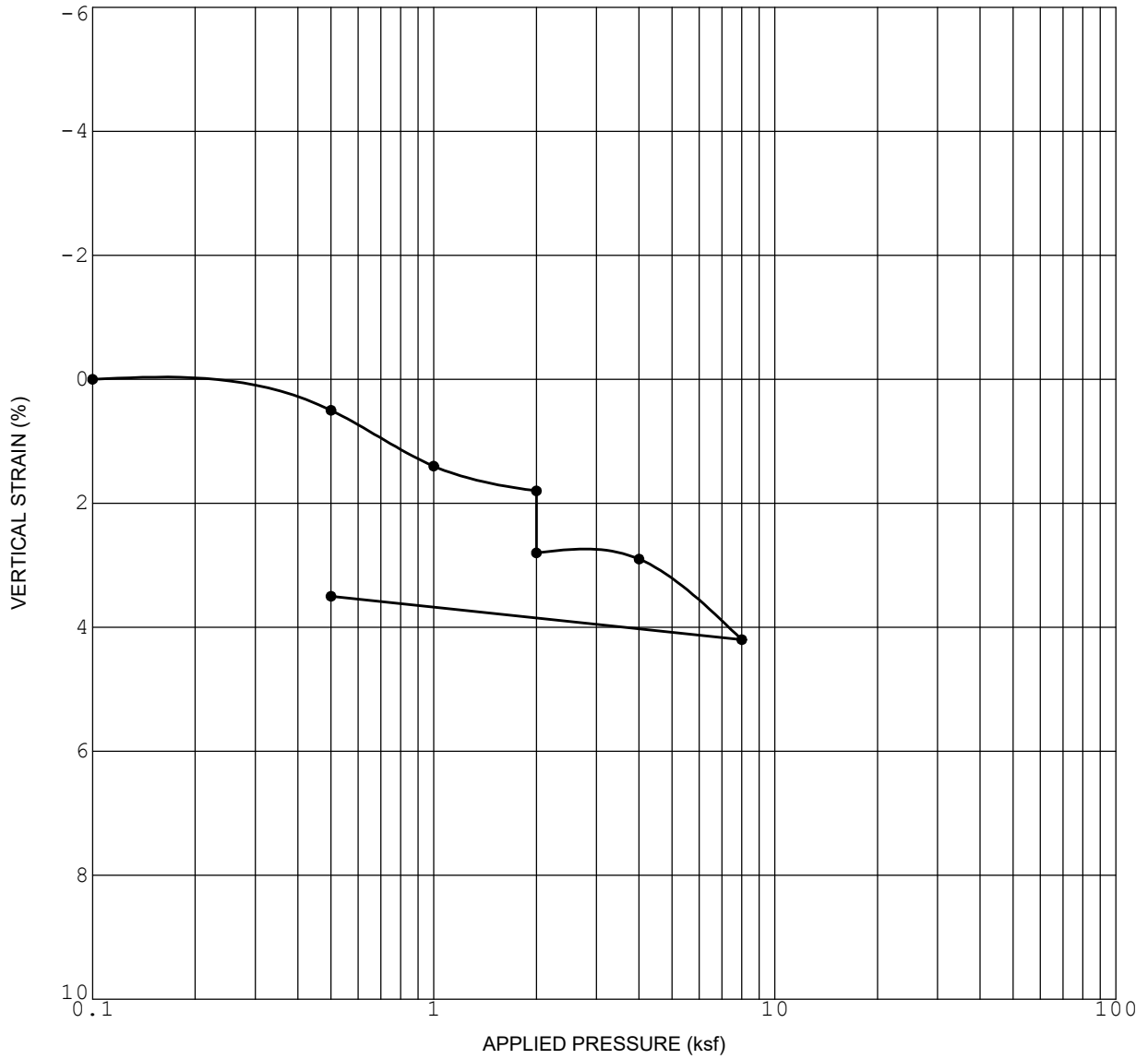

ASTM D2435

Initial Dry Density (pcf)	115.2
Initial Water Content (%)	10.0

Initial Saturation (%)	60.0
Sample Saturated at (ksf)	2.0

CONSOLIDATION CURVE

PIRAEUS POINT

ENCINITAS, CALIFORNIA

SAMPLE NO. SB2-7

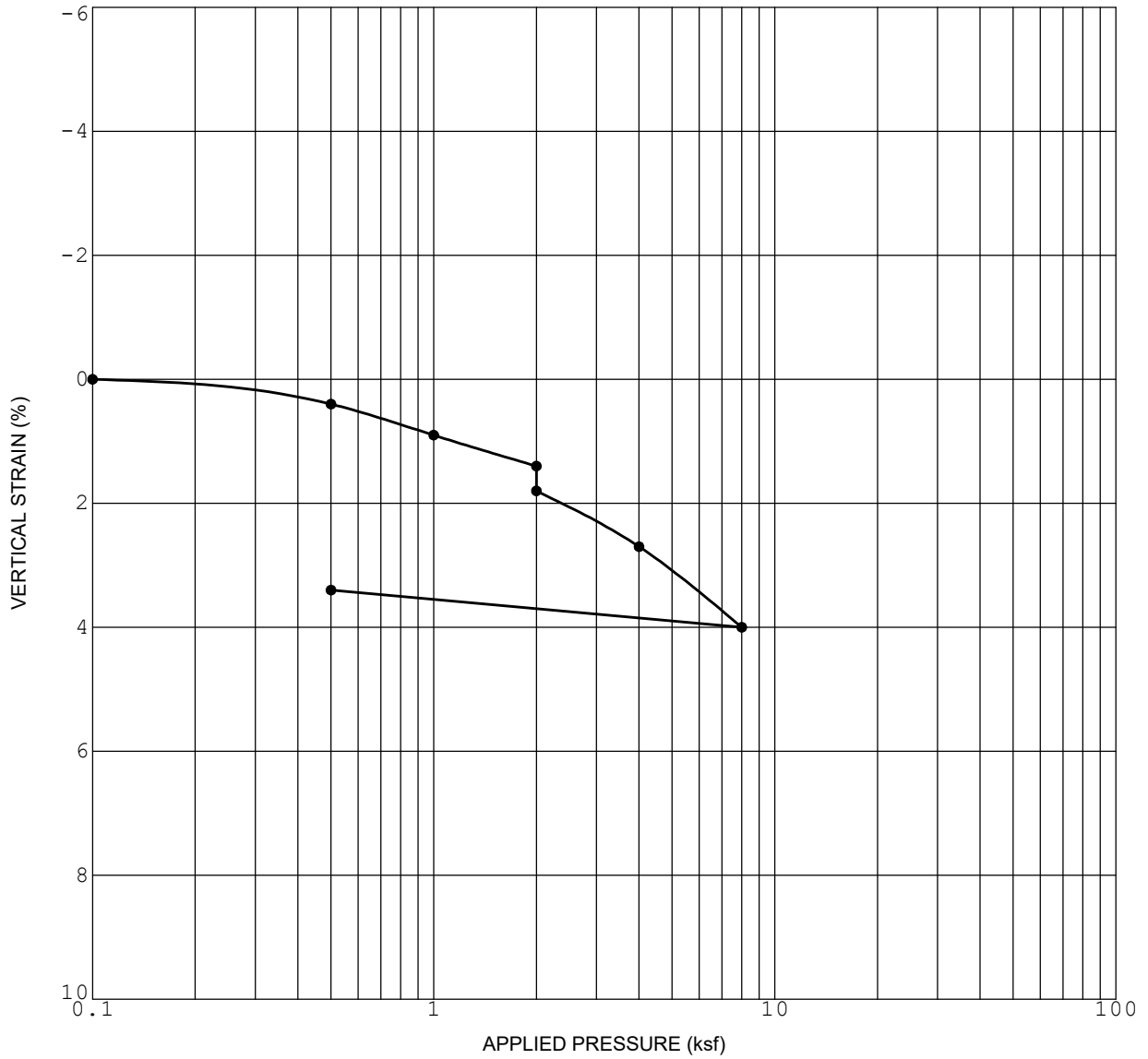

APPLIED PRESSURE (ksf)

ASTM D2435

Initial Dry Density (pcf)	111.7
Initial Water Content (%)	11.3

Initial Saturation (%)	61.7
Sample Saturated at (ksf)	2.0

CONSOLIDATION CURVE

PIRAEUS POINT

ENCINITAS, CALIFORNIA

SAMPLE NO. SB2-11

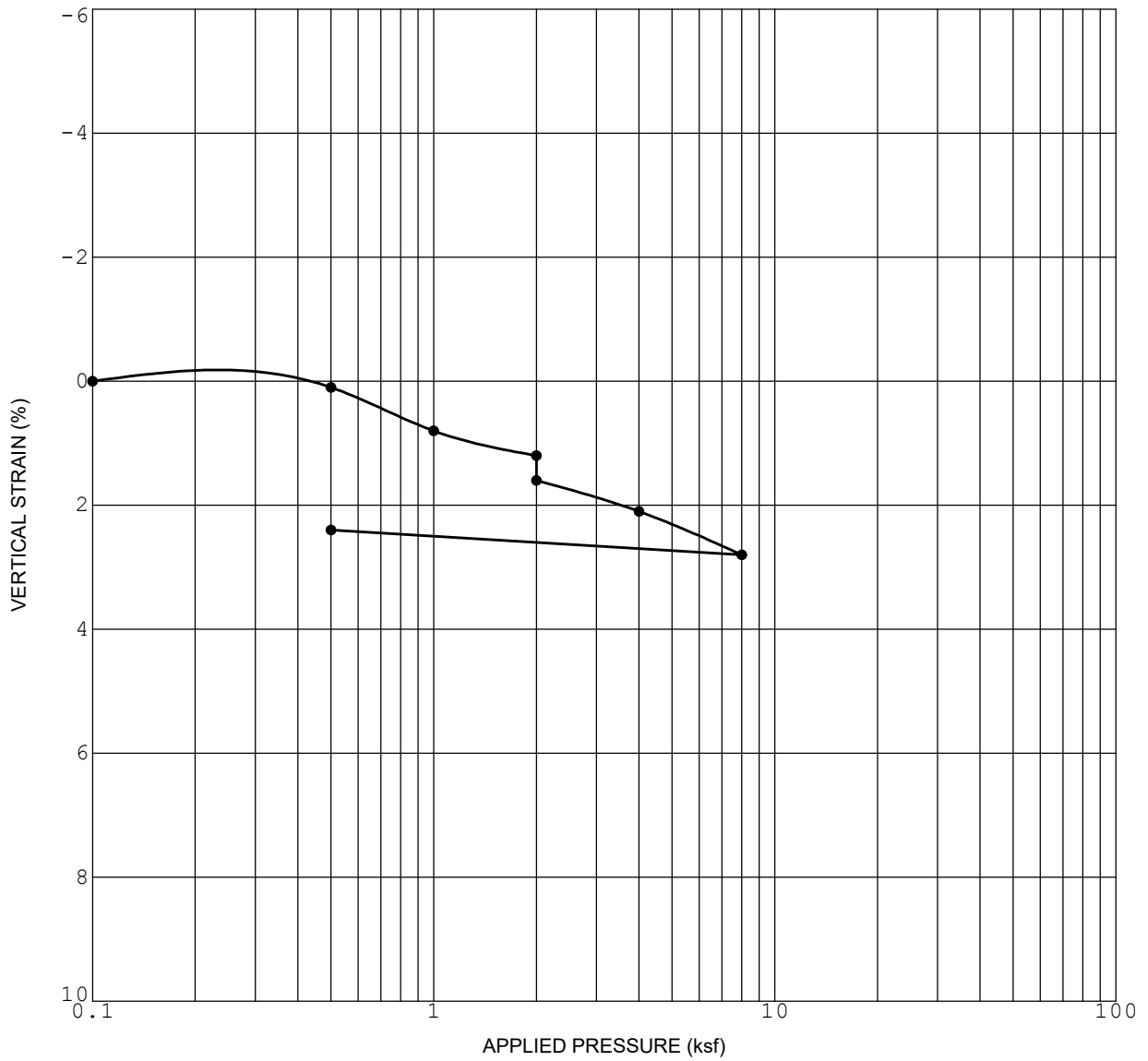

ASTM D2435

Initial Dry Density (pcf)	115.6
Initial Water Content (%)	18.4

Initial Saturation (%)	100
Sample Saturated at (ksf)	.1

CONSOLIDATION CURVE

PIRAEUS POINT

ENCINITAS, CALIFORNIA

SAMPLE NO. SB3-3

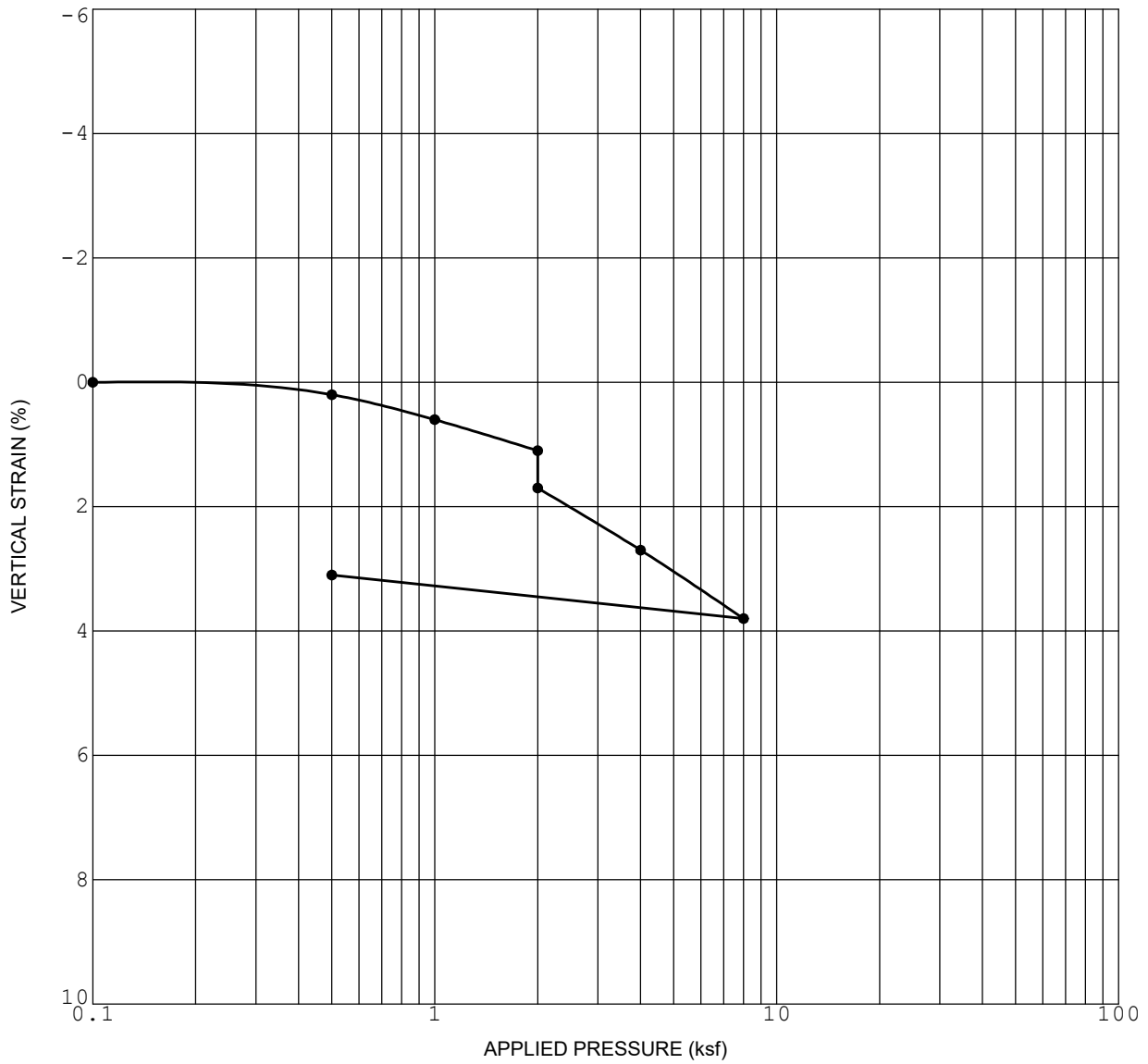

APPLIED PRESSURE (ksf)
ASTM D2435

Initial Dry Density (pcf)	110.8
Initial Water Content (%)	9.3

Initial Saturation (%)	49.8
Sample Saturated at (ksf)	2.0

CONSOLIDATION CURVE

PIRAEUS POINT

ENCINITAS, CALIFORNIA

SAMPLE NO. SB3-5

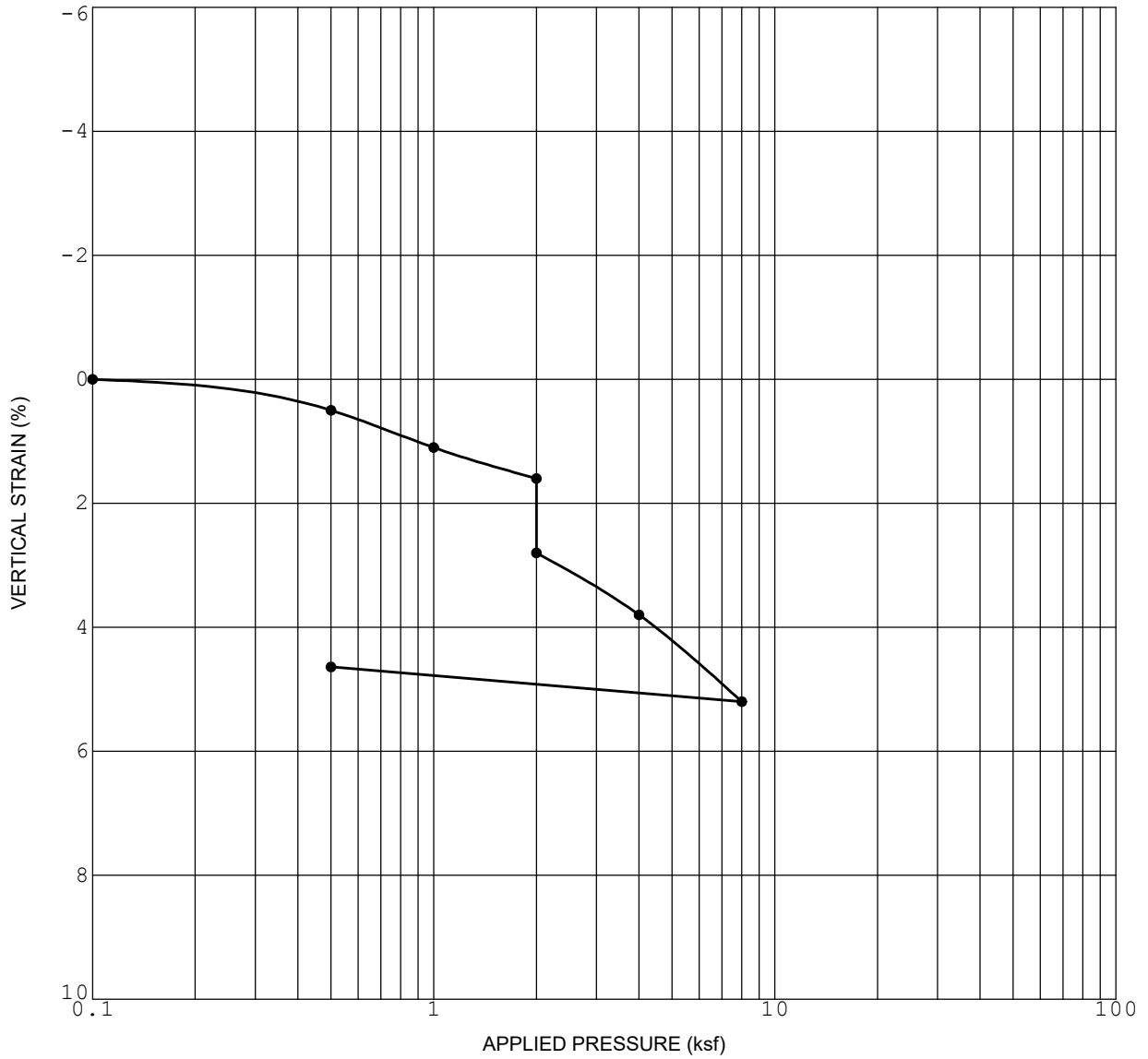

ASTM D2435

Initial Dry Density (pcf)	116.1
Initial Water Content (%)	9.4

Initial Saturation (%)	58.0
Sample Saturated at (ksf)	2.0

CONSOLIDATION CURVE

PIRAEUS POINT

ENCINITAS, CALIFORNIA

Sample SB2-7 (TR 4000)

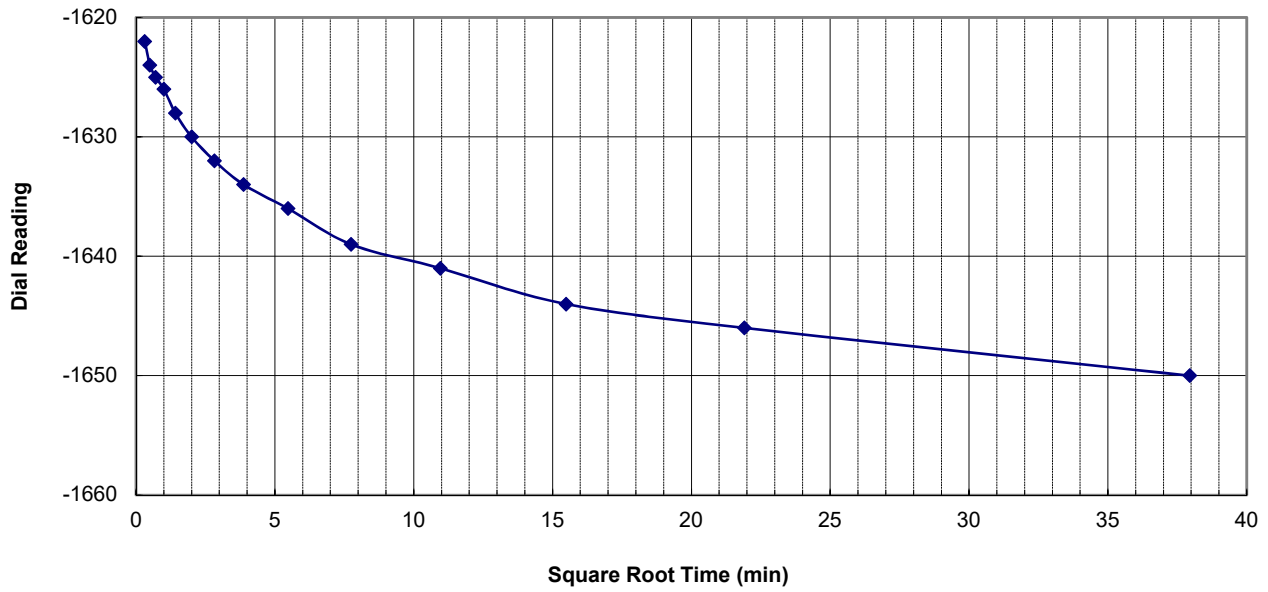

Sample SB2-7 (TR 8000)

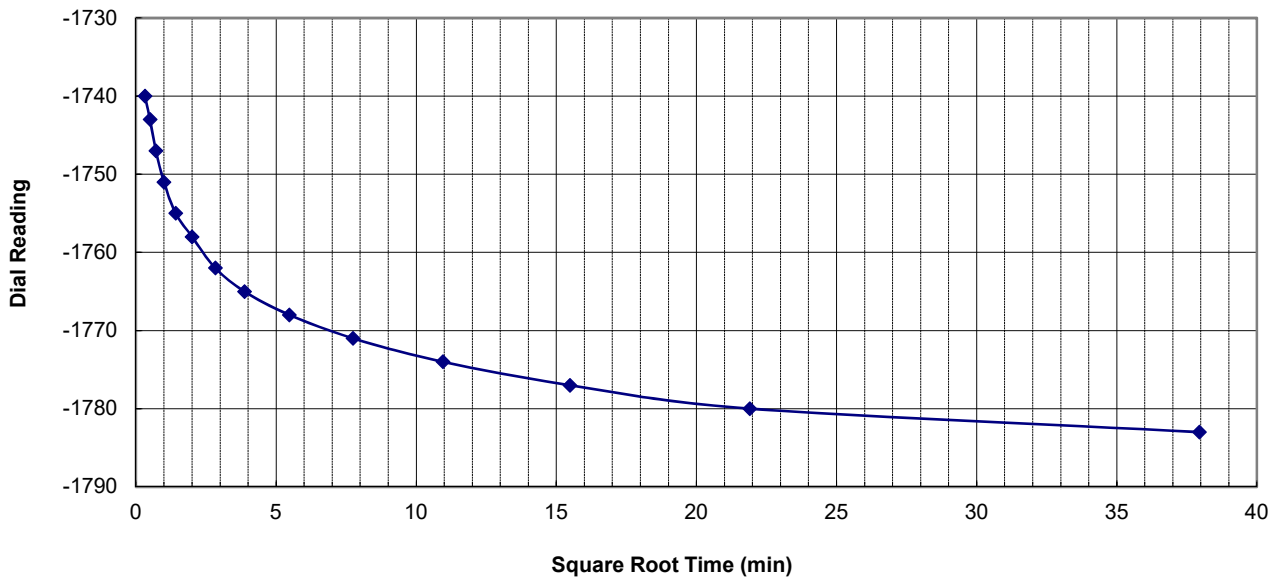

GEOCON
INCORPORATED



GEOTECHNICAL CONSULTANTS
6960 FLANDERS DRIVE - SAN DIEGO, CALIFORNIA 92121-2974
PHONE 858 558-6900 - FAX 858 558-6159

TIME RATE OF CONSOLIDATION RESULTS

PIRAEUS POINT
ENCINITAS, CALIFORNIA

LR / SW

PROJECT NO. G2307-32-05

Sample SB2-11 (TR 2000)

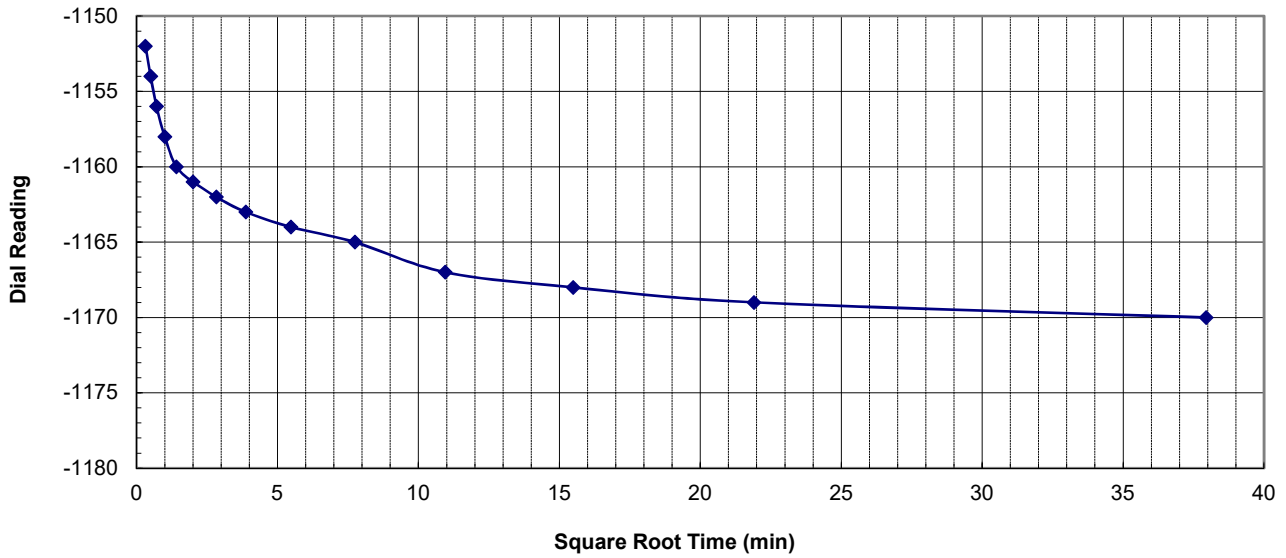

Sample SB2-11 (TR 4000)

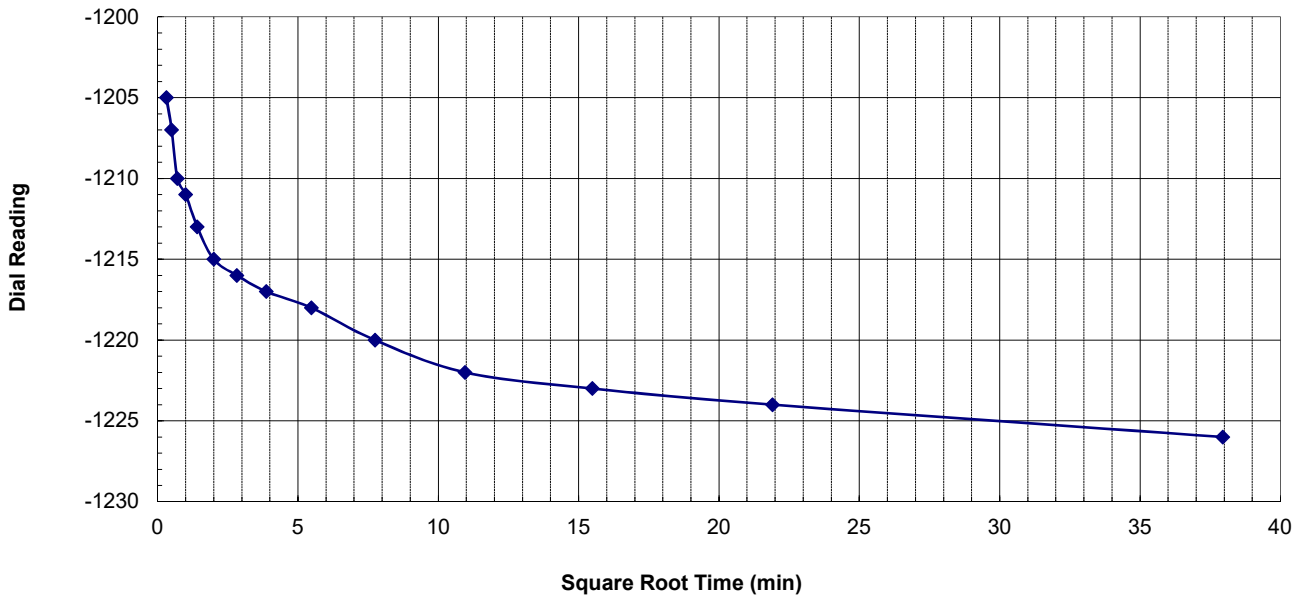

GEOCON
INCORPORATED



GEOTECHNICAL CONSULTANTS
6960 FLANDERS DRIVE - SAN DIEGO, CALIFORNIA 92121-2974
PHONE 858 558-6900 - FAX 858 558-6159

TIME RATE OF CONSOLIDATION RESULTS

PIRAEUS POINT
ENCINITAS, CALIFORNIA

LR / SW

PROJECT NO. G2307-32-05

Sample SB3-4 (TR 4000)

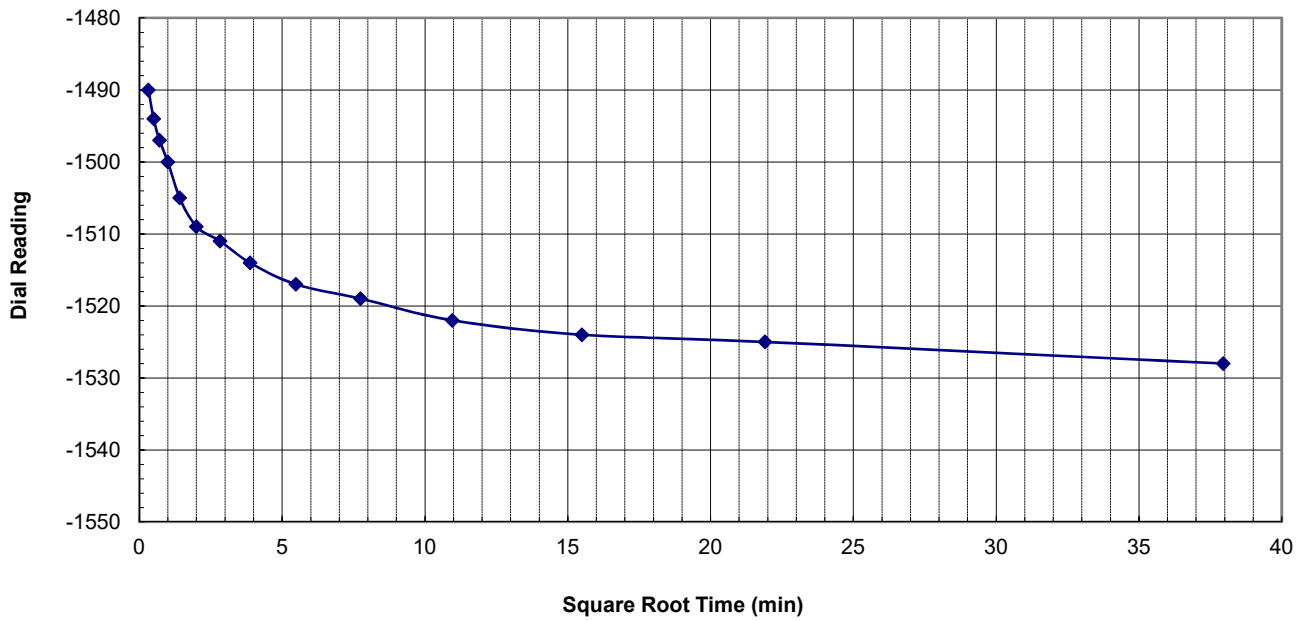

Sample SB3-4 (TR 8000)

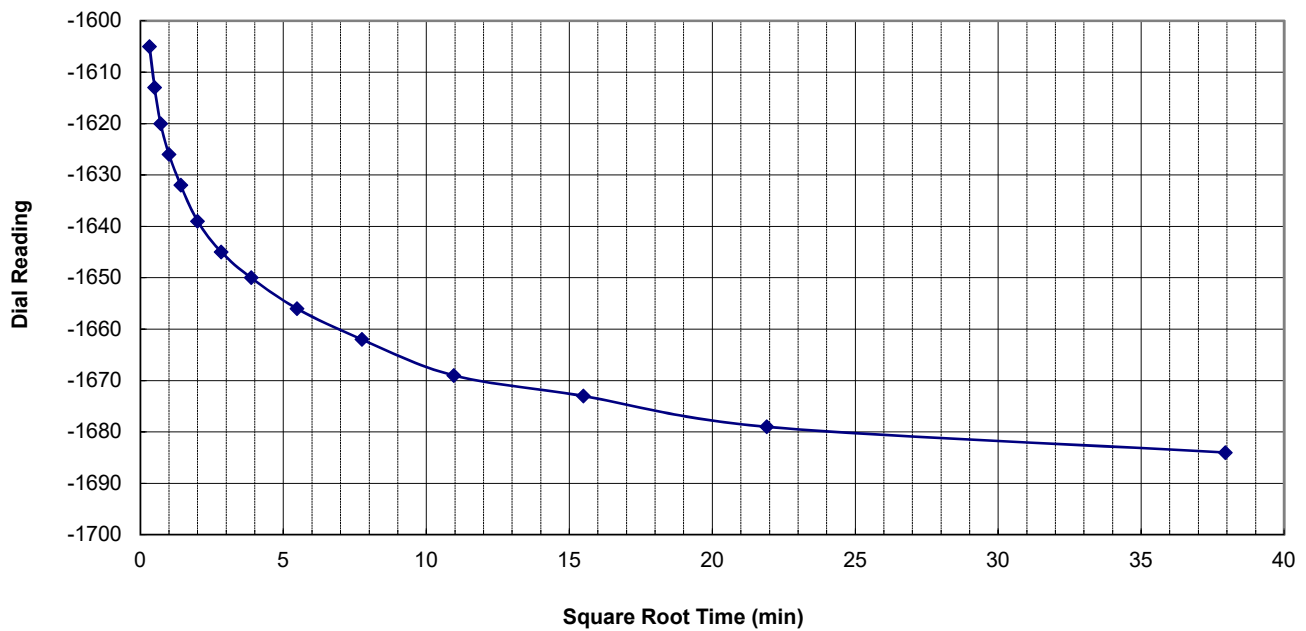

GEOCON
INCORPORATED



GEOTECHNICAL CONSULTANTS
6960 FLANDERS DRIVE - SAN DIEGO, CALIFORNIA 92121-2974
PHONE 858 558-6900 - FAX 858 558-6159

TIME RATE OF CONSOLIDATION RESULTS

PIRAEUS POINT
ENCINITAS, CALIFORNIA

LR / SW

PROJECT NO. G2307-32-05

APPENDIX

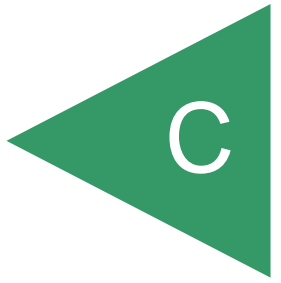

APPENDIX C
SLOPE STABILITY ANALYSES
FOR
PIRAEUS POINT
ENCINITAS, CALIFORNIA
PROJECT NO. G2307-32-05

Piraeus Point
 Project No. G2307-32-05
 Section A-A'
 Name: AA-Case1.gsz
 Date: 01/20/2022 Time: 02:55:21 PM

Proposed Condition
 Static Analysis

Color	Name	Unit Weight (pcf)	Cohesion' (psf)	Phi' (°)
Red	BPS	115	100	8
Cyan	Qcf	125	300	28
Yellow	Qvop	120	350	28
Light Green	Tsa (ML,CL)	130	500	23
Light Green	Tsa (SM,SP)	130	750	33

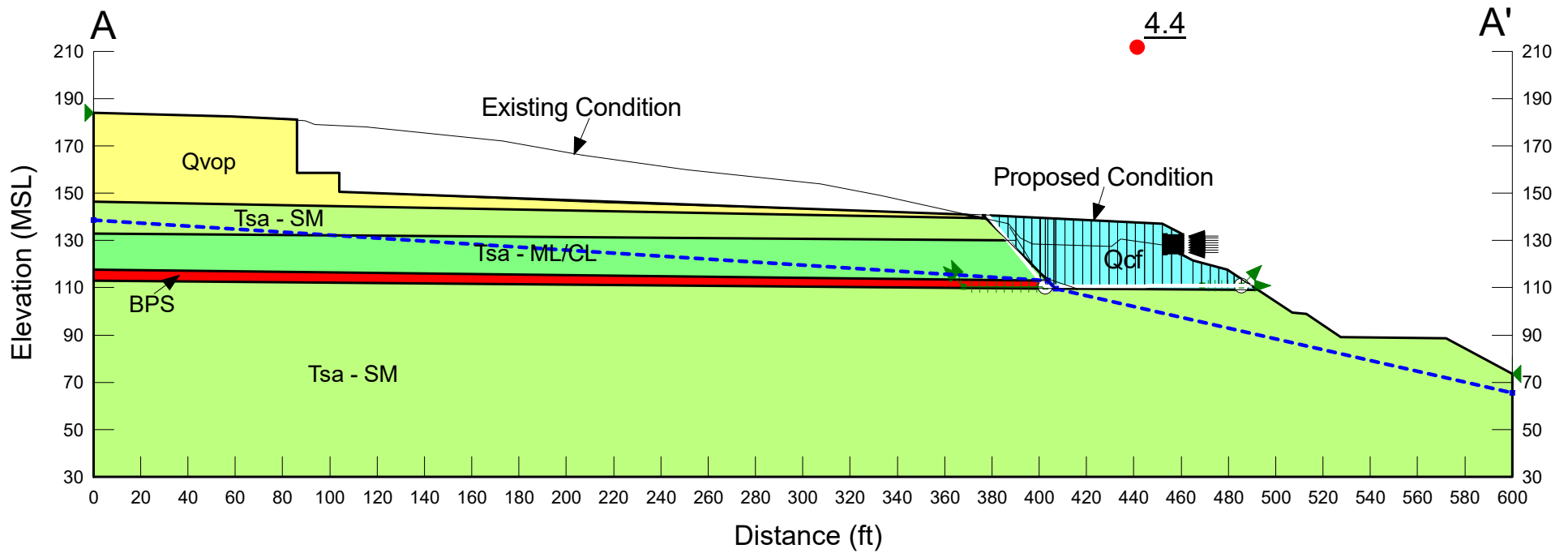

Figure C-1

Piraeus Point
 Project No. G2307-32-05
 Section A-A'
 Name: AA-Case1s.gsz
 Date: 01/21/2022 Time: 09:00:42 AM

Proposed Condition

Seismic Analysis
 $k_{eq} = 0.13g$

Color	Name	Unit Weight (pcf)	Cohesion' (psf)	Phi' (°)
Red	BPS	115	100	8
Cyan	Qcf	125	300	28
Yellow	Qvop	120	350	28
Light Green	Tsa (ML,CL)	130	500	23
Light Green	Tsa (SM,SP)	130	750	33

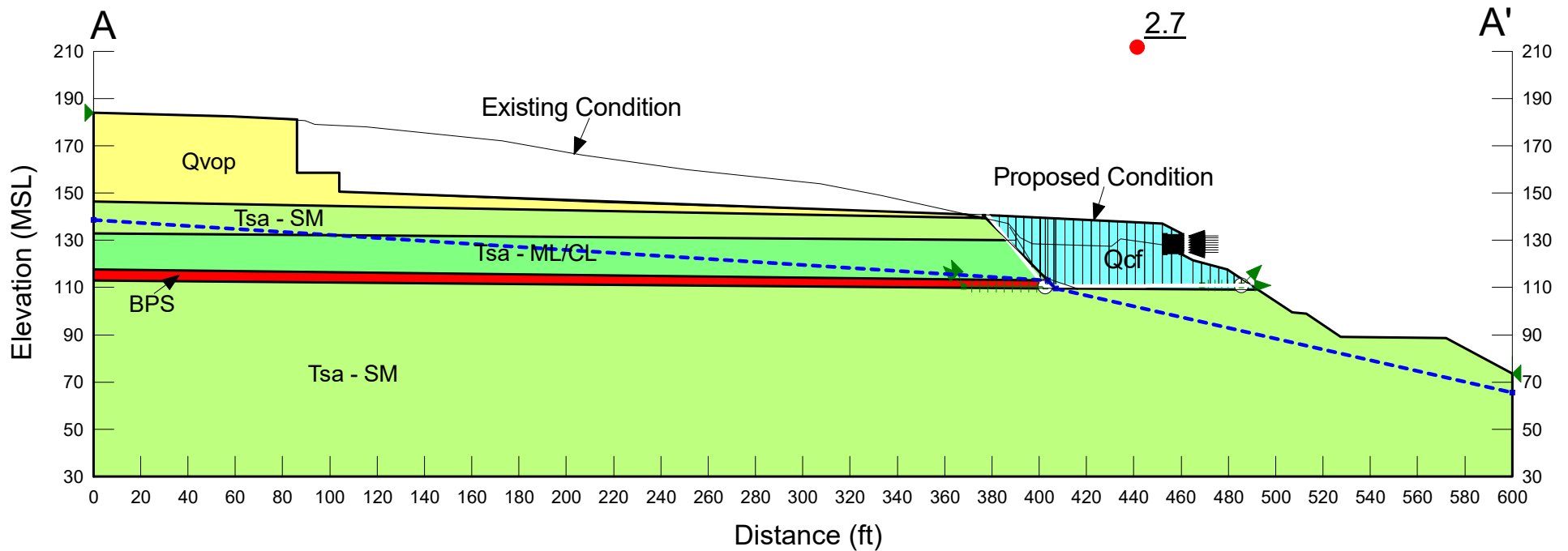

Figure C-2

Piraeus Point
 Project No. G2307-32-05
 Section A-A'
 Name: AA-Case2.gsz
 Date: 01/20/2022 Time: 02:57:03 PM

Proposed Condition
 Static Analysis

Color	Name	Unit Weight (pcf)	Cohesion' (psf)	Phi' (°)
Red	BPS	115	100	8
Cyan	Qcf	125	300	28
Yellow	Qvop	120	350	28
Light Green	Tsa (ML,CL)	130	500	23
Light Green	Tsa (SM,SP)	130	750	33

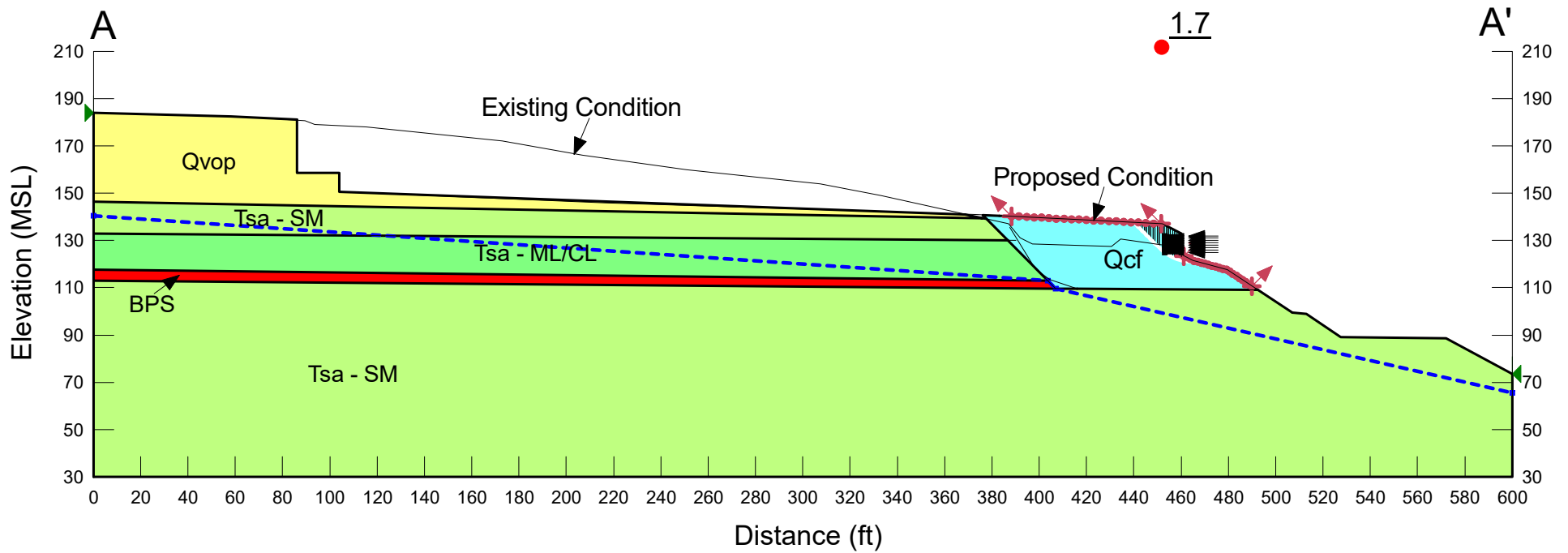

Figure C-3

Piraeus Point
 Project No. G2307-32-05
 Section A-A'
 Name: AA-Case2s.gsz
 Date: 01/21/2022 Time: 09:03:00 AM

Proposed Condition

Seismic Analysis
 $keq = 0.13g$

Color	Name	Unit Weight (pcf)	Cohesion' (psf)	Phi' (°)
Red	BPS	115	100	8
Cyan	Qcf	125	300	28
Yellow	Qvop	120	350	28
Light Green	Tsa (ML,CL)	130	500	23
Light Green	Tsa (SM,SP)	130	750	33

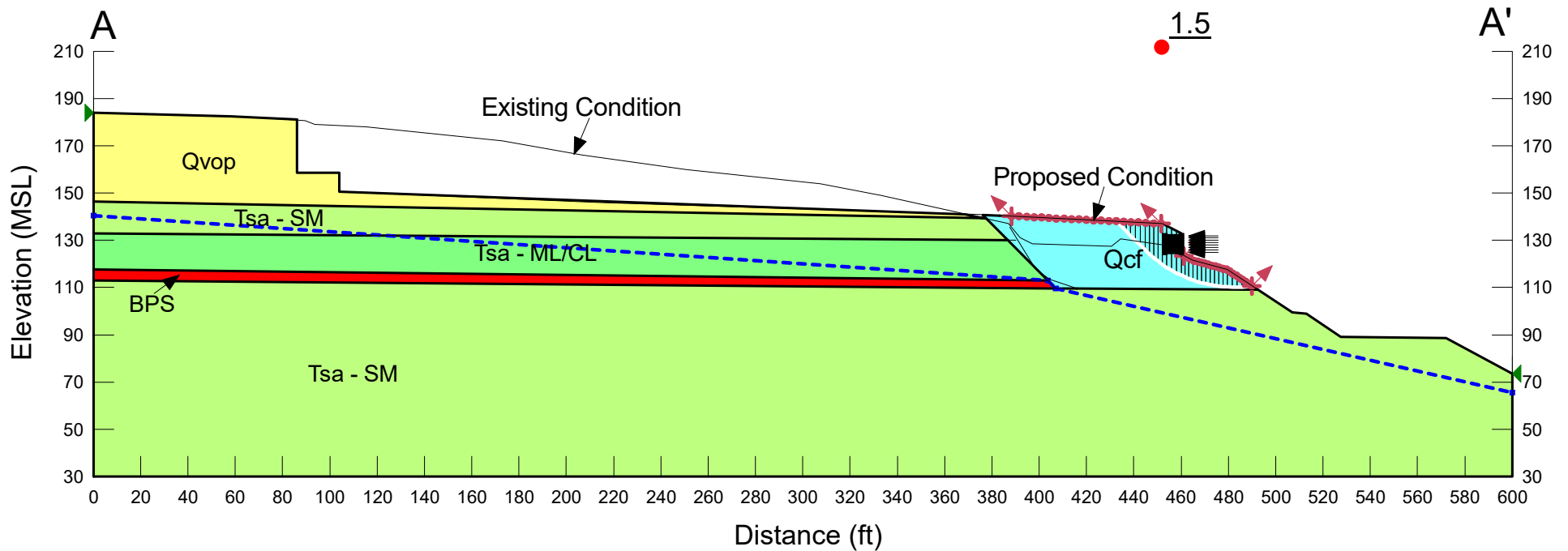

Figure C-4

Piraeus Point
 Project No. G2307-32-05
 Section A-A'
 Name: AA-Case3.gsz
 Date: 01/20/2022 Time: 02:58:54 PM

Proposed Condition

Static Analysis

Color	Name	Unit Weight (pcf)	Cohesion' (psf)	Phi' (°)
Red	BPS	115	100	8
Cyan	Qcf	125	300	28
Yellow	Qvop	120	350	28
Light Green	Tsa (ML,CL)	130	500	23
Light Green	Tsa (SM,SP)	130	750	33

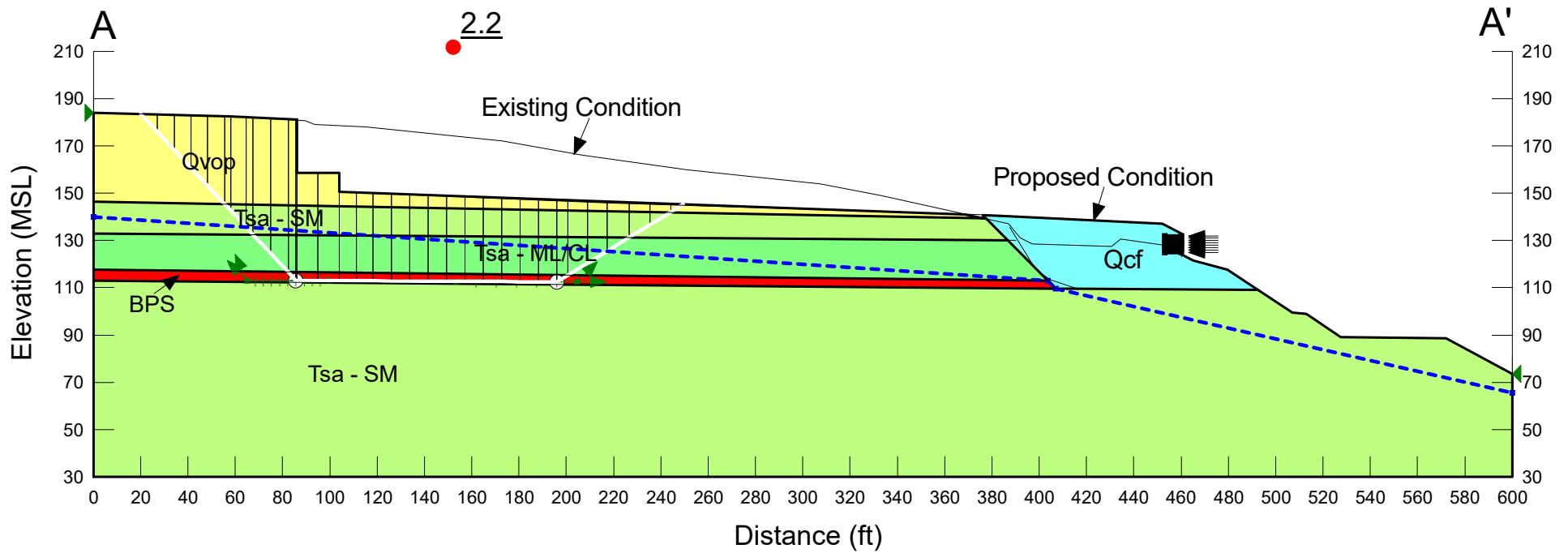

Figure C-5

Piraeus Point
 Project No. G2307-32-05
 Section A-A'
 Name: AA-Case3s.gsz
 Date: 01/21/2022 Time: 09:08:25 AM

Proposed Condition

Seismic Analysis
 $k_{eq} = 0.13g$

Color	Name	Unit Weight (pcf)	Cohesion' (psf)	Phi' (°)
Red	BPS	115	100	8
Cyan	Qcf	125	300	28
Yellow	Qvop	120	350	28
Light Green	Tsa (ML,CL)	130	500	23
Light Green	Tsa (SM,SP)	130	750	33

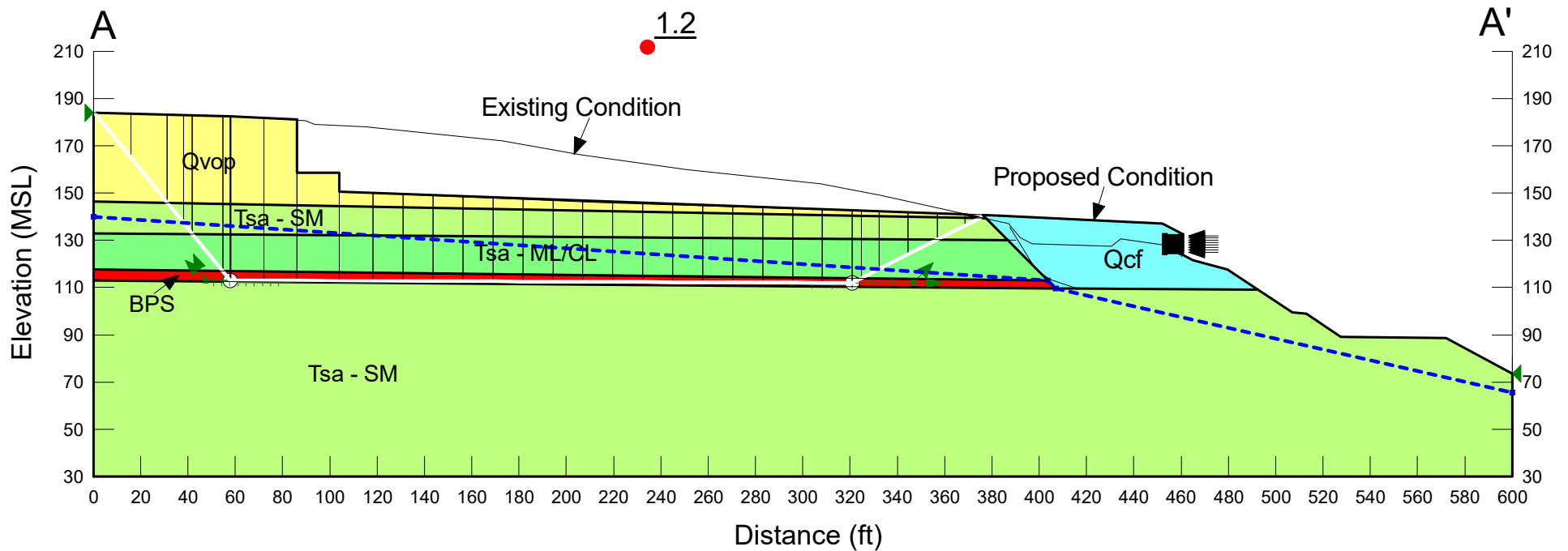

Figure C-6

Piraeus Point
 Project No. G2307-32-05
 Section A-A'
 Name: AA-Case4.gsz
 Date: 01/20/2022 Time: 03:12:49 PM

Proposed Condition

Static Analysis

Micropile Wall (6,500 lbf/ft reinforcement load)

Color	Name	Unit Weight (pcf)	Cohesion' (psf)	Phi' (°)
Red	BPS	115	100	8
Cyan	Qcf	125	300	28
Yellow	Qvop	120	350	28
Light Green	Tsa (ML,CL)	130	500	23
Light Green	Tsa (SM,SP)	130	750	33

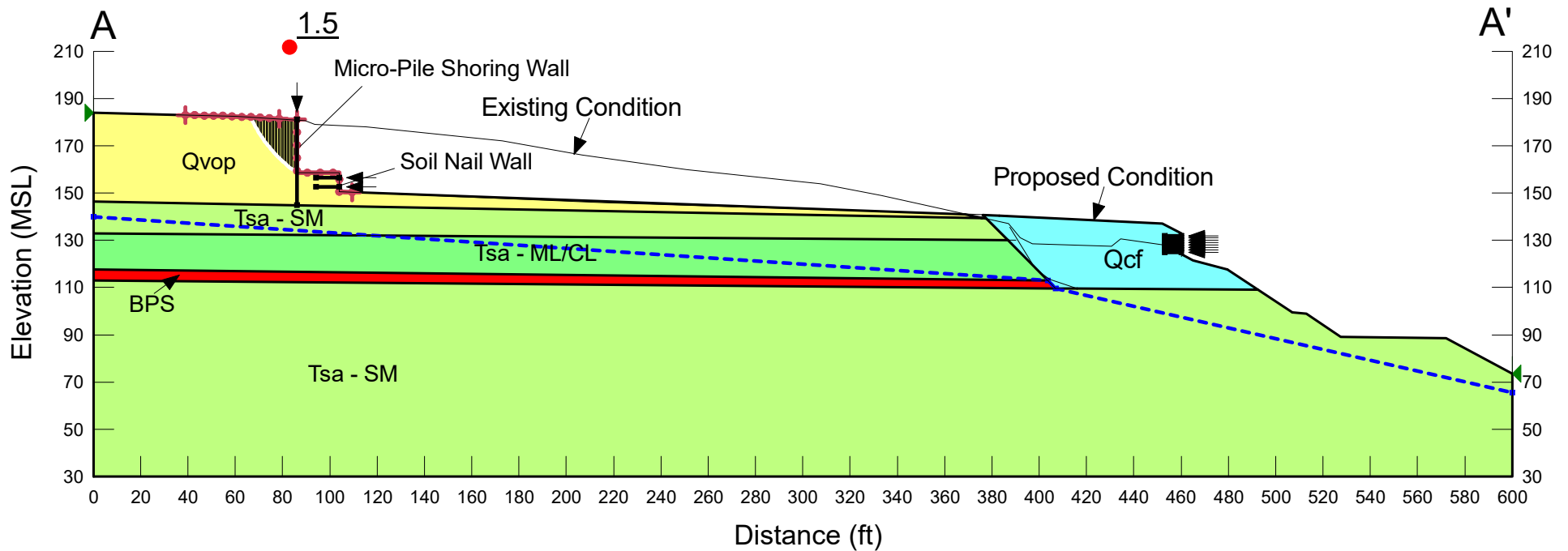

Figure C-7

Piraeus Point
 Project No. G2307-32-05
 Section A-A'
 Name: AA-Case4s.gsz
 Date: 01/21/2022 Time: 09:10:50 AM

Color	Name	Unit Weight (pcf)	Cohesion' (psf)	Phi' (°)
Red	BPS	115	100	8
Cyan	Qcf	125	300	28
Yellow	Qvop	120	350	28
Light Green	Tsa (ML,CL)	130	500	23
Light Green	Tsa (SM,SP)	130	750	33

Proposed Condition

Seismic Analysis
 $k_{eq} = 0.13g$

Micropile Wall (6,500 lbf/ft reinforcement load)

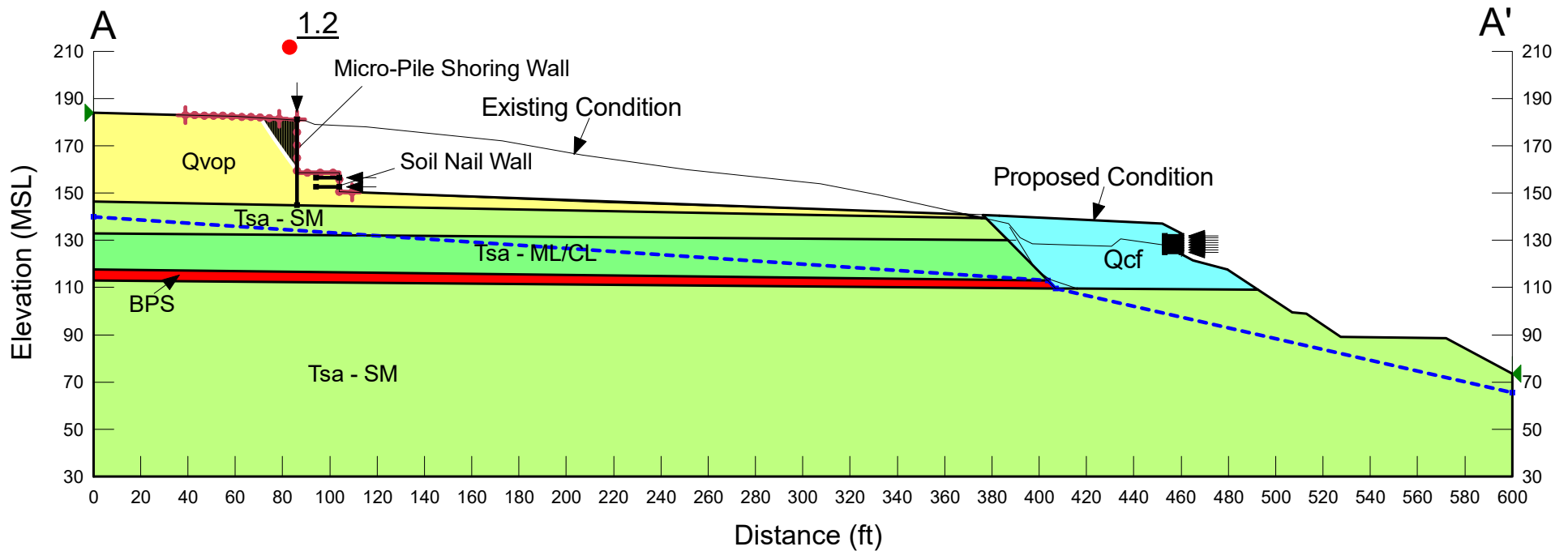

Figure C-8

Piraeus Point
 Project No. G2307-32-05
 Section A-A'
 Name: AA-Case5.gsz
 Date: 01/20/2022 Time: 03:18:38 PM

Proposed Condition

Static Analysis

Micropile Wall (6,500 lbf/ft reinforcement load)

Color	Name	Unit Weight (pcf)	Cohesion' (psf)	Phi' (°)
Red	BPS	115	100	8
Cyan	Qcf	125	300	28
Yellow	Qvop	120	350	28
Light Green	Tsa (ML,CL)	130	500	23
Light Green	Tsa (SM,SP)	130	750	33

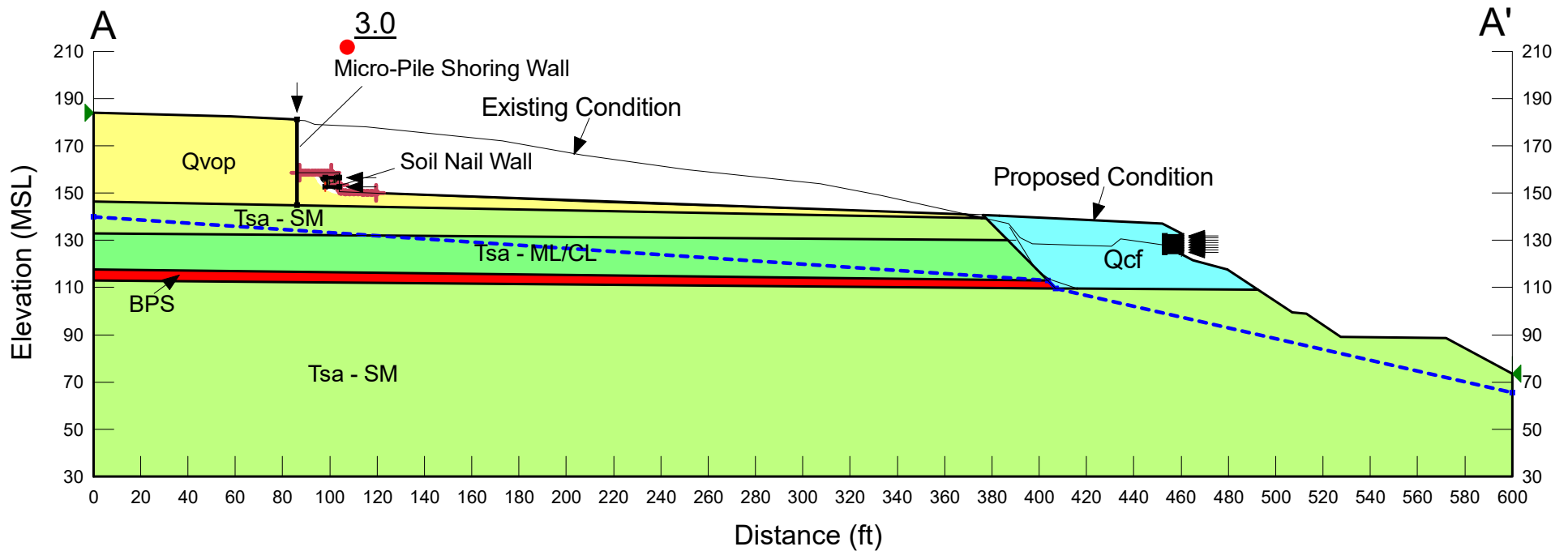

Figure C-9

Piraeus Point
 Project No. G2307-32-05
 Section A-A'
 Name: AA-Case5s.gsz
 Date: 01/21/2022 Time: 09:13:09 AM

Proposed Condition

Seismic Analysis
 $keq = 0.13g$

Micropile Wall (6,500 lbf/ft reinforcement load)

Color	Name	Unit Weight (pcf)	Cohesion' (psf)	Phi' (°)
Red	BPS	115	100	8
Cyan	Qcf	125	300	28
Yellow	Qvop	120	350	28
Light Green	Tsa (ML,CL)	130	500	23
Light Green	Tsa (SM,SP)	130	750	33

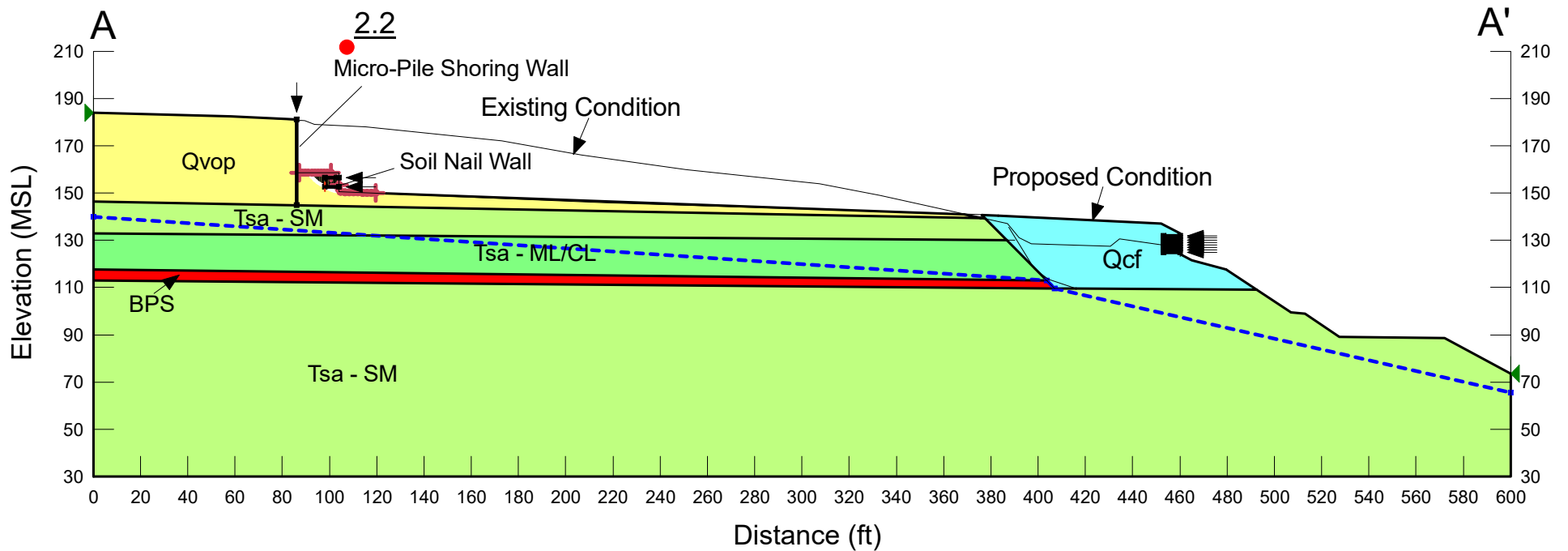

Figure C-10

Piraeus Point
 Project No. G2307-32-05
 Section B-B'
 Name: BB-Case1.gsz
 Date: 01/21/2022 Time: 09:37:58 AM

Color	Name	Unit Weight (pcf)	Cohesion' (psf)	Phi' (°)
Red	BPS	115	100	8
Cyan	Qcf	125	300	28
Yellow	Qvop	120	350	28
Light Green	Tsa (ML,CL)	130	500	23
Light Green	Tsa (SM,SP)	130	750	33

Proposed Condition

Static Analysis

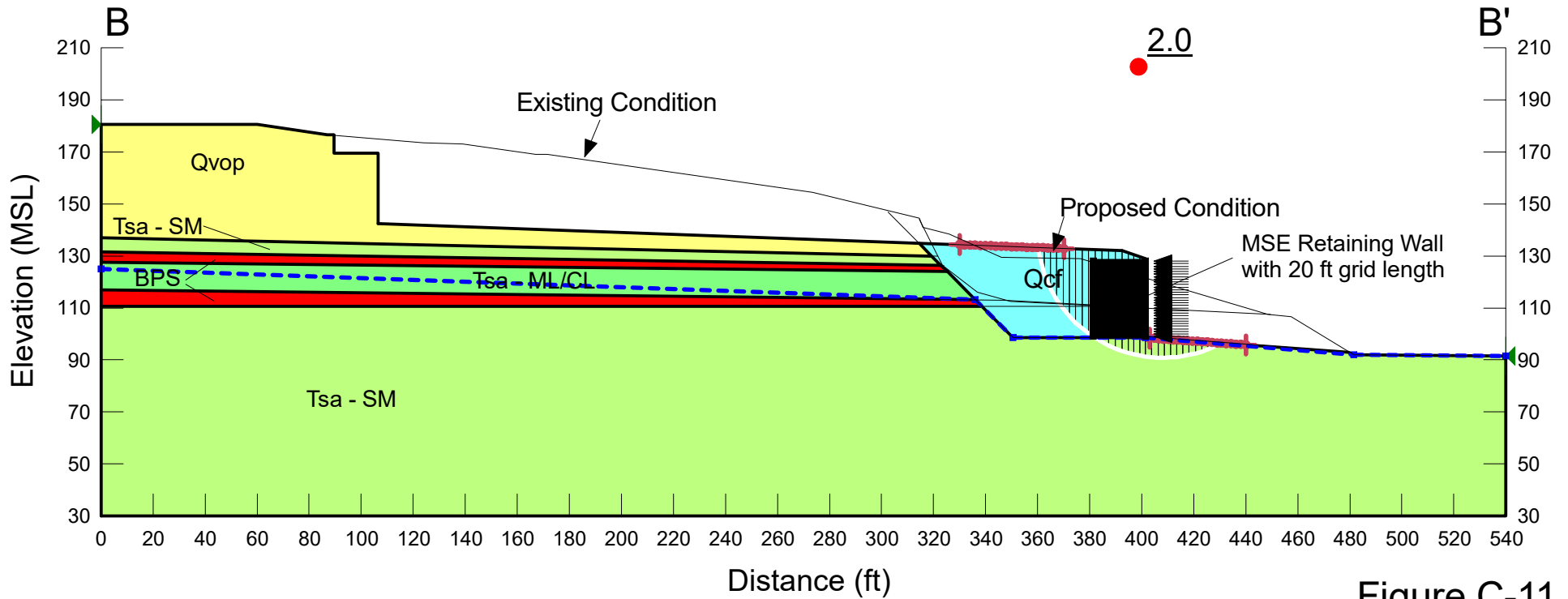

Figure C-11

Piraeus Point
 Project No. G2307-32-05
 Section B-B'
 Name: BB-Case1s.gsz
 Date: 01/21/2022 Time: 09:39:10 AM

Proposed Condition

Seismic Analysis
 $k_{eq} = 0.13g$

Color	Name	Unit Weight (pcf)	Cohesion' (psf)	Phi' (°)
Red	BPS	115	100	8
Cyan	Qcf	125	300	28
Yellow	Qvop	120	350	28
Light Green	Tsa (ML,CL)	130	500	23
Light Green	Tsa (SM,SP)	130	750	33

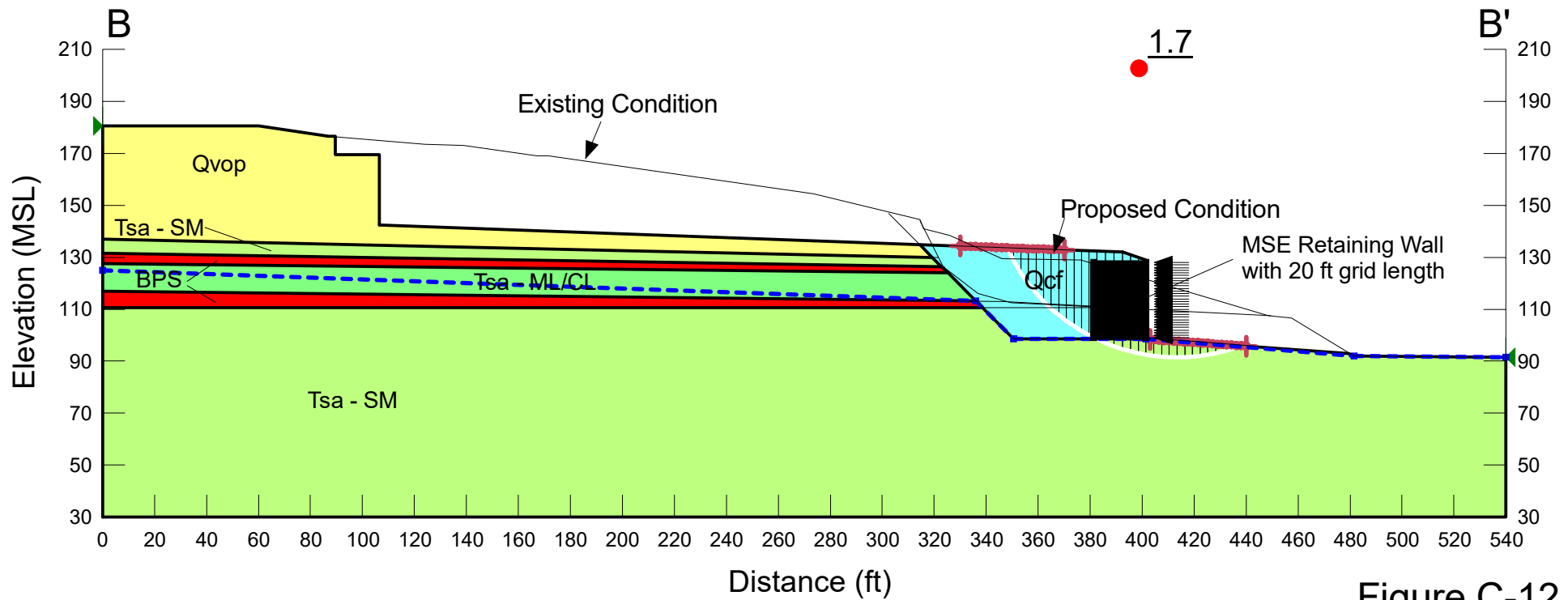

Figure C-12

Piraeus Point
 Project No. G2307-32-05
 Section B-B'
 Name: BB-Case2.gsz
 Date: 01/21/2022 Time: 09:40:20 AM

Color	Name	Unit Weight (pcf)	Cohesion' (psf)	Phi' (°)
Red	BPS	115	100	8
Cyan	Qcf	125	300	28
Yellow	Qvop	120	350	28
Light Green	Tsa (ML,CL)	130	500	23
Light Green	Tsa (SM,SP)	130	750	33

Proposed Condition

Static Analysis

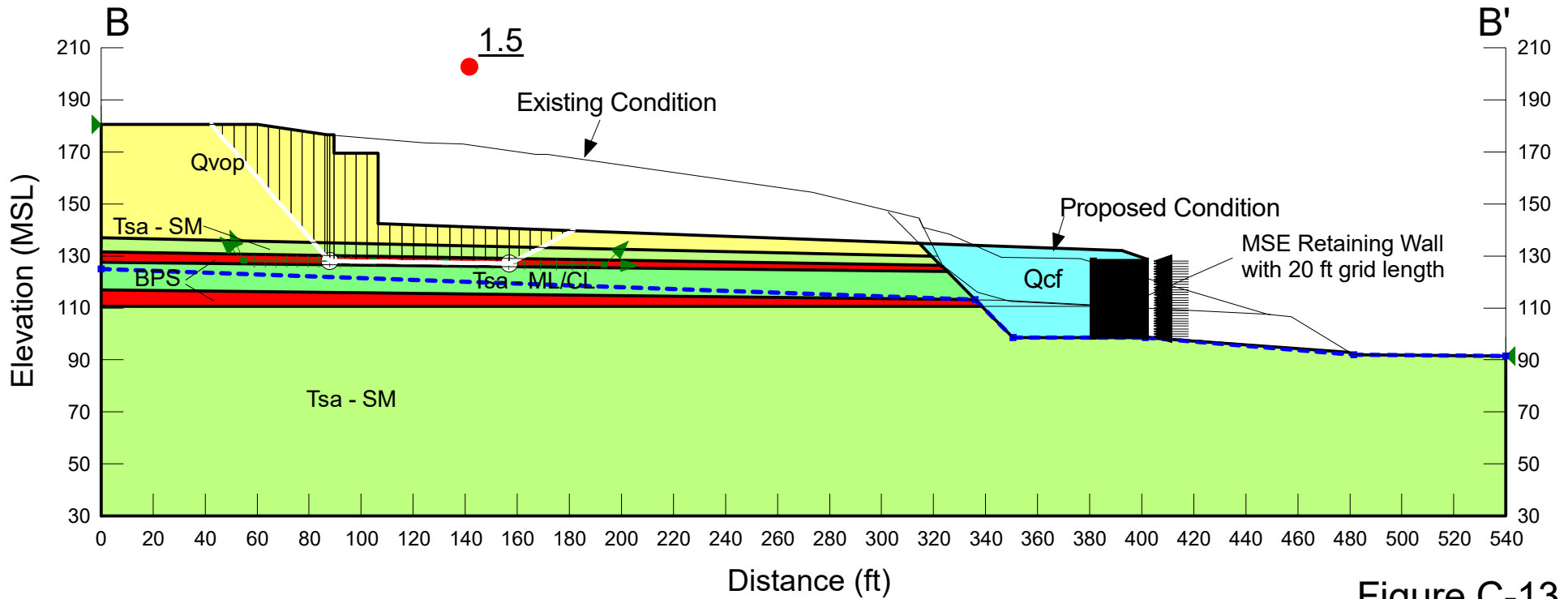

Figure C-13

Piraeus Point
 Project No. G2307-32-05
 Section B-B'
 Name: BB-Case2s.gsz
 Date: 01/21/2022 Time: 09:41:31 AM

Proposed Condition

Seismic Analysis
 $k_{eq} = 0.13g$

Color	Name	Unit Weight (pcf)	Cohesion' (psf)	Phi' (°)
Red	BPS	115	100	8
Cyan	Qcf	125	300	28
Yellow	Qvop	120	350	28
Light Green	Tsa (ML,CL)	130	500	23
Light Green	Tsa (SM,SP)	130	750	33

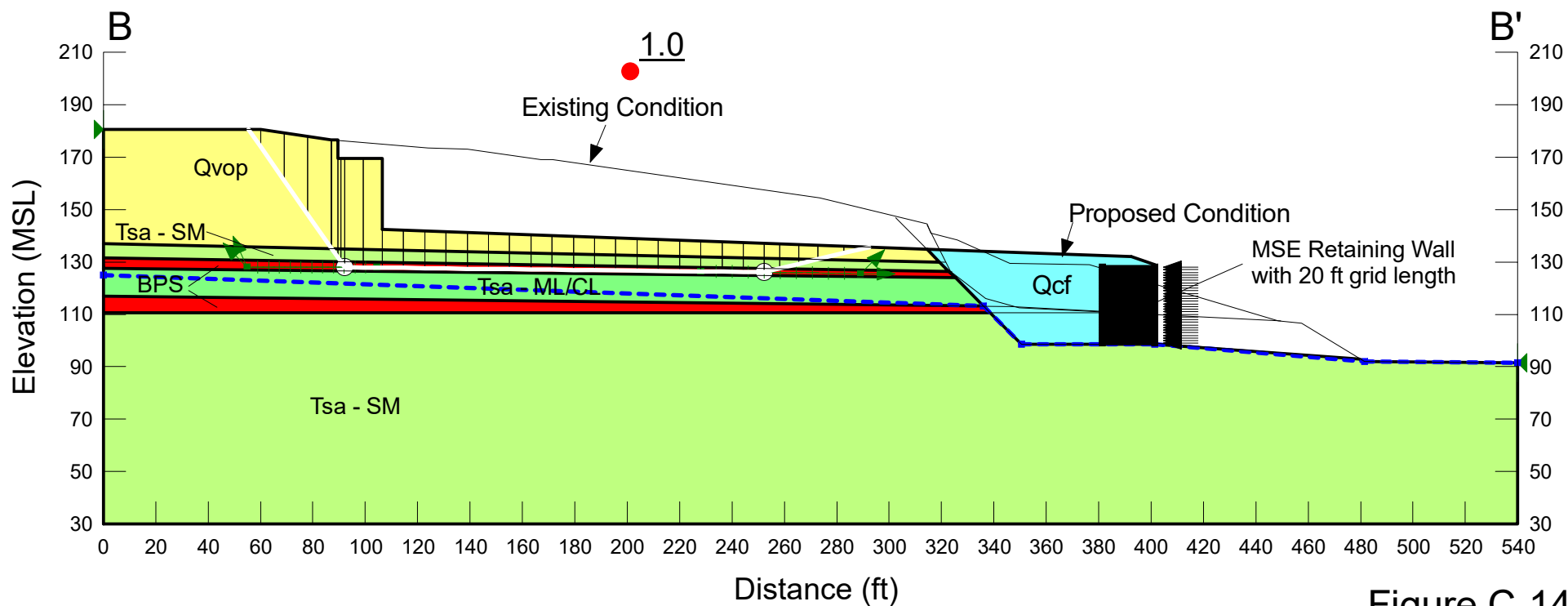

Figure C-14

Piraeus Point
 Project No. G2307-32-05
 Section B-B'
 Name: BB-Case3.gsz
 Date: 01/21/2022 Time: 09:57:23 AM

Color	Name	Unit Weight (pcf)	Cohesion' (psf)	Phi' (°)
Red	BPS	115	100	8
Cyan	Qcf	125	300	28
Yellow	Qvop	120	350	28
Green	Tsa (ML,CL)	130	500	23
Light Green	Tsa (SM,SP)	130	750	33

Proposed Condition

Static Analysis

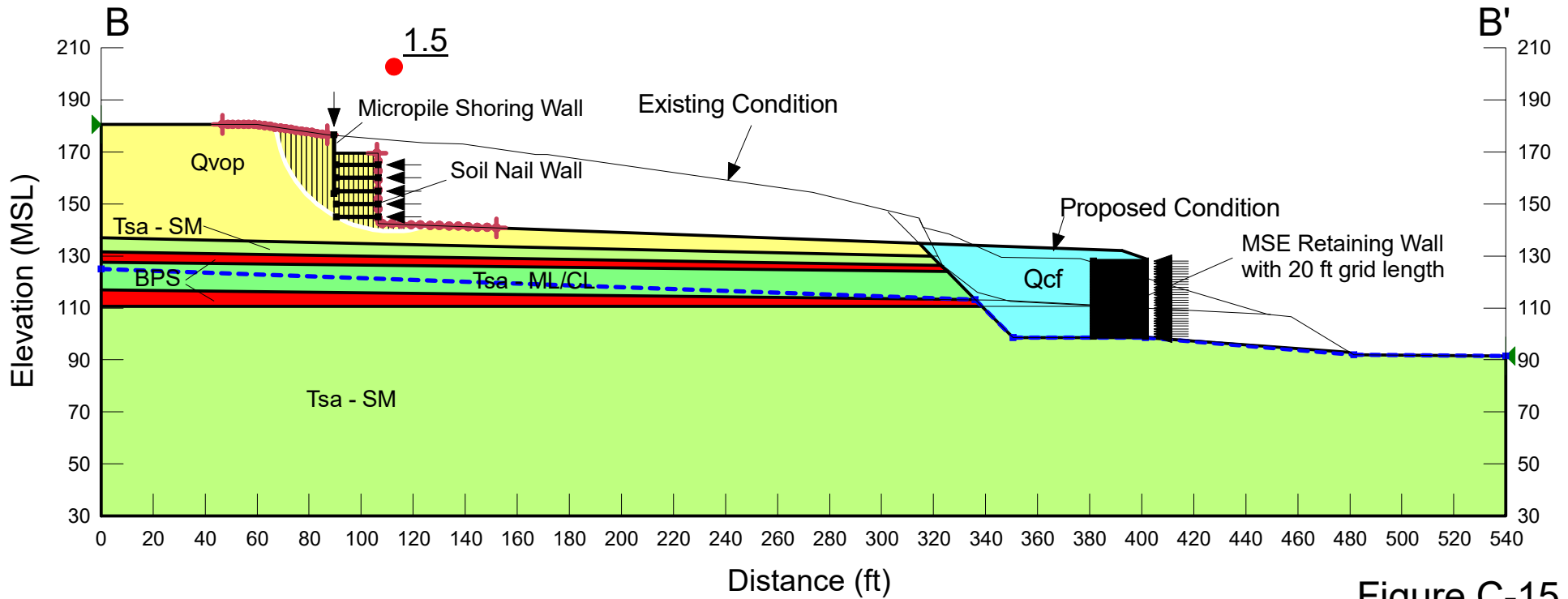

Figure C-15

Piraeus Point
 Project No. G2307-32-05
 Section B-B'
 Name: BB-Case3s.gsz
 Date: 01/21/2022 Time: 10:00:04 AM

Proposed Condition

Seismic Analysis
 $keq = 0.13g$

Color	Name	Unit Weight (pcf)	Cohesion' (psf)	Phi' (°)
Red	BPS	115	100	8
Cyan	Qcf	125	300	28
Yellow	Qvop	120	350	28
Light Green	Tsa (ML,CL)	130	500	23
Light Green	Tsa (SM,SP)	130	750	33

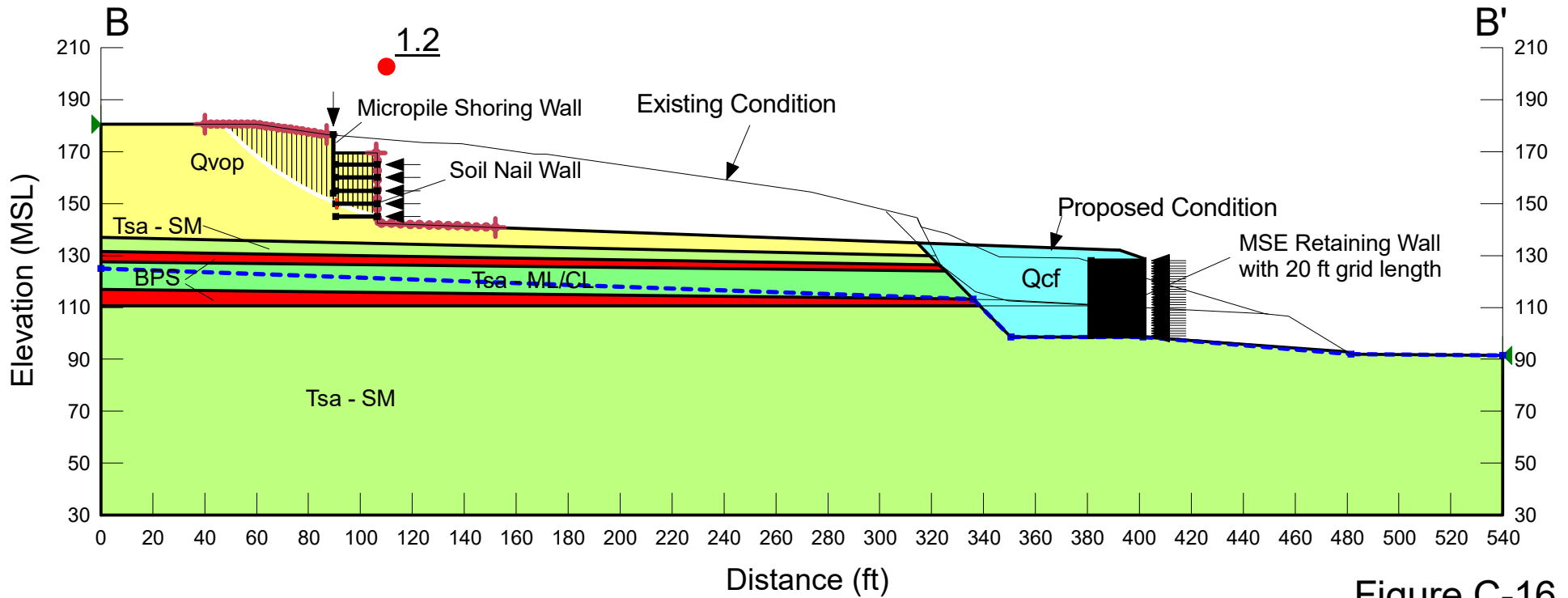

Figure C-16

Piraeus Point
 Project No. G2307-32-05
 Section B-B'
 Name: BB-Case4.gsz
 Date: 01/21/2022 Time: 10:05:49 AM

Color	Name	Unit Weight (pcf)	Cohesion' (psf)	Phi' (°)
Red	BPS	115	100	8
Cyan	Qcf	125	300	28
Yellow	Qvop	120	350	28
Light Green	Tsa (ML,CL)	130	500	23
Light Green	Tsa (SM,SP)	130	750	33

Proposed Condition

Static Analysis

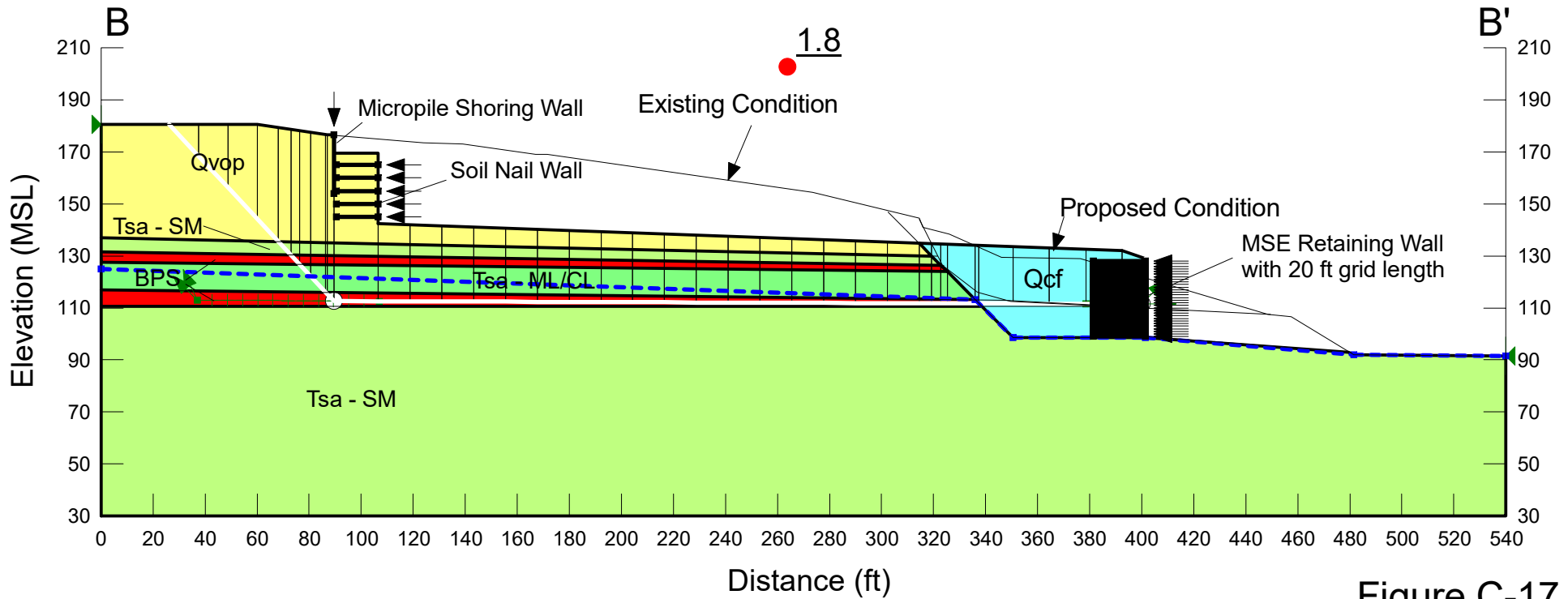

Figure C-17

Piraeus Point
 Project No. G2307-32-05
 Section B-B'
 Name: BB-Case4s.gsz
 Date: 01/21/2022 Time: 10:07:34 AM

Color	Name	Unit Weight (pcf)	Cohesion' (psf)	Phi' (°)
Red	BPS	115	100	8
Cyan	Qcf	125	300	28
Yellow	Qvop	120	350	28
Light Green	Tsa (ML,CL)	130	500	23
Light Green	Tsa (SM,SP)	130	750	33

Proposed Condition

Seismic Analysis
 $k_{eq} = 0.13g$

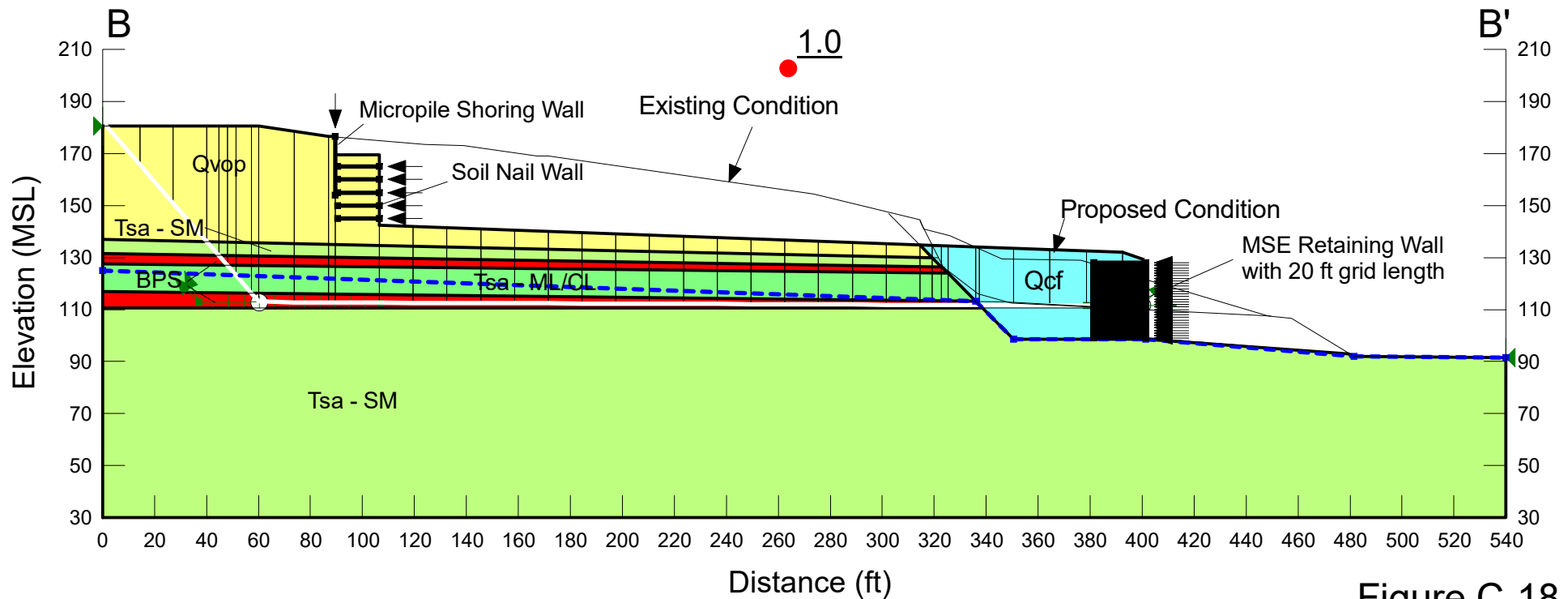

Figure C-18

Piraeus Point
 Project No. G2307-32-05
 Section B-B'
 Name: BB-Case5.gsz
 Date: 01/21/2022 Time: 10:10:46 AM

Color	Name	Unit Weight (pcf)	Cohesion' (psf)	Phi' (°)
Red	BPS	115	100	8
Cyan	Qcf	125	300	28
Yellow	Qvop	120	350	28
Light Green	Tsa (ML,CL)	130	500	23
Light Green	Tsa (SM,SP)	130	750	33

Proposed Condition

Static Analysis

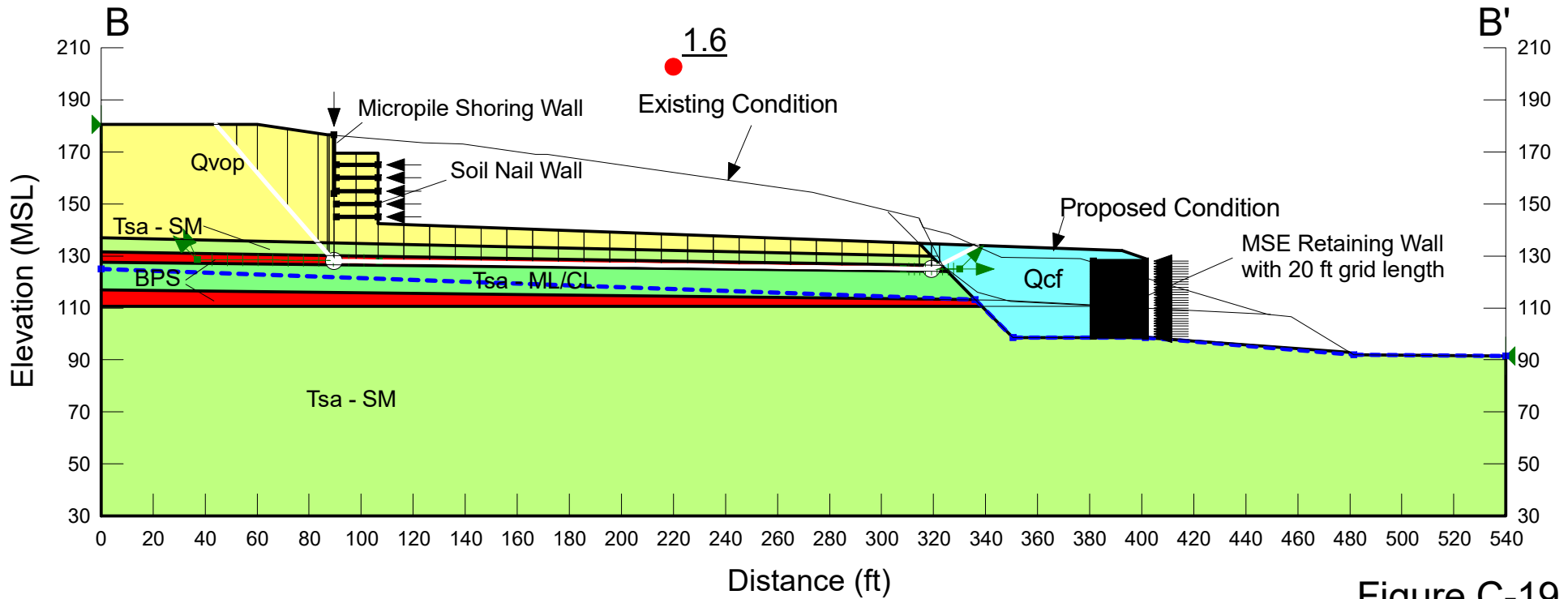

Figure C-19

Piraeus Point
 Project No. G2307-32-05
 Section B-B'
 Name: BB-Case5s.gsz
 Date: 01/21/2022 Time: 10:12:33 AM

Proposed Condition

Seismic Analysis
 $k_{eq} = 0.13g$

Color	Name	Unit Weight (pcf)	Cohesion' (psf)	Phi' (°)
Red	BPS	115	100	8
Cyan	Qcf	125	300	28
Yellow	Qvop	120	350	28
Light Green	Tsa (ML,CL)	130	500	23
Light Green	Tsa (SM,SP)	130	750	33

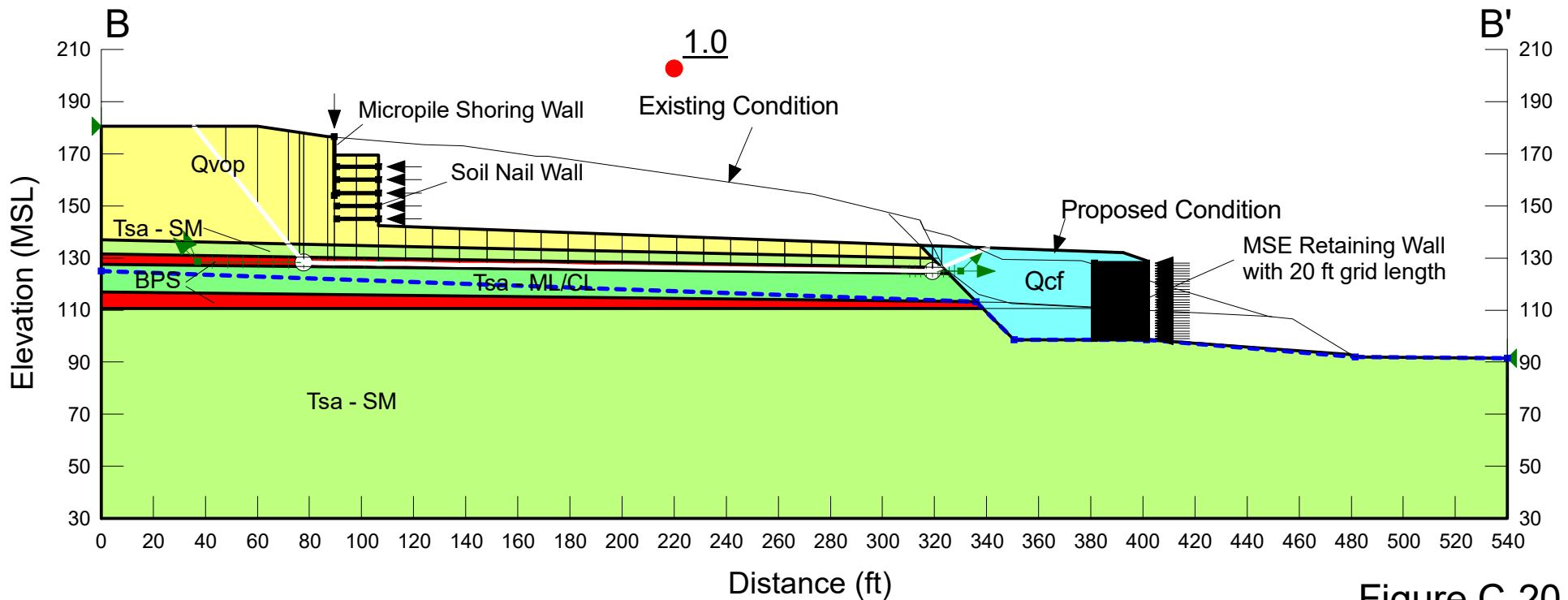

Figure C-20

Piraeus Point
 Project No. G2307-32-05
 Section C-C'
 Name: CC-Case1.gsz
 Date: 01/21/2022 Time: 11:10:39 AM

Proposed Condition

Static Analysis

Color	Name	Unit Weight (pcf)	Cohesion' (psf)	Phi' (°)
Red	BPS	115	100	8
Cyan	Qcf	125	300	28
Yellow	Qvop	120	350	28
Light Green	Tsa (ML,CL)	130	500	23
Light Green	Tsa (SM,SP)	130	750	33

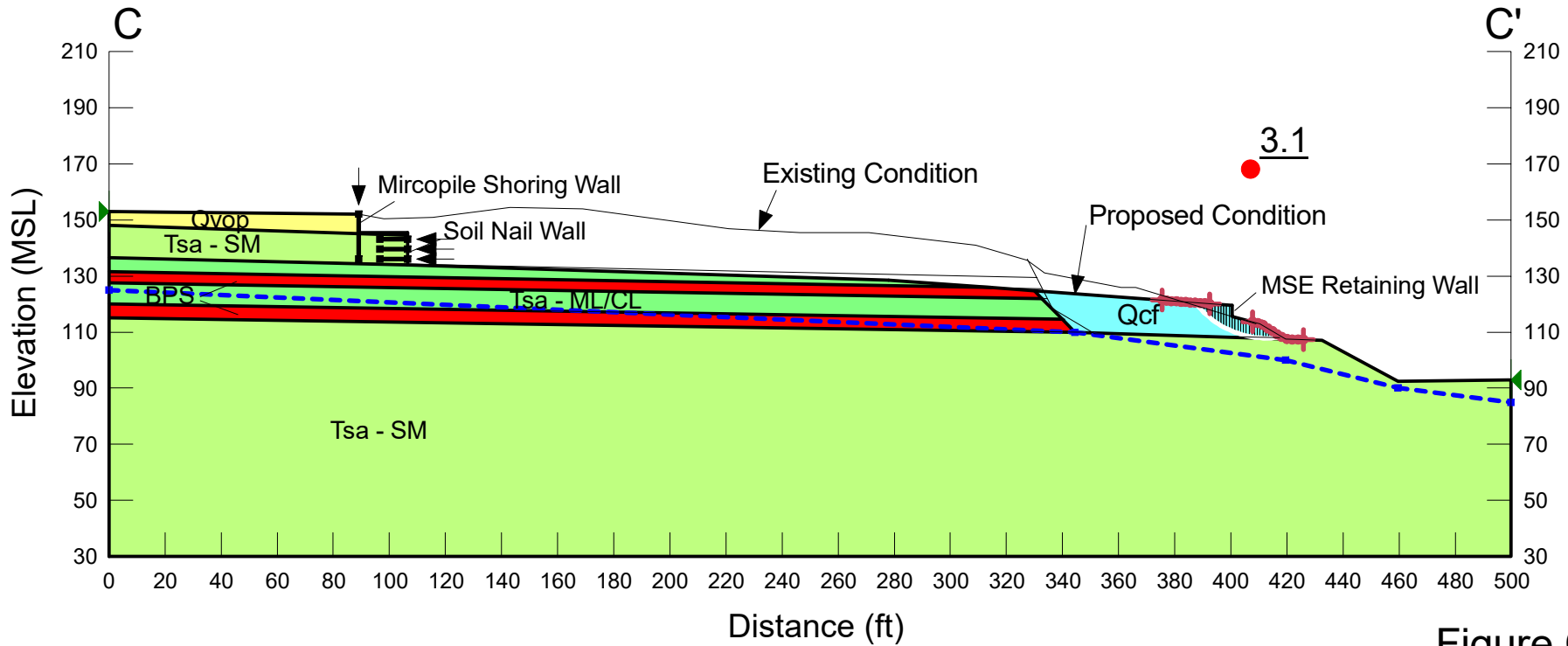

Figure C-21

Piraeus Point
 Project No. G2307-32-05
 Section C-C'
 Name: CC-Case1s.gsz
 Date: 01/21/2022 Time: 11:12:31 AM

Proposed Condition

Seismic Analysis
 $keq = 0.13g$

Color	Name	Unit Weight (pcf)	Cohesion' (psf)	Phi' (°)
Red	BPS	115	100	8
Cyan	Qcf	125	300	28
Yellow	Qvop	120	350	28
Light Green	Tsa (ML,CL)	130	500	23
Light Green	Tsa (SM,SP)	130	750	33

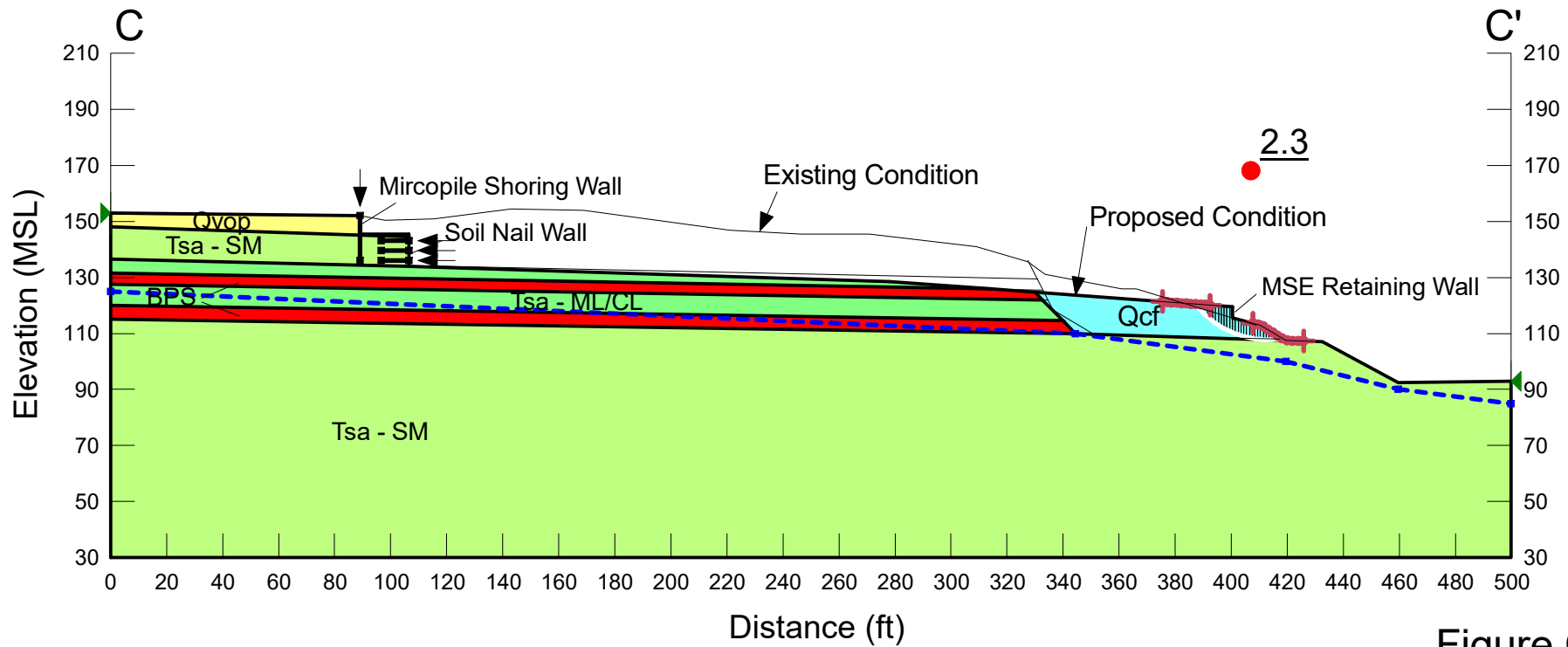

Figure C-22

Piraeus Point
 Project No. G2307-32-05
 Section C-C'
 Name: CC-Case2.gsz
 Date: 01/21/2022 Time: 11:16:57 AM

Proposed Condition

Static Analysis

Color	Name	Unit Weight (pcf)	Cohesion' (psf)	Phi' (°)
Red	BPS	115	100	8
Cyan	Qcf	125	300	28
Yellow	Qvop	120	350	28
Light Green	Tsa (ML,CL)	130	500	23
Light Green	Tsa (SM,SP)	130	750	33

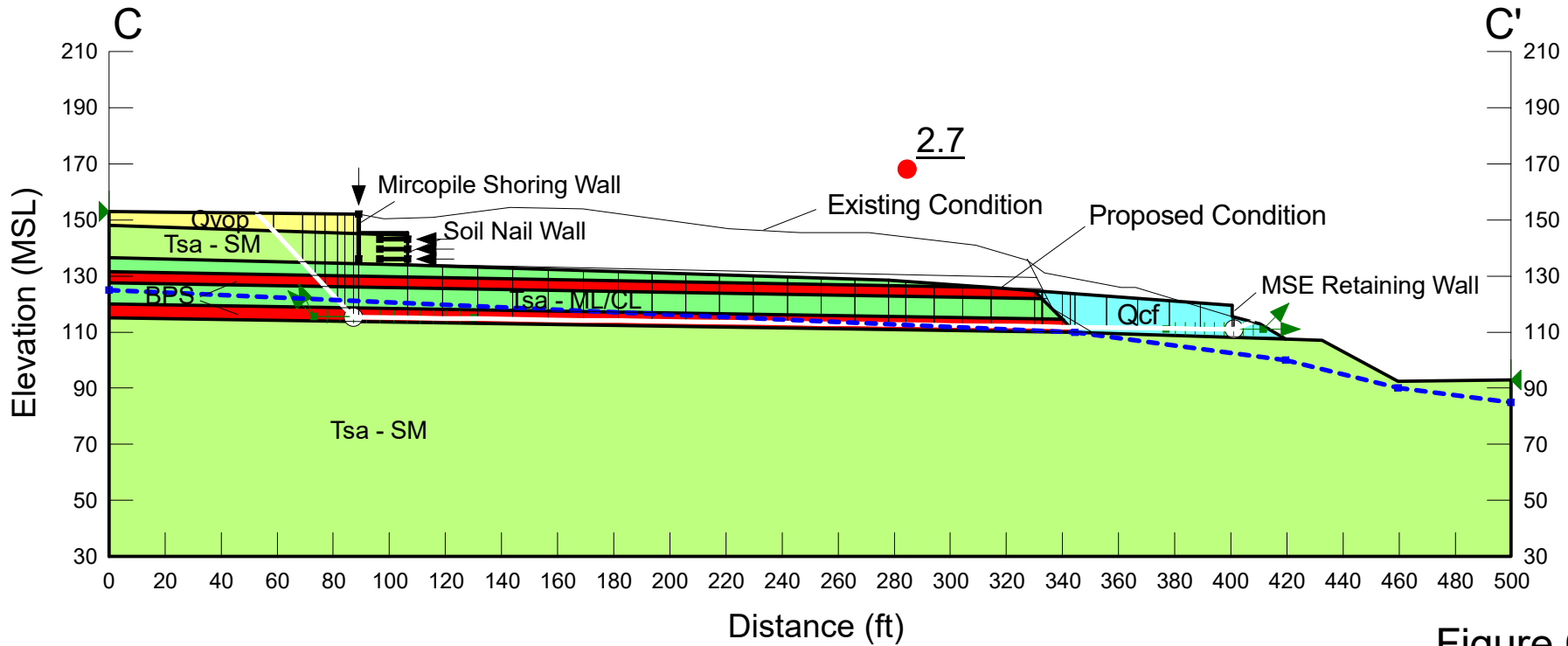

Figure C-23

Piraeus Point
 Project No. G2307-32-05
 Section C-C'
 Name: CC-Case2s.gsz
 Date: 01/21/2022 Time: 11:22:11 AM

Proposed Condition

Seismic Analysis
 $k_{eq} = 0.13g$

Color	Name	Unit Weight (pcf)	Cohesion' (psf)	Phi' (°)
Red	BPS	115	100	8
Cyan	Qcf	125	300	28
Yellow	Qvop	120	350	28
Light Green	Tsa (ML,CL)	130	500	23
Light Green	Tsa (SM,SP)	130	750	33

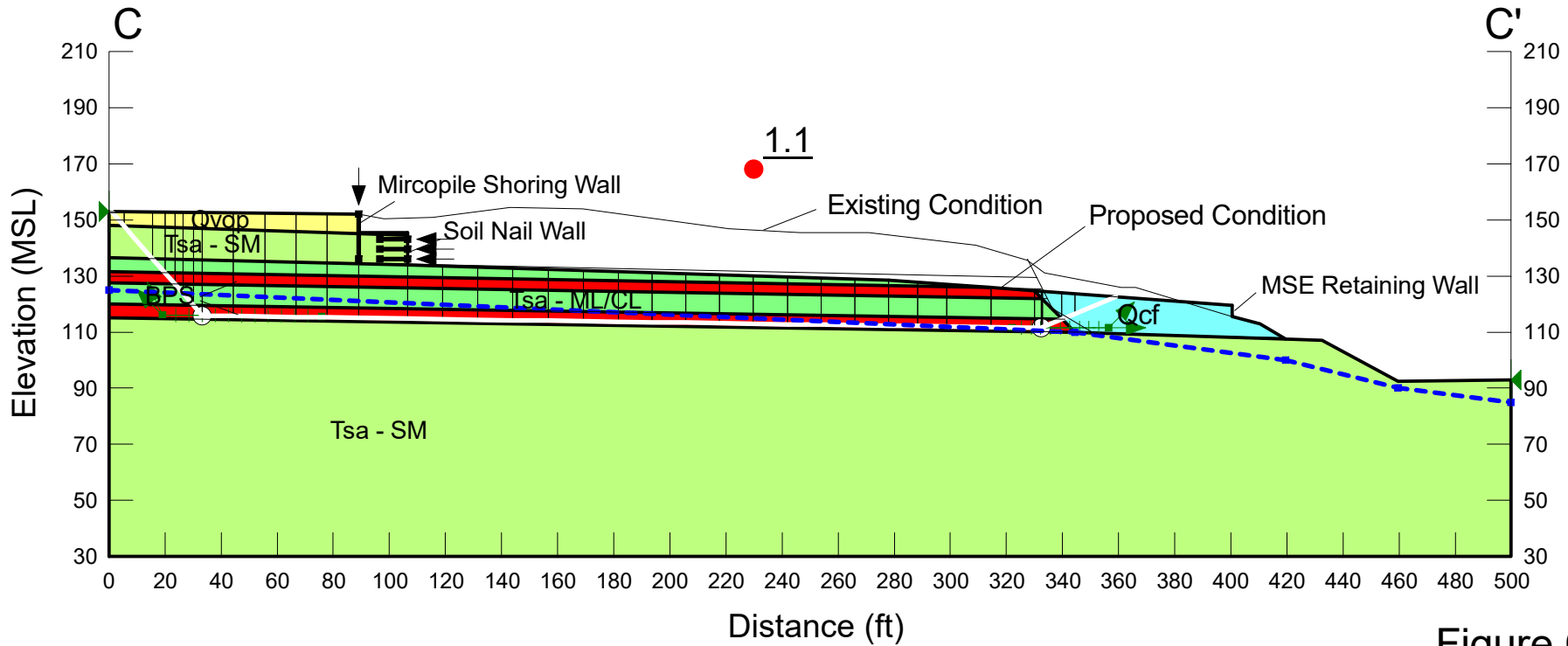

Figure C-24

Piraeus Point
 Project No. G2307-32-05
 Section C-C'
 Name: CC-Case3.gsz
 Date: 01/21/2022 Time: 12:26:27 PM

Proposed Condition

Static Analysis

Color	Name	Unit Weight (pcf)	Cohesion' (psf)	Phi' (°)
Red	BPS	115	100	8
Cyan	Qcf	125	300	28
Yellow	Qvop	120	350	28
Light Green	Tsa (ML,CL)	130	500	23
Light Green	Tsa (SM,SP)	130	750	33

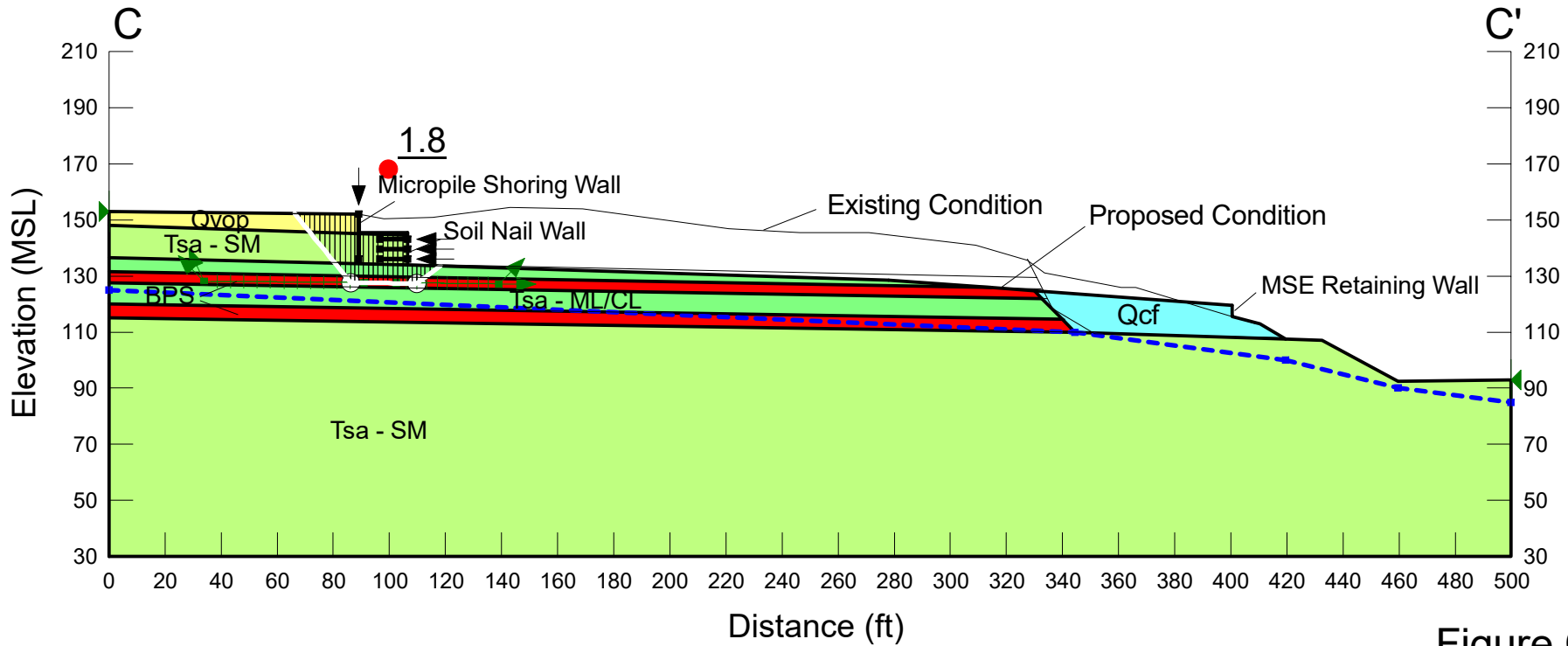

Figure C-25

Piraeus Point
 Project No. G2307-32-05
 Section C-C'
 Name: CC-Case3s.gsz
 Date: 01/21/2022 Time: 12:32:57 PM

Proposed Condition

Seismic Analysis
 $keq = 0.13g$

Color	Name	Unit Weight (pcf)	Cohesion' (psf)	Phi' (°)
Red	BPS	115	100	8
Cyan	Qcf	125	300	28
Yellow	Qvop	120	350	28
Light Green	Tsa (ML,CL)	130	500	23
Light Green	Tsa (SM,SP)	130	750	33

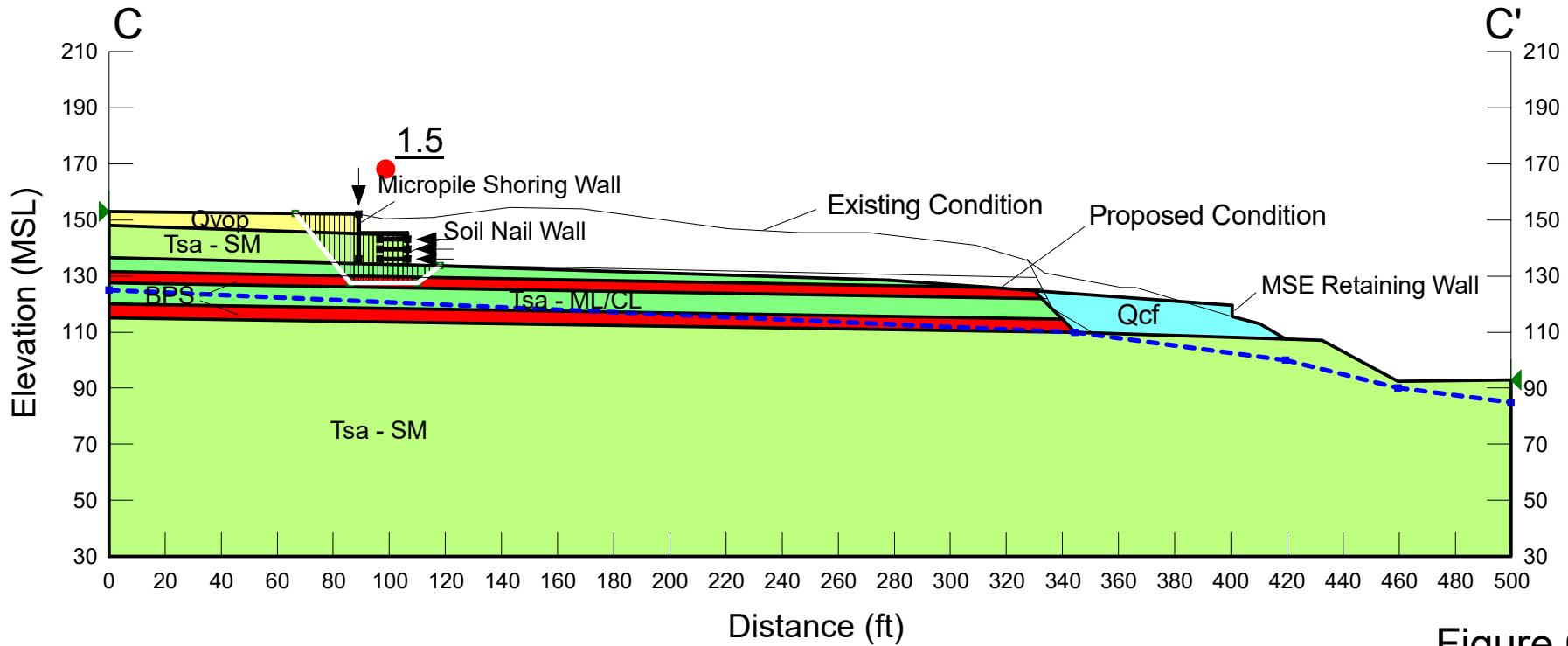

Figure C-26

Piraeus Point
 Project No. G2307-32-05
 Section C-C'
 Name: CC-Case4.gsz
 Date: 01/21/2022 Time: 12:37:01 PM

Proposed Condition

Static Analysis

Color	Name	Unit Weight (pcf)	Cohesion' (psf)	Phi' (°)
Red	BPS	115	100	8
Cyan	Qcf	125	300	28
Yellow	Qvop	120	350	28
Light Green	Tsa (ML,CL)	130	500	23
Light Green	Tsa (SM,SP)	130	750	33

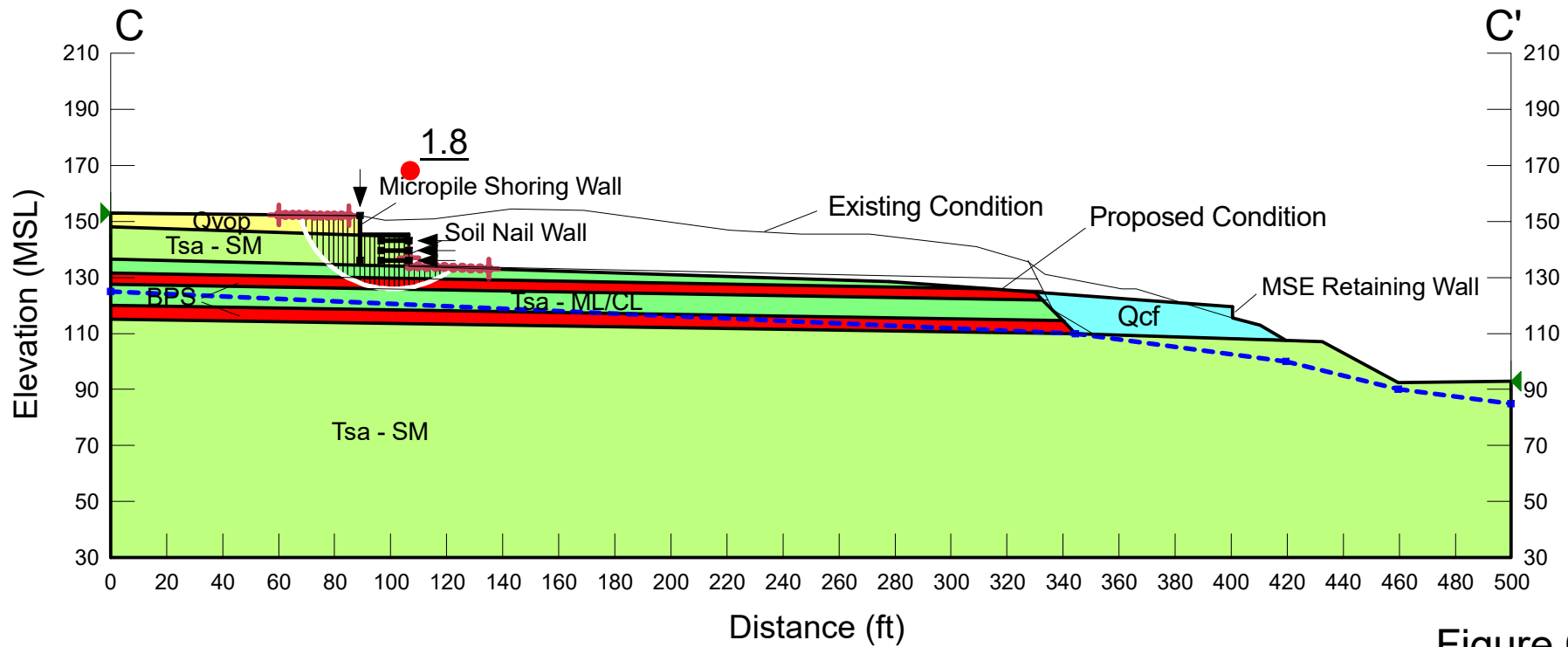

Figure C-27

Piraeus Point
 Project No. G2307-32-05
 Section C-C'
 Name: CC-Case4s.gsz
 Date: 01/21/2022 Time: 12:38:21 PM

Proposed Condition

Seismic Analysis
 $k_{eq} = 0.13g$

Color	Name	Unit Weight (pcf)	Cohesion' (psf)	Phi' (°)
Red	BPS	115	100	8
Cyan	Qcf	125	300	28
Yellow	Qvop	120	350	28
Light Green	Tsa (ML,CL)	130	500	23
Light Green	Tsa (SM,SP)	130	750	33

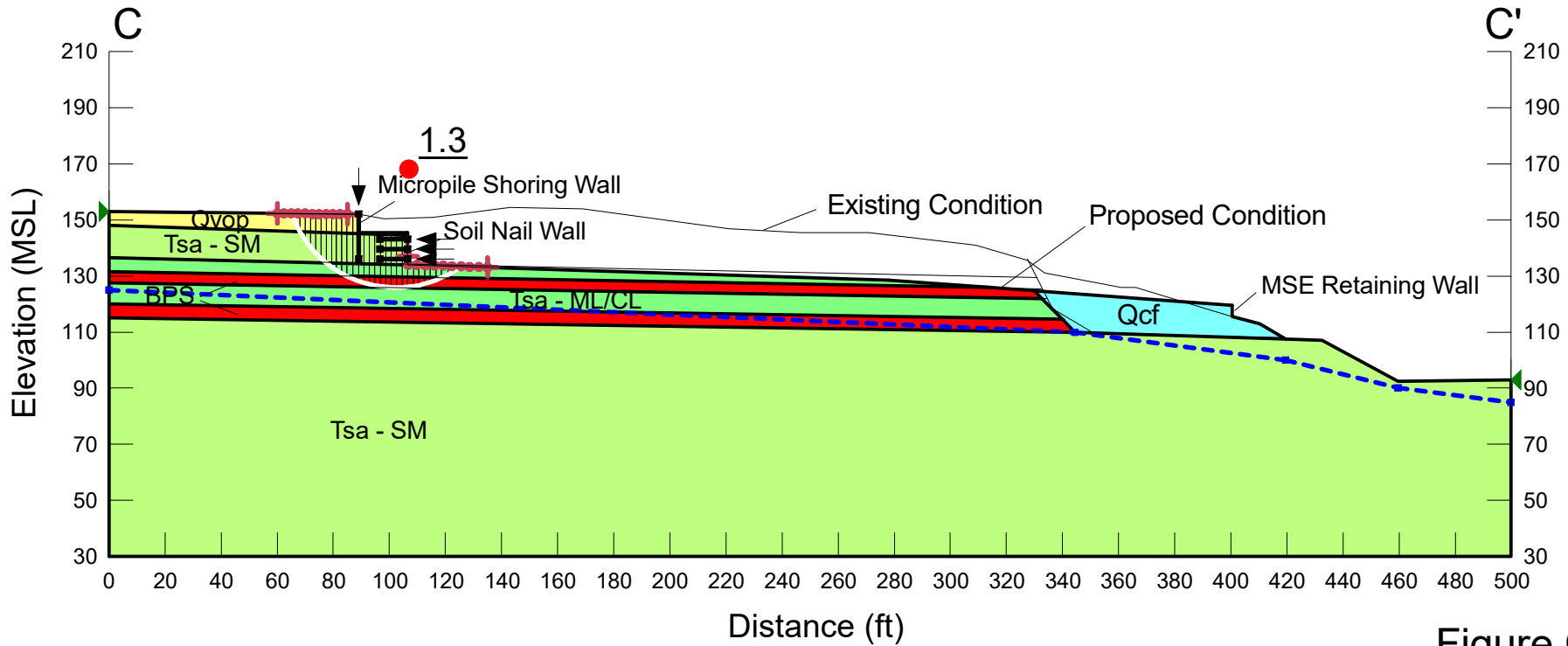

Figure C-28

Piraeus Point
 Project No. G2307-32-05
 Section E-E'
 Name: EE-Case7.gsz
 Date: 01/31/2022 Time: 10:24:42 AM

Proposed Condition

Static Analysis

Color	Name	Unit Weight (pcf)	Cohesion' (psf)	Phi' (°)
Red	BPS	115	100	8
Pink	Qal	120	200	28
Cyan	Qcf	125	300	28
Yellow	Qvop	120	350	28
Light Green	Tsa (ML,CL)	130	500	23
Light Green	Tsa (SM,SP)	130	750	33

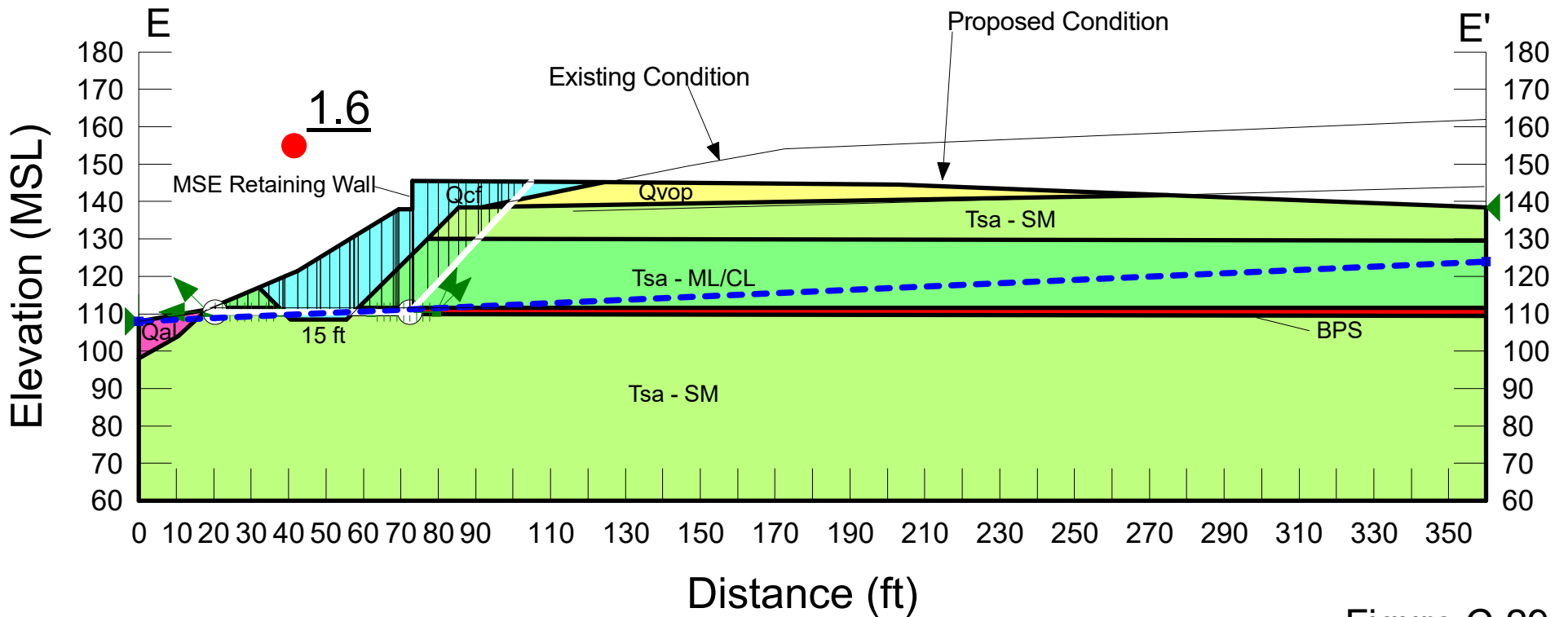

Figure C-29

Piraeus Point
 Project No. G2307-32-05
 Section E-E'
 Name: EE-Case7s.gsz
 Date: 01/31/2022 Time: 11:22:21 AM

Proposed Condition

Seismic Analysis
 $k_{eq} = 0.13g$

Color	Name	Unit Weight (pcf)	Cohesion' (psf)	Phi' (°)
Red	BPS	115	100	8
Pink	Qal	120	200	28
Cyan	Qcf	125	300	28
Yellow	Qvop	120	350	28
Light Green	Tsa (ML,CL)	130	500	23
Light Green	Tsa (SM,SP)	130	750	33

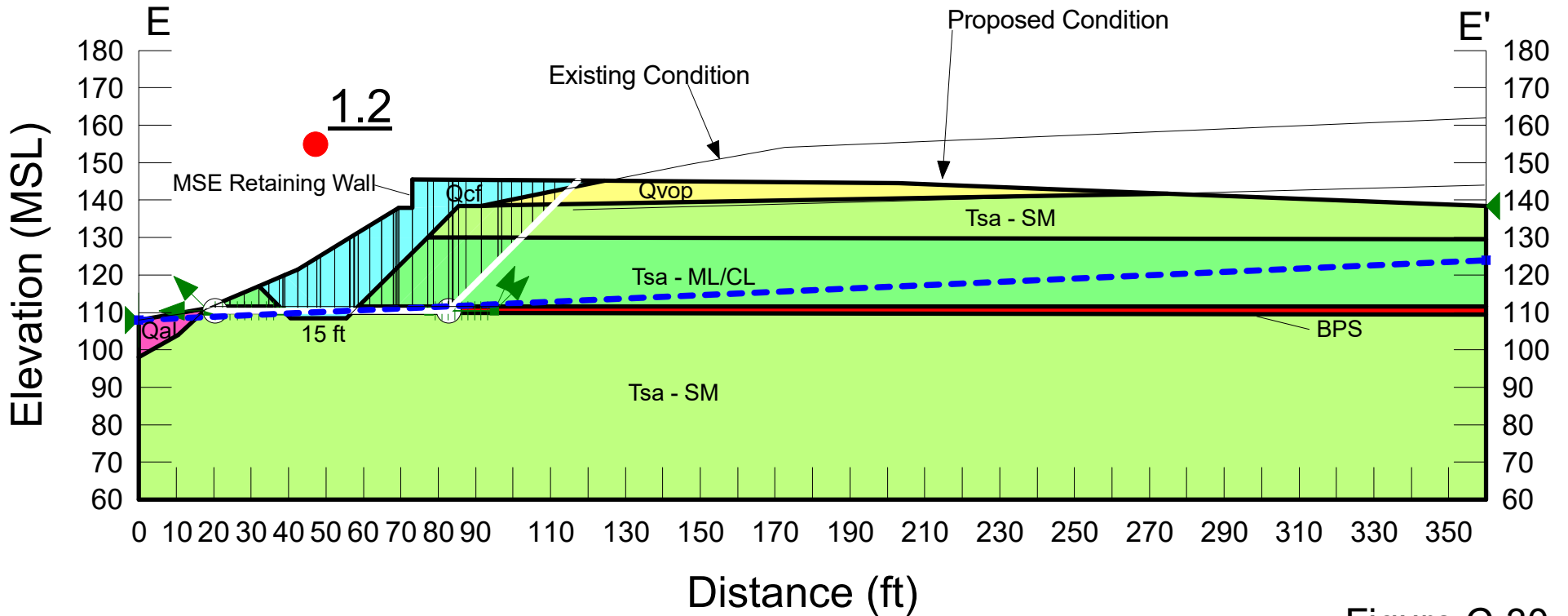

Figure C-30

Piraeus Point
 Project No. G2307-32-05
 Section E-E'
 Name: EE-Case8s.gsz
 Date: 01/31/2022 Time: 11:31:55 AM

Proposed Condition

Seismic Analysis
 $k_{eq} = 0.13g$

Color	Name	Unit Weight (pcf)	Cohesion' (psf)	Phi' (°)
Red	BPS	115	100	8
Pink	Qal	120	200	28
Cyan	Qcf	125	300	28
Yellow	Qvop	120	350	28
Light Green	Tsa (ML,CL)	130	500	23
Light Green	Tsa (SM,SP)	130	750	33

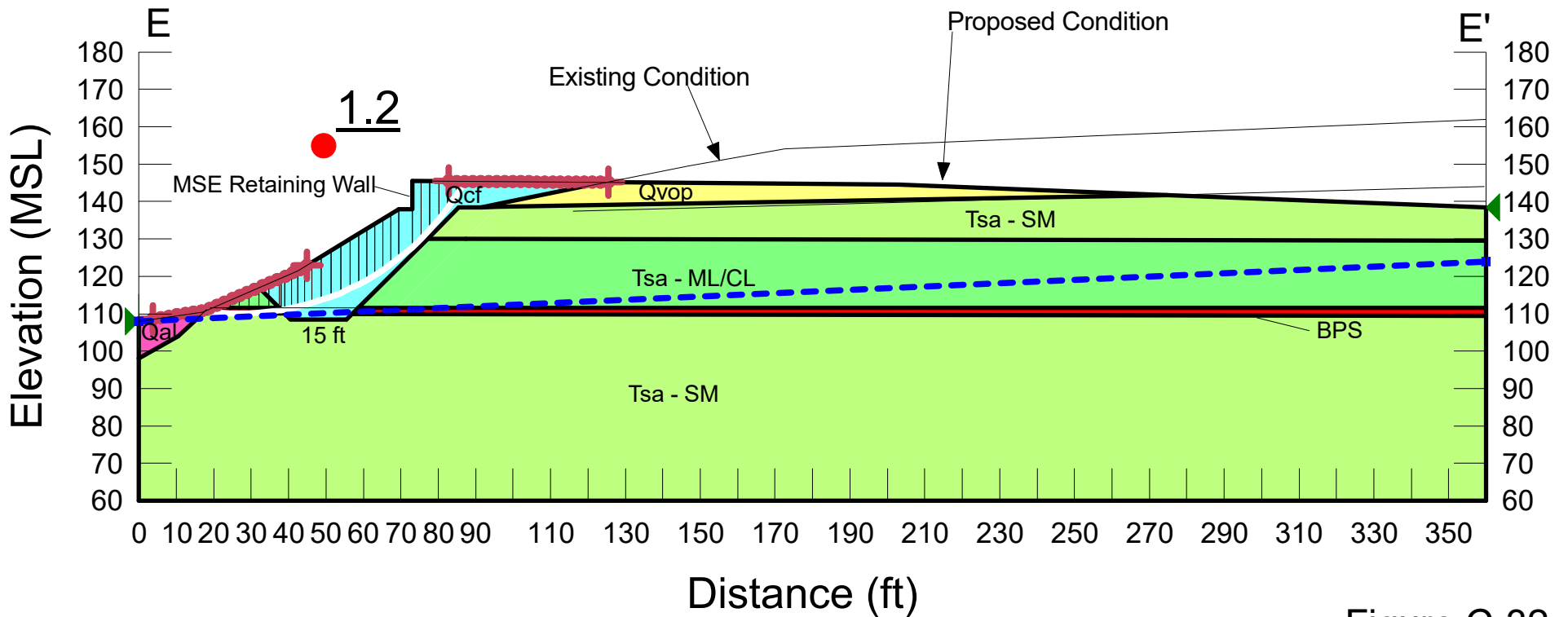

Figure C-32

Piraeus Point
 Project No. G2307-32-05
 Section F-F'
 Name: FF-Case2.gsz
 Date: 01/31/2022 Time: 09:25:50 AM

Proposed Condition

Static Analysis

Color	Name	Unit Weight (pcf)	Cohesion' (psf)	Phi' (°)
Red	BPS	115	100	8
Orange	Qal	120	350	28
Cyan	Qcf	125	300	28
Yellow	Qvop	120	350	28
Light Green	Tsa (ML,CL)	130	500	23
Light Green	Tsa (SM,SP)	130	750	33

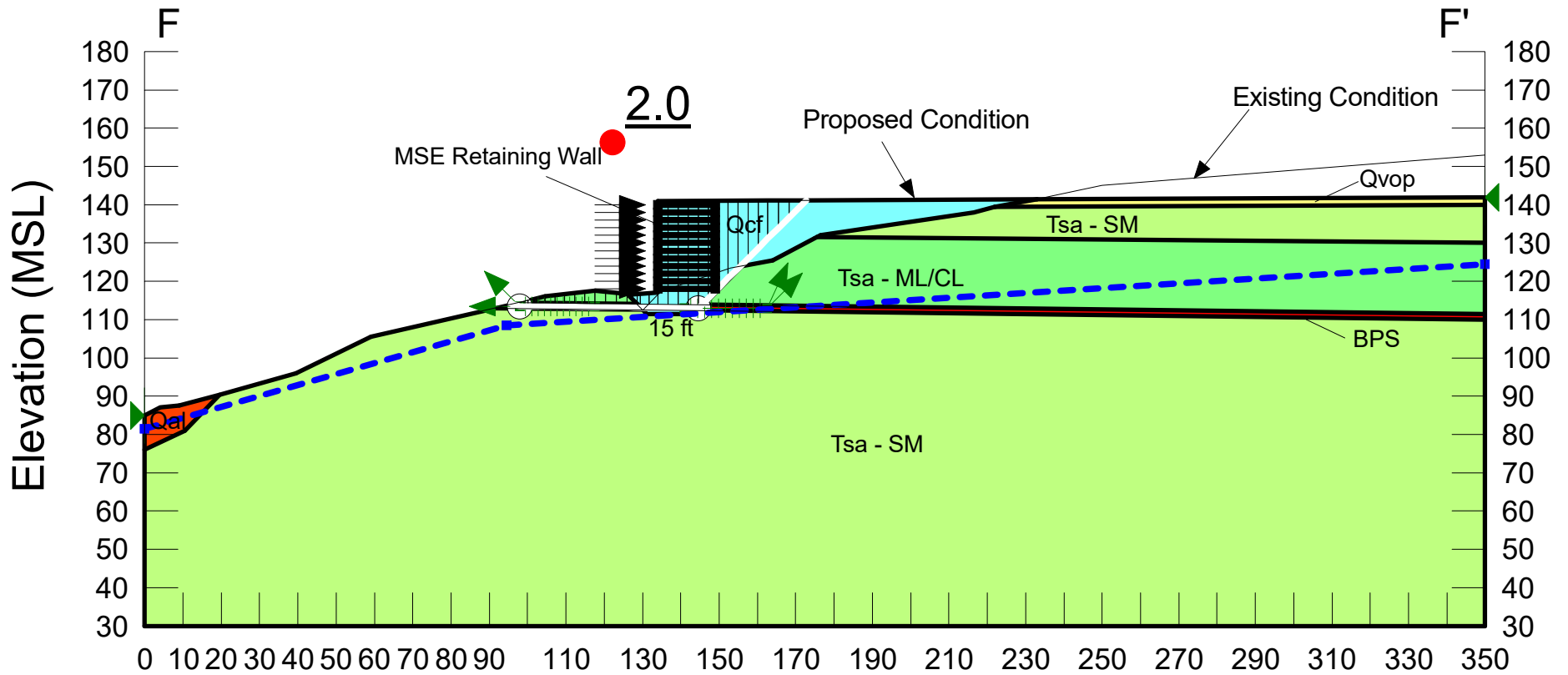

Figure C-33

Piraeus Point
 Project No. G2307-32-05
 Section F-F'
 Name: FF-Case2s.gsz
 Date: 01/31/2022 Time: 11:43:30 AM

Proposed Condition

Seismic Analysis
 $k_{eq} = 0.13g$

Color	Name	Unit Weight (pcf)	Cohesion' (psf)	Phi' (°)
Red	BPS	115	100	8
Orange	Qal	120	350	28
Cyan	Qcf	125	300	28
Yellow	Qvop	120	350	28
Light Green	Tsa (ML,CL)	130	500	23
Light Green	Tsa (SM,SP)	130	750	33

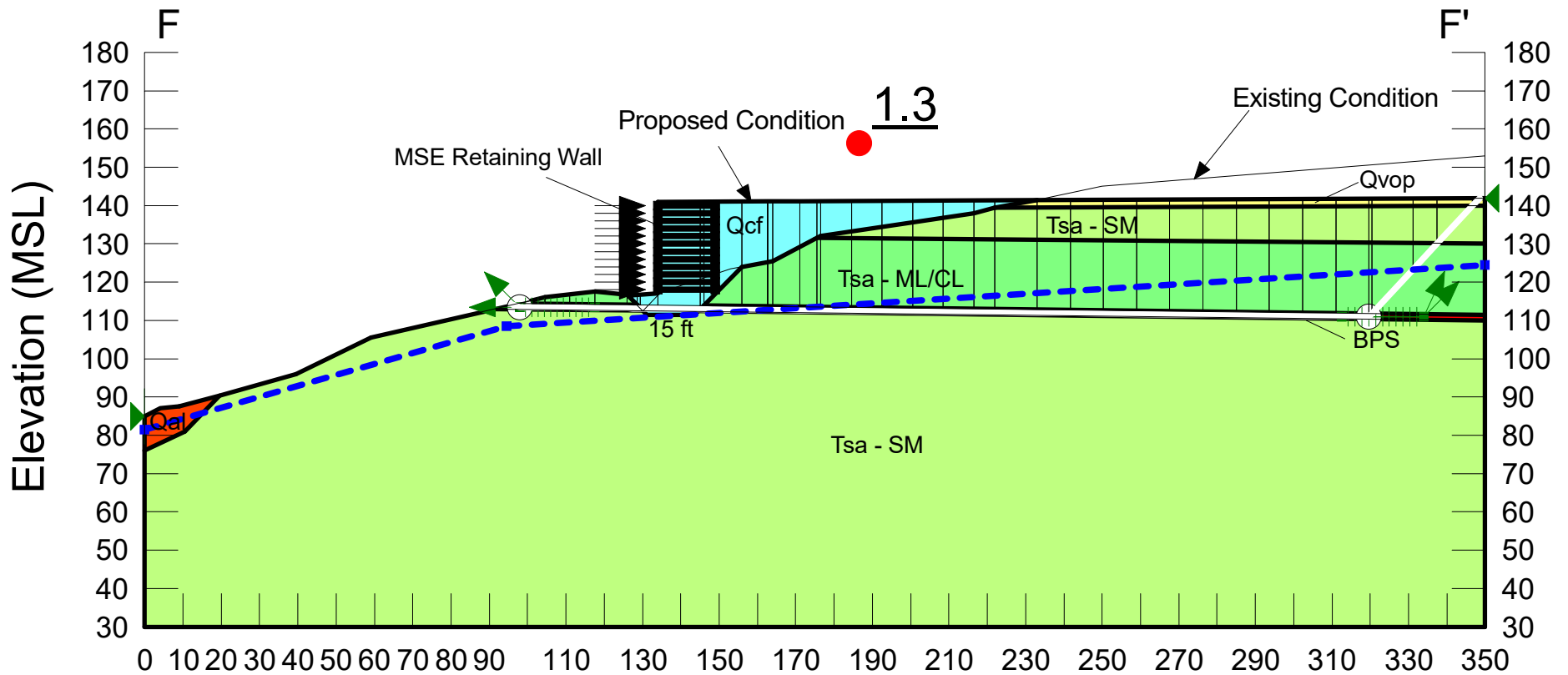

Figure C-34

Piraeus Point
 Project No. G2307-32-05
 Section F-F'
 Name: FF-Case2a.gsz
 Date: 01/31/2022 Time: 09:30:41 AM

Proposed Condition

Static Analysis

Color	Name	Unit Weight (pcf)	Cohesion' (psf)	Phi' (°)
Red	BPS	115	100	8
Orange	Qal	120	350	28
Cyan	Qcf	125	300 </td <td>28</td>	28
Yellow	Qvop	120	350	28
Light Green	Tsa (ML,CL)	130	500	23
Light Green	Tsa (SM,SP)	130	750	33

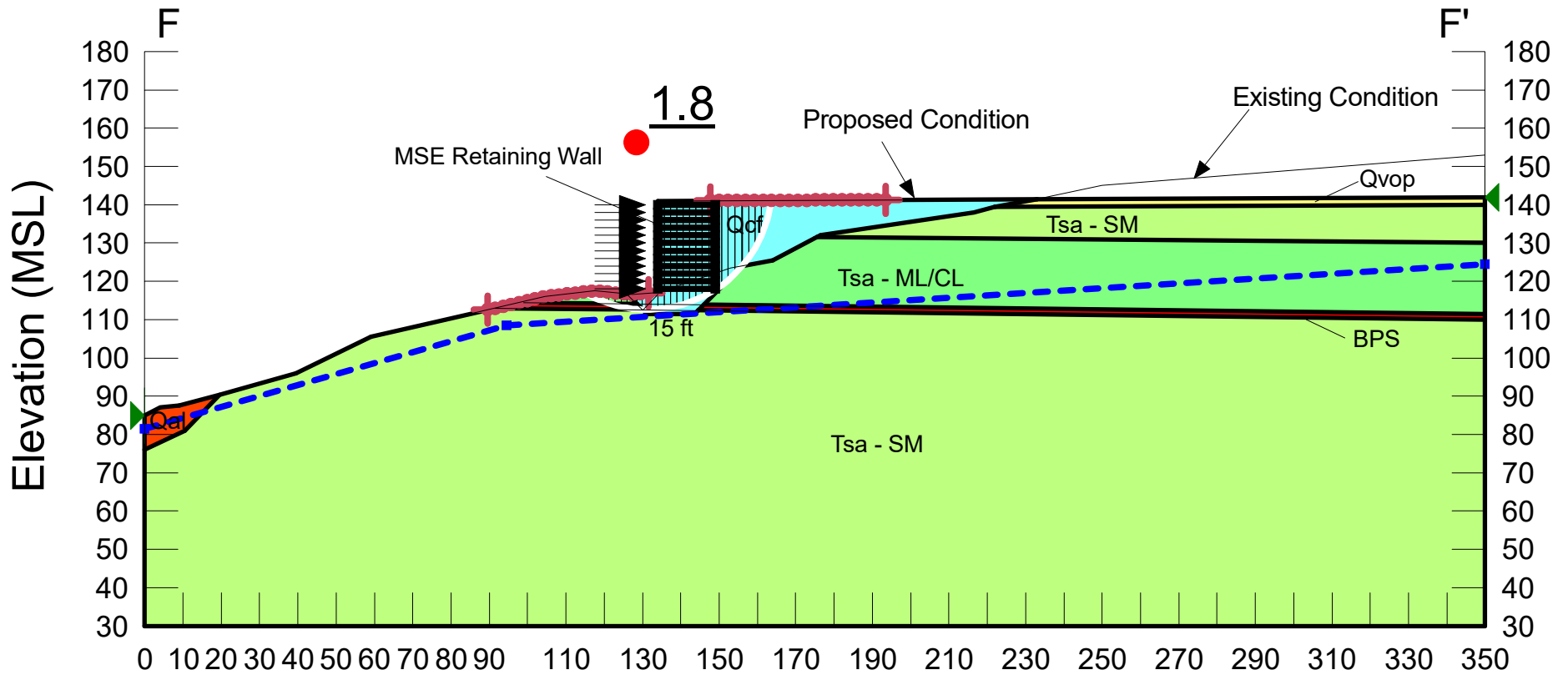

Figure C-35

Piraeus Point
 Project No. G2307-32-05
 Section F-F'
 Name: FF-Case2as.gsz
 Date: 01/31/2022 Time: 11:47:22 AM

Proposed Condition

Seismic Analysis
 $k_{eq} = 0.13g$

Color	Name	Unit Weight (pcf)	Cohesion' (psf)	Phi' (°)									
Red	BPS	115	100	8									
Orange	Qal	120	350	28									
Cyan	Qcf	125	300	28									
Yellow	Qvop	120 <td 350	28	Light Green	Tsa (ML,CL)	130	500	23	Light Green	Tsa (SM,SP)	130	750	33
Light Green	Tsa (ML,CL)	130	500	23									
Light Green	Tsa (SM,SP)	130	750	33									

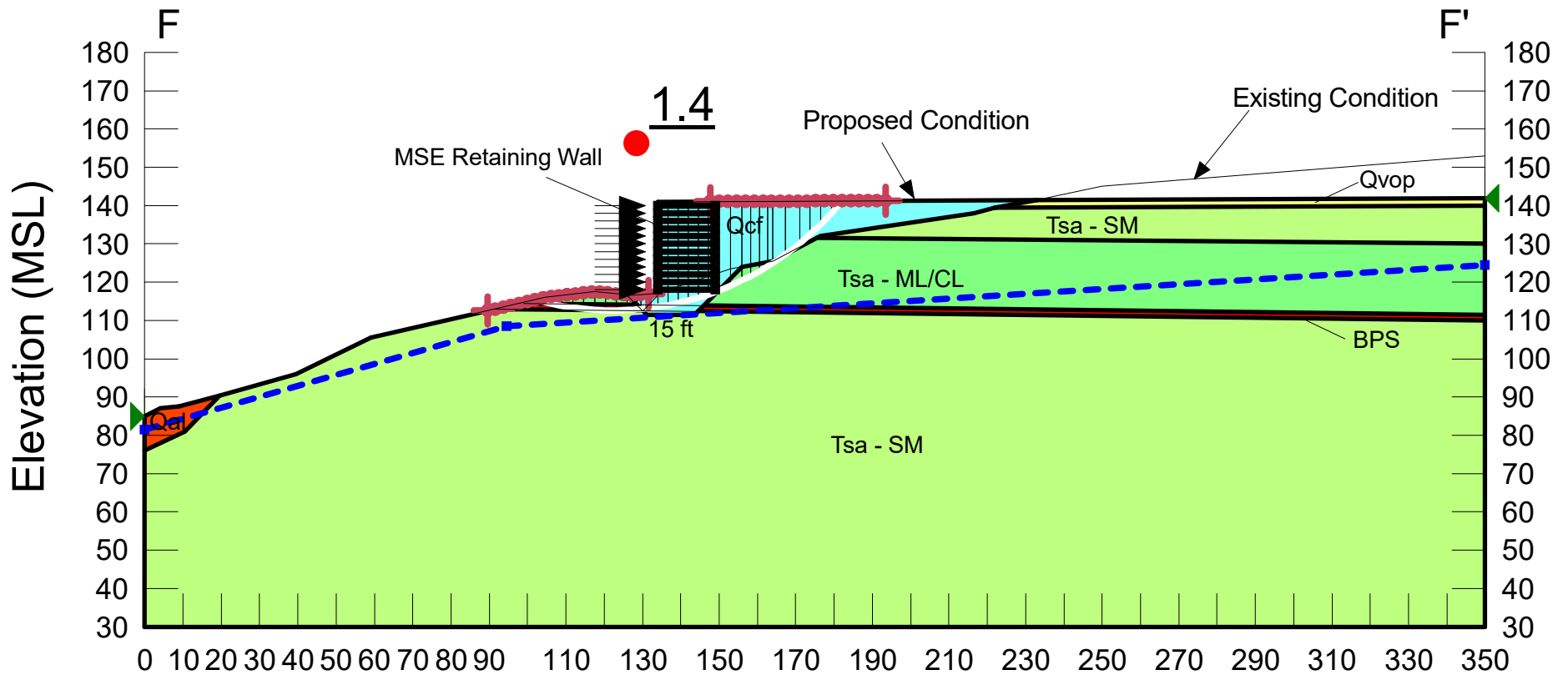

Figure C-36

Piraeus Point
 Project No. G2307-32-05
 Section G-G'
 Name: GG-Case2.gsz
 Date: 01/31/2022 Time: 09:44:12 AM

Proposed Condition

Static Analysis

Color	Name	Unit Weight (pcf)	Cohesion' (psf)	Phi' (°)
Red	BPS	115	100	8
Magenta	Qal	120	200	28
Cyan	Qcf	125	300	28
Light Green	Tsa (ML,CL)	130	500	23
Light Green	Tsa (SM,SP)	130	750	33

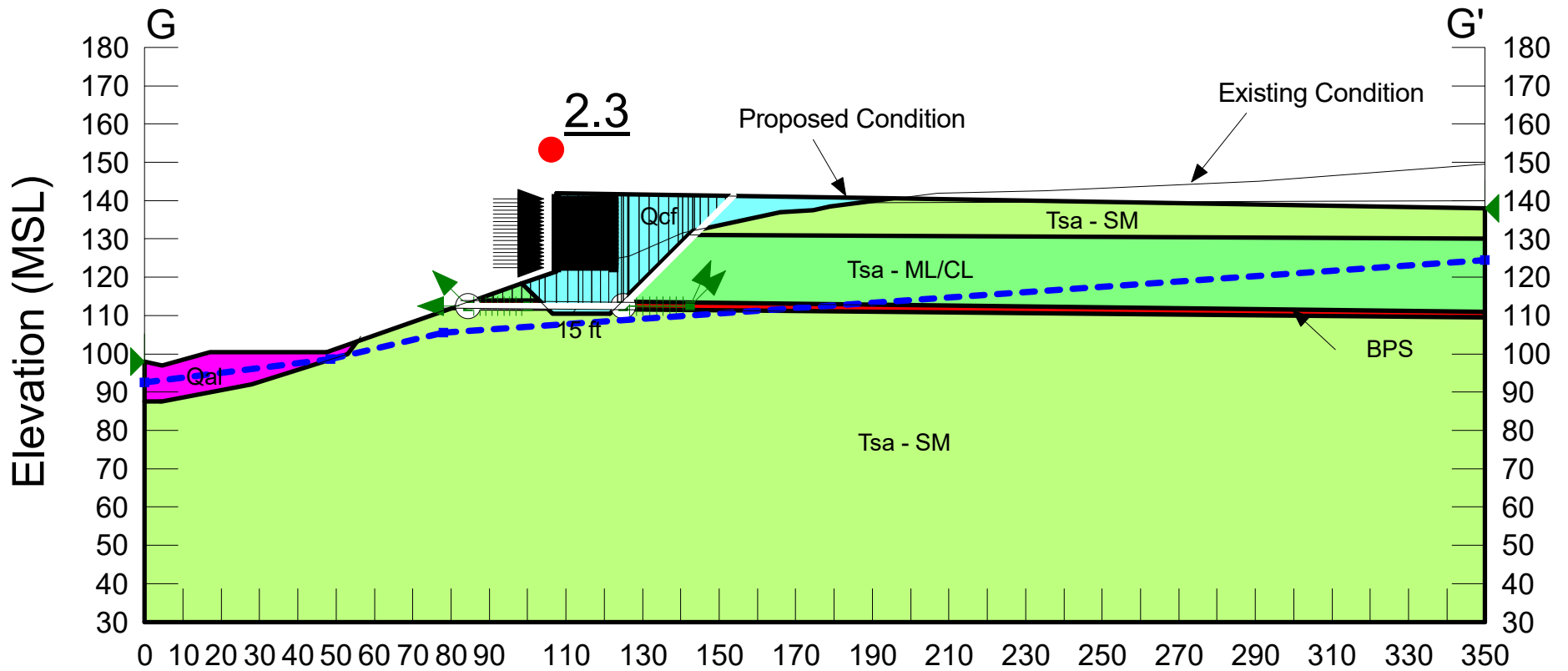

Figure C-37

Piraeus Point
 Project No. G2307-32-05
 Section G-G'
 Name: GG-Case2s.gsz
 Date: 01/31/2022 Time: 11:53:14 AM

Proposed Condition

Seismic Analysis
 $k_{eq} = 0.13g$

Color	Name	Unit Weight (pcf)	Cohesion' (psf)	Phi' (°)
Red	BPS	115	100	8
Magenta	Qal	120	200	28
Cyan	Qcf	125	300	28
Light Green	Tsa (ML,CL)	130	500	23
Light Green	Tsa (SM,SP)	130	750	33

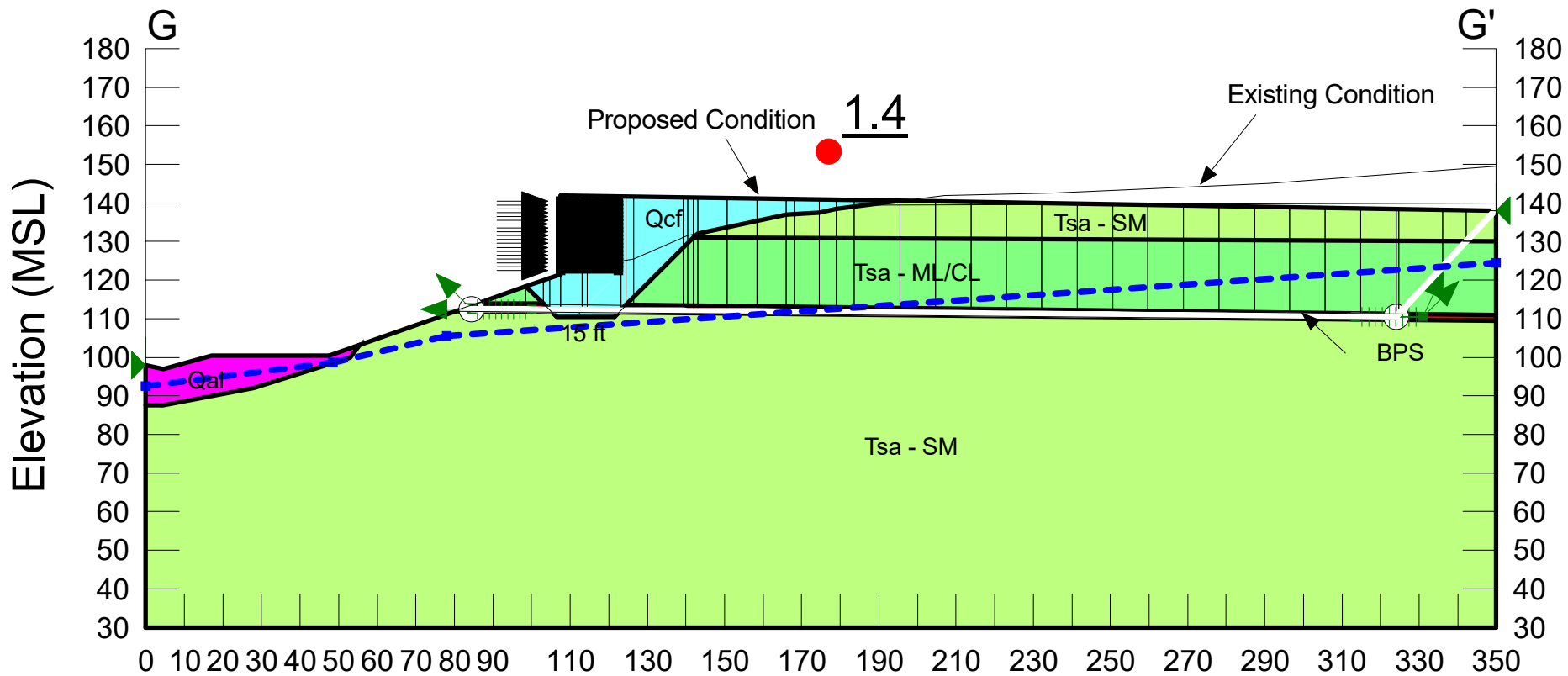

Figure C-38

Piraeus Point
 Project No. G2307-32-05
 Section G-G'
 Name: GG-Case2a.gsz
 Date: 01/31/2022 Time: 09:51:59 AM

Proposed Condition

Static Analysis

Color	Name	Unit Weight (pcf)	Cohesion' (psf)	Phi' (°)
Red	BPS	115	100	8
Magenta	Qal	120	200	28
Cyan	Qcf	125	300	28
Light Green	Tsa (ML,CL)	130	500	23
Light Green	Tsa (SM,SP)	130	750	33

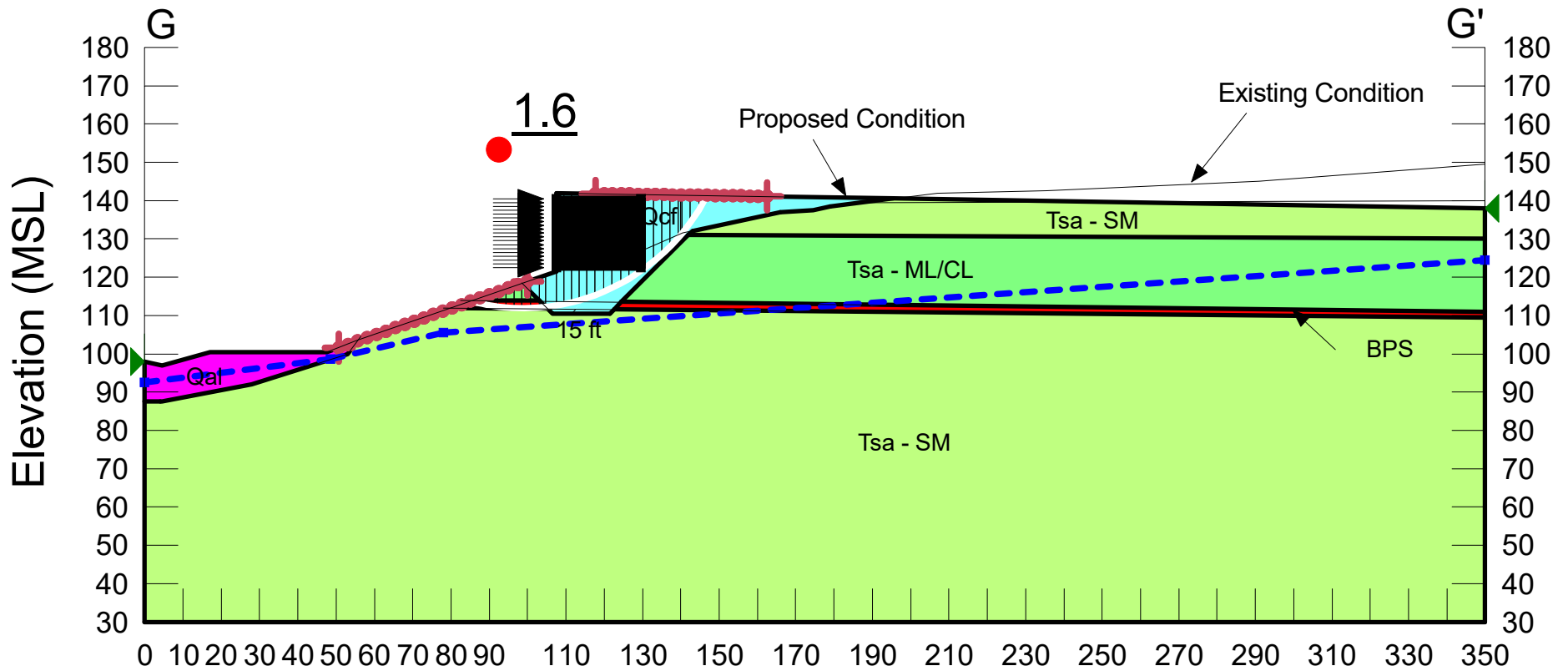

Figure C-39

Piraeus Point
 Project No. G2307-32-05
 Section G-G'
 Name: GG-Case2as.gsz
 Date: 01/31/2022 Time: 11:56:17 AM

Proposed Condition

Seismic Analysis
 $k_{eq} = 0.13g$

Color	Name	Unit Weight (pcf)	Cohesion' (psf)	Phi' (°)
Red	BPS	115	100	8
Magenta	Qal	120	200	28
Cyan	Qcf	125	300	28
Light Green	Tsa (ML,CL)	130	500	23
Light Green	Tsa (SM,SP)	130	750	33

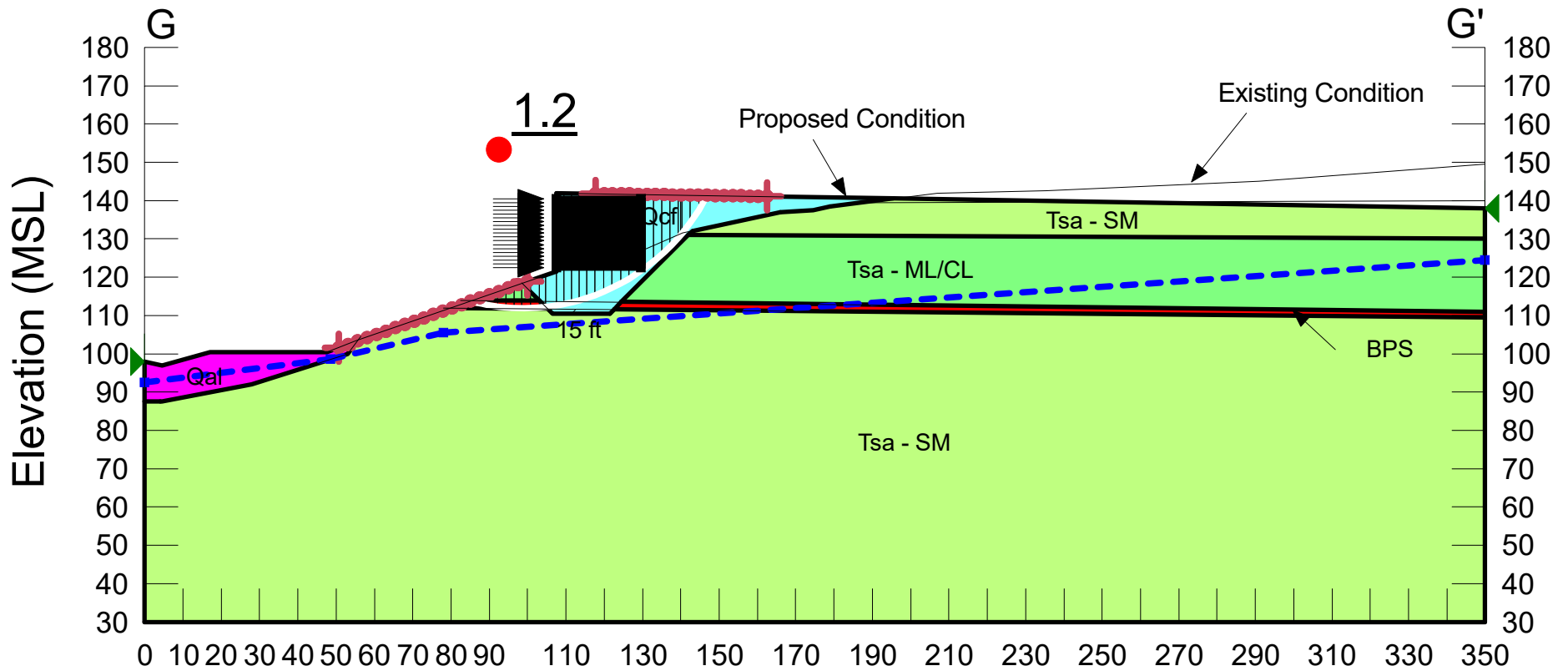

Figure C-40

Surficial Slope Stability Evaluation

Slope Height, H (feet)	∞
Vertical Depth of Saturation, Z (feet)	3
Slope Inclination	2.00 :1
Slope Inclination, I (degrees)	26.6
Unit Weight of Water, γ_W (pcf)	62.4
Total Unit Weight of Soil, γ_T (pcf)	125
Friction Angle, ϕ (degrees)	28
Cohesion, C (psf)	300
Factor of Safety = $(C + (\gamma_T - \gamma_W)Z \cos^2 i \tan \phi) / (\gamma_T Z \sin i \cos i)$	<u>2.53</u>

References: (1) Haefeli, R. *The Stability of Slopes Acted Upon by Parallel Seepage*, Proc. Second International Conference, SMFE, Rotterdam, 1948, 1, 57-62.
 (2) Skempton, A. W., and F. A. Delory, *Stability of Natural Slopes in London Clay*, Proc. Fourth International Conference, SMFE, London, 1957, 2, 378-81.

Slope Stability Evaluation

Slope Height, H (feet)	25
Slope Inclination	2.0 :1
Total Unit Weight of Soil, γ_T (pcf)	125
Friction Angle, ϕ (degrees)	28
Cohesion, C (psf)	300
$\gamma_{C\phi} = (\gamma H \tan \phi) / C$	5.5
$N_{C\phi}$ (from Chart)	20
Factor of Safety = $(N_{C\phi} C) / (\gamma H)$	<u>1.92</u>

References: (1) Janbu, N. *Stability Analysis of Slopes with Dimensionless Parameters*, Harvard Soil Mechanics, Series No. 46, 1954.
 (2) Janbu, N. *Discussion of J.M. Bell, Dimensionless Parameters for Homogeneous Earth Slopes*, Journal of Soil Mechanics and Foundation Design, No. SM6, November 1967.

GEOCON
INCORPORATED



GEOTECHNICAL CONSULTANTS
6960 FLANDERS DRIVE - SAN DIEGO, CALIFORNIA 92121 - 2974
PHONE 858 558-6900 - FAX 858 558-6159

TM / TM

SLOPE STABILITY ANALYSIS

PIRAEUS POINT
ENCINITAS, CALIFORNIA

DATE 1-31-2022

PROJECT NO. G2307-32-05

FIG. C-41

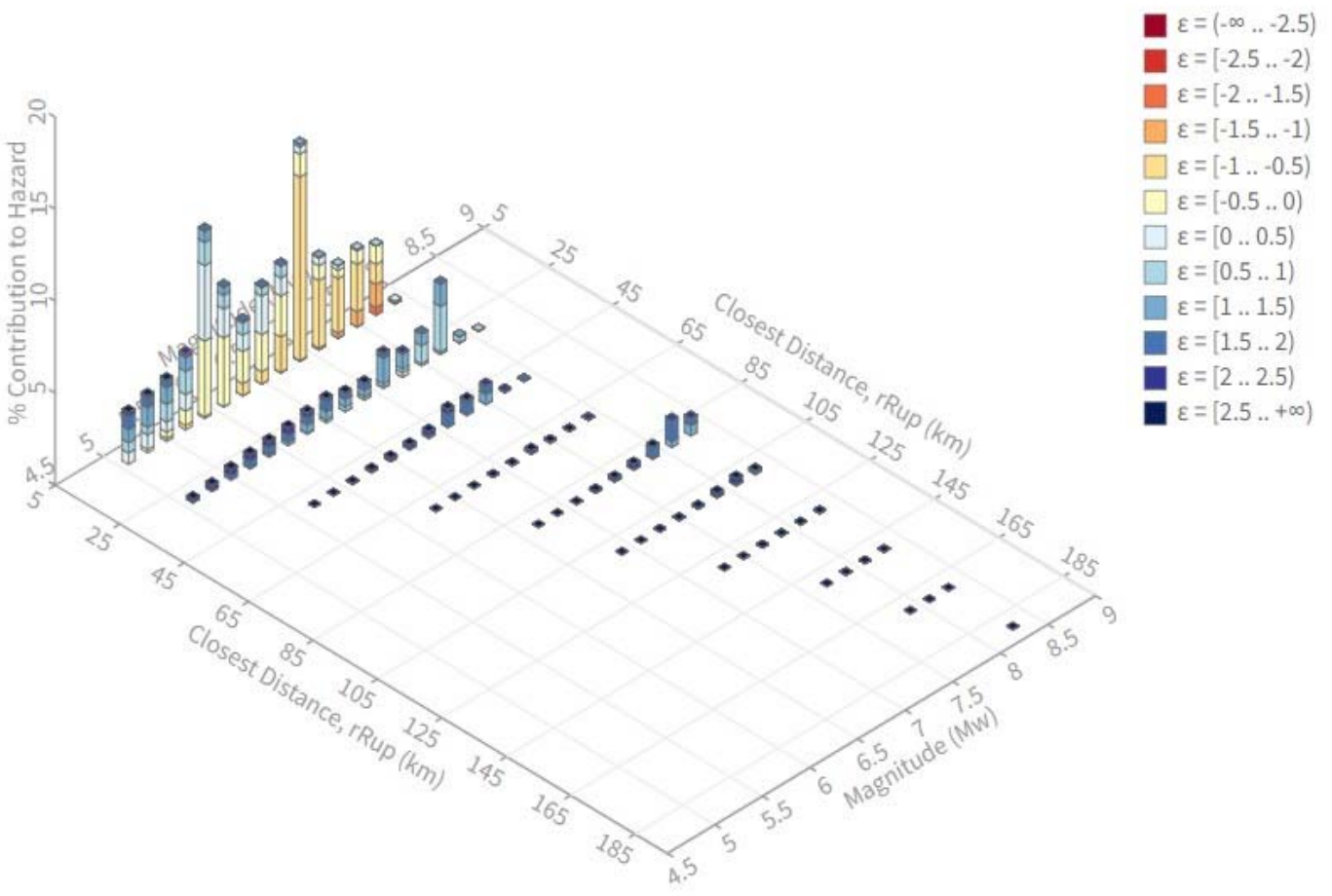

Secondary statistics for Deaggregation: Total

Deaggregation ranges	Secondary ranges	Units	Mean (per all sources)
Return period: 175 yr Exceedance rate: 0.00271827 yr ⁻¹ Risk ground motion: 0.2776128g	Return period: 100,000 yr Exceedance rate: 0.00001000 yr ⁻¹	Exceed: 100 % Residual: 0 % Mean: 0.00 %	m: 0.01 s: 10.0000 w: 0.00 %
Mode (logarithmic)	Mode (logarithmic)	Elementation	Spine logs
m: 0.01 s: 0.0000 w: 0.00 % Contribution: 0.00 %	m: 0.01 s: 0.0000 w: 0.00 % Contribution: 0.00 %	m: min=0.01, max=10000.0+0.000000 w: min=0.0, max=10.0, s=0.0 m: min=0.00, max=0.00, s=0.00	AB: 0.00 - 0.00 AB: 0.00 - 0.00 AB: 0.00 - 0.00 AB: 0.00 - 0.00 AB: 0.00 - 0.00 AB: 0.00 - 0.00 AB: 0.00 - 0.00 AB: 0.00 - 0.00 AB: 0.00 - 0.00 AB: 0.00 - 0.00

GEOCON
INCORPORATED



GEOTECHNICAL CONSULTANTS
6960 FLANDERS DRIVE - SAN DIEGO, CALIFORNIA 92121 - 2974
PHONE 858 558-6900 - FAX 858 558-6159

SEISMIC DEAGGREGATION

PIRAEUS POINT
ENCINITAS, CALIFORNIA

TM / TM

DATE 1-31-2022 PROJECT NO. G2307-32-05 FIG. C-42



Seismic Slope Stability Evaluation

Input Data in Shaded Areas

Project Piraeus Point Computed By TEM
 Project Number G2307-32-05
 Date 01/31/22
 Filename

Peak Ground Acceleration (Firm Rock), MHA_r , g	0.23	10% in 50 years
Modal Magnitude, M	6.9	
Modal Distance, r, km	6.3	
Site Condition, S (0 for rock, 1 for soil)	1	
Yield Acceleration, k_y/g	NA	<-- Enter Value or NA for Screening Analysis
Shear Wave Velocity, V_s (ft/sec)	NA	<--
Max Vertical Distance, H (Feet)	NA	<--
Is Slide X-Area > 25,000ft ² (Y/N)	N	<-- Use "N" for Buttress Fills
Correction for horizontal incoherence	1.0	
Duration, $D_{5-95 med}$, sec	12.801	
Coefficient, C_1	0.5190	
Coefficient, C_2	0.0837	
Coefficient, C_3	0.0019	
Standard Error, ϵ_T	0.437	
Mean Square Period, T_m , sec	0.606	

Initial Screening with $MHEA = MHA = k_{max}g$

k_y/MHA	NA
$f_{EO}(u=5cm) = (NRF/3.477) * (1.87 - \log(u / ((MHA_r/g) * NRF * D_{5-95})))$	0.5752
$k_{EO} = feq(MHA_r)/g$	0.132
Factor of Safety in Slope Analysis Using k_{EO}	1.00

Passes Initial Screening Analysis

Approximation of Seismic Demand

Period of Sliding Mass, $T_s = 4H/V_s$, sec	NA
T_s/T_m	NA
$MHEA/(MHA * NRF)$	NA
$NRF = 0.6225 + 0.9196 \exp(-2.25 * MHA_r/g)$	1.17
$MHEA/g$	NA
$k_y/MHEA = k_y/k_{max}$	NA
Normalized Displacement, Normu	NA
Estimated Displacement, u (cm)	NA

FIGURE C-43

APPENDIX

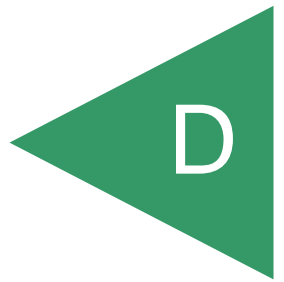

APPENDIX D

LIQUEFACTION ANALYSIS

FOR

PIRAEUS POINT
ENCINITAS, CALIFORNIA

PROJECT NO. G2307-32-05



Hammer Energy Correction Factors

Reference: Youd, et al, Liquefaction Resistance of Soils: Summary Report from the 1996 NCEER/NSF Workshops on Evaluation of Liquefaction Resistance of Soils, Journal of Geotechnical and Environmental Engineering, October, 2001, Vol. 127, No. 10

Project Name: Piraeus Point Date: 1/24/2022
 Project Number: G2307-32-05

Hole Diameter, Inches: 8 Hole Diameter Correction, C_B : 1.15
 Average Unit Weight, γ (pcf): 125
 Adjustment Factor for 350 LB Hammer Above Groundwater: 1.00 <-- Enter 1.0 if an adjustment is not required; Applied to "MC" Samples
 Adjustment Factor for 350 LB Hammer Below Groundwater: 1.00 <-- Enter 1.0 if an adjustment is not required; Applied to "MC" Samples
 Approximate Depth to Groundwater in Boring B-1: 39
 Approximate Depth to Groundwater in Boring B-2: 43 *Auto, Cathead, or Downhole Hammer
 Approximate Depth to Groundwater in Boring B-3: 15

Sample	Depth, Feet	Field Blow Count (per Foot)	Type of Sampler (MC or SPT)	Hammer Type* (A/C/D)	Adjust for each GWT Level		Energy Correction, C_E (1.0 Safe-T-Driver/Cathead, 1.3 Automatic)				
					Equiv. SPT Blow Count, N	$\sigma'_{v,}$ psf	Overburden Pressure Correction, C_N	Energy Ratio Correction, C_E	Rod Length Correction, C_R	Sampling Correction, C_S	N1 60 Blowcounts (Prior to Fines)
B1-1	5.0	80	MC	C	53.3	625.0	1.70	1.0	0.75	1.00	78.20
B1-2	10.0	33	MC	A	22.0	1250.0	1.26	1.3	0.80	1.00	33.28
B1-3	15.0	52	MC	A	34.7	1875.0	1.03	1.3	0.85	1.00	45.50
B1-4	20.0	18	MC	A	12.0	2500.0	0.89	1.3	0.95	1.00	15.24
B1-5	25.0	33	MC	A	22.0	3125.0	0.80	1.3	0.95	1.00	25.00
B1-6	30.0	82	MC	A	54.7	3750.0	0.73	1.3	1.00	1.00	59.68
B1-7	31.0	30	SPT	A	30.0	3875.0	0.72	1.3	1.00	1.10	35.44
B1-8	35.0	35	MC	A	23.3	4375.0	0.68	1.3	1.00	1.00	23.59
B1-9	36.0	26	SPT	A	26.0	4500.0	0.67	1.3	1.00	1.10	28.50
B1-10	40.0	49	MC	A	32.7	4937.6	0.64	1.3	1.00	1.00	31.08
B1-11	41.0	36	SPT	A	36.0	5000.2	0.63	1.3	1.00	1.10	37.44
B1-12	45.0	50	MC	A	33.3	5250.6	0.62	1.3	1.00	1.00	30.76
B1-13	46.0	28	SPT	A	28.0	5313.2	0.61	1.3	1.00	1.10	28.25
B1-14	50.0	31	MC	A	20.7	5563.6	0.60	1.3	1.00	1.00	18.52
B1-15	51.0	28	MC	A	18.7	5626.2	0.60	1.3	1.00	1.00	16.64
B2-1	5.0	50	MC	A	33.3	625.0	1.70	1.3	0.75	1.00	63.54
B2-2	10.0	82	MC	A	54.7	1250.0	1.26	1.3	0.80	1.00	82.70
B2-3	15.0	63	MC	A	42.0	1875.0	1.03	1.3	0.85	1.00	55.12
B2-4	20.0	42	MC	A	28.0	2500.0	0.89	1.3	0.95	1.00	35.57
B2-5	25.0	44	MC	A	29.3	3125.0	0.80	1.3	0.95	1.00	33.33
B2-6	30.0	63	MC	A	42.0	3750.0	0.73	1.3	1.00	1.00	45.86
B2-7	31.0	39	SPT	A	39.0	3875.0	0.72	1.3	1.00	1.10	46.08
B2-8	35.0	71	MC	A	47.3	4375.0	0.68	1.3	1.00	1.00	47.84
B2-9	36.0	39	SPT	A	39.0	4500.0	0.67	1.3	1.00	1.10	42.76
B2-10	40.0	36	MC	A	24.0	5000.0	0.63	1.3	1.00	1.00	22.69
B2-11	41.0	29	SPT	A	29.0	5125.0	0.62	1.3	1.00	1.10	29.79
B2-12	45.0	34	MC	A	22.7	5500.2	0.60	1.3	1.00	1.00	20.43
B2-13	46.0	16	SPT	A	16.0	5562.8	0.60	1.3	1.00	1.10	15.78
B2-14	50.0	41	MC	A	27.3	5813.2	0.59	1.3	1.00	1.00	23.97
B2-15	51.0	71	SPT	A	71.0	5875.8	0.58	1.3	1.00	1.10	68.12
B3-1	5.0	50	MC	A	33.3	625.0	1.70	1.3	0.75	1.00	63.54
B3-2	10.0	63	MC	A	42.0	1250.0	1.26	1.3	0.80	1.00	63.54
B3-3	15.0	36	MC	A	24.0	1875.0	1.03	1.3	0.85	1.00	31.50
B3-4	20.0	38	MC	A	25.3	2188.0	0.96	1.3	0.95	1.00	34.40

Boring B-1 N1|60 Blowcounts

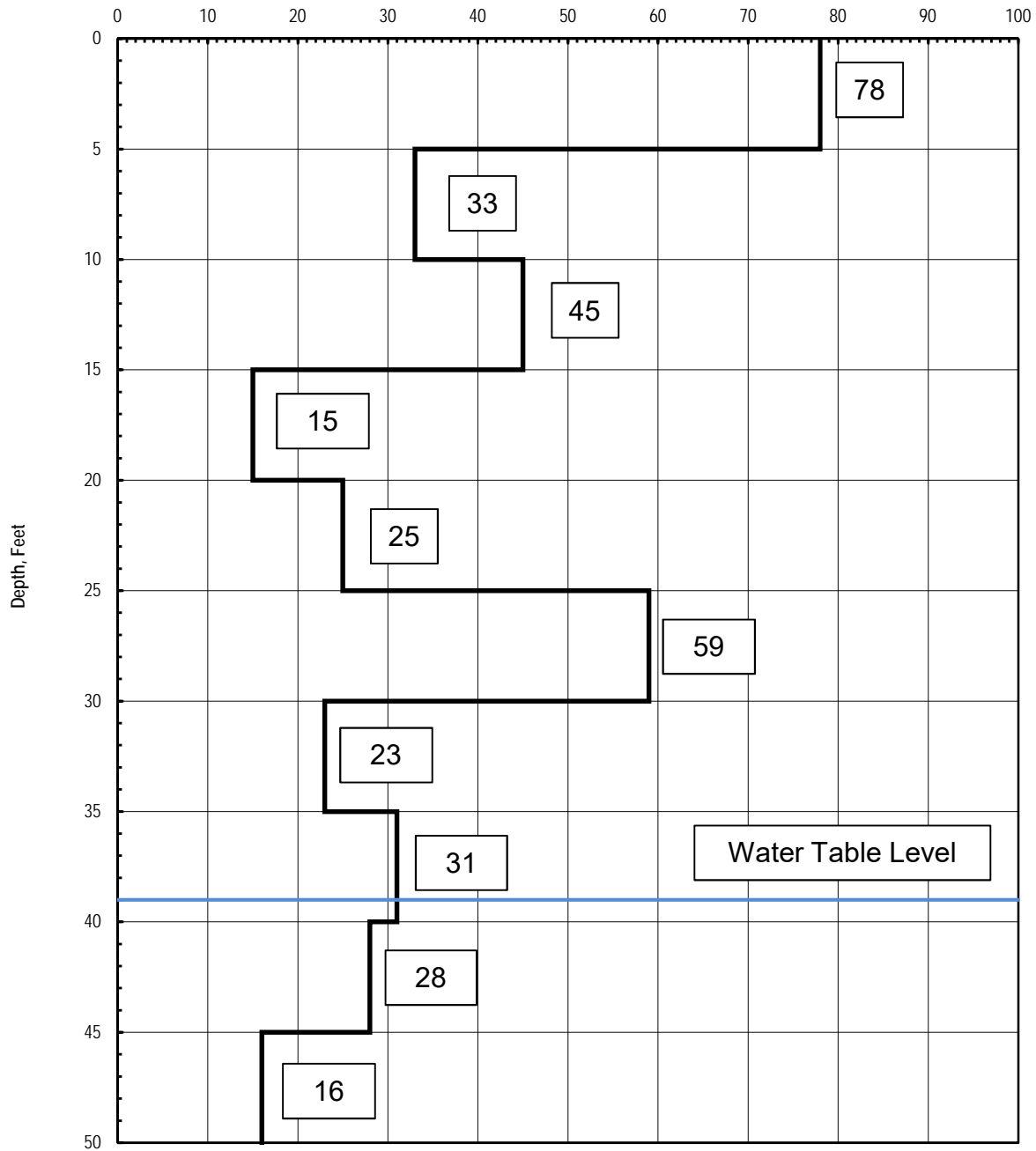

GEOCON
INCORPORATED



GEOTECHNICAL CONSULTANTS
6960 FLANDERS DRIVE - SAN DIEGO, CALIFORNIA 92121-2974
PHONE 858 558-6900 - FAX 858 558-6159

TM / DG

LIQUEFACTION - N 1 | 60 BLOW COUNT

PIRAEUS POINT
ENCINITAS, CALIFORNIA

PROJECT NO. G2307-32-05



Liquefaction Analysis Using SPT

References

1. Youd, et al, *Liquefaction Resistance of Soils: Summary Report from the 1996 NCEE/NSF Workshops on Evaluation of Liquefactor. Resistance of Soils, Journal of Geotechnical and Environmental Engineering, October, 2001, Vol. 127, No. 10*
2. Seed, et al, *Recent Advances in Soil Liquefaction Engineering: A Unified and Consistent Framework, 2003*

Project Name: Piraeus Point
 Project Number: G2307-32-05
 Boring: B-1

a_{max}/g : 0.56
 Magnitude: 6.9
 Groundwater Depth, Ft: 39.0
 Reference Pressure, p_a : 2000
 Unit Weight of Water: 62.4
 Soil Unit Weight, pcf: 125

Include K_σ (Y/N): N
 Use NCEEER CRR7.5 (1) or Rauch CRR7.5 (2): 2
 Minimum Factor of Safety for Liquefaction: 1

Depth, ft	Enter for Fine-Grained Materials						Old		New		MWF Idriss(1997) = $(\sigma'_{vs})^{2.56}/10^{2.24}$			From Graph						
	N_{160}	Fines Content, FC (%)	Water Content, w_c (%)	Liquid Limit	Plastic Limit	Plasticity Index	N_{160} Adj. for Fines	N_{160} Adj. for Fines	σ'_{vs} , psf	σ'_{vs} , psf	r_d	K_σ	NCEEER CRR7.5	RAUCH CRR7.5	CSR M=7.5	Fines Liquefiable (Y/N)	Liquefaction Potential	Factor of Safety	Volumetric Strain, %	Settlement, in.
1	78	35	3.8	30	15	15	98.6	84.0	125	125	1.00	1.00	0.800	0.800	0.294	N	Above GWT	2.721		
2	78	35	3.8	30	15	15	98.6	84.0	250	250	1.00	1.00	0.800	0.800	0.293	N	Above GWT	2.727		
3	78	35	3.8	30	15	15	98.6	84.0	375	375	0.99	1.00	0.800	0.800	0.293	N	Above GWT	2.734		
4	78	35	3.8	30	15	15	98.6	84.0	500	500	0.99	1.00	0.800	0.800	0.292	N	Above GWT	2.740		
5	78	35	3.8	30	15	15	98.6	84.0	625	625	0.99	1.00	0.800	0.800	0.291	N	Above GWT	2.747		
6	33	35	3.8	30	15	15	44.6	39.0	750	750	0.99	1.00	0.800	0.800	0.291	N	Above GWT	2.753		
7	33	35	3.8	30	15	15	44.6	39.0	875	875	0.99	1.00	0.800	0.800	0.290	N	Above GWT	2.759		
8	33	35	3.8	30	15	15	44.6	39.0	1000	1000	0.98	1.00	0.800	0.800	0.289	N	Above GWT	2.766		
9	33	35	3.8	30	15	15	44.6	39.0	1125	1125	0.98	1.00	0.800	0.800	0.289	N	Above GWT	2.772		
10	33	35	3.8	30	15	15	44.6	39.0	1250	1250	0.98	1.00	0.800	0.800	0.288	N	Above GWT	2.778		
11	45	35	5.4	30	15	15	59.0	51.0	1375	1375	0.98	1.00	0.800	0.800	0.287	N	Above GWT	2.784		
12	45	35	5.4	30	15	15	59.0	51.0	1500	1500	0.97	1.00	0.800	0.800	0.287	N	Above GWT	2.790		
13	45	35	5.4	30	15	15	59.0	51.0	1625	1625	0.97	1.00	0.800	0.800	0.286	N	Above GWT	2.796		
14	45	35	5.4	30	15	15	59.0	51.0	1750	1750	0.97	1.00	0.800	0.800	0.286	N	Above GWT	2.802		
15	15	35	5.4	30	15	15	23.0	21.0	1875	1875	0.97	1.00	0.255	0.257	0.285	N	Above GWT	0.902		
16	15	35	5.4	30	15	15	23.0	21.0	2000	2000	0.97	1.00	0.255	0.257	0.284	N	Above GWT	0.904		
17	15	35	5.4	30	15	15	23.0	21.0	2125	2125	0.96	1.00	0.255	0.257	0.284	N	Above GWT	0.906		
18	15	35	5.4	30	15	15	23.0	21.0	2250	2250	0.96	1.00	0.255	0.257	0.283	N	Above GWT	0.908		
19	15	35	5.4	30	15	15	23.0	21.0	2375	2375	0.96	1.00	0.255	0.257	0.282	N	Above GWT	0.911		
20	15	35	5.4	30	15	15	23.0	21.0	2500	2500	0.96	1.00	0.255	0.257	0.281	N	Above GWT	0.913		
21	25	35	14.8	30	15	15	35.0	31.0	2625	2625	0.95	1.00	0.800	0.800	0.281	N	Above GWT	2.850		
22	25	35	14.8	30	15	15	35.0	31.0	2750	2750	0.95	1.00	0.800	0.800	0.280	N	Above GWT	2.859		
23	25	35	14.8	30	15	15	35.0	31.0	2875	2875	0.95	1.00	0.800	0.800	0.279	N	Above GWT	2.868		
24	25	35	14.8	30	15	15	35.0	31.0	3000	3000	0.95	1.00	0.800	0.800	0.278	N	Above GWT	2.877		
25	25	35	14.8	30	15	15	35.0	31.0	3125	3125	0.94	1.00	0.800	0.800	0.277	N	Above GWT	2.888		
26	59	35	8.7	30	15	15	75.8	65.0	3250	3250	0.94	1.00	0.800	0.800	0.276	N	Above GWT	2.899		
27	59	35	8.7	30	15	15	75.8	65.0	3375	3375	0.93	1.00	0.800	0.800	0.275	N	Above GWT	2.911		
28	59	35	8.7	30	15	15	75.8	65.0	3500	3500	0.93	1.00	0.800	0.800	0.274	N	Above GWT	2.925		
29	59	35	8.7	30	15	15	75.8	65.0	3625	3625	0.93	1.00	0.800	0.800	0.272	N	Above GWT	2.939		
30	59	35	8.7	30	15	15	75.8	65.0	3750	3750	0.92	1.00	0.800	0.800	0.271	N	Above GWT	2.955		
31	23	35	8.7	30	15	15	32.6	29.0	3875	3875	0.92	1.00	0.800	0.800	0.269	N	Above GWT	2.972		
32	23	35	8.7	30	15	15	32.6	29.0	4000	4000	0.91	1.00	0.800	0.800	0.268	N	Above GWT	2.990		
33	23	35	8.7	30	15	15	32.6	29.0	4125	4125	0.90	1.00	0.800	0.800	0.266	N	Above GWT	3.010		
34	23	35	8.7	30	15	15	32.6	29.0	4250	4250	0.90	1.00	0.800	0.800	0.264	N	Above GWT	3.031		
35	23	35	8.7	30	15	15	32.6	29.0	4375	4375	0.89	1.00	0.800	0.800	0.262	N	Above GWT	3.054		
36	31	35	8.7	30	15	15	42.2	37.0	4500	4500	0.88	1.00	0.800	0.800	0.260	N	Above GWT	3.079		
37	31	35	15.3	30	15	15	42.2	37.0	4625	4625	0.88	1.00	0.800	0.800	0.258	N	Above GWT	3.106		
38	31	35	15.3	30	15	15	42.2	37.0	4750	4750	0.87	1.00	0.800	0.800	0.255	N	Above GWT	3.134		
39	31	35	15.3	30	15	15	42.2	37.0	4875	4875	0.86	1.00	0.800	0.800	0.253	N	NL	3.165		
40	31	35	15.3	30	15	15	42.2	37.0	5000	4938	0.85	1.00	0.800	0.800	0.253	N	NL	3.157		
41	28	35	15.3	30	15	15	38.6	34.0	5125	5000	0.84	1.00	0.800	0.800	0.254	N	NL	3.152		
42	28	35	15.3	30	15	15	38.6	34.0	5250	5063	0.83	1.00	0.800	0.800	0.254	N	NL	3.150		
43	28	35	15.3	30	15	15	38.6	34.0	5375	5125	0.82	1.00	0.800	0.800	0.254	N	NL	3.151		
44	28	35	15.3	30	15	15	38.6	34.0	5500	5188	0.81	1.00	0.800	0.800	0.254	N	NL	3.155		
45	28	35	20.0	30	15	15	38.6	34.0	5625	5251	0.80	1.00	0.800	0.800	0.253	N	NL	3.160		
46	16	35	20.0	30	15	15	24.2	22.0	5750	5313	0.79	1.00	0.273	0.277	0.253	N	NL	1.097		
47	16	35	20.0	30	15	15	24.2	22.0	5875	5376	0.78	1.00	0.273	0.277	0.252	N	NL	1.100		
48	16	35	20.0	30	15	15	24.2	22.0	6000	5438	0.77	1.00	0.273	0.277	0.251	N	NL	1.104		
49	16	35	20.0	30	15	15	24.2	22.0	6125	5501	0.76	1.00	0.273	0.277	0.250	N	NL	1.109		
50	16	35	20.0	30	15	15	24.2	22.0	6250	5564	0.75	1.00	0.273	0.277	0.249	N	NL	1.114		
51	16	35	20.0	30	15	15	24.2	22.0	6375	5626	0.74	1.00	0.273	0.277	0.247	N	NL	1.119		

Total Settlement, S_{10} (in.) = 0
 Total Liquefiable Layers = 0

Factor of Safety - Boring B-1

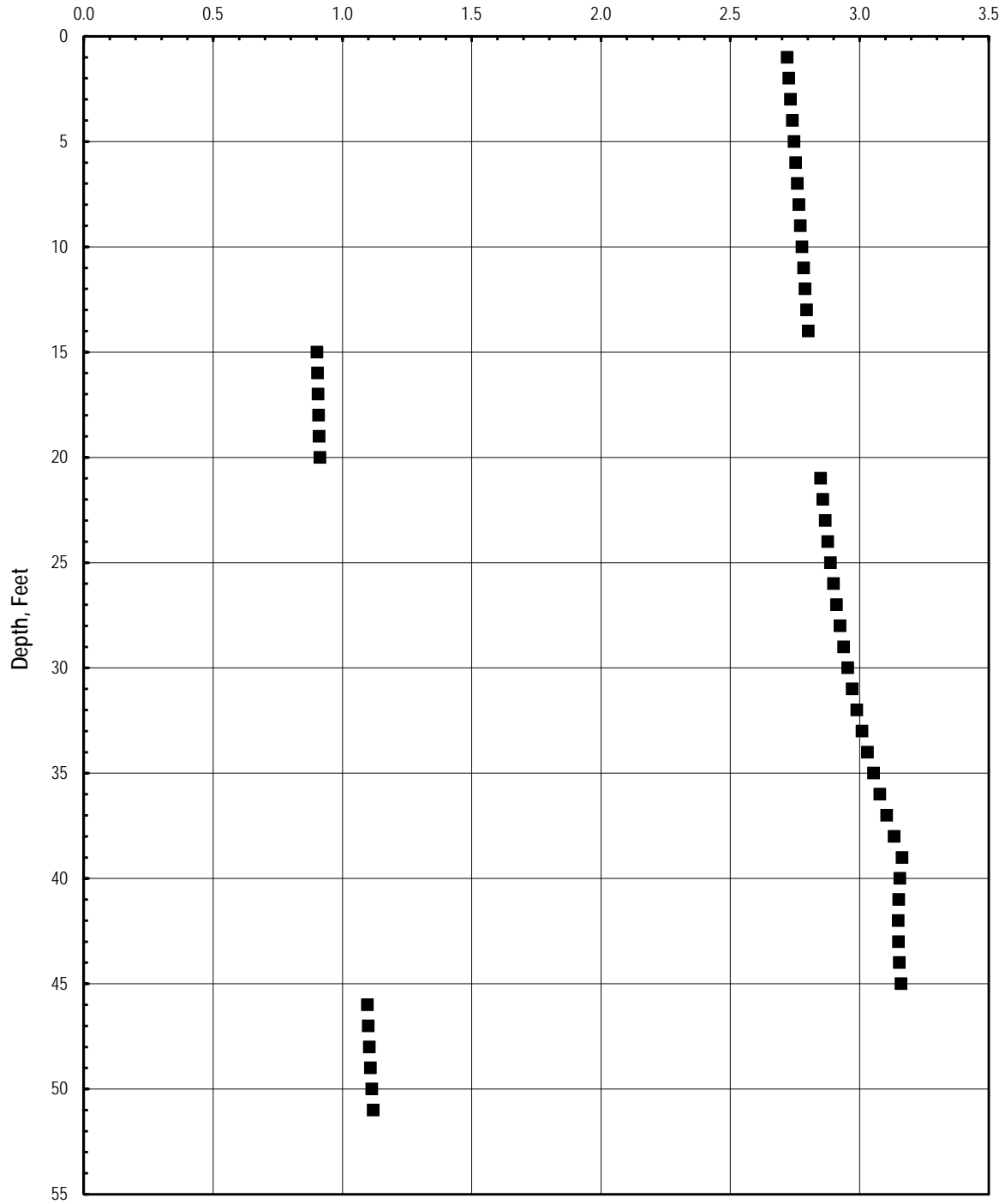

GEOCON
INCORPORATED



GEOTECHNICAL CONSULTANTS
 6960 FLANDERS DRIVE - SAN DIEGO, CALIFORNIA 92121-2974
 PHONE 858 558-6900 - FAX 858 558-6159

SW / SW		
---------	--	--

LIQUEFACTION - FACTOR OF SAFETY

PIRAEUS POINT
 ENCINITAS, CALIFORNIA

	PROJECT NO. G2307-32-05
--	-------------------------

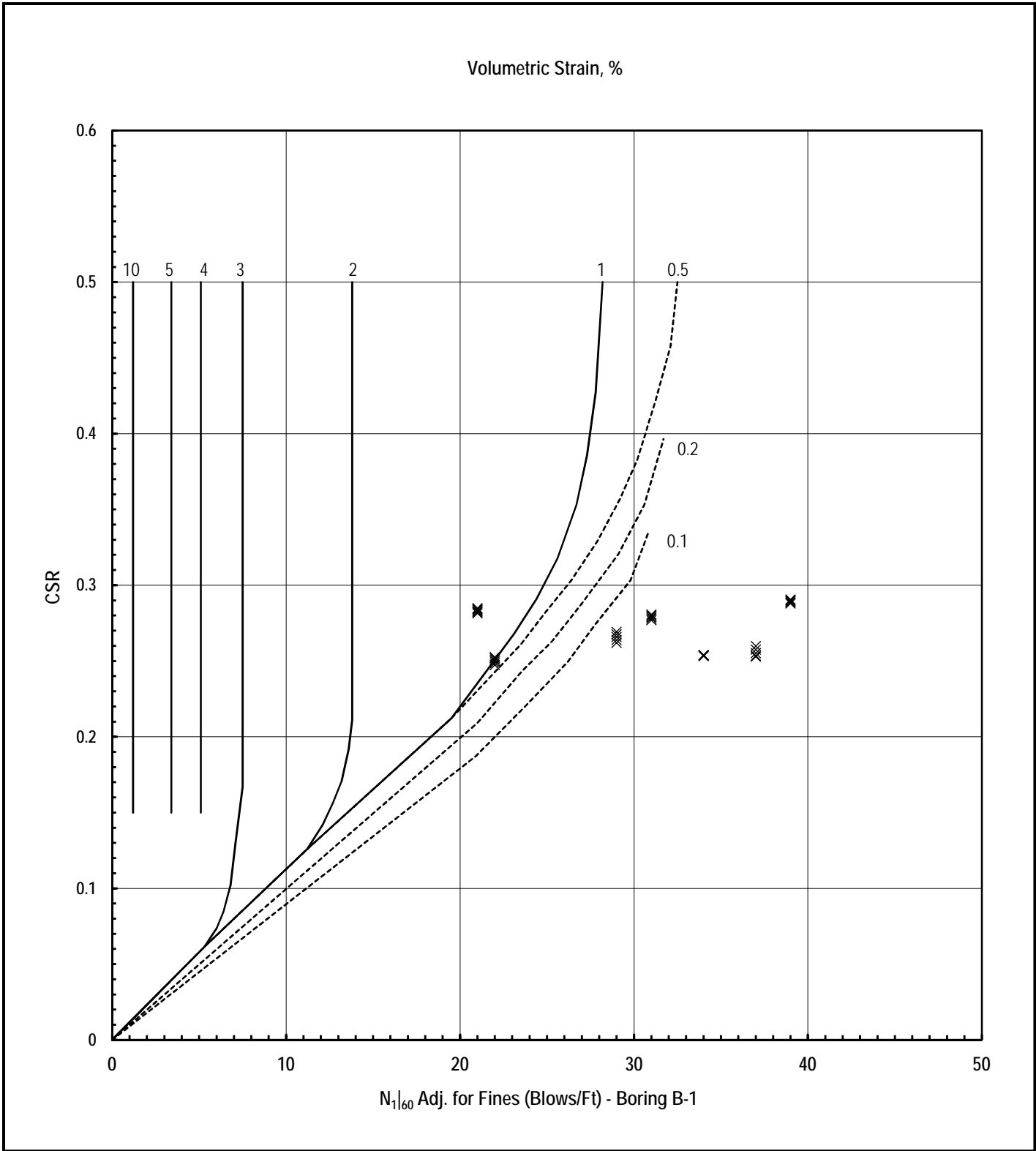

GEOCON
INCORPORATED



GEOTECHNICAL CONSULTANTS
 6960 FLANDERS DRIVE - SAN DIEGO, CALIFORNIA 92121-2974
 PHONE 858 558-6900 - FAX 858 558-6159

SW / SW		
---------	--	--

LIQUEFACTION - VOLUMETRIC STRAIN

PIRAEUS POINT
 ENCINITAS, CALIFORNIA

	PROJECT NO. G2307-32-05
--	-------------------------

Boring B-2 N1|60 Blowcounts

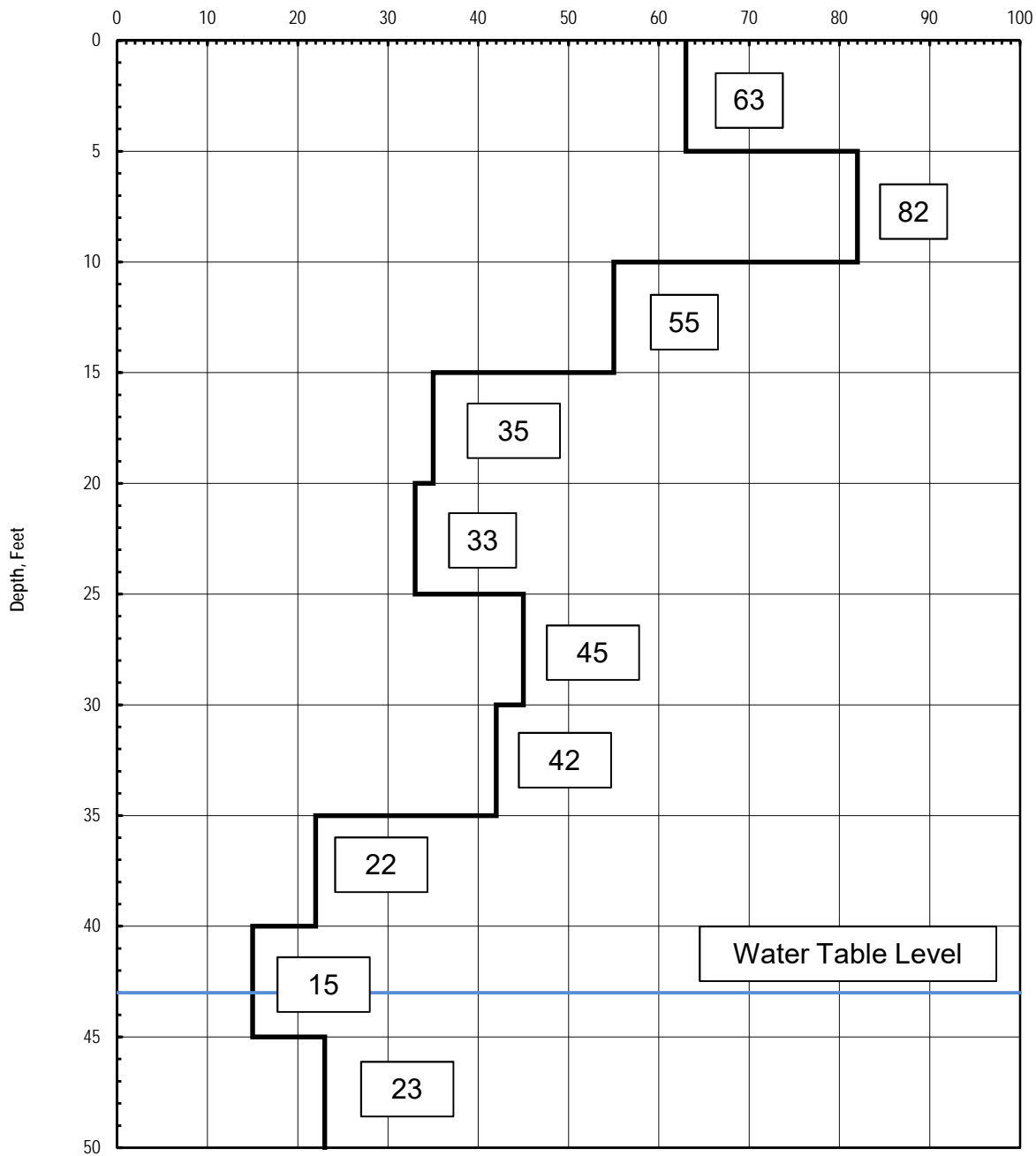

GEOCON
INCORPORATED



GEOTECHNICAL CONSULTANTS
6960 FLANDERS DRIVE - SAN DIEGO, CALIFORNIA 92121 - 2974
PHONE 858 558-6900 - FAX 858 558-6159

TM / DG

LIQUEFACTION - N 1 | 60 BLOW COUNT

PIRAEUS POINT
ENCINITAS, CALIFORNIA

PROJECT NO. G2307-32-05



Liquefaction Analysis Using SPT

References

1. Youd, et al, Liquefaction Resistance of Soils: Summary Report from the 1996 NCEE/NSF Workshops on Evaluation of Liquefactor. Resistance of Soils, Journal of Geotechnical and Environmental Engineering, October, 2001, Vol. 127, No. 10
2. Seed, et al, Recent Advances in Soil Liquefaction Engineering: A Unified and Consistent Framework, 2003

Project Name: Piraeus Point
 Project Number: G2307-32-05
 Boring: B-2

a_{max}/g : 0.56
 Magnitude: 6.9
 Groundwater Depth, Ft: 43.0
 Reference Pressure, p_a : 2000
 Unit Weight of Water: 62.4
 Soil Unit Weight, pcf: 125

Include K_{σ} (Y/N): N
 Use NCEEER CRR7.5 (1) or Rauch CRR7.5 (2): 2
 Minimum Factor of Safety for Liquefaction: 1

Depth, ft	Enter for Fine-Grained Materials						Old		New		MWF Idriss(1997) = $(N_1)^{0.25} / 10^{2.4}$					From Graph				
	N_{160}	Fines Content, FC (%)	Water Content, w_c (%)	Liquid Limit	Plastic Limit	Plasticity Index	N_{160} Adj. for Fines	N_{160} Adj. for Fines	σ_v , psf	σ'_v , psf	r_d	K_{σ}	NCEEER CRR7.5	RAUCH CRR7.5	CSR M=7.5	Fines Liquefiable (Y/N)	Liquefaction Potential	Factor of Safety	Volumetric Strain, %	Settlement, in.
1	63	35	5.3	30	15	15	80.6	69.0	125	125	1.00	1.00	0.800	0.800	0.294	N	Above GWT	2.721		
2	63	35	5.3	30	15	15	80.6	69.0	250	250	1.00	1.00	0.800	0.800	0.293	N	Above GWT	2.727		
3	63	35	5.3	30	15	15	80.6	69.0	375	375	0.99	1.00	0.800	0.800	0.293	N	Above GWT	2.734		
4	63	35	5.3	30	15	15	80.6	69.0	500	500	0.99	1.00	0.800	0.800	0.292	N	Above GWT	2.740		
5	63	35	5.3	30	15	15	80.6	69.0	625	625	0.99	1.00	0.800	0.800	0.291	N	Above GWT	2.747		
6	82	35	5.3	30	15	15	103.4	88.0	750	750	0.99	1.00	0.800	0.800	0.291	N	Above GWT	2.753		
7	82	35	5.3	30	15	15	103.4	88.0	875	875	0.99	1.00	0.800	0.800	0.290	N	Above GWT	2.759		
8	82	35	5.3	30	15	15	103.4	88.0	1000	1000	0.98	1.00	0.800	0.800	0.289	N	Above GWT	2.766		
9	82	35	5.3	30	15	15	103.4	88.0	1125	1125	0.98	1.00	0.800	0.800	0.289	N	Above GWT	2.772		
10	82	35	5.3	30	15	15	103.4	88.0	1250	1250	0.98	1.00	0.800	0.800	0.288	N	Above GWT	2.778		
11	55	35	15.2	30	15	15	71.0	61.0	1375	1375	0.98	1.00	0.800	0.800	0.287	N	Above GWT	2.784		
12	55	35	15.2	30	15	15	71.0	61.0	1500	1500	0.97	1.00	0.800	0.800	0.287	N	Above GWT	2.790		
13	55	35	15.2	30	15	15	71.0	61.0	1625	1625	0.97	1.00	0.800	0.800	0.286	N	Above GWT	2.796		
14	55	35	15.2	30	15	15	71.0	61.0	1750	1750	0.97	1.00	0.800	0.800	0.286	N	Above GWT	2.802		
15	55	35	15.2	30	15	15	71.0	61.0	1875	1875	0.97	1.00	0.800	0.800	0.285	N	Above GWT	2.808		
16	35	35	9.6	30	15	15	47.0	41.0	2000	2000	0.97	1.00	0.800	0.800	0.284	N	Above GWT	2.814		
17	35	35	9.6	30	15	15	47.0	41.0	2125	2125	0.96	1.00	0.800	0.800	0.284	N	Above GWT	2.821		
18	35	35	9.6	30	15	15	47.0	41.0	2250	2250	0.96	1.00	0.800	0.800	0.283	N	Above GWT	2.828		
19	35	35	9.6	30	15	15	47.0	41.0	2375	2375	0.96	1.00	0.800	0.800	0.282	N	Above GWT	2.835		
20	35	35	9.6	30	15	15	47.0	41.0	2500	2500	0.96	1.00	0.800	0.800	0.281	N	Above GWT	2.842		
21	33	35	12.5	30	15	15	44.6	39.0	2625	2625	0.95	1.00	0.800	0.800	0.281	N	Above GWT	2.850		
22	33	35	12.5	30	15	15	44.6	39.0	2750	2750	0.95	1.00	0.800	0.800	0.280	N	Above GWT	2.859		
23	33	35	12.5	30	15	15	44.6	39.0	2875	2875	0.95	1.00	0.800	0.800	0.279	N	Above GWT	2.868		
24	33	35	12.5	30	15	15	44.6	39.0	3000	3000	0.95	1.00	0.800	0.800	0.278	N	Above GWT	2.877		
25	33	35	12.5	30	15	15	44.6	39.0	3125	3125	0.94	1.00	0.800	0.800	0.277	N	Above GWT	2.888		
26	45	35	12.5	30	15	15	59.0	51.0	3250	3250	0.94	1.00	0.800	0.800	0.276	N	Above GWT	2.899		
27	45	35	12.5	30	15	15	59.0	51.0	3375	3375	0.93	1.00	0.800	0.800	0.275	N	Above GWT	2.911		
28	45	35	12.5	30	15	15	59.0	51.0	3500	3500	0.93	1.00	0.800	0.800	0.274	N	Above GWT	2.925		
29	45	35	12.5	30	15	15	59.0	51.0	3625	3625	0.93	1.00	0.800	0.800	0.272	N	Above GWT	2.939		
30	45	35	12.5	30	15	15	59.0	51.0	3750	3750	0.92	1.00	0.800	0.800	0.271	N	Above GWT	2.955		
31	42	35	12.5	30	15	15	55.4	48.0	3875	3875	0.92	1.00	0.800	0.800	0.269	N	Above GWT	2.972		
32	42	35	12.5	30	15	15	55.4	48.0	4000	4000	0.91	1.00	0.800	0.800	0.268	N	Above GWT	2.990		
33	42	35	12.5	30	15	15	55.4	48.0	4125	4125	0.90	1.00	0.800	0.800	0.266	N	Above GWT	3.010		
34	42	35	12.5	30	15	15	55.4	48.0	4250	4250	0.90	1.00	0.800	0.800	0.264	N	Above GWT	3.031		
35	42	35	12.5	30	15	15	55.4	48.0	4375	4375	0.89	1.00	0.800	0.800	0.262	N	Above GWT	3.054		
36	22	35	15.4	30	15	15	31.4	28.0	4500	4500	0.88	1.00	0.800	0.800	0.260	N	Above GWT	3.079		
37	22	35	15.4	30	15	15	31.4	28.0	4625	4625	0.88	1.00	0.800	0.800	0.258	N	Above GWT	3.106		
38	22	35	15.4	30	15	15	31.4	28.0	4750	4750	0.87	1.00	0.800	0.800	0.255	N	Above GWT	3.134		
39	22	35	15.4	30	15	15	31.4	28.0	4875	4875	0.86	1.00	0.800	0.800	0.253	N	Above GWT	3.165		
40	22	35	15.4	30	15	15	31.4	28.0	5000	5000	0.85	1.00	0.800	0.800	0.250	N	Above GWT	3.197		
41	15	35	15.4	30	15	15	23.0	21.0	5125	5125	0.84	1.00	0.255	0.257	0.248	N	Above GWT	1.038		
42	15	35	15.4	30	15	15	23.0	21.0	5250	5250	0.83	1.00	0.255	0.257	0.245	N	Above GWT	1.049		
43	15	35	15.4	30	15	15	23.0	21.0	5375	5375	0.82	1.00	0.255	0.257	0.242	N	NL	1.061		
44	15	35	15.4	30	15	15	23.0	21.0	5500	5438	0.81	1.00	0.255	0.257	0.242	N	NL	1.062		
45	15	35	15.4	30	15	15	23.0	21.0	5625	5500	0.80	1.00	0.255	0.257	0.242	N	NL	1.063		
46	23	35	19.5	30	15	15	32.6	29.0	5750	5563	0.79	1.00	0.800	0.800	0.241	N	NL	3.317		
47	23	35	19.5	30	15	15	32.6	29.0	5875	5625	0.78	1.00	0.800	0.800	0.241	N	NL	3.326		
48	23	35	19.5	30	15	15	32.6	29.0	6000	5688	0.77	1.00	0.800	0.800	0.240	N	NL	3.336		
49	23	35	19.5	30	15	15	32.6	29.0	6125	5751	0.76	1.00	0.800	0.800	0.239	N	NL	3.348		
50	23	35	19.5	30	15	15	32.6	29.0	6250	5813	0.75	1.00	0.800	0.800	0.238	N	NL	3.362		
51	23	35	19.5	30	15	15	32.6	29.0	6375	5876	0.74	1.00	0.800	0.800	0.237	N	NL	3.377		

Total Settlement, S_{10} (in.) = 0
 Total Liquefiable Layers = 0

Factor of Safety - Boring B-2

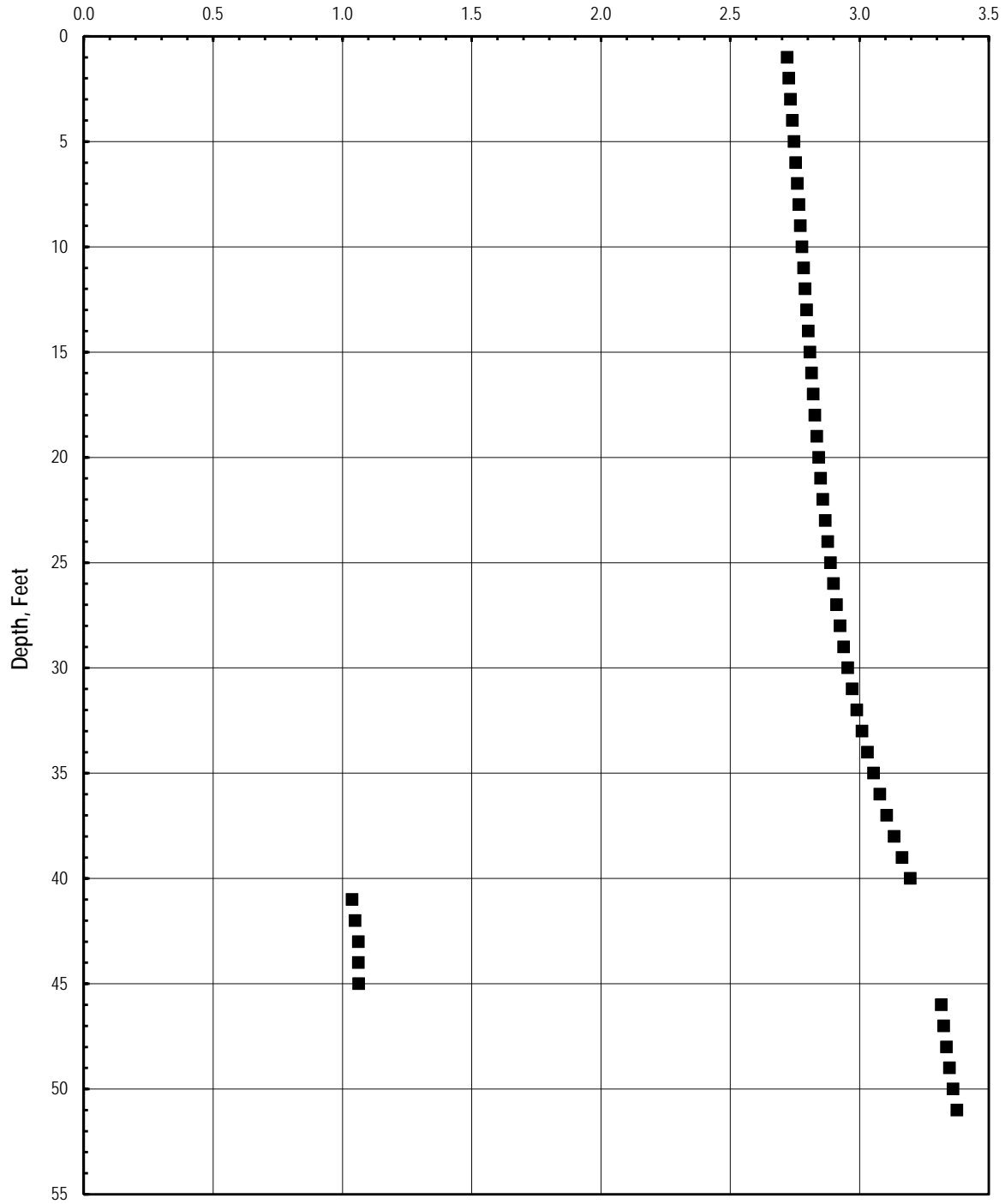

GEOCON
INCORPORATED
 GEOTECHNICAL CONSULTANTS
 6960 FLANDERS DRIVE - SAN DIEGO, CALIFORNIA 92121-2974
 PHONE 858 558-6900 - FAX 858 558-6159



SW / SW

LIQUEFACTION - FACTOR OF SAFETY

PIRAEUS POINT
 ENCINITAS, CALIFORNIA

PROJECT NO. G2307-32-05

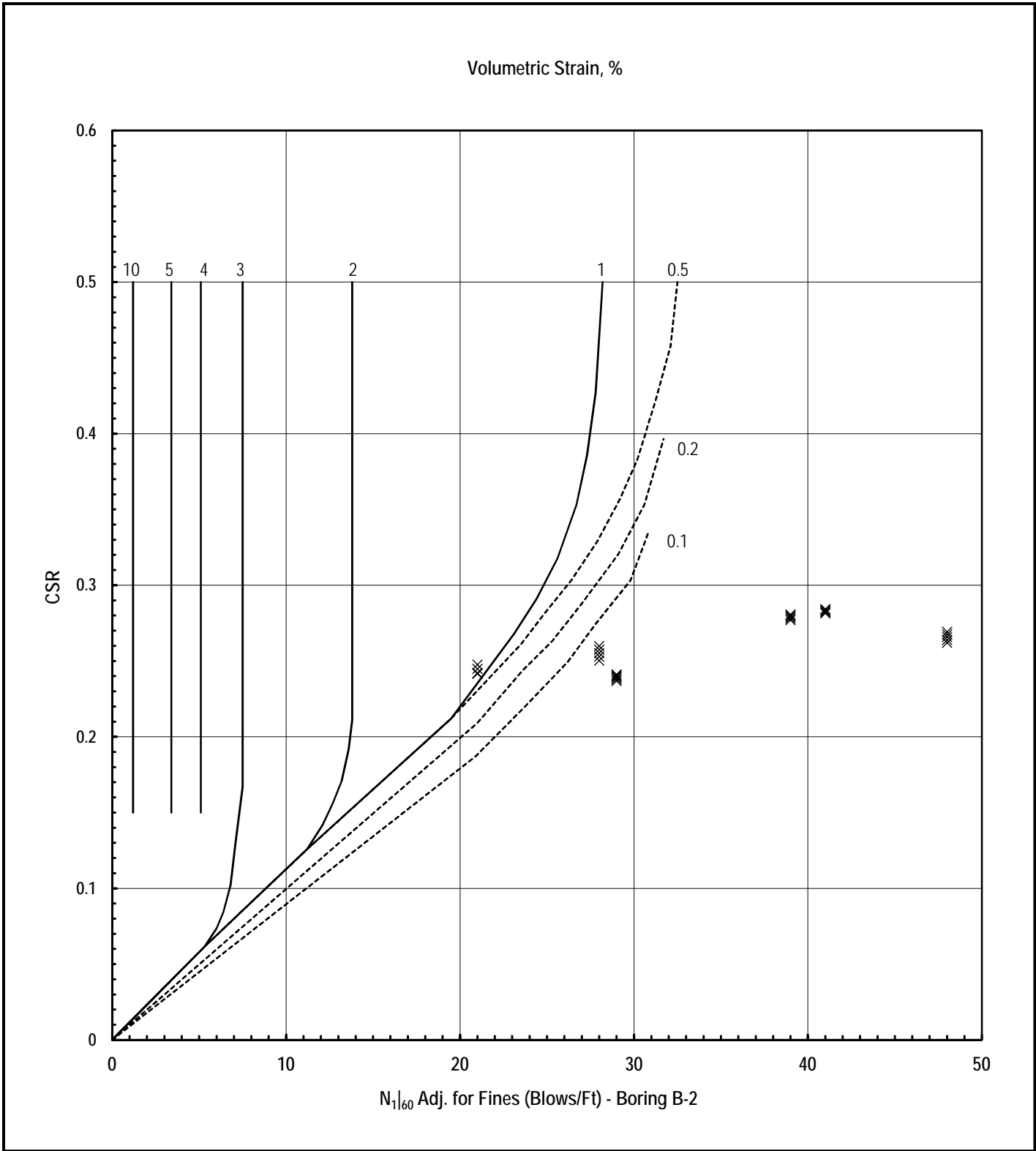

GEOCON
INCORPORATED
 GEOTECHNICAL CONSULTANTS
 6960 FLANDERS DRIVE - SAN DIEGO, CALIFORNIA 92121-2974
 PHONE 858 558-6900 - FAX 858 558-6159



SW / SW

LIQUEFACTION - VOLUMETRIC STRAIN

PIRAEUS POINT
 ENCINITAS, CALIFORNIA

PROJECT NO. G2307-32-05

Boring B-3 N1|60 Blowcounts

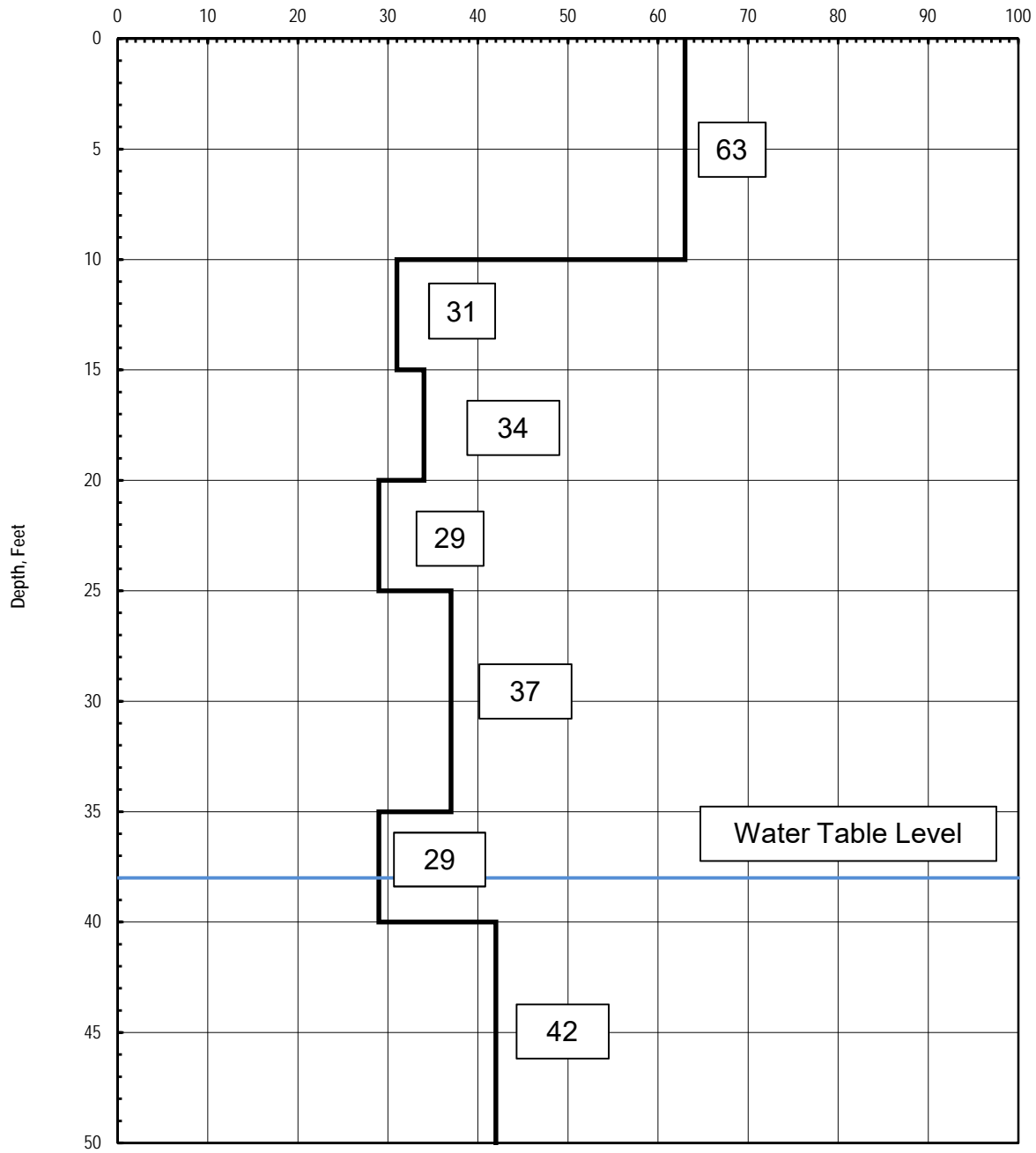

GEOCON
INCORPORATED



GEOTECHNICAL CONSULTANTS
6960 FLANDERS DRIVE - SAN DIEGO, CALIFORNIA 92121 - 2974
PHONE 858 558-6900 - FAX 858 558-6159

TM / DG

LIQUEFACTION - N 1 | 60 BLOW COUNT

PIRAEUS POINT
ENCINITAS, CALIFORNIA

PROJECT NO. G2307-32-05



Liquefaction Analysis Using SPT

References

1. Youd, et al, Liquefaction Resistance of Soils: Summary Report from the 1996 NCEE/NSF Workshops on Evaluation of Liquefactor. Resistance of Soils, Journal of Geotechnical and Environmental Engineering, October, 2001, Vol. 127, No. 10
2. Seed, et al, Recent Advances in Soil Liquefaction Engineering: A Unified and Consistent Framework, 2003

Project Name: Piraeus Point
 Project Number: G2307-32-05
 Boring: B-3

a_{max}/g : 0.56
 Magnitude: 6.9
 Groundwater Depth, Ft: 38.0
 Reference Pressure, p_a : 2000
 Unit Weight of Water: 62.4
 Soil Unit Weight, pcf: 125

Include K_{σ} (Y/N): N
 Use NCEEER CRR7.5 (1) or Rauch CRR7.5 (2): 2
 Minimum Factor of Safety for Liquefaction: 1

Depth, ft	Enter for Fine-Grained Materials							Old				New				MWF Idriss(1997) = $(\sigma'_{vs})^{2.56}/10^{2.24}$			From Graph	
	N_{160}	Fines Content, FC (%)	Water Content, w_c (%)	Liquid Limit	Plastic Limit	Plasticity Index	N_{160} Adj. for Fines	N_{160} Adj. for Fines	σ'_{vs} , psf	σ'_{vs} , psf	r_d	K_{σ}	NCEEER CRR7.5	RAUCH CRR7.5	CSR M=7.5	Fines Liquefiable (Y/N)	Liquefaction Potential	Factor of Safety	Volumetric Strain, %	Settlement, in.
1	63	35	11.1	30	15	15	80.6	69.0	125	125	1.00	1.00	0.800	0.800	0.294	N	Above GWT	2.721		
2	63	35	11.1	30	15	15	80.6	69.0	250	250	1.00	1.00	0.800	0.800	0.293	N	Above GWT	2.727		
3	63	35	11.1	30	15	15	80.6	69.0	375	375	0.99	1.00	0.800	0.800	0.293	N	Above GWT	2.734		
4	63	35	11.1	30	15	15	80.6	69.0	500	500	0.99	1.00	0.800	0.800	0.292	N	Above GWT	2.740		
5	63	35	11.1	30	15	15	80.6	69.0	625	625	0.99	1.00	0.800	0.800	0.291	N	Above GWT	2.747		
6	63	35	11.1	30	15	15	80.6	69.0	750	750	0.99	1.00	0.800	0.800	0.291	N	Above GWT	2.753		
7	63	35	11.1	30	15	15	80.6	69.0	875	875	0.99	1.00	0.800	0.800	0.290	N	Above GWT	2.759		
8	63	35	11.1	30	15	15	80.6	69.0	1000	1000	0.98	1.00	0.800	0.800	0.289	N	Above GWT	2.766		
9	63	35	11.1	30	15	15	80.6	69.0	1125	1125	0.98	1.00	0.800	0.800	0.289	N	Above GWT	2.772		
10	63	35	11.1	30	15	15	80.6	69.0	1250	1250	0.98	1.00	0.800	0.800	0.288	N	Above GWT	2.778		
11	31	35	10.9	30	15	15	42.2	37.0	1375	1375	0.98	1.00	0.800	0.800	0.287	N	Above GWT	2.784		
12	31	35	10.9	30	15	15	42.2	37.0	1500	1500	0.97	1.00	0.800	0.800	0.287	N	Above GWT	2.790		
13	31	35	10.9	30	15	15	42.2	37.0	1625	1625	0.97	1.00	0.800	0.800	0.286	N	Above GWT	2.796		
14	31	35	10.9	30	15	15	42.2	37.0	1750	1750	0.97	1.00	0.800	0.800	0.286	N	Above GWT	2.802		
15	31	35	10.9	30	15	15	42.2	37.0	1875	1875	0.97	1.00	0.800	0.800	0.285	N	Above GWT	2.808		
16	34	35	10.2	30	15	15	45.8	40.0	2000	2000	0.97	1.00	0.800	0.800	0.284	N	Above GWT	2.814		
17	34	35	10.2	30	15	15	45.8	40.0	2125	2125	0.96	1.00	0.800	0.800	0.284	N	Above GWT	2.821		
18	34	35	10.2	30	15	15	45.8	40.0	2250	2250	0.96	1.00	0.800	0.800	0.283	N	Above GWT	2.828		
19	34	35	10.2	30	15	15	45.8	40.0	2375	2375	0.96	1.00	0.800	0.800	0.282	N	Above GWT	2.835		
20	34	35	10.2	30	15	15	45.8	40.0	2500	2500	0.96	1.00	0.800	0.800	0.281	N	Above GWT	2.842		
21	29	35	10.2	30	15	15	39.8	35.0	2625	2625	0.95	1.00	0.800	0.800	0.281	N	Above GWT	2.850		
22	29	35	10.2	30	15	15	39.8	35.0	2750	2750	0.95	1.00	0.800	0.800	0.280	N	Above GWT	2.859		
23	29	35	10.2	30	15	15	39.8	35.0	2875	2875	0.95	1.00	0.800	0.800	0.279	N	Above GWT	2.868		
24	29	35	10.2	30	15	15	39.8	35.0	3000	3000	0.95	1.00	0.800	0.800	0.278	N	Above GWT	2.877		
25	29	35	10.2	30	15	15	39.8	35.0	3125	3125	0.94	1.00	0.800	0.800	0.277	N	Above GWT	2.888		
26	37	35	17.3	30	15	15	49.4	43.0	3250	3250	0.94	1.00	0.800	0.800	0.276	N	Above GWT	2.899		
27	37	35	17.3	30	15	15	49.4	43.0	3375	3375	0.93	1.00	0.800	0.800	0.275	N	Above GWT	2.911		
28	37	35	17.3	30	15	15	49.4	43.0	3500	3500	0.93	1.00	0.800	0.800	0.274	N	Above GWT	2.925		
29	37	35	17.3	30	15	15	49.4	43.0	3625	3625	0.93	1.00	0.800	0.800	0.272	N	Above GWT	2.939		
30	37	35	17.3	30	15	15	49.4	43.0	3750	3750	0.92	1.00	0.800	0.800	0.271	N	Above GWT	2.955		
31	37	35	17.3	30	15	15	49.4	43.0	3875	3875	0.92	1.00	0.800	0.800	0.269	N	Above GWT	2.972		
32	37	35	17.3	30	15	15	49.4	43.0	4000	4000	0.91	1.00	0.800	0.800	0.268	N	Above GWT	2.990		
33	37	35	17.3	30	15	15	49.4	43.0	4125	4125	0.90	1.00	0.800	0.800	0.266	N	Above GWT	3.010		
34	37	35	17.3	30	15	15	49.4	43.0	4250	4250	0.90	1.00	0.800	0.800	0.264	N	Above GWT	3.031		
35	37	35	17.3	30	15	15	49.4	43.0	4375	4375	0.89	1.00	0.800	0.800	0.262	N	Above GWT	3.054		
36	29	35	51.7	30	15	15	39.8	35.0	4500	4500	0.88	1.00	0.800	0.800	0.260	Y	Above GWT	3.079		
37	29	35	17.3	30	15	15	39.8	35.0	4625	4625	0.88	1.00	0.800	0.800	0.258	N	Above GWT	3.106		
38	29	35	17.3	30	15	15	39.8	35.0	4750	4750	0.87	1.00	0.800	0.800	0.255	N	NL	3.134		
39	29	35	17.3	30	15	15	39.8	35.0	4875	4813	0.86	1.00	0.800	0.800	0.256	N	NL	3.124		
40	29	35	17.3	30	15	15	39.8	35.0	5000	4875	0.85	1.00	0.800	0.800	0.257	N	NL	3.117		
41	42	35	20.1	30	15	15	55.4	48.0	5125	4938	0.84	1.00	0.800	0.800	0.257	N	NL	3.113		
42	42	35	20.1	30	15	15	55.4	48.0	5250	5000	0.83	1.00	0.800	0.800	0.257	N	NL	3.111		
43	42	35	20.1	30	15	15	55.4	48.0	5375	5063	0.82	1.00	0.800	0.800	0.257	N	NL	3.113		
44	42	35	20.1	30	15	15	55.4	48.0	5500	5126	0.81	1.00	0.800	0.800	0.257	N	NL	3.117		
45	42	35	20.1	30	15	15	55.4	48.0	5625	5188	0.80	1.00	0.800	0.800	0.256	N	NL	3.123		
46	42	35	15.7	30	15	15	55.4	48.0	5750	5251	0.79	1.00	0.800	0.800	0.256	N	NL	3.131		
47	42	35	15.7	30	15	15	55.4	48.0	5875	5313	0.78	1.00	0.800	0.800	0.255	N	NL	3.141		
48	42	35	15.7	30	15	15	55.4	48.0	6000	5376	0.77	1.00	0.800	0.800	0.254	N	NL	3.153		
49	42	35	15.7	30	15	15	55.4	48.0	6125	5439	0.76	1.00	0.800	0.800	0.253	N	NL	3.167		
50	42	35	15.7	30	15	15	55.4	48.0	6250	5501	0.75	1.00	0.800	0.800	0.251	N	NL	3.182		
51	42	35	15.7	30	15	15	55.4	48.0	6375	5564	0.74	1.00	0.800	0.800	0.250	N	NL	3.198		

Total Settlement, S_{10} (in.) = 0
 Total Liquefiable Layers = 0

Factor of Safety - Boring B-3

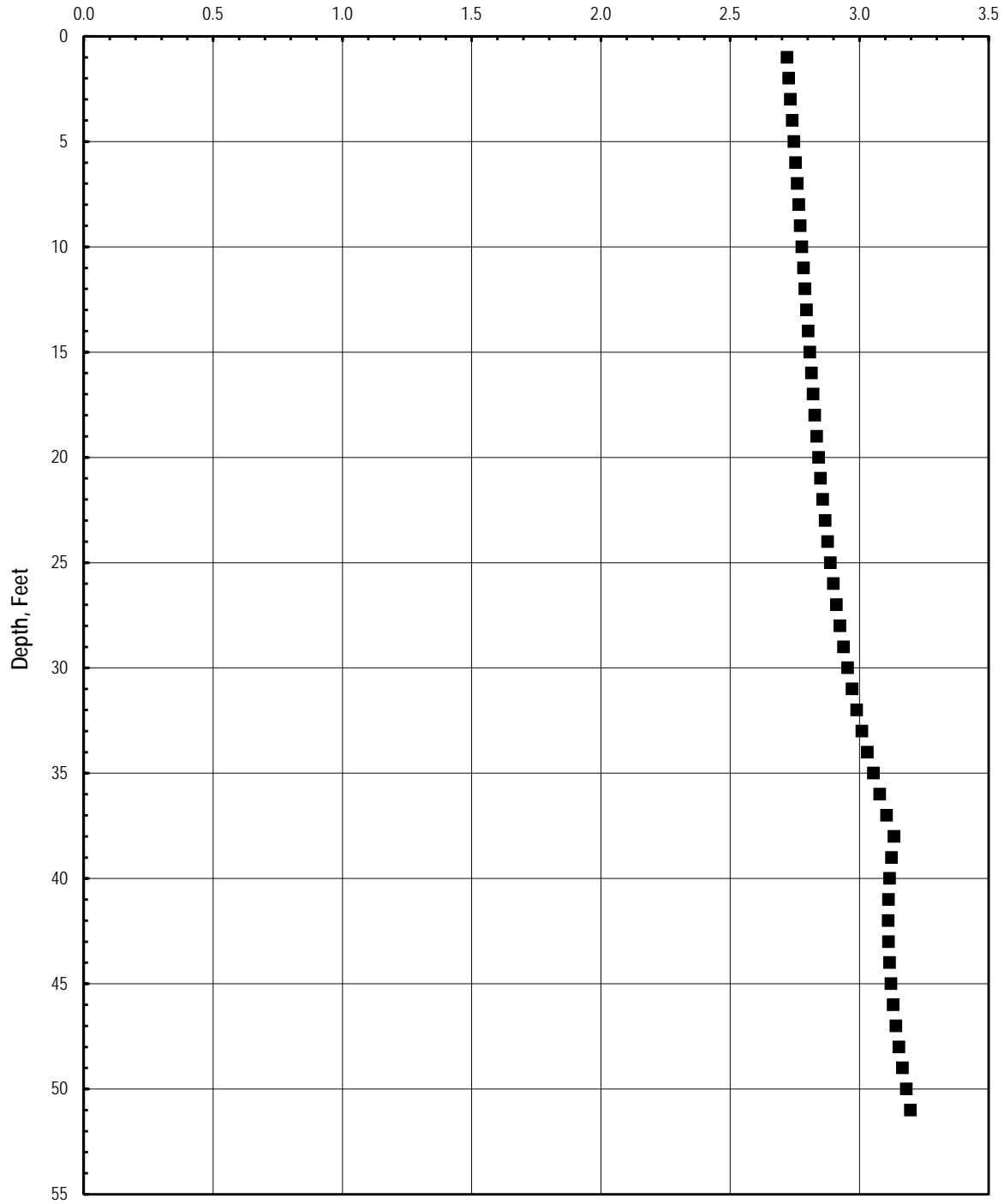

GEOCON
INCORPORATED



GEOTECHNICAL CONSULTANTS
 6960 FLANDERS DRIVE - SAN DIEGO, CALIFORNIA 92121-2974
 PHONE 858 558-6900 - FAX 858 558-6159

SW / SW		
---------	--	--

LIQUEFACTION - FACTOR OF SAFETY		
PIRAEUS POINT ENCINITAS, CALIFORNIA		
	PROJECT NO. G2307-32-05	

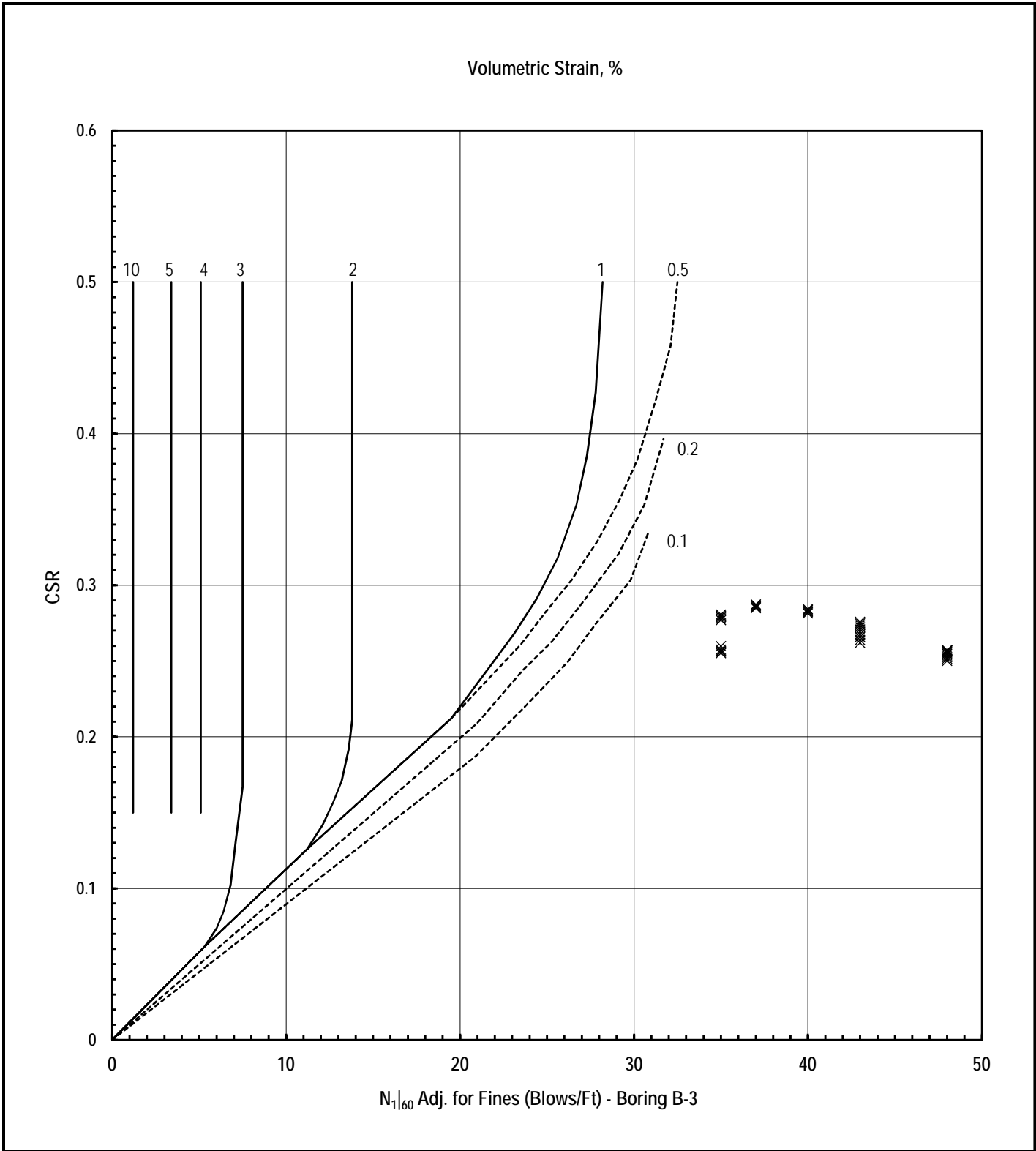

GEOCON
INCORPORATED



GEOTECHNICAL CONSULTANTS
 6960 FLANDERS DRIVE - SAN DIEGO, CALIFORNIA 92121-2974
 PHONE 858 558-6900 - FAX 858 558-6159

SW / SW		
---------	--	--

LIQUEFACTION - VOLUMETRIC STRAIN

PIRAEUS POINT
 ENCINITAS, CALIFORNIA

	PROJECT NO. G2307-32-05
--	-------------------------

APPENDIX

A solid green triangle pointing to the left, containing the letter 'E' in white.

E

APPENDIX E

RECOMMENDED GRADING SPECIFICATIONS

FOR

PIRAEUS POINT
ENCINITAS, CALIFORNIA

PROJECT NO. G2307-32-05

RECOMMENDED GRADING SPECIFICATIONS

1. GENERAL

- 1.1 These Recommended Grading Specifications shall be used in conjunction with the Geotechnical Report for the project prepared by Geocon. The recommendations contained in the text of the Geotechnical Report are a part of the earthwork and grading specifications and shall supersede the provisions contained hereinafter in the case of conflict.
- 1.2 Prior to the commencement of grading, a geotechnical consultant (Consultant) shall be employed for the purpose of observing earthwork procedures and testing the fills for substantial conformance with the recommendations of the Geotechnical Report and these specifications. The Consultant should provide adequate testing and observation services so that they may assess whether, in their opinion, the work was performed in substantial conformance with these specifications. It shall be the responsibility of the Contractor to assist the Consultant and keep them apprised of work schedules and changes so that personnel may be scheduled accordingly.
- 1.3 It shall be the sole responsibility of the Contractor to provide adequate equipment and methods to accomplish the work in accordance with applicable grading codes or agency ordinances, these specifications and the approved grading plans. If, in the opinion of the Consultant, unsatisfactory conditions such as questionable soil materials, poor moisture condition, inadequate compaction, and/or adverse weather result in a quality of work not in conformance with these specifications, the Consultant will be empowered to reject the work and recommend to the Owner that grading be stopped until the unacceptable conditions are corrected.

2. DEFINITIONS

- 2.1 **Owner** shall refer to the owner of the property or the entity on whose behalf the grading work is being performed and who has contracted with the Contractor to have grading performed.
- 2.2 **Contractor** shall refer to the Contractor performing the site grading work.
- 2.3 **Civil Engineer** or **Engineer of Work** shall refer to the California licensed Civil Engineer or consulting firm responsible for preparation of the grading plans, surveying and verifying as-graded topography.
- 2.4 **Consultant** shall refer to the soil engineering and engineering geology consulting firm retained to provide geotechnical services for the project.

- 2.5 **Soil Engineer** shall refer to a California licensed Civil Engineer retained by the Owner, who is experienced in the practice of geotechnical engineering. The Soil Engineer shall be responsible for having qualified representatives on-site to observe and test the Contractor's work for conformance with these specifications.
- 2.6 **Engineering Geologist** shall refer to a California licensed Engineering Geologist retained by the Owner to provide geologic observations and recommendations during the site grading.
- 2.7 **Geotechnical Report** shall refer to a soil report (including all addenda) which may include a geologic reconnaissance or geologic investigation that was prepared specifically for the development of the project for which these Recommended Grading Specifications are intended to apply.

3. MATERIALS

- 3.1 Materials for compacted fill shall consist of any soil excavated from the cut areas or imported to the site that, in the opinion of the Consultant, is suitable for use in construction of fills. In general, fill materials can be classified as *soil* fills, *soil-rock* fills or *rock* fills, as defined below.
- 3.1.1 **Soil fills** are defined as fills containing no rocks or hard lumps greater than 12 inches in maximum dimension and containing at least 40 percent by weight of material smaller than $\frac{3}{4}$ inch in size.
- 3.1.2 **Soil-rock fills** are defined as fills containing no rocks or hard lumps larger than 4 feet in maximum dimension and containing a sufficient matrix of soil fill to allow for proper compaction of soil fill around the rock fragments or hard lumps as specified in Paragraph 6.2. **Oversize rock** is defined as material greater than 12 inches.
- 3.1.3 **Rock fills** are defined as fills containing no rocks or hard lumps larger than 3 feet in maximum dimension and containing little or no fines. Fines are defined as material smaller than $\frac{3}{4}$ inch in maximum dimension. The quantity of fines shall be less than approximately 20 percent of the rock fill quantity.
- 3.2 Material of a perishable, spongy, or otherwise unsuitable nature as determined by the Consultant shall not be used in fills.
- 3.3 Materials used for fill, either imported or on-site, shall not contain hazardous materials as defined by the California Code of Regulations, Title 22, Division 4, Chapter 30, Articles 9

and 10; 40CFR; and any other applicable local, state or federal laws. The Consultant shall not be responsible for the identification or analysis of the potential presence of hazardous materials. However, if observations, odors or soil discoloration cause Consultant to suspect the presence of hazardous materials, the Consultant may request from the Owner the termination of grading operations within the affected area. Prior to resuming grading operations, the Owner shall provide a written report to the Consultant indicating that the suspected materials are not hazardous as defined by applicable laws and regulations.

- 3.4 The outer 15 feet of *soil-rock* fill slopes, measured horizontally, should be composed of properly compacted *soil* fill materials approved by the Consultant. *Rock* fill may extend to the slope face, provided that the slope is not steeper than 2:1 (horizontal:vertical) and a soil layer no thicker than 12 inches is track-walked onto the face for landscaping purposes. This procedure may be utilized provided it is acceptable to the governing agency, Owner and Consultant.
- 3.5 Samples of soil materials to be used for fill should be tested in the laboratory by the Consultant to determine the maximum density, optimum moisture content, and, where appropriate, shear strength, expansion, and gradation characteristics of the soil.
- 3.6 During grading, soil or groundwater conditions other than those identified in the Geotechnical Report may be encountered by the Contractor. The Consultant shall be notified immediately to evaluate the significance of the unanticipated condition.

4. CLEARING AND PREPARING AREAS TO BE FILLED

- 4.1 Areas to be excavated and filled shall be cleared and grubbed. Clearing shall consist of complete removal above the ground surface of trees, stumps, brush, vegetation, man-made structures, and similar debris. Grubbing shall consist of removal of stumps, roots, buried logs and other unsuitable material and shall be performed in areas to be graded. Roots and other projections exceeding 1½ inches in diameter shall be removed to a depth of 3 feet below the surface of the ground. Borrow areas shall be grubbed to the extent necessary to provide suitable fill materials.
- 4.2 Asphalt pavement material removed during clearing operations should be properly disposed at an approved off-site facility or in an acceptable area of the project evaluated by Geocon and the property owner. Concrete fragments that are free of reinforcing steel may be placed in fills, provided they are placed in accordance with Section 6.2 or 6.3 of this document.

- 4.3 After clearing and grubbing of organic matter and other unsuitable material, loose or porous soils shall be removed to the depth recommended in the Geotechnical Report. The depth of removal and compaction should be observed and approved by a representative of the Consultant. The exposed surface shall then be plowed or scarified to a minimum depth of 6 inches and until the surface is free from uneven features that would tend to prevent uniform compaction by the equipment to be used.
- 4.4 Where the slope ratio of the original ground is steeper than 5:1 (horizontal:vertical), or where recommended by the Consultant, the original ground should be benched in accordance with the following illustration.

TYPICAL BENCHING DETAIL

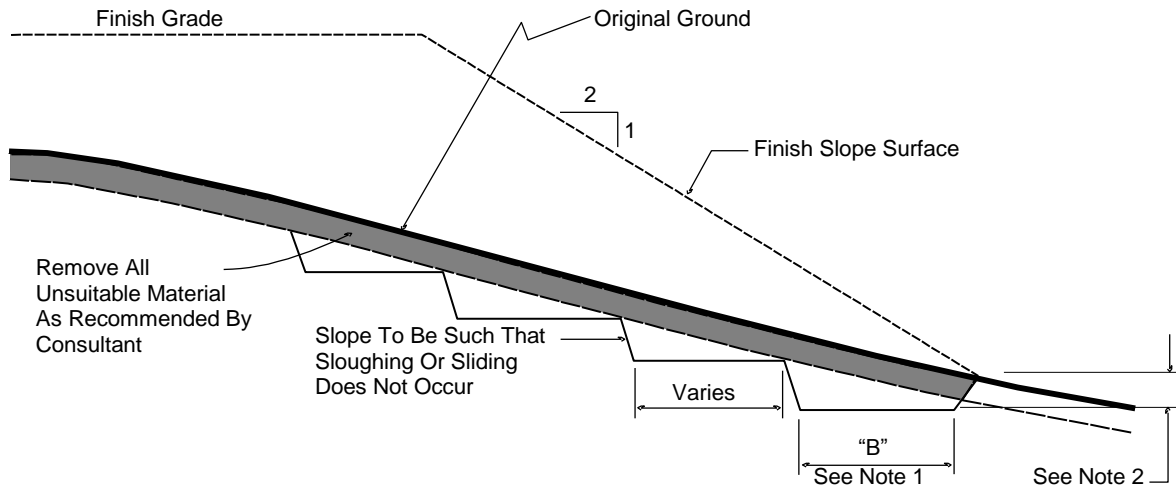

No Scale

- DETAIL NOTES: (1) Key width "B" should be a minimum of 10 feet, or sufficiently wide to permit complete coverage with the compaction equipment used. The base of the key should be graded horizontal, or inclined slightly into the natural slope.
- (2) The outside of the key should be below the topsoil or unsuitable surficial material and at least 2 feet into dense formational material. Where hard rock is exposed in the bottom of the key, the depth and configuration of the key may be modified as approved by the Consultant.

- 4.5 After areas to receive fill have been cleared and scarified, the surface should be moisture conditioned to achieve the proper moisture content, and compacted as recommended in Section 6 of these specifications.

5. COMPACTION EQUIPMENT

- 5.1 Compaction of *soil* or *soil-rock* fill shall be accomplished by sheepsfoot or segmented-steel wheeled rollers, vibratory rollers, multiple-wheel pneumatic-tired rollers, or other types of acceptable compaction equipment. Equipment shall be of such a design that it will be capable of compacting the *soil* or *soil-rock* fill to the specified relative compaction at the specified moisture content.
- 5.2 Compaction of *rock* fills shall be performed in accordance with Section 6.3.

6. PLACING, SPREADING AND COMPACTION OF FILL MATERIAL

- 6.1 *Soil* fill, as defined in Paragraph 3.1.1, shall be placed by the Contractor in accordance with the following recommendations:
- 6.1.1 *Soil* fill shall be placed by the Contractor in layers that, when compacted, should generally not exceed 8 inches. Each layer shall be spread evenly and shall be thoroughly mixed during spreading to obtain uniformity of material and moisture in each layer. The entire fill shall be constructed as a unit in nearly level lifts. Rock materials greater than 12 inches in maximum dimension shall be placed in accordance with Section 6.2 or 6.3 of these specifications.
- 6.1.2 In general, the *soil* fill shall be compacted at a moisture content at or above the optimum moisture content as determined by ASTM D 1557.
- 6.1.3 When the moisture content of *soil* fill is below that specified by the Consultant, water shall be added by the Contractor until the moisture content is in the range specified.
- 6.1.4 When the moisture content of the *soil* fill is above the range specified by the Consultant or too wet to achieve proper compaction, the *soil* fill shall be aerated by the Contractor by blading/mixing, or other satisfactory methods until the moisture content is within the range specified.
- 6.1.5 After each layer has been placed, mixed, and spread evenly, it shall be thoroughly compacted by the Contractor to a relative compaction of at least 90 percent. Relative compaction is defined as the ratio (expressed in percent) of the in-place dry density of the compacted fill to the maximum laboratory dry density as determined in accordance with ASTM D 1557. Compaction shall be continuous over the entire area, and compaction equipment shall make sufficient passes so that the specified minimum relative compaction has been achieved throughout the entire fill.

- 6.1.6 Where practical, soils having an Expansion Index greater than 50 should be placed at least 3 feet below finish pad grade and should be compacted at a moisture content generally 2 to 4 percent greater than the optimum moisture content for the material.
 - 6.1.7 Properly compacted *soil* fill shall extend to the design surface of fill slopes. To achieve proper compaction, it is recommended that fill slopes be over-built by at least 3 feet and then cut to the design grade. This procedure is considered preferable to track-walking of slopes, as described in the following paragraph.
 - 6.1.8 As an alternative to over-building of slopes, slope faces may be back-rolled with a heavy-duty loaded sheepsfoot or vibratory roller at maximum 4-foot fill height intervals. Upon completion, slopes should then be track-walked with a D-8 dozer or similar equipment, such that a dozer track covers all slope surfaces at least twice.
- 6.2 *Soil-rock* fill, as defined in Paragraph 3.1.2, shall be placed by the Contractor in accordance with the following recommendations:
- 6.2.1 Rocks larger than 12 inches but less than 4 feet in maximum dimension may be incorporated into the compacted *soil* fill, but shall be limited to the area measured 15 feet minimum horizontally from the slope face and 5 feet below finish grade or 3 feet below the deepest utility, whichever is deeper.
 - 6.2.2 Rocks or rock fragments up to 4 feet in maximum dimension may either be individually placed or placed in windrows. Under certain conditions, rocks or rock fragments up to 10 feet in maximum dimension may be placed using similar methods. The acceptability of placing rock materials greater than 4 feet in maximum dimension shall be evaluated during grading as specific cases arise and shall be approved by the Consultant prior to placement.
 - 6.2.3 For individual placement, sufficient space shall be provided between rocks to allow for passage of compaction equipment.
 - 6.2.4 For windrow placement, the rocks should be placed in trenches excavated in properly compacted *soil* fill. Trenches should be approximately 5 feet wide and 4 feet deep in maximum dimension. The voids around and beneath rocks should be filled with approved granular soil having a Sand Equivalent of 30 or greater and should be compacted by flooding. Windrows may also be placed utilizing an "open-face" method in lieu of the trench procedure, however, this method should first be approved by the Consultant.

- 6.2.5 Windrows should generally be parallel to each other and may be placed either parallel to or perpendicular to the face of the slope depending on the site geometry. The minimum horizontal spacing for windrows shall be 12 feet center-to-center with a 5-foot stagger or offset from lower courses to next overlying course. The minimum vertical spacing between windrow courses shall be 2 feet from the top of a lower windrow to the bottom of the next higher windrow.
- 6.2.6 Rock placement, fill placement and flooding of approved granular soil in the windrows should be continuously observed by the Consultant.
- 6.3 *Rock* fills, as defined in Section 3.1.3, shall be placed by the Contractor in accordance with the following recommendations:
- 6.3.1 The base of the *rock* fill shall be placed on a sloping surface (minimum slope of 2 percent). The surface shall slope toward suitable subdrainage outlet facilities. The *rock* fills shall be provided with subdrains during construction so that a hydrostatic pressure buildup does not develop. The subdrains shall be permanently connected to controlled drainage facilities to control post-construction infiltration of water.
- 6.3.2 *Rock* fills shall be placed in lifts not exceeding 3 feet. Placement shall be by rock trucks traversing previously placed lifts and dumping at the edge of the currently placed lift. Spreading of the *rock* fill shall be by dozer to facilitate *seating* of the rock. The *rock* fill shall be watered heavily during placement. Watering shall consist of water trucks traversing in front of the current rock lift face and spraying water continuously during rock placement. Compaction equipment with compactive energy comparable to or greater than that of a 20-ton steel vibratory roller or other compaction equipment providing suitable energy to achieve the required compaction or deflection as recommended in Paragraph 6.3.3 shall be utilized. The number of passes to be made should be determined as described in Paragraph 6.3.3. Once a *rock* fill lift has been covered with *soil* fill, no additional *rock* fill lifts will be permitted over the *soil* fill.
- 6.3.3 Plate bearing tests, in accordance with ASTM D 1196, may be performed in both the compacted *soil* fill and in the *rock* fill to aid in determining the required minimum number of passes of the compaction equipment. If performed, a minimum of three plate bearing tests should be performed in the properly compacted *soil* fill (minimum relative compaction of 90 percent). Plate bearing tests shall then be performed on areas of *rock* fill having two passes, four passes and six passes of the compaction equipment, respectively. The number of passes required for the *rock* fill shall be determined by comparing the results of the plate bearing tests for the *soil* fill and the *rock* fill and by evaluating the deflection

variation with number of passes. The required number of passes of the compaction equipment will be performed as necessary until the plate bearing deflections are equal to or less than that determined for the properly compacted *soil* fill. In no case will the required number of passes be less than two.

- 6.3.4 A representative of the Consultant should be present during *rock* fill operations to observe that the minimum number of “passes” have been obtained, that water is being properly applied and that specified procedures are being followed. The actual number of plate bearing tests will be determined by the Consultant during grading.
- 6.3.5 Test pits shall be excavated by the Contractor so that the Consultant can state that, in their opinion, sufficient water is present and that voids between large rocks are properly filled with smaller rock material. In-place density testing will not be required in the *rock* fills.
- 6.3.6 To reduce the potential for “piping” of fines into the *rock* fill from overlying *soil* fill material, a 2-foot layer of graded filter material shall be placed above the uppermost lift of *rock* fill. The need to place graded filter material below the *rock* should be determined by the Consultant prior to commencing grading. The gradation of the graded filter material will be determined at the time the *rock* fill is being excavated. Materials typical of the *rock* fill should be submitted to the Consultant in a timely manner, to allow design of the graded filter prior to the commencement of *rock* fill placement.
- 6.3.7 *Rock* fill placement should be continuously observed during placement by the Consultant.

7. SUBDRAINS

- 7.1 The geologic units on the site may have permeability characteristics and/or fracture systems that could be susceptible under certain conditions to seepage. The use of canyon subdrains may be necessary to mitigate the potential for adverse impacts associated with seepage conditions. Canyon subdrains with lengths in excess of 500 feet or extensions of existing offsite subdrains should use 8-inch-diameter pipes. Canyon subdrains less than 500 feet in length should use 6-inch-diameter pipes.

TYPICAL CANYON DRAIN DETAIL

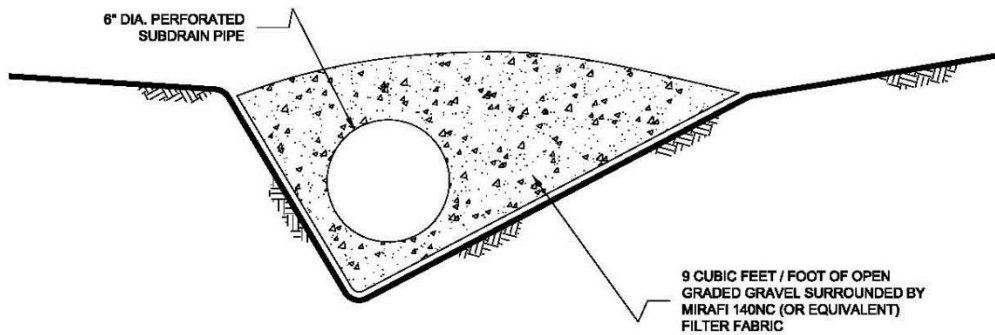
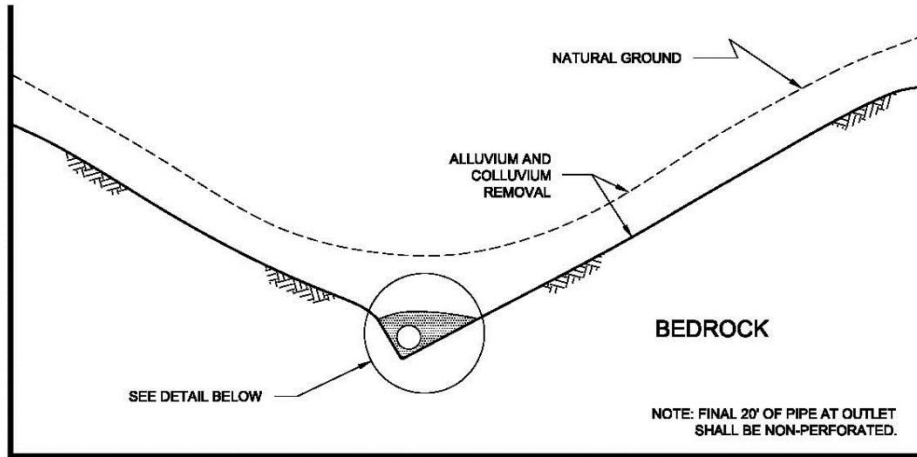

NOTES:

- 1.....8-INCH DIAMETER, SCHEDULE 80 PVC PERFORATED PIPE FOR FILLS IN EXCESS OF 100-FEET IN DEPTH OR A PIPE LENGTH OF LONGER THAN 500 FEET.
- 2.....6-INCH DIAMETER, SCHEDULE 40 PVC PERFORATED PIPE FOR FILLS LESS THAN 100-FEET IN DEPTH OR A PIPE LENGTH SHORTER THAN 500 FEET.

NO SCALE

7.2 Slope drains within stability fill keyways should use 4-inch-diameter (or larger) pipes.

TYPICAL STABILITY FILL DETAIL

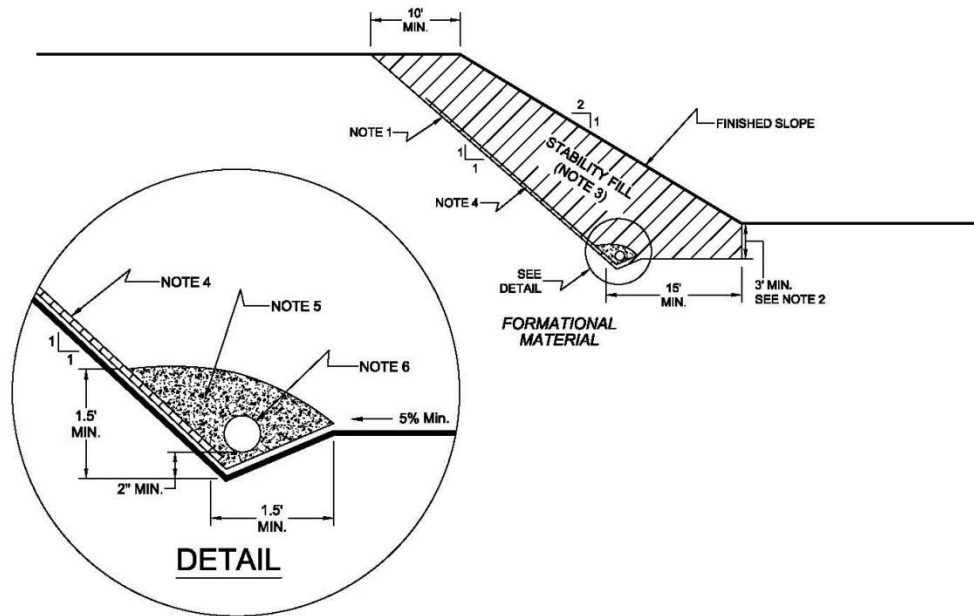

NOTES:

- 1.....EXCAVATE BACKCUT AT 1:1 INCLINATION (UNLESS OTHERWISE NOTED).
- 2.....BASE OF STABILITY FILL TO BE 3 FEET INTO FORMATIONAL MATERIAL, SLOPING A MINIMUM 5% INTO SLOPE.
- 3.....STABILITY FILL TO BE COMPOSED OF PROPERLY COMPACTED GRANULAR SOIL.
- 4.....CHIMNEY DRAINS TO BE APPROVED PREFABRICATED CHIMNEY DRAIN PANELS (MIRADRAIN G200N OR EQUIVALENT) SPACED APPROXIMATELY 20 FEET CENTER TO CENTER AND 4 FEET WIDE. CLOSER SPACING MAY BE REQUIRED IF SEEPAGE IS ENCOUNTERED.
- 5.....FILTER MATERIAL TO BE 3/4-INCH, OPEN-GRADED CRUSHED ROCK ENCLOSED IN APPROVED FILTER FABRIC (MIRAFI 140NC).
- 6.....COLLECTOR PIPE TO BE 4-INCH MINIMUM DIAMETER, PERFORATED, THICK-WALLED PVC SCHEDULE 40 OR EQUIVALENT, AND SLOPED TO DRAIN AT 1 PERCENT MINIMUM TO APPROVED OUTLET.

NO SCALE

7.3 The actual subdrain locations will be evaluated in the field during the remedial grading operations. Additional drains may be necessary depending on the conditions observed and the requirements of the local regulatory agencies. Appropriate subdrain outlets should be evaluated prior to finalizing 40-scale grading plans.

7.4 *Rock fill or soil-rock fill* areas may require subdrains along their down-slope perimeters to mitigate the potential for buildup of water from construction or landscape irrigation. The subdrains should be at least 6-inch-diameter pipes encapsulated in gravel and filter fabric. *Rock fill* drains should be constructed using the same requirements as canyon subdrains.

7.5 Prior to outletting, the final 20-foot segment of a subdrain that will not be extended during future development should consist of non-perforated drainpipe. At the non-perforated/perforated interface, a seepage cutoff wall should be constructed on the downslope side of the pipe.

TYPICAL CUT OFF WALL DETAIL

FRONT VIEW

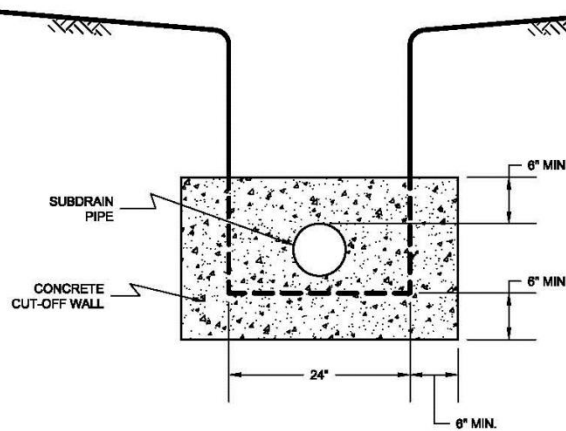

NO SCALE

SIDE VIEW

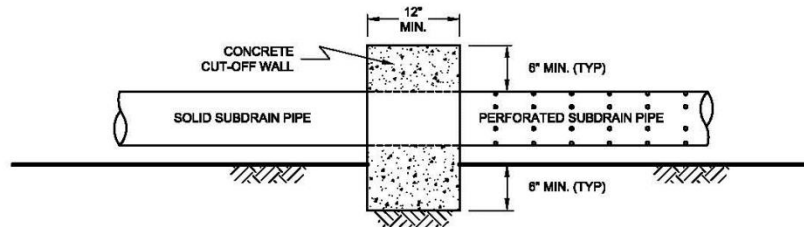

NO SCALE

7.6 Subdrains that discharge into a natural drainage course or open space area should be provided with a permanent headwall structure.

TYPICAL HEADWALL DETAIL

FRONT VIEW

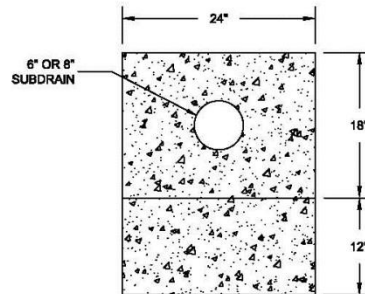

NO SCALE

SIDE VIEW

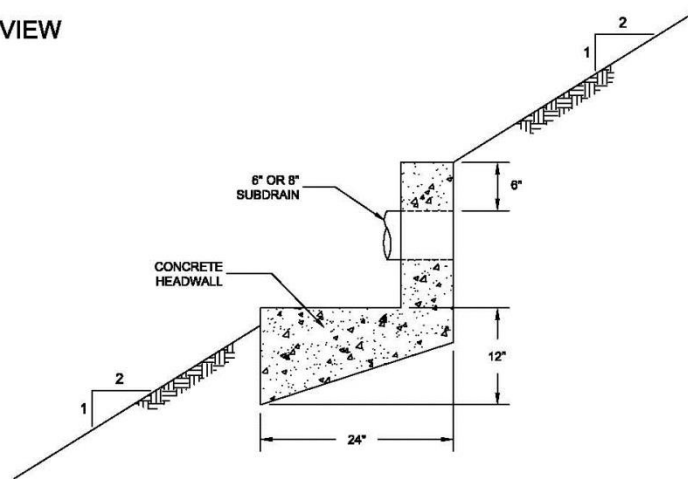

NOTE: HEADWALL SHOULD OUTLET AT TOE OF FILL SLOPE
OR INTO CONTROLLED SURFACE DRAINAGE

NO SCALE

- 7.7 The final grading plans should show the location of the proposed subdrains. After completion of remedial excavations and subdrain installation, the project civil engineer should survey the drain locations and prepare an “as-built” map showing the drain locations. The final outlet and connection locations should be determined during grading operations. Subdrains that will be extended on adjacent projects after grading can be placed on formational material and a vertical riser should be placed at the end of the subdrain. The grading contractor should consider videoing the subdrains shortly after burial to check proper installation and functionality. The contractor is responsible for the performance of the drains.

8. OBSERVATION AND TESTING

- 8.1 The Consultant shall be the Owner's representative to observe and perform tests during clearing, grubbing, filling, and compaction operations. In general, no more than 2 feet in vertical elevation of *soil* or *soil-rock* fill should be placed without at least one field density test being performed within that interval. In addition, a minimum of one field density test should be performed for every 2,000 cubic yards of *soil* or *soil-rock* fill placed and compacted.
- 8.2 The Consultant should perform a sufficient distribution of field density tests of the compacted *soil* or *soil-rock* fill to provide a basis for expressing an opinion whether the fill material is compacted as specified. Density tests shall be performed in the compacted materials below any disturbed surface. When these tests indicate that the density of any layer of fill or portion thereof is below that specified, the particular layer or areas represented by the test shall be reworked until the specified density has been achieved.
- 8.3 During placement of *rock* fill, the Consultant should observe that the minimum number of passes have been obtained per the criteria discussed in Section 6.3.3. The Consultant should request the excavation of observation pits and may perform plate bearing tests on the placed *rock* fills. The observation pits will be excavated to provide a basis for expressing an opinion as to whether the *rock* fill is properly seated and sufficient moisture has been applied to the material. When observations indicate that a layer of *rock* fill or any portion thereof is below that specified, the affected layer or area shall be reworked until the *rock* fill has been adequately seated and sufficient moisture applied.
- 8.4 A settlement monitoring program designed by the Consultant may be conducted in areas of *rock* fill placement. The specific design of the monitoring program shall be as recommended in the Conclusions and Recommendations section of the project Geotechnical Report or in the final report of testing and observation services performed during grading.
- 8.5 We should observe the placement of subdrains, to check that the drainage devices have been placed and constructed in substantial conformance with project specifications.
- 8.6 Testing procedures shall conform to the following Standards as appropriate:

8.6.1 Soil and Soil-Rock Fills:

- 8.6.1.1 Field Density Test, ASTM D 1556, *Density of Soil In-Place By the Sand-Cone Method.*

- 8.6.1.2 Field Density Test, Nuclear Method, ASTM D 6938, *Density of Soil and Soil-Aggregate In-Place by Nuclear Methods (Shallow Depth)*.
- 8.6.1.3 Laboratory Compaction Test, ASTM D 1557, *Moisture-Density Relations of Soils and Soil-Aggregate Mixtures Using 10-Pound Hammer and 18-Inch Drop*.
- 8.6.1.4 Expansion Index Test, ASTM D 4829, *Expansion Index Test*.

9. PROTECTION OF WORK

- 9.1 During construction, the Contractor shall properly grade all excavated surfaces to provide positive drainage and prevent ponding of water. Drainage of surface water shall be controlled to avoid damage to adjoining properties or to finished work on the site. The Contractor shall take remedial measures to prevent erosion of freshly graded areas until such time as permanent drainage and erosion control features have been installed. Areas subjected to erosion or sedimentation shall be properly prepared in accordance with the Specifications prior to placing additional fill or structures.
- 9.2 After completion of grading as observed and tested by the Consultant, no further excavation or filling shall be conducted except in conjunction with the services of the Consultant.

10. CERTIFICATIONS AND FINAL REPORTS

- 10.1 Upon completion of the work, Contractor shall furnish Owner a certification by the Civil Engineer stating that the lots and/or building pads are graded to within 0.1 foot vertically of elevations shown on the grading plan and that all tops and toes of slopes are within 0.5 foot horizontally of the positions shown on the grading plans. After installation of a section of subdrain, the project Civil Engineer should survey its location and prepare an *as-built* plan of the subdrain location. The project Civil Engineer should verify the proper outlet for the subdrains and the Contractor should ensure that the drain system is free of obstructions.
- 10.2 The Owner is responsible for furnishing a final as-graded soil and geologic report satisfactory to the appropriate governing or accepting agencies. The as-graded report should be prepared and signed by a California licensed Civil Engineer experienced in geotechnical engineering and by a California Certified Engineering Geologist, indicating that the geotechnical aspects of the grading were performed in substantial conformance with the Specifications or approved changes to the Specifications.

LIST OF REFERENCES

1. *2019 California Building Code, California Code of Regulations, Title 24, Part 2, based on the 2018 International Building Code*, prepared by California Building Standards Commission, dated July 2016.
2. *ACI 318-14, Building Code Requirements for Structural Concrete and Commentary on Building Code Requirements for Structural Concrete*, prepared by the American Concrete Institute, dated September, 2014.
3. *ACI 330-08, Guide for the Design and Construction of Concrete Parking Lots*, prepared by the American Concrete Institute, dated June, 2008.
4. *ASCE 7-16, Minimum Design Loads and Associated Criteria for Buildings and Other Structures*, dated 2017.
5. California Department of Conservation, Division of Mines and Geology, Probabilistic Seismic Hazard Assessment for the State of California, Open File Report 96-08, 1996.
6. County of San Diego, *San Diego County Multi Jurisdiction Hazard Mitigation Plan, San Diego, California, dated October 2017*.
7. Risk Engineering, *EZ-FRISK*, 2016.
8. Structural Engineers Association of California (SEAOC) and Office of Statewide Health Planning and Development (OSHPD), *Seismic Design Maps*, <https://seismicmaps.org/>, accessed January 11, 2019.
9. United States Geological Survey, *2002 Interactive Deaggregations*, <http://eqint.cr.usgs.gov/deaggint/2002/index.php>.
10. United States Department of Agriculture, *1953 Stereoscopic Aerial Photographs, Flight AXN-8M*, Photos Nos. 74 and 75 (scale 1:20,000).