

Appendix J

Low Impact Development Plan



Low Impact Development Plan (LID Plan)

Project Name:

Carson Self-Storage
21611 South Perry St.
Carson, CA 90745

Prepared for:

21611 PERRY STREET LLC
4132 Katella Avenue, #205b
Los Alamitos, Ca 90720

Prepared by:

Omega Engineering Consultants
4340 Viewridge Avenue, Suite B
San Diego, Ca 92123
(858) 634-8620



PE Stamp & Sign Here

October 5, 2021

Project Owner's Certification

I certify under penalty of law that this document and all attachments were prepared under my jurisdiction or supervision in accordance with a system designed to assure that qualified personnel properly gather and evaluate the information submitted. Based on my inquiry of the person or persons who manage the system or those persons directly responsible for gathered the information, to the best of my knowledge and belief, the information submitted is true, accurate, and complete. I am aware that there are significant penalties for submitting false information, including the possibility of fine and imprisonment for knowing violations.

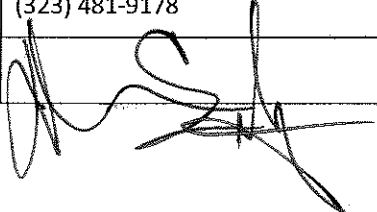
| | | | |
|--------------------|--|-------|----------|
| Applicant's Name: | Darren Embry | | |
| Applicant's Title: | VP of Community Development | | |
| Company: | 21611 Perry Street, LLC | | |
| Address: | 4132 Katella Avenue, #205B Los Alamitos, CA 90720 | | |
| Email: | darren@faring.com | | |
| Telephone No: | (323) 481-9178 | | |
| Signature: |  | Date: | 10/12/21 |

Preparer (Engineer) Certification



| | | | |
|--|--|------|-----------|
| Engineer's Name: | Patric de Boer | | |
| Engineer's Title: | Project Engineer | | |
| Company: | Omega Engineering Consultants | | |
| Address: | 4340 Viewridge Avenue, Suite B, San Diego, CA 90069 | | |
| Email: | patric@omega-consultants.com | | |
| Telephone No: | (858) 634-8620 | | |
| <p>I hereby certify that this Low Impact Development Plan is in compliance with, and meets the requirements set forth in, Order No. R4-2012-0175, of the Los Angeles Regional Water Quality Control Board.</p> | | | |
| Engineer's Signature |  | Date | 5/20/2021 |
| Place Stamp Here |  | | |

Table of Contents

- 1. Project Description 1
 - 1.1. Project Category..... 1
 - 1.2. Project Description..... 2
 - 1.3. Hydromodification Analysis..... 4
 - 1.4. Property Ownership/Management..... 5
- 2. Best Management Practices (BMPs)..... 6
 - 2.1. Site Design 6
 - 2.2. BMP Selection 7
 - 2.2.1. Infiltration BMPs..... 7
 - 2.2.2. Rainwater Harvest and Use BMPs..... 8
 - 2.2.3. Hydromodification Control BMPs 12
 - 2.2.4. Alternative Compliance BMPs 9
 - 2.2.5. Treatment Control BMPs 11
 - 2.2.6. Non-structural Source Control BMPs..... 13
 - 2.2.7. Structural Source Control BMPs..... 14

Attachments

- Attachment A Calculations
- Attachment B..... Geotechnical Investigation
- Attachment C..... City Forms
- Attachment D Master Covenant and Agreement (MCA)
- Attachment E..... Operations and Maintenance (O&M) Plan
- Attachment F..... Construction Plans

1. PROJECT DESCRIPTION

1.1. PROJECT CATEGORY

| Category | YES | NO |
|---|-------------------------------------|-------------------------------------|
| 1. Development ^a of a new project equal to 1 acre or greater of disturbed area and adding more than 10,000 square feet of impervious area ^b | <input checked="" type="checkbox"/> | <input type="checkbox"/> |
| 2. Development ^a of a new industrial park with 10,000 square feet or more of surface area ^c | <input type="checkbox"/> | <input checked="" type="checkbox"/> |
| 3. Development ^a of a new commercial mall with 10,000 square feet or more surface area ^c | <input type="checkbox"/> | <input checked="" type="checkbox"/> |
| 4. Development ^a of a new retail gasoline outlet with 5,000 square feet or more of surface area ^c | <input type="checkbox"/> | <input checked="" type="checkbox"/> |
| 5. Development ^a of a new restaurant (SIC 5812) with 5,000 square feet or more of surface area ^c | <input type="checkbox"/> | <input checked="" type="checkbox"/> |
| 6. Development ^a of a new parking lot with either 5,000 ft ² or more of impervious area ^b or with 25 or more parking spaces | <input type="checkbox"/> | <input checked="" type="checkbox"/> |
| 7. Development ^a of a new automotive service facility (SIC 5013, 5014, 5511, 5541, 7532-7534 and 7536-7539) with 5,000 square feet or more of surface area ^c | <input type="checkbox"/> | <input checked="" type="checkbox"/> |
| 8. Projects located in or directly adjacent to, or discharging directly to a Significant Ecological Area (SEA), ^d where the development will: a. Discharge stormwater runoff that is likely to impact a sensitive biological species or habitat; and b. Create 2,500 square feet or more of impervious area ^b | <input type="checkbox"/> | <input checked="" type="checkbox"/> |
| 9. Redevelopment ^e of 5,000 square feet or more in one of the categories listed above If yes, list redevelopment category here: | <input type="checkbox"/> | <input checked="" type="checkbox"/> |
| 10. Redevelopment ^e of 10,000 square feet or more to a Single Family Home, without a change in landuse. | <input type="checkbox"/> | <input checked="" type="checkbox"/> |
| a Development includes any construction or demolition activity, clearing, grading, grubbing, or excavation or any other activity that results in land disturbance. b Surfaces that do not allow stormwater runoff to percolate into the ground. Typical impervious surfaces include: concrete, asphalt, roofing materials, etc. c The surface area is the total footprint of an area. Not to include the cumulative area above or below the ground surface. d An area in which plant or animal life or their habitats are either rare or especially valuable because of their special nature or role in an ecosystem and would be disturbed or degraded by human activities and developments. Also, an area designated by the City as approved by the Regional Water Quality Control Board. e Land-disturbing activities that result in the creation, addition, or replacement of a certain amount of impervious surface area on an already developed site. If the activity results in an alteration to more than 50% of the impervious surface area on the already developed site and the existing site was not subject to post-construction storm water quality control requirements, then the entire site must be mitigated. | | |

1.2. PROJECT DESCRIPTION

Total Project Area (ft²): 120,644

Total Project Area (Ac): 2.77

EXISTING CONDITIONS

| Condition | Area (ft ²) | Percentage (%) |
|------------------|-------------------------|----------------|
| Pervious Area: | 4,322 | 3.6 |
| Impervious Area: | 116,322 | 96.4 |

PROPOSED CONDITIONS

| Condition | Area (ft ²) | Percentage (%) |
|------------------|-------------------------|----------------|
| Pervious Area: | 12,359 | 10.2 |
| Impervious Area: | 108,285 | 89.8 |

SITE CHARACTERISTICS

| | |
|--------------------------------|---|
| DRAINAGE PATTERNS/CONNECTIONS | Existing: The site is currently a vacant, mass graded lot. The site is relatively level with drainage consisting of surface flow. The site drains towards the west to an existing 5' storm drain inlet that outlets directly to the Dominguez Channel thence to Long Beach Harbor and ultimately to the Pacific Ocean. |
| | Proposed: The site will drain from east to west via gutters that wrap around the proposed self-storage facilities. The runoff generated from the entire site will be treated by a proposed 10'x20' Modular Wetland System that will discharge via an 18" pipe to the existing 5' storm drain inlet. The discharge point will remain the same as the existing conditions. |
| NARRATIVE PROJECT DESCRIPTION: | The project consists of the construction of a two-story self-storage facility with asphalt drive aisles. The site address is 21611 South Perry St. in Carson, CA 90745. |

Low Impact Development Plan (LID Plan)
Carson Self-Storage

| | |
|--|---|
| OFFSITE RUNON | No off-site run-on is anticipated to be received by the site. |
| UTILITY AND INFRASTRUCTURE INFORMATION | Site is currently a vacant lot. No utilities are anticipated on-site. |
| SIGNIFICANT ECOLOGICAL AREAS (SEAs) | N/A |

1.3. HYDROMODIFICATION ANALYSIS

| DOES THE PROPOSED PROJECT FALL INTO ONE OF THE FOLLOWING CATEGORIES? CHECK YES/NO. | YES | NO |
|--|-------------------------------------|-------------------------------------|
| 1. <i>Project is a redevelopment that decreases the effective impervious area compared to the pre-project conditions.</i> | <input type="checkbox"/> | <input checked="" type="checkbox"/> |
| Describe: | | |
| 2. <i>Project is a redevelopment that increases the infiltration capacity of pervious areas compared to the pre-project conditions.</i> | <input type="checkbox"/> | <input checked="" type="checkbox"/> |
| Describe: | | |
| 3. <i>Project discharges directly or via a storm drain to a sump, lake, area under tidal influence, into a waterway that has a 100-year peak flow (Q_{100}) of 25,000 cfs or more.</i> | <input checked="" type="checkbox"/> | <input type="checkbox"/> |
| Describe: | | |
| 4. <i>Project discharges directly or via a storm drain into concrete or otherwise engineered (not natural) channels (e.g., channelized or armored with rip rap, shotcrete, etc.), which, in turn, discharge into receiving water that is not susceptible to hydromodification impacts.</i> | <input checked="" type="checkbox"/> | <input type="checkbox"/> |
| Describe: Project discharges directly to the Dominguez channel, a concrete-lined channel. | | |

HYDROMODIFICATION ANALYSIS

Project is hydromodification exempt.

1.4. PROPERTY OWNERSHIP/MANAGEMENT

| | |
|--|---|
| | <p>Faring Capital, LLC 659 North Robertson Blvd. West Hollywood, CA 90069</p> |
|--|---|

2. BEST MANAGEMENT PRACTICES (BMPs)

2.1. SITE DESIGN

| | |
|--|---|
| 85 TH PERCENTILE, 24-HOUR STORM DEPTH | 0.80" |
| SITE DESIGN | The project proposes a 10'x20' Modular Wetland System to treat the entire site prior to discharging to the Dominguez Channel. |

BMP LIST

| DMA DESIGNATION | SQUARE FOOTAGE (SF) | ACREAGE (Ac) | STORM WATER QUALITY DESIGN FLOWRATE (SWQDQ, CFS) | BMP TYPE | BMP PROVIDED FLOWRATE (CFS) | GPS COORDINATES |
|-----------------|---------------------|--------------|--|-------------|-----------------------------|---------------------------------|
| DMA-1 | 120,644 | 2.77 | 0.702 | 10'X20' MWS | 0.710 | 33°49'56.58"N 118°15'15.60"W |
| | | | | | | |
| | | | | | | |
| | | | | | | |
| | | | | | | |

2.2. BMP SELECTION

2.2.1. INFILTRATION BMPs

| NAME | INCLUDED |
|--|--------------------------|
| Bioretention without underdrains | <input type="checkbox"/> |
| Infiltration Trench | <input type="checkbox"/> |
| Infiltration Basin | <input type="checkbox"/> |
| Drywell | <input type="checkbox"/> |
| Proprietary Subsurface Infiltration Gallery | <input type="checkbox"/> |
| Permeable Pavement (concrete, asphalt, pavers) | <input type="checkbox"/> |
| Other: | <input type="checkbox"/> |
| Other: | <input type="checkbox"/> |

| | |
|--------------|--|
| DESCRIPTION | Per the Geotechnical Report, "Based on the shallow groundwater and impermeable nature of the fine grained soils which underly the site, infiltration of stormwater at this site is not considered feasible. Infiltration of stormwater at this site would be considered detrimental to the project." |
| CALCULATIONS | N/A |

2.2.2. RAINWATER HARVEST AND USE BMPs

| NAME | INCLUDED |
|----------------------------------|--------------------------|
| Above-ground cisterns and basins | <input type="checkbox"/> |
| Underground detention | <input type="checkbox"/> |
| Other: | <input type="checkbox"/> |
| Other: | <input type="checkbox"/> |
| Other: | <input type="checkbox"/> |

| | |
|--------------|---|
| DESCRIPTION | The proposed site has a low demand for harvested rainwater... |
| CALCULATIONS | N/A |

2.2.3. ALTERNATIVE COMPLIANCE BMPs

BIOFILTRATION BMPs

(If Infiltration BMPs and Rainwater Harvest and Use BMPs are Infeasible)

| NAME | INCLUDED |
|---|--------------------------|
| Bioretention with underdrains (i.e. planter box, rain garden, etc.) | <input type="checkbox"/> |
| Constructed Wetland | <input type="checkbox"/> |
| Vegetated Swale | <input type="checkbox"/> |
| Vegetated Filter Strip | <input type="checkbox"/> |
| Tree-Well Filter | <input type="checkbox"/> |
| Other: | <input type="checkbox"/> |
| Other: | <input type="checkbox"/> |

| | |
|--------------|-----|
| DESCRIPTION | N/A |
| CALCULATIONS | N/A |

Low Impact Development Plan (LID Plan)
Carson Self-Storage

OFFSITE BMPs

(If Infiltration BMPs, Rainwater Harvest and Use BMPs, and Biofiltration BMPs are Infeasible)

| NAME | INCLUDED |
|---|--------------------------|
| Offsite Infiltration | <input type="checkbox"/> |
| Ground Water Replenishment Projects | <input type="checkbox"/> |
| Offsite Project - Retrofit Existing Development | <input type="checkbox"/> |
| Regional Storm Water Mitigation Program | <input type="checkbox"/> |
| Other: | <input type="checkbox"/> |
| Other: | <input type="checkbox"/> |

| | |
|--------------|-----|
| DESCRIPTION | N/A |
| CALCULATIONS | N/A |

2.2.4. TREATMENT CONTROL BMPS

| NAME | INCLUDED |
|--|-------------------------------------|
| Media Filter | <input type="checkbox"/> |
| Filter Insert | <input type="checkbox"/> |
| CDS Unit | <input type="checkbox"/> |
| Other: Flow-through modular treatment system | <input checked="" type="checkbox"/> |
| Other: | <input type="checkbox"/> |

| DESCRIPTION | |
|-------------|---|
| | <p>Project proposes a 10'x20' Modular Wetland System to treat the entire site. See below for calculations regarding the sizing of the Modular Wetland System.</p> <p><u>BMP Sizing Calculations:</u></p> <p>Tributary Area: 2.77 acres</p> <p>Intensity_{1yr, 1hr}: 0.31"</p> <p>Runoff Coefficient: 0.818</p> <p>Required Flowrate/Discharge rate: $Q=C*I*A = 0.702$ cfs</p> <p>BMP Flowrate: 0.710 cfs</p> |

2.2.5. HYDROMODIFICATION CONTROL BMPs

| NAME | INCLUDED |
|-----------------------|--------------------------|
| Infiltration System | <input type="checkbox"/> |
| Above-ground Cistern | <input type="checkbox"/> |
| Above-ground Basin | <input type="checkbox"/> |
| Underground Detention | <input type="checkbox"/> |
| Other: | <input type="checkbox"/> |
| Other: | <input type="checkbox"/> |

| | |
|--------------|-----|
| DESCRIPTION | N/A |
| CALCULATIONS | N/A |

Low Impact Development Plan (LID Plan)
Carson Self-Storage

2.2.6. NON-STRUCTURAL SOURCE CONTROL BMPs

| NAME | CHECK ONE | |
|--|-------------------------------------|-------------------------------------|
| | Included | Not Applicable |
| Education for Property Owners, Tenants and Occupants | <input checked="" type="checkbox"/> | <input type="checkbox"/> |
| Activity Restrictions | <input checked="" type="checkbox"/> | <input type="checkbox"/> |
| Common Area Landscape Management | <input checked="" type="checkbox"/> | <input type="checkbox"/> |
| Common Area Litter Control | <input checked="" type="checkbox"/> | <input type="checkbox"/> |
| Housekeeping of Loading Docks | <input type="checkbox"/> | <input checked="" type="checkbox"/> |
| Common Area Catch Basin Inspection | <input checked="" type="checkbox"/> | <input type="checkbox"/> |
| Street Sweeping Private Streets and Parking Lots | <input checked="" type="checkbox"/> | <input type="checkbox"/> |

2.2.7. STRUCTURAL SOURCE CONTROL BMPs

| NAME | CHECK ONE | |
|--|-------------------------------------|-------------------------------------|
| | Included | Not Applicable |
| Provide storm drain system stenciling and signage | <input checked="" type="checkbox"/> | <input type="checkbox"/> |
| Design and construct outdoor material storage areas to reduce pollution introduction | <input type="checkbox"/> | <input checked="" type="checkbox"/> |
| Design and construct trash and waste storage areas to reduce pollution introduction | <input checked="" type="checkbox"/> | <input type="checkbox"/> |
| Use efficient irrigation systems & landscape design, water conservation, smart controllers, and source control | <input checked="" type="checkbox"/> | <input type="checkbox"/> |
| Protect slopes and channels and provide energy dissipation | <input type="checkbox"/> | <input checked="" type="checkbox"/> |
| Loading docks | <input type="checkbox"/> | <input checked="" type="checkbox"/> |
| Maintenance bays | <input type="checkbox"/> | <input checked="" type="checkbox"/> |
| Vehicle wash areas | <input type="checkbox"/> | <input checked="" type="checkbox"/> |
| Outdoor processing areas | <input type="checkbox"/> | <input checked="" type="checkbox"/> |
| Equipment wash areas/racks | <input type="checkbox"/> | <input checked="" type="checkbox"/> |
| Fueling areas | <input type="checkbox"/> | <input checked="" type="checkbox"/> |
| Hillside landscaping | <input type="checkbox"/> | <input checked="" type="checkbox"/> |

Attachment A

Calculations

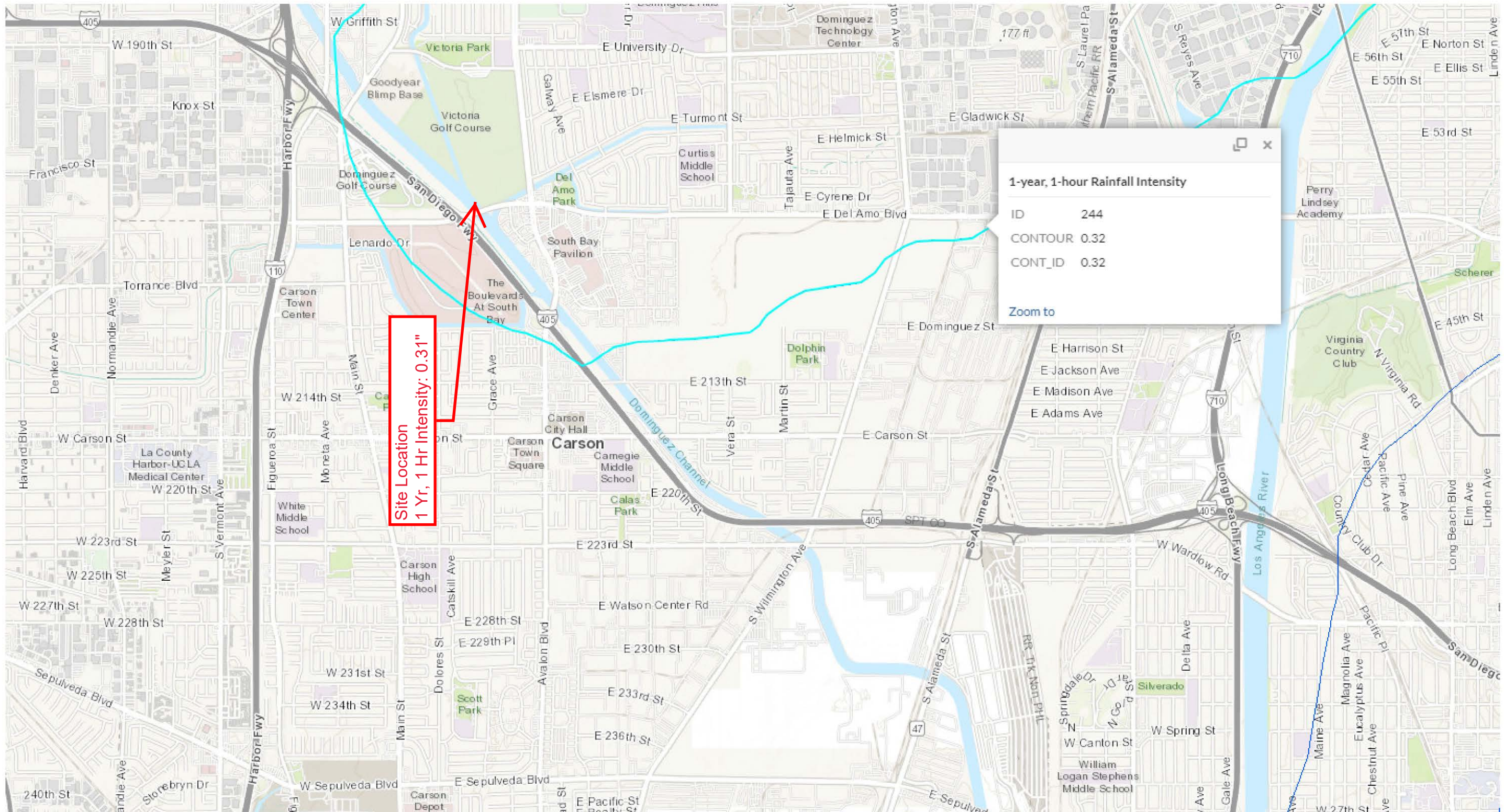

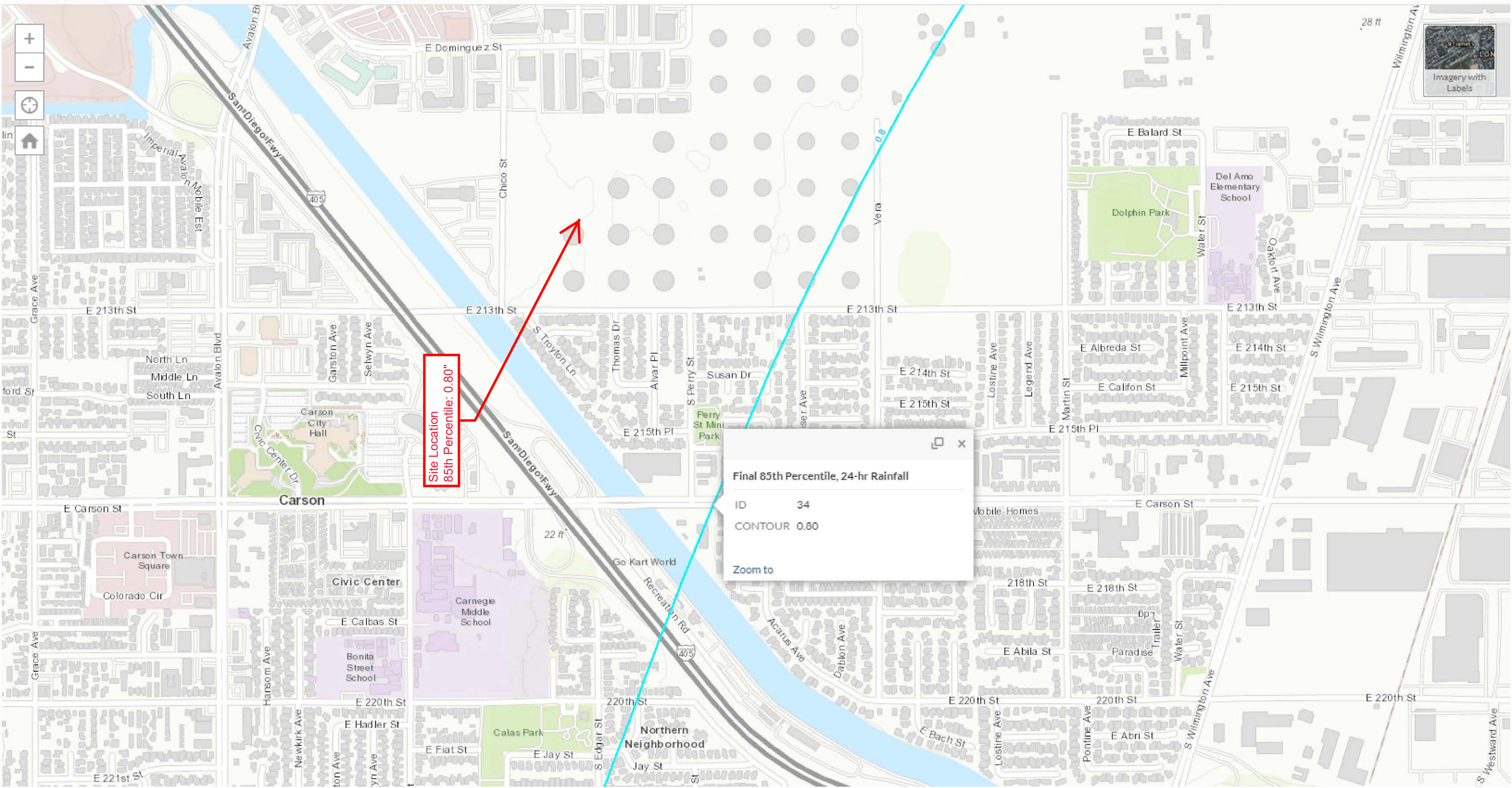

$C_D = (0.9 * IMP) + (1.0 - IMP) * C_U$
 Where: C_D = Developed Runoff Coefficient
 IMP = Proportion Impervious
 C_U = Undeveloped runoff coefficient



Los Angeles County Department of Public Works

RUNOFF COEFFICIENT CURVE
SOIL TYPE NO. 003

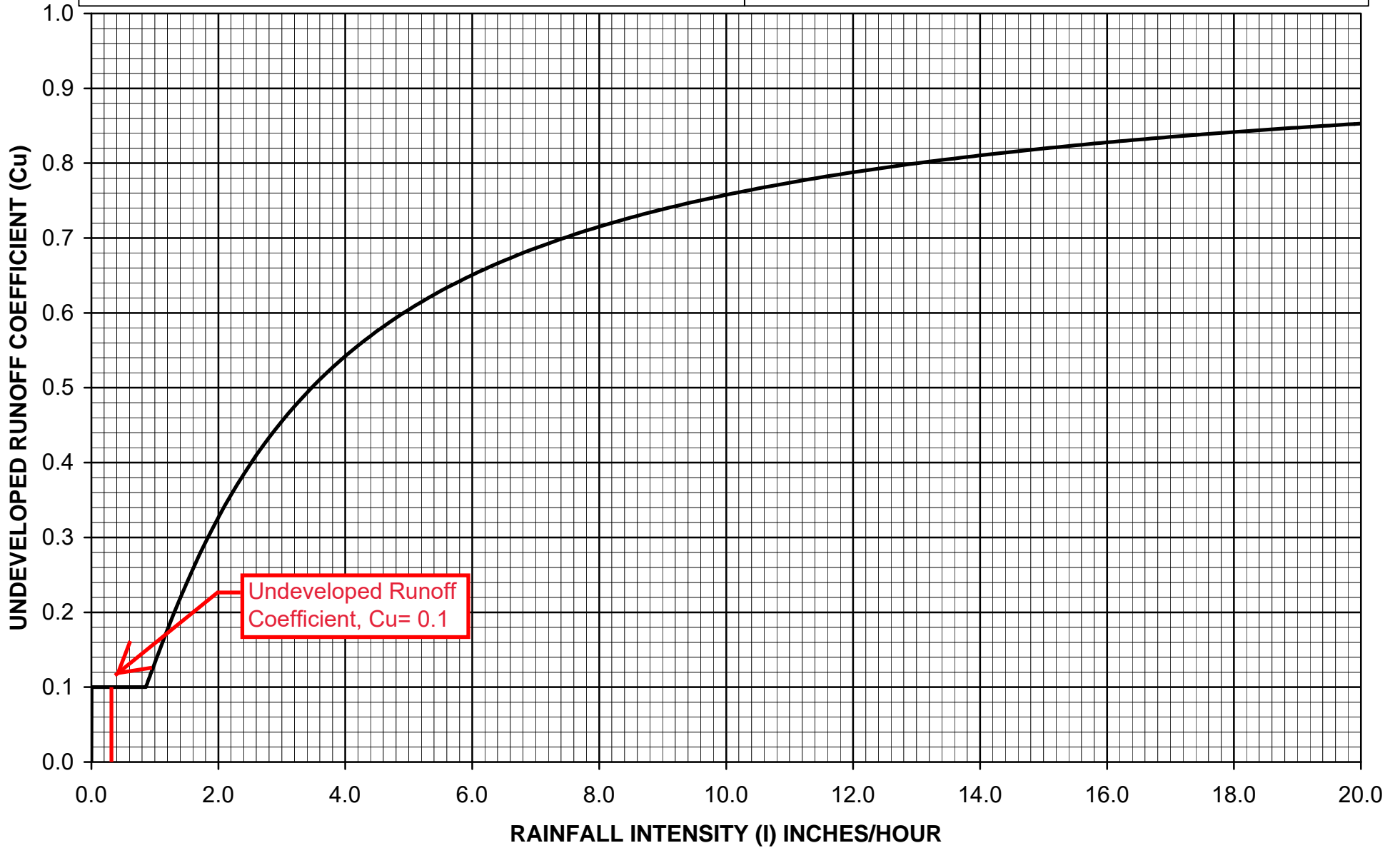

| Flow Based BMP's | | | | | | | | |
|------------------|-----------------|----------|---------------------|-------------------|--------------------------|---|--------------------|---------------------------|
| BMP-# | BMP type | BMP size | Tributary Area (ac) | Intensity (in/hr) | Runoff Coefficient (c) | Req'd flowrate/Discharge rate (cfs) $Q=C*I*A$ | BMP Flowrate (cfs) | Notes |
| BMP-1 | Modular wetland | 10'x20' | 2.77 | 0.31 | 0.818 | 0.702 | 0.710 | BMP flowrate given by mfr |

| BASIN | AREA (SF) | AREA (AC) | % Imp | "C" Value |
|-------|-----------|-----------|-------|-----------|
| DMA-1 | 120,644 | 2.77 | 89.8% | 0.818 |

| SITE SPECIFIC DATA | | | |
|--|----------------|------------------|-------------|
| PROJECT NUMBER | | | |
| PROJECT NAME | | | |
| PROJECT LOCATION | | | |
| STRUCTURE ID | | | |
| TREATMENT REQUIRED | | | |
| VOLUME BASED (CF) | | FLOW BASED (CFS) | |
| N/A | | 0.710 | |
| TREATMENT HGL AVAILABLE (FT) | | N/K | |
| PEAK BYPASS REQUIRED (CFS) - IF APPLICABLE | | FLOW BY | |
| PIPE DATA | I.E. | MATERIAL | DIAMETER |
| INLET PIPE 1 | | | |
| INLET PIPE 2 | | | |
| OUTLET PIPE | | | |
| | PRETREATMENT | BIOFILTRATION | DISCHARGE |
| RIM ELEVATION | | | |
| SURFACE LOAD | PEDESIRIAN | OPEN PLANIER | PEDESTRIAN |
| FRAME & COVER | 2 EA 36" X 36" | N/A | 2 EA Ø24" |
| WETLANDMEDIA VOLUME (CY) | | | |
| ORIFICE SIZE (DIA. INCHES) | | | 2 EA Ø2.67" |
| NOTES: PRELIMINARY. NOT FOR CONSTRUCTION. | | | |

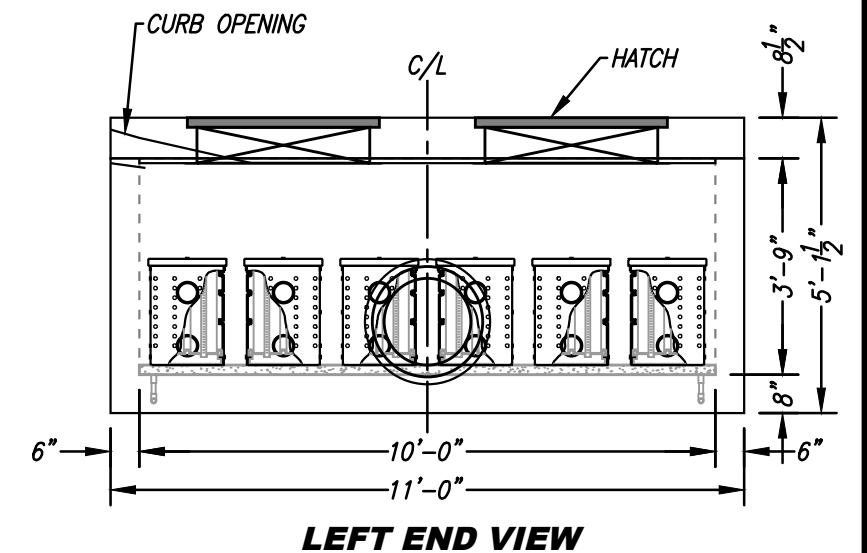
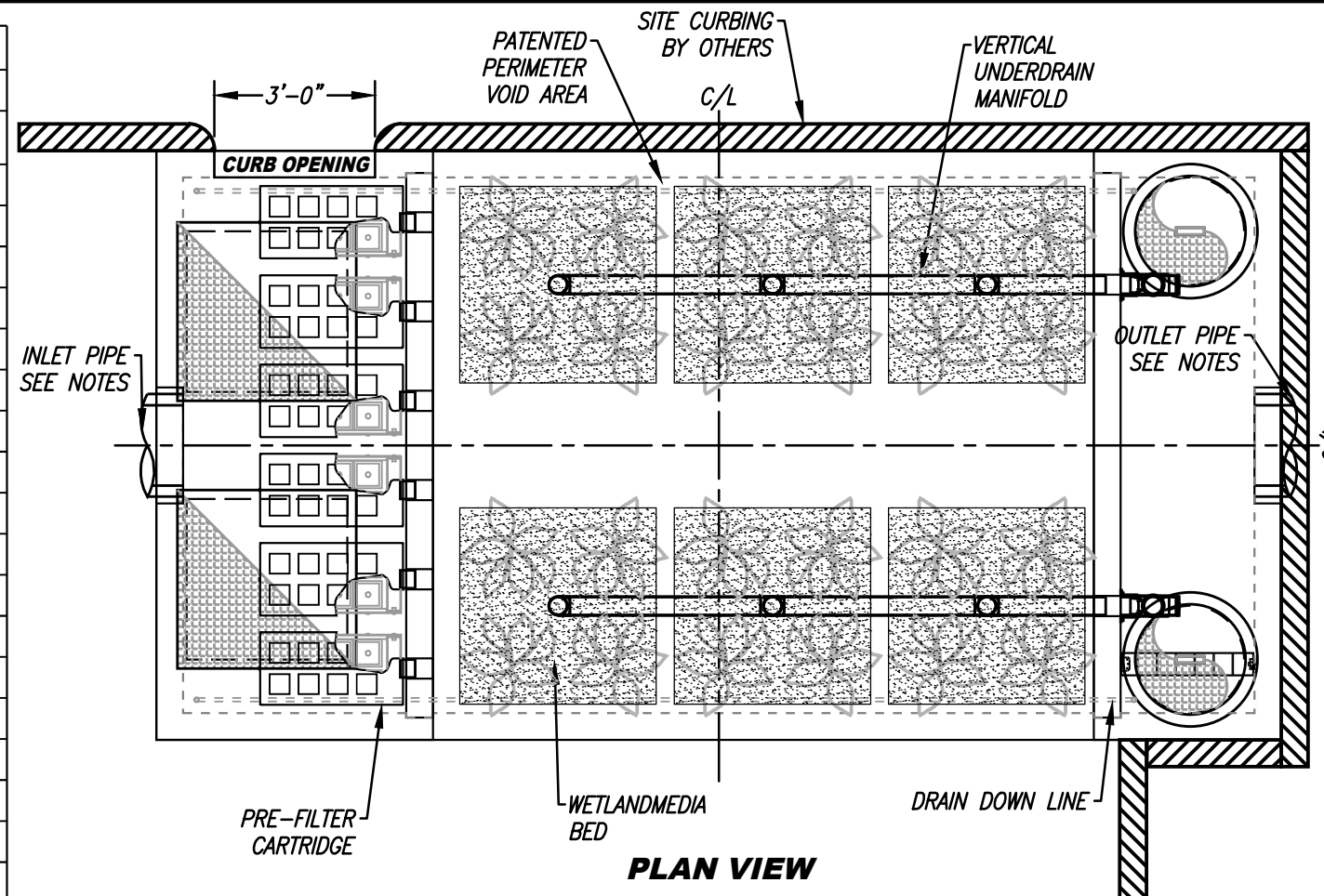

INSTALLATION NOTES

- CONTRACTOR TO PROVIDE ALL LABOR, EQUIPMENT, MATERIALS AND INCIDENTALS REQUIRED TO OFFLOAD AND INSTALL THE SYSTEM AND APPURTENANCES IN ACCORDANCE WITH THIS DRAWING AND THE MANUFACTURERS SPECIFICATIONS, UNLESS OTHERWISE STATED IN MANUFACTURERS CONTRACT.
- UNIT MUST BE INSTALLED ON LEVEL BASE. MANUFACTURER RECOMMENDS A MINIMUM 6" LEVEL ROCK BASE UNLESS SPECIFIED BY THE PROJECT ENGINEER. CONTRACTOR IS RESPONSIBLE TO VERIFY PROJECT ENGINEERS RECOMMENDED BASE SPECIFICATIONS.
- ALL PIPES MUST BE FLUSH WITH INSIDE SURFACE OF CONCRETE. (PIPES CANNOT INTRUDE BEYOND FLUSH). INVERT OF OUTFLOW PIPE MUST BE FLUSH WITH DISCHARGE CHAMBER FLOOR. ALL GAPS AROUND PIPES SHALL BE SEALED WATER TIGHT WITH A NON-SHRINK GROUT PER MANUFACTURERS STANDARD CONNECTION DETAIL AND SHALL MEET OR EXCEED REGIONAL PIPE CONNECTION STANDARDS.
- CONTRACTOR TO SUPPLY AND INSTALL ALL EXTERNAL CONNECTING PIPES.
- CONTRACTOR RESPONSIBLE FOR INSTALLATION OF ALL RISERS, MANHOLES, AND HATCHES. CONTRACTOR TO GROUT ALL MANHOLES AND HATCHES TO MATCH FINISHED SURFACE UNLESS SPECIFIED OTHERWISE.
- DRIP OR SPRAY IRRIGATION REQUIRED ON ALL UNITS WITH VEGETATION.
- CONTRACTOR RESPONSIBLE FOR CONTACTING MODULAR WETLANDS FOR ACTIVATION OF UNIT. MANUFACTURES WARRANTY IS VOID WITH OUT PROPER ACTIVATION BY A MODULAR WETLANDS REPRESENTATIVE.

GENERAL NOTES

- MANUFACTURER TO PROVIDE ALL MATERIALS UNLESS OTHERWISE NOTED.
- ALL DIMENSIONS, ELEVATIONS, SPECIFICATIONS AND CAPACITIES ARE SUBJECT TO CHANGE. FOR PROJECT SPECIFIC DRAWINGS DETAILING EXACT DIMENSIONS, WEIGHTS AND ACCESSORIES PLEASE CONTACT MANUFACTURER.

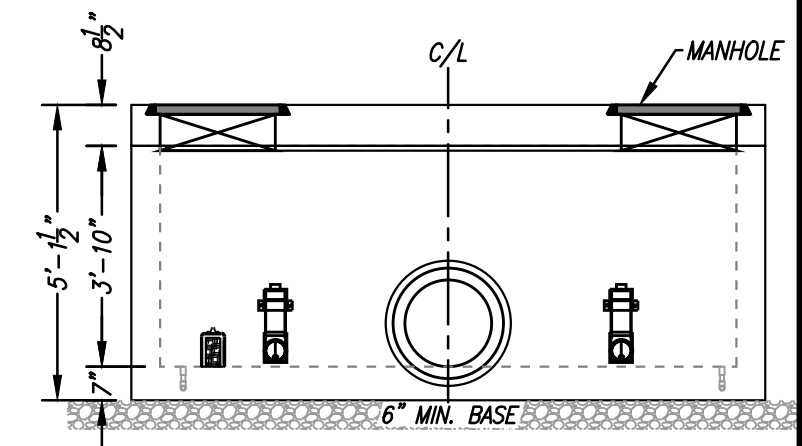
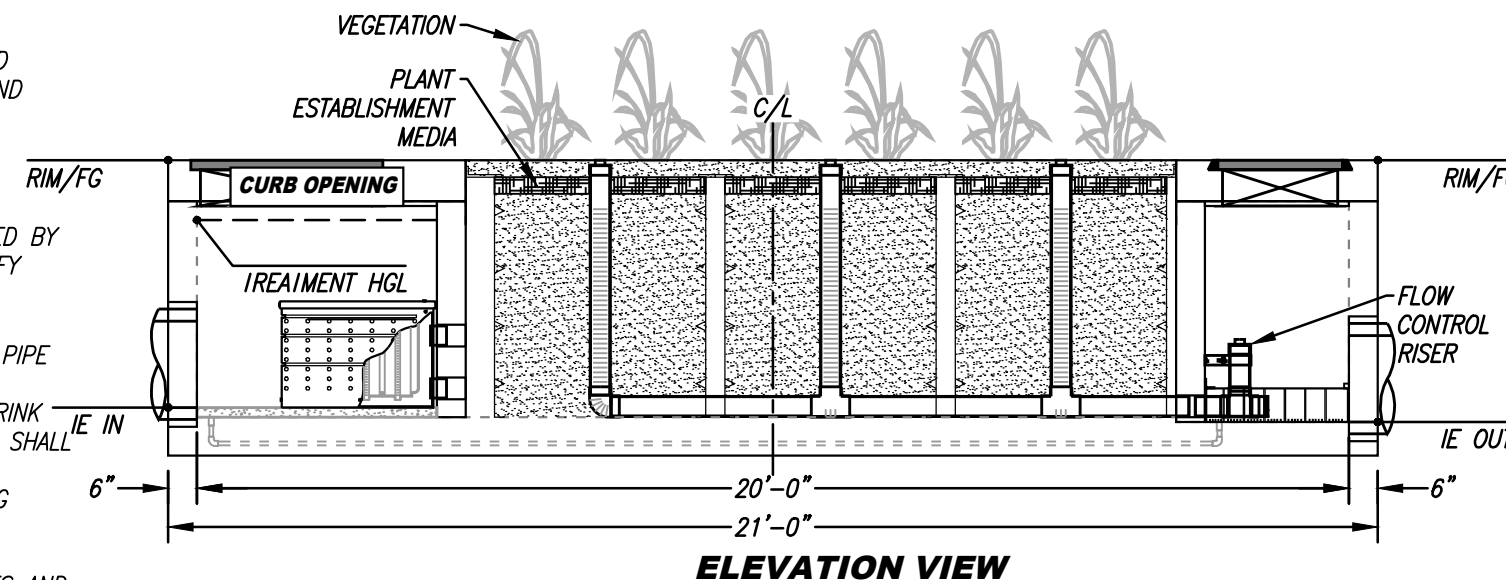

LOW INFLOW PIPE DISCLOSURE:

IT IS RECOMMENDED THAT A SUFFICIENT VARIATION IN ELEVATION BETWEEN THE INLET AND OUTLET BE PROVIDED TO ALLOW FOR ACCUMULATION OF SEDIMENT IN THE PRE-TREATMENT CHAMBER. FAILURE TO DO SO MAY RESULT IN BLOCKAGE AT INFLOW POINT(S) WHICH MAY CAUSE UPSTREAM FLOODING.

| | |
|-------------------------------------|-------|
| TREATMENT FLOW (CFS) | 0.710 |
| OPERATING HEAD (FT) | 3.5 |
| PRETREATMENT LOADING RATE (GPM/SF) | 2.1 |
| WETLAND MEDIA LOADING RATE (GPM/SF) | 1.0 |

MWS-L-10-20-4'-5.5"-C-HC
STORMWATER BIOFILTRATION SYSTEM
STANDARD DETAIL

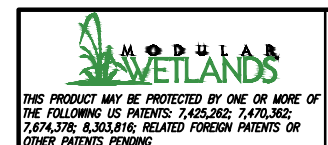

PROPRIETARY AND CONFIDENTIAL:
THE INFORMATION CONTAINED IN THIS DRAWING IS THE SOLE PROPERTY OF MODULAR WETLANDS SYSTEMS. ANY REPRODUCTION IN PART OR AS A WHOLE WITHOUT THE WRITTEN PERMISSION OF MODULAR WETLANDS SYSTEMS IS PROHIBITED.



DATE: 5/14/2021 11:41:32 AM

FILENAME: P:\DWG\OMEGA\633 Faring SS Carson\STORMWATER REPORTS\Water Quality\ATTACHMENTS\85th Percentile Hydro

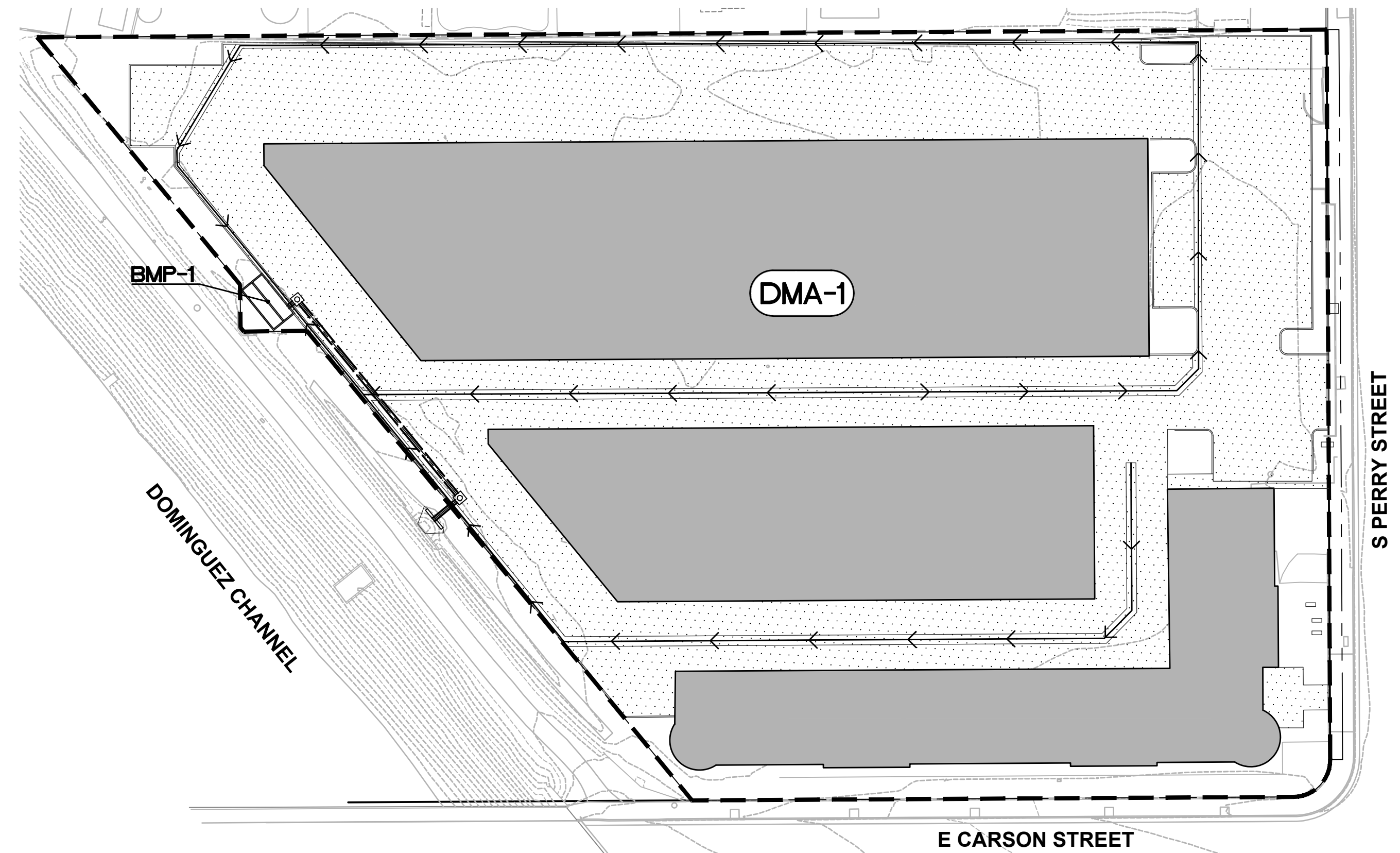

LEGEND

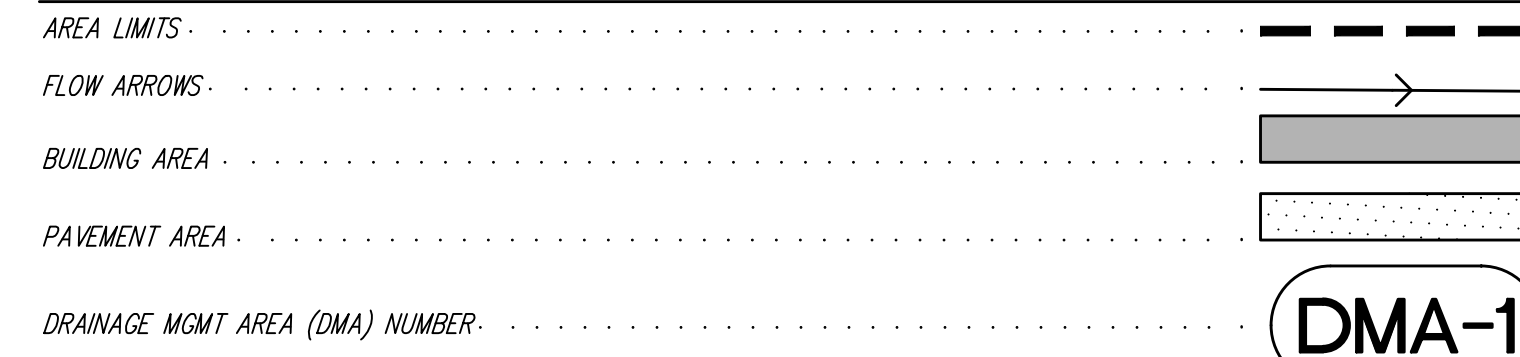

DMA DATA TABLE

| DMA-NO. | TOT. AREA (SF) | IMPERVIOUS (%) | REQ'D FLOWRATE (CFS) | BMP FLOWRATE (CFS) | TYPE/TREATED BY |
|---------|----------------|----------------|----------------------|--------------------|-----------------------|
| DMA-1 | 120,644 | 89.8 | 0.702 | 0.710 | BMP-1/MODULAR WETLAND |

GENERAL STORM WATER NOTES

- GROUNDWATER IS ANTICIPATED AT APPROXIMATELY 12.5 FEET BELOW EXISTING GRADE ON SITE.
- NO EXISTING NATURAL HYDROLOGIC FEATURES
- NO SIGNIFICANT ECOLOGICAL AREAS ON SITE
- ALL APPLICABLE SOURCE CONTROL BMPs SHALL BE IMPLEMENTED
- SOURCE CONTROL NOTES TO COME IN MINISTERIAL REVIEW

Peak Flow Hydrologic Analysis

File location: P:\DWG\OMEGA\633 Faring SS Carson\STORMWATER REPORTS\Water Quality\ATTACHMENTS\85th Percentile Hydro
Version: HydroCalc 1.0.3

Input Parameters

| | |
|-------------------------------------|-----------------------|
| Project Name | Carson Self Storage |
| Subarea ID | DMA-1 |
| Area (ac) | 2.77 |
| Flow Path Length (ft) | 475.0 |
| Flow Path Slope (vft/hft) | 0.006 |
| 85th Percentile Rainfall Depth (in) | 0.8 |
| Percent Impervious | 0.898 |
| Soil Type | 3 |
| Design Storm Frequency | 85th percentile storm |
| Fire Factor | 0 |
| LID | True |

Output Results

| | |
|---|-----------|
| Modeled (85th percentile storm) Rainfall Depth (in) | 0.8 |
| Peak Intensity (in/hr) | 0.2025 |
| Undeveloped Runoff Coefficient (Cu) | 0.1 |
| Developed Runoff Coefficient (Cd) | 0.8184 |
| Time of Concentration (min) | 31.0 |
| Clear Peak Flow Rate (cfs) | 0.459 |
| Burned Peak Flow Rate (cfs) | 0.459 |
| 24-Hr Clear Runoff Volume (ac-ft) | 0.1499 |
| 24-Hr Clear Runoff Volume (cu-ft) | 6528.9479 |

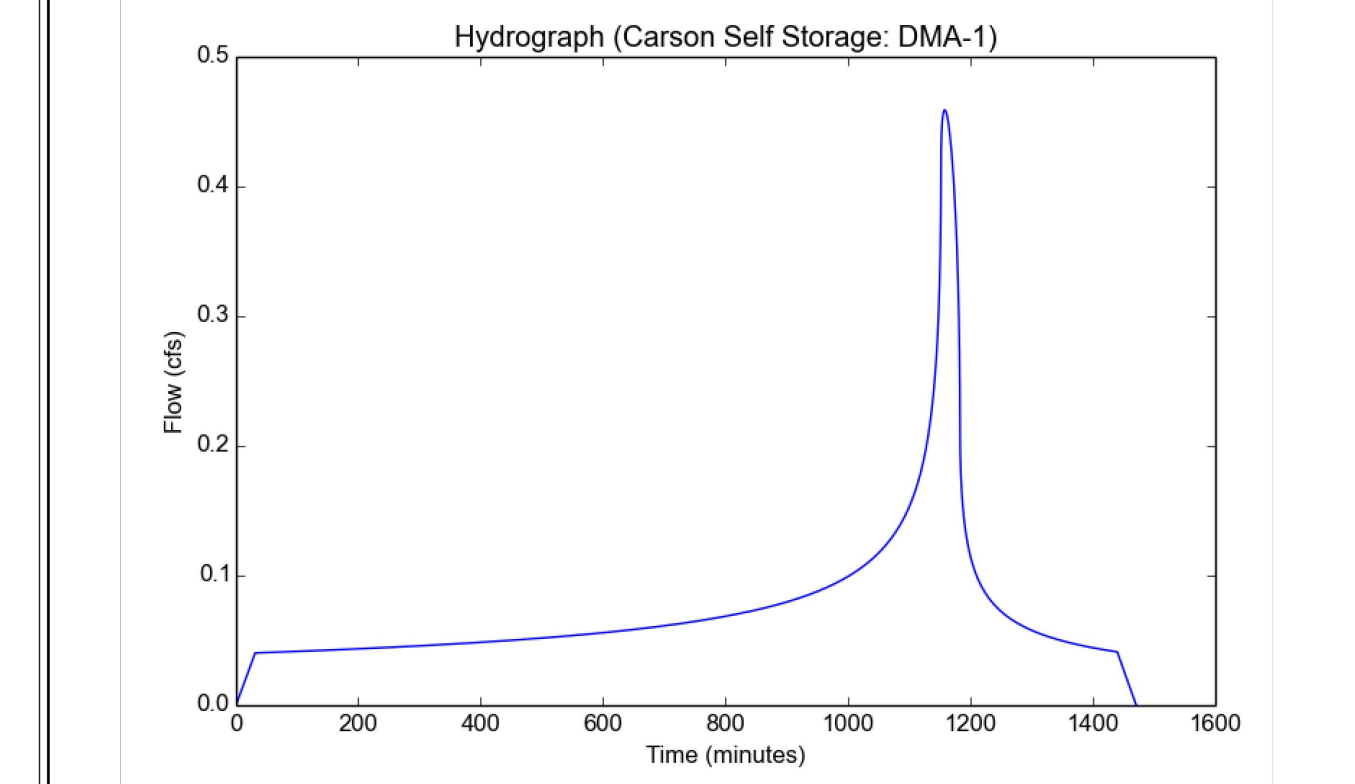

PROJECT HYDROGRAPH

| SITE SPECIFIC DATA | | | |
|--|------------------------------|---------------|------------|
| PROJECT NUMBER | | | |
| PROJECT NAME | | | |
| PROJECT LOCATION | | | |
| STRUCTURE ID | | | |
| TREATMENT REQUIRED | | | |
| VOLUME BASED (CF) | FLOW BASED (CFS) | | |
| N/A | 0.710 | | |
| TREATMENT HGL AVAILABLE (FT) | N/K | | |
| PEAK BYPASS REQUIRED (CFS) - IF APPLICABLE | FLOW BY | | |
| PIPE DATA | I.E. | MATERIAL | DIAMETER |
| INLET PIPE 1 | | | |
| INLET PIPE 2 | | | |
| OUTLET PIPE | | | |
| | PRETREATMENT | BIOFILTRATION | DISCHARGE |
| RIM ELEVATION | | | |
| SURFACE LOAD | PEDESTRIAN | OPEN PLANNER | PEDESTRIAN |
| FRAME & COVER | 2 EA 36" X 36" N/A 2 EA #24" | | |
| WETLAND MEDIA VOLUME (CY) | | | |
| ORIFICE SIZE (DIA. INCHES) | 2 EA #2.67" | | |
| NOTES: PRELIMINARY. NOT FOR CONSTRUCTION. | | | |

INSTALLATION NOTES

- CONTRACTOR TO PROVIDE ALL LABOR, EQUIPMENT, MATERIALS AND INCIDENTALS REQUIRED TO OFFLOAD AND INSTALL THE SYSTEM AND APPURTENANCES IN ACCORDANCE WITH THIS DRAWING AND THE MANUFACTURER'S SPECIFICATIONS, UNLESS OTHERWISE STATED IN MANUFACTURER'S CONTRACT.
- UNIT MUST BE INSTALLED ON LEVEL BASE. MANUFACTURER RECOMMENDS A MINIMUM 6" LEVEL ROCK BASE UNLESS SPECIFIED BY THE PROJECT ENGINEER. CONTRACTOR IS RESPONSIBLE TO VERIFY PROJECT ENGINEER'S RECOMMENDED BASE SPECIFICATIONS.
- ALL PIPES MUST BE FLUSH WITH INSIDE SURFACE OF CONCRETE. (PIPES CANNOT INTRUDE BEYOND FLUSH). INVERT OF OUTFLOW PIPE MUST BE FLUSH WITH DISCHARGE CHAMBER FLOOR. ALL GAPS AROUND PIPES SHALL BE SEALED WATER TIGHT WITH A NON-SHRINK GROUT PER MANUFACTURER'S STANDARD CONNECTION DETAIL AND SHALL MEET OR EXCEED REGIONAL PIPE CONNECTION STANDARDS.
- CONTRACTOR TO SUPPLY AND INSTALL ALL EXTERNAL CONNECTING PIPES.
- CONTRACTOR RESPONSIBLE FOR INSTALLATION OF ALL RISERS, MANHOLES, AND HATCHES. CONTRACTOR TO GROUT ALL MANHOLES AND HATCHES TO MATCH FINISHED SURFACE UNLESS SPECIFIED OTHERWISE. Drip or spray irrigation required on all units with vegetation.
- CONTRACTOR RESPONSIBLE FOR CONTACTING MODULAR WETLANDS FOR ACTIVATION OF UNIT. MANUFACTURER'S WARRANTY IS VOID WITH OUT PROPER ACTIVATION BY A MODULAR WETLANDS REPRESENTATIVE.

GENERAL NOTES

- MANUFACTURER TO PROVIDE ALL MATERIALS UNLESS OTHERWISE NOTED.
- ALL DIMENSIONS, ELEVATIONS, SPECIFICATIONS AND CAPACITIES ARE SUBJECT TO CHANGE. FOR PROJECT SPECIFIC DRAWINGS DETAILING EXACT DIMENSIONS, WEIGHTS AND ACCESSORIES PLEASE CONTACT MANUFACTURER.

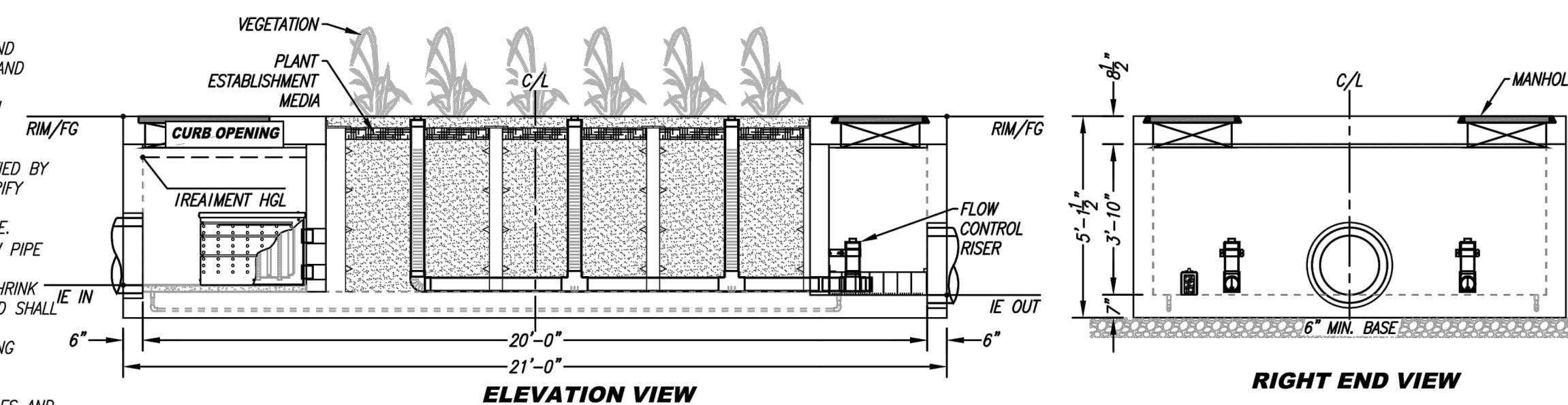
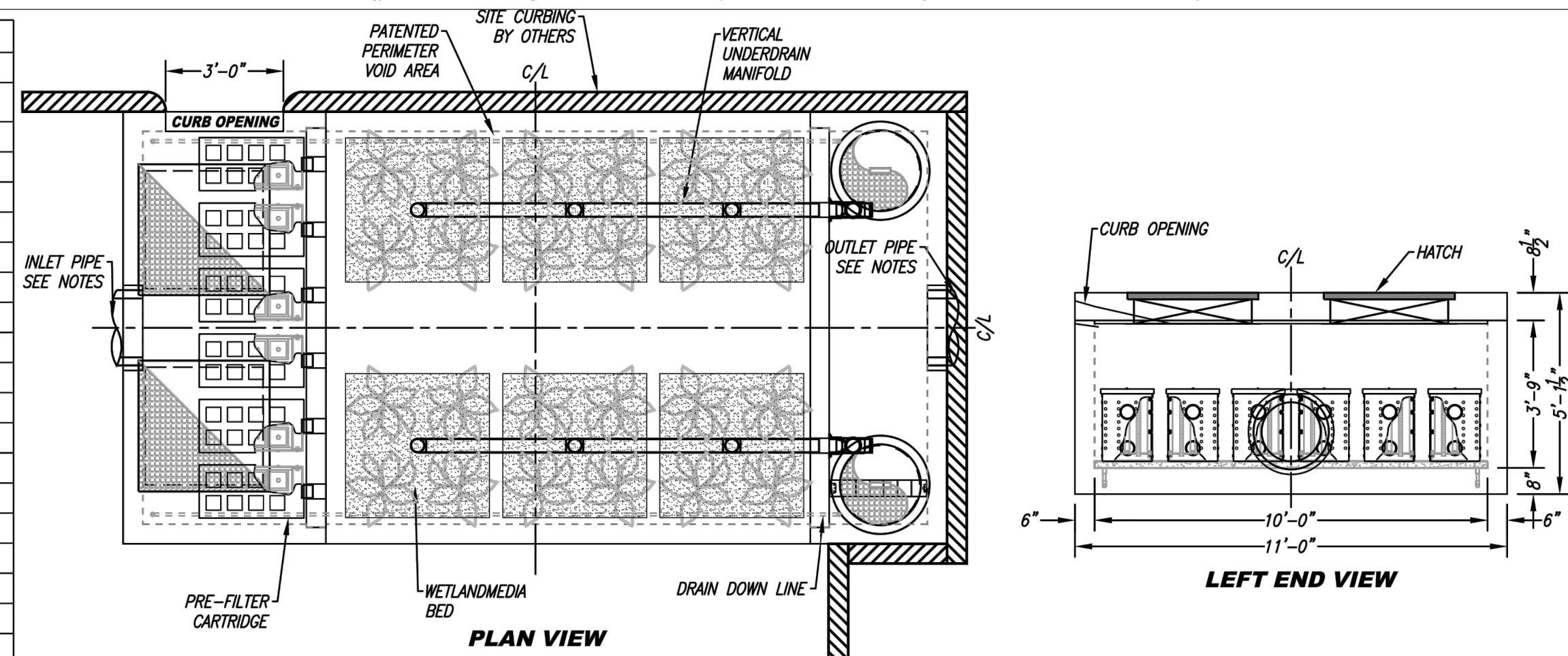

LOW INFLOW PIPE DISCLOSURE:

IT IS RECOMMENDED THAT A SUFFICIENT VARIATION IN ELEVATION BETWEEN THE INLET AND OUTLET BE PROVIDED TO ALLOW FOR ACCUMULATION OF SEDIMENT IN THE PRE-TREATMENT CHAMBER. FAILURE TO DO SO MAY RESULT IN BLOCKAGE AT INFLOW POINT(S) WHICH MAY CAUSE UPSTREAM FLOODING.

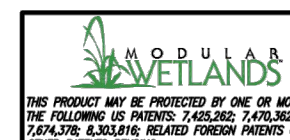

PROPRIETARY AND CONFIDENTIAL:
THE INFORMATION CONTAINED IN THIS DRAWING IS THE SOLE PROPERTY OF MODULAR WETLANDS SYSTEMS. ANY REPRODUCTION IN PART OR AS A WHOLE WITHOUT THE WRITTEN PERMISSION OF MODULAR WETLANDS SYSTEMS IS PROHIBITED.



MWS-L-10-20-4'-5.5"-C-HC
STORMWATER BIOFILTRATION SYSTEM
STANDARD DETAIL

| | |
|-------------------------------------|-------|
| TREATMENT FLOW (CFS) | 0.710 |
| OPERATING HEAD (FT) | 3.5 |
| PRETREATMENT LOADING RATE (GPM/SF) | 2.1 |
| WETLAND MEDIA LOADING RATE (GPM/SF) | 1.0 |

PERRY STREET
CARSON STREET SS
CARSON, CA

MODULAR WETLAND DETAIL

NOT TO SCALE



FOR PLAN CHECK ONLY

SEAN M. SAVAGE R.C.E. 75677

DATE

ja
JORDAN ARCHITECTS
131 CALLE IGLESIA, SUITE 100
SAN CLEMENTE, CA 92672
949.388.8090

THIS DRAWING AND ITS CONTENTS ARE INSTRUMENTS OF SERVICE AND ARE THE COPYRIGHTED PROPERTY OF JORDAN ARCHITECTS, INC. THE USE IS EXPRESSLY INTENDED FOR THE PROJECT NOTED ABOVE AND MAY NOT BE REUSED OR REPRODUCED IN WHOLE OR IN PART WITHOUT THE WRITTEN PERMISSION OF JORDAN ARCHITECTS, INC. "COPYRIGHT" YEAR OF FIRST PUBLICATION 2020 JORDAN ARCHITECTS, INC.

JOB NUMBER: 20-817

DATE: 10/05/2021

PLAN PREPARED BY:

OMEGA ENGINEERING CONSULTANTS
4340 VIEWRIDGE AVE. SUITE B
SAN DIEGO, CA 92123
PH: (858) 634-8620 FAX: (858)-634-8627

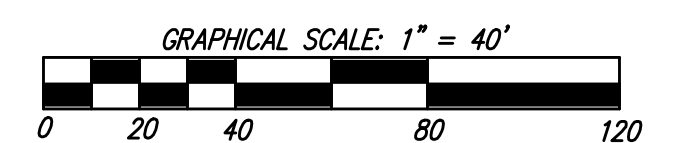

Attachment B

Geotechnical Investigation

GEOTECHNICAL INVESTIGATION

**PROPOSED COMMERCIAL
DEVELOPMENT
21611 SOUTH PERRY STREET
CARSON, CALIFORNIA
APN: 7327-010-014**



GEOCON
W E S T, I N C.

GEOTECHNICAL
ENVIRONMENTAL
MATERIALS

**PREPARED FOR
FARING CAPITAL, LLC
WEST HOLLYWOOD, CALIFORNIA**

PROJECT NO. W1301-06-01

APRIL 23, 2021



Project No. W1301-06-01
April 23, 2021

Faring Capital, LLC
659 North Robertson Boulevard,
West Hollywood, California 90069

Attention: Mr. Darren Embry

Subject: GEOTECHNICAL INVESTIGATION
PROPOSED COMMERCIAL DEVELOPMENT
21611 SOUTH PERRY STREET
CARSON, CALIFORNIA
APN: 7327-010-014

Dear Mr. Embry:

In accordance with your authorization of our proposal dated December 11, 2020, we have prepared this geotechnical investigation report for the proposed commercial development located at 21611 South Perry Street in the City of Carson, California. The accompanying report presents the findings of our study, and our conclusions and recommendations pertaining to the geotechnical aspects of proposed design and construction. Based on the results of our investigation, it is our opinion that the site can be developed as proposed, provided the recommendations of this report are followed and implemented during design and construction.

If you have any questions regarding this report, or if we may be of further service, please contact the undersigned.

Very truly yours,

GEOCON WEST, INC.

Joe Hicks
Staff Engineer

Jelisa Thomas Adams
GE 3092

Susan F. Kirkgard
CEG 1754

(EMAIL) Addressee

TABLE OF CONTENTS

| | | |
|------|---|----|
| 1. | PURPOSE AND SCOPE | 1 |
| 2. | SITE AND PROJECT DESCRIPTION | 1 |
| 3. | BACKGROUND | 2 |
| 4. | GEOLOGIC SETTING | 3 |
| 5. | SOIL AND GEOLOGIC CONDITIONS | 3 |
| 5.1 | Artificial Fill | 3 |
| 5.2 | Alluvium | 3 |
| 6. | GROUNDWATER | 4 |
| 7. | GEOLOGIC HAZARDS | 5 |
| 7.1 | Surface Fault Rupture | 5 |
| 7.2 | Seismicity | 6 |
| 7.3 | Seismic Design Criteria | 6 |
| 7.4 | Liquefaction Potential | 8 |
| 7.5 | Seismically Induced Settlement | 10 |
| 7.6 | Lateral Spreading | 10 |
| 7.7 | Slope Stability | 11 |
| 7.8 | Earthquake-Induced Flooding | 11 |
| 7.9 | Tsunamis, Seiches, and Flooding | 11 |
| 7.10 | Oil Fields & Methane Potential | 12 |
| 7.11 | Subsidence | 12 |
| 8. | CONCLUSIONS AND RECOMMENDATIONS | 13 |
| 8.1 | General | 13 |
| 8.2 | Soil and Excavation Characteristics | 15 |
| 8.3 | Minimum Resistivity, pH, and Water-Soluble Sulfate | 16 |
| 8.4 | Grading | 16 |
| 8.5 | Shrinkage | 20 |
| 8.6 | Mat Foundation Design | 20 |
| 8.7 | Miscellaneous Foundations | 21 |
| 8.8 | Lateral Design | 22 |
| 8.9 | Concrete Slabs-on-Grade | 22 |
| 8.10 | Preliminary Paving Design | 24 |
| 8.11 | Retaining Wall Design | 25 |
| 8.12 | Retaining Wall Drainage | 26 |
| 8.13 | Elevator Pit Design | 27 |
| 8.14 | Elevator Piston | 27 |
| 8.15 | Temporary Excavations | 28 |
| 8.16 | Surcharge from Adjacent Structures and Improvements | 29 |
| 8.17 | Surface Drainage | 30 |
| 8.18 | Plan Review | 31 |

LIMITATIONS AND UNIFORMITY OF CONDITIONS

LIST OF REFERENCES

TABLE OF CONTENTS (Continued)

MAPS, TABLES, AND ILLUSTRATIONS

- Figure 1, Vicinity Map
- Figure 2, Site Plan
- Figure 3, Regional Fault Map
- Figure 4, Regional Seismicity Map
- Figures 5, Correlation of Boring & CPT N60
- Figures 6, CPT Liquefaction Settlement Summary (DE)
- Figures 7, CPT Liquefaction Settlement Summary (MCE)
- Figures 8 and 9, Dry Seismic Settlement Calculations
- Figures 10 and 11, Retaining Wall Drain Detail

APPENDIX A

FIELD INVESTIGATION

- Figures A1 through A5, Boring Logs
- Figures A6 through A10, CPT Logs

APPENDIX B

LABORATORY TESTING

- Figures B1 through B4, Direct Shear Test Results
- Figures B5 through B17, Consolidation Test Results
- Figure B18, Grain Size Analysis
- Figure B19, Atterberg Limits
- Figure B20, Expansion Test Results
- Figures B21 and B22, Compaction Test Results
- Figure B23, Corrosivity Test Results

APPENDIX C

- CPT Liquefaction Analysis

GEOTECHNICAL INVESTIGATION

1. PURPOSE AND SCOPE

This report presents the results of a geotechnical investigation for the proposed commercial development located at 21611 South Perry Street in the City of Carson, California (see Vicinity Map, Figure 1). The purpose of the investigation was to evaluate subsurface soil and geologic conditions underlying the site and, based on conditions encountered, to provide conclusions and recommendations pertaining to the geotechnical aspects of design and construction.

The scope of this investigation included a review of prior environmental reports for the site provided by the client, a site reconnaissance, field exploration, laboratory testing, engineering analysis, and the preparation of this report. The site was explored on February 9, 2021 by drilling five 8-inch diameter borings using a truck-mounted hollow-stem auger drilling machine and advancing five cone penetrometer tests (CPTs). The borings were excavated to depths between approximately 20½ and 51 feet beneath the existing ground surface. The CPTs were advanced to depths of approximately 60 feet below existing ground surface. The approximate locations of the exploratory borings and CPTs are depicted on the Site Plan (see Figure 2). A detailed discussion of the field investigation, including the boring and CPT logs, is presented in Appendix A.

Laboratory tests were performed on selected soil samples obtained during the investigation to determine pertinent physical and chemical soil properties. Appendix B presents a summary of the laboratory test results.

The recommendations presented herein are based on analysis of the data obtained during the investigation and our experience with similar soil and geologic conditions. References reviewed to prepare this report are provided in the *List of References* section.

If project details vary significantly from those described herein, Geocon should be contacted to determine the necessity for review and possible revision of this report.

2. SITE AND PROJECT DESCRIPTION

The subject site is an approximately 2.6-acre irregularly shaped parcel located at 21611 South Perry Street in the City of Carson, California. The site is currently vacant. The site is bounded by South Perry Street on the east, by the Dominguez Channel to the west, by one- to two-story single-family homes to the north, and by East Carson Street to the south. The site is relatively level, with no pronounced highs or lows. Surface water drainage at the site appears to be by sheet flow along the existing ground contours to the city streets.

Based on the information provided by the Client, it is our understanding that the proposed development will consist of three 2-story self-storage structures. Based on preliminary plans it is anticipated that the development will be approximately 25 feet in height and will be constructed at or near present grade (see Figure 2).

Based on the preliminary nature of the design at this time, wall and column loads were not available. It is anticipated that column loads for the proposed structures will be up to 300 kips, and wall loads will be up to 3 kips per linear foot.

Once the design phase and foundation loading configuration proceeds to a more finalized plan, the recommendations within this report should be reviewed and revised, if necessary. Any changes in the design, location or elevation of any structure, as outlined in this report, should be reviewed by this office. Geocon should be contacted to determine the necessity for review and possible revision of this report.

3. BACKGROUND

Prior environmental reports were prepared for the site and provided for our review, and include the following:

Phase 1 Environmental Site Assessment, 21611 S. Perry Street, Carson, CA. 90745-1613, Prepared by Weis Environmental, dated January 25, 2021.

2020 First Semi-Annual Groundwater Monitoring Report, January Through June 2020, Dominguez Channel Release, Carson, California, Prepared by AECOM, dated July 14, 2020.

Based on the prior reports, petroleum hydrocarbon impacted soil and groundwater were previously identified at the site that originated from on-site underground storage tanks (USTs) and migration of contaminants from off-site sources. AECOM (formerly URS) developed a workplan that developed cleanup goals and excavation limits to remove impacted soils that was approved by the LARWQCB. In 2014, approximately 4,800 cubic yards of impacted soils were excavated from four areas and removed from the site. The excavations were approximately 5 to 8 feet deep and were backfilled with clean import soils (Weis Environmental, 2021). The approximate locations and depths of these areas are indicated on the Site Plan (see Figure 2). The backfill was reportedly placed, compacted, and tested as a certified backfill material; however, a copy of the compaction report was not included as an exhibit. Therefore, for the purposes of this report, the backfill is considered to be uncertified fill.

Also, as part of the prior site remediation, groundwater monitoring wells were installed at the site and the immediately surrounding area. The monitoring wells present at the site are limited to the eastern, western, and southern property boundaries. Groundwater monitoring is ongoing in these wells in compliance with a semi-annual groundwater monitoring program required by the LARWQCB.

Based on documents included in the referenced environmental reports, the known soil and groundwater impacts are within acceptable levels for commercial use and further assessment or remediation is not required. However, a soil management plan (SMP) is anticipated required for further development of the site. Development of a soil management plan is beyond the scope of the Geotechnical Investigation.

4. GEOLOGIC SETTING

The site is located in the southern portion of the Los Angeles Basin, a coastal plain bounded by the Santa Monica Mountains on the north, the Elysian Hills and Repetto Hills on the northeast, the Puente Hills and the Whittier Fault on the east, the Palos Verdes Peninsula and Pacific Ocean on the west and south, and the Santa Ana Mountains and San Joaquin Hills on the southeast. The basin is underlain by a deep structural depression which has been filled by both marine and continental sedimentary deposits underlain by a basement complex of igneous and metamorphic composition. Regionally, the site is located within the northern portion of the Peninsular Ranges geomorphic province. This geomorphic province is characterized by northwest-trending physiographic and geologic features such as the nearby Newport-Inglewood Fault Zone located approximately 2.7 miles to the east-northeast.

5. SOIL AND GEOLOGIC CONDITIONS

Based on our field investigation and published geologic maps of the area, the site is underlain by artificial fill and Holocene age alluvium consisting sand, silt, and clay (California Geological Survey, 2010). Detailed stratigraphic profiles of the materials encountered at the site are provided on the boring logs in Appendix A.

5.1 Artificial Fill

Artificial fill was encountered in our explorations to depths ranging from 3 to 9 feet below existing ground surface. The deep fill, observed in boring B3, is associated with an area of a former UST removal. The artificial generally consists of light brown to brown or grayish brown sand and silty sand. The artificial fill is characterized as fine-grained with some medium-grained, moist, and loose to dense. The fill is likely the result of past grading, UST removal and environmental remediation, and past construction activities at the site. Deeper fill may exist between excavations and in other portions of the site that were not directly explored.

5.2 Alluvium

Holocene age alluvium was encountered beneath the fill to the maximum depth explored (51 feet below the ground surface). The alluvium generally consists of light brown to brown, olive brown, or gray to dark gray interbedded clay, sandy clay, silt, sandy silt, silty sand and clayey sand. The alluvial soils are characterized as primarily fine-grained, moist to wet, and loose to dense or soft to stiff.

6. GROUNDWATER

A review of the Seismic Hazard Zone Report for the Torrance Quadrangle (California Division of Mines and Geology [CDMG], 1998) indicates the historically highest groundwater level in the area is approximately 9 feet beneath the ground surface. Groundwater information presented in this document is generated from data collected in the early 1900's to the late 1990s. Based on current groundwater basin management practices, it is unlikely that groundwater levels will ever exceed the historic high levels.

Groundwater was encountered in borings B1 and B3 at depths of 12.5 feet and 17.6 feet beneath the existing ground surface, respectively. Additionally, readings from groundwater monitoring wells established on the site were taken on February 23, 2021. The locations of the accessible monitoring wells are indicated on the site plan (see Figure 2) and a summary of groundwater levels at the time of the investigation is provided in the table below.

Monitoring Well Readings

| Well ID | MW-3 | MW-4 | MW-5 | MW-7A | MW-8A | MW-9B |
|--|-------|--------|--------|--------|--------|--------|
| Depth to GW (Below Ground Surface) | 12.0' | 13.17' | 12.25' | 12.33' | 12.67' | 14.67' |

Based on the depth to groundwater and the on-grade nature of the development, groundwater is not expected to have a detrimental effect on the project. Groundwater may be encountered during construction in deep drilled excavations, such as for ground improvement or elevator pistons. It is not uncommon for groundwater levels to vary seasonally or for groundwater seepage conditions to develop where none previously existed, especially in impermeable fine-grained soils which are heavily irrigated or after seasonal rainfall. In addition, recent requirements for stormwater infiltration could result in shallower seepage conditions in the immediate site vicinity. Proper surface drainage of irrigation and precipitation will be critical for future performance of the project. Recommendations for drainage are provided in the *Surface Drainage* section of this report (see Section 8.20).

7. GEOLOGIC HAZARDS

7.1 Surface Fault Rupture

The numerous faults in Southern California include Holocene-active, pre-Holocene, and inactive faults. The criteria for these major groups are based on criteria developed by the California Geological Survey (CGS, formerly known as CDMG) for the Alquist-Priolo Earthquake Fault Zone Program (CGS, 2018). By definition, a Holocene-active fault is one that has had surface displacement within Holocene time (about the last 11,700 years). A pre-Holocene fault has demonstrated surface displacement during Quaternary time (approximately the last 1.6 million years) but has had no known Holocene movement. Faults that have not moved in the last 1.6 million years are considered inactive.

The site is not within a state-designated Alquist-Priolo Earthquake Fault Zone for surface fault rupture hazards (CGS, 2021a; CGS, 2021b; CDMG 1986). No Holocene-active or pre-Holocene active faults with the potential for surface fault rupture are known to pass directly beneath the site. Therefore, the potential for surface rupture due to faulting occurring beneath the site during the design life of the proposed development is considered low. However, the site is located in the seismically active Southern California region, and could be subjected to moderate to strong ground shaking in the event of an earthquake on one of the many active Southern California faults. The faults in the vicinity of the site are shown in Figure 3, Regional Fault Map.

The closest surface trace of an active fault to the site is the Newport-Inglewood Fault Zone located approximately 2.7 miles to the east-northeast (USGS, 2006; CDMG, 1986). Other nearby active faults are the Palos Verdes Fault, the Cabrillo Fault, and the Whittier Fault located approximately 4.2 miles south-southwest, 8.2 miles south, and 16 miles northeast of the site, respectively. The active San Andreas Fault Zone is located approximately 48 miles northeast of the site.

Several buried thrust faults, commonly referred to as blind thrusts, underlie the Los Angeles Basin at depth. These faults are not exposed at the ground surface and are typically identified at depths greater than 3.0 kilometers. The October 1, 1987, M_w 5.9 Whittier Narrows earthquake and the January 17, 1994, M_w 6.7 Northridge earthquake were a result of movement on the Puente Hills Blind Thrust and the Northridge Thrust, respectively. These thrust faults and others in the Los Angeles area are not exposed at the surface and do not present a potential surface fault rupture hazard at the site; however, these deep thrust faults are considered active features capable of generating future earthquakes that could result in moderate to significant ground shaking at the site.

7.2 Seismicity

As with all of Southern California, the site has experienced historic earthquakes from various regional faults. The seismicity of the region surrounding the site was formulated based on research of an electronic database of earthquake data. The epicenters of recorded earthquakes with magnitudes equal to or greater than 5.0 in the site vicinity are depicted on Figure 4, Regional Seismicity Map. A partial list of moderate to major magnitude earthquakes that have occurred in the Southern California area within the last 100 years is included in the following table.

LIST OF HISTORIC EARTHQUAKES

| Earthquake (Oldest to Youngest) | Date of Earthquake | Magnitude | Distance to Epicenter (Miles) | Direction to Epicenter |
|--|---------------------------|------------------|--|---------------------------------------|
| Near Redlands | July 23, 1923 | 6.3 | 59 | E |
| Long Beach | March 10, 1933 | 6.4 | 22 | SE |
| Tehachapi | July 21, 1952 | 7.5 | 91 | NW |
| San Fernando | February 9, 1971 | 6.6 | 41 | NNW |
| Whittier Narrows | October 1, 1987 | 5.9 | 19 | NE |
| Sierra Madre | June 28, 1991 | 5.8 | 33 | NE |
| Landers | June 28, 1992 | 7.3 | 107 | ENE |
| Big Bear | June 28, 1992 | 6.4 | 85 | ENE |
| Northridge | January 17, 1994 | 6.7 | 31 | NW |
| Hector Mine | October 16, 1999 | 7.1 | 125 | ENE |
| Ridgecrest | July 5, 2019 | 7.1 | 138 | NNE |

The site could be subjected to strong ground shaking in the event of an earthquake. However, this hazard is common in Southern California and the effects of ground shaking can be mitigated if the proposed structures are designed and constructed in conformance with current building codes and engineering practices.

7.3 Seismic Design Criteria

The following table summarizes the site-specific design criteria obtained from the 2019 California Building Code (CBC; Based on the 2018 International Building Code [IBC] and NEHRP-2015), Chapter 16 Structural Design, Section 1613, Earthquake Loads. The data was calculated using the online application *Seismic Design Maps*, provided by OSHPD. The short spectral response uses a period of 0.2 second. We evaluated the Site Class based on the discussion in Section 1613.2.2 of the 2019 CBC and Section 11.4.3 of NEHRP-2015. The values presented on the following page are for the risk-targeted maximum considered earthquake (MCE_R).

2019 CBC SEISMIC DESIGN PARAMETERS

| Parameter | Value | 2019 CBC Reference |
|---|--------|------------------------------|
| Site Class | D | Section 1613.2.2 |
| MCE _R Ground Motion Spectral Response Acceleration – Class B (short), S _S | 1.711g | Figure 1613.2.1(1) |
| MCE _R Ground Motion Spectral Response Acceleration – Class B (1 sec), S ₁ | 0.618g | Figure 1613.2.1(2) |
| Site Coefficient, F _A | 1 | Table 1613.2.3(1) |
| Site Coefficient, F _V | 1.7* | Table 1613.2.3(2) |
| Site Class Modified MCE _R Spectral Response Acceleration (short), S _{MS} | 1.711g | Section 1613.2.3 (Eqn 16-36) |
| Site Class Modified MCE _R Spectral Response Acceleration – (1 sec), S _{M1} | 1.05g* | Section 1613.2.3 (Eqn 16-37) |
| 5% Damped Design Spectral Response Acceleration (short), S _{DS} | 1.141g | Section 1613.2.4 (Eqn 16-38) |
| 5% Damped Design Spectral Response Acceleration (1 sec), S _{D1} | 0.7g* | Section 1613.2.4 (Eqn 16-39) |
| <p>Note: *Per Section 11.4.8 of ASCE/SEI 7-16, a ground motion hazard analysis shall be performed for projects for Site Class “E” sites with S_s greater than or equal to 1.0g and for Site Class “D” and “E” sites with S₁ greater than 0.2g. Section 11.4.8 also provides exceptions which indicates that the ground motion hazard analysis may be waived provided the exceptions are followed. Using the code based values presented in the table above, in lieu of a performing a ground motion hazard analysis, requires the exceptions outlined in ASCE 7-16 Section 11.4.8 be followed.</p> | | |

The table below presents the mapped maximum considered geometric mean (MCE_G) seismic design parameters for projects located in Seismic Design Categories of D through F in accordance with NEHRP-2015.

ASCE 7-16 PEAK GROUND ACCELERATION

| Parameter | Value | ASCE 7-16 Reference |
|---|--------|-----------------------------|
| Mapped MCE _G Peak Ground Acceleration, PGA | 0.748g | Figure 22-7 |
| Site Coefficient, F _{PGA} | 1.1 | Table 11.8-1 |
| Site Class Modified MCE _G Peak Ground Acceleration, PGA _M | 0.823g | Section 11.8.3 (Eqn 11.8-1) |

The Maximum Considered Earthquake Ground Motion (MCE) is the level of ground motion that has a 2 percent chance of exceedance in 50 years, with a statistical return period of 2,475 years. According to the 2019 California Building Code and ASCE 7-16, the MCE is to be utilized for the evaluation of liquefaction, lateral spreading, seismic settlements, and it is our understanding that the intent of the Building code is to maintain “Life Safety” during a MCE event. The Design Earthquake Ground Motion (DE) is the level of ground motion that has a 10 percent chance of exceedance in 50 years, with a statistical return period of 475 years.

Deaggregation of the MCE peak ground acceleration was performed using the USGS online Unified Hazard Tool, 2014 Conterminous U.S. Dynamic edition (v4.2.0). The result of the deaggregation analysis indicates that the predominant earthquake contributing to the MCE peak ground acceleration is characterized as a 6.87 magnitude event occurring at a hypocentral distance of 8.35 kilometers from the site.

Deaggregation was also performed for the Design Earthquake (DE) peak ground acceleration, and the result of the analysis indicates that the predominant earthquake contributing to the DE peak ground acceleration is characterized as a 6.68 magnitude occurring at a hypocentral distance of 13.48 kilometers from the site.

Conformance to the criteria in the above tables for seismic design does not constitute any kind of guarantee or assurance that significant structural damage or ground failure will not occur if a large earthquake occurs. The primary goal of seismic design is to protect life, not to avoid all damage, since such design may be economically prohibitive.

7.4 Liquefaction Potential

Liquefaction is a phenomenon in which loose, saturated, relatively cohesionless soil deposits lose shear strength during strong ground motions. Primary factors controlling liquefaction include intensity and duration of ground motion, gradation characteristics of the subsurface soils, in-situ stress conditions, and the depth to groundwater. Liquefaction is typified by a loss of shear strength in the liquefied layers due to rapid increases in pore water pressure generated by earthquake accelerations.

The current standard of practice, as outlined in the “Recommended Procedures for Implementation of DMG Special Publication 117, Guidelines for Analyzing and Mitigating Liquefaction in California” and “Special Publication 117A, Guidelines for Evaluating and Mitigating Seismic Hazards in California” requires liquefaction analysis to a depth of 50 feet below the lowest portion of the proposed structure. Liquefaction typically occurs in areas where the soils below the water table are composed of poorly consolidated, fine to medium-grained, primarily sandy soil. In addition to the requisite soil conditions, the ground acceleration and duration of the earthquake must also be of a sufficient level to induce liquefaction.

A review of the State of California Seismic Hazard Zone Map for the Torrance Quadrangle (CDMG, 1999) indicates that the site is located in an area designated as having a potential for liquefaction. Also, the City of Carson (2002) indicates the site is located within an area that has a potential for liquefaction.

The Standard Penetration Test (SPT) blow counts obtained from boring B3 were compared with the blow counts estimated from the CPT soundings. SPTs were performed in boring B3 at intervals of approximately 5 feet. In order to supplement the SPT blow count data, select California Modified Sampler blow count data were converted to equivalent SPT blow counts based on a correlation factor of 0.55 (Rogers, 2006). The field collected blow counts were corrected for hammer efficiency to N60 blow count values. The boring N60 values were compared with the N60 values generated by the program CpetIT (Version 3.2.1.7). The comparison of CPT-3 and boring B3 are shown as Figure 5. It is our opinion that the boring and CPT N60 values show a very reasonable correlation and that analysis of the liquefaction potential may be based on the CPT data.

Liquefaction analyses of the CPT soundings were performed using the program CLiq (Version 3.0.3.2). This program utilizes the 2001 NCEER method of analysis. This semi-empirical method is based on correlations with the data collected from the CPT soundings.

The liquefaction analysis was performed for a Design Earthquake level by using a historic groundwater level of 9 feet below the ground surface, a magnitude 6.68 earthquake, and a peak horizontal acceleration of 0.549g (2/3PGAM). The results of the enclosed liquefaction analyses included herein for CPTs 1 through 5 indicate that the alluvial soils below the design groundwater level could be susceptible to the liquefaction induced settlements summarized in the table below during Design Earthquake ground motion. A summary of the anticipated liquefaction induced settlements is provided as Figure 6; calculations and output from CLiq are provided as Appendix C.

Liquefaction Induced Settlements (Design Earthquake)

| CPT Number | CPT-1 | CPT-2 | CPT-3 | CPT-4 | CPT-5 |
|-------------------------------------|--------------|--------------|--------------|--------------|--------------|
| Liquefaction Settlement (in) | 0.43 | 0.11 | 0.20 | 0.00 | 0.28 |

It is our understanding that the intent of the Building Code is to maintain “Life Safety” during Maximum Considered Earthquake level events. Therefore, additional analysis was performed to evaluate the potential for liquefaction during a MCE event. The structural engineer should evaluate the proposed structure for the anticipated MCE liquefaction induced settlements and verify that anticipated deformations would not cause the foundation system to lose the ability to support the gravity loads and/or cause collapse of the structure.

The liquefaction analysis performed for the Maximum Considered Earthquake level by using a historic groundwater level of 9 feet below the ground surface, a magnitude 6.87 earthquake, and a peak horizontal acceleration of 0.823g (PGAM). The results of the enclosed liquefaction analyses included herein for CPTs 1 through 5 indicate that the alluvial soils below the design groundwater level could be susceptible to the liquefaction induced settlements summarized in the table below during Maximum Considered Earthquake ground motion. A summary of the anticipated liquefaction induced settlements is provided as Figure 7.

Liquefaction Induced Settlements (Maximum Considered Earthquake)

| CPT Number | CPT-1 | CPT-2 | CPT-3 | CPT-4 | CPT-4 |
|------------------------------|-------|-------|-------|-------|-------|
| Liquefaction Settlement (in) | 0.80 | 0.19 | 0.33 | 0.00 | 0.41 |

7.5 Seismically Induced Settlement

Dynamic compaction of dry and loose sands may occur during a major earthquake. Typically, settlements occur in thick beds of such soils. The seismically induced settlement calculations were performed in accordance with the American Society of Civil Engineers, Technical Engineering and Design Guides as adapted from the US Army Corps of Engineers, No. 9.

The calculations provided herein in Figures 8 and 9 indicate that the soil above the historic high groundwater level of 9 feet would not be susceptible to significant settlement as a result of the Design Earthquake peak ground acceleration ($\frac{2}{3}PGAM$).

7.6 Lateral Spreading

Due to the presence of the Dominguez Channel located to the west of the site, the potential for lateral spread was evaluated. Lateral spread occurs as a result of liquefaction induced lateral ground movement and typically occurs due to the presence of a slope comprised of and/or underlain by liquefiable soils.

Analysis of the potential for lateral spread was performed using the program CLiq (Version 1.7). The program utilizes the method proposed by Zhang et. al. (2004) to evaluate the potential for lateral spread and the resulting lateral displacements.

This method of analysis recommends evaluating the potential for lateral displacements to a distance of 50H from the slope, where H is the height of the slope. Beyond a horizontal distance of 50H lateral displacements due to the presence of a slope are not anticipated to occur. This method of analysis considers soils to a depth of twice the total slope height as potentially subject to lateral spread, up to a distance of 50H away from the toe of the slope.

The drainage channel is trapezoidal in shape and consists of two slopes approximately 12 feet in height inclined at a gradient of approximately 2:1 (estimated via satellite images). The proposed improvements have a minimum setback of 90 feet from the toe of the drainage channel. Therefore, lateral displacements using a horizontal setback of 90 feet was utilized.

Based on the results of the analyses it is anticipated that up to 10 inches of lateral displacements towards the drainage channel could occur during a Design Earthquake ground motion. The lateral displacements are anticipated to occur between depths of 10 and 15 feet below the ground surface. Calculations and output from CLiq are provided as Appendix C.

The grading and foundation design recommendations presented in this report are intended to minimize the effects of lateral spread on the proposed improvements.

7.7 Slope Stability

The topography at the site is relatively level and the topography in the immediate site vicinity slopes gently to the west-southwest. The County of Los Angeles Safety Element (Leighton, 1990) indicates the site is not located within an area identified as a “hillside area” or having a potential for slope instability. Additionally, the site is not within an area identified as having a potential for seismic slope instability (CDMG, 1999). There are no known landslides near the site, nor is the site in the path of any known or potential landslides. Therefore, the potential for slope stability hazards to adversely affect the proposed development is considered low.

7.8 Earthquake-Induced Flooding

Earthquake-induced flooding is inundation caused by failure of dams or other water-retaining structures due to earthquakes. Based on a review of the County of Los Angeles Safety Element (Leighton, 1990), the site is not located within a potential inundation area for an earthquake-induced dam failure. Therefore, the probability of earthquake-induced flooding is considered very low.

7.9 Tsunamis, Seiches, and Flooding

The site is not located within a coastal area. Therefore, tsunamis are not considered a significant hazard at the site.

Seiches are large waves generated in enclosed bodies of water in response to ground shaking. No major water-retaining structures are located immediately up gradient from the project site. Therefore, flooding resulting from a seismic-induced seiche is considered unlikely.

The site is within an area of minimal flooding (Zone X) as defined by the Federal Emergency Management Agency (FEMA, 2021; LACDPW, 2021).

7.10 Oil Fields & Methane Potential

Based on a review of the California Geologic Energy Management Division (CalGEM) Well Finder Website, the site is not located within an oil field and oil or gas wells are not documented in the immediate site vicinity (CalGEM, 2021). However, due to the voluntary nature of record reporting by the oil well drilling companies, wells may be improperly located or not shown on the location map and undocumented wells could be encountered during construction. Any wells encountered during construction will need to be properly abandoned in accordance with the current requirements of the CalGEM.

Since the site is not located within an oil field, the potential for methane or other volatile gases associated with oil and gas fields to be present at the site is considered low. However, as discussed in the Background section of this report (see Section 3), due to the site history there is a potential for low levels of volatile gases to be present, particularly during site grading. Should it be determined that a methane study or further environmental studies are required for the proposed development, it is recommended that a qualified methane or environmental consultant be retained to perform the study and provide mitigation measures as necessary.

7.11 Subsidence

Subsidence occurs when a large portion of land is displaced vertically, usually due to the withdrawal of groundwater, oil, or natural gas. Soils that are particularly subject to subsidence include those with high silt or clay content. The site is not located within an area of known ground subsidence. No large-scale extraction of groundwater, gas, oil, or geothermal energy is occurring or planned at the site or in the general site vicinity. There appears to be little or no potential for ground subsidence due to withdrawal of fluids or gases at the site.

8. CONCLUSIONS AND RECOMMENDATIONS

8.1 General

- 8.1.1 It is our opinion that neither soil nor geologic conditions were encountered during the investigation that would preclude construction of the proposed development provided the recommendations presented herein are followed and implemented during design and construction.
- 8.1.2 Up to 5 feet of existing artificial fill was encountered during the site investigation with localized areas of deeper fill of to 9 feet in depth. The existing fill encountered is believed to be the result of past grading and construction activities at the site. Deeper fill may exist in other areas of the site that were not directly explored. It is our opinion that the existing fill, in its present condition, is not suitable for direct support of proposed foundations or slabs. The existing fill and site soils are suitable for re-use as engineered fill provided the recommendations in the Grading section of this report are followed (see Section 8.4).
- 8.1.3 The enclosed liquefaction and seismically-induced settlement analyses indicate that the site soils could be susceptible to approximately ½ inch of total settlement as a result of the Design Earthquake peak ground acceleration ($\frac{2}{3}PGA_M$). Differential settlement at the foundation level is anticipated to be less than ¼ inch over a distance of 20 feet.
- 8.1.4 The results of the field data and laboratory testing indicate that the upper alluvial soils are relatively soft and compressible in their current condition (see Figure B5 thru B17) and could yield excessive static and differential settlements upon application of foundation loads.
- 8.1.5 The foundation design recommendations presented herein are intended to minimize the effects of settlement from liquefaction and consolidation on the proposed improvements. Based on our discussions with you, we understand that the preferred foundation system is a reinforced concrete mat foundation deriving support in newly placed engineered fill. Recommendations for a reinforced mat foundation system is provided in Sections 8.7 of this report.
- 8.1.6 For support of a mat foundation, it is recommended that the upper 6 feet of existing earth materials within the proposed building footprint areas be excavated and properly compacted for foundation and slab support. Deeper excavations should be conducted as necessary to remove deeper artificial fill or soft alluvial soil at the direction of the Geotechnical Engineer (a representative of Geocon). Proposed building foundations should be underlain by a minimum of 4 feet of newly placed engineered fill. The excavation should extend laterally a minimum distance of 3 feet beyond the building footprint area, including building appurtenances, or a distance equal to the depth of fill below the foundation, whichever is greater. The contractor should be aware that up to 9 feet of artificial fill was encountered in Boring B3. The limits of existing fill and/or soft alluvial soils removal will be verified by the Geocon representative during site grading activities. All excavations must be observed and approved in writing by the Geotechnical Engineer (a representative of Geocon).

- 8.1.7 It is anticipated that the recommended grading can be achieved with sloping measures. However, if excavations in close proximity to an adjacent property line and/or structure are required, special excavation measures in order to maintain lateral support of existing adjacent improvements will be required. Excavation recommendations are provided in the *Temporary Excavations* section of this report (Section 8.18).
- 8.1.8 Based on the relatively shallow groundwater table, the upper alluvial soils have the potential to be very moist and the grading contractor should be aware that the soils may be above optimum moisture content. If the soils are more than 3 percent above the optimum moisture content at the time of construction the soils will likely require some spreading and drying activities in order to achieve proper compaction. Bottom stabilization may also be necessary. Recommendations for bottom stabilization and earthwork are provided in the *Grading* section of this report (see Section 8.4).
- 8.1.9 Foundations for small outlying structures, such as block walls up to 6 feet in height, planter walls or trash enclosures, which will not be tied to the proposed structure, may be supported on conventional foundations deriving support on a minimum of 12 inches of newly placed engineered fill which extends laterally at least 12 inches beyond the foundation area. Where excavation and compaction cannot be performed or is undesirable, foundations may derive support directly in the competent undisturbed alluvial soils and should be deepened as necessary to maintain a minimum 12 inch embedment into the recommended bearing materials. If the soils exposed in the excavation bottom are soft or loose, compaction of the soils will be required prior to placing steel or concrete. Compaction of the foundation excavation bottom is typically accomplished with a compaction wheel or mechanical whacker and must be observed and approved in writing by a Geocon representative.
- 8.1.10 Where new paving is to be placed, it is recommended that all existing fill and soft alluvial soils be excavated and properly compacted for paving support. The client should be aware that excavation and compaction of all existing fill and soft alluvial soils in the area of new paving is not required; however, paving constructed over existing uncertified fill or unsuitable alluvial soil may experience increased settlement and/or cracking, and may therefore have a shorter design life and increased maintenance costs. As a minimum, the upper 12 inches of subgrade soil should be scarified and properly compacted for paving support. Paving recommendations are provided in *Preliminary Pavement Recommendations* section of this report (see Section 8.13).
- 8.1.11 Based on the shallow groundwater and impermeable nature of the fine grained soils which underly the site, infiltration of stormwater at this site is not considered feasible. Infiltration of stormwater at this site would be considered detrimental to the project. It is recommended that stormwater be retained, filtered, and discharged in accordance with the requirements of the local governing agency.

- 8.1.12 It should be noted that implementation of the recommendations presented herein is not intended to completely prevent damage to the structure during the occurrence of strong ground shaking as a result of nearby earthquakes. It is intended that the structure be designed in such a way that the amount of damage incurred as a result of strong ground shaking be minimized.
- 8.1.13 It is recommended that flexible utility connections be utilized for all rigid utilities to minimize or prevent damage to utilities from minor differential movements.
- 8.1.14 Once the design and foundation loading configuration for the proposed structure proceeds to a more finalized plan, the recommendations within this report should be reviewed and revised, if necessary. Based on the final foundation loading configurations, the potential for settlement should be reevaluated by this office.
- 8.1.15 Any changes in the design, location or elevation of improvements, as outlined in this report, should be reviewed by this office. Geocon should be contacted to determine the necessity for review and possible revision of this report.

8.2 Soil and Excavation Characteristics

- 8.2.1 The in-situ soils can be excavated with moderate effort using conventional excavation equipment. Some caving should be anticipated in unshored excavations, especially where granular soils are encountered.
- 8.2.2 It is the responsibility of the contractor to ensure that all excavations and trenches are properly shored and maintained in accordance with applicable OSHA rules and regulations to maintain safety and maintain the stability of existing adjacent improvements.
- 8.2.3 All onsite excavations must be conducted in such a manner that potential surcharges from existing structures, construction equipment, and vehicle loads are resisted. The surcharge area may be defined by a 1:1 projection down and away from the bottom of an existing foundation or vehicle load. Penetrations below this 1:1 projection will require special excavation measures such as sloping or shoring. Excavation recommendations are provided in the *Temporary Excavations* section of this report (see Section 8.18).
- 8.2.4 The upper 5 feet of existing site soils encountered during the investigation are considered to have a “medium” expansive potential ($EI = 63$) and are classified as “expansive” in accordance with the 2019 California Building Code (CBC) Section 1803.5.3. The recommendations presented herein assume that the building foundations and slabs will derive support in these materials.

8.3 Minimum Resistivity, pH, and Water-Soluble Sulfate

- 8.3.1 Potential of Hydrogen (pH) and resistivity testing, as well as chloride content testing, were performed on representative samples of on-site material to generally evaluate the corrosion potential to surface utilities. The tests were performed in accordance with California Test Method Nos. 643 and 422 and indicate that the soils are considered “moderately corrosive” to “severely corrosive” with respect to corrosion of buried ferrous metals on site. The results are presented in Appendix B (Figure B23) and should be considered for design of underground structures. Due to the corrosive potential of the soils, it is suggested that ABS pipes be considered in lieu of cast-iron for subdrains and retaining wall drains beneath the structure.
- 8.3.2 Laboratory tests were performed on representative samples of the site materials to measure the percentage of water-soluble sulfate content. Results from the laboratory water-soluble sulfate tests are presented in Appendix B (Figure B23) and indicate that the on-site materials possess a sulfate exposure class of “S0” to concrete structures as defined by 2019 CBC Section 1904 and ACI 318-14 Table 19.3.1.1.
- 8.3.3 Geocon West, Inc. does not practice in the field of corrosion engineering and mitigation. If corrosion sensitive improvements are planned, it is recommended that a corrosion engineer be retained to evaluate corrosion test results and incorporate the necessary precautions to avoid premature corrosion of buried metal pipes and concrete structures in direct contact with the soils.

8.4 Grading

- 8.4.1 Grading is anticipated to include preparation of building pads and paving subgrade, excavation of site soils for proposed foundations and utility trenches, as well as placement of backfill for utility trenches.
- 8.4.2 A preconstruction conference should be held at the site prior to the beginning of grading operations with the owner, contractor, civil engineer and soil engineer in attendance. Special soil handling requirements can be discussed at that time.
- 8.4.3 Earthwork should be observed, and compacted fill tested by representatives of Geocon West, Inc. The existing fill and alluvial soils encountered during exploration are suitable for reuse as engineered fill, provided any encountered oversize material (greater than 6 inches) and any encountered deleterious debris is removed.

- 8.4.4 Grading should commence with the removal of all existing vegetation and existing improvements from the area to be graded. Deleterious debris such as wood and root structures should be exported from the site and should not be mixed with the fill soils. Asphalt and concrete should not be mixed with the fill soils unless approved by the Geotechnical Engineer. All existing underground improvements planned for removal should be completely excavated and the resulting depressions properly backfilled in accordance with the procedures described herein. Once a clean excavation bottom has been established it must be observed and approved in writing by the Geotechnical Engineer (a representative of Geocon West, Inc.).
- 8.4.5 For support of a mat foundation, it is recommended that the upper 6 feet of existing earth materials within the proposed building footprint areas be excavated and properly compacted for foundation and slab support. Deeper excavations should be conducted as necessary to remove deeper artificial fill or soft alluvial soil at the direction of the Geotechnical Engineer (a representative of Geocon). Proposed building foundations should be underlain by a minimum of 4 feet of newly placed engineered fill. The excavation should extend laterally a minimum distance of 3 feet beyond the building footprint area, including building appurtenances, or a distance equal to the depth of fill below the foundation, whichever is greater. The contractor should be aware that up to 9 feet of artificial fill was encountered in Boring B3. The limits of existing fill and/or soft alluvial soils removal will be verified by the Geocon representative during site grading activities.
- 8.4.6 All excavations must be observed and approved in writing by the Geotechnical Engineer (a representative of Geocon). If determined to be excessively soft, stabilization of the bottom of the excavation may be required in order to provide a firm working surface upon which engineered fill can be placed and heavy equipment can operate.
- 8.4.7 Prior to placing fill or constructing proposed improvements, a stable excavation bottom must be established. In areas where the subgrade is saturated or soft, proper compaction will likely not be possible or achieved in a timely manner without introducing stabilization measures. If subgrade stabilization is required at the excavation bottom, rubber tire equipment should not be allowed in the excavation bottom until it is stabilized or extensive soil disturbance could result. It is suggested that excavation and grading be performed during the summer season to promote moisture control of the soils. In addition, the use of track equipment should be used to minimize disturbance to the soils at the excavation bottom.

- 8.4.8 Bottom stabilization, if necessary, may be achieved placing a thin lift of 3- to 6-inch-diameter crushed angular rock into the soft excavation bottom. The use of crushed concrete will also be acceptable. The crushed rock should be spread thinly across the excavation bottom and pressed into the soils by track rolling or wheel rolling with heavy equipment. It is very important that voids between the rock fragments are not created so the rock must be thoroughly pressed or blended into the soils. All subgrade soils must be properly compacted and proof-rolled in the presence of the Geotechnical Engineer (a representative of Geocon West, Inc.).
- 8.4.9 An alternative method of subgrade stabilization may be accomplished by placing a one-foot-thick layer of washed, angular 3/4-inch gravel atop a stabilization fabric (Mirafi 500X or equivalent) subsequent to subgrade approval. Stabilization fabric should also be placed over the top of the gravel. This procedure should be conducted in sections until the entire excavation bottom has been blanketed by fabric and gravel. Heavy equipment may operate on the gravel once it has been placed. The gravel should be compacted to a dense state using a vibratory drum roller. It is recommended that the contractor meet with the Geotechnical Engineer to discuss this procedure in more detail.
- 8.4.10 The upper soils encountered during site exploration were moist to wet and the grading contractor should be aware that the existing soils are currently above optimum moisture content. Conditions could change seasonally. If the soils are more than 3 percent above the optimum moisture content at the time of construction the soils will likely require spreading, processing, and drying activities in order to achieve proper compaction.
- 8.4.11 All fill and backfill soils should be placed in horizontal loose layers approximately 6 to 8 inches thick, moisture conditioned to near 2 percent above optimum moisture content, and properly compacted to a minimum of 90 percent of the maximum dry density per ASTM D 1557 (latest edition).
- 8.4.12 It is anticipated that stable excavations for the recommended grading can be achieved with sloping measures. However, if excavations in close proximity to an adjacent property line and/or structure are required, special excavation measures may be necessary in order to maintain lateral support of offsite improvements. Excavation recommendations are provided in the *Temporary Excavations* section of this report (see Section 8.18).
- 8.4.13 Although not anticipated for this project, all imported fill shall be observed, tested, and approved by Geocon West, Inc. prior to bringing soil to the site. Rocks larger than 6 inches in diameter shall not be used in the fill. If necessary, import soils used as structural fill should have an expansion index less than 50 and corrosivity properties that are equally or less detrimental to that of the existing onsite soils (see Figure B23).

- 8.4.14. Where new paving is to be placed, it is recommended that all existing fill and soft alluvium be excavated and properly compacted for paving support. As a minimum, the upper 12 inches of soil should be scarified, moisture conditioned to near two percent over optimum moisture content, and compacted to at least 92 percent relative compaction, as determined by ASTM Test Method D 1557 (latest edition). Paving recommendations are provided in *Preliminary Pavement Recommendations* section of this report (see Section 8.13).
- 8.4.15 Foundations for small outlying structures, such as block walls up to 6 feet in height, planter walls or trash enclosures, which will not be tied to the proposed structure, may be supported on conventional foundations deriving support on a minimum of 12 inches of newly placed engineered fill which extends laterally at least 12 inches beyond the foundation area. Where excavation and compaction cannot be performed or is undesirable, foundations may derive support directly in the competent undisturbed alluvial soils and should be deepened as necessary to maintain a minimum 12 inch embedment into the recommended bearing materials. If the soils exposed in the excavation bottom are soft or loose, compaction of the soils will be required prior to placing steel or concrete. Compaction of the foundation excavation bottom is typically accomplished with a compaction wheel or mechanical whacker and must be observed and approved by a Geocon representative.
- 8.4.16 It is recommended that flexible utility connections be utilized for all rigid utilities to minimize or prevent damage to utilities from minor differential movements. Utility trenches should be properly backfilled in accordance with the requirements of the Green Book (latest edition). The pipe should be bedded with clean sands (Sand Equivalent greater than 30) to a depth of at least 1 foot over the pipe, and the bedding material must be inspected and approved in writing by the Geotechnical Engineer (a representative of Geocon). The use of gravel is not acceptable unless used in conjunction with filter fabric to prevent the gravel from having direct contact with soil. The remainder of the trench backfill may be derived from onsite soil or approved import soil, compacted as necessary, until the required compaction is obtained. The use of minimum 2-sack slurry as backfill is also acceptable. Prior to placing any bedding materials or pipes, the trench excavation bottom must be observed and approved in writing by the Geotechnical Engineer (a representative of Geocon).
- 8.4.17 All trench and foundation excavation bottoms must be observed and approved in writing by the Geotechnical Engineer (a representative of Geocon), prior to placing bedding sands, fill, steel, gravel, or concrete.

8.5 Shrinkage

- 8.5.1 Shrinkage results when a volume of material removed at one density is compacted to a higher density. A shrinkage factor between 10 and 15 percent should be anticipated when excavating and compacting the upper 5 feet of existing earth materials on the site to an average relative compaction of 92 percent.
- 8.5.2 If import soils will be utilized in the building pad, the soils must be placed uniformly and at equal thickness at the direction of the Geotechnical Engineer (a representative of Geocon West, Inc.). Soils can be borrowed from non-building pad areas and later replaced with imported soils.

8.6 Mat Foundation Design

- 8.6.1 Subsequent to the recommended grading, a reinforced concrete mat foundation may be utilized for support of the proposed structures. The reinforced concrete mat foundation should derive support in the newly placed engineered fill and be underlain by at least 4 feet of newly placed engineered fill.
- 8.6.2 Foundation excavations should be observed and approved in writing by the Geotechnical Engineer (a representative of Geocon West, Inc.), prior to the placement of reinforcing steel and concrete to verify that the excavations and exposed soil conditions are consistent with those anticipated. If unanticipated soil conditions are encountered, foundation modifications may be required.
- 8.6.3 It is anticipated that the mat foundation constructed for the on-grade structure will impart an average pressure between 2,000 psf to 3,500 psf. The recommended maximum allowable bearing value is 3,500 psf. The allowable bearing pressure may be increased by up to one-third for transient loads due to wind or seismic forces.
- 8.6.4 A vertical modulus of subgrade reaction of 100 pci may be used in the design of mat foundations deriving support in competent alluvial soils. This value is a unit value for use with a 1-foot square footing. The modulus should be reduced in accordance with the following equation when used with larger foundations:

$$K_R = K \left[\frac{B+1}{2B} \right]^2$$

where: K_R = reduced subgrade modulus
 K = unit subgrade modulus
 B = foundation width (in feet)

- 8.6.5 The thickness of and reinforcement for the mat foundation should be designed by the project structural engineer.
- 8.6.6 For seismic design purposes, a coefficient of friction of 0.35 may be utilized between the concrete mat and newly placed engineered fill without a moisture barrier, and 0.15 for slabs underlain by a moisture barrier.
- 8.6.7 The enclosed liquefaction settlement analyses indicate that the site soils could be susceptible to less than ½ inch of total seismic settlement as a result of the Design Earthquake peak ground acceleration ($\frac{2}{3}PGA_M$). Differential settlement at the foundation level is anticipated to be less than ¼ inches over a distance of 20 feet. The foundation design recommendations presented herein are intended to minimize the effects of settlement on proposed improvements.
- 8.6.8 The maximum expected total settlement for a structure support on a mat foundation system designed with the maximum allowable bearing value of 3,500 psf and deriving support in the recommended bearing materials is estimated to be approximately 2 inches and occur below the heaviest loaded structural element. A majority of the settlement of the foundation system is expected to occur on initial application of loading; however, additional settlements are expected within the first twelve months. Differential settlement is not expected to exceed 1 inch over a distance of 20 feet.
- 8.6.9 Based on these considerations it is recommended that the proposed structure, designed with a maximum allowable bearing value of 3,500 psf, be designed for a combined static and seismically induced differential settlement of 1 ½ inch over a distance of 20 feet.
- 8.6.10 This office should be provided a copy of the final construction plans so that the excavation recommendations presented herein could be properly reviewed and revised if necessary.
- 8.6.11 Once the design and foundation loading configurations for the proposed structures proceeds to a more finalized plan, the estimated settlements presented in this report should be reviewed and revised, if necessary. If the final foundation loading configurations are greater than the assumed loading conditions, the potential for settlement should be reevaluated by this office.

8.7 Miscellaneous Foundations

- 8.7.1 Foundations for small outlying structures, such as block walls up to 6 feet in height, planter walls or trash enclosures, which will not be tied to the proposed structure, may be supported on conventional foundations deriving support on a minimum of 12 inches of newly placed engineered fill which extends laterally at least 12 inches beyond the foundation area. Where excavation and compaction cannot be performed or is undesirable, foundations may derive support directly in the competent undisturbed alluvial soils, and should be deepened as necessary to maintain a minimum 12 inch embedment into the recommended bearing materials.

8.7.2 If the soils exposed in the excavation bottom are soft, compaction of the soft soils will be required prior to placing steel or concrete. Compaction of the foundation excavation bottom is typically accomplished with a compaction wheel or mechanical whacker and must be observed and approved by a Geocon representative. Miscellaneous foundations may be designed for a bearing value of 1,500 psf, and should be a minimum of 12 inches in width, 24 inches in depth below the lowest adjacent grade and 12 inches into the recommended bearing material. The allowable bearing pressure may be increased by up to one-third for transient loads due to wind or seismic forces.

8.7.3 Foundation excavations should be observed and approved in writing by the Geotechnical Engineer (a representative of Geocon West, Inc.), prior to the placement of reinforcing steel and concrete to verify that the excavations and exposed soil conditions are consistent with those anticipated.

8.8 Lateral Design

8.8.1 Resistance to lateral loading may be provided by friction acting at the base of foundations, slabs and by passive earth pressure. An allowable coefficient of friction of 0.35 may be used with the dead load forces in the undisturbed alluvial soils and newly placed engineered fill.

8.8.2 Passive earth pressure for the sides of foundations and slabs poured against newly placed engineered fill or undisturbed alluvial soils may be computed as an equivalent fluid having a density of 230 pounds per cubic foot (pcf) with a maximum earth pressure of 2,300 psf. When combining passive and friction for lateral resistance, the passive component should be reduced by one-third. A one-third increase in the passive value may be used for wind or seismic loads.

8.9 Concrete Slabs-on-Grade

8.9.1 Exterior concrete slabs-on-grade subject to vehicle loading should be designed in accordance with the recommendations in the *Preliminary Pavement Recommendations* section of this report (Section 8.10).

- 8.9.2 Slabs-on-grade at the ground surface that may receive moisture-sensitive floor coverings or may be used to store moisture-sensitive materials should be underlain by a vapor retarder placed directly beneath the slab. The vapor retarder and acceptable permeance should be specified by the project architect or developer based on the type of floor covering that will be installed. The vapor retarder design should be consistent with the guidelines presented in Section 9.3 of the American Concrete Institute's (ACI) Guide for Concrete Slabs that Receive Moisture-Sensitive Flooring Materials (ACI 302.2R-06) and should be installed in general conformance with ASTM E 1643 (latest edition) and the manufacturer's recommendations. A minimum thickness of 15 mils extruded polyolefin plastic is recommended; vapor retarders which contain recycled content or woven materials are not recommended. The vapor retarder should have a permeance of less than 0.01 perms demonstrated by testing before and after mandatory conditioning. The vapor retarder should be installed in direct contact with the concrete slab with proper perimeter seal. If the Los Angeles Green Building Code requirements apply to this project, the vapor retarder should be underlain by 4 inches of clean aggregate. It is important that the vapor retarder be puncture resistant since it will be in direct contact with angular gravel. As an alternative to the clean aggregate suggested in the Los Angeles Green Building Code, it is our opinion that the concrete slab-on-grade may be underlain by a vapor retarder over 4 inches of clean sand (sand equivalent greater than 30), since the sand will serve a capillary break and will minimize the potential for punctures and damage to the vapor barrier.
- 8.9.3 For seismic design purposes, a coefficient of friction of 0.35 may be utilized between concrete slabs and subgrade soils without a moisture barrier, and 0.15 for slabs underlain by a moisture barrier.
- 8.9.4 Exterior slabs, not subject to traffic loads, should be at least 4 inches thick and reinforced with No. 3 steel reinforcing bars placed 18 inches on center in both horizontal directions, positioned near the slab midpoint. Prior to construction of slabs, the upper 12 inches of subgrade should be moistened to optimum moisture content and properly compacted to at least 92 percent relative compaction, as determined by ASTM Test Method D 1557 (latest edition). Crack control joints should be spaced at intervals not greater than 10 feet and should be constructed using saw-cuts or other methods as soon as practical following concrete placement. Crack control joints should extend a minimum depth of one-fourth the slab thickness. The project structural engineer should design construction joints as necessary.
- 8.9.5 Due to the expansive potential of the anticipated subgrade soils, the moisture content of the slab subgrade should be maintained and sprinkled as necessary to maintain a moist condition as would be expected in any concrete placement. Furthermore, consideration should be given to doweling slabs into adjacent curbs and foundations to minimize movements and offsets which could lead to a potential tripping hazard.

8.9.6 The recommendations of this report are intended to reduce the potential for cracking of slabs due to settlement. However, even with the incorporation of the recommendations presented herein, foundations, stucco walls, and slabs-on-grade may exhibit some cracking due to minor soil movement and/or concrete shrinkage. The occurrence of concrete shrinkage cracks is independent of the supporting soil characteristics. Their occurrence may be reduced and/or controlled by limiting the slump of the concrete, proper concrete placement and curing, and by the placement of crack control joints at periodic intervals, in particular, where re-entrant slab corners occur.

8.10 Preliminary Paving Design

8.10.1 Where new paving is to be placed, it is recommended that all existing fill and soft alluvium materials be excavated and properly compacted for paving support. The client should be aware that excavation and compaction of all existing artificial fill and soft alluvium in the area of new paving is not required; however, paving constructed over existing uncertified fill or unsuitable alluvium material may experience increased settlement and/or cracking, and may therefore have a shorter design life and increased maintenance costs. As a minimum, the upper 12 inches of paving subgrade should be scarified, moisture conditioned to at least 2 percent above optimum moisture content, and properly compacted to at least 92 percent relative compaction, as determined by ASTM Test Method D 1557 (latest edition).

8.10.2 The following pavement sections are based on an assumed R-Value of 20. Once site grading activities are complete an R-Value should be obtained by laboratory testing to confirm the properties of the soils serving as paving subgrade, prior to placing pavement.

8.10.3 The Traffic Indices listed below are estimates. Geocon does not practice in the field of traffic engineering. The actual Traffic Index for each area should be determined by the project civil engineer. If pavement sections for Traffic Indices other than those listed below are required, Geocon should be contacted to provide additional recommendations. Pavement thicknesses were determined following procedures outlined in the *California Highway Design Manual* (Caltrans). It is anticipated that the majority of traffic will consist of automobile and large truck traffic.

PRELIMINARY PAVEMENT DESIGN SECTIONS

| Location | Estimated Traffic Index (TI) | Asphalt Concrete (inches) | Class 2 Aggregate Base (inches) |
|----------------------------------|-------------------------------------|----------------------------------|--|
| Automobile Parking and Driveways | 4.0 | 3.0 | 4.0 |
| Trash Truck & Fire Lanes | 7.0 | 4.0 | 12.0 |

- 8.10.4 Asphalt concrete should conform to Section 203-6 of the “*Standard Specifications for Public Works Construction*” (Green Book). Class 2 aggregate base materials should conform to Section 26-1.02A of the “*Standard Specifications of the State of California, Department of Transportation*” (Caltrans). The use of Crushed Miscellaneous Base (CMB) in lieu of Class 2 aggregate base is acceptable. Crushed Miscellaneous Base should conform to Section 200-2.4 of the “*Standard Specifications for Public Works Construction*” (Green Book).
- 8.10.5 Unless specifically designed and evaluated by the project structural engineer, where exterior concrete paving will be utilized for support of vehicles, it is recommended that the concrete be a minimum of 6 inches of concrete reinforced with No. 3 steel reinforcing bars placed 18 inches on center in both horizontal directions. Concrete paving supporting vehicular traffic should be underlain by a minimum of 4 inches of aggregate base and a properly compacted subgrade. As a minimum, the upper 12 inches of paving subgrade should be scarified, moisture conditioned to 2 percent above optimum moisture content, and properly compacted to at least 92 percent relative compaction, as determined by ASTM Test Method D 1557 (latest edition). The base material should be compacted to 95 percent relative compaction as determined by ASTM Test Method D 1557 (latest edition).
- 8.10.6 The performance of pavements is highly dependent upon providing positive surface drainage away from the edge of pavements. Ponding of water on or adjacent to the pavement will likely result in saturation of the subgrade materials and subsequent cracking, subsidence and pavement distress. If planters are planned adjacent to paving, it is recommended that the perimeter curb be extended at least 12 inches below the bottom of the aggregate base to minimize the introduction of water beneath the paving.

8.11 Retaining Wall Design

- 8.11.1 The recommendations presented below are generally applicable to the design of rigid concrete or masonry retaining walls having a maximum height of 5 feet. In the event that walls significantly higher than 5 feet are planned, Geocon should be contacted for additional recommendations.
- 8.11.2 Retaining wall foundations should be designed in accordance with the recommendations provided in the *Foundation Design* section of this report (see Sections 8.6 through 8.9).
- 8.11.3 Retaining walls with a level backfill surface that are not restrained at the top should be designed utilizing a triangular distribution of pressure (active pressure). Restrained walls are those that are not allowed to rotate more than 0.001H (where H equals the height of the retaining portion of the wall in feet) at the top of the wall. Where walls are restrained from movement at the top, walls may be designed utilizing a triangular distribution of pressure (at-rest pressure). The table on the following page presents recommended pressures to be used in retaining wall design.

RETAINING WALL WITH LEVEL BACKFILL SURFACE

| HEIGHT OF RETAINING WALL (Feet) | ACTIVE PRESSURE EQUIVALENT FLUID PRESSURE (Pounds Per Cubic Foot) | AT-REST PRESSURE EQUIVALENT FLUID PRESSURE (Pounds Per Cubic Foot) |
|---------------------------------------|--|---|
| Up to 5 | 30 | 74 |

- 8.11.4 The wall pressures provided above assume that the proposed retaining walls will support a wedge of engineered fill derived from onsite soils. If import soil will be used to backfill proposed retaining walls, revised earth pressures may be required to account for the geotechnical properties of the import soil used as engineered fill. This should be evaluated once the use of import soil is established. All imported fill shall be observed, tested, and approved by Geocon West, Inc. prior to bringing soil to the site.
- 8.11.5 The wall pressures provided above assume that the retaining wall will be properly drained preventing the buildup of hydrostatic pressure. If retaining wall drainage is not implemented, the equivalent fluid pressure to be used in design of undrained walls is 100 pcf. The value includes hydrostatic pressures plus buoyant lateral earth pressures.
- 8.11.6 Additional active pressure should be added for a surcharge condition due to sloping ground, vehicular traffic or adjacent structures and should be designed for each condition as the project progresses. Surcharges may be evaluated using Section 8.19 of this report. Once the design becomes more finalized, an addendum letter can be prepared revising recommendations and addressing specific surcharge conditions throughout the project, if necessary.

8.12 Retaining Wall Drainage

- 8.12.1 Where not designed for hydrostatic pressure, retaining walls should be provided with a drainage system. At the base of the drain system, a subdrain covered with a minimum of 12 inches of gravel should be installed, and a compacted fill blanket or other seal placed at the surface (see Figure 10). The clean bottom and subdrain pipe, behind a retaining wall, should be observed by the Geotechnical Engineer (a representative of Geocon), prior to placement of gravel or compacting backfill.
- 8.12.2 As an alternative, a plastic drainage composite such as Miradrain or equivalent may be installed in continuous, 4-foot-wide columns along the entire back face of the wall, at 8 feet on center. The top of these drainage composite columns should terminate approximately 18 inches below the ground surface, where either hardscape or a minimum of 18 inches of relatively cohesive material should be placed as a cap (see Figure 11). These vertical columns of drainage material would then be connected at the bottom of the wall to a collection panel or a 1-cubic-foot rock pocket drained by a 4-inch subdrain pipe.

- 8.12.3 Subdrainage pipes at the base of the retaining wall drainage system should outlet to an acceptable location via controlled drainage structures.
- 8.12.4 Moisture affecting below grade walls is one of the most common post-construction complaints. Poorly applied or omitted waterproofing can lead to efflorescence or standing water. Particular care should be taken in the design and installation of waterproofing to avoid moisture problems, or actual water seepage into the structure through any normal shrinkage cracks which may develop in the concrete walls, floor slab, foundations and/or construction joints. The design and inspection of the waterproofing is not the responsibility of the geotechnical engineer. A waterproofing consultant should be retained in order to recommend a product or method, which would provide protection to subterranean walls, floor slabs and foundations.

8.13 Elevator Pit Design

- 8.13.1 The elevator pit slab and retaining wall should be designed by the project structural engineer. Elevator pit walls may be designed in accordance with the recommendations in the *Retaining Wall Design* section of this report (see Section 8.14).
- 8.13.2 Additional active pressure should be added for a surcharge condition due to sloping ground, vehicular traffic or adjacent foundations and should be designed for each condition as the project progresses.
- 8.13.3 If retaining wall drainage is to be provided, the drainage system should be designed in accordance with the *Retaining Wall Drainage* section of this report (see Section 8.15).
- 8.13.4 It is suggested that the exterior walls and slab be waterproofed to prevent excessive moisture inside of the elevator pit. Waterproofing design and installation is not the responsibility of the geotechnical engineer.

8.14 Elevator Piston

- 8.14.1 If a plunger-type elevator piston is installed for this project, a deep drilled excavation will be required. It is important to verify that the drilled excavation is not situated immediately adjacent to a foundation, or the drilled excavation could compromise the existing foundation support, especially if the drilling is performed subsequent to the foundation construction.
- 8.14.2 Due to the preliminary nature of the project at this time, it is unknown if a plunger-type elevator piston will be included for this project. If in the future it is determined that a plunger-type elevator piston will be constructed, the location of the proposed elevator should be reviewed by the Geotechnical Engineer to evaluate the setback from foundations. Additional recommendations will be provided as necessary.

- 8.14.3 Some caving is anticipated in the granular soils below a depth of 20 feet. The contractor should be prepared to use casing and should have it readily available at the commencement of drilling activities. Continuous observation of the drilling and installation of the elevator piston by the Geotechnical Engineer (a representative of Geocon West, Inc.) is required.
- 8.14.4 The annular space between the piston casing and drilled excavation wall should be filled with a minimum of 1½-sack slurry pumped from the bottom up. As an alternative, pea gravel may be utilized. The use of soil to backfill the annular space is not acceptable.

8.15 Temporary Excavations

- 8.15.1 Excavations on the order of 6 feet in height are generally anticipated during grading activities, and isolated excavations up to 9 feet in height may also be required. The excavations are expected to expose artificial fill and alluvial soils, which may be subject to some caving where granular soils are exposed. Temporary vertical excavations up to 5 feet in height may be attempted where not surcharged by adjacent traffic or structures.
- 8.15.2 Vertical excavations greater than 5 feet or where surcharged by existing structures will require sloping or shoring measures in order to provide a stable excavation. Where sufficient space is available, temporary unsurcharged embankments could be sloped back at a uniform 1:1 slope gradient or flatter up to a maximum of 9 feet in height. A uniform slope does not have a vertical portion. Where space is limited, shoring measures will be required. *Shoring* recommendations can be provided under separate cover if necessary.
- 8.15.3 If excavations in close proximity to an adjacent property line and/or structure are required, special excavation measures such as slot-cutting or shoring may be necessary in order to maintain lateral support of offsite improvements. Recommendations for slot-cutting and shoring can be provided under separate cover.
- 8.15.4 Where sloped embankments are utilized, the top of the slope should be barricaded to prevent vehicles and storage loads at the top of the slope within a horizontal distance equal to the height of the slope. If the temporary construction embankments are to be maintained during the rainy season, berms are suggested along the tops of the slopes where necessary to prevent runoff water from entering the excavation and eroding the slope faces. Geocon personnel should inspect the soils exposed in the cut slopes during excavation so that modifications of the slopes can be made if variations in the soil conditions occur. All excavations should be stabilized within 30 days of initial excavation.

8.16 Surcharge from Adjacent Structures and Improvements

- 8.16.1 Additional pressure should be added for a surcharge condition due to sloping ground, vehicular traffic or adjacent structures and should be designed for each condition as the project progresses.
- 8.16.2 It is recommended that line-load surcharges from adjacent wall footings, use horizontal pressures generated from NAV-FAC DM 7.2. The governing equations are:

$$\text{For } x/H \leq 0.4$$
$$\sigma_H(z) = \frac{0.20 \times \left(\frac{z}{H}\right)}{\left[0.16 + \left(\frac{z}{H}\right)^2\right]^2} \times \frac{Q_L}{H}$$

and

$$\text{For } x/H > 0.4$$
$$\sigma_H(z) = \frac{1.28 \times \left(\frac{x}{H}\right)^2 \times \left(\frac{z}{H}\right)}{\left[\left(\frac{x}{H}\right)^2 + \left(\frac{z}{H}\right)^2\right]^2} \times \frac{Q_L}{H}$$

where x is the distance from the face of the excavation or wall to the vertical line-load, H is the distance from the bottom of the footing to the bottom of excavation or wall, z is the depth at which the horizontal pressure is desired, Q_L is the vertical line-load and $\sigma_H(z)$ is the horizontal pressure at depth z .

- 8.16.3 It is recommended that vertical point-loads, from construction equipment outriggers or adjacent building columns use horizontal pressures generated from NAV-FAC DM 7.2. The governing equations are:

$$\text{For } x/H \leq 0.4$$

$$\sigma_H(z) = \frac{0.28 \times \left(\frac{z}{H}\right)^2}{\left[0.16 + \left(\frac{z}{H}\right)^2\right]^3} \times \frac{Q_P}{H^2}$$

and

$$\text{For } x/H > 0.4$$

$$\sigma_H(z) = \frac{1.77 \times \left(\frac{x}{H}\right)^2 \times \left(\frac{z}{H}\right)^2}{\left[\left(\frac{x}{H}\right)^2 + \left(\frac{z}{H}\right)^2\right]^3} \times \frac{Q_P}{H^2}$$

then

$$\sigma'_H(z) = \sigma_H(z) \cos^2(1.1\theta)$$

where x is the distance from the face of the excavation/wall to the vertical point-load, H is distance from the outrigger/bottom of column footing to the bottom of excavation, z is the depth at which the horizontal pressure is desired, Q_P is the vertical point-load, $\sigma_H(z)$ is the horizontal pressure at depth z , θ is the angle between a line perpendicular to the excavation/wall and a line from the point-load to location on the excavation/wall where the surcharge is being evaluated, and $\sigma_H(z)$ is the horizontal pressure at depth z .

8.17 Surface Drainage

- 8.17.1 Proper surface drainage is critical to the future performance of the project. Uncontrolled infiltration of irrigation excess and storm runoff into the soils can adversely affect the performance of the planned improvements. Saturation of a soil can cause it to lose internal shear strength and increase its compressibility, resulting in a change in the original designed engineering properties. Proper drainage should be maintained at all times.
- 8.17.2 All site drainage should be collected and controlled in non-erosive drainage devices. Drainage should not be allowed to pond anywhere on the site, and especially not against any foundation or retaining wall. The site should be graded and maintained such that surface drainage is directed away from structures in accordance with 2019 CBC 1804.4 or other applicable standards. In addition, drainage should not be allowed to flow uncontrolled over any descending slope. Discharge from downspouts, roof drains and scuppers are not recommended onto unprotected soils within 5 feet of the building perimeter. Planters which are located adjacent to foundations should be sealed to prevent moisture intrusion into the soils providing foundation support. Landscape irrigation is not recommended within 5 feet of the building perimeter footings except when enclosed in protected planters.

- 8.17.3 Positive site drainage should be provided away from structures, pavement, and the tops of slopes to swales or other controlled drainage structures. The building pad and pavement areas should be fine graded such that water is not allowed to pond.
- 8.17.4 Landscaping planters immediately adjacent to paved areas are not recommended due to the potential for surface or irrigation water to infiltrate the pavement's subgrade and base course. Either a subdrain, which collects excess irrigation water and transmits it to drainage structures, or impervious above-grade planter boxes should be used. In addition, where landscaping is planned adjacent to the pavement, it is recommended that consideration be given to providing a cutoff wall along the edge of the pavement that extends at least 12 inches below the base material.

8.18 Plan Review

- 8.18.1 Grading, foundation, and shoring plans should be reviewed by the Geotechnical Engineer (a representative of Geocon West, Inc.), prior to finalization to verify that the plans have been prepared in substantial conformance with the recommendations of this report and to provide additional analyses or recommendations.

LIMITATIONS AND UNIFORMITY OF CONDITIONS

1. The recommendations of this report pertain only to the site investigated and are based upon the assumption that the soil conditions do not deviate from those disclosed in the investigation. If any variations or undesirable conditions are encountered during construction, or if the proposed construction will differ from that anticipated herein, Geocon West, Inc. should be notified so that supplemental recommendations can be given. The evaluation or identification of the potential presence of hazardous or corrosive materials was not part of the scope of services provided by Geocon West, Inc.
2. This report is issued with the understanding that it is the responsibility of the owner, or of his representative, to ensure that the information and recommendations contained herein are brought to the attention of the architect and engineer for the project and incorporated into the plans, and the necessary steps are taken to see that the contractor and subcontractors carry out such recommendations in the field.
3. The findings of this report are valid as of the date of this report. However, changes in the conditions of a property can occur with the passage of time, whether they are due to natural processes or the works of man on this or adjacent properties. In addition, changes in applicable or appropriate standards may occur, whether they result from legislation or the broadening of knowledge. Accordingly, the findings of this report may be invalidated wholly or partially by changes outside our control. Therefore, this report is subject to review and should not be relied upon after a period of three years.
4. The firm that performed the geotechnical investigation for the project should be retained to provide testing and observation services during construction to provide continuity of geotechnical interpretation and to check that the recommendations presented for geotechnical aspects of site development are incorporated during site grading, construction of improvements, and excavation of foundations. If another geotechnical firm is selected to perform the testing and observation services during construction operations, that firm should prepare a letter indicating their intent to assume the responsibilities of project geotechnical engineer of record. A copy of the letter should be provided to the regulatory agency for their records. In addition, that firm should provide revised recommendations concerning the geotechnical aspects of the proposed development, or a written acknowledgement of their concurrence with the recommendations presented in our report. They should also perform additional analyses deemed necessary to assume the role of Geotechnical Engineer of Record.

LIST OF REFERENCES







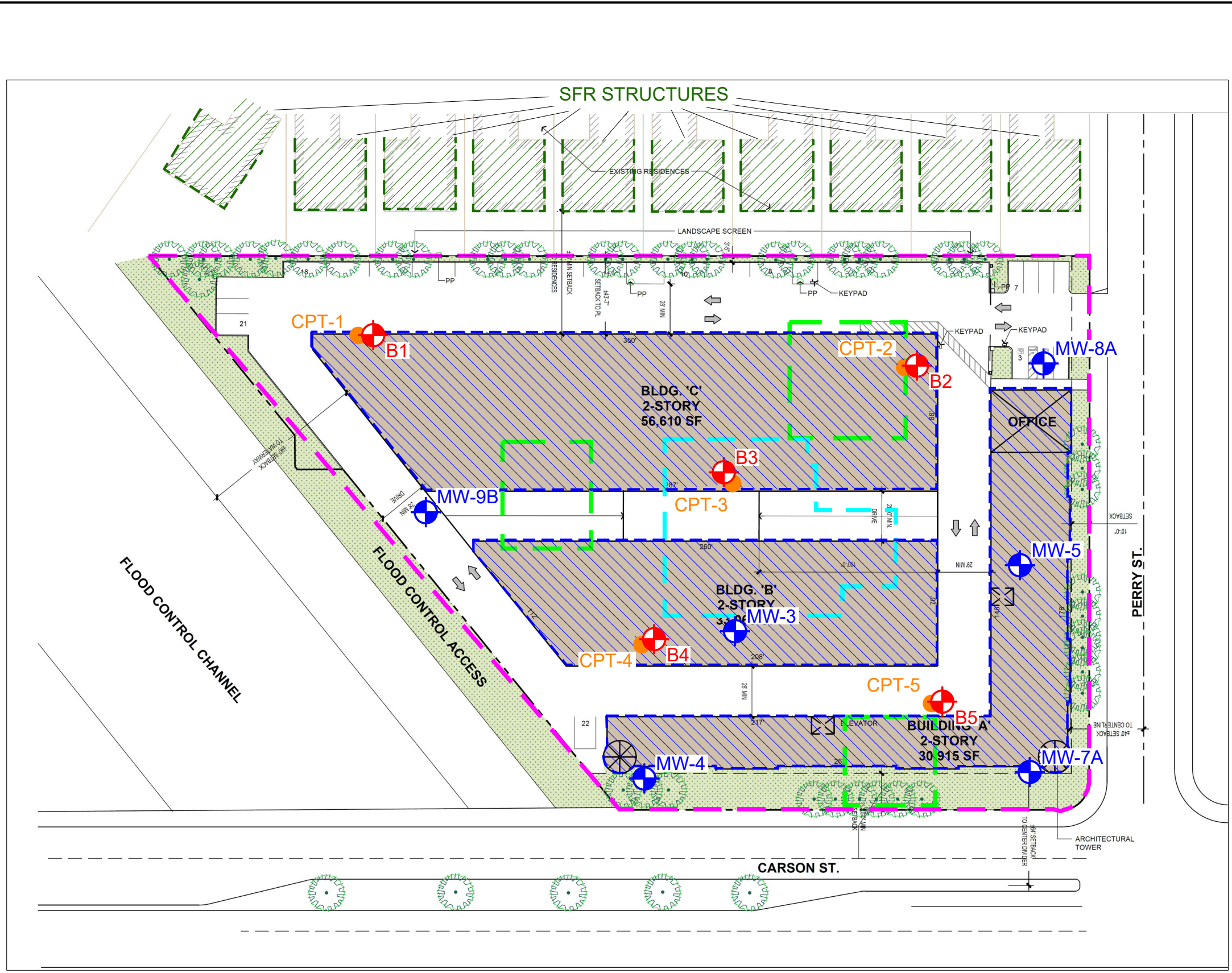

- California Division of Mines and Geology, 1998, *Seismic Hazard Evaluation of the Torrance 7.5-Minute Quadrangle, Los Angeles County, California*, Open-File Report 98-26.
- California Division of Mines and Geology, 1999; *State of California Seismic Hazard Zones, Torrance Quadrangle*, Official Map, Released: March 25, 1999.
- California Division of Mines and Geology, 1986, *State of California, Special Studies Zones, Torrance Quadrangle, Revised Official Map*, Effective: July 1, 1986.
- California Geologic Energy Management Division, 2021, Geologic Energy Management Division Well Finder, <http://maps.conservation.ca.gov.doggr/index.html#close>.
- California Geological Survey, 2021a, CGS Information Warehouse, Regulatory Map Portal, <http://maps.conservation.ca.gov/cgs/informationwarehouse/index.html?map=regulatorymaps>.
- California Geological Survey, 2021b, Earthquake Zones of Required Investigation, <https://maps.conservation.ca.gov/cgs/EQZApp/app/>.
- California Geological Survey, 2018, *Earthquake Fault Zones, A Guide for Government Agencies, Property Owners/Developers, and Geoscience Practitioners for Assessing Fault Rupture Hazards in California*, Special Publication 42, Revised 2018.
- California Geological Survey, 2010, *Geologic Compilation of Quaternary Surficial Deposits in Southern California, Onshore Portion of the Long Beach 30' X 60' Quadrangle*, A Project for the Department of Water Resources by the California Geological Survey, Compiled from existing sources by Trinda L. Bedrossian, CEG and Peter D. Roffers, CGS Special Report 217, Plate 8, Scale 1:100,000.
- Carson, City of, 2002, *Safety Element, Carson General Plan, Chapter 6*.
- FEMA, 2021, Online Flood Hazard Maps, <http://www.esri.com/hazards/index.html>.
- Jennings, C. W. and Bryant, W. A., 2010, *Fault Activity Map of California*, California Geological Survey Geologic Data Map No. 6.
- Leighton and Associates, Inc., 1990, *Technical Appendix to the Safety Element of the Los Angeles County General Plan, Hazard Reduction in Los Angeles County*.
- Los Angeles County Department of Public Works, 2021, Flood Zone Determination Website, <http://dpw.lacounty.gov/apps/wmd/floodzone/map.htm>.
- State Water Resources Control Board, 2021, GeoTracker website, <https://geotracker.waterboards.ca.gov/>.

LIST OF REFERENCES (Continued)

- Topozada, T., Branum, D., Petersen, M., Hallstrom, C., and Reichle, M., 2000, *Epicenters and Areas Damaged by $M > 5$ California Earthquakes, 1800 – 1999*, California Geological Survey, Map Sheet 49.
- U.S. Geological Survey and California Geological Survey, 2006, *Quaternary Fault and Fold Database for the United States*, accessed March 4, 2021 from USGS web site: <http://earthquake.usgs.gov/hazards/qfaults/>.
- Yerkes, R. F., McCulloch, T. H., Schoellhamer, J. E., and Vedder, J. G., 1965, *Geology of the Los Angeles Basin—An Introduction*, U.S. Geological Survey Professional Paper 420-A .
- Ziony, J. I., and Jones, L. M., 1989, *Map Showing Late Quaternary Faults and 1978–1984 Seismicity of the Los Angeles Region, California*, U.S. Geological Survey Miscellaneous Field Studies Map MF-1964.



LEGEND

-  B5 Approximate Location of Boring
-  CPT-5 Approximate Location of CPT
-  MW-9B Approximate Location of Monitoring Well
-  Property Limits
-  Existing Off-Site Structures
-  Proposed New Medical Office Building
-  Extent of URS Removal and Recompaction (5 FT BGS)
-  Extent of URS Removal and Recompaction (8 FT BGS)

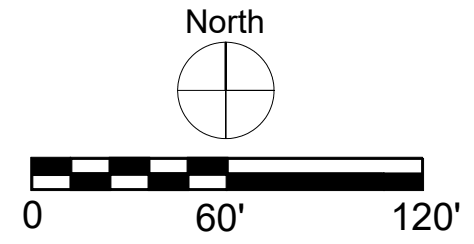

| | | |
|---|-------------------------|---|
| GEOCON WEST, INC. | |  |
| ENVIRONMENTAL GEOTECHNICAL MATERIALS 3303 N. SAN FERNANDO BLVD. - SUITE 100 - BURBANK, CA 91504 PHONE (818) 841-8388 - FAX (818) 841-1704 | | |
| DRAFTED BY: JMH | CHECKED BY: JTA | |
| SITE PLAN | | |
| 21611 S PERRY STREET CARSON, CALIFORNIA | | |
| APRIL 2021 | PROJECT NO. W1301-06-01 | FIG. 2 |

Reference: Jennings, C.W. and Bryant, W. A., 2010, Fault Activity Map of California, California Geological Survey Geologic Data Map No. 6.

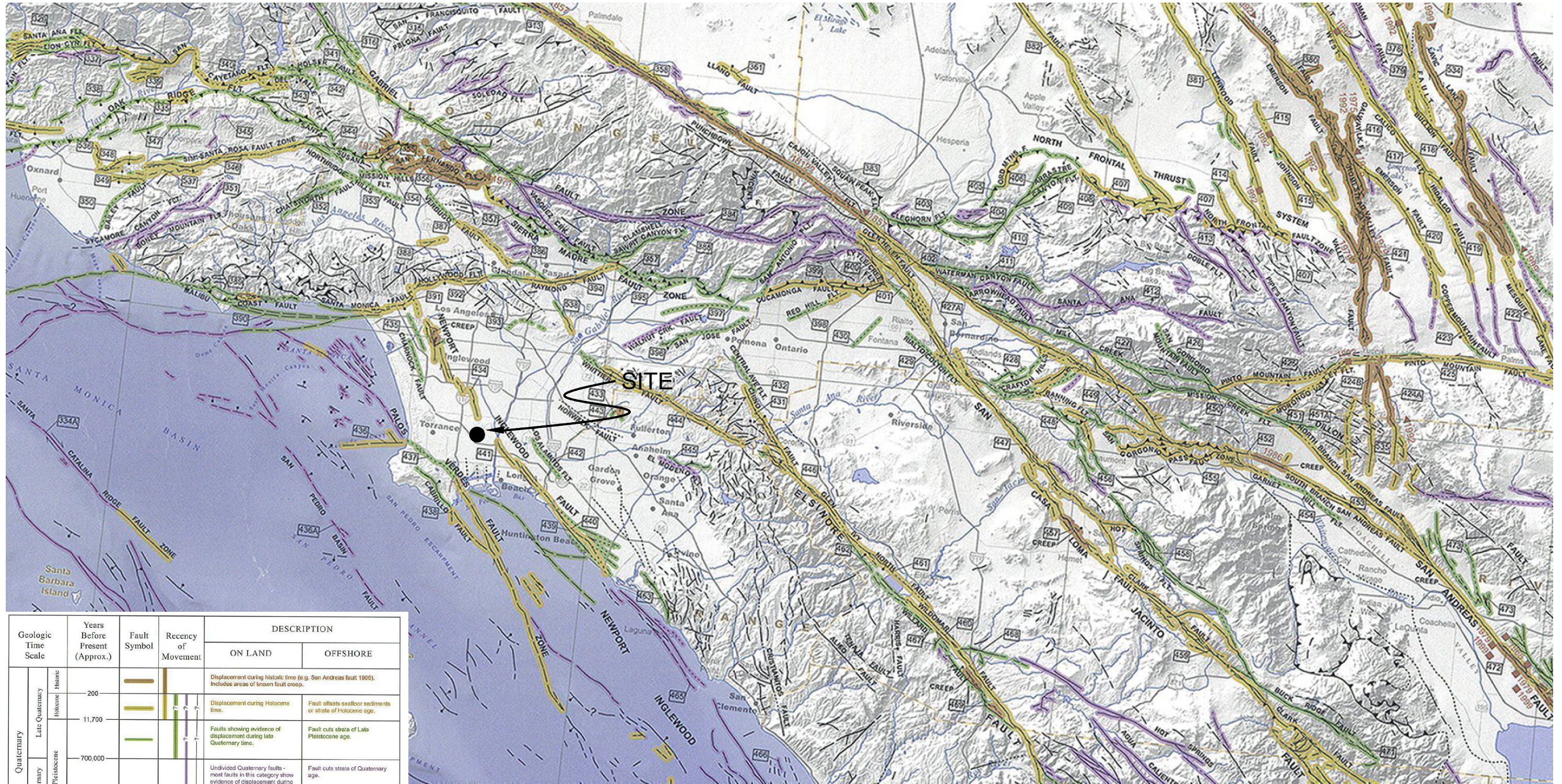

| Geologic Time Scale | Years Before Present (Approx.) | Fault Symbol | Recency of Movement | DESCRIPTION | |
|---------------------|---|--------------|---------------------|---|--|
| | | | | ON LAND | OFFSHORE |
| Quaternary | Late Quaternary Holocene Historic | [Symbol] | [Symbol] | Displacement during historic time (e.g. San Andreas fault 1906). Includes areas of known fault creep. | |
| | | | | Displacement during Holocene time. | Fault offsets soil/rock sediments or strata of Holocene age. |
| | Early Quaternary Pleistocene | 700,000 | [Symbol] | Faults showing evidence of displacement during late Quaternary time. | Fault cuts strata of Late Pleistocene age. |
| Pre-Quaternary | 1,600,000 | [Symbol] | [Symbol] | Undivided Quaternary faults - most faults in this category show evidence of displacement during the last 1,600,000 years; possible exceptions are faults which displace rocks of undifferentiated Plio-Pleistocene age. | Fault cuts strata of Quaternary age. |
| | | | | Faults without recognized Quaternary displacement or showing evidence of no displacement during Quaternary time. Not necessarily inactive. | Fault cuts strata of Pliocene or older age. |
| | 4.5 billion (Age of Earth) | | | | |

* Quaternary now recognized as extending to 2.6 Ma (Walker and Geissman, 2009). Quaternary faults in this map were established using the previous 1.6 Ma criterion.

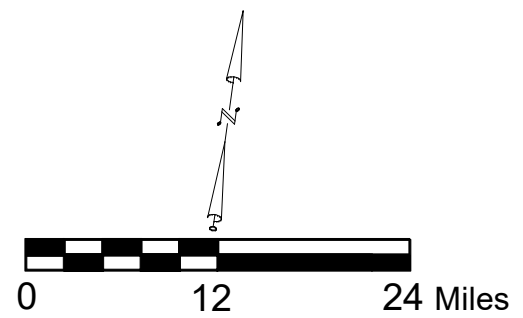

GEOCON WEST, INC.

ENVIRONMENTAL GEOTECHNICAL MATERIALS
 3303 N. SAN FERNANDO BLVD. - SUITE 100 - BURBANK, CA 91504
 PHONE (818) 841-8388 - FAX (818) 841-1704

DRAFTED BY: CB CHECKED BY: SFK

REGIONAL FAULT MAP

21611 SOUTH PERRY STREET
 CARSON, CALIFORNIA

APRIL 2021 PROJECT NO. W1301-06-01 FIG. 3

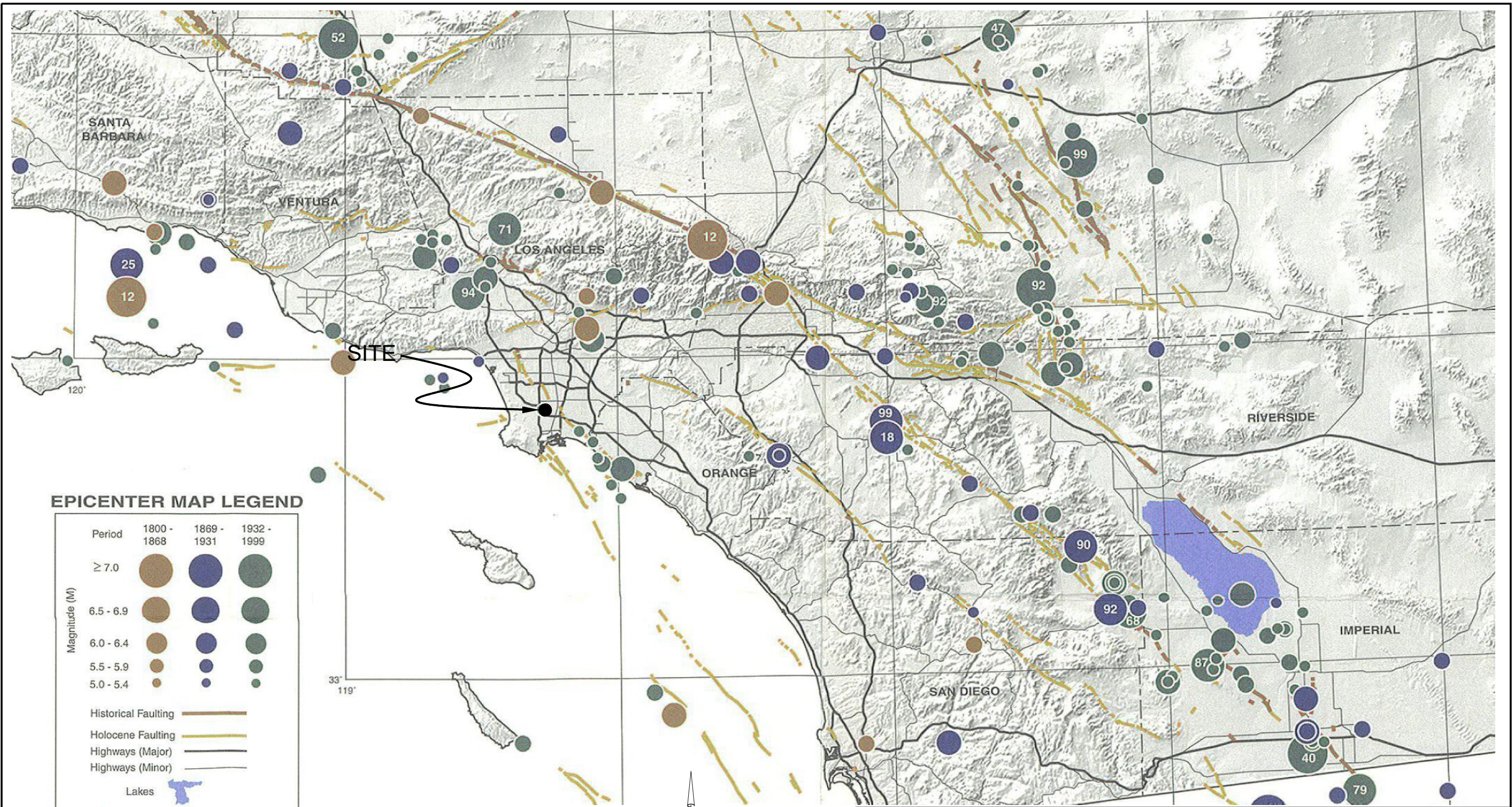

EPICENTER MAP LEGEND

| Period | 1800 - 1868 | 1869 - 1931 | 1932 - 1999 |
|---------------------|--|-------------|-------------|
| Magnitude (M) | | | |
| ≥ 7.0 | | | |
| 6.5 - 6.9 | | | |
| 6.0 - 6.4 | | | |
| 5.5 - 5.9 | | | |
| 5.0 - 5.4 | | | |
| Historical Faulting | | | |
| Holocene Faulting | | | |
| Highways (Major) | | | |
| Highways (Minor) | | | |
| Lakes | | | |
| | Last two digits of M ≥ 6.5 earthquake year | | |

Reference: Topozada, T., Branum, D., Petersen, M., Hallstrom, C., Cramer, C., and Reichle, M., 2000, Epicenters and Areas Damaged by M≥5 California Earthquakes, 1800 - 1999, California Geological Survey, Map Sheet 49.

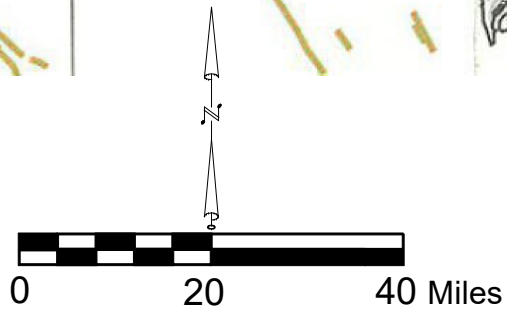

GEOCON
WEST, INC.

ENVIRONMENTAL GEOTECHNICAL MATERIALS
3303 N. SAN FERNANDO BLVD. - SUITE 100 - BURBANK, CA 91504
PHONE (818) 841-8388 - FAX (818) 841-1704

DRAFTED BY: CB

CHECKED BY: SFK

REGIONAL SEISMICITY MAP

21611 SOUTH PERRY STREET
CARSON, CALIFORNIA

APRIL 2021

PROJECT NO. W1301-06-01

FIG.4

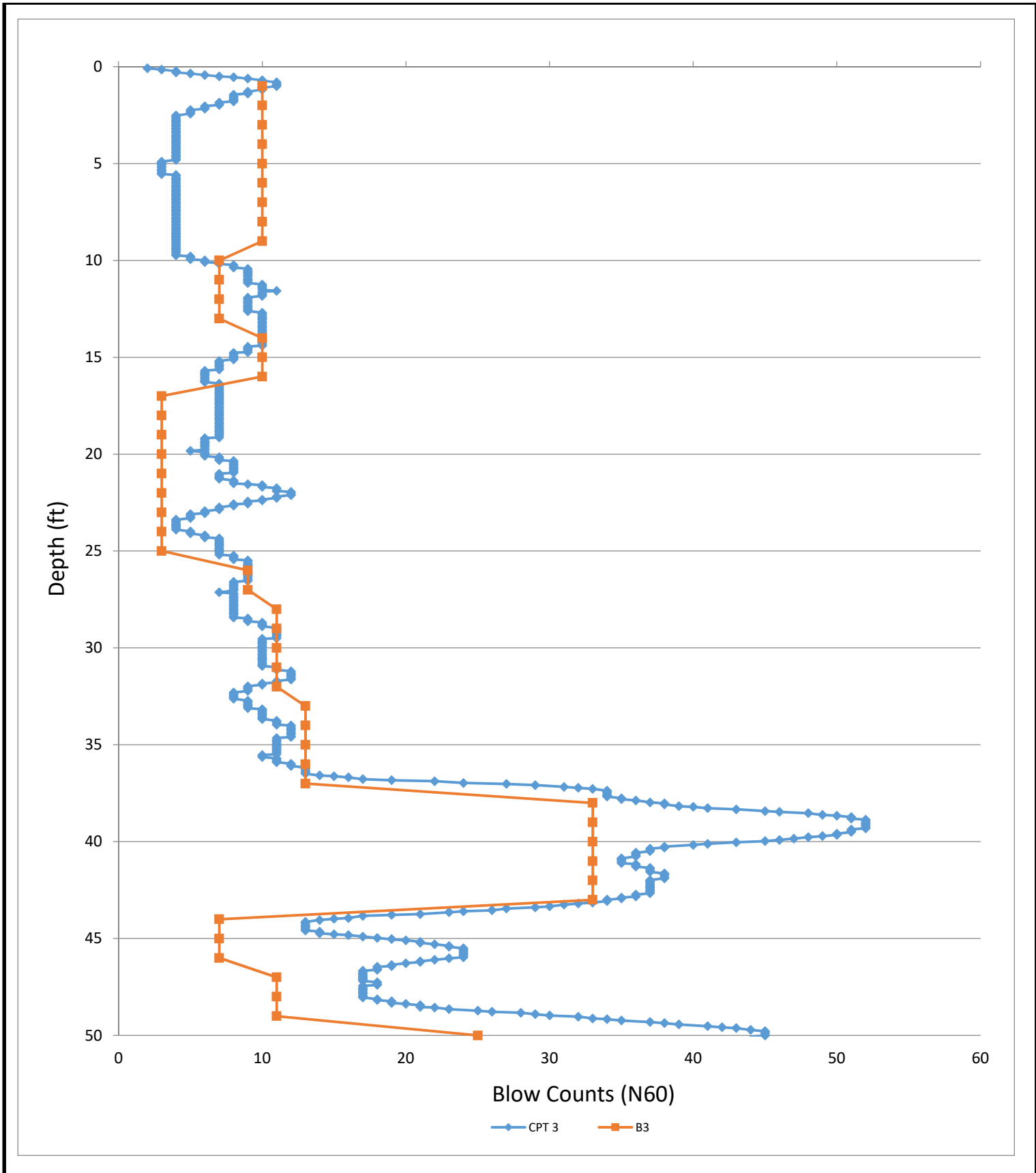

GEOCON
WEST, INC.



ENVIRONMENTAL GEOTECHNICAL MATERIALS
3303 N. SAN FERNANDO BLVD. - SUITE 100 - BURBANK, CA 91504
PHONE (818) 841-8388 - FAX (818) 841-1704

| | | |
|-----|--|--|
| JMH | | |
|-----|--|--|

CORRELATION OF BORING & CPT N60

21611 SOUTH PERRY STREET
CARSON, CA

| | | |
|------------|-------------------------|-------|
| APRIL 2021 | PROJECT NO. W1301-06-01 | FIG.5 |
|------------|-------------------------|-------|

Project title : W1301-06-01

Location : Perry Street

Overall vertical settlements report

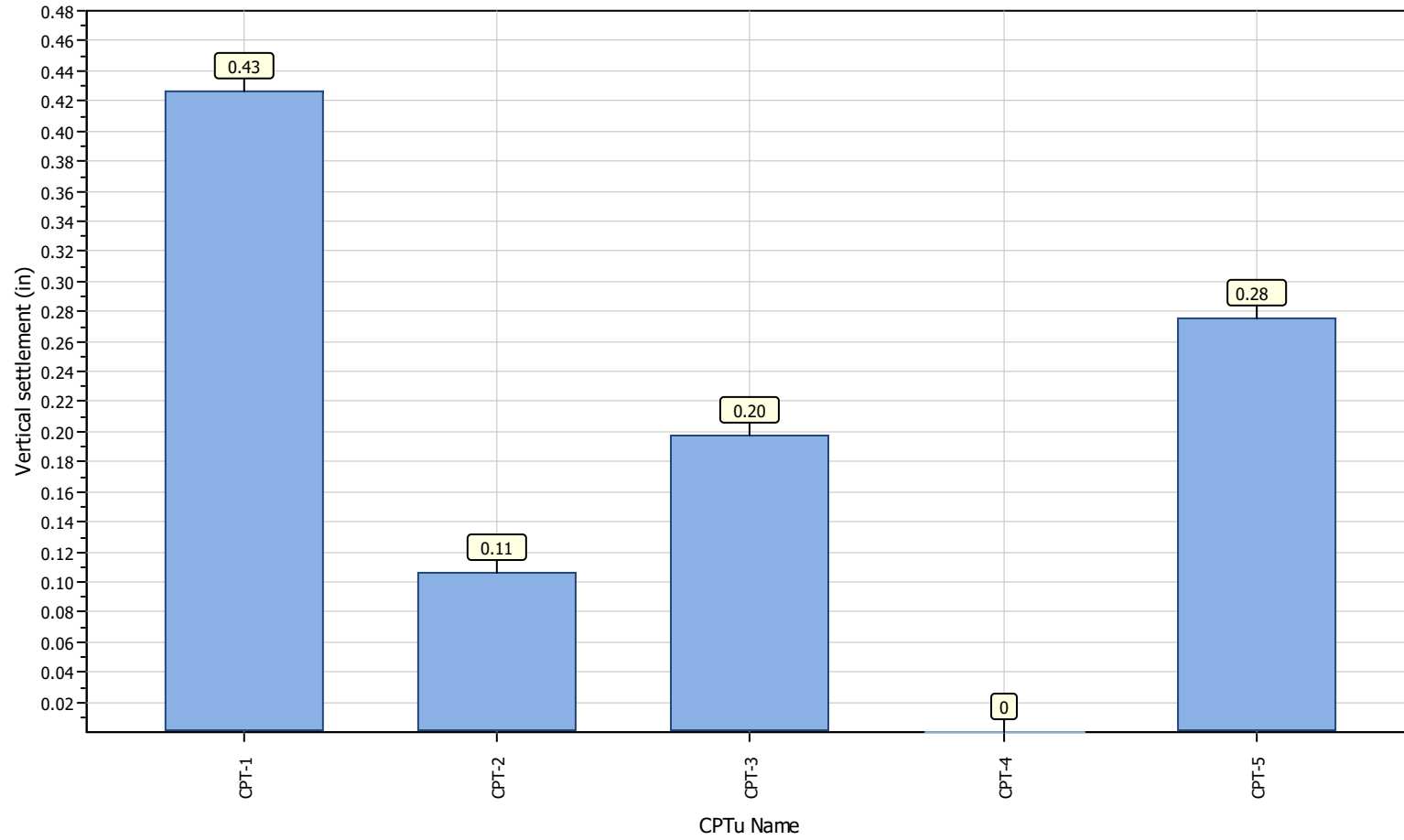

Project title : W1301-06-01

Location : Perry Street

Overall vertical settlements report

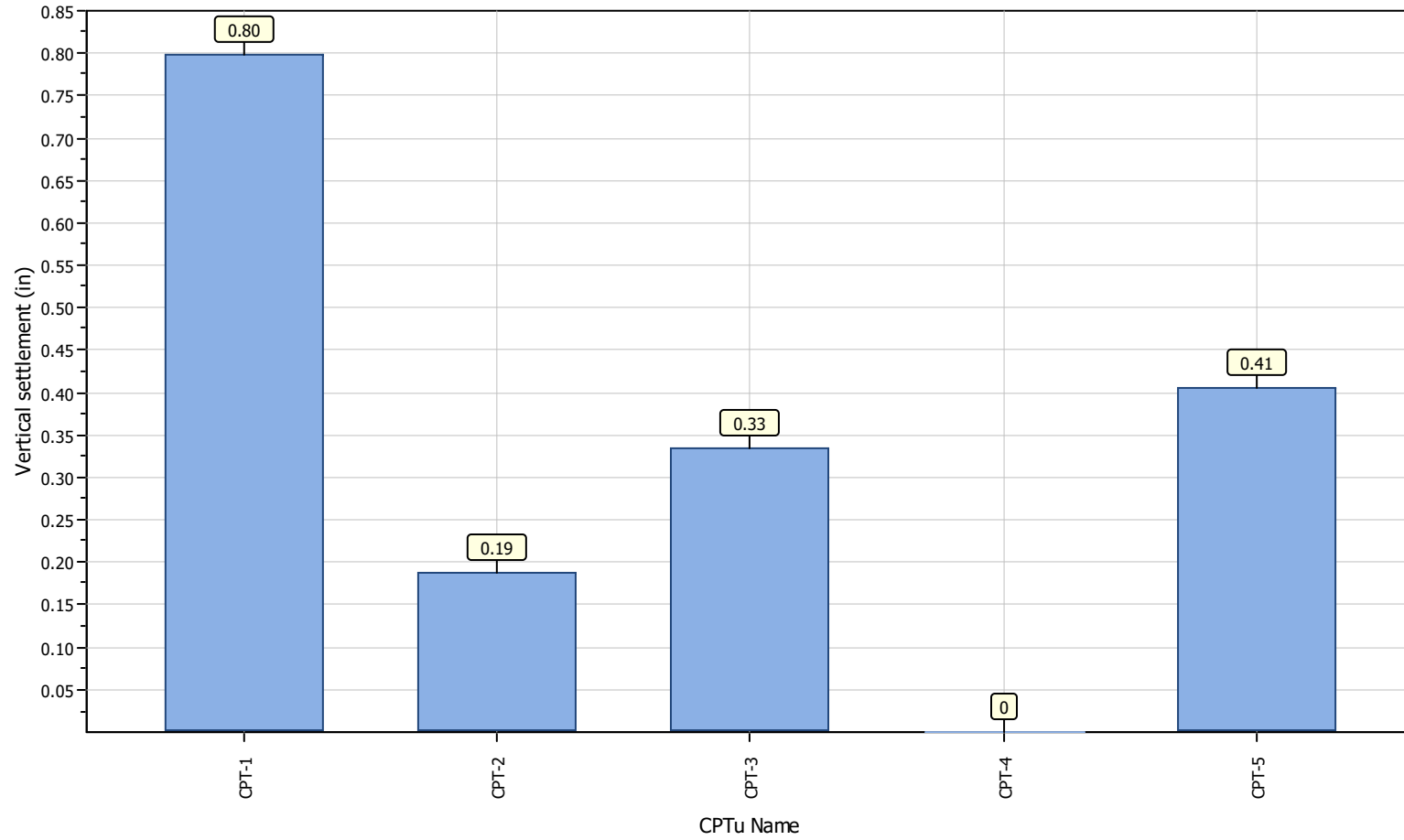

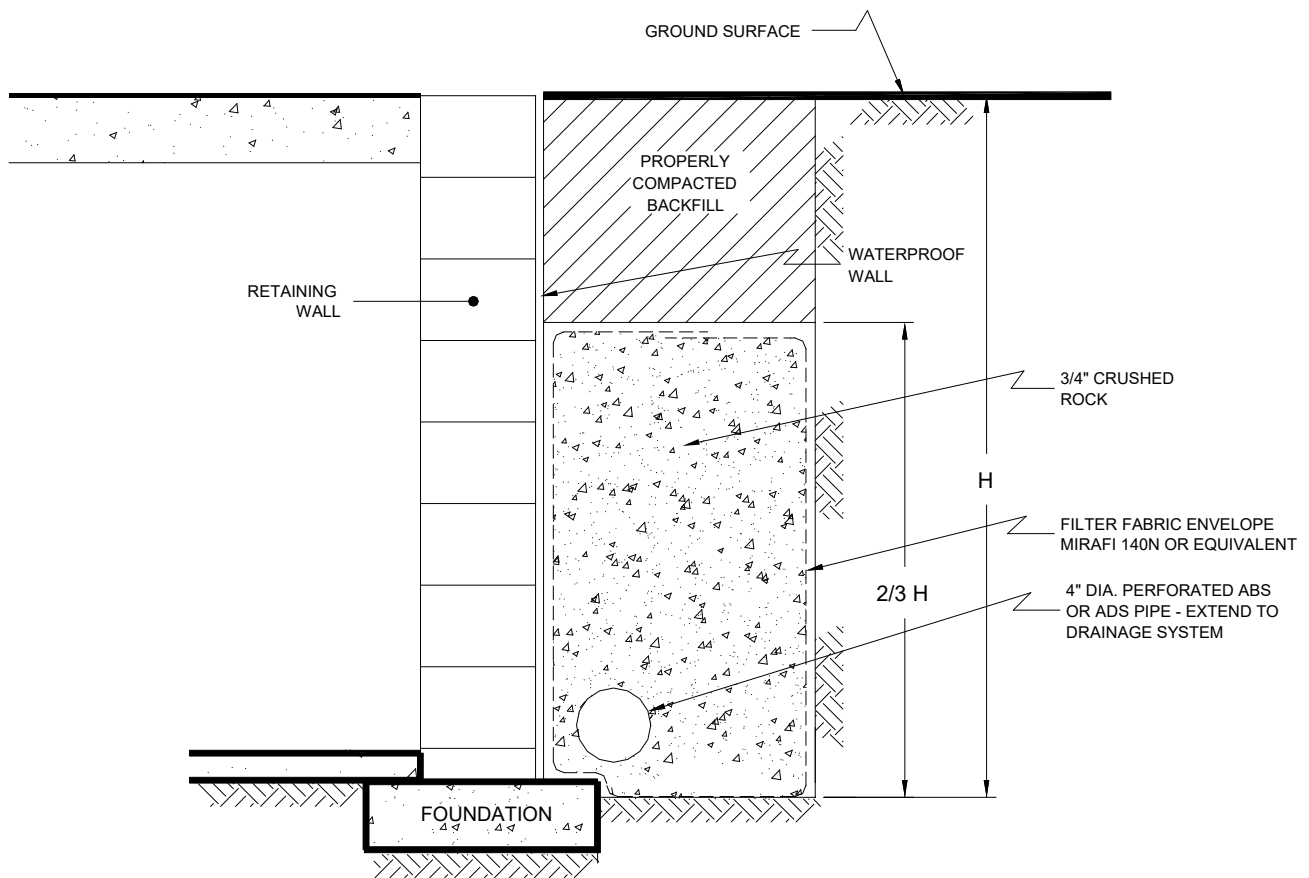

NO SCALE

GEOCON
WEST, INC.



ENVIRONMENTAL GEOTECHNICAL MATERIALS
3303 N. SAN FERNANDO BLVD. - SUITE 100 - BURBANK, CA 91504
PHONE (818) 841-8388 - FAX (818) 841-1704

DRAFTED BY: JMH

CHECKED BY: JTA

RETAINING WALL DRAIN DETAIL

21611 SOUTH PERRY STREET
CARSON, CALIFORNIA

APRIL 2021

NO. W1301-06-01

FIG. 10

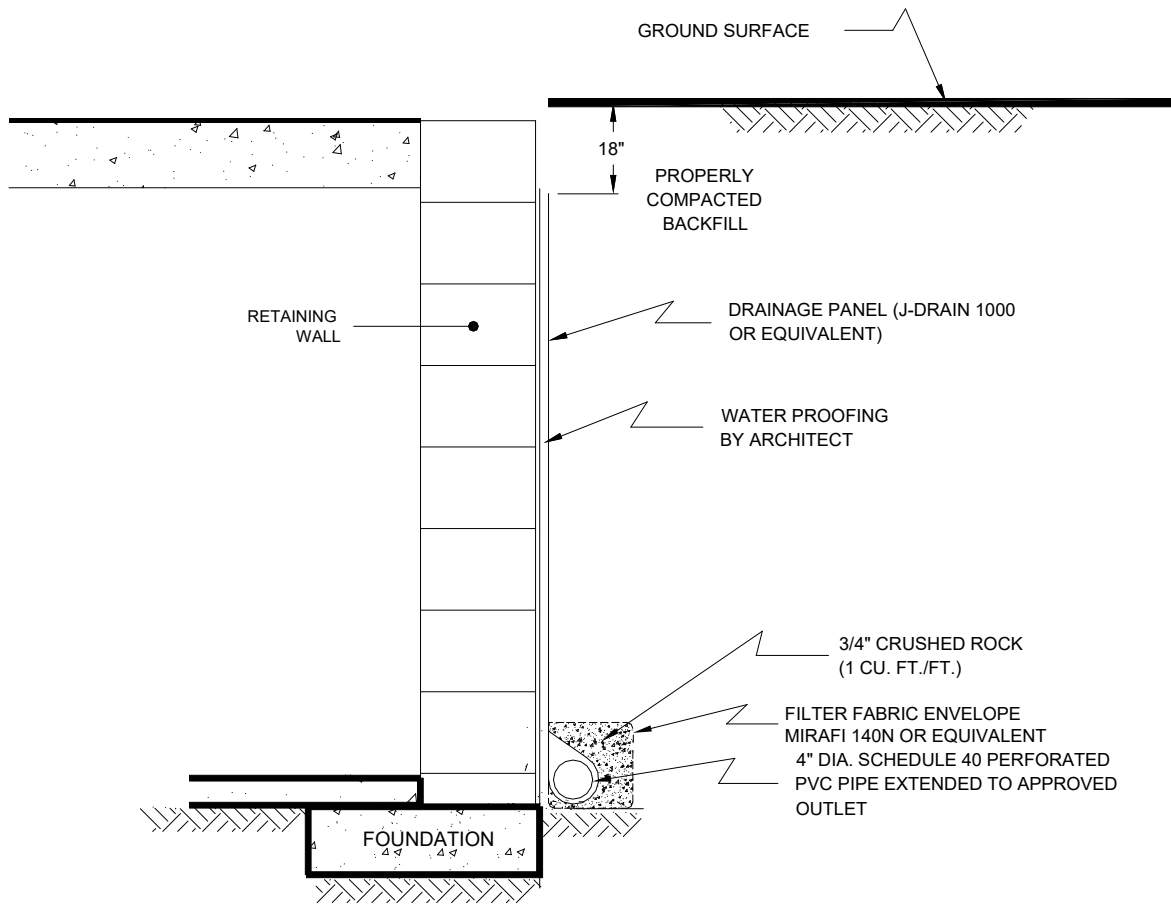

NO SCALE

GEOCON
WEST, INC.



ENVIRONMENTAL GEOTECHNICAL MATERIALS
3303 N. SAN FERNANDO BLVD. - SUITE 100 - BURBANK, CA 91504
PHONE (818) 841-8388 - FAX (818) 841-1704

DRAFTED BY: JMH

CHECKED BY: JTA

RETAINING WALL DRAIN DETAIL

21611 SOUTH PERRY STREET
CARSON, CALIFORNIA

APRIL 2021

NO. W1301-06-01

FIG. 11

APPENDIX

A

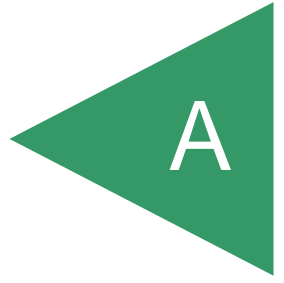

APPENDIX A

FIELD INVESTIGATION







The site was explored on February 9, 2021 by drilling five 8-inch diameter borings using a truck-mounted hollow-stem auger drilling machine and advancing five cone penetrometer tests (CPTs). The borings were excavated to depths between approximately 20½ and 51 feet beneath the existing ground surface. The CPTs were advanced to depths of approximately 60 feet below existing ground surface. Representative and relatively undisturbed samples were obtained by driving a 4 inch, O. D., California Modified Sampler into the “undisturbed” soil mass with blows from a 140 pound hammer falling 30 inches. Bulk samples were also obtained. Standard Penetration Tests were performed in boring B3.

The soil conditions encountered in the borings were visually examined, classified and logged in general accordance with the Unified Soil Classification System (USCS). Logs of the borings are presented on Figures A1 through A5. The CPT data is presented as Figures A6 through A10. The logs depict the soil and geologic conditions encountered and the depth at which samples were obtained. The logs also include our interpretation of the conditions between sampling intervals. Therefore, the logs contain both observed and interpreted data. We determined the lines designating the interface between soil materials on the logs using visual observations, penetration rates, excavation characteristics and other factors. The transition between materials may be abrupt or gradual. Where applicable, the boring logs were revised based on subsequent laboratory testing. The approximate locations of the borings and CPTs are depicted on the Site Plan (see Figure 2)

| DEPTH IN FEET | SAMPLE NO. | LITHOLOGY | GROUNDWATER | SOIL CLASS (USCS) | BORING 1 | | | PENETRATION RESISTANCE (BLOWS/FT*) | DRY DENSITY (P.C.F.) | MOISTURE CONTENT (%) |
|----------------------|------------|-----------|-------------|-------------------|---|-------------------|----------------|------------------------------------|----------------------|----------------------|
| | | | | | ELEV. (MSL.) | -- | DATE COMPLETED | | | |
| | | | | | ELEV. (MSL.) | -- | DATE COMPLETED | | | |
| | | | | | EQUIPMENT | HOLLOW STEM AUGER | | BY: | JMH | |
| MATERIAL DESCRIPTION | | | | | | | | | | |
| 0 | BULK 0-5' | | | | ARTIFICIAL FILL Silty Sand, poorly graded, dense, moist, light brown, fine-grained, some medium-grained, some gravel. | | | | | |
| 2 | | | | | | | | | | |
| 4 | | | | | | | | | | |
| 6 | B1@5' | | | | ALLUVIUM Clay, firm, moist, dark gray, high plasticity. | | | 19 | 105.0 | 24.0 |
| 8 | B1@7.5' | | | CH | - some sand | | | 13 | 106.1 | 19.7 |
| 10 | B1@10' | | | | - olive brown mottles | | | 21 | 103.7 | 22.0 |
| 12 | | | ▼ | | | | | | | |
| 14 | | | | | Clayey Sand, poorly graded, loose, saturated, brown, fine-grained. | | | | | |
| 16 | B1@15' | | | SC | | | | 10 | 111.6 | 19.8 |
| 18 | | | | | Silty Sand, poorly graded, medium dense, saturated, brown, fine-grained. | | | | | |
| 20 | B1@20' | | | SM | | | | 22 | 114.5 | 19.2 |
| | | | | | Total depth of boring: 20.5 feet Fill to 4.5 feet. Groundwater encountered at 12.5 feet. Backfilled with grout. *Penetration resistance for 140-pound hammer falling 30 inches by auto-hammer. NOTE: The stratification lines presented herein represent the approximate boundary between earth types; the transitions may be gradual. | | | | | |

**Figure A1,
Log of Boring 1, Page 1 of 1**

W1301-06-01 BORING LOGS.GPJ

| | | | |
|----------------|---|---|--|
| SAMPLE SYMBOLS |  ... SAMPLING UNSUCCESSFUL |  ... STANDARD PENETRATION TEST |  ... DRIVE SAMPLE (UNDISTURBED) |
| |  ... DISTURBED OR BAG SAMPLE |  ... CHUNK SAMPLE |  ... WATER TABLE OR SEEPAGE |

NOTE: THE LOG OF SUBSURFACE CONDITIONS SHOWN HEREON APPLIES ONLY AT THE SPECIFIC BORING OR TRENCH LOCATION AND AT THE DATE INDICATED. IT IS NOT WARRANTED TO BE REPRESENTATIVE OF SUBSURFACE CONDITIONS AT OTHER LOCATIONS AND TIMES.

| DEPTH IN FEET | SAMPLE NO. | LITHOLOGY | GROUNDWATER | SOIL CLASS (USCS) | BORING 2 | | PENETRATION RESISTANCE (BLOWS/FT*) | DRY DENSITY (P.C.F.) | MOISTURE CONTENT (%) |
|----------------------|------------|-----------|-------------|-------------------|---|--------------------------------|------------------------------------|----------------------|----------------------|
| | | | | | ELEV. (MSL.) -- | DATE COMPLETED <u>2/9/2021</u> | | | |
| | | | | | EQUIPMENT <u>HOLLOW STEM AUGER</u> BY: <u>JMH</u> | | | | |
| MATERIAL DESCRIPTION | | | | | | | | | |
| 0 | BULK 0-5' | | | | ARTIFICIAL FILL Silty Sand, poorly graded, loose, moist, brown, fine-grained. | | | | |
| 2 | | | | | | | | | |
| 4 | B2@3' | | | ML | ALLUVIUM Sandy Silt, firm, moist, dark gray. | | 14 | 73.4 | 29.6 |
| 6 | B2@6' | | | | Clay, soft, wet, gray, high plasticity. | | 10 | 29.3 | 32.0 |
| 8 | | | | | | | | | |
| 10 | B2@9' | | | CH | - firm, dark gray | | 15 | 73.9 | 49.8 |
| 12 | B2@12' | | | | | | 15 | 87.2 | 35.9 |
| 14 | | | | | | | | | |
| 16 | B2@15' | | | | - soft | | 8 | 75.1 | 45.2 |
| 18 | | | | | | | | | |
| 20 | B2@20' | | | | - firm | | 17 | 101.7 | 27.4 |
| | | | | | Total depth of boring: 20.5 feet Fill to 3 feet. No groundwater encountered. Backfilled with grout. *Penetration resistance for 140-pound hammer falling 30 inches by auto-hammer. NOTE: The stratification lines presented herein represent the approximate boundary between earth types; the transitions may be gradual. | | | | |

Figure A2,
Log of Boring 2, Page 1 of 1

W1301-06-01 BORING LOGS.GPJ







| | | | | | | |
|----------------|--|-----------------------------|--|-------------------------------|--|--------------------------------|
| SAMPLE SYMBOLS | | ... SAMPLING UNSUCCESSFUL | | ... STANDARD PENETRATION TEST | | ... DRIVE SAMPLE (UNDISTURBED) |
| | | ... DISTURBED OR BAG SAMPLE | | ... CHUNK SAMPLE | | ... WATER TABLE OR SEEPAGE |

NOTE: THE LOG OF SUBSURFACE CONDITIONS SHOWN HEREON APPLIES ONLY AT THE SPECIFIC BORING OR TRENCH LOCATION AND AT THE DATE INDICATED. IT IS NOT WARRANTED TO BE REPRESENTATIVE OF SUBSURFACE CONDITIONS AT OTHER LOCATIONS AND TIMES.

| DEPTH IN FEET | SAMPLE NO. | LITHOLOGY | GROUNDWATER | SOIL CLASS (USCS) | BORING 3 | | PENETRATION RESISTANCE (BLOWS/FT*) | DRY DENSITY (P.C.F.) | MOISTURE CONTENT (%) |
|----------------------|------------|-----------|-------------|-------------------|--|--------------------------------|------------------------------------|----------------------|----------------------|
| | | | | | ELEV. (MSL.) -- | DATE COMPLETED <u>2/9/2021</u> | | | |
| | | | | | EQUIPMENT <u>HOLLOW STEM AUGER</u> BY: <u>JMH</u> | | | | |
| MATERIAL DESCRIPTION | | | | | | | | | |
| 0 | BULK 0-5' | | | | ARTIFICIAL FILL Sand, poorly graded, dense, moist, light brown, fine-grained, some medium-grained. | | | | |
| 2 | B3@1.5' | | | | | | 50 (6") | 107.1 | 4.0 |
| 4 | | | | | | | | | |
| 6 | B3@5' | | | | | | 50 (6") | | |
| 8 | B3@7' | | | | - grayish brown, some fine gravel | | 50 (3") | 103.4 | 8.7 |
| 10 | B3@10' | | | MH | ALLUVIUM Silt, soft, moist, dark gray, high plasticity, some sand. | | 7 | | |
| 12 | | | | | | | | | |
| 14 | B3@12.5' | | | CH | Clay, firm, moist, dark gray, high plasticity. | | 21 | 91.7 | 31.6 |
| 16 | B3@15' | | | | | | 10 | | |
| 18 | B3@17.5' | | | | Clay, firm, moist, dark gray. | | 14 | 103.7 | 26.1 |
| 20 | B3@20' | | | CL | - soft, wet | | 3 | | |
| 22 | | | | | | | | | |
| 24 | B3@22.5' | | | | - firm, light brown | | 11 | 105.7 | 27.3 |
| 26 | B3@25' | | | | Clay, firm, moist, olive brown, some sand, trace gravel, high plasticity. | | 9 | | |
| 28 | B3@27.5' | | | CH | - mottled calcium deposits, increase in sand | | 21 | 89.9 | 32.6 |

Figure A3,
Log of Boring 3, Page 1 of 2

W1301-06-01 BORING LOGS.GPJ

| | | | |
|----------------|---|---|--|
| SAMPLE SYMBOLS |  ... SAMPLING UNSUCCESSFUL |  ... STANDARD PENETRATION TEST |  ... DRIVE SAMPLE (UNDISTURBED) |
| |  ... DISTURBED OR BAG SAMPLE |  ... CHUNK SAMPLE |  ... WATER TABLE OR SEEPAGE |

NOTE: THE LOG OF SUBSURFACE CONDITIONS SHOWN HEREON APPLIES ONLY AT THE SPECIFIC BORING OR TRENCH LOCATION AND AT THE DATE INDICATED. IT IS NOT WARRANTED TO BE REPRESENTATIVE OF SUBSURFACE CONDITIONS AT OTHER LOCATIONS AND TIMES.

| DEPTH IN FEET | SAMPLE NO. | LITHOLOGY | GROUNDWATER | SOIL CLASS (USCS) | BORING 3 | | PENETRATION RESISTANCE (BLOWS/FT*) | DRY DENSITY (P.C.F.) | MOISTURE CONTENT (%) |
|----------------------|------------|-----------|-------------|-------------------|---|--------------------------------|------------------------------------|----------------------|----------------------|
| | | | | | ELEV. (MSL.) -- | DATE COMPLETED <u>2/9/2021</u> | | | |
| | | | | | EQUIPMENT <u>HOLLOW STEM AUGER</u> BY: <u>JMH</u> | | | | |
| MATERIAL DESCRIPTION | | | | | | | | | |
| 30 | B3@30' | | | | - decrease in sand | | 11 | | |
| 32 | B3@32.5' | | | CH | - stiff | | 22 | 98.4 | 27.3 |
| 34 | B3@35' | | | | - firm, increase in sand | | 13 | | |
| 38 | B3@37.5' | | | | Silty Sand, poorly graded, dense, wet, olive brown, fine-grained. | | 67 | 117.6 | 16.4 |
| 40 | B3@40' | | | SM | | | 33 | | |
| 42 | B3@42.5' | | | | - medium dense, trace shells | | 36 | 101.9 | 25.0 |
| 44 | B3@45' | | | CL | Sandy Clay, soft, wet, olive brown. | | 7 | | |
| 46 | B3@47.5' | | | SC | Clayey Sand, poorly graded, medium dense, saturated, olive brown with oxidation mottles, fine-grained. | | 20 | 100.0 | 25.4 |
| 48 | B3@47.5' | | | SC | | | | | |
| 50 | B3@50' | | | SM | Silty Sand, poorly graded, medium dense, saturated, olive brown. | | 25 | | |
| | | | | | Total depth of boring: 51 feet Fill to 9 feet. Groundwater encountered at 17.6 feet. Backfilled with grout. *Penetration resistance for 140-pound hammer falling 30 inches by auto-hammer. NOTE: The stratification lines presented herein represent the approximate boundary between earth types; the transitions may be gradual. | | | | |

Figure A3,
Log of Boring 3, Page 2 of 2

W1301-06-01 BORING LOGS.GPJ

| | | | | | | |
|----------------|--|-----------------------------|--|-------------------------------|--|--------------------------------|
| SAMPLE SYMBOLS | | ... SAMPLING UNSUCCESSFUL | | ... STANDARD PENETRATION TEST | | ... DRIVE SAMPLE (UNDISTURBED) |
| | | ... DISTURBED OR BAG SAMPLE | | ... CHUNK SAMPLE | | ... WATER TABLE OR SEEPAGE |

NOTE: THE LOG OF SUBSURFACE CONDITIONS SHOWN HEREON APPLIES ONLY AT THE SPECIFIC BORING OR TRENCH LOCATION AND AT THE DATE INDICATED. IT IS NOT WARRANTED TO BE REPRESENTATIVE OF SUBSURFACE CONDITIONS AT OTHER LOCATIONS AND TIMES.













| DEPTH IN FEET | SAMPLE NO. | LITHOLOGY | GROUNDWATER | SOIL CLASS (USCS) | BORING 4 | | PENETRATION RESISTANCE (BLOWS/FT*) | DRY DENSITY (P.C.F.) | MOISTURE CONTENT (%) |
|----------------------|------------|--|-------------|-------------------|---|--|------------------------------------|----------------------|----------------------|
| | | | | | ELEV. (MSL.) -- | DATE COMPLETED <u>2/9/2021</u> | | | |
| | | | | | EQUIPMENT <u>HOLLOW STEM AUGER</u> BY: <u>JMH</u> | | | | |
| MATERIAL DESCRIPTION | | | | | | | | | |
| 0 | BULK 0-5' |  | | | | ARTIFICIAL FILL Silty Sand, poorly graded, dense, moist, brown, fine-grained, some medium-grained, some gravel. | 50 (6") | | |
| 2 | B4@3' |  | | | | | | | |
| 4 | B4@5' |  | | ML | | ALLUVIUM Sandy Silt, soft, moist, dark gray. Clay, soft, wet, dark gray, high plasticity. | 10 | 78.1 | 31.1 |
| 6 | B4@7.5' |  | | | | | | | |
| 8 | B4@10' |  | | CH | | | 10 | 80.7 | 38.9 |
| 10 | B4@15' |  | | | | | | | |
| 12 | B4@20' |  | | | | | 8 | 77.8 | 42.4 |
| 14 | | | | | | | | | |
| 16 | | | | | | | 10 | 85.0 | 38.5 |
| 18 | | | | | | | | | |
| 20 | | | | | | | 4 | 80.0 | 42.3 |
| | | | | | | | | | |
| | | | | | Total depth of boring: 20.5 feet Fill to 5 feet. No groundwater encountered. Backfilled with grout. *Penetration resistance for 140-pound hammer falling 30 inches by auto-hammer. NOTE: The stratification lines presented herein represent the approximate boundary between earth types; the transitions may be gradual. | | | | |

Figure A4,
Log of Boring 4, Page 1 of 1

W1301-06-01 BORING LOGS.GPJ







| | | | |
|----------------|---|---|--|
| SAMPLE SYMBOLS |  ... SAMPLING UNSUCCESSFUL |  ... STANDARD PENETRATION TEST |  ... DRIVE SAMPLE (UNDISTURBED) |
| |  ... DISTURBED OR BAG SAMPLE |  ... CHUNK SAMPLE |  ... WATER TABLE OR SEEPAGE |

NOTE: THE LOG OF SUBSURFACE CONDITIONS SHOWN HEREON APPLIES ONLY AT THE SPECIFIC BORING OR TRENCH LOCATION AND AT THE DATE INDICATED. IT IS NOT WARRANTED TO BE REPRESENTATIVE OF SUBSURFACE CONDITIONS AT OTHER LOCATIONS AND TIMES.

| DEPTH IN FEET | SAMPLE NO. | LITHOLOGY | GROUNDWATER | SOIL CLASS (USCS) | BORING 5 | | | PENETRATION RESISTANCE (BLOWS/FT*) | DRY DENSITY (P.C.F.) | MOISTURE CONTENT (%) |
|----------------------|------------|-----------|-------------|-------------------|--|----------------|--------------------------------|------------------------------------|----------------------|----------------------|
| | | | | | ELEV. (MSL.) | -- | DATE COMPLETED <u>2/9/2021</u> | | | |
| | | | | | EQUIPMENT <u>HOLLOW STEM AUGER</u> | BY: <u>JMH</u> | | | | |
| MATERIAL DESCRIPTION | | | | | | | | | | |
| 0 | | | | | ARTIFICIAL FILL Silty Sand, poorly graded, loose, moist, brown, fine-grained, some medium-grained. | | | | | |
| 2 | | | | | | | | | | |
| 4 | | | | | | | | | | |
| 6 | B5@5' | | | | ALLUVIUM Clay, soft, moist, dark gray, high plasticity. | | | 11 | 79.5 | 42.3 |
| 8 | B5@7.5' | | | | - wet | | | 10 | 82.2 | 38.4 |
| 10 | B5@10' | | | CH | | | | 7 | 74.1 | 37.5 |
| 12 | | | | | | | | | | |
| 14 | | | | | | | | | | |
| 16 | B5@15' | | | | - saturated | | | 11 | 97.9 | 47.5 |
| 18 | | | | | | | | | | |
| 20 | B5@20' | | | | - firm, no recovery | | | 17 | | |
| | | | | | Total depth of boring: 20.5 feet Fill to 5 feet. No groundwater encountered. Backfilled with grout. *Penetration resistance for 140-pound hammer falling 30 inches by auto-hammer. NOTE: The stratification lines presented herein represent the approx | | | | | |

Figure A5,
Log of Boring 5, Page 1 of 1

W1301-06-01 BORING LOGS.GPJ

| | | | |
|----------------|---|---|--|
| SAMPLE SYMBOLS |  ... SAMPLING UNSUCCESSFUL |  ... STANDARD PENETRATION TEST |  ... DRIVE SAMPLE (UNDISTURBED) |
| |  ... DISTURBED OR BAG SAMPLE |  ... CHUNK SAMPLE |  ... WATER TABLE OR SEEPAGE |

NOTE: THE LOG OF SUBSURFACE CONDITIONS SHOWN HEREON APPLIES ONLY AT THE SPECIFIC BORING OR TRENCH LOCATION AND AT THE DATE INDICATED. IT IS NOT WARRANTED TO BE REPRESENTATIVE OF SUBSURFACE CONDITIONS AT OTHER LOCATIONS AND TIMES.

Shear-Induced Building Settlement (Ds) calculation procedure

The shear-induced building settlement (Ds) due to liquefaction below the building can be estimated using the relationship developed by Bray and Macedo (2017):

$$\begin{aligned} \ln(D_s) = & c_1 + c_2 * LBS + 0.58 * \ln\left(\tanh\left(\frac{HL}{6}\right)\right) + \\ & 4.59 * \ln(Q) - 0.42 * \ln(Q)^2 - 0.02 * B + \\ & 0.84 * \ln(CAVdp) + 0.41 * \ln(Sa1) + \varepsilon \end{aligned}$$

where Ds is in the units of mm, c1= -8.35 and c2= 0.072 for LBS ≤ 16, and c1= -7.48 and c2= 0.014 otherwise. Q is the building contact pressure in units of kPa, HL is the cumulative thickness of the liquefiable layers in the units of m, B is the building width in the units of m, CAVdp is a standardized version of the cumulative absolute velocity in the units of g-s, Sa1 is 5%-damped pseudo-acceleration response spectral value at a period of 1 s in the units of g, and ε is a normal random variable with zero mean and 0.50 standard deviation in Ln units. The liquefaction-induced building settlement index (LBS) is:

$$LBS = \sum W * \frac{\varepsilon_{shear}}{z} dz$$

where z (m) is the depth measured from the ground surface > 0, W is a foundation-weighting factor wherein W = 0.0 for z less than Df, which is the embedment depth of the foundation, and W = 1.0 otherwise. The shear strain parameter (ε_{shear}) is the liquefaction-induced free-field shear strain (in %) estimated using Zhang et al. (2004). It is calculated based on the estimated Dr of the liquefied soil layer and the calculated safety factor against liquefaction triggering (FSL).

References

- Lunne, T., Robertson, P.K., and Powell, J.J.M 1997. Cone penetration testing in geotechnical practice, E & FN Spon Routledge, 352 p, ISBN 0-7514-0393-8.
- Boulanger, R.W. and Idriss, I. M., 2007. Evaluation of Cyclic Softening in Silts and Clays. ASCE Journal of Geotechnical and Geoenvironmental Engineering June, Vol. 133, No. 6 pp 641-652
- Boulanger, R.W. and Idriss, I. M., 2014. CPT AND SPT BASED LIQUEFACTION TRIGGERING PROCEDURES. DEPARTMENT OF CIVIL & ENVIRONMENTAL ENGINEERING COLLEGE OF ENGINEERING UNIVERSITY OF CALIFORNIA AT DAVIS
- Robertson, P.K. and Cabal, K.L., 2007, Guide to Cone Penetration Testing for Geotechnical Engineering. Available at no cost at <http://www.geologismiki.gr/>
- Robertson, P.K. 1990. Soil classification using the cone penetration test. Canadian Geotechnical Journal, 27 (1), 151-8.
- Robertson, P.K. and Wride, C.E., 1998. Cyclic Liquefaction and its Evaluation based on the CPT Canadian Geotechnical Journal, 1998, Vol. 35, August.
- Youd, T.L., Idriss, I.M., Andrus, R.D., Arango, I., Castro, G., Christian, J.T., Dobry, R., Finn, W.D.L., Harder, L.F., Hynes, M.E., Ishihara, K., Koester, J., Liao, S., Marcuson III, W.F., Martin, G.R., Mitchell, J.K., Moriwaki, Y., Power, M.S., Robertson, P.K., Seed, R., and Stokoe, K.H., Liquefaction Resistance of Soils: Summary Report from the 1996 NCEER and 1998 NCEER/NSF Workshop on Evaluation of Liquefaction Resistance of Soils, ASCE, Journal of Geotechnical & Geoenvironmental Engineering, Vol. 127, October, pp 817-833
- Zhang, G., Robertson. P.K., Brachman, R., 2002, Estimating Liquefaction Induced Ground Settlements from the CPT, Canadian Geotechnical Journal, 39: pp 1168-1180
- Zhang, G., Robertson. P.K., Brachman, R., 2004, Estimating Liquefaction Induced Lateral Displacements using the SPT and CPT, ASCE, Journal of Geotechnical & Geoenvironmental Engineering, Vol. 130, No. 8, 861-871
- Pradel, D., 1998, Procedure to Evaluate Earthquake-Induced Settlements in Dry Sandy Soils, ASCE, Journal of Geotechnical & Geoenvironmental Engineering, Vol. 124, No. 4, 364-368
- Iwasaki, T., 1986, Soil liquefaction studies in Japan: state-of-the-art, Soil Dynamics and Earthquake Engineering, Vol. 5, No. 1, 2-70
- Papathanassiou G., 2008, LPI-based approach for calibrating the severity of liquefaction-induced failures and for assessing the probability of liquefaction surface evidence, Eng. Geol. 96:94-104
- P.K. Robertson, 2009, Interpretation of Cone Penetration Tests - a unified approach., Canadian Geotechnical Journal, Vol. 46, No. 11, pp 1337-1355
- P.K. Robertson, 2009. "Performance based earthquake design using the CPT", Keynote Lecture, International Conference on Performance-based Design in Earthquake Geotechnical Engineering - from case history to practice, IS-Tokyo, June 2009
- Robertson, P.K. and Lisheng, S., 2010, "Estimation of seismic compression in dry soils using the CPT" FIFTH INTERNATIONAL CONFERENCE ON RECENT ADVANCES IN GEOTECHNICAL EARTHQUAKE ENGINEERING AND SOIL DYNAMICS, *Symposium in honor of professor I. M. Idriss*, SAN diego, CA
- R. E. S. Moss, R. B. Seed, R. E. Kayen, J. P. Stewart, A. Der Kiureghian, K. O. Cetin, CPT-Based Probabilistic and Deterministic Assessment of In Situ Seismic Soil Liquefaction Potential, Journal of Geotechnical and Geoenvironmental Engineering, Vol. 132, No. 8, August 1, 2006
- I. M. Idriss and R. W. Boulanger, 2008. Soil liquefaction during earthquakes, Earthquake Engineering Research Institute MNO-12
- Jonathan D. Bray & Jorge Macedo, Department of Civil & Environmental Engineering, Univ. of California, Berkeley, CA, USA, Simplified procedure for estimating liquefaction-induced building settlement, *Proceedings of the 19th International Conference on Soil Mechanics and Geotechnical Engineering, Seoul 201*

Attachment C

City Forms

Attachment D

Master Covenant Agreement (MCA)

MCA will be provided in ministerial Review

Attachment E

Operations and Maintenance (O&M) Plan

Carson Self-Storage
21611 South Perry St., Carson, Ca 90745
Grading Plan Permit No.: Tbd
Apn: 7327-010-014

REQUIRED PERMITS

This section must list any permits required for the implementation, operation, and maintenance of the BMPs. Possible examples are:

- Permits for connection to sanitary sewer
- Permits from California Department of Fish and Game
- Encroachment permits

If no permits are required, a statement to that effect should be made.

RECORDKEEPING

All records must be made available for review upon request.

RESPONSIBLE PARTY

The owner is aware of the maintenance responsibilities of the proposed BMPs. A funding mechanism is in place to maintain the BMPs at the frequency stated in the LID Plan. The contact information for the entity responsible is below:

Name: _____
Company: Faring Capital, LLC _____
Title: _____
Address 1: _____
Address 2: _____
Phone Number: _____
Email: _____

| BMP Name | BMP Implementation, Maintenance, and Inspection Procedures | Implementation, Maintenance, and Inspection Frequency and Schedule | Person or Entity with Operation & Maintenance Responsibility |
|---|---|--|--|
| Non-Structural Source Control BMPs | | | |
| Education for Property Owners, Tenants and Occupants | Practical informational materials will be provided to employees on general good housekeeping practices that contribute to protection of storm water quality. Among other things, these materials will describe the use of chemicals (including household type) that should be limited to the property, with no discharge of specified wastes via hosing or other direct discharge to gutters, catch basins and storm drains. Faring Capital, LLC will provide these materials through an education program. This program must be maintained, enforced, and updated periodically by Faring Capital, LLC. Educational materials including, but not limited to, the materials included in Section VII of this plan will be made available to the employees, members and occupants periodically thereafter | On-going | Owner |
| Activity Restriction | Activities on this site will be limited to activities related to the transfer of solid waste. | On-going | Owner |

| BMP Name | BMP Implementation, Maintenance, and Inspection Procedures | Implementation, Maintenance, and Inspection Frequency and Schedule | Person or Entity with Operation & Maintenance Responsibility |
|---|--|---|---|
| Common Area Landscape Management | Management programs will be designed and established by Faring Capital, LLC who will maintain the common areas within the project site. These programs will include how to mitigate the potential dangers of fertilizer and pesticide usage (refer to the Maintenance and Frequency Table). Ongoing maintenance will be consistent with the State of California Model Water-Efficient Landscape Ordinance. | On-going | Owner |
| Common Area Litter Control | Faring Capital, LLC will be required to implement waste management and litter control procedures in the common areas aimed at reducing pollution of surface runoff. Faring Capital, LLC may also contract with their landscape maintenance firm to provide this service during regularly scheduled maintenance, which should consist of litter patrol, to prevent emptying of waste receptacles in common areas, and noting waste disposal violations and reporting the violations to Faring Capital, LLC for investigation | Inspected on a monthly basis | Owner |

| BMP Name | BMP Implementation, Maintenance, and Inspection Procedures | Implementation, Maintenance, and Inspection Frequency and Schedule | Person or Entity with Operation & Maintenance Responsibility |
|---|--|---|--|
| Common Area Catch Basin Inspection | Faring Capital, LLC will be required to have at least 80 percent of the catch basins and inlets inspected, cleaned and maintained on an annual basis and 100 percent of the basins and inlets included in a two-year period. Cleaning should take place in the late summer/early fall prior to the start of the rainy season | Prior to August 31 each year and weekly during rainy season or within 24 hours prior to rain forecasts. | Owner |
| Street Sweeping Private Streets and Parking Lots | Faring Capital, LLC shall have parking lots swept prior to the storm season, in late summer and early fall, prior to the start of the rainy season, as defined by the City of Carson | Prior to the storm season, in late summer and early fall, prior to the start of the rainy season | Owner |
| Structural Source Control BMPs | | | |
| Provide Storm Drain System Stenciling and Signage | All proposed catch basins and inlets will have either a stencil and/or placard with verbiage conforming to City of Carson requirements. Faring Capital, LLC will maintain the stenciling and labels. | Semi-annually, Prior to August 31 each year & monthly during rainy season. Repaint stenciling and/or replace signs Prior to August 31 | Owner |
| Design and Construct Trash and Waste Storage Areas to Reduce Pollutant Introduction | The proposed Waste Management Areas will be within the building footprint | Inspected on a monthly basis | Owner |

| BMP Name | BMP Implementation, Maintenance, and Inspection Procedures | Implementation, Maintenance, and Inspection Frequency and Schedule | Person or Entity with Operation & Maintenance Responsibility |
|---|--|--|--|
| Use Efficient Irrigation Systems & Landscape Design | Design of an effective irrigation system will reduce the amount of runoff from excess irrigation water into the storm drain system. The system design will incorporate the use of a centralized evapotranspiration-based irrigation controllers, rain shutdown devices, master valves, and low precipitation spray heads. The system will have the ability to run multiple programs with cycle and soak to prevent run-off, and emergency shut-off devices for excessive flow conditions to minimize water waste. The design will comply with the State Ordinance AB325 and City of Carson requirements for water conservation | Prior to August 31 each year and once during the rainy season (Prior to August 31st) | Owner |
| Treatment Control BMPs | | | |
| 10'20' Modular Wetland System | Modular Wetland System – Linear Maintenance: <ul style="list-style-type: none"> - Removed trash from screening device. - Removed sediment from separation chamber. - Replace cartridge filter media. - Replace drain down filter media. - Trim vegetation. | As needed | Owner |

Maintenance Guidelines for Modular Wetland System - Linear

Maintenance Summary

- Remove Trash from Screening Device – average maintenance interval is 6 to 12 months.
 - *(5 minute average service time).*
- Remove Sediment from Separation Chamber – average maintenance interval is 12 to 24 months.
 - *(10 minute average service time).*
- Replace Cartridge Filter Media – average maintenance interval 12 to 24 months.
 - *(10-15 minute per cartridge average service time).*
- Replace Drain Down Filter Media – average maintenance interval is 12 to 24 months.
 - *(5 minute average service time).*
- Trim Vegetation – average maintenance interval is 6 to 12 months.
 - *(Service time varies).*

System Diagram

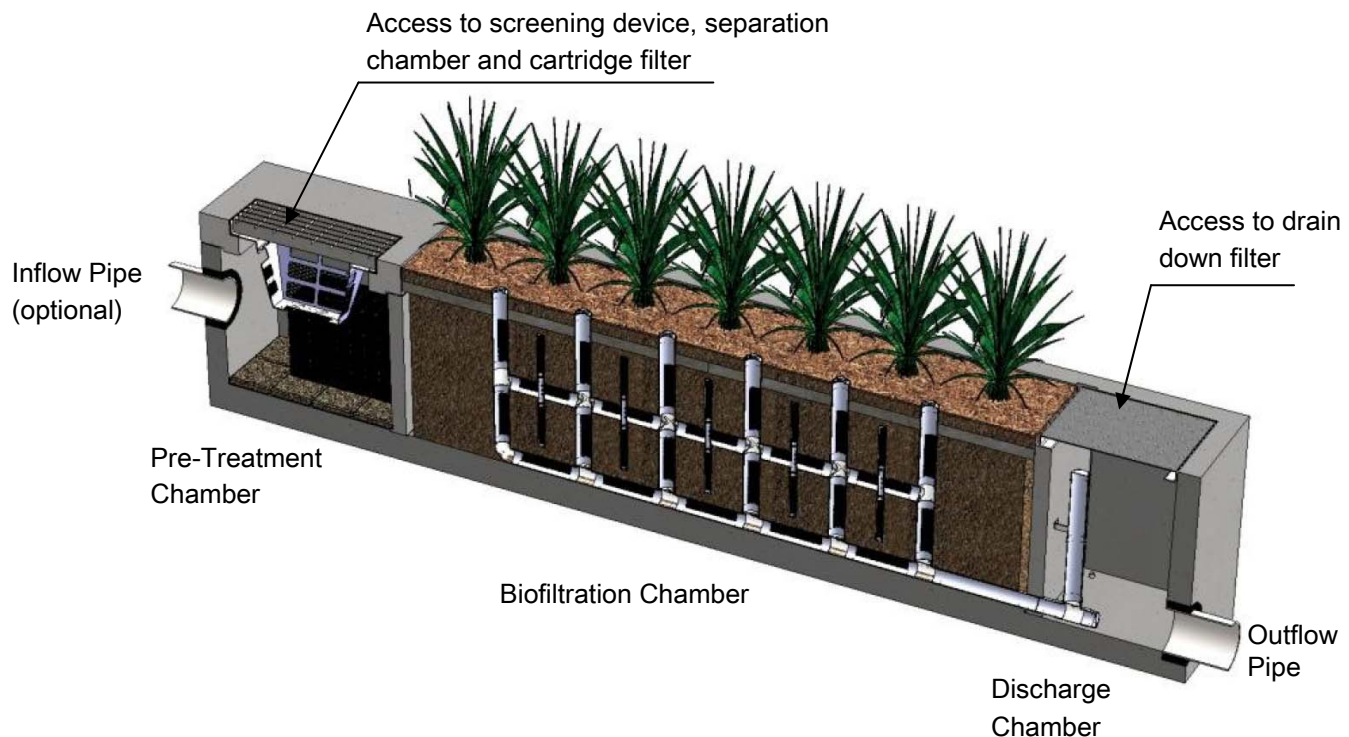

Maintenance Procedures

Screening Device

1. Remove grate or manhole cover to gain access to the screening device in the Pre-Treatment Chamber. Vault type units do not have screening device. Maintenance can be performed without entry.
2. Remove all pollutants collected by the screening device. Removal can be done manually or with the use of a vacuum truck. The hose of the vacuum truck will not damage the screening device.
3. Screening device can easily be removed from the Pre-Treatment Chamber to gain access to separation chamber and media filters below. Replace grate or manhole cover when completed.

Separation Chamber

1. Perform maintenance procedures of screening device listed above before maintaining the separation chamber.
2. With a pressure washer spray down pollutants accumulated on walls and cartridge filters.
3. Vacuum out Separation Chamber and remove all accumulated pollutants. Replace screening device, grate or manhole cover when completed.

Cartridge Filters

1. Perform maintenance procedures on screening device and separation chamber before maintaining cartridge filters.
2. Enter separation chamber.
3. Unscrew the two bolts holding the lid on each cartridge filter and remove lid.
4. Remove each of 4 to 8 media cages holding the media in place.
5. Spray down the cartridge filter to remove any accumulated pollutants.
6. Vacuum out old media and accumulated pollutants.
7. Reinstall media cages and fill with new media from manufacturer or outside supplier. Manufacturer will provide specification of media and sources to purchase.
8. Replace the lid and tighten down bolts. Replace screening device, grate or manhole cover when completed.

Drain Down Filter

1. Remove hatch or manhole cover over discharge chamber and enter chamber.
2. Unlock and lift drain down filter housing and remove old media block. Replace with new media block. Lower drain down filter housing and lock into place.
3. Exit chamber and replace hatch or manhole cover.



Maintenance Notes

1. Following maintenance and/or inspection, it is recommended the maintenance operator prepare a maintenance/inspection record. The record should include any maintenance activities performed, amount and description of debris collected, and condition of the system and its various filter mechanisms.
2. The owner should keep maintenance/inspection record(s) for a minimum of five years from the date of maintenance. These records should be made available to the governing municipality for inspection upon request at any time.
3. Transport all debris, trash, organics and sediments to approved facility for disposal in accordance with local and state requirements.
4. Entry into chambers may require confined space training based on state and local regulations.
5. No fertilizer shall be used in the Biofiltration Chamber.
6. Irrigation should be provided as recommended by manufacturer and/or landscape architect. Amount of irrigation required is dependent on plant species. Some plants may require irrigation.

Maintenance Procedure Illustration

Screening Device

The screening device is located directly under the manhole or grate over the Pre-Treatment Chamber. It's mounted directly underneath for easy access and cleaning. Device can be cleaned by hand or with a vacuum truck.



Separation Chamber

The separation chamber is located directly beneath the screening device. It can be quickly cleaned using a vacuum truck or by hand. A pressure washer is useful to assist in the cleaning process.

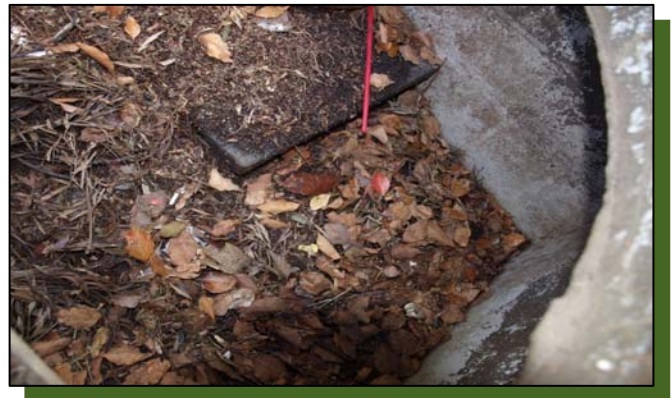

Cartridge Filters

The cartridge filters are located in the Pre-Treatment chamber connected to the wall adjacent to the biofiltration chamber. The cartridges have removable tops to access the individual media filters. Once the cartridge is open media can be easily removed and replaced by hand or a vacuum truck.



Drain Down Filter

The drain down filter is located in the Discharge Chamber. The drain filter unlocks from the wall mount and hinges up. Remove filter block and replace with new block.



Trim Vegetation

Vegetation should be maintained in the same manner as surrounding vegetation and trimmed as needed. No fertilizer shall be used on the plants. Irrigation per the recommendation of the manufacturer and or landscape architect. Different types of vegetation requires different amounts of irrigation.





Inspection Form



Modular Wetland System, Inc.

P. 760.433-7640

F. 760-433-3176

E. Info@modularwetlands.com

www.modularwetlands.com



Inspection Report Modular Wetlands System



Project Name _____

Project Address _____ (city) (Zip Code)

Owner / Management Company _____

Contact _____

Phone () -

Inspector Name _____

Date ____ / ____ / ____ Time ____ AM / PM

Type of Inspection Routine Follow Up Complaint Storm Storm Event in Last 72-hours? No Yes

Weather Condition _____

Additional Notes _____

| |
|---|
| For Office Use Only |
| (Reviewed By) |
| (Date) Office personnel to complete section to the left. |

Inspection Checklist

Modular Wetland System Type (Curb, Grate or UG Vault): _____ Size (22', 14' or etc.): _____

| Structural Integrity: | Yes | No | Comments |
|---|-----|----|----------|
| Damage to pre-treatment access cover (manhole cover/grate) or cannot be opened using normal lifting pressure? | | | |
| Damage to discharge chamber access cover (manhole cover/grate) or cannot be opened using normal lifting pressure? | | | |
| Does the MWS unit show signs of structural deterioration (cracks in the wall, damage to frame)? | | | |
| Is the inlet/outlet pipe or drain down pipe damaged or otherwise not functioning properly? | | | |
| Working Condition: | | | |
| Is there evidence of illicit discharge or excessive oil, grease, or other automobile fluids entering and clogging the unit? | | | |
| Is there standing water in inappropriate areas after a dry period? | | | |
| Is the filter insert (if applicable) at capacity and/or is there an accumulation of debris/trash on the shelf system? | | | |
| Does the depth of sediment/trash/debris suggest a blockage of the inflow pipe, bypass or cartridge filter? If yes, specify which one in the comments section. Note depth of accumulation in in pre-treatment chamber. | | | Depth: |
| Does the cartridge filter media need replacement in pre-treatment chamber and/or discharge chamber? | | | Chamber: |
| Any signs of improper functioning in the discharge chamber? Note issues in comments section. | | | |
| Other Inspection Items: | | | |
| Is there an accumulation of sediment/trash/debris in the wetland media (if applicable)? | | | |
| Is it evident that the plants are alive and healthy (if applicable)? Please note Plant Information below. | | | |
| Is there a septic or foul odor coming from inside the system? | | | |

| Waste: | Yes | No |
|--------------------------------|-----|----|
| Sediment / Silt / Clay | | |
| Trash / Bags / Bottles | | |
| Green Waste / Leaves / Foliage | | |

| Recommended Maintenance | |
|---------------------------------|--|
| No Cleaning Needed | |
| Schedule Maintenance as Planned | |
| Needs Immediate Maintenance | |

| Plant Information | |
|-------------------|--|
| Damage to Plants | |
| Plant Replacement | |
| Plant Trimming | |

Additional Notes: _____

Maintenance Report



Modular Wetland System, Inc.

P. 760.433-7640

F. 760-433-3176

E. Info@modularwetlands.com

www.modularwetlands.com



Cleaning and Maintenance Report Modular Wetlands System



Project Name _____

Project Address _____
(city) (Zip Code)

Owner / Management Company _____

Contact _____ Phone () -

Inspector Name _____ Date ____ / ____ / ____ Time _____ AM / PM

Type of Inspection Routine Follow Up Complaint Storm Storm Event in Last 72-hours? No Yes

Weather Condition _____ Additional Notes _____

For Office Use Only

(Reviewed By) _____

(Date) _____
 Office personnel to complete section to the left.

| Site Map # | GPS Coordinates of Insert | Manufacturer / Description / Sizing | Trash Accumulation | Foliage Accumulation | Sediment Accumulation | Total Debris Accumulation | Condition of Media 25/50/75/100 (will be changed @ 75%) | Operational Per Manufactures' Specifications (If not, why?) |
|------------|---------------------------|-------------------------------------|--------------------|----------------------|-----------------------|---------------------------|---|---|
| | Lat: Long: | MWS Catch Basins | | | | | | |
| | | MWS Sedimentation Basin | | | | | | |
| | | Media Filter Condition | | | | | | |
| | | Plant Condition | | | | | | |
| | | Drain Down Media Condition | | | | | | |
| | | Discharge Chamber Condition | | | | | | |
| | | Drain Down Pipe Condition | | | | | | |
| | | Inlet and Outlet Pipe Condition | | | | | | |

Comments:

Attachment F

Plans

PLAN PREPARED BY:

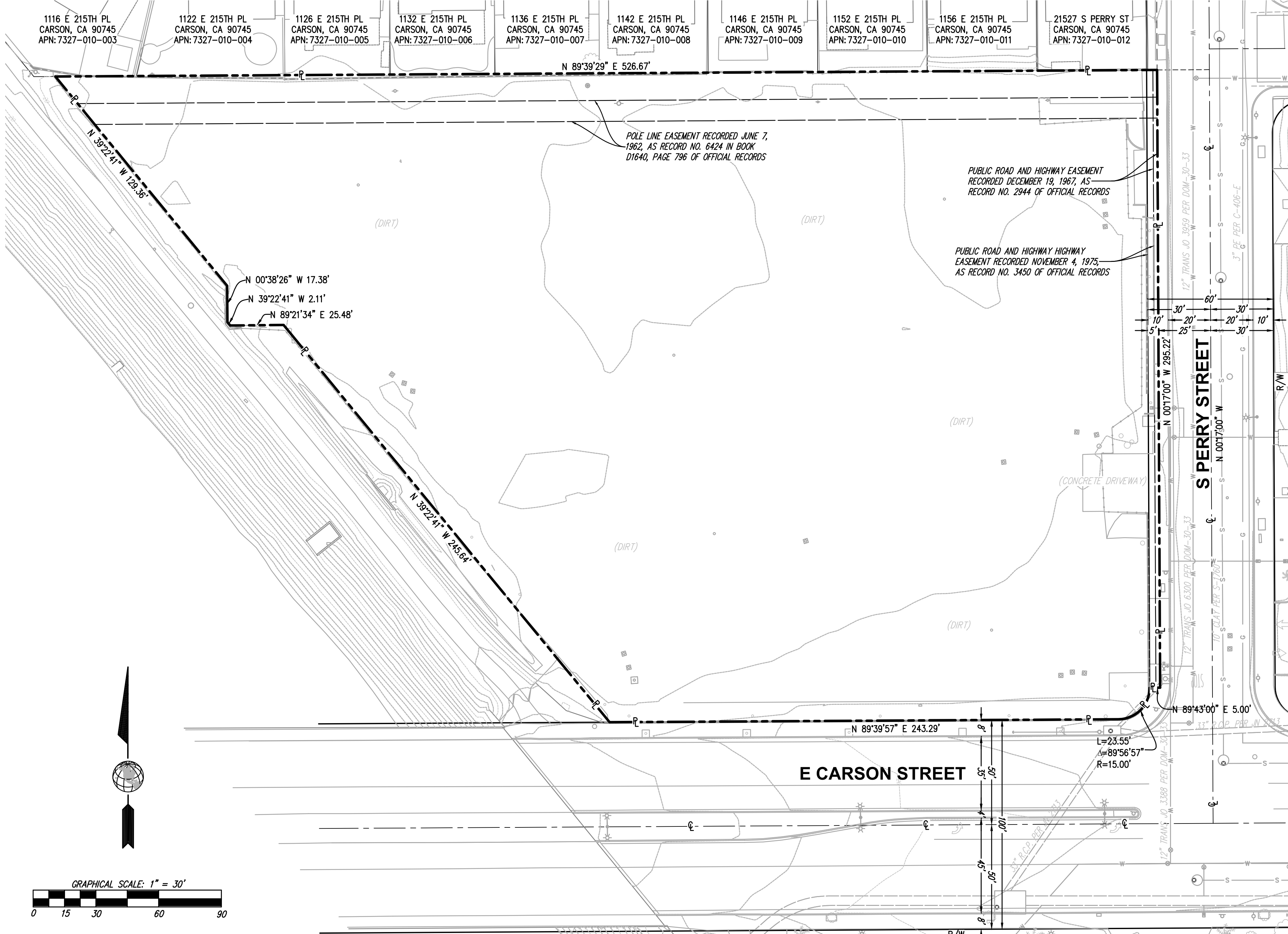

EXISTING LEGEND:

Table with 2 columns: ITEM and SYMBOL. Includes entries for PROPERTY LINE, CENTERLINE, RIGHT-OF-WAY, EASEMENT, EX. CONTOUR, and EX. CURB & GUTTER.

OWNER: SITE ADDRESS:

RECREATION ROAD LLC 21611 SOUTH PERRY STREET CARSON, CA 90745

ASSESSOR'S PARCEL NUMBER:

7327-010-014 & 7327-010-015

TITLE INFORMATION:

TITLE INFORMATION FOR THIS SURVEY BASED ON A PRELIMINARY REPORT PREPARED BY COMMONWEALTH LAND TITLE INSURANCE COMPANY AS ORDER NO. 09174014-917-EQL, DATED: AUGUST 4, 2020.

LEGAL DESCRIPTION:

THAT PORTION OF LOT 15 OF TRACT NO. 4054, IN THE CITY OF CARSON, COUNTY OF LOS ANGELES, STATE OF CALIFORNIA, AS PER MAP RECORDED IN BOOK 44, PAGES 39 THROUGH 41 INCLUSIVE OF MAPS, IN THE OFFICE OF THE COUNTY RECORDER OF SAID COUNTY, DESCRIBED AS FOLLOWS:

BEGINNING AT THE INTERSECTION OF THE NORTHERLY LINE OF THE SOUTHERLY 20 FEET OF SAID LOT WITH A LINE PARALLEL WITH AND NORTHEASTERLY 27 FEET, MEASURED AT RIGHT ANGLES, FROM THE SOUTHWESTERLY LINE OF SAID LOT; THENCE ALONG SAID PARALLEL LINE NORTH 39°21'48" WEST 245.64 FEET; THENCE SOUTH 89°22'27" WEST 25.48 FEET; THENCE NORTH 39°21'48" WEST 2.11 FEET; THENCE NORTH 00°37'33" WEST 17.38 FEET TO A LINE PARALLEL WITH AND NORTHEASTERLY 18 FEET, MEASURED AT RIGHT ANGLES, FROM SAID SOUTHWESTERLY LINE; THENCE ALONG SAID LAST MENTIONED PARALLEL LINE NORTH 39°21'48" WEST TO THE SOUTHERLY LINE OF TRACT NO. 29360, AS PER MAP RECORDED IN BOOK 734, PAGES 45 AND 46 OF MAPS; THENCE EASTERLY ALONG SAID SOUTHERLY LINE TO THE EASTERLY LINE OF SAID LOT 15; THENCE SOUTHERLY ALONG SAID EASTERLY LINE TO SAID NORTHERLY LINE; THENCE WESTERLY ALONG SAID NORTHERLY LINE TO THE POINT OF BEGINNING.

EXCEPT THEREFROM THAT PORTION OF SAID LAND DESIGNATED AS PARCELS 2-36 INCLUSIVE IN THE FINAL DECREE OF CONDEMNATION ENTERED IN SUPERIOR COURT, LOS ANGELES COUNTY, CASE NO. 909,461, A CERTIFIED COPY OF WHICH WAS RECORDED AUGUST 26, 1969 AS INSTRUMENT NO. 2734, IN BOOK D-4478, PAGE 350 OF OFFICIAL RECORDS OF SAID COUNTY AND MORE PARTICULARLY DESCRIBED AS FOLLOWS:

BEGINNING AT THE INTERSECTION OF THE EASTERLY LINE OF SAID LOT WITH THE NORTHERLY LINE OF THE SOUTHERLY 20 FEET OF SAID LOT; THENCE WESTERLY ALONG SAID NORTHERLY LINE 19.99 FEET TO THE BEGINNING OF A CURVE CONCAVE TO THE NORTHWEST, HAVING A RADIUS OF 15 FEET, TANGENT TO SAID NORTHERLY LINE AND TANGENT TO THE WESTERLY LINE OF THE EASTERLY 5 FEET OF SAID LOT; THENCE NORTHEASTERLY ALONG SAID CURVE 23.55 FEET TO SAID WESTERLY LINE; THENCE EASTERLY AT RIGHT ANGLES FROM SAID WESTERLY LINE 5 FEET TO SAID EASTERLY LINE; THENCE SOUTHERLY ALONG SAID EASTERLY LINE 14.99 FEET TO THE POINT OF BEGINNING.

VERTICAL BENCHMARK:

DESCRIPTION: LOS ANGELES COUNTY PUBLIC WORKS BENCHMARK NUMBER "Y 10545" IN TOP OF CURB ON SOUTH SIDE OF E 213TH STREET APPROXIMATELY 40 FEET WEST OF THE CENTERLINE OF PERRY STREET (APPROXIMATELY 1,010' NORTH OF SITE)

ELEVATION: 18.248' (NAVD88)

SOURCE OF TOPOGRAPHY:

TOPOGRAPHY SHOWN HEREON IS BASED ON AERIAL PHOTOGRAMMETRIC MAPPING CONDUCTED BY PRECISION UAV. HORIZONTAL AND VERTICAL GROUND CONTROL WERE ESTABLISHED BY OMEGA LAND SURVEYING, INC. ON FEBRUARY 01, 2021 WITH SUPPLEMENTAL DATA COLLECTED ON FEBRUARY 03, 2021.

BASIS OF BEARINGS:

THE BASIS OF BEARINGS FOR THIS SURVEY IS THE CENTERLINE OF PERRY STREET AS SHOWN ON SUBDIVISION MAP FOR TRACT NO. 29360 FILED IN BOOK 734, PAGE 46-47, OF MAP RECORDS, SAID BEARING BEING "N 00°17'17" W".

AREA SUMMARY:

TOTAL PARCEL AREA (NET) 110,643 SF
TOTAL PARCEL AREA (GROSS) 112,119 SF

GRADING INFORMATION:

CUT (TO FINISH SURFACE) 357 CY
FILL (TO FINISH SURFACE) 4,199 CY
UNDERCUTS 4,281 CY
REMEDIAL GRADING 15,037 CY
EXPORT (IMBALANCE) 725 CY

EASEMENTS:

- 1. POLE LINE EASEMENT RECORDED JUNE 7, 1962, AS RECORD NO. 6424 IN BOOK D1640, PAGE 796 OF OFFICIAL RECORDS.
2. PUBLIC ROAD AND HIGHWAY EASEMENT RECORDED DECEMBER 19, 1967, AS RECORD NO. 2944 OF OFFICIAL RECORDS.
3. PUBLIC STREET OR HIGHWAY EASEMENT RECORDED NOVEMBER 4, 1975, AS RECORD NO. 3450 OF OFFICIAL RECORDS.

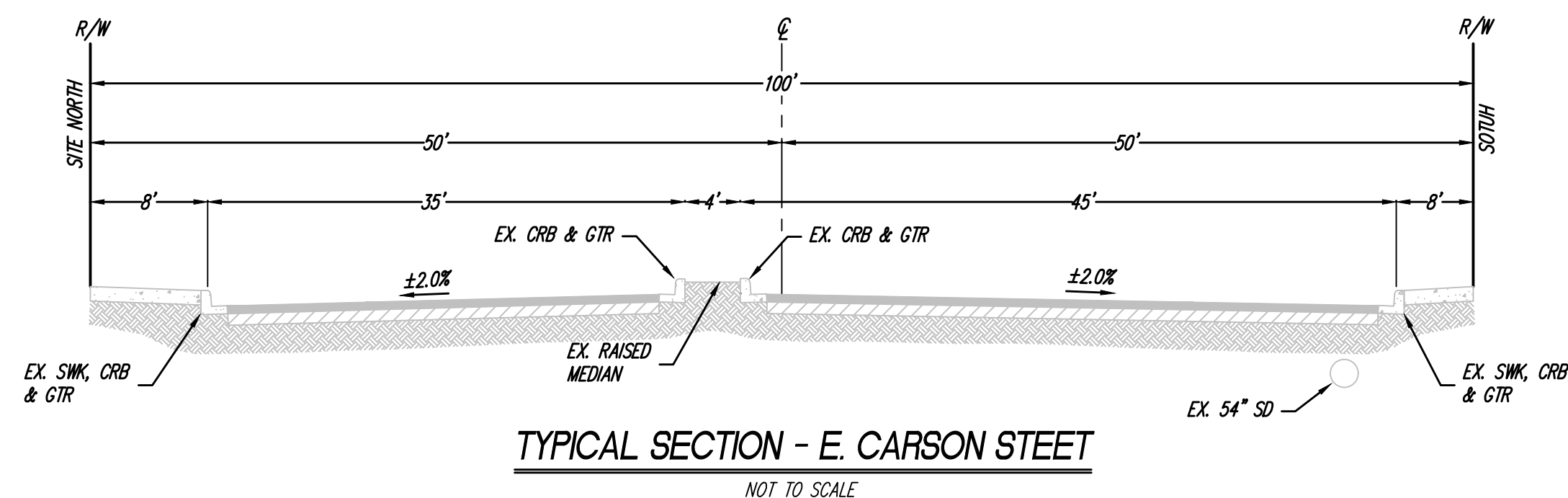
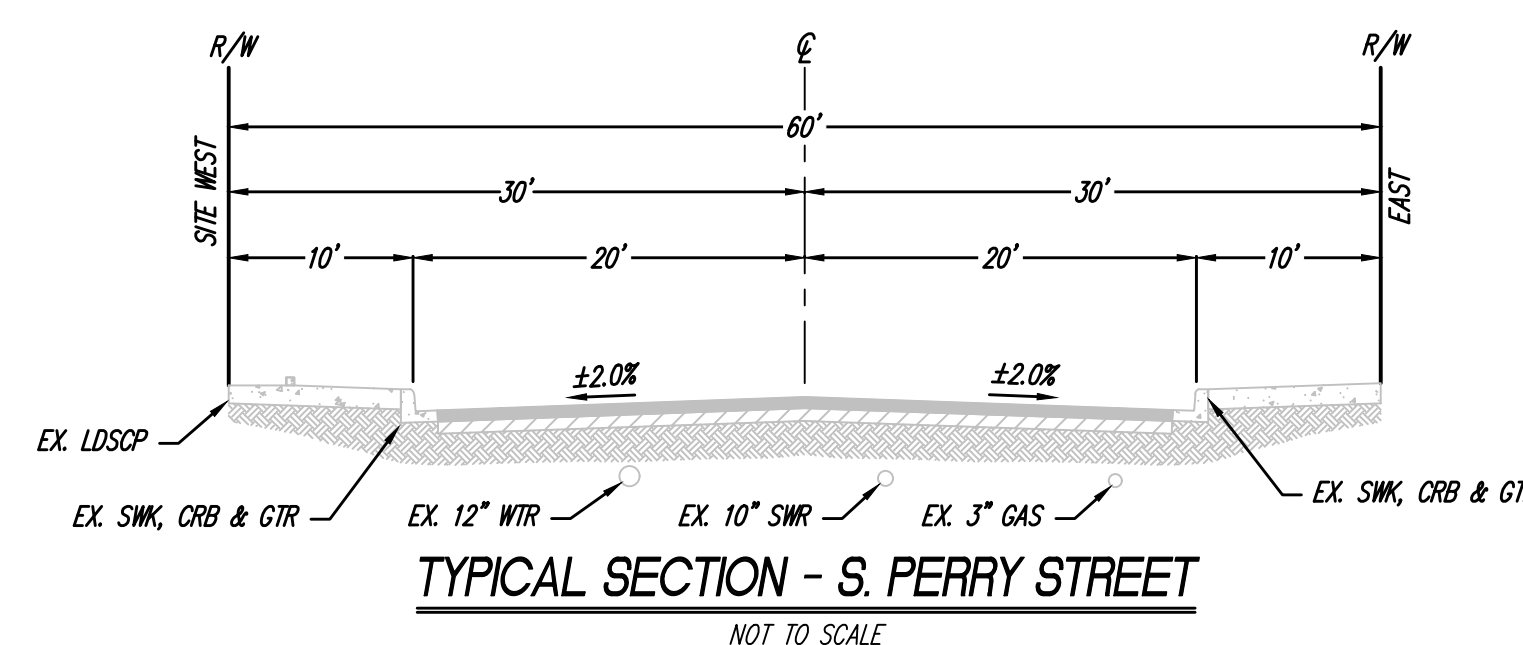
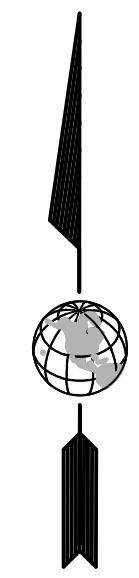
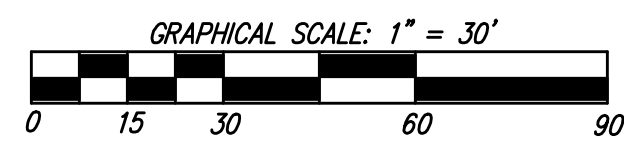

PERRY STREET
CARSON STREET SS
CARSON, CA



FOR PLAN CHECK ONLY

SEAN M. SAVAGE R.C.E. 75677 DATE

THIS DRAWING AND ITS CONTENTS ARE INSTRUMENTS OF SERVICE AND ARE THE COPYRIGHTED PROPERTY OF JORDAN ARCHITECTS, INC. THE USE IS EXPRESSLY INTENDED FOR THE PROJECT NOTED ABOVE AND MAY NOT BE REUSED OR REPRODUCED IN WHOLE OR IN PART WITHOUT THE WRITTEN PERMISSION OF JORDAN ARCHITECTS, INC. COPYRIGHT YEAR OF FIRST PUBLICATION 2020 JORDAN ARCHITECTS, INC.

JOB NUMBER: 20-817
DATE: 10/05/2021

Jordan Architects logo and contact information: 131 CALLE IGLESIA, SUITE 100 SAN CLEMENTE, CA 92672 949.388.8090

DATE: 10/05/2021 11:20:02 AM
FILENAME: P:\DWG\OMEGA\PROJECT FARMING SS CARSON\CAD\DISCREETINARY\0633-COP-01-CONSTRAINTS.DWG

PRELIMINARY GRADING PLAN

PLAN PREPARED BY:

OMEGA
ENGINEERING CONSULTANTS
 4340 VIEWRIDGE AVE. SUITE B
 SAN DIEGO, CA 92123
 PH: (858) 634-8620 FAX: (858)-634-8627

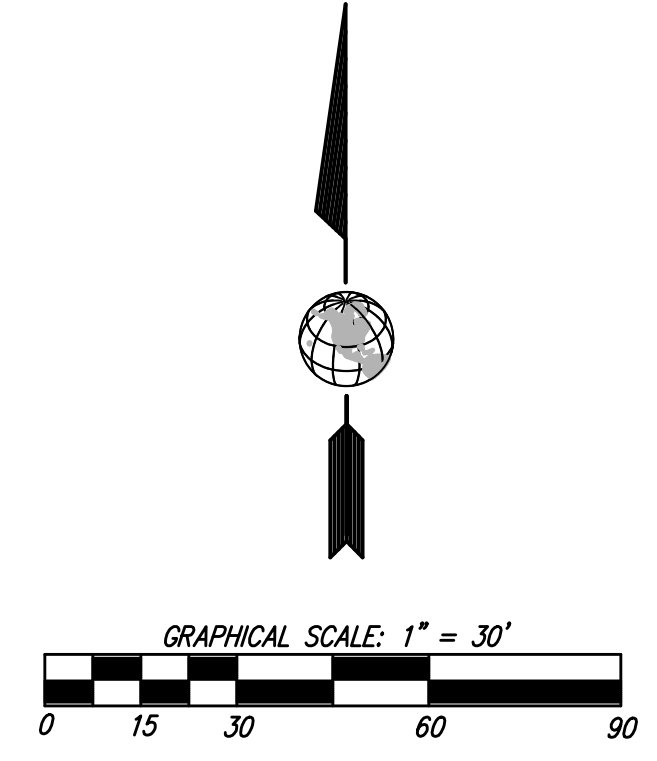
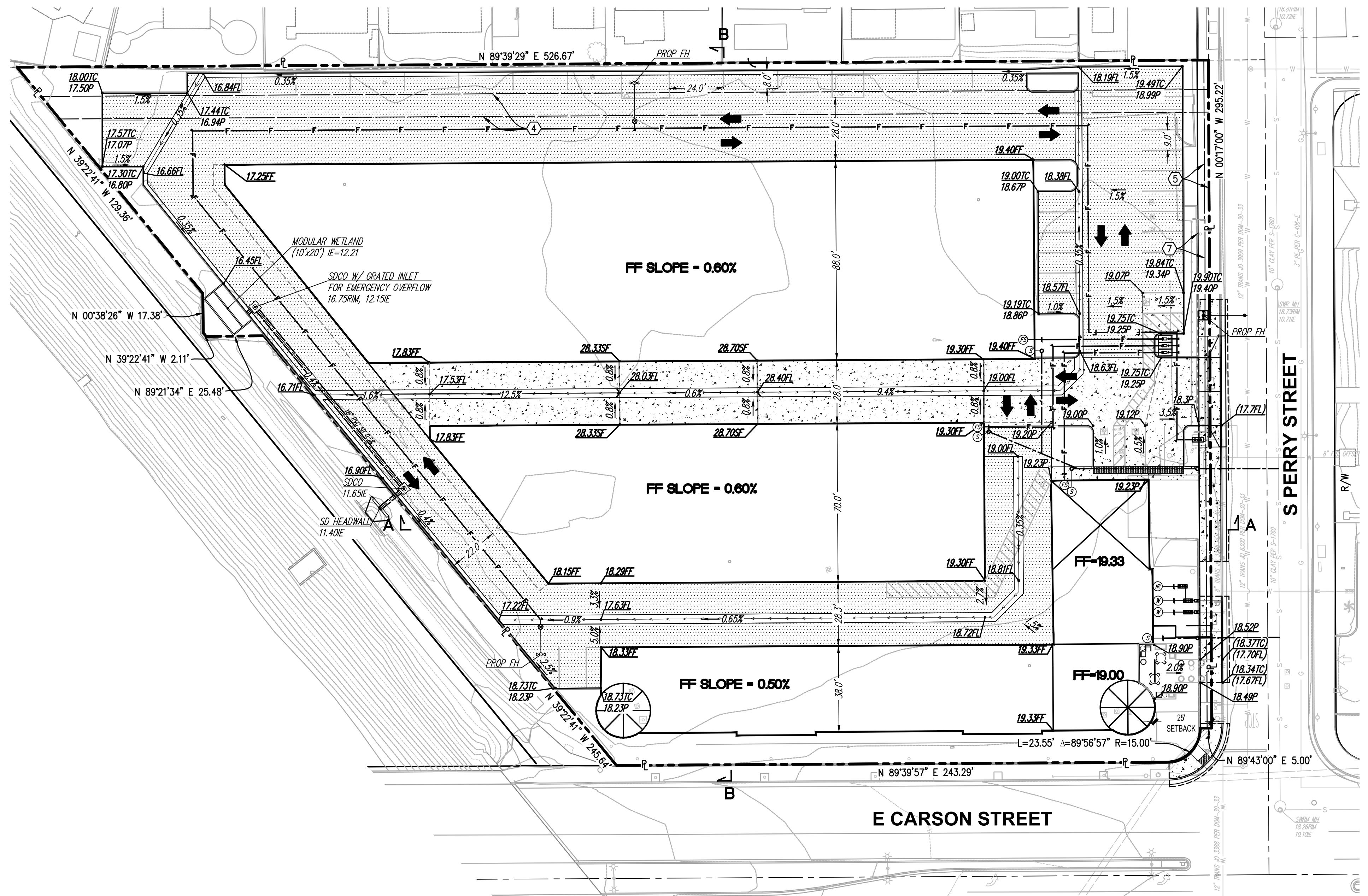

EXISTING LEGEND

| ITEM | SYMBOL |
|-------------------|--------|
| PROPERTY LINE | ----- |
| CENTERLINE | ----- |
| RIGHT-OF-WAY | ----- |
| EX. CONTOUR | ----- |
| EX. CURB & GUTTER | ----- |

PROPOSED LEGEND

| ITEM | SYMBOL |
|---|-----------------------|
| PROPOSED GRADE BREAK | ----- |
| PROPOSED FINISH FLOOR SLOPE | FF SLOPE -0.5% |
| PROPOSED FINISH FLOOR ELEVATION | 374.0OFF |
| PROPOSED PAVEMENT ELEVATION | 374.0OP |
| PROPOSED FLOWLINE ELEVATION | 374.0OFL |
| PROPOSED GRADIENT | 1.1% |
| PROPOSED 6" PCC CURB | ----- |
| PROPOSED 6" PCC CURB & GUTTER | ----- |
| PROPOSED FLOW LINE | ----- |
| PROPOSED BUILDING | ----- |
| PROPOSED PARKING STALL STRIPING | ----- |
| PROPOSED HANDICAP STRIPING | ----- |
| PROPOSED PVT. STORM DRAIN (SIZE PER PLAN) | ----- |
| PROPOSED PVT. FIRE SERVICE LATERAL | ----- |
| PROPOSED PVT. SEWER LATERAL | ----- |
| PROPOSED SEWER POINT OF CONNECTION | ----- |
| PROPOSED FIRE POINT OF CONNECTION | ----- |
| PROPOSED FIRE SERVICE BACKFLOW | ----- |
| PROPOSED FDC/PIV | ----- |
| PROPOSED FIRE HYDRANT | ----- |
| PROPOSED PVT. STORM DRAIN CLEAN OUT/CONNECTION (SIZE AND TYPE PER PLAN) | ----- |
| PROPOSED PVT. PCC PAVEMENT WALK | ----- |
| PROPOSED PVT. ADA RAMP | ----- |
| PROPOSED PVT. AC PAVEMENT HEAVY DRIVE AISLE | ----- |
| PROPOSED PVT. MODULAR WETLAND | ----- |

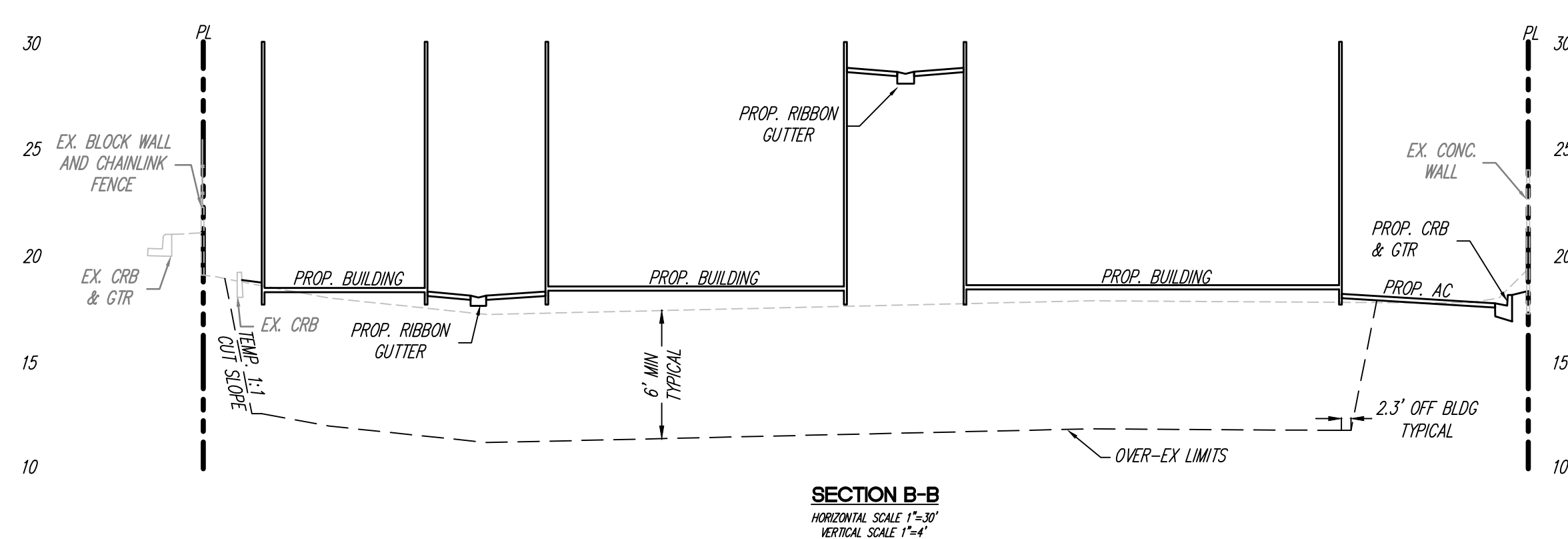
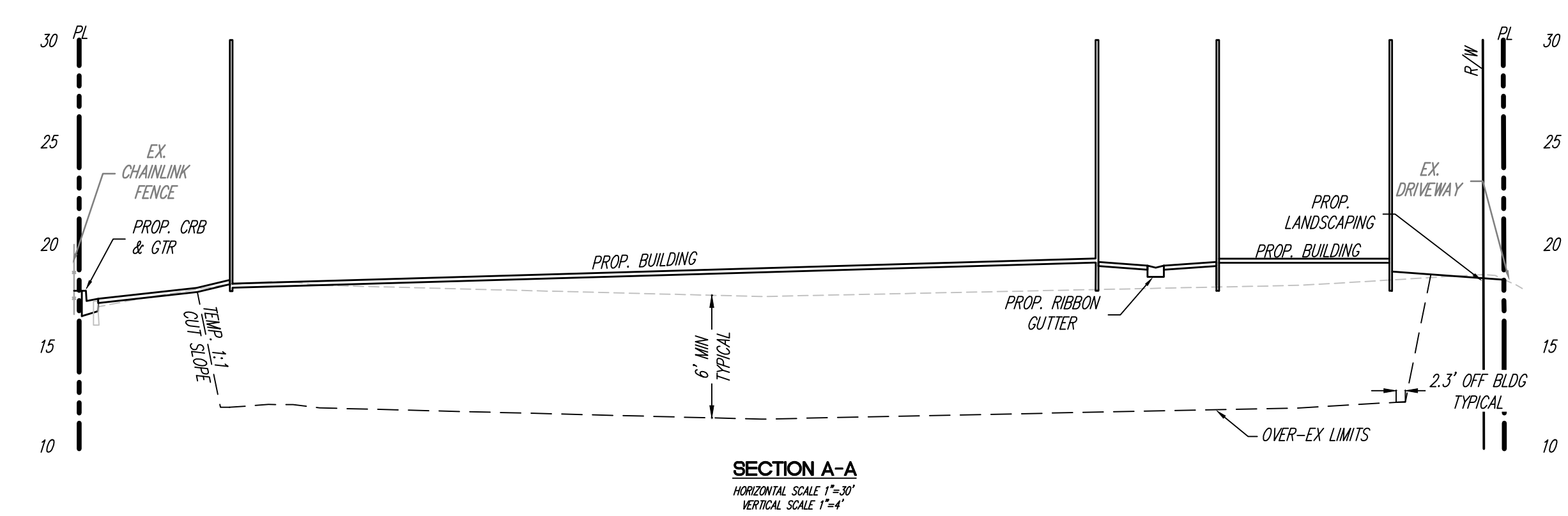

PERRY STREET
CARSON STREET SS
CARSON, CA



FOR PLAN CHECK ONLY
 SEAN M. SAVAGE R.C.E. 75677

DATE

ja
.ORDAN
ARCHITECTS
 131 CALLE IGLESIA, SUITE 100
 SAN CLEMENTE, CA 92672
 949.388.8090

THIS DRAWING AND ITS CONTENTS ARE INSTRUMENTS OF SERVICE AND ARE THE COPYRIGHTED PROPERTY OF JORDAN ARCHITECTS, INC. THE USE IS EXPRESSLY INTENDED FOR THE PROJECT NOTED ABOVE AND MAY NOT BE REUSED OR REPRODUCED IN WHOLE OR IN PART WITHOUT THE WRITTEN PERMISSION OF JORDAN ARCHITECTS, INC. "COPYRIGHT" YEAR OF FIRST PUBLICATION 2020 JORDAN ARCHITECTS, INC.

JOB NUMBER: 20-817
 DATE: 10/05/2021

DATE: 10/05/2021 12:24:33 PM

FILENAME: P:\DWG\OMEGA\BEST PAVING SS CARSON\LOCAL\DISCREETINARY\0633-COP-02-COR.DWG

DATE: 5/14/2021 11:41:32 AM

FILENAME: P:\DWG\OMEGA\633 Faring SS Carson\STORMWATER REPORTS\Water Quality\ATTACHMENTS\85th Percentile Hydro

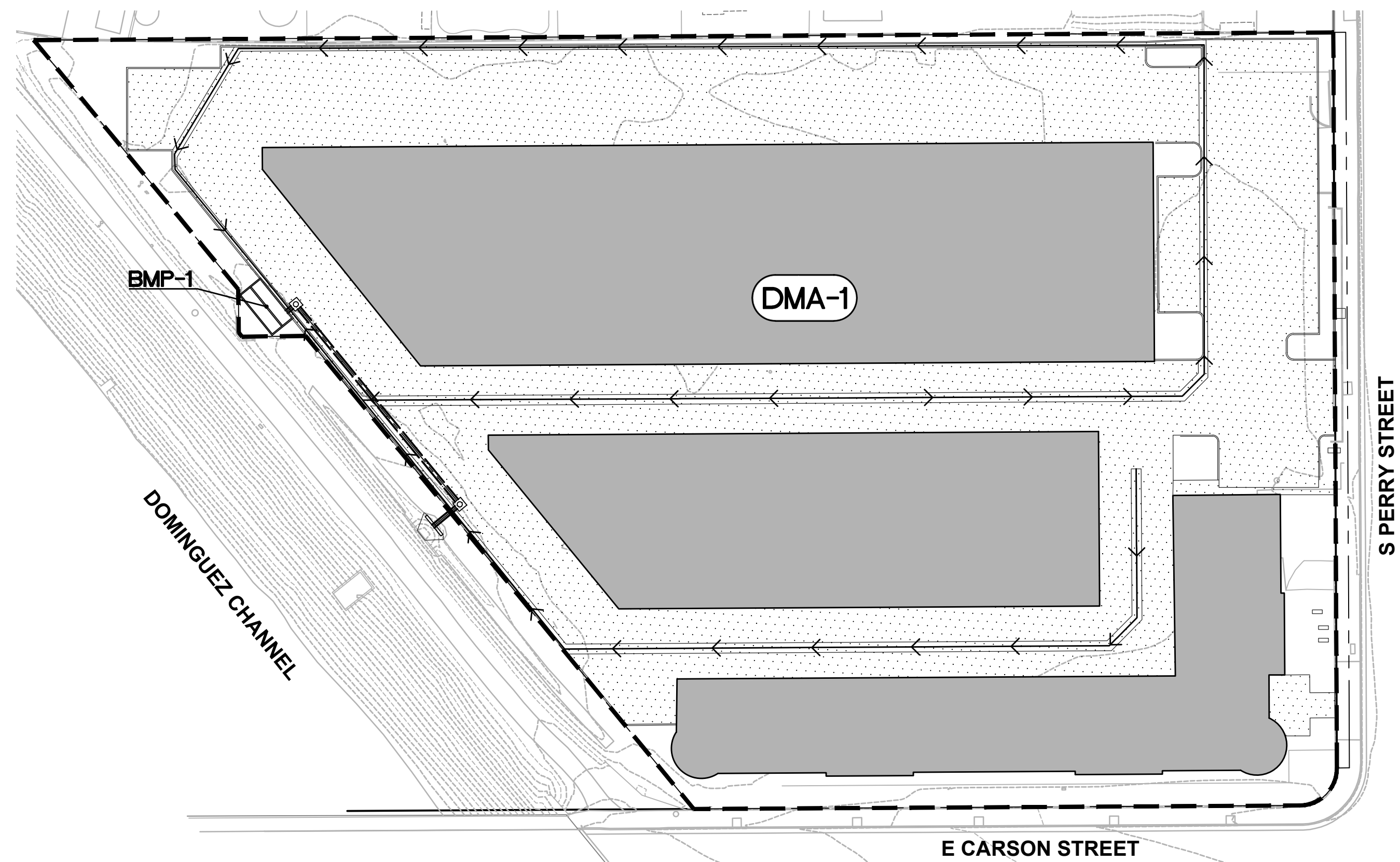

LEGEND

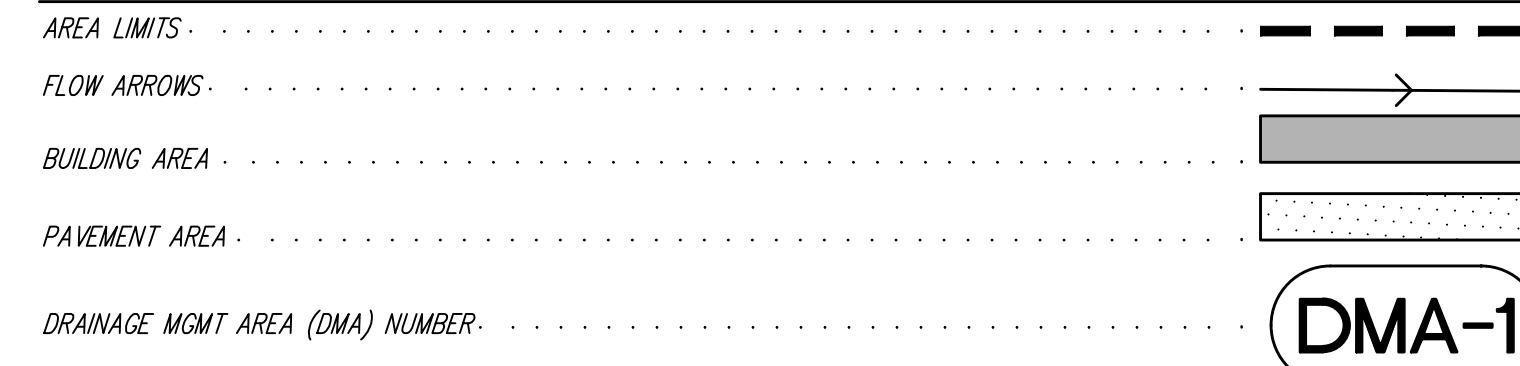

DMA DATA TABLE

| DMA-NO. | TOT. AREA (SF) | IMPERVIOUS (%) | REQ'D FLOWRATE (CFS) | BMP FLOWRATE (CFS) | TYPE/TREATED BY |
|---------|----------------|----------------|----------------------|--------------------|-----------------------|
| DMA-1 | 120,644 | 89.8 | 0.702 | 0.710 | BMP-1/MODULAR WETLAND |

GENERAL STORM WATER NOTES

- GROUNDWATER IS ANTICIPATED AT APPROXIMATELY 12.5 FEET BELOW EXISTING GRADE ON SITE.
- NO EXISTING NATURAL HYDROLOGIC FEATURES
- NO SIGNIFICANT ECOLOGICAL AREAS ON SITE
- ALL APPLICABLE SOURCE CONTROL BMPs SHALL BE IMPLEMENTED
- SOURCE CONTROL NOTES TO COME IN MINISTERIAL REVIEW

Peak Flow Hydrologic Analysis

File location: P:\DWG\OMEGA\633 Faring SS Carson\STORMWATER REPORTS\Water Quality\ATTACHMENTS\85th Percentile Hydro
Version: HydroCalc 1.0.3

Input Parameters

| | |
|-------------------------------------|-----------------------|
| Project Name | Carson Self Storage |
| Subarea ID | DMA-1 |
| Area (ac) | 2.77 |
| Flow Path Length (ft) | 475.0 |
| Flow Path Slope (vft/hft) | 0.006 |
| 85th Percentile Rainfall Depth (in) | 0.8 |
| Percent Impervious | 0.898 |
| Soil Type | 3 |
| Design Storm Frequency | 85th percentile storm |
| Fire Factor | 0 |
| LID | True |

Output Results

| | |
|---|-----------|
| Modeled (85th percentile storm) Rainfall Depth (in) | 0.8 |
| Peak Intensity (in/hr) | 0.2025 |
| Undeveloped Runoff Coefficient (Cu) | 0.1 |
| Developed Runoff Coefficient (Cd) | 0.8184 |
| Time of Concentration (min) | 31.0 |
| Clear Peak Flow Rate (cfs) | 0.459 |
| Burned Peak Flow Rate (cfs) | 0.459 |
| 24-Hr Clear Runoff Volume (ac-ft) | 0.1499 |
| 24-Hr Clear Runoff Volume (cu-ft) | 6528.9479 |

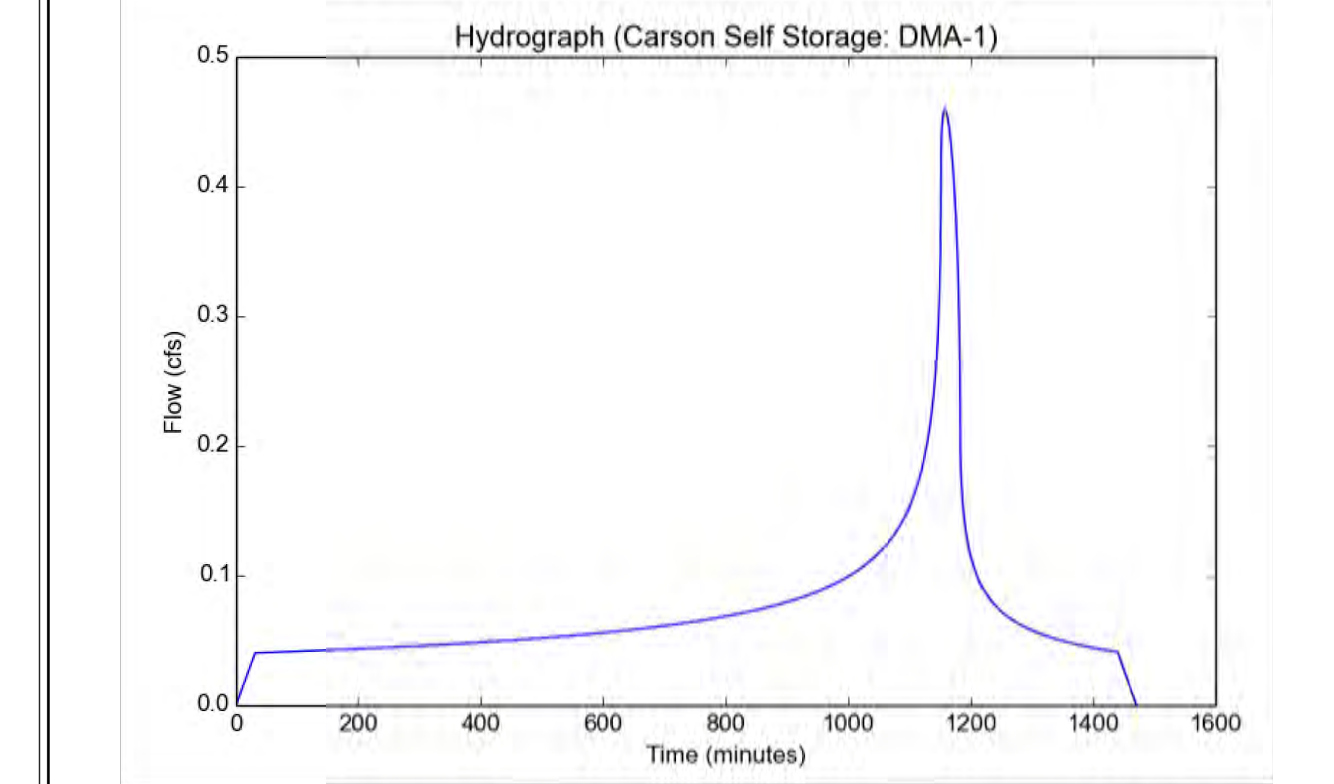

PROJECT HYDROGRAPH

| SITE SPECIFIC DATA | | | |
|--|--------------------------|---------------|------------|
| PROJECT NUMBER | | | |
| PROJECT NAME | | | |
| PROJECT LOCATION | | | |
| STRUCTURE ID | | | |
| TREATMENT REQUIRED | | | |
| VOLUME BASED (CF) | FLOW BASED (CFS) | | |
| N/A | 0.710 | | |
| TREATMENT HGL AVAILABLE (FT) | N/A | | |
| PEAK BYPASS REQUIRED (CFS) - IF APPLICABLE | FLOW BY | | |
| PIPE DATA | I.E. | MATERIAL | DIAMETER |
| INLET PIPE 1 | | | |
| INLET PIPE 2 | | | |
| OUTLET PIPE | | | |
| | PRETREATMENT | BIOFILTRATION | DISCHARGE |
| RIM ELEVATION | | | |
| SURFACE LOAD | PEDESTRIAN | OPEN PLANNED | PEDESTRIAN |
| FRAME & COVER | 2 EA 36" X 36" 2 EA #24" | | |
| WETLAND MEDIA VOLUME (CY) | | | |
| ORIFICE SIZE (DIA. INCHES) | 2 EA #2.67" | | |
| NOTES: PRELIMINARY. NOT FOR CONSTRUCTION. | | | |

INSTALLATION NOTES

- CONTRACTOR TO PROVIDE ALL LABOR, EQUIPMENT, MATERIALS AND INCIDENTALS REQUIRED TO OFFLOAD AND INSTALL THE SYSTEM AND APPURTENANCES IN ACCORDANCE WITH THIS DRAWING AND THE MANUFACTURER'S SPECIFICATIONS, UNLESS OTHERWISE STATED IN MANUFACTURER'S CONTRACT.
- UNIT MUST BE INSTALLED ON LEVEL BASE. MANUFACTURER RECOMMENDS A MINIMUM 6" LEVEL ROCK BASE UNLESS SPECIFIED BY THE PROJECT ENGINEER. CONTRACTOR IS RESPONSIBLE TO VERIFY PROJECT ENGINEER'S RECOMMENDED BASE SPECIFICATIONS.
- ALL PIPES MUST BE FLUSH WITH INSIDE SURFACE OF CONCRETE. (PIPES CANNOT INTRUDE BEYOND FLUSH). INVERT OF OUTFLOW PIPE MUST BE FLUSH WITH DISCHARGE CHAMBER FLOOR. ALL GAPS AROUND PIPES SHALL BE SEALED WATER TIGHT WITH A NON-SHRINK GROUT PER MANUFACTURER'S STANDARD CONNECTION DETAIL AND SHALL MEET OR EXCEED REGIONAL PIPE CONNECTION STANDARDS.
- CONTRACTOR TO SUPPLY AND INSTALL ALL EXTERNAL CONNECTING PIPES.
- CONTRACTOR RESPONSIBLE FOR INSTALLATION OF ALL RISERS, MANHOLES, AND HATCHES. CONTRACTOR TO GROUT ALL MANHOLES AND HATCHES TO MATCH FINISHED SURFACE UNLESS SPECIFIED OTHERWISE.
- Drip or spray irrigation required on all units with vegetation.
- CONTRACTOR RESPONSIBLE FOR CONTACTING MODULAR WETLANDS FOR ACTIVATION OF UNIT. MANUFACTURER'S WARRANTY IS VOID WITH OUT PROPER ACTIVATION BY A MODULAR WETLANDS REPRESENTATIVE.

GENERAL NOTES

- MANUFACTURER TO PROVIDE ALL MATERIALS UNLESS OTHERWISE NOTED.
- ALL DIMENSIONS, ELEVATIONS, SPECIFICATIONS AND CAPACITIES ARE SUBJECT TO CHANGE. FOR PROJECT SPECIFIC DRAWINGS DETAILING EXACT DIMENSIONS, WEIGHTS AND ACCESSORIES PLEASE CONTACT MANUFACTURER.

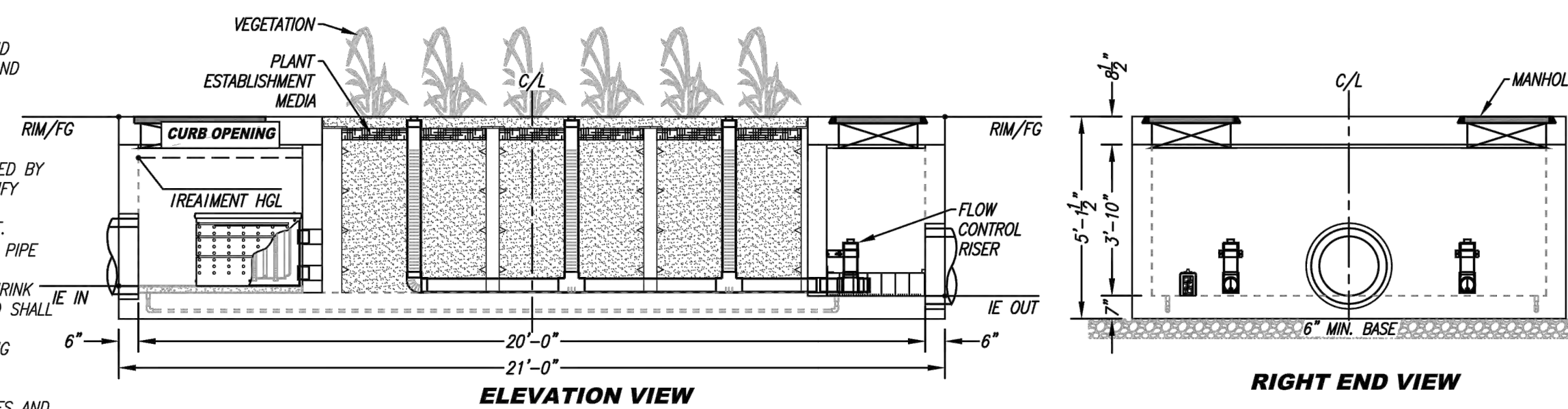
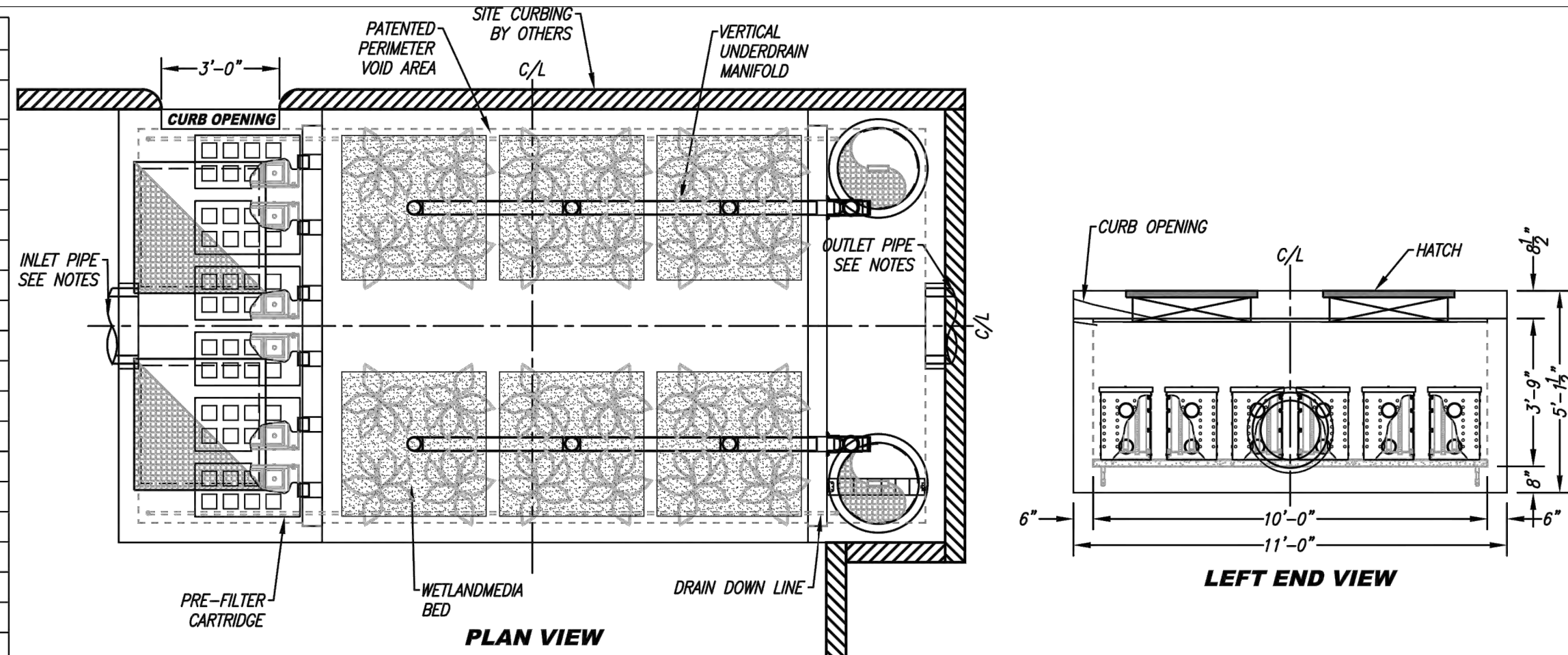

LOW INFLOW PIPE DISCLOSURE:

IT IS RECOMMENDED THAT A SUFFICIENT VARIATION IN ELEVATION BETWEEN THE INLET AND OUTLET BE PROVIDED TO ALLOW FOR ACCUMULATION OF SEDIMENT IN THE PRE-TREATMENT CHAMBER. FAILURE TO DO SO MAY RESULT IN BLOCKAGE AT INFLOW POINT(S) WHICH MAY CAUSE UPSTREAM FLOODING.

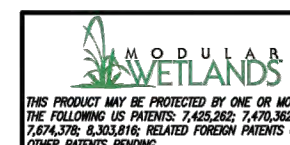

PROPRIETARY AND CONFIDENTIAL:
THE INFORMATION CONTAINED IN THIS DRAWING IS THE SOLE PROPERTY OF MODULAR WETLANDS SYSTEMS. ANY REPRODUCTION IN PART OR AS A WHOLE WITHOUT THE WRITTEN PERMISSION OF MODULAR WETLANDS SYSTEMS IS PROHIBITED.



MWS-L-10-20-4'-5.5"-C-HC
STORMWATER BIOFILTRATION SYSTEM
STANDARD DETAIL

| | |
|-------------------------------------|-------|
| TREATMENT FLOW (CFS) | 0.710 |
| OPERATING HEAD (FT) | 3.5 |
| PRETREATMENT LOADING RATE (GPM/SF) | 2.1 |
| WETLAND MEDIA LOADING RATE (GPM/SF) | 1.0 |

PERRY STREET
CARSON STREET SS
CARSON, CA

MODULAR WETLAND DETAIL

NOT TO SCALE



FOR PLAN CHECK ONLY

SEAN M. SAVAGE R.C.E. 75677 DATE

PLAN PREPARED BY:



THIS DRAWING AND ITS CONTENTS ARE INSTRUMENTS OF SERVICE AND ARE THE COPYRIGHTED PROPERTY OF JORDAN ARCHITECTS, INC. THE USE IS EXPRESSLY INTENDED FOR THE PROJECT NOTED ABOVE AND MAY NOT BE REUSED OR REPRODUCED IN WHOLE OR IN PART WITHOUT THE WRITTEN PERMISSION OF JORDAN ARCHITECTS, INC. "COPYRIGHT" YEAR OF FIRST PUBLICATION 2020 JORDAN ARCHITECTS, INC.

JOB NUMBER: 20-817

DATE: 10/05/2021

