



AGS

ADVANCED GEOTECHNICAL SOLUTIONS, INC.

485 Corporate Drive, Suite B

Escondido, California 92029

Telephone: (619) 867-0487 Fax: (714) 409-3287

AMBIENT COMMUNITIES

179 Calle Magdalena Suite #201

Encinitas, Ca. 92024

August 26, 2021

PW 1912-01

Report No. 1912-01-B-4

Attention: Duncan Budinger
Director of Retail Development

**Subject: Supplemental Geotechnical Investigation and Design Recommendations,
Multifamily Residential Development, 555 Hollister Street, San Diego, California**

References: See Appendix A

Gentlemen:

Pursuant to your request, presented herein are the results of Advanced Geotechnical Solutions, Inc.'s (AGS) supplemental geotechnical investigation and design recommendations for the proposed multi-family residential development located at 555 Hollister Street in the City of San Diego, California.

The purpose of this supplemental geotechnical investigation is to evaluate the proposed development as depicted in the preliminary grading exhibit relative to the near-site and on-site geologic and geotechnical conditions, as well as to provide conclusions and recommendation to aid in the design and construction of the proposed multi-family residential development and associated improvements.

Advanced Geotechnical Solutions, Inc., appreciates the opportunity to provide you with geotechnical consulting services and professional opinions. If you have any questions, please contact the undersigned at (619) 867-0487.

Respectfully Submitted,
Advanced Geotechnical Solutions, Inc.

ANDRES BERNAL, Sr. Geotechnical Engineer
RCE 62366, RGE 2715, Reg. Exp. 9-30-21

PAUL J. DERISI, Principal Geologist
CEG 2536, Reg. Exp. 5-31-23

Distribution: (1) Addressee



TABLE OF CONTENTS

	Page
1.0 INTRODUCTION	1
1.1. Scope of Work	1
1.2. Geotechnical Study Limitations.....	1
2.0 SITE DESCRIPTION AND PROPOSED DEVELOPMENT	2
3.0 FIELD AND LABORATORY INVESTIGATION	2
3.1. Previous Study	2
3.2. Current Investigation	2
3.3. Infiltration Testing	3
4.0 ENGINEERING GEOLOGY	3
4.1. Regional Geologic and Geomorphic Setting	3
4.2. Site Geology.....	3
4.2.1. Topsoil (No map symbol).....	3
4.2.2. Artificial Fill - Undocumented (Map symbol afu).....	4
4.2.3. Young Alluvial Flood-Plain Deposits (Map symbol Qya)	4
4.2.4. Old Paralic Deposits (Map symbol Qop6).....	4
4.3. Geologic Structure	4
4.4. Groundwater	4
4.5. Seismic Hazards.....	5
4.5.1. Surface Fault Rupture	5
4.5.2. Seismicity.....	5
4.5.3. City of San Diego Seismic Safety Study	5
4.5.4. Liquefaction	5
4.5.5. Dynamic Settlement.....	6
4.5.6. Seismically Induced Landsliding.....	6
4.5.7. Seismic Design Parameters.....	6
4.6. Non-seismic Geologic Hazards.....	7
4.6.1. Mass Wasting.....	7
4.6.2. Flooding.....	7
5.0 GEOTECHNICAL ENGINEERING.....	7
5.1. Material Properties.....	7
5.1.1. Excavation Characteristics.....	7
5.1.2. Compressibility	7
5.1.3. Expansion Potential	7
5.1.4. Shear Strength Characteristics	7
5.1.5. Earthwork Adjustments	8
5.2. Analytical Methods.....	8
5.2.1. Bearing Capacity and Lateral Earth Pressures.....	8
6.0 GRADING RECOMMENDATIONS	8
6.1. Earthwork Recommendations.....	8
6.1.1. Site Preparation.....	9
6.1.2. Removals.....	9
6.1.3. Removals Along Grading Limits and Adjacent to Property Lines	9
6.1.4. Overexcavation	9
6.1.5. Dewatering and Stabilization of Saturated Removal Bottoms	10

6.1.6.	Materials for Fill	10
6.1.7.	Oversize Materials	10
6.1.7.1.	Rock Blankets	11
6.1.7.2.	Rock Windrows	11
6.1.7.3.	Individual Rock Burial.....	11
6.1.7.4.	Rock Disposal Logistics	12
6.2.	Compacted Fill.....	12
6.3.	Settlement Monitoring	12
6.4.	Utility Trench Excavation and Backfill	12
6.5.	Flatwork Subgrade Preparation.....	13
7.0	DESIGN RECOMMENDATIONS	13
7.1.	Foundation Design Recommendations	13
7.1.1.	Foundation Design	13
7.1.2.	Conventional Foundation Design Recommendations.....	13
7.1.3.	Footing Excavations.....	14
7.1.4.	Moisture and Vapor Barrier	14
7.2.	Conventional Retaining Walls	15
7.3.	Mechanically Stabilized Earth (MSE) Retaining Wall.....	16
7.4.	Corrosivity	17
7.5.	Concrete Design.....	17
7.6.	Civil Design Recommendations	18
7.6.1.	Drainage.....	18
7.6.2.	Exterior Flatwork	18
7.6.2.1.	Slab Thickness	18
7.6.2.2.	Control Joints	18
7.6.2.3.	Flatwork Reinforcement	18
7.6.2.4.	Thickened Edge	18
7.7.	Preliminary Pavement Design.....	18
8.0	FUTURE STUDY NEEDS.....	19
8.1.	Construction Plans	19
9.0	CLOSURE	19
9.1.	Geotechnical Review	19
9.2.	Limitations	19

ATTACHMENTS:

- Appendix A - References
- Appendix B - Subsurface Investigation
- Appendix C - Laboratory Test Results
- Appendix D - Infiltration Feasibility Study
- Appendix E - Slope Stability
- Appendix F - General Earthwork Specifications and Grading Details

- Figure 1 - Site Location Map
- Figure 2 - Regional Geologic Map
- Figure 3 - Seismic Hazard Zones Map
- Plate 1 - Geologic Map and Exploration Location Plan

***Supplemental Geotechnical Investigation and Design Recommendations
Proposed Multi-Family Residential Development
555 Hollister Street, City of San Diego, California***

1.0 INTRODUCTION

This study is aimed at providing geologic and geotechnical information and recommendations for the development of the proposed multi-family residential structures relative to: 1) existing site soil and geologic conditions; 2) engineering characteristics of the onsite earth materials; 3) earthwork recommendations; 4) seismic design parameters for use in the geotechnical analysis; and, 5) preliminary foundation design parameters.

1.1. Scope of Work

The scope of our study included the following tasks:

- Review of pertinent published and unpublished geologic and geotechnical literature, maps, and aerial photographs readily available to this firm (Appendix A, References).
- Review the previous geotechnical investigation report by AGS (2020) for the site which included thirteen test pit excavations within the limits of the project. The test pit logs are included in Appendix B.
- Excavate, log, and sample seven exploratory borings extending to a maximum depth of 31.5 feet below ground surface. The boring logs are presented in Appendix B.
- Perform four borehole percolation tests onsite and prepare a site-specific infiltration feasibility report presented in Appendix D.
- Conduct laboratory testing of samples of the onsite soils obtained during the subsurface investigation. Results of laboratory testing are presented in Appendix C.
- Utilize the preliminary grading exhibit by Pasco Laret Suiter (2021) to prepare Plate 1, Geologic Map and Exploration Location Plan which depicts the proposed project limits, exploratory locations, abbreviated logs, and approximate geologic contacts.
- Prepare geologic cross sections for the project site as shown in Plate 1.
- Conduct a geotechnical engineering and geologic hazard analysis of the site.
- Conduct a limited seismic hazards evaluation including a liquefaction potential and dynamic settlement analysis.
- Evaluate the excavation characteristics of the onsite materials.
- Determine design parameters for foundations.
- Provide a preliminary corrosivity evaluation of the onsite soils.
- Prepare this report with exhibits summarizing our findings. This report would be suitable for design, construction, and regulatory review.

1.2. Geotechnical Study Limitations

The conclusions and recommendations in this report are professional opinions based on the data developed during our investigation. Detailed development plans were not available at the time of this report. The conclusions presented herein are based upon the current proposed development as

depicted on the 40-scale preliminary grading exhibit by Pasco Laret Suiter (2021). When detailed plans become available, further review by AGS will be necessary.

The materials immediately adjacent to or beneath those observed may have different characteristics than those observed. No representations are made as to the quality or extent of materials not observed. Any evaluation regarding the presence or absence of hazardous material is beyond the scope of this firm's services.

2.0 SITE DESCRIPTION AND PROPOSED DEVELOPMENT

The rectangular shaped property covers approximately 6.3 acres and currently supports a residential structure on the central portion of the site along with several outbuildings. The site is bounded on the north and east by active nursery facilities, on the west by Metropolitan Transit System trolley tracks on an embankment fill, and to the south by an asphalt paved parking lot, a mobile home park, unimproved property, and a playing field (see Figure 1, Site Location Map). Elevations onsite ranges from a high of 54 feet above mean sea level (msl) at the southeast corner to a low of 22 feet msl in the northwest corner. An approximately 20-foot high descending slope is located along the northern portion of the site. The southern portion of the site is flat, has been cleared of vegetation and is currently being used as a storage yard by a general contractor. The descending slope to the north is covered by grass, weeds and isolated trees. Drainage across the site generally flows to the north and west.

It is our understanding that the residential development will consist of five 3- to 4-story wood-frame apartment buildings, a two-story carport with a residential structure above, and a 1-story recreation/leasing building all of which will be supported by conventional slab-on-grade foundations. The apartment buildings will be located on the northern portion of the property and will require construction of ~22-foot high retaining wall. Parking areas and an access driveway will be located along the south central portion of the property. At this time detailed grading plans are not available; however, it is our understanding that design cuts will likely be up to roughly 8 feet with design fills of up to 26 feet. It is anticipated that cut-fill grading techniques will be utilized and approximately 7,000 cu. yd. of import soil will be required to develop the site. A preliminary grading plan exhibit has been provided and used herein; however, the plan is subject to change.

3.0 FIELD AND LABORATORY INVESTIGATION

3.1. Previous Study

AGS performed a previous subsurface investigation at the site on December 19, 2019, and consisted of excavating, logging and sampling thirteen exploratory test pits (TP-1 through TP-13) with a rubber tire backhoe to a maximum depth of 15.0 feet below existing ground surface (bgs). The samples were transported to AGS's laboratory for testing. Our findings and recommendations were summarized in a geotechnical report (AGS, 2020)

3.2. Current Investigation

A supplemental subsurface investigation was performed on June 7 through 9, 2021, and consisted of seven borings (B-1 through B-7) extending to depths ranging between 8.25 and 31.5 feet bgs advanced with a truck-mounted drill rig equipped with hollow-stem augers. The borings were logged by a representative of AGS and both bulk and relatively undisturbed samples were collected for laboratory testing. The approximate exploratory locations are shown on Plate 1, Geologic Map and



**SITE LOCATION MAP
555 HOLLISTER STREET,
SAN DIEGO, CALIFORNIA**

P/W 1912-01

FIGURE 1

SOURCE MAP - U.S.G.S. TOPOGRAPHIC MAP OF THE
IMPERIAL BEACH 7.5 MINUTE QUADRANGLE,
SAN DIEGO COUNTY, CALIFORNIA (2018)



AGS

ADVANCED GEOTECHNICAL SOLUTIONS, INC.

485 Corporate Drive, Suite B

Escondido, CA 92029

Telephone: (619) 867-0487 Fax: (714) 409-3287

Exploratory Location Plan which is based on the 40-scale preliminary grading exhibit by Pasco Laret Suiter & Associates (2021). Logs of the test pits, borings and percolation tests are presented in Appendix B.

The samples were transported to AGS's approved laboratory for testing. Laboratory testing included: sieve and hydrometer analysis, Atterberg limits, expansion index, consolidation, undisturbed and remolded direct shear, maximum density and optimum moisture content, and corrosivity analyses. The laboratory test results are presented in Appendix C.

3.3. Infiltration Testing

As part of the current geotechnical investigation, four borings (P-1 through P-4) were advanced in the south central portion of the site to depths of 4.5 to 5.5 feet below existing grade to perform borehole percolation tests. Percolation test results and an evaluation of onsite infiltration feasibility are presented in Appendix D.

4.0 ENGINEERING GEOLOGY

4.1. Regional Geologic and Geomorphic Setting

The subject site is situated within the western portion of the Peninsular Ranges Geomorphic Province. The Peninsular Ranges province occupies the southwestern portion of California, extending southward from the Transverse Ranges and Los Angeles Basin to the southern tip of Baja California. In general, the province consists of young, steeply sloped, northwest trending mountain ranges underlain by metamorphosed Late Jurassic to Early Cretaceous-aged extrusive volcanic rock and Cretaceous-aged igneous plutonic rock of the Peninsular Ranges Batholith.

The project site is situated within the coastal plain zone. The regional geology is controlled by both alluvial and marine influences. Quaternary aged alluvial deposits interbedded with marine embayment deposits underlie the area. The westernmost portion of the province is predominantly underlain by younger marine and non-marine sedimentary rocks. The Peninsular Ranges dominant structural feature is northwest-southeast trending crustal blocks bounded by active faults of the San Andreas transform system.

4.2. Site Geology

The site has been mapped as being underlain by Young Alluvial Flood-Plain Deposits and Old Paralic Deposits as shown in Figure 2, Regional Geologic Map. A brief description of the earth materials encountered onsite is presented in the following sections. More detailed description of these materials is provided in the subsurface logs included in Appendix B.

4.2.1. Topsoil (No map symbol)

A relatively thin veneer of topsoil ranging in thickness from 1 to 4 feet was observed within several test pits and borings. As encountered, the topsoil generally consisted of brown to dark red brown silty to clayey fine-grained sand in a moist and loose condition with roots and organic content.

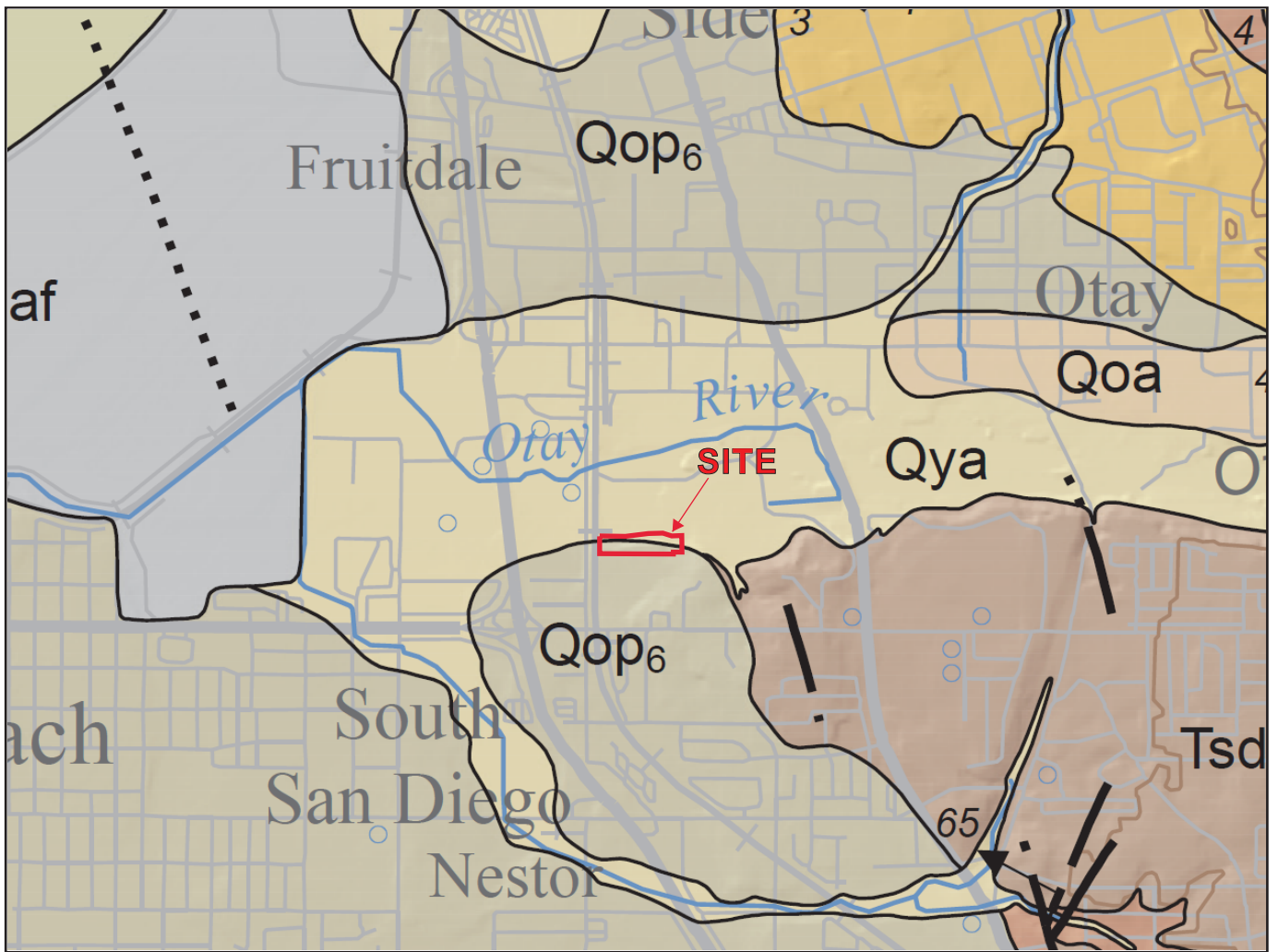

**REGIONAL GEOLOGIC MAP
555 HOLLISTER STREET,
SAN DIEGO, CALIFORNIA**

LEGEND

- af Artificial Fill
- Qya Young Alluvial Flood-plain Deposits
- Qop₆ Old Paralic Deposits, Unit 6
- Tsd San Diego Formation

P/W 1912-01

FIGURE 2

SOURCE MAP - GEOLOGIC MAP OF THE SAN DIEGO 30'X60' QUADRANGLE, CALIFORNIA. KENNEDY & TAN 2008.



AGS

ADVANCED GEOTECHNICAL SOLUTIONS, INC.
485 Corporate Drive, Suite B
Escondido, CA 92029
Telephone: (619) 867-0487 Fax: (714) 409-3287

4.2.2. Artificial Fill - Undocumented (Map symbol afu)

Artificial fill was encountered in the majority of test pits and borings. Generally, the fill extended to depths of 2 to 6 feet below existing ground surface (bgs). Thicker deposits of undocumented fill were encountered within the northeasterly portion of the site where it extended to depths of at least 13 feet and may be locally deeper. The approximate limits of the suspected deep fill area are shown on Figure 2. As encountered, the fill materials can generally be described as orange to red brown and gray brown sandy clay and clayey sand with gravel and cobble in a moist and loose to medium dense condition. Abundant trash and construction debris were encountered in some of the fill including piping, plastic, glass, metal, wood, and concrete fragments.

4.2.3. Young Alluvial Flood-Plain Deposits (Map symbol Qya)

Holocene and late Pleistocene young alluvial flood-plain deposits were encountered primarily within the northern portion of the site. The young alluvium was found to underlie the fill or topsoil and extended to depths ranging from 6 feet to more than 15 feet. As encountered, the young alluvial deposits can generally be described as dark yellow brown to gray brown silty to clayey fine- to coarse-grained sand with abundant sub-rounded gravel and cobble in a moist to very moist and loose to medium dense condition. Caving within these materials was observed in several trench excavations.

4.2.4. Old Paralic Deposits (Map symbol Qop6)

Late to middle Pleistocene aged old paralic deposits (Unit 6), formerly known as the Baypoint Formation, were generally encountered underlying the surficial deposits at depths ranging from 1.5 feet to 9 feet except where the excavations ended in young alluvium. The old paralic deposits predominantly consist of slightly moist to moist silty fine-grained micaceous sand interbedded with coarse-grained gravel and cobble-rich lenses. These materials were generally orange, yellow brown and dark gray brown with common iron oxide development in a medium dense to dense and weakly to moderately cemented condition. Carbonate nodules and stringers were commonly observed.

4.3. Geologic Structure

Old paralic deposits underlie the project site at depth. Young alluvial deposits unconformably overlie old paralic deposits in the lower, northerly portion of the site. The old paralic deposits consist of thinly to thickly bedded, marine terrace deposits that are flat lying to very shallowly dipping to the southwest. The geologic structure is considered neutral to favorable with respect to the proposed development.

4.4. Groundwater

Groundwater was encountered at depths of 10 and 6.5 feet bgs in borings B-5 and B-7 drilled at the toe of the northerly descending slope. Based on these observations, the groundwater level was at approximate elevation 12.5 feet msl during our subsurface exploration. According to our review, no natural groundwater condition is known to exist at the site that would preclude the proposed development; however, groundwater will be encountered during remedial grading activities extending into the lower, northern portion of the site. It should be noted that localized perched

groundwater may develop at a later date, most likely at or near fill/bedrock contacts, due to fluctuations in precipitation, irrigation practices, or factors not evident at the time of our field exploration.

An existing water supply well is located in the vicinity of Boring B-5. It is anticipated that this well will be abandoned during earthwork activities.

4.5. Seismic Hazards

The site is located in the tectonically active Southern California area and will therefore likely experience shaking effects from earthquakes. The type and severity of seismic hazards affecting the site are to a large degree dependent upon the distance to the causative fault, the intensity of the seismic event, and the underlying soil characteristics. The seismic hazard may be primary, such as surface rupture and/or ground shaking, or secondary, such as liquefaction or dynamic settlement. The following is a site-specific discussion of ground motion parameters, earthquake-induced landslide hazards, settlement, and liquefaction. The purpose of this analysis is to identify potential seismic hazards and propose mitigations, if necessary, to reduce the hazard to an acceptable level of risk. The following seismic hazards discussion is guided by the California Building Code (2019), CDMG (2008), and Martin and Lew (1998).

4.5.1. Surface Fault Rupture

No known active faults have been mapped within the project site. The nearest known active surface fault is the Silver Strand section of Newport-Inglewood-Rose Canyon fault zone which is approximately 3.9 miles west of the project site. Accordingly, the potential for surface fault rupture on the subject site is very low. This conclusion is based on literature review and aerial photographic analysis.

4.5.2. Seismicity

As noted, the site is within the tectonically active southern California area with the active Newport-Inglewood-Rose Canyon fault zone located approximately 3.9 miles west from the site. The potential exists for strong ground motion that may affect future improvements.

4.5.3. City of San Diego Seismic Safety Study

The project site is located within Grid Tile 6 of the San Diego Seismic Safety Study and is mapped as Geologic Hazard Category 53 on the southern portion of the site and as Geologic Hazard Category 31 for the northern portion. Geologic Hazard Category 53 is identified as ‘Level or sloping terrain, unfavorable geologic structure, low to moderate risk’. Geologic Hazard Category 31 is identified as ‘High Liquefaction Potential – shallow groundwater, major drainages, hydraulic fill’ as shown in Figure 3, Seismic Hazard Map.

4.5.4. Liquefaction

Liquefaction is the phenomenon where seismic agitation of loose, saturated sands and silty sands can result in a buildup of pore pressures that, if sufficient to overcome overburden stresses, can produce a temporary quick condition. City of San Diego has mapped the northern portion of the site as having “high liquefaction potential”. Due to the shallow depth to dense old paralic deposits and the recommended removal and recompaction of loose

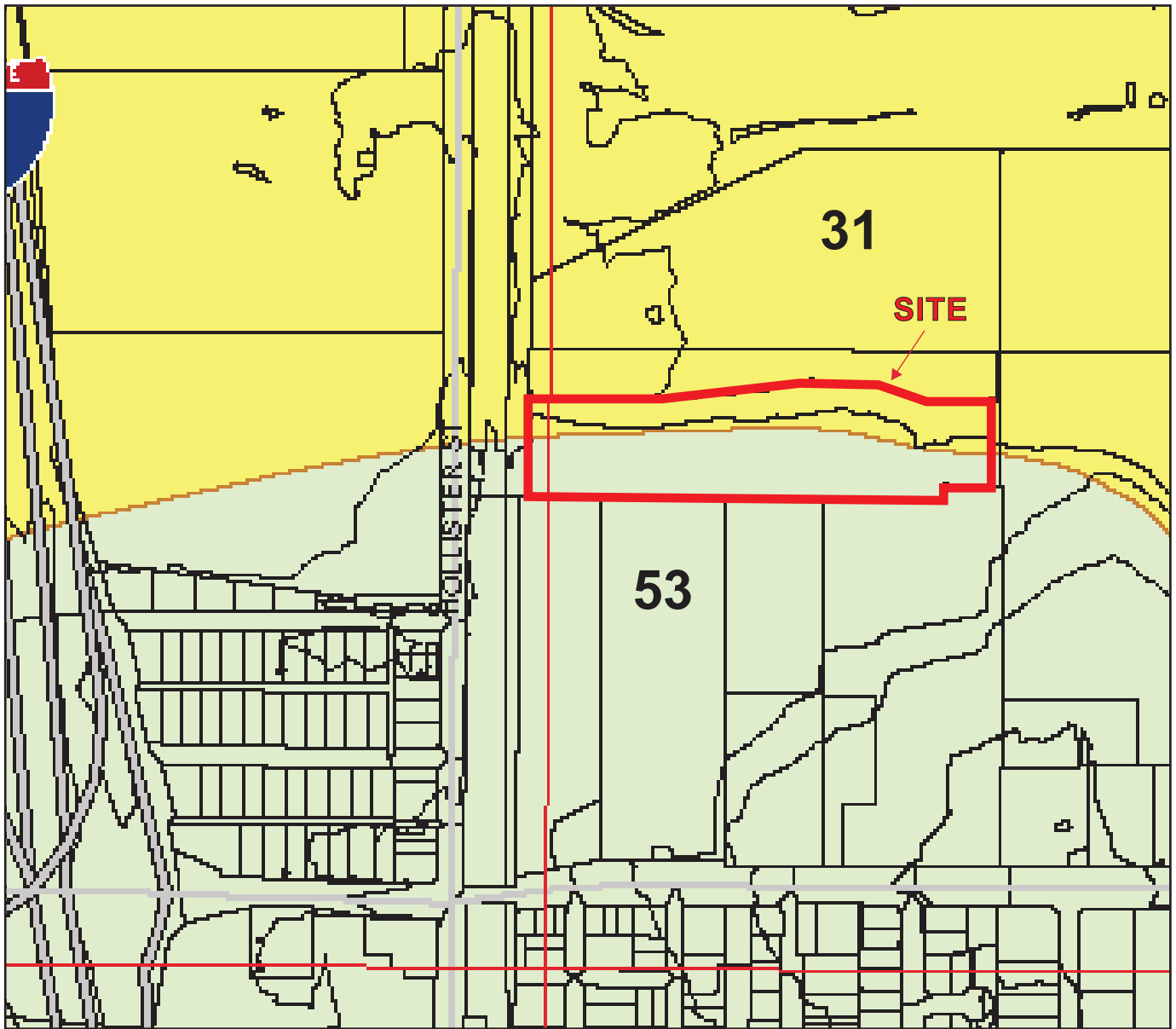

**CITY OF SAN DIEGO
SEISMIC SAFETY STUDY
555 HOLLISTER STREET,
SAN DIEGO, CALIFORNIA**

- 31 High Liquefaction Potential – shallow groundwater major drainages, hydraulic fills
- 53 Level or sloping terrain, unfavorable geologic structure, Low to moderate risk.

P/W 1912-01

FIGURE 3

SOURCE MAP - CITY OF SAN DIEGO
SEISMIC SAFETY STUDY
GRID TILE 6, 2008.



ADVANCED GEOTECHNICAL SOLUTIONS, INC.
485 Corporate Drive, Suite B
Escondido, CA 92029
Telephone: (619) 867-0487 Fax: (714) 409-3287

surficial deposits within the northern portion of the site, where development is planned, the potential for liquefaction to affect the proposed development is considered “low”.

4.5.5. Dynamic Settlement

Dynamic settlement occurs in loose sandy earth materials in response to an earthquake event. Loose alluvial soils were encountered within the northern portion of the site and are considered potentially susceptible to dynamic settlement, however, the recommended removal and recompaction of loose surficial deposits will mitigate this potential

4.5.6. Seismically Induced Landsliding

Seismically induced landsliding is considered very low due to the remedial grading proposed herein to mitigate this hazard to an acceptable level of risk.

4.5.7. Seismic Design Parameters

Based on the results of our field investigation and the proposed removal and recompaction of loose deposits, the site may be classified as Site Class D, consisting of a stiff soil profile with average SPT (N) blowcount between 15 and 50 blows per foot. Table 4.5.7 presents ASCE 7-16 seismic design parameters in accordance with 2019 CBC and USGS mapped spectral acceleration parameters (SEAOC/OSHPD, 2021) utilizing site coordinates of Latitude 32.5870°N and Longitude 117.0835°W.

TABLE 4.5.7 2019 CALIFORNIA BUILDING CODE DESIGN PARAMETERS	
Design Parameter	Value
Site Class	D
Mapped Spectral Acceleration Parameter at Period of 0.2-Second, S_s	1.157g
Mapped Spectral Acceleration Parameter at Period 1-Second, S_1	0.389g
Site Coefficient, F_a	1.200
Site Coefficient, F_v	N/A ³
Adjusted MCE_R^1 Spectral Response Acceleration Parameter at Short Period, S_{MS}	1.388g
1-Second Period Adjusted MCE_R^1 Spectral Response Acceleration Parameter, S_{M1}	N/A ³
Short Period Design Spectral Response Acceleration Parameter, S_{DS}	0.926g
1-Second Period Design Spectral Response Acceleration Parameter, S_{D1}	N/A ³
Peak Ground Acceleration, PGA_M^2	0.623g
Seismic Design Category	N/A ³
Notes: ¹ Risk-Targeted Maximum Considered Earthquake ² Peak Ground Acceleration adjusted for site effects ³ Requires Site Specific Ground Motion Hazard Analysis per ASCE 7-16 Section 11.4.8	

As indicated in Note 3 above, ASCE 7-16 Section 11.4.8 requires a site specific ground motion hazard analysis unless, per Exception 2, the value of the seismic response coefficient, C_s , is determined by Equation (12.8-2) for values of $T \leq 1.5T_s$ and taken as equal to 1.5 times the values computed with either Equation (12.8-3) for $T_L \geq T > 1.5T_s$ or Equation (12.8-4) for $T > T_L$.

4.6. Non-seismic Geologic Hazards

4.6.1. Mass Wasting

No evidence of mass wasting was observed onsite nor was any noted on the reviewed maps.

4.6.2. Flooding

According to available FEMA maps, the northern edge of the site is within the 1% annual chance flood area with average water surface elevations ranging from 29 to 31 feet msl. The southern portion of the site is not in a FEMA identified flood hazard area.

5.0 GEOTECHNICAL ENGINEERING

Presented herein is a general discussion of the geotechnical properties of the various soil types and the analytic methods used in this report.

5.1. Material Properties

5.1.1. Excavation Characteristics

Based on our previous experience near the subject site and the information gathered during our investigation, it is our opinion that the topsoil, artificial fill and young alluvial flood-plain deposit materials are readily excavatable with conventional earthmoving equipment. Portions of the old paralic deposits may be cemented and contain cobble lenses that could be difficult to excavate with conventional equipment and may require specialized grading equipment (large excavators and/or bull dozers) to efficiently excavate. Excavation into young alluvial deposits on the northern portion of the site will encounter groundwater and may require top loading.

5.1.2. Compressibility

The existing topsoil, fill and young alluvial flood-plain deposit materials are considered moderately compressible in their present condition. Compressibility of topsoil, undocumented fill and young alluvial deposit materials will be mitigated by removal and recompaction.

5.1.3. Expansion Potential

The expansion potential of the upper topsoil and fill soils is “very low” to “low” when classified in accordance with ASTM D 4829. It is anticipated that the majority of the fills derived primarily from onsite materials will exhibit “very low” to “low” expansion potential. Excavations extending into old paralic deposits may encounter “low” to “medium” expansion potential materials depending on the amount of clay present in the deposits.

5.1.4. Shear Strength Characteristics

Based upon the results of shear strength testing conducted on the onsite soils and our previous experience in the general area with similar soils the following are assumed shear strengths for young alluvial flood-plain deposits, compacted fill soils, old paralic deposits.

TABLE 5.1.4 SHEAR STRENGTH		
Material	Cohesion (psf)	Friction Angle (degrees)
Young Alluvial Flood-Plain Deposits (Qya)	100	29
Compacted Fill (afc)	150	30
Old Paralic Deposits (Qop)	200	32

5.1.5. Earthwork Adjustments

It is anticipated that the onsite undocumented fill and young alluvial flood plain deposits will shrink on the order of 5 to 15 percent when recompacted. The unweathered old paralic deposits are anticipated to bulk on the order of 0 to 5 percent when used to make compacted fill. These values may be used in an effort to balance the earthwork quantities. As is the case with every project, contingencies should be made to adjust the earthwork balance when grading is in progress and actual conditions are better defined.

5.2. Analytical Methods

5.2.1. Bearing Capacity and Lateral Earth Pressures

Ultimate bearing capacity values were obtained using the graphs and formulas presented in NAVFAC DM-7.1. Allowable bearing was determined by applying a factor of safety of at least three (3) to the ultimate bearing capacity.

Static lateral earth pressures were calculated using Rankine methods for active and passive cases. If it is desired to use Coulomb forces, a separate analysis specific to the application can be conducted.

6.0 GRADING RECOMMENDATIONS

Construction of the proposed multi-family residential structures and associated improvements is considered feasible, from a geotechnical standpoint, provided that the conclusions and recommendations presented herein are incorporated into the design and construction of the project. Presented below are specific issues identified by this study as possibly affecting site development. Recommendations to mitigate these issues are presented in the text of this report.

6.1. Earthwork Recommendations

All grading should be accomplished under the observation and testing of the project soils engineer and engineering geologist or their authorized representative in accordance with the recommendations contained in the approved geotechnical reports, the current grading ordinance of the City of San Diego, and AGS's Earthwork Specifications (Appendix F). Prior to fill placement, the bottoms of all removal areas should be observed and approved by the engineering geologist/soils engineer or their authorized representative.

6.1.1. Site Preparation

Existing vegetation, trash, debris, and other deleterious materials should be removed and wasted from the site prior to commencing removal of unsuitable soils and placement of compacted fill materials. Additionally, all pre-existing utility conduits and foundations should be removed and wasted off-site. Concrete can be placed in the fill provided it is broken down into pieces smaller than 12 inches (largest dimension) and placed in accordance with the oversize materials recommendations. Alternatively, the concrete can be used to stabilize saturated removal bottoms. Abandoned utilities should be removed and/or abandoned in accordance with local regulations. Wells, cesspools and septic systems should be properly removed and/or backfilled in accordance with the local governing agency.

6.1.2. Removals

Topsoil, undocumented fill, young alluvial deposits and highly weathered formational material should be removed in areas planned to receive fill or where exposed at final grade. If encountered, any existing utility lines and/or subterranean structures should be removed prior to fill placement. Removals should expose competent formational materials and be observed and mapped by the engineering geologist prior to fill placement. It is anticipated that the upper 2 to 15 feet of the onsite soils will require removal and recompaction for the support of settlement sensitive structures. Localized areas may require deeper removals. The resulting undercuts should be replaced with engineered fill. The extent of removals can best be determined in the field during grading when observation and evaluation can be performed by the soil engineer and/or engineering geologist. In general, soils removed during remedial grading will be suitable for reuse in compacted fills, provided they are properly mixed and moisture conditioned and do not contain deleterious materials.

6.1.3. Removals Along Grading Limits and Adjacent to Property Lines

Removals of unsuitable soils will be required prior to fill placement along the grading limit. A 1:1 projection, from toe of slope or grading limit, outward to competent materials should be established, when possible. Where removals are not possible due to grading limits, property line or easement restrictions, removals should be initiated at the grading boundary (property line, easement, grading limit or outside the improvement) at a 1:1 ratio (1.5:1 where seepage is encountered) inward to competent materials. This reduced removal criteria should not be implemented prior to review by the Geotechnical Consultant and approval by the Owner. Where this reduced removal criteria is implemented, special maintenance zones may be necessary. These areas, if present, will need to be identified during grading. Alternatively, grading limits can be initiated offsite.

6.1.4. Overexcavation

Overexcavation of building pad areas should be accomplished where cut-fill transitions occur and to provide a more uniform blanket of fill below the buildings. It is recommended that backcut ratios below buildings be laid back to a gradient of 2:1 (H:V) or shallower. Additionally, the cut portions of the building pad should be overexcavated to provide a minimum of 5 to 7 feet of fill below the building pad. Deeper overexcavations may be

necessary based on conditions exposed during grading and the final building locations and elevations.

6.1.5. Dewatering and Stabilization of Saturated Removal Bottoms

Due to the presence of shallow groundwater and the saturated soils that were encountered during our field exploration along the toe of the existing slope, it should be anticipated that the bottoms of the overexcavations will be soft/wet and unstable. Dewatering may also be necessary. Unstable bottoms encountered should be mitigated by placing at least two (2) feet of angular rock wrapped in geotextile over a relatively undisturbed bottom. Angular rock or concrete debris can also be considered. The recommended depth of stabilization (i.e. approximately 2 feet) could be greater depending on the condition encountered. Use of a stronger geotextile (such as Mirafi PET high strength geotextile) may allow the thickness of rock to be reduced. The contractor should evaluate the most cost effective solution for stabilizing yielding removal bottoms. Consideration should be given to constructing test sections during grading to evaluate the effectiveness of different options.

The bottoms of the excavation should be kept in an undisturbed state to the maximum extent possible. If it is necessary to operate equipment within excavations, we note that the use of track-mounted excavation equipment will be required as rubber-tired vehicles will likely sink into the subgrade and cause unwanted disturbance of the excavated surface. All exposed bottoms should be observed by a representative of AGS prior to placement of any materials so that we can evaluate the suitability of the exposed soils. After the excavated bottoms have been approved by an engineer from AGS, they should be backfilled with engineered fill to the elevations necessary to achieve the proposed grades.

We note that the intent of subgrade stabilization is to achieve a non-yielding subgrade when subjected to relatively heavy, rubber tired construction equipment loading such as a loaded water truck or loader with full bucket. The stabilized subgrade should be proof-rolled with this type of equipment after remediation to confirm that it is unyielding.

6.1.6. Materials for Fill

On-site soils with an organic content of less than 3 percent by volume (or 1 percent by weight) are suitable for use as fill. Soil material to be used as fill should not contain contaminated materials. Oversize materials (greater than 8 inches), if generated during excavation, may be broken into acceptably sized pieces, may be disposed offsite, or placed in deeper fills in accordance with the recommendations in Section 6.1.7 below. Imported fill material should consist of granular soil with “low” expansion potential (i.e. expansion index of 50 or less). Import material should also have low corrosion potential. Materials to be used as fill should be evaluated by AGS prior to importing or filling.

6.1.7. Oversize Materials

Oversized rock material [i.e., rock fragments greater than eight (8) inches] will be produced during the excavation of the design cuts and recommended overexcavation. Provided that the procedure is acceptable to the developer and governing agency, this rock may be incorporated into the compacted fill section to within three (3) feet of finish grade within residential areas and to two (2) foot below the deepest utility in street and utility connection

areas. Maximum rock size in the upper portion of the hold-down zone is restricted to eight (8) inches. The upper five (5) feet in driveways and parking areas should have a maximum particle size of six (6) inches or less. Excavations to accommodate swimming pools, spas, and other appurtenances will likely encounter oversize rock [i.e., rocks greater than eight (8) inches] below three (3) feet. Rock disposal details are presented on Detail 10, Appendix F. Rocks in excess of eight (8) inches in maximum dimension may be placed within the deeper fills, provided rock fills are handled in a manner described below. In order to separate oversized materials from the rock hold-down zones, the use of a rock rake may be necessary.

6.1.7.1. Rock Blankets

Rock blankets consisting of a mixture of gravel, sand and rock to a maximum dimension of two (2) feet may be constructed. The rocks should be placed on prepared grade, mixed with sand and gravel, watered and worked forward with bulldozers and pneumatic compaction equipment such that the resulting fill is comprised of a mixture of the various particle sizes, contains no significant voids, and forms a dense, compact, fill matrix.

Rock blankets may be extended to the slope face provided the following additional conditions are met: 1) no rocks greater than twelve (12) inches in diameter are allowed within six (6) horizontal feet of the slope face; 2) 50 percent (by volume) of the material is three-quarter- (3/4) inch minus; and 3) back rolling of the slope face is conducted at four- (4) foot vertical intervals and satisfies project compaction specifications.

6.1.7.2. Rock Windrows

Rocks to maximum dimension of four (4) feet may be placed in windrows in deeper fill areas in accordance with the details on Detail 10 (Appendix F). The base of the windrow should be excavated an equipment-width into the compacted fill core with rocks placed in single file within the excavation. Sands and gravels should be added and thoroughly flooded and tracked until voids are filled. Windrows should be separated horizontally by at least fifteen (15) feet of compacted fill, be staggered vertically, and separated by at least four (4) vertical feet of compacted fill. Windrows should not be placed within ten (10) feet of finish grade, within two (2) vertical feet of the lowest buried utility conduit in structural fills, or within fifteen (15) feet of the finish slope surface unless specifically approved by the developer, geotechnical consultant, and governing agency.

6.1.7.3. Individual Rock Burial

Rocks in excess of four (4) feet, but no greater than eight (8) feet may be buried in the compacted fill mass on an individual basis. Rocks of this size may be buried separately within the compacted fill by excavating a trench and covering the rock with sand/gravel and compacting the fines surrounding the rock. Distances from slope face, utilities, and building pad areas (i.e., hold-down depth) should be the same as windrows.

6.1.7.4. Rock Disposal Logistics

The grading contractor should consider the amount of available rock disposal volume afforded by the design when excavation techniques and grading logistics are formulated. Rock disposal techniques should be discussed and approved by the geotechnical consultant and developer prior to implementation.

6.2. Compacted Fill

Fill and processed natural ground shall be compacted to at least 90 percent of the maximum dry density determined by ASTM D 1557. All fill to be placed below twenty (20) feet from ultimate grade should be compacted to at least 93 percent of maximum dry density. Compaction shall be achieved at or slightly above the optimum moisture content and as generally discussed in the attached Earthwork Specifications (Appendix F).

At the completion of unsuitable soil removals, the exposed bottom should be scarified to a minimum depth of eight inches, moisture conditioned to above optimum moisture and compacted in-place to the standards set forth in this report.

Fill should be placed in thin lifts (eight-inch bulk), moisture conditioned to at or slightly above the optimum moisture content, uniformly mixed, and compacted by the use of wheel rolling or kneading type (sheep's foot) compaction equipment until the designed grades are achieved.

6.3. Settlement Monitoring

Fills are subject to post-grading settlement. It is recommended that all fills overlying saturated old paralic deposits be monitored prior to release for construction. The monitoring can be accomplished by installation of surface monuments as shown on Detail 12 (Appendix F). Monuments should be placed near the toe of the wall and near the top of the wall.

Surface monuments should be surveyed every week for two months and monthly thereafter until data warrants release of the area for utility or residential construction. It is likely that infrastructure development can be initiated in advance of completion of the primary settlement process, depending upon the sensitivity of improvements to the anticipated settlement.

6.4. Utility Trench Excavation and Backfill

All utility trenches should be shored or laid back in accordance with applicable Cal/OSHA standards. For trenches or other temporary excavations, OSHA requirements regarding personnel safety should be met by laying back the slopes to a gradient no steeper than 1.5:1 (horizontal:vertical) for fill materials and 1:1 (H:V) for old paralic deposit materials. Onsite soils will not be suitable for use as bedding material but will be suitable for use as trench backfill provided oversized materials are removed. Utility trench backfill should be compacted to at least 90 percent of maximum dry density as determined by ASTM D 1557. Compaction should be accomplished by mechanical means. Jetting of native soils will not be acceptable.

No surcharge loads should be imposed above excavations. This includes spoil piles, lumber, concrete trucks or other construction materials and equipment. Drainage above excavations should be directed away from the banks. Care should be taken to avoid saturation of the soils.

6.5. Flatwork Subgrade Preparation

If native soils are used, the upper one foot of subgrade below exterior slabs, sidewalks, patios, etc. should be compacted to a minimum of 90 percent of the maximum dry density as determined by ASTM D1557. The subgrade below exterior slabs, sidewalks, driveways, patios, etc. should be moisture conditioned to a minimum of optimum moisture content prior to concrete placement.

7.0 DESIGN RECOMMENDATIONS

Construction of the proposed multi-family structures is considered feasible, from a geotechnical standpoint, provided that the conclusions and recommendations presented herein are incorporated into the design and construction of the project.

7.1. Foundation Design Recommendations

Detailed foundation plans are not currently available; however, it is our understanding that the proposed multi-family three- and four-story residential structures will be wood framed and supported by a conventional shallow foundation system. The proposed foundation for the proposed carport and overlying building is not know at this time. For preliminary design of shallow foundations supported on compacted fill or undisturbed formational materials, the values presented below may be used. It is recommended that the building and wall foundations be supported entirely in compacted fill or competent formational materials.

7.1.1. Foundation Design

Residential structures can be supported on conventional shallow foundations and slab-on-grade or post-tensioned slab/foundation systems, as discussed above. The design of foundation systems should be based on as-graded conditions as determined after grading completion. The following values may be used in preliminary foundation design:

Allowable Bearing: 2,500 psf. Bearing capacity can increase 250 psf for each additional foot of width, and 500 psf for each additional foot of depth to a maximum allowable capacity of 3,000 psf.

Sliding Coefficient: 0.35

Lateral Bearing: 250 psf/foot of depth to a maximum of 2,500 psf

The above values may be increased as allowed by Code to resist transient loads such as wind or seismic. Building code and structural design considerations may govern. Depth and reinforcement requirements and should be evaluated by a qualified engineer.

7.1.2. Conventional Foundation Design Recommendations

Based upon the onsite soil conditions and information supplied by the 2019 CBC, conventional foundation systems for “Low to Medium” expansion potential should be designed by the Structural Engineer in accordance with Section 7.1.1 and the following recommendations:

- **Three- to Four-story** - Interior and exterior footings should be a minimum of 18 inches wide and extend to a minimum depth of 18 inches below lowest adjacent grade. Footing

reinforcement should minimally consist of four No. 5 reinforcing bars, two top and two bottom.

- **Slab** - Conventional, slab-on-grade floors or parking garage slabs, underlain by “very low” to “low” expansive compacted fill, should be five or more inches thick and be reinforced with No. 4 or larger reinforcing bars spaced 15 inches on center each way. The slab reinforcement and expansion joint spacing should be designed by the Structural Engineer.
- **Embedment** - If exterior footings adjacent to drainage swales are to exist within five feet horizontally of the swale, the footing should be embedded sufficiently to assure embedment below the swale bottom is maintained. Footings adjacent to slopes should be embedded such that a least seven feet are provided horizontally from edge of the footing to the face of the slope.
- **Garage** - A grade beam reinforced continuously with the garage footings shall be constructed across the garage entrance, tying together the ends of the perimeter footings and between individual spread footings. This grade beam should be embedded at the same depth as the adjacent perimeter footings. A thickened slab, separated by a cold joint from the garage beam, should be provided at the garage entrance. Minimum dimensions of the thickened edge shall be six (6) inches deep. Footing depth, width and reinforcement should be the same as the structure. Slab thickness, reinforcement and under-slab treatment should be the same as the structure.
- **Isolated Spread Footings** - Isolated spread footings should be embedded a minimum of 18 inches below lowest adjacent finish grade and should at least 24 inches wide. A grade beam should also be constructed for interior and exterior spread footings and should be tied into the structure in two orthogonal directions footing dimensions and reinforcement should be similar to the aforementioned continuous footing recommendations. Final depth, width and reinforcement should be determined by the structural engineer.
- **Presaturation** - Prior to concrete placement the subgrade soils should be moisture conditioned to a minimum of optimum moisture prior to concrete placement.

7.1.3. Footing Excavations

Footing excavations should be observed by the geotechnical consultant. Footings should be excavated into either competent engineered fill or undisturbed formational deposits. Excavations should be free of all loose and sloughed materials, be neatly trimmed, and moisture conditioned at the time of concrete placement.

7.1.4. Moisture and Vapor Barrier

A moisture and vapor retarding system should be placed below the slabs-on-grade in portions of the structure considered to be moisture sensitive. The retarder should be of suitable composition, thickness, strength and low permeance to effectively prevent the migration of water and reduce the transmission of water vapor to acceptable levels. Historically, a 10-mil plastic membrane, such as Visqueen, placed between one to four

inches of clean sand, has been used for this purpose. More recently, 15-mil polyolefin membrane underlayments (Stego® Wrap or similar material) have been used to lower permeance to effectively prevent the migration of water and reduce the transmission of water vapor to acceptable levels. The use of this system or other systems, materials or techniques can be considered, at the discretion of the designer.

7.2. Conventional Retaining Walls

The following earth pressures are recommended for the design of conventional retaining walls onsite. These earth pressures assume that a select backfill will be used behind the walls:

Static Case

<u>Level Backfill</u>	<u>Rankine Coefficients</u>	<u>Equivalent Fluid Pressure (psf/lin.ft.)</u>
Coefficient of Active Pressure:	$K_a = 0.33$	42
Coefficient of Passive Pressure:	$K_p = 3.00$	375
Coefficient of at Rest Pressure:	$K_o = 0.50$	63

<u>2 : 1 Backfill</u>	<u>Rankine Coefficients</u>	<u>Equivalent Fluid Pressure (psf/lin.ft.)</u>
Coefficient of Active Pressure:	$K_a = 0.54$	67
Coefficient of At Rest Pressure:	$K_o = 0.90$	113

Seismic Case

In addition to the above static pressures, unrestrained retaining walls located should be designed to resist seismic loading as required by the 2019 CBC. The seismic load can be modeled as a thrust load applied at a point 0.6H above the base of the wall, where H is equal to the height of the wall. This seismic load (in pounds per lineal foot of wall) is represented by the following equation:

$$P_e = \frac{3}{8} * \gamma * H^2 * k_h$$

- Where:
- P_e = Seismic thrust load
 - H = Height of the wall (feet)
 - γ = soil density = 125 pounds per cubic foot (pcf)
 - k_h = seismic pseudostatic coefficient = $0.5 * PG_{AM}$

The peak horizontal ground acceleration (PG_{AM}) is provided in Section 4.5.7. Walls should be designed to resist the combined effects of static pressures and the above seismic thrust load.

The foundations for retaining walls of appurtenant structures structurally separated from the building structures, may bear on properly compacted fill or competent formational deposits. Retaining wall footings should be designed to resist the lateral forces by passive soil resistance and/or base friction as recommended for foundation lateral resistance. To relieve the potential for hydrostatic pressure wall backfill should consist of a free draining backfill (sand equivalent “SE” >20) and a heel drain should be constructed. The heel drain should be placed at the heel of the wall and should consist of a 4-inch diameter perforated

pipe (SDR35 or SCHD 40) surrounded by 4 cubic feet of crushed rock (3/4-inch) per lineal foot, wrapped in filter fabric (Mirafi® 140N or equivalent) as shown in Figure 4.

FIGURE 4
Retaining Wall Backfill and Drainage

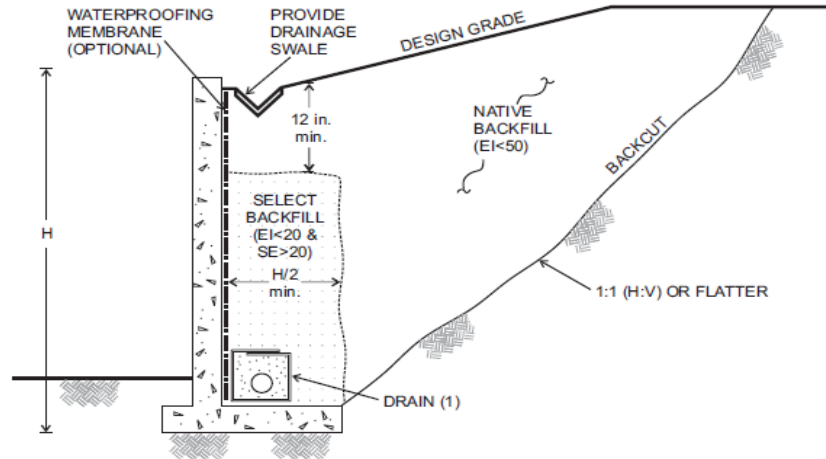

NOTES: (1) DRAIN: 4-INCH PERFORATED ABS OR PVC PIPE OR APPROVED EQUIVALENT SUBSTITUTE PLACED PERFORATIONS DOWN AND SURROUNDED BY A MINIMUM OF 1 CUBIC FEET OF 3/4 INCH ROCK OR APPROVED EQUIVALENT SUBSTITUTE AND WRAPPED IN MIRAFI 140 FILTER FABRIC OR APPROVED EQUIVALENT SUBSTITUTE

Proper drainage devices should be installed along the top of the wall backfill, which should be properly sloped to prevent surface water ponding adjacent to the wall. In addition to the wall drainage system, for building perimeter walls extending below the finished grade, the wall should be waterproofed and/or damp-proofed to effectively seal the wall from moisture infiltration through the wall section to the interior wall face.

The wall should be backfilled with granular soils placed in loose lifts no greater than 8-inches thick, at or near optimum moisture content, and mechanically compacted to a minimum 90 percent relative compaction as determined by ASTM Test Method D1557. Flooding or jetting of backfill materials generally do not result in the required degree and uniformity of compaction and, therefore, is not recommended. The soils engineer or his representative should observe the retaining wall footings, backdrain installation and be present during placement of the wall backfill to confirm that the walls are properly backfilled and compacted.

7.3. Mechanically Stabilized Earth (MSE) Retaining Wall

Based on our review of the preliminary grading exhibit, the proposed wall on the northern limit of the site may consist of a mechanically stabilized earth (MSE) retaining wall. According to our subsurface investigation and laboratory testing, the following soil parameters for MSE wall design are presented in Table 7.3. AGS assumes that for the MSE wall, the reinforced and foundation zones will consist of compacted fill and the retained zone will consist of old paralic deposits or compacted fill.

TABLE 7.3 PRELIMINARY MSE RETAINING WALL DESIGN PARAMETERS			
Ultimate Strength Parameters			
Material	Cohesion (psf)	Friction Angle (degrees)	Density (pcf)
Reinforced Zone and Foundation Zone (Compacted Artificial Fill)	200	30	120
Retained Zone (Compacted Fill)	200	30	120
Retained Zone (Old Paralac Deposits)	500	30	130

The global stability of the MSE retaining wall was analyzed for both static and seismic (pseudo-static) conditions using GStabl7 slope stability software and an assumed geogrid reinforcement geometry. The Modified Bishop method was used to analyze circular type failures. It is anticipated that MSE walls will be globally stable to the proposed heights. Stability analyses supporting this conclusion are presented on Plates E-1 and E-2 (Appendix E). These analyses should be reevaluated after the MSE wall design is finalized.

7.4. Corrosivity

Laboratory testing was performed on a representative sample of onsite earth materials to evaluate pH and electrical resistivity, as well as chloride and sulfate contents. electrical resistivity The pH and tests were performed in accordance with California Test (CT) 643 and the sulfate and chloride content tests were performed in accordance with CT 417 and CT 422, respectively. These laboratory test results are presented in Appendix C.

The results of the corrosivity testing indicated an electrical resistivity value of 3,800 ohm-cm, soil pH value of 8.4, chloride content of 76 parts per million (ppm) and sulfate content of 0.02 percent (i.e., 209 ppm). Based on Caltrans (2018) corrosion criteria, the onsite soils would be classified as non-corrosive, which is defined as soils with less than 500 ppm chlorides, less than 0.2 percent sulfates, and pH higher than 5.5.

The onsite soils are expected to be “mildly corrosive” to buried metallic materials. AGS recommends minimally that the current standard of care be employed for protection of metallic construction materials in contact with onsite soils or that consultation with an engineer specializing in corrosion to determine specifications for protection of construction materials. Additional corrosivity testing is recommended during site grading

7.5. Concrete Design

Testing by AGS indicates that the onsite soils have low concentrations of soluble sulfate, corresponding to an S0 exposure class when classified in accordance with ACI 318-14. Sulfate resistant concrete is not required per code; however, additional sulfate content testing is recommended during site grading..

7.6. Civil Design Recommendations

7.6.1. Drainage

Roof and pad drainage should be collected and directed away from structures and slopes and toward approved disposal areas. Design fine-grade elevations should be maintained through the life of the structure or if design fine grade elevations are altered, adequate area drains should be installed in order to provide rapid discharge of water, away from structures and slopes. Residents should be made aware that they are responsible for maintenance and cleaning of all drainage terraces, down drains and other devices that have been installed to promote structure and slope stability

7.6.2. Exterior Flatwork

7.6.2.1. Slab Thickness

Concrete flatwork should be designed utilizing 4-inch minimum thickness.

7.6.2.2. Control Joints

Weakened plane joints should be installed on walkways at intervals of approximately 6 to 8 feet. Exterior slabs should be designed to withstand shrinkage of the concrete.

7.6.2.3. Flatwork Reinforcement

Consideration should be given to reinforcing any exterior flatwork.

7.6.2.4. Thickened Edge

Consideration should be given to construct a thickened edge (scoop footing) at the perimeter of slabs and walkways adjacent to landscape areas to minimize moisture variation below these improvements. The thickened edge (scoop footing) should extend approximately 8 inches below concrete slabs and should be a minimum of 6 inches wide.

7.7. Preliminary Pavement Design

For preliminary pavement design, we have assumed an “R” Value of 30 for the onsite subgrade soils. Utilizing City of San Diego Pavement Design Standards Schedule “J” and assuming the subject site is classified equivalent to “Local Residential” (max ADT=1200) which equates to a Traffic Index TI=6.0 the following pavement section is presented below. Additional pavement design recommendations will be provided during grading based on as-graded conditions and R-value testing.

Standard Pavement Section

3-inches Asphalt Concrete
over
8.5-inches Aggregate Base

Pavement subgrade soils should be at or near optimum moisture content and should be compacted to a minimum of 95 percent of the maximum dry density as determined by ASTM D1557. Aggregate base should be compacted to a minimum of 95 percent relative compaction and should conform with the specifications in Section 26 of the Standard Specifications for the State of California Department of Transportation (Caltrans) or Section 200-2 of the Standard Specifications for Public Works Construction (Green Book). The asphalt concrete should conform to Section 26 of the Caltrans Standard Specifications or Section 203-6 of the Green Book.

8.0 FUTURE STUDY NEEDS

8.1. Construction Plans

Construction plans have not yet been developed. The recommendations provided herein are considered preliminary and subject to change based on the actual design. When available, the geotechnical engineer should review detailed construction plans. The following plans should be reviewed:

- Grading and improvement plans
- Structural plans including foundation and wall plans and calculations.

If the project description or final design varies from that described in this report, AGS must be consulted regarding the applicability of, and the necessity for, any revisions to the recommendations presented herein. AGS accepts no liability for any use of its recommendations if the project description or final design varies and AGS is not consulted regarding the changes.

9.0 CLOSURE

9.1. Geotechnical Review

AGS should review the final project plans and project specifications to evaluate conformance with the intent of the recommendations contained in this report. Our recommendations may be modified if conditions encountered in the field differ significantly from those assumed in this report.

Continuous geologic and geotechnical observations, testing, and mapping should be provided throughout site development. Additional soil samples should be collected by the geotechnical consultant during grading and subjected to laboratory testing. Final design recommendations should be provided in a grading report based on the observation and test results collected during grading.

9.2. Limitations

The findings and recommendations in this report are based on the specific excavations, observations, and tests results obtained during this and prior investigations. The findings are based on the review and interpretation of the field and laboratory data combined with an interpolation and extrapolation of conditions between and beyond the exploratory excavations. Services performed by AGS have been conducted in a manner consistent with that level of care and skill ordinarily exercised by members of the profession currently practicing in the same locality under similar conditions. No other representation, either expressed or implied, and no warranty or guarantee is included or intended.

The recommendations presented in this report are based on the assumption that an appropriate level

of field review will be provided by geotechnical engineers and engineering geologists who are familiar with the design and site geologic conditions. That field review shall be sufficient to confirm that geotechnical and geologic conditions exposed during grading are consistent with the geologic representations and corresponding recommendations presented in this report. If the project description varies from what is described in this report, AGS must be consulted regarding the applicability of, and the necessity for, any revisions to the recommendations presented herein. AGS accepts no liability for use of its recommendations if AGS is not consulted regarding any project changes.

The data, opinions, and recommendations of this report are applicable to the specific design of this project as discussed in this report. They have no applicability to any other project or to any other location, and any and all subsequent users accept any and all liability resulting from any use or reuse of the data, opinions, and recommendations without the prior written consent of AGS.

AGS has no responsibility for construction means, methods, techniques, sequences, or procedures, or for safety precautions or programs in connection with the construction, for the acts or omissions of the CONTRACTOR, or any other person performing any of the construction, or for failure of any of them to carry out the construction in accordance with the final design drawings and specifications.

APPENDIX A
REFERENCES

APPENDIX A
REFERENCES

- Advanced Geotechnical Solutions, Inc., 2020, "Preliminary Geotechnical Investigation and Design Recommendations, 6.3 Acre Site Located at 555 Hollister Street, City of San Diego, California", dated January 29, 2020, Report No. 1912-01-B-2.
- California Building Standards Commission, 2019, California Building Code, Title 24, Part 2, Volumes 1 and 2.
- City of San Diego Development Services Department, 2008, City of San Diego Seismic Safety Geologic Hazards and Faults Grid Tile 6, dated April 3, 2008.
- Kennedy, M.P., and Tan, S.S., 2008, Geologic Map of the San Diego 30' x 60' Quadrangle, California Regional Geologic Map Series, Scale 1:100,000, Map No. 2, Sheet 1 of 2.
- Pasco Laret Suiter & Associates, 2021, 40-scale Preliminary Grading Exhibit, Palm and Hollister, dated August 18, 2021.
- SEAOC/OSHPD, 2021, USGS Seismic Design Maps, <https://seismicmaps.org/>
- United States Geological Survey, 2021, Unified Hazards Tool, <https://earthquake.usgs.gov/hazards/interactive/>

APPENDIX B
SUBSURFACE EXPLORATION

CLIENT AMBIENT COMMUNITIES
PROJECT NUMBER 1912-01
DATE STARTED 6/7/21 **COMPLETED** 6/7/21
DRILLING CONTRACTOR Pacific Drilling
DRILLING METHOD Hollow Stem Auger
LOGGED BY AB **CHECKED BY** PJD
NOTES Auto-trip hammer

PROJECT NAME Hollister Apartments
PROJECT LOCATION 555 Hollister Street, San Diego
GROUND ELEVATION 41 ft **HOLE SIZE** 8 inch
GROUND WATER LEVELS:
AT TIME OF DRILLING ---
AT END OF DRILLING ---
AFTER DRILLING ---

AGS BORING LOG V2 - GINT STD US LAB.GDT - 8/26/21 10:45 - Z:\PROJECT FILES\1912-01 AMBIENT HOLLISTER STREET PROJ\LOGS AND LAB\1912-01 LOGS.GPJ



DEPTH (ft)	GRAPHIC LOG	USCS	MATERIAL DESCRIPTION	SAMPLE TYPE NUMBER	BLOW COUNTS (N VALUE)	DRY UNIT WT. (pcf)	MOISTURE CONTENT (%)	SATURATION (%)	OTHER TESTS	ATTERBERG LIMITS			FINES CONTENT (%)
										LIQUID LIMIT	PLASTIC LIMIT	PLASTICITY INDEX	
0													
		SC	Topsoil Clayey SAND, dark red brown, moist, loose to medium dense, fine- to coarse-grained; with gravel; roots on top 6 inches. @2.5 ft., red brown.	SPT	4-8-9 (17)	130	2.3	21					
		SM	Old Paralic Deposits (Qop6) Silty SAND, red brown, damp to moist, medium dense, fine- to coarse-grained; with gravel and cobbles; few carbonate stringers.	MC	12-17-18 (35)								
		SP	@10 ft., abundant gravel and cobbles; difficult drilling, grinding on rock.	MC	25-36-33 (69)								
		ML	@14 ft., SILT, gray and orange brown, damp to moist, very dense, trace sand.	SPT	8-18-43 (61)								
		SM	@16.3 ft., Silty SAND, gray and orange, damp, very dense, fine- to coarse-grained; with gravel.										
		SM	@20 ft., red brown.	SPT	13-26-33 (59)								

Terminated at 21.5 feet.
 No groundwater. Caving in gravel and cobbles.
 Backfilled in accordance with SDCDEH requirements.

CLIENT AMBIENT COMMUNITIES
PROJECT NUMBER 1912-01
DATE STARTED 6/7/21 **COMPLETED** 6/7/21
DRILLING CONTRACTOR Pacific Drilling
DRILLING METHOD Hollow Stem Auger
LOGGED BY AB **CHECKED BY** PJD
NOTES Auto-trip hammer

PROJECT NAME Hollister Apartments
PROJECT LOCATION 555 Hollister Street, San Diego
GROUND ELEVATION 42 ft **HOLE SIZE** 8 inch
GROUND WATER LEVELS:
AT TIME OF DRILLING ---
AT END OF DRILLING ---
AFTER DRILLING ---

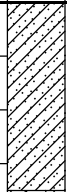
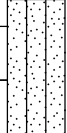
AGS BORING LOG V2 - GINT STD US LAB.GDT - 8/26/21 10:45 - Z:\PROJECT FILES\1912-01 AMBIENT HOLLISTER STREET PROJ\LOGS AND LAB\1912-01 LOGS.GPJ

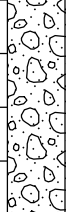
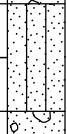
DEPTH (ft)	GRAPHIC LOG	USCS	MATERIAL DESCRIPTION	SAMPLE TYPE NUMBER	BLOW COUNTS (N VALUE)	DRY UNIT WT. (pcf)	MOISTURE CONTENT (%)	SATURATION (%)	OTHER TESTS	ATTERBERG LIMITS			FINES CONTENT (%)
										LIQUID LIMIT	PLASTIC LIMIT	PLASTICITY INDEX	
0													
		SC	Artificial Fill (afu) Clayey SAND, red brown, moist, medium dense, fine- to coarse-grained; with gravel; trace cobbles. @2.5 ft., damp to moist, dense.										
		SM	@3.5 ft., Silty SAND, red brown, damp to moist, medium dense, fine- to coarse-grained; few carbonate stringers; with gravel and cobbles. @5 ft., damp, medium dense.	SPT	8-13-14 (27)								
		SP	Old Paralac Deposits (Qop6) SAND, red brown, damp to moist, medium dense, fine- to coarse-grained; with gravel and cobbles. @8 ft., abundant gravel and cobbles; difficult drilling, grinding on rock.	SPT	4-5-14 (19)								
		GP	@14 ft., Gravelly SAND to Sandy GRAVEL, light red brown, damp, very dense, partial recovery, 3-inch gravel in tip. @15 ft., same.	SPT	21-33-44 (77)								
		SM	@19 ft., Silty SAND, red brown, damp, dense, fine- to coarse-grained.	SPT	27-39-28 (67)								
		SP	@14 ft., Gravelly SAND to Sandy GRAVEL, gray brown to red brown, damp, dense.	SPT	3-4-27 (31)								
			Terminated at 21.5 feet. No groundwater. Caving in gravel and cobbles. Backfilled in accordance with SDCDEH requirements.										



CLIENT AMBIENT COMMUNITIES
 PROJECT NUMBER 1912-01
 DATE STARTED 6/7/21 COMPLETED 6/7/21
 DRILLING CONTRACTOR Pacific Drilling
 DRILLING METHOD Hollow Stem Auger
 LOGGED BY AB CHECKED BY PJD
 NOTES Auto-trip hammer

PROJECT NAME Hollister Apartments
 PROJECT LOCATION 555 Hollister Street, San Diego
 GROUND ELEVATION 48 ft HOLE SIZE 8 inch
 GROUND WATER LEVELS:
 AT TIME OF DRILLING ---
 AT END OF DRILLING ---
 AFTER DRILLING ---

AGS BORING LOG V2 - GINT STD US LAB.GDT - 8/26/21 10:45 - Z:\PROJECT FILES\1912-01 AMBIENT HOLLISTER STREET PROJ\LOGS AND LAB\1912-01 LOGS.GPJ

DEPTH (ft)	GRAPHIC LOG	USCS	MATERIAL DESCRIPTION	SAMPLE TYPE NUMBER	BLOW COUNTS (N VALUE)	DRY UNIT WT. (pcf)	MOISTURE CONTENT (%)	SATURATION (%)	OTHER TESTS	ATTERBERG LIMITS			FINES CONTENT (%)
										LIQUID LIMIT	PLASTIC LIMIT	PLASTICITY INDEX	
0		SC	Artificial Fill (afu) Clayey SAND, orange, moist, loose to medium dense, fine- to coarse-grained; with gravel; trace cobbles.	BU					Sieve E1 MAX RDS	24	15	9	40
2.5		CL	@2.5 ft., sandy to silty CLAY, moist, red brown, very stiff, with gravel.	SPT	8-8-7 (15)								
5		SM	Old Paralic Deposits (Qop6) Silty SAND, red brown, damp to moist, very dense, fine- to coarse-grained; with gravel and cobbles.	SPT	15-24-39 (63)								
7		GP	@7 ft. to 17 ft., Sandy GRAVEL, gray and red brown, dry to damp, very dense; difficult drilling, grinding on rock.										
10			@10 ft., medium dense, partial recovery, 2-inch gravel in tip.	SPT	9-8-12 (20)								
12			@12 ft., difficult drilling, grinding on rock.										
15			@15 ft., very dense, partial recovery.	SPT	15-32-45 (77)								
17			@17 ft., abundant gravel and cobbles; difficult drilling, grinding on rock.										
20			@20 ft., dry to damp.	SPT	21-35-50/3"								

Terminated at 21.5 feet.
 No groundwater. Caving in gravel and cobbles.
 Backfilled in accordance with SDCDEH requirements.

CLIENT AMBIENT COMMUNITIES
PROJECT NUMBER 1912-01
DATE STARTED 6/8/21 **COMPLETED** 6/8/21
DRILLING CONTRACTOR Pacific Drilling
DRILLING METHOD Hollow Stem Auger
LOGGED BY AB **CHECKED BY** PJD
NOTES Auto-trip hammer

PROJECT NAME Hollister Apartments
PROJECT LOCATION 555 Hollister Street, San Diego
GROUND ELEVATION 47 ft **HOLE SIZE** 8 inch
GROUND WATER LEVELS:
AT TIME OF DRILLING ---
AT END OF DRILLING ---
AFTER DRILLING ---

DEPTH (ft)	GRAPHIC LOG	USCS	MATERIAL DESCRIPTION	SAMPLE TYPE NUMBER	BLOW COUNTS (N VALUE)	DRY UNIT WT. (pcf)	MOISTURE CONTENT (%)	SATURATION (%)	OTHER TESTS	ATTERBERG LIMITS			FINES CONTENT (%)
										LIQUID LIMIT	PLASTIC LIMIT	PLASTICITY INDEX	
0													
		SC	Artificial Fill (afu) Clayey SAND to sandy CLAY, orange, damp, loose to medium dense, fine- to coarse-grained; some gravel; few roots. @2.5 ft., same.	SPT	7-10-23 (33)								
		GP	Old Paralic Deposits (Qop6) Sandy GRAVEL, gray and red brown, dry to damp, dense; difficult drilling, grinding on rock; with cobbles. @5 ft., very dense, no recovery. @6 ft. difficult drilling, grinding on rock.	SPT	15-25-23 (48)								
		GP	@10 ft., GRAVEL, medium dense, few cobble to 4-inch size. @11 to 19 ft. difficult drilling, grinding on rock.	SPT	11-7-9 (16)								
		GP	@21 ft., Sandy GRAVEL with clay, gray and red brown, damp to moist, very dense; carbonate stringers; with cobbles.	SPT	12-31-39 (70)								

AGS BORING LOG V2 - GINT STD US LAB.GDT - 8/26/21 10:45 - Z:\PROJECT FILES\1912-01 AMBIENT HOLLISTER STREET PROJ\LOGS AND LAB\1912-01 LOGS.GPJ

CLIENT AMBIENT COMMUNITIES PROJECT NAME Hollister Apartments
 PROJECT NUMBER 1912-01 PROJECT LOCATION 555 Hollister Street, San Diego

DEPTH (ft)	GRAPHIC LOG	USCS	MATERIAL DESCRIPTION	SAMPLE TYPE NUMBER	BLOW COUNTS (N VALUE)	DRY UNIT WT. (pcf)	MOISTURE CONTENT (%)	SATURATION (%)	OTHER TESTS	ATTERBERG LIMITS			FINES CONTENT (%)
										LIQUID LIMIT	PLASTIC LIMIT	PLASTICITY INDEX	
25		GP	<p>Old Paralic Deposits (Qop6) (continued) Sandy GRAVEL with clay, gray and red brown, damp to moist, very dense; carbonate stringers; with cobbles. Difficult drilling, grinding on rock.</p> <p>@28 ft., refusal to further drilling.</p>										
Terminated at 28 feet (Refusal) No groundwater. Caving in gravel and cobbles. Backfilled in accordance with SDCDEH requirements.													

AGS BORING LOG V2 - GINT STD US LAB.GDT - 8/26/21 10:45 - Z:\PROJECT FILES\1912-01 AMBIENT HOLLISTER STREET PROJ\LOGS AND LAB\1912-01 LOGS.GPJ

CLIENT AMBIENT COMMUNITIES
PROJECT NUMBER 1912-01
DATE STARTED 6/9/21 **COMPLETED** 6/9/21
DRILLING CONTRACTOR Pacific Drilling
DRILLING METHOD Hollow Stem Auger
LOGGED BY AB **CHECKED BY** PJD
NOTES Auto-trip hammer

PROJECT NAME Hollister Apartments
PROJECT LOCATION 555 Hollister Street, San Diego
GROUND ELEVATION 22.5 ft **HOLE SIZE** 8 inch
GROUND WATER LEVELS:
 ∇ **AT TIME OF DRILLING** 10.00 ft / Elev 12.50 ft
 ▼ **AT END OF DRILLING** 10.00 ft / Elev 12.50 ft
 ▼ **AFTER DRILLING** 10.00 ft / Elev 12.50 ft

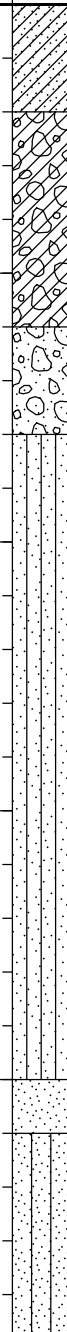
DEPTH (ft)	GRAPHIC LOG	USCS	MATERIAL DESCRIPTION	SAMPLE TYPE NUMBER	BLOW COUNTS (N VALUE)	DRY UNIT WT. (pcf)	MOISTURE CONTENT (%)	SATURATION (%)	OTHER TESTS	ATTERBERG LIMITS			FINES CONTENT (%)
										LIQUID LIMIT	PLASTIC LIMIT	PLASTICITY INDEX	
0													
		SC	Artificial Fill (afu) Clayey SAND, red brown, moist, loose to medium dense, fine- to coarse-grained; some gravel and cobbles; with roots and organic content to 6 inches.										
		SC	Young Alluvium (Qya?) Clayey SAND, red brown, moist, medium dense; with gravel and cobbles; grinding on rock. @2.5 ft., dense, no recovery. @4 ft., difficult drilling, grinding on rock; with cobbles.	X SPT	7-7-12 (19)								
5		GP	Old Paralic Deposits (Qop6) Sandy GRAVEL with clay, gray and red brown, damp to moist, dense; carbonate stringers. @6.5 ft., difficult drilling, grinding on gravel and cobbles.	▲ SPT	23-9-13 (22)								
		ML	@8 ft., Sandy CLAY to sandy SILT, gray to gray brown, moist to wet, dense; carbonate stringers.										
10			▼ @10 ft., Groundwater.	▲ MC	8-12-26 (38)	102	22.1	91	Sieve Cons DS	45	27	18	63
15													
20		SP	@20 ft., SAND, gray to red brown, saturated, dense, fine- to medium-grained; some silt.	▲ SPT	10-10-14 (24)				Hydro Sieve	NP	NP	NP	17
		SM	@21 ft., Silty SAND, gray to red brown, saturated, dense, fine- to medium-grained; micaceous, iron oxide; laminated.										31
25													

(Continued Next Page)

AGS BORING LOG V2 - GINT STD US LAB.GDT - 8/26/21 10:45 - Z:\PROJECT FILES\1912-01 AMBIENT HOLLISTER STREET PROJ\LOGS AND LAB\1912-01 LOGS.GPJ

CLIENT AMBIENT COMMUNITIES PROJECT NAME Hollister Apartments
 PROJECT NUMBER 1912-01 PROJECT LOCATION 555 Hollister Street, San Diego

DEPTH (ft)	GRAPHIC LOG	USCS	MATERIAL DESCRIPTION	SAMPLE TYPE NUMBER	BLOW COUNTS (N VALUE)	DRY UNIT WT. (pcf)	MOISTURE CONTENT (%)	SATURATION (%)	OTHER TESTS	ATTERBERG LIMITS			FINES CONTENT (%)
										LIQUID LIMIT	PLASTIC LIMIT	PLASTICITY INDEX	
25													
		SM	Old Parallic Deposits (Qop6) (continued) Silty SAND, gray to red brown, saturated, dense, fine- to medium-grained; micaceous, iron oxide; laminated.										
30		ML	30 ft., SILT, gray brown, saturated, medium dense, some fine-grained sand; micaceous.	MC	2-5-10 (15)	101	20.3	81	Hydro Cons	49	29	20	84

Terminated at 31.5 feet.
 Groundwater at 10 ft. at end of drilling.
 Caving in gravel and cobbles.
 Backfilled in accordance with SDCDEH requirements.

AGS BORING LOG V2 - GINT STD US LAB.GDT - 8/26/21 10:45 - Z:\PROJECT FILES\1912-01 AMBIENT HOLLISTER STREET PROJ\LOGS AND LAB\1912-01 LOGS.GPJ



CLIENT AMBIENT COMMUNITIES
 PROJECT NUMBER 1912-01
 DATE STARTED 6/9/21 COMPLETED 6/9/21
 DRILLING CONTRACTOR Pacific Drilling
 DRILLING METHOD Hollow Stem Auger
 LOGGED BY AB CHECKED BY PJD
 NOTES Auto-trip hammer

PROJECT NAME Hollister Apartments
 PROJECT LOCATION 555 Hollister Street, San Diego
 GROUND ELEVATION 19 ft HOLE SIZE 8 inch
 GROUND WATER LEVELS:
 ▽ AT TIME OF DRILLING 10.00 ft / Elev 9.00 ft
 ▼ AT END OF DRILLING 6.50 ft / Elev 12.50 ft
 ▼ AFTER DRILLING 6.50 ft / Elev 12.50 ft

AGS BORING LOG V2 - GINT STD US LAB.GDT - 8/26/21 10:45 - Z:\PROJECT FILES\1912-01 AMBIENT HOLLISTER STREET PROJ\LOGS AND LAB\1912-01 LOGS.GPJ

DEPTH (ft)	GRAPHIC LOG	USCS	MATERIAL DESCRIPTION	SAMPLE TYPE NUMBER	BLOW COUNTS (N VALUE)	DRY UNIT WT. (pcf)	MOISTURE CONTENT (%)	SATURATION (%)	OTHER TESTS	ATTERBERG LIMITS			FINES CONTENT (%)
										LIQUID LIMIT	PLASTIC LIMIT	PLASTICITY INDEX	
0													
		SC SM SM GP	<p>Topsoil Clayey SAND, light gray brown, dry to damp, loose, fine- to coarse-grained; with fine gravel; abundant roots and organic content.</p> <p>@1.0 ft., Silty SAND to sandy SILT, dark brown to black, moist, loose, fine-grained; urea odor, micaceous, organic content and fine roots.</p> <p>Young Alluvium (Qya) Silty SAND, dark red brown, moist to wet, loose; manganese nodules.</p> <p>▼</p> <p>▽ @10 ft., wet to saturated. Groundwater.</p> <p>Old Paralic Deposits (Qop6) Sandy GRAVEL, gray and red brown, wet to saturated, dense; difficult drilling, grinding on rock; with cobbles.</p> <p>@15 ft., grinding on cobbles. Refusal to further drilling.</p>	SPT	2-2-3 (5)								
				SPT	3-3-2 (5)								
				SPT	4-8-15 (23)								

Terminated at 15 feet (Refusal).
 Groundwater at 6.5 ft. at end of drilling.
 Caving in gravel and cobbles.
 Backfilled in accordance with SDCDEH requirements.



CLIENT AMBIENT COMMUNITIES
PROJECT NUMBER 1912-01
DATE STARTED 6/7/21 **COMPLETED** 6/7/21
DRILLING CONTRACTOR Pacific Drilling
DRILLING METHOD Hollow Stem Auger
LOGGED BY AB **CHECKED BY** PJD
NOTES _____

PROJECT NAME Hollister Apartments
PROJECT LOCATION 555 Hollister Street, San Diego
GROUND ELEVATION 42.5 ft **HOLE SIZE** 8 inch
GROUND WATER LEVELS:
AT TIME OF DRILLING ---
AT END OF DRILLING ---
AFTER DRILLING ---

AGS BORING LOG V2 - GINT STD US LAB.GDT - 8/26/21 10:45 - Z:\PROJECT FILES\1912-01 AMBIENT HOLLISTER STREET PROJ\LOGS AND LAB\1912-01 LOGS.GPJ

DEPTH (ft)	GRAPHIC LOG	USCS	MATERIAL DESCRIPTION	SAMPLE TYPE NUMBER	BLOW COUNTS (N VALUE)	DRY UNIT WT. (pcf)	MOISTURE CONTENT (%)	SATURATION (%)	OTHER TESTS	ATTERBERG LIMITS			FINES CONTENT (%)
										LIQUID LIMIT	PLASTIC LIMIT	PLASTICITY INDEX	
0.0		SM	Artificial Fill (afu) Sandy CLAY, red brown, moist, stiff, sand is fine- to coarse-grained; with gravel.										
2.5		CL	@3 ft., Gravelly CLAY, red brown, with fine- to medium-grained sand, moist, stiff.										
5.0		GC	@4.5 ft., abundant gravel and cobbles.										

Terminated at 5.5 feet.
 No groundwater. Caving on gravel and cobbles.
 Pipe set to 4.5 ft. Backfilled with gravel.

CLIENT AMBIENT COMMUNITIES **PROJECT NAME** Hollister Apartments
PROJECT NUMBER 1912-01 **PROJECT LOCATION** 555 Hollister Street, San Diego
DATE STARTED 6/7/21 **COMPLETED** 6/7/21 **GROUND ELEVATION** 45.5 ft **HOLE SIZE** 8 inch
DRILLING CONTRACTOR Pacific Drilling **GROUND WATER LEVELS:**
DRILLING METHOD Hollow Stem Auger **AT TIME OF DRILLING** ---
LOGGED BY AB **CHECKED BY** PJD **AT END OF DRILLING** ---
NOTES _____ **AFTER DRILLING** ---

AGS BORING LOG V2 - GINT STD US LAB.GDT - 8/26/21 10:45 - Z:\PROJECT FILES\1912-01 AMBIENT HOLLISTER STREET PROJ\LOGS AND LAB\1912-01 LOGS.GPJ

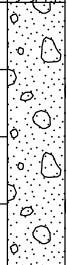
DEPTH (ft)	GRAPHIC LOG	USCS	MATERIAL DESCRIPTION	SAMPLE TYPE NUMBER	BLOW COUNTS (N VALUE)	DRY UNIT WT. (pcf)	MOISTURE CONTENT (%)	SATURATION (%)	OTHER TESTS	ATTERBERG LIMITS			FINES CONTENT (%)
										LIQUID LIMIT	PLASTIC LIMIT	PLASTICITY INDEX	
0.0													
		SM	Artificial Fill (afu) Silty to clayey SAND, red brown, moist, loose to medium dense, fine- to coarse-grained; with gravel.										
2.5			Old Paralic Deposits (Qop6) Gravelly SAND, red brown, fine- to medium-grained, damp, loose to medium dense; abundant cobbles.										

Terminated at 4.5 feet.
 No groundwater. Caving on gravel and cobbles.
 Pipe set to 4.5 ft. Backfilled with gravel.

CLIENT AMBIENT COMMUNITIES
 PROJECT NUMBER 1912-01
 DATE STARTED 6/7/21 COMPLETED 6/7/21
 DRILLING CONTRACTOR Pacific Drilling
 DRILLING METHOD Hollow Stem Auger
 LOGGED BY AB CHECKED BY PJD
 NOTES _____

PROJECT NAME Hollister Apartments
 PROJECT LOCATION 555 Hollister Street, San Diego
 GROUND ELEVATION 49 ft HOLE SIZE 8 inch
 GROUND WATER LEVELS:
 AT TIME OF DRILLING ---
 AT END OF DRILLING ---
 AFTER DRILLING ---

AGS BORING LOG V2 - GINT STD US LAB.GDT - 8/26/21 10:45 - Z:\PROJECT FILES\1912-01 AMBIENT HOLLISTER STREET PROJ\LOGS AND LAB\1912-01 LOGS.GPJ

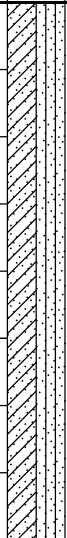
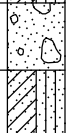
DEPTH (ft)	GRAPHIC LOG	USCS	MATERIAL DESCRIPTION	SAMPLE TYPE NUMBER	BLOW COUNTS (N VALUE)	DRY UNIT WT. (pcf)	MOISTURE CONTENT (%)	SATURATION (%)	OTHER TESTS	ATTERBERG LIMITS			FINES CONTENT (%)
										LIQUID LIMIT	PLASTIC LIMIT	PLASTICITY INDEX	
0.0													
0.0 - 4.5		SM	Artificial Fill (afu) Silty to clayey SAND, orange, moist, loose to medium dense, fine- to coarse-grained; with gravel.										
4.5 - 5.0		SM	Old Paralic Deposits (Qop6) Gravelly SAND, red brown, fine- to medium-grained, damp, loose to medium dense; abundant cobbles.										
5.0			Silty to clayey SAND, red brown, moist, loose to medium dense, fine- to coarse-grained; with gravel.										
Terminated at 5 feet. No groundwater. Caving on gravel and cobbles. Pipe set to 5 ft. Backfilled with gravel.													

CLIENT <u>AMBIENT COMMUNITIES</u>	PROJECT NAME <u>Hollister Apartments</u>
PROJECT NUMBER <u>1912-01</u>	PROJECT LOCATION <u>555 Hollister Street, San Diego</u>
DATE STARTED <u>6/7/21</u> COMPLETED <u>6/7/21</u>	GROUND ELEVATION <u>49 ft</u> HOLE SIZE <u>8 inch</u>
DRILLING CONTRACTOR <u>Pacific Drilling</u>	GROUND WATER LEVELS:
DRILLING METHOD <u>Hollow Stem Auger</u>	AT TIME OF DRILLING <u>---</u>
LOGGED BY <u>AB</u> CHECKED BY <u>PJD</u>	AT END OF DRILLING <u>---</u>
NOTES _____	AFTER DRILLING <u>---</u>

AGS BORING LOG V2 - GINT STD US LAB.GDT - 8/26/21 10:45 - Z:\PROJECT FILES\1912-01 AMBIENT HOLLISTER STREET PROJ\LOGS AND LAB\1912-01 LOGS.GPJ

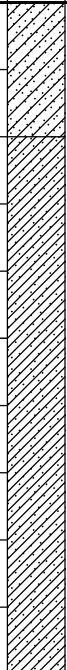
DEPTH (ft)	GRAPHIC LOG	USCS	MATERIAL DESCRIPTION	SAMPLE TYPE NUMBER	BLOW COUNTS (N VALUE)	DRY UNIT WT. (pcf)	MOISTURE CONTENT (%)	SATURATION (%)	OTHER TESTS	ATTERBERG LIMITS			FINES CONTENT (%)
										LIQUID LIMIT	PLASTIC LIMIT	PLASTICITY INDEX	
0.0		SC	Topsoil Silty to clayey SAND, red brown to dark brown, moist, loose, fine- to coarse-grained; with roots and organic content.										
2.5		CL	Artificial Fill (afu) Sandy CLAY, yellow brown, moist, very stiff; some gravel.										
5.0													

Terminated at 5 feet.
 No groundwater.
 Pipe set to 5 ft. Backfilled with gravel.

Project 555 Hollister Street
Date Excavated 12/19/2019
Logged by SS
Equipment Cat 420F/24" Bucket

LOG OF TEST PITS

Test Pit No.	Depth (ft.)	USCS	Description
TP-1	0.0 – 4.5	SC	<u>Artificial Fill – Undocumented (afu):</u> Clayey SAND with sub-rounded Gravel to Cobble, red brown, moist, loose; construction debris: asphalt and concrete
	4.5 – 7.0	SM	<u>Young Alluvial Flood-Plain Deposits (Qva)</u> Silty fine- to coarse-grained SAND with abundant sub-rounded Gravel to Cobble, yellow brown, slightly moist, loose

TOTAL DEPTH 7.0 FT.
NO WATER, NO CAVING

Test Pit No.	Depth (ft.)	USCS	Description
TP-2	0.0 – 3.5	SC/CL	<u>Topsoil:</u> Clayey SAND to Sandy Clay, red brown, moist, loose
	3.5 – 5.0	SM	<u>Old Paralic Deposits (Qop6)</u> Silty fine-grained SAND with abundant sub-rounded Gravel to Cobble, yellow brown to gray brown, dense; weakly cemented, minor iron oxide staining

TOTAL DEPTH 5.0 FT.
NO WATER, NO CAVING

Test Pit No.	Depth (ft.)	USCS	Description
TP-3	0.0 – 4.0	SC	<u>Artificial Fill – Undocumented (afu):</u> Clayey SAND with sub-rounded Gravel to Cobble, red brown, very moist; mixed with some light gray brown Clayey SAND
	4.0 – 9.0	SP	<u>Young Alluvial Flood-Plain Deposits (Qva)</u> Coarse-grained SAND with abundant Gravel to Cobble, moist, loose; trace Silt and Clay (CAVING from 4' – 9')
	9.0 – 11.0	SC	<u>Old Paralic Deposits (Qop6)</u> Clayey fine- to coarse-grained SAND with common Gravel, dark gray brown to red brown, moist, dense; weakly cemented

TOTAL DEPTH 11.0 FT.
NO WATER, CAVING SOILS



Test Pit No.	Depth (ft.)	USCS	Description
TP-4	0.0 – 2.5	SC/SM	<u>Artificial Fill – Undocumented (afu):</u> Silty to Clayey fine- to medium-grained SAND with some Gravel to Cobble, very moist, loose
	2.5 – 4.0	SM	<u>Old Paralic Deposits (Qop₆)</u> Silty fine- to coarse-grained SAND with some sub-rounded Gravel to Cobble, dark gray brown to dark red brown, dense; weakly cemented
			TOTAL DEPTH 4.0 FT. NO WATER, NO CAVING
TP-5	0.0 – 2.5	SC	<u>Artificial Fill – Undocumented (afu):</u> Clayey fine-grained SAND with some Gravel to Cobble, red brown, very moist, loose
	2.5 – 7.5	SM	<u>Old Paralic Deposits (Qop₆)</u> Silty fine-grained SAND with small rounded Gravel, dark gray brown to dark orange brown, moist, dense; trace Clay, weakly cemented, carbonate stringers, slightly micaceous @ 6.5 ft., yellow brown to dark yellow brown, slightly moist, dense; moderately cemented, carbonate nodules, minor iron oxide staining
			TOTAL DEPTH 7.5 FT. NO WATER, NO CAVING

Test Pit No.	Depth (ft.)	USCS	Description
TP-6	0.0 – 2.0	SC	<u>Artificial Fill – Undocumented (afu):</u> Clayey fine- to coarse-grained SAND with some Gravel to Cobble, red brown, loose; abundance of organics @ 1.0 ft., encountered a 2” steel pipe (moved trench 5’ north)
	2.0 – 15.0	SP	<u>Young Alluvial Flood-Plain Deposits (Qva)</u> Coarse-grained SAND with abundant sub-rounded Gravel to Cobble, dark yellow brown to dark orange brown, very moist to wet, loose (CAVING from 2’ – 15’) @ 3.5 ft., moist, occasional boulders @ 10.0 ft., becomes slightly moist

TOTAL DEPTH 15.0 FT.
NO WATER, CAVING SOILS



<u>Test</u>			
<u>Pit No.</u>	<u>Depth (ft.)</u>	<u>USCS</u>	<u>Description</u>
TP-7	0.0 – 3.5	SC	<u>Artificial Fill – Undocumented (afu):</u> Clayey fine- to coarse-grained SAND with some Gravel to Cobble, red brown, very moist, loose
	3.5 – 13.0	SM	<u>Old Paralic Deposits (Qop6)</u> Silty fine- to medium-grained SAND, dark gray brown to red brown, moist, dense; weakly cemented, slightly micaceous
		SP	@ 5.5 ft., Coarse-grained SAND with abundant sub-rounded Gravel to Cobble, dark yellow brown, moist @ 7.0 ft., slightly moist
TOTAL DEPTH 13.0 FT. NO WATER, NO CAVING			

<u>Test</u>			
<u>Pit No.</u>	<u>Depth (ft.)</u>	<u>USCS</u>	<u>Description</u>
TP-8	0.0 – 4.0	SC/CL	<u>Topsoil:</u> Clayey SAND to Sandy CLAY, fine- to coarse-grained, dark red brown, very moist to wet, loose to soft; occasional sub-rounded Gravel to Cobble
	4.0 – 13.0	SM	<u>Old Paralic Deposits (Qop6)</u> Silty fine-grained SAND, dark yellow brown to gray brown, slightly moist to moist, dense; moderately cemented, carbonate nodules, slightly micaceous, minor porosity
		SW	@ 7.0 ft., Fine- to coarse SAND with sub-rounded Gravel to Cobble, light yellow brown, slightly moist
		SP	@ 10.0 ft., Coarse-grained SAND with abundant sub-rounded Gravel to Cobble
TOTAL DEPTH 13.0 FT. NO WATER, NO CAVING			

Test Pit No.	Depth (ft.)	USCS	Description
TP-9	0.0 – 11.0	SC	<u>Artificial Fill – Undocumented (afu):</u> Clayey SAND with Gravel to Cobble, yellow brown to gray brown, very moist, loose; trash debris: PVC pipe, plastic, glass, metal, wood, concrete etc. (CAVING from 0' – 11')
	11.0 – 13.0	SP	<u>Young Alluvial Flood-Plain Deposits (Ova)</u> Coarse-grained SAND with abundant sub-rounded Gravel to Cobble, dark yellow brown to gray brown, moist, loose

TOTAL DEPTH 13.0 FT.
NO WATER, CAVING SOILS



Test			
<u>Pit No.</u>	<u>Depth (ft.)</u>	<u>USCS</u>	<u>Description</u>
TP-10	0.0 – 13.0	SC	<u>Artificial Fill – Undocumented (afu):</u> Clayey SAND with Gravel to Cobble, gray brown, moist, loose; trash debris: PVC pipe, plastic, glass, metal, wood, concrete etc. TOTAL DEPTH 13.0 FT. NO WATER, NO CAVING



Test Pit No.	Depth (ft.)	USCS	Description
TP-11	0.0 – 1.5	SM/SC	<u>Topsoil:</u> Silty to Clayey SAND, fine-grained, red brown to dark gray brown, moist, loose
	1.5 – 10.0	SM	<u>Old Paralic Deposits (Qop₆)</u> Silty fine- to coarse-grained SAND, dark gray brown to dark blueish brown, slightly moist, dense; moderately cemented, slightly micaceous, minor porosity @ 3.0 ft., non-porous CL/ML @ 7.0 ft., Silty CLAY to Clayey SILT SM @ 8.0 ft., grades back to Silty SAND TOTAL DEPTH 10.0 FT. NO WATER, NO CAVING



Test Pit No.	Depth (ft.)	USCS	Description
TP-12	0.0 – 1.0	SM	<u>Topsoil:</u> Silty to Clayey fine- to coarse-grained SAND with some Gravel, red brown, moist to very moist loose
	1.0 – 13.0	SM-SC	<u>Young Alluvial Flood-Plain Deposits (Qva)</u> Silty to Clayey fine- to coarse-grained SAND with sub-rounded Gravel to Cobble, gray brown to dark yellow brown, moist to very moist, loose (CAVING from 1' – 13')
		SP	Coarse-grained SAND with abundant sub-rounded Gravel to Cobble, yellow brown to gray brown, moist to very moist, loose; occasional boulder

TOTAL DEPTH 13.0 FT.
NO WATER, CAVING SOILS



Test Pit No.	Depth (ft.)	USCS	Description
TP-13	0.0 – 2.5.	SC	<u>Artificial Fill – Undocumented (afu):</u> Clayey SAND with sub-rounded Gravel to Cobble, dark brown, very moist, loose
	2.5 – 6.0	SM/SC	<u>Young Alluvial Flood-Plain Deposits (Qva)</u> Silty to Clayey fine- to coarse-grained SAND with abundant sub-rounded Gravel to Cobble, dark yellow brown, to gray brown, moist, loose
	6.0 – 12.0	SM	<u>Old Paralic Deposits (Qop6)</u> Silty fine-grained SAND with abundant Gravel to Cobble, yellow brown, slightly moist to moist, dense; moderately cemented, abundant carbonate stringers, slightly micaceous

TOTAL DEPTH 12.0 FT.
NO WATER, NO CAVING

APPENDIX C
LABORATORY TESTING RESULTS

ADVANCED GEOTECHNICAL SOLUTIONS, INC.

AGS Form E-2

ATTERBERG LIMITS - ASTM D4318

Project Name: 555 Hollister St.
 Location: San Diego
 Project No: 1912-01
 Date: 6/29/2021

Excavation: B-3
 Depth: 0-2 ft
 Description: SC
 By: FV

LIQUID LIMIT

Can No.	4	1	6
Wt. wet soil+can (g)	21.55	20.31	21.52
Wt. dry soil+can (g)	19.60	18.58	19.50
Wt. can (g)	11.10	11.27	11.26
Wt. moisture (g)	1.95	1.73	2.02
Wt. dry soil (g)	8.50	7.31	8.24
Water Content %	22.94	23.67	24.51
No. of Blows	35	25	16

PLASTIC LIMIT

109	111
60.78	60.00
59.65	58.87
51.57	51.44
1.13	1.13
8.08	7.43
13.99	15.21

LIQUID LIMIT



PLASTICITY CHART

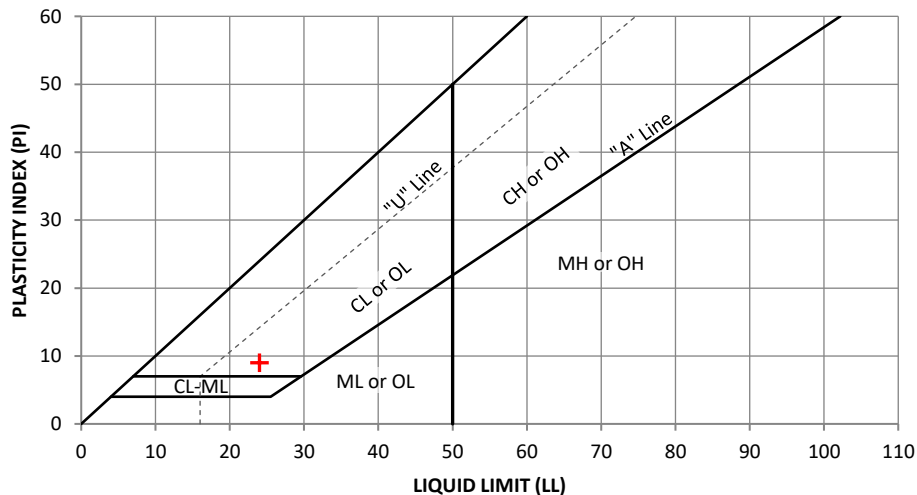

Liquid Limit (LL) 24 Plastic Limit (PL) 15 Plasticity Index (PI) 9

ADVANCED GEOTECHNICAL SOLUTIONS, INC.

AGS Form E-2

ATTERBERG LIMITS - ASTM D4318

Project Name: 555 Hollister
 Location: San Diego
 Project No: 1912-01
 Date: 7/16/2021

Excavation: B-5
 Depth: 10-11.5 ft
 Description: ML
 By: FV

LIQUID LIMIT

Can No.	2	14	5
Wt. wet soil+can (g)	19.29	19.27	19.65
Wt. dry soil+can (g)	16.81	16.80	17.01
Wt. can (g)	11.12	11.25	11.30
Wt. moisture (g)	2.48	2.47	2.64
Wt. dry soil (g)	5.69	5.55	5.71
Water Content %	43.59	44.50	46.23
No. of Blows	34	25	15

PLASTIC LIMIT

106	104
57.81	56.69
56.44	55.51
51.32	51.03
1.37	1.18
5.12	4.48
26.76	26.34

LIQUID LIMIT



PLASTICITY CHART

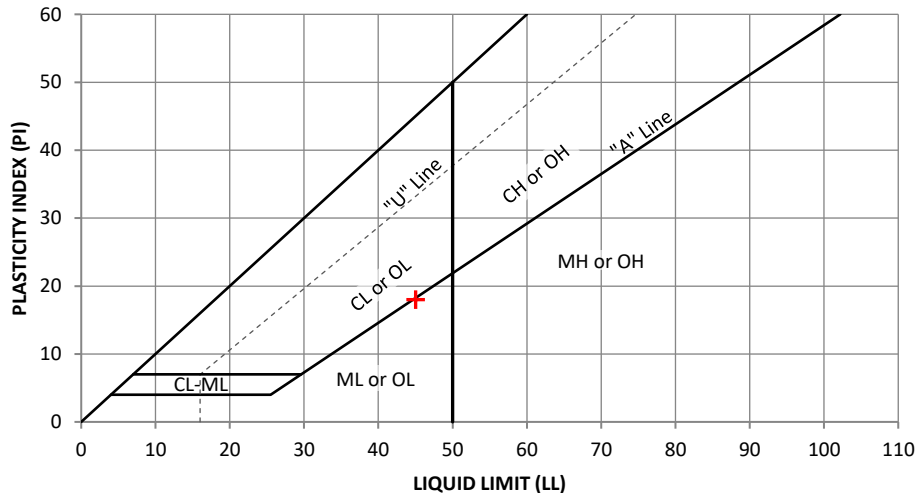

Liquid Limit (LL) 45 Plastic Limit (PL) 27 Plasticity Index (PI) 18

ADVANCED GEOTECHNICAL SOLUTIONS, INC.

AGS Form E-2

ATTERBERG LIMITS - ASTM D4318

Project Name: 555 Hollister
 Location: San Diego
 Project No: 1912-01
 Date: 7/14/2021

Excavation: B-5
 Depth: 30-31.5 ft
 Description: ML
 By: FV

LIQUID LIMIT

Can No.	3	11	10
Wt. wet soil+can (g)	19.97	20.16	20.92
Wt. dry soil+can (g)	17.16	17.22	17.60
Wt. can (g)	11.23	11.25	11.15
Wt. moisture (g)	2.81	2.94	3.32
Wt. dry soil (g)	5.93	5.97	6.45
Water Content %	47.39	49.25	51.47
No. of Blows	35	25	15

PLASTIC LIMIT

	111	109
	57.24	57.59
	55.92	56.23
	51.42	51.56
	1.32	1.36
	4.50	4.67
	29.33	29.12

LIQUID LIMIT



PLASTICITY CHART

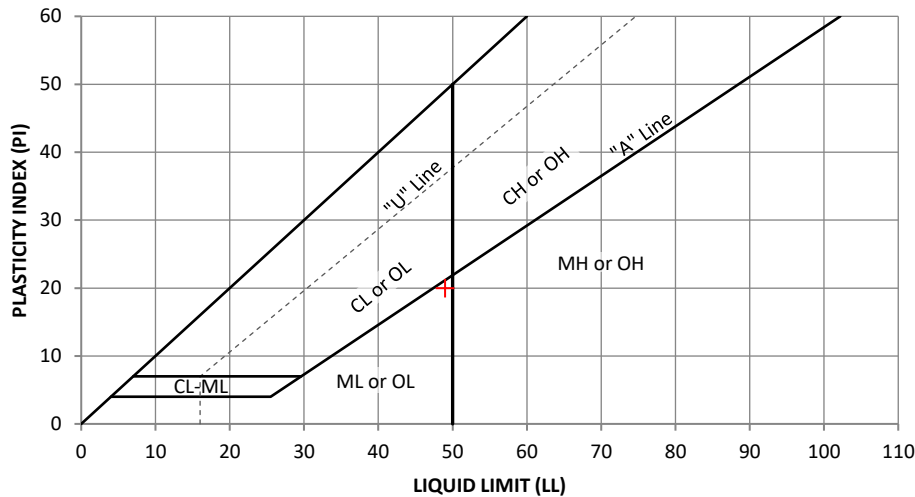

Liquid Limit (LL) 49 Plastic Limit (PL) 29 Plasticity Index (PI) 20

ADVANCED GEOTECHNICAL SOLUTIONS, INC.

EXPANSION INDEX - ASTM D4829

AGS FORM E-6

Project Name: 555 Hollister St.
Location: San Diego
P/W: 1902-01
Date: 7/1/21

Excavation/Tract: B-3
Depth/Lot: 0-2 ft
Description: SC
Tested by: FV
Checked by: AB

Expansion Index - ASTM D4829	
Initial Dry Density (pcf):	117.6
Initial Moisture Content (%):	8.3
Initial Saturation (%):	51.7
Final Dry Density (pcf):	116.9
Final Moisture Content (%):	14.9
Final Saturation (%):	91.5
Expansion Index:	6
Potential Expansion:	Very Low

ASTM D4829 - Table 5.3	
Expansion Index	Potential Expansion
0 - 20	Very Low
21 - 50	Low
51 - 90	Medium
91 - 130	High
>130	Very High

ADVANCED GEOTECHNICAL SOLUTIONS, INC.

EXPANSION INDEX - ASTM D4829

AGS FORM E-6

Project Name: 555 Hollister St
Location: San Diego
P/W: 1912-01
Date: 1/22/20

Excavation/Tract: TP-4
Depth/Lot: 0.0-2.0 ft
Description: Reddish Brn SM
Tested by: FV
Checked by: SS

Expansion Index - ASTM D4829	
Initial Dry Density (pcf):	103.3
Initial Moisture Content (%):	11.5
Initial Saturation (%):	49.2
Final Dry Density (pcf):	99.9
Final Moisture Content (%):	25.3
Final Saturation (%):	99.7
Expansion Index:	34
Potential Expansion:	Low

ASTM D4829 - Table 5.3	
Expansion Index	Potential Expansion
0 - 20	Very Low
21 - 50	Low
51 - 90	Medium
91 - 130	High
>130	Very High

ADVANCED GEOTECHNICAL SOLUTIONS, INC.

EXPANSION INDEX - ASTM D4829

AGS FORM E-6

Project Name: 555 Hollister St
 Location: San Diego
 P/W: 1912-01
 Date: 1/23/20

Excavation/Tract: TP-8
 Depth/Lot: 1-3 ft
 Description: Brown SC-SM
 Tested by: FV
 Checked by: SS

Expansion Index - ASTM D4829	
Initial Dry Density (pcf):	120.0
Initial Moisture Content (%):	7.7
Initial Saturation (%):	51.4
Final Dry Density (pcf):	120.8
Final Moisture Content (%):	12.8
Final Saturation (%):	87.3
Expansion Index:	0
Potential Expansion:	Very Low

ASTM D4829 - Table 5.3	
Expansion Index	Potential Expansion
0 - 20	Very Low
21 - 50	Low
51 - 90	Medium
91 - 130	High
>130	Very High

ADVANCED GEOTECHNICAL SOLUTIONS, INC.

PARTICLE SIZE ANALYSIS - ASTM D422

AGS FORM E-7

Project Name: 555 Hollister St.
 Location: San Diego
 Project No.: 1912-01
 Date: 06-2021

Excavation: B-3
 Depth: 0-2 ft
 Tested by: FV
 Checked by: AB

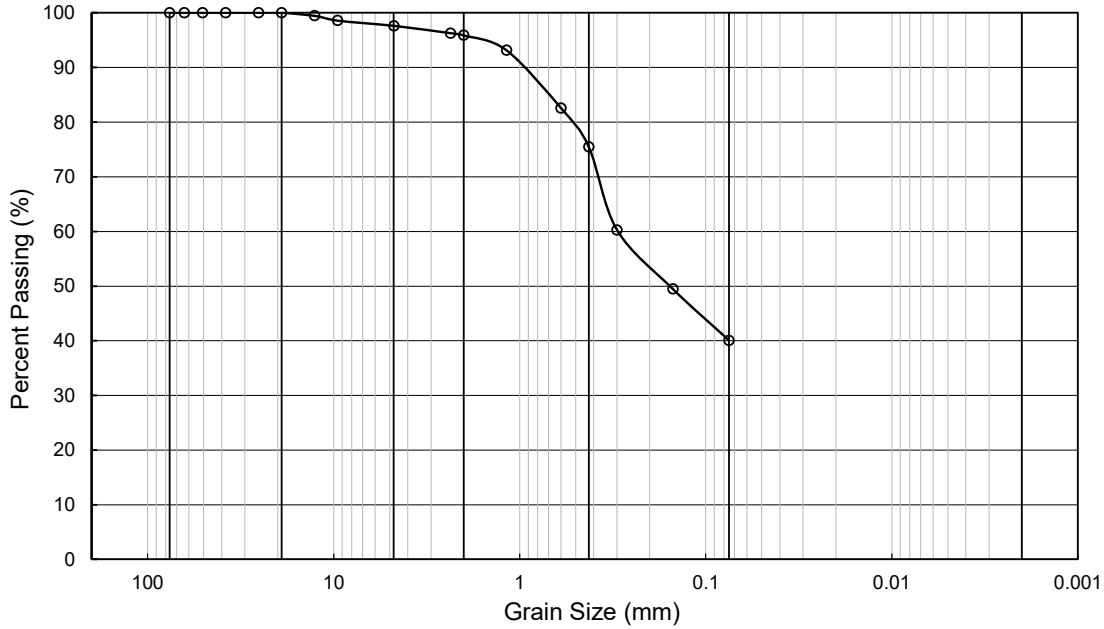

COBBLE	GRAVEL		SAND			SILT	CLAY
	Coarse	Fine	Coarse	Medium	Fine		

Grain Size (in/#)	Grain Size (mm)	Amount Passing (%)
3 "	76.20	100
2 1/2 "	63.50	100
2 "	50.80	100
1 1/2 "	38.10	100
1 "	25.40	100
3/4 "	19.05	100
1/2 "	12.70	99
3/8 "	9.53	99
# 4	4.75	97.6
# 8	2.36	96.2
#10	2.00	95.9
#16	1.18	93.2
# 30	0.60	82.5
# 40	0.425	75.4
# 50	0.30	60.2
# 100	0.15	49.5
# 200	0.075	40.0

Summary	
% Gravel =	2.4
% Sand =	57.6
% Fines =	40.0
Sum =	100.0

LL= 24
 PL= 15
 PI = 9

Soil Type: SC

ADVANCED GEOTECHNICAL SOLUTIONS, INC.

PARTICLE SIZE ANALYSIS - ASTM D422

AGS FORM E-7

Project Name: 555 Hollister St.
 Location: San Diego
 Project No.: 1912-01
 Date: 07-2021

Excavation: B-5
 Depth: 10-11.5 ft
 Tested by: FV
 Checked by: AB

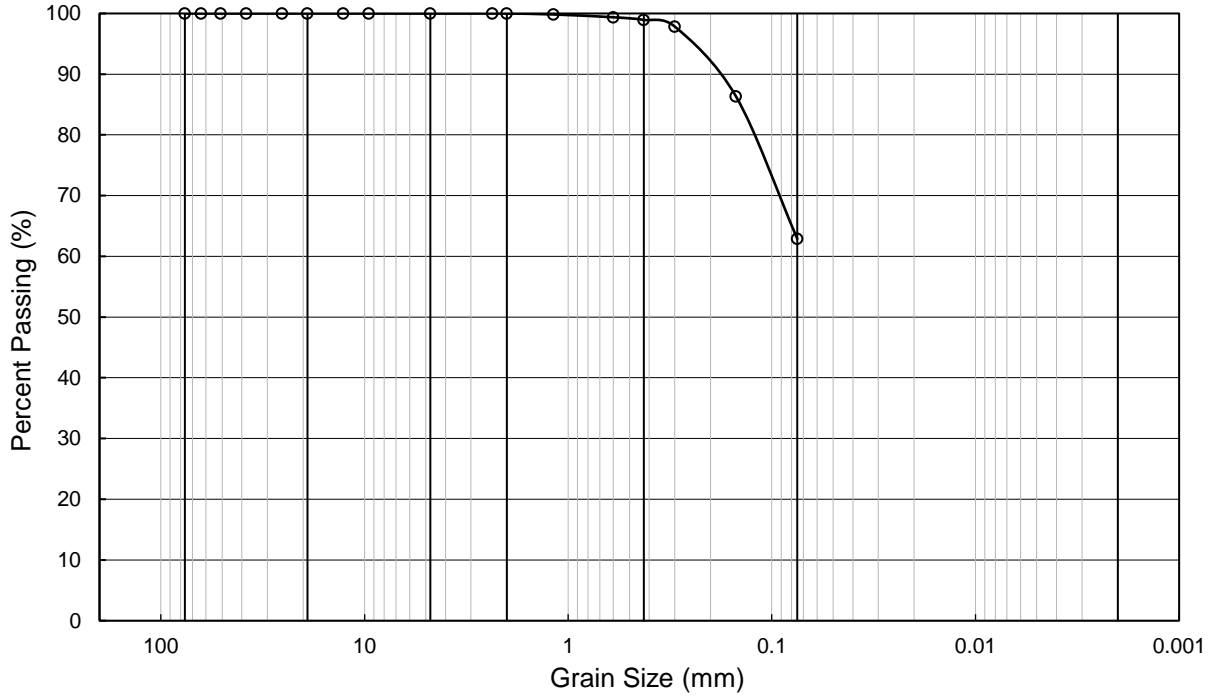

COBBLE	GRAVEL		SAND			SILT	CLAY
	Coarse	Fine	Coarse	Medium	Fine		

Grain Size (in/#)	Grain Size (mm)	Amount Passing (%)
3 "	76.20	100
2 1/2 "	63.50	100
2 "	50.80	100
1 1/2 "	38.10	100
1 "	25.40	100
3/4 "	19.05	100
1/2 "	12.70	100
3/8 "	9.53	100
# 4	4.75	100.0
# 8	2.36	100.0
#10	2.00	100.0
#16	1.18	99.8
# 30	0.60	99.4
# 40	0.425	98.9
# 50	0.30	97.9
# 100	0.15	86.4
# 200	0.075	62.9

Summary	
% Gravel =	0.0
% Sand =	37.1
% Fines =	62.9
Sum =	100.0

LL= 45
 PL= 27
 PI = 18

Soil Type: ML

ADVANCED GEOTECHNICAL SOLUTIONS, INC.

PARTICLE SIZE ANALYSIS - ASTM D422

Project Name: 555 Hollister St.
 Location: San Diego
 Project No.: 1912-01
 Date: 7/15/2021

Excavation: B-5
 Depth: 20-21 ft
 Tested by: FV
 Checked by: AB

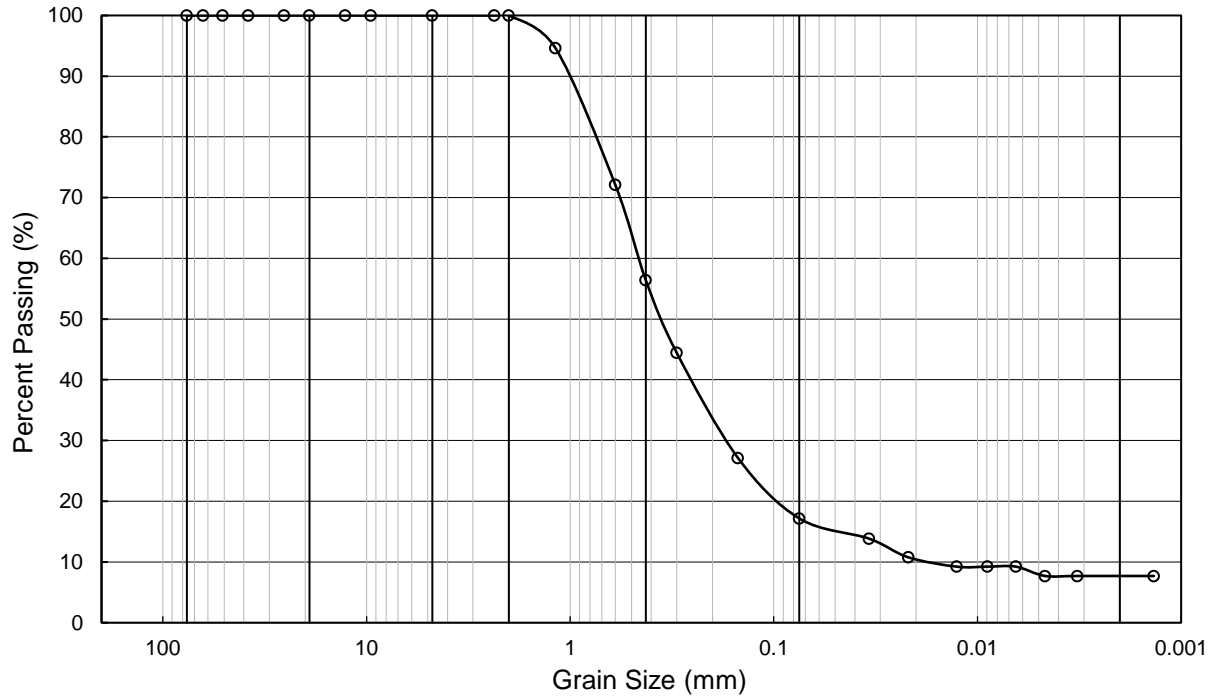

COBBLE	GRAVEL		SAND			SILT	CLAY
	Coarse	Fine	Coarse	Medium	Fine		

Grain Size (in/#)	Grain Size (mm)	Amount Passing (%)
3 "	76.20	100
2 1/2 "	63.50	100
2 "	50.80	100
1 1/2 "	38.10	100
1 "	25.40	100
3/4 "	19.05	100
1/2 "	12.70	100
3/8 "	9.53	100
# 4	4.75	100
# 8	2.36	100
#10	2.00	100
#16	1.18	95
# 30	0.60	72.1
# 40	0.425	56.4
# 50	0.30	44.5
# 100	0.15	27.1
# 200	0.075	17.2
Hydro	0.0341	13.8
Hydro	0.0218	10.8
Hydro	0.0127	9.2
Hydro	0.0089	9.2
Hydro	0.0065	9.2
Hydro	0.0047	7.7
Hydro	0.0032	7.7
Hydro	0.0014	7.7

Summary	
% Gravel =	0.0
% Sand =	82.8
% Fines =	17.2
Sum =	100.0

LL= n/a
 PL= n/a
 PI = n/a

Soil Type: SP

ADVANCED GEOTECHNICAL SOLUTIONS, INC.

PARTICLE SIZE ANALYSIS - ASTM D422

AGS FORM E-7

Project Name: 555 Hollister
 Location: San Diego
 Project No.: 1912-01
 Date: 07-2021

Excavation: B-5
 Depth: 21-21.5 ft
 Tested by: FV
 Checked by: AB

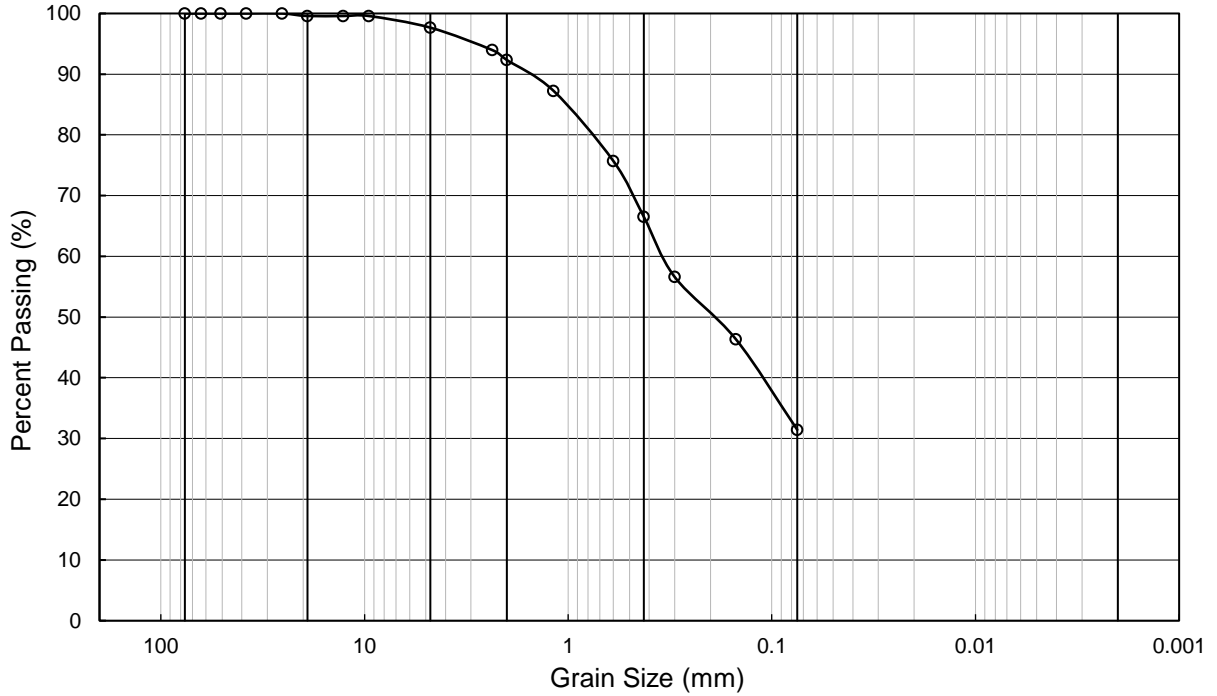

COBBLE	GRAVEL		SAND			SILT	CLAY
	Coarse	Fine	Coarse	Medium	Fine		

Grain Size (in/#)	Grain Size (mm)	Amount Passing (%)
3 "	76.20	100
2 1/2 "	63.50	100
2 "	50.80	100
1 1/2 "	38.10	100
1 "	25.40	100
3/4 "	19.05	100
1/2 "	12.70	100
3/8 "	9.53	100
# 4	4.75	97.7
# 8	2.36	94.0
#10	2.00	92.3
#16	1.18	87.3
# 30	0.60	75.7
# 40	0.425	66.5
# 50	0.30	56.6
# 100	0.15	46.3
# 200	0.075	31.4

Summary	
% Gravel =	2.3
% Sand =	66.2
% Fines =	31.4
Sum =	100.0

LL= NP
 PL= NP
 PI = NP

Soil Type: SM

ADVANCED GEOTECHNICAL SOLUTIONS, INC.

PARTICLE SIZE ANALYSIS - ASTM D422

Project Name: 555 Hollister St.
 Location: San Diego
 Project No.: 1912-01
 Date: 7/15/2021

Excavation: B-5
 Depth: 30-31.5 ft
 Tested by: FV
 Checked by: AB

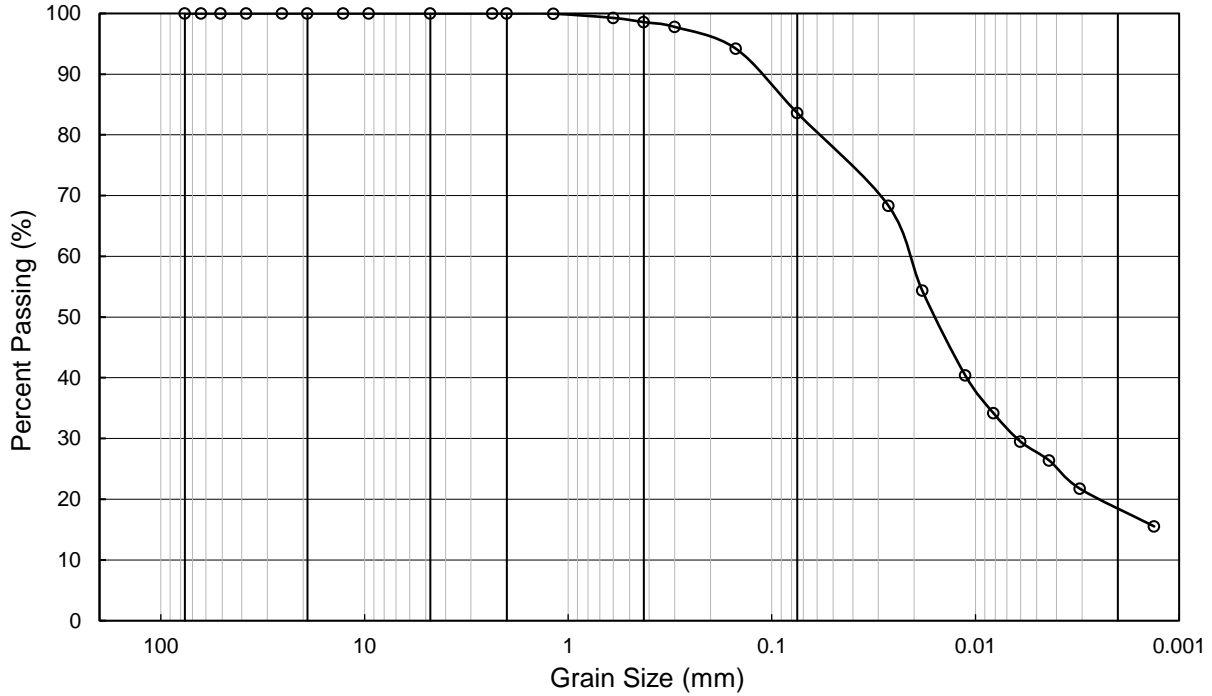

COBBLE	GRAVEL		SAND			SILT	CLAY
	Coarse	Fine	Coarse	Medium	Fine		

Grain Size (in/#)	Grain Size (mm)	Amount Passing (%)
3 "	76.20	100
2 1/2 "	63.50	100
2 "	50.80	100
1 1/2 "	38.10	100
1 "	25.40	100
3/4 "	19.05	100
1/2 "	12.70	100
3/8 "	9.53	100
# 4	4.75	100
# 8	2.36	100
#10	2.00	100
#16	1.18	100
# 30	0.60	99.3
# 40	0.425	98.6
# 50	0.30	97.8
# 100	0.15	94.2
# 200	0.075	83.6
Hydro	0.0267	68.3
Hydro	0.0182	54.3
Hydro	0.0112	40.4
Hydro	0.0082	34.2
Hydro	0.0060	29.5
Hydro	0.0044	26.4
Hydro	0.0031	21.7
Hydro	0.0013	15.5

Summary	
% Gravel =	0.0
% Sand =	16.4
% Fines =	83.6
Sum =	100.0

LL= 49
 PL= 29
 PI = 20

Soil Type: ML

ADVANCED GEOTECHNICAL SOLUTIONS, INC.

CONSOLIDATION - ASTM D2435

AGS Form E-3

Project Name: 555 Hollister St.
 Location: San Diego
 Project No: 1912-01
 Date: 7/12/21

Excavation: B-5
 Depth: 10-11.5 ft
 Description: CL-ML
 By: FV

Consolidation-Pressure Curve

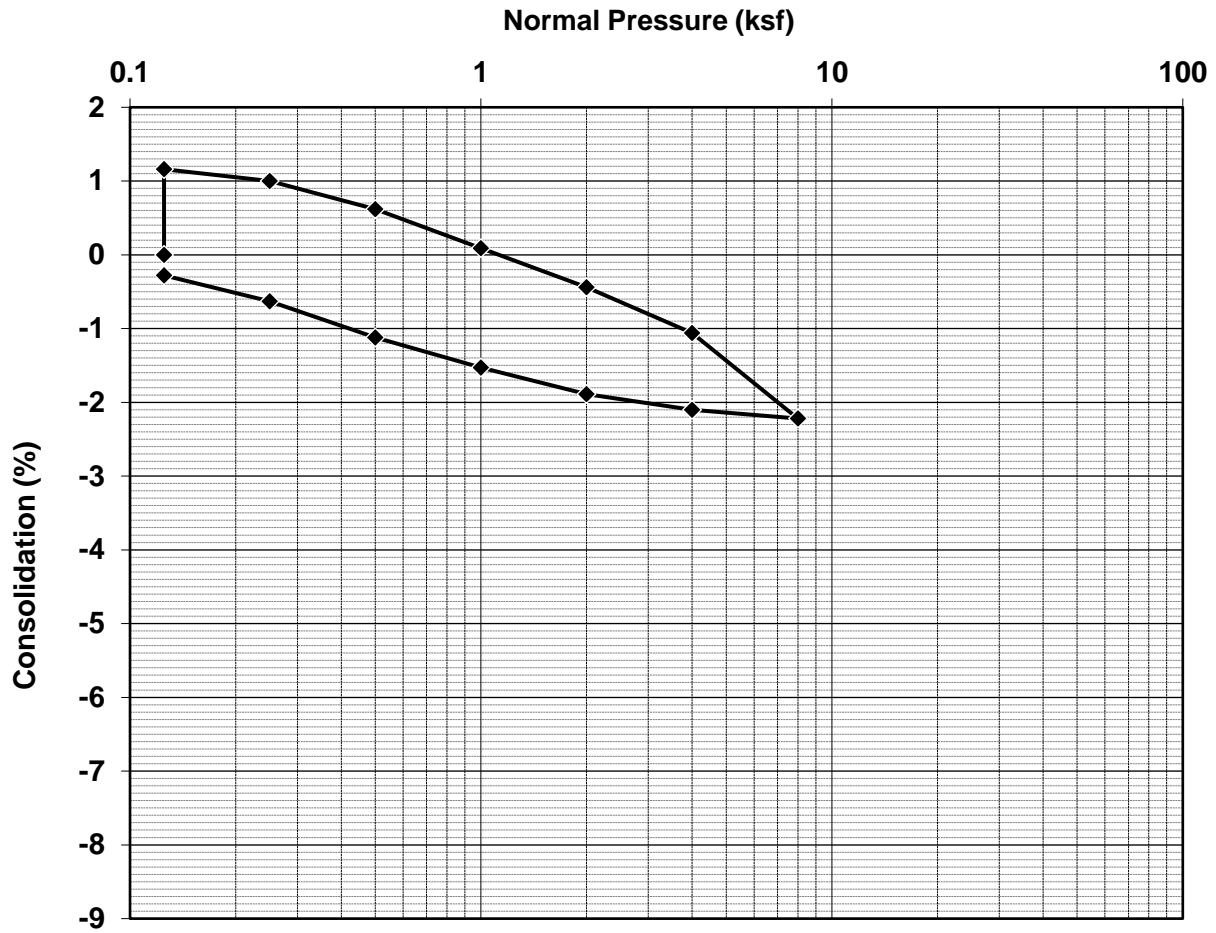

Test Data	Before Test	After Test
Water Content, w	22.1%	27.7%
Void Ratio, e	0.791	0.786
Saturation, S	80%	100%
Dry Density (pcf)	99.3	99.5
Wet Density (pcf)	121.2	127.2

ADVANCED GEOTECHNICAL SOLUTIONS, INC.

CONSOLIDATION - ASTM D2435

AGS Form E-3

Project Name: 555 Hollister St.
 Location: San Diego
 Project No: 1912-01
 Date: 7/12/21

Excavation: B-5
 Depth: 30.5-31 ft
 Description: ML
 By: FV

Consolidation-Pressure Curve

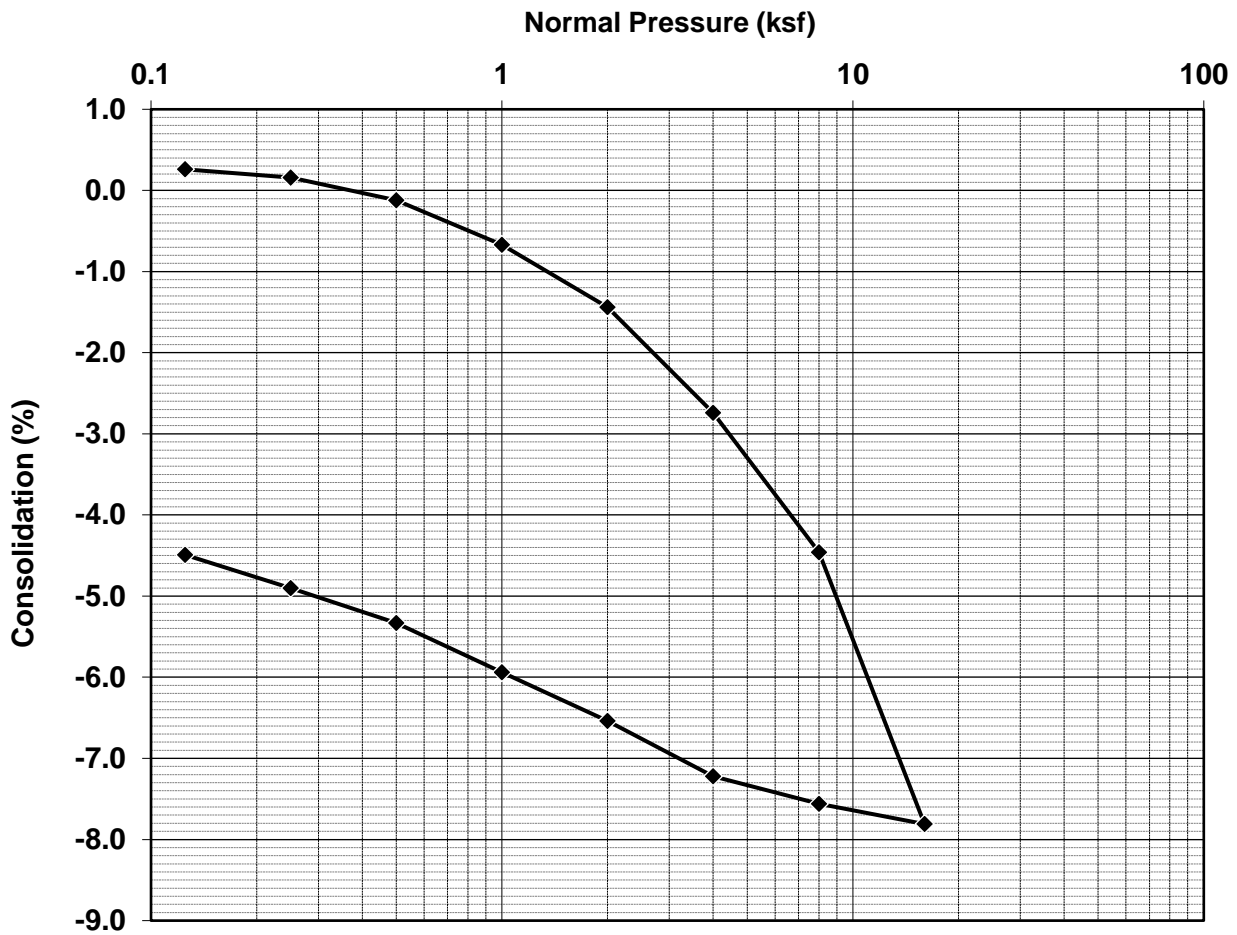

Test Data	Before Test	After Test
Water Content, w	20.3%	31.2%
Void Ratio, e	0.653	0.579
Saturation, S	84%	145%
Dry Density (pcf)	101.9	106.7
Wet Density (pcf)	122.6	140.0

ADVANCED GEOTECHNICAL SOLUTIONS, INC.

MAXIMUM DENSITY - ASTM D1557

AGS FORM E-8

Project Name: 555 Hollister St.
 Location: San Diego
 P/W No.: 1912-01
 Date: 07-2021

Excavation: B-3
 Depth: 0-2 ft
 Soil Type: SC
 Tested by: FV
 Checked by: AB

Method:	A				Oversize Retained:	10 %			
Point No.	1	2	3	4					
Dry Density (pcf)	125.6	127.9	128.6	126.3					
Moisture Content (%)	6.0	8.0	9.9	11.9					

MAXIMUM DENSITY CURVE

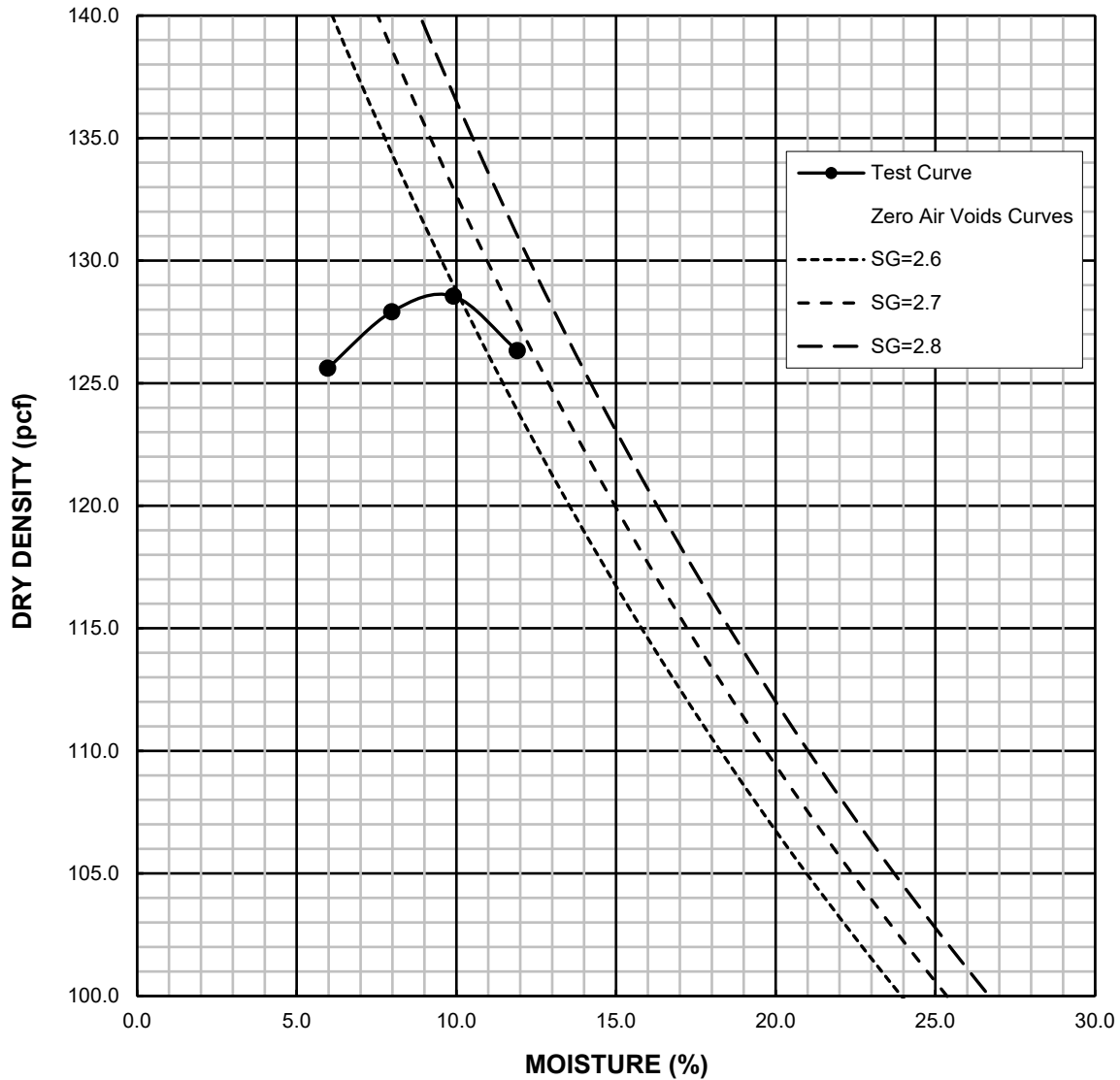

Corrected Max. Dry Density 131.7 pcf Corrected Moisture 8.6 %
 Max. Dry Density 128.7 pcf Optimum Moisture 9.5 %

ADVANCED GEOTECHNICAL SOLUTIONS, INC.

MAXIMUM DENSITY - ASTM D1557

AGS FORM E-8

Project Name: 555 Hollister St
 Location: San Diego
 P/W No.: 1912-01
 Date: 01-2020

Excavation: TP-11
 Depth: 1.5-2.5 ft
 Soil Type: Brown SC-SM
 Tested by: FV
 Checked by: JC

Method:	A	Oversize Retained: 0 %		
Point No.	1	2	3	4
Dry Density (pcf)	118.2	123.7	127.6	124.4
Moisture Content (%)	4.5	6.3	8.5	10.7

MAXIMUM DENSITY CURVE

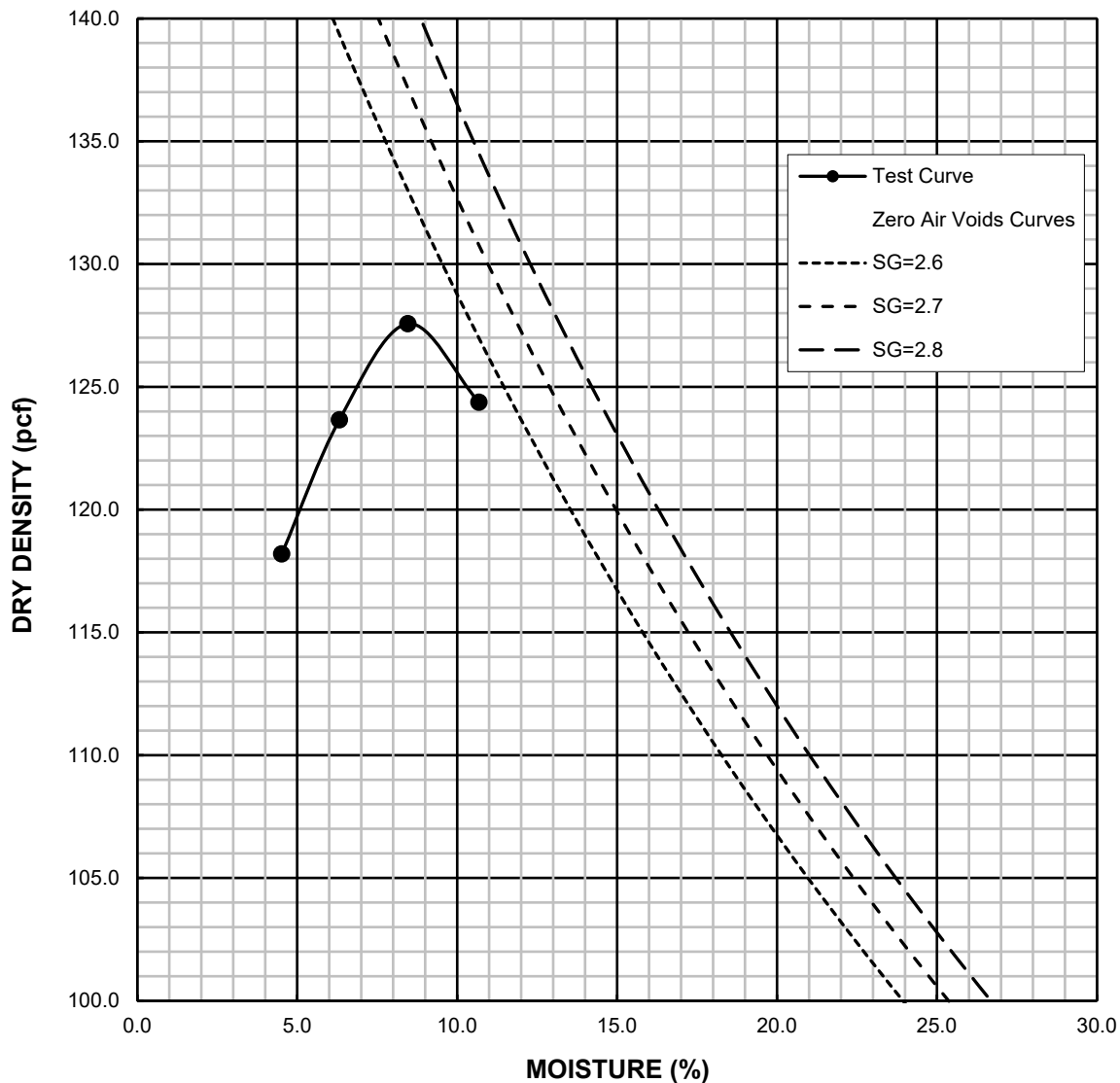

Corrected Max. Dry Density 127.5 pcf Corrected Moisture 8.5 %
 Max. Dry Density 127.5 pcf Optimum Moisture 8.5 %

ADVANCED GEOTECHNICAL SOLUTIONS, INC.

MAXIMUM DENSITY - ASTM D1557

AGS FORM E-8

Project Name: 555 Holister St
 Location: San Diego
 P/W No.: 1912-01
 Date: 01-2020

Excavation: TP-3
 Depth: 4-5 ft
 Soil Type: Reddish Brn. SC-SM
 Tested by: FV
 Checked by: JC

Method:	A	Oversize Retained: 0 %		
Point No.	1	2	3	4
Dry Density (pcf)	114.3	117.8	120.4	117.6
Moisture Content (%)	3.7	5.6	7.6	9.8

MAXIMUM DENSITY CURVE

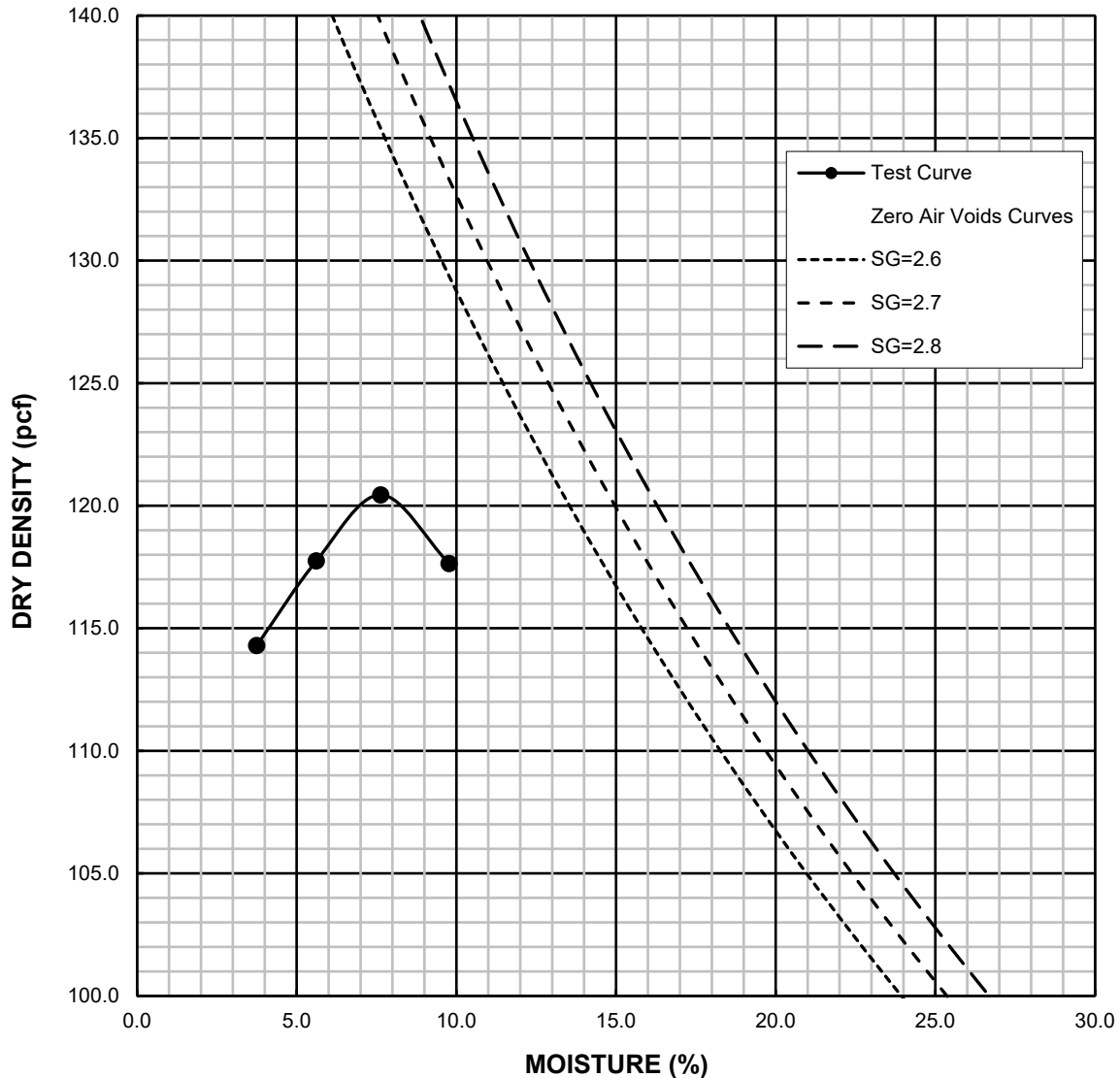

Corrected Max. Dry Density 120.5 pcf Corrected Moisture 7.5 %
 Max. Dry Density 120.5 pcf Optimum Moisture 7.5 %

ADVANCED GEOTECHNICAL SOLUTIONS, INC.

DIRECT SHEAR - ASTM D3080

Project Name: 555 Hollister St.
 Location: San Diego
 Project No.: 1912-01
 Date: 7/2/2021

Excavation: B-3
 Depth: 0-2 ft
 Tested by: FV
 Reviewed by: AB

Samples Tested	1	2	3
Initial Moisture (%)	9.5	9.5	9.5
Initial Dry Density (pcf)	115.8	115.8	115.8
Normal Stress (psf)	500	1000	2000
Peak Shear Stress (psf)	456	660	1296
Ult. Shear Stress (psf)	384	660	1272

Soil Type: SC
 Test: Remolded 90%
 Method: Drained
 Consolidation: Yes
 Saturation: Yes
 Shear Rate (ⁱⁿ/min): 0.01

Strength Parameters	Peak	Ultimate
Friction Angle, phi (deg)	30	30
Cohesion (psf)	140	100

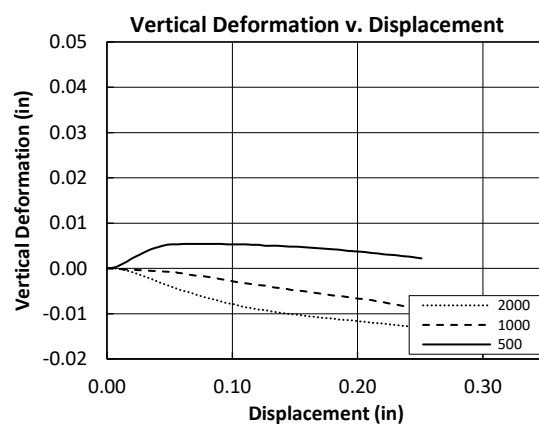
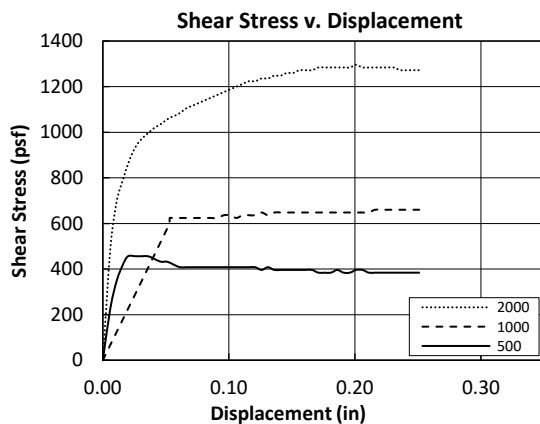
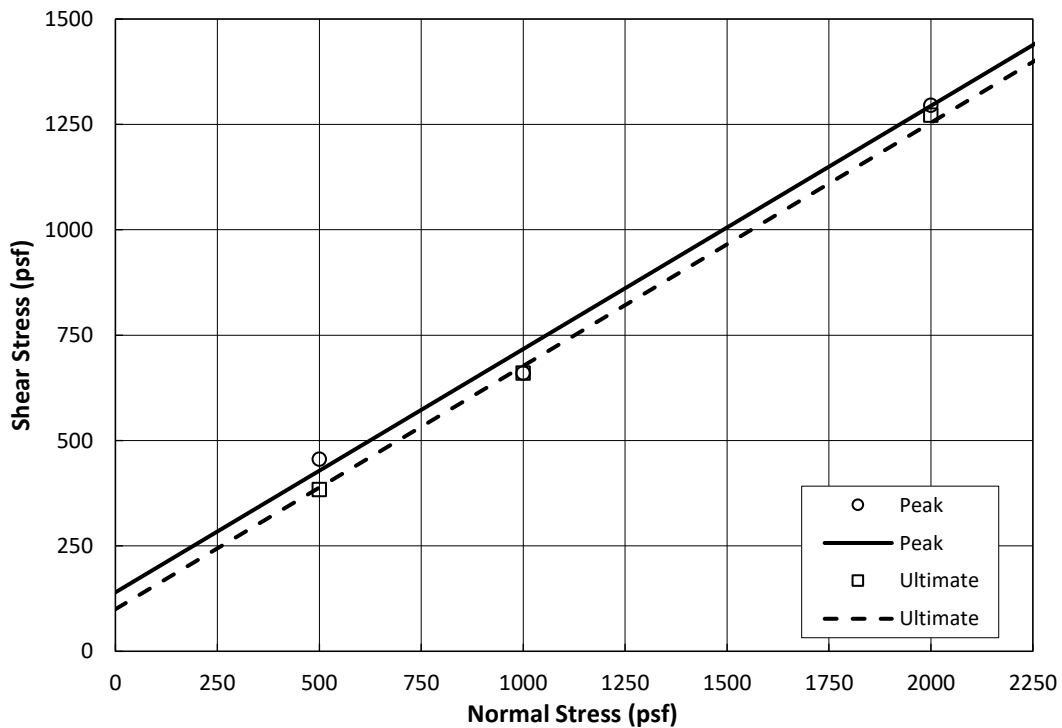

ADVANCED GEOTECHNICAL SOLUTIONS, INC.

DIRECT SHEAR - ASTM D3080

Project Name: 555 Hollister St.
 Location: San Diego
 Project No.: 1912-01
 Date: 6/28/2021

Excavation: B-5
 Depth: 10-11.5 ft
 Tested by: FV
 Reviewed by: AB

Samples Tested	1	2	3
Initial Moisture (%)	22.1	22.1	22.1
Initial Dry Density (pcf)	100.7	100.7	101.6
Normal Stress (psf)	1000	2000	4000
Peak Shear Stress (psf)	1176	1536	2832
Ult. Shear Stress (psf)	696	1224	1968

Soil Type: CL-ML
 Test: Undisturbed
 Method: Drained
 Consolidation: Yes
 Saturation: Yes
 Shear Rate (ⁱⁿ/min): 0.01

Strength Parameters	Peak	Ultimate
Friction Angle, phi (deg)	30	23
Cohesion (psf)	500	325

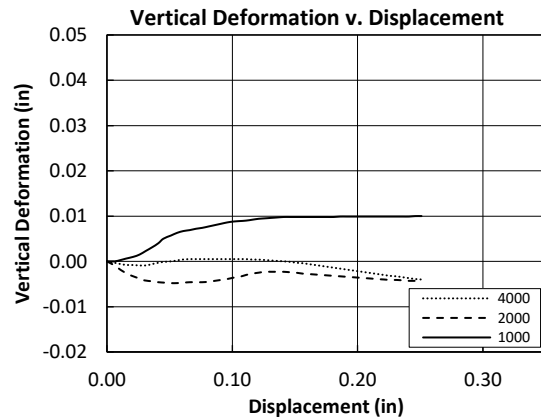
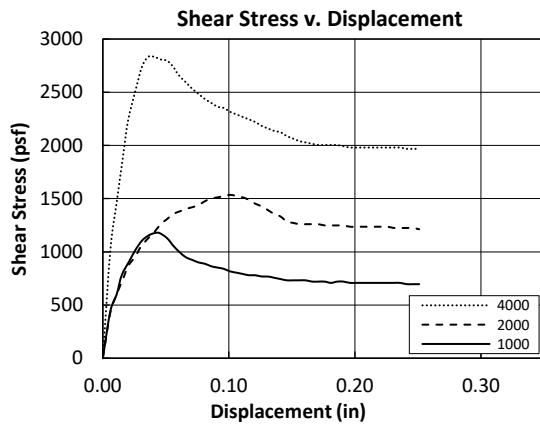
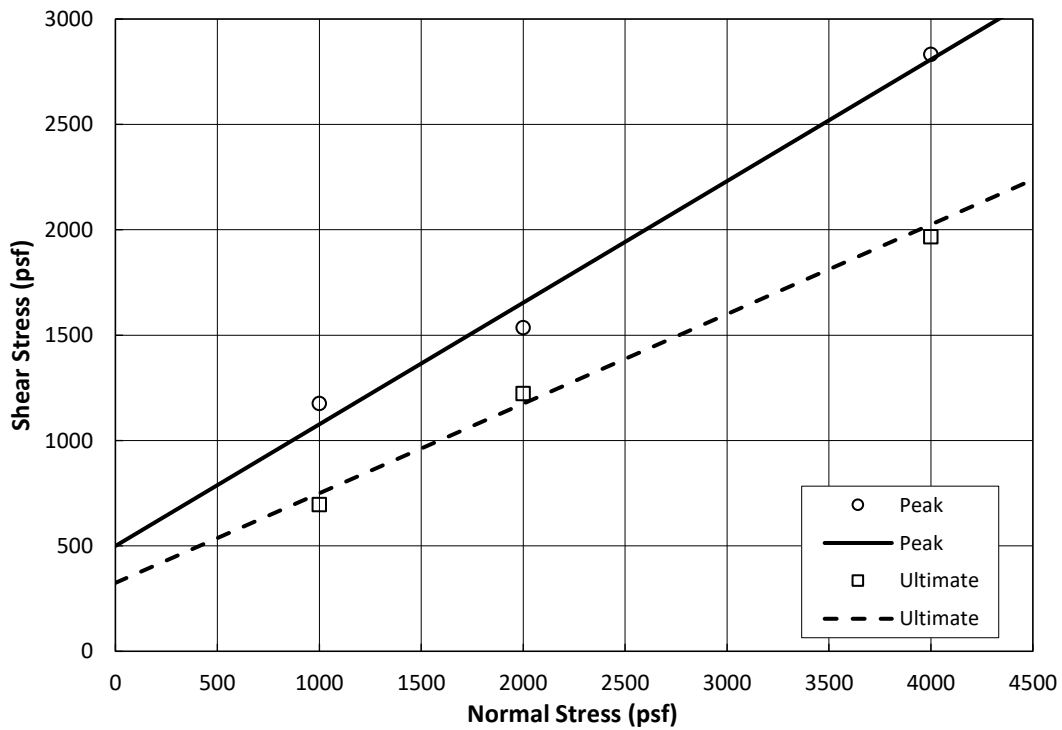

ADVANCED GEOTECHNICAL SOLUTIONS, INC.

DIRECT SHEAR - ASTM D3080

Project Name: 555 Hollister St
 Location: San Deigo
 Project No.: 1912-01
 Date: 1/20/2020

Excavation: TP-3
 Depth: 4-5 FT
 Tested by: FV
 Reviewed by: JC

Samples Tested	1	2	3
Intial Moisture (%)	7.5	7.5	7.5
Initial Dry Density (pcf)	108.3	108.3	108.3
Normal Stress (psf)	1000	2000	4000
Peak Shear Stress (psf)	864	1608	2604
Ult. Shear Stress (psf)	696	1356	2448

Soil Type: Reddish Brn SC-SM
 Test: Remolded 90%
 Method: Drained
 Consolidation: Yes
 Saturation: Yes
 Shear Rate (ⁱⁿ/min): 0.01

Strength Parameters	Peak	Ultimate
Friction Angle, phi (deg)	30	30
Cohesion (psf)	366	150

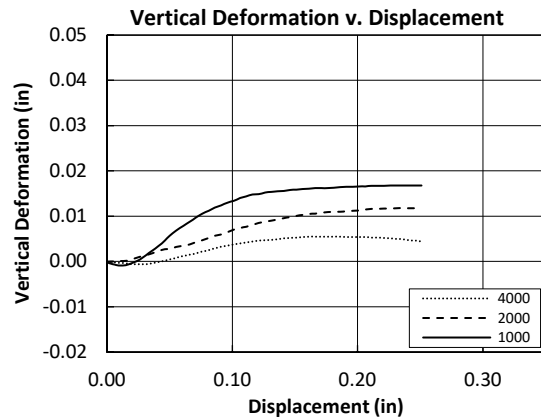
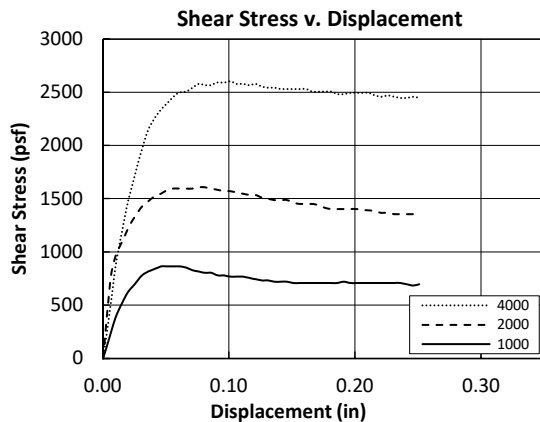
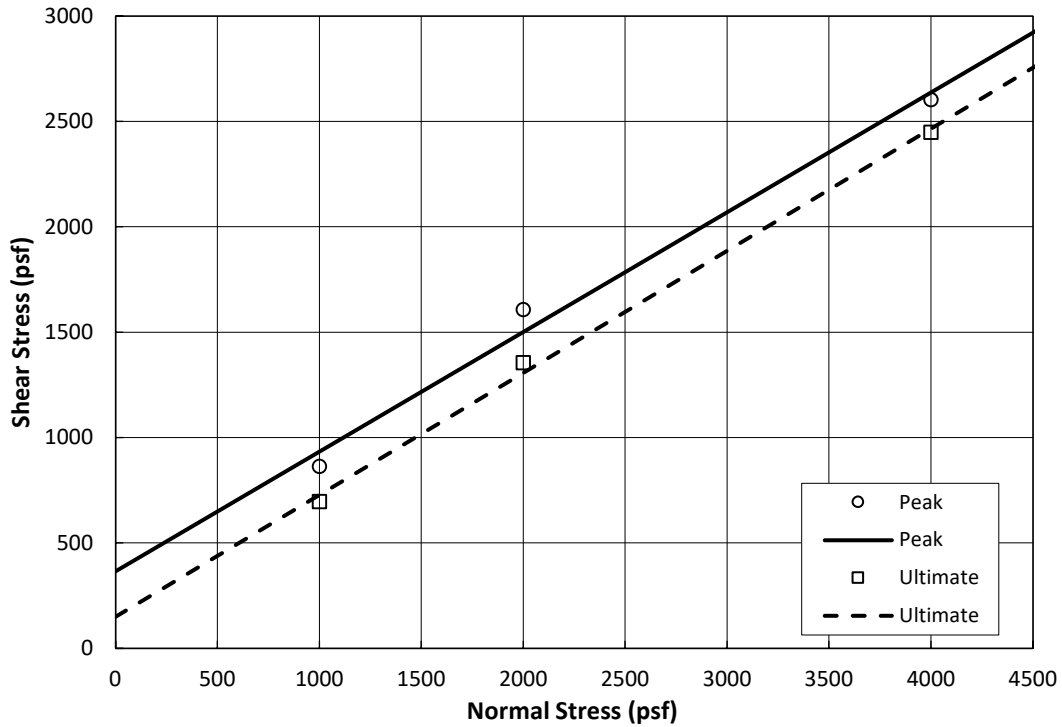

ADVANCED GEOTECHNICAL SOLUTIONS, INC.

DIRECT SHEAR - ASTM D3080

Project Name: 555 Hollister St
 Location: San Diego
 Project No.: 1912-01
 Date: 1/23/2020

Excavation: TP-11
 Depth: 1.5-2.5 ft
 Tested by: FV
 Reviewed by: JC

Samples Tested	1	2	3
Initial Moisture (%)	8.5	8.5	8.5
Initial Dry Density (pcf)	114.7	114.7	114.7
Normal Stress (psf)	1000	2000	4000
Peak Shear Stress (psf)	780	1284	2472
Ult. Shear Stress (psf)	756	1260	2472

Soil Type: Brown SC-SM
 Test: Remolded 90%
 Method: Drained
 Consolidation: Yes
 Saturation: Yes
 Shear Rate (ⁱⁿ/min): 0.01

Strength Parameters	Peak	Ultimate
Friction Angle, phi (deg)	30	30
Cohesion (psf)	186	150

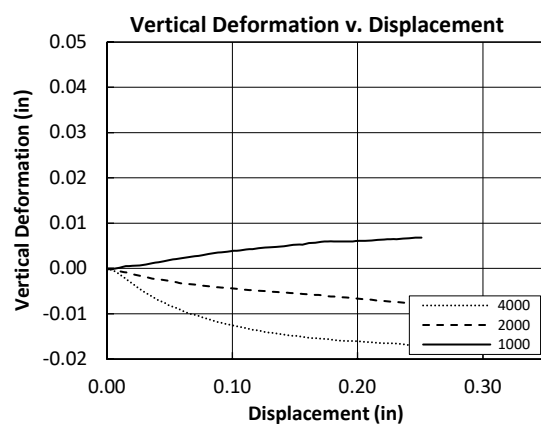
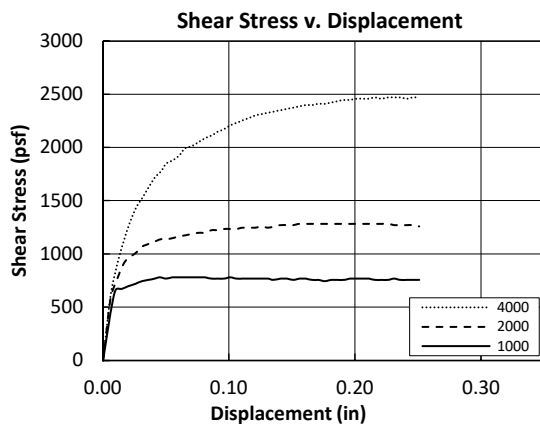
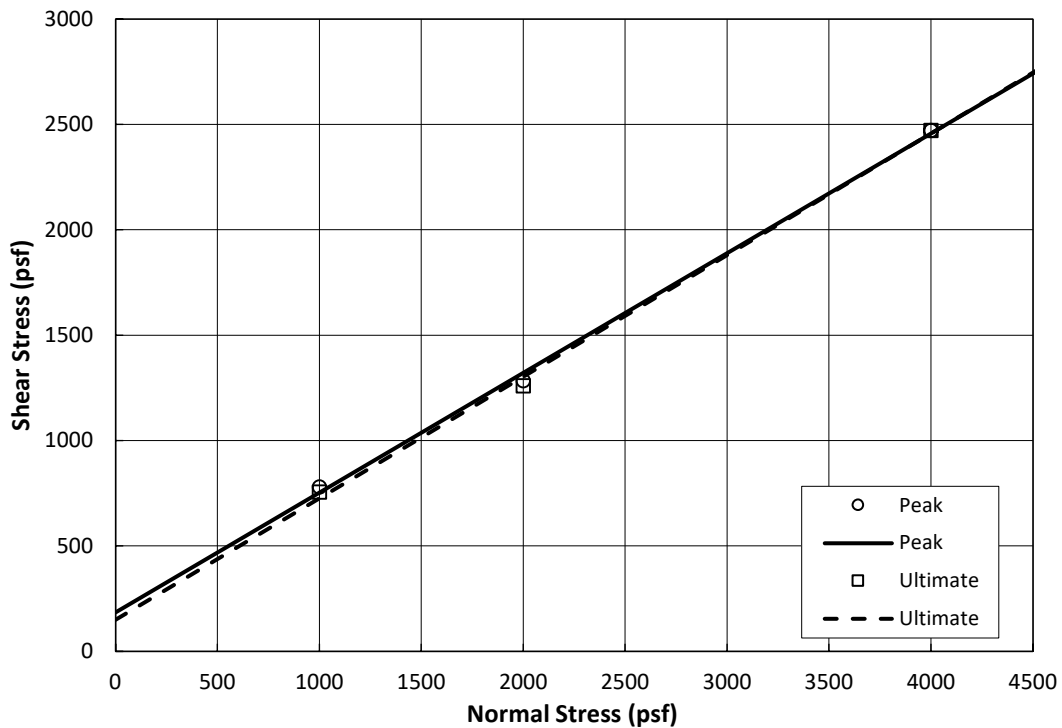

ANAHEIM TEST LAB, INC

196 Technology Drive, Unit D
Irvine, CA 92618
Phone (949)336-6544

Advanced Geotechnical Solutions, Inc.
485 Corporate Ave., Suite B
Escondido, CA 92029

DATE: 07/06/2021

P.O. NO.: Chain of Custody

LAB NO.: C-4983

SPECIFICATION: CTM-643/417/422

MATERIAL: Soil

Project No.: 1912-01
Project: 555 Hollister St.
Date sampled: 06/29/2021
Sample ID: B-3 @ 0-2'

ANALYTICAL REPORT CORROSION SERIES SUMMARY OF DATA

pH	MIN. RESISTIVITY per CT. 643 ohm-cm	SOLUBLE SULFATES per CT. 417 ppm	SOLUBLE CHLORIDES per CT. 422 ppm
8.4	3,800	209	76

RESPECTFULLY SUBMITTED



WES BRIDGER, LAB MANAGER

APPENDIX D
INFILTRATION FEASIBILITY STUDY



AGS

ADVANCED GEOTECHNICAL SOLUTIONS, INC.

485 Corporate Drive, Suite B

Escondido, California 92029

P: (619) 867-0487 | E: info@adv-geosolutions.com

AMBIENT COMMUNITIES

179 Calle Magdalena Suite #201
Encinitas, Ca. 92024

August 26, 2021

PW 1912-01

Report No. 1912-01-B-5

Attention: **Duncan Budinger**
 Director of Retail Development

Subject: ***Preliminary Infiltration Feasibility Study, Multifamily Residential Development, 555 Hollister Street, San Diego, California***

References: See Attached

Gentleperson:

In accordance with your request, Advanced Geotechnical Solutions, Inc. (AGS) has prepared this infiltration feasibility study for the proposed Multifamily Residential Development located on 555 Hollister Street in the City of San Diego, California. This report is intended to meet the preliminary infiltration testing requirements of the City of San Diego. AGS has evaluated the feasibility for storm water infiltration in accordance with the City of San Diego Storm Water Standards (2018).

1.0 SITE DESCRIPTION AND PROPOSED DEVELOPMENT

The rectangular shaped property covers approximately 6.3 acres and currently supports a residential structure on the central portion of the site along with several outbuildings. The site is bounded on the north and east by active nursery facilities, on the west by Metropolitan Transit System trolley tracks on an embankment fill, and to the south by an asphalt paved parking lot, a mobile home park, unimproved property, and a playing field. Elevations onsite ranges from a high of 54 feet above mean sea level (msl) at the southeast corner to a low of 22 feet msl in the northwest corner. An approximately 20-foot high descending slope is located along the northern portion of the site. The southern portion of the site is flat, has been cleared of vegetation and is currently being used as a storage yard by a general contractor. The descending slope to the north is covered by grass, weeds and isolated trees. Drainage across the site generally flows to the north and west (see Figure 1, Site Location Map)..

It is our understanding that the residential development will consist of five 3- to 4-story wood-frame apartment buildings and one 1-story recreation/leasing building that will be supported by conventional slab-on-grade foundations. The apartment buildings will be located on the northern portion of the property and will require construction of ~22-foot high retaining walls. Parking areas and an access driveway will be located along the south central portion of the property. At this time detailed grading plans are not available; however, based on the reviewed preliminary grading plan, which is subject to change, it is our understanding that design cuts will likely be on the order of 8 feet with design fills of up to 26 feet. It is anticipated that cut-fill grading techniques will be utilized and approximately 7,000 cu. yd. of import soil will be required to develop the site..

2.0 FIELD INVESTIGATION

On June 7, 2021, four percolation test borings (labeled P-1 through P-4) were advanced to depths ranging between 4.5 and 5.5 feet below ground surface using a truck mounted drill rig equipped with 8-inch diameter hollow-stem augers. Approximate boring and percolation test locations are shown on Plate 1, Geologic Map and Exploration Location Plan. An engineer from our firm logged the percolation test borings for soil and geologic conditions. Boring logs are presented in Appendix B.

3.0 GEOLOGY

Based upon our subsurface exploration and familiarity with the area, the site is mantled by artificial underlain by Old Paralic Deposits, Unit 6.

4.0 TEST PROCEDURE

Borehole percolation tests were performed to evaluate the feasibility of storm water infiltration in general conformance with Appendix D of the City of San Diego Storm Water Standards (2018). After drilling, the test holes were cleaned of sediment and the bottom was lined with approximately 2 inches of washed gravel. Four-inch diameter slotted PVC pipe was installed in the holes and the annular space was backfilled with gravel. The test holes were then successively filled with clean, potable water and allowed to pre-soak.

On June 8, 2021, the borehole percolation tests were performed by filling the test holes with clean potable water.. Water was allowed to infiltrate during 30-minute periods and the water drop was measured to calculate the percolation rate in inches per hour. The test hole was then refilled with water as necessary and the test procedure was repeated over the course of several hours until a stabilized percolation rate was recorded. The stabilized percolation rate was then converted to an infiltration rate based on the "Porchet Method" utilizing the following equation:

$$I_t = \frac{\Delta H \pi r^2 60}{\Delta t (\pi r^2 + 2\pi r H_{avg})} = \frac{\Delta H 60 r}{\Delta t (r + 2H_{avg})}$$

Where:

- I_t = tested infiltration rate, inches/hour
- ΔH = change in head over the time interval, inches
- Δt = time interval, minutes
- r = effective radius of test hole
- H_{avg} = average head over the time interval, inches

The infiltration rate was modified due to the use of gravel in the annular space by multiplying it by the following adjustment factor:

$$AF = \frac{r}{p + n(r - p)}$$

Where:

- p = pipe radius
- n = gravel porosity

Logs of field testing and graphical representations of test data presented as infiltration versus time interval are included in Appendix AA.

5.0 TEST RESULTS AND PRELIMINARY DESIGN VALUES

In accordance with Appendix D, Section D.5.4 of the BMP Design Manual, a minimum ‘Factor of Safety’ of 2 should be applied to the tested infiltration rates to determine the design infiltration rates. The percolation test observations and results are summarized in Table 1.

Test No.	Depth of Test Hole (ft)	Approximate Test Elevation (ft, msl)	Geologic Unit	Soil Classification (USCS)	Infiltration Rate (in/hr)	Factor of Safety	Design Infiltration Rate (in/hr)
P-1	4.5	42.5	Afu/Qop	Gravelly Clay (CL)	0.0	2	0.0
P-2	4.5	45.5	Afu/Qop	Silty Sand (SM)	5.6	2	2.8
P-3	5.0	49.0	Afu/Qop	Silty Sand (SM)	0.58	2	0.29
P-4	5.0	49.0	Afu/Qop	Sandy Clay (CL)	0.14	2	0.07

Note: *Calculated by Porchet Method. Incorporates gravel Adjustment Factor (AF).

Utilizing a factor of safety of 2, the design infiltration rate ranges between 0.0 in/hr and 2.8 in/hr, which can be categorized as “No Infiltration” to “Full Infiltration” conditions.

6.0 DESIGN CONSIDERATIONS

6.1. Groundwater

Groundwater was encountered at depths of 10 and 6.5 feet bgs in borings B-5 and B-7 drilled at the toe of the northerly descending slope. Based on these observations, the groundwater level was at approximate El. 12.5 feet msl during our subsurface exploration. According to our review, no natural groundwater condition is known to exist at the site that would impact the proposed development. Groundwater will be encountered during remedial grading activities extending into the lower, northern portion of the site. It should be noted that localized perched groundwater may develop at a later date, most likely at or near fill/bedrock contacts, due to fluctuations in precipitation, irrigation practices, or factors not evident at the time of our field exploration. According to the BMP Design Handbook, in areas where infiltration BMPs are planned, a minimum separation of 10 feet between the infiltration surface and the historic high groundwater should be maintained.

6.2. Soil Characteristics and Anticipated Flow Paths

Based on our subsurface exploration and infiltration testing performed at the site, Old Paralic Deposits will allow for “No Infiltration” to a “Full Infiltration” with design infiltration rates on the order of 0.0 to 2.8 inches per hour. The highly variable rates observed may be related to the presence of discontinuous layers of gravelly sands encountered in the Old Paralic Deposits. These may be underlain by less permeable materials. As such, infiltrating water may flow vertically within the sandy gravel layers until less permeable materials are encountered. The infiltrating water may then flow laterally.

6.3. Geotechnical Hazards

We anticipate that the stormwater basins will be located in close proximity to proposed structures and underground utilities. There is a high likelihood for water intrusion to occur in subjacent utility trenches and artificial fill which could create saturated soil conditions beneath structures and other settlement sensitive improvements. This potential geotechnical hazard could be mitigated by designing the basin for no infiltration and lining the basin with an impermeable membrane, deepening foundation elements of nearby proposed structures, installing moisture cut-off walls between the infiltration basins and nearby settlement-sensitive improvements, and/or backfilling subjacent utility trenches with a lean sand-cement slurry.

6.4. Soil Contamination

During our recent site investigation, no evidence of soil contamination was observed, nor is any contamination known to exist onsite. Utilizing the DWR online resource Geotracker.ca.gov, no open cases were identified within 1000 feet of the subject site.

6.5. Proximity to Water Supply Wells

An existing water supply well is located in the vicinity of Boring B-5. It is anticipated that this well will be abandoned during earthwork activities.

6.6. Maintenance of Infiltration Device

Regular maintenance of any infiltration system is critical to the long term successful operation of the system. Responsibilities of maintaining the system are typically borne by the owner. Improperly maintained infiltration devices and basins have a high failure rate. A plan should be developed by the designer of the system and implemented throughout the project's lifetime.

7.0 CONCLUSIONS AND RECOMMENDATIONS

Infiltration testing in the upper soils yielded preliminary design infiltration rates ranging between 0.0 to 2.8 inches per hour which correspond to a "No Infiltration" to "Full Infiltration" condition. Vertical infiltration is feasible in the vicinity of boring P-2.

Infiltration at the potential BMP locations will increase the potential for geotechnical issues such as water intrusion and ground settlement. Mitigation typically includes an appropriate setback between nearby improvements and infiltration devices. A minimum setback of 25 feet to nearby structures and 75 feet to the MSE wall is recommended. An alternative mitigation can include construction of a cutoff wall, such as placement of a vertical impermeable liner or slurry filled trench, to mitigate infiltration of water below adjacent improvements. To prevent the migration of water along utility pipe bedding zones, slurry backfill should be considered in utility pipes located near infiltration devices. Preventing all water intrusion may be accomplished by installing an impermeable liner on all underground BMP improvements. It should be recognized that if infiltration is allowed, some water intrusion is possible beneath nearby existing improvements such as roadways and nearby structures.

The infiltration rates presented in this report are based on limited testing performed as part of a preliminary screening for feasibility purposes. Dependent upon the final location, depth, and type of proposed BMP, additional testing may be warranted.

Advanced Geotechnical Solutions, Inc. appreciates the opportunity to provide you with geotechnical consulting services and professional opinions. If you have any questions, please contact the undersigned at (619) 867-0487.

Respectfully Submitted,
Advanced Geotechnical Solutions, Inc.



ANDRES BERNAL, Sr. Geotechnical Engineer
RCE 62366/RGE 2715



PAUL J. DERISI, Vice President
CEG 2536, Reg. Exp. 5-31-23



Distribution: (1) Addressee

Attachments: References
Appendix AA - Borehole Percolation Field Data
Appendix B - Boring Logs
Figure 1 - Site Location Map
Plate 1 - Geologic Map and Exploration Location Plan

REFERENCES

Advanced Geotechnical Solutions, Inc., 2021, Supplemental Geotechnical Investigation and Design Recommendations, Multifamily Residential Development, 555 Hollister Street, San Diego, California, dated August 26, 2021 (Report No. 1912-01-B-4).

City of San Diego, 2018, Storm Water Standards, dated October 1, 2018.

APPENDIX AA

BOREHOLE PERCOLATION FIELD DATA

PERCOLATION TEST DATA SHEET

Project: 555 Hollister Street Surface El.: 42.5 ft, msl Date: 6/8/2021
 Project No.: 1912-01 Depth of Test Hole: 4.5 ft. Weather: Sunny 75-80°
 Test Hole No.: P-1 Test El.: 38 ft, msl Tested By: AB

Test Hole Dimensions (in.)

Depth: 54 Pipe Diameter: 3 USCS: SM
 Diameter: 8 Gravel (Y or N): Y Gravel Adjustment Factor: 2.06

Infiltration Test

Trial No.	Start Time (hr:min)	Stop Time (hr:min)	Interval (min)	Depth to Water (in.)			Ave. Water Column (in.)	Perc. Rate (in/hr)	Infiltration Rate (in/hr)*
				Start	End	Change			
1	8:24	8:53	29	13.00	13.00	0.00	41.00	0.00	0.000
2	8:54	9:21	27	11.50	11.50	0.00	42.50	0.00	0.000
3	9:23	9:51	28	11.50	11.50	0.00	42.50	0.00	0.000
4	9:53	10:21	28	11.50	11.50	0.00	42.50	0.00	0.000
5	10:22	10:50	28	11.50	11.50	0.00	42.50	0.00	0.000
6	10:50	11:23	33	12.00	12.00	0.00	42.00	0.00	0.000
7									
8									

*Calculated by Porchet Method. Incorporates Gravel Adjustment Factor.

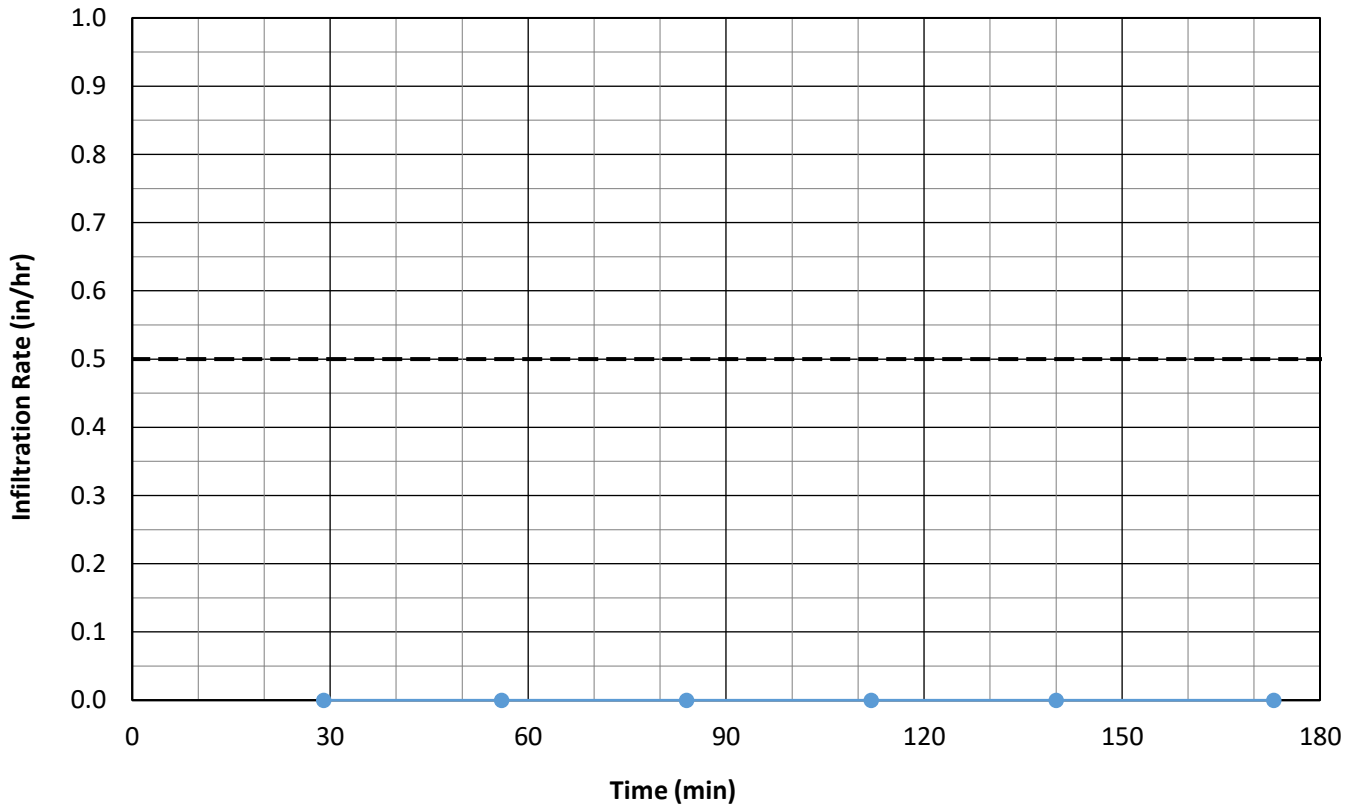

PERCOLATION TEST DATA SHEET

Project: 555 Hollister Street Surface El.: 45.5 ft, msl Date: 6/8/2021
 Project No.: 1912-01 Depth of Test Hole: 4.5 ft. Weather: Sunny 75-80°
 Test Hole No.: P-2 Test El.: 41 ft, msl Tested By: AB

Test Hole Dimensions (in.)

Depth: 54 Pipe Diameter: 3 USCS: SM
 Diameter: 8 Gravel (Y or N): Y Gravel Adjustment Factor: 2.06

Infiltration Test

Trial No.	Start Time (hr:min)	Stop Time (hr:min)	Interval (min)	Depth to Water (in.)			Ave. Water Column (in.)	Perc. Rate (in/hr)	Infiltration Rate (in/hr)*
				Start	End	Change			
1	8:27	8:57	30	1.25	36.00	34.75	35.38	69.50	7.678
2	8:59	9:28	29	4.00	31.00	27.00	36.50	55.86	5.991
3	9:29	9:55	26	4.00	29.00	25.00	37.50	57.69	6.031
4	9:56	10:24	28	1.50	27.00	25.50	39.75	54.64	5.404
5	10:25	10:55	30	2.50	29.00	26.50	38.25	53.00	5.437
6	10:55	11:26	31	4.00	31.00	27.00	36.50	52.26	5.605
7									
8									

*Calculated by Porchet Method. Incorporates Gravel Adjustment Factor.

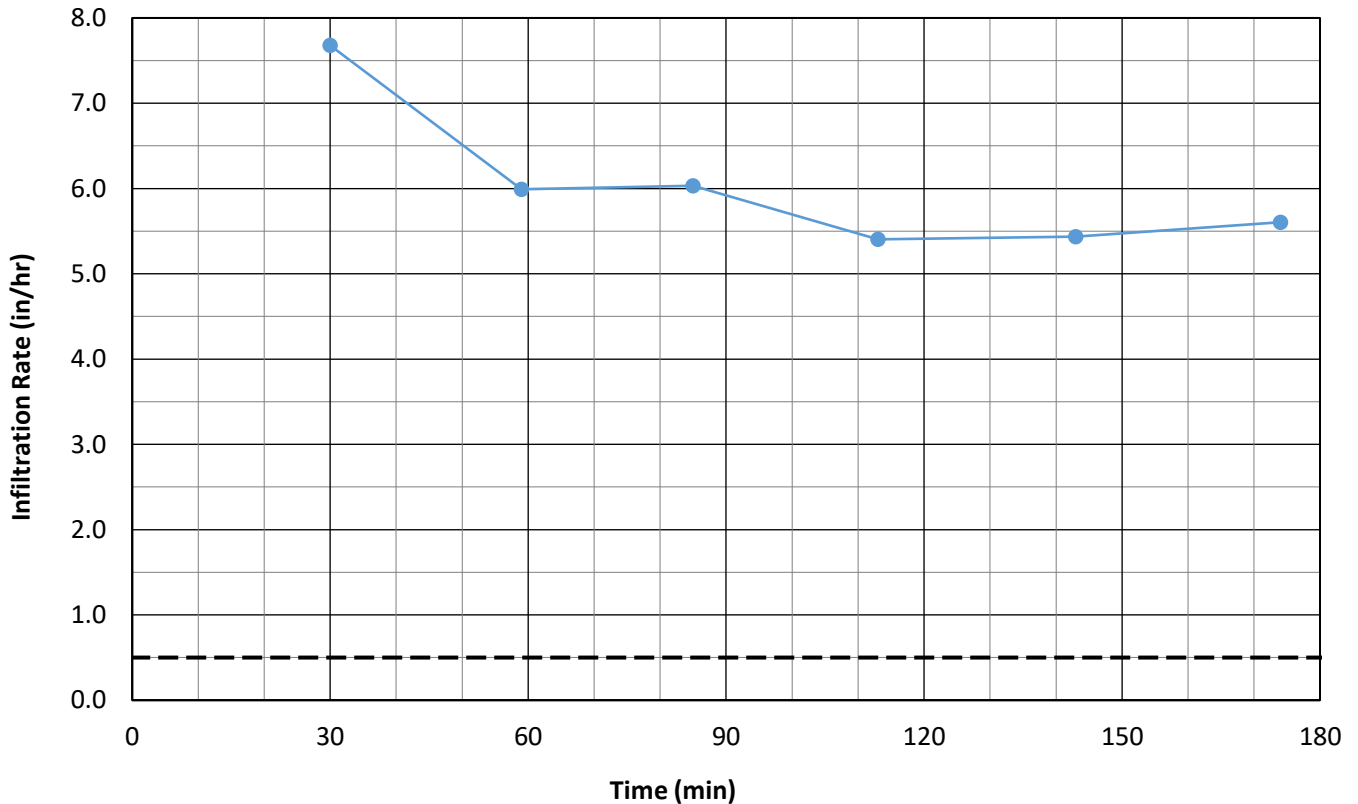

PERCOLATION TEST DATA SHEET

Project: 555 Hollister Street Surface El.: 49 ft, msl Date: 6/8/2021
 Project No.: 1912-01 Depth of Test Hole: 5 ft. Weather: Sunny 75-80°
 Test Hole No.: P-3 Test El.: 44 ft, msl Tested By: AB

Test Hole Dimensions (in.)

Depth: 60 Pipe Diameter: 3 USCS: SM
 Diameter: 8 Gravel (Y or N): Y Gravel Adjustment Factor: 2.06

Infiltration Test

Trial No.	Start Time (hr:min)	Stop Time (hr:min)	Interval (min)	Depth to Water (in.)			Ave. Water Column (in.)	Perc. Rate (in/hr)	Infiltration Rate (in/hr)*
				Start	End	Change			
1	8:30	9:00	30	2.50	7.75	5.25	54.88	10.50	0.762
2	9:03	9:31	28	1.00	6.50	5.50	56.25	11.79	0.835
3	9:32	9:59	27	3.00	7.00	4.00	55.00	8.89	0.644
4	10:00	10:27	27	3.00	7.00	4.00	55.00	8.89	0.644
5	10:28	10:57	29	3.00	7.00	4.00	55.00	8.28	0.599
6	10:57	11:27	30	3.00	7.00	4.00	55.00	8.00	0.580
7									
8									

*Calculated by Porchet Method. Incorporates Gravel Adjustment Factor.

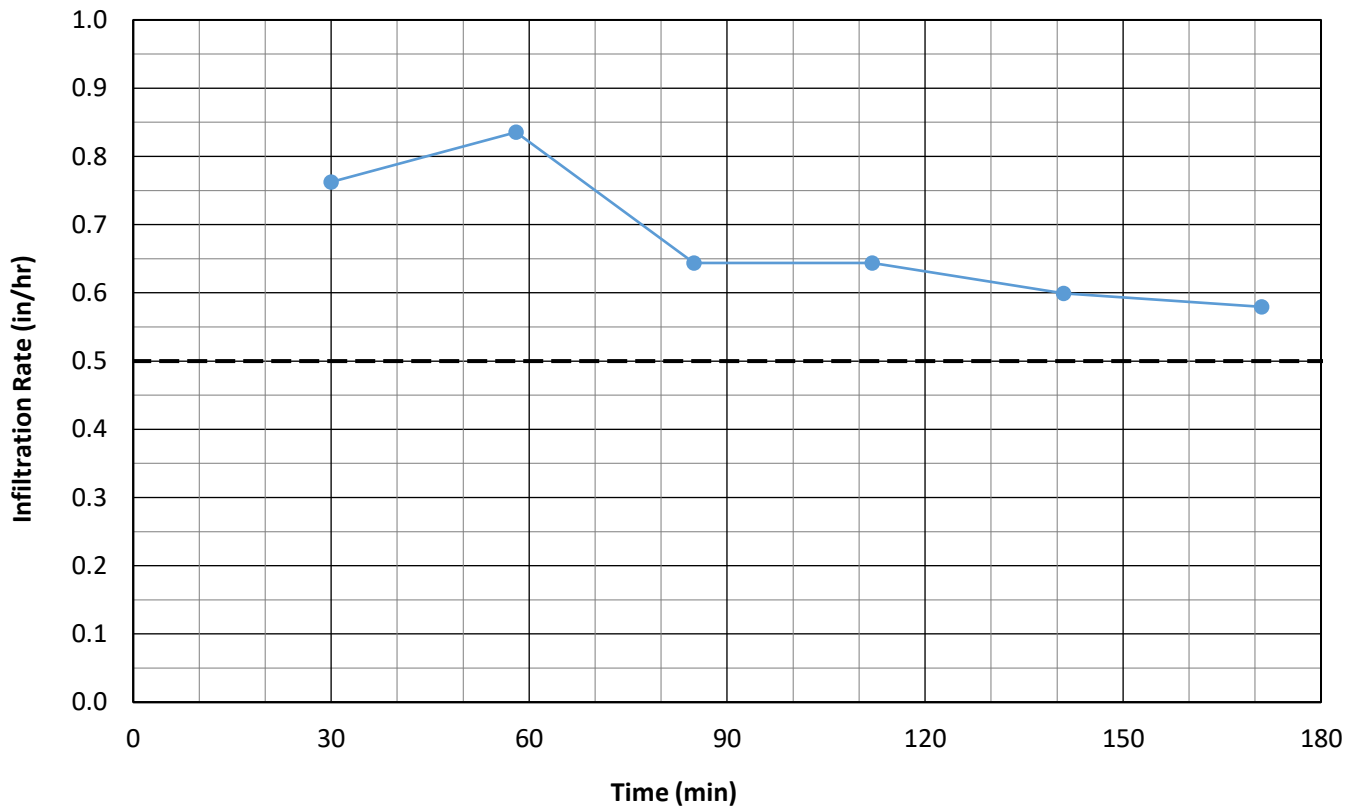

PERCOLATION TEST DATA SHEET

Project: 555 Hollister Street Surface El.: 49 ft, msl Date: 6/8/2021
 Project No.: 1912-01 Depth of Test Hole: 5 ft. Weather: Sunny 75-80°
 Test Hole No.: P-4 Test El.: 44 ft, msl Tested By: AB

Test Hole Dimensions (in.)

Depth: 60 Pipe Diameter: 3 USCS: SM
 Diameter: 8 Gravel (Y or N): Y Gravel Adjustment Factor: 2.06

Infiltration Test

Trial No.	Start Time (hr:min)	Stop Time (hr:min)	Interval (min)	Depth to Water (in.)			Ave. Water Column (in.)	Perc. Rate (in/hr)	Infiltration Rate (in/hr)*
				Start	End	Change			
1	8:33	9:05	32	0.75	2.75	2.00	58.25	3.75	0.257
2	9:06	9:35	29	1.25	2.75	1.50	58.00	3.10	0.214
3	9:36	10:03	27	1.50	4.00	2.50	57.25	5.56	0.387
4	10:04	10:32	28	1.00	2.00	1.00	58.50	2.14	0.146
5	10:32	11:02	30	2.00	3.00	1.00	57.50	2.00	0.139
6	11:02	11:32	30	3.00	4.00	1.00	56.50	2.00	0.141
7									
8									

*Calculated by Porchet Method. Incorporates Gravel Adjustment Factor.

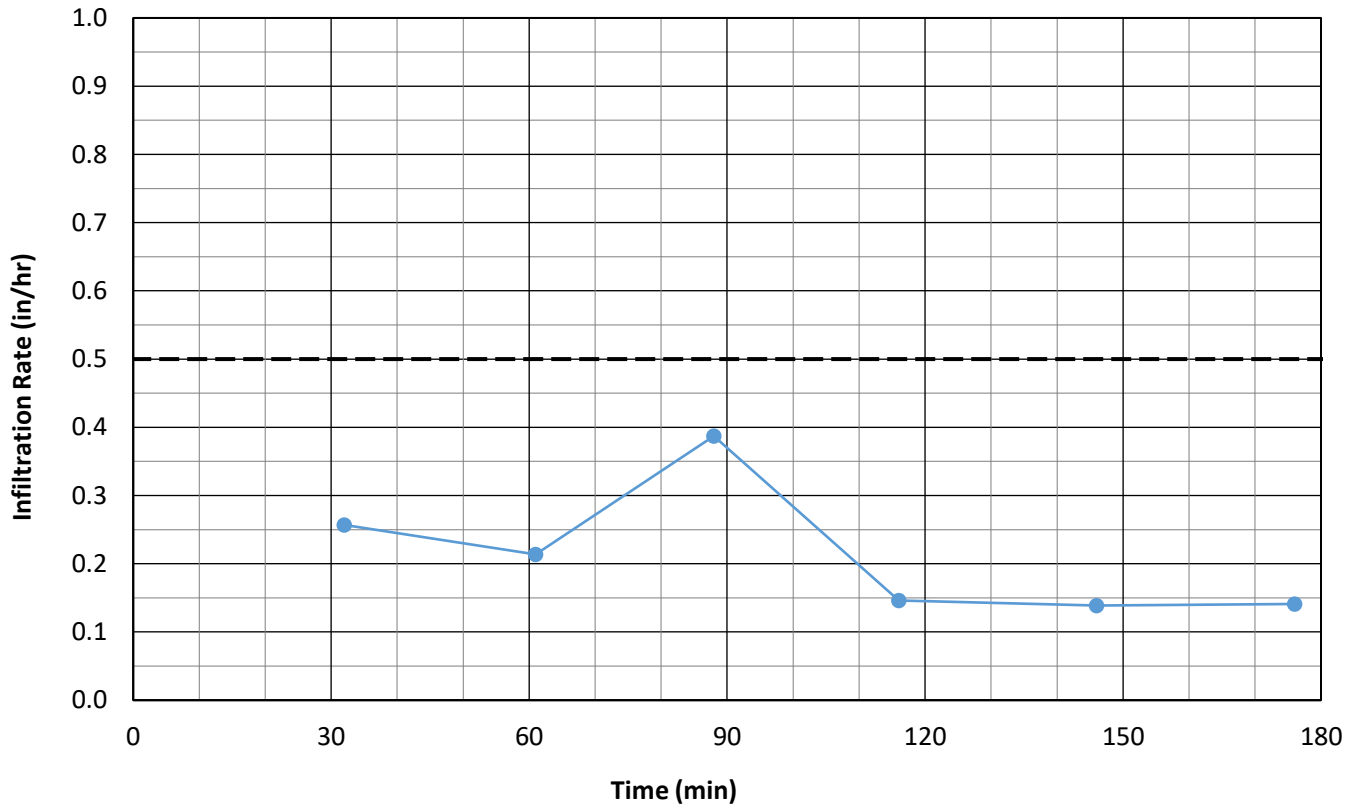

APPENDIX E
SLOPE STABILITY

1912-01 Hollister St. 22 ft. MSE Wall - Static

k:\1912-01 ambient hollister street proj\slope stability\gg wall static.pl2 Run By: AGS 8/20/2021 03:32PM

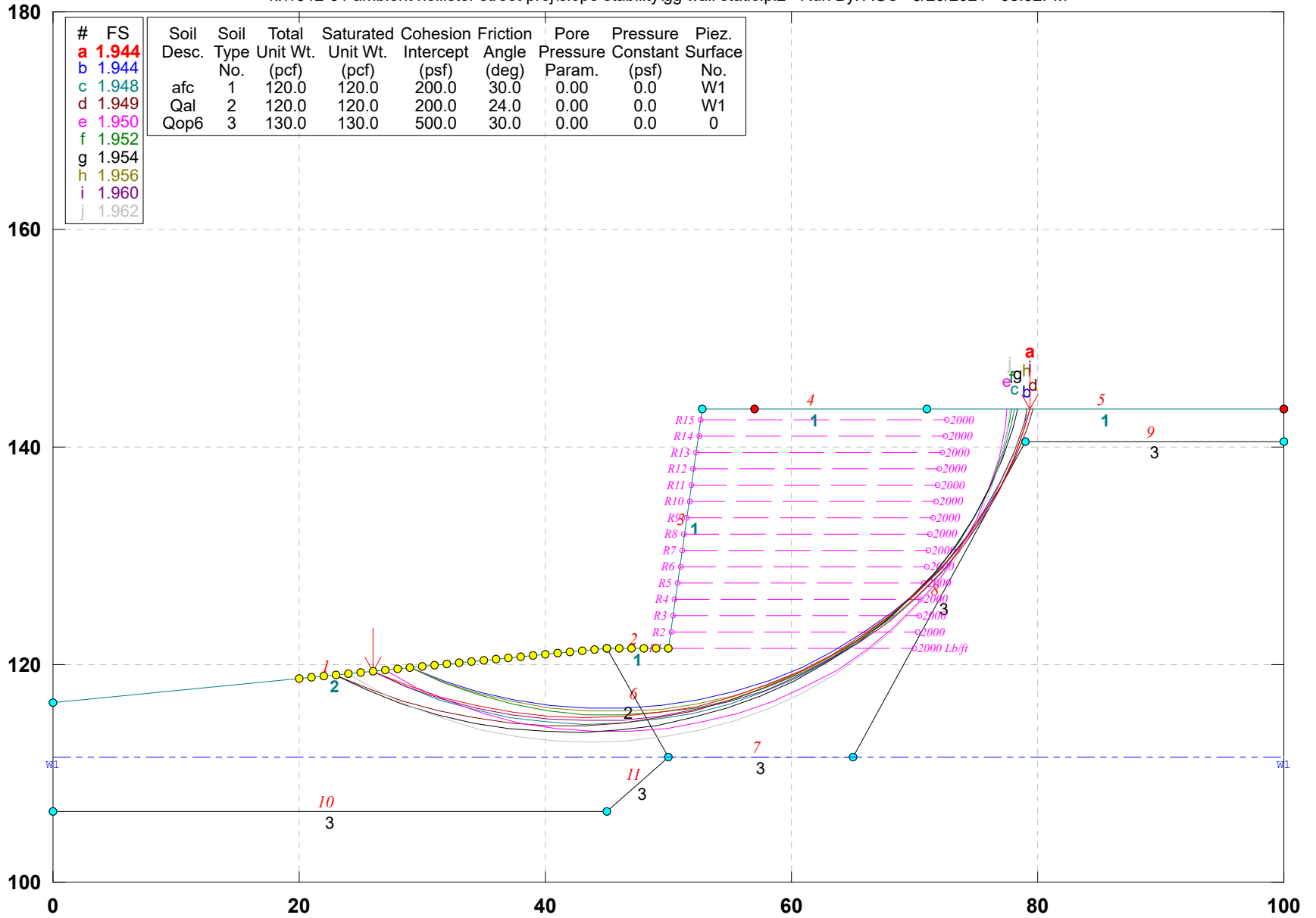

GSTABL7 v.2 FSmin=1.944

Safety Factors Are Calculated By The Modified Bishop Method

1912-01 Hollister St. 22 ft. MSE Wall - Pseudo-static (Seismic)

k:\1912-01 ambient hollister street proj\slope stability\gg wall seismic.pl2 Run By: AGS 8/20/2021 03:30PM

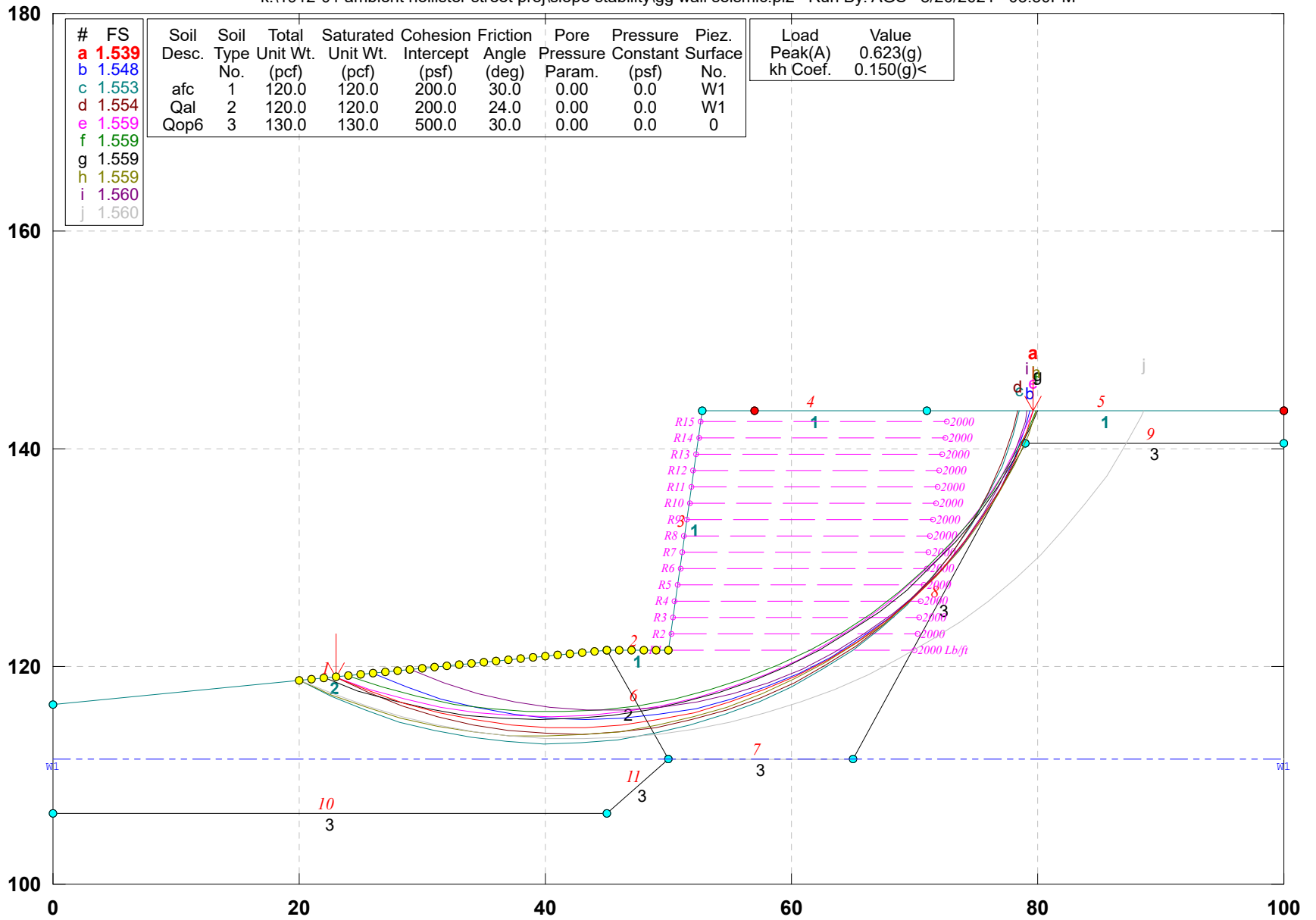

GSTABL7 v.2 FSmin=1.539

Safety Factors Are Calculated By The Modified Bishop Method

APPENDIX F
GENERAL EARTHWORK SPECIFICATIONS AND GRADING DETAILS

GENERAL EARTHWORK SPECIFICATIONS

I. General

A. General procedures and requirements for earthwork and grading are presented herein. The earthwork and grading recommendations provided in the geotechnical report are considered part of these specifications, and where the general specifications provided herein conflict with those provided in the geotechnical report, the recommendations in the geotechnical report shall govern. Recommendations provided herein and in the geotechnical report may need to be modified depending on the conditions encountered during grading.

B. The contractor is responsible for the satisfactory completion of all earthwork in accordance with the project plans, specifications, applicable building codes, and local governing agency requirements. Where these requirements conflict, the stricter requirements shall govern.

C. It is the contractor's responsibility to read and understand the guidelines presented herein and in the geotechnical report as well as the project plans and specifications. Information presented in the geotechnical report is subject to verification during grading. The information presented on the exploration logs depicts conditions at the particular time of excavation and at the location of the excavation. Subsurface conditions present at other locations may differ, and the passage of time may result in different subsurface conditions being encountered at the locations of the exploratory excavations. The contractor shall perform an independent investigation and evaluate the nature of the surface and subsurface conditions to be encountered and the procedures and equipment to be used in performing his work.

D. The contractor shall have the responsibility to provide adequate equipment and procedures to accomplish the earthwork in accordance with applicable requirements. When the quality of work is less than that required, the Geotechnical Consultant may reject the work and may recommend that the operations be suspended until the conditions are corrected.

E. Prior to the start of grading, a qualified Geotechnical Consultant should be employed to observe grading procedures and provide testing of the fills for conformance with the project specifications, approved grading plan, and guidelines presented herein. All remedial removals, clean-outs, removal bottoms, keyways, and subdrain installations should be observed and documented by the Geotechnical Consultant prior to placing fill. It is the contractor's responsibility to apprise the Geotechnical Consultant of their schedules and notify the Geotechnical Consultant when those areas are ready for observation.

F. The contractor is responsible for providing a safe environment for the Geotechnical Consultant to observe grading and conduct tests.

II. Site Preparation

A. Clearing and Grubbing: Excessive vegetation and other deleterious material shall be sufficiently removed as required by the Geotechnical Consultant, and such materials shall be properly disposed of offsite in a method acceptable to the owner and governing agencies. Where applicable, the contractor may obtain permission from the Geotechnical Consultant, owner, and governing agencies to dispose of vegetation and other deleterious materials in designated areas onsite.

B. Unsuitable Soils Removals: Earth materials that are deemed unsuitable for the support of fill shall be removed as necessary to the satisfaction of the Geotechnical Consultant.

C. Any underground structures such as cesspools, cisterns, mining shafts, tunnels, septic tanks, wells, pipelines, other utilities, or other structures located within the limits of grading shall be removed and/or abandoned in accordance with the requirements of the governing agency and to the satisfaction of the Geotechnical Consultant.

D. Preparation of Areas to Receive Fill: After removals are completed, the exposed surfaces shall be scarified to a depth of approximately 8 inches, watered or dried, as needed, to achieve a generally uniform moisture content that is at or near optimum moisture content. The scarified materials shall then be compacted to the project requirements and tested as specified.

E. All areas receiving fill shall be observed and approved by the Geotechnical Consultant prior to the placement of fill. A licensed surveyor shall provide survey control for determining elevations of processed areas and keyways.

III. Placement of Fill

A. Suitability of fill materials: Any materials, derived onsite or imported, may be utilized as fill provided that the materials have been determined to be suitable by the Geotechnical Consultant. Such materials shall be essentially free of organic matter and other deleterious materials, and be of a gradation, expansion potential, and/or strength that is acceptable to the Geotechnical Consultant. Fill materials shall be tested in a laboratory approved by the Geotechnical Consultant, and import materials shall be tested and approved prior to being imported.

B. Generally, different fill materials shall be thoroughly mixed to provide a relatively uniform blend of materials and prevent abrupt changes in material type. Fill materials derived from benching should be dispersed throughout the fill area instead of placing the materials within only an equipment-width from the cut/fill contact.

C. Oversize Materials: Rocks greater than 8 inches in largest dimension shall be disposed of offsite or be placed in accordance with the recommendations by the Geotechnical Consultant in the areas that are designated as suitable for oversize rock placement. Rocks that are smaller than 8 inches in largest dimension may be utilized in the fill provided that they are not nested and are their quantity and distribution are acceptable to the Geotechnical Consultant.

D. The fill materials shall be placed in thin, horizontal layers such that, when compacted, shall not exceed 6 inches. Each layer shall be spread evenly and shall be thoroughly mixed to obtain near uniform moisture content and uniform blend of materials.

E. Moisture Content: Fill materials shall be placed at or above the optimum moisture content or as recommended by the geotechnical report. Where the moisture content of the engineered fill is less than recommended, water shall be added, and the fill materials shall be blended so that near uniform moisture content is achieved. If the moisture content is above the limits specified by the Geotechnical Consultant, the fill materials shall be aerated by discing, blading, or other methods until the moisture content is acceptable.

F. Each layer of fill shall be compacted to the project standards in accordance to the project specifications and recommendations of the Geotechnical Consultant. Unless otherwise specified by the Geotechnical Consultant, the fill shall be compacted to a minimum of 90 percent of the maximum dry density as determined by ASTM Test Method: D1557-09.

G. Benching: Where placing fill on a slope exceeding a ratio of 5 to 1 (horizontal to vertical), the ground should be keyed or benched. The keyways and benches shall extend through all unsuitable materials into suitable materials such as firm materials or sound bedrock or as recommended by the Geotechnical Consultant. The minimum keyway width shall be 15 feet and extend into suitable materials, or as recommended by the geotechnical report and approved by the Geotechnical Consultant. The minimum keyway width for fill over cut slopes is also 15 feet, or as recommended by the geotechnical report and approved by the Geotechnical Consultant. As a general rule, unless otherwise recommended by the Geotechnical Consultant, the minimum width of the keyway shall be equal to 1/2 the height of the fill slope.

H. Slope Face: The specified minimum relative compaction shall be maintained out to the finish face of fill and stabilization fill slopes. Generally, this may be achieved by overbuilding the slope and cutting back to the compacted core. The actual amount of overbuilding may vary as field conditions dictate. Alternately, this may be achieved by back rolling the slope face with suitable equipment or other methods that produce the designated result. Loose soil should not be allowed to build up on the slope face. If present, loose soils shall be trimmed to expose the compacted slope face.

I. Slope Ratio: Unless otherwise approved by the Geotechnical Consultant and governing agencies, permanent fill slopes shall be designed and constructed no steeper than 2 to 1 (horizontal to vertical).

J. Natural Ground and Cut Areas: Design grades that are in natural ground or in cuts should be evaluated by the Geotechnical Consultant to determine whether scarification and processing of the ground and/or overexcavation is needed.

K. Fill materials shall not be placed, spread, or compacted during unfavorable weather conditions. When grading is interrupted by rain, filing operations shall not resume until the Geotechnical Consultant approves the moisture and density of the previously placed compacted fill.

IV. Cut Slopes

A. The Geotechnical Consultant shall inspect all cut slopes, including fill over cut slopes, and shall be notified by the contractor when cut slopes are started.

B. If adverse or potentially adverse conditions are encountered during grading; the Geotechnical Consultant shall investigate, evaluate, and make recommendations to mitigate the adverse conditions.

C. Unless otherwise stated in the geotechnical report, cut slopes shall not be excavated higher or steeper than the requirements of the local governing agencies. Short-term stability of the cut slopes and other excavations is the contractor's responsibility.

V. Drainage

A. Back drains and Subdrains: Back drains and subdrains shall be provided in fill as recommended by the Geotechnical Consultant and shall be constructed in accordance with the governing agency and/or recommendations of the Geotechnical Consultant. The location of subdrains, especially outlets, shall be surveyed and recorded by the Civil Engineer.

B. Top-of-slope Drainage: Positive drainage shall be established away from the top of slope. Site drainage shall not be permitted to flow over the tops of slopes.

C. Drainage terraces shall be constructed in compliance with the governing agency requirements and/or in accordance with the recommendations of the Geotechnical Consultant.

D. Non-erodible interceptor swales shall be placed at the top of cut slopes that face the same direction as the prevailing drainage.

VI. Erosion Control

A. All finish cut and fill slopes shall be protected from erosion and/or planted in accordance with the project specifications and/or landscape architect's recommendations. Such measures to protect the slope face shall be undertaken as soon as practical after completion of grading.

B. During construction, the contractor shall maintain proper drainage and prevent the ponding of water. The contractor shall take remedial measures to prevent the erosion of graded areas until permanent drainage and erosion control measures have been installed.

VII. Trench Excavation and Backfill

A. Safety: The contractor shall follow all OSHA requirements for safety of trench excavations. Knowing and following these requirements is the contractor's responsibility. All trench excavations or open cuts in excess of 5 feet in depth shall be shored or laid back. Trench excavations and open cuts exposing adverse geologic conditions may require further evaluation by the Geotechnical Consultant. If a contractor fails to provide safe access for compaction testing, backfill not tested due to safety concerns may be subject to removal.

B. Bedding: Bedding materials shall be non-expansive and have a Sand Equivalent greater than 30. Where permitted by the Geotechnical Consultant, the bedding materials can be densified by jetting.

C. Backfill: Jetting of backfill materials is generally not acceptable. Where permitted by the Geotechnical Consultant, the bedding materials can be densified by jetting provided the backfill materials are granular, free-draining and have a Sand Equivalent greater than 30.

VIII. Geotechnical Observation and Testing During Grading

A. Compaction Testing: Fill shall be tested by the Geotechnical Consultant for evaluation of general compliance with the recommended compaction and moisture conditions. The tests shall be taken in the compacted soils beneath the surface if the surficial materials are disturbed. The contractor shall assist the Geotechnical Consultant by excavating suitable test pits for testing of compacted fill.

B. Where tests indicate that the density of a layer of fill is less than required, or the moisture content not within specifications, the Geotechnical Consultant shall notify the contractor of the unsatisfactory conditions of the fill. The portions of the fill that are not within specifications shall be reworked until the required density and/or moisture content has been attained. No additional fill shall be placed until the last lift of fill is tested and found to meet the project specifications and approved by the Geotechnical Consultant.

C. If, in the opinion of the Geotechnical Consultant, unsatisfactory conditions, such as adverse weather, excessive rock or deleterious materials being placed in the fill, insufficient equipment, excessive rate of fill placement, results in a quality of work that is unacceptable, the consultant shall notify the contractor, and the contractor shall rectify the conditions, and if necessary, stop work until conditions are satisfactory.

D. Frequency of Compaction Testing: The location and frequency of tests shall be at the Geotechnical Consultant's discretion. Generally, compaction tests shall be taken at intervals not exceeding two feet in fill height and 1,000 cubic yards of fill materials placed.

E. Compaction Test Locations: The Geotechnical Consultant shall document the approximate elevation and horizontal coordinates of the compaction test locations. The contractor shall coordinate with the surveyor to assure that sufficient grade stakes are established so that the Geotechnical Consultant can determine the test locations. Alternately, the test locations can be surveyed and the results provided to the Geotechnical Consultant.

F. Areas of fill that have not been observed or tested by the Geotechnical Consultant may have to be removed and recompacted at the contractor's expense. The depth and extent of removals will be determined by the Geotechnical Consultant.

G. Observation and testing by the Geotechnical Consultant shall be conducted during grading in order for the Geotechnical Consultant to state that, in his opinion, grading has been completed in accordance with the approved geotechnical report and project specifications.

H. Reporting of Test Results: After completion of grading operations, the Geotechnical Consultant shall submit reports documenting their observations during construction and test results. These reports may be subject to review by the local governing agencies.

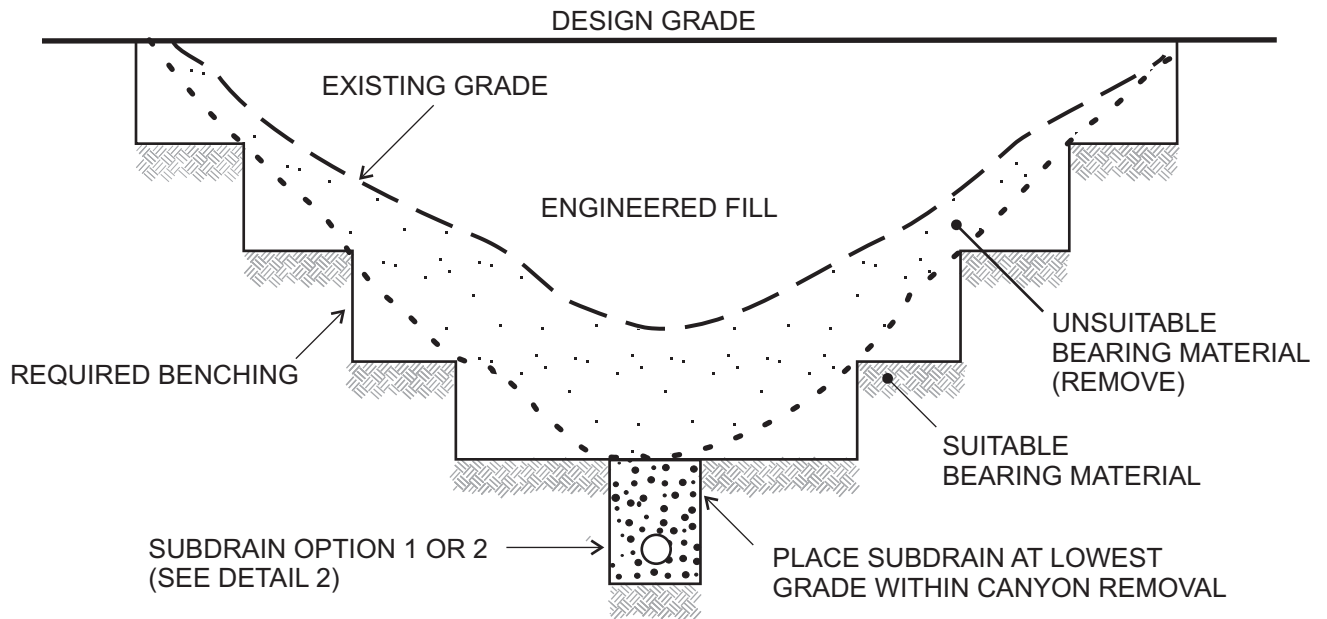

CANYON SUBDRAIN PROFILE

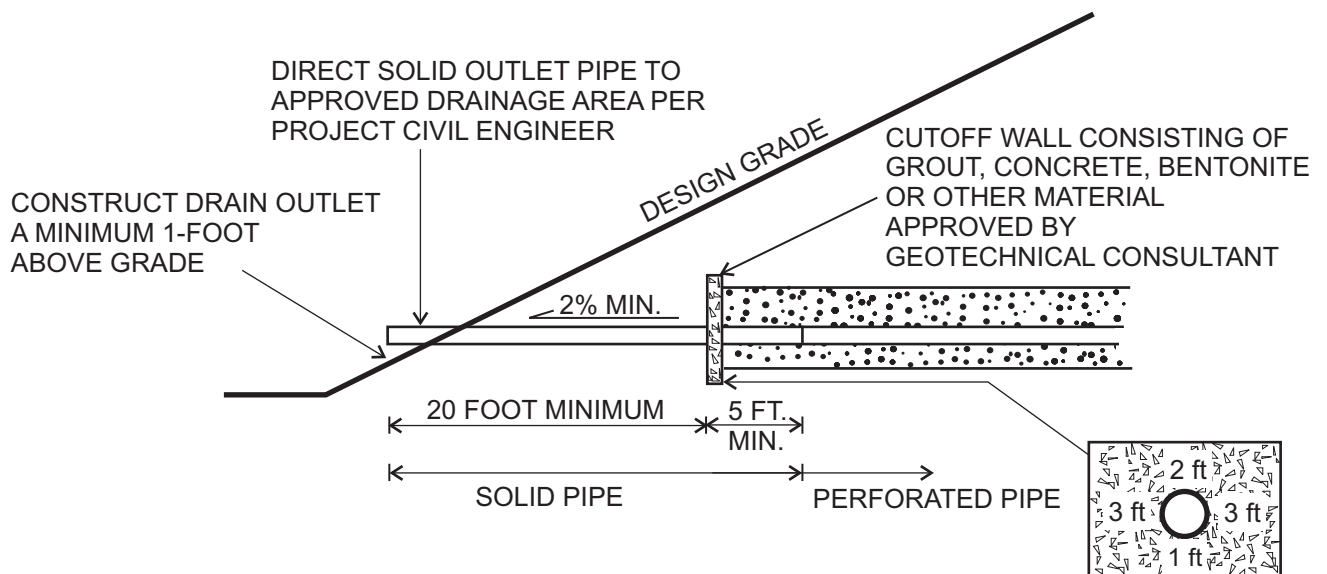

NOTE: LOCATION OF CANYON SUBDRAINS AND OUTLETS SHOULD BE DOCUMENTED BY PROJECT CIVIL ENGINEER. OUTLETS MUST BE KEPT UNOBSTRUCTED AT ALL TIMES.

CANYON SUBDRAIN TERMINUS

VER 1.0

NTS



ADVANCED GEOTECHNICAL SOLUTIONS

CANYON SUBDRAIN

DETAIL 1

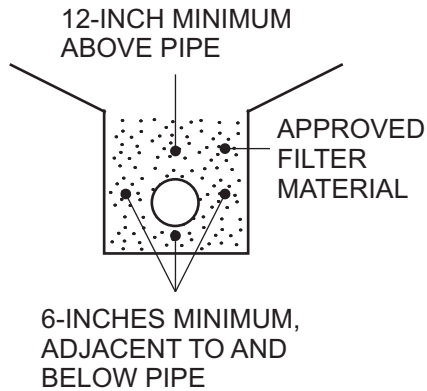

OPTION 1

FILTER MATERIAL: MINIMUM VOLUME OF 9 CUBIC FEET PER LINEAL FOOT OF CALTRANS CLASS 2 PERMEABLE MATERIAL

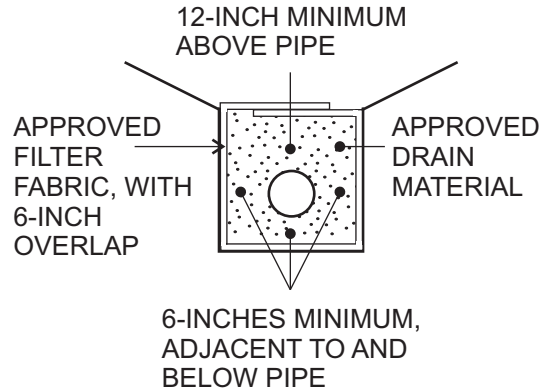

OPTION 2

DRAIN MATERIAL: MINIMUM VOLUME OF 9 CUBIC FEET PER LINEAL FOOT OF 3/4-INCH MAX ROCK OR APPROVED EQUIVALENT SUBSTITUTE

FILTER FABRIC: MIRAFI 140 FILTER FABRIC OR APPROVED EQUIVALENT SUBSTITUTE

PIPE: 6 OR 8-INCH ABS OR PVC PIPE OR APPROVED SUBSTITUTE WITH A MINIMUM OF 8 PERFORATIONS (1/4-INCH DIAMETER) PER LINEAL FOOT IN BOTTOM HALF OF PIPE

(ASTM D2751, SDR-35 OR ASTM D3034, SDR-35
ASTM D1527, SCHD. 40 OR ASTM D1785, SCHD. 40)

NOTE: CONTINUOUS RUN IN EXCESS OF 500 FEET REQUIRES 8-INCH DIAMETER PIPE (ASTM D3034, SDR-35, OR ASTM D1785, SCHD. 40)

CANYON SUBDRAIN

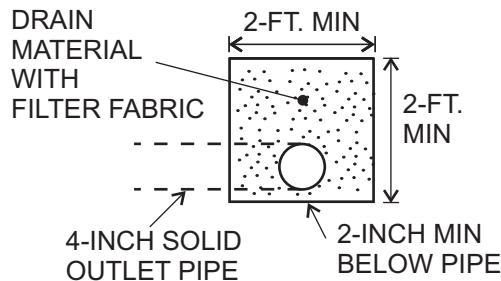

OPTION 1

DRAIN MATERIAL: GRAVEL TRENCH TO BE FILLED WITH 3/4-INCH MAX ROCK OR APPROVED EQUIVALENT SUBSTITUTE

FILTER FABRIC: MIRAFI 140 FILTER FABRIC OR EQUIVALENT SUBSTITUTE WITH A MINIMUM 6-INCH OVERLAP

PIPE: 4-INCH ABS OR PVC PIPE OR APPROVED EQUIVALENT SUBSTITUTE WITH A MINIMUM OF 8 PERFORATIONS (1/4-INCH DIAMETER) PER LINEAL FOOT IN BOTTOM HALF OF PIPE

(ASTM D2751, SDR-35 OR ASTM D3034, SDR-35
ASTM D1527, SCHD. 40 OR ASTM D1785, SCHD. 40)

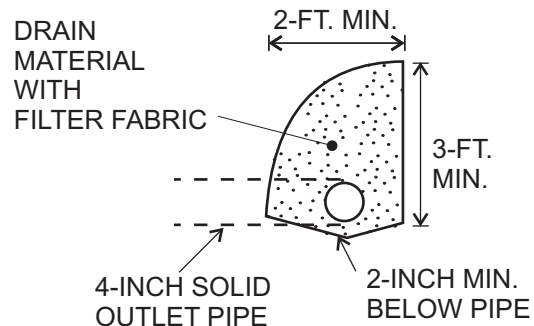

OPTION 2

BUTTRESS/STABILIZATION DRAIN

VER 1.0

NTS



ADVANCED GEOTECHNICAL SOLUTIONS

DRAIN SPECIFICATIONS

DETAIL 2

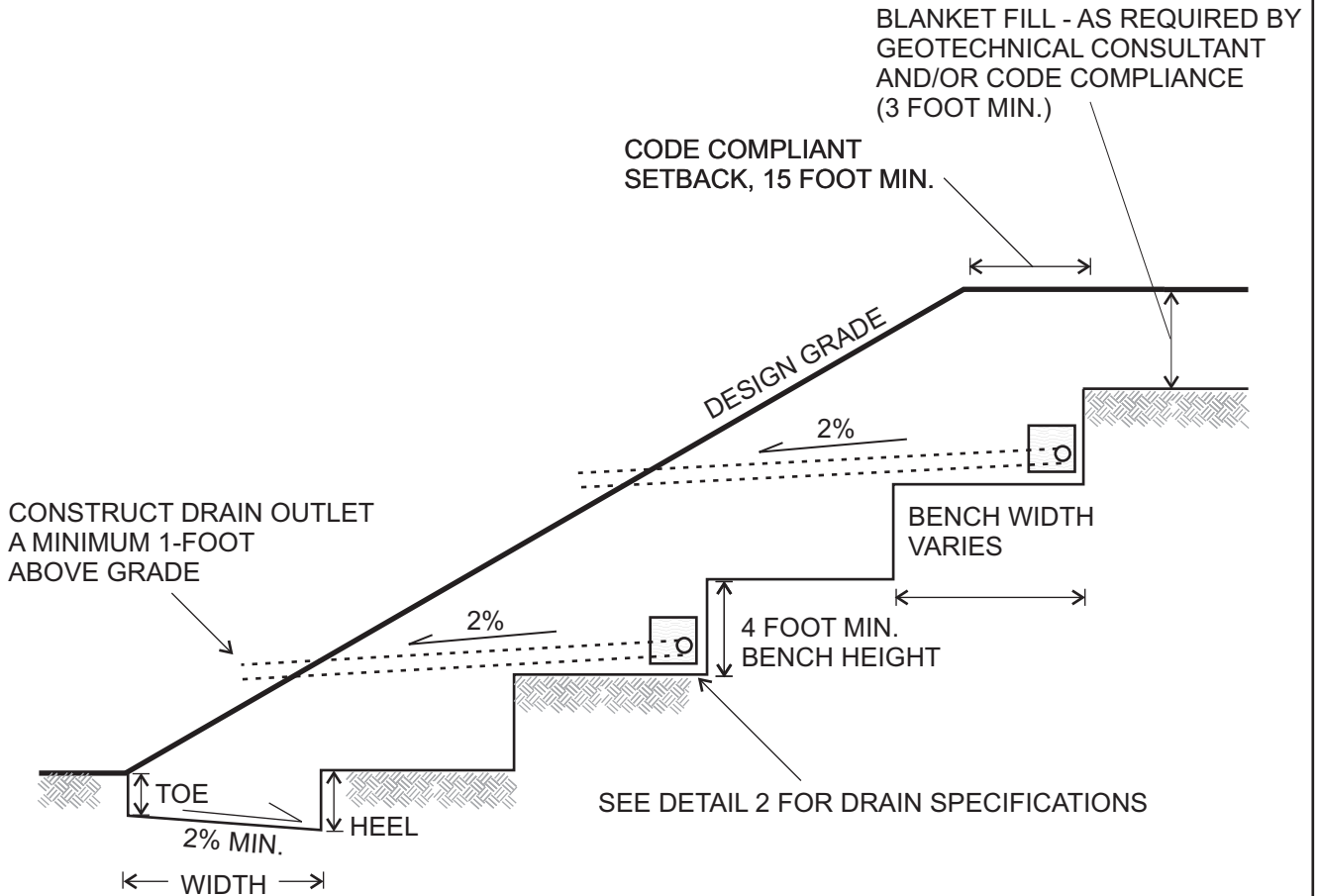

CODE COMPLIANT KEYWAY
WITH MINIMUM DIMENSIONS:

TOE 2 FOOT MIN.
HEEL 3 FOOT MIN.
WIDTH 15 FOOT MIN.

NOTES:

1. DRAIN OUTLETS TO BE PROVIDED EVERY 100 FEET CONNECT TO PERFORATED DRAIN PIPE BY "L" OR "T" AT A MINIMUM 2% GRADIENT.
2. THE NECESSITY AND LOCATION OF ADDITIONAL DRAINS SHALL BE DETERMINED IN THE FIELD BY THE GEOTECHNICAL CONSULTANT. UPPER STAGE OUTLETS SHOULD BE EMPTIED ONTO CONCRETE TERRACE DRAINS.
3. DRAIN PIPE TO EXTEND FULL LENGTH OF STABILIZATION/BUTTRESS WITH A MINIMUM GRADIENT OF 2% TO SOLID OUTLET PIPES.
4. LOCATION OF DRAINS AND OUTLETS SHOULD BE DOCUMENTED BY PROJECT CIVIL ENGINEER. OUTLETS MUST BE KEPT UNOBSTRUCTED AT ALL TIMES.

VER 1.0

NTS



ADVANCED GEOTECHNICAL SOLUTIONS

STABILIZATION/BUTTRESS FILL

DETAIL 3

* THE "CUT" PORTION OF THE SLOPE SHALL BE EXCAVATED AND EVALUATED BY THE GEOTECHNICAL CONSULTANT PRIOR TO CONSTRUCTING THE "FILL" PORTION

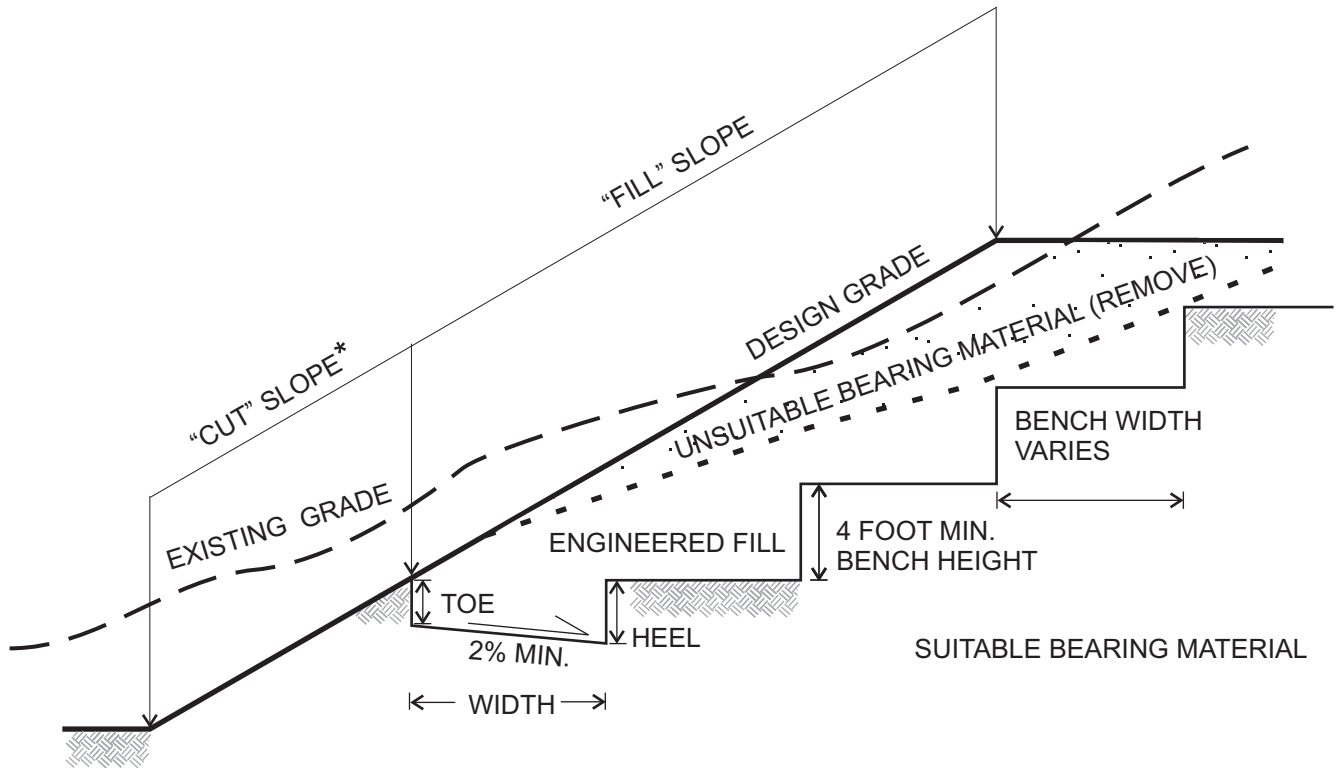

SUITABLE BEARING MATERIAL

CODE COMPLIANT KEYWAY WITH MINIMUM DIMENSIONS:

TOE: 2 FOOT MIN.
 HEEL: 3 FOOT MIN.
 WIDTH: 15 FOOT MIN.

NOTES:

1. THE NECESSITY AND LOCATION OF DRAINS SHALL BE DETERMINED IN THE FIELD BY THE GEOTECHNICAL CONSULTANT
2. SEE DETAIL 2 FOR DRAIN SPECIFICATIONS

VER 1.0

NTS



ADVANCED GEOTECHNICAL SOLUTIONS

FILL OVER CUT SLOPE

DETAIL 4

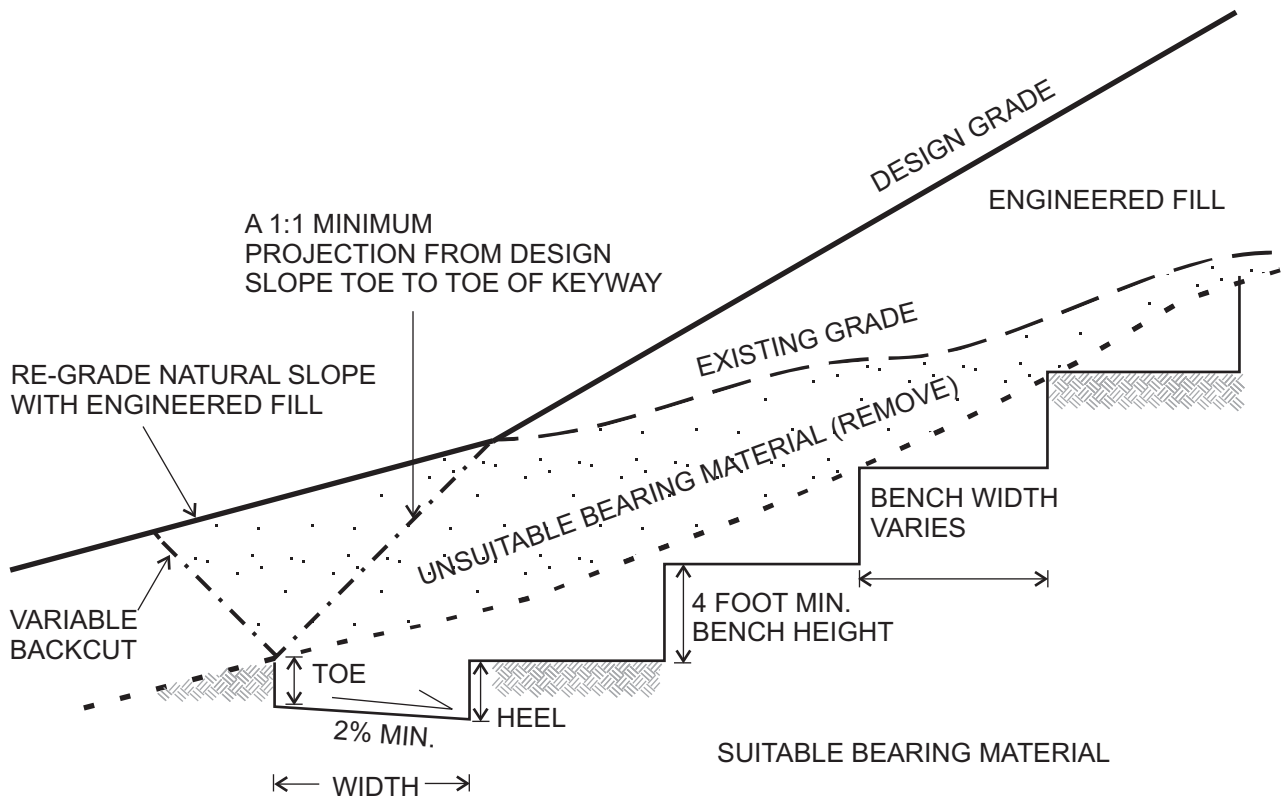

CODE COMPLIANT KEYWAY
WITH MINIMUM DIMENSIONS:

TOE: 2 FOOT MIN.
HEEL: 3 FOOT MIN.
WIDTH: 15 FOOT MIN.

NOTES:

1. WHEN THE NATURAL SLOPE APPROACHES OR EXCEEDS THE DESIGN GRADE SLOPE RATIO, SPECIAL RECOMMENDATIONS ARE NECESSARY BY THE GEOTECHNICAL CONSULTANT
2. THE GEOTECHNICAL CONSULTANT WILL DETERMINE THE REQUIREMENT FOR AND LOCATION OF SUBSURFACE DRAINAGE SYSTEMS.
3. MAINTAIN MINIMUM 15 FOOT HORIZONTAL WIDTH FROM FACE OF SLOPE TO BENCH/BACKCUT

VER 1.0

NTS



ADVANCED GEOTECHNICAL SOLUTIONS

FILL OVER NATURAL SLOPE

DETAIL 5

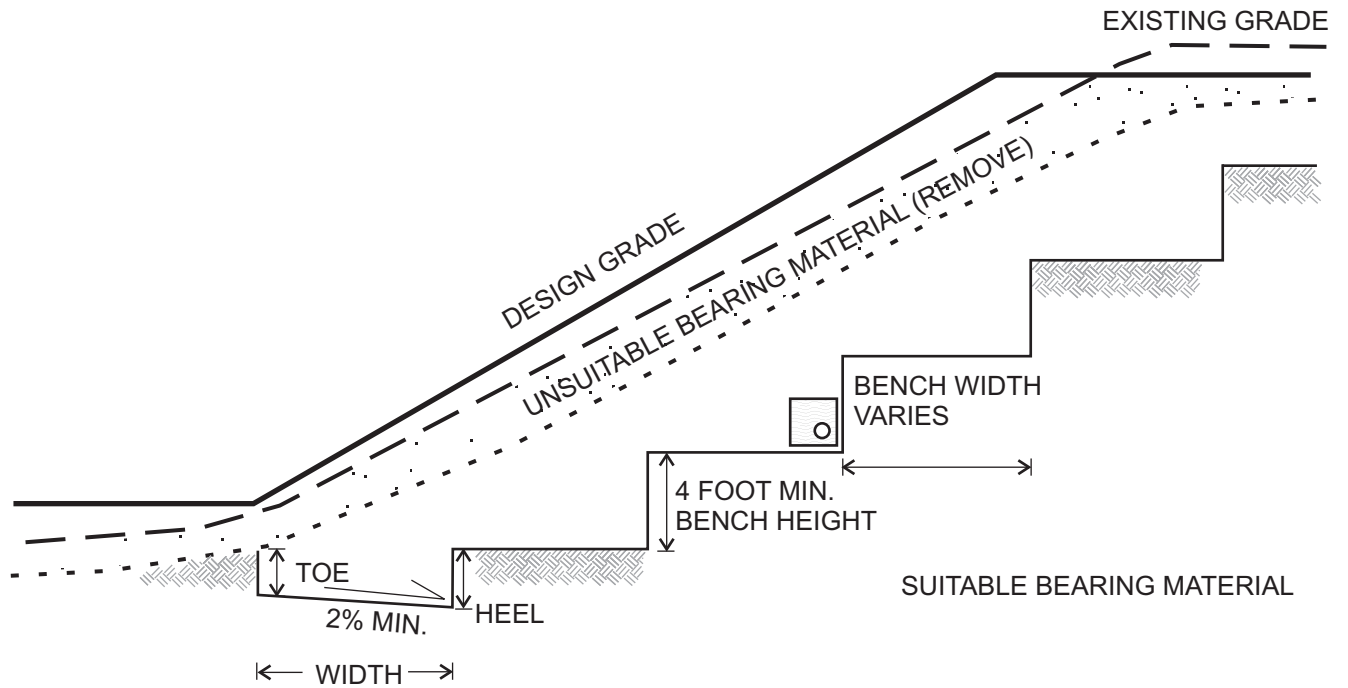

CODE COMPLIANT KEYWAY
WITH MINIMUM DIMENSIONS:

TOE: 2 FOOT MIN.
HEEL: 3 FOOT MIN.
WIDTH: 15 FOOT MIN.

NOTES:

1. MAINTAIN MINIMUM 15 FOOT HORIZONTAL WIDTH FROM FACE OF SLOPE TO BENCH/BACKCUT
2. SEE DETAIL 2 FOR DRAIN SPECIFICATIONS

VER 1.0

NTS



ADVANCED GEOTECHNICAL SOLUTIONS

SKIN FILL CONDITION

DETAIL 6

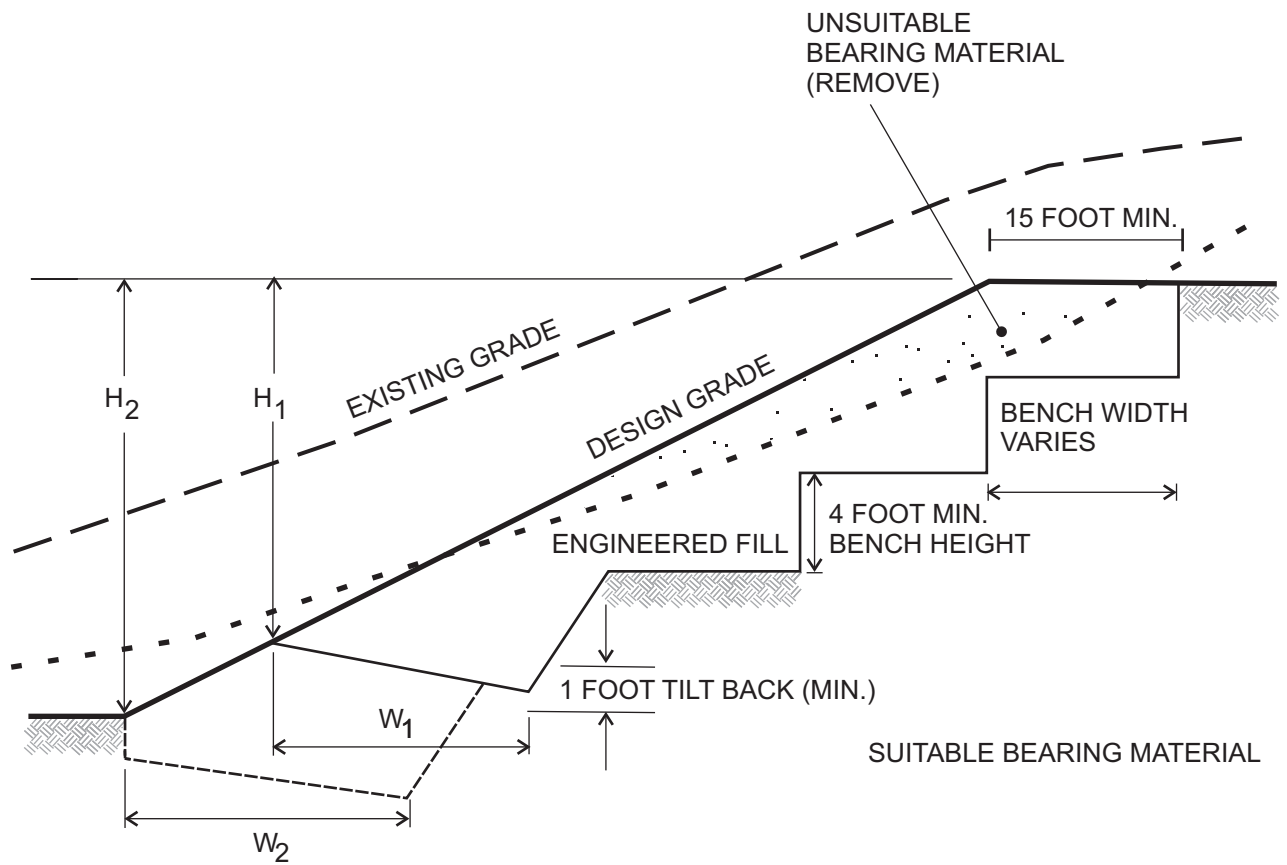

NOTES:

1. IF RECOMMENDED BY THE GEOTECHNICAL CONSULTANT, THE REMAINING CUT PORTION OF THE SLOPE MAY REQUIRE REMOVAL AND REPLACEMENT WITH AN ENGINEERED FILL
2. "W" SHALL BE EQUIPMENT WIDTH (15 FEET) FOR SLOPE HEIGHT LESS THAN 25 FEET. FOR SLOPES GREATER THAN 25 FEET, "W" SHALL BE DETERMINED BY THE GEOTECHNICAL CONSULTANT. AT NO TIME SHALL "W" BE LESS THAN H/2
3. DRAINS WILL BE REQUIRED (SEE DETAIL 2)

VER 1.0

NTS



ADVANCED GEOTECHNICAL SOLUTIONS

PARTIAL CUT SLOPE
STABILIZATION

DETAIL 7

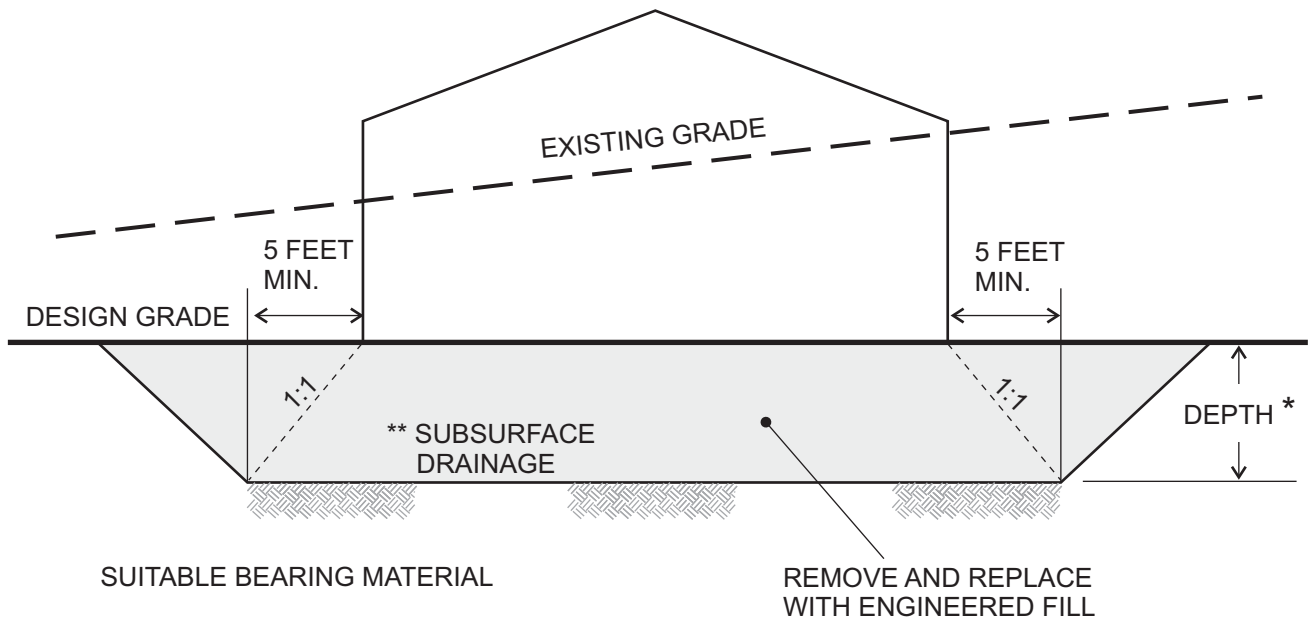

CUT LOT OVEREXCAVATION

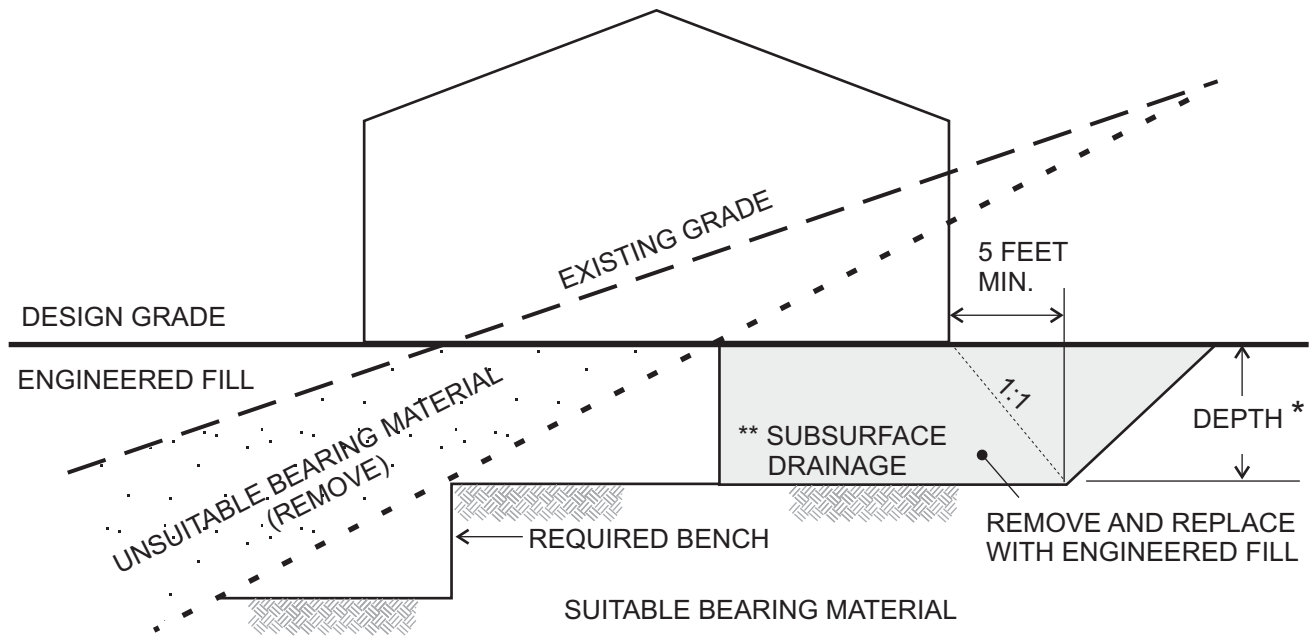

CUT-FILL LOT OVEREXCAVATION

NOTES:

* SEE REPORT FOR RECOMMENDED DEPTHS, DEEPER OVEREXCAVATION MAY BE REQUIRED BY THE GEOTECHNICAL CONSULTANT BASED ON EXPOSED FIELD CONDITIONS

** CONSTRUCT EXCAVATION TO PROVIDE FOR POSITIVE DRAINAGE TOWARDS STREETS, DEEPER FILL AREAS OR APPROVED DRAINAGE DEVICES BASED ON FIELD CONDITIONS

VER 1.0

NTS



ADVANCED GEOTECHNICAL SOLUTIONS

CUT & CUT-FILL LOT OVEREXCAVATION

DETAIL 8

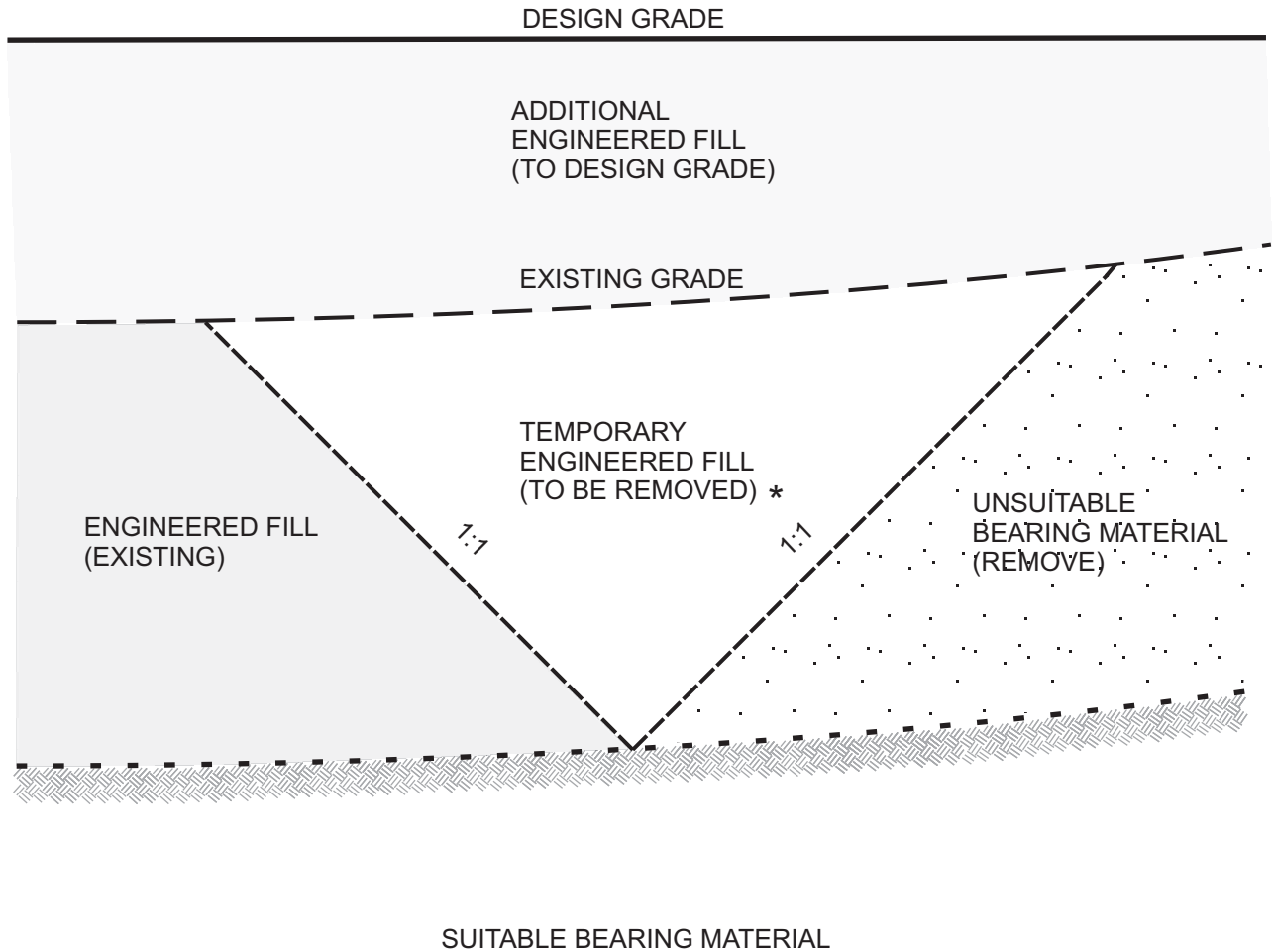

* REMOVE BEFORE PLACING ADDITIONAL ENGINEERED FILL

TYPICAL UP-CANYON PROFILE

VER 1.0

NTS



ADVANCED GEOTECHNICAL SOLUTIONS

REMOVAL ADJACENT TO
EXISTING FILL

DETAIL 9

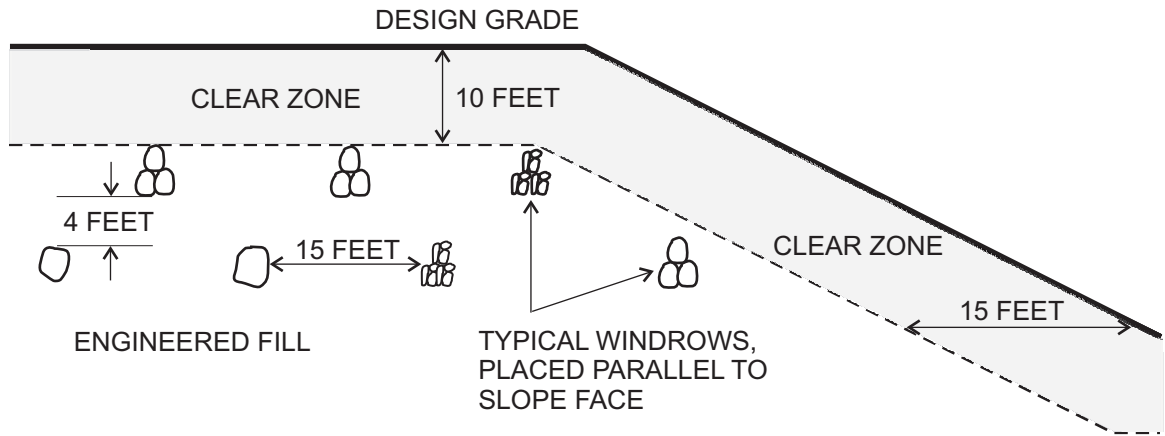

CLEAR ZONE DIMENSIONS FOR REFERENCE ONLY, ACTUAL DEPTH, WIDTH, WINDROW LENGTH, ETC. TO BE BASED ON ELEVATIONS OF FOUNDATIONS, UTILITIES OR OTHER STRUCTURES PER THE GEOTECHNICAL CONSULTANT OR GOVERNING AGENCY APPROVAL

OVERSIZED MATERIAL DISPOSAL PROFILE

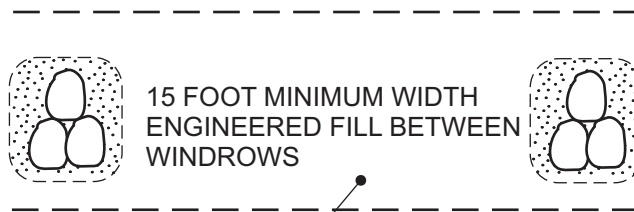

HORIZONTALLY PLACED ENGINEERED FILL, FREE OF OVERSIZED MATERIALS AND COMPACTED TO MINIMUM PROJECT STANDARDS

COMPACT ENGINEERED FILL ABOVE OVERSIZED MATERIALS TO FACILITATE "TRENCH" CONDITION PRIOR TO FLOODING GRANULAR MATERIALS

WINDROW CROSS-SECTION

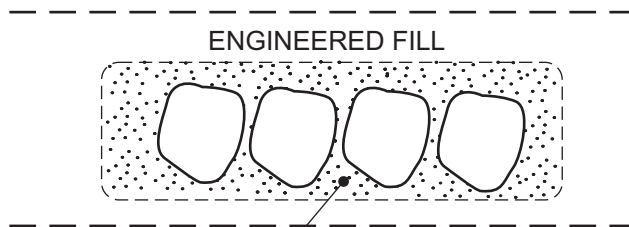

GRANULAR MATERIAL APPROVED BY THE GEOTECHNICAL CONSULTANT AND CONSOLIDATED IN-PLACE BY FLOODING

WINDROW PROFILE

VER 1.0

NTS



ADVANCED GEOTECHNICAL SOLUTIONS

OVERSIZED MATERIAL DISPOSAL CRITERIA

DETAIL 10

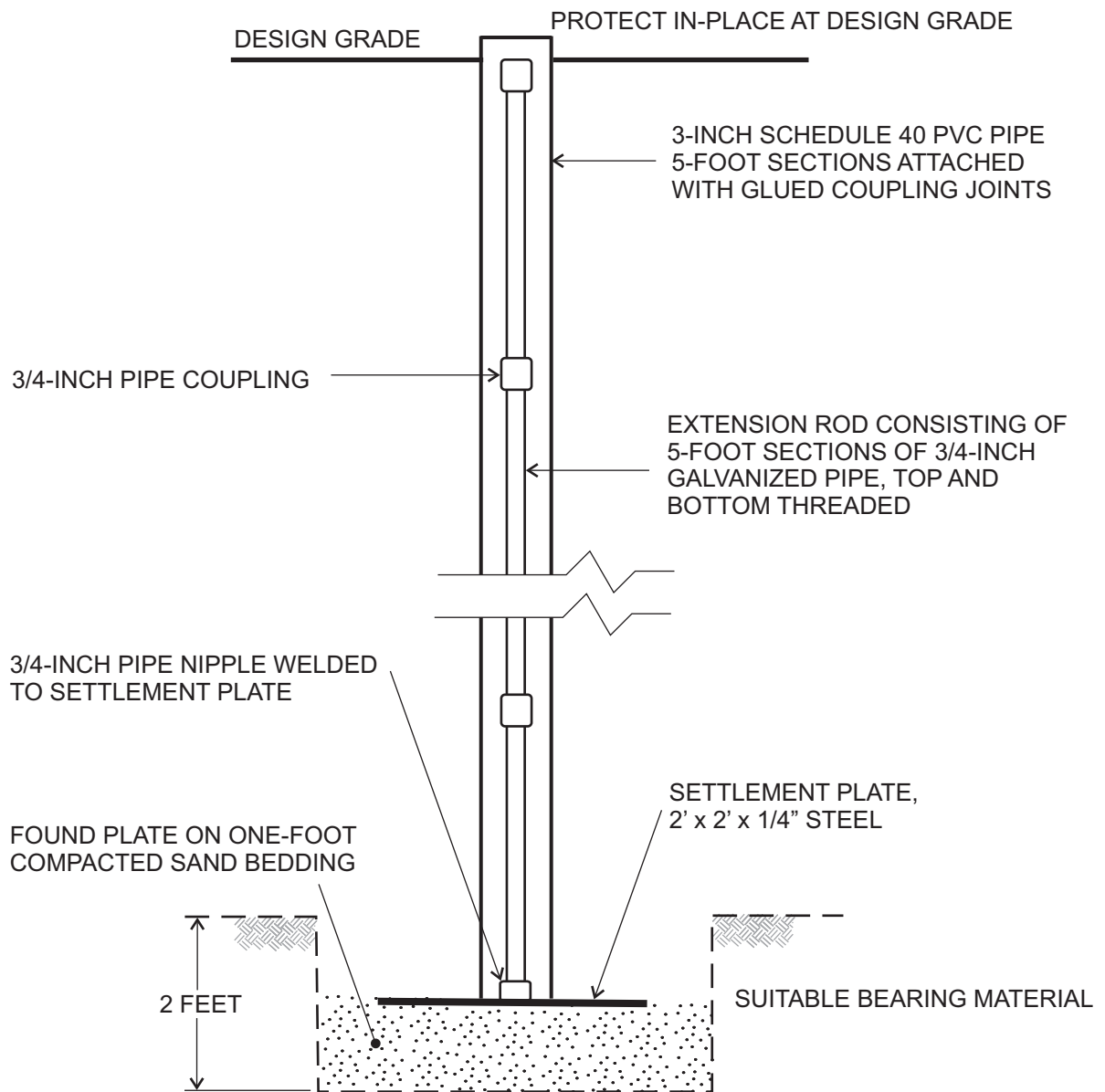

NOTES:

1. SETTLEMENT PLATE LOCATIONS SHALL BE SUFFICIENTLY IDENTIFIED BY THE CONTRACTOR AND BE READILY VISIBLE TO EQUIPMENT OPERATORS.
2. CONTRACTOR SHALL MAINTAIN ADEQUATE HORIZONTAL CLEARANCE FOR EQUIPMENT OPERATION AND SHALL BE RESPONSIBLE FOR REPAIRING ANY DAMAGE TO SETTLEMENT PLATE DURING SITE CONSTRUCTION.
3. A MINIMUM 5-FOOT ZONE ADJACENT TO SETTLEMENT PLATE/EXTENSION RODS SHALL BE ESTABLISHED FOR HAND-HELD MECHANICAL COMPACTION OF ENGINEERED FILL. ENGINEERED FILL SHALL BE COMPACTED TO MINIMUM PROJECT STANDARD.
4. ELEVATIONS OF SETTLEMENT PLATE AND ALL EXTENSION ROD PLACEMENT SHALL BE DOCUMENTED BY PROJECT CIVIL ENGINEER OR SURVEYOR.

VER 1.0

NTS



ADVANCED GEOTECHNICAL SOLUTIONS

SETTLEMENT PLATE

DETAIL 11

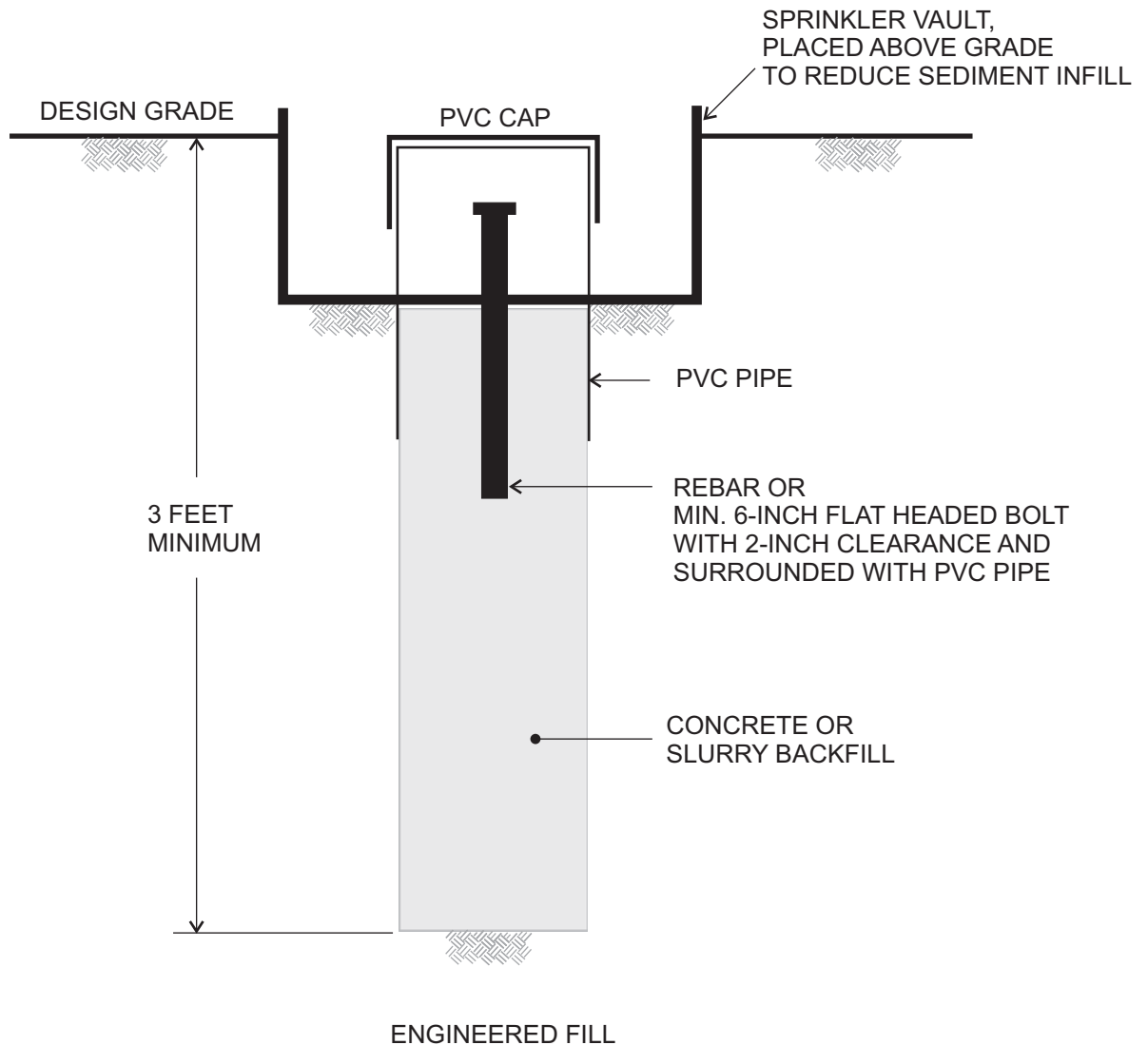

NOTES:

1. SETTLEMENT MONUMENT LOCATIONS SHALL BE SUFFICIENTLY IDENTIFIED AND BE READILY VISIBLE TO EQUIPMENT OPERATORS.
2. ELEVATIONS OF SURFACE MONUMENTS SHALL BE DOCUMENTED BY PROJECT CIVIL ENGINEER OR SURVEYOR.

VER 1.0

NTS



ADVANCED GEOTECHNICAL SOLUTIONS

SETTLEMENT MONUMENT

DETAIL 12

LEGEND

- B-7 Approximate Boring Location (AGS, 2021)
- P-1 Approximate Percolation Boring Location (AGS, 2021)
- TP-7 Approximate Exploratory Test Pit Location (AGS, 2019)
- - - ? - - - Approximate Location of Geologic Contact (Queried where uncertain, dotted where buried)
- ▨ Approximate Location of Deep Undocumented Fill
- afu Artificial Fill - Undocumented
- Qya Young Alluvial Flood-plain Deposits
- Qop₆ Old Paralic Deposits, Unit 6
- A-A' Cross Section Location
- 5 OX Estimated Overexcavation Depth (in feet)
- 4 Estimated Removal Depth (in feet)

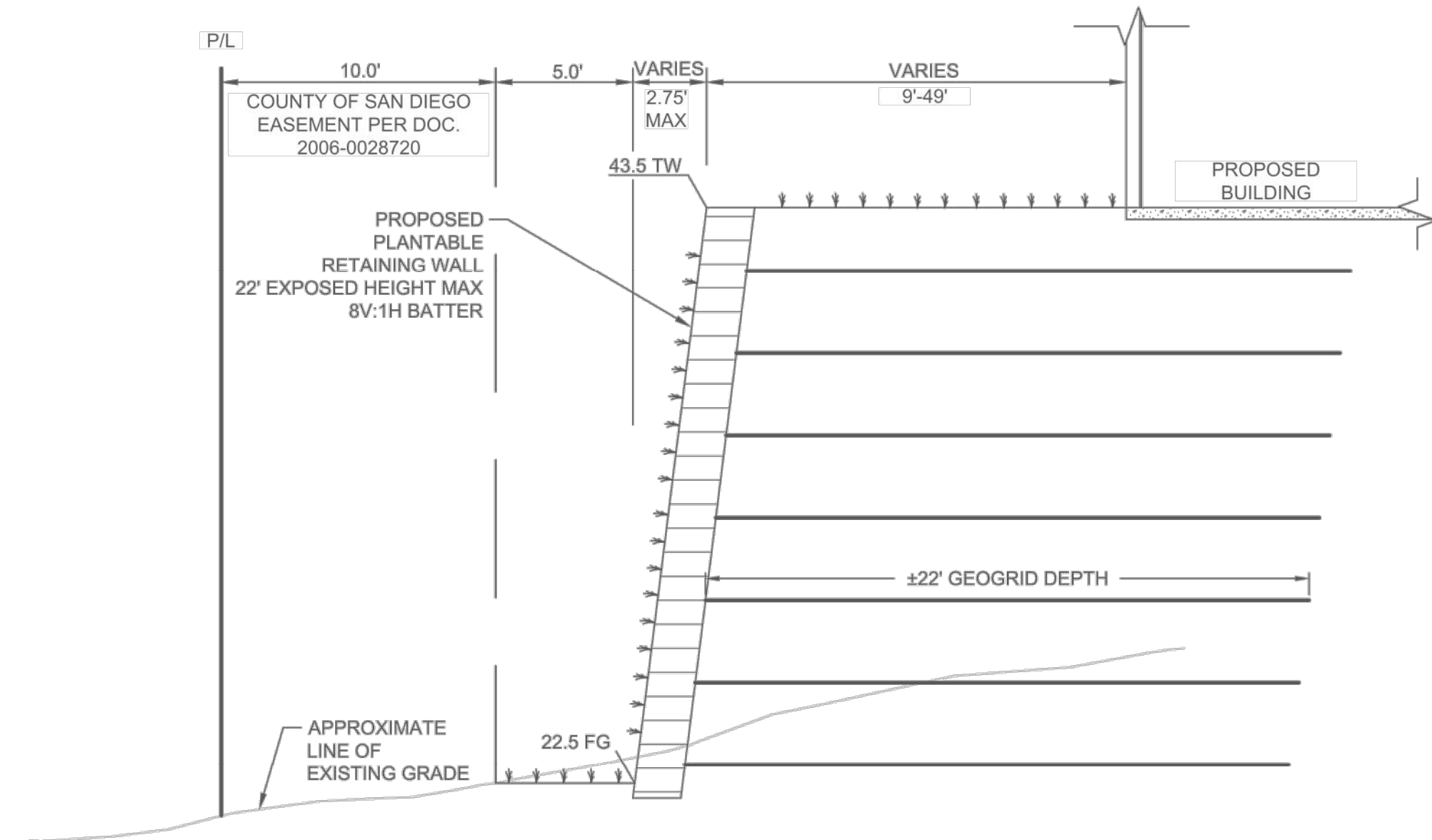
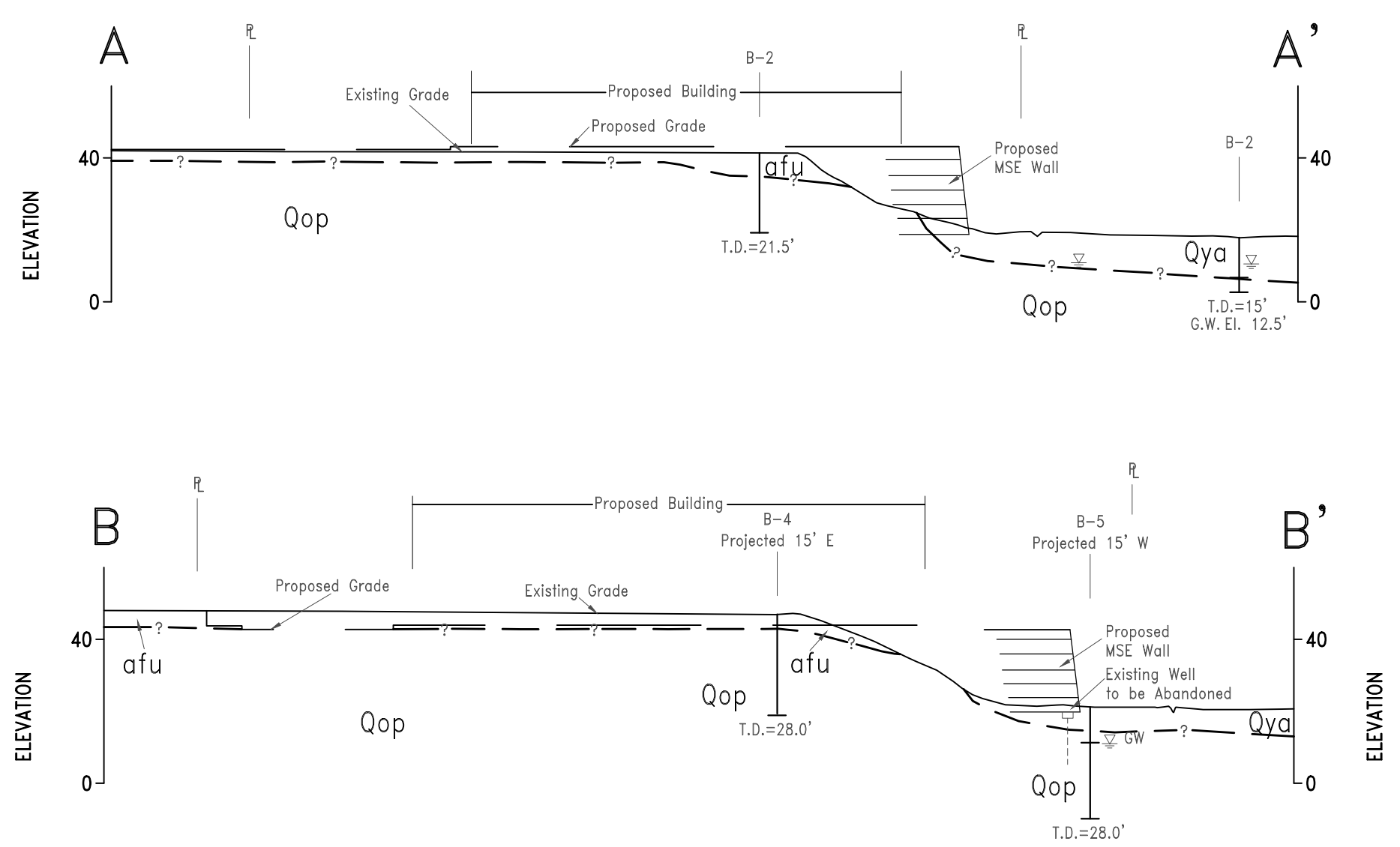
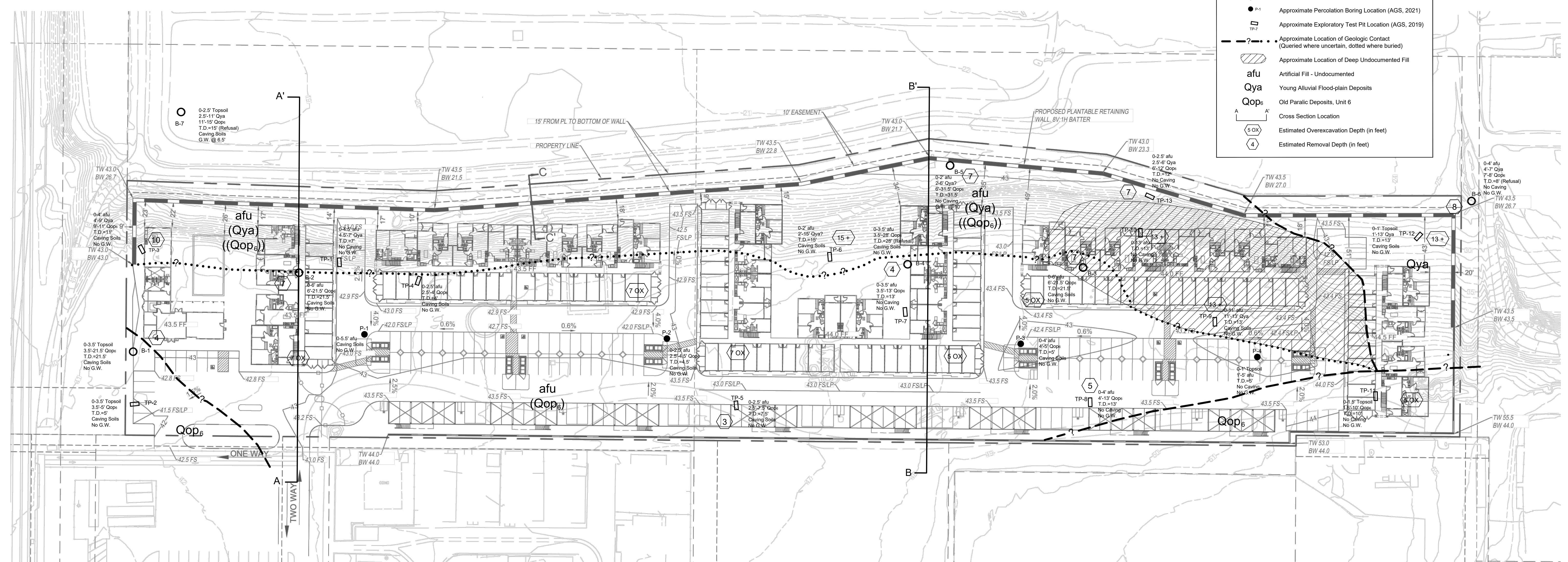

PRELIMINARY GRADING QUANTITIES

GRADED AREA	5.50 [ACRES]	MAX. CUT DEPTH	14 [FT]
CUT QUANTITIES	19,500 [CYD]	MAX CUT SLOPE RATIO	2:1
FILL QUANTITIES	26,500 [CYD]	MAX FILL DEPTH	23 [FT]
IMPORT	7,000 [CYD]	MAX FILL SLOPE RATIO	2:1

NOTE:
 THE GRADING QUANTITIES SHOWN ARE AN ESTIMATE ONLY. THE GRADING HAS BEEN PERFORMED TO FINISH GRADE AND THE QUANTITIES SHOWN DO NOT ACCOUNT FOR BUILDING PAD AND SUBGRADE PAVEMENT SECTIONS. THE GRADING QUANTITIES DO NOT ACCOUNT FOR VARIATIONS DUE TO LOSS FROM CLEARING AND GRUBBING, STRIPPING, SHRINKAGE, SWELL, BULKING, UNSUITABLE MATERIALS, FOUNDATION SPOILS, UTILITY TRENCH SPOILS, ETC. THE CONTRACTOR SHALL BE RESPONSIBLE FOR DETERMINING THEIR OWN INDEPENDENT QUANTITY & MATERIAL TAKE-OFFS TO CONSTRUCT THE DESIGN AS INDICATED ON THESE DRAWINGS & IN CONFORMANCE WITH THE PROJECT'S GEOTECHNICAL REPORT & SUBSEQUENT UPDATE LETTERS.

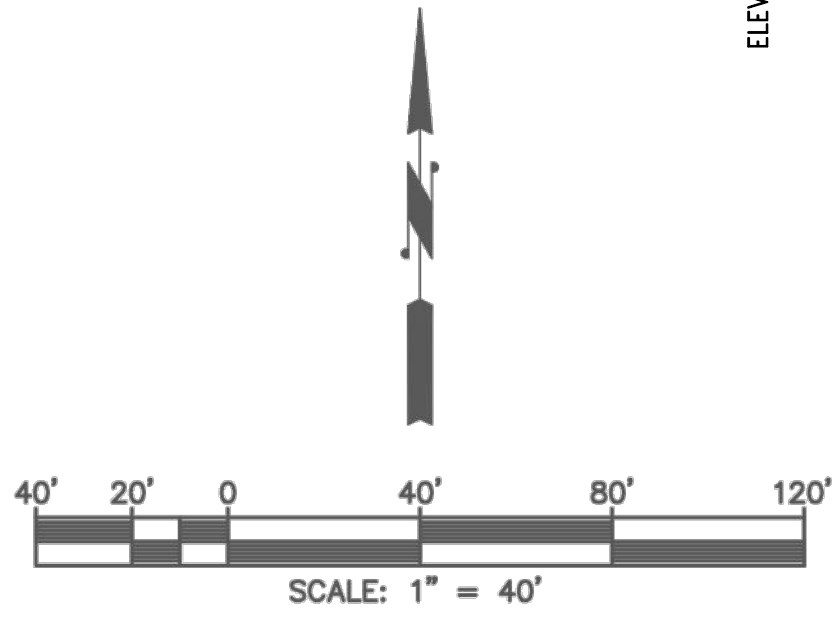

RETAINING WALL SECTION C-C'
 SCALE: 1"=5'

PLATE 1

AGS ADVANCED GEOTECHNICAL SOLUTIONS, INC.
 485 Corporate Drive, Suite B
 Encinitas, California 92029
 Telephone: (714) 786-5661 Fax: (714) 469-3287

Project# P/W 1912-01 Report# 1912-01-B-4 Date: August 2021

PASCO LARET SUITER & ASSOCIATES
 San Diego | Solana Beach | Orange County
 Phone 858.259.8212 | www.plsaengineering.com

PRELIMINARY GRADING EXHIBIT
 PALM AND HOLLISTER
 SAN DIEGO, CA
 PLSA JOB NO. 3372
 SCALE 1"=40'
 AUGUST 18, 2021