

## GEOTECHNICAL INVESTIGATION

---

**SHINOHARA INDUSTRIAL BUILDING  
517 SHINOHARA LANE  
INDUSTRIAL BUILDING  
CHULA VISTA, CALIFORNIA**



**GEOCON**  
INCORPORATED

GEOTECHNICAL  
ENVIRONMENTAL  
MATERIALS

PREPARED FOR

**VWP-OP SHINOHARA OWNER, LLC  
PHOENIX, ARIZONA**

**JULY 28, 2021  
PROJECT NO. G2762-42-01**



Project No. G2762-42-01  
July 28, 2021

VWP-OP Shinohara Owner, LLC  
2390 East Camelback Road, Suite 305  
Phoenix, Arizona 85016

Attention: Mr. Steven Schwarz

Subject: GEOTECHNICAL INVESTIGATION  
SHINOHARA INDUSTRIAL BUILDING  
517 SHINOHARA LANE  
CHULA VISTA, CALIFORNIA

Dear Mr. Schwarz:

In accordance with your request, we have prepared this geotechnical investigation report for the proposed industrial building at the subject site. The site is underlain by Tertiary age San Diego Formation mantled by Very Old Paralic Deposits, alluvium, and topsoil. Undocumented fill berms are present on the property.

This report is based on our observations made during our field investigation performed between June 30 and July 7, 2021, and laboratory testing. Based on the results of this study, we opine that the subject site is suitable for construction of the proposed industrial building. The accompanying report includes the results of our study and conclusions and recommendations regarding geotechnical aspects of site development.

Should you have questions regarding this investigation, or if we may be of further service, please contact the undersigned at your convenience.

Very truly yours,

GEOCON INCORPORATED

Rodney C. Mikesell  
GE 2533

RCM:RSA:arm

(e-mail) Addressee



Rupert S. Adams  
CEG 2561



## TABLE OF CONTENTS

1.	PURPOSE AND SCOPE .....	1
2.	SITE AND PROJECT DESCRIPTION .....	2
3.	SOIL AND GEOLOGIC CONDITIONS .....	2
3.1	Undocumented Fill (Qudf) .....	3
3.2	Previously Placed Fill (Qpf) .....	3
3.3	Topsoil (Unmapped).....	3
3.4	Alluvium (Qal) .....	3
3.5	Terrace Deposits (Qt) .....	3
3.6	Very Old Paralic Deposits (Qvop).....	4
3.7	San Diego Formation (Tsd) .....	4
4.	GROUNDWATER .....	4
5.	GEOLOGIC HAZARDS .....	4
5.1	Faulting and Seismicity .....	4
5.2	Ground Rupture .....	6
5.3	Storm Surge, Tsunamis, and Seiches.....	6
5.4	Flooding.....	7
5.5	Liquefaction.....	7
5.6	Landslides.....	7
6.	CONCLUSIONS AND RECOMMENDATIONS.....	8
6.1	General.....	8
6.2	Soil and Excavation Characteristics .....	9
6.3	Grading Recommendations .....	11
6.4	Slopes.....	13
6.5	Earthwork Grading Factors.....	15
6.6	Subdrains .....	15
6.7	Settlement Monitoring .....	15
6.8	Seismic Design Criteria .....	17
6.9	Shallow Foundations .....	19
6.10	Conventional Retaining Wall Recommendations.....	21
6.11	Lateral Loading.....	24
6.12	Mechanically Stabilized Earth (MSE) Retaining Walls .....	25
6.13	Soil Nail Walls.....	27
6.14	Preliminary Pavement Recommendations .....	29
6.15	Exterior Concrete Flatwork .....	32
6.16	Slope Maintenance.....	33
6.17	Storm Water Management.....	34
6.18	Site Drainage and Moisture Protection.....	34
6.19	Grading and Foundation Plan Review .....	35

### MAPS AND ILLUSTRATIONS

Figure 1, Geologic Map

Figure 2, Geologic Cross Section A-A'

## TABLE OF CONTENTS (Concluded)

### APPENDIX A

#### FIELD INVESTIGATION

Figure A-1, Log of Small Diameter Boring

Figures A-2 and A-3, Logs of Large Diameter Boring

Figures A-4 to A-23, Logs of Exploratory Test Pits

### APPENDIX B

#### LABORATORY TESTING

Summary of Laboratory Maximum Dry Density and Optimum Moisture Content Test Results

Summary of Laboratory Expansion Index Test Results

Summary of Laboratory Water-Soluble Sulfate Test Results

Summary of Laboratory Chloride Ion Content Test Results

Summary of Laboratory pH and Resistivity Test Results

Summary of Laboratory Atterberg Test Results

### APPENDIX C

#### RECOMMENDED GRADING SPECIFICATIONS

### LIST OF REFERENCES



# GEOTECHNICAL INVESTIGATION

## 1. PURPOSE AND SCOPE

This report contains the results of our geotechnical investigation for a proposed industrial building located at the terminus of Shinohara Lane, in Chula Vista, California (see Vicinity Map).



Vicinity Map

The purpose of our investigation was to evaluate subsurface soil and geologic conditions at the site, and provide conclusions and recommendations pertaining to geotechnical aspects of developing the property as proposed.

The scope of our investigation included a site reconnaissance, excavating and logging 20 backhoe test pits, 2 large diameter borings, 1 small diameter boring, and reviewing published and unpublished geologic literature and reports (see List of References). Appendix A presents a discussion of our field investigation. We performed laboratory tests on soil samples obtained from the exploratory test pits to evaluate pertinent physical properties for engineering analyses. The results of laboratory testing are presented in Appendix B.

Site geologic conditions are depicted on Figure 1 (Geologic Map). A CAD file of the preliminary grading plan prepared by Pasco Laret Suiter & Associates was utilized as a base map to plot geologic

contacts and exploratory excavation locations. It is our understanding the site plan has not yet been finalized and building configuration and location might be adjusted from what is shown on our geologic map. An updated geologic map can be provided once final site configuration is known.

The conclusions and recommendations presented herein are based on our analysis of the data obtained during the investigation, and our experience with similar soil and geologic conditions on this and adjacent properties.

## **2. SITE AND PROJECT DESCRIPTION**

The property consists of a rectangular parcel located west of the terminus of Shinohara Lane, north of Main Street and west of Brandywine Avenue, in Chula Vista, California (see Vicinity Map). The approximately 10-acre parcel is currently undeveloped except for minor surface drainage improvements. The property is fenced with gated access via Shinohara Lane at the southeast corner. Based on review of historical aerial photographs, the site was partially graded circa 1992 when it was used as a borrow site. Except for the graded area in the north-central area of the property, the site slopes moderately to steeply from north to south. Site elevations range from approximately 250 feet mean sea level (MSL) at the north end to 145 feet MSL at the south end. The site is boarded by residential developments to the north and west, and commercial/industrial buildings to the south and east.

The current proposed improvements consist of a single-story approximately 190,000 square-foot industrial warehouse building with associated improvements including utilities, paving, storm water management devices, and landscape improvements. Proposed cuts and fills are estimated to be up to 50 feet, with new slopes being up to approximately 10 feet in height. Retaining walls will be required along the perimeter of the site to reach pad grades. We understand the walls will likely be soil nail walls and mechanically stabilized earth (MSE) walls. Paved parking lots and driveways are planned along the perimeter of the site.

The locations and descriptions of the site and proposed development are based on our site reconnaissance and recent field investigations, and our understanding of site development as shown on the preliminary grading study plans prepared Pasco Laret Suiter & Associates. If project details vary significantly from those described, Geocon Incorporated should be contacted to review the changes and provide additional analyses and/or revisions to this report, if warranted.

## **3. SOIL AND GEOLOGIC CONDITIONS**

Based on the results of the field investigation, the site is underlain by Tertiary San Diego Formation capped with Very Old Paralic Deposits, terrace deposits, alluvium, topsoil, previously placed fill and undocumented fill, which are described below in order of increasing age. Mapped geologic conditions

are depicted on the *Geologic Map* (Figure 1), and on the *Geologic Cross Section* (Figure 2). Exploratory test pit and boring logs are presented in Appendix A.

### **3.1 Undocumented Fill (Qudf)**

The southeast and central portions of the site have soil berms that appear to have been constructed during previous grading to control surface water runoff. The undocumented soil generally consists of loose to medium dense, dry to damp, clayey sand with cobble. Several small trash piles are also present at the site. The undocumented fill and trash are unsuitable for support of structural fill or other improvements in their present condition. Undocumented fill should be removed and replaced as compacted fill. Trash should be hauled offsite prior to grading. Soil berms can be incorporated into fill areas during grading, provided they are free of trash and/or hazardous substances.

### **3.2 Previously Placed Fill (Qpf)**

Previously placed compacted fill (by others) associated with a sewer easement adjacent to the northwest corner of the site extends on to the site. We did not evaluate the condition of this fill during our subsurface exploration. However, it is located behind the proposed soil nail wall and will likely not be encountered during grading operations. It might be encountered when drilling soil nails.

### **3.3 Topsoil (Unmapped)**

Topsoil mantles the site, typically consisting of loose/soft to stiff, dry to damp, silty and clayey sand and sandy silt and clay with gravel. Topsoil ranges from one to three feet thick across the site. Remedial grading in the form of removal and recompaction will be required in areas receiving improvements. Portions of the topsoils are highly expansive.

### **3.4 Alluvium (Qal)**

Alluvium is present in the shallow drainages along the east and west sides of the site, and across most of the southern portion of the site. The alluvium ranges in thickness from 2 feet to greater than 20 feet. The alluvium generally consist of medium dense to dense, silty to clayey sand with minor amounts of gravel and cobble. The upper five feet of the alluvium is unsuitable for the support of foundations or structural fills and will require removal during remedial grading operations. Deeper removals may be required if pockets of loose/soft alluvium extend below the recommended remedial depth.

### **3.5 Terrace Deposits (Qt)**

Pleistocene-age Terrace Deposits are present in limited area the site, consisting of loose to medium dense, damp, sand with gravel and cobble up to 10-inches in diameter. The Terrace Deposits are considered suitable for support or structural loads but may require some remedial grading in the upper

five feet. Remedial grading depths in Terrace Deposits should be verified by a Geocon representative during grading operations.

### **3.6 Very Old Paralic Deposits (Qvop)**

Quaternary-age Very Old Paralic Deposits caps the San Diego Formation in the northwest portion of the site. The Very Old Paralic Deposits were up to approximately 8 feet thick in the areas explored and consisted of dense to very dense, medium to coarse grained sandstone with cobble. We expect grading will remove the majority of the Very Old Paralic Deposits within the building pad area. Vertical wall cuts may expose Very Old Paralic Deposits in the northwest corner of the site.

### **3.7 San Diego Formation (Tsd)**

Tertiary-age San Diego Formation underlies the Very Old Paralic Deposits and surficial deposits, is exposed at grade in the central and northern portions of the site, and was identified in most of test pits in the southern portion of the site. The San Diego Formation generally consists of weakly to moderately cemented, massive to laminated/cross-bedded, micaceous, damp to moist, fine- to medium-grained sandstone and silty sandstone, with occasional gravel and cobble beds. The San Diego Formation possesses a “very low” to “low” expansion potential (expansion index of 50 or less). The San Diego Formation is considered suitable for support of structural loads.

Bedding attitudes measured in Test Pit No. 11 and in both large diameter borings (Appendix A) range from approximately N10E to N30W, with dips between 9 and 20 degrees to the west. Measured bedding attitudes were similar to those reported on regional geologic maps of the area.

## **4. GROUNDWATER**

We did not encounter groundwater or seepage during our site investigation. However, it is not uncommon for shallow seepage conditions to develop where none previously existed when sites are irrigated or infiltration is implemented. Seepage is dependent on seasonal precipitation, irrigation, land use, among other factors, and varies as a result. Proper surface drainage will be important to future performance of the project.

## **5. GEOLOGIC HAZARDS**

### **5.1 Faulting and Seismicity**

A review of the referenced geologic materials and our knowledge of the general area indicates that the site is not underlain by active, potentially active, or inactive faults. However, a strand of the potentially active La Nacion Fault is mapped approximately 400 feet east of the site. An active fault is defined by the California Geological Survey (CGS) as a fault showing evidence for activity within the



last 11,700 years. The closest active fault is Newport Inglewood-Rose Canyon Fault zone, located approximately eight miles west of the site. The site is not located within a State of California Earthquake Fault Zone.

The United States Geological Survey (USGS) has developed a program to evaluate the approximate location of faulting in the area of properties. The following figure shows the location of the existing faulting in the San Diego County and Southern California region. The faults are shown as solid, dashed and dotted traces representing well constrained, moderately constrained and inferred faults, respectively. The fault line colors represent faults with ages less than 150 years (red), 15,000 years (orange), 130,000 years (green), 750,000 years (blue) and 1.6 million years (black).



Faults in the San Diego Area

The San Diego County and Southern California region is seismically active. The following figure presents the occurrence of earthquakes with a magnitude greater than 2.5 from the period of 1900 through 2015 according to the Bay Area Earthquake Alliance website.

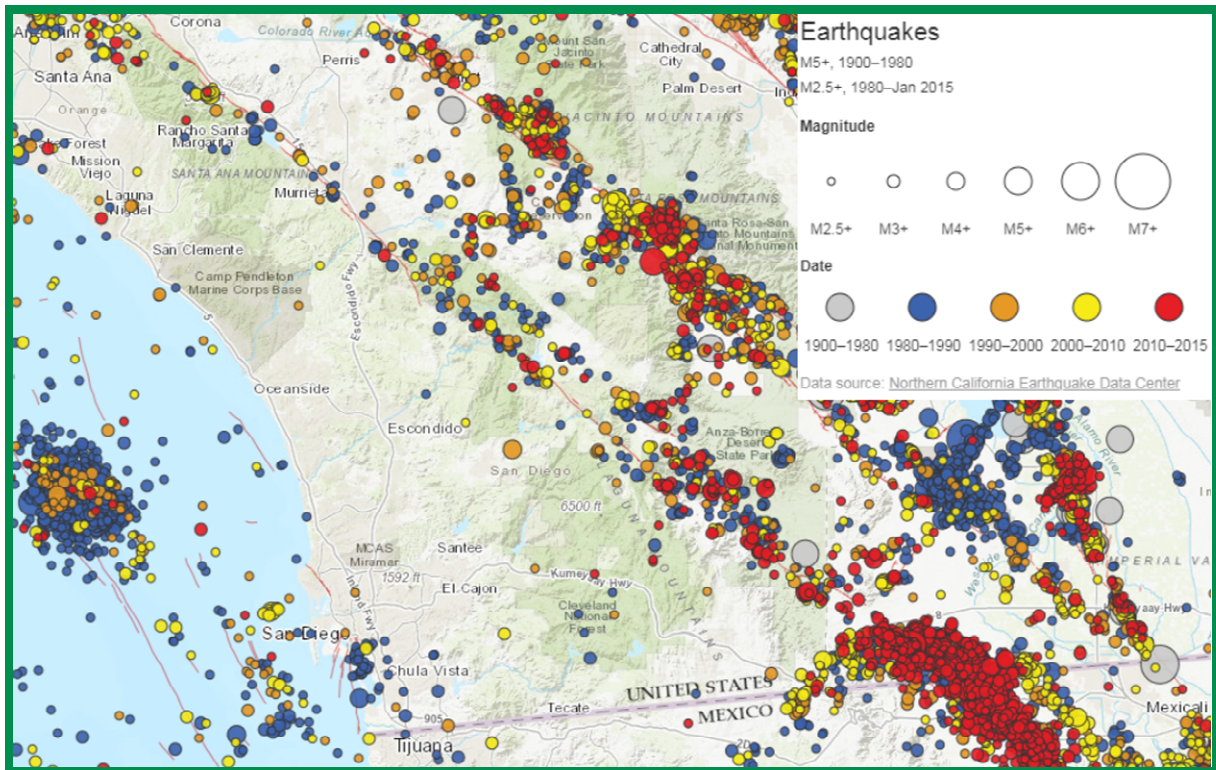

**Earthquakes in Southern California**

Considerations important in seismic design include the frequency and duration of motion and the soil conditions underlying the site. Seismic design of structures should be evaluated in accordance with the California Building Code (CBC) guidelines currently adopted by the local agency.

## 5.2 Ground Rupture

The risk associated with ground rupture hazard is very low due to the absence of active faults at the subject site.

## 5.3 Storm Surge, Tsunamis, and Seiches

Storm surges are large ocean waves that sweep across coastal areas when storms make landfall. Storm surges can cause inundation, severe erosion and backwater flooding along the waterfront. The site is located over six miles from the Pacific Ocean and is at an elevation of about 145 feet or greater above Mean Sea Level (MSL). Therefore, the potential of storm surges affecting the site is considered low.

A tsunami is a series of long period waves generated in the ocean by a sudden displacement of large volumes of water. Causes of tsunamis include underwater earthquakes, volcanic eruptions, or offshore slope failures. The potential for the site to be affected by a tsunami is negligible due to the distance from the Pacific Ocean and the site elevation.

A seiche is a run-up of water within a lake or embayment triggered by fault- or landslide-induced ground displacement. The site is not located in the vicinity of or downstream from such bodies of water. Therefore, the risk of seiches affecting the site is negligible.

#### **5.4 Flooding**

According to maps produced by the Federal Emergency Management Agency (FEMA), the site is zoned as “Zone X – Minimal Flood Hazard.” Based on our review of FEMA flood maps, the risk of site flooding is considered low.

#### **5.5 Liquefaction**

Liquefaction typically occurs when a site is located in a zone with seismic activity, onsite soils are cohesionless or silt/clay with low plasticity, groundwater is encountered within 50 feet of the surface and soil densities are less than about 70 percent of the maximum dry densities. If the four previous criteria are met, a seismic event could result in a rapid pore water pressure increase from the earthquake-generated ground accelerations. Due to the lack of a permanent, near-surface groundwater table and the dense nature of the underlying geologic units on the property, liquefaction potential for the site is considered very low.

#### **5.6 Landslides**

We did not observe evidence of previous or incipient slope instability at the site during our study. Published geologic mapping indicates landslides are not present on or immediately adjacent to the site. Therefore, the risk of landsliding at the site is considered low.

## 6. CONCLUSIONS AND RECOMMENDATIONS

### 6.1 General

- 6.1.1 No soil or geologic conditions were observed that would preclude the development of the property as presently proposed provided that the recommendations of this report are followed.
- 6.1.2 The site is underlain by compressible surficial deposits consisting of undocumented fill, topsoil and alluvium, overlying Quaternary-age Terrace Deposits, Very Old Paralic Deposits, and Tertiary-age San Diego Formation. The undocumented fill and topsoil range from approximately one to 4 feet thick. The alluvium extends to depths greater than 20 feet thick in the southeast corner of the site, but may be thicker in unexplored areas of the site. Additionally, minor amounts of trash and construction debris have been placed at the site.
- 6.1.3 Undocumented fill, topsoil, and the upper five feet of alluvium and Terrace Deposits are unsuitable in their present condition to receive additional fill or settlement-sensitive structures and will require removal and recompaction. Portions of the topsoil are highly expansive. To reduce the potential for soil heave impacting foundations and site improvements, we recommend burial of clayey topsoil at least five feet below design pad grade and outside of the foundation, reinforced, and retained zones of MSE walls.
- 6.1.4 We did not encounter groundwater during our subsurface exploration, and groundwater should not be a constraint to project development. However, seepage within surficial soils and formational materials may be encountered during the grading operations, especially during the rainy seasons.
- 6.1.5 Except for possible strong seismic shaking, no significant geologic hazards were observed or are known to exist on the site that would adversely affect the site. No special seismic design considerations, other than those recommended herein, are required.
- 6.1.6 Proper drainage should be maintained in order to preserve the engineering properties of the fill in both the building pads and slope areas. Recommendations for site drainage are provided herein.
- 6.1.7 We did not perform infiltration testing as part of this study as preliminary design plans were not available. Due to the proposed MSE walls and deep fills required in the south (down-gradient) portion of the site needed to create a level building pad, infiltration of storm water is not recommended on this site.



- 6.1.8 Provided the recommendations of this report are followed, it is our opinion that the proposed development will not destabilize or result in settlement of adjacent properties and City right-of-way.
- 6.1.9 Subsurface conditions observed may be extrapolated to reflect general soil/geologic conditions; however, some variations in subsurface conditions between trench locations should be anticipated.

## **6.2 Soil and Excavation Characteristics**

- 6.2.1 The recommendations included herein are provided for stable excavations. It is the responsibility of the contractor and their competent person to ensure all excavations, temporary slopes and trenches are properly constructed and maintained in accordance with applicable OSHA guidelines in order to maintain safety and the stability of the excavations and adjacent improvements. These excavations should not be allowed to become saturated or to dry out. Surcharge loads should not be permitted to a distance equal to the height of the excavation from the top of the excavation. The top of the excavation should be a minimum of 15 feet from the edge of existing improvements. Excavations steeper than those recommended or closer than 15 feet from an existing surface improvement should be shored in accordance with applicable OSHA codes and regulations.
- 6.2.2 The stability of the excavations is dependent on the design and construction of the shoring system and site conditions. Therefore, Geocon Incorporated cannot be responsible for site safety and the stability of the proposed excavations.
- 6.2.3 Excavation of existing undocumented fill and surficial deposits should be possible with moderate to heavy effort using conventional heavy-duty equipment. We expect excavation of the Terrace Deposits, Very Old Paralic Deposits, and the San Diego Formation will require moderate to very heavy effort. Weakly to moderately cemented gravel and/or cobble and zones may be encountered requiring very heavy effort to excavate.
- 6.2.4 The soil encountered in the field investigation is considered to be both “non-expansive” (expansion index [EI] of 20 and less) and “expansive” (EI greater than 20) as defined by 2019 California Building Code (CBC) Section 1803.5.3. Table 6.2.1 presents soil classifications based on the expansion index. We expect the majority of the soils that will be encountered in remedial grading and cut areas will have a “low” expansion potential. Portions of the topsoil possess a “medium” to “high” expansion potential (EI of 51 or greater).

**TABLE 6.2.1  
EXPANSION CLASSIFICATION BASED ON EXPANSION INDEX**

Expansion Index (EI)	ASTM D 4829 Expansion Classification	2019 CBC Expansion Classification
0 – 20	Very Low	Non-Expansive
21 – 50	Low	Expansive
51 – 90	Medium	
91 – 130	High	
Greater Than 130	Very High	

6.2.5 We performed laboratory tests on samples of the site materials to evaluate the percentage of water-soluble sulfate content. Appendix B presents results of the laboratory water-soluble sulfate content tests. The test results indicate the on-site materials at the locations tested possess “S0” sulfate exposure to concrete structures as defined by 2019 CBC Section 1904 and ACI 318-14 Chapter 19. Table 6.2.2 presents a summary of concrete requirements set forth by 2019 CBC Section 1904 and ACI 318. The presence of water-soluble sulfates is not a visually discernible characteristic; therefore, other soil samples from the site could yield different concentrations. Additionally, over time landscaping activities (i.e., addition of fertilizers and other soil nutrients) may affect the concentration.

**TABLE 6.2.2  
REQUIREMENTS FOR CONCRETE EXPOSED TO  
SULFATE-CONTAINING SOLUTIONS**

Exposure Class	Water-Soluble Sulfate (SO <sub>4</sub> ) Percent by Weight	Cement Type (ASTM C 150)	Maximum Water to Cement Ratio by Weight <sup>1</sup>	Minimum Compressive Strength (psi)
S0	SO <sub>4</sub> <0.10	No Type Restriction	n/a	2,500
S1	0.10≤SO <sub>4</sub> <0.20	II	0.50	4,000
S2	0.20≤SO <sub>4</sub> ≤2.00	V	0.45	4,500
S3	SO <sub>4</sub> >2.00	V+Pozzolan or Slag	0.45	4,500

6.2.6 We tested samples for potential of hydrogen (pH) and resistivity and chloride to aid in evaluating the corrosion potential. Appendix B presents the laboratory test results.

6.2.7 Geocon Incorporated does not practice in the field of corrosion engineering. Therefore, further evaluation by a corrosion engineer may be needed if improvements susceptible to corrosion are planned.

## 6.3 Grading Recommendations

- 6.3.1 Grading should be performed in accordance with the recommendations provided in this report, the Recommended Grading Specifications contained in Appendix C and the City of Chula Vista's Grading Ordinance. Where the recommendations of this section conflict with those of Appendix C, **the recommendations of this section take precedence**. Geocon Incorporated should observe the grading operations on a full-time basis and provide testing during the fill placement.
- 6.3.2 Prior to commencing grading, a preconstruction conference should be held at the site with the City inspector, developer, grading and underground contractors, civil engineer, and geotechnical engineer in attendance. Special soil handling and/or the grading plans can be discussed at that time.
- 6.3.3 Site preparation should begin with the removal of deleterious material, trash and debris, and vegetation. The depth of vegetation removal should be such that material exposed in cut areas or soil to be used as fill is relatively free of organic matter. Material generated during stripping and/or site demolition should be exported from the site. Asphalt and concrete (if encountered) should not be mixed with the fill soil unless approved by the Geotechnical Engineer.
- 6.3.4 Abandoned foundations and buried utilities (if encountered) should be removed and the resultant depressions and/or trenches should be backfilled with properly compacted material as part of the remedial grading.
- 6.3.5 We recommend undocumented fill, topsoil, and the upper five feet of alluvium and Terrace Deposits be removed and replaced as compacted fill throughout the site. Trash and debris may be encountered in the undocumented fill. Trash and debris, if encountered, should be removed from the fill and exported.
- 6.3.6 Estimated remedial removal depths are shown on the Geologic Map (Figure 1). The actual depth of remedial removals should be determined in the field during grading by a representative of Geocon Incorporated prior to placement and compaction of fill.
- 6.3.7 Based on the existing site conditions, we expect grading will result in cuts and fills from existing grade up to approximately 50 feet to create a level building pad. A cut-to-fill transition will be created in the proposed building pad resulting in San Diego Formation at grade in the north portion of the site and compacted fills up to 50 feet deep in the south portion of the site. Undercutting of the north side of the building pad will be required as shown in Table 6.3.1 below.

- 6.3.8 Expansive soils found in the upper three to four feet below existing site grades should be buried in deep fills and outside of the foundation, reinforced and retained zones of MSE walls, and at least five feet below pad grade or three feet below the deepest foundation element, whichever is deeper.
- 6.3.9. Removals at the toes of proposed fill slopes and in front of retaining walls should extend horizontally beyond the edge of the slope toe or wall a distance equal to the depth of removal. A typical detail of remedial grading beyond slope toes is presented below.

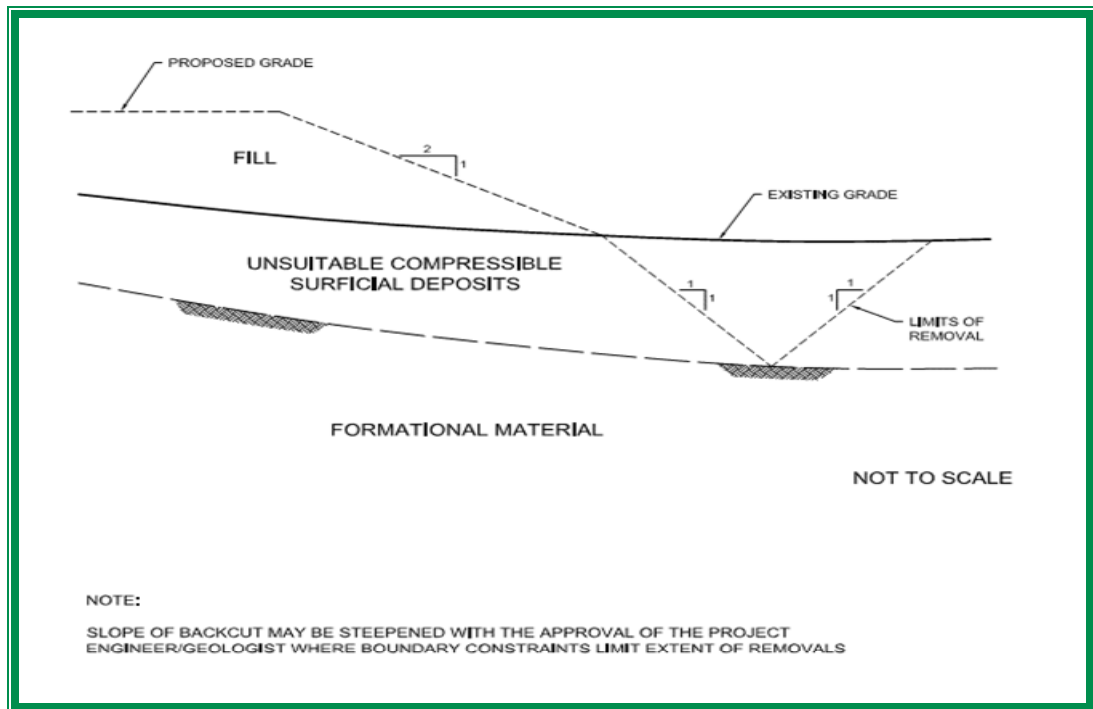

**TABLE 6.3.1  
SUMMARY OF GRADING RECOMMENDATIONS**

Area	Removal Requirements
All Structural Improvement Areas	All undocumented fill and topsoil and the Upper 5 feet of Alluvium and Terrace Deposits
Building Pad (North Side [Cut])	Undercut building pad 5 feet below bottom of building footings to remove cut to fill transition
Fill Areas	Expansive Soil Buried at Least 5 Feet Below Pad Grade or at Least 3 Feet Below Bottom of Footings
Remedial Grading Limits	<ul style="list-style-type: none"> <li>• 10 Feet Outside of Building Pads;</li> <li>• 2 Feet Outside of Improvement Areas;</li> <li>• Beyond toe of slopes and retaining walls a distance equal to the depth of the remedial excavation, where possible</li> </ul>
Exposed Bottoms of Remedial Grading	Scarify Upper 12 Inches

- 6.3.10 Along the south side of the site an existing retaining wall adjacent to the property margin may impact remedial grading limits. Deepened wall footings may be required so as to not impact the existing retaining wall.
- 6.3.11 Excavation bottoms should be sloped 1 percent to the adjacent street or deepest fill. Prior to fill soil being placed, the existing ground surface should be scarified, moisture conditioned as necessary, and compacted to a depth of at least 12 inches. Deeper removals may be required if saturated or loose fill soil is encountered. A representative of Geocon should be on-site during removals to evaluate the limits of the remedial grading.
- 6.3.12 The site should then be brought to final subgrade elevations with fill compacted in layers. In general, soil native to the site is suitable for use from a geotechnical engineering standpoint as fill if relatively free from vegetation, debris and other deleterious material. Layers of fill should be no thicker than will allow for adequate bonding and compaction. Fill, including backfill and scarified ground surfaces, should be compacted to a dry density of at least 90 percent of the laboratory maximum dry density near to slightly above optimum moisture content in accordance with ASTM Test Procedure D 1557. Fill materials placed below optimum moisture content may require additional moisture conditioning prior to placing additional fill.
- 6.3.13 Imported fill (if necessary) should consist of the characteristics presented in Table 6.3.2. Geocon Incorporated should be notified of the import soil source and should perform laboratory testing of import soil prior to its arrival at the site to determine its suitability as fill material.

**TABLE 6.3.2  
SUMMARY OF IMPORT FILL RECOMMENDATIONS**

Soil Characteristic	Values
Expansion Potential	“Very Low” to “Low” (Expansion Index of 50 or less)
Particle Size	Maximum Dimension Less Than 3 Inches
	Generally Free of Debris

## **6.4 Slopes**

- 6.4.1 Slope stability analyses were performed for proposed cut and fill slopes up to 10 feet high (2:1 gradient). The stability analyses were performed using simplified Janbu analysis. Our analyses utilized average drained direct shear strength parameters based on laboratory tests performed for this project and our experience with similar soils. The analyses indicate planned cut and fill slopes, and the existing native perimeter slope will have a calculated factors of safety in excess of 1.5 under static conditions for both deep-seated failure and shallow sloughing conditions. Table 6.4.1 presents the slope stability analysis. Slope

stability analysis for MSE walls should be performed once the wall design is complete and grid locations and lengths are known.

**TABLE 6.4.1  
SLOPE STABILITY EVALUATION**

Parameter	Value
Slope Height, H	20 Feet
Slope Inclination, I (Horizontal to Vertical)	2:1
Total Soil Unit Weight, $\gamma$	125 pcf
Friction Angle, $\phi$	30 Degrees
Cohesion, C	200 psf
Slope Factor $\lambda_{C\phi} = (\gamma H \tan \phi) / C$	7.2
NCf (From Chart)	25
Factor of Safety = $(N_C C) / (\gamma H)$	2.0

6.4.2 Table 6.4.2 presents the surficial slope stability analysis for the proposed sloping conditions.

**TABLE 6.4.2  
SURFICIAL SLOPE STABILITY EVALUATION**

Parameter	Value
Slope Height, H	$\infty$
Vertical Depth of Saturation, Z	3 Feet
Slope Inclination, I (Horizontal to Vertical)	2:1 (26.6 Degrees)
Total Soil Unit Weight, $\gamma$	125 pcf
Water Unit Weight, $\gamma_w$	62.4 pcf
Friction Angle, $\phi$	30 Degrees
Cohesion, C	200 psf
Factor of Safety = $(C + (\gamma + \gamma_w) Z \cos^2 I \tan \phi) / (\gamma Z \sin I \cos I)$	1.9

6.4.3 All cut slope excavations should be observed during grading by an engineering geologist to verify that soil and geologic conditions do not differ significantly from those anticipated.

6.4.4 The outer 15 feet (or a distance equal to the height of the slope, whichever is less) of fill slopes should be composed of properly compacted granular *soil* fill to reduce the potential for surficial sloughing. Granular “soil” fill is defined as a well-graded soil mix with less than 20 percent fines (silt and clay particles). Poorly graded soils with less than 5 percent fines should not be used in the slope zone due to high erosion potential. All slopes should be compacted by backrolling with a loaded sheepsfoot roller at vertical intervals not to exceed 4 feet and should

be track-walked at the completion of each slope such that the fill soils are uniformly compacted to at least 90 percent relative compaction to the face of the finished sloped.

- 6.4.5 All slopes should be landscaped with drought-tolerant vegetation, having variable root depths and requiring minimal landscape irrigation. In addition, all slopes should be drained and properly maintained to reduce erosion.

## 6.5 Earthwork Grading Factors

- 6.5.1 Estimates of shrink-swell factors are based on comparing laboratory compaction tests with the density of the material in its natural state and experience with similar soil types. Variations in natural soil density and compacted fill render shrinkage value estimates very approximate. As an example, the contractor can compact fill to a density of 90 percent or higher of the laboratory maximum dry density. Thus, the contractor has at least a 10 percent range of control over the fill volume. Based on the work performed to date and considering the discussion herein, the earthwork factors in Table 6.5 may be used as a basis for estimating how much the on-site soils may shrink or swell when removed from their natural state and placed as compacted fill.

**TABLE 6.5  
SHRINKAGE AND BULK FACTORS**

Soil Unit	Shrink/Bulk Factor
Undocumented Fill (Qudf)	10-15% Shrink
Previously Placed Fill (Qpf)	0-3% Shrink
Topsoil (unmapped)	5-10% Shrink
Alluvium (Qal)	4-8% Shrink
Terrace Deposits (Qt)	0-5% Bulk
Very Old Paralic Deposits (Qvop)	3-5% Bulk
San Diego Formation (Tsd)	3-5% Bulk

## 6.6 Subdrains

- 6.6.1 With the exception of retaining wall drains, we do not expect subdrains will be required. We should be contacted to provide recommendations for subdrains if field conditions differ from those described herein.

## 6.7 Settlement Monitoring

- 6.7.1 At the completion of grading, the south side of the site will be underlain by up to 50 feet of compacted fill behind MSE walls. Post-grading settlement (hydro-compression) of properly compacted new fill with a maximum thickness of 50 feet could be up to about 2.5 inches.

We expect the settlement could occur over 20+ years depending on the influx of rain and irrigation water into the fill mass. This settlement will likely be linear from the time the fill is placed to the end of the settlement period. We do not expect the settlement will impact proposed utilities with proposed gradients of 1 percent or greater. The building foundation design should be designed to account for potential hydro-compression settlement. It has been our experience that developments/improvements, such as proposed, can be constructed with the planned fill depths and proposed settlements.

6.7.2 We expect settlement in the fill as a result of self-weight compression could take up to 3 to 9 months. If building foundations will be constructed shortly after completion of the fill mass, building foundations will need to be designed to accommodate differential settlement as a result of self-weight compression. If the planned structures cannot tolerate the expected movement, a construction waiting period should be implemented until settlement monitoring indicates self-weight compression has essentially ceased.

6.7.3 At the south end of the property where fills are the greatest, we recommend settlement monuments be installed subsequent to the wall construction. A typical settlement monument is shown below.

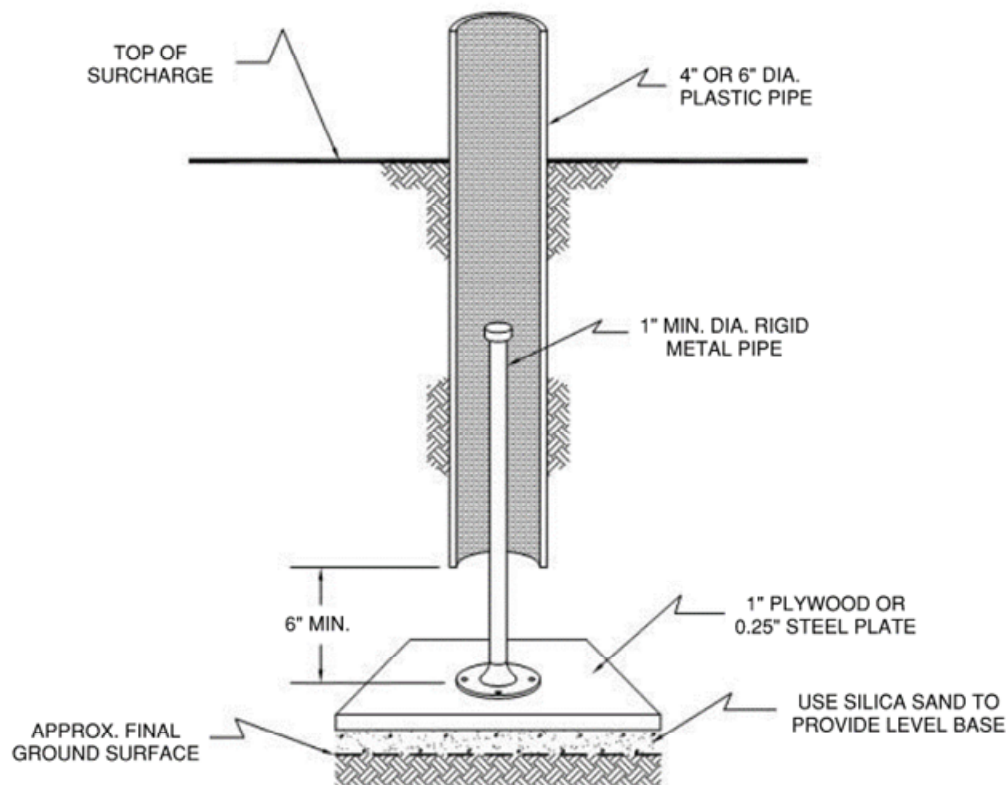

**Settlement Plate Detail**



6.7.4 Surveying of the surface monument should be performed by the project civil engineer every two weeks for at least three months with the results provided to Geocon for review. Settlement due to primary consolidation will be considered to have ceased when survey readings show a relatively level plateau of settlement data over 4 consecutive readings.

## 6.8 Seismic Design Criteria

6.8.1 Table 6.8.1 summarizes site-specific design criteria obtained from the 2019 California Building Code (CBC; Based on the 2018 International Building Code [IBC] and ASCE 7-16), Chapter 16 Structural Design, Section 1613 Earthquake Loads. We used the computer program *Seismic Design Maps*, provided by the Structural Engineers Association (SEA) to calculate the seismic design parameters. The short spectral response uses a period of 0.2 second. We evaluated the Site Class based on the discussion in Section 1613.2.2 of the 2019 CBC and Table 20.3-1 of ASCE 7-16. The values presented herein are for the risk-targeted maximum considered earthquake (MCE<sub>R</sub>) for Site Classes C and D. The southern portion of the building will be underlain by compacted fill in excess of 40 feet. A Site Class D is appropriate for this condition. The northern portion of the building pad will be underlain by shallow compacted fills. Site Class C is appropriate for this condition.

**TABLE 6.8.1  
2019 CBC SEISMIC DESIGN PARAMETERS**

Parameter	Value		2019 CBC Reference
	C	D	
Site Class	C	D	Section 1613.2.2
MCE <sub>R</sub> Ground Motion Spectral Response Acceleration – Class B (short), S <sub>S</sub>	0.896g	0.896g	Figure 1613.2.1(1)
MCE <sub>R</sub> Ground Motion Spectral Response Acceleration – Class B (1 sec), S <sub>1</sub>	0.313g	0.313g	Figure 1613.2.1(2)
Site Coefficient, F <sub>A</sub>	1.2	1.142	Table 1613.2.3(1)
Site Coefficient, F <sub>V</sub>	1.5	1.987*	Table 1613.2.3(2)
Site Class Modified MCE <sub>R</sub> Spectral Response Acceleration (short), S <sub>MS</sub>	1.075g	1.023g	Section 1613.2.3 (Eqn 16-36)
Site Class Modified MCE <sub>R</sub> Spectral Response Acceleration – (1 sec), S <sub>M1</sub>	0.47g	0.622g*	Section 1613.2.3 (Eqn 16-37)
5% Damped Design Spectral Response Acceleration (short), S <sub>DS</sub>	0.717g	0.682g	Section 1613.2.4 (Eqn 16-38)
5% Damped Design Spectral Response Acceleration (1 sec), S <sub>D1</sub>	0.313g	0.415g*	Section 1613.2.4 (Eqn 16-39)

\*Using the code-based values presented in this table, in lieu of a performing a ground motion hazard analysis, requires the exceptions outlined in ASCE 7-16 Section 11.4.8 be followed by the project structural engineer. Per Section 11.4.8 of ASCE/SEI 7-16, a ground motion hazard analysis should be performed for projects for Site Class “E” sites with S<sub>S</sub> greater than or equal to 1.0g and for Site Class “D” and “E” sites with S<sub>1</sub> greater than 0.2g. Section 11.4.8 also provides exceptions which indicates that the ground motion hazard analysis may be waived provided the exceptions are followed.

6.8.2 Table 6.8.2 presents the mapped maximum considered geometric mean ( $MCE_G$ ) seismic design parameters for projects located in Seismic Design Categories of D through F in accordance with ASCE 7-16.

**TABLE 6.8.2  
ASCE 7-16 PEAK GROUND ACCELERATION**

Parameter	Value		ASCE 7-16 Reference
	C	D	
Site Class	C	D	Section 1613.2.2 (2019 CBC)
Mapped $MCE_G$ Peak Ground Acceleration, PGA	0.394g	0.394g	Figure 22-7
Site Coefficient, $F_{PGA}$	1.2	1.206	Table 11.8-1
Site Class Modified $MCE_G$ Peak Ground Acceleration, $PGA_M$	0.473g	0.475g	Section 11.8.3 (Eqn 11.8-1)

6.8.3 Conformance to the criteria in Tables 6.8.1 and 6.8.2 for seismic design does not constitute any kind of guarantee or assurance that significant structural damage or ground failure will not occur if a large earthquake occurs. The primary goal of seismic design is to protect life, not to avoid all damage, since such design may be economically prohibitive.

6.8.4 The project structural engineer and architect should evaluate the appropriate Risk Category and Seismic Design Category for the planned structures. The values presented herein assume a Risk Category of II and resulting in a Seismic Design Category D. Table 6.8.3 presents a summary of the risk categories.

**TABLE 6.8.3  
ASCE 7-16 RISK CATEGORIES**

Risk Category	Building Use	Examples
I	Low risk to Human Life at Failure	Barn, Storage Shelter
II	Nominal Risk to Human Life at Failure (Buildings Not Designated as I, III or IV)	Residential, Commercial and Industrial Buildings
III	Substantial Risk to Human Life at Failure	Theaters, Lecture Halls, Dining Halls, Schools, Prisons, Small Healthcare Facilities, Infrastructure Plants, Storage for Explosives/Toxins
IV	Essential Facilities	Hazardous Material Facilities, Hospitals, Fire and Rescue, Emergency Shelters, Police Stations, Power Stations, Aviation Control Facilities, National Defense, Water Storage

## 6.9 Shallow Foundations

6.9.1 The proposed structure can be supported on a shallow foundation system founded in compacted fill provided the grading recommendations provided in Section 6.3 are followed. Foundations for the structure should consist of continuous strip footings and/or isolated spread footings. Table 6.9.1 provides a summary of the foundation design recommendations.

**TABLE 6.9.1  
SUMMARY OF FOUNDATION RECOMMENDATIONS**

Parameter	Value
Minimum Continuous Foundation Width	12 inches
Minimum Isolated Foundation Width	24 inches
Minimum Foundation Depth	24 Inches Below Lowest Adjacent Grade
Minimum Steel Reinforcement	4 No. 5 Bars, 2 at the Top and 2 at the Bottom
Allowable Bearing Capacity	2,500 psf
Bearing Capacity Increase	500 psf per Foot of Depth
	300 psf per Foot of Width
Maximum Allowable Bearing Capacity	4,000 psf
Estimated Total Settlement	1 Inch
Estimated Differential Settlement	½ Inch in 40 Feet
Footing Size Used for Settlement	9-Foot Square
Design Expansion Index	50 or less

6.9.2 Additional settlement as a result of self-weight compression and hydro-compression could occur over the life of the structure. We estimate approximately 0.4 percent of the total fill thickness underlying the building pad. Self-weight compression is expected to occur over 3 to 9 months. Hydro-compression is expected to occur over a 20 year or more duration. The estimated fill thickness and total settlement as a result of self-weight compression and hydro-compression is shown on Table 6.9.2 and is in addition to the static settlement indicated on Table 6.9.1. An estimate of total and differential fill settlement, including settlement contours thickness and final foundation recommendations to be used in design can be provided, if desired.

**TABLE 6.9.2**  
**ESTIMATED FILL THICKNESS AND TOTAL AND DIFFERENTIAL FILL SETTLEMENT**  
**AS A RESULT OF SELF-WEIGHT AND HYDRO-COMPRESSION**

Estimated Compacted Fill Thickness (after grading) (feet)	Estimated Total Fill Settlement (Self-Weight and Hydro-Compression) (inches)	Estimated Differential Fill Settlement (Self-Weight and Hydro-Compression) (inches)
0 to 50	0 to 2.5	2.5 inches over a span of 200 feet (angular distortion of 1/960)

6.9.3 The foundations should be embedded in accordance with the recommendations herein and the Wall/Column Footing Dimension Detail. The embedment depths should be measured from the lowest adjacent pad grade for both interior and exterior footings. Footings should be deepened such that the bottom outside edge of the footing is at least 7 feet horizontally from the face of the slope (unless designed with a post-tensioned foundation system as discussed herein).

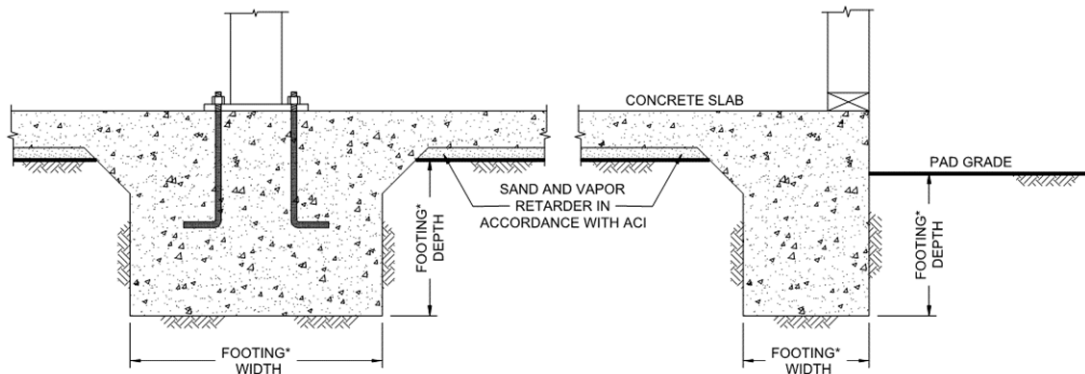

**Wall/Column Footing Dimension Detail**

6.9.4 The bearing capacity values presented herein are for dead plus live loads and may be increased by one-third when considering transient loads due to wind or seismic forces.

6.9.5 Where buildings or other improvements are planned near the top of a slope steeper than 3:1 (horizontal:vertical), special foundations and/or design considerations are recommended due to the tendency for lateral soil movement to occur.

- For fill slopes less than 20 feet high or cut slopes regardless of height, footings should be deepened such that the bottom outside edge of the footing is at least 7 feet horizontally from the face of the slope.

- When located next to a descending 3:1 (horizontal:vertical) fill slope or steeper, the foundations should be extended to a depth where the minimum horizontal distance is equal to H/3 (where H equals the vertical distance from the top of the fill slope to the base of the fill soil) with a minimum of 7 feet but need not exceed 40 feet. The horizontal distance is measured from the outer, deepest edge of the footing to the face of the slope. A post-tensioned slab and foundation system or mat foundation system can be used to reduce the potential for distress in the structures associated with strain softening and lateral fill extension. Specific design parameters or recommendations for either of these alternatives can be provided once the building location and fill slope geometry have been determined.
- Although other improvements, which are relatively rigid or brittle, such as concrete flatwork or masonry walls, may experience some distress if located near the top of a slope, it is generally not economical to mitigate this potential. It may be possible, however, to incorporate design measures that would permit some lateral soil movement without causing extensive distress. Geocon Incorporated should be consulted for specific recommendations.

6.9.6 We should observe the foundation excavations prior to the placement of reinforcing steel and concrete to check that the exposed soil conditions are similar to those expected and that they have been extended to the appropriate bearing strata. Foundation modifications may be required if unexpected soil conditions are encountered.

6.9.7 Geocon Incorporated should be consulted to provide additional design parameters as required by the structural engineer.

## 6.10 Conventional Retaining Wall Recommendations

6.10.1 Retaining walls should be designed using the values presented in Table 6.10.1. Soil with an expansion index (EI) of greater than 50 should not be used as backfill soil behind retaining walls.

**TABLE 6.10.1  
RETAINING WALL DESIGN RECOMMENDATIONS**

Parameter	Value
Active Soil Pressure, A (Fluid Density, Level Backfill)	35 pcf
Active Soil Pressure, A (Fluid Density, 2:1 Sloping Backfill)	50 pcf
Seismic Pressure, S	18H psf
At-Rest/Restrained Walls Additional Uniform Pressure (0 to 8 Feet High)	7H psf
At-Rest/Restrained Walls Additional Uniform Pressure (8+ Feet High)	13H psf
Expected Expansion Index for the Subject Property	$EI \leq 50$

H equals the height of the retaining portion of the wall

6.10.2 The project retaining walls should be designed as shown in the Retaining Wall Loading Diagram.

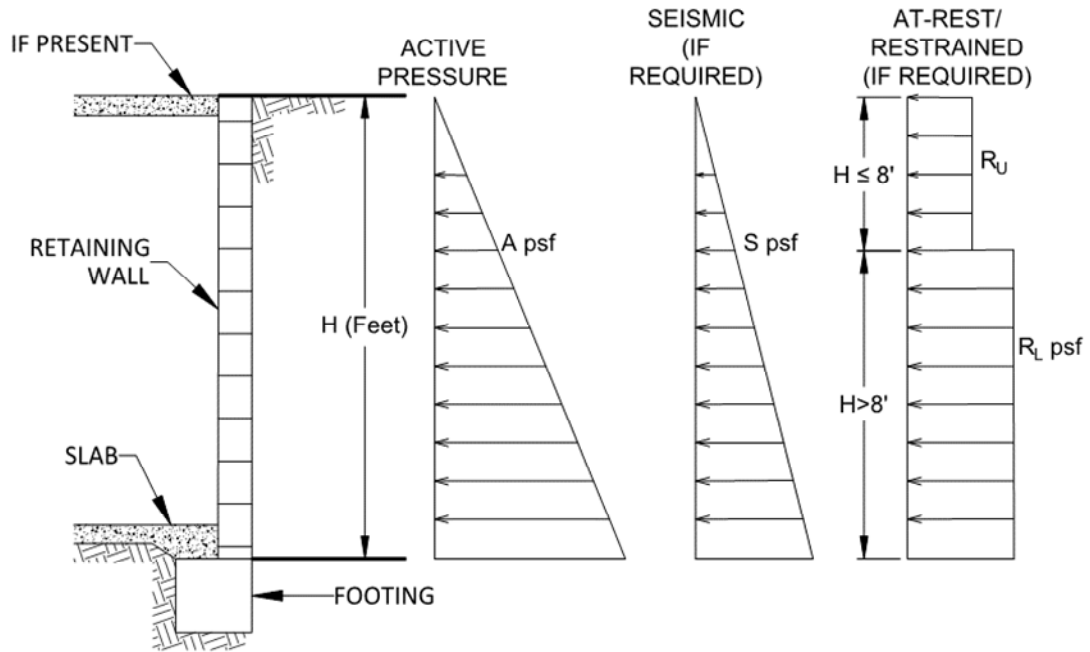

**Retaining Wall Loading Diagram**

6.10.3 Unrestrained walls are those that are allowed to rotate more than  $0.001H$  (where  $H$  equals the height of the retaining portion of the wall) at the top of the wall. Where walls are restrained from movement at the top (at-rest condition), an additional uniform pressure should be applied to the wall. For retaining walls subject to vehicular loads within a horizontal distance equal to two-thirds the wall height, a surcharge equivalent to 2 feet of fill soil should be added.

6.10.4 The structural engineer should determine the Seismic Design Category for the project in accordance with Section 1613.2.5 of the 2019 CBC or Section 11.6 of ASCE 7-16. For structures assigned to Seismic Design Category of D, E, or F, retaining walls that support more than 6 feet of backfill should be designed with seismic lateral pressure in accordance with Section 1803.5.12 of the 2019 CBC. The seismic load is dependent on the retained height where  $H$  is the height of the wall, in feet, and the calculated loads result in pounds per square foot (psf) exerted at the base of the wall and zero at the top of the wall.

6.10.5 Retaining walls should be designed to ensure stability against overturning sliding, and excessive foundation pressure. Where a keyway is extended below the wall base with the intent to engage passive pressure and enhance sliding stability, it is not necessary to consider active pressure on the keyway.

6.10.6 Drainage openings through the base of the wall (weep holes) should not be used where the seepage could be a nuisance or otherwise adversely affect the property adjacent to the base of the wall. The recommendations herein assume a properly compacted granular (EI of 50 or less) free-draining backfill material with no hydrostatic forces or imposed surcharge load. The retaining wall should be properly drained as shown in the Typical Retaining Wall Drainage Detail. If conditions different than those described are expected, or if specific drainage details are desired, Geocon Incorporated should be contacted for additional recommendations.

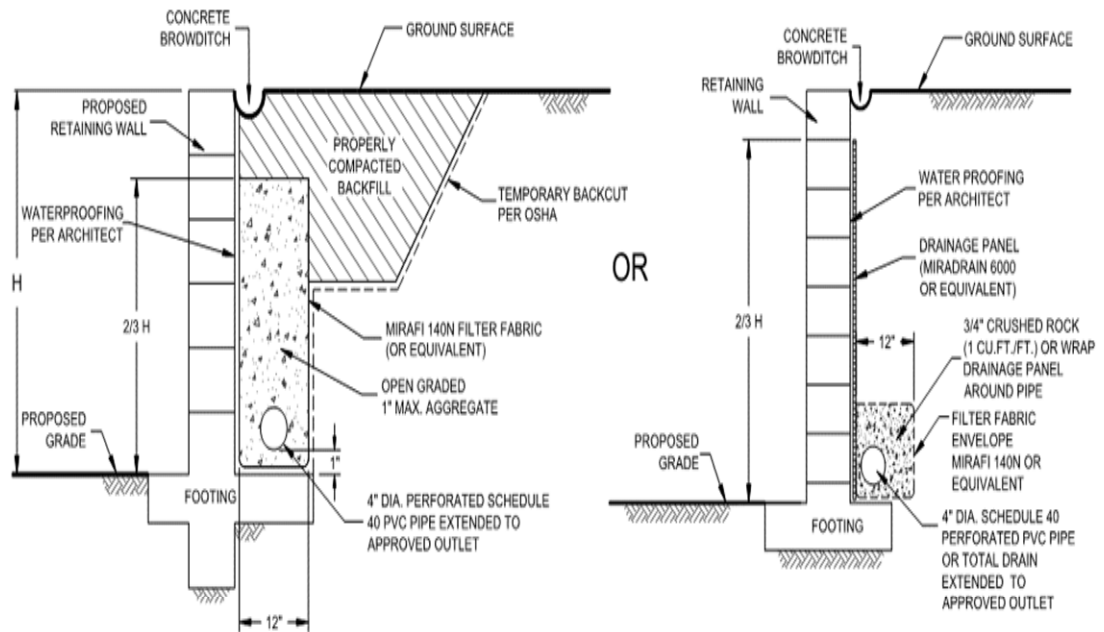

**Typical Retaining Wall Drainage Detail**

6.10.7 The retaining walls may be designed using either the active and restrained (at-rest) loading condition or the active and seismic loading condition as suggested by the structural engineer. Typically, it appears the design of the restrained condition for retaining wall loading may be adequate for the seismic design of the retaining walls. However, the active earth pressure combined with the seismic design load should be reviewed and also considered in the design of the retaining walls.

6.10.8 In general, wall foundations having should be designed in accordance with Table 6.10.2. The proximity of the foundation to the top of a slope steeper than 3:1 could impact the allowable soil bearing pressure. Therefore, retaining wall foundations should be deepened such that the bottom outside edge of the footing is at least 7 feet horizontally from the face of the slope.

**TABLE 6.10.2  
SUMMARY OF RETAINING WALL FOUNDATION RECOMMENDATIONS**

Parameter	Value
Minimum Retaining Wall Foundation Width	12 inches
Minimum Retaining Wall Foundation Depth	12 Inches
Minimum Steel Reinforcement	Per Structural Engineer
Bearing Capacity	2,500 psf
Bearing Capacity Increase	500 psf per additional foot of footing depth
	300 psf per additional foot of footing width
Maximum Bearing Capacity	4,000 psf
Estimated Total Settlement	1 Inch
Estimated Differential Settlement	½ Inch in 40 Feet

6.10.9 The recommendations presented herein are generally applicable to the design of rigid concrete or masonry retaining walls. Additional recommendations for MSE walls and soil nail walls are provided in Sections 6.12 and 6.13.

6.10.10 Unrestrained walls will move laterally when backfilled and loading is applied. The amount of lateral deflection is dependent on the wall height, the type of soil used for backfill, and loads acting on the wall. The retaining walls and improvements above the retaining walls should be designed to incorporate an appropriate amount of lateral deflection as determined by the structural engineer.

6.10.11 Soil contemplated for use as retaining wall backfill, including import materials, should be identified in the field prior to backfill. At that time, Geocon Incorporated should obtain samples for laboratory testing to evaluate its suitability. Modified lateral earth pressures may be necessary if the backfill soil does not meet the required expansion index or shear strength. City or regional standard wall designs, if used, are based on a specific active lateral earth pressure and/or soil friction angle. In this regard, on-site soil to be used as backfill may or may not meet the values for standard wall designs. Geocon Incorporated should be consulted to assess the suitability of the on-site soil for use as wall backfill if standard wall designs will be used.

## **6.11 Lateral Loading**

6.11.1 Table 6.11 should be used to help design the proposed structures and improvements to resist lateral loads for the design of footings or shear keys. The allowable passive pressure assumes a horizontal surface extending at least 5 feet, or three times the surface generating the passive pressure, whichever is greater. The upper 12 inches of material in areas not



protected by floor slabs or pavement should not be included in design for passive resistance. Where walls are planned adjacent to and/or on descending slopes, a passive pressure of 150 pcf should be used in design.

**TABLE 6.11  
SUMMARY OF LATERAL LOAD DESIGN RECOMMENDATIONS**

Parameter	Value
Passive Pressure Fluid Density	350 pcf
Passive Pressure Fluid Density Adjacent to and/or on Descending Slopes	150 pcf
Coefficient of Friction (Concrete and Soil)	0.35
Coefficient of Friction (Along Vapor Barrier)	0.2 to 0.25*

\*Per manufacturer's recommendations.

6.11.2 The passive and frictional resistant loads can be combined for design purposes. The lateral passive pressures may be increased by one-third when considering transient loads due to wind or seismic forces.

## **6.12 Mechanically Stabilized Earth (MSE) Retaining Walls**

6.12.1 Mechanized stabilized earth (MSE) retaining walls are planned for the project. MSE retaining walls are alternative walls that consist of modular block facing units with geogrid reinforced earth behind the block. The reinforcement grid attaches to the block units and is typically placed at specified vertical intervals and embedment lengths. The grid length and spacing will be determined by the wall designer.

6.12.2 The geotechnical parameters listed in Table 6.12.1 can be used for preliminary design of the MSE walls. Once actual soil to be used as backfill has been determined and stockpiled, laboratory testing should be performed to check that the soil meets the parameters used in the design of the MSE walls.

**TABLE 6.12.1  
GEOTECHNICAL PARAMETERS FOR MSE WALLS**

Parameter	Reinforced Zone	Retained Zone	Foundation Zone
Angle of Internal Friction	30 degrees	30 degrees	30 degrees
Cohesion	100 psf	100 psf	100 psf
Wet Unit Density	125 pcf	125 pcf	125 pcf

- 6.12.3 The soil parameters presented in Table 6.12.1 are based on our experience and direct shear-strength tests performed during the geotechnical investigation and represent some of the on-site materials. The wet unit density values presented in Table 6.12.1 can be used for design but actual in-place densities may range from approximately 110 to 130 pounds per cubic foot. Geocon has no way of knowing which materials will actually be used as backfill behind the wall during construction. It is up to the wall designers to use their judgment in selection of the design parameters. As such, once backfill materials have been selected and/or stockpiled, sufficient shear tests should be conducted on samples of the proposed backfill materials to check that they conform to actual design values. Results should be provided to the designer to re-evaluate stability of the walls. Dependent upon test results, the designer may require modifications to the original wall design (e.g., longer reinforcement embedment lengths and/or steel reinforcement).
- 6.12.4 Wall foundations should be designed in accordance with Table 6.12.2 The walls should be deepened such that the bottom outside edge of the footing is at least 7 feet horizontally from the face of the slope.

**TABLE 6.12.2  
SUMMARY OF MSE RETAINING WALL FOUNDATION RECOMMENDATIONS**

Parameter	Value
Minimum Retaining Wall Foundation Width	12 inches
Minimum Retaining Wall Foundation Depth	12 Inches
Bearing Capacity	2,000 psf
Bearing Capacity Increase	500 psf per Foot of Depth
	300 psf per Foot of Width
Maximum Bearing Capacity	4,000 psf
Estimated Total Settlement	1 Inch
Estimated Differential Settlement	½ Inch in 40 Feet

- 6.12.5 Backfill materials within the reinforced zone should be compacted to a dry density of at least 90 percent of the laboratory maximum dry density near to slightly above optimum moisture content in accordance with ASTM D 1557. This is applicable to the entire embedment width of the reinforcement. Typically, wall designers specify no heavy compaction equipment within 3 feet of the face of the wall. However, smaller equipment (e.g., walk-behind, self-driven compactors or hand whackers) can be used to compact the materials without causing deformation of the wall. If the designer specifies no compactive effort for this zone, the materials are essentially not properly compacted and the reinforcement grid within the uncompacted zone should not be relied upon for

reinforcement, and overall embedment lengths will have to be increased to account for the difference.

- 6.12.6 The wall should be provided with a drainage system sufficient to prevent excessive seepage through the wall and the base of the wall, thus preventing hydrostatic pressures behind the wall.
- 6.12.7 Geosynthetic reinforcement must elongate to develop full tensile resistance. This elongation generally results in movement at the top of the wall. The amount of movement is dependent on the height of the wall (e.g., higher walls rotate more) and the type of reinforcing grid used. In addition, over time the reinforcement grid has been known to exhibit creep (sometimes as much as 5 percent) and can undergo additional movement. Given this condition, the owner should be aware that structures and pavement placed within the reinforced and retained zones of the wall may undergo movement.
- 6.12.8 The MSE wall contractor should provide the estimated deformation of wall and adjacent ground in associated with wall construction. The calculated horizontal and vertical deformations should be determined by the wall designer. Where buildings are located adjacent to the walls, the estimated movements should be provided to the project structural engineer to evaluate if the building foundation can tolerate the expected movements. With respect to improvements adjacent to the wall, cracking and/or movement should be expected.
- 6.12.9 The MSE wall designer/contractor should review this report, including the slope stability requirements, and incorporate our recommendations as presented herein. We should be provided the plans for the MSE walls to check if they are in conformance with our recommendations prior to issuance of a permit and construction.

### **6.13 Soil Nail Walls**

- 6.13.1 We understand soil nail walls are planned for the project. Soil nail walls consist of installing closely spaced steel bars (nails) into a slope or excavation in a top-down construction sequence. Following installation of a horizontal row of nails, drains, waterproofing and wall reinforcing steel are placed and shotcrete applied to create a final wall. The wall should be designed by an engineer familiar with the design of soil nail walls.
- 6.13.2 In general, ground conditions are moderately suited to soil nail wall construction techniques. However, localized gravel, cobble and oversized material could be encountered in the existing materials that could be difficult to drill. Additionally, relatively clean sands may be

encountered that may result in some raveling of the unsupported excavation. Casing or specialized drilling techniques should be planned where raveling exists (e.g. casing).

6.13.3 Testing of the soil nails should be performed in accordance with the guidelines of the Federal Highway Administration or similar guidelines. At least two verification tests should be performed to confirm design assumptions for each soil/rock type encountered. Verification tests nails should be sacrificial and should not be used to support the proposed wall. The bond length should be adjusted to allow for pullout testing of the verification nails to evaluate the ultimate bond stress. A minimum of 5 percent of the production nails should also be proof tested and a minimum of 4 sacrificial nails should be tested at the discretion of Geocon Incorporated. Consideration should be given to testing sacrificial nails with an adjusted bond length rather than testing production nails. Geocon Incorporated should observe the nail installation and perform the nail testing.

6.13.4 The soil strength parameters listed in Table 6.13 can be used in design of the soil nails. The bond stress is dependent on drilling method, diameter, and construction method. Therefore, the designer should evaluate the bond stress based on soil conditions and the construction method.

**TABLE 6.13  
SOIL STRENGTH PARAMETERS FOR SOIL NAIL WALLS**

Description	Cohesion (psf)	Friction Angle (degrees)	Estimated Ultimate Bond Stress (psi)*
Previously Placed Fill	100	28	10
Alluvium	100	28	10
Very Old Paralic Deposits	200	33	20
San Diego Formation	200	33	20

\*Assuming gravity fed, open hole drilling techniques.

6.13.5 A wall drain system should be incorporated into the design of the soil nail wall as shown herein. Corrosion protection should be provided for the nails.

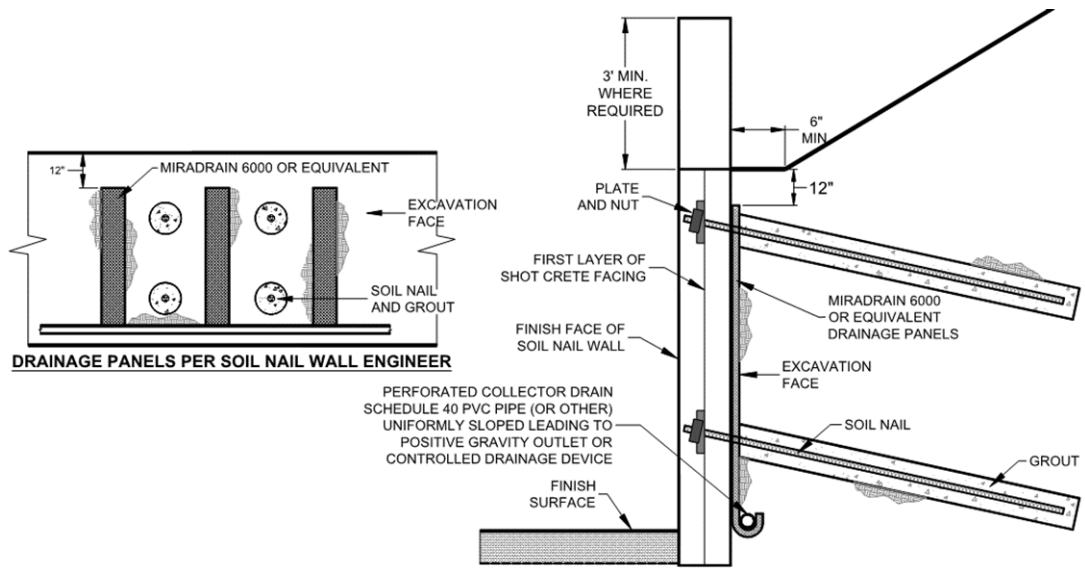

**Soil Nail Wall Drainage Detail**

**6.14 Preliminary Pavement Recommendations**

6.14.1 Preliminary pavement recommendations for the driveways and parking areas are provided below. The final pavement sections should be based on the R-Value of the subgrade soil encountered at final subgrade elevation. For preliminary design, we used a laboratory R-Value of 15. We calculated the preliminary flexible pavement sections for asphalt concrete using varying traffic indices (TIs) in general conformance with the *Caltrans Method of Flexible Pavement Design* (Highway Design Manual, Section 608.4). The project civil engineer or traffic engineer should determine the appropriate Traffic Index (TI) or traffic loading expected on the project for the various pavement areas that will be constructed. Recommended preliminary asphalt concrete pavement sections are provided on Table 6.14.1.

**TABLE 16.14.1  
PRELIMINARY ASPHALT CONCRETE PAVEMENT SECTIONS**

Traffic Index	Asphalt Concrete (inches)	Class 2 Base (inches)
4.5	3	6
5	3	8
5.5	3	10
6	3.5	10.5
6.5	3.5	12.5
7	4	13
7.5	4.5	15
8	5	15

- 6.14.2 Asphalt concrete should conform to Section 203-6 of the *Standard Specifications for Public Works Construction* (Green Book). Class 2 aggregate base materials should conform to Section 26-1.02B of the *Standard Specifications of the State of California, Department of Transportation* (Caltrans).
- 6.14.3 Prior to placing base material, the subgrade should be scarified, moisture conditioned and recompacted to a minimum of 95 percent relative compaction. The depth of compaction should be at least 12 inches. The base material should be compacted to at least 95 percent relative compaction. Asphalt concrete should be compacted to a density of at least 95 percent of the laboratory Hveem density in accordance with ASTM D 2726.
- 6.14.4 A rigid Portland Cement concrete (PCC) pavement section can also be used. We calculated the rigid pavement section in general conformance with the procedure recommended by the American Concrete Institute report ACI 330R-08 Guide for Design and Construction of Concrete Parking Lots using the parameters presented in Table 6.14.2.

**TABLE 6.14.2  
PRELIMINARY RIGID PAVEMENT DESIGN PARAMETERS**

Design Parameter	Design Value
Modulus of subgrade reaction, k	100 pci
Modulus of rupture for concrete, $M_R$	500 psi
Concrete Compressive Strength	3,000 psi
Traffic Category, TC	A and C
Average daily truck traffic, ADTT	10 and 300

- 6.14.5 Based on the criteria presented herein, the PCC pavement sections should have a minimum thickness as presented in Table 6.14.3.

**TABLE 6.14.3  
RIGID VEHICULAR PAVEMENT RECOMMENDATIONS**

Location	Portland Cement Concrete (inches)
Automobile Parking Stalls (TC=A, ADTT=10)	5.5
Driveways (TC=C, ADTT=100)	7.5

- 6.14.6 The PCC vehicular pavement should be placed over subgrade soil that is compacted to a dry density of at least 95 percent of the laboratory maximum dry density near to slightly above optimum moisture content.
- 6.14.7 The rigid pavement should also be designed and constructed incorporating the parameters presented in Table 6.14.4.

**TABLE 6.14.4  
ADDITIONAL RIGID PAVEMENT RECOMMENDATIONS**

Subject	Value
Thickened Edge	1.2 Times Slab Thickness
	Minimum Increase of 2 Inches
	4 Feet Wide
Crack Control Joint Spacing	30 Times Slab Thickness
	Max. Spacing of 12 feet for 5.5-Inch-Thick
	Max. Spacing of 15 Feet for Slabs 6 Inches and Thicker
Crack Control Joint Depth	Per ACI 330R-08
	1 Inch Using Early-Entry Saws on Slabs Less Than 9 Inches Thick
Crack Control Joint Width	$\frac{1}{4}$ -Inch for Sealed Joints
	$\frac{3}{8}$ -Inch is Common for Sealed Joints
	$\frac{1}{10}$ - to $\frac{1}{8}$ -Inch is Common for Unsealed Joints

- 6.14.8 Reinforcing steel will not be necessary within the concrete for geotechnical purposes with the possible exception of dowels at construction joints as discussed herein.
- 6.14.9 To control the location and spread of concrete shrinkage cracks, crack-control joints (weakened plane joints) should be included in the design of the concrete pavement slab. Crack-control joints should be sealed with an appropriate sealant to prevent the migration of water through the control joint to the subgrade materials. The depth of the crack-control joints should be determined by the referenced ACI report.
- 6.14.10 To provide load transfer between adjacent pavement slab sections, a butt-type construction joint should be constructed. The butt-type joint should be thickened by at least 20 percent at the edge and taper back at least 4 feet from the face of the slab. As an alternative to the butt-type construction joint, dowelling can be used between construction joints for pavements of 7 inches or thicker. As discussed in the referenced ACI guide, dowels should consist of

smooth, 1-inch-diameter reinforcing steel 14 inches long embedded a minimum of 6 inches into the slab on either side of the construction joint. Dowels should be located at the midpoint of the slab, spaced at 12 inches on center and lubricated to allow joint movement while still transferring loads. In addition, tie bars should be installed as recommended in Section 3.8.3 of the referenced ACI guide. The structural engineer should provide other alternative recommendations for load transfer.

- 6.14.11 Concrete curb/gutter should be placed on soil subgrade compacted to a dry density of at least 90 percent of the laboratory maximum dry density near to slightly above optimum moisture content. Cross-gutters that receives vehicular should be placed on subgrade soil compacted to a dry density of at least 95 percent of the laboratory maximum dry density near to slightly above optimum moisture content. Base materials should not be placed below the curb/gutter, or cross-gutters so water is not able to migrate from the adjacent parkways to the pavement sections. Where flatwork is located directly adjacent to the curb/gutter, the concrete flatwork should be structurally connected to the curbs to help reduce the potential for offsets between the curbs and the flatwork.

## 6.15 Exterior Concrete Flatwork

- 6.15.1 Exterior concrete flatwork not subject to vehicular traffic should be constructed in accordance with the recommendations presented in Table 6.15. The recommended steel reinforcement would help reduce the potential for cracking.

**TABLE 6.15  
MINIMUM CONCRETE FLATWORK RECOMMENDATIONS**

Expansion Index, EI	Minimum Steel Reinforcement* Options	Minimum Thickness
EI ≤ 90	6x6-W2.9/W2.9 (6x6-6/6) welded wire mesh	4 Inches
	No. 3 Bars 18 inches on center, Both Directions	
EI ≤ 130	4x4-W4.0/W4.0 (4x4-4/4) welded wire mesh	
	No. 4 Bars 12 inches on center, Both Directions	

\*In excess of 8 feet square.

- 6.15.2 Even with the incorporation of the recommendations of this report, the exterior concrete flatwork has a potential to experience some uplift due to expansive soil beneath grade. The steel reinforcement should overlap continuously in flatwork to reduce the potential for vertical offsets within flatwork. Additionally, flatwork should be structurally connected to the curbs, where possible, to reduce the potential for offsets between the curbs and the flatwork.



- 6.15.3 Concrete flatwork should be provided with crack control joints to reduce and/or control shrinkage cracking. Crack control spacing should be determined by the project structural engineer based upon the slab thickness and intended usage. Criteria of the American Concrete Institute (ACI) should be taken into consideration when establishing crack control spacing. Subgrade soil for exterior slabs not subjected to vehicle loads should be compacted in accordance with criteria presented in the grading section prior to concrete placement. Subgrade soil should be properly compacted, and the moisture content of subgrade soil should be verified prior to placing concrete. Base materials will not be required below concrete improvements.
- 6.15.4 Where exterior flatwork abuts the structure at entrant or exit points, the exterior slab should be dowelled into the structure's foundation stemwall. This recommendation is intended to reduce the potential for differential elevations that could result from differential settlement or minor heave of the flatwork. Dowelling details should be designed by the project structural engineer.
- 6.15.5 The recommendations presented herein are intended to reduce the potential for cracking of exterior slabs as a result of differential movement. However, even with the incorporation of the recommendations presented herein, slabs-on-grade will still crack. The occurrence of concrete shrinkage cracks is independent of the soil supporting characteristics. Their occurrence may be reduced and/or controlled by limiting the slump of the concrete, the use of crack control joints and proper concrete placement and curing. Crack control joints should be spaced at intervals no greater than 12 feet. Literature provided by the Portland Concrete Association (PCA) and American Concrete Institute (ACI) present recommendations for proper concrete mix, construction, and curing practices, and should be incorporated into project construction.

## **6.16 Slope Maintenance**

- 6.16.1 Slopes that are steeper than 3:1 (horizontal:vertical) may, under conditions which are both difficult to prevent and predict, be susceptible to near surface (surficial) slope instability. The instability is typically limited to the outer three feet of a portion of the slope and usually does not directly impact the improvements on the pad areas above or below the slope. The occurrence of surficial instability is more prevalent on fill slopes and is generally preceded by a period of heavy rainfall, excessive irrigation, or the migration of subsurface seepage. The disturbance and/or loosening of the surficial soils, as might result from root growth, soil expansion, or excavation for irrigation lines and slope planting, may also be a significant contributing factor to surficial instability. It is, therefore, recommended that, to the maximum extent practical: (a) disturbed/loosened surficial soils be either removed or properly recompacted, (b) irrigation systems be periodically inspected and maintained to

eliminate leaks and excessive irrigation, and (c) surface drains on and adjacent to slopes be periodically maintained to preclude ponding or erosion. Although the incorporation of the above recommendations should reduce the potential for surficial slope instability, it will not eliminate the possibility, and, therefore, it may be necessary to rebuild or repair a portion of the project's slopes in the future.

## **6.17 Storm Water Management**

- 6.17.1 If storm water management devices are not properly designed and constructed, there is a risk for distress to improvements and property located hydrologically down gradient or adjacent to these devices. Factors such as the amount of water being detained, its residence time, and soil permeability have an important effect on seepage transmission and the potential adverse impacts that may occur if the storm water management features are not properly designed and constructed. We have not performed a hydrogeological study at the site. If infiltration of storm water runoff into the subsurface occurs, downstream improvements may be subjected to seeps, springs, slope instability, raised groundwater, movement of foundations and slabs, or other undesirable impacts as a result of water infiltration.
- 6.17.2 We did not perform an infiltration study on the property. However, based on predicted site conditions at the completion of grading, full and partial infiltration is considered infeasible due to the presence of deep fills surrounded by MSE walls at the down-gradient end of the site. Basins or other storm water devices should utilize a liner to prevent infiltration from causing adverse settlement and heave, and migrating to utilities, and foundations.

## **6.18 Site Drainage and Moisture Protection**

- 6.18.1 Adequate site drainage is critical to reduce the potential for differential soil movement, erosion and subsurface seepage. Under no circumstances should water be allowed to pond adjacent to footings. The site should be graded and maintained such that surface drainage is directed away from structures in accordance with 2019 CBC 1803.3 or other applicable standards. In addition, surface drainage should be directed away from the top of slopes into swales or other controlled drainage devices. Roof and pavement drainage should be directed into conduits that carry runoff away from the proposed structure.
- 6.18.2 In the case of basement walls or building walls retaining landscaping areas, a water-proofing system should be used on the wall and joints, and a Miradrain drainage panel (or similar) should be placed over the waterproofing. The project architect or civil engineer should provide detailed specifications on the plans for all waterproofing and drainage.

- 6.18.3 Underground utilities should be leak free. Utility and irrigation lines should be checked periodically for leaks, and detected leaks should be repaired promptly. Detrimental soil movement could occur if water is allowed to infiltrate the soil for prolonged periods of time.
  
- 6.18.4 Landscaping planters adjacent to paved areas are not recommended due to the potential for surface or irrigation water to infiltrate the pavement's subgrade and base course. We recommend that subdrains to collect excess irrigation water and transmit it to drainage structures, or impervious above-grade planter boxes be used. In addition, where landscaping is planned adjacent to the pavement, we recommend construction of a cutoff wall along the edge of the pavement that extends at least 6 inches below the bottom of the base material.

### **6.19 Grading and Foundation Plan Review**

- 6.19.1 Geocon Incorporated should review the grading plans and foundation plans for the project prior to final design submittal to evaluate whether additional analyses and/or recommendations are required.

## LIMITATIONS AND UNIFORMITY OF CONDITIONS

1. The firm that performed the geotechnical investigation for the project should be retained to provide testing and observation services during construction to provide continuity of geotechnical interpretation and to check that the recommendations presented for geotechnical aspects of site development are incorporated during site grading, construction of improvements, and excavation of foundations. If another geotechnical firm is selected to perform the testing and observation services during construction operations, that firm should prepare a letter indicating their intent to assume the responsibilities of project geotechnical engineer of record. A copy of the letter should be provided to the regulatory agency for their records. In addition, that firm should provide revised recommendations concerning the geotechnical aspects of the proposed development, or a written acknowledgement of their concurrence with the recommendations presented in our report. They should also perform additional analyses deemed necessary to assume the role of Geotechnical Engineer of Record.
2. The recommendations of this report pertain only to the site investigated and are based upon the assumption that the soil conditions do not deviate from those disclosed in the investigation. If any variations or undesirable conditions are encountered during construction, or if the proposed construction will differ from that anticipated herein, Geocon Incorporated should be notified so that supplemental recommendations can be given. The evaluation or identification of the potential presence of hazardous or corrosive materials was not part of the scope of services provided by Geocon Incorporated.
3. This report is issued with the understanding that it is the responsibility of the owner or his representative to ensure that the information and recommendations contained herein are brought to the attention of the architect and engineer for the project and incorporated into the plans, and the necessary steps are taken to see that the contractor and subcontractors carry out such recommendations in the field.
4. The findings of this report are valid as of the present date. However, changes in the conditions of a property can occur with the passage of time, whether they be due to natural processes or the works of man on this or adjacent properties. In addition, changes in applicable or appropriate standards may occur, whether they result from legislation or the broadening of knowledge. Accordingly, the findings of this report may be invalidated wholly or partially by changes outside our control. Therefore, this report is subject to review and should not be relied upon after a period of three years.



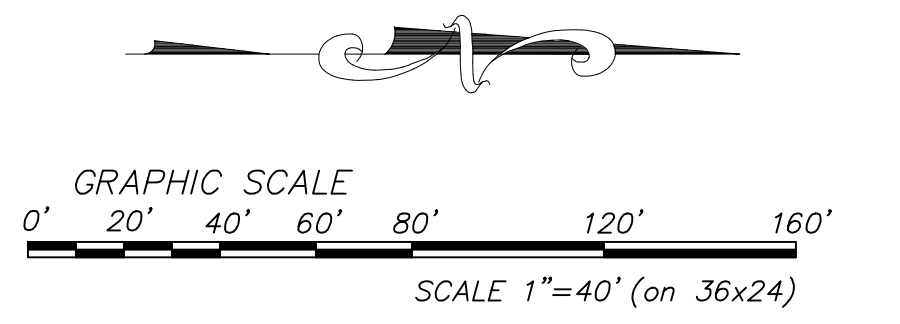
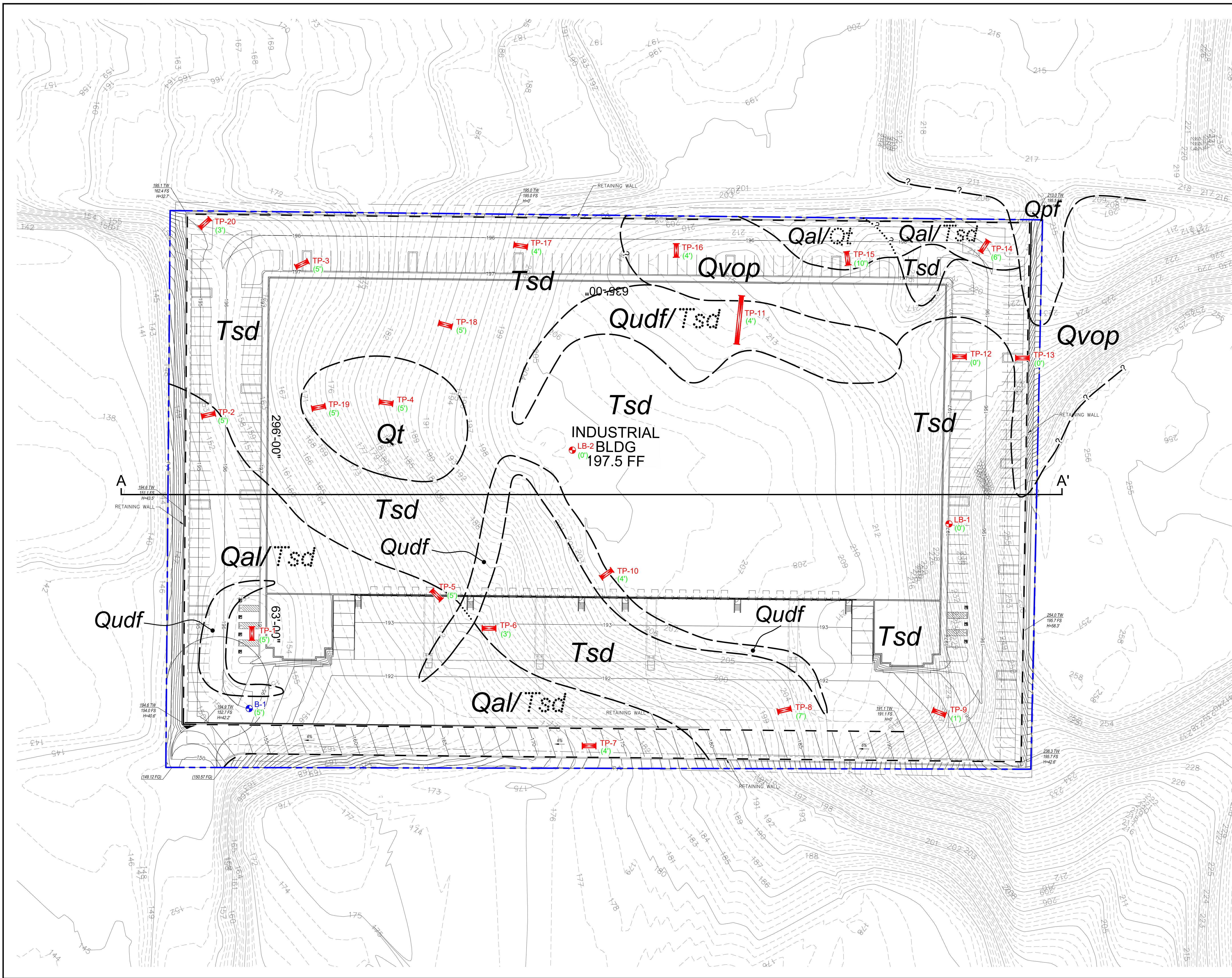

- GEOCON LEGEND**
- Qu*.....UNDOCUMENTED FILL
  - Qp*.....PREVIOUSLY PLACED FILL
  - Qal*.....ALLUVIUM
  - Qv*.....VERY OLD PARALIC DEPOSITS
  - Qt*.....TERRACE DEPOSITS  
(Dotted Where Buried)
  - Tsd*.....SAN DIEGO FORMATION  
(Dotted Where Buried)
  - .....APPROX. LOCATION OF GEOLOGIC CONTACT  
(Dotted Where Buried, Queried Where Uncertain)
  - B-1.....APPROX. LOCATION OF BORING
  - LB-2.....APPROX. LOCATION OF LARGE DIAMETER BORING
  - TP-20.....APPROX. LOCATION OF TRENCH
  - (5).....APPROX. DEPTH OF REMEDIAL GRADING (In Feet)
  - A-A'.....APPROX. LOCATION OF GEOLOGIC CROSS SECTION

**GEOLOGIC MAP**  
SHINOHARA INDUSTRIAL BUILDING  
517 SHINOHARA LANE  
SAN DIEGO, CALIFORNIA

<b>GEOCON</b> INCORPORATED GEO TECHNICAL ■ ENVIRONMENTAL ■ MATERIALS 6940 FLANDERS DRIVE - SAN DIEGO, CALIFORNIA 92121-2974 PHONE 619 538 6900 - FAX 619 538 6159	 PROJECT NO. G2762 - 42 - 01 SHEET 1 OF 1	SCALE 1" = 40' DATE 07 - 28 - 2021 FIGURE 1
---	---	---

Printed 07/27/2021 9:20AM | By ALVIN LADRILLON | File Location: Y:\PROJECTS\G2762-42-01 (Shinohara Lane)\SHEETS\G2762-42-01 Geo Map.dwg



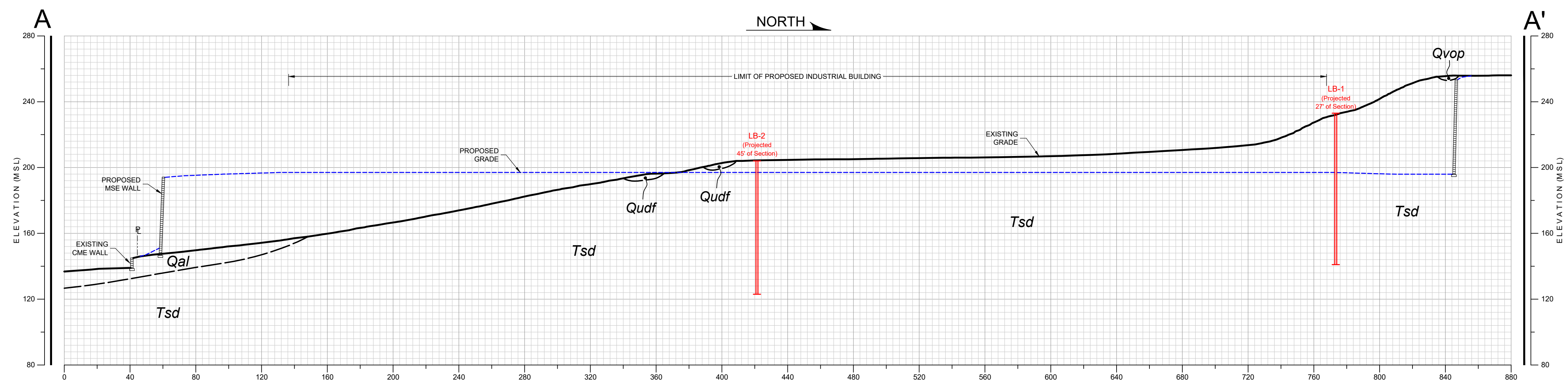

GEOCON LEGEND

<i>Qudf</i>	..... UNDOCUMENTED FILL
<i>Qal</i>	..... ALLUVIUM
<i>Qvop</i>	..... VERY OLD PARALIC DEPOSITS
<i>Tsd</i>	..... SAN DIEGO FORMATION
~	..... APPROX. LOCATION OF GEOLOGIC CONTACT
LB-1 	..... APPROX. LOCATION OF LARGE DIAMETER BORING

**GEOLOGIC CROSS SECTION**  
 SHINOHARA INDUSTRIAL BUILDING  
 517 SHINOHARA LANE  
 SAN DIEGO, CALIFORNIA

 <small>GEOCON        INCORPORATED        GEOTECHNICAL ■ ENVIRONMENTAL ■ MATERIALS        6960 FLANDERS DRIVE - SAN DIEGO, CALIFORNIA 92121 - 2974        PHONE 658-558-6900 - FAX 658-558-6159</small>	SCALE 1" = 40'	DATE 07 - 28 - 2021
	PROJECT NO. G2762 - 42 - 01	FIGURE 2
SHEET 1 OF 1		

Plotted 07/27/2021 9:07AM | By ALVIN LADRILLON | File Location: Y:\PROJECTS\G2762-42-01 (517 Shinohara Lane)\SHEETS\G2762-42-01.XSection.dwg

APPENDIX

A

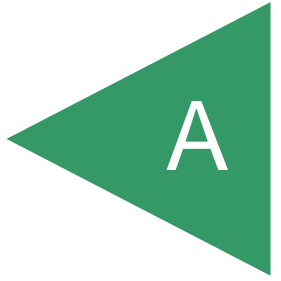









## APPENDIX A

### FIELD INVESTIGATION







We performed our field investigation between June 30 and July 7, 2021. Our investigation consisted of a site reconnaissance, logging of 20 exploratory test pits, two large diameter borings and one small diameter boring. The exploratory test pits were excavated to depths between 2- and 16-feet using a rubber-tire Caterpillar 430F backhoe. Exploratory borings were drilled to depths between 20- and 92-feet using truck mounted hollow stem and bucket auger drill rigs. The approximate locations of the exploratory test pits borings tests are shown on Figure 1.

The soil conditions encountered in the trenches were visually examined, classified, and logged in general conformance with the American Society for Testing and Materials (ASTM) Practice for Description and Identification of Soils (Visual-Manual Procedure D 2488). Exploratory boring logs are presented in Figures A-1 through A-3, and test pit logs are presented on Figures A-4 through A-23. The logs depict the various soil types encountered and indicate the depths at which samples were obtained.

DEPTH IN FEET	SAMPLE NO.	LITHOLOGY	GROUNDWATER	SOIL CLASS (USCS)	<b>BORING B 1</b>		PENETRATION RESISTANCE (BLOWS/FT.)	DRY DENSITY (P.C.F.)	MOISTURE CONTENT (%)
					ELEV. (MSL.) <u>153'</u>	DATE COMPLETED <u>07-07-2021</u>			
					EQUIPMENT <u>IR A-300</u>		BY: <u>B. KUNA</u>		
MATERIAL DESCRIPTION									
0				SC	<b>ALLUVIUM (Qal)</b> Medium dense, moist, reddish-brown, Clayey, fine to medium SAND; little silt				
2	B1-1						37		
4	B1-2						67		
6					-At 5.5 feet: becomes dense				
8	B1-3						78	120.0	8.3
10	B1-4						91/11.5"	117.7	8.1
12					-At 10.5 feet: becomes very dense				
14									
16	B1-5						50/6"	120.0	9.5
18	B1-6						78/10"		
20					BORING TERMINATED AT 20 FEET Groundwater not encountered Backfilled with drill cuttings on 07-07-2021				

**Figure A-1,**  
**Log of Boring B 1, Page 1 of 1**

G2762-42-01.GPJ







SAMPLE SYMBOLS		... SAMPLING UNSUCCESSFUL		... STANDARD PENETRATION TEST		... DRIVE SAMPLE (UNDISTURBED)
		... DISTURBED OR BAG SAMPLE		... CHUNK SAMPLE		... WATER TABLE OR  ... SEEPAGE

NOTE: THE LOG OF SUBSURFACE CONDITIONS SHOWN HEREON APPLIES ONLY AT THE SPECIFIC BORING OR TRENCH LOCATION AND AT THE DATE INDICATED. IT IS NOT WARRANTED TO BE REPRESENTATIVE OF SUBSURFACE CONDITIONS AT OTHER LOCATIONS AND TIMES.

DEPTH IN FEET	SAMPLE NO.	LITHOLOGY	GROUNDWATER	SOIL CLASS (USCS)	<b>BORING LB 1</b>		PENETRATION RESISTANCE (BLOWS/FT.)	DRY DENSITY (P.C.F.)	MOISTURE CONTENT (%)
					ELEV. (MSL.) <u>233'</u>	DATE COMPLETED <u>07-05-2021</u>			
					EQUIPMENT <u>EZ BORE</u> BY: <u>R. ADAMS</u>				
					MATERIAL DESCRIPTION				
0				SM	<b>SAN DIEGO FORMATION (Tsd)</b> Dense, damp, pale yellowish-brown to grayish-brown, Silty, very fine grained SANDSTONE; massive, powdery texture, micaceous				
2									
4									
6									
8				SM	-At 7.5 feet: 1-inch thick orangish-brown sand bed; Bedding: N28W/14°SW Dense, damp, pale yellowish-brown to orangish-brown, Silty, fine to medium SANDSTONE; trace gravel (subrounded) up to 4-inch diameter; trace clay, few closed fractures <1/16" thick				
10	LB1-1			SM	Dense, damp, grayish-white, Silty, very fine grained SANDSTONE; massive, highly micaceous		3	104.7	12.8
12									
14									
16									
18				SP	Dense, damp, white to blackish-brown, medium to coarse SANDSTONE; laminated, low cohesion, trace fine gravel; Bedding: N25W/9°SW				
20	LB1-2						5	97.8	4.3
22					-At 21 feet: band of orangish-brown, coarse sand; cross-bedded with subangular gravel lenses, very low cohesion				
24									
26				SP	Dense, dry to damp, orange to dark reddish-brown, medium coarse SANDSTONE; laminated and cross bedded, micaceous, low cohesion, basal contact N30W/20°SW				
28				SM	Dense, damp, grayish-white, Silty, very fine grained SANDSTONE; micaceous				

**Figure A-2,**  
**Log of Boring LB 1, Page 1 of 4**

G2762-42-01.GPJ

SAMPLE SYMBOLS	 ... SAMPLING UNSUCCESSFUL	 ... STANDARD PENETRATION TEST	 ... DRIVE SAMPLE (UNDISTURBED)
	 ... DISTURBED OR BAG SAMPLE	 ... CHUNK SAMPLE	 ... WATER TABLE OR  ... SEEPAGE

NOTE: THE LOG OF SUBSURFACE CONDITIONS SHOWN HEREON APPLIES ONLY AT THE SPECIFIC BORING OR TRENCH LOCATION AND AT THE DATE INDICATED. IT IS NOT WARRANTED TO BE REPRESENTATIVE OF SUBSURFACE CONDITIONS AT OTHER LOCATIONS AND TIMES.

DEPTH IN FEET	SAMPLE NO.	LITHOLOGY	GROUNDWATER	SOIL CLASS (USCS)	<b>BORING LB 1</b>		PENETRATION RESISTANCE (BLOWS/FT.)	DRY DENSITY (P.C.F.)	MOISTURE CONTENT (%)
					ELEV. (MSL.) <u>233'</u>	DATE COMPLETED <u>07-05-2021</u>			
					EQUIPMENT <u>EZ BORE</u> BY: <u>R. ADAMS</u>				
					MATERIAL DESCRIPTION				
30	LB1-3						7		
32			SP	Dense to very dense, damp, dark reddish-brown to orangish-brown, fine to medium SANDSTONE; massive to weakly laminated, bottom contact N11W/17°W					
34			SM	Dense, damp, whitish-gray, Silty, very fine grained SANDSTONE; laminated, highly micaceous with pockets of 100% biotite/muscovite mica					
36				-At 36 feet: 2-inch thick fine gravel bed; <1/2" subrounded to subangular gravel					
38									
40	LB1-4						8	87.3	5.7
42									
44									
46									
48									
50	LB1-5						8		
52			SM	Dense to very dense, damp, grayish-white, Silty, very fine grained SANDSTONE; massive, micaceous, small irregular pockets of yellowish white, silt present white some oxidation staining, trace subangular fine gravel					
54									
56									
58									

**Figure A-2,**  
**Log of Boring LB 1, Page 2 of 4**

G2762-42-01.GPJ

SAMPLE SYMBOLS	... SAMPLING UNSUCCESSFUL	... STANDARD PENETRATION TEST	... DRIVE SAMPLE (UNDISTURBED)
	... DISTURBED OR BAG SAMPLE	... CHUNK SAMPLE	... WATER TABLE OR  ... SEEPAGE

NOTE: THE LOG OF SUBSURFACE CONDITIONS SHOWN HEREON APPLIES ONLY AT THE SPECIFIC BORING OR TRENCH LOCATION AND AT THE DATE INDICATED. IT IS NOT WARRANTED TO BE REPRESENTATIVE OF SUBSURFACE CONDITIONS AT OTHER LOCATIONS AND TIMES.

DEPTH IN FEET	SAMPLE NO.	LITHOLOGY	GROUNDWATER	SOIL CLASS (USCS)	<b>BORING LB 1</b>		PENETRATION RESISTANCE (BLOWS/FT.)	DRY DENSITY (P.C.F.)	MOISTURE CONTENT (%)
					ELEV. (MSL.) <u>233'</u>	DATE COMPLETED <u>07-05-2021</u>			
					EQUIPMENT <u>EZ BORE</u>		BY: <u>R. ADAMS</u>		
MATERIAL DESCRIPTION									
60				SM					
62									
64									
66					SM	Very dense, damp, orange-brown to reddish-brown, Silty, fine to medium SANDSTONE; several coarse sand interbeds, massive, micaceous			
68									
70	LB1-6						15		
72						-At 71 to 72 feet: 1-foot thick yellowish-orange, siltstone bed; Bedding: N20W/14°SW			
74					SM	Dense, damp, grayish-white, Silty, very fine grained SANDSTONE; massive, micaceous, low cohesion; Bedding: N10W/21°W			
76									
78									
80									
82									
84									
86									
88									
					-At 84 to 88 feet: few thin subrounded gravel beds				

**Figure A-2,**  
**Log of Boring LB 1, Page 3 of 4**

G2762-42-01.GPJ







SAMPLE SYMBOLS	... SAMPLING UNSUCCESSFUL	... STANDARD PENETRATION TEST	... DRIVE SAMPLE (UNDISTURBED)
	... DISTURBED OR BAG SAMPLE	... CHUNK SAMPLE	... WATER TABLE OR  ... SEEPAGE

NOTE: THE LOG OF SUBSURFACE CONDITIONS SHOWN HEREON APPLIES ONLY AT THE SPECIFIC BORING OR TRENCH LOCATION AND AT THE DATE INDICATED. IT IS NOT WARRANTED TO BE REPRESENTATIVE OF SUBSURFACE CONDITIONS AT OTHER LOCATIONS AND TIMES.

DEPTH IN FEET	SAMPLE NO.	LITHOLOGY	GROUNDWATER	SOIL CLASS (USCS)	<b>BORING LB 1</b> ELEV. (MSL.) <u>233'</u> DATE COMPLETED <u>07-05-2021</u> EQUIPMENT <u>EZ BORE</u> BY: <u>R. ADAMS</u>	PENETRATION RESISTANCE (BLOWS/FT.)	DRY DENSITY (P.C.F.)	MOISTURE CONTENT (%)
90	LB1-7			SM	MATERIAL DESCRIPTION	20		
92					BORING TERMINATED AT 92 FEET Groundwater not encountered Backfilled on 07-05-2021			

**Figure A-2,  
Log of Boring LB 1, Page 4 of 4**

G2762-42-01.GPJ







SAMPLE SYMBOLS	 ... SAMPLING UNSUCCESSFUL	 ... STANDARD PENETRATION TEST	 ... DRIVE SAMPLE (UNDISTURBED)
	 ... DISTURBED OR BAG SAMPLE	 ... CHUNK SAMPLE	 ... WATER TABLE OR  ... SEEPAGE

NOTE: THE LOG OF SUBSURFACE CONDITIONS SHOWN HEREON APPLIES ONLY AT THE SPECIFIC BORING OR TRENCH LOCATION AND AT THE DATE INDICATED. IT IS NOT WARRANTED TO BE REPRESENTATIVE OF SUBSURFACE CONDITIONS AT OTHER LOCATIONS AND TIMES.

DEPTH IN FEET	SAMPLE NO.	LITHOLOGY	GROUNDWATER	SOIL CLASS (USCS)	<b>BORING LB 2</b>		PENETRATION RESISTANCE (BLOWS/FT.)	DRY DENSITY (P.C.F.)	MOISTURE CONTENT (%)
					ELEV. (MSL.) <b>204'</b>	DATE COMPLETED <b>07-06-2021</b>			
					EQUIPMENT <b>EZ BORE</b>		BY: <b>R. ADAMS</b>		
MATERIAL DESCRIPTION									
0				SM	<b>SAN DIEGO FORMATION (Tsd)</b> Dense, dry to damp, orange-brown to reddish-brown, Silty, fine to medium SANDSTONE; laminated, slightly bioturbated with pockets of biotite/muscovite mica; Bedding: N30W/14°SW				
2									
4									
6				SP	Dense, dry to damp, orange-brown, Silty, medium coarse SANDSTONE; some subrounded gravel, laminated, low cohesion				
8				SM	Dense to very dense, damp, grayish-white to pale yellowish-white, silty, fine SANDSTONE; highly micaceous, cross-bedded				
10	LB2-1				-At 9 feet: becomes orange-brown to reddish-brown -At 10 feet: 2-inch thick subrounded/subangular gravel bed		5		
12				SM	Dense, damp, whitish-gray, Silty, very fine grained SANDSTONE; highly micaceous, powdery texture, moderate cohesion, pocket of biotite/muscovite, mica throughout, trace 1/4"-1/5" subrounded gravel				
14									
16									
18									
20	LB2-2						4		
22					-At 22 feet: medium to coarse, reddish-brown sandstone bed; Bedding: N5E/11°W				
24					-At 24 to 26 feet: some bioturbation				
26									
28					-At 27 feet: becomes massive				

**Figure A-3,**  
**Log of Boring LB 2, Page 1 of 3**

G2762-42-01.GPJ

SAMPLE SYMBOLS	 ... SAMPLING UNSUCCESSFUL	 ... STANDARD PENETRATION TEST	 ... DRIVE SAMPLE (UNDISTURBED)
	 ... DISTURBED OR BAG SAMPLE	 ... CHUNK SAMPLE	 ... WATER TABLE OR  ... SEEPAGE

NOTE: THE LOG OF SUBSURFACE CONDITIONS SHOWN HEREON APPLIES ONLY AT THE SPECIFIC BORING OR TRENCH LOCATION AND AT THE DATE INDICATED. IT IS NOT WARRANTED TO BE REPRESENTATIVE OF SUBSURFACE CONDITIONS AT OTHER LOCATIONS AND TIMES.



DEPTH IN FEET	SAMPLE NO.	LITHOLOGY	GROUNDWATER	SOIL CLASS (USCS)	<b>BORING LB 2</b>		PENETRATION RESISTANCE (BLOWS/FT.)	DRY DENSITY (P.C.F.)	MOISTURE CONTENT (%)
					ELEV. (MSL.) <u>204'</u>	DATE COMPLETED <u>07-06-2021</u>			
					EQUIPMENT <u>EZ BORE</u>		BY: <u>R. ADAMS</u>		
MATERIAL DESCRIPTION									
30				SM					
32									
34									
36									
38					SM	Dense, damp, bluish-gray, Silty, fine to medium SANDSTONE; some subrounded cobble up to 8-inch diameter, moderately lubricated; Bedding: N10E/15°W			
40	LB2-3				SM	Dense, damp, whitish-gray, Silty, very fine grained SANDSTONE; massive to weakly laminated, minor bioturbation	10		
42				SM	Very dense, damp, pale yellowish-brown, Silty, fine to medium SANDSTONE; few coarse grained laminate				
44									
46				SP	Dense, dry to damp, orange-brown to grayish-brown, medium to coarse SANDSTONE; cross-bedded, low cohesion, few subrounded and imbricated clay rip clasts 1/2"-3" long; Bedding: NS/10°W				
48									
50				SM	Very dense, damp, orange-brown, Silty, very fine grained SANDSTONE; massive -At 49 feet: contact is offset 4-inch along high angle closed fracture; Fracture: N310E/Vertical, Bedding: N10W/11°W				
52									
54									
56									
58									
					-At 59 to 60 feet: trace subrounded cobble up to 4-inch diameter				

**Figure A-3,**  
**Log of Boring LB 2, Page 2 of 3**

G2762-42-01.GPJ

SAMPLE SYMBOLS	... SAMPLING UNSUCCESSFUL	... STANDARD PENETRATION TEST	... DRIVE SAMPLE (UNDISTURBED)
	... DISTURBED OR BAG SAMPLE	... CHUNK SAMPLE	... WATER TABLE OR  ... SEEPAGE

NOTE: THE LOG OF SUBSURFACE CONDITIONS SHOWN HEREON APPLIES ONLY AT THE SPECIFIC BORING OR TRENCH LOCATION AND AT THE DATE INDICATED. IT IS NOT WARRANTED TO BE REPRESENTATIVE OF SUBSURFACE CONDITIONS AT OTHER LOCATIONS AND TIMES.



DEPTH IN FEET	SAMPLE NO.	LITHOLOGY	GROUNDWATER	SOIL CLASS (USCS)	<b>BORING LB 2</b> ELEV. (MSL.) <u>204'</u> DATE COMPLETED <u>07-06-2021</u> EQUIPMENT <u>EZ BORE</u> BY: <u>R. ADAMS</u>	PENETRATION RESISTANCE (BLOWS/FT.)	DRY DENSITY (P.C.F.)	MOISTURE CONTENT (%)
MATERIAL DESCRIPTION								
60	LB2-4			SM	-At 64 feet: becomes bluish-gray to whitish-gray, Silty, very fine grained SANDSTONE; Bedding: N10W/12°W	18		
62								
64								
66								
68				SM	Very dense, damp, grayish-brown to bluish-gray, Silty, fine to meduim SANDSTONE; massive, oxidation mottling in bioturbated areas			
70								
72								
74								
76								
78								
80	LB2-5					20		
BORING TERMINATED AT 81 FEET Groundwater not encountered Backfilled on 07-06-2021								

**Figure A-3,**  
**Log of Boring LB 2, Page 3 of 3**

G2762-42-01.GPJ







SAMPLE SYMBOLS		
	... SAMPLING UNSUCCESSFUL	
	... DISTURBED OR BAG SAMPLE	
	... CHUNK SAMPLE	

NOTE: THE LOG OF SUBSURFACE CONDITIONS SHOWN HEREON APPLIES ONLY AT THE SPECIFIC BORING OR TRENCH LOCATION AND AT THE DATE INDICATED. IT IS NOT WARRANTED TO BE REPRESENTATIVE OF SUBSURFACE CONDITIONS AT OTHER LOCATIONS AND TIMES.



DEPTH IN FEET	SAMPLE NO.	LITHOLOGY	GROUNDWATER	SOIL CLASS (USCS)	TEST PIT TP 1		PENETRATION RESISTANCE (BLOWS/FT.)	DRY DENSITY (P.C.F.)	MOISTURE CONTENT (%)
					ELEV. (MSL.) <u>152'</u>	DATE COMPLETED <u>06-30-2021</u>			
					EQUIPMENT <u>BACKHOE CAT 430F</u>		BY: <u>R. ADAMS</u>		
MATERIAL DESCRIPTION									
0				SC	<b>ALLUVIUM (Qal)</b> Medium dense, dry to damp, reddish-brown, Clayey, fine to medium SAND; abundant caliche, some silt, blocky, slightly porous.				
2	TP1-1				-At 2 feet: becomes moist				
4					-At 3 feet: clay films and manganese films on parting surface pockets/lenses of sandy clay present				
6					-At 6 feet: occasional subrounded gravel				
8					-At 9 feet: pin-hole porosity and manganese films present with blocky structure and trace subrounded gravel, no caliche				
10	TP1-2			SM	Dense, damp, yellowish-brown, Silty, fine to medium SAND; trace clay, trace subrounded gravel				
12					-At 11 feet: becomes weakly cemented, cobble up to 6-inch diameter				
14				SM	<b>SAN DIEGO FORMATION (Tsd)</b> Dense, damp, pale yellowish-brown to whitish-brown, Silty, fine SANDSTONE; massive, weakly bioturbated, trace angular gravel				
16					TRENCH TERMINATED AT 16 FEET Groundwater not encountered Backfilled on 06-30-2021				

**Figure A-4,**  
**Log of Test Pit TP 1, Page 1 of 1**

G2762-42-01.GPJ







SAMPLE SYMBOLS		... SAMPLING UNSUCCESSFUL		... STANDARD PENETRATION TEST		... DRIVE SAMPLE (UNDISTURBED)
		... DISTURBED OR BAG SAMPLE		... CHUNK SAMPLE		... WATER TABLE OR  ... SEEPAGE

NOTE: THE LOG OF SUBSURFACE CONDITIONS SHOWN HEREON APPLIES ONLY AT THE SPECIFIC BORING OR TRENCH LOCATION AND AT THE DATE INDICATED. IT IS NOT WARRANTED TO BE REPRESENTATIVE OF SUBSURFACE CONDITIONS AT OTHER LOCATIONS AND TIMES.

DEPTH IN FEET	SAMPLE NO.	LITHOLOGY	GROUNDWATER	SOIL CLASS (USCS)	TEST PIT TP 2		PENETRATION RESISTANCE (BLOWS/FT.)	DRY DENSITY (P.C.F.)	MOISTURE CONTENT (%)
					ELEV. (MSL.) <u>153'</u>	DATE COMPLETED <u>06-30-2021</u>			
					EQUIPMENT <u>BACKHOE CAT 430F</u>		BY: <u>R. ADAMS</u>		
MATERIAL DESCRIPTION									
0				ML	<b>TOPSOIL</b> Firm, dry, pale brown, fine Sandy SILT; trace gravel and cobble				
2				SM	<b>ALLUVIUM (Qal)</b> Dense, dry to damp, yellowish-brown, Silty, fine SAND; trace subrounded to subangular gravel, some porosity				
4	TP2-1								
6									
8				SM	<b>SAN DIEGO FORMATION (Tsd)</b> Very dense, damp, yellowish-brown, Silty, very fine grained SAND; trace porosity, few clay lined burrows and abundant oxidation mottling				
10	TP2-2								
12					TRENCH TERMINATED AT 12 FEET Groundwater not encountered Backfilled on 06-30-2021				

**Figure A-5,**  
**Log of Test Pit TP 2, Page 1 of 1**

G2762-42-01.GPJ





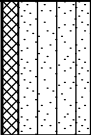
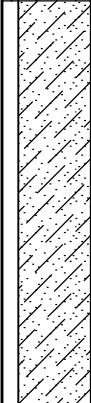
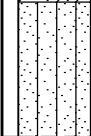
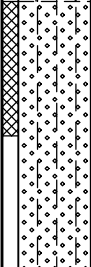

SAMPLE SYMBOLS		... SAMPLING UNSUCCESSFUL		... STANDARD PENETRATION TEST		... DRIVE SAMPLE (UNDISTURBED)
		... DISTURBED OR BAG SAMPLE		... CHUNK SAMPLE		... WATER TABLE OR  ... SEEPAGE

NOTE: THE LOG OF SUBSURFACE CONDITIONS SHOWN HEREON APPLIES ONLY AT THE SPECIFIC BORING OR TRENCH LOCATION AND AT THE DATE INDICATED. IT IS NOT WARRANTED TO BE REPRESENTATIVE OF SUBSURFACE CONDITIONS AT OTHER LOCATIONS AND TIMES.

DEPTH IN FEET	SAMPLE NO.	LITHOLOGY	GROUNDWATER	SOIL CLASS (USCS)	TEST PIT TP 3		PENETRATION RESISTANCE (BLOWS/FT.)	DRY DENSITY (P.C.F.)	MOISTURE CONTENT (%)	
					ELEV. (MSL.) <u>165'</u>	DATE COMPLETED <u>06-30-2021</u>				
					EQUIPMENT <u>BACKHOE CAT 430F</u> BY: <u>R. ADAMS</u>					
					MATERIAL DESCRIPTION					
0	TP3-1			ML	<b>TOPSOIL</b> Firm dry, pale pinkish-brown to grayish brown, fine to medium Sandy SILT; porous					
2				SC	<b>ALLUVIUM (Qal)</b> Medium dense, moist, dark brown to reddish-brown, Clayey, fine to coarse SAND; trace subrounded gravel  -At 4 feet: subrounded gravel/cobble up to 4-inch in diameter  -At 4 feet: abundant pin-hole porosity  -At 6 feet: becomes dense, blocky texture with clay films on parting surfaces					
4										
6										
8				ML	<b>SAN DIEGO FORMATION (Tsd)</b> Dense to very dense, damp, orangish-brown to pale yellowish-brown, very fine Sandy SILT; some pinhole porosity					
10	TP3-2			SM	Dense, damp, whitish-gray, Silty, fine fine grained SANDSTONE; powdery texture when excavated; micaceous					
12										
14					TRENCH TERMINATED AT 14 FEET Groundwater not encountered Backfilled on 06-30-2021					

**Figure A-6,**  
**Log of Test Pit TP 3, Page 1 of 1**

G2762-42-01.GPJ

SAMPLE SYMBOLS	 ... SAMPLING UNSUCCESSFUL	 ... STANDARD PENETRATION TEST	 ... DRIVE SAMPLE (UNDISTURBED)
	 ... DISTURBED OR BAG SAMPLE	 ... CHUNK SAMPLE	 ... WATER TABLE OR  ... SEEPAGE

NOTE: THE LOG OF SUBSURFACE CONDITIONS SHOWN HEREON APPLIES ONLY AT THE SPECIFIC BORING OR TRENCH LOCATION AND AT THE DATE INDICATED. IT IS NOT WARRANTED TO BE REPRESENTATIVE OF SUBSURFACE CONDITIONS AT OTHER LOCATIONS AND TIMES.

DEPTH IN FEET	SAMPLE NO.	LITHOLOGY	GROUNDWATER	SOIL CLASS (USCS)	TEST PIT TP 4		PENETRATION RESISTANCE (BLOWS/FT.)	DRY DENSITY (P.C.F.)	MOISTURE CONTENT (%)
					ELEV. (MSL.) <u>185'</u>	DATE COMPLETED <u>06-30-2021</u>			
					EQUIPMENT <u>BACKHOE CAT 430F</u>		BY: <u>R. ADAMS</u>		
MATERIAL DESCRIPTION									
0				GM	<b>TOPSOIL</b> Loose, dry, pale brown, Silty GRAVEL; rounded to subrounded gravel up to 6-inch diameter				
2	TP4-1			GP	<b>TERRACE DEPOSITS (Qt)</b> Dense, dry to damp, pale yellowish-brown, fine to medium Sandy GRAVEL; subrounded gravel and cobble up to 10-inch diameter				
4									
6									
8				SM	<b>SAN DIEGO FORMATION (Tsd)</b> Dense, damp, light gray to pale yellowish-gray, Silty, very fine grained SANDSTONE; micaceous, powdery texture, some gravel and cobble up to 6-inch diameter (subrounded)				
10					TRENCH TERMINATED AT 10 FEET Groundwater not encountered Backfilled on 06-30-2021				

**Figure A-7,**  
**Log of Test Pit TP 4, Page 1 of 1**

G2762-42-01.GPJ







SAMPLE SYMBOLS		... SAMPLING UNSUCCESSFUL		... STANDARD PENETRATION TEST		... DRIVE SAMPLE (UNDISTURBED)
		... DISTURBED OR BAG SAMPLE		... CHUNK SAMPLE		... WATER TABLE OR ... SEEPAGE

NOTE: THE LOG OF SUBSURFACE CONDITIONS SHOWN HEREON APPLIES ONLY AT THE SPECIFIC BORING OR TRENCH LOCATION AND AT THE DATE INDICATED. IT IS NOT WARRANTED TO BE REPRESENTATIVE OF SUBSURFACE CONDITIONS AT OTHER LOCATIONS AND TIMES.

DEPTH IN FEET	SAMPLE NO.	LITHOLOGY	GROUNDWATER	SOIL CLASS (USCS)	TEST PIT TP 5		PENETRATION RESISTANCE (BLOWS/FT.)	DRY DENSITY (P.C.F.)	MOISTURE CONTENT (%)
					ELEV. (MSL.) 173'	DATE COMPLETED 06-30-2021			
					EQUIPMENT BACKHOE CAT 430F		BY: R. ADAMS		
MATERIAL DESCRIPTION									
0				ML	<b>TOPSOIL</b> Soft to firm, dry, pale pinkish-brown to brown, Sandy SILT; porous, abundant rootlets				
2				SC	<b>ALLUVIUM (Qal)</b> Loose to medium dense, dry to damp, Clayey, fine to medium SAND; blocky, clay/manganese films on parting surfaces				
4					-At 4 feet: cobble layer, subrounded up to 12-inch diameter				
6				SM	<b>SAN DIEGO FORMATION (Tsd)</b> Dense, dry to damp, orangish brown to yellowish gray, Silty, fine to medium SAND; weakly cemented, bioturbated with few 1/8-inch open burrows, trace caliche, oxidation, mottling, no gravel or cobble				
8					-At 7 feet: becomes yellowish orange, very dense				
10	TP5-1				-At 10 feet: shell fragments observed				
12					TRENCH TERMINATED AT 12 FEET Groundwater not encountered Backfilled on 06-30-2021				

**Figure A-8,**  
**Log of Test Pit TP 5, Page 1 of 1**

G2762-42-01.GPJ

SAMPLE SYMBOLS	 ... SAMPLING UNSUCCESSFUL	 ... STANDARD PENETRATION TEST	 ... DRIVE SAMPLE (UNDISTURBED)
	 ... DISTURBED OR BAG SAMPLE	 ... CHUNK SAMPLE	 ... WATER TABLE OR  ... SEEPAGE







NOTE: THE LOG OF SUBSURFACE CONDITIONS SHOWN HEREON APPLIES ONLY AT THE SPECIFIC BORING OR TRENCH LOCATION AND AT THE DATE INDICATED. IT IS NOT WARRANTED TO BE REPRESENTATIVE OF SUBSURFACE CONDITIONS AT OTHER LOCATIONS AND TIMES.



DEPTH IN FEET	SAMPLE NO.	LITHOLOGY	GROUNDWATER	SOIL CLASS (USCS)	TEST PIT TP 6		PENETRATION RESISTANCE (BLOWS/FT.)	DRY DENSITY (P.C.F.)	MOISTURE CONTENT (%)
					ELEV. (MSL.) <u>178'</u>	DATE COMPLETED <u>06-30-2021</u>			
					EQUIPMENT <u>BACKHOE CAT 430F</u>		BY: <u>R. ADAMS</u>		
MATERIAL DESCRIPTION									
0		[Lithology pattern: silty sand]		SM	<b>TOPSOIL</b> Firm to stiff, dry, brown to grayish-brown, Silty SAND; strong blocky structure, good ped development				
2				SM	<b>SAN DIEGO FORMATION (Tsd)</b> Dense, dry, very pale yellowish-brown to whitish-gray, Silty, very fine grained SAND; powdery texture in places, massive, weakly, bioturbated, some oxidation mottling				
4					TRENCH TERMINATED AT 5 FEET Groundwater not encountered Backfilled on 06-30-2021				

**Figure A-9,**  
**Log of Test Pit TP 6, Page 1 of 1**

G2762-42-01.GPJ

SAMPLE SYMBOLS	 ... SAMPLING UNSUCCESSFUL	 ... STANDARD PENETRATION TEST	 ... DRIVE SAMPLE (UNDISTURBED)
	 ... DISTURBED OR BAG SAMPLE	 ... CHUNK SAMPLE	 ... WATER TABLE OR  ... SEEPAGE

NOTE: THE LOG OF SUBSURFACE CONDITIONS SHOWN HEREON APPLIES ONLY AT THE SPECIFIC BORING OR TRENCH LOCATION AND AT THE DATE INDICATED. IT IS NOT WARRANTED TO BE REPRESENTATIVE OF SUBSURFACE CONDITIONS AT OTHER LOCATIONS AND TIMES.









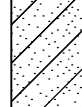
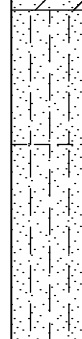
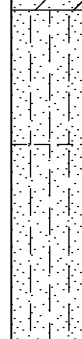
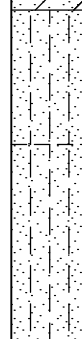
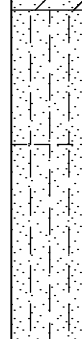
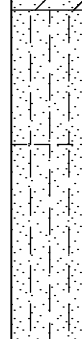
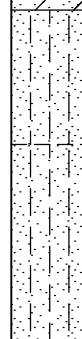

DEPTH IN FEET	SAMPLE NO.	LITHOLOGY	GROUNDWATER	SOIL CLASS (USCS)	TEST PIT TP 7		PENETRATION RESISTANCE (BLOWS/FT.)	DRY DENSITY (P.C.F.)	MOISTURE CONTENT (%)
					ELEV. (MSL.) 176'	DATE COMPLETED 06-30-2021			
					EQUIPMENT BACKHOE CAT 430F		BY: R. ADAMS		
MATERIAL DESCRIPTION									
0				ML	<b>TOPSOIL</b>				
				CL	Hard, dry, brown, Clayey SILT; trace gravel				
2					<b>ALLUVIUM (Qal)</b>				
					Hard, moist, reddish-brown, fine to medium Sandy CLAY; trace gravel, some caliche				
4				SM	<b>SAN DIEGO FORMATION (Tsd)</b>				
					Medium dense to dense, damp to moist, orangish-brown, Silty, fine to coarse SAND; some caliche, weathered, trace clay				
					-At 4.5 feet: becomes yellowish-brown, some cobble				
6				SM	Dense, damp, pale yellowish-brown, Silty, very fine grained SAND; massive, oxidation mottling				
8					TRENCH TERMINATED AT 8 FEET				
					Groundwater not encountered				
					Backfilled on 06-30-2021				

Figure A-10,  
Log of Test Pit TP 7, Page 1 of 1

G2762-42-01.GPJ





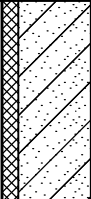
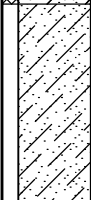
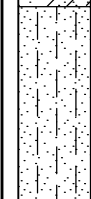

SAMPLE SYMBOLS		... SAMPLING UNSUCCESSFUL		... STANDARD PENETRATION TEST		... DRIVE SAMPLE (UNDISTURBED)
		... DISTURBED OR BAG SAMPLE		... CHUNK SAMPLE		... WATER TABLE OR  ... SEEPAGE

NOTE: THE LOG OF SUBSURFACE CONDITIONS SHOWN HEREON APPLIES ONLY AT THE SPECIFIC BORING OR TRENCH LOCATION AND AT THE DATE INDICATED. IT IS NOT WARRANTED TO BE REPRESENTATIVE OF SUBSURFACE CONDITIONS AT OTHER LOCATIONS AND TIMES.

DEPTH IN FEET	SAMPLE NO.	LITHOLOGY	GROUNDWATER	SOIL CLASS (USCS)	TEST PIT TP 8		PENETRATION RESISTANCE (BLOWS/FT.)	DRY DENSITY (P.C.F.)	MOISTURE CONTENT (%)
					ELEV. (MSL.) <u>204'</u>	DATE COMPLETED <u>06-30-2021</u>			
					EQUIPMENT <u>BACKHOE CAT 430F</u>		BY: <u>R. ADAMS</u>		
MATERIAL DESCRIPTION									
0	TP8-1			CL	<b>TOPSOIL</b> Soft to stiff, dry to moist, grayish-brown to dark reddish brown, Sandy CLAY; trace gravel				
2									
4				SC	<b>ALLUVIUM (Qal)</b> Medium dense, damp to moist, reddish-brown to orangish-brown, Clayey, fine to coarse SAND and Sandy CLAY; weathered				
6									
8				SM	<b>SAN DIEGO FORMATION (Tsd)</b> Dense to vern dense, damp, whitish-gray, Silty, very fine grained SAND; powder texture, micaceous				
					TRENCH TERMINATED AT 9 FEET Groundwater not encountered Backfilled on 06-30-2021				

**Figure A-11,**  
**Log of Test Pit TP 8, Page 1 of 1**

G2762-42-01.GPJ

SAMPLE SYMBOLS		... SAMPLING UNSUCCESSFUL		... STANDARD PENETRATION TEST		... DRIVE SAMPLE (UNDISTURBED)
		... DISTURBED OR BAG SAMPLE		... CHUNK SAMPLE		... WATER TABLE OR  ... SEEPAGE

NOTE: THE LOG OF SUBSURFACE CONDITIONS SHOWN HEREON APPLIES ONLY AT THE SPECIFIC BORING OR TRENCH LOCATION AND AT THE DATE INDICATED. IT IS NOT WARRANTED TO BE REPRESENTATIVE OF SUBSURFACE CONDITIONS AT OTHER LOCATIONS AND TIMES.



DEPTH IN FEET	SAMPLE NO.	LITHOLOGY	GROUNDWATER	SOIL CLASS (USCS)	TEST PIT TP 9		PENETRATION RESISTANCE (BLOWS/FT.)	DRY DENSITY (P.C.F.)	MOISTURE CONTENT (%)
					ELEV. (MSL.) <u>223'</u>	DATE COMPLETED <u>06-30-2021</u>			
					EQUIPMENT <u>BACKHOE CAT 430F</u>		BY: <u>R. ADAMS</u>		
MATERIAL DESCRIPTION									
0				SM	<b>SAN DIEGO FORMATION (Tsd)</b> Very dense, dry to damp, pale yellowish-brown to gray, Silty, fine fine grained SANDSTONE; massive				
2					-At 2 feet: subrounded gravel layer, 4-inch thick				
4					-At 5-7 feet: thin subvertical 1/4-inch, clay filled fractures				
6				-At 6.5 feet: subrounded pods of caliche					
					TRENCH TERMINATED AT 7 FEET Groundwater not encountered Backfilled on 06-30-2021				

**Figure A-12,**  
**Log of Test Pit TP 9, Page 1 of 1**

G2762-42-01.GPJ







SAMPLE SYMBOLS	... SAMPLING UNSUCCESSFUL	... STANDARD PENETRATION TEST	... DRIVE SAMPLE (UNDISTURBED)
	... DISTURBED OR BAG SAMPLE	... CHUNK SAMPLE	... WATER TABLE OR  ... SEEPAGE

NOTE: THE LOG OF SUBSURFACE CONDITIONS SHOWN HEREON APPLIES ONLY AT THE SPECIFIC BORING OR TRENCH LOCATION AND AT THE DATE INDICATED. IT IS NOT WARRANTED TO BE REPRESENTATIVE OF SUBSURFACE CONDITIONS AT OTHER LOCATIONS AND TIMES.



DEPTH IN FEET	SAMPLE NO.	LITHOLOGY	GROUNDWATER	SOIL CLASS (USCS)	TEST PIT TP 10		PENETRATION RESISTANCE (BLOWS/FT.)	DRY DENSITY (P.C.F.)	MOISTURE CONTENT (%)
					ELEV. (MSL.) <u>205'</u>	DATE COMPLETED <u>06-30-2021</u>			
					EQUIPMENT <u>BACKHOE CAT 430F</u>		BY: <u>R. ADAMS</u>		
MATERIAL DESCRIPTION									
0				SC	<b>UNDOCUMENTED FILL (Qudf)</b> Loose to medium dense, dry to damp, brown to grayish-brown, Clayey, fine to medium SAND; abundant cobble, fill place for perimeter berm				
2									
4				SM	<b>SAN DIEGO FORMATION (Tsd)</b> Very dense, damp, pale yellowish-brown to grayish-brown, Silty, very fine grained SANDSTONE; trace gravel, massive, oxidation mottling throughout				
6									
8					TRENCH TERMINATED AT 8 FEET Groundwater not encountered Backfilled on 06-30-2021				

**Figure A-13,**  
**Log of Test Pit TP 10, Page 1 of 1**

G2762-42-01.GPJ







SAMPLE SYMBOLS	 ... SAMPLING UNSUCCESSFUL	 ... STANDARD PENETRATION TEST	 ... DRIVE SAMPLE (UNDISTURBED)
	 ... DISTURBED OR BAG SAMPLE	 ... CHUNK SAMPLE	 ... WATER TABLE OR  ... SEEPAGE

NOTE: THE LOG OF SUBSURFACE CONDITIONS SHOWN HEREON APPLIES ONLY AT THE SPECIFIC BORING OR TRENCH LOCATION AND AT THE DATE INDICATED. IT IS NOT WARRANTED TO BE REPRESENTATIVE OF SUBSURFACE CONDITIONS AT OTHER LOCATIONS AND TIMES.

DEPTH IN FEET	SAMPLE NO.	LITHOLOGY	GROUNDWATER	SOIL CLASS (USCS)	TEST PIT TP 11		PENETRATION RESISTANCE (BLOWS/FT.)	DRY DENSITY (P.C.F.)	MOISTURE CONTENT (%)
					ELEV. (MSL.) <u>213'</u>	DATE COMPLETED <u>06-30-2021</u>			
					EQUIPMENT <u>BACKHOE CAT 430F</u>		BY: <u>R. ADAMS</u>		
MATERIAL DESCRIPTION									
0				ML	<b>UNDOCUMENTED FILL (Qudf)</b> Loose, dry, pale reddish-brown, fine Sandy SILT; abundant, cobbles and chunks of the brownish black sandy clay topsoil				
2									
4				SM	<b>SAN DIEGO FORMATION (Tsd)</b> Very dense, damp, whitish-gray to yellowish-gray, Silty, very fine grained SANDSTONE; massive  -At 4.5 feet: 4-inch thick coarse grained, orangish-black sand bed; Bedding: N20W/6°W				
6						TRENCH TERMINATED AT 6 FEET Groundwater not encountered Backfilled on 06-30-2021			

**Figure A-14,**  
**Log of Test Pit TP 11, Page 1 of 1**

G2762-42-01.GPJ







SAMPLE SYMBOLS	 ... SAMPLING UNSUCCESSFUL	 ... STANDARD PENETRATION TEST	 ... DRIVE SAMPLE (UNDISTURBED)
	 ... DISTURBED OR BAG SAMPLE	 ... CHUNK SAMPLE	 ... WATER TABLE OR  ... SEEPAGE

NOTE: THE LOG OF SUBSURFACE CONDITIONS SHOWN HEREON APPLIES ONLY AT THE SPECIFIC BORING OR TRENCH LOCATION AND AT THE DATE INDICATED. IT IS NOT WARRANTED TO BE REPRESENTATIVE OF SUBSURFACE CONDITIONS AT OTHER LOCATIONS AND TIMES.

DEPTH IN FEET	SAMPLE NO.	LITHOLOGY	GROUNDWATER	SOIL CLASS (USCS)	<b>TEST PIT TP 12</b>			PENETRATION RESISTANCE (BLOWS/FT.)	DRY DENSITY (P.C.F.)	MOISTURE CONTENT (%)
					ELEV. (MSL.) <u>227'</u>	DATE COMPLETED <u>06-30-2021</u>	EQUIPMENT <u>BACKHOE CAT 430F</u> BY: <u>R. ADAMS</u>			
MATERIAL DESCRIPTION										
0				SM	<b>SAN DIEGO FORMATION (Tsd)</b> Very dense, dry to damp, pale yellowish-brown, Silty, very fine grained SANDSTONE					
2					TRENCH TERMINATED AT 2 FEET Groundwater not encountered Backfilled on 06-30-2021					

**Figure A-15,**  
**Log of Test Pit TP 12, Page 1 of 1**

G2762-42-01.GPJ

SAMPLE SYMBOLS	 ... SAMPLING UNSUCCESSFUL	 ... STANDARD PENETRATION TEST	 ... DRIVE SAMPLE (UNDISTURBED)
	 ... DISTURBED OR BAG SAMPLE	 ... CHUNK SAMPLE	 ... WATER TABLE OR  ... SEEPAGE

NOTE: THE LOG OF SUBSURFACE CONDITIONS SHOWN HEREON APPLIES ONLY AT THE SPECIFIC BORING OR TRENCH LOCATION AND AT THE DATE INDICATED. IT IS NOT WARRANTED TO BE REPRESENTATIVE OF SUBSURFACE CONDITIONS AT OTHER LOCATIONS AND TIMES.

DEPTH IN FEET	SAMPLE NO.	LITHOLOGY	GROUNDWATER	SOIL CLASS (USCS)	<b>TEST PIT TP 13</b>			PENETRATION RESISTANCE (BLOWS/FT.)	DRY DENSITY (P.C.F.)	MOISTURE CONTENT (%)
					ELEV. (MSL.) <u>231'</u>	DATE COMPLETED <u>06-30-2021</u>	EQUIPMENT <u>BACKHOE CAT 430F</u> BY: <u>R. ADAMS</u>			
MATERIAL DESCRIPTION										
0	TP13-1			GP	<b>VERY OLD PARALIC DEPOSITS (Qvop)</b> Dense, dry to damp, brown to grayish-brown, medium coarse SAND with cobble; cobble +/-30%, subrounded up to 10-inch diameter					
2										
4										
6										
8										
10				SM	<b>SAN DIEGO FORMATION (Tsd)</b> Dense, damp to moist, yellowish-brown, Silty, fine to medium SANDSTONE					
TRENCH TERMINATED AT 10 FEET Groundwater not encountered Backfilled on 06-30-2021										

**Figure A-16,**  
**Log of Test Pit TP 13, Page 1 of 1**

G2762-42-01.GPJ

SAMPLE SYMBOLS		... SAMPLING UNSUCCESSFUL		... STANDARD PENETRATION TEST		... DRIVE SAMPLE (UNDISTURBED)
		... DISTURBED OR BAG SAMPLE		... CHUNK SAMPLE		... WATER TABLE OR  ... SEEPAGE

NOTE: THE LOG OF SUBSURFACE CONDITIONS SHOWN HEREON APPLIES ONLY AT THE SPECIFIC BORING OR TRENCH LOCATION AND AT THE DATE INDICATED. IT IS NOT WARRANTED TO BE REPRESENTATIVE OF SUBSURFACE CONDITIONS AT OTHER LOCATIONS AND TIMES.



DEPTH IN FEET	SAMPLE NO.	LITHOLOGY	GROUNDWATER	SOIL CLASS (USCS)	TEST PIT TP 14		PENETRATION RESISTANCE (BLOWS/FT.)	DRY DENSITY (P.C.F.)	MOISTURE CONTENT (%)
					ELEV. (MSL.) <b>212'</b>	DATE COMPLETED <b>06-30-2021</b>			
					EQUIPMENT <b>BACKHOE CAT 430F</b>		BY: <b>R. ADAMS</b>		
MATERIAL DESCRIPTION									
0				SC	<b>TOPSOIL</b> Soft, dry, light brown, Clayey SAND; trace cobble				
				CL	Stiff, moist, blackish-brown, Sandy CLAY; some gravel and cobble				
2				SC	<b>ALLUVIUM (Qal)</b> Loose to medium dense, moist, brownish-black, Clayey SAND; some gravel and cobble, pin-hole porosity throughout				
4				SC	<b>SAN DIEGO FORMATION (Tsd)</b> Medium dense, moist, pinkish-brown to yellowish brown, Clayey, fine to medium SANDSTONE, mottled, weathered, manganese films on parting surfaces				
6				SM	Dense, moist, pale yellowish-brown to yellowish-gray, Silty, very fine grained SANDSTONE; massive, friable				
8					TRENCH TERMINATED AT 9 FEET Groundwater not encountered Backfilled on 06-30-2021				

**Figure A-17,**  
**Log of Test Pit TP 14, Page 1 of 1**

G2762-42-01.GPJ

SAMPLE SYMBOLS		... SAMPLING UNSUCCESSFUL		... STANDARD PENETRATION TEST		... DRIVE SAMPLE (UNDISTURBED)
		... DISTURBED OR BAG SAMPLE		... CHUNK SAMPLE		... WATER TABLE OR  ... SEEPAGE

NOTE: THE LOG OF SUBSURFACE CONDITIONS SHOWN HEREON APPLIES ONLY AT THE SPECIFIC BORING OR TRENCH LOCATION AND AT THE DATE INDICATED. IT IS NOT WARRANTED TO BE REPRESENTATIVE OF SUBSURFACE CONDITIONS AT OTHER LOCATIONS AND TIMES.



DEPTH IN FEET	SAMPLE NO.	LITHOLOGY	GROUNDWATER	SOIL CLASS (USCS)	<b>TEST PIT TP 15</b>		PENETRATION RESISTANCE (BLOWS/FT.)	DRY DENSITY (P.C.F.)	MOISTURE CONTENT (%)
					ELEV. (MSL.) <u>215'</u>	DATE COMPLETED <u>06-30-2021</u>			
					EQUIPMENT <u>BACKHOE CAT 430F</u>		BY: <u>R. ADAMS</u>		
MATERIAL DESCRIPTION									
0	TP15-1			SM	<b>TOPSOIL</b> Loose, dry to damp, brown, Silty, fine SAND; some cobble				
2				CL	<b>ALLUVIUM (Qal)</b> Stiff, moist, grayish-brown, Sandy CLAY; trace gravel and cobble; pinhole porosity				
4									
6									
8									
10				GP	<b>VERY OLD PARALIC DEPOSITS (Qvop)</b> Dense, damp, reddish-brown to brown, medium to coarse SAND with gravel; trace silt				
12									
14									
16				SM	<b>SAN DIEGO FORMATION (Tsd)</b> Dense, damp, yellow to pale yellowish-gray, Silty, fine to medium SANDSTONE				
					TRENCH TERMINATED AT 16 FEET Groundwater not encountered Backfilled on 06-30-2021				

**Figure A-18,**  
**Log of Test Pit TP 15, Page 1 of 1**

G2762-42-01.GPJ







<b>SAMPLE SYMBOLS</b>	... SAMPLING UNSUCCESSFUL	... STANDARD PENETRATION TEST	... DRIVE SAMPLE (UNDISTURBED)
	... DISTURBED OR BAG SAMPLE	... CHUNK SAMPLE	... WATER TABLE OR  ... SEEPAGE

NOTE: THE LOG OF SUBSURFACE CONDITIONS SHOWN HEREON APPLIES ONLY AT THE SPECIFIC BORING OR TRENCH LOCATION AND AT THE DATE INDICATED. IT IS NOT WARRANTED TO BE REPRESENTATIVE OF SUBSURFACE CONDITIONS AT OTHER LOCATIONS AND TIMES.

DEPTH IN FEET	SAMPLE NO.	LITHOLOGY	GROUNDWATER	SOIL CLASS (USCS)	TEST PIT TP 16		PENETRATION RESISTANCE (BLOWS/FT.)	DRY DENSITY (P.C.F.)	MOISTURE CONTENT (%)
					ELEV. (MSL.) <u>213'</u>	DATE COMPLETED <u>06-30-2021</u>			
					EQUIPMENT <u>BACKHOE CAT 430F</u>		BY: <u>R. ADAMS</u>		
MATERIAL DESCRIPTION									
0				CL	<b>TOPSOIL</b> Soft to firm, dry to damp, brown, Sandy CLAY; some gravel and cobble				
2									
4				SW	<b>VERY OLD PARALIC DEPOSITS (Qvop)</b> Dense, damp, orange brown, SAND with cobble; cobble subrounded up to 12-inch diameter				
6									
8				SM	<b>SAN DIEGO FORMATION (Tsd)</b> Dense, damp, pale, yellowish-brown to grayish brown, Silty, fine SANDSTONE; massive, micaceous				
					TRENCH TERMINATED AT 9 FEET Groundwater not encountered Backfilled on 06-30-2021				

**Figure A-19,**  
**Log of Test Pit TP 16, Page 1 of 1**

G2762-42-01.GPJ

SAMPLE SYMBOLS	 ... SAMPLING UNSUCCESSFUL	 ... STANDARD PENETRATION TEST	 ... DRIVE SAMPLE (UNDISTURBED)
	 ... DISTURBED OR BAG SAMPLE	 ... CHUNK SAMPLE	 ... WATER TABLE OR  ... SEEPAGE

NOTE: THE LOG OF SUBSURFACE CONDITIONS SHOWN HEREON APPLIES ONLY AT THE SPECIFIC BORING OR TRENCH LOCATION AND AT THE DATE INDICATED. IT IS NOT WARRANTED TO BE REPRESENTATIVE OF SUBSURFACE CONDITIONS AT OTHER LOCATIONS AND TIMES.



DEPTH IN FEET	SAMPLE NO.	LITHOLOGY	GROUNDWATER	SOIL CLASS (USCS)	TEST PIT TP 17		PENETRATION RESISTANCE (BLOWS/FT.)	DRY DENSITY (P.C.F.)	MOISTURE CONTENT (%)
					ELEV. (MSL.) <u>198'</u>	DATE COMPLETED <u>06-30-2021</u>			
					EQUIPMENT <u>BACKHOE CAT 430F</u>		BY: <u>R. ADAMS</u>		
MATERIAL DESCRIPTION									
0				ML	<b>TOPSOIL</b> Loose, dry to damp, brown to pale reddish brown, fine to medium Sandy SILT; trace gravel				
2									
4				SM	<b>SAN DIEGO FORMATION (Tsd)</b> Dense, damp, pale yellowish-brown to yellowish-orange, Silty, very fine grained SANDSTONE; massive, mottled, weathered in upper 3 feet, trace gravel, micaceous				
6									
8									
					TRENCH TERMINATED AT 8 FEET Groundwater not encountered Backfilled on 06-30-2021				

**Figure A-20,**  
**Log of Test Pit TP 17, Page 1 of 1**

G2762-42-01.GPJ



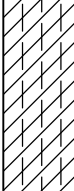



SAMPLE SYMBOLS		... SAMPLING UNSUCCESSFUL		... STANDARD PENETRATION TEST		... DRIVE SAMPLE (UNDISTURBED)
		... DISTURBED OR BAG SAMPLE		... CHUNK SAMPLE		... WATER TABLE OR ... SEEPAGE

NOTE: THE LOG OF SUBSURFACE CONDITIONS SHOWN HEREON APPLIES ONLY AT THE SPECIFIC BORING OR TRENCH LOCATION AND AT THE DATE INDICATED. IT IS NOT WARRANTED TO BE REPRESENTATIVE OF SUBSURFACE CONDITIONS AT OTHER LOCATIONS AND TIMES.

DEPTH IN FEET	SAMPLE NO.	LITHOLOGY	GROUNDWATER	SOIL CLASS (USCS)	TEST PIT TP 18		PENETRATION RESISTANCE (BLOWS/FT.)	DRY DENSITY (P.C.F.)	MOISTURE CONTENT (%)
					ELEV. (MSL.) <u>190'</u>	DATE COMPLETED <u>06-30-2021</u>			
					EQUIPMENT <u>BACKHOE CAT 430F</u>		BY: <u>R. ADAMS</u>		
MATERIAL DESCRIPTION									
0				CL	<b>TOPSOIL</b> Soft to stiff, dry to moist, light brown to reddish-brown, Silty CLAY; trace sand, manganese coatings on parting surfaces				
2									
4				SC	<b>ALLUVIUM (Qal)</b> Medium dense to dense, moist, orange brown, Clayey, medium to coarse SAND; few gravel and cobble				
6				SM	<b>SAN DIEGO FORMATION (Tsd)</b> Dense, damp to moist, pale yellowish-brown to yellowish-gray, Silty, fine to medium SANDSTONE; micaceous, mottled				
8					TRENCH TERMINATED AT 8 FEET Groundwater not encountered Backfilled on 06-30-2021				

**Figure A-21,**  
**Log of Test Pit TP 18, Page 1 of 1**

G2762-42-01.GPJ





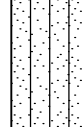
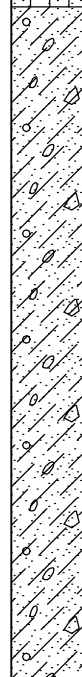

SAMPLE SYMBOLS		... SAMPLING UNSUCCESSFUL		... STANDARD PENETRATION TEST		... DRIVE SAMPLE (UNDISTURBED)
		... DISTURBED OR BAG SAMPLE		... CHUNK SAMPLE		... WATER TABLE OR  ... SEEPAGE

NOTE: THE LOG OF SUBSURFACE CONDITIONS SHOWN HEREON APPLIES ONLY AT THE SPECIFIC BORING OR TRENCH LOCATION AND AT THE DATE INDICATED. IT IS NOT WARRANTED TO BE REPRESENTATIVE OF SUBSURFACE CONDITIONS AT OTHER LOCATIONS AND TIMES.

DEPTH IN FEET	SAMPLE NO.	LITHOLOGY	GROUNDWATER	SOIL CLASS (USCS)	TEST PIT TP 19		PENETRATION RESISTANCE (BLOWS/FT.)	DRY DENSITY (P.C.F.)	MOISTURE CONTENT (%)
					ELEV. (MSL.) <u>173'</u>	DATE COMPLETED <u>06-30-2021</u>			
					EQUIPMENT <u>BACKHOE CAT 430F</u>		BY: <u>R. ADAMS</u>		
MATERIAL DESCRIPTION									
0				ML	<b>TOPSOIL</b> Soft, dry, pale reddish-brown, Sandy SILT; trace gravel				
2				SC	<b>TERRACE DEPOSITS (Qt)</b> Dense, moist, yellow to yellowish-brown, Clayey, fine to medium SAND with cobble; caliche stringers common, cobble is subrounded up to 10-inch diameter				
4									
6									
8									
10									
12					TRENCH TERMINATED AT 12 FEET Groundwater not encountered Backfilled on 06-30-2021				

**Figure A-22,**  
**Log of Test Pit TP 19, Page 1 of 1**

G2762-42-01.GPJ

SAMPLE SYMBOLS	 ... SAMPLING UNSUCCESSFUL	 ... STANDARD PENETRATION TEST	 ... DRIVE SAMPLE (UNDISTURBED)
	 ... DISTURBED OR BAG SAMPLE	 ... CHUNK SAMPLE	 ... WATER TABLE OR  ... SEEPAGE

NOTE: THE LOG OF SUBSURFACE CONDITIONS SHOWN HEREON APPLIES ONLY AT THE SPECIFIC BORING OR TRENCH LOCATION AND AT THE DATE INDICATED. IT IS NOT WARRANTED TO BE REPRESENTATIVE OF SUBSURFACE CONDITIONS AT OTHER LOCATIONS AND TIMES.

DEPTH IN FEET	SAMPLE NO.	LITHOLOGY	GROUNDWATER	SOIL CLASS (USCS)	TEST PIT TP 20		PENETRATION RESISTANCE (BLOWS/FT.)	DRY DENSITY (P.C.F.)	MOISTURE CONTENT (%)
					ELEV. (MSL.) <u>160'</u>	DATE COMPLETED <u>06-30-2021</u>			
					EQUIPMENT <u>BACKHOE CAT 430F</u>		BY: <u>R. ADAMS</u>		
MATERIAL DESCRIPTION									
0				SM	<b>TOPSOIL</b> Loose, dry, olive brown, Silty, very fine grained SAND; trace subrounded gravel				
2				SM	<b>SAN DIEGO FORMATION (Tsd)</b> Dense, damp, orangish-brown to whitish-gray, Silty, very fine grained SANDSTONE; highly micaceous				
4									
6									
					TRENCH TERMINATED AT 7 FEET Groundwater not encountered Backfilled on 06-30-2021				

**Figure A-23,**  
**Log of Test Pit TP 20, Page 1 of 1**

G2762-42-01.GPJ

SAMPLE SYMBOLS		... SAMPLING UNSUCCESSFUL		... STANDARD PENETRATION TEST		... DRIVE SAMPLE (UNDISTURBED)
		... DISTURBED OR BAG SAMPLE		... CHUNK SAMPLE		... WATER TABLE OR  ... SEEPAGE

NOTE: THE LOG OF SUBSURFACE CONDITIONS SHOWN HEREON APPLIES ONLY AT THE SPECIFIC BORING OR TRENCH LOCATION AND AT THE DATE INDICATED. IT IS NOT WARRANTED TO BE REPRESENTATIVE OF SUBSURFACE CONDITIONS AT OTHER LOCATIONS AND TIMES.

APPENDIX

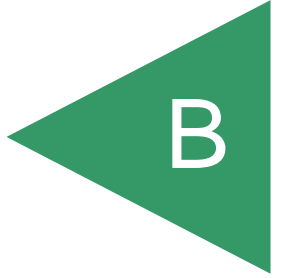



## APPENDIX B

### LABORATORY TESTING

Laboratory tests were performed in accordance with generally accepted test methods of the American Society for Testing and Materials (ASTM) or other suggested procedures. Selected samples were tested for *in-situ* dry density and moisture content, maximum dry density and optimum moisture content, expansion potential, consolidation potential, gradation, soluble sulfate content, chloride content, p.H. and resistivity, and shear strength. The results of these tests are summarized on the following tables and figures. The in-place dry density and moisture content of the samples tested are presented on the boring logs in Appendix A.

#### SUMMARY OF LABORATORY MAXIMUM DRY DENSITY AND OPTIMUM MOISTURE CONTENT TEST RESULTS ASTM D 1557-02

Sample No.	Description	Maximum Dry Density (pcf)	Optimum Moisture Content (% dry wt.)
T1-1	Brown clayey fine to medium SAND	123.3	12.1
T1-2	Brown silty SAND with gravel	121.3	12.7
T3-2	Dark yellow Silty fine SAND	103.2	16.5

#### SUMMARY OF LABORATORY EXPANSION INDEX TEST RESULTS ASTM D 4829-03

Sample No.	Moisture Content		Dry Density (pcf)	Expansion Index
	Before Test (%)	After Test (%)		
T1-1	10.9	22.0	107.3	46
T1-2	10.8	18.0	107.3	16
T3-1	8.3	13.8	116.8	0
T3-2	14.4	26.7	94.1	0
T8-1	11.7	28.0	103.8	99

**SUMMARY OF LABORATORY WATER-SOLUBLE SULFATE TEST RESULTS  
CALIFORNIA TEST NO. 417**

Sample No.	Water-Soluble Sulfate (%)	Sulfate Exposure
T1-1	0.020	S0
T3-2	0.001	S0

**SUMMARY OF LABORATORY WATER-SOLUBLE CHLORIDE ION CONTENT TEST RESULTS  
AASHTO TEST NO. T 291**

Sample No.	Chloride Ion Content ppm (%)
T1-1	380 (0.038)
T3-2	71 (0.007)

**SUMMARY OF LABORATORY POTENTIAL OF HYDROGEN (PH) AND  
RESISTIVITY TEST RESULTS  
CALIFORNIA TEST METHOD 643**

Sample No.	Geologic Unit	pH	Minimum Resistivity (ohm-centimeters)
T1-1	Qal	8.92	700

**SUMMARY OF LABORATORY ATTERBERG LIMITS TEST RESULTS  
ASTM D 4318**

Sample No.	Liquid Limit (%)	Plastic Limit (%)	Plasticity Index
T1-1	42	20	22
T1-2	30	22	8
T3-2	Non Plastic	Non Plastic	Non Plastic

TEST RESULTS					
SAMPLE NO.	GEOLOGIC UNIT	LIQUID LIMIT	PLASTIC LIMIT	PLASTICITY INDEX	SOIL TYPE
T1-1	Qal	42	20	22	CL

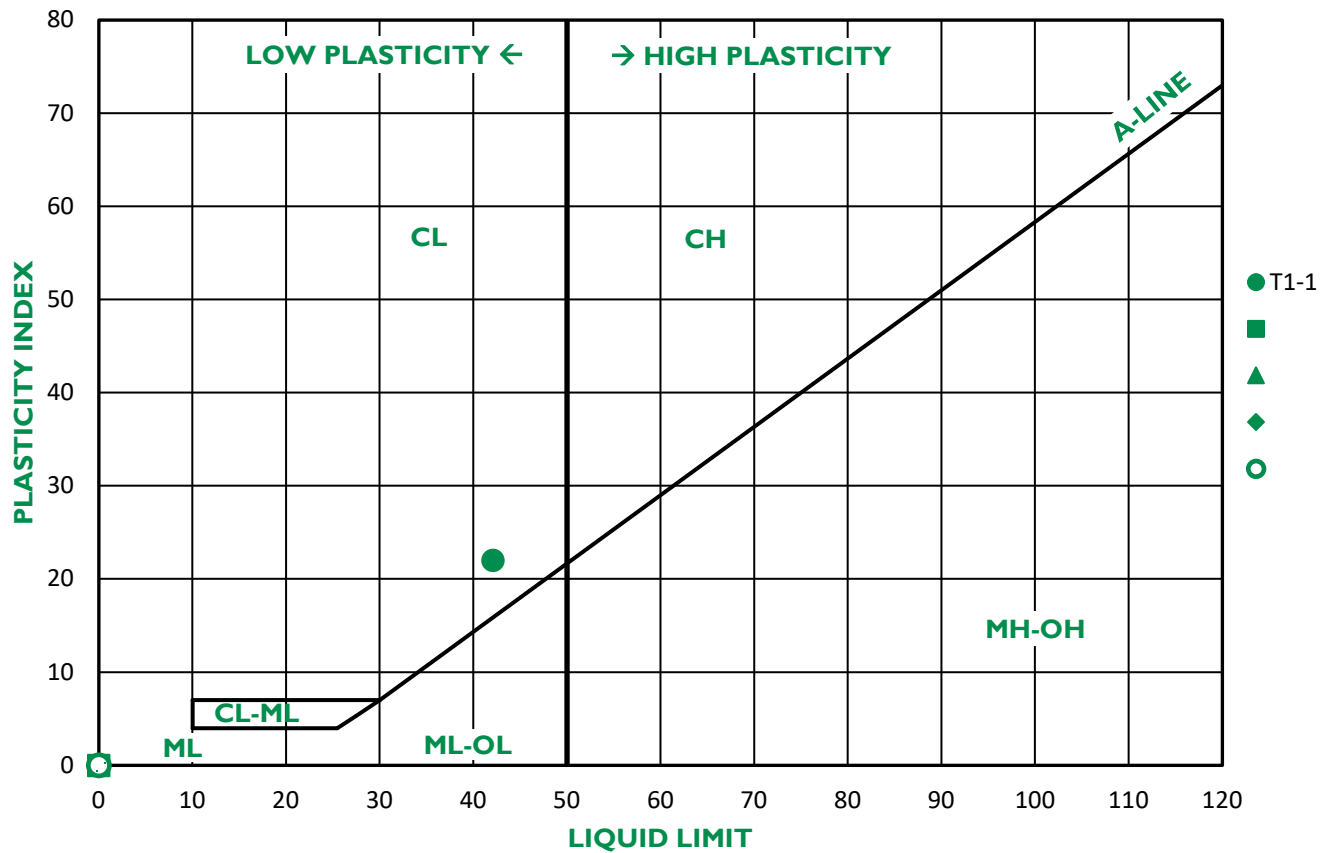

SOIL TYPE DESCRIPTION	
CH	High-Plasticity Clay
CL	Low-Plasticity Clay
ML	Low-Plasticity Silt
CL-ML	Low-Plasticity Clay to Low-Plasticity Silt
MH-OH	High-Plasticity Silt to High-Plasticity, Organic Silt
ML-OL	Low-Plasticity Silt to Low-Plasticity, Organic Silt

**GEOCON**  
INCORPORATED



GEOTECHNICAL CONSULTANTS  
6960 FLANDERS DRIVE - SAN DIEGO, CALIFORNIA 92121-2974  
PHONE 858 558-6900 - FAX 858 558-6159

**PLASTICITY INDEX - ASTM D 4318**

**SHINOHARA**  
**PROJECT NO.: G2762-42-01**

TEST RESULTS					
SAMPLE NO.	GEOLOGIC UNIT	LIQUID LIMIT	PLASTIC LIMIT	PLASTICITY INDEX	SOIL TYPE
T1-2	Qal	30	22	8	CL

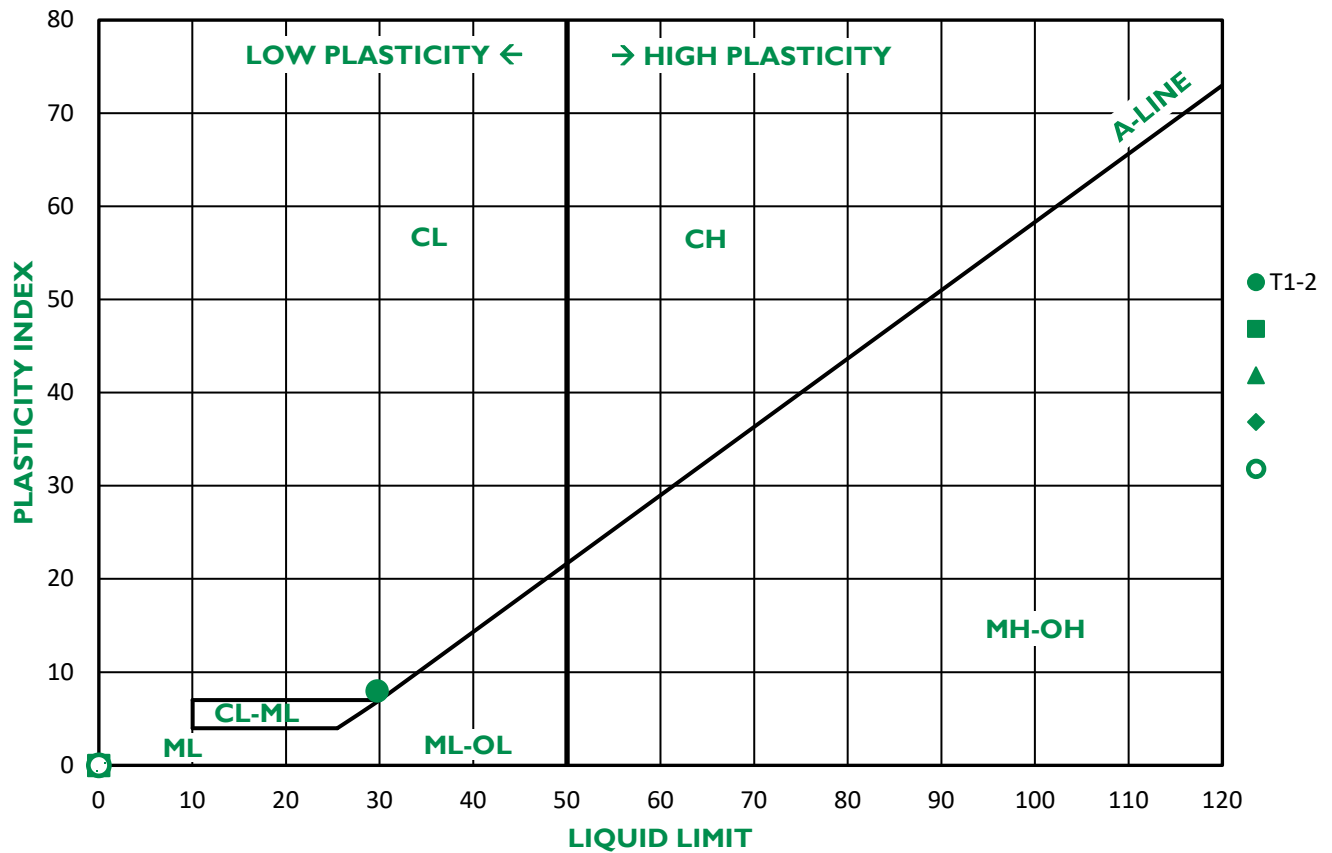

SOIL TYPE DESCRIPTION	
CH	High-Plasticity Clay
CL	Low-Plasticity Clay
ML	Low-Plasticity Silt
CL-ML	Low-Plasticity Clay to Low-Plasticity Silt
MH-OH	High-Plasticity Silt to High-Plasticity, Organic Silt
ML-OL	Low-Plasticity Silt to Low-Plasticity, Organic Silt

**GEOCON**  
INCORPORATED



GEOTECHNICAL CONSULTANTS  
6960 FLANDERS DRIVE - SAN DIEGO, CALIFORNIA 92121 - 2974  
PHONE 858 558-6900 - FAX 858 558-6159

**PLASTICITY INDEX - ASTM D 4318**

**SHINOHARA**  
**PROJECT NO.: G2762-42-01**

SAMPLE NO.: TI-1  
 SAMPLE DEPTH (FT.): 2'-4'

GEOLOGIC UNIT: Qal

<b>GRAVEL</b>		<b>SAND</b>			<b>SILT OR CLAY</b>
COARSE	FINE	COARSE	MEDIUM	FINE	

U.S. STANDARD SIEVE SIZE

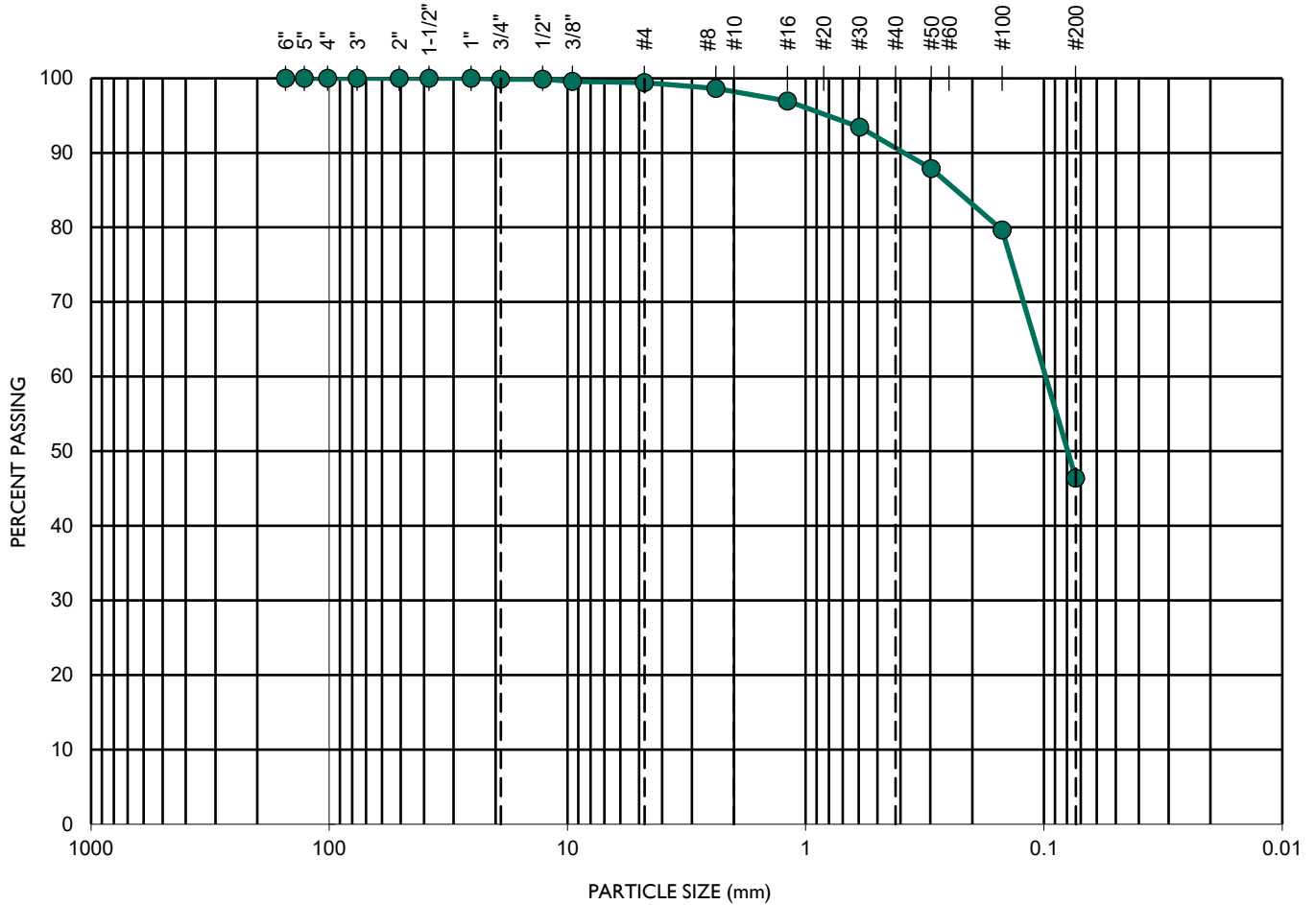

TEST DATA					SOIL DESCRIPTION
D <sub>10</sub> (mm)	D <sub>30</sub> (mm)	D <sub>60</sub> (mm)	C <sub>c</sub>	C <sub>u</sub>	
0.016	0.048	0.105	1.4	6.6	SC - Clayey SAND

**GEOCON**  
INCORPORATED



GEOTECHNICAL CONSULTANTS  
 6960 FLANDERS DRIVE - SAN DIEGO, CALIFORNIA 92121 - 2974  
 PHONE 858 558-6900 - FAX 858 558-6159

**SIEVE ANALYSES - ASTM D 135**

**SHINOHARA**

**PROJECT NO.: G2762-42-01**

SAMPLE NO.: TI-2  
 SAMPLE DEPTH (FT.): 10'-12'

GEOLOGIC UNIT: Qal

<b>GRAVEL</b>		<b>SAND</b>			<b>SILT OR CLAY</b>
COARSE	FINE	COARSE	MEDIUM	FINE	

U.S. STANDARD SIEVE SIZE

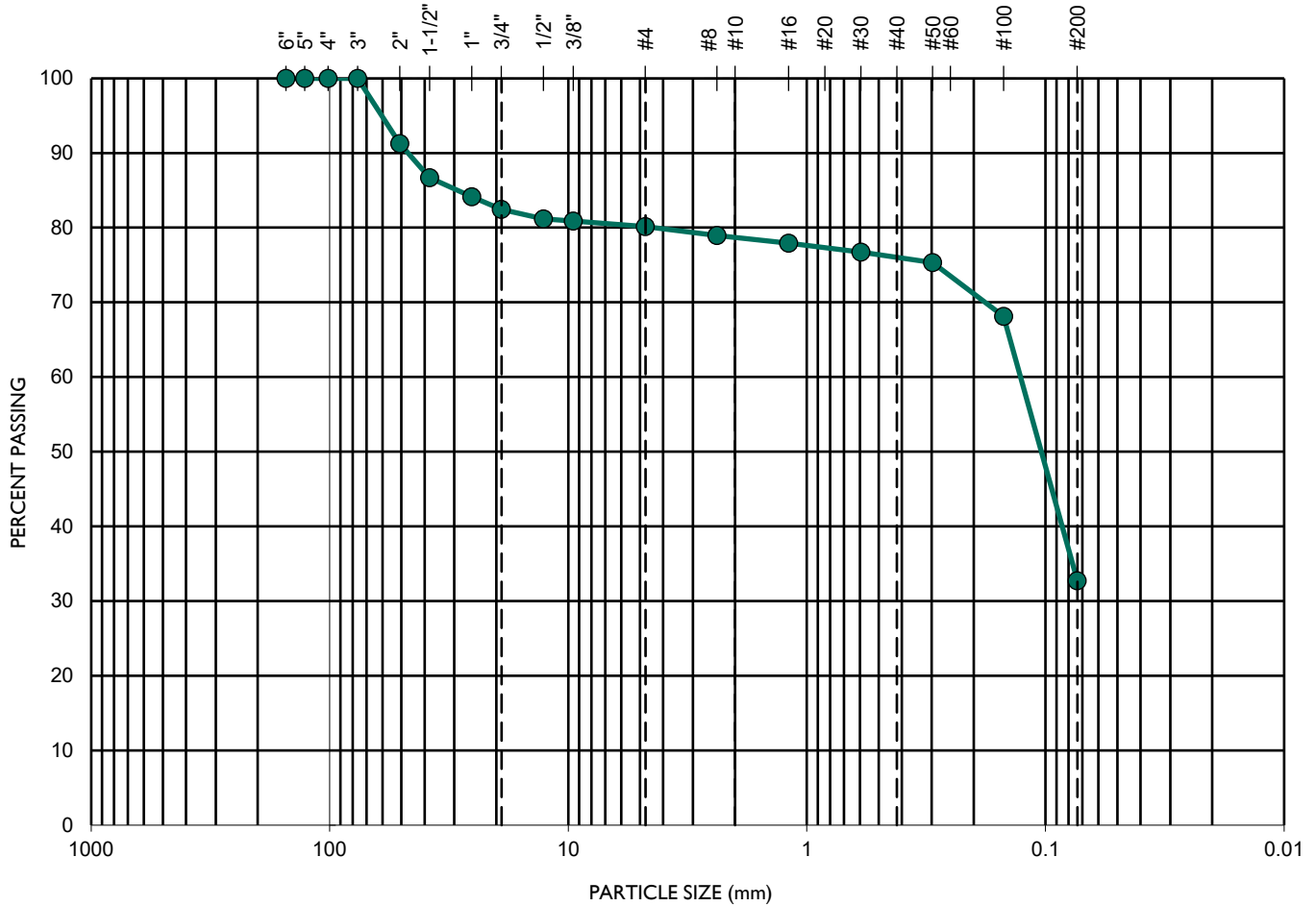

TEST DATA					
D <sub>10</sub> (mm)	D <sub>30</sub> (mm)	D <sub>60</sub> (mm)	C <sub>c</sub>	C <sub>u</sub>	SOIL DESCRIPTION
0.023	0.068	0.132	1.5	5.9	SM - Silty SAND with gravel

**GEOCON**  
INCORPORATED



GEOTECHNICAL CONSULTANTS  
 6960 FLANDERS DRIVE - SAN DIEGO, CALIFORNIA 92121 - 2974  
 PHONE 858 558-6900 - FAX 858 558-6159

**SIEVE ANALYSES - ASTM D 135**

**SHINOHARA**

**PROJECT NO.: G2762-42-01**

SAMPLE NO.: **T3-2**  
 SAMPLE DEPTH (FT.): **10'-12'**

GEOLOGIC UNIT: **Tsd**

<b>GRAVEL</b>		<b>SAND</b>			<b>SILT OR CLAY</b>
COARSE	FINE	COARSE	MEDIUM	FINE	

U.S. STANDARD SIEVE SIZE

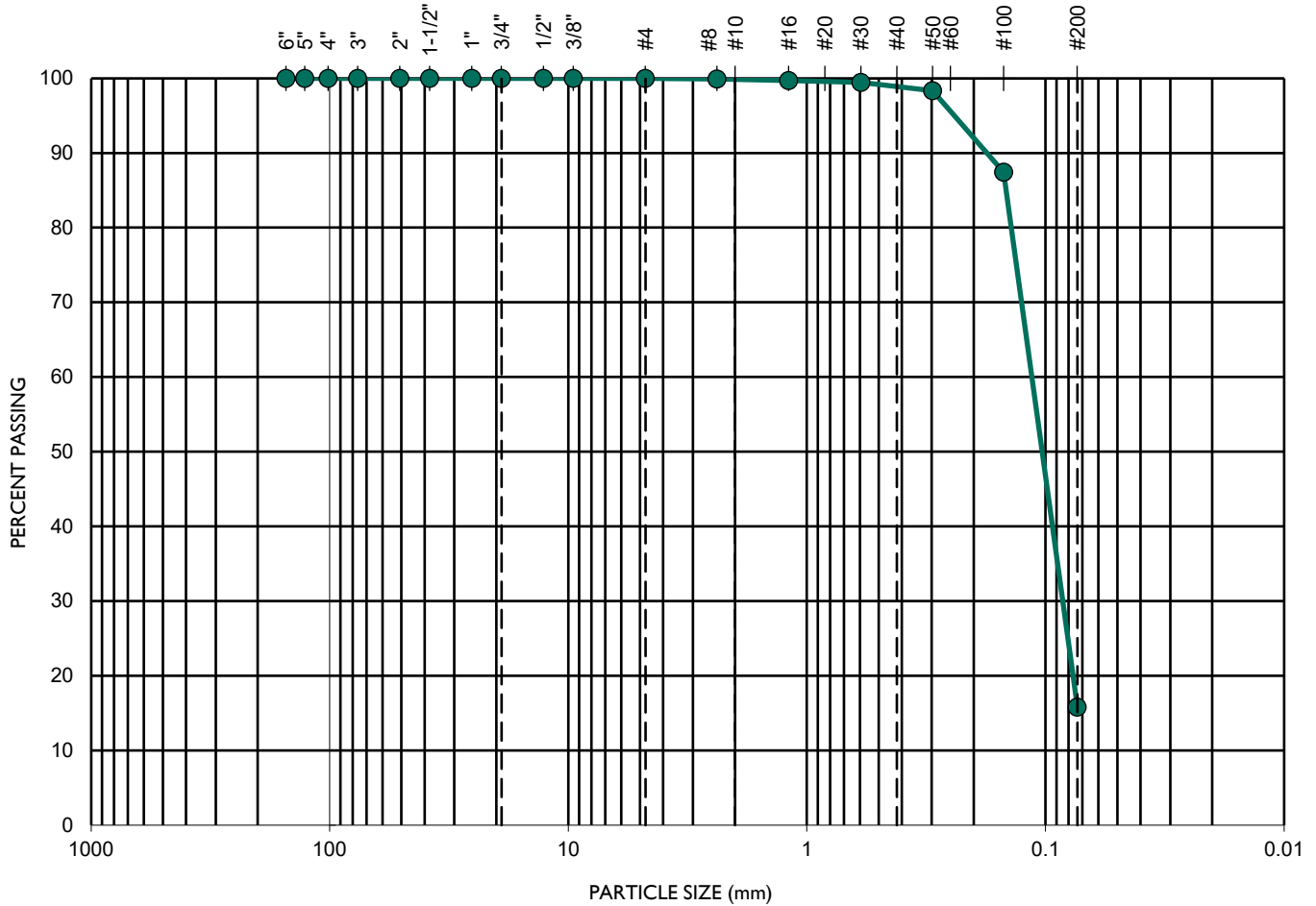

TEST DATA					SOIL DESCRIPTION
$D_{10}$ (mm)	$D_{30}$ (mm)	$D_{60}$ (mm)	$C_c$	$C_u$	
0.047	0.089	0.121	1.4	2.6	SM - Silty SAND

**GEOCON**  
INCORPORATED



GEOTECHNICAL CONSULTANTS  
 6960 FLANDERS DRIVE - SAN DIEGO, CALIFORNIA 92121 - 2974  
 PHONE 858 558-6900 - FAX 858 558-6159

**SIEVE ANALYSES - ASTM D 135**

**SHINOHARA**

**PROJECT NO.: G2762-42-01**

SAMPLE NO.: LBI-1 GEOLOGIC UNIT: Tsd  
 SAMPLE DEPTH (FT): 10'-11' NATURAL/REMOVED: N

INITIAL CONDITIONS				
NORMAL STRESS TEST LOAD	1 K	2 K	4 K	AVERAGE
ACTUAL NORMAL STRESS (PSF):	1000	2000	4000	--
WATER CONTENT (%):	13.0	13.2	12.2	12.8
DRY DENSITY (PCF):	100.7	108.8	104.5	104.7

AFTER TEST CONDITIONS				
NORMAL STRESS TEST LOAD	1 K	2 K	4 K	AVERAGE
WATER CONTENT (%):	28.7	25.9	26.1	26.9
PEAK SHEAR STRESS (PSF):	1125	1599	3046	--
ULT.-E.O.T. SHEAR STRESS (PSF):	1004	1602	3046	--

RESULTS		
PEAK	COHESION, C (PSF)	400
	FRICTION ANGLE (DEGREES)	33
ULTIMATE	COHESION, C (PSF)	280
	FRICTION ANGLE (DEGREES)	34

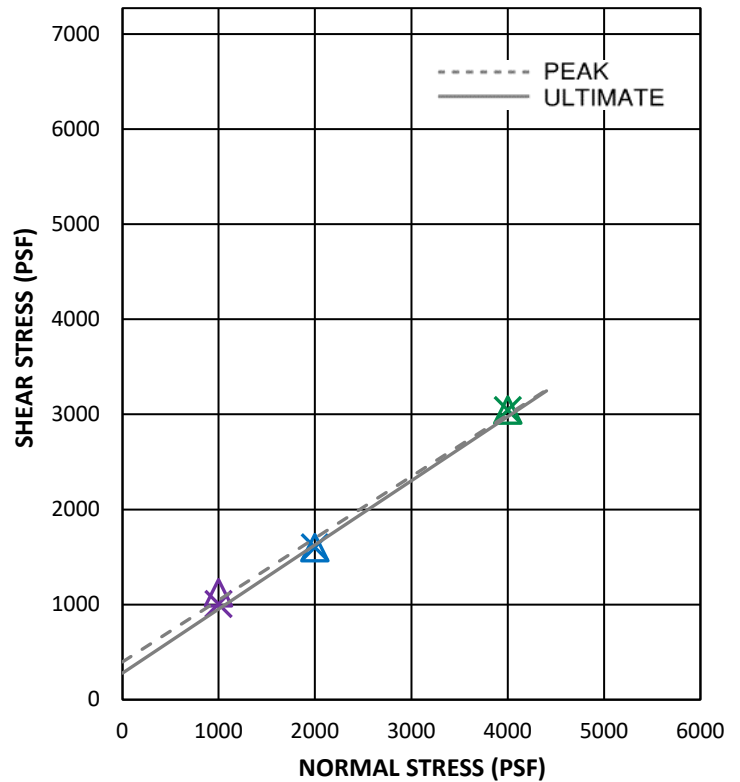
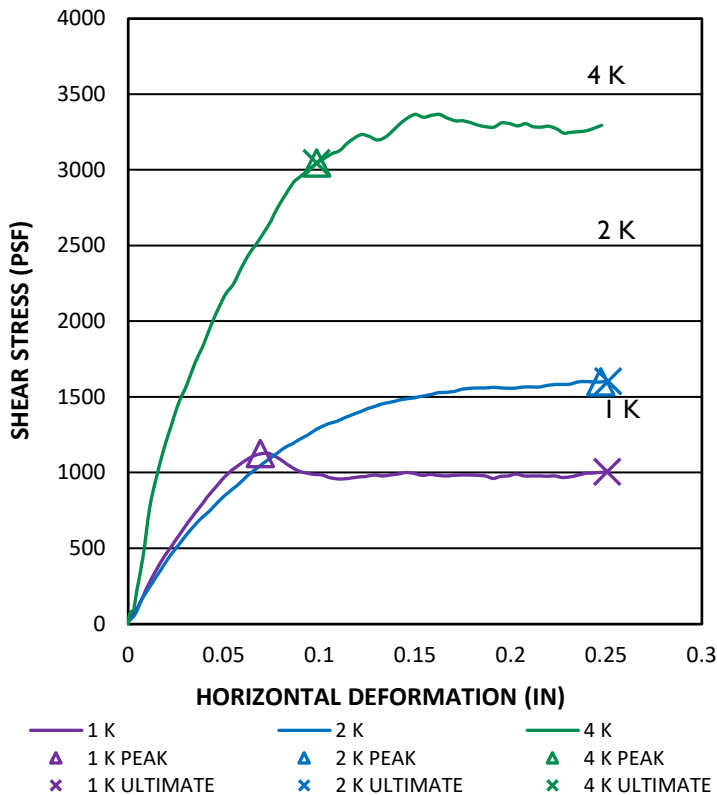

**DIRECT SHEAR - ASTM D 3080**

**GEOCON**  
 INCORPORATED



GEOTECHNICAL CONSULTANTS  
 6960 FLANDERS DRIVE - SAN DIEGO, CALIFORNIA 92121-2974  
 PHONE 858 558-6900 - FAX 858 558-6159

**517 SHINOHARA**

**PROJECT NO.: G2762-42-01**



SAMPLE NO.: LB I-2 GEOLOGIC UNIT: Tsd  
 SAMPLE DEPTH (FT): 20' NATURAL/REMOLDED: N

INITIAL CONDITIONS				
NORMAL STRESS TEST LOAD	1 K	2 K	4 K	AVERAGE
ACTUAL NORMAL STRESS (PSF):	1000	2000	4000	--
WATER CONTENT (%):	4.0	4.8	4.1	4.3
DRY DENSITY (PCF):	95.3	97.4	100.8	97.8

AFTER TEST CONDITIONS				
NORMAL STRESS TEST LOAD	1 K	2 K	4 K	AVERAGE
WATER CONTENT (%):	23.1	21.5	19.5	21.4
PEAK SHEAR STRESS (PSF):	1118	1687	3348	--
ULT.-E.O.T. SHEAR STRESS (PSF):	1112	1693	3046	--

RESULTS		
PEAK	COHESION, C (PSF)	290
	FRICTION ANGLE (DEGREES)	37
ULTIMATE	COHESION, C (PSF)	440
	FRICTION ANGLE (DEGREES)	33

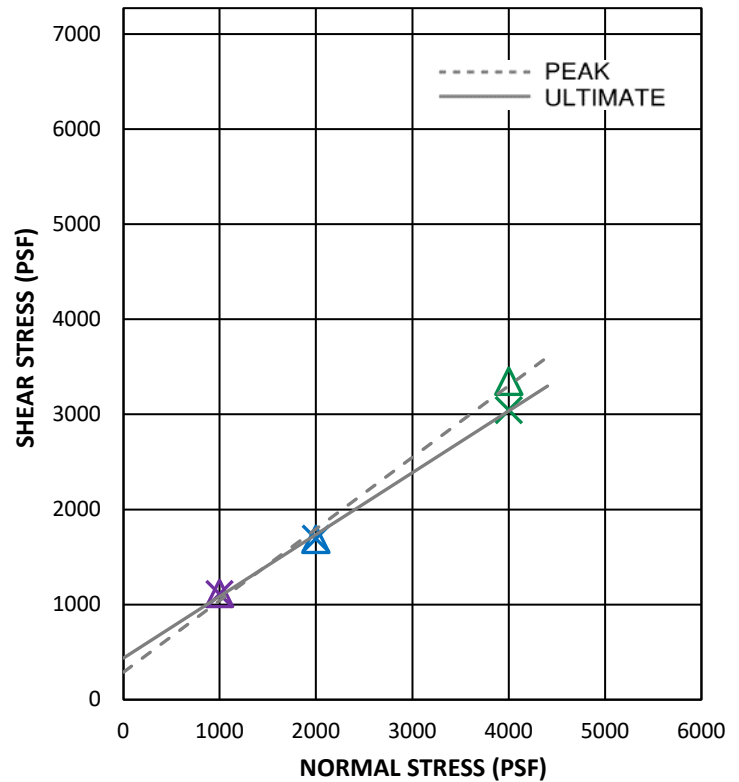
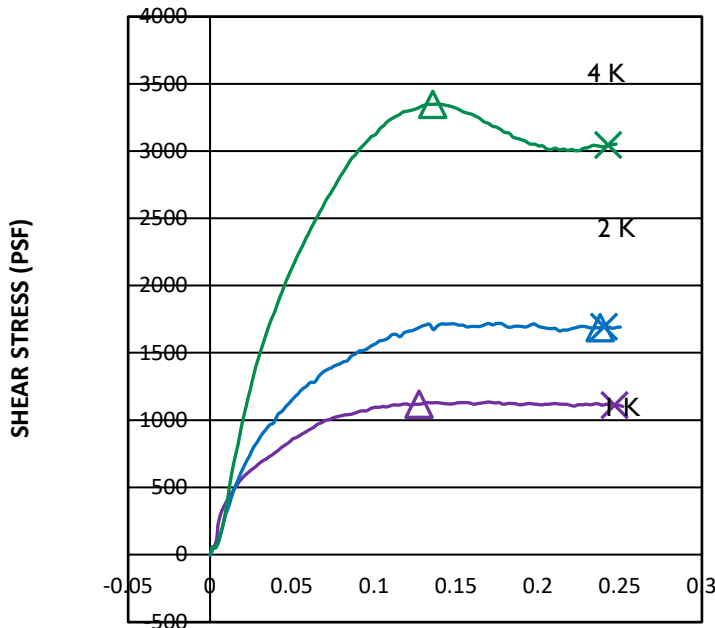

HORIZONTAL DEFORMATION (IN)

— 1 K      — 2 K      — 4 K  
 ▲ 1 K PEAK    ▲ 2 K PEAK    ▲ 4 K PEAK  
 × 1 K ULTIMATE    × 2 K ULTIMATE    × 4 K ULTIMATE

**DIRECT SHEAR - ASTM D 3080**

**GEOCON**  
INCORPORATED



GEOTECHNICAL CONSULTANTS  
 6960 FLANDERS DRIVE - SAN DIEGO, CALIFORNIA 92121-2974  
 PHONE 858 558-6900 - FAX 858 558-6159

**SHINOHARA**

**PROJECT NO.: G2762-42-01**

SAMPLE NO.: LB I-4 GEOLOGIC UNIT: Tsd  
 SAMPLE DEPTH (FT): 40' NATURAL/REMOLDED: N

INITIAL CONDITIONS				
NORMAL STRESS TEST LOAD	1 K	2 K	4 K	AVERAGE
ACTUAL NORMAL STRESS (PSF):	1000	2000	4000	--
WATER CONTENT (%):	5.2	5.4	6.4	5.7
DRY DENSITY (PCF):	94.5	81.3	86.3	87.3

AFTER TEST CONDITIONS				
NORMAL STRESS TEST LOAD	1 K	2 K	4 K	AVERAGE
WATER CONTENT (%):	28.3	37.5	35.1	33.6
PEAK SHEAR STRESS (PSF):	1086	1586	3338	--
ULT.-E.O.T. SHEAR STRESS (PSF):	793	1563	3361	--

RESULTS		
<b>PEAK</b>	COHESION, C (PSF)	210
	FRICTION ANGLE (DEGREES)	37
<b>ULTIMATE</b>	COHESION, C (PSF)	0
	FRICTION ANGLE (DEGREES)	39

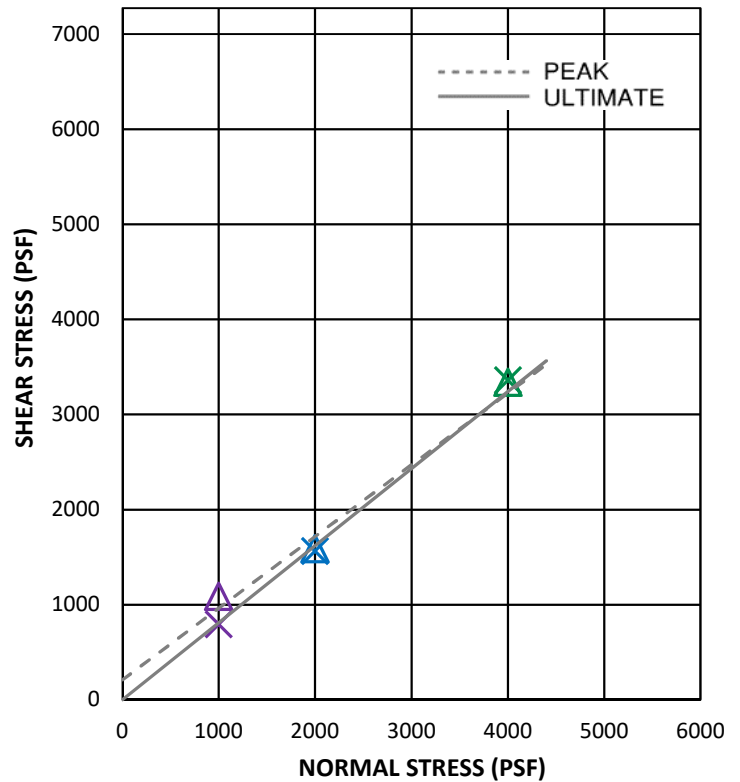
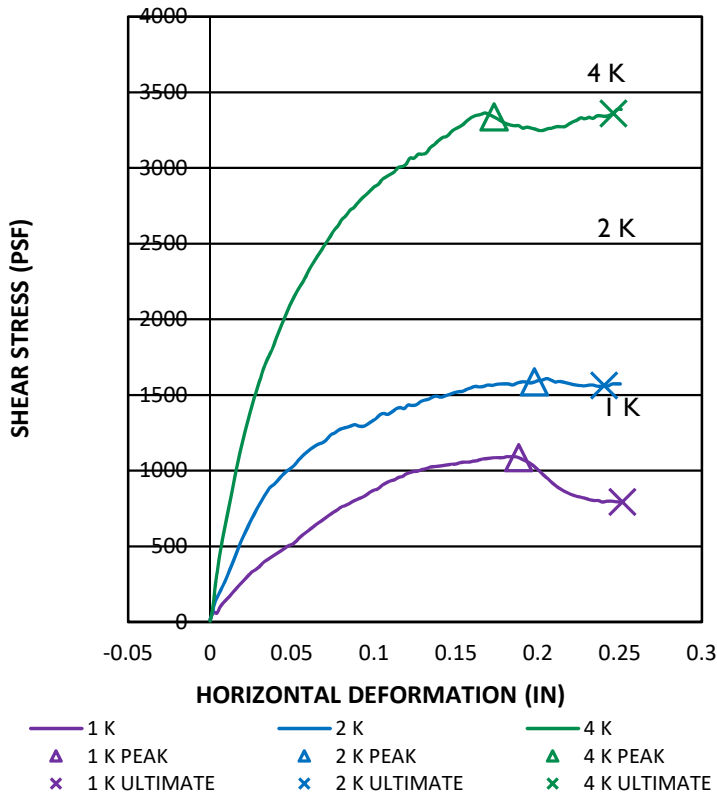

**DIRECT SHEAR - ASTM D 3080**

**GEOCON**  
 INCORPORATED



GEOTECHNICAL CONSULTANTS  
 6960 FLANDERS DRIVE - SAN DIEGO, CALIFORNIA 92121-2974  
 PHONE 858 558-6900 - FAX 858 558-6159

**517 SHINOHARA**

**PROJECT NO.: G2762-42-01**

SAMPLE NO.: TI-1 GEOLOGIC UNIT: Qal  
 SAMPLE DEPTH (FT): 2'-4' NATURAL/REMOVED: R

INITIAL CONDITIONS				
NORMAL STRESS TEST LOAD	1 K	2 K	4 K	AVERAGE
ACTUAL NORMAL STRESS (PSF):	890	2030	4300	--
WATER CONTENT (%):	13.1	10.7	11.5	11.8
DRY DENSITY (PCF):	109.6	113.3	112.6	111.8

AFTER TEST CONDITIONS				
NORMAL STRESS TEST LOAD	1 K	2 K	4 K	AVERAGE
WATER CONTENT (%):	19.0	16.8	18.0	17.9
PEAK SHEAR STRESS (PSF):	1141	1904	2866	--
ULT.-E.O.T. SHEAR STRESS (PSF):	1103	1904	2866	--

RESULTS		
<b>PEAK</b>	COHESION, C (PSF)	780
	FRICTION ANGLE (DEGREES)	26
<b>ULTIMATE</b>	COHESION, C (PSF)	750
	FRICTION ANGLE (DEGREES)	27

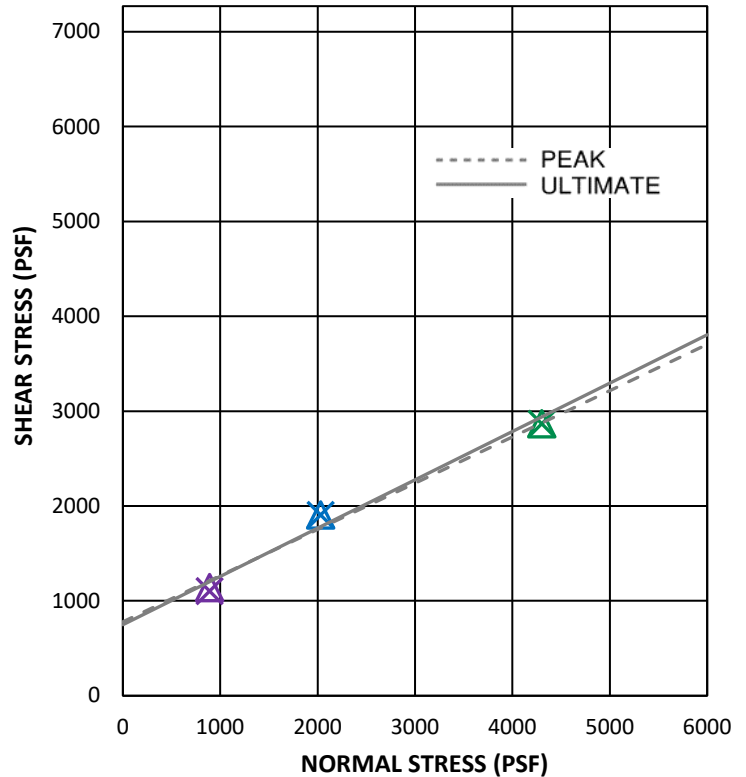
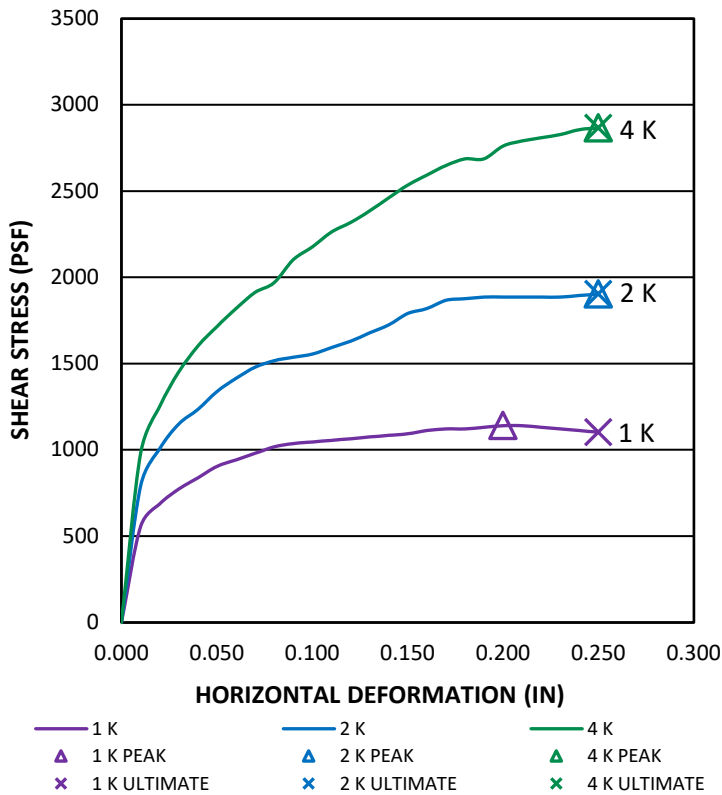

**DIRECT SHEAR - ASTM D 3080**

**GEOCON**  
 INCORPORATED



GEOTECHNICAL CONSULTANTS  
 6960 FLANDERS DRIVE - SAN DIEGO, CALIFORNIA 92121-2974  
 PHONE 858 558-6900 - FAX 858 558-6159

**SHINOHARA**

**PROJECT NO.: G2762-42-01**

SAMPLE NO.: T1-2 GEOLOGIC UNIT: Qal  
 SAMPLE DEPTH (FT): 10'-12' NATURAL/REMODELED: R

INITIAL CONDITIONS				
NORMAL STRESS TEST LOAD	1 K	2 K	4 K	AVERAGE
ACTUAL NORMAL STRESS (PSF):	1000	2000	4000	--
WATER CONTENT (%):	13.6	12.8	13.3	13.2
DRY DENSITY (PCF):	109.0	109.3	109.2	109.2

AFTER TEST CONDITIONS				
NORMAL STRESS TEST LOAD	1 K	2 K	4 K	AVERAGE
WATER CONTENT (%):	17.5	16.9	21.6	18.7
PEAK SHEAR STRESS (PSF):	1219	2012	3530	--
ULT.-E.O.T. SHEAR STRESS (PSF):	1160	2012	3530	--

RESULTS		
<b>PEAK</b>	COHESION, C (PSF)	460
	FRICTION ANGLE (DEGREES)	38
<b>ULTIMATE</b>	COHESION, C (PSF)	400
	FRICTION ANGLE (DEGREES)	38

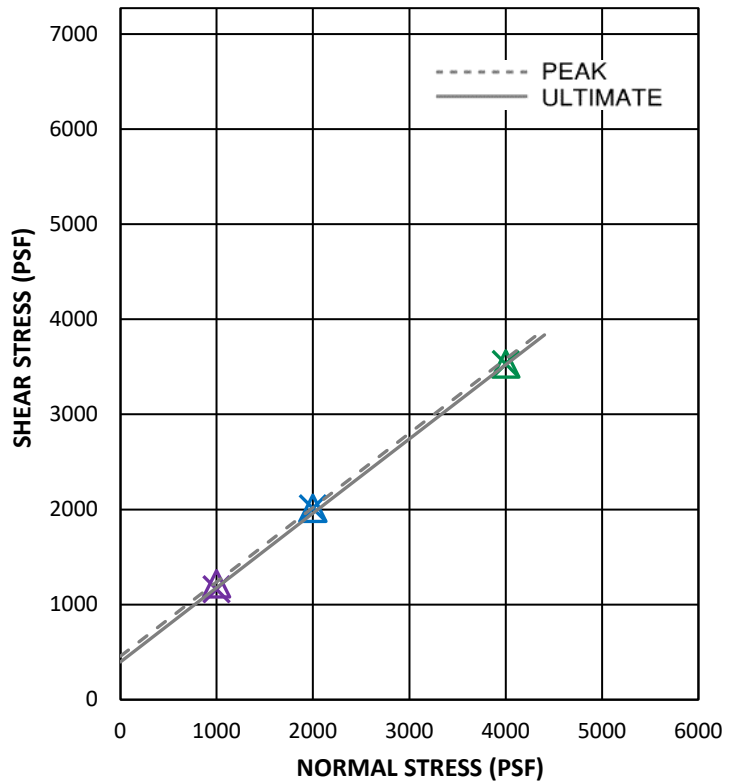
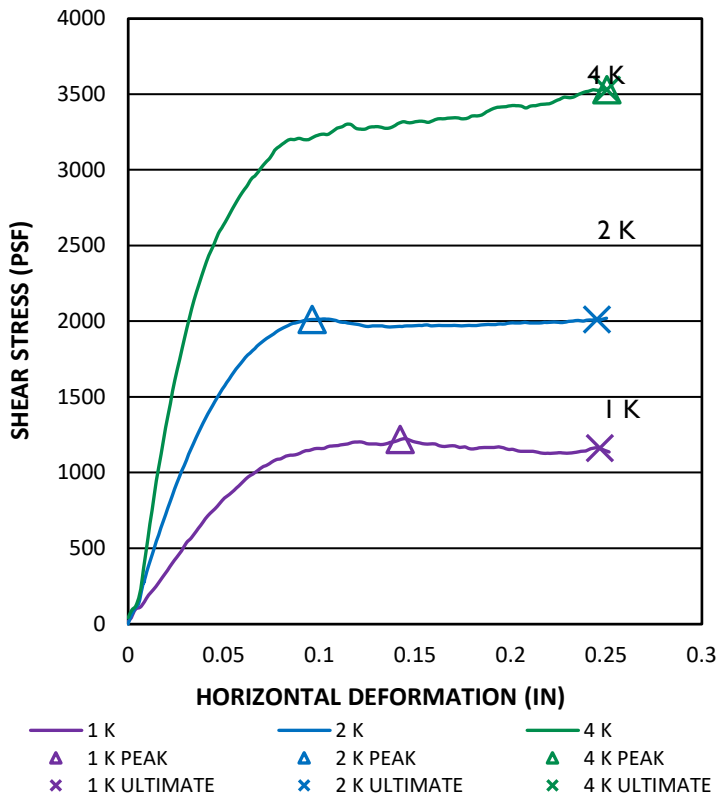

**DIRECT SHEAR - ASTM D 3080**

**GEOCON**  
INCORPORATED



GEOTECHNICAL CONSULTANTS  
 6960 FLANDERS DRIVE - SAN DIEGO, CALIFORNIA 92121-2974  
 PHONE 858 558-6900 - FAX 858 558-6159

**SHINOHARA**

**PROJECT NO.: G2762-42-01**

SAMPLE NO.: T3-2 GEOLOGIC UNIT: Tsd  
 SAMPLE DEPTH (FT): 10'-12' NATURAL/REMODELED: R

INITIAL CONDITIONS				
NORMAL STRESS TEST LOAD	1 K	2 K	4 K	AVERAGE
ACTUAL NORMAL STRESS (PSF):	890	2030	4300	--
WATER CONTENT (%):	18.5	16.8	18.3	17.9
DRY DENSITY (PCF):	90.9	92.8	91.2	91.6

AFTER TEST CONDITIONS				
NORMAL STRESS TEST LOAD	1 K	2 K	4 K	AVERAGE
WATER CONTENT (%):	32.7	29.7	31.1	31.2
PEAK SHEAR STRESS (PSF):	886	1518	2904	--
ULT.-E.O.T. SHEAR STRESS (PSF):	886	1461	2866	--

RESULTS		
PEAK	COHESION, C (PSF)	340
	FRICTION ANGLE (DEGREES)	31
ULTIMATE	COHESION, C (PSF)	330
	FRICTION ANGLE (DEGREES)	30

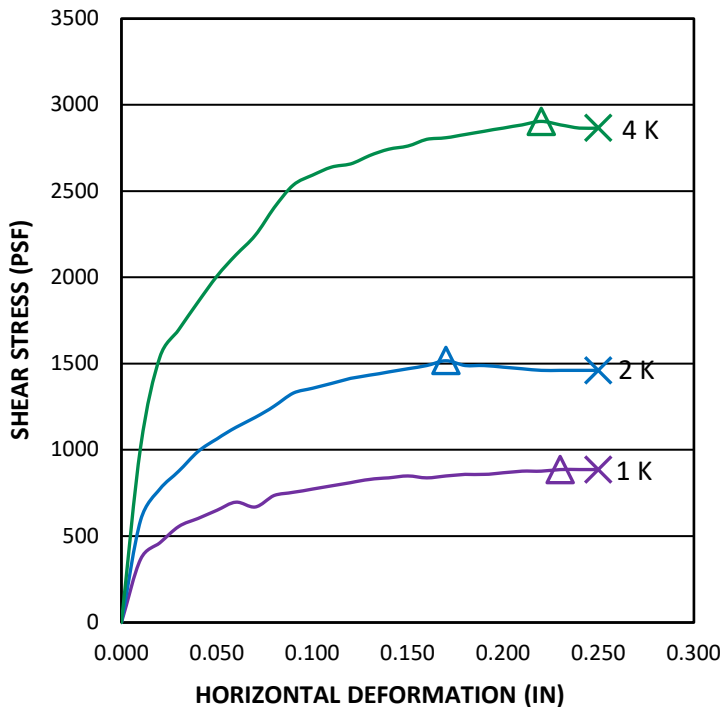

1 K                      2 K                      4 K  
 ▲ 1 K PEAK            ▲ 2 K PEAK            ▲ 4 K PEAK  
 × 1 K ULTIMATE      × 2 K ULTIMATE      × 4 K ULTIMATE

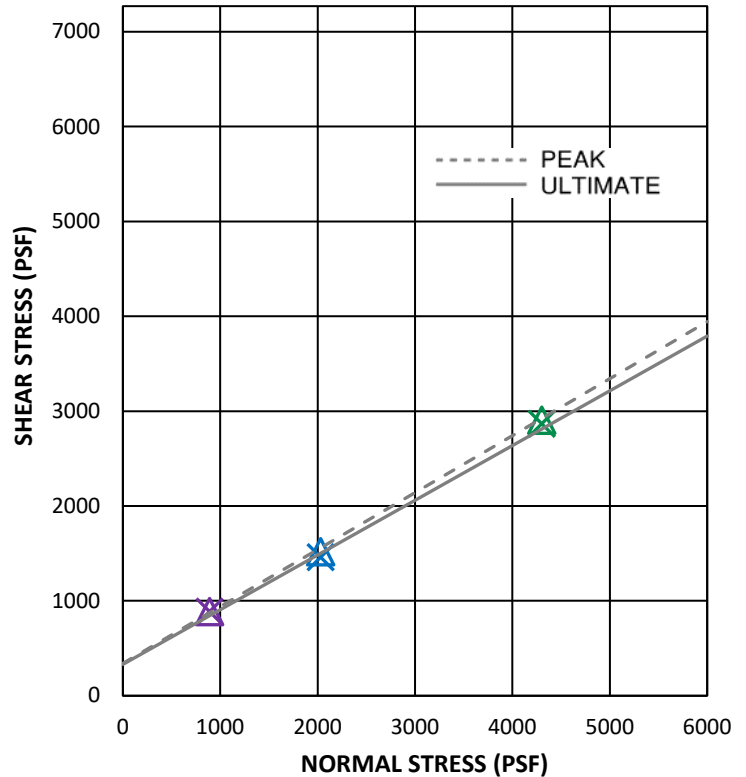

**DIRECT SHEAR - ASTM D 3080**

**GEOCON**  
 INCORPORATED



GEOTECHNICAL CONSULTANTS  
 6960 FLANDERS DRIVE - SAN DIEGO, CALIFORNIA 92121-2974  
 PHONE 858 558-6900 - FAX 858 558-6159

**SHINOHARA**

**PROJECT NO.: G2762-42-01**

SAMPLE NO.: **B1-3**  
 SAMPLE DEPTH (FT): **7.5'**

GEOLOGIC UNIT: **Qal**

TEST INFORMATION	
INITIAL DRY DENSITY (PCF):	120.0
INITIAL WATER CONTENT (%):	8.3%
SAMPLE SATURATED AT (KSF):	4.0
INITIAL SATURATION (%):	57.4%

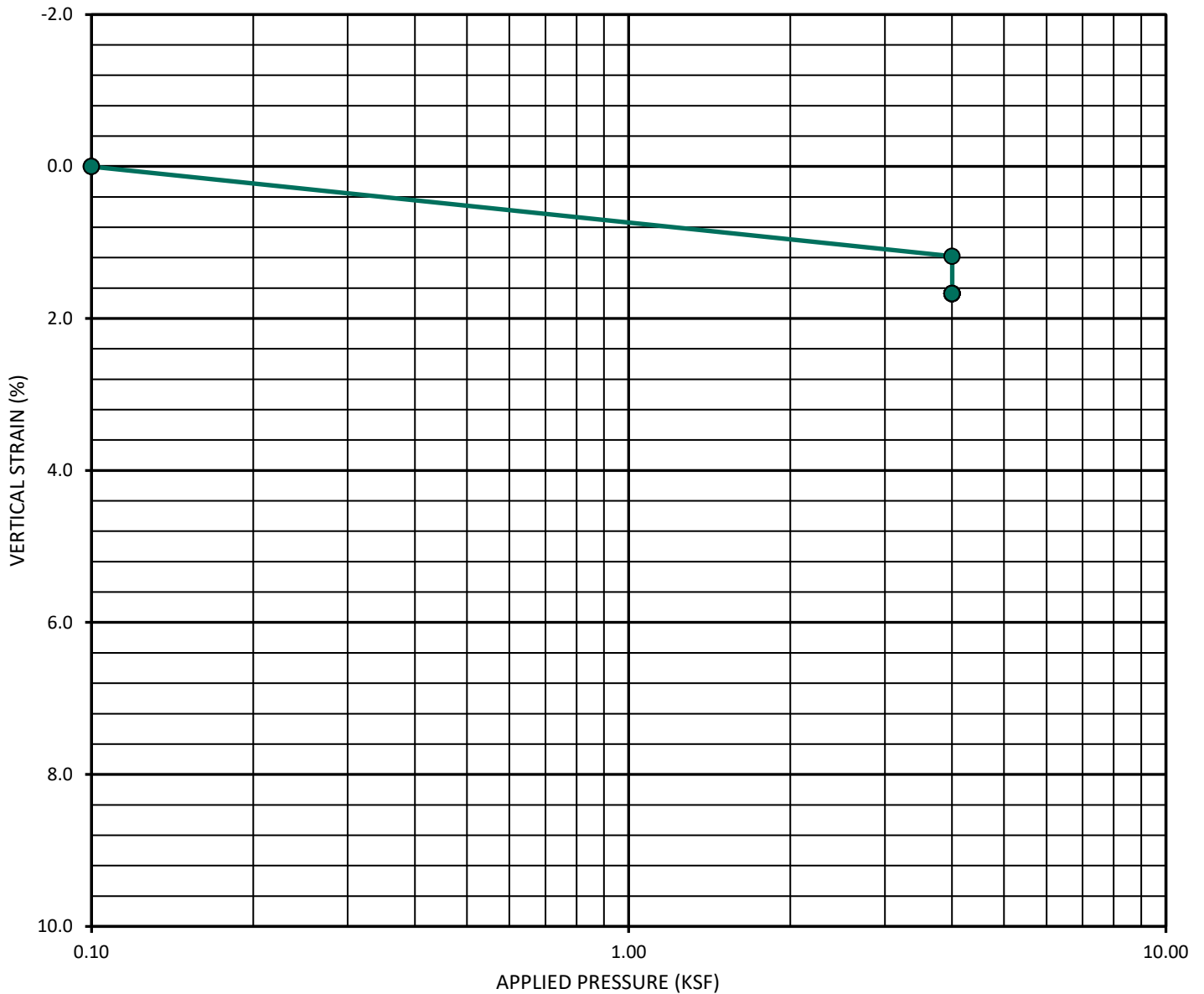

**CONSOLIDATION CURVE - ASTM D 2435**

**GEOCON**  
 INCORPORATED



GEOTECHNICAL CONSULTANTS  
 6960 FLANDERS DRIVE - SAN DIEGO, CALIFORNIA 92121 - 2974  
 PHONE 858 558-6900 - FAX 858 558-6159

**SHINOHARA**

**PROJECT NO.: G2762-42-01**

SAMPLE NO.: **B1-4**  
SAMPLE DEPTH (FT): **10'**

GEOLOGIC UNIT: **Qal**

TEST INFORMATION	
INITIAL DRY DENSITY (PCF):	117.7
INITIAL WATER CONTENT (%):	8.1%
SAMPLE SATURATED AT (KSF):	4.0
INITIAL SATURATION (%):	52.7%

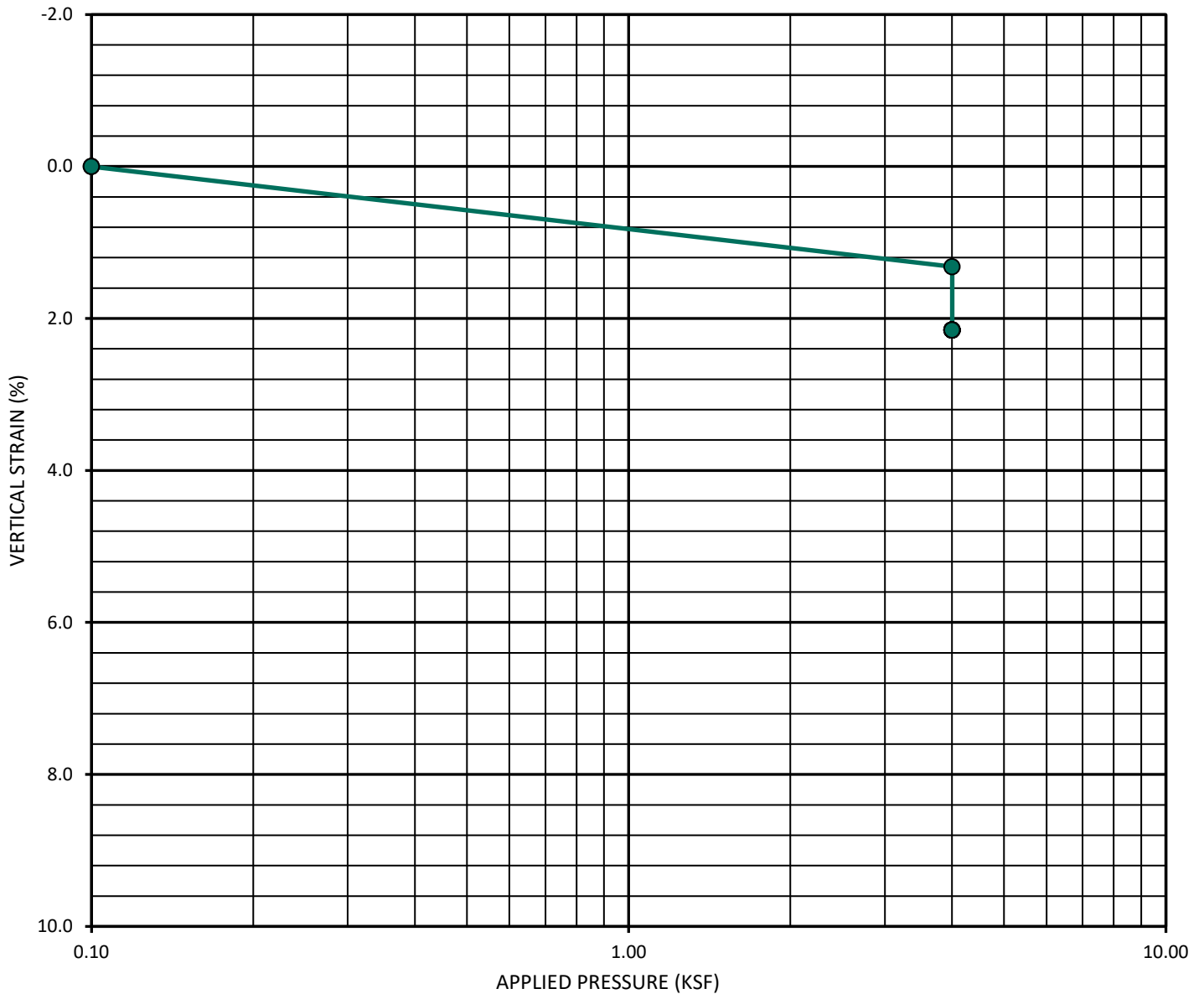

**CONSOLIDATION CURVE - ASTM D 2435**

**GEOCON**  
INCORPORATED



GEOTECHNICAL CONSULTANTS  
6960 FLANDERS DRIVE - SAN DIEGO, CALIFORNIA 92121 - 2974  
PHONE 858 558-6900 - FAX 858 558-6159

**SHINOHARA**

**PROJECT NO.: G2762-42-01**

SAMPLE NO.: **B1-5**  
SAMPLE DEPTH (FT): **15'**

GEOLOGIC UNIT: **Qal**

TEST INFORMATION	
INITIAL DRY DENSITY (PCF):	120.0
INITIAL WATER CONTENT (%):	9.5%
SAMPLE SATURATED AT (KSF):	4.0
INITIAL SATURATION (%):	65.9%

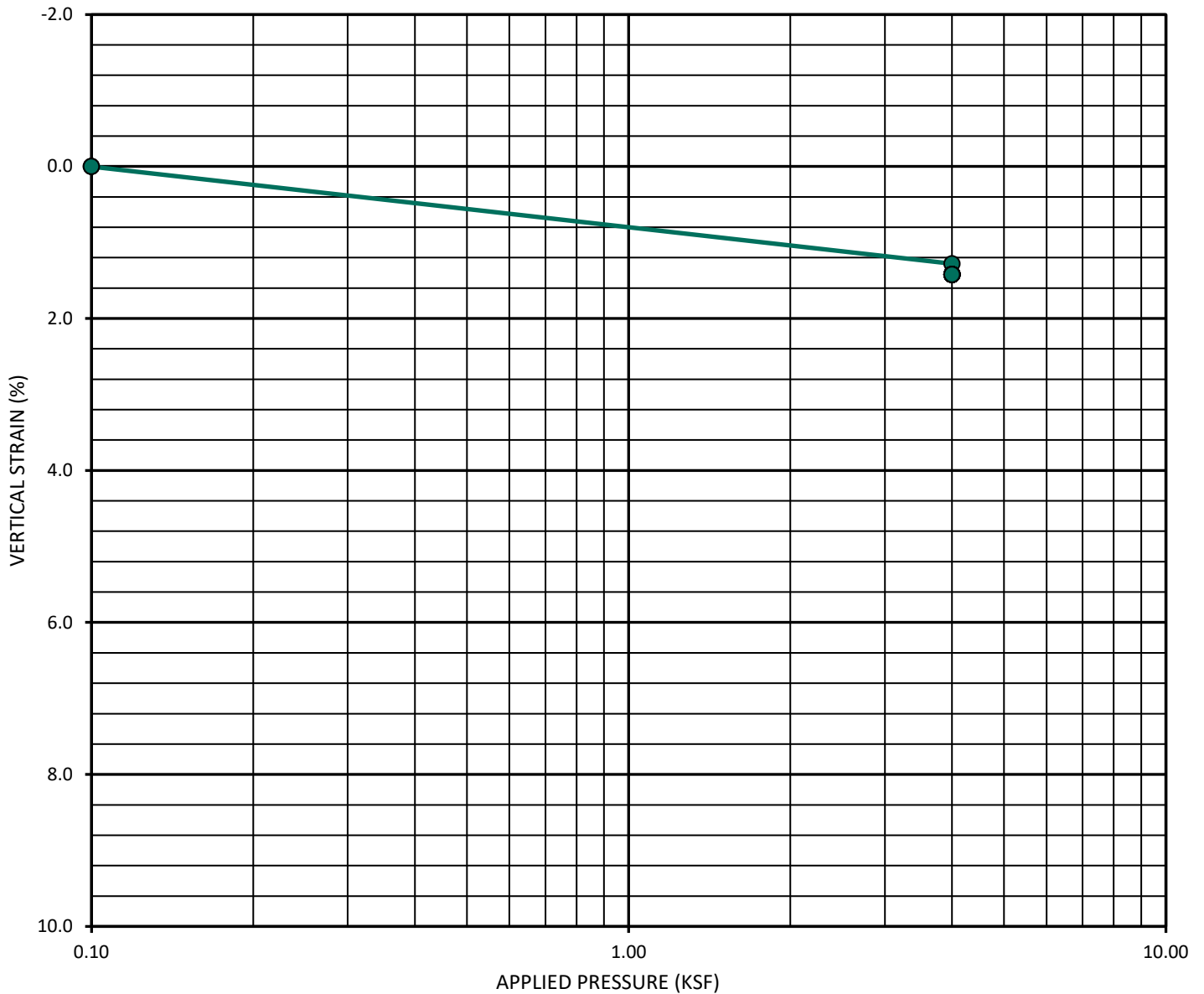

**CONSOLIDATION CURVE - ASTM D 2435**

**GEOCON**  
INCORPORATED



GEOTECHNICAL CONSULTANTS  
6960 FLANDERS DRIVE - SAN DIEGO, CALIFORNIA 92121 - 2974  
PHONE 858 558-6900 - FAX 858 558-6159

**SHINOHARA**

**PROJECT NO.: G2762-42-01**



APPENDIX

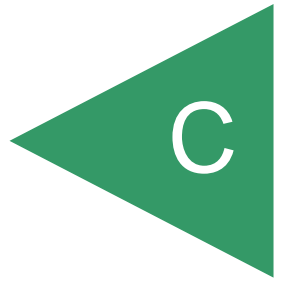

**APPENDIX C**  
**RECOMMENDED GRADING SPECIFICATIONS**

**FOR**

**517 SHINOHARA LANE  
INDUSTRIAL BUILDING  
SAN DIEGO, CALIFORNIA**

**PROJECT NO. G2762-42-01**

## RECOMMENDED GRADING SPECIFICATIONS

### 1. GENERAL

- 1.1 These Recommended Grading Specifications shall be used in conjunction with the Geotechnical Report for the project prepared by Geocon. The recommendations contained in the text of the Geotechnical Report are a part of the earthwork and grading specifications and shall supersede the provisions contained hereinafter in the case of conflict.
- 1.2 Prior to the commencement of grading, a geotechnical consultant (Consultant) shall be employed for the purpose of observing earthwork procedures and testing the fills for substantial conformance with the recommendations of the Geotechnical Report and these specifications. The Consultant should provide adequate testing and observation services so that they may assess whether, in their opinion, the work was performed in substantial conformance with these specifications. It shall be the responsibility of the Contractor to assist the Consultant and keep them apprised of work schedules and changes so that personnel may be scheduled accordingly.
- 1.3 It shall be the sole responsibility of the Contractor to provide adequate equipment and methods to accomplish the work in accordance with applicable grading codes or agency ordinances, these specifications and the approved grading plans. If, in the opinion of the Consultant, unsatisfactory conditions such as questionable soil materials, poor moisture condition, inadequate compaction, and/or adverse weather result in a quality of work not in conformance with these specifications, the Consultant will be empowered to reject the work and recommend to the Owner that grading be stopped until the unacceptable conditions are corrected.

### 2. DEFINITIONS

- 2.1 **Owner** shall refer to the owner of the property or the entity on whose behalf the grading work is being performed and who has contracted with the Contractor to have grading performed.
- 2.2 **Contractor** shall refer to the Contractor performing the site grading work.
- 2.3 **Civil Engineer** or **Engineer of Work** shall refer to the California licensed Civil Engineer or consulting firm responsible for preparation of the grading plans, surveying and verifying as-graded topography.
- 2.4 **Consultant** shall refer to the soil engineering and engineering geology consulting firm retained to provide geotechnical services for the project.

- 2.5 **Soil Engineer** shall refer to a California licensed Civil Engineer retained by the Owner, who is experienced in the practice of geotechnical engineering. The Soil Engineer shall be responsible for having qualified representatives on-site to observe and test the Contractor's work for conformance with these specifications.
- 2.6 **Engineering Geologist** shall refer to a California licensed Engineering Geologist retained by the Owner to provide geologic observations and recommendations during the site grading.
- 2.7 **Geotechnical Report** shall refer to a soil report (including all addenda) which may include a geologic reconnaissance or geologic investigation that was prepared specifically for the development of the project for which these Recommended Grading Specifications are intended to apply.

### 3. MATERIALS

- 3.1 Materials for compacted fill shall consist of any soil excavated from the cut areas or imported to the site that, in the opinion of the Consultant, is suitable for use in construction of fills. In general, fill materials can be classified as *soil* fills, *soil-rock* fills or *rock* fills, as defined below.
- 3.1.1 **Soil fills** are defined as fills containing no rocks or hard lumps greater than 12 inches in maximum dimension and containing at least 40 percent by weight of material smaller than  $\frac{3}{4}$  inch in size.
- 3.1.2 **Soil-rock fills** are defined as fills containing no rocks or hard lumps larger than 4 feet in maximum dimension and containing a sufficient matrix of soil fill to allow for proper compaction of soil fill around the rock fragments or hard lumps as specified in Paragraph 6.2. **Oversize rock** is defined as material greater than 12 inches.
- 3.1.3 **Rock fills** are defined as fills containing no rocks or hard lumps larger than 3 feet in maximum dimension and containing little or no fines. Fines are defined as material smaller than  $\frac{3}{4}$  inch in maximum dimension. The quantity of fines shall be less than approximately 20 percent of the rock fill quantity.
- 3.2 Material of a perishable, spongy, or otherwise unsuitable nature as determined by the Consultant shall not be used in fills.
- 3.3 Materials used for fill, either imported or on-site, shall not contain hazardous materials as defined by the California Code of Regulations, Title 22, Division 4, Chapter 30, Articles 9

and 10; 40CFR; and any other applicable local, state or federal laws. The Consultant shall not be responsible for the identification or analysis of the potential presence of hazardous materials. However, if observations, odors or soil discoloration cause Consultant to suspect the presence of hazardous materials, the Consultant may request from the Owner the termination of grading operations within the affected area. Prior to resuming grading operations, the Owner shall provide a written report to the Consultant indicating that the suspected materials are not hazardous as defined by applicable laws and regulations.

- 3.4 The outer 15 feet of *soil-rock* fill slopes, measured horizontally, should be composed of properly compacted *soil* fill materials approved by the Consultant. *Rock* fill may extend to the slope face, provided that the slope is not steeper than 2:1 (horizontal:vertical) and a soil layer no thicker than 12 inches is track-walked onto the face for landscaping purposes. This procedure may be utilized provided it is acceptable to the governing agency, Owner and Consultant.
- 3.5 Samples of soil materials to be used for fill should be tested in the laboratory by the Consultant to determine the maximum density, optimum moisture content, and, where appropriate, shear strength, expansion, and gradation characteristics of the soil.
- 3.6 During grading, soil or groundwater conditions other than those identified in the Geotechnical Report may be encountered by the Contractor. The Consultant shall be notified immediately to evaluate the significance of the unanticipated condition.

#### **4. CLEARING AND PREPARING AREAS TO BE FILLED**

- 4.1 Areas to be excavated and filled shall be cleared and grubbed. Clearing shall consist of complete removal above the ground surface of trees, stumps, brush, vegetation, man-made structures, and similar debris. Grubbing shall consist of removal of stumps, roots, buried logs and other unsuitable material and shall be performed in areas to be graded. Roots and other projections exceeding 1½ inches in diameter shall be removed to a depth of 3 feet below the surface of the ground. Borrow areas shall be grubbed to the extent necessary to provide suitable fill materials.
- 4.2 Asphalt pavement material removed during clearing operations should be properly disposed at an approved off-site facility or in an acceptable area of the project evaluated by Geocon and the property owner. Concrete fragments that are free of reinforcing steel may be placed in fills, provided they are placed in accordance with Section 6.2 or 6.3 of this document.

- 4.3 After clearing and grubbing of organic matter and other unsuitable material, loose or porous soils shall be removed to the depth recommended in the Geotechnical Report. The depth of removal and compaction should be observed and approved by a representative of the Consultant. The exposed surface shall then be plowed or scarified to a minimum depth of 6 inches and until the surface is free from uneven features that would tend to prevent uniform compaction by the equipment to be used.
- 4.4 Where the slope ratio of the original ground is steeper than 5:1 (horizontal:vertical), or where recommended by the Consultant, the original ground should be benched in accordance with the following illustration.

**TYPICAL BENCHING DETAIL**

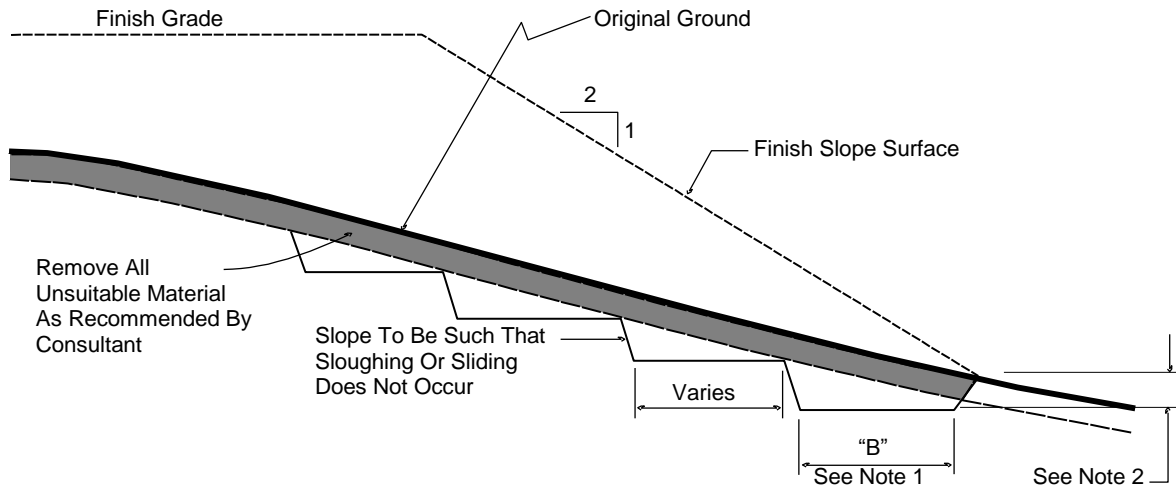

No Scale

- DETAIL NOTES:
- (1) Key width "B" should be a minimum of 10 feet, or sufficiently wide to permit complete coverage with the compaction equipment used. The base of the key should be graded horizontal, or inclined slightly into the natural slope.
  - (2) The outside of the key should be below the topsoil or unsuitable surficial material and at least 2 feet into dense formational material. Where hard rock is exposed in the bottom of the key, the depth and configuration of the key may be modified as approved by the Consultant.

- 4.5 After areas to receive fill have been cleared and scarified, the surface should be moisture conditioned to achieve the proper moisture content, and compacted as recommended in Section 6 of these specifications.

## 5. COMPACTION EQUIPMENT

- 5.1 Compaction of *soil* or *soil-rock* fill shall be accomplished by sheepsfoot or segmented-steel wheeled rollers, vibratory rollers, multiple-wheel pneumatic-tired rollers, or other types of acceptable compaction equipment. Equipment shall be of such a design that it will be capable of compacting the *soil* or *soil-rock* fill to the specified relative compaction at the specified moisture content.
- 5.2 Compaction of *rock* fills shall be performed in accordance with Section 6.3.

## 6. PLACING, SPREADING AND COMPACTION OF FILL MATERIAL

- 6.1 *Soil* fill, as defined in Paragraph 3.1.1, shall be placed by the Contractor in accordance with the following recommendations:
- 6.1.1 *Soil* fill shall be placed by the Contractor in layers that, when compacted, should generally not exceed 8 inches. Each layer shall be spread evenly and shall be thoroughly mixed during spreading to obtain uniformity of material and moisture in each layer. The entire fill shall be constructed as a unit in nearly level lifts. Rock materials greater than 12 inches in maximum dimension shall be placed in accordance with Section 6.2 or 6.3 of these specifications.
- 6.1.2 In general, the *soil* fill shall be compacted at a moisture content at or above the optimum moisture content as determined by ASTM D 1557.
- 6.1.3 When the moisture content of *soil* fill is below that specified by the Consultant, water shall be added by the Contractor until the moisture content is in the range specified.
- 6.1.4 When the moisture content of the *soil* fill is above the range specified by the Consultant or too wet to achieve proper compaction, the *soil* fill shall be aerated by the Contractor by blading/mixing, or other satisfactory methods until the moisture content is within the range specified.
- 6.1.5 After each layer has been placed, mixed, and spread evenly, it shall be thoroughly compacted by the Contractor to a relative compaction of at least 90 percent. Relative compaction is defined as the ratio (expressed in percent) of the in-place dry density of the compacted fill to the maximum laboratory dry density as determined in accordance with ASTM D 1557. Compaction shall be continuous over the entire area, and compaction equipment shall make sufficient passes so that the specified minimum relative compaction has been achieved throughout the entire fill.

- 6.1.6 Where practical, soils having an Expansion Index greater than 50 should be placed at least 3 feet below finish pad grade and should be compacted at a moisture content generally 2 to 4 percent greater than the optimum moisture content for the material.
  - 6.1.7 Properly compacted *soil* fill shall extend to the design surface of fill slopes. To achieve proper compaction, it is recommended that fill slopes be over-built by at least 3 feet and then cut to the design grade. This procedure is considered preferable to track-walking of slopes, as described in the following paragraph.
  - 6.1.8 As an alternative to over-building of slopes, slope faces may be back-rolled with a heavy-duty loaded sheepsfoot or vibratory roller at maximum 4-foot fill height intervals. Upon completion, slopes should then be track-walked with a D-8 dozer or similar equipment, such that a dozer track covers all slope surfaces at least twice.
- 6.2 *Soil-rock* fill, as defined in Paragraph 3.1.2, shall be placed by the Contractor in accordance with the following recommendations:
- 6.2.1 Rocks larger than 12 inches but less than 4 feet in maximum dimension may be incorporated into the compacted *soil* fill, but shall be limited to the area measured 15 feet minimum horizontally from the slope face and 5 feet below finish grade or 3 feet below the deepest utility, whichever is deeper.
  - 6.2.2 Rocks or rock fragments up to 4 feet in maximum dimension may either be individually placed or placed in windrows. Under certain conditions, rocks or rock fragments up to 10 feet in maximum dimension may be placed using similar methods. The acceptability of placing rock materials greater than 4 feet in maximum dimension shall be evaluated during grading as specific cases arise and shall be approved by the Consultant prior to placement.
  - 6.2.3 For individual placement, sufficient space shall be provided between rocks to allow for passage of compaction equipment.
  - 6.2.4 For windrow placement, the rocks should be placed in trenches excavated in properly compacted *soil* fill. Trenches should be approximately 5 feet wide and 4 feet deep in maximum dimension. The voids around and beneath rocks should be filled with approved granular soil having a Sand Equivalent of 30 or greater and should be compacted by flooding. Windrows may also be placed utilizing an "open-face" method in lieu of the trench procedure, however, this method should first be approved by the Consultant.



- 6.2.5 Windrows should generally be parallel to each other and may be placed either parallel to or perpendicular to the face of the slope depending on the site geometry. The minimum horizontal spacing for windrows shall be 12 feet center-to-center with a 5-foot stagger or offset from lower courses to next overlying course. The minimum vertical spacing between windrow courses shall be 2 feet from the top of a lower windrow to the bottom of the next higher windrow.
- 6.2.6 Rock placement, fill placement and flooding of approved granular soil in the windrows should be continuously observed by the Consultant.
- 6.3 *Rock* fills, as defined in Section 3.1.3, shall be placed by the Contractor in accordance with the following recommendations:
- 6.3.1 The base of the *rock* fill shall be placed on a sloping surface (minimum slope of 2 percent). The surface shall slope toward suitable subdrainage outlet facilities. The *rock* fills shall be provided with subdrains during construction so that a hydrostatic pressure buildup does not develop. The subdrains shall be permanently connected to controlled drainage facilities to control post-construction infiltration of water.
- 6.3.2 *Rock* fills shall be placed in lifts not exceeding 3 feet. Placement shall be by rock trucks traversing previously placed lifts and dumping at the edge of the currently placed lift. Spreading of the *rock* fill shall be by dozer to facilitate *seating* of the rock. The *rock* fill shall be watered heavily during placement. Watering shall consist of water trucks traversing in front of the current rock lift face and spraying water continuously during rock placement. Compaction equipment with compactive energy comparable to or greater than that of a 20-ton steel vibratory roller or other compaction equipment providing suitable energy to achieve the required compaction or deflection as recommended in Paragraph 6.3.3 shall be utilized. The number of passes to be made should be determined as described in Paragraph 6.3.3. Once a *rock* fill lift has been covered with *soil* fill, no additional *rock* fill lifts will be permitted over the *soil* fill.
- 6.3.3 Plate bearing tests, in accordance with ASTM D 1196, may be performed in both the compacted *soil* fill and in the *rock* fill to aid in determining the required minimum number of passes of the compaction equipment. If performed, a minimum of three plate bearing tests should be performed in the properly compacted *soil* fill (minimum relative compaction of 90 percent). Plate bearing tests shall then be performed on areas of *rock* fill having two passes, four passes and six passes of the compaction equipment, respectively. The number of passes required for the *rock* fill shall be determined by comparing the results of the plate bearing tests for the *soil* fill and the *rock* fill and by evaluating the deflection

variation with number of passes. The required number of passes of the compaction equipment will be performed as necessary until the plate bearing deflections are equal to or less than that determined for the properly compacted *soil* fill. In no case will the required number of passes be less than two.

- 6.3.4 A representative of the Consultant should be present during *rock* fill operations to observe that the minimum number of “passes” have been obtained, that water is being properly applied and that specified procedures are being followed. The actual number of plate bearing tests will be determined by the Consultant during grading.
- 6.3.5 Test pits shall be excavated by the Contractor so that the Consultant can state that, in their opinion, sufficient water is present and that voids between large rocks are properly filled with smaller rock material. In-place density testing will not be required in the *rock* fills.
- 6.3.6 To reduce the potential for “piping” of fines into the *rock* fill from overlying *soil* fill material, a 2-foot layer of graded filter material shall be placed above the uppermost lift of *rock* fill. The need to place graded filter material below the *rock* should be determined by the Consultant prior to commencing grading. The gradation of the graded filter material will be determined at the time the *rock* fill is being excavated. Materials typical of the *rock* fill should be submitted to the Consultant in a timely manner, to allow design of the graded filter prior to the commencement of *rock* fill placement.
- 6.3.7 *Rock* fill placement should be continuously observed during placement by the Consultant.

## 7. SUBDRAINS

- 7.1 The geologic units on the site may have permeability characteristics and/or fracture systems that could be susceptible under certain conditions to seepage. The use of canyon subdrains may be necessary to mitigate the potential for adverse impacts associated with seepage conditions. Canyon subdrains with lengths in excess of 500 feet or extensions of existing offsite subdrains should use 8-inch-diameter pipes. Canyon subdrains less than 500 feet in length should use 6-inch-diameter pipes.

## TYPICAL CANYON DRAIN DETAIL

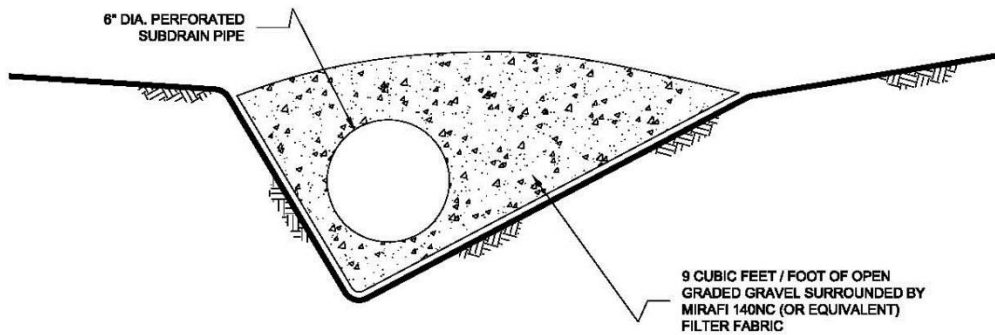
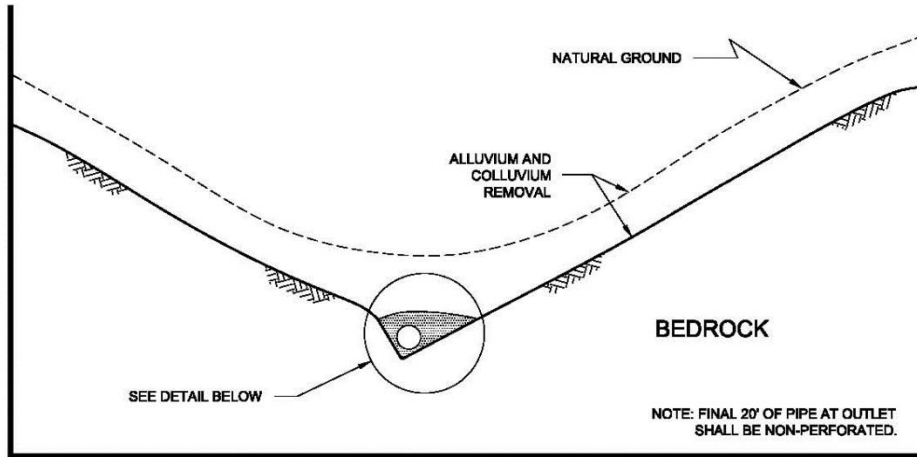

### NOTES:

- 1.....8-INCH DIAMETER, SCHEDULE 80 PVC PERFORATED PIPE FOR FILLS IN EXCESS OF 100-FEET IN DEPTH OR A PIPE LENGTH OF LONGER THAN 500 FEET.
- 2.....6-INCH DIAMETER, SCHEDULE 40 PVC PERFORATED PIPE FOR FILLS LESS THAN 100-FEET IN DEPTH OR A PIPE LENGTH SHORTER THAN 500 FEET.

NO SCALE

7.2 Slope drains within stability fill keyways should use 4-inch-diameter (or larger) pipes.

## TYPICAL STABILITY FILL DETAIL

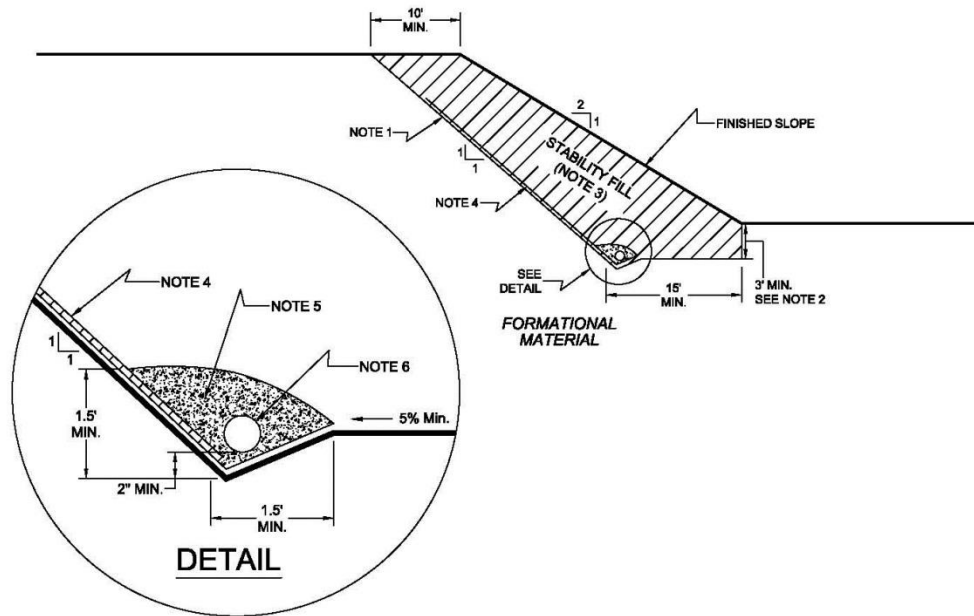

### NOTES:

- 1.....EXCAVATE BACKCUT AT 1:1 INCLINATION (UNLESS OTHERWISE NOTED).
- 2.....BASE OF STABILITY FILL TO BE 3 FEET INTO FORMATIONAL MATERIAL, SLOPING A MINIMUM 5% INTO SLOPE.
- 3.....STABILITY FILL TO BE COMPOSED OF PROPERLY COMPACTED GRANULAR SOIL.
- 4.....CHIMNEY DRAINS TO BE APPROVED PREFABRICATED CHIMNEY DRAIN PANELS (MIRADRAIN G200N OR EQUIVALENT) SPACED APPROXIMATELY 20 FEET CENTER TO CENTER AND 4 FEET WIDE. CLOSER SPACING MAY BE REQUIRED IF SEEPAGE IS ENCOUNTERED.
- 5.....FILTER MATERIAL TO BE 3/4-INCH, OPEN-GRADED CRUSHED ROCK ENCLOSED IN APPROVED FILTER FABRIC (MIRAFI 140NC).
- 6.....COLLECTOR PIPE TO BE 4-INCH MINIMUM DIAMETER, PERFORATED, THICK-WALLED PVC SCHEDULE 40 OR EQUIVALENT, AND SLOPED TO DRAIN AT 1 PERCENT MINIMUM TO APPROVED OUTLET.

NO SCALE

7.3 The actual subdrain locations will be evaluated in the field during the remedial grading operations. Additional drains may be necessary depending on the conditions observed and the requirements of the local regulatory agencies. Appropriate subdrain outlets should be evaluated prior to finalizing 40-scale grading plans.

7.4 *Rock fill or soil-rock fill* areas may require subdrains along their down-slope perimeters to mitigate the potential for buildup of water from construction or landscape irrigation. The subdrains should be at least 6-inch-diameter pipes encapsulated in gravel and filter fabric. *Rock fill* drains should be constructed using the same requirements as canyon subdrains.

7.5 Prior to outletting, the final 20-foot segment of a subdrain that will not be extended during future development should consist of non-perforated drainpipe. At the non-perforated/perforated interface, a seepage cutoff wall should be constructed on the downslope side of the pipe.

TYPICAL CUT OFF WALL DETAIL

FRONT VIEW

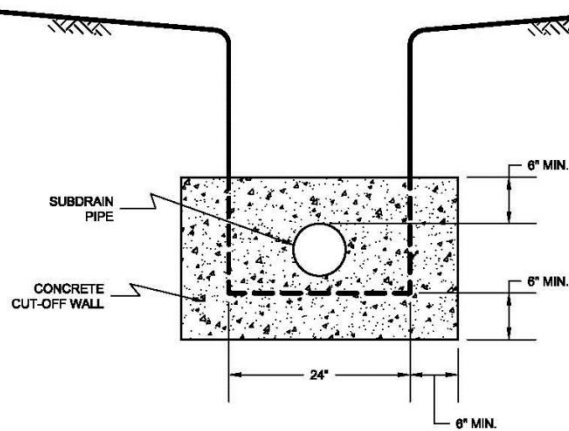

NO SCALE

SIDE VIEW

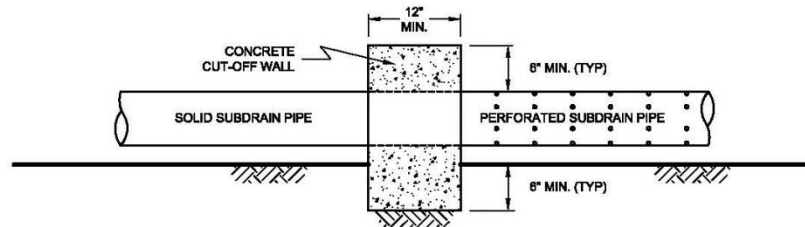

NO SCALE

7.6 Subdrains that discharge into a natural drainage course or open space area should be provided with a permanent headwall structure.

## TYPICAL HEADWALL DETAIL

### FRONT VIEW

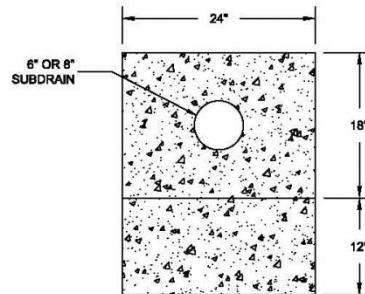

NO SCALE

### SIDE VIEW

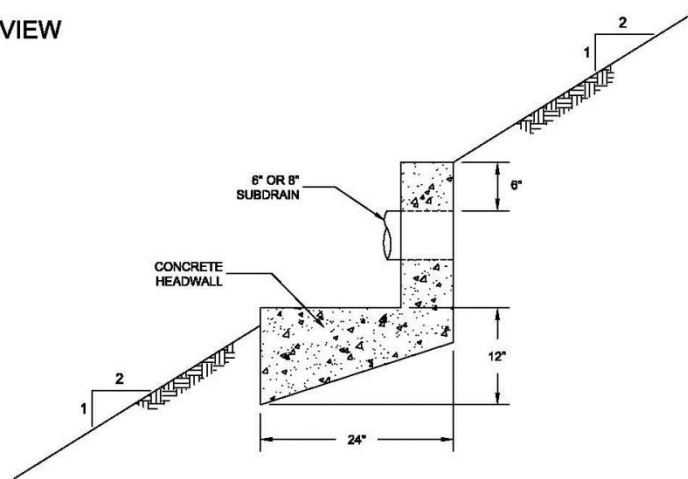

NOTE: HEADWALL SHOULD OUTLET AT TOE OF FILL SLOPE  
OR INTO CONTROLLED SURFACE DRAINAGE

NO SCALE

- 7.7 The final grading plans should show the location of the proposed subdrains. After completion of remedial excavations and subdrain installation, the project civil engineer should survey the drain locations and prepare an “as-built” map showing the drain locations. The final outlet and connection locations should be determined during grading operations. Subdrains that will be extended on adjacent projects after grading can be placed on formational material and a vertical riser should be placed at the end of the subdrain. The grading contractor should consider videoing the subdrains shortly after burial to check proper installation and functionality. The contractor is responsible for the performance of the drains.

## 8. OBSERVATION AND TESTING

- 8.1 The Consultant shall be the Owner's representative to observe and perform tests during clearing, grubbing, filling, and compaction operations. In general, no more than 2 feet in vertical elevation of *soil* or *soil-rock* fill should be placed without at least one field density test being performed within that interval. In addition, a minimum of one field density test should be performed for every 2,000 cubic yards of *soil* or *soil-rock* fill placed and compacted.
- 8.2 The Consultant should perform a sufficient distribution of field density tests of the compacted *soil* or *soil-rock* fill to provide a basis for expressing an opinion whether the fill material is compacted as specified. Density tests shall be performed in the compacted materials below any disturbed surface. When these tests indicate that the density of any layer of fill or portion thereof is below that specified, the particular layer or areas represented by the test shall be reworked until the specified density has been achieved.
- 8.3 During placement of *rock* fill, the Consultant should observe that the minimum number of passes have been obtained per the criteria discussed in Section 6.3.3. The Consultant should request the excavation of observation pits and may perform plate bearing tests on the placed *rock* fills. The observation pits will be excavated to provide a basis for expressing an opinion as to whether the *rock* fill is properly seated and sufficient moisture has been applied to the material. When observations indicate that a layer of *rock* fill or any portion thereof is below that specified, the affected layer or area shall be reworked until the *rock* fill has been adequately seated and sufficient moisture applied.
- 8.4 A settlement monitoring program designed by the Consultant may be conducted in areas of *rock* fill placement. The specific design of the monitoring program shall be as recommended in the Conclusions and Recommendations section of the project Geotechnical Report or in the final report of testing and observation services performed during grading.
- 8.5 We should observe the placement of subdrains, to check that the drainage devices have been placed and constructed in substantial conformance with project specifications.
- 8.6 Testing procedures shall conform to the following Standards as appropriate:

### 8.6.1 Soil and Soil-Rock Fills:

- 8.6.1.1 Field Density Test, ASTM D 1556, *Density of Soil In-Place By the Sand-Cone Method.*

- 8.6.1.2 Field Density Test, Nuclear Method, ASTM D 6938, *Density of Soil and Soil-Aggregate In-Place by Nuclear Methods (Shallow Depth)*.
- 8.6.1.3 Laboratory Compaction Test, ASTM D 1557, *Moisture-Density Relations of Soils and Soil-Aggregate Mixtures Using 10-Pound Hammer and 18-Inch Drop*.
- 8.6.1.4. Expansion Index Test, ASTM D 4829, *Expansion Index Test*.

## **9. PROTECTION OF WORK**

- 9.1 During construction, the Contractor shall properly grade all excavated surfaces to provide positive drainage and prevent ponding of water. Drainage of surface water shall be controlled to avoid damage to adjoining properties or to finished work on the site. The Contractor shall take remedial measures to prevent erosion of freshly graded areas until such time as permanent drainage and erosion control features have been installed. Areas subjected to erosion or sedimentation shall be properly prepared in accordance with the Specifications prior to placing additional fill or structures.
- 9.2 After completion of grading as observed and tested by the Consultant, no further excavation or filling shall be conducted except in conjunction with the services of the Consultant.

## **10. CERTIFICATIONS AND FINAL REPORTS**

- 10.1 Upon completion of the work, Contractor shall furnish Owner a certification by the Civil Engineer stating that the lots and/or building pads are graded to within 0.1 foot vertically of elevations shown on the grading plan and that all tops and toes of slopes are within 0.5 foot horizontally of the positions shown on the grading plans. After installation of a section of subdrain, the project Civil Engineer should survey its location and prepare an *as-built* plan of the subdrain location. The project Civil Engineer should verify the proper outlet for the subdrains and the Contractor should ensure that the drain system is free of obstructions.
- 10.2 The Owner is responsible for furnishing a final as-graded soil and geologic report satisfactory to the appropriate governing or accepting agencies. The as-graded report should be prepared and signed by a California licensed Civil Engineer experienced in geotechnical engineering and by a California Certified Engineering Geologist, indicating that the geotechnical aspects of the grading were performed in substantial conformance with the Specifications or approved changes to the Specifications.



## LIST OF REFERENCES

1. FEMA (2012), *Flood Map Service Center*, FEMA website, <https://msc.fema.gov/portal/home>, flood map numbers 06073C2156G and 06073C2157G, effective May 16, 2012, accessed July 16, 2021;
2. Kennedy, M. P., and S. S. Tan, 2007, *Geologic Map of the Oceanside 30'x60' Quadrangle, California*, USGS Regional Map Series Map No. 1, Scale 1:100,000.
3. SEAOC (2019), *OSHPD Seismic Design Maps*: Structural Engineers Association of California website, <http://seismicmaps.org/>, accessed July 19, 2021;
4. USGS (2019), *Quaternary Fault and Fold Database of the United States*: U.S. Geological Survey website, <https://www.usgs.gov/natural-hazards/earthquake-hazards/faults>, accessed July 19, 2021;
5. Unpublished reports and maps on file with Geocon Incorporated.