

APPENDIX C – WATER QUALITY MANAGEMENT PLAN

Water Quality Management Plan

For:

Sierra Southridge

CITY OF FONTANA

WQMP #20-000xxx

Prepared for:

The Related Companies

18201 Von Karman Ave, Ste 900

Irvine, CA 92612

949-660-7272

Prepared by:

KES Technologies Inc.

1 Venture Ste 130

Irvine, CA 92618

(949) 339-5331

Submittal Date: November 2020

Revision Date: _____, 2020

Preliminary Approval Date: _____

Construction Approval Date: _____

Final Approval Date: _____

Project Owner's Certification

This Water Quality Management Plan (WQMP) has been prepared for Related Companies by KES Technologies. The WQMP is intended to comply with the requirements of the City of Fontana and the NPDES Areawide Stormwater Program requiring the preparation of a WQMP. The undersigned, while it owns the subject property, is responsible for the implementation of the provisions of this plan and will ensure that this plan is amended as appropriate to reflect up-to-date conditions on the site consistent with San Bernardino County's Municipal Storm Water Management Program and the intent of the NPDES Permit for San Bernardino County and the incorporated cities of San Bernardino County within the Santa Ana Region. Once the undersigned transfers its interest in the property, its successors in interest and the city/county shall be notified of the transfer. The new owner will be informed of its responsibility under this WQMP. A copy of the approved WQMP shall be available on the subject site in perpetuity.

"I certify under a penalty of law that the provisions (implementation, operation, maintenance, and funding) of the WQMP have been accepted and that the plan will be transferred to future successors."

Project Data			
Permit/Application Number(s):	WQMP #20-000xxx	Grading Permit Number(s):	TBD
Tract/Parcel Map Number(s):	N/A	Building Permit Number(s):	TBD
CUP, SUP, and/or APN (Specify Lot Numbers if Portions of Tract):			255-101-22,23
Owner's Signature			
Owner Name: Stan Smith			
Title	Vice President		
Company	Related Companies		
Address	18201 Von Karman		
Email	ssmith@related.com		
Telephone #	949-660-7272		
Signature		Date	

Preparer's Certification

Project Data			
Permit/Application Number(s):	WQMP #20-0000XX	Grading Permit Number(s):	TBD
Tract/Parcel Map Number(s):	N/A	Building Permit Number(s):	TBD
CUP, SUP, and/or APN (Specify Lot Numbers if Portions of Tract):			255-101-23

“The selection, sizing and design of stormwater treatment and other stormwater quality and quantity control measures in this plan were prepared under my oversight and meet the requirements of Regional Water Quality Control Board Order No. R8-2010-0036.”

Engineer: Ali Monshizadeh		PE Stamp Below
Title	Project Engineer	
Company	KES Technologies	
Address	1 Venture Ste 130	
Email	Ali@Mfkessler.com	
Telephone #	(949) 339-5330	
Signature		
Date		

Table of Contents

Section 1 Discretionary Permits	1-1
Section 2 Project Description.....	2-1
2.1 Project Information.....	2-1
2.2 Property Ownership / Management	2-2
2.3 Potential Stormwater Pollutants.....	2-3
2.4 Water Quality Credits	2-4
Section 3 Site and Watershed Description.....	3-1
Section 4 Best Management Practices.....	4-1
4.1 Source Control BMP	4-1
4.1.1 Pollution Prevention	4-1
4.1.2 Preventative LID Site Design Practices.....	4-6
4.2 Project Performance Criteria.....	4-7
4.3 Project Conformance Analysis.....	4-12
4.3.1 Site Design Hydrologic Source Control BMP	4-14
4.3.2 Infiltration BMP	4-16
4.3.3 Harvest and Use BMP	4-18
4.3.4 Biotreatment BMP.....	4-19
4.3.5 Conformance Summary.....	4-23
4.3.6 Hydromodification Control BMP	4-24
4.4 Alternative Compliance Plan (if applicable).....	4-25
Section 5 Inspection & Maintenance Responsibility Post Construction BMPs.....	5-1
Section 6 Site Plan and Drainage Plan	6-1
6.1. Site Plan and Drainage Plan.....	6-1
6.2 Electronic Data Submittal	6-1

Forms

Form 1-1 Project Information	1-1
Form 2.1-1 Description of Proposed Project.....	2-1
Form 2.2-1 Property Ownership/Management.....	2-2
Form 2.3-1 Pollutants of Concern	2-3
Form 2.4-1 Water Quality Credits	2-4
Form 3-1 Site Location and Hydrologic Features	3-1
Form 3-2 Hydrologic Characteristics.....	3-2
Form 3-3 Watershed Description.....	3-3
Form 4.1-1 Non-Structural Source Control BMP.....	4-2
Form 4.1-2 Structural Source Control BMP	4-4
Form 4.1-3 Site Design Practices Checklist.....	4-6
Form 4.2-1 LID BMP Performance Criteria for Design Capture Volume	4-7
Form 4.2-2 Summary of HCOG Assessment.....	4-8
Form 4.2-3 HCOG Assessment for Runoff Volume	4-9

Form 4.2-4 HCOC Assessment for Time of Concentration	4-10
Form 4.2-5 HCOC Assessment for Peak Runoff.....	4-11
Form 4.3-1 Infiltration BMP Feasibility	4-13
Form 4.3-2 Site Design Hydrologic Source Control BMP	4-14
Form 4.3-3 Infiltration LID BMP.....	4-17
Form 4.3-4 Harvest and Use BMP	4-18
Form 4.3-5 Selection and Evaluation of Biotreatment BMP	4-19
Form 4.3-6 Volume Based Biotreatment – Bioretention and Planter Boxes w/Underdrains	4-20
Form 4.3-7 Volume Based Biotreatment- Constructed Wetlands and Extended Detention	4-21
Form 4.3-8 Flow Based Biotreatment	4-22
Form 4.3-9 Conformance Summary and Alternative Compliance Volume Estimate	4-23
Form 4.3-10 Hydromodification Control BMP	4-24
Form 5-1 BMP Inspection and Maintenance	5-1

Section 1 Discretionary Permit(s)

Form 1-1 Project Information					
Project Name		Sierra South Ridge			
Project Owner Contact Name:		Stan Smith			
Mailing Address:	18201 Von Karman , Irvine CA	E-mail Address:	ssmith@related.com	Telephone:	949-660-7272
Permit/Application Number(s):		WQMP #20-0000XX	Tract/Parcel Map Number(s):	n/a	
Additional Information/ Comments:		The current site does not treat any storm drain runoff for water quality.			
Description of Project:		<p>The project is 4.72 AC (gross) proposed residential project to be developed in two phases. The project includes various residential buildings that are three and four stories tall, landscape features and associated open space and drive aisles. The proposed project is to the west of Sierra Avenue and north of Jurupa Avenue in the City of Fontana, County of San Bernardino. The site will be filled in from its current basin configuration and will be primarily flat and is bordered by commercial use to the west, south and north. The site currently is a basin and will filled in. The entire project is proposed to be cleared and grubbed of a existing vegetation.</p> <p>The subject site is proposed to be self-contained and will not include any off site flows from adjacent properties. All proposed waters will flow into on site basins and down drains/area drains. All proposed storm water will flow into proposed infiltration basin located within the perimter improvements per a City CIP. The BMP volume is proposed to then be infiltrated into the soils.</p> <p>Storm water flows will pass through the infiltration facilities and will then flow through the storm drain to the west or east pending storm flow.</p> <p>The proposed project will construct public street improvements including driveway connections along Sierra Avenues and will include street widening and associated parkway improvements. Street improvements within the public right of way are exempt per the Transportation Projects TGR. This associated area will be included within the on site calculations.</p> <p>The project site is currently being entitled by Related Companies (RC). RC will be responsible for setting up a Maintenance and Ownership covenant or Management Company (MC) for long term operation and maintenance of the site and proposed structural and treatment BMPs..</p>			

Water Quality Management Plan (WQMP)

<p>Provide summary of Conceptual WQMP conditions (if previously submitted and approved). Attach complete copy.</p>	<p>Project conditions related to water quality have not been provided at this time. This section will be completed as part of final engineering.</p>
--	--

Section 2 Project Description

2.1 Project Information

This section of the WQMP should provide the information listed below. The information provided for Conceptual/ Preliminary WQMP should give sufficient detail to identify the major proposed site design and LID BMPs and other anticipated water quality features that impact site planning. Final Project WQMP must specifically identify all BMP incorporated into the final site design and provide other detailed information as described herein.

The purpose of this information is to help determine the applicable development category, pollutants of concern, watershed description, and long term maintenance responsibilities for the project, and any applicable water quality credits. This information will be used in conjunction with the information in Section 3, Site Description, to establish the performance criteria and to select the LID BMP or other BMP for the project or other alternative programs that the project will participate in, which are described in Section 4.

Form 2.1-1 Description of Proposed Project			
1 Development Category (Select all that apply):			
<input type="checkbox"/> Significant re-development involving the addition or replacement of 5,000 ft ² or more of impervious surface on an already developed site	<input checked="" type="checkbox"/> New development involving the creation of 10,000 ft ² or more of impervious surface collectively over entire site	<input type="checkbox"/> Automotive repair shops with standard industrial classification (SIC) codes 5013, 5014, 5541, 7532- 7534, 7536-7539	<input type="checkbox"/> Restaurants (with SIC code 5812) where the land area of development is 5,000 ft ² or more
<input type="checkbox"/> Hillside developments of 5,000 ft ² or more which are located on areas with known erosive soil conditions or where the natural slope is 25 percent or more	<input type="checkbox"/> Developments of 2,500 ft ² of impervious surface or more adjacent to (within 200 ft) or discharging directly into environmentally sensitive areas or waterbodies listed on the CWA Section 303(d) list of impaired waters.	<input checked="" type="checkbox"/> Parking lots of 5,000 ft ² or more exposed to storm water	<input type="checkbox"/> Retail gasoline outlets that are either 5,000 ft ² or more, or have a projected average daily traffic of 100 or more vehicles per day
<input type="checkbox"/> Non-Priority / Non-Category Project <i>May require source control LID BMPs and other LIP requirements. Please consult with local jurisdiction on specific requirements.</i>			
2 Project Area (ft ²):	303,056	3 Number of Dwelling Units:	4 SIC Code: 1520
5 Is Project going to be phased? Yes <input checked="" type="checkbox"/> No <input type="checkbox"/> <i>If yes, ensure that the WQMP evaluates each phase as a distinct DA, requiring LID BMPs to address runoff at time of completion.</i>			
6 Does Project include roads? Yes <input type="checkbox"/> No <input checked="" type="checkbox"/> <i>If yes, ensure that applicable requirements for transportation projects are addressed (see Appendix A of TGD for WQMP)</i>			

2.2 Property Ownership/Management

Describe the ownership/management of all portions of the project and site. State whether any infrastructure will transfer to public agencies (City, County, Caltrans, etc.) after project completion. State if a homeowners or property owners association will be formed and be responsible for the long-term maintenance of project stormwater facilities. Describe any lot-level stormwater features that will be the responsibility of individual property owners.

Form 2.2-1 Property Ownership/Management

Describe property ownership/management responsible for long-term maintenance of WQMP stormwater facilities:

The post-development BMPs as described in this report related to storm water quality runoff treatment will be maintained the Owner or appointed Property Management Company (PMC).

Related Companies
Contact: Stan Smith
18201 Von Karman Ste 900
Irvine, CA 92612
(949) 660-7272 T
ssmith@related.com

The owner will be responsible for setting up the PMC and if disbanded will be the responsible for maintenance. The on-site water, sanitary sewer, storm drain and parking improvements will be considered private and will be the responsibility of the property management Company (PMC). The property maintenance company will be contracted and will be signing a separate maintenance agreement. All landscaping and/ or common area maintenance will be the responsibility of the PMC or by an appointed professional landscaping consultant.

2.3 Potential Stormwater Pollutants

Determine and describe expected stormwater pollutants of concern based on land uses and site activities (refer to Table 3-3 in the TGD for WQMP).

Form 2.3-1 Pollutants of Concern			
Pollutant	Please check: E=Expected, N=Not Expected		Additional Information and Comments
Pathogens (Bacterial / Virus)	E <input checked="" type="checkbox"/>	N <input type="checkbox"/>	Per Santa Ana River 303d
Phosphorous	E <input checked="" type="checkbox"/>	N <input type="checkbox"/>	
Nitrogen	E <input checked="" type="checkbox"/>	N <input type="checkbox"/>	
Sediment	E <input checked="" type="checkbox"/>	N <input type="checkbox"/>	
Metals	E <input checked="" type="checkbox"/>	N <input type="checkbox"/>	Per Santa Ana River 303d
Oil and Grease	E <input checked="" type="checkbox"/>	N <input type="checkbox"/>	
Trash/Debris	E <input checked="" type="checkbox"/>	N <input type="checkbox"/>	
Pesticides / Herbicides	E <input checked="" type="checkbox"/>	N <input type="checkbox"/>	
Organic Compounds	E <input checked="" type="checkbox"/>	N <input type="checkbox"/>	
Other: Nutrients/Noxious Aquatic Plants	E <input type="checkbox"/>	N <input type="checkbox"/>	Per Santa Ana River 303d
Other:	E <input type="checkbox"/>	N <input type="checkbox"/>	
Other:	E <input type="checkbox"/>	N <input type="checkbox"/>	
Other:	E <input type="checkbox"/>	N <input type="checkbox"/>	
Other:	E <input type="checkbox"/>	N <input type="checkbox"/>	
Other:	E <input type="checkbox"/>	N <input type="checkbox"/>	

2.4 Water Quality Credits

A water quality credit program is applicable for certain types of development projects if it is not feasible to meet the requirements for on-site LID. Proponents for eligible projects, as described below, can apply for water quality credits that would reduce project obligations for selecting and sizing other treatment BMP or participating in other alternative compliance programs. Refer to Section 6.2 in the TGD for WQMP to determine if water quality credits are applicable for the project.

Form 2.4-1 Water Quality Credits			
1 Project Types that Qualify for Water Quality Credits: <i>Select all that apply</i>			
<input type="checkbox"/> Redevelopment projects that reduce the overall impervious footprint of the project site. [Credit = % impervious reduced]	Higher density development projects <input type="checkbox"/> Vertical density [20%] <input type="checkbox"/> 7 units/ acre [5%]	<input type="checkbox"/> Mixed use development, (combination of residential, commercial, industrial, office, institutional, or other land uses which incorporate design principles that demonstrate environmental benefits not realized through single use projects) [20%]	<input type="checkbox"/> Brownfield redevelopment (redevelop real property complicated by presence or potential of hazardous contaminants) [25%]
<input type="checkbox"/> Redevelopment projects in established historic district, historic preservation area, or similar significant core city center areas [10%]	<input type="checkbox"/> Transit-oriented developments (mixed use residential or commercial area designed to maximize access to public transportation) [20%]	<input type="checkbox"/> In-fill projects (conversion of empty lots & other underused spaces < 5 acres, substantially surrounded by urban land uses, into more beneficially used spaces, such as residential or commercial areas) [10%]	<input type="checkbox"/> Live-Work developments (variety of developments designed to support residential and vocational needs) [20%]
2 Total Credit % <i>(Total all credit percentages up to a maximum allowable credit of 50 percent)</i>			
Description of Water Quality Credit Eligibility (if applicable)	This proposed development will not be utilizing Water Quality Credits		

Section 3 Site and Watershed Description

Describe the project site conditions that will facilitate the selection of BMP through an analysis of the physical conditions and limitations of the site and its receiving waters. Identify distinct drainage areas (DA) that collect flow from a portion of the site and describe how runoff from each DA (and sub-watershed DMAs) is conveyed to the site outlet(s). Refer to Section 3.2 in the TGD for WQMP. The form below is provided as an example. Then complete Forms 3.2 and 3.3 for each DA on the project site. ***If the project has more than one drainage area for stormwater management, then complete additional versions of these forms for each DA / outlet.***

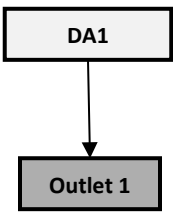
Form 3-1 Site Location and Hydrologic Features			
Site coordinates <i>take GPS measurement at approximate center of site</i>	Latitude 34-03-02.53 N	Longitude 117-26-08.86 W	Thomas Bros Map page 620
<p>¹ San Bernardino County climatic region: <input checked="" type="checkbox"/> Valley <input type="checkbox"/> Mountain</p>			
<p>² Does the site have more than one drainage area (DA): Yes <input type="checkbox"/> No <input checked="" type="checkbox"/> <i>If no, proceed to Form 3-2. If yes, then use this form to show a conceptual schematic describing DMAs and hydrologic feature connecting DMAs to the site outlet(s). An example is provided below that can be modified for proposed project or a drawing clearly showing DMA and flow routing may be attached</i></p>			
			
<p>Example only – modify for project specific WQMP using additional form</p>			
Conveyance	Briefly describe on-site drainage features to convey runoff that is not retained within a DMA		
DA1 DMA C flows to DA1 DMA A	<i>Ex. Bioretention overflow to vegetated bioswale with 4' bottom width, 5:1 side slopes and bed slope of 0.01. Conveys runoff for 1000' through DMA 1 to existing catch basin on SE corner of property</i>		
DA1 DMA A to Outlet 1	DA 1 - DMA-1 collects surface flows and drains into the proposed site infiltration basin. All over flow enter the public right of way through Underwalk Drain.		
DA1 DMA B to Outlet 1			
DA2 to Outlet 2			

Form 3-2 Existing Hydrologic Characteristics for Drainage Area 1				
For Drainage Area 1's sub-watershed DMA, provide the following characteristics	DMA A	DMA B	DMA C	DMA D
1 DMA drainage area (ft ²)	205,247			
2 Existing site impervious area (ft ²)	0.0			
3 Antecedent moisture condition <i>For desert areas, use http://www.sbcounty.gov/dpw/floodcontrol/pdf/20100412_map.pdf</i>	2			
4 Hydrologic soil group <i>Refer to Watershed Mapping Tool – http://sbcounty.permitrack.com/WAP</i>	A			
5 Longest flowpath length (ft)	520			
6 Longest flowpath slope (ft/ft)	.007			
7 Current land cover type(s) <i>Select from Fig C-3 of Hydrology Manual</i>	Open			
8 Pre-developed pervious area condition: <i>Based on the extent of wet season vegetated cover good >75%; Fair 50-75%; Poor <50% Attach photos of site to support rating</i>	Fair			

Form 3-2 Existing Hydrologic Characteristics for Drainage Area 1 (use only as needed for additional DMA w/in DA 1)				
For Drainage Area 1's sub-watershed DMA, provide the following characteristics	DMA E	DMA F	DMA G	DMA H
1 DMA drainage area (ft ²)				
2 Existing site impervious area (ft ²)				
3 Antecedent moisture condition <i>For desert areas, use http://www.sbcounty.gov/dpw/floodcontrol/pdf/20100412_map.pdf</i>				
4 Hydrologic soil group <i>Refer to Watershed Mapping Tool – http://sbcounty.permitrack.com/WAP</i>				
5 Longest flowpath length (ft)				
6 Longest flowpath slope (ft/ft)				
7 Current land cover type(s) <i>Select from Fig C-3 of Hydrology Manual</i>				
8 Pre-developed pervious area condition: <i>Based on the extent of wet season vegetated cover good >75%; Fair 50-75%; Poor <50% Attach photos of site to support rating</i>				

Form 3-3 Watershed Description for Drainage Area	
Receiving waters <i>Refer to Watershed Mapping Tool - http://sbcounty.permitrack.com/WAP</i> See "Drainage Facilities" link at this website	Banana Avenue Storm Drain, San Sevaine Channel, Santa Ana River Reach 3, Prado Flood Control Basin, Santa Ana River Reach 2, Santa Ana River Reach 1, Newport Beach
Applicable TMDLs <i>Refer to Local Implementation Plan</i>	Bacterial Indicator for Santa Ana River Reach 3
303(d) listed impairments <i>Refer to Local Implementation Plan and Watershed Mapping Tool - http://sbcounty.permitrack.com/WAP and State Water Resources Control Board website - http://www.waterboards.ca.gov/santaana/water_issues/programs/tmdl/index.shtml</i>	Reach 2 of the Santa Ana River is impaired for Bacteria, Reach 3 is Impaired for Copper, Pathogens and Lead, and Reach 4 is impaired for Pathogens. Prado Park Lake is impaired for nutrients and pathogens
Environmentally Sensitive Areas (ESA) <i>Refer to Watershed Mapping Tool - http://sbcounty.permitrack.com/WAP</i>	NO
Unlined Downstream Water Bodies <i>Refer to Watershed Mapping Tool - http://sbcounty.permitrack.com/WAP</i>	Santa Ana River Reach 1-3
Hydrologic Conditions of Concern	<input type="checkbox"/> Yes Complete Hydrologic Conditions of Concern (HCOC) Assessment. Include Forms 4.2-2 through Form 4.2-5 and Hydromodification BMP Form 4.3-10 in submittal <input checked="" type="checkbox"/> No
Watershed-based BMP included in a RWQCB approved WAP	<input type="checkbox"/> Yes Attach verification of regional BMP evaluation criteria in WAP <ul style="list-style-type: none"> • More Effective than On-site LID • Remaining Capacity for Project DCV • Upstream of any Water of the US • Operational at Project Completion • Long-Term Maintenance Plan <input checked="" type="checkbox"/> No

Section 4 Best Management Practices (BMP)

4.1 Source Control BMP

4.1.1 Pollution Prevention

Non-structural and structural source control BMP are required to be incorporated into all new development and significant redevelopment projects. Form 4.1-1 and 4.1-2 are used to describe specific source control BMPs used in the WQMP or to explain why a certain BMP is not applicable. Table 7-3 of the TGD for WQMP provides a list of applicable source control BMP for projects with specific types of potential pollutant sources or activities. The source control BMP in this table must be implemented for projects with these specific types of potential pollutant sources or activities.

The preparers of this WQMP have reviewed the source control BMP requirements for new development and significant redevelopment projects. The preparers have also reviewed the specific BMP required for project as specified in Forms 4.1-1 and 4.1-2. All applicable non-structural and structural source control BMP shall be implemented in the project.

Form 4.1-1 Non-Structural Source Control BMPs				
Identifier	Name	Check One		Describe BMP Implementation OR, if not applicable, state reason
		Included	Not Applicable	
N1	Education of Property Owners, Tenants and Occupants on Stormwater BMPs	<input checked="" type="checkbox"/>	<input type="checkbox"/>	<p>Practical informational materials will be provided to property owner, tenants and occupants on general good housekeeping practices that contribute to protection of storm water quality. Among other things, these materials will describe the use of chemicals that should be limited to the property, with no discharge of specified wastes via hosing or other direct discharge to gutters, catch basins and storm drains. Initially, PMC will provide these materials. Thereafter, such materials will be available through the PMC education program.</p> <p>This program must be maintained, enforced, and updated periodically by the PMC. Educational materials including, but not limited to, the materials included in the Attachment A of this plan will be made available to the employees and contractors of the PMC.</p>
N2	Activity Restrictions	<input checked="" type="checkbox"/>	<input type="checkbox"/>	<p>Activities on this site will be limited to activities related to warehouse use. The project's Conditions, Covenants, and Restrictions (CC&Rs) will outline the activities that are restricted on the property. Such activities related to the WQMP restrictions that include vehicle washing, car maintenance, pesticide application by a professional licensed by the State, and disposal of used motor fluids, pet waste cleanup, and trash container areas.</p>
N3	Landscape Management BMPs	<input checked="" type="checkbox"/>	<input type="checkbox"/>	<p>Landscape Management BMPs will be designed and established by the PMC, who will maintain the common areas within the project site. These programs will include how to mitigate the potential dangers of fertilizer and pesticide usage (refer to attachment A of this report). Ongoing maintenance will be consistent with the State of California Model-Water Efficient Landscape Ordinance. Fertilizer and pesticide usage shall be consistent with County Management Guidelines for use of Fertilizers and Pesticides. PMC will be bound by contract with PP with written agreements.</p>
N4	BMP Maintenance	<input checked="" type="checkbox"/>	<input type="checkbox"/>	<p>The PMC will comply with BMP Maintenance materials as part of this WQMP report, refer to Section 5 by agreement and contract by use of inspection forms to be submitted to the owner.</p>
N5	Title 22 CCR Compliance (How development will comply)	<input checked="" type="checkbox"/>	<input type="checkbox"/>	<p>The Owner will contract with a PMC to comply with the Regulation as denoted within the CC&R's not limited to this water quality document. The CC&R's will document the</p>

Form 4.1-1 Non-Structural Source Control BMPs				
				proceedures, restriction in which PI will need to comply. These will be recorded on title with the County. The PMC will be bound by contract by contract.
N6	Local Water Quality Ordinances	<input checked="" type="checkbox"/>	<input type="checkbox"/>	The PMC and/ or selected professional landscaping service provider will comply with all local water quality ordinances as denoted within this document and as contrated with PP. The project will comply by installing infiltration basins, pre treatment methods and storm water mitigation
N7	Spill Contingency Plan	<input checked="" type="checkbox"/>	<input type="checkbox"/>	The PMC will be responsible for establishing a Spill Contingency Plan that involves clean up and removal requirements. All spills will be cleaned up immediately. Materials to be stored on site will be documented and registered with the County Fire Hazmat Division.
N8	Underground Storage Tank Compliance	<input type="checkbox"/>	<input checked="" type="checkbox"/>	No proposed Underground Storage Tanks
N9	Hazardous Materials Disclosure Compliance	<input checked="" type="checkbox"/>	<input type="checkbox"/>	The PMC will provide a Hazardouse Materials Disclosure to tenants, and/ or employees listing all hazardous materials located onsite. The tenants will be required to disclose hazardess materials to County Fire Hazmat Division

Form 4.1-1 Non-Structural Source Control BMPs				
Identifier	Name	Check One		Describe BMP Implementation OR, if not applicable, state reason
		Included	Not Applicable	
N10	Uniform Fire Code Implementation	<input checked="" type="checkbox"/>	<input type="checkbox"/>	The Owner and PMC will comply with the Uniform Fire Code through permitted documents (being Hazard Mat material storage if necessary, building permits, building drawings). These documents through plan check and permit will adhere to local ordinances.
N11	Litter/Debris Control Program	<input checked="" type="checkbox"/>	<input type="checkbox"/>	The PMC will be required to implement trash management and litter control procedures in the common areas aimed at reducing pollution of drainage water. The PMC may also contract with their landscape maintenance firm to provide this service during regularly scheduled maintenance, which will consist of litter patrol, emptying of trash receptacles in common areas, and noting trash disposal violations and reporting the violations to the PMC for remediation.
N12	Employee Training	<input checked="" type="checkbox"/>	<input type="checkbox"/>	<p>Practical informational materials will be provided to employees on general good housekeeping practices that contribute to protection of storm water quality. Among other things, these materials will describe the use of chemicals that should be limited to the property, with no discharge of specified wastes via hosing or other direct discharge to gutters, catch basins and storm drains.</p> <p>This program must be maintained, enforced, and updated periodically by the Owner. Educational materials including, but not limited to, the materials included in the Attachment A of this plan will be made available to the employees and contractors of the Owner.</p>
N13	Housekeeping of Loading Docks	<input type="checkbox"/>	<input checked="" type="checkbox"/>	No Loading Docks Proposed
N14	Catch Basin Inspection Program	<input checked="" type="checkbox"/>	<input type="checkbox"/>	The PMC will maintain the drainage systems, including catch basins and culverts. The PMC is required to have catch basins inspected and, if necessary, cleaned prior to the storm season, no later than October 15th each year or prior to the first 24-hour storm event, whichever occurs first. These duties may be contracted out to the landscape maintenance firm hired by the Owner.

Water Quality Management Plan (WQMP)

N15	Vacuum Sweeping of Private Streets and Parking Lots	<input checked="" type="checkbox"/>	<input type="checkbox"/>	The PMC shall have all private drive aisles and parking areas swept on a weekly basis.
N16	Other Non-structural Measures for Public Agency Projects	<input type="checkbox"/>	<input checked="" type="checkbox"/>	Not Applicable no part of this project is for a public agency
N17	Comply with all other applicable NPDES permits	<input checked="" type="checkbox"/>	<input type="checkbox"/>	The Owner/PMC will be required to comply with the NOI and SWPPP. The general construction permit by Filing an NOI and implimenting a SWPPP with applicable BMP's and erosion control as bound by the SWPPP doucment will will doucment and provide methodology to comply

Form 4.1-2 Structural Source Control BMPs				
Identifier	Name	Check One		Describe BMP Implementation OR, If not applicable, state reason
		Included	Not Applicable	
S1	Provide storm drain system stenciling and signage (CASQA New Development BMP Handbook SD-13)	<input checked="" type="checkbox"/>	<input type="checkbox"/>	Phrase "No Dumping – Drains to Ocean" or equally effective phrase to be stenciled on catch basins to alert the public to the destination of pollutants discharged into storm water. This stenciling will be inspected and re-stenciled on a periodic basis by the PMC.
S2	Design and construct outdoor material storage areas to reduce pollution introduction (CASQA New Development BMP Handbook SD-34)	<input type="checkbox"/>	<input checked="" type="checkbox"/>	No proposed outdoor storage areas
S3	Design and construct trash and waste storage areas to reduce pollution introduction (CASQA New Development BMP Handbook SD-32)	<input checked="" type="checkbox"/>	<input type="checkbox"/>	All trash enclosures shall employ door and covers to lessen transport of solid waste.
S4	Use efficient irrigation systems & landscape design, water conservation, smart controllers, and source control (Statewide Model Landscape Ordinance; CASQA New Development BMP Handbook SD-12)	<input checked="" type="checkbox"/>	<input type="checkbox"/>	As part of the design of all common area landscape irrigation shall employ water conservation principals, including, but not limited to, such provisions as water sensors, programmable irrigation times (for short cycles), etc. will be used. Such common areas will be maintained by the PMC. Refer to separately prepared by others Landscaping Plans for details.
S5	Finish grade of landscaped areas at a minimum of 1-2 inches below top of curb, sidewalk, or pavement	<input checked="" type="checkbox"/>	<input type="checkbox"/>	Through final engineering the project will install landscape features 1-2" below the adjacent hardened surface. The improvements will be detailed on the approved precise engineering documents and will be coordinated with the landscape plan and inspected during construction.
S6	Protect slopes and channels and provide energy dissipation (CASQA New Development BMP Handbook SD-10)	<input type="checkbox"/>	<input checked="" type="checkbox"/>	Protect slopes for all proposed basins. Slopes to be hydro seeded or landscaped prior to release of project. All flow through curb to be dissipated with cobble/slope protection. All inlets and outlets of pipes shall be protected with rip-rap.
S7	Covered dock areas (CASQA New Development BMP Handbook SD-31)	<input type="checkbox"/>	<input checked="" type="checkbox"/>	All proposed loading docks shall be covered in accordance with City planning department and approved architecture
S8	Covered maintenance bays with spill containment plans (CASQA New Development BMP Handbook SD-31)	<input type="checkbox"/>	<input checked="" type="checkbox"/>	Bays not Proposed

Water Quality Management Plan (WQMP)

S9	Vehicle wash areas with spill containment plans (CASQA New Development BMP Handbook SD-33)	<input type="checkbox"/>	<input checked="" type="checkbox"/>	No proposed vehicle washing areas
S10	Covered outdoor processing areas (CASQA New Development BMP Handbook SD-36)	<input type="checkbox"/>	<input checked="" type="checkbox"/>	No proposed outdoor processing areas

Form 4.1-2 Structural Source Control BMPs

Identifier	Name	Check One		Describe BMP Implementation OR, If not applicable, state reason
		Included	Not Applicable	
S11	Equipment wash areas with spill containment plans (CASQA New Development BMP Handbook SD-33)	<input type="checkbox"/>	<input checked="" type="checkbox"/>	no wash areas are proposed
S12	Fueling areas (CASQA New Development BMP Handbook SD-30)	<input type="checkbox"/>	<input checked="" type="checkbox"/>	no fuelings areas are proposed
S13	Hillside landscaping (CASQA New Development BMP Handbook SD-10)	<input type="checkbox"/>	<input checked="" type="checkbox"/>	No proposed Hillside Landscaping
S14	Wash water control for food preparation areas	<input type="checkbox"/>	<input checked="" type="checkbox"/>	no food preparation are proposed
S15	Community car wash racks (CASQA New Development BMP Handbook SD-33)	<input type="checkbox"/>	<input checked="" type="checkbox"/>	No proposed community car washing areas

4.1.2 Preventative LID Site Design Practices

Site design practices associated with new LID requirements in the MS4 Permit should be considered in the earliest phases of a project. Preventative site design practices can result in smaller DCV for LID BMP and hydromodification control BMP by reducing runoff generation. Describe site design and drainage plan including:

- A narrative of site design practices utilized or rationale for not using practices
- A narrative of how site plan incorporates preventive site design practices
- Include an attached Site Plan layout which shows how preventative site design practices are included in WQMP

Refer to Section 5.2 of the TGD for WQMP for more details.

Form 4.1-3 Preventative LID Site Design Practices Checklist
<p>Site Design Practices <i>If yes, explain how preventative site design practice is addressed in project site plan. If no, other LID BMPs must be selected to meet targets</i></p>
<p>Minimize impervious areas: Yes <input type="checkbox"/> No <input checked="" type="checkbox"/></p> <p>Explanation: Site Plan was developed in accordance to planning parking standards and will capture all required run off for full LID BMP volume infiltration. The existing site is 64% impervious in comparison to an average post development of 87%.</p>
<p>Maximize natural infiltration capacity: Yes <input checked="" type="checkbox"/> No <input type="checkbox"/></p> <p>Explanation: Site will propose an Infiltration BMP</p>
<p>Preserve existing drainage patterns and time of concentration: Yes <input checked="" type="checkbox"/> No <input type="checkbox"/></p> <p>Explanation: Site will be designed to maintain the historic drainage path of travel by utilizing the same drainage paths and outlets. Basins will limit outlet to pre development condition.</p>
<p>Disconnect impervious areas: Yes <input checked="" type="checkbox"/> No <input type="checkbox"/></p> <p>Explanation: All impervious area will flow into infiltration systems disconnecting the flow from the outlet.</p>
<p>Protect existing vegetation and sensitive areas: Yes <input type="checkbox"/> No <input checked="" type="checkbox"/></p> <p>Explanation: The project will not protect vegetation on the project and will plant some disturbed open space pervious as shown on the exhibit. Site plan and improvements are set as part of this entitlement</p>
<p>Re-vegetate disturbed areas: Yes <input checked="" type="checkbox"/> No <input type="checkbox"/></p> <p>Explanation: Project will plant in all proposed open spaces as shown on final WQMP exhibit.</p>
<p>Minimize unnecessary compaction in stormwater retention/infiltration basin/trench areas: Yes <input type="checkbox"/> No <input checked="" type="checkbox"/></p> <p>Explanation: All compaction will be established per the projects soils report.</p>
<p>Utilize vegetated drainage swales in place of underground piping or imperviously lined swales: Yes <input type="checkbox"/> No <input checked="" type="checkbox"/></p> <p>Explanation: Portions of piping will drain into pervious chambers.</p>
<p>Stake off areas that will be used for landscaping to minimize compaction during construction : Yes <input checked="" type="checkbox"/> No <input type="checkbox"/></p> <p>Explanation: Landscape areas will be staked and sectioned off.</p>

4.2 Project Performance Criteria

The purpose of this section of the Project WQMP is to establish targets for post-development hydrology based on performance criteria specified in the MS4 Permit. These targets include runoff volume for water quality control (referred to as LID design capture volume), and runoff volume, time of concentration, and peak runoff for protection of any downstream waterbody segments with a HCOC. ***If the project has more than one outlet for stormwater runoff, then complete additional versions of these forms for each DA / outlet.***

Methods applied in the following forms include:

- For LID BMP Design Capture Volume (DCV), the San Bernardino County Stormwater Program requires use of the P₆ method (MS4 Permit Section XI.D.6a.ii) – Form 4.2-1
- For HCOC pre- and post-development hydrologic calculation, the San Bernardino County Stormwater Program requires the use of the Rational Method (San Bernardino County Hydrology Manual Section D). Forms 4.2-2 through Form 4.2-5 calculate hydrologic variables including runoff volume, time of concentration, and peak runoff from the project site pre- and post-development using the Hydrology Manual Rational Method approach. For projects greater than 640 acres (1.0 mi²), the Rational Method and these forms should not be used. For such projects, the Unit Hydrograph Method (San Bernardino County Hydrology Manual Section E) shall be applied for hydrologic calculations for HCOC performance criteria.

Refer to Section 4 in the TGD for WQMP for detailed guidance and instructions.

Form 4.2-1 LID BMP Performance Criteria for Design Capture Volume (DA 1)		
1 Project area DA 1 (ft ²): 205,247	2 Imperviousness after applying preventative site design practices (Imp%): 77	3 Runoff Coefficient (Rc): <u>.69</u> $R_c = 0.858(\text{Imp}\%)^{1.3} - 0.78(\text{Imp}\%)^{1.2} + 0.774(\text{Imp}\%) + 0.04$
4 Determine 1-hour rainfall depth for a 2-year return period P _{2yr-1hr} (in): 0.525 http://hdsc.nws.noaa.gov/hdsc/pfds/so/sca_pfds.html		
5 Compute P ₆ , Mean 6-hr Precipitation (inches): 0.78 <i>P₆ = Item 4 * C₁, where C₁ is a function of site climatic region specified in Form 3-1 Item 1 (Valley = 1.4807; Mountain = 1.909; Desert = 1.2371)</i>		
6 Drawdown Rate <i>Use 48 hours as the default condition. Selection and use of the 24 hour drawdown time condition is subject to approval by the local jurisdiction. The necessary BMP footprint is a function of drawdown time. While shorter drawdown times reduce the performance criteria for LID BMP design capture volume, the depth of water that can be stored is also reduced.</i>		24-hrs <input type="checkbox"/> 48-hrs <input checked="" type="checkbox"/>
7 Compute design capture volume, DCV (ft ³): 26,188 $DCV = 1/12 * [\text{Item 1} * \text{Item 3} * \text{Item 5} * C_2]$, where C ₂ is a function of drawdown rate (24-hr = 1.582; 48-hr = 1.963) <i>Compute separate DCV for each outlet from the project site per schematic drawn in Form 3-1 Item 2</i>		

Form 4.2-2 Summary of HCOC Assessment (DA 1)

Does project have the potential to cause or contribute to an HCOC in a downstream channel: Yes No

Go to: <http://sbcounty.permitrack.com/WAP>

If "Yes", then complete HCOC assessment of site hydrology for 2yr storm event using Forms 4.2-3 through 4.2-5 and insert results below
(Forms 4.2-3 through 4.2-5 may be replaced by computer software analysis based on the San Bernardino County Hydrology Manual)

If "No," then proceed to Section 4.3 Project Conformance Analysis

Condition	Runoff Volume (ft ³)	Time of Concentration (min)	Peak Runoff (cfs)
Pre-developed	1 <i>Form 4.2-3 Item 12</i>	2 <i>Form 4.2-4 Item 13</i>	3 <i>Form 4.2-5 Item 10</i>
Post-developed	4 <i>Form 4.2-3 Item 13</i>	5 <i>Form 4.2-4 Item 14</i>	6 <i>Form 4.2-5 Item 14</i>
Difference	7 <i>Item 4 – Item 1</i>	8 <i>Item 5 – Item 2</i>	9 <i>Item 6 – Item 3</i>
Difference (as % of pre-developed)	10 % <i>Item 7 / Item 1</i>	11 % <i>Item 8 / Item 2</i>	12 % <i>Item 9 / Item 3</i>

Form 4.2-3 HCOC Assessment for Runoff Volume (DA 1)

Weighted Curve Number Determination for: Pre-developed DA	DMA A	DMA B	DMA C	DMA D	DMA E	DMA F	DMA G	DMA H
1a Land Cover type								
2a Hydrologic Soil Group (HSG)								
3a DMA Area, ft ² sum of areas of DMA should equal area of DA								
4a Curve Number (CN) use Items 1 and 2 to select the appropriate CN from Appendix C-2 of the TGD for WQMP								
Weighted Curve Number Determination for: Post-developed DA	DMA A	DMA B	DMA C	DMA D	DMA E	DMA F	DMA G	DMA H
1b Land Cover type								
2b Hydrologic Soil Group (HSG)								
3b DMA Area, ft ² sum of areas of DMA should equal area of DA								
4b Curve Number (CN) use Items 5 and 6 to select the appropriate CN from Appendix C-2 of the TGD for WQMP								
5 Pre-Developed area-weighted CN:	7 Pre-developed soil storage capacity, S (in): $S = (1000 / \text{Item } 5) - 10$				9 Initial abstraction, I _a (in): $I_a = 0.2 * \text{Item } 7$			
6 Post-Developed area-weighted CN:	8 Post-developed soil storage capacity, S (in): $S = (1000 / \text{Item } 6) - 10$				10 Initial abstraction, I _a (in): $I_a = 0.2 * \text{Item } 8$			
11 Precipitation for 2 yr, 24 hr storm (in): Go to: http://hdsc.nws.noaa.gov/hdsc/pfds/sa/sca_pfds.html								
12 Pre-developed Volume (ft ³): $V_{pre} = (1 / 12) * (\text{Item sum of Item } 3) * [(\text{Item } 11 - \text{Item } 9)^2 / ((\text{Item } 11 - \text{Item } 9 + \text{Item } 7))$								
13 Post-developed Volume (ft ³): $V_{pre} = (1 / 12) * (\text{Item sum of Item } 3) * [(\text{Item } 11 - \text{Item } 10)^2 / ((\text{Item } 11 - \text{Item } 10 + \text{Item } 8))$								
14 Volume Reduction needed to meet HCOC Requirement, (ft ³): $V_{HCOC} = (\text{Item } 13 * 0.95) - \text{Item } 12$								

Form 4.2-4 HCOC Assessment for Time of Concentration (DA 1)

Compute time of concentration for pre and post developed conditions for each DA (For projects using the Hydrology Manual complete the form below)

Variables	Pre-developed DA1 <i>Use additional forms if there are more than 4 DMA</i>				Post-developed DA1 <i>Use additional forms if there are more than 4 DMA</i>			
	DMA A	DMA B	DMA C	DMA D	DMA A	DMA B	DMA C	DMA D
1 Length of flowpath (ft) <i>Use Form 3-2 Item 5 for pre-developed condition</i>								
2 Change in elevation (ft)								
3 Slope (ft/ft), $S_o = \text{Item 2} / \text{Item 1}$								
4 Land cover								
5 Initial DMA Time of Concentration (min) <i>Appendix C-1 of the TGD for WQMP</i>								
6 Length of conveyance from DMA outlet to project site outlet (ft) <i>May be zero if DMA outlet is at project site outlet</i>								
7 Cross-sectional area of channel (ft ²)								
8 Wetted perimeter of channel (ft)								
9 Manning's roughness of channel (n)								
10 Channel flow velocity (ft/sec) $V_{fps} = (1.49 / \text{Item 9}) * (\text{Item 7}/\text{Item 8})^{0.67} * (\text{Item 3})^{0.5}$								
11 Travel time to outlet (min) $T_t = \text{Item 6} / (\text{Item 10} * 60)$								
12 Total time of concentration (min) $T_c = \text{Item 5} + \text{Item 11}$								
13 Pre-developed time of concentration (min):	<i>Minimum of Item 12 pre-developed DMA</i>							
14 Post-developed time of concentration (min):	<i>Minimum of Item 12 post-developed DMA</i>							
15 Additional time of concentration needed to meet HCOC requirement (min):	$T_{C-HCOC} = (\text{Item 14} * 0.95) - \text{Item 13}$							

Form 4.2-5 HCOC Assessment for Peak Runoff (DA 1)

Compute peak runoff for pre- and post-developed conditions

Variables	Pre-developed DA to Project Outlet <i>(Use additional forms if more than 3 DMA)</i>			Post-developed DA to Project Outlet <i>(Use additional forms if more than 3 DMA)</i>		
	DMA A	DMA B	DMA C	DMA A	DMA B	DMA C
1 Rainfall Intensity for storm duration equal to time of concentration <i>$I_{peak} = 10^{(LOG Form 4.2-1 Item 4 - 0.6 LOG Form 4.2-4 Item 5 / 60)}$</i>						
2 Drainage Area of each DMA (ft ²) <i>For DMA with outlet at project site outlet, include upstream DMA (Using example schematic in Form 3-1, DMA A will include drainage from DMA C)</i>						
3 Ratio of pervious area to total area <i>For DMA with outlet at project site outlet, include upstream DMA (Using example schematic in Form 3-1, DMA A will include drainage from DMA C)</i>						
4 Pervious area infiltration rate (in/hr) <i>Use pervious area CN and antecedent moisture condition with Appendix C-3 of the TGD for WQMP</i>						
5 Maximum loss rate (in/hr) <i>$F_m = Item 3 * Item 4$</i> <i>Use area-weighted F_m from DMA with outlet at project site outlet, include upstream DMA (Using example schematic in Form 3-1, DMA A will include drainage from DMA C)</i>						
6 Peak Flow from DMA (cfs) <i>$Q_p = Item 2 * 0.9 * (Item 1 - Item 5)$</i>						
7 Time of concentration adjustment factor for other DMA to site discharge point <i>Form 4.2-4 Item 12 DMA / Other DMA upstream of site discharge point (If ratio is greater than 1.0, then use maximum value of 1.0)</i>	DMA A	n/a		n/a		
	DMA B		n/a		n/a	
	DMA C		n/a			n/a
8 Pre-developed Q_p at T_c for DMA A: <i>$Q_p = Item 6_{DMAA} + [Item 6_{DMAB} * (Item 1_{DMAA} - Item 5_{DMAB}) / (Item 1_{DMAB} - Item 5_{DMAB}) * Item 7_{DMAA/2}] + [Item 6_{DMAC} * (Item 1_{DMAA} - Item 5_{DMAC}) / (Item 1_{DMAC} - Item 5_{DMAC}) * Item 7_{DMAA/3}]$</i>	9 Pre-developed Q_p at T_c for DMA B: <i>$Q_p = Item 6_{DMAB} + [Item 6_{DMAA} * (Item 1_{DMAB} - Item 5_{DMAA}) / (Item 1_{DMAA} - Item 5_{DMAA}) * Item 7_{DMAB/1}] + [Item 6_{DMAC} * (Item 1_{DMAB} - Item 5_{DMAC}) / (Item 1_{DMAC} - Item 5_{DMAC}) * Item 7_{DMAB/3}]$</i>			10 Pre-developed Q_p at T_c for DMA C: <i>$Q_p = Item 6_{DMAC} + [Item 6_{DMAA} * (Item 1_{DMAC} - Item 5_{DMAA}) / (Item 1_{DMAA} - Item 5_{DMAA}) * Item 7_{DMAC/1}] + [Item 6_{DMAB} * (Item 1_{DMAC} - Item 5_{DMAB}) / (Item 1_{DMAB} - Item 5_{DMAB}) * Item 7_{DMAC/2}]$</i>		
10 Peak runoff from pre-developed condition confluence analysis (cfs): <i>Maximum of Item 8, 9, and 10 (including additional forms as needed)</i>						
11 Post-developed Q_p at T_c for DMA A: <i>Same as Item 8 for post-developed values</i>	12 Post-developed Q_p at T_c for DMA B: <i>Same as Item 9 for post-developed values</i>			13 Post-developed Q_p at T_c for DMA C: <i>Same as Item 10 for post-developed values</i>		
14 Peak runoff from post-developed condition confluence analysis (cfs): <i>Maximum of Item 11, 12, and 13 (including additional forms as needed)</i>						
15 Peak runoff reduction needed to meet HCOC Requirement (cfs): <i>$Q_{p-HCOC} = (Item 14 * 0.95) - Item 10$</i>						

4.3 Project Conformance Analysis

Complete the following forms for each project site DA to document that the proposed LID BMPs conform to the project DCV developed to meet performance criteria specified in the MS4 Permit (WQMP Template Section 4.2). For the LID DCV, the forms are ordered according to hierarchy of BMP selection as required by the MS4 Permit (see Section 5.3.1 in the TGD for WQMP). The forms compute the following for on-site LID BMP:

- Site Design and Hydrologic Source Controls (Form 4.3-2)
- Retention and Infiltration (Form 4.3-3)
- Harvested and Use (Form 4.3-4) or
- Biotreatment (Form 4.3-5).

At the end of each form, additional fields facilitate the determination of the extent of mitigation provided by the specific BMP category, allowing for use of the next category of BMP in the hierarchy, if necessary.

The first step in the analysis, using Section 5.3.2.1 of the TGD for WQMP, is to complete Forms 4.3-1 and 4.3-3) to determine if retention and infiltration BMPs are infeasible for the project. For each feasibility criterion in Form 4.3-1, if the answer is “Yes,” provide all study findings that includes relevant calculations, maps, data sources, etc. used to make the determination of infeasibility.

Next, complete Forms 4.3-2 and 4.3-4 to determine the feasibility of applicable HSC and harvest and use BMPs, and, if their implementation is feasible, the extent of mitigation of the DCV.

If no site constraints exist that would limit the type of BMP to be implemented in a DA, evaluate the use of combinations of LID BMPs, including all applicable HSC BMPs to maximize on-site retention of the DCV. If no combination of BMP can mitigate the entire DCV, implement the single BMP type, or combination of BMP types, that maximizes on-site retention of the DCV within the minimum effective area.

If the combination of LID HSC, retention and infiltration, and harvest and use BMPs are unable to mitigate the entire DCV, then biotreatment BMPs may be implemented by the project proponent. If biotreatment BMPs are used, then they must be sized to provide sufficient capacity for effective treatment of the remainder of the volume-based performance criteria that cannot be achieved with LID BMPs (TGD for WQMP Section 5.4.4.2). **Under no circumstances shall any portion of the DCV be released from the site without effective mitigation and/or treatment.**

Form 4.3-1 Infiltration BMP Feasibility (DA 1)

Feasibility Criterion – Complete evaluation for each DA on the Project Site

1 Would infiltration BMP pose significant risk for groundwater related concerns? Yes No

Refer to Section 5.3.2.1 of the TGD for WQMP

If Yes, Provide basis: (attach)

2 Would installation of infiltration BMP significantly increase the risk of geotechnical hazards? Yes No

(Yes, if the answer to any of the following questions is yes, as established by a geotechnical expert):

- The location is less than 50 feet away from slopes steeper than 15 percent
- The location is less than eight feet from building foundations or an alternative setback.
- A study certified by a geotechnical professional or an available watershed study determines that stormwater infiltration would result in significantly increased risks of geotechnical hazards.

If Yes, Provide basis: (attach)

3 Would infiltration of runoff on a Project site violate downstream water rights? Yes No

If Yes, Provide basis: (attach)

4 Is proposed infiltration facility located on hydrologic soil group (HSG) D soils or does the site geotechnical investigation indicate presence of soil characteristics, which support categorization as D soils?

Yes No

If Yes, Provide basis: (attach)

5 Is the design infiltration rate, after accounting for safety factor of 2.0, below proposed facility less than 0.3 in/hr (accounting for soil amendments)? Yes No

If Yes, Provide basis: (attach)

6 Would on-site infiltration or reduction of runoff over pre-developed conditions be partially or fully inconsistent with watershed management strategies as defined in the WAP, or impair beneficial uses? Yes No

See Section 3.5 of the TGD for WQMP and WAP

If Yes, Provide basis: (attach)

7 Any answer from Item 1 through Item 3 is “Yes”: Yes No

If yes, infiltration of any volume is not feasible onsite. Proceed to Form 4.3-4, Harvest and Use BMP. If no, then proceed to Item 9 below.

8 Any answer from Item 4 through Item 6 is “Yes”: Yes No

If yes, infiltration is permissible but is not required to be considered. Proceed to Form 4.3-2, Hydrologic Source Control BMP. If no, then proceed to Item 9, below.

9 All answers to Item 1 through Item 6 are “No”:

Infiltration of the full DCV is potentially feasible, LID infiltration BMP must be designed to infiltrate the full DCV to the MEP. Proceed to Form 4.3-2, Hydrologic Source Control BMP.

4.3.1 Site Design Hydrologic Source Control BMP

Section XI.E. of the Permit emphasizes the use of LID preventative measures; and the use of LID HSC BMPs reduces the portion of the DCV that must be addressed in downstream BMPs. Therefore, all applicable HSC shall be provided except where they are mutually exclusive with each other, or with other BMPs. Mutual exclusivity may result from overlapping BMP footprints such that either would be potentially feasible by itself, but both could not be implemented. Please note that while there are no numeric standards regarding the use of HSC, if a project cannot feasibly meet BMP sizing requirements or cannot fully address HCOCs, feasibility of all applicable HSC must be part of demonstrating that the BMP system has been designed to retain the maximum feasible portion of the DCV. Complete Form 4.3-2 to identify and calculate estimated retention volume from implementing site design HSC BMP. Refer to Section 5.4.1 in the TGD for more detailed guidance.

Form 4.3-2 Site Design Hydrologic Source Control BMPs (DA 1)			
1 Implementation of Impervious Area Dispersion BMP (i.e. routing runoff from impervious to pervious areas), excluding impervious areas planned for routing to on-lot infiltration BMP: Yes <input type="checkbox"/> No <input checked="" type="checkbox"/> <i>If yes, complete Items 2-5; If no, proceed to Item 6</i>	DA DMA BMP Type	DA DMA BMP Type	DA DMA BMP Type <i>(Use additional forms for more BMPs)</i>
2 Total impervious area draining to pervious area (ft ²)			
3 Ratio of pervious area receiving runoff to impervious area			
4 Retention volume achieved from impervious area dispersion (ft ³) $V = \text{Item 2} * \text{Item 3} * (0.5/12)$, assuming retention of 0.5 inches of runoff			
5 Sum of retention volume achieved from impervious area dispersion (ft ³):		<i>V_{retention} = Sum of Item 4 for all BMPs</i>	
6 Implementation of Localized On-lot Infiltration BMPs (e.g. on-lot rain gardens): Yes <input type="checkbox"/> No <input checked="" type="checkbox"/> <i>If yes, complete Items 7-13 for aggregate of all on-lot infiltration BMP in each DA; If no, proceed to Item 14</i>	DA DMA BMP Type	DA DMA BMP Type	DA DMA BMP Type <i>(Use additional forms for more BMPs)</i>
7 Ponding surface area (ft ²)	-		
8 Ponding depth (ft)	-		
9 Surface area of amended soil/gravel (ft ²)	0		
10 Average depth of amended soil/gravel (ft)	0		
11 Average porosity of amended soil/gravel	0		
12 Retention volume achieved from on-lot infiltration (ft ³) <i>V_{retention} = (Item 7 * Item 8) + (Item 9 * Item 10 * Item 11)</i>	0		

13 Runoff volume retention from on-lot infiltration (ft ³): 30,138 $V_{\text{retention}} = \text{Sum of Item 12 for all BMPs}$			
Form 4.3-2 cont. Site Design Hydrologic Source Control BMPs (DA 1)			
14 Implementation of evapotranspiration BMP (green, brown, or blue roofs): Yes <input type="checkbox"/> No <input checked="" type="checkbox"/> <i>If yes, complete Items 15-20. If no, proceed to Item 21</i>	DA DMA BMP Type	DA DMA BMP Type	DA DMA BMP Type <i>(Use additional forms for more BMPs)</i>
15 Rooftop area planned for ET BMP (ft ²)			
16 Average wet season ET demand (in/day) <i>Use local values, typical ~ 0.1</i>			
17 Daily ET demand (ft ³ /day) <i>Item 15 * (Item 16 / 12)</i>			
18 Drawdown time (hrs) <i>Copy Item 6 in Form 4.2-1</i>			
19 Retention Volume (ft ³) $V_{\text{retention}} = \text{Item 17} * (\text{Item 18} / 24)$			
20 Runoff volume retention from evapotranspiration BMPs (ft ³): $V_{\text{retention}} = \text{Sum of Item 19 for all BMPs}$			
21 Implementation of Street Trees: Yes <input type="checkbox"/> No <input checked="" type="checkbox"/> <i>If yes, complete Items 20-2. If no, proceed to Item 24</i>	DA DMA BMP Type	DA DMA BMP Type	DA DMA BMP Type <i>(Use additional forms for more BMPs)</i>
22 Number of Street Trees			
23 Average canopy cover over impervious area (ft ²)			
24 Runoff volume retention from street trees (ft ³) $V_{\text{retention}} = \text{Item 22} * \text{Item 23} * (0.05/12)$ assume runoff retention of 0.05 inches			
25 Runoff volume retention from street tree BMPs (ft ³): $V_{\text{retention}} = \text{Sum of Item 24 for all BMPs}$			
26 Implementation of residential rain barrels/cisterns: Yes <input type="checkbox"/> No <input checked="" type="checkbox"/> <i>If yes, complete Items 27-28; If no, proceed to Item 29</i>	DA DMA BMP Type	DA DMA BMP Type	DA DMA BMP Type <i>(Use additional forms for more BMPs)</i>
27 Number of rain barrels/cisterns			
28 Runoff volume retention from rain barrels/cisterns (ft ³) $V_{\text{retention}} = \text{Item 27} * 3$			
29 Runoff volume retention from residential rain barrels/Cisterns (ft ³): $V_{\text{retention}} = \text{Sum of Item 28 for all BMPs}$			
30 Total Retention Volume from Site Design Hydrologic Source Control BMPs: $\text{Sum of Items 5, 13, 20, 25 and 29}$			

4.3.2 Infiltration BMPs

Use Form 4.3-3 to compute on-site retention of runoff from proposed retention and infiltration BMPs. Volume retention estimates are sensitive to the percolation rate used, which determines the amount of runoff that can be infiltrated within the specified drawdown time. The infiltration safety factor reduces field measured percolation to account for potential inaccuracy associated with field measurements, declining BMP performance over time, and compaction during construction. Appendix D of the TGD for WQMP provides guidance on estimating an appropriate safety factor to use in Form 4.3-3.

If site constraints limit the use of BMPs to a single type and implementation of retention and infiltration BMPs mitigate no more than 40% of the DCV, then they are considered infeasible and the Project Proponent may evaluate the effectiveness of BMPs lower in the LID hierarchy of use (Section 5.5.1 of the TGD for WQMP)

If implementation of infiltrations BMPs is feasible as determined using Form 4.3-1, then LID infiltration BMPs shall be implemented to the MEP (section 4.1 of the TGD for WQMP).

Form 4.3-3 Infiltration LID BMP - including underground BMPs (DA 1)

1 Remaining LID DCV not met by site design HSC BMP (ft³): 9,645, 15489 $V_{unmet} = \text{Form 4.2-1 Item 7} - \text{Form 4.3-2 Item 30}$

BMP Type <i>Use columns to the right to compute runoff volume retention from proposed infiltration BMP (select BMP from Table 5-4 in TGD for WQMP) - Use additional forms for more BMPs</i>	DA 1 DMA A BMP Type Infiltration Chamber	DA 2 DMA B BMP Type Infiltration Chamber	DA DMA C BMP Type <i>(Use additional forms for more BMPs)</i>
2 Infiltration rate of underlying soils (in/hr) <i>See Section 5.4.2 and Appendix D of the TGD for WQMP for minimum requirements for assessment methods</i>	2.5		
3 Infiltration safety factor <i>See TGD Section 5.4.2 and Appendix D</i>	2		
4 Design percolation rate (in/hr) $P_{design} = \text{Item 2} / \text{Item 3}$	1.25		
5 Ponded water drawdown time (hr) <i>Copy Item 6 in Form 4.2-1</i>	48		
6 Maximum ponding depth (ft) <i>BMP specific, see Table 5-4 of the TGD for WQMP for BMP design details</i>	Na		
7 Ponding Depth (ft) $d_{BMP} = \text{Minimum of } (1/12 * \text{Item 4} * \text{Item 5}) \text{ or Item 6}$	Na		
8 Infiltrating surface area, SA_{BMP} (ft ²) <i>the lesser of the area needed for infiltration of full DCV or minimum space requirements from Table 5.7 of the TGD for WQMP</i>	6900		
9 Amended soil depth, d_{media} (ft) <i>Only included in certain BMP types, see Table 5-4 in the TGD for WQMP for reference to BMP design details</i>	1.0		
10 Amended soil porosity	n/a		
11 Gravel depth, d_{media} (ft) <i>Only included in certain BMP types, see Table 5-4 of the TGD for WQMP for BMP design details</i>	1.0'		
12 Gravel porosity	0.4		
13 Duration of storm as basin is filling (hrs) <i>Typical ~ 3hrs</i>	3		
14 Above Ground Retention Volume (ft ³) $V_{retention} = \text{Item 8} * [\text{Item 7} + (\text{Item 9} * \text{Item 10}) + (\text{Item 11} * \text{Item 12}) + (\text{Item 13} * (\text{Item 4} / 12))]$	0	0	
15 Underground Retention Volume (ft ³) <i>Volume determined using manufacturer's specifications and calculations</i>	33,729		
16 Total Retention Volume from LID Infiltration BMPs:(33729 pipe/2760 gravel) <i>(Sum of Items 14 and 15 for all infiltration BMP included in</i>			
17 Fraction of DCV achieved with infiltration BMP: 139%, $\text{Retention}\% = \text{Item 16} / \text{Form 4.2-1 Item 7}$			
18 Is full LID DCV retained on-site with combination of hydrologic source control and LID retention and infiltration BMPs? Yes <input checked="" type="checkbox"/> No <input type="checkbox"/> <i>If yes, demonstrate conformance using Form 4.3-10; if no, then reduce Item 3, Factor of Safety to 2.0 and increase Item 8, Infiltrating Surface Area, such that the portion of the site area used for retention and infiltration BMPs equals or exceeds the minimum effective area thresholds (Table 5-7 of the TGD for WQMP) for the applicable category of development and repeat all above calculations.</i>			

4.3.3 Harvest and Use BMP

Harvest and use BMP may be considered if the full LID DCV cannot be met by maximizing infiltration BMPs. Use Form 4.3-4 to compute on-site retention of runoff from proposed harvest and use BMPs.

Volume retention estimates for harvest and use BMPs are sensitive to the on-site demand for captured stormwater. Since irrigation water demand is low in the wet season, when most rainfall events occur in San Bernardino County, the volume of water that can be used within a specified drawdown period is relatively low. The bottom portion of Form 4.3-4 facilitates the necessary computations to show infeasibility if a minimum incremental benefit of 40 percent of the LID DCV would not be achievable with MEP implementation of on-site harvest and use of stormwater (Section 5.5.4 of the TGD for WQMP).

Form 4.3-4 Harvest and Use BMPs (DA 1)			
1 Remaining LID DCV not met by site design HSC or infiltration BMP (ft ³): <i>V_{unmet} = Form 4.2-1 Item 7 - Form 4.3-2 Item 30 - Form 4.3-3 Item 16</i>			
BMP Type(s) <i>Compute runoff volume retention from proposed harvest and use BMP (Select BMPs from Table 5-4 of the TGD for WQMP) - Use additional forms for more BMPs</i>	DA DMA BMP Type	DA DMA BMP Type	DA DMA BMP Type <i>(Use additional forms for more BMPs)</i>
2 Describe cistern or runoff detention facility			
3 Storage volume for proposed detention type (ft ³) <i>Volume of cistern</i>			
4 Landscaped area planned for use of harvested stormwater (ft ²)			
5 Average wet season daily irrigation demand (in/day) Use local values, typical ~ 0.1 in/day			
6 Daily water demand (ft ³ /day) <i>Item 4 * (Item 5 / 12)</i>			
7 Drawdown time (hrs) <i>Copy Item 6 from Form 4.2-1</i>			
8 Retention Volume (ft ³) <i>V_{retention} = Minimum of (Item 3) or (Item 6 * (Item 7 / 24))</i>			
9 Total Retention Volume (ft ³) from Harvest and Use BMP <i>Sum of Item 8 for all harvest and use BMP included in plan</i>			
10 Is the full DCV retained with a combination of LID HSC, retention and infiltration, and harvest and use BMPs? Yes <input type="checkbox"/> No <input type="checkbox"/> <i>If yes, demonstrate conformance using Form 4.3-10. If no, then re-evaluate combinations of all LID BMP and optimize their implementation such that the maximum portion of the DCV is retained on-site (using a single BMP type or combination of BMP types). If the full DCV cannot be mitigated after this optimization process, proceed to Section 4.3.4.</i>			

4.3.4 Biotreatment BMP

Biotreatment BMPs may be considered if the full LID DCV cannot be met by maximizing retention and infiltration, and harvest and use BMPs. A key consideration when using biotreatment BMP is the effectiveness of the proposed BMP in addressing the pollutants of concern for the project (see Table 5-5 of the TGD for WQMP).

Use Form 4.3-5 to summarize the potential for volume based and/or flow based biotreatment options to biotreat the remaining unmet LID DCV w. Biotreatment computations are included as follows:

- Use Form 4.3-6 to compute biotreatment in small volume based biotreatment BMP (e.g. bioretention w/underdrains);
- Use Form 4.3-7 to compute biotreatment in large volume based biotreatment BMP (e.g. constructed wetlands);
- Use Form 4.3-8 to compute sizing criteria for flow-based biotreatment BMP (e.g. bioswales)

Form 4.3-5 Selection and Evaluation of Biotreatment BMP (DA 1)		
1 Remaining LID DCV not met by site design HSC, infiltration, or harvest and use BMP for potential biotreatment (ft ³): na Form 4.2-1 Item 7 - Form 4.3-2 Item 30 – Form 4.3-3 Item 16- Form 4.3-4 Item 9	List pollutants of concern <i>Copy from Form 2.3-1.</i>	
2 Biotreatment BMP Selected <i>(Select biotreatment BMP(s) necessary to ensure all pollutants of concern are addressed through Unit Operations and Processes, described in Table 5-5 of the TGD for WQMP)</i>	Volume-based biotreatment <i>Use Forms 4.3-6 and 4.3-7 to compute treated volume</i>	Flow-based biotreatment <i>Use Form 4.3-8 to compute treated volume</i>
<input type="checkbox"/> Bioretention with underdrain <input type="checkbox"/> Planter box with underdrain <input type="checkbox"/> Constructed wetlands <input type="checkbox"/> Wet extended detention <input type="checkbox"/> Dry extended detention	<input type="checkbox"/> Vegetated swale <input type="checkbox"/> Vegetated filter strip <input type="checkbox"/> Proprietary biotreatment	
3 Volume biotreated in volume based biotreatment BMP (ft ³): Form 4.3-6 Item 15 + Form 4.3-7 Item 13	4 Compute remaining LID DCV with implementation of volume based biotreatment BMP (ft ³): Item 1 – Item 3	5 Remaining fraction of LID DCV for sizing flow based biotreatment BMP: % Item 4 / Item 1
6 Flow-based biotreatment BMP capacity provided (cfs): <i>Use Figure 5-2 of the TGD for WQMP to determine flow capacity required to provide biotreatment of remaining percentage of unmet LID DCV (Item 5), for the project’s precipitation zone (Form 3-1 Item 1)</i>		
7 Metrics for MEP determination: <ul style="list-style-type: none"> • Provided a WQMP with the portion of site area used for suite of LID BMP equal to minimum thresholds in Table 5-7 of the TGD for WQMP for the proposed category of development: <input type="checkbox"/> <i>If maximized on-site retention BMPs is feasible for partial capture, then LID BMP implementation must be optimized to retain and infiltrate the maximum portion of the DCV possible within the prescribed minimum effective area. The remaining portion of the DCV shall then be mitigated using biotreatment BMP.</i> 		

Form 4.3-6 Volume Based Biotreatment (DA 1) – Bioretention and Planter Boxes with Underdrains			
Biotreatment BMP Type <i>(Bioretention w/underdrain, planter box w/underdrain, other comparable BMP)</i>	DA DMA BMP Type	DA DMA BMP Type	DA DMA BMP Type <i>(Use additional forms for more BMPs)</i>
1 Pollutants addressed with BMP <i>List all pollutant of concern that will be effectively reduced through specific Unit Operations and Processes described in Table 5-5 of the TGD for WQMP</i>			
2 Amended soil infiltration rate <i>Typical ~ 5.0</i>			
3 Amended soil infiltration safety factor <i>Typical ~ 2.0</i>			
4 Amended soil design percolation rate (in/hr) $P_{design} = \text{Item 2} / \text{Item 3}$			
5 Ponded water drawdown time (hr) <i>Copy Item 6 from Form 4.2-1</i>			
6 Maximum ponding depth (ft) <i>see Table 5-6 of the TGD for WQMP for reference to BMP design details</i>			
7 Ponding Depth (ft) $d_{BMP} = \text{Minimum of } (1/12 * \text{Item 4} * \text{Item 5}) \text{ or Item 6}$			
8 Amended soil surface area (ft ²)			
9 Amended soil depth (ft) <i>see Table 5-6 of the TGD for WQMP for reference to BMP design details</i>			
10 Amended soil porosity, <i>n</i>			
11 Gravel depth (ft) <i>see Table 5-6 of the TGD for WQMP for reference to BMP design details</i>			
12 Gravel porosity, <i>n</i>			
13 Duration of storm as basin is filling (hrs) <i>Typical ~ 3hrs</i>			
14 Biotreated Volume (ft ³) $V_{biotreated} = \text{Item 8} * [(\text{Item 7}/2) + (\text{Item 9} * \text{Item 10}) + (\text{Item 11} * \text{Item 12}) + (\text{Item 13} * (\text{Item 4} / 12))]$			
15 Total biotreated volume from bioretention and/or planter box with underdrains BMP: <i>Sum of Item 14 for all volume-based BMPs included in this form</i>			

Form 4.3-7 Volume Based Biotreatment (DA 1) – Constructed Wetlands and Extended Detention

Biotreatment BMP Type <i>Constructed wetlands, extended wet detention, extended dry detention, or other comparable proprietary BMP. If BMP includes multiple modules (e.g. forebay and main basin), provide separate estimates for storage and pollutants treated in each module.</i>	DA DMA BMP Type		DA DMA BMP Type <i>(Use additional forms for more BMPs)</i>	
	Forebay	Basin	Forebay	Basin
1 Pollutants addressed with BMP forebay and basin <i>List all pollutant of concern that will be effectively reduced through specific Unit Operations and Processes described in Table 5-5 of the TGD for WQMP</i>				
2 Bottom width (ft)				
3 Bottom length (ft)				
4 Bottom area (ft ²) $A_{bottom} = \text{Item 2} * \text{Item 3}$				
5 Side slope (ft/ft)				
6 Depth of storage (ft)				
7 Water surface area (ft ²) $A_{surface} = (\text{Item 2} + (2 * \text{Item 5} * \text{Item 6})) * (\text{Item 3} + (2 * \text{Item 5} * \text{Item 6}))$				
8 Storage volume (ft ³) <i>For BMP with a forebay, ensure fraction of total storage is within ranges specified in BMP specific fact sheets, see Table 5-6 of the TGD for WQMP for reference to BMP design details</i> $V = \text{Item 6} / 3 * [\text{Item 4} + \text{Item 7} + (\text{Item 4} * \text{Item 7})^{0.5}]$				
9 Drawdown Time (hrs) <i>Copy Item 6 from Form 2.1</i>				
10 Outflow rate (cfs) $Q_{BMP} = (\text{Item 8}_{forebay} + \text{Item 8}_{basin}) / (\text{Item 9} * 3600)$				
11 Duration of design storm event (hrs)				
12 Biotreated Volume (ft ³) $V_{biotreated} = (\text{Item 8}_{forebay} + \text{Item 8}_{basin}) + (\text{Item 10} * \text{Item 11} * 3600)$				
13 Total biotreated volume from constructed wetlands, extended dry detention, or extended wet detention : <i>(Sum of Item 12 for all BMP included in plan)</i>				

Form 4.3-8 Flow Based Biotreatment (DA 1)			
Biotreatment BMP Type <i>Vegetated swale, vegetated filter strip, or other comparable proprietary BMP</i>	DA DMA BMP Type	DA DMA BMP Type	DA DMA BMP Type <i>(Use additional forms for more BMPs)</i>
1 Pollutants addressed with BMP <i>List all pollutant of concern that will be effectively reduced through specific Unit Operations and Processes described in TGD Table 5-5</i>			
2 Flow depth for water quality treatment (ft) <i>BMP specific, see Table 5-6 of the TGD for WQMP for reference to BMP design details</i>			
3 Bed slope (ft/ft) <i>BMP specific, see Table 5-6 of the TGD for WQMP for reference to BMP design details</i>			
4 Manning's roughness coefficient			
5 Bottom width (ft) <i>$b_w = (\text{Form 4.3-5 Item 6} * \text{Item 4}) / (1.49 * \text{Item 2}^{1.67} * \text{Item 3}^{0.5})$</i>			
6 Side Slope (ft/ft) <i>BMP specific, see Table 5-6 of the TGD for WQMP for reference to BMP design details</i>			
7 Cross sectional area (ft ²) <i>$A = (\text{Item 5} * \text{Item 2}) + (\text{Item 6} * \text{Item 2}^2)$</i>			
8 Water quality flow velocity (ft/sec) <i>$V = \text{Form 4.3-5 Item 6} / \text{Item 7}$</i>			
9 Hydraulic residence time (min) <i>Pollutant specific, see Table 5-6 of the TGD for WQMP for reference to BMP design details</i>			
10 Length of flow based BMP (ft) <i>$L = \text{Item 8} * \text{Item 9} * 60$</i>			
11 Water surface area at water quality flow depth (ft ²) <i>$SA_{top} = (\text{Item 5} + (2 * \text{Item 2} * \text{Item 6})) * \text{Item 10}$</i>			

4.3.5 Conformance Summary

Complete Form 4.3-9 to demonstrate how on-site LID DCV is met with proposed site design hydrologic source control, infiltration, harvest and use, and/or biotreatment BMP. The bottom line of the form is used to describe the basis for infeasibility determination for on-site LID BMP to achieve full LID DCV, and provides methods for computing remaining volume to be addressed in an alternative compliance plan. If the project has more than one outlet, then complete additional versions of this form for each outlet.

Form 4.3-9 Conformance Summary and Alternative Compliance Volume Estimate (DA 1)	
1	Total LID DCV for the Project DA-1 (ft ³): 26681 <i>Copy Item 7 in Form 4.2-1</i>
2	On-site retention with site design hydrologic source control LID BMP (ft ³): <i>Copy Item 30 in Form 4.3-2</i>
3	On-site retention with LID infiltration BMP (ft ³): 31893 <i>Copy Item 16 in Form 4.3-3</i>
4	On-site retention with LID harvest and use BMP (ft ³): <i>Copy Item 9 in Form 4.3-4</i>
5	On-site biotreatment with volume based biotreatment BMP (ft ³): <i>Copy Item 3 in Form 4.3-5</i>
6	Flow capacity provided by flow based biotreatment BMP (cfs): <i>Copy Item 6 in Form 4.3-5</i>
7	<p>LID BMP performance criteria are achieved if answer to any of the following is "Yes":</p> <ul style="list-style-type: none"> • Full retention of LID DCV with site design HSC, infiltration, or harvest and use BMP: Yes <input checked="" type="checkbox"/> No <input type="checkbox"/> <i>If yes, sum of Items 2, 3, and 4 is greater than Item 1</i> • Combination of on-site retention BMPs for a portion of the LID DCV and volume-based biotreatment BMP that address all pollutants of concern for the remaining LID DCV: Yes <input type="checkbox"/> No <input checked="" type="checkbox"/> <i>If yes, a) sum of Items 2, 3, 4, and 5 is greater than Item 1, and Items 2, 3 and 4 are maximized; or b) Item 6 is greater than Form 4.3-5 Item 6 and Items 2, 3 and 4 are maximized</i> ▪ On-site retention and infiltration is determined to be infeasible and biotreatment BMP provide biotreatment for all pollutants of concern for full LID DCV: Yes <input type="checkbox"/> No <input checked="" type="checkbox"/> <i>If yes, Form 4.3-1 Items 7 and 8 were both checked yes</i>
8	<p>If the LID DCV is not achieved by any of these means, then the project may be allowed to develop an alternative compliance plan. Check box that describes the scenario which caused the need for alternative compliance:</p> <ul style="list-style-type: none"> • Combination of HSC, retention and infiltration, harvest and use, and biotreatment BMPs provide less than full LID DCV capture: <input type="checkbox"/> <i>Checked yes for Form 4.3-5 Item 7, Item 6 is zero, and sum of Items 2, 3, 4, and 5 is less than Item 1. If so, apply water quality credits and calculate volume for alternative compliance, $V_{alt} = (Item\ 1 - Item\ 2 - Item\ 3 - Item\ 4 - Item\ 5) * (100 - Form\ 2.4-1\ Item\ 2)\%$</i> • An approved Watershed Action Plan (WAP) demonstrates that water quality and hydrologic impacts of urbanization are more effective when managed in at an off-site facility: <input type="checkbox"/> <i>Attach appropriate WAP section, including technical documentation, showing effectiveness comparisons for the project site and regional watershed</i>

4.3.6 Hydromodification Control BMP

Use Form 4.3-10 to compute the remaining runoff volume retention, after LID BMP are implemented, needed to address HCOC, and the increase in time of concentration and decrease in peak runoff necessary to meet targets for protection of waterbodies with a potential HCOC. Describe hydromodification control BMP that address HCOC, which may include off-site BMP and/or in-stream controls. Section 5.6 of the TGD for WQMP provides additional details on selection and evaluation of hydromodification control BMP.

Form 4.3-10 Hydromodification Control BMPs (DA 1)	
<p>1 Volume reduction needed for HCOC performance criteria (ft³): TBD during Final Engineering <i>(Form 4.2-2 Item 4 * 0.95) – Form 4.2-2 Item 1</i></p>	<p>2 On-site retention with site design hydrologic source control, infiltration, and harvest and use LID BMP (ft³): <i>Sum of Form 4.3-9 Items 2, 3, and 4 Evaluate option to increase implementation of on-site retention in Forms 4.3-2, 4.3-3, and 4.3-4 in excess of LID DCV toward achieving HCOC volume reduction</i></p>
<p>3 Remaining volume for HCOC volume capture (ft³): <i>Item 1 – Item 2</i></p>	<p>4 Volume capture provided by incorporating additional on-site or off-site retention BMPs (ft³): <i>Existing downstream BMP may be used to demonstrate additional volume capture (if so, attach to this WQMP a hydrologic analysis showing how the additional volume would be retained during a 2-yr storm event for the regional watershed)</i></p>
<p>5 If Item 4 is less than Item 3, incorporate in-stream controls on downstream waterbody segment to prevent impacts due to hydromodification <input type="checkbox"/> <i>Attach in-stream control BMP selection and evaluation to this WQMP</i></p>	
<p>6 Is Form 4.2-2 Item 11 less than or equal to 5%: Yes <input type="checkbox"/> No <input type="checkbox"/> <i>If yes, HCOC performance criteria is achieved. If no, select one or more mitigation options below:</i></p> <ul style="list-style-type: none"> • Demonstrate increase in time of concentration achieved by proposed LID site design, LID BMP, and additional on-site or off-site retention BMP <input type="checkbox"/> <i>BMP upstream of a waterbody segment with a potential HCOC may be used to demonstrate increased time of concentration through hydrograph attenuation (if so, show that the hydraulic residence time provided in BMP for a 2-year storm event is equal or greater than the addition time of concentration requirement in Form 4.2-4 Item 15)</i> • Increase time of concentration by preserving pre-developed flow path and/or increase travel time by reducing slope and increasing cross-sectional area and roughness for proposed on-site conveyance facilities <input type="checkbox"/> • Incorporate appropriate in-stream controls for downstream waterbody segment to prevent impacts due to hydromodification, in a plan approved and signed by a licensed engineer in the State of California <input type="checkbox"/> 	
<p>7 Form 4.2-2 Item 12 less than or equal to 5%: Yes <input type="checkbox"/> No <input type="checkbox"/> <i>If yes, HCOC performance criteria is achieved. If no, select one or more mitigation options below:</i></p> <ul style="list-style-type: none"> • Demonstrate reduction in peak runoff achieved by proposed LID site design, LID BMPs, and additional on-site or off-site retention BMPs <input type="checkbox"/> <i>BMPs upstream of a waterbody segment with a potential HCOC may be used to demonstrate additional peak runoff reduction through hydrograph attenuation (if so, attach to this WQMP, a hydrograph analysis showing how the peak runoff would be reduced during a 2-yr storm event)</i> • Incorporate appropriate in-stream controls for downstream waterbody segment to prevent impacts due to hydromodification, in a plan approved and signed by a licensed engineer in the State of California <input type="checkbox"/> 	

4.4 Alternative Compliance Plan (if applicable)

Describe an alternative compliance plan (if applicable) for projects not fully able to infiltrate, harvest and use, or biotreat the DCV via on-site LID practices. A project proponent must develop an alternative compliance plan to address the remainder of the LID DCV. Depending on project type some projects may qualify for water quality credits that can be applied to reduce the DCV that must be treated prior to development of an alternative compliance plan (see Form 2.4-1, Water Quality Credits). Form 4.3-9 Item 8 includes instructions on how to apply water quality credits when computing the DCV that must be met through alternative compliance. Alternative compliance plans may include one or more of the following elements:

- On-site structural treatment control BMP - All treatment control BMP should be located as close to possible to the pollutant sources and should not be located within receiving waters;
- Off-site structural treatment control BMP - Pollutant removal should occur prior to discharge of runoff to receiving waters;
- Urban runoff fund or In-lieu program, if available

Depending upon the proposed alternative compliance plan, approval by the executive officer may or may not be required (see Section 6 of the TGD for WQMP).

Section 5 Inspection and Maintenance Responsibility for Post Construction BMP

All BMP included as part of the project WQMP are required to be maintained through regular scheduled inspection and maintenance (refer to Section 8, Post Construction BMP Requirements, in the TGD for WQMP). Fully complete Form 5-1 summarizing all BMP included in the WQMP. Attach additional forms as needed. The WQMP shall also include a detailed Operation and Maintenance Plan for all BMP and may require a Maintenance Agreement (consult the jurisdiction's LIP). If a Maintenance Agreement is required, it must also be attached to the WQMP.

Form 5-1 BMP Inspection and Maintenance (use additional forms as necessary)			
BMP	Responsible Party(s)	Inspection/ Maintenance Activities Required	Minimum Frequency of Activities
N3 – Landscape Management	PMC	inspection/ maintenance as needed per the management guidelines for use of fertilizers/ pesticides and water use efficiency. Verify that runoff minimizing landscape design continues to function by checking that water sensors are functioning properly, that irrigation heads are adjusted to eliminate overspray, and adjust timing and cycle lengths in accordance with the water demands, season and time of day.	Once per month or as recommended by professional service provider
N15 – Vacuum Sweeping of Private Streets and Lots	PMC	Private Drive Aisles and Parking Areas are to be swept on a routine basis to facilitate trash/ debris pick up, removal and to dispose of excessive oil/ grease buildup. This maintenance requirement will be listed in the project's CC&Rs and recorded with the County Recorder's Office.	Once per month or as recommended by professional service provider
N14 - Common Area Catch Basin Cleaning & Inspection	PMC	Clean debris and silt in bottom of catch basin as needed. Replace any damaged or illegible storm drain signage.	Once per month and before
N11 - Litter Control	PMC	Weekly inspections of common area trash receptacles are emptied, all trash/ debris within the location removed and lids are replaced.	Weekly

Water Quality Management Plan (WQMP)

		Note any trash disposal violations to the appropriate PMC personel.	
Infiltration Chambers	PMC or by an selected approved service provider	Basin Bottoms shall be maintned - silt free and landscpae shall be maintained	After the first 12 monts, an initial cleaning is required. Thereafter, annual inspections are recommended. Any damage and/ or deficiencies shall be reported to the manufacturer. Additional cleaning will be required every 3-5 years after the first year of operation.
S1 - Storm Drain Signage	PMC	PMC to inspect, repair or replace storm drain signage and verify if ledigle.	Inspect once per month, repair or replace immediately
N2 – Activity Restrictions	PMC	Activities on this site will be limited to activities related to warehouse use.	Ongoing.
N4 – BMP Maintenance	PMC	The PMC will comply with BMP Maintenance materials as part of this WQMP report, refer to Section 5 by agreement and contract by use of inspection forms to be submitted to the owner.	Once per month.
N5 – Title 22 CCR	Owner	The Owner will contract with a PMC to comply with the Regulation as denoted within the CC&R's not limited to this water quality document	Upon completion of project
N6 – Local Water Quality Ordinances	PMC	The PMC and/ or selected professional landscaping service provider will comply with all local water quality ordinances as denoted within this document and as contracted with PP.	Ongoing.
N7 – Spill Contingency Plan	PMC	The PMC will be responsible for establishing a Spill Contingency Plan that involves clean up and removal requirements.	In the event of a spill.

Water Quality Management Plan (WQMP)

N9 – Hazardous Materials Disclosure	PMC	The PMC will provide a Hazardous Materials Disclosure to tenants, and/ or employees listing all hazardous materials located onsite.	Upon hire/lease signing of employees/tenants
N10 – Fire Code Implementation	PMC	The PMC will comply with the Uniform Fire Code through permitted documents (being Hazardous material storage if necessary, building permits, building drawings).	Ongoing
N12 – Employee Training	PMC	Practical informational materials will be provided to employees on general good housekeeping practices that contribute to protection of storm water quality.	Upon hire of employees
N13 – Loading Docks	PMC	Loading Docks shall remain clear and clean of debris without standing material and will be cleaned upon regular street sweeping.	Weekly
N17 – NPDES permits	Owner	The Owner will be required to comply with the NOI and SWPPP	During Construction
S3 – Trash Storage	Owner	All trash enclosures shall employ doors and covers to lessen transport of solid waste.	During Construction
S4 – Efficient Irrigation	PMC	As part of the design of all common area landscape irrigation shall employ water conservation principals, including, but not limited to, such provisions as water sensors, programmable irrigation times (for short cycles), etc. will be used.	Weekly
S5 – Landscape Grade 2 inches below impervious surfaces	Owner	Through final engineering the project will install landscape features 1-2" below the adjacent hardened surface.	During Construction

Section 6 WQMP Attachments

6.1. Site Plan and Drainage Plan

Include a site plan and drainage plan sheet set containing the following minimum information:

- Project location
- Site boundary
- Land uses and land covers, as applicable
- Suitability/feasibility constraints
- Structural Source Control BMP locations
- Site Design Hydrologic Source Control BMP locations
- LID BMP details
- Drainage delineations and flow information
- Drainage connections

6.2 Electronic Data Submittal

Minimum requirements include submittal of PDF exhibits in addition to hard copies. Format must not require specialized software to open. If the local jurisdiction requires specialized electronic document formats (as described in their local Local Implementation Plan), this section will describe the contents (e.g., layering, nomenclature, geo-referencing, etc.) of these documents so that they may be interpreted efficiently and accurately.

6.3 Post Construction

Attach all O&M Plans and Maintenance Agreements for BMP to the WQMP.

6.4 Other Supporting Documentation

- BMP Educational Materials
- Activity Restriction – C, C&R's & Lease Agreements

Section 6.1.1
WQMP Exhibit

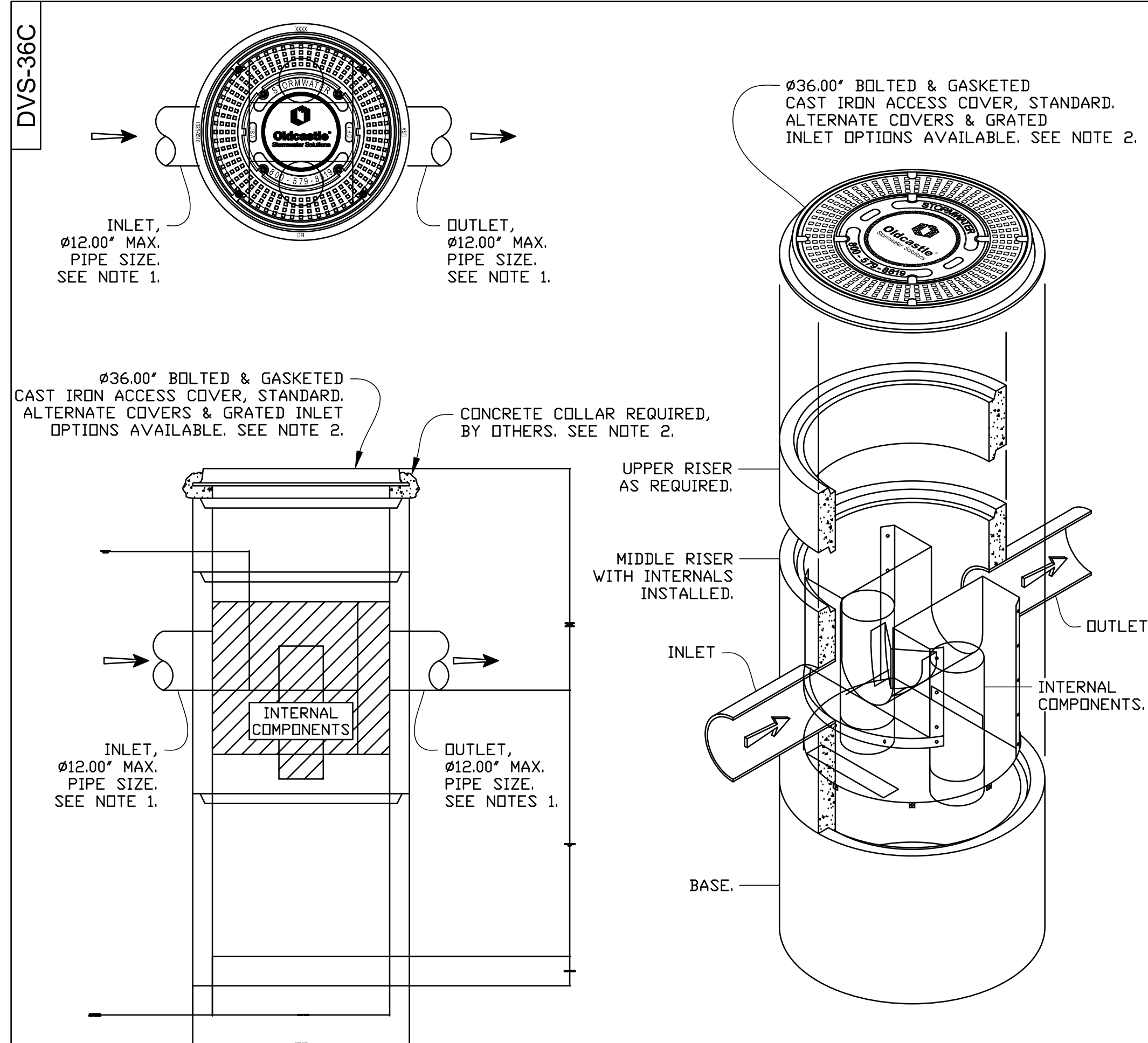

- NOTES:**
- STANDARD INLET/OUTLET PIPE CONFIGURATION TO ENTER & EXIT SEPARATOR AT 180°. CUSTOM ANGLED CONFIGURATIONS AVAILABLE UPON REQUEST, SPECIFIC MAXIMUM ANGLES & PIPE SIZES APPLY. CONTACT OLDCASTLE® STORMWATER SOLUTIONS FOR ENGINEERING DETAILS.
 - BOLTED & GASKETED MANHOLE ACCESS COVER ELEVATION MAY BE ADJUSTED TO GRADE. FIELD POURED CONCRETE COLLAR AS REQUIRED, BY OTHERS. INLET GRATES & ALTERNATE COVER OPTIONS AVAILABLE.
 - FDR DEPTHS LESS THAN THE MINIMUM SHOWN CONTACT OLDCASTLE® STORMWATER SOLUTIONS FOR ENGINEERING DESIGN ASSISTANCE.
 - CONCRETE COMPONENTS SHALL BE MANUFACTURED IN ACCORDANCE WITH ASTM DESIGNATION C478.



Oldcastle®
Stormwater Solutions

7921 Southpark Plaza, Suite 200 | Littleton, CO | 80120 | Ph: 800.579.8819 | oldcastlestormwater.com

THIS DOCUMENT IS THE PROPERTY OF OLDCASTLE PRECAST, INC. IT IS SUBMITTED FOR REFERENCE PURPOSES ONLY AND SHALL NOT BE USED IN ANY WAY INJURIOUS TO THE INTERESTS OF SAID COMPANY. COPYRIGHT © 2010 OLDCASTLE PRECAST, INC. ALL RIGHTS RESERVED.

DRAWING NO. DVS-36C REV. C ECD-0136 DATE JPR 7/16/15 DATE JPR 4/25/11 SHEET 1 OF 1

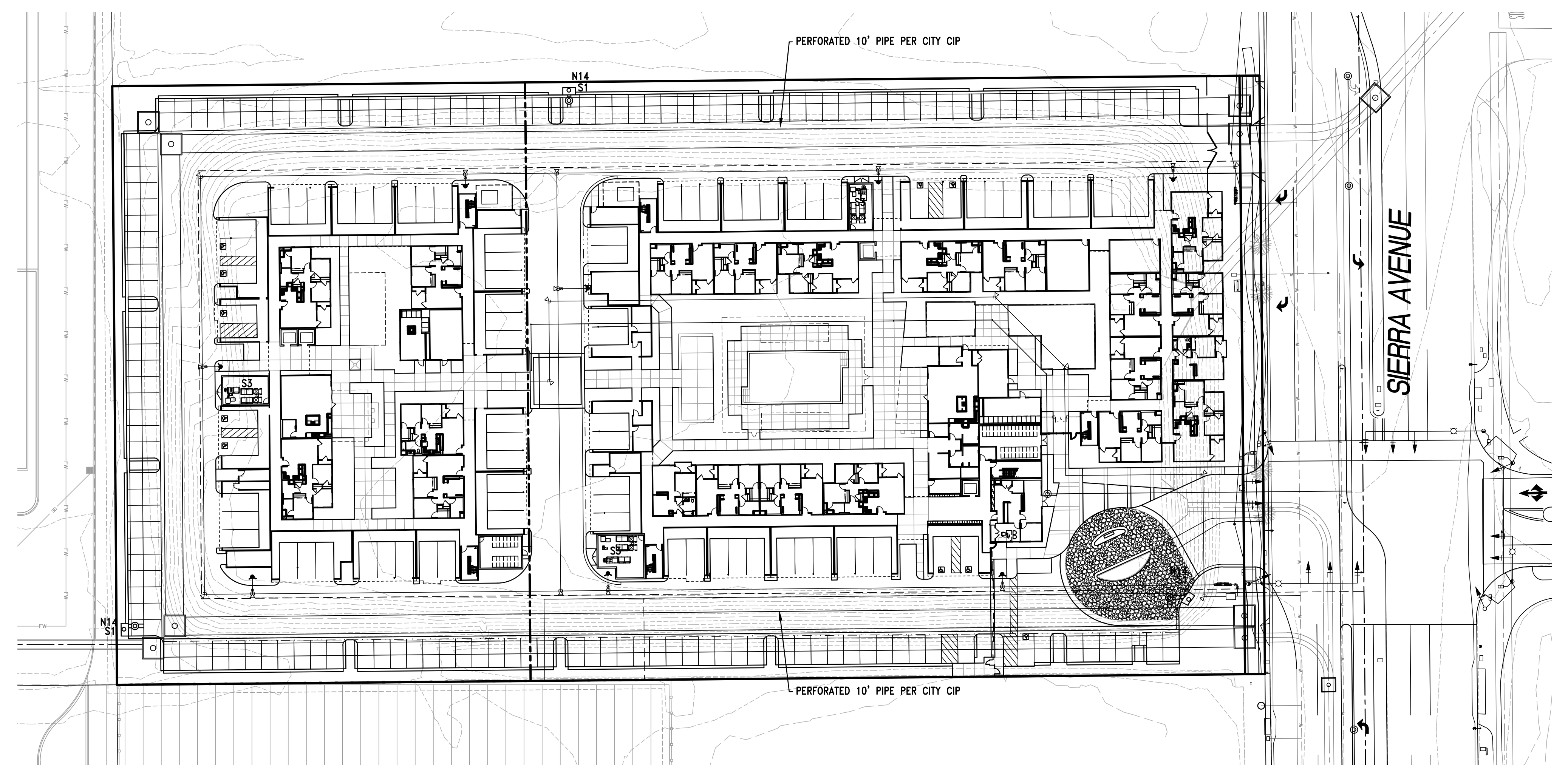

CATCH BASIN STENCILING DETAIL
NTS

MAINTENANCE SCHEDULE

ALL WQMP/BMP MAINTENANCE SHALL BE MADE BY THE OWNER OR QUALIFIED MAINTENANCE COMPANY.

FILTERS: INSPECTED MONTHLY AND 1 WEEK PRIOR TO OCTOBER 15TH. MAINTAIN AND REPLACE IN ACCORDANCE WITH MANUFACTURERS RECOMMENDATIONS.

STREET SWEEPING SHALL BE CONDUCTED EVERY WEEK OVER ALL OPEN PAVEMENT.

CATCH BASIN STENCILS: SHALL BE INSPECTED EVERY 6 MONTHS. REPAIR AS NEEDED.

LANDSCAPE AND OPEN SPACE AREAS: SHALL BE INSPECTED EVERY WEEK.

EFFICIENT IRRIGATION: SHALL BE INSPECTED EVERY WEEK.

CHAMBERS: SHALL BE INSPECTED EVERY MONTH AND PER MANUFACTURERS RECOMMENDATIONS.

LID AREA CALCULATIONS

PRE DEVELOPMENT NET AREA: 4.71 ACRES (205,247 SF) IMPERVIOUS AREA: 0.00 AC PERVIOUS AREA: 4.71 AC	PRE DEVELOPMENT NET AREA: 4.71 ACRES (205,247 SF) IMPERVIOUS AREA: 3.63 AC PERVIOUS AREA: 1.08 AC
--	--

BMP AS-BUILT CERTIFICATE

I HEREBY CERTIFY THAT ALL PROPOSED PROJECT BMP'S AS SHOWN HEREON HAVE BEEN INSTALLED PER PLAN.

SIGNATURE AND DATE: _____

KES TECHNOLOGIES INC
1 VENTURE STE 130
IRVINE, CA, 92618
P: 949-339-5330

N14

SOURCE CONTROL BMPs:

- S1 STORM DRAIN SIGNAGE
- S3 TRASH STORAGE AREAS
- S4 EFFICIENT IRRIGATION SYSTEMS (ALL OPEN AREAS)
- N3 LANDSCAPE MANAGEMENT - ALL OPEN PLANTED AREA
- N14 CATCH BASIN INSPECTION - ALL PROPOSED CATCH BASINS
- N15 STREET SWEEPING AND VACUUMING - ALL ON SITE VEHICULAR PAVEMENT

PRETREATMENT NOTE:
ALL AREA DRAINS TO BE EQUIPPED WITH FILTERS TO SERVE AS PRETREATMENT PRIOR TO INFILTRATION.

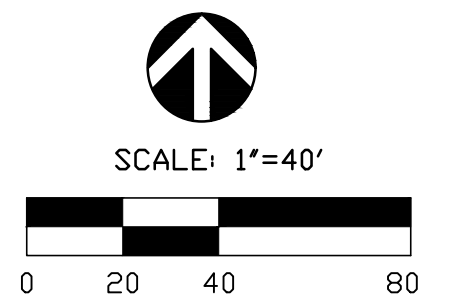

REVISIONS			
NO	DATE	INITIAL	DESCRIPTION

BENCH MARK :
CHISELED SQUARE IN WEST CURB RETURN N.W. CORNER SLOVER & CITRUS AVENUE ELEV = 1067.73

BASIS OF BEARINGS:
BASIS OF BEARINGS IS THE ☉ OF SIERRA AVENUE AS SHOWN ON PARCEL MAP NO. 5083 PMB 48-31
BEING: NORTH 00°32'15" WEST

OWNER OR DEVELOPER :

RELATED THE RELATED COMPANIES

3008 VON KARMAN AVENUE, SUITE 500
IRVINE, CALIFORNIA 92618
PHONE: (949) 609-7222

PREPARED BY :

KES TECHNOLOGIES INC
CIVIL ENGINEERING
LAND PLANNING AND SURVEYING

1 VENTURE STE 130
IRVINE, CALIFORNIA 92618
PHONE (949) 339-5331



ENGINEER _____ DATE _____
EXP. DATE _____

WQMP SITE PLAN

CITY ADDRESS :
11196 SIERRA AVENUE
FONTANA, CA

SCALE: AS SHOWN DRAWN BY: DSK CHECKED BY: AM

CITY OF FONTANA

C-1
SHEET 1 OF 1

Section 6.1.2

Sizing Calculations

Infiltration Trench Sizing Calculation

Design Capture Volume (cf) 26,188

Chambers	1150 Bottom 48"
Ponding Depth, p (ft)	4
Gravel Depth, g (ft)	1
Void Factor, v	0.4
Design Infiltration Rate, i (in/hr)	1.25
Gravel void = LFX12'X1.0X0.40	2760

Provided Infiltration Volume (cf) = 36489

36489 cf > 26,188 cf ✓



NOAA Atlas 14, Volume 6, Version 2
Location name: Fontana, California, USA*
Latitude: 34.052°, Longitude: -117.4365°
Elevation: 1052.1 ft**
 * source: ESRI Maps
 ** source: USGS



POINT PRECIPITATION FREQUENCY ESTIMATES

Sanja Perica, Sarah Dietz, Sarah Heim, Lillian Hiner, Kazungu Maitaria, Deborah Martin, Sandra Pavlovic, Ishani Roy, Carl Trypaluk, Dale Unruh, Fenglin Yan, Michael Yekta, Tan Zhao, Geoffrey Bonnin, Daniel Brewer, Li-Chuan Chen, Tye Parzybok, John Yarchoan

NOAA, National Weather Service, Silver Spring, Maryland

[PF_tabular](#) | [PF_graphical](#) | [Maps_&_aerials](#)

PF tabular

PDS-based point precipitation frequency estimates with 90% confidence intervals (in inches)¹										
Duration	Average recurrence interval (years)									
	1	2	5	10	25	50	100	200	500	1000
5-min	0.106 (0.089-0.129)	0.138 (0.115-0.168)	0.181 (0.151-0.221)	0.218 (0.179-0.267)	0.269 (0.214-0.341)	0.310 (0.241-0.402)	0.352 (0.267-0.469)	0.398 (0.293-0.546)	0.463 (0.327-0.663)	0.516 (0.352-0.765)
10-min	0.152 (0.127-0.185)	0.198 (0.165-0.240)	0.260 (0.216-0.316)	0.312 (0.257-0.383)	0.385 (0.306-0.489)	0.444 (0.345-0.576)	0.505 (0.383-0.673)	0.571 (0.421-0.783)	0.664 (0.469-0.950)	0.740 (0.504-1.10)
15-min	0.184 (0.154-0.223)	0.240 (0.199-0.291)	0.314 (0.261-0.383)	0.377 (0.311-0.463)	0.466 (0.371-0.592)	0.537 (0.418-0.697)	0.611 (0.463-0.814)	0.690 (0.509-0.946)	0.803 (0.567-1.15)	0.895 (0.609-1.33)
30-min	0.275 (0.229-0.333)	0.358 (0.298-0.434)	0.470 (0.390-0.572)	0.564 (0.464-0.692)	0.696 (0.554-0.884)	0.802 (0.624-1.04)	0.913 (0.693-1.22)	1.03 (0.760-1.41)	1.20 (0.847-1.72)	1.34 (0.911-1.98)
60-min	0.403 (0.336-0.489)	0.525 (0.437-0.636)	0.688 (0.571-0.838)	0.826 (0.680-1.01)	1.02 (0.811-1.30)	1.18 (0.914-1.53)	1.34 (1.01-1.78)	1.51 (1.11-2.07)	1.76 (1.24-2.52)	1.96 (1.33-2.91)
2-hr	0.597 (0.497-0.723)	0.769 (0.640-0.933)	0.996 (0.827-1.21)	1.18 (0.975-1.45)	1.44 (1.15-1.83)	1.65 (1.28-2.14)	1.86 (1.41-2.47)	2.07 (1.53-2.84)	2.38 (1.68-3.40)	2.62 (1.79-3.89)
3-hr	0.751 (0.626-0.910)	0.964 (0.803-1.17)	1.25 (1.03-1.52)	1.47 (1.21-1.81)	1.79 (1.42-2.27)	2.03 (1.58-2.63)	2.28 (1.73-3.03)	2.53 (1.87-3.47)	2.89 (2.04-4.13)	3.17 (2.16-4.70)
6-hr	1.07 (0.888-1.29)	1.37 (1.14-1.66)	1.76 (1.46-2.14)	2.08 (1.71-2.55)	2.51 (1.99-3.18)	2.83 (2.20-3.67)	3.16 (2.40-4.21)	3.50 (2.58-4.79)	3.95 (2.79-5.65)	4.31 (2.93-6.39)
12-hr	1.41 (1.18-1.71)	1.83 (1.52-2.22)	2.36 (1.96-2.87)	2.78 (2.29-3.41)	3.34 (2.66-4.25)	3.77 (2.93-4.89)	4.19 (3.18-5.58)	4.62 (3.40-6.33)	5.19 (3.67-7.43)	5.63 (3.84-8.35)
24-hr	1.89 (1.67-2.18)	2.48 (2.19-2.86)	3.23 (2.85-3.74)	3.83 (3.35-4.46)	4.61 (3.91-5.56)	5.20 (4.31-6.40)	5.79 (4.69-7.29)	6.37 (5.02-8.25)	7.16 (5.41-9.65)	7.75 (5.67-10.8)
2-day	2.29 (2.03-2.64)	3.07 (2.71-3.54)	4.06 (3.58-4.70)	4.86 (4.25-5.66)	5.92 (5.01-7.13)	6.72 (5.58-8.27)	7.53 (6.10-9.48)	8.35 (6.58-10.8)	9.44 (7.14-12.7)	10.3 (7.52-14.3)
3-day	2.47 (2.18-2.84)	3.35 (2.96-3.87)	4.50 (3.97-5.21)	5.43 (4.75-6.34)	6.69 (5.66-8.06)	7.65 (6.35-9.41)	8.62 (6.98-10.9)	9.61 (7.58-12.4)	11.0 (8.29-14.8)	12.0 (8.78-16.7)
4-day	2.65 (2.35-3.06)	3.65 (3.22-4.21)	4.94 (4.35-5.71)	5.99 (5.24-6.99)	7.42 (6.28-8.94)	8.52 (7.07-10.5)	9.64 (7.81-12.1)	10.8 (8.50-14.0)	12.4 (9.35-16.7)	13.6 (9.93-18.9)
7-day	3.03 (2.69-3.50)	4.22 (3.73-4.87)	5.78 (5.10-6.69)	7.07 (6.18-8.24)	8.82 (7.47-10.6)	10.2 (8.44-12.5)	11.6 (9.37-14.6)	13.0 (10.3-16.9)	15.0 (11.3-20.2)	16.6 (12.1-23.1)
10-day	3.29 (2.91-3.79)	4.61 (4.08-5.32)	6.36 (5.61-7.36)	7.80 (6.83-9.10)	9.79 (8.29-11.8)	11.3 (9.40-13.9)	12.9 (10.5-16.3)	14.6 (11.5-18.9)	16.9 (12.8-22.8)	18.7 (13.7-26.1)
20-day	3.95 (3.50-4.56)	5.60 (4.95-6.46)	7.80 (6.88-9.03)	9.65 (8.44-11.3)	12.2 (10.3-14.7)	14.3 (11.8-17.5)	16.4 (13.3-20.6)	18.6 (14.7-24.1)	21.8 (16.5-29.4)	24.3 (17.8-33.9)
30-day	4.67 (4.13-5.38)	6.61 (5.85-7.63)	9.24 (8.15-10.7)	11.5 (10.0-13.4)	14.6 (12.3-17.6)	17.1 (14.2-21.0)	19.7 (16.0-24.8)	22.5 (17.8-29.2)	26.5 (20.1-35.8)	29.7 (21.8-41.5)
45-day	5.56 (4.92-6.41)	7.80 (6.89-9.00)	10.9 (9.58-12.6)	13.5 (11.8-15.7)	17.2 (14.6-20.7)	20.2 (16.8-24.8)	23.4 (19.0-29.5)	26.8 (21.2-34.8)	31.8 (24.1-42.9)	35.9 (26.2-50.0)
60-day	6.52 (5.77-7.52)	9.03 (7.99-10.4)	12.5 (11.0-14.5)	15.5 (13.5-18.0)	19.7 (16.7-23.8)	23.2 (19.3-28.6)	26.9 (21.8-33.9)	31.0 (24.4-40.1)	36.9 (27.9-49.7)	41.7 (30.5-58.2)

¹ Precipitation frequency (PF) estimates in this table are based on frequency analysis of partial duration series (PDS). Numbers in parenthesis are PF estimates at lower and upper bounds of the 90% confidence interval. The probability that precipitation frequency estimates (for a given duration and average recurrence interval) will be greater than the upper bound (or less than the lower bound) is 5%. Estimates at upper bounds are not checked against probable maximum precipitation (PMP) estimates and may be higher than currently valid PMP values. Please refer to NOAA Atlas 14 document for more information.

[Back to Top](#)

PF graphical

PDS-based depth-duration-frequency (DDF) curves
 Latitude: 34.0520°, Longitude: -117.4365°

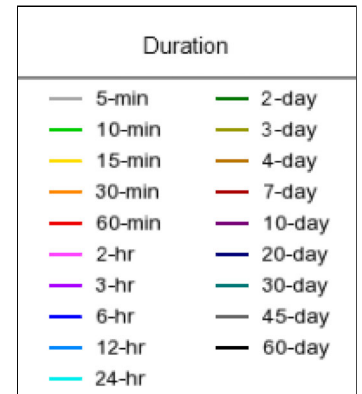
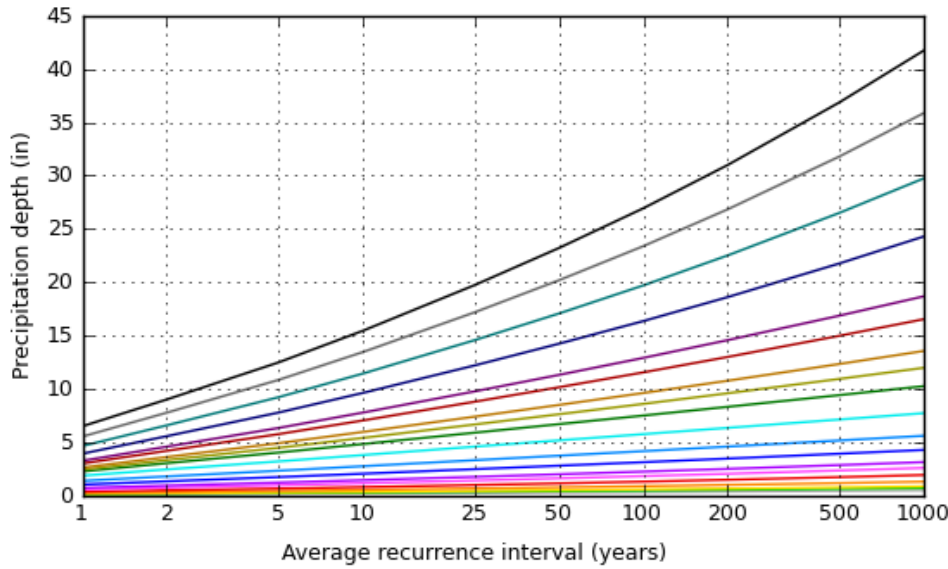
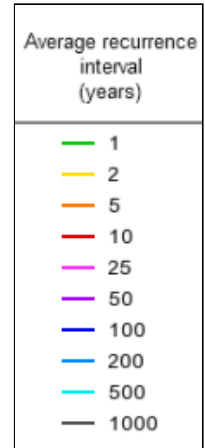
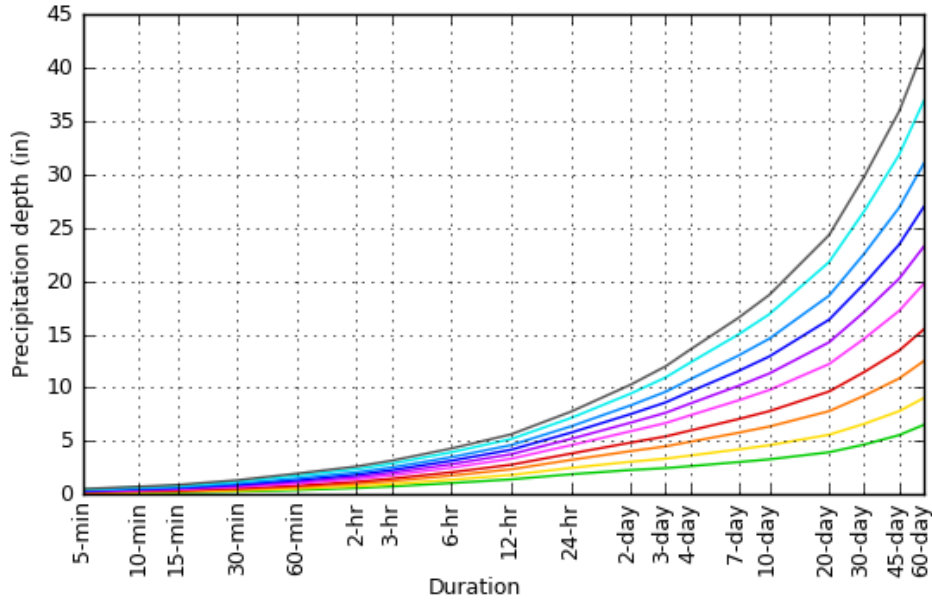

[Back to Top](#)

Maps & aerials

Small scale terrain



Large scale terrain



Large scale map



Large scale aerial



[Back to Top](#)

[US Department of Commerce](#)
[National Oceanic and Atmospheric Administration](#)
[National Weather Service](#)
[National Water Center](#)
1325 East West Highway
Silver Spring, MD 20910
Questions?: HDSC.Questions@noaa.gov

[Disclaimer](#)

Section 6.1.3

Hydrology Calculations

To be provided at later date

Section 6.1.4

Soils Report



Percolation Test Report

**Proposed Expanded Housing Area
Fontana, California**

July 22, 2020

Terracon Project No. CB205095

Prepared for:

Related California
Irvine, California

Prepared by:

Terracon Consultants, Inc.
Colton, California



July 22, 2020



Related California
18201 Von Karman Avenue, Suite 900
Irvine, California 92612

Attn: Mr. Stan Smith, Vice President
P: (949) 660-7272
E: ssmith@related.com

Re: Percolation Test Report
Proposed Expanded Housing Area
11180 Sierra Avenue
Fontana, California
Terracon Project No. CB205095

Dear Mr. Smith:

We have completed the Percolation Test services for the above referenced project. This study was performed in general accordance with Terracon Proposal No. PCB205095 dated June 30, 2019. This report presents the findings of the subsurface exploration and the results of percolation tests for the proposed project.

We appreciate the opportunity to be of service to you on this project. If you have any questions concerning this report or if we may be of further service, please contact us.

Sincerely,

Terracon Consultants, Inc.

A blue ink handwritten signature, appearing to read "F. Fred Buhamdan", written over a horizontal line.

Fred Yi, Ph.D., G.E. 2967
Sr. Geotechnical Engineer

F. Fred Buhamdan
Sr. Principal

REPORT TOPICS

INTRODUCTION.....	1
SITE CONDITIONS.....	1
PROJECT DESCRIPTION.....	2
GEOTECHNICAL CHARACTERIZATION.....	2
STORM WATER MANAGEMENT	3
GENERAL COMMENTS.....	4

Note: This report was originally delivered in a web-based format. **Orange Bold** text in the report indicates a referenced section heading. The PDF version also includes hyperlinks which direct the reader to that section and clicking on the **GeoReport** logo will bring you back to this page. For more interactive features, please view your project online at client.terracon.com.

ATTACHMENTS

EXPLORATION AND TESTING PROCEDURES
SITE LOCATION AND EXPLORATION PLANS
EXPLORATION RESULTS
SUPPORTING INFORMATION

Note: Refer to each individual Attachment for a listing of contents.

Percolation Test Report
Proposed Expanded Housing Area
11180 Sierra Avenue
Fontana, California
Terracon Project No. CB205095
July 22, 2020

INTRODUCTION

This report presents the results of our subsurface exploration and percolation tests performed for the proposed expanded housing area to be located west end of 11180 Sierra Avenue in Fontana, California. The purpose of these services is to provide information and geotechnical engineering recommendations relative to:

- Subsurface soil conditions
- Groundwater conditions and historical high groundwater
- On-site infiltration rate

The Scope of Services for this project included the advancement of five test borings to depths ranging from approximately 5 to 21 ½ feet below existing site grades.

Maps showing the site and boring locations are shown in the **Site Location** and **Exploration Plan** sections, respectively. The results of the laboratory testing performed on soil samples obtained from the site during the field exploration are included on the boring logs in the **Exploration Results** section.

SITE CONDITIONS

The following description of site conditions is derived from our site visit in association with the field exploration and our review of publicly available geologic and topographic maps.

Item	Description
Parcel Information	The project is located 11180 Sierra Avenue in Fontana, California. A multifamily apartment complex is proposed on the site (approximately 3.82 acres) which is currently a storm water retention basin. A smaller basin, or optional terminal storage, is planned to the west of the planned apartment site. The center of the new basin is approximately at: Latitude: 34.0508°; Longitude: -117.4375° See Site Location .
Existing Improvements	The site is currently a stormwater detention basin.
Current Ground Cover	Earthen with sparse bushes and seasonal weeds

Percolation Test Report

Proposed Expanded Housing Area ■ Fontana, California

July 22, 2020 ■ Terracon Project No. CB205095



Item	Description
Existing Topography (from Google Earth)	The existing stormwater retention basin is a surface type basin. The bottom of the basin is approximately 12 to 15 feet deep measured from the surrounding property grade. The basin side slopes have inclinations of approximately 2:1 (horizontal:vertical) descending from all sides to the basin bottom. An access road exists on the west slope of the existing basin.

PROJECT DESCRIPTION

Our initial understanding of the project was provided in our proposal and was discussed during project planning. A period of collaboration has transpired since the project was initiated, and our final understanding of the project conditions is as follows:

Item	Description
Information Provided	Project information was furnished to us via emails dated June 19, 2020, with attached maps showing the topography of the existing basin and the location of the proposed new basin and the optional terminal storage.
Project Description	<p>As the development of the surrounding properties and the construction of on-site stormwater retention system associated with each development are completed, the full capacity of the existing detention basin is not needed. It is proposed to backfill the existing basin with compacted fill soils for development of multi-family residential units and associated infrastructure.</p> <p>The project will include grading a new basin with 2:1 slope at the west side of the property with a bottom depth of 9 feet future adjacent finish grade. The provided plan prepared by KES Technologies show an option for underground chambers at the bottom of the proposed basin. We were requested to perform percolation tests to assist in the design of the proposed basin and the optional underground chamber.</p> <p>This report provides the results to percolation testing only. The earthwork recommendations, the stability of the new basin slopes, and the backfilling of the existing basin and for the future apartment complex project is beyond the scope of this report.</p>
Stormwater Retention	Open basin with bottom depth approximately 9' from the future adjacent finish grade. An optional terminal storage (underground chambers) may be placed under the proposed basin.
Estimated Start of Construction	Unknown

GEOTECHNICAL CHARACTERIZATION

The subsurface soils encountered at the site consist of loose silty sand, and stiff to very stiff silt to the maximum depths drilled. Fill/sediment was encountered in the borings to depth of approximately 1-foot bgs.

Percolation Test Report

Proposed Expanded Housing Area ■ Fontana, California

July 22, 2020 ■ Terracon Project No. CB205095



Conditions encountered at each boring location are indicated on the individual boring logs shown in the **Exploration Results** section and are attached to this report. Stratification boundaries on the boring logs represent the approximate location of changes in native soil types; in situ, the transition between materials may be gradual.

Groundwater Conditions

The boreholes were observed while drilling and after completion for the presence and level of groundwater. Groundwater was not observed in the borings while drilling or for the short duration the borings could remain open.

Based on our experience within the vicinity, the historical high groundwater depth is deeper than 50 feet.

STORM WATER MANAGEMENT

Percolation tests were performed generally following the test method described Appendix D, of the San Bernardino County, "Technical Guidance Document for Water Quality Management Plans" (2013). The soil at the percolation test locations was classified in the field using a visual/manual procedure and verified by laboratory tests. The infiltration velocity is presented as the infiltration rate and is summarized in the following table. The infiltration rates provided do not include safety factors.

Test	Test Depth (feet) ¹	Soil Type	Infiltration Rate ² (in./hr.)	Initial Water Head
P-1	5	SM	6.2	3'8"
P-2	5	SM	1.8	4'8"
P-3	10	SM	6.9	4'4"
P-4	10	ML	2.4	4'6"

1. Below existing ground surface

2. The correlated infiltration rates were calculated using the Porchet method.

The above infiltration rates determined by the shallow percolation test method are based on field test results utilizing clear water. Infiltration rates can be affected by silt buildup, debris, degree of soil saturation, site variability and other factors. With time, the bottoms of infiltration systems tend to plug with organics, sediments, and other debris. Long term maintenance will likely be required to remove these deleterious materials to help reduce decreases in actual percolation rates. The rate obtained at a specific location and depth is representative of the location and depth tested and may not be representative of the entire site.

Percolation Test Report

Proposed Expanded Housing Area ■ Fontana, California

July 22, 2020 ■ Terracon Project No. CB205095



The soil profile consisted of silty sand soils over less permeable silt soils. The silt layer may act as a barrier and cause perched water conditions. Therefore, we recommend the designer utilize the lowest infiltration rate in the above table with appropriate safety factors. Application of an appropriate safety factor is prudent to account for subsoil inconsistencies, possible compaction related to site grading, and potential silting of the percolating soils, depending on the application. A minimum safety factor of 2.0 may be used if the water will be treated prior to infiltration.

The percolation tests were performed with clear water, whereas the storm water will likely not be clear, but may contain organics, fines, and grease/oil. The presence of these deleterious materials will tend to decrease the rate that water percolates from the infiltration systems. Design of the stormwater infiltration systems should account for the presence of these materials and should incorporate structures/devices to remove these deleterious materials. A safety factor should be applied to these measured rates.

The design engineer should also check with the local agency for the limitation of the infiltration rate allowed in the design. If the maximum allowable design infiltration rate is lower than the above recommended rate, the maximum allowable design infiltration rate should be used. The designer of the basins should also consider other possible site variability in the design.

Infiltration testing should be performed after construction of the infiltration system to verify the design infiltration rates. Upon completion of excavation, care should be taken to avoid compacting the bottom of the proposed infiltration system. Construction traffic over the bottom of the excavation should be avoided. Otherwise, bottom of infiltration systems should be scarified to enhance infiltration capacity of the soils.

GENERAL COMMENTS

Our analysis and opinions are based upon our understanding of the project, the geotechnical conditions in the area, and the data obtained from our site exploration. Natural variations will occur between exploration point locations or due to the modifying effects of construction or weather. The nature and extent of such variations may not become evident until during or after construction. Terracon should be retained as the Geotechnical Engineer, where noted in this report, to provide observation and testing services during pertinent construction phases. If variations appear, we can provide further evaluation and supplemental recommendations. If variations are noted in the absence of our observation and testing services on-site, we should be immediately notified so that we can provide evaluation and supplemental recommendations.

Our Scope of Services does not include either specifically or by implication any environmental or biological (e.g., mold, fungi, bacteria) assessment of the site or identification or prevention of

Percolation Test Report

Proposed Expanded Housing Area ■ Fontana, California

July 22, 2020 ■ Terracon Project No. CB205095



pollutants, hazardous materials or conditions. If the owner is concerned about the potential for such contamination or pollution, other studies should be undertaken.

Our services and any correspondence or collaboration through this system are intended for the sole benefit and exclusive use of our client for specific application to the project discussed and are accomplished in accordance with generally accepted geotechnical engineering practices with no third-party beneficiaries intended. Any third-party access to services or correspondence is solely for information purposes to support the services provided by Terracon to our client. Reliance upon the services and any work product is limited to our client and is not intended for third parties. Any use or reliance of the provided information by third parties is done solely at their own risk. No warranties, either express or implied, are intended or made.

Site characteristics as provided are for design purposes and not to estimate excavation cost. Any use of our report in that regard is done at the sole risk of the excavating cost estimator as there may be variations on the site that are not apparent in the data that could significantly impact excavation cost. Any parties charged with estimating excavation costs should seek their own site characterization for specific purposes to obtain the specific level of detail necessary for costing. Site safety and cost estimating, including excavation support and dewatering requirements/design, are the responsibility of others. If changes in the nature, design, or location of the project are planned, our conclusions and recommendations shall not be considered valid unless we review the changes and either verify or modify our conclusions in writing.

ATTACHMENTS

Percolation Test Report

Proposed Expanded Housing Area ■ Fontana, California

July 22, 2020 ■ Terracon Project No. CB205095



EXPLORATION AND TESTING PROCEDURES

Field Exploration

The field exploration program consists of the following:

Number of Borings	Boring Depth (feet) ¹	Location
1	21-1/2	See Exploration Plan .
2	5	See Exploration Plan .
2	10	See Exploration Plan .

1. Below ground surface.

Boring Layout and Elevations: Unless otherwise noted, Terracon personnel provided the boring layout. Coordinates were obtained with a handheld GPS unit (estimated horizontal accuracy of about ±10 feet) and approximate elevations were obtained by interpolation from Google Earth. If elevations and a more precise boring layout are desired, we recommend borings be surveyed following completion of fieldwork.

Subsurface Exploration Procedures: We advanced the soil profile boring with truck-mounted drill rig using hollow stem augers. Both a standard penetration test (SPT) sampler (2-inch outer diameter and 1-3/8-inch inner diameter) was utilized in our investigation. The penetration resistance was recorded on the boring logs as the number of hammer blows used to advance the sampler in 6-inch increments (or less if noted). The samplers were driven with an automatic hammer that drops a 140-pound weight 30 inches for each blow. After the required seating, samplers were advanced up to 18 inches, providing up to three sets of blowcounts at each sampling interval.

The sampling depths, penetration distances, and other sampling information are recorded on the field boring logs. The recorded blows are raw numbers without any corrections for hammer type (automatic vs. manual cathead). The samples were placed in appropriate containers and taken to our soil laboratory for testing and classification by a Geotechnical Engineer. Our exploration team prepared field boring logs as part of the drilling operations. These field logs included visual classifications of the materials encountered during drilling and our interpretation of the subsurface conditions between samples. Final boring logs were prepared from the field logs. The final boring logs represent the Geotechnical Engineer's interpretation of the field logs and include modifications based on observations and tests of the samples in our laboratory.

We observed and recorded groundwater levels during drilling and sampling. For safety purposes, all borings were backfilled with auger cuttings after their completion.

Percolation Test Report

Proposed Expanded Housing Area ■ Fontana, California

July 22, 2020 ■ Terracon Project No. CB205095



Laboratory Testing

The project engineer reviewed the field data and assigned laboratory tests to understand the engineering properties of the various soil strata, as necessary, for this project. Procedural standards noted below are for reference to methodology in general. In some cases, variations to methods were applied because of local practice or professional judgment. Standards noted below include reference to other, related standards. Such references are not necessarily applicable to describe the specific test performed.

- ASTM D1140 Standard Test Methods for Determining the Amount of Material Finer than 75- μ m (No. 200) Sieve in Soils by Washing

The laboratory testing program often included examination of soil samples by an engineer. Based on the material's texture and plasticity, we described and classified the soil samples in accordance with the Unified Soil Classification System.

Percolation Testing (Storm Water) San Bernardino County

Field Testing: Our percolation tests were performed generally following the test method described Appendix D, of the San Bernardino County, "Technical Guidance Document for Water Quality Management Plans" (2013).

Our field percolation test included drilling borings to a depth of 5 to 10 feet below the existing grade using a drill rig and obtaining bulk samples near the bottom of the test borings. The bottoms of the test holes were covered with 2 inches of gravel. In order to prevent caving of the test holes, a 3-inch perforated PVC pipe was placed inside the test hole, and 3/4-inch gravel was placed in the annular space between the PVC pipe and the sides of the hole. A 24-hour pre-soaking period was performed. Per the guideline, gravel packed holes must have four (4) consecutive readings where the water seeps faster than half the initial wetted depth in 30-minute intervals to compensate for the reduced water volume of each pre-soak.

Number of Test Borings	Test Depth (feet) ¹	Location
2 (P-1 & P-2)	5	See Exploration Plan
2 (P-3 & P-4)	10	See Exploration Plan

1. Below ground surface

Pre-soaking entailed filling the borehole with clear water to the surface. Testing commenced after all of the water had percolated through the test hole or after 15 hours had elapsed since initiating the pre-soak.

Percolation Test Report

Proposed Expanded Housing Area ■ Fontana, California

July 22, 2020 ■ Terracon Project No. CB205095



The material on site is considered sandy (where four consecutive measurements showed that at least half the distance of the hole seeped away in less than 30 minutes), so the tests were performed for an additional hour with measurements taken every 10 minutes. The drop-in water level that occurred within the final two 10 minutes is used to calculate the percolation rate.

Laboratory Testing: Bulk samples were obtained near the bottom of percolation test hole. Sieve analysis testing was performed on the bulk samples in our laboratory.

SITE LOCATION AND EXPLORATION PLANS

Contents:

Site Location Plan

Exploration Plan

Note: All attachments are one page unless noted above.

SITE LOCATION

Proposed Expanded Housing Area ■ Fontana, California
July 22, 2020 ■ Terracon Project No. CB205095



DIAGRAM IS FOR GENERAL LOCATION ONLY, AND IS NOT INTENDED FOR CONSTRUCTION PURPOSES

MAP PROVIDED BY MICROSOFT BING MAPS

EXPLORATION PLAN

Proposed Expanded Housing Area ■ Fontana, California

July 22, 2020 ■ Terracon Project No. CB205095

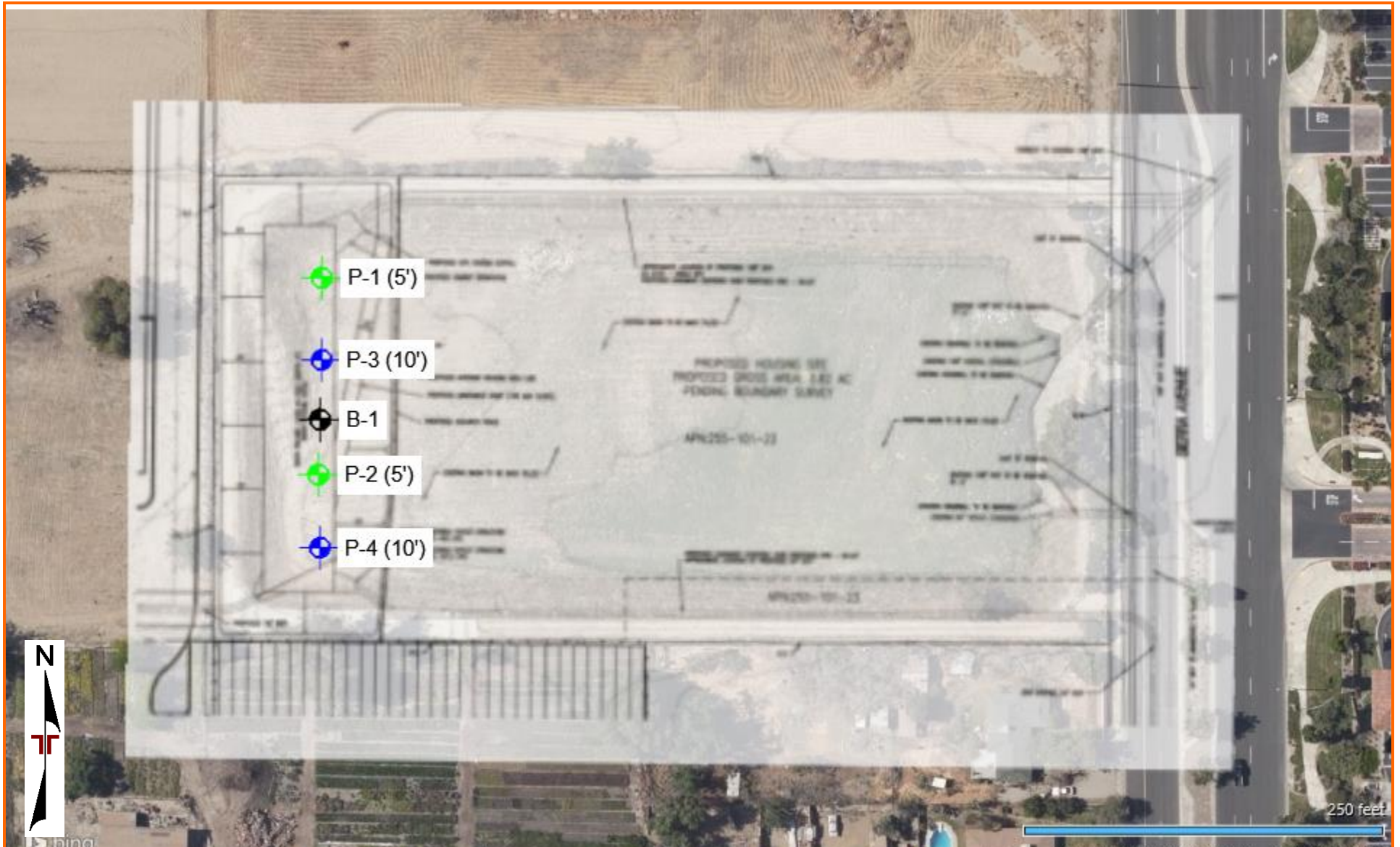

DIAGRAM IS FOR GENERAL LOCATION ONLY, AND IS NOT INTENDED FOR CONSTRUCTION PURPOSES

MAP PROVIDED BY MICROSOFT BING MAPS

EXPLORATION RESULTS

Contents:

Boring Logs (B-1)

Boring Logs (P-1 through P-4)

Percolation Test Data (P-1 through P-4)

Note: All attachments are one page unless noted above.

BORING LOG NO. B-1

PROJECT: Percolation Test Services

CLIENT: Related Companies of CA
Irvine, CA

SITE: 11180 Sierra Ave
Fontana, CA

THIS BORING LOG IS NOT VALID IF SEPARATED FROM ORIGINAL REPORT. GEO SMART LOG-NO WELL_CB205095 PERCOLATION TESTI.GPJ TERRACON.DATATEMPLATE.GDT 7/22/20

GRAPHIC LOG	LOCATION See Exploration Plan Latitude: 34.0508° Longitude: -117.4375°	DEPTH (Ft.)	WATER LEVEL OBSERVATIONS	SAMPLE TYPE	FIELD TEST RESULTS	PERCENT FINES
DEPTH						
1.0	FILL - SILTY SAND (SM) , fine grained, light brown, dry					
10.0	SILTY SAND (SM) , fine grained, light grayish brown, dry, loose to medium dense becomes moist	5	X		3-4-5 N=9	
12.0	POORLY GRADED SAND (SP) , grayish brown, moist, medium dense	10	X		2-4-5 N=9	
21.5	SILT (ML) , fine grained, grayish brown, moist, stiff	15	X		8-12-12 N=24	86
21.5	Boring Terminated at 21.5 Feet	20	X		4-4-8 N=12	
					5-7-9 N=16	

Stratification lines are approximate. In-situ, the transition may be gradual.

Hammer Type: Automatic

Advancement Method: 6" Hollow Stem Auger	See Exploration and Testing Procedures for a description of field and laboratory procedures used and additional data (if any). See Supporting Information for explanation of symbols and abbreviations.	Notes:
Abandonment Method: Boring backfilled with auger cuttings upon completion.		
WATER LEVEL OBSERVATIONS Groundwater not encountered	1355 E Cooley Dr, Ste C Colton, CA	Boring Started: 07-08-2020 Boring Completed: 07-08-2020 Drill Rig: Mobile LAR Driller: CalPac Drilling Project No.: CB205095

BORING LOG NO. P-1

PROJECT: Percolation Test Services

CLIENT: Related Companies of CA
Irvine, CA

SITE: 11180 Sierra Ave
Fontana, CA

GRAPHIC LOG	LOCATION See Exploration Plan Latitude: 34.051° Longitude: -117.4375°	DEPTH (Ft)	WATER LEVEL OBSERVATIONS	SAMPLE TYPE	FIELD TEST RESULTS	PERCENT FINES
DEPTH						
1.0	FILL - SILTY SAND (SM) , fine grained, light brown, dry					
5.0	SILTY SAND (SM) , fine grained, light grayish brown, dry becomes moist	5				45
Boring Terminated at 5 Feet						

Stratification lines are approximate. In-situ, the transition may be gradual.

Advancement Method: 8" Hollow Stem Auger	See Exploration and Testing Procedures for a description of field and laboratory procedures used and additional data (if any). See Supporting Information for explanation of symbols and abbreviations.	Notes:
Abandonment Method: Boring backfilled with auger cuttings and gravel upon completion.		
WATER LEVEL OBSERVATIONS <i>Groundwater not encountered</i>	 1355 E Cooley Dr, Ste C Colton, CA	Boring Started: 07-08-2020 Drill Rig: Mobile LAR Project No.: CB205095
		Boring Completed: 07-08-2020 Driller: CalPac Drilling

THIS BORING LOG IS NOT VALID IF SEPARATED FROM ORIGINAL REPORT. GEO SMART LOG-NO WELL_CB205095 PERCOLATION TESTI.GPJ TERRACON_DATATEMPLATE.GDT 7/22/20

BORING LOG NO. P-2

PROJECT: Percolation Test Services

CLIENT: Related Companies of CA
Irvine, CA

SITE: 11180 Sierra Ave
Fontana, CA

GRAPHIC LOG	LOCATION See Exploration Plan Latitude: 34.0506° Longitude: -117.4375°	DEPTH (Ft)	WATER LEVEL OBSERVATIONS	SAMPLE TYPE	FIELD TEST RESULTS	PERCENT FINES
DEPTH						
1.0	FILL - SILTY SAND (SM) , fine grained, light brown, dry					
5.0	SILTY SAND (SM) , fine grained, light grayish brown, dry becomes moist					47
	Boring Terminated at 5 Feet	5				

Stratification lines are approximate. In-situ, the transition may be gradual.

Advancement Method: 8" Hollow Stem Auger	See Exploration and Testing Procedures for a description of field and laboratory procedures used and additional data (if any). See Supporting Information for explanation of symbols and abbreviations.	Notes:
Abandonment Method: Boring backfilled with auger cuttings and gravel upon completion.		
WATER LEVEL OBSERVATIONS <i>Groundwater not encountered</i>	 1355 E Cooley Dr, Ste C Colton, CA	Boring Started: 07-08-2020 Drill Rig: Mobile LAR Project No.: CB205095
		Boring Completed: 07-08-2020 Driller: CalPac Drilling

THIS BORING LOG IS NOT VALID IF SEPARATED FROM ORIGINAL REPORT. GEO SMART LOG-NO WELL_CB205095 PERCOLATION TESTI.GPJ TERRACON_DATATEMPLATE.GDT 7/22/20

BORING LOG NO. P-3

PROJECT: Percolation Test Services

CLIENT: Related Companies of CA
Irvine, CA

SITE: 11180 Sierra Ave
Fontana, CA

GRAPHIC LOG	LOCATION See Exploration Plan Latitude: 34.0508° Longitude: -117.4375°	DEPTH (Ft)	WATER LEVEL OBSERVATIONS	SAMPLE TYPE	FIELD TEST RESULTS	PERCENT FINES
DEPTH						
1.0	FILL - SILTY SAND (SM) , fine grained, light brown, dry					
10.0	SILTY SAND (SM) , fine grained, light grayish brown, dry becomes moist	5		5		35
	Boring Terminated at 10 Feet	10				

Stratification lines are approximate. In-situ, the transition may be gradual.

Advancement Method: 8" Hollow Stem Auger	See Exploration and Testing Procedures for a description of field and laboratory procedures used and additional data (if any). See Supporting Information for explanation of symbols and abbreviations.	Notes:
Abandonment Method: Boring backfilled with auger cuttings and gravel upon completion.		
WATER LEVEL OBSERVATIONS <i>Groundwater not encountered</i>	 1355 E Cooley Dr, Ste C Colton, CA	Boring Started: 07-08-2020 Boring Completed: 07-08-2020 Drill Rig: Mobile LAR Driller: CalPac Drilling Project No.: CB205095

THIS BORING LOG IS NOT VALID IF SEPARATED FROM ORIGINAL REPORT. GEO SMART LOG-NO WELL_CB205095 PERCOLATION TESTI.GPJ TERRACON_DATATEMPLATE.GDT 7/22/20

BORING LOG NO. P-4

PROJECT: Percolation Test Services

CLIENT: Related Companies of CA
Irvine, CA

SITE: 11180 Sierra Ave
Fontana, CA

GRAPHIC LOG	LOCATION See Exploration Plan Latitude: 34.0506° Longitude: -117.4375°	DEPTH (Ft)	WATER LEVEL OBSERVATIONS	SAMPLE TYPE	FIELD TEST RESULTS	PERCENT FINES
DEPTH						
1.0	FILL - SILTY SAND (SM) , fine grained, light brown, dry					
5.0	SILTY SAND (SM) , fine grained, light grayish brown, dry becomes moist					
10.0	SILT (ML) , fine grained, light grayish brown					73
	Boring Terminated at 10 Feet					

Stratification lines are approximate. In-situ, the transition may be gradual.

Advancement Method: 8" Hollow Stem Auger	See Exploration and Testing Procedures for a description of field and laboratory procedures used and additional data (if any). See Supporting Information for explanation of symbols and abbreviations.	Notes:
Abandonment Method: Boring backfilled with auger cuttings and gravel upon completion.		
WATER LEVEL OBSERVATIONS <i>Groundwater not encountered</i>	 1355 E Cooley Dr, Ste C Colton, CA	Boring Started: 07-08-2020 Boring Completed: 07-08-2020 Drill Rig: Mobile LAR Driller: CalPac Drilling Project No.: CB205095

THIS BORING LOG IS NOT VALID IF SEPARATED FROM ORIGINAL REPORT. GEO SMART LOG-NO WELL_CB205095 PERCOLATION TESTI.GPJ TERRACON_DATATEMPLATE.GDT 7/22/20

PERCOLATION TEST DATA

BORING NUMBER: P-1
LOT No: N/A
TRACT No: N/A

CLIENT: Related Companies of CA
PROJECT: Percolation Test Services

DATE OF DRILLING:	July 8, 2020	DEPTH BEFORE (ft.):	4.5
DATE OF TESTING:	July 8, 2020	DEPTH AFTER (ft.):	4.2
DRILLED BY:	KBR	PVC PIPE DIA. (in.):	3.0
TESTED BY:	KBR	PERC HOLE DIA. (in.):	8.0
			0.50

Time Interval (min.)	Total Elapsed Time (min.)	Initial Water Level (ft.)	Initial Water Level (in)	Final Water Level (ft.)	Final Water Level (in)	Change in Water Level (ft.)	Initial Hole Depth (ft.)	Initial Hole Depth (in)	Final Hole Depth (ft.)	Final Hole Depth (in)	Percolation Rate (min./in.)	Infiltration rate (Porchet Method) (in/hr)
25	25	0	0	3	11	3.92	4.5		4.2		0.53	6.94
25	50	0	0	3	7	3.58	4.5		4.2		0.58	5.98
10	60	0	0	2	9	2.75	4.5		4.2		0.30	10.03
10	70	0	0	2	7	2.58	4.5		4.2		0.32	9.19
10	80	0	0	2	5	2.42	4.5		4.2		0.34	8.39
10	90	0	0	2	2	2.17	4.5		4.2		0.38	7.26
10	100	0	4	2	2	1.83	4.5		4.2		0.45	6.44
10	110	0	10	2	5	1.58	4.5		4.2		0.53	6.25

PERCOLATION TEST DATA

BORING NUMBER: P-2
LOT No: N/A
TRACT No: N/A

CLIENT: Related Companies of CA
PROJECT: Percolation Test Services

DATE OF DRILLING: July 8, 2020	DEPTH BEFORE (ft.): 4.7
DATE OF TESTING: July 8, 2020	DEPTH AFTER (ft.): 4.6
DRILLED BY: KBR	PVC PIPE DIA. (in.): 3.0
TESTED BY: KBR	PERC HOLE DIA. (in.): 8.0
	0.50

Time Interval (min.)	Total Elapsed Time (min.)	Initial Water Level (ft.) (in)	Final Water Level (ft.) (in)	Change in Water Level (ft.)	Initial Hole Depth (ft.) (in)	Final Hole Depth (ft.) (in)	Percolation Rate (min./in.)	Infiltration rate (Porchet Method) (in/hr)
42	42	0 0	5 0	5.00	4.7	4.6	0.70	6.14
25	67	0 0	3 4	3.33	4.7	4.6	0.63	5.06
10	77	0 0	0 11	0.92	4.7	4.6	0.91	2.52
10	87	0 0	0 10	0.83	4.7	4.6	1.00	2.27
10	97	0 0	0 10	0.83	4.7	4.6	1.00	2.27
10	107	0 0	0 9	0.75	4.7	4.6	1.11	2.02
10	117	0 0	0 9	0.75	4.7	4.6	1.11	2.02
10	127	0 0	0 8	0.67	4.7	4.6	1.25	1.78

PERCOLATION TEST DATA

BORING NUMBER: P-3
LOT No: N/A
TRACT No: N/A

CLIENT: Related Companies of CA
PROJECT: Percolation Test Services

DATE OF DRILLING: July 8, 2020	DEPTH BEFORE (ft.): 9.3
DATE OF TESTING: July 8, 2020	DEPTH AFTER (ft.): 9.0
DRILLED BY: KBR	PVC PIPE DIA. (in.): 3.0
TESTED BY: KBR	PERC HOLE DIA. (in.): 8.0
	0.50

Time Interval (min.)	Total Elapsed Time (min.)	Initial Water Level (ft.) (in)	Final Water Level (ft.) (in)	Change in Water Level (ft.)	Initial Hole Depth (ft.) (in)	Final Hole Depth (ft.) (in)	Percolation Rate (min./in.)	Infiltration rate (Porchet Method) (in/hr)
25	25	4 7	9 2	4.58	9.3	9.0	0.45	8.39
25	50	4 3	8 10	4.58	9.3	9.0	0.45	7.45
10	60	4 7	7 10	3.25	9.3	9.0	0.26	11.86
10	70	4 11	7 6	2.58	9.3	9.0	0.32	9.43
10	80	4 7	7 5	2.83	9.3	9.0	0.29	9.72
10	90	4 5	7 3	2.83	9.3	9.0	0.29	9.28
10	100	5 2	7 2	2.00	9.3	9.0	0.42	7.21
10	110	5 0	7 0	2.00	9.3	9.0	0.42	6.86

PERCOLATION TEST DATA

BORING NUMBER: P-4
LOT No: N/A
TRACT No: N/A

CLIENT: Related Companies of CA
PROJECT: Percolation Test Services

DATE OF DRILLING: July 8, 2020	DEPTH BEFORE (ft.): 9.8
DATE OF TESTING: July 8, 2020	DEPTH AFTER (ft.): 9.6
DRILLED BY: KBR	PVC PIPE DIA. (in.): 3.0
TESTED BY: KBR	PERC HOLE DIA. (in.): 8.0
	0.50

Time Interval (min.)	Total Elapsed Time (min.)	Initial Water Level (ft.) (in)		Final Water Level (ft.) (in)		Change in Water Level (ft.)	Initial Hole Depth (ft.) (in)		Final Hole Depth (ft.) (in)		Percolation Rate (min./in.)	Infiltration rate (Porchet Method) (in/hr)
25	25	3	0	6	8	3.67	9.8		9.6		0.57	3.46
25	50	3	6	6	6	3.00	9.8		9.6		0.69	2.93
10	60	3	6	4	11	1.42	9.8		9.6		0.59	2.98
10	70	4	11	6	1	1.17	9.8		9.6		0.71	3.17
10	80	4	2	5	7	1.42	9.8		9.6		0.59	3.37
10	90	4	4	5	6	1.17	9.8		9.6		0.71	2.80
10	100	4	2	5	4	1.17	9.8		9.6		0.71	2.71
10	110	5	4	6	2	0.83	9.8		9.6		1.00	2.40

SUPPORTING INFORMATION

Contents:

General Notes

Unified Soil Classification System







Note: All attachments are one page unless noted above.

GENERAL NOTES

DESCRIPTION OF SYMBOLS AND ABBREVIATIONS

Percolation Test Services ■ Fontana, CA

Terracon Project No. CB205095

SAMPLING	WATER LEVEL	FIELD TESTS
 Auger Cuttings  Standard Penetration Test	 Water Initially Encountered  Water Level After a Specified Period of Time  Water Level After a Specified Period of Time  Cave In Encountered Water levels indicated on the soil boring logs are the levels measured in the borehole at the times indicated. Groundwater level variations will occur over time. In low permeability soils, accurate determination of groundwater levels is not possible with short term water level observations.	N Standard Penetration Test Resistance (Blows/Ft.) (HP) Hand Penetrometer (T) Torvane (DCP) Dynamic Cone Penetrometer UC Unconfined Compressive Strength (PID) Photo-Ionization Detector (OVA) Organic Vapor Analyzer

DESCRIPTIVE SOIL CLASSIFICATION
<p>Soil classification as noted on the soil boring logs is based Unified Soil Classification System. Where sufficient laboratory data exist to classify the soils consistent with ASTM D2487 "Classification of Soils for Engineering Purposes" this procedure is used. ASTM D2488 "Description and Identification of Soils (Visual-Manual Procedure)" is also used to classify the soils, particularly where insufficient laboratory data exist to classify the soils in accordance with ASTM D2487. In addition to USCS classification, coarse grained soils are classified on the basis of their in-place relative density, and fine-grained soils are classified on the basis of their consistency. See "Strength Terms" table below for details. The ASTM standards noted above are for reference to methodology in general. In some cases, variations to methods are applied as a result of local practice or professional judgment.</p>

LOCATION AND ELEVATION NOTES
<p>Exploration point locations as shown on the Exploration Plan and as noted on the soil boring logs in the form of Latitude and Longitude are approximate. See Exploration and Testing Procedures in the report for the methods used to locate the exploration points for this project. Surface elevation data annotated with +/- indicates that no actual topographical survey was conducted to confirm the surface elevation. Instead, the surface elevation was approximately determined from topographic maps of the area.</p>

STRENGTH TERMS				
RELATIVE DENSITY OF COARSE-GRAINED SOILS		CONSISTENCY OF FINE-GRAINED SOILS		
(More than 50% retained on No. 200 sieve.) Density determined by Standard Penetration Resistance		(50% or more passing the No. 200 sieve.) Consistency determined by laboratory shear strength testing, field visual-manual procedures or standard penetration resistance		
Descriptive Term (Density)	Standard Penetration or N-Value Blows/Ft.	Descriptive Term (Consistency)	Unconfined Compressive Strength Qu, (tsf)	Standard Penetration or N-Value Blows/Ft.
Very Loose	0 - 3	Very Soft	less than 0.25	0 - 1
Loose	4 - 9	Soft	0.25 to 0.50	2 - 4
Medium Dense	10 - 29	Medium Stiff	0.50 to 1.00	4 - 8
Dense	30 - 50	Stiff	1.00 to 2.00	8 - 15
Very Dense	> 50	Very Stiff	2.00 to 4.00	15 - 30
		Hard	> 4.00	> 30

RELEVANCE OF SOIL BORING LOG
<p>The soil boring logs contained within this document are intended for application to the project as described in this document. Use of these soil boring logs for any other purpose may not be appropriate.</p>

Criteria for Assigning Group Symbols and Group Names Using Laboratory Tests ^A				Soil Classification	
				Group Symbol	Group Name ^B
Coarse-Grained Soils: More than 50% retained on No. 200 sieve	Gravels: More than 50% of coarse fraction retained on No. 4 sieve	Clean Gravels: Less than 5% fines ^C	$Cu \geq 4$ and $1 \leq Cc \leq 3$ ^E	GW	Well-graded gravel ^F
			$Cu < 4$ and/or [$Cc < 1$ or $Cc > 3.0$] ^E	GP	Poorly graded gravel ^F
		Gravels with Fines: More than 12% fines ^C	Fines classify as ML or MH	GM	Silty gravel ^{F, G, H}
			Fines classify as CL or CH	GC	Clayey gravel ^{F, G, H}
	Sands: 50% or more of coarse fraction passes No. 4 sieve	Clean Sands: Less than 5% fines ^D	$Cu \geq 6$ and $1 \leq Cc \leq 3$ ^E	SW	Well-graded sand ^I
			$Cu < 6$ and/or [$Cc < 1$ or $Cc > 3.0$] ^E	SP	Poorly graded sand ^I
		Sands with Fines: More than 12% fines ^D	Fines classify as ML or MH	SM	Silty sand ^{G, H, I}
			Fines classify as CL or CH	SC	Clayey sand ^{G, H, I}
Fine-Grained Soils: 50% or more passes the No. 200 sieve	Silts and Clays: Liquid limit less than 50	Inorganic:	$PI > 7$ and plots on or above "A" line	CL	Lean clay ^{K, L, M}
			$PI < 4$ or plots below "A" line ^J	ML	Silt ^{K, L, M}
		Organic:	Liquid limit - oven dried < 0.75	OL	Organic clay ^{K, L, M, N}
			Liquid limit - not dried < 0.75		Organic silt ^{K, L, M, O}
	Silts and Clays: Liquid limit 50 or more	Inorganic:	PI plots on or above "A" line	CH	Fat clay ^{K, L, M}
			PI plots below "A" line	MH	Elastic Silt ^{K, L, M}
		Organic:	Liquid limit - oven dried < 0.75	OH	Organic clay ^{K, L, M, P}
			Liquid limit - not dried < 0.75		Organic silt ^{K, L, M, Q}
Highly organic soils:	Primarily organic matter, dark in color, and organic odor			PT	Peat

^A Based on the material passing the 3-inch (75-mm) sieve.

^B If field sample contained cobbles or boulders, or both, add "with cobbles or boulders, or both" to group name.

^C Gravels with 5 to 12% fines require dual symbols: GW-GM well-graded gravel with silt, GW-GC well-graded gravel with clay, GP-GM poorly graded gravel with silt, GP-GC poorly graded gravel with clay.

^D Sands with 5 to 12% fines require dual symbols: SW-SM well-graded sand with silt, SW-SC well-graded sand with clay, SP-SM poorly graded sand with silt, SP-SC poorly graded sand with clay.

^E $Cu = D_{60}/D_{10}$ $Cc = \frac{(D_{30})^2}{D_{10} \times D_{60}}$

^F If soil contains $\geq 15\%$ sand, add "with sand" to group name.

^G If fines classify as CL-ML, use dual symbol GC-GM, or SC-SM.

^H If fines are organic, add "with organic fines" to group name.

^I If soil contains $\geq 15\%$ gravel, add "with gravel" to group name.

^J If Atterberg limits plot in shaded area, soil is a CL-ML, silty clay.

^K If soil contains 15 to 29% plus No. 200, add "with sand" or "with gravel," whichever is predominant.

^L If soil contains $\geq 30\%$ plus No. 200 predominantly sand, add "sandy" to group name.

^M If soil contains $\geq 30\%$ plus No. 200, predominantly gravel, add "gravelly" to group name.

^N $PI \geq 4$ and plots on or above "A" line.

^O $PI < 4$ or plots below "A" line.

^P PI plots on or above "A" line.

^Q PI plots below "A" line.

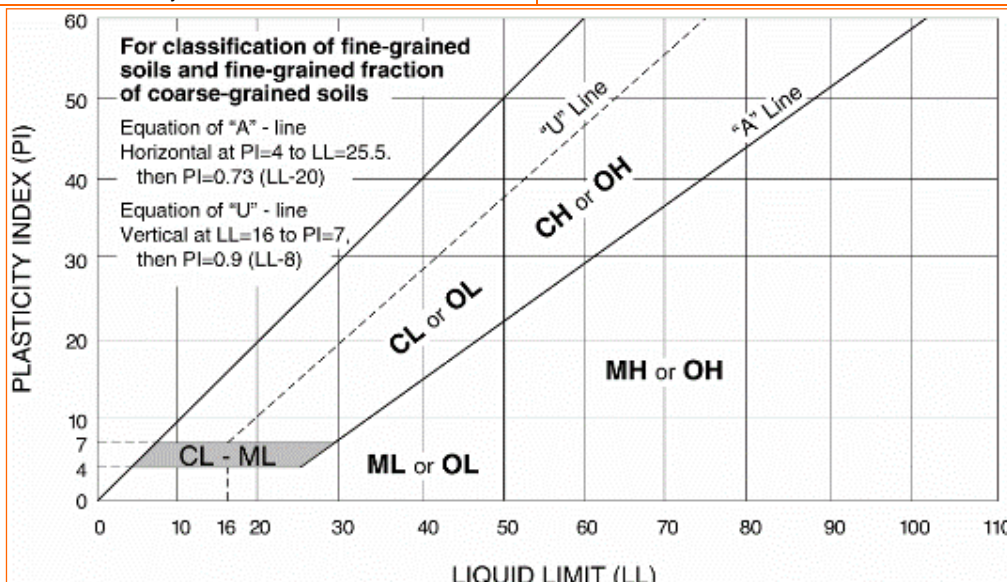

Section 6.1.5

BMP Details

Description

Drain inserts are manufactured filters or fabric placed in a drop inlet to remove sediment and debris. There are a multitude of inserts of various shapes and configurations, typically falling into one of three different groups: socks, boxes, and trays. The sock consists of a fabric, usually constructed of polypropylene. The fabric may be attached to a frame or the grate of the inlet holds the sock. Socks are meant for vertical (drop) inlets. Boxes are constructed of plastic or wire mesh. Typically a polypropylene "bag" is placed in the wire mesh box. The bag takes the form of the box. Most box products are one box; that is, the setting area and filtration through media occur in the same box. Some products consist of one or more trays or mesh grates. The trays may hold different types of media. Filtration media vary by manufacturer. Types include polypropylene, porous polymer, treated cellulose, and activated carbon.

California Experience

The number of installations is unknown but likely exceeds a thousand. Some users have reported that these systems require considerable maintenance to prevent plugging and bypass.

Advantages

- Does not require additional space as inserts as the drain inlets are already a component of the standard drainage systems.
- Easy access for inspection and maintenance.
- As there is no standing water, there is little concern for mosquito breeding.
- A relatively inexpensive retrofit option.

Limitations

Performance is likely significantly less than treatment systems that are located at the end of the drainage system such as ponds and vaults. Usually not suitable for large areas or areas with trash or leaves than can plug the insert.

Design and Sizing Guidelines

Refer to manufacturer's guidelines. Drain inserts come any many configurations but can be placed into three general groups: socks, boxes, and trays. The sock consists of a fabric, usually constructed of polypropylene. The fabric may be attached to a frame or the grate of the inlet holds the sock. Socks are meant for vertical (drop) inlets. Boxes are constructed of plastic or wire mesh. Typically a polypropylene "bag" is placed in the wire mesh box. The bag takes the form of the box. Most box products are

Design Considerations

- Use with other BMPs
- Fit and Seal Capacity within Inlet

Targeted Constituents

- Sediment
- Nutrients
- Trash
- Metals
- Bacteria
- Oil and Grease
- Organics

Removal Effectiveness

See New Development and Redevelopment Handbook-Section 5.



one box; that is, the setting area and filtration through media occurs in the same box. One manufacturer has a double-box. Stormwater enters the first box where setting occurs. The stormwater flows into the second box where the filter media is located. Some products consist of one or more trays or mesh grates. The trays can hold different types of media. Filtration media vary with the manufacturer: types include polypropylene, porous polymer, treated cellulose, and activated carbon.

Construction/Inspection Considerations

Be certain that installation is done in a manner that makes certain that the stormwater enters the unit and does not leak around the perimeter. Leakage between the frame of the insert and the frame of the drain inlet can easily occur with vertical (drop) inlets.

Performance

Few products have performance data collected under field conditions.

Siting Criteria

It is recommended that inserts be used only for retrofit situations or as pretreatment where other treatment BMPs presented in this section area used.

Additional Design Guidelines

Follow guidelines provided by individual manufacturers.

Maintenance

Likely require frequent maintenance, on the order of several times per year.

Cost

- The initial cost of individual inserts ranges from less than \$100 to about \$2,000. The cost of using multiple units in curb inlet drains varies with the size of the inlet.
- The low cost of inserts may tend to favor the use of these systems over other, more effective treatment BMPs. However, the low cost of each unit may be offset by the number of units that are required, more frequent maintenance, and the shorter structural life (and therefore replacement).

References and Sources of Additional Information

Hrachovec, R., and G. Minton, 2001, Field testing of a sock-type catch basin insert, Planet CPR, Seattle, Washington

Interagency Catch Basin Insert Committee, Evaluation of Commercially-Available Catch Basin Inserts for the Treatment of Stormwater Runoff from Developed Sites, 1995

Larry Walker Associates, June 1998, NDMP Inlet/In-Line Control Measure Study Report

Manufacturers literature

Santa Monica (City), Santa Monica Bay Municipal Stormwater/Urban Runoff Project - Evaluation of Potential Catch basin Retrofits, Woodward Clyde, September 24, 1998

Woodward Clyde, June 11, 1996, Parking Lot Monitoring Report, Santa Clara Valley Nonpoint Source Pollution Control Program.

Site Design & Landscape Planning SD-10



Design Objectives

- Maximize Infiltration
- Provide Retention
- Slow Runoff
- Minimize Impervious Land Coverage
- Prohibit Dumping of Improper Materials
- Contain Pollutants
- Collect and Convey

Description

Each project site possesses unique topographic, hydrologic, and vegetative features, some of which are more suitable for development than others. Integrating and incorporating appropriate landscape planning methodologies into the project design is the most effective action that can be done to minimize surface and groundwater contamination from stormwater.

Approach

Landscape planning should couple consideration of land suitability for urban uses with consideration of community goals and projected growth. Project plan designs should conserve natural areas to the extent possible, maximize natural water storage and infiltration opportunities, and protect slopes and channels.

Suitable Applications

Appropriate applications include residential, commercial and industrial areas planned for development or redevelopment.

Design Considerations

Design requirements for site design and landscapes planning should conform to applicable standards and specifications of agencies with jurisdiction and be consistent with applicable General Plan and Local Area Plan policies.



SD-10 Site Design & Landscape Planning

Designing New Installations

Begin the development of a plan for the landscape unit with attention to the following general principles:

- Formulate the plan on the basis of clearly articulated community goals. Carefully identify conflicts and choices between retaining and protecting desired resources and community growth.
- Map and assess land suitability for urban uses. Include the following landscape features in the assessment: wooded land, open unwooded land, steep slopes, erosion-prone soils, foundation suitability, soil suitability for waste disposal, aquifers, aquifer recharge areas, wetlands, floodplains, surface waters, agricultural lands, and various categories of urban land use. When appropriate, the assessment can highlight outstanding local or regional resources that the community determines should be protected (e.g., a scenic area, recreational area, threatened species habitat, farmland, fish run). Mapping and assessment should recognize not only these resources but also additional areas needed for their sustenance.

Project plan designs should conserve natural areas to the extent possible, maximize natural water storage and infiltration opportunities, and protect slopes and channels.

Conserve Natural Areas during Landscape Planning

If applicable, the following items are required and must be implemented in the site layout during the subdivision design and approval process, consistent with applicable General Plan and Local Area Plan policies:

- Cluster development on least-sensitive portions of a site while leaving the remaining land in a natural undisturbed condition.
- Limit clearing and grading of native vegetation at a site to the minimum amount needed to build lots, allow access, and provide fire protection.
- Maximize trees and other vegetation at each site by planting additional vegetation, clustering tree areas, and promoting the use of native and/or drought tolerant plants.
- Promote natural vegetation by using parking lot islands and other landscaped areas.
- Preserve riparian areas and wetlands.

Maximize Natural Water Storage and Infiltration Opportunities Within the Landscape Unit

- Promote the conservation of forest cover. Building on land that is already deforested affects basin hydrology to a lesser extent than converting forested land. Loss of forest cover reduces interception storage, detention in the organic forest floor layer, and water losses by evapotranspiration, resulting in large peak runoff increases and either their negative effects or the expense of countering them with structural solutions.
- Maintain natural storage reservoirs and drainage corridors, including depressions, areas of permeable soils, swales, and intermittent streams. Develop and implement policies and

Site Design & Landscape Planning SD-10

regulations to discourage the clearing, filling, and channelization of these features. Utilize them in drainage networks in preference to pipes, culverts, and engineered ditches.

- Evaluating infiltration opportunities by referring to the stormwater management manual for the jurisdiction and pay particular attention to the selection criteria for avoiding groundwater contamination, poor soils, and hydrogeological conditions that cause these facilities to fail. If necessary, locate developments with large amounts of impervious surfaces or a potential to produce relatively contaminated runoff away from groundwater recharge areas.

Protection of Slopes and Channels during Landscape Design

- Convey runoff safely from the tops of slopes.
- Avoid disturbing steep or unstable slopes.
- Avoid disturbing natural channels.
- Stabilize disturbed slopes as quickly as possible.
- Vegetate slopes with native or drought tolerant vegetation.
- Control and treat flows in landscaping and/or other controls prior to reaching existing natural drainage systems.
- Stabilize temporary and permanent channel crossings as quickly as possible, and ensure that increases in run-off velocity and frequency caused by the project do not erode the channel.
- Install energy dissipaters, such as riprap, at the outlets of new storm drains, culverts, conduits, or channels that enter unlined channels in accordance with applicable specifications to minimize erosion. Energy dissipaters shall be installed in such a way as to minimize impacts to receiving waters.
- Line on-site conveyance channels where appropriate, to reduce erosion caused by increased flow velocity due to increases in tributary impervious area. The first choice for linings should be grass or some other vegetative surface, since these materials not only reduce runoff velocities, but also provide water quality benefits from filtration and infiltration. If velocities in the channel are high enough to erode grass or other vegetative linings, riprap, concrete, soil cement, or geo-grid stabilization are other alternatives.
- Consider other design principles that are comparable and equally effective.

Redeveloping Existing Installations

Various jurisdictional stormwater management and mitigation plans (SUSMP, WQMP, etc.) define “redevelopment” in terms of amounts of additional impervious area, increases in gross floor area and/or exterior construction, and land disturbing activities with structural or impervious surfaces. The definition of “redevelopment” must be consulted to determine whether or not the requirements for new development apply to areas intended for redevelopment. If the definition applies, the steps outlined under “designing new installations” above should be followed.

SD-10 Site Design & Landscape Planning

Redevelopment may present significant opportunity to add features which had not previously been implemented. Examples include incorporation of depressions, areas of permeable soils, and swales in newly redeveloped areas. While some site constraints may exist due to the status of already existing infrastructure, opportunities should not be missed to maximize infiltration, slow runoff, reduce impervious areas, disconnect directly connected impervious areas.

Other Resources

A Manual for the Standard Urban Stormwater Mitigation Plan (SUSMP), Los Angeles County Department of Public Works, May 2002.

Stormwater Management Manual for Western Washington, Washington State Department of Ecology, August 2001.

Model Standard Urban Storm Water Mitigation Plan (SUSMP) for San Diego County, Port of San Diego, and Cities in San Diego County, February 14, 2002.

Model Water Quality Management Plan (WQMP) for County of Orange, Orange County Flood Control District, and the Incorporated Cities of Orange County, Draft February 2003.

Ventura Countywide Technical Guidance Manual for Stormwater Quality Control Measures, July 2002.



Rain Garden

Design Objectives

- Maximize Infiltration
- Provide Retention
- Slow Runoff
- Minimize Impervious Land Coverage
- Prohibit Dumping of Improper Materials
- Contain Pollutants
- Collect and Convey

Description

Various roof runoff controls are available to address stormwater that drains off rooftops. The objective is to reduce the total volume and rate of runoff from individual lots, and retain the pollutants on site that may be picked up from roofing materials and atmospheric deposition. Roof runoff controls consist of directing the roof runoff away from paved areas and mitigating flow to the storm drain system through one of several general approaches: cisterns or rain barrels; dry wells or infiltration trenches; pop-up emitters, and foundation planting. The first three approaches require the roof runoff to be contained in a gutter and downspout system. Foundation planting provides a vegetated strip under the drip line of the roof.

Approach

Design of individual lots for single-family homes as well as lots for higher density residential and commercial structures should consider site design provisions for containing and infiltrating roof runoff or directing roof runoff to vegetative swales or buffer areas. Retained water can be reused for watering gardens, lawns, and trees. Benefits to the environment include reduced demand for potable water used for irrigation, improved stormwater quality, increased groundwater recharge, decreased runoff volume and peak flows, and decreased flooding potential.

Suitable Applications

Appropriate applications include residential, commercial and industrial areas planned for development or redevelopment.

Design Considerations

Designing New Installations

Cisterns or Rain Barrels

One method of addressing roof runoff is to direct roof downspouts to cisterns or rain barrels. A cistern is an above ground storage vessel with either a manually operated valve or a permanently open outlet. Roof runoff is temporarily stored and then released for irrigation or infiltration between storms. The number of rain



barrels needed is a function of the rooftop area. Some low impact developers recommend that every house have at least 2 rain barrels, with a minimum storage capacity of 1000 liters. Roof barrels serve several purposes including mitigating the first flush from the roof which has a high volume, amount of contaminants, and thermal load. Several types of rain barrels are commercially available. Consideration must be given to selecting rain barrels that are vector proof and childproof. In addition, some barrels are designed with a bypass valve that filters out grit and other contaminants and routes overflow to a soak-away pit or rain garden.

If the cistern has an operable valve, the valve can be closed to store stormwater for irrigation or infiltration between storms. This system requires continual monitoring by the resident or grounds crews, but provides greater flexibility in water storage and metering. If a cistern is provided with an operable valve and water is stored inside for long periods, the cistern must be covered to prevent mosquitoes from breeding.

A cistern system with a permanently open outlet can also provide for metering stormwater runoff. If the cistern outlet is significantly smaller than the size of the downspout inlet (say ¼ to ½ inch diameter), runoff will build up inside the cistern during storms, and will empty out slowly after peak intensities subside. This is a feasible way to mitigate the peak flow increases caused by rooftop impervious land coverage, especially for the frequent, small storms.

Dry wells and Infiltration Trenches

Roof downspouts can be directed to dry wells or infiltration trenches. A dry well is constructed by excavating a hole in the ground and filling it with an open graded aggregate, and allowing the water to fill the dry well and infiltrate after the storm event. An underground connection from the downspout conveys water into the dry well, allowing it to be stored in the voids. To minimize sedimentation from lateral soil movement, the sides and top of the stone storage matrix can be wrapped in a permeable filter fabric, though the bottom may remain open. A perforated observation pipe can be inserted vertically into the dry well to allow for inspection and maintenance.

In practice, dry wells receiving runoff from single roof downspouts have been successful over long periods because they contain very little sediment. They must be sized according to the amount of rooftop runoff received, but are typically 4 to 5 feet square, and 2 to 3 feet deep, with a minimum of 1-foot soil cover over the top (maximum depth of 10 feet).

To protect the foundation, dry wells must be set away from the building at least 10 feet. They must be installed in solids that accommodate infiltration. In poorly drained soils, dry wells have very limited feasibility.

Infiltration trenches function in a similar manner and would be particularly effective for larger roof areas. An infiltration trench is a long, narrow, rock-filled trench with no outlet that receives stormwater runoff. These are described under Treatment Controls.

Pop-up Drainage Emitter

Roof downspouts can be directed to an underground pipe that daylight some distance from the building foundation, releasing the roof runoff through a pop-up emitter. Similar to a pop-up irrigation head, the emitter only opens when there is flow from the roof. The emitter remains flush to the ground during dry periods, for ease of lawn or landscape maintenance.

Foundation Planting

Landscape planting can be provided around the base to allow increased opportunities for stormwater infiltration and protect the soil from erosion caused by concentrated sheet flow coming off the roof. Foundation plantings can reduce the physical impact of water on the soil and provide a subsurface matrix of roots that encourage infiltration. These plantings must be sturdy enough to tolerate the heavy runoff sheet flows, and periodic soil saturation.

Redeveloping Existing Installations

Various jurisdictional stormwater management and mitigation plans (SUSMP, WQMP, etc.) define “redevelopment” in terms of amounts of additional impervious area, increases in gross floor area and/or exterior construction, and land disturbing activities with structural or impervious surfaces. The definition of “redevelopment” must be consulted to determine whether or not the requirements for new development apply to areas intended for redevelopment. If the definition applies, the steps outlined under “designing new installations” above should be followed.

Supplemental Information

Examples

- City of Ottawa’s Water Links Surface –Water Quality Protection Program
- City of Toronto Downspout Disconnection Program
- City of Boston, MA, Rain Barrel Demonstration Program

Other Resources

Hager, Marty Catherine, Stormwater, “Low-Impact Development”, January/February 2003.
www.stormh2o.com

Low Impact Urban Design Tools, Low Impact Development Design Center, Beltsville, MD.
www.lid-stormwater.net

Start at the Source, Bay Area Stormwater Management Agencies Association, 1999 Edition

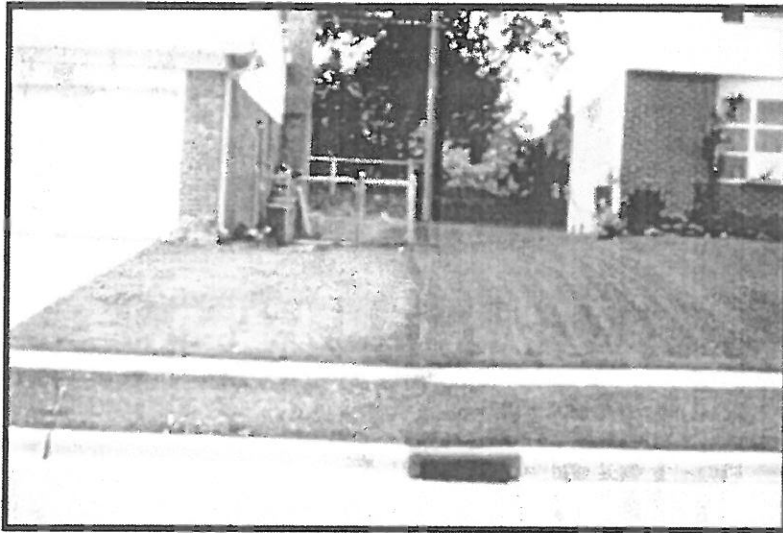

Design Objectives

- Maximize Infiltration
- Provide Retention
- Slow Runoff
- Minimize Impervious Land Coverage
- Prohibit Dumping of Improper Materials
- Contain Pollutants
- Collect and Convey

Description

Irrigation water provided to landscaped areas may result in excess irrigation water being conveyed into stormwater drainage systems.

Approach

Project plan designs for development and redevelopment should include application methods of irrigation water that minimize runoff of excess irrigation water into the stormwater conveyance system.

Suitable Applications

Appropriate applications include residential, commercial and industrial areas planned for development or redevelopment. (Detached residential single-family homes are typically excluded from this requirement.)

Design Considerations

Designing New Installations

The following methods to reduce excessive irrigation runoff should be considered, and incorporated and implemented where determined applicable and feasible by the Permittee:

- Employ rain-triggered shutoff devices to prevent irrigation after precipitation.
- Design irrigation systems to each landscape area's specific water requirements.
- Include design featuring flow reducers or shutoff valves triggered by a pressure drop to control water loss in the event of broken sprinkler heads or lines.
- Implement landscape plans consistent with County or City water conservation resolutions, which may include provision of water sensors, programmable irrigation times (for short cycles), etc.



- Design timing and application methods of irrigation water to minimize the runoff of excess irrigation water into the storm water drainage system.
- Group plants with similar water requirements in order to reduce excess irrigation runoff and promote surface filtration. Choose plants with low irrigation requirements (for example, native or drought tolerant species). Consider design features such as:
 - Using mulches (such as wood chips or bark) in planter areas without ground cover to minimize sediment in runoff
 - Installing appropriate plant materials for the location, in accordance with amount of sunlight and climate, and use native plant materials where possible and/or as recommended by the landscape architect
 - Leaving a vegetative barrier along the property boundary and interior watercourses, to act as a pollutant filter, where appropriate and feasible
 - Choosing plants that minimize or eliminate the use of fertilizer or pesticides to sustain growth
- Employ other comparable, equally effective methods to reduce irrigation water runoff.

Redeveloping Existing Installations

Various jurisdictional stormwater management and mitigation plans (SUSMP, WQMP, etc.) define “redevelopment” in terms of amounts of additional impervious area, increases in gross floor area and/or exterior construction, and land disturbing activities with structural or impervious surfaces. The definition of “redevelopment” must be consulted to determine whether or not the requirements for new development apply to areas intended for redevelopment. If the definition applies, the steps outlined under “designing new installations” above should be followed.

Other Resources

A Manual for the Standard Urban Stormwater Mitigation Plan (SUSMP), Los Angeles County Department of Public Works, May 2002.

Model Standard Urban Storm Water Mitigation Plan (SUSMP) for San Diego County, Port of San Diego, and Cities in San Diego County, February 14, 2002.

Model Water Quality Management Plan (WQMP) for County of Orange, Orange County Flood Control District, and the Incorporated Cities of Orange County, Draft February 2003.

Ventura Countywide Technical Guidance Manual for Stormwater Quality Control Measures, July 2002.

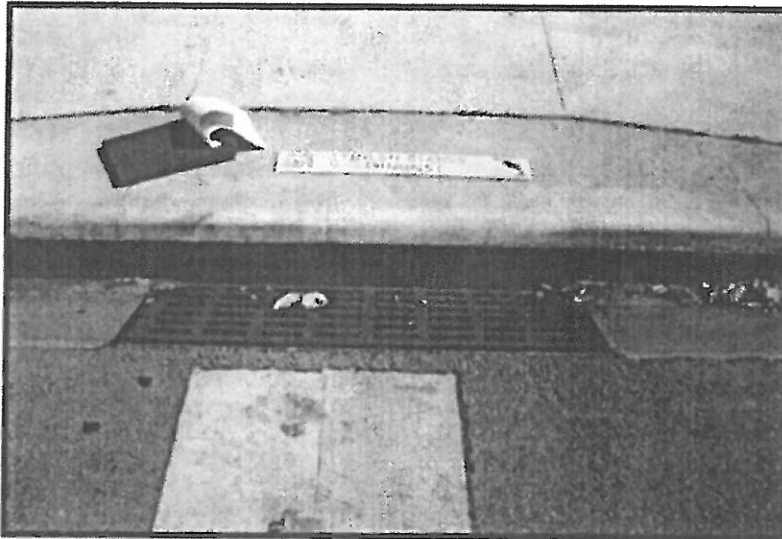

Design Objectives

- Maximize Infiltration
- Provide Retention
- Slow Runoff
- Minimize Impervious Land Coverage
- Prohibit Dumping of Improper Materials
- Contain Pollutants
- Collect and Convey

Description

Waste materials dumped into storm drain inlets can have severe impacts on receiving and ground waters. Posting notices regarding discharge prohibitions at storm drain inlets can prevent waste dumping. Storm drain signs and stencils are highly visible source controls that are typically placed directly adjacent to storm drain inlets.

Approach

The stencil or affixed sign contains a brief statement that prohibits dumping of improper materials into the urban runoff conveyance system. Storm drain messages have become a popular method of alerting the public about the effects of and the prohibitions against waste disposal.

Suitable Applications

Stencils and signs alert the public to the destination of pollutants discharged to the storm drain. Signs are appropriate in residential, commercial, and industrial areas, as well as any other area where contributions or dumping to storm drains is likely.

Design Considerations

Storm drain message markers or placards are recommended at all storm drain inlets within the boundary of a development project. The marker should be placed in clear sight facing toward anyone approaching the inlet from either side. All storm drain inlet locations should be identified on the development site map.

Designing New Installations

The following methods should be considered for inclusion in the project design and show on project plans:

- Provide stenciling or labeling of all storm drain inlets and catch basins, constructed or modified, within the project area with prohibitive language. Examples include "NO DUMPING



– DRAINS TO OCEAN” and/or other graphical icons to discourage illegal dumping.

- Post signs with prohibitive language and/or graphical icons, which prohibit illegal dumping at public access points along channels and creeks within the project area.

Note - Some local agencies have approved specific signage and/or storm drain message placards for use. Consult local agency stormwater staff to determine specific requirements for placard types and methods of application.

Redeveloping Existing Installations

Various jurisdictional stormwater management and mitigation plans (SUSMP, WQMP, etc.) define “redevelopment” in terms of amounts of additional impervious area, increases in gross floor area and/or exterior construction, and land disturbing activities with structural or impervious surfaces. If the project meets the definition of “redevelopment”, then the requirements stated under “designing new installations” above should be included in all project design plans.

Additional Information

Maintenance Considerations

- Legibility of markers and signs should be maintained. If required by the agency with jurisdiction over the project, the owner/operator or homeowner’s association should enter into a maintenance agreement with the agency or record a deed restriction upon the property title to maintain the legibility of placards or signs.

Placement

- Signage on top of curbs tends to weather and fade.
- Signage on face of curbs tends to be worn by contact with vehicle tires and sweeper brooms.

Supplemental Information

Examples

- Most MS4 programs have storm drain signage programs. Some MS4 programs will provide stencils, or arrange for volunteers to stencil storm drains as part of their outreach program.

Other Resources

A Manual for the Standard Urban Stormwater Mitigation Plan (SUSMP), Los Angeles County Department of Public Works, May 2002.

Model Standard Urban Storm Water Mitigation Plan (SUSMP) for San Diego County, Port of San Diego, and Cities in San Diego County, February 14, 2002.

Model Water Quality Management Plan (WQMP) for County of Orange, Orange County Flood Control District, and the Incorporated Cities of Orange County, Draft February 2003.

Ventura Countywide Technical Guidance Manual for Stormwater Quality Control Measures, July 2002.

Description

Trash storage areas are areas where a trash receptacle (s) are located for use as a repository for solid wastes. Stormwater runoff from areas where trash is stored or disposed of can be polluted. In addition, loose trash and debris can be easily transported by water or wind into nearby storm drain inlets, channels, and/or creeks. Waste handling operations that may be sources of stormwater pollution include dumpsters, litter control, and waste piles.

Approach

This fact sheet contains details on the specific measures required to prevent or reduce pollutants in stormwater runoff associated with trash storage and handling. Preventative measures including enclosures, containment structures, and impervious pavements to mitigate spills, should be used to reduce the likelihood of contamination.

Suitable Applications

Appropriate applications include residential, commercial and industrial areas planned for development or redevelopment. (Detached residential single-family homes are typically excluded from this requirement.)

Design Considerations

Design requirements for waste handling areas are governed by Building and Fire Codes, and by current local agency ordinances and zoning requirements. The design criteria described in this fact sheet are meant to enhance and be consistent with these code and ordinance requirements. Hazardous waste should be handled in accordance with legal requirements established in Title 22, California Code of Regulation.

Wastes from commercial and industrial sites are typically hauled by either public or commercial carriers that may have design or access requirements for waste storage areas. The design criteria in this fact sheet are recommendations and are not intended to be in conflict with requirements established by the waste hauler. The waste hauler should be contacted prior to the design of your site trash collection areas. Conflicts or issues should be discussed with the local agency.

Designing New Installations

Trash storage areas should be designed to consider the following structural or treatment control BMPs:

- Design trash container areas so that drainage from adjoining roofs and pavement is diverted around the area(s) to avoid run-on. This might include berming or grading the waste handling area to prevent run-on of stormwater.
- Make sure trash container areas are screened or walled to prevent off-site transport of trash.

Design Objectives

- Maximize Infiltration
- Provide Retention
- Slow Runoff
- Minimize Impervious Land Coverage
- Prohibit Dumping of Improper Materials
- Contain Pollutants
- Collect and Convey



- Use lined bins or dumpsters to reduce leaking of liquid waste.
- Provide roofs, awnings, or attached lids on all trash containers to minimize direct precipitation and prevent rainfall from entering containers.
- Pave trash storage areas with an impervious surface to mitigate spills.
- Do not locate storm drains in immediate vicinity of the trash storage area.
- Post signs on all dumpsters informing users that hazardous materials are not to be disposed of therein.

Redeveloping Existing Installations

Various jurisdictional stormwater management and mitigation plans (SUSMP, WQMP, etc.) define “redevelopment” in terms of amounts of additional impervious area, increases in gross floor area and/or exterior construction, and land disturbing activities with structural or impervious surfaces. The definition of “redevelopment” must be consulted to determine whether or not the requirements for new development apply to areas intended for redevelopment. If the definition applies, the steps outlined under “designing new installations” above should be followed.

Additional Information***Maintenance Considerations***

The integrity of structural elements that are subject to damage (i.e., screens, covers, and signs) must be maintained by the owner/operator. Maintenance agreements between the local agency and the owner/operator may be required. Some agencies will require maintenance deed restrictions to be recorded of the property title. If required by the local agency, maintenance agreements or deed restrictions must be executed by the owner/operator before improvement plans are approved.

Other Resources

A Manual for the Standard Urban Stormwater Mitigation Plan (SUSMP), Los Angeles County Department of Public Works, May 2002.

Model Standard Urban Storm Water Mitigation Plan (SUSMP) for San Diego County, Port of San Diego, and Cities in San Diego County, February 14, 2002.

Model Water Quality Management Plan (WQMP) for County of Orange, Orange County Flood Control District, and the Incorporated Cities of Orange County, Draft February 2003.

Ventura Countywide Technical Guidance Manual for Stormwater Quality Control Measures, July 2002.

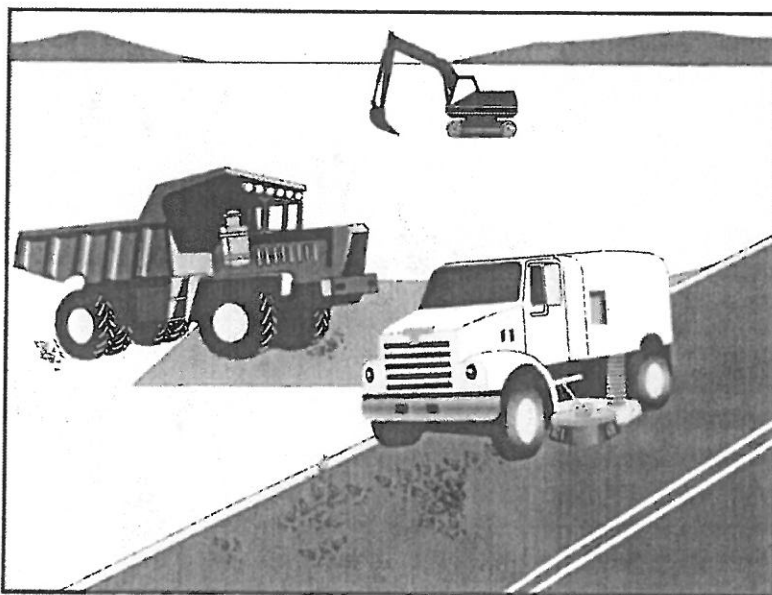

Description and Purpose

Street sweeping and vacuuming includes use of self-propelled and walk-behind equipment to remove sediment from streets and roadways, and to clean paved surfaces in preparation for final paving. Sweeping and vacuuming prevents sediment from the project site from entering storm drains or receiving waters.

Suitable Applications

Sweeping and vacuuming are suitable anywhere sediment is tracked from the project site onto public or private paved streets and roads, typically at points of egress. Sweeping and vacuuming are also applicable during preparation of paved surfaces for final paving.

Limitations

Sweeping and vacuuming may not be effective when sediment is wet or when tracked soil is caked (caked soil may need to be scraped loose).

Implementation

- Controlling the number of points where vehicles can leave the site will allow sweeping and vacuuming efforts to be focused, and perhaps save money.
- Inspect potential sediment tracking locations daily.
- Visible sediment tracking should be swept or vacuumed on a daily basis.
- Do not use kick brooms or sweeper attachments. These tend to spread the dirt rather than remove it.

Categories

EC	Erosion Control	
SE	Sediment Control	<input checked="" type="checkbox"/>
TC	Tracking Control	<input checked="" type="checkbox"/>
WE	Wind Erosion Control	
NS	Non-Stormwater Management Control	
WM	Waste Management and Materials Pollution Control	

Legend:

- Primary Objective
- Secondary Objective

Targeted Constituents

Sediment	<input checked="" type="checkbox"/>
Nutrients	
Trash	<input checked="" type="checkbox"/>
Metals	
Bacteria	
Oil and Grease	<input checked="" type="checkbox"/>
Organics	

Potential Alternatives

None



- If not mixed with debris or trash, consider incorporating the removed sediment back into the project

Costs

Rental rates for self-propelled sweepers vary depending on hopper size and duration of rental. Expect rental rates from \$58/hour (3 yd³ hopper) to \$88/hour (9 yd³ hopper), plus operator costs. Hourly production rates vary with the amount of area to be swept and amount of sediment. Match the hopper size to the area and expect sediment load to minimize time spent dumping.

Inspection and Maintenance

- Inspect BMPs prior to forecast rain, daily during extended rain events, after rain events, weekly during the rainy season, and at two-week intervals during the non-rainy season.
- When actively in use, points of ingress and egress must be inspected daily.
- When tracked or spilled sediment is observed outside the construction limits, it must be removed at least daily. More frequent removal, even continuous removal, may be required in some jurisdictions.
- Be careful not to sweep up any unknown substance or any object that may be potentially hazardous.
- Adjust brooms frequently; maximize efficiency of sweeping operations.
- After sweeping is finished, properly dispose of sweeper wastes at an approved dumpsite.

References

Stormwater Quality Handbooks - Construction Site Best Management Practices (BMPs) Manual, State of California Department of Transportation (Caltrans), November 2000.

Labor Surcharge and Equipment Rental Rates, State of California Department of Transportation (Caltrans), April 1, 2002 – March 31, 2003.

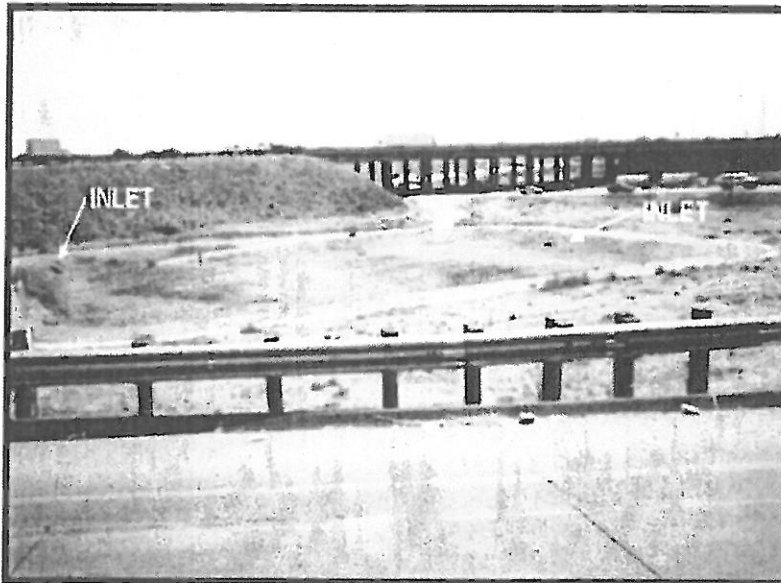

Description

An infiltration basin is a shallow impoundment that is designed to infiltrate stormwater. Infiltration basins use the natural filtering ability of the soil to remove pollutants in stormwater runoff. Infiltration facilities store runoff until it gradually exfiltrates through the soil and eventually into the water table. This practice has high pollutant removal efficiency and can also help recharge groundwater, thus helping to maintain low flows in stream systems. Infiltration basins can be challenging to apply on many sites, however, because of soils requirements. In addition, some studies have shown relatively high failure rates compared with other management practices.

California Experience

Infiltration basins have a long history of use in California, especially in the Central Valley. Basins located in Fresno were among those initially evaluated in the National Urban Runoff Program and were found to be effective at reducing the volume of runoff, while posing little long-term threat to groundwater quality (EPA, 1983; Schroeder, 1995). Proper siting of these devices is crucial as underscored by the experience of Caltrans in siting two basins in Southern California. The basin with marginal separation from groundwater and soil permeability failed immediately and could never be rehabilitated.

Advantages

- Provides 100% reduction in the load discharged to surface waters.
- The principal benefit of infiltration basins is the approximation of pre-development hydrology during which a

Design Considerations

- Soil for Infiltration
- Slope
- Aesthetics

Targeted Constituents

- | | | |
|-------------------------------------|----------------|---|
| <input checked="" type="checkbox"/> | Sediment | ■ |
| <input checked="" type="checkbox"/> | Nutrients | ■ |
| <input checked="" type="checkbox"/> | Trash | ■ |
| <input checked="" type="checkbox"/> | Metals | ■ |
| <input checked="" type="checkbox"/> | Bacteria | ■ |
| <input checked="" type="checkbox"/> | Oil and Grease | ■ |
| <input checked="" type="checkbox"/> | Organics | ■ |

Legend (Removal Effectiveness)

- | | |
|----------|--------|
| ● Low | ■ High |
| ▲ Medium | |



significant portion of the average annual rainfall runoff is infiltrated and evaporated rather than flushed directly to creeks.

- If the water quality volume is adequately sized, infiltration basins can be useful for providing control of channel forming (erosion) and high frequency (generally less than the 2-year) flood events.

Limitations

- May not be appropriate for industrial sites or locations where spills may occur.
- Infiltration basins require a minimum soil infiltration rate of 0.5 inches/hour, not appropriate at sites with Hydrologic Soil Types C and D.
- If infiltration rates exceed 2.4 inches/hour, then the runoff should be fully treated prior to infiltration to protect groundwater quality.
- Not suitable on fill sites or steep slopes.
- Risk of groundwater contamination in very coarse soils.
- Upstream drainage area must be completely stabilized before construction.
- Difficult to restore functioning of infiltration basins once clogged.

Design and Sizing Guidelines

- Water quality volume determined by local requirements or sized so that 85% of the annual runoff volume is captured.
- Basin sized so that the entire water quality volume is infiltrated within 48 hours.
- Vegetation establishment on the basin floor may help reduce the clogging rate.

Construction/Inspection Considerations

- Before construction begins, stabilize the entire area draining to the facility. If impossible, place a diversion berm around the perimeter of the infiltration site to prevent sediment entrance during construction or remove the top 2 inches of soil after the site is stabilized. Stabilize the entire contributing drainage area, including the side slopes, before allowing any runoff to enter once construction is complete.
- Place excavated material such that it can not be washed back into the basin if a storm occurs during construction of the facility.
- Build the basin without driving heavy equipment over the infiltration surface. Any equipment driven on the surface should have extra-wide ("low pressure") tires. Prior to any construction, rope off the infiltration area to stop entrance by unwanted equipment.
- After final grading, till the infiltration surface deeply.
- Use appropriate erosion control seed mix for the specific project and location.

Performance

As water migrates through porous soil and rock, pollutant attenuation mechanisms include precipitation, sorption, physical filtration, and bacterial degradation. If functioning properly, this approach is presumed to have high removal efficiencies for particulate pollutants and moderate removal of soluble pollutants. Actual pollutant removal in the subsurface would be expected to vary depending upon site-specific soil types. This technology eliminates discharge to surface waters except for the very largest storms; consequently, complete removal of all stormwater constituents can be assumed.

There remain some concerns about the potential for groundwater contamination despite the findings of the NURP and Nightingale (1975; 1987a,b,c; 1989). For instance, a report by Pitt et al. (1994) highlighted the potential for groundwater contamination from intentional and unintentional stormwater infiltration. That report recommends that infiltration facilities not be sited in areas where high concentrations are present or where there is a potential for spills of toxic material. Conversely, Schroeder (1995) reported that there was no evidence of groundwater impacts from an infiltration basin serving a large industrial catchment in Fresno, CA.

Siting Criteria

The key element in siting infiltration basins is identifying sites with appropriate soil and hydrogeologic properties, which is critical for long term performance. In one study conducted in Prince George's County, Maryland (Galli, 1992), all of the infiltration basins investigated clogged within 2 years. It is believed that these failures were for the most part due to allowing infiltration at sites with rates of less than 0.5 in/hr, basing siting on soil type rather than field infiltration tests, and poor construction practices that resulted in soil compaction of the basin invert.

A study of 23 infiltration basins in the Pacific Northwest showed better long-term performance in an area with highly permeable soils (Hilding, 1996). In this study, few of the infiltration basins had failed after 10 years. Consequently, the following guidelines for identifying appropriate soil and subsurface conditions should be rigorously adhered to.

- Determine soil type (consider RCS soil type 'A, B or C' only) from mapping and consult USDA soil survey tables to review other parameters such as the amount of silt and clay, presence of a restrictive layer or seasonal high water table, and estimated permeability. The soil should not have more than 30% clay or more than 40% of clay and silt combined. Eliminate sites that are clearly unsuitable for infiltration.
- Groundwater separation should be at least 3 m from the basin invert to the measured ground water elevation. There is concern at the state and regional levels of the impact on groundwater quality from infiltrated runoff, especially when the separation between groundwater and the surface is small.
- Location away from buildings, slopes and highway pavement (greater than 6 m) and wells and bridge structures (greater than 30 m). Sites constructed of fill, having a base flow or with a slope greater than 15% should not be considered.
- Ensure that adequate head is available to operate flow splitter structures (to allow the basin to be offline) without ponding in the splitter structure or creating backwater upstream of the splitter.

- Base flow should not be present in the tributary watershed.

Secondary Screening Based on Site Geotechnical Investigation

- At least three in-hole conductivity tests shall be performed using USBR 7300-89 or Bouwer-Rice procedures (the latter if groundwater is encountered within the boring), two tests at different locations within the proposed basin and the third down gradient by no more than approximately 10 m. The tests shall measure permeability in the side slopes and the bed within a depth of 3 m of the invert.
- The minimum acceptable hydraulic conductivity as measured in any of the three required test holes is 13 mm/hr. If any test hole shows less than the minimum value, the site should be disqualified from further consideration.
- Exclude from consideration sites constructed in fill or partially in fill unless no silts or clays are present in the soil boring. Fill tends to be compacted, with clays in a dispersed rather than flocculated state, greatly reducing permeability.
- The geotechnical investigation should be such that a good understanding is gained as to how the stormwater runoff will move in the soil (horizontally or vertically) and if there are any geological conditions that could inhibit the movement of water.

Additional Design Guidelines

- (1) Basin Sizing - The required water quality volume is determined by local regulations or sufficient to capture 85% of the annual runoff.
- (2) Provide pretreatment if sediment loading is a maintenance concern for the basin.
- (3) Include energy dissipation in the inlet design for the basins. Avoid designs that include a permanent pool to reduce opportunity for standing water and associated vector problems.
- (4) Basin invert area should be determined by the equation:

$$A = \frac{WQV}{kt}$$

where A = Basin invert area (m²)

WQV = water quality volume (m³)

k = 0.5 times the lowest field-measured hydraulic conductivity (m/hr)

t = drawdown time (48 hr)

- (5) The use of vertical piping, either for distribution or infiltration enhancement shall not be allowed to avoid device classification as a Class V injection well per 40 CFR146.5(e)(4).

Maintenance

Regular maintenance is critical to the successful operation of infiltration basins. Recommended operation and maintenance guidelines include:

- Inspections and maintenance to ensure that water infiltrates into the subsurface completely (recommended infiltration rate of 72 hours or less) and that vegetation is carefully managed to prevent creating mosquito and other vector habitats.
- Observe drain time for the design storm after completion or modification of the facility to confirm that the desired drain time has been obtained.
- Schedule semiannual inspections for beginning and end of the wet season to identify potential problems such as erosion of the basin side slopes and invert, standing water, trash and debris, and sediment accumulation.
- Remove accumulated trash and debris in the basin at the start and end of the wet season.
- Inspect for standing water at the end of the wet season.
- Trim vegetation at the beginning and end of the wet season to prevent establishment of woody vegetation and for aesthetic and vector reasons.
- Remove accumulated sediment and regrade when the accumulated sediment volume exceeds 10% of the basin.
- If erosion is occurring within the basin, revegetate immediately and stabilize with an erosion control mulch or mat until vegetation cover is established.
- To avoid reversing soil development, scarification or other disturbance should only be performed when there are actual signs of clogging, rather than on a routine basis. Always remove deposited sediments before scarification, and use a hand-guided rotary tiller, if possible, or a disc harrow pulled by a very light tractor.

Cost

Infiltration basins are relatively cost-effective practices because little infrastructure is needed when constructing them. One study estimated the total construction cost at about \$2 per ft (adjusted for inflation) of storage for a 0.25-acre basin (SWRPC, 1991). As with other BMPs, these published cost estimates may deviate greatly from what might be incurred at a specific site. For instance, Caltrans spent about \$18/ft³ for the two infiltration basins constructed in southern California, each of which had a water quality volume of about 0.34 ac.-ft. Much of the higher cost can be attributed to changes in the storm drain system necessary to route the runoff to the basin locations.

Infiltration basins typically consume about 2 to 3% of the site draining to them, which is relatively small. Additional space may be required for buffer, landscaping, access road, and fencing. Maintenance costs are estimated at 5 to 10% of construction costs.

One cost concern associated with infiltration practices is the maintenance burden and longevity. If improperly maintained, infiltration basins have a high failure rate. Thus, it may be necessary to replace the basin with a different technology after a relatively short period of time.

References and Sources of Additional Information

Caltrans, 2002, BMP Retrofit Pilot Program Proposed Final Report, Rpt. CTSW-RT-01-050, California Dept. of Transportation, Sacramento, CA.

Galli, J. 1992. *Analysis of Urban BMP Performance and Longevity in Prince George's County, Maryland*. Metropolitan Washington Council of Governments, Washington, DC.

Hilding, K. 1996. Longevity of infiltration basins assessed in Puget Sound. *Watershed Protection Techniques* 1(3):124-125.

Maryland Department of the Environment (MDE). 2000. *Maryland Stormwater Design Manual*. <http://www.mde.state.md.us/environment/wma/stormwatermanual>. Accessed May 22, 2002.

Metzger, M. E., D. F. Messer, C. L. Beitia, C. M. Myers, and V. L. Kramer. 2002. The Dark Side Of Stormwater Runoff Management: Disease Vectors Associated With Structural BMPs. *Stormwater* 3(2): 24-39.

Nightingale, H.I., 1975, "Lead, Zinc, and Copper in Soils of Urban Storm-Runoff Retention Basins," *American Water Works Assoc. Journal*. Vol. 67, p. 443-446.

Nightingale, H.I., 1987a, "Water Quality beneath Urban Runoff Water Management Basins," *Water Resources Bulletin*, Vol. 23, p. 197-205.

Nightingale, H.I., 1987b, "Accumulation of As, Ni, Cu, and Pb in Retention and Recharge Basin Soils from Urban Runoff," *Water Resources Bulletin*, Vol. 23, p. 663-672.

Nightingale, H.I., 1987c, "Organic Pollutants in Soils of Retention/Recharge Basins Receiving Urban Runoff Water," *Soil Science* Vol. 148, pp. 39-45.

Nightingale, H.I., Harrison, D., and Salo, J.E., 1985, "An Evaluation Technique for Groundwater Quality Beneath Urban Runoff Retention and Percolation Basins," *Ground Water Monitoring Review*, Vol. 5, No. 1, pp. 43-50.

Oberts, G. 1994. Performance of Stormwater Ponds and Wetlands in Winter. *Watershed Protection Techniques* 1(2): 64-68.

Pitt, R., et al. 1994, *Potential Groundwater Contamination from Intentional and Nonintentional Stormwater Infiltration*, EPA/600/R-94/051, Risk Reduction Engineering Laboratory, U.S. EPA, Cincinnati, OH.

Schueler, T. 1987. *Controlling Urban Runoff: A Practical Manual for Planning and Designing Urban BMPs*. Metropolitan Washington Council of Governments, Washington, DC.

Schroeder, R.A., 1995, *Potential For Chemical Transport Beneath a Storm-Runoff Recharge (Retention) Basin for an Industrial Catchment in Fresno, CA*, USGS Water-Resource Investigations Report 93-4140.

Southeastern Wisconsin Regional Planning Commission (SWRPC). 1991. *Costs of Urban Nonpoint Source Water Pollution Control Measures*. Southeastern Wisconsin Regional Planning Commission, Waukesha, WI.

U.S. EPA, 1983, *Results of the Nationwide Urban Runoff Program: Volume 1 – Final Report*, WH-554, Water Planning Division, Washington, DC.

Watershed Management Institute (WMI). 1997. *Operation, Maintenance, and Management of Stormwater Management Systems*. Prepared for U.S. Environmental Protection Agency Office of Water, Washington, DC.

Information Resources

Center for Watershed Protection (CWP). 1997. *Stormwater BMP Design Supplement for Cold Climates*. Prepared for U.S. Environmental Protection Agency Office of Wetlands, Oceans and Watersheds. Washington, DC.

Ferguson, B.K., 1994. *Stormwater Infiltration*. CRC Press, Ann Arbor, MI.

USEPA. 1993. *Guidance to Specify Management Measures for Sources of Nonpoint Pollution in Coastal Waters*. EPA-840-B-92-002. U.S. Environmental Protection Agency, Office of Water, Washington, DC.

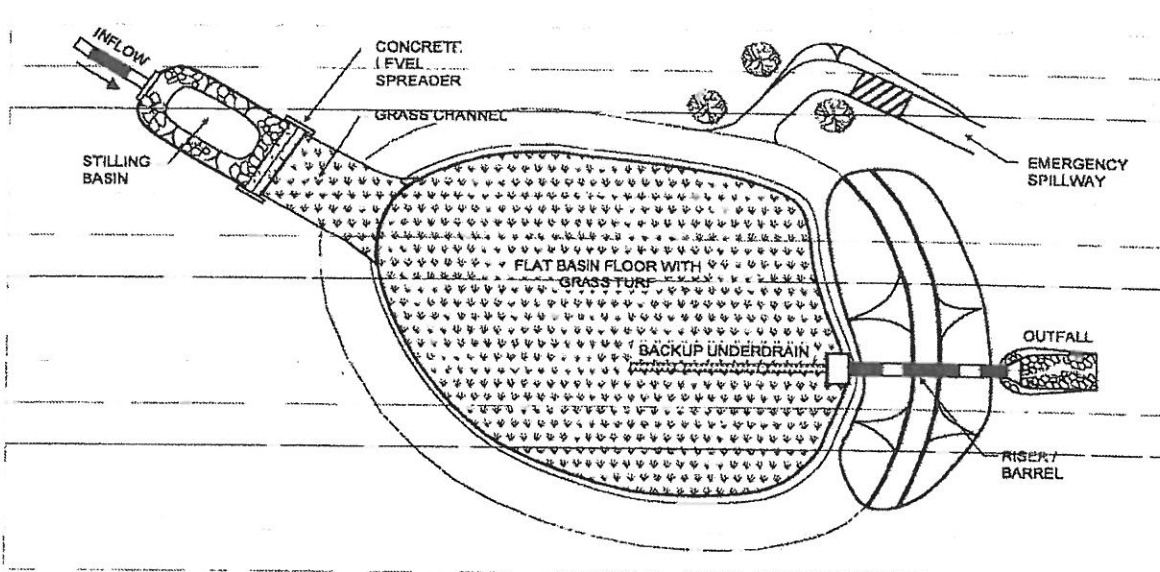

PLAN VIEW

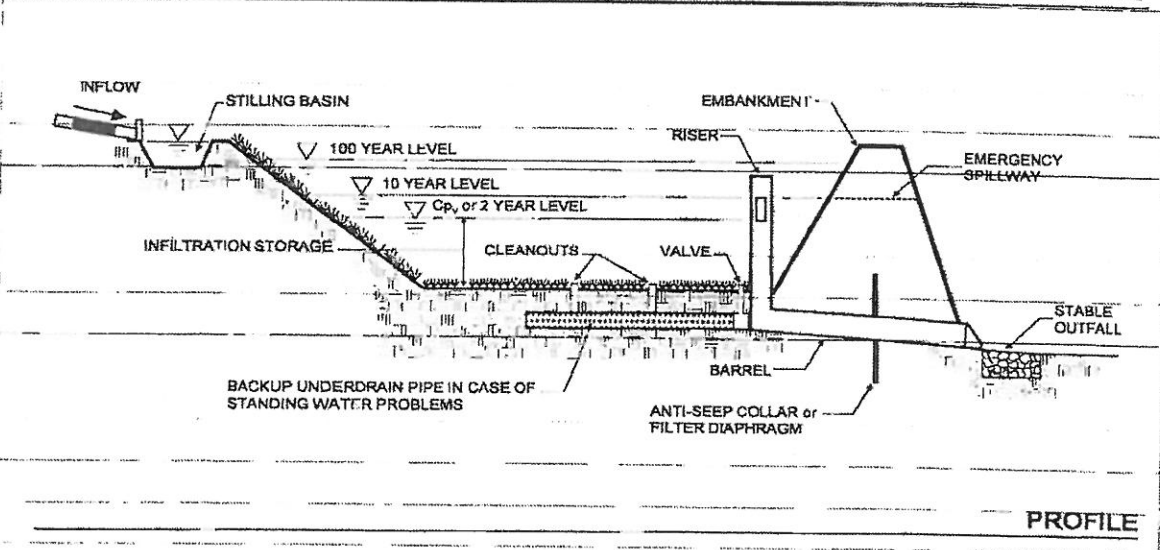

PROFILE

Section 6.2
Electronic Data Submittal
(Exhibits)

To be provided at later date

Section 6.3

O&M and Covenant

To be provided at later date

Section 6.4

Supporting Documentation

- Educational Materials

 - Worksheet H

- NOAA Rainfall Data

 - HCOC Map



A SAFE GARDEN: A LOT DEPENDS ON IT.



Protect your family and community
when using pesticides and fertilizers.

- **STRATEGICALLY** apply products on your lawn only when rain is not expected.
 - **SPOT-APPLY** directly on the problem instead of the whole area.
 - **SAFELY** dispose of unwanted products. The County of San Bernardino offers 9 HHW Centers that accept pesticides, fertilizers and other toxic waste **FREE** of charge.
- 

To report illegal dumping, call
(877) WASTE18 or visit
sbcountystormwater.org





UN JARDÍN SANO: MUCHO DEPENDE DE ÉL.

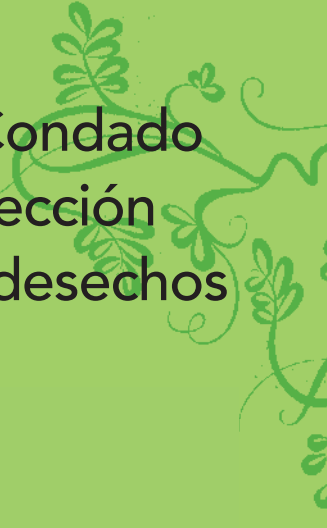

Proteja a su familia y a su comunidad cuando utilice pesticidas y fertilizantes.

- **ESTRATÉGICAMENTE** aplique productos en su césped solamente cuando no se espera lluvia.
 - **ESCASAMENTE** aplique los productos directamente en el área en donde exista el problema en lugar de distribuirlo en todo el jardín.
 - **ELIMINE** productos tóxicos sanamente. El Condado de San Bernardino ofrece 9 centros de recolección que aceptan pesticidas, fertilizantes y otros desechos tóxicos **GRATUITAMENTE**.
- 

Para reportar actividades ilegales llame al
(877) WASTE18 o visite
sbcountystormwater.org



SPOT-APPLY

pesticides directly on the
problem rather than
blanketing the whole area.



sbcountystormwater.org

**A SAFE GARDEN:
A LOT DEPENDS ON IT.**



(877) WASTE18

Artwork Courtesy of the City of Los Angeles Stormwater Program. Printed on recycled paper.

ESCASAMENTE

aplique pesticidas directamente
en el problema en lugar de
distribuirlo en todo el jardín.



sbcountystormwater.org

**UN JARDÍN SANO:
MUCHO DEPENDE DE EL.**



(877) WASTE18

Arte Cortesia del Programa de Agua Pluvial de la Ciudad de Los Angeles. Impreso en papel reciclado.

A SAFE GARDEN: A LOT DEPENDS ON IT.



Protect your family and community when using pesticides and fertilizers.

- ❖ **STRATEGICALLY** apply products on your lawn when rain is not expected. Rain can wash toxic chemicals from your lawn into local waterways.
- ❖ **SPOT-APPLY** products directly on the problem instead of the whole area. Use less chemicals, and conserve the supply of your product.
- ❖ **SAFELY** dispose of unwanted products. The County of San Bernardino offers 9 HHW Centers that accept pesticides, fertilizers and other toxic waste FREE of charge.

To report illegal dumping, call
(877) WASTE18 or visit
sbcountystormwater.org



UN JARDÍN SANO: MUCHO DEPENDE DE ÉL.



Proteja a su familia y a su comunidad cuando utilice pesticidas y fertilizantes.

- ❖ **ESTRATÉGICAMENTE** aplique productos en su césped solamente cuando no se espera lluvia. La lluvia puede llevarse químicos tóxicos de su césped hacia los canales pluviales en su área.
- ❖ **ESCASAMENTE** aplique los productos directamente en el área en donde exista el problema en lugar de distribuirlo en todo el jardín. Así, utilizará menos productos químicos y le rendirá más.
- ❖ **ELIMINE** productos tóxicos sanamente. El Condado de San Bernardino ofrece 9 centros de recolección que aceptan pesticidas, fertilizantes y otros desechos tóxicos **GRATUITAMENTE**.

Para reportar actividades ilegales llamar al
(877) WASTE18 o visite
sbcountystormwater.org



TOO TOXIC TO TRASH

Dispose of your **HOUSEHOLD HAZARDOUS WASTE (HHW)** at a **FREE HHW Center** near you. Examples of items collected: pesticides, fertilizers, paints, cleaners, antifreeze, batteries, motor oil, oil filters, and electronic waste.

SERVICE AREA	LOCATION	DAYS OPEN	HOURS
Big Bear Lake (does not accept E-waste)	42040 Garstin Dr. (cross: Big Bear Blvd.)	Saturdays	9 a.m. - 2 p.m.
Chino	5050 Schaefer Ave. (cross: 4th St.)	2 nd & 4 th Sat.	8 a.m. - 1 p.m.
Fontana (Fontana residents only)	16454 Orange Way (cross: Cypress Ave.) <small>Note: Provide a trash bill and a driver's license as proof of residency.</small>	Saturdays	8 a.m. - 12 p.m.
Ontario	1430 S. Cucamonga Ave. (cross: Belmont St.)	Fri. & Sat.	9 a.m. - 2 p.m.
Rancho Cucamonga	8794 Lion Street. (Off 9th St, between Vineyard and Hellman)	Saturdays	8 a.m. - 12 p.m.
Redlands	500 Kansas St. (cross: Park Ave.)	Saturdays	9:30 a.m. - 12:30 p.m.
Rialto (does not accept E-waste)	246 Willow Ave. (cross: Rialto Ave.)	2 nd & 4 th Fri. & Sat.	8 a.m. - 12 p.m.
San Bernardino	2824 East 'W' St., 302 (cross: Victoria Ave.)	Mon. - Fri.	9 a.m. - 4 p.m.
Upland	1370 N. Benson Ave. (cross: 14th St.)	Saturdays	9 a.m. - 2 p.m.



To report illegal dumping, call **(877) WASTE18**
or visit **sbcountystormwater.org**

Artwork Courtesy of the City of Los Angeles Stormwater Program. Printed on recycled paper.

TAKE ONE

MUY TÓXICO PARA LA BASURA

Deshágase de sus **DESECHOS PELIGROSOS** gratuitamente en un centro de recolección cerca de usted. Ejemplos de artículos que se aceptan: pesticidas, fertilizantes, pinturas, limpiadores, anticongelante, baterías, aceite de motores y filtros, y aparatos electrónicos.

ÁREA DE SERVICIO	UBICACIÓN	ABIERTO	HORARIO
Big Bear Lake (no se acepta materiales electrónicos)	42040 Garstin Dr. (Big Bear Blvd.)	Sábado	9 a.m. - 2 p.m.
Chino	5050 Schaefer Ave. (4th St.)	2 nd & 4 th Sábado	8 a.m. - 1 p.m.
Fontana (residentes de Fontana solamente)	16454 Orange Way (Cypress Ave.)	Sábado	8 a.m. - 12 p.m.
Ontario	1430 S. Cucamonga Ave. (Belmont St.)	Viernes & Sábado	9 a.m. - 2 p.m.
Rancho Cucamonga	8794 Lion Street (Off 9th St, between Vineyard & Hellman)	Sábado	8 a.m. - 12 p.m.
Redlands	500 Kansas St. (Park Ave.)	Sábado	9:30 a.m. - 12:30 p.m.
Rialto (no se acepta materiales electrónicos)	246 Willow Ave. (Rialto Ave.)	2 nd & 4 th Viernes & Sábado	8 a.m. - 12 p.m.
San Bernardino	2824 East 'W' St., 302 (Victoria Ave.)	Lunes - Viernes	9 a.m. - 4 p.m.
Upland	1370 N. Benson Ave. (14th St.)	Sábado	9 a.m. - 2 p.m.



Para reportar actividades ilegales llamar al **(877) WASTE18**
o visite **sbcountystormwater.org**

Arte Cortesía del Programa de Agua Pluvial de la Ciudad de Los Angeles. Impreso en papel reciclado.

TOME UNO

LANDSCAPE MAINTENANCE

DISCHARGE TO THE STORM DRAIN, ACCIDENTAL OR NOT, COULD LEAD TO ENFORCEMENT ACTIONS, WHICH COULD INCLUDE FINES.

Follow the best practices below to **prevent water pollution from landscaping activities.**

RECYCLE YARD WASTE



- ✓ Recycle leaves, grass clippings and other yard waste.
- ✓ Do not blow, sweep, rake or hose yard waste into the street or catch basin.
- ✓ **Try grasscycling:** the natural recycling of grass by leaving clippings on the lawn when mowing.

For more information, please visit:
www.calrecycle.ca.gov/organics/grasscycling

USE FERTILIZERS, HERBICIDES AND PESTICIDES SAFELY



- ✓ Fertilizers, herbicides and pesticides are often carried into the storm drain system by sprinkler runoff. Use natural and non-toxic alternatives as often as possible.
- ✓ If you must use chemical fertilizers, herbicides or pesticides:
 - Spot apply, rather than blanketing entire areas.
 - Avoid applying near curbs and driveways, and **never** before a rain.
 - Apply fertilizers as needed: when plants could best use it and when the potential runoff would be low.
 - Follow the manufacturer's instructions carefully—this will not only give the best results, but will save money.

USE WATER WISELY



- ✓ Control the amount of water and direction of sprinklers. Sprinklers should only be on long enough to allow water to soak into the ground, but not so long as to cause runoff.
- ✓ Periodically inspect, fix leaks and realign sprinkler heads.
- ✓ Plant native vegetation to reduce the need of water, fertilizers, herbicides and pesticides.

! HOMEOWNERS

KEEP THESE TIPS IN MIND WHEN HIRING PROFESSIONAL LANDSCAPERS AND REMIND AS NECESSARY.



Leftover pesticides, fertilizers, and herbicides contaminate landfills and should be disposed of through a Hazardous Waste Facility.

For more information on proper disposal call,
(909) 382-5401 or 1-800-OILY CAT.

*FREE for San Bernardino County residents only. Businesses can call for cost inquiries and to schedule an appointment.



To report illegal dumping, call (877) WASTE18 or visit sbcountystormwater.org
To report toxic spills, call 1(800) 33 TOXIC
To dispose of hazardous waste, call 1(800) OILY CAT

sbcountystormwater.org

Big Bear • Chino • Chino Hills • Colton • Fontana • Grand Terrace • Highland • Loma Linda • Montclair • Ontario • Rancho Cucamonga • Redlands • Rialto • San Bernardino • San Bernardino County • San Bernardino County Flood Control District • Upland • Yucaipa

MANTENIMIENTO DE JARDINERÍA

LAS DESCARGAS A LOS DESAGUES PLUVIALES, DE MANERA ACCIDENTAL O NO, PUEDEN INDUCIR A LA APLICACIÓN DE MULTAS Y OTRAS MEDIDAS.

Siga las mejores prácticas descritas debajo para evitar la contaminación del agua por actividades de jardinería.

RECICLAJE DE LOS DESECHOS DE JARDÍN



- ✓ Reciclar las hojas, recortes de césped y otros desechos de jardín.
- ✓ No soplar, barrer, o usar la manguera para empujar los desechos de jardín a la calle.
- ✓ Poner a prueba el reciclaje de césped (grasscycling): la manera natural de reciclar el césped dejando los recortes sobre el césped cuando son cortados. Para más información, visite la página web: www.calrecycle.ca.gov/organics/grasscycling

USAR FERTILIZANTES, HERBICIDAS Y PESTICIDAS DE MANERA SEGURA



- ✓ Los fertilizantes, herbicidas y pesticidas son arrastrados con frecuencia hacia el sistema de desagüe pluvial mediante el escurrimiento de los rociadores. Use alternativas naturales no tóxicas siempre que sea posible.
- ✓ Si tiene que usar fertilizantes, herbicidas o pesticidas químicos: Aplicar solo en el sitio necesario, en lugar de cubrir todas las áreas. Evitar aplicar cerca de los bordillos y las calzadas, y nunca antes de que llueva. Aplicar los fertilizantes cuando sea necesario: esto es, cuando las plantas mejor podrían usarlo y el posible escurrimiento sea bajo. Seguir las instrucciones del fabricante cuidadosamente – esto no solo le proporcionará los mejores resultados, pero le permitirá ahorrar dinero.

USAR EL AGUA DE MANERA PRUDENTE



- ✓ Controlar la cantidad de agua y la orientación de los rociadores. Los rociadores deben ser solo lo suficientemente largos como para permitir que el agua remoje el suelo, pero no tan largos que causen un escurrimiento.
- ✓ Inspeccione, repare los escapes y alinee los aspersores periódicamente.
- ✓ Siembre plantas nativas para reducir el uso de agua, fertilizantes, herbicidas y pesticidas.

PROPIETARIOS DE HOGARES

Tengan en cuenta estos consejos cuando contraten a paisajistas profesionales y recuérdenselos según sea necesario.



Los sobrantes de pesticidas, fertilizantes y herbicidas contaminan los vertederos y deben ser desechados a través de Plantas de Tratamiento para Residuos Peligrosos.

Para más información sobre el manejo adecuado de residuos peligrosos, llame a (909) 382-5401 o 1-800-OILY CAT.

*GRATIS únicamente para los residentes del Condado de San Bernardino. Las empresas pueden llamar para indagar sobre los costos y concertar una cita.



Para denunciar el vertido ilegal de basura, llame al (877) WASTE18 o visite sbcountystormwater.org
Para denunciar derrames tóxicos, llame al 1(800) 33 TOXIC
Para desechar residuos peligrosos, llame al 1(800) OILY CAT

sbcountystormwater.org

Big Bear • Chino • Chino Hills • Colton • Fontana • Grand Terrace • Highland • Loma Linda • Montclair • Ontario • Rancho Cucamonga • Redlands • Rialto • San Bernardino • San Bernardino County • San Bernardino County Flood Control District • Upland • Yucaipa

Paint



PAINTS that are water-based are less toxic and should be used whenever possible.

BRUSHES with water-based paint should be washed in the sink. Those with oil-based paint should be cleaned with paint thinner.

SAFELY dispose of unwanted paint. The County of San Bernardino offers 9 HHW Centers that accept paint and other toxic waste **FREE** of charge.

**WE DID IT OURSELVES
AND WE DID IT RIGHT**



To report illegal dumping, call
(877) WASTE18 or visit
sbcountystormwater.org



Pinte De Manera

SANA



PINTURAS a base de agua son menos tóxicas y debe de utilizarlas cuando sea posible.

BROCHAS a base de agua deben ser lavadas en el lavabo. Esas con pintura a base de aceite deben ser limpiadas con disolvente.

SANAMENTE deshágase de la pintura que no necesita. El Condado de San Bernardino ofrece 9 centros de recolección que aceptan pintura y otros desechos tóxicos **GRATUITAMENTE.**

LO HICIMOS NOSOTROS MISMOS
Y LO HICIMOS BIEN



Para reportar actividades ilegales llamar al
(877) WASTE18 o visite
sbcountystormwater.org



WE DID IT OURSELVES AND WE DID IT RIGHT



When painting your home,
protect your family and community.

- ◆ **PAINTS** that are water-based are less toxic and should be used whenever possible.
- ◆ **BRUSHES** with water-based paint should be washed in the sink. Those with oil-based paint should be cleaned with paint thinner.
- ◆ **SAFELY** dispose of unwanted paint. The County of San Bernardino offers 9 HHW Centers that accept paint and other toxic waste **FREE** of charge.

To report illegal dumping, call
(877) WASTE18 or visit
sbcountystormwater.org



LO HICIMOS NOSOTROS MISMOS Y LO HICIMOS BIEN

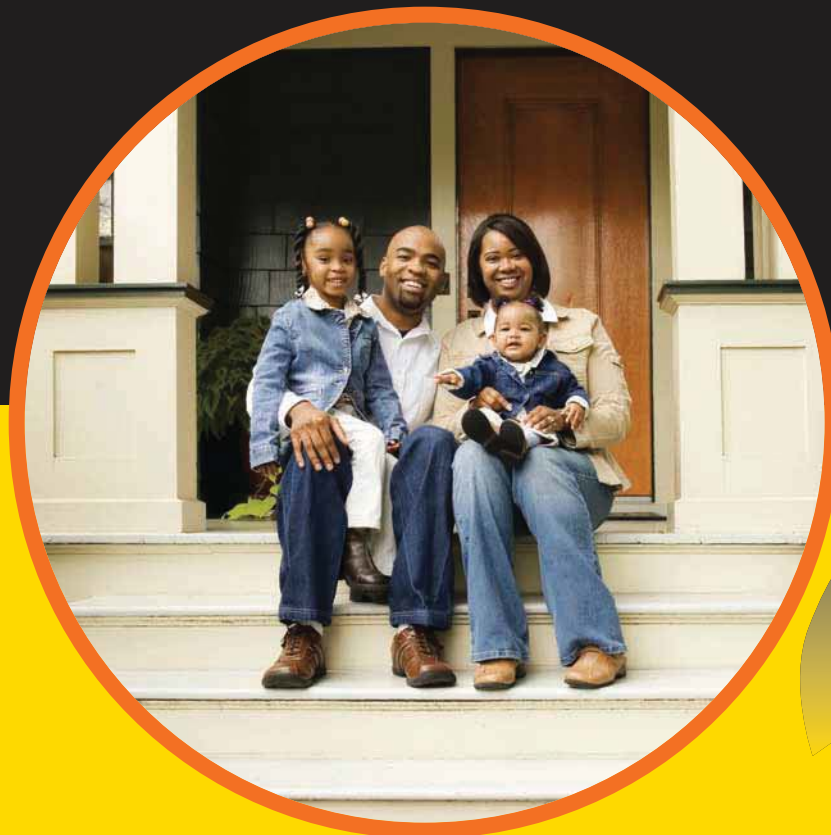

**Cuando pinte su casa, proteja
a su familia y a su comunidad.**

- 🔹 **PINTURAS** a base de agua son menos tóxicas y debe de utilizarlas cuando sea posible.
- 🔹 **BROCHAS** a base de agua deben ser lavadas en el lavabo. Esas con pintura a base de aceite deben ser limpiadas con disolvente.
- 🔹 **SANAMENTE** deshágase de la pintura que no necesita. El Condado de San Bernardino ofrece 9 centros de recolección que aceptan pintura y otros desechos tóxicos **GRATUITAMENTE**.

Para reportar actividades ilegales llamar al
(877) WASTE18 o visite
sbcountystormwater.org

Arte Cortesía del Programa de Agua Pluvial de la Ciudad de Los Angeles. Impreso en papel reciclado.





WE DID IT OURSELVES AND WE DID IT RIGHT



When painting your home,
protect your family and community.

- **PAINTS** that are water-based are less toxic and should be used whenever possible.
- **BRUSHES** with water-based paint should be washed in the sink. Those with oil-based paint should be cleaned with paint thinner.
- **SAFELY** dispose of unwanted paint. The County of San Bernardino offers 9 HHW Centers that accept paint and other toxic waste **FREE** of charge.

To report illegal dumping, call
(877) WASTE18 or visit
sbcountystormwater.org





LO HICIMOS NOSOTROS MISMOS Y LO HICIMOS BIEN



Cuando pinte su casa, proteja a su familia y a su comunidad.

- **PINTURAS** a base de agua son menos tóxicas y debe de utilizarlas cuando sea posible.
- **BROCHAS** a base de agua deben ser lavadas en el lavabo. Esas con pintura a base de aceite deben ser limpiadas con disolvente.
- **SANAMENTE** deshágase de la pintura que no necesita. El Condado de San Bernardino ofrece 9 centros de recolección que aceptan pintura y otros desechos tóxicos **GRATUITAMENTE**.

Para reportar actividades ilegales llamar al
(877) WASTE18 o visite
sbcountystormwater.org



Worksheet H: Factor of Safety and Design Infiltration Rate Worksheet

Factor Category		Factor Description	Assigned Weight (w)	Factor Value (v)	Product (p) $p = w \times v$
A	Suitability Assessment	Soil assessment methods	0.25	1	0.25
		Predominant soil texture	0.25	1	0.25
		Site soil variability	0.25	1	0.25
		Depth to groundwater / impervious layer	0.25	1	0.25
		Suitability Assessment Safety Factor, $S_A = S_p$			
B	Design	Tributary area size	0.25	1	0.25
		Level of pretreatment/ expected sediment loads	0.25	1	0.25
		Redundancy	0.25	1	0.25
		Compaction during construction	0.25	1	0.25
		Design Safety Factor, $S_B = S_p$			
Combined Safety Factor, $S_{total} = S_A \times S_B$				2.00	
Observed Infiltration Rate, inch/hr, $K_{observed}$ (corrected for test-specific bias) ¹				2.5 in/hr	
Design Infiltration Rate, in/hr, $K_{design} = K_{observed} / S_{total}$				1.25 in/hr	

Supporting Data

Briefly describe infiltration test and provide reference to test forms: See geotechnical report

Note: The minimum combined adjustment factor shall not be less than 2.0 and the maximum combined adjustment factor shall not exceed 9.0.

1 - $K_{observed}$ is the vertical infiltration measured in the field, before applying a factor of safety. If field testing measures a rate that is different than the vertical infiltration rate (for example, three-dimensional borehole percolation rate), then this rate must be adjusted by an acceptable method (for example, Porchet method) to yield the field estimate of vertical infiltration rate, $K_{observed}$.



NOAA Atlas 14, Volume 6, Version 2
Location name: Fontana, California, USA*
Latitude: 34.053°, Longitude: -117.4927°
Elevation: 954.42 ft**



* source: ESRI Maps
 ** source: USGS

POINT PRECIPITATION FREQUENCY ESTIMATES

Sanja Perica, Sarah Dietz, Sarah Heim, Lillian Hiner, Kazungu Maitaria, Deborah Martin, Sandra Pavlovic, Ishani Roy, Carl Trypaluk, Dale Unruh, Fenglin Yan, Michael Yekta, Tan Zhao, Geoffrey Bonnin, Daniel Brewer, Li-Chuan Chen, Tye Parzybok, John Yarchoan

NOAA, National Weather Service, Silver Spring, Maryland

[PF_tabular](#) | [PF_graphical](#) | [Maps_&_aerials](#)

PF tabular

PDS-based point precipitation frequency estimates with 90% confidence intervals (in inches)¹										
Duration	Average recurrence interval (years)									
	1	2	5	10	25	50	100	200	500	1000
5-min	0.102 (0.085-0.124)	0.134 (0.112-0.163)	0.177 (0.147-0.215)	0.212 (0.175-0.260)	0.260 (0.207-0.331)	0.298 (0.232-0.387)	0.337 (0.256-0.449)	0.378 (0.278-0.518)	0.435 (0.307-0.622)	0.480 (0.327-0.711)
10-min	0.147 (0.122-0.177)	0.193 (0.160-0.234)	0.254 (0.211-0.309)	0.304 (0.250-0.373)	0.373 (0.297-0.474)	0.427 (0.332-0.555)	0.483 (0.366-0.643)	0.542 (0.399-0.742)	0.623 (0.440-0.891)	0.688 (0.468-1.02)
15-min	0.177 (0.148-0.215)	0.233 (0.194-0.283)	0.307 (0.255-0.373)	0.368 (0.303-0.451)	0.451 (0.359-0.573)	0.517 (0.402-0.671)	0.584 (0.443-0.778)	0.655 (0.483-0.898)	0.753 (0.532-1.08)	0.831 (0.566-1.23)
30-min	0.267 (0.222-0.323)	0.351 (0.292-0.425)	0.462 (0.384-0.562)	0.553 (0.456-0.679)	0.679 (0.540-0.863)	0.778 (0.605-1.01)	0.879 (0.667-1.17)	0.986 (0.727-1.35)	1.13 (0.800-1.62)	1.25 (0.852-1.86)
60-min	0.393 (0.327-0.476)	0.516 (0.430-0.626)	0.680 (0.564-0.827)	0.814 (0.670-0.999)	1.00 (0.795-1.27)	1.15 (0.891-1.49)	1.29 (0.982-1.72)	1.45 (1.07-1.99)	1.67 (1.18-2.39)	1.84 (1.25-2.73)
2-hr	0.584 (0.487-0.707)	0.759 (0.632-0.920)	0.986 (0.818-1.20)	1.17 (0.963-1.43)	1.42 (1.13-1.80)	1.61 (1.25-2.09)	1.80 (1.37-2.40)	2.00 (1.48-2.74)	2.27 (1.60-3.25)	2.49 (1.69-3.69)
3-hr	0.738 (0.616-0.894)	0.956 (0.796-1.16)	1.24 (1.03-1.50)	1.46 (1.20-1.79)	1.76 (1.40-2.24)	1.99 (1.55-2.58)	2.22 (1.68-2.96)	2.46 (1.81-3.37)	2.77 (1.96-3.97)	3.02 (2.06-4.47)
6-hr	1.05 (0.872-1.27)	1.35 (1.13-1.64)	1.74 (1.45-2.12)	2.05 (1.69-2.52)	2.46 (1.96-3.12)	2.76 (2.15-3.59)	3.07 (2.33-4.08)	3.37 (2.48-4.62)	3.78 (2.67-5.40)	4.08 (2.78-6.05)
12-hr	1.37 (1.15-1.67)	1.79 (1.49-2.17)	2.32 (1.92-2.82)	2.73 (2.25-3.35)	3.26 (2.60-4.14)	3.66 (2.85-4.75)	4.04 (3.07-5.38)	4.43 (3.26-6.07)	4.92 (3.48-7.05)	5.30 (3.61-7.85)
24-hr	1.84 (1.63-2.12)	2.43 (2.15-2.81)	3.18 (2.80-3.68)	3.76 (3.29-4.38)	4.51 (3.82-5.43)	5.06 (4.19-6.22)	5.59 (4.53-7.04)	6.12 (4.82-7.92)	6.80 (5.15-9.18)	7.31 (5.35-10.2)
2-day	2.23 (1.97-2.57)	3.01 (2.66-3.47)	4.00 (3.53-4.63)	4.79 (4.19-5.58)	5.81 (4.92-7.01)	6.58 (5.46-8.09)	7.33 (5.94-9.24)	8.09 (6.37-10.5)	9.07 (6.87-12.2)	9.81 (7.18-13.7)
3-day	2.42 (2.14-2.79)	3.33 (2.94-3.84)	4.49 (3.96-5.19)	5.41 (4.74-6.31)	6.64 (5.63-8.01)	7.57 (6.28-9.31)	8.50 (6.88-10.7)	9.43 (7.43-12.2)	10.7 (8.08-14.4)	11.6 (8.50-16.2)
4-day	2.63 (2.33-3.03)	3.65 (3.22-4.21)	4.96 (4.38-5.74)	6.02 (5.27-7.03)	7.44 (6.30-8.97)	8.52 (7.07-10.5)	9.60 (7.78-12.1)	10.7 (8.44-13.9)	12.2 (9.22-16.4)	13.3 (9.74-18.6)
7-day	3.04 (2.69-3.50)	4.27 (3.77-4.93)	5.88 (5.18-6.80)	7.19 (6.29-8.39)	8.97 (7.60-10.8)	10.3 (8.58-12.7)	11.7 (9.51-14.8)	13.2 (10.4-17.1)	15.1 (11.4-20.4)	16.6 (12.2-23.2)
10-day	3.28 (2.91-3.79)	4.64 (4.10-5.36)	6.44 (5.68-7.45)	7.92 (6.93-9.24)	9.94 (8.42-12.0)	11.5 (9.56-14.2)	13.1 (10.6-16.5)	14.8 (11.7-19.2)	17.1 (12.9-23.1)	18.9 (13.8-26.3)
20-day	3.87 (3.42-4.46)	5.54 (4.90-6.39)	7.80 (6.87-9.02)	9.69 (8.47-11.3)	12.3 (10.4-14.9)	14.4 (12.0-17.8)	16.6 (13.5-20.9)	18.9 (14.9-24.5)	22.1 (16.8-29.9)	24.7 (18.1-34.5)
30-day	4.56 (4.04-5.26)	6.55 (5.79-7.56)	9.26 (8.16-10.7)	11.6 (10.1-13.5)	14.8 (12.5-17.9)	17.4 (14.5-21.4)	20.2 (16.3-25.4)	23.1 (18.2-29.9)	27.2 (20.6-36.7)	30.6 (22.4-42.7)
45-day	5.40 (4.78-6.23)	7.70 (6.81-8.89)	10.9 (9.61-12.6)	13.6 (11.9-15.9)	17.5 (14.9-21.1)	20.7 (17.2-25.5)	24.1 (19.5-30.4)	27.7 (21.9-35.9)	32.9 (24.9-44.4)	37.2 (27.2-51.9)
60-day	6.32 (5.60-7.29)	8.92 (7.89-10.3)	12.6 (11.1-14.5)	15.7 (13.7-18.3)	20.2 (17.1-24.4)	23.9 (19.8-29.4)	27.9 (22.6-35.1)	32.2 (25.4-41.7)	38.3 (29.0-51.7)	43.4 (31.8-60.6)

¹ Precipitation frequency (PF) estimates in this table are based on frequency analysis of partial duration series (PDS). Numbers in parenthesis are PF estimates at lower and upper bounds of the 90% confidence interval. The probability that precipitation frequency estimates (for a given duration and average recurrence interval) will be greater than the upper bound (or less than the lower bound) is 5%. Estimates at upper bounds are not checked against probable maximum precipitation (PMP) estimates and may be higher than currently valid PMP values. Please refer to NOAA Atlas 14 document for more information.

[Back to Top](#)

PF graphical

PDS-based depth-duration-frequency (DDF) curves
 Latitude: 34.0530°, Longitude: -117.4927°

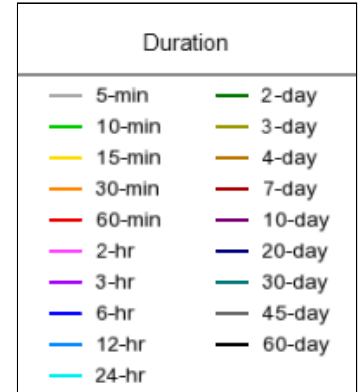
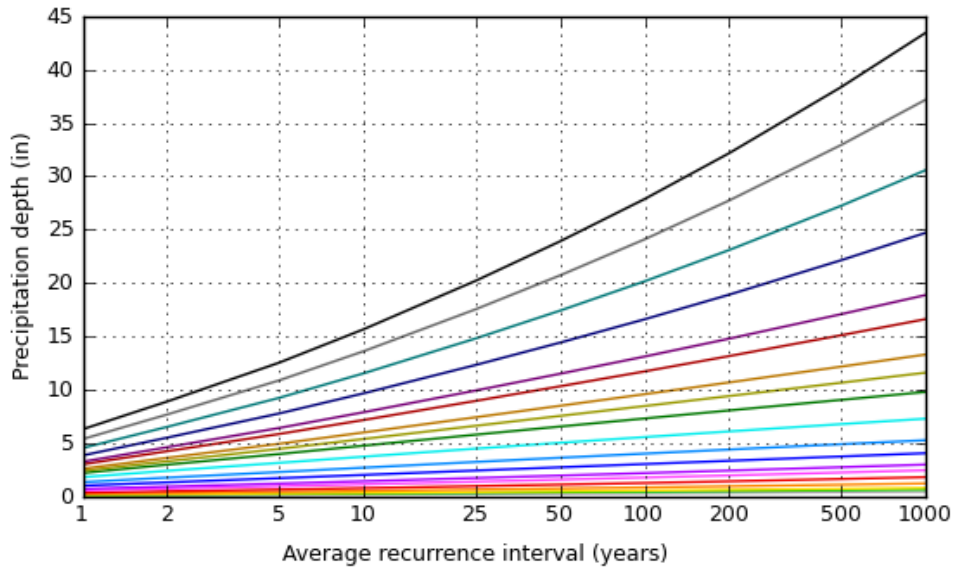
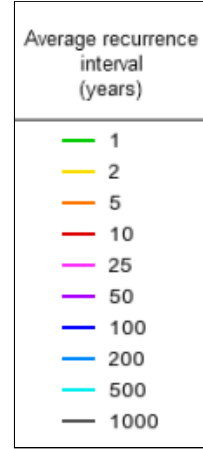
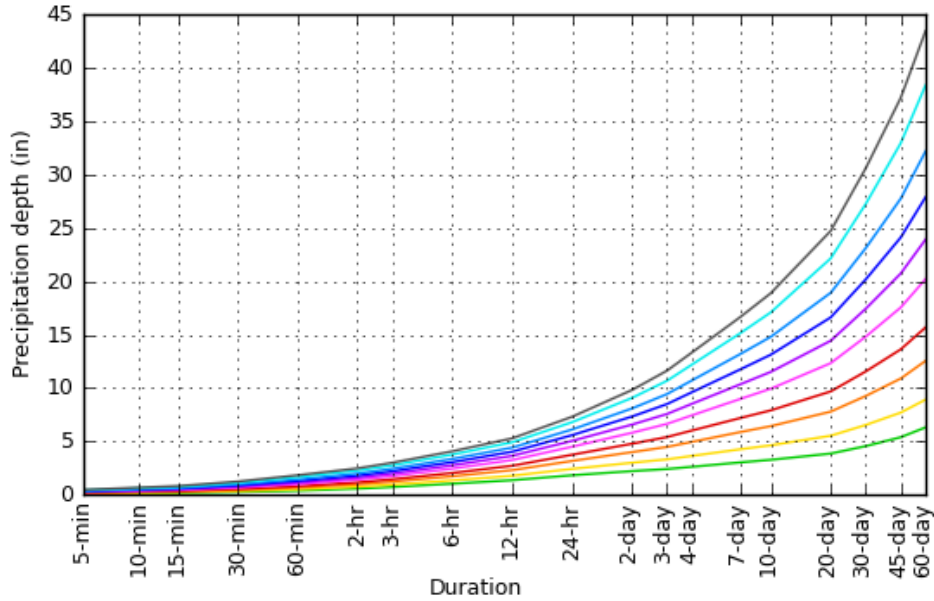

[Back to Top](#)

Maps & aerials

Small scale terrain



Large scale terrain



Large scale map

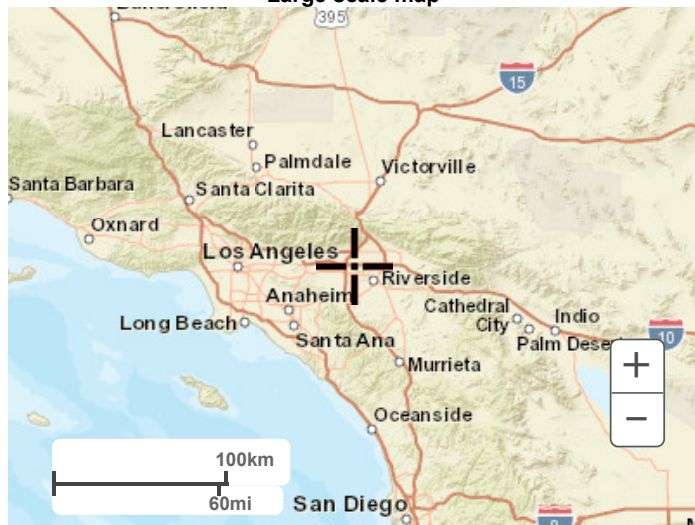

Large scale aerial



[Back to Top](#)

[US Department of Commerce](#)
[National Oceanic and Atmospheric Administration](#)
[National Weather Service](#)
[National Water Center](#)
1325 East West Highway
Silver Spring, MD 20910
Questions?: HDSC.Questions@noaa.gov

[Disclaimer](#)