



Thienes Engineering, Inc.
CIVIL ENGINEERING • LAND SURVEYING

Storm Water Quality Management Plan (SWQMP)

For:

**Santa Ana Avenue Industrial Development
(Building 3)
NEC of Santa Ana Ave and Oleander Ave
Fontana, CA 92337**

APNs: 0255-021-17, -18, -22, -23, -24

Prepared for:

Acacia Real Estate Group
260 Newport Center Drive, Suite 100
Newport Beach, CA 92660
Phone: (949) 640-9995
Contact: David Pittman

Prepared by:

Thienes Engineering, Inc.
14349 Firestone Boulevard
La Mirada, CA 90638
Phone: (714) 521-4811
Contact: Mira Bogdanova (mira@thieneseng.com)
Job No. 3615

Preliminary Approval Date: _____

Construction Approval Date: _____

Final Approval Date: _____

Preliminary Submittal: June 16, 2022

Construction Submittal: _____

Final Submittal: _____

WQMPXX-XXXXXX

Project Owner's Certification

This Water Quality Management Plan (WQMP) has been prepared for **Acacia Real Estate Group** by **Thienes Engineering, Inc.** The WQMP is intended to comply with the requirements of the **City of Fontana** and the NPDES Areawide Stormwater Program requiring the preparation of a WQMP.

The undersigned, while it owns the subject property, is responsible for the implementation of the provisions of this plan and will ensure that this plan is amended as appropriate to reflect up-to-date conditions on the site consistent with the San Bernardino County's Municipal Storm Water Management Program and the intent of the NPDES Permit for San Bernardino County and the incorporated cities of San Bernardino County within the Santa Ana Region. Once the undersigned transfers its interest in the property, its successors in interest and the city/county shall be notified of the transfer. The new owner will be informed of its responsibility under this WQMP. A copy of the approved WQMP shall be available on the subject site in perpetuity.



"I certify under a penalty of law that the provisions (implementation, operation, maintenance, and fund) of the WQMP have been accepted and that the plan will be transferred to future successors."

Project Data			
Permit/Application Number(s):	WQMPXX-XXXXXX	Grading Permit Number(s):	TBD
Tract/Parcel Map Number(s):	TPM XXXXX	Building Permit Number(s):	TBD
CUP, SUP, and/or APN (Specify Lot Numbers if Portions of Tract):		APN: 0255-021-17, -18, -22, -23, -24	
Owner's Signature			
Owner Name: Acacia Real Estate Group			
Name/Title	David Pittman / Managing Partner		
Company	Acacia Real Estate Group		
Address	260 Newport Center Drive, Suite 100, Newport Beach, CA 92660		
Email	david.pittman@acaciareg.com		
Telephone #	(949) 640-9995		
Signature			Date

Preparer's Certification

Project Data			
Permit/Application Number(s):	WQMPXX-XXXXXX	Grading Permit Number(s):	TBD
Tract/Parcel Map Number(s):	TPM XXXXX	Building Permit Number(s):	TBD
CUP, SUP, and/or APN (Specify Lot Numbers if Portions of Tract):		APN: 0255-021-17, -18, -22, -23, -24	

“The selection, sizing and design of stormwater treatment and other stormwater quality and quantity control measures in this plan were prepared under my oversight and meet the requirements of Regional Water Quality Control Board Order No. R8-2010-0036.”

Engineer: Reinhard Stenzel		<p>PE Stamp Below</p> 
Title	Director of Engineering	
Company	Thienes Engineering, Inc.	
Address	14349 Firestone Boulevard, La Mirada, CA 90638	
Email	reinhard@thieneseng.com	
Telephone #	(714) 521-4811	
Signature		

Contents

Section 1	Discretionary Permit(s)	1-1
Section 2	Project Description.....	2-1
2.1	Project Information.....	2-1
2.2	Property Ownership/Management	2-2
2.3	Potential Stormwater Pollutants	2-2
2.4	Water Quality Credits	2-3
Section 3	Site and Watershed Description	3-1
Section 4	Best Management Practices (BMP)	4-1
4.1	Source Control BMP	4-1
4.1.1	Pollution Prevention	4-1
4.1.2	Preventive LID Site Design Practices	4-6
4.2	Project Performance Criteria	4-7
4.3	Project Conformance Analysis	4-13
4.3.1	Site Design Hydrologic Source Control BMP	4-15
4.3.2	Infiltration BMPs	4-17
4.3.3	Harvest and Use BMP.....	4-19
4.3.4	Biotreatment BMP	4-20
4.3.5	Conformance Summary	4-24
4.3.6	Hydromodification Control BMP.....	4-25
4.4	Alternative Compliance Plan (if applicable).....	4-26
Section 5	Inspection and Maintenance Responsibility for Post Construction BMP	5-1
Section 6	WQMP Attachments	6-1
6.1	Site Plan and Drainage Plan	6-1
6.2	Electronic Data Submittal	6-1
6.3	Post Construction.....	6-1
6.4	Other Supporting Documentation	6-1
6.5	WQMP Certification	6-2

Forms

Form 1-1 Project Information	1-1
Form 2.1-1 Description of Proposed Project	2-1
Form 2.2-1 Property Ownership/Management.....	2-2
Form 2.3-1 Pollutants of Concern	2-2
Form 2.4-1 Water Quality Credits	2-3
Form 3-1 Site Location and Hydrologic Features.....	3-1
Form 3-2 Existing Hydrologic Characteristics for Drainage Area (DA).....	3-2
Form 3-3 Watershed Description.....	3-3
Form 4.1-1 Non-Structural Source Control BMPs.....	4-2
Form 4.1-2 Structural Source Control BMPs.....	4-4
Form 4.1-3 Preventive LID Site Design Practices Checklist.....	4-6
Form 4.2-1 LID BMP Performance Criteria for Design Capture Volume (DA 1 DMA A)	4-7
Form 4.2-2 Summary of HCOC Assessment.....	4-9
Form 4.2-3 HCOC Assessment for Runoff Volume.....	4-10
Form 4.2-4 HCOC Assessment for Time of Concentration.....	4-11
Form 4.2-5 HCOC Assessment for Peak Runoff	4-12
Form 4.3-1 Infiltration BMP Feasibility	4-14
Form 4.3-2 Site Design Hydrologic Source Control BMPs.....	4-16
Form 4.3-3 Infiltration LID BMP (including underground BMPs) - DA 1 DMA A.....	4-18
Form 4.3-4 Harvest and Use BMPs	4-19
Form 4.3-5 Selection and Evaluation of Biotreatment BMP.....	4-20
Form 4.3-6 Volume Based Biotreatment – Bioretention and Planter Boxes with Underdrains.....	4-21
Form 4.3-7 Volume Based Biotreatment – Constructed Wetlands and Extended Detention.....	4-22
Form 4.3-8 Flow Based Biotreatment.....	4-23
Form 4.3-9 Conformance Summary and Alternative Compliance Volume Estimate (DA 1 DMA A)	4-24
Form 4.3-10 Hydromodification Control BMPs	4-25
Form 5-1 BMP Inspection and Maintenance	5-1

Attachments

Attachment A: Existing Condition Site Photos

Attachment B: BMP Design Calculations & Supporting Documentation

Attachment C: WQMP Site Map

Attachment D: WQMP and Stormwater BMP Transfer, Access and Maintenance Agreement

Attachment E: Educational Materials

Attachment F: Infiltration Report

Attachment G: Hydrologic Conditions of Concern (HCOC)

Section 1 Discretionary Permit(s)

Form 1-1 Project Information					
Project Name		Santa Ana Avenue Industrial Development (Building 3)			
Project Owner Contact Name:		David Pittman			
Mailing Address:	260 Newport Center Drive, Ste 100 Newport Beach, CA 92660	E-mail Address:	david.pittman@acaciareg.com	Telephone:	(949) 640-9995
Permit/Application Number(s):		WQMPXX-XXXXXX		Tract/Parcel Map Number(s):	
Additional Information/ Comments:		n/a			
Description of Project:		<p>The project site encompasses approximately 8.76 acres. Proposed improvements to the site include one commercial type building. A loading dock will be located on the easterly side of the building, and vehicle parking will be located the easterly and westerly sides of the building. The remainder of the site will be reserved for landscape. An underground retention system and a hydrodynamic separator will be located in the easterly truck yard.</p> <p>In existing conditions, the site consists of residential and vacant land that sheet flows southerly to Santa Ana Avenue. In proposed conditions, run off from the westerly side of the proposed building and westerly vehicle parking lot is collected by a catch basin in the westerly vehicle parking lot. Run off is routed southerly, then easterly to discharge to Santa Ana Avenue. Runoff from the easterly side of the building and the truck yard will be collected by catch basins in the truck yard and routed southerly. These flows will confluence with runoff from the southeasterly vehicle parking lot and will continue southerly to discharge to Santa Ana Avenue. Prior to discharging, stormwater will be diverted to the proposed underground retention system for infiltration and a hydrodynamic separator for pretreatment.</p> <p>Approximately 0.57 acres of landscape and driveway areas will drain offsite without being routed to the onsite BMPs for treatment. Of this 0.57 acres, 0.47 acres is landscape areas, considered to be self-treating. The remaining 0.10 acres consists of the driveway areas, which will be accounted for in the underground retention system even though it does not physically drain there.</p> <p>As shown in Worksheet H of Attachment B, the minimum design infiltration rate is 3.2 in/hr which can drawdown up to 76.80 inches of stormwater within 24 hours. The effective ponding depth is 61.80 inches for the onsite underground retention system. With this justification, the project's design capture volume is determined using the 1.582 regression constant for 24 hours.</p>			
Provide summary of Conceptual WQMP conditions (if previously submitted and approved). Attach complete copy.		n/a			

Section 2 Project Description

2.1 Project Information

This section of the WQMP should provide the information listed below. The information provided for Conceptual/Preliminary WQMP should give sufficient detail to identify the major proposed site design and LID BMPs and other anticipated water quality features that impact site planning. Final Project WQMP must specifically identify all BMP incorporated into the final site design and provide other detailed information as described herein.

The purpose of this information is to help determine the applicable development category, pollutants of concern, watershed description, and long term maintenance responsibilities for the project, and any applicable water quality credits. This information will be used in conjunction with the information in Section 3, Site Description, to establish the performance criteria and to select the LID BMP or other BMP for the project or other alternative programs that the project will participate in, which are described in Section 4.

Form 2.1-1 Description of Proposed Project					
¹ Development Category (Select all that apply):					
<input checked="" type="checkbox"/> Significant re-development involving the addition or replacement of 5,000 ft ² or more of impervious surface on an already developed site	<input type="checkbox"/> New development involving the creation of 10,000 ft ² or more of impervious surface collectively over entire site	<input type="checkbox"/> Automotive repair shops with standard industrial classification (SIC) codes 5013, 5014, 5541, 7532-7534, 7536-7539	<input type="checkbox"/> Restaurants (with SIC code 5812) where the land area of development is 5,000 ft ² or more		
<input type="checkbox"/> Hillside developments of 5,000 ft ² or more which are located on areas with known erosive soil conditions or where the natural slope is 25 percent or more	<input type="checkbox"/> Developments of 2,500 ft ² of impervious surface or more adjacent to (within 200 ft) or discharging directly into environmentally sensitive areas or waterbodies listed on the CWA Section 303(d) list of impaired waters.	<input checked="" type="checkbox"/> Parking lots of 5,000 ft ² or more exposed to storm water	<input type="checkbox"/> Retail gasoline outlets that are either 5,000 ft ² or more, or have a projected average daily traffic of 100 or more vehicles per day		
<input type="checkbox"/> Non-Priority / Non-Category Project <i>May require source control LID BMPs and other LIP requirements. Please consult with local jurisdiction on specific requirements.</i>					
² Project Area (ft²):	381,586 (8.76 acres) *	³ Number of Dwelling Units:	n/a	⁴ SIC Code:	4225
⁵ Is Project going to be phased? <input type="checkbox"/> Yes <input checked="" type="checkbox"/> No <i>If yes, ensure that the WQMP evaluates each phase as a distinct DA, requiring LID BMPs to address runoff at time of completion.</i>					
⁶ Does Project include roads? <input type="checkbox"/> Yes <input checked="" type="checkbox"/> No <i>If yes, ensure that applicable requirements for road projects are addressed (see Appendix A of TGD for WQMP)</i>					

*This value includes 0.57 acres of landscape and driveway areas which will drain offsite. The landscape areas (0.47 acres) are considered to be self-treating. The driveway areas (0.10 acres) will be accounted for in the underground retention system even though it does not physically drain there.

2.2 Property Ownership/Management

Describe the ownership/management of all portions of the project and site. State whether any infrastructure will transfer to public agencies (City, County, Caltrans, etc.) after project completion. State if a homeowners or property owners association will be formed and be responsible for the long-term maintenance of project stormwater facilities. Describe any lot-level stormwater features that will be the responsibility of individual property owners.

Form 2.2-1 Property Ownership/Management	
Describe property ownership/management responsible for long-term maintenance of WQMP stormwater facilities:	
Acacia Real Estate Group 260 Newport Center Drive, Suite 100 Newport Beach, CA 92660 Phone: (949) 640-9995 Contact: David Pittman	
A property owner's association (POA) will not be formed for long-term maintenance of onsite stormwater facilities. The owner will maintain onsite stormwater facilities as shown in Attachment D.	

2.3 Potential Stormwater Pollutants

Determine and describe expected stormwater pollutants of concern based on land uses and site activities (refer to Table 3-3 in the TGD for WQMP).

Form 2.3-1 Pollutants of Concern				
Pollutant	Circle One: E=Expected, N=Not Expected		Listed for Receiving Water	Additional Information and Comments
Pathogens (Bacterial / Virus)	E	N	X	Pathogens are routinely detected in pavement runoff.
Nutrients - Phosphorous	E	N		Expected pollutant if landscaping exists on-site.
Nutrients - Nitrogen	E	N	X	Expected pollutant if landscaping exists on-site.
Noxious Aquatic Plants	E	N		Expected pollutant if landscaping exists on-site.
Sediment	E	N	X	Expected pollutant if landscaping exists on-site.
Metals	E	N		
Oil and Grease	E	N		
Trash/Debris	E	N		
Pesticides / Herbicides	E	N		
Organic Compounds	E	N		Expected pollutant if landscaping exists on-site. Including petroleum hydrocarbons.
Other:				

The expected POCs for the project site are ***Pathogens, Nitrogen, and Metals.***

2.4 Water Quality Credits

A water quality credit program is applicable for certain types of development projects if it is not feasible to meet the requirements for on-site LID. Proponents for eligible projects, as described below, can apply for water quality credits that would reduce project obligations for selecting and sizing other treatment BMP or participating in other alternative compliance programs. Refer to Section 6.2 in the TGD for WQMP to determine if water quality credits are applicable for the project.

Form 2.4-1 Water Quality Credits			
¹ Project Types that Qualify for Water Quality Credits: <i>Select all that apply</i>			
<input type="checkbox"/> Redevelopment projects that reduce the overall impervious footprint of the project site. [Credit = % impervious reduced]	Higher density development projects <input type="checkbox"/> Vertical density [20%] <input type="checkbox"/> 7 units/ acre [5%]	<input type="checkbox"/> Mixed use development, (combination of residential, commercial, industrial, office, institutional, or other land uses which incorporate design principles that demonstrate environmental benefits not realized through single use projects) [20%]	<input type="checkbox"/> Brownfield redevelopment (redevelop real property complicated by presence or potential of hazardous contaminants) [25%]
<input type="checkbox"/> Redevelopment projects in established historic district, historic preservation area, or similar significant core city center areas [10%]	<input type="checkbox"/> Transit-oriented developments (mixed use residential or commercial area designed to maximize access to public transportation) [20%]	<input type="checkbox"/> In-fill projects (conversion of empty lots & other underused spaces < 5 acres, substantially surrounded by urban land uses, into more beneficially used spaces, such as residential or commercial areas) [10%]	<input type="checkbox"/> Live-Work developments (variety of developments designed to support residential and vocational needs) [20%]
² Total Credit %: n/a <i>(Total all credit percentages up to a maximum allowable credit of 50 percent)</i>			
Description of Water Quality Credit Eligibility (if applicable)	n/a		

The proposed project will **not** utilize any water quality credits.

Section 3 Site and Watershed Description

Describe the project site conditions that will facilitate the selection of BMP through an analysis of the physical conditions and limitations of the site and its receiving waters. Identify distinct drainage areas (DA) that collect flow from a portion of the site and describe how runoff from each DA (and sub-watershed DMAs) is conveyed to the site outlet(s). Refer to Section 3.2 in the TGD for WQMP. Complete form 3.2 for each DA on the project site.

Form 3-1 Site Location and Hydrologic Features			
Site coordinates <i>Take GPS measurement at approximate center of site</i>	Latitude: 34.056769	Longitude: -117.44761	Thomas Bros Map page: Page 644
¹ San Bernardino County climatic region: <input checked="" type="checkbox"/> Valley <input type="checkbox"/> Mountain <input type="checkbox"/> Desert			
² Does the site have more than one drainage area (DA): <input type="checkbox"/> Yes <input checked="" type="checkbox"/> No			
<i>If no, proceed to Form 3-2. If yes, then use this form to show a conceptual schematic describing DMAs and hydrologic feature connecting DMAs to the site outlet(s). An example is provided below that can be modified for proposed project or a drawing clearly showing DMA and flow routing may be attached.</i>			
Conveyance	Briefly describe on-site drainage features to convey runoff that is not retained within a DMA		

Form 3-2 Existing Hydrologic Characteristics for Drainage Area (DA)

For each drainage area's sub-watershed DMA, provide the following characteristics	Hyd Nodes 300-301	n/a	n/a	n/a	n/a
¹ DMA drainage area (ft ²)	381,150 (8.73 ac)	n/a	n/a	n/a	n/a
² Existing site impervious area (ft ²)	24,449	n/a	n/a	n/a	n/a
³ Antecedent moisture condition <i>For desert areas, use</i> http://www.sbcounty.gov/dpw/floodcontrol/pdf/20100412_map.pdf	AMC II	n/a	n/a	n/a	n/a
⁴ Hydrologic soil group <i>Refer to Watershed Mapping Tool –</i> http://sbcounty.permitrack.com/WAP	HSG A	n/a	n/a	n/a	n/a
⁵ Longest flowpath length (ft)	643	n/a	n/a	n/a	n/a
⁶ Longest flowpath slope (ft/ft)	0.013	n/a	n/a	n/a	n/a
⁷ Current land cover type(s) <i>Select from Fig C-3 of Hydrology Manual</i>	Residential/Open Brush	n/a	n/a	n/a	n/a
⁸ Pre-developed pervious area condition: <i>Based on the extent of wet season vegetated cover >75%; Fair 50-75%; Poor <50%</i> <i>See Attachment A for photos of site to support rating</i>	Fair	n/a	n/a	n/a	n/a

Form 3-3 Watershed Description	
<p>Receiving Waters Refer to Watershed Mapping Tool - http://sbcounty.permitrack.com/WAP See "Drainage Facilities" link at this website</p>	<p>Storm drain westerly along Santa Ana Avenue Storm drain southerly along Oleander Avenue Decléz Channel San Sevaine Channel Santa Ana River, Reach 3 Prado Dam Santa Ana River, Reach 2 Santa Ana River, Reach 1 Pacific Ocean</p>
<p>Applicable TMDLs Refer to Local Implementation Plan</p>	<p>Storm drain westerly along Santa Ana Avenue: None Storm drain southerly along Oleander Avenue: None Decléz Channel: None San Sevaine Channel: None Santa Ana River, Reach 3: Pathogens, Nitrate Prado Dam: Pathogens, Indicator Bacteria Santa Ana River, Reach 2: Indicator Bacteria Santa Ana River, Reach 1: None Pacific Ocean: None</p>
<p>303(d) listed impairments Refer to Local Implementation Plan and Watershed Mapping Tool - http://sbcounty.permitrack.com/WAP and State Water Resources Control Board website - http://www.waterboards.ca.gov/santaana/water_issues/programs/tmdl/index.shtml</p>	<p>Storm drain westerly along Santa Ana Avenue: None Storm drain southerly along Oleander Avenue: None Decléz Channel: None San Sevaine Channel: None Santa Ana River, Reach 3: Copper, Indicator Bacteria, Lead Prado Dam: pH Santa Ana River, Reach 2: None Santa Ana River, Reach 1: None Pacific Ocean: None</p>
<p>Environmentally Sensitive Areas (ESA) Refer to Watershed Mapping Tool - http://sbcounty.permitrack.com/WAP</p>	<p>N/A</p>
<p>Unlined Downstream Water Bodies Refer to Watershed Mapping Tool - http://sbcounty.permitrack.com/WAP</p>	<p>Santa Ana River</p>
<p>Hydrologic Conditions of Concern</p>	<p><input type="checkbox"/> Yes Complete Hydrologic Conditions of Concern (HCOC) Assessment. Include Forms 4.2-2 through Form 4.2-5 and Hydromodification BMP Form 4.3-10 in submittal <input checked="" type="checkbox"/> No (see Appendix G for applicability map)</p>
<p>Watershed-based BMP included in a RWQCB approved WAP</p>	<p><input type="checkbox"/> Yes Attach verification of regional BMP evaluation criteria in WAP</p> <ul style="list-style-type: none"> • More Effective than On-site LID • Remaining Capacity for Project DCV • Upstream of any Water of the US • Operational at Project Completion • Long-Term Maintenance Plan <p><input checked="" type="checkbox"/> No</p>

Section 4 Best Management Practices (BMP)

4.1 Source Control BMP

4.1.1 Pollution Prevention

Non-structural and structural source control BMP are required to be incorporated into all new development and significant redevelopment projects. Form 4.1-1 and 4.1-2 are used to describe specific source control BMPs used in the WQMP or to explain why a certain BMP is not applicable. Table 7-3 of the TGD for WQMP provides a list of applicable source control BMP for projects with specific types of potential pollutant sources or activities. The source control BMP in this table must be implemented for projects with these specific types of potential pollutant sources or activities.

The preparers of this WQMP have reviewed the source control BMP requirements for new development and significant redevelopment projects. The preparers have also reviewed the specific BMP required for project as specified in Forms 4.1-1 and 4.1-2. All applicable non-structural and structural source control BMP shall be implemented in the project.

Form 4.1-1 Non-Structural Source Control BMPs				
Identifier	Name	Check One		Describe BMP Implementation OR, if not applicable, state reason
		Included	Not Applicable	
N1	Education of Property Owners, Tenants and Occupants on Stormwater BMPs	X		Property owner will familiarize him/herself with the educational materials in Attachment "E" and the contents of the WQMP.
N2	Activity Restrictions	X		No outdoor work areas, processing, storage or wash area.
N3	Landscape Management BMPs	X		Irrigation must be consistent with the local agency's Water Conservation Ordinance. Fertilizer and pesticide usage will be consistent with local agency's Management Guidelines for Use of Fertilizers and Pesticides.
N4	BMP Maintenance	X		BMP maintenance, implementation schedules, and responsible parties are included with each specific BMP narrative.
N5	Title 22 CCR Compliance (How development will comply)		X	No hazardous wastes onsite.
N6	Local Water Quality Ordinances		X	Local agency does not have additional water quality ordinances.
N7	Spill Contingency Plan	X		Owner/tenant will have a spill contingency plan based on individual site needs.
N8	Underground Storage Tank Compliance		X	No USTs onsite.
N9	Hazardous Materials Disclosure Compliance		X	No hazardous materials onsite.
N10	Uniform Fire Code Implementation	X		Owner will comply with Article 80 of the Uniform Fire Code enforced by the fire protection agency.
N11	Litter/Debris Control Program	X		Contract with their landscape maintenance firm to provide this service during regularly schedule maintenance.
N12	Employee Training	X		The owner will ensure that tenants are also familiar with onsite BMPs and necessary maintenance required of the tenants. Owner will check with City and County at least once a year to obtain new or updated educational materials and provide these materials to tenants. Employees shall be trained to clean up spills and participate in ongoing maintenance. The WQMP requires annual employee training and new hires within 2 months.
N13	Housekeeping of Loading Docks	X		Keep all fluids indoors. Clean up spills immediately and keep spills from entering storm drain system. No direct discharges into the storm drain system. Area shall be inspected weekly for proper containment and practices with spills cleaned up immediately and disposed of properly.
N14	Catch Basin Inspection Program	X		Monthly inspection by property owner's designee. Vacuum basins when sediment or trash becomes 2-inches deep and dispose of properly.
N15	Vacuum Sweeping of Private Streets and Parking Lots	X		All landscape maintenance contractors will be required to sweep up all landscape cuttings, mowings and fertilizer materials off paved areas weekly and dispose of properly. Parking areas and drive ways will be swept monthly by sweeping contractor.

Form 4.1-1 Non-Structural Source Control BMPs				
Identifier	Name	Check One		Describe BMP Implementation OR, if not applicable, state reason
		Included	Not Applicable	
N16	Other Non-structural Measures for Public Agency Projects	<input type="checkbox"/>	<input checked="" type="checkbox"/>	Not a public agency project.
N17	Comply with all other applicable NDPES permits	<input checked="" type="checkbox"/>	<input type="checkbox"/>	Will comply with Construction General Permit and Industrial General Permit (may apply for No Exposure Certification/NEC).

Form 4.1-2 Structural Source Control BMPs

Identifier	Name	Check One		Describe BMP Implementation OR, if not applicable, state reason
		Included	Not Applicable	
S1	Provide storm drain system stenciling and signage (CASQA New Development BMP Handbook SD-13)	X		“No Dumping – Drains to River” stencils will be applied. Legibility of stencil will be maintained on a yearly basis.
S2	Design and construct outdoor material storage areas to reduce pollution introduction (CASQA New Development BMP Handbook SD-34)		X	No outdoor material storage areas onsite.
S3	Design and construct trash and waste storage areas to reduce pollution introduction (CASQA New Development BMP Handbook SD-32)	X		Paved with an impervious surface, designed not to allow run-on from adjoining areas, designed to divert drainage from adjoining roofs and pavements diverted around the area, screened or walled to prevent off-site transport of trash. Provide solid roof or awning to prevent direct contact with rainfall.
S4	Use efficient irrigation systems & landscape design, water conservation, smart controllers, and source control (Statewide Model Landscape Ordinance; CASQA New Development BMP Handbook SD-12)	X		Irrigation systems shall include shutoff valves triggered by a pressure drop to control water loss in the event of broken sprinkler heads or lines. Timers will be used to avoid over watering and watering cycles and duration shall be adjusted seasonally by the landscape maintenance contractor. The landscaping areas will be grouped with plants that have similar water requirements. Native or drought tolerant species shall also be used where appropriate to reduce excess irrigation runoff and promote surface filtration.
S5	Finish grade of landscaped areas at a minimum of 1-2 inches below top of curb, sidewalk, or pavement	X		Landscaped areas will be depressed in order to increase retention of stormwater/irrigation water and promote infiltration.
S6	Protect slopes and channels and provide energy dissipation (CASQA New Development BMP Handbook SD-10)		X	Not applicable; no slopes or channels to protect.
S7	Covered dock areas (CASQA New Development BMP Handbook SD-31)		X	Finished goods being loaded and unloaded at the docks do not have the potential to contribute to stormwater pollution. No direct connections will be made to a MS4.
S8	Covered maintenance bays with spill containment plans (CASQA New Development BMP Handbook SD-31)		X	No maintenance bays onsite.
S9	Vehicle wash areas with spill containment plans (CASQA New Development BMP Handbook SD-33)		X	No vehicle washing onsite.
S10	Covered outdoor processing areas (CASQA New Development BMP Handbook SD-36)		X	No outdoor processing onsite.

Form 4.1-2 Structural Source Control BMPs

Identifier	Name	Check One		Describe BMP Implementation OR, if not applicable, state reason
		Included	Not Applicable	
S11	Equipment wash areas with spill containment plans (CASQA New Development BMP Handbook SD-33)		X	No equipment washing onsite.
S12	Fueling areas (CASQA New Development BMP Handbook SD-30)		X	No fueling onsite.
S13	Hillside landscaping (CASQA New Development BMP Handbook SD-10)		X	No hillsides onsite.
S14	Wash water control for food preparation areas		X	No food preparation onsite.
S15	Community car wash racks (CASQA New Development BMP Handbook SD-33)		X	No community cars wash racks onsite.

4.1.2 Preventive LID Site Design Practices

Site design practices associated with new LID requirements in the MS4 Permit should be considered in the earliest phases of a project. Preventative site design practices can result in smaller DCV for LID BMP and hydromodification control BMP by reducing runoff generation. Describe site design and drainage plan including:

- A narrative of site design practices utilized or rationale for not using practices
- A narrative of how site plan incorporates preventative site design practices
- Include an attached Site Plan layout which shows how preventative site design practices are included in WQMP

Refer to Section 5.2 of the TGD for WQMP for more details.

Form 4.1-3 Preventive LID Site Design Practices Checklist	
Site Design Practices <i>If yes, explain how preventative site design practice is addressed in project site plan. If no, other LID BMPs must be selected to meet targets.</i>	
Minimize impervious areas: <input type="checkbox"/> Yes <input checked="" type="checkbox"/> No	The project will utilize an underground retention system to collect runoff from impervious areas.
Maximize natural infiltration capacity: <input checked="" type="checkbox"/> Yes <input type="checkbox"/> No	The underground retention system will maximize natural infiltration.
Preserve existing drainage patterns and time of concentration: <input checked="" type="checkbox"/> Yes <input type="checkbox"/> No	Post-development drainage patterns will mimic pre-development conditions.
Disconnect impervious areas: <input checked="" type="checkbox"/> Yes <input type="checkbox"/> No	The underground retention system will disconnect impervious areas before discharging offsite.
Protect existing vegetation and sensitive areas: <input type="checkbox"/> Yes <input checked="" type="checkbox"/> No	Not applicable, there are no existing vegetation onsite (see Attachment A for recent site photos).
Re-vegetate disturbed areas: <input type="checkbox"/> Yes <input checked="" type="checkbox"/> No	Not applicable, development consists of light industrial facilities. Most of the disturbed areas will be paved; however, all disturbed areas will be collected by the underground retention system for treatment.
Minimize unnecessary compaction in stormwater retention/infiltration basin/trench areas: <input checked="" type="checkbox"/> Yes <input type="checkbox"/> No	Heavy construction vehicles will be prohibited from unnecessary soil compaction at the underground retention system locations.
Utilize vegetated drainage swales in place of underground piping or imperviously lined swales: <input type="checkbox"/> Yes <input checked="" type="checkbox"/> No	Underground piping and imperviously lined swales are located in traffic areas and could not be substituted with a vegetated swale.
Stake off areas that will be used for landscaping to minimize compaction during construction : <input checked="" type="checkbox"/> Yes <input type="checkbox"/> No	Landscaped areas will be staked to minimize unnecessary compaction during construction.

4.2 Project Performance Criteria

The purpose of this section of the Project WQMP is to establish targets for post development hydrology based on performance criteria specified in the MS4 Permit. These targets include runoff volume for water quality control (referred to as LID design capture volume), and runoff volume, time of concentration, and peak runoff for protection of any downstream waterbody segments with a HCOC. ***If the project has more than one outlet for stormwater runoff, then complete additional versions of these forms for each DA / outlet.***

Methods applied in the following forms include:

- For LID BMP Design Capture Volume (DCV), the San Bernardino County Stormwater Program requires use of the P6 method (MS4 Permit Section XI.D.6a.ii) – Form 4.2-1
- For HCOC pre- and post-development hydrologic calculation, the San Bernardino County Stormwater Program requires the use of the Rational Method (San Bernardino County Hydrology Manual Section D). Forms 4.2-2 through Form 4.2-5 calculate hydrologic variables including runoff volume, time of concentration, and peak runoff from the project site pre- and post-development using the Hydrology Manual Rational Method approach. For projects greater than 640 acres (1.0 mi²), the Rational Method and these forms should not be used. For such projects, the Unit Hydrograph Method (San Bernardino County Hydrology Manual Section E) shall be applied for hydrologic calculations for HCOC performance criteria.

Refer to Section 4 in the TGD for WQMP for detailed guidance and instructions.

Form 4.2-1 LID BMP Performance Criteria for Design Capture Volume (DA 1 DMA A)		
¹ Project area (ft²): 356,756 DA 1 DMA A (8.19 ac)	² Imperviousness after applying preventative site design practices (Imp%): 95%	³ Runoff Coefficient (R_c): 0.807 $R_c = 0.858(\text{Imp}\%)^3 - 0.78(\text{Imp}\%)^2 + 0.774(\text{Imp}\%) + 0.04$
⁴ Determine 1-hour rainfall depth for a 2-year return period P_{2yr-1hr} (in): 0.528 http://hdsc.nws.noaa.gov/hdsc/pfds/sa/sca_pfds.html		
⁵ Compute P6, Mean 6-hr Precipitation (inches): 0.782 <i>P6 = Item 4 * C₁, where C₁ is a function of site climatic region specified in Form 3-1 Item 1 (Valley = 1.4807; Mountain = 1.909; Desert = 1.2371)</i>		
⁶ Drawdown Rate <i>Use 48 hours as the default condition. Selection and use of the 24 hour drawdown time condition is subject to approval by the local jurisdiction. The necessary BMP footprint is a function of drawdown time. While shorter drawdown times reduce the performance criteria for LID BMP design capture volume, the depth of water that can be stored is also reduced.</i>		24-hrs <input checked="" type="checkbox"/> 48-hrs <input type="checkbox"/>
⁷ Compute design capture volume, DCV (ft³): 29,673 <i>DCV = 1/12 * [Item 1 * Item 3 * Item 5 * C₂], where C₂ is a function of drawdown rate (24-hr = 1.582; 48-hr = 1.963)</i> <i>Compute separate DCV for each outlet from the project site per schematic drawn in Form 3-1 Item 2</i>		
¹ Project area (ft²): 4,356 Driveway Runoff (0.10 ac)	² Imperviousness after applying preventative site design practices (Imp%): 100%	³ Runoff Coefficient (R_c): 0.892 $R_c = 0.858(\text{Imp}\%)^3 - 0.78(\text{Imp}\%)^2 + 0.774(\text{Imp}\%) + 0.04$
⁴ Determine 1-hour rainfall depth for a 2-year return period P_{2yr-1hr} (in): 0.528 http://hdsc.nws.noaa.gov/hdsc/pfds/sa/sca_pfds.html		

<p>⁵ Compute P6, Mean 6-hr Precipitation (inches): 0.782 <i>P6 = Item 4 * C₁, where C₁ is a function of site climatic region specified in Form 3-1 Item 1 (Valley = 1.4807; Mountain = 1.909; Desert = 1.2371)</i></p>	
<p>⁶ Drawdown Rate <i>Use 48 hours as the default condition. Selection and use of the 24 hour drawdown time condition is subject to approval by the local jurisdiction. The necessary BMP footprint is a function of drawdown time. While shorter drawdown times reduce the performance criteria for LID BMP design capture volume, the depth of water that can be stored is also reduced.</i></p>	<p>24-hrs <input checked="" type="checkbox"/> 48-hrs <input type="checkbox"/></p>
<p>⁷ Compute design capture volume, DCV (ft³): 400 <i>DCV = 1/12 * [Item 1 * Item 3 * Item 5 * C₂], where C₂ is a function of drawdown rate (24-hr = 1.582; 48-hr = 1.963) Compute separate DCV for each outlet from the project site per schematic drawn in Form 3-1 Item 2</i></p>	

¹This value does not include 0.47 acres of landscape that will drain offsite and is considered to be self-treating.

Form 4.2-2 Summary of HCOC Assessment

Does project have the potential to cause or contribute to an HCOC in a downstream channel: Yes No

Go to: <http://sbcounty.permitrack.com/WAP/>

If "Yes", then complete HCOC assessment of site hydrology for 2yr storm event using Forms 4.2-3 through 4.2-5 and insert results below (Forms 4.2-3 through 4.2-5 may be replaced by computer software analysis based on the San Bernardino County Hydrology Manual)

If "No," then proceed to Section 4.3 Project Conformance Analysis

Condition	Runoff Volume (ft ³)	Time of Concentration (min)	Peak Runoff (cfs)
Pre-developed	¹ n/a Form 4.2-3 Item 12	² n/a Form 4.2-4 Item 13	³ n/a Form 4.2-5 Item 10
Post-developed	⁴ n/a Form 4.2-3 Item 13	⁵ n/a Form 4.2-4 Item 14	⁶ n/a Form 4.2-5 Item 14
Difference	⁷ n/a Item 4 – Item 1	⁸ n/a Item 5 – Item 2	⁹ n/a Item 6 – Item 3
Difference (as % of pre-developed)	¹⁰ n/a Item 7 / Item 1	¹¹ n/a Item 8 / Item 2	¹² n/a Item 9 / Item 3

Form 4.2-3 HCOC Assessment for Runoff Volume

Compute weighted curve number for pre and post developed conditions	Pre-developed DA <i>Add more columns if more than 4 DMA</i>				Post-developed DA <i>Add more columns if more than 4 DMA</i>			
	DMA A	DMA B	DMA C	DMA D	DMA A	DMA B	DMA C	DMA D
¹ Land Cover type								
² Hydrologic Soil Group (HSG)								
³ DMA Area, ft ² <i>sum of areas of DMA should equal area of DA</i>								
⁴ Curve Number (CN) <i>Use Items 1 and 2 to select the appropriate CN from Appendix C-2 of the TGD for WQMP</i>								
	⁵ Pre-Developed area-weighted CN:				⁶ Post-Developed area-weighted CN:			
	⁷ Pre-developed soil storage capacity, S (in): <i>S = (1000 / Item 5) - 10</i>				⁸ Post-developed soil storage capacity, S (in): <i>S = (1000 / Item 6) - 10</i>			
	⁹ Initial abstraction, I _a (in): <i>I_a = 0.2 * Item 7</i>				¹⁰ Initial abstraction, I _a (in): <i>I_a = 0.2 * Item 8</i>			
¹¹ Precipitation for 2 yr, 24 hr storm (in): <i>Go to: http://hdsc.nws.noaa.gov/hdsc/pfds/sa/sca_pfds.html</i>								
¹² Pre-developed Volume (ft ³): <i>V_{pre} = (1 / 12) * (Item sum of Item 3) * [(Item 11 - Item 9)² / ((Item 11 - Item 9 + Item 7))</i>								
¹³ Post-developed Volume (ft ³): <i>V_{pre} = (1 / 12) * (Item sum of Item 3) * [(Item 11 - Item 10)² / ((Item 11 - Item 10 + Item 8))</i>								
¹⁴ Volume Reduction needed to meet HCOC Requirement, (ft ³): <i>V_{HCOC} = (Item 13 * 0.95) - Item 12</i>								

Form 4.2-4 HCOC Assessment for Time of Concentration

Compute time of concentration for pre and post developed conditions for each DA (For projects using the Hydrology Manual complete the form below)

Variables	Pre-developed DA <i>Add more columns if more than 4 DMA</i>				Post-developed DA <i>Add more columns if more than 4 DMA</i>			
	DMA A	DMA B	DMA C	DMA D	DMA A	DMA B	DMA C	DMA D
¹ Length of flowpath (ft) <i>Use Form 3-2 Item 5 for pre-developed condition</i>								
² Change in elevation (ft)								
³ Slope (ft/ft), $S_o = \text{Item 2} / \text{Item 1}$								
⁴ Land cover								
⁵ Initial DMA Time of Concentration (min) <i>Appendix C-1 of the TGD for WQMP</i>								
⁶ Length of conveyance from DMA outlet to project site outlet (ft) <i>May be zero if DMA outlet is at project site outlet</i>								
⁷ Cross-sectional area of channel (ft ²)								
⁸ Wetted perimeter of channel (ft)								
⁹ Manning's roughness of channel (n)								
¹⁰ Channel flow velocity (ft/sec) $V_{fps} = (1.49 / \text{Item 9}) * (\text{Item 7} / \text{Item 8})^{0.67} * (\text{Item 3})^{0.5}$								
¹¹ Travel time to outlet (min) $T_t = \text{Item 6} / (\text{Item 10} * 60)$								
¹² Total time of concentration (min) $T_c = \text{Item 5} + \text{Item 11}$								
¹³ Pre-developed time of concentration (min): <i>Minimum of Item 12 pre-developed DMA</i>								
¹⁴ Post-developed time of concentration (min): <i>Minimum of Item 12 post-developed DMA</i>								
¹⁵ Additional time of concentration needed to meet HCOC requirement (min): $T_{CHCOC} = (\text{Item 14} * 0.95) - \text{Item 13}$								

Form 4.2-5 HCOC Assessment for Peak Runoff

Compute peak runoff for pre and post developed conditions

Variables	Pre-developed DA <i>Add more columns if more than 3 DMA</i>			Post-developed DA <i>Add more columns if more than 3 DMA</i>		
	DMA A	DMA B	DMA C	DMA A	DMA B	DMA C
¹ Rainfall Intensity for storm duration equal to time of concentration <i>$I_{peak} = 10^{(LOG Form 4.2-1 Item 4 - 0.6 LOG Form 4.2-4 Item 5 / 60)}$</i>						
² Drainage Area of each DMA (ft²) <i>For DMA with outlet at project site outlet, include upstream DMA (Using example schematic in Form 3-1, DMA A will include drainage from DMA C)</i>						
³ Ratio of pervious area to total area <i>For DMA with outlet at project site outlet, include upstream DMA (Using example schematic in Form 3-1, DMA A will include drainage from DMA C)</i>						
⁴ Pervious area infiltration rate (in/hr) <i>Use pervious area CN and antecedent moisture condition with Appendix C-3 of the TGD for WQMP</i>						
⁵ Maximum loss rate (in/hr) <i>$F_m = Item 3 * Item 4$ Use area-weighted F_m from DMA with outlet at project site outlet, include upstream DMA (Using example schematic in Form 3-1, DMA A will include drainage from DMA C)</i>						
⁶ Peak Flow from DMA (cfs) <i>$Q_p = Item 2 * 0.9 * (Item 1 - Item 5)$</i>						
⁷ Time of concentration adjustment factor for other DMA to site discharge point <i>Form 4.2-4 Item 12 DMA / Other DMA upstream of site discharge point (If ratio is greater than 1.0, then use maximum value of 1.0)</i>	DMA A	n/a		n/a		
	DMA B		n/a		n/a	
	DMA C		n/a			n/a
⁸ Pre-developed Q_p at T_c for DMA A: <i>$Q_p = Item 6_{DMAA} + [Item 6_{DMAB} * (Item 1_{DMAA} - Item 5_{DMAB}) / (Item 1_{DMAB} - Item 5_{DMAB}) * Item 7_{DMAA/2}] + [Item 6_{DMAC} * (Item 1_{DMAA} - Item 5_{DMAC}) / (Item 1_{DMAC} - Item 5_{DMAC}) * Item 7_{DMAA/3}]$</i>	⁹ Pre-developed Q_p at T_c for DMA B: <i>$Q_p = Item 6_{DMAB} + [Item 6_{DMAA} * (Item 1_{DMAB} - Item 5_{DMAA}) / (Item 1_{DMAA} - Item 5_{DMAA}) * Item 7_{DMAB/1}] + [Item 6_{DMAC} * (Item 1_{DMAB} - Item 5_{DMAC}) / (Item 1_{DMAC} - Item 5_{DMAC}) * Item 7_{DMAB/3}]$</i>			¹⁰ Pre-developed Q_p at T_c for DMA C: <i>$Q_p = Item 6_{DMAC} + [Item 6_{DMAA} * (Item 1_{DMAC} - Item 5_{DMAA}) / (Item 1_{DMAA} - Item 5_{DMAA}) * Item 7_{DMAC/1}] + [Item 6_{DMAB} * (Item 1_{DMAC} - Item 5_{DMAB}) / (Item 1_{DMAB} - Item 5_{DMAB}) * Item 7_{DMAC/2}]$</i>		
¹¹ Peak runoff from pre-developed condition confluence analysis (cfs): <i>Maximum of Item 8, 9, and 10</i>						
¹² Post-developed Q_p at T_c for DMA A: <i>Same as Item 8 for post-developed values</i>	¹³ Post-developed Q_p at T_c for DMA B: <i>Same as Item 9 for post-developed values</i>			¹⁴ Post-developed Q_p at T_c for DMA C: <i>Same as Item 10 for post-developed values</i>		
¹⁵ Peak runoff from post-developed condition confluence analysis (cfs): <i>Maximum of Item 12, 13, and 14</i>						
¹⁶ Peak runoff reduction needed to meet HCOC Requirement (cfs): <i>$Q_{p-HCOC} = (Item 14 * 0.95) - Item 11$</i>						

4.3 Project Conformance Analysis

Complete the following forms for each project site DA to document that the proposed LID BMPs conform to the project DCV developed to meet performance criteria specified in the MS4 Permit (WQMP Template Section 4.2). For the LID DCV, the forms are ordered according to hierarchy of BMP selection as required by the MS4 Permit (see Section 5.3.1 in the TGD for WQMP). The forms compute the following for on-site LID BMP:

- Site Design and Hydrologic Source Controls (Form 4.3-2)
- Retention and Infiltration (Form 4.3-3)
- Harvested and Use (Form 4.3-4) or
- Biotreatment (Form 4.3-5).

At the end of each form, additional fields facilitate the determination of the extent of mitigation provided by the specific BMP category, allowing for use of the next category of BMP in the hierarchy, if necessary.

The first step in the analysis, using Section 5.3.2.1 of the TGD for WQMP, is to complete Forms 4.3-1 and 4.3-3) to determine if retention and infiltration BMPs are infeasible for the project. For each feasibility criterion in Form 4.3-1, if the answer is “Yes,” provide all study findings that includes relevant calculations, maps, data sources, etc. used to make the determination of infeasibility.

Next, complete Forms 4.3-2 and 4.3-4 to determine the feasibility of applicable HSC and harvest and use BMPs, and, if their implementation is feasible, the extent of mitigation of the DCV.

If no site constraints exist that would limit the type of BMP to be implemented in a DA, evaluate the use of combinations of LID BMPs, including all applicable HSC BMPs to maximize on-site retention of the DCV. If no combination of BMP can mitigate the entire DCV, implement the single BMP type, or combination of BMP types, that maximizes on-site retention of the DCV within the minimum effective area.

If the combination of LID HSC, retention and infiltration, and harvest and use BMPs are unable to mitigate the entire DCV, then biotreatment BMPs may be implemented by the project proponent. If biotreatment BMPs are used, then they must be sized to provide sufficient capacity for effective treatment of the remainder of the volume-based performance criteria that cannot be achieved with LID BMPs (TGD for WQMP Section 5.4.4.2). Under no circumstances shall any portion of the DCV be released from the site without effective mitigation and/or treatment.

Form 4.3-1 Infiltration BMP Feasibility

Feasibility Criterion – Complete evaluation for each DA on the Project Site

¹ Would infiltration BMP pose significant risk for groundwater related concerns? Yes No

Refer to Section 5.3.2.1 of the TGD for WQMP

If Yes, Provide basis: (attach)

² Would installation of infiltration BMP significantly increase the risk of geotechnical hazards? Yes No

(Yes, if the answer to any of the following questions is yes, as established by a geotechnical expert):

- *The location is less than 50 feet away from slopes steeper than 15 percent*
- *The location is less than eight feet from building foundations or an alternative setback.*
- *A study certified by a geotechnical professional or an available watershed study determines that stormwater infiltration would result in significantly increased risks of geotechnical hazards.*

If Yes, Provide basis: (attach)

³ Would infiltration of runoff on a Project site violate downstream water rights? Yes No

If Yes, Provide basis: (attach)

⁴ Is proposed infiltration facility located on hydrologic soil group (HSG) D soils or does the site geotechnical investigation indicate presence of soil characteristics, which support categorization as D soils? Yes No

If Yes, Provide basis: (attach)

⁵ Is the design infiltration rate, after accounting for safety factor of 2.0, below proposed facility less than 0.3 in/hr (accounting for soil amendments)? Yes No

If Yes, Provide basis: (attach)

⁶ Would on-site infiltration or reduction of runoff over pre-developed conditions be partially or fully inconsistent with watershed management strategies as defined in the WAP, or impair beneficial uses? Yes No

See Section 3.5 of the TGD for WQMP and WAP

If Yes, Provide basis: (attach)

⁷ Any answer from Item 1 through Item 3 is “Yes”: Yes No

If yes, infiltration of any volume is not feasible onsite. Proceed to Form 4.3-4, Harvest and Use BMP. If no, then proceed to Item 9 below.

⁸ Any answer from Item 4 through Item 6 is “Yes”: Yes No

If yes, infiltration is permissible but is not required to be considered. Proceed to Form 4.3-2, Hydrologic Source Control BMP.

If no, then proceed to Item 9, below.

⁹ All answers to Item 1 through Item 6 are “No”: Yes No

Infiltration of the full DCV is potentially feasible, LID infiltration BMP must be designed to infiltrate the full DCV to the MEP.

Proceed to Form 4.3-2, Hydrologic Source Control BMP.

4.3.1 Site Design Hydrologic Source Control BMP

Section XI.E. of the Permit emphasizes the use of LID preventative measures; and the use of LID HSC BMPs reduces the portion of the DCV that must be addressed in downstream BMPs. Therefore, all applicable HSC shall be provided except where they are mutually exclusive with each other, or with other BMPs. Mutual exclusivity may result from overlapping BMP footprints such that either would be potentially feasible by itself, but both could not be implemented. Please note that while there are no numeric standards regarding the use of HSC, if a project cannot feasibly meet BMP sizing requirements or cannot fully address HCOCs, feasibility of all applicable HSC must be part of demonstrating that the BMP system has been designed to retain the maximum feasible portion of the DCV. Complete Form 4.3-2 to identify and calculate estimated retention volume from implementing site design HSC BMP. Refer to Section 5.4.1 in the TGD for more detailed guidance.

Form 4.3-2 Site Design Hydrologic Source Control BMPs			
1 Implementation of Impervious Area Dispersion BMP (i.e. routing runoff from impervious to pervious areas), excluding impervious areas planned for routing to on-lot infiltration BMP): <input type="checkbox"/> Yes <input checked="" type="checkbox"/> No <i>If yes, complete Items 2-5; If no, proceed to Item 6</i>			
Variables	BMP Type and DA	BMP Type and DA	BMP Type and DA
<i>Aggregate impervious area dispersion with equal ratios of pervious to impervious;</i>			
2 Total impervious area draining to pervious area			
3 Ratio of pervious area receiving runoff to impervious area			
4 Retention volume achieved from impervious area dispersion (ft³) <i>V = Item 2 * Item 3 * (0.5/12), assuming retention of 0.5 inches of runoff</i>			
5 Sum of retention volume achieved from impervious area dispersion (ft³): 0 <i>V_{retention} = Sum of Item 4 for all BMPs</i>			
6 Implementation of Localized On-lot Infiltration BMPs (e.g. on-lot rain gardens): <input type="checkbox"/> Yes <input checked="" type="checkbox"/> No <i>If yes, complete Items 7-13 for aggregate of all on-lot infiltration BMP in each DA; If no, proceed to Item 14</i>			
BMP Type and DA	BMP Type and DA	BMP Type and DA	BMP Type and DA
7 Ponding surface area (ft²)			
Ponding depth (ft)			
9 Surface area of amended soil/gravel (ft²)			
10 Average depth of amended soil/gravel (ft)			
11 Average porosity of amended soil/gravel			
12 Retention volume achieved from on-lot infiltration (ft³) <i>V_{retention} = (Item 7 * Item 8) + (Item 9 * Item 10 * Item 11)</i>			
13 Runoff volume retention from on-lot infiltration (ft³): 0 <i>V_{retention} = Sum of Item 12 for all BMPs</i>			
14 Implementation of evapotranspiration BMP (green, brown, or blue roofs): <input type="checkbox"/> Yes <input checked="" type="checkbox"/> No <i>If yes, complete Items 15-20. If no, proceed to Item 21</i>			
BMP Type and DA	BMP Type and DA	BMP Type and DA	BMP Type and DA
15 Rooftop area planned for ET BMP (ft²)			
16 Average wet season ET demand (in/day) <i>Use local values, typical ~ 0.1</i>			
17 Daily ET demand (ft³/day) <i>Item 15 * (Item 16 / 12)</i>			
18 Drawdown time (hrs) <i>Copy Item 6 in Form 4.2-1</i>			
19 Retention Volume (ft³) <i>V_{retention} = Item 17 * (Item 18 / 24)</i>			
20 Runoff volume retention from evapotranspiration BMPs (ft³): 0 <i>V = Sum of Item 19 for all BMPs</i>			
21 Implementation of Street Trees: <input type="checkbox"/> Yes <input checked="" type="checkbox"/> No <i>If yes, complete Items 20-2. If no, proceed to Item 26</i>			
BMP Type and DA	BMP Type and DA	BMP Type and DA	BMP Type and DA
22 Number of Street Trees			
23 Average canopy cover over impervious area (ft²)			
24 Runoff volume retention from street trees (ft³) <i>V_{retention} = Item 22 * Item 23 * (0.05/12) assume runoff retention of 0.05 inches</i>			
25 Runoff volume retention from street tree BMPs (ft³): 0 <i>V_{retention} = Sum of Item 24 for all BMPs</i>			
26 Implementation of residential rain barrels/cisterns: <input type="checkbox"/> Yes <input checked="" type="checkbox"/> No <i>If yes, complete Items 27-28; If no, proceed to Item 30</i>			
BMP Type and DA	BMP Type and DA	BMP Type and DA	BMP Type and DA
27 Number of rain barrels/cisterns			
28 Runoff volume retention from rain barrels/cisterns (ft³) <i>V_{retention} = Item 27 * 3</i>			
29 Runoff volume retention from residential rain barrels/Cisterns (ft³): 0 <i>V_{retention} = Sum of Item 28 for all BMPs</i>			
30 Total Retention Volume from Site Design Hydrologic Source Control BMPs: 0 <i>Sum of Items 5, 13, 20, 25 and 29</i>			

4.3.2 Infiltration BMPs

Use Form 4.3-3 to compute on-site retention of runoff from proposed retention and infiltration BMPs. Volume retention estimates are sensitive to the percolation rate used, which determines the amount of runoff that can be infiltrated within the specified drawdown time. The infiltration safety factor reduces field measured percolation to account for potential inaccuracy associated with field measurements, declining BMP performance over time, and compaction during construction. Appendix D of the TGD for WQMP provides guidance on estimating an appropriate safety factor to use in Form 4.3-3.

If site constraints limit the use of BMPs to a single type and implementation of retention and infiltration BMPs mitigate no more than 40% of the DCV, then they are considered infeasible and the Project Proponent may evaluate the effectiveness of BMPs lower in the LID hierarchy of use (Section 5.5.1 of the TGD for WQMP)

If implementation of infiltrations BMPs is feasible as determined using Form 4.3-1, then LID infiltration BMPs shall be implemented to the MEP (section 4.1 of the TGD for WQMP).

Form 4.3-3 Infiltration LID BMP (including underground BMPs) - DA 1 DMA A

¹ Remaining LID DCV not met by site design HSC BMP (ft³): 30,073

V = Form 4.2-1 Item 7 - Form 4.3-2 Item 30

BMP Type <i>Use columns to the right to compute runoff volume retention from proposed infiltration BMP (select BMP from Table 5-4 in TGD for WQMP)</i>	DA 1 DMA A	n/a	n/a
² Infiltration rate of underlying soils (in/hr) <i>See Section 5.4.2 and Appendix D of the TGD for WQMP for minimum requirements for assessment methods</i>	6.4	n/a	n/a
³ Infiltration safety factor <i>See TGD Section 5.4.2 and Appendix D</i>	2.0	n/a	n/a
⁴ Design percolation rate (in/hr) <i>P_{design} = Item 2 / Item 3</i>	3.2	n/a	n/a
⁵ Ponded water drawdown time (hr) <i>Copy Item 6 in Form 4.2-1</i>	24	n/a	n/a
⁶ Maximum ponding depth (ft) <i>BMP specific, see Table 5-4 of the TGD for WQMP for BMP design details</i>	6.4' (76.80")	n/a	n/a
⁷ Ponding Depth (ft) <i>d_{BMP} = Minimum of (1/12 * Item 4 * Item 5) or Item 6</i>	5.15' (61.80")	n/a	n/a
⁸ Infiltrating surface area, SA (ft ²) <i>The lesser of the area needed for BMP infiltration of full DCV or minimum space requirements from Table 5-7 of the TGD for WQMP</i>	7,516	n/a	n/a
⁹ Amended soil depth, d _{media} (ft) <i>Only included in certain BMP types, see Table 5-4 in the TGD for WQMP for reference to BMP design details</i>	n/a	n/a	n/a
¹⁰ Amended soil porosity	n/a	n/a	n/a
¹¹ Gravel depth, d _{media} (ft) <i>Only included in certain BMP types, see Table 5-4 of the TGD for WQMP for BMP design details</i>	2.5' (30")	n/a	n/a
¹² Gravel porosity	0.40	n/a	n/a
¹³ Duration of storm as basin is filling (hrs) <i>Typical ~ 3hrs</i>	3	n/a	n/a
¹⁴ Above Ground Retention Volume (ft ³) <i>V_{retention} = Item 8 * [Item 7 + (Item 9 retention * Item 10) + (Item 11 * Item 12) + (Item 13 * (Item 4 / 12))]</i>	n/a	n/a	n/a
¹⁵ Underground Retention Volume (ft ³) <i>Volume determined using manufacturer's specifications and calculations</i>	30,245 (see Attach. B for detailed calculations)	n/a	n/a
¹⁶ Total Retention Volume from LID Infiltration BMPs (ft ³): 30,245 <i>(Sum of Items 14 and 15 for all infiltration BMP included in plan)</i>			
¹⁷ Fraction of DCV achieved with infiltration BMP: 100.57% <i>Retention% = Item 16 / Form 4.2-1 Item 7</i>			
¹⁸ Is full LID DCV retained on-site with combination of hydrologic source control and LID retention and infiltration BMPs? <input checked="" type="checkbox"/> Yes <input type="checkbox"/> No <i>If yes, demonstrate conformance using Form 4.3-10; If no, then reduce Item 3, Factor of Safety to 2.0 and increase Item 8, Infiltrating Surface Area, such that the portion of the site area used for retention and infiltration BMPs equals or exceeds the minimum effective area thresholds (Table 5-7 of the TGD for WQMP) for the applicable category of development and repeat all above calculations.</i>			

4.3.3 Harvest and Use BMP

Harvest and use BMP may be considered if the full LID DCV cannot be met by maximizing infiltration BMPs. Use Form 4.3-4 to compute on-site retention of runoff from proposed harvest and use BMPs.

Volume retention estimates for harvest and use BMPs are sensitive to the on-site demand for captured stormwater. Since irrigation water demand is low in the wet season, when most rainfall events occur in San Bernardino County, the volume of water that can be used within a specified drawdown period is relatively low. The bottom portion of Form 4.3-4 facilitates the necessary computations to show infeasibility if a minimum incremental benefit of 40 percent of the LID DCV would not be achievable with MEP implementation of on-site harvest and use of stormwater (Section 5.5.4 of the TGD for WQMP).

Form 4.3-4 Harvest and Use BMPs			
¹ Remaining LID DCV not met by site design HSC or infiltration BMP (ft³): <i>V_{unmet} = Form 4.2-1 Item 7 - Form 4.3-2 Item 30 – Form 4.3-3 Item 16</i>			
BMP Type(s) <i>Compute runoff volume retention from proposed harvest and use BMP (Select BMPs from Table 5-4 of the TGD for WQMP)</i>	BMP Type and DA	BMP Type and DA	BMP Type and DA
² Describe cistern or runoff detention facility			
³ Storage volume for proposed detention type (ft³) <i>Volume of cistern</i>			
⁴ Landscaped area planned for use of harvested stormwater (ft²)			
⁵ Average wet season daily irrigation demand (in/day) <i>Use local values, typical ~ 0.1 in/day</i>			
⁶ Daily water demand (ft³/day) <i>Item 4 * (Item 5 / 12)</i>			
⁷ Drawdown time (hrs) <i>Copy Item 6 from Form 4.2-1</i>			
⁸ Retention Volume (ft³) <i>V_{retention} = Minimum of (Item 3) or (Item 6 * (Item 7 / 24))</i>			
⁹ Total Retention Volume (ft³) from Harvest and Use BMP: <i>Sum of Item 8 for all harvest and use BMP included in plan</i>			
¹⁰ Is the full DCV retained with a combination of LID HSC, retention and infiltration, and harvest and use BMPs? <input type="checkbox"/> Yes <input type="checkbox"/> No <i>If yes, demonstrate conformance using Form 4.3-10. If no, then re-evaluate combinations of all LID BMP and optimize their implementation such that the maximum portion of the DCV is retained on-site (using a single BMP type or combination of BMP types). If the full DCV cannot be mitigated after this optimization process, proceed to Section 4.3.4.</i>			

4.3.4 Biotreatment BMP

Biotreatment BMPs may be considered if the full LID DCV cannot be met by maximizing retention and infiltration, and harvest and use BMPs. A key consideration when using biotreatment BMP is the effectiveness of the proposed BMP in addressing the pollutants of concern for the project (see Table 5-5 of the TGD for WQMP).

Use Form 4.3-5 to summarize the potential for volume based and/or flow based biotreatment options to biotreat the remaining unmet LID DCV. Biotreatment computations are included as follows:

- Use Form 4.3-6 to compute biotreatment in small volume based biotreatment BMP (e.g. bioretention w/underdrains);
- Use Form 4.3-7 to compute biotreatment in large volume based biotreatment BMP (e.g. constructed wetlands);
- Use Form 4.3-8 to compute sizing criteria for flow-based biotreatment BMP (e.g. bioswales)

Form 4.3-5 Selection and Evaluation of Biotreatment BMP		
¹ Remaining LID DCV not met by site design HSC, infiltration, or harvest and use BMP for potential biotreatment (ft ³): <i>Form 4.2-1 Item 7 – Form 4.3-2 Item 30 – Form 4.3-3 Item 16- Form 4.3-4 Item 9</i>	List pollutants of concern <i>Copy from Form 2.3-1</i>	
² Biotreatment BMP Selected <i>(Select biotreatment BMP(s) necessary to ensure all pollutants of concern are addressed through Unit Operations and Processes, described in Table 5-5 of the TGD for WQMP)</i>	Volume-based biotreatment <i>Use Forms 4.3-6 and 4.3-7 to compute treated volume</i> <input type="checkbox"/> Bioretention with underdrain <input type="checkbox"/> Planter box with underdrain <input type="checkbox"/> Constructed wetlands <input type="checkbox"/> Wet extended detention <input type="checkbox"/> Dry extended detention	Flow-based biotreatment <i>Use Form 4.3-8 to compute treated volume</i> <input type="checkbox"/> Vegetated swale <input type="checkbox"/> Vegetated filter strip <input type="checkbox"/> Proprietary biotreatment
³ Volume biotreated in volume based biotreatment BMP (ft ³): <i>Form 4.3-6 Item 15 + Form 4.3-7 Item 13</i>	⁴ Compute remaining LID DCV with implementation of volume based biotreatment BMP (ft ³): <i>Item 1 – Item 3</i>	⁵ Remaining fraction of LID DCV for sizing flow based biotreatment BMP: % <i>Item 4 / Item 1</i>
⁶ Flow-based biotreatment BMP capacity provided (cfs): <i>Use Figure 5-2 of the TGD for WQMP to determine flow capacity required to provide biotreatment of remaining percentage of unmet LID DCV (Item 5), for the project's precipitation zone (Form 3-1 Item 1)</i>		
⁷ Metrics for MEP determination: <input type="checkbox"/> Provided a WQMP with the portion of site area used for suite of LID BMP equal to minimum thresholds in Table 5-7 of the TGD for WQMP for the proposed category of development: <i>If maximized on-site retention BMPs is feasible for partial capture, then LID BMP implementation must be optimized to retain and infiltrate the maximum portion of the DCV possible within the prescribed minimum effective area. The remaining portion of the DCV shall then be mitigated using biotreatment BMP.</i>		

Form 4.3-6 Volume Based Biotreatment – Bioretention and Planter Boxes with Underdrains

BMP Type(s) <i>Compute runoff volume retention from proposed harvest and use BMP (Select BMPs from Table 5-4 of the TGD for WQMP)</i>	BMP Type and DA	BMP Type and DA	BMP Type and DA
¹ Pollutants addressed with BMP <i>List all pollutant of concern that will be effectively reduced through specific Unit Operations and Processes described in Table 5-5 of the TGD for WQMP</i>			
² Amended soil infiltration rate <i>Typical ~ 5.0 in/hr</i>			
³ Amended soil infiltration safety factor <i>Typical ~ 2.0</i>			
⁴ Amended soil design percolation rate (in/hr) <i>P_{design} = Item 2 / Item 3</i>			
⁵ Pondered water drawdown time (hr) <i>Copy Item 6 from Form 4.2-1</i>			
⁶ Maximum ponding depth (ft) <i>See Table 5-6 of the TGD for WQMP for reference to BMP design details</i>			
⁷ Ponding Depth (ft) <i>d_{BMP} = Minimum of (1/12 * Item 4 * Item 5) or Item 6</i>			
⁸ Amended soil surface area (ft²)			
⁹ Amended soil depth (ft) <i>See Table 5-6 of the TGD for WQMP for reference to BMP design details</i>			
¹⁰ Amended soil porosity, n			
¹¹ Gravel depth (ft) <i>See Table 5-6 of the TGD for WQMP for reference to BMP design details</i>			
¹² Gravel porosity, n			
¹³ Duration of storm as basin is filling (hrs) <i>Typical ~ 3hrs</i>			
¹⁴ Biotreated Volume (ft³) <i>V_{biotreated} = Item 8 * [(Item 7/2) + (Item 9 * Item 10) + (Item 11 * Item 12) + (Item 13 * (Item 4 / 12))]</i>			
¹⁵ Total biotreated volume from bioretention and/or planter box with underdrains BMP: <i>Sum of Item 14 for all volume-based BMPs included in this form</i>			

Form 4.3-7 Volume Based Biotreatment – Constructed Wetlands and Extended Detention

Biotreatment BMP Type <i>Constructed wetlands, extended wet detention, extended dry detention, or other comparable proprietary BMP. If BMP includes multiple modules (e.g. forebay and main basin), provide separate estimates for storage and pollutants treated in each module.</i>	BMP Type and DA		BMP Type and DA		BMP Type and DA	
	Forebay	Basin	Forebay	Basin	Forebay	Basin
¹ Pollutants addressed with BMP forebay and basin <i>List all pollutant of concern that will be effectively reduced through specific Unit Operations and Processes described in Table 5-5 of the TGD for WQMP</i>						
² Bottom width (ft)						
³ Bottom length (ft)						
⁴ Bottom area (ft²) <i>A_{bottom} = Item 2 * Item 3</i>						
⁵ Side slope (ft/ft)						
⁶ Depth of storage (ft)						
⁷ Water surface area (ft²) <i>A_{surface} = (Item 2 + (2 * Item 5 * Item 6)) * (Item 3 + (2 * Item 5 * Item 6))</i>						
⁸ Storage volume (ft³) <i>For BMP with a forebay, ensure fraction of total storage is within ranges specified in BMP specific fact sheets, see Table 5-6 of the TGD for WQMP for reference to BMP design details V = Item 6 / 3 * [Item 4 + Item 7 + (Item 4 * Item 7)^{0.5}]</i>						
⁹ Drawdown Time (hrs) <i>Copy Item 6 from Form 2.1</i>						
¹⁰ Outflow rate (cfs) <i>Q_{BMP} = (Item 8_{forebay} + Item 8_{basin}) / (Item 9 * 3600)</i>						
¹¹ Duration of design storm event (hrs)						
¹² Biotreated Volume (ft³) <i>V_{biotreated} = (Item 8_{forebay} + Item 8_{basin}) + (Item 10 * Item 11 * 3600)</i>						
¹³ Total biotreated volume from constructed wetlands, extended dry detention, or extended wet detention: <i>(Sum of Item 12 for all BMP included in plan)</i>						

Form 4.3-8 Flow Based Biotreatment			
Biotreatment BMP Type <i>Vegetated swale, vegetated filter strip, or other comparable proprietary BMP</i>	BMP Type and DA	BMP Type and DA	BMP Type and DA
¹ Pollutants addressed with BMP <i>List all pollutant of concern that will be effectively reduced through specific Unit Operations and Processes described in TGD Table 5-5</i>			
² Flow depth for water quality treatment (ft) <i>BMP specific, see Table 5-6 of the TGD for WQMP for reference to BMP design details</i>			
³ Bed slope (ft/ft) <i>BMP specific, see Table 5-6 of the TGD for WQMP for reference to BMP design details</i>			
⁴ Manning's roughness coefficient			
⁵ Bottom width (ft) <i>$b_w = (\text{Form 4.3-5 Item 6} * \text{Item 4}) / (1.49 * \text{Item 2}^{1.67} * \text{Item 3}^{0.5})$</i>			
⁶ Side Slope (ft/ft) <i>BMP specific, see Table 5-6 of the TGD for WQMP for reference to BMP design details</i>			
⁷ Cross sectional area (ft²) <i>$A = (\text{Item 5} * \text{Item 2}) + (\text{Item 6} * \text{Item 2}^2)$</i>			
⁸ Water quality flow velocity (ft/sec) <i>$V = \text{Form 4.3-5 Item 6} / \text{Item 7}$</i>			
⁹ Hydraulic residence time (min) <i>Pollutant specific, see Table 5-6 of the TGD for WQMP for reference to BMP design details</i>			
¹⁰ Length of flow based BMP (ft) <i>$L = \text{Item 8} * \text{Item 9} * 60$</i>			
¹¹ Water surface area at water quality flow depth (ft²) <i>$SA_{top} = (\text{Item 5} + (2 * \text{Item 2} * \text{Item 6})) * \text{Item 10}$</i>			

4.3.5 Conformance Summary

Complete Form 4.3-9 to demonstrate how on-site LID DCV is met with proposed site design hydrologic source control, infiltration, harvest and use, and/or biotreatment BMP. The bottom line of the form is used to describe the basis for infeasibility determination for on-site LID BMP to achieve full LID DCV, and provides methods for computing remaining volume to be addressed in an alternative compliance plan. If the project has more than one outlet, then complete additional versions of this form for each outlet.

Form 4.3-9 Conformance Summary and Alternative Compliance Volume Estimate (DA 1 DMA A)	
¹	Total LID DCV for the Project (ft³): 30,073 <i>Copy Item 7 in Form 4.2-1</i>
²	On-site retention with site design hydrologic source control LID BMP (ft³): 0 <i>Copy Item 30 in Form 4.3-2</i>
³	On-site retention with LID infiltration BMP (ft³): 30,245 <i>Copy Item 16 in Form 4.3-3</i>
⁴	On-site retention with LID harvest and use BMP (ft³): 0 <i>Copy Item 9 in Form 4.3-4</i>
⁵	On-site biotreatment with volume based biotreatment BMP (ft³): 0 <i>Copy Item 3 in Form 4.3-5</i>
⁶	Flow capacity provided by flow based biotreatment BMP (cfs): 0 <i>Copy Item 6 in Form 4.3-5</i>
⁷	<p>LID BMP performance criteria are achieved if answer to any of the following is "Yes":</p> <ul style="list-style-type: none"> • Full retention of LID DCV with site design HSC, infiltration, or harvest and use BMP: <input checked="" type="checkbox"/>Yes <input type="checkbox"/>No <i>If yes, sum of Items 2, 3, and 4 is greater than Item 1</i> • Combination of on-site retention BMPs for a portion of the LID DCV and volume-based biotreatment BMP that address all pollutants of concern for the remaining LID DCV: <input type="checkbox"/>Yes <input checked="" type="checkbox"/>No <i>If yes, a) sum of Items 2, 3, 4, and 5 is greater than Item 1, and Items 2, 3 and 4 are maximized; or b) Item 6 is greater than Form 4.3-5 Item 6 and Items 2, 3 and 4 are maximized</i> • On-site retention and infiltration is determined to be infeasible and biotreatment BMP provide biotreatment for all pollutants of concern for full LID DCV: <input type="checkbox"/>Yes <input checked="" type="checkbox"/>No <i>If yes, Form 4.3-1 Items 7 and 8 were both checked yes</i>
⁸	<p>If the LID DCV is not achieved by any of these means, then the project may be allowed to develop an alternative compliance plan. Check box that describes the scenario which caused the need for alternative compliance:</p> <p><input type="checkbox"/> Combination of HSC, retention and infiltration, harvest and use, and biotreatment BMPs provide less than full LID DCV capture. <i>Checked yes for Form 4.3-5 Item 7, Item 6 is zero, and sum of Items 2, 3, 4, and 5 is less than Item 1. If so, apply water quality credits and calculate volume for alternative compliance, $V_{alt} = (Item\ 1 - Item\ 2 - Item\ 3 - Item\ 4 - Item\ 5) * (100 - Form\ 2.4-1\ Item\ 2)\%$</i></p> <p><input type="checkbox"/> An approved Watershed Action Plan (WAP) demonstrates that water quality and hydrologic impacts of urbanization are more effective when managed in at an off-site facility. <i>Attach appropriate WAP section, including technical documentation, showing effectiveness comparisons for the project site and regional watershed</i></p>

4.3.6 Hydromodification Control BMP

Use Form 4.3-10 to compute the remaining runoff volume retention, after LID BMP are implemented, needed to address HCOC, and the increase in time of concentration and decrease in peak runoff necessary to meet targets for protection of waterbodies with a potential HCOC. Describe hydromodification control BMP that address HCOC, which may include off-site BMP and/or in-stream controls. Section 5.6 of the TGD for WQMP provides additional details on selection and evaluation of hydromodification control BMP.

Form 4.3-10 Hydromodification Control BMPs	
<p>¹ Volume reduction needed for HCOC performance criteria (ft³): <i>(Form 4.2-2 Item 4 * 0.95) – Form 4.2-2 Item 1</i></p>	<p>² On-site retention with site design hydrologic source control, infiltration, and harvest and use LID BMP (ft³): <i>Sum of Form 4.3-9 Items 2, 3, and 4. Evaluate option to increase implementation of on-site retention in Forms 4.3-2, 4.3-3, and 4.3-4 in excess of LID DCV toward achieving HCOC volume reduction</i></p>
<p>³ Remaining volume for HCOC volume capture (ft³): <i>Item 1 – Item 2</i></p>	<p>⁴ Volume capture provided by incorporating additional on-site or off-site retention BMPs (ft³): <i>Existing downstream BMP may be used to demonstrate additional volume capture (if so, attach to this WQMP a hydrologic analysis showing how the additional volume would be retained during a 2-yr storm event for the regional watershed)</i></p>
<p>⁵ If Item 4 is less than Item 3, incorporate in-stream controls on downstream waterbody segment to prevent impacts due to hydromodification <input type="checkbox"/></p> <p><i>Attach in-stream control BMP selection and evaluation to this WQMP</i></p>	
<p>⁶ Is Form 4.2-2 Item 11 less than or equal to 5%: <input type="checkbox"/>Yes <input type="checkbox"/>No</p> <p><i>If yes, HCOC performance criteria is achieved. If no, select one or more mitigation options below:</i></p> <ul style="list-style-type: none"> <input type="checkbox"/> Demonstrate increase in time of concentration achieved by proposed LID site design, LID BMP, and additional on-site or off-site retention BMP. <i>BMP upstream of a waterbody segment with a potential HCOC may be used to demonstrate increased time of concentration through hydrograph attenuation (if so, show that the hydraulic residence time provided in BMP for a 2-year storm event is equal or greater than the addition time of concentration requirement in Form 4.2-4 Item 15)</i> <input type="checkbox"/> Increase time of concentration by preserving pre-developed flow path and/or increase travel time by reducing slope and increasing cross-sectional area and roughness for proposed on-site conveyance facilities. <input type="checkbox"/> Incorporate appropriate in-stream controls for downstream waterbody segment to prevent impacts due to hydromodification, in a plan approved and signed by a licensed engineer in the State of California. 	
<p>⁷ Form 4.2-2 Item 12 less than or equal to 5%: <input type="checkbox"/>Yes <input type="checkbox"/>No</p> <p><i>If yes, HCOC performance criteria are achieved. If no, select one or more mitigation options below:</i></p> <ul style="list-style-type: none"> <input type="checkbox"/> Demonstrate reduction in peak runoff achieved by proposed LID site design, LID BMPs, and additional on-site or off-site retention BMPs. <i>BMPs upstream of a waterbody segment with a potential HCOC may be used to demonstrate additional peak runoff reduction through hydrograph attenuation (if so, attach to this WQMP, a hydrograph analysis showing how the peak runoff would be reduced during a 2-yr storm event)</i> <input type="checkbox"/> Incorporate appropriate in-stream controls for downstream waterbody segment to prevent impacts due to hydromodification, in a plan approved and signed by a licensed engineer in the State of California. 	

4.4 Alternative Compliance Plan (if applicable)

Describe an alternative compliance plan (if applicable) for projects not fully able to infiltrate, harvest and use, or biotreat the DCV via on-site LID practices. A project proponent must develop an alternative compliance plan to address the remainder of the LID DCV. Depending on project type some projects may qualify for water quality credits that can be applied to reduce the DCV that must be treated prior to development of an alternative compliance plan (see Form 2.4-1, Water Quality Credits). Form 4.3-9 Item 8 includes instructions on how to apply water quality credits when computing the DCV that must be met through alternative compliance. Alternative compliance plans may include one or more of the following elements:

- On-site structural treatment control BMP - All treatment control BMP should be located as close to possible to the pollutant sources and should not be located within receiving waters;
- Off-site structural treatment control BMP - Pollutant removal should occur prior to discharge of runoff to receiving waters;
- Urban runoff fund or In-lieu program, if available

Depending upon the proposed alternative compliance plan, approval by the executive officer may or may not be required (see Section 6 of the TGD for WQMP).

Section 5 Inspection and Maintenance Responsibility for Post Construction BMP

All BMP included as part of the project WQMP are required to be maintained through regular scheduled inspection and maintenance (refer to Section 8, Post Construction BMP Requirements, in the TGD for WQMP). Fully complete Form 5-1 summarizing all BMP included in the WQMP. Attach additional forms as needed. The WQMP shall also include a detailed Operation and Maintenance Plan for all BMP and may require a Maintenance Agreement (consult the jurisdiction's LIP). If a Maintenance Agreement is required, it must also be attached to the WQMP.

Form 5-1 BMP Inspection and Maintenance			
BMP	Responsible Party(ies)	Inspection/Maintenance Activities Required	Minimum Frequency of Activities
Underground Infiltration Chambers	Owner	The isolator row shall be inspected for debris and sediment accumulations and maintained by a qualified technician and he/she will properly dispose of all wastes and inspect for standing water. A manhole is installed in order to inspect and maintain the inlet row. All entry into the chamber system must be done per OSHA codes to ensure operator and inspector safety. Inspection ports should be checked 48 hours after storm events to see that the water is draining down, at least once each rainy season, following a major storm event. Records shall be maintained by owner to document inspections.	The isolator row shall be inspected semi-annually (by October 1st and February 1st) and cleaned by water-flush and vacuum when solids accumulate to 3" depth. Maintenance to be conducted through service contract with the vendor or equally qualified contractor.
Hydrodynamic Separator	Owner	Visual inspection to quantify the accumulation of hydrocarbons, trash, and sediment in the system. Use vacuum truck to clean and remove pollutants from the system upon reaching 75% capacity. Clean area outside of the screen if pollutant build-up exists.	Visually inspect twice a year (spring and fall) or as frequently as needed. Vacuum frequency as determined by inspection.
N1: Education of Property Owners, Tenants and Occupants on Stormwater BMPs	Owner	Property owner will familiarize him/herself with the educational materials in Attachment "E" and the contents of the WQMP.	Annually for all employees and within 2 months for new hires.
N2: Activity Restrictions	Owner	No outdoor work areas, processing, storage or wash area.	Ongoing
N3: Landscape Management BMPs	Owner	Irrigation must be consistent with the local agency's Water Conservation Ordinance. Fertilizer and pesticide usage will be consistent with local agency's Management Guidelines for Use of Fertilizers and Pesticides.	Ongoing
N4: BMP Maintenance	Owner	BMP maintenance, implementation schedules, and responsible parties are included with each specific BMP narrative.	As described in each BMP.
N7: Spill Contingency Plan	Owner	Owner/tenant will have a spill contingency plan based on individual site needs.	Ongoing
N10: Uniform Fire Code Implementation	Owner	Owner will comply with Article 80 of the Uniform Fire Code enforced by the fire protection agency.	Ongoing

Form 5-1 BMP Inspection and Maintenance			
N11: Litter/Debris Control Program	Owner	Contract with their landscape maintenance firm to provide this service during regularly schedule maintenance.	Weekly
N12: Employee Training	Owner	The owner will ensure that tenants are also familiar with onsite BMPs and necessary maintenance required of the tenants. Employees shall be trained to clean up spills and participate in ongoing maintenance. Owner will check with City and County at least once a year to obtain new or updated educational materials and provide these materials to tenants. Employees shall be trained to clean up spills and participate in ongoing maintenance. The WQMP requires annual employee training and new hires within 2 months.	Annually for all employees and within 2 months for new hires.
N14: Catch Basin Inspection Program	Owner	Monthly inspection by property owner's designee. Vacuum basin when sediment or trash becomes 2-inches deep and dispose of properly.	Monthly inspection and maintain as necessary.
N15: Vacuum Sweeping of Private Streets and Parking Lots	Owner	All landscape maintenance contractors will be required to sweep up all landscape cuttings, mowings and fertilizer materials off paved areas weekly and dispose of properly. Parking areas and drive ways will be swept monthly by sweeping contractor.	Monthly
N17: Comply with all other applicable NPDES permits	Owner	Will comply with Construction General Permit and Industrial General (may apply for No Exposure Certification/NEC).	Ongoing
S1: Provide storm drain system stenciling and signage (CASQA New Development BMP Handbook SD-13)	Owner	"No Dumping – Drains to River" stencils will be applied. Legibility of stencil will be maintained on a yearly basis.	Annually
S3: Design and construct trash and waste storage areas to reduce pollution introduction (CASQA New Development BMP Handbook SD-32)	Owner	Paved with an impervious surface, designed not to allow run-on from adjoining areas, designed to divert drainage from adjoining roofs and pavements diverted around the area, screened or walled to prevent off-site transport of trash. Provide solid roof or awning to prevent direct contact with rainfall.	Annually
S4: Use efficient irrigation systems & landscape design, water conservation, smart controllers, and source control (Statewide Model Landscape Ordinance; CASQA New Development BMP Handbook SD-12)	Owner	Irrigation systems shall include reducers or shutoff valves triggered by a pressure drop to control water loss in the event of broken sprinkler heads or lines. Timers will be used to avoid over watering and watering cycles and duration shall be adjusted seasonally by the landscape maintenance contractor. The landscaping areas will be grouped with plants that have similar water requirements. Native or drought tolerant species shall also be used where appropriate to reduce excess irrigation runoff and promote surface filtration.	Adjust watering cycles and duration seasonally / quarterly.
S5: Finish grade of landscaped areas at a minimum of 1-2 inches below top of curb, sidewalk, or pavement	Owner	Landscaped areas will be suppressed in order to increase retention of stormwater/irrigation water and promote infiltration.	Ongoing

Section 6 WQMP Attachments

6.1 Site Plan and Drainage Plan

Include a site plan and drainage plan sheet set containing the following minimum information:

- Project location
- Site boundary
- Land uses and land covers, as applicable
- Suitability/feasibility constraints
- Structural Source Control BMP locations
- Site Design Hydrologic Source Control BMP locations
- LID BMP details
- Drainage delineations and flow information
- Drainage connections

See Attachment C for WQMP Site Map.

6.2 Electronic Data Submittal

Minimum requirements include submittal of PDF exhibits in addition to hard copies. Format must not require specialized software to open. If the local jurisdiction requires specialized electronic document formats (consult the LIP), this section will describe the contents (e.g., layering, nomenclature, geo-referencing, etc.) of these documents so that they may be interpreted efficiently and accurately.

6.3 Post Construction

Attach all O&M Plans and Maintenance Agreements for BMP to the WQMP (Attachment D).

6.4 Other Supporting Documentation

- WQMP Certification (Section 6.5)
- BMP Design Calculations & Supporting Documentation (Attachment B)
- Memorandum of Agreement for Water Quality Management Plan and Storm Water BMP Transfer, Access and Maintenance (Attachment D)
- BMP Educational Materials (Attachment E)
- Infiltration Report (Attachment F)
- Hydrologic Conditions of Concern (HCOC) (Attachment G)

6.5 WQMP Certification

Certifications

I certify under penalty of law that this document and all attachments were prepared under my direction or supervision in accordance with a system designed to assure that qualified personnel properly gather and evaluate the information submitted. Based on my inquiry of the person or persons who manage the system or those persons directly responsible for gathering the information, the information submitted is to the best of my knowledge and belief, true, accurate and complete. I am aware that there are significant penalties for submitting false information, including the possibility of fine and imprisonment for knowing violations.

Developer's Project Engineer Signature

Signature

Date

I/we certify that I/we am/are the legal owner of the project and hereby accept responsibility for the implementation of the provisions of this SWQMP as long as I/we retain ownership of this property and that upon the sale of this land, I/we will deliver this plan to the future owner and inform him of the requirement to implement the plan.

Owner(s) Signature

David Pittman

Name

Managing Partner

Title

Signature

Date

for use by City of Fontana only

Environmental Section Approval of SWQMP

I, and /or personnel acting under my direction and supervision, have reviewed this SWQMP and find that it meets the requirements set forth in the City of Fontana's Storm Water Ordinance. Acceptance or approval of this Storm Water Quality Management Plan in no way precludes the authority of this agency to require modification to the plan as conditions warrant nor does this agency take responsibility for performance of BMPs provided for in the Plan.

Signature

Date of SWQMP Approval

Attachment A
Existing Condition Site Photos



Attachment B
BMP Design Calculations & Supporting
Documentation



Home Site Map Organization Search NWS All NOAA

- General Information
- Homepage
- Progress Reports
- FAQ
- Glossary

NOAA ATLAS 14 POINT PRECIPITATION FREQUENCY ESTIMATES: CA

Data description

Data type: Units: Time series type:

Select location

1) Manually:

a) By location (decimal degrees, use "-" for S and W): Latitude: Longitude:

b) By station (list of CA stations):

c) By address

2) Use map (if ESRI interactive map is not loading, try adding the host: <https://js.arcgis.com/> to the firewall, or contact us at hdsc.questions@noaa.gov):

a) Select location
Move crosshair or double click

b) Click on station icon
 Show stations on map

Location information:
 Name: Fontana, California, USA*
 Latitude: 34.0568*
 Longitude: -117.4476*
 Elevation: 1053.37 ft **

* Source: ESRI Maps
 ** Source: USGS

POINT PRECIPITATION FREQUENCY (PF) ESTIMATES WITH 90% CONFIDENCE INTERVALS AND SUPPLEMENTARY INFORMATION NOAA Atlas 14, Volume 6, Version 2

PF tabular PF graphical Supplementary information [Print page](#)

Duration	PDS-based precipitation frequency estimates with 90% confidence intervals (in inches) ¹									
	Average recurrence interval (years)									
	1	2	5	10	25	50	100	200	500	1000
5-min	0.106 (0.088-0.129)	0.139 (0.116-0.169)	0.184 (0.152-0.223)	0.222 (0.182-0.272)	0.275 (0.219-0.350)	0.318 (0.248-0.413)	0.364 (0.276-0.484)	0.413 (0.304-0.566)	0.482 (0.340-0.690)	0.539 (0.367-0.799)
10-min	0.152 (0.127-0.184)	0.199 (0.166-0.242)	0.263 (0.219-0.320)	0.317 (0.261-0.390)	0.394 (0.314-0.501)	0.456 (0.355-0.592)	0.521 (0.395-0.694)	0.591 (0.436-0.811)	0.691 (0.488-0.989)	0.772 (0.526-1.15)
15-min	0.184 (0.153-0.223)	0.241 (0.201-0.292)	0.318 (0.264-0.387)	0.384 (0.316-0.471)	0.477 (0.379-0.606)	0.552 (0.429-0.716)	0.630 (0.478-0.840)	0.715 (0.527-0.980)	0.836 (0.590-1.20)	0.934 (0.636-1.39)
30-min	0.275 (0.229-0.334)	0.361 (0.300-0.437)	0.477 (0.396-0.580)	0.575 (0.473-0.705)	0.714 (0.568-0.907)	0.826 (0.642-1.07)	0.944 (0.716-1.26)	1.07 (0.789-1.47)	1.25 (0.883-1.79)	1.40 (0.952-2.07)
60-min	0.403 (0.336-0.489)	0.528 (0.440-0.641)	0.698 (0.580-0.849)	0.842 (0.693-1.03)	1.05 (0.831-1.33)	1.21 (0.941-1.57)	1.38 (1.05-1.84)	1.57 (1.16-2.15)	1.83 (1.29-2.62)	2.05 (1.40-3.04)
2-hr	0.602 (0.501-0.729)	0.778 (0.648-0.944)	1.01 (0.841-1.23)	1.21 (0.994-1.48)	1.48 (1.18-1.88)	1.69 (1.31-2.19)	1.91 (1.45-2.54)	2.14 (1.58-2.93)	2.46 (1.74-3.52)	2.72 (1.85-4.03)
3-hr	0.763 (0.636-0.925)	0.983 (0.818-1.19)	1.27 (1.06-1.55)	1.51 (1.24-1.85)	1.83 (1.46-2.33)	2.09 (1.62-2.71)	2.34 (1.78-3.12)	2.61 (1.93-3.58)	2.98 (2.11-4.27)	3.27 (2.23-4.85)
6-hr	1.09 (0.906-1.32)	1.40 (1.16-1.70)	1.80 (1.50-2.19)	2.13 (1.75-2.61)	2.56 (2.04-3.26)	2.90 (2.25-3.76)	3.23 (2.45-4.31)	3.58 (2.64-4.90)	4.04 (2.85-5.78)	4.40 (3.00-6.52)
12-hr	1.44	1.87	2.41	2.84	3.41	3.83	4.25	4.68	5.24	5.67

	(1.20-1.75)	(1.55-2.27)	(2.00-2.93)	(2.34-3.48)	(2.71-4.33)	(2.98-4.97)	(3.23-5.66)	(3.45-6.41)	(3.70-7.50)	(3.86-8.40)
24-hr	1.94 (1.71-2.23)	2.55 (2.25-2.94)	3.31 (2.92-3.84)	3.92 (3.43-4.57)	4.71 (3.99-5.67)	5.29 (4.39-6.51)	5.87 (4.75-7.39)	6.44 (5.08-8.34)	7.19 (5.44-9.70)	7.76 (5.67-10.8)
2-day	2.33 (2.07-2.69)	3.14 (2.77-3.62)	4.16 (3.67-4.81)	4.97 (4.35-5.80)	6.04 (5.12-7.28)	6.84 (5.67-8.41)	7.63 (6.18-9.62)	8.43 (6.64-10.9)	9.48 (7.18-12.8)	10.3 (7.52-14.3)
3-day	2.52 (2.23-2.90)	3.44 (3.04-3.97)	4.63 (4.08-5.36)	5.58 (4.89-6.51)	6.86 (5.81-8.26)	7.82 (6.49-9.62)	8.78 (7.11-11.1)	9.76 (7.69-12.6)	11.1 (8.37-14.9)	12.1 (8.82-16.8)
4-day	2.71 (2.40-3.12)	3.74 (3.31-4.32)	5.08 (4.48-5.88)	6.17 (5.40-7.19)	7.62 (6.46-9.19)	8.73 (7.25-10.7)	9.85 (7.98-12.4)	11.0 (8.66-14.2)	12.5 (9.48-16.9)	13.7 (10.0-19.1)
7-day	3.08 (2.73-3.55)	4.33 (3.83-5.00)	5.98 (5.27-6.92)	7.32 (6.40-8.53)	9.14 (7.74-11.0)	10.5 (8.74-13.0)	12.0 (9.69-15.1)	13.4 (10.6-17.4)	15.4 (11.7-20.8)	17.0 (12.4-23.7)
10-day	3.33 (2.95-3.84)	4.73 (4.19-5.46)	6.59 (5.81-7.62)	8.11 (7.09-9.46)	10.2 (8.63-12.3)	11.8 (9.80-14.5)	13.5 (10.9-17.0)	15.2 (12.0-19.7)	17.5 (13.3-23.7)	19.4 (14.2-27.1)
20-day	3.98 (3.52-4.59)	5.73 (5.07-6.61)	8.08 (7.13-9.35)	10.0 (8.79-11.7)	12.8 (10.8-15.4)	15.0 (12.4-18.4)	17.2 (14.0-21.7)	19.6 (15.5-25.4)	23.0 (17.4-31.0)	25.6 (18.7-35.7)
30-day	4.70 (4.16-5.41)	6.75 (5.97-7.79)	9.55 (8.43-11.1)	11.9 (10.4-13.9)	15.3 (12.9-18.4)	18.0 (14.9-22.1)	20.8 (16.8-26.2)	23.8 (18.8-30.8)	28.1 (21.3-37.9)	31.6 (23.1-44.0)
45-day	5.57 (4.93-6.43)	7.92 (7.00-9.14)	11.2 (9.84-12.9)	13.9 (12.2-16.3)	17.9 (15.2-21.6)	21.2 (17.6-26.0)	24.6 (19.9-31.0)	28.4 (22.4-36.7)	33.7 (25.5-45.5)	38.1 (27.9-53.2)
60-day	6.57 (5.82-7.58)	9.19 (8.12-10.6)	12.8 (11.3-14.9)	16.0 (14.0-18.7)	20.6 (17.4-24.8)	24.4 (20.2-30.0)	28.4 (23.0-35.8)	32.9 (25.9-42.6)	39.3 (29.7-53.0)	44.6 (32.6-62.3)

¹ Precipitation frequency (PF) estimates in this table are based on frequency analysis of partial duration series (PDS). Numbers in parenthesis are PF estimates at lower and upper bounds of the 90% confidence interval. The probability that precipitation frequency estimates (for a given duration and average recurrence interval) will be greater than the upper bound (or less than the lower bound) is 5%. Estimates at upper bounds are not checked against probable maximum precipitation (PMP) estimates and may be higher than currently valid PMP values. Please refer to NOAA Atlas 14 document for more information.

Estimates from the table in CSV format:

Main Link Categories:
[Home](#) | [OWP](#)

US Department of Commerce
 National Oceanic and Atmospheric Administration
 National Weather Service
 Office of Water Prediction (OWP)
 1325 East West Highway
 Silver Spring, MD 20910
 Page Author: [HDSC webmaster](#)
 Page last modified: April 21, 2017

Map Disclaimer
 Disclaimer
 Credits
 Glossary

Privacy Policy
 About Us
 Career Opportunities

Worksheet H: Factor of Safety and Design Infiltration Rate Worksheet

Factor Category		Factor Description	Assigned Weight (w)	Factor Value (v)	Product (p) $p = w \times v$
A	Suitability Assessment	Soil assessment methods	0.25	1	0.25
		Predominant soil texture	0.25	1	0.25
		Site soil variability	0.25	1	0.25
		Depth to groundwater / impervious layer	0.25	1	0.25
		Suitability Assessment Safety Factor, $S_A = \Sigma p$			
B	Design	Tributary area size	0.25	2	0.50
		Level of pretreatment/ expected sediment loads	0.25	1	0.25
		Redundancy	0.25	3	0.75
		Compaction during construction	0.25	1	0.25
		Design Safety Factor, $S_B = \Sigma p$			
Combined Safety Factor, $S_{TOT} = S_A \times S_B$				1.75; use 2.00	
Measured Infiltration Rate, inch/hr, K_M (corrected for test-specific bias)				6.4	
Design Infiltration Rate, in/hr, $K_{DESIGN} = K_M / S_{TOT}$				3.2	

Supporting Data

Briefly describe infiltration test and provide reference to test forms:

A site-specific infiltration test has been conducted at the location of the infiltrating BMP to support a measured infiltration rate of 6.4 in/hr. The design infiltration rate will be 3.2 in/hr after applying the appropriate safety factor. This design rate is suitable for infiltration facilities.

Note: The minimum combined adjustment factor shall not be less than 2.0 and the maximum combined adjustment factor shall not exceed 9.0.

LOW-BASED BMP DESIGN (pretreatment)

$$C_{BMP} = 0.858(\text{imp})^3 - 0.78(\text{imp})^2 + 0.774(\text{imp}) + 0.04$$

$$I_{BMP} = (0.528)(0.2787)(2) = 0.294 \text{ in/hr}$$

$$Q = C_{BMP} * 0.294 * \text{Area}$$

DA 1 DMA A – BAR #1

Region		Valley	
Drainage Area (acres)		8.29	acres
Drainage Area (sq-ft)		361,112	sq-ft
Impervious Coeff	i =	0.95	< 1.0
Runoff Coeff	C =	0.81	
1-hr 2-yr from NOAA		0.528	
Intensity Coeff		0.2787	
Intensity BMP (in/hr)		0.294	
Flow (cfs)	Q =	1.97	cfs

Barracuda Unit S6

Q-required = 1.97 cfs

Q-provided = 2.80 cfs

VOLUME-BASED BMP DESIGN

$$C_{BMP} = 0.858(\text{imp})^3 - 0.78(\text{imp})^2 + 0.774(\text{imp}) + 0.04$$

$$P_6 = (0.528)(1.4807) = 0.782 \text{ inches}$$

$$P_0 = (1.582)(C_{BMP})(0.782)$$

$$DCV = (P_0 * \text{Area}) / 12$$

DA 1 DMA A – UNDERGROUND INFILTRATION CHAMBERS (STC #1)

Region		Valley	
Drainage Area (acres)		8.19	acres
Drainage Area (sq-ft)		356,756	sq-ft
Impervious Coeff	i =	0.95	< 1.0
Runoff Coeff	C =	0.807	
1-hr 2-yr from NOAA		0.528	
P6 Coeff		1.4807	
Mean 6-hr (P6)		0.782	
Drawdown Rate (a)		1.582	
DCV		29,673	cu-ft
DCV		0.681	acre-ft

DA 1 DMA A – DRIVEWAY RUNOFF (STC #1)

Region		Valley	
Drainage Area (acres)		0.10	acres
Drainage Area (sq-ft)		4,356	sq-ft
Impervious Coeff	i =	1.00	< 1.0
Runoff Coeff	C =	0.892	
1-hr 2-yr from NOAA		0.528	
P6 Coeff		1.4807	
Mean 6-hr (P6)		0.782	
Drawdown Rate (a)		1.582	
DCV		400	cu-ft
DCV		0.009	acre-ft

$$\text{Total DCV} = 29,673 \text{ cu-ft} + 400 \text{ cu-ft} = 30,073 \text{ cu-ft}$$

$$\text{Design infiltration rate} = 3.2 \text{ in/hr}$$

$$d_{\text{max}} = 76.80 \text{ inches} = \text{Design infiltration rate} \times 24 \text{ hours} = 3.2 \text{ in/hr} \times 24 \text{ hrs}$$

$$d_{\text{BMP-eff}} = 61.80 \text{ inches} = [(30 \text{ inches} + 12 \text{ inches}) \times 0.40] + 45 \text{ inches}$$

$$d_{\text{max}} > d_{\text{BMP-eff}}$$



MC-3500 Site Calculator

Project Information:	
Project Name:	Santa Ana Ave (TEI 3615 - Building 3)
Location:	Fontana, CA
Date:	16-Jun
Engineer:	Thienes Engineering, Inc
StormTech RPM:	

System Requirements

Units	Imperial
Required Storage Volume	30073 CF
Stone Porosity (Industry Standard = 40%)	40 %
Stone Above Chambers (12 inch min.)	12 inches
Stone Foundation Depth (9 inch min.)	30 inches
Average Cover over Chambers (24 inch min.)	24 inches
Bed size controlled by WIDTH or LENGTH?	WIDTH
Limiting WIDTH or LENGTH dimension	40 feet
Storage Volume per Chamber	214.9 CF
Storage Volume per End Cap	58.9 CF

System Sizing

Number of Chambers Required	138 each
Number of End Caps Required	10 each
Bed Size (including perimeter stone)	7,516 square feet
Stone Required (including perimeter stone)	2034 tons
Volume of Excavation	2297 cubic yards
Non-woven Filter Fabric Required (20% Safety Factor)	2473 square yards
Length of Isolator Row	205.4 feet
Non-woven Isolator Row Fabric (20% Safety Factor)	356 square yards
Woven Isolator Row Fabric (20% Safety Factor)	452 square yards
Installed Storage Volume	30,245 cubic feet

Controlled by Width (Rows)

Maximum Width =	40 feet
3 rows of	28 chambers
2 row of	27 chambers
Maximum Length =	205.44 feet
Maximum Width =	37.09 feet

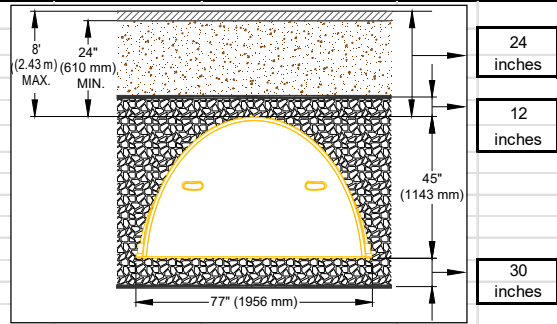

Attachment C WQMP Site Map

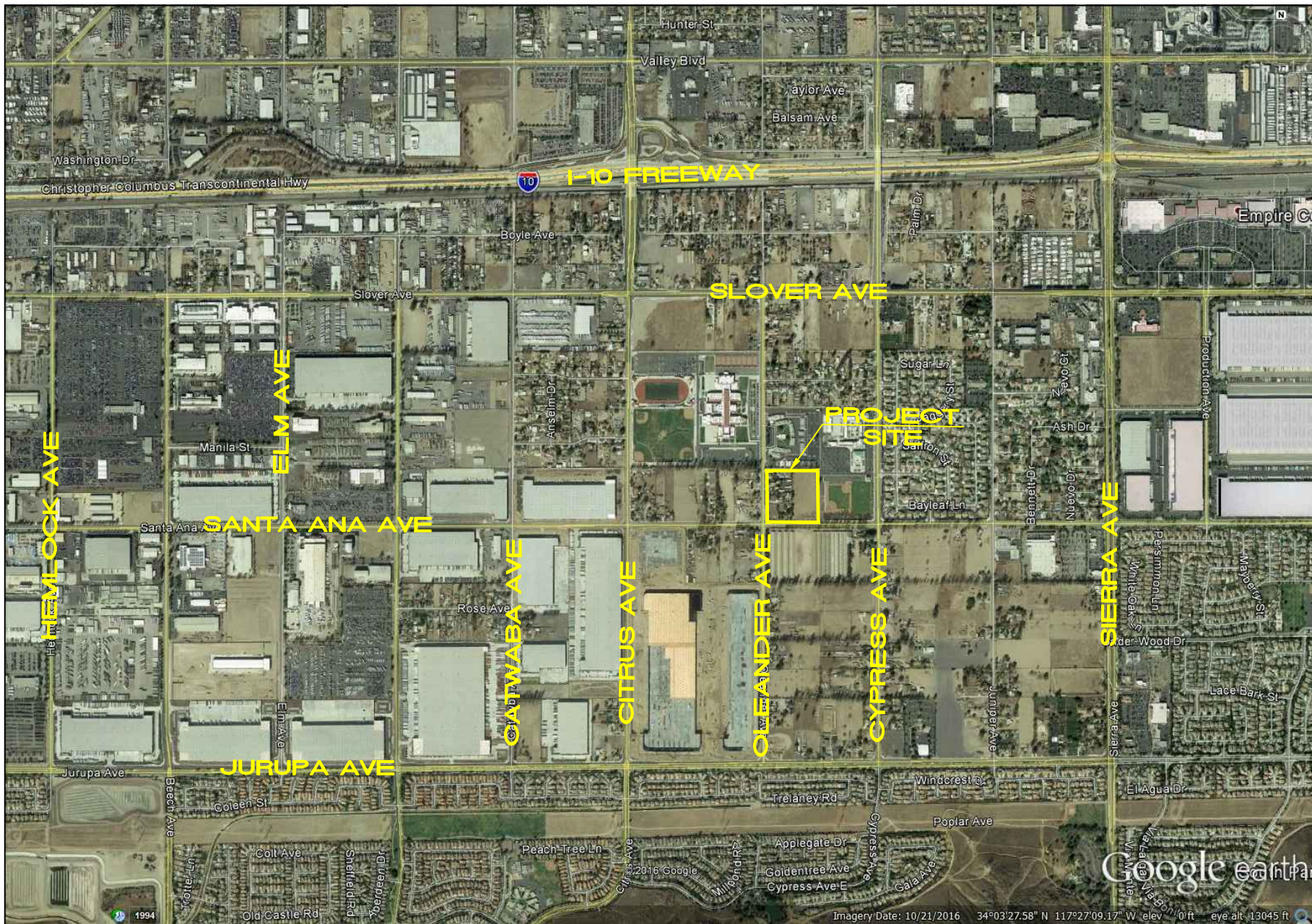

"VICINITY MAP"

FOR

**SANTA ANA AVENUE INDUSTRIAL DEVELOPMENT
(BUILDING 3)**

TI Thienes Engineering, Inc.
 CIVIL ENGINEERING • LAND SURVEYING
 14349 FIRESTONE BOULEVARD
 LA MIRADA, CALIFORNIA 90638
 PH.(714)521-4811 FAX(714)521-4173





Last Update: 3/30/22
 O:\3600-3699\3615\3615VicMap.dwg



"RECEIVING WATERS MAP"

FOR



**SANTA ANA AVENUE INDUSTRIAL DEVELOPMENT
(BUILDING 3)**

THI Thienes Engineering, Inc.
 CIVIL ENGINEERING • LAND SURVEYING
 14349 FIRESTONE BOULEVARD
 LA MIRADA, CALIFORNIA 90638
 PH.(714)521-4811 FAX(714)521-4173

OLEANDER AVE

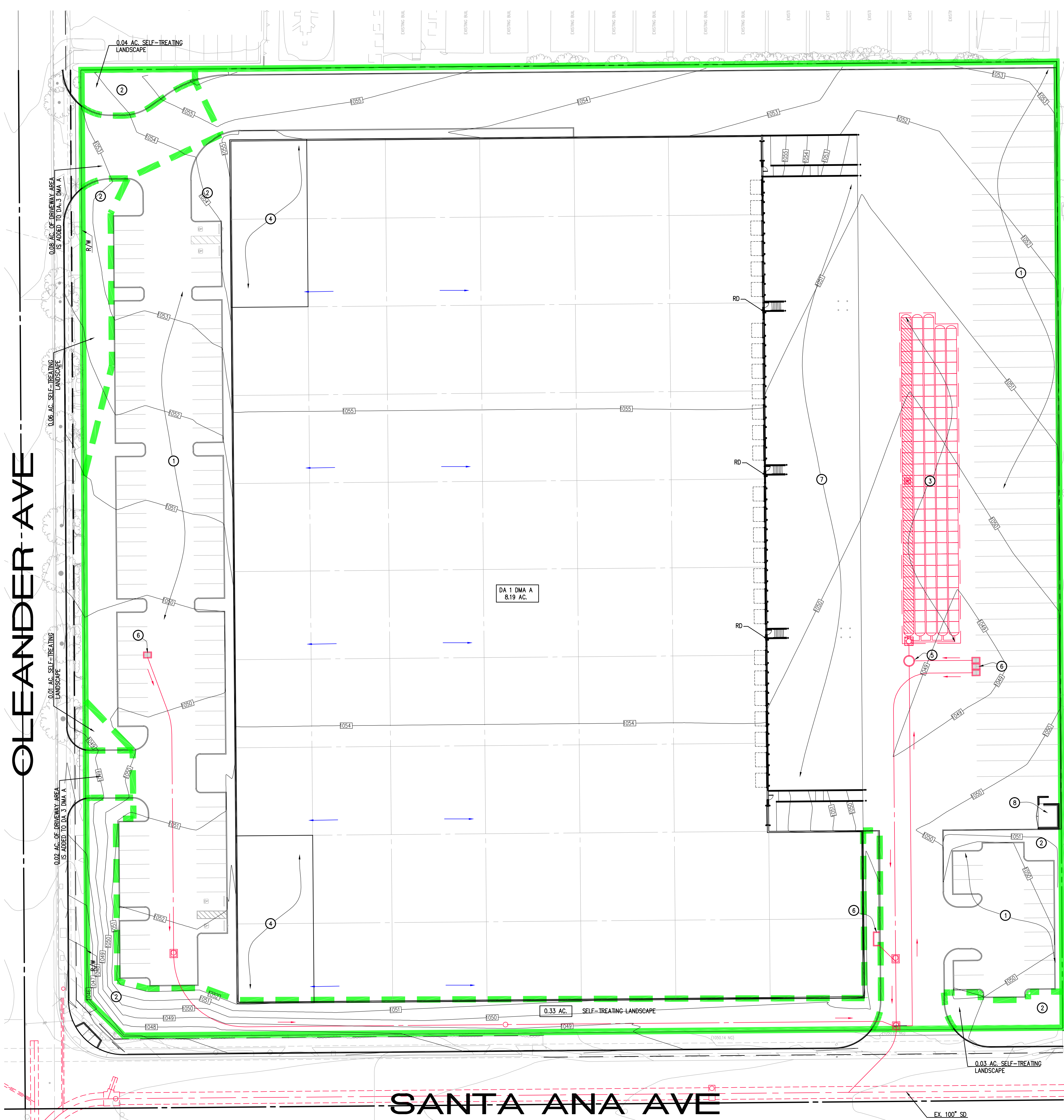

DA DMA ID	VOL REQ'D	VOL PROVIDED	BMP UNITS	FLOW REQ'D	FLOW PROVIDED
DA 1 DMA A	30,073 CF	30,245 CF	138	1.97 CFS	2.08 CFS

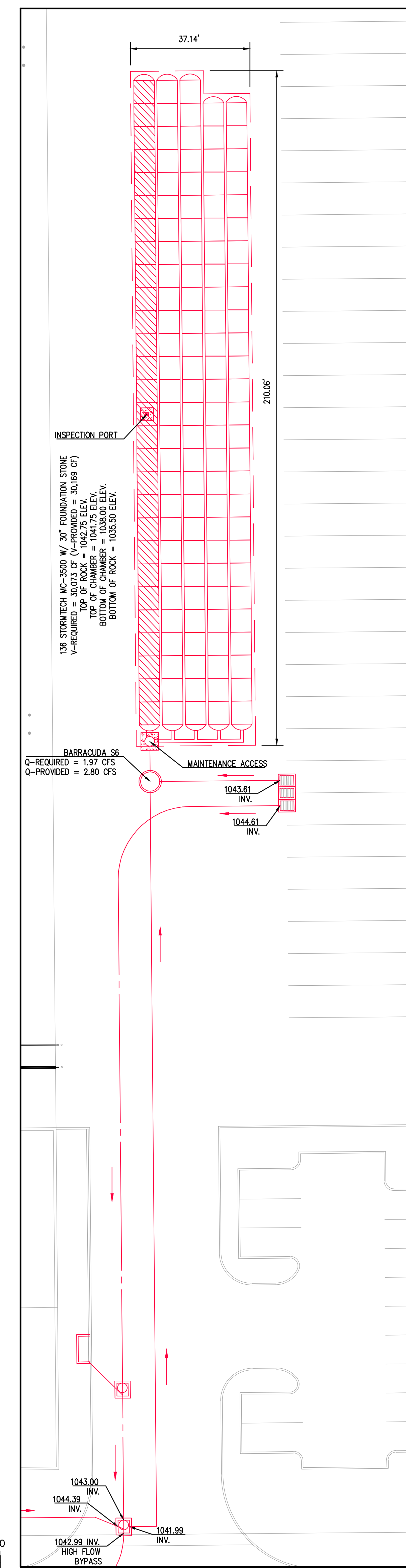
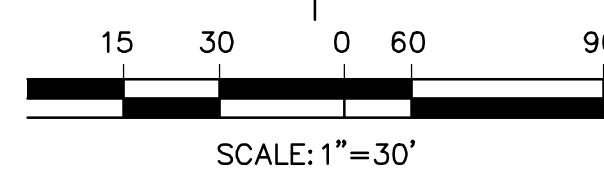

ENLARGED INFILTRATION CHAMBER DETAIL (3)

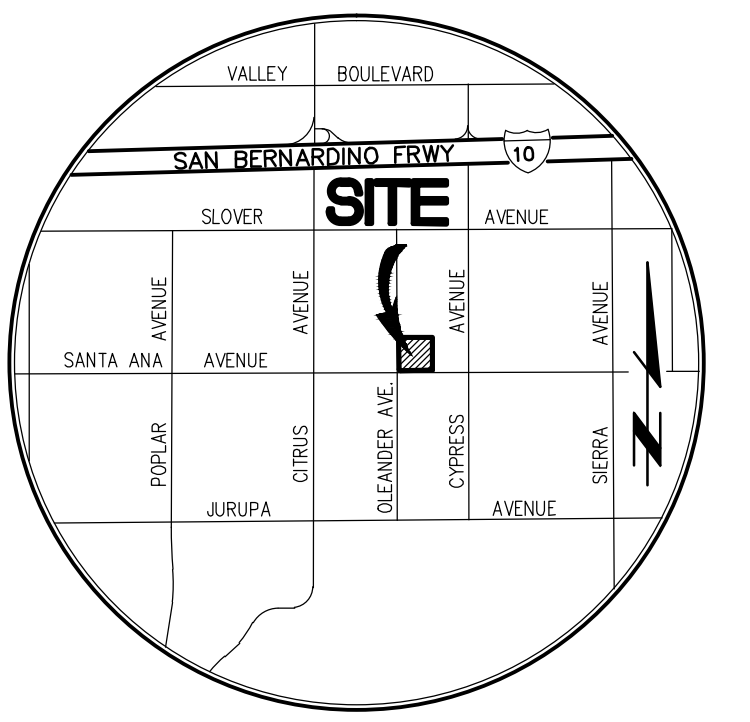

VICINITY MAP
N.T.S.

LEGEND	
①	NIS: VACUUM SWEEPING
②	N3 & S4: LANDSCAPE MANAGEMENT BMPs (EFFICIENT IRRIGATION)
③	STORMTECH MC-3500 INFILTRATION CHAMBERS
④	N1: EDUCATION OF STORMWATER BMPs N2: EMPLOYEE TRAINING
⑤	ADS BARRACUDA UNIT (PRE-TREATMENT)
⑥	S1: CATCH BASIN STENCIL - "NO DUMPING-DRAINS TO RIVER" N4: CATCH BASIN INSPECTION
⑦	N13: HOUSEKEEPING OF LOADING DOCKS
⑧	S3: TRASH ENCLOSURE
RD	ROOF DRAIN
—	BOUNDARY
—	SUBAREAS
—	FLOW LINE - SURFACE
—	FLOW LINE - SD

Last Update: 6/16/22
C:\3600-3699\3615\361504P9ITEMAP.dwg

CITY OF FONTANA ENGINEERING DEPARTMENT WOMP SITE MAP SANTA ANA AVENUE INDUSTRIAL DEVELOPMENT (BUILDING 3) FONTANA, CA		3615/1 OF 2 SHEETS
Prepared For: ACACIA REAL ESTATE GROUP 260 NEWPORT CENTER DR., SUITE 100 NEWPORT BEACH, CA 92660 PHONE: (949) 640-9995	Prepared By: T.E.I. Thienes Engineering, Inc. CIVIL ENGINEERING - LAND SURVEYING 14340 FIRESTONE BOULEVARD LA MIRADA, CALIFORNIA 90638 PH: (714) 521-4811 FAX: (714) 521-4733	
Designed by _____ Checked by _____ Date _____ Designed by _____ Checked by _____ Date _____	Approved by _____ Date _____ Public Works Director R.C.E. XXXXX Sheet 1 of 2 Sheets	

STORMTECH MC-3500 CHAMBER

Designed to meet the most stringent industry performance standards for superior structural integrity while providing designers with a cost-effective method to save valuable land and protect water resources. The StormTech system is designed primarily to be used under parking lots, thus maximizing land usage for private (commercial) and public applications. StormTech chambers can also be used in conjunction with Green Infrastructure, thus enhancing the performance and extending the service life of these practices.



STORMTECH MC-3500 CHAMBER
(not to scale)

Nominal Chamber Specifications

- Size (L x W x H)
90" x 77" x 45"
- 2,286 mm x 1,956 mm x 1,143 mm
- Chamber Storage
109.9 ft³ (3.11 m³)
- Min. Installed Storage*
175.0 ft³ (4.96 m³)
- Weight
134 lbs (60.8 kg)
- Shipping
15 chambers/pallet
7 end caps/pallet
7 pallets/truck

STORMTECH MC-3500 END CAP
(not to scale)

Nominal End Cap Specifications

- Size (L x W x H)
26.5" x 11" x 4.5"
- 673 mm x 1,903 mm x 1,145 mm
- End Cap Storage
14.9 ft³ (0.42 m³)
- Min. Installed Storage*
45.1 ft³ (1.28 m³)
- Weight
49 lbs (22.2 kg)

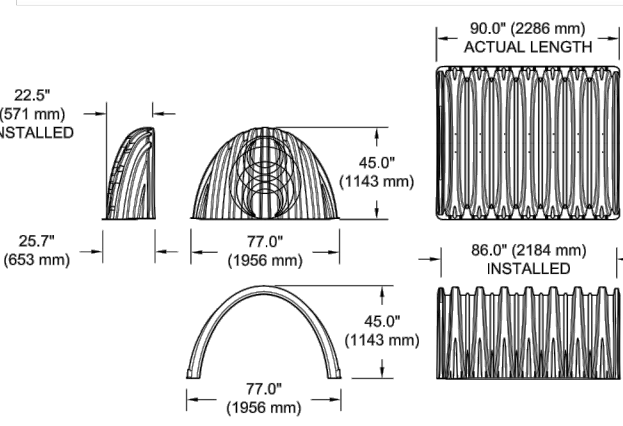

*Assumes a minimum of 12" (300 mm) of stone above, 9" (230 mm) of stone below, 6" (150 mm) of stone between chambers, and 45% stone porosity.

*Assumes a minimum of 12" (300 mm) of stone above, 9" (230 mm) of stone below, 6" (150 mm) of stone between chambers, and 45% stone porosity.

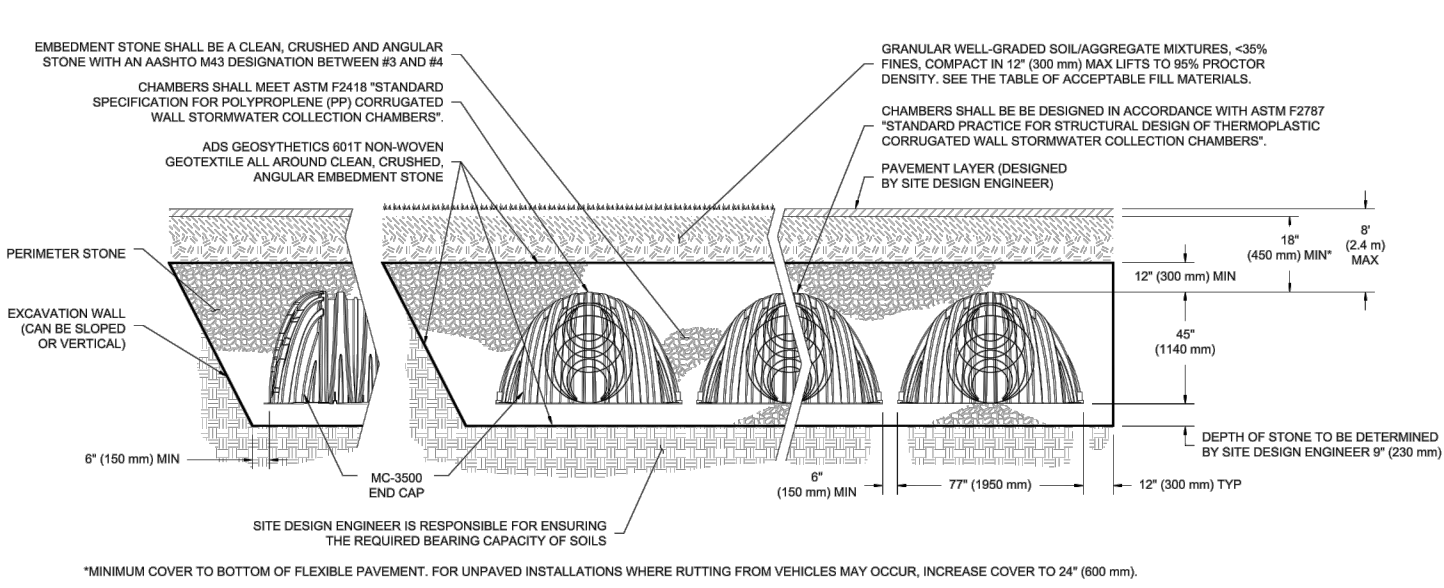

STORMTECH MC-3500 CHAMBER SPECIFICATION

STORAGE VOLUME PER CHAMBER FT³ (M³)

Chamber	Stone Chamber	Chamber and Stone
18" (450 mm)	9" (230 mm)	12" (300 mm)
MC-3500 Chamber	109.9 (3.11)	175.0 (4.96)
MC-3500 End Cap	14.9 (0.42)	45.1 (1.28)

AMOUNT OF STONE PER CHAMBER

ENGLISH TONS (yd ³)	Stone Foundation Depth			
	9"	12"	15"	18"
MC-3500 Chamber	8.5 (8.9)	9.1 (9.5)	9.7 (9.9)	10.4 (10.7)
MC-3500 End Cap	3.9 (2.8)	4.1 (2.8)	4.3 (3.1)	4.5 (3.2)

VOLUME EXCAVATION PER CHAMBER YD³ (M³)

ENGLISH TONS (yd ³)	Stone Foundation Depth			
	9"	12"	15"	18"
MC-3500 Chamber	11.9 (9.3)	12.4 (9.5)	12.8 (9.6)	13.3 (10.3)
MC-3500 End Cap	4.9 (3.5)	4.1 (3.2)	4.3 (3.3)	4.4 (3.4)

Note: Assumes 6" (150 mm) of separation between chamber rows and 24" (600 mm) of cover. The volume of excavation will vary as depth of cover increases.



Working on a project? Visit us at www.stormtech.com and utilize the StormTech Design Tool

For more information on the StormTech MC-3500 Chamber and other ADS products, please contact our Customer Service Representatives at 1-800-821-6710

THE MOST ADVANCED NAME IN WATER MANAGEMENT SOLUTIONSSM

Advanced Drainage Systems, Inc.
4640 Trouman Blvd., Milford, OH 43005
1-800-821-6710 www.ads-pipe.com

OPEN AREAS TO ALLOW CONCRETE TO SHOW THROUGH TO CREEK

BLUE MATERIAL

PLACEMENT: THERMOPLASTIC SIGNAGE IS TO BE INSTALLED ON THE TOP OF THE CURB APPROXIMATELY 1/2" INCH BEHIND THE CURB FACE. IT SHOULD BE PLACED LATERALLY CENTERED OVER THE INLET STRUCTURE.

NOTE: SEE PAGE 2 OF 2 FOR MATERIAL SPECIFICATIONS.

NOT TO SCALE

APPROVED BY: *[Signature]* DATE: *[Date]*

CITY OF FONTANA
STORM DRAIN INLET SIGNAGE

REG. PROFESSIONAL ENGINEER
No. 51152
EXP. 03/07
CIVIL
STATE OF CALIFORNIA

DATE OF LAST REVISION: _____

STD. PLAN NO. 6002 SHT 1 OF 2

PERIMETER STONE MUST ALWAYS BE BROUGHT UP EVENLY WITH BACKFILL OF BED. PERIMETER STONE MUST EXTEND HORIZONTALLY TO THE EXCAVATION WALL FOR BOTH STRAIGHT OR SLOPED SIDEWALLS.

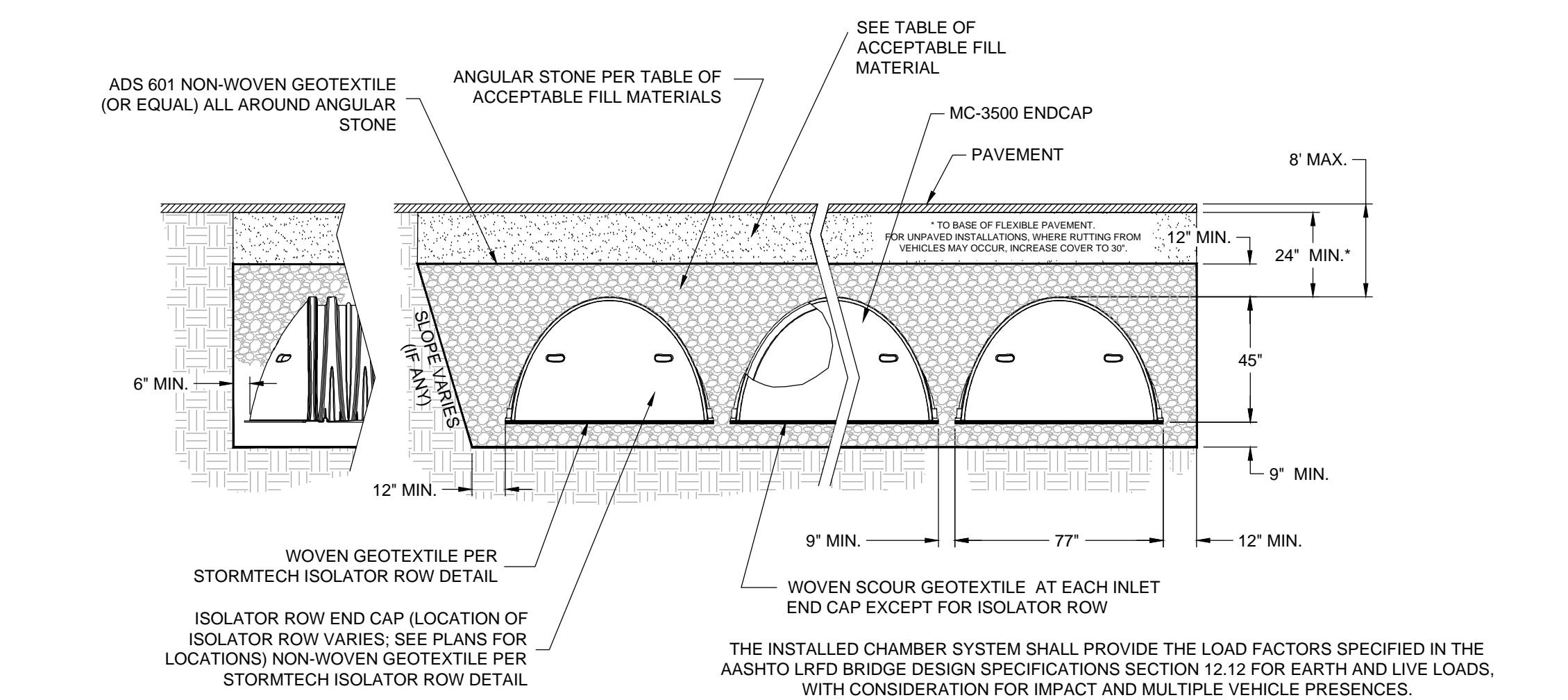

MC-3500 TYPICAL CROSS SECTION

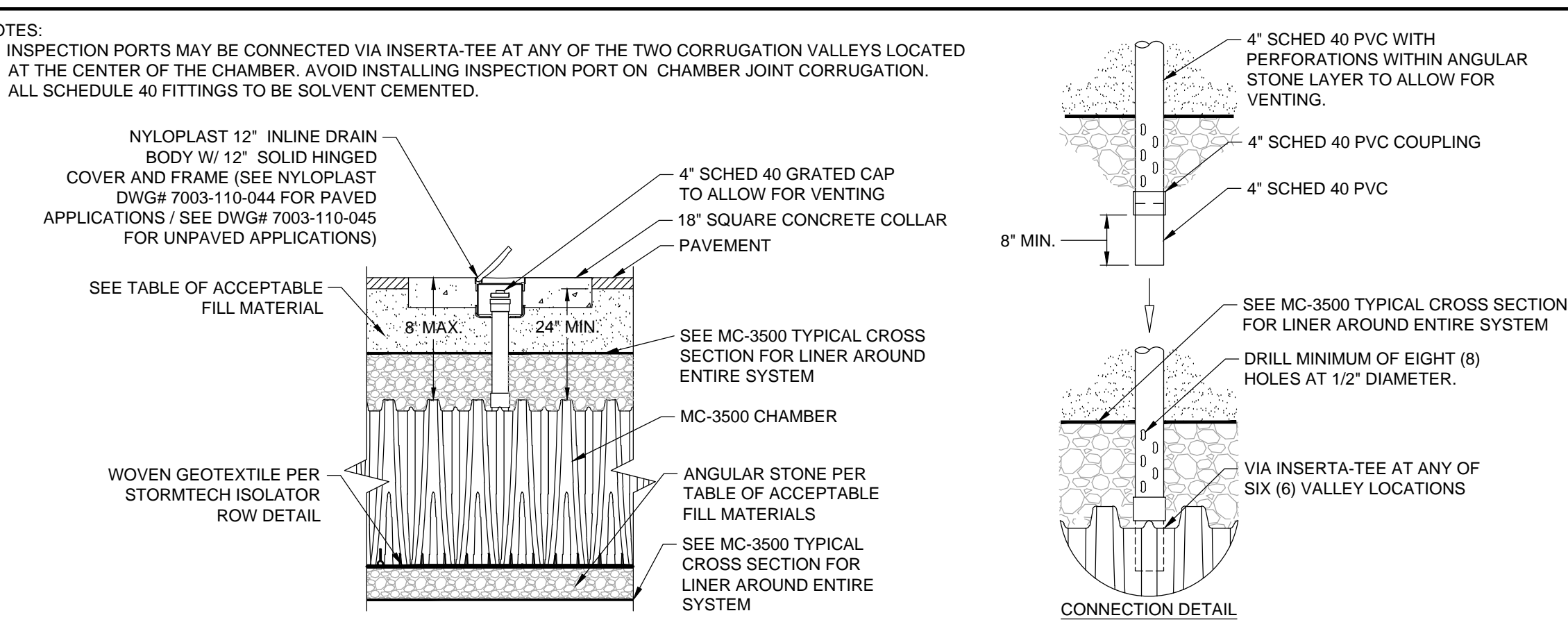

INSPECTION PORT DETAIL

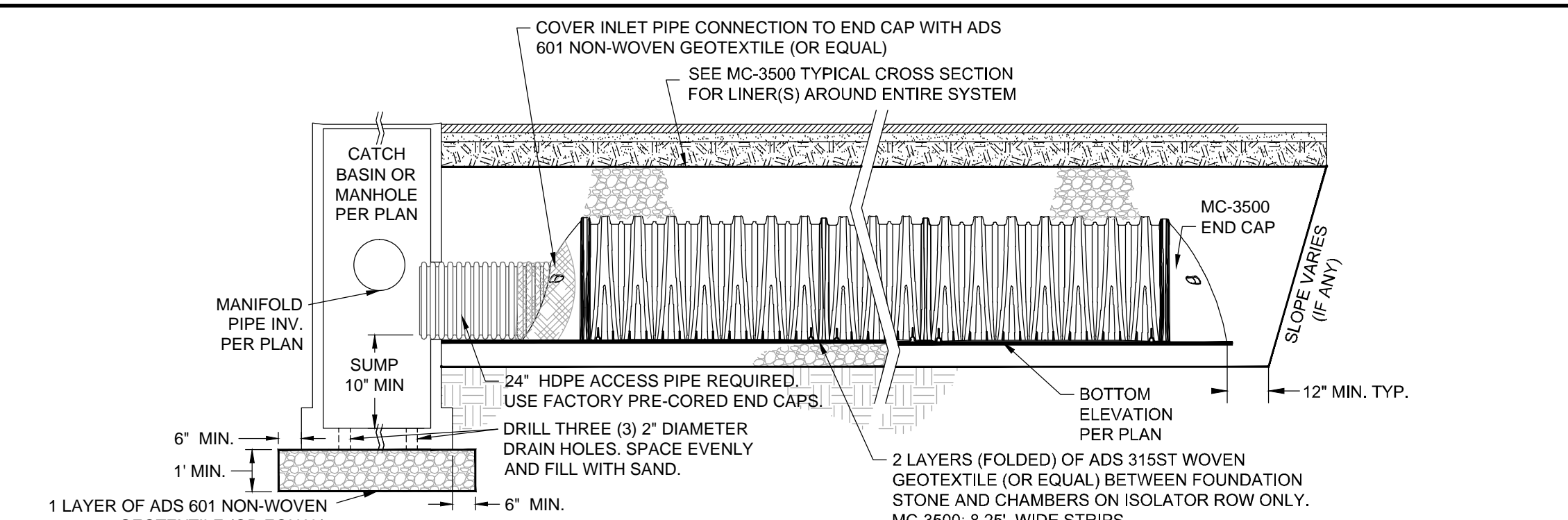

STORMTECH ISOLATOR ROW DETAIL

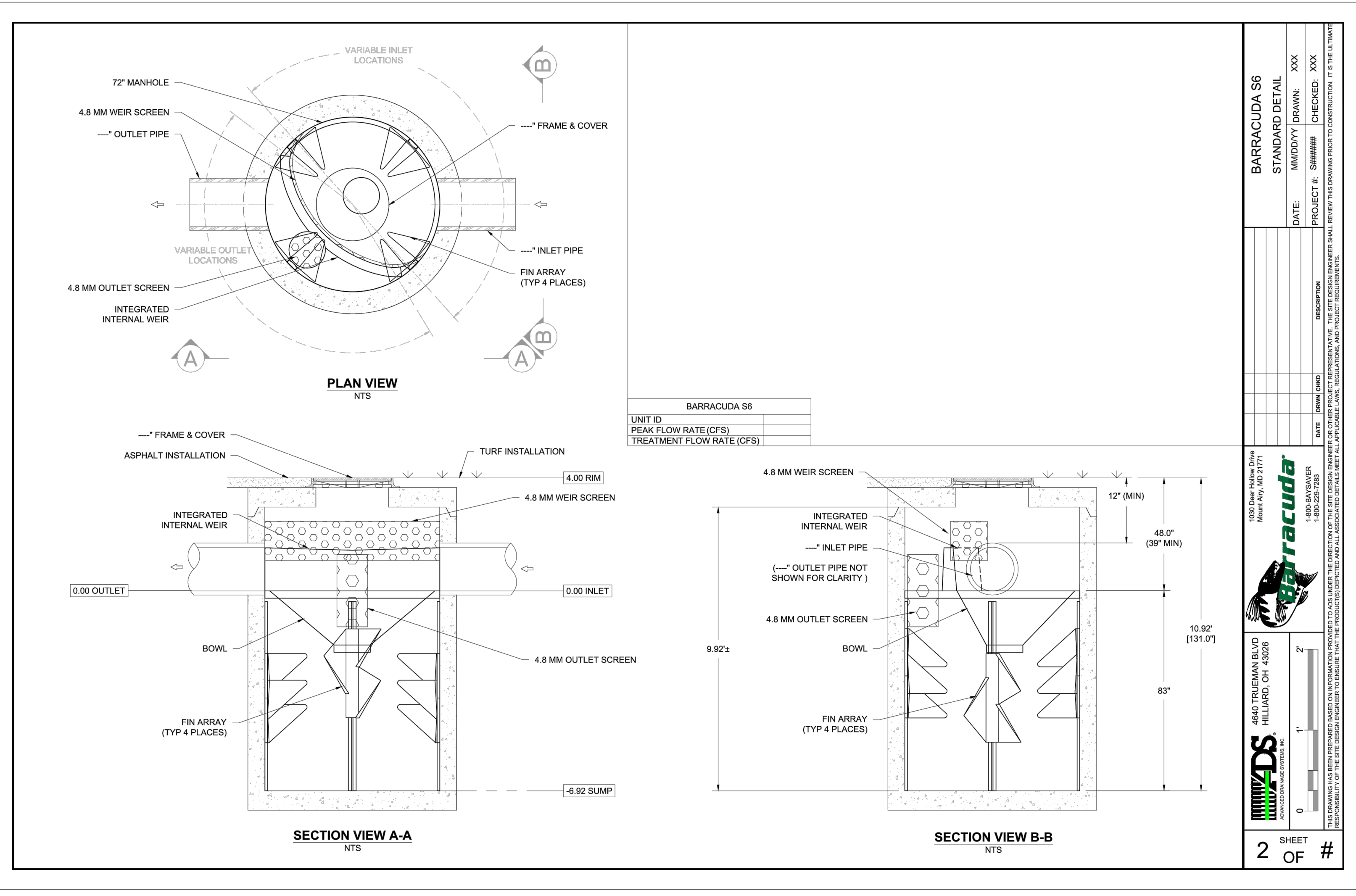
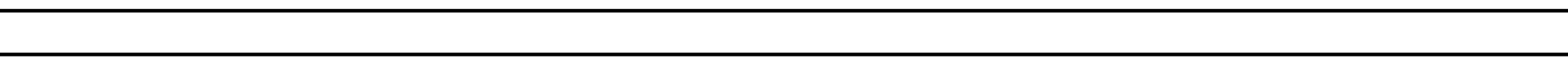

BARRACUDA S6
STANDARD DETAIL

DATE: _____
DESIGNED BY: _____
CHECKED BY: _____
DRAWN BY: _____

4640 TROUMAN BLVD
MILFORD, OH 43005
1-800-821-6710
www.ads-pipe.com

2 SHEET OF #

CITY OF FONTANA
ENGINEERING DEPARTMENT

WOMP SITE MAP

SANTA ANA AVENUE
INDUSTRIAL DEVELOPMENT
(BUILDING 3)
FONTANA, CA

Prepared for: ACACIA REAL ESTATE GROUP
260 NEWPORT CENTER DR, SUITE 100
NEWPORT BEACH, CA 92660
PHONE: (949) 640-9995

Prepared by: **Tai** Thienes Engineering, Inc.
CIVIL ENGINEERING • LAND SURVEYING
14146 FIRESTONE BOULEVARD
LA MIRADA, CALIFORNIA 90638
PH: (714) 521-4811 FAX: (714) 521-4133

Designed by: _____ Date: _____
Checked by: _____ Date: _____
Designed by: _____ Date: _____
Checked by: _____ Date: _____

Approved by: _____ Date: _____
Public Works Director: R.C.E. XXXXX

Sheet **2** of **2** Sheets

3615/2 OF 2 SHEETS

Attachment D
WQMP and Stormwater BMP Transfer, Access
and Maintenance Agreement

RECORDING REQUESTED BY:

CITY OF FONTANA
ENGINEERING DEPARTMENT
8353 SIERRA AVENUE,
FONTANA CA 92335

SPACE ABOVE FOR RECORDER'S USE ONLY

**Memorandum of Agreement for Water Quality Management
Plan and Storm Water BMP Transfer, Access and Maintenance**

OWNER/APPLICANT NAME: Acacia Real Estate Group
PROPERTY ADDRESS: NEC of Santa Ana Ave and Oleander Ave
Fontana, CA 92337

APN: 0255-021-17, -18, -22, -23, -24

THIS Memorandum of Agreement hereinafter referred to as "Agreement" is made and entered on this _____ day of _____, **2022** by the undersigned herein after referred to as "Owner" and the City of Fontana, a municipal corporation, located in the County of San Bernardino, State of California hereinafter referred to as "CITY";

WHEREAS, the Owner owns real property ("Property") in the City of Fontana, County of San Bernardino, State of California, more specifically described in Exhibit "A" and depicted in Exhibit "B", each of which exhibits is attached hereto and incorporated herein by this reference;

WHEREAS, at the time of initial approval of development project within the Property described above, the City required the project to employ Best Management Practices, hereinafter referred to as "BMPs," to minimize pollutants in urban runoff;

WHEREAS, the Owner has chosen to install and/or implement BMPs as described in the Water Quality Management Plan as described in Exhibit "C" and on file with the City, hereinafter referred to as "WQMP", to minimize pollutants in urban runoff and to minimize other adverse impacts of urban runoff;

WHEREAS, said WQMP has been certified by the Owner and reviewed and approved by the City;

WHEREAS, said BMPs, with installation and/or implementation on private property and draining only private property, are part of a private facility with all maintenance or replacement, therefore, the sole responsibility of the Owner;

WHEREAS, the Owner is aware that periodic and continuous maintenance, including, but not necessarily limited to, filter material replacement and sediment removal, is required to assure peak performance of all BMPs in the WQMP and that, furthermore, such maintenance activity will require compliance with all Local, State, or Federal laws and regulations, including those pertaining to confined space and waste disposal methods, in effect at the time such maintenance occurs;

NOW THEREFORE, it is hereby agreed by the Owner as follows:

1. Owner hereby provides the City of City's designee complete access, of any duration, to the BMPs and their immediate vicinity at any time, upon reasonable notice, or in the event of emergency, as determined by City's Director of Public Works no advance notice, for the purpose of inspection, sampling, testing of the Device, and in case of emergency, to undertake all necessary repairs or other preventative measures at owner's expense as provided in paragraph 3 below. City shall make every effort at all times to minimize or avoid interference with Owner's use of the Property.
2. Owner shall use its best efforts diligently to maintain all BMPs in a manner assuring peak performance at all times. All reasonable precautions shall be exercised by Owner and Owner's representative or contractor in the removal and extraction of any material(s) from the BMPs and the ultimate disposal of the material(s) in a manner consistent with all relevant laws and regulations in effect at the time. As may be requested from time to time by the City, the Owner shall provide the City with documentation identifying the material(s) removed, the quantity, and disposal destination.
3. In the event Owner, or its successors or assigns, fails to accomplish the necessary maintenance contemplated by this Agreement, within five (5) days of being given written notice by the City, the City is hereby authorized to cause any maintenance necessary to be done and charge the entire cost and expense to the Owner or Owner's successors or assigns, including administrative costs, attorneys fees and interest thereon at the maximum rate authorized by the Civil Code from the date of the notice of expense until paid in full.
4. The Owner agrees to hold the City, its officials, officers, employees, volunteers, and agents free and harmless from any and all claims, demands, causes of action, costs, expenses, liability, loss, damage, or injury, in law or equity, to property or persons, arising from the imposition of the plan by the City;
5. The City may require the owner to post security in form and for a time period satisfactory to the city to guarantee the performance of the obligations state herein. Should the Owner fail to perform the obligations under the Agreement, the City may, in the case of a cash bond, act for the Owner using the proceeds from it, or in the case of a surety bond, require the sureties to perform the obligations of the Agreement. As an additional remedy, the Director may withdraw any previous storm water-related approval with respect to the property on which BMPs have been installed and/or implemented until such time as Owner repays to City its reasonable costs incurred in accordance with paragraph 3 above.
6. This agreement shall be recorded in the Office of the Recorder of San Bernardino County, California, at the expense of the Owner and shall constitute notice to all successors and assigns of the title to said Property of the obligation herein set forth, and also a lien in such amount as will fully reimburse the City, including interest as herein above set forth, subject to foreclosure in event of default in payment.
7. In event of legal action occasioned by any default or action of the Owner, or its successors or assigns, then the Owner and its successors or assigns agree(s) to pay all costs incurred by the City in enforcing the terms of this Agreement, including reasonable attorney's fees and costs, and that the same shall become a part of the lien against said Property.

8. It is the intent of the parties hereto that burdens and benefits herein undertaken shall constitute covenants that run with said Property and constitute a lien there against.
9. The obligations herein undertaken shall be binding upon the heirs, successors, executors, administrators and assigns of the parties hereto. The term "Owner" shall include not only the present Owner, but also its heirs, successors, executors, administrators, and assigns. Owner shall notify any successor to title of all or part of the Property about the existence of this Agreement. Owner shall provide such notice prior to such successor obtaining an interest in all or part of the Property. Owner shall provide a copy of such notice to the City at the same time such notice is provided to the successor.
10. This Agreement shall not be amended, modified or terminated without the prior written consent of the City, which consent to be effective, shall be contained in a document executed by the City and recorded against the Real Property.

OWNER:

Owner/Applicant Name: Acacia Real Estate Group

Owner/Applicant Signature: _____
David Pittman, Managing Partner

Date: _____

NOTARY

Notary acknowledgement is required for recordation (attach appropriate acknowledgement).

(INSERT NOTARY ACKNOWLEDGEMENT PAGE HERE)

EXHIBIT A
(Legal Description)

EXHIBIT B
(Map/illustration)

EXHIBIT C
(WQMP Exhibit)

Attachment E

Educational Materials

POLLUTION PREVENTION

STORMWATER

FRESH CONCRETE & MORTAR APPLICATION

Cement wash, sediment, vehicle fluids, dust and hazardous debris from construction sites often make their way into the San Bernardino County storm drain system and do not get treated before reaching the Santa Ana River. This pollutes our drinking water and contaminates waterways, making them unsafe for people and wildlife. Follow these best management practices to prevent pollution and protect public health.



Storing Materials

Keep construction materials and debris away from the street, gutter and storm drains. Secure open bags of cement and cover exposed stockpiles of soil, sand or gravel and excavated material with plastic sheeting, protected from rain, wind and runoff.



Ordering Materials & Recycling Waste

Reduce waste by ordering only the amounts of materials needed for the job. Use recycled or recyclable materials whenever possible. When breaking up paving, recycle the pieces at a crushing company. You can also recycle broken asphalt, concrete, wood, and cleared vegetation. Non-recyclable materials should be taken to a landfill or disposed of as hazardous waste. Call (909) 386-8401 for recycling and disposal information.



During Construction

Schedule excavation and grading during dry weather. Prevent mortar and cement from entering the street and storm drains by placing erosion controls. Setup small mixers on tarps or drop cloths, for easy cleanup of debris. Never bury waste material. Recycle or dispose of it as hazardous waste.

Cleaning Up

Wash concrete dust onto designated dirt areas, not down driveways or into the street or storm drains. Wash out concrete mixers and equipment in specified washout areas, where water can flow into a containment pond. Cement washwater can be recycled by pumping it back into cement mixers for reuse. Never dispose of cement washout into driveways, streets, gutters, storm drains or drainage ditches.

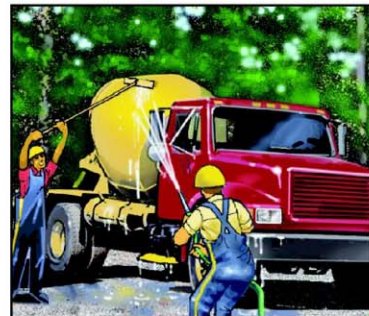

To report illegal dumping or for more information on stormwater pollution prevention, call:
1 (800) CLEANUP
www.1800cleanup.org



Fertilizer Tips to Prevent Pollution

Water that runs off your lawn and garden can carry excess fertilizer into the San Bernardino County storm drain system, and it does not get treated before reaching the Santa Ana River. This pollutes our drinking water and contaminates waterways, making them unsafe for people and wildlife. Follow these simple tips to prevent pollution and protect your health:



- Read the product label and follow the directions carefully, using only as directed.
- Avoid applying near driveways or gutters.
- Never apply fertilizer before a rain.
- Store fertilizers and chemicals in a covered area and in sealed, waterproof containers.
- Take unwanted lawn or garden chemicals to a household hazardous waste collection facility. Call (800) 253-2687.
- Use non-toxic products for your garden and lawn whenever possible.

To report illegal dumping or for more information on Stormwater pollution prevention, call:



1 (800) CLEANUP

www.1800cleanup.org



POLLUTION STORMWATER Prevention

HOME & GARDEN

Yard waste and household toxics like paints and pesticides often make their way into the San Bernardino County storm drain system and do not get treated before reaching the Santa Ana River. This pollutes our drinking water and contaminates waterways, making them unsafe for people and wildlife. Follow these simple tips to prevent pollution and protect your health.



Recycle Household Hazardous Waste

Household products like paint, pesticides, solvents and cleaners are too dangerous to dump and too toxic to trash. Take them to be recycled at a convenient household hazardous waste collection facility. Call (800) CLEANUP for the facility in your area.



Disposing of Yard Waste

Recycle leaves, grass clippings and other yard waste, instead of blowing, sweeping or hosing into the street. Try grasscycling, leaving grass clippings on your lawn instead of using a grass catcher. The clippings act as a natural fertilizer, and because grass is mostly water, it also irrigates your lawn, conserving water.



Use Fertilizers & Pesticides Safely

Fertilizers and pesticides are often carried into the storm drain system by sprinkler runoff. Try using organic or non-toxic alternatives. If you use chemical fertilizers or pesticides, avoid applying near curbs and driveways and never apply before a rain.



Planting in the Yard

Produce less yard waste and save water by planting low maintenance, drought-tolerant trees and shrubs. Using drip irrigation, soaker hoses or micro-spray systems for flower beds and vegetation can also help reduce your water bill and prevent runoff.



Use Water Wisely

Cut your water costs and prevent runoff by controlling the amount of water and direction of sprinklers. The average lawn needs about an inch of water a week, including rainfall, or 10 to 20 minutes of watering. A half-inch per week is enough for fall and spring. Sprinklers should be on long enough to allow water to soak into the ground but not so long as to cause runoff.



To report illegal dumping or for more information on stormwater pollution prevention, call:

1 (800) CLEANUP

www.1800cleanup.org



POLLUTION STORMWATER Prevention

PAINTING

Paints, solvents, adhesives and other toxic chemicals used in painting often make their way into the San Bernardino County storm drain system and do not get treated before reaching the Santa Ana River. This pollutes our drinking water and contaminates waterways, making them unsafe for people and wildlife. Follow these simple tips to prevent pollution and protect our health.



Water-Based Paints

Use water-based paints whenever possible. They are less toxic than oil-based paints and easier to clean up. Look for products labeled "latex" or "cleans with water."



Paint Removal

Sweep up paint stripping residue, chips and dust instead of hosing into the street and dispose of them safely at a household hazardous waste collection facility. Call (800) CLEANUP for the facility in your area.



Painting Cleanup

Never clean brushes or rinse paint containers in the street, gutter or near a storm drain. Clean water-based paints in the sink. Clean oil-based paints with thinner, which can be reused by putting it in a jar to settle out the paint particles and then pouring off the clear liquid for future use. Wrap dried paint residue in newspaper and dispose of it in the trash.

Exterior Paint Removal

When stripping or cleaning building exteriors with high-pressure water, block nearby storm drains and divert washwater onto a designated dirt area. Ask your local wastewater treatment authority if you can collect building cleaning water and discharge it to the sewer.



Recycling Paint

Recycle leftover paint at a household hazardous waste collection facility, save it for touch ups or give it to someone who can use it, like a theatre group, school, city or community organization.



To report illegal dumping or for more information on stormwater pollution prevention, call:

1 (800) CLEANUP

www.1800cleanup.org



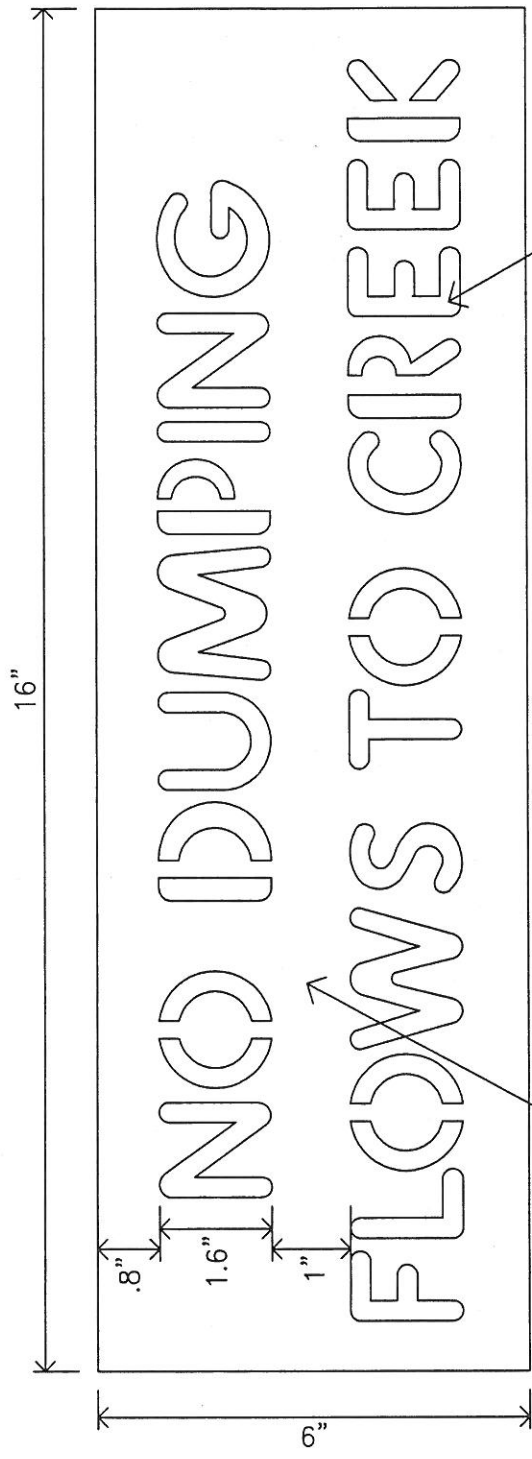

OPEN AREAS TO ALLOW CONCRETE TO SHOW THROUGH

BLUE MATERIAL

PLACEMENT: THERMOPLASTIC SIGNAGE IS TO BE INSTALLED ON THE TOP OF THE CURB APPROXIMATELY 1/2 INCH BEHIND THE CURB FACE. IT SHOULD BE PLACED Laterally CENTERED OVER THE INLET STRUCTURE.

NOTE: SEE PAGE 2 OF 2 FOR MATERIAL SPECIFICATIONS.

NOT TO SCALE

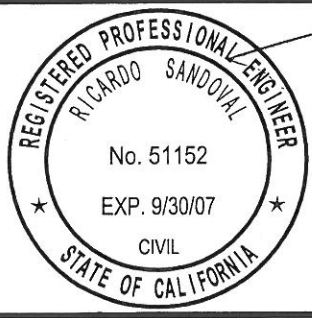

APPROVED BY: *Ricardo Sandoval*
 CITY ENGINEER DATE 10.18.06
 REVIEWED BY: *DG*
 DATE OF LAST REVISION: _____

CITY OF FONTANA	
STORM DRAIN INLET SIGNAGE	
07/10/06	
STD. PLAN NO. 6002	SHT 1 OF 2

STORMTECH MC-3500 CHAMBER

Designed to meet the most stringent industry performance standards for superior structural integrity while providing designers with a cost-effective method to save valuable land and protect water resources. The StormTech system is designed primarily to be used under parking lots, thus maximizing land usage for private (commercial) and public applications. StormTech chambers can also be used in conjunction with Green Infrastructure, thus enhancing the performance and extending the service life of these practices.

STORMTECH MC-3500 CHAMBER (not to scale)

Nominal Chamber Specifications

Size (L x W x H)
90" x 77" x 45"
2,286 mm x 1,956 mm x 1,143 mm

Chamber Storage
109.9 ft³ (3.11 m³)

Min. Installed Storage*
175.0 ft³ (4.96 m³)

Weight
134 lbs (60.8 kg)

Shipping
15 chambers/pallet
7 end caps/pallet
7 pallets/truck

*Assumes a minimum of 12" (300 mm) of stone above, 9" (230 mm) of stone below chambers, 6" (150 mm) of stone between chambers/end caps and 40% stone porosity.

STORMTECH MC-3500 END CAP (not to scale)

Nominal End Cap Specifications

Size (L x W x H)
26.5" x 71" x 45.1"
673 mm x 1,803 mm x 1,145 mm

End Cap Storage
14.9 ft³ (0.42 m³)

Min. Installed Storage*
45.1 ft³ (1.28 m³)

Weight
49 lbs (22.2 kg)

*Assumes a minimum of 12" (300 mm) of stone above, 9" (230 mm) of stone below, 6" (150 mm) of stone between chambers, 6" (150 mm) of stone between chambers/end caps and 40% stone porosity.

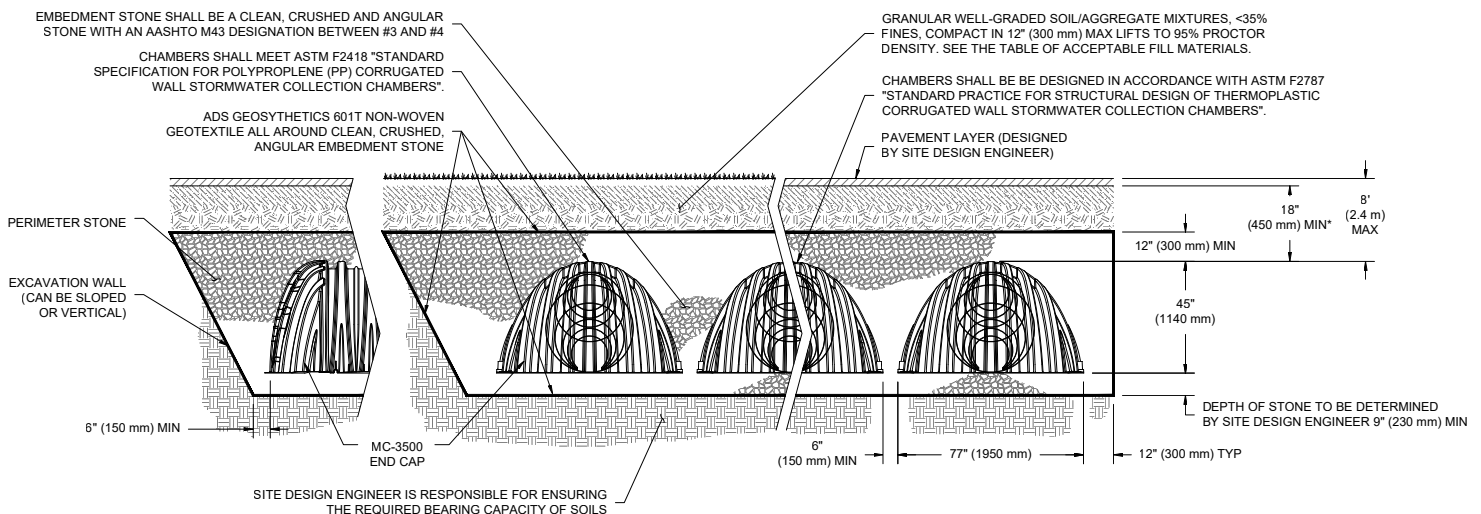
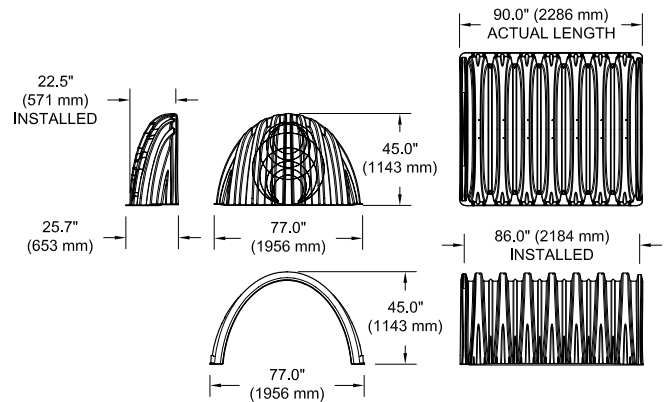

*MINIMUM COVER TO BOTTOM OF FLEXIBLE PAVEMENT. FOR UNPAVED INSTALLATIONS WHERE RUTTING FROM VEHICLES MAY OCCUR, INCREASE COVER TO 24" (600 mm).

MC-3500 CHAMBER SPECIFICATION

STORAGE VOLUME PER CHAMBER FT³ (M³)

	Bare Chamber Storage ft ³ (m ³)	Chamber and Stone Foundation Depth in. (mm)			
		9" (230 mm)	12" (300 mm)	15" (375 mm)	18" (450 mm)
MC-3500 Chamber	109.9 (3.11)	175.0 (4.96)	179.9 (5.09)	184.9 (5.24)	189.9 (5.38)
MC-3500 End Cap	14.9 (.42)	45.1 (1.28)	46.6 (1.32)	48.3 (1.37)	49.9 (1.41)

Note: Assumes 6" (150 mm) row spacing, 40% stone porosity, 12" (300 mm) stone above and includes the bare chamber/end cap volume.

AMOUNT OF STONE PER CHAMBER

ENGLISH TONS (yds ³)	Stone Foundation Depth			
	9"	12"	15"	18"
MC-3500 Chamber	8.5 (6.0)	9.1 (6.5)	9.7 (6.9)	10.4 (7.4)
MC-3500 End Cap	3.9 (2.8)	4.1 (2.9)	4.3 (3.1)	4.5 (3.2)
METRIC KILOGRAMS (m ³)	230 mm	300 mm	375 mm	450 mm
MC-3500 Chamber	7711 (4.6)	8255 (5.0)	8800 (5.3)	9435 (5.7)
MC-3500 End Cap	3538 (2.1)	3719 (2.2)	3901 (2.4)	4082 (2.5)

Note: Assumes 12" (300 mm) of stone above and 6" (150 mm) row spacing and 6" (150 mm) of perimeter stone in front of end caps.

VOLUME EXCAVATION PER CHAMBER YD³ (M³)

	Stone Foundation Depth			
	9" (230 mm)	12" (300 mm)	15" (375mm)	18" (450 mm)
MC-3500 Chamber	11.9 (9.1)	12.4 (9.5)	12.8(9.8)	13.3 (10.2)
MC-3500 End Cap	4.0 (3.1)	4.1 (3.2)	4.3 (3.3)	4.4 (3.4)

Note: Assumes 6" (150 mm) of separation between chamber rows and 24" (600 mm) of cover. The volume of excavation will vary as depth of cover increases.



Working on a project?
 Visit us at www.stormtech.com
 and utilize the **StormTech Design Tool**

For more information on the StormTech MC-3500 Chamber and other ADS products, please contact our Customer Service Representatives at 1-800-821-6710

Isolator[®] Row O&M Manual



THE ISOLATOR[®] ROW

INTRODUCTION

An important component of any Stormwater Pollution Prevention Plan is inspection and maintenance. The StormTech Isolator Row is a technique to inexpensively enhance Total Suspended Solids (TSS) removal and provide easy access for inspection and maintenance.

THE ISOLATOR ROW

The Isolator Row is a row of StormTech chambers, either SC-160LP, SC-310, SC-310-3, SC-740, DC-780, MC-3500 or MC-4500 models, that is surrounded with filter fabric and connected to a closely located manhole for easy access. The fabric-wrapped chambers provide for settling and filtration of sediment as storm water rises in the Isolator Row and ultimately passes through the filter fabric. The open bottom chambers and perforated sidewalls (SC-310, SC-310-3 and SC-740 models) allow storm water to flow both vertically and horizontally out of the chambers. Sediments are captured in the Isolator Row protecting the storage areas of the adjacent stone and chambers from sediment accumulation.

Two different fabrics are used for the Isolator Row. A woven geotextile fabric is placed between the stone and the Isolator Row chambers. The tough geotextile provides a media for storm water filtration and provides a durable surface for maintenance operations. It is also designed to prevent scour of the underlying stone and remain intact during high pressure jetting. A non-woven fabric is placed over the chambers to provide a filter media for flows passing through the perforations in the sidewall of the chamber. The non-woven fabric is not required over the SC-160LP, DC-780, MC-3500 or MC-4500 models as these chambers do not have perforated side walls.

The Isolator Row is typically designed to capture the “first flush” and offers the versatility to be sized on a volume basis or flow rate basis. An upstream manhole not only provides access to the Isolator Row but typically includes a high flow weir such that storm water flowrates or volumes that exceed the capacity of the Isolator Row overtop the overflow weir and discharge through a manifold to the other chambers.

The Isolator Row may also be part of a treatment train. By treating storm water prior to entry into the chamber system, the service life can be extended and pollutants such as hydrocarbons can be captured. Pre-treatment best management practices can be as simple as deep sump catch basins, oil-water separators or can be innovative storm water treatment devices. The design of the treatment train and selection of pretreatment devices by the design engineer is often driven by regulatory requirements. Whether pretreatment is used or not, the Isolator Row is recommended by StormTech as an effective means to minimize maintenance requirements and maintenance costs.

Note: See the StormTech Design Manual for detailed information on designing inlets for a StormTech system, including the Isolator Row.



Looking down the Isolator Row from the manhole opening, woven geotextile is shown between the chamber and stone base.



StormTech Isolator Row with Overflow Spillway (not to scale)

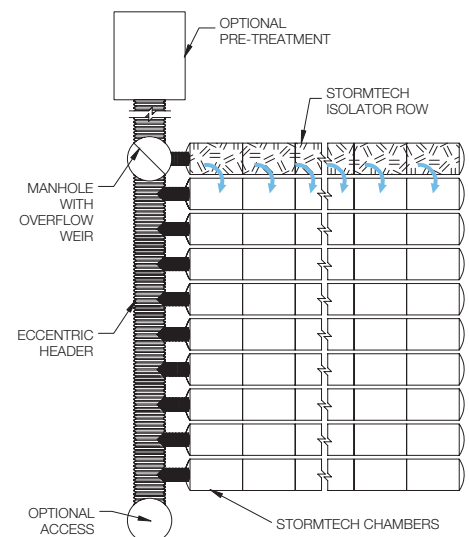

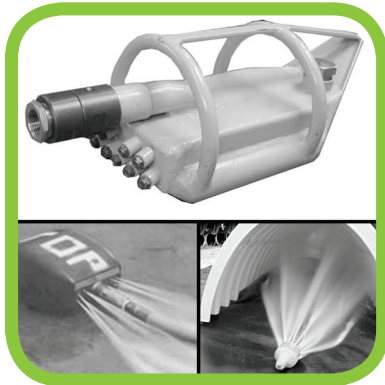

ISOLATOR ROW INSPECTION/MAINTENANCE

INSPECTION

The frequency of inspection and maintenance varies by location. A routine inspection schedule needs to be established for each individual location based upon site specific variables. The type of land use (i.e. industrial, commercial, residential), anticipated pollutant load, percent imperviousness, climate, etc. all play a critical role in determining the actual frequency of inspection and maintenance practices.

At a minimum, StormTech recommends annual inspections. Initially, the Isolator Row should be inspected every 6 months for the first year of operation. For subsequent years, the inspection should be adjusted based upon previous observation of sediment deposition.

The Isolator Row incorporates a combination of standard manhole(s) and strategically located inspection ports (as needed). The inspection ports allow for easy access to the system from the surface, eliminating the need to perform a confined space entry for inspection purposes.

If upon visual inspection it is found that sediment has accumulated, a stadia rod should be inserted to determine the depth of sediment. When the average depth of sediment exceeds 3 inches throughout the length of the Isolator Row, clean-out should be performed.

MAINTENANCE

The Isolator Row was designed to reduce the cost of periodic maintenance. By “isolating” sediments to just one row, costs are dramatically reduced by eliminating the need to clean out each row of the entire storage bed. If inspection indicates the potential need for maintenance, access is provided via a manhole(s) located on the end(s) of the row for cleanout. If entry into the manhole is required, please follow local and OSHA rules for a confined space entries.

Maintenance is accomplished with the JetVac process. The JetVac process utilizes a high pressure water nozzle to propel itself down the Isolator Row while scouring and suspending sediments. As the nozzle is retrieved, the captured pollutants are flushed back into the manhole for vacuuming. Most sewer and pipe maintenance companies have vacuum/JetVac combination vehicles. Selection of an appropriate JetVac nozzle will improve maintenance efficiency. Fixed nozzles designed for culverts or large diameter pipe cleaning are preferable. Rear facing jets with an effective spread of at least 45” are best. Most JetVac reels have 400 feet of hose allowing maintenance of an Isolator Row up to 50 chambers long. **The JetVac process shall only be performed on StormTech Isolator Rows that have AASHTO class 1 woven geotextile (as specified by StormTech) over their angular base stone.**

StormTech Isolator Row (not to scale)

Note: Non-woven fabric is only required over the inlet pipe connection into the end cap for SC-160LP, DC-780, MC-3500 and MC-4500 chamber models and is not required over the entire Isolator Row.

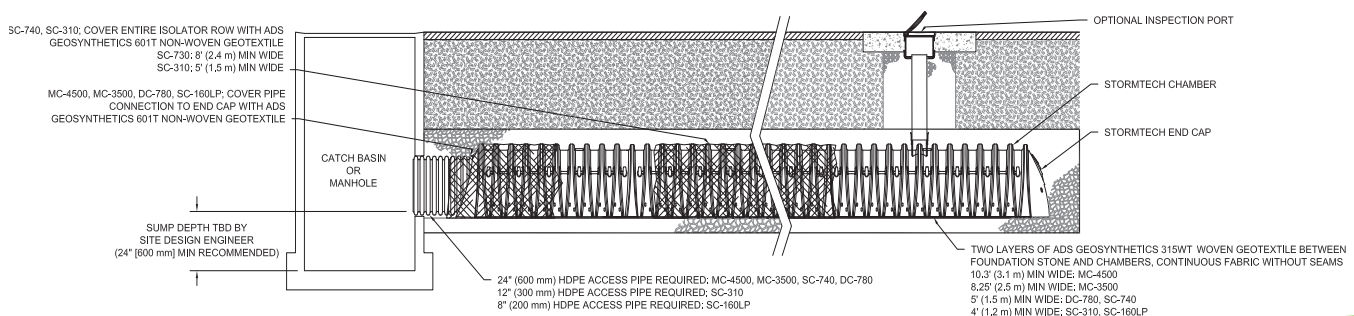

ISOLATOR ROW STEP BY STEP MAINTENANCE PROCEDURES

STEP 1

Inspect Isolator Row for sediment.

- A) Inspection ports (if present)
 - i. Remove lid from floor box frame
 - ii. Remove cap from inspection riser
 - iii. Using a flashlight and stadia rod, measure depth of sediment and record results on maintenance log.
 - iv. If sediment is at or above 3 inch depth, proceed to Step 2. If not, proceed to Step 3.
- B) All Isolator Rows
 - i. Remove cover from manhole at upstream end of Isolator Row
 - ii. Using a flashlight, inspect down Isolator Row through outlet pipe
 - 1. Mirrors on poles or cameras may be used to avoid a confined space entry
 - 2. Follow OSHA regulations for confined space entry if entering manhole
 - iii. If sediment is at or above the lower row of sidewall holes (approximately 3 inches), proceed to Step 2. If not, proceed to Step 3.

STEP 2

Clean out Isolator Row using the JetVac process.

- A) A fixed floor cleaning nozzle with rear facing nozzle spread of 45 inches or more is preferable
- B) Apply multiple passes of JetVac until backflush water is clean
- C) Vacuum manhole sump as required

STEP 3

Replace all caps, lids and covers, record observations and actions.

STEP 4

Inspect & clean catch basins and manholes upstream of the StormTech system.

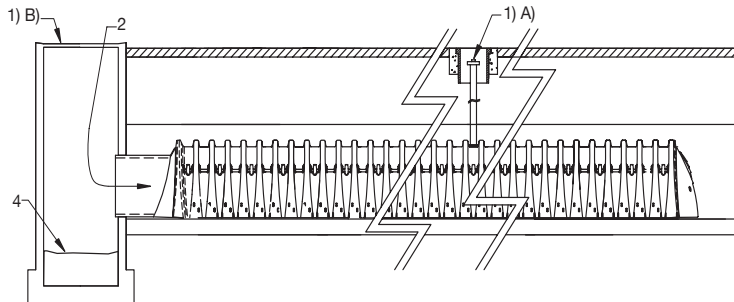

SAMPLE MAINTENANCE LOG

Date	Stadia Rod Readings		Sediment Depth (1)-(2)	Observations/Actions	Inspector
	Fixed point to chamber bottom (1)	Fixed point to top of sediment (2)			
3/15/11	6.3 ft	none		New installation. Fixed point is CI frame at grade	DJM
9/24/11		6.2	0.1 ft	Some grit felt	SM
6/20/13		5.8	0.5 ft	Mucky feel, debris visible in manhole and in Isolator Row, maintenance due	NV
7/7/13	6.3 ft		0	System jetted and vacuumed	DJM

Maintenance Guide

BaySaver Barracuda™

July 2017

One of the advantages of the BaySaver Barracuda is the ease of maintenance. Like any system that collects pollutants, the BaySaver Barracuda must be maintained for continued effectiveness. Maintenance is a simple procedure performed using a vacuum truck or similar equipment. The systems were designed to minimize the volume of water removed during routine maintenance, reducing disposal costs.

Contractors can access the pollutants stored in the manhole through the manhole cover. This allows them to gain vacuum hose access to the bottom of the manhole to remove sediment and trash. There is no confined space entry necessary for inspection or maintenance.

The entire maintenance procedure typically takes from 2 to 4 hours, depending on the size of the system, the captured material, and the capacity of the vacuum truck.

Local regulations may apply to the maintenance procedure. Safe and legal disposal of pollutants is the responsibility of the maintenance contractor. Maintenance should be performed only by a qualified contractor.

Inspection and Cleaning Cycle

Periodic inspection is needed to determine the need for and frequency of maintenance. You should begin inspecting as soon as construction is complete and thereafter on an annual basis. Typically, the system needs to be cleaned every 1-3 years.

Excessive oils, fuels or sediments may reduce the maintenance cycle. Periodic inspection is important.

Determining When to Clean

To determine the sediment depth, the maintenance contractor should lower a stadia rod into the manhole until it contacts the top of the captured sediment and mark that spot on the rod. Then push the probe through to the bottom of the sump and mark that spot to determine sediment depth.

Maintenance should occur when the sediment has reached the levels indicated in the Storage Capacity Chart.

BaySaver Barracuda Storage Capacities

Model	Manhole Diameter	Treatment Chamber Capacity	Standard Sediment Capacity (20" depth)	NJDEP Sediment Capacity (50% of standard depth)
S3	36"	212 gallons	0.44 cubic yards	0.22 cubic yards
S4	48"	564 gallons	0.78 cubic yards	0.39 cubic yards
S5	60"	881 gallons	1.21 cubic yards	0.61 cubic yards
S6	72"	1269 gallons	1.75 cubic yards	0.88 cubic yards
S8	96"	3835 gallons	3.10 cubic yards	1.55 cubic yards
S10	120"	7496 gallons	4.85 cubic yards	2.43 cubic yards

Maintenance Instructions

1. Remove the manhole cover to provide access to the pollutant storage. Pollutants are stored in the sump, below the bowl assembly visible from the surface. You'll access this area through the 10" diameter access cylinder.



2. Use a vacuum truck or other similar equipment to remove all water, debris, oils and sediment. See figure 1.
3. Use a high pressure hose to clean the manhole of all the remaining sediment and debris. Then, use the vacuum truck to remove the water.
4. Fill the cleaned manhole with water until the level reaches the invert of the outlet pipe.
5. Replace the manhole cover.
6. Dispose of the polluted water, oils, sediment and trash at an approved facility.
 - Local regulations prohibit the discharge of solid material into the sanitary system. Check with the local sewer authority for authority to discharge the liquid.
 - Some localities treat the pollutants as leachate. Check with local regulators about disposal requirements.
 - Additional local regulations may apply to the maintenance procedure.

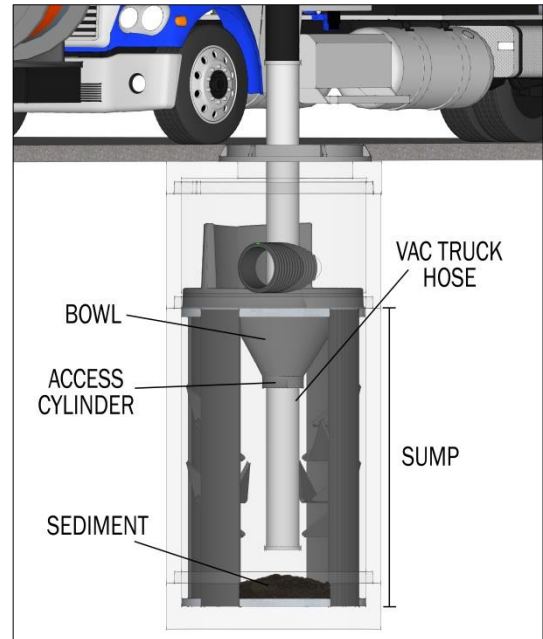

Figure 1

Description

Non-stormwater discharges (NSWDs) are flows that do not consist entirely of stormwater. Some non-stormwater discharges do not include pollutants and may be discharged to the storm drain if local regulations allow. These include uncontaminated groundwater and natural springs. There are also some non-stormwater discharges that typically do not contain pollutants and may be discharged to the storm drain with conditions. These include: potable water sources, fire hydrant flushing, air conditioner condensate, landscape irrigation drainage and landscape watering, emergency firefighting, etc. as discussed in Section 2.

However there are certain non-stormwater discharges that pose an environmental concern. These discharges may originate from illegal dumping of industrial material or wastes and illegal connections such as internal floor drains, appliances, industrial processes, sinks, and toilets that are illegally connected to the nearby storm drainage system through on-site drainage and piping. These unauthorized discharges (examples of which may include: process waste waters, cooling waters, wash waters, and sanitary wastewater) can carry substances such as paint, oil, fuel and other automotive fluids, chemicals and other pollutants into storm drains.

Non-stormwater discharges will need to be addressed through a combination of detection and elimination. The ultimate goal is to effectively eliminate unauthorized non-stormwater discharges to the stormwater drainage system through implementation of measures to detect, correct, and enforce against illicit connections and illegal discharges of

Objectives

- *Cover*
- *Contain*
- *Educate*
- *Reduce/Minimize*
- *Product Substitution*

Targeted Constituents

<i>Sediment</i>	
<i>Nutrients</i>	✓
<i>Trash</i>	
<i>Metals</i>	✓
<i>Bacteria</i>	✓
<i>Oil and Grease</i>	✓
<i>Organics</i>	✓

Minimum BMPs Covered

	<i>Good Housekeeping</i>	✓
	<i>Preventative Maintenance</i>	
	<i>Spill and Leak Prevention and Response</i>	✓
	<i>Material Handling & Waste Management</i>	
	<i>Erosion and Sediment Controls</i>	
	<i>Employee Training Program</i>	✓
	<i>Quality Assurance Record Keeping</i>	✓



pollutants on streets and into the storm drain system and downstream water bodies.

Approach

Initially the Discharger must make an assessment of non-stormwater discharges to determine which types must be eliminated or addressed through BMPs. The focus of the following approach is the elimination of unauthorized non-stormwater discharges. See other BMP Fact Sheets for activity-specific pollution prevention procedures.

General Pollution Prevention Protocols

- Implement waste management controls described in SC-34 Waste Handling and Disposal.
- Develop clear protocols and lines of communication for effectively prohibiting non-stormwater discharges, especially those that are not classified as hazardous. These are often not responded to as effectively as they need to be.
- Stencil or demarcate storm drains, where applicable, to prevent illegal disposal of pollutants. Storm drain inlets should have messages such as “Dump No Waste Drains to Stream” or similar stenciled or demarcated next to them to warn against ignorant or unintentional dumping of pollutants into the storm drainage system.
- Manage and control sources of water such as hose bibs, faucets, wash racks, irrigation heads, etc. Identify hoses and faucets in the SWPPP, and post signage for appropriate use.

Non-Stormwater Discharge Investigation Protocols

Identifying the sources of non-stormwater discharges requires the Discharger to conduct an investigation of the facility at regular intervals. There are several categories of non-stormwater discharges:

- Visible, easily identifiable discharges, typically generated as surface runoff, such as uncontained surface runoff from vehicle or equipment washing; and
- Non-visible, (e.g., subsurface) discharges into the site drainage system through a variety of pathways that are not obvious.

The approach to detecting and eliminating non-stormwater discharges will vary considerably, as discussed below:

Visible and identifiable discharges

- Conduct routine inspections of the facilities and of each major activity area and identify visible evidence of unauthorized non-stormwater discharges. This may include:
 - ✓ Visual observations of actual discharges occurring;

- ✓ Evidence of surface staining, discoloring etc. that indicates that discharges have occurred;
 - ✓ Pools of water in low lying areas when a rain event has not occurred; and
 - ✓ Discussions with operations personnel to understand practices that may lead to unauthorized discharges.
- If evidence of non-stormwater discharges is discovered:
- ✓ Document the location and circumstances using Worksheets 5 and 6 (Section 2 of the manual), including digital photos;
 - ✓ Identify and implement any quick remedy or corrective action (e.g., moving uncovered containers inside or to a proper location); and
 - ✓ Develop a plan to eliminate the discharge. Consult the appropriate activity-specific BMP Fact Sheet for alternative approaches to manage and eliminate the discharge.
- Consult the appropriate activity-specific BMP Fact Sheet for alternative approaches to manage and eliminate the discharge. Make sure the facility SWPPP is up-to-date and includes applicable BMPs to address the non-stormwater discharge.

Other Illegal Discharges (Non visible)

Illicit Connections

- Locate discharges from the industrial storm drainage system to the municipal storm drain system through review of “as-built” piping schematics.
- Isolate problem areas and plug illicit discharge points.
- Locate and evaluate discharges to the storm drain system.
- Visual Inspection and Inventory:
 - ✓ Inventory and inspect each discharge point during dry weather.
 - ✓ Keep in mind that drainage from a storm event can continue for a day or two following the end of a storm and groundwater may infiltrate the underground stormwater collection system.
 - ✓ Non-stormwater discharges are often intermittent and may require periodic inspections.

Review Infield Piping

- A review of the “as-built” piping schematic is a way to determine if there are any connections to the stormwater collection system.

- Inspect the path of loading/unloading area drain inlets and floor drains in older buildings.
- Never assume storm drains are connected to the sanitary sewer system.

Monitoring for investigation/detection of illegal discharges

- If a suspected illegal or unknown discharge is detected, monitoring of the discharge may help identify the content and/or suggest the source. This may be done with a field screening analysis, flow meter measurements, or by collecting a sample for laboratory analysis. Section 5 and Appendix D describe the necessary field equipment and procedures for field investigations.
- Investigative monitoring may be conducted over time. For example if, a discharge is intermittent, then monitoring might be conducted to determine the timing of the discharge to determine the source.
- Investigative monitoring may be conducted over a spatial area. For example, if a discharge is observed in a pipe, then monitoring might be conducted at accessible upstream locations in order to pinpoint the source of the discharge.
- Generally, investigative monitoring requiring collection of samples and submittal for lab analysis requires proper planning and specially trained staff.

Smoke Testing

Smoke testing of wastewater and stormwater collection systems is used to detect connections between the two piping systems. Smoke testing is generally performed at a downstream location and the smoke is forced upstream using blowers to create positive pressure. The advantage to smoke testing is that it can potentially identify multiple potential discharge sources at once.

- Smoke testing uses a harmless, non-toxic smoke cartridges developed specifically for this purpose.
- Smoke testing requires specialized equipment (e.g., cartridges, blowers) and is generally only appropriate for specially trained staff.
- A Standard Operating Procedure (SOP) for smoke testing is highly desirable. The SOP should address the following elements:
 - ✓ Proper planning and notification of nearby residents and emergency services is necessary since introducing smoke into the system may result in false alarms;
 - ✓ During dry weather, the stormwater collection system is filled with smoke and then traced back to sources;

- ✓ Temporary isolation of segments of pipe using sand bags is often needed to force the smoke into leaking pipes; and
- ✓ The appearance of smoke in a waste vent pipe, at a sewer manhole, or even the base of a toilet indicates that there may be a connection between the sanitary and storm water systems.
- Most municipal wastewater agencies will have necessary staff and equipment to conduct smoke testing and they should be contacted if cross connections with the sanitary sewer are suspected. See SC-44 Drainage System Maintenance for more information.

Dye Testing

- Dye testing is typically performed when there is a suspected specific pollutant source and location (i.e., leaking sanitary sewer) and there is evidence of dry weather flows in the stormwater collection system.
- Dye is released at a probable upstream source location, either the facility's sanitary or process wastewater system. The dye must be released with a sufficient volume of water to flush the system.
- Operators then visually examine the downstream discharge points from the stormwater collection system for the presence of the dye.
- Dye testing can be performed informally using commercially available products in order to conduct an initial investigation for fairly obvious cross-connections.
- More detailed dye testing should be performed by properly trained staff and follow SOPs. Specialized equipment such as fluorometers may be necessary to detect low concentrations of dye.
- Most municipal wastewater agencies will have necessary staff and equipment to conduct dye testing and they should be contacted if cross connections with the sanitary sewer are suspected.

TV Inspection of Drainage System

- Closed Circuit Television (CCTV) can be employed to visually identify illicit connections to the industrial storm drainage system. Two types of CCTV systems are available: (1) a small specially designed camera that can be manually pushed on a stiff cable through storm drains to observe the interior of the piping, or (2) a larger remote operated video camera on treads or wheels that can be guided through storm drains to view the interior of the pipe.
- CCTV systems often include a high-pressure water jet and camera on a flexible cable. The water jet cleans debris and biofilm off the inside of pipes so the camera can take video images of the pipe condition.

- CCTV units can detect large cracks and other defects such as offsets in pipe ends caused by root intrusions or shifting substrate.
- CCTV can also be used to detect dye introduced into the sanitary sewer.
- CCTV inspections require specialized equipment and properly trained staff and are generally best left to specialized contractors or municipal public works staff.

Illegal Dumping

- Substances illegally dumped on streets and into the storm drain systems and creeks may include paints, used oil and other automotive fluids, construction debris, chemicals, fresh concrete, leaves, grass clippings, and pet wastes. These wastes can cause stormwater and receiving water quality problems as well as clog the storm drain system itself.
- Establish a system for tracking incidents. The system should be designed to identify the following:
 - ✓ Illegal dumping hot spots;
 - ✓ Types and quantities (in some cases) of wastes;
 - ✓ Patterns in time of occurrence (time of day/night, month, or year);
 - ✓ Mode of dumping (abandoned containers, “midnight dumping” from moving vehicles, direct dumping of materials, accidents/spills);
 - ✓ An anonymous tip/reporting mechanism; and
 - ✓ Evidence of responsible parties (e.g., tagging, encampments, etc.).
- One of the keys to success of reducing or eliminating illegal dumping is increasing the number of people at the facility who are aware of the problem and who have the tools to at least identify the incident, if not correct it. Therefore, train field staff to recognize and report the incidents.

Once a site has been cleaned:

- Post “No Dumping” signs with a phone number for reporting dumping and disposal.
- Landscaping and beautification efforts of hot spots may also discourage future dumping, as well as provide open space and increase property values.
- Lighting or barriers may also be needed to discourage future dumping.
- See fact sheet SC-11 Spill Prevention, Control, and Cleanup.

Inspection

- Regularly inspect and clean up hot spots and other storm drainage areas where illegal dumping and disposal occurs.
- Conduct field investigations of the industrial storm drain system for potential sources of non-stormwater discharges.
- Pro-actively conduct investigations of high priority areas. Based on historical data, prioritize specific geographic areas and/or incident type for pro-active investigations.



Spill and Leak Prevention and Response

- On paved surfaces, clean up spills with as little water as possible. Use a rag for small spills, a damp mop for general cleanup, and absorbent material for larger spills. If the spilled material is hazardous, then the used cleanup materials are also hazardous and must be sent to a certified laundry (rags) or disposed of as hazardous waste.
- Never hose down or bury dry material spills. Sweep up the material and dispose of properly.
- Use adsorbent materials on small spills rather than hosing down the spill. Remove the adsorbent materials promptly and dispose of properly.
- For larger spills, a private spill cleanup company or Hazmat team may be necessary.
- See SC-11 Spill Prevention Control and Cleanup.



Employee Training Program

- Training of technical staff in identifying and documenting illegal dumping incidents is required. The frequency of training must be presented in the SWPPP, and depends on site-specific industrial materials and activities.
- Consider posting a quick reference table near storm drains to reinforce training.
- Train employees to identify non-stormwater discharges and report discharges to the appropriate departments.
- Educate employees about spill prevention and cleanup.
- Well-trained employees can reduce human errors that lead to accidental releases or spills. The employee should have the tools and knowledge to immediately begin cleaning up a spill should one occur. Employees should be familiar with the Spill Prevention Control and Countermeasure Plan. Employees should be able to identify work/jobs with high potential for spills and suggest methods to reduce possibility.
- Determine and implement appropriate outreach efforts to reduce non-permissible non-stormwater discharges.

- Conduct spill response drills annually (if no events occurred) in order to evaluate the effectiveness of the plan.
- When a responsible party is identified, educate the party on the impacts of his or her actions.



Quality Assurance and Record Keeping

Performance Evaluation

- Annually review internal investigation results; assess whether goals were met and what changes or improvements are necessary.
- Obtain feedback from personnel assigned to respond to, or inspect for, illicit connections and illegal dumping incidents.
- Develop document and data management procedures.
- A database is useful for defining and tracking the magnitude and location of the problem.
- Report prohibited non-stormwater discharges observed during the course of normal daily activities so they can be investigated, contained, and cleaned up or eliminated.
- Document that non-stormwater discharges have been eliminated by recording tests performed, methods used, dates of testing, and any on-site drainage points observed.
- Annually document and report the results of the program.
- Maintain documentation of illicit connection and illegal dumping incidents, including significant conditionally exempt discharges that are not properly managed.
- Document training activities.

Potential Limitations and Work-Arounds

Some facilities may have space constraints, limited staffing and time limitations that may preclude implementation of BMPs. Provided below are typical limitations and recommended “work-arounds.”

- Many facilities do not have accurate, up-to-date ‘as-built’ plans or drawings which may be necessary in order to conduct non-stormwater discharge assessments.
 - ✓ Online tools such as Google Earth™ can provide an aerial view of the facility and may be useful in understanding drainage patterns and potential sources of non-stormwater discharges
 - ✓ Local municipal jurisdictions may have useful drainage systems maps.

- Video surveillance cameras are commonly used to secure the perimeter of industrial facilities against break-ins and theft. These surveillance systems may also be useful for capturing illegal dumping activities. Minor, temporary adjustments to the field of view of existing surveillance camera systems to target known or suspected problem areas may be a cost-effective way of capturing illegal dumping activities and identifying the perpetrators.

Potential Capital Facility Costs and Operation & Maintenance Requirements

Facilities

- Capital facility cost requirements may be minimal unless cross-connections to storm drains are detected.
- Indoor floor drains may require re-plumbing if cross-connections are detected.
- Leaky sanitary sewers will require repair or replacement which can have significant costs depending on the size and industrial activity at the facility.

Maintenance (including administrative and staffing)

- The primary effort is for staff time and depends on how aggressively a program is implemented.
- Costs for containment, and disposal of any leak or discharge is borne by the Discharger.
- Illicit connections can be difficult to locate especially if there is groundwater infiltration.
- Illegal dumping and illicit connection violations requires technical staff to detect and investigate them.

Supplemental Information

Permit Requirements

The IGP authorizes certain Non-Storm Water Discharges (NSWDs) provided BMPs are included in the SWPPP and implemented to:

- Reduce or prevent the contact of authorized NSWDs with materials or equipment that are potential sources of pollutants;
- Reduce, to the extent practicable, the flow or volume of authorized NSWDs;
- Ensure that authorized NSWDs do not contain quantities of pollutants that cause or contribute to an exceedance of a water quality standards (WQS); and,

- Reduce or prevent discharges of pollutants in authorized NSWs in a manner that reflects best industry practice considering technological availability and economic practicability and achievability.”

References and Resources

Center for Watershed Protection, 2004. *Illicit Discharge Detection and Elimination: A Guidance Manual for Program Development and Technical Assessments*, EPA Cooperative Agreement X-82907801-0.

Dublin San Ramon Sanitation District. <http://www.dsrsd.com/www/smoketest.html>.

Orange County Stormwater Program, Best Management Practices for Industrial/Commercial Business Activities. Available online at: <http://ocwatersheds.com/documents/bmp/industrialcommercialbusinessesactivities>.

Sacramento Stormwater Management Program, *Best Management Practices for Industrial Storm Water Pollution Control*, Available online at: <http://www.msa.saccounty.net/sactostormwater/documents/guides/industrial-BMP-manual.pdf>.

Santa Clara Valley Urban Runoff Pollution Prevention Program. <http://www.scvurppp.org>.

Southern California Coastal Water Research Project, 2013. *The California Microbial Source Identification Manual: A Tiered Approach to Identifying Fecal Pollution Sources to Beaches*, Technical Report 804.

The Storm Water Managers Resource Center, <http://www.stormwatercenter.net/>.

US EPA. National Pollutant Discharge Elimination System. Available online at: http://cfpub.epa.gov/npdes/stormwater/menuofbmps/index.cfm?action=factsheet_results&view=specific&bmp=111.

WEF Press Alexandria, Virginia, 2009. Existing Sewer Evaluation and Rehabilitation: *WEF Manual of Practice No. FD-6 ASCE/EWRI Manuals and Reports on Engineering Practice No. 62, Third Edition*.

Spill Prevention, Control & Cleanup SC-11

Description

Many activities that occur at an industrial or commercial site have the potential to cause accidental spills. Preparation for accidental spills, with proper training and reporting systems implemented, can minimize the discharge of pollutants to the environment.

Spills and leaks are one of the largest contributors of stormwater pollutants. Spill prevention and control plans are applicable to any site at which hazardous materials are stored or used. An effective plan should have spill prevention and response procedures that identify hazardous material storage areas, specify material handling procedures, describe spill response procedures, and provide locations of spill clean-up equipment and materials. The plan should take steps to identify and characterize potential spills, eliminate and reduce spill potential, respond to spills when they occur in an effort to prevent pollutants from entering the stormwater drainage system, and train personnel to prevent and control future spills. An adequate supply of spill clean-up materials must be maintained onsite.

Approach

General Pollution Prevention Protocols

- Develop procedures to prevent/mitigate spills to storm drain systems.
- Develop and standardize reporting procedures, containment, storage, and disposal activities, documentation, and follow-up procedures.
- Establish procedures and/or controls to minimize spills and leaks. The procedures should address:
 - ✓ Description of the facility, owner and address, activities, chemicals, and quantities present;

Objectives

- Cover
- Contain
- Educate
- Reduce/Minimize
- Product Substitution

Targeted Constituents

Sediment	
Nutrients	
Trash	
Metals	✓
Bacteria	
Oil and Grease	✓
Organics	✓

Minimum BMPs Covered

 Good Housekeeping	
 Preventative Maintenance	
 Spill and Leak Prevention and Response	✓
 Material Handling & Waste Management	
 Erosion and Sediment Controls	
 Employee Training Program	✓
 Quality Assurance Record Keeping	✓



Spill Prevention, Control & Cleanup SC-11

- ✓ Facility map of the locations of industrial materials;
 - ✓ Notification and evacuation procedures;
 - ✓ Cleanup instructions;
 - ✓ Identification of responsible departments; and
 - ✓ Identify key spill response personnel.
- Recycle, reclaim, or reuse materials whenever possible. This will reduce the amount of process materials that are brought into the facility.



Spill and Leak Prevention and Response

Spill Prevention

- Develop procedures to prevent/mitigate spills to storm drain systems. Develop and standardize reporting procedures, containment, storage, and disposal activities, documentation, and follow-up procedures.
- If illegal dumping is observed at the facility:
 - ✓ Post “No Dumping” signs with a phone number for reporting illegal dumping and disposal. Signs should also indicate fines and penalties applicable for illegal dumping.
 - ✓ Landscaping and beautification efforts may also discourage illegal dumping.
 - ✓ Bright lighting and/or entrance barriers may also be needed to discourage illegal dumping.
- Store and contain liquid materials in such a manner that if the container is ruptured, the contents will not discharge, flow, or be washed into the storm drainage system, surface waters, or groundwater.
- If the liquid is oil, gas, or other material that separates from and floats on water, install a spill control device (such as a tee section) in the catch basins that collect runoff from the storage tank area.



Preventative Maintenance

- Place drip pans or absorbent materials beneath all mounted taps, and at all potential drip and spill locations during filling and unloading of tanks. Any collected liquids or soiled absorbent materials must be reused/recycled or properly disposed.
- Store and maintain appropriate spill cleanup materials in a location known to all near the tank storage area; and ensure that employees are familiar with the site’s spill control plan and/or proper spill cleanup procedures.

Spill Prevention, Control & Cleanup SC-11

- Sweep and clean the storage area monthly if it is paved, *do not hose down the area to a storm drain.*
- Check tanks (and any containment sumps) daily for leaks and spills. Replace tanks that are leaking, corroded, or otherwise deteriorating with tanks in good condition. Collect all spilled liquids and properly dispose of them.
- Label all containers according to their contents (e.g., solvent, gasoline).
- Label hazardous substances regarding the potential hazard (corrosive, radioactive, flammable, explosive, poisonous).
- Prominently display required labels on transported hazardous and toxic materials (per US DOT regulations).
- Identify key spill response personnel.

Spill Response

- Clean up leaks and spills immediately.
- Place a stockpile of spill cleanup materials where it will be readily accessible (e.g., near storage and maintenance areas).
- On paved surfaces, clean up spills with as little water as possible.
 - ✓ Use a rag for small spills, a damp mop for general cleanup, and absorbent material for larger spills.
 - ✓ If the spilled material is hazardous, then the used cleanup materials are also hazardous and must be sent to a certified laundry (rags) or disposed of as hazardous waste.
 - ✓ If possible use physical methods for the cleanup of dry chemicals (e.g., brooms, shovels, sweepers, or vacuums).
- Never hose down or bury dry material spills. Sweep up the material and dispose of properly.
- Chemical cleanups of material can be achieved with the use of adsorbents, gels, and foams. Use adsorbent materials on small spills rather than hosing down the spill. Remove the adsorbent materials promptly and dispose of properly.
- For larger spills, a private spill cleanup company or Hazmat team may be necessary.

Spill Prevention, Control & Cleanup SC-11

Reporting

- Report spills that pose an immediate threat to human health or the environment to the Regional Water Quality Control Board or local authority as location regulations dictate.
- Federal regulations require that any oil spill into a water body or onto an adjoining shoreline be reported to the National Response Center (NRC) at 800-424-8802 (24 hour).
- Report spills to 911 for dispatch and clean-up assistance when needed. Do not contact fire agencies directly.
- Establish a system for tracking incidents. The system should be designed to identify the following:
 - ✓ Types and quantities (in some cases) of wastes;
 - ✓ Patterns in time of occurrence (time of day/night, month, or year);
 - ✓ Mode of dumping (abandoned containers, “midnight dumping” from moving vehicles, direct dumping of materials, accidents/spills);
 - ✓ Clean-up procedures; and
 - ✓ Responsible parties.



Employee Training Program

- Educate employees about spill prevention and cleanup.
- Well-trained employees can reduce human errors that lead to accidental releases or spills:
 - ✓ The employee should have the tools and knowledge to immediately begin cleaning up a spill should one occur; and
 - ✓ Employees should be familiar with the Spill Prevention Control and Countermeasure Plan.
- Employees should be educated about aboveground storage tank requirements. Employees responsible for aboveground storage tanks and liquid transfers should be thoroughly familiar with the Spill Prevention Control and Countermeasure Plan and the plan should be readily available.
- Train employees to recognize and report illegal dumping incidents.

Spill Prevention, Control & Cleanup SC-11

Other Considerations (Limitations and Regulations)

- ❑ State regulations exist for facilities with a storage capacity of 10,000 gallons or more of petroleum to prepare a Spill Prevention Control and Countermeasure (SPCC) Plan (Health & Safety Code Chapter 6.67).
- ❑ State regulations also exist for storage of hazardous materials (Health & Safety Code Chapter 6.95), including the preparation of area and business plans for emergency response to the releases or threatened releases.
- ❑ Consider requiring smaller secondary containment areas (less than 200 sq. ft.) to be connected to the sanitary sewer, prohibiting any hard connections to the storm drain.

Requirements

Costs (including capital and operation & maintenance)

- ❑ Will vary depending on the size of the facility and the necessary controls.
- ❑ Prevention of leaks and spills is inexpensive. Treatment and/or disposal of contaminated soil or water can be quite expensive.

Maintenance (including administrative and staffing)

- ❑ Develop spill prevention and control plan, provide and document training, conduct inspections of material storage areas, and supply spill kits.
- ❑ Extra time is needed to properly handle and dispose of spills, which results in increased labor costs.

Supplemental Information

Further Detail of the BMP

Reporting

Record keeping and internal reporting represent good operating practices because they can increase the efficiency of the facility and the effectiveness of BMPs. A good record keeping system helps the facility minimize incident recurrence, correctly respond with appropriate cleanup activities, and comply with legal requirements. A record keeping and reporting system should be set up for documenting spills, leaks, and other discharges, including discharges of hazardous substances in reportable quantities. Incident records describe the quality and quantity of non-stormwater discharges to the storm sewer. These records should contain the following information:

- ❑ Date and time of the incident;
- ❑ Weather conditions;
- ❑ Duration of the spill/leak/discharge;

Spill Prevention, Control & Cleanup SC-11

- Cause of the spill/leak/discharge;
- Response procedures implemented;
- Persons notified; and
- Environmental problems associated with the spill/leak/discharge.

Separate record keeping systems should be established to document housekeeping and preventive maintenance inspections, and training activities. All housekeeping and preventive maintenance inspections should be documented. Inspection documentation should contain the following information:

- Date and time the inspection was performed;
- Name of the inspector;
- Items inspected;
- Problems noted;
- Corrective action required; and
- Date corrective action was taken.

Other means to document and record inspection results are field notes, timed and dated photographs, videotapes, and drawings and maps.

Aboveground Tank Leak and Spill Control

Accidental releases of materials from aboveground liquid storage tanks present the potential for contaminating stormwater with many different pollutants. Materials spilled, leaked, or lost from tanks may accumulate in soils or on impervious surfaces and be carried away by stormwater runoff.

The most common causes of unintentional releases are:

- Installation problems;
- Failure of piping systems (pipes, pumps, flanges, couplings, hoses, and valves);
- External corrosion and structural failure;
- Spills and overfills due to operator error; and
- Leaks during pumping of liquids or gases from truck or rail car to a storage tank or vice versa.

Spill Prevention, Control & Cleanup SC-11

Storage of reactive, ignitable, or flammable liquids should comply with the Uniform Fire Code and the National Electric Code. Practices listed below should be employed to enhance the code requirements:

- Tanks should be placed in a designated area.
- Tanks located in areas where firearms are discharged should be encapsulated in concrete or the equivalent.
- Designated areas should be impervious and paved with Portland cement concrete, free of cracks and gaps, in order to contain leaks and spills.
- Liquid materials should be stored in UL approved double walled tanks or surrounded by a curb or dike to provide the volume to contain 10 percent of the volume of all of the containers or 110 percent of the volume of the largest container, whichever is greater. The area inside the curb should slope to a drain.
- For used oil or dangerous waste, a dead-end sump should be installed in the drain.
- All other liquids should be drained to the sanitary sewer if available. The drain must have a positive control such as a lock, valve, or plug to prevent release of contaminated liquids.
- Accumulated stormwater in petroleum storage areas should be passed through an oil/water separator.

Maintenance is critical to preventing leaks and spills. Conduct routine inspections and:

- Check for external corrosion and structural failure.
- Check for spills and overfills due to operator error.
- Check for failure of piping system (pipes, pumps, flanges, coupling, hoses, and valves).
- Check for leaks or spills during pumping of liquids or gases from truck or rail car to a storage facility or vice versa.
- Visually inspect new tank or container installation for loose fittings, poor welding, and improper or poorly fitted gaskets.
- Inspect tank foundations, connections, coatings, and tank walls and piping system. Look for corrosion, leaks, cracks, scratches, and other physical damage that may weaken the tank or container system.
- Frequently relocate accumulated stormwater during the wet season.

Spill Prevention, Control & Cleanup SC-11

- Periodically conduct integrity testing by a qualified professional.

Vehicle Leak and Spill Control

Major spills on roadways and other public areas are generally handled by highly trained Hazmat teams from local fire departments or environmental health departments. The measures listed below pertain to leaks and smaller spills at vehicle maintenance shops.

In addition to implementing the spill prevention, control, and clean up practices above, use the following measures related to specific activities:

Vehicle and Equipment Maintenance

- Perform all vehicle fluid removal or changing inside or under cover to prevent the run-on of stormwater and the runoff of spills.
- Regularly inspect vehicles and equipment for leaks, and repair immediately.
- Check incoming vehicles and equipment (including delivery trucks, and employee and subcontractor vehicles) for leaking oil and fluids. Do not allow leaking vehicles or equipment onsite.
- Always use secondary containment, such as a drain pan or drop cloth, to catch spills or leaks when removing or changing fluids.
- Immediately drain all fluids from wrecked vehicles.
- Store wrecked vehicles or damaged equipment under cover.
- Place drip pans or absorbent materials under heavy equipment when not in use.
- Use absorbent materials on small spills rather than hosing down the spill.
- Remove the adsorbent materials promptly and dispose of properly.
- Promptly transfer used fluids to the proper waste or recycling drums. Don't leave full drip pans or other open containers lying around.
- Oil filters disposed of in trashcans or dumpsters can leak oil and contaminate stormwater. Place the oil filter in a funnel over a waste oil recycling drum to drain excess oil before disposal. Oil filters can also be recycled. Ask your oil supplier or recycler about recycling oil filters.
- Store cracked batteries in a non-leaking secondary container. Do this with all cracked batteries, even if you think all the acid has drained out. If you drop a battery, treat it as if it is cracked. Put it into the containment area until you are sure it is not leaking.

Spill Prevention, Control & Cleanup SC-11

Vehicle and Equipment Fueling

- Design the fueling area to prevent the run-on of stormwater and the runoff of spills:
 - Cover fueling area if possible.
 - Use a perimeter drain or slope pavement inward with drainage to a sump.
 - Pave fueling area with concrete rather than asphalt.
- If dead-end sump is not used to collect spills, install an oil/water separator.
- Install vapor recovery nozzles to help control drips as well as air pollution.
- Discourage “topping-off” of fuel tanks.
- Use secondary containment when transferring fuel from the tank truck to the fuel tank.
- Use absorbent materials on small spills and general cleaning rather than hosing down the area. Remove the absorbent materials promptly.
- Carry out all Federal and State requirements regarding underground storage tanks, or install above ground tanks.
- Do not use mobile fueling of mobile industrial equipment around the facility; rather, transport the equipment to designated fueling areas.
- Keep your Spill Prevention Control and Countermeasure (SPCC) Plan up-to-date.
- Train employees in proper fueling and cleanup procedures.

Industrial Spill Prevention Response

For the purposes of developing a spill prevention and response program to meet the stormwater regulations, facility managers should use information provided in this fact sheet and the spill prevention/response portions of the fact sheets in this handbook, for specific activities.

The program should:

- Integrate with existing emergency response/hazardous materials programs (e.g., Fire Department).
- Develop procedures to prevent/mitigate spills to storm drain systems.
- Identify responsible departments.

Spill Prevention, Control & Cleanup SC-11

- Develop and standardize reporting procedures, containment, storage, and disposal activities, documentation, and follow-up procedures.
- Address spills at municipal facilities, as well as public areas.
- Provide training concerning spill prevention, response and cleanup to all appropriate personnel.

References and Resources

California's Nonpoint Source Program Plan. <http://www.swrcb.ca.gov/nps/index.html>.

Clark County Storm Water Pollution Control Manual. Available online at:
<http://www.co.clark.wa.us/pubworks/bmpman.pdf>.

King County Storm Water Pollution Control Manual. Available online at:
<http://dnr.metrokc.gov/wlr/dss/spcm.htm>.

Orange County Stormwater Program, Best Management Practices for Industrial/Commercial Business Activities. Available online at:
<http://ocwatersheds.com/documents/bmp/industrialcommercialbusinessesactivities>

Santa Clara Valley Urban Runoff Pollution Prevention Program.
<http://www.scvurppp.org>.

The Stormwater Managers Resource Center. <http://www.stormwatercenter.net/>.

Description

The loading/unloading of materials usually takes place outside on docks or terminals; therefore, materials spilled, leaked, or lost during loading/unloading may collect in the soil or on other surfaces and have the potential to be carried away by wind, stormwater runoff or when the area is cleaned. Additionally, rainfall may wash pollutants from machinery used to unload or move materials. Implementation of the following protocols will prevent or reduce the discharge of pollutants to stormwater from outdoor loading/unloading of materials.

Approach

Reduce potential for pollutant discharge through source control pollution prevention and BMP implementation. Successful implementation depends on effective training of employees on applicable BMPs and general pollution prevention strategies and objectives.

General Pollution Prevention Protocols

- Park tank trucks or delivery vehicles in designated areas so that spills or leaks can be contained.
- Limit exposure of material to rainfall whenever possible.
- Prevent stormwater run-on.
- Check equipment regularly for leaks.



Good Housekeeping

- Develop an operations plan that describes procedures for loading and/or unloading.
- Conduct loading and unloading in dry weather if possible.

Objectives

- Cover
- Contain
- Educate
- Reduce/Minimize
- Product Substitution

Targeted Constituents

Sediment	✓
Nutrients	✓
Trash	
Metals	✓
Bacteria	
Oil and Grease	✓
Organics	✓

Minimum BMPs Covered

 Good Housekeeping	✓
 Preventative Maintenance	
 Spill and Leak Prevention and Response	✓
 Material Handling & Waste Management	✓
 Erosion and Sediment Controls	
 Employee Training Program	✓
 Quality Assurance Record Keeping	✓



- ❑ Cover designated loading/unloading areas to reduce exposure of materials to rain.
- ❑ Consider placing a seal or door skirt between delivery vehicles and building to prevent exposure to rain.
- ❑ Design loading/unloading area to prevent stormwater run-on, which would include grading or berming the area, and position roof downspouts so they direct stormwater away from the loading/unloading areas.
- ❑ Have employees load and unload all materials and equipment in covered areas such as building overhangs at loading docks if feasible.
- ❑ Load/unload only at designated loading areas.
- ❑ Use drip pans underneath hose and pipe connections and other leak-prone spots during liquid transfer operations, and when making and breaking connections. Several drip pans should be stored in a covered location near the liquid transfer area so that they are always available, yet protected from precipitation when not in use. Drip pans can be made specifically for railroad tracks. Drip pans must be cleaned periodically, and drip collected materials must be disposed of properly.
- ❑ Pave loading areas with concrete instead of asphalt.
- ❑ Avoid placing storm drains inlets in the area.
- ❑ Grade and/or berm the loading/unloading area with drainage to sump; regularly remove materials accumulated in sump.



Spill Response and Prevention Procedures

- ❑ Keep your spill prevention and control plan up-to-date or have an emergency spill cleanup plan readily available, as applicable.
- ❑ Contain leaks during transfer.
- ❑ Store and maintain appropriate spill cleanup materials in a location that is readily accessible and known to all employees.
- ❑ Ensure that employees are familiar with the site's spill control plan and proper spill cleanup procedures.
- ❑ Use drip pans or comparable devices when transferring oils, solvents, and paints.



Material Handling and Waste Management

- ❑ Spot clean leaks and drips routinely to prevent runoff of spillage.
- ❑ Do not pour liquid wastes into floor drains, sinks, outdoor storm drain inlets, or other storm drains or sewer connections.

- ❑ Do not put used or leftover cleaning solutions, solvents, and automotive fluids in the storm drain or sanitary sewer.
- ❑ Collect leaking or dripping fluids in drip pans or containers. Fluids are easier to recycle if kept separate.
- ❑ Promptly transfer used fluids to the proper waste or recycling drums. Do not leave drip pans or other open containers lying around.
- ❑ Minimize the possibility of stormwater pollution from outside waste receptacles by doing at least one of the following:
 - ✓ Use only watertight waste receptacle(s) and keep the lid(s) closed.
 - ✓ Grade and pave the waste receptacle area to prevent run-on of stormwater.
 - ✓ Install a roof over the waste receptacle area.
 - ✓ Install a low containment berm around the waste receptacle area.
 - ✓ Use and maintain drip pans under waste receptacles.
- ❑ Post “no littering” signs.
- ❑ Perform work area clean-up and dry sweep after daily operations.



Employee Training Program

- ❑ Train employees (e.g., fork lift operators) and contractors on proper spill containment and cleanup.
- ❑ Have employees trained in spill containment and cleanup present during loading/unloading.
- ❑ Train employees in proper handling techniques during liquid transfers to avoid spills.
- ❑ Make sure forklift operators are properly trained on loading and unloading procedures.



Quality Assurance and Record Keeping

- ❑ Keep accurate maintenance logs that document activities performed, quantities of materials removed, and improvement actions.
- ❑ Keep accurate logs of spill response actions that document what was spilled, how it was cleaned up, and how the waste was disposed.
- ❑ Establish procedures to complete logs and file them in the central office.
- ❑ Keep accurate logs of daily clean-up operations.

Potential Limitations and Work-Arounds

Some facilities may have space constraints, limited staffing and time limitations that may preclude implementation of BMPs. Provided below are typical limitations and recommended “work-arounds.”

- Space and time limitations may preclude all transfers from being performed indoors or under cover.
 - ✓ Designate specific areas for outdoor loading and unloading.
 - ✓ Require employees to understand and follow spill and leak prevention BMPs.
- It may not be possible to conduct transfers only during dry weather.
 - ✓ Limit materials and equipment rainfall exposure to all extents practicable.
 - ✓ Require employees to understand and follow spill and leak prevention BMPs.

Potential Capital Facility Costs and Operation & Maintenance Requirements

Facilities

Many facilities will already have indoor or covered areas where loading/unloading takes place and will require no additional capital expenditures.

If outdoor activities are required, construction of berms or other means to retain spills and leaks may require appropriate constructed systems for containment. These containment areas may require significant new capital investment.

Capital investments will likely be required at some sites if adequate cover and containment facilities do not exist and can vary significantly depending upon site conditions.

Maintenance

Most of the operations and maintenance activities associated with implementing this BMP are integrally linked to routine operations as previously described. Therefore additional O&M is not required.

- Conduct regular inspections and make repairs and improvements as necessary.
- Check loading and unloading equipment regularly for leaks.
- Conduct regular broom dry-sweeping of area. Do not wash with water.

Supplemental Information

Loading and Unloading of Liquids

- Loading or unloading of liquids should occur in the manufacturing building so that any spills that are not completely retained can be discharged to the sanitary sewer,

treatment plant, or treated in a manner consistent with local sewer authorities and permit requirements.

- For loading and unloading tank trucks to above and below ground storage tanks, the following procedures should be used:
 - ✓ The area where the transfer takes place should be paved. If the liquid is reactive with the asphalt, Portland cement should be used to pave the area.
 - ✓ The transfer area should be designed to prevent run-on of stormwater from adjacent areas. Sloping the pad and using a curb, like a speed bump, around the uphill side of the transfer area should reduce run-on.
 - ✓ The transfer area should be designed to prevent runoff of spilled liquids from the area. Sloping the area to a drain should prevent runoff. The drain should be connected to a dead-end sump or to the sanitary sewer. A positive control valve should be installed on the drain.
- For transfer from rail cars to storage tanks that must occur outside, use the following procedures:
 - ✓ Drip pans should be placed at locations where spillage may occur, such as hose connections, hose reels, and filler nozzles. Use drip pans when making and breaking connections.
 - ✓ Drip pan systems should be installed between the rails to collect spillage from tank cars.

References and Resources

Minnesota Pollution Control Agency, *Industrial Stormwater Best Management Practices Guidebook BMP 26 Fueling and Liquid Loading/Unloading Operations*. Available online at: <http://www.pca.state.mn.us/index.php/view-document.html?gid=10557>.

New Jersey Department of Environmental Protection, 2013. *Basic Industrial Stormwater General Permit Guidance Document NJPDES General Permit No NJ0088315*. Available online at: http://www.nj.gov/dep/dwq/pdf/5G2_guidance_color.pdf.

Orange County Stormwater Program, Best Management Practices for Industrial/Commercial Business Activities. Available online at: <http://ocwatersheds.com/documents/bmp/industrialcommercialbusinessesactivities>.

Oregon Department of Environmental Quality, 2013. *Industrial Stormwater Best Management Practices Manual- BMP 26 Fueling and Liquid Loading/Unloading Operations*. Available online at: <http://www.deq.state.or.us/wq/wqpermit/docs/IndBMP021413.pdf>.

Sacramento Stormwater Management Program, *Best Management Practices for Industrial Storm Water Pollution Control*. Available online at: <http://www.msa.saccounty.net/sactostormwater/documents/guides/industrial-BMP-manual.pdf>.

Sacramento County Environmental Management Stormwater Program: *Best Management Practices*. Available online at: <http://www.emd.saccounty.net/EnvHealth/Stormwater/Stormwater-BMPs.html>.

Santa Clara Valley Urban Runoff Pollution Prevention Program. <http://www.scvurppp-w2k.com/>.

US EPA. National Pollutant Discharge Elimination System – Industrial Fact Sheet Series for Activities Covered by EPA’s Multi Sector General Permit. Available online at: <http://cfpub.epa.gov/npdes/stormwater/swsectors.cfm>.

Outdoor Equipment Operations SC-32

Description

Outside process equipment operations and maintenance can contaminate stormwater runoff. Activities, such as grinding, painting, coating, sanding, degreasing or parts cleaning, landfills and waste piles, and solid waste treatment and disposal are examples of process operations that can lead to contamination of stormwater runoff. The targeted constituents will vary for each site depending on the operation being performed.

Approach

Implement source control BMPs to limit exposure of outdoor equipment to direct precipitation and stormwater run-on. Refer to SC-22 Vehicle and Equipment Repair for additional information.

General Pollution Prevention Protocols

- Perform the activity during dry periods whenever possible.
- Install secondary containment measures where leaks and spills may occur.
- Use non-toxic chemicals for maintenance and minimize or eliminate the use of solvents.
- Connect process equipment area to public sanitary sewer or facility wastewater treatment system when possible. Some jurisdictions require that secondary containment areas be connected to the sanitary sewer, prohibiting any hard connections to the storm drain.



Good Housekeeping

- Manage materials and waste properly (see Material Handling and Waste Management) to reduce adverse impacts on stormwater quality.

Objectives

- Cover
- Contain
- Educate
- Reduce/Minimize

Targeted Constituents

Sediment	✓
Nutrients	✓
Trash	✓
Metals	✓
Bacteria	✓
Oil and Grease	✓
Organics	✓

Minimum BMPs Covered

	Good Housekeeping	✓
	Preventative Maintenance	✓
	Spill and Leak Prevention and Response	✓
	Material Handling & Waste Management	✓
	Erosion and Sediment Controls	
	Employee Training Program	✓
	Quality Assurance Record Keeping	✓



CALIFORNIA STORMWATER QUALITY ASSOCIATION®

Outdoor Equipment Operations SC-32

- Cover the work area with a permanent roof if possible.
- Use drop cloths for sanding and painting operations.
- Use a vacuum for fine particle clean-up in pavement cracks and crevices.
- Minimize contact of stormwater with outside process equipment operations through berming and drainage routing (run-on prevention).
- "Spot clean" leaks and drips routinely. Leaks are not cleaned up until the absorbent is picked up and disposed of properly.
- Paint signs on storm drain inlets to indicate that they are not to receive liquid or solid wastes.
- Use roll down or permanent walls when windy/breezy to prevent wind transport of particulates/pollutants.



Preventative Maintenance

- Design outdoor equipment areas to prevent stormwater runoff and spills. Use a perimeter drain or slope pavement inward with drainage to sump.
- Dry clean the work area regularly. Do not wash outdoor equipment with water if there is a direct connection to the storm drain.
- Pave area with concrete rather than asphalt.
- Inspect outdoor equipment regularly for leaks or spills. Also check for structural failure, spills and overfills due to operator error, and/or failure of piping system.
- Inspect and clean, if necessary, storm drain inlets and catch basins within the outdoor equipment area before October 1 each year.



Spill Response and Prevention Procedures

- Keep your Spill Prevention Control and Countermeasure (SPCC) Plan up-to-date.
- Have employees trained in emergency spill cleanup procedures present when dangerous waste, liquid chemicals, or other wastes are delivered.
- Place a stockpile of spill cleanup materials where it will be readily accessible.
- Prevent operator errors by using engineering safe guards and thus reducing accidental releases of pollutant.



Material Handling and Waste Management

Outdoor Equipment Operations SC-32

- Do not pour liquid wastes into floor drains, sinks, outdoor storm drain inlets, or other storm drain or sewer connections.
- Collect leaking or dripping fluids in drip pans or containers. Fluids are easier to recycle if kept separate.
- Promptly transfer used fluids to the proper waste or recycling drums. Do not leave drip pans or other open containers lying around.
- Minimize the possibility of stormwater pollution from outside waste receptacles by doing at least one of the following:
 - ✓ Use only watertight waste receptacle(s) and keep the lid(s) closed.
 - ✓ Grade and pave the waste receptacle area to prevent run-on of stormwater.
 - ✓ Install a roof over the waste receptacle area.



Employee Training Program

- Educate employees about pollution prevention measures and goals.
- Train employees on proper equipment operation and maintenance procedures.
- Train all employees upon hiring and annually thereafter on proper methods for handling and disposing of waste. Ensure that all employees understand stormwater discharge prohibitions, wastewater discharge requirements, and these best management practices.
- Use a training log or similar method to document training.
- Ensure that employees are familiar with the site's spill control plan and/or proper spill cleanup procedures.



Quality Assurance and Record Keeping

- Keep accurate maintenance logs that document minimum BMP activities performed for outdoor equipment, types and quantities of materials removed and disposed of, and any improvement actions.
- Keep accurate logs of spill response actions that document what was spilled, how it was cleaned up, and how the waste was disposed.
- Establish procedures to complete logs and file them in the central office.

Potential Limitations and Work-Arounds

Some facilities may have space constraints, limited staffing and time limitations that may preclude implementation of BMPs. Provided below are typical limitations and recommended “work-arounds.”

Outdoor Equipment Operations SC-32

- Providing cover over outdoor equipment may be impractical or cost-prohibitive.
 - ✓ Operate outdoor equipment only during periods of dry weather.
- Regular operations and time limitations may require outdoor activities during wet weather.
 - ✓ Designate specific areas for outdoor activities.
 - ✓ Allow time for work area clean-up after each shift.
 - ✓ Require employees to understand and follow preventive maintenance and spill and leak prevention BMPs.
 - ✓ Design and install secondary containment and good housekeeping BMPs for outdoor equipment area.
- Storage sheds often must meet building and fire code requirements.

Potential Capital Facility Costs and Operation & Maintenance Requirements

Facilities

- Many facilities will already have indoor covered areas where vehicle and equipment repairs take place and will require no additional capital expenditures.
- If outdoor activities are required, construction of berms or other means to retain spills and leaks may require appropriate constructed systems for containment. These containment areas may require significant new capital investment.
- Capital investments will likely be required at some sites if adequate cover and containment facilities do not exist and can vary significantly depending upon site conditions.

Maintenance

- Most of the operations and maintenance activities associated with implementing this BMP are integrally linked to routine operations as previously described. Therefore additional O&M is not required.
- For facilities responsible for pre-treating their wastewater prior to discharging, the proper functioning of structural treatment system is an important maintenance consideration.
- Routine cleanout of oil and grease is required for the devices to maintain their effectiveness, usually at least once a month. During periods of heavy rainfall, cleanout is required more often to ensure pollutants are not washed through the trap. Sediment removal is also required on a regular basis to keep the device working efficiently.

Outdoor Equipment Operations SC-32

References and Resources

Minnesota Pollution Control Agency. *Industrial Stormwater Best Management Practices Guidebook BMP 26 Fueling and Liquid Loading/Unloading Operations*.

Available online at: <http://www.pca.state.mn.us/index.php/view-document.html?gid=10557>.

New Jersey Department of Environmental Protection, 2013. *Basic Industrial Stormwater General Permit Guidance Document NJPDES General Permit No NJ0088315*. Available online at:

http://www.nj.gov/dep/dwq/pdf/5G2_guidance_color.pdf.

Orange County Stormwater Program, Best Management Practices for Industrial/Commercial Business Activities. Available online at:

<http://ocwatersheds.com/documents/bmp/industrialcommercialbusinessesactivities>.

Oregon Department of Environmental Quality, *Industrial Stormwater Best Management Practices Manual- BMP 26 Fueling and Liquid Loading/Unloading Operations*, February 2013. Available online at:

<http://www.deq.state.or.us/wq/wqpermit/docs/IndBMP021413.pdf>.

Sacramento Stormwater Management Program. *Best Management Practices for Industrial Storm Water Pollution Control*. Available online at:

<http://www.msa.saccounty.net/sactostormwater/documents/guides/industrial-BMP-manual.pdf>.

Sacramento County Environmental Management Stormwater Program: Best Management Practices. Available online at:

<http://www.emd.saccounty.net/EnvHealth/Stormwater/Stormwater-BMPs.html>.

Santa Clara Valley Urban Runoff Pollution Prevention Program. <http://www.scvurppp-w2k.com/>

US EPA. National Pollutant Discharge Elimination System – Industrial Fact Sheet Series for Activities Covered by EPA’s Multi Sector General Permit. Available online at:

<http://cfpub.epa.gov/npdes/stormwater/swsectors.cfm>.

Description

Improper storage and handling of solid wastes can allow toxic compounds, oils and greases, heavy metals, nutrients, suspended solids, and other pollutants to enter stormwater runoff. The discharge of pollutants to stormwater from waste handling and disposal can be prevented and reduced by tracking waste generation, storage, and disposal; reducing waste generation and disposal through source reduction, reuse, and recycling; and preventing run-on and runoff.

Approach

Reduce potential for pollutant discharge through source control pollution prevention and BMP implementation. Successful implementation depends on effective training of employees on applicable BMPs and general pollution prevention strategies and objectives.

General Pollution Prevention Protocols

- Accomplish reduction in the amount of waste generated using the following source controls:
 - ✓ Production planning and sequencing;
 - ✓ Process or equipment modification;
 - ✓ Raw material substitution or elimination;
 - ✓ Loss prevention and housekeeping;
 - ✓ Waste segregation and separation; and
 - ✓ Close loop recycling.
- Establish a material tracking system to increase awareness about material usage. This may reduce spills and minimize contamination, thus reducing the amount of waste produced.
- Recycle materials whenever possible.

Objectives

- Cover
- Contain
- Educate
- Reduce/Minimize
- Product Substitution

Targeted Constituents

Sediment	
Nutrients	
Trash	
Metals	✓
Bacteria	✓
Oil and Grease	✓
Organics	✓

Minimum BMPs Covered

 Good Housekeeping	✓
 Preventative Maintenance	✓
 Spill and Leak Prevention and Response	✓
 Material Handling & Waste Management	✓
 Erosion and Sediment Controls	
 Employee Training Program	✓
 Quality Assurance Record Keeping	✓



- Use the entire product before disposing of the container.
- To the extent possible, store wastes under cover or indoors after ensuring all safety concerns such as fire hazard and ventilation are addressed.
- Provide containers for each waste stream at each work station. Allow time after shift to clean area.



Good Housekeeping

- Cover storage containers with leak proof lids or some other means. If waste is not in containers, cover all waste piles (plastic tarps are acceptable coverage) and prevent stormwater run-on and runoff with a berm. The waste containers or piles must be covered except when in use.
- Use drip pans or absorbent materials whenever grease containers are emptied by vacuum trucks or other means. Grease cannot be left on the ground. Collected grease must be properly disposed of as garbage.
- Dispose of rinse and wash water from cleaning waste containers into a sanitary sewer if allowed by the local sewer authority. Do not discharge wash water to the street or storm drain. Clean in a designated wash area that drains to a clarifier.
- Transfer waste from damaged containers into safe containers.
- Take special care when loading or unloading wastes to minimize losses. Loading systems can be used to minimize spills and fugitive emission losses such as dust or mist. Vacuum transfer systems can minimize waste loss.
- Keep the waste management area clean at all times by sweeping and cleaning up spills immediately.
- Use dry methods when possible (e.g., sweeping, use of absorbents) when cleaning around restaurant/food handling dumpster areas. If water must be used after sweeping/using absorbents, collect water and discharge through grease interceptor to the sewer.
- Stencil or demarcate storm drains on the facility's property with prohibitive message regarding waste disposal.
- Cover waste piles with temporary covering material such as reinforced tarpaulin, polyethylene, polyurethane, polypropylene or hypalon.
- If possible, move the activity indoor after ensuring all safety concerns such as fire hazard and ventilation are addressed.



Preventative Maintenance

- Prevent stormwater run-on from entering the waste management area by enclosing the area or building a berm around the area.
- Prevent waste materials from directly contacting rain.

- ❑ Cover waste piles with temporary covering material such as reinforced tarpaulin, polyethylene, polyurethane, polypropylene or hypalon.
- ❑ Cover the area with a permanent roof if feasible.
- ❑ Cover dumpsters to prevent rain from washing waste out of holes or cracks in the bottom of the dumpster.
- ❑ Check waste containers weekly for leaks and to ensure that lids are on tightly. Replace any that are leaking, corroded, or otherwise deteriorating.
- ❑ Sweep and clean the waste management area regularly. Use dry methods when possible (e.g., sweeping, vacuuming, use of absorbents) when cleaning around restaurant/food handling dumpster areas. If water must be used after sweeping/using absorbents, collect water and discharge through grease interceptor to the sewer.
- ❑ Inspect and replace faulty pumps or hoses regularly to minimize the potential of releases and spills.
- ❑ Repair leaking equipment including valves, lines, seals, or pumps promptly.



Spill Response and Prevention Procedures

- ❑ Keep your spill prevention and plan up-to-date.
- ❑ Have an emergency plan, equipment and trained personnel ready at all times to deal immediately with major spills.
- ❑ Collect all spilled liquids and properly dispose of them.
- ❑ Store and maintain appropriate spill cleanup materials in a location known to all near the designated wash area.
- ❑ Ensure that vehicles transporting waste have spill prevention equipment that can prevent spills during transport. Spill prevention equipment includes:
 - ✓ Vehicles equipped with baffles for liquid waste; and
 - ✓ Trucks with sealed gates and spill guards for solid waste.



Material Handling and Waste Management

Litter Control

- ❑ Post “No Littering” signs and enforce anti-litter laws.
- ❑ Provide a sufficient number of litter receptacles for the facility.
- ❑ Clean out and cover litter receptacles frequently to prevent spillage.

Waste Collection

- ❑ Keep waste collection areas clean.

- Inspect solid waste containers for structural damage regularly. Repair or replace damaged containers as necessary.
- Secure solid waste containers; containers must be closed tightly when not in use.
- Do not fill waste containers with washout water or any other liquid.
- Ensure that only appropriate solid wastes are added to the solid waste container. Certain wastes such as hazardous wastes, appliances, fluorescent lamps, pesticides, etc., may not be disposed of in solid waste containers (see chemical/ hazardous waste collection section below).
- Do not mix wastes; this can cause chemical reactions, make recycling impossible, and complicate disposal. Affix labels to all waste containers.

Chemical/Hazardous Wastes

- Select designated hazardous waste collection areas on-site.
- Store hazardous materials and wastes in covered containers and protect them from vandalism.
- Place hazardous waste containers in secondary containment.
- Make sure that hazardous waste is collected, removed, and disposed of only at authorized disposal areas.
- Hazardous waste cannot be reused or recycled; it must be disposed of by a licensed hazardous waste hauler.



Employee Training Program

- Educate employees about pollution prevention measures and goals.
- Train employees how to properly handle and dispose of waste using the source control BMPs described above.
- Train employees and subcontractors in proper hazardous waste management.
- Use a training log or similar method to document training.
- Ensure that employees are familiar with the site's spill control plan and/or proper spill cleanup procedures.



Quality Assurance and Record Keeping

- Keep accurate maintenance logs that document minimum BMP activities performed for waste handling and disposal, types and quantities of waste disposed of, and any improvement actions.
- Keep accurate logs of spill response actions that document what was spilled, how it was cleaned up, and how the waste was disposed.

- Establish procedures to complete logs and file them in the central office.

Potential Capital Facility Costs and Operation & Maintenance Requirements

Facilities

- Capital costs will vary substantially depending on the size of the facility and the types of waste handled. Significant capital costs may be associated with reducing wastes by modifying processes or implementing closed-loop recycling.
- Many facilities will already have indoor covered areas where waste materials will be stored and will require no additional capital expenditures for providing cover.
- If outdoor storage of wastes is required, construction of berms or other means to prevent stormwater run-on and runoff may require appropriate constructed systems for containment.
- Capital investments will likely be required at some sites if adequate cover and containment facilities do not exist and can vary significantly depending upon site conditions.

Maintenance

- Check waste containers weekly for leaks and to ensure that lids are on tightly. Replace any that are leaking, corroded, or otherwise deteriorating.
- Sweep and clean the waste management area regularly. Use dry methods when possible (e.g., sweeping, use of absorbents) when cleaning around restaurant/food handling dumpster areas. If water must be used after sweeping/using absorbents, collect water and discharge through grease interceptor to the sewer.
- Inspect and replace faulty pumps or hoses regularly to minimize the potential of releases and spills.
- Repair leaking equipment including valves, lines, seals, or pumps promptly.

References and Resources

Minnesota Pollution Control Agency, *Industrial Stormwater Best Management Practices Guidebook*. Available online at: <http://www.pca.state.mn.us/index.php/view-document.html?gid=10557>.

New Jersey Department of Environmental Protection, 2013. *Basic Industrial Stormwater General Permit Guidance Document NJPDES General Permit No NJ0088315*, Revised. Available online at: http://www.nj.gov/dep/dwq/pdf/5G2_guidance_color.pdf.

Orange County Stormwater Program, *Best Management Practices for Industrial/Commercial Business Activities*. Available online at: <http://ocwatersheds.com/documents/bmp/industrialcommercialbusinessactivities>

Oregon Department of Environmental Quality, 2013. *Industrial Stormwater Best Management Practices Manual- BMP 26 Fueling and Liquid Loading/Unloading Operations*. Available online at:
<http://www.deq.state.or.us/wq/wqpermit/docs/IndBMP021413.pdf>.

Sacramento Stormwater Management Program. *Best Management Practices for Industrial Storm Water Pollution Control*. Available online at:
<http://www.msa.saccounty.net/sactostormwater/documents/guides/industrial-BMP-manual.pdf>.

Sacramento County Environmental Management Stormwater Program: Best Management Practices. Available online at:
<http://www.emd.saccounty.net/EnvHealth/Stormwater/Stormwater-BMPs.html>.

Santa Clara Valley Urban Runoff Pollution Prevention Program. <http://www.scvurppp-w2k.com/>

US EPA. National Pollutant Discharge Elimination System – Industrial Fact Sheet Series for Activities Covered by EPA’s Multi Sector General Permit. Available online at:
<http://cfpub.epa.gov/npdes/stormwater/swsectors.cfm>.

Description

Promote the use of less harmful products and products that contain little or no TMDL and 303(d) list pollutants. Alternatives exist for most product classes including chemical fertilizers, pesticides, cleaning solutions, janitorial chemicals, automotive and paint products, and consumables (batteries, fluorescent lamps).

Approach

Pattern a new program after the many established programs around the state and country. Integrate this best management practice as much as possible with existing programs at your facility.

Develop a comprehensive program based on:

- The “Precautionary Principle,” which is an alternative to the "Risk Assessment" model that says it's acceptable to use a potentially harmful product until physical evidence of its harmful effects are established and deemed too costly from an environmental or public health perspective. For instance, a risk assessment approach might say it's acceptable to use a pesticide until there is direct proof of an environmental impact. The Precautionary Principle approach is used to evaluate whether a given product is safe, whether it is really necessary, and whether alternative products would perform just as well.
- Environmentally Preferable Purchasing Program to minimize the purchase of products containing hazardous ingredients used in the facility's custodial services, fleet maintenance, and facility maintenance in favor of using alternate products that pose less risk to employees and to the environment.
- Integrated Pest Management (IPM) or Less-Toxic Pesticide Program, which uses a pest management approach that minimizes the use of toxic chemicals and gets rid of pests

Objectives

- Educate
- Reduce/Minimize
- Product Substitution

Targeted Constituents

Sediment	
Nutrients	✓
Trash	
Metals	✓
Bacteria	
Oil and Grease	✓
Organics	✓

Minimum BMPs Covered

 Good Housekeeping	
 Preventative Maintenance	
 Spill and Leak Prevention and Response	
 Material Handling & Waste Management	
 Erosion and Sediment Controls	
 Employee Training Program	✓
 Quality Assurance Record Keeping	



by methods that pose a lower risk to employees, the public, and the environment.

- Energy Efficiency Program including no-cost and low-cost energy conservation and efficiency actions that can reduce both energy consumption and electricity bills, along with long-term energy efficiency investments.

Consider the following mechanisms for developing and implementing a comprehensive program:

- Policies
- Procedures
 - ✓ Standard operating procedures (SOPs);
 - ✓ Purchasing guidelines and procedures; and
 - ✓ Bid packages (services and supplies).
- Materials
 - ✓ Preferred or approved product and supplier lists;
 - ✓ Product and supplier evaluation criteria;
 - ✓ Training sessions and manuals; and
 - ✓ Fact sheets for employees.

Implement this BMP in conjunction with the Vehicle and Equipment Management fact sheets (SC-20 – SC-22) and SC-41 Building and Grounds Maintenance.



Employee Training Program

- Employees who handle potentially harmful materials should be trained in the use of safer alternatives.
- Purchasing departments should be trained on safer alternative products and encouraged to procure less hazardous materials and products that contain little or no harmful substances or TMDL pollutants.
- Employees and contractors / service providers can both be educated about safer alternatives by using information developed by a number of organizations including the references and resources provided in this fact sheet.

Potential Limitations and Work-Arounds

Some facilities may have space constraints, limited staffing and time limitations that may preclude implementation of BMPs. Provided below are typical limitations and recommended “work-arounds”

- Alternative products may not be available, suitable, or effective in every case.

- ✓ Minimize use of hazardous/harmful products if no alternative product is available.

Regulatory Considerations

This BMP has no regulatory requirements unless local/municipal ordinance applies. Existing regulations already encourage facilities to reduce the use of hazardous materials through incentives such as reduced:

- Specialized equipment storage and handling requirements;
- Storm water runoff sampling requirements;
- Training and licensing requirements; and
- Record keeping and reporting requirements.

Cost Considerations

- The primary cost is for staff time to: 1) develop new policies and procedures and 2) educate purchasing departments and employees who handle potentially harmful materials about the availability, procurement, and use of safer alternatives.
- Some alternative products may be slightly more expensive than conventional products.

Supplemental Information

The following discussion provides some general information on safer alternatives. More specific information on particular hazardous materials and the available alternatives may be found in the references and resources listed below.

- Automotive products – Less toxic alternatives are not available for many automotive products, especially engine fluids. But there are alternatives to grease lubricants, car polishes, degreasers, and windshield washer solution. Refined motor oil is also available.
- Vehicle/Trailer lubrication – Fifth wheel bearings on trucks require routine lubrication. Adhesive lubricants are available to replace typical chassis grease.
- Cleaners – Vegetables-based or citrus-based soaps are available to replace petroleum-based soaps/detergents.
- Paint products – Water-based paints, wood preservatives, stains, and finishes with low VOC content are available.
- Pesticides – Specific alternative products or methods exist to control most insects, fungi, and weeds.
- Chemical Fertilizers – Compost and soil amendments are natural alternatives.
- Consumables – Manufacturers have either reduced or are in the process of reducing the amount of heavy metals in consumables such as batteries and fluorescent lamps.

All fluorescent lamps contain mercury, however low-mercury containing lamps are now available from most hardware and lighting stores. Fluorescent lamps are also more energy efficient than the average incandescent lamp.

- Janitorial chemicals – Even biodegradable soap can harm fish and wildlife before it biodegrades. Biodegradable does not mean non-toxic. Safer products and procedures are available for floor stripping and cleaning, as well as carpet, glass, metal, and restroom cleaning and disinfecting. Use paper products with post-consumer recycled content and implement electric had dryers.

Examples

There are a number of business and trade associations, and communities with effective programs. Some of the more prominent are listed below in the references and resources section.

References and Resources

Note: Many of these references provide alternative products for materials that typically are used inside and disposed to the sanitary sewer as well as alternatives to products that usually end up in the storm drain.

General Sustainable Practices and Pollution Prevention Including Pollutant-Specific Information

California Department of Toxic Substances Control,
<http://www.dtsc.ca.gov/PollutionPrevention/GreenTechnology/Index.cfm>.

CalRecycle, <http://www.calrecycle.ca.gov/Business/Regulated.htm>.

City of Santa Monica Office of Sustainability and Environment,
<http://www.smgov.net/departments/ose/>.

City of Palo Alto, <http://www.city.palo-alto.ca.us/cleanbay>.

City and County of San Francisco, Department of the Environment,
<http://www.sfenvironment.org/toxics-health/greener-business-practices>.

Green Business Program, <http://www.greenbiz.ca.gov/GRlocal.html> .

Product Stewardship Institute, <http://www.productstewardship.us/index.cfm>.

Sacramento Clean Water Business Partners.
<http://www.sacstormwater.org/CleanWaterBusinessPartners/CleanWaterBusinessPartners.html>.

USEPA. National Pollutant Discharge Elimination System (NPDES) Stormwater Discharges From Industrial Facilities,
<http://cfpub.epa.gov/npdes/stormwater/indust.cfm>.

USEPA Region IX Pollution Prevention Program,
<http://www.epa.gov/region9/waste/p2/business.html>.

Western Sustainability and Pollution Prevention Network, <http://wsppn.org/>.

Metals (mercury, copper)

National Electrical Manufacturers Association – Environmental Stewardship,
<http://www.nema.org/Policy/Environmental-Stewardship/pages/default.aspx>.

Sustainable Conservation, <http://www.suscon.org>.

Auto Recycling Project

Brake Pad Partnership

Pesticides and Chemical Fertilizers

Bio-Integral Resource Center, <http://www.birc.org>.

California Department of Pesticide Regulation,
<http://www.cdpr.ca.gov/dprprograms.htm>.

University of California Statewide IPM Program,
<http://www.ipm.ucdavis.edu/default.html>.

Dioxins

Bay Area Dioxins Project,
http://www.abag.ca.gov/bayarea/dioxin/project_materials.htm.

Building & Grounds Maintenance SC-41

Description

Stormwater runoff from building and grounds maintenance activities can be contaminated with toxic hydrocarbons in solvents, fertilizers and pesticides, suspended solids, heavy metals, abnormal pH, and oils and greases. Utilizing the protocols in this fact sheet will prevent or reduce the discharge of pollutants to stormwater from building and grounds maintenance activities by washing and cleaning up with as little water as possible, following good landscape management practices, preventing and cleaning up spills immediately, keeping debris from entering the storm drains, and maintaining the stormwater collection system.

Approach

Reduce potential for pollutant discharge through source control pollution prevention and BMP implementation. Successful implementation depends on effective training of employees on applicable BMPs and general pollution prevention strategies and objectives.

General Pollution Prevention Protocols

- Switch to non-toxic chemicals for maintenance to the maximum extent possible.
- Choose cleaning agents that can be recycled.
- Encourage proper lawn management and landscaping, including use of native vegetation.
- Encourage use of Integrated Pest Management techniques for pest control.
- Encourage proper onsite recycling of yard trimmings.
- Recycle residual paints, solvents, lumber, and other material as much as possible.

Objectives

- Cover
- Contain
- Educate
- Reduce/Minimize
- Product Substitution

Targeted Constituents

Sediment	✓
Nutrients	✓
Trash	
Metals	✓
Bacteria	✓
Oil and Grease	
Organics	

Minimum BMPs Covered

 Good Housekeeping	✓
 Preventative Maintenance	
 Spill and Leak Prevention and Response	✓
 Material Handling & Waste Management	✓
 Erosion and Sediment Controls	
 Employee Training Program	✓
 Quality Assurance Record Keeping	✓



Building & Grounds Maintenance SC-41

- Clean work areas at the end of each work shift using dry cleaning methods such as sweeping and vacuuming.



Good Housekeeping

Pressure Washing of Buildings, Rooftops, and Other Large Objects

- In situations where soaps or detergents are used and the surrounding area is paved, pressure washers must use a water collection device that enables collection of wash water and associated solids. A sump pump, wet vacuum or similarly effective device must be used to collect the runoff and loose materials. The collected runoff and solids must be disposed of properly.
- If soaps or detergents are not used, and the surrounding area is paved, wash runoff does not have to be collected but must be screened. Pressure washers must use filter fabric or some other type of screen on the ground and/or in the catch basin to trap the particles in wash water runoff.
- If you are pressure washing on a grassed area (with or without soap), runoff must be dispersed as sheet flow as much as possible, rather than as a concentrated stream. The wash runoff must remain on the grass and not drain to pavement.

Landscaping Activities

- Dispose of grass clippings, leaves, sticks, or other collected vegetation as garbage, or by composting. Do not dispose of collected vegetation into waterways or storm drainage systems.
- Use mulch or other erosion control measures on exposed soils. See also SC-40, Contaminated and Erodible Areas, for more information.

Building Repair, Remodeling, and Construction

- Do not dump any toxic substance or liquid waste on the pavement, the ground, or toward a storm drain.
- Use ground or drop cloths underneath outdoor painting, scraping, and sandblasting work, and properly dispose of collected material daily.
- Use a ground cloth or oversized tub for activities such as paint mixing and tool cleaning.
- Clean paintbrushes and tools covered with water-based paints in sinks connected to sanitary sewers or in portable containers that can be dumped into a sanitary sewer drain. Brushes and tools covered with non-water-based paints, finishes, or other materials must be cleaned in a manner that enables collection of used solvents (e.g., paint thinner, turpentine, etc.) for recycling or proper disposal.
- Use a storm drain cover, filter fabric, or similarly effective runoff control mechanism if dust, grit, wash water, or other pollutants may escape the work area and enter a catch basin. This is particularly necessary on rainy days. The containment device(s) must be in place at the beginning of the work day, and accumulated dirty runoff and

Building & Grounds Maintenance SC-41

solids must be collected and disposed of before removing the containment device(s) at the end of the work day.

- If you need to de-water an excavation site, you may need to filter the water before discharging to a catch basin or off-site. If directed off-site, you should direct the water through hay bales and filter fabric or use other sediment filters or traps.
- Store toxic material under cover during precipitation events and when not in use. A cover would include tarps or other temporary cover material.

Mowing, Trimming, and Planting

- Dispose of leaves, sticks, or other collected vegetation as garbage, by composting or at a permitted landfill. Do not dispose of collected vegetation into waterways or storm drainage systems.
- Use mulch or other erosion control measures when soils are exposed.
- Place temporarily stockpiled material away from watercourses and drain inlets, and berm or cover stockpiles to prevent material releases to the storm drain system.
- Consider an alternative approach when bailing out muddy water: do not put it in the storm drain; pour over landscaped areas.
- Use hand weeding where practical.

Fertilizer and Pesticide Management

- Do not use pesticides if rain is expected.
- Do not mix or prepare pesticides for application near storm drains.
- Use the minimum amount needed for the job.
- Calibrate fertilizer distributors to avoid excessive application.
- Employ techniques to minimize off-target application (e.g., spray drift) of pesticides, including consideration of alternative application techniques.
- Apply pesticides only when wind speeds are low.
- Fertilizers should be worked into the soil rather than dumped or broadcast onto the surface.
- Irrigate slowly to prevent runoff and then only as much as is needed.
- Clean pavement and sidewalk if fertilizer is spilled on these surfaces before applying irrigation water.

Inspection

- Inspect irrigation system periodically to ensure that the right amount of water is being applied and that excessive runoff is not occurring. Minimize excess watering and repair leaks in the irrigation system as soon as they are observed.

Building & Grounds Maintenance SC-41



Spill Response and Prevention Procedures

- Keep your Spill Prevention Control and Countermeasure (SPCC) Plan up-to-date.
- Place a stockpile of spill cleanup materials, such as brooms, dustpans, and vacuum sweepers (if desired) near the storage area where it will be readily accessible.
- Have employees trained in spill containment and cleanup present during the loading/unloading of dangerous wastes, liquid chemicals, or other materials.
- Familiarize employees with the Spill Prevention Control and Countermeasure Plan.
- Clean up spills immediately.



Material Handling and Waste Management

- Follow all federal, state, and local laws and regulations governing the use, storage, and disposal of fertilizers and pesticides and training of applicators and pest control advisors.
- Use less toxic pesticides that will do the job when applicable. Avoid use of copper-based pesticides if possible.
- Dispose of empty pesticide containers according to the instructions on the container label.
- Use up the pesticides. Rinse containers, and use rinse water as product. Dispose of unused pesticide as hazardous waste.
- Implement storage requirements for pesticide products with guidance from the local fire department and County Agricultural Commissioner. Provide secondary containment for pesticides.



Employee Training Program

- Educate and train employees on pesticide use and in pesticide application techniques to prevent pollution.
- Train employees and contractors in proper techniques for spill containment and cleanup.
- Be sure the frequency of training takes into account the complexity of the operations and the needs of individual staff.



Quality Assurance and Record Keeping

- Keep accurate logs that document maintenance activities performed and minimum BMP measures implemented.
- Keep accurate logs of spill response actions that document what was spilled, how it was cleaned up, and how the waste was disposed.
- Establish procedures to complete logs and file them in the central office.

Building & Grounds Maintenance SC-41

Potential Capital Facility Costs and Operation & Maintenance Requirements

Facilities

- Additional capital costs are not anticipated for building and grounds maintenance. Implementation of the minimum BMPs described above should be conducted as part of regular site operations.

Maintenance

- Maintenance activities for the BMPs described above will be minimal, and no additional cost is anticipated.

Supplemental Information

Fire Sprinkler Line Flushing

Site fire sprinkler line flushing may be a source of non-stormwater runoff pollution. The water entering the system is usually potable water, though in some areas it may be non-potable reclaimed wastewater. There are subsequent factors that may drastically reduce the quality of the water in such systems. Black iron pipe is usually used since it is cheaper than potable piping, but it is subject to rusting and results in lower quality water. Initially, the black iron pipe has an oil coating to protect it from rusting between manufacture and installation; this will contaminate the water from the first flush but not from subsequent flushes. Nitrates, poly-phosphates and other corrosion inhibitors, as well as fire suppressants and antifreeze may be added to the sprinkler water system. Water generally remains in the sprinkler system a long time (typically a year) and between flushes may accumulate iron, manganese, lead, copper, nickel, and zinc. The water generally becomes anoxic and contains living and dead bacteria and breakdown products from chlorination. This may result in a significant BOD problem and the water often smells. Consequently dispose fire sprinkler line flush water into the sanitary sewer. Do not allow discharge to storm drain or infiltration due to potential high levels of pollutants in fire sprinkler line water.

References and Resources

City of Seattle, Seattle Public Utilities Department of Planning and Development, 2009. *Stormwater Manual Vol. 1 Source Control Technical Requirements Manual*.

Kennedy/Jenks Consultants, 2007. *The Truckee Meadows Industrial and Commercial Storm Water Best Management Practices Handbook*. Available online at: http://www.cityofsparks.us/sites/default/files/assets/documents/env-control/construction/TM-I-C_BMP_Handbook_2-07-final.pdf.

Orange County Stormwater Program, Best Management Practices for Industrial/Commercial Business Activities. Available online at: <http://ocwatersheds.com/documents/bmp/industrialcommercialbusinessesactivities>.

Sacramento Stormwater Management Program. *Best Management Practices for Industrial Storm Water Pollution Control*. Available online at:

Building & Grounds Maintenance SC-41

<http://www.msa.saccounty.net/sactostormwater/documents/guides/industrial-BMP-manual.pdf>.

US EPA, 1997. *Best Management Practices Handbook for Hazardous Waste Containers*. Available online at: <http://www.epa.gov/region6/6en/h/handbk4.pdf>.

Ventura Countywide Stormwater Management Program Clean Business Fact Sheets. Available online at: http://www.vcstormwater.org/documents/programs_business/building.pdf.

Building Repair and Construction SC-42

Description

Site modifications are common, particularly at large industrial sites. The activity may vary from minor and normal building repair to major remodeling, or the construction of new facilities. These activities can generate pollutants including solvents, paints, paint and varnish removers, finishing residues, spent thinners, soap cleaners, kerosene, asphalt and concrete materials, adhesive residues, and old asbestos installation. Protocols in this fact sheet are intended to prevent or reduce the discharge of pollutants to stormwater from building repair, remodeling, and minor construction by using soil erosion controls, enclosing or covering building material storage areas, using good housekeeping practices, using safer alternative products, and training employees.

This fact sheet is intended to be used for minor repairs and construction. If major construction is required, the guidelines in the Construction BMP Handbook should be followed.

Approach

The BMP approach is to reduce potential for pollutant discharges through source control pollution prevention and BMP implementation. Successful implementation depends on effective training of employees on applicable BMPs and general pollution prevention strategies and objectives.

General Pollution Prevention Protocols

- Recycle residual paints, solvents, lumber, and other materials to the maximum extent practicable.
- Avoid outdoor repairs and construction during periods of wet weather.
- Use safer alternative products to the maximum extent practicable. See also SC-35 Safer Alternative Products for more information.

Objectives

- Cover
- Contain
- Educate
- Reduce/Minimize
- Product Substitution

Targeted Constituents

Sediment	✓
Nutrients	
Trash	✓
Metals	✓
Bacteria	
Oil and Grease	✓
Organics	✓

Minimum BMPs Covered

	Good Housekeeping	✓
	Preventative Maintenance	
	Spill and Leak Prevention and Response	✓
	Material Handling & Waste Management	✓
	Erosion and Sediment Controls	✓
	Employee Training Program	✓
	Quality Assurance Record Keeping	✓



CALIFORNIA STORMWATER
QUALITY ASSOCIATION®

Building Repair and Construction SC-42

- Buy recycled products to the maximum extent practicable.
- Inform on-site contractors of company policy on these matters and include appropriate provisions in their contract to ensure certain proper housekeeping and disposal practices are implemented.
- Make sure that nearby storm drains are well marked to minimize the chance of inadvertent disposal of residual paints and other liquids.



Good Housekeeping

Repair & Remodeling

- Keep the work site clean and orderly. Remove debris in a timely fashion. Sweep and vacuum the area regularly to remove sediments and small debris.
- Cover raw materials of particular concern that must be left outside, particularly during the rainy season. See also SC-33 Outdoor Storage of Raw Materials for more information.
- Use equipment and tools such as bag sanders to reduce accumulation of debris.
- Limit/prohibit work on windy days; implement roll-down walls or other measures to reduce wind transport of pollutants.
- Do not dump waste liquids down the storm drain.
- Dispose of wash water, sweepings, and sediments properly.
- Store liquid materials properly that are normally used in repair and remodeling such as paints and solvents. See also SC-31 Outdoor Liquid Container Storage for more information.
- Sweep out rain gutters or wash the gutter and trap the particles at the outlet of the downspout. A sock or geofabric placed over the outlet may effectively trap the materials. If the downspout is tight lined, place a temporary plug at the first convenient point in the storm drain and pump out the water with a vactor truck, and clean the catch basin sump where you placed the plug.
- Clean the storm drain system in the immediate vicinity of the construction activity after it is completed. See also SC-44 Drainage System Maintenance for more information.

Painting

- Enclose painting operations consistent with local air quality regulations and OSHA.
- Local air pollution regulations may, in many areas of the state, specify painting procedures which if properly carried out are usually sufficient to protect water quality.
- Develop paint handling procedures for proper use, storage, and disposal of paints.

Building Repair and Construction SC-42

- Transport paint and materials to and from job sites in containers with secure lids and tied down to the transport vehicle.
- Test and inspect spray equipment prior to starting to paint. Tighten all hoses and connections and do not overfill paint containers.
- Mix paint indoors before using so that any spill will not be exposed to rain. Do so even during dry weather because cleanup of a spill will never be 100 percent effective.
- Transfer and load paint and hot thermoplastic away from storm drain inlets.
- Do not transfer or load paint near storm drain inlets.
- Plug nearby storm drain inlets prior to starting painting and remove plugs when job is complete when there is risk of a spill reaching storm drains.
- Cover nearby storm drain inlets prior to starting work if sand blasting is used to remove paint.
- Use a ground cloth to collect the chips if painting requires scraping or sand blasting of the existing surface. Dispose of the residue properly.
- Cover or enclose painting operations properly to avoid drift.
- Clean the application equipment in a sink that is connected to the sanitary sewer if using water based paints.
- Capture all cleanup-water and dispose of properly.
- Dispose of paints containing lead or tributyl tin and considered a hazardous waste properly.
- Store leftover paints if they are to be kept for the next job properly, or dispose properly.
- Recycle paint when possible. Dispose of paint at an appropriate household hazardous waste facility.



Spill Response and Prevention Procedures

- Keep your spill prevention and control plan up-to-date.
- Place a stockpile of spill cleanup materials where it will be readily accessible.
- Clean up spills immediately.
- Excavate and remove the contaminated (stained) soil if a spill occurs on dirt.



Material Handling and Waste Management

- Post “No Littering” signs and enforce anti-litter laws.

Building Repair and Construction SC-42

- Provide a sufficient number of litter receptacles for the facility.
- Clean out and cover litter receptacles frequently to prevent spillage.
- Keep waste collection areas clean.
- Inspect solid waste containers for structural damage regularly. Repair or replace damaged containers as necessary.
- Secure solid waste containers; containers must be closed tightly when not in use.
- Do not fill waste containers with washout water or any other liquid.
- Ensure that only appropriate solid wastes are added to the solid waste container. Certain wastes such as hazardous wastes, appliances, fluorescent lamps, pesticides, etc., may not be disposed of in solid waste containers (see chemical/ hazardous waste collection section below).
- Do not mix wastes; this can cause chemical reactions, make recycling impossible, and complicate disposal. Affix labels to all waste containers.
- Make sure that hazardous waste is collected, removed, and disposed of properly. See also SC-34, Waste Handling and Disposal for more information.



Sediment and Erosion Controls

- Limit disturbance to bare soils and preserve natural vegetation whenever possible. See also EC-2, Preservation of Existing Vegetation, in the Construction BMP Handbook.
- Stabilize loose soils by re-vegetating whenever possible. See also EC-4 Hydroseeding, in the Construction BMP Handbook.
- Utilize non-vegetative stabilization methods for areas prone to erosion where vegetative options are not feasible. Examples include:
 - ✓ Areas of vehicular or pedestrian traffic such as roads or paths;
 - ✓ Arid environments where vegetation would not provide timely ground coverage, or would require excessive irrigation;
 - ✓ Rocky substrate, infertile or droughty soils where vegetation would be difficult to establish; and
 - ✓ Areas where vegetation will not grow adequately within the construction time frame.

There are several non-vegetative stabilization methods and selection should be based on site-specific conditions. See also EC-16 Non-Vegetative Stabilization, in the Construction BMP Handbook.

Building Repair and Construction SC-42

- Utilize chemical stabilization when needed. See also EC-5 Soil Binders, in the Construction BMP Handbook.
- Use geosynthetic membranes to control erosion if feasible. See also EC-7 Geotextiles and Mats, in the Construction BMP Handbook.
- Stabilize all roadways, entrances, and exits to sufficiently control discharges of erodible materials from discharging or being tracked off the site. See also TC 1-3 Tracking Control, in the Construction BMP Handbook.
- Refer to the supplemental information provided below for projects that involve more extensive soil disturbance activities.



Employee Training Program

- Educate employees about pollution prevention measures and goals.
- Train employees how to properly implement the source control BMPs described above. Detailed information for Sediment and Erosion Control BMPs is provided in the Construction BMP Handbook.
- Proper education of off-site contractors is often overlooked. The conscientious efforts of well trained employees can be lost by unknowing off-site contractors, so make sure they are well informed about pollutant source control responsibilities.
- Use a training log or similar method to document training.



Quality Assurance and Record Keeping

- Keep accurate maintenance logs that document minimum BMP activities performed for building repair and construction, types and quantities of waste disposed of, and any improvement actions.
- Keep accurate logs of spill response actions that document what was spilled, how it was cleaned up, and how the waste was disposed.
- Establish procedures to complete logs and file them in the central office.

Potential Limitations and Work-Arounds

Some facilities may have space constraints, limited staffing and time limitations that may preclude implementation of BMPs. Provided below are typical limitations and recommended “work-arounds.”

- This BMP is for minor construction only. The State’s General Construction Activity Stormwater Permit has more extensive requirements for larger projects that would disturb one or more acres of surface.
 - ✓ Refer to the companion “Construction Best Management Practice Handbook” which contains specific guidance and best management practices for larger-scale projects.

Building Repair and Construction SC-42

- Time constraints may require some outdoor repairs and construction during wet weather.
 - ✓ Require employees to understand and follow good housekeeping and spill and leak prevention BMPs.
 - ✓ Inspect sediment and erosion control BMPs daily during periods of wet weather and repair or improve BMP implementation as necessary.
- Hazardous waste that cannot be reused or recycled must be disposed of by a licensed hazardous waste hauler.
 - ✓ Minimize use of hazardous materials to the maximum extent practicable.
- Be certain that actions to help stormwater quality are consistent with Cal- and Fed-OSHA and air quality regulations.
- Prices for recycled/safer alternative materials and fluids may be higher than those of conventional materials.

Potential Capital Facility Costs and Operation & Maintenance Requirements

Facilities

- Limited capital investments may be required at some sites if adequate cover and containment facilities do not exist for construction materials and wastes.
- Purchase and installation of erosion and sediment controls, if needed will require additional capital investments, and this amount will vary depending on site characteristics and the types of BMPs being implemented.
- Minimize costs by maintaining existing vegetation and limiting construction operations on bare soils.

Maintenance

- The erosion and sediment control BMPs described above require periodic inspection and maintenance to remain effective. The cost of these actions will vary depending on site characteristics and the types of BMPs being implemented.
- Irrigation costs may be required to establish and maintain vegetation.

Supplemental Information

Soil/Erosion Control

If the work involves exposing large areas of soil, employ the appropriate soil erosion and control techniques. See the Construction Best Management Practice Handbook. If old buildings are being torn down and not replaced in the near future, stabilize the site using measures described in SC-40 Contaminated or Erodible Areas.

Building Repair and Construction SC-42

If a building is to be placed over an open area with a storm drainage system, make sure the storm inlets within the building are covered or removed, or the storm line is connected to the sanitary sewer. If because of the remodeling a new drainage system is to be installed or the existing system is to be modified, consider installing catch basins as they serve as effective “in-line” treatment devices. Include in the catch basin a “turn-down” elbow or similar device to trap floatables.

References and Resources

City of Seattle, Seattle Public Utilities Department of Planning and Development, 2009. *Stormwater Manual Vol. 1 Source Control Technical Requirements Manual*.

California Stormwater Quality Association, 2012. *Construction Stormwater Best Management Practice Handbook*. Available at <http://www.casqa.org>.

Kennedy/Jenks Consultants, 2007. *The Truckee Meadows Industrial and Commercial Storm Water Best Management Practices Handbook*. Available online at: http://www.cityofsparks.us/sites/default/files/assets/documents/env-control/construction/TM-I-C_BMP_Handbook_2-07-final.pdf.

Sacramento Stormwater Management Program. *Best Management Practices for Industrial Storm Water Pollution Control*. Available online at: <http://www.msa.saccounty.net/sactostormwater/documents/guides/industrial-BMP-manual.pdf>.

US EPA. *Construction Site Stormwater Runoff Control*. Available online at: http://cfpub.epa.gov/npdes/stormwater/menuofbmps/index.cfm?action=min_measure&min_measure_id=4.

Description

Parking lots can contribute a number of substances, such as trash, suspended solids, hydrocarbons, oil and grease, and heavy metals that can enter receiving waters through stormwater runoff or non-stormwater discharges. The protocols in this fact sheet are intended to prevent or reduce the discharge of pollutants from parking areas and include using good housekeeping practices, following appropriate cleaning BMPs, and training employees.

BMPs for other outdoor areas on site (loading/unloading, material storage, and equipment operations) are described in SC-30 through SC-33.

Approach

The goal of this program is to ensure stormwater pollution prevention practices are considered when conducting activities on or around parking areas to reduce potential for pollutant discharge to receiving waters. Successful implementation depends on effective training of employees on applicable BMPs and general pollution prevention strategies and objectives.

General Pollution Prevention Protocols

- Encourage advanced designs and maintenance strategies for impervious parking lots. Refer to the treatment control BMP fact sheets in this manual for additional information.
- Keep accurate maintenance logs to evaluate BMP implementation.



Good Housekeeping

- Keep all parking areas clean and orderly. Remove debris, litter, and sediments in a timely fashion.
- Post “No Littering” signs and enforce anti-litter laws.

Objectives

- Cover
- Contain
- Educate
- Reduce/Minimize
- Product Substitution

Targeted Constituents

Sediment	✓
Nutrients	
Trash	✓
Metals	✓
Bacteria	
Oil and Grease	✓
Organics	✓

Minimum BMPs Covered

	Good Housekeeping	✓
	Preventative Maintenance	✓
	Spill and Leak Prevention and Response	✓
	Material Handling & Waste Management	
	Erosion and Sediment Controls	
	Employee Training Program	✓
	Quality Assurance Record Keeping	✓



CALIFORNIA STORMWATER
QUALITY ASSOCIATION®

- Provide an adequate number of litter receptacles.
- Clean out and cover litter receptacles frequently to prevent spillage.



Preventative Maintenance

Inspection

Have designated personnel conduct inspections of parking facilities and stormwater conveyance systems associated with parking facilities on a regular basis.

- Inspect cleaning equipment/sweepers for leaks on a regular basis.

Surface Cleaning

- Use dry cleaning methods (e.g., sweeping, vacuuming) to prevent the discharge of pollutants into the stormwater conveyance system if possible.
- Establish frequency of public parking lot sweeping based on usage and field observations of waste accumulation.
- Sweep all parking lots at least once before the onset of the wet season.
- Dispose of parking lot sweeping debris and dirt at a landfill.
- Follow the procedures below if water is used to clean surfaces:
 - ✓ Block the storm drain or contain runoff.
 - ✓ Collect and pump wash water to the sanitary sewer or discharge to a pervious surface. Do not allow wash water to enter storm drains.
- Follow the procedures below when cleaning heavy oily deposits:
 - ✓ Clean oily spots with absorbent materials.
 - ✓ Use a screen or filter fabric over inlet, then wash surfaces.
 - ✓ Do not allow discharges to the storm drain.
 - ✓ Vacuum/pump discharges to a tank or discharge to sanitary sewer.
 - ✓ Dispose of spilled materials and absorbents appropriately.

Surface Repair

- Check local ordinance for SUSMP/LID ordinance.
- Preheat, transfer or load hot bituminous material away from storm drain inlets.
- Apply concrete, asphalt, and seal coat during dry weather to prevent contamination from contacting stormwater runoff.
- Cover and seal nearby storm drain inlets where applicable (with waterproof material or mesh) and manholes before applying seal coat, slurry seal, etc. Leave covers in

place until job is complete and all water from emulsified oil sealants has drained or evaporated. Clean any debris from these covered manholes and drains for proper disposal.

- Use only as much water as necessary for dust control during sweeping to avoid runoff.
- Catch drips from paving equipment that is not in use with pans or absorbent material placed under the machines. Dispose of collected material and absorbents properly.



Spill Response and Prevention Procedures

- Keep your Spill Prevention Control and Countermeasure (SPCC) Plan up-to-date.
- Place a stockpile of spill cleanup materials where it will be readily accessible or at a central location.
- Clean up fluid spills immediately with absorbent rags or material.
- Dispose of spilled material and absorbents properly.



Employee Training Program

- Provide regular training to field employees and/or contractors regarding cleaning of paved areas and proper operation of equipment.
- Train employees and contractors in proper techniques for spill containment and cleanup.
- Use a training log or similar method to document training.



Quality Assurance and Record Keeping

- Keep accurate maintenance logs that document minimum BMP activities performed for parking area maintenance, types and quantities of waste disposed of, and any improvement actions.
- Keep accurate logs of spill response actions that document what was spilled, how it was cleaned up, and how the waste was disposed.
- Establish procedures to complete logs and file them in the central office.

Potential Capital Facility Costs and Operation & Maintenance Requirements

Facilities

- Capital investments may be required at some sites to purchase sweeping equipment, train sweeper operators, install oil/water/sand separators, or implement advanced BMPs. These costs can vary significantly depending upon site conditions and the amount of BMPs required.

Maintenance

- Sweep and clean parking lots regularly to minimize pollutant transport into storm drains from stormwater runoff.
- Clean out oil/water/sand separators regularly, especially after heavy storms.
- Maintain advanced BMPs such as vegetated swales, infiltration trenches, or detention basins as appropriate. Refer to the treatment control fact sheets for more information.

Supplemental Information

Advanced BMPs

Some parking areas may require advanced BMPs to further reduce pollutants in stormwater runoff, and a few examples are listed below. Refer to the Treatment Control Fact Sheets and the New Development and Redevelopment Manual for more information.

- When possible, direct sheet runoff to flow into biofilters (vegetated strip and swale) and/or infiltration devices.
- Utilize sand filters or oleophilic collectors for oily waste in low quantities.
- Arrange rooftop drains to prevent drainage directly onto paved surfaces.
- Design lot to include semi-permeable hardscape.

References and Resources

City of Seattle, Seattle Public Utilities Department of Planning and Development, 2009. *Stormwater Manual Vol. 1 Source Control Technical Requirements Manual*.

California Stormwater Quality Association, 2003. *New Development and Redevelopment Stormwater Best Management Practice Handbook*. Available online at: <https://www.casqa.org/resources/bmp-handbooks/new-development-redevelopment-bmp-handbook>.

Kennedy/Jenks Consultants, 2007. *The Truckee Meadows Industrial and Commercial Storm Water Best Management Practices Handbook*. Available online at: [http://www.cityofsparks.us/sites/default/files/assets/documents/env-control/construction/TM-I-C BMP Handbook 2-07-final.pdf](http://www.cityofsparks.us/sites/default/files/assets/documents/env-control/construction/TM-I-C_BMP_Handbook_2-07-final.pdf).

Orange County Stormwater Program, Best Management Practices for Industrial/Commercial Business Activities. Available online at: <http://ocwatersheds.com/documents/bmp/industrialcommercialbusinessactivities>.

Pollution from Surface Cleaning Folder, 1996, 2003. Bay Area Stormwater Management Agencies Association. Available online at:

<http://basmaa.org/Portals/0/documents/pdf/Pollution%20from%20Surface%20Cleaning.pdf>.

Sacramento Stormwater Management Program. *Best Management Practices for Industrial Storm Water Pollution Control*. Available online at:

<http://www.msa.saccounty.net/sactostormwater/documents/guides/industrial-BMP-manual.pdf>.

The Storm Water Managers Resource Center, <http://www.stormwatercenter.net>.

US EPA. *Post-Construction Stormwater Management in New Development and Redevelopment*. BMP Fact Sheets. Available online at:

http://cfpub.epa.gov/npdes/stormwater/menuofbmps/index.cfm?action=min_measure&min_measure_id=5.

Drainage System Maintenance SC-44

Description

As a consequence of its function, the stormwater drainage facilities on site convey stormwater that may contain certain pollutants either to the offsite conveyance system that collects and transports urban runoff and stormwater, or directly to receiving waters. The protocols in this fact sheet are intended to reduce pollutants leaving the site to the offsite drainage infrastructure or to receiving waters through proper on-site conveyance system operation and maintenance. The targeted constituents will vary depending on site characteristics and operations.

Approach

Successful implementation depends on effective training of employees on applicable BMPs and general pollution prevention strategies and objectives.

General Pollution Prevention Protocols

- Maintain catch basins, stormwater inlets, and other stormwater conveyance structures on a regular basis to remove pollutants, reduce high pollutant concentrations during the first flush of storms, prevent clogging of the downstream conveyance system, restore catch basins' sediment trapping capacity, and ensure the system functions properly hydraulically to avoid flooding.
- Develop and follow a site specific drainage system maintenance plan that describes maintenance locations, methods, required equipment, water sources, sediment collection areas, disposal requirements, and any other pertinent information.



Good Housekeeping

Illicit Connections and Discharges

- Look for evidence of illegal discharges or illicit connections during routine maintenance of conveyance system and drainage structures:

Objectives

- Cover
- Contain
- Educate
- Reduce/Minimize

Targeted Constituents

Sediment	✓
Nutrients	✓
Trash	✓
Metals	✓
Bacteria	✓
Oil and Grease	✓
Organics	✓

Minimum BMPs Covered

 Good Housekeeping	✓
 Preventative Maintenance	✓
 Spill and Leak Prevention and Response	✓
 Material Handling & Waste Management	
 Erosion and Sediment Controls	
 Employee Training Program	✓
 Quality Assurance Record Keeping	✓



CALIFORNIA STORMWATER
QUALITY ASSOCIATION®

Drainage System Maintenance SC-44

- ✓ Identify evidence of spills such as paints, discoloring, odors, etc.
- ✓ Record locations of apparent illegal discharges/illicit connections.
- ✓ Track flows back to potential discharges and conduct aboveground inspections. This can be done through visual inspection of upgradient manholes or alternate techniques including zinc chloride smoke testing, fluorometric dye testing, physical inspection testing, or television camera inspection.
- ✓ Eliminate the discharge once the origin of flow is established.
- Stencil or demarcate storm drains, where applicable, to prevent illegal disposal of pollutants. Storm drain inlets should have messages such as “Dump No Waste Drains to Stream” or similar stenciled next to them to warn against ignorant or intentional dumping of pollutants into the storm drainage system.
- Refer to fact sheet SC-10 Non-Stormwater Discharges for additional information.

Illegal Dumping

- Inspect and clean up hot spots and other storm drainage areas regularly where illegal dumping and disposal occurs.
- Establish a system for tracking incidents. The system should be designed to identify the following:
 - ✓ Illegal dumping hot spots;
 - ✓ Types and quantities (in some cases) of wastes;
 - ✓ Patterns in time of occurrence (time of day/night, month, or year);
 - ✓ Mode of dumping (abandoned containers, “midnight dumping” from moving vehicles, direct dumping of materials, accidents/spills); and
 - ✓ Responsible parties.
- Post “No Dumping” signs in problem areas with a phone number for reporting dumping and disposal. Signs should also indicate fines and penalties for illegal dumping.
- Refer to fact sheet SC-10 Non-Stormwater Discharges for additional information.



Preventative Maintenance

Catch Basins/Inlet Structures

- Staff should regularly inspect facilities to ensure compliance with the following:
 - ✓ Immediate repair of any deterioration threatening structural integrity.
 - ✓ Cleaning before the sump is 40% full. Catch basins should be cleaned as frequently as needed to meet this standard.

Drainage System Maintenance **SC-44**

- Clean catch basins, storm drain inlets, and other conveyance structures before the wet season to remove sediments and debris accumulated during the summer.
- Conduct inspections more frequently during the wet season for problem areas where sediment or trash accumulates more often. Prioritize storm drain inlets; clean and repair as needed.
- Keep accurate logs of the number of catch basins cleaned.
- Store wastes collected from cleaning activities of the drainage system in appropriate containers or temporary storage sites in a manner that prevents discharge to the storm drain.
- Dewater the wastes if necessary with outflow into the sanitary sewer if permitted. Water should be treated with an appropriate filtering device prior to discharge to the sanitary sewer. If discharge to the sanitary sewer is not allowed, water should be pumped or vacuumed to a tank and properly disposed. Do not dewater near a storm drain or stream.

Storm Drain Conveyance System

- Locate reaches of storm drain with deposit problems and develop a flushing schedule that keeps the pipe clear of excessive buildup.
- Collect and pump flushed effluent to the sanitary sewer for treatment whenever possible.

Pump Stations

- Clean all storm drain pump stations prior to the wet season to remove silt and trash.
- Do not allow discharge to reach the storm drain system when cleaning a storm drain pump station or other facility.
- Conduct routine maintenance at each pump station.
- Inspect, clean, and repair as necessary all outlet structures prior to the wet season.

Open Channel

- Modify storm channel characteristics to improve channel hydraulics, increase pollutant removals, and enhance channel/creek aesthetic and habitat value.
- Conduct channel modification/improvement in accordance with existing laws. Any person, government agency, or public utility proposing an activity that will change the natural state of any river, stream, or lake in California, must enter into a Stream or Lake Alteration Agreement with the Department of Fish and Wildlife. The developer-applicant should also contact local governments (city, county, special districts), other state agencies (SWRCB, RWQCB, Department of Forestry, Department of Water Resources), and Army Corps of Engineers and USFWS.



Spill Response and Prevention Procedures

- Keep your spill prevention control plan up-to-date.

Drainage System Maintenance **SC-44**

- Investigate all reports of spills, leaks, and/or illegal dumping promptly.
- Place a stockpile of spill cleanup materials where it will be readily accessible or at a central location.
- Clean up all spills and leaks using “dry” methods (with absorbent materials and/or rags) or dig up, remove, and properly dispose of contaminated soil.



Employee Training Program

- Educate employees about pollution prevention measures and goals.
- Train employees how to properly handle and dispose of waste using the source control BMPs described above.
- Train employees and subcontractors in proper hazardous waste management.
- Use a training log or similar method to document training.
- Ensure that employees are familiar with the site’s spill control plan and/or proper spill cleanup procedures.
- Have staff involved in detection and removal of illicit connections trained in the following:
 - ✓ OSHA-required Health and Safety Training (29 CFR 1910.120) plus annual refresher training (as needed).
 - ✓ OSHA Confined Space Entry training (Cal-OSHA Confined Space, Title 8 and Federal OSHA 29 CFR 1910.146).
 - ✓ Procedural training (field screening, sampling, smoke/dye testing, TV inspection).



Quality Assurance and Record Keeping

- Keep accurate maintenance logs that document minimum BMP activities performed for drainage system maintenance, types and quantities of waste disposed of, and any improvement actions.
- Keep accurate logs of spill response actions that document what was spilled, how it was cleaned up, and how the waste was disposed.
- Keep accurate logs of illicit connections, illicit discharges, and illegal dumping into the storm drain system including how wastes were cleaned up and disposed.
- Establish procedures to complete logs and file them in the central office.

Potential Limitations and Work-Arounds

Provided below are typical limitations and recommended “work-arounds” for drainage system maintenance:

Drainage System Maintenance SC-44

- Clean-up activities may create a slight disturbance for local aquatic species. Access to items and material on private property may be limited. Trade-offs may exist between channel hydraulics and water quality/riparian habitat. If storm channels or basins are recognized as wetlands, many activities, including maintenance, may be subject to regulation and permitting.
 - ✓ Perform all maintenance onsite and do not flush accumulated material downstream to private property or riparian habitats.
- Storm drain flushing is most effective in small diameter pipes (36-inch diameter pipe or less, depending on water supply and sediment collection capacity). Other considerations associated with storm drain flushing may include the availability of a water source, finding a downstream area to collect sediments, and liquid/sediment disposal.
 - ✓ Develop and follow a site specific drainage system maintenance plan that describes maintenance locations, methods, required equipment, water sources, sediment collection areas, disposal requirements, and any other pertinent information.
- Regulations may include adoption of substantial penalties for illegal dumping and disposal.
 - ✓ Do not dump illegal materials anywhere onsite.
 - ✓ Identify illicit connections, illicit discharge, and illegal dumping.
 - ✓ Cleanup spills immediately and properly dispose of wastes.
- Local municipal codes may include sections prohibiting discharge of soil, debris, refuse, hazardous wastes, and other pollutants into the sanitary sewer system.
 - ✓ Collect all materials and pollutants accumulated in drainage system and dispose of according to local regulations.
 - ✓ Install debris excluders in areas with a trash TMDL.

Potential Capital Facility Costs and Operation & Maintenance Requirements

Facilities

- Capital costs will vary substantially depending on the size of the facility and characteristics of the drainage system. Significant capital costs may be associated with purchasing water trucks, vacuum trucks, and any other necessary cleaning equipment or improving the drainage infrastructure to reduce the potential .
- Developing and implementing a site specific drainage system maintenance plan will require additional capital if a similar program is not already in place.

Maintenance

- Two-person teams may be required to clean catch basins with vactor trucks.
- Teams of at least two people plus administrative personnel are required to identify illicit discharges, depending on the complexity of the storm sewer system.
- Arrangements must be made for proper disposal of collected wastes.
- Technical staff are required to detect and investigate illegal dumping violations.
- Methods used for illicit connection detection (smoke testing, dye testing, visual inspection, and flow monitoring) can be costly and time-consuming. Site-specific factors, such as the level of impervious area, the density and ages of buildings, and type of land use will determine the level of investigation necessary.

Supplemental Information

Storm Drain Flushing

Flushing is a common maintenance activity used to improve pipe hydraulics and to remove pollutants in storm drainage systems. Flushing may be designed to hydraulically convey accumulated material to strategic locations, such as an open channel, another point where flushing will be initiated, or the sanitary sewer and the treatment facilities, thus preventing re-suspension and overflow of a portion of the solids during storm events. Flushing prevents “plug flow” discharges of concentrated pollutant loadings and sediments. Deposits can hinder the designed conveyance capacity of the storm drain system and potentially cause backwater conditions in severe cases of clogging.

Storm drain flushing usually takes place along segments of pipe with grades that are too flat to maintain adequate velocity to keep particles in suspension. An upstream manhole is selected to place an inflatable device that temporarily plugs the pipe. Further upstream, water is pumped into the line to create a flushing wave. When the upstream reach of pipe is sufficiently full to cause a flushing wave, the inflated device is rapidly deflated with the assistance of a vacuum pump, thereby releasing the backed up water and resulting in the cleaning of the storm drain segment.

To further reduce impacts of stormwater pollution, a second inflatable device placed well downstream may be used to recollect the water after the force of the flushing wave has dissipated. A pump may then be used to transfer the water and accumulated material to the sanitary sewer for treatment. In some cases, an interceptor structure may be more practical or required to recollect the flushed waters.

It has been found that cleansing efficiency of periodic flush waves is dependent upon flush volume, flush discharge rate, sewer slope, sewer length, sewer flow rate, sewer diameter, and population density. As a rule of thumb, the length of line to be flushed should not exceed 700 feet. At this maximum recommended length, the percent removal efficiency ranges between 65-75% for organics and 55-65% for dry weather grit/inorganic material. The percent removal efficiency drops rapidly beyond that. Water is commonly supplied by a water truck, but fire hydrants can also supply water. To make the best use of water, it is recommended that reclaimed water be used if allowed or that fire hydrant line flushing coincide with storm sewer flushing.

Drainage System Maintenance SC-44

References and Resources

City of Seattle, Seattle Public Utilities Department of Planning and Development, 2009. *Stormwater Manual Vol. 1 Source Control Technical Requirements Manual*.

Knox County Tennessee *Stormwater Management Manual* Chapter 5 Drainage System Maintenance, 2008. Available online at:
http://www.knoxcounty.org/stormwater/manual/Volume%201/knoxco_swmm_v1_chap5_jan2008.pdf.

US EPA. Storm Drain System Cleaning, 2012. Available online at:
<http://cfpub.epa.gov/npdes/stormwater/menuofbmps/index.cfm?action=browse&button=detail&bmp=102>.



Design Objectives

- Maximize Infiltration
- Provide Retention
- Slow Runoff
- Minimize Impervious Land Coverage
- Prohibit Dumping of Improper Materials
- Contain Pollutants
- Collect and Convey

Description

Irrigation water provided to landscaped areas may result in excess irrigation water being conveyed into stormwater drainage systems.

Approach

Project plan designs for development and redevelopment should include application methods of irrigation water that minimize runoff of excess irrigation water into the stormwater conveyance system.

Suitable Applications

Appropriate applications include residential, commercial and industrial areas planned for development or redevelopment. (Detached residential single-family homes are typically excluded from this requirement.)

Design Considerations

Designing New Installations

The following methods to reduce excessive irrigation runoff should be considered, and incorporated and implemented where determined applicable and feasible by the Permittee:

- Employ rain-triggered shutoff devices to prevent irrigation after precipitation.
- Design irrigation systems to each landscape area's specific water requirements.
- Include design featuring flow reducers or shutoff valves triggered by a pressure drop to control water loss in the event of broken sprinkler heads or lines.
- Implement landscape plans consistent with County or City water conservation resolutions, which may include provision of water sensors, programmable irrigation times (for short cycles), etc.



- Design timing and application methods of irrigation water to minimize the runoff of excess irrigation water into the storm water drainage system.
- Group plants with similar water requirements in order to reduce excess irrigation runoff and promote surface filtration. Choose plants with low irrigation requirements (for example, native or drought tolerant species). Consider design features such as:
 - Using mulches (such as wood chips or bar) in planter areas without ground cover to minimize sediment in runoff
 - Installing appropriate plant materials for the location, in accordance with amount of sunlight and climate, and use native plant materials where possible and/or as recommended by the landscape architect
 - Leaving a vegetative barrier along the property boundary and interior watercourses, to act as a pollutant filter, where appropriate and feasible
 - Choosing plants that minimize or eliminate the use of fertilizer or pesticides to sustain growth
- Employ other comparable, equally effective methods to reduce irrigation water runoff.

Redeveloping Existing Installations

Various jurisdictional stormwater management and mitigation plans (SUSMP, WQMP, etc.) define “redevelopment” in terms of amounts of additional impervious area, increases in gross floor area and/or exterior construction, and land disturbing activities with structural or impervious surfaces. The definition of “redevelopment” must be consulted to determine whether or not the requirements for new development apply to areas intended for redevelopment. If the definition applies, the steps outlined under “designing new installations” above should be followed.

Other Resources

A Manual for the Standard Urban Stormwater Mitigation Plan (SUSMP), Los Angeles County Department of Public Works, May 2002.

Model Standard Urban Storm Water Mitigation Plan (SUSMP) for San Diego County, Port of San Diego, and Cities in San Diego County, February 14, 2002.

Model Water Quality Management Plan (WQMP) for County of Orange, Orange County Flood Control District, and the Incorporated Cities of Orange County, Draft February 2003.

Ventura Countywide Technical Guidance Manual for Stormwater Quality Control Measures, July 2002.



Design Objectives

- Maximize Infiltration
- Provide Retention
- Slow Runoff
- Minimize Impervious Land Coverage
- Prohibit Dumping of Improper Materials
- Contain Pollutants
- Collect and Convey

Description

Waste materials dumped into storm drain inlets can have severe impacts on receiving and ground waters. Posting notices regarding discharge prohibitions at storm drain inlets can prevent waste dumping. Storm drain signs and stencils are highly visible source controls that are typically placed directly adjacent to storm drain inlets.

Approach

The stencil or affixed sign contains a brief statement that prohibits dumping of improper materials into the urban runoff conveyance system. Storm drain messages have become a popular method of alerting the public about the effects of and the prohibitions against waste disposal.

Suitable Applications

Stencils and signs alert the public to the destination of pollutants discharged to the storm drain. Signs are appropriate in residential, commercial, and industrial areas, as well as any other area where contributions or dumping to storm drains is likely.

Design Considerations

Storm drain message markers or placards are recommended at all storm drain inlets within the boundary of a development project. The marker should be placed in clear sight facing toward anyone approaching the inlet from either side. All storm drain inlet locations should be identified on the development site map.

Designing New Installations

The following methods should be considered for inclusion in the project design and show on project plans:

- Provide stenciling or labeling of all storm drain inlets and catch basins, constructed or modified, within the project area with prohibitive language. Examples include “NO DUMPING



– DRAINS TO OCEAN” and/or other graphical icons to discourage illegal dumping.

- Post signs with prohibitive language and/or graphical icons, which prohibit illegal dumping at public access points along channels and creeks within the project area.

Note - Some local agencies have approved specific signage and/or storm drain message placards for use. Consult local agency stormwater staff to determine specific requirements for placard types and methods of application.

Redeveloping Existing Installations

Various jurisdictional stormwater management and mitigation plans (SUSMP, WQMP, etc.) define “redevelopment” in terms of amounts of additional impervious area, increases in gross floor area and/or exterior construction, and land disturbing activities with structural or impervious surfaces. If the project meets the definition of “redevelopment”, then the requirements stated under “designing new installations” above should be included in all project design plans.

Additional Information

Maintenance Considerations

- Legibility of markers and signs should be maintained. If required by the agency with jurisdiction over the project, the owner/operator or homeowner’s association should enter into a maintenance agreement with the agency or record a deed restriction upon the property title to maintain the legibility of placards or signs.

Placement

- Signage on top of curbs tends to weather and fade.
- Signage on face of curbs tends to be worn by contact with vehicle tires and sweeper brooms.

Supplemental Information

Examples

- Most MS4 programs have storm drain signage programs. Some MS4 programs will provide stencils, or arrange for volunteers to stencil storm drains as part of their outreach program.

Other Resources

A Manual for the Standard Urban Stormwater Mitigation Plan (SUSMP), Los Angeles County Department of Public Works, May 2002.

Model Standard Urban Storm Water Mitigation Plan (SUSMP) for San Diego County, Port of San Diego, and Cities in San Diego County, February 14, 2002.

Model Water Quality Management Plan (WQMP) for County of Orange, Orange County Flood Control District, and the Incorporated Cities of Orange County, Draft February 2003.

Ventura Countywide Technical Guidance Manual for Stormwater Quality Control Measures, July 2002.



Design Objectives

- Maximize Infiltration
- Provide Retention
- Slow Runoff
- Minimize Impervious Land Coverage
- Prohibit Dumping of Improper Materials
- Contain Pollutants
- Collect and Convey

Description

Several measures can be taken to prevent operations at maintenance bays and loading docks from contributing a variety of toxic compounds, oil and grease, heavy metals, nutrients, suspended solids, and other pollutants to the stormwater conveyance system.

Approach

In designs for maintenance bays and loading docks, containment is encouraged. Preventative measures include overflow containment structures and dead-end sumps. However, in the case of loading docks from grocery stores and warehouse/distribution centers, engineered infiltration systems may be considered.

Suitable Applications

Appropriate applications include commercial and industrial areas planned for development or redevelopment.

Design Considerations

Design requirements for vehicle maintenance and repair are governed by Building and Fire Codes, and by current local agency ordinances, and zoning requirements. The design criteria described in this fact sheet are meant to enhance and be consistent with these code requirements.

Designing New Installations

Designs of maintenance bays should consider the following:

- Repair/maintenance bays and vehicle parts with fluids should be indoors; or designed to preclude urban run-on and runoff.
- Repair/maintenance floor areas should be paved with Portland cement concrete (or equivalent smooth impervious surface).



- Repair/maintenance bays should be designed to capture all wash water leaks and spills. Provide impermeable berms, drop inlets, trench catch basins, or overflow containment structures around repair bays to prevent spilled materials and wash-down waters from entering the storm drain system. Connect drains to a sump for collection and disposal. Direct connection of the repair/maintenance bays to the storm drain system is prohibited. If required by local jurisdiction, obtain an Industrial Waste Discharge Permit.
- Other features may be comparable and equally effective.

The following designs of loading/unloading dock areas should be considered:

- Loading dock areas should be covered, or drainage should be designed to preclude urban run-on and runoff.
- Direct connections into storm drains from depressed loading docks (truck wells) are prohibited.
- Below-grade loading docks from grocery stores and warehouse/distribution centers of fresh food items should drain through water quality inlets, or to an engineered infiltration system, or an equally effective alternative. Pre-treatment may also be required.
- Other features may be comparable and equally effective.

Redeveloping Existing Installations

Various jurisdictional stormwater management and mitigation plans (SUSMP, WQMP, etc.) define “redevelopment” in terms of amounts of additional impervious area, increases in gross floor area and/or exterior construction, and land disturbing activities with structural or impervious surfaces. The definition of “redevelopment” must be consulted to determine whether or not the requirements for new development apply to areas intended for redevelopment. If the definition applies, the steps outlined under “designing new installations” above should be followed.

Additional Information

Stormwater and non-stormwater will accumulate in containment areas and sumps with impervious surfaces. Contaminated accumulated water must be disposed of in accordance with applicable laws and cannot be discharged directly to the storm drain or sanitary sewer system without the appropriate permit.

Other Resources

A Manual for the Standard Urban Stormwater Mitigation Plan (SUSMP), Los Angeles County Department of Public Works, May 2002.

Model Standard Urban Storm Water Mitigation Plan (SUSMP) for San Diego County, Port of San Diego, and Cities in San Diego County, February 14, 2002.

Model Water Quality Management Plan (WQMP) for County of Orange, Orange County Flood Control District, and the Incorporated Cities of Orange County, Draft February 2003.

Ventura Countywide Technical Guidance Manual for Stormwater Quality Control Measures, July 2002.

Description

Trash storage areas are areas where a trash receptacle (s) are located for use as a repository for solid wastes. Stormwater runoff from areas where trash is stored or disposed of can be polluted. In addition, loose trash and debris can be easily transported by water or wind into nearby storm drain inlets, channels, and/or creeks. Waste handling operations that may be sources of stormwater pollution include dumpsters, litter control, and waste piles.

Approach

This fact sheet contains details on the specific measures required to prevent or reduce pollutants in stormwater runoff associated with trash storage and handling. Preventative measures including enclosures, containment structures, and impervious pavements to mitigate spills, should be used to reduce the likelihood of contamination.

Suitable Applications

Appropriate applications include residential, commercial and industrial areas planned for development or redevelopment. (Detached residential single-family homes are typically excluded from this requirement.)

Design Considerations

Design requirements for waste handling areas are governed by Building and Fire Codes, and by current local agency ordinances and zoning requirements. The design criteria described in this fact sheet are meant to enhance and be consistent with these code and ordinance requirements. Hazardous waste should be handled in accordance with legal requirements established in Title 22, California Code of Regulation.

Wastes from commercial and industrial sites are typically hauled by either public or commercial carriers that may have design or access requirements for waste storage areas. The design criteria in this fact sheet are recommendations and are not intended to be in conflict with requirements established by the waste hauler. The waste hauler should be contacted prior to the design of your site trash collection areas. Conflicts or issues should be discussed with the local agency.

Designing New Installations

Trash storage areas should be designed to consider the following structural or treatment control BMPs:

- Design trash container areas so that drainage from adjoining roofs and pavement is diverted around the area(s) to avoid run-on. This might include berming or grading the waste handling area to prevent run-on of stormwater.
- Make sure trash container areas are screened or walled to prevent off-site transport of trash.

Design Objectives

- Maximize Infiltration
- Provide Retention
- Slow Runoff
- Minimize Impervious Land Coverage
- Prohibit Dumping of Improper Materials
- Contain Pollutants
- Collect and Convey



- Use lined bins or dumpsters to reduce leaking of liquid waste.
- Provide roofs, awnings, or attached lids on all trash containers to minimize direct precipitation and prevent rainfall from entering containers.
- Pave trash storage areas with an impervious surface to mitigate spills.
- Do not locate storm drains in immediate vicinity of the trash storage area.
- Post signs on all dumpsters informing users that hazardous materials are not to be disposed of therein.

Redeveloping Existing Installations

Various jurisdictional stormwater management and mitigation plans (SUSMP, WQMP, etc.) define “redevelopment” in terms of amounts of additional impervious area, increases in gross floor area and/or exterior construction, and land disturbing activities with structural or impervious surfaces. The definition of “redevelopment” must be consulted to determine whether or not the requirements for new development apply to areas intended for redevelopment. If the definition applies, the steps outlined under “designing new installations” above should be followed.

Additional Information

Maintenance Considerations

The integrity of structural elements that are subject to damage (i.e., screens, covers, and signs) must be maintained by the owner/operator. Maintenance agreements between the local agency and the owner/operator may be required. Some agencies will require maintenance deed restrictions to be recorded of the property title. If required by the local agency, maintenance agreements or deed restrictions must be executed by the owner/operator before improvement plans are approved.

Other Resources

A Manual for the Standard Urban Stormwater Mitigation Plan (SUSMP), Los Angeles County Department of Public Works, May 2002.

Model Standard Urban Storm Water Mitigation Plan (SUSMP) for San Diego County, Port of San Diego, and Cities in San Diego County, February 14, 2002.

Model Water Quality Management Plan (WQMP) for County of Orange, Orange County Flood Control District, and the Incorporated Cities of Orange County, Draft February 2003.

Ventura Countywide Technical Guidance Manual for Stormwater Quality Control Measures, July 2002.

Attachment F Infiltration Report

NorCal Engineering

Soils and Geotechnical Consultants
10641 Humbolt Street Los Alamitos, CA 90720
(562) 799-9469 Fax (562) 799-9459

May 31, 2022

Project Number 23086-22

Acacia Real Estate Group, Inc.
260 Newport Center Drive, Suite 100
Newport Beach, California 92660

Attn: Mr. David Pittman

RE: **Updated Soils Infiltration Study** - Proposed Industrial Warehouse
Development - Located at the Northeast Corner of Citrus Avenue and
Santa Ana Avenue, in the City of Fontana, California

Dear Mr. Pittman:

Pursuant to your request, this firm has performed an Updated Soil Infiltration Study for the above referenced project. The purpose of this study is to evaluate the feasibility of an on-site water disposal system for the proposed industrial warehouse development. The scope of work included the following: 1) site reconnaissance; 2) subsurface geotechnical exploration; 3) soil infiltration testing; 4) engineering analysis of field and laboratory data; and 5) preparation of a report.

Project Description

The 24.79-acre subject property is located at the northeast Corner of Citrus Avenue and Santa Ana Avenue, in the City of Fontana. The generally rectangular-shaped parcel is elongated in an east to west direction with topography of the relatively level property descending from gradually from a north to south direction on the order of a few feet. The majority of the parcel is occupied by several single family residences along with undeveloped parcels covered with sparse growth of vegetation cover.

Project Description

It is proposed to construct an industrial warehouse development consisting of three (3) large buildings totaling 570,196 square feet as shown on the attached Site Plan by HPA Architects dated October 26, 2021. The proposed concrete tilt-up buildings will be supported by a conventional slab-on-grade foundation system with perimeter-spread footings and isolated interior footings. Other improvements will include asphalt and concrete pavement areas, hardscape and landscaping. It is assumed that the proposed grading for the development will include cut and fill procedures on the order of a few feet to achieve finished grade elevations. Final building plans shall be reviewed by this firm prior to submittal for city approval to determine the need for any additional study and revised recommendations pertinent to the proposed development, if necessary.

An on-site storm water disposal system and been proposed within proposed pavement areas as shown on the attached Site Plan. The bottom of the system has been proposed at depths ranging between 15 and 20 feet below existing ground surface. Infiltration tests were performed to provide preliminary infiltration rates for the purpose of planning and design of a storm water disposal system. Final building plans shall be reviewed by this firm prior to submittal for city/county approval to determine the need for any additional study and revised recommendations pertinent to the proposed development, if necessary.

Field Exploration and Testing

A truck mounted Simco 2800 Drill Rig equipped with a hollow stem auger was used to excavate the exploratory borings (B-1, B-2 and B-3) to depths of ranging between 15 and 20 feet below existing ground surface within the proposed infiltration areas. The site was found to be underlain by fill and alluvial deposits consisting of a brown, fine to coarse grained, silty to gravelly SAND to a sandy SILT. These soils were noted to be medium dense to medium stiff and damp to moist. The location of the exploratory borings are shown on the attached Site Plan. Detailed description of the subsurface soils is shown on the attached logs in Appendix A.

Infiltration tests within the site were performed to provide preliminary infiltration rates for the purpose of planning and design of an on-site water disposal system field testing the San Bernardino County Stormwater Program.

The borings consisted of six-inch diameter test holes. A three-inch diameter perforated PVC casing with solid end cap was installed in the borings and then surrounded with gravel materials to prevent caving. The infiltration holes were carefully filled with clean water and refilled after two initial readings.

Results of Field Infiltration Tests

Based upon the initial rates of infiltration at each location, test measurements were measured at selected maximum intervals thereafter. Measurements were obtained by using an electronic tape measure with 1/16-inch divisions and timed with a stopwatch. The field data sheets are provided in Appendix D.

Based upon the results of our testing, the soils encountered in the planned on-site drainage disposal system area exhibit the following field infiltration rates calculated using the Porchet Method (aka Inverse Borehole Method). The drainage disposal system shall utilize design infiltration rates based on the safety factor required by the county standard.

Boring/Test No.	Depth	Soil Classification	Field Infiltration Rate
B-1/TH-1	20'	Silty SAND	6.4 in/hr
B-2/TH-2	15'	Sandy SILT	1.5 in/hr
B-3/TH-3	20'	Gravelly SAND	5.7 in/hr

No groundwater was encountered to the depth of our borings to a maximum depth of 20 feet below existing ground surface. Based on review of local groundwater maps, the depth of groundwater is in excess of 250 feet (Carson & Matti 1982). A nearby groundwater monitoring well located approximately 0.25 mile to the east from the subject site noted a groundwater depth of 317 feet below ground surface last measured in October 2008.

It is recommended that foundations shall be setback a minimum distance of 10 feet from the drainage disposal system and the bottom of footing shall be a minimum of 10 feet from the expected zone of saturation. The boundary of the zone of saturation may be assumed to project downward from the top of the permeable portion of the disposal system at an inclination of 1 to 1 or flatter, as determined by the geotechnical engineer.

Closure

The recommendations and conclusions contained in this report are based upon the soil conditions uncovered in our test excavation. No warranty of the soil condition between our excavations is implied. NorCal Engineering should be notified for possible further recommendations if unexpected to unfavorable conditions are encountered during construction phase.

This firm should have the opportunity to review the final plans to verify that all our recommendations are incorporated. This report and all conclusions are subject to the review of the controlling authorities for the project. Our representative should be present during the grading operations and construction phase to certify that such recommendations are complied within the field.

This geotechnical investigation has been conducted in a manner consistent with the level of care and skill exercised by members of our profession currently practicing under similar conditions in the Southern California area. No other warranty, expressed or implied is made.

We appreciate this opportunity to be of service to you. If you have any further questions, please do not hesitate to contact the undersigned.

Respectfully submitted,
NORCAL ENGINEERING



Keith D. Tucker
Project Engineer
R.G.E. 841



Scott D. Spensiero
Project Manager

References

1. California Department of Water Resources, Internet Website, <http://www.water.ca.gov/waterdatalibrary/index.cfm>.
2. NorCal Engineering Inc. - Geotechnical Engineering Investigation – Proposed Industrial Warehouse Development - Located at the Northeast Corner of Citrus Avenue and Santa Ana Avenue, in the City of Fontana, California, dated April 23, 2022.
3. San Bernardino County – Appendix VII - Infiltration Rate Evaluation Protocol and Factor of Safety Recommendations dated May 19, 2011.
4. U.S. Geological Survey – J.C. Matti and S.E. Carson – Contour Map Showing Minimum Depth to Groundwater, Upper Santa Ana River Valley, California 1973-1979, 1983.

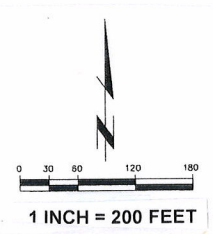
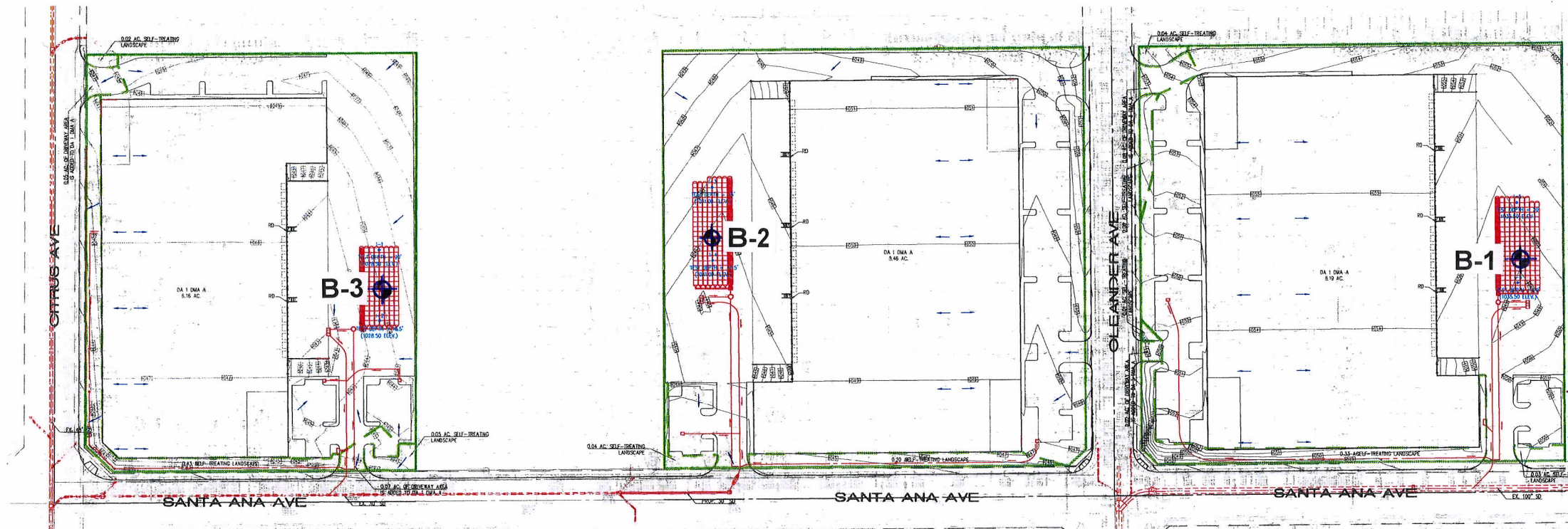

MODIFIED PLAN BASED ON THIENES ENGINEERING
INFILTRATOION EXHIBIT DATED APRIL 2022

NorCal Engineering
SOILS AND GEOTECHNICAL CONSULTANTS

SITE PLAN

PROJECT	23268-22	DATE	MAY 2022
---------	----------	------	----------

List of Appendices
(in order of appearance)

Appendix A – Log of Excavations

- Log of Borings B-1 to B-3

Appendix B – Field Infiltration Data

- Field Test Data
- Infiltration Test Calculations

Appendix A

Log of Excavations

MAJOR DIVISION			GRAPHIC SYMBOL	LETTER SYMBOL	TYPICAL DESCRIPTIONS	
COARSE GRAINED SOILS	GRAVEL AND GRAVELLY SOILS	CLEAN GRAVELS (LITTLE OR NO FINES)		GW	WELL-GRADED GRAVELS, GRAVEL-SAND MIXTURES, LITTLE OR NO FINES	
		MORE THAN 50% OF COARSE FRACTION <u>RETAINED</u> ON NO. 4 SIEVE	GRAVELS WITH FINES (APPRECIABLE AMOUNT OF FINES)		GP	POORLY-GRADED GRAVELS, GRAVEL-SAND MIXTURES, LITTLE OR NO FINES
			GRAVELS WITH FINES (APPRECIABLE AMOUNT OF FINES)		GM	SILTY GRAVELS, GRAVEL-SAND-SILT MIXTURES
		GRAVELS WITH FINES (APPRECIABLE AMOUNT OF FINES)		GC	CLAYEY GRAVELS, GRAVEL-SAND-CLAY MIXTURES	
	SAND AND SANDY SOILS	CLEAN SAND (LITTLE OR NO FINES)		SW	WELL-GRADED SANDS, GRAVELLY SANDS, LITTLE OR NO FINES	
		MORE THAN 50% OF COARSE FRACTION <u>PASSING</u> ON NO. 4 SIEVE	SANDS WITH FINE (APPRECIABLE AMOUNT OF FINES)		SP	POORLY-GRADED SANDS, GRAVELLY SANDS, LITTLE OR NO FINES
			SANDS WITH FINE (APPRECIABLE AMOUNT OF FINES)		SM	SILTY SANDS, SAND-SILT MIXTURES
		SANDS WITH FINE (APPRECIABLE AMOUNT OF FINES)		SC	CLAYEY SANDS, SAND-CLAY MIXTURES	
FINE GRAINED SOILS	SILTS AND CLAYS	LIQUID LIMIT <u>LESS</u> THAN 50		ML	INORGANIC SILTS AND VERY FINE SANDS, ROCK FLOUR, SILTY OR CLAYEY FINE SANDS OR CLAYEY SILTS WITH SLIGHT PLASTICITY	
				CL	INORGANIC CLAYS OF LOW TO MEDIUM PLASTICITY, GRAVELLY CLAYS, SANDY CLAYS, SILTY CLAYS, LEAN CLAYS	
				OL	ORGANIC SILTS AND ORGANIC SILTY CLAYS OF LOW PLASTICITY	
	SILTS AND CLAYS	LIQUID LIMIT <u>GREATER</u> THAN 50		MH	INORGANIC SILTS, MICACEOUS OR DIATOMACEOUS FINE SAND OR SILTY SOILS	
				CH	INORGANIC CLAYS OF HIGH PLASTICITY, FAT CLAYS	
				OH	ORGANIC CLAYS OF MEDIUM TO HIGH PLASTICITY, ORGANIC SILTS	
HIGHLY ORGANIC SOILS				PT	PEAT, HUMUS, SWAMP SOILS WITH HIGH ORGANIC CONTENTS	

NOTE: DUAL SYMBOLS ARE USED TO INDICATE BORDERLINE SOIL CLASSIFICATIONS

UNIFIED SOIL CLASSIFICATION SYSTEM

KEY:

- Indicates 2.5-inch Inside Diameter. Ring Sample.
- ☒ Indicates 2-inch OD Split Spoon Sample (SPT).
- ☐ Indicates Shelby Tube Sample.
- ▢ Indicates No Recovery.
- ▣ Indicates SPT with 140# Hammer 30 in. Drop.
- ☑ Indicates Bulk Sample.
- ▤ Indicates Small Bag Sample.
- ▥ Indicates Non-Standard
- ☒ Indicates Core Run.

COMPONENT DEFINITIONS

COMPONENT	SIZE RANGE
Boulders	Larger than 12 in
Cobbles	3 in to 12 in
Gravel	3 in to No 4 (4.5mm)
Coarse gravel	3 in to 3/4 in
Fine gravel	3/4 in to No 4 (4.5mm)
Sand	No. 4 (4.5mm) to No. 200 (0.074mm)
Coarse sand	No. 4 (4.5 mm) to No. 10 (2.0 mm)
Medium sand	No. 10 (2.0 mm) to No. 40 (0.42 mm)
Fine sand	No. 40 (0.42 mm) to No. 200 (0.074 mm)
Silt and Clay	Smaller than No. 200 (0.074 mm)

COMPONENT PROPORTIONS

DESCRIPTIVE TERMS	RANGE OF PROPORTION
Trace	1 - 5%
Few	5 - 10%
Little	10 - 20%
Some	20 - 35%
And	35 - 50%

MOISTURE CONTENT

DRY	Absence of moisture, dusty, dry to the touch.
DAMP	Some perceptible moisture; below optimum
MOIST	No visible water; near optimum moisture content
WET	Visible free water, usually soil is below water table.

RELATIVE DENSITY OR CONSISTENCY VERSUS SPT N -VALUE

COHESIONLESS SOILS		COHESIVE SOILS		
Density	N (blows/ft)	Consistency	N (blows/ft)	Approximate Undrained Shear Strength (psf)
Very Loose	0 to 4	Very Soft	0 to 2	< 250
Loose	4 to 10	Soft	2 to 4	250 - 500
Medium Dense	10 to 30	Medium Stiff	4 to 8	500 - 1000
Dense	30 to 50	Stiff	8 to 15	1000 - 2000
Very Dense	over 50	Very Stiff	15 to 30	2000 - 4000
		Hard	over 30	> 4000

Boring Location: Citrus & Santa Ana, Fontana

Date of Drilling: 5/23/2022

Groundwater Depth: None Encountered

Drilling Method: Simco 2800HS

Hammer Weight: 140 lbs

Drop: 30"

Surface Elevation: Not Measured

Depth (feet)	Lithology	Material Description	Samples		Laboratory	
			Type	Blow Counts	Moisture	Dry Density
0		FILL Silty (fine to coarse grained) SAND Brown, loose, damp; with occasional gravel				
5		NATURAL Silty (fine to coarse grained) SAND Brown, medium dense, damp; with occasional gravel and some cobble				
10		Silty (medium to coarse grained) SAND Light brown, medium dense, moist; slightly silty with gravel and cobble				
20		Boring completed at depth of 20'				

File: C:\Superlog4\PROJECT\2308622-2.log Date: 5/25/2022
 SuperLog CivilTech Software, USA www.civiltech.com

Boring Location: Citrus & Santa Ana, Fontana

Date of Drilling: 5/23/2022

Groundwater Depth: None Encountered

Drilling Method: Simco 2800HS

Hammer Weight: 140 lbs

Drop: 30"

Surface Elevation: Not Measured

Depth (feet)	Lithology	Material Description	Samples		Laboratory	
			Type	Blow Counts	Moisture	Dry Density
0		FILL Silty (fine to coarse grained) SAND Brown, loose, damp; with occasional gravel				
5		NATURAL Silty (fine to coarse grained) SAND Brown, medium dense, damp; with occasional gravel and some cobble				
13		Sandy SILT Brown, medium stiff, moist				
15		Boring completed at depth of 15'				

SuperLog CivilTech Software, USA www.civiltech.com
 File: C:\Superlog\PROJECT\2308622-2.log Date: 5/25/2022

Boring Location: Citrus & Santa Ana, Fontana

Date of Drilling: 5/23/2022

Groundwater Depth: None Encountered

Drilling Method: Simco 2800HS

Hammer Weight: 140 lbs

Drop: 30"

Surface Elevation: Not Measured

Depth (feet)	Lithology	Material Description	Samples		Laboratory		
			Type	Blow Counts	Moisture	Dry Density	Fines Content %
0	GWT not encountered	FILL Silty (fine to coarse grained) SAND Brown, loose, damp; with occasional gravel					
5		NATURAL Silty (fine to coarse grained) SAND Brown, medium dense, damp; with occasional gravel and some cobble					
20		Gravelly (medium to coarse grained) SAND Light brown, medium dense, damp; with cobbles; slightly silty					
		Boring completed at depth of 20'					

SuperLog CivilTech Software, USA www.civiltech.com File: C:\Superlog\PROJECT\2308622-2.log Date: 5/31/2022

Appendix B

Field Infiltration Data



SOILS AND GEOTECHNICAL CONSULTANTS

PERCOLATION TEST DATA

Client: Acacia Real Estate Group	Tested By: J.S.
Project No.: 23086-22	Date Tested: 5/23/2022
Test Hole: 1	Caving:
Depth of Test Hole: 20'	Notes:
Diameter of Test Hole: 8"	Strata Peculiarities:
Date Excavated: 5/23/2022	

Sandy Soil Criteria Test

TIME	TRIAL NO.	T1	H1	H2	D
8:53	1	30	0.0	237.5	237.5
9:23					
9:23	2	30	0.0	229.0	229.0
9:53					

Soil Criteria

TIME	T1	TE	H1	H2	D
9:53	10	10	0.0	202.5	202.5
10:03					
10:03	10	20	0.0	200.5	200.5
10:13					
10:13	10	30	0.0	199.0	199.0
10:23					
10:23	10	40	0.0	199.0	199.0
10:33					
10:33	10	50	0.0	197.5	197.5
10:43					
10:43	10	60	0.0	198.0	198.0
10:53					
10:53	10	70	0.0	199.5	199.5
11:03					
11:03	10	80	0.0	199.0	199.0
11:13					
11:13	10	90	199.0	218.0	19.0
11:23					
11:23	10	100	218.0	229.0	11.0
11:33					

T1 – Time Interval (min)
H2 – Final Water Level (in)

TE – Total Elapsed Time (min)
D – Change in H₂O Level (in)

H1 – Initial Water Level



SOILS AND GEOTECHNICAL CONSULTANTS

PERCOLATION TEST DATA

Client: Acacia Real Estate Group	Tested By: J.S.
Project No.: 23086-22	Date Tested: 5/23/2022
Test Hole: 2	Caving:
Depth of Test Hole: 15'	Notes:
Diameter of Test Hole: 8"	Strata Peculiarities:
Date Excavated: 5/23/2022	

Sandy Soil Criteria Test

TIME	TRIAL NO.	T1	H1	H2	D
11:40	1	30	0.0	82.0	82.0
12:10					
12:10	2	30	0.0	78.5	78.5
12:40					

____ Soil Criteria

TIME	T1	TE	H1	H2	D
7:20	30	30	0.0	78.0	78.0
7:50					
7:50	30	60	0.0	76.5	76.5
8:20					
8:20	30	90	0.0	76.0	76.0
8:50					
8:50	30	120	0.0	76.0	76.0
9:20					
9:20	30	150	0.0	75.0	75.0
9:50					
9:50	30	180	0.0	75.0	75.0
10:20					
10:20	30	210	0.0	75.0	75.0
10:50					
10:50	30	240	0.0	75.0	75.0
11:20					
11:20	30	270	75.0	103.0	28.0
11:50					
11:50	30	300	103.0	133.0	30.0
12:20					

T1 – Time Interval (min)
H2 – Final Water Level (in)

TE – Total Elapsed Time (min)
D – Change in H₂O Level (in)

H1 – Initial Water Level



SOILS AND GEOTECHNICAL CONSULTANTS

PERCOLATION TEST DATA

Client: Acacia Real Estate Group	Tested By: J.S.
Project No.: 23086-22	Date Tested: 5/23/2022
Test Hole: 3	Caving:
Depth of Test Hole: 20'	Notes:
Diameter of Test Hole: 8"	Strata Peculiarities:
Date Excavated: 5/23/2022	

Sandy Soil Criteria Test

TIME	TRIAL NO.	T1	H1	H2	D
7:51	1	30	0.0	222.5	222.5
8:21					
8:21	2	30	0.0	215.5	215.5
8:51					

Soil Criteria

TIME	T1	TE	H1	H2	D
8:51	10	10	0.0	202.0	202.0
9:01					
9:01	10	20	0.0	198.0	198.0
9:11					
9:11	10	30	0.0	192.5	192.5
9:21					
9:21	10	40	0.0	183.0	183.0
9:31					
9:31	10	50	0.0	181.0	181.0
9:41					
9:41	10	60	0.0	182.0	182.0
9:51					
9:51	10	70	0.0	178.0	178.0
10:01					
10:01	10	80	0.0	176.0	176.0
10:11					
10:11	10	90	176.0	203.5	27.5
10:21					
10:21	10	100	203.5	218.5	15.0
10:31					

T1 – Time Interval (min)
H2 – Final Water Level (in)

TE – Total Elapsed Time (min)
D – Change in H₂O Level (in)

H1 – Initial Water Level

SOIL INFILTRATION RATE CALCS ⇒ PORCHET METHOD

Location:	TH-1	TH-2	TH-3
• Depth of Hole =	20'	15'	20'
• Hole Radius =	4"	4"	4"
• Drop = Δh	30"	58"	42.5"
• Time = Δt Interval	20 min	60 min	20 min
• Initial Water Depth = H_0	41"	105"	64"
• Final Water Depth = H_t	11"	47"	21.5"
• Average Water Head = H_{avg}	26"	76"	42.8"
• INFILTRATION RATE	6.4 in/hr	1.5 in/hr	5.7 in/hr

$$\text{Infiltration Rate} = \frac{\Delta h (60)(r)}{\Delta t (r + z \cdot H_{avg})}$$

$$\text{Average Water Head} = \frac{1}{2} (H_t - H_0)$$

Geotechnical Engineering Investigation
Proposed Industrial Warehouse Development
Northeast Corner of Citrus Avenue
and Santa Ana Avenue
Fontana, California

Acacia Real Estate Group, Inc.
260 Newport Center Drive, Suite 100
Newport Beach, California 92660

Attn: Mr. David Pittman

Project Number 23086-22
April 25, 2022

NorCal Engineering

NorCal Engineering

Soils and Geotechnical Consultants
10641 Humbolt Street Los Alamitos, CA 90720
(562) 799-9469 Fax (562) 799-9459

April 25, 2022

Project Number 23086-22

Acacia Real Estate Group, Inc.
260 Newport Center Drive, Suite 100
Newport Beach, California 92660

Attn: Mr. David Pittman

RE: **Geotechnical Engineering Investigation** - Proposed Industrial Warehouse
Development - Located at the Northeast Corner of Citrus Avenue and Santa Ana
Avenue, in the City of Fontana, California

Dear Mr. Pittman:

Pursuant to your request, this firm has performed a Geotechnical Engineering Investigation for the above referenced project in accordance with your approval of our proposal dated January 21, 2022. The purpose of this investigation is to evaluate the geotechnical conditions of the subject site and to provide recommendations for the construction of a proposed industrial warehouse development.

The scope of work included the following: 1) site reconnaissance; 2) subsurface geotechnical exploration and sampling; 3) laboratory testing; 4) soil infiltration testing; 5) engineering analysis of field and laboratory data; 6) preparation of a geotechnical engineering report. It is the opinion of this firm that the proposed development is feasible from a geotechnical standpoint provided that the recommendations presented in this report are followed in the design and construction of the project.

1.0 Project Description

It is proposed to construct an industrial warehouse development consisting of three (3) large buildings totaling 570,196 square feet as shown on the attached Site Plan by HPA Architects dated October 26, 2021. The proposed concrete tilt-up buildings will be supported by a conventional slab-on-grade foundation system with perimeter-spread footings and isolated interior footings. Other improvements will include asphalt and concrete pavement areas, hardscape and landscaping. It is assumed that the proposed grading for the development will include cut and fill procedures on the order of a few feet to achieve finished grade elevations. Final building plans shall be reviewed by this firm prior to submittal for city approval to determine the need for any additional study and revised recommendations pertinent to the proposed development, if necessary.

2.0 Site Description

The 24.79-acre subject property is located at the northeast Corner of Citrus Avenue and Santa Ana Avenue, in the City of Fontana. The generally rectangular-shaped parcel is elongated in an east to west direction with topography of the relatively level property descending from gradually from a north to south direction on the order of a few feet. The majority of the parcel is occupied by several single family residences along with undeveloped parcels covered with sparse growth of vegetation cover.

3.0 Site Exploration

The investigation consisted of the placement of fourteen (14) subsurface exploratory borings by a truck mounted hollow stem auger and hand operated auger to depths ranging between 5 and 21 feet below current ground elevations. The borings were placed at accessible locations throughout the property. The explorations were visually classified and logged by a field engineer with locations of the subsurface explorations shown on the attached plan. The exploratory borings revealed the existing earth materials to consist of fill and natural soil. Detailed descriptions of the subsurface conditions are listed on the boring logs in Appendix A.

It should be noted that the transition from one soil type to another as shown on the trench logs is approximate and may in fact be a gradual transition. The soils encountered are described as follows:

Fill: A fill soil classifying as a brown, fine to medium grained, silty SAND with gravel and cobbles were encountered across the site to depths ranging from 1 to 4 feet below ground surface. These soils were noted to be loose and dry to damp.

Natural: A natural undisturbed soil classifying as a brown to light brown, fine to coarse grained, silty to slightly silty SAND with gravel and cobble was encountered beneath the upper fill soils. The native soils were observed to be medium dense to very dense and damp to moist.

The overall engineering characteristics of the earth material were relatively uniform with each excavation. Groundwater was not encountered to the depth of our borings and slight caving occurred in the deeper cohesionless soils.

4.0 Laboratory Tests

Relatively undisturbed samples of the subsurface soils were obtained to perform laboratory testing and analysis for direct shear, consolidation tests, and to determine in-place moisture/densities. These relatively undisturbed ring samples were obtained by driving a thin-walled steel sampler lined with one-inch long brass rings with an inside diameter of 2.42 inches into the undisturbed soils. Bulk bag samples were obtained in the upper soils for expansion index tests and maximum density tests. All test results are included in Appendix B, unless otherwise noted.

4.1 **Field Moisture Content** (ASTM: D 2216) and the dry density of the ring samples were determined in the laboratory. This data is listed on the logs of explorations.

4.2 **Maximum Density tests** (ASTM: D 1557) were performed on typical samples of the upper soils. Results of these tests are shown on Table I.

- 4.3 **Expansion Index tests** (ASTM: D 4829) were performed on remolded samples of the upper soils to determine expansive characteristics. Results of these tests are provided on Table II.
- 4.4 **Corrosion tests** consisting of sulfate, pH, resistivity and chloride analysis to determine potential corrosive effects of soils on concrete and underground utilities. Test results are provided on Table III.
- 4.5 **R-Value test** per California Test Method 301 was performed on a representative sample, which may be anticipated to be near subgrade to determine pavement design. Results are provided within the pavement design section of the report.
- 4.6 **Direct Shear tests** (ASTM: D 3080) were performed on undisturbed and/or remolded samples of the subsurface soils. The test is performed under saturated conditions at loads of 1,000 lbs./sq.ft., 2,000 lbs./sq.ft., and 3,000 lbs./sq.ft. with results shown on Plates A and B.
- 4.7 **Consolidation tests** (ASTM: D 2435) were performed on undisturbed samples to determine the differential and total settlement which may be anticipated based upon the proposed loads. Water was added to the samples at a surcharge of one KSF and the settlement curves are plotted on Plates C to F.

5.0 Seismicity Evaluation

The proposed development lies outside of any Alquist Priolo Special Studies Zone and the potential for damage due to direct fault rupture is considered unlikely. The Cucamonga Fault is located about 12 kilometers from the site and is capable of producing a Magnitude 7.0 earthquake. Ground shaking originating from earthquakes along other active faults in the region is expected to induce lower horizontal accelerations due to smaller anticipated earthquakes and/or greater distances to other faults.

The seismic design acceleration parameters for the project site are provided below based on the ASCE/SEI 7-22 American Society of Civil Engineers (ASCE) website, <https://asce7hazardtool.online/>. The ASCE/SEI 7-22 report is attached is Appendix C

Seismic Design Acceleration Parameters

Latitude	34.056
Longitude	-117.453
Site Class	D
Risk Category	II
Peak Ground Acceleration	$PGA_M = 0.68$
Adjusted Maximum Acceleration	$S_{MS} = 1.90$ $S_{M1} = 1.70$
Design Spectral Response Acceleration Parameters	$S_{DS} = 1.26$ $S_{D1} = 1.13$
Mapped Spectral Response Acceleration	$S_S = 1.99$ $S_1 = 0.63$

Use of these values is dependent on the latest requirements of the ASCE, 11-4.8, Exception 2 that requires the value of the seismic response coefficient C_s be determined by Equation 12.8.2 for values of $T \leq 1.5T_s$ and taken as equal to 1.5 times the value computed in accordance with either 12.8-3 for $T_L \geq T \geq 1.5T_s$ or Equation 12.8-4 for $T > T_L$. Computations and verification of these conditions is referred to the structural engineer.

6.0 Liquefaction Evaluation

The site is expected to experience ground shaking and earthquake activity that is typical of the Southern California area. It is during severe shaking that loose, granular soils below the groundwater table can liquefy. Based on review of the *County of San Bernardino County Land Use Plan – General Plan – Geologic Hazard Overlays (2009)*, the site lies outside a zone of “Suspected Liquefaction Susceptibility”. Based on review of local groundwater maps, the depth of groundwater is in excess of 250 feet (Carson & Matti 1982). Thus, the design of the proposed construction in conformance with the latest Building Code provisions for earthquake design is expected to provide mitigation of ground shaking hazards that are typical to Southern California.

7.0 Infiltration Characteristics

Infiltration tests within the site were performed to provide preliminary infiltration rates for the purpose of planning and design of an on-site water disposal system field testing the San Bernardino County Stormwater Program. A truck mounted Simco 2800 Drill Rig equipped with a hollow stem auger was used to excavate the exploratory borings (B-1, B-2 and B-3) to depths of 5 to 15 feet below existing ground surface within the proposed infiltration areas.

The borings consisted of six-inch diameter test holes. A three-inch diameter perforated PVC casing with solid end cap was installed in the borings and then surrounded with gravel materials to prevent caving. The infiltration holes were carefully filled with clean water and refilled after two initial readings. Based upon the initial rates of infiltration at each location, test measurements were measured at selected maximum intervals thereafter. Measurements were obtained by using an electronic tape measure with 1/16-inch divisions and timed with a stopwatch. Field data sheets are provided in Appendix D.

Based upon the results of our testing, the soils encountered in the planned on-site drainage disposal system area exhibit the following field infiltration rates calculated using the Porchet Method (aka Inverse Borehole Method). The drainage disposal system shall utilize design infiltration rates based on the safety factor required by the county standard.

Boring/Test No.	Depth	Soil Classification	Field Infiltration Rate
B-1/TH-1	5'	Silty SAND	20.5 in/hr
B-2/TH-2	10'	Silty SAND	9.9 in/hr
B-3/TH-3	15'	Silty SAND	4.2 in/hr

No groundwater was encountered to the depth of our borings to a maximum depth of 20 feet below existing ground surface. Based on review of local groundwater maps, the depth of groundwater is in excess of 250 feet (Carson & Matti 1982). A nearby groundwater monitoring well located approximately 0.25 mile to the east from the subject site noted a groundwater depth of 317 feet below ground surface last measured in October 2008.

It is recommended that foundations shall be setback a minimum distance of 10 feet from the drainage disposal system and the bottom of footing shall be a minimum of 10 feet from the expected zone of saturation. The boundary of the zone of saturation may be assumed to project downward from the top of the permeable portion of the disposal system at an inclination of 1 to 1 or flatter, as determined by the geotechnical engineer.

8.0 Conclusions and Recommendations

Based upon our evaluations, the proposed development is acceptable from a geotechnical engineering standpoint. By following the recommendations and guidelines set forth in our report, the structures will be safe from excessive settlements under the anticipated design loadings and conditions. The proposed development shall meet all requirements of the City Building Ordinance and will not impose any adverse effect on existing adjacent structures.

The following recommendations are based upon soil conditions encountered in our field investigation; these near-surface soil conditions could vary across the site. Variations in the soil conditions may not become evident until the commencement of grading operations for the proposed development and revised recommendations from the soils engineer may be necessary based upon the conditions encountered.

It is recommended that site inspections be performed by a representative of this firm during all grading and construction of the development to verify the findings and recommendations documented in this report. Any unusual conditions which may be encountered in the course of the project development may require the need for additional study and revised recommendations.

8.1 Site Grading Recommendations

Any vegetation and/or demolition debris shall be removed and hauled from proposed grading areas prior to the start of grading operations. Existing vegetation shall not be mixed or disced into the soils. Any removed soils may be reutilized as compacted fill once any deleterious material or oversized materials (in excess of eight inches) is removed. Grading operations shall be performed in accordance with the attached *Specifications for Placement of Compacted Fill*.

8.1.1 **Removal and Recompaction Recommendations**

All disturbed soils and/or fill (about 1 to 1.5 feet below ground surface) shall be removed to competent native material, the exposed surface scarified to a depth of 12 inches, brought to within 2% of optimum moisture content and compacted to a minimum of 90% of the laboratory standard (ASTM: D-1557) prior to placement of any additional compacted fill soils, foundations, slabs-on-grade and pavement. Grading shall extend a minimum of five horizontal feet outside the edges of foundations or equidistant to the depth of fill placed, whichever is greater.

It is possible that isolated areas of undiscovered fill not described in this report are present on site; if found, these areas should be treated as discussed earlier. A diligent search shall also be conducted during grading operations in an effort to uncover any underground structures, irrigation or utility lines. If encountered, these structures and lines shall be either removed or properly abandoned prior to the proposed construction.

Any imported fill material should be preferably soil similar to the upper soils encountered at the subject site. All soils shall be approved by this firm prior to importing at the site and will be subjected to additional laboratory testing to assure concurrence with the recommendations stated in this report.

If placement of slabs-on-grade and pavement is not completed immediately upon completion of grading operations, additional testing and grading of the areas may be necessary prior to continuation of construction operations. Likewise, if adverse weather conditions occur which may damage the subgrade soils, additional assessment by the soils engineer as to the suitability of the supporting soils may be needed.

Care should be taken to provide or maintain adequate lateral support for all adjacent improvements and structures at all times during the grading operations and construction phase. Adequate drainage away from the structures, pavement and slopes should be provided at all times.

8.1.2 **Fill Blanket Recommendations**

Due to the potential for differential settlement of foundations placed on compacted fill and native materials, it is recommended that all foundations including floor slab areas be underlain by a uniform compacted fill blanket at least two feet in thickness. This fill blanket shall extend a minimum of five horizontal feet outside the edges of foundations or equidistant to the depth of fill placed, whichever is greater.

8.2 **Shrinkage and Subsidence**

Results of our in-place density tests reveal that the soil shrinkage of the matrix will be on the order of 5 to 10% due to excavation and recompaction, based upon the assumption that the fill is compacted to 92% of the maximum dry density per ASTM standards. Subsidence should be 0.2 feet due to earthwork operations. If crushing of the oversized alluvial material is performed and is utilized as fill, bulking of these materials will be estimated to be about 5%.

The volume change does not include any allowance for vegetation or organic stripping, removal of subsurface improvements, or topographic approximations. Although these values are only approximate, they represent our best estimate of lost yardage, which will likely occur during grading. If more accurate shrinkage and subsidence factors are needed, it is recommended that field testing the actual equipment and grading techniques should be conducted.

8.3 **Temporary Excavations**

Temporary unsurcharged excavations in the existing site materials may be made at vertical inclinations up to 4 feet in height unless cohesionless soils are encountered. In areas where soils with little or no binder are encountered, where adverse geological conditions are exposed, or where excavations are adjacent to existing structures, shoring or flatter excavations may be required. The temporary cut slope gradients given above do not preclude local raveling and sloughing. All excavations shall be made in accordance with the requirements of the soils engineer, CAL-OSHA and other public agencies having jurisdiction. Care should be taken to provide or maintain adequate lateral support for all adjacent improvements and structures at all times during the grading operations and construction phase.

8.4 **Foundation Design**

All foundations may be designed utilizing the following allowable bearing capacities for an embedded depth of 18 inches into approved engineered fill with the corresponding widths:

Allowable Bearing Capacity (psf)		
Width (feet)	Continuous Foundation	Isolated Foundation
1.5	2000	2500
2.0	2075	2575
4.0	2375	2875
6.0	2500	3000

The bearing value may be increased by 500 psf for each additional foot of depth in excess of the 18-inch minimum depth, up to a maximum of 4,000 psf. A one-third increase may be used when considering short-term loading and seismic forces. Any foundations located along property line may utilize an allowable bearing capacity of 1,500 psf and embedded into competent native soils. A modulus of subgrade reaction (k) of 200 pci may be used for design of slabs placed on engineered fill soils supporting sustained concentrated loads. A representative of this firm shall inspect all foundation excavations prior to pouring concrete.

8.5 **Settlement Analysis**

Resultant pressure curves for the consolidation tests are shown on Plates C to E. Computations utilizing these curves and the recommended allowable soil bearing capacities reveal that the foundations will experience settlements on the order of $\frac{3}{4}$ inch and differential settlements of less than $\frac{1}{4}$ inch.

8.6 **Lateral Resistance**

The following values may be utilized in resisting lateral loads imposed on the structure. Requirements of the California Building Code should be adhered to when the coefficient of friction and passive pressures are combined.

Coefficient of Friction - 0.40

Equivalent Passive Fluid Pressure = 250 lbs./cu.ft.

Maximum Passive Pressure = 2,500 lbs./cu.ft.

The passive pressure recommendations are valid only for approved compacted fill soils or competent native materials.

8.7 **Retaining Wall Design Parameters**

Active earth pressures against retaining walls will be equal to the pressures developed by the following fluid densities. These values are for **granular backfill material** placed behind the walls at various ground slopes above the walls.

Surface Slope of Retained Materials (Horizontal to Vertical)	Equivalent Fluid Density (lb./cu.ft.)
Level	30
5 to 1	35
4 to 1	38
3 to 1	40
2 to 1	45

Any applicable short-term construction surcharges and seismic forces should be added to the above lateral pressure values. An equivalent fluid pressure of 45 pcf may be utilized for the restrained wall condition with a level grade behind the wall.

The seismic-induced lateral soil pressure for walls greater than 6 feet may be computed using a triangular pressure distribution with the maximum value at the top of the wall. The maximum lateral pressure of (20 pcf) H where H is the height of the retained soils above the wall footing should be used in final design of retaining walls. Sliding resistance values and passive fluid pressure values may be increased by 1/3 during short-term wind and seismic loading conditions.

All walls shall be waterproofed as needed and protected from hydrostatic pressure by a reliable permanent subdrain system. The granular backfill to be utilized immediately adjacent to retaining walls shall consist of an approved select granular soil with a sand equivalency greater than 30. This backfill zone of free draining material shall consist of a wedge beginning a minimum of one horizontal foot from the base of the wall extending upward at an inclination of no less than ¾ to 1 (horizontal to vertical).

8.8 **Slab Design**

All concrete slabs shall be a minimum of six inches in thickness in the proposed warehouse areas and four inches in office and hardscape and placed on approved subgrade soils. Additional reinforcement requirements and an increase in thickness of the slabs-on-grade may be necessary based upon soils expansion potential and proposed loading conditions in the structures and should be evaluated further by the project engineers and/or architect.

A vapor retarder (10-mil minimum thickness) should be utilized in areas which would be sensitive to the infiltration of moisture. This retarder shall meet requirements of ASTM E 96, *Water Vapor Transmission of Materials* and ASTM E 1745, *Standard Specification for Water Vapor Retarders used in Contact with Soil or Granular Fill Under Concrete Slabs*. The vapor retarder shall be installed in accordance with procedures stated in ASTM E 1643, *Standard practice for Installation of Water Vapor Retarders used in Contact with Earth or Granular Fill Under Concrete Slabs*.

The moisture retarder may be placed directly upon compacted subgrade soils conditioned to near optimum moisture levels, although one to two inches of sand beneath the membrane is desirable. The subgrade upon which the retarder is placed shall be smooth and free of rocks, gravel or other protrusions which may damage the retarder. Use of sand above the retarder is under the purview of the structural engineer; if sand is used over the retarder, it should be placed in a dry condition.

8.9 **Pavement Section Design**

The table below provides a preliminary pavement design based upon an R-Value of 65 for the subgrade soils for the proposed pavement areas. Final pavement design may need to be based on R-Value testing of the subgrade soils near the conclusion of site grading to assure that these soils are consistent with those assumed in this preliminary design. *The recommendations are based upon estimated traffic loads. Client should submit any other anticipated traffic loadings to the geotechnical engineer, if necessary, so that pavement sections may be reviewed to determine adequacy to support the proposed loadings.*

Type of Traffic	Traffic Index	Asphalt (in.)	Base Material (in.)
Automobile Parking Stalls	4.0	3.0	3.0
Light Vehicle Circulation Areas	5.5	3.5	4.5
Heavy Truck Access Areas	7.0	4.0	8.0

Any concrete slab-on-grade in pavement areas shall be a minimum of six inches in thickness and may be placed on approved subgrade soils.

All pavement areas shall have positive drainage toward an approved outlet from the site. Drain lines behind curbs and/or adjacent to landscape areas should be considered by client and the appropriate design engineers to prevent water from infiltrating beneath pavement. If such infiltration occurs, damage to pavement, curbs and flow lines, especially on sites with expansive soils, may occur during the life of the project.

Any approved base material shall consist of a Class II aggregate or equivalent and should be compacted to a minimum of 95% relative compaction. All pavement materials shall conform to the requirements set forth by the City of Fontana. The base material; and asphaltic concrete should be tested prior to delivery to the site and during placement to determine conformance with the project specifications. A pavement engineer shall designate the specific asphalt mix design to meet the required project specifications.

8.10 Utility Trench and Excavation Backfill

Trenches from installation of utility lines and other excavations may be backfilled with on-site soils or approved imported soils compacted to a minimum of 90% relative compaction. All utility lines shall be properly bedded with clean sand having a sand equivalency rating of 30 or more. This bedding material shall be thoroughly water jetted around the pipe structure prior to placement of compacted backfill soils.

8.11 Corrosion Design Criteria

Representative samples of the surficial soils, typical of the subgrade soils expected to be encountered within foundation excavations and underground utilities were tested for corrosion potential. The minimum resistivity value obtained for the samples tested is representative of an environment that may be severely corrosive to metals. The soil pH value was considered mildly acidic and may not have a significant effect on soil corrosivity. Consideration should be given to corrosion protection systems for buried metal such as protective coatings, wrappings or the use of PVC where permitted by local building codes.

According to Table 4.3.1 of ACI 318 Building Code and Commentary, these contents revealed negligible sulfate concentrations. Therefore, a Type II cement according to latest CBC specifications may be utilized for building foundations at this time. It is recommended that additional sulfate tests be performed at the completion of site grading to assure that the as graded conditions are consistent with the recommendations stated in this design. Corrosion test results may be found on the attached Table IV.

8.12 Expansive Soil

If expansive soils are encountered, special attention should be given to the project design and maintenance. The attached *Expansive Soil Guidelines* should be reviewed by the engineers, architects, owner, maintenance personnel and other interested parties and considered during the design of the project and future property maintenance.

9.0 Closure

The recommendations and conclusions contained in this report are based upon the soil conditions uncovered in our test excavations. No warranty of the soil condition between our excavations is implied. NorCal Engineering should be notified for possible further recommendations if unexpected to unfavorable conditions are encountered during construction phase. It is the responsibility of the owner to ensure that all information within this report is submitted to the Architect and appropriate Engineers for the project.

A preconstruction conference should be held between the developer, general contractor, grading contractor, city inspector, architect, and soil engineer to clarify any questions relating to the grading operations and subsequent construction. Our representative should be present during the grading operations and construction phase to certify that such recommendations are complied within the field.

This geotechnical investigation has been conducted in a manner consistent with the level of care and skill exercised by members of our profession currently practicing under similar conditions in the Southern California area. No other warranty, expressed or implied is made.

We appreciate this opportunity to be of service to you. If you have any further questions, please do not hesitate to contact the undersigned.

Respectfully submitted,
NORCAL ENGINEERING



Keith D. Tucker
Project Engineer
R.G.E. 841



Scott D. Spensiero
Project Manager

References

1. American Society of Civil Engineers (ASCE) website, <https://asce7hazardtool.online/>
2. California Building Code, 2019.
3. California Department of Conservation, California Geological Survey, 2007, Fault-Rupture Hazard Zones in California; Special Publication 42.
4. California Department of Water Resources, Internet Website, <http://www.water.ca.gov/waterdatalibrary/index.cfm>.
5. California Division of Mines and Geology, 2008, Guidelines for Evaluating and Mitigating Seismic Hazards in California: Special Publication 117A.
6. Morton, D.M., and Miller, F.K., 2006 "Geologic Map of the San Bernardino and Santa Ana 30' x 60' Quadrangles", U.S. Geologic Survey, scale 1:100,00.
7. San Bernardino County – Appendix VII - Infiltration Rate Evaluation Protocol and Factor of Safety Recommendations dated May 19, 2011.
8. San Bernardino County Land Use Plan – General Plan Geologic Hazard Overlays dated March 9, 2010.
9. U.S. Geological Survey – J.C. Matti and S.E. Carson – Contour Map Showing Minimum Depth to Groundwater, Upper Santa Ana River Valley, California 1973-1979, 1983.

SPECIFICATIONS FOR PLACEMENT OF COMPACTED FILL

Excavation

Any existing low-density soils and/or saturated soils shall be removed to competent natural soil under the inspection of the Geotechnical Engineering Firm. After the exposed surface has been cleansed of debris and/or vegetation, it shall be scarified until it is uniform in consistency, brought to the proper moisture content and compacted to a minimum of 90% relative compaction (in accordance with ASTM: D 1557).

In any area where a transition between fill and native soil or between bedrock and soil are encountered, additional excavation beneath foundations and slabs will be necessary in order to provide uniform support and avoid differential settlement of the structure.

Material for Fill

The on-site soils or approved import soils may be utilized for the compacted fill provided they are free of any deleterious materials and shall not contain any rocks, brick, asphaltic concrete, concrete or other hard materials greater than eight inches in maximum dimensions. Any import soil must be approved by the Geotechnical Engineering firm a minimum of 72 hours prior to importation of site.

Placement of Compacted Fill Soils

The approved fill soils shall be placed in layers not excess of six inches in thickness. Each lift shall be uniform in thickness and thoroughly blended. The fill soils shall be brought to within 2% of the optimum moisture content, unless otherwise specified by the Soils Engineering firm. Each lift shall be compacted to a minimum of 90% relative compaction (in accordance with ASTM: D 1557) and approved prior to the placement of the next layer of soil. Compaction tests shall be obtained at the discretion of the Geotechnical Engineering firm but to a minimum of one test for every 500 cubic yards placed and/or for every 2 feet of compacted fill placed.

The minimum relative compaction shall be obtained in accordance with accepted methods in the construction industry. The final grade of the structural areas shall be in a dense and smooth condition prior to placement of slabs-on-grade or pavement areas. No fill soils shall be placed, spread or compacted during unfavorable weather conditions. When the grading is interrupted by heavy rains, compaction operations shall not be resumed until approved by the Geotechnical Engineering firm.

Grading Observations

The controlling governmental agencies should be notified prior to commencement of any grading operations. This firm recommends that the grading operations be conducted under the observation of a Soils Engineering firm as deemed necessary. A 24-hour notice must be provided to this firm prior to the time of our initial inspection.

Observation shall include the clearing and grubbing operations to assure that all unsuitable materials have been properly removed; approve the exposed subgrade in areas to receive fill and in areas where excavation has resulted in the desired finished grade and designate areas of overexcavation; and perform field compaction tests to determine relative compaction achieved during fill placement. In addition, all foundation excavations shall be observed by the Soils Engineering firm to confirm that appropriate bearing materials are present at the design grades and recommend any modifications to construct footings.

EXPANSIVE SOIL GUIDELINES

The following expansive soil guidelines are provided for your project. The intent of these guidelines is to inform you, the client, of the importance of proper design and maintenance of projects supported on expansive soils. ***You, as the owner or other interested party, should be warned that you have a duty to provide the information contained in the soil report including these guidelines to your design engineers, architects, landscapers and other design parties in order to enable them to provide a design that takes into consideration expansive soils.***

In addition, you should provide the soil report with these guidelines to any property manager, lessee, property purchaser or other interested party that will have or assume the responsibility of maintaining the development in the future.

Expansive soils are fine-grained silts and clays which are subject to swelling and contracting. The amount of this swelling and contracting is subject to the amount of fine-grained clay materials present in the soils and the amount of moisture either introduced or extracted from the soils. Expansive soils are divided into five categories ranging from “very low” to “very high”. Expansion indices are assigned to each classification and are included in the laboratory testing section of this report. *If the expansion index of the soils on your site, as stated in this report, is 21 or higher, you have expansive soils.* The classifications of expansive soils are as follows:

Classification of Expansive Soil*

Expansion Index	Potential Expansion
0-20	Very Low
21-50	Low
51-90	Medium
91-130	High
Above 130	Very High

*From Table 18A-I-B of California Building Code (1988)

When expansive soils are compacted during site grading operations, care is taken to place the materials at or slightly above optimum moisture levels and perform proper compaction operations. Any subsequent excessive wetting and/or drying of expansive soils will cause the soil materials to expand and/or contract. These actions are likely to cause distress of foundations, structures, slabs-on-grade, sidewalks and pavement over the life of the structure. ***It is therefore imperative that even after construction of improvements, the moisture contents are maintained at relatively constant levels, allowing neither excessive wetting or drying of soils.***

Evidence of excessive wetting of expansive soils may be seen in concrete slabs, both interior and exterior. Slabs may lift at construction joints producing a trip hazard or may crack from the pressure of soil expansion. Wet clays in foundation areas may result in lifting of the structure causing difficulty in the opening and closing of doors and windows, as well as cracking in exterior and interior wall surfaces. In extreme wetting of soils to depth, settlement of the structure may eventually result. Excessive wetting of soils in landscape areas adjacent to concrete or asphaltic pavement areas may also result in expansion of soils beneath pavement and resultant distress to the pavement surface.

Excessive drying of expansive soils is initially evidenced by cracking in the surface of the soils due to contraction. Settlement of structures and on-grade slabs may also eventually result along with problems in the operation of doors and windows.

Projects located in areas of expansive clay soils will be subject to more movement and "hairline" cracking of walls and slabs than similar projects situated on non-expansive sandy soils. There are, however, measures that developers and property owners may take to reduce the amount of movement over the life the development. The following guidelines are provided to assist you in both design and maintenance of projects on expansive soils:

- Drainage away from structures and pavement is essential to prevent excessive wetting of expansive soils. Grades should be designed to the latest building code and maintained to allow flow of irrigation and rain water to approved drainage devices or to the street. Any “ponding” of water adjacent to buildings, slabs and pavement after rains is evidence of poor drainage; the installation of drainage devices or regrading of the area may be required to assure proper drainage. Installation of rain gutters is also recommended to control the introduction of moisture next to buildings. Gutters should discharge into a drainage device or onto pavement which drains to roadways.
- Irrigation should be strictly controlled around building foundations, slabs and pavement and may need to be adjusted depending upon season. This control is essential to maintain a relatively uniform moisture content in the expansive soils and to prevent swelling and contracting. Over-watering adjacent to improvements may result in damage to those improvements. NorCal Engineering makes no specific recommendations regarding landscape irrigation schedules.
- Planting schemes for landscaping around structures and pavement should be analyzed carefully. Plants (including sod) requiring high amounts of water may result in excessive wetting of soils. Trees and large shrubs may actually extract moisture from the expansive soils, thus causing contraction of the fine-grained soils.
- Thickened edges on exterior slabs will assist in keeping excessive moisture from entering directly beneath the concrete. A six-inch thick or greater deepened edge on slabs may be considered. Underlying interior and exterior slabs with 6 to 12 inches or more of non-expansive soils and providing presaturation of the underlying clayey soils as recommended in the soil report will improve the overall performance of on-grade slabs.

- Increase the amount of steel reinforcing in concrete slabs, foundations and other structures to resist the forces of expansive soils. The precise amount of reinforcing should be determined by the appropriate design engineers and/or architects.
- Recommendations of the soil report should always be followed in the development of the project. Any recommendations regarding presaturation of the upper subgrade soils in slab areas should be performed in the field and verified by the Soil Engineer.

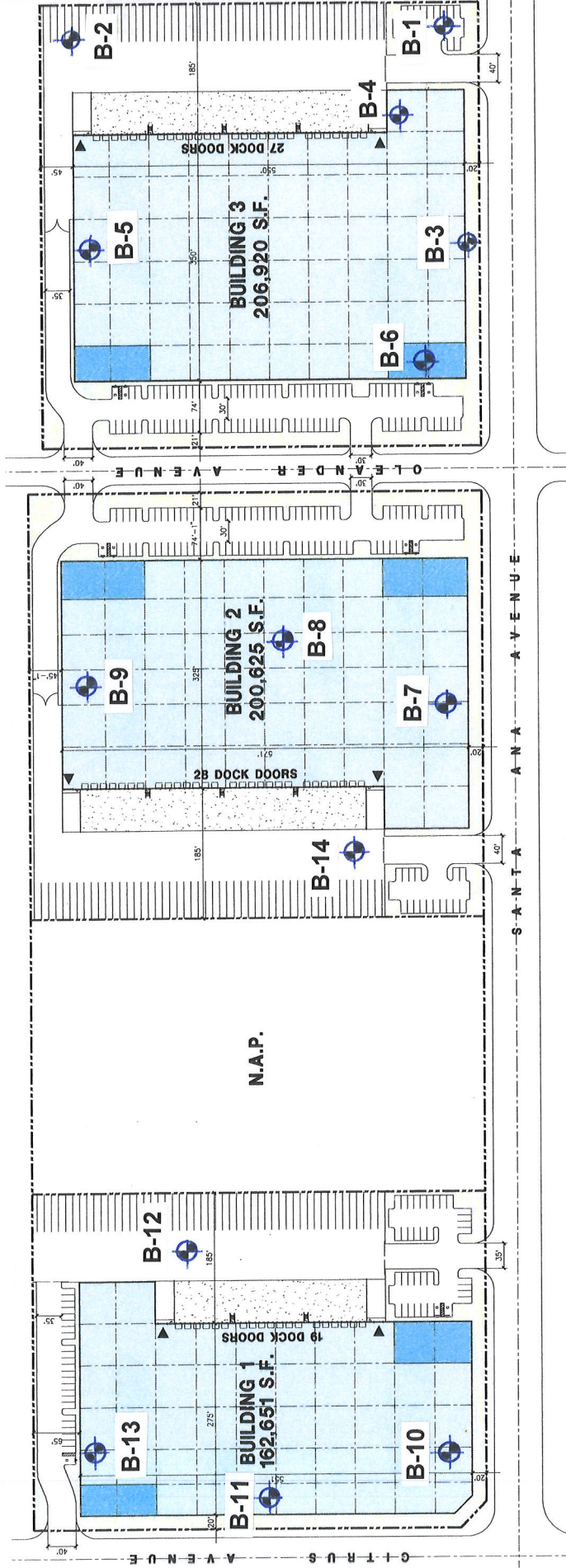

1 INCH = 100 FEET

NorCal Engineering

SOILS AND GEOTECHNICAL CONSULTANTS

SITE PLAN

PROJECT: 23086-22

DATE: APRIL 2022

List of Appendices (in order of appearance)

Appendix A – Log of Excavations

Log of Borings B-1 to B-14

Appendix B – Laboratory Tests

Table I – Maximum Dry Density

Table II – Expansion

Table III – Corrosion

Plates A and B – Direct Shear

Plates C to F - Consolidation

Appendix C –Seismic Design

ASCE /SEI 7-22 Seismic Hazards Report

Appendix D – Soil Infiltration Data

Field Data Sheets and Calculations

Appendix A

Log of Excavations

MAJOR DIVISION			GRAPHIC SYMBOL	LETTER SYMBOL	TYPICAL DESCRIPTIONS	
COARSE GRAINED SOILS	GRAVEL AND GRAVELLY SOILS	CLEAN GRAVELS (LITTLE OR NO FINES)		GW	WELL-GRADED GRAVELS, GRAVEL, SAND MIXTURES, LITTLE OR NO FINES	
		MORE THAN 50% OF COARSE FRACTION RETAINED ON NO. 4 SIEVE	GRAVELS WITH FINES (APPRECIABLE AMOUNT OF FINES)		GM	SILTY GRAVELS, GRAVEL-SAND-SILT MIXTURES
			GRAVELS WITH FINES (APPRECIABLE AMOUNT OF FINES)		GC	CLAYEY GRAVELS, GRAVEL-SAND-CLAY MIXTURES
		SAND AND SANDY SOILS	CLEAN SAND (LITTLE OR NO FINES)		SW	WELL-GRADED SANDS, GRAVELLY SANDS, LITTLE OR NO FINES
	MORE THAN 50% OF COARSE FRACTION PASSING ON NO. 4 SIEVE		SANDS WITH FINE (APPRECIABLE AMOUNT OF FINES)		SM	SILTY SANDS, SAND-SILT MIXTURES
			SANDS WITH FINE (APPRECIABLE AMOUNT OF FINES)		SC	CLAYEY SANDS, SAND-CLAY MIXTURES
	FINE GRAINED SOILS		SILTS AND CLAYS	LIQUID LIMIT LESS THAN 50		ML
					CL	INORGANIC CLAYS OF LOW TO MEDIUM PLASTICITY, GRAVELLY CLAYS, SANDY CLAYS, SILTY CLAYS, LEAN CLAYS
		OL			ORGANIC SILTS AND ORGANIC SILTY CLAYS OF LOW PLASTICITY	
SILTS AND CLAYS		LIQUID LIMIT GREATER THAN 50		MH	INORGANIC SILTS, MICACEOUS OR DIATOMACEOUS FINE SAND OR SILTY SOILS	
				CH	INORGANIC CLAYS OF HIGH PLASTICITY, FAT CLAYS	
				OH	ORGANIC CLAYS OF MEDIUM TO HIGH PLASTICITY, ORGANIC SILTS	
HIGHLY ORGANIC SOILS				PT	PEAT, HUMUS, SWAMP SOILS WITH HIGH ORGANIC CONTENTS	

NOTE: DUAL SYMBOLS ARE USED TO INDICATE BORDERLINE SOIL CLASSIFICATIONS

UNIFIED SOIL CLASSIFICATION SYSTEM

KEY:

- Indicates 2.5-inch Inside Diameter. Ring Sample.
- ☒ Indicates 2-inch OD Split Spoon Sample (SPT).
- ☐ Indicates Shelby Tube Sample.
- ▢ Indicates No Recovery.
- ▣ Indicates SPT with 140# Hammer 30 in. Drop.
- ☑ Indicates Bulk Sample.
- ▤ Indicates Small Bag Sample.
- ▥ Indicates Non-Standard
- ☒ Indicates Core Run.

COMPONENT DEFINITIONS

COMPONENT	SIZE RANGE
Boulders	Larger than 12 in
Cobbles	3 in to 12 in
Gravel	3 in to No 4 (4.5mm)
Coarse gravel	3 in to 3/4 in
Fine gravel	3/4 in to No 4 (4.5mm)
Sand	No. 4 (4.5mm) to No. 200 (0.074mm)
Coarse sand	No. 4 (4.5 mm) to No. 10 (2.0 mm)
Medium sand	No. 10 (2.0 mm) to No. 40 (0.42 mm)
Fine sand	No. 40 (0.42 mm) to No. 200 (0.074 mm)
Silt and Clay	Smaller than No. 200 (0.074 mm)

COMPONENT PROPORTIONS

DESCRIPTIVE TERMS	RANGE OF PROPORTION
Trace	1 - 5%
Few	5 - 10%
Little	10 - 20%
Some	20 - 35%
And	35 - 50%

MOISTURE CONTENT

DRY	Absence of moisture, dusty, dry to the touch.
DAMP	Some perceptible moisture; below optimum
MOIST	No visible water; near optimum moisture content
WET	Visible free water, usually soil is below water table.

RELATIVE DENSITY OR CONSISTENCY VERSUS SPT N -VALUE

COHESIONLESS SOILS		COHESIVE SOILS		
Density	N (blows/ft)	Consistency	N (blows/ft)	Approximate Undrained Shear Strength (psf)
Very Loose	0 to 4	Very Soft	0 to 2	< 250
Loose	4 to 10	Soft	2 to 4	250 - 500
Medium Dense	10 to 30	Medium Stiff	4 to 8	500 - 1000
Dense	30 to 50	Stiff	8 to 15	1000 - 2000
Very Dense	over 50	Very Stiff	15 to 30	2000 - 4000
		Hard	over 30	> 4000

Boring Location: Citrus & Santa Ana, Fontana

Date of Drilling: 4/13/2022

Groundwater Depth: None Encountered

Drilling Method: Simco 2800HS

Hammer Weight: 140 lbs

Drop: 30"

Surface Elevation: Not Measured

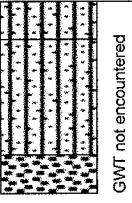
Depth (feet)	Lithology	Material Description	Samples		Laboratory	
			Type	Blow Counts	Moisture	Dry Density
0		FILL				
		Silty (fine to coarse grained) SAND				
		Brown, loose, damp; with gravel				
		NATURAL				
		Silty (fine to coarse grained) SAND				
		Brown, medium dense, damp; with gravel				
5		Silty (medium to coarse grained) SAND				
		Light brown, medium dense, damp; slightly silty				
		Boring completed at depth of 5'				
10						
15						
20						
25						
30						
35						

Boring Location: Citrus & Santa Ana, Fontana

Date of Drilling: 4/13/2022

Groundwater Depth: None Encountered

Drilling Method: Simco 2800HS

Hammer Weight: 140 lbs

Drop: 30"

Surface Elevation: Not Measured

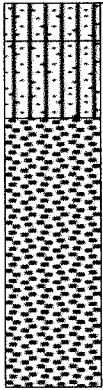
Depth (feet)	Lithology	Material Description	Samples		Laboratory	
			Type	Blow Counts	Moisture	Dry Density
0		FILL Silty (fine to coarse grained) SAND Brown, loose, damp; with gravel				
5		NATURAL Silty (fine to coarse grained) SAND Brown, medium dense, damp; with gravel Silty (medium to coarse grained) SAND Light brown, medium dense, damp; slightly silty				
10		Boring completed at depth of 10'				
15						
20						
25						
30						
35						

Boring Location: Citrus & Santa Ana, Fontana

Date of Drilling: 4/13/2022

Groundwater Depth: None Encountered

Drilling Method: Simco 2800HS

Hammer Weight: 140 lbs

Drop: 30"

Surface Elevation: Not Measured

Depth (feet)	Lithology	Material Description	Samples		Laboratory		
			Type	Blow Counts	Moisture	Dry Density	Fines Content %
0	GWT not encountered	FILL Silty (fine to coarse grained) SAND Brown, loose, damp; with gravel					
5		NATURAL Silty (fine to coarse grained) SAND Brown, medium dense to dense, damp; with gravel					
15		Boring completed at depth of 15'					
20							
25							
30							
35							

Boring Location: Citrus & Santa Ana, Fontana

Date of Drilling: 4/13/2022

Groundwater Depth: None Encountered

Drilling Method: Simco 2800HS

Hammer Weight: 140 lbs

Drop: 30"

Surface Elevation: Not Measured

Depth (feet)	Lithology	Material Description	Samples		Laboratory	
			Type	Blow Counts	Moisture	Dry Density
0	<p style="writing-mode: vertical-rl; transform: rotate(180deg);">GWT not encountered</p>	FILL Silty (fine to coarse grained) SAND Brown, loose, damp; with gravel and asphalt/concrete fragments	█	6/7	2.4	109.2
5		NATURAL Silty (fine to coarse grained) SAND Brown, medium dense, damp; with gravel Silty (medium to coarse grained) SAND Light brown, medium dense to dense, damp; slightly silty with gravel and cobble	▽	7/8	2.7	110.0
10		Silty (fine to coarse grained) SAND Brown, medium dense, moist; with gravel	█	7/14	11.1	108.8
15		Silty (medium to coarse grained) SAND Light brown, medium dense, damp with gravel and cobble; slightly silty	█	7/11	9.3	108.6
20		Sandy SILT Brown, medium stiff, moist	█	7/10	10.7	96.1
		Boring completed at depth of 21'				

SuperLog CivilTech Software, USA www.civiltech.com File: C:\Superlog\PROJECT\23086-22.log Date: 4/21/2022

Boring Location: Citrus & Santa Ana, Fontana

Date of Drilling: 4/13/2022

Groundwater Depth: None Encountered

Drilling Method: Simco 2800HS

Hammer Weight: 140 lbs

Drop: 30"

Surface Elevation: Not Measured

Depth (feet)	Lithology	Material Description	Samples		Laboratory	
			Type	Blow Counts	Moisture	Dry Density
0		FILL Silty (fine to coarse grained) SAND Brown, loose, damp; with gravel				
5		NATURAL Silty (fine to coarse grained) SAND Brown, medium dense to dense, damp; with gravel and cobble; silty to slightly silty	█	10/15	3.0	117.5
10			█	9/16	2.5	121.3
15			█	8/12	4.7	118.3
		Boring completed at depth of 15'				

Boring Location: Citrus & Santa Ana, Fontana

Date of Drilling: 4/13/2022

Groundwater Depth: None Encountered

Drilling Method: Simco 2800HS

Hammer Weight: 140 lbs

Drop: 30"

Surface Elevation: Not Measured

Depth (feet)	Lithology	Material Description	Samples		Laboratory		
			Type	Blow Counts	Moisture	Dry Density	Fines Content %
0	GWT not encountered	FILL Silty (fine to coarse grained) SAND Brown, loose, damp; with gravel	█	7/10	2.2	110.7	
5		NATURAL Silty (fine to coarse grained) SAND Brown, medium dense to dense, damp; with gravel	█	8/12	3.9	115.0	
10		Boring completed at depth of 10'					
15							
20							
25							
30							
35							

Boring Location: Citrus & Santa Ana, Fontana

Date of Drilling: 4/13/2022

Groundwater Depth: None Encountered

Drilling Method: Simco 2800HS

Hammer Weight: 140 lbs

Drop: 30"

Surface Elevation: Not Measured

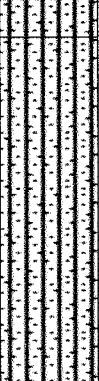
Depth (feet)	Lithology	Material Description	Samples		Laboratory		
			Type	Blow Counts	Moisture	Dry Density	Fines Content %
0		FILL Silty (fine to coarse grained) SAND Brown, loose, damp; with gravel					
5		NATURAL Silty (fine to coarse grained) SAND Brown, medium dense to dense, damp; with gravel	■	7/11	2.2	107.5	
10		Boring completed at depth of 10'	■	11/14	2.3	111.4	

Boring Location: Citrus & Santa Ana, Fontana

Date of Drilling: 4/13/2022







Groundwater Depth: None Encountered

Drilling Method: Simco 2800HS

Hammer Weight: 140 lbs

Drop: 30"

Surface Elevation: Not Measured

Depth (feet)	Lithology	Material Description	Samples		Laboratory	
			Type	Blow Counts	Moisture	Dry Density
0		FILL Silty (fine to coarse grained) SAND Brown, loose, damp; with gravel and asphalt fragments		6/7	6.6	105.3
5		NATURAL Silty (fine to coarse grained) SAND Brown, medium dense, damp to moist; with gravel and some cobble		7/9	2.3	109.2
10				8/10	11.2	111.3
15				7/11	12.4	108.4
20		Sandy SILT Brown, medium stiff, moist		8/10	9.8	97.9
		Boring completed at depth of 21'				

SuperLog CivilTech Software, USA www.civiltech.com File: C:\Superlog4\PROJECT\23086-22.log Date: 4/21/2022

Boring Location: Citrus & Santa Ana, Fontana

Date of Drilling: 4/13/2022

Groundwater Depth: None Encountered

Drilling Method: Simco 2800HS

Hammer Weight: 140 lbs

Drop: 30"

Surface Elevation: Not Measured

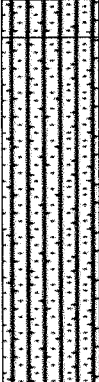
Depth (feet)	Lithology	Material Description	Samples		Laboratory		
			Type	Blow Counts	Moisture	Dry Density	Fines Content %
0		FILL Silty (fine to coarse grained) SAND Brown, loose, damp; with gravel					
5		NATURAL Silty (fine to coarse grained) SAND Brown, medium dense to dense, damp; with gravel and cobbles	█	11/13	3.0	119.9	
10		Boring completed at depth of 10'	█	10/13	2.0	121.7	
15							
20							
25							
30							
35							

Boring Location: Citrus & Santa Ana, Fontana

Date of Drilling: 4/13/2022

Groundwater Depth: None Encountered

Drilling Method: Simco 2800HS

Hammer Weight: 140 lbs

Drop: 30"

Surface Elevation: Not Measured

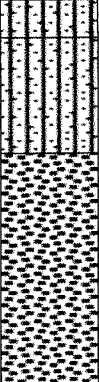
Depth (feet)	Lithology	Material Description	Samples		Laboratory	
			Type	Blow Counts	Moisture	Dry Density
0		FILL Silty (fine to coarse grained) SAND Brown, loose, damp; with gravel				
5		NATURAL Silty (fine to coarse grained) SAND Brown, medium dense, damp; with gravel Silty (medium to coarse grained) SAND Light brown, medium dense to dense, damp; slightly silty with cobbles	█	9/13	3.0	124.0
10		Boring completed at depth of 10'	█	11/17	2.1	120.7
15						
20						
25						
30						
35						

Boring Location: Citrus & Santa Ana, Fontana

Date of Drilling: 4/13/2022

Groundwater Depth: None Encountered

Drilling Method: Simco 2800HS

Hammer Weight: 140 lbs

Drop: 30"

Surface Elevation: Not Measured

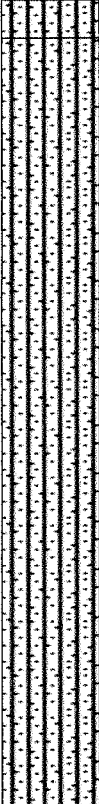
Depth (feet)	Lithology	Material Description	Samples		Laboratory	
			Type	Blow Counts	Moisture	Dry Density
0		FILL Silty (fine to coarse grained) SAND Brown, loose, damp; with gravel	█	4/4	2.9	108.3
5		NATURAL Silty (fine to coarse grained) SAND Brown, medium dense to very dense, damp; with gravel and cobbles	█	9/15	2.9	114.8
10			█	17/30	2.1	121.7
15			█	21/30	2.3	123.8
20			█	18/28	4.0	125.7
Boring completed at depth of 21'						

SuperLog CivilTech Software, USA www.civiltech.com File: C:\Superlog\PROJECT\23086-22.log Date: 4/21/2022

Boring Location: Citrus & Santa Ana, Fontana

Date of Drilling: 4/13/2022

Groundwater Depth: None Encountered

Drilling Method: Hand Auger

Hammer Weight:

Drop:

Surface Elevation: Not Measured

Depth (feet)	Lithology	Material Description	Samples		Laboratory		
			Type	Blow Counts	Moisture	Dry Density	Fines Content %
0		FILL Silty (fine to coarse grained) SAND Brown, loose, damp; with gravel	■		3.1	107.8	
5		NATURAL Silty (fine to coarse grained) SAND Brown, medium dense, damp; with gravel and cobble	■		2.7	108.2	
10	Boring completed at depth of 10'						
15							
20							
25							
30							
35							

Boring Location: Citrus & Santa Ana, Fontana

Date of Drilling: 4/13/2022

Groundwater Depth: None Encountered

Drilling Method: Simco 2800HS

Hammer Weight: 140 lbs

Drop: 30"

Surface Elevation: Not Measured

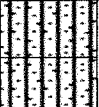
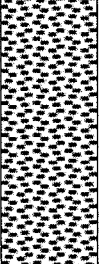
Depth (feet)	Lithology	Material Description	Samples		Laboratory	
			Type	Blow Counts	Moisture	Dry Density
0		FILL Silty (fine to coarse grained) SAND Brown, loose, damp; with gravel				
4		NATURAL Silty (fine to coarse grained) SAND Brown, medium dense to dense, damp; with gravel				
5		Silty (medium to coarse grained) SAND Light brown, medium dense, damp; slightly silty with gravel and cobble	█	12/14	3.0	117.9
10		Boring completed at depth of 10'	█	11/15	2.2	119.2
15						
20						
25						
30						
35						

Boring Location: Citrus & Santa Ana, Fontana

Date of Drilling: 4/13/2022

Groundwater Depth: None Encountered

Drilling Method: Simco 2800HS

Hammer Weight: 140 lbs

Drop: 30"

Surface Elevation: Not Measured

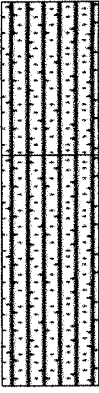
Depth (feet)	Lithology	Material Description	Samples		Laboratory	
			Type	Blow Counts	Moisture	Dry Density
0	 GWT not encountered	FILL Silty (fine to coarse grained) SAND Brown, loose, damp; with gravel				
5		NATURAL Silty (fine to coarse grained) SAND Brown, medium dense to dense, damp; with gravel and cobble; slightly silty to silty	█	9/18	2.8	114.5
10		Boring completed at depth of 10'				
15						
20						
25						
30						
35						

Appendix B

Laboratory Tests

TABLE I
MAXIMUM DENSITY TESTS

Sample	Classification	Optimum Moisture (%)	Maximum Dry Density (lbs/cu.ft)
B-4 @ 2'	Silty SAND	8.0	133.0
B-11 @ 2'	Silty SAND	8.5	130.0

TABLE II
EXPANSION TESTS

Sample	Classification	Expansion Index
B-4 @ 2'	Silty SAND	0

TABLE III
CORROSION TESTS

Sample	pH	Electrical Resistivity	Sulfate (%)	Chloride (ppm)
B-4 @ 2'	6.9	6,590	0.002	217
B-11 @ 2'	6.9	4,987	0.003	289

% by weight
ppm – mg/kg

Sample No. B4@2'
 Sample Type: Undisturbed/Saturated
 Soil Description: Fine-Very Coarse Grained Sand w/ Some Silt & Gravel

		1	2	3
Normal Stress	(psf)	1000	2000	3000
Peak Stress	(psf)	804	1236	2004
Displacement	(in)	0.250	0.250	0.225
Residual Stress	(psf)	804	1236	2004
Displacement	(in.)	0.250	0.250	0.250
In Situ Dry Density	(pcf)	109.2	109.2	109.2
In Situ Water Content	(%)	2.4	2.4	2.4
Saturated Water Content	(%)	20.1	20.1	20.1
Strain Rate	(in/min)	0.020	0.020	0.020

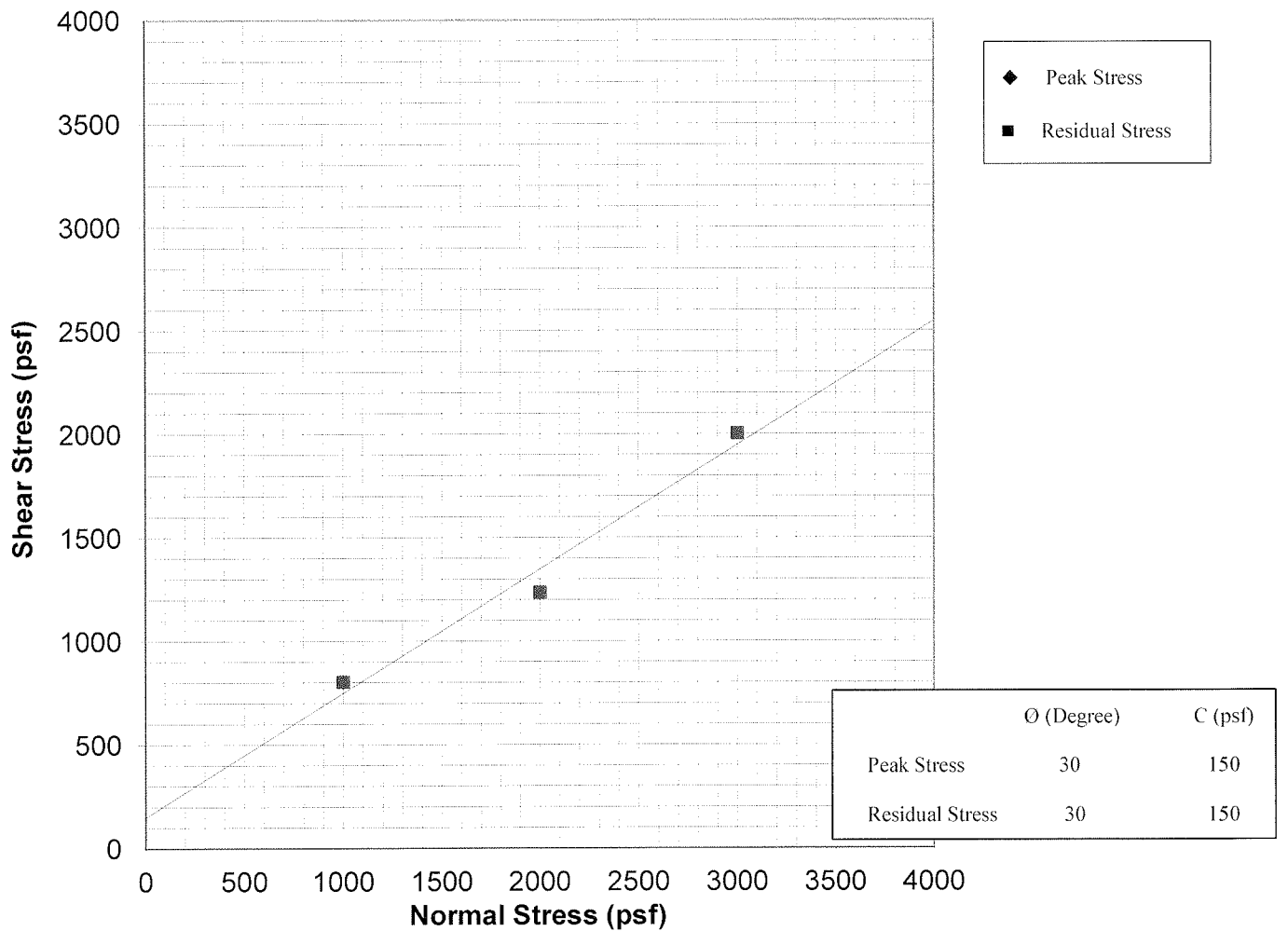
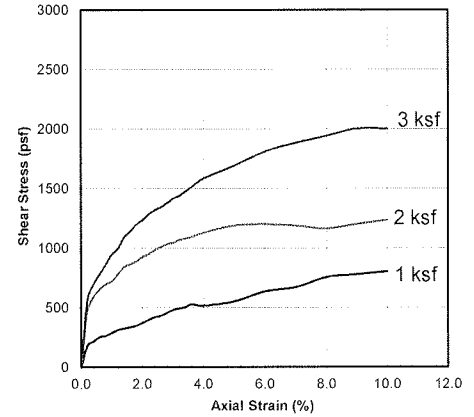

NorCal Engineering
 SOILS AND GEOTECHNICAL CONSULTANTS

Acacia Real Estate Group

PROJECT NUMBER: 23086-22

DATE: 4/22/2022

DIRECT SHEAR TEST

ASTM D3080

Plate A

Sample No. B11@2'
 Sample Type: Undisturbed/Saturated
 Soil Description: Fine-Coarse Grained Sand w/ Some Silt & Small Gravel

		1	2	3
Normal Stress	(psf)	1000	2000	3000
Peak Stress	(psf)	624	1320	1692
Displacement	(in)	0.225	0.250	0.250
Residual Stress	(psf)	612	1320	1692
Displacement	(in.)	0.250	0.250	0.250
In Situ Dry Density	(pcf)	108.3	108.3	108.3
In Situ Water Content	(%)	2.9	2.9	2.9
Saturated Water Content	(%)	20.5	20.5	20.5
Strain Rate	(in/min)	0.020	0.020	0.020

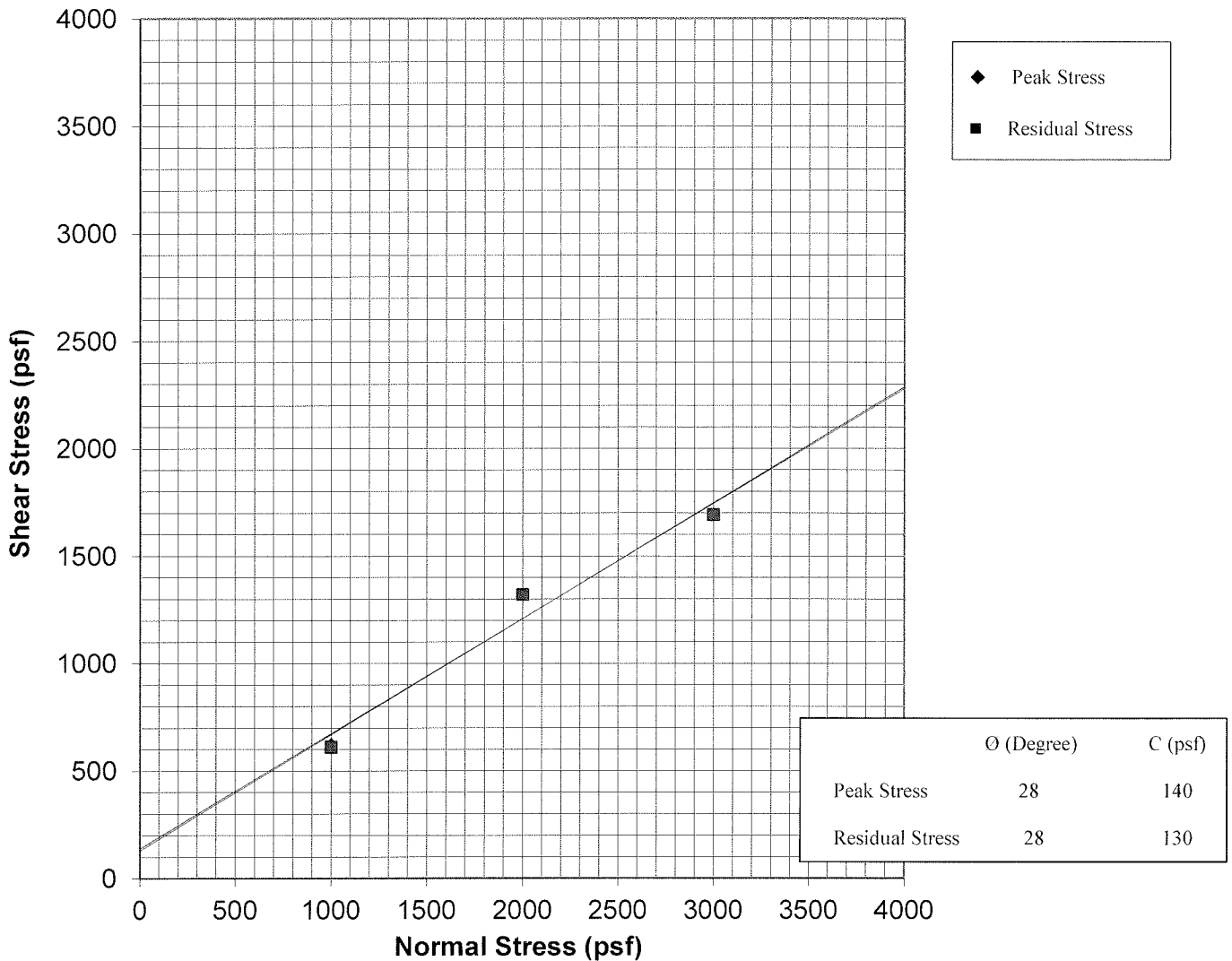
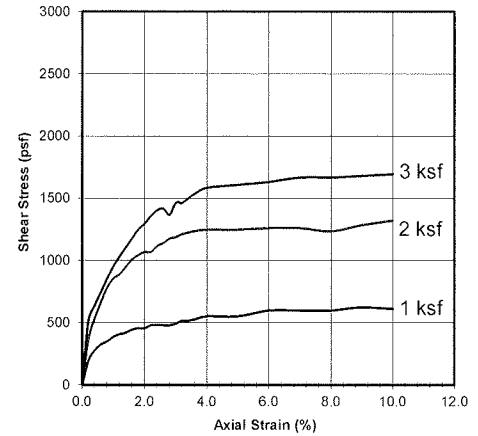

NorCal Engineering

SOILS AND GEOTECHNICAL CONSULTANTS

Acacia Real Estate Group

PROJECT NUMBER: 23086-22

DATE: 4/22/2022

DIRECT SHEAR TEST

ASTM D3080

Plate B

Vertical Pressure (kips/sq.ft.)	Sample Height (inches)	Consolidation (percent)	Sample No.	B4	Depth	5'	Date	4/22/2022
------------------------------------	------------------------	----------------------------	------------	----	-------	----	------	-----------

0.125	1.0000	0.0
0.25	0.9970	0.3
0.5	0.9960	0.4
1	0.9940	0.6
1	0.9910	0.9
2	0.9835	1.7
4	0.9770	2.3
8	0.9680	3.2
0.25	0.9750	2.5

Saturated

Date Tested: 4/19/2022
Sample: B4
Depth: 5'

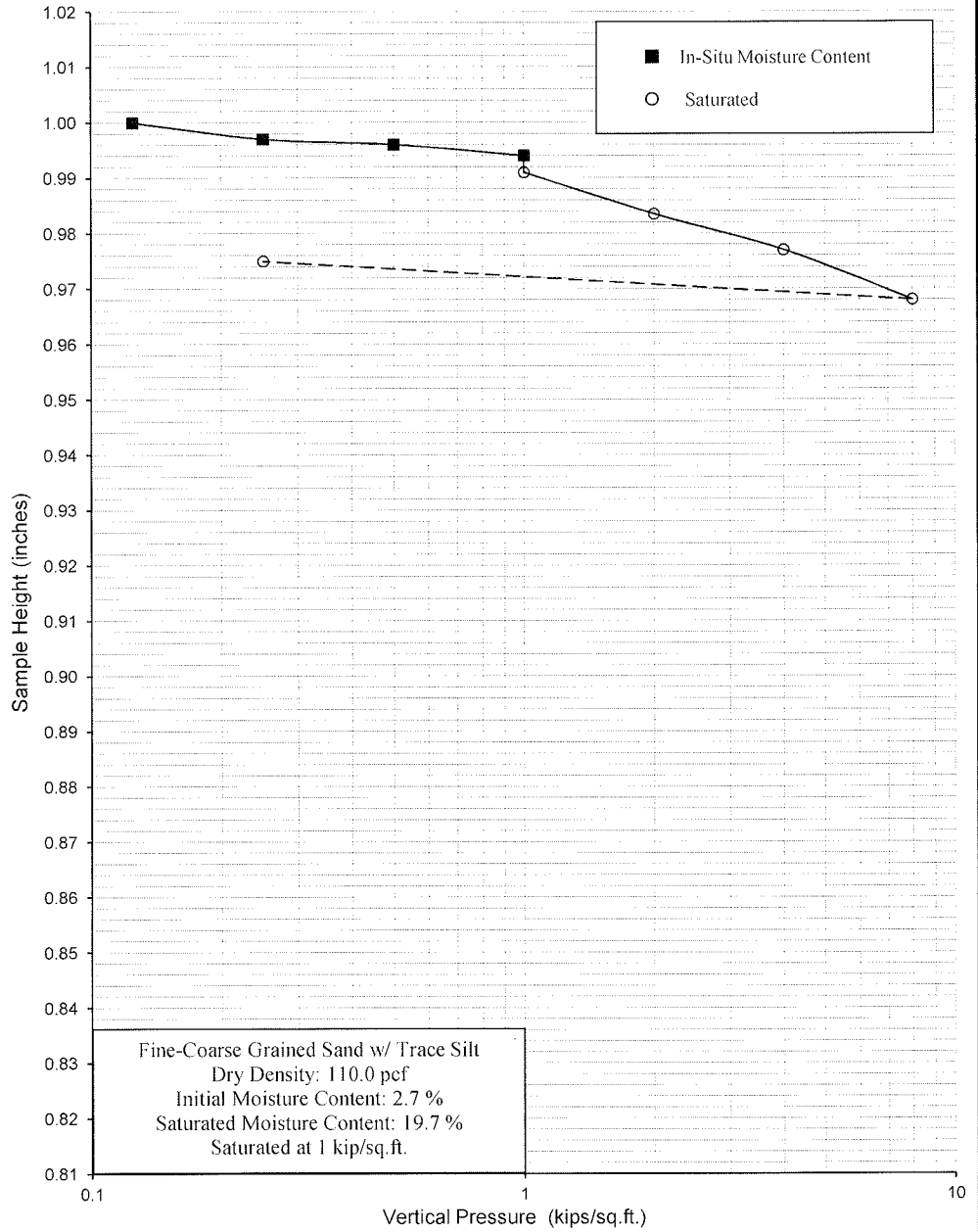

NorCal Engineering

SOILS AND GEOTECHNICAL CONSULTANTS

Acacia Real Estate Group

PROJECT NUMBER: 23086-22

DATE: 4/22/2022

CONSOLIDATION TEST

ASTM D2435

Plate C

Vertical Pressure (kips/sq.ft.)	Sample Height (inches)	Consolidation (percent)	Sample No.	B4	Depth	10'	Date	4/22/2022
------------------------------------	------------------------	----------------------------	------------	----	-------	-----	------	-----------

0.125	1.0000	0.0
0.25	0.9990	0.1
0.5	0.9970	0.3
1	0.9940	0.6
1	0.9920	0.8
2	0.9860	1.4
4	0.9800	2.0
8	0.9710	2.9
0.25	0.9790	2.1

Saturated

Date Tested: 4/19/2022
Sample: B4
Depth: 10'

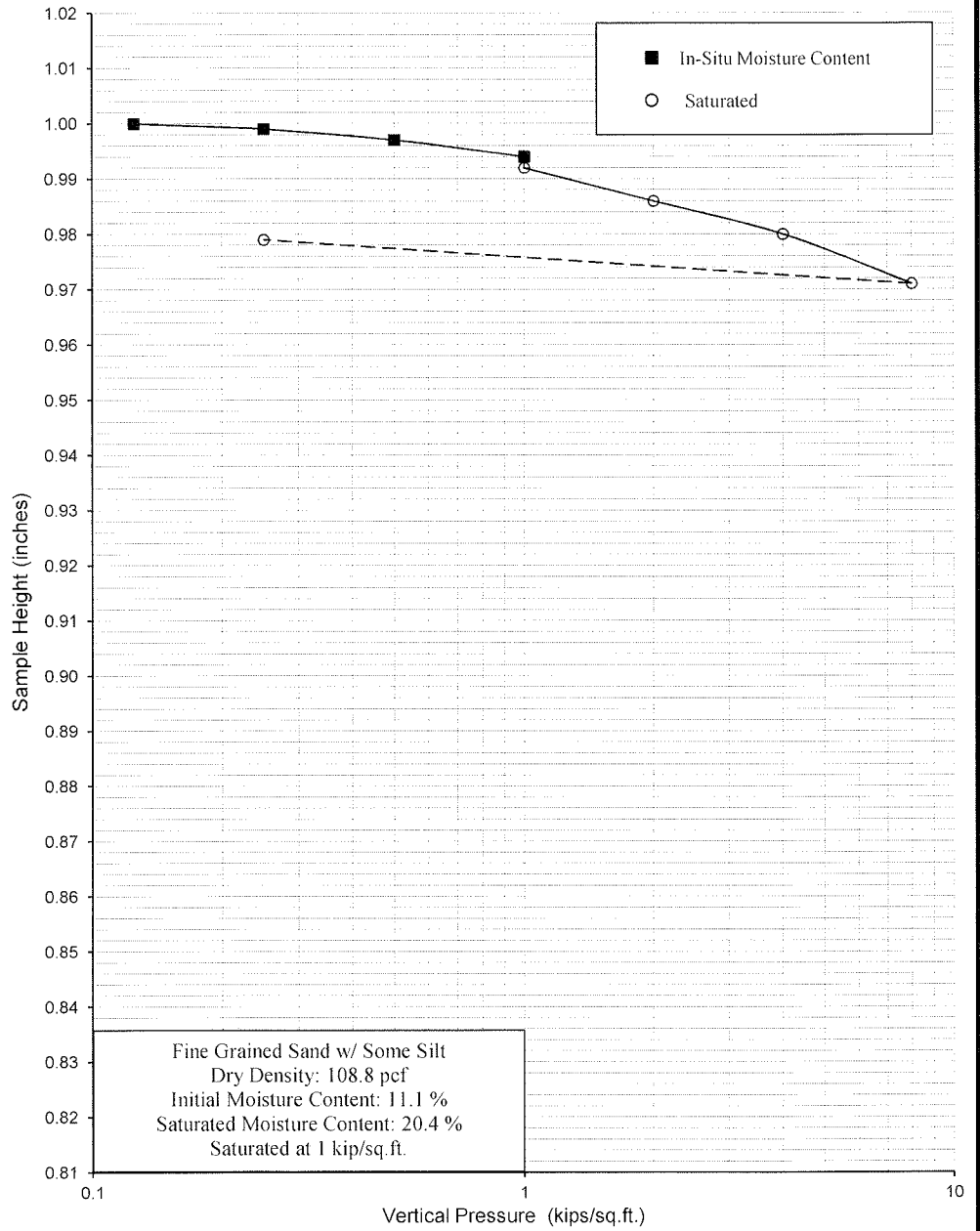

NorCal Engineering

SOILS AND GEOTECHNICAL CONSULTANTS

Acacia Real Estate Group

PROJECT NUMBER: 23086-22

DATE: 4/22/2022

CONSOLIDATION TEST

ASTM D2435

Plate D

Vertical Pressure (kips/sq.ft.)	Sample Height (inches)	Consolidation (percent)	Sample No.	B11	Depth	5'	Date	4/22/2022
------------------------------------	------------------------	----------------------------	------------	-----	-------	----	------	-----------

0.125	1.0000	0.0
0.25	0.9995	0.0
0.5	0.9980	0.2
1	0.9960	0.4
1	0.9900	1.0
2	0.9840	1.6
4	0.9760	2.4
8	0.9670	3.3
0.25	0.9720	2.8

Saturated

Date Tested: 4/20/2022
Sample: B11
Depth: 5'

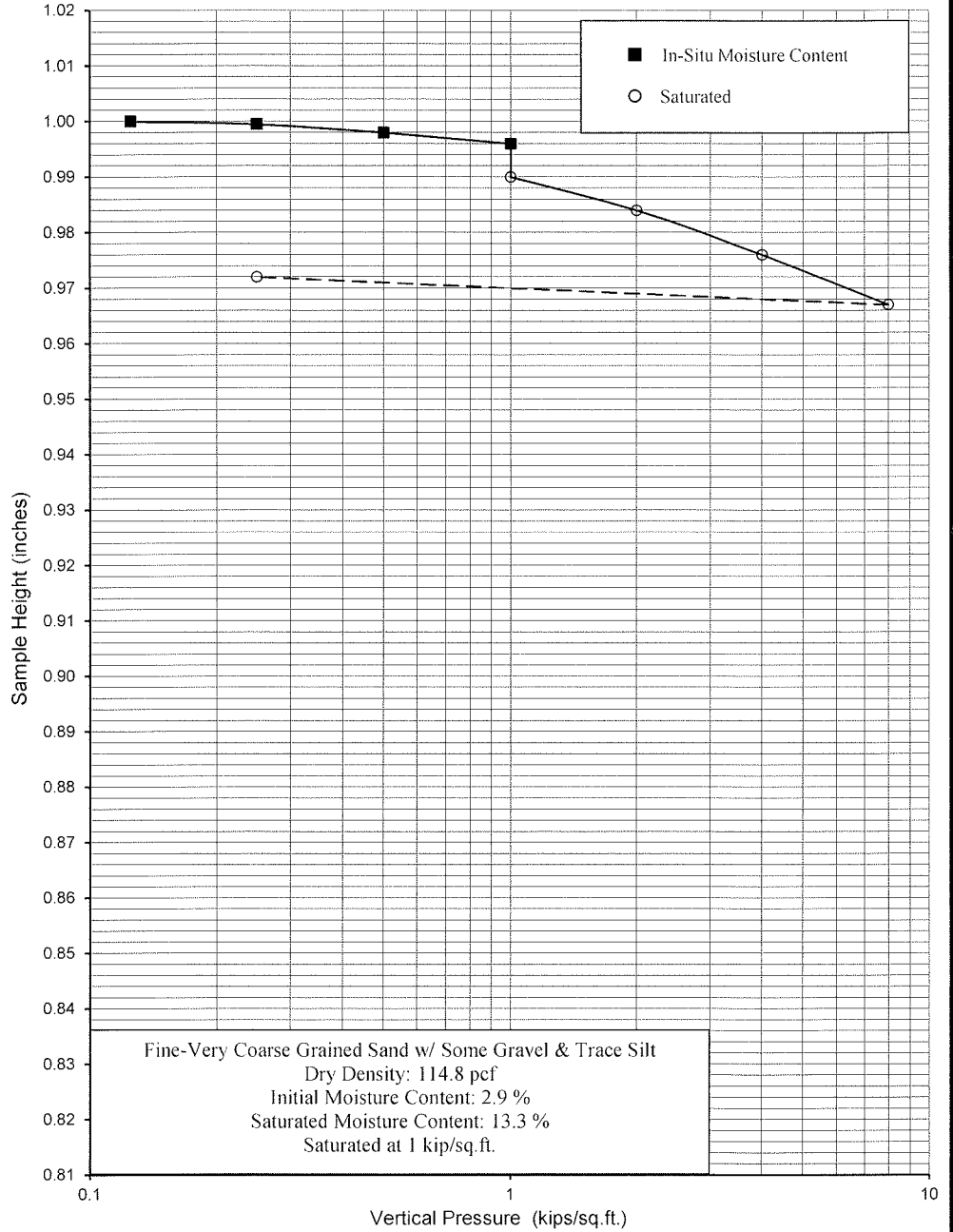

NorCal Engineering

SOILS AND GEOTECHNICAL CONSULTANTS

Acacia Real Estate Group

PROJECT NUMBER: 23086-22

DATE: 4/22/2022

CONSOLIDATION TEST

ASTM D2435

Plate E

Vertical Pressure (kips/sq.ft.)	Sample Height (inches)	Consolidation (percent)	Sample No.	B11	Depth	10'	Date	4/22/2022
------------------------------------	------------------------	----------------------------	------------	-----	-------	-----	------	-----------

0.125	1.0000	0.0
0.25	0.9970	0.3
0.5	0.9940	0.6
1	0.9900	1.0
1	0.9780	2.2
2	0.9695	3.1
4	0.9610	3.9
8	0.9510	4.9
0.25	0.9555	4.5

Saturated

Date Tested: 4/20/2022
Sample: B11
Depth: 10'

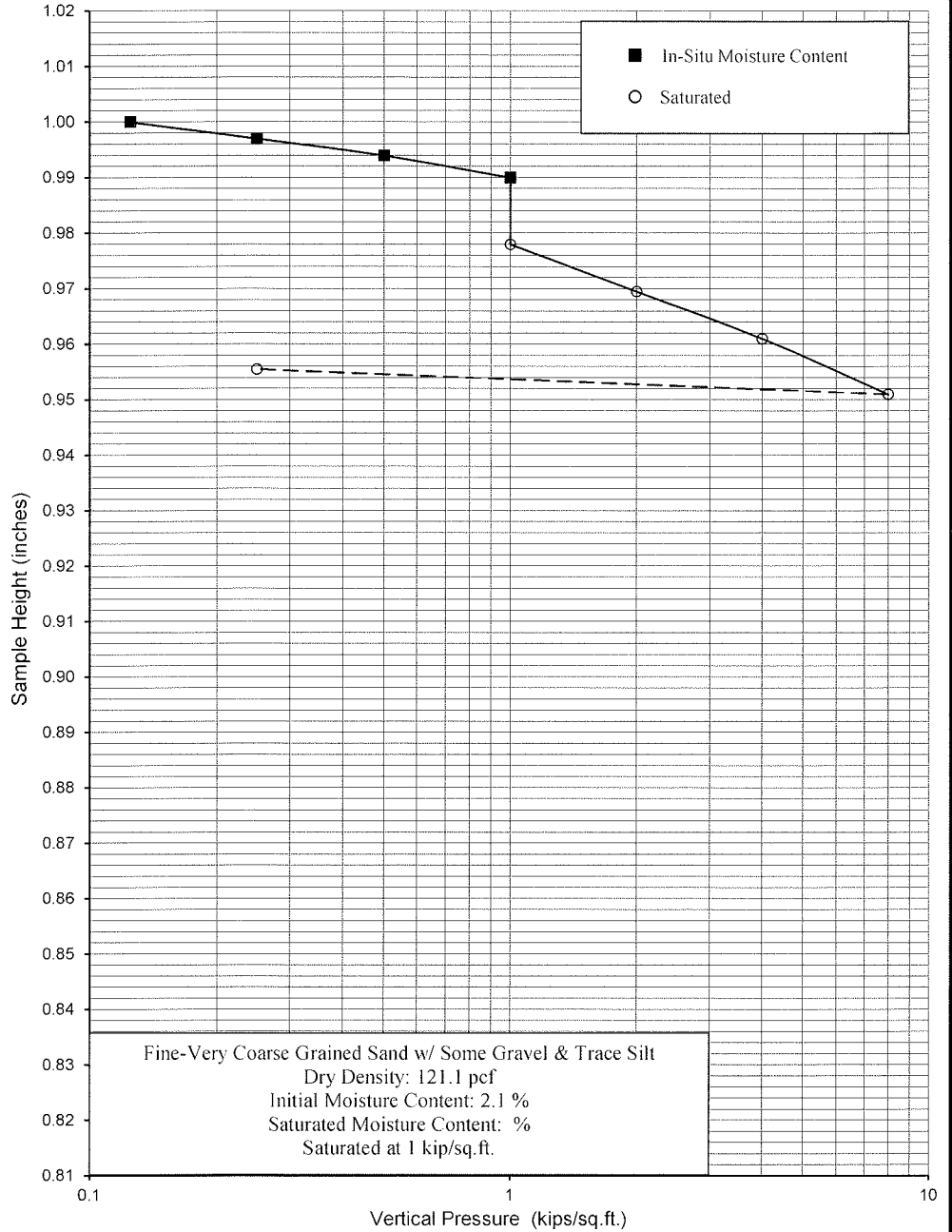

NorCal Engineering

SOILS AND GEOTECHNICAL CONSULTANTS

Acacia Real Estate Group

PROJECT NUMBER: 23086-22

DATE: 4/22/2022

CONSOLIDATION TEST

ASTM D2435

Plate F

Appendix C

Seismic Design Report



ASCE 7 Hazards Report

Address:
No Address at This
Location

Standard: ASCE/SEI 7-22
Risk Category: II
Soil Class: D - Stiff Soil

Elevation: 1044.52 ft (NAVD 88)
Latitude: 34.056149
Longitude: -117.453035

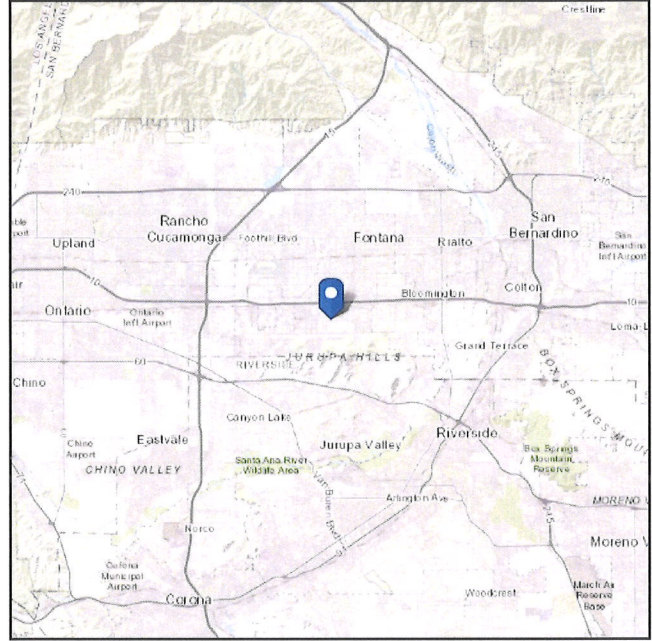

Site Soil Class:

Results:

PGA _M :	0.68	T _L :	12
S _{MS} :	1.9	S _S :	1.99
S _{M1} :	1.7	S _I :	0.63
S _{DS} :	1.26	S _{DC} :	
S _{D1} :	1.13	V _{S30} :	260

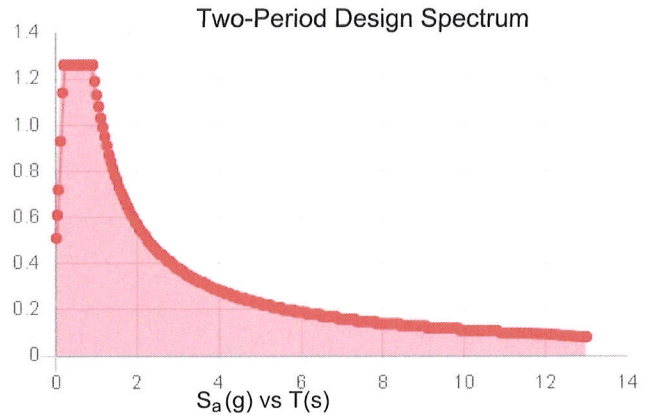
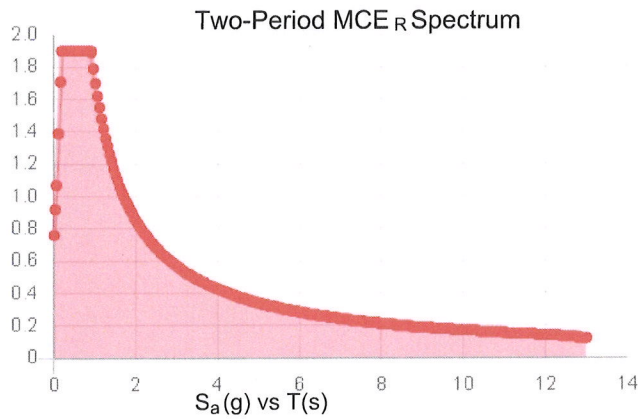
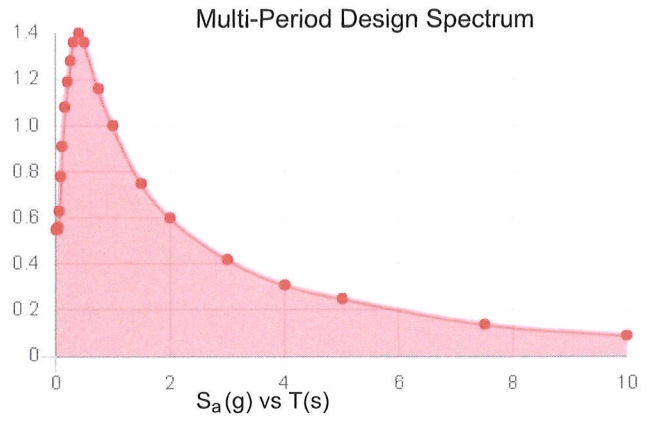
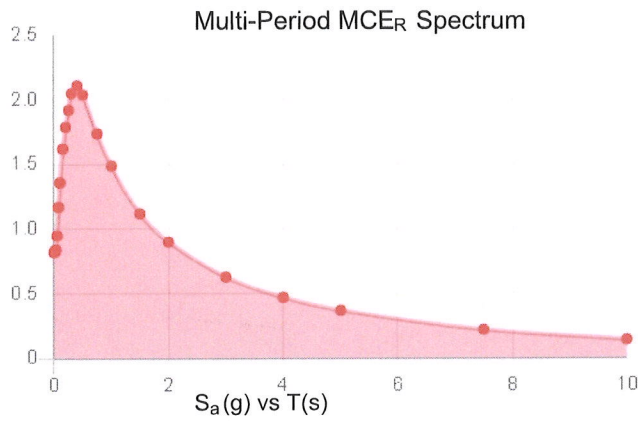

MCE_R Vertical Response Spectrum

Vertical ground motion data has not yet been made available by USGS.

Design Vertical Response Spectrum

Vertical ground motion data has not yet been made available by USGS.



Data Accessed: Tue Apr 19 2022

Date Source:

USGS Seismic Design Maps based on ASCE/SEI 7-22 and ASCE/SEI 7-22 Table 1.5-2. Additional data for site-specific ground motion procedures in accordance with ASCE/SEI 7-22 Ch. 21 are available from USGS.

The ASCE 7 Hazard Tool is provided for your convenience, for informational purposes only, and is provided “as is” and without warranties of any kind. The location data included herein has been obtained from information developed, produced, and maintained by third party providers; or has been extrapolated from maps incorporated in the ASCE 7 standard. While ASCE has made every effort to use data obtained from reliable sources or methodologies, ASCE does not make any representations or warranties as to the accuracy, completeness, reliability, currency, or quality of any data provided herein. Any third-party links provided by this Tool should not be construed as an endorsement, affiliation, relationship, or sponsorship of such third-party content by or from ASCE.

ASCE does not intend, nor should anyone interpret, the results provided by this Tool to replace the sound judgment of a competent professional, having knowledge and experience in the appropriate field(s) of practice, nor to substitute for the standard of care required of such professionals in interpreting and applying the contents of this Tool or the ASCE 7 standard.

In using this Tool, you expressly assume all risks associated with your use. Under no circumstances shall ASCE or its officers, directors, employees, members, affiliates, or agents be liable to you or any other person for any direct, indirect, special, incidental, or consequential damages arising from or related to your use of, or reliance on, the Tool or any information obtained therein. To the fullest extent permitted by law, you agree to release and hold harmless ASCE from any and all liability of any nature arising out of or resulting from any use of data provided by the ASCE 7 Hazard Tool.

Appendix D

Soil Infiltration Data



SOILS AND GEOTECHNICAL CONSULTANTS

PERCOLATION TEST DATA

Client: Acacia Real Estate Group	Tested By: J.S.
Project No.: 23086-22	Date Tested: 4/13/2022
Test Hole: 1	Caving:
Depth of Test Hole: 5'	Notes:
Diameter of Test Hole: 8"	Strata Peculiarities:
Date Excavated: 4/13/2022	

Sandy Soil Criteria Test

TIME	TRIAL NO.	T1	H1	H2	D
8:02	1	4	0.0	60.0	60.0
8:06					
8:06	2	5	0.0	60.0	60.0
8:11					

Soil Criteria

TIME	T1	TE	H1	H2	D
8:1	7	7	0.0	60.0	60.0
8:18					
8:18	8	15	0.0	60.0	60.0
8:26					
8:26	9	24	0.0	60.0	60.0
8:35					
8:35	9	33	0.0	60.0	60.0
8:44					
8:44	10	43	0.0	60.0	60.0
8:54					
8:54	10	53	0.0	60.0	60.0
9:04					
9:04	10	63	0.0	60.0	60.0
9:14					
9:14	10	73	0.0	59.5	59.5
9:24					
9:24	1	74	59.5	60.0	0.5
9:25					

T1 – Time Interval (min)
H2 – Final Water Level (in)

TE – Total Elapsed Time (min)
D – Change in H₂O Level (in)

H1 – Initial Water Level



SOILS AND GEOTECHNICAL CONSULTANTS

PERCOLATION TEST DATA

Client: Acacia Real Estate Group	Tested By: J.S.
Project No.: 23086-22	Date Tested: 4/13/2022
Test Hole: 2	Caving:
Depth of Test Hole: 10'	Notes:
Diameter of Test Hole: 8"	Strata Peculiarities:
Date Excavated: 4/13/2022	

Sandy Soil Criteria Test

TIME	TRIAL NO.	T1	H1	H2	D
9:55	1	29	0.0	120.0	120.0
10:24					
10:24	2	30	0.0	115.0	115.0
10:54					

Soil Criteria

TIME	T1	TE	H1	H2	D
10:54	10	10	0.0	98.0	98.0
11:04					
11:04	10	20	0.0	96.0	96.0
11:14					
11:14	10	30	0.0	97.0	97.0
11:24					
11:24	10	40	0.0	96.0	96.0
11:34					
11:34	10	50	0.0	98.0	98.0
11:44					
11:44	10	60	0.0	98.0	98.0
11:54					
11:54	10	70	0.0	96.0	96.0
12:04					
12:04	10	80	0.0	96.0	96.0
12:14					
12:14	10	90	96.0	117.0	21.0
12:24					
12:24	10	100	117.0	125.0	8.0
12:34					

T1 – Time Interval (min)
H2 – Final Water Level (in)

TE – Total Elapsed Time (min)
D – Change in H₂O Level (in)

H1 – Initial Water Level



SOILS AND GEOTECHNICAL CONSULTANTS

PERCOLATION TEST DATA

Client: Acacia Real Estate Group	Tested By: J.S.
Project No.: 23086-22	Date Tested: 4/13/2022
Test Hole: 3	Caving:
Depth of Test Hole: 15'	Notes:
Diameter of Test Hole: 8"	Strata Peculiarities:
Date Excavated: 4/13/2022	

Sandy Soil Criteria Test

TIME	TRIAL NO.	T1	H1	H2	D
7:20	1	27	0.0	180.0	180.0
7:47					
7:47	2	30	0.0	180.0	180.0
8:17					

Soil Criteria

TIME	T1	TE	H1	H2	D
8:17	10	10	0.0	166.5	166.5
8:27					
8:27	10	20	0.0	162.0	162.0
8:37					
8:37	10	30	0.0	160.5	160.5
8:47					
8:47	10	40	0.0	161.0	161.0
8:57					
8:57	10	50	0.0	160.0	160.0
9:07					
9:07	10	60	0.0	160.0	160.0
9:17					
9:17	10	70	0.0	159.5	159.5
9:27					
9:27	10	80	0.0	159.0	159.0
9:37					
9:37	10	90	159.0	167.0	8.0
9:47					
9:47	10	100	167.0	171.0	4.0
9:57					

T1 – Time Interval (min)
H2 – Final Water Level (in)

TE – Total Elapsed Time (min)
D – Change in H₂O Level (in)

H1 – Initial Water Level

SOIL INFILTRATION RATE CALCS ⇒ PORCHET METHOD

Location:	TH-1	TH-2	TH-3
• Depth of Hole =	5.0'	10.0'	15.0'
• Hole Radius =	4"	4"	4"
• Drop = Δh	60"	29"	12"
• Time = Δt Interval	11 min	20 min	20 min
• Initial Water Depth = H_0	60"	30"	21"
• Final Water Depth = H_t	0	1"	9"
• Average Water Head = H_{avg}	30"	15.5"	15"
• INFILTRATION RATE	20.5 in/hr	9.9 in/hr	4.2 in/hr

$$\text{Infiltration Rate} = \frac{\Delta h (60)(r)}{\Delta t (r + z \cdot H_{avg})}$$

$$\text{Average Water Head} = \frac{1}{2} (H_t + H_0)$$

Attachment G
Hydrologic Conditions of Concern
(HCOOC)

STORMWATER FACILITY MAPPING TOOL

TOC Choose search item from list Enter Value Locate Clear

Clear All Metadata

- Base Maps
 - Topo Map
 - Street Map
 - Aerial Map
- Base Data
- Stormwater Data
 - Drainage Facilities
 - EHM
 - Santa Ana River
 - Non-EHM (low)
 - Non-EHM (medium)
 - Non-EHM (high)
 - Non-EHM (default-high)
 - 2006 - 303d/TMDL
 - Water Storage Facility
 - Interim
 - Ultimate
 - Other
 - Drainage Area Boundaries
 - HCOC Exempt Areas
 - City Storm Drains
 - Ground Water Basins
 - Ground Water Contours
 - Septic
 - Plumes
 - Soils
 - As-Built Plans
 - Hydromod Field Observations
- Habitat/Species

1 Miles

RBF CONSULTING GIS

Identify Features
Click on map to view data.

San Sevaine Channel (Sub Watersheds)

OBJECTID	10
NAME	San Sevaine Channel
SHAPE_Leng	233380.841385
Shape	Polygon
Shape.STArea()	1834630074.24024
Shape.STLength()	233380.841385

PROJECT SITE