

TRANSPORTATION IMPACT ANALYSIS

Downtown Watsonville Specific Plan

PREPARED FOR:
THE CITY OF WATSONVILLE



MARCH 2023 | FINAL REPORT

Prepared By:

Kimley»»Horn



WARNING!

The electronic data files ("Files") furnished by Kimley-Horn and Associates, Inc. to the intended receiver of the Files ("Receiving Party") are provided only for the convenience of Receiving Party and only for its sole use.

In the case of any defects in the Files or any discrepancies between the electronic Files and the hardcopy of the Files prepared by Kimley-Horn, the hardcopy shall govern. Only printed copies of documents conveyed by Kimley-Horn may be relied upon. Any use of the information obtained or derived from these electronic files will be at the Receiving Party's sole risk. Because data stored in electronic media format can deteriorate or be modified inadvertently or otherwise without authorization of the data's creator, the Receiving Party agrees that it has 60 days to perform acceptance tests, after which it shall be deemed to have accepted the data transferred. Receiving Party accepts the Files on an "as is" basis with all faults. There are no express warranties made by Kimley-Horn with respect to the Files, and any implied warranties are excluded.



CONTENTS

| | |
|--|-----|
| Contents | iii |
| Tables | iv |
| Figures | v |
| Appendix | i |
| Executive Summary | i |
| Project land use And Roadway Improvements | i |
| Project Impacts and Deficiencies | ii |
| 1. Introduction | 1 |
| Study Methodology | 1 |
| 2. Existing Conditions | 6 |
| Roadway Network | 6 |
| Study Intersection Lane Configuration and Traffic Control | 8 |
| Peak-Hour Turning Movement Volumes | 8 |
| Bicycle Facilities | 11 |
| Transit Facilities | 13 |
| 3. Project Description | 17 |
| Proposed Growth And Roadway Improvements | 17 |
| 4. California Environmental Quality Act (CEQA) Analysis | 19 |
| VMT Analysis | 19 |
| Transit, Roadway, Bicycle, and Pedestrian Circulation System | 26 |
| 5. Local Transportation Analysis | 28 |
| Existing Conditions Analysis | 28 |
| Existing Plus Project Conditions Analysis | 28 |
| Future Plus Project Conditions analysis | 34 |
| 6. Vehicle Queuing Analysis | 37 |
| Vehicle Queuing | 37 |
| 7. Regional Traffic Patterns and Projects | 40 |
| Appendix | 42 |



TABLES

| | |
|---|----|
| Table 1: Study Intersections..... | 4 |
| Table 2: Intersection Level of Service Definitions..... | 6 |
| Table 3: Existing Transit Service..... | 13 |
| Table 4: DWSP Growth Projections by Land Use..... | 17 |
| Table 5: Proposed Roadway Improvements..... | 18 |
| Table 6: SCC Travel Demand Model Land Use Inputs for Proposed Growth | 19 |
| Table 7: Project Vehicle Miles Traveled (VMT) by Land Use..... | 20 |
| Table 8: Existing and Existing Plus Project Level of Service Summary | 30 |
| Table 9: Existing Plus Project Roundabout V/C Summary | 30 |
| Table 10: Future Plus Project Level of Service Summary..... | 35 |
| Table 11: Future Plus Project Roundabout V/C Summary..... | 35 |
| Table 12 – Summary of Intersection Queuing Deficiencies – Existing Conditions | 38 |
| Table 13 – Summary of Intersection Queuing Deficiencies – Future Plus Project | 38 |
| Table 14 – Summary of Roundabout Queuing Deficiencies – Future Plus Project | 39 |

FIGURES

| | |
|--|----|
| Figure 1: Study Intersections..... | 3 |
| Figure 2: Existing Conditions Lane Geometry and Traffic Control | 9 |
| Figure 3: Existing Conditions Peak Hour Turning Movement Volumes..... | 10 |
| Figure 4: Existing and Proposed Bicycle Facilities | 12 |
| Figure 5: Transit Facilities | 16 |
| Figure 6: Project Vehicle Miles Traveled (VMT) by Land Use - Graph..... | 21 |
| Figure 7: Illustration of the VMT Reducing Effect of Local Serving Retail | 22 |
| Figure 8: Existing Plus Project Conditions Lane Geometry and Traffic Control | 31 |
| Figure 9: Land Use Growth Trip Assignment – Hour Turning Movement Volumes | 32 |
| Figure 10: Existing Plus Project Conditions Peak Hour Turning Movement Volumes | 33 |
| Figure 11: Future Plus Project Peak Hour Turning Movement Volumes..... | 36 |
| Figure 12: Roundabout at the State Route 129 and Lakeview Road | 40 |

APPENDIX

- A – EXISTING TRAFFIC VOLUME DATA SHEETS
- B – EXISTING TRAFFIC CONDITIONS
- C – EXISTING PLUS PROJECT TRAFFIC CONDITIONS
- D – FUTURE PLUS PROJECT TRAFFIC CONDITIONS
- E – QUEUING SUMMARY
- F – SIDRA OUTPUTS

EXECUTIVE SUMMARY

The following transportation impact analysis has been prepared to determine potential Vehicle Miles Traveled (VMT) impacts and/or Level of Service (LOS) deficiencies associated with the Downtown Watsonville Specific Plan (DWSP, “Project”), a mixed-use proposed land use plan with road diet and roadway modifications. The specific plan area generally extends slightly north of Union Street, south to Walker Street, east to Riverside Drive (SR 129) and west to about Freedom Boulevard. The project will include development of multi-story mixed use buildings through both new construction and adaptive reuse of historic buildings. Along with land use development, the project will also include a road diet on Main Street, roadway network changes at Alexander Street, Brennan Street, Union Street, decoupling the one-way couplet of East Beach Street and East Lake Avenue, and a roundabout intersection at Main Street and Freedom Boulevard.

This analysis addresses the Project’s VMT and LOS effects in order to assist the City of Watsonville (“City”) with planning and the identification of conditions of approval, and to mitigate the Project’s VMT impacts or improve identified LOS deficiencies, if necessary.

PROJECT LAND USE AND ROADWAY IMPROVEMENTS

The Project’s projected housing and employment estimates to determine the With Project traffic conditions were developed from plan specific information provided by the City and Raimi + Associates, projected land uses, households, and number of employees for each parcel within the Specific Plan area.

Based on the proposed land use plan, the Project is estimated to develop 3,886 multi-family new residential units and generate a total of 1,416 new jobs (796 restaurants/cafes/bars jobs, 63 retail jobs, 184 R&D jobs, 198 office jobs, 175 industrial jobs) in the project area.

A road diet is proposed along Main Street to reduce the roadway between Freedom Boulevard and Riverside Drive from four lanes to three lanes. Main Street would consist of one lane in each direction with a two-way left-turn lane. A roundabout is also considered as an alternative traffic control at the intersection of Main Street and Freedom Boulevard. The one-way couplet in the westbound direction along East Lake Avenue between Lincoln Street and Rodriguez Street will be converted to a three-lane roadway with one lane in the eastbound direction, one lane in the westbound direction, and a two-way left-turn lane. The one-way couplet in the eastbound direction along East Beach Street between Main Street and Lincoln Street will be converted to a three-lane roadway with one lane in the eastbound direction, one lane in the westbound direction, and a two-way left-turn lane. Class II Bicycle Lanes and traffic calming measures along 5th Street between Rodriguez Street and Brennan Street are proposed. Shared bike lanes and traffic calming measures along Union Street between Front Street and East Beach Street are also proposed. Union Street between Alexander Street and East Beach Street is vacated and Union Street realigned with Alexander Street as a straight roadway.

Since the project includes new mixed-use development as well as significant roadway modifications, traffic forecasts were developed using the Santa Cruz County (SCC) Travel Demand Model in order to account for interactions between the land uses within the specific plan area and travel pattern changes resulted due to the proposed roadway modifications.

PROJECT IMPACTS AND DEFICIENCIES

The following summarizes the transportation impacts, project deficiencies, and intersection deficiencies related to the proposed project and the study area. Transportation impacts are based on vehicle miles traveled and not intersection level of service. Intersection level of service deficiencies under project conditions were also identified and summarized.

VEHICLE MILES TRAVELED (VMT)

Per the City of Watsonville Draft VMT analysis guidelines, the threshold for residential VMT and employment-based VMT is set at 15 percent below the regional average. Note that for the purposes of this analysis, the region is defined as Santa Cruz County. Therefore, if the project VMT were to exceed the 15 percent below the regional average VMT, this would be considered a significant transportation impact.

VMT Impact Analysis and Results

For Existing Plus Project and Future Plus Project scenarios, the residential land uses result in a VMT per Capita below the City's established threshold. The Existing No Project scenario shows VMT per Capita above the City's established threshold, and with the projected residential growth the project area VMT per Capita reduces to below threshold level. Anticipated development in the DWSP area would result in a reduction of VMT per employee (office and industrial), as expected from more infill development. However, the amount of reduction would not reduce VMT below the City's threshold of 15 percent below the regional average VMT. The VMT per Employee (office and industrial) for Existing No Project, Existing Plus Project and Future Plus Project is above the City's established threshold.

VMT Mitigations

Many aspects of the DWSP will result in people driving less or driving shorter distances. In this sense, implementation of the DWSP is self-mitigating with respect to reducing VMT on a per capita and per employee basis. However, given the programmatic level data available for this downtown level plan, a detailed TDM plan typically required for each individual project cannot be developed at this stage. However, the VMT reducing design principles and policies included in the City's VMT policies provides and adequate toolbox of measures to mitigate the VMT impacts.

INTERSECTION LEVEL OF SERVICE

Traffic operations were evaluated at the study intersections under existing, existing plus project and future plus project conditions. The development of the proposed project and resulting traffic generation would result in the following LOS operations deficiencies. It should be noted that few LOS and several queuing deficiencies were identified which are mainly resulting due to the proposed roadway modifications.

Intersection LOS Deficiencies

As shown in **Table E-1**, the intersection of Main Street / Riverside Drive will have an LOS deficiency in the Future Plus Project for both the AM and PM peak hours. Rest of the study intersections function within acceptable LOS standards under the Existing, Existing Plus Project and Future Plus Project scenarios.

Table E-1: Intersection LOS Deficiencies

| # | Intersection | Scenario |
|---|-------------------------------|---|
| 3 | Riverside Drive / Main Street | Future Plus Project Weekday AM Peak Hour (LOS E), Weekday PM peak hour (LOS F) |

This intersection is significantly impacted by regional traffic that originates from outside of Watsonville. It includes traffic from San Benito and Santa Clara counties that is traveling west on State Route 129/Riverside Drive and from Monterey County that is traveling north on Salinas Road/Porter Street/Main Street. This is confirmed in the queuing analysis done in Section 6, which shows long queues in the west and north directions. The number of motorists is expected to increase in the future. There are local and regional projects that will have a positive impact on traffic volumes at this intersection. The City is currently working on a project to convert one of the two northbound through lanes to a left turn lane and lengthen the storage length to 300 feet for the two left turn lanes. The G12: Pajaro to Prunedale Corridor Study published by the Transportation Agency of Monterey County (TAMC) in 2019 proposes improvements along the Porter Street/Salinas Road/County Road G12 that will positively impact the subject intersection. One is to reduce the number of northbound travel lanes from two to one on the portions of Salinas Road and Porter Street that lead to the Pajaro River crossing. Another improves the intersection of Salinas Road, Werner Road and G12 which would encourage motorists using G12 to access State Route 1 via Salinas Road and not Main Street and State Route 129 as is currently done.

Intersection Queuing Deficiencies

Vehicle queuing analysis was conducted at all study intersections for the project scenarios to analyze whether the storage capacity of a roadway segment would be exceeded. This analysis modeled the queuing of vehicles at left-turn and right-turn pockets as well as through lanes to determine whether vehicles might affect an intersection’s operation from extending beyond a street’s available storage and into adjacent through lanes.

Locations where the 95th percentile queues exceed the available storage are summarized in **Table E-2** for Future Plus Project Conditions. As the Future Plus Project Conditions represents the worse-case scenario only the Future Plus Project Queue lengths are reported in this table.

Table E-2: Intersection Queuing Deficiencies

| # | Intersection | Control | Movement | Storage Length (ft) | Peak Hour | 95th Percentile Queue |
|-----|-------------------------------|---------|----------|---------------------|-----------|--|
| | | | | | | Future Plus Project ft (# of Cars Spillover) |
| 1 | Lake Avenue / Main Street | Signal | NBR | 150 | AM | 231 (3) |
| | | | | | PM | 235 (3) |
| | | | SBL | 350 | PM | 458 (4) |
| | | | | | SBR | 100 |
| PM | 188 (4) | | | | | |
| 2 | Beach Street / Main Street | Signal | NBR | 75 | AM | 151 (3) |
| | | | | | PM | 150 (3) |
| | | | SBR | 100 | AM | 180 (3) |
| | | | | | PM | 164 (3) |
| WBT | 260 | AM | 323 (3) | | | |
| | | PM | 196 (2) | | | |
| 3 | Riverside Drive / Main Street | Signal | WBL | 140 | AM | 196 (2) |
| | | | | | PM | 212 (3) |

| # | Intersection | Control | Movement | Storage Length (ft) | Peak Hour | 95th Percentile Queue |
|---|-----------------------------|---------|----------|---------------------|-----------|--|
| | | | | | | Future Plus Project ft (# of Cars Spillover) |
| | | | NBR | 165 | AM | 290 (5) |
| | | | | | PM | 295 (5) |
| | | | WBT | 245 | PM | 882 (25) |
| | | | NBT | 1170 | AM | 1433 (11) |
| | | | | | PM | 1289 (5) |
| | | | SBT | 520 | PM | 718 (8) |
| 5 | Beach Street / Union Street | Signal | EBT | 260 | AM | 329 (3) |
| | | | | | PM | 321 (2) |

As shown in the table, intersections of Main Street and East Lake Avenue, Main Street and West Beach Street and East Beach Street and Union Street show queues exceeding the storage capacity by about 3 cars and therefore might extend into the adjacent intersections of Main Street and 5th Street, Main Street and East Lake Avenue, Beach Street and Rodriguez Street, 2nd Street and Maple Avenue, and Beach Street and Alexander Street.

The closely spaced intersections of East Beach Street and Union Street and East Beach Street and Alexander Street requires a synchronized signal operations system which results in no queuing occurring on the short block along East Beach Street and between these two intersections. In addition, this short block will be reconfigured to consist of two westbound and one eastbound lane. The two westbound lanes will continue to Main Street and provide a dedicated westbound left turn and a shared through-right turn lane at the intersection.

Management of traffic through the corridor will also be extremely important. This can be done through the implementation of an adaptive traffic signal system. An adaptive traffic signal system adjusts signal timing to accommodate changing traffic patterns and ease traffic congestion. It progressively moves vehicles through green lights, creating smoother flow and reducing congestion. The system can use existing traffic signals with minor modifications to the hardware and installation of new signal software.

The intersection of Riverside Drive/State Route 129 and Main Street is built out at its ultimate capacity and adding lanes would mean acquiring private property to widen the road. The existing queuing deficiencies at this intersection are from regional traffic traveling between Highway 1, Highway 129 and Monterey County which is across the Pajaro River. There are several projects in design or under consideration that will affect the regional traffic flowing into this intersection.

1. INTRODUCTION

The following Transportation Impact Analysis has been prepared to determine potential Vehicle Miles Traveled (VMT) impacts and Level of Service (LOS) deficiencies associated with the Downtown Watsonville Specific Plan (DWSP, “Project”). The DWSP provides a comprehensive land use and mobility plan to guide development and public improvements over the next 20-30 years. The DWSP area constitutes about 195.5 acres with about 55.5 acres dedicated to streets and rights-of-way. As shown in **Figure 1**, this area generally extends slightly east of Union Street, west to Walker Street, south to Riverside Drive (SR 129) and north to near Freedom Boulevard. Downtown is centered on Main Street and extends west to the edge of existing neighborhoods and the industrial district, south to Pajaro, and several blocks east to the existing neighborhoods.

The DWSP area is mostly developed with historic commercial buildings and established residential neighborhoods. Hence, future potential growth is likely to be directed to identified opportunity sites, vacant City-owned parcels, and a limited number of vacant or under-utilized sites that could be redeveloped. As discussed in Section 3.4 of the DWSP, this approach allowed the development of growth projections that can cover all anticipated development in the next 25 years but not over-estimate what could be built. In short, anticipated development consists of multi-story, mixed-use buildings through new construction and the adaptive reuse of historic buildings. A detailed breakdown of anticipated growth is provided in Table 4 under the Project Description section.

The downtown roadway network accommodates regional traffic movement and local access. State Route (SR) 152 and SR 129 pass through downtown east to west serving as conduits of regional travel. SR 152 continues as Main Street serving as the north-south spine of the network, distributing traffic beyond the DWSP area throughout the city and connecting to Highway 1. The existing roadway network in downtown is not developed in a uniform grid but features a multitude of varying block lengths, several curvilinear streets, and some one-way streets.

The DWSP includes several key roadway improvements to support multimodal travel, increase safety, and improve access to local amenities and businesses. The future improvements are also designed to reduce potential conflict points between motorists, people who walk, and people who bike. Key improvements would change the existing roadway network and are included in this study for analysis. As further described in Table 5 in the Project Description section, the following roadway network changes have been assumed under Project conditions:

- Implementing a road diet on Main Street,
- Decoupling the one-way couplets at East Beach Street and East Lake Avenue,
- Realigning Union Street near Brennan Street and Alexander Street, and
- Installing a roundabout at Freedom Boulevard and Main Street.

In summary, this Transportation Impact Analysis addresses the Project’s VMT and LOS effects in order to assist the City of Watsonville (“City”) with project planning and to mitigate the Project’s VMT impacts or improve identified LOS deficiencies, if necessary.

STUDY METHODOLOGY

With the passage of SB 743 (Steinberg, 2013), automotive delay, typically measures as “level of service” or LOS, can no longer be used when evaluating transportation impacts under the California Environmental Quality Act (CEQA) for new land use development and transportation infrastructure projects. In accordance

with SB 743, the City has adopted a VMT Policy, which established formally VMT as the appropriate metric for evaluating transportation-related impacts under CEQA, VMT thresholds of significance, screening criteria, Transportation Demand Management (TDM) strategies, and a VMT Mitigation Banking Program (Resolution No. 205-22 CM). This report summarizes VMT as well as the local transportation analysis and resultant findings for the DWSP.

VEHICLE MILES TRAVELED

This analysis includes a determination of whether projected growth for the DWSP area would result in significant transportation-related impacts. The following growth projections by land use serve as the basis for traffic forecasts and associated VMT:

- Residential – 3,886 dwelling units
- Restaurant – 157,785 sq. ft.
- Retail – 57,788 sq. ft.
- Office – 60,798 sq. ft.
- Research and Development (R&D) – 56,524 sq. ft.
- Industrial – 275,084 sq. ft.

For residential, restaurant, office, and industrial land uses, the SCC Travel Demand Model was used as the principal tool to determine VMT. The SCC Travel Demand Model contains a base year of 2019 and future year of 2040, both of which were used to determine the VMT impact of projected residential, restaurant, office and industrial development. Retail land-uses typically are considered local-serving and therefore redistribute shopping trips rather than create new trips. Because of this fact, adding retail opportunities will often shorten the distance people drive to shop and, thereby, reduce VMT. For this reason, a qualitative analysis is included in this study for projected retail development.

The City's adopted VMT thresholds and analysis guidelines were used as the basis of the analysis contained herein. Per the City's VMT analysis guidelines, the threshold for residential and employment-based VMT uses is set at 15 percent below the regional average. For the purposes of this analysis, the region is defined as Santa Cruz County.

As the DWSP strives to create walkable and complete neighborhoods and foster higher-intensity, mixed-use development that provide a mix of retail, services, amenities, employment and housing, implementation of the DWSP should result in lower per capita and per employee miles driven. The DWSP also encourages development near transit to decrease automobile dependency and increase multimodal access to and from the downtown area. In addition, a key component of the mobility framework of the DWSP is to reduce vehicle trips and accommodate future demands through implementing parking and other TDM strategies. TDM strategies aim to reduce single-occupant travel, minimize peak period vehicle trips, and shift trips to transit, biking, walking, or shared rides. By working to reduce single-occupant vehicle trips within the DWSP area, impacts from future development can be reduced. However, if the Project VMT were to exceed the 15 percent below the regional average VMT, this would be considered a significant transportation-related impact under CEQA.

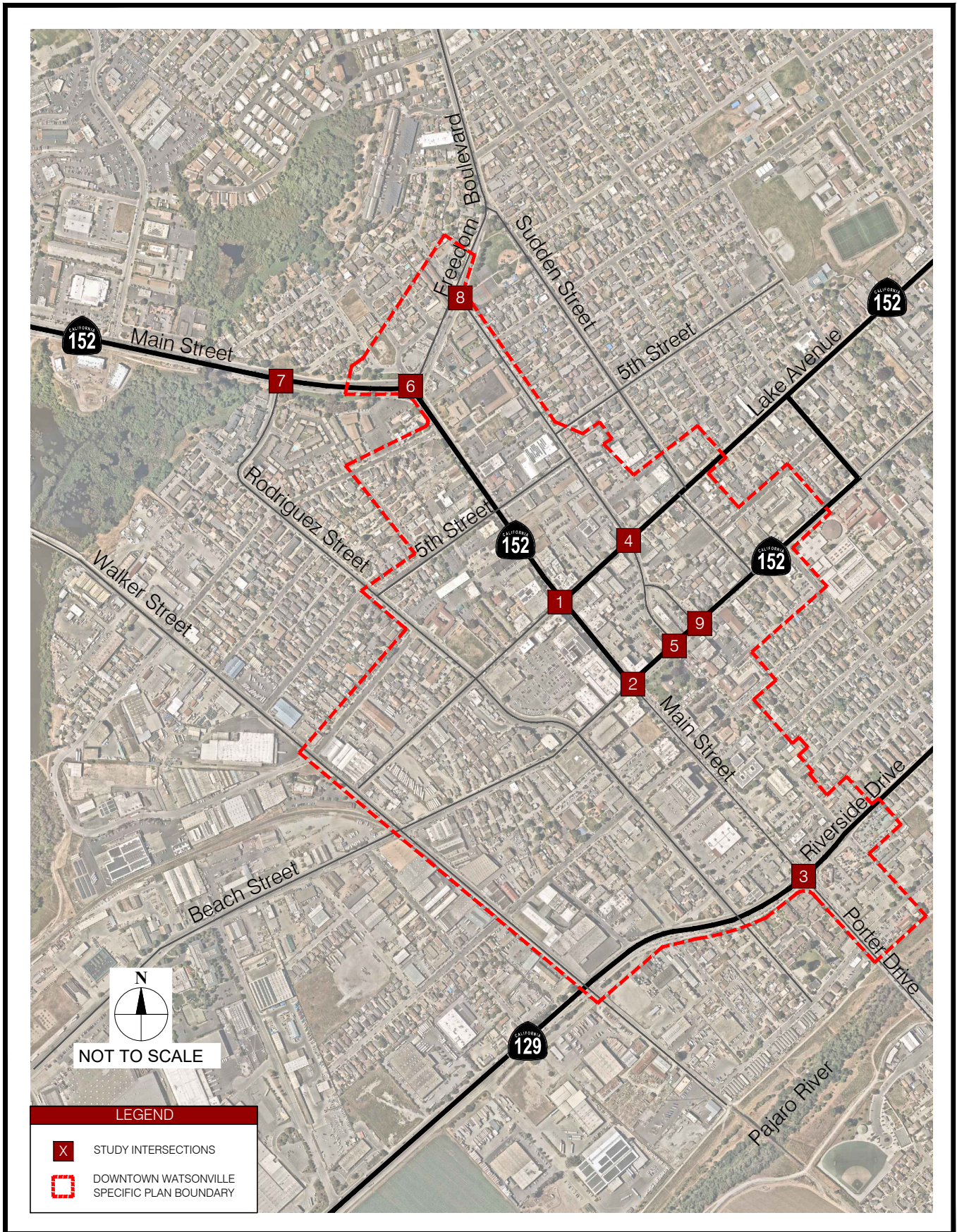

LOCAL TRANSPORTATION ANALYSIS

A supplemental traffic operations analysis was conducted to evaluate the Project’s effect on LOS operations within the study area. Please note that this analysis is not for the purpose of determining transportation-related impacts under CEQA, in accordance with SB 743 and section 15064.3 of the CEQA Guidelines. Rather, it is intended to provide information on existing roadway conditions and determine whether the projected growth and recommended roadway improvements in the DWSP would create significant congestion and/or contribute to existing operational deficiencies, such as at Main Street and Riverside Drive during the PM peak period. In all, nine (9) study intersections were evaluated during weekday AM and PM peak hour conditions and four (4) study intersections were evaluated during Saturday Midday peak hour conditions.

Study Area

The Project would generate new vehicular trips that would increase traffic volumes on downtown’s street network. The proposed roadway improvements would also result in a change in driving behavior and patterns. To assess changes in traffic conditions associated with the proposed Project, including diverting existing vehicle trips as a result of the proposed “road diet” and other improvements, the intersections in **Table 1** were evaluated. **Figure 1** illustrates the location of each intersection relative to the DWSP area.

Table 1: Study Intersections

| # | Intersection | Existing Control | Analysis Period |
|---|---|---|--------------------------------------|
| 1 | Main Street (SR 152) / East Lake Avenue | Signal | Weekday AM and PM Saturday Midday |
| 2 | Main Street (SR 152) / East Beach Street | Signal | Weekday AM and PM Saturday Midday |
| 3 | Main Street / Riverside Drive (SR 129) | Signal | Weekday AM and PM Saturday Midday |
| 4 | East Lake Avenue / Union Street | Signal | Weekday AM and PM |
| 5 | East Beach Street / Union Street | Signal | Weekday AM and PM |
| 6 | Main Street (State Route 152) / Freedom Boulevard | Signal (Future Roundabout) | Weekday AM and PM Saturday Midday |
| 7 | Rodriguez Street / Main Street | Signal | Weekday AM and PM |
| 8 | Freedom Boulevard / Brennan Street | Signal | Weekday AM and PM |
| 9 | East Beach Street / Alexander Street | Side-Street Stop-Control (Future Signal) | Weekday AM and PM |

Analysis Scenarios

Three (3) scenarios were analyzed as part of the supplemental traffic operations analysis, listed below:

- Existing conditions – Based on traffic counts collected in October 2018 and May 2022 and existing lane geometry and traffic control.
- Existing plus project traffic conditions – Based on Existing conditions plus the traffic generated by the Project. This scenario assumes the roadway improvements to be constructed by the project including the road diet, one-way couplet elimination, roadway realignment, and roundabout implementation. Any redistribution of existing volumes as a result of these roadway improvements are assumed under this scenario.
- Future plus project traffic conditions – Based on Future conditions plus the traffic generated by the Project. Future conditions are based on traffic forecasts in the SCC Travel Demand Model for the

future year of 2040. This scenario assumes the roadway improvements to be constructed by the project including the road diet, one-way couplet elimination, roadway realignment, and roundabout implementation. Any redistribution of existing volumes as a result of these roadway improvements are assumed under this scenario.

Intersection Level of Service

The LOS of an intersection is a qualitative measure of vehicular roadway congestion used to describe operational conditions in terms of delay. LOS ranges from A (best), which represents minimal delay, to F (worst), which represents heavy delay and a facility that is operating at or near its functional capacity. Levels of service for signalized and unsignalized intersections were determined using methods defined in the latest *Highway Capacity Manual, 6th Edition* (HCM 6th) within the *Synchro 11* traffic analysis software. However, due to the lane configurations and signal timing phasing at Intersection #6 under Existing Conditions and Intersections #5 and #9 under Existing Plus Project Conditions, and subsequent software limitations HCM 6th was not capable of analyzing these intersections and therefore was analyzed using the previous HCM 2000 methodology instead. HCM 6th methodology does not support signal phasing for the combination of shared and exclusive lanes as in the case for Intersection #6, as well as it does not support synchronized intersections with one signal control as in the case of proposed signal control for Intersections #5 and #9. Intersection LOS under Future Plus Project Conditions were analyzed using the SimTraffic simulation software within Synchro to analyze the effects of upstream and downstream intersections. SimTraffic simulations were conducted for 12 runs and results are based on an average of all runs. As the project involves installation of a roundabout at Intersection#6, level of service for the new roundabout at this location was determined using the *SIDRA 9* software. The HCM includes procedures for analyzing side-street stop-controlled (SSSC), all-way stop-controlled (AWSC), and signalized intersections. The SSSC procedure defines LOS as the highest delay of each minor street movement or major street left turns. Conversely, the AWSC and signalized intersection procedures define LOS as a function of average control delay for the entire intersection. **Table 2** relates the operational characteristics associated with each LOS category for signalized and unsignalized intersections.

According to Watsonville General Plan 2005 policies, the City shall maintain a minimum LOS D on signalized intersections on arterial and collector streets serving the City. Caltrans' Guide for the Preparation of Traffic Impact Studies no longer establishes a threshold for facility LOS. However, Caltrans will work with local agencies to determine an acceptable LOS standard on a case-by-case basis when the study roadway or intersection facility is constrained, and the LOS D objective is infeasible; therefore, deficiencies were considered project deficiencies if the addition of project traffic causes an intersection to:

- Operate at LOS E or F overall for a signalized or AWSC intersection or the worst-case movement for a SSSC intersection, or
- Adds five seconds of delay to an intersection already operating at LOS E or F under the comparable No Project scenario.

As suggested in *National Cooperative Highway Research Program (NCHRP) Report 672, Roundabouts: An Informational Guide*, an approximate threshold for satisfactory operation of the roundabout is the volume-to-capacity (V/C) ratios in the range of 0.85 to 0.90. It should be noted that this threshold is not defined in the HCM but it is a standard that is suggested based on international and domestic experience. Where an operational analysis finds the volume-to-capacity ratio above 0.85, it is encouraged to conduct additional sensitivity analysis to evaluate whether relatively small increments of additional volume have dramatic impacts on delay or queues. Therefore, for the purpose of this study a standard of $V/C > 0.85$ was used for the roundabout analysis.

Table 2: Intersection Level of Service Definitions

| Level of Service | Description | Signalized (Avg. control delay per vehicle sec/veh.) | Unsignalized (Avg. control delay per vehicle sec/veh.) |
|------------------|---|--|--|
| A | Free flow with no delays. Users are virtually unaffected by others in the traffic stream | ≤ 10 | ≤ 10 |
| B | Stable traffic. Traffic flows smoothly with few delays. | > 10 – 20 | > 10 – 15 |
| C | Stable flow but the operation of individual users becomes affected by other vehicles. Modest delays. | > 20 – 35 | > 15 – 25 |
| D | Approaching unstable flow. Operation of individual users becomes significantly affected by other vehicles. Delays may be more than one cycle during peak hours. | > 35 – 55 | > 25 – 35 |
| E | Unstable flow with operating conditions at or near the capacity level. Long delays and vehicle queuing. | > 55 – 80 | > 35 – 50 |
| F | Forced or breakdown flow that causes reduced capacity. Stop and go traffic conditions. Excessive long delays and vehicle queuing. | > 80 | > 50 |

Sources: Transportation Research Board, Highway Capacity Manual 2016, National Research Council, 2016.

2. EXISTING CONDITIONS

This chapter describes the existing conditions of the roadway network, traffic volumes, transit service, pedestrian facilities, and bicycle facilities within the DWSP area and its vicinity.

ROADWAY NETWORK

Roadways within the DWSP area include major arterials, minor arterials, collectors, and local streets. See Figure 4-2 in the DWSP for a map showing roadway designations in the area. This section provides a description of the specific roadways included in this study.

MAJOR ARTERIALS

Main Street (SR 152) is a north-south major arterial that runs through the center of downtown Watsonville providing access to commercial and restaurant uses as well as connections to the minor arterials and collectors located to the west of east of Main Street. The roadway connects to Highway 1 to the northeast and transitions to Porter Drive to the south at San Juan Road. As shown in **Figure 1**, most of Main Street through downtown Watsonville is part of the state highway system as SR 152. Main Street is a four-lane roadway with two lanes in each direction north of East Beach Street and a five-lane roadway with two lanes in each direction and a two-way left-turn lane south of East Beach Street. On-street parking is allowed on various portions of the roadway. The posted speed limit for Main Street through downtown is 25 miles per hour.

Freedom Boulevard is an east-west major arterial that provides access to residential land uses to the north of downtown Watsonville. The roadway extends north of the City of Watsonville and connects to Highway 1 in the unincorporated town of Aptos Hills-Larkin Valley. Within the study area, Freedom Boulevard is one lane in each direction with a two-way left-turn lane. The posted speed limit is 25 miles per hour within the study area.

Lake Avenue is an east-west major arterial east of Main Street and a minor arterial west of Main Street. West Lake Avenue connects to Walker Street to the west and transitions into Hecker Pass Road to the north at Carlton Road. The roadway provides access to retail, residential, and school uses within the study area. Lake Avenue has two lanes in each direction with the exception of the segment between Rodriguez Street and Lincoln Street which is two lanes in the westbound direction (eastbound travel is not allowed). The posted speed limit is 25 miles per hour within the study area.

Beach Street is an east-west major arterial providing access to industrial and residential uses within the study area. The roadway connects to Palm Beach State Park to the west and Hushbeck Avenue to the east. Beach Street has four lanes west of Harvest Drive and two lanes east of Harvest Drive. Between Main Street and Lincoln Street, East Beach Street is two lanes in the eastbound direction. The posted speed limit on West Beach Street from Walker Street to Hushbeck Avenue is 25 mph.

Riverside Drive (SR 129) is an east-west major arterial providing access to industrial, commercial, and residential uses within the study area. Riverside Drive is part of the state highway system as SR 129 and spans from Highway 1 to the west and Highway 101 to the east. Riverside Drive is a four-lane roadway east of the Highway 1 northbound ramp intersection and two-lane roadway west of the Highway 1 southbound ramp intersection. Within the urbanized portion of Watsonville between Sakata Lane and Blackburn Street, the posted speed limit is 25 mph.

MINOR ARTERIALS

Union Street is a north-south minor arterial providing access to residential uses, commercial uses and public building uses including the Watsonville Police Department. Union Street is one lane in each direction and spans from Front Street to the south and transitions into Brennan Street to the north at East Lake Avenue. Brennan Street then terminates at Gonzales Street just north of Freedom Boulevard. While there is no posted speed limit on Union Street, it is a prima facie 25 miles per hour based on California Vehicle Code 22352(b)(1).

Rodriguez Street is a north-south minor arterial providing access to residential uses to the north and commercial as well as building uses to the south including United States Postal Service, and the Superior Court of California County of Santa Cruz. The roadway connects to Front Street to the south and Main Street to the north. Within the study area, Rodriguez Street has a posted speed limit of 25 mph and is one lane in each direction, except between West Beach Street and West Lake Avenue where there are two lanes in each direction.

COLLECTORS

Brennan Street is a north-south collector providing access to residential uses to the east and commercial uses to the west. The roadway connects to Gonzales Street to the north and transitions into Union Street to the south. Within the study area, Brennan Street is one lane in each direction with a posted speed limit of 25 mph.

LOCAL STREETS

5th Street is a discontinuous east-west local street providing access to mainly residential land uses with some commercial uses near Main Street. 5th Street is a two-lane roadway that connects to Walker Street to the west and extends just past Brewington Avenue to the east. There is no posted speed limit within the study area but is assumed to be 25 mph due to the adjacent residential land uses.

STUDY INTERSECTION LANE CONFIGURATION AND TRAFFIC CONTROL

The existing intersection lane configuration and traffic controls, as of September 2022, are illustrated in **Figure 2**.

PEAK-HOUR TURNING MOVEMENT VOLUMES

Weekday intersection turning movement volumes for eight (8) study intersections were collected on Thursday, May 19, 2022 between 7:00 AM – 7:00 PM to capture the AM and PM peak periods. Since weekday AM and PM peak period volumes were not collected at Intersection #3 (Riverside Drive and Main Street), historical volumes collected in October 2018 were used for the analysis. In addition, weekend intersection turning movement volumes for four (4) study intersections were collected on Saturday July 23, 2022 during the AM peak period between 7:00 AM – 9:00 AM, the midday peak period between 11:00 AM – 1:00 PM, and the PM peak period between 4:00 PM – 6:00 PM. Traffic volumes were collected outside of holiday breaks and when local schools were in session. Intersection volume data sheets are provided in **Appendix A**.

To determine whether 2022 counts collected were impacted by COVID-19, the 2022 counts were compared to historical counts from January 2018 at certain intersections where historical data was available. In general, the May 2022 volumes were comparable to the January 2018 volumes and therefore, May 2022 volumes were used without any adjustments to account for COVID-19. Existing (2022) peak hour turning movement volumes are shown in **Figure 3**.

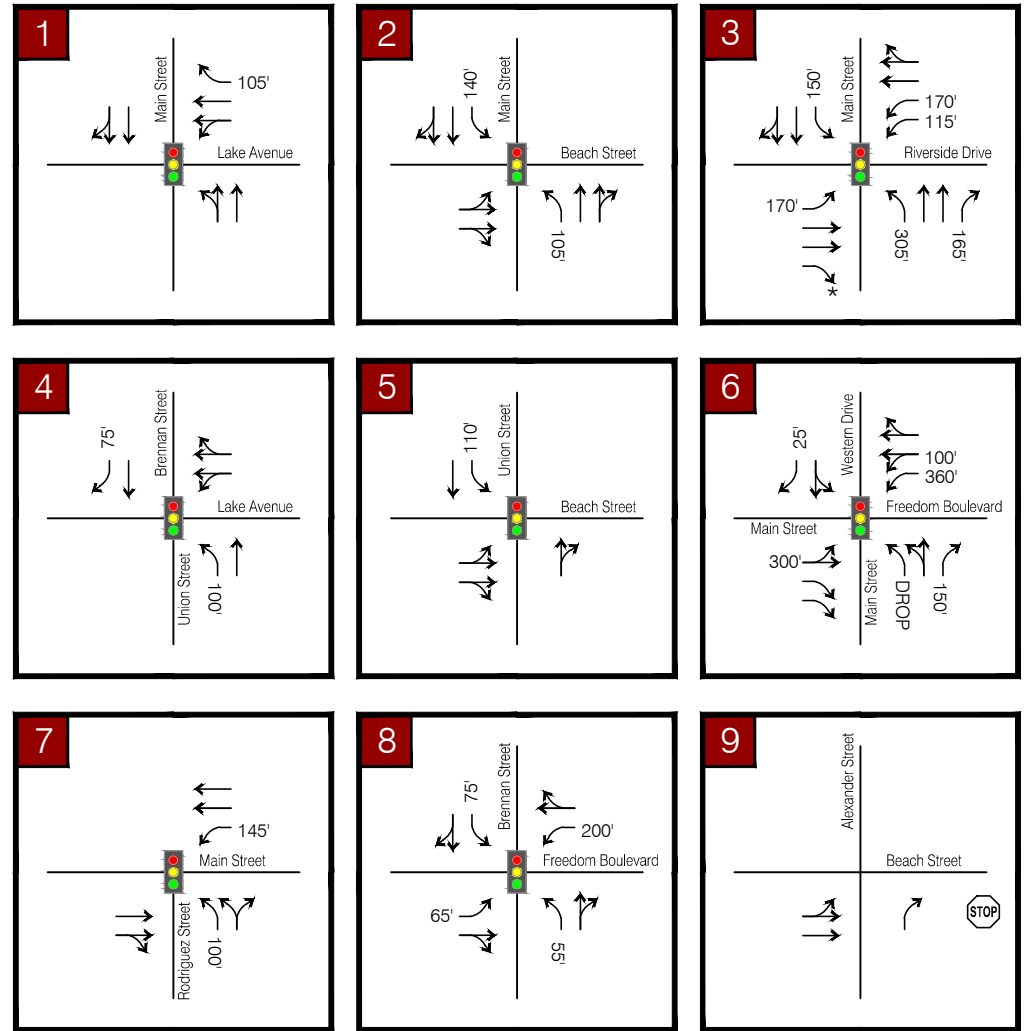
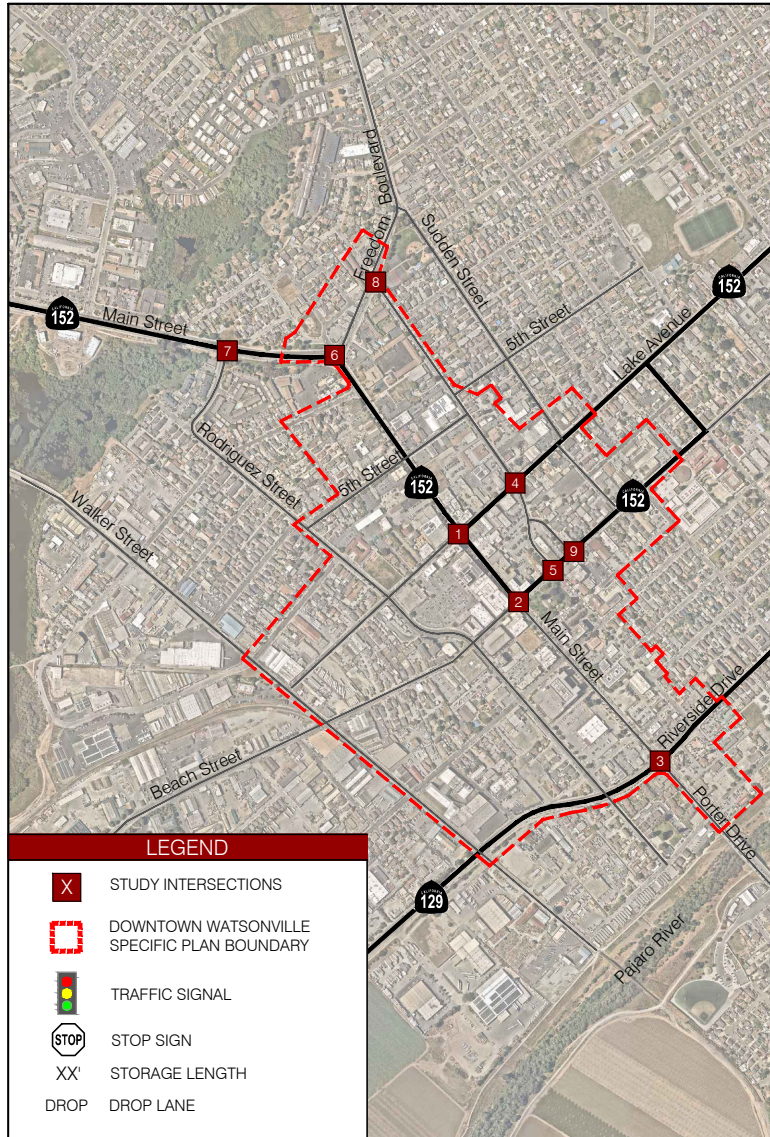

* STRIPED AS A SHARED THROUGH/RIGHT TURN LANE, ANALYZED AS A SEPARATE DE FACTOR RIGHT TURN LANE

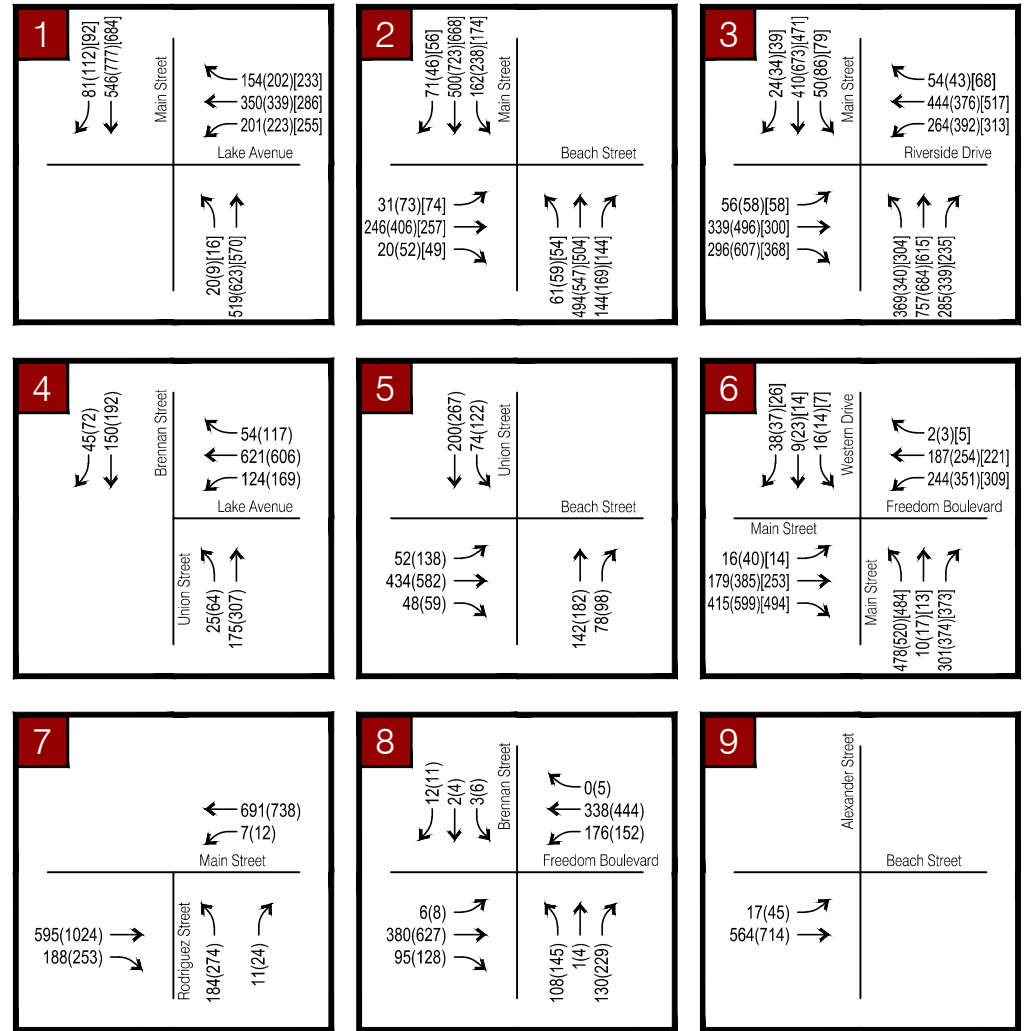
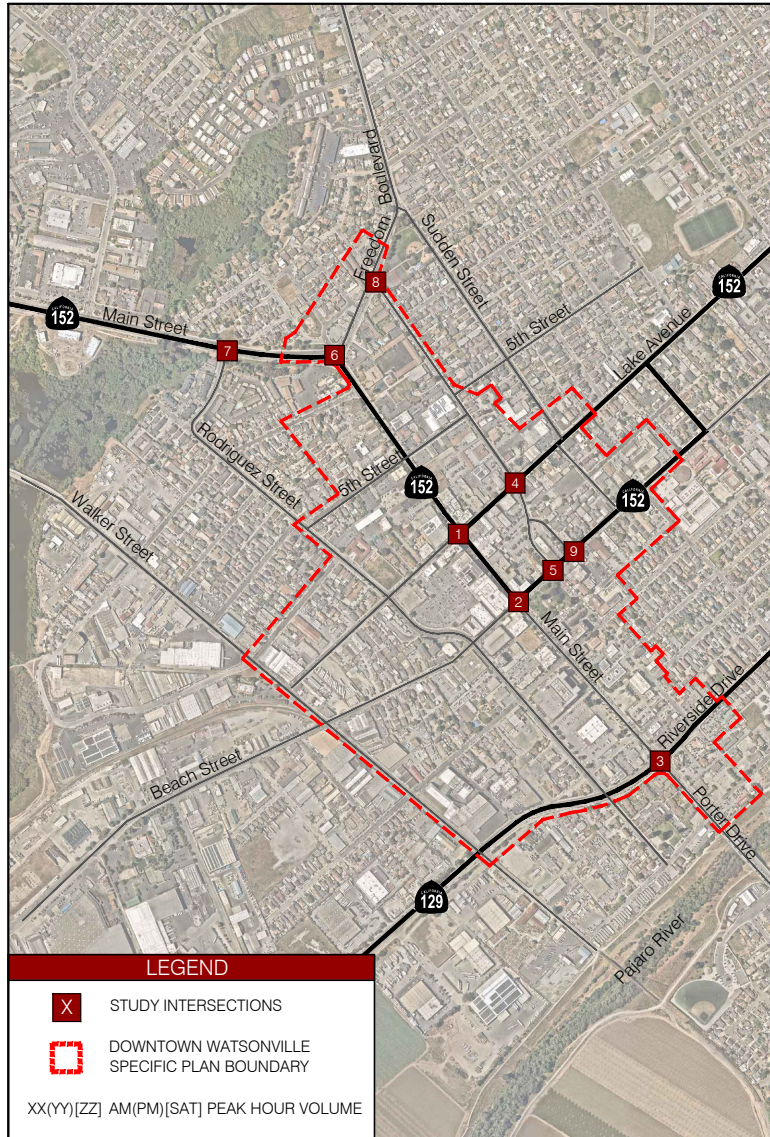

BICYCLE FACILITIES

Figure 4 illustrates existing and proposed bicycle facilities in the study area. Class I bicycle facilities are bike paths/trails, Class II bicycle facilities are defined as bike lanes, Class III bicycle facilities are bike routes, and Class IV bicycle facilities are separated bikeways or cycle tracks.

Within the project study area and its vicinity, there are Class I, II, and III bicycle facilities along the following corridors:

- Class I bike paths:
 - Main Street from Pennsylvania Drive to Freedom Boulevard (outside the study area)
- Class II bike lanes:
 - W Beach Street from Highway 1 to Walker Street (outside the study area)
 - Walker Street from Harkins Slough Road to Riverside Drive
 - Rodriguez Street from Main Street to Riverside Drive
 - Freedom Boulevard from Main Street to High Street
- Class III bike routes:
 - Main Street from Freedom Boulevard to Riverside Drive (removed as part of the Project)
 - W Beach Street from Walker Street to Lincoln Street (removed as part of the Project)
 - Riverside Drive from Walker Street to Bronte Avenue (removed as part of the Project)
 - Lincoln Street from Riverside Drive to Freedom Boulevard (outside the study area)

The DWSP includes several future bicycle facilities. The new bicycle facilities include Class I, II and II bike lanes along the following corridors:

- Class I bike paths:
 - Along Rodriguez Street from West Front Street to the Levee Trail
 - At Pajaro River Park, from East Front Street to the Levee Trail
 - Monterey Bay Sanctuary Scenic Trail, along rail line to Walker Street
- Class II bike lanes:
 - Walker Street from West Riverside Drive to the Pajaro River.
 - 5th Street between Rodriguez Street and Brennan Street.
 - Improved wider bicycle lanes, with an enhanced buffer between adjacent vehicular travel lanes and the bicycle lane, on Rodriguez Street between West Lake Avenue and West Beach Street.
- Class III bike routes:
 - Marchant Street between East Beach Street and the Levee Trail.
 - Sudden Street between Freedom Boulevard and East Beach Street.
 - Brennan Street/Union Street between Freedom Boulevard and the Levee Trail.
 - Ford Street between Walker Street and Main Street.
 - West 5th Street between Walker Street and Rodriguez Street.
 - 2nd Street/Maple Avenue between Walker Street to Lincoln Street.
 - East Front Street between Main Street and Marchant Street.

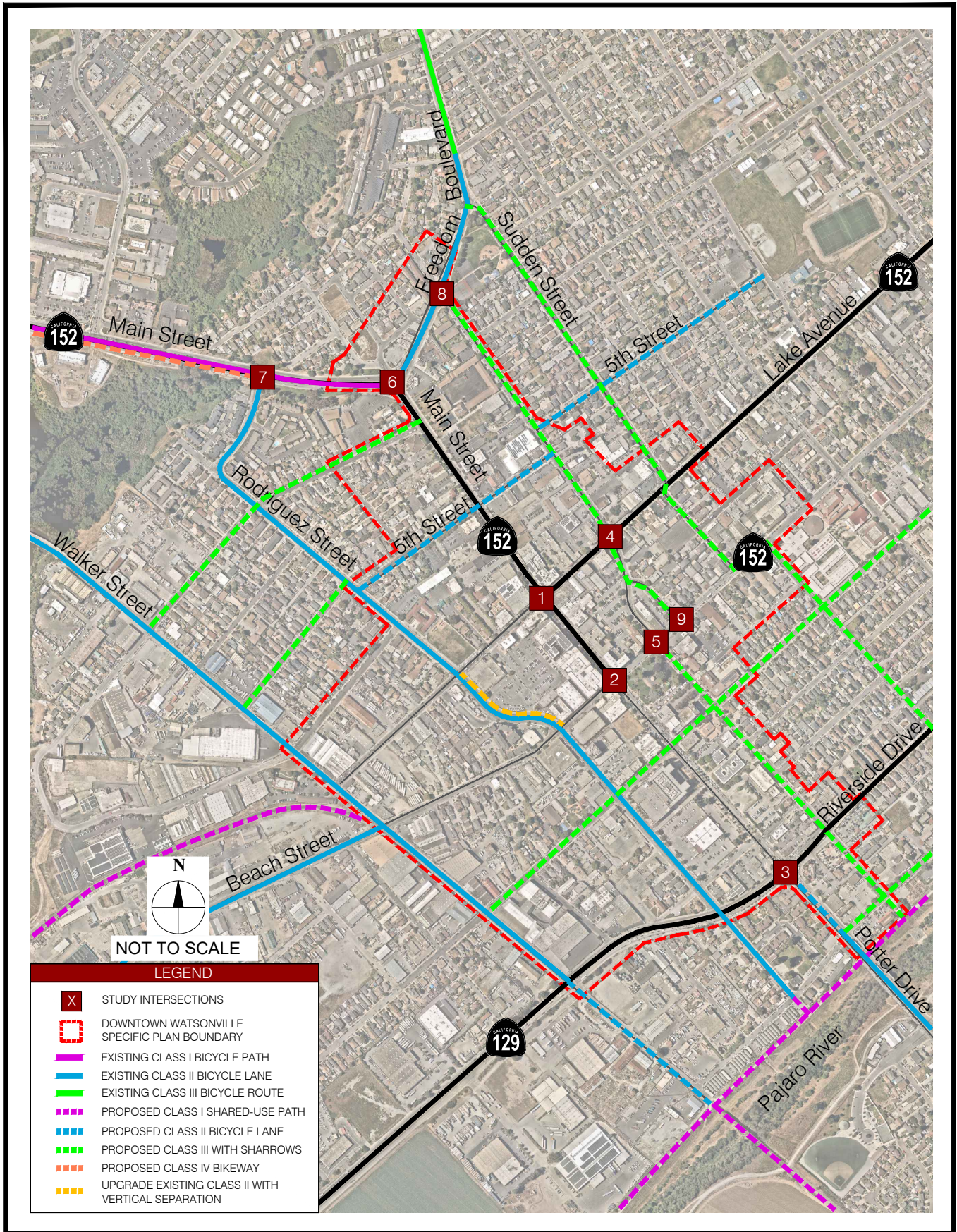

TRANSIT FACILITIES

Santa Cruz Metro provides transit services in the study area. In addition, the Monterey-Salinas Transit operates bus lines between Salinas and Watsonville. **Figure 5** illustrates the existing transit services within the study area and are described in this section. **Table 3** provides a summary of the existing transit service in the study area followed by detailed description of each route. It should be noted that these routes are not considered as high-quality transit service. High-quality transit areas are considered for screening for non-significant VMT impacts, which includes transit services with fixed service intervals no longer than 15 minutes during peak commute hours. Combined transit service is not considered as high-quality transit.

Santa Cruz County Regional Transportation Commission (SCCRTC) is moving forward with plans for reactivating the rail line for passenger rail service. The SCCRTC has recently initiated the preliminary engineering and environmental documentation (PAED) phase for the proposed Santa Cruz Branch Line (SCBRL) Electric Passenger Rail Transit & Trail Project between Pajaro Junction and Santa Cruz.

Table 3: Existing Transit Service

| Route | Description | Weekdays | | Weekends | |
|---------------------------------------|------------------------------------|--|--------------------------------|--------------------|--------------------------------|
| | | Operating Hours | Headway ¹ (minutes) | Operating Hours | Headway ¹ (minutes) |
| Santa Cruz METRO | | | | | |
| 69W | Capitola/Cabrillo | 6:37 AM – 10:28 PM | 60 | 7:50 AM – 7:40 PM | 60 |
| 69A | Capitola/Airport | 6:20 AM – 6:56 PM | 60 | 8:07 AM – 7:52 PM | 60 |
| 71 | Soquel/Freedom | 5:40 AM – 12:40 AM | 30 | 5:58 AM – 12:40 AM | 30-60 |
| 91X | Cabrillo Express | 5:55 AM – 5:22 PM | 60-120 | - | - |
| 72 | Green Valley - Hospital | 6:45 AM – 6:40 PM | 60 | - | - |
| 72W | Green Valley- Corralitos | - | - | 9:25 AM – 6:27 PM | 120 |
| 74S | PVHS/Hospital | 7:00 AM – 8:02 AM 3:05 PM – 4:00 PM | - | - | - |
| 75 | Green Valley - Wheelock | 5:15 AM – 7:15 PM | 60 | 6:05 AM – 6:45 PM | 70 |
| 79 | East Lake/Crestview | 7:25 AM – 6:00 PM | 60 | 8:30 AM – 5:14 PM | 120 |
| WC | Watsonville Circular | 8:44 AM – 4:17 PM | 60 | 8:44 AM – 4:14 PM | 60 |
| Monterey-Salinas Transit (MST) | | | | | |
| 27 | Watsonville – Marina | 6:53 AM – 7:48 PM | 60 | - | - |
| 28 | Watsonville – Salinas ² | 6:45 AM – 7:30 PM | 120 | 6:45 AM – 7:30 PM | 120 |
| 29 | Watsonville – Salinas ³ | 5:45 AM – 6:50 PM | 120 | 7:34 AM – 8:00 PM | 120 |

Notes:

¹ Headways are defined as the time between transit vehicles on the same route.

² Via Castroville

³ Via Prunedale

Route 69W (Capitola/Cabrillo) operates between the Santa Cruz Metro Center to the Watsonville Transit Center. Route 69W operates on weekdays between 6:37 AM and 10:28 PM on 60-minute headways and on weekends between 7:50 AM and 7:40 PM on 60-minute headways. The route runs along Main Street and Rodriguez Street. Bus stops are located at the intersection of Rodriguez Street and Main Street and at the Watsonville Transit Center.

Route 69A (Capitola/Airport) operates between the Santa Cruz Metro Center to the Watsonville Transit Center. Route 69A operates on weekdays between 6:20 AM – 6:56 PM on 60-minute headways and on

weekends between 8:07 AM – 7:52 PM on 60- minute headways. The route runs along Lake Avenue, Beach Street, Rodriguez Street, Lincoln Street, and Freedom Boulevard with various bus stops located along its route.

Route 71 (Soquel/Freedom) operates between Santa Cruz Metro Center to the Watsonville Transit Center. Route 71 operates on weekdays between 5:40 AM and 12:40 AM of the next day on 30-minutes headways, and on weekends between 5:58 AM and 12:40 AM of the next day on 30- to 60-minute headways. The route runs along Freedom Boulevard, Main Street, 5th Street, Rodriguez Street, and Lake Avenue in Watsonville. Bus stops are located along Main Street at Lake Avenue, 5th Street, and Ford Street and at the Watsonville Transit Center.

Route 91X (Cabrillo Express) operates between Santa Cruz Metro Center to the Watsonville Transit Center. On weekdays, Route 91X operates between 5:55 AM and 5:22 PM on 60- to 120-minute headways. There is no weekend service. The route runs along Main Street and Rodriguez Street in Watsonville. Bus stops are located at the intersection of Rodriguez Street and Main Street and at the Watsonville Transit Center.

Route 72 (Green Valley - Hospital) operates on a loop to and from the Watsonville Transit Center. This route services the Watsonville Community Hospital. On weekdays, Route 72 operates between 6:45 AM and 6:40 PM on 60-minute headways. There is no weekend service. The route runs along Main Street and Rodriguez Street in Watsonville. Bus stops are located along Rodriguez Street at Main Street, Ford Street, 5th Street, and Kearney Street and at the Watsonville Transit Center.

Route 72W (Green Valley- Corralitos) operates between the intersection of Browns Valley Road and Corralitos Road to the Watsonville Transit Center. There is no weekday service. On weekends, Route 72W operates between 9:25 AM and 6:27 PM on 120-minute headways. The route runs along Main Street and Rodriguez Street in Watsonville. Bus stops are located along Rodriguez Street at Main Street, Ford Street, 5th Street, and Kearney Street and at the Watsonville Transit Center.

Route 74S (PVHS/Hospital) operates on a loop to and from the Watsonville Transit Center. This route services Pajaro High School and the Watsonville Community Hospital. On weekdays, Route 74S operates twice, one loop from 7:00 AM to 8:02 AM and one loop from 3:05 PM to 3:00 PM. The route runs along Main Street and Rodriguez Street in Watsonville. Bus stops are located along Rodriguez Street at Main Street, Ford Street, 5th Street, and Kearney Street and at the Watsonville Transit Center.

Route 75 (Green Valley - Wheelock) operates between the Watsonville Transit Center and Wheelock and Monte Vista Schools. On weekdays, Route 75 operates between 5:15 AM and 7:15 PM on 60-minute headways. On weekends, the route operates between 6:05 AM to 6:45 PM on 70-minute headways. The route runs along Main Street, 5th Street, Rodriguez Street, and Lake Avenue. Bus stops are located along Main Street at Ford Street, 5th Street, and Lake Avenue and at the Watsonville Transit Center.

Route 79 (East Lake/Crestview) operates on a loop to and from the Watsonville Transit Center. This route services Watsonville High School, East Lake Shopping Center, and Crestview Center. On weekdays, Route 79 operates between 7:25 AM and 6:00 PM on 60-minute headways. On weekends, the route operates between 8:30 AM and 5:15 PM on 120-minute headways. The route runs along Freedom Boulevard, Main Street, Lake Avenue, Beach Street, and Rodriguez Street. Bus stops are located along Main Street at 5th Street and Lake Avenue and at the Watsonville Transit Center.

Route WC (Watsonville Circular) connects the downtown transit center with primary retail and medical destinations in Watsonville. This route operates in a counterclockwise loop from Watsonville Transit Center, serving Freedom Boulevard and Lincoln Street, Freedom Centre, Green Valley Road, and Main Street. On weekdays, the route operates between 8:44 AM and 4:17 PM on 60-minute headways. On weekends, the route operates between 8:44 AM and 4:14 PM on 60-minute headways.

Route 27 (Watsonville - Marina) is a north-south route connecting Downtown Watsonville to Moss Landing, Castroville, and Marina. Key destinations include the Marina Transit Exchange, the Moro Cojo neighborhood, and the Watsonville Transit Center. Route 27 travels north on Del Monte Avenue from the Marina Transit Exchange onto State Route 1 where it continues north towards the Watsonville Transit Center. Outbound weekday service to Watsonville runs from 6:53 a.m. to 7:48 p.m. with 60-minute headways while inbound weekday service to Marina operates from 5:50 a.m. to 6:44 p.m. with 120-minute headways.

Route 28 (Watsonville – Salinas via Castroville) provides connections between Watsonville and Moss Landing, Castroville, Prunedale, and Salinas. Major destinations include the Salinas Amtrak/Greyhound Station, the Salinas Transit Center, the Watsonville Transit Center and several park and ride sites along State Route 1. Route 28 travels northwest on W Market Street from the Salinas Transit Center to Highway 183, then continues north on State Route 1 towards the Watsonville Transit Center. Select trips detour to Prunedale via Highway 156. Weekday service operates between 6:45 a.m. to 7:30 p.m. with 120-minute headways while weekend service operates between 6:45 a.m. to 7:30 p.m. with 120-minute headways.

Route 29 (Watsonville – Salinas via Prunedale) connects downtown Watsonville to Las Lomas, Prunedale, and Salinas. Key destinations include the Salinas Transit Center, Northridge Mall in Salinas, the Prunetree Center, and the Watsonville Transit Center. Route 29 provides limited local service along N Main Street and Prunedale Road before continuing north on San Miguel Canyon Road and Salinas Road towards the Watsonville Transit Center. Service operates between 5:45 a.m. to 6:50 p.m. on weekdays with 120-minute headways and between 7:34 a.m. to 8:00 p.m. on weekends with 120-minute headways.

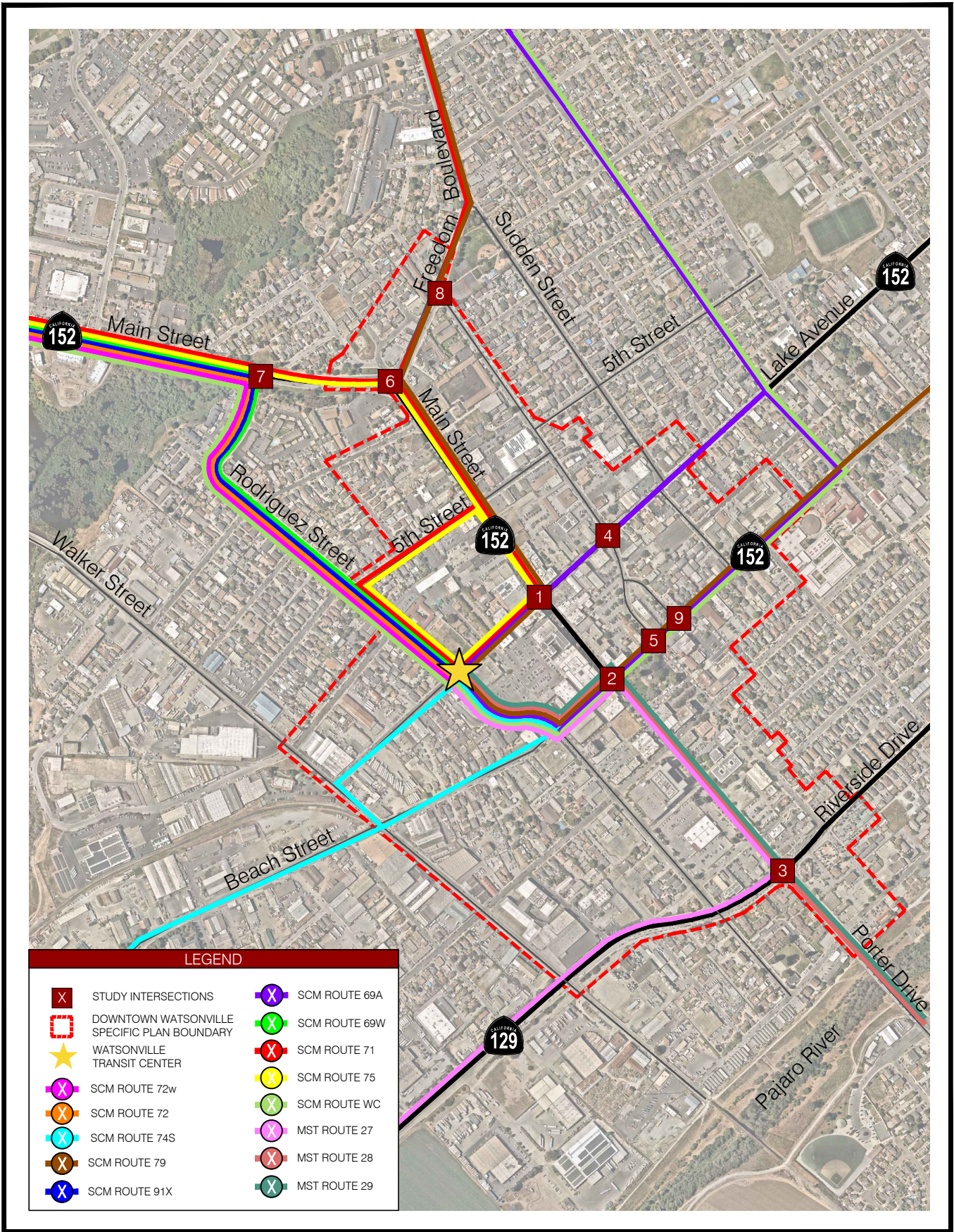

3. PROJECT DESCRIPTION

This chapter presents a description of anticipated growth and recommended roadway improvement in the DWSP.

PROPOSED GROWTH AND ROADWAY IMPROVEMENTS

The DWSP growth projections are intended to cover all anticipated development in the next 25 years. **Table 4** provides a detailed breakdown of anticipated development by land use. As shown in this table, the projected growth in the DWSP area consists of 3,886 residential units, 157,785 square feet of restaurants, 57,788 square feet of retail, 56,524 square feet of R&D, 60,798 square feet of office, 114,572 square feet of civic use, and 275,084 square feet of industrial use. For non-residential uses, the equivalent in employment jobs as a result of the projected land development is 796 restaurant jobs, 63 retail jobs, 184 R&D jobs, 198 office jobs, and 175 industrial jobs. As the DWSP includes plans for redeveloping the Old City Hall building and consolidating City essential services—Police and Fire—at the Fire station site on Rodriguez Street, existing City employees would have new homes downtown. Therefore, the number of Civic jobs remain the same and have been redistributed to future sites.

Table 4: DWSP Growth Projections by Land Use

| Proposed Use | Type | Size (Square Feet) | Total | Size (Jobs) | Total |
|--------------------------|--|--|-------------------|---|-------------------|
| Residential | Residential | 3,886 DU | 3,886 DU | 3,886 DU | 3,886 DU |
| Restaurants, Cafes, Bars | Commercial Industrial | 150,248 SF 7,537 SF | 157,785 SF | 758 jobs 38 jobs | 796 jobs |
| Retail | Commercial | 57,788 SF | 57,788 SF | 63 jobs | 63 jobs |
| R&D | Industrial | 56,524 SF | 56,524 SF | 184 jobs | 184 jobs |
| Office | Commercial Industrial | 23,115 SF 37,683 SF | 60,798 SF | 75 jobs 123 jobs | 198 jobs |
| Civic | Civic | 114,572 SF | 114,572 SF | N/A ¹ | N/A ¹ |
| Industrial | Industrial | 275,084 SF | 275,084 SF | 175 jobs | 175 jobs |
| Total | Residential Commercial Industrial Civic | 3,886 DU 231,151 SF 376,827 SF 114,572 SF | 722,550 SF | 3,886 DU 896 jobs 520 jobs – | 1,416 jobs |

¹ Civic jobs remain the same and are redistributed within the DWSP boundary. Therefore, no growth is shown for the Civic land use.

As discussed in the Introduction, the DWSP includes several key recommended roadway improvements, which are further described in detail in **Table 5**:

Table 5: Proposed Roadway Improvements

| Roadway | Proposed Improvement |
|---------------------------|--|
| Main Street | A road diet is proposed along Main Street to reduce the roadway between Freedom Boulevard and Riverside Drive from four lanes to three lanes. Main Street would consist of one lane in each direction with a two-way left-turn lane. A roundabout is also considered as an alternative traffic control at the intersection of Main Street and Freedom Boulevard (Intersection #6). |
| East and West Lake Avenue | The one-way couplet in the westbound direction along Lake Avenue between Lincoln Street and Rodriguez Street will be converted to a three-way roadway with one lane in the eastbound direction, one lane in the westbound direction, and a two-way left-turn lane. |
| East Beach Street | The one-way couplet in the eastbound direction along Beach Street between Main Street and Lincoln Street will be converted to a three-lane roadway with one lane in the eastbound direction, one lane in the westbound direction, and a two-way left-turn lane. |
| 5 th Street | Proposed shared bike lanes and traffic calming measures along 5th Street between Harkins Sough Road and Brennan Street |
| Union Street | Proposed shared bike lanes and traffic calming measures along Union Street between Front Street and Beach Street. Remove Union Street between Alexander Street and Beach Street and to realign Union Street with Alexander Street as a straight roadway |

4. CALIFORNIA ENVIRONMENTAL QUALITY ACT (CEQA) ANALYSIS

This chapter presents an analysis of the project impacts under CEQA as it relates to VMT and facilities for alternative modes of transportation including pedestrian, bicycle, and transit facilities.

VMT ANALYSIS

The VMT analysis was conducted based on the City's adopted VMT Policy. In accordance with the City's SB 743 implementation guidelines for analyzing VMT for CEQA compliance, the SCC Travel Demand Model was used to determine the Project's VMT impacts.

In order to evaluate the Specific Plan's VMT, the zoning for the Specific Plan needed to be first entered in the SCC Travel Demand Model. This dataset relied on land use growth projections developed as part of the Specific Plan update.

To determine the amount of VMT associated with the projected land use growth, first the number of households and jobs for the Project needed to be determined. While the SCC Travel Demand Model uses dwelling units as its input, there is no differentiation between single-family and multi-family residential in terms of trip generation and distribution. Therefore, the trip generation and travel characteristics are not sensitive to the type of residential units. The SCC Travel Demand Model also only represents non-residential land uses as number of jobs. Therefore, the projected non-residential growth was converted into number of jobs from building square feet using the rates from ITE Trip Generation Manual 11th Edition. Note that the growth between the model base year (2019) and future year (2040) was replaced by the growth projected as part of the DWSP. The land use totals for the projected Specific Plan input into the model are summarized in **Table 6** below.

Table 6: SCC Travel Demand Model Land Use Inputs for Proposed Growth

| Land Use Type | Household | Non-residential Development (Square Feet) | Adjustment Factor (ITE Rates) | Employment |
|--------------------------|--------------|---|-------------------------------|--------------|
| Multi-Family Residential | 3,886 | - | - | - |
| Restaurant | - | 157,785 | 5.04 | 776 |
| Retail | - | 57,788 | 1.44 | 83 |
| Office | - | 117,32 | 3.26 | 382 |
| Industrial | - | 275,084 | 1.00 | 175 |
| Total | 3,886 | 607,978 | | 1,416 |

The VMT for the residential land uses was computed by combining the production VMT for all Home-Based trip purposes. VMT for non-residential land uses was computed from the attraction Home-Based Work VMT. The external VMT for residential land uses was determined by multiplying the calibrated external trip distance by TAZ determined using big data (Teralytics) by the total internal-external (I-X) Home-Based trips for that TAZ. The external VMT for non-residential land uses was determined by multiplying the calibrated external trip distance by TAZ determined previously by the total internal-external (I-X) Home-Based Work trips for that TAZ.

To determine the share of the non-residential VMT for the office and industrial land uses, the total number of trips attracted to each TAZ were calculated by multiplying the model's underlying trip generation rate for

the Home-Based Work trip purpose by employment type. The office land use share of the total VMT was then calculated by dividing the number of trips generated from office employment by the total number of Home-Based Work Trips calculated using the trip generation rates. The VMT for the office land uses was calculated by multiplying the office land use share by the total Home-Based Work VMT (including External VMT). Similarly, the VMT for the industrial land uses was calculated by multiplying the industrial land use share by the total Home-Based Work VMT (including External VMT).

Residential VMT per Capita, and office/industrial VMT per Employee, for each TAZ were computed by dividing the residential and office/industrial VMT by TAZ by the total population or total office/industrial employees, respectively. A VMT per Capita and VMT per Employee weighted average was calculated for the TAZs comprising proposed Specific Plan based on population and employment, respectively.

Table 7 summarizes the VMT per Capita and VMT per Employee for the proposed Specific Plan by scenario. As shown in **Table 7**, For Existing Plus Project and Future Plus Project scenarios, the residential land uses result in a VMT per Capita below the City’s established threshold. Note that the Existing No Project scenario shows VMT per Capita above the City’s established threshold, and with the projected residential growth the project area VMT per Capita reduces to below threshold level. The results are also illustrated in **Figure 6**. As shown in **Figure 6**, anticipated development in the DWSP area would result in a reduction of VMT per employee (office and industrial), as expected from more infill development. However, the amount of reduction would not reduce VMT below the City’s threshold of 15 percent below the regional average VMT. As shown in Table 7, the VMT per Employee (office and industrial) for Existing No Project, Existing Plus Project and Future Plus Project is above the this threshold.

Table 7: Project Vehicle Miles Traveled (VMT) by Land Use

| Scenario | VMT Per Capita (Residential) | VMT Per Employee (Office) | VMT Per Employee (Industrial) |
|---|------------------------------|---------------------------|-------------------------------|
| Project VMT per Capita or VMT per Employee by Scenario | | | |
| Threshold | 8.9 | 7.4 | 11.0 |
| 2019 Existing (No Project) | 9.4 | 9.6 | 14.2 |
| 2019 Existing Plus Project | 7.9 | 9.0 | 13.5 |
| 2040 Existing Plus Project | 7.4 | 8.5 | 12.8 |
| Over Threshold? | | | |
| 2019 Existing (No Project) | Yes | Yes | Yes |
| 2019 Existing Plus Project | No | Yes | Yes |
| 2040 Existing Plus Project | No | Yes | Yes |

Note: Project VMT represents weighted average VMT of Downtown Watsonville Specific Plan TAZs

Figure 6: Project Vehicle Miles Traveled (VMT) by Land Use - Graph

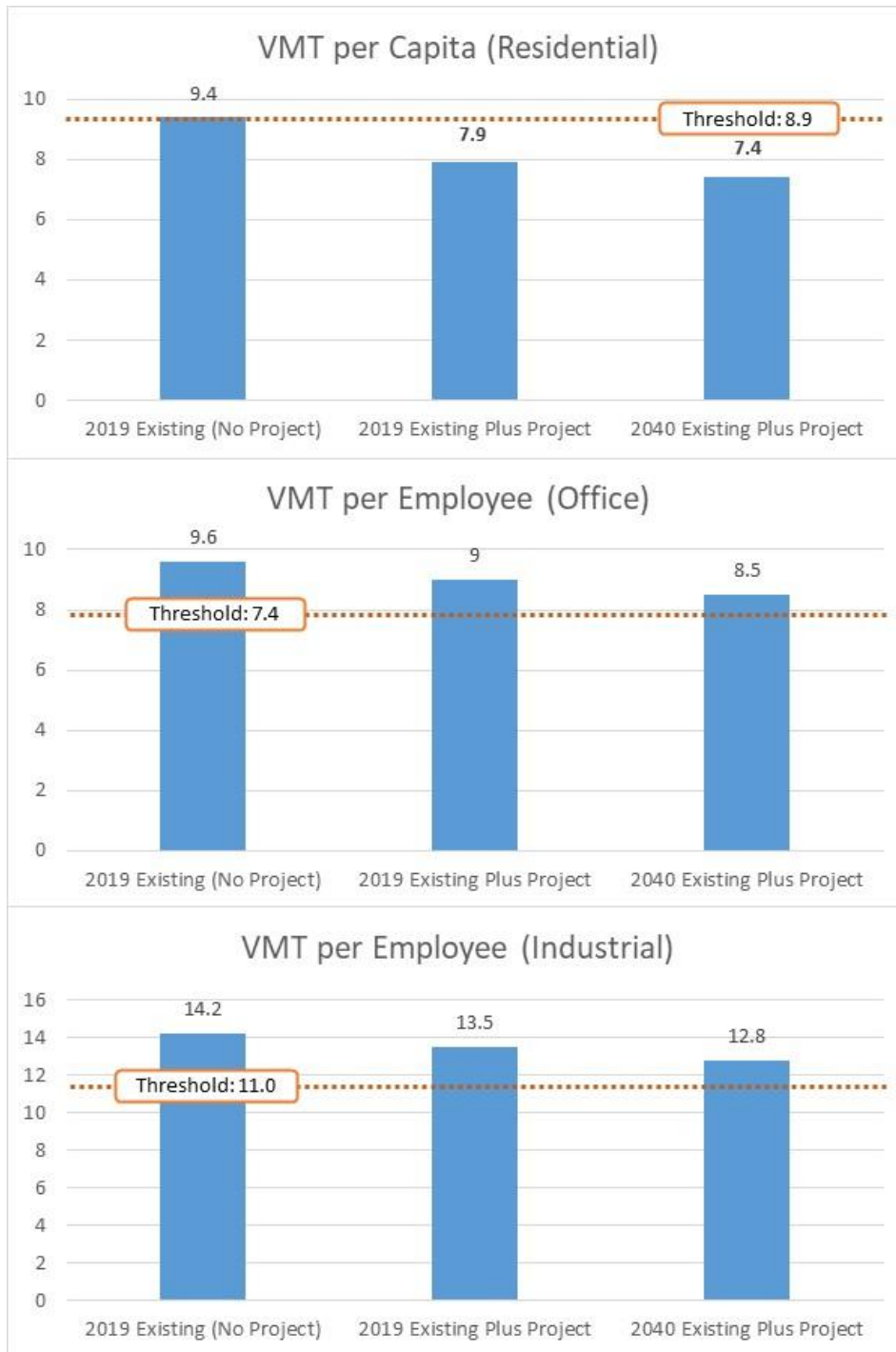

As previously noted, the retail land uses were analyzed qualitatively. The City of Watsonville SB 743 Implementation Guidelines specifically addresses some of the key issues surrounding how a local serving retail store should be evaluated in terms of its VMT impact. As described, the threshold for significance is “a net increase.” This means that if a proposed retail use results in additional VMT, it would result in a finding of significance.

Local serving retail primarily serves pre-existing shopping needs in the community (i.e., they do not generate new trips because they meet existing demand). Because of this, local-serving retail uses can be presumed to reduce trip lengths when a new store is proposed. Essentially, the assumption is that someone will travel to a newly constructed local serving store, such as a coffee shop, restaurant, clothing store, or other type of commercial business because it is nearby. Proximity is the main factor, rather than a proposed retail store fulfilling an unmet need (i.e., the person has an existing need that was met by the retail located further away and is now traveling to the new retail use because it is closer to the person's origin location). This results in a trip on the roadway network becoming shorter, rather than a new trip being added to the roadway network, which would result in an impact to the overall transportation system. Conversely, residential and office land uses often drive new trips given that they introduce new participants to the transportation system. The City of Watsonville SB 743 Implementation Guidelines provides for a general threshold of 50,000 square-feet as an indicator as to whether a retail store can be considered local serving or not. Based on the understanding that no single store within the estimated 875,000 square feet of retail uses will exceed 50,000 square feet, it is presumed that the proposed retail uses will not result in a net increase in VMT and would therefore not result in a significant impact. Retail stores exceeding 50,000 square feet are generally categorized as big-box retail shops which are not envisioned for the proposed downtown specific plan.

Figure 7 has been provided to visually demonstrate the basis of this finding. Note that the numbers provided are for illustrative purposes as the analysis technique used is qualitative.

Figure 7: Illustration of the VMT Reducing Effect of Local Serving Retail

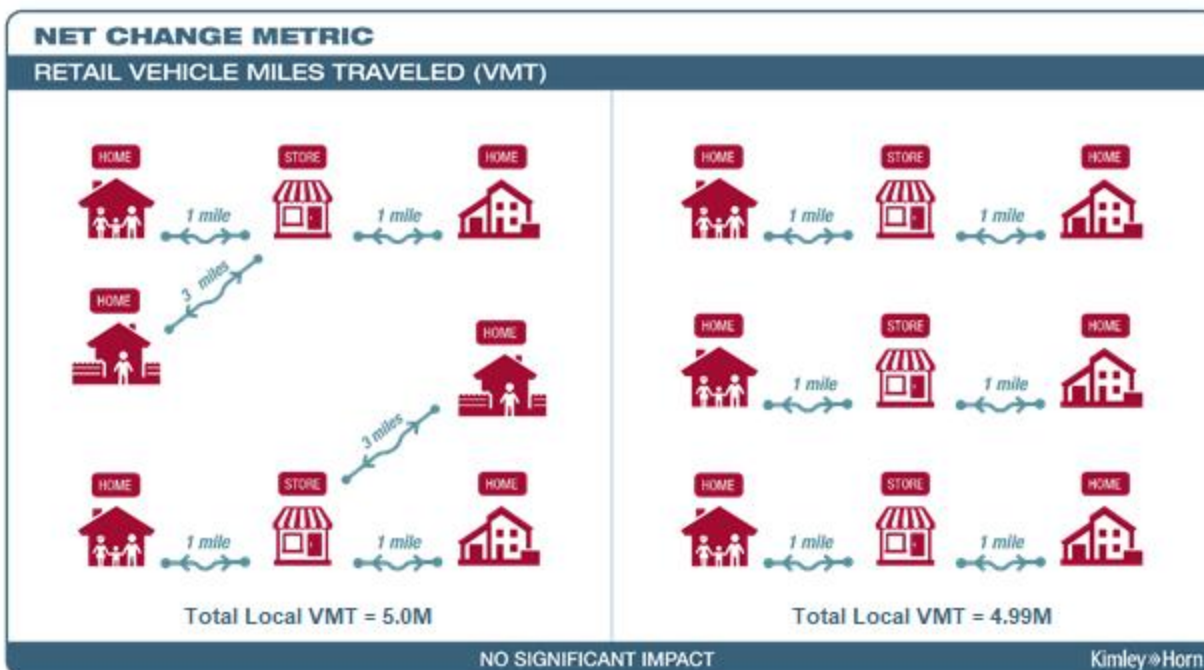

Regional serving retail is not considered for the proposed downtown specific plan, as mentioned above.

Summary of VMT Findings

Based on the results of this analysis, the following findings are made:

- The residential land uses do not exceed the threshold of significance for the Project scenarios. **The project is determined to not have a significant transportation impact for residential development.**
- The office and industrial land uses do exceed the threshold for the Existing Plus Project scenario and the Future Plus Project scenario. As a result, **the project is determined for office and industrial land uses to have a significant transportation impact.**
- The proposed project's retail stores are assumed to be smaller than 50,000 square feet per store, per the City of Watsonville SB 743 Implementation Guidelines, **they are presumed to not have a significant impact.**

VMT Reducing Design Principles, Policies, and Improvements

The DWSP does not involve individual development projects and therefore is evaluated at a programmatic level. Given that the DWSP is not evaluated on a project level, the effect of specific design principles, policies, and improvements that will reduce VMT cannot be accounted for fully as part of this analysis. However, these approaches are still important considerations in evaluating the results of this VMT analysis and as appropriate they should be accounted for in subsequent VMT evaluations of future individual development projects within the DWSP area.

VMT Reducing Design Principles

Certain design elements of a project may reduce VMT. The following elements of the DWSP are considered VMT reducing yet difficult to evaluate at a programmatic level:

- Compact development near transit
- A walkable environment with a mix of uses
- A range of housing options
- A variety of transportation options
- Preservation of open space

Mixed-Use Specific Principles

Mixed-use development combines two or more types of land uses into a building or set of buildings that are physically or functionally integrated. Mixed-use, as planned for downtown Watsonville, seeks to promote smart growth principles that can result in less driving than compared with suburb and other forms of urban development patterns and includes the following:

- Diversity and appropriate mix of uses
- Pedestrian orientation
- Community focal point
- Excellence in design
- Coordination of development strategies
- Sustainability

The DWSP includes a mix of land use types (e.g., retail, restaurants, industrial, residential, etc.) within and near to Watsonville's historic downtown. This is intended to help foster favorable conditions for creating an active, vibrant pedestrian-oriented environment. The SCC Travel Demand Model does not, however, have the functionality to analyze many of the design principles. In addition, as development will occur over time, the exact nature, location, and timing of VMT reducing considerations cannot be known at present. The additional effect of these design features will need to be evaluated at the individual project-level—rather than at the programmatic level. However, it should be noted that consideration of the project features will have a noticeable impact on analyzing development projects, but the impact will vary on the location and design features selected. Project features may include addition of live/work units, designated pickup zone for carpooling and vanpooling programs, secured bike storage etc.

Transportation Demand Management Measures

VMT mitigation often relies heavily on TDM measures. These measures generally represent two basic approaches: policy and infrastructure. The California Air Pollution Control Officers Association (CAPCOA) guide for Quantifying Greenhouse Gas Mitigation Measures, recently updated in December 2021, is one of

the primary bases for estimating mitigation effects in California. Although this resource is invaluable, care needs to be taken in terms of its application given that some TDMs have limited sample sizes and many of the measures are based on experiences in highly urbanized areas. Depending on the selected TDMs, it can also be challenging from the standpoint of mitigation monitoring and are often unpopular with project applicants because they may need to be managed and paid for in perpetuity. These limitations have led jurisdictions to increasingly consider programmatic approaches to VMT mitigation.

As part of the City's adopted VMT Policy are a range of TDM measures which were selected for their appropriateness for Watsonville's setting and include reasonable maximums for their expected VMT reductions. Future project level analyses for individual development projects will rely on the City's TDM options.

Although many of the TDM measures may be appropriate to individual project implementation, many of the identified TDMs may be better suited to a programmatic approach where they are implemented across the entire DWSP area. VMT reductions from these TDM measures will be evaluated based on methodology from the most recent version of the CAPCOA guidelines¹. The following TDMs (included in the City's VMT policy) have been identified as the potential basis for a programmatic approach to TDM implementation within the DWSP area:

Each individual project will have to provide a TDM plan and monitoring program. This plan will identify the TDM reductions. The monitoring program will establish goals and policies to ensure the efficient implementation of the TDM plan.

- Reduce parking supply (TDM measure #27)
- Transit stops (TDM measure #1)
- Mandatory travel behavior change program (TDM measure #5)
- Promotions and marketing (TDM measure #6)
- Emergency Ride Home (ERH) program (TDM measure #11)
- Bike share (TDM measure #12)
- Implement on-street and on-site pedestrian facilities (TDM measure #24)
- Implement/Improve on-street and on-site bicycle facilities (TDM measure #19)
- Traffic calming improvements (TDM measure #23)

Multimodal Improvements

In terms of transit, the Watsonville Transit Center provides transit service within and beyond the DWSP area. The DWSP includes a number of recommendations for improving the transit network and access to transit, including by working with local agencies to expand the speed and frequencies of fixed-route bus service and by connecting pedestrian and bicycle improvements to bus stops and requiring new developments near transit to improve stop amenities (e.g., real-time information, enhanced lighting, upgraded shelters). It is reasonable to assume that at a minimum 4% VMT reduction will result from these transit improvements in the DWSP area. It is likely that higher transit use may occur given that additional capacities are not planned for SR 152 and SR 129 in the future.

¹ Handbook for Analyzing Greenhouse Gas Emission Reductions, Assessing Climate Vulnerabilities, and Advancing Health and Equity, December 2021

Participation in a VMT Bank

Programmatic approaches that rely on collectively funding larger infrastructure projects hold great promise for VMT mitigation as they allow a project to obtain an amount of mitigation commensurate with their impact, include only a single payment without the complexity of ongoing management, and do not require on-going mitigation monitoring. Programmatic approaches can also provide a public benefit in terms of funding transportation improvements that would not otherwise be constructed, resulting in improvements to congestion, GHG emissions, increased transportation choices, and additional opportunities for active transportation.

Under a VMT Banking framework, unfunded projects that would reduce VMT if constructed, such as new trail and other active transportation projects, are grouped together and their associated VMT reductions are monetized in the form of credits. These credits are then purchased for the purposes of mitigating VMT in excess of determined impact thresholds. The underlying projects may be either regionally or locally beneficial to the area in which the project is located. The City has an established VMT Banking program as part of its recently adopted VMT Policy; however, it is early in its development and implementation so the impact on VMT mitigation of such a program is still being determined. The purpose of a VMT Bank is to provide another option for development projects to mitigate VMT impacts to a less than significant level that might otherwise not have the ability to reduce VMT using TDM and other onsite measures.

VMT Mitigation

Many aspects of the DWSP will result in people driving less or driving shorter distances. In this sense, implementation of the DWSP is self-mitigating with respects to reducing VMT on a per capita and per employee basis. However, given the programmatic level data that is available for this downtown level plan, a detailed TDM plan typically required for each individual project cannot be developed at this stage. However, the VMT reducing design principles and policies included in the City's VMT policies provides an adequate tool box of measures to mitigate the VMT impacts.

TRANSIT, ROADWAY, BICYCLE, AND PEDESTRIAN CIRCULATION SYSTEM

The following describes the project's potential impact on transit, roadway, bicycle, and pedestrian circulation as it relates to City programs, plans, ordinances, or policies.

Transit Access and Circulation

The Watsonville Transit Center, located on the corner of Rodriguez Street and West Lake Avenue, provides inter- and intra-city transit connections for the DWSP area. The Transit Center is served by Santa Cruz METRO's fixed-route and paratransit services, in addition to a limited number of Monterey-Salinas Transit fixed-route and Greyhound bus services. The Project would not result in a disruption of existing transit; rather, it would likely result in residents utilizing nearby transit facilities and thereby increase ridership. In addition, transit is expected to be improved in the future by expanding the speed and frequency of fixed-bus routes and enhancing access from connecting pedestrian and bicycle improvements to bus stops, encouraging new developments near transit, and improving amenities at bus stops. The DWSP includes specific goals (Goal #12) and General Plan Policies (Policy #10.F) related to transit that calls for leveraging and supporting existing transit service to help realize downtown's potential to become a multi-modal mixed-use district.

Therefore, the Project would not conflict with the City's adopted plans and policies as it relates to transit facilities.

Bicycle Access and Circulation

Class I bicycle facility currently exist on Main St, Class II bicycle facility currently exist on Rodriguez Street, Walker Street and Freedom Boulevard. These facilities are proposed to expand as part of the project as well as additional bicycle facilities are proposed on Brennan Street, Union Street, Sudden Street, Marchant Street, and Maple Avenue. The project is not proposing any features that would disrupt the existing and future bicycle facilities adjacent and near the project site. The DWSP includes specific goals (Goal #10) and General Plan Policies (Policy #10.5) that calls for providing convenient access and circulation for all modes of transportation and enhancing the walkability and bikeability in downtown.

Therefore, the project would not conflict with the City's adopted plans and policies as it relates to bicycle facilities.

Pedestrian Access and Circulation

There are currently sidewalks along most of the roadways within the Specific Plan area. The DWSP identifies opportunities to expand the pedestrian realm with parklets and curb extensions, and to increase the permeability of the Downtown street network with paseos. The project is recommending pedestrian network improvements to address the need for safer, more visible crossings on high-speed, high-volume arterial streets and comfortable off-street facilities that provide alternative access routes to local amenities. Underutilized alleyways and spaces between buildings are recommended to be repurposed to create a paseo network, which will provide pedestrians alternative paths to travel around Downtown. Upgrades at major intersections such as Main Street and East Lake Avenue may include curb extensions, crosswalk visibility enhancements, and leading pedestrian intervals are recommended. The future pedestrian facilities improvements are not expected to conflict with the existing or planned pedestrian facilities. The DWSP includes specific goals (Goal #10) and General Plan Policies (Policy #10.7) that calls for improving pedestrian facilities to improve safe and efficient pedestrian circulation in downtown.

Therefore, the project would not conflict with the City's adopted plans and policies as it relates to pedestrian facilities.

5. LOCAL TRANSPORTATION ANALYSIS

This chapter discusses the local transportation analysis to determine the operational effects of the proposed project on the transportation system, including LOS and vehicle queuing analyses.

EXISTING CONDITIONS ANALYSIS

Existing conditions analysis is based on traffic counts shown in **Figure 3** as well as existing roadway geometry, and traffic controls, shown in **Figure 2**, as of September 2022. **Table 8** displays the intersection LOS analysis results under Existing Conditions. All study intersections function within acceptable LOS standards under this analysis scenario.

Intersection LOS calculation worksheets are provided in **Appendix B**.

EXISTING PLUS PROJECT CONDITIONS ANALYSIS

LANE GEOMETRY AND CONTROL

Existing Plus Project conditions lane geometry and traffic control is illustrated in **Figure 8**. The figure depicts the change in geometry and traffic control as a result of the roadway improvements which include implementing a road diet on Main Street, decoupling the one-way couplet at Beach Street and Lake Avenue, realigning Union Street near Brennan Street and Alexander Street, and installing a roundabout at Freedom Boulevard and Main Street. It should be noted that a roundabout is being considered as an alternative traffic control at Intersection #6 (Main Street / Freedom Boulevard). Therefore, both a roundabout and signal control are included in the figure and were analyzed under plus project conditions. The roundabout alternative was analyzed considering two alternatives at the intersection of Main Street / Ford Street, one with a traffic signal as existing and one with right-in/right-out movement only at Ford Street approach.

TRAFFIC VOLUMES

Existing Plus Project volumes were determined using a two-step approach to account for anticipated growth and the proposed roadway network modifications. The first step was to enter the proposed roadway network modifications into the SCC Travel Demand Model and determine the shift in travel pattern as a result of the change in the roadway network. As previously discussed, these roadway improvements include implementing a road diet on Main Street, decoupling the one-way couplet at Beach Street and Lake Avenue, realigning Union Street near Brennan Street and Alexander Street and implementing traffic calming measures on Union St and 5th Street. Based on the changes observed from the shift in traffic within the model, existing volumes were manually reassigned from intersection of Beach St and Main St to Lake St and Main St via Rodriguez. The second step was to apply the increase in traffic volumes as a result of the projected growth in the DWSP area. For this step separate model runs were conducted, one with only the roadway modifications and a second with both the roadway modifications and the projected growth. The projected growth in household and jobs were applied to the relevant traffic analysis zones (TAZs) within the SCC Travel Demand Model. The difference in traffic volumes between the two model runs were added to the reassigned existing volumes developed in the previous step to determine Existing Plus Project volumes. Project generated peak hour volumes associated with the projected growth is shown in **Figure 9**. Redistribution of baseline volumes as a result of roadway improvements are not reflected in **Figure 9**. Volumes generated from the projected growth and redistribution of existing volumes were added to the existing volumes to develop Existing Plus Project peak hour volumes and are shown in **Figure 10**.

INTERSECTION LEVEL OF SERVICE

Traffic operations were evaluated at the study intersections under existing conditions plus traffic generated by the Project and the redistribution of volumes as a result of the roadway changes. **Table 8** displays the intersection LOS analysis results under Existing Plus Project Conditions. As shown in the table, all study intersections operate at acceptable LOS D or better.

Intersection LOS calculation worksheets are provided in **Appendix C**.

The proposed roundabout at Intersection #6 (Main Street / Freedom Boulevard) was analyzed using SIDRA software and results of the analysis are shown in **Table 9**. The roundabout was analyzed along with the adjacent intersection of Main Street / Ford Street in order to assess queues between the two closely spaced intersections. The intersection of Main Street / Ford Street is signalized, therefore the southbound and northbound traffic coming in and out of the roundabout is affected by the signal control at Main Street / Ford Street. As shown in the table, the roundabout will operate at a V/C less than 0.85 and the signal operates at acceptable LOS B or better in the AM, PM, and Saturday peak hours.

Table 8: Existing and Existing Plus Project Level of Service Summary

| # | Intersection | LOS Criteria | Jurisdiction | Control | Existing | | | | | | Existing Plus Project | | | | | | | | |
|---|------------------------------------|--------------|--------------|---------|----------|-------------|---------|-------------|----------|-------------|-----------------------|-------------|------|---------|-------------|------|----------|-------------|------|
| | | | | | AM Peak | | PM Peak | | Saturday | | AM Peak | | | PM Peak | | | Saturday | | |
| | | | | | LOS | Delay (sec) | LOS | Delay (sec) | LOS | Delay (sec) | LOS | Delay (sec) | Var | LOS | Delay (sec) | Var | LOS | Delay (sec) | Var |
| 1 | Lake Avenue / Main Street | D | Caltrans | Signal | A | 8.3 | B | 12.0 | B | 12.5 | C | 28.5 | 20.2 | D | 44.5 | 32.5 | C | 26.8 | 14.3 |
| 2 | Beach Street / Main Street | D | Caltrans | Signal | B | 13.3 | C | 22.3 | B | 18.9 | D | 53.9 | 40.6 | D | 45.9 | 23.6 | C | 29.4 | 10.5 |
| 3 | Riverside Drive / Main Street | D | Caltrans | Signal | D | 40.3 | D | 41.6 | D | 38.7 | D | 39.6 | -0.7 | D | 46.2 | 4.6 | D | 44.0 | 5.3 |
| 4 | Lake Avenue / Union Street | D | Caltrans | Signal | A | 7.8 | C | 24.5 | - | - | C | 33.8 | 26.0 | C | 29.2 | 4.7 | - | - | - |
| 5 | Beach Street / Union Street | D | Caltrans | Signal | A | 7.4 | B | 16.2 | - | - | C | 27.3 | 19.9 | C | 30.9 | 14.7 | - | - | - |
| 6 | Main Street / Freedom Boulevard | D | Caltrans | Signal | C | 33.7 | D | 39.8 | C | 26.5 | D | 41.2 | 7.5 | C | 34.3 | -5.5 | C | 30.0 | 3.5 |
| 7 | Main Street / Rodriguez Street | D | Caltrans | Signal | C | 23.0 | C | 22.4 | - | - | D | 40.3 | 17.3 | D | 36.2 | 13.8 | - | - | - |
| 8 | Freedom Boulevard / Brennan Street | D | City | Signal | B | 12.4 | C | 27.6 | - | - | B | 13.6 | 1.2 | C | 30.6 | 3.0 | - | - | - |
| 9 | Beach Street / Alexander Street | D | Caltrans | SSSC/ | A | 0.3 | A | 0.6 | - | - | C | 24.5 | 24.2 | C | 24.0 | 23.4 | - | - | - |
| | Worst Approach | | | Signal | | | | | | | | | | | | | | | |

Note: Intersections that are operating below acceptable levels are shown in **BOLD**. Project caused deficiencies are shaded.

¹ SSSC = Side Street Stop Control

² The average control delay is reported for signalized intersections. The average control delay and the delay for the worst movement is reported for SSSC intersections.

³ Intersection #6 in Existing Conditions and Intersections #5 and 9 in Existing Plus Project Conditions were analyzed using HCM 2000 methodology. All other intersections were analyzed using HCM 6th methodology.

⁴ Intersection #9 will be signalized under plus project conditions.

Table 9: Existing Plus Project Roundabout V/C Summary

| # | Intersection | RAB V/C Criteria Signal LOS Criteria | Jurisdiction | Control | Existing Plus Project | | |
|----|--|---|--------------|---------|-----------------------------|-----------------------------|-----------------------------|
| | | | | | AM Peak | PM Peak | Saturday |
| | | | | | RAB V/C Signal LOS/Delay | RAB V/C Signal LOS/Delay | RAB V/C Signal LOS/Delay |
| 6 | Main Street / Freedom Boulevard ¹ | 0.85 | Caltrans | RAB | 0.433 | 0.690 | 0.567 |
| 10 | Main Street / Ford Street | D | Caltrans | Signal | LOS A - 9.9 secs | LOS B - 13.4 secs | LOS B - 14.0 secs |

Note:

¹ RAB = Roundabout Intersection

² Intersection V/C and LOS was analyzed using HCM 6th Edition methodology

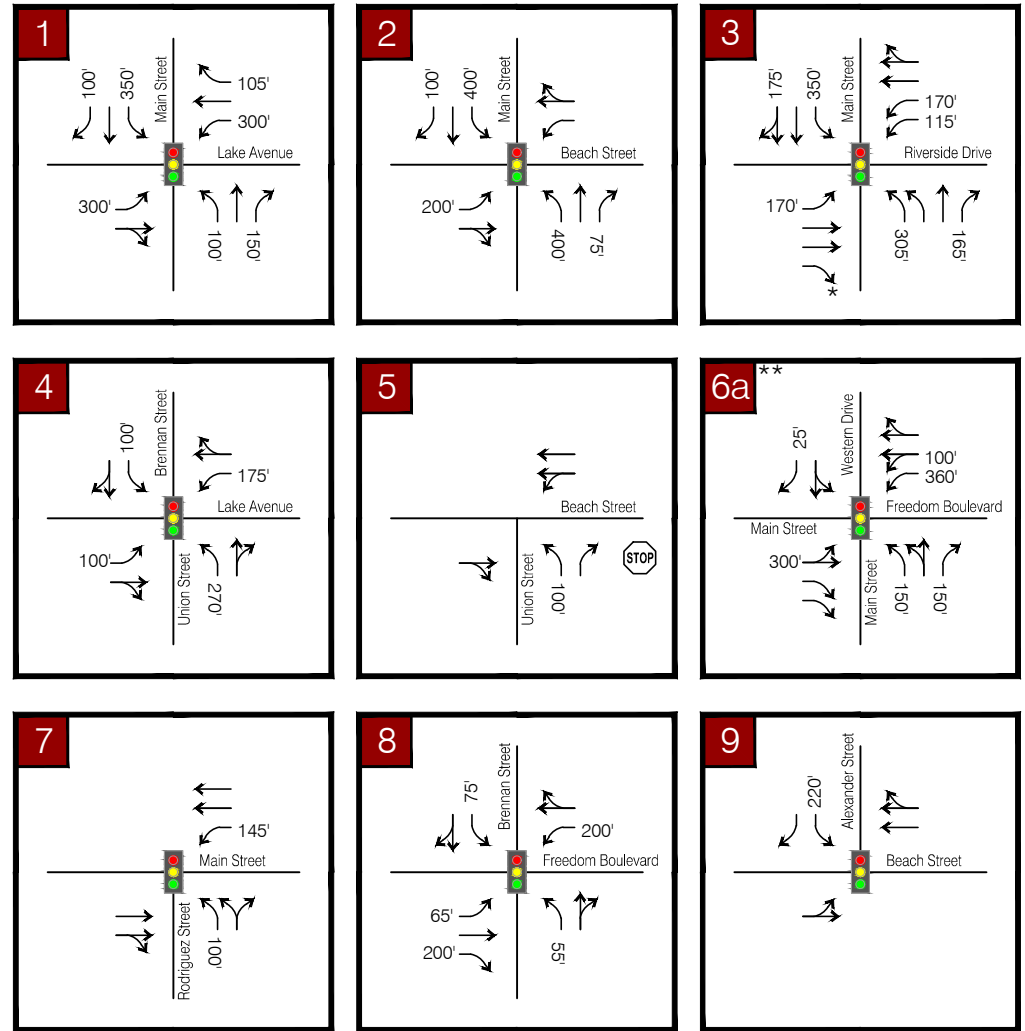
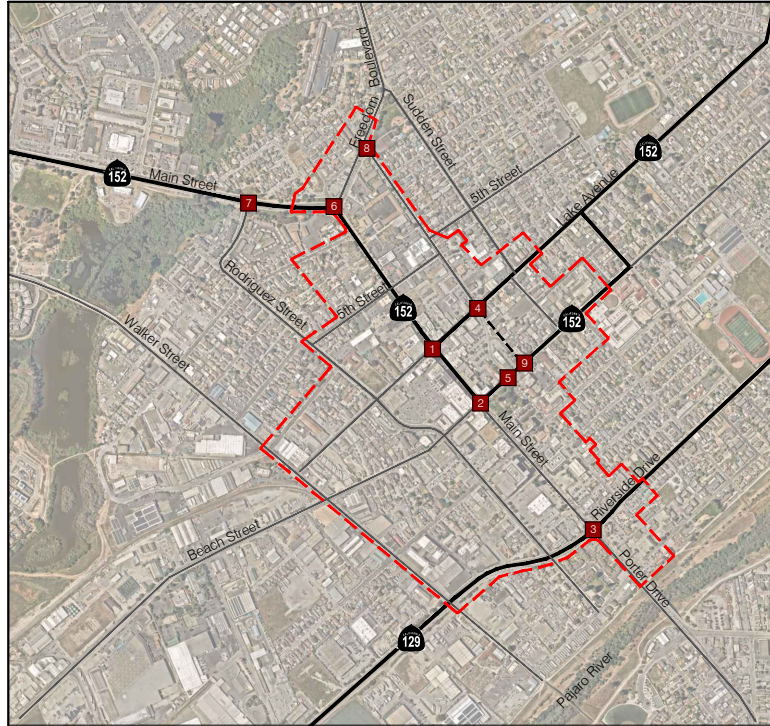

| LEGEND | |
|--------|---|
| | STUDY INTERSECTIONS |
| | DOWNTOWN WATSONVILLE SPECIFIC PLAN BOUNDARY |
| | FUTURE ROADWAY |
| | TRAFFIC SIGNAL |
| | ONE-LANE ROUNDABOUT |
| | STOP SIGN |
| XX' | STORAGE LENGTH |
| DROP | DROP LANE |

* STRIPED AS A SHARED THROUGH/RIGHT TURN LANE, ANALYZED AS A SEPARATE DE FACTOR RIGHT TURN LANE.

**A TRAFFIC SIGNAL AND ROUNDABOUT ARE CONSIDERED AT INTERSECTION #6 AND THEREFORE BOTH TYPES OF CONTROLS WERE ANALYZED IN PLUS PROJECT CONDITIONS.

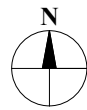

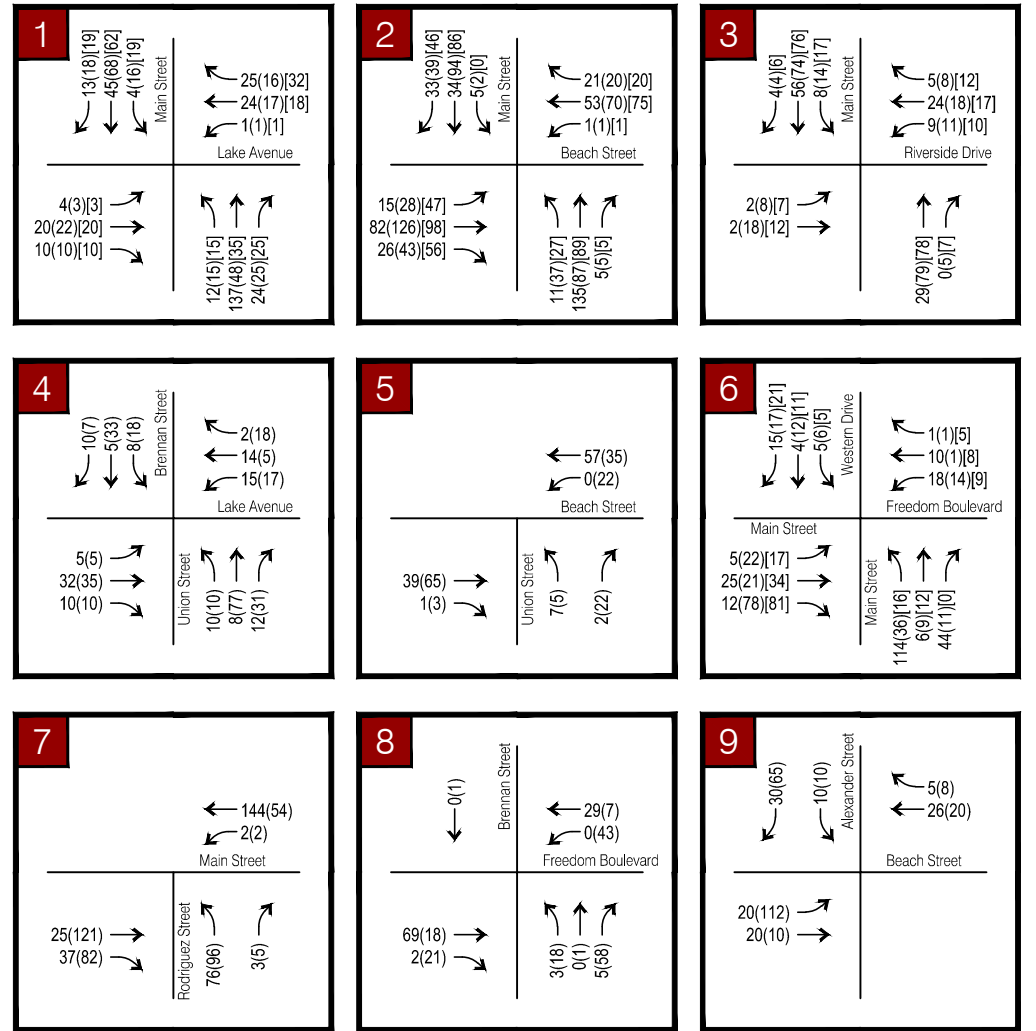
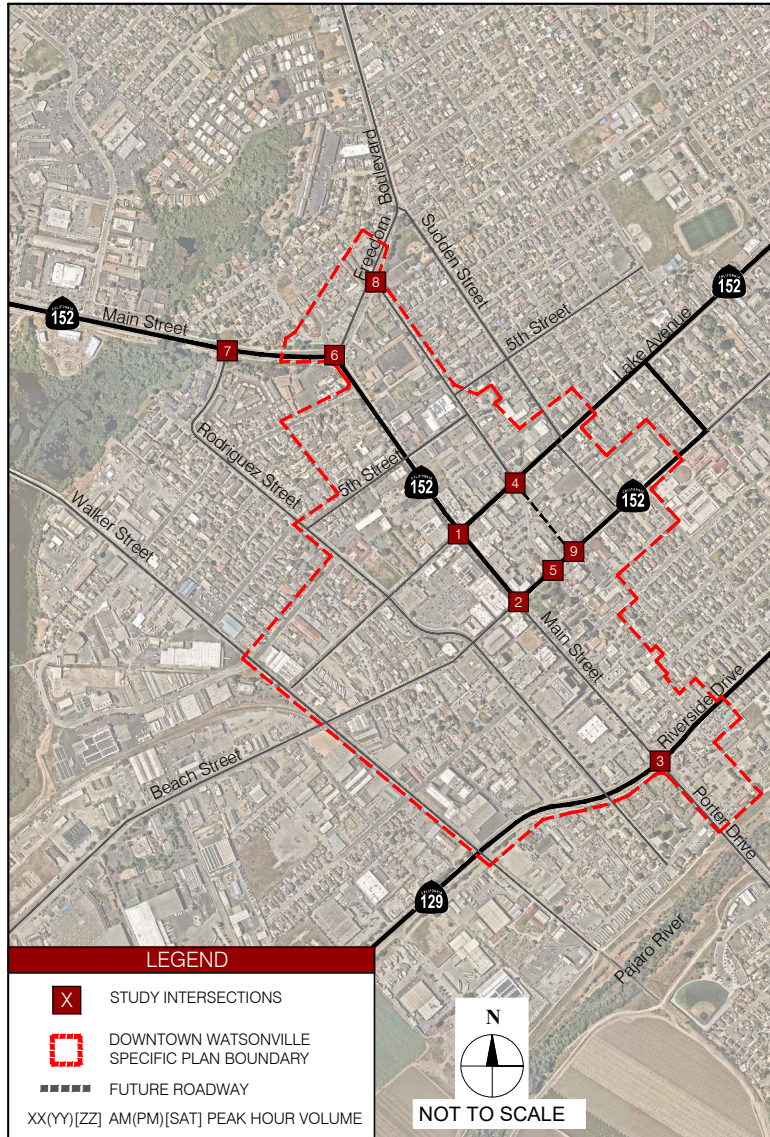

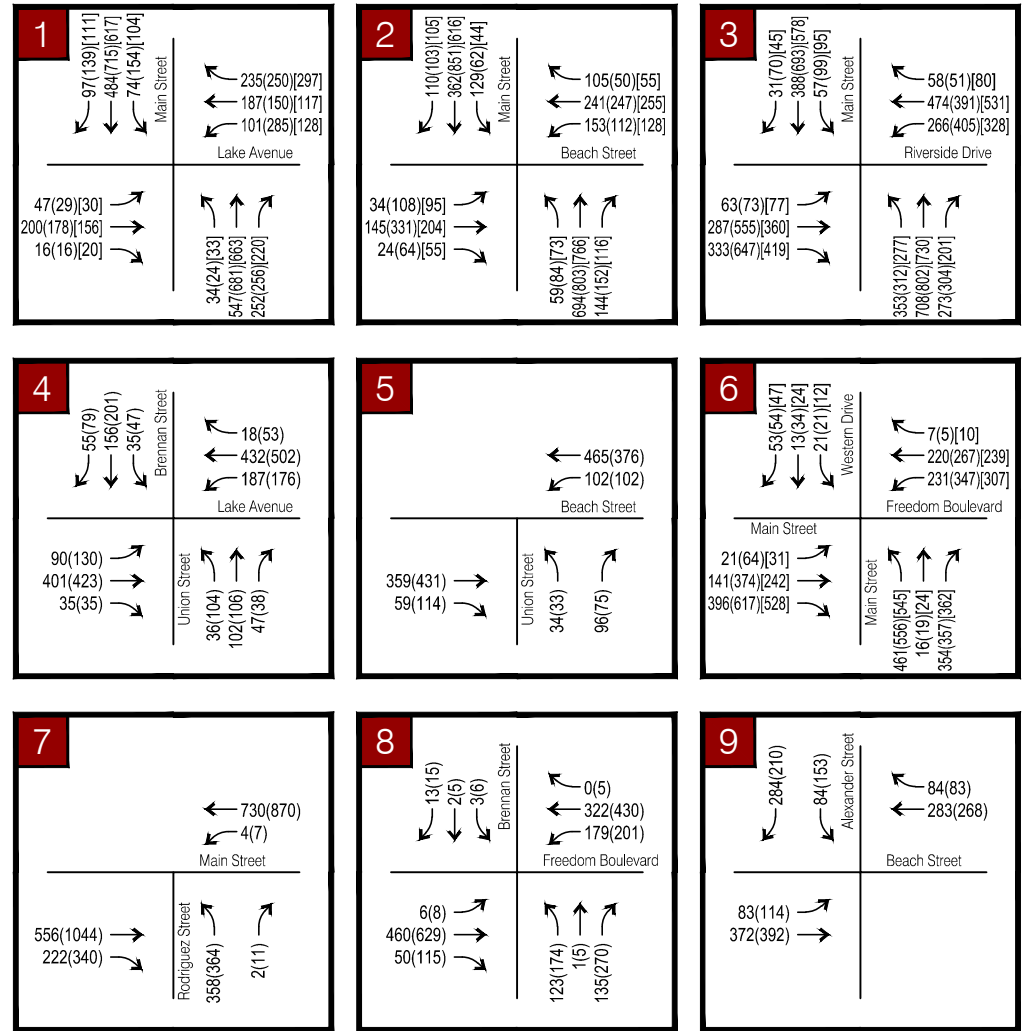
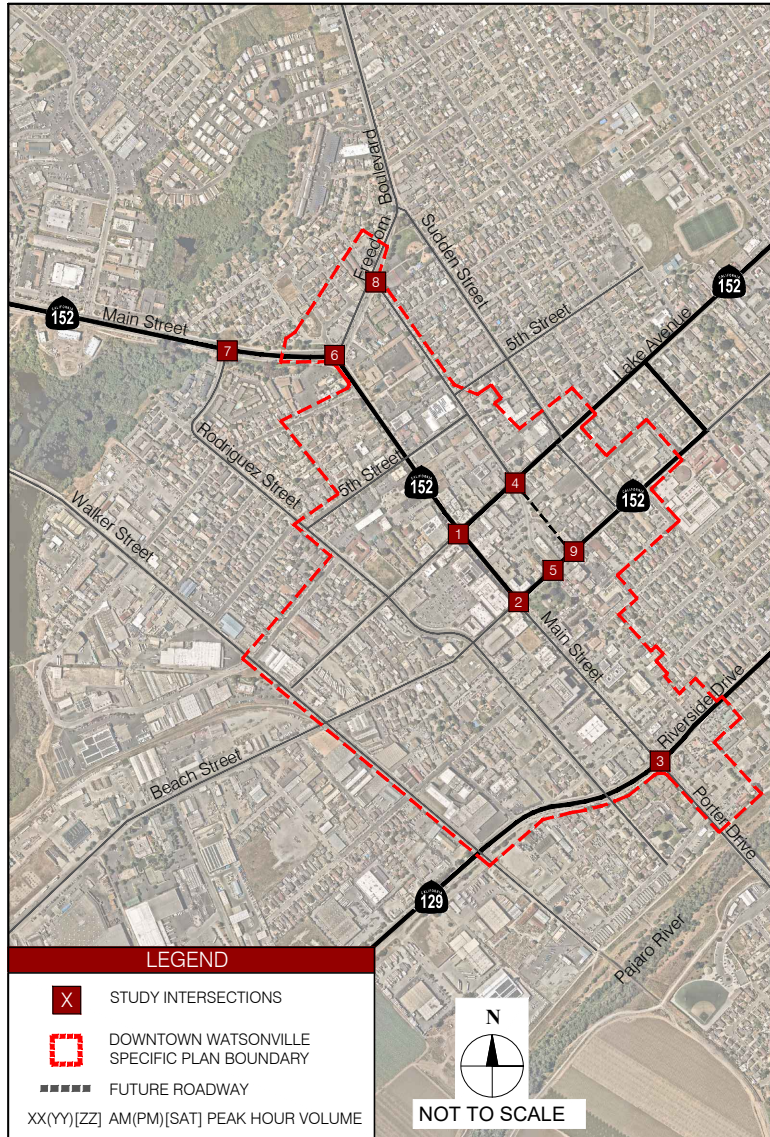

FUTURE PLUS PROJECT CONDITIONS ANALYSIS

LANE GEOMETRY AND CONTROL

Future Plus Project conditions are assumed to be the same as Existing Plus Project conditions since no further roadway improvements were identified. **Figure 8** illustrates the intersection geometry and traffic control assumed for the Future Plus Project analysis.

TRAFFIC VOLUMES

Similar to the Existing Plus Project volume development, Future Plus Project volumes were determined using a two-step approach to account for anticipated growth and the proposed roadway network modifications. The first step was to enter the proposed roadway network modifications into the SCC Travel Demand Model and determine the shift in travel pattern as a result of the change in the roadway network, and manually reassign volumes where needed. The second step was to apply the increase in traffic volumes as a result of the projected growth in the DWSP area. For this step separate model runs were conducted, one with only the roadway modifications in the future and a second with both the roadway modifications and the projected growth in the Year 2040. The projected growth in household and jobs were applied to the relevant TAZs within the SCC Travel Demand Model. The difference in traffic volumes between the two model runs were added to the reassigned future volumes developed in the previous step to determine Future Plus Project volumes. Since the travel demand model is not sensitive to the intersection traffic operations, additional traffic volume adjustments were made based on the congestion observed during the intersection operations analysis to account for travel pattern changes that are expected due to the road diet and the proposed roadway modifications. Based on the queuing analysis, northbound and southbound queues might exceed the storage capacity along Main Street and traffic would be expected to reroute to other streets with more capacity. To reflect this shift in traffic, about 150 peak hour vehicles traveling northbound and using East Beach Street were reassigned to use instead East Lake Avenue. Additional 150 vehicles in the northbound and southbound through directions along Main Street were reassigned to other side streets. Future Plus Project peak hour volumes are shown in **Figure 11**.

INTERSECTION LEVEL OF SERVICE

Intersection LOS under Future Plus Project Conditions were analyzed using SimTraffic simulation within Synchro software and are based on an average result of 12 runs. **Table 10** displays the intersection LOS analysis results under Future Plus Project Conditions. All intersection operates at an acceptable LOS with the exception of the following:

- #3 – Riverside Drive / Main Street (Weekday AM and PM Peak Hours)

This intersection is significantly impacted by regional traffic that originates from outside of Watsonville. It includes traffic from San Benito and Santa Clara counties that is traveling west on State Route 129/Riverside Drive and from Monterey County that is traveling north on Salinas Road/Porter Street/Main Street. This is confirmed in the queuing analysis done in Section 6, which shows large queues in the west and north directions. The number of motorists is expected to increase in the future. There are local and regional projects that will have a positive impact on traffic volumes at this intersection. The City is currently working on a project to convert one of the two northbound through lanes to a left turn lane and lengthen the storage length to 300 feet for the two left turn lanes. The G12: Pajaro to Prunedale Corridor Study published by the Transportation Agency of Monterey County (TAMC) in 2019 proposes improvements along Porter Street/Salinas Road/County Road G12 that will positively impact the subject intersection. One is to reduce

the number of northbound travel lanes from two to one on the portions of Salinas Road and Porter Street that lead to the Pajaro River crossing. Another improves the intersection of Salinas Road, Werner Road and G12 which would encourage motorists using G12 to access State Route 1 via Salinas Road and not Main Street and State Route 129 as is currently done.

Intersection LOS calculation worksheets are provided in **Appendix D**.

The proposed roundabout at Intersection #6 (Main Street / Freedom Boulevard) was analyzed using SIDRA software and results of the analysis are shown in **Table 11**. The roundabout was analyzed along with the adjacent intersection of Main Street / Ford Street in order to assess queues between the two closely spaced intersections. The intersection of Main Street / Ford Street is signalized, therefore the southbound and northbound traffic coming in and out of the roundabout is affected by the signal control at Main Street / Ford Street. As shown in the table, the roundabout will operate at a V/C less than 0.85 and the signal operates at acceptable LOS B or better in the AM, PM, and Saturday peak hours.

Table 10: Future Plus Project Level of Service Summary

| # | Intersection | LOS Criteria | Jurisdiction | Control | Future + Project | | | | | |
|---|------------------------------------|--------------|--------------|-----------------|------------------|-------------|----------|-------------|----------|-------------|
| | | | | | AM Peak | | PM Peak | | Saturday | |
| | | | | | LOS | Delay (sec) | LOS | Delay (sec) | LOS | Delay (sec) |
| 1 | Lake Avenue / Main Street | D | Caltrans | Signal | C | 23.3 | D | 50.3 | C | 23.3 |
| 2 | Beach Street / Main Street | D | Caltrans | Signal | D | 40.5 | D | 38.9 | D | 40.1 |
| 3 | Riverside Drive / Main Street | D | Caltrans | Signal | E | 68.3 | F | 88.0 | D | 42.0 |
| 4 | Lake Avenue / Union Street | D | Caltrans | Signal | C | 21.1 | D | 37.0 | - | - |
| 5 | Beach Street / Union Street | D | Caltrans | Signal | B | 18.2 | B | 17.3 | - | - |
| 6 | Main Street / Freedom Boulevard | D | Caltrans | Signal | C | 24.9 | D | 38.8 | C | 23.6 |
| 7 | Main Street / Rodriguez Street | D | Caltrans | Signal | B | 11.8 | C | 29.3 | - | - |
| 8 | Freedom Boulevard / Brennan Street | D | City | Signal | B | 13.4 | C | 26.7 | - | - |
| 9 | Beach Street / Alexander Street | D | Caltrans | SSSC/ Signal | C | 24.3 | C | 21.6 | - | - |
| | <i>Worst Approach</i> | | | | | | | | | |

Note: Intersections that are operating below acceptable levels are shown in **BOLD**. Project caused deficiencies are shaded.

¹ SSSC = Side Street Stop Control

² The average control delay is reported for signalized intersections.

³ Intersection LOS was analyzed using SimTraffic simulation for an average of 12 runs.

Table 11: Future Plus Project Roundabout V/C Summary

| # | Intersection | RAB V/C Criteria Signal LOS Criteria | Jurisdiction | Control | Future Plus Project | | |
|----|--|---|--------------|---------|-----------------------------|-----------------------------|-----------------------------|
| | | | | | AM Peak | PM Peak | Saturday |
| | | | | | RAB V/C Signal LOS/Delay | RAB V/C Signal LOS/Delay | RAB V/C Signal LOS/Delay |
| 6 | Main Street / Freedom Boulevard ¹ | 0.85 | Caltrans | RAB | 0.494 | 0.590 | 0.601 |
| 10 | Main Street / Ford Street | D | Caltrans | Signal | LOS B - 11 secs | LOS B - 11.8 secs | LOS B - 12.1 secs |

Note:

¹ RAB = Roundabout Intersection

² Intersection V/C and LOS was analyzed using HCM 6th Edition methodology

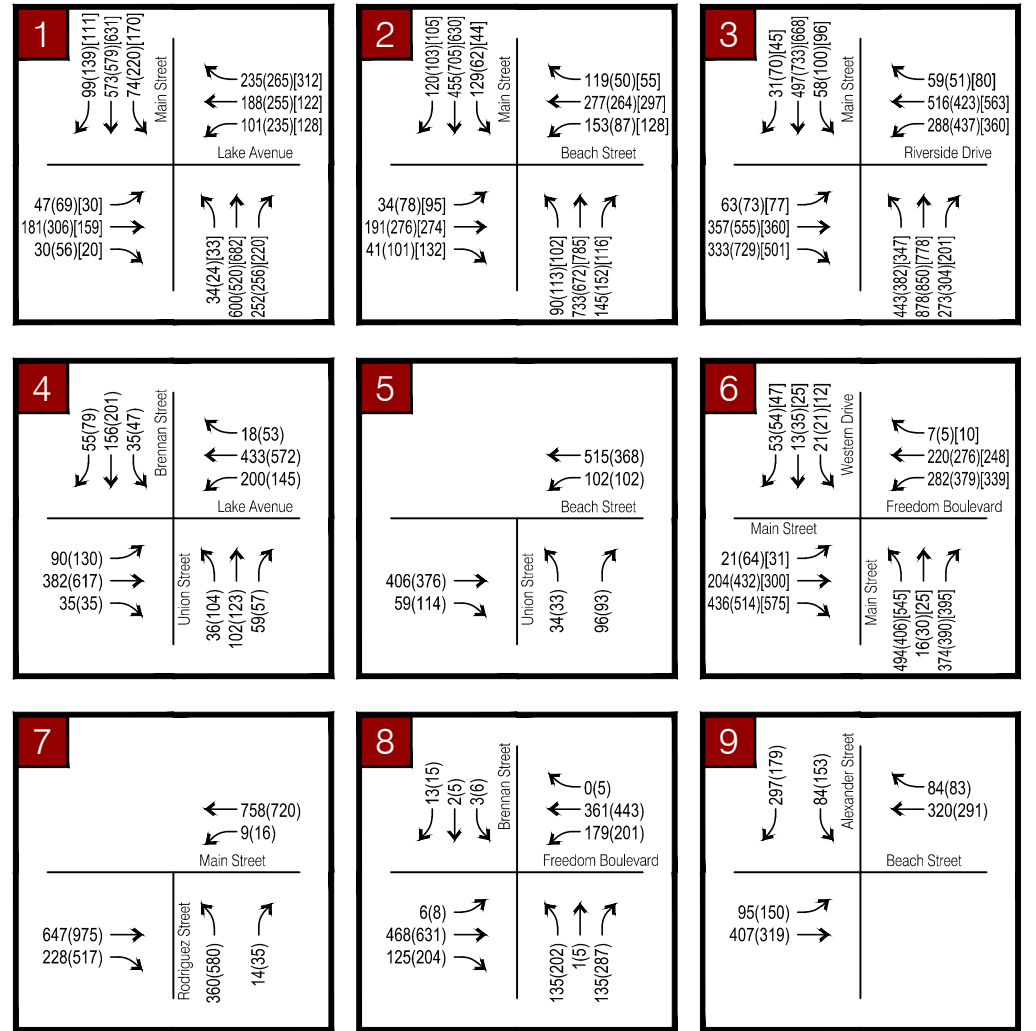
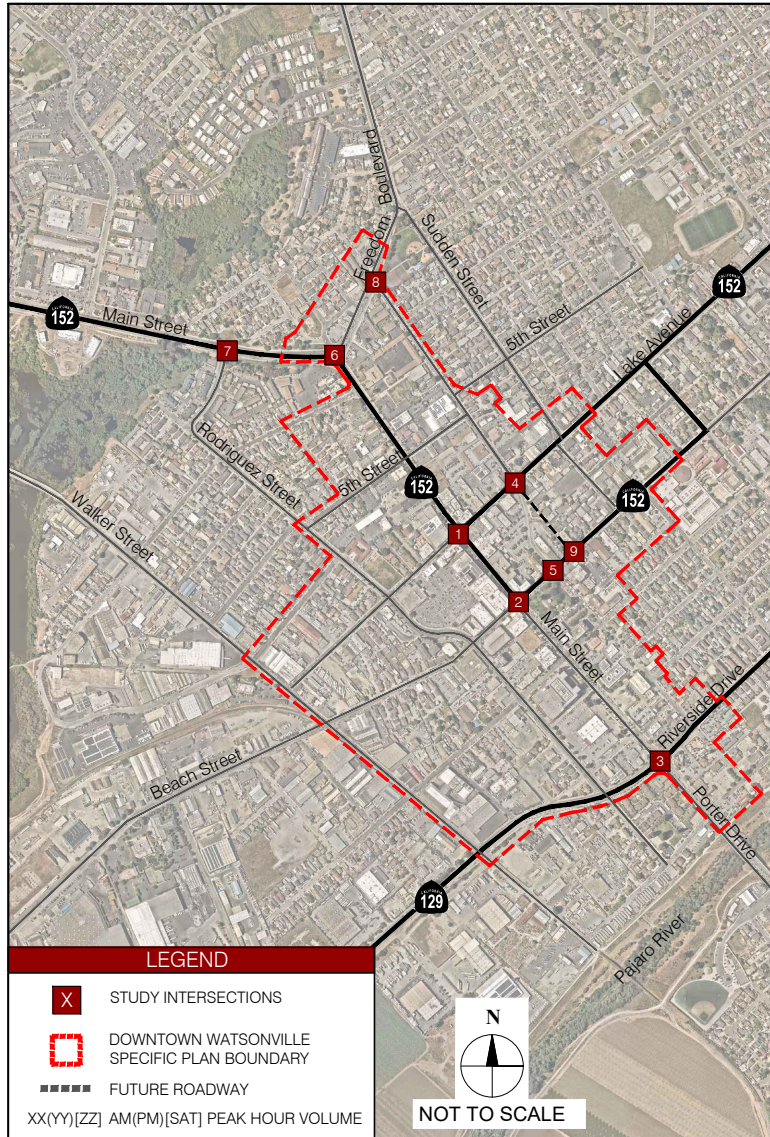

6. VEHICLE QUEUING ANALYSIS

This chapter presents the results of the vehicle queuing analysis completed at all study intersections to analyze whether the storage capacity of a roadway segment would be exceeded. This analysis modeled the queuing of vehicles at left-turn and right-turn pockets as well as through lanes to determine whether vehicles might affect an intersection's operation from extending beyond a street's available storage and into adjacent through lanes. In addition, a qualitative analysis was conducted if the Project results in queuing along the study roadways that extend into parallel roadways.

VEHICLE QUEUING

The implementation of a road diet along Main Street improves pedestrian safety through reduced crosswalk distances and lower vehicle speeds. It is also important to accommodate the vehicle progression in a manner that will not result in a gridlock. This project also proposes improved access through the elimination of the one-way couplet of East Beach Street and East Lake Avenue. Vehicles traveling through downtown will change their travel patterns based on the reconfiguration of the roadways and some spill over will occur on parallel routes (i.e., Rodriguez Street and Brennan Street between Freedom Boulevard and SR 129 and also to and from local destinations) as discussed in previous sections.

As traffic flows increase and shift, it is common for traffic at intersections to experience lower travel speeds and increased delay, which, in part is the purpose of implementing a road diet. Queue lengths were determined for all approach lanes at each study intersection. Synchro software calculates the 95th percentile queues based on Synchro methodology. The 95th percentile queue is used to account for fluctuations in traffic and is defined to be the queue length (in vehicles) that has only a 5-percent probability of being exceeded during the analysis time period. It is used as a benchmark for determining deficiencies as a standard transportation engineering practice. A typical vehicle length of 25 feet was used in the queuing analysis. An operational deficiency was assumed to occur if the 95th percentile queue exceeds the movement storage by more than two vehicles. This criteria was determined using the Caltrans' Traffic Safety Bulletin 20-02-R1, which is also adopted by some local jurisdictions with urban areas. A summary of the queuing results is included in **Appendix E**. It should be noted that 95th percentile queues were determined using Synchro for Existing and Existing Plus Project Conditions while SimTraffic was used for Future Plus Project Conditions.

Locations where the 95th percentile queues exceed the available storage are summarized in **Table 12** for Existing Conditions and **Table 13** for Future Plus Project Conditions. As the Future Plus Project Conditions represents the worse-case scenario only the Future Plus Project Queue lengths are reported in this table which are based on a detailed SimTraffic analysis. It can thus be concluded that the Existing Plus Project queues will be less than the Future Plus Project conditions since the Existing traffic volumes are less than the Future traffic volumes. The Existing Plus Project queues are included in **Appendix E**. These queues are reported considering the signalized intersection of Main Street and Freedom Boulevard. As shown in the table, intersections of Main Street and East Lake Avenue, Main Street and West Beach Street and East Beach Street and Union Street show queues exceeding the storage capacity by about 3 cars and therefore might extend into the adjacent intersections of Main Street and 5th Street, Main Street and East Lake Avenue, Beach Street and Rodriguez Street, 2nd Street and Maple Avenue, and Beach Street and Alexander Street.

The closely spaced intersections of East Beach Street and Union Street and East Beach Street and Alexander Street requires a synchronized signal operations system which results in no queuing occurring on the short block along East Beach Street and between these two intersections. In addition, this short

block will be reconfigured to consist of two westbound and one eastbound lane. The two westbound lanes will continue to Main Street and provide a dedicated westbound left turn and a shared through-right turn lane at the intersection.

Management of traffic through the corridor is going to be extremely important. This can be done through the implementation of an adaptive traffic signal system. An adaptive traffic signal system adjusts signal timing to accommodate changing traffic patterns and ease traffic congestion. It progressively moves vehicles through green lights, creating smoother flow and reducing congestion. The system can use existing traffic signals with minor modifications to the hardware and installation of new signal software.

The intersection of Riverside Drive/State Route 129 and Main Street is built out at its ultimate capacity and adding lanes would mean acquiring private property to widen the road. As shown in **Table 12**, there is not enough storage length for the westbound left (WBL) lane in the morning and the evening. The existing queuing deficiencies at this intersection are from regional traffic traveling between Highway 1, Highway 129 and Monterey County which is across the Pajaro River. As noted in Section 5 and Section 7, there are several projects in design or under consideration that will affect the regional traffic flowing into this intersection.

Table 12 – Summary of Intersection Queuing Deficiencies – Existing Conditions

| # | Intersection | Control | Movement | Storage Length (ft) | Peak Hour | 95th Percentile Queue |
|---|-------------------------------|---------|----------|---------------------|-----------|-----------------------|
| | | | | | | Existing Conditions |
| 3 | Riverside Drive / Main Street | Signal | WBL | 140 | AM | 173 (2) |
| | | | | | PM | 268 (7) |

Table 13 – Summary of Intersection Queuing Deficiencies – Future Plus Project

| # | Intersection | Control | Movement | Storage Length (ft) | Peak Hour | 95th Percentile Queue |
|-----|-------------------------------|---------|----------|---------------------|-----------|--|
| | | | | | | Future Plus Project ft (# of Cars Spillover) |
| 1 | Lake Avenue / Main Street | Signal | NBR | 150 | AM | 231 (3) |
| | | | | | PM | 235 (3) |
| | | | SBL | 350 | PM | 458 (4) |
| | | | | | SBR | 100 |
| | | PM | 188 (4) | | | |
| 2 | Beach Street / Main Street | Signal | NBR | 75 | AM | 151 (3) |
| | | | | | PM | 150 (3) |
| | | | SBR | 100 | AM | 180 (3) |
| | | | | | PM | 164 (3) |
| | | | WBT | 260 | AM | 323 (3) |
| 3 | Riverside Drive / Main Street | Signal | WBL | 140 | AM | 196 (2) |
| | | | | | PM | 212 (3) |
| | | | NBR | 165 | AM | 290 (5) |
| | | | | | PM | 295 (5) |
| | | | WBT | 245 | PM | 882 (25) |
| | | | NBT | 1170 | AM | 1433 (11) |
| | | | | | PM | 1289 (5) |
| SBT | 520 | PM | 718 (8) | | | |
| 5 | Beach Street / Union Street | Signal | EBT | 260 | AM | 329 (3) |
| | | | | | PM | 321 (2) |

A queuing analysis for the closely spaced intersections of Main Street and Freedom Boulevard (roundabout) and Main Street and Ford Street (signal) was conducted separately to determine whether northbound and southbound queues for one intersection would extend into the other. 95th percentile queues for the northbound and southbound approach are summarized in **Table 14** for the Future Plus Project Conditions. These queues are reported for the worse lane of the approach. As shown in the table, due to the closely spaced intersection of Main Street and Freedom Boulevard and Main Street and Ford Street, the southbound queues at the Main Street and Ford Street intersection is at capacity and may spillover onto the eastbound approach at the Main Street and Freedom Boulevard intersection. If the turning movements on the Ford Street approach are limited to right-in and right-out only during the peak hours, the queueing concerns at the intersection on Main Street is resolved. The queues at the roundabout intersection of Main Street and Freedom Boulevard have adequate storage at all approach lanes.

Table 14 – Summary of Roundabout Queuing Deficiencies – Future Plus Project

| # | Intersection | Control | Approach | Storage Length (ft) | Peak Hour | 95th Percentile Queue |
|----|---------------------------------|------------|----------|---------------------|-----------|-----------------------|
| | | | | | | Future Plus Project |
| 6 | Main Street / Freedom Boulevard | Roundabout | NB | 210 | AM | 30 |
| | | | | | PM | 43 |
| 10 | Main Street / Ford Street | Signal | SB | 210 | AM | 175 |
| | | | | | PM | 200 |

7. REGIONAL TRAFFIC PATTERNS AND PROJECTS

Regional Traffic has a tremendous impact on the project area as there are two State Routes that pass through the downtown area. Many of these travelers are passing through Watsonville as they use State Routes 129 and 152 to travel between Santa Cruz, Santa Clara, San Benito and Monterey Counties. The improvements proposed with this traffic plan will likely alter some of these regional travel patterns, but not in a way that can be accounted for in this study.

One of the goals of the proposed improvements is to slow traffic and make the downtown Watsonville area safer for bicyclists and pedestrians. While the study shows that almost all of the intersections will maintain an acceptable LOS of D or less, it also shows that traffic will slow down as the LOS goes from B to C or C to D at many locations. As this occurs, some regional travelers may seek alternative routes and reduce congestion within these parts of the project.

Listed below are transportation projects that have or will take place in and outside of Watsonville that will also impact regional travel patterns.

Caltrans recently installed a roundabout on State Route 129 at Lakeview Road, as shown in **Figure 8**. This may regulate the flow of vehicles traveling west and entering Watsonville and impact congestion on this corridor.

Figure 12: Roundabout at the State Route 129 and Lakeview Road



As noted earlier, the City is working with Caltrans to make a modification at the intersection of State Route 129/Riverside Drive and Main Street. The modification would remove one of the two northbound through lanes and make it a second left turn lane. This may improve the LOS at this intersection.

The TAMC G12: Pajaro to Prunedale Corridor Study proposes a project to reduce the number of travel lanes from two to one on northbound Salinas Road from G12 to Porter Street and on northbound Porter Street from Salinas Road to San Juan Road². This improvement would align with the City plans to reduce the number of through lanes on this portion of northbound Main Street at the intersection with State Route 129/Riverside Drive from two to one and improve traffic flow.

Another transportation project included in the TAMC G12: Pajaro to Prunedale Corridor Study involves improvements to the Salinas Road/Werner Road/County Road G-12 intersection. The current alignment limits turning movements between Werner Road and G12. The Study considers two improvements that would improve this turning movement. One includes installation of traffic signals to regulate flow. Another proposes to reconfigure the intersection and install a roundabout where the three roads would come together. These improvements would encourage travelers to access State Route 1 at the Salinas Road interchange and avoid using Main Street and State Route 129/Riverside Drive.

² The Pajaro to Prunedale G12 Study is available online at <https://www.tamcmonterey.org/pajaro-to-prunedale-g12-study>.

APPENDIX

A – EXISTING TRAFFIC VOLUME DATA SHEETS

B – EXISTING TRAFFIC CONDITIONS

C – EXISTING PLUS PROJECT TRAFFIC CONDITIONS

D – FUTURE PLUS PROJECT TRAFFIC CONDITIONS

E – QUEUING SUMMARY

F – SIDRA OUTPUTS

A – Existing Traffic Volume Data Sheets



Traffic Data Service

San Jose, CA
 (408) 622-4787
 tdsbay@cs.com

File Name : 1 FINAL
 Site Code : 00000001
 Start Date : 5/19/2022
 Page No : 3

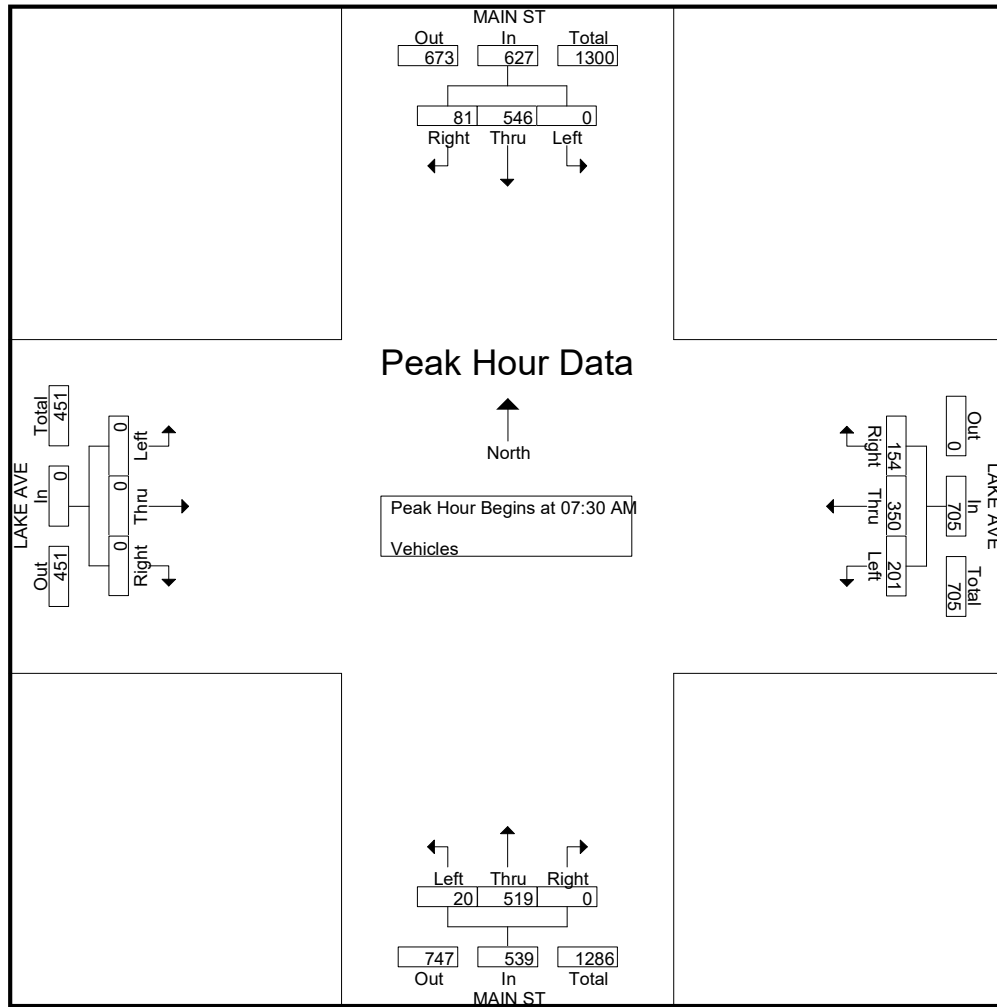

Peak Hour Analysis From 11:00 AM to 02:45 PM - Peak 1 of 1

Peak Hour for Entire Intersection Begins at 01:00 PM

| | | | | | | | | | | | | | | | | | |
|--------------|-----------|------------|------|------------|-----------|-----------|-----------|------------|------|------------|----------|------------|------|------|------|------|------------|
| 01:00 PM | 23 | 192 | 0 | 215 | 44 | 57 | 42 | 143 | 0 | 137 | 3 | 140 | 0 | 0 | 0 | 0 | 498 |
| 01:15 PM | 21 | 178 | 0 | 199 | 34 | 58 | 34 | 126 | 0 | 126 | 5 | 131 | 0 | 0 | 0 | 0 | 456 |
| 01:30 PM | 18 | 147 | 0 | 165 | 39 | 72 | 50 | 161 | 0 | 119 | 3 | 122 | 0 | 0 | 0 | 0 | 448 |
| 01:45 PM | 32 | 156 | 0 | 188 | 31 | 77 | 49 | 157 | 0 | 140 | 4 | 144 | 0 | 0 | 0 | 0 | 489 |
| Total Volume | 94 | 673 | 0 | 767 | 148 | 264 | 175 | 587 | 0 | 522 | 15 | 537 | 0 | 0 | 0 | 0 | 1891 |
| % App. Total | 12.3 | 87.7 | 0 | | 25.2 | 45 | 29.8 | | 0 | 97.2 | 2.8 | | 0 | 0 | 0 | | |
| PHF | .734 | .876 | .000 | .892 | .841 | .857 | .875 | .911 | .000 | .932 | .750 | .932 | .000 | .000 | .000 | .000 | .949 |

Traffic Data Service

San Jose, CA
 (408) 622-4787
 tdsbay@cs.com

File Name : 1 FINAL
 Site Code : 00000001
 Start Date : 5/19/2022
 Page No : 5

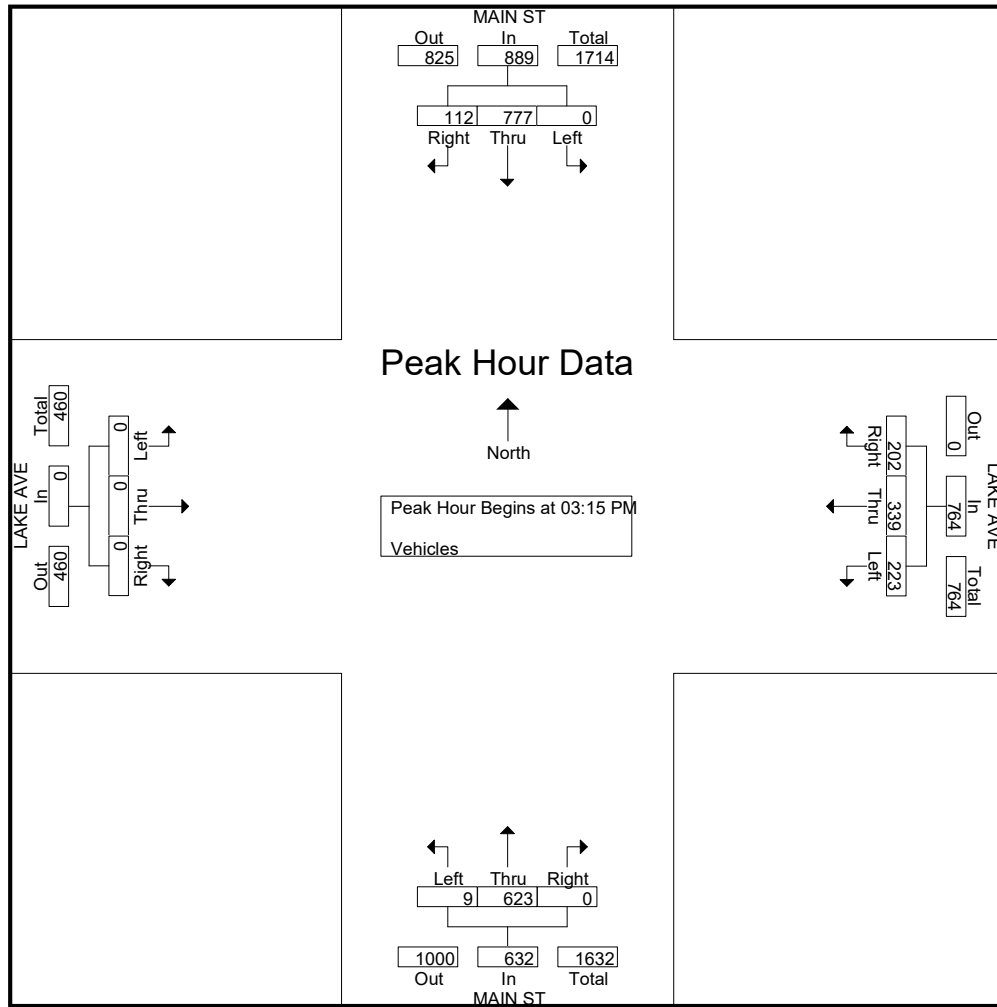

Peak Hour Analysis From 07:00 AM to 06:45 PM - Peak 1 of 1

Peak Hour for Entire Intersection Begins at 03:15 PM

| | | | | | | | | | | | | | | | | | |
|--------------|-----------|------------|------|------------|-----------|-----------|-----------|------------|------|------------|----------|------------|------|------|------|------|------------|
| 03:15 PM | 28 | 194 | 0 | 222 | 58 | 95 | 47 | 200 | 0 | 151 | 3 | 154 | 0 | 0 | 0 | 0 | 576 |
| 03:30 PM | 27 | 176 | 0 | 203 | 46 | 94 | 61 | 201 | 0 | 135 | 3 | 138 | 0 | 0 | 0 | 0 | 542 |
| 03:45 PM | 29 | 194 | 0 | 223 | 40 | 76 | 65 | 181 | 0 | 179 | 1 | 180 | 0 | 0 | 0 | 0 | 584 |
| 04:00 PM | 28 | 213 | 0 | 241 | 58 | 74 | 50 | 182 | 0 | 158 | 2 | 160 | 0 | 0 | 0 | 0 | 583 |
| Total Volume | 112 | 777 | 0 | 889 | 202 | 339 | 223 | 764 | 0 | 623 | 9 | 632 | 0 | 0 | 0 | 0 | 2285 |
| % App. Total | 12.6 | 87.4 | 0 | | 26.4 | 44.4 | 29.2 | | 0 | 98.6 | 1.4 | | 0 | 0 | 0 | | |
| PHF | .966 | .912 | .000 | .922 | .871 | .892 | .858 | .950 | .000 | .870 | .750 | .878 | .000 | .000 | .000 | .000 | .978 |

Traffic Data Service

San Jose, CA
 (408) 622-4787
 tdsbay@cs.com

File Name : 2 FINAL
 Site Code : 00000002
 Start Date : 5/19/2022
 Page No : 3

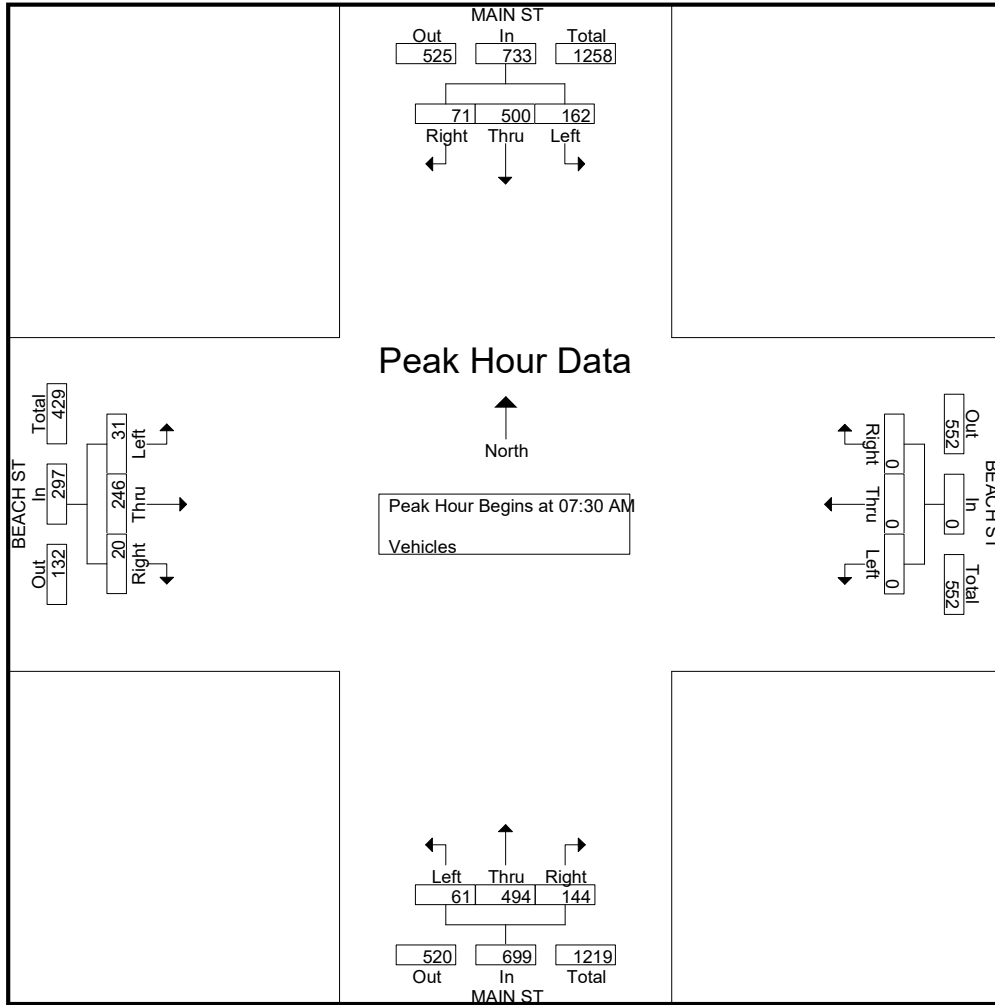

Peak Hour Analysis From 11:00 AM to 02:45 PM - Peak 1 of 1

Peak Hour for Entire Intersection Begins at 01:00 PM

| | | | | | | | | | | | | | | | | | |
|--------------|-----------|------------|-----------|------------|------|------|------|------|-----------|------------|-----------|------------|-----------|-----------|-----------|------------|------------|
| 01:00 PM | 17 | 142 | 71 | 230 | 0 | 0 | 0 | 0 | 31 | 125 | 8 | 164 | 10 | 53 | 17 | 80 | 474 |
| 01:15 PM | 16 | 137 | 71 | 224 | 0 | 0 | 0 | 0 | 40 | 114 | 10 | 164 | 9 | 77 | 19 | 105 | 493 |
| 01:30 PM | 13 | 128 | 54 | 195 | 0 | 0 | 0 | 0 | 23 | 106 | 11 | 140 | 10 | 69 | 15 | 94 | 429 |
| 01:45 PM | 18 | 137 | 49 | 204 | 0 | 0 | 0 | 0 | 28 | 123 | 10 | 161 | 11 | 62 | 24 | 97 | 462 |
| Total Volume | 64 | 544 | 245 | 853 | 0 | 0 | 0 | 0 | 122 | 468 | 39 | 629 | 40 | 261 | 75 | 376 | 1858 |
| % App. Total | 7.5 | 63.8 | 28.7 | | 0 | 0 | 0 | | 19.4 | 74.4 | 6.2 | | 10.6 | 69.4 | 19.9 | | |
| PHF | .889 | .958 | .863 | .927 | .000 | .000 | .000 | .000 | .763 | .936 | .886 | .959 | .909 | .847 | .781 | .895 | .942 |

Traffic Data Service

San Jose, CA
 (408) 622-4787
 tdsbay@cs.com

File Name : 2 FINAL
 Site Code : 00000002
 Start Date : 5/19/2022
 Page No : 5

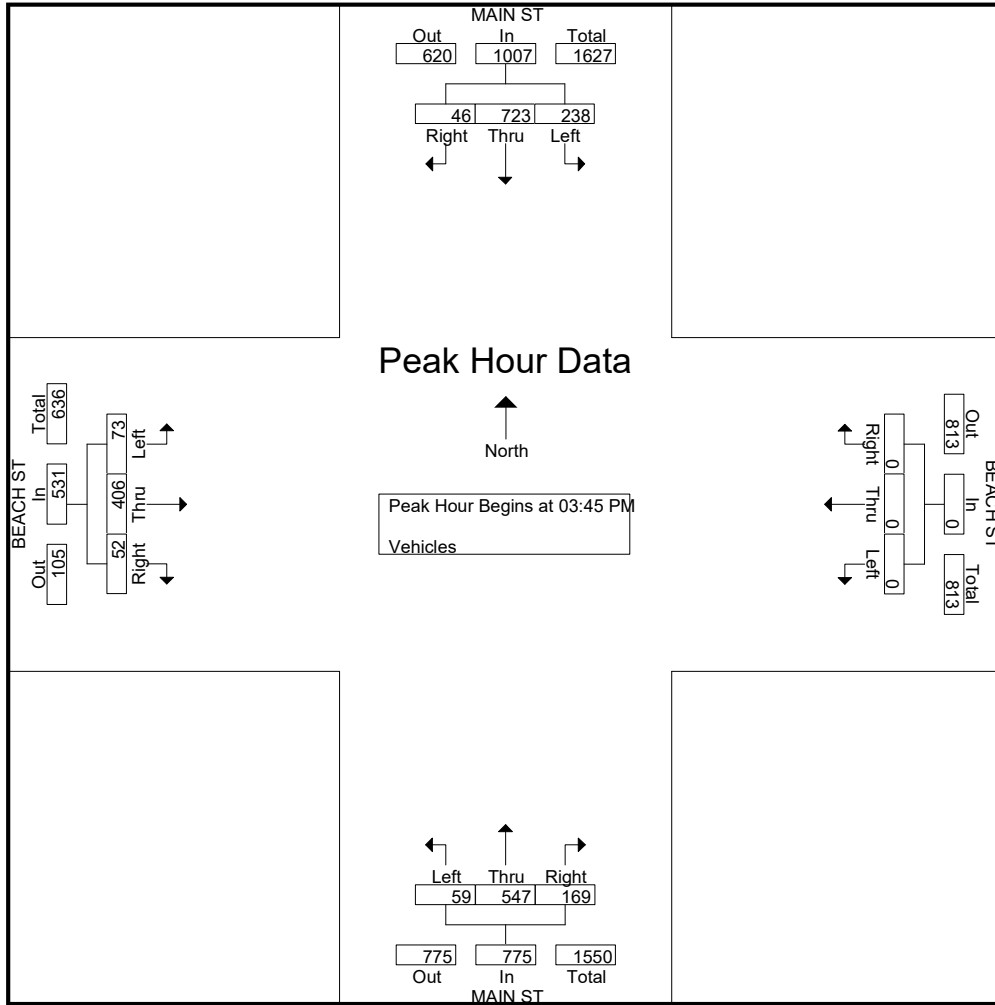

Peak Hour Analysis From 07:00 AM to 06:45 PM - Peak 1 of 1

Peak Hour for Entire Intersection Begins at 03:45 PM

| | | | | | | | | | | | | | | | | | |
|--------------|-----------|------------|-----------|------------|------|------|------|------|-----------|------------|-----------|------------|-----------|------------|-----------|------------|------------|
| 03:45 PM | 12 | 182 | 57 | 251 | 0 | 0 | 0 | 0 | 44 | 165 | 14 | 223 | 11 | 114 | 14 | 139 | 613 |
| 04:00 PM | 14 | 187 | 57 | 258 | 0 | 0 | 0 | 0 | 55 | 136 | 11 | 202 | 9 | 111 | 25 | 145 | 605 |
| 04:15 PM | 10 | 176 | 58 | 244 | 0 | 0 | 0 | 0 | 36 | 119 | 15 | 170 | 16 | 93 | 13 | 122 | 536 |
| 04:30 PM | 10 | 178 | 66 | 254 | 0 | 0 | 0 | 0 | 34 | 127 | 19 | 180 | 16 | 88 | 21 | 125 | 559 |
| Total Volume | 46 | 723 | 238 | 1007 | 0 | 0 | 0 | 0 | 169 | 547 | 59 | 775 | 52 | 406 | 73 | 531 | 2313 |
| % App. Total | 4.6 | 71.8 | 23.6 | | 0 | 0 | 0 | | 21.8 | 70.6 | 7.6 | | 9.8 | 76.5 | 13.7 | | |
| PHF | .821 | .967 | .902 | .976 | .000 | .000 | .000 | .000 | .768 | .829 | .776 | .869 | .813 | .890 | .730 | .916 | .943 |

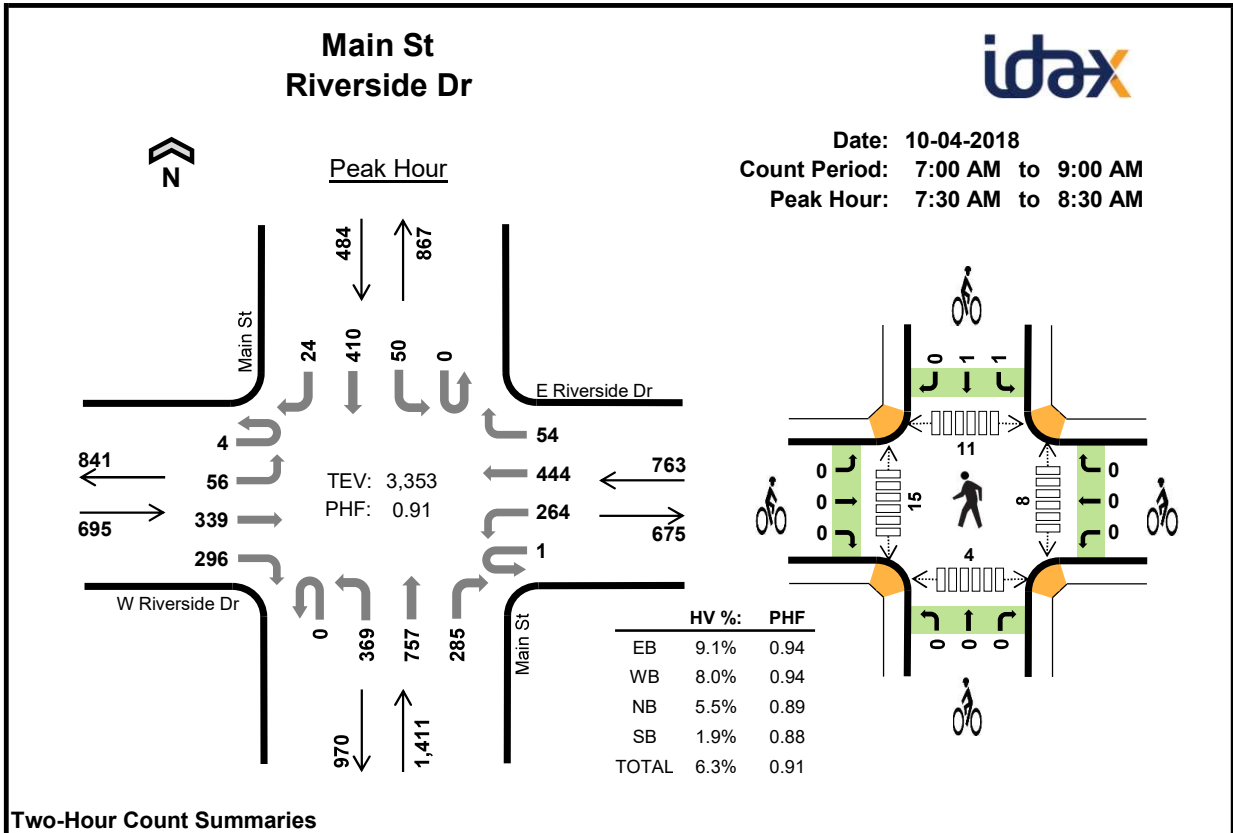

Two-Hour Count Summaries

| Interval Start | W Riverside Dr | | | | E Riverside Dr | | | | Main St | | | | Main St | | | | 15-min Total | Rolling One Hour | |
|----------------|----------------|-----|-----|-----|----------------|-----|-----|-----|------------|-----|-------|-----|------------|----|-----|-----|--------------|------------------|---|
| | Eastbound | | | | Westbound | | | | Northbound | | | | Southbound | | | | | | |
| | UT | LT | TH | RT | UT | LT | TH | RT | UT | LT | TH | RT | UT | LT | TH | RT | | | |
| 7:00 AM | 0 | 7 | 74 | 73 | 2 | 63 | 121 | 10 | 0 | 99 | 157 | 80 | 0 | 16 | 82 | 7 | 791 | 0 | |
| 7:15 AM | 0 | 9 | 76 | 59 | 0 | 77 | 118 | 9 | 0 | 106 | 156 | 75 | 0 | 9 | 80 | 10 | 784 | 0 | |
| 7:30 AM | 1 | 10 | 91 | 82 | 0 | 48 | 107 | 15 | 0 | 103 | 187 | 83 | 0 | 11 | 81 | 5 | 824 | 0 | |
| 7:45 AM | 2 | 16 | 78 | 89 | 0 | 71 | 118 | 13 | 0 | 94 | 219 | 82 | 0 | 14 | 118 | 5 | 919 | 3,318 | |
| 8:00 AM | 1 | 17 | 75 | 59 | 1 | 71 | 118 | 10 | 0 | 93 | 185 | 63 | 0 | 11 | 108 | 7 | 819 | 3,346 | |
| 8:15 AM | 0 | 13 | 95 | 66 | 0 | 74 | 101 | 16 | 0 | 79 | 166 | 57 | 0 | 14 | 103 | 7 | 791 | 3,353 | |
| 8:30 AM | 1 | 14 | 68 | 70 | 0 | 72 | 86 | 13 | 0 | 83 | 136 | 47 | 0 | 6 | 98 | 5 | 699 | 3,228 | |
| 8:45 AM | 2 | 17 | 60 | 72 | 2 | 45 | 69 | 14 | 0 | 94 | 121 | 39 | 0 | 18 | 79 | 6 | 638 | 2,947 | |
| Count Total | 7 | 103 | 617 | 570 | 5 | 521 | 838 | 100 | 0 | 751 | 1,327 | 526 | 0 | 99 | 749 | 52 | 6,265 | 0 | |
| Peak Hour | All | 4 | 56 | 339 | 296 | 1 | 264 | 444 | 54 | 0 | 369 | 757 | 285 | 0 | 50 | 410 | 24 | 3,353 | 0 |
| | HV | 0 | 2 | 33 | 28 | 0 | 15 | 43 | 3 | 0 | 48 | 21 | 8 | 0 | 1 | 7 | 1 | 210 | 0 |
| | HV% | 0% | 4% | 10% | 9% | 0% | 6% | 10% | 6% | - | 13% | 3% | 3% | - | 2% | 2% | 4% | 6% | 0 |

Note: Two-hour count summary volumes include heavy vehicles but exclude bicycles in overall count.

| Interval Start | Heavy Vehicle Totals | | | | | Bicycles | | | | | Pedestrians (Crossing Leg) | | | | |
|----------------|----------------------|----|-----|----|-------|----------|----|----|----|-------|----------------------------|------|-------|-------|-------|
| | EB | WB | NB | SB | Total | EB | WB | NB | SB | Total | East | West | North | South | Total |
| 7:00 AM | 16 | 16 | 14 | 1 | 47 | 0 | 0 | 0 | 0 | 0 | 0 | 2 | 1 | 0 | 3 |
| 7:15 AM | 15 | 8 | 16 | 1 | 40 | 0 | 0 | 0 | 0 | 0 | 2 | 1 | 0 | 4 | 7 |
| 7:30 AM | 17 | 17 | 26 | 2 | 62 | 0 | 0 | 0 | 1 | 1 | 1 | 3 | 4 | 3 | 11 |
| 7:45 AM | 15 | 9 | 14 | 1 | 39 | 0 | 0 | 0 | 1 | 1 | 2 | 6 | 5 | 1 | 14 |
| 8:00 AM | 8 | 22 | 19 | 2 | 51 | 0 | 0 | 0 | 0 | 0 | 2 | 1 | 0 | 0 | 3 |
| 8:15 AM | 23 | 13 | 18 | 4 | 58 | 0 | 0 | 0 | 0 | 0 | 3 | 5 | 2 | 0 | 10 |
| 8:30 AM | 18 | 9 | 14 | 2 | 43 | 0 | 0 | 0 | 0 | 0 | 3 | 0 | 1 | 0 | 4 |
| 8:45 AM | 23 | 5 | 12 | 3 | 43 | 0 | 0 | 0 | 0 | 0 | 2 | 0 | 1 | 0 | 3 |
| Count Total | 135 | 99 | 133 | 16 | 383 | 0 | 0 | 0 | 2 | 2 | 15 | 18 | 14 | 8 | 55 |
| Peak Hour | 63 | 61 | 77 | 9 | 210 | 0 | 0 | 0 | 2 | 2 | 8 | 15 | 11 | 4 | 38 |

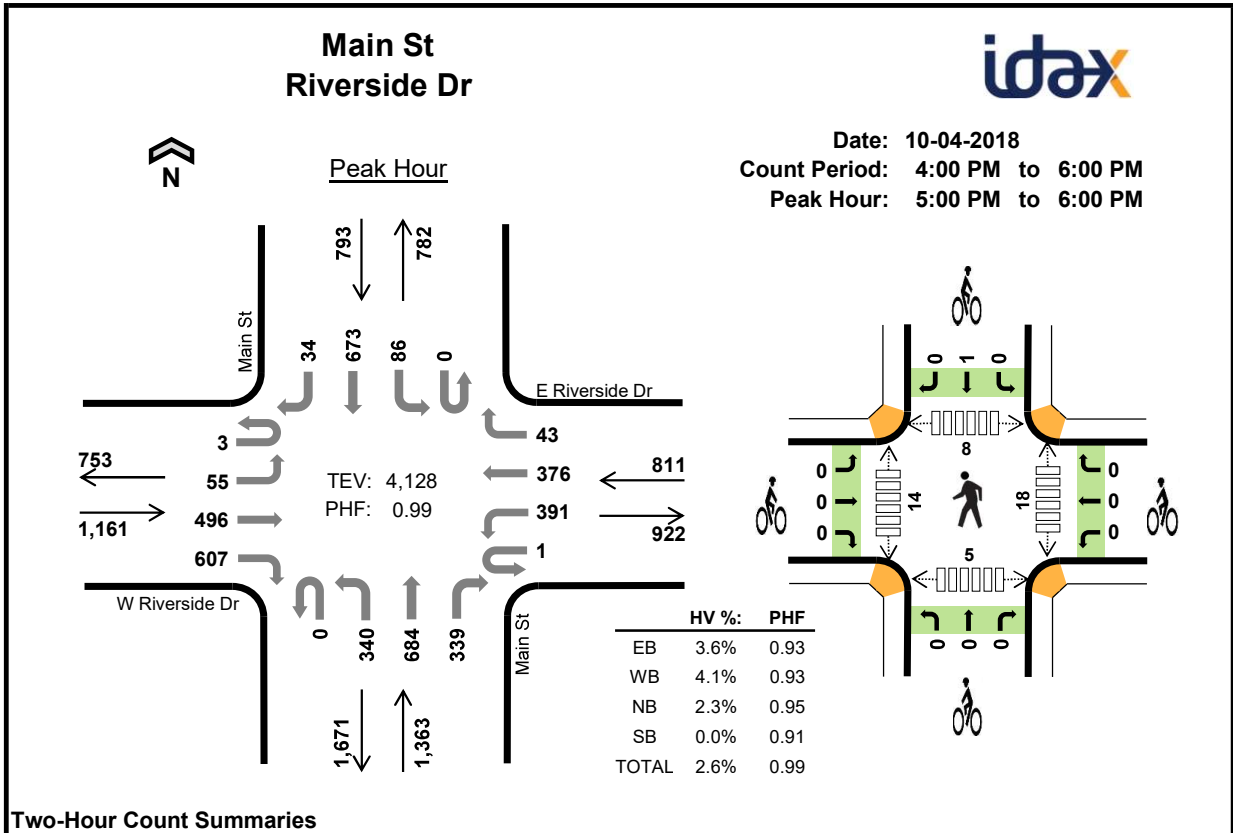

Two-Hour Count Summaries

| Interval Start | W Riverside Dr | | | | E Riverside Dr | | | | Main St | | | | Main St | | | | 15-min Total | Rolling One Hour | |
|----------------|----------------|-----------|------------|------------|----------------|------------|------------|-----------|----------|-----------|------------|-----------|----------|-----------|------------|-----------|--------------|------------------|---|
| | Eastbound | | Westbound | | Northbound | | Southbound | | UT | LT | TH | RT | UT | LT | TH | RT | | | |
| 4:00 PM | 1 | 16 | 108 | 126 | 0 | 82 | 80 | 22 | 0 | 72 | 171 | 66 | 0 | 13 | 168 | 8 | 933 | 0 | |
| 4:15 PM | 0 | 16 | 123 | 133 | 1 | 80 | 90 | 9 | 0 | 86 | 160 | 77 | 0 | 18 | 148 | 5 | 946 | 0 | |
| 4:30 PM | 1 | 17 | 105 | 142 | 0 | 78 | 85 | 14 | 0 | 86 | 162 | 76 | 0 | 11 | 175 | 9 | 961 | 0 | |
| 4:45 PM | 1 | 19 | 125 | 129 | 0 | 89 | 93 | 17 | 0 | 81 | 145 | 76 | 0 | 16 | 147 | 3 | 941 | 3,781 | |
| 5:00 PM | 1 | 11 | 124 | 146 | 0 | 107 | 82 | 13 | 0 | 82 | 181 | 95 | 0 | 21 | 168 | 14 | 1,045 | 3,893 | |
| 5:15 PM | 1 | 17 | 109 | 177 | 0 | 95 | 98 | 9 | 0 | 90 | 152 | 81 | 0 | 17 | 158 | 6 | 1,010 | 3,957 | |
| 5:30 PM | 0 | 12 | 122 | 128 | 0 | 111 | 95 | 11 | 0 | 80 | 182 | 86 | 0 | 29 | 183 | 7 | 1,046 | 4,042 | |
| 5:45 PM | 1 | 15 | 141 | 156 | 1 | 78 | 101 | 10 | 0 | 88 | 169 | 77 | 0 | 19 | 164 | 7 | 1,027 | 4,128 | |
| Count Total | 6 | 123 | 957 | 1,137 | 2 | 720 | 724 | 105 | 0 | 665 | 1,322 | 634 | 0 | 144 | 1,311 | 59 | 7,909 | 0 | |
| Peak Hour | All | 3 | 55 | 496 | 607 | 1 | 391 | 376 | 43 | 0 | 340 | 684 | 339 | 0 | 86 | 673 | 34 | 4,128 | 0 |
| | HV | 0 | 0 | 20 | 22 | 0 | 4 | 29 | 0 | 0 | 22 | 3 | 7 | 0 | 0 | 0 | 0 | 107 | 0 |
| | HV% | 0% | 0% | 4% | 4% | 0% | 1% | 8% | 0% | - | 6% | 0% | 2% | - | 0% | 0% | 0% | 3% | 0 |

Note: Two-hour count summary volumes include heavy vehicles but exclude bicycles in overall count.

| Interval Start | Heavy Vehicle Totals | | | | | Bicycles | | | | | Pedestrians (Crossing Leg) | | | | |
|----------------|----------------------|-----------|----------|----------|-----------|----------|----------|----------|----------|----------|----------------------------|----------|----------|----------|-----------|
| | EB | WB | NB | SB | Total | EB | WB | NB | SB | Total | East | West | North | South | Total |
| 4:00 PM | 24 | 10 | 8 | 0 | 42 | 0 | 0 | 0 | 0 | 0 | 1 | 5 | 0 | 2 | 8 |
| 4:15 PM | 21 | 11 | 8 | 2 | 42 | 0 | 1 | 0 | 0 | 1 | 5 | 5 | 2 | 5 | 17 |
| 4:30 PM | 10 | 8 | 6 | 2 | 26 | 1 | 0 | 0 | 0 | 1 | 4 | 3 | 2 | 2 | 11 |
| 4:45 PM | 12 | 8 | 7 | 2 | 29 | 0 | 0 | 0 | 0 | 0 | 3 | 2 | 1 | 0 | 6 |
| 5:00 PM | 11 | 10 | 6 | 0 | 27 | 0 | 0 | 0 | 0 | 0 | 1 | 1 | 0 | 2 | 4 |
| 5:15 PM | 13 | 6 | 8 | 0 | 27 | 0 | 0 | 0 | 0 | 0 | 6 | 6 | 0 | 0 | 12 |
| 5:30 PM | 11 | 7 | 9 | 0 | 27 | 0 | 0 | 0 | 1 | 1 | 5 | 2 | 3 | 2 | 12 |
| 5:45 PM | 7 | 10 | 9 | 0 | 26 | 0 | 0 | 0 | 0 | 0 | 6 | 5 | 5 | 1 | 17 |
| Count Total | 109 | 70 | 61 | 6 | 246 | 1 | 1 | 0 | 1 | 3 | 31 | 29 | 13 | 14 | 87 |
| Peak Hour | 42 | 33 | 32 | 0 | 107 | 0 | 0 | 0 | 1 | 1 | 18 | 14 | 8 | 5 | 45 |

Traffic Data Service

San Jose, CA
 (408) 622-4787
 tdsbay@cs.com

File Name : 3 FINAL
 Site Code : 00000003
 Start Date : 5/19/2022
 Page No : 3

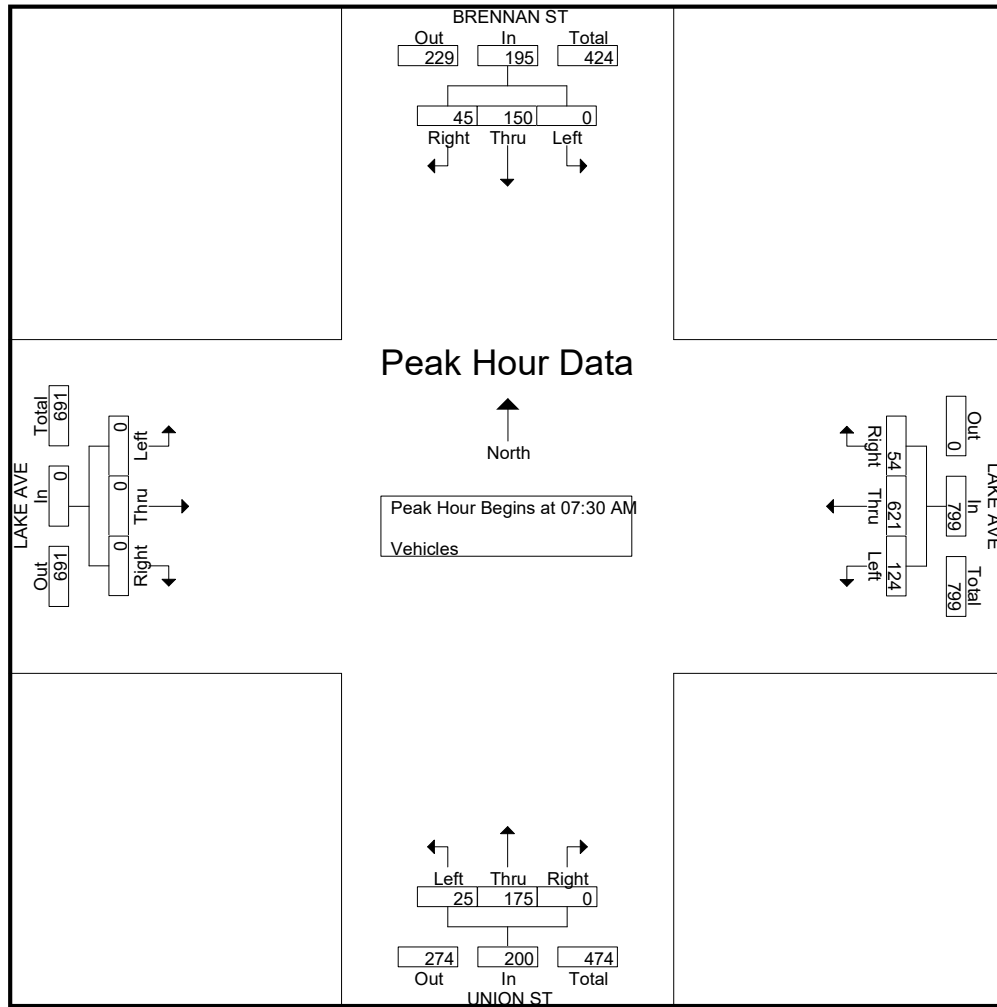

Peak Hour Analysis From 11:00 AM to 02:45 PM - Peak 1 of 1
 Peak Hour for Entire Intersection Begins at 02:00 PM

| | | | | | | | | | | | | | | | | | |
|--------------|------|------|------|------|------|------|------|------|------|------|------|------|------|------|------|------|------|
| 02:00 PM | 10 | 31 | 0 | 41 | 12 | 117 | 26 | 155 | 0 | 46 | 16 | 62 | 0 | 0 | 0 | 0 | 258 |
| 02:15 PM | 12 | 38 | 0 | 50 | 16 | 122 | 26 | 164 | 0 | 59 | 15 | 74 | 0 | 0 | 0 | 0 | 288 |
| 02:30 PM | 8 | 39 | 0 | 47 | 23 | 152 | 25 | 200 | 0 | 53 | 21 | 74 | 0 | 0 | 0 | 0 | 321 |
| 02:45 PM | 19 | 48 | 0 | 67 | 17 | 139 | 20 | 176 | 0 | 65 | 10 | 75 | 0 | 0 | 0 | 0 | 318 |
| Total Volume | 49 | 156 | 0 | 205 | 68 | 530 | 97 | 695 | 0 | 223 | 62 | 285 | 0 | 0 | 0 | 0 | 1185 |
| % App. Total | 23.9 | 76.1 | 0 | | 9.8 | 76.3 | 14 | | 0 | 78.2 | 21.8 | | 0 | 0 | 0 | | |
| PHF | .645 | .813 | .000 | .765 | .739 | .872 | .933 | .869 | .000 | .858 | .738 | .950 | .000 | .000 | .000 | .000 | .923 |

Traffic Data Service

San Jose, CA
 (408) 622-4787
 tdsbay@cs.com

File Name : 3 FINAL
 Site Code : 00000003
 Start Date : 5/19/2022
 Page No : 5

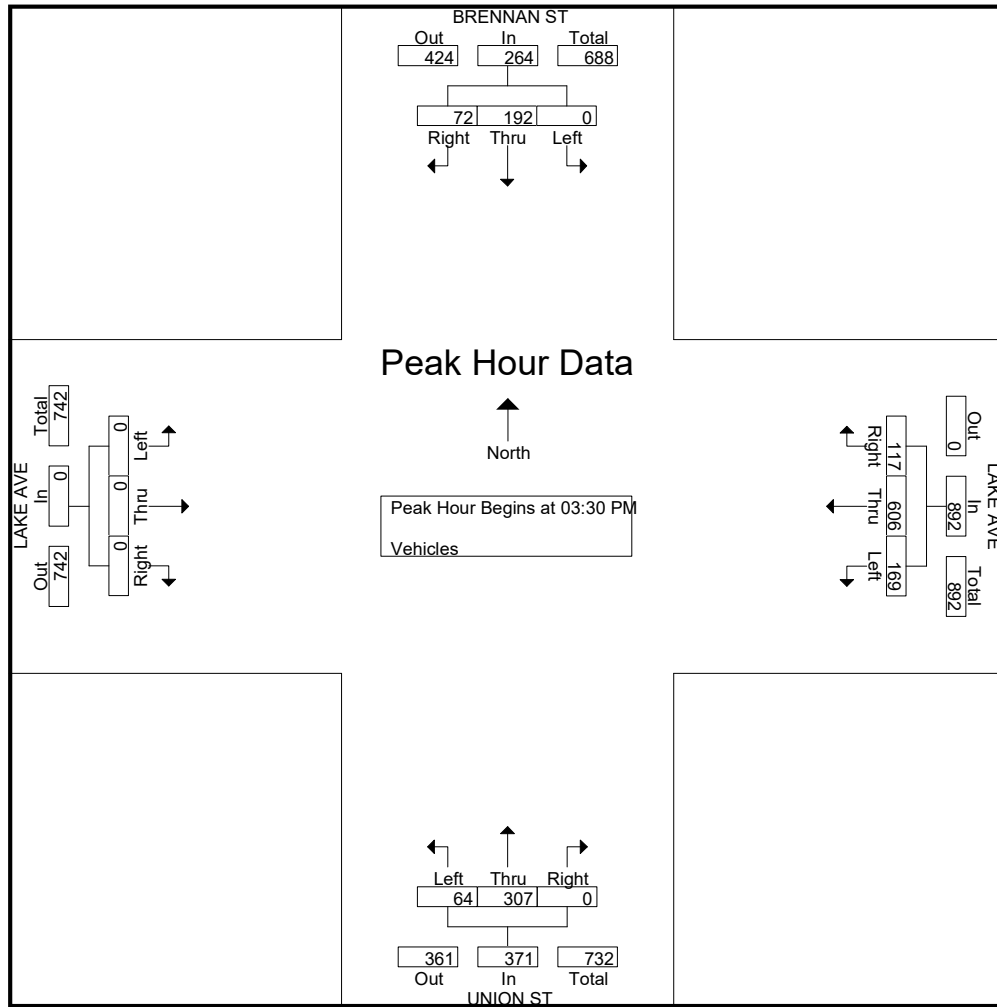

Peak Hour Analysis From 07:00 AM to 06:45 PM - Peak 1 of 1

Peak Hour for Entire Intersection Begins at 03:30 PM

| | | | | | | | | | | | | | | | | | |
|--------------|------|------|------|------|------|------|------|------|------|------|------|------|------|------|------|------|------|
| 03:30 PM | 21 | 57 | 0 | 78 | 20 | 165 | 44 | 229 | 0 | 61 | 12 | 73 | 0 | 0 | 0 | 0 | 380 |
| 03:45 PM | 18 | 33 | 0 | 51 | 23 | 143 | 41 | 207 | 0 | 90 | 18 | 108 | 0 | 0 | 0 | 0 | 366 |
| 04:00 PM | 15 | 41 | 0 | 56 | 33 | 149 | 39 | 221 | 0 | 84 | 17 | 101 | 0 | 0 | 0 | 0 | 378 |
| 04:15 PM | 18 | 61 | 0 | 79 | 41 | 149 | 45 | 235 | 0 | 72 | 17 | 89 | 0 | 0 | 0 | 0 | 403 |
| Total Volume | 72 | 192 | 0 | 264 | 117 | 606 | 169 | 892 | 0 | 307 | 64 | 371 | 0 | 0 | 0 | 0 | 1527 |
| % App. Total | 27.3 | 72.7 | 0 | | 13.1 | 67.9 | 18.9 | | 0 | 82.7 | 17.3 | | 0 | 0 | 0 | | |
| PHF | .857 | .787 | .000 | .835 | .713 | .918 | .939 | .949 | .000 | .853 | .889 | .859 | .000 | .000 | .000 | .000 | .947 |

Traffic Data Service

San Jose, CA
 (408) 622-4787
 tdsbay@cs.com

File Name : 4 FINAL
 Site Code : 00000004
 Start Date : 5/19/2022
 Page No : 3

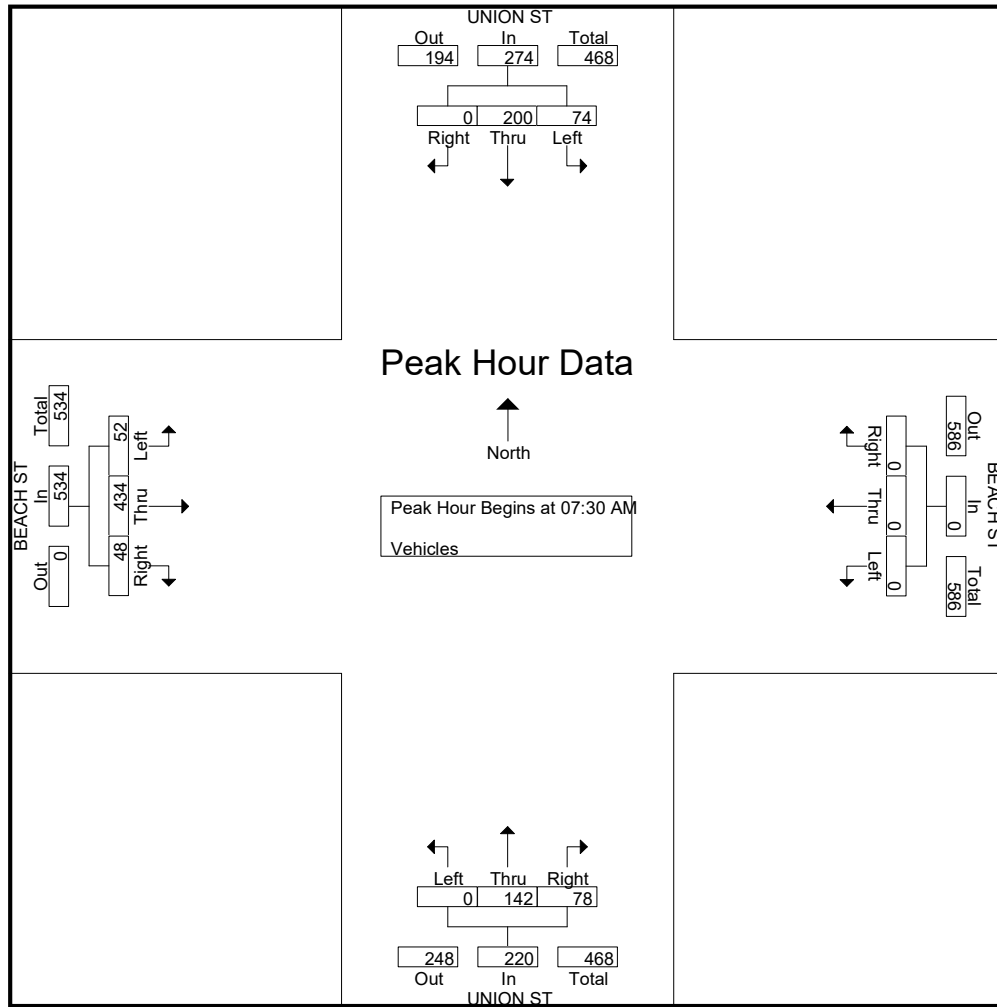

Peak Hour Analysis From 11:00 AM to 02:45 PM - Peak 1 of 1

Peak Hour for Entire Intersection Begins at 12:45 PM

| | | | | | | | | | | | | | | | | | |
|--------------|------|-----------|-----------|-----------|------|------|------|------|-----------|-----------|------|-----------|-----------|------------|-----------|------------|------------|
| 12:45 PM | 0 | 54 | 22 | 76 | 0 | 0 | 0 | 0 | 11 | 38 | 0 | 49 | 14 | 111 | 25 | 150 | 275 |
| 01:00 PM | 0 | 49 | 24 | 73 | 0 | 0 | 0 | 0 | 19 | 33 | 0 | 52 | 7 | 116 | 24 | 147 | 272 |
| 01:15 PM | 0 | 42 | 20 | 62 | 0 | 0 | 0 | 0 | 15 | 34 | 0 | 49 | 12 | 148 | 31 | 191 | 302 |
| 01:30 PM | 0 | 56 | 16 | 72 | 0 | 0 | 0 | 0 | 11 | 29 | 0 | 40 | 16 | 97 | 32 | 145 | 257 |
| Total Volume | 0 | 201 | 82 | 283 | 0 | 0 | 0 | 0 | 56 | 134 | 0 | 190 | 49 | 472 | 112 | 633 | 1106 |
| % App. Total | 0 | 71 | 29 | | 0 | 0 | 0 | | 29.5 | 70.5 | 0 | | 7.7 | 74.6 | 17.7 | | |
| PHF | .000 | .897 | .854 | .931 | .000 | .000 | .000 | .000 | .737 | .882 | .000 | .913 | .766 | .797 | .875 | .829 | .916 |

Traffic Data Service

San Jose, CA
 (408) 622-4787
 tdsbay@cs.com

File Name : 4 FINAL
 Site Code : 00000004
 Start Date : 5/19/2022
 Page No : 5

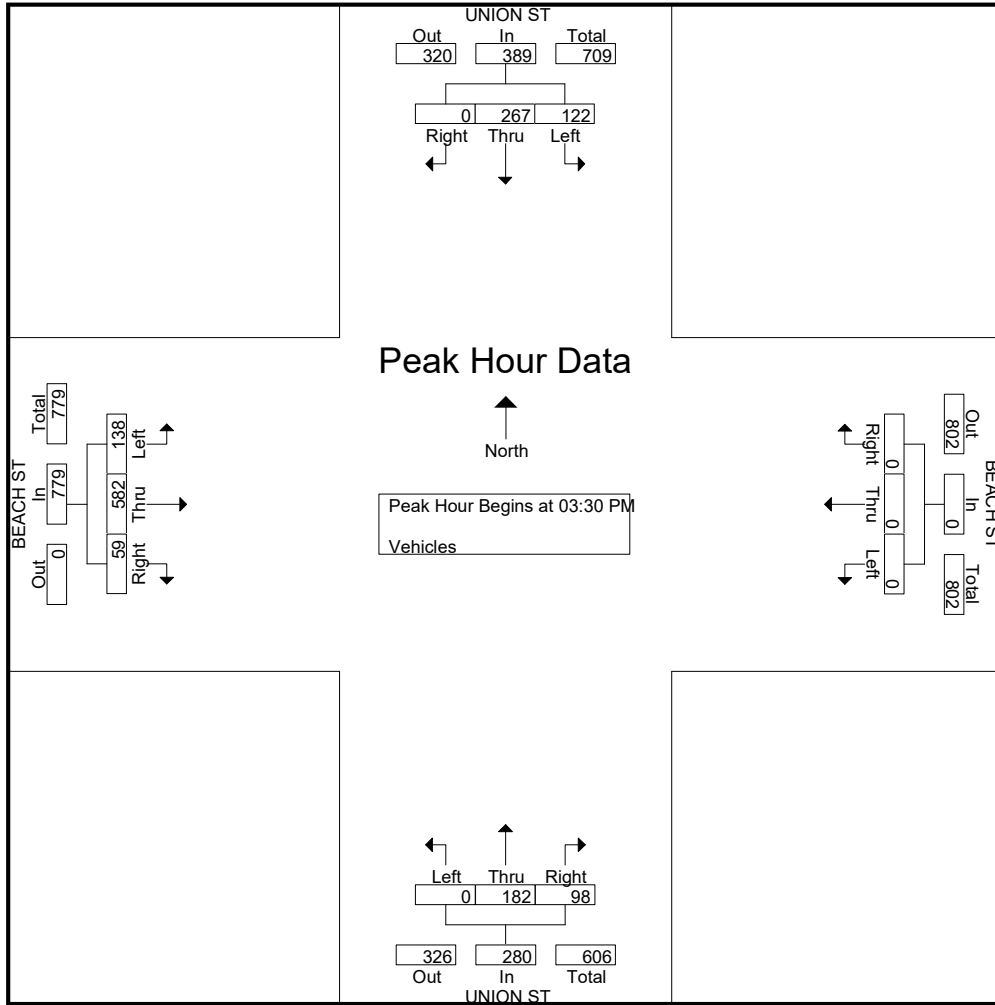

Peak Hour Analysis From 07:00 AM to 06:45 PM - Peak 1 of 1

Peak Hour for Entire Intersection Begins at 03:30 PM

| | | | | | | | | | | | | | | | | | |
|--------------|------|-----------|-----------|------------|------|------|------|------|-----------|-----------|------|-----------|-----------|------------|-----------|------------|------------|
| 03:30 PM | 0 | 71 | 29 | 100 | 0 | 0 | 0 | 0 | 19 | 39 | 0 | 58 | 15 | 121 | 32 | 168 | 326 |
| 03:45 PM | 0 | 59 | 33 | 92 | 0 | 0 | 0 | 0 | 29 | 57 | 0 | 86 | 13 | 145 | 44 | 202 | 380 |
| 04:00 PM | 0 | 63 | 25 | 88 | 0 | 0 | 0 | 0 | 31 | 52 | 0 | 83 | 17 | 180 | 26 | 223 | 394 |
| 04:15 PM | 0 | 74 | 35 | 109 | 0 | 0 | 0 | 0 | 19 | 34 | 0 | 53 | 14 | 136 | 36 | 186 | 348 |
| Total Volume | 0 | 267 | 122 | 389 | 0 | 0 | 0 | 0 | 98 | 182 | 0 | 280 | 59 | 582 | 138 | 779 | 1448 |
| % App. Total | 0 | 68.6 | 31.4 | | 0 | 0 | 0 | | 35 | 65 | 0 | | 7.6 | 74.7 | 17.7 | | |
| PHF | .000 | .902 | .871 | .892 | .000 | .000 | .000 | .000 | .790 | .798 | .000 | .814 | .868 | .808 | .784 | .873 | .919 |

Traffic Data Service

San Jose, CA
 (408) 622-4787
 tdsbay@cs.com

File Name : 5 FINAL
 Site Code : 00000005
 Start Date : 5/19/2022
 Page No : 3

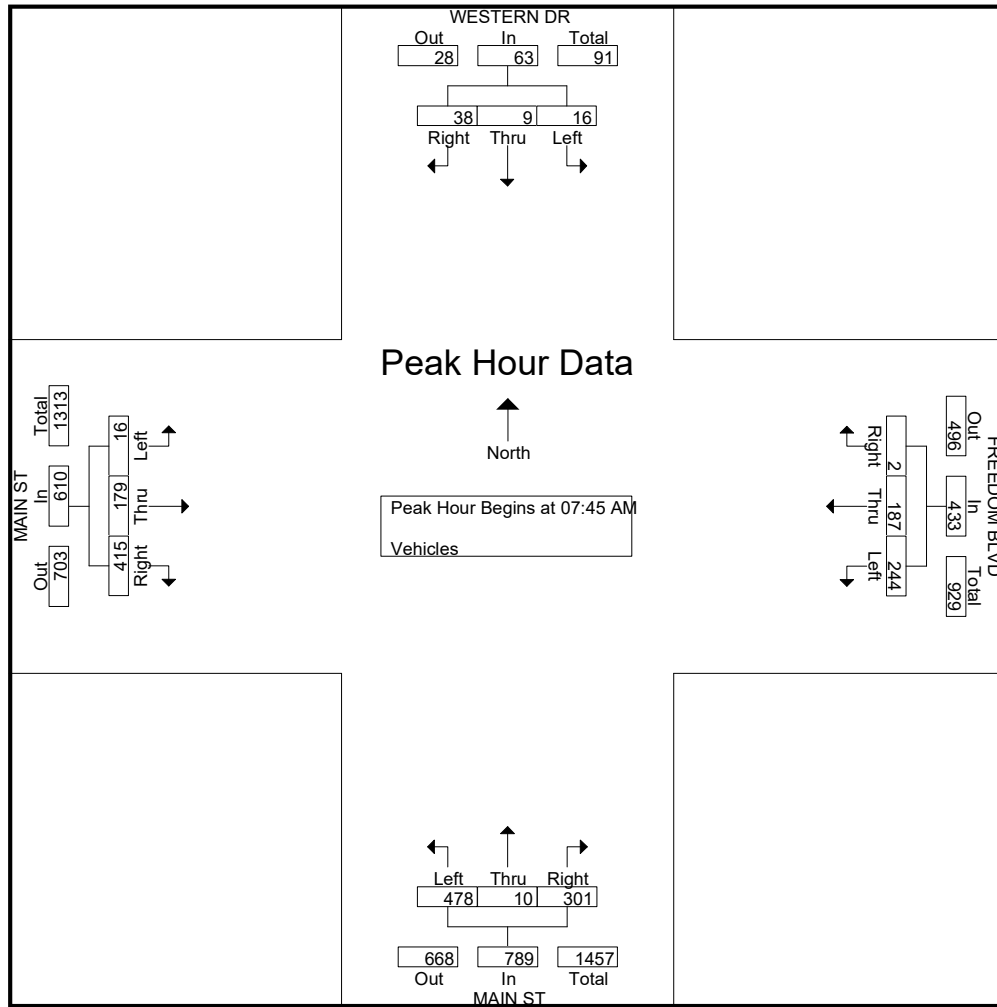

Peak Hour Analysis From 11:00 AM to 02:45 PM - Peak 1 of 1

Peak Hour for Entire Intersection Begins at 01:00 PM

| | | | | | | | | | | | | | | | | | |
|--------------|------|------|------|------|------|------|------|------|------|------|------|------|------|------|------|------|------|
| 01:00 PM | 7 | 4 | 4 | 15 | 0 | 56 | 58 | 114 | 108 | 2 | 106 | 216 | 155 | 77 | 2 | 234 | 579 |
| 01:15 PM | 7 | 1 | 4 | 12 | 3 | 65 | 58 | 126 | 95 | 3 | 96 | 194 | 155 | 68 | 4 | 227 | 559 |
| 01:30 PM | 4 | 5 | 2 | 11 | 0 | 49 | 54 | 103 | 67 | 1 | 89 | 157 | 117 | 82 | 5 | 204 | 475 |
| 01:45 PM | 4 | 6 | 3 | 13 | 0 | 42 | 66 | 108 | 70 | 0 | 110 | 180 | 131 | 86 | 7 | 224 | 525 |
| Total Volume | 22 | 16 | 13 | 51 | 3 | 212 | 236 | 451 | 340 | 6 | 401 | 747 | 558 | 313 | 18 | 889 | 2138 |
| % App. Total | 43.1 | 31.4 | 25.5 | | 0.7 | 47 | 52.3 | | 45.5 | 0.8 | 53.7 | | 62.8 | 35.2 | 2 | | |
| PHF | .786 | .667 | .813 | .850 | .250 | .815 | .894 | .895 | .787 | .500 | .911 | .865 | .900 | .910 | .643 | .950 | .923 |

Traffic Data Service

San Jose, CA
 (408) 622-4787
 tdsbay@cs.com

File Name : 5 FINAL
 Site Code : 00000005
 Start Date : 5/19/2022
 Page No : 5

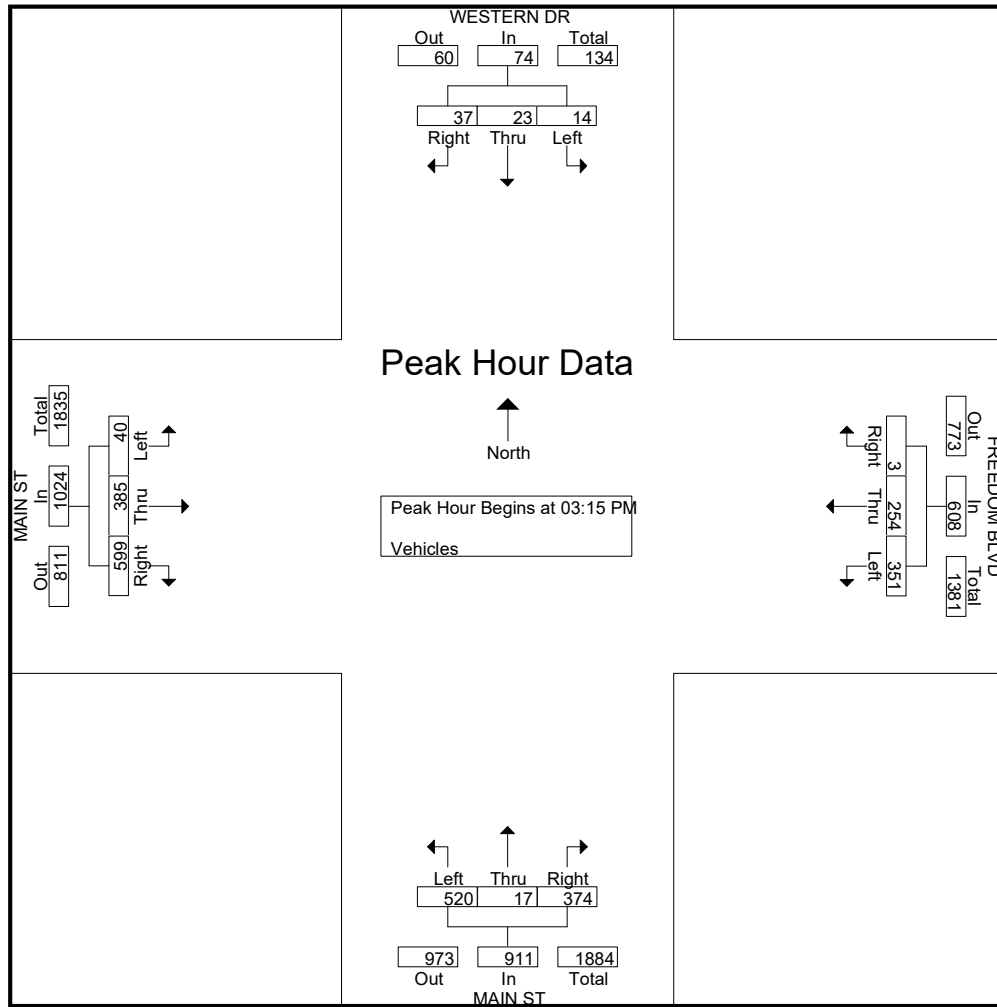

Peak Hour Analysis From 07:00 AM to 06:45 PM - Peak 1 of 1

Peak Hour for Entire Intersection Begins at 03:15 PM

| | | | | | | | | | | | | | | | | | |
|--------------|-----------|----------|------|-----------|----------|-----------|-----------|------------|------------|----------|------------|------------|------------|------------|-----------|------------|------------|
| 03:15 PM | 8 | 6 | 4 | 18 | 0 | 68 | 99 | 167 | 85 | 1 | 149 | 235 | 145 | 100 | 12 | 257 | 677 |
| 03:30 PM | 8 | 3 | 4 | 15 | 1 | 71 | 66 | 138 | 80 | 4 | 118 | 202 | 150 | 94 | 8 | 252 | 607 |
| 03:45 PM | 9 | 7 | 2 | 18 | 1 | 57 | 90 | 148 | 108 | 5 | 123 | 236 | 156 | 96 | 12 | 264 | 666 |
| 04:00 PM | 12 | 7 | 4 | 23 | 1 | 58 | 96 | 155 | 101 | 7 | 130 | 238 | 148 | 95 | 8 | 251 | 667 |
| Total Volume | 37 | 23 | 14 | 74 | 3 | 254 | 351 | 608 | 374 | 17 | 520 | 911 | 599 | 385 | 40 | 1024 | 2617 |
| % App. Total | 50 | 31.1 | 18.9 | | 0.5 | 41.8 | 57.7 | | 41.1 | 1.9 | 57.1 | | 58.5 | 37.6 | 3.9 | | |
| PHF | .771 | .821 | .875 | .804 | .750 | .894 | .886 | .910 | .866 | .607 | .872 | .957 | .960 | .963 | .833 | .970 | .966 |

Traffic Data Service

San Jose, CA
 (408) 622-4787
 tdsbay@cs.com

File Name : 6 FINAL
 Site Code : 00000006
 Start Date : 5/19/2022
 Page No : 3

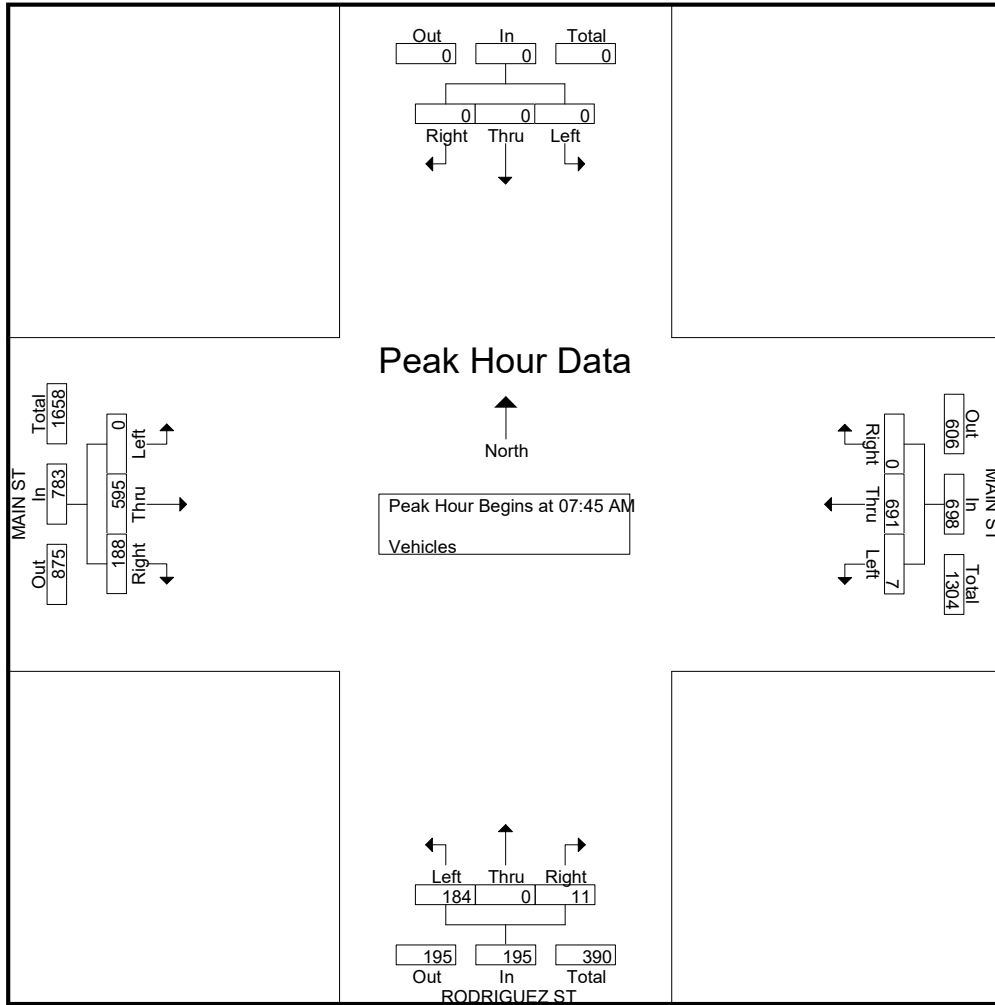

Peak Hour Analysis From 11:00 AM to 02:45 PM - Peak 1 of 1

Peak Hour for Entire Intersection Begins at 02:00 PM

| | | | | | | | | | | | | | | | | | |
|--------------|------|------|------|------|------|------|------|------|------|------|------|------|------|------|------|------|------|
| 02:00 PM | 0 | 0 | 0 | 0 | 0 | 171 | 1 | 172 | 2 | 0 | 47 | 49 | 48 | 171 | 0 | 219 | 440 |
| 02:15 PM | 0 | 0 | 0 | 0 | 0 | 166 | 2 | 168 | 3 | 0 | 61 | 64 | 42 | 211 | 0 | 253 | 485 |
| 02:30 PM | 0 | 0 | 0 | 0 | 0 | 138 | 2 | 140 | 2 | 0 | 38 | 40 | 55 | 199 | 0 | 254 | 434 |
| 02:45 PM | 0 | 0 | 0 | 0 | 0 | 181 | 2 | 183 | 6 | 0 | 67 | 73 | 42 | 229 | 0 | 271 | 527 |
| Total Volume | 0 | 0 | 0 | 0 | 0 | 656 | 7 | 663 | 13 | 0 | 213 | 226 | 187 | 810 | 0 | 997 | 1886 |
| % App. Total | 0 | 0 | 0 | 0 | 0 | 98.9 | 1.1 | | 5.8 | 0 | 94.2 | | 18.8 | 81.2 | 0 | | |
| PHF | .000 | .000 | .000 | .000 | .000 | .906 | .875 | .906 | .542 | .000 | .795 | .774 | .850 | .884 | .000 | .920 | .895 |

Traffic Data Service

San Jose, CA
 (408) 622-4787
 tdsbay@cs.com

File Name : 6 FINAL
 Site Code : 00000006
 Start Date : 5/19/2022
 Page No : 5

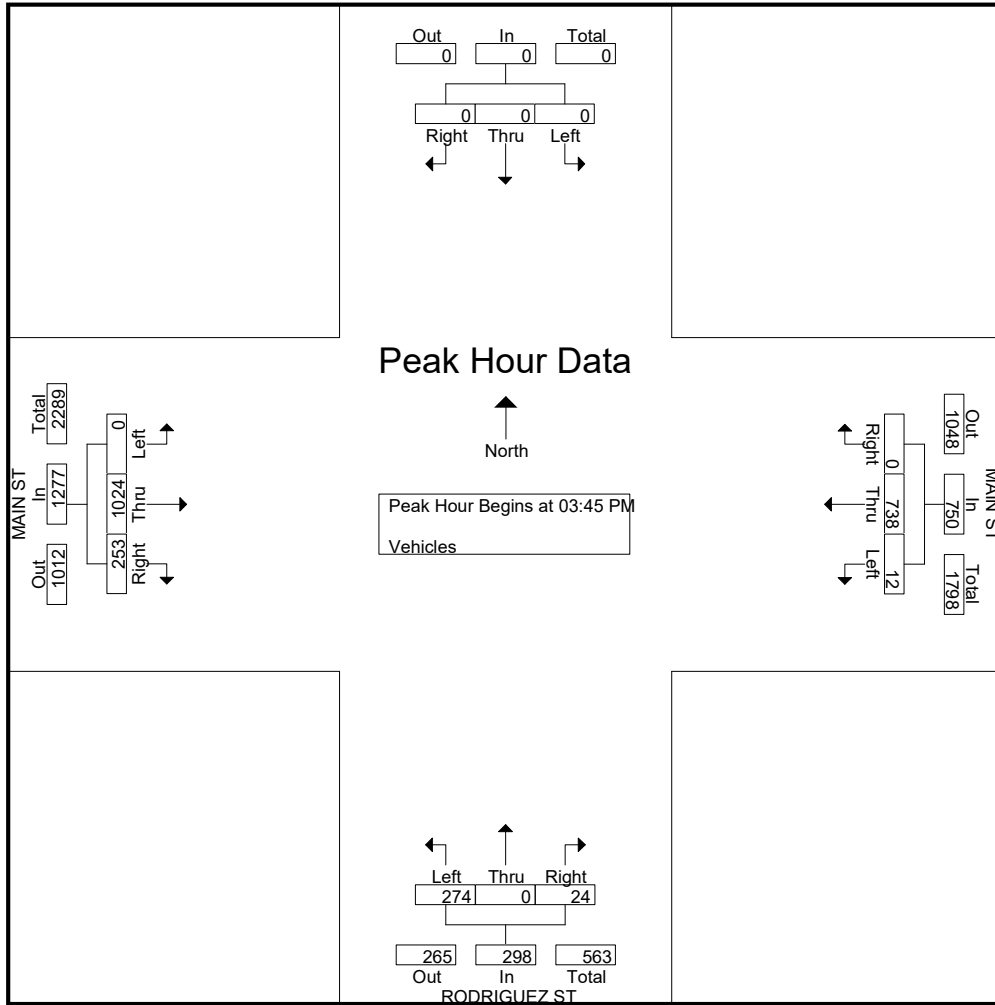

Peak Hour Analysis From 07:00 AM to 06:45 PM - Peak 1 of 1

Peak Hour for Entire Intersection Begins at 03:45 PM

| | | | | | | | | | | | | | | | | | |
|--------------|------|------|------|------|------|------|------|------|------|------|------|------|------|------|------|------|------|
| 03:45 PM | 0 | 0 | 0 | 0 | 0 | 173 | 1 | 174 | 9 | 0 | 76 | 85 | 62 | 254 | 0 | 316 | 575 |
| 04:00 PM | 0 | 0 | 0 | 0 | 0 | 194 | 5 | 199 | 5 | 0 | 70 | 75 | 58 | 237 | 0 | 295 | 569 |
| 04:15 PM | 0 | 0 | 0 | 0 | 0 | 171 | 1 | 172 | 6 | 0 | 73 | 79 | 77 | 266 | 0 | 343 | 594 |
| 04:30 PM | 0 | 0 | 0 | 0 | 0 | 200 | 5 | 205 | 4 | 0 | 55 | 59 | 56 | 267 | 0 | 323 | 587 |
| Total Volume | 0 | 0 | 0 | 0 | 0 | 738 | 12 | 750 | 24 | 0 | 274 | 298 | 253 | 1024 | 0 | 1277 | 2325 |
| % App. Total | 0 | 0 | 0 | 0 | 0 | 98.4 | 1.6 | | 8.1 | 0 | 91.9 | | 19.8 | 80.2 | 0 | | |
| PHF | .000 | .000 | .000 | .000 | .000 | .923 | .600 | .915 | .667 | .000 | .901 | .876 | .821 | .959 | .000 | .931 | .979 |

Traffic Data Service

San Jose, CA
 (408) 622-4787
 tdsbay@cs.com

File Name : 7 FINAL
 Site Code : 00000007
 Start Date : 5/19/2022
 Page No : 3

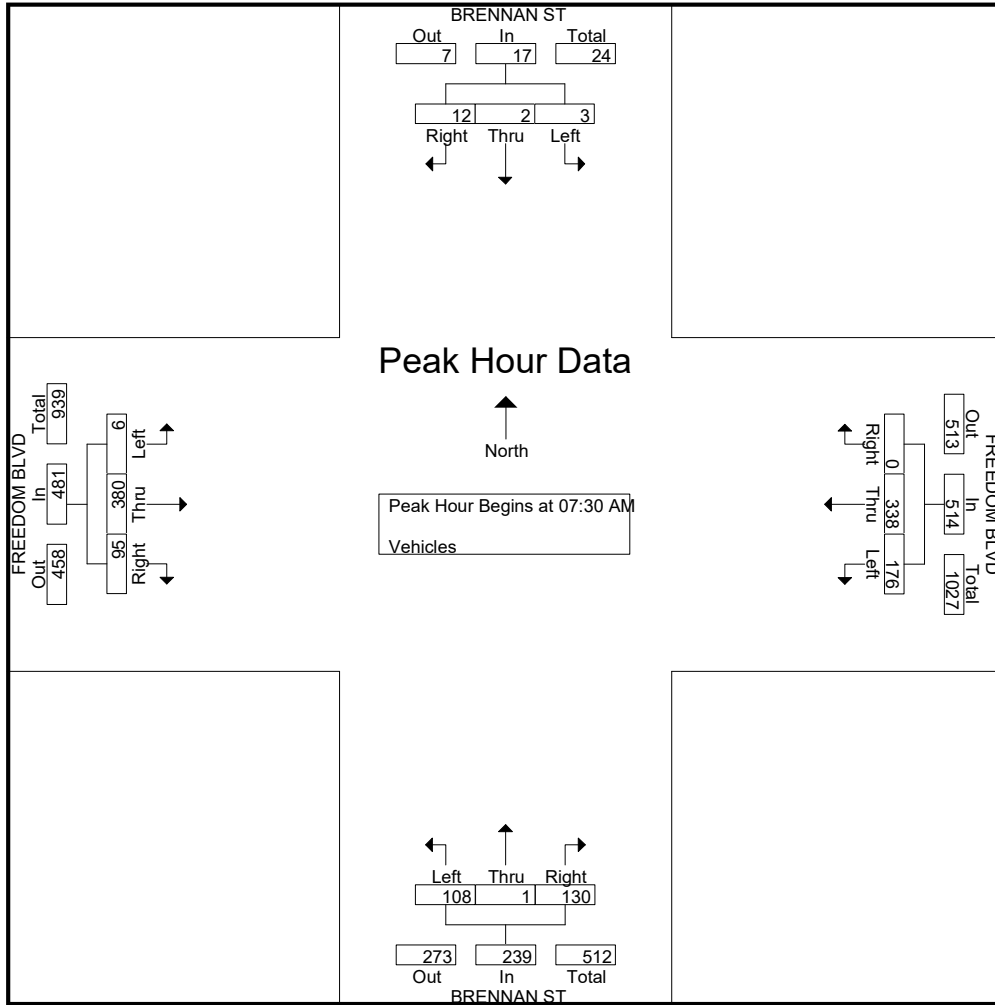

Peak Hour Analysis From 11:00 AM to 02:45 PM - Peak 1 of 1

Peak Hour for Entire Intersection Begins at 01:00 PM

| | | | | | | | | | | | | | | | | | |
|--------------|----------|----------|----------|----------|------|-----------|-----------|------------|-----------|----------|-----------|-----------|-----------|------------|----------|------------|------------|
| 01:00 PM | 0 | 0 | 0 | 0 | 0 | 92 | 32 | 124 | 41 | 1 | 36 | 78 | 38 | 152 | 1 | 191 | 393 |
| 01:15 PM | 1 | 0 | 1 | 2 | 0 | 95 | 29 | 124 | 43 | 2 | 32 | 77 | 23 | 139 | 1 | 163 | 366 |
| 01:30 PM | 0 | 0 | 1 | 1 | 0 | 71 | 30 | 101 | 53 | 0 | 24 | 77 | 29 | 126 | 0 | 155 | 334 |
| 01:45 PM | 5 | 1 | 0 | 6 | 0 | 91 | 37 | 128 | 50 | 1 | 21 | 72 | 29 | 126 | 3 | 158 | 364 |
| Total Volume | 6 | 1 | 2 | 9 | 0 | 349 | 128 | 477 | 187 | 4 | 113 | 304 | 119 | 543 | 5 | 667 | 1457 |
| % App. Total | 66.7 | 11.1 | 22.2 | | 0 | 73.2 | 26.8 | | 61.5 | 1.3 | 37.2 | | 17.8 | 81.4 | 0.7 | | |
| PHF | .300 | .250 | .500 | .375 | .000 | .918 | .865 | .932 | .882 | .500 | .785 | .974 | .783 | .893 | .417 | .873 | .927 |

Traffic Data Service

San Jose, CA
 (408) 622-4787
 tdsbay@cs.com

File Name : 7 FINAL
 Site Code : 00000007
 Start Date : 5/19/2022
 Page No : 5

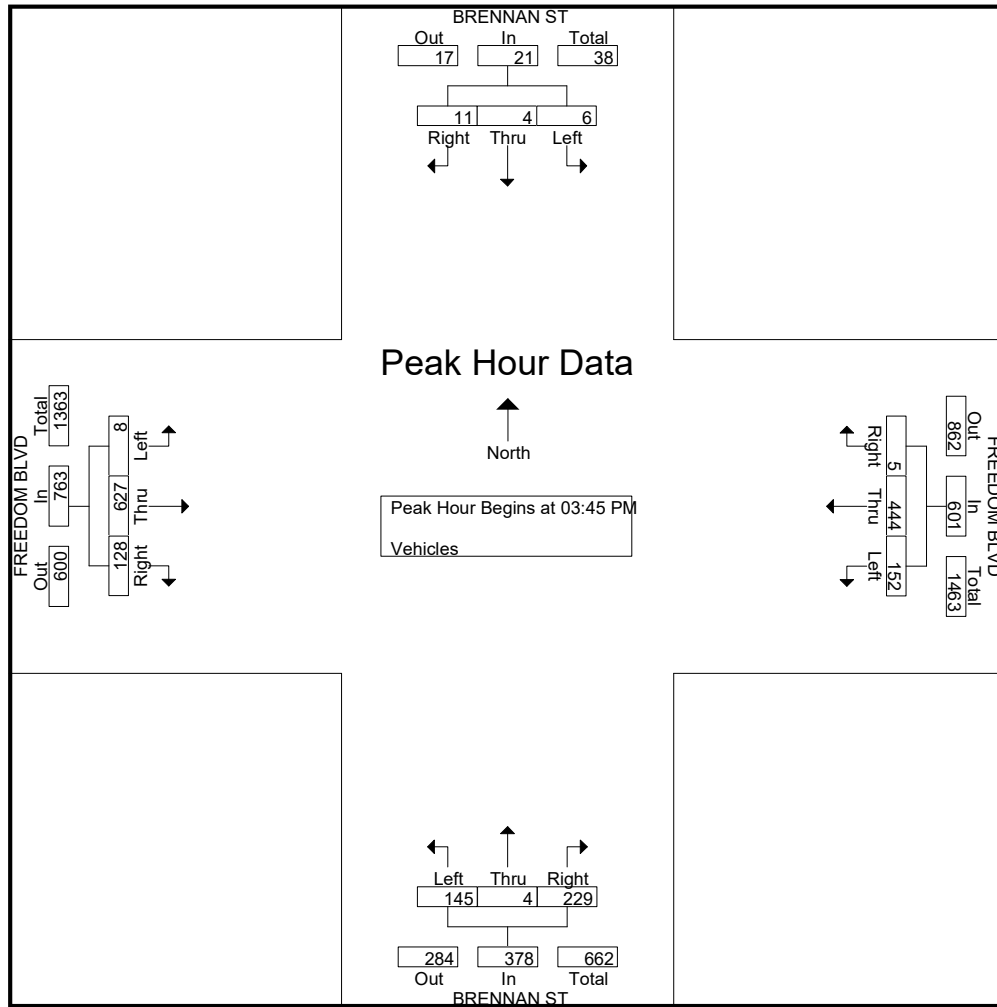

Peak Hour Analysis From 07:00 AM to 06:45 PM - Peak 1 of 1

Peak Hour for Entire Intersection Begins at 03:45 PM

| | | | | | | | | | | | | | | | | | |
|--------------|------|------|------|------|------|------|------|------|------|------|------|------|------|------|------|------|------|
| 03:45 PM | 0 | 0 | 1 | 1 | 3 | 108 | 39 | 150 | 60 | 1 | 32 | 93 | 30 | 161 | 3 | 194 | 438 |
| 04:00 PM | 6 | 0 | 3 | 9 | 1 | 114 | 41 | 156 | 58 | 2 | 37 | 97 | 35 | 166 | 3 | 204 | 466 |
| 04:15 PM | 3 | 2 | 2 | 7 | 0 | 114 | 40 | 154 | 52 | 0 | 36 | 88 | 30 | 170 | 1 | 201 | 450 |
| 04:30 PM | 2 | 2 | 0 | 4 | 1 | 108 | 32 | 141 | 59 | 1 | 40 | 100 | 33 | 130 | 1 | 164 | 409 |
| Total Volume | 11 | 4 | 6 | 21 | 5 | 444 | 152 | 601 | 229 | 4 | 145 | 378 | 128 | 627 | 8 | 763 | 1763 |
| % App. Total | 52.4 | 19 | 28.6 | | 0.8 | 73.9 | 25.3 | | 60.6 | 1.1 | 38.4 | | 16.8 | 82.2 | 1 | | |
| PHF | .458 | .500 | .500 | .583 | .417 | .974 | .927 | .963 | .954 | .500 | .906 | .945 | .914 | .922 | .667 | .935 | .946 |

Traffic Data Service

San Jose, CA
 (408) 622-4787
 tdsbay@cs.com

File Name : 8 FINAL
 Site Code : 00000008
 Start Date : 5/19/2022
 Page No : 3

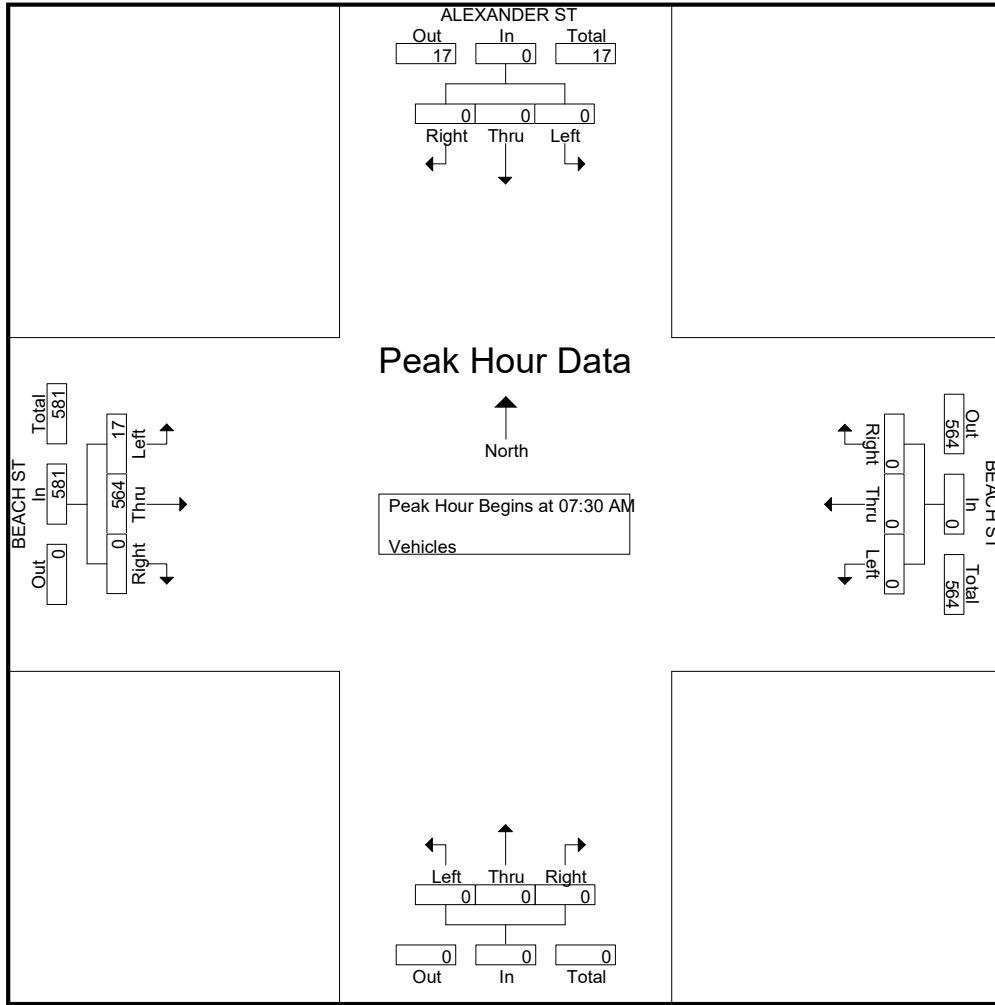

Peak Hour Analysis From 11:00 AM to 02:45 PM - Peak 1 of 1

Peak Hour for Entire Intersection Begins at 02:00 PM

| | | | | | | | | | | | | | | | | | |
|--------------|------|------|------|------|------|------|------|------|------|------|------|------|------|------------|-----------|------------|------------|
| 02:00 PM | 0 | 0 | 0 | 0 | 0 | 0 | 0 | 0 | 0 | 0 | 0 | 0 | 0 | 123 | 10 | 133 | 133 |
| 02:15 PM | 0 | 0 | 0 | 0 | 0 | 0 | 0 | 0 | 0 | 0 | 0 | 0 | 0 | 141 | 7 | 148 | 148 |
| 02:30 PM | 0 | 0 | 0 | 0 | 0 | 0 | 0 | 0 | 0 | 0 | 0 | 0 | 0 | 159 | 10 | 169 | 169 |
| 02:45 PM | 0 | 0 | 0 | 0 | 0 | 0 | 0 | 0 | 0 | 0 | 0 | 0 | 0 | 150 | 10 | 160 | 160 |
| Total Volume | 0 | 0 | 0 | 0 | 0 | 0 | 0 | 0 | 0 | 0 | 0 | 0 | 0 | 573 | 37 | 610 | 610 |
| % App. Total | 0 | 0 | 0 | 0 | 0 | 0 | 0 | 0 | 0 | 0 | 0 | 0 | 0 | 93.9 | 6.1 | | |
| PHF | .000 | .000 | .000 | .000 | .000 | .000 | .000 | .000 | .000 | .000 | .000 | .000 | .000 | .901 | .925 | .902 | .902 |

Traffic Data Service

San Jose, CA
 (408) 622-4787
 tdsbay@cs.com

File Name : 8 FINAL
 Site Code : 00000008
 Start Date : 5/19/2022
 Page No : 5

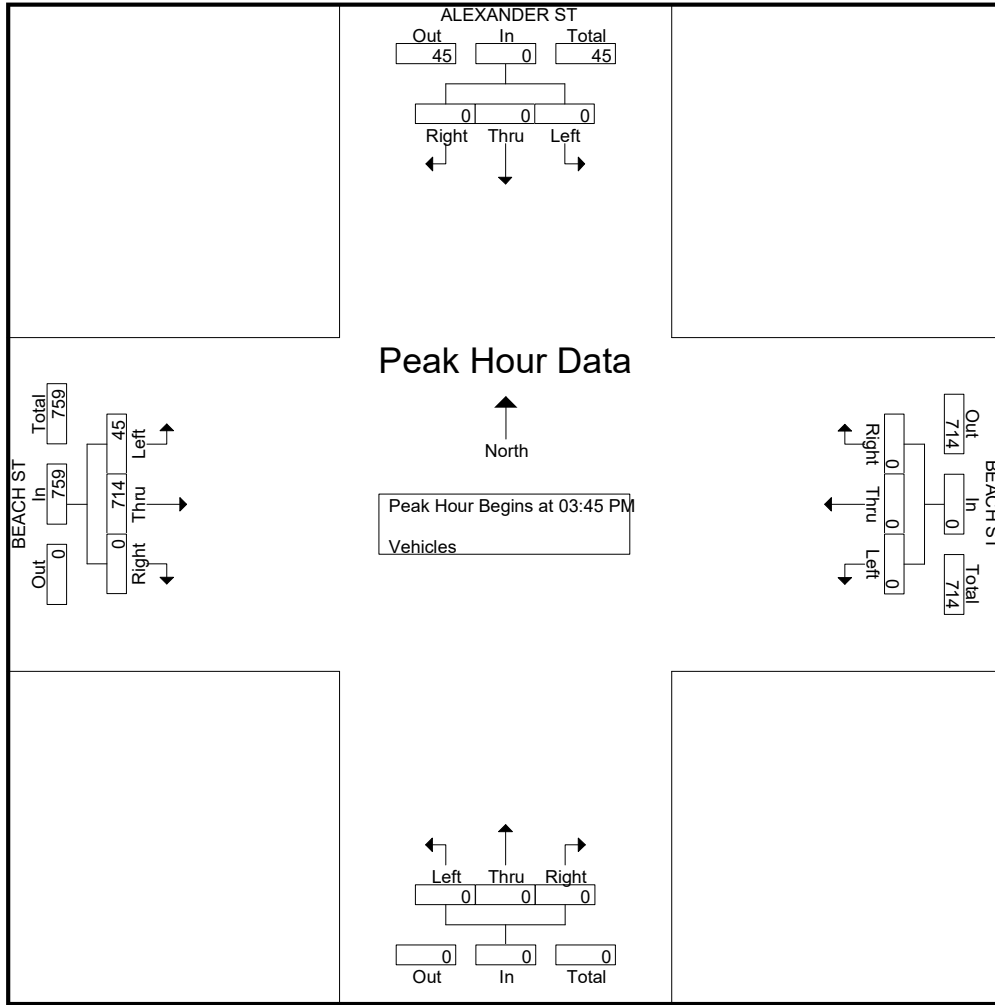

Peak Hour Analysis From 07:00 AM to 06:45 PM - Peak 1 of 1

Peak Hour for Entire Intersection Begins at 03:45 PM

| | | | | | | | | | | | | | | | | | | |
|--------------|------|------|------|------|------|------|------|------|------|------|------|------|------|------|------------|-----------|------------|------------|
| 03:45 PM | 0 | 0 | 0 | 0 | 0 | 0 | 0 | 0 | 0 | 0 | 0 | 0 | 0 | 0 | 187 | 8 | 195 | 195 |
| 04:00 PM | 0 | 0 | 0 | 0 | 0 | 0 | 0 | 0 | 0 | 0 | 0 | 0 | 0 | 0 | 213 | 13 | 226 | 226 |
| 04:15 PM | 0 | 0 | 0 | 0 | 0 | 0 | 0 | 0 | 0 | 0 | 0 | 0 | 0 | 0 | 161 | 12 | 173 | 173 |
| 04:30 PM | 0 | 0 | 0 | 0 | 0 | 0 | 0 | 0 | 0 | 0 | 0 | 0 | 0 | 0 | 153 | 12 | 165 | 165 |
| Total Volume | 0 | 0 | 0 | 0 | 0 | 0 | 0 | 0 | 0 | 0 | 0 | 0 | 0 | 0 | 714 | 45 | 759 | 759 |
| % App. Total | 0 | 0 | 0 | 0 | 0 | 0 | 0 | 0 | 0 | 0 | 0 | 0 | 0 | 0 | 94.1 | 5.9 | | |
| PHF | .000 | .000 | .000 | .000 | .000 | .000 | .000 | .000 | .000 | .000 | .000 | .000 | .000 | .000 | .838 | .865 | .840 | .840 |

Traffic Data Service

San Jose, CA
 (408) 622-4787
 tdsbay@cs.com

File Name : 1MID FINAL
 Site Code : 00000001
 Start Date : 7/23/2022
 Page No : 2

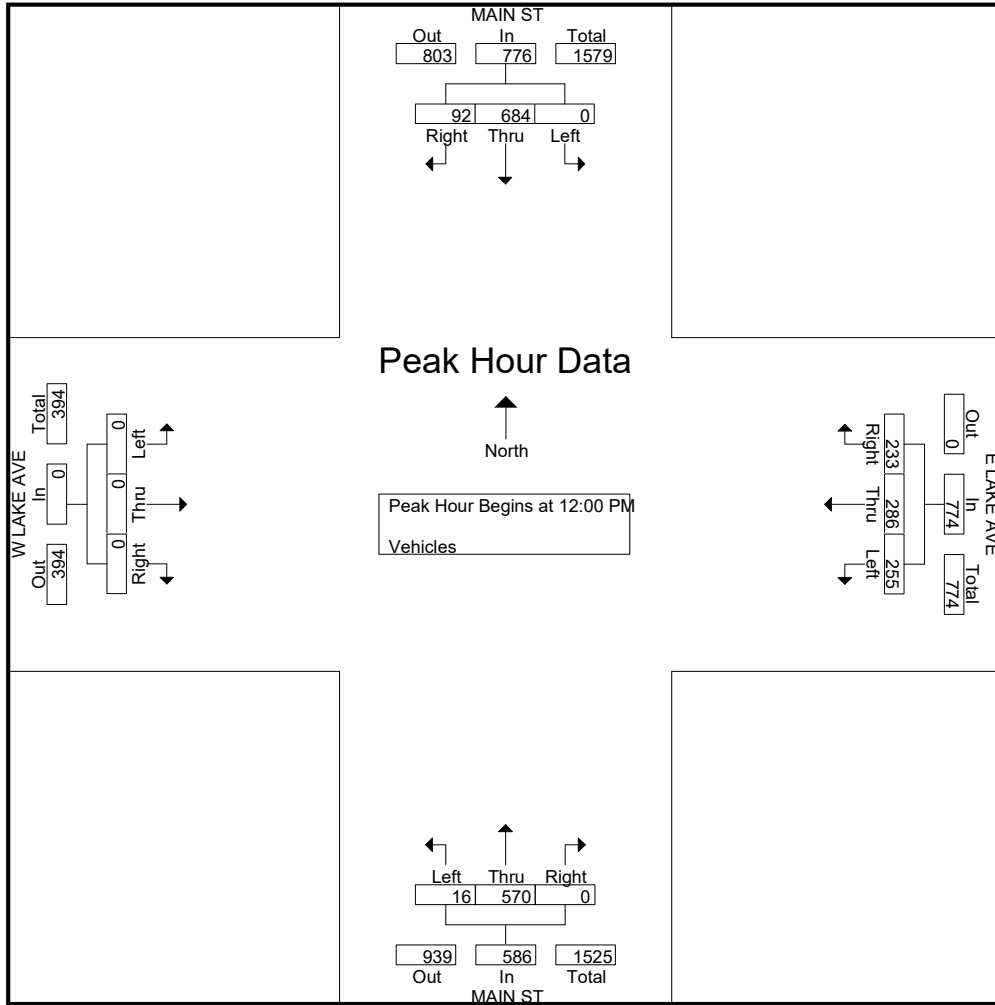

Traffic Data Service

San Jose, CA
 (408) 622-4787
 tdsbay@cs.com

File Name : 2MID FINAL
 Site Code : 00000002
 Start Date : 7/23/2022
 Page No : 2

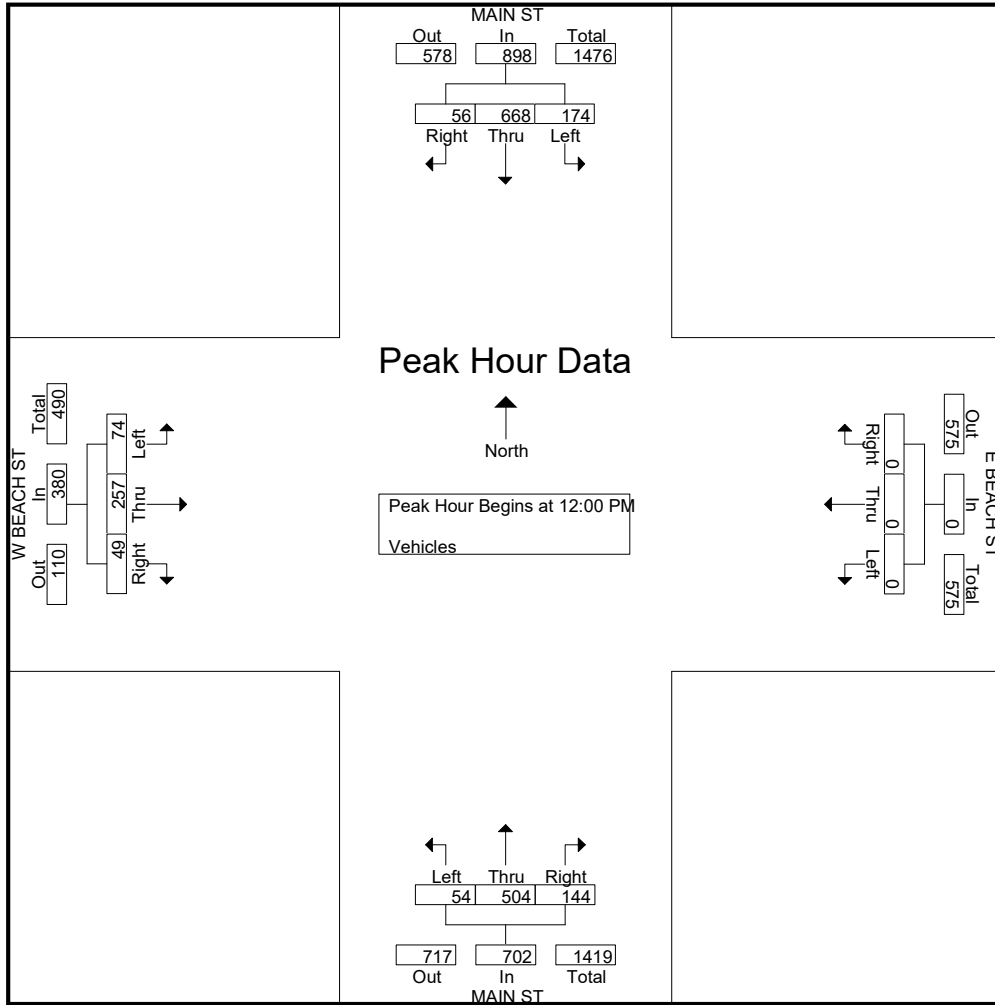

Traffic Data Service

San Jose, CA
 (408) 622-4787
 tdsbay@cs.com

File Name : 3MID FINAL
 Site Code : 00000003
 Start Date : 7/23/2022
 Page No : 2

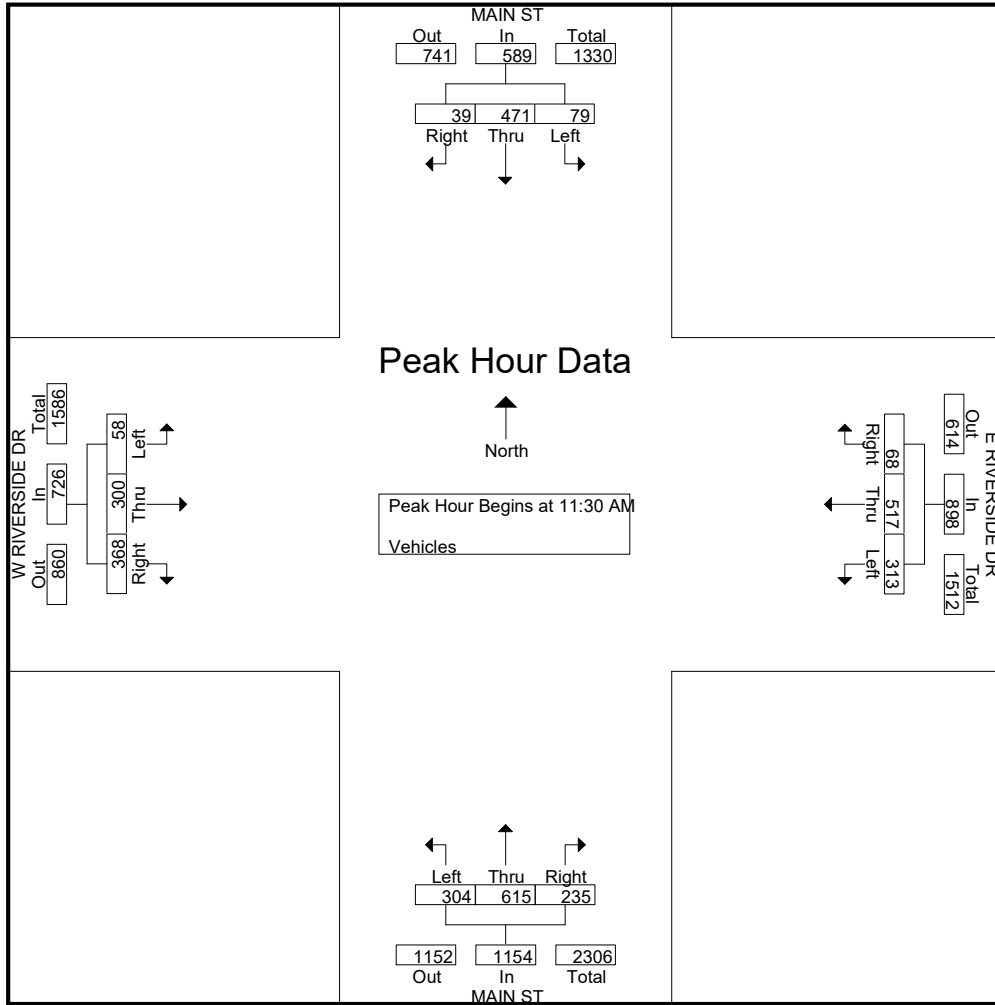

Traffic Data Service

San Jose, CA
 (408) 622-4787
 tdsbay@cs.com

File Name : 4MID FINAL
 Site Code : 00000004
 Start Date : 7/23/2022
 Page No : 2

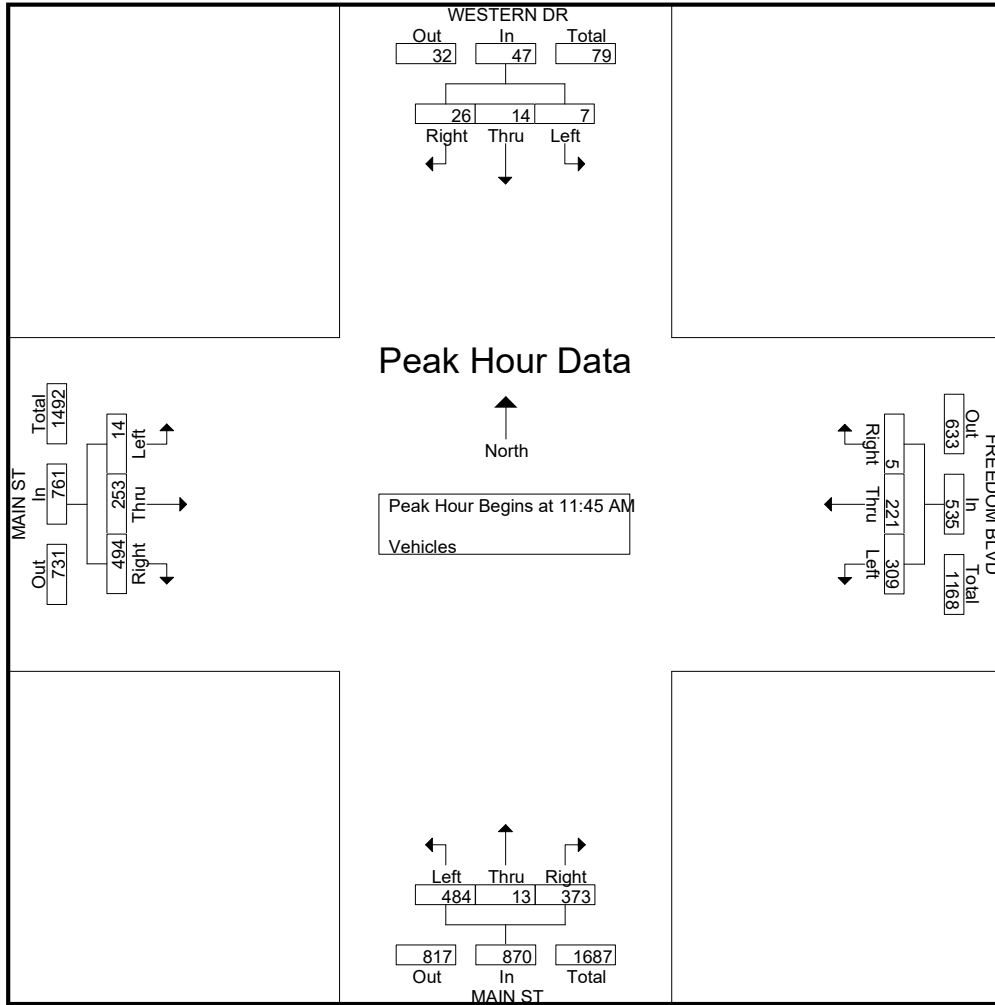

B – Existing Traffic Conditions



| Intersection | | | | | | | | | | | | |
|--------------------------|------|------|------|------|------|------|------|------|------|------|------|------|
| Int Delay, s/veh | 0.3 | | | | | | | | | | | |
| Movement | EBL | EBT | EBR | WBL | WBT | WBR | NBL | NBT | NBR | SBL | SBT | SBR |
| Lane Configurations | | ↔↑ | | | | | | | ↔↑ | | | |
| Traffic Vol, veh/h | 17 | 564 | 0 | 0 | 0 | 0 | 0 | 0 | 0 | 0 | 0 | 0 |
| Future Vol, veh/h | 17 | 564 | 0 | 0 | 0 | 0 | 0 | 0 | 0 | 0 | 0 | 0 |
| Conflicting Peds, #/hr | 17 | 0 | 0 | 0 | 0 | 17 | 0 | 0 | 15 | 15 | 0 | 0 |
| Sign Control | Free | Free | Free | Free | Free | Free | Stop | Stop | Stop | Stop | Stop | Stop |
| RT Channelized | - | - | None | - | - | None | - | - | None | - | - | None |
| Storage Length | - | - | - | - | - | - | - | - | 0 | - | - | - |
| Veh in Median Storage, # | - | 0 | - | - | 0 | - | - | 0 | - | - | 0 | - |
| Grade, % | - | 0 | - | - | 0 | - | - | 0 | - | - | 0 | - |
| Peak Hour Factor | 83 | 83 | 83 | 83 | 83 | 83 | 83 | 83 | 83 | 83 | 83 | 83 |
| Heavy Vehicles, % | 2 | 2 | 2 | 2 | 2 | 2 | 2 | 2 | 2 | 2 | 2 | 2 |
| Mvmt Flow | 20 | 680 | 0 | 0 | 0 | 0 | 0 | 0 | 0 | 0 | 0 | 0 |

| Major/Minor | Major1 | | | Minor1 | | |
|----------------------|--------|---|---|--------|---|------|
| Conflicting Flow All | 17 | 0 | - | - | - | 355 |
| Stage 1 | - | - | - | - | - | - |
| Stage 2 | - | - | - | - | - | - |
| Critical Hdwy | 4.14 | - | - | - | - | 6.94 |
| Critical Hdwy Stg 1 | - | - | - | - | - | - |
| Critical Hdwy Stg 2 | - | - | - | - | - | - |
| Follow-up Hdwy | 2.22 | - | - | - | - | 3.32 |
| Pot Cap-1 Maneuver | 1599 | - | 0 | 0 | 0 | 641 |
| Stage 1 | - | - | 0 | 0 | 0 | - |
| Stage 2 | - | - | 0 | 0 | 0 | - |
| Platoon blocked, % | - | - | - | - | - | - |
| Mov Cap-1 Maneuver | 1599 | - | - | - | 0 | 641 |
| Mov Cap-2 Maneuver | - | - | - | - | 0 | - |
| Stage 1 | - | - | - | - | 0 | - |
| Stage 2 | - | - | - | - | 0 | - |























| Approach | EB | NB |
|----------------------|-----|----|
| HCM Control Delay, s | 0.3 | 0 |
| HCM LOS | | A |

| Minor Lane/Major Mvmt | NBLn1 | EBL | EBT |
|-----------------------|-------|-------|-----|
| Capacity (veh/h) | - | 1599 | - |
| HCM Lane V/C Ratio | - | 0.013 | - |
| HCM Control Delay (s) | 0 | 7.3 | 0.1 |
| HCM Lane LOS | A | A | A |
| HCM 95th %tile Q(veh) | - | 0 | - |

HCM Signalized Intersection Capacity Analysis

6: Main St & Freedom Blvd & Western Dr

Existing
Timing Plan: AM PEAK HOUR

| |  |  |  |  |  |  |  |  |  |  |  |  |
|-----------------------------------|---|---|---|---|---|---|---|---|---|---|---|---|
| Movement | EBL | EBT | EBR | WBL | WBT | WBR | NBL | NBT | NBR | SBL | SBT | SBR |
| Lane Configurations | |  |  |  |  |  |  |  |  | |  |  |
| Traffic Volume (vph) | 16 | 179 | 415 | 244 | 187 | 2 | 478 | 10 | 301 | 16 | 9 | 38 |
| Future Volume (vph) | 16 | 179 | 415 | 244 | 187 | 2 | 478 | 10 | 301 | 16 | 9 | 38 |
| Ideal Flow (vphpl) | 1900 | 1900 | 1900 | 1900 | 1900 | 1900 | 1900 | 1900 | 1900 | 1900 | 1900 | 1900 |
| Total Lost time (s) | | 4.6 | 4.6 | 4.6 | 4.6 | | 5.3 | 5.3 | 4.6 | | 4.6 | 4.6 |
| Lane Util. Factor | | 1.00 | 0.88 | 0.91 | 0.91 | | 0.95 | 0.95 | 1.00 | | 1.00 | 1.00 |
| Frbp, ped/bikes | | 1.00 | 1.00 | 1.00 | 1.00 | | 1.00 | 1.00 | 1.00 | | 1.00 | 1.00 |
| Flpb, ped/bikes | | 1.00 | 1.00 | 1.00 | 1.00 | | 1.00 | 1.00 | 1.00 | | 1.00 | 1.00 |
| Frt | | 1.00 | 0.85 | 1.00 | 1.00 | | 1.00 | 1.00 | 0.85 | | 1.00 | 0.85 |
| Flt Protected | | 1.00 | 1.00 | 0.95 | 0.98 | | 0.95 | 0.95 | 1.00 | | 0.97 | 1.00 |
| Satd. Flow (prot) | | 1855 | 2787 | 1610 | 3328 | | 1681 | 1688 | 1583 | | 1805 | 1583 |
| Flt Permitted | | 1.00 | 1.00 | 0.95 | 0.98 | | 0.95 | 0.95 | 1.00 | | 0.97 | 1.00 |
| Satd. Flow (perm) | | 1855 | 2787 | 1610 | 3328 | | 1681 | 1688 | 1583 | | 1805 | 1583 |
| Peak-hour factor, PHF | 0.87 | 0.87 | 0.87 | 0.87 | 0.87 | 0.87 | 0.87 | 0.87 | 0.87 | 0.87 | 0.87 | 0.87 |
| Adj. Flow (vph) | 18 | 206 | 477 | 280 | 215 | 2 | 549 | 11 | 346 | 18 | 10 | 44 |
| RTOR Reduction (vph) | 0 | 0 | 158 | 0 | 0 | 0 | 0 | 0 | 130 | 0 | 0 | 41 |
| Lane Group Flow (vph) | 0 | 224 | 319 | 162 | 335 | 0 | 280 | 280 | 216 | 0 | 28 | 3 |
| Confl. Peds. (#/hr) | 8 | | | | | 8 | | | | | | |
| Turn Type | Split | NA | pt+ov | Split | NA | | Split | NA | pm+ov | Split | NA | Perm |
| Protected Phases | 5 | 5 | 5 6 | 8 | 8 | | 6 | 6 | 8 | 7 | 7 | |
| Permitted Phases | | | | | | | | | 6 | | | 7 |
| Actuated Green, G (s) | | 17.3 | 80.3 | 16.4 | 16.4 | | 58.4 | 58.4 | 74.8 | | 8.8 | 8.8 |
| Effective Green, g (s) | | 17.3 | 80.3 | 16.4 | 16.4 | | 58.4 | 58.4 | 74.8 | | 8.8 | 8.8 |
| Actuated g/C Ratio | | 0.14 | 0.67 | 0.14 | 0.14 | | 0.49 | 0.49 | 0.62 | | 0.07 | 0.07 |
| Clearance Time (s) | | 4.6 | | 4.6 | 4.6 | | 5.3 | 5.3 | 4.6 | | 4.6 | 4.6 |
| Vehicle Extension (s) | | 0.2 | | 0.2 | 0.2 | | 0.2 | 0.2 | 0.2 | | 0.2 | 0.2 |
| Lane Grp Cap (vph) | | 267 | 1864 | 220 | 454 | | 818 | 821 | 986 | | 132 | 116 |
| v/s Ratio Prot | | c0.12 | 0.11 | 0.10 | c0.10 | | c0.17 | 0.17 | 0.03 | | c0.02 | |
| v/s Ratio Perm | | | | | | | | | 0.11 | | | 0.00 |
| v/c Ratio | | 0.84 | 0.17 | 0.74 | 0.74 | | 0.34 | 0.34 | 0.22 | | 0.21 | 0.03 |
| Uniform Delay, d1 | | 50.0 | 7.4 | 49.7 | 49.7 | | 19.0 | 19.0 | 9.9 | | 52.3 | 51.6 |
| Progression Factor | | 1.01 | 3.17 | 1.00 | 1.00 | | 1.00 | 1.00 | 1.00 | | 1.00 | 1.00 |
| Incremental Delay, d2 | | 18.6 | 0.0 | 10.5 | 5.3 | | 1.1 | 1.1 | 0.0 | | 0.3 | 0.0 |
| Delay (s) | | 69.1 | 23.5 | 60.2 | 55.1 | | 20.1 | 20.1 | 9.9 | | 52.6 | 51.7 |
| Level of Service | | E | C | E | E | | C | C | A | | D | D |
| Approach Delay (s) | | 38.1 | | | 56.8 | | | 16.2 | | | 52.0 | |
| Approach LOS | | D | | | E | | | B | | | D | |
| Intersection Summary | | | | | | | | | | | | |
| HCM 2000 Control Delay | | | 33.7 | | | | HCM 2000 Level of Service | | C | | | |
| HCM 2000 Volume to Capacity ratio | | | 0.48 | | | | | | | | | |
| Actuated Cycle Length (s) | | | 120.0 | | | | Sum of lost time (s) | | 19.1 | | | |
| Intersection Capacity Utilization | | | 53.1% | | | | ICU Level of Service | | A | | | |
| Analysis Period (min) | | | 15 | | | | | | | | | |
| c Critical Lane Group | | | | | | | | | | | | |

HCM 6th Signalized Intersection Summary
 1: Main St & W Lake Ave/E Lake Ave

Existing
 Timing Plan: PM PEAK HOUR

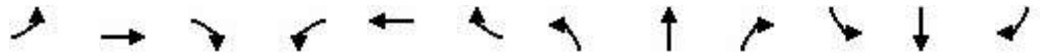

| Movement | EBL | EBT | EBR | WBL | WBT | WBR | NBL | NBT | NBR | SBL | SBT | SBR |
|--|-----|------|-----|-------|------|------|------|------|------|------|------|------|
| Lane Configurations | | | | | ↕↕ | ↗ | | ↕↕ | | | ↕↕ | |
| Traffic Volume (veh/h) | 0 | 0 | 0 | 223 | 339 | 202 | 9 | 623 | 0 | 0 | 777 | 112 |
| Future Volume (veh/h) | 0 | 0 | 0 | 223 | 339 | 202 | 9 | 623 | 0 | 0 | 777 | 112 |
| Initial Q (Qb), veh | | | | 0 | 0 | 0 | 0 | 0 | 0 | 0 | 0 | 0 |
| Ped-Bike Adj(A_pbT) | | | | 1.00 | | 0.93 | 1.00 | | 1.00 | 1.00 | | 0.98 |
| Parking Bus, Adj | | | | 1.00 | 1.00 | 1.00 | 1.00 | 1.00 | 1.00 | 1.00 | 1.00 | 1.00 |
| Work Zone On Approach | | | | No | | | No | | | No | | |
| Adj Sat Flow, veh/h/ln | | | | 1870 | 1870 | 1870 | 1870 | 1870 | 0 | 0 | 1870 | 1870 |
| Adj Flow Rate, veh/h | | | | 228 | 346 | 206 | 9 | 636 | 0 | 0 | 793 | 114 |
| Peak Hour Factor | | | | 0.98 | 0.98 | 0.98 | 0.98 | 0.98 | 0.98 | 0.98 | 0.98 | 0.98 |
| Percent Heavy Veh, % | | | | 2 | 2 | 2 | 2 | 2 | 0 | 0 | 2 | 2 |
| Cap, veh/h | | | | 310 | 508 | 338 | 58 | 2256 | 0 | 0 | 2034 | 292 |
| Arrive On Green | | | | 0.23 | 0.23 | 0.23 | 1.00 | 1.00 | 0.00 | 0.00 | 0.65 | 0.65 |
| Sat Flow, veh/h | | | | 1357 | 2222 | 1479 | 13 | 3534 | 0 | 0 | 3203 | 447 |
| Grp Volume(v), veh/h | | | | 303 | 271 | 206 | 344 | 301 | 0 | 0 | 453 | 454 |
| Grp Sat Flow(s),veh/h/ln | | | | 1802 | 1777 | 1479 | 1844 | 1617 | 0 | 0 | 1777 | 1780 |
| Q Serve(g_s), s | | | | 11.7 | 10.4 | 9.4 | 0.0 | 0.0 | 0.0 | 0.0 | 8.9 | 8.9 |
| Cycle Q Clear(g_c), s | | | | 11.7 | 10.4 | 9.4 | 0.0 | 0.0 | 0.0 | 0.0 | 8.9 | 8.9 |
| Prop In Lane | | | | 0.75 | | 1.00 | 0.03 | | 0.00 | 0.00 | | 0.25 |
| Lane Grp Cap(c), veh/h | | | | 412 | 406 | 338 | 1256 | 1058 | 0 | 0 | 1162 | 1164 |
| V/C Ratio(X) | | | | 0.73 | 0.67 | 0.61 | 0.27 | 0.28 | 0.00 | 0.00 | 0.39 | 0.39 |
| Avail Cap(c_a), veh/h | | | | 668 | 659 | 548 | 1256 | 1058 | 0 | 0 | 1162 | 1164 |
| HCM Platoon Ratio | | | | 1.00 | 1.00 | 1.00 | 2.00 | 2.00 | 1.00 | 1.00 | 1.00 | 1.00 |
| Upstream Filter(I) | | | | 1.00 | 1.00 | 1.00 | 0.79 | 0.79 | 0.00 | 0.00 | 1.00 | 1.00 |
| Uniform Delay (d), s/veh | | | | 26.8 | 26.3 | 25.9 | 0.0 | 0.0 | 0.0 | 0.0 | 6.0 | 6.0 |
| Incr Delay (d2), s/veh | | | | 1.0 | 0.7 | 0.7 | 0.4 | 0.5 | 0.0 | 0.0 | 1.0 | 1.0 |
| Initial Q Delay(d3),s/veh | | | | 0.0 | 0.0 | 0.0 | 0.0 | 0.0 | 0.0 | 0.0 | 0.0 | 0.0 |
| %ile BackOfQ(50%),veh/ln | | | | 4.9 | 4.3 | 3.2 | 0.1 | 0.2 | 0.0 | 0.0 | 2.9 | 3.0 |
| Unsig. Movement Delay, s/veh | | | | | | | | | | | | |
| LnGrp Delay(d),s/veh | | | | 27.8 | 27.0 | 26.6 | 0.4 | 0.5 | 0.0 | 0.0 | 7.0 | 7.0 |
| LnGrp LOS | | | | C | C | C | A | A | A | A | A | A |
| Approach Vol, veh/h | | | | | 780 | | | 645 | | | 907 | |
| Approach Delay, s/veh | | | | | 27.2 | | | 0.5 | | | 7.0 | |
| Approach LOS | | | | | C | | | A | | | A | |
| Timer - Assigned Phs | | 2 | | 4 | | 6 | | | | | | |
| Phs Duration (G+Y+Rc), s | | 53.7 | | 21.3 | | 53.7 | | | | | | |
| Change Period (Y+Rc), s | | 4.6 | | * 4.2 | | 4.6 | | | | | | |
| Max Green Setting (Gmax), s | | 38.4 | | * 28 | | 38.4 | | | | | | |
| Max Q Clear Time (g_c+I1), s | | 10.9 | | 13.7 | | 2.0 | | | | | | |
| Green Ext Time (p_c), s | | 4.1 | | 2.4 | | 2.8 | | | | | | |
| Intersection Summary | | | | | | | | | | | | |
| HCM 6th Ctrl Delay | | | | 12.0 | | | | | | | | |
| HCM 6th LOS | | | | B | | | | | | | | |
| Notes | | | | | | | | | | | | |
| * HCM 6th computational engine requires equal clearance times for the phases crossing the barrier. | | | | | | | | | | | | |

HCM 6th Signalized Intersection Summary

2: Main St & W Beach St/E Beach St

Existing
Timing Plan: PM PEAK HOUR



| Movement | EBL | EBT | EBR | WBL | WBT | WBR | NBL | NBT | NBR | SBL | SBT | SBR |
|------------------------------|------|------|------|-----|------|-------|------|------|------|------|------|------|
| Lane Configurations | | ↔ | | | | | ↔ | ↔ | | ↔ | ↔ | |
| Traffic Volume (veh/h) | 73 | 406 | 52 | 0 | 0 | 0 | 59 | 547 | 169 | 238 | 723 | 46 |
| Future Volume (veh/h) | 73 | 406 | 52 | 0 | 0 | 0 | 59 | 547 | 169 | 238 | 723 | 46 |
| Initial Q (Qb), veh | 0 | 0 | 0 | | | | 0 | 0 | 0 | 0 | 0 | 0 |
| Ped-Bike Adj(A_pbT) | 1.00 | | 0.93 | | | | 1.00 | | 0.94 | 1.00 | | 0.95 |
| Parking Bus, Adj | 1.00 | 1.00 | 1.00 | | | | 1.00 | 1.00 | 1.00 | 1.00 | 1.00 | 1.00 |
| Work Zone On Approach | | No | | | | | | No | | | No | |
| Adj Sat Flow, veh/h/ln | 1870 | 1870 | 1870 | | | | 1870 | 1870 | 1870 | 1870 | 1870 | 1870 |
| Adj Flow Rate, veh/h | 78 | 432 | 55 | | | | 63 | 582 | 180 | 253 | 769 | 49 |
| Peak Hour Factor | 0.94 | 0.94 | 0.94 | | | | 0.94 | 0.94 | 0.94 | 0.94 | 0.94 | 0.94 |
| Percent Heavy Veh, % | 2 | 2 | 2 | | | | 2 | 2 | 2 | 2 | 2 | 2 |
| Cap, veh/h | 100 | 577 | 77 | | | | 122 | 857 | 264 | 513 | 1882 | 120 |
| Arrive On Green | 0.21 | 0.21 | 0.21 | | | | 0.07 | 0.33 | 0.33 | 0.29 | 0.56 | 0.56 |
| Sat Flow, veh/h | 479 | 2772 | 369 | | | | 1781 | 2633 | 812 | 1781 | 3379 | 215 |
| Grp Volume(v), veh/h | 301 | 0 | 264 | | | | 63 | 392 | 370 | 253 | 404 | 414 |
| Grp Sat Flow(s),veh/h/ln | 1846 | 0 | 1773 | | | | 1781 | 1777 | 1668 | 1781 | 1777 | 1817 |
| Q Serve(g_s), s | 11.5 | 0.0 | 10.4 | | | | 2.6 | 14.3 | 14.4 | 8.8 | 9.8 | 9.8 |
| Cycle Q Clear(g_c), s | 11.5 | 0.0 | 10.4 | | | | 2.6 | 14.3 | 14.4 | 8.8 | 9.8 | 9.8 |
| Prop In Lane | 0.26 | | 0.21 | | | | 1.00 | | 0.49 | 1.00 | | 0.12 |
| Lane Grp Cap(c), veh/h | 384 | 0 | 369 | | | | 122 | 578 | 543 | 513 | 990 | 1012 |
| V/C Ratio(X) | 0.78 | 0.00 | 0.72 | | | | 0.52 | 0.68 | 0.68 | 0.49 | 0.41 | 0.41 |
| Avail Cap(c_a), veh/h | 512 | 0 | 492 | | | | 435 | 578 | 543 | 513 | 990 | 1012 |
| HCM Platoon Ratio | 1.00 | 1.00 | 1.00 | | | | 1.00 | 1.00 | 1.00 | 1.00 | 1.00 | 1.00 |
| Upstream Filter(I) | 1.00 | 0.00 | 1.00 | | | | 0.85 | 0.85 | 0.85 | 0.92 | 0.92 | 0.92 |
| Uniform Delay (d), s/veh | 28.1 | 0.0 | 27.6 | | | | 33.8 | 21.9 | 21.9 | 22.2 | 9.5 | 9.5 |
| Incr Delay (d2), s/veh | 3.9 | 0.0 | 1.8 | | | | 1.1 | 5.4 | 5.8 | 0.3 | 1.2 | 1.1 |
| Initial Q Delay(d3),s/veh | 0.0 | 0.0 | 0.0 | | | | 0.0 | 0.0 | 0.0 | 0.0 | 0.0 | 0.0 |
| %ile BackOfQ(50%),veh/ln | 5.3 | 0.0 | 4.4 | | | | 1.1 | 6.5 | 6.2 | 3.6 | 3.6 | 3.7 |
| Unsig. Movement Delay, s/veh | | | | | | | | | | | | |
| LnGrp Delay(d),s/veh | 31.9 | 0.0 | 29.4 | | | | 34.8 | 27.3 | 27.7 | 22.4 | 10.7 | 10.7 |
| LnGrp LOS | C | A | C | | | | C | C | C | C | B | B |
| Approach Vol, veh/h | | 565 | | | | | | 825 | | | 1071 | |
| Approach Delay, s/veh | | 30.8 | | | | | | 28.1 | | | 13.4 | |
| Approach LOS | | C | | | | | | C | | | B | |
| Timer - Assigned Phs | 1 | 2 | | | 5 | 6 | | 8 | | | | |
| Phs Duration (G+Y+Rc), s | 8.8 | 46.4 | | | 26.2 | 29.0 | | 19.8 | | | | |
| Change Period (Y+Rc), s | 3.7 | 4.6 | | | 4.6 | * 4.6 | | 4.2 | | | | |
| Max Green Setting (Gmax), s | 18.3 | 23.4 | | | 17.3 | * 24 | | 20.8 | | | | |
| Max Q Clear Time (g_c+I1), s | 4.6 | 11.8 | | | 10.8 | 16.4 | | 13.5 | | | | |
| Green Ext Time (p_c), s | 0.0 | 2.8 | | | 0.1 | 2.2 | | 1.4 | | | | |

Intersection Summary





























| | |
|--------------------|------|
| HCM 6th Ctrl Delay | 22.3 |
| HCM 6th LOS | C |

Notes

* HCM 6th computational engine requires equal clearance times for the phases crossing the barrier.

HCM 6th Signalized Intersection Summary
 3: W Riverside Dr/E Riverside Dr & Main St

Existing
 Timing Plan: PM PEAK HOUR

| |  |  |  |  |  |  |  |  |  |  |  |  |
|--|---|--|---|--|--|---|--|--|---|---|--|---|
| Movement | EBL | EBT | EBR | WBL | WBT | WBR | NBL | NBT | NBR | SBL | SBT | SBR |
| Lane Configurations |  |   |  |   |   | |  |   |  |  |   |  |
| Traffic Volume (veh/h) | 58 | 496 | 607 | 392 | 376 | 43 | 340 | 684 | 339 | 86 | 673 | 34 |
| Future Volume (veh/h) | 58 | 496 | 607 | 392 | 376 | 43 | 340 | 684 | 339 | 86 | 673 | 34 |
| Initial Q (Qb), veh | 0 | 0 | 0 | 0 | 0 | 0 | 0 | 0 | 0 | 0 | 0 | 0 |
| Ped-Bike Adj(A_pbT) | 1.00 | | 0.99 | 1.00 | | 0.99 | 1.00 | | 0.99 | 1.00 | | 0.96 |
| Parking Bus, Adj | 1.00 | 1.00 | 1.00 | 1.00 | 1.00 | 1.00 | 1.00 | 1.00 | 1.00 | 1.00 | 1.00 | 1.00 |
| Work Zone On Approach | | No | | | No | | | No | | | No | |
| Adj Sat Flow, veh/h/ln | 1870 | 1870 | 1870 | 1870 | 1870 | 1870 | 1870 | 1870 | 1870 | 1870 | 1870 | 1870 |
| Adj Flow Rate, veh/h | 59 | 501 | 613 | 396 | 380 | 43 | 343 | 691 | 342 | 87 | 680 | 34 |
| Peak Hour Factor | 0.99 | 0.99 | 0.99 | 0.99 | 0.99 | 0.99 | 0.99 | 0.99 | 0.99 | 0.99 | 0.99 | 0.99 |
| Percent Heavy Veh, % | 2 | 2 | 2 | 2 | 2 | 2 | 2 | 2 | 2 | 2 | 2 | 2 |
| Cap, veh/h | 118 | 983 | 762 | 480 | 1137 | 128 | 369 | 1300 | 571 | 131 | 772 | 39 |
| Arrive On Green | 0.07 | 0.28 | 0.28 | 0.14 | 0.35 | 0.35 | 0.21 | 0.37 | 0.37 | 0.07 | 0.22 | 0.22 |
| Sat Flow, veh/h | 1781 | 3554 | 1571 | 3456 | 3217 | 362 | 1781 | 3554 | 1562 | 1781 | 3437 | 172 |
| Grp Volume(v), veh/h | 59 | 501 | 613 | 396 | 209 | 214 | 343 | 691 | 342 | 87 | 351 | 363 |
| Grp Sat Flow(s),veh/h/ln | 1781 | 1777 | 1571 | 1728 | 1777 | 1802 | 1781 | 1777 | 1562 | 1781 | 1777 | 1832 |
| Q Serve(g_s), s | 3.7 | 13.7 | 13.9 | 12.8 | 9.9 | 10.0 | 21.8 | 17.6 | 13.5 | 5.5 | 22.0 | 22.0 |
| Cycle Q Clear(g_c), s | 3.7 | 13.7 | 13.9 | 12.8 | 9.9 | 10.0 | 21.8 | 17.6 | 13.5 | 5.5 | 22.0 | 22.0 |
| Prop In Lane | 1.00 | | 1.00 | 1.00 | | 0.20 | 1.00 | | 1.00 | 1.00 | | 0.09 |
| Lane Grp Cap(c), veh/h | 118 | 983 | 762 | 480 | 628 | 637 | 369 | 1300 | 571 | 131 | 399 | 411 |
| V/C Ratio(X) | 0.50 | 0.51 | 0.80 | 0.82 | 0.33 | 0.34 | 0.93 | 0.53 | 0.60 | 0.67 | 0.88 | 0.88 |
| Avail Cap(c_a), veh/h | 191 | 983 | 762 | 480 | 628 | 637 | 393 | 1300 | 571 | 206 | 439 | 452 |
| HCM Platoon Ratio | 1.00 | 1.00 | 1.00 | 1.00 | 1.00 | 1.00 | 1.00 | 1.00 | 1.00 | 1.00 | 1.00 | 1.00 |
| Upstream Filter(I) | 1.00 | 1.00 | 1.00 | 1.00 | 1.00 | 1.00 | 1.00 | 1.00 | 1.00 | 0.92 | 0.92 | 0.92 |
| Uniform Delay (d), s/veh | 51.8 | 35.0 | 25.0 | 48.1 | 27.2 | 27.3 | 44.8 | 28.7 | 12.9 | 51.9 | 43.1 | 43.1 |
| Incr Delay (d2), s/veh | 1.2 | 1.9 | 8.8 | 10.5 | 1.4 | 1.4 | 26.9 | 0.2 | 1.2 | 2.0 | 15.1 | 14.9 |
| Initial Q Delay(d3),s/veh | 0.0 | 0.0 | 0.0 | 0.0 | 0.0 | 0.0 | 0.0 | 0.0 | 0.0 | 0.0 | 0.0 | 0.0 |
| %ile BackOfQ(50%),veh/ln | 1.7 | 6.2 | 5.0 | 6.2 | 4.5 | 4.6 | 12.3 | 7.5 | 4.8 | 2.5 | 11.3 | 11.6 |
| Unsig. Movement Delay, s/veh | | | | | | | | | | | | |
| LnGrp Delay(d),s/veh | 53.0 | 36.9 | 33.8 | 58.7 | 28.7 | 28.7 | 71.7 | 28.9 | 14.1 | 53.9 | 58.2 | 58.0 |
| LnGrp LOS | D | D | C | E | C | C | E | C | B | D | E | E |
| Approach Vol, veh/h | | 1173 | | | 819 | | | 1376 | | | 801 | |
| Approach Delay, s/veh | | 36.1 | | | 43.2 | | | 35.9 | | | 57.6 | |
| Approach LOS | | D | | | D | | | D | | | E | |
| Timer - Assigned Phs | 1 | 2 | 3 | 4 | 5 | 6 | 7 | 8 | | | | |
| Phs Duration (G+Y+Rc), s | 20.2 | 36.0 | 28.4 | 30.4 | 11.3 | 44.8 | 12.1 | 46.7 | | | | |
| Change Period (Y+Rc), s | * 4.2 | * 4.2 | 4.6 | 4.6 | 3.7 | * 4.2 | 3.7 | 4.6 | | | | |
| Max Green Setting (Gmax), s | * 12 | * 32 | 25.4 | 28.4 | 12.3 | * 32 | 13.3 | 41.4 | | | | |
| Max Q Clear Time (g_c+I1), s | 14.8 | 15.9 | 23.8 | 24.0 | 5.7 | 12.0 | 7.5 | 19.6 | | | | |
| Green Ext Time (p_c), s | 0.0 | 3.4 | 0.0 | 1.1 | 0.0 | 1.6 | 0.0 | 2.9 | | | | |
| Intersection Summary | | | | | | | | | | | | |
| HCM 6th Ctrl Delay | | | 41.6 | | | | | | | | | |
| HCM 6th LOS | | | D | | | | | | | | | |
| Notes | | | | | | | | | | | | |
| * HCM 6th computational engine requires equal clearance times for the phases crossing the barrier. | | | | | | | | | | | | |

HCM 6th Signalized Intersection Summary

4: Union St/Brennan St & E Lake Ave

Existing
Timing Plan: PM PEAK HOUR



| Movement | EBL | EBT | EBR | WBL | WBT | WBR | NBL | NBT | NBR | SBL | SBT | SBR |
|--|-----|-----|-----|-------|------|------|------|-------|------|------|------|------|
| Lane Configurations | | | | | ↔↔ | | ↗ | ↖ | | | ↖ | ↗ |
| Traffic Volume (veh/h) | 0 | 0 | 0 | 169 | 606 | 117 | 64 | 307 | 0 | 0 | 192 | 72 |
| Future Volume (veh/h) | 0 | 0 | 0 | 169 | 606 | 117 | 64 | 307 | 0 | 0 | 192 | 72 |
| Initial Q (Qb), veh | | | | 0 | 0 | 0 | 0 | 0 | 0 | 0 | 0 | 0 |
| Ped-Bike Adj(A_pbT) | | | | 1.00 | | 0.98 | 0.99 | | 1.00 | 1.00 | | 0.98 |
| Parking Bus, Adj | | | | 1.00 | 1.00 | 1.00 | 1.00 | 1.00 | 1.00 | 1.00 | 1.00 | 1.00 |
| Work Zone On Approach | | | | No | | | No | | No | | | No |
| Adj Sat Flow, veh/h/ln | | | | 1870 | 1870 | 1870 | 1870 | 1870 | 0 | 0 | 1870 | 1870 |
| Adj Flow Rate, veh/h | | | | 178 | 638 | 123 | 67 | 323 | 0 | 0 | 202 | 76 |
| Peak Hour Factor | | | | 0.95 | 0.95 | 0.95 | 0.95 | 0.95 | 0.95 | 0.95 | 0.95 | 0.95 |
| Percent Heavy Veh, % | | | | 2 | 2 | 2 | 2 | 2 | 0 | 0 | 2 | 2 |
| Cap, veh/h | | | | 268 | 1008 | 204 | 233 | 412 | 0 | 0 | 412 | 342 |
| Arrive On Green | | | | 0.41 | 0.41 | 0.41 | 0.22 | 0.22 | 0.00 | 0.00 | 0.22 | 0.22 |
| Sat Flow, veh/h | | | | 653 | 2455 | 496 | 1089 | 1870 | 0 | 0 | 1870 | 1553 |
| Grp Volume(v), veh/h | | | | 501 | 0 | 438 | 67 | 323 | 0 | 0 | 202 | 76 |
| Grp Sat Flow(s),veh/h/ln | | | | 1838 | 0 | 1766 | 1089 | 1870 | 0 | 0 | 1870 | 1553 |
| Q Serve(g_s), s | | | | 16.6 | 0.0 | 14.6 | 4.3 | 12.2 | 0.0 | 0.0 | 7.1 | 3.0 |
| Cycle Q Clear(g_c), s | | | | 16.6 | 0.0 | 14.6 | 11.4 | 12.2 | 0.0 | 0.0 | 7.1 | 3.0 |
| Prop In Lane | | | | 0.36 | | 0.28 | 1.00 | | 0.00 | 0.00 | | 1.00 |
| Lane Grp Cap(c), veh/h | | | | 755 | 0 | 725 | 233 | 412 | 0 | 0 | 412 | 342 |
| V/C Ratio(X) | | | | 0.66 | 0.00 | 0.60 | 0.29 | 0.78 | 0.00 | 0.00 | 0.49 | 0.22 |
| Avail Cap(c_a), veh/h | | | | 755 | 0 | 725 | 513 | 893 | 0 | 0 | 893 | 741 |
| HCM Platoon Ratio | | | | 1.00 | 1.00 | 1.00 | 1.00 | 1.00 | 1.00 | 1.00 | 1.00 | 1.00 |
| Upstream Filter(I) | | | | 1.00 | 0.00 | 1.00 | 1.00 | 1.00 | 0.00 | 0.00 | 1.00 | 1.00 |
| Uniform Delay (d), s/veh | | | | 17.9 | 0.0 | 17.3 | 30.5 | 27.6 | 0.0 | 0.0 | 25.6 | 24.0 |
| Incr Delay (d2), s/veh | | | | 4.6 | 0.0 | 3.7 | 0.5 | 2.5 | 0.0 | 0.0 | 0.7 | 0.2 |
| Initial Q Delay(d3),s/veh | | | | 0.0 | 0.0 | 0.0 | 0.0 | 0.0 | 0.0 | 0.0 | 0.0 | 0.0 |
| %ile BackOfQ(50%),veh/ln | | | | 7.4 | 0.0 | 6.2 | 1.1 | 5.5 | 0.0 | 0.0 | 3.1 | 1.1 |
| Unsig. Movement Delay, s/veh | | | | | | | | | | | | |
| LnGrp Delay(d),s/veh | | | | 22.5 | 0.0 | 21.0 | 31.0 | 30.0 | 0.0 | 0.0 | 26.2 | 24.2 |
| LnGrp LOS | | | | C | A | C | C | C | A | A | C | C |
| Approach Vol, veh/h | | | | | 939 | | | 390 | | | 278 | |
| Approach Delay, s/veh | | | | | 21.8 | | | 30.2 | | | 25.7 | |
| Approach LOS | | | | | C | | | C | | | C | |
| Timer - Assigned Phs | | | | 4 | | 6 | | 8 | | | | |
| Phs Duration (G+Y+Rc), s | | | | 20.7 | | 35.0 | | 20.7 | | | | |
| Change Period (Y+Rc), s | | | | * 4.2 | | 4.2 | | * 4.2 | | | | |
| Max Green Setting (Gmax), s | | | | * 36 | | 30.8 | | * 36 | | | | |
| Max Q Clear Time (g_c+I1), s | | | | 9.1 | | 18.6 | | 14.2 | | | | |
| Green Ext Time (p_c), s | | | | 1.1 | | 4.2 | | 1.8 | | | | |
| Intersection Summary | | | | | | | | | | | | |
| HCM 6th Ctrl Delay | | | | 24.5 | | | | | | | | |
| HCM 6th LOS | | | | C | | | | | | | | |
| Notes | | | | | | | | | | | | |
| * HCM 6th computational engine requires equal clearance times for the phases crossing the barrier. | | | | | | | | | | | | |

HCM 6th Signalized Intersection Summary
5: Union St & E Beach St

Existing
Timing Plan: PM PEAK HOUR

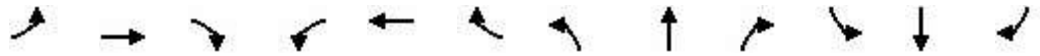

| Movement | EBL | EBT | EBR | WBL | WBT | WBR | NBL | NBT | NBR | SBL | SBT | SBR |
|------------------------------|------|------|------|------|-----|-----|------|------|------|------|------|------|
| Lane Configurations | | ↔↔ | | | | | | ↔ | | ↔ | ↔ | |
| Traffic Volume (veh/h) | 138 | 582 | 59 | 0 | 0 | 0 | 0 | 182 | 98 | 122 | 267 | 0 |
| Future Volume (veh/h) | 138 | 582 | 59 | 0 | 0 | 0 | 0 | 182 | 98 | 122 | 267 | 0 |
| Initial Q (Qb), veh | 0 | 0 | 0 | | | | 0 | 0 | 0 | 0 | 0 | 0 |
| Ped-Bike Adj(A_pbT) | 1.00 | | 0.94 | | | | 1.00 | | 0.96 | 0.99 | | 1.00 |
| Parking Bus, Adj | 1.00 | 1.00 | 1.00 | | | | 1.00 | 1.00 | 1.00 | 1.00 | 1.00 | 1.00 |
| Work Zone On Approach | | No | | | | | | No | | | No | |
| Adj Sat Flow, veh/h/ln | 1870 | 1870 | 1870 | | | | 0 | 1945 | 1945 | 1870 | 1870 | 0 |
| Adj Flow Rate, veh/h | 150 | 633 | 64 | | | | 0 | 198 | 107 | 133 | 290 | 0 |
| Peak Hour Factor | 0.92 | 0.92 | 0.92 | | | | 0.92 | 0.92 | 0.92 | 0.92 | 0.92 | 0.92 |
| Percent Heavy Veh, % | 2 | 2 | 2 | | | | 0 | 2 | 2 | 2 | 2 | 0 |
| Cap, veh/h | 359 | 1594 | 168 | | | | 0 | 343 | 186 | 256 | 550 | 0 |
| Arrive On Green | 0.58 | 0.58 | 0.58 | | | | 0.00 | 0.29 | 0.29 | 0.29 | 0.29 | 0.00 |
| Sat Flow, veh/h | 616 | 2733 | 288 | | | | 0 | 1168 | 631 | 1068 | 1870 | 0 |
| Grp Volume(v), veh/h | 448 | 0 | 399 | | | | 0 | 0 | 305 | 133 | 290 | 0 |
| Grp Sat Flow(s),veh/h/ln | 1840 | 0 | 1797 | | | | 0 | 0 | 1800 | 1068 | 1870 | 0 |
| Q Serve(g_s), s | 10.1 | 0.0 | 8.9 | | | | 0.0 | 0.0 | 10.8 | 9.1 | 9.7 | 0.0 |
| Cycle Q Clear(g_c), s | 10.1 | 0.0 | 8.9 | | | | 0.0 | 0.0 | 10.8 | 19.9 | 9.7 | 0.0 |
| Prop In Lane | 0.33 | | 0.16 | | | | 0.00 | | 0.35 | 1.00 | | 0.00 |
| Lane Grp Cap(c), veh/h | 1073 | 0 | 1049 | | | | 0 | 0 | 529 | 256 | 550 | 0 |
| V/C Ratio(X) | 0.42 | 0.00 | 0.38 | | | | 0.00 | 0.00 | 0.58 | 0.52 | 0.53 | 0.00 |
| Avail Cap(c_a), veh/h | 1073 | 0 | 1049 | | | | 0 | 0 | 610 | 304 | 633 | 0 |
| HCM Platoon Ratio | 1.00 | 1.00 | 1.00 | | | | 1.00 | 1.00 | 1.00 | 1.00 | 1.00 | 1.00 |
| Upstream Filter(l) | 0.65 | 0.00 | 0.65 | | | | 0.00 | 0.00 | 1.00 | 1.00 | 1.00 | 0.00 |
| Uniform Delay (d), s/veh | 8.6 | 0.0 | 8.4 | | | | 0.0 | 0.0 | 22.5 | 31.0 | 22.1 | 0.0 |
| Incr Delay (d2), s/veh | 0.8 | 0.0 | 0.7 | | | | 0.0 | 0.0 | 0.4 | 0.6 | 0.3 | 0.0 |
| Initial Q Delay(d3),s/veh | 0.0 | 0.0 | 0.0 | | | | 0.0 | 0.0 | 0.0 | 0.0 | 0.0 | 0.0 |
| %ile BackOfQ(50%),veh/ln | 3.7 | 0.0 | 3.2 | | | | 0.0 | 0.0 | 4.4 | 2.3 | 4.1 | 0.0 |
| Unsig. Movement Delay, s/veh | | | | | | | | | | | | |
| LnGrp Delay(d),s/veh | 9.4 | 0.0 | 9.0 | | | | 0.0 | 0.0 | 22.9 | 31.6 | 22.4 | 0.0 |
| LnGrp LOS | A | A | A | | | | A | A | C | C | C | A |
| Approach Vol, veh/h | | 847 | | | | | | 305 | | | 423 | |
| Approach Delay, s/veh | | 9.2 | | | | | | 22.9 | | | 25.3 | |
| Approach LOS | | A | | | | | | C | | | C | |
| Timer - Assigned Phs | | 2 | | 4 | | | | 8 | | | | |
| Phs Duration (G+Y+Rc), s | | 48.4 | | 26.6 | | | | 26.6 | | | | |
| Change Period (Y+Rc), s | | 4.6 | | 4.6 | | | | 4.6 | | | | |
| Max Green Setting (Gmax), s | | 40.4 | | 25.4 | | | | 25.4 | | | | |
| Max Q Clear Time (g_c+I1), s | | 12.1 | | 21.9 | | | | 12.8 | | | | |
| Green Ext Time (p_c), s | | 0.9 | | 0.2 | | | | 0.3 | | | | |
| Intersection Summary | | | | | | | | | | | | |
| HCM 6th Ctrl Delay | | | 16.2 | | | | | | | | | |
| HCM 6th LOS | | | B | | | | | | | | | |

HCM 6th Signalized Intersection Summary

7: Rodriguez St & Main St

Existing
Timing Plan: PM PEAK HOUR



| Movement | EBT | EBR | WBL | WBT | NBL | NBR |
|------------------------------|------|------|------|------|------|-------|
| Lane Configurations | ↑↑ | | ↵ | ↑↑ | ↵↵ | |
| Traffic Volume (veh/h) | 1024 | 253 | 12 | 738 | 274 | 24 |
| Future Volume (veh/h) | 1024 | 253 | 12 | 738 | 274 | 24 |
| Initial Q (Qb), veh | 0 | 0 | 0 | 0 | 0 | 0 |
| Ped-Bike Adj(A_pbT) | | 0.97 | 1.00 | | 1.00 | 1.00 |
| Parking Bus, Adj | 1.00 | 1.00 | 1.00 | 1.00 | 1.00 | 1.00 |
| Work Zone On Approach | No | | | No | No | |
| Adj Sat Flow, veh/h/ln | 1870 | 1870 | 1870 | 1945 | 1870 | 1870 |
| Adj Flow Rate, veh/h | 1045 | 258 | 12 | 753 | 302 | 0 |
| Peak Hour Factor | 0.98 | 0.98 | 0.98 | 0.98 | 0.98 | 0.98 |
| Percent Heavy Veh, % | 2 | 2 | 2 | 2 | 2 | 2 |
| Cap, veh/h | 1487 | 365 | 398 | 2977 | 369 | 164 |
| Arrive On Green | 0.53 | 0.53 | 0.07 | 0.27 | 0.10 | 0.00 |
| Sat Flow, veh/h | 2904 | 690 | 1781 | 3793 | 3563 | 1585 |
| Grp Volume(v), veh/h | 659 | 644 | 12 | 753 | 302 | 0 |
| Grp Sat Flow(s),veh/h/ln | 1777 | 1723 | 1781 | 1848 | 1781 | 1585 |
| Q Serve(g_s), s | 27.7 | 28.1 | 0.6 | 16.0 | 8.3 | 0.0 |
| Cycle Q Clear(g_c), s | 27.7 | 28.1 | 0.6 | 16.0 | 8.3 | 0.0 |
| Prop In Lane | | 0.40 | 1.00 | | 1.00 | 1.00 |
| Lane Grp Cap(c), veh/h | 940 | 912 | 398 | 2977 | 369 | 164 |
| V/C Ratio(X) | 0.70 | 0.71 | 0.03 | 0.25 | 0.82 | 0.00 |
| Avail Cap(c_a), veh/h | 940 | 912 | 398 | 2977 | 873 | 388 |
| HCM Platoon Ratio | 1.00 | 1.00 | 0.33 | 0.33 | 1.00 | 1.00 |
| Upstream Filter(I) | 1.00 | 1.00 | 0.70 | 0.70 | 1.00 | 0.00 |
| Uniform Delay (d), s/veh | 17.6 | 17.7 | 36.3 | 13.0 | 43.9 | 0.0 |
| Incr Delay (d2), s/veh | 4.3 | 4.6 | 0.0 | 0.1 | 1.7 | 0.0 |
| Initial Q Delay(d3),s/veh | 0.0 | 0.0 | 0.0 | 0.0 | 0.0 | 0.0 |
| %ile BackOfQ(50%),veh/ln | 11.8 | 11.7 | 0.3 | 7.9 | 3.7 | 0.0 |
| Unsig. Movement Delay, s/veh | | | | | | |
| LnGrp Delay(d),s/veh | 22.0 | 22.3 | 36.3 | 13.2 | 45.6 | 0.0 |
| LnGrp LOS | C | C | D | B | D | A |
| Approach Vol, veh/h | 1303 | | | 765 | 302 | |
| Approach Delay, s/veh | 22.1 | | | 13.5 | 45.6 | |
| Approach LOS | C | | | B | D | |
| Timer - Assigned Phs | 1 | 2 | | 4 | | 6 |
| Phs Duration (G+Y+Rc), s | 27.0 | 58.2 | | 14.8 | | 85.2 |
| Change Period (Y+Rc), s | 4.6 | 5.3 | | 4.5 | | * 4.6 |
| Max Green Setting (Gmax), s | 8.2 | 52.9 | | 24.5 | | * 67 |
| Max Q Clear Time (g_c+I1), s | 2.6 | 30.1 | | 10.3 | | 18.0 |
| Green Ext Time (p_c), s | 0.0 | 1.6 | | 0.0 | | 1.1 |

Intersection Summary

| | |
|--------------------|------|
| HCM 6th Ctrl Delay | 22.4 |
| HCM 6th LOS | C |

Notes

User approved volume balancing among the lanes for turning movement.

* HCM 6th computational engine requires equal clearance times for the phases crossing the barrier.

HCM 6th Signalized Intersection Summary

8: Brennan St & Freedom Blvd

Existing
Timing Plan: PM PEAK HOUR



| Movement | EBL | EBT | EBR | WBL | WBT | WBR | NBL | NBT | NBR | SBL | SBT | SBR |
|------------------------------|------|------|------|------|------|------|------|------|------|------|------|------|
| Lane Configurations | | | | | | | | | | | | |
| Traffic Volume (veh/h) | 8 | 627 | 128 | 152 | 444 | 5 | 145 | 4 | 229 | 6 | 4 | 11 |
| Future Volume (veh/h) | 8 | 627 | 128 | 152 | 444 | 5 | 145 | 4 | 229 | 6 | 4 | 11 |
| Initial Q (Qb), veh | 0 | 0 | 0 | 0 | 0 | 0 | 0 | 0 | 0 | 0 | 0 | 0 |
| Ped-Bike Adj(A_pbT) | 1.00 | | 0.99 | 1.00 | | 0.97 | 0.94 | | 0.94 | 1.00 | | 0.91 |
| Parking Bus, Adj | 1.00 | 1.00 | 1.00 | 1.00 | 1.00 | 1.00 | 1.00 | 1.00 | 1.00 | 1.00 | 1.00 | 1.00 |
| Work Zone On Approach | | No | | | No | | | No | | | No | |
| Adj Sat Flow, veh/h/ln | 1870 | 1945 | 1870 | 1870 | 1870 | 1870 | 1870 | 1870 | 1870 | 1870 | 1870 | 1870 |
| Adj Flow Rate, veh/h | 8 | 660 | 135 | 160 | 467 | 5 | 153 | 4 | 241 | 6 | 4 | 12 |
| Peak Hour Factor | 0.95 | 0.95 | 0.95 | 0.95 | 0.95 | 0.95 | 0.95 | 0.95 | 0.95 | 0.95 | 0.95 | 0.95 |
| Percent Heavy Veh, % | 2 | 2 | 2 | 2 | 2 | 2 | 2 | 2 | 2 | 2 | 2 | 2 |
| Cap, veh/h | 89 | 1182 | 954 | 190 | 1226 | 13 | 293 | 5 | 272 | 89 | 71 | 214 |
| Arrive On Green | 0.05 | 0.61 | 0.61 | 0.11 | 0.66 | 0.66 | 0.19 | 0.19 | 0.19 | 0.19 | 0.19 | 0.19 |
| Sat Flow, veh/h | 1781 | 1945 | 1569 | 1781 | 1846 | 20 | 1313 | 24 | 1464 | 1135 | 384 | 1152 |
| Grp Volume(v), veh/h | 8 | 660 | 135 | 160 | 0 | 472 | 153 | 0 | 245 | 6 | 0 | 16 |
| Grp Sat Flow(s),veh/h/ln | 1781 | 1945 | 1569 | 1781 | 0 | 1866 | 1313 | 0 | 1488 | 1135 | 0 | 1536 |
| Q Serve(g_s), s | 0.5 | 24.2 | 4.4 | 10.6 | 0.0 | 13.6 | 13.0 | 0.0 | 19.3 | 0.6 | 0.0 | 1.0 |
| Cycle Q Clear(g_c), s | 0.5 | 24.2 | 4.4 | 10.6 | 0.0 | 13.6 | 14.1 | 0.0 | 19.3 | 19.9 | 0.0 | 1.0 |
| Prop In Lane | 1.00 | | 1.00 | 1.00 | | 0.01 | 1.00 | | 0.98 | 1.00 | | 0.75 |
| Lane Grp Cap(c), veh/h | 89 | 1182 | 954 | 190 | 0 | 1239 | 293 | 0 | 277 | 89 | 0 | 286 |
| V/C Ratio(X) | 0.09 | 0.56 | 0.14 | 0.84 | 0.00 | 0.38 | 0.52 | 0.00 | 0.89 | 0.07 | 0.00 | 0.06 |
| Avail Cap(c_a), veh/h | 89 | 1182 | 954 | 312 | 0 | 1239 | 344 | 0 | 335 | 133 | 0 | 346 |
| HCM Platoon Ratio | 1.00 | 1.00 | 1.00 | 1.00 | 1.00 | 1.00 | 1.00 | 1.00 | 1.00 | 1.00 | 1.00 | 1.00 |
| Upstream Filter(l) | 0.67 | 0.67 | 0.67 | 1.00 | 0.00 | 1.00 | 1.00 | 0.00 | 1.00 | 1.00 | 0.00 | 1.00 |
| Uniform Delay (d), s/veh | 54.4 | 14.0 | 10.1 | 52.6 | 0.0 | 9.1 | 46.0 | 0.0 | 47.6 | 57.3 | 0.0 | 40.2 |
| Incr Delay (d2), s/veh | 1.3 | 0.4 | 0.0 | 10.6 | 0.0 | 0.9 | 1.4 | 0.0 | 20.8 | 0.3 | 0.0 | 0.1 |
| Initial Q Delay(d3),s/veh | 0.0 | 0.0 | 0.0 | 0.0 | 0.0 | 0.0 | 0.0 | 0.0 | 0.0 | 0.0 | 0.0 | 0.0 |
| %ile BackOfQ(50%),veh/ln | 0.3 | 10.3 | 1.5 | 5.3 | 0.0 | 5.6 | 4.4 | 0.0 | 8.7 | 0.2 | 0.0 | 0.4 |
| Unsig. Movement Delay, s/veh | | | | | | | | | | | | |
| LnGrp Delay(d),s/veh | 55.7 | 14.4 | 10.2 | 63.2 | 0.0 | 10.0 | 47.4 | 0.0 | 68.4 | 57.6 | 0.0 | 40.3 |
| LnGrp LOS | E | B | B | E | A | A | D | A | E | E | A | D |
| Approach Vol, veh/h | | 803 | | | 632 | | | 398 | | | | 22 |
| Approach Delay, s/veh | | 14.1 | | | 23.4 | | | 60.3 | | | | 45.0 |
| Approach LOS | | B | | | C | | | E | | | | D |
| Timer - Assigned Phs | 1 | 2 | | 4 | 5 | 6 | | 8 | | | | |
| Phs Duration (G+Y+Rc), s | 10.0 | 83.7 | | 26.3 | 16.8 | 76.9 | | 26.3 | | | | |
| Change Period (Y+Rc), s | 4.0 | 4.0 | | 4.0 | 4.0 | 4.0 | | 4.0 | | | | |
| Max Green Setting (Gmax), s | 6.0 | 75.0 | | 27.0 | 21.0 | 60.0 | | 27.0 | | | | |
| Max Q Clear Time (g_c+I1), s | 2.5 | 15.6 | | 21.3 | 12.6 | 26.2 | | 21.9 | | | | |
| Green Ext Time (p_c), s | 0.0 | 3.4 | | 1.1 | 0.3 | 5.8 | | 0.0 | | | | |
| Intersection Summary | | | | | | | | | | | | |
| HCM 6th Ctrl Delay | | | | 27.6 | | | | | | | | |
| HCM 6th LOS | | | | C | | | | | | | | |

| Intersection | | | | | | | | | | | | |
|--------------------------|------|------|------|------|------|------|------|------|------|------|------|------|
| Int Delay, s/veh | 0.6 | | | | | | | | | | | |
| Movement | EBL | EBT | EBR | WBL | WBT | WBR | NBL | NBT | NBR | SBL | SBT | SBR |
| Lane Configurations | | ↔↑ | | | | | | | ↔↑ | | | |
| Traffic Vol, veh/h | 45 | 714 | 0 | 0 | 0 | 0 | 0 | 0 | 0 | 0 | 0 | 0 |
| Future Vol, veh/h | 45 | 714 | 0 | 0 | 0 | 0 | 0 | 0 | 0 | 0 | 0 | 0 |
| Conflicting Peds, #/hr | 58 | 0 | 0 | 0 | 0 | 58 | 0 | 0 | 15 | 15 | 0 | 0 |
| Sign Control | Free | Free | Free | Free | Free | Free | Stop | Stop | Stop | Stop | Stop | Stop |
| RT Channelized | - | - | None | - | - | None | - | - | None | - | - | None |
| Storage Length | - | - | - | - | - | - | - | - | 0 | - | - | - |
| Veh in Median Storage, # | - | 0 | - | 1080 | 3036 | 16 | - | - | 0 | - | - | 0 |
| Grade, % | - | 0 | - | - | 0 | - | - | 0 | - | - | 0 | - |
| Peak Hour Factor | 84 | 84 | 84 | 84 | 84 | 84 | 84 | 84 | 84 | 84 | 84 | 84 |
| Heavy Vehicles, % | 2 | 2 | 2 | 2 | 2 | 2 | 2 | 2 | 2 | 2 | 2 | 2 |
| Mvmt Flow | 54 | 850 | 0 | 0 | 0 | 0 | 0 | 0 | 0 | 0 | 0 | 0 |

| Major/Minor | Major1 | | | Minor1 | | |
|----------------------|--------|---|---|--------|---|------|
| Conflicting Flow All | 58 | 0 | - | - | - | 440 |
| Stage 1 | - | - | - | - | - | - |
| Stage 2 | - | - | - | - | - | - |
| Critical Hdwy | 4.14 | - | - | - | - | 6.94 |
| Critical Hdwy Stg 1 | - | - | - | - | - | - |
| Critical Hdwy Stg 2 | - | - | - | - | - | - |
| Follow-up Hdwy | 2.22 | - | - | - | - | 3.32 |
| Pot Cap-1 Maneuver | 1544 | - | 0 | 0 | 0 | 565 |
| Stage 1 | - | - | 0 | 0 | 0 | - |
| Stage 2 | - | - | 0 | 0 | 0 | - |
| Platoon blocked, % | | - | | | | |
| Mov Cap-1 Maneuver | 1544 | - | - | - | 0 | 565 |
| Mov Cap-2 Maneuver | - | - | - | - | 0 | - |
| Stage 1 | - | - | - | - | 0 | - |
| Stage 2 | - | - | - | - | 0 | - |

| Approach | EB | NB |
|----------------------|-----|----|
| HCM Control Delay, s | 0.6 | 0 |
| HCM LOS | | A |

| Minor Lane/Major Mvmt | NBLn1 | EBL | EBT |
|-----------------------|-------|-------|-----|
| Capacity (veh/h) | - | 1544 | - |
| HCM Lane V/C Ratio | - | 0.035 | - |
| HCM Control Delay (s) | 0 | 7.4 | 0.2 |
| HCM Lane LOS | A | A | A |
| HCM 95th %tile Q(veh) | - | 0.1 | - |

HCM Signalized Intersection Capacity Analysis

6: Main St & Freedom Blvd & Western Dr

Existing
Timing Plan: PM PEAK HOUR



| Movement | EBL | EBT | EBR | WBL | WBT | WBR | NBL | NBT | NBR | SBL | SBT | SBR |
|------------------------|-------|-------|-------|-------|------|------|-------|------|-------|-------|-------|------|
| Lane Configurations | | ↖ | ↗ | ↖ | ↗ | | ↖ | ↗ | ↗ | | ↖ | ↗ |
| Traffic Volume (vph) | 40 | 385 | 599 | 351 | 254 | 3 | 520 | 17 | 374 | 14 | 23 | 37 |
| Future Volume (vph) | 40 | 385 | 599 | 351 | 254 | 3 | 520 | 17 | 374 | 14 | 23 | 37 |
| Ideal Flow (vphpl) | 1900 | 1900 | 1900 | 1900 | 1900 | 1900 | 1900 | 1900 | 1900 | 1900 | 1900 | 1900 |
| Total Lost time (s) | | 4.6 | 4.6 | 4.6 | 4.6 | | 5.3 | 5.3 | 4.6 | | 4.6 | 4.6 |
| Lane Util. Factor | | 1.00 | 0.88 | 0.91 | 0.91 | | 0.95 | 0.95 | 1.00 | | 1.00 | 1.00 |
| Frbp, ped/bikes | | 1.00 | 1.00 | 1.00 | 1.00 | | 1.00 | 1.00 | 0.95 | | 1.00 | 1.00 |
| Flpb, ped/bikes | | 1.00 | 1.00 | 1.00 | 1.00 | | 1.00 | 1.00 | 1.00 | | 1.00 | 1.00 |
| Frt | | 1.00 | 0.85 | 1.00 | 1.00 | | 1.00 | 1.00 | 0.85 | | 1.00 | 0.85 |
| Flt Protected | | 1.00 | 1.00 | 0.95 | 0.98 | | 0.95 | 0.96 | 1.00 | | 0.98 | 1.00 |
| Satd. Flow (prot) | | 1854 | 2787 | 1610 | 3324 | | 1681 | 1691 | 1503 | | 1829 | 1583 |
| Flt Permitted | | 1.00 | 1.00 | 0.95 | 0.98 | | 0.95 | 0.96 | 1.00 | | 0.98 | 1.00 |
| Satd. Flow (perm) | | 1854 | 2787 | 1610 | 3324 | | 1681 | 1691 | 1503 | | 1829 | 1583 |
| Peak-hour factor, PHF | 0.97 | 0.97 | 0.97 | 0.97 | 0.97 | 0.97 | 0.97 | 0.97 | 0.97 | 0.97 | 0.97 | 0.97 |
| Adj. Flow (vph) | 41 | 397 | 618 | 362 | 262 | 3 | 536 | 18 | 386 | 14 | 24 | 38 |
| RTOR Reduction (vph) | 0 | 0 | 242 | 0 | 1 | 0 | 0 | 0 | 201 | 0 | 0 | 35 |
| Lane Group Flow (vph) | 0 | 438 | 376 | 206 | 420 | 0 | 279 | 275 | 185 | 0 | 38 | 3 |
| Confl. Peds. (#/hr) | 11 | | 1 | 1 | | 11 | | | 21 | 21 | | |
| Turn Type | Split | NA | pt+ov | Split | NA | | Split | NA | pm+ov | Split | NA | Perm |
| Protected Phases | 5 | 5 | 5 6 | 8 | 8 | | 6 | 6 | 8 | 7 | 7 | |
| Permitted Phases | | | | | | | | | 6 | | | 7 |
| Actuated Green, G (s) | | 25.7 | 60.9 | 15.8 | 15.8 | | 30.6 | 30.6 | 46.4 | | 8.8 | 8.8 |
| Effective Green, g (s) | | 25.7 | 60.9 | 15.8 | 15.8 | | 30.6 | 30.6 | 46.4 | | 8.8 | 8.8 |
| Actuated g/C Ratio | | 0.26 | 0.61 | 0.16 | 0.16 | | 0.31 | 0.31 | 0.46 | | 0.09 | 0.09 |
| Clearance Time (s) | | 4.6 | | 4.6 | 4.6 | | 5.3 | 5.3 | 4.6 | | 4.6 | 4.6 |
| Vehicle Extension (s) | | 0.2 | | 0.2 | 0.2 | | 0.2 | 0.2 | 0.2 | | 0.2 | 0.2 |
| Lane Grp Cap (vph) | | 476 | 1697 | 254 | 525 | | 514 | 517 | 697 | | 160 | 139 |
| v/s Ratio Prot | | c0.24 | 0.14 | c0.13 | 0.13 | | c0.17 | 0.16 | 0.04 | | c0.02 | |
| v/s Ratio Perm | | | | | | | | | 0.08 | | | 0.00 |
| v/c Ratio | | 0.92 | 0.22 | 0.81 | 0.80 | | 0.54 | 0.53 | 0.27 | | 0.24 | 0.02 |
| Uniform Delay, d1 | | 36.2 | 8.8 | 40.7 | 40.6 | | 28.9 | 28.8 | 16.4 | | 42.5 | 41.7 |
| Progression Factor | | 1.30 | 3.23 | 1.00 | 1.00 | | 1.00 | 1.00 | 1.00 | | 1.00 | 1.00 |
| Incremental Delay, d2 | | 20.7 | 0.0 | 16.7 | 8.1 | | 4.1 | 3.9 | 0.1 | | 0.3 | 0.0 |
| Delay (s) | | 67.8 | 28.5 | 57.4 | 48.6 | | 33.0 | 32.6 | 16.5 | | 42.8 | 41.7 |
| Level of Service | | E | C | E | D | | C | C | B | | D | D |
| Approach Delay (s) | | 44.8 | | | 51.5 | | | 26.1 | | | 42.2 | |
| Approach LOS | | D | | | D | | | C | | | D | |

Intersection Summary

| | | | |
|-----------------------------------|-------|---------------------------|------|
| HCM 2000 Control Delay | 39.8 | HCM 2000 Level of Service | D |
| HCM 2000 Volume to Capacity ratio | 0.68 | | |
| Actuated Cycle Length (s) | 100.0 | Sum of lost time (s) | 19.1 |
| Intersection Capacity Utilization | 69.7% | ICU Level of Service | C |
| Analysis Period (min) | 15 | | |
| c Critical Lane Group | | | |

HCM 6th Signalized Intersection Summary

Existing

1: Main St & W Lake Ave/E Lake Ave

Timing Plan: SATURDAY PEAK HOUR



| Movement | EBL | EBT | EBR | WBL | WBT | WBR | NBL | NBT | NBR | SBL | SBT | SBR |
|--|-----|------|-----|-------|------|------|------|------|------|------|------|------|
| Lane Configurations | | | | | ↕↕ | ↗ | | ↕↕ | | | ↕↕ | |
| Traffic Volume (veh/h) | 0 | 0 | 0 | 255 | 286 | 233 | 16 | 570 | 0 | 0 | 684 | 92 |
| Future Volume (veh/h) | 0 | 0 | 0 | 255 | 286 | 233 | 16 | 570 | 0 | 0 | 684 | 92 |
| Initial Q (Qb), veh | | | | 0 | 0 | 0 | 0 | 0 | 0 | 0 | 0 | 0 |
| Ped-Bike Adj(A_pbT) | | | | 1.00 | | 0.94 | 1.00 | | 1.00 | 1.00 | | 0.97 |
| Parking Bus, Adj | | | | 1.00 | 1.00 | 1.00 | 1.00 | 1.00 | 1.00 | 1.00 | 1.00 | 1.00 |
| Work Zone On Approach | | | | No | | | No | | | No | | |
| Adj Sat Flow, veh/h/ln | | | | 1870 | 1870 | 1870 | 1870 | 1870 | 0 | 0 | 1870 | 1870 |
| Adj Flow Rate, veh/h | | | | 263 | 295 | 240 | 16 | 588 | 0 | 0 | 705 | 95 |
| Peak Hour Factor | | | | 0.97 | 0.97 | 0.97 | 0.97 | 0.97 | 0.97 | 0.97 | 0.97 | 0.97 |
| Percent Heavy Veh, % | | | | 2 | 2 | 2 | 2 | 2 | 0 | 0 | 2 | 2 |
| Cap, veh/h | | | | 360 | 440 | 334 | 76 | 2227 | 0 | 0 | 2065 | 278 |
| Arrive On Green | | | | 0.22 | 0.22 | 0.22 | 1.00 | 1.00 | 0.00 | 0.00 | 0.66 | 0.66 |
| Sat Flow, veh/h | | | | 1605 | 1962 | 1490 | 39 | 3466 | 0 | 0 | 3229 | 422 |
| Grp Volume(v), veh/h | | | | 293 | 265 | 240 | 319 | 285 | 0 | 0 | 399 | 401 |
| Grp Sat Flow(s),veh/h/ln | | | | 1790 | 1777 | 1490 | 1803 | 1617 | 0 | 0 | 1777 | 1780 |
| Q Serve(g_s), s | | | | 11.4 | 10.2 | 11.2 | 0.0 | 0.0 | 0.0 | 0.0 | 7.4 | 7.4 |
| Cycle Q Clear(g_c), s | | | | 11.4 | 10.2 | 11.2 | 0.0 | 0.0 | 0.0 | 0.0 | 7.4 | 7.4 |
| Prop In Lane | | | | 0.90 | | 1.00 | 0.05 | | 0.00 | 0.00 | | 0.24 |
| Lane Grp Cap(c), veh/h | | | | 401 | 398 | 334 | 1238 | 1065 | 0 | 0 | 1170 | 1173 |
| V/C Ratio(X) | | | | 0.73 | 0.66 | 0.72 | 0.26 | 0.27 | 0.00 | 0.00 | 0.34 | 0.34 |
| Avail Cap(c_a), veh/h | | | | 664 | 659 | 552 | 1238 | 1065 | 0 | 0 | 1170 | 1173 |
| HCM Platoon Ratio | | | | 1.00 | 1.00 | 1.00 | 2.00 | 2.00 | 1.00 | 1.00 | 1.00 | 1.00 |
| Upstream Filter(I) | | | | 1.00 | 1.00 | 1.00 | 0.88 | 0.88 | 0.00 | 0.00 | 1.00 | 1.00 |
| Uniform Delay (d), s/veh | | | | 27.0 | 26.5 | 26.9 | 0.0 | 0.0 | 0.0 | 0.0 | 5.6 | 5.6 |
| Incr Delay (d2), s/veh | | | | 1.0 | 0.7 | 1.1 | 0.4 | 0.5 | 0.0 | 0.0 | 0.8 | 0.8 |
| Initial Q Delay(d3),s/veh | | | | 0.0 | 0.0 | 0.0 | 0.0 | 0.0 | 0.0 | 0.0 | 0.0 | 0.0 |
| %ile BackOfQ(50%),veh/ln | | | | 4.8 | 4.2 | 3.9 | 0.2 | 0.2 | 0.0 | 0.0 | 2.4 | 2.5 |
| Unsig. Movement Delay, s/veh | | | | | | | | | | | | |
| LnGrp Delay(d),s/veh | | | | 28.0 | 27.2 | 28.0 | 0.4 | 0.5 | 0.0 | 0.0 | 6.4 | 6.4 |
| LnGrp LOS | | | | C | C | C | A | A | A | A | A | A |
| Approach Vol, veh/h | | | | | 798 | | | 604 | | | 800 | |
| Approach Delay, s/veh | | | | | 27.7 | | | 0.5 | | | 6.4 | |
| Approach LOS | | | | | C | | | A | | | A | |
| Timer - Assigned Phs | | 2 | | 4 | | 6 | | | | | | |
| Phs Duration (G+Y+Rc), s | | 54.0 | | 21.0 | | 54.0 | | | | | | |
| Change Period (Y+Rc), s | | 4.6 | | * 4.2 | | 4.6 | | | | | | |
| Max Green Setting (Gmax), s | | 38.4 | | * 28 | | 38.4 | | | | | | |
| Max Q Clear Time (g_c+I1), s | | 9.4 | | 13.4 | | 2.0 | | | | | | |
| Green Ext Time (p_c), s | | 3.5 | | 2.4 | | 2.6 | | | | | | |
| Intersection Summary | | | | | | | | | | | | |
| HCM 6th Ctrl Delay | | | | 12.5 | | | | | | | | |
| HCM 6th LOS | | | | B | | | | | | | | |
| Notes | | | | | | | | | | | | |
| * HCM 6th computational engine requires equal clearance times for the phases crossing the barrier. | | | | | | | | | | | | |

HCM 6th Signalized Intersection Summary

2: Main St & W Beach St/E Beach St

Existing

Timing Plan: SATURDAY PEAK HOUR



| Movement | EBL | EBT | EBR | WBL | WBT | WBR | NBL | NBT | NBR | SBL | SBT | SBR |
|------------------------------|------|------|------|------|-------|-----|------|------|------|------|------|------|
| Lane Configurations | | ↔ | | | | | ↔ | ↔ | | ↔ | ↔ | |
| Traffic Volume (veh/h) | 74 | 257 | 49 | 0 | 0 | 0 | 54 | 504 | 144 | 174 | 668 | 56 |
| Future Volume (veh/h) | 74 | 257 | 49 | 0 | 0 | 0 | 54 | 504 | 144 | 174 | 668 | 56 |
| Initial Q (Qb), veh | 0 | 0 | 0 | | | | 0 | 0 | 0 | 0 | 0 | 0 |
| Ped-Bike Adj(A_pbT) | 1.00 | | 0.91 | | | | 1.00 | | 0.96 | 1.00 | | 0.96 |
| Parking Bus, Adj | 1.00 | 1.00 | 1.00 | | | | 1.00 | 1.00 | 1.00 | 1.00 | 1.00 | 1.00 |
| Work Zone On Approach | | No | | | | | | No | | | No | |
| Adj Sat Flow, veh/h/ln | 1870 | 1870 | 1870 | | | | 1870 | 1870 | 1870 | 1870 | 1870 | 1870 |
| Adj Flow Rate, veh/h | 76 | 262 | 50 | | | | 55 | 514 | 147 | 178 | 682 | 57 |
| Peak Hour Factor | 0.98 | 0.98 | 0.98 | | | | 0.98 | 0.98 | 0.98 | 0.98 | 0.98 | 0.98 |
| Percent Heavy Veh, % | 2 | 2 | 2 | | | | 2 | 2 | 2 | 2 | 2 | 2 |
| Cap, veh/h | 119 | 425 | 84 | | | | 113 | 952 | 271 | 522 | 1964 | 164 |
| Arrive On Green | 0.18 | 0.18 | 0.18 | | | | 0.06 | 0.35 | 0.35 | 0.29 | 0.59 | 0.59 |
| Sat Flow, veh/h | 675 | 2414 | 478 | | | | 1781 | 2705 | 769 | 1781 | 3309 | 276 |
| Grp Volume(v), veh/h | 207 | 0 | 181 | | | | 55 | 336 | 325 | 178 | 366 | 373 |
| Grp Sat Flow(s),veh/h/ln | 1837 | 0 | 1730 | | | | 1781 | 1777 | 1697 | 1781 | 1777 | 1808 |
| Q Serve(g_s), s | 7.8 | 0.0 | 7.2 | | | | 2.2 | 11.4 | 11.5 | 5.9 | 7.9 | 7.9 |
| Cycle Q Clear(g_c), s | 7.8 | 0.0 | 7.2 | | | | 2.2 | 11.4 | 11.5 | 5.9 | 7.9 | 7.9 |
| Prop In Lane | 0.37 | | 0.28 | | | | 1.00 | | 0.45 | 1.00 | | 0.15 |
| Lane Grp Cap(c), veh/h | 323 | 0 | 305 | | | | 113 | 625 | 598 | 522 | 1055 | 1073 |
| V/C Ratio(X) | 0.64 | 0.00 | 0.59 | | | | 0.49 | 0.54 | 0.54 | 0.34 | 0.35 | 0.35 |
| Avail Cap(c_a), veh/h | 460 | 0 | 434 | | | | 197 | 625 | 598 | 522 | 1055 | 1073 |
| HCM Platoon Ratio | 1.00 | 1.00 | 1.00 | | | | 1.00 | 1.00 | 1.00 | 1.00 | 1.00 | 1.00 |
| Upstream Filter(I) | 1.00 | 0.00 | 1.00 | | | | 0.83 | 0.83 | 0.83 | 0.94 | 0.94 | 0.94 |
| Uniform Delay (d), s/veh | 28.7 | 0.0 | 28.4 | | | | 33.9 | 19.4 | 19.5 | 20.8 | 7.8 | 7.8 |
| Incr Delay (d2), s/veh | 0.8 | 0.0 | 0.7 | | | | 1.0 | 2.7 | 2.9 | 0.1 | 0.8 | 0.8 |
| Initial Q Delay(d3),s/veh | 0.0 | 0.0 | 0.0 | | | | 0.0 | 0.0 | 0.0 | 0.0 | 0.0 | 0.0 |
| %ile BackOfQ(50%),veh/ln | 3.4 | 0.0 | 2.9 | | | | 1.0 | 4.9 | 4.7 | 2.4 | 2.8 | 2.9 |
| Unsig. Movement Delay, s/veh | | | | | | | | | | | | |
| LnGrp Delay(d),s/veh | 29.5 | 0.0 | 29.1 | | | | 34.9 | 22.2 | 22.4 | 20.9 | 8.7 | 8.6 |
| LnGrp LOS | C | A | C | | | | C | C | C | C | A | A |
| Approach Vol, veh/h | | 388 | | | | | | 716 | | | 917 | |
| Approach Delay, s/veh | | 29.3 | | | | | | 23.3 | | | 11.0 | |
| Approach LOS | | C | | | | | | C | | | B | |
| Timer - Assigned Phs | 1 | 2 | | 5 | 6 | | | 8 | | | | |
| Phs Duration (G+Y+Rc), s | 8.5 | 49.1 | | 26.6 | 31.0 | | | 17.4 | | | | |
| Change Period (Y+Rc), s | 3.7 | 4.6 | | 4.6 | * 4.6 | | | 4.2 | | | | |
| Max Green Setting (Gmax), s | 8.3 | 35.4 | | 17.3 | * 26 | | | 18.8 | | | | |
| Max Q Clear Time (g_c+I1), s | 4.2 | 9.9 | | 7.9 | 13.5 | | | 9.8 | | | | |
| Green Ext Time (p_c), s | 0.0 | 3.1 | | 0.1 | 2.3 | | | 1.0 | | | | |

Intersection Summary

| | |
|--------------------|------|
| HCM 6th Ctrl Delay | 18.9 |
| HCM 6th LOS | B |

Notes

* HCM 6th computational engine requires equal clearance times for the phases crossing the barrier.

HCM 6th Signalized Intersection Summary
 3: W Riverside Dr/E Riverside Dr & Main St

Existing
 Timing Plan: SATURDAY PEAK HOUR

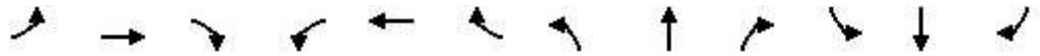

| Movement | EBL | EBT | EBR | WBL | WBT | WBR | NBL | NBT | NBR | SBL | SBT | SBR |
|------------------------------|-------|-------|------|------|------|-------|------|------|------|------|------|------|
| Lane Configurations | | | | | | | | | | | | |
| Traffic Volume (veh/h) | 58 | 300 | 368 | 313 | 517 | 68 | 304 | 615 | 235 | 79 | 471 | 39 |
| Future Volume (veh/h) | 58 | 300 | 368 | 313 | 517 | 68 | 304 | 615 | 235 | 79 | 471 | 39 |
| Initial Q (Qb), veh | 0 | 0 | 0 | 0 | 0 | 0 | 0 | 0 | 0 | 0 | 0 | 0 |
| Ped-Bike Adj(A_pbT) | 1.00 | | 0.99 | 1.00 | | 0.99 | 1.00 | | 0.99 | 1.00 | | 0.97 |
| Parking Bus, Adj | 1.00 | 1.00 | 1.00 | 1.00 | 1.00 | 1.00 | 1.00 | 1.00 | 1.00 | 1.00 | 1.00 | 1.00 |
| Work Zone On Approach | | No | | | No | | | No | | | No | |
| Adj Sat Flow, veh/h/ln | 1870 | 1870 | 1870 | 1870 | 1870 | 1870 | 1870 | 1870 | 1870 | 1870 | 1870 | 1870 |
| Adj Flow Rate, veh/h | 60 | 312 | 383 | 326 | 539 | 71 | 317 | 641 | 245 | 82 | 491 | 41 |
| Peak Hour Factor | 0.96 | 0.96 | 0.96 | 0.96 | 0.96 | 0.96 | 0.96 | 0.96 | 0.96 | 0.96 | 0.96 | 0.96 |
| Percent Heavy Veh, % | 2 | 2 | 2 | 2 | 2 | 2 | 2 | 2 | 2 | 2 | 2 | 2 |
| Cap, veh/h | 116 | 942 | 720 | 742 | 1322 | 174 | 342 | 1105 | 487 | 125 | 601 | 50 |
| Arrive On Green | 0.06 | 0.27 | 0.27 | 0.21 | 0.42 | 0.42 | 0.19 | 0.31 | 0.31 | 0.07 | 0.18 | 0.18 |
| Sat Flow, veh/h | 1781 | 3554 | 1569 | 3456 | 3155 | 414 | 1781 | 3554 | 1567 | 1781 | 3311 | 276 |
| Grp Volume(v), veh/h | 60 | 312 | 383 | 326 | 303 | 307 | 317 | 641 | 245 | 82 | 263 | 269 |
| Grp Sat Flow(s),veh/h/ln | 1781 | 1777 | 1569 | 1728 | 1777 | 1793 | 1781 | 1777 | 1567 | 1781 | 1777 | 1810 |
| Q Serve(g_s), s | 3.9 | 8.5 | 0.0 | 9.8 | 14.3 | 14.4 | 21.0 | 18.2 | 8.9 | 5.4 | 17.0 | 17.2 |
| Cycle Q Clear(g_c), s | 3.9 | 8.5 | 0.0 | 9.8 | 14.3 | 14.4 | 21.0 | 18.2 | 8.9 | 5.4 | 17.0 | 17.2 |
| Prop In Lane | 1.00 | | 1.00 | 1.00 | | 0.23 | 1.00 | | 1.00 | 1.00 | | 0.15 |
| Lane Grp Cap(c), veh/h | 116 | 942 | 720 | 742 | 745 | 751 | 342 | 1105 | 487 | 125 | 322 | 328 |
| V/C Ratio(X) | 0.52 | 0.33 | 0.53 | 0.44 | 0.41 | 0.41 | 0.93 | 0.58 | 0.50 | 0.66 | 0.81 | 0.82 |
| Avail Cap(c_a), veh/h | 212 | 942 | 720 | 742 | 745 | 751 | 392 | 1105 | 487 | 257 | 421 | 428 |
| HCM Platoon Ratio | 1.00 | 1.00 | 1.00 | 1.00 | 1.00 | 1.00 | 1.00 | 1.00 | 1.00 | 1.00 | 1.00 | 1.00 |
| Upstream Filter(I) | 1.00 | 1.00 | 1.00 | 1.00 | 1.00 | 1.00 | 1.00 | 1.00 | 1.00 | 0.94 | 0.94 | 0.94 |
| Uniform Delay (d), s/veh | 54.3 | 35.5 | 23.3 | 40.8 | 24.4 | 24.4 | 47.6 | 34.8 | 11.4 | 54.4 | 47.2 | 47.2 |
| Incr Delay (d2), s/veh | 1.3 | 0.9 | 2.8 | 0.2 | 1.6 | 1.6 | 24.6 | 0.5 | 0.3 | 2.0 | 6.6 | 6.9 |
| Initial Q Delay(d3),s/veh | 0.0 | 0.0 | 0.0 | 0.0 | 0.0 | 0.0 | 0.0 | 0.0 | 0.0 | 0.0 | 0.0 | 0.0 |
| %ile BackOfQ(50%),veh/ln | 1.8 | 3.8 | 8.2 | 4.2 | 6.4 | 6.5 | 11.6 | 7.9 | 3.1 | 2.5 | 8.1 | 8.3 |
| Unsig. Movement Delay, s/veh | | | | | | | | | | | | |
| LnGrp Delay(d),s/veh | 55.6 | 36.5 | 26.1 | 41.0 | 26.1 | 26.1 | 72.3 | 35.3 | 11.8 | 56.4 | 53.8 | 54.1 |
| LnGrp LOS | E | D | C | D | C | C | E | D | B | E | D | D |
| Approach Vol, veh/h | | 755 | | | 936 | | | 1203 | | | 614 | |
| Approach Delay, s/veh | | 32.7 | | | 31.3 | | | 40.2 | | | 54.3 | |
| Approach LOS | | C | | | C | | | D | | | D | |
| Timer - Assigned Phs | 1 | 2 | 3 | 4 | 5 | 6 | 7 | 8 | | | | |
| Phs Duration (G+Y+Rc), s | 30.0 | 36.0 | 27.7 | 26.4 | 11.5 | 54.5 | 12.1 | 41.9 | | | | |
| Change Period (Y+Rc), s | * 4.2 | * 4.2 | 4.6 | 4.6 | 3.7 | * 4.2 | 3.7 | 4.6 | | | | |
| Max Green Setting (Gmax), s | * 16 | * 32 | 26.4 | 28.4 | 14.3 | * 34 | 17.3 | 34.4 | | | | |
| Max Q Clear Time (g_c+I1), s | 11.8 | 10.5 | 23.0 | 19.2 | 5.9 | 16.4 | 7.4 | 20.2 | | | | |
| Green Ext Time (p_c), s | 0.1 | 2.0 | 0.1 | 1.2 | 0.0 | 2.3 | 0.0 | 2.3 | | | | |

Intersection Summary

| | |
|--------------------|------|
| HCM 6th Ctrl Delay | 38.7 |
| HCM 6th LOS | D |

Notes

* HCM 6th computational engine requires equal clearance times for the phases crossing the barrier.

HCM Signalized Intersection Capacity Analysis

6: Main St & Freedom Blvd & Western Dr

Existing

Timing Plan: SATURDAY PEAK HOUR



| Movement | EBL | EBT | EBR | WBL | WBT | WBR | NBL | NBT | NBR | SBL | SBT | SBR |
|-----------------------------------|-------|-------|-------|-------|------|------|---------------------------|-------|-------|------|-------|------|
| Lane Configurations | | ↖ | ↗ | ↖ | ↗ | | ↖ | ↗ | ↗ | | ↖ | ↗ |
| Traffic Volume (vph) | 14 | 253 | 494 | 309 | 221 | 5 | 484 | 13 | 373 | 7 | 14 | 26 |
| Future Volume (vph) | 14 | 253 | 494 | 309 | 221 | 5 | 484 | 13 | 373 | 7 | 14 | 26 |
| Ideal Flow (vphpl) | 1900 | 1900 | 1900 | 1900 | 1900 | 1900 | 1900 | 1900 | 1900 | 1900 | 1900 | 1900 |
| Total Lost time (s) | | 4.6 | 4.6 | 4.6 | 4.6 | | 5.3 | 5.3 | 4.6 | | 4.6 | 4.6 |
| Lane Util. Factor | | 1.00 | 0.88 | 0.91 | 0.91 | | 0.95 | 0.95 | 1.00 | | 1.00 | 1.00 |
| Frbp, ped/bikes | | 1.00 | 1.00 | 1.00 | 1.00 | | 1.00 | 1.00 | 0.97 | | 1.00 | 1.00 |
| Flpb, ped/bikes | | 1.00 | 1.00 | 1.00 | 1.00 | | 1.00 | 1.00 | 1.00 | | 1.00 | 1.00 |
| Frt | | 1.00 | 0.85 | 1.00 | 1.00 | | 1.00 | 1.00 | 0.85 | | 1.00 | 0.85 |
| Flt Protected | | 1.00 | 1.00 | 0.95 | 0.98 | | 0.95 | 0.95 | 1.00 | | 0.98 | 1.00 |
| Satd. Flow (prot) | | 1858 | 2787 | 1610 | 3320 | | 1681 | 1689 | 1542 | | 1827 | 1583 |
| Flt Permitted | | 1.00 | 1.00 | 0.95 | 0.98 | | 0.95 | 0.95 | 1.00 | | 0.79 | 1.00 |
| Satd. Flow (perm) | | 1858 | 2787 | 1610 | 3320 | | 1681 | 1689 | 1542 | | 1474 | 1583 |
| Peak-hour factor, PHF | 0.98 | 0.98 | 0.98 | 0.98 | 0.98 | 0.98 | 0.98 | 0.98 | 0.98 | 0.98 | 0.98 | 0.98 |
| Adj. Flow (vph) | 14 | 258 | 504 | 315 | 226 | 5 | 494 | 13 | 381 | 7 | 14 | 27 |
| RTOR Reduction (vph) | 0 | 0 | 184 | 0 | 1 | 0 | 0 | 0 | 170 | 0 | 0 | 25 |
| Lane Group Flow (vph) | 0 | 272 | 320 | 180 | 365 | 0 | 252 | 255 | 211 | 0 | 21 | 2 |
| Confl. Peds. (#/hr) | 11 | | | | | | 11 | | 6 | 6 | | |
| Confl. Bikes (#/hr) | | | | | | 1 | | | | | | |
| Turn Type | Split | NA | pt+ov | Split | NA | | Split | NA | pm+ov | Perm | NA | Perm |
| Protected Phases | 5 | 5 | 5 6 | 8 | 8 | | 6 | 6 | 8 | | 7 | |
| Permitted Phases | | | | | | | | | 6 | 7 | | 7 |
| Actuated Green, G (s) | | 18.8 | 63.4 | 15.5 | 15.5 | | 40.0 | 40.0 | 55.5 | | 6.6 | 6.6 |
| Effective Green, g (s) | | 18.8 | 63.4 | 15.5 | 15.5 | | 40.0 | 40.0 | 55.5 | | 6.6 | 6.6 |
| Actuated g/C Ratio | | 0.19 | 0.63 | 0.16 | 0.16 | | 0.40 | 0.40 | 0.56 | | 0.07 | 0.07 |
| Clearance Time (s) | | 4.6 | | 4.6 | 4.6 | | 5.3 | 5.3 | 4.6 | | 4.6 | 4.6 |
| Vehicle Extension (s) | | 0.2 | | 0.2 | 0.2 | | 0.2 | 0.2 | 0.2 | | 0.2 | 0.2 |
| Lane Grp Cap (vph) | | 349 | 1766 | 249 | 514 | | 672 | 675 | 855 | | 97 | 104 |
| v/s Ratio Prot | | c0.15 | 0.11 | c0.11 | 0.11 | | 0.15 | c0.15 | 0.04 | | | |
| v/s Ratio Perm | | | | | | | | | 0.10 | | c0.01 | 0.00 |
| v/c Ratio | | 0.78 | 0.18 | 0.72 | 0.71 | | 0.38 | 0.38 | 0.25 | | 0.22 | 0.02 |
| Uniform Delay, d1 | | 38.6 | 7.6 | 40.2 | 40.1 | | 21.2 | 21.2 | 11.5 | | 44.3 | 43.7 |
| Progression Factor | | 1.00 | 1.00 | 1.00 | 1.00 | | 1.00 | 1.00 | 1.00 | | 1.00 | 1.00 |
| Incremental Delay, d2 | | 9.6 | 0.0 | 8.5 | 3.8 | | 1.6 | 1.6 | 0.1 | | 0.4 | 0.0 |
| Delay (s) | | 48.3 | 7.6 | 48.7 | 44.0 | | 22.8 | 22.8 | 11.5 | | 44.7 | 43.7 |
| Level of Service | | D | A | D | D | | C | C | B | | D | D |
| Approach Delay (s) | | 21.8 | | | 45.5 | | | 18.0 | | | 44.1 | |
| Approach LOS | | C | | | D | | | B | | | D | |
| Intersection Summary | | | | | | | | | | | | |
| HCM 2000 Control Delay | | | 26.5 | | | | HCM 2000 Level of Service | | | | C | |
| HCM 2000 Volume to Capacity ratio | | | 0.52 | | | | | | | | | |
| Actuated Cycle Length (s) | | | 100.0 | | | | Sum of lost time (s) | | | | 19.1 | |
| Intersection Capacity Utilization | | | 60.3% | | | | ICU Level of Service | | | | B | |
| Analysis Period (min) | | | 15 | | | | | | | | | |

c Critical Lane Group

HCM 6th Signalized Intersection Summary
 1: Main St & W Lake Ave/E Lake Ave

Existing
 Timing Plan: AM PEAK HOUR



| Movement | EBL | EBT | EBR | WBL | WBT | WBR | NBL | NBT | NBR | SBL | SBT | SBR |
|--|-----|------|-----|-------|------|------|------|------|------|------|------|------|
| Lane Configurations | | | | | ↕↕ | ↗ | | ↕↕ | | | ↕↕ | |
| Traffic Volume (veh/h) | 0 | 0 | 0 | 201 | 350 | 154 | 20 | 519 | 0 | 0 | 546 | 81 |
| Future Volume (veh/h) | 0 | 0 | 0 | 201 | 350 | 154 | 20 | 519 | 0 | 0 | 546 | 81 |
| Initial Q (Qb), veh | | | | 0 | 0 | 0 | 0 | 0 | 0 | 0 | 0 | 0 |
| Ped-Bike Adj(A_pbT) | | | | 1.00 | | 0.99 | 1.00 | | 1.00 | 1.00 | | 0.99 |
| Parking Bus, Adj | | | | 1.00 | 1.00 | 1.00 | 1.00 | 1.00 | 1.00 | 1.00 | 1.00 | 1.00 |
| Work Zone On Approach | | | | No | | | No | | | No | | |
| Adj Sat Flow, veh/h/ln | | | | 1870 | 1870 | 1870 | 1870 | 1870 | 0 | 0 | 1870 | 1870 |
| Adj Flow Rate, veh/h | | | | 254 | 443 | 195 | 25 | 657 | 0 | 0 | 691 | 103 |
| Peak Hour Factor | | | | 0.79 | 0.79 | 0.79 | 0.79 | 0.79 | 0.79 | 0.79 | 0.79 | 0.79 |
| Percent Heavy Veh, % | | | | 2 | 2 | 2 | 2 | 2 | 0 | 0 | 2 | 2 |
| Cap, veh/h | | | | 444 | 831 | 557 | 139 | 1236 | 0 | 0 | 1143 | 170 |
| Arrive On Green | | | | 0.36 | 0.36 | 0.36 | 0.37 | 0.37 | 0.00 | 0.00 | 0.37 | 0.37 |
| Sat Flow, veh/h | | | | 1248 | 2337 | 1566 | 50 | 3436 | 0 | 0 | 3191 | 461 |
| Grp Volume(v), veh/h | | | | 368 | 329 | 195 | 361 | 321 | 0 | 0 | 396 | 398 |
| Grp Sat Flow(s),veh/h/ln | | | | 1808 | 1777 | 1566 | 1784 | 1617 | 0 | 0 | 1777 | 1782 |
| Q Serve(g_s), s | | | | 5.3 | 4.7 | 2.9 | 0.0 | 5.0 | 0.0 | 0.0 | 5.8 | 5.8 |
| Cycle Q Clear(g_c), s | | | | 5.3 | 4.7 | 2.9 | 4.8 | 5.0 | 0.0 | 0.0 | 5.8 | 5.8 |
| Prop In Lane | | | | 0.69 | | 1.00 | 0.07 | | 0.00 | 0.00 | | 0.26 |
| Lane Grp Cap(c), veh/h | | | | 643 | 632 | 557 | 779 | 597 | 0 | 0 | 656 | 657 |
| V/C Ratio(X) | | | | 0.57 | 0.52 | 0.35 | 0.46 | 0.54 | 0.00 | 0.00 | 0.60 | 0.61 |
| Avail Cap(c_a), veh/h | | | | 2197 | 2159 | 1903 | 2379 | 2147 | 0 | 0 | 2360 | 2366 |
| HCM Platoon Ratio | | | | 1.00 | 1.00 | 1.00 | 1.00 | 1.00 | 1.00 | 1.00 | 1.00 | 1.00 |
| Upstream Filter(I) | | | | 1.00 | 1.00 | 1.00 | 1.00 | 1.00 | 0.00 | 0.00 | 1.00 | 1.00 |
| Uniform Delay (d), s/veh | | | | 8.3 | 8.1 | 7.6 | 7.9 | 7.9 | 0.0 | 0.0 | 8.2 | 8.2 |
| Incr Delay (d2), s/veh | | | | 0.3 | 0.2 | 0.1 | 0.2 | 0.3 | 0.0 | 0.0 | 0.3 | 0.3 |
| Initial Q Delay(d3),s/veh | | | | 0.0 | 0.0 | 0.0 | 0.0 | 0.0 | 0.0 | 0.0 | 0.0 | 0.0 |
| %ile BackOfQ(50%),veh/ln | | | | 1.5 | 1.3 | 0.7 | 1.3 | 1.2 | 0.0 | 0.0 | 1.6 | 1.6 |
| Unsig. Movement Delay, s/veh | | | | | | | | | | | | |
| LnGrp Delay(d),s/veh | | | | 8.6 | 8.4 | 7.7 | 8.0 | 8.2 | 0.0 | 0.0 | 8.5 | 8.5 |
| LnGrp LOS | | | | A | A | A | A | A | A | A | A | A |
| Approach Vol, veh/h | | | | | 892 | | | 682 | | | 794 | |
| Approach Delay, s/veh | | | | | 8.3 | | | 8.1 | | | 8.5 | |
| Approach LOS | | | | | A | | | A | | | A | |
| Timer - Assigned Phs | | 2 | | 4 | | 6 | | | | | | |
| Phs Duration (G+Y+Rc), s | | 16.4 | | 15.5 | | 16.4 | | | | | | |
| Change Period (Y+Rc), s | | 4.6 | | * 4.2 | | 4.6 | | | | | | |
| Max Green Setting (Gmax), s | | 42.4 | | * 39 | | 42.4 | | | | | | |
| Max Q Clear Time (g_c+I1), s | | 7.8 | | 7.3 | | 7.0 | | | | | | |
| Green Ext Time (p_c), s | | 3.8 | | 3.6 | | 3.3 | | | | | | |
| Intersection Summary | | | | | | | | | | | | |
| HCM 6th Ctrl Delay | | | | 8.3 | | | | | | | | |
| HCM 6th LOS | | | | A | | | | | | | | |
| Notes | | | | | | | | | | | | |
| * HCM 6th computational engine requires equal clearance times for the phases crossing the barrier. | | | | | | | | | | | | |

HCM 6th Signalized Intersection Summary

2: Main St & W Beach St/E Beach St

Existing
Timing Plan: AM PEAK HOUR



| Movement | EBL | EBT | EBR | WBL | WBT | WBR | NBL | NBT | NBR | SBL | SBT | SBR |
|------------------------------|------|------|------|-----|------|-------|------|------|------|------|------|------|
| Lane Configurations | | ↔ | | | | | ↔ | ↔ | | ↔ | ↔ | |
| Traffic Volume (veh/h) | 31 | 246 | 20 | 0 | 0 | 0 | 61 | 494 | 144 | 162 | 500 | 71 |
| Future Volume (veh/h) | 31 | 246 | 20 | 0 | 0 | 0 | 61 | 494 | 144 | 162 | 500 | 71 |
| Initial Q (Qb), veh | 0 | 0 | 0 | | | | 0 | 0 | 0 | 0 | 0 | 0 |
| Ped-Bike Adj(A_pbT) | 1.00 | | 0.94 | | | | 1.00 | | 0.99 | 1.00 | | 0.98 |
| Parking Bus, Adj | 1.00 | 1.00 | 1.00 | | | | 1.00 | 1.00 | 1.00 | 1.00 | 1.00 | 1.00 |
| Work Zone On Approach | | No | | | | | | No | | | No | |
| Adj Sat Flow, veh/h/ln | 1870 | 1870 | 1870 | | | | 1870 | 1870 | 1870 | 1870 | 1870 | 1870 |
| Adj Flow Rate, veh/h | 38 | 304 | 25 | | | | 75 | 610 | 178 | 200 | 617 | 88 |
| Peak Hour Factor | 0.81 | 0.81 | 0.81 | | | | 0.81 | 0.81 | 0.81 | 0.81 | 0.81 | 0.81 |
| Percent Heavy Veh, % | 2 | 2 | 2 | | | | 2 | 2 | 2 | 2 | 2 | 2 |
| Cap, veh/h | 79 | 661 | 57 | | | | 171 | 889 | 259 | 261 | 1245 | 177 |
| Arrive On Green | 0.22 | 0.22 | 0.22 | | | | 0.10 | 0.33 | 0.33 | 0.15 | 0.40 | 0.40 |
| Sat Flow, veh/h | 364 | 3034 | 260 | | | | 1781 | 2704 | 788 | 1781 | 3114 | 443 |
| Grp Volume(v), veh/h | 194 | 0 | 173 | | | | 75 | 400 | 388 | 200 | 352 | 353 |
| Grp Sat Flow(s),veh/h/ln | 1852 | 0 | 1805 | | | | 1781 | 1777 | 1715 | 1781 | 1777 | 1780 |
| Q Serve(g_s), s | 4.0 | 0.0 | 3.6 | | | | 1.7 | 8.5 | 8.5 | 4.7 | 6.5 | 6.5 |
| Cycle Q Clear(g_c), s | 4.0 | 0.0 | 3.6 | | | | 1.7 | 8.5 | 8.5 | 4.7 | 6.5 | 6.5 |
| Prop In Lane | 0.20 | | 0.14 | | | | 1.00 | | 0.46 | 1.00 | | 0.25 |
| Lane Grp Cap(c), veh/h | 403 | 0 | 393 | | | | 171 | 584 | 564 | 261 | 710 | 711 |
| V/C Ratio(X) | 0.48 | 0.00 | 0.44 | | | | 0.44 | 0.69 | 0.69 | 0.77 | 0.49 | 0.50 |
| Avail Cap(c_a), veh/h | 1138 | 0 | 1109 | | | | 788 | 1524 | 1471 | 993 | 1728 | 1731 |
| HCM Platoon Ratio | 1.00 | 1.00 | 1.00 | | | | 1.00 | 1.00 | 1.00 | 1.00 | 1.00 | 1.00 |
| Upstream Filter(I) | 1.00 | 0.00 | 1.00 | | | | 1.00 | 1.00 | 1.00 | 1.00 | 1.00 | 1.00 |
| Uniform Delay (d), s/veh | 14.9 | 0.0 | 14.8 | | | | 18.6 | 12.7 | 12.7 | 17.9 | 9.8 | 9.8 |
| Incr Delay (d2), s/veh | 0.3 | 0.0 | 0.3 | | | | 0.7 | 0.5 | 0.6 | 1.8 | 0.2 | 0.2 |
| Initial Q Delay(d3),s/veh | 0.0 | 0.0 | 0.0 | | | | 0.0 | 0.0 | 0.0 | 0.0 | 0.0 | 0.0 |
| %ile BackOfQ(50%),veh/ln | 1.5 | 0.0 | 1.3 | | | | 0.7 | 2.9 | 2.8 | 1.9 | 2.1 | 2.1 |
| Unsig. Movement Delay, s/veh | | | | | | | | | | | | |
| LnGrp Delay(d),s/veh | 15.2 | 0.0 | 15.0 | | | | 19.3 | 13.2 | 13.3 | 19.7 | 10.0 | 10.0 |
| LnGrp LOS | B | A | B | | | | B | B | B | B | A | B |
| Approach Vol, veh/h | | 367 | | | | | | 863 | | | 905 | |
| Approach Delay, s/veh | | 15.1 | | | | | | 13.8 | | | 12.1 | |
| Approach LOS | | B | | | | | | B | | | B | |
| Timer - Assigned Phs | 1 | 2 | | | 5 | 6 | | 8 | | | | |
| Phs Duration (G+Y+Rc), s | 7.9 | 22.0 | | | 11.0 | 18.9 | | 13.7 | | | | |
| Change Period (Y+Rc), s | 3.7 | 4.6 | | | 4.6 | * 4.6 | | 4.2 | | | | |
| Max Green Setting (Gmax), s | 19.3 | 42.4 | | | 24.3 | * 37 | | 26.8 | | | | |
| Max Q Clear Time (g_c+I1), s | 3.7 | 8.5 | | | 6.7 | 10.5 | | 6.0 | | | | |
| Green Ext Time (p_c), s | 0.0 | 3.3 | | | 0.1 | 3.8 | | 1.4 | | | | |

Intersection Summary

| | |
|--------------------|------|
| HCM 6th Ctrl Delay | 13.3 |
| HCM 6th LOS | B |

Notes

* HCM 6th computational engine requires equal clearance times for the phases crossing the barrier.

HCM 6th Signalized Intersection Summary
 3: W Riverside Dr/E Riverside Dr & Main St

Existing
 Timing Plan: AM PEAK HOUR

| Movement | EBL | EBT | EBR | WBL | WBT | WBR | NBL | NBT | NBR | SBL | SBT | SBR |
|------------------------------|-------|-------|------|------|------|-------|------|------|------|------|------|------|
| Lane Configurations | | | | | | | | | | | | |
| Traffic Volume (veh/h) | 56 | 339 | 296 | 264 | 444 | 54 | 369 | 757 | 285 | 50 | 410 | 24 |
| Future Volume (veh/h) | 56 | 339 | 296 | 264 | 444 | 54 | 369 | 757 | 285 | 50 | 410 | 24 |
| Initial Q (Qb), veh | 0 | 0 | 0 | 0 | 0 | 0 | 0 | 0 | 0 | 0 | 0 | 0 |
| Ped-Bike Adj(A_pbT) | 1.00 | | 0.99 | 1.00 | | 0.99 | 1.00 | | 0.99 | 1.00 | | 0.96 |
| Parking Bus, Adj | 1.00 | 1.00 | 1.00 | 1.00 | 1.00 | 1.00 | 1.00 | 1.00 | 1.00 | 1.00 | 1.00 | 1.00 |
| Work Zone On Approach | | No | | | No | | | No | | | No | |
| Adj Sat Flow, veh/h/ln | 1870 | 1870 | 1870 | 1870 | 1870 | 1870 | 1870 | 1870 | 1870 | 1870 | 1870 | 1870 |
| Adj Flow Rate, veh/h | 62 | 373 | 325 | 290 | 488 | 59 | 405 | 832 | 313 | 55 | 451 | 26 |
| Peak Hour Factor | 0.91 | 0.91 | 0.91 | 0.91 | 0.91 | 0.91 | 0.91 | 0.91 | 0.91 | 0.91 | 0.91 | 0.91 |
| Percent Heavy Veh, % | 2 | 2 | 2 | 2 | 2 | 2 | 2 | 2 | 2 | 2 | 2 | 2 |
| Cap, veh/h | 120 | 983 | 783 | 612 | 1246 | 150 | 393 | 1196 | 526 | 115 | 588 | 34 |
| Arrive On Green | 0.07 | 0.28 | 0.28 | 0.18 | 0.39 | 0.39 | 0.22 | 0.34 | 0.34 | 0.06 | 0.17 | 0.17 |
| Sat Flow, veh/h | 1781 | 3554 | 1566 | 3456 | 3190 | 384 | 1781 | 3554 | 1564 | 1781 | 3407 | 196 |
| Grp Volume(v), veh/h | 62 | 373 | 325 | 290 | 271 | 276 | 405 | 832 | 313 | 55 | 235 | 242 |
| Grp Sat Flow(s),veh/h/ln | 1781 | 1777 | 1566 | 1728 | 1777 | 1797 | 1781 | 1777 | 1564 | 1781 | 1777 | 1825 |
| Q Serve(g_s), s | 3.9 | 9.8 | 0.0 | 8.7 | 12.6 | 12.7 | 25.4 | 23.3 | 11.8 | 3.4 | 14.5 | 14.6 |
| Cycle Q Clear(g_c), s | 3.9 | 9.8 | 0.0 | 8.7 | 12.6 | 12.7 | 25.4 | 23.3 | 11.8 | 3.4 | 14.5 | 14.6 |
| Prop In Lane | 1.00 | | 1.00 | 1.00 | | 0.21 | 1.00 | | 1.00 | 1.00 | | 0.11 |
| Lane Grp Cap(c), veh/h | 120 | 983 | 783 | 612 | 694 | 702 | 393 | 1196 | 526 | 115 | 307 | 315 |
| V/C Ratio(X) | 0.52 | 0.38 | 0.41 | 0.47 | 0.39 | 0.39 | 1.03 | 0.70 | 0.59 | 0.48 | 0.76 | 0.77 |
| Avail Cap(c_a), veh/h | 191 | 983 | 783 | 612 | 694 | 702 | 393 | 1196 | 526 | 206 | 439 | 451 |
| HCM Platoon Ratio | 1.00 | 1.00 | 1.00 | 1.00 | 1.00 | 1.00 | 1.00 | 1.00 | 1.00 | 1.00 | 1.00 | 1.00 |
| Upstream Filter(I) | 1.00 | 1.00 | 1.00 | 1.00 | 1.00 | 1.00 | 1.00 | 1.00 | 1.00 | 0.92 | 0.92 | 0.92 |
| Uniform Delay (d), s/veh | 51.8 | 33.6 | 18.3 | 42.5 | 25.2 | 25.2 | 44.8 | 33.1 | 12.1 | 51.9 | 45.4 | 45.4 |
| Incr Delay (d2), s/veh | 1.3 | 1.1 | 1.6 | 0.2 | 1.7 | 1.7 | 53.1 | 1.5 | 1.3 | 1.0 | 2.5 | 2.6 |
| Initial Q Delay(d3),s/veh | 0.0 | 0.0 | 0.0 | 0.0 | 0.0 | 0.0 | 0.0 | 0.0 | 0.0 | 0.0 | 0.0 | 0.0 |
| %ile BackOfQ(50%),veh/ln | 1.8 | 4.4 | 5.6 | 3.8 | 5.7 | 5.8 | 16.7 | 10.0 | 4.0 | 1.5 | 6.5 | 6.7 |
| Unsig. Movement Delay, s/veh | | | | | | | | | | | | |
| LnGrp Delay(d),s/veh | 53.1 | 34.7 | 19.9 | 42.7 | 26.9 | 26.9 | 97.9 | 34.6 | 13.4 | 52.9 | 47.8 | 48.0 |
| LnGrp LOS | D | C | B | D | C | C | F | C | B | D | D | D |
| Approach Vol, veh/h | | 760 | | | 837 | | | 1550 | | | 532 | |
| Approach Delay, s/veh | | 29.9 | | | 32.4 | | | 46.8 | | | 48.4 | |
| Approach LOS | | C | | | C | | | D | | | D | |
| Timer - Assigned Phs | 1 | 2 | 3 | 4 | 5 | 6 | 7 | 8 | | | | |
| Phs Duration (G+Y+Rc), s | 24.6 | 36.0 | 30.0 | 24.4 | 11.5 | 49.1 | 11.1 | 43.3 | | | | |
| Change Period (Y+Rc), s | * 4.2 | * 4.2 | 4.6 | 4.6 | 3.7 | * 4.2 | 3.7 | 4.6 | | | | |
| Max Green Setting (Gmax), s | * 12 | * 32 | 25.4 | 28.4 | 12.3 | * 32 | 13.3 | 34.4 | | | | |
| Max Q Clear Time (g_c+I1), s | 10.7 | 11.8 | 27.4 | 16.6 | 5.9 | 14.7 | 5.4 | 25.3 | | | | |
| Green Ext Time (p_c), s | 0.1 | 2.3 | 0.0 | 1.0 | 0.0 | 2.2 | 0.0 | 2.4 | | | | |

Intersection Summary

| | |
|--------------------|------|
| HCM 6th Ctrl Delay | 40.3 |
| HCM 6th LOS | D |

Notes

* HCM 6th computational engine requires equal clearance times for the phases crossing the barrier.

HCM 6th Signalized Intersection Summary

4: Union St/Brennan St & E Lake Ave

Existing
Timing Plan: AM PEAK HOUR



| Movement | EBL | EBT | EBR | WBL | WBT | WBR | NBL | NBT | NBR | SBL | SBT | SBR |
|--|-----|-----|-----|-------|------|------|------|-------|------|------|------|------|
| Lane Configurations | | | | | ↔ | | ↗ | ↖ | | | ↘ | ↙ |
| Traffic Volume (veh/h) | 0 | 0 | 0 | 124 | 621 | 54 | 25 | 175 | 0 | 0 | 150 | 45 |
| Future Volume (veh/h) | 0 | 0 | 0 | 124 | 621 | 54 | 25 | 175 | 0 | 0 | 150 | 45 |
| Initial Q (Qb), veh | | | | 0 | 0 | 0 | 0 | 0 | 0 | 0 | 0 | 0 |
| Ped-Bike Adj(A_pbT) | | | | 1.00 | | 0.97 | 0.99 | | 1.00 | 1.00 | | 0.99 |
| Parking Bus, Adj | | | | 1.00 | 1.00 | 1.00 | 1.00 | 1.00 | 1.00 | 1.00 | 1.00 | 1.00 |
| Work Zone On Approach | | | | No | | | No | | No | | | No |
| Adj Sat Flow, veh/h/ln | | | | 1870 | 1870 | 1870 | 1870 | 1870 | 0 | 0 | 1870 | 1870 |
| Adj Flow Rate, veh/h | | | | 159 | 796 | 69 | 32 | 224 | 0 | 0 | 192 | 58 |
| Peak Hour Factor | | | | 0.78 | 0.78 | 0.78 | 0.78 | 0.78 | 0.78 | 0.78 | 0.78 | 0.78 |
| Percent Heavy Veh, % | | | | 2 | 2 | 2 | 2 | 2 | 0 | 0 | 2 | 2 |
| Cap, veh/h | | | | 265 | 1397 | 127 | 408 | 472 | 0 | 0 | 472 | 394 |
| Arrive On Green | | | | 0.49 | 0.49 | 0.49 | 0.25 | 0.25 | 0.00 | 0.00 | 0.25 | 0.25 |
| Sat Flow, veh/h | | | | 542 | 2856 | 259 | 1121 | 1870 | 0 | 0 | 1870 | 1564 |
| Grp Volume(v), veh/h | | | | 540 | 0 | 484 | 32 | 224 | 0 | 0 | 192 | 58 |
| Grp Sat Flow(s),veh/h/ln | | | | 1843 | 0 | 1813 | 1121 | 1870 | 0 | 0 | 1870 | 1564 |
| Q Serve(g_s), s | | | | 6.9 | 0.0 | 6.0 | 0.8 | 3.3 | 0.0 | 0.0 | 2.8 | 0.9 |
| Cycle Q Clear(g_c), s | | | | 6.9 | 0.0 | 6.0 | 3.6 | 3.3 | 0.0 | 0.0 | 2.8 | 0.9 |
| Prop In Lane | | | | 0.29 | | 0.14 | 1.00 | | 0.00 | 0.00 | | 1.00 |
| Lane Grp Cap(c), veh/h | | | | 902 | 0 | 887 | 408 | 472 | 0 | 0 | 472 | 394 |
| V/C Ratio(X) | | | | 0.60 | 0.00 | 0.55 | 0.08 | 0.48 | 0.00 | 0.00 | 0.41 | 0.15 |
| Avail Cap(c_a), veh/h | | | | 2089 | 0 | 2055 | 1293 | 1947 | 0 | 0 | 1947 | 1628 |
| HCM Platoon Ratio | | | | 1.00 | 1.00 | 1.00 | 1.00 | 1.00 | 1.00 | 1.00 | 1.00 | 1.00 |
| Upstream Filter(I) | | | | 1.00 | 0.00 | 1.00 | 1.00 | 1.00 | 0.00 | 0.00 | 1.00 | 1.00 |
| Uniform Delay (d), s/veh | | | | 6.0 | 0.0 | 5.8 | 11.6 | 10.3 | 0.0 | 0.0 | 10.1 | 9.4 |
| Incr Delay (d2), s/veh | | | | 0.5 | 0.0 | 0.4 | 0.1 | 0.6 | 0.0 | 0.0 | 0.4 | 0.1 |
| Initial Q Delay(d3),s/veh | | | | 0.0 | 0.0 | 0.0 | 0.0 | 0.0 | 0.0 | 0.0 | 0.0 | 0.0 |
| %ile BackOfQ(50%),veh/ln | | | | 1.6 | 0.0 | 1.4 | 0.2 | 1.1 | 0.0 | 0.0 | 0.9 | 0.3 |
| Unsig. Movement Delay, s/veh | | | | | | | | | | | | |
| LnGrp Delay(d),s/veh | | | | 6.5 | 0.0 | 6.2 | 11.7 | 10.9 | 0.0 | 0.0 | 10.5 | 9.6 |
| LnGrp LOS | | | | A | A | A | B | B | A | A | B | A |
| Approach Vol, veh/h | | | | | 1024 | | | 256 | | | 250 | |
| Approach Delay, s/veh | | | | | 6.3 | | | 11.0 | | | 10.3 | |
| Approach LOS | | | | | A | | | B | | | B | |
| Timer - Assigned Phs | | | | 4 | | 6 | | 8 | | | | |
| Phs Duration (G+Y+Rc), s | | | | 12.4 | | 20.1 | | 12.4 | | | | |
| Change Period (Y+Rc), s | | | | * 4.2 | | 4.2 | | * 4.2 | | | | |
| Max Green Setting (Gmax), s | | | | * 34 | | 36.8 | | * 34 | | | | |
| Max Q Clear Time (g_c+I1), s | | | | 4.8 | | 8.9 | | 5.6 | | | | |
| Green Ext Time (p_c), s | | | | 1.1 | | 6.7 | | 1.2 | | | | |
| Intersection Summary | | | | | | | | | | | | |
| HCM 6th Ctrl Delay | | | | 7.8 | | | | | | | | |
| HCM 6th LOS | | | | A | | | | | | | | |
| Notes | | | | | | | | | | | | |
| * HCM 6th computational engine requires equal clearance times for the phases crossing the barrier. | | | | | | | | | | | | |

HCM 6th Signalized Intersection Summary
 5: Union St & E Beach St

Existing
 Timing Plan: AM PEAK HOUR

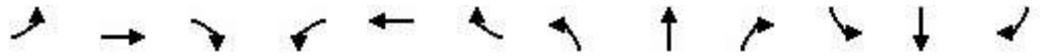

| Movement | EBL | EBT | EBR | WBL | WBT | WBR | NBL | NBT | NBR | SBL | SBT | SBR |
|------------------------------|------|------|------|------|-----|-----|------|------|------|------|------|------|
| Lane Configurations | | ↔ | | | | | | ↑ | | ↔ | ↑ | |
| Traffic Volume (veh/h) | 52 | 434 | 48 | 0 | 0 | 0 | 0 | 142 | 78 | 74 | 200 | 0 |
| Future Volume (veh/h) | 52 | 434 | 48 | 0 | 0 | 0 | 0 | 142 | 78 | 74 | 200 | 0 |
| Initial Q (Qb), veh | 0 | 0 | 0 | | | | 0 | 0 | 0 | 0 | 0 | 0 |
| Ped-Bike Adj(A_pbT) | 1.00 | | 0.95 | | | | 1.00 | | 0.99 | 1.00 | | 1.00 |
| Parking Bus, Adj | 1.00 | 1.00 | 1.00 | | | | 1.00 | 1.00 | 1.00 | 1.00 | 1.00 | 1.00 |
| Work Zone On Approach | | No | | | | | | No | | | No | |
| Adj Sat Flow, veh/h/ln | 1870 | 1870 | 1870 | | | | 0 | 1945 | 1945 | 1870 | 1870 | 0 |
| Adj Flow Rate, veh/h | 67 | 556 | 62 | | | | 0 | 182 | 100 | 95 | 256 | 0 |
| Peak Hour Factor | 0.78 | 0.78 | 0.78 | | | | 0.78 | 0.78 | 0.78 | 0.78 | 0.78 | 0.78 |
| Percent Heavy Veh, % | 2 | 2 | 2 | | | | 0 | 2 | 2 | 2 | 2 | 0 |
| Cap, veh/h | 105 | 909 | 106 | | | | 0 | 369 | 203 | 502 | 586 | 0 |
| Arrive On Green | 0.31 | 0.31 | 0.31 | | | | 0.00 | 0.31 | 0.31 | 0.31 | 0.31 | 0.00 |
| Sat Flow, veh/h | 341 | 2954 | 346 | | | | 0 | 1177 | 647 | 1093 | 1870 | 0 |
| Grp Volume(v), veh/h | 364 | 0 | 321 | | | | 0 | 0 | 282 | 95 | 256 | 0 |
| Grp Sat Flow(s),veh/h/ln | 1853 | 0 | 1787 | | | | 0 | 0 | 1824 | 1093 | 1870 | 0 |
| Q Serve(g_s), s | 4.1 | 0.0 | 3.7 | | | | 0.0 | 0.0 | 3.0 | 1.9 | 2.6 | 0.0 |
| Cycle Q Clear(g_c), s | 4.1 | 0.0 | 3.7 | | | | 0.0 | 0.0 | 3.0 | 4.9 | 2.6 | 0.0 |
| Prop In Lane | 0.18 | | 0.19 | | | | 0.00 | | 0.35 | 1.00 | | 0.00 |
| Lane Grp Cap(c), veh/h | 570 | 0 | 550 | | | | 0 | 0 | 571 | 502 | 586 | 0 |
| V/C Ratio(X) | 0.64 | 0.00 | 0.58 | | | | 0.00 | 0.00 | 0.49 | 0.19 | 0.44 | 0.00 |
| Avail Cap(c_a), veh/h | 2628 | 0 | 2534 | | | | 0 | 0 | 2586 | 1710 | 2652 | 0 |
| HCM Platoon Ratio | 1.00 | 1.00 | 1.00 | | | | 1.00 | 1.00 | 1.00 | 1.00 | 1.00 | 1.00 |
| Upstream Filter(I) | 1.00 | 0.00 | 1.00 | | | | 0.00 | 0.00 | 1.00 | 1.00 | 1.00 | 0.00 |
| Uniform Delay (d), s/veh | 7.2 | 0.0 | 7.1 | | | | 0.0 | 0.0 | 6.8 | 8.8 | 6.6 | 0.0 |
| Incr Delay (d2), s/veh | 0.4 | 0.0 | 0.4 | | | | 0.0 | 0.0 | 0.2 | 0.1 | 0.2 | 0.0 |
| Initial Q Delay(d3),s/veh | 0.0 | 0.0 | 0.0 | | | | 0.0 | 0.0 | 0.0 | 0.0 | 0.0 | 0.0 |
| %ile BackOfQ(50%),veh/ln | 1.0 | 0.0 | 0.8 | | | | 0.0 | 0.0 | 0.7 | 0.3 | 0.6 | 0.0 |
| Unsig. Movement Delay, s/veh | | | | | | | | | | | | |
| LnGrp Delay(d),s/veh | 7.7 | 0.0 | 7.5 | | | | 0.0 | 0.0 | 7.0 | 8.8 | 6.8 | 0.0 |
| LnGrp LOS | A | A | A | | | | A | A | A | A | A | A |
| Approach Vol, veh/h | | 685 | | | | | | 282 | | | 351 | |
| Approach Delay, s/veh | | 7.6 | | | | | | 7.0 | | | 7.4 | |
| Approach LOS | | A | | | | | | A | | | A | |
| Timer - Assigned Phs | | 2 | | 4 | | | | 8 | | | | |
| Phs Duration (G+Y+Rc), s | | 12.1 | | 12.2 | | | | 12.2 | | | | |
| Change Period (Y+Rc), s | | 4.6 | | 4.6 | | | | 4.6 | | | | |
| Max Green Setting (Gmax), s | | 34.4 | | 34.4 | | | | 34.4 | | | | |
| Max Q Clear Time (g_c+I1), s | | 6.1 | | 6.9 | | | | 5.0 | | | | |
| Green Ext Time (p_c), s | | 0.9 | | 0.3 | | | | 0.4 | | | | |
| Intersection Summary | | | | | | | | | | | | |
| HCM 6th Ctrl Delay | | | 7.4 | | | | | | | | | |
| HCM 6th LOS | | | A | | | | | | | | | |

HCM 6th Signalized Intersection Summary

7: Rodriguez St & Main St

Existing
Timing Plan: AM PEAK HOUR



| Movement | EBT | EBR | WBL | WBT | NBL | NBR |
|------------------------------|------|-------|------|------|------|-------|
| Lane Configurations | ↑↑ | | ↵ | ↑↑ | ↵↵ | |
| Traffic Volume (veh/h) | 595 | 188 | 7 | 691 | 184 | 11 |
| Future Volume (veh/h) | 595 | 188 | 7 | 691 | 184 | 11 |
| Initial Q (Qb), veh | 0 | 0 | 0 | 0 | 0 | 0 |
| Ped-Bike Adj(A_pbT) | | 0.97 | 1.00 | | 1.00 | 1.00 |
| Parking Bus, Adj | 1.00 | 1.00 | 1.00 | 1.00 | 1.00 | 1.00 |
| Work Zone On Approach | No | | | No | No | |
| Adj Sat Flow, veh/h/ln | 1870 | 1870 | 1870 | 1945 | 1870 | 1870 |
| Adj Flow Rate, veh/h | 676 | 214 | 8 | 785 | 220 | 0 |
| Peak Hour Factor | 0.88 | 0.88 | 0.88 | 0.88 | 0.88 | 0.88 |
| Percent Heavy Veh, % | 2 | 2 | 2 | 2 | 2 | 2 |
| Cap, veh/h | 1334 | 422 | 508 | 3086 | 294 | 131 |
| Arrive On Green | 0.51 | 0.51 | 0.09 | 0.28 | 0.08 | 0.00 |
| Sat Flow, veh/h | 2730 | 834 | 1781 | 3793 | 3563 | 1585 |
| Grp Volume(v), veh/h | 455 | 435 | 8 | 785 | 220 | 0 |
| Grp Sat Flow(s),veh/h/ln | 1777 | 1694 | 1781 | 1848 | 1781 | 1585 |
| Q Serve(g_s), s | 20.4 | 20.5 | 0.5 | 19.9 | 7.2 | 0.0 |
| Cycle Q Clear(g_c), s | 20.4 | 20.5 | 0.5 | 19.9 | 7.2 | 0.0 |
| Prop In Lane | | 0.49 | 1.00 | | 1.00 | 1.00 |
| Lane Grp Cap(c), veh/h | 899 | 857 | 508 | 3086 | 294 | 131 |
| V/C Ratio(X) | 0.51 | 0.51 | 0.02 | 0.25 | 0.75 | 0.00 |
| Avail Cap(c_a), veh/h | 899 | 857 | 508 | 3086 | 813 | 362 |
| HCM Platoon Ratio | 1.00 | 1.00 | 0.33 | 0.33 | 1.00 | 1.00 |
| Upstream Filter(I) | 1.00 | 1.00 | 0.83 | 0.83 | 1.00 | 0.00 |
| Uniform Delay (d), s/veh | 19.7 | 19.7 | 39.1 | 14.4 | 53.8 | 0.0 |
| Incr Delay (d2), s/veh | 2.0 | 2.1 | 0.0 | 0.2 | 3.8 | 0.0 |
| Initial Q Delay(d3),s/veh | 0.0 | 0.0 | 0.0 | 0.0 | 0.0 | 0.0 |
| %ile BackOfQ(50%),veh/ln | 8.5 | 8.2 | 0.2 | 9.8 | 3.4 | 0.0 |
| Unsig. Movement Delay, s/veh | | | | | | |
| LnGrp Delay(d),s/veh | 21.7 | 21.8 | 39.1 | 14.5 | 57.6 | 0.0 |
| LnGrp LOS | C | C | D | B | E | A |
| Approach Vol, veh/h | 890 | | | 793 | 220 | |
| Approach Delay, s/veh | 21.8 | | | 14.8 | 57.6 | |
| Approach LOS | C | | | B | E | |
| Timer - Assigned Phs | 1 | 2 | | 4 | | 6 |
| Phs Duration (G+Y+Rc), s | 39.5 | 66.0 | | 14.5 | | 105.5 |
| Change Period (Y+Rc), s | 5.3 | * 5.3 | | 4.6 | | 5.3 |
| Max Green Setting (Gmax), s | 17.4 | * 61 | | 27.4 | | 82.7 |
| Max Q Clear Time (g_c+I1), s | 2.5 | 22.5 | | 9.2 | | 21.9 |
| Green Ext Time (p_c), s | 0.0 | 0.8 | | 0.7 | | 0.9 |

Intersection Summary

| | |
|--------------------|------|
| HCM 6th Ctrl Delay | 23.0 |
| HCM 6th LOS | C |

Notes

User approved volume balancing among the lanes for turning movement.

* HCM 6th computational engine requires equal clearance times for the phases crossing the barrier.

HCM 6th Signalized Intersection Summary
8: Brennan St & Freedom Blvd

Existing
Timing Plan: AM PEAK HOUR

| Movement | EBL | EBT | EBR | WBL | WBT | WBR | NBL | NBT | NBR | SBL | SBT | SBR |
|------------------------------|------|------|------|------|------|------|------|------|------|------|------|------|
| Lane Configurations | | | | | | | | | | | | |
| Traffic Volume (veh/h) | 6 | 380 | 95 | 176 | 338 | 0 | 108 | 1 | 130 | 3 | 2 | 12 |
| Future Volume (veh/h) | 6 | 380 | 95 | 176 | 338 | 0 | 108 | 1 | 130 | 3 | 2 | 12 |
| Initial Q (Qb), veh | 0 | 0 | 0 | 0 | 0 | 0 | 0 | 0 | 0 | 0 | 0 | 0 |
| Ped-Bike Adj(A_pbT) | 1.00 | | 0.99 | 1.00 | | 1.00 | 0.98 | | 0.97 | 0.98 | | 0.97 |
| Parking Bus, Adj | 1.00 | 1.00 | 1.00 | 1.00 | 1.00 | 1.00 | 1.00 | 1.00 | 1.00 | 1.00 | 1.00 | 1.00 |
| Work Zone On Approach | | No | | | No | | | No | | | No | |
| Adj Sat Flow, veh/h/ln | 1870 | 1945 | 1870 | 1870 | 1870 | 1870 | 1870 | 1870 | 1870 | 1870 | 1870 | 1870 |
| Adj Flow Rate, veh/h | 7 | 452 | 113 | 210 | 402 | 0 | 129 | 1 | 155 | 4 | 2 | 14 |
| Peak Hour Factor | 0.84 | 0.84 | 0.84 | 0.84 | 0.84 | 0.84 | 0.84 | 0.84 | 0.84 | 0.84 | 0.84 | 0.84 |
| Percent Heavy Veh, % | 2 | 2 | 2 | 2 | 2 | 2 | 2 | 2 | 2 | 2 | 2 | 2 |
| Cap, veh/h | 13 | 722 | 581 | 283 | 977 | 0 | 407 | 2 | 276 | 280 | 35 | 248 |
| Arrive On Green | 0.01 | 0.37 | 0.37 | 0.16 | 0.52 | 0.00 | 0.18 | 0.18 | 0.18 | 0.18 | 0.18 | 0.18 |
| Sat Flow, veh/h | 1781 | 1945 | 1564 | 1781 | 1870 | 0 | 1364 | 10 | 1537 | 1212 | 197 | 1382 |
| Grp Volume(v), veh/h | 7 | 452 | 113 | 210 | 402 | 0 | 129 | 0 | 156 | 4 | 0 | 16 |
| Grp Sat Flow(s),veh/h/ln | 1781 | 1945 | 1564 | 1781 | 1870 | 0 | 1364 | 0 | 1547 | 1212 | 0 | 1580 |
| Q Serve(g_s), s | 0.2 | 7.9 | 2.0 | 4.6 | 5.4 | 0.0 | 3.6 | 0.0 | 3.8 | 0.1 | 0.0 | 0.3 |
| Cycle Q Clear(g_c), s | 0.2 | 7.9 | 2.0 | 4.6 | 5.4 | 0.0 | 3.9 | 0.0 | 3.8 | 3.9 | 0.0 | 0.3 |
| Prop In Lane | 1.00 | | 1.00 | 1.00 | | 0.00 | 1.00 | | 0.99 | 1.00 | | 0.88 |
| Lane Grp Cap(c), veh/h | 13 | 722 | 581 | 283 | 977 | 0 | 407 | 0 | 277 | 280 | 0 | 283 |
| V/C Ratio(X) | 0.53 | 0.63 | 0.19 | 0.74 | 0.41 | 0.00 | 0.32 | 0.00 | 0.56 | 0.01 | 0.00 | 0.06 |
| Avail Cap(c_a), veh/h | 173 | 2262 | 1818 | 1251 | 3307 | 0 | 989 | 0 | 937 | 797 | 0 | 957 |
| HCM Platoon Ratio | 1.00 | 1.00 | 1.00 | 1.00 | 1.00 | 1.00 | 1.00 | 1.00 | 1.00 | 1.00 | 1.00 | 1.00 |
| Upstream Filter(I) | 1.00 | 1.00 | 1.00 | 1.00 | 1.00 | 0.00 | 1.00 | 0.00 | 1.00 | 1.00 | 0.00 | 1.00 |
| Uniform Delay (d), s/veh | 20.4 | 10.6 | 8.8 | 16.6 | 6.0 | 0.0 | 15.7 | 0.0 | 15.5 | 17.3 | 0.0 | 14.0 |
| Incr Delay (d2), s/veh | 28.6 | 0.9 | 0.2 | 3.8 | 0.3 | 0.0 | 0.4 | 0.0 | 1.8 | 0.0 | 0.0 | 0.1 |
| Initial Q Delay(d3),s/veh | 0.0 | 0.0 | 0.0 | 0.0 | 0.0 | 0.0 | 0.0 | 0.0 | 0.0 | 0.0 | 0.0 | 0.0 |
| %ile BackOfQ(50%),veh/ln | 0.2 | 2.6 | 0.5 | 1.9 | 1.3 | 0.0 | 0.9 | 0.0 | 1.2 | 0.0 | 0.0 | 0.1 |
| Unsig. Movement Delay, s/veh | | | | | | | | | | | | |
| LnGrp Delay(d),s/veh | 49.0 | 11.5 | 9.0 | 20.4 | 6.3 | 0.0 | 16.1 | 0.0 | 17.3 | 17.3 | 0.0 | 14.1 |
| LnGrp LOS | D | B | A | C | A | A | B | A | B | B | A | B |
| Approach Vol, veh/h | | 572 | | | 612 | | | 285 | | | | 20 |
| Approach Delay, s/veh | | 11.5 | | | 11.1 | | | 16.7 | | | | 14.8 |
| Approach LOS | | B | | | B | | | B | | | | B |
| Timer - Assigned Phs | 1 | 2 | | 4 | 5 | 6 | | 8 | | | | |
| Phs Duration (G+Y+Rc), s | 4.3 | 25.6 | | 11.4 | 10.6 | 19.3 | | 11.4 | | | | |
| Change Period (Y+Rc), s | 4.0 | 4.0 | | 4.0 | 4.0 | 4.0 | | 4.0 | | | | |
| Max Green Setting (Gmax), s | 4.0 | 73.0 | | 25.0 | 29.0 | 48.0 | | 25.0 | | | | |
| Max Q Clear Time (g_c+I1), s | 2.2 | 7.4 | | 5.9 | 6.6 | 9.9 | | 5.9 | | | | |
| Green Ext Time (p_c), s | 0.0 | 2.7 | | 1.2 | 0.6 | 3.4 | | 0.0 | | | | |
| Intersection Summary | | | | | | | | | | | | |
| HCM 6th Ctrl Delay | | | | 12.4 | | | | | | | | |
| HCM 6th LOS | | | | B | | | | | | | | |

C – Existing Plus Project Traffic Conditions



HCM Signalized Intersection Capacity Analysis

5: Union St & E Beach St

Existing Plus Project
Timing Plan: AM PEAK HOUR

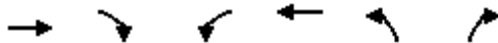





















| Movement | EBT | EBR | WBL | WBT | NBL | NBR |
|------------------------|-------|------|-------|-------|-------|------|
| Lane Configurations | ↩ | | | ↩↩ | ↩ | ↩ |
| Traffic Volume (vph) | 359 | 59 | 102 | 465 | 34 | 96 |
| Future Volume (vph) | 359 | 59 | 102 | 465 | 34 | 96 |
| Ideal Flow (vphpl) | 1900 | 1900 | 1900 | 1900 | 1900 | 1900 |
| Total Lost time (s) | 3.7 | | | 3.7 | 3.7 | 3.7 |
| Lane Util. Factor | 1.00 | | | 0.95 | 1.00 | 1.00 |
| Frbp, ped/bikes | 0.98 | | | 1.00 | 1.00 | 0.96 |
| Flpb, ped/bikes | 1.00 | | | 1.00 | 1.00 | 1.00 |
| Frt | 0.98 | | | 1.00 | 1.00 | 0.85 |
| Flt Protected | 1.00 | | | 0.99 | 0.95 | 1.00 |
| Satd. Flow (prot) | 1793 | | | 3508 | 1770 | 1522 |
| Flt Permitted | 1.00 | | | 0.99 | 0.95 | 1.00 |
| Satd. Flow (perm) | 1793 | | | 3508 | 1770 | 1522 |
| Peak-hour factor, PHF | 0.81 | 0.81 | 0.81 | 0.81 | 0.81 | 0.81 |
| Adj. Flow (vph) | 443 | 73 | 126 | 574 | 42 | 119 |
| RTOR Reduction (vph) | 5 | 0 | 0 | 0 | 0 | 97 |
| Lane Group Flow (vph) | 511 | 0 | 0 | 700 | 42 | 22 |
| Confl. Peds. (#/hr) | | 30 | 30 | | 21 | 7 |
| Turn Type | NA | | Split | NA | Prot | Perm |
| Protected Phases | 4 | | 3 6 | 3 6 | 5 | |
| Permitted Phases | | | | | | 5 |
| Actuated Green, G (s) | 28.7 | | | 34.9 | 17.0 | 17.0 |
| Effective Green, g (s) | 28.7 | | | 34.9 | 17.0 | 17.0 |
| Actuated g/C Ratio | 0.31 | | | 0.38 | 0.19 | 0.19 |
| Clearance Time (s) | 3.7 | | | | 3.7 | 3.7 |
| Vehicle Extension (s) | 2.0 | | | | 3.0 | 3.0 |
| Lane Grp Cap (vph) | 561 | | | 1335 | 328 | 282 |
| v/s Ratio Prot | c0.28 | | | c0.20 | c0.02 | |
| v/s Ratio Perm | | | | | | 0.01 |
| v/c Ratio | 0.91 | | | 0.52 | 0.13 | 0.08 |
| Uniform Delay, d1 | 30.3 | | | 22.0 | 31.2 | 30.9 |
| Progression Factor | 1.00 | | | 0.48 | 1.00 | 1.00 |
| Incremental Delay, d2 | 18.3 | | | 0.3 | 0.2 | 0.1 |
| Delay (s) | 48.6 | | | 10.8 | 31.3 | 31.0 |
| Level of Service | D | | | B | C | C |
| Approach Delay (s) | 48.6 | | | 10.8 | 31.1 | |
| Approach LOS | D | | | B | C | |

Intersection Summary

| | | | |
|-----------------------------------|-------|---------------------------|------|
| HCM 2000 Control Delay | 27.3 | HCM 2000 Level of Service | C |
| HCM 2000 Volume to Capacity ratio | 0.61 | | |
| Actuated Cycle Length (s) | 91.7 | Sum of lost time (s) | 14.8 |
| Intersection Capacity Utilization | 54.9% | ICU Level of Service | A |
| Analysis Period (min) | 15 | | |
| c Critical Lane Group | | | |

HCM Signalized Intersection Capacity Analysis
6: Main St & Freedom Blvd & Western Dr

Existing Plus Project
Timing Plan: AM PEAK HOUR

| |  |  |  |  |  |  |  |  |  |  |  |  |
|-----------------------------------|---|---|---|---|---|---|---|---|---|---|---|---|
| Movement | EBL | EBT | EBR | WBL | WBT | WBR | NBL | NBT | NBR | SBL | SBT | SBR |
| Lane Configurations | |  |  |  |  | |  |  |  | |  |  |
| Traffic Volume (vph) | 21 | 141 | 396 | 231 | 220 | 7 | 461 | 16 | 354 | 21 | 13 | 53 |
| Future Volume (vph) | 21 | 141 | 396 | 231 | 220 | 7 | 461 | 16 | 354 | 21 | 13 | 53 |
| Ideal Flow (vphpl) | 1900 | 1900 | 1900 | 1900 | 1900 | 1900 | 1900 | 1900 | 1900 | 1900 | 1900 | 1900 |
| Total Lost time (s) | | 5.3 | 5.3 | 5.3 | 5.3 | | 5.3 | 5.3 | 5.3 | | 5.3 | 5.3 |
| Lane Util. Factor | | 1.00 | 0.88 | 0.91 | 0.91 | | 0.95 | 0.95 | 1.00 | | 1.00 | 1.00 |
| Frbp, ped/bikes | | 1.00 | 1.00 | 1.00 | 1.00 | | 1.00 | 1.00 | 1.00 | | 1.00 | 1.00 |
| Flpb, ped/bikes | | 1.00 | 1.00 | 1.00 | 1.00 | | 1.00 | 1.00 | 1.00 | | 1.00 | 1.00 |
| Frt | | 1.00 | 0.85 | 1.00 | 1.00 | | 1.00 | 1.00 | 0.85 | | 1.00 | 0.85 |
| Flt Protected | | 0.99 | 1.00 | 0.95 | 0.99 | | 0.95 | 0.96 | 1.00 | | 0.97 | 1.00 |
| Satd. Flow (prot) | | 1851 | 2787 | 1610 | 3332 | | 1681 | 1691 | 1583 | | 1807 | 1583 |
| Flt Permitted | | 0.99 | 1.00 | 0.95 | 0.99 | | 0.95 | 0.96 | 1.00 | | 0.97 | 1.00 |
| Satd. Flow (perm) | | 1851 | 2787 | 1610 | 3332 | | 1681 | 1691 | 1583 | | 1807 | 1583 |
| Peak-hour factor, PHF | 0.87 | 0.87 | 0.87 | 0.87 | 0.87 | 0.87 | 0.87 | 0.87 | 0.87 | 0.87 | 0.87 | 0.87 |
| Adj. Flow (vph) | 24 | 162 | 455 | 266 | 253 | 8 | 530 | 18 | 407 | 24 | 15 | 61 |
| RTOR Reduction (vph) | 0 | 0 | 394 | 0 | 2 | 0 | 0 | 0 | 176 | 0 | 0 | 56 |
| Lane Group Flow (vph) | 0 | 186 | 61 | 173 | 352 | 0 | 276 | 272 | 231 | 0 | 39 | 5 |
| Confl. Peds. (#/hr) | 8 | | | | | 8 | | | | | | |
| Turn Type | Split | NA | Perm | Split | NA | | Split | NA | pm+ov | Split | NA | Perm |
| Protected Phases | 5 | 5 | | 8 | 8 | | 6 | 6 | 8 | 7 | 7 | |
| Permitted Phases | | | 5 | | | | | | 6 | | | 7 |
| Actuated Green, G (s) | | 13.3 | 13.3 | 15.0 | 15.0 | | 41.7 | 41.7 | 56.7 | | 8.8 | 8.8 |
| Effective Green, g (s) | | 13.3 | 13.3 | 15.0 | 15.0 | | 41.7 | 41.7 | 56.7 | | 8.8 | 8.8 |
| Actuated g/C Ratio | | 0.13 | 0.13 | 0.15 | 0.15 | | 0.42 | 0.42 | 0.57 | | 0.09 | 0.09 |
| Clearance Time (s) | | 5.3 | 5.3 | 5.3 | 5.3 | | 5.3 | 5.3 | 5.3 | | 5.3 | 5.3 |
| Vehicle Extension (s) | | 0.2 | 0.2 | 0.2 | 0.2 | | 0.2 | 0.2 | 0.2 | | 0.2 | 0.2 |
| Lane Grp Cap (vph) | | 246 | 370 | 241 | 499 | | 700 | 705 | 897 | | 159 | 139 |
| v/s Ratio Prot | | c0.10 | | c0.11 | 0.11 | | c0.16 | 0.16 | 0.04 | | c0.02 | |
| v/s Ratio Perm | | | 0.02 | | | | | | 0.11 | | | 0.00 |
| v/c Ratio | | 0.76 | 0.16 | 0.72 | 0.71 | | 0.39 | 0.39 | 0.26 | | 0.25 | 0.04 |
| Uniform Delay, d1 | | 41.8 | 38.4 | 40.5 | 40.4 | | 20.3 | 20.3 | 11.0 | | 42.5 | 41.7 |
| Progression Factor | | 1.07 | 2.09 | 1.00 | 1.00 | | 1.00 | 1.00 | 1.00 | | 1.00 | 1.00 |
| Incremental Delay, d2 | | 10.6 | 0.1 | 8.2 | 3.7 | | 1.7 | 1.6 | 0.1 | | 0.3 | 0.0 |
| Delay (s) | | 55.2 | 80.4 | 48.7 | 44.1 | | 22.0 | 21.8 | 11.0 | | 42.8 | 41.8 |
| Level of Service | | E | F | D | D | | C | C | B | | D | D |
| Approach Delay (s) | | 73.1 | | | 45.6 | | | 17.3 | | | 42.2 | |
| Approach LOS | | E | | | D | | | B | | | D | |
| Intersection Summary | | | | | | | | | | | | |
| HCM 2000 Control Delay | | | 41.2 | | | | HCM 2000 Level of Service | | D | | | |
| HCM 2000 Volume to Capacity ratio | | | 0.50 | | | | | | | | | |
| Actuated Cycle Length (s) | | | 100.0 | | | | Sum of lost time (s) | | 21.2 | | | |
| Intersection Capacity Utilization | | | 52.9% | | | | ICU Level of Service | | A | | | |
| Analysis Period (min) | | | 15 | | | | | | | | | |
| c Critical Lane Group | | | | | | | | | | | | |

HCM Signalized Intersection Capacity Analysis
 9: E Beach St & Alexander St

Existing Plus Project
 Timing Plan: AM PEAK HOUR

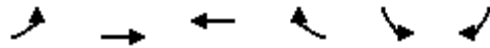

| Movement | EBL | EBT | WBT | WBR | SBL | SBR |
|-----------------------------------|-------|-------|-------|------|---------------------------|------|
| Lane Configurations | | ↶ | ↶↷ | | ↷ | ↷ |
| Traffic Volume (vph) | 83 | 372 | 283 | 84 | 84 | 284 |
| Future Volume (vph) | 83 | 372 | 283 | 84 | 84 | 284 |
| Ideal Flow (vphpl) | 1900 | 1900 | 1900 | 1900 | 1900 | 1900 |
| Total Lost time (s) | | 3.7 | 3.7 | | 3.7 | 3.7 |
| Lane Util. Factor | | 1.00 | 0.95 | | 1.00 | 1.00 |
| Frbp, ped/bikes | | 1.00 | 0.98 | | 1.00 | 0.99 |
| Flpb, ped/bikes | | 1.00 | 1.00 | | 1.00 | 1.00 |
| Frt | | 1.00 | 0.97 | | 1.00 | 0.85 |
| Flt Protected | | 0.99 | 1.00 | | 0.95 | 1.00 |
| Satd. Flow (prot) | | 1846 | 3353 | | 1770 | 1562 |
| Flt Permitted | | 0.99 | 1.00 | | 0.95 | 1.00 |
| Satd. Flow (perm) | | 1846 | 3353 | | 1770 | 1562 |
| Peak-hour factor, PHF | 0.83 | 0.83 | 0.83 | 0.83 | 0.83 | 0.83 |
| Adj. Flow (vph) | 100 | 448 | 341 | 101 | 101 | 342 |
| RTOR Reduction (vph) | 0 | 0 | 27 | 0 | 0 | 294 |
| Lane Group Flow (vph) | 0 | 548 | 415 | 0 | 101 | 48 |
| Confl. Peds. (#/hr) | 17 | | | 17 | 15 | |
| Confl. Bikes (#/hr) | | | | | | 1 |
| Turn Type | Split | NA | NA | | Prot | Perm |
| Protected Phases | 4 5 | 4 5 | 3 | | 6 | |
| Permitted Phases | | | | | | 6 |
| Actuated Green, G (s) | | 49.4 | 18.2 | | 13.0 | 13.0 |
| Effective Green, g (s) | | 49.4 | 18.2 | | 13.0 | 13.0 |
| Actuated g/C Ratio | | 0.54 | 0.20 | | 0.14 | 0.14 |
| Clearance Time (s) | | | 3.7 | | 3.7 | 3.7 |
| Vehicle Extension (s) | | | 3.0 | | 2.0 | 2.0 |
| Lane Grp Cap (vph) | | 994 | 665 | | 250 | 221 |
| v/s Ratio Prot | | c0.30 | c0.12 | | c0.06 | |
| v/s Ratio Perm | | | | | | 0.03 |
| v/c Ratio | | 0.55 | 0.62 | | 0.40 | 0.22 |
| Uniform Delay, d1 | | 13.9 | 33.6 | | 35.8 | 34.9 |
| Progression Factor | | 0.48 | 1.00 | | 1.00 | 1.00 |
| Incremental Delay, d2 | | 0.2 | 1.8 | | 0.4 | 0.2 |
| Delay (s) | | 6.9 | 35.4 | | 36.2 | 35.0 |
| Level of Service | | A | D | | D | D |
| Approach Delay (s) | | 6.9 | 35.4 | | 35.3 | |
| Approach LOS | | A | D | | D | |
| Intersection Summary | | | | | | |
| HCM 2000 Control Delay | | | 24.5 | | HCM 2000 Level of Service | C |
| HCM 2000 Volume to Capacity ratio | | | 0.57 | | | |
| Actuated Cycle Length (s) | | | 91.7 | | Sum of lost time (s) | 14.8 |
| Intersection Capacity Utilization | | | 50.1% | | ICU Level of Service | A |
| Analysis Period (min) | | | 15 | | | |

c Critical Lane Group

HCM 6th Signalized Intersection Summary
 1: Main St & W Lake Ave/E Lake Ave

Existing Plus Project
 Timing Plan: PM PEAK HOUR



| Movement | EBL | EBT | EBR | WBL | WBT | WBR | NBL | NBT | NBR | SBL | SBT | SBR |
|------------------------------|------|------|------|------|------|------|------|------|------|-------|------|------|
| Lane Configurations | | | | | | | | | | | | |
| Traffic Volume (veh/h) | 29 | 178 | 16 | 285 | 150 | 250 | 24 | 681 | 256 | 154 | 715 | 139 |
| Future Volume (veh/h) | 29 | 178 | 16 | 285 | 150 | 250 | 24 | 681 | 256 | 154 | 715 | 139 |
| Initial Q (Qb), veh | 0 | 0 | 0 | 0 | 0 | 0 | 0 | 0 | 0 | 0 | 0 | 0 |
| Ped-Bike Adj(A_pbT) | 1.00 | | 0.87 | 1.00 | | 0.91 | 1.00 | | 0.95 | 1.00 | | 0.95 |
| Parking Bus, Adj | 1.00 | 1.00 | 1.00 | 1.00 | 1.00 | 1.00 | 1.00 | 1.00 | 1.00 | 1.00 | 1.00 | 1.00 |
| Work Zone On Approach | | No | | | No | | | No | | | No | |
| Adj Sat Flow, veh/h/ln | 1870 | 1870 | 1870 | 1870 | 1870 | 1870 | 1870 | 1870 | 1870 | 1870 | 1870 | 1870 |
| Adj Flow Rate, veh/h | 30 | 182 | 16 | 291 | 153 | 255 | 24 | 695 | 261 | 157 | 730 | 142 |
| Peak Hour Factor | 0.98 | 0.98 | 0.98 | 0.98 | 0.98 | 0.98 | 0.98 | 0.98 | 0.98 | 0.98 | 0.98 | 0.98 |
| Percent Heavy Veh, % | 2 | 2 | 2 | 2 | 2 | 2 | 2 | 2 | 2 | 2 | 2 | 2 |
| Cap, veh/h | 50 | 275 | 24 | 281 | 559 | 431 | 161 | 734 | 590 | 160 | 724 | 581 |
| Arrive On Green | 0.03 | 0.16 | 0.16 | 0.16 | 0.30 | 0.30 | 0.18 | 0.79 | 0.79 | 0.09 | 0.39 | 0.39 |
| Sat Flow, veh/h | 1781 | 1672 | 147 | 1781 | 1870 | 1442 | 1781 | 1870 | 1502 | 1781 | 1870 | 1501 |
| Grp Volume(v), veh/h | 30 | 0 | 198 | 291 | 153 | 255 | 24 | 695 | 261 | 157 | 730 | 142 |
| Grp Sat Flow(s),veh/h/ln | 1781 | 0 | 1819 | 1781 | 1870 | 1442 | 1781 | 1870 | 1502 | 1781 | 1870 | 1501 |
| Q Serve(g_s), s | 1.7 | 0.0 | 10.2 | 15.8 | 6.2 | 15.1 | 1.1 | 31.1 | 3.3 | 8.8 | 38.7 | 5.1 |
| Cycle Q Clear(g_c), s | 1.7 | 0.0 | 10.2 | 15.8 | 6.2 | 15.1 | 1.1 | 31.1 | 3.3 | 8.8 | 38.7 | 5.1 |
| Prop In Lane | 1.00 | | 0.08 | 1.00 | | 1.00 | 1.00 | | 1.00 | 1.00 | | 1.00 |
| Lane Grp Cap(c), veh/h | 50 | 0 | 299 | 281 | 559 | 431 | 161 | 734 | 590 | 160 | 724 | 581 |
| V/C Ratio(X) | 0.60 | 0.00 | 0.66 | 1.03 | 0.27 | 0.59 | 0.15 | 0.95 | 0.44 | 0.98 | 1.01 | 0.24 |
| Avail Cap(c_a), veh/h | 107 | 0 | 391 | 281 | 585 | 451 | 161 | 734 | 590 | 160 | 724 | 581 |
| HCM Platoon Ratio | 1.00 | 1.00 | 1.00 | 1.00 | 1.00 | 1.00 | 2.00 | 2.00 | 2.00 | 1.00 | 1.00 | 1.00 |
| Upstream Filter(l) | 0.61 | 0.00 | 0.61 | 0.49 | 0.49 | 0.49 | 0.33 | 0.33 | 0.33 | 1.00 | 1.00 | 1.00 |
| Uniform Delay (d), s/veh | 48.0 | 0.0 | 39.2 | 42.1 | 26.8 | 29.8 | 37.7 | 9.9 | 2.4 | 45.4 | 30.6 | 13.2 |
| Incr Delay (d2), s/veh | 6.7 | 0.0 | 1.2 | 46.6 | 0.1 | 0.9 | 0.1 | 10.1 | 0.8 | 64.7 | 35.6 | 1.0 |
| Initial Q Delay(d3),s/veh | 0.0 | 0.0 | 0.0 | 0.0 | 0.0 | 0.0 | 0.0 | 0.0 | 0.0 | 0.0 | 0.0 | 0.0 |
| %ile BackOfQ(50%),veh/ln | 0.8 | 0.0 | 4.6 | 10.5 | 2.8 | 5.2 | 0.5 | 6.0 | 1.5 | 6.7 | 23.8 | 2.3 |
| Unsig. Movement Delay, s/veh | | | | | | | | | | | | |
| LnGrp Delay(d),s/veh | 54.7 | 0.0 | 40.4 | 88.7 | 26.9 | 30.8 | 37.8 | 19.9 | 3.2 | 110.1 | 66.2 | 14.2 |
| LnGrp LOS | D | A | D | F | C | C | D | B | A | F | F | B |
| Approach Vol, veh/h | | 228 | | | 699 | | | 980 | | | 1029 | |
| Approach Delay, s/veh | | 42.3 | | | 54.0 | | | 15.9 | | | 65.7 | |
| Approach LOS | | D | | | D | | | B | | | E | |
| Timer - Assigned Phs | 1 | 2 | 3 | 4 | 5 | 6 | 7 | 8 | | | | |
| Phs Duration (G+Y+Rc), s | 13.5 | 44.3 | 20.8 | 21.4 | 14.1 | 43.7 | 7.3 | 34.9 | | | | |
| Change Period (Y+Rc), s | 4.5 | 5.0 | 5.0 | * 5 | 5.0 | * 5 | 4.5 | 5.0 | | | | |
| Max Green Setting (Gmax), s | 9.0 | 34.7 | 15.8 | * 22 | 5.0 | * 39 | 6.0 | 31.3 | | | | |
| Max Q Clear Time (g_c+l1), s | 10.8 | 33.1 | 17.8 | 12.2 | 3.1 | 40.7 | 3.7 | 17.1 | | | | |
| Green Ext Time (p_c), s | 0.0 | 0.8 | 0.0 | 0.6 | 0.0 | 0.0 | 0.0 | 1.6 | | | | |

Intersection Summary

| | |
|--------------------|------|
| HCM 6th Ctrl Delay | 44.5 |
| HCM 6th LOS | D |

Notes

* HCM 6th computational engine requires equal clearance times for the phases crossing the barrier.

HCM 6th Signalized Intersection Summary
 2: Main St & W Beach St/E Beach St

Existing Plus Project
 Timing Plan: PM PEAK HOUR



| Movement | EBL | EBT | EBR | WBL | WBT | WBR | NBL | NBT | NBR | SBL | SBT | SBR |
|------------------------------|------|------|------|-------|------|------|------|------|------|------|------|------|
| Lane Configurations | | | | | | | | | | | | |
| Traffic Volume (veh/h) | 108 | 331 | 64 | 112 | 247 | 50 | 84 | 803 | 152 | 62 | 851 | 103 |
| Future Volume (veh/h) | 108 | 331 | 64 | 112 | 247 | 50 | 84 | 803 | 152 | 62 | 851 | 103 |
| Initial Q (Qb), veh | 0 | 0 | 0 | 0 | 0 | 0 | 0 | 0 | 0 | 0 | 0 | 0 |
| Ped-Bike Adj(A_pbT) | 1.00 | | 0.90 | 1.00 | | 0.92 | 1.00 | | 0.94 | 1.00 | | 0.94 |
| Parking Bus, Adj | 1.00 | 1.00 | 1.00 | 1.00 | 1.00 | 1.00 | 1.00 | 1.00 | 1.00 | 1.00 | 1.00 | 1.00 |
| Work Zone On Approach | | No | | | No | | | No | | | No | |
| Adj Sat Flow, veh/h/ln | 1870 | 1870 | 1870 | 1870 | 1870 | 1870 | 1870 | 1870 | 1870 | 1870 | 1870 | 1870 |
| Adj Flow Rate, veh/h | 115 | 352 | 68 | 119 | 263 | 53 | 89 | 854 | 162 | 66 | 905 | 110 |
| Peak Hour Factor | 0.94 | 0.94 | 0.94 | 0.94 | 0.94 | 0.94 | 0.94 | 0.94 | 0.94 | 0.94 | 0.94 | 0.94 |
| Percent Heavy Veh, % | 2 | 2 | 2 | 2 | 2 | 2 | 2 | 2 | 2 | 2 | 2 | 2 |
| Cap, veh/h | 143 | 343 | 66 | 125 | 327 | 66 | 89 | 888 | 705 | 116 | 916 | 729 |
| Arrive On Green | 0.08 | 0.23 | 0.23 | 0.07 | 0.22 | 0.22 | 0.05 | 0.48 | 0.48 | 0.09 | 0.65 | 0.65 |
| Sat Flow, veh/h | 1781 | 1492 | 288 | 1781 | 1486 | 299 | 1781 | 1870 | 1485 | 1781 | 1870 | 1488 |
| Grp Volume(v), veh/h | 115 | 0 | 420 | 119 | 0 | 316 | 89 | 854 | 162 | 66 | 905 | 110 |
| Grp Sat Flow(s),veh/h/ln | 1781 | 0 | 1780 | 1781 | 0 | 1785 | 1781 | 1870 | 1485 | 1781 | 1870 | 1488 |
| Q Serve(g_s), s | 6.3 | 0.0 | 23.0 | 6.7 | 0.0 | 16.8 | 5.0 | 44.1 | 6.4 | 3.6 | 47.3 | 2.9 |
| Cycle Q Clear(g_c), s | 6.3 | 0.0 | 23.0 | 6.7 | 0.0 | 16.8 | 5.0 | 44.1 | 6.4 | 3.6 | 47.3 | 2.9 |
| Prop In Lane | 1.00 | | 0.16 | 1.00 | | 0.17 | 1.00 | | 1.00 | 1.00 | | 1.00 |
| Lane Grp Cap(c), veh/h | 143 | 0 | 409 | 125 | 0 | 393 | 89 | 888 | 705 | 116 | 916 | 729 |
| V/C Ratio(X) | 0.81 | 0.00 | 1.03 | 0.95 | 0.00 | 0.80 | 1.00 | 0.96 | 0.23 | 0.57 | 0.99 | 0.15 |
| Avail Cap(c_a), veh/h | 143 | 0 | 409 | 125 | 0 | 393 | 89 | 916 | 728 | 116 | 916 | 729 |
| HCM Platoon Ratio | 1.00 | 1.00 | 1.00 | 1.00 | 1.00 | 1.00 | 1.00 | 1.00 | 1.00 | 1.33 | 1.33 | 1.33 |
| Upstream Filter(l) | 0.69 | 0.00 | 0.69 | 0.90 | 0.00 | 0.90 | 0.28 | 0.28 | 0.28 | 0.41 | 0.41 | 0.41 |
| Uniform Delay (d), s/veh | 45.2 | 0.0 | 38.5 | 46.3 | 0.0 | 37.0 | 47.5 | 25.4 | 15.5 | 44.3 | 17.1 | 9.4 |
| Incr Delay (d2), s/veh | 20.6 | 0.0 | 43.7 | 62.4 | 0.0 | 9.8 | 50.3 | 9.2 | 0.2 | 2.7 | 16.3 | 0.2 |
| Initial Q Delay(d3),s/veh | 0.0 | 0.0 | 0.0 | 0.0 | 0.0 | 0.0 | 0.0 | 0.0 | 0.0 | 0.0 | 0.0 | 0.0 |
| %ile BackOfQ(50%),veh/ln | 3.6 | 0.0 | 14.8 | 5.1 | 0.0 | 8.3 | 3.4 | 20.6 | 2.2 | 1.6 | 19.0 | 0.9 |
| Unsig. Movement Delay, s/veh | | | | | | | | | | | | |
| LnGrp Delay(d),s/veh | 65.8 | 0.0 | 82.2 | 108.8 | 0.0 | 46.8 | 97.7 | 34.6 | 15.7 | 47.1 | 33.4 | 9.6 |
| LnGrp LOS | E | A | F | F | A | D | F | C | B | D | C | A |
| Approach Vol, veh/h | | 535 | | | 435 | | | 1105 | | | 1081 | |
| Approach Delay, s/veh | | 78.6 | | | 63.7 | | | 36.9 | | | 31.8 | |
| Approach LOS | | E | | | E | | | D | | | C | |
| Timer - Assigned Phs | 1 | 2 | 3 | 4 | 5 | 6 | 7 | 8 | | | | |
| Phs Duration (G+Y+Rc), s | 10.5 | 51.5 | 11.0 | 27.0 | 9.0 | 53.0 | 12.0 | 26.0 | | | | |
| Change Period (Y+Rc), s | 4.0 | 4.0 | 4.0 | 4.0 | 4.0 | 4.0 | 4.0 | 4.0 | | | | |
| Max Green Setting (Gmax), s | 5.0 | 49.0 | 7.0 | 23.0 | 5.0 | 49.0 | 8.0 | 22.0 | | | | |
| Max Q Clear Time (g_c+I1), s | 5.6 | 46.1 | 8.7 | 25.0 | 7.0 | 49.3 | 8.3 | 18.8 | | | | |
| Green Ext Time (p_c), s | 0.0 | 1.4 | 0.0 | 0.0 | 0.0 | 0.0 | 0.0 | 0.4 | | | | |
| Intersection Summary | | | | | | | | | | | | |
| HCM 6th Ctrl Delay | | | 45.9 | | | | | | | | | |
| HCM 6th LOS | | | D | | | | | | | | | |

HCM 6th Signalized Intersection Summary
3: W Riverside Dr/E Riverside Dr & Main St

Existing Plus Project
Timing Plan: PM PEAK HOUR



| Movement | EBL | EBT | EBR | WBL | WBT | WBR | NBL | NBT | NBR | SBL | SBT | SBR |
|------------------------------|------|-------|------|------|------|-------|------|-------|------|------|------|------|
| Lane Configurations | | | | | | | | | | | | |
| Traffic Volume (veh/h) | 73 | 555 | 647 | 405 | 391 | 51 | 312 | 802 | 304 | 99 | 693 | 70 |
| Future Volume (veh/h) | 73 | 555 | 647 | 405 | 391 | 51 | 312 | 802 | 304 | 99 | 693 | 70 |
| Initial Q (Qb), veh | 0 | 0 | 0 | 0 | 0 | 0 | 0 | 0 | 0 | 0 | 0 | 0 |
| Ped-Bike Adj(A_pbT) | 1.00 | | 0.99 | 1.00 | | 0.99 | 1.00 | | 0.99 | 1.00 | | 0.96 |
| Parking Bus, Adj | 1.00 | 1.00 | 1.00 | 1.00 | 1.00 | 1.00 | 1.00 | 1.00 | 1.00 | 1.00 | 1.00 | 1.00 |
| Work Zone On Approach | | No | | | No | | | No | | | No | |
| Adj Sat Flow, veh/h/ln | 1870 | 1870 | 1870 | 1870 | 1870 | 1870 | 1870 | 1870 | 1870 | 1870 | 1870 | 1870 |
| Adj Flow Rate, veh/h | 74 | 561 | 654 | 409 | 395 | 52 | 315 | 810 | 307 | 100 | 700 | 71 |
| Peak Hour Factor | 0.99 | 0.99 | 0.99 | 0.99 | 0.99 | 0.99 | 0.99 | 0.99 | 0.99 | 0.99 | 0.99 | 0.99 |
| Percent Heavy Veh, % | 2 | 2 | 2 | 2 | 2 | 2 | 2 | 2 | 2 | 2 | 2 | 2 |
| Cap, veh/h | 115 | 801 | 805 | 449 | 918 | 120 | 985 | 831 | 696 | 123 | 767 | 78 |
| Arrive On Green | 0.06 | 0.23 | 0.23 | 0.13 | 0.29 | 0.29 | 0.29 | 0.44 | 0.44 | 0.07 | 0.24 | 0.24 |
| Sat Flow, veh/h | 1781 | 3554 | 1568 | 3456 | 3154 | 412 | 3456 | 1870 | 1566 | 1781 | 3245 | 329 |
| Grp Volume(v), veh/h | 74 | 561 | 654 | 409 | 221 | 226 | 315 | 810 | 307 | 100 | 383 | 388 |
| Grp Sat Flow(s),veh/h/ln | 1781 | 1777 | 1568 | 1728 | 1777 | 1789 | 1728 | 1870 | 1566 | 1781 | 1777 | 1797 |
| Q Serve(g_s), s | 5.3 | 18.9 | 14.7 | 15.2 | 13.1 | 13.3 | 9.3 | 55.2 | 11.5 | 7.2 | 27.3 | 27.3 |
| Cycle Q Clear(g_c), s | 5.3 | 18.9 | 14.7 | 15.2 | 13.1 | 13.3 | 9.3 | 55.2 | 11.5 | 7.2 | 27.3 | 27.3 |
| Prop In Lane | 1.00 | | 1.00 | 1.00 | | 0.23 | 1.00 | | 1.00 | 1.00 | | 0.18 |
| Lane Grp Cap(c), veh/h | 115 | 801 | 805 | 449 | 517 | 521 | 985 | 831 | 696 | 123 | 420 | 425 |
| V/C Ratio(X) | 0.64 | 0.70 | 0.81 | 0.91 | 0.43 | 0.43 | 0.32 | 0.97 | 0.44 | 0.82 | 0.91 | 0.91 |
| Avail Cap(c_a), veh/h | 163 | 806 | 808 | 449 | 517 | 521 | 985 | 840 | 703 | 123 | 478 | 484 |
| HCM Platoon Ratio | 1.00 | 1.00 | 1.00 | 1.00 | 1.00 | 1.00 | 1.00 | 1.00 | 1.00 | 1.00 | 1.00 | 1.00 |
| Upstream Filter(l) | 1.00 | 1.00 | 1.00 | 1.00 | 1.00 | 1.00 | 1.00 | 1.00 | 1.00 | 0.12 | 0.12 | 0.12 |
| Uniform Delay (d), s/veh | 59.4 | 46.3 | 10.5 | 55.8 | 37.3 | 37.4 | 36.6 | 35.4 | 10.6 | 59.7 | 48.3 | 48.3 |
| Incr Delay (d2), s/veh | 2.2 | 5.1 | 8.8 | 22.0 | 2.6 | 2.6 | 0.1 | 24.7 | 0.2 | 4.8 | 3.1 | 3.1 |
| Initial Q Delay(d3),s/veh | 0.0 | 0.0 | 0.0 | 0.0 | 0.0 | 0.0 | 0.0 | 0.0 | 0.0 | 0.0 | 0.0 | 0.0 |
| %ile BackOfQ(50%),veh/ln | 2.5 | 8.9 | 9.3 | 8.0 | 6.1 | 6.2 | 4.0 | 30.2 | 3.9 | 3.4 | 12.4 | 12.6 |
| Unsig. Movement Delay, s/veh | | | | | | | | | | | | |
| LnGrp Delay(d),s/veh | 61.6 | 51.4 | 19.2 | 77.8 | 39.9 | 40.0 | 36.6 | 60.1 | 10.8 | 64.5 | 51.4 | 51.5 |
| LnGrp LOS | E | D | B | E | D | D | D | E | B | E | D | D |
| Approach Vol, veh/h | | 1289 | | | 856 | | | 1432 | | | 871 | |
| Approach Delay, s/veh | | 35.7 | | | 58.0 | | | 44.4 | | | 52.9 | |
| Approach LOS | | D | | | E | | | D | | | D | |
| Timer - Assigned Phs | 1 | 2 | 3 | 4 | 5 | 6 | 7 | 8 | | | | |
| Phs Duration (G+Y+Rc), s | 20.6 | 33.5 | 41.7 | 34.2 | 12.1 | 42.0 | 13.6 | 62.3 | | | | |
| Change Period (Y+Rc), s | 3.7 | * 4.2 | 4.6 | 3.5 | 3.7 | * 4.2 | 4.6 | * 4.6 | | | | |
| Max Green Setting (Gmax), s | 16.9 | * 30 | 32.6 | 35.0 | 11.9 | * 35 | 9.0 | * 58 | | | | |
| Max Q Clear Time (g_c+l1), s | 17.2 | 20.9 | 11.3 | 29.3 | 7.3 | 15.3 | 9.2 | 57.2 | | | | |
| Green Ext Time (p_c), s | 0.0 | 2.9 | 0.2 | 1.4 | 0.0 | 1.7 | 0.0 | 0.6 | | | | |

Intersection Summary

| | |
|--------------------|------|
| HCM 6th Ctrl Delay | 46.2 |
| HCM 6th LOS | D |

Notes

* HCM 6th computational engine requires equal clearance times for the phases crossing the barrier.

HCM 6th Signalized Intersection Summary
4: Union St/Brennan St & E Lake Ave

Existing Plus Project
Timing Plan: PM PEAK HOUR

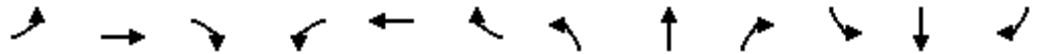

| Movement | EBL | EBT | EBR | WBL | WBT | WBR | NBL | NBT | NBR | SBL | SBT | SBR |
|--|------|-------|------|-------|------|-------|------|-------|------|------|------|------|
| Lane Configurations | | | | | | | | | | | | |
| Traffic Volume (veh/h) | 130 | 423 | 35 | 176 | 502 | 53 | 104 | 106 | 38 | 47 | 201 | 79 |
| Future Volume (veh/h) | 130 | 423 | 35 | 176 | 502 | 53 | 104 | 106 | 38 | 47 | 201 | 79 |
| Initial Q (Qb), veh | 0 | 0 | 0 | 0 | 0 | 0 | 0 | 0 | 0 | 0 | 0 | 0 |
| Ped-Bike Adj(A_pbT) | 1.00 | | 0.97 | 1.00 | | 0.97 | 1.00 | | 0.93 | 1.00 | | 0.95 |
| Parking Bus, Adj | 1.00 | 1.00 | 1.00 | 1.00 | 1.00 | 1.00 | 1.00 | 1.00 | 1.00 | 1.00 | 1.00 | 1.00 |
| Work Zone On Approach | | No | | | No | | | No | | | No | |
| Adj Sat Flow, veh/h/ln | 1870 | 1870 | 1870 | 1870 | 1870 | 1870 | 1870 | 1870 | 1870 | 1870 | 1870 | 1870 |
| Adj Flow Rate, veh/h | 137 | 445 | 37 | 185 | 528 | 56 | 109 | 112 | 40 | 49 | 212 | 83 |
| Peak Hour Factor | 0.95 | 0.95 | 0.95 | 0.95 | 0.95 | 0.95 | 0.95 | 0.95 | 0.95 | 0.95 | 0.95 | 0.95 |
| Percent Heavy Veh, % | 2 | 2 | 2 | 2 | 2 | 2 | 2 | 2 | 2 | 2 | 2 | 2 |
| Cap, veh/h | 173 | 535 | 44 | 256 | 610 | 65 | 140 | 339 | 121 | 77 | 287 | 112 |
| Arrive On Green | 0.10 | 0.32 | 0.32 | 0.14 | 0.37 | 0.37 | 0.08 | 0.26 | 0.26 | 0.04 | 0.23 | 0.23 |
| Sat Flow, veh/h | 1781 | 1698 | 141 | 1781 | 1657 | 176 | 1781 | 1286 | 459 | 1781 | 1256 | 492 |
| Grp Volume(v), veh/h | 137 | 0 | 482 | 185 | 0 | 584 | 109 | 0 | 152 | 49 | 0 | 295 |
| Grp Sat Flow(s),veh/h/ln | 1781 | 0 | 1839 | 1781 | 0 | 1833 | 1781 | 0 | 1746 | 1781 | 0 | 1748 |
| Q Serve(g_s), s | 5.4 | 0.0 | 17.5 | 7.2 | 0.0 | 21.3 | 4.3 | 0.0 | 5.1 | 2.0 | 0.0 | 11.3 |
| Cycle Q Clear(g_c), s | 5.4 | 0.0 | 17.5 | 7.2 | 0.0 | 21.3 | 4.3 | 0.0 | 5.1 | 2.0 | 0.0 | 11.3 |
| Prop In Lane | 1.00 | | 0.08 | 1.00 | | 0.10 | 1.00 | | 0.26 | 1.00 | | 0.28 |
| Lane Grp Cap(c), veh/h | 173 | 0 | 580 | 256 | 0 | 675 | 140 | 0 | 460 | 77 | 0 | 399 |
| V/C Ratio(X) | 0.79 | 0.00 | 0.83 | 0.72 | 0.00 | 0.87 | 0.78 | 0.00 | 0.33 | 0.63 | 0.00 | 0.74 |
| Avail Cap(c_a), veh/h | 247 | 0 | 1084 | 282 | 0 | 1124 | 222 | 0 | 591 | 124 | 0 | 495 |
| HCM Platoon Ratio | 1.00 | 1.00 | 1.00 | 1.00 | 1.00 | 1.00 | 1.00 | 1.00 | 1.00 | 1.00 | 1.00 | 1.00 |
| Upstream Filter(l) | 1.00 | 0.00 | 1.00 | 1.00 | 0.00 | 1.00 | 1.00 | 0.00 | 1.00 | 1.00 | 0.00 | 1.00 |
| Uniform Delay (d), s/veh | 31.8 | 0.0 | 22.9 | 29.5 | 0.0 | 21.1 | 32.6 | 0.0 | 21.4 | 33.9 | 0.0 | 25.8 |
| Incr Delay (d2), s/veh | 10.6 | 0.0 | 3.2 | 8.0 | 0.0 | 3.2 | 9.0 | 0.0 | 0.3 | 8.3 | 0.0 | 4.0 |
| Initial Q Delay(d3),s/veh | 0.0 | 0.0 | 0.0 | 0.0 | 0.0 | 0.0 | 0.0 | 0.0 | 0.0 | 0.0 | 0.0 | 0.0 |
| %ile BackOfQ(50%),veh/ln | 2.8 | 0.0 | 7.6 | 3.5 | 0.0 | 9.0 | 2.2 | 0.0 | 2.0 | 1.0 | 0.0 | 4.9 |
| Unsig. Movement Delay, s/veh | | | | | | | | | | | | |
| LnGrp Delay(d),s/veh | 42.4 | 0.0 | 26.1 | 37.5 | 0.0 | 24.3 | 41.6 | 0.0 | 21.7 | 42.2 | 0.0 | 29.8 |
| LnGrp LOS | D | A | C | D | A | C | D | A | C | D | A | C |
| Approach Vol, veh/h | | 619 | | | 769 | | | 261 | | | | 344 |
| Approach Delay, s/veh | | 29.7 | | | 27.5 | | | 30.0 | | | | 31.6 |
| Approach LOS | | C | | | C | | | C | | | | C |
| Timer - Assigned Phs | 1 | 2 | 3 | 4 | 5 | 6 | 7 | 8 | | | | |
| Phs Duration (G+Y+Rc), s | 14.5 | 27.2 | 9.7 | 20.7 | 11.0 | 30.7 | 7.1 | 23.2 | | | | |
| Change Period (Y+Rc), s | 4.2 | * 4.5 | 4.0 | * 4.2 | 4.0 | * 4.2 | 4.0 | * 4.2 | | | | |
| Max Green Setting (Gmax), s | 11.4 | * 43 | 9.0 | * 20 | 10.0 | * 44 | 5.0 | * 24 | | | | |
| Max Q Clear Time (g_c+I1), s | 9.2 | 19.5 | 6.3 | 13.3 | 7.4 | 23.3 | 4.0 | 7.1 | | | | |
| Green Ext Time (p_c), s | 0.1 | 3.2 | 0.1 | 0.8 | 0.1 | 3.2 | 0.0 | 0.6 | | | | |
| Intersection Summary | | | | | | | | | | | | |
| HCM 6th Ctrl Delay | | | | 29.2 | | | | | | | | |
| HCM 6th LOS | | | | C | | | | | | | | |
| Notes | | | | | | | | | | | | |
| * HCM 6th computational engine requires equal clearance times for the phases crossing the barrier. | | | | | | | | | | | | |

HCM 6th Signalized Intersection Summary
7: Rodriguez St & Main St

Existing Plus Project
Timing Plan: PM PEAK HOUR

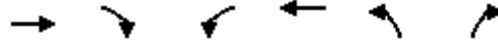

| Movement | EBT | EBR | WBL | WBT | NBL | NBR |
|------------------------------|------|------|------|------|------|-------|
| Lane Configurations | ↑↑ | | ↵ | ↑↑ | ↵↵ | |
| Traffic Volume (veh/h) | 1044 | 340 | 7 | 870 | 364 | 11 |
| Future Volume (veh/h) | 1044 | 340 | 7 | 870 | 364 | 11 |
| Initial Q (Qb), veh | 0 | 0 | 0 | 0 | 0 | 0 |
| Ped-Bike Adj(A_pbT) | | 0.97 | 1.00 | | 1.00 | 1.00 |
| Parking Bus, Adj | 1.00 | 1.00 | 1.00 | 1.00 | 1.00 | 1.00 |
| Work Zone On Approach | No | | | No | No | |
| Adj Sat Flow, veh/h/ln | 1870 | 1870 | 1870 | 1945 | 1870 | 1870 |
| Adj Flow Rate, veh/h | 1065 | 347 | 7 | 888 | 381 | 0 |
| Peak Hour Factor | 0.98 | 0.98 | 0.98 | 0.98 | 0.98 | 0.98 |
| Percent Heavy Veh, % | 2 | 2 | 2 | 2 | 2 | 2 |
| Cap, veh/h | 1146 | 369 | 507 | 2862 | 479 | 213 |
| Arrive On Green | 0.44 | 0.44 | 0.09 | 0.26 | 0.13 | 0.00 |
| Sat Flow, veh/h | 2716 | 843 | 1781 | 3793 | 3563 | 1585 |
| Grp Volume(v), veh/h | 717 | 695 | 7 | 888 | 381 | 0 |
| Grp Sat Flow(s),veh/h/ln | 1777 | 1689 | 1781 | 1848 | 1781 | 1585 |
| Q Serve(g_s), s | 38.1 | 39.4 | 0.4 | 19.4 | 10.4 | 0.0 |
| Cycle Q Clear(g_c), s | 38.1 | 39.4 | 0.4 | 19.4 | 10.4 | 0.0 |
| Prop In Lane | | 0.50 | 1.00 | | 1.00 | 1.00 |
| Lane Grp Cap(c), veh/h | 777 | 738 | 507 | 2862 | 479 | 213 |
| V/C Ratio(X) | 0.92 | 0.94 | 0.01 | 0.31 | 0.79 | 0.00 |
| Avail Cap(c_a), veh/h | 944 | 897 | 507 | 2862 | 866 | 385 |
| HCM Platoon Ratio | 1.00 | 1.00 | 0.33 | 0.33 | 1.00 | 1.00 |
| Upstream Filter(l) | 1.00 | 1.00 | 0.68 | 0.68 | 1.00 | 0.00 |
| Uniform Delay (d), s/veh | 26.6 | 26.9 | 32.6 | 15.6 | 41.9 | 0.0 |
| Incr Delay (d2), s/veh | 18.2 | 21.6 | 0.0 | 0.2 | 3.0 | 0.0 |
| Initial Q Delay(d3),s/veh | 0.0 | 0.0 | 0.0 | 0.0 | 0.0 | 0.0 |
| %ile BackOfQ(50%),veh/ln | 19.2 | 19.5 | 0.2 | 9.6 | 4.7 | 0.0 |
| Unsig. Movement Delay, s/veh | | | | | | |
| LnGrp Delay(d),s/veh | 44.8 | 48.5 | 32.6 | 15.8 | 45.0 | 0.0 |
| LnGrp LOS | D | D | C | B | D | A |
| Approach Vol, veh/h | 1412 | | | 895 | 381 | |
| Approach Delay, s/veh | 46.6 | | | 15.9 | 45.0 | |
| Approach LOS | D | | | B | D | |
| Timer - Assigned Phs | 1 | 2 | | 4 | | 6 |
| Phs Duration (G+Y+Rc), s | 33.0 | 49.0 | | 18.0 | | 82.0 |
| Change Period (Y+Rc), s | 4.6 | 5.3 | | 4.5 | | * 4.6 |
| Max Green Setting (Gmax), s | 8.2 | 53.1 | | 24.3 | | * 67 |
| Max Q Clear Time (g_c+l1), s | 2.4 | 41.4 | | 12.4 | | 21.4 |
| Green Ext Time (p_c), s | 0.0 | 2.3 | | 1.1 | | 1.8 |

Intersection Summary

| | |
|--------------------|------|
| HCM 6th Ctrl Delay | 36.2 |
| HCM 6th LOS | D |

Notes

User approved volume balancing among the lanes for turning movement.

* HCM 6th computational engine requires equal clearance times for the phases crossing the barrier.

HCM 6th Signalized Intersection Summary
8: Brennan St & Freedom Blvd

Existing Plus Project
Timing Plan: PM PEAK HOUR



| Movement | EBL | EBT | EBR | WBL | WBT | WBR | NBL | NBT | NBR | SBL | SBT | SBR |
|------------------------------|------|------|------|------|------|------|------|------|------|------|------|------|
| Lane Configurations | | | | | | | | | | | | |
| Traffic Volume (veh/h) | 8 | 629 | 115 | 201 | 430 | 5 | 174 | 5 | 270 | 6 | 5 | 15 |
| Future Volume (veh/h) | 8 | 629 | 115 | 201 | 430 | 5 | 174 | 5 | 270 | 6 | 5 | 15 |
| Initial Q (Qb), veh | 0 | 0 | 0 | 0 | 0 | 0 | 0 | 0 | 0 | 0 | 0 | 0 |
| Ped-Bike Adj(A_pbT) | 1.00 | | 0.99 | 1.00 | | 0.97 | 0.95 | | 0.94 | 1.00 | | 0.92 |
| Parking Bus, Adj | 1.00 | 1.00 | 1.00 | 1.00 | 1.00 | 1.00 | 1.00 | 1.00 | 1.00 | 1.00 | 1.00 | 1.00 |
| Work Zone On Approach | | No | | | No | | | No | | | No | |
| Adj Sat Flow, veh/h/ln | 1870 | 1945 | 1870 | 1870 | 1870 | 1870 | 1870 | 1870 | 1870 | 1870 | 1870 | 1870 |
| Adj Flow Rate, veh/h | 8 | 662 | 121 | 212 | 453 | 5 | 183 | 5 | 284 | 6 | 5 | 16 |
| Peak Hour Factor | 0.95 | 0.95 | 0.95 | 0.95 | 0.95 | 0.95 | 0.95 | 0.95 | 0.95 | 0.95 | 0.95 | 0.95 |
| Percent Heavy Veh, % | 2 | 2 | 2 | 2 | 2 | 2 | 2 | 2 | 2 | 2 | 2 | 2 |
| Cap, veh/h | 157 | 1046 | 842 | 244 | 1082 | 12 | 336 | 6 | 319 | 98 | 79 | 254 |
| Arrive On Green | 0.09 | 0.54 | 0.54 | 0.14 | 0.59 | 0.59 | 0.22 | 0.22 | 0.22 | 0.22 | 0.22 | 0.22 |
| Sat Flow, veh/h | 1781 | 1945 | 1567 | 1781 | 1846 | 20 | 1320 | 26 | 1476 | 1090 | 368 | 1177 |
| Grp Volume(v), veh/h | 8 | 662 | 121 | 212 | 0 | 458 | 183 | 0 | 289 | 6 | 0 | 21 |
| Grp Sat Flow(s),veh/h/ln | 1781 | 1945 | 1567 | 1781 | 0 | 1866 | 1320 | 0 | 1502 | 1090 | 0 | 1544 |
| Q Serve(g_s), s | 0.5 | 26.2 | 4.3 | 12.8 | 0.0 | 14.8 | 14.1 | 0.0 | 20.5 | 0.6 | 0.0 | 1.2 |
| Cycle Q Clear(g_c), s | 0.5 | 26.2 | 4.3 | 12.8 | 0.0 | 14.8 | 15.3 | 0.0 | 20.5 | 21.1 | 0.0 | 1.2 |
| Prop In Lane | 1.00 | | 1.00 | 1.00 | | 0.01 | 1.00 | | 0.98 | 1.00 | | 0.76 |
| Lane Grp Cap(c), veh/h | 157 | 1046 | 842 | 244 | 0 | 1094 | 336 | 0 | 325 | 98 | 0 | 334 |
| V/C Ratio(X) | 0.05 | 0.63 | 0.14 | 0.87 | 0.00 | 0.42 | 0.54 | 0.00 | 0.89 | 0.06 | 0.00 | 0.06 |
| Avail Cap(c_a), veh/h | 157 | 1046 | 842 | 340 | 0 | 1094 | 387 | 0 | 382 | 139 | 0 | 393 |
| HCM Platoon Ratio | 1.00 | 1.00 | 1.00 | 1.00 | 1.00 | 1.00 | 1.00 | 1.00 | 1.00 | 1.00 | 1.00 | 1.00 |
| Upstream Filter(l) | 0.66 | 0.66 | 0.66 | 1.00 | 0.00 | 1.00 | 1.00 | 0.00 | 1.00 | 1.00 | 0.00 | 1.00 |
| Uniform Delay (d), s/veh | 45.9 | 17.8 | 12.7 | 46.5 | 0.0 | 12.5 | 40.3 | 0.0 | 41.8 | 52.1 | 0.0 | 34.3 |
| Incr Delay (d2), s/veh | 0.4 | 0.6 | 0.0 | 15.6 | 0.0 | 1.2 | 1.4 | 0.0 | 19.8 | 0.3 | 0.0 | 0.1 |
| Initial Q Delay(d3),s/veh | 0.0 | 0.0 | 0.0 | 0.0 | 0.0 | 0.0 | 0.0 | 0.0 | 0.0 | 0.0 | 0.0 | 0.0 |
| %ile BackOfQ(50%),veh/ln | 0.2 | 11.5 | 1.5 | 6.7 | 0.0 | 6.3 | 4.7 | 0.0 | 9.3 | 0.2 | 0.0 | 0.5 |
| Unsig. Movement Delay, s/veh | | | | | | | | | | | | |
| LnGrp Delay(d),s/veh | 46.3 | 18.5 | 12.8 | 62.1 | 0.0 | 13.7 | 41.7 | 0.0 | 61.6 | 52.4 | 0.0 | 34.3 |
| LnGrp LOS | D | B | B | E | A | B | D | A | E | D | A | C |
| Approach Vol, veh/h | | 791 | | | 670 | | | 472 | | | | 27 |
| Approach Delay, s/veh | | 17.9 | | | 29.0 | | | 53.9 | | | | 38.3 |
| Approach LOS | | B | | | C | | | D | | | | D |
| Timer - Assigned Phs | 1 | 2 | | 4 | 5 | 6 | | 8 | | | | |
| Phs Duration (G+Y+Rc), s | 13.7 | 68.5 | | 27.8 | 19.1 | 63.1 | | 27.8 | | | | |
| Change Period (Y+Rc), s | 4.0 | 4.0 | | 4.0 | 4.0 | 4.0 | | 4.0 | | | | |
| Max Green Setting (Gmax), s | 5.5 | 64.5 | | 28.0 | 21.0 | 49.0 | | 28.0 | | | | |
| Max Q Clear Time (g_c+l1), s | 2.5 | 16.8 | | 22.5 | 14.8 | 28.2 | | 23.1 | | | | |
| Green Ext Time (p_c), s | 0.0 | 3.3 | | 1.2 | 0.3 | 3.2 | | 0.0 | | | | |
| Intersection Summary | | | | | | | | | | | | |
| HCM 6th Ctrl Delay | | | | 30.6 | | | | | | | | |
| HCM 6th LOS | | | | C | | | | | | | | |

HCM Signalized Intersection Capacity Analysis
5: Union St & E Beach St

Existing Plus Project
Timing Plan: PM PEAK HOUR

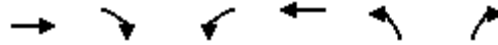























| Movement | EBT | EBR | WBL | WBT | NBL | NBR |
|-----------------------------------|-------|------|-------|-------|---------------------------|------|
| Lane Configurations | ↔ | | | ↔↔ | ↔ | ↔ |
| Traffic Volume (vph) | 431 | 114 | 102 | 376 | 33 | 75 |
| Future Volume (vph) | 431 | 114 | 102 | 376 | 33 | 75 |
| Ideal Flow (vphpl) | 1900 | 1900 | 1900 | 1900 | 1900 | 1900 |
| Total Lost time (s) | 3.5 | | | 3.5 | 3.5 | 3.5 |
| Lane Util. Factor | 1.00 | | | 0.95 | 1.00 | 1.00 |
| Frbp, ped/bikes | 0.96 | | | 1.00 | 1.00 | 0.90 |
| Flpb, ped/bikes | 1.00 | | | 1.00 | 1.00 | 1.00 |
| Frt | 0.97 | | | 1.00 | 1.00 | 0.85 |
| Flt Protected | 1.00 | | | 0.99 | 0.95 | 1.00 |
| Satd. Flow (prot) | 1742 | | | 3502 | 1770 | 1422 |
| Flt Permitted | 1.00 | | | 0.99 | 0.95 | 1.00 |
| Satd. Flow (perm) | 1742 | | | 3502 | 1770 | 1422 |
| Peak-hour factor, PHF | 0.92 | 0.92 | 0.92 | 0.92 | 0.92 | 0.92 |
| Adj. Flow (vph) | 468 | 124 | 111 | 409 | 36 | 82 |
| RTOR Reduction (vph) | 10 | 0 | 0 | 0 | 0 | 69 |
| Lane Group Flow (vph) | 582 | 0 | 0 | 520 | 36 | 13 |
| Confl. Peds. (#/hr) | | 45 | 45 | | 44 | 25 |
| Confl. Bikes (#/hr) | | 1 | | | | |
| Turn Type | NA | | Split | NA | Prot | Perm |
| Protected Phases | 4 | | 3 6 | 3 6 | 5 | |
| Permitted Phases | | | | | | 5 |
| Actuated Green, G (s) | 31.1 | | | 28.4 | 13.4 | 13.4 |
| Effective Green, g (s) | 31.1 | | | 28.4 | 13.4 | 13.4 |
| Actuated g/C Ratio | 0.36 | | | 0.33 | 0.15 | 0.15 |
| Clearance Time (s) | 3.5 | | | | 3.5 | 3.5 |
| Vehicle Extension (s) | 3.0 | | | | 3.0 | 3.0 |
| Lane Grp Cap (vph) | 623 | | | 1144 | 272 | 219 |
| v/s Ratio Prot | c0.33 | | | c0.15 | c0.02 | |
| v/s Ratio Perm | | | | | | 0.01 |
| v/c Ratio | 0.93 | | | 0.45 | 0.13 | 0.06 |
| Uniform Delay, d1 | 26.9 | | | 23.1 | 31.7 | 31.4 |
| Progression Factor | 1.00 | | | 0.47 | 1.00 | 1.00 |
| Incremental Delay, d2 | 21.2 | | | 0.2 | 0.2 | 0.1 |
| Delay (s) | 48.1 | | | 11.1 | 32.0 | 31.5 |
| Level of Service | D | | | B | C | C |
| Approach Delay (s) | 48.1 | | | 11.1 | 31.6 | |
| Approach LOS | D | | | B | C | |
| Intersection Summary | | | | | | |
| HCM 2000 Control Delay | | | 30.9 | | HCM 2000 Level of Service | C |
| HCM 2000 Volume to Capacity ratio | | | 0.60 | | | |
| Actuated Cycle Length (s) | | | 86.9 | | Sum of lost time (s) | 14.0 |
| Intersection Capacity Utilization | | | 61.7% | | ICU Level of Service | B |
| Analysis Period (min) | | | 15 | | | |

c Critical Lane Group

HCM Signalized Intersection Capacity Analysis
6: Main St & Freedom Blvd & Western Dr

Existing Plus Project
Timing Plan: PM PEAK HOUR

| |  |  |  |  |  |  |  |  |  |  |  |  |
|-----------------------------------|---|---|--|---|--|---|---|---|---|---|---|---|
| Movement | EBL | EBT | EBR | WBL | WBT | WBR | NBL | NBT | NBR | SBL | SBT | SBR |
| Lane Configurations | |  |   |  |   | |  |  |  | |  |  |
| Traffic Volume (vph) | 64 | 374 | 617 | 347 | 267 | 5 | 556 | 19 | 357 | 21 | 34 | 54 |
| Future Volume (vph) | 64 | 374 | 617 | 347 | 267 | 5 | 556 | 19 | 357 | 21 | 34 | 54 |
| Ideal Flow (vphpl) | 1900 | 1900 | 1900 | 1900 | 1900 | 1900 | 1900 | 1900 | 1900 | 1900 | 1900 | 1900 |
| Total Lost time (s) | | 5.3 | 5.3 | 5.3 | 5.3 | | 5.3 | 5.3 | 5.3 | | 5.3 | 5.3 |
| Lane Util. Factor | | 1.00 | 0.88 | 0.91 | 0.91 | | 0.95 | 0.95 | 1.00 | | 1.00 | 1.00 |
| Frbp, ped/bikes | | 1.00 | 1.00 | 1.00 | 1.00 | | 1.00 | 1.00 | 0.95 | | 1.00 | 1.00 |
| Flpb, ped/bikes | | 1.00 | 1.00 | 1.00 | 1.00 | | 1.00 | 1.00 | 1.00 | | 1.00 | 1.00 |
| Frt | | 1.00 | 0.85 | 1.00 | 1.00 | | 1.00 | 1.00 | 0.85 | | 1.00 | 0.85 |
| Flt Protected | | 0.99 | 1.00 | 0.95 | 0.98 | | 0.95 | 0.96 | 1.00 | | 0.98 | 1.00 |
| Satd. Flow (prot) | | 1849 | 2787 | 1610 | 3324 | | 1681 | 1691 | 1504 | | 1827 | 1583 |
| Flt Permitted | | 0.99 | 1.00 | 0.95 | 0.98 | | 0.95 | 0.96 | 1.00 | | 0.98 | 1.00 |
| Satd. Flow (perm) | | 1849 | 2787 | 1610 | 3324 | | 1681 | 1691 | 1504 | | 1827 | 1583 |
| Peak-hour factor, PHF | 0.97 | 0.97 | 0.97 | 0.97 | 0.97 | 0.97 | 0.97 | 0.97 | 0.97 | 0.97 | 0.97 | 0.97 |
| Adj. Flow (vph) | 66 | 386 | 636 | 358 | 275 | 5 | 573 | 20 | 368 | 22 | 35 | 56 |
| RTOR Reduction (vph) | 0 | 0 | 143 | 0 | 1 | 0 | 0 | 0 | 150 | 0 | 0 | 53 |
| Lane Group Flow (vph) | 0 | 452 | 493 | 208 | 429 | 0 | 298 | 295 | 218 | 0 | 57 | 3 |
| Confl. Peds. (#/hr) | 11 | | 1 | 1 | | 11 | | | 21 | 21 | | |
| Turn Type | Split | NA | pt+ov | Split | NA | | Split | NA | pm+ov | Split | NA | Prot |
| Protected Phases | 5 | 5 | 5 6 | 8 | 8 | | 6 | 6 | 8 | 7 | 7 | 7 |
| Permitted Phases | | | | | | | | | 6 | | | |
| Actuated Green, G (s) | | 26.8 | 62.4 | 16.1 | 16.1 | | 30.3 | 30.3 | 46.4 | | 5.6 | 5.6 |
| Effective Green, g (s) | | 26.8 | 62.4 | 16.1 | 16.1 | | 30.3 | 30.3 | 46.4 | | 5.6 | 5.6 |
| Actuated g/C Ratio | | 0.27 | 0.62 | 0.16 | 0.16 | | 0.30 | 0.30 | 0.46 | | 0.06 | 0.06 |
| Clearance Time (s) | | 5.3 | | 5.3 | 5.3 | | 5.3 | 5.3 | 5.3 | | 5.3 | 5.3 |
| Vehicle Extension (s) | | 1.0 | | 1.0 | 1.0 | | 1.0 | 1.0 | 1.0 | | 1.0 | 1.0 |
| Lane Grp Cap (vph) | | 495 | 1739 | 259 | 535 | | 509 | 512 | 777 | | 102 | 88 |
| v/s Ratio Prot | | c0.24 | 0.18 | c0.13 | 0.13 | | c0.18 | 0.17 | 0.05 | | c0.03 | 0.00 |
| v/s Ratio Perm | | | | | | | | | 0.10 | | | |
| v/c Ratio | | 0.91 | 0.28 | 0.80 | 0.80 | | 0.59 | 0.58 | 0.28 | | 0.56 | 0.04 |
| Uniform Delay, d1 | | 35.5 | 8.6 | 40.4 | 40.4 | | 29.5 | 29.4 | 16.5 | | 46.0 | 44.6 |
| Progression Factor | | 0.99 | 1.43 | 1.00 | 1.00 | | 1.00 | 1.00 | 1.00 | | 1.00 | 1.00 |
| Incremental Delay, d2 | | 18.0 | 0.0 | 15.4 | 8.0 | | 4.9 | 4.7 | 0.1 | | 3.7 | 0.1 |
| Delay (s) | | 53.0 | 12.3 | 55.9 | 48.4 | | 34.4 | 34.1 | 16.6 | | 49.7 | 44.7 |
| Level of Service | | D | B | E | D | | C | C | B | | D | D |
| Approach Delay (s) | | 29.2 | | | 50.9 | | | 27.5 | | | 47.2 | |
| Approach LOS | | C | | | D | | | C | | | D | |
| Intersection Summary | | | | | | | | | | | | |
| HCM 2000 Control Delay | | | 34.3 | | | | HCM 2000 Level of Service | | C | | | |
| HCM 2000 Volume to Capacity ratio | | | 0.74 | | | | | | | | | |
| Actuated Cycle Length (s) | | | 100.0 | | | | Sum of lost time (s) | | 21.2 | | | |
| Intersection Capacity Utilization | | | 71.8% | | | | ICU Level of Service | | C | | | |
| Analysis Period (min) | | | 15 | | | | | | | | | |
| c | Critical Lane Group | | | | | | | | | | | |

HCM Signalized Intersection Capacity Analysis

9: E Beach St & Alexander St



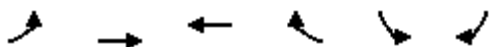



















Existing Plus Project
Timing Plan: PM PEAK HOUR



| Movement | EBL | EBT | WBT | WBR | SBL | SBR |
|-----------------------------------|-------|-------|-------|------|---------------------------|------|
| Lane Configurations | | ↕ | ↕↔ | | ↕ | ↕ |
| Traffic Volume (vph) | 114 | 392 | 268 | 83 | 153 | 210 |
| Future Volume (vph) | 114 | 392 | 268 | 83 | 153 | 210 |
| Ideal Flow (vphpl) | 1900 | 1900 | 1900 | 1900 | 1900 | 1900 |
| Total Lost time (s) | | 3.5 | 3.5 | | 3.5 | 3.5 |
| Lane Util. Factor | | 1.00 | 0.95 | | 1.00 | 1.00 |
| Frbp, ped/bikes | | 1.00 | 0.95 | | 1.00 | 1.00 |
| Flpb, ped/bikes | | 1.00 | 1.00 | | 1.00 | 1.00 |
| Frt | | 1.00 | 0.96 | | 1.00 | 0.85 |
| Flt Protected | | 0.99 | 1.00 | | 0.95 | 1.00 |
| Satd. Flow (prot) | | 1842 | 3244 | | 1770 | 1583 |
| Flt Permitted | | 0.99 | 1.00 | | 0.95 | 1.00 |
| Satd. Flow (perm) | | 1842 | 3244 | | 1770 | 1583 |
| Peak-hour factor, PHF | 0.84 | 0.84 | 0.84 | 0.84 | 0.84 | 0.84 |
| Adj. Flow (vph) | 136 | 467 | 319 | 99 | 182 | 250 |
| RTOR Reduction (vph) | 0 | 0 | 33 | 0 | 0 | 212 |
| Lane Group Flow (vph) | 0 | 603 | 385 | 0 | 182 | 38 |
| Confl. Peds. (#/hr) | 58 | | | 58 | 15 | |
| Turn Type | Split | NA | NA | | Prot | Perm |
| Protected Phases | 4 5 | 4 5 | 3 | | 6 | |
| Permitted Phases | | | | | | 6 |
| Actuated Green, G (s) | | 44.5 | 15.1 | | 13.3 | 13.3 |
| Effective Green, g (s) | | 44.5 | 15.1 | | 13.3 | 13.3 |
| Actuated g/C Ratio | | 0.51 | 0.17 | | 0.15 | 0.15 |
| Clearance Time (s) | | | 3.5 | | 3.5 | 3.5 |
| Vehicle Extension (s) | | | 3.0 | | 3.0 | 3.0 |
| Lane Grp Cap (vph) | | 943 | 563 | | 270 | 242 |
| v/s Ratio Prot | | c0.33 | c0.12 | | c0.10 | |
| v/s Ratio Perm | | | | | | 0.02 |
| v/c Ratio | | 0.64 | 0.68 | | 0.67 | 0.16 |
| Uniform Delay, d1 | | 15.4 | 33.7 | | 34.8 | 31.9 |
| Progression Factor | | 0.35 | 1.00 | | 1.00 | 1.00 |
| Incremental Delay, d2 | | 0.9 | 3.4 | | 6.5 | 0.3 |
| Delay (s) | | 6.3 | 37.1 | | 41.2 | 32.2 |
| Level of Service | | A | D | | D | C |
| Approach Delay (s) | | 6.3 | 37.1 | | 36.0 | |
| Approach LOS | | A | D | | D | |
| Intersection Summary | | | | | | |
| HCM 2000 Control Delay | | | 24.0 | | HCM 2000 Level of Service | C |
| HCM 2000 Volume to Capacity ratio | | | 0.65 | | | |
| Actuated Cycle Length (s) | | | 86.9 | | Sum of lost time (s) | 14.0 |
| Intersection Capacity Utilization | | | 56.5% | | ICU Level of Service | B |
| Analysis Period (min) | | | 15 | | | |
| c Critical Lane Group | | | | | | |

HCM 6th Signalized Intersection Summary
 1: Main St & W Lake Ave/E Lake Ave

Existing Plus Project
 Timing Plan: SATURDAY PEAK HOUR

| |  |  |  |  |  |  |  |  |  |  |  |  |
|------------------------------|---|---|---|---|---|---|---|---|---|---|---|---|
| Movement | EBL | EBT | EBR | WBL | WBT | WBR | NBL | NBT | NBR | SBL | SBT | SBR |
| Lane Configurations |  |  | |  |  |  |  |  |  |  |  |  |
| Traffic Volume (veh/h) | 30 | 156 | 20 | 128 | 117 | 297 | 33 | 663 | 220 | 104 | 617 | 111 |
| Future Volume (veh/h) | 30 | 156 | 20 | 128 | 117 | 297 | 33 | 663 | 220 | 104 | 617 | 111 |
| Initial Q (Qb), veh | 0 | 0 | 0 | 0 | 0 | 0 | 0 | 0 | 0 | 0 | 0 | 0 |
| Ped-Bike Adj(A_pbT) | 1.00 | | 0.90 | 1.00 | | 0.90 | 1.00 | | 0.96 | 1.00 | | 0.94 |
| Parking Bus, Adj | 1.00 | 1.00 | 1.00 | 1.00 | 1.00 | 1.00 | 1.00 | 1.00 | 1.00 | 1.00 | 1.00 | 1.00 |
| Work Zone On Approach | | No | | | No | | | No | | | No | |
| Adj Sat Flow, veh/h/ln | 1870 | 1870 | 1870 | 1870 | 1870 | 1870 | 1870 | 1870 | 1870 | 1870 | 1870 | 1870 |
| Adj Flow Rate, veh/h | 31 | 161 | 21 | 132 | 121 | 306 | 34 | 684 | 227 | 107 | 636 | 114 |
| Peak Hour Factor | 0.97 | 0.97 | 0.97 | 0.97 | 0.97 | 0.97 | 0.97 | 0.97 | 0.97 | 0.97 | 0.97 | 0.97 |
| Percent Heavy Veh, % | 2 | 2 | 2 | 2 | 2 | 2 | 2 | 2 | 2 | 2 | 2 | 2 |
| Cap, veh/h | 51 | 283 | 37 | 151 | 437 | 334 | 54 | 898 | 728 | 135 | 982 | 783 |
| Arrive On Green | 0.03 | 0.18 | 0.18 | 0.09 | 0.23 | 0.23 | 0.06 | 0.96 | 0.96 | 0.08 | 0.53 | 0.53 |
| Sat Flow, veh/h | 1781 | 1598 | 208 | 1781 | 1870 | 1431 | 1781 | 1870 | 1516 | 1781 | 1870 | 1490 |
| Grp Volume(v), veh/h | 31 | 0 | 182 | 132 | 121 | 306 | 34 | 684 | 227 | 107 | 636 | 114 |
| Grp Sat Flow(s),veh/h/ln | 1781 | 0 | 1807 | 1781 | 1870 | 1431 | 1781 | 1870 | 1516 | 1781 | 1870 | 1490 |
| Q Serve(g_s), s | 1.7 | 0.0 | 9.2 | 7.3 | 5.3 | 20.9 | 1.9 | 5.4 | 0.9 | 5.9 | 24.5 | 3.9 |
| Cycle Q Clear(g_c), s | 1.7 | 0.0 | 9.2 | 7.3 | 5.3 | 20.9 | 1.9 | 5.4 | 0.9 | 5.9 | 24.5 | 3.9 |
| Prop In Lane | 1.00 | | 0.12 | 1.00 | | 1.00 | 1.00 | | 1.00 | 1.00 | | 1.00 |
| Lane Grp Cap(c), veh/h | 51 | 0 | 320 | 151 | 437 | 334 | 54 | 898 | 728 | 135 | 982 | 783 |
| V/C Ratio(X) | 0.60 | 0.00 | 0.57 | 0.87 | 0.28 | 0.92 | 0.62 | 0.76 | 0.31 | 0.79 | 0.65 | 0.15 |
| Avail Cap(c_a), veh/h | 91 | 0 | 396 | 151 | 473 | 362 | 89 | 898 | 728 | 194 | 982 | 783 |
| HCM Platoon Ratio | 1.00 | 1.00 | 1.00 | 1.00 | 1.00 | 1.00 | 2.00 | 2.00 | 2.00 | 1.00 | 1.00 | 1.00 |
| Upstream Filter(l) | 0.93 | 0.00 | 0.93 | 1.00 | 1.00 | 1.00 | 0.49 | 0.49 | 0.49 | 1.00 | 1.00 | 1.00 |
| Uniform Delay (d), s/veh | 48.0 | 0.0 | 37.6 | 45.2 | 31.4 | 37.4 | 46.4 | 1.1 | 1.1 | 45.5 | 17.1 | 12.2 |
| Incr Delay (d2), s/veh | 10.1 | 0.0 | 1.1 | 38.7 | 0.3 | 26.3 | 5.6 | 3.1 | 0.5 | 13.4 | 3.3 | 0.4 |
| Initial Q Delay(d3),s/veh | 0.0 | 0.0 | 0.0 | 0.0 | 0.0 | 0.0 | 0.0 | 0.0 | 0.0 | 0.0 | 0.0 | 0.0 |
| %ile BackOfQ(50%),veh/ln | 0.9 | 0.0 | 4.1 | 4.8 | 2.4 | 9.6 | 0.9 | 1.4 | 0.3 | 3.1 | 10.8 | 1.4 |
| Unsig. Movement Delay, s/veh | | | | | | | | | | | | |
| LnGrp Delay(d),s/veh | 58.1 | 0.0 | 38.7 | 83.9 | 31.8 | 63.6 | 52.0 | 4.2 | 1.6 | 58.8 | 20.4 | 12.6 |
| LnGrp LOS | E | A | D | F | C | E | D | A | A | E | C | B |
| Approach Vol, veh/h | | 213 | | | 559 | | | 945 | | | 857 | |
| Approach Delay, s/veh | | 41.5 | | | 61.5 | | | 5.3 | | | 24.1 | |
| Approach LOS | | D | | | E | | | A | | | C | |
| Timer - Assigned Phs | 1 | 2 | 3 | 4 | 5 | 6 | 7 | 8 | | | | |
| Phs Duration (G+Y+Rc), s | 7.6 | 57.1 | 13.0 | 22.3 | 12.1 | 52.6 | 7.4 | 27.9 | | | | |
| Change Period (Y+Rc), s | 4.5 | 4.6 | 4.5 | 4.6 | 4.5 | 4.6 | 4.5 | 4.6 | | | | |
| Max Green Setting (Gmax), s | 5.0 | 46.4 | 8.5 | 21.9 | 10.9 | 40.5 | 5.1 | 25.3 | | | | |
| Max Q Clear Time (g_c+I1), s | 3.9 | 26.5 | 9.3 | 11.2 | 7.9 | 7.4 | 3.7 | 22.9 | | | | |
| Green Ext Time (p_c), s | 0.0 | 3.9 | 0.0 | 0.6 | 0.1 | 5.1 | 0.0 | 0.5 | | | | |
| Intersection Summary | | | | | | | | | | | | |
| HCM 6th Ctrl Delay | | | 26.8 | | | | | | | | | |
| HCM 6th LOS | | | C | | | | | | | | | |

HCM 6th Signalized Intersection Summary
 2: Main St & W Beach St/E Beach St

Existing Plus Project
 Timing Plan: SATURDAY PEAK HOUR

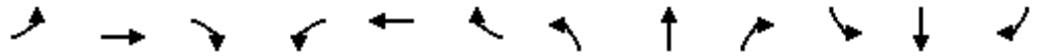

| Movement | EBL | EBT | EBR | WBL | WBT | WBR | NBL | NBT | NBR | SBL | SBT | SBR |
|------------------------------|------|------|------|------|------|------|------|------|------|------|------|------|
| Lane Configurations | | | | | | | | | | | | |
| Traffic Volume (veh/h) | 95 | 204 | 55 | 128 | 255 | 55 | 73 | 766 | 116 | 44 | 616 | 105 |
| Future Volume (veh/h) | 95 | 204 | 55 | 128 | 255 | 55 | 73 | 766 | 116 | 44 | 616 | 105 |
| Initial Q (Qb), veh | 0 | 0 | 0 | 0 | 0 | 0 | 0 | 0 | 0 | 0 | 0 | 0 |
| Ped-Bike Adj(A_pbT) | 1.00 | | 0.86 | 1.00 | | 0.89 | 1.00 | | 0.96 | 1.00 | | 0.96 |
| Parking Bus, Adj | 1.00 | 1.00 | 1.00 | 1.00 | 1.00 | 1.00 | 1.00 | 1.00 | 1.00 | 1.00 | 1.00 | 1.00 |
| Work Zone On Approach | | No | | | No | | | No | | | No | |
| Adj Sat Flow, veh/h/ln | 1870 | 1870 | 1870 | 1870 | 1870 | 1870 | 1870 | 1870 | 1870 | 1870 | 1870 | 1870 |
| Adj Flow Rate, veh/h | 97 | 208 | 56 | 131 | 260 | 56 | 74 | 782 | 118 | 45 | 629 | 107 |
| Peak Hour Factor | 0.98 | 0.98 | 0.98 | 0.98 | 0.98 | 0.98 | 0.98 | 0.98 | 0.98 | 0.98 | 0.98 | 0.98 |
| Percent Heavy Veh, % | 2 | 2 | 2 | 2 | 2 | 2 | 2 | 2 | 2 | 2 | 2 | 2 |
| Cap, veh/h | 118 | 253 | 68 | 144 | 291 | 63 | 95 | 965 | 784 | 64 | 932 | 756 |
| Arrive On Green | 0.07 | 0.19 | 0.19 | 0.08 | 0.20 | 0.20 | 0.05 | 0.52 | 0.52 | 0.07 | 1.00 | 1.00 |
| Sat Flow, veh/h | 1781 | 1365 | 368 | 1781 | 1454 | 313 | 1781 | 1870 | 1519 | 1781 | 1870 | 1517 |
| Grp Volume(v), veh/h | 97 | 0 | 264 | 131 | 0 | 316 | 74 | 782 | 118 | 45 | 629 | 107 |
| Grp Sat Flow(s),veh/h/ln | 1781 | 0 | 1733 | 1781 | 0 | 1767 | 1781 | 1870 | 1519 | 1781 | 1870 | 1517 |
| Q Serve(g_s), s | 5.4 | 0.0 | 14.6 | 7.3 | 0.0 | 17.4 | 4.1 | 34.8 | 4.1 | 2.5 | 0.3 | 0.0 |
| Cycle Q Clear(g_c), s | 5.4 | 0.0 | 14.6 | 7.3 | 0.0 | 17.4 | 4.1 | 34.8 | 4.1 | 2.5 | 0.3 | 0.0 |
| Prop In Lane | 1.00 | | 0.21 | 1.00 | | 0.18 | 1.00 | | 1.00 | 1.00 | | 1.00 |
| Lane Grp Cap(c), veh/h | 118 | 0 | 321 | 144 | 0 | 354 | 95 | 965 | 784 | 64 | 932 | 756 |
| V/C Ratio(X) | 0.83 | 0.00 | 0.82 | 0.91 | 0.00 | 0.89 | 0.78 | 0.81 | 0.15 | 0.71 | 0.67 | 0.14 |
| Avail Cap(c_a), veh/h | 118 | 0 | 406 | 144 | 0 | 440 | 125 | 965 | 784 | 89 | 932 | 756 |
| HCM Platoon Ratio | 1.00 | 1.00 | 1.00 | 1.00 | 1.00 | 1.00 | 1.00 | 1.00 | 1.00 | 2.00 | 2.00 | 2.00 |
| Upstream Filter(l) | 0.58 | 0.00 | 0.58 | 1.00 | 0.00 | 1.00 | 0.30 | 0.30 | 0.30 | 0.70 | 0.70 | 0.70 |
| Uniform Delay (d), s/veh | 46.1 | 0.0 | 39.2 | 45.6 | 0.0 | 38.9 | 46.8 | 20.1 | 12.7 | 45.9 | 0.1 | 0.1 |
| Incr Delay (d2), s/veh | 23.4 | 0.0 | 5.1 | 48.5 | 0.0 | 15.5 | 6.8 | 2.3 | 0.1 | 10.0 | 2.8 | 0.3 |
| Initial Q Delay(d3),s/veh | 0.0 | 0.0 | 0.0 | 0.0 | 0.0 | 0.0 | 0.0 | 0.0 | 0.0 | 0.0 | 0.0 | 0.0 |
| %ile BackOfQ(50%),veh/ln | 3.1 | 0.0 | 6.6 | 5.1 | 0.0 | 9.0 | 2.0 | 14.8 | 1.4 | 1.2 | 0.8 | 0.1 |
| Unsig. Movement Delay, s/veh | | | | | | | | | | | | |
| LnGrp Delay(d),s/veh | 69.6 | 0.0 | 44.2 | 94.1 | 0.0 | 54.4 | 53.6 | 22.4 | 12.8 | 55.9 | 2.8 | 0.4 |
| LnGrp LOS | E | A | D | F | A | D | D | C | B | E | A | A |
| Approach Vol, veh/h | | 361 | | | 447 | | | 974 | | | 781 | |
| Approach Delay, s/veh | | 51.0 | | | 66.0 | | | 23.6 | | | 5.6 | |
| Approach LOS | | D | | | E | | | C | | | A | |
| Timer - Assigned Phs | 1 | 2 | 3 | 4 | 5 | 6 | 7 | 8 | | | | |
| Phs Duration (G+Y+Rc), s | 8.1 | 56.2 | 12.6 | 23.1 | 9.8 | 54.4 | 11.1 | 24.6 | | | | |
| Change Period (Y+Rc), s | 4.5 | 4.6 | 4.5 | 4.6 | 4.5 | 4.6 | 4.5 | 4.6 | | | | |
| Max Green Setting (Gmax), s | 5.0 | 45.3 | 8.1 | 23.4 | 7.0 | 43.3 | 6.6 | 24.9 | | | | |
| Max Q Clear Time (g_c+I1), s | 4.5 | 36.8 | 9.3 | 16.6 | 6.1 | 2.3 | 7.4 | 19.4 | | | | |
| Green Ext Time (p_c), s | 0.0 | 2.7 | 0.0 | 0.6 | 0.0 | 3.2 | 0.0 | 0.6 | | | | |
| Intersection Summary | | | | | | | | | | | | |
| HCM 6th Ctrl Delay | | | 29.4 | | | | | | | | | |
| HCM 6th LOS | | | C | | | | | | | | | |

HCM 6th Signalized Intersection Summary
3: W Riverside Dr/E Riverside Dr & Main St





















Existing Plus Project
Timing Plan: SATURDAY PEAK HOUR



| Movement | EBL | EBT | EBR | WBL | WBT | WBR | NBL | NBT | NBR | SBL | SBT | SBR |
|--|-------|-------|------|------|------|-------|------|------|------|------|------|------|
| Lane Configurations | | | | | | | | | | | | |
| Traffic Volume (veh/h) | 77 | 360 | 419 | 328 | 531 | 80 | 277 | 730 | 201 | 95 | 578 | 45 |
| Future Volume (veh/h) | 77 | 360 | 419 | 328 | 531 | 80 | 277 | 730 | 201 | 95 | 578 | 45 |
| Initial Q (Qb), veh | 0 | 0 | 0 | 0 | 0 | 0 | 0 | 0 | 0 | 0 | 0 | 0 |
| Ped-Bike Adj(A_pbT) | 1.00 | | 0.98 | 1.00 | | 0.99 | 1.00 | | 0.99 | 1.00 | | 0.97 |
| Parking Bus, Adj | 1.00 | 1.00 | 1.00 | 1.00 | 1.00 | 1.00 | 1.00 | 1.00 | 1.00 | 1.00 | 1.00 | 1.00 |
| Work Zone On Approach | | No | | | No | | | No | | | No | |
| Adj Sat Flow, veh/h/ln | 1870 | 1870 | 1870 | 1870 | 1870 | 1870 | 1870 | 1870 | 1870 | 1870 | 1870 | 1870 |
| Adj Flow Rate, veh/h | 80 | 375 | 436 | 342 | 553 | 83 | 289 | 760 | 209 | 99 | 602 | 47 |
| Peak Hour Factor | 0.96 | 0.96 | 0.96 | 0.96 | 0.96 | 0.96 | 0.96 | 0.96 | 0.96 | 0.96 | 0.96 | 0.96 |
| Percent Heavy Veh, % | 2 | 2 | 2 | 2 | 2 | 2 | 2 | 2 | 2 | 2 | 2 | 2 |
| Cap, veh/h | 124 | 579 | 686 | 712 | 938 | 140 | 941 | 785 | 659 | 129 | 706 | 55 |
| Arrive On Green | 0.07 | 0.16 | 0.16 | 0.21 | 0.30 | 0.30 | 0.27 | 0.42 | 0.42 | 0.07 | 0.21 | 0.21 |
| Sat Flow, veh/h | 1781 | 3554 | 1559 | 3456 | 3093 | 463 | 3456 | 1870 | 1571 | 1781 | 3331 | 260 |
| Grp Volume(v), veh/h | 80 | 375 | 436 | 342 | 317 | 319 | 289 | 760 | 209 | 99 | 321 | 328 |
| Grp Sat Flow(s),veh/h/ln | 1781 | 1777 | 1559 | 1728 | 1777 | 1779 | 1728 | 1870 | 1571 | 1781 | 1777 | 1814 |
| Q Serve(g_s), s | 5.2 | 11.8 | 0.0 | 10.5 | 18.1 | 18.3 | 8.0 | 47.7 | 5.5 | 6.6 | 20.8 | 20.9 |
| Cycle Q Clear(g_c), s | 5.2 | 11.8 | 0.0 | 10.5 | 18.1 | 18.3 | 8.0 | 47.7 | 5.5 | 6.6 | 20.8 | 20.9 |
| Prop In Lane | 1.00 | | 1.00 | 1.00 | | 0.26 | 1.00 | | 1.00 | 1.00 | | 0.14 |
| Lane Grp Cap(c), veh/h | 124 | 579 | 686 | 712 | 539 | 540 | 941 | 785 | 659 | 129 | 377 | 385 |
| V/C Ratio(X) | 0.64 | 0.65 | 0.64 | 0.48 | 0.59 | 0.59 | 0.31 | 0.97 | 0.32 | 0.77 | 0.85 | 0.85 |
| Avail Cap(c_a), veh/h | 135 | 885 | 820 | 712 | 539 | 540 | 941 | 801 | 673 | 134 | 674 | 688 |
| HCM Platoon Ratio | 1.00 | 1.00 | 1.00 | 1.00 | 1.00 | 1.00 | 1.00 | 1.00 | 1.00 | 1.00 | 1.00 | 1.00 |
| Upstream Filter(l) | 1.00 | 1.00 | 1.00 | 1.00 | 1.00 | 1.00 | 1.00 | 1.00 | 1.00 | 0.61 | 0.61 | 0.61 |
| Uniform Delay (d), s/veh | 54.4 | 47.0 | 26.4 | 42.0 | 35.4 | 35.5 | 34.7 | 34.0 | 6.3 | 54.7 | 45.5 | 45.5 |
| Incr Delay (d2), s/veh | 6.3 | 5.5 | 4.5 | 0.2 | 4.6 | 4.7 | 0.1 | 23.8 | 0.1 | 13.2 | 1.3 | 1.3 |
| Initial Q Delay(d3),s/veh | 0.0 | 0.0 | 0.0 | 0.0 | 0.0 | 0.0 | 0.0 | 0.0 | 0.0 | 0.0 | 0.0 | 0.0 |
| %ile BackOfQ(50%),veh/ln | 2.6 | 5.7 | 10.4 | 4.5 | 8.5 | 8.6 | 3.4 | 26.3 | 3.7 | 3.4 | 9.3 | 9.5 |
| Unsig. Movement Delay, s/veh | | | | | | | | | | | | |
| LnGrp Delay(d),s/veh | 60.6 | 52.5 | 30.9 | 42.2 | 40.1 | 40.2 | 34.7 | 57.9 | 6.4 | 67.9 | 46.8 | 46.8 |
| LnGrp LOS | E | D | C | D | D | D | C | E | A | E | D | D |
| Approach Vol, veh/h | | 891 | | | 978 | | | 1258 | | | 748 | |
| Approach Delay, s/veh | | 42.6 | | | 40.8 | | | 44.0 | | | 49.6 | |
| Approach LOS | | D | | | D | | | D | | | D | |
| Timer - Assigned Phs | 1 | 2 | 3 | 4 | 5 | 6 | 7 | 8 | | | | |
| Phs Duration (G+Y+Rc), s | 28.9 | 23.8 | 37.3 | 30.0 | 12.1 | 40.6 | 12.4 | 54.9 | | | | |
| Change Period (Y+Rc), s | * 4.2 | * 4.2 | 4.6 | 4.6 | 3.7 | * 4.2 | 3.7 | 4.6 | | | | |
| Max Green Setting (Gmax), s | * 14 | * 30 | 14.0 | 45.5 | 9.1 | * 34 | 9.0 | 51.4 | | | | |
| Max Q Clear Time (g_c+l1), s | 12.5 | 13.8 | 10.0 | 22.9 | 7.2 | 20.3 | 8.6 | 49.7 | | | | |
| Green Ext Time (p_c), s | 0.0 | 2.3 | 0.1 | 2.0 | 0.0 | 2.3 | 0.0 | 0.7 | | | | |
| Intersection Summary | | | | | | | | | | | | |
| HCM 6th Ctrl Delay | | | 44.0 | | | | | | | | | |
| HCM 6th LOS | | | D | | | | | | | | | |
| Notes | | | | | | | | | | | | |
| * HCM 6th computational engine requires equal clearance times for the phases crossing the barrier. | | | | | | | | | | | | |

HCM Signalized Intersection Capacity Analysis
6: Main St & Freedom Blvd & Western Dr

Existing Plus Project
Timing Plan: SATURDAY PEAK HOUR

| |  |  |  |  |  |  |  |  |  |  |  |  |
|-----------------------------------|---|---|---|---|---|---|---|---|---|---|---|---|
| Movement | EBL | EBT | EBR | WBL | WBT | WBR | NBL | NBT | NBR | SBL | SBT | SBR |
| Lane Configurations | |  |  |  |  | |  |  |  | |  |  |
| Traffic Volume (vph) | 31 | 242 | 528 | 307 | 239 | 10 | 545 | 24 | 362 | 12 | 24 | 47 |
| Future Volume (vph) | 31 | 242 | 528 | 307 | 239 | 10 | 545 | 24 | 362 | 12 | 24 | 47 |
| Ideal Flow (vphpl) | 1900 | 1900 | 1900 | 1900 | 1900 | 1900 | 1900 | 1900 | 1900 | 1900 | 1900 | 1900 |
| Total Lost time (s) | | 4.6 | 4.6 | 4.6 | 4.6 | | 5.3 | 5.3 | 4.6 | | 4.6 | 4.6 |
| Lane Util. Factor | | 1.00 | 0.88 | 0.91 | 0.91 | | 0.95 | 0.95 | 1.00 | | 1.00 | 1.00 |
| Frbp, ped/bikes | | 1.00 | 1.00 | 1.00 | 1.00 | | 1.00 | 1.00 | 0.97 | | 1.00 | 1.00 |
| Flpb, ped/bikes | | 1.00 | 1.00 | 1.00 | 1.00 | | 1.00 | 1.00 | 1.00 | | 1.00 | 1.00 |
| Frt | | 1.00 | 0.85 | 1.00 | 1.00 | | 1.00 | 1.00 | 0.85 | | 1.00 | 0.85 |
| Flt Protected | | 0.99 | 1.00 | 0.95 | 0.98 | | 0.95 | 0.96 | 1.00 | | 0.98 | 1.00 |
| Satd. Flow (prot) | | 1852 | 2787 | 1610 | 3317 | | 1681 | 1692 | 1543 | | 1828 | 1583 |
| Flt Permitted | | 0.99 | 1.00 | 0.95 | 0.98 | | 0.95 | 0.96 | 1.00 | | 0.80 | 1.00 |
| Satd. Flow (perm) | | 1852 | 2787 | 1610 | 3317 | | 1681 | 1692 | 1543 | | 1486 | 1583 |
| Peak-hour factor, PHF | 0.98 | 0.98 | 0.98 | 0.98 | 0.98 | 0.98 | 0.98 | 0.98 | 0.98 | 0.98 | 0.98 | 0.98 |
| Adj. Flow (vph) | 32 | 247 | 539 | 313 | 244 | 10 | 556 | 24 | 369 | 12 | 24 | 48 |
| RTOR Reduction (vph) | 0 | 0 | 210 | 0 | 2 | 0 | 0 | 0 | 171 | 0 | 0 | 44 |
| Lane Group Flow (vph) | 0 | 279 | 329 | 185 | 380 | 0 | 289 | 291 | 198 | 0 | 36 | 4 |
| Confl. Peds. (#/hr) | 11 | | | | | | 11 | | 6 | 6 | | |
| Confl. Bikes (#/hr) | | | | | | 1 | | | | | | |
| Turn Type | Split | NA | pt+ov | Split | NA | | Split | NA | pm+ov | Perm | NA | Perm |
| Protected Phases | 5 | 5 | 5 6 | 8 | 8 | | 6 | 6 | 8 | | 7 | |
| Permitted Phases | | | | | | | | | 6 | 7 | | 7 |
| Actuated Green, G (s) | | 18.4 | 61.0 | 15.7 | 15.7 | | 38.0 | 38.0 | 53.7 | | 8.8 | 8.8 |
| Effective Green, g (s) | | 18.4 | 61.0 | 15.7 | 15.7 | | 38.0 | 38.0 | 53.7 | | 8.8 | 8.8 |
| Actuated g/C Ratio | | 0.18 | 0.61 | 0.16 | 0.16 | | 0.38 | 0.38 | 0.54 | | 0.09 | 0.09 |
| Clearance Time (s) | | 4.6 | | 4.6 | 4.6 | | 5.3 | 5.3 | 4.6 | | 4.6 | 4.6 |
| Vehicle Extension (s) | | 1.0 | | 1.0 | 1.0 | | 1.0 | 1.0 | 1.0 | | 1.0 | 1.0 |
| Lane Grp Cap (vph) | | 340 | 1700 | 252 | 520 | | 638 | 642 | 828 | | 130 | 139 |
| v/s Ratio Prot | | c0.15 | 0.12 | c0.11 | 0.11 | | 0.17 | c0.17 | 0.04 | | | |
| v/s Ratio Perm | | | | | | | | | 0.09 | | c0.02 | 0.00 |
| v/c Ratio | | 0.82 | 0.19 | 0.73 | 0.73 | | 0.45 | 0.45 | 0.24 | | 0.28 | 0.03 |
| Uniform Delay, d1 | | 39.2 | 8.6 | 40.2 | 40.1 | | 23.2 | 23.2 | 12.3 | | 42.6 | 41.7 |
| Progression Factor | | 1.00 | 1.00 | 1.00 | 1.00 | | 0.96 | 0.96 | 2.02 | | 1.00 | 1.00 |
| Incremental Delay, d2 | | 14.0 | 0.0 | 9.2 | 4.5 | | 1.9 | 1.9 | 0.0 | | 0.4 | 0.0 |
| Delay (s) | | 53.2 | 8.6 | 49.3 | 44.7 | | 24.1 | 24.2 | 24.9 | | 43.0 | 41.7 |
| Level of Service | | D | A | D | D | | C | C | C | | D | D |
| Approach Delay (s) | | 23.8 | | | 46.2 | | | 24.5 | | | 42.3 | |
| Approach LOS | | C | | | D | | | C | | | D | |
| Intersection Summary | | | | | | | | | | | | |
| HCM 2000 Control Delay | | | 30.0 | | | | HCM 2000 Level of Service | | C | | | |
| HCM 2000 Volume to Capacity ratio | | | 0.57 | | | | | | | | | |
| Actuated Cycle Length (s) | | | 100.0 | | | | Sum of lost time (s) | | 19.1 | | | |
| Intersection Capacity Utilization | | | 61.0% | | | | ICU Level of Service | | B | | | |
| Analysis Period (min) | | | 15 | | | | | | | | | |

c Critical Lane Group

HCM 6th Signalized Intersection Summary
 1: Main St & W Lake Ave/E Lake Ave

Existing Plus Project
 Timing Plan: AM PEAK HOUR

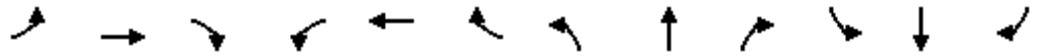

| Movement | EBL | EBT | EBR | WBL | WBT | WBR | NBL | NBT | NBR | SBL | SBT | SBR |
|------------------------------|------|------|------|------|------|------|------|------|------|------|------|------|
| Lane Configurations | | | | | | | | | | | | |
| Traffic Volume (veh/h) | 47 | 200 | 16 | 101 | 187 | 235 | 34 | 547 | 252 | 74 | 484 | 97 |
| Future Volume (veh/h) | 47 | 200 | 16 | 101 | 187 | 235 | 34 | 547 | 252 | 74 | 484 | 97 |
| Initial Q (Qb), veh | 0 | 0 | 0 | 0 | 0 | 0 | 0 | 0 | 0 | 0 | 0 | 0 |
| Ped-Bike Adj(A_pbT) | 1.00 | | 0.96 | 1.00 | | 0.97 | 1.00 | | 0.98 | 1.00 | | 0.98 |
| Parking Bus, Adj | 1.00 | 1.00 | 1.00 | 1.00 | 1.00 | 1.00 | 1.00 | 1.00 | 1.00 | 1.00 | 1.00 | 1.00 |
| Work Zone On Approach | | No | | | No | | | No | | | No | |
| Adj Sat Flow, veh/h/ln | 1870 | 1870 | 1870 | 1870 | 1870 | 1870 | 1870 | 1870 | 1870 | 1870 | 1870 | 1870 |
| Adj Flow Rate, veh/h | 59 | 253 | 20 | 128 | 237 | 297 | 43 | 692 | 319 | 94 | 613 | 123 |
| Peak Hour Factor | 0.79 | 0.79 | 0.79 | 0.79 | 0.79 | 0.79 | 0.79 | 0.79 | 0.79 | 0.79 | 0.79 | 0.79 |
| Percent Heavy Veh, % | 2 | 2 | 2 | 2 | 2 | 2 | 2 | 2 | 2 | 2 | 2 | 2 |
| Cap, veh/h | 81 | 322 | 25 | 160 | 436 | 358 | 69 | 795 | 661 | 120 | 849 | 707 |
| Arrive On Green | 0.05 | 0.19 | 0.19 | 0.09 | 0.23 | 0.23 | 0.04 | 0.43 | 0.43 | 0.07 | 0.45 | 0.45 |
| Sat Flow, veh/h | 1781 | 1705 | 135 | 1781 | 1870 | 1537 | 1781 | 1870 | 1555 | 1781 | 1870 | 1557 |
| Grp Volume(v), veh/h | 59 | 0 | 273 | 128 | 237 | 297 | 43 | 692 | 319 | 94 | 613 | 123 |
| Grp Sat Flow(s),veh/h/ln | 1781 | 0 | 1840 | 1781 | 1870 | 1537 | 1781 | 1870 | 1555 | 1781 | 1870 | 1557 |
| Q Serve(g_s), s | 2.6 | 0.0 | 11.3 | 5.6 | 8.9 | 14.6 | 1.9 | 26.9 | 11.8 | 4.1 | 21.2 | 3.7 |
| Cycle Q Clear(g_c), s | 2.6 | 0.0 | 11.3 | 5.6 | 8.9 | 14.6 | 1.9 | 26.9 | 11.8 | 4.1 | 21.2 | 3.7 |
| Prop In Lane | 1.00 | | 0.07 | 1.00 | | 1.00 | 1.00 | | 1.00 | 1.00 | | 1.00 |
| Lane Grp Cap(c), veh/h | 81 | 0 | 347 | 160 | 436 | 358 | 69 | 795 | 661 | 120 | 849 | 707 |
| V/C Ratio(X) | 0.72 | 0.00 | 0.79 | 0.80 | 0.54 | 0.83 | 0.63 | 0.87 | 0.48 | 0.78 | 0.72 | 0.17 |
| Avail Cap(c_a), veh/h | 134 | 0 | 485 | 177 | 538 | 442 | 112 | 1101 | 915 | 134 | 1124 | 936 |
| HCM Platoon Ratio | 1.00 | 1.00 | 1.00 | 1.00 | 1.00 | 1.00 | 1.00 | 1.00 | 1.00 | 1.00 | 1.00 | 1.00 |
| Upstream Filter(l) | 1.00 | 0.00 | 1.00 | 1.00 | 1.00 | 1.00 | 1.00 | 1.00 | 1.00 | 1.00 | 1.00 | 1.00 |
| Uniform Delay (d), s/veh | 37.5 | 0.0 | 30.8 | 35.5 | 26.8 | 29.0 | 37.7 | 20.9 | 16.6 | 36.6 | 17.7 | 12.9 |
| Incr Delay (d2), s/veh | 11.5 | 0.0 | 4.8 | 20.6 | 0.8 | 9.7 | 9.0 | 5.2 | 0.4 | 23.2 | 1.3 | 0.1 |
| Initial Q Delay(d3),s/veh | 0.0 | 0.0 | 0.0 | 0.0 | 0.0 | 0.0 | 0.0 | 0.0 | 0.0 | 0.0 | 0.0 | 0.0 |
| %ile BackOfQ(50%),veh/ln | 1.4 | 0.0 | 5.4 | 3.3 | 4.0 | 6.2 | 1.0 | 12.2 | 4.1 | 2.6 | 8.9 | 1.3 |
| Unsig. Movement Delay, s/veh | | | | | | | | | | | | |
| LnGrp Delay(d),s/veh | 49.0 | 0.0 | 35.6 | 56.1 | 27.6 | 38.7 | 46.8 | 26.1 | 17.0 | 59.7 | 18.9 | 13.0 |
| LnGrp LOS | D | A | D | E | C | D | D | C | B | E | B | B |
| Approach Vol, veh/h | | 332 | | | 662 | | | 1054 | | | 830 | |
| Approach Delay, s/veh | | 38.0 | | | 38.1 | | | 24.2 | | | 22.7 | |
| Approach LOS | | D | | | D | | | C | | | C | |
| Timer - Assigned Phs | 1 | 2 | 3 | 4 | 5 | 6 | 7 | 8 | | | | |
| Phs Duration (G+Y+Rc), s | 7.6 | 40.8 | 11.7 | 19.6 | 9.9 | 38.5 | 8.1 | 23.2 | | | | |
| Change Period (Y+Rc), s | 4.5 | 4.6 | 4.5 | 4.6 | 4.5 | 4.6 | 4.5 | 4.6 | | | | |
| Max Green Setting (Gmax), s | 5.0 | 47.9 | 7.9 | 21.0 | 6.0 | 46.9 | 6.0 | 22.9 | | | | |
| Max Q Clear Time (g_c+I1), s | 3.9 | 23.2 | 7.6 | 13.3 | 6.1 | 28.9 | 4.6 | 16.6 | | | | |
| Green Ext Time (p_c), s | 0.0 | 4.1 | 0.0 | 0.8 | 0.0 | 5.0 | 0.0 | 1.2 | | | | |
| Intersection Summary | | | | | | | | | | | | |
| HCM 6th Ctrl Delay | | | 28.5 | | | | | | | | | |
| HCM 6th LOS | | | C | | | | | | | | | |

HCM 6th Signalized Intersection Summary
 2: Main St & W Beach St/E Beach St

Existing Plus Project
 Timing Plan: AM PEAK HOUR



| Movement | EBL | EBT | EBR | WBL | WBT | WBR | NBL | NBT | NBR | SBL | SBT | SBR |
|------------------------------|------|------|------|-------|------|------|------|------|------|------|------|------|
| Lane Configurations | | | | | | | | | | | | |
| Traffic Volume (veh/h) | 34 | 145 | 24 | 153 | 241 | 105 | 59 | 694 | 144 | 129 | 362 | 110 |
| Future Volume (veh/h) | 34 | 145 | 24 | 153 | 241 | 105 | 59 | 694 | 144 | 129 | 362 | 110 |
| Initial Q (Qb), veh | 0 | 0 | 0 | 0 | 0 | 0 | 0 | 0 | 0 | 0 | 0 | 0 |
| Ped-Bike Adj(A_pbT) | 1.00 | | 0.85 | 1.00 | | 0.92 | 1.00 | | 0.98 | 1.00 | | 0.98 |
| Parking Bus, Adj | 1.00 | 1.00 | 1.00 | 1.00 | 1.00 | 1.00 | 1.00 | 1.00 | 1.00 | 1.00 | 1.00 | 1.00 |
| Work Zone On Approach | | No | | | No | | | No | | | No | |
| Adj Sat Flow, veh/h/ln | 1870 | 1870 | 1870 | 1870 | 1870 | 1870 | 1870 | 1870 | 1870 | 1870 | 1870 | 1870 |
| Adj Flow Rate, veh/h | 42 | 179 | 30 | 189 | 298 | 130 | 73 | 857 | 178 | 159 | 447 | 136 |
| Peak Hour Factor | 0.81 | 0.81 | 0.81 | 0.81 | 0.81 | 0.81 | 0.81 | 0.81 | 0.81 | 0.81 | 0.81 | 0.81 |
| Percent Heavy Veh, % | 2 | 2 | 2 | 2 | 2 | 2 | 2 | 2 | 2 | 2 | 2 | 2 |
| Cap, veh/h | 57 | 205 | 34 | 245 | 290 | 126 | 94 | 885 | 738 | 174 | 970 | 810 |
| Arrive On Green | 0.03 | 0.14 | 0.14 | 0.14 | 0.24 | 0.24 | 0.05 | 0.47 | 0.47 | 0.10 | 0.52 | 0.52 |
| Sat Flow, veh/h | 1781 | 1517 | 254 | 1781 | 1197 | 522 | 1781 | 1870 | 1558 | 1781 | 1870 | 1561 |
| Grp Volume(v), veh/h | 42 | 0 | 209 | 189 | 0 | 428 | 73 | 857 | 178 | 159 | 447 | 136 |
| Grp Sat Flow(s),veh/h/ln | 1781 | 0 | 1771 | 1781 | 0 | 1719 | 1781 | 1870 | 1558 | 1781 | 1870 | 1561 |
| Q Serve(g_s), s | 2.7 | 0.0 | 13.6 | 12.0 | 0.0 | 28.4 | 4.8 | 52.3 | 4.7 | 10.4 | 17.7 | 5.4 |
| Cycle Q Clear(g_c), s | 2.7 | 0.0 | 13.6 | 12.0 | 0.0 | 28.4 | 4.8 | 52.3 | 4.7 | 10.4 | 17.7 | 5.4 |
| Prop In Lane | 1.00 | | 0.14 | 1.00 | | 0.30 | 1.00 | | 1.00 | 1.00 | | 1.00 |
| Lane Grp Cap(c), veh/h | 57 | 0 | 239 | 245 | 0 | 416 | 94 | 885 | 738 | 174 | 970 | 810 |
| V/C Ratio(X) | 0.74 | 0.00 | 0.87 | 0.77 | 0.00 | 1.03 | 0.78 | 0.97 | 0.24 | 0.91 | 0.46 | 0.17 |
| Avail Cap(c_a), veh/h | 77 | 0 | 296 | 245 | 0 | 416 | 159 | 905 | 754 | 174 | 970 | 810 |
| HCM Platoon Ratio | 1.00 | 1.00 | 1.00 | 1.00 | 1.00 | 1.00 | 1.00 | 1.00 | 1.00 | 1.00 | 1.00 | 1.00 |
| Upstream Filter(l) | 1.00 | 0.00 | 1.00 | 1.00 | 0.00 | 1.00 | 1.00 | 1.00 | 1.00 | 1.00 | 1.00 | 1.00 |
| Uniform Delay (d), s/veh | 56.4 | 0.0 | 49.8 | 48.8 | 0.0 | 44.5 | 55.0 | 30.0 | 6.4 | 52.4 | 17.9 | 14.9 |
| Incr Delay (d2), s/veh | 21.8 | 0.0 | 18.1 | 13.9 | 0.0 | 51.8 | 13.0 | 22.0 | 0.1 | 43.6 | 0.1 | 0.0 |
| Initial Q Delay(d3),s/veh | 0.0 | 0.0 | 0.0 | 0.0 | 0.0 | 0.0 | 0.0 | 0.0 | 0.0 | 0.0 | 0.0 | 0.0 |
| %ile BackOfQ(50%),veh/ln | 1.6 | 0.0 | 7.3 | 6.3 | 0.0 | 18.1 | 2.5 | 28.4 | 2.8 | 6.8 | 7.7 | 1.9 |
| Unsig. Movement Delay, s/veh | | | | | | | | | | | | |
| LnGrp Delay(d),s/veh | 78.2 | 0.0 | 67.9 | 62.8 | 0.0 | 96.3 | 68.0 | 52.0 | 6.5 | 96.1 | 18.0 | 14.9 |
| LnGrp LOS | E | A | E | E | A | F | E | D | A | F | B | B |
| Approach Vol, veh/h | | 251 | | | 617 | | | 1108 | | | 742 | |
| Approach Delay, s/veh | | 69.6 | | | 86.0 | | | 45.7 | | | 34.2 | |
| Approach LOS | | E | | | F | | | D | | | C | |
| Timer - Assigned Phs | 1 | 2 | 3 | 4 | 5 | 6 | 7 | 8 | | | | |
| Phs Duration (G+Y+Rc), s | 16.0 | 60.2 | 20.8 | 20.5 | 10.7 | 65.5 | 8.2 | 33.0 | | | | |
| Change Period (Y+Rc), s | 4.5 | 4.6 | 4.6 | * 4.6 | 4.5 | 4.6 | 4.5 | 4.6 | | | | |
| Max Green Setting (Gmax), s | 11.5 | 56.8 | 13.9 | * 20 | 10.5 | 57.8 | 5.1 | 28.4 | | | | |
| Max Q Clear Time (g_c+l1), s | 12.4 | 54.3 | 14.0 | 15.6 | 6.8 | 19.7 | 4.7 | 30.4 | | | | |
| Green Ext Time (p_c), s | 0.0 | 1.3 | 0.0 | 0.3 | 0.0 | 2.3 | 0.0 | 0.0 | | | | |

Intersection Summary

| | |
|--------------------|------|
| HCM 6th Ctrl Delay | 53.9 |
| HCM 6th LOS | D |

Notes

* HCM 6th computational engine requires equal clearance times for the phases crossing the barrier.

HCM 6th Signalized Intersection Summary
3: W Riverside Dr/E Riverside Dr & Main St

Existing Plus Project
Timing Plan: AM PEAK HOUR



| Movement | EBL | EBT | EBR | WBL | WBT | WBR | NBL | NBT | NBR | SBL | SBT | SBR |
|------------------------------|-------|-------|------|------|------|-------|------|------|------|------|------|------|
| Lane Configurations | | | | | | | | | | | | |
| Traffic Volume (veh/h) | 63 | 287 | 333 | 266 | 474 | 58 | 353 | 708 | 273 | 57 | 388 | 31 |
| Future Volume (veh/h) | 63 | 287 | 333 | 266 | 474 | 58 | 353 | 708 | 273 | 57 | 388 | 31 |
| Initial Q (Qb), veh | 0 | 0 | 0 | 0 | 0 | 0 | 0 | 0 | 0 | 0 | 0 | 0 |
| Ped-Bike Adj(A_pbT) | 1.00 | | 0.98 | 1.00 | | 0.98 | 1.00 | | 0.99 | 1.00 | | 0.96 |
| Parking Bus, Adj | 1.00 | 1.00 | 1.00 | 1.00 | 1.00 | 1.00 | 1.00 | 1.00 | 1.00 | 1.00 | 1.00 | 1.00 |
| Work Zone On Approach | | No | | | No | | | No | | | No | |
| Adj Sat Flow, veh/h/ln | 1870 | 1870 | 1870 | 1870 | 1870 | 1870 | 1870 | 1870 | 1870 | 1870 | 1870 | 1870 |
| Adj Flow Rate, veh/h | 69 | 315 | 366 | 292 | 521 | 64 | 388 | 778 | 300 | 63 | 426 | 34 |
| Peak Hour Factor | 0.91 | 0.91 | 0.91 | 0.91 | 0.91 | 0.91 | 0.91 | 0.91 | 0.91 | 0.91 | 0.91 | 0.91 |
| Percent Heavy Veh, % | 2 | 2 | 2 | 2 | 2 | 2 | 2 | 2 | 2 | 2 | 2 | 2 |
| Cap, veh/h | 124 | 562 | 751 | 689 | 929 | 114 | 1103 | 803 | 674 | 121 | 566 | 45 |
| Arrive On Green | 0.07 | 0.16 | 0.16 | 0.20 | 0.29 | 0.29 | 0.32 | 0.43 | 0.43 | 0.07 | 0.17 | 0.17 |
| Sat Flow, veh/h | 1781 | 3554 | 1552 | 3456 | 3179 | 389 | 3456 | 1870 | 1568 | 1781 | 3323 | 264 |
| Grp Volume(v), veh/h | 69 | 315 | 366 | 292 | 290 | 295 | 388 | 778 | 300 | 63 | 227 | 233 |
| Grp Sat Flow(s),veh/h/ln | 1781 | 1777 | 1552 | 1728 | 1777 | 1792 | 1728 | 1870 | 1568 | 1781 | 1777 | 1810 |
| Q Serve(g_s), s | 4.3 | 9.4 | 0.0 | 8.5 | 15.9 | 16.0 | 9.9 | 46.7 | 8.0 | 3.9 | 14.0 | 14.1 |
| Cycle Q Clear(g_c), s | 4.3 | 9.4 | 0.0 | 8.5 | 15.9 | 16.0 | 9.9 | 46.7 | 8.0 | 3.9 | 14.0 | 14.1 |
| Prop In Lane | 1.00 | | 1.00 | 1.00 | | 0.22 | 1.00 | | 1.00 | 1.00 | | 0.15 |
| Lane Grp Cap(c), veh/h | 124 | 562 | 751 | 689 | 519 | 524 | 1103 | 803 | 674 | 121 | 303 | 308 |
| V/C Ratio(X) | 0.56 | 0.56 | 0.49 | 0.42 | 0.56 | 0.56 | 0.35 | 0.97 | 0.45 | 0.52 | 0.75 | 0.76 |
| Avail Cap(c_a), veh/h | 141 | 930 | 912 | 689 | 519 | 524 | 1103 | 820 | 687 | 139 | 637 | 648 |
| HCM Platoon Ratio | 1.00 | 1.00 | 1.00 | 1.00 | 1.00 | 1.00 | 1.00 | 1.00 | 1.00 | 1.00 | 1.00 | 1.00 |
| Upstream Filter(l) | 1.00 | 1.00 | 1.00 | 1.00 | 1.00 | 1.00 | 1.00 | 1.00 | 1.00 | 0.79 | 0.79 | 0.79 |
| Uniform Delay (d), s/veh | 51.8 | 44.7 | 20.4 | 40.2 | 34.4 | 34.5 | 30.0 | 32.1 | 6.2 | 51.8 | 45.4 | 45.4 |
| Incr Delay (d2), s/veh | 1.4 | 4.0 | 2.3 | 0.2 | 4.3 | 4.3 | 0.1 | 23.5 | 0.2 | 1.0 | 1.1 | 1.1 |
| Initial Q Delay(d3),s/veh | 0.0 | 0.0 | 0.0 | 0.0 | 0.0 | 0.0 | 0.0 | 0.0 | 0.0 | 0.0 | 0.0 | 0.0 |
| %ile BackOfQ(50%),veh/ln | 2.0 | 4.5 | 6.8 | 3.7 | 7.5 | 7.7 | 4.0 | 25.1 | 4.9 | 1.8 | 6.1 | 6.3 |
| Unsig. Movement Delay, s/veh | | | | | | | | | | | | |
| LnGrp Delay(d),s/veh | 53.2 | 48.7 | 22.7 | 40.4 | 38.7 | 38.8 | 30.1 | 55.6 | 6.3 | 52.8 | 46.5 | 46.6 |
| LnGrp LOS | D | D | C | D | D | D | C | E | A | D | D | D |
| Approach Vol, veh/h | | 750 | | | 877 | | | 1466 | | | 523 | |
| Approach Delay, s/veh | | 36.4 | | | 39.3 | | | 38.8 | | | 47.3 | |
| Approach LOS | | D | | | D | | | D | | | D | |
| Timer - Assigned Phs | 1 | 2 | 3 | 4 | 5 | 6 | 7 | 8 | | | | |
| Phs Duration (G+Y+Rc), s | 27.1 | 22.4 | 41.3 | 24.2 | 11.7 | 37.8 | 11.5 | 54.0 | | | | |
| Change Period (Y+Rc), s | * 4.2 | * 4.2 | 4.6 | 4.6 | 3.7 | * 4.2 | 3.7 | 4.6 | | | | |
| Max Green Setting (Gmax), s | * 9.3 | * 30 | 17.3 | 41.2 | 9.1 | * 30 | 9.0 | 50.4 | | | | |
| Max Q Clear Time (g_c+l1), s | 10.5 | 11.4 | 11.9 | 16.1 | 6.3 | 18.0 | 5.9 | 48.7 | | | | |
| Green Ext Time (p_c), s | 0.0 | 2.1 | 0.2 | 1.2 | 0.0 | 2.1 | 0.0 | 0.7 | | | | |

Intersection Summary

| | |
|--------------------|------|
| HCM 6th Ctrl Delay | 39.6 |
| HCM 6th LOS | D |

Notes

* HCM 6th computational engine requires equal clearance times for the phases crossing the barrier.

HCM 6th Signalized Intersection Summary
4: Union St/Brennan St & E Lake Ave

Existing Plus Project
Timing Plan: AM PEAK HOUR

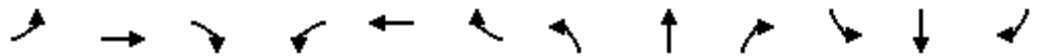

| Movement | EBL | EBT | EBR | WBL | WBT | WBR | NBL | NBT | NBR | SBL | SBT | SBR |
|------------------------------|------|------|------|-------|------|-------|------|-------|------|------|------|------|
| Lane Configurations | | | | | | | | | | | | |
| Traffic Volume (veh/h) | 90 | 401 | 35 | 187 | 432 | 18 | 36 | 102 | 47 | 35 | 156 | 55 |
| Future Volume (veh/h) | 90 | 401 | 35 | 187 | 432 | 18 | 36 | 102 | 47 | 35 | 156 | 55 |
| Initial Q (Qb), veh | 0 | 0 | 0 | 0 | 0 | 0 | 0 | 0 | 0 | 0 | 0 | 0 |
| Ped-Bike Adj(A_pbT) | 1.00 | | 0.98 | 1.00 | | 0.96 | 1.00 | | 0.93 | 1.00 | | 0.95 |
| Parking Bus, Adj | 1.00 | 1.00 | 1.00 | 1.00 | 1.00 | 1.00 | 1.00 | 1.00 | 1.00 | 1.00 | 1.00 | 1.00 |
| Work Zone On Approach | | No | | | No | | | No | | | No | |
| Adj Sat Flow, veh/h/ln | 1870 | 1870 | 1870 | 1870 | 1870 | 1870 | 1870 | 1870 | 1870 | 1870 | 1870 | 1870 |
| Adj Flow Rate, veh/h | 115 | 514 | 45 | 240 | 554 | 23 | 46 | 131 | 60 | 45 | 200 | 71 |
| Peak Hour Factor | 0.78 | 0.78 | 0.78 | 0.78 | 0.78 | 0.78 | 0.78 | 0.78 | 0.78 | 0.78 | 0.78 | 0.78 |
| Percent Heavy Veh, % | 2 | 2 | 2 | 2 | 2 | 2 | 2 | 2 | 2 | 2 | 2 | 2 |
| Cap, veh/h | 146 | 549 | 48 | 286 | 717 | 30 | 76 | 258 | 118 | 75 | 282 | 100 |
| Arrive On Green | 0.08 | 0.32 | 0.32 | 0.16 | 0.40 | 0.40 | 0.04 | 0.22 | 0.22 | 0.04 | 0.22 | 0.22 |
| Sat Flow, veh/h | 1781 | 1692 | 148 | 1781 | 1780 | 74 | 1781 | 1184 | 543 | 1781 | 1300 | 461 |
| Grp Volume(v), veh/h | 115 | 0 | 559 | 240 | 0 | 577 | 46 | 0 | 191 | 45 | 0 | 271 |
| Grp Sat Flow(s),veh/h/ln | 1781 | 0 | 1840 | 1781 | 0 | 1854 | 1781 | 0 | 1727 | 1781 | 0 | 1761 |
| Q Serve(g_s), s | 4.4 | 0.0 | 20.4 | 9.0 | 0.0 | 18.7 | 1.8 | 0.0 | 6.7 | 1.7 | 0.0 | 9.9 |
| Cycle Q Clear(g_c), s | 4.4 | 0.0 | 20.4 | 9.0 | 0.0 | 18.7 | 1.8 | 0.0 | 6.7 | 1.7 | 0.0 | 9.9 |
| Prop In Lane | 1.00 | | 0.08 | 1.00 | | 0.04 | 1.00 | | 0.31 | 1.00 | | 0.26 |
| Lane Grp Cap(c), veh/h | 146 | 0 | 597 | 286 | 0 | 746 | 76 | 0 | 376 | 75 | 0 | 382 |
| V/C Ratio(X) | 0.79 | 0.00 | 0.94 | 0.84 | 0.00 | 0.77 | 0.61 | 0.00 | 0.51 | 0.60 | 0.00 | 0.71 |
| Avail Cap(c_a), veh/h | 167 | 0 | 598 | 348 | 0 | 798 | 131 | 0 | 499 | 162 | 0 | 540 |
| HCM Platoon Ratio | 1.00 | 1.00 | 1.00 | 1.00 | 1.00 | 1.00 | 1.00 | 1.00 | 1.00 | 1.00 | 1.00 | 1.00 |
| Upstream Filter(l) | 1.00 | 0.00 | 1.00 | 1.00 | 0.00 | 1.00 | 1.00 | 0.00 | 1.00 | 1.00 | 0.00 | 1.00 |
| Uniform Delay (d), s/veh | 31.2 | 0.0 | 22.7 | 28.2 | 0.0 | 17.9 | 32.6 | 0.0 | 23.8 | 32.6 | 0.0 | 25.1 |
| Incr Delay (d2), s/veh | 19.2 | 0.0 | 22.4 | 14.2 | 0.0 | 3.9 | 7.7 | 0.0 | 0.4 | 7.6 | 0.0 | 1.0 |
| Initial Q Delay(d3),s/veh | 0.0 | 0.0 | 0.0 | 0.0 | 0.0 | 0.0 | 0.0 | 0.0 | 0.0 | 0.0 | 0.0 | 0.0 |
| %ile BackOfQ(50%),veh/ln | 2.6 | 0.0 | 12.0 | 4.9 | 0.0 | 8.2 | 0.9 | 0.0 | 2.7 | 0.9 | 0.0 | 4.1 |
| Unsig. Movement Delay, s/veh | | | | | | | | | | | | |
| LnGrp Delay(d),s/veh | 50.3 | 0.0 | 45.1 | 42.3 | 0.0 | 21.8 | 40.2 | 0.0 | 24.2 | 40.2 | 0.0 | 26.0 |
| LnGrp LOS | D | A | D | D | A | C | D | A | C | D | A | C |
| Approach Vol, veh/h | | 674 | | | 817 | | | 237 | | | | 316 |
| Approach Delay, s/veh | | 46.0 | | | 27.8 | | | 27.3 | | | | 28.1 |
| Approach LOS | | D | | | C | | | C | | | | C |
| Timer - Assigned Phs | 1 | 2 | 3 | 4 | 5 | 6 | 7 | 8 | | | | |
| Phs Duration (G+Y+Rc), s | 15.6 | 26.9 | 7.4 | 19.2 | 10.2 | 32.4 | 7.4 | 19.3 | | | | |
| Change Period (Y+Rc), s | 4.5 | 4.5 | 4.5 | * 4.2 | 4.5 | * 4.5 | 4.5 | * 4.2 | | | | |
| Max Green Setting (Gmax), s | 13.5 | 22.5 | 5.1 | * 21 | 6.5 | * 30 | 6.3 | * 20 | | | | |
| Max Q Clear Time (g_c+l1), s | 11.0 | 22.4 | 3.8 | 11.9 | 6.4 | 20.7 | 3.7 | 8.7 | | | | |
| Green Ext Time (p_c), s | 0.2 | 0.0 | 0.0 | 0.8 | 0.0 | 1.9 | 0.0 | 0.5 | | | | |

Intersection Summary

| | |
|--------------------|------|
| HCM 6th Ctrl Delay | 33.8 |
| HCM 6th LOS | C |

Notes

* HCM 6th computational engine requires equal clearance times for the phases crossing the barrier.

HCM 6th Signalized Intersection Summary
7: Rodriguez St & Main St

Existing Plus Project
Timing Plan: AM PEAK HOUR

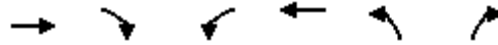

| Movement | EBT | EBR | WBL | WBT | NBL | NBR |
|------------------------------|------|-------|------|------|------|------|
| Lane Configurations | ↑↑ | | ↵ | ↑↑ | ↵↵ | |
| Traffic Volume (veh/h) | 556 | 222 | 4 | 730 | 358 | 2 |
| Future Volume (veh/h) | 556 | 222 | 4 | 730 | 358 | 2 |
| Initial Q (Qb), veh | 0 | 0 | 0 | 0 | 0 | 0 |
| Ped-Bike Adj(A_pbT) | | 0.97 | 1.00 | | 1.00 | 1.00 |
| Parking Bus, Adj | 1.00 | 1.00 | 1.00 | 1.00 | 1.00 | 1.00 |
| Work Zone On Approach | No | | | No | No | |
| Adj Sat Flow, veh/h/ln | 1870 | 1870 | 1870 | 1945 | 1870 | 1870 |
| Adj Flow Rate, veh/h | 632 | 252 | 5 | 830 | 409 | 0 |
| Peak Hour Factor | 0.88 | 0.88 | 0.88 | 0.88 | 0.88 | 0.88 |
| Percent Heavy Veh, % | 2 | 2 | 2 | 2 | 2 | 2 |
| Cap, veh/h | 684 | 272 | 759 | 2798 | 512 | 228 |
| Arrive On Green | 0.28 | 0.28 | 0.14 | 0.25 | 0.14 | 0.00 |
| Sat Flow, veh/h | 2549 | 978 | 1781 | 3793 | 3563 | 1585 |
| Grp Volume(v), veh/h | 457 | 427 | 5 | 830 | 409 | 0 |
| Grp Sat Flow(s),veh/h/ln | 1777 | 1657 | 1781 | 1848 | 1781 | 1585 |
| Q Serve(g_s), s | 25.0 | 25.0 | 0.2 | 18.2 | 11.1 | 0.0 |
| Cycle Q Clear(g_c), s | 25.0 | 25.0 | 0.2 | 18.2 | 11.1 | 0.0 |
| Prop In Lane | | 0.59 | 1.00 | | 1.00 | 1.00 |
| Lane Grp Cap(c), veh/h | 495 | 461 | 759 | 2798 | 512 | 228 |
| V/C Ratio(X) | 0.92 | 0.93 | 0.01 | 0.30 | 0.80 | 0.00 |
| Avail Cap(c_a), veh/h | 883 | 824 | 759 | 2798 | 976 | 434 |
| HCM Platoon Ratio | 1.00 | 1.00 | 0.33 | 0.33 | 1.00 | 1.00 |
| Upstream Filter(l) | 1.00 | 1.00 | 0.83 | 0.83 | 1.00 | 0.00 |
| Uniform Delay (d), s/veh | 35.1 | 35.1 | 24.8 | 15.9 | 41.4 | 0.0 |
| Incr Delay (d2), s/veh | 25.4 | 26.8 | 0.0 | 0.2 | 2.9 | 0.0 |
| Initial Q Delay(d3),s/veh | 0.0 | 0.0 | 0.0 | 0.0 | 0.0 | 0.0 |
| %ile BackOfQ(50%),veh/ln | 13.8 | 13.0 | 0.1 | 8.9 | 5.0 | 0.0 |
| Unsig. Movement Delay, s/veh | | | | | | |
| LnGrp Delay(d),s/veh | 60.5 | 61.9 | 24.8 | 16.2 | 44.3 | 0.0 |
| LnGrp LOS | E | E | C | B | D | A |
| Approach Vol, veh/h | 884 | | | 835 | 409 | |
| Approach Delay, s/veh | 61.2 | | | 16.2 | 44.3 | |
| Approach LOS | E | | | B | D | |
| Timer - Assigned Phs | 1 | 2 | | 4 | | 6 |
| Phs Duration (G+Y+Rc), s | 47.9 | 33.1 | | 19.0 | | 81.0 |
| Change Period (Y+Rc), s | 5.3 | * 5.3 | | 4.6 | | 5.3 |
| Max Green Setting (Gmax), s | 8.4 | * 50 | | 27.4 | | 62.7 |
| Max Q Clear Time (g_c+l1), s | 2.2 | 27.0 | | 13.1 | | 20.2 |
| Green Ext Time (p_c), s | 0.0 | 0.8 | | 1.3 | | 1.0 |

Intersection Summary

| | |
|--------------------|------|
| HCM 6th Ctrl Delay | 40.3 |
| HCM 6th LOS | D |

Notes

User approved volume balancing among the lanes for turning movement.

* HCM 6th computational engine requires equal clearance times for the phases crossing the barrier.

HCM 6th Signalized Intersection Summary
8: Brennan St & Freedom Blvd

Existing Plus Project
Timing Plan: AM PEAK HOUR



| Movement | EBL | EBT | EBR | WBL | WBT | WBR | NBL | NBT | NBR | SBL | SBT | SBR |
|------------------------------|------|------|------|------|------|------|------|------|------|------|------|------|
| Lane Configurations | | | | | | | | | | | | |
| Traffic Volume (veh/h) | 6 | 460 | 50 | 179 | 322 | 0 | 123 | 1 | 135 | 3 | 2 | 13 |
| Future Volume (veh/h) | 6 | 460 | 50 | 179 | 322 | 0 | 123 | 1 | 135 | 3 | 2 | 13 |
| Initial Q (Qb), veh | 0 | 0 | 0 | 0 | 0 | 0 | 0 | 0 | 0 | 0 | 0 | 0 |
| Ped-Bike Adj(A_pbT) | 1.00 | | 0.99 | 1.00 | | 1.00 | 0.98 | | 0.98 | 0.99 | | 0.98 |
| Parking Bus, Adj | 1.00 | 1.00 | 1.00 | 1.00 | 1.00 | 1.00 | 1.00 | 1.00 | 1.00 | 1.00 | 1.00 | 1.00 |
| Work Zone On Approach | | No | | | No | | | No | | | No | |
| Adj Sat Flow, veh/h/ln | 1870 | 1945 | 1870 | 1870 | 1870 | 1870 | 1870 | 1870 | 1870 | 1870 | 1870 | 1870 |
| Adj Flow Rate, veh/h | 7 | 548 | 60 | 213 | 383 | 0 | 146 | 1 | 161 | 4 | 2 | 15 |
| Peak Hour Factor | 0.84 | 0.84 | 0.84 | 0.84 | 0.84 | 0.84 | 0.84 | 0.84 | 0.84 | 0.84 | 0.84 | 0.84 |
| Percent Heavy Veh, % | 2 | 2 | 2 | 2 | 2 | 2 | 2 | 2 | 2 | 2 | 2 | 2 |
| Cap, veh/h | 13 | 743 | 598 | 283 | 998 | 0 | 408 | 2 | 291 | 276 | 35 | 264 |
| Arrive On Green | 0.01 | 0.38 | 0.38 | 0.16 | 0.53 | 0.00 | 0.19 | 0.19 | 0.19 | 0.19 | 0.19 | 0.19 |
| Sat Flow, veh/h | 1781 | 1945 | 1564 | 1781 | 1870 | 0 | 1364 | 10 | 1539 | 1207 | 186 | 1394 |
| Grp Volume(v), veh/h | 7 | 548 | 60 | 213 | 383 | 0 | 146 | 0 | 162 | 4 | 0 | 17 |
| Grp Sat Flow(s),veh/h/ln | 1781 | 1945 | 1564 | 1781 | 1870 | 0 | 1364 | 0 | 1549 | 1207 | 0 | 1579 |
| Q Serve(g_s), s | 0.2 | 10.8 | 1.1 | 5.1 | 5.3 | 0.0 | 4.4 | 0.0 | 4.2 | 0.1 | 0.0 | 0.4 |
| Cycle Q Clear(g_c), s | 0.2 | 10.8 | 1.1 | 5.1 | 5.3 | 0.0 | 4.8 | 0.0 | 4.2 | 4.3 | 0.0 | 0.4 |
| Prop In Lane | 1.00 | | 1.00 | 1.00 | | 0.00 | 1.00 | | 0.99 | 1.00 | | 0.88 |
| Lane Grp Cap(c), veh/h | 13 | 743 | 598 | 283 | 998 | 0 | 408 | 0 | 293 | 276 | 0 | 299 |
| V/C Ratio(X) | 0.53 | 0.74 | 0.10 | 0.75 | 0.38 | 0.00 | 0.36 | 0.00 | 0.55 | 0.01 | 0.00 | 0.06 |
| Avail Cap(c_a), veh/h | 160 | 2232 | 1795 | 1002 | 3029 | 0 | 948 | 0 | 906 | 753 | 0 | 924 |
| HCM Platoon Ratio | 1.00 | 1.00 | 1.00 | 1.00 | 1.00 | 1.00 | 1.00 | 1.00 | 1.00 | 1.00 | 1.00 | 1.00 |
| Upstream Filter(l) | 1.00 | 1.00 | 1.00 | 1.00 | 1.00 | 0.00 | 1.00 | 0.00 | 1.00 | 1.00 | 0.00 | 1.00 |
| Uniform Delay (d), s/veh | 22.0 | 11.8 | 8.8 | 17.9 | 6.1 | 0.0 | 16.7 | 0.0 | 16.3 | 18.3 | 0.0 | 14.8 |
| Incr Delay (d2), s/veh | 28.8 | 1.5 | 0.1 | 4.0 | 0.2 | 0.0 | 0.5 | 0.0 | 1.6 | 0.0 | 0.0 | 0.1 |
| Initial Q Delay(d3),s/veh | 0.0 | 0.0 | 0.0 | 0.0 | 0.0 | 0.0 | 0.0 | 0.0 | 0.0 | 0.0 | 0.0 | 0.0 |
| %ile BackOfQ(50%),veh/ln | 0.2 | 3.7 | 0.3 | 2.1 | 1.3 | 0.0 | 1.2 | 0.0 | 1.3 | 0.0 | 0.0 | 0.1 |
| Unsig. Movement Delay, s/veh | | | | | | | | | | | | |
| LnGrp Delay(d),s/veh | 50.8 | 13.3 | 8.9 | 21.9 | 6.3 | 0.0 | 17.3 | 0.0 | 18.0 | 18.3 | 0.0 | 14.9 |
| LnGrp LOS | D | B | A | C | A | A | B | A | B | B | A | B |
| Approach Vol, veh/h | | 615 | | | 596 | | | 308 | | | | 21 |
| Approach Delay, s/veh | | 13.3 | | | 11.9 | | | 17.6 | | | | 15.5 |
| Approach LOS | | B | | | B | | | B | | | | B |
| Timer - Assigned Phs | 1 | 2 | | 4 | 5 | 6 | | 8 | | | | |
| Phs Duration (G+Y+Rc), s | 4.3 | 27.7 | | 12.4 | 11.1 | 21.0 | | 12.4 | | | | |
| Change Period (Y+Rc), s | 4.0 | 4.0 | | 4.0 | 4.0 | 4.0 | | 4.0 | | | | |
| Max Green Setting (Gmax), s | 4.0 | 72.0 | | 26.0 | 25.0 | 51.0 | | 26.0 | | | | |
| Max Q Clear Time (g_c+I1), s | 2.2 | 7.3 | | 6.8 | 7.1 | 12.8 | | 6.3 | | | | |
| Green Ext Time (p_c), s | 0.0 | 2.5 | | 1.3 | 0.5 | 4.1 | | 0.0 | | | | |
| Intersection Summary | | | | | | | | | | | | |
| HCM 6th Ctrl Delay | | | | 13.6 | | | | | | | | |
| HCM 6th LOS | | | | B | | | | | | | | |

D – Future Plus Project Traffic Conditions



1: Main St & W Lake Ave/E Lake Ave Performance by movement

| Movement | EBL | EBT | EBR | WBL | WBT | WBR | NBL | NBT | NBR | SBL | SBT | SBR |
|--------------------|------|------|------|------|------|------|------|------|------|-------|------|------|
| Denied Del/Veh (s) | 0.0 | 0.1 | 0.0 | 0.0 | 0.0 | 0.0 | 0.0 | 0.0 | 0.0 | 0.0 | 0.3 | 0.0 |
| Total Del/Veh (s) | 58.9 | 68.4 | 58.8 | 88.4 | 30.7 | 18.8 | 65.0 | 33.3 | 21.2 | 117.2 | 47.6 | 32.5 |

1: Main St & W Lake Ave/E Lake Ave Performance by movement

| Movement | All |
|--------------------|------|
| Denied Del/Veh (s) | 0.1 |
| Total Del/Veh (s) | 50.3 |

2: Main St & W Beach St/E Beach St Performance by movement

| Movement | EBL | EBT | EBR | WBL | WBT | WBR | NBL | NBT | NBR | SBL | SBT | SBR |
|--------------------|------|------|------|------|------|------|------|------|------|------|------|------|
| Denied Del/Veh (s) | 0.0 | 0.0 | 0.0 | 0.0 | 0.0 | 0.0 | 0.0 | 0.0 | 0.0 | 0.0 | 0.0 | 0.0 |
| Total Del/Veh (s) | 57.0 | 48.1 | 38.7 | 58.7 | 35.2 | 31.2 | 83.4 | 37.0 | 28.1 | 49.1 | 32.4 | 19.4 |

2: Main St & W Beach St/E Beach St Performance by movement

| Movement | All |
|--------------------|------|
| Denied Del/Veh (s) | 0.0 |
| Total Del/Veh (s) | 38.9 |

3: W Riverside Dr/E Riverside Dr & Main St Performance by movement

| Movement | EBL | EBT | EBR | WBL | WBT | WBR | NBL | NBT | NBR | SBL | SBT | SBR |
|--------------------|------|------|------|-------|------|------|-------|-------|-------|------|------|------|
| Denied Del/Veh (s) | 1.7 | 0.2 | 0.3 | 1.6 | 0.2 | 0.3 | 513.6 | 513.6 | 508.1 | 0.1 | 0.0 | 0.1 |
| Total Del/Veh (s) | 62.2 | 49.0 | 64.5 | 135.8 | 42.6 | 36.8 | 71.7 | 164.8 | 158.9 | 62.7 | 62.6 | 56.5 |

3: W Riverside Dr/E Riverside Dr & Main St Performance by movement

| Movement | All |
|--------------------|-------|
| Denied Del/Veh (s) | 173.0 |
| Total Del/Veh (s) | 88.0 |

4: Union St/Brennan St & E Lake Ave Performance by movement

| Movement | EBL | EBT | EBR | WBL | WBT | WBR | NBL | NBT | NBR | SBL | SBT | SBR |
|--------------------|------|------|------|------|------|------|------|------|------|------|------|------|
| Denied Del/Veh (s) | 0.0 | 0.0 | 0.4 | 7.6 | 5.9 | 5.8 | 0.7 | 0.1 | 0.1 | 3.9 | 1.1 | 1.1 |
| Total Del/Veh (s) | 78.1 | 34.8 | 30.4 | 43.9 | 24.9 | 21.3 | 51.5 | 31.3 | 22.2 | 54.5 | 48.2 | 37.2 |

4: Union St/Brennan St & E Lake Ave Performance by movement

| Movement | All |
|--------------------|------|
| Denied Del/Veh (s) | 2.5 |
| Total Del/Veh (s) | 37.0 |

5: Union St & E Beach St Performance by movement

| Movement | EBT | EBR | WBL | WBT | NBL | NBR | All |
|--------------------|------|------|-----|-----|------|-----|------|
| Denied Del/Veh (s) | 0.0 | 0.0 | 0.0 | 0.0 | 4.0 | 0.3 | 0.2 |
| Total Del/Veh (s) | 29.4 | 25.0 | 5.8 | 7.0 | 32.1 | 9.2 | 17.3 |

7: Rodriguez St & Main St Performance by movement

| Movement | EBT | EBR | WBL | WBT | NBL | NBR | All |
|--------------------|------|------|------|------|------|------|------|
| Denied Del/Veh (s) | 0.6 | 0.6 | 0.0 | 0.0 | 2.1 | 1.9 | 0.7 |
| Total Del/Veh (s) | 38.6 | 30.1 | 50.7 | 13.0 | 31.7 | 33.1 | 29.3 |

8: Brennan St & Freedom Blvd Performance by movement

| Movement | EBL | EBT | EBR | WBL | WBT | WBR | NBL | NBT | NBR | SBL | SBT | SBR |
|--------------------|------|------|------|------|------|-----|------|------|------|------|------|-----|
| Denied Del/Veh (s) | 0.0 | 0.0 | 0.0 | 3.3 | 1.0 | 1.1 | 9.9 | 14.4 | 8.2 | 4.0 | 0.1 | 0.1 |
| Total Del/Veh (s) | 48.1 | 24.0 | 10.4 | 47.4 | 12.2 | 8.9 | 56.3 | 43.9 | 29.7 | 70.1 | 42.6 | 7.6 |

8: Brennan St & Freedom Blvd Performance by movement

| Movement | All |
|--------------------|------|
| Denied Del/Veh (s) | 2.8 |
| Total Del/Veh (s) | 26.7 |

9: E Beach St & Alexander St Performance by movement

| Movement | EBL | EBT | WBT | WBR | SBL | SBT | SBR | All |
|--------------------|-----|-----|------|------|------|-----|-----|------|
| Denied Del/Veh (s) | 0.0 | 0.0 | 2.2 | 1.1 | 0.0 | 0.0 | 0.0 | 0.6 |
| Total Del/Veh (s) | 4.9 | 5.8 | 45.5 | 38.0 | 35.0 | 1.7 | 8.8 | 21.6 |

Total Zone Performance

| | |
|--------------------|--------|
| Denied Del/Veh (s) | 94.9 |
| Total Del/Veh (s) | 1913.2 |

Intersection: 1: Main St & W Lake Ave/E Lake Ave

| Movement | EB | EB | WB | WB | WB | NB | NB | NB | SB | SB | SB | B36 |
|-----------------------|-----|-----|-----|-----|-----|-----|-----|-----|-----|-----|-----|-----|
| Directions Served | L | TR | L | T | R | L | T | R | L | T | R | T |
| Maximum Queue (ft) | 349 | 546 | 341 | 427 | 155 | 134 | 556 | 200 | 400 | 798 | 150 | 269 |
| Average Queue (ft) | 85 | 265 | 208 | 182 | 98 | 27 | 244 | 119 | 258 | 433 | 83 | 78 |
| 95th Queue (ft) | 246 | 485 | 354 | 404 | 178 | 90 | 487 | 235 | 458 | 928 | 188 | 295 |
| Link Distance (ft) | | 626 | | 467 | | | 587 | | | 811 | | 328 |
| Upstream Blk Time (%) | | 1 | | 2 | | | 0 | | | 11 | | 6 |
| Queuing Penalty (veh) | | 2 | | 13 | | | 3 | | | 107 | | 29 |
| Storage Bay Dist (ft) | 300 | | 300 | | 105 | 100 | | 150 | 350 | | 100 | |
| Storage Blk Time (%) | | 14 | 8 | 14 | 5 | 0 | 32 | 1 | 12 | 37 | 0 | |
| Queuing Penalty (veh) | | 10 | 43 | 72 | 26 | 0 | 90 | 5 | 83 | 132 | 1 | |

Intersection: 1: Main St & W Lake Ave/E Lake Ave

| Movement | B36 |
|-----------------------|-----|
| Directions Served | |
| Maximum Queue (ft) | 210 |
| Average Queue (ft) | 54 |
| 95th Queue (ft) | 245 |
| Link Distance (ft) | 328 |
| Upstream Blk Time (%) | 3 |
| Queuing Penalty (veh) | 14 |
| Storage Bay Dist (ft) | |
| Storage Blk Time (%) | |
| Queuing Penalty (veh) | |

Intersection: 2: Main St & W Beach St/E Beach St

| Movement | EB | EB | WB | WB | NB | NB | NB | SB | SB | SB |
|-----------------------|-----|-----|-----|-----|-----|------|-----|-----|-----|-----|
| Directions Served | L | TR | L | TR | L | T | R | L | T | R |
| Maximum Queue (ft) | 250 | 403 | 177 | 273 | 449 | 665 | 125 | 277 | 546 | 150 |
| Average Queue (ft) | 84 | 225 | 73 | 156 | 128 | 354 | 65 | 71 | 303 | 63 |
| 95th Queue (ft) | 211 | 366 | 144 | 254 | 331 | 632 | 150 | 241 | 578 | 164 |
| Link Distance (ft) | | 385 | 267 | 267 | | 1438 | | | 587 | |
| Upstream Blk Time (%) | | 2 | 0 | 0 | | | | | 1 | |
| Queuing Penalty (veh) | | 7 | 0 | 1 | | | | | 8 | |
| Storage Bay Dist (ft) | 200 | | | | 400 | | 75 | 400 | | 100 |
| Storage Blk Time (%) | 0 | 18 | | | | 40 | 1 | | 40 | 0 |
| Queuing Penalty (veh) | 0 | 14 | | | | 106 | 8 | | 65 | 0 |

Intersection: 3: W Riverside Dr/E Riverside Dr & Main St

| Movement | EB | EB | EB | EB | WB | WB | WB | WB | NB | NB | NB | NB |
|-----------------------|-----|------|------|------|-----|-----|------|------|-----|------|------|-----|
| Directions Served | L | T | T | R | L | L | T | TR | L | L | T | R |
| Maximum Queue (ft) | 220 | 350 | 555 | 841 | 164 | 190 | 756 | 706 | 165 | 1290 | 1304 | 215 |
| Average Queue (ft) | 85 | 201 | 209 | 491 | 157 | 181 | 441 | 374 | 64 | 1267 | 1270 | 158 |
| 95th Queue (ft) | 189 | 295 | 385 | 885 | 184 | 212 | 882 | 798 | 135 | 1281 | 1289 | 295 |
| Link Distance (ft) | | 1444 | 1444 | 1444 | | | 1793 | 1793 | | 1249 | 1249 | |
| Upstream Blk Time (%) | | | | | | | | | | 53 | 77 | |
| Queuing Penalty (veh) | | | | | | | | | | 0 | 0 | |
| Storage Bay Dist (ft) | 170 | | | | 140 | 140 | | | 305 | | | 165 |
| Storage Blk Time (%) | 0 | 16 | | | 29 | 54 | 4 | | | | 53 | 0 |
| Queuing Penalty (veh) | 1 | 12 | | | 61 | 114 | 18 | | | | 162 | 2 |

Intersection: 3: W Riverside Dr/E Riverside Dr & Main St

| Movement | SB | SB | SB |
|-----------------------|-----|------|-----|
| Directions Served | L | T | TR |
| Maximum Queue (ft) | 399 | 790 | 225 |
| Average Queue (ft) | 122 | 421 | 218 |
| 95th Queue (ft) | 303 | 718 | 246 |
| Link Distance (ft) | | 1438 | |
| Upstream Blk Time (%) | | | |
| Queuing Penalty (veh) | | | |
| Storage Bay Dist (ft) | 350 | | 175 |
| Storage Blk Time (%) | | 37 | 33 |
| Queuing Penalty (veh) | | 199 | 154 |

Intersection: 4: Union St/Brennan St & E Lake Ave

| Movement | EB | EB | WB | WB | NB | NB | SB | SB |
|-----------------------|-----|-----|-----|-----|-----|-----|-----|-----|
| Directions Served | L | TR | L | TR | L | TR | L | TR |
| Maximum Queue (ft) | 150 | 498 | 225 | 295 | 166 | 202 | 149 | 318 |
| Average Queue (ft) | 111 | 341 | 131 | 243 | 79 | 91 | 56 | 172 |
| 95th Queue (ft) | 178 | 518 | 249 | 333 | 145 | 169 | 136 | 306 |
| Link Distance (ft) | | 467 | | 262 | | 568 | | 390 |
| Upstream Blk Time (%) | | 4 | | 15 | | | | 1 |
| Queuing Penalty (veh) | | 30 | | 0 | | | | 0 |
| Storage Bay Dist (ft) | 100 | | 175 | | 270 | | 100 | |
| Storage Blk Time (%) | 18 | 42 | 1 | 24 | | 0 | 0 | 32 |
| Queuing Penalty (veh) | 117 | 55 | 6 | 35 | | 0 | 1 | 15 |

Intersection: 5: Union St & E Beach St

| Movement | EB | WB | WB | NB | NB |
|-----------------------|-----|----|-----|-----|-----|
| Directions Served | TR | LT | T | L | R |
| Maximum Queue (ft) | 300 | 93 | 101 | 72 | 89 |
| Average Queue (ft) | 202 | 42 | 55 | 25 | 38 |
| 95th Queue (ft) | 321 | 78 | 94 | 59 | 69 |
| Link Distance (ft) | 267 | 98 | 98 | | 497 |
| Upstream Blk Time (%) | 6 | 0 | 0 | | |
| Queuing Penalty (veh) | 29 | 0 | 1 | | |
| Storage Bay Dist (ft) | | | | 100 | |
| Storage Blk Time (%) | | | | 0 | 0 |
| Queuing Penalty (veh) | | | | 0 | 0 |

Intersection: 7: Rodriguez St & Main St

| Movement | EB | EB | WB | WB | WB | NB | NB |
|-----------------------|------|------|-----|-----|-----|-----|-----|
| Directions Served | T | TR | L | T | T | L | LR |
| Maximum Queue (ft) | 690 | 688 | 110 | 254 | 261 | 150 | 375 |
| Average Queue (ft) | 376 | 362 | 19 | 115 | 118 | 120 | 277 |
| 95th Queue (ft) | 667 | 668 | 67 | 230 | 239 | 209 | 406 |
| Link Distance (ft) | 1000 | 1000 | | 691 | 691 | | 346 |
| Upstream Blk Time (%) | 0 | 0 | | | | | 8 |
| Queuing Penalty (veh) | 0 | 0 | | | | | 0 |
| Storage Bay Dist (ft) | | | 145 | | | 100 | |
| Storage Blk Time (%) | | | | 4 | | 2 | 44 |
| Queuing Penalty (veh) | | | | 1 | | 8 | 129 |

Intersection: 8: Brennan St & Freedom Blvd

| Movement | EB | EB | EB | WB | WB | NB | NB | SB | SB |
|-----------------------|----|-----|-----|-----|-----|-----|-----|----|-----|
| Directions Served | L | T | R | L | TR | L | TR | L | TR |
| Maximum Queue (ft) | 91 | 518 | 250 | 241 | 317 | 105 | 290 | 27 | 26 |
| Average Queue (ft) | 5 | 254 | 101 | 122 | 138 | 93 | 192 | 3 | 2 |
| 95th Queue (ft) | 41 | 449 | 257 | 211 | 253 | 126 | 330 | 15 | 13 |
| Link Distance (ft) | | 506 | | | 393 | | 267 | | 373 |
| Upstream Blk Time (%) | | 1 | | | 0 | | 13 | | |
| Queuing Penalty (veh) | | 6 | | | 0 | | 0 | | |
| Storage Bay Dist (ft) | 65 | | 200 | 200 | | 55 | | 75 | |
| Storage Blk Time (%) | 0 | 32 | 0 | 1 | 2 | 48 | 28 | | |
| Queuing Penalty (veh) | 0 | 68 | 0 | 6 | 4 | 139 | 56 | | |

Intersection: 9: E Beach St & Alexander St

| Movement | EB | WB | WB | SB | SB |
|-----------------------|-----|-----|-----|-----|-----|
| Directions Served | LT | T | TR | L | R |
| Maximum Queue (ft) | 107 | 150 | 366 | 173 | 109 |
| Average Queue (ft) | 62 | 99 | 167 | 87 | 54 |
| 95th Queue (ft) | 111 | 175 | 316 | 153 | 91 |
| Link Distance (ft) | 98 | | 390 | | 568 |
| Upstream Blk Time (%) | 3 | | 2 | | |
| Queuing Penalty (veh) | 13 | | 0 | | |
| Storage Bay Dist (ft) | | 100 | | 220 | |
| Storage Blk Time (%) | | 6 | 34 | | |
| Queuing Penalty (veh) | | 14 | 49 | | |

Zone Summary

Zone wide Queuing Penalty: 2343

6: Main St & Freedom Blvd & Western Dr Performance by movement

| Movement | EBL | EBT | EBR | WBL | WBT | WBR | NBL | NBT | NBR | SBL | SBT | SBR |
|--------------------|------|------|-----|------|------|------|------|------|-----|------|------|-----|
| Denied Del/Veh (s) | 0.0 | 0.0 | 0.0 | 0.0 | 0.0 | 0.0 | 0.0 | 0.0 | 0.0 | 0.2 | 0.2 | 4.0 |
| Total Del/Veh (s) | 67.7 | 68.3 | 8.2 | 41.9 | 40.4 | 21.4 | 17.5 | 21.9 | 4.9 | 41.9 | 40.5 | 9.5 |

6: Main St & Freedom Blvd & Western Dr Performance by movement

| Movement | All |
|--------------------|------|
| Denied Del/Veh (s) | 0.1 |
| Total Del/Veh (s) | 24.9 |

Intersection: 6: Main St & Freedom Blvd & Western Dr

| Movement | EB | EB | EB | WB | WB | WB | NB | NB | NB | SB | SB |
|-----------------------|-----|-----|-----|-----|-----|-----|-----|-----|-----|-----|----|
| Directions Served | LT | R | R | L | LT | TR | L | LT | R | LT | R |
| Maximum Queue (ft) | 260 | 127 | 97 | 196 | 248 | 170 | 174 | 200 | 192 | 88 | 70 |
| Average Queue (ft) | 133 | 29 | 18 | 115 | 143 | 107 | 76 | 99 | 62 | 23 | 29 |
| 95th Queue (ft) | 235 | 102 | 76 | 173 | 212 | 181 | 145 | 165 | 138 | 60 | 62 |
| Link Distance (ft) | | 691 | 691 | | 506 | | | 216 | | 286 | |
| Upstream Blk Time (%) | | | | | | | 0 | 0 | 0 | | |
| Queuing Penalty (veh) | | | | | | | 0 | 1 | 0 | | |
| Storage Bay Dist (ft) | 300 | | | 360 | | 120 | 150 | | 150 | | 25 |
| Storage Blk Time (%) | 1 | | | | 16 | 3 | 0 | 2 | 0 | 28 | 11 |
| Queuing Penalty (veh) | 2 | | | | 41 | 11 | 2 | 10 | 1 | 15 | 4 |

6: Main St & Freedom Blvd & Western Dr Performance by movement

| Movement | EBL | EBT | EBR | WBL | WBT | WBR | NBL | NBT | NBR | SBL | SBT | SBR |
|--------------------|------|------|------|------|------|------|------|------|-----|------|------|------|
| Denied Del/Veh (s) | 0.0 | 0.2 | 0.0 | 0.0 | 0.0 | 0.0 | 0.0 | 0.0 | 0.0 | 0.2 | 0.3 | 4.0 |
| Total Del/Veh (s) | 90.1 | 89.1 | 15.4 | 43.6 | 42.9 | 26.6 | 22.1 | 23.2 | 9.9 | 48.0 | 48.0 | 47.6 |

6: Main St & Freedom Blvd & Western Dr Performance by movement

| Movement | All |
|--------------------|------|
| Denied Del/Veh (s) | 0.1 |
| Total Del/Veh (s) | 38.8 |

Intersection: 6: Main St & Freedom Blvd & Western Dr

| Movement | EB | EB | EB | WB | WB | WB | NB | NB | NB | SB | SB |
|-----------------------|-----|-----|-----|-----|-----|-----|-----|-----|-----|-----|----|
| Directions Served | LT | R | R | L | LT | TR | L | LT | R | LT | R |
| Maximum Queue (ft) | 350 | 684 | 626 | 273 | 329 | 170 | 171 | 200 | 186 | 143 | 75 |
| Average Queue (ft) | 298 | 321 | 187 | 146 | 173 | 127 | 82 | 108 | 76 | 51 | 42 |
| 95th Queue (ft) | 430 | 764 | 582 | 227 | 269 | 194 | 149 | 173 | 156 | 115 | 81 |
| Link Distance (ft) | | 691 | 691 | | 506 | | | 216 | | 286 | |
| Upstream Blk Time (%) | | 4 | 0 | | 0 | | 0 | 0 | 0 | | |
| Queuing Penalty (veh) | | 18 | 1 | | 0 | | 0 | 3 | 0 | | |
| Storage Bay Dist (ft) | 300 | | | 360 | | 120 | 150 | | 150 | | 25 |
| Storage Blk Time (%) | 36 | 0 | | | 25 | 6 | 0 | 1 | 1 | 43 | 42 |
| Queuing Penalty (veh) | 92 | 0 | | | 84 | 33 | 2 | 8 | 5 | 23 | 23 |

6: Main St & Freedom Blvd & Western Dr Performance by movement

| Movement | EBL | EBT | EBR | WBL | WBT | WBR | NBL | NBT | NBR | SBL | SBT | SBR |
|--------------------|------|------|------|------|------|------|------|------|-----|------|------|-----|
| Denied Del/Veh (s) | 0.0 | 0.0 | 0.0 | 0.0 | 0.0 | 0.0 | 0.0 | 0.0 | 0.0 | 0.2 | 0.3 | 4.1 |
| Total Del/Veh (s) | 30.2 | 31.7 | 17.7 | 37.7 | 35.7 | 17.0 | 19.3 | 14.3 | 7.3 | 42.0 | 44.8 | 7.7 |

6: Main St & Freedom Blvd & Western Dr Performance by movement

| Movement | All |
|--------------------|------|
| Denied Del/Veh (s) | 0.1 |
| Total Del/Veh (s) | 23.6 |

Intersection: 6: Main St & Freedom Blvd & Western Dr

| Movement | EB | EB | EB | WB | WB | WB | NB | NB | NB | SB | SB |
|-----------------------|-----|-----|-----|-----|-----|-----|-----|-----|-----|-----|----|
| Directions Served | LT | R | R | L | LT | TR | L | LT | R | LT | R |
| Maximum Queue (ft) | 229 | 174 | 158 | 190 | 218 | 162 | 144 | 165 | 148 | 54 | 56 |
| Average Queue (ft) | 154 | 102 | 97 | 138 | 153 | 104 | 91 | 114 | 79 | 26 | 31 |
| 95th Queue (ft) | 280 | 206 | 192 | 214 | 245 | 186 | 167 | 192 | 160 | 60 | 63 |
| Link Distance (ft) | | 691 | 691 | | 506 | | | 216 | | 286 | |
| Upstream Blk Time (%) | | | | | | | | 0 | 0 | | |
| Queuing Penalty (veh) | | | | | | | | 1 | 0 | | |
| Storage Bay Dist (ft) | 300 | | | 360 | | 120 | 150 | | 150 | | 25 |
| Storage Blk Time (%) | 1 | | | | 16 | 3 | 1 | 3 | 1 | 32 | 9 |
| Queuing Penalty (veh) | 2 | | | | 47 | 13 | 5 | 19 | 3 | 15 | 3 |

1: Main St & W Lake Ave/E Lake Ave Performance by movement

| Movement | EBL | EBT | EBR | WBL | WBT | WBR | NBL | NBT | NBR | SBL | SBT | SBR |
|--------------------|------|------|------|------|------|------|------|------|-----|------|------|-----|
| Denied Del/Veh (s) | 0.0 | 0.0 | 0.0 | 0.0 | 0.0 | 0.0 | 0.0 | 0.0 | 0.0 | 0.0 | 0.0 | 0.0 |
| Total Del/Veh (s) | 50.1 | 31.4 | 24.3 | 43.9 | 23.6 | 15.8 | 57.2 | 22.8 | 9.8 | 51.7 | 16.9 | 9.8 |

1: Main St & W Lake Ave/E Lake Ave Performance by movement

| Movement | All |
|--------------------|------|
| Denied Del/Veh (s) | 0.0 |
| Total Del/Veh (s) | 23.3 |

2: Main St & W Beach St/E Beach St Performance by movement

| Movement | EBL | EBT | EBR | WBL | WBT | WBR | NBL | NBT | NBR | SBL | SBT | SBR |
|--------------------|------|------|------|------|------|------|------|------|------|------|------|------|
| Denied Del/Veh (s) | 0.0 | 0.4 | 0.1 | 0.0 | 0.0 | 0.0 | 0.6 | 0.2 | 0.3 | 0.0 | 0.0 | 0.0 |
| Total Del/Veh (s) | 75.3 | 92.1 | 81.4 | 55.9 | 38.9 | 34.8 | 59.1 | 27.4 | 21.5 | 68.4 | 19.2 | 10.4 |

2: Main St & W Beach St/E Beach St Performance by movement

| Movement | All |
|--------------------|------|
| Denied Del/Veh (s) | 0.1 |
| Total Del/Veh (s) | 40.1 |

3: W Riverside Dr/E Riverside Dr & Main St Performance by movement

| Movement | EBL | EBT | EBR | WBL | WBT | WBR | NBL | NBT | NBR | SBL | SBT | SBR |
|--------------------|------|------|------|------|------|------|------|------|------|------|------|------|
| Denied Del/Veh (s) | 1.9 | 0.1 | 0.2 | 1.6 | 0.2 | 0.3 | 3.1 | 3.8 | 3.7 | 0.0 | 0.0 | 0.0 |
| Total Del/Veh (s) | 56.2 | 41.3 | 17.5 | 44.7 | 33.0 | 26.7 | 39.6 | 65.8 | 48.2 | 59.7 | 37.2 | 36.6 |

3: W Riverside Dr/E Riverside Dr & Main St Performance by movement

| Movement | All |
|--------------------|------|
| Denied Del/Veh (s) | 1.4 |
| Total Del/Veh (s) | 42.0 |

4: Union St/Brennan St & E Lake Ave Performance by movement

| Movement | EBL | EBT | EBR | WBL | WBT | WBR | NBL | NBT | NBR | SBL | SBT | SBR |
|--------------------|------|------|-----|------|-----|-----|------|------|-----|------|------|-----|
| Denied Del/Veh (s) | 0.1 | 0.0 | 0.0 | 3.3 | 0.5 | 0.7 | 0.0 | 0.0 | 0.0 | 3.8 | 0.4 | 0.4 |
| Total Del/Veh (s) | 14.2 | 10.3 | 8.7 | 13.7 | 8.1 | 4.9 | 19.9 | 11.6 | 5.4 | 18.5 | 14.1 | 7.2 |

4: Union St/Brennan St & E Lake Ave Performance by movement

| Movement | All |
|--------------------|------|
| Denied Del/Veh (s) | 0.5 |
| Total Del/Veh (s) | 10.9 |

5: Union St & E Beach St Performance by movement

| Movement | EBT | EBR | WBL | WBT | NBL | NBR | All |
|--------------------|------|------|-----|------|------|-----|------|
| Denied Del/Veh (s) | 0.0 | 0.0 | 0.0 | 0.0 | 3.8 | 0.2 | 0.3 |
| Total Del/Veh (s) | 34.5 | 28.9 | 7.2 | 12.1 | 25.1 | 7.8 | 21.7 |

7: Rodriguez St & Main St Performance by movement

| Movement | EBT | EBR | WBL | WBT | NBL | NBR | All |
|--------------------|------|------|------|-----|------|------|------|
| Denied Del/Veh (s) | 0.3 | 0.2 | 0.0 | 0.0 | 0.4 | 0.3 | 0.2 |
| Total Del/Veh (s) | 18.3 | 12.3 | 31.1 | 3.6 | 38.8 | 35.0 | 17.7 |

8: Brennan St & Freedom Blvd Performance by movement

| Movement | EBL | EBT | EBR | WBL | WBT | WBR | NBL | NBT | NBR | SBL | SBT | SBR |
|--------------------|------|------|-----|------|------|------|------|------|------|------|------|------|
| Denied Del/Veh (s) | 0.0 | 0.0 | 0.0 | 3.2 | 0.8 | 0.6 | 3.8 | 0.4 | 0.5 | 3.9 | 0.5 | 0.3 |
| Total Del/Veh (s) | 37.3 | 16.8 | 6.6 | 40.2 | 18.5 | 10.0 | 38.4 | 29.5 | 12.5 | 34.0 | 28.0 | 18.1 |

8: Brennan St & Freedom Blvd Performance by movement

| Movement | All |
|--------------------|------|
| Denied Del/Veh (s) | 0.8 |
| Total Del/Veh (s) | 21.6 |

9: E Beach St & Alexander St Performance by movement

| Movement | EBL | EBT | WBT | WBR | SBL | SBR | All |
|--------------------|-----|-----|------|------|------|-----|------|
| Denied Del/Veh (s) | 0.0 | 0.0 | 2.8 | 3.6 | 0.0 | 0.0 | 1.4 |
| Total Del/Veh (s) | 2.7 | 3.1 | 46.1 | 40.5 | 32.4 | 6.1 | 24.6 |

Total Zone Performance

| | |
|--------------------|-------|
| Denied Del/Veh (s) | 1.5 |
| Total Del/Veh (s) | 293.3 |

Intersection: 1: Main St & W Lake Ave/E Lake Ave

| Movement | EB | EB | WB | WB | WB | NB | NB | NB | SB | SB | SB | B36 |
|-----------------------|-----|-----|-----|-----|-----|-----|-----|-----|-----|-----|-----|-----|
| Directions Served | L | TR | L | T | R | L | T | R | L | T | R | T |
| Maximum Queue (ft) | 50 | 131 | 114 | 122 | 134 | 107 | 253 | 162 | 180 | 344 | 129 | 93 |
| Average Queue (ft) | 24 | 88 | 78 | 67 | 90 | 51 | 173 | 77 | 116 | 244 | 63 | 24 |
| 95th Queue (ft) | 59 | 155 | 126 | 140 | 153 | 120 | 282 | 194 | 208 | 389 | 165 | 133 |
| Link Distance (ft) | | 626 | | 467 | | | 587 | | | 811 | | 328 |
| Upstream Blk Time (%) | | | | | | | | | | | | 0 |
| Queuing Penalty (veh) | | | | | | | | | | | | 0 |
| Storage Bay Dist (ft) | 300 | | 300 | | 105 | 100 | | 150 | 350 | | 100 | |
| Storage Blk Time (%) | | | | 3 | 5 | 1 | 38 | | | 20 | 0 | |
| Queuing Penalty (veh) | | | | 12 | 13 | 7 | 97 | | | 57 | 0 | |

Intersection: 1: Main St & W Lake Ave/E Lake Ave

| Movement | B36 |
|-----------------------|-----|
| Directions Served | |
| Maximum Queue (ft) | 9 |
| Average Queue (ft) | 2 |
| 95th Queue (ft) | 17 |
| Link Distance (ft) | 328 |
| Upstream Blk Time (%) | |
| Queuing Penalty (veh) | |
| Storage Bay Dist (ft) | |
| Storage Blk Time (%) | |
| Queuing Penalty (veh) | |

Intersection: 2: Main St & W Beach St/E Beach St

| Movement | EB | EB | WB | WB | NB | NB | NB | SB | SB | SB |
|-----------------------|-----|-----|-----|-----|-----|------|-----|-----|-----|-----|
| Directions Served | L | TR | L | TR | L | T | R | L | T | R |
| Maximum Queue (ft) | 249 | 412 | 162 | 246 | 331 | 568 | 122 | 62 | 273 | 134 |
| Average Queue (ft) | 189 | 369 | 100 | 173 | 132 | 326 | 51 | 39 | 167 | 48 |
| 95th Queue (ft) | 341 | 478 | 196 | 272 | 371 | 664 | 138 | 79 | 293 | 138 |
| Link Distance (ft) | | 385 | 267 | 267 | | 1438 | | | 587 | |
| Upstream Blk Time (%) | | 23 | 0 | 1 | | | | | | |
| Queuing Penalty (veh) | | 116 | 0 | 3 | | | | | | |
| Storage Bay Dist (ft) | 200 | | | | 400 | | 75 | 400 | | 100 |
| Storage Blk Time (%) | 0 | 64 | | | 0 | 34 | 1 | | 30 | 0 |
| Queuing Penalty (veh) | 2 | 61 | | | 0 | 74 | 5 | | 44 | 0 |

Intersection: 3: W Riverside Dr/E Riverside Dr & Main St

| Movement | EB | EB | EB | EB | WB | WB | WB | WB | NB | NB | NB | NB |
|-----------------------|-----|------|------|------|-----|-----|------|------|-----|------|------|-----|
| Directions Served | L | T | T | R | L | L | T | TR | L | L | T | R |
| Maximum Queue (ft) | 106 | 185 | 171 | 249 | 156 | 186 | 265 | 243 | 146 | 730 | 895 | 215 |
| Average Queue (ft) | 64 | 145 | 123 | 169 | 121 | 149 | 185 | 188 | 88 | 406 | 697 | 141 |
| 95th Queue (ft) | 133 | 218 | 207 | 283 | 183 | 211 | 286 | 270 | 171 | 1139 | 1267 | 295 |
| Link Distance (ft) | | 1444 | 1444 | 1444 | | | 1793 | 1793 | | 1249 | 1249 | |
| Upstream Blk Time (%) | | | | | | | | | | 6 | 8 | |
| Queuing Penalty (veh) | | | | | | | | | | 0 | 0 | |
| Storage Bay Dist (ft) | 170 | | | | 140 | 140 | | | 305 | | | 165 |
| Storage Blk Time (%) | | 3 | | | 1 | 6 | 12 | | | | 46 | |
| Queuing Penalty (veh) | | 2 | | | 3 | 18 | 43 | | | | 92 | |

Intersection: 3: W Riverside Dr/E Riverside Dr & Main St

| Movement | SB | SB | SB |
|-----------------------|-----|------|-----|
| Directions Served | L | T | TR |
| Maximum Queue (ft) | 143 | 326 | 225 |
| Average Queue (ft) | 77 | 219 | 186 |
| 95th Queue (ft) | 174 | 353 | 270 |
| Link Distance (ft) | | 1438 | |
| Upstream Blk Time (%) | | | |
| Queuing Penalty (veh) | | | |
| Storage Bay Dist (ft) | 350 | | 175 |
| Storage Blk Time (%) | | 18 | 17 |
| Queuing Penalty (veh) | | 87 | 72 |

Intersection: 4: Union St/Brennan St & E Lake Ave

| Movement | EB | EB | WB | WB | NB | NB | SB | SB |
|-----------------------|-----|-----|-----|-----|-----|-----|-----|-----|
| Directions Served | L | TR | L | TR | L | TR | L | TR |
| Maximum Queue (ft) | 88 | 198 | 42 | 126 | 85 | 67 | 71 | 89 |
| Average Queue (ft) | 40 | 115 | 21 | 80 | 58 | 40 | 39 | 59 |
| 95th Queue (ft) | 100 | 222 | 51 | 143 | 100 | 82 | 84 | 105 |
| Link Distance (ft) | | 467 | | 262 | | 568 | | 390 |
| Upstream Blk Time (%) | | | | | | | | |
| Queuing Penalty (veh) | | | | | | | | |
| Storage Bay Dist (ft) | 100 | | 175 | | 270 | | 100 | |
| Storage Blk Time (%) | 0 | 8 | | 0 | | | 0 | 1 |
| Queuing Penalty (veh) | 0 | 6 | | 0 | | | 1 | 1 |

Intersection: 5: Union St & E Beach St

| Movement | EB | WB | WB | NB | NB |
|-----------------------|-----|----|----|-----|-----|
| Directions Served | TR | LT | T | L | R |
| Maximum Queue (ft) | 283 | 73 | 84 | 73 | 40 |
| Average Queue (ft) | 203 | 42 | 59 | 43 | 24 |
| 95th Queue (ft) | 320 | 82 | 94 | 85 | 52 |
| Link Distance (ft) | 267 | 98 | 98 | | 497 |
| Upstream Blk Time (%) | 6 | 0 | 1 | | |
| Queuing Penalty (veh) | 25 | 0 | 3 | | |
| Storage Bay Dist (ft) | | | | 100 | |
| Storage Blk Time (%) | | | | 0 | |
| Queuing Penalty (veh) | | | | 0 | |

Intersection: 7: Rodriguez St & Main St

| Movement | EB | EB | WB | WB | WB | NB | NB |
|-----------------------|------|------|-----|-----|-----|-----|-----|
| Directions Served | T | TR | L | T | T | L | LR |
| Maximum Queue (ft) | 269 | 227 | 123 | 81 | 91 | 149 | 256 |
| Average Queue (ft) | 204 | 163 | 79 | 31 | 39 | 76 | 191 |
| 95th Queue (ft) | 296 | 252 | 138 | 93 | 102 | 190 | 283 |
| Link Distance (ft) | 1000 | 1000 | | 691 | 691 | | 346 |
| Upstream Blk Time (%) | | | | | | | 0 |
| Queuing Penalty (veh) | | | | | | | 0 |
| Storage Bay Dist (ft) | | | 145 | | | 100 | |
| Storage Blk Time (%) | | | 2 | 0 | | 0 | 39 |
| Queuing Penalty (veh) | | | 5 | 0 | | 0 | 49 |

Intersection: 8: Brennan St & Freedom Blvd

| Movement | EB | EB | EB | WB | WB | NB | NB | SB | SB |
|-----------------------|-----|-----|-----|-----|-----|----|-----|----|-----|
| Directions Served | L | T | R | L | TR | L | TR | L | TR |
| Maximum Queue (ft) | 90 | 290 | 101 | 93 | 273 | 74 | 121 | 58 | 94 |
| Average Queue (ft) | 48 | 166 | 43 | 43 | 172 | 41 | 60 | 32 | 50 |
| 95th Queue (ft) | 118 | 331 | 137 | 110 | 317 | 91 | 143 | 67 | 110 |
| Link Distance (ft) | | 506 | | | 393 | | 267 | | 373 |
| Upstream Blk Time (%) | | | | | 1 | | 0 | | |
| Queuing Penalty (veh) | | | | | 0 | | 0 | | |
| Storage Bay Dist (ft) | 65 | | 200 | 200 | | 55 | | 75 | |
| Storage Blk Time (%) | 2 | 21 | | | 6 | 10 | 12 | 0 | 5 |
| Queuing Penalty (veh) | 13 | 42 | | | 5 | 16 | 9 | 1 | 4 |

Intersection: 9: E Beach St & Alexander St

| Movement | EB | WB | WB | SB | SB |
|-----------------------|----|-----|-----|-----|-----|
| Directions Served | LT | T | TR | L | R |
| Maximum Queue (ft) | 40 | 149 | 313 | 87 | 58 |
| Average Queue (ft) | 18 | 113 | 217 | 47 | 38 |
| 95th Queue (ft) | 50 | 191 | 388 | 98 | 62 |
| Link Distance (ft) | 98 | | 390 | | 568 |
| Upstream Blk Time (%) | | | 7 | | |
| Queuing Penalty (veh) | | | 0 | | |
| Storage Bay Dist (ft) | | 100 | | 220 | |
| Storage Blk Time (%) | | 9 | 47 | | |
| Queuing Penalty (veh) | | 28 | 78 | | |

Zone Summary

Zone wide Queuing Penalty: 1093

1: Main St & W Lake Ave/E Lake Ave Performance by movement

| Movement | EBL | EBT | EBR | WBL | WBT | WBR | NBL | NBT | NBR | SBL | SBT | SBR |
|--------------------|------|------|------|------|------|------|------|------|------|------|------|-----|
| Denied Del/Veh (s) | 0.0 | 0.0 | 0.0 | 0.0 | 0.0 | 0.0 | 0.0 | 0.0 | 0.0 | 0.0 | 0.0 | 0.0 |
| Total Del/Veh (s) | 44.9 | 34.5 | 25.8 | 49.8 | 29.2 | 17.5 | 56.2 | 20.6 | 11.6 | 46.8 | 18.5 | 9.7 |

1: Main St & W Lake Ave/E Lake Ave Performance by movement

| Movement | All |
|--------------------|------|
| Denied Del/Veh (s) | 0.0 |
| Total Del/Veh (s) | 23.3 |

2: Main St & W Beach St/E Beach St Performance by movement

| Movement | EBL | EBT | EBR | WBL | WBT | WBR | NBL | NBT | NBR | SBL | SBT | SBR |
|--------------------|------|------|------|------|------|------|------|------|------|------|------|------|
| Denied Del/Veh (s) | 0.0 | 0.0 | 0.0 | 0.0 | 0.0 | 0.0 | 0.0 | 0.0 | 0.0 | 0.0 | 0.0 | 0.0 |
| Total Del/Veh (s) | 51.9 | 52.0 | 43.6 | 55.1 | 47.9 | 41.5 | 43.7 | 35.0 | 27.3 | 93.1 | 28.5 | 14.8 |

2: Main St & W Beach St/E Beach St Performance by movement

| Movement | All |
|--------------------|------|
| Denied Del/Veh (s) | 0.0 |
| Total Del/Veh (s) | 40.5 |

3: W Riverside Dr/E Riverside Dr & Main St Performance by movement

| Movement | EBL | EBT | EBR | WBL | WBT | WBR | NBL | NBT | NBR | SBL | SBT | SBR |
|--------------------|------|------|------|------|------|------|-------|-------|-------|------|------|------|
| Denied Del/Veh (s) | 1.8 | 0.1 | 0.2 | 1.4 | 0.2 | 0.2 | 268.7 | 268.6 | 274.3 | 0.0 | 0.0 | 0.0 |
| Total Del/Veh (s) | 55.9 | 39.4 | 10.8 | 49.3 | 35.5 | 32.8 | 63.4 | 143.0 | 137.8 | 55.6 | 39.2 | 34.5 |

3: W Riverside Dr/E Riverside Dr & Main St Performance by movement

| Movement | All |
|--------------------|-------|
| Denied Del/Veh (s) | 112.7 |
| Total Del/Veh (s) | 68.3 |

4: Union St/Brennan St & E Lake Ave Performance by movement

| Movement | EBL | EBT | EBR | WBL | WBT | WBR | NBL | NBT | NBR | SBL | SBT | SBR |
|--------------------|------|------|------|------|------|------|------|------|------|------|------|------|
| Denied Del/Veh (s) | 0.0 | 0.0 | 0.0 | 3.4 | 1.1 | 1.1 | 0.3 | 0.0 | 0.0 | 3.7 | 0.4 | 0.4 |
| Total Del/Veh (s) | 35.3 | 23.1 | 18.9 | 27.6 | 14.7 | 11.3 | 31.0 | 20.6 | 12.2 | 31.8 | 21.1 | 12.8 |

4: Union St/Brennan St & E Lake Ave Performance by movement

| Movement | All |
|--------------------|------|
| Denied Del/Veh (s) | 0.9 |
| Total Del/Veh (s) | 21.1 |

5: Union St & E Beach St Performance by movement

| Movement | EBT | EBR | WBL | WBT | NBL | NBR | All |
|--------------------|------|------|-----|-----|------|------|------|
| Denied Del/Veh (s) | 0.0 | 0.0 | 0.0 | 0.0 | 3.9 | 0.3 | 0.1 |
| Total Del/Veh (s) | 30.7 | 26.0 | 8.5 | 9.3 | 45.1 | 11.1 | 18.2 |

7: Rodriguez St & Main St Performance by movement

| Movement | EBT | EBR | WBL | WBT | NBL | NBR | All |
|--------------------|------|-----|------|-----|------|------|------|
| Denied Del/Veh (s) | 0.2 | 0.3 | 0.0 | 0.0 | 0.4 | 0.4 | 0.2 |
| Total Del/Veh (s) | 12.6 | 6.5 | 33.2 | 8.6 | 19.6 | 15.9 | 11.8 |

8: Brennan St & Freedom Blvd Performance by movement

| Movement | EBL | EBT | EBR | WBL | WBT | NBL | NBT | NBR | SBL | SBT | SBR | All |
|--------------------|------|------|-----|------|-----|------|------|-----|------|------|-----|------|
| Denied Del/Veh (s) | 0.0 | 0.0 | 0.0 | 3.4 | 0.8 | 3.7 | 0.6 | 0.6 | 4.7 | 0.1 | 0.1 | 1.1 |
| Total Del/Veh (s) | 38.7 | 15.4 | 6.4 | 24.3 | 5.9 | 22.5 | 15.2 | 9.0 | 29.1 | 37.8 | 4.4 | 13.4 |

9: E Beach St & Alexander St Performance by movement

| Movement | EBL | EBT | WBT | WBR | SBL | SBT | SBR | All |
|--------------------|-----|-----|------|------|------|-----|------|------|
| Denied Del/Veh (s) | 0.0 | 0.0 | 5.3 | 3.6 | 0.0 | 0.0 | 0.0 | 1.6 |
| Total Del/Veh (s) | 8.0 | 8.0 | 49.5 | 39.5 | 33.0 | 1.3 | 16.5 | 24.3 |

Total Zone Performance

| | |
|--------------------|--------|
| Denied Del/Veh (s) | 65.4 |
| Total Del/Veh (s) | 1621.8 |

Intersection: 1: Main St & W Lake Ave/E Lake Ave

| Movement | EB | EB | WB | WB | WB | NB | NB | NB | SB | SB | SB | B36 |
|-----------------------|-----|-----|-----|-----|-----|-----|-----|-----|-----|-----|-----|-----|
| Directions Served | L | TR | L | T | R | L | T | R | L | T | R | T |
| Maximum Queue (ft) | 95 | 223 | 199 | 266 | 155 | 149 | 482 | 200 | 257 | 480 | 150 | 61 |
| Average Queue (ft) | 37 | 110 | 77 | 104 | 88 | 39 | 238 | 104 | 58 | 222 | 56 | 2 |
| 95th Queue (ft) | 78 | 191 | 152 | 197 | 156 | 108 | 462 | 231 | 146 | 409 | 151 | 31 |
| Link Distance (ft) | | 626 | | 467 | | | 587 | | | 811 | | 328 |
| Upstream Blk Time (%) | | | | | | | 0 | | | | | |
| Queuing Penalty (veh) | | | | | | | 0 | | | | | |
| Storage Bay Dist (ft) | 300 | | 300 | | 105 | 100 | | 150 | 350 | | 100 | |
| Storage Blk Time (%) | | 0 | | 8 | 5 | 0 | 22 | 0 | | 21 | 0 | |
| Queuing Penalty (veh) | | 0 | | 28 | 15 | 2 | 64 | 0 | | 37 | 0 | |

Intersection: 1: Main St & W Lake Ave/E Lake Ave

| Movement | B36 |
|-----------------------|-----|
| Directions Served | |
| Maximum Queue (ft) | 44 |
| Average Queue (ft) | 2 |
| 95th Queue (ft) | 23 |
| Link Distance (ft) | 328 |
| Upstream Blk Time (%) | |
| Queuing Penalty (veh) | |
| Storage Bay Dist (ft) | |
| Storage Blk Time (%) | |
| Queuing Penalty (veh) | |

Intersection: 2: Main St & W Beach St/E Beach St

| Movement | EB | EB | WB | WB | NB | NB | NB | SB | SB | SB |
|-----------------------|-----|-----|-----|-----|-----|------|-----|-----|-----|-----|
| Directions Served | L | TR | L | TR | L | T | R | L | T | R |
| Maximum Queue (ft) | 183 | 312 | 287 | 300 | 449 | 749 | 125 | 342 | 514 | 150 |
| Average Queue (ft) | 33 | 148 | 149 | 221 | 113 | 392 | 67 | 130 | 261 | 80 |
| 95th Queue (ft) | 106 | 270 | 279 | 323 | 344 | 700 | 151 | 280 | 465 | 180 |
| Link Distance (ft) | | 385 | 267 | 267 | | 1438 | | | 587 | |
| Upstream Blk Time (%) | | 0 | 2 | 9 | | | | | 0 | |
| Queuing Penalty (veh) | | 0 | 6 | 26 | | | | | 2 | |
| Storage Bay Dist (ft) | 200 | | | | 400 | | 75 | 400 | | 100 |
| Storage Blk Time (%) | | 6 | | | | 40 | 1 | 2 | 30 | 0 |
| Queuing Penalty (veh) | | 2 | | | | 93 | 8 | 9 | 75 | 0 |

Intersection: 3: W Riverside Dr/E Riverside Dr & Main St

| Movement | EB | EB | EB | EB | WB | WB | WB | WB | NB | NB | NB | NB |
|-----------------------|-----|------|------|------|-----|-----|------|------|-----|------|------|-----|
| Directions Served | L | T | T | R | L | L | T | TR | L | L | T | R |
| Maximum Queue (ft) | 144 | 198 | 193 | 225 | 164 | 190 | 268 | 268 | 204 | 1296 | 1301 | 215 |
| Average Queue (ft) | 53 | 119 | 109 | 95 | 89 | 123 | 154 | 166 | 90 | 1230 | 1251 | 162 |
| 95th Queue (ft) | 110 | 176 | 175 | 175 | 162 | 196 | 248 | 249 | 174 | 1561 | 1433 | 290 |
| Link Distance (ft) | | 1444 | 1444 | 1444 | | | 1793 | 1793 | | 1249 | 1249 | |
| Upstream Blk Time (%) | | | | | | | | | | 48 | 68 | |
| Queuing Penalty (veh) | | | | | | | | | | 0 | 0 | |
| Storage Bay Dist (ft) | 170 | | | | 140 | 140 | | | 305 | | | 165 |
| Storage Blk Time (%) | 0 | 1 | | | 1 | 3 | 9 | | | | 48 | 0 |
| Queuing Penalty (veh) | 0 | 1 | | | 2 | 8 | 27 | | | | 132 | 1 |

Intersection: 3: W Riverside Dr/E Riverside Dr & Main St

| Movement | SB | SB | SB |
|-----------------------|-----|------|-----|
| Directions Served | L | T | TR |
| Maximum Queue (ft) | 176 | 355 | 225 |
| Average Queue (ft) | 54 | 172 | 154 |
| 95th Queue (ft) | 119 | 289 | 240 |
| Link Distance (ft) | | 1438 | |
| Upstream Blk Time (%) | | | |
| Queuing Penalty (veh) | | | |
| Storage Bay Dist (ft) | 350 | | 175 |
| Storage Blk Time (%) | | 8 | 6 |
| Queuing Penalty (veh) | | 28 | 20 |

Intersection: 4: Union St/Brennan St & E Lake Ave

| Movement | EB | EB | WB | WB | NB | NB | SB | SB |
|-----------------------|-----|-----|-----|-----|-----|-----|-----|-----|
| Directions Served | L | TR | L | TR | L | TR | L | TR |
| Maximum Queue (ft) | 150 | 357 | 224 | 278 | 72 | 141 | 111 | 186 |
| Average Queue (ft) | 75 | 169 | 105 | 145 | 28 | 67 | 30 | 85 |
| 95th Queue (ft) | 152 | 296 | 187 | 246 | 62 | 119 | 74 | 151 |
| Link Distance (ft) | | 467 | | 262 | | 568 | | 390 |
| Upstream Blk Time (%) | | 0 | | 1 | | | | |
| Queuing Penalty (veh) | | 0 | | 0 | | | | |
| Storage Bay Dist (ft) | 100 | | 175 | | 270 | | 100 | |
| Storage Blk Time (%) | 2 | 24 | 1 | 4 | | | 0 | 5 |
| Queuing Penalty (veh) | 7 | 22 | 3 | 7 | | | 0 | 2 |

Intersection: 5: Union St & E Beach St

| Movement | EB | WB | WB | NB | NB |
|-----------------------|-----|-----|-----|-----|-----|
| Directions Served | TR | LT | T | L | R |
| Maximum Queue (ft) | 300 | 105 | 116 | 87 | 100 |
| Average Queue (ft) | 209 | 57 | 67 | 28 | 38 |
| 95th Queue (ft) | 329 | 106 | 118 | 67 | 73 |
| Link Distance (ft) | 267 | 98 | 98 | | 497 |
| Upstream Blk Time (%) | 6 | 3 | 6 | | |
| Queuing Penalty (veh) | 28 | 8 | 20 | | |
| Storage Bay Dist (ft) | | | | 100 | |
| Storage Blk Time (%) | | | | 1 | 0 |
| Queuing Penalty (veh) | | | | 1 | 0 |

Intersection: 7: Rodriguez St & Main St

| Movement | EB | EB | WB | WB | WB | NB | NB |
|-----------------------|------|------|-----|-----|-----|-----|-----|
| Directions Served | T | TR | L | T | T | L | LR |
| Maximum Queue (ft) | 237 | 203 | 38 | 174 | 177 | 149 | 283 |
| Average Queue (ft) | 116 | 81 | 9 | 77 | 70 | 42 | 141 |
| 95th Queue (ft) | 195 | 161 | 31 | 142 | 136 | 146 | 232 |
| Link Distance (ft) | 1000 | 1000 | | 691 | 691 | | 346 |
| Upstream Blk Time (%) | | | | | | | 0 |
| Queuing Penalty (veh) | | | | | | | 0 |
| Storage Bay Dist (ft) | | | 145 | | | 100 | |
| Storage Blk Time (%) | | | | 1 | | 0 | 17 |
| Queuing Penalty (veh) | | | | 0 | | 0 | 31 |

Intersection: 8: Brennan St & Freedom Blvd

| Movement | EB | EB | EB | WB | WB | NB | NB | SB | SB |
|-----------------------|----|-----|-----|-----|-----|----|-----|----|-----|
| Directions Served | L | T | R | L | TR | L | TR | L | TR |
| Maximum Queue (ft) | 37 | 285 | 178 | 156 | 152 | 96 | 139 | 11 | 8 |
| Average Queue (ft) | 2 | 124 | 37 | 69 | 58 | 47 | 36 | 1 | 0 |
| 95th Queue (ft) | 20 | 231 | 106 | 130 | 118 | 87 | 96 | 6 | 5 |
| Link Distance (ft) | | 506 | | | 393 | | 267 | | 373 |
| Upstream Blk Time (%) | | | | | | | | | |
| Queuing Penalty (veh) | | | | | | | | | |
| Storage Bay Dist (ft) | 65 | | 200 | 200 | | 55 | | 75 | |
| Storage Blk Time (%) | | 18 | | | 0 | 8 | 2 | | |
| Queuing Penalty (veh) | | 23 | | | 0 | 12 | 3 | | |

Intersection: 9: E Beach St & Alexander St

| Movement | EB | WB | WB | SB | SB |
|-----------------------|-----|-----|-----|-----|-----|
| Directions Served | LT | T | TR | L | R |
| Maximum Queue (ft) | 107 | 150 | 381 | 150 | 239 |
| Average Queue (ft) | 69 | 106 | 192 | 56 | 97 |
| 95th Queue (ft) | 117 | 182 | 352 | 125 | 213 |
| Link Distance (ft) | 98 | | 390 | | 568 |
| Upstream Blk Time (%) | 8 | | 5 | | 0 |
| Queuing Penalty (veh) | 41 | | 0 | | 2 |
| Storage Bay Dist (ft) | | 100 | | 220 | |
| Storage Blk Time (%) | | 9 | 39 | | 2 |
| Queuing Penalty (veh) | | 23 | 62 | | 2 |

Zone Summary

Zone wide Queuing Penalty: 880

E – Queuing Summary



Queues

1: Main St & W Lake Ave/E Lake Ave

Existing
Timing Plan: AM PEAK HOUR



| Lane Group | WBT | WBR | NBT | SBT |
|-----------------------------|------|------|------|------|
| Lane Group Flow (vph) | 697 | 195 | 682 | 794 |
| v/c Ratio | 0.53 | 0.28 | 0.54 | 0.58 |
| Control Delay | 12.0 | 4.4 | 11.9 | 11.9 |
| Queue Delay | 0.0 | 0.0 | 0.0 | 0.0 |
| Total Delay | 12.0 | 4.4 | 11.9 | 11.9 |
| Queue Length 50th (ft) | 59 | 5 | 58 | 66 |
| Queue Length 95th (ft) | 108 | 29 | 105 | 117 |
| Internal Link Dist (ft) | 140 | | 577 | 679 |
| Turn Bay Length (ft) | | 105 | | |
| Base Capacity (vph) | 3080 | 1393 | 2993 | 3207 |
| Starvation Cap Reductn | 0 | 0 | 0 | 0 |
| Spillback Cap Reductn | 0 | 0 | 0 | 0 |
| Storage Cap Reductn | 0 | 0 | 0 | 0 |
| Reduced v/c Ratio | 0.23 | 0.14 | 0.23 | 0.25 |
| Intersection Summary | | | | |

Queues

2: Main St & W Beach St/E Beach St

Existing
Timing Plan: AM PEAK HOUR



| Lane Group | EBT | NBL | NBT | SBL | SBT |
|-------------------------|------|------|------|------|------|
| Lane Group Flow (vph) | 367 | 75 | 788 | 200 | 705 |
| v/c Ratio | 0.46 | 0.30 | 0.68 | 0.58 | 0.41 |
| Control Delay | 21.8 | 30.2 | 19.2 | 30.3 | 11.6 |
| Queue Delay | 0.0 | 0.0 | 0.0 | 0.0 | 0.0 |
| Total Delay | 21.8 | 30.2 | 19.2 | 30.3 | 11.6 |
| Queue Length 50th (ft) | 54 | 26 | 120 | 67 | 95 |
| Queue Length 95th (ft) | 103 | 63 | 173 | 127 | 126 |
| Internal Link Dist (ft) | 380 | | 1445 | | 577 |
| Turn Bay Length (ft) | | 105 | | 140 | |
| Base Capacity (vph) | 1746 | 643 | 2394 | 809 | 2687 |
| Starvation Cap Reductn | 0 | 0 | 0 | 0 | 0 |
| Spillback Cap Reductn | 0 | 0 | 0 | 0 | 0 |
| Storage Cap Reductn | 0 | 0 | 0 | 0 | 0 |
| Reduced v/c Ratio | 0.21 | 0.12 | 0.33 | 0.25 | 0.26 |

Intersection Summary

Queues
3: W Riverside Dr/E Riverside Dr & Main St

Existing
Timing Plan: AM PEAK HOUR



| Lane Group | EBL | EBT | EBR | WBL | WBT | NBL | NBT | NBR | SBL | SBT |
|-------------------------|------|------|------|------|------|------|------|------|------|------|
| Lane Group Flow (vph) | 62 | 373 | 325 | 290 | 547 | 405 | 832 | 313 | 55 | 477 |
| v/c Ratio | 0.43 | 0.36 | 0.35 | 0.79 | 0.46 | 0.83 | 0.59 | 0.40 | 0.39 | 0.77 |
| Control Delay | 59.6 | 33.9 | 9.8 | 66.3 | 32.1 | 55.4 | 29.5 | 6.4 | 58.3 | 53.1 |
| Queue Delay | 0.0 | 0.0 | 0.0 | 0.0 | 0.0 | 0.0 | 0.0 | 0.0 | 0.0 | 0.0 |
| Total Delay | 59.6 | 33.9 | 9.8 | 66.3 | 32.1 | 55.4 | 29.5 | 6.4 | 58.3 | 53.1 |
| Queue Length 50th (ft) | 45 | 117 | 75 | 109 | 171 | 273 | 252 | 21 | 39 | 178 |
| Queue Length 95th (ft) | 88 | 162 | 155 | #173 | 233 | #513 | 323 | 85 | 81 | 216 |
| Internal Link Dist (ft) | | 412 | | | 555 | | 462 | | | 1445 |
| Turn Bay Length (ft) | 170 | | | 140 | | 305 | | 165 | 150 | |
| Base Capacity (vph) | 189 | 1036 | 923 | 367 | 1189 | 488 | 1418 | 776 | 204 | 869 |
| Starvation Cap Reductn | 0 | 0 | 0 | 0 | 0 | 0 | 0 | 0 | 0 | 0 |
| Spillback Cap Reductn | 0 | 0 | 0 | 0 | 0 | 0 | 0 | 0 | 0 | 0 |
| Storage Cap Reductn | 0 | 0 | 0 | 0 | 0 | 0 | 0 | 0 | 0 | 0 |
| Reduced v/c Ratio | 0.33 | 0.36 | 0.35 | 0.79 | 0.46 | 0.83 | 0.59 | 0.40 | 0.27 | 0.55 |

Intersection Summary

95th percentile volume exceeds capacity, queue may be longer.
Queue shown is maximum after two cycles.

Queues
4: Union St/Brennan St & E Lake Ave

Existing
Timing Plan: AM PEAK HOUR



| Lane Group | WBT | NBL | NBT | SBT | SBR |
|-------------------------|------|------|------|------|------|
| Lane Group Flow (vph) | 1024 | 32 | 224 | 192 | 58 |
| v/c Ratio | 0.59 | 0.10 | 0.43 | 0.37 | 0.12 |
| Control Delay | 9.1 | 13.2 | 15.8 | 15.1 | 5.3 |
| Queue Delay | 0.0 | 0.0 | 0.0 | 0.0 | 0.0 |
| Total Delay | 9.1 | 13.2 | 15.8 | 15.1 | 5.3 |
| Queue Length 50th (ft) | 66 | 5 | 38 | 32 | 0 |
| Queue Length 95th (ft) | 133 | 20 | 92 | 80 | 15 |
| Internal Link Dist (ft) | 220 | | 196 | 348 | |
| Turn Bay Length (ft) | | 100 | | | 75 |
| Base Capacity (vph) | 3064 | 1020 | 1617 | 1617 | 1348 |
| Starvation Cap Reductn | 0 | 0 | 0 | 0 | 0 |
| Spillback Cap Reductn | 0 | 0 | 0 | 0 | 0 |
| Storage Cap Reductn | 0 | 0 | 0 | 0 | 0 |
| Reduced v/c Ratio | 0.33 | 0.03 | 0.14 | 0.12 | 0.04 |

Intersection Summary

Queues
5: Union St & E Beach St

Existing
Timing Plan: AM PEAK HOUR



| Lane Group | EBT | NBT | SBL | SBT |
|-----------------------------|------|------|------|------|
| Lane Group Flow (vph) | 685 | 282 | 95 | 256 |
| v/c Ratio | 0.61 | 0.43 | 0.28 | 0.44 |
| Control Delay | 10.5 | 8.5 | 9.6 | 10.1 |
| Queue Delay | 0.0 | 0.0 | 0.0 | 0.0 |
| Total Delay | 10.5 | 8.5 | 9.6 | 10.1 |
| Queue Length 50th (ft) | 30 | 21 | 8 | 23 |
| Queue Length 95th (ft) | 81 | 56 | 28 | 59 |
| Internal Link Dist (ft) | 271 | 352 | | 238 |
| Turn Bay Length (ft) | | | 110 | |
| Base Capacity (vph) | 3323 | 1938 | 1055 | 1810 |
| Starvation Cap Reductn | 0 | 0 | 0 | 0 |
| Spillback Cap Reductn | 0 | 0 | 0 | 0 |
| Storage Cap Reductn | 0 | 0 | 0 | 0 |
| Reduced v/c Ratio | 0.21 | 0.15 | 0.09 | 0.14 |
| Intersection Summary | | | | |

Queues
6: Main St & Freedom Blvd & Western Dr

Existing
Timing Plan: AM PEAK HOUR



| Lane Group | EBT | EBR | WBL | WBT | NBL | NBT | NBR | SBT | SBR |
|-------------------------|------|------|------|------|------|------|------|------|------|
| Lane Group Flow (vph) | 224 | 477 | 162 | 335 | 280 | 280 | 346 | 28 | 44 |
| v/c Ratio | 0.84 | 0.23 | 0.74 | 0.74 | 0.34 | 0.34 | 0.30 | 0.17 | 0.18 |
| Control Delay | 75.0 | 3.1 | 68.8 | 59.3 | 23.6 | 23.5 | 1.4 | 53.0 | 1.7 |
| Queue Delay | 0.0 | 0.0 | 0.0 | 0.0 | 0.0 | 0.0 | 0.0 | 0.0 | 0.0 |
| Total Delay | 75.0 | 3.1 | 68.8 | 59.3 | 23.6 | 23.5 | 1.4 | 53.0 | 1.7 |
| Queue Length 50th (ft) | 172 | 0 | 136 | 141 | 137 | 137 | 0 | 20 | 0 |
| Queue Length 95th (ft) | 260 | 63 | 195 | 171 | 253 | 253 | 20 | 49 | 0 |
| Internal Link Dist (ft) | 722 | | | 546 | | 740 | | 295 | |
| Turn Bay Length (ft) | | | 360 | | | | 150 | | 25 |
| Base Capacity (vph) | 408 | 2046 | 327 | 676 | 831 | 835 | 1226 | 171 | 245 |
| Starvation Cap Reductn | 0 | 0 | 0 | 0 | 0 | 0 | 0 | 0 | 0 |
| Spillback Cap Reductn | 0 | 0 | 0 | 0 | 0 | 0 | 0 | 0 | 0 |
| Storage Cap Reductn | 0 | 0 | 0 | 0 | 0 | 0 | 0 | 0 | 0 |
| Reduced v/c Ratio | 0.55 | 0.23 | 0.50 | 0.50 | 0.34 | 0.34 | 0.28 | 0.16 | 0.18 |
| Intersection Summary | | | | | | | | | |

Queues
7: Rodriguez St & Main St

Existing
Timing Plan: AM PEAK HOUR



| Lane Group | EBT | WBL | WBT | NBL |
|-------------------------|------|------|------|------|
| Lane Group Flow (vph) | 890 | 8 | 785 | 222 |
| v/c Ratio | 0.34 | 0.05 | 0.25 | 0.53 |
| Control Delay | 6.8 | 45.3 | 1.3 | 52.3 |
| Queue Delay | 0.0 | 0.0 | 0.0 | 0.0 |
| Total Delay | 6.8 | 45.3 | 1.3 | 52.3 |
| Queue Length 50th (ft) | 68 | 5 | 2 | 84 |
| Queue Length 95th (ft) | 251 | m13 | 6 | 109 |
| Internal Link Dist (ft) | 958 | | 722 | 320 |
| Turn Bay Length (ft) | | 145 | | 100 |
| Base Capacity (vph) | 2584 | 256 | 3196 | 782 |
| Starvation Cap Reductn | 0 | 0 | 0 | 0 |
| Spillback Cap Reductn | 0 | 0 | 0 | 0 |
| Storage Cap Reductn | 0 | 0 | 0 | 0 |
| Reduced v/c Ratio | 0.34 | 0.03 | 0.25 | 0.28 |

Intersection Summary

m Volume for 95th percentile queue is metered by upstream signal.

Queues

8: Brennan St & Freedom Blvd

Existing

Timing Plan: AM PEAK HOUR



| Lane Group | EBL | EBT | EBR | WBL | WBT | NBL | NBT | SBL | SBT |
|-------------------------|------|------|------|------|------|------|------|------|------|
| Lane Group Flow (vph) | 7 | 452 | 113 | 210 | 402 | 129 | 156 | 4 | 16 |
| v/c Ratio | 0.05 | 0.61 | 0.19 | 0.52 | 0.34 | 0.47 | 0.36 | 0.02 | 0.06 |
| Control Delay | 34.5 | 20.8 | 6.2 | 27.2 | 6.9 | 29.6 | 7.8 | 23.7 | 14.1 |
| Queue Delay | 0.0 | 0.0 | 0.0 | 0.0 | 0.0 | 0.0 | 0.0 | 0.0 | 0.0 |
| Total Delay | 34.5 | 20.8 | 6.2 | 27.2 | 6.9 | 29.6 | 7.8 | 23.7 | 14.1 |
| Queue Length 50th (ft) | 2 | 121 | 4 | 61 | 48 | 38 | 0 | 1 | 1 |
| Queue Length 95th (ft) | 15 | 251 | 33 | 147 | 145 | 103 | 39 | 9 | 15 |
| Internal Link Dist (ft) | | 546 | | | 380 | | 266 | | 359 |
| Turn Bay Length (ft) | 65 | | 150 | 200 | | 55 | | 75 | |
| Base Capacity (vph) | 128 | 1762 | 1270 | 929 | 1814 | 612 | 770 | 512 | 709 |
| Starvation Cap Reductn | 0 | 0 | 0 | 0 | 0 | 0 | 0 | 0 | 0 |
| Spillback Cap Reductn | 0 | 0 | 0 | 0 | 0 | 0 | 0 | 0 | 0 |
| Storage Cap Reductn | 0 | 0 | 0 | 0 | 0 | 0 | 0 | 0 | 0 |
| Reduced v/c Ratio | 0.05 | 0.26 | 0.09 | 0.23 | 0.22 | 0.21 | 0.20 | 0.01 | 0.02 |

Intersection Summary

Queues

1: Main St & W Lake Ave/E Lake Ave

Existing
Timing Plan: PM PEAK HOUR



| Lane Group | WBT | WBR | NBT | SBT |
|-----------------------------|------|------|------|------|
| Lane Group Flow (vph) | 574 | 206 | 645 | 907 |
| v/c Ratio | 0.69 | 0.41 | 0.30 | 0.41 |
| Control Delay | 25.4 | 6.0 | 2.4 | 7.7 |
| Queue Delay | 0.0 | 0.0 | 0.0 | 0.0 |
| Total Delay | 25.4 | 6.0 | 2.4 | 7.7 |
| Queue Length 50th (ft) | 131 | 32 | 23 | 89 |
| Queue Length 95th (ft) | 164 | 31 | 31 | 158 |
| Internal Link Dist (ft) | 140 | | 577 | 679 |
| Turn Bay Length (ft) | | 105 | | |
| Base Capacity (vph) | 1261 | 676 | 2133 | 2208 |
| Starvation Cap Reductn | 0 | 0 | 0 | 0 |
| Spillback Cap Reductn | 0 | 0 | 0 | 0 |
| Storage Cap Reductn | 0 | 0 | 0 | 0 |
| Reduced v/c Ratio | 0.46 | 0.30 | 0.30 | 0.41 |
| Intersection Summary | | | | |

Queues

2: Main St & W Beach St/E Beach St

Existing
Timing Plan: PM PEAK HOUR



| Lane Group | EBT | NBL | NBT | SBL | SBT |
|-------------------------|------|------|------|------|------|
| Lane Group Flow (vph) | 565 | 63 | 762 | 253 | 818 |
| v/c Ratio | 0.74 | 0.36 | 0.58 | 0.62 | 0.41 |
| Control Delay | 32.4 | 37.3 | 19.8 | 27.6 | 8.4 |
| Queue Delay | 0.0 | 0.0 | 0.0 | 0.0 | 0.0 |
| Total Delay | 32.4 | 37.3 | 19.8 | 27.6 | 8.4 |
| Queue Length 50th (ft) | 126 | 28 | 132 | 111 | 85 |
| Queue Length 95th (ft) | 165 | 62 | 207 | 129 | 136 |
| Internal Link Dist (ft) | 380 | | 1445 | | 577 |
| Turn Bay Length (ft) | | 105 | | 140 | |
| Base Capacity (vph) | 960 | 431 | 1309 | 408 | 1991 |
| Starvation Cap Reductn | 0 | 0 | 0 | 0 | 0 |
| Spillback Cap Reductn | 0 | 0 | 0 | 0 | 0 |
| Storage Cap Reductn | 0 | 0 | 0 | 0 | 0 |
| Reduced v/c Ratio | 0.59 | 0.15 | 0.58 | 0.62 | 0.41 |

Intersection Summary

Queues
3: W Riverside Dr/E Riverside Dr & Main St

Existing
Timing Plan: PM PEAK HOUR



| Lane Group | EBL | EBT | EBR | WBL | WBT | NBL | NBT | NBR | SBL | SBT |
|-------------------------|------|------|------|-------|------|------|------|------|------|------|
| Lane Group Flow (vph) | 59 | 501 | 613 | 396 | 423 | 343 | 691 | 342 | 87 | 714 |
| v/c Ratio | 0.41 | 0.46 | 0.72 | 1.08 | 0.34 | 0.92 | 0.52 | 0.43 | 0.55 | 0.89 |
| Control Delay | 59.0 | 34.9 | 22.6 | 118.2 | 29.6 | 76.0 | 29.5 | 4.5 | 63.4 | 56.9 |
| Queue Delay | 0.0 | 0.0 | 0.0 | 0.0 | 0.0 | 0.0 | 0.0 | 0.0 | 0.0 | 0.0 |
| Total Delay | 59.0 | 34.9 | 22.6 | 118.2 | 29.6 | 76.0 | 29.5 | 4.5 | 63.4 | 56.9 |
| Queue Length 50th (ft) | 42 | 164 | 275 | ~169 | 126 | 246 | 198 | 0 | 63 | 263 |
| Queue Length 95th (ft) | 85 | 218 | 416 | #268 | 177 | #411 | 272 | 61 | 114 | 336 |
| Internal Link Dist (ft) | | 412 | | | 555 | | 462 | | | 1445 |
| Turn Bay Length (ft) | 170 | | | 140 | | 305 | | 165 | 150 | |
| Base Capacity (vph) | 189 | 1085 | 858 | 367 | 1238 | 391 | 1339 | 796 | 204 | 869 |
| Starvation Cap Reductn | 0 | 0 | 0 | 0 | 0 | 0 | 0 | 0 | 0 | 0 |
| Spillback Cap Reductn | 0 | 0 | 0 | 0 | 0 | 0 | 0 | 0 | 0 | 0 |
| Storage Cap Reductn | 0 | 0 | 0 | 0 | 0 | 0 | 0 | 0 | 0 | 0 |
| Reduced v/c Ratio | 0.31 | 0.46 | 0.71 | 1.08 | 0.34 | 0.88 | 0.52 | 0.43 | 0.43 | 0.82 |

Intersection Summary

~ Volume exceeds capacity, queue is theoretically infinite.
Queue shown is maximum after two cycles.

95th percentile volume exceeds capacity, queue may be longer.
Queue shown is maximum after two cycles.

Queues
4: Union St/Brennan St & E Lake Ave

Existing
Timing Plan: PM PEAK HOUR



| Lane Group | WBT | NBL | NBT | SBT | SBR |
|-----------------------------|------|------|------|------|------|
| Lane Group Flow (vph) | 939 | 67 | 323 | 202 | 76 |
| v/c Ratio | 0.43 | 0.28 | 0.70 | 0.44 | 0.17 |
| Control Delay | 8.1 | 23.8 | 33.6 | 25.7 | 6.0 |
| Queue Delay | 0.0 | 0.0 | 0.0 | 0.0 | 0.0 |
| Total Delay | 8.1 | 23.8 | 33.6 | 25.7 | 6.0 |
| Queue Length 50th (ft) | 94 | 25 | 138 | 80 | 0 |
| Queue Length 95th (ft) | 176 | 51 | 191 | 119 | 26 |
| Internal Link Dist (ft) | 220 | | 196 | 348 | |
| Turn Bay Length (ft) | | 100 | | | 75 |
| Base Capacity (vph) | 2185 | 466 | 889 | 889 | 773 |
| Starvation Cap Reductn | 0 | 0 | 0 | 0 | 0 |
| Spillback Cap Reductn | 0 | 0 | 0 | 0 | 0 |
| Storage Cap Reductn | 0 | 0 | 0 | 0 | 0 |
| Reduced v/c Ratio | 0.43 | 0.14 | 0.36 | 0.23 | 0.10 |
| Intersection Summary | | | | | |

Queues
5: Union St & E Beach St

Existing
Timing Plan: PM PEAK HOUR



| Lane Group | EBT | NBT | SBL | SBT |
|-------------------------|------|------|-------|------|
| Lane Group Flow (vph) | 847 | 305 | 133 | 290 |
| v/c Ratio | 0.38 | 0.67 | 1.10 | 0.72 |
| Control Delay | 5.6 | 29.8 | 139.2 | 37.0 |
| Queue Delay | 0.5 | 0.0 | 0.0 | 0.0 |
| Total Delay | 6.1 | 29.8 | 139.2 | 37.0 |
| Queue Length 50th (ft) | 70 | 112 | ~68 | 124 |
| Queue Length 95th (ft) | 176 | 165 | #144 | 177 |
| Internal Link Dist (ft) | 271 | 352 | | 238 |
| Turn Bay Length (ft) | | | 110 | |
| Base Capacity (vph) | 2241 | 694 | 191 | 630 |
| Starvation Cap Reductn | 881 | 0 | 0 | 0 |
| Spillback Cap Reductn | 0 | 0 | 0 | 0 |
| Storage Cap Reductn | 0 | 0 | 0 | 0 |
| Reduced v/c Ratio | 0.62 | 0.44 | 0.70 | 0.46 |

Intersection Summary

- ~ Volume exceeds capacity, queue is theoretically infinite.
Queue shown is maximum after two cycles.
- # 95th percentile volume exceeds capacity, queue may be longer.
Queue shown is maximum after two cycles.

Queues

6: Main St & Freedom Blvd & Western Dr

Existing

Timing Plan: PM PEAK HOUR



| Lane Group | EBT | EBR | WBL | WBT | NBL | NBT | NBR | SBT | SBR |
|-------------------------|------|------|------|------|------|------|------|------|------|
| Lane Group Flow (vph) | 438 | 618 | 206 | 421 | 279 | 275 | 386 | 38 | 38 |
| v/c Ratio | 0.92 | 0.31 | 0.81 | 0.80 | 0.53 | 0.52 | 0.42 | 0.19 | 0.13 |
| Control Delay | 71.0 | 3.3 | 64.5 | 52.3 | 33.9 | 33.7 | 2.4 | 43.1 | 1.0 |
| Queue Delay | 0.0 | 0.0 | 0.0 | 0.0 | 0.0 | 0.0 | 0.0 | 0.0 | 0.0 |
| Total Delay | 71.0 | 3.3 | 64.5 | 52.3 | 33.9 | 33.7 | 2.4 | 43.1 | 1.0 |
| Queue Length 50th (ft) | 301 | 0 | 139 | 142 | 160 | 156 | 2 | 22 | 0 |
| Queue Length 95th (ft) | #517 | 90 | #235 | 193 | 251 | 247 | 29 | 54 | 0 |
| Internal Link Dist (ft) | 722 | | | 546 | | 740 | | 295 | |
| Turn Bay Length (ft) | | | 360 | | | | 150 | | 25 |
| Base Capacity (vph) | 477 | 1974 | 305 | 632 | 529 | 532 | 954 | 201 | 285 |
| Starvation Cap Reductn | 0 | 0 | 0 | 0 | 0 | 0 | 0 | 0 | 0 |
| Spillback Cap Reductn | 0 | 0 | 0 | 0 | 0 | 0 | 0 | 0 | 0 |
| Storage Cap Reductn | 0 | 0 | 0 | 0 | 0 | 0 | 0 | 0 | 0 |
| Reduced v/c Ratio | 0.92 | 0.31 | 0.68 | 0.67 | 0.53 | 0.52 | 0.40 | 0.19 | 0.13 |

Intersection Summary

95th percentile volume exceeds capacity, queue may be longer.
 Queue shown is maximum after two cycles.

Queues
7: Rodriguez St & Main St

Existing
Timing Plan: PM PEAK HOUR



| Lane Group | EBT | WBL | WBT | NBL |
|-------------------------|------|------|------|------|
| Lane Group Flow (vph) | 1303 | 12 | 753 | 304 |
| v/c Ratio | 0.51 | 0.08 | 0.24 | 0.67 |
| Control Delay | 7.9 | 42.5 | 3.7 | 46.6 |
| Queue Delay | 0.0 | 0.0 | 0.0 | 0.0 |
| Total Delay | 7.9 | 42.5 | 3.7 | 46.6 |
| Queue Length 50th (ft) | 112 | 9 | 85 | 95 |
| Queue Length 95th (ft) | 381 | m16 | 111 | 120 |
| Internal Link Dist (ft) | 958 | | 722 | 320 |
| Turn Bay Length (ft) | | 145 | | 100 |
| Base Capacity (vph) | 2550 | 145 | 3130 | 840 |
| Starvation Cap Reductn | 0 | 0 | 0 | 0 |
| Spillback Cap Reductn | 0 | 0 | 0 | 0 |
| Storage Cap Reductn | 0 | 0 | 0 | 0 |
| Reduced v/c Ratio | 0.51 | 0.08 | 0.24 | 0.36 |

Intersection Summary

m Volume for 95th percentile queue is metered by upstream signal.

Queues
8: Brennan St & Freedom Blvd

Existing
Timing Plan: PM PEAK HOUR



| Lane Group | EBL | EBT | EBR | WBL | WBT | NBL | NBT | SBL | SBT |
|-------------------------|------|------|------|------|------|------|------|------|------|
| Lane Group Flow (vph) | 8 | 660 | 135 | 160 | 472 | 153 | 245 | 6 | 16 |
| v/c Ratio | 0.04 | 0.52 | 0.14 | 0.68 | 0.41 | 0.73 | 0.55 | 0.10 | 0.07 |
| Control Delay | 53.1 | 17.4 | 6.0 | 64.0 | 12.6 | 66.9 | 10.1 | 42.5 | 22.1 |
| Queue Delay | 0.0 | 1.2 | 0.0 | 0.0 | 0.0 | 0.0 | 0.0 | 0.0 | 0.0 |
| Total Delay | 53.1 | 18.7 | 6.0 | 64.0 | 12.6 | 66.9 | 10.1 | 42.5 | 22.1 |
| Queue Length 50th (ft) | 6 | 278 | 15 | 120 | 171 | 114 | 3 | 4 | 3 |
| Queue Length 95th (ft) | 23 | 485 | 53 | 185 | 240 | 177 | 70 | 16 | 22 |
| Internal Link Dist (ft) | | 546 | | | 380 | | 266 | | 359 |
| Turn Bay Length (ft) | 65 | | 150 | 200 | | 55 | | 75 | |
| Base Capacity (vph) | 198 | 1275 | 934 | 309 | 1161 | 288 | 528 | 99 | 353 |
| Starvation Cap Reductn | 0 | 380 | 0 | 0 | 0 | 0 | 0 | 0 | 0 |
| Spillback Cap Reductn | 0 | 0 | 0 | 0 | 0 | 0 | 0 | 0 | 0 |
| Storage Cap Reductn | 0 | 0 | 0 | 0 | 0 | 0 | 0 | 0 | 0 |
| Reduced v/c Ratio | 0.04 | 0.74 | 0.14 | 0.52 | 0.41 | 0.53 | 0.46 | 0.06 | 0.05 |
| Intersection Summary | | | | | | | | | |

Queues

1: Main St & W Lake Ave/E Lake Ave

Existing

Timing Plan: SATURDAY PEAK HOUR



| Lane Group | WBT | WBR | NBT | SBT |
|-----------------------------|------|------|------|------|
| Lane Group Flow (vph) | 558 | 240 | 604 | 800 |
| v/c Ratio | 0.68 | 0.46 | 0.29 | 0.36 |
| Control Delay | 29.5 | 8.6 | 3.1 | 7.3 |
| Queue Delay | 0.0 | 0.0 | 0.0 | 0.0 |
| Total Delay | 29.5 | 8.6 | 3.1 | 7.3 |
| Queue Length 50th (ft) | 123 | 16 | 23 | 77 |
| Queue Length 95th (ft) | 155 | 63 | 33 | 137 |
| Internal Link Dist (ft) | 140 | | 577 | 679 |
| Turn Bay Length (ft) | | 105 | | |
| Base Capacity (vph) | 1257 | 685 | 2102 | 2213 |
| Starvation Cap Reductn | 0 | 0 | 0 | 0 |
| Spillback Cap Reductn | 0 | 0 | 0 | 0 |
| Storage Cap Reductn | 0 | 0 | 0 | 0 |
| Reduced v/c Ratio | 0.44 | 0.35 | 0.29 | 0.36 |
| Intersection Summary | | | | |

Queues

2: Main St & W Beach St/E Beach St

Existing

Timing Plan: SATURDAY PEAK HOUR



| Lane Group | EBT | NBL | NBT | SBL | SBT |
|-----------------------------|------|------|------|------|------|
| Lane Group Flow (vph) | 388 | 55 | 661 | 178 | 739 |
| v/c Ratio | 0.60 | 0.32 | 0.46 | 0.44 | 0.35 |
| Control Delay | 29.7 | 36.7 | 16.5 | 23.7 | 6.8 |
| Queue Delay | 0.0 | 0.0 | 0.0 | 0.0 | 0.0 |
| Total Delay | 29.7 | 36.7 | 16.5 | 23.7 | 6.8 |
| Queue Length 50th (ft) | 78 | 24 | 111 | 76 | 85 |
| Queue Length 95th (ft) | 120 | 57 | 160 | 94 | 108 |
| Internal Link Dist (ft) | 380 | | 1445 | | 577 |
| Turn Bay Length (ft) | | 105 | | 140 | |
| Base Capacity (vph) | 861 | 196 | 1424 | 408 | 2102 |
| Starvation Cap Reductn | 0 | 0 | 0 | 0 | 0 |
| Spillback Cap Reductn | 0 | 0 | 0 | 0 | 0 |
| Storage Cap Reductn | 0 | 0 | 0 | 0 | 0 |
| Reduced v/c Ratio | 0.45 | 0.28 | 0.46 | 0.44 | 0.35 |
| Intersection Summary | | | | | |

Queues
3: W Riverside Dr/E Riverside Dr & Main St

Existing
Timing Plan: SATURDAY PEAK HOUR



| Lane Group | EBL | EBT | EBR | WBL | WBT | NBL | NBT | NBR | SBL | SBT |
|-------------------------|------|------|------|------|------|------|------|------|------|------|
| Lane Group Flow (vph) | 60 | 313 | 383 | 326 | 610 | 317 | 641 | 245 | 82 | 532 |
| v/c Ratio | 0.43 | 0.26 | 0.44 | 0.70 | 0.42 | 0.89 | 0.55 | 0.36 | 0.55 | 0.82 |
| Control Delay | 62.7 | 31.7 | 13.3 | 58.4 | 28.2 | 72.7 | 34.7 | 5.0 | 66.3 | 57.1 |
| Queue Delay | 0.0 | 0.0 | 0.0 | 0.0 | 0.0 | 0.0 | 0.0 | 0.0 | 0.0 | 0.0 |
| Total Delay | 62.7 | 31.7 | 13.3 | 58.4 | 28.2 | 72.7 | 34.7 | 5.0 | 66.3 | 57.1 |
| Queue Length 50th (ft) | 45 | 94 | 118 | 125 | 179 | 237 | 212 | 1 | 63 | 207 |
| Queue Length 95th (ft) | 90 | 145 | 213 | 176 | 264 | #374 | 262 | 55 | 113 | 255 |
| Internal Link Dist (ft) | | 412 | | | 555 | | 462 | | | 1445 |
| Turn Bay Length (ft) | 170 | | | 140 | | 305 | | 165 | 150 | |
| Base Capacity (vph) | 210 | 1187 | 897 | 466 | 1443 | 397 | 1192 | 682 | 255 | 831 |
| Starvation Cap Reductn | 0 | 0 | 0 | 0 | 0 | 0 | 0 | 0 | 0 | 0 |
| Spillback Cap Reductn | 0 | 0 | 0 | 0 | 0 | 0 | 0 | 0 | 0 | 0 |
| Storage Cap Reductn | 0 | 0 | 0 | 0 | 0 | 0 | 0 | 0 | 0 | 0 |
| Reduced v/c Ratio | 0.29 | 0.26 | 0.43 | 0.70 | 0.42 | 0.80 | 0.54 | 0.36 | 0.32 | 0.64 |

Intersection Summary

95th percentile volume exceeds capacity, queue may be longer.
Queue shown is maximum after two cycles.

Queues

6: Main St & Freedom Blvd & Western Dr

Existing

Timing Plan: SATURDAY PEAK HOUR



| Lane Group | EBT | EBR | WBL | WBT | NBL | NBT | NBR | SBT | SBR |
|-------------------------|------|------|------|------|------|------|------|------|------|
| Lane Group Flow (vph) | 272 | 504 | 180 | 366 | 252 | 255 | 381 | 21 | 27 |
| v/c Ratio | 0.78 | 0.25 | 0.72 | 0.71 | 0.36 | 0.36 | 0.36 | 0.13 | 0.09 |
| Control Delay | 56.1 | 1.4 | 55.9 | 47.3 | 25.0 | 25.0 | 1.6 | 42.4 | 0.7 |
| Queue Delay | 0.0 | 0.0 | 0.0 | 0.0 | 0.0 | 0.0 | 0.0 | 0.0 | 0.0 |
| Total Delay | 56.1 | 1.4 | 55.9 | 47.3 | 25.0 | 25.0 | 1.6 | 42.4 | 0.7 |
| Queue Length 50th (ft) | 163 | 0 | 124 | 125 | 126 | 128 | 0 | 12 | 0 |
| Queue Length 95th (ft) | #330 | 25 | 185 | 159 | 214 | 216 | 19 | 35 | 0 |
| Internal Link Dist (ft) | 722 | | | 546 | | 740 | | 295 | |
| Turn Bay Length (ft) | | | 360 | | | | 150 | | 25 |
| Base Capacity (vph) | 348 | 2008 | 335 | 693 | 702 | 706 | 1118 | 212 | 334 |
| Starvation Cap Reductn | 0 | 0 | 0 | 0 | 0 | 0 | 0 | 0 | 0 |
| Spillback Cap Reductn | 0 | 0 | 0 | 0 | 0 | 0 | 0 | 0 | 0 |
| Storage Cap Reductn | 0 | 0 | 0 | 0 | 0 | 0 | 0 | 0 | 0 |
| Reduced v/c Ratio | 0.78 | 0.25 | 0.54 | 0.53 | 0.36 | 0.36 | 0.34 | 0.10 | 0.08 |

Intersection Summary

95th percentile volume exceeds capacity, queue may be longer.
 Queue shown is maximum after two cycles.

Queues
1: Main St & W Lake Ave/E Lake Ave

Existing Plus Project
Timing Plan: AM PEAK HOUR



| Lane Group | EBL | EBT | WBL | WBT | WBR | NBL | NBT | NBR | SBL | SBT | SBR |
|-------------------------|------|------|------|------|------|------|------|------|------|------|------|
| Lane Group Flow (vph) | 59 | 273 | 128 | 237 | 297 | 43 | 692 | 319 | 94 | 613 | 123 |
| v/c Ratio | 0.48 | 0.77 | 0.79 | 0.52 | 0.54 | 0.42 | 0.86 | 0.42 | 0.76 | 0.66 | 0.15 |
| Control Delay | 58.0 | 49.8 | 75.6 | 36.3 | 11.9 | 57.3 | 34.5 | 7.3 | 81.4 | 22.3 | 3.8 |
| Queue Delay | 0.0 | 0.0 | 0.0 | 0.0 | 0.0 | 0.0 | 0.0 | 0.0 | 0.0 | 0.0 | 0.0 |
| Total Delay | 58.0 | 49.8 | 75.6 | 36.3 | 11.9 | 57.3 | 34.6 | 7.3 | 81.4 | 22.3 | 3.8 |
| Queue Length 50th (ft) | 34 | 148 | 75 | 123 | 26 | 25 | 341 | 33 | 55 | 276 | 2 |
| Queue Length 95th (ft) | #70 | 212 | #160 | 182 | 70 | 55 | 413 | 64 | #129 | 341 | 22 |
| Internal Link Dist (ft) | | 625 | | 469 | | | 577 | | | 809 | |
| Turn Bay Length (ft) | 300 | | 300 | | 105 | 100 | | 150 | 350 | | 100 |
| Base Capacity (vph) | 124 | 454 | 163 | 499 | 582 | 103 | 1022 | 907 | 124 | 1044 | 888 |
| Starvation Cap Reductn | 0 | 0 | 0 | 0 | 0 | 0 | 8 | 0 | 0 | 0 | 0 |
| Spillback Cap Reductn | 0 | 0 | 0 | 0 | 0 | 0 | 0 | 0 | 0 | 0 | 0 |
| Storage Cap Reductn | 0 | 0 | 0 | 0 | 0 | 0 | 0 | 0 | 0 | 0 | 0 |
| Reduced v/c Ratio | 0.48 | 0.60 | 0.79 | 0.47 | 0.51 | 0.42 | 0.68 | 0.35 | 0.76 | 0.59 | 0.14 |

Intersection Summary

95th percentile volume exceeds capacity, queue may be longer.
Queue shown is maximum after two cycles.

Queues
2: Main St & W Beach St/E Beach St

Existing Plus Project
Timing Plan: AM PEAK HOUR



| Lane Group | EBL | EBT | WBL | WBT | NBL | NBT | NBR | SBL | SBT | SBR |
|-------------------------|------|------|------|-------|------|------|------|-------|------|------|
| Lane Group Flow (vph) | 42 | 209 | 189 | 428 | 73 | 857 | 178 | 159 | 447 | 136 |
| v/c Ratio | 0.54 | 0.81 | 0.83 | 0.98 | 0.53 | 0.97 | 0.23 | 0.91 | 0.47 | 0.16 |
| Control Delay | 81.5 | 71.1 | 79.5 | 81.9 | 66.7 | 55.7 | 5.9 | 101.4 | 21.7 | 3.2 |
| Queue Delay | 0.0 | 0.0 | 0.0 | 38.3 | 0.0 | 0.0 | 0.0 | 0.0 | 0.0 | 0.0 |
| Total Delay | 81.5 | 71.1 | 79.5 | 120.2 | 66.7 | 55.7 | 5.9 | 101.4 | 21.7 | 3.2 |
| Queue Length 50th (ft) | 33 | 153 | 145 | ~332 | 55 | 631 | 16 | 124 | 229 | 0 |
| Queue Length 95th (ft) | #70 | 209 | #244 | #453 | 94 | #753 | 44 | #220 | 279 | 23 |
| Internal Link Dist (ft) | | 386 | | 269 | | 1445 | | | 577 | |
| Turn Bay Length (ft) | 200 | | | | 400 | | 75 | 400 | | 100 |
| Base Capacity (vph) | 78 | 304 | 228 | 436 | 159 | 912 | 781 | 175 | 957 | 857 |
| Starvation Cap Reductn | 0 | 0 | 0 | 78 | 0 | 0 | 0 | 0 | 0 | 0 |
| Spillback Cap Reductn | 0 | 0 | 0 | 0 | 0 | 0 | 0 | 0 | 0 | 0 |
| Storage Cap Reductn | 0 | 0 | 0 | 0 | 0 | 0 | 0 | 0 | 0 | 0 |
| Reduced v/c Ratio | 0.54 | 0.69 | 0.83 | 1.20 | 0.46 | 0.94 | 0.23 | 0.91 | 0.47 | 0.16 |

Intersection Summary

- ~ Volume exceeds capacity, queue is theoretically infinite.
Queue shown is maximum after two cycles.
- # 95th percentile volume exceeds capacity, queue may be longer.
Queue shown is maximum after two cycles.

Queues
3: W Riverside Dr/E Riverside Dr & Main St

Existing Plus Project
Timing Plan: AM PEAK HOUR

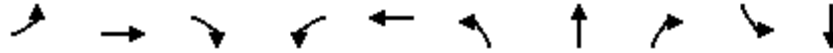

| Lane Group | EBL | EBT | EBR | WBL | WBT | NBL | NBT | NBR | SBL | SBT |
|-------------------------|------|------|------|------|------|------|------|------|------|------|
| Lane Group Flow (vph) | 69 | 315 | 366 | 292 | 585 | 388 | 778 | 300 | 63 | 460 |
| v/c Ratio | 0.50 | 0.37 | 0.39 | 0.69 | 0.55 | 0.36 | 0.95 | 0.39 | 0.46 | 0.75 |
| Control Delay | 63.7 | 39.0 | 7.6 | 58.2 | 37.2 | 31.7 | 52.9 | 10.9 | 61.9 | 52.2 |
| Queue Delay | 0.0 | 0.0 | 0.0 | 0.0 | 0.0 | 0.0 | 0.0 | 0.0 | 0.0 | 0.0 |
| Total Delay | 63.7 | 39.0 | 7.6 | 58.2 | 37.2 | 31.7 | 52.9 | 10.9 | 61.9 | 52.2 |
| Queue Length 50th (ft) | 50 | 117 | 66 | 103 | 209 | 102 | 502 | 57 | 45 | 170 |
| Queue Length 95th (ft) | 98 | 143 | 130 | #197 | 260 | 169 | #808 | 130 | 91 | 207 |
| Internal Link Dist (ft) | | 1419 | | | 1765 | | 1236 | | | 1445 |
| Turn Bay Length (ft) | 170 | | | 140 | | 305 | | 165 | 350 | |
| Base Capacity (vph) | 140 | 997 | 943 | 425 | 1104 | 1082 | 835 | 780 | 138 | 1256 |
| Starvation Cap Reductn | 0 | 0 | 0 | 0 | 0 | 0 | 0 | 0 | 0 | 0 |
| Spillback Cap Reductn | 0 | 0 | 0 | 0 | 0 | 0 | 0 | 0 | 0 | 0 |
| Storage Cap Reductn | 0 | 0 | 0 | 0 | 0 | 0 | 0 | 0 | 0 | 0 |
| Reduced v/c Ratio | 0.49 | 0.32 | 0.39 | 0.69 | 0.53 | 0.36 | 0.93 | 0.38 | 0.46 | 0.37 |

Intersection Summary

95th percentile volume exceeds capacity, queue may be longer.
Queue shown is maximum after two cycles.

Queues
4: Union St/Brennan St & E Lake Ave

Existing Plus Project
Timing Plan: AM PEAK HOUR

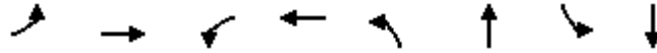

| Lane Group | EBL | EBT | WBL | WBT | NBL | NBT | SBL | SBT |
|-------------------------|------|------|------|------|------|------|------|------|
| Lane Group Flow (vph) | 115 | 559 | 240 | 577 | 46 | 191 | 45 | 271 |
| v/c Ratio | 0.67 | 0.90 | 0.74 | 0.73 | 0.34 | 0.53 | 0.28 | 0.72 |
| Control Delay | 55.2 | 45.3 | 44.2 | 25.5 | 41.4 | 27.7 | 37.8 | 35.1 |
| Queue Delay | 0.0 | 0.0 | 0.0 | 0.0 | 0.0 | 0.0 | 0.0 | 0.0 |
| Total Delay | 55.2 | 45.3 | 44.2 | 25.5 | 41.4 | 27.7 | 37.8 | 35.1 |
| Queue Length 50th (ft) | 52 | 248 | 104 | 218 | 20 | 68 | 20 | 107 |
| Queue Length 95th (ft) | #116 | #403 | #181 | 311 | 48 | 106 | 46 | 151 |
| Internal Link Dist (ft) | | 469 | | 220 | | 559 | | 348 |
| Turn Bay Length (ft) | 100 | | 175 | | 270 | | 100 | |
| Base Capacity (vph) | 172 | 622 | 358 | 828 | 135 | 541 | 167 | 578 |
| Starvation Cap Reductn | 0 | 0 | 0 | 0 | 0 | 0 | 0 | 0 |
| Spillback Cap Reductn | 0 | 0 | 0 | 0 | 0 | 0 | 0 | 0 |
| Storage Cap Reductn | 0 | 0 | 0 | 0 | 0 | 0 | 0 | 0 |
| Reduced v/c Ratio | 0.67 | 0.90 | 0.67 | 0.70 | 0.34 | 0.35 | 0.27 | 0.47 |

Intersection Summary

95th percentile volume exceeds capacity, queue may be longer.
Queue shown is maximum after two cycles.

Queues
5: Union St & E Beach St

Existing Plus Project
Timing Plan: AM PEAK HOUR

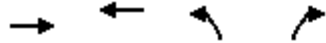

| Lane Group | EBT | WBT | NBL | NBR |
|-------------------------|-------|------|------|------|
| Lane Group Flow (vph) | 516 | 700 | 42 | 119 |
| v/c Ratio | 0.91 | 0.52 | 0.13 | 0.32 |
| Control Delay | 54.1 | 11.8 | 34.4 | 9.3 |
| Queue Delay | 48.8 | 0.6 | 0.0 | 0.1 |
| Total Delay | 102.8 | 12.3 | 34.4 | 9.4 |
| Queue Length 50th (ft) | 290 | 82 | 21 | 0 |
| Queue Length 95th (ft) | #443 | 66 | 48 | 36 |
| Internal Link Dist (ft) | 269 | 84 | 454 | |
| Turn Bay Length (ft) | | | 100 | |
| Base Capacity (vph) | 580 | 1573 | 345 | 392 |
| Starvation Cap Reductn | 116 | 463 | 0 | 0 |
| Spillback Cap Reductn | 10 | 0 | 0 | 26 |
| Storage Cap Reductn | 0 | 0 | 0 | 0 |
| Reduced v/c Ratio | 1.11 | 0.63 | 0.12 | 0.33 |

Intersection Summary

95th percentile volume exceeds capacity, queue may be longer.
Queue shown is maximum after two cycles.

Queues
6: Main St & Freedom Blvd & Western Dr

Existing Plus Project
Timing Plan: AM PEAK HOUR



| Lane Group | EBT | EBR | WBL | WBT | NBL | NBT | NBR | SBT | SBR |
|-------------------------|------|------|------|------|------|------|------|------|------|
| Lane Group Flow (vph) | 186 | 455 | 173 | 354 | 276 | 272 | 407 | 39 | 61 |
| v/c Ratio | 0.76 | 0.59 | 0.72 | 0.71 | 0.38 | 0.38 | 0.37 | 0.20 | 0.20 |
| Control Delay | 62.5 | 10.9 | 56.8 | 47.8 | 25.3 | 25.1 | 1.7 | 43.3 | 1.5 |
| Queue Delay | 0.0 | 0.0 | 0.0 | 0.0 | 1.3 | 1.3 | 0.2 | 0.0 | 0.0 |
| Total Delay | 62.5 | 10.9 | 56.8 | 47.8 | 26.6 | 26.4 | 1.9 | 43.3 | 1.5 |
| Queue Length 50th (ft) | 103 | 0 | 117 | 119 | 128 | 126 | 0 | 23 | 0 |
| Queue Length 95th (ft) | 151 | 86 | 175 | 151 | 237 | 233 | 21 | 53 | 0 |
| Internal Link Dist (ft) | 727 | | | 547 | | 224 | | 295 | |
| Turn Bay Length (ft) | | | | 360 | | 150 | | 150 | |
| Base Capacity (vph) | 346 | 891 | 314 | 652 | 724 | 728 | 1152 | 198 | 299 |
| Starvation Cap Reductn | 0 | 0 | 0 | 0 | 268 | 272 | 221 | 0 | 0 |
| Spillback Cap Reductn | 0 | 0 | 0 | 0 | 0 | 0 | 0 | 0 | 0 |
| Storage Cap Reductn | 0 | 0 | 0 | 0 | 0 | 0 | 0 | 0 | 0 |
| Reduced v/c Ratio | 0.54 | 0.51 | 0.55 | 0.54 | 0.61 | 0.60 | 0.44 | 0.20 | 0.20 |

Intersection Summary

Queues
7: Rodriguez St & Main St

Existing Plus Project
Timing Plan: AM PEAK HOUR



| Lane Group | EBT | WBL | WBT | NBL |
|-------------------------|------|------|------|------|
| Lane Group Flow (vph) | 884 | 5 | 830 | 409 |
| v/c Ratio | 0.37 | 0.04 | 0.29 | 0.67 |
| Control Delay | 7.2 | 31.2 | 2.9 | 43.8 |
| Queue Delay | 0.0 | 0.0 | 0.0 | 0.0 |
| Total Delay | 7.2 | 31.2 | 2.9 | 43.8 |
| Queue Length 50th (ft) | 81 | 3 | 36 | 127 |
| Queue Length 95th (ft) | 201 | m7 | 83 | 159 |
| Internal Link Dist (ft) | 958 | | 727 | 320 |
| Turn Bay Length (ft) | | 145 | | 100 |
| Base Capacity (vph) | 2371 | 148 | 2906 | 942 |
| Starvation Cap Reductn | 0 | 0 | 0 | 0 |
| Spillback Cap Reductn | 0 | 0 | 0 | 0 |
| Storage Cap Reductn | 0 | 0 | 0 | 0 |
| Reduced v/c Ratio | 0.37 | 0.03 | 0.29 | 0.43 |

Intersection Summary

m Volume for 95th percentile queue is metered by upstream signal.

Queues
8: Brennan St & Freedom Blvd

Existing Plus Project
Timing Plan: AM PEAK HOUR

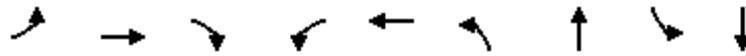

| Lane Group | EBL | EBT | EBR | WBL | WBT | NBL | NBT | SBL | SBT |
|-----------------------------|------|------|------|------|------|------|------|------|------|
| Lane Group Flow (vph) | 7 | 548 | 60 | 213 | 383 | 146 | 162 | 4 | 17 |
| v/c Ratio | 0.06 | 0.68 | 0.10 | 0.55 | 0.32 | 0.53 | 0.37 | 0.02 | 0.07 |
| Control Delay | 40.3 | 23.2 | 2.4 | 32.1 | 6.9 | 34.6 | 8.1 | 27.3 | 15.4 |
| Queue Delay | 0.0 | 0.0 | 0.0 | 0.0 | 0.0 | 0.0 | 0.0 | 0.0 | 0.0 |
| Total Delay | 40.3 | 23.2 | 2.4 | 32.1 | 6.9 | 34.6 | 8.1 | 27.3 | 15.4 |
| Queue Length 50th (ft) | 3 | 168 | 0 | 72 | 50 | 49 | 0 | 1 | 1 |
| Queue Length 95th (ft) | 17 | 339 | 10 | 173 | 147 | 129 | 42 | 10 | 17 |
| Internal Link Dist (ft) | | 547 | | | 380 | | 266 | | 359 |
| Turn Bay Length (ft) | 65 | | 200 | 200 | | 55 | | 75 | |
| Base Capacity (vph) | 115 | 1683 | 1216 | 725 | 1749 | 575 | 737 | 454 | 668 |
| Starvation Cap Reductn | 0 | 21 | 0 | 0 | 0 | 0 | 0 | 0 | 0 |
| Spillback Cap Reductn | 0 | 0 | 0 | 0 | 0 | 0 | 0 | 0 | 0 |
| Storage Cap Reductn | 0 | 0 | 0 | 0 | 0 | 0 | 0 | 0 | 0 |
| Reduced v/c Ratio | 0.06 | 0.33 | 0.05 | 0.29 | 0.22 | 0.25 | 0.22 | 0.01 | 0.03 |
| Intersection Summary | | | | | | | | | |

Queues
 9: E Beach St & Alexander St

Existing Plus Project
 Timing Plan: AM PEAK HOUR

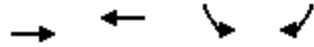

| Lane Group | EBT | WBT | SBL | SBR |
|-------------------------|------|------|------|------|
| Lane Group Flow (vph) | 548 | 442 | 101 | 342 |
| v/c Ratio | 0.55 | 0.64 | 0.40 | 0.66 |
| Control Delay | 8.7 | 37.0 | 40.9 | 10.9 |
| Queue Delay | 2.1 | 0.9 | 0.0 | 0.2 |
| Total Delay | 10.7 | 37.9 | 40.9 | 11.1 |
| Queue Length 50th (ft) | 55 | 118 | 55 | 0 |
| Queue Length 95th (ft) | m79 | 165 | 95 | 52 |
| Internal Link Dist (ft) | 84 | 346 | 559 | |
| Turn Bay Length (ft) | | | 220 | |
| Base Capacity (vph) | 1008 | 706 | 380 | 604 |
| Starvation Cap Reductn | 308 | 0 | 0 | 0 |
| Spillback Cap Reductn | 0 | 88 | 0 | 26 |
| Storage Cap Reductn | 0 | 0 | 0 | 0 |
| Reduced v/c Ratio | 0.78 | 0.72 | 0.27 | 0.59 |

Intersection Summary

m Volume for 95th percentile queue is metered by upstream signal.

Queues
1: Main St & W Lake Ave/E Lake Ave

Existing Plus Project
Timing Plan: PM PEAK HOUR



| Lane Group | EBL | EBT | WBL | WBT | WBR | NBL | NBT | NBR | SBL | SBT | SBR |
|-------------------------|------|------|------|------|------|------|-------|------|------|------|------|
| Lane Group Flow (vph) | 30 | 198 | 291 | 153 | 255 | 24 | 695 | 261 | 157 | 730 | 142 |
| v/c Ratio | 0.29 | 0.67 | 0.80 | 0.24 | 0.38 | 0.27 | 1.08 | 0.44 | 0.92 | 0.87 | 0.20 |
| Control Delay | 52.3 | 49.2 | 57.4 | 25.6 | 5.1 | 38.0 | 70.1 | 3.9 | 97.3 | 39.5 | 2.1 |
| Queue Delay | 0.0 | 0.0 | 0.0 | 0.0 | 0.0 | 0.0 | 0.0 | 0.0 | 0.0 | 8.7 | 0.0 |
| Total Delay | 52.3 | 49.2 | 57.4 | 25.6 | 5.1 | 38.0 | 70.1 | 3.9 | 97.3 | 48.2 | 2.1 |
| Queue Length 50th (ft) | 19 | 119 | 174 | 73 | 0 | 14 | ~482 | 6 | 102 | 382 | 0 |
| Queue Length 95th (ft) | 49 | 181 | #361 | 125 | 55 | m16 | m#606 | m8 | #231 | #716 | 22 |
| Internal Link Dist (ft) | | 625 | | 469 | | | 577 | | | 809 | |
| Turn Bay Length (ft) | 300 | | 300 | | 105 | 100 | | 150 | 350 | | 100 |
| Base Capacity (vph) | 106 | 395 | 363 | 648 | 674 | 88 | 646 | 587 | 171 | 839 | 708 |
| Starvation Cap Reductn | 0 | 0 | 0 | 0 | 0 | 0 | 0 | 0 | 0 | 0 | 0 |
| Spillback Cap Reductn | 0 | 0 | 0 | 0 | 0 | 0 | 0 | 0 | 0 | 89 | 0 |
| Storage Cap Reductn | 0 | 0 | 0 | 0 | 0 | 0 | 0 | 0 | 0 | 0 | 0 |
| Reduced v/c Ratio | 0.28 | 0.50 | 0.80 | 0.24 | 0.38 | 0.27 | 1.08 | 0.44 | 0.92 | 0.97 | 0.20 |

Intersection Summary

- ~ Volume exceeds capacity, queue is theoretically infinite.
Queue shown is maximum after two cycles.
- # 95th percentile volume exceeds capacity, queue may be longer.
Queue shown is maximum after two cycles.
- m Volume for 95th percentile queue is metered by upstream signal.

Queues
2: Main St & W Beach St/E Beach St

Existing Plus Project
Timing Plan: PM PEAK HOUR



| Lane Group | EBL | EBT | WBL | WBT | NBL | NBT | NBR | SBL | SBT | SBR |
|-------------------------|------|------|-------|------|-------|------|------|------|-------|------|
| Lane Group Flow (vph) | 115 | 420 | 119 | 316 | 89 | 854 | 162 | 66 | 905 | 110 |
| v/c Ratio | 0.82 | 1.00 | 0.97 | 0.79 | 1.01 | 0.90 | 0.23 | 0.71 | 0.99 | 0.14 |
| Control Delay | 85.5 | 84.3 | 121.5 | 51.9 | 148.8 | 37.9 | 4.2 | 57.5 | 34.1 | 0.5 |
| Queue Delay | 0.0 | 0.0 | 0.0 | 2.4 | 0.0 | 0.0 | 0.0 | 0.0 | 3.1 | 0.0 |
| Total Delay | 85.5 | 84.3 | 121.5 | 54.3 | 148.8 | 37.9 | 4.2 | 57.5 | 37.3 | 0.5 |
| Queue Length 50th (ft) | 73 | ~266 | 77 | 186 | ~58 | 493 | 6 | 41 | 260 | 2 |
| Queue Length 95th (ft) | #171 | #467 | #190 | #320 | #160 | #763 | 40 | m48 | m#781 | m1 |
| Internal Link Dist (ft) | | 386 | | 269 | | 1445 | | | 577 | |
| Turn Bay Length (ft) | 200 | | | | 400 | | 75 | 400 | | 100 |
| Base Capacity (vph) | 141 | 418 | 123 | 398 | 88 | 946 | 718 | 93 | 912 | 777 |
| Starvation Cap Reductn | 0 | 0 | 0 | 26 | 0 | 0 | 0 | 0 | 12 | 0 |
| Spillback Cap Reductn | 0 | 0 | 0 | 0 | 0 | 0 | 0 | 0 | 0 | 0 |
| Storage Cap Reductn | 0 | 0 | 0 | 0 | 0 | 0 | 0 | 0 | 0 | 0 |
| Reduced v/c Ratio | 0.82 | 1.00 | 0.97 | 0.85 | 1.01 | 0.90 | 0.23 | 0.71 | 1.01 | 0.14 |

Intersection Summary

- ~ Volume exceeds capacity, queue is theoretically infinite.
Queue shown is maximum after two cycles.
- # 95th percentile volume exceeds capacity, queue may be longer.
Queue shown is maximum after two cycles.
- m Volume for 95th percentile queue is metered by upstream signal.

Queues
3: W Riverside Dr/E Riverside Dr & Main St

Existing Plus Project
Timing Plan: PM PEAK HOUR

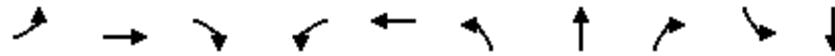

| Lane Group | EBL | EBT | EBR | WBL | WBT | NBL | NBT | NBR | SBL | SBT |
|-------------------------|------|------|------|------|------|------|------|------|-------|------|
| Lane Group Flow (vph) | 74 | 561 | 654 | 409 | 447 | 315 | 810 | 307 | 100 | 771 |
| v/c Ratio | 0.55 | 0.73 | 0.81 | 0.92 | 0.44 | 0.33 | 0.95 | 0.39 | 0.81 | 0.89 |
| Control Delay | 73.3 | 53.8 | 23.2 | 82.4 | 39.4 | 38.7 | 55.4 | 13.2 | 100.3 | 60.0 |
| Queue Delay | 0.0 | 0.0 | 0.0 | 0.0 | 0.0 | 0.0 | 0.0 | 0.0 | 0.0 | 0.0 |
| Total Delay | 73.3 | 53.8 | 23.2 | 82.4 | 39.4 | 38.7 | 55.4 | 13.2 | 100.3 | 60.0 |
| Queue Length 50th (ft) | 62 | 241 | 242 | 177 | 166 | 105 | 607 | 78 | 85 | 324 |
| Queue Length 95th (ft) | 112 | 295 | #383 | #273 | 217 | 157 | #931 | 159 | #187 | 397 |
| Internal Link Dist (ft) | | 1419 | | | 1765 | | 1236 | | | 1445 |
| Turn Bay Length (ft) | 170 | | | 140 | | 305 | | 165 | 350 | |
| Base Capacity (vph) | 162 | 830 | 812 | 453 | 1027 | 968 | 860 | 789 | 124 | 946 |
| Starvation Cap Reductn | 0 | 0 | 0 | 0 | 0 | 0 | 0 | 0 | 0 | 0 |
| Spillback Cap Reductn | 0 | 0 | 0 | 0 | 0 | 0 | 0 | 0 | 0 | 0 |
| Storage Cap Reductn | 0 | 0 | 0 | 0 | 0 | 0 | 0 | 0 | 0 | 0 |
| Reduced v/c Ratio | 0.46 | 0.68 | 0.81 | 0.90 | 0.44 | 0.33 | 0.94 | 0.39 | 0.81 | 0.82 |

Intersection Summary

95th percentile volume exceeds capacity, queue may be longer.
Queue shown is maximum after two cycles.

Queues
4: Union St/Brennan St & E Lake Ave

Existing Plus Project
Timing Plan: PM PEAK HOUR

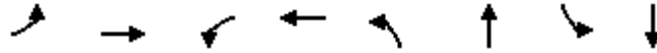

| Lane Group | EBL | EBT | WBL | WBT | NBL | NBT | SBL | SBT |
|-------------------------|------|------|------|------|------|------|------|------|
| Lane Group Flow (vph) | 137 | 482 | 185 | 584 | 109 | 152 | 49 | 295 |
| v/c Ratio | 0.67 | 0.79 | 0.67 | 0.85 | 0.60 | 0.29 | 0.45 | 0.80 |
| Control Delay | 57.0 | 35.3 | 50.7 | 36.2 | 55.1 | 25.6 | 57.7 | 48.5 |
| Queue Delay | 0.0 | 0.0 | 0.0 | 0.0 | 0.0 | 0.0 | 0.0 | 0.0 |
| Total Delay | 57.0 | 35.3 | 50.7 | 36.2 | 55.1 | 25.6 | 57.7 | 48.5 |
| Queue Length 50th (ft) | 74 | 237 | 98 | 287 | 59 | 59 | 27 | 143 |
| Queue Length 95th (ft) | #186 | 346 | #236 | 427 | #149 | 129 | #82 | #302 |
| Internal Link Dist (ft) | | 469 | | 220 | | 559 | | 348 |
| Turn Bay Length (ft) | 100 | | 175 | | 270 | | 100 | |
| Base Capacity (vph) | 216 | 954 | 278 | 991 | 194 | 551 | 108 | 452 |
| Starvation Cap Reductn | 0 | 24 | 0 | 0 | 0 | 0 | 0 | 0 |
| Spillback Cap Reductn | 0 | 0 | 0 | 0 | 0 | 0 | 0 | 0 |
| Storage Cap Reductn | 0 | 0 | 0 | 0 | 0 | 0 | 0 | 0 |
| Reduced v/c Ratio | 0.63 | 0.52 | 0.67 | 0.59 | 0.56 | 0.28 | 0.45 | 0.65 |

Intersection Summary

95th percentile volume exceeds capacity, queue may be longer.
Queue shown is maximum after two cycles.

Queues
5: Union St & E Beach St

Existing Plus Project
Timing Plan: PM PEAK HOUR

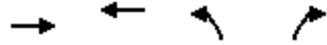

| Lane Group | EBT | WBT | NBL | NBR |
|-------------------------|------|------|------|------|
| Lane Group Flow (vph) | 592 | 520 | 36 | 82 |
| v/c Ratio | 0.94 | 0.46 | 0.13 | 0.29 |
| Control Delay | 51.9 | 7.1 | 34.2 | 11.0 |
| Queue Delay | 46.6 | 0.4 | 0.0 | 0.1 |
| Total Delay | 98.5 | 7.5 | 34.2 | 11.1 |
| Queue Length 50th (ft) | 318 | 32 | 18 | 0 |
| Queue Length 95th (ft) | #537 | 36 | 45 | 39 |
| Internal Link Dist (ft) | 269 | 84 | 454 | |
| Turn Bay Length (ft) | | | 100 | |
| Base Capacity (vph) | 643 | 1229 | 288 | 299 |
| Starvation Cap Reductn | 130 | 302 | 0 | 0 |
| Spillback Cap Reductn | 0 | 0 | 0 | 11 |
| Storage Cap Reductn | 0 | 0 | 0 | 0 |
| Reduced v/c Ratio | 1.15 | 0.56 | 0.13 | 0.28 |

Intersection Summary

95th percentile volume exceeds capacity, queue may be longer.
Queue shown is maximum after two cycles.

Queues
6: Main St & Freedom Blvd & Western Dr

Existing Plus Project
Timing Plan: PM PEAK HOUR



| Lane Group | EBT | EBR | WBL | WBT | NBL | NBT | NBR | SBT | SBR |
|-------------------------|------|------|------|------|------|------|------|------|------|
| Lane Group Flow (vph) | 452 | 636 | 208 | 430 | 298 | 295 | 368 | 57 | 56 |
| v/c Ratio | 0.91 | 0.33 | 0.81 | 0.81 | 0.57 | 0.56 | 0.43 | 0.45 | 0.23 |
| Control Delay | 56.2 | 5.7 | 63.7 | 52.4 | 36.2 | 35.9 | 5.6 | 56.4 | 2.2 |
| Queue Delay | 0.0 | 0.0 | 0.0 | 0.0 | 1.2 | 1.2 | 0.1 | 0.0 | 0.0 |
| Total Delay | 56.2 | 5.7 | 63.7 | 52.4 | 37.4 | 37.1 | 5.7 | 56.4 | 2.2 |
| Queue Length 50th (ft) | 263 | 9 | 139 | 143 | 187 | 185 | 31 | 36 | 0 |
| Queue Length 95th (ft) | #454 | 183 | #249 | 200 | 274 | 272 | 82 | 77 | 0 |
| Internal Link Dist (ft) | 727 | | | 547 | | 224 | | 295 | |
| Turn Bay Length (ft) | | | 360 | | 150 | | 150 | | 25 |
| Base Capacity (vph) | 513 | 1899 | 289 | 599 | 540 | 543 | 881 | 127 | 241 |
| Starvation Cap Reductn | 0 | 0 | 0 | 0 | 97 | 99 | 48 | 0 | 0 |
| Spillback Cap Reductn | 0 | 0 | 0 | 0 | 0 | 0 | 0 | 0 | 0 |
| Storage Cap Reductn | 0 | 0 | 0 | 0 | 0 | 0 | 0 | 0 | 0 |
| Reduced v/c Ratio | 0.88 | 0.33 | 0.72 | 0.72 | 0.67 | 0.66 | 0.44 | 0.45 | 0.23 |

Intersection Summary

95th percentile volume exceeds capacity, queue may be longer.
Queue shown is maximum after two cycles.

Queues
7: Rodriguez St & Main St

Existing Plus Project
Timing Plan: PM PEAK HOUR



| Lane Group | EBT | WBL | WBT | NBL |
|-------------------------|------|------|------|------|
| Lane Group Flow (vph) | 1412 | 7 | 888 | 382 |
| v/c Ratio | 0.59 | 0.05 | 0.30 | 0.65 |
| Control Delay | 9.8 | 55.7 | 5.2 | 43.4 |
| Queue Delay | 0.0 | 0.0 | 0.0 | 0.0 |
| Total Delay | 9.8 | 55.7 | 5.2 | 43.4 |
| Queue Length 50th (ft) | 167 | 4 | 4 | 118 |
| Queue Length 95th (ft) | 430 | m9 | 356 | 152 |
| Internal Link Dist (ft) | 958 | | 727 | 320 |
| Turn Bay Length (ft) | | 145 | | 100 |
| Base Capacity (vph) | 2407 | 145 | 2977 | 835 |
| Starvation Cap Reductn | 0 | 0 | 0 | 0 |
| Spillback Cap Reductn | 0 | 0 | 0 | 0 |
| Storage Cap Reductn | 0 | 0 | 0 | 0 |
| Reduced v/c Ratio | 0.59 | 0.05 | 0.30 | 0.46 |

Intersection Summary

m Volume for 95th percentile queue is metered by upstream signal.

Queues
8: Brennan St & Freedom Blvd

Existing Plus Project
Timing Plan: PM PEAK HOUR

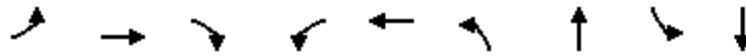

| Lane Group | EBL | EBT | EBR | WBL | WBT | NBL | NBT | SBL | SBT |
|-------------------------|------|------|------|------|------|------|------|------|------|
| Lane Group Flow (vph) | 8 | 662 | 121 | 212 | 458 | 183 | 289 | 6 | 21 |
| v/c Ratio | 0.09 | 0.58 | 0.14 | 0.75 | 0.38 | 0.75 | 0.56 | 0.10 | 0.08 |
| Control Delay | 52.2 | 21.6 | 5.5 | 60.7 | 10.9 | 60.0 | 8.8 | 36.5 | 17.9 |
| Queue Delay | 0.0 | 1.0 | 0.0 | 0.0 | 0.0 | 0.0 | 0.0 | 0.0 | 0.0 |
| Total Delay | 52.2 | 22.6 | 5.5 | 60.7 | 10.9 | 60.0 | 8.8 | 36.5 | 17.9 |
| Queue Length 50th (ft) | 6 | 308 | 8 | 143 | 140 | 122 | 3 | 4 | 3 |
| Queue Length 95th (ft) | 22 | 506 | 44 | 220 | 238 | 188 | 70 | 15 | 23 |
| Internal Link Dist (ft) | | 547 | | | 380 | | 266 | | 359 |
| Turn Bay Length (ft) | 65 | | 200 | 200 | | 55 | | 75 | |
| Base Capacity (vph) | 88 | 1142 | 851 | 337 | 1209 | 327 | 599 | 102 | 402 |
| Starvation Cap Reductn | 0 | 245 | 0 | 0 | 0 | 0 | 0 | 0 | 0 |
| Spillback Cap Reductn | 0 | 0 | 0 | 0 | 0 | 0 | 0 | 0 | 0 |
| Storage Cap Reductn | 0 | 0 | 0 | 0 | 0 | 0 | 0 | 0 | 0 |
| Reduced v/c Ratio | 0.09 | 0.74 | 0.14 | 0.63 | 0.38 | 0.56 | 0.48 | 0.06 | 0.05 |
| Intersection Summary | | | | | | | | | |

Queues
9: E Beach St & Alexander St

Existing Plus Project
Timing Plan: PM PEAK HOUR

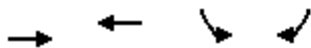

| Lane Group | EBT | WBT | SBL | SBR |
|-------------------------|------|------|------|------|
| Lane Group Flow (vph) | 603 | 418 | 182 | 250 |
| v/c Ratio | 0.64 | 0.70 | 0.67 | 0.55 |
| Control Delay | 5.2 | 38.0 | 48.8 | 9.8 |
| Queue Delay | 1.5 | 0.0 | 0.0 | 0.0 |
| Total Delay | 6.7 | 38.0 | 48.8 | 9.8 |
| Queue Length 50th (ft) | 42 | 106 | 98 | 0 |
| Queue Length 95th (ft) | m55 | 144 | 154 | 51 |
| Internal Link Dist (ft) | 84 | 346 | 559 | |
| Turn Bay Length (ft) | | | 220 | |
| Base Capacity (vph) | 970 | 634 | 292 | 469 |
| Starvation Cap Reductn | 199 | 0 | 0 | 0 |
| Spillback Cap Reductn | 0 | 0 | 0 | 0 |
| Storage Cap Reductn | 0 | 0 | 0 | 0 |
| Reduced v/c Ratio | 0.78 | 0.66 | 0.62 | 0.53 |

Intersection Summary

m Volume for 95th percentile queue is metered by upstream signal.

Queues
1: Main St & W Lake Ave/E Lake Ave

Existing Plus Project
Timing Plan: SATURDAY PEAK HOUR



| Lane Group | EBL | EBT | WBL | WBT | WBR | NBL | NBT | NBR | SBL | SBT | SBR |
|-------------------------|------|------|------|------|------|------|-------|------|------|------|------|
| Lane Group Flow (vph) | 31 | 182 | 132 | 121 | 306 | 34 | 684 | 227 | 107 | 636 | 114 |
| v/c Ratio | 0.34 | 0.64 | 0.88 | 0.29 | 0.59 | 0.31 | 0.77 | 0.31 | 0.59 | 0.61 | 0.14 |
| Control Delay | 56.6 | 47.6 | 94.1 | 33.8 | 12.6 | 52.8 | 23.5 | 6.5 | 43.5 | 23.0 | 5.4 |
| Queue Delay | 0.0 | 0.0 | 0.0 | 0.0 | 0.0 | 0.0 | 0.0 | 0.0 | 0.0 | 0.0 | 0.0 |
| Total Delay | 56.6 | 47.6 | 94.1 | 33.8 | 12.6 | 52.8 | 23.5 | 6.5 | 43.5 | 23.0 | 5.4 |
| Queue Length 50th (ft) | 20 | 108 | 85 | 68 | 30 | 22 | 176 | 16 | 55 | 360 | 13 |
| Queue Length 95th (ft) | 50 | 167 | #194 | 113 | 110 | m29 | m#610 | m27 | 101 | 510 | 48 |
| Internal Link Dist (ft) | | 625 | | 469 | | | 577 | | | 809 | |
| Turn Bay Length (ft) | 300 | | 300 | | 105 | 100 | | 150 | 350 | | 100 |
| Base Capacity (vph) | 90 | 401 | 150 | 471 | 550 | 109 | 884 | 726 | 200 | 1038 | 823 |
| Starvation Cap Reductn | 0 | 0 | 0 | 0 | 0 | 0 | 0 | 0 | 0 | 0 | 0 |
| Spillback Cap Reductn | 0 | 0 | 0 | 0 | 0 | 0 | 0 | 0 | 0 | 0 | 0 |
| Storage Cap Reductn | 0 | 0 | 0 | 0 | 0 | 0 | 0 | 0 | 0 | 0 | 0 |
| Reduced v/c Ratio | 0.34 | 0.45 | 0.88 | 0.26 | 0.56 | 0.31 | 0.77 | 0.31 | 0.54 | 0.61 | 0.14 |

Intersection Summary

- # 95th percentile volume exceeds capacity, queue may be longer.
Queue shown is maximum after two cycles.
- m Volume for 95th percentile queue is metered by upstream signal.

Queues
2: Main St & W Beach St/E Beach St

Existing Plus Project
Timing Plan: SATURDAY PEAK HOUR



| Lane Group | EBL | EBT | WBL | WBT | NBL | NBT | NBR | SBL | SBT | SBR |
|-------------------------|------|------|-------|------|------|------|------|------|------|------|
| Lane Group Flow (vph) | 97 | 264 | 131 | 316 | 74 | 782 | 118 | 45 | 629 | 107 |
| v/c Ratio | 0.84 | 0.76 | 0.92 | 0.84 | 0.55 | 0.80 | 0.16 | 0.42 | 0.69 | 0.14 |
| Control Delay | 96.1 | 50.5 | 103.2 | 56.4 | 60.7 | 29.8 | 3.8 | 60.6 | 19.1 | 4.0 |
| Queue Delay | 0.0 | 0.0 | 0.0 | 1.2 | 0.0 | 0.0 | 0.0 | 0.0 | 0.0 | 0.0 |
| Total Delay | 96.1 | 50.5 | 103.2 | 57.5 | 60.7 | 29.8 | 3.8 | 60.6 | 19.1 | 4.0 |
| Queue Length 50th (ft) | 62 | 151 | 84 | 186 | 45 | 454 | 1 | 31 | 121 | 1 |
| Queue Length 95th (ft) | #156 | 231 | #198 | 276 | #108 | #707 | 32 | m49 | m243 | m11 |
| Internal Link Dist (ft) | | 386 | | 269 | | 1445 | | | 577 | |
| Turn Bay Length (ft) | 200 | | | | 400 | | 75 | 400 | | 100 |
| Base Capacity (vph) | 116 | 416 | 143 | 447 | 138 | 979 | 753 | 108 | 910 | 757 |
| Starvation Cap Reductn | 0 | 0 | 0 | 32 | 0 | 0 | 0 | 0 | 0 | 0 |
| Spillback Cap Reductn | 0 | 0 | 0 | 0 | 0 | 0 | 0 | 0 | 0 | 0 |
| Storage Cap Reductn | 0 | 0 | 0 | 0 | 0 | 0 | 0 | 0 | 0 | 0 |
| Reduced v/c Ratio | 0.84 | 0.63 | 0.92 | 0.76 | 0.54 | 0.80 | 0.16 | 0.42 | 0.69 | 0.14 |

Intersection Summary

- # 95th percentile volume exceeds capacity, queue may be longer.
Queue shown is maximum after two cycles.
- m Volume for 95th percentile queue is metered by upstream signal.

Queues
3: W Riverside Dr/E Riverside Dr & Main St

Existing Plus Project
Timing Plan: SATURDAY PEAK HOUR

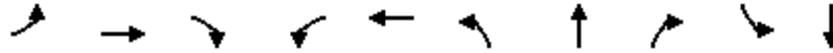

| Lane Group | EBL | EBT | EBR | WBL | WBT | NBL | NBT | NBR | SBL | SBT |
|-------------------------|------|------|------|------|------|------|------|------|------|------|
| Lane Group Flow (vph) | 80 | 375 | 436 | 342 | 636 | 289 | 760 | 209 | 99 | 649 |
| v/c Ratio | 0.60 | 0.51 | 0.53 | 0.73 | 0.62 | 0.29 | 0.94 | 0.28 | 0.67 | 0.82 |
| Control Delay | 73.0 | 45.5 | 17.3 | 59.1 | 40.4 | 35.3 | 53.1 | 10.4 | 75.1 | 52.4 |
| Queue Delay | 0.0 | 0.0 | 0.0 | 0.0 | 0.0 | 0.0 | 0.0 | 0.0 | 0.0 | 0.0 |
| Total Delay | 73.0 | 45.5 | 17.3 | 59.1 | 40.4 | 35.3 | 53.1 | 10.4 | 75.1 | 52.4 |
| Queue Length 50th (ft) | 61 | 148 | 163 | 128 | 242 | 83 | 509 | 39 | 75 | 251 |
| Queue Length 95th (ft) | #126 | 178 | 267 | #209 | 286 | 142 | #819 | 96 | #167 | 296 |
| Internal Link Dist (ft) | | 1419 | | | 1765 | | 1236 | | | 1445 |
| Turn Bay Length (ft) | 170 | | | 140 | | 305 | | 165 | 350 | |
| Base Capacity (vph) | 134 | 911 | 822 | 475 | 1094 | 980 | 822 | 746 | 148 | 1330 |
| Starvation Cap Reductn | 0 | 0 | 0 | 0 | 0 | 0 | 0 | 0 | 0 | 0 |
| Spillback Cap Reductn | 0 | 0 | 0 | 0 | 0 | 0 | 0 | 0 | 0 | 0 |
| Storage Cap Reductn | 0 | 0 | 0 | 0 | 0 | 0 | 0 | 0 | 0 | 0 |
| Reduced v/c Ratio | 0.60 | 0.41 | 0.53 | 0.72 | 0.58 | 0.29 | 0.92 | 0.28 | 0.67 | 0.49 |

Intersection Summary

95th percentile volume exceeds capacity, queue may be longer.
Queue shown is maximum after two cycles.

Queues
6: Main St & Freedom Blvd & Western Dr

Existing Plus Project
Timing Plan: SATURDAY PEAK HOUR



| Lane Group | EBT | EBR | WBL | WBT | NBL | NBT | NBR | SBT | SBR |
|-------------------------|------|------|------|------|------|------|------|------|------|
| Lane Group Flow (vph) | 279 | 539 | 185 | 382 | 289 | 291 | 369 | 36 | 48 |
| v/c Ratio | 0.82 | 0.28 | 0.73 | 0.73 | 0.44 | 0.44 | 0.36 | 0.22 | 0.17 |
| Control Delay | 57.9 | 1.3 | 57.2 | 48.5 | 27.6 | 27.6 | 2.7 | 44.3 | 1.3 |
| Queue Delay | 0.0 | 0.0 | 0.0 | 0.0 | 1.0 | 1.0 | 0.1 | 0.0 | 0.0 |
| Total Delay | 57.9 | 1.3 | 57.2 | 48.5 | 28.6 | 28.6 | 2.8 | 44.3 | 1.3 |
| Queue Length 50th (ft) | 170 | 0 | 125 | 128 | 187 | 188 | 32 | 21 | 0 |
| Queue Length 95th (ft) | 250 | 23 | 201 | 176 | 235 | 236 | 20 | 53 | 0 |
| Internal Link Dist (ft) | 727 | | | 547 | | 224 | | 295 | |
| Turn Bay Length (ft) | | | | 360 | | 150 | | 150 | |
| Base Capacity (vph) | 433 | 1930 | 299 | 617 | 654 | 658 | 1053 | 163 | 285 |
| Starvation Cap Reductn | 0 | 0 | 0 | 0 | 169 | 172 | 151 | 0 | 0 |
| Spillback Cap Reductn | 0 | 0 | 0 | 0 | 0 | 0 | 0 | 0 | 0 |
| Storage Cap Reductn | 0 | 0 | 0 | 0 | 0 | 0 | 0 | 0 | 0 |
| Reduced v/c Ratio | 0.64 | 0.28 | 0.62 | 0.62 | 0.60 | 0.60 | 0.41 | 0.22 | 0.17 |
| Intersection Summary | | | | | | | | | |

F – SIDRA Outputs



MOVEMENT SUMMARY

Site: 101 [WDSP_RAB_AM_2022WP_HCM6_1Ln_V6_Net2 (Site Folder: General)]

Network: N101 [2022_AM_NetworkV2 (Network Folder: General)]

New Site
Site Category: (None)
Roundabout

| Vehicle Movement Performance | | | | | | | | | | | | | | |
|------------------------------|------|-----------------|------|-----------------|------|-----------|-------------|------------------|-----------------------|--------------|-----------|---------------------|------------------|-------------|
| Mov ID | Turn | DEMAND FLOWS | | ARRIVAL FLOWS | | Deg. Satn | Aver. Delay | Level of Service | AVERAGE BACK OF QUEUE | | Prop. Que | Effective Stop Rate | Aver. No. Cycles | Aver. Speed |
| | | [Total veh/h] | HV % | [Total veh/h] | HV % | | | | [Veh. veh] | [Dist. ft] | | | | |
| SouthEast: (NB) Main St | | | | | | | | | | | | | | |
| 3x | L2 | 501 | 2.0 | 501 | 2.0 | 0.433 | 7.6 | LOS A | 1.0 | 25.3 | 0.45 | 0.32 | 0.45 | 22.9 |
| 8x | T1 | 17 | 2.0 | 17 | 2.0 | 0.347 | 6.5 | LOS A | 0.7 | 18.3 | 0.41 | 0.28 | 0.41 | 14.6 |
| 18x | R2 | 385 | 2.0 | 385 | 2.0 | 0.347 | 6.5 | LOS A | 0.7 | 18.3 | 0.41 | 0.28 | 0.41 | 22.7 |
| Approach | | 903 | 2.0 | 903 | 2.0 | 0.433 | 7.1 | LOS A | 1.0 | 25.3 | 0.44 | 0.30 | 0.44 | 22.7 |
| NorthEast: (WB) Freedom St | | | | | | | | | | | | | | |
| 1x | L2 | 251 | 2.0 | 251 | 2.0 | 0.304 | 7.8 | LOS A | 0.4 | 11.4 | 0.50 | 0.50 | 0.50 | 16.9 |
| 6x | T1 | 239 | 2.0 | 239 | 2.0 | 0.304 | 7.1 | LOS A | 0.4 | 11.4 | 0.50 | 0.49 | 0.50 | 27.3 |
| 16x | R2 | 8 | 2.0 | 8 | 2.0 | 0.304 | 7.1 | LOS A | 0.4 | 11.4 | 0.50 | 0.49 | 0.50 | 20.4 |
| Approach | | 498 | 2.0 | 498 | 2.0 | 0.304 | 7.5 | LOS A | 0.4 | 11.4 | 0.50 | 0.49 | 0.50 | 22.3 |
| NorthWest: (SB) Western Dr | | | | | | | | | | | | | | |
| 7x | L2 | 23 | 2.0 | 23 | 2.0 | 0.150 | 7.4 | LOS A | 0.2 | 5.0 | 0.59 | 0.59 | 0.59 | 19.9 |
| 4x | T1 | 14 | 2.0 | 14 | 2.0 | 0.150 | 7.4 | LOS A | 0.2 | 5.0 | 0.59 | 0.59 | 0.59 | 11.8 |
| 14x | R2 | 58 | 2.0 | 58 | 2.0 | 0.150 | 7.4 | LOS A | 0.2 | 5.0 | 0.59 | 0.59 | 0.59 | 23.1 |
| Approach | | 95 | 2.0 | 95 | 2.0 | 0.150 | 7.4 | LOS A | 0.2 | 5.0 | 0.59 | 0.59 | 0.59 | 21.3 |
| SouthWest: (EB) Main St | | | | | | | | | | | | | | |
| 5x | L2 | 23 | 2.0 | 23 | 2.0 | 0.305 | 6.4 | LOS A | 0.5 | 12.6 | 0.43 | 0.34 | 0.43 | 21.5 |
| 2x | T1 | 153 | 2.0 | 153 | 2.0 | 0.305 | 6.4 | LOS A | 0.5 | 12.6 | 0.43 | 0.34 | 0.43 | 28.3 |
| 12x | R2 | 430 | 2.0 | 430 | 2.0 | 0.305 | 6.6 | LOS A | 0.5 | 13.5 | 0.48 | 0.41 | 0.48 | 22.2 |
| Approach | | 607 | 2.0 | 607 | 2.0 | 0.305 | 6.6 | LOS A | 0.5 | 13.5 | 0.46 | 0.39 | 0.46 | 24.0 |
| All Vehicles | | 2102 | 2.0 | 2102 | 2.0 | 0.433 | 7.1 | LOS A | 1.0 | 25.3 | 0.47 | 0.39 | 0.47 | 22.9 |

Site Level of Service (LOS) Method: Delay & v/c (HCM 6). Site LOS Method is specified in the Network Data dialog (Network tab).

Roundabout LOS Method: Same as Sign Control.

Vehicle movement LOS values are based on average delay and v/c ratio (degree of saturation) per movement.

LOS F will result if v/c > 1 irrespective of movement delay value (does not apply for approaches and intersection).

Intersection and Approach LOS values are based on average delay for all movements (v/c not used as specified in HCM 6).

Roundabout Capacity Model: US HCM 6.

Delay Model: HCM Delay Formula (Geometric Delay is not included).

Gap-Acceptance Capacity: Traditional M1.

HV (%) values are calculated for All Movement Classes of All Heavy Vehicle Model Designation.

MOVEMENT SUMMARY

Site: 101 [WDSP_RAB_PM_2022WP_HCM6_1Ln_V6_Net2 (Site Folder: General)]

Network: N101 [2022_PM_NetworkV2 (Network Folder: General)]

New Site
 Site Category: (None)
 Roundabout

| Vehicle Movement Performance | | | | | | | | | | | | | | |
|------------------------------|------|-----------------|----------|-----------------|----------|------------------|--------------------|------------------|-----------------------|--------------|-----------|---------------------|------------------|--------------------|
| Mov ID | Turn | DEMAND FLOWS | | ARRIVAL FLOWS | | Deg. Satn v/c | Aver. Delay sec | Level of Service | AVERAGE BACK OF QUEUE | | Prop. Que | Effective Stop Rate | Aver. No. Cycles | Aver. Speed mph |
| | | [Total veh/h] | [HV %] | [Total veh/h] | [HV %] | | | | [Veh. veh] | [Dist. ft] | | | | |
| SouthEast: (NB) Main St | | | | | | | | | | | | | | |
| 3x | L2 | 604 | 2.0 | 604 | 2.0 | 0.690 | 16.2 | LOS C | 3.2 | 81.8 | 0.81 | 1.07 | 1.51 | 18.3 |
| 8x | T1 | 21 | 2.0 | 21 | 2.0 | 0.466 | 10.0 | LOS A | 1.2 | 29.9 | 0.65 | 0.72 | 0.85 | 12.4 |
| 18x | R2 | 388 | 2.0 | 388 | 2.0 | 0.466 | 10.0 | LOS A | 1.2 | 29.9 | 0.65 | 0.72 | 0.85 | 19.7 |
| Approach | | 1013 | 2.0 | 1013 | 2.0 | 0.690 | 13.7 | LOS B | 3.2 | 81.8 | 0.75 | 0.93 | 1.24 | 18.6 |
| NorthEast: (WB) Freedom St | | | | | | | | | | | | | | |
| 1x | L2 | 377 | 2.0 | 377 | 2.0 | 0.593 | 18.4 | LOS C | 4.0 | 100.4 | 0.66 | 0.84 | 1.20 | 12.5 |
| 6x | T1 | 290 | 2.0 | 290 | 2.0 | 0.593 | 14.1 | LOS B | 1.8 | 44.6 | 0.73 | 0.91 | 1.27 | 22.1 |
| 16x | R2 | 5 | 2.0 | 5 | 2.0 | 0.593 | 14.1 | LOS B | 1.8 | 44.6 | 0.73 | 0.91 | 1.27 | 15.9 |
| Approach | | 673 | 2.0 | 673 | 2.0 | 0.593 | 16.5 | LOS C | 4.0 | 100.4 | 0.69 | 0.87 | 1.23 | 16.9 |
| NorthWest: (SB) Western Dr | | | | | | | | | | | | | | |
| 7x | L2 | 23 | 2.0 | 23 | 2.0 | 0.249 | 11.3 | LOS B | 0.3 | 8.7 | 0.72 | 0.73 | 0.75 | 17.5 |
| 4x | T1 | 37 | 2.0 | 37 | 2.0 | 0.249 | 11.3 | LOS B | 0.3 | 8.7 | 0.72 | 0.73 | 0.75 | 9.7 |
| 14x | R2 | 59 | 2.0 | 59 | 2.0 | 0.249 | 11.3 | LOS B | 0.3 | 8.7 | 0.72 | 0.73 | 0.75 | 20.6 |
| Approach | | 118 | 2.0 | 118 | 2.0 | 0.249 | 11.3 | LOS B | 0.3 | 8.7 | 0.72 | 0.73 | 0.75 | 17.6 |
| SouthWest: (EB) Main St | | | | | | | | | | | | | | |
| 5x | L2 | 70 | 2.0 | 70 | 2.0 | 0.654 | 14.7 | LOS B | 2.4 | 60.5 | 0.68 | 0.88 | 1.23 | 17.1 |
| 2x | T1 | 407 | 2.0 | 407 | 2.0 | 0.654 | 14.7 | LOS B | 2.4 | 60.5 | 0.68 | 0.88 | 1.23 | 22.5 |
| 12x | R2 | 671 | 2.0 | 671 | 2.0 | 0.654 | 14.4 | LOS B | 2.7 | 69.7 | 0.74 | 0.97 | 1.33 | 16.7 |
| Approach | | 1147 | 2.0 | 1147 | 2.0 | 0.654 | 14.5 | LOS B | 2.7 | 69.7 | 0.72 | 0.93 | 1.29 | 19.1 |
| All Vehicles | | 2951 | 2.0 | 2951 | 2.0 | 0.690 | 14.6 | LOS B | 4.0 | 100.4 | 0.72 | 0.91 | 1.24 | 18.3 |

Site Level of Service (LOS) Method: Delay & v/c (HCM 6). Site LOS Method is specified in the Network Data dialog (Network tab).

Roundabout LOS Method: Same as Sign Control.

Vehicle movement LOS values are based on average delay and v/c ratio (degree of saturation) per movement.

LOS F will result if v/c > 1 irrespective of movement delay value (does not apply for approaches and intersection).

Intersection and Approach LOS values are based on average delay for all movements (v/c not used as specified in HCM 6).

Roundabout Capacity Model: US HCM 6.

Delay Model: HCM Delay Formula (Geometric Delay is not included).

Gap-Acceptance Capacity: Traditional M1.

HV (%) values are calculated for All Movement Classes of All Heavy Vehicle Model Designation.

MOVEMENT SUMMARY

Site: 101 [WDSP_RAB_SAT_2022WP_HCM6_1Ln_V6_Net2
(Site Folder: General)]

Network: N101
[2022_SAT_NetworkV2 (Network
Folder: General)]

New Site
Site Category: (None)
Roundabout

| Vehicle Movement Performance | | | | | | | | | | | | | | |
|------------------------------|------|---------------|------|---------------|------|-----------|-------------|------------------|-----------------------|-----------|-----------|---------------------|------------------|-------------|
| Mov ID | Turn | DEMAND FLOWS | | ARRIVAL FLOWS | | Deg. Satn | Aver. Delay | Level of Service | AVERAGE BACK OF QUEUE | | Prop. Que | Effective Stop Rate | Aver. No. Cycles | Aver. Speed |
| | | [Total veh/h | HV % | [Total veh/h | HV % | | | | [Veh. veh | Dist] ft | | | | |
| SouthEast: (NB) Main St | | | | | | | | | | | | | | |
| 3x | L2 | 592 | 2.0 | 592 | 2.0 | 0.567 | 10.7 | LOS B | 2.0 | 51.0 | 0.64 | 0.63 | 0.84 | 21.0 |
| 8x | T1 | 26 | 2.0 | 26 | 2.0 | 0.402 | 7.8 | LOS A | 0.8 | 21.3 | 0.53 | 0.43 | 0.53 | 13.7 |
| 18x | R2 | 393 | 2.0 | 393 | 2.0 | 0.402 | 7.8 | LOS A | 0.8 | 21.3 | 0.53 | 0.43 | 0.53 | 21.6 |
| Approach | | 1012 | 2.0 | 1012 | 2.0 | 0.567 | 9.5 | LOS A | 2.0 | 51.0 | 0.59 | 0.55 | 0.71 | 21.0 |
| NorthEast: (WB) Freedom St | | | | | | | | | | | | | | |
| 1x | L2 | 334 | 2.0 | 334 | 2.0 | 0.497 | 14.0 | LOS B | 1.3 | 32.5 | 0.59 | 0.71 | 0.93 | 14.1 |
| 6x | T1 | 260 | 2.0 | 260 | 2.0 | 0.497 | 11.0 | LOS B | 1.2 | 30.2 | 0.65 | 0.76 | 0.98 | 23.8 |
| 16x | R2 | 11 | 2.0 | 11 | 2.0 | 0.497 | 11.0 | LOS B | 1.2 | 30.2 | 0.65 | 0.76 | 0.98 | 17.4 |
| Approach | | 604 | 2.0 | 604 | 2.0 | 0.497 | 12.6 | LOS B | 1.3 | 32.5 | 0.62 | 0.73 | 0.95 | 18.7 |
| NorthWest: (SB) Western Dr | | | | | | | | | | | | | | |
| 7x | L2 | 13 | 2.0 | 13 | 2.0 | 0.171 | 9.1 | LOS A | 0.2 | 5.7 | 0.66 | 0.66 | 0.66 | 19.0 |
| 4x | T1 | 26 | 2.0 | 26 | 2.0 | 0.171 | 9.1 | LOS A | 0.2 | 5.7 | 0.66 | 0.66 | 0.66 | 10.9 |
| 14x | R2 | 51 | 2.0 | 51 | 2.0 | 0.171 | 9.1 | LOS A | 0.2 | 5.7 | 0.66 | 0.66 | 0.66 | 22.2 |
| Approach | | 90 | 2.0 | 90 | 2.0 | 0.171 | 9.1 | LOS A | 0.2 | 5.7 | 0.66 | 0.66 | 0.66 | 19.5 |
| SouthWest: (EB) Main St | | | | | | | | | | | | | | |
| 5x | L2 | 34 | 2.0 | 34 | 2.0 | 0.503 | 10.6 | LOS B | 1.0 | 25.0 | 0.54 | 0.55 | 0.69 | 19.1 |
| 2x | T1 | 263 | 2.0 | 263 | 2.0 | 0.503 | 10.6 | LOS B | 1.0 | 25.0 | 0.54 | 0.55 | 0.69 | 25.1 |
| 12x | R2 | 574 | 2.0 | 574 | 2.0 | 0.503 | 10.3 | LOS B | 1.4 | 35.1 | 0.62 | 0.68 | 0.84 | 19.3 |
| Approach | | 871 | 2.0 | 871 | 2.0 | 0.503 | 10.4 | LOS B | 1.4 | 35.1 | 0.59 | 0.64 | 0.79 | 21.4 |
| All Vehicles | | 2577 | 2.0 | 2577 | 2.0 | 0.567 | 10.5 | LOS B | 2.0 | 51.0 | 0.60 | 0.63 | 0.79 | 20.5 |

Site Level of Service (LOS) Method: Delay & v/c (HCM 6). Site LOS Method is specified in the Network Data dialog (Network tab).

Roundabout LOS Method: Same as Sign Control.

Vehicle movement LOS values are based on average delay and v/c ratio (degree of saturation) per movement.

LOS F will result if v/c > 1 irrespective of movement delay value (does not apply for approaches and intersection).

Intersection and Approach LOS values are based on average delay for all movements (v/c not used as specified in HCM 6).

Roundabout Capacity Model: US HCM 6.

Delay Model: HCM Delay Formula (Geometric Delay is not included).

Gap-Acceptance Capacity: Traditional M1.

HV (%) values are calculated for All Movement Classes of All Heavy Vehicle Model Designation.

SIDRA INTERSECTION 9.0 | Copyright © 2000-2020 Akcelik and Associates Pty Ltd | sidrasolutions.com

Organisation: KIMLEY-HORN & ASSOCIATES INC | Licence: NETWORK / Enterprise | Processed: Wednesday, October 12, 2022 6:45:21 PM
Project: K:\SJC_TPTO\City of Watsonville\197xxxxxxx - Watsonville Downtown SP\04 Analysis\Sidra\WDSP_RAB_Ex_Fut_Rev2022.10.12.sip9

MOVEMENT SUMMARY

Site: 101 [WDSP_RAB_AM_2040WP_HCM6_1Ln_V6_Net2 (Site Folder: General)]

Network: N101 [2040_AM_NetworkV2 (Network Folder: General)]

New Site
Site Category: (None)
Roundabout

| Vehicle Movement Performance | | | | | | | | | | | | | | |
|------------------------------|------|-----------------|----------|-----------------|----------|-----------|-------------|------------------|-----------------------|-----------|-----------|---------------------|------------------|-------------|
| Mov ID | Turn | DEMAND FLOWS | | ARRIVAL FLOWS | | Deg. Satn | Aver. Delay | Level of Service | AVERAGE BACK OF QUEUE | | Prop. Que | Effective Stop Rate | Aver. No. Cycles | Aver. Speed |
| | | [Total veh/h] | [HV %] | [Total veh/h] | [HV %] | | | | [Veh.] | [Dist.] | | | | |
| SouthEast: (NB) Main St | | | | | | | | | | | | | | |
| 3x | L2 | 537 | 2.0 | 537 | 2.0 | 0.494 | 9.0 | LOS A | 1.2 | 29.8 | 0.55 | 0.44 | 0.55 | 22.0 |
| 8x | T1 | 17 | 2.0 | 17 | 2.0 | 0.390 | 7.4 | LOS A | 0.8 | 20.8 | 0.49 | 0.38 | 0.49 | 14.0 |
| 18x | R2 | 407 | 2.0 | 407 | 2.0 | 0.390 | 7.4 | LOS A | 0.8 | 20.8 | 0.49 | 0.38 | 0.49 | 21.9 |
| Approach | | 961 | 2.0 | 961 | 2.0 | 0.494 | 8.3 | LOS A | 1.2 | 29.8 | 0.53 | 0.42 | 0.53 | 21.9 |
| NorthEast: (WB) Freedom St | | | | | | | | | | | | | | |
| 1x | L2 | 307 | 2.0 | 307 | 2.0 | 0.394 | 10.1 | LOS B | 0.7 | 18.3 | 0.54 | 0.58 | 0.65 | 15.9 |
| 6x | T1 | 239 | 2.0 | 239 | 2.0 | 0.394 | 8.6 | LOS A | 0.7 | 18.3 | 0.56 | 0.60 | 0.67 | 25.5 |
| 16x | R2 | 8 | 2.0 | 8 | 2.0 | 0.394 | 8.6 | LOS A | 0.7 | 18.3 | 0.56 | 0.60 | 0.67 | 18.9 |
| Approach | | 553 | 2.0 | 553 | 2.0 | 0.394 | 9.4 | LOS A | 0.7 | 18.3 | 0.55 | 0.59 | 0.66 | 20.5 |
| NorthWest: (SB) Western Dr | | | | | | | | | | | | | | |
| 7x | L2 | 23 | 2.0 | 23 | 2.0 | 0.163 | 8.2 | LOS A | 0.2 | 5.4 | 0.63 | 0.63 | 0.63 | 19.3 |
| 4x | T1 | 14 | 2.0 | 14 | 2.0 | 0.163 | 8.2 | LOS A | 0.2 | 5.4 | 0.63 | 0.63 | 0.63 | 11.2 |
| 14x | R2 | 58 | 2.0 | 58 | 2.0 | 0.163 | 8.2 | LOS A | 0.2 | 5.4 | 0.63 | 0.63 | 0.63 | 22.5 |
| Approach | | 95 | 2.0 | 95 | 2.0 | 0.163 | 8.2 | LOS A | 0.2 | 5.4 | 0.63 | 0.63 | 0.63 | 20.7 |
| SouthWest: (EB) Main St | | | | | | | | | | | | | | |
| 5x | L2 | 23 | 2.0 | 23 | 2.0 | 0.388 | 8.0 | LOS A | 0.6 | 15.3 | 0.49 | 0.41 | 0.49 | 20.6 |
| 2x | T1 | 222 | 2.0 | 222 | 2.0 | 0.388 | 8.0 | LOS A | 0.6 | 15.3 | 0.49 | 0.41 | 0.49 | 27.0 |
| 12x | R2 | 474 | 2.0 | 474 | 2.0 | 0.388 | 8.0 | LOS A | 0.7 | 18.4 | 0.54 | 0.49 | 0.54 | 21.0 |
| Approach | | 718 | 2.0 | 718 | 2.0 | 0.388 | 8.0 | LOS A | 0.7 | 18.4 | 0.52 | 0.46 | 0.52 | 23.2 |
| All Vehicles | | 2327 | 2.0 | 2327 | 2.0 | 0.494 | 8.5 | LOS A | 1.2 | 29.8 | 0.53 | 0.48 | 0.56 | 21.9 |

Site Level of Service (LOS) Method: Delay & v/c (HCM 6). Site LOS Method is specified in the Network Data dialog (Network tab).

Roundabout LOS Method: Same as Sign Control.

Vehicle movement LOS values are based on average delay and v/c ratio (degree of saturation) per movement.

LOS F will result if v/c > 1 irrespective of movement delay value (does not apply for approaches and intersection).

Intersection and Approach LOS values are based on average delay for all movements (v/c not used as specified in HCM 6).

Roundabout Capacity Model: US HCM 6.

Delay Model: HCM Delay Formula (Geometric Delay is not included).

Gap-Acceptance Capacity: Traditional M1.

HV (%) values are calculated for All Movement Classes of All Heavy Vehicle Model Designation.

MOVEMENT SUMMARY

Site: 101 [WDSP_RAB_PM_2040WP_HCM6_1Ln_V6_Net2 (Site Folder: General)]

Network: N101 [2040_PM_NetworkV2 (Network Folder: General)]

New Site
 Site Category: (None)
 Roundabout

| Vehicle Movement Performance | | | | | | | | | | | | | | |
|------------------------------|------|---------------|------|---------------|------|-----------|-------------|------------------|-----------------------|-----------|-----------|---------------------|------------------|-------------|
| Mov ID | Turn | DEMAND FLOWS | | ARRIVAL FLOWS | | Deg. Satn | Aver. Delay | Level of Service | AVERAGE BACK OF QUEUE | | Prop. Que | Effective Stop Rate | Aver. No. Cycles | Aver. Speed |
| | | [Total veh/h | HV % | [Total veh/h | HV % | | | | [Veh. veh | Dist] ft | | | | |
| SouthEast: (NB) Main St | | | | | | | | | | | | | | |
| 3x | L2 | 441 | 2.0 | 441 | 2.0 | 0.534 | 11.9 | LOS B | 1.6 | 39.7 | 0.71 | 0.84 | 1.07 | 20.3 |
| 8x | T1 | 33 | 2.0 | 33 | 2.0 | 0.552 | 12.4 | LOS B | 1.7 | 43.0 | 0.72 | 0.87 | 1.12 | 11.3 |
| 18x | R2 | 424 | 2.0 | 424 | 2.0 | 0.552 | 12.4 | LOS B | 1.7 | 43.0 | 0.72 | 0.87 | 1.12 | 18.1 |
| Approach | | 898 | 2.0 | 898 | 2.0 | 0.552 | 12.1 | LOS B | 1.7 | 43.0 | 0.72 | 0.85 | 1.09 | 19.2 |
| NorthEast: (WB) Freedom St | | | | | | | | | | | | | | |
| 1x | L2 | 412 | 2.0 | 412 | 2.0 | 0.554 | 14.9 | LOS B | 3.2 | 80.6 | 0.60 | 0.75 | 1.00 | 13.7 |
| 6x | T1 | 300 | 2.0 | 300 | 2.0 | 0.554 | 11.7 | LOS B | 1.6 | 41.7 | 0.67 | 0.81 | 1.06 | 23.3 |
| 16x | R2 | 5 | 2.0 | 5 | 2.0 | 0.554 | 11.7 | LOS B | 1.6 | 41.7 | 0.67 | 0.81 | 1.06 | 17.0 |
| Approach | | 717 | 2.0 | 717 | 2.0 | 0.554 | 13.6 | LOS B | 3.2 | 80.6 | 0.63 | 0.77 | 1.02 | 18.1 |
| NorthWest: (SB) Western Dr | | | | | | | | | | | | | | |
| 7x | L2 | 23 | 2.0 | 23 | 2.0 | 0.227 | 10.0 | LOS A | 0.3 | 7.8 | 0.68 | 0.68 | 0.68 | 18.4 |
| 4x | T1 | 38 | 2.0 | 38 | 2.0 | 0.227 | 10.0 | LOS A | 0.3 | 7.8 | 0.68 | 0.68 | 0.68 | 10.5 |
| 14x | R2 | 59 | 2.0 | 59 | 2.0 | 0.227 | 10.0 | LOS A | 0.3 | 7.8 | 0.68 | 0.68 | 0.68 | 21.5 |
| Approach | | 120 | 2.0 | 120 | 2.0 | 0.227 | 10.0 | LOS A | 0.3 | 7.8 | 0.68 | 0.68 | 0.68 | 18.4 |
| SouthWest: (EB) Main St | | | | | | | | | | | | | | |
| 5x | L2 | 70 | 2.0 | 70 | 2.0 | 0.590 | 12.3 | LOS B | 2.1 | 52.7 | 0.70 | 0.86 | 1.12 | 18.3 |
| 2x | T1 | 470 | 2.0 | 470 | 2.0 | 0.590 | 12.3 | LOS B | 2.1 | 52.7 | 0.70 | 0.86 | 1.12 | 23.9 |
| 12x | R2 | 559 | 2.0 | 559 | 2.0 | 0.590 | 12.1 | LOS B | 2.1 | 53.9 | 0.69 | 0.84 | 1.10 | 17.9 |
| Approach | | 1098 | 2.0 | 1098 | 2.0 | 0.590 | 12.2 | LOS B | 2.1 | 53.9 | 0.69 | 0.85 | 1.11 | 20.9 |
| All Vehicles | | 2833 | 2.0 | 2833 | 2.0 | 0.590 | 12.4 | LOS B | 3.2 | 80.6 | 0.68 | 0.82 | 1.07 | 19.5 |

Site Level of Service (LOS) Method: Delay & v/c (HCM 6). Site LOS Method is specified in the Network Data dialog (Network tab).

Roundabout LOS Method: Same as Sign Control.

Vehicle movement LOS values are based on average delay and v/c ratio (degree of saturation) per movement.

LOS F will result if v/c > 1 irrespective of movement delay value (does not apply for approaches and intersection).

Intersection and Approach LOS values are based on average delay for all movements (v/c not used as specified in HCM 6).

Roundabout Capacity Model: US HCM 6.

Delay Model: HCM Delay Formula (Geometric Delay is not included).

Gap-Acceptance Capacity: Traditional M1.

HV (%) values are calculated for All Movement Classes of All Heavy Vehicle Model Designation.

MOVEMENT SUMMARY

Site: 101 [WDSP_RAB_SAT_2040WP_HCM6_1Ln_V6_Net2
(Site Folder: General)]

Network: N101
[2040_SAT_NetworkV2 (Network
Folder: General)]

New Site
Site Category: (None)
Roundabout

| Vehicle Movement Performance | | | | | | | | | | | | | | |
|------------------------------|------|-----------------|----------|-----------------|----------|-----------|-------------|------------------|-----------------------|--------------|-----------|---------------------|------------------|-------------|
| Mov ID | Turn | DEMAND FLOWS | | ARRIVAL FLOWS | | Deg. Satn | Aver. Delay | Level of Service | AVERAGE BACK OF QUEUE | | Prop. Que | Effective Stop Rate | Aver. No. Cycles | Aver. Speed |
| | | [Total veh/h] | [HV %] | [Total veh/h] | [HV %] | | | | [Veh. veh] | [Dist. ft] | | | | |
| SouthEast: (NB) Main St | | | | | | | | | | | | | | |
| 3x | L2 | 592 | 2.0 | 592 | 2.0 | 0.601 | 12.0 | LOS B | 2.4 | 61.3 | 0.70 | 0.79 | 1.06 | 20.3 |
| 8x | T1 | 27 | 2.0 | 27 | 2.0 | 0.464 | 9.1 | LOS A | 1.1 | 28.5 | 0.60 | 0.57 | 0.67 | 12.9 |
| 18x | R2 | 429 | 2.0 | 429 | 2.0 | 0.464 | 9.1 | LOS A | 1.1 | 28.5 | 0.60 | 0.57 | 0.67 | 20.4 |
| Approach | | 1049 | 2.0 | 1049 | 2.0 | 0.601 | 10.7 | LOS B | 2.4 | 61.3 | 0.65 | 0.69 | 0.89 | 20.2 |
| NorthEast: (WB) Freedom St | | | | | | | | | | | | | | |
| 1x | L2 | 368 | 2.0 | 368 | 2.0 | 0.543 | 15.6 | LOS C | 2.3 | 59.5 | 0.62 | 0.77 | 1.05 | 13.5 |
| 6x | T1 | 270 | 2.0 | 270 | 2.0 | 0.543 | 12.2 | LOS B | 1.5 | 37.1 | 0.68 | 0.82 | 1.10 | 23.1 |
| 16x | R2 | 11 | 2.0 | 11 | 2.0 | 0.543 | 12.2 | LOS B | 1.5 | 37.1 | 0.68 | 0.82 | 1.10 | 16.7 |
| Approach | | 649 | 2.0 | 649 | 2.0 | 0.543 | 14.1 | LOS B | 2.3 | 59.5 | 0.65 | 0.79 | 1.07 | 17.8 |
| NorthWest: (SB) Western Dr | | | | | | | | | | | | | | |
| 7x | L2 | 13 | 2.0 | 13 | 2.0 | 0.183 | 9.7 | LOS A | 0.2 | 6.1 | 0.68 | 0.68 | 0.68 | 18.6 |
| 4x | T1 | 27 | 2.0 | 27 | 2.0 | 0.183 | 9.7 | LOS A | 0.2 | 6.1 | 0.68 | 0.68 | 0.68 | 10.5 |
| 14x | R2 | 51 | 2.0 | 51 | 2.0 | 0.183 | 9.7 | LOS A | 0.2 | 6.1 | 0.68 | 0.68 | 0.68 | 21.7 |
| Approach | | 91 | 2.0 | 91 | 2.0 | 0.183 | 9.7 | LOS A | 0.2 | 6.1 | 0.68 | 0.68 | 0.68 | 19.0 |
| SouthWest: (EB) Main St | | | | | | | | | | | | | | |
| 5x | L2 | 34 | 2.0 | 34 | 2.0 | 0.577 | 12.5 | LOS B | 1.5 | 38.6 | 0.60 | 0.70 | 0.94 | 18.2 |
| 2x | T1 | 326 | 2.0 | 326 | 2.0 | 0.577 | 12.5 | LOS B | 1.5 | 38.6 | 0.60 | 0.70 | 0.94 | 23.9 |
| 12x | R2 | 625 | 2.0 | 625 | 2.0 | 0.577 | 12.2 | LOS B | 1.9 | 49.2 | 0.68 | 0.83 | 1.08 | 18.0 |
| Approach | | 985 | 2.0 | 985 | 2.0 | 0.577 | 12.3 | LOS B | 1.9 | 49.2 | 0.65 | 0.78 | 1.03 | 20.3 |
| All Vehicles | | 2774 | 2.0 | 2774 | 2.0 | 0.601 | 12.1 | LOS B | 2.4 | 61.3 | 0.65 | 0.75 | 0.97 | 19.6 |

Site Level of Service (LOS) Method: Delay & v/c (HCM 6). Site LOS Method is specified in the Network Data dialog (Network tab).

Roundabout LOS Method: Same as Sign Control.

Vehicle movement LOS values are based on average delay and v/c ratio (degree of saturation) per movement.

LOS F will result if v/c > 1 irrespective of movement delay value (does not apply for approaches and intersection).

Intersection and Approach LOS values are based on average delay for all movements (v/c not used as specified in HCM 6).

Roundabout Capacity Model: US HCM 6.

Delay Model: HCM Delay Formula (Geometric Delay is not included).

Gap-Acceptance Capacity: Traditional M1.

HV (%) values are calculated for All Movement Classes of All Heavy Vehicle Model Designation.

MOVEMENT SUMMARY

Site: 102 [WDSP_Ford_AM_2022WP_HCM6_1Ln_V6_Net2 (Site Folder: General)]

Network: N101 [2022_AM_NetworkV2 (Network Folder: General)]

New Site

Site Category: (None)

Signals - EQUISAT (Pre-timed) Isolated Cycle Time = 40 seconds (Site Practical Cycle Time)

| Vehicle Movement Performance | | | | | | | | | | | | | | |
|------------------------------|------|-----------------|------|-----------------|------|------------------|--------------------|------------------|-----------------------|--------------|-----------|---------------------|------------------|--------------------|
| Mov ID | Turn | DEMAND FLOWS | | ARRIVAL FLOWS | | Deg. Satn v/c | Aver. Delay sec | Level of Service | AVERAGE BACK OF QUEUE | | Prop. Que | Effective Stop Rate | Aver. No. Cycles | Aver. Speed mph |
| | | [Total veh/h] | HV % | [Total veh/h] | HV % | | | | [Veh. veh] | [Dist. ft] | | | | |
| SouthEast: (NB) Main St | | | | | | | | | | | | | | |
| 3x | L2 | 24 | 2.0 | 24 | 2.0 | * 0.090 | 14.8 | LOS B | 0.3 | 6.5 | 0.89 | 0.63 | 0.89 | 28.4 |
| 8x | T1 | 877 | 2.0 | 877 | 2.0 | 0.554 | 9.4 | LOS A | 4.3 | 110.2 | 0.80 | 0.69 | 0.80 | 30.0 |
| Approach | | 901 | 2.0 | 901 | 2.0 | 0.554 | 9.5 | LOS A | 4.3 | 110.2 | 0.80 | 0.69 | 0.80 | 29.9 |
| NorthWest: (SB) Main St | | | | | | | | | | | | | | |
| 4x | T1 | 676 | 2.0 | 676 | 2.0 | * 0.646 | 10.6 | LOS B | 5.5 | 139.2 | 0.80 | 0.70 | 0.82 | 30.5 |
| 14x | R2 | 20 | 2.0 | 20 | 2.0 | 0.234 | 6.2 | LOS A | 1.3 | 34.1 | 0.67 | 0.55 | 0.67 | 31.2 |
| Approach | | 696 | 2.0 | 696 | 2.0 | 0.646 | 10.5 | LOS B | 5.5 | 139.2 | 0.80 | 0.70 | 0.82 | 30.5 |
| SouthWest: (EB) Ford St | | | | | | | | | | | | | | |
| 5x | L2 | 26 | 2.0 | 26 | 2.0 | * 0.074 | 13.1 | LOS B | 0.3 | 6.6 | 0.84 | 0.60 | 0.84 | 23.9 |
| 12x | R2 | 36 | 2.0 | 36 | 2.0 | 0.036 | 5.6 | LOS A | 0.1 | 3.5 | 0.37 | 0.28 | 0.37 | 33.8 |
| Approach | | 62 | 2.0 | 62 | 2.0 | 0.074 | 8.7 | LOS A | 0.3 | 6.6 | 0.57 | 0.41 | 0.57 | 30.4 |
| All Vehicles | | 1659 | 2.0 | 1659 | 2.0 | 0.646 | 9.9 | LOS A | 5.5 | 139.2 | 0.79 | 0.68 | 0.80 | 30.2 |

Site Level of Service (LOS) Method: Delay & v/c (HCM 6). Site LOS Method is specified in the Network Data dialog (Network tab).

Vehicle movement LOS values are based on average delay and v/c ratio (degree of saturation) per movement.

LOS F will result if v/c > 1 irrespective of movement delay value (does not apply for approaches and intersection).

Intersection and Approach LOS values are based on average delay for all movements (v/c not used as specified in HCM 6).

Delay Model: HCM Delay Formula (Geometric Delay is not included).

Gap-Acceptance Capacity: Traditional M1.

HV (%) values are calculated for All Movement Classes of All Heavy Vehicle Model Designation.

* Critical Movement (Signal Timing)

| Pedestrian Movement Performance | | | | | | | | | | | |
|---------------------------------|----------|--------------------|--------------------|------------------|-----------------------|--------------|-----------|---------------------|--------------------|--------------------|-----------------------|
| Mov ID | Crossing | Dem. Flow ped/h | Aver. Delay sec | Level of Service | AVERAGE BACK OF QUEUE | | Prop. Que | Effective Stop Rate | Travel Time sec | Travel Dist. ft | Aver. Speed ft/sec |
| | | | | | [Ped ped] | [Dist. ft] | | | | | |
| SouthEast: (NB) Main St | | | | | | | | | | | |
| 9P | Full | 54 | 12.0 | LOS B | 0.0 | 0.1 | 0.78 | 0.78 | 166.9 | 666.0 | 0.76 |
| SouthWest: (EB) Ford St | | | | | | | | | | | |
| 3P | Full | 54 | 12.0 | LOS B | 0.0 | 0.1 | 0.78 | 0.78 | 161.3 | 642.0 | 0.75 |
| All Pedestrians | | 109 | 12.0 | LOS B | 0.0 | 0.1 | 0.78 | 0.78 | 164.1 | 654.0 | 0.75 |

Level of Service (LOS) Method: SIDRA Pedestrian LOS Method (Based on Average Delay)

Pedestrian movement LOS values are based on average delay per pedestrian movement.

Intersection LOS value for Pedestrians is based on average delay for all pedestrian movements.

MOVEMENT SUMMARY

Site: 102 [WDSP_Ford_PM_2022WP_HCM6_1Ln_V6_Net2 (Site Folder: General)]

Network: N101 [2022_PM_NetworkV2 (Network Folder: General)]

New Site

Site Category: (None)

Signals - EQUISAT (Pre-timed) Isolated Cycle Time = 50 seconds (Site Practical Cycle Time)

| Vehicle Movement Performance | | | | | | | | | | | | | | |
|------------------------------|------|-----------------|------|-----------------|------|-----------|-------------|------------------|-----------------------|--------------|-----------|---------------------|------------------|-------------|
| Mov ID | Turn | DEMAND FLOWS | | ARRIVAL FLOWS | | Deg. Satn | Aver. Delay | Level of Service | AVERAGE BACK OF QUEUE | | Prop. Que | Effective Stop Rate | Aver. No. Cycles | Aver. Speed |
| | | [Total veh/h] | HV % | [Total veh/h] | HV % | | | | [Veh. veh] | [Dist. ft] | | | | |
| SouthEast: (NB) Main St | | | | | | | | | | | | | | |
| 3x | L2 | 50 | 2.0 | 50 | 2.0 | * 0.235 | 20.3 | LOS C | 0.7 | 18.0 | 0.94 | 0.70 | 0.94 | 26.5 |
| 8x | T1 | 993 | 2.0 | 993 | 2.0 | 0.546 | 9.1 | LOS A | 5.7 | 145.1 | 0.73 | 0.64 | 0.73 | 30.2 |
| Approach | | 1043 | 2.0 | 1043 | 2.0 | 0.546 | 9.6 | LOS A | 5.7 | 145.1 | 0.74 | 0.64 | 0.74 | 29.8 |
| NorthWest: (SB) Main St | | | | | | | | | | | | | | |
| 4x | T1 | 1071 | 2.0 | 1071 | 2.0 | * 0.856 | 17.2 | LOS B | 7.9 | 200.0 | 0.86 | 0.89 | 1.04 | 26.6 |
| 14x | R2 | 14 | 2.0 | 14 | 2.0 | 0.310 | 7.2 | LOS A | 2.6 | 66.6 | 0.63 | 0.54 | 0.63 | 30.6 |
| Approach | | 1085 | 2.0 | 1085 | 2.0 | 0.856 | 17.1 | LOS B | 7.9 | 200.0 | 0.86 | 0.88 | 1.03 | 26.7 |
| SouthWest: (EB) Ford St | | | | | | | | | | | | | | |
| 5x | L2 | 20 | 2.0 | 20 | 2.0 | * 0.058 | 16.2 | LOS B | 0.2 | 6.1 | 0.84 | 0.59 | 0.84 | 22.4 |
| 12x | R2 | 25 | 2.0 | 25 | 2.0 | 0.031 | 10.2 | LOS B | 0.2 | 4.3 | 0.51 | 0.36 | 0.51 | 32.4 |
| Approach | | 45 | 2.0 | 45 | 2.0 | 0.058 | 12.8 | LOS B | 0.2 | 6.1 | 0.65 | 0.47 | 0.65 | 28.8 |
| All Vehicles | | 2173 | 2.0 | 2173 | 2.0 | 0.856 | 13.4 | LOS B | 7.9 | 200.0 | 0.80 | 0.76 | 0.88 | 28.1 |

Site Level of Service (LOS) Method: Delay & v/c (HCM 6). Site LOS Method is specified in the Network Data dialog (Network tab).

Vehicle movement LOS values are based on average delay and v/c ratio (degree of saturation) per movement.

LOS F will result if v/c > 1 irrespective of movement delay value (does not apply for approaches and intersection).

Intersection and Approach LOS values are based on average delay for all movements (v/c not used as specified in HCM 6).

Delay Model: HCM Delay Formula (Geometric Delay is not included).

Gap-Acceptance Capacity: Traditional M1.

HV (%) values are calculated for All Movement Classes of All Heavy Vehicle Model Designation.

* Critical Movement (Signal Timing)

| Pedestrian Movement Performance | | | | | | | | | | | |
|---------------------------------|----------|-----------|-------------|------------------|-----------------------|--------------|-----------|---------------------|-------------|--------------|-------------|
| Mov ID | Crossing | Dem. Flow | Aver. Delay | Level of Service | AVERAGE BACK OF QUEUE | | Prop. Que | Effective Stop Rate | Travel Time | Travel Dist. | Aver. Speed |
| | | | | | [Ped ped] | [Dist. ft] | | | | | |
| SouthEast: (NB) Main St | | | | | | | | | | | |
| 9P | Full | 54 | 16.8 | LOS B | 0.1 | 0.2 | 0.82 | 0.82 | 171.7 | 666.0 | 0.73 |
| SouthWest: (EB) Ford St | | | | | | | | | | | |
| 3P | Full | 54 | 16.8 | LOS B | 0.1 | 0.2 | 0.82 | 0.82 | 166.2 | 642.0 | 0.73 |
| All Pedestrians | | 109 | 16.8 | LOS B | 0.1 | 0.2 | 0.82 | 0.82 | 168.9 | 654.0 | 0.73 |

Level of Service (LOS) Method: SIDRA Pedestrian LOS Method (Based on Average Delay)

Pedestrian movement LOS values are based on average delay per pedestrian movement.

Intersection LOS value for Pedestrians is based on average delay for all pedestrian movements.

MOVEMENT SUMMARY

Site: 102 [WDSP_Ford_SAT_2022WP_HCM6_1Ln_V6_Net2 (Site Folder: General)]

Network: N101 [2022_SAT_NetworkV2 (Network Folder: General)]

New Site

Site Category: (None)

Signals - EQUISAT (Pretimed) Isolated Cycle Time = 40 seconds (Site Practical Cycle Time)

| Vehicle Movement Performance | | | | | | | | | | | | | | |
|------------------------------|------|-----------------|------|-----------------|------|-----------|-------------|------------------|-----------------------|--------------|-----------|---------------------|------------------|-------------|
| Mov ID | Turn | DEMAND FLOWS | | ARRIVAL FLOWS | | Deg. Satn | Aver. Delay | Level of Service | AVERAGE BACK OF QUEUE | | Prop. Que | Effective Stop Rate | Aver. No. Cycles | Aver. Speed |
| | | [Total veh/h] | HV % | [Total veh/h] | HV % | | | | [Veh. veh] | [Dist. ft] | | | | |
| SouthEast: (NB) Main St | | | | | | | | | | | | | | |
| 3x | L2 | 37 | 2.0 | 37 | 2.0 | * 0.139 | 14.9 | LOS B | 0.4 | 10.1 | 0.90 | 0.66 | 0.90 | 28.3 |
| 8x | T1 | 989 | 2.0 | 989 | 2.0 | 0.625 | 10.4 | LOS B | 5.2 | 132.0 | 0.84 | 0.73 | 0.84 | 29.2 |
| Approach | | 1026 | 2.0 | 1026 | 2.0 | 0.625 | 10.6 | LOS B | 5.2 | 132.0 | 0.84 | 0.73 | 0.84 | 29.1 |
| NorthWest: (SB) Main St | | | | | | | | | | | | | | |
| 4x | T1 | 917 | 2.0 | 917 | 2.0 | * 0.867 | 18.3 | LOS B | 7.9 | 200.0 | 0.91 | 0.95 | 1.18 | 25.9 |
| 14x | R2 | 16 | 2.0 | 16 | 2.0 | 0.314 | 7.2 | LOS A | 2.0 | 50.7 | 0.70 | 0.59 | 0.70 | 30.5 |
| Approach | | 934 | 2.0 | 934 | 2.0 | 0.867 | 18.1 | LOS B | 7.9 | 200.0 | 0.90 | 0.94 | 1.17 | 26.0 |
| SouthWest: (EB) Ford St | | | | | | | | | | | | | | |
| 5x | L2 | 23 | 2.0 | 23 | 2.0 | * 0.064 | 13.0 | LOS B | 0.2 | 5.8 | 0.84 | 0.60 | 0.84 | 23.9 |
| 12x | R2 | 30 | 2.0 | 30 | 2.0 | 0.033 | 8.2 | LOS A | 0.2 | 4.0 | 0.50 | 0.35 | 0.50 | 33.0 |
| Approach | | 53 | 2.0 | 53 | 2.0 | 0.064 | 10.3 | LOS B | 0.2 | 5.8 | 0.64 | 0.46 | 0.64 | 29.9 |
| All Vehicles | | 2013 | 2.0 | 2013 | 2.0 | 0.867 | 14.0 | LOS B | 7.9 | 200.0 | 0.86 | 0.82 | 0.99 | 27.6 |

Site Level of Service (LOS) Method: Delay & v/c (HCM 6). Site LOS Method is specified in the Network Data dialog (Network tab).

Vehicle movement LOS values are based on average delay and v/c ratio (degree of saturation) per movement.

LOS F will result if v/c > 1 irrespective of movement delay value (does not apply for approaches and intersection).

Intersection and Approach LOS values are based on average delay for all movements (v/c not used as specified in HCM 6).

Delay Model: HCM Delay Formula (Geometric Delay is not included).

Gap-Acceptance Capacity: Traditional M1.

HV (%) values are calculated for All Movement Classes of All Heavy Vehicle Model Designation.

* Critical Movement (Signal Timing)

| Pedestrian Movement Performance | | | | | | | | | | | |
|---------------------------------|----------|-----------|-------------|------------------|-----------------------|--------------|-----------|---------------------|-------------|--------------|-------------|
| Mov ID | Crossing | Dem. Flow | Aver. Delay | Level of Service | AVERAGE BACK OF QUEUE | | Prop. Que | Effective Stop Rate | Travel Time | Travel Dist. | Aver. Speed |
| | | | | | [Ped ped] | [Dist. ft] | | | | | |
| SouthEast: (NB) Main St | | | | | | | | | | | |
| 9P | Full | 54 | 12.0 | LOS B | 0.0 | 0.1 | 0.78 | 0.78 | 166.9 | 666.0 | 0.76 |
| SouthWest: (EB) Ford St | | | | | | | | | | | |
| 3P | Full | 54 | 12.0 | LOS B | 0.0 | 0.1 | 0.78 | 0.78 | 161.3 | 642.0 | 0.75 |
| All Pedestrians | | 109 | 12.0 | LOS B | 0.0 | 0.1 | 0.78 | 0.78 | 164.1 | 654.0 | 0.75 |

Level of Service (LOS) Method: SIDRA Pedestrian LOS Method (Based on Average Delay)

Pedestrian movement LOS values are based on average delay per pedestrian movement.

Intersection LOS value for Pedestrians is based on average delay for all pedestrian movements.

MOVEMENT SUMMARY

Site: 102 [WDSP_Ford_AM_2040WP_HCM6_1Ln_V6_Net2 (Site Folder: General)]

Network: N101 [2040_AM_NetworkV2 (Network Folder: General)]

New Site

Site Category: (None)

Signals - EQUISAT (Pretimed) Isolated Cycle Time = 40 seconds (Site Practical Cycle Time)

| Vehicle Movement Performance | | | | | | | | | | | | | | |
|------------------------------|------|-----------------|------|-----------------|------|------------------|--------------------|------------------|-----------------------|--------------|-----------|---------------------|------------------|--------------------|
| Mov ID | Turn | DEMAND FLOWS | | ARRIVAL FLOWS | | Deg. Satn v/c | Aver. Delay sec | Level of Service | AVERAGE BACK OF QUEUE | | Prop. Que | Effective Stop Rate | Aver. No. Cycles | Aver. Speed mph |
| | | [Total veh/h] | HV % | [Total veh/h] | HV % | | | | [Veh. veh] | [Dist. ft] | | | | |
| SouthEast: (NB) Main St | | | | | | | | | | | | | | |
| 3x | L2 | 24 | 2.0 | 24 | 2.0 | * 0.090 | 14.8 | LOS B | 0.3 | 6.5 | 0.89 | 0.63 | 0.89 | 28.4 |
| 8x | T1 | 935 | 2.0 | 935 | 2.0 | 0.590 | 9.8 | LOS A | 4.8 | 121.0 | 0.82 | 0.71 | 0.82 | 29.6 |
| Approach | | 959 | 2.0 | 959 | 2.0 | 0.590 | 10.0 | LOS A | 4.8 | 121.0 | 0.82 | 0.71 | 0.82 | 29.6 |
| NorthWest: (SB) Main St | | | | | | | | | | | | | | |
| 4x | T1 | 775 | 2.0 | 775 | 2.0 | * 0.738 | 12.6 | LOS B | 6.9 | 175.3 | 0.84 | 0.78 | 0.93 | 29.2 |
| 14x | R2 | 20 | 2.0 | 20 | 2.0 | 0.267 | 6.6 | LOS A | 1.6 | 40.7 | 0.68 | 0.57 | 0.68 | 30.9 |
| Approach | | 795 | 2.0 | 795 | 2.0 | 0.738 | 12.4 | LOS B | 6.9 | 175.3 | 0.84 | 0.78 | 0.93 | 29.3 |
| SouthWest: (EB) Ford St | | | | | | | | | | | | | | |
| 5x | L2 | 26 | 2.0 | 26 | 2.0 | * 0.074 | 13.1 | LOS B | 0.3 | 6.6 | 0.84 | 0.60 | 0.84 | 23.9 |
| 12x | R2 | 36 | 2.0 | 36 | 2.0 | 0.038 | 6.6 | LOS A | 0.2 | 4.0 | 0.42 | 0.31 | 0.42 | 33.5 |
| Approach | | 62 | 2.0 | 62 | 2.0 | 0.074 | 9.3 | LOS A | 0.3 | 6.6 | 0.60 | 0.43 | 0.60 | 30.2 |
| All Vehicles | | 1815 | 2.0 | 1815 | 2.0 | 0.738 | 11.0 | LOS B | 6.9 | 175.3 | 0.82 | 0.73 | 0.86 | 29.5 |

Site Level of Service (LOS) Method: Delay & v/c (HCM 6). Site LOS Method is specified in the Network Data dialog (Network tab).

Vehicle movement LOS values are based on average delay and v/c ratio (degree of saturation) per movement.

LOS F will result if v/c > 1 irrespective of movement delay value (does not apply for approaches and intersection).

Intersection and Approach LOS values are based on average delay for all movements (v/c not used as specified in HCM 6).

Delay Model: HCM Delay Formula (Geometric Delay is not included).

Gap-Acceptance Capacity: Traditional M1.

HV (%) values are calculated for All Movement Classes of All Heavy Vehicle Model Designation.

* Critical Movement (Signal Timing)

| Pedestrian Movement Performance | | | | | | | | | | | |
|---------------------------------|----------|--------------------|--------------------|------------------|-----------------------|--------------|-----------|---------------------|--------------------|--------------------|-----------------------|
| Mov ID | Crossing | Dem. Flow ped/h | Aver. Delay sec | Level of Service | AVERAGE BACK OF QUEUE | | Prop. Que | Effective Stop Rate | Travel Time sec | Travel Dist. ft | Aver. Speed ft/sec |
| | | | | | [Ped ped] | [Dist. ft] | | | | | |
| SouthEast: (NB) Main St | | | | | | | | | | | |
| 9P | Full | 54 | 12.0 | LOS B | 0.0 | 0.1 | 0.78 | 0.78 | 166.9 | 666.0 | 0.76 |
| SouthWest: (EB) Ford St | | | | | | | | | | | |
| 3P | Full | 54 | 12.0 | LOS B | 0.0 | 0.1 | 0.78 | 0.78 | 161.3 | 642.0 | 0.75 |
| All Pedestrians | | 109 | 12.0 | LOS B | 0.0 | 0.1 | 0.78 | 0.78 | 164.1 | 654.0 | 0.75 |

Level of Service (LOS) Method: SIDRA Pedestrian LOS Method (Based on Average Delay)

Pedestrian movement LOS values are based on average delay per pedestrian movement.

Intersection LOS value for Pedestrians is based on average delay for all pedestrian movements.

MOVEMENT SUMMARY

Site: 102 [WDSP_Ford_PM_2040WP_HCM6_1Ln_V6_Net2 (Site Folder: General)]

Network: N101 [2040_PM_NetworkV2 (Network Folder: General)]

New Site

Site Category: (None)

Signals - EQUISAT (Pre-timed) Isolated Cycle Time = 50 seconds (Site Practical Cycle Time)

| Vehicle Movement Performance | | | | | | | | | | | | | | |
|------------------------------|------|-----------------|------|-----------------|------|-----------|-------------|------------------|-----------------------|--------------|-----------|---------------------|------------------|-------------|
| Mov ID | Turn | DEMAND FLOWS | | ARRIVAL FLOWS | | Deg. Satn | Aver. Delay | Level of Service | AVERAGE BACK OF QUEUE | | Prop. Que | Effective Stop Rate | Aver. No. Cycles | Aver. Speed |
| | | [Total veh/h] | HV % | [Total veh/h] | HV % | | | | [Veh. veh] | [Dist. ft] | | | | |
| SouthEast: (NB) Main St | | | | | | | | | | | | | | |
| 3x | L2 | 50 | 2.0 | 50 | 2.0 | * 0.235 | 20.3 | LOS C | 0.7 | 18.0 | 0.94 | 0.70 | 0.94 | 26.5 |
| 8x | T1 | 878 | 2.0 | 878 | 2.0 | 0.471 | 8.5 | LOS A | 4.6 | 117.5 | 0.70 | 0.61 | 0.70 | 30.7 |
| Approach | | 928 | 2.0 | 928 | 2.0 | 0.471 | 9.1 | LOS A | 4.6 | 117.5 | 0.71 | 0.61 | 0.71 | 30.3 |
| NorthWest: (SB) Main St | | | | | | | | | | | | | | |
| 4x | T1 | 995 | 2.0 | 995 | 2.0 | * 0.796 | 14.4 | LOS B | 7.9 | 200.0 | 0.82 | 0.80 | 0.92 | 28.2 |
| 14x | R2 | 14 | 2.0 | 14 | 2.0 | 0.288 | 7.1 | LOS A | 2.4 | 60.8 | 0.62 | 0.53 | 0.62 | 30.7 |
| Approach | | 1009 | 2.0 | 1009 | 2.0 | 0.796 | 14.3 | LOS B | 7.9 | 200.0 | 0.82 | 0.79 | 0.92 | 28.3 |
| SouthWest: (EB) Ford St | | | | | | | | | | | | | | |
| 5x | L2 | 20 | 2.0 | 20 | 2.0 | * 0.055 | 16.2 | LOS B | 0.2 | 6.1 | 0.84 | 0.59 | 0.84 | 22.4 |
| 12x | R2 | 25 | 2.0 | 25 | 2.0 | 0.030 | 9.0 | LOS A | 0.2 | 3.9 | 0.46 | 0.34 | 0.46 | 32.8 |
| Approach | | 45 | 2.0 | 45 | 2.0 | 0.055 | 12.2 | LOS B | 0.2 | 6.1 | 0.63 | 0.45 | 0.63 | 29.0 |
| All Vehicles | | 1982 | 2.0 | 1982 | 2.0 | 0.796 | 11.8 | LOS B | 7.9 | 200.0 | 0.77 | 0.70 | 0.82 | 29.1 |

Site Level of Service (LOS) Method: Delay & v/c (HCM 6). Site LOS Method is specified in the Network Data dialog (Network tab).

Vehicle movement LOS values are based on average delay and v/c ratio (degree of saturation) per movement.

LOS F will result if v/c > 1 irrespective of movement delay value (does not apply for approaches and intersection).

Intersection and Approach LOS values are based on average delay for all movements (v/c not used as specified in HCM 6).

Delay Model: HCM Delay Formula (Geometric Delay is not included).

Gap-Acceptance Capacity: Traditional M1.

HV (%) values are calculated for All Movement Classes of All Heavy Vehicle Model Designation.

* Critical Movement (Signal Timing)

| Pedestrian Movement Performance | | | | | | | | | | | |
|---------------------------------|----------|-----------|-------------|------------------|-----------------------|--------------|-----------|---------------------|-------------|--------------|-------------|
| Mov ID | Crossing | Dem. Flow | Aver. Delay | Level of Service | AVERAGE BACK OF QUEUE | | Prop. Que | Effective Stop Rate | Travel Time | Travel Dist. | Aver. Speed |
| | | | | | [Ped ped] | [Dist. ft] | | | | | |
| SouthEast: (NB) Main St | | | | | | | | | | | |
| 9P | Full | 54 | 16.8 | LOS B | 0.1 | 0.2 | 0.82 | 0.82 | 171.7 | 666.0 | 0.73 |
| SouthWest: (EB) Ford St | | | | | | | | | | | |
| 3P | Full | 54 | 16.8 | LOS B | 0.1 | 0.2 | 0.82 | 0.82 | 166.2 | 642.0 | 0.73 |
| All Pedestrians | | 109 | 16.8 | LOS B | 0.1 | 0.2 | 0.82 | 0.82 | 168.9 | 654.0 | 0.73 |

Level of Service (LOS) Method: SIDRA Pedestrian LOS Method (Based on Average Delay)

Pedestrian movement LOS values are based on average delay per pedestrian movement.

Intersection LOS value for Pedestrians is based on average delay for all pedestrian movements.

MOVEMENT SUMMARY

Site: 102 [WDSP_Ford_SAT_2040WP_HCM6_1Ln_V6_Net2 (Site Folder: General)]

Network: N101 [2040_SAT_NetworkV2 (Network Folder: General)]

New Site

Site Category: (None)

Signals - EQUISAT (Pre-timed) Isolated Cycle Time = 50 seconds (Site Practical Cycle Time)

| Vehicle Movement Performance | | | | | | | | | | | | | | |
|------------------------------|------|-----------------|------|-----------------|------|------------------|--------------------|------------------|-----------------------|--------------|-----------|---------------------|------------------|--------------------|
| Mov ID | Turn | DEMAND FLOWS | | ARRIVAL FLOWS | | Deg. Satn v/c | Aver. Delay sec | Level of Service | AVERAGE BACK OF QUEUE | | Prop. Que | Effective Stop Rate | Aver. No. Cycles | Aver. Speed mph |
| | | [Total veh/h] | HV % | [Total veh/h] | HV % | | | | [Veh. veh] | [Dist. ft] | | | | |
| SouthEast: (NB) Main St | | | | | | | | | | | | | | |
| 3x | L2 | 37 | 2.0 | 37 | 2.0 | * 0.174 | 20.1 | LOS C | 0.5 | 13.1 | 0.93 | 0.68 | 0.93 | 26.6 |
| 8x | T1 | 1026 | 2.0 | 1026 | 2.0 | 0.564 | 9.3 | LOS A | 6.0 | 152.3 | 0.74 | 0.65 | 0.74 | 30.0 |
| Approach | | 1063 | 2.0 | 1063 | 2.0 | 0.564 | 9.7 | LOS A | 6.0 | 152.3 | 0.75 | 0.65 | 0.75 | 29.8 |
| NorthWest: (SB) Main St | | | | | | | | | | | | | | |
| 4x | T1 | 1004 | 2.0 | 1004 | 2.0 | * 0.806 | 14.7 | LOS B | 7.9 | 200.0 | 0.83 | 0.81 | 0.94 | 28.0 |
| 14x | R2 | 16 | 2.0 | 16 | 2.0 | 0.292 | 7.0 | LOS A | 2.4 | 61.4 | 0.62 | 0.53 | 0.62 | 30.7 |
| Approach | | 1021 | 2.0 | 1021 | 2.0 | 0.806 | 14.6 | LOS B | 7.9 | 200.0 | 0.83 | 0.81 | 0.94 | 28.1 |
| SouthWest: (EB) Ford St | | | | | | | | | | | | | | |
| 5x | L2 | 23 | 2.0 | 23 | 2.0 | * 0.064 | 16.3 | LOS B | 0.3 | 7.2 | 0.84 | 0.60 | 0.84 | 22.4 |
| 12x | R2 | 30 | 2.0 | 30 | 2.0 | 0.037 | 9.1 | LOS A | 0.2 | 4.8 | 0.47 | 0.34 | 0.47 | 32.8 |
| Approach | | 53 | 2.0 | 53 | 2.0 | 0.064 | 12.2 | LOS B | 0.3 | 7.2 | 0.63 | 0.45 | 0.63 | 29.1 |
| All Vehicles | | 2137 | 2.0 | 2137 | 2.0 | 0.806 | 12.1 | LOS B | 7.9 | 200.0 | 0.78 | 0.72 | 0.83 | 28.9 |

Site Level of Service (LOS) Method: Delay & v/c (HCM 6). Site LOS Method is specified in the Network Data dialog (Network tab).

Vehicle movement LOS values are based on average delay and v/c ratio (degree of saturation) per movement.

LOS F will result if v/c > 1 irrespective of movement delay value (does not apply for approaches and intersection).

Intersection and Approach LOS values are based on average delay for all movements (v/c not used as specified in HCM 6).

Delay Model: HCM Delay Formula (Geometric Delay is not included).

Gap-Acceptance Capacity: Traditional M1.

HV (%) values are calculated for All Movement Classes of All Heavy Vehicle Model Designation.

* Critical Movement (Signal Timing)

| Pedestrian Movement Performance | | | | | | | | | | | |
|---------------------------------|----------|--------------------|--------------------|------------------|-----------------------|--------------|-----------|---------------------|--------------------|--------------------|-----------------------|
| Mov ID | Crossing | Dem. Flow ped/h | Aver. Delay sec | Level of Service | AVERAGE BACK OF QUEUE | | Prop. Que | Effective Stop Rate | Travel Time sec | Travel Dist. ft | Aver. Speed ft/sec |
| | | | | | [Ped ped] | [Dist. ft] | | | | | |
| SouthEast: (NB) Main St | | | | | | | | | | | |
| 9P | Full | 54 | 16.8 | LOS B | 0.1 | 0.2 | 0.82 | 0.82 | 171.7 | 666.0 | 0.73 |
| SouthWest: (EB) Ford St | | | | | | | | | | | |
| 3P | Full | 54 | 16.8 | LOS B | 0.1 | 0.2 | 0.82 | 0.82 | 166.2 | 642.0 | 0.73 |
| All Pedestrians | | 109 | 16.8 | LOS B | 0.1 | 0.2 | 0.82 | 0.82 | 168.9 | 654.0 | 0.73 |

Level of Service (LOS) Method: SIDRA Pedestrian LOS Method (Based on Average Delay)

Pedestrian movement LOS values are based on average delay per pedestrian movement.

Intersection LOS value for Pedestrians is based on average delay for all pedestrian movements.