



Mission Grove Apartments Project

Draft Environmental Impact Report
SCH#2022100610

Appendix E: Due Diligence Geotechnical Investigation Report & Grading Plan Review and Geotechnical Update



**DUE DILIGENCE GEOTECHNICAL
INVESTIGATION**

**MISSION GROVE REDEVELOPMENT
375 EAST ALESSANDRO BOULEVARD
RIVERSIDE, CALIFORNIA**



GEOCON
WEST, INC.

GEOTECHNICAL
ENVIRONMENTAL
MATERIALS

PREPARED FOR

**ANTON MISSION GROVE, LLC.
WALNUT CREEK, CALIFORNIA**

**JUNE 13, 2022
PROJECT NO. T2979-22-01**



Project No. T2979-22-01
June 13, 2022

Anton Mission Grove, LLC.
1676 N California Boulevard, Suite 250
Walnut Creek, California 94596

Attention: Ms. Vanessa Garza, Development Manager

Subject: DUE DILIGENCE GEOTECHNICAL INVESTIGATION
MISSION GROVE REDEVELOPMENT
375 EAST ALESSANDRO BOULEVARD
RIVERSIDE, CALIFORNIA

Dear Ms. Garza:

In accordance with your authorization of Proposal No. IE-2891, Geocon West Inc. (Geocon) herein submits the results of our due diligence geotechnical investigation for the subject site. The accompanying report presents the results of our study and conclusions and recommendations pertaining to the geotechnical aspects of the proposed redevelopment project. The site is considered suitable for development provided the recommendations of this report are followed.

Should you have questions regarding this report, or if we may be of further service, please contact the undersigned at your convenience.

Very truly yours,

GEOCON WEST, INC.

Luke C. Weidman
Staff Geologist, GIT 891

Lisa A. Battiato
CEG 2316



Petrina Zen
PE 87489



Joseph J. Vettel
GE 2401



LCW:LAB:PZ:JIV:hd

TABLE OF CONTENTS

1.	PURPOSE AND SCOPE	1
2.	SITE AND PROJECT DESCRIPTION	2
3.	GEOLOGIC SETTING.....	2
4.	SOIL AND GEOLOGIC CONDITIONS	3
4.1	Asphaltic Concrete Pavement and Aggregate Base.....	3
4.2	Previously Placed Fill.....	3
4.3	Quartz Diorite (qdi)	3
5.	GROUNDWATER	3
6.	GEOLOGIC HAZARDS	4
6.1	Surface Fault Rupture.....	4
6.2	Seismicity	5
6.3	Liquefaction.....	6
6.4	Expansive Soil.....	6
6.5	Hydrocompression.....	7
6.6	Seiches and Tsunamis.....	7
6.7	Inundation.....	7
6.8	Landslides.....	7
6.9	Rock Fall Hazards.....	7
6.10	Slope Stability.....	7
7.	SITE INFILTRATION.....	8
8.	CONCLUSIONS AND RECOMMENDATIONS.....	9
8.1	General.....	9
8.2	Excavation and Soil Characteristics	10
8.3	Grading.....	12
8.4	Earthwork Grading Factors.....	13
8.5	Utility Trench Backfill.....	14
8.6	Seismic Design Criteria	14
8.7	Shallow Foundation and Concrete Slabs-On-Grade.....	16
8.8	Miscellaneous Foundations	18
8.9	Concrete Flatwork	19
8.10	Conventional Retaining Walls.....	20
8.11	Elevator Pit Design.....	21
8.12	Elevator Piston.....	21
8.13	Swimming Pool	22
8.14	Lateral Loading.....	23
8.15	Preliminary Pavement Recommendations.....	23
8.16	Temporary Excavations	26
8.17	Site Drainage and Moisture Protection.....	27
8.18	Grading and Foundation Plan Review	27

LIMITATIONS AND UNIFORMITY OF CONDITIONS

LIST OF REFERENCES

TABLE OF CONTENTS (Concluded)

MAPS AND ILLUSTRATIONS

- Figure 1, Vicinity Map
- Figure 2, Geologic Map

APPENDIX A

FIELD INVESTIGATION

- Figures A-1 through A-7, Logs of Borings
- Figures A-8 through A-13, Logs of Percolation Borings
- Figures A-14 through A-19, Percolation Test Report Data

APPENDIX B

LABORATORY TESTING

- Figures B-1 and B-2, Compaction Characteristics Using Modified Effort Test Results
- Figure B-3, Expansion Index Test Results
- Figure B-4, Corrosivity Test Results
- Figures B-5 through B-7, Grain Size Distribution
- Figure B-8 through B-10, Direct Shear Test Results

APPENDIX C

RECOMMENDED GRADING SPECIFICATIONS

DUE DILIGENCE GEOTECHNICAL INVESTIGATION

1. PURPOSE AND SCOPE

The purpose of the investigation was to evaluate the subsurface soil and geologic conditions at the site and, based on the conditions encountered and geotechnical analyses performed, provide remedial grading recommendations and geotechnical parameters for project design and construction.

The scope of our investigation included review of published geologic information and aerial photographs, subsurface utility location, subsurface exploration and sample collection, percolation testing, laboratory testing, engineering analyses, and preparation of this report. A summary of the information and documentation reviewed for this study is presented in the *List of References*.

Our field investigation was conducted on May 13 and 16, 2022. Work on May 13 included the drilling of seven geotechnical borings to depths of 15 feet 2 inches to 26 feet 3 inches and six percolation test borings to depths between 2 and 4½ feet below the existing ground surface. The purpose was to observe the subsurface geological and groundwater conditions at the site, and to collect undisturbed and disturbed samples for laboratory testing. Work on May 16 included performing percolation tests at the proposed infiltration basin locations as indicated by the project civil engineer.

A detailed discussion of the field investigation, boring logs and the percolation test results are presented in *Appendix A*. Laboratory tests were performed on select soil samples obtained to evaluate the physical and chemical soil properties for use in engineering analysis. *Appendix B* presents a summary of the laboratory test results.

2. SITE AND PROJECT DESCRIPTION

The site is located at 375 East Alessandro Boulevard in Riverside, California. The property consists of a previous K-mart store with asphalt drive isles and parking spaces, landscaped medians, and landscaped lawn areas between the former K-mart and the roadways to the east and south. The subject site is bounded on the north and west by the active Mission Grove Shopping Center, on the east by Mission Grove Parkway, and on the south by Mission Village Drive. The shopping center was developed before 1994 and after 1985. Aerial photographs taken in 1974 show a gently sloping erosion plain was present at the site prior to development. Val Verde tonalite is geologically mapped at the site. The existing grades range from approximately elevation 1,588 feet above mean sea level (MSL) to the west to 1,598 feet above MSL to the east. The site is at latitude 33.9135 and longitude -117.3256.

Grading plans were not available for our review at the time of this due diligence investigation. The *Infiltration Testing Location* map prepared by Rick Engineering was used as the base for our *Geologic Map*, Figure 2. The site will be redeveloped into a multi-family residential development at or near current grades.

We expect the redevelopment will include cuts and fills of less than 5 feet to reach planned finish grades. Structural plans were not provided for the buildings; however, we assume that the residential structures will be one to four stories, lightly loaded wood and/or metal stud framed buildings. For the purpose of our geotechnical evaluation, we assume that column loads for the proposed residential structures will be up to 400 kips, and wall loads will be up to 5 kips per linear foot. Once the design phase and foundation loading configuration proceeds to a more finalized plan, the recommendations within this report should be reviewed and revised, if necessary.

The locations and descriptions provided herein are based on a site reconnaissance, our field exploration, and project information provided by the client. If project details differ significantly from those described herein, Geocon should be contacted for review and possible revision to this report.

3. GEOLOGIC SETTING

The subject site is located within a seismically active region near the margin between the North American and Pacific tectonic plates. The property is located within the Peninsular Ranges Geomorphic Province which is bounded on the north by the Cucamonga and Sierra Madre faults along the Transverse Ranges, the east by the San Jacinto Fault and the Colorado Desert Geomorphic Province. The Peninsular Ranges extend west off the coast of California and south to the tip of Baja California. Specifically, the site is located on a Perris Erosion Surface in the Woodcrest area of Riverside. The major faults within this area include the San Jacinto Valley (Casa Loma and Claremont branches) and San Bernardino segments of the San Jacinto fault, and the Glen Ivy and Wildomar segments of the Elsinore fault.

4. SOIL AND GEOLOGIC CONDITIONS

Site geologic materials encountered consist of asphalt pavement over aggregate base and previously placed artificial fill to depths of 0 to 2½ feet overlying quartz diorite bedrock. Descriptions of the soil and geologic conditions are shown on the boring logs located in *Appendix A* and are described herein in order of increasing age. The soil and geologic units encountered at the site are discussed below with the geologic nomenclature following that of Dibblee, 2003.

4.1 Asphaltic Concrete Pavement and Aggregate Base

Asphalt and aggregate base were measured at thicknesses of 3 to 6 inches of asphalt over 4 to 8 inches of aggregate base.

4.2 Previously Placed Fill

Previously placed fill was encountered to depths of 0 to 2.5 feet. The fill, as encountered, consists of poorly graded to silty sand which is brown to red brown, moist, and medium dense. Deeper fill is likely present beneath the building due to the common practice of over excavating bedrock to create a fill pad on which to perform construction of buildings. This fill was likely placed during grading of the shopping center between 1985 and 1994.

4.3 Quartz Diorite (qdi)

Quartz diorite was encountered below the pavement sections and previously placed fill and underlies the site at depth. The bedrock consists of white and black granitic rock with oxidized zones of brown. It excavated as well-graded sand. The rock is moderately strong and highly to moderately weathered and moist to wet. We did not encounter refusal during drilling to depths of up to 26 feet 3 inches. However, core stones are common in granitic bedrock and difficult excavations and possible blasting cannot be ruled out between borings.

5. GROUNDWATER

We encountered perched groundwater in the weathered zone of the bedrock in our borings B-1 at 16.5 feet, B-2 at 11.5 feet, B-3 at 11 feet, B-4 at 13.5 feet, B-5 at 15 feet, and B-6 at 15 feet. We did not encounter perched groundwater in B-7 to depths of 15 feet 2 inches. The perched water is likely the result of surficial infiltration in the vicinity of the site moving through the subsurface above the impenetrable bedrock below. The California Department of Water Resources, does not show any wells located on the Perris Erosional Surface within several miles of the site.

It is not uncommon for seepage conditions to develop where none previously existed. Groundwater and seepage are dependent on seasonal precipitation, irrigation, land use, among other factors, and varies as a result. Proper surface drainage will be important to future performance of the project.

6. GEOLOGIC HAZARDS

6.1 Surface Fault Rupture

The numerous faults in southern California include active, potentially active, and inactive faults. The criteria for these major groups are based on criteria developed by the California Geological Survey (CGS, formerly known as CDMG) for the Alquist-Priolo Earthquake Fault Zone Program (Bryant and Hart, 2007). By definition, an active fault is one that has had surface displacement within Holocene time (about the last 11,700 years). A potentially active fault has demonstrated surface displacement during Quaternary time (approximately the last 1.6 million years) but has had no known Holocene movement. Faults that have not moved in the last 1.6 million years are considered inactive.

The site is not within a currently established State of California Alquist-Priolo Earthquake Fault Zone or a Riverside County Fault Hazard Zone for surface fault rupture hazards. No active or potentially active faults with the potential for surface fault rupture are known to pass directly beneath the site.

The closest surface traces of an active faults to the site are the Glen Ivy North branch of the Elsinore Fault Zone and the San Jacinto Valley segment of the San Jacinto Fault, both located 12 miles from the site to the southwest and northeast, respectively. Other nearby active faults are listed in Table 6.1, below.

**TABLE 6.1
ACTIVE FAULTS WITHIN 50 MILES OF THE SITE**

Fault Name	Maximum Magnitude (Mw)	Distance from Site (mi)	Direction from Site
Glen Ivy Fault	6.8	12	SW
San Jacinto-Valley Segment	6.9	12	NE
Chino Fault	6.7	13	W
Casa Loma Fault	6.9	16	SE
Claremont Fault	6.9	18	SE
Glen Helen Fault	6.7	18	N
Whittier Fault	6.8	18	W
Wildomar Fault	6.8	19	W
San Andreas Fault	7.5	19	NE
Cucamonga Fault	6.9	19	N
San Geronio Pass Fault	n/a	26	E
Clark Fault	7.2	29	SE
North Frontal Fault	6.7	38	NE
Newport-Inglewood	7.1	38	W
Pinto Mtn/Morongó Vly	7.2	40	E
Sand Andreas – South Branch	7.5	42	E
Helendale	7.3	44	NE

Geometry: BT = blind thrust, LL = left lateral, N = normal, O = oblique, R = reverse, RL = right lateral, SS = strike slip.

Information Sources: a = Cao, T., Bryant, W.A., Rowshandel, B., Branum, D., and Wills, C.J., 2003, The Revised 2002 California Probabilistic Seismic Hazard Maps, including Appendices A, B, and C, dated June; b = online Fault Activity Map of California website, maps.conservation.ca.gov/cgs/fam/, as of 1/2017.

n/a = data not available.

6.2 Seismicity

As with all of southern California, the site has experienced historic earthquakes from various regional faults. The seismicity of the region surrounding the site was formulated based on research of an electronic database of earthquake data. A number of earthquakes of moderate to major magnitude have occurred in the southern California area within the last 100 years. A partial list of these earthquakes is included in the following table.

**TABLE 6.2
HISTORIC EARTHQUAKE EVENTS WITH RESPECT TO THE SITE**

Earthquake (Oldest to Youngest)	Date of Earthquake	Magnitude	Distance to Epicenter (Miles)	Direction to Epicenter
Near Redlands	July 23, 1923	6.3	31	N
Long Beach	March 10, 1933	6.4	37	W
Tehachapi	July 21, 1952	7.5	139	NW
San Fernando	February 9, 1971	6.6	85	NW
Whittier Narrows	October 1, 1987	5.9	56	NW
Sierra Madre	June 28, 1991	5.8	62	NW
Landers	June 28, 1992	7.3	68	NE
Big Bear	June 28, 1992	6.4	53	NE
Northridge	January 17, 1994	6.7	83	WNW
Hector Mine	October 16, 1999	7.1	94	NE
Ridgecrest China Lake Fault	July 5, 2019	7.1	153	N

6.3 Liquefaction

Liquefaction is a phenomenon in which loose, saturated, relatively cohesionless soil deposits lose shear strength during strong ground motions. Primary factors controlling liquefaction include intensity and duration of ground motion, gradation characteristics of the subsurface soils, in-situ stress conditions, and the depth to groundwater. Liquefaction is typified by a loss of shear strength in the liquefied layers due to rapid increases in pore water pressure generated by earthquake accelerations. Seismically induced “dry-sand” settlement may occur whether the potential for liquefaction exists or not.

Liquefaction typically occurs in areas where the soils below the water table are composed of poorly consolidated, fine to medium-grained, primarily sandy soil. In addition to the requisite soil conditions, the ground acceleration and duration of the earthquake must also be of a sufficient level to induce liquefaction.

The site is underlain at shallow depths by granitic bedrock; therefore, the potential for liquefaction induced settlement or seismic “dry-sand” settlement to occur beneath the site is considered low.

6.4 Expansive Soil

The onsite soils encountered include sands and decomposed granitic rock. Clay develops as granitic rock weathers; therefore, we would also expect some clay to be present within the soils at the site. Laboratory testing result indicates a sample of the near surface soil exhibits a “very low” expansion potential (expansion index [EI] of 20 or less) with test results showing an expansion index of 0.

6.5 Hydrocompression

Hydrocompression is the tendency of unsaturated soil structure to collapse upon wetting resulting in the overall settlement of the affected soil and overlying foundations or improvements supported thereon. Potentially compressible soils underlying the site are typically removed and recompacted during remedial site grading. However, if compressible soil is left in-place, a potential for settlement due to hydrocompression of the soil exists.

Remedial grading will remove and reprocess the site soils resulting in compacted fill overlying granitic bedrock. Therefore, hydrocompression is not a design consideration for this site.

6.6 Seiches and Tsunamis

Seiches are caused by the movement of an inland body of water due to the movement from seismic forces. There are no bodies of water near the site. Therefore, flooding due a seiche is not a design consideration.

A tsunami is a series of long-period waves generated in the ocean by a sudden displacement of large volumes of water. Causes of tsunamis include underwater earthquakes, volcanic eruptions, or offshore slope failures. The site is located approximately 37 miles from the Pacific Ocean at an elevation greater than 1,500 feet MSL. Therefore, the risk of tsunamis affecting the site is negligible and not a design consideration.

6.7 Inundation

According to the State of California, Department of Water Resources, the site is not within an inundation zone due to dam failure. Therefore, inundation due to dam failure is not a design consideration.

6.8 Landslides

Landslides are not mapped on or near the site. Due to the relatively level topography at the site, we opine that landslides are not present at the property or at a location that could impact the subject site.

6.9 Rock Fall Hazards

Rock falls are not a design consideration due to the lack of natural bedrock slopes above and adjacent to the site.

6.10 Slope Stability

Graded slopes are not proposed on the site at this time, therefore slope stability is not a design consideration.

7. SITE INFILTRATION

Percolation testing was performed in accordance with the procedures outlined in *Riverside County Flood Control and Water Conservation District LID BMP, Appendix A* for infiltration basins. The percolation test locations are depicted on the *Geologic Map* (see Figure 2).

Percolation test holes were excavated to a depth of 2 to 4½ feet below existing grades. Approximately two inches of gravel was placed at the bottom of each test hole and a perforated pipe was placed atop the gravel to keep the test hole open. Gravel was placed around the bottom of the test hole to support the test pipe. The test locations were pre-saturated prior to testing. Percolation testing began within 24 hours after the holes were presaturated. Percolation data sheets are presented in *Appendix A* of this report. Percolation test rates were converted to infiltration test rates using the Porchet Method and the results are presented in Table 7.0 below. Test locations are shown on the *Geologic Map* (see Figure 2).

**TABLE 7.0
INFILTRATION TEST RATES FOR PERCOLATION AREAS**

Parameter	P-1	P-2	P-3	P-4	P-5	P-6
Depth (inches)	36	24	54	54	54	54
Test Type	Sandy	Sandy	Sandy	Sandy	Sandy	Sandy
Change in head over time: ΔH (inches)	28.9	28.8	14.6	12.6	25.1	13.4
Average head: Havg (inches)	21.5	21.6	28.7	29.7	23.5	29.3
Time Interval (minutes): Δt (minutes)	10	10	10	10	10	10
Radius of test hole: r (inches)	4	4	4	4	4	4
Tested Infiltration Rate: It (inches/hour)	14.7	4.6	5.7	4.8	11.8	5.2

The results of the infiltration testing indicate that infiltration at the site ranges from 4.6 to 14.7 inches per hour. The appropriate factor of safety should be applied to these values per the Handbook.

The in-situ field percolation tests performed provide short-term infiltration rates, which apply mainly to the initiation of the infiltration process due to the short time of the test (hours instead of days) and the amount of water used. Where appropriate the short-term infiltration rates shall be converted to long-term infiltration rates using reduction factors depending upon the degree of infiltrate quality, maintenance access and frequency, site variability, subsurface stratigraphy variation, and other factors. The small-scale percolation testing cannot model the complexity of the effect of interbedded layers of different soil composition, and our test results should be considered only as index values of infiltration rates.

8. CONCLUSIONS AND RECOMMENDATIONS

8.1 General

- 8.1.1 From a geotechnical engineering standpoint, the site is suitable for redevelopment and construction of the proposed multi-family development, provided the recommendations presented herein are implemented in design and construction of the project.
- 8.1.2 Potential geologic hazards at the site include seismic shaking and compressible near surface previously placed fill.
- 8.1.3 The site is located approximately 12 miles from the nearest active fault. Based on our background research and previous investigation, it is our opinion active, potentially active, or inactive faults do not extend across the site. Risks associated with seismic activity consist of the potential for moderate to strong seismic shaking.
- 8.1.4 The previously placed fill is not considered suitable for the support of compacted fill and settlement-sensitive structures. Remedial grading of the soil will be required as discussed herein. The existing site soils are suitable for re-use as engineered fill provided the recommendations in the *Grading* section of this report are followed.
- 8.1.5 Based on our field investigation, granitic bedrock is present directly below the paving section to 2½ feet below ground surface and may be deeper below the existing retail building. Although not encountered in our exploration, grading operations may encounter zones of hard bedrock, particularly at depth which may require heavy ripping, the use of breakers, or blasting.
- 8.1.6 We recommended that the previously placed fill within the proposed building footprint areas be excavated and properly compacted for foundation and slab support. Areas where structures are proposed should be over excavated to a depth of three feet below planned finished grades or 1 foot below footings, whichever is deeper. Fill should then be placed and compacted in layers to provide a fill mat on which to construct the proposed buildings. Deeper excavations should be conducted as needed to remove existing fill or loose soils at the direction of the Geotechnical Engineer (a representative of Geocon). The overexcavation should extend beyond the building footprint at least 3 feet or a distance equal to the fill depth at a 1:1 (horizontal:vertical) projection from the edge of the building.
- 8.1.7 Grading operations are expected to generate oversize rock which will require special placement. Oversize rock placement recommendations are provided in the *Recommended Grading Specifications in Appendix C*.

- 8.1.8 Some granular on-site soils may have little to no cohesion and are thus subject to caving in unshored excavations. It is the responsibility of the contractor to ensure that excavations and trenches are properly laid back and/or shored and maintained in accordance with OSHA rules and regulations to maintain the stability of adjacent existing improvements and life-safety.
- 8.1.9 The laboratory tests indicate that the site soils are non-expansive and have a “very low” expansion potential. If medium to highly expansive soils are encountered at the site, they should be exported from the site or selectively graded and placed in the deeper fill areas to allow for the placement of low expansion material at the finish pad grade.
- 8.1.10 Grading plans were not available to review at the time of this report. However, based on the existing grades and anticipated grades, cuts and fills of up to 5 feet are expected, not including remedial grading.
- 8.1.11 An existing structure, flatwork, and asphalt concrete parking lots at the site will be demolished as part of the redevelopment. The asphalt concrete can be pulverized, blended with soil, and used as fill or as a subbase within the site roadways and walkway areas, provided it is processed to meet the requirements for use as roadway fill or subbase material. Portland cement concrete (PCC) can be crushed to 6-inch minus with the rebar or other foreign matter removed and can be mixed with soil for use in the fill.
- 8.1.12 Seepage may be encountered during grading and construction of utilities.
- 8.1.13 Proper drainage should be maintained to preserve the design properties of the engineered fill in the sheet-graded pad areas.
- 8.1.14 Once grading and foundation plans become available, they should be reviewed by this office to evaluate the necessity for review and possible revision of this report.

8.2 Excavation and Soil Characteristics

- 8.2.1 Excavation of the previously placed fill and upper portion of the granitic bedrock should be possible with moderate effort using conventional heavy-duty equipment in proper functioning order. Excavation of deeper areas of granitic bedrock, or core stones, if encountered, should be possible with moderate difficulty but is expected to increase in difficulty with depth; zones of hard bedrock may be encountered during grading operations, particularly at depth which may require heavy ripping, the use of breakers, or blasting. Areas where deep excavations are expected should be evaluated via a rippability investigation once final grading and utility plans are available. Excavations in the bedrock are expected to generate oversize rock and may encounter core stones which will require special placement in accordance with the *Recommended Grading Specifications in Appendix C*.

8.2.2 The soil encountered in the field investigation is “non-expansive” (expansion index [EI] of less than 20) as defined by 2019 California Building Code (CBC) Section 1803.5.3. Table 8.2.2 presents soil classifications based on the expansion index. Based on the laboratory test results, we expect a majority of the soil encountered will possess a “very low” expansion potential (EI between 0 and 20). Although unlikely, any medium to highly expansive soils encountered at the site should not be placed within 4 feet of the proposed foundations, flatwork or paving improvements.

**TABLE 8.2.2
EXPANSION CLASSIFICATION BASED ON EXPANSION INDEX**

Expansion Index (EI)	ASTM D 4829 Expansion Classification	2019 CBC Expansion Classification
0 – 20	Very Low	Non-Expansive
21 – 50	Low	Expansive
51 – 90	Medium	
91 – 130	High	
Greater Than 130	Very High	

8.2.3 Additional testing for expansion potential should be performed during finish grading along with plasticity index testing on soils with expansion indices of more than 20.

8.2.4 Laboratory tests performed on samples of the site materials indicate that the on-site materials possess a sulfate content of 0.000 percent (0 parts per million [ppm]) equating to a S0 sulfate exposure to concrete structures as defined by 2019 CBC Section 1904.3 and ACI 318. Table 8.2.3 presents a summary of concrete requirements set forth by 2019 CBC Section 1904.3 and ACI 318. The presence of water-soluble sulfates is not a visually discernible characteristic; therefore, other soil samples from the site could yield different concentrations. Additionally, over time landscaping activities (i.e., addition of fertilizers and other soil nutrients) may affect the concentration.

**TABLE 8.2.4
REQUIREMENTS FOR CONCRETE EXPOSED TO
SULFATE-CONTAINING SOLUTIONS**

Exposure Class	Water-Soluble Sulfate (SO ₄) Percent by Weight	Cement Type (ASTM C 150)	Maximum Water to Cement Ratio by Weight ¹	Minimum Compressive Strength (psi)
S0	SO ₄ <0.10	No Type Restriction	n/a	2,500
S1	0.10≤SO ₄ <0.20	II	0.50	4,000
S2	0.20≤SO ₄ ≤2.00	V	0.45	4,500
S3	SO ₄ >2.00	V+Pozzolan or Slag	0.45	4,500

¹ Maximum water to cement ratio limits do not apply to lightweight concrete.

8.2.5 Laboratory testing indicates the site soils have a minimum electrical resistivity of 8,000 ohm-cm, possess 20 ppm chloride, 0 ppm sulfate, and a pH of 8.4. As shown in Table 8.2.5 below, the site would **not** be classified as “corrosive” to buried improvements, in accordance with the Caltrans Corrosion Guidelines (Caltrans, 2021).

**TABLE 8.2.5
CALTRANS CORROSION GUIDELINES**

Corrosion Exposure	Resistivity (ohm-cm)	Chloride (ppm)	Sulfate (ppm)	pH
Corrosive	<1,500	500 or greater	1,500 or greater	5.5 or less

8.2.6 Geocon does not practice in the field of corrosion engineering. Therefore, further evaluation by a corrosion engineer may be performed if improvements that could be susceptible to corrosion are planned.

8.3 Grading

8.3.1 Grading should be performed in accordance with the *Recommended Grading Specifications of Appendix C* and the grading ordinances of the City of Riverside.

8.3.2 Prior to commencing grading, a preconstruction conference should be held at the site with the City Inspector, Owner or Developer, Grading Contractor, Civil Engineer, and Geotechnical Engineer in attendance. Special soil handling and/or the grading plans can be discussed at that time.

8.3.3 Site preparation should begin with the removal of existing improvements, deleterious material, debris and vegetation. The depth of removal should be such that material exposed in cut areas or soil to be used as fill is relatively free of organic matter. Material generated during stripping and/or site demolition should be exported from the site.

8.3.4 Remedial grading should entail the removal of the previously placed fill to expose granitic bedrock. Based on our investigation, removals will be 1 to 3 feet deep; however, deeper removals could be required if deeper fill is located beneath the existing building. Areas where structures are proposed should be over excavated to a depth of three feet below planned finished grades or 1 foot below footings, whichever is deeper. The actual depth of remedial grading should be evaluated by the Engineering Geologist during grading operations. Removals should extend laterally a minimum of 3 feet or for a distance equal to the depth of the removal, whichever is greater, so as to maintain a 1:1 (h:v) projection from the outside bottom edge of footings. The bottom of the excavations in soil should be scarified to a depth of at least 1 foot, moisture conditioned at or slightly above optimum moisture content, and compacted to 90 percent of the laboratory maximum dry density, as determined by ASTM D1557, prior to fill placement.

- 8.3.5 The site should be brought to finish grade elevations with engineered fill compacted in layers. Layers of fill should be no thicker than will allow for adequate bonding and compaction. Fill, including backfill and scarified ground surfaces, should be compacted to a dry density of at least 90 percent of the laboratory maximum dry density at or slightly above optimum moisture content (as determined by ASTM D1557). Fill materials placed below optimum moisture content may require additional moisture conditioning prior to placing additional fill.
- 8.3.6 The fill placed within 4 feet of proposed finish grade should possess a “low” to “very low” expansion potential (EI of 50 or less), where practical.
- 8.3.7 Over excavation of cut fill transition lots and cut lots should be performed in accordance with the appended *Recommended Grading Specifications*.
- 8.3.8 Oversized rock (i.e. rock greater than 12-inches in maximum dimension) will be encountered and generated during grading operations. The oversize rock will require special handling and placement. Rocks greater than 3 inches in maximum dimensions should not be placed within utility trench backfill. Rocks greater than 6 inches in maximum dimension should not be placed in soil fill within the upper 3 feet of finish grade. Rocks 6 to 12 inches in maximum dimension should be placed deeper than 3 feet below finished grade elevations. Rocks 12 inches or larger in maximum dimension should be exported from the site or placed at specified depths in accordance with the *Recommended Grading Specifications* in *Appendix C*.
- 8.3.9 Import fill (if necessary) should consist of granular materials with a “low” expansion potential (EI of 50 or less), generally free of deleterious material and rock fragments larger than 6 inches and should be compacted as recommended herein. Geocon should be notified of the import soil source and should perform laboratory testing of import soil prior to its arrival at the site to evaluate its suitability as fill material.

8.4 Earthwork Grading Factors

- 8.4.1 Estimates of shrinkage factors are based on empirical judgments comparing the material in its existing or natural state as encountered in the exploratory excavations to a compacted state. Variations in natural soil density and in compacted fill density render shrinkage value estimates very approximate. As an example, the contractor can compact the fill to a dry density of 90 percent or higher of the laboratory maximum dry density. Thus, the contractor has an approximately 10 percent range of control over the fill volume. Due to the variations in the actual shrinkage/bulking factors, a balance area should be provided to accommodate variations.

8.5 Utility Trench Backfill

- 8.5.1 Utility trenches should be properly backfilled in accordance with the requirements of the City of Riverside and the latest edition of the *Standard Specifications for Public Works Construction* (Greenbook). The pipes should be bedded with well-graded crushed rock or clean sand (Sand Equivalent greater than 30) to a depth of at least one foot over the pipe. If open graded rock is used it should be wrapped in filter fabric to prevent finer soils from migrating into the rock voids. The remainder of the trench backfill may be derived from onsite soil or approved import soil. Backfill of utility trenches should not contain rocks greater than 3 inches in diameter. The use of 2-sack slurry and controlled low strength material (CLSM) are also acceptable as backfill. However, consideration should be given to the possibility of differential settlement where the slurry ends and earthen backfill begins. These transitions should be minimized, and additional stabilization should be considered at these transitions.
- 8.5.2 Utility trench backfill should be placed in layers no thicker than will allow for adequate bonding and compaction. Utility backfill should be compacted to a dry density of at least 90 percent of the laboratory maximum dry density and moisture conditioned at or slightly above optimum moisture content (as determined by ASTM D1557). Backfill at the finish subgrade elevation of new pavements should be compacted to at least 95 percent of the maximum dry density. Backfill materials placed below the recommended moisture content may require additional moisture conditioning prior to placing additional fill.

8.6 Seismic Design Criteria

- 8.6.1 The following table summarizes site-specific design criteria obtained from the 2019 California Building Code (CBC; Based on the 2018 International Building Code [IBC] and ASCE 7-16), Chapter 16 Structural Design, Section 1613 Earthquake Loads. We used the computer program *Seismic Design Maps*, provided by the Structural Engineers Association (SEA) to calculate the seismic design parameters. The short spectral response uses a period of 0.2 second. We evaluated the Site Class based on the discussion in Section 1613.2.2 of the 2019 CBC and Table 20.3-1 of ASCE 7-16. The values presented herein are for the risk-targeted maximum considered earthquake (MCE_R).

**TABLE 8.6.1
2019 CBC SEISMIC DESIGN PARAMETERS**

Parameter	Value	2019 CBC Reference
Site Class	B	Section 1613.3.2
MCE _R Ground Motion Spectral Response Acceleration – Class B (short), S _S	1.5g	Figure 1613.3.1(1)
MCE _R Ground Motion Spectral Response Acceleration – Class B (1 sec), S ₁	0.594g	Figure 1613.3.1(2)
Site Coefficient, F _A	0.9	Table 1613.3.3(1)
Site Coefficient, F _V	0.8	Table 1613.3.3(2)
Site Class Modified MCE _R Spectral Response Acceleration (short), S _{MS}	1.35g	Section 1613.3.3 (Eqn 16-37)
Site Class Modified MCE _R Spectral Response Acceleration (1 sec), S _{M1}	0.476g	Section 1613.3.3 (Eqn 16-38)
5% Damped Design Spectral Response Acceleration (short), S _{DS}	0.9g	Section 1613.3.4 (Eqn 16-39)
5% Damped Design Spectral Response Acceleration (1 sec), S _{D1}	0.317g	Section 1613.3.4 (Eqn 16-40)

8.6.2 The table below presents the mapped maximum considered geometric mean (MCE_G) seismic design parameters for projects located in Seismic Design Categories of D through F in accordance with ASCE 7-16.

**TABLE 8.6.2
ASCE 7-16 PEAK GROUND ACCELERATION**

Parameter	Value	ASCE 7-16 Reference
Mapped MCE _G Peak Ground Acceleration, PGA	0.5g	Figure 22-9
Site Coefficient, F _{PGA}	0.9	Table 11.8-1
Site Class Modified MCE _G Peak Ground Acceleration, PGA _M	0.45g	Section 11.8.3 (Eqn 11.8-1)

8.6.3 Conformance to the criteria in the above tables for seismic design does not constitute any kind of guarantee or assurance that significant structural damage or ground failure will not occur if a large earthquake occurs. The primary goal of seismic design is to protect life, not to avoid all damage, since such design may be economically prohibitive.

8.7 Shallow Foundation and Concrete Slabs-On-Grade

- 8.7.1 The foundation recommendations presented herein are for the proposed residential buildings subsequent to the recommended grading. We understand that future buildings will be supported on a conventional shallow foundation with concrete slabs-on-grade, deriving support in newly placed engineered fill.
- 8.7.2 The foundation for structures may consist of either continuous strip footings and/or isolated spread footings. Conventionally reinforced continuous footings should be at least 12 inches wide and extend at least 18 inches below lowest adjacent pad grade; isolated spread footings should have a minimum width of 24 inches and should extend at least 18 inches below lowest adjacent pad grade. A graphic depicting the foundation embedment is provided below.

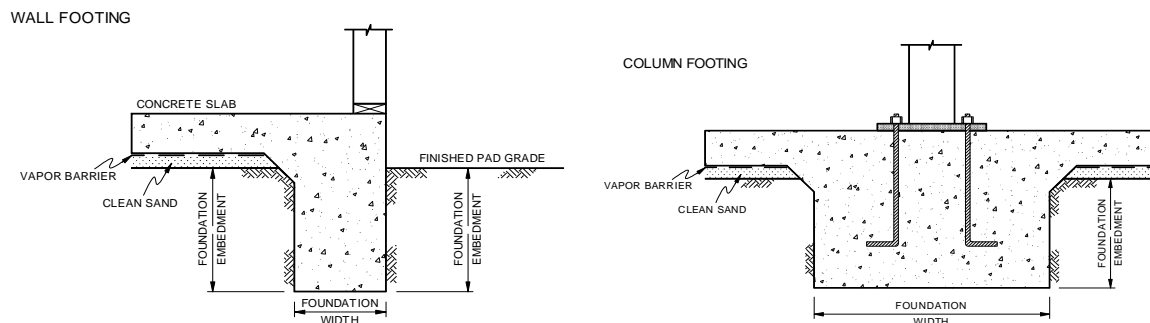

Wall/Column Footing Detail

- 8.7.3 From a geotechnical engineering standpoint, concrete slabs-on-grade for the structure should be at least 4 inches thick and be reinforced with at least No. 3 steel reinforcing bars placed 18 inches on center in both directions. The concrete slab-on-grade recommendations are based on soil support characteristics only. The project structural engineer should evaluate the structural requirements of the concrete slab for supporting equipment and storage loads. A thicker concrete slab may be required for heavier loading conditions. To reduce the effects of differential settlement on the foundation system, thickened slabs and/or an increase in steel reinforcement can provide a benefit to reduce concrete cracking.
- 8.7.4 Reinforcing steel for continuous footings should consist of at least four No. 4 steel reinforcing bars placed horizontally in the footings, two near the top and two near the bottom for the warehouse and commercial buildings; and at least two No. 4 steel bars placed horizontally in the footings, one near the top and one near the bottom for the residential buildings. Reinforcing steel for the spread footings should be designed by the project structural engineer.

- 8.7.5 Following remedial grading, foundations for the buildings may be designed for an allowable soil bearing pressure of 2,500 psf (dead plus live load). The soil bearing pressure may be increased by 250 psf and 500 psf for each additional foot of foundation width and depth, respectively, up to a maximum allowable soil bearing pressure of 4,500 psf. The allowable bearing pressure may be increased by one-third for transient loads due to wind or seismic forces.
- 8.7.6 The maximum expected static settlement for the planned structures, supported on conventional foundation systems with the above allowable bearing pressures and deriving support in engineered fill, is estimated to be on the order of ½ inch and to occur below the heaviest loaded structural element, with differential static settlement to be on the order of ¼ inch over a horizontal distance of 40 feet. Settlement of the foundation system is expected to occur on initial application of loading.
- 8.7.7 Once the design and foundation loading configuration proceeds to a more finalized plan, the estimated settlements within this report should be reviewed and revised, if necessary.
- 8.7.8 Foundation excavation bottoms must be observed and approved in writing by a qualified representative of Geocon, prior to placement of reinforcing steel or concrete.
- 8.7.9 Slabs that may receive moisture-sensitive floor coverings or may be used to store moisture-sensitive materials should be underlain by a vapor retarder. The vapor retarder design should be consistent with the guidelines presented in the American Concrete Institute's (ACI) Guide for Concrete Slabs that Receive Moisture-Sensitive Flooring Materials (ACI 302.2R-06). The vapor retarder used should be specified by the project architect or developer based on the type of floor covering that will be installed and if the structure will possess a humidity-controlled environment.
- 8.7.10 The bedding sand thickness should be evaluated by the project foundation engineer, architect, and/or developer. However, we should be contacted to provide recommendations if the bedding sand is thicker than 4 inches. Placement of 4 inches of sand is common practice in Southern California for 5 4-inch-thick slabs. The foundation engineer should provide appropriate concrete mix design criteria and curing measures that may be utilized to assure proper curing of the slab to reduce the potential for rapid moisture loss and subsequent cracking and/or slab curl. We suggest that the foundation design engineer present the concrete mix design and proper curing methods on the foundation plans. It is critical that the foundation contractor understands and follows the recommendations presented on the foundation plans.

- 8.7.11 Special subgrade presaturation is not deemed necessary prior to placing concrete; however, the exposed foundation and slab subgrade soil should be moisturized to maintain a moist condition between 0 and 2 percent above optimum moisture content.
- 8.7.12 The recommendations of this report are intended to reduce the potential for cracking of slabs due to expansive soil (if present), differential settlement of existing soil or soil with varying thicknesses. However, even with the incorporation of the recommendations presented herein, foundations, walls, and slabs-on-grade placed on such conditions may still exhibit some cracking due to soil movement and/or shrinkage. The occurrence of concrete shrinkage cracks is independent of the supporting soil characteristics. Their occurrence may be reduced and/or controlled by limiting the slump of the concrete, proper concrete placement and curing, and by the placement of crack control joints at periodic intervals, in particular where re-entrant slab corners occur.
- 8.7.13 Geocon should be consulted to provide additional design parameters as required by the structural engineer.

8.8 Miscellaneous Foundations

- 8.8.1 Foundations for small outlying structures, such as block walls up to 6 feet in height, planter walls or trash enclosures which will not be tied to the proposed structures may be supported on conventional foundations bearing on a minimum of 12 inches of newly placed engineered fill which extends laterally at least 12 inches beyond the foundation area. Where excavation and compaction cannot be performed, such as adjacent to property lines, foundations may derive support in the undisturbed granitic bedrock, and should be deepened as necessary to maintain a minimum 12-inch embedment into undisturbed granitic bedrock and must be observed and approved by a Geocon representative.
- 8.8.2 If soils exposed in the footing excavations are loose or soft, subgrade stabilization will be required prior to placing steel or concrete. Miscellaneous foundations may be designed for an allowable bearing value of 1,500 psf, and should be a minimum of 12 inches in width, 18 inches in depth below the lowest adjacent grade and 12 inches into the recommended bearing material. The allowable bearing pressure may be increased by up to one-third for transient loads due to wind or seismic forces.
- 8.8.3 Foundation excavations should be observed and approved in writing by the geotechnical engineer, prior to the placement of reinforcing steel and concrete to verify that the excavations and exposed soil conditions are consistent with those anticipated.

8.9 Concrete Flatwork

- 8.9.1 Exterior concrete flatwork not subject to vehicular traffic should be constructed in accordance with the recommendations herein assuming the subgrade materials possess an Expansion Index of 50 or less. Subgrade soils should be compacted to 90 percent relative compaction at or slightly above optimum moisture content. Slab panels should be a minimum of 4 inches thick and when in excess of 8 feet square should be reinforced with No. 3 reinforcing bars spaced 18 inches center-to-center in both directions to reduce the potential for cracking. In addition, concrete flatwork should be provided with crack control joints to reduce and/or control shrinkage cracking. Crack control spacing should be determined by the project structural engineer based upon the slab thickness and intended usage. Criteria of the American Concrete Institute (ACI) should be taken into consideration when establishing crack control spacing. Subgrade soil for exterior slabs not subjected to vehicle loads should be compacted in accordance with criteria presented in the *Grading* section prior to concrete placement. Subgrade soil should be properly compacted, and the moisture content of subgrade soil should be verified prior to placing concrete. Base materials will not be required below concrete improvements.
- 8.9.2 Even with the incorporation of the recommendations of this report, the exterior concrete flatwork has a potential to experience some uplift due to expansive soil beneath grade. The reinforcement steel should overlap continuously in flatwork to reduce the potential for vertical offsets within flatwork. Additionally, flatwork should be structurally connected to the curbs, where possible, to reduce the potential for offsets between the curbs and the flatwork.
- 8.9.3 Where exterior flatwork abuts the structure at entrant or exit points, the exterior slab should be dowelled into the structure's foundation stem wall. This recommendation is intended to reduce the potential for differential elevations that could result from differential settlement or minor heave of the flatwork. Dowelling details should be designed by the project structural engineer.
- 8.9.4 The recommendations presented herein are intended to reduce the potential for cracking of exterior slabs as a result of differential movement. However, even with the incorporation of the recommendations presented herein, slabs-on-grade will still crack. The occurrence of concrete shrinkage cracks is independent of the soil supporting characteristics. Their occurrence may be reduced and/or controlled by limiting the slump of the concrete, the use of crack control joints and proper concrete placement and curing. Crack control joints should be spaced at intervals no greater than 12 feet. Literature provided by the Portland Concrete Association (PCA) and American Concrete Institute (ACI) present recommendations for proper concrete mix, construction, and curing practices, and should be incorporated into project construction.

8.10 Conventional Retaining Walls

- 8.10.1 The recommendations presented herein are generally applicable to the design of rigid concrete or masonry retaining walls having a maximum height of 5 feet. In the event that walls higher than 5 feet or other types of walls are planned, Geocon should be consulted for additional recommendations.
- 8.10.2 Retaining wall foundations may be designed in accordance with the recommendations provided in the *Foundation and Concrete Slabs-On-Grade Recommendations* section of this report.
- 8.10.3 Retaining walls that are allowed to rotate more than $0.001H$ (where H equals the height of the retaining portion of the wall in feet) at the top of the wall with a level backfill surface should be designed utilizing a triangular distribution of pressure (active pressure) of 30 psf/ft. Where walls are restrained from movement at the top and are retaining a level soil backfill, walls may be designed utilizing a triangular distribution of pressure (at-rest pressure) of 53 pcf.
- 8.10.4 The wall pressures provided above assume that the retaining wall will be properly drained preventing the buildup of hydrostatic pressure. If retaining wall drainage is not implemented, the equivalent fluid pressure to be used in design of undrained walls is 89 pcf. The value includes hydrostatic pressures plus buoyant lateral earth pressures.
- 8.10.5 Retaining walls not designed for hydrostatic pressures should be provided with a drainage system adequate to prevent the buildup of hydrostatic forces and waterproofed as required by the project architect. The soil immediately adjacent to the backfilled retaining wall should be composed of free draining material completely wrapped in Mirafi 140 (or equivalent) filter fabric for a lateral distance of 1 foot for the bottom two-thirds of the height of the retaining wall. The upper one-third should be backfilled with less permeable compacted fill to reduce water infiltration. The use of drainage openings through the base of the wall (weep holes) is not recommended where the seepage could be a nuisance or otherwise adversely affect the property adjacent to the base of the wall. The recommendations herein assume a properly compacted backfill (EI of 50 or less) with no hydrostatic forces or imposed surcharge load. If conditions different than those described are expected or if specific drainage details are desired, Geocon should be contacted for additional recommendations. A graphic depicting typical retaining wall drainage is provided below.

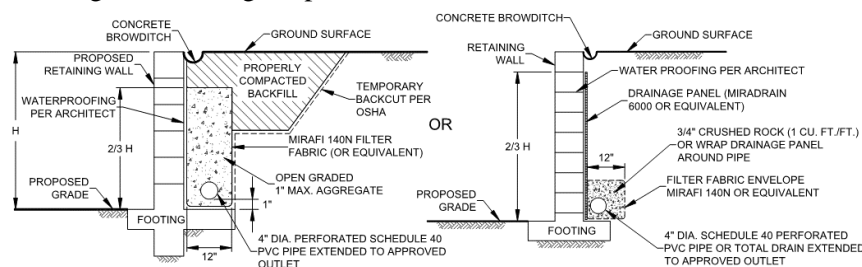

Typical Retaining Wall Drainage Detail

- 8.10.6 The wall pressures provided above assume that the proposed retaining walls will support relatively undisturbed soils or engineered fill derived from onsite soils, with an EI of 50 or less. If imported soil will be used to backfill proposed retaining walls, revised earth pressures may be required to account for the geotechnical properties of the import soil used as engineered fill. This should be evaluated once the use of import soil is established. All imported fills shall be observed, tested, and approved by Geocon West, Inc. prior to bringing soil to the site.
- 8.10.7 Additional active pressure should be added for a surcharge condition due to sloping ground, vehicular traffic, or adjacent structures. Once the design becomes more finalized, an addendum letter can be prepared revising recommendations and addressing specific surcharge conditions throughout the project, if necessary.
- 8.10.8 Unrestrained walls will move laterally when backfilled and loading is applied. The amount of lateral deflection is dependent on the wall height, the type of soil used for backfill, and loads acting on the wall. The retaining walls and improvements above the retaining walls should be designed to incorporate an appropriate amount of lateral deflection as determined by the structural engineer.

8.11 Elevator Pit Design

- 8.11.1 The elevator pit slab and retaining wall should be designed by the project structural engineer. Elevator pit walls may be designed in accordance with the recommendations in the *Shallow Foundation and Concrete Slabs-On-Grade* and *Conventional Retaining Walls* sections of this report.
- 8.11.2 Additional active pressure should be added for a surcharge condition due to sloping ground, vehicular traffic or adjacent foundations and should be designed for each condition as the project progresses.
- 8.11.3 If retaining wall drainage is to be provided, the drainage system should be designed in accordance with the *Conventional Retaining Walls* section of this report.
- 8.11.4 We recommend that the elevator pit walls and slab be waterproofed to prevent excessive moisture inside of the elevator pit. Waterproofing design and installation is not the responsibility of the geotechnical engineer.

8.12 Elevator Piston

- 8.12.1 If a plunger-type elevator piston is installed for this project, a deep drilled excavation will be required. It is important to verify that the drilled excavation is not situated immediately adjacent to a foundation, or the drilled excavation could compromise the existing foundation, especially if the drilling is performed subsequent to the foundation construction.

- 8.12.2 Casing may be required if caving is experienced in the drilled excavation. The contractor should be prepared to use casing and should have it readily available at the commencement of drilling activities. Continuous observation of the drilling and installation of the elevator piston by the Geotechnical Engineer (a representative of Geocon West, Inc.) is required.
- 8.12.3 The annular space between the piston casing and drilled excavation wall should be filled with a minimum of 1½-sack slurry pumped from the bottom up. As an alternative, pea gravel may be utilized. The use of soil to backfill the annular space is not acceptable.

8.13 Swimming Pool

- 8.13.1 For the proposed pools, the shell bottoms should be designed as a free-standing structure and may derive support on undisturbed granitic bedrock or a minimum of 2 feet of engineered fill compacted to a dry density of at least 90 percent of the laboratory maximum dry density at 0 to 2 percent above optimum moisture content as determined by ASTM D1557.
- 8.13.2 Swimming pool foundations and walls may be designed in accordance with the *Shallow Foundation and Concrete Slabs-On-Grade* and *Conventional Retaining Walls* sections of this report. A hydrostatic relief valve should be considered as part of the swimming pool design unless a gravity drain system can be placed beneath the pool shell.
- 8.13.3 Surface drainage around the pool/spa should be designed to prevent water from ponding and seeping into the ground. Surface water should be collected and conducted through non-erosive devices to the street, storm drain or other approved water course or disposal area. Leakage from the proposed pool/spa could create an artificial groundwater condition that will likely create instability problems. Therefore, all plumbing and the pool/spa should be leak free.
- 8.13.4 The deck for the swimming pool/spa should be cast separately of the swimming pool/spa, and water stops should be provided between the bond beam and the deck. Jointing for concrete flatwork should be provided in accordance with the recommendations of the American Concrete Institute. The joints should be sealed with an approved flexible sealant to reduce the potential for introduction of surface water into the underlying soil.
- 8.13.5 Consideration should be given to installing a subdrain system for the pool area. The subgrade surface should be graded to slope a minimum of 1 percent away from the pool. An impermeable liner (e.g. High-density polyethylene, HDPE, with a thickness of about 30 mil or equivalent PVC liner) could be placed over the subgrade soil. The liner, if installed, should overlap by at least 12 inches and sealed in accordance with manufacturer's recommendations.

- 8.13.6 To mitigate the potential for moisture infiltration into the subgrade soils beneath the pool deck, we recommend the construction of a deepened footing along the outside edge of the pool deck flatwork. A subdrain consisting of 4-inch diameter perforated PVC pipe should be installed inside the deepened footing and sloped to drain into an approved outlet. The pipe should be surrounded by $\frac{3}{4}$ inch open-graded gravel and wrapped with filter fabric.
- 8.13.7 If the proposed pools are in proximity to a proposed or existing structure, consideration should be given to the construction sequence. If the proposed pool is to be constructed near an existing structure, or a proposed structure that is constructed before the pool's construction, the excavation required for the pool could remove a critical component of lateral support from the structure's foundations and would therefore require shoring to safeguard the structure's foundations. Once information regarding the pool locations and depth becomes available, this information should be provided to Geocon for review and possible revision of these recommendations.

8.14 Lateral Loading

- 8.14.1 To resist lateral loads, a passive pressure exerted by an equivalent fluid density of 310 pounds per cubic foot (pcf) should be used for the design of footings or shear keys. The allowable passive pressure assumes a horizontal surface extending at least 5 feet, or three times the surface generating the passive pressure, whichever is greater. The upper 12 inches of material in areas not protected by floor slabs or pavement should not be included in design for passive resistance.
- 8.14.2 If friction is to be used to resist lateral loads, an allowable coefficient of friction between soil and concrete of 0.4 should be used for design. The friction coefficient may be reduced depending on the vapor barrier or waterproofing material used for construction in accordance with the manufacturer's recommendations.
- 8.14.3 The passive and frictional resistant loads can be combined for design purposes. The lateral passive pressures may be increased by one-third when considering transient loads due to wind or seismic forces.

8.15 Preliminary Pavement Recommendations

- 8.15.1 We calculated the flexible pavement sections in general conformance with the *Caltrans Method of Flexible Pavement Design* (Highway Design Manual, Section 608.4) and the County of Riverside's *Road Improvement Standards & Specifications* (Ordinance No. 461) using a range of Traffic Indices. The project civil engineer and owner should evaluate the final Traffic Index for the pavements and review the pavement designations to determine appropriate locations for pavement thickness. For the purpose of our preliminary analysis, an R-value test result of 70 was determined from a sample of near surface soils

from the site. However, Caltrans allows a maximum R-value of 50 to be used for pavement design. The final pavement sections should be based on the R-value of the subgrade soil encountered at final subgrade elevation. Table 8.15.1 presents the preliminary flexible pavement sections with various roadway traffic demands.

**TABLE 8.15.1
PRELIMINARY FLEXIBLE PAVEMENT SECTION**

Road Classification	Assumed Traffic Index	Preliminary Subgrade R-Value	Asphalt Concrete (inches)	Aggregate Base (inches)
Local Street/Access Road	5.5	50	3.0	4.0
Enhanced Local Street at School or Park	6.5		3.5	4.5
Collector	7.0		4.0	5.0
Industrial Collector	8.0		4.5	6.0

8.15.2 The upper 12 inches of the roadway subgrade soil should be compacted to a dry density of at least 95 percent of the laboratory maximum dry density at 0 to 2 percent above optimum moisture content as determined by ASTM D1557.

8.15.3 The aggregate base and asphalt concrete materials should conform to Section 200-2.4 and Section 203-6, respectively, of the latest edition of the California *Greenbook* and County of Riverside’s *Road Improvement Standards & Specifications* (Ordinance No. 461). Base materials should be compacted to a dry density of at least 95 percent of the laboratory maximum dry density at or slightly above optimum moisture content as determined by ASTM D1557. Asphalt concrete should be compacted to a density of 95 percent of the laboratory Hveem density as determined by ASTM D1561.

8.15.4 A rigid Portland cement concrete (PCC) pavement section should be placed in driveway aprons and cross gutters, and may be used in driveways and parking areas where desired. We calculated the rigid pavement section in general conformance with the procedure recommended by the American Concrete Institute, Report ACI 330R-08, *Guide for Design and Construction of Concrete Parking Lots* using the parameters presented in Table 8.15.4.

**TABLE 8.15.4
RIGID PAVEMENT DESIGN PARAMETERS**

Design Parameter	Design Value
Modulus of subgrade reaction, k	150 pci
Modulus of rupture for concrete, M_R	500 psi
Traffic Category, TC	C and D
Average daily truck traffic, ADTT	300 and 700

8.15.5 Based on the criteria presented herein, the PCC pavement sections should have a minimum thickness as presented in Table 8.15.5.

**TABLE 8.15.5
RIGID PAVEMENT RECOMMENDATIONS**

Location	Portland Cement Concrete (inches)
Light Truck Traffic (TC = C, ADTT = 300)	7.0
Medium and Heavy Truck Traffic (TC = D, ADTT = 700)	7.5

8.15.6 The PCC pavement should be placed over subgrade soil that is compacted to a dry density of at least 95 percent of the laboratory maximum dry density at 0 to 2 percent above optimum moisture content. This pavement section is based on a minimum concrete compressive strength of approximately 3,500 psi (pounds per square inch).

8.15.7 A thickened edge or integral curb should be constructed on the outside of concrete slabs subjected to wheel loads. The thickened edge should be 1.2 times the slab thickness or a minimum thickness of 2 inches, whichever results in a thicker edge, and taper back to the recommended slab thickness 4 feet behind the face of the slab (e.g., 7.5-inch-thick slabs would have a 9.5-inch-thick edge). Reinforcing steel will not be necessary within the concrete for geotechnical purposes with the possible exception of dowels at construction joints as discussed herein.

8.15.8 In order to control the location and spread of concrete shrinkage cracks, crack-control joints (weakened plane joints) should be included in the design of the concrete pavement slab in accordance with the referenced ACI report.

8.15.9 The performance of pavements is highly dependent on providing positive surface drainage away from the edge of the pavement. Ponding of water on or adjacent to the pavement surfaces will likely result in pavement distress and subgrade failure. Drainage from landscaped areas should be directed to controlled drainage structures. Landscape areas adjacent to the edge of asphalt pavements are not recommended due to the potential for surface or irrigation water to infiltrate the underlying permeable aggregate base and cause distress. Where such a condition cannot be avoided, consideration should be given to incorporating measures that will significantly reduce the potential for subsurface water migration into the aggregate base. If planter islands are planned, the perimeter curb should extend at least 6 inches below the level of the base materials.

8.16 Temporary Excavations

- 8.16.1 The recommendations included herein are provided for temporary excavations. It is the responsibility of the contractor to provide a safe excavation during the construction of the proposed project.
- 8.16.2 Excavations of up to 10 feet in vertical height are expected during utility installation. The contractor's competent person should evaluate the necessity for lay back of vertical cut areas. Vertical excavations up to 5 feet may be attempted where loose soils or caving sands are not present, and where not surcharged by existing structures or vehicle/construction equipment loads.
- 8.16.3 Vertical excavations greater than 5 feet will require sloping measures in order to provide a stable excavation. Where sufficient space is available, temporary unsurcharged embankments should be designed by the contractor's competent person in accordance with OSHA regulations.
- 8.16.4 Where sufficient space is available, temporary unsurcharged embankments in soil may be sloped back at a uniform 1.5:1 (h:v) slope gradient or flatter. Excavations in bedrock may be steepened per Cal OSHA requirements. Note, a uniform slope does not have a vertical portion.
- 8.4.5 Where there is insufficient space for sloped excavations, shoring or trench shields should be used to support excavations. Shoring may also be necessary where sloped excavation could remove vertical or lateral support of existing improvements, including existing utilities and adjacent structures. Recommendations for temporary shoring can be provided in an addendum if needed.
- 8.16.5 Where temporary construction slopes are utilized, the top of the slope should be barricaded to prevent vehicles and storage loads at the top of the slope within a horizontal distance equal to the height of the slope. If the temporary construction slopes are to be maintained during the rainy season, berms are suggested along the tops of the slopes where necessary to prevent runoff water from entering the excavation and eroding the slope faces. The contractor's personnel should inspect the soil exposed in the cut slopes during excavation so that modifications of the slopes can be made if variations in the soil conditions occur. Excavations should be stabilized within 30 days of initial excavation.

8.17 Site Drainage and Moisture Protection

- 8.17.1 Adequate site drainage is critical to reduce the potential for differential soil movement, erosion and subsurface seepage. Under no circumstances should water be allowed to pond adjacent to footings. The site should be graded and maintained such that surface drainage is directed away from structures in accordance with 2019 CBC 1804.4 or other applicable standards. In addition, surface drainage should be directed away from the top of slopes into swales or other controlled drainage devices. Roof and pavement drainage should be directed into conduits that carry runoff away from the proposed structure.
- 8.17.2 Underground utilities should be leak free. Utility and irrigation lines should be checked periodically for leaks and detected leaks should be repaired promptly. Detrimental soil movement could occur if water can infiltrate the soil for prolonged periods of time.
- 8.17.3 Storm water mitigation systems should be offset a minimum of 20 feet from the outside edge of structural footings, so as to reduce the occurrence of water migrating within the structures' load projection.
- 8.17.4 Landscaping planters adjacent to paved areas are not recommended due to the potential for surface or irrigation water to infiltrate the pavement's subgrade and base course. We recommend that area drains to collect excess irrigation water and transmit it to drainage structures or impervious above-grade planter boxes be used. In addition, where landscaping is planned adjacent to the pavement, we recommend construction of a cutoff wall or the use of an impermeable geosynthetic along the edge of the pavement that extends at least 6 inches below the bottom of the base material.
- 8.17.5 If not properly constructed, there is a potential for distress to improvements and properties located hydrologically down gradient or adjacent to infiltration areas. Factors such as the amount of water to be detained, its residence time, and soil permeability have an important effect on seepage transmission and the potential adverse impacts that may occur if the storm water management features are not properly designed and constructed. We have not performed a hydrogeology study at the site. Downgradient and adjacent structures may be subjected to seeps, movement of foundations and slabs, or other impacts as a result of water infiltration.

8.18 Grading and Foundation Plan Review

- 8.18.1 Geocon should review the project grading and foundation plans prior to final design submittal to verify that the plans have been prepared in substantial conformance with the recommendations of this report and to provide additional analyses or recommendations, if necessary.

LIMITATIONS AND UNIFORMITY OF CONDITIONS

The recommendations of this report pertain only to the site investigated and are based upon the assumption that the soil conditions do not deviate from those disclosed in this investigation. If any variations or undesirable conditions are encountered during construction, or if the proposed construction will differ from that expected herein, Geocon West, Inc. should be notified so that supplemental recommendations can be given. The evaluation or identification of the potential presence of hazardous materials was not part of the scope of services provided by Geocon West, Inc.

This report is issued with the understanding that it is the responsibility of the owner, or of their representative, to ensure that the information and recommendations contained herein are brought to the attention of the architect and engineer for the project and incorporated into the plans, and the necessary steps are taken to see that the contractor and subcontractors carry out such recommendations in the field.

The requirements for concrete and steel reinforcement presented in this report are preliminary recommendations from a geotechnical perspective. The Structural Engineer should provide the final recommendations for structural design of concrete and steel reinforcement for foundation systems, floor slabs, exterior concrete, or other systems where concrete and steel reinforcement are utilized, in accordance with the latest version of applicable codes.

The findings of this report are valid as of the present date. However, changes in the conditions of a property can occur with the passage of time, whether they are due to natural processes or the works of man on this or adjacent properties. In addition, changes in applicable or appropriate standards may occur, whether they result from legislation or the broadening of knowledge. Accordingly, the findings of this report may be invalidated wholly or partially by changes outside our control. Therefore, this report is subject to review and should not be relied upon after a period of three years.

The firm that performed the geotechnical investigation for the project should be retained to provide testing and observation services during construction to provide continuity of geotechnical interpretation and to check that the recommendations presented for geotechnical aspects of site development are incorporated during site grading, construction of improvements, and excavation of foundations. If another geotechnical firm is selected to perform the testing and observation services during construction operations, that firm should prepare a letter indicating their intent to assume the responsibilities of project Geotechnical Engineer of Record. A copy of the letter should be provided to the regulatory agency for their records. In addition, that firm should provide revised recommendations concerning the geotechnical aspects of the proposed development, or a written acknowledgement of their concurrence with the recommendations presented in our report. They should also perform additional analyses deemed necessary to assume the role of Geotechnical Engineer of Record.

LIST OF REFERENCES

1. American Concrete Institute, 2011, *Building Code Requirements for Structural Concrete*, Report by ACI Committee 318.
2. American Concrete Institute, 2008, *Guide for Design and Construction of Concrete Parking Lots*, Report by ACI Committee 330.
3. ASCE 7-16, 2019, *Minimum Design Loads for Buildings and Other Structures*.
4. California Building Standards Commission, 2019, *California Building Code (CBC)*, California Code of Regulations Title 24, Part 2.
5. California Department of Transportation (Caltrans), 2021, Division of Engineering Services, Materials Engineering and Testing Services, *Corrosion Guidelines, Version 3.2*, dated March.
6. California Department of Water Resources, *Water Data Library* website, <https://wdl.water.ca.gov/>; accessed May 2022.
7. California Geological Survey (CGS), 2003, *Earthquake Shaking Potential for California*, from USGS/CGS Seismic Hazards Model, CSSC No. 03-02
8. California Geological Survey, 2002, *Seismic Shaking Hazards in California*, Based on the USGS/CGS Probabilistic Seismic Hazards Assessment (PSHA) Model, (revised April 2003). 10% probability of being exceeded in 50 years, <http://redirect.conservation.ca.gov/cgs/rghm/pshamap/pshamain.html>
9. California Geologic Survey, 2008, Special Publication 117A, *Guidelines for Evaluating and Mitigating Seismic Hazards in California*, Revised and Re-adopted September 11.
10. Dibblee, T.W. and Minch, J.A., 2003, *Geologic Map of the Riverside East/south 1/2 of San Bernardino South quadrangles, San Bernardino and Riverside County, California*, DF-109, Scale 1:24,000.
11. Google Earth Pro, 2022, accessed May 2022.
12. Harden, Deborah R., 1998, *California Geology*, Prentice Hall Publishing.
13. Historic Aerials, Aerial Photographs of the site from 1966 through 2018, historicaerials.com, accessed June 2022.
14. Jennings, C. W., 2010, California Division of Mines and Geology, *Fault Activity Map of California and Adjacent Areas*, California Geologic Data Map Series Map No. 6.
15. Legg, M. R., J. C. Borrero, and C. E. Synolakis, *Evaluation of Tsunami Risk to Southern California Coastal Cities*, 2002 NEHRP Professional Fellowship Report, dated January 2003.
16. OSPD, 2018, *Seismic Design Maps*, <https://seismicmaps.org> Accessed May 2022.
17. Public Works Standards, Inc., 2021, *Standard Specifications for Public Works Construction "Greenbook"*, Published by BNi Building News.
18. Riverside County, *Map My County Website*, accessed May 2022.
19. Riverside County Flood Control and Water Conservation District, 2011, *Design Handbook for Low Impact Development Best Management Practices*, September.
20. Riverside County, Transportation Department, 2007, *Road Improvement Standards & Specifications*, Ordinance No. 461, dated December 20.



SITE

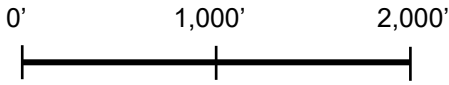

SCALE: 1" = 1,000'



SOURCE: Google Earth 2022

VICINITY MAP

GEOCON
WEST, INC.



GEOTECHNICAL, ENVIRONMENTAL, MATERIALS
41571 CORNING PLACE #101, MURRIETA, CALIFORNIA 92562
PHONE 951-304-2300 FAX 951-304-2392

MISSION GROVE REDEVELOPMENT
375 EAST ALESSANDRO BOULEVARD
RIVERSIDE, CALIFORNIA

HD

JUNE 2022

PROJECT NO. T2979-22-01

FIG. 1



GEOCON LEGEND

Locations are approximate

- B-7 GEOTECHNICAL BORING LOCATION
- 3 REMEDIAL REMOVAL DEPTHS IN FEET
- P-6 PERCOLATION TEST LOCATION
- LIMITS OF THIS STUDY
- GEOLOGIC CONTACT
- afu PREVIOUSLY PLACED FILL
- qdi QUARTZ DIORITE BEDROCK



SCALE: 1" = 100'



Source: Rick Engineering Company, Infiltration Testing Locations, Plot Date April 27, 2022

GEOCON
 WEST, INC.
 GEOTECHNICAL, ENVIRONMENTAL, MATERIALS
 41571 CORNING PLACE #101, MURRIETA, CALIFORNIA 92562
 PHONE 951-304-2300 FAX 951-304-2392



GEOLOGIC MAP

MISSION GOVE REDEVELOPMENT
 375 EAST ALESSANDRO BOULEVARD
 RIVERSIDE, CALIFORNIA

APPENDIX



APPENDIX A

FIELD INVESTIGATION

The field investigation was performed on May 13 and 16, 2022, and consisted of excavation of seven geotechnical borings and six percolation borings utilizing a truck-mounted hollow-stem auger drilling rig. The borings were drilled to depths of 2 to 26 feet 3 inches below existing grades. Representative and relatively undisturbed samples were obtained by driving a 3-inch O. D., California Modified Sampler into the “undisturbed” soil mass with blows from a 140-pound auto hammer falling 30 inches. The California Modified Sampler was equipped with 1-inch high by 2³/₈-inch diameter brass sampler rings to facilitate removal and testing.

The geotechnical conditions encountered in the excavations were visually examined, classified and logged in general accordance with ASTM International (ASTM) practice for Description and Identification of Soils (Visual-Manual Procedure D 2488).

Logs of the geotechnical and percolation borings are presented on Figures A-1 through A-13. The logs depict the soil and geologic conditions encountered and the depth at which samples were obtained. The approximate locations of the exploratory borings are shown on the *Geologic Map*, Figure 2. Percolation test results are presented in Figures A-14 through A-19. Percolation testing was performed in accordance with *Riverside County Flood Control and Water Conservation District, LID BMP Manual, Appendix A*.

DEPTH IN FEET	SAMPLE NO.	LITHOLOGY	GROUNDWATER	SOIL CLASS (USCS)	BORING B-1		PENETRATION RESISTANCE (BLOWS/FT.)	DRY DENSITY (P.C.F.)	MOISTURE CONTENT (%)
					ELEV. (MSL.) 1584	DATE COMPLETED 5/13/2022			
					EQUIPMENT CME 75 HSA BY: L. WEIDMAN				
MATERIAL DESCRIPTION									
0	B-1@0-5'			SP	PAVEMENT SECTION 3" AC, 4" BASE				
2	B-1@2.5'				PREVIOUSLY PLACED FILL (afu) Poorly-graded SAND, medium dense, slightly moist, golden brown; medium sand; some coarse sand		50-3.5"		
4	B-1@20'				QUARTZ DIORITE BEDROCK (qdi) White black brown; hard, moist, mica rich; excavates as Well-graded SAND with Silt; dry; friable; slightly oxidized; coarse grained		50-3"		
8	B-1@7.5'				-Becomes fine grained; hornblend rich		50-3"		
10	B-1@10'						50-4"		
16	B-1@15'				-Becomes more flesic		88-9"		
20	B-1@20'				-Becomes wet		50-2"		
26	B-1@25'						50-3"		
					Total Depth = 26'3" Groundwater encountered at 16'6" Penetration resistance for 140-lb hammer falling 30 inches by auto hammer Backfilled with cuttings 5/13/2022				

Figure A-1,
Log of Boring B-1, Page 1 of 1

T2979-22-01 BORING LOGS.GPJ

SAMPLE SYMBOLS	... SAMPLING UNSUCCESSFUL	... STANDARD PENETRATION TEST	... DRIVE SAMPLE (UNDISTURBED)
	... DISTURBED OR BAG SAMPLE	... CHUNK SAMPLE	... WATER TABLE OR SEEPAGE

NOTE: THE LOG OF SUBSURFACE CONDITIONS SHOWN HEREON APPLIES ONLY AT THE SPECIFIC BORING OR TRENCH LOCATION AND AT THE DATE INDICATED. IT IS NOT WARRANTED TO BE REPRESENTATIVE OF SUBSURFACE CONDITIONS AT OTHER LOCATIONS AND TIMES.

















DEPTH IN FEET	SAMPLE NO.	LITHOLOGY	GROUNDWATER	SOIL CLASS (USCS)	BORING B-2		PENETRATION RESISTANCE (BLOWS/FT.)	DRY DENSITY (P.C.F.)	MOISTURE CONTENT (%)
					ELEV. (MSL.) 1583	DATE COMPLETED 5/13/2022			
					EQUIPMENT CME 75 HSA		BY: L. WEIDMAN		
MATERIAL DESCRIPTION									
0					PAVEMENT SECTION 4" AC, 6" BASE				
2	B-2@2.5'				QUARTZ DIORITE BEDROCK (qdi) White black brown; hard, moist, mica rich; excavates as Well-graded SAND with Silt; slightly moist; friable; coarse grained; slightly oxidized		50-3"		
4									
6	B-2@20' B-2@5-10'				-Becomes moist; fine to coarse grained		50-2"		
8	B-2@7.5'				-Becomes wet		50-5"		
10	B-2@10'						50-4"		
12									
14	B-2@12.5'						50-3.5"		
16	B-2@15'						50-5"		
18	B-2@17.5'						50-4.5"		
20	B-2@20'				-NO RECOVERY		50-1"		
					Total Depth = 20'1" Groundwater encountered at 11'6" Penetration resistance for 140-lb hammer falling 30 inches by auto hammer Backfilled with cuttings 5/13/2022				

Figure A-2,
Log of Boring B-2, Page 1 of 1

T2979-22-01 BORING LOGS.GPJ







SAMPLE SYMBOLS		... SAMPLING UNSUCCESSFUL		... STANDARD PENETRATION TEST		... DRIVE SAMPLE (UNDISTURBED)
		... DISTURBED OR BAG SAMPLE		... CHUNK SAMPLE		... WATER TABLE OR SEEPAGE

NOTE: THE LOG OF SUBSURFACE CONDITIONS SHOWN HEREON APPLIES ONLY AT THE SPECIFIC BORING OR TRENCH LOCATION AND AT THE DATE INDICATED. IT IS NOT WARRANTED TO BE REPRESENTATIVE OF SUBSURFACE CONDITIONS AT OTHER LOCATIONS AND TIMES.

DEPTH IN FEET	SAMPLE NO.	LITHOLOGY	GROUNDWATER	SOIL CLASS (USCS)	BORING B-3		PENETRATION RESISTANCE (BLOWS/FT.)	DRY DENSITY (P.C.F.)	MOISTURE CONTENT (%)
					ELEV. (MSL.) 1588	DATE COMPLETED 5/13/2022			
					EQUIPMENT CME 75 HSA		BY: L. WEIDMAN		
MATERIAL DESCRIPTION									
0					PAVEMENT SECTION 3.5" AC, 4" BASE				
2					QUARTZ DIORITE BEDROCK (qdi) White black brown; hard, moist, mica rich; excavates as Well-graded SAND with Silt; moist; friable; slightly oxidized; micaceous		50-3"		
4	B-3@2.5'								
6	B-3@20' B-3@5-10'				-Becomes moist; fine to coarse grained		50-3"		
8	B-3@7.5'				-Becomes wet		50-3"		
10	B-3@10'						50-2"		
12									
14	B-3@15'				-NO RECOVERY		50-2"		
					Total Depth = 15'2" Groundwater encountered at 11' Penetration resistance for 140-lb hammer falling 30 inches by auto hammer Backfilled with cuttings 5/13/2022				

Figure A-3,
Log of Boring B-3, Page 1 of 1

T2979-22-01 BORING LOGS.GPJ

SAMPLE SYMBOLS		... SAMPLING UNSUCCESSFUL		... STANDARD PENETRATION TEST		... DRIVE SAMPLE (UNDISTURBED)
		... DISTURBED OR BAG SAMPLE		... CHUNK SAMPLE		... WATER TABLE OR SEEPAGE

NOTE: THE LOG OF SUBSURFACE CONDITIONS SHOWN HEREON APPLIES ONLY AT THE SPECIFIC BORING OR TRENCH LOCATION AND AT THE DATE INDICATED. IT IS NOT WARRANTED TO BE REPRESENTATIVE OF SUBSURFACE CONDITIONS AT OTHER LOCATIONS AND TIMES.

DEPTH IN FEET	SAMPLE NO.	LITHOLOGY	GROUNDWATER	SOIL CLASS (USCS)	BORING B-4 ELEV. (MSL.) <u>1584</u> DATE COMPLETED <u>5/13/2022</u> EQUIPMENT <u>CME 75 HSA</u> BY: <u>L. WEIDMAN</u>	PENETRATION RESISTANCE (BLOWS/FT.)	DRY DENSITY (P.C.F.)	MOISTURE CONTENT (%)
MATERIAL DESCRIPTION								
0	B-4@0-5'			SM	PAVEMENT SECTION 6" AC, 4" BASE			
2	B-4@2.5'				PREVIOUSLY PLACED FILL (afu) Silty SAND, medium dense, slightly moist, brown; medium to coarse sand; some mica	50-3"		
4	B-4@20'				QUARTZ DIORITE BEDROCK (qdi) White black brown; hard, moist, mica rich; excavates as Well-graded SAND with Silt; medium to coarse sand; slightly oxidized; micaceous; friable	50-2"		
8	B-4@7.5'				-Becomes hornblend rich	50-5"		
10	B-4@10'				-Becomes wet	50-5"		
14	B-4@15'				-NO RECOVERY Total Depth = 15'4" Groundwater encountered at 13'6" Penetration resistance for 140-lb hammer falling 30 inches by auto hammer Backfilled with cuttings 5/13/2022	50-4"		

Figure A-4,
Log of Boring B-4, Page 1 of 1

T2979-22-01 BORING LOGS.GPJ

SAMPLE SYMBOLS	... SAMPLING UNSUCCESSFUL	... STANDARD PENETRATION TEST	... DRIVE SAMPLE (UNDISTURBED)
	... DISTURBED OR BAG SAMPLE	... CHUNK SAMPLE	... WATER TABLE OR SEEPAGE

NOTE: THE LOG OF SUBSURFACE CONDITIONS SHOWN HEREON APPLIES ONLY AT THE SPECIFIC BORING OR TRENCH LOCATION AND AT THE DATE INDICATED. IT IS NOT WARRANTED TO BE REPRESENTATIVE OF SUBSURFACE CONDITIONS AT OTHER LOCATIONS AND TIMES.

DEPTH IN FEET	SAMPLE NO.	LITHOLOGY	GROUNDWATER	SOIL CLASS (USCS)	BORING B-5		PENETRATION RESISTANCE (BLOWS/FT.)	DRY DENSITY (P.C.F.)	MOISTURE CONTENT (%)
					ELEV. (MSL.) 1585	DATE COMPLETED 5/13/2022			
					EQUIPMENT CME 75 HSA BY: L. WEIDMAN				
MATERIAL DESCRIPTION									
0	B-5@0-5'			SM	PAVEMENT SECTION 4" AC, 4" BASE				
2	B-5@2.5'				PREVIOUSLY PLACED FILL (afu) Silty SAND, medium dense, slightly moist, golden brown; fine to coarse sand; little mica		50-5"		
4	B-5@20'				QUARTZ DIORITE BEDROCK (qdi) White black brown; hard, moist, mica rich; excavates as Well-graded SAND with Silt; coarse grained; slightly oxidized; micaceous; friable		50-4"		
8	B-5@7.5'				-Becomes fine grained; felsic		50-4"		
10	B-5@10'				-Becomes wet		50-3"		
14	B-5@15'				-NO RECOVERY Total Depth = 15'4" Groundwater encountered at 15' Penetration resistance for 140-lb hammer falling 30 inches by auto hammer Backfilled with cuttings 5/13/2022		50-4"		

Figure A-5,
Log of Boring B-5, Page 1 of 1

T2979-22-01 BORING LOGS.GPJ







SAMPLE SYMBOLS		... SAMPLING UNSUCCESSFUL		... STANDARD PENETRATION TEST		... DRIVE SAMPLE (UNDISTURBED)
		... DISTURBED OR BAG SAMPLE		... CHUNK SAMPLE		... WATER TABLE OR SEEPAGE

NOTE: THE LOG OF SUBSURFACE CONDITIONS SHOWN HEREON APPLIES ONLY AT THE SPECIFIC BORING OR TRENCH LOCATION AND AT THE DATE INDICATED. IT IS NOT WARRANTED TO BE REPRESENTATIVE OF SUBSURFACE CONDITIONS AT OTHER LOCATIONS AND TIMES.

DEPTH IN FEET	SAMPLE NO.	LITHOLOGY	GROUNDWATER	SOIL CLASS (USCS)	BORING B-6 ELEV. (MSL.) <u>1584</u> DATE COMPLETED <u>5/13/2022</u> EQUIPMENT <u>CME 75 HSA</u> BY: <u>L. WEIDMAN</u>	PENETRATION RESISTANCE (BLOWS/FT.)	DRY DENSITY (P.C.F.)	MOISTURE CONTENT (%)	
MATERIAL DESCRIPTION									
0					PAVEMENT SECTION 5" AC, 4" BASE				
2	B-6@2.5'			SM	PREVIOUSLY PLACED FILL (afu) Silty SAND, medium dense, moist, dark yellow brown; fine to coarse sand; little mica	50-6"			
4	B-6@20'				QUARTZ DIORITE BEDROCK (qdi) White black brown; hard, moist, mica rich; excavates as Well-graded SAND with Silt; slightly oxidized; micaceous; friable -Becomes moist -Becomes fine grained -Becomes wet	50-5"			
6	B-6@5-10'								
8	B-6@7.5'						50-4"		
10	B-6@10'						50-4"		
12									
14	B-6@15'		▼			50-4.5"			
					Total Depth = 15'4" Groundwater encountered at 15' Penetration resistance for 140-lb hammer falling 30 inches by auto hammer Backfilled with cuttings 5/13/2022				

Figure A-6,
Log of Boring B-6, Page 1 of 1

T2979-22-01 BORING LOGS.GPJ

SAMPLE SYMBOLS	 ... SAMPLING UNSUCCESSFUL	 ... STANDARD PENETRATION TEST	 ... DRIVE SAMPLE (UNDISTURBED)
	 ... DISTURBED OR BAG SAMPLE	 ... CHUNK SAMPLE	 ... WATER TABLE OR SEEPAGE

NOTE: THE LOG OF SUBSURFACE CONDITIONS SHOWN HEREON APPLIES ONLY AT THE SPECIFIC BORING OR TRENCH LOCATION AND AT THE DATE INDICATED. IT IS NOT WARRANTED TO BE REPRESENTATIVE OF SUBSURFACE CONDITIONS AT OTHER LOCATIONS AND TIMES.











DEPTH IN FEET	SAMPLE NO.	LITHOLOGY	GROUNDWATER	SOIL CLASS (USCS)	BORING B-7		PENETRATION RESISTANCE (BLOWS/FT.)	DRY DENSITY (P.C.F.)	MOISTURE CONTENT (%)
					ELEV. (MSL.) 1585	DATE COMPLETED 5/13/2022			
					EQUIPMENT CME 75 HSA		BY: L. WEIDMAN		
MATERIAL DESCRIPTION									
0					PAVEMENT SECTION 4" AC, 8" BASE				
2	B-7@2-7' B-7@2.5'			SM	PREVIOUSLY PLACED FILL (afu) Silty SAND, medium dense, moist, dark red brown; fine to coarse sand; little mica		61-8"		
4	B-7@20'				QUARTZ DIORITE BEDROCK (qdi) White black brown; hard, moist, mica rich; excavates as Well-graded SAND with Silt; slightly oxidized; micaceous; friable -Becomes fine grained		50-3"		
8	B-7@7.5'				-Poor recovery		50-2"		
10	B-7@10'						50-2"		
14	B-7@15'				-Poor recovery		50-2"		
					Total Depth = 15'2" Groundwater not encountered Penetration resistance for 140-lb hammer falling 30 inches by auto hammer Backfilled with cuttings 5/16/2022				

Figure A-7,
Log of Boring B-7, Page 1 of 1

T2979-22-01 BORING LOGS.GPJ

SAMPLE SYMBOLS		... SAMPLING UNSUCCESSFUL		... STANDARD PENETRATION TEST		... DRIVE SAMPLE (UNDISTURBED)
		... DISTURBED OR BAG SAMPLE		... CHUNK SAMPLE		... WATER TABLE OR SEEPAGE

NOTE: THE LOG OF SUBSURFACE CONDITIONS SHOWN HEREON APPLIES ONLY AT THE SPECIFIC BORING OR TRENCH LOCATION AND AT THE DATE INDICATED. IT IS NOT WARRANTED TO BE REPRESENTATIVE OF SUBSURFACE CONDITIONS AT OTHER LOCATIONS AND TIMES.









DEPTH IN FEET	SAMPLE NO.	LITHOLOGY	GROUNDWATER	SOIL CLASS (USCS)	BORING P-1 ELEV. (MSL.) <u>1582</u> DATE COMPLETED <u>5/13/2022</u> EQUIPMENT <u>CME 75 HSA</u> BY: <u>L. WEIDMAN</u>	PENETRATION RESISTANCE (BLOWS/FT.)	DRY DENSITY (P.C.F.)	MOISTURE CONTENT (%)
0					MATERIAL DESCRIPTION			
				SP	PAVEMENT SECTION 3" AC, 4" BASE			
2	P-1@3'				PREVIOUSLY PLACED FILL (afu) Poorly-graded SAND, medium dense, slightly moist, golden brown; medium sand; some coarse sand; few mica			
4					QUARTZ DIORITE BEDROCK (qdi) White black brown; hard, moist, mica rich; excavates as Well-graded SAND with Silt; dry; friable; slightly oxidized			
					Total Depth = 4.5' No Groundwater encountered Percolation Test Equipment set Presaturated with 5 gallons of water Backfilled with cuttings 5/16/2022			

Figure A-8,
Log of Boring P-1, Page 1 of 1

T2979-22-01 BORING LOGS.GPJ

SAMPLE SYMBOLS  ... SAMPLING UNSUCCESSFUL  ... DISTURBED OR BAG SAMPLE	 ... STANDARD PENETRATION TEST  ... CHUNK SAMPLE	 ... DRIVE SAMPLE (UNDISTURBED)  ... WATER TABLE OR SEEPAGE
--	---	--

NOTE: THE LOG OF SUBSURFACE CONDITIONS SHOWN HEREON APPLIES ONLY AT THE SPECIFIC BORING OR TRENCH LOCATION AND AT THE DATE INDICATED. IT IS NOT WARRANTED TO BE REPRESENTATIVE OF SUBSURFACE CONDITIONS AT OTHER LOCATIONS AND TIMES.

DEPTH IN FEET	SAMPLE NO.	LITHOLOGY	GROUNDWATER	SOIL CLASS (USCS)	BORING P-2		PENETRATION RESISTANCE (BLOWS/FT.)	DRY DENSITY (P.C.F.)	MOISTURE CONTENT (%)
					ELEV. (MSL.) 1582	DATE COMPLETED 5/13/2022			
					EQUIPMENT CME 75 HSA BY: L. WEIDMAN				
0					MATERIAL DESCRIPTION				
0									
2	P-2@2'			SP	PAVEMENT SECTION 3" AC, 4" BASE				
					PREVIOUSLY PLACED FILL (afu) Poorly-graded SAND, medium dense, slightly moist, golden brown; medium sand; some coarse sand; few mica				
					QUARTZ DIORITE BEDROCK (qdi) White black brown; hard, moist, mica rich; excavates as Well-graded SAND with Silt; dry; friable; slightly oxidized				
					Total Depth = 3.5' No Groundwater encountered Percolation Test Equipment set Presaturated with 5 gallons of water Backfilled with cuttings 5/16/2022				

Figure A-9,
Log of Boring P-2, Page 1 of 1

T2979-22-01 BORING LOGS.GPJ

SAMPLE SYMBOLS	<input type="checkbox"/>	... SAMPLING UNSUCCESSFUL	<input type="checkbox"/>	... STANDARD PENETRATION TEST	<input type="checkbox"/>	... DRIVE SAMPLE (UNDISTURBED)
	<input checked="" type="checkbox"/>	... DISTURBED OR BAG SAMPLE	<input checked="" type="checkbox"/>	... CHUNK SAMPLE	<input checked="" type="checkbox"/>	... WATER TABLE OR SEEPAGE

NOTE: THE LOG OF SUBSURFACE CONDITIONS SHOWN HEREON APPLIES ONLY AT THE SPECIFIC BORING OR TRENCH LOCATION AND AT THE DATE INDICATED. IT IS NOT WARRANTED TO BE REPRESENTATIVE OF SUBSURFACE CONDITIONS AT OTHER LOCATIONS AND TIMES.

DEPTH IN FEET	SAMPLE NO.	LITHOLOGY	GROUNDWATER	SOIL CLASS (USCS)	BORING P-3 ELEV. (MSL.) <u>1585</u> DATE COMPLETED <u>5/13/2022</u> EQUIPMENT <u>CME 75 HSA</u> BY: <u>L. WEIDMAN</u>	PENETRATION RESISTANCE (BLOWS/FT.)	DRY DENSITY (P.C.F.)	MOISTURE CONTENT (%)
0		<div style="border-left: 1px solid black; border-right: 1px solid black; width: 100%; text-align: center; font-size: 8px; line-height: 1;"> BULK SAMPLE </div>			MATERIAL DESCRIPTION			
					PAVEMENT SECTION 4" AC, 5" BASE			
2					QUARTZ DIORITE BEDROCK (qdi) White black brown; hard, moist, mica rich; excavates as Well-graded SAND with Silt; dry; friable; slightly oxidized; micaceous			
4	P-3@4.5'							
6					Total Depth = 6' No Groundwater encountered Percolation Test Equipment set Presaturated with 5 gallons of water Backfilled with cuttings 5/16/2022			

Figure A-10,
Log of Boring P-3, Page 1 of 1

T2979-22-01 BORING LOGS.GPJ

SAMPLE SYMBOLS	... SAMPLING UNSUCCESSFUL	... STANDARD PENETRATION TEST	... DRIVE SAMPLE (UNDISTURBED)
	... DISTURBED OR BAG SAMPLE	... CHUNK SAMPLE	... WATER TABLE OR SEEPAGE

NOTE: THE LOG OF SUBSURFACE CONDITIONS SHOWN HEREON APPLIES ONLY AT THE SPECIFIC BORING OR TRENCH LOCATION AND AT THE DATE INDICATED. IT IS NOT WARRANTED TO BE REPRESENTATIVE OF SUBSURFACE CONDITIONS AT OTHER LOCATIONS AND TIMES.



DEPTH IN FEET	SAMPLE NO.	LITHOLOGY	GROUNDWATER	SOIL CLASS (USCS)	BORING P-4 ELEV. (MSL.) <u>1585</u> DATE COMPLETED <u>5/13/2022</u> EQUIPMENT <u>CME 75 HSA</u> BY: <u>L. WEIDMAN</u>	PENETRATION RESISTANCE (BLOWS/FT.)	DRY DENSITY (P.C.F.)	MOISTURE CONTENT (%)
0					MATERIAL DESCRIPTION			
					PAVEMENT SECTION 4" AC, 5" BASE			
2					QUARTZ DIORITE BEDROCK (qdi) White black brown; hard, moist, mica rich; excavates as Well-graded SAND with Silt; dry; friable; slightly oxidized; micaceous			
4	P-4@4.5'							
6					Total Depth = 6' No Groundwater encountered Percolation Test Equipment set Presaturated with 5 gallons of water Backfilled with cuttings 5/16/2022			

Figure A-11,
Log of Boring P-4, Page 1 of 1

T2979-22-01 BORING LOGS.GPJ

SAMPLE SYMBOLS	<input type="checkbox"/> ... SAMPLING UNSUCCESSFUL	<input type="checkbox"/> ... STANDARD PENETRATION TEST	<input type="checkbox"/> ... DRIVE SAMPLE (UNDISTURBED)
	<input checked="" type="checkbox"/> ... DISTURBED OR BAG SAMPLE	<input checked="" type="checkbox"/> ... CHUNK SAMPLE	<input type="checkbox"/> ... WATER TABLE OR SEEPAGE

NOTE: THE LOG OF SUBSURFACE CONDITIONS SHOWN HEREON APPLIES ONLY AT THE SPECIFIC BORING OR TRENCH LOCATION AND AT THE DATE INDICATED. IT IS NOT WARRANTED TO BE REPRESENTATIVE OF SUBSURFACE CONDITIONS AT OTHER LOCATIONS AND TIMES.

DEPTH IN FEET	SAMPLE NO.	LITHOLOGY	GROUNDWATER	SOIL CLASS (USCS)	BORING P-5 ELEV. (MSL.) <u>1588</u> DATE COMPLETED <u>5/13/2022</u> EQUIPMENT <u>CME 75 HSA</u> BY: <u>L. WEIDMAN</u>	PENETRATION RESISTANCE (BLOWS/FT.)	DRY DENSITY (P.C.F.)	MOISTURE CONTENT (%)
0					MATERIAL DESCRIPTION			
0				SM	PAVEMENT SECTION 3" AC, 5" BASE			
2					PREVIOUSLY PLACED FILL (afu) Silty SAND, medium dense, moist, dark red brown; fine to coarse sand; few mica			
4	P-5@4.5'				QUARTZ DIORITE BEDROCK (qdi) White black brown; hard, moist, mica rich; excavates as Well-graded SAND with Silt; dry; friable; slightly oxidized			
6					Total Depth = 6' No Groundwater encountered Percolation Test Equipment set Presaturated with 5 gallons of water Backfilled with cuttings 5/16/2022			

Figure A-12,
Log of Boring P-5, Page 1 of 1

T2979-22-01 BORING LOGS.GPJ

SAMPLE SYMBOLS	... SAMPLING UNSUCCESSFUL	... STANDARD PENETRATION TEST	... DRIVE SAMPLE (UNDISTURBED)
	... DISTURBED OR BAG SAMPLE	... CHUNK SAMPLE	... WATER TABLE OR SEEPAGE

NOTE: THE LOG OF SUBSURFACE CONDITIONS SHOWN HEREON APPLIES ONLY AT THE SPECIFIC BORING OR TRENCH LOCATION AND AT THE DATE INDICATED. IT IS NOT WARRANTED TO BE REPRESENTATIVE OF SUBSURFACE CONDITIONS AT OTHER LOCATIONS AND TIMES.

DEPTH IN FEET	SAMPLE NO.	LITHOLOGY	GROUNDWATER	SOIL CLASS (USCS)	BORING P-6 ELEV. (MSL.) <u>1588</u> DATE COMPLETED <u>5/13/2022</u> EQUIPMENT <u>CME 75 HSA</u> BY: <u>L. WEIDMAN</u>	PENETRATION RESISTANCE (BLOWS/FT.)	DRY DENSITY (P.C.F.)	MOISTURE CONTENT (%)
0					MATERIAL DESCRIPTION			
0				SM	PAVEMENT SECTION 3" AC, 5" BASE			
2					PREVIOUSLY PLACED FILL (afu) Silty SAND, medium dense, moist, dark red brown; fine to coarse sand; few mica			
4	P-6@4.5'				QUARTZ DIORITE BEDROCK (qdi) White black brown; hard, moist, mica rich; excavates as Well-graded SAND with Silt; dry; friable; slightly oxidized			
6					Total Depth = 6' No Groundwater encountered Percolation Test Equipment set Presaturated with 5 gallons of water Backfilled with cuttings 5/16/2022			

Figure A-13,
Log of Boring P-6, Page 1 of 1

T2979-22-01 BORING LOGS.GPJ

SAMPLE SYMBOLS	... SAMPLING UNSUCCESSFUL	... STANDARD PENETRATION TEST	... DRIVE SAMPLE (UNDISTURBED)
	... DISTURBED OR BAG SAMPLE	... CHUNK SAMPLE	... WATER TABLE OR SEEPAGE

NOTE: THE LOG OF SUBSURFACE CONDITIONS SHOWN HEREON APPLIES ONLY AT THE SPECIFIC BORING OR TRENCH LOCATION AND AT THE DATE INDICATED. IT IS NOT WARRANTED TO BE REPRESENTATIVE OF SUBSURFACE CONDITIONS AT OTHER LOCATIONS AND TIMES.

PERCOLATION TEST REPORT

Project Name:	Riverside Redevelopment	Project No.:	T2979-22-01
Test Hole No.:	P-1	Date Excavated:	5/13/2022
Length of Test Pipe:	36.0 inches	Soil Classification:	SM
Height of Pipe above Ground:	0.0 inches	Presoak Date:	5/13/2022
Depth of Test Hole:	36.0 inches	Perc Test Date:	5/16/2022
Check for Sandy Soil Criteria Tested by:	Weidman	Percolation Tested by:	Weidman

Water level measured from BOTTOM of hole

Sandy Soil Criteria Test

Trial No.	Time	Time Interval (min)	Total Elapsed Time (min)	Initial Water Level (in)	Final Water Level (in)	Δ in Water Level (in)	Percolation Rate (min/inch)
1	8:52 AM	25	25	12.0	0.0	12.0	2.1
	9:17 AM						
2	9:17 AM	25	50	12.0	4.8	7.2	3.5
	9:42 AM						

Soil Criteria: Sandy

Percolation Test

Reading No.	Time	Time Interval (min)	Total Elapsed Time (min)	Initial Water Head (in)	Final Water Head (in)	Δ in Water Level (in)	Percolation Rate (min/inch)
1	12:16 AM	10	10	36.0	3.8	32.2	0.3
	12:26 AM						
2	12:26 AM	10	20	36.0	4.9	31.1	0.3
	12:36 AM						
3	12:36 AM	10	30	36.0	5.4	30.6	0.3
	12:46 AM						
4	12:46 AM	10	40	36.0	5.8	30.2	0.3
	12:56 AM						
5	12:56 AM	10	50	36.0	6.5	29.5	0.3
	1:06 AM						
6	1:06 AM	10	60	36.0	7.1	28.9	0.3
	1:16 AM						

Infiltration Rate (in/hr):	14.7	
Radius of test hole (in):	4	Figure A-14
Average Head (in):	21.5	

PERCOLATION TEST REPORT

Project Name:	Riverside Redevelopment	Project No.:	T2979-22-01
Test Hole No.:	P-2	Date Excavated:	5/13/2022
Length of Test Pipe:	24.0 inches	Soil Classification:	SM
Height of Pipe above Ground:	0.0 inches	Presoak Date:	5/13/2022
Depth of Test Hole:	24.0 inches	Perc Test Date:	5/16/2022
Check for Sandy Soil Criteria Tested by:	Weidman	Percolation Tested by:	Weidman

Water level measured from BOTTOM of hole

Sandy Soil Criteria Test

Trial No.	Time	Time Interval (min)	Total Elapsed Time (min)	Initial Water Level (in)	Final Water Level (in)	Δ in Water Level (in)	Percolation Rate (min/inch)
1	8:51 AM	25	25	8.4	0.8	7.6	3.3
	9:16 AM						
2	9:16 AM	25	50	8.4	3.6	4.8	5.2
	9:41 AM						

Soil Criteria: Sandy

Percolation Test

Reading No.	Time	Time Interval (min)	Total Elapsed Time (min)	Initial Water Head (in)	Final Water Head (in)	Δ in Water Level (in)	Percolation Rate (min/inch)
1	12:15 AM	10	10	36.0	6.4	29.6	0.3
	12:25 AM						
2	12:25 AM	10	20	36.0	6.7	29.3	0.3
	12:35 AM						
3	12:35 AM	10	30	36.0	6.8	29.2	0.3
	12:45 AM						
4	12:45 AM	10	40	36.0	7.0	29.0	0.3
	12:55 AM						
5	12:55 AM	10	50	36.0	7.1	28.9	0.3
	1:05 AM						
6	1:05 AM	10	60	36.0	7.2	28.8	0.3
	1:15 AM						

Infiltration Rate (in/hr):	14.6		
Radius of test hole (in):	4		Figure A-15
Average Head (in):	21.6		

PERCOLATION TEST REPORT

Project Name:	Riverside Redevelopment	Project No.:	T2979-22-01
Test Hole No.:	P-3	Date Excavated:	5/13/2022
Length of Test Pipe:	54.0 inches	Soil Classification:	SM
Height of Pipe above Ground:	0.0 inches	Presoak Date:	5/13/2022
Depth of Test Hole:	54.0 inches	Perc Test Date:	5/16/2022
Check for Sandy Soil Criteria Tested by:	Weidman	Percolation Tested by:	Weidman

Water level measured from BOTTOM of hole

Sandy Soil Criteria Test

Trial No.	Time	Time Interval (min)	Total Elapsed Time (min)	Initial Water Level (in)	Final Water Level (in)	Δ in Water Level (in)	Percolation Rate (min/inch)
1	8:49 AM	25	25	24.0	13.0	11.0	2.3
	9:14 AM						
2	9:14 AM	25	50	24.0	16.3	7.7	3.3
	9:39 AM						

Soil Criteria: Sandy

Percolation Test

Reading No.	Time	Time Interval (min)	Total Elapsed Time (min)	Initial Water Head (in)	Final Water Head (in)	Δ in Water Level (in)	Percolation Rate (min/inch)
1	11:01 AM	10	10	36.0	20.6	15.4	0.7
	11:11 AM						
2	11:11 AM	10	20	36.0	21.2	14.8	0.7
	11:21 AM						
3	11:21 AM	10	30	36.0	21.6	14.4	0.7
	11:31 AM						
4	11:31 AM	10	40	36.0	21.6	14.4	0.7
	11:41 AM						
5	11:41 AM	10	50	36.0	21.5	14.5	0.7
	11:51 AM						
6	11:51 AM	10	60	36.0	21.4	14.6	0.7
	12:01 PM						

Infiltration Rate (in/hr):	5.7	
Radius of test hole (in):	4	Figure A-16
Average Head (in):	28.7	

PERCOLATION TEST REPORT

Project Name:	Riverside Redevelopment	Project No.:	T2979-22-01
Test Hole No.:	P-4	Date Excavated:	5/13/2022
Length of Test Pipe:	54.0 inches	Soil Classification:	SM
Height of Pipe above Ground:	0.0 inches	Presoak Date:	5/13/2022
Depth of Test Hole:	54.0 inches	Perc Test Date:	5/16/2022
Check for Sandy Soil Criteria Tested by:	Weidman	Percolation Tested by:	Weidman

Water level measured from BOTTOM of hole

Sandy Soil Criteria Test

Trial No.	Time	Time Interval (min)	Total Elapsed Time (min)	Initial Water Level (in)	Final Water Level (in)	Δ in Water Level (in)	Percolation Rate (min/inch)
1	8:48 AM	25	25	24.0	15.2	8.8	2.9
	9:13 AM						
2	9:13 AM	25	50	24.0	17.9	6.1	4.1
	9:38 AM						

Soil Criteria: Sandy

Percolation Test

Reading No.	Time	Time Interval (min)	Total Elapsed Time (min)	Initial Water Head (in)	Final Water Head (in)	Δ in Water Level (in)	Percolation Rate (min/inch)
1	11:00 AM	10	10	36.0	21.8	14.2	0.7
	11:10 AM						
2	11:10 AM	10	20	36.0	22.1	13.9	0.7
	11:20 AM						
3	11:20 AM	10	30	36.0	22.3	13.7	0.7
	11:30 AM						
4	11:30 AM	10	40	36.0	22.7	13.3	0.8
	11:40 AM						
5	11:40 AM	10	50	36.0	23.0	13.0	0.8
	11:50 AM						
6	11:50 AM	10	60	36.0	23.4	12.6	0.8
	12:00 PM						

Infiltration Rate (in/hr):	4.8	
Radius of test hole (in):	4	Figure A-17
Average Head (in):	29.7	

PERCOLATION TEST REPORT

Project Name:	Riverside Redevelopment	Project No.:	T2979-22-01
Test Hole No.:	P-5	Date Excavated:	5/13/2022
Length of Test Pipe:	54.0 inches	Soil Classification:	SM
Height of Pipe above Ground:	0.0 inches	Presoak Date:	5/13/2022
Depth of Test Hole:	54.0 inches	Perc Test Date:	5/16/2022
Check for Sandy Soil Criteria Tested by:	Weidman	Percolation Tested by:	Weidman

Water level measured from BOTTOM of hole

Sandy Soil Criteria Test

Trial No.	Time	Time Interval (min)	Total Elapsed Time (min)	Initial Water Level (in)	Final Water Level (in)	Δ in Water Level (in)	Percolation Rate (min/inch)
1	8:46 AM	25	25	24.0	15.0	9.0	2.8
	9:11 AM						
2	9:11 AM	25	50	24.0	18.0	6.0	4.2
	9:36 AM						

Soil Criteria: Sandy

Percolation Test

Reading No.	Time	Time Interval (min)	Total Elapsed Time (min)	Initial Water Head (in)	Final Water Head (in)	Δ in Water Level (in)	Percolation Rate (min/inch)
1	9:46 AM	10	10	36.0	10.2	25.8	0.4
	9:56 AM						
2	9:56 AM	10	20	36.0	10.6	25.4	0.4
	10:06 AM						
3	10:06 AM	10	30	36.0	10.8	25.2	0.4
	10:16 AM						
4	10:16 AM	10	40	36.0	10.9	25.1	0.4
	10:26 AM						
5	10:26 AM	10	50	36.0	10.9	25.1	0.4
	10:36 AM						
6	10:36 AM	10	60	36.0	10.9	25.1	0.4
	10:46 AM						

Infiltration Rate (in/hr):	11.8		
Radius of test hole (in):	4		Figure A-18
Average Head (in):	23.5		

PERCOLATION TEST REPORT

Project Name:	Riverside Redevelopment	Project No.:	T2979-22-01
Test Hole No.:	P-6	Date Excavated:	5/13/2022
Length of Test Pipe:	54.0 inches	Soil Classification:	SM
Height of Pipe above Ground:	0.0 inches	Presoak Date:	5/13/2022
Depth of Test Hole:	54.0 inches	Perc Test Date:	5/16/2022
Check for Sandy Soil Criteria Tested by:	Weidman	Percolation Tested by:	Weidman

Water level measured from BOTTOM of hole

Sandy Soil Criteria Test

Trial No.	Time	Time Interval (min)	Total Elapsed Time (min)	Initial Water Level (in)	Final Water Level (in)	Δ in Water Level (in)	Percolation Rate (min/inch)
1	8:45 AM	25	25	24.0	16.4	7.6	3.3
	9:10 AM						
2	9:10 AM	25	50	24.0	18.0	6.0	4.2
	9:35 AM						

Soil Criteria: Sandy

Percolation Test

Reading No.	Time	Time Interval (min)	Total Elapsed Time (min)	Initial Water Head (in)	Final Water Head (in)	Δ in Water Level (in)	Percolation Rate (min/inch)
1	9:45 AM	10	10	36.0	21.6	14.4	0.7
	9:55 AM						
2	9:55 AM	10	20	36.0	21.7	14.3	0.7
	10:05 AM						
3	10:05 AM	10	30	36.0	22.0	14.0	0.7
	10:15 AM						
4	10:15 AM	10	40	36.0	22.2	13.8	0.7
	10:25 AM						
5	10:25 AM	10	50	36.0	22.4	13.6	0.7
	10:35 AM						
6	10:35 AM	10	60	36.0	22.6	13.4	0.7
	10:45 AM						

Infiltration Rate (in/hr):	5.2		
Radius of test hole (in):	4		Figure A-19
Average Head (in):	29.3		

APPENDIX

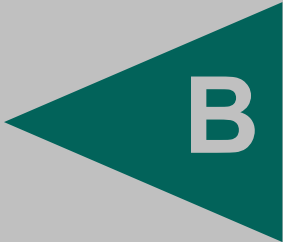

B

APPENDIX B

LABORATORY TESTING

We performed laboratory tests in accordance with current, generally accepted test methods of ASTM International (ASTM) or other suggested procedures. We analyzed selected soil samples for maximum dry density and optimum moisture content, expansion index, corrosivity, grain size distribution, and direct shear strength. The results of the laboratory tests are presented on Figures B-1 through B-10. The in-place dry density and moisture content are presented on the boring logs in *Appendix A*.

Sample No:

B4@0-5'	Poorly Graded SAND with Silt (SP-SM), olive brown
----------------	---

TEST NO.		1	2	3	4	5	6
Wt. Compacted Soil + Mold	(g)	6468	6490	6469	6407		
Weight of Mold	(g)	4265	4265	4265	4265	4265	
Net Weight of Soil	(g)	2203	2225	2204	2142	-4265	
Wet Weight of Soil + Cont.	(g)	693.9	723.1	633.4	621.5		
Dry Weight of Soil + Cont.	(g)	671.6	690.3	601.2	610.0		
Weight of Container	(g)	259.3	256.1	259.9	257.7		
Moisture Content	(%)	5.4	7.6	9.4	3.3		
Wet Density	(pcf)	146.3	147.7	146.4	142.2	-283.2	
Dry Density	(pcf)	138.8	137.4	133.7	137.7		

Maximum Dry Density (pcf)	139.0
Bulk Specific Gravity (dry)	2.66
Corrected Maximum Dry Density (pcf)	142.0

Optimum Moisture Content (%)	6.0
Oversized Fraction (%)	12.0
Corrected Moisture Content (%)	5.5

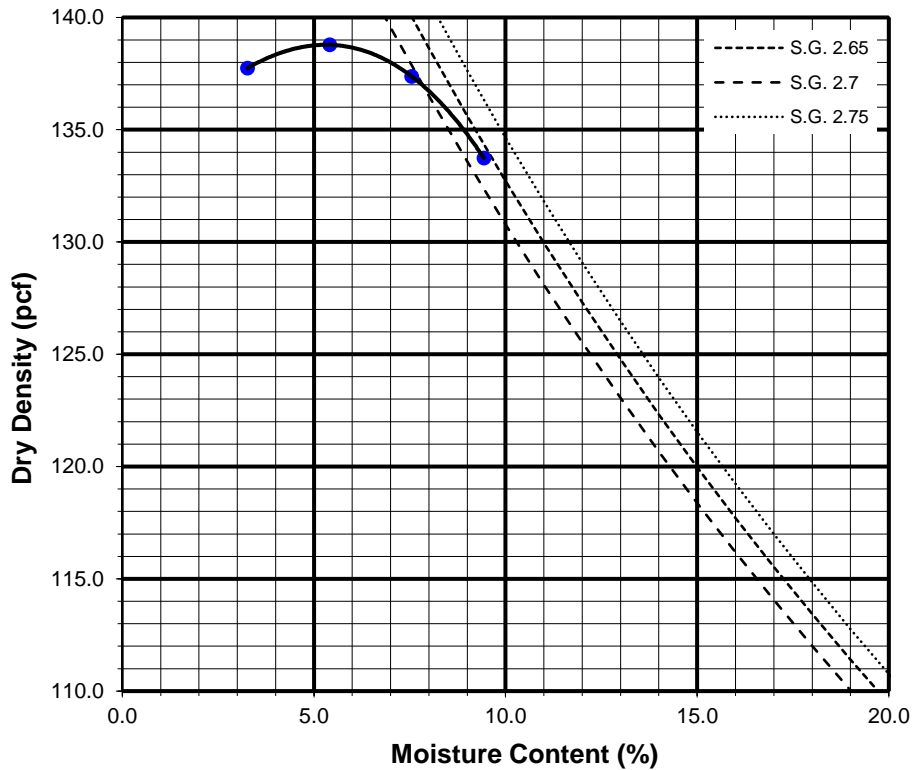

Preparation Method: A



**COMPACTION CHARACTERISTICS USING
MODIFIED EFFORT TEST RESULTS**

ASTM D-1557

Checked by:

Project No.: T2979-22-01

MISSION GROVE REDEVELOPMENT
375 EAST ALESSANDRO BOULEVARD
RIVERSIDE, CALIFORNIA

Jun 22

Figure B-1

Sample No:

B7@2-7'	Poorly Graded SAND with Silt (SP-SM), dark yellowish brown
----------------	--

TEST NO.		1	2	3	4	5	6
Wt. Compacted Soil + Mold	(g)	6448	6418	6417	6322		
Weight of Mold	(g)	4265	4265	4265	4265	4265	
Net Weight of Soil	(g)	2183	2153	2152	2057	-4265	
Wet Weight of Soil + Cont.	(g)	613.0	734.6	613.0	743.4		
Dry Weight of Soil + Cont.	(g)	586.3	691.1	592.4	724.2		
Weight of Container	(g)	254.4	257.5	253.5	257.6		
Moisture Content	(%)	8.0	10.0	6.1	4.1		
Wet Density	(pcf)	145.0	143.0	142.9	136.6	-283.2	
Dry Density	(pcf)	134.2	129.9	134.7	131.2		

Maximum Dry Density (pcf)	135.5
Bulk Specific Gravity (dry)	2.57
Corrected Maximum Dry Density (pcf)	137.0

Optimum Moisture Content (%)	7.0
Oversized Fraction (%)	8.0
Corrected Moisture Content (%)	6.5

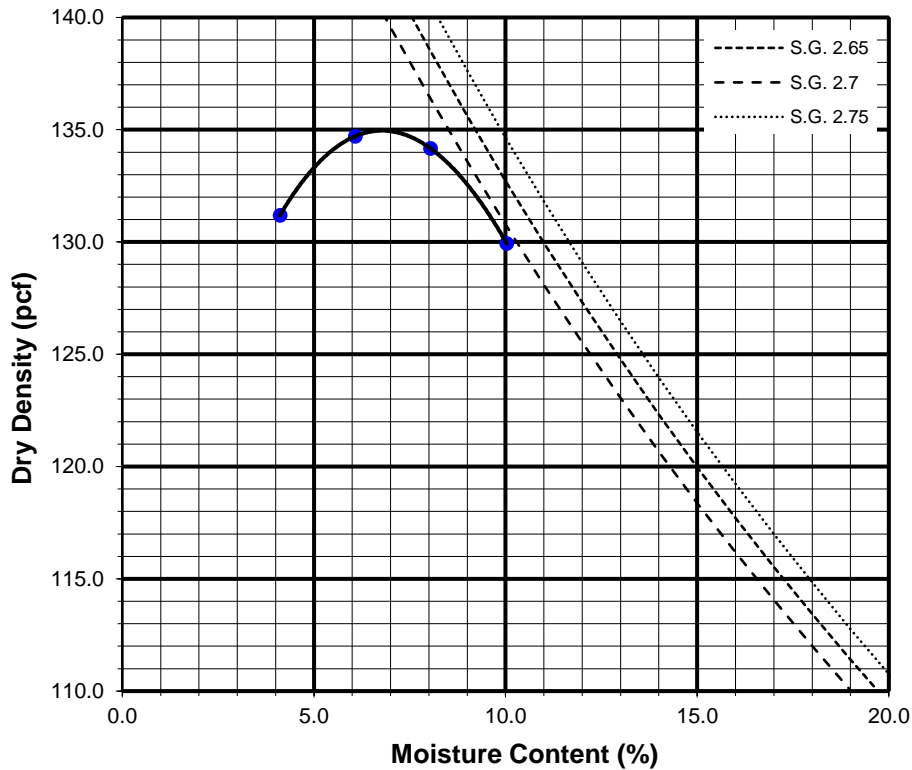

Preparation Method: A



**COMPACTION CHARACTERISTICS USING
MODIFIED EFFORT TEST RESULTS**

ASTM D-1557

Checked by:

Project No.: T2979-22-01

MISSION GROVE REDEVELOPMENT
375 EAST ALESSANDRO BOULEVARD
RIVERSIDE, CALIFORNIA

Jun 22

Figure B-2

B-2@5-10

MOLDED SPECIMEN		BEFORE TEST	AFTER TEST
Specimen Diameter	(in.)	4.0	4.0
Specimen Height	(in.)	1.0	1.0
Wt. Comp. Soil + Mold	(gm)	613.4	635.0
Wt. of Mold	(gm)	202.0	202.0
Specific Gravity	(Assumed)	2.7	2.7
Wet Wt. of Soil + Cont.	(gm)	556.0	635.0
Dry Wt. of Soil + Cont.	(gm)	532.5	379.2
Wt. of Container	(gm)	256.0	202.0
Moisture Content	(%)	8.5	14.2
Wet Density	(pcf)	124.1	130.4
Dry Density	(pcf)	114.4	114.2
Void Ratio		0.5	0.5
Total Porosity		0.3	0.3
Pore Volume	(cc)	66.6	66.4
Degree of Saturation	(%) [S_{meas}]	48.8	81.1

Date	Time	Pressure (psi)	Elapsed Time (min)	Dial Readings (in.)
6/1/2022	10:00	1.0	0	0.3775
6/1/2022	10:10	1.0	10	0.3774
Add Distilled Water to the Specimen				
6/2/2022	10:00	1.0	1430	0.3765
6/2/2022	11:00	1.0	1490	0.3765

Expansion Index (EI meas) =	-0.9
Expansion Index (Report) =	0

Expansion Index, EI_{50}	CBC CLASSIFICATION *	UBC CLASSIFICATION **
0-20	Non-Expansive	Very Low
21-50	Expansive	Low
51-90	Expansive	Medium
91-130	Expansive	High
>130	Expansive	Very High

* Reference: 2019 California Building Code, Section 1803.5.3

** Reference: 1997 Uniform Building Code, Table 18-1-B.



EXPANSION INDEX TEST RESULTS

ASTM D-4829

Checked by:

Project No.: T2979-22-01

MISSION GROVE REDEVELOPMENT
375 EAST ALESSANDRO BOULEVARD
RIVERSIDE, CALIFORNIA

Jun 22

Figure B-3

SUMMARY OF LABORATORY
 POTENTIAL OF HYDROGEN (pH) AND RESISTIVITY TEST RESULTS
 AASHTO T289 ASTM D4972 and AASHTO T288 ASTM G187

Sample No.	pH	Resistivity (ohm centimeters)
B2@44691	8.4	8000

SUMMARY OF LABORATORY CHLORIDE CONTENT TEST RESULTS
 AASHTO T291 ASTM C1218

Sample No.	Chloride Ion Content (%)
B2@5-10	0.002

SUMMARY OF LABORATORY WATER SOLUBLE SULFATE TEST RESULTS
 AASHTO T290 ASTM C1580

Sample No.	Water Soluble Sulfate (% SO ₄)	Sulfate Exposure
B2@5-10	0.000	S0

 GEOCON	CORROSIVITY TEST RESULTS	Project No.: T2979-22-01
	Checked by:	MISSION GROVE REDEVELOPMENT 375 EAST ALESSANDRO BOULEVARD RIVERSIDE, CALIFORNIA
		Jun 22 Figure B-4

GRAVEL		SAND			SILT AND CLAY
COARSE	FINE	COARSE	MEDIUM	FINE	

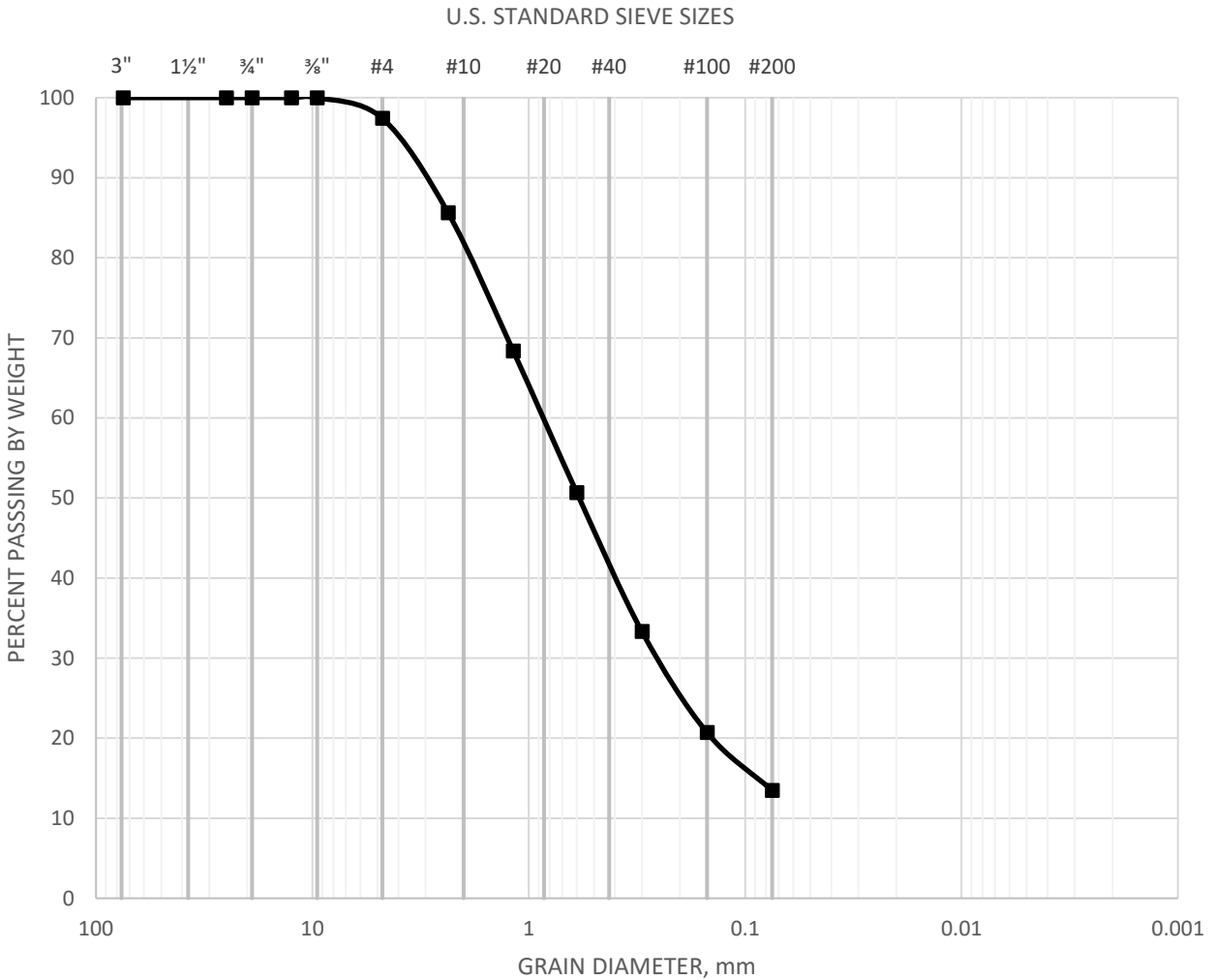

SAMPLE	CLASSIFICATION	D60	D30	D10
P-1@3	Silty SAND (SM), olive	0.87	0.25	0.073



GRAIN SIZE DISTRIBUTION

ASTM D 6913

Checked by:

Project No.: T2979-22-01

MISSION GROVE REDEVELOPMENT
375 EAST ALESSANDRO BOULEVARD
RIVERSIDE, CALIFORNIA

Jun 22

Figure B-5

GRAVEL		SAND			SILT AND CLAY
COARSE	FINE	COARSE	MEDIUM	FINE	

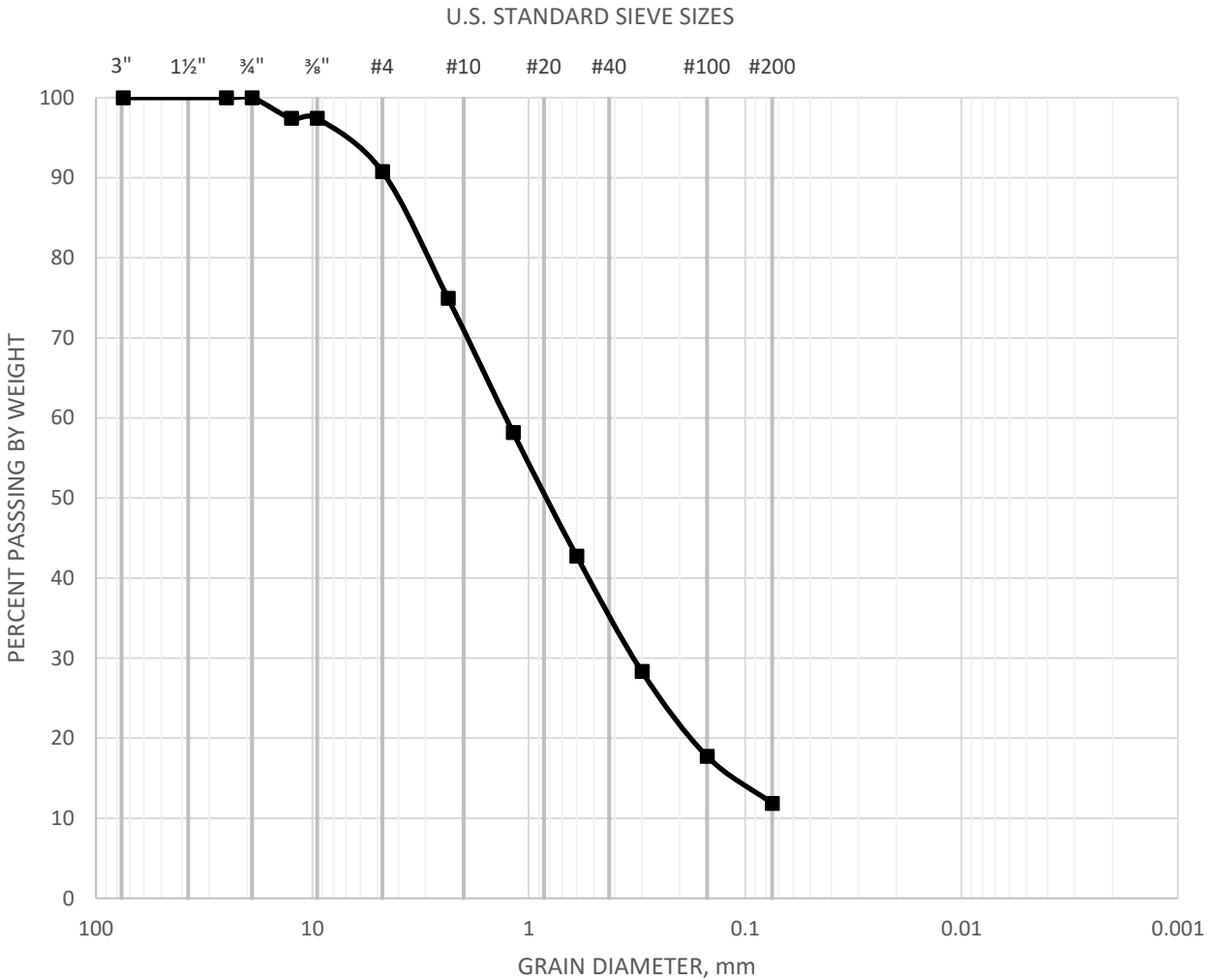

SAMPLE	CLASSIFICATION	D60	D30	D10
P-3@4.5	Well Graded SAND with Silt (SW-SM), olive brown	1.2	0.31	0.073



GRAIN SIZE DISTRIBUTION

ASTM D 6913

Checked by:

Project No.: T2979-22-01

MISSION GROVE REDEVELOPMENT
375 EAST ALESSANDRO BOULEVARD
RIVERSIDE, CALIFORNIA

Jun 22

Figure B-6

GRAVEL		SAND			SILT AND CLAY
COARSE	FINE	COARSE	MEDIUM	FINE	

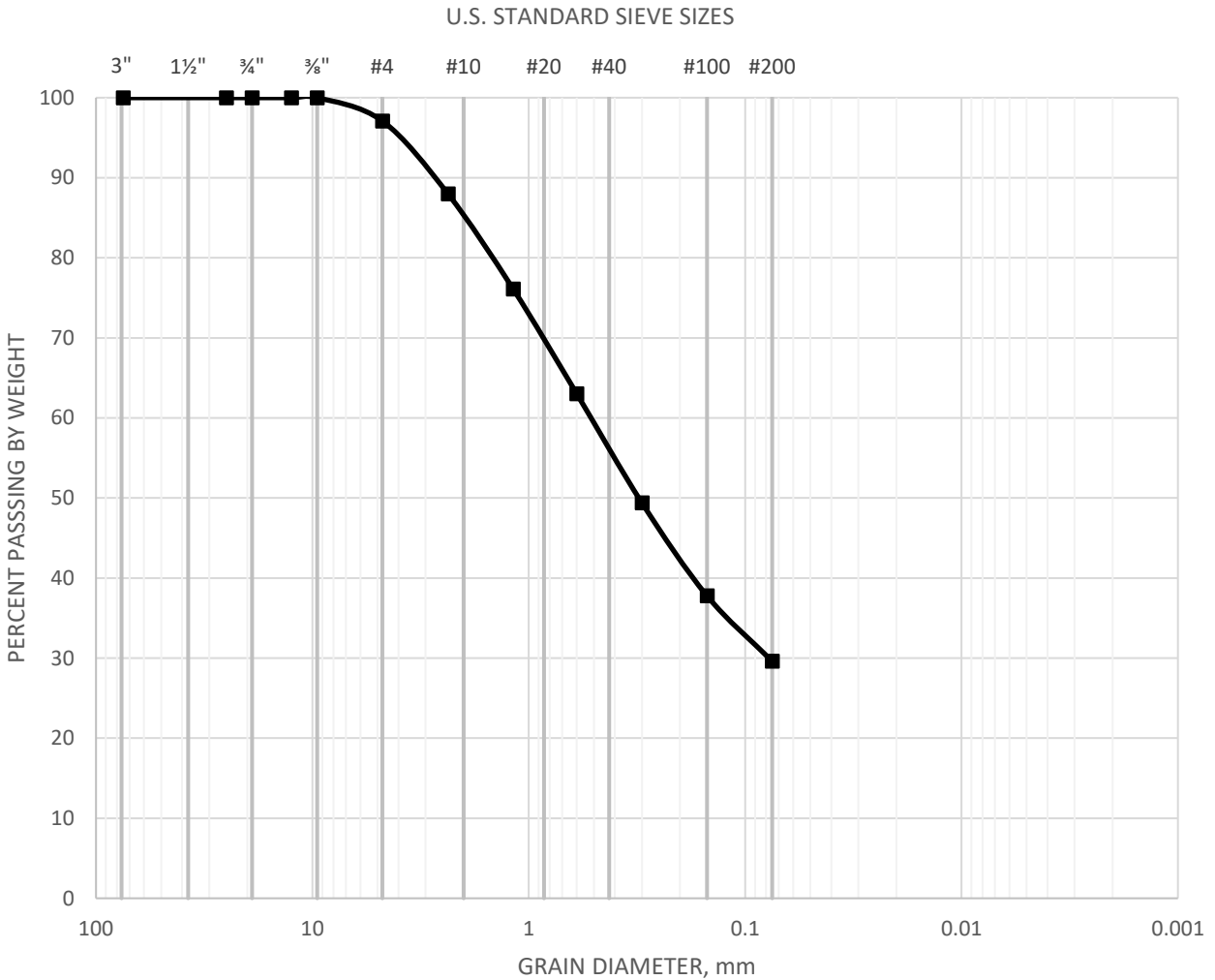

SAMPLE	CLASSIFICATION	D60	D30	D10
P-5@4.5	Silty SAND (SM), dark yellowish brown	0.5	0.073	0.073



GRAIN SIZE DISTRIBUTION

ASTM D 6913

Checked by:

Project No.: T2979-22-01

MISSION GROVE REDEVELOPMENT
375 EAST ALESSANDRO BOULEVARD
RIVERSIDE, CALIFORNIA

Jun 22

Figure B-7

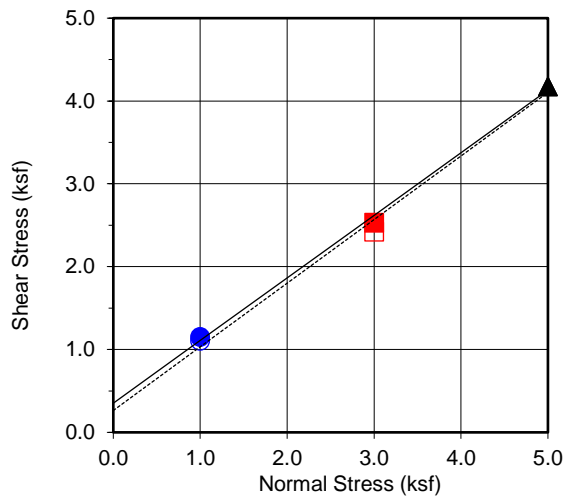
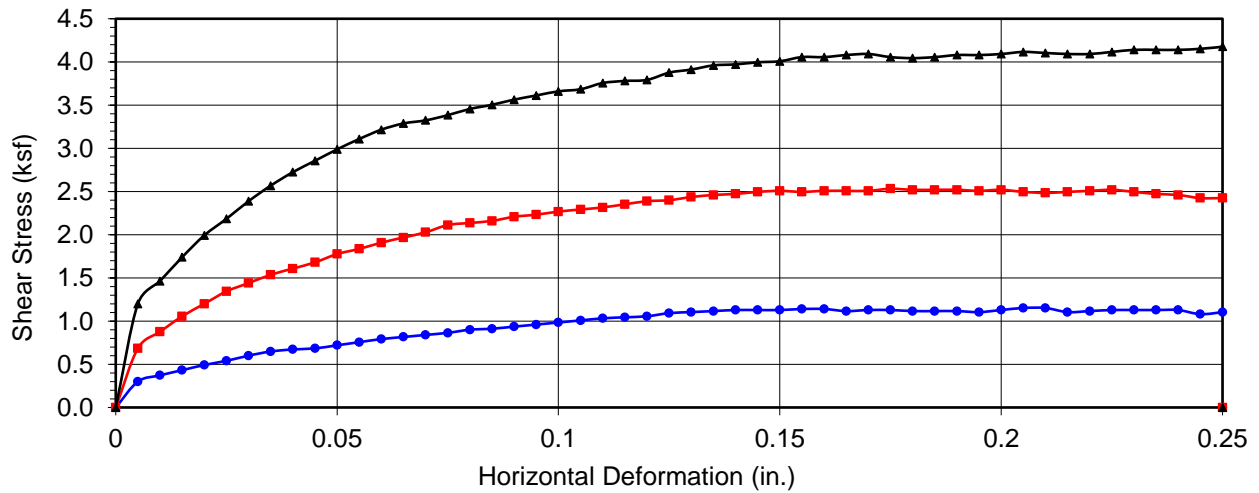

Boring No.	B1
Sample No.	B-1@5
Depth (ft)	5
Sample Type:	ring

<u>Soil Identification:</u>		
Silty SAND with Gravel (SM)g, light grayish brown		
Strength Parameters		
	C (psf)	ϕ ($^{\circ}$)
Peak	352	37.1
Ultimate	264	37.5

Normal Stress (kip/ft ²)	1	3	5
Peak Shear Stress (kip/ft ²)	● 1.15	■ 2.53	▲ 4.18
Shear Stress @ End of Test (ksf)	○ 1.10	□ 2.42	△ 4.18
Deformation Rate (in./min.)	0.05	0.05	0.05
Initial Sample Height (in.)	1.0	1.0	1.0
Ring Inside Diameter (in.)	2.375	2.375	2.375
Initial Moisture Content (%)	5.9	6.1	7.8
Initial Dry Density (pcf)	112.8	109.5	113.8
Initial Degree of Saturation (%)	32.1	30.4	44.0
Soil Height Before Shearing (in.)	1.2	1.2	1.2
Final Moisture Content (%)	15.9	15.6	11.4



DIRECT SHEAR TEST RESULTS

Consolidated Drained ASTM D-3080

Checked by:

Project No.: T2979-22-01

MISSION GROVE REDEVELOPMENT
375 EAST ALESSANDRO BOULEVARD
RIVERSIDE, CALIFORNIA

Jun 22

Figure B-8

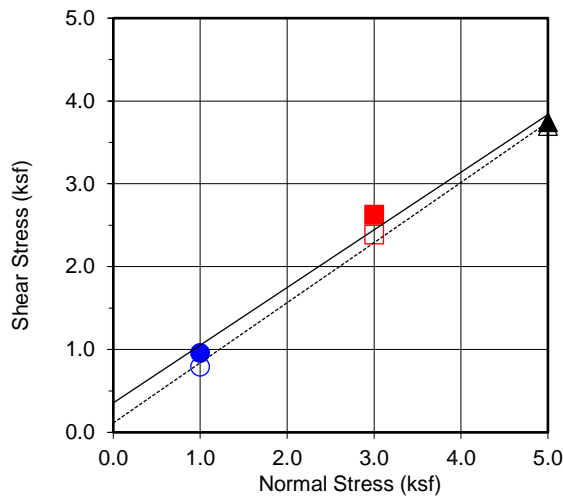
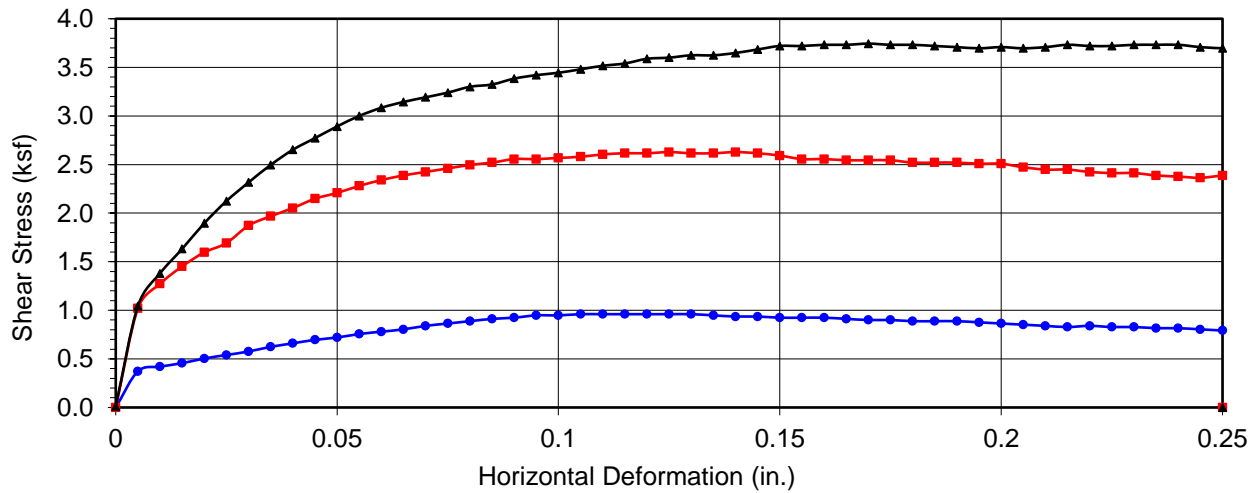

Boring No.	B4
Sample No.	B-4@0-5
Depth (ft)	0-5
<u>Sample Type:</u>	Bulk

<u>Soil Identification:</u>		
Poorly Graded SAND with Silt (SP-SM), olive brown		
Strength Parameters		
	C (psf)	ϕ (°)
Peak	356	34.8
Ultimate	114	36.0

Normal Stress (kip/ft ²)	1	3	5
Peak Shear Stress (kip/ft ²)	● 0.96	■ 2.63	▲ 3.74
Shear Stress @ End of Test (ksf)	○ 0.79	□ 2.39	△ 3.70
Deformation Rate (in./min.)	0.05	0.05	0.05
Initial Sample Height (in.)	1.0	1.0	1.0
Ring Inside Diameter (in.)	2.375	2.375	2.375
Initial Moisture Content (%)	5.9	5.9	5.9
Initial Dry Density (pcf)	124.9	124.9	125.1
Initial Degree of Saturation (%)	45.7	45.4	46.1
Soil Height Before Shearing (in.)	1.2	1.2	1.2
Final Moisture Content (%)	12.9	13.1	12.5



DIRECT SHEAR TEST RESULTS

Consolidated Drained ASTM D-3080

Checked by:

Project No.: T2979-22-01

MISSION GROVE REDEVELOPMENT
375 EAST ALESSANDRO BOULEVARD
RIVERSIDE, CALIFORNIA

Jun 22

Figure B-9

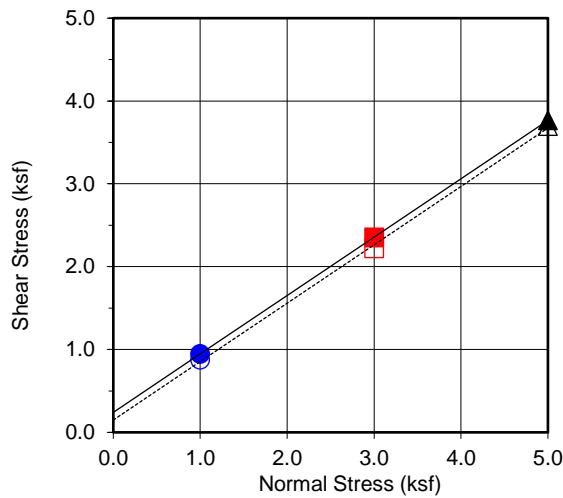
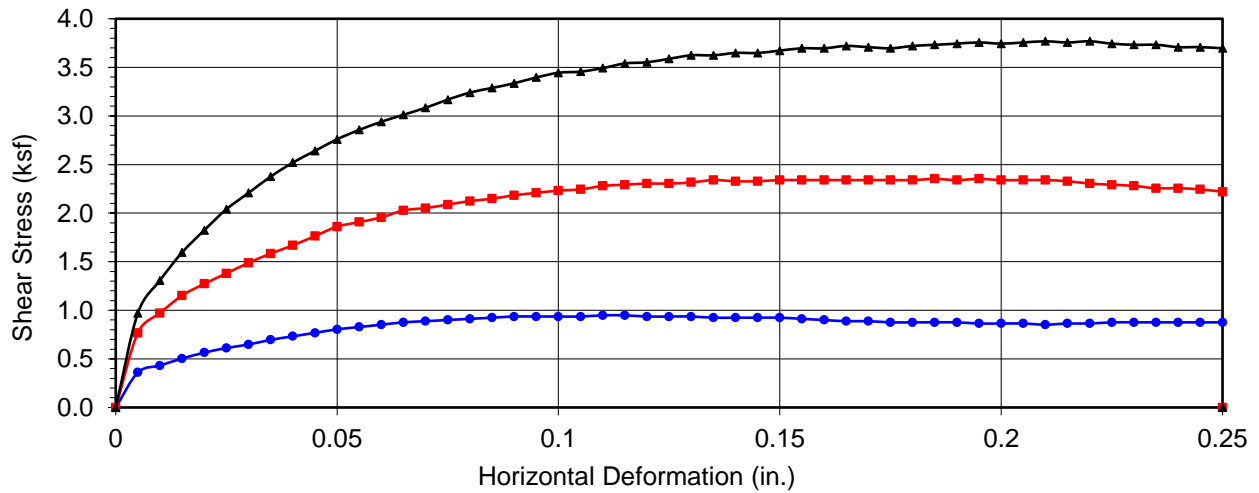

Boring No.	B7
Sample No.	B-7@2-7
Depth (ft)	44599
Sample Type:	Bulk

<u>Soil Identification:</u>		
Highly Graded SAND with Silt (SP-SM), dark yellowish brown		
Strength Parameters		
	C (psf)	ϕ (°)
Peak	241	35.2
Ultimate	149	35.2

Normal Stress (kip/ft ²)	1	3	5
Peak Shear Stress (kip/ft ²)	● 0.95	■ 2.35	▲ 3.77
Shear Stress @ End of Test (ksf)	○ 0.88	□ 2.22	△ 3.70
Deformation Rate (in./min.)	0.05	0.05	0.05
Initial Sample Height (in.)	1.0	1.0	1.0
Ring Inside Diameter (in.)	2.375	2.375	2.375
Initial Moisture Content (%)	6.9	6.9	6.9
Initial Dry Density (pcf)	122.1	122.0	122.1
Initial Degree of Saturation (%)	48.8	48.9	49.0
Soil Height Before Shearing (in.)	1.2	1.2	1.2
Final Moisture Content (%)	13.1	12.9	10.8



DIRECT SHEAR TEST RESULTS

Consolidated Drained ASTM D-3080

Checked by:

Project No.: T2979-22-01

MISSION GROVE REDEVELOPMENT
375 EAST ALESSANDRO BOULEVARD
RIVERSIDE, CALIFORNIA

Jun 22

Figure B-10

APPENDIX



C

APPENDIX C

RECOMMENDED GRADING SPECIFICATIONS

FOR

MISSION GROVE REDEVELOPMENT
375 EAST ALESSANDRO BOULEVARD
RIVERSIDE, CALIFORNIA

PROJECT NO. T2979-22-01

RECOMMENDED GRADING SPECIFICATIONS

1. GENERAL

- 1.1 These Recommended Grading Specifications shall be used in conjunction with the Geotechnical Report for the project prepared by Geocon. The recommendations contained in the text of the Geotechnical Report are a part of the earthwork and grading specifications and shall supersede the provisions contained hereinafter in the case of conflict.
- 1.2 Prior to the commencement of grading, a geotechnical consultant (Consultant) shall be employed for the purpose of observing earthwork procedures and testing the fills for substantial conformance with the recommendations of the Geotechnical Report and these specifications. The Consultant should provide adequate testing and observation services so that they may assess whether, in their opinion, the work was performed in substantial conformance with these specifications. It shall be the responsibility of the Contractor to assist the Consultant and keep them apprised of work schedules and changes so that personnel may be scheduled accordingly.
- 1.3 It shall be the sole responsibility of the Contractor to provide adequate equipment and methods to accomplish the work in accordance with applicable grading codes or agency ordinances, these specifications and the approved grading plans. If, in the opinion of the Consultant, unsatisfactory conditions such as questionable soil materials, poor moisture condition, inadequate compaction, and/or adverse weather result in a quality of work not in conformance with these specifications, the Consultant will be empowered to reject the work and recommend to the Owner that grading be stopped until the unacceptable conditions are corrected.

2. DEFINITIONS

- 2.1 **Owner** shall refer to the owner of the property or the entity on whose behalf the grading work is being performed and who has contracted with the Contractor to have grading performed.
- 2.2 **Contractor** shall refer to the Contractor performing the site grading work.
- 2.3 **Civil Engineer** or **Engineer of Work** shall refer to the California licensed Civil Engineer or consulting firm responsible for preparation of the grading plans, surveying and verifying as-graded topography.
- 2.4 **Consultant** shall refer to the soil engineering and engineering geology consulting firm retained to provide geotechnical services for the project.

- 2.5 **Soil Engineer** shall refer to a California licensed Civil Engineer retained by the Owner, who is experienced in the practice of geotechnical engineering. The Soil Engineer shall be responsible for having qualified representatives on-site to observe and test the Contractor's work for conformance with these specifications.
- 2.6 **Engineering Geologist** shall refer to a California licensed Engineering Geologist retained by the Owner to provide geologic observations and recommendations during the site grading.
- 2.7 **Geotechnical Report** shall refer to a soil report (including all addenda) which may include a geologic reconnaissance or geologic investigation that was prepared specifically for the development of the project for which these Recommended Grading Specifications are intended to apply.

3. MATERIALS

- 3.1 Materials for compacted fill shall consist of any soil excavated from the cut areas or imported to the site that, in the opinion of the Consultant, is suitable for use in construction of fills. In general, fill materials can be classified as *soil* fills, *soil-rock* fills or *rock* fills, as defined below.
- 3.1.1 **Soil fills** are defined as fills containing no rocks or hard lumps greater than 12 inches in maximum dimension and containing at least 40 percent by weight of material smaller than $\frac{3}{4}$ inch in size.
- 3.1.2 **Soil-rock fills** are defined as fills containing no rocks or hard lumps larger than 4 feet in maximum dimension and containing a sufficient matrix of soil fill to allow for proper compaction of soil fill around the rock fragments or hard lumps as specified in Paragraph 6.2. **Oversize rock** is defined as material greater than 12 inches.
- 3.1.3 **Rock fills** are defined as fills containing no rocks or hard lumps larger than 3 feet in maximum dimension and containing little or no fines. Fines are defined as material smaller than $\frac{3}{4}$ inch in maximum dimension. The quantity of fines shall be less than approximately 20 percent of the rock fill quantity.
- 3.2 Material of a perishable, spongy, or otherwise unsuitable nature as determined by the Consultant shall not be used in fills.
- 3.3 Materials used for fill, either imported or on-site, shall not contain hazardous materials as defined by the California Code of Regulations, Title 22, Division 4, Chapter 30, Articles 9

and 10; 40CFR; and any other applicable local, state or federal laws. The Consultant shall not be responsible for the identification or analysis of the potential presence of hazardous materials. However, if observations, odors or soil discoloration cause Consultant to suspect the presence of hazardous materials, the Consultant may request from the Owner the termination of grading operations within the affected area. Prior to resuming grading operations, the Owner shall provide a written report to the Consultant indicating that the suspected materials are not hazardous as defined by applicable laws and regulations.

- 3.4 The outer 15 feet of *soil-rock* fill slopes, measured horizontally, should be composed of properly compacted *soil* fill materials approved by the Consultant. *Rock* fill may extend to the slope face, provided that the slope is not steeper than 2:1 (horizontal:vertical) and a soil layer no thicker than 12 inches is track-walked onto the face for landscaping purposes. This procedure may be utilized provided it is acceptable to the governing agency, Owner and Consultant.
- 3.5 Samples of soil materials to be used for fill should be tested in the laboratory by the Consultant to determine the maximum density, optimum moisture content, and, where appropriate, shear strength, expansion, and gradation characteristics of the soil.
- 3.6 During grading, soil or groundwater conditions other than those identified in the Geotechnical Report may be encountered by the Contractor. The Consultant shall be notified immediately to evaluate the significance of the unanticipated condition

4. CLEARING AND PREPARING AREAS TO BE FILLED

- 4.1 Areas to be excavated and filled shall be cleared and grubbed. Clearing shall consist of complete removal above the ground surface of trees, stumps, brush, vegetation, man-made structures, and similar debris. Grubbing shall consist of removal of stumps, roots, buried logs and other unsuitable material and shall be performed in areas to be graded. Roots and other projections exceeding 1½ inches in diameter shall be removed to a depth of 3 feet below the surface of the ground. Borrow areas shall be grubbed to the extent necessary to provide suitable fill materials.
- 4.2 Asphalt pavement material removed during clearing operations should be properly disposed at an approved off-site facility or in an acceptable area of the project evaluated by Geocon and the property owner. Concrete fragments that are free of reinforcing steel may be placed in fills, provided they are placed in accordance with Section 6.2 or 6.3 of this document.

- 4.3 After clearing and grubbing of organic matter and other unsuitable material, loose or porous soils shall be removed to the depth recommended in the Geotechnical Report. The depth of removal and compaction should be observed and approved by a representative of the Consultant. The exposed surface shall then be plowed or scarified to a minimum depth of 6 inches and until the surface is free from uneven features that would tend to prevent uniform compaction by the equipment to be used.
- 4.4 Where the slope ratio of the original ground is steeper than 5:1 (horizontal:vertical), or where recommended by the Consultant, the original ground should be benched in accordance with the following illustration.

TYPICAL BENCHING DETAIL

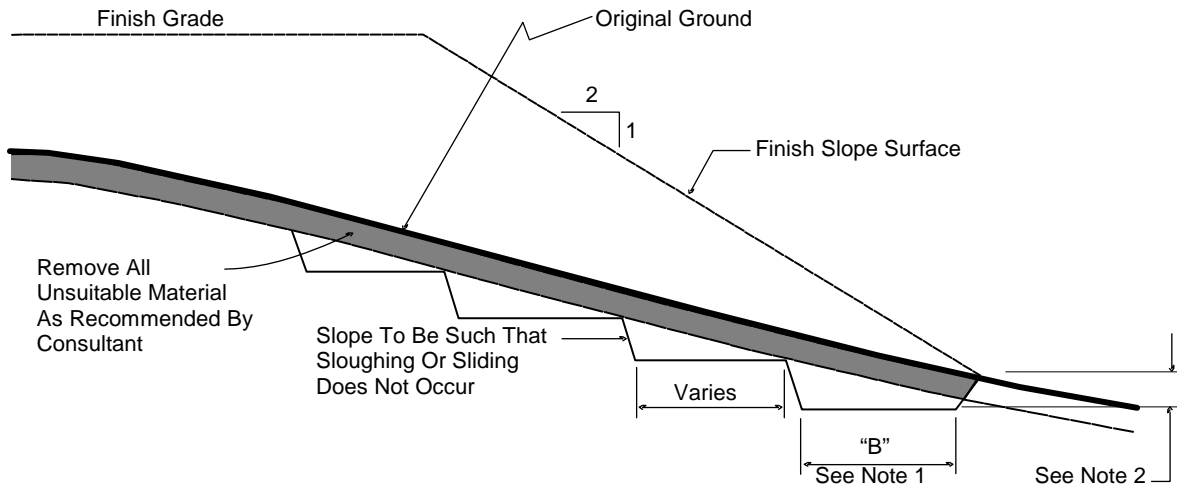

No Scale

- DETAIL NOTES: (1) Key width "B" should be a minimum of 10 feet, or sufficiently wide to permit complete coverage with the compaction equipment used. The base of the key should be graded horizontal, or inclined slightly into the natural slope.
- (2) The outside of the key should be below the topsoil or unsuitable surficial material and at least 2 feet into dense formational material. Where hard rock is exposed in the bottom of the key, the depth and configuration of the key may be modified as approved by the Consultant.

- 4.5 After areas to receive fill have been cleared and scarified, the surface should be moisture conditioned to achieve the proper moisture content, and compacted as recommended in Section 6 of these specifications.

5. COMPACTION EQUIPMENT

- 5.1 Compaction of *soil* or *soil-rock* fill shall be accomplished by sheepsfoot or segmented-steel wheeled rollers, vibratory rollers, multiple-wheel pneumatic-tired rollers, or other types of acceptable compaction equipment. Equipment shall be of such a design that it will be capable of compacting the *soil* or *soil-rock* fill to the specified relative compaction at the specified moisture content.
- 5.2 Compaction of *rock* fills shall be performed in accordance with Section 6.3.

6. PLACING, SPREADING AND COMPACTION OF FILL MATERIAL

- 6.1 *Soil* fill, as defined in Paragraph 3.1.1, shall be placed by the Contractor in accordance with the following recommendations:
- 6.1.1 *Soil* fill shall be placed by the Contractor in layers that, when compacted, should generally not exceed 8 inches. Each layer shall be spread evenly and shall be thoroughly mixed during spreading to obtain uniformity of material and moisture in each layer. The entire fill shall be constructed as a unit in nearly level lifts. Rock materials greater than 12 inches in maximum dimension shall be placed in accordance with Section 6.2 or 6.3 of these specifications.
- 6.1.2 In general, the *soil* fill shall be compacted at a moisture content at or above the optimum moisture content as determined by ASTM D 1557.
- 6.1.3 When the moisture content of *soil* fill is below that specified by the Consultant, water shall be added by the Contractor until the moisture content is in the range specified.
- 6.1.4 When the moisture content of the *soil* fill is above the range specified by the Consultant or too wet to achieve proper compaction, the *soil* fill shall be aerated by the Contractor by blading/mixing, or other satisfactory methods until the moisture content is within the range specified.
- 6.1.5 After each layer has been placed, mixed, and spread evenly, it shall be thoroughly compacted by the Contractor to a relative compaction of at least 90 percent. Relative compaction is defined as the ratio (expressed in percent) of the in-place dry density of the compacted fill to the maximum laboratory dry density as determined in accordance with ASTM D 1557. Compaction shall be continuous over the entire area, and compaction equipment shall make sufficient passes so that the specified minimum relative compaction has been achieved throughout the entire fill.

- 6.1.6 Where practical, soils having an Expansion Index greater than 50 should be placed at least 3 feet below finish pad grade and should be compacted at a moisture content generally 2 to 4 percent greater than the optimum moisture content for the material.
 - 6.1.7 Properly compacted *soil* fill shall extend to the design surface of fill slopes. To achieve proper compaction, it is recommended that fill slopes be over-built by at least 3 feet and then cut to the design grade. This procedure is considered preferable to track-walking of slopes, as described in the following paragraph.
 - 6.1.8 As an alternative to over-building of slopes, slope faces may be back-rolled with a heavy-duty loaded sheepsfoot or vibratory roller at maximum 4-foot fill height intervals. Upon completion, slopes should then be track-walked with a D-8 dozer or similar equipment, such that a dozer track covers all slope surfaces at least twice.
- 6.2 *Soil-rock* fill, as defined in Paragraph 3.1.2, shall be placed by the Contractor in accordance with the following recommendations:
- 6.2.1 Rocks larger than 12 inches but less than 4 feet in maximum dimension may be incorporated into the compacted *soil* fill, but shall be limited to the area measured 15 feet minimum horizontally from the slope face and 5 feet below finish grade or 3 feet below the deepest utility, whichever is deeper.
 - 6.2.2 Rocks or rock fragments up to 4 feet in maximum dimension may either be individually placed or placed in windrows. Under certain conditions, rocks or rock fragments up to 10 feet in maximum dimension may be placed using similar methods. The acceptability of placing rock materials greater than 4 feet in maximum dimension shall be evaluated during grading as specific cases arise and shall be approved by the Consultant prior to placement.
 - 6.2.3 For individual placement, sufficient space shall be provided between rocks to allow for passage of compaction equipment.
 - 6.2.4 For windrow placement, the rocks should be placed in trenches excavated in properly compacted *soil* fill. Trenches should be approximately 5 feet wide and 4 feet deep in maximum dimension. The voids around and beneath rocks should be filled with approved granular soil having a Sand Equivalent of 30 or greater and should be compacted by flooding. Windrows may also be placed utilizing an "open-face" method in lieu of the trench procedure, however, this method should first be approved by the Consultant.

- 6.2.5 Windrows should generally be parallel to each other and may be placed either parallel to or perpendicular to the face of the slope depending on the site geometry. The minimum horizontal spacing for windrows shall be 12 feet center-to-center with a 5-foot stagger or offset from lower courses to next overlying course. The minimum vertical spacing between windrow courses shall be 2 feet from the top of a lower windrow to the bottom of the next higher windrow.
- 6.2.6 Rock placement, fill placement and flooding of approved granular soil in the windrows should be continuously observed by the Consultant.
- 6.3 *Rock* fills, as defined in Section 3.1.3, shall be placed by the Contractor in accordance with the following recommendations:
- 6.3.1 The base of the *rock* fill shall be placed on a sloping surface (minimum slope of 2 percent). The surface shall slope toward suitable subdrainage outlet facilities. The *rock* fills shall be provided with subdrains during construction so that a hydrostatic pressure buildup does not develop. The subdrains shall be permanently connected to controlled drainage facilities to control post-construction infiltration of water.
- 6.3.2 *Rock* fills shall be placed in lifts not exceeding 3 feet. Placement shall be by rock trucks traversing previously placed lifts and dumping at the edge of the currently placed lift. Spreading of the *rock* fill shall be by dozer to facilitate *seating* of the rock. The *rock* fill shall be watered heavily during placement. Watering shall consist of water trucks traversing in front of the current rock lift face and spraying water continuously during rock placement. Compaction equipment with compactive energy comparable to or greater than that of a 20-ton steel vibratory roller or other compaction equipment providing suitable energy to achieve the required compaction or deflection as recommended in Paragraph 6.3.3 shall be utilized. The number of passes to be made should be determined as described in Paragraph 6.3.3. Once a *rock* fill lift has been covered with *soil* fill, no additional *rock* fill lifts will be permitted over the *soil* fill.
- 6.3.3 Plate bearing tests, in accordance with ASTM D 1196, may be performed in both the compacted *soil* fill and in the *rock* fill to aid in determining the required minimum number of passes of the compaction equipment. If performed, a minimum of three plate bearing tests should be performed in the properly compacted *soil* fill (minimum relative compaction of 90 percent). Plate bearing tests shall then be performed on areas of *rock* fill having two passes, four passes and six passes of the compaction equipment, respectively. The number of passes required for the *rock* fill shall be determined by comparing the results of the plate bearing tests for the *soil* fill and the *rock* fill and by evaluating the deflection

variation with number of passes. The required number of passes of the compaction equipment will be performed as necessary until the plate bearing deflections are equal to or less than that determined for the properly compacted *soil* fill. In no case will the required number of passes be less than two.

- 6.3.4 A representative of the Consultant should be present during *rock* fill operations to observe that the minimum number of “passes” have been obtained, that water is being properly applied and that specified procedures are being followed. The actual number of plate bearing tests will be determined by the Consultant during grading.
- 6.3.5 Test pits shall be excavated by the Contractor so that the Consultant can state that, in their opinion, sufficient water is present and that voids between large rocks are properly filled with smaller rock material. In-place density testing will not be required in the *rock* fills.
- 6.3.6 To reduce the potential for “piping” of fines into the *rock* fill from overlying *soil* fill material, a 2-foot layer of graded filter material shall be placed above the uppermost lift of *rock* fill. The need to place graded filter material below the *rock* should be determined by the Consultant prior to commencing grading. The gradation of the graded filter material will be determined at the time the *rock* fill is being excavated. Materials typical of the *rock* fill should be submitted to the Consultant in a timely manner, to allow design of the graded filter prior to the commencement of *rock* fill placement.
- 6.3.7 *Rock* fill placement should be continuously observed during placement by the Consultant.

7. SUBDRAINS

- 7.1 The geologic units on the site may have permeability characteristics and/or fracture systems that could be susceptible under certain conditions to seepage. The use of canyon subdrains may be necessary to mitigate the potential for adverse impacts associated with seepage conditions. Canyon subdrains with lengths in excess of 500 feet or extensions of existing offsite subdrains should use 8-inch-diameter pipes. Canyon subdrains less than 500 feet in length should use 6-inch-diameter pipes.

TYPICAL CANYON DRAIN DETAIL

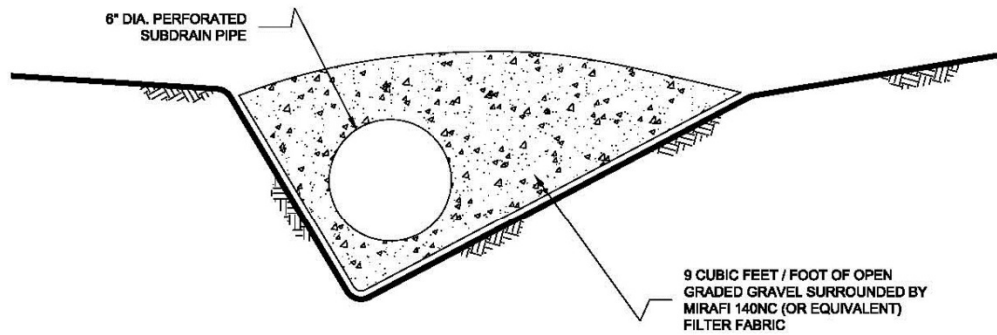
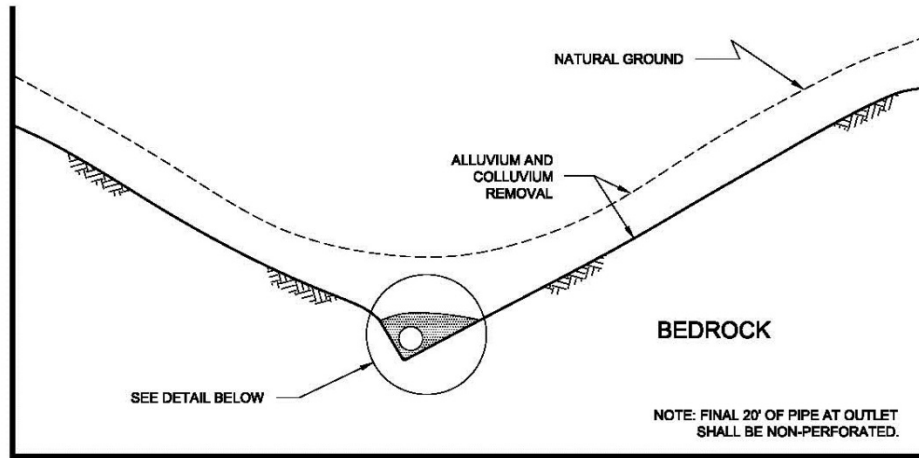

NOTES:

- 1.....8-INCH DIAMETER, SCHEDULE 80 PVC PERFORATED PIPE FOR FILLS IN EXCESS OF 100-FEET IN DEPTH OR A PIPE LENGTH OF LONGER THAN 500 FEET.
- 2.....6-INCH DIAMETER, SCHEDULE 40 PVC PERFORATED PIPE FOR FILLS LESS THAN 100-FEET IN DEPTH OR A PIPE LENGTH SHORTER THAN 500 FEET.

NO SCALE

7.2 Slope drains within stability fill keyways should use 4-inch-diameter (or larger) pipes.

TYPICAL STABILITY FILL DETAIL

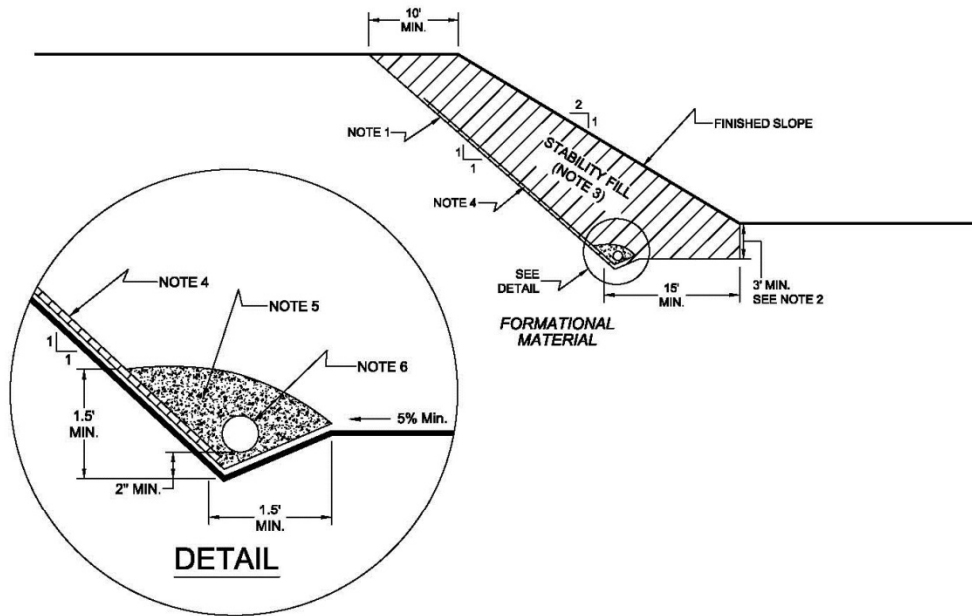

NOTES:

- 1.....EXCAVATE BACKCUT AT 1:1 INCLINATION (UNLESS OTHERWISE NOTED).
- 2.....BASE OF STABILITY FILL TO BE 3 FEET INTO FORMATIONAL MATERIAL, SLOPING A MINIMUM 5% INTO SLOPE.
- 3.....STABILITY FILL TO BE COMPOSED OF PROPERLY COMPACTED GRANULAR SOIL.
- 4.....CHIMNEY DRAINS TO BE APPROVED PREFABRICATED CHIMNEY DRAIN PANELS (MIRADRAIN G200N OR EQUIVALENT) SPACED APPROXIMATELY 20 FEET CENTER TO CENTER AND 4 FEET WIDE. CLOSER SPACING MAY BE REQUIRED IF SEEPAGE IS ENCOUNTERED.
- 5.....FILTER MATERIAL TO BE 3/4-INCH, OPEN-GRADED CRUSHED ROCK ENCLOSED IN APPROVED FILTER FABRIC (MIRAFI 140NC).
- 6.....COLLECTOR PIPE TO BE 4-INCH MINIMUM DIAMETER, PERFORATED, THICK-WALLED PVC SCHEDULE 40 OR EQUIVALENT, AND SLOPED TO DRAIN AT 1 PERCENT MINIMUM TO APPROVED OUTLET.

NO SCALE

- 7.3 The actual subdrain locations will be evaluated in the field during the remedial grading operations. Additional drains may be necessary depending on the conditions observed and the requirements of the local regulatory agencies. Appropriate subdrain outlets should be evaluated prior to finalizing 40-scale grading plans.
- 7.4 *Rock fill or soil-rock fill* areas may require subdrains along their down-slope perimeters to mitigate the potential for buildup of water from construction or landscape irrigation. The subdrains should be at least 6-inch-diameter pipes encapsulated in gravel and filter fabric. *Rock fill* drains should be constructed using the same requirements as canyon subdrains.

7.5 Prior to outletting, the final 20-foot segment of a subdrain that will not be extended during future development should consist of non-perforated drainpipe. At the non-perforated/perforated interface, a seepage cutoff wall should be constructed on the downslope side of the pipe.

TYPICAL CUT OFF WALL DETAIL

FRONT VIEW

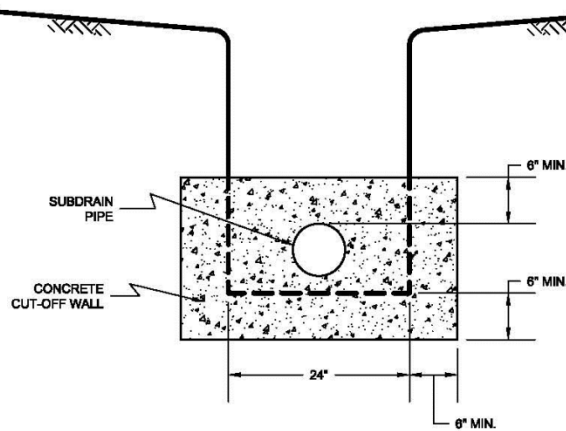

NO SCALE

SIDE VIEW

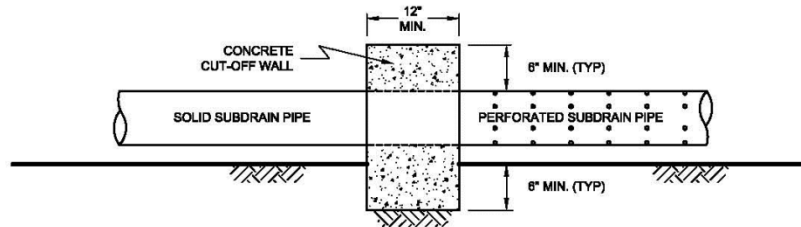

NO SCALE

7.6 Subdrains that discharge into a natural drainage course or open space area should be provided with a permanent headwall structure.

TYPICAL HEADWALL DETAIL

FRONT VIEW

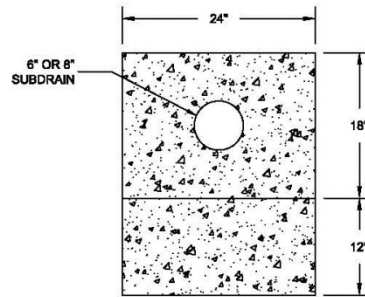

NO SCALE

SIDE VIEW

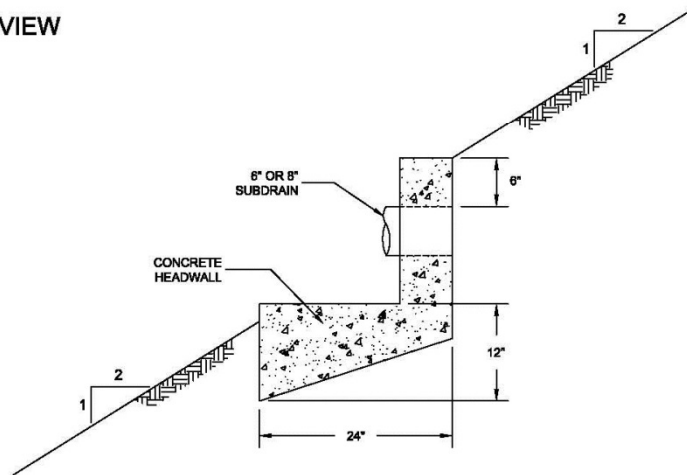

NOTE: HEADWALL SHOULD OUTLET AT TOE OF FILL SLOPE
OR INTO CONTROLLED SURFACE DRAINAGE

NO SCALE

- 7.7 The final grading plans should show the location of the proposed subdrains. After completion of remedial excavations and subdrain installation, the project civil engineer should survey the drain locations and prepare an “as-built” map showing the drain locations. The final outlet and connection locations should be determined during grading operations. Subdrains that will be extended on adjacent projects after grading can be placed on formational material and a vertical riser should be placed at the end of the subdrain. The grading contractor should consider videoing the subdrains shortly after burial to check proper installation and functionality. The contractor is responsible for the performance of the drains.

8. OBSERVATION AND TESTING

- 8.1 The Consultant shall be the Owner's representative to observe and perform tests during clearing, grubbing, filling, and compaction operations. In general, no more than 2 feet in vertical elevation of *soil* or *soil-rock* fill should be placed without at least one field density test being performed within that interval. In addition, a minimum of one field density test should be performed for every 2,000 cubic yards of *soil* or *soil-rock* fill placed and compacted.
- 8.2 The Consultant should perform a sufficient distribution of field density tests of the compacted *soil* or *soil-rock* fill to provide a basis for expressing an opinion whether the fill material is compacted as specified. Density tests shall be performed in the compacted materials below any disturbed surface. When these tests indicate that the density of any layer of fill or portion thereof is below that specified, the particular layer or areas represented by the test shall be reworked until the specified density has been achieved.
- 8.3 During placement of *rock* fill, the Consultant should observe that the minimum number of passes have been obtained per the criteria discussed in Section 6.3.3. The Consultant should request the excavation of observation pits and may perform plate bearing tests on the placed *rock* fills. The observation pits will be excavated to provide a basis for expressing an opinion as to whether the *rock* fill is properly seated and sufficient moisture has been applied to the material. When observations indicate that a layer of *rock* fill or any portion thereof is below that specified, the affected layer or area shall be reworked until the *rock* fill has been adequately seated and sufficient moisture applied.
- 8.4 A settlement monitoring program designed by the Consultant may be conducted in areas of *rock* fill placement. The specific design of the monitoring program shall be as recommended in the Conclusions and Recommendations section of the project Geotechnical Report or in the final report of testing and observation services performed during grading.
- 8.5 We should observe the placement of subdrains, to check that the drainage devices have been placed and constructed in substantial conformance with project specifications.
- 8.6 Testing procedures shall conform to the following Standards as appropriate:

8.6.1 Soil and Soil-Rock Fills:

- 8.6.1.1 Field Density Test, ASTM D 1556, *Density of Soil In-Place By the Sand-Cone Method.*

- 8.6.1.2 Field Density Test, Nuclear Method, ASTM D 6938, *Density of Soil and Soil-Aggregate In-Place by Nuclear Methods (Shallow Depth)*.
- 8.6.1.3 Laboratory Compaction Test, ASTM D 1557, *Moisture-Density Relations of Soils and Soil-Aggregate Mixtures Using 10-Pound Hammer and 18-Inch Drop*.
- 8.6.1.4. Expansion Index Test, ASTM D 4829, *Expansion Index Test*.

9. PROTECTION OF WORK

- 9.1 During construction, the Contractor shall properly grade all excavated surfaces to provide positive drainage and prevent ponding of water. Drainage of surface water shall be controlled to avoid damage to adjoining properties or to finished work on the site. The Contractor shall take remedial measures to prevent erosion of freshly graded areas until such time as permanent drainage and erosion control features have been installed. Areas subjected to erosion or sedimentation shall be properly prepared in accordance with the Specifications prior to placing additional fill or structures.
- 9.2 After completion of grading as observed and tested by the Consultant, no further excavation or filling shall be conducted except in conjunction with the services of the Consultant.

10. CERTIFICATIONS AND FINAL REPORTS

- 10.1 Upon completion of the work, Contractor shall furnish Owner a certification by the Civil Engineer stating that the lots and/or building pads are graded to within 0.1 foot vertically of elevations shown on the grading plan and that all tops and toes of slopes are within 0.5 foot horizontally of the positions shown on the grading plans. After installation of a section of subdrain, the project Civil Engineer should survey its location and prepare an *as-built* plan of the subdrain location. The project Civil Engineer should verify the proper outlet for the subdrains and the Contractor should ensure that the drain system is free of obstructions.
- 10.2 The Owner is responsible for furnishing a final as-graded soil and geologic report satisfactory to the appropriate governing or accepting agencies. The as-graded report should be prepared and signed by a California licensed Civil Engineer experienced in geotechnical engineering and by a California Certified Engineering Geologist, indicating that the geotechnical aspects of the grading were performed in substantial conformance with the Specifications or approved changes to the Specifications.

GRADING PLAN REVIEW AND GEOTECHNICAL UPDATE

**MISSION GROVE REDEVELOPMENT
375 EAST ALESSANDRO BOULEVARD
RIVERSIDE, CALIFORNIA**



GEOCON
W E S T, I N C.

GEOTECHNICAL
ENVIRONMENTAL
MATERIALS

PREPARED FOR

**ANTON MISSION GROVE, LLC.
WALNUT CREEK, CALIFORNIA**

**MARCH 2, 2023
REVISED MARCH 20, 2023
PROJECT NO. T2979-22-01**



Project No. T2979-22-01
March 2, 2023
REVISED March 20, 2023

Anton Mission Grove, LLC.
1676 N California Boulevard, Suite 250
Walnut Creek, California 94596

Attention: Ms. Vanessa Garza, Development Manager

Subject: GRADING PLAN REVIEW AND GEOTECHNICAL UPDATE
MISSION GROVE REDEVELOPMENT
375 EAST ALESSANDRO BOULEVARD
RIVERSIDE, CALIFORNIA

Reference: *Due Diligence Geotechnical Investigation, Mission Grove Redevelopment, 375 East Alessandro Boulevard, Riverside, California*, prepared by Geocon West, Inc., dated June 13, 2022.

Dear Ms. Garza:

In accordance with your request, Geocon West Inc. (Geocon) herein submits the results of our grading plan review and geotechnical update for the proposed Mission Grove Apartments planned northwest of the intersection of Mission Grove Parkway South and Mission Village Drive in Riverside, California. The accompanying report presents the results of our review of the *Preliminary Grading Plans* and update of pertinent geotechnical information in accordance with the 2022 California Building Code. The referenced *Due Diligence Geotechnical Investigation* report is included in Appendix A for ease of reference. The site is considered suitable for development provided the recommendations of this report are followed.

Should you have questions regarding this report, or if we may be of further service, please contact the undersigned at your convenience.

Very truly yours,

GEOCON WEST, INC.

Luke C. Weidman
Staff Geologist, GIT 891

Andrew T. Shoashekan
PE 93940



Lisa A. Battiato
CEG 2316



Petrina Zen
GE 3217



LCW:LAB:ATS:PZ:hd

TABLE OF CONTENTS

1. PURPOSE AND SCOPE	1
2. SITE AND PROJECT DESCRIPTION	1
3. SOIL AND GEOLOGIC CONDITIONS	2
3.1 Asphaltic Concrete Pavement and Aggregate Base.....	2
3.2 Previously Placed Fill.....	2
3.3 Quartz Diorite (qdi)	2
4. GROUNDWATER	3
5. CONCLUSIONS AND RECOMMENDATIONS.....	4
5.1 General.....	4
5.2 Excavation and Soil Characteristics	5
5.3 Seismic Design Criteria	6
5.4 Shallow Foundation and Concrete Slabs-On-Grade.....	7
5.5 Miscellaneous Foundations	10
5.6 Conventional Retaining Walls.....	10
5.7 Swimming Pool	12
5.8 Lateral Loading.....	13
5.9 Temporary Excavations	14
5.10 Grading and Foundation Plan Review	14

LIMITATIONS AND UNIFORMITY OF CONDITIONS

LIST OF REFERENCES

MAPS AND ILLUSTRATIONS

Figure 1, Geologic Map

APPENDIX A

Pertinent Data from *Due Diligence Geotechnical Investigation*, dated June 13, 2022

Boring Logs

Percolation Test Data

Laboratory Test Results

APPENDIX B

Preliminary Geotechnical Report, Geocon June 13, 2022

GEOTECHNICAL UPDATE AND GRADING PLAN REVIEW

1. PURPOSE AND SCOPE

The purpose of this geotechnical update and grading plan review is to review the project grading plans with respect to the existing topography and geotechnical conditions encountered during our due diligence geotechnical investigation of the site and provide geotechnical parameters with respect to the recently implemented 2022 *California Building Code* (CBC) for use in project design and construction. Where differing, the recommendations presented herein supersede the previous recommendations and may be utilized for design and construction.

The scope of our work included a review of the *Preliminary Grading Plan*, prepared by Rick Engineering, Inc. and dated October 21, 2022, and performing an update of seismic design parameters in accordance with the 2022 CBC. Pertinent data from the *Due Diligence Geotechnical Investigation* report, dated June 13, 2022, is presented herein in Appendix A for ease of reference. A summary of the information and documentation reviewed for this study is presented in the *List of References*.

2. SITE AND PROJECT DESCRIPTION

The site is located at 375 East Alessandro Boulevard in Riverside, California. The property consists of a previous K-mart store with asphalt drive isles and parking spaces, landscaped medians, and landscaped lawn areas between the former K-mart and the roadways to the east and south. The subject site is bounded on the north and west by the active Mission Grove Shopping Center, on the east by Mission Grove Parkway South, and on the south by Mission Village Drive. The shopping center was developed before 1994 and after 1985. Aerial photographs taken in 1974 show a gently sloping erosion plain was present at the site prior to development. Quartz diorite is geologically mapped at the site. The existing elevations range from approximately 1,588 feet above mean sea level (MSL) to the west to 1,598 feet above MSL to the east. The site is at latitude 33.9135 and longitude -117.3256.

The *Preliminary Grading Plans* depict five multi-family residential buildings with a pool, club house, and dog park. Grading is expected to result in cuts and fills of approximately 2 and 7 feet, respectively. The site will be relatively level with no cut or fill slopes. Utilities are expected to be installed at depths of approximately 4, 5, 6, 8, and 13 feet deep for water, fire water, storm drain, sewer, and sewer tie in, respectively. The conceptual site plan provided by you was used as the base for our *Geologic Map*, Figure 2.

The locations and descriptions provided herein are based on a site reconnaissance, our field exploration, review of *Preliminary Grading Plans*, and project information provided by the client. If project details differ significantly from those described herein, Geocon should be contacted for review and possible revision to this report.

3. SOIL AND GEOLOGIC CONDITIONS

Site geologic materials encountered consist of asphalt pavement over aggregate base and previously placed artificial fill to depths of 0 to 2½ feet overlying quartz diorite bedrock. The *Preliminary Geotechnical Investigation* mentioned that blasting may be necessary to excavate core stones or hard bedrock. However, due to the site location within an active shopping center with developments surrounding the subject site, blasting is not a feasible option for the excavation of bedrock. Based on discussions with Anton personnel, we understand that if core stones or hard bedrock are encountered, they will be excavated with heavy duty grading equipment or breakers rather than blasting. Descriptions of the soil and geologic conditions are shown on the boring logs located in the *Due Diligence Geotechnical Investigation* report, dated June 13, 2022, and are described herein in order of increasing age. The soil and geologic units encountered at the site are discussed below with the geologic nomenclature following that of Dibblee, 2003.

3.1 Asphaltic Concrete Pavement and Aggregate Base

Asphalt and aggregate base were measured at thicknesses of 3 to 6 inches of asphalt over 4 to 8 inches of aggregate base.

3.2 Previously Placed Fill

Previously placed fill was encountered to depths of 0 to 2.5 feet. The fill, as encountered, consists of poorly graded to silty sand, which is brown to red brown, moist, and medium dense. Deeper fill is likely present beneath the building due to the common practice of over excavating bedrock to create a fill pad on which to perform construction of buildings. This fill was likely placed during grading of the shopping center between 1985 and 1994.

3.3 Quartz Diorite (qdi)

Quartz diorite was encountered below the pavement sections and previously placed fill and underlies the site at depth. The bedrock consists of white and black granitic rock with oxidized zones of brown. It excavated as well-graded sand. The rock is moderately strong and highly to moderately weathered and moist to wet. We did not encounter refusal during drilling to depths of up to 26 feet 3 inches. However, core stones and zones of hard rock are common in granitic bedrock construction operations may need to implement breaking and industry standard methods for difficult excavations.

4. GROUNDWATER

We encountered perched groundwater in the weathered zone of the bedrock in our borings B-1 at 16.5 feet, B-2 at 11.5 feet, B-3 at 11 feet, B-4 at 13.5 feet, B-5 at 15 feet, and B-6 at 15 feet. We did not encounter perched groundwater in B-7, drilled to a depth of 15 feet 2 inches. The perched water is likely the result of surficial infiltration in the vicinity of the site moving through the subsurface above the impenetrable bedrock below. The California Department of Water Resources does not show any wells located on the Perris Erosional Surface within several miles of the site.

It is not uncommon for seepage conditions to develop where none previously existed. Groundwater and seepage are dependent on seasonal precipitation, irrigation, land use, among other factors, and varies as a result. Proper surface drainage will be important to future performance of the project.

5. CONCLUSIONS AND RECOMMENDATIONS

5.1 General

- 5.1.1 From a geotechnical engineering standpoint, the site is suitable for redevelopment and construction of the proposed multi-family development, provided the recommendations presented herein are implemented in design and construction of the project.
- 5.1.2 Potential geologic hazards at the site include seismic shaking and compressible near surface previously placed fill.
- 5.1.3 The site is located approximately 12 miles from the nearest active fault. Based on our background research and previous investigation, it is our opinion active, potentially active, or inactive faults do not extend across the site. Risks associated with seismic activity consist of the potential for moderate to strong seismic shaking.
- 5.1.4 The previously placed fill is not considered suitable for the support of compacted fill and settlement-sensitive structures. Remedial grading of the soil will be required as discussed herein as well as in the *Grading* section of the *Due Diligence Geotechnical Investigation* report, dated June 13, 2022. Estimated removal depths are depicted on the *Geologic Map* (Figure 1). The existing site soils are suitable for re-use as engineered fill provided the recommendations in the *Grading* section of the prior report are followed.
- 5.1.5 Based on our field investigation, granitic bedrock is present directly below the paving section to 2½ feet below ground surface and may be deeper below the existing retail building. Although not encountered in our exploration, grading operations may encounter zones of hard bedrock and core stones, particularly at depth, which may require heavy ripping, the use of breakers, or other industry standard methods for difficult excavations.
- 5.1.6 We recommended that the previously placed fill within the proposed building footprint areas be excavated and properly compacted for foundation and slab support. Areas where structures are proposed should be over excavated to a depth of three feet below planned finished grades or 1 foot below footings, whichever is deeper. Fill should then be placed and compacted in layers to provide a fill mat on which to construct the proposed buildings. Deeper excavations should be conducted as needed to remove existing fill or loose soils at the direction of the Geotechnical Engineer (a representative of Geocon). The over excavation should extend beyond the building footprint at least 3 feet or a distance equal to the fill depth at a 1:1 (horizontal:vertical) projection from the edge of the building.

- 5.1.7 Grading operations are expected to generate oversize rock which will require special placement. Oversize rock placement recommendations are provided in the *Recommended Grading Specifications* section of the previous report in *Appendix A*.
- 5.1.8 Some granular on-site soils may have little to no cohesion and are thus subject to caving in unshored excavations. It is the responsibility of the contractor to ensure that excavations and trenches are properly laid back and/or shored and maintained in accordance with OSHA rules and regulations to maintain the stability of adjacent existing improvements and life-safety.
- 5.1.9 The laboratory tests indicate that the site soils are non-expansive and have a “very low” expansion potential. If medium to highly expansive soils are encountered at the site, they should be exported from the site or selectively graded and placed in the deeper fill areas to allow for the placement of low expansion material at the finish pad grade.
- 5.1.10 Based on the *Preliminary Grading Plans* provided to us, grading is expected to result in cuts and fills of approximately 2 and 7 feet, respectively, not including remedial grading.
- 5.1.11 The existing structure, flatwork, and asphalt concrete parking lots at the site will be demolished as part of the redevelopment. The asphalt concrete can be pulverized, blended with soil, and used as fill or as a subbase within the site roadways and walkway areas, provided it is processed to meet the requirements for use as roadway fill or subbase material. Portland cement concrete (PCC) can be crushed to 6-inch minus with the rebar or other foreign matter removed and can be mixed with soil for use in the fill.
- 5.1.12 Seepage may be encountered during grading and construction of utilities, particularly near the soil/bedrock contact.
- 5.1.13 Proper drainage should be maintained to preserve the design properties of the engineered fill.
- 5.1.14 Once final grading and foundation plans become available, they should be reviewed by this office to evaluate the necessity for review and possible revision of this report.

5.2 Excavation and Soil Characteristics

- 5.2.1 Excavation of the previously placed fill and upper portion of the granitic bedrock should be possible with moderate effort using conventional heavy-duty equipment in proper functioning order. Excavation of deeper areas of granitic bedrock, or core stones, if encountered, should be possible with moderate difficulty but is expected to increase in difficulty with depth; zones of hard bedrock and core stones may be encountered during grading operations, particularly at depth, which may require heavy ripping, the use of breakers, or other industry standard methods for difficult excavations. Areas where deep

excavations are expected should be evaluated via a rippability investigation once final grading and utility plans are available. Excavations in the bedrock are expected to generate oversized rock which will require special placement in accordance with the *Recommended Grading Specifications* in the previous report located in *Appendix A*.

5.3 Seismic Design Criteria

5.3.1 The following table summarizes the site-specific design criteria obtained from the 2022 California Building Code (CBC; Based on the 2021 International Building Code [IBC] and ASCE 7-16), Chapter 16 Structural Design, Section 1613 Earthquake Loads. We used the computer program *Seismic Design Maps*, provided by the Structural Engineers Association of California (SEAOC) to calculate the seismic design parameters. The short spectral response uses a period of 0.2 second. We evaluated the Site Class based on the discussion in Section 1613.2.2 of the 2022 CBC and Table 20.3-1 of ASCE 7-16. The values presented herein are for the risk-targeted maximum considered earthquake (MCE_R).

2022 CBC SEISMIC DESIGN PARAMETERS

Parameter	Value	2022 CBC Reference
Site Class	B	Section 1613.2.2
MCE_R Ground Motion Spectral Response Acceleration – Class B (short), S_S	1.5g	Figure 1613.2.1(1)
MCE_R Ground Motion Spectral Response Acceleration – Class B (1 sec), S_1	0.594g	Figure 1613.2.1(3)
Site Coefficient, F_A	0.9	Table 1613.2.3(1)
Site Coefficient, F_V	0.8	Table 1613.2.3(2)
Site Class Modified MCE_R Spectral Response Acceleration (short), S_{MS}	1.35g	Section 1613.2.3 (Eqn 16-20)
Site Class Modified MCE_R Spectral Response Acceleration (1 sec), S_{M1}	0.476g	Section 1613.2.3 (Eqn 16-21)
5% Damped Design Spectral Response Acceleration (short), S_{DS}	0.9g	Section 1613.2.4 (Eqn 16-22)
5% Damped Design Spectral Response Acceleration (1 sec), S_{D1}	0.317g	Section 1613.2.4 (Eqn 16-23)

5.3.2 The table below presents the mapped maximum considered geometric mean (MCE_G) seismic design parameters for projects located in Seismic Design Categories of D through F in accordance with ASCE 7-16.

ASCE 7-16 PEAK GROUND ACCELERATION

Parameter	Value	ASCE 7-16 Reference
Mapped MCE_G Peak Ground Acceleration, PGA	0.5g	Figure 22-9
Site Coefficient, F_{PGA}	0.9	Table 11.8-1
Site Class Modified MCE_G Peak Ground Acceleration, PGA_M	0.45g	Section 11.8.3 (Eqn 11.8-1)

5.3.3 Conformance to the criteria in the above tables for seismic design does not constitute any kind of guarantee or assurance that significant structural damage or ground failure will not occur if a large earthquake occurs. The primary goal of seismic design is to protect life, not to avoid all damage, since such design may be economically prohibitive.

5.4 Shallow Foundation and Concrete Slabs-On-Grade

5.4.1 The foundation recommendations presented herein are for the proposed multi-family residential buildings subsequent to the recommended grading. We understand that future buildings will be supported on a conventional shallow foundation with concrete slabs-on-grade, deriving support in newly placed engineered fill.

5.4.2 The foundation for structures may consist of either continuous strip footings and/or isolated spread footings. Conventionally reinforced continuous footings should be at least 12 inches wide and extend at least 18 inches below lowest adjacent pad grade; isolated spread footings should have a minimum width of 24 inches and should extend at least 18 inches below lowest adjacent pad grade. A graphic depicting the foundation embedment is provided below.

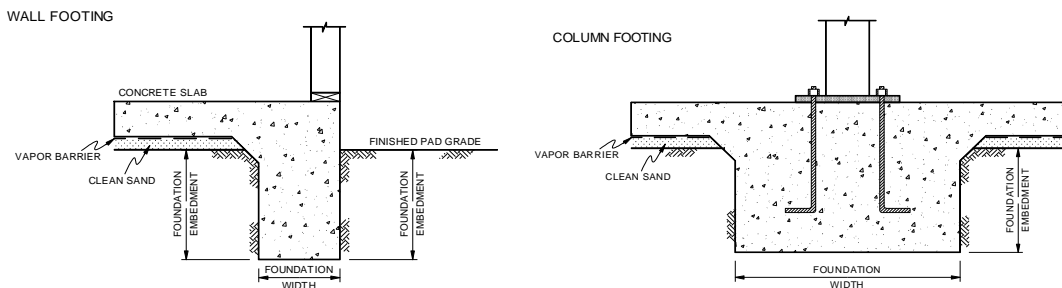

Wall/Column Footing Detail

- 5.4.3 From a geotechnical engineering standpoint, concrete slabs-on-grade for the structure should be at least 4 inches thick and be reinforced with at least No. 3 steel reinforcing bars placed 18 inches on center in both directions. The concrete slab-on-grade recommendations are based on soil support characteristics only. The project structural engineer should evaluate the structural requirements of the concrete slab for supporting equipment and storage loads. A thicker concrete slab may be required for heavier loading conditions. To reduce the effects of differential settlement on the foundation system, thickened slabs and/or an increase in steel reinforcement can provide a benefit to reduce concrete cracking.
- 5.4.4 Reinforcing steel for continuous footings should consist of at least four No. 4 steel reinforcing bars placed horizontally in the footings, two near the top and two near the bottom for the warehouse and commercial buildings; and at least two No. 4 steel bars placed horizontally in the footings, one near the top and one near the bottom for the residential buildings. Reinforcing steel for the spread footings should be designed by the project structural engineer.
- 5.4.5 Following remedial grading, foundations for the buildings may be designed for an allowable soil bearing pressure of 3,500 psf (dead plus live load). The soil bearing pressure may be increased by 250 psf and 500 psf for each additional foot of foundation width and depth, respectively, up to a maximum allowable soil bearing pressure of 5,000 psf. The allowable bearing pressure may be increased by one-third for transient loads due to wind or seismic forces.
- 5.4.6 The maximum expected static settlement for the planned structures, supported on conventional foundation systems with the above allowable bearing pressures and deriving support in engineered fill, is estimated to be on the order of ½ inch and to occur below the heaviest loaded structural element, with differential static settlement to be on the order of ¼ inch over a horizontal distance of 40 feet. Settlement of the foundation system is expected to occur on initial application of loading.
- 5.4.7 Once the design and foundation loading configuration proceeds to a more finalized plan, the estimated settlements within this report should be reviewed and revised, if necessary.
- 5.4.8 Foundation excavation bottoms must be observed and approved in writing by a qualified representative of Geocon, prior to placement of reinforcing steel or concrete.

- 5.4.9 Slabs that may receive moisture-sensitive floor coverings or may be used to store moisture-sensitive materials should be underlain by a vapor retarder. The vapor retarder design should be consistent with the guidelines presented in the American Concrete Institute's (ACI) Guide for Concrete Slabs that Receive Moisture-Sensitive Flooring Materials (ACI 302.2R-06). The vapor retarder used should be specified by the project architect or developer based on the type of floor covering that will be installed and if the structure will possess a humidity-controlled environment.
- 5.4.10 The bedding sand thickness should be evaluated by the project foundation engineer, architect, and/or developer. However, we should be contacted to provide recommendations if the bedding sand is thicker than 4 inches. Placement of 4 inches of sand is common practice in Southern California for 4-inch-thick slabs. The foundation engineer should provide appropriate concrete mix design criteria and curing measures that may be utilized to assure proper curing of the slab to reduce the potential for rapid moisture loss and subsequent cracking and/or slab curl. We suggest that the foundation design engineer present the concrete mix design and proper curing methods on the foundation plans. It is critical that the foundation contractor understands and follows the recommendations presented on the foundation plans.
- 5.4.11 Special subgrade presaturation is not deemed necessary prior to placing concrete; however, the exposed foundation and slab subgrade soil should be moisturized to maintain a moist condition between 0 and 2 percent above optimum moisture content.
- 5.4.12 The recommendations of this report are intended to reduce the potential for cracking of slabs due to expansive soil (if present), differential settlement of existing soil or soil with varying thicknesses. However, even with the incorporation of the recommendations presented herein, foundations, walls, and slabs-on-grade placed on such conditions may still exhibit some cracking due to soil movement and/or shrinkage. The occurrence of concrete shrinkage cracks is independent of the supporting soil characteristics. Their occurrence may be reduced and/or controlled by limiting the slump of the concrete, proper concrete placement and curing, and by the placement of crack control joints at periodic intervals, in particular where re-entrant slab corners occur.
- 5.4.13 Geocon should be consulted to provide additional design parameters as required by the structural engineer.

5.5 Miscellaneous Foundations

- 5.5.1 Foundations for small outlying structures, such as block walls up to 6 feet in height, planter walls or trash enclosures which will not be tied to the proposed structures may be supported on conventional foundations bearing on a minimum of 12 inches of newly placed engineered fill which extends laterally at least 12 inches beyond the foundation area. Where excavation and compaction cannot be performed, such as adjacent to property lines, foundations may derive support in the undisturbed granitic bedrock, and should be deepened as necessary to maintain a minimum 12-inch embedment into undisturbed granitic bedrock and must be observed and approved by a Geocon representative.
- 5.5.2 If soils exposed in the footing excavations are loose or soft, subgrade stabilization will be required prior to placing steel or concrete. Miscellaneous foundations may be designed for an allowable bearing value of 1,500 psf, and should be a minimum of 12 inches in width, 18 inches in depth below the lowest adjacent grade and 12 inches into the recommended bearing material. The allowable bearing pressure may be increased by up to one-third for transient loads due to wind or seismic forces.
- 5.5.3 Foundation excavations should be observed and approved in writing by the geotechnical engineer, prior to the placement of reinforcing steel and concrete to verify that the excavations and exposed soil conditions are consistent with those anticipated.

5.6 Conventional Retaining Walls

- 5.6.1 The recommendations presented herein are generally applicable to the design of rigid concrete or masonry retaining walls having a maximum height of 5 feet. In the event that walls higher than 5 feet or other types of walls are planned, Geocon should be consulted for additional recommendations.
- 5.6.2 Retaining wall foundations may be designed in accordance with the recommendations provided in the *Foundation and Concrete Slabs-On-Grade Recommendations* section of this report.
- 5.6.3 Retaining walls that are allowed to rotate more than $0.001H$ (where H equals the height of the retaining portion of the wall in feet) at the top of the wall with a level backfill surface should be designed utilizing a triangular distribution of pressure (active pressure) of 30 psf/ft. Where walls are restrained from movement at the top and are retaining a level soil backfill, walls may be designed utilizing a triangular distribution of pressure (at-rest pressure) of 56 pcf.

5.6.4 The wall pressures provided above assume that the retaining wall will be properly drained preventing the buildup of hydrostatic pressure. If retaining wall drainage is not implemented, an at-rest equivalent fluid pressure of 91 pcf should be used in design of undrained, restrained walls for the full height of the wall. The value includes hydrostatic pressures plus buoyant lateral earth pressures. If a partially drained wall is proposed, Geocon should be contacted to provide additional recommendations.

5.6.5 Retaining walls not designed for hydrostatic pressures should be provided with a drainage system adequate to prevent the buildup of hydrostatic forces and waterproofed as required by the project architect. The soil immediately adjacent to the backfilled retaining wall should be composed of free draining material completely wrapped in Mirafi 140 (or equivalent) filter fabric for a lateral distance of 1 foot for the bottom two-thirds of the height of the retaining wall. The upper one-third should be backfilled with less permeable compacted fill to reduce water infiltration. The use of drainage openings through the base of the wall (weep holes) is not recommended where the seepage could be a nuisance or otherwise adversely affect the property adjacent to the base of the wall. The recommendations herein assume a properly compacted backfill (EI of 50 or less) with no hydrostatic forces or imposed surcharge load. If conditions different than those described are expected or if specific drainage details are desired, Geocon should be contacted for additional recommendations. A graphic depicting typical retaining wall drainage is provided below.

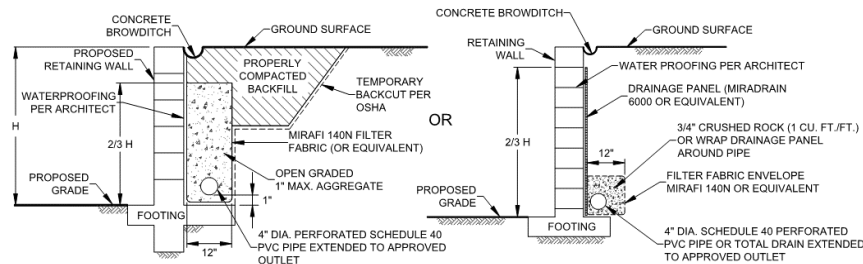

Typical Retaining Wall Drainage Detail

5.6.6 The wall pressures provided above assume that the proposed retaining walls will support relatively undisturbed soils or engineered fill derived from onsite soils, with an EI of 50 or less. If imported soil will be used to backfill proposed retaining walls, revised earth pressures may be required to account for the geotechnical properties of the import soil used as engineered fill. This should be evaluated once the use of import soil is established. All imported fills shall be observed, tested, and approved by Geocon West, Inc. prior to bringing soil to the site.

- 5.6.7 Additional active pressure should be added for a surcharge condition due to sloping ground, vehicular traffic, or adjacent structures. Once the design becomes more finalized, an addendum letter can be prepared revising recommendations and addressing specific surcharge conditions throughout the project, if necessary.
- 5.6.8 Unrestrained walls will move laterally when backfilled and loading is applied. The amount of lateral deflection is dependent on the wall height, the type of soil used for backfill, and loads acting on the wall. The retaining walls and improvements above the retaining walls should be designed to incorporate an appropriate amount of lateral deflection as determined by the structural engineer.

5.7 Swimming Pool

- 5.7.1 For the proposed pools, the shell bottoms should be designed as a free-standing structure and may derive support in its entirety on either undisturbed granitic bedrock or a minimum of 2 feet of engineered fill compacted to a dry density of at least 90 percent of the laboratory maximum dry density at 0 to 2 percent above optimum moisture content as determined by ASTM D1557.
- 5.7.2 Swimming pool foundations and walls may be designed in accordance with the *Shallow Foundation and Concrete Slabs-On-Grade* and *Conventional Retaining Walls* sections of this report. A hydrostatic relief valve should be considered as part of the swimming pool design unless a gravity drain system can be placed beneath the pool shell.
- 5.7.3 Based on the soil overburden load that will be removed during excavation of the swimming pool, anticipated settlements are expected to be small. Static differential settlement of the pool is not expected to exceed ¼ inch over a horizontal distance of 40 feet.
- 5.7.4 Surface drainage around the pool/spa should be designed to prevent water from ponding and seeping into the ground. Surface water should be collected and conducted through non-erosive devices to the street, storm drain or other approved water course or disposal area. Leakage from the proposed pool/spa could create an artificial groundwater condition that will likely create instability problems. Therefore, all plumbing and the pool/spa should be leak free.
- 5.7.5 The deck for the swimming pool/spa should be cast separately of the swimming pool/spa, and water stops should be provided between the bond beam and the deck. Jointing for concrete flatwork should be provided in accordance with the recommendations of the American Concrete Institute. The joints should be sealed with an approved flexible sealant to reduce the potential for introduction of surface water into the underlying soil.

- 5.7.6 Consideration should be given to installing a subdrain system for the pool area. The subgrade surface should be graded to slope a minimum of 1 percent away from the pool. An impermeable liner (e.g. High-density polyethylene, HDPE, with a thickness of about 30 mil or equivalent PVC liner) could be placed over the subgrade soil. The liner, if installed, should overlap by at least 12 inches and sealed in accordance with manufacturer's recommendations.
- 5.7.7 To mitigate the potential for moisture infiltration into the subgrade soils beneath the pool deck, we recommend the construction of a deepened footing along the outside edge of the pool deck flatwork. A subdrain consisting of 4-inch diameter perforated PVC pipe should be installed inside the deepened footing and sloped to drain into an approved outlet. The pipe should be surrounded by $\frac{3}{4}$ inch open-graded gravel and wrapped with filter fabric.
- 5.7.8 If the proposed pools are in proximity to a proposed or existing structure, consideration should be given to the construction sequence. If the proposed pool is to be constructed near an existing structure, or a proposed structure that is constructed before the pool's construction, the excavation required for the pool could remove a critical component of lateral support from the structure's foundations and would therefore require shoring to safeguard the structure's foundations. Once information regarding the pool locations and depth becomes available, this information should be provided to Geocon for review and possible revision of these recommendations.

5.8 Lateral Loading

- 5.8.1 To resist lateral loads, a passive pressure exerted by an equivalent fluid density of 320 pounds per cubic foot (pcf) should be used for the design of footings or shear keys. The allowable passive pressure assumes a horizontal surface extending at least 5 feet, or three times the surface generating the passive pressure, whichever is greater. The upper 12 inches of material in areas not protected by floor slabs or pavement should not be included in design for passive resistance.
- 5.8.2 If friction is to be used to resist lateral loads, an allowable coefficient of friction between soil and concrete of 0.4 should be used for design. The friction coefficient may be reduced depending on the vapor barrier or waterproofing material used for construction in accordance with the manufacturer's recommendations.
- 5.8.3 The passive and frictional resistant loads can be combined for design purposes. The lateral passive pressures may be increased by one-third when considering transient loads due to wind or seismic forces.

5.9 Temporary Excavations

- 5.9.1 The recommendations included herein are provided for temporary excavations. It is the responsibility of the contractor to provide a safe excavation during the construction of the proposed project.
- 5.9.2 Excavations of up to 13 feet in vertical height are expected during utility installation for the sewer tie in. The contractor's competent person should evaluate the necessity for lay back of vertical cut areas. Vertical excavations up to 5 feet may be attempted where loose soils or caving sands are not present, and where not surcharged by existing structures or vehicle/construction equipment loads.
- 5.9.3 Vertical excavations greater than 5 feet will require sloping measures in order to provide a stable excavation. Where sufficient space is available, temporary unsurcharged embankments should be designed by the contractor's competent person in accordance with OSHA regulations.
- 5.9.4 Where sufficient space is available, temporary unsurcharged embankments in soil may be sloped back at a uniform 1.5:1 (h:v) slope gradient or flatter. Excavations in bedrock may be steepened per Cal OSHA requirements. Note, a uniform slope does not have a vertical portion.
- 5.9.5 Where there is insufficient space for sloped excavations, shoring or trench shields should be used to support excavations. Shoring may also be necessary where sloped excavation could remove vertical or lateral support of existing improvements, including existing utilities and adjacent structures. Recommendations for temporary shoring can be provided in an addendum if needed.
- 5.9.6 Where temporary construction slopes are utilized, the top of the slope should be barricaded to prevent vehicles and storage loads at the top of the slope within a horizontal distance equal to the height of the slope. If the temporary construction slopes are to be maintained during the rainy season, berms are suggested along the tops of the slopes where necessary to prevent runoff water from entering the excavation and eroding the slope faces. The contractor's personnel should inspect the soil exposed in the cut slopes during excavation so that modifications of the slopes can be made if variations in the soil conditions occur. Excavations should be stabilized within 30 days of initial excavation.

5.10 Grading and Foundation Plan Review

- 5.10.1 Geocon should review the final grading and foundation plans prior to final design submittal to verify that the plans have been prepared in substantial conformance with the recommendations of this report and to provide additional analyses or recommendations, if necessary.

LIMITATIONS AND UNIFORMITY OF CONDITIONS

The recommendations of this report pertain only to the site investigated and are based upon the assumption that the soil conditions do not deviate from those disclosed in this investigation. If any variations or undesirable conditions are encountered during construction, or if the proposed construction will differ from that expected herein, Geocon West, Inc. should be notified so that supplemental recommendations can be given. The evaluation or identification of the potential presence of hazardous materials was not part of the scope of services provided by Geocon West, Inc.

This report is issued with the understanding that it is the responsibility of the owner, or of their representative, to ensure that the information and recommendations contained herein are brought to the attention of the architect and engineer for the project and incorporated into the plans, and the necessary steps are taken to see that the contractor and subcontractors carry out such recommendations in the field.

The requirements for concrete and steel reinforcement presented in this report are preliminary recommendations from a geotechnical perspective. The Structural Engineer should provide the final recommendations for structural design of concrete and steel reinforcement for foundation systems, floor slabs, exterior concrete, or other systems where concrete and steel reinforcement are utilized, in accordance with the latest version of applicable codes.

The findings of this report are valid as of the date of this report. However, changes in the conditions of a property can occur with the passage of time, whether they are due to natural processes or the works of man on this or adjacent properties. In addition, changes in applicable or appropriate standards may occur, whether they result from legislation or the broadening of knowledge. Accordingly, the findings of this report may be invalidated wholly or partially by changes outside our control. Therefore, this report is subject to review and should not be relied upon after a period of three years.

The firm that performed the geotechnical investigation for the project should be retained to provide testing and observation services during construction to provide continuity of geotechnical interpretation and to check that the recommendations presented for geotechnical aspects of site development are incorporated during site grading, construction of improvements, and excavation of foundations. If another geotechnical firm is selected to perform the testing and observation services during construction operations, that firm should prepare a letter indicating their intent to assume the responsibilities of project Geotechnical Engineer of Record. A copy of the letter should be provided to the regulatory agency for their records. In addition, that firm should provide revised recommendations concerning the geotechnical aspects of the proposed development, or a written acknowledgement of their concurrence with the recommendations presented in our report. They should also perform additional analyses deemed necessary to assume the role of Geotechnical Engineer of Record.

LIST OF REFERENCES

1. American Concrete Institute, 2011, *Building Code Requirements for Structural Concrete*, Report by ACI Committee 318.
2. American Concrete Institute, 2008, *Guide for Design and Construction of Concrete Parking Lots*, Report by ACI Committee 330.
3. ASCE 7-16, 2019, *Minimum Design Loads for Buildings and Other Structures*.
4. California Building Standards Commission, 2022, *California Building Code (CBC)*, California Code of Regulations Title 24, Part 2.
5. California Department of Transportation (Caltrans), 2021, Division of Engineering Services, Materials Engineering and Testing Services, *Corrosion Guidelines, Version 3.2*, dated March.
6. California Department of Water Resources, *Water Data Library* website, <https://wdl.water.ca.gov/> ; accessed May 2022.
7. California Geological Survey (CGS), 2003, *Earthquake Shaking Potential for California*, from USGS/CGS Seismic Hazards Model, CSSC No. 03-02
8. California Geological Survey, 2002, *Seismic Shaking Hazards in California*, Based on the USGS/CGS Probabilistic Seismic Hazards Assessment (PSHA) Model, (revised April 2003). 10% probability of being exceeded in 50 years, <http://redirect.conservacion.ca.gov/cgs/rghm/pshamap/pshamain.html>
9. Google Earth Pro, 2022, accessed May 2022.
10. OSHPD *Seismic Design Maps*, <https://seismicmaps.org> Accessed February 2023.
11. Public Works Standards, Inc., 2021, *Standard Specifications for Public Works Construction "Greenbook,"* Published by BNi Building News.

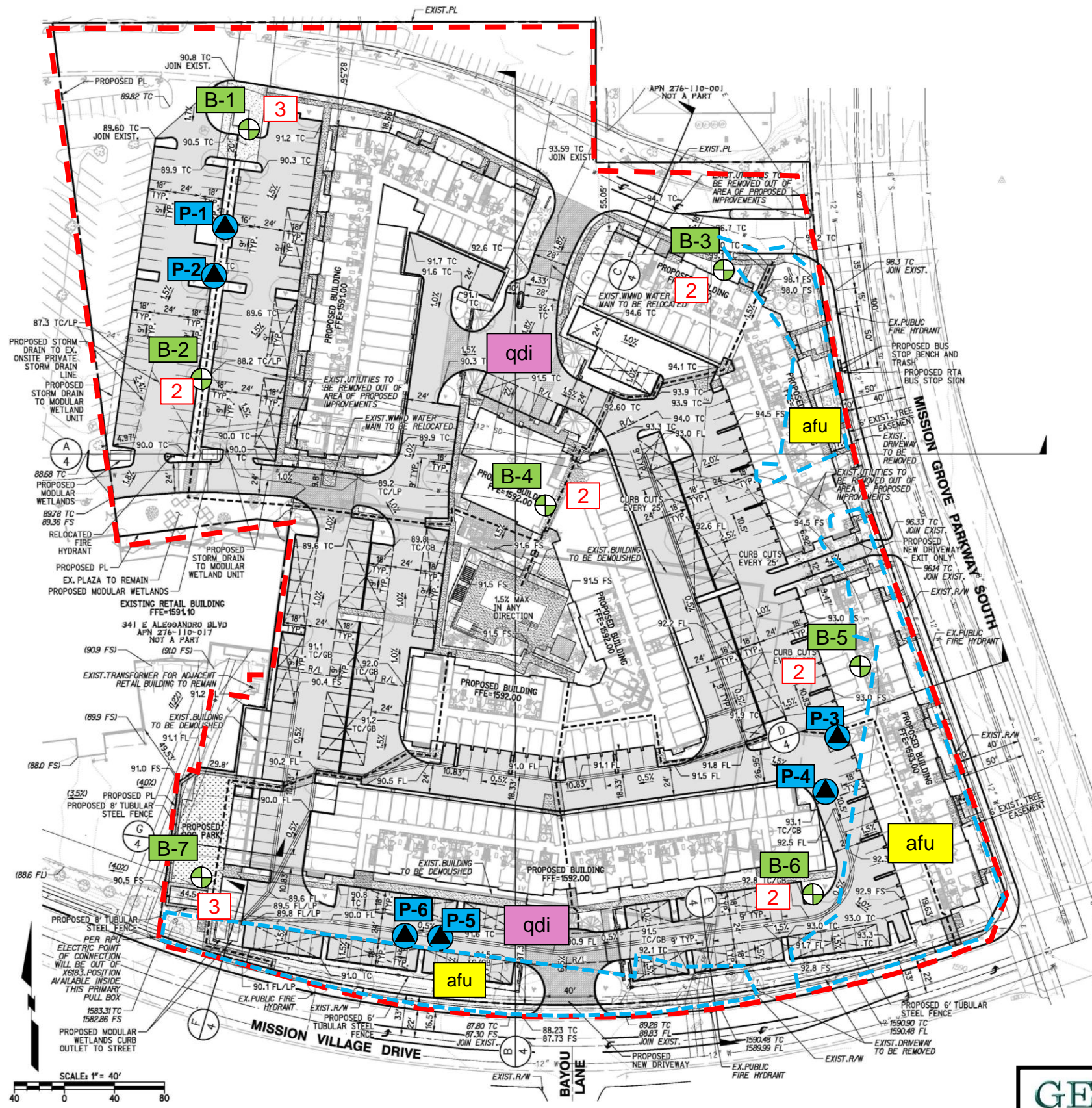

GEOCON LEGEND

Locations are approximate

- B-7 GEOTECHNICAL BORING LOCATION
- 3 EXPECTED DEPTH OF REMEDIAL GRADING (NOTE: OVER EXCAVATION FOR BUILDING FOUNDATION MAY DIFFER)
- P-6 PERCOLATION TEST LOCATION
- LIMITS OF THIS STUDY
- GEOLOGIC CONTACT
- afu PREVIOUSLY PLACED FILL
- qdi QUARTZ DIORITE BEDROCK

Source: Rick Engineering Company, Preliminary Grading Plan, Plot Date October 21, 2022

GEOCON
WEST, INC.

GEOTECHNICAL, ENVIRONMENTAL, MATERIALS
41571 CORNING PLACE #101, MURRIETA, CALIFORNIA 92562
PHONE 951-304-2300 www.geoconinc.com

GEOLOGIC MAP		
MISSION GROVE REDEVELOPMENT 375 EAST ALESSANDRO BOULEVARD RIVERSIDE, CALIFORNIA		
HD	MARCH 2023	PROJECT NO. T2979-22-01
		FIG. 1

APPENDIX



DEPTH IN FEET	SAMPLE NO.	LITHOLOGY	GROUNDWATER	SOIL CLASS (USCS)	BORING B-1		PENETRATION RESISTANCE (BLOWS/FT.)	DRY DENSITY (P.C.F.)	MOISTURE CONTENT (%)
					ELEV. (MSL.) 1584	DATE COMPLETED 5/13/2022			
					EQUIPMENT CME 75 HSA BY: L. WEIDMAN				
					MATERIAL DESCRIPTION				
0	B-1@0-5'			SP	PAVEMENT SECTION 3" AC, 4" BASE				
2	B-1@2.5'				PREVIOUSLY PLACED FILL (afu) Poorly-graded SAND, medium dense, slightly moist, golden brown; medium sand; some coarse sand		50-3.5"		
4	B-1@20'				QUARTZ DIORITE BEDROCK (qdi) White black brown; hard, moist, mica rich; excavates as Well-graded SAND with Silt; dry; friable; slightly oxidized; coarse grained		50-3"		
8	B-1@7.5'				-Becomes fine grained; hornblend rich		50-3"		
10	B-1@10'						50-4"		
16	B-1@15'				-Becomes more flesic		88-9"		
20	B-1@20'				-Becomes wet		50-2"		
26	B-1@25'						50-3"		
					Total Depth = 26'3" Groundwater encountered at 16'6" Penetration resistance for 140-lb hammer falling 30 inches by auto hammer Backfilled with cuttings 5/13/2022				

Figure A-1,
Log of Boring B-1, Page 1 of 1

T2979-22-01 BORING LOGS.GPJ

SAMPLE SYMBOLS		... SAMPLING UNSUCCESSFUL		... STANDARD PENETRATION TEST		... DRIVE SAMPLE (UNDISTURBED)
		... DISTURBED OR BAG SAMPLE		... CHUNK SAMPLE		... WATER TABLE OR SEEPAGE

NOTE: THE LOG OF SUBSURFACE CONDITIONS SHOWN HEREON APPLIES ONLY AT THE SPECIFIC BORING OR TRENCH LOCATION AND AT THE DATE INDICATED. IT IS NOT WARRANTED TO BE REPRESENTATIVE OF SUBSURFACE CONDITIONS AT OTHER LOCATIONS AND TIMES.

















DEPTH IN FEET	SAMPLE NO.	LITHOLOGY	GROUNDWATER	SOIL CLASS (USCS)	BORING B-2		PENETRATION RESISTANCE (BLOWS/FT.)	DRY DENSITY (P.C.F.)	MOISTURE CONTENT (%)
					ELEV. (MSL.) 1583	DATE COMPLETED 5/13/2022			
					EQUIPMENT CME 75 HSA		BY: L. WEIDMAN		
MATERIAL DESCRIPTION									
0					PAVEMENT SECTION 4" AC, 6" BASE				
2	B-2@2.5'				QUARTZ DIORITE BEDROCK (qdi) White black brown; hard, moist, mica rich; excavates as Well-graded SAND with Silt; slightly moist; friable; coarse grained; slightly oxidized		50-3"		
4									
6	B-2@20' B-2@5-10'				-Becomes moist; fine to coarse grained		50-2"		
8	B-2@7.5'				-Becomes wet		50-5"		
10	B-2@10'						50-4"		
12									
14	B-2@12.5'						50-3.5"		
16	B-2@15'						50-5"		
18	B-2@17.5'						50-4.5"		
20	B-2@20'				-NO RECOVERY		50-1"		
					Total Depth = 20'1" Groundwater encountered at 11'6" Penetration resistance for 140-lb hammer falling 30 inches by auto hammer Backfilled with cuttings 5/13/2022				

Figure A-2,
Log of Boring B-2, Page 1 of 1

T2979-22-01 BORING LOGS.GPJ







SAMPLE SYMBOLS	 ... SAMPLING UNSUCCESSFUL	 ... STANDARD PENETRATION TEST	 ... DRIVE SAMPLE (UNDISTURBED)
	 ... DISTURBED OR BAG SAMPLE	 ... CHUNK SAMPLE	 ... WATER TABLE OR SEEPAGE

NOTE: THE LOG OF SUBSURFACE CONDITIONS SHOWN HEREON APPLIES ONLY AT THE SPECIFIC BORING OR TRENCH LOCATION AND AT THE DATE INDICATED. IT IS NOT WARRANTED TO BE REPRESENTATIVE OF SUBSURFACE CONDITIONS AT OTHER LOCATIONS AND TIMES.

DEPTH IN FEET	SAMPLE NO.	LITHOLOGY	GROUNDWATER	SOIL CLASS (USCS)	BORING B-3		PENETRATION RESISTANCE (BLOWS/FT.)	DRY DENSITY (P.C.F.)	MOISTURE CONTENT (%)
					ELEV. (MSL.) 1588	DATE COMPLETED 5/13/2022			
					EQUIPMENT CME 75 HSA		BY: L. WEIDMAN		
MATERIAL DESCRIPTION									
0					PAVEMENT SECTION 3.5" AC, 4" BASE				
2					QUARTZ DIORITE BEDROCK (qdi) White black brown; hard, moist, mica rich; excavates as Well-graded SAND with Silt; moist; friable; slightly oxidized; micaceous		50-3"		
4	B-3@2.5'								
6	B-3@20'				-Becomes moist; fine to coarse grained		50-3"		
6	B-3@5-10'								
8	B-3@7.5'				-Becomes wet		50-3"		
10	B-3@10'						50-2"		
12									
14	B-3@15'				-NO RECOVERY		50-2"		
					Total Depth = 15'2" Groundwater encountered at 11' Penetration resistance for 140-lb hammer falling 30 inches by auto hammer Backfilled with cuttings 5/13/2022				

Figure A-3,
Log of Boring B-3, Page 1 of 1

T2979-22-01 BORING LOGS.GPJ

SAMPLE SYMBOLS		... SAMPLING UNSUCCESSFUL		... STANDARD PENETRATION TEST		... DRIVE SAMPLE (UNDISTURBED)
		... DISTURBED OR BAG SAMPLE		... CHUNK SAMPLE		... WATER TABLE OR SEEPAGE

NOTE: THE LOG OF SUBSURFACE CONDITIONS SHOWN HEREON APPLIES ONLY AT THE SPECIFIC BORING OR TRENCH LOCATION AND AT THE DATE INDICATED. IT IS NOT WARRANTED TO BE REPRESENTATIVE OF SUBSURFACE CONDITIONS AT OTHER LOCATIONS AND TIMES.

DEPTH IN FEET	SAMPLE NO.	LITHOLOGY	GROUNDWATER	SOIL CLASS (USCS)	BORING B-4		PENETRATION RESISTANCE (BLOWS/FT.)	DRY DENSITY (P.C.F.)	MOISTURE CONTENT (%)
					ELEV. (MSL.) 1584	DATE COMPLETED 5/13/2022			
					EQUIPMENT CME 75 HSA	BY: L. WEIDMAN			
					MATERIAL DESCRIPTION				
0	B-4@0-5'			SM	PAVEMENT SECTION 6" AC, 4" BASE				
2	B-4@2.5'				PREVIOUSLY PLACED FILL (afu) Silty SAND, medium dense, slightly moist, brown; medium to coarse sand; some mica		50-3"		
4	B-4@20"				QUARTZ DIORITE BEDROCK (qdi) White black brown; hard, moist, mica rich; excavates as Well-graded SAND with Silt; medium to coarse sand; slightly oxidized; micaceous; friable		50-2"		
8	B-4@7.5'				-Becomes hornblend rich		50-5"		
10	B-4@10'				-Becomes wet		50-5"		
14	B-4@15'				-NO RECOVERY Total Depth = 15'4" Groundwater encountered at 13'6" Penetration resistance for 140-lb hammer falling 30 inches by auto hammer Backfilled with cuttings 5/13/2022		50-4"		

Figure A-4,
Log of Boring B-4, Page 1 of 1

T2979-22-01 BORING LOGS.GPJ

SAMPLE SYMBOLS		... SAMPLING UNSUCCESSFUL		... STANDARD PENETRATION TEST		... DRIVE SAMPLE (UNDISTURBED)
		... DISTURBED OR BAG SAMPLE		... CHUNK SAMPLE		... WATER TABLE OR SEEPAGE

NOTE: THE LOG OF SUBSURFACE CONDITIONS SHOWN HEREON APPLIES ONLY AT THE SPECIFIC BORING OR TRENCH LOCATION AND AT THE DATE INDICATED. IT IS NOT WARRANTED TO BE REPRESENTATIVE OF SUBSURFACE CONDITIONS AT OTHER LOCATIONS AND TIMES.

DEPTH IN FEET	SAMPLE NO.	LITHOLOGY	GROUNDWATER	SOIL CLASS (USCS)	BORING B-5		PENETRATION RESISTANCE (BLOWS/FT.)	DRY DENSITY (P.C.F.)	MOISTURE CONTENT (%)
					ELEV. (MSL.) 1585	DATE COMPLETED 5/13/2022			
					EQUIPMENT CME 75 HSA BY: L. WEIDMAN				
MATERIAL DESCRIPTION									
0	B-5@0-5'			SM	PAVEMENT SECTION 4" AC, 4" BASE				
2	B-5@2.5'				PREVIOUSLY PLACED FILL (afu) Silty SAND, medium dense, slightly moist, golden brown; fine to coarse sand; little mica		50-5"		
4	B-5@20'				QUARTZ DIORITE BEDROCK (qdi) White black brown; hard, moist, mica rich; excavates as Well-graded SAND with Silt; coarse grained; slightly oxidized; micaceous; friable		50-4"		
8	B-5@7.5'				-Becomes fine grained; felsic		50-4"		
10	B-5@10'				-Becomes wet		50-3"		
14	B-5@15'				-NO RECOVERY Total Depth = 15'4" Groundwater encountered at 15' Penetration resistance for 140-lb hammer falling 30 inches by auto hammer Backfilled with cuttings 5/13/2022		50-4"		

Figure A-5,
Log of Boring B-5, Page 1 of 1

T2979-22-01 BORING LOGS.GPJ







SAMPLE SYMBOLS		... SAMPLING UNSUCCESSFUL		... STANDARD PENETRATION TEST		... DRIVE SAMPLE (UNDISTURBED)
		... DISTURBED OR BAG SAMPLE		... CHUNK SAMPLE		... WATER TABLE OR SEEPAGE

NOTE: THE LOG OF SUBSURFACE CONDITIONS SHOWN HEREON APPLIES ONLY AT THE SPECIFIC BORING OR TRENCH LOCATION AND AT THE DATE INDICATED. IT IS NOT WARRANTED TO BE REPRESENTATIVE OF SUBSURFACE CONDITIONS AT OTHER LOCATIONS AND TIMES.

DEPTH IN FEET	SAMPLE NO.	LITHOLOGY	GROUNDWATER	SOIL CLASS (USCS)	BORING B-6 ELEV. (MSL.) <u>1584</u> DATE COMPLETED <u>5/13/2022</u> EQUIPMENT <u>CME 75 HSA</u> BY: <u>L. WEIDMAN</u>	PENETRATION RESISTANCE (BLOWS/FT.)	DRY DENSITY (P.C.F.)	MOISTURE CONTENT (%)	
MATERIAL DESCRIPTION									
0					PAVEMENT SECTION 5" AC, 4" BASE				
2	B-6@2.5'			SM	PREVIOUSLY PLACED FILL (afu) Silty SAND, medium dense, moist, dark yellow brown; fine to coarse sand; little mica	50-6"			
4	B-6@20'				QUARTZ DIORITE BEDROCK (qdi) White black brown; hard, moist, mica rich; excavates as Well-graded SAND with Silt; slightly oxidized; micaceous; friable -Becomes moist -Becomes fine grained -Becomes wet	50-5"			
6	B-6@5-10'								
8	B-6@7.5'						50-4"		
10	B-6@10'						50-4"		
12									
14	B-6@15'		▼			50-4.5"			
					Total Depth = 15'4" Groundwater encountered at 15' Penetration resistance for 140-lb hammer falling 30 inches by auto hammer Backfilled with cuttings 5/13/2022				

Figure A-6,
Log of Boring B-6, Page 1 of 1

T2979-22-01 BORING LOGS.GPJ

SAMPLE SYMBOLS	 ... SAMPLING UNSUCCESSFUL	 ... STANDARD PENETRATION TEST	 ... DRIVE SAMPLE (UNDISTURBED)
	 ... DISTURBED OR BAG SAMPLE	 ... CHUNK SAMPLE	 ... WATER TABLE OR SEEPAGE

NOTE: THE LOG OF SUBSURFACE CONDITIONS SHOWN HEREON APPLIES ONLY AT THE SPECIFIC BORING OR TRENCH LOCATION AND AT THE DATE INDICATED. IT IS NOT WARRANTED TO BE REPRESENTATIVE OF SUBSURFACE CONDITIONS AT OTHER LOCATIONS AND TIMES.













DEPTH IN FEET	SAMPLE NO.	LITHOLOGY	GROUNDWATER	SOIL CLASS (USCS)	BORING B-7			PENETRATION RESISTANCE (BLOWS/FT.)	DRY DENSITY (P.C.F.)	MOISTURE CONTENT (%)
					ELEV. (MSL.)	1585	DATE COMPLETED			
					MATERIAL DESCRIPTION					
0					PAVEMENT SECTION 4" AC, 8" BASE					
2	B-7@2-7' B-7@2.5'			SM	PREVIOUSLY PLACED FILL (afu) Silty SAND, medium dense, moist, dark red brown; fine to coarse sand; little mica			61-8"		
4	B-7@20'				QUARTZ DIORITE BEDROCK (qdi) White black brown; hard, moist, mica rich; excavates as Well-graded SAND with Silt; slightly oxidized; micaceous; friable -Becomes fine grained			50-3"		
8	B-7@7.5'				-Poor recovery			50-2"		
10	B-7@10'							50-2"		
14	B-7@15'				-Poor recovery			50-2"		
					Total Depth = 15'2" Groundwater not encountered Penetration resistance for 140-lb hammer falling 30 inches by auto hammer Backfilled with cuttings 5/16/2022					

Figure A-7,
Log of Boring B-7, Page 1 of 1

T2979-22-01 BORING LOGS.GPJ

SAMPLE SYMBOLS		... SAMPLING UNSUCCESSFUL		... STANDARD PENETRATION TEST		... DRIVE SAMPLE (UNDISTURBED)
		... DISTURBED OR BAG SAMPLE		... CHUNK SAMPLE		... WATER TABLE OR SEEPAGE

NOTE: THE LOG OF SUBSURFACE CONDITIONS SHOWN HEREON APPLIES ONLY AT THE SPECIFIC BORING OR TRENCH LOCATION AND AT THE DATE INDICATED. IT IS NOT WARRANTED TO BE REPRESENTATIVE OF SUBSURFACE CONDITIONS AT OTHER LOCATIONS AND TIMES.

DEPTH IN FEET	SAMPLE NO.	LITHOLOGY	GROUNDWATER	SOIL CLASS (USCS)	BORING P-1		PENETRATION RESISTANCE (BLOWS/FT.)	DRY DENSITY (P.C.F.)	MOISTURE CONTENT (%)
					ELEV. (MSL.) 1582	DATE COMPLETED 5/13/2022			
					EQUIPMENT CME 75 HSA BY: L. WEIDMAN				
0					MATERIAL DESCRIPTION				
				SP	PAVEMENT SECTION 3" AC, 4" BASE				
2					PREVIOUSLY PLACED FILL (afu) Poorly-graded SAND, medium dense, slightly moist, golden brown; medium sand; some coarse sand; few mica				
4	P-1@3'				QUARTZ DIORITE BEDROCK (qdi) White black brown; hard, moist, mica rich; excavates as Well-graded SAND with Silt; dry; friable; slightly oxidized				
					Total Depth = 4.5' No Groundwater encountered Percolation Test Equipment set Presaturated with 5 gallons of water Backfilled with cuttings 5/16/2022				

Figure A-8,
Log of Boring P-1, Page 1 of 1

T2979-22-01 BORING LOGS.GPJ

SAMPLE SYMBOLS	<input type="checkbox"/>	... SAMPLING UNSUCCESSFUL	<input type="checkbox"/>	... STANDARD PENETRATION TEST	<input checked="" type="checkbox"/>	... DRIVE SAMPLE (UNDISTURBED)
	<input checked="" type="checkbox"/>	... DISTURBED OR BAG SAMPLE	<input checked="" type="checkbox"/>	... CHUNK SAMPLE	<input type="checkbox"/>	... WATER TABLE OR SEEPAGE

NOTE: THE LOG OF SUBSURFACE CONDITIONS SHOWN HEREON APPLIES ONLY AT THE SPECIFIC BORING OR TRENCH LOCATION AND AT THE DATE INDICATED. IT IS NOT WARRANTED TO BE REPRESENTATIVE OF SUBSURFACE CONDITIONS AT OTHER LOCATIONS AND TIMES.









DEPTH IN FEET	SAMPLE NO.	LITHOLOGY	GROUNDWATER	SOIL CLASS (USCS)	BORING P-2		PENETRATION RESISTANCE (BLOWS/FT.)	DRY DENSITY (P.C.F.)	MOISTURE CONTENT (%)
					ELEV. (MSL.) 1582	DATE COMPLETED 5/13/2022			
					EQUIPMENT CME 75 HSA BY: L. WEIDMAN				
					MATERIAL DESCRIPTION				
0				SP	PAVEMENT SECTION 3" AC, 4" BASE				
2	P-2@2'				PREVIOUSLY PLACED FILL (afu) Poorly-graded SAND, medium dense, slightly moist, golden brown; medium sand; some coarse sand; few mica				
					QUARTZ DIORITE BEDROCK (qdi) White black brown; hard, moist, mica rich; excavates as Well-graded SAND with Silt; dry; friable; slightly oxidized				
					Total Depth = 3.5' No Groundwater encountered Percolation Test Equipment set Presaturated with 5 gallons of water Backfilled with cuttings 5/16/2022				

Figure A-9,
Log of Boring P-2, Page 1 of 1

T2979-22-01 BORING LOGS.GPJ

SAMPLE SYMBOLS	 ... SAMPLING UNSUCCESSFUL	 ... STANDARD PENETRATION TEST	 ... DRIVE SAMPLE (UNDISTURBED)
	 ... DISTURBED OR BAG SAMPLE	 ... CHUNK SAMPLE	 ... WATER TABLE OR SEEPAGE

NOTE: THE LOG OF SUBSURFACE CONDITIONS SHOWN HEREON APPLIES ONLY AT THE SPECIFIC BORING OR TRENCH LOCATION AND AT THE DATE INDICATED. IT IS NOT WARRANTED TO BE REPRESENTATIVE OF SUBSURFACE CONDITIONS AT OTHER LOCATIONS AND TIMES.



DEPTH IN FEET	SAMPLE NO.	LITHOLOGY	GROUNDWATER	SOIL CLASS (USCS)	BORING P-3 ELEV. (MSL.) <u>1585</u> DATE COMPLETED <u>5/13/2022</u> EQUIPMENT <u>CME 75 HSA</u> BY: <u>L. WEIDMAN</u>	PENETRATION RESISTANCE (BLOWS/FT.)	DRY DENSITY (P.C.F.)	MOISTURE CONTENT (%)
0					MATERIAL DESCRIPTION			
					PAVEMENT SECTION 4" AC, 5" BASE			
2					QUARTZ DIORITE BEDROCK (qdi) White black brown; hard, moist, mica rich; excavates as Well-graded SAND with Silt; dry; friable; slightly oxidized; micaceous			
4	P-3@4.5'							
6					Total Depth = 6' No Groundwater encountered Percolation Test Equipment set Presaturated with 5 gallons of water Backfilled with cuttings 5/16/2022			

Figure A-10,
Log of Boring P-3, Page 1 of 1

T2979-22-01 BORING LOGS.GPJ

SAMPLE SYMBOLS	<input type="checkbox"/> ... SAMPLING UNSUCCESSFUL	<input type="checkbox"/> ... STANDARD PENETRATION TEST	<input type="checkbox"/> ... DRIVE SAMPLE (UNDISTURBED)
	<input checked="" type="checkbox"/> ... DISTURBED OR BAG SAMPLE	<input checked="" type="checkbox"/> ... CHUNK SAMPLE	<input type="checkbox"/> ... WATER TABLE OR SEEPAGE

NOTE: THE LOG OF SUBSURFACE CONDITIONS SHOWN HEREON APPLIES ONLY AT THE SPECIFIC BORING OR TRENCH LOCATION AND AT THE DATE INDICATED. IT IS NOT WARRANTED TO BE REPRESENTATIVE OF SUBSURFACE CONDITIONS AT OTHER LOCATIONS AND TIMES.

DEPTH IN FEET	SAMPLE NO.	LITHOLOGY	GROUNDWATER	SOIL CLASS (USCS)	BORING P-4 ELEV. (MSL.) <u>1585</u> DATE COMPLETED <u>5/13/2022</u> EQUIPMENT <u>CME 75 HSA</u> BY: <u>L. WEIDMAN</u>	PENETRATION RESISTANCE (BLOWS/FT.)	DRY DENSITY (P.C.F.)	MOISTURE CONTENT (%)
0					MATERIAL DESCRIPTION			
0 - 2					PAVEMENT SECTION 4" AC, 5" BASE			
2 - 6					QUARTZ DIORITE BEDROCK (qdi) White black brown; hard, moist, mica rich; excavates as Well-graded SAND with Silt; dry; friable; slightly oxidized; micaceous			
6	P-4@4.5'				Total Depth = 6' No Groundwater encountered Percolation Test Equipment set Presaturated with 5 gallons of water Backfilled with cuttings 5/16/2022			

Figure A-11,
Log of Boring P-4, Page 1 of 1

T2979-22-01 BORING LOGS.GPJ

SAMPLE SYMBOLS	... SAMPLING UNSUCCESSFUL	... STANDARD PENETRATION TEST	... DRIVE SAMPLE (UNDISTURBED)
	... DISTURBED OR BAG SAMPLE	... CHUNK SAMPLE	... WATER TABLE OR SEEPAGE

NOTE: THE LOG OF SUBSURFACE CONDITIONS SHOWN HEREON APPLIES ONLY AT THE SPECIFIC BORING OR TRENCH LOCATION AND AT THE DATE INDICATED. IT IS NOT WARRANTED TO BE REPRESENTATIVE OF SUBSURFACE CONDITIONS AT OTHER LOCATIONS AND TIMES.

DEPTH IN FEET	SAMPLE NO.	LITHOLOGY	GROUNDWATER	SOIL CLASS (USCS)	BORING P-5		PENETRATION RESISTANCE (BLOWS/FT.)	DRY DENSITY (P.C.F.)	MOISTURE CONTENT (%)
					ELEV. (MSL.) 1588	DATE COMPLETED 5/13/2022			
					EQUIPMENT CME 75 HSA BY: L. WEIDMAN				
					MATERIAL DESCRIPTION				
0				SM	PAVEMENT SECTION 3" AC, 5" BASE				
2					PREVIOUSLY PLACED FILL (afu) Silty SAND, medium dense, moist, dark red brown; fine to coarse sand; few mica				
4	P-5@4.5'				QUARTZ DIORITE BEDROCK (qdi) White black brown; hard, moist, mica rich; excavates as Well-graded SAND with Silt; dry; friable; slightly oxidized				
6					Total Depth = 6' No Groundwater encountered Percolation Test Equipment set Presaturated with 5 gallons of water Backfilled with cuttings 5/16/2022				

Figure A-12,
Log of Boring P-5, Page 1 of 1

T2979-22-01 BORING LOGS.GPJ

SAMPLE SYMBOLS	... SAMPLING UNSUCCESSFUL	... STANDARD PENETRATION TEST	... DRIVE SAMPLE (UNDISTURBED)
	... DISTURBED OR BAG SAMPLE	... CHUNK SAMPLE	... WATER TABLE OR SEEPAGE

NOTE: THE LOG OF SUBSURFACE CONDITIONS SHOWN HEREON APPLIES ONLY AT THE SPECIFIC BORING OR TRENCH LOCATION AND AT THE DATE INDICATED. IT IS NOT WARRANTED TO BE REPRESENTATIVE OF SUBSURFACE CONDITIONS AT OTHER LOCATIONS AND TIMES.

DEPTH IN FEET	SAMPLE NO.	LITHOLOGY	GROUNDWATER	SOIL CLASS (USCS)	BORING P-6 ELEV. (MSL.) <u>1588</u> DATE COMPLETED <u>5/13/2022</u> EQUIPMENT <u>CME 75 HSA</u> BY: <u>L. WEIDMAN</u>	PENETRATION RESISTANCE (BLOWS/FT.)	DRY DENSITY (P.C.F.)	MOISTURE CONTENT (%)
0					MATERIAL DESCRIPTION			
0				SM	PAVEMENT SECTION 3" AC, 5" BASE			
2					PREVIOUSLY PLACED FILL (afu) Silty SAND, medium dense, moist, dark red brown; fine to coarse sand; few mica			
4	P-6@4.5'				QUARTZ DIORITE BEDROCK (qdi) White black brown; hard, moist, mica rich; excavates as Well-graded SAND with Silt; dry; friable; slightly oxidized			
6					Total Depth = 6' No Groundwater encountered Percolation Test Equipment set Presaturated with 5 gallons of water Backfilled with cuttings 5/16/2022			

Figure A-13,
Log of Boring P-6, Page 1 of 1

T2979-22-01 BORING LOGS.GPJ

SAMPLE SYMBOLS	... SAMPLING UNSUCCESSFUL	... STANDARD PENETRATION TEST	... DRIVE SAMPLE (UNDISTURBED)
	... DISTURBED OR BAG SAMPLE	... CHUNK SAMPLE	... WATER TABLE OR SEEPAGE

NOTE: THE LOG OF SUBSURFACE CONDITIONS SHOWN HEREON APPLIES ONLY AT THE SPECIFIC BORING OR TRENCH LOCATION AND AT THE DATE INDICATED. IT IS NOT WARRANTED TO BE REPRESENTATIVE OF SUBSURFACE CONDITIONS AT OTHER LOCATIONS AND TIMES.

PERCOLATION TEST REPORT

Project Name:	Riverside Redevelopment	Project No.:	T2979-22-01
Test Hole No.:	P-1	Date Excavated:	5/13/2022
Length of Test Pipe:	36.0 inches	Soil Classification:	SM
Height of Pipe above Ground:	0.0 inches	Presoak Date:	5/13/2022
Depth of Test Hole:	36.0 inches	Perc Test Date:	5/16/2022
Check for Sandy Soil Criteria Tested by:	Weidman	Percolation Tested by:	Weidman

Water level measured from BOTTOM of hole

Sandy Soil Criteria Test

Trial No.	Time	Time Interval (min)	Total Elapsed Time (min)	Initial Water Level (in)	Final Water Level (in)	Δ in Water Level (in)	Percolation Rate (min/inch)
1	8:52 AM	25	25	12.0	0.0	12.0	2.1
	9:17 AM						
2	9:17 AM	25	50	12.0	4.8	7.2	3.5
	9:42 AM						

Soil Criteria: Sandy

Percolation Test

Reading No.	Time	Time Interval (min)	Total Elapsed Time (min)	Initial Water Head (in)	Final Water Head (in)	Δ in Water Level (in)	Percolation Rate (min/inch)
1	12:16 AM	10	10	36.0	3.8	32.2	0.3
	12:26 AM						
2	12:26 AM	10	20	36.0	4.9	31.1	0.3
	12:36 AM						
3	12:36 AM	10	30	36.0	5.4	30.6	0.3
	12:46 AM						
4	12:46 AM	10	40	36.0	5.8	30.2	0.3
	12:56 AM						
5	12:56 AM	10	50	36.0	6.5	29.5	0.3
	1:06 AM						
6	1:06 AM	10	60	36.0	7.1	28.9	0.3
	1:16 AM						

Infiltration Rate (in/hr):	14.7	
Radius of test hole (in):	4	Figure A-14
Average Head (in):	21.5	

PERCOLATION TEST REPORT

Project Name:	Riverside Redevelopment	Project No.:	T2979-22-01
Test Hole No.:	P-2	Date Excavated:	5/13/2022
Length of Test Pipe:	24.0 inches	Soil Classification:	SM
Height of Pipe above Ground:	0.0 inches	Presoak Date:	5/13/2022
Depth of Test Hole:	24.0 inches	Perc Test Date:	5/16/2022
Check for Sandy Soil Criteria Tested by:	Weidman	Percolation Tested by:	Weidman

Water level measured from BOTTOM of hole

Sandy Soil Criteria Test

Trial No.	Time	Time Interval (min)	Total Elapsed Time (min)	Initial Water Level (in)	Final Water Level (in)	Δ in Water Level (in)	Percolation Rate (min/inch)
1	8:51 AM	25	25	8.4	0.8	7.6	3.3
	9:16 AM						
2	9:16 AM	25	50	8.4	3.6	4.8	5.2
	9:41 AM						

Soil Criteria: Sandy

Percolation Test

Reading No.	Time	Time Interval (min)	Total Elapsed Time (min)	Initial Water Head (in)	Final Water Head (in)	Δ in Water Level (in)	Percolation Rate (min/inch)
1	12:15 AM	10	10	36.0	6.4	29.6	0.3
	12:25 AM						
2	12:25 AM	10	20	36.0	6.7	29.3	0.3
	12:35 AM						
3	12:35 AM	10	30	36.0	6.8	29.2	0.3
	12:45 AM						
4	12:45 AM	10	40	36.0	7.0	29.0	0.3
	12:55 AM						
5	12:55 AM	10	50	36.0	7.1	28.9	0.3
	1:05 AM						
6	1:05 AM	10	60	36.0	7.2	28.8	0.3
	1:15 AM						

Infiltration Rate (in/hr):	14.6		
Radius of test hole (in):	4		Figure A-15
Average Head (in):	21.6		

PERCOLATION TEST REPORT

Project Name:	Riverside Redevelopment	Project No.:	T2979-22-01
Test Hole No.:	P-3	Date Excavated:	5/13/2022
Length of Test Pipe:	54.0 inches	Soil Classification:	SM
Height of Pipe above Ground:	0.0 inches	Presoak Date:	5/13/2022
Depth of Test Hole:	54.0 inches	Perc Test Date:	5/16/2022
Check for Sandy Soil Criteria Tested by:	Weidman	Percolation Tested by:	Weidman

Water level measured from BOTTOM of hole

Sandy Soil Criteria Test

Trial No.	Time	Time Interval (min)	Total Elapsed Time (min)	Initial Water Level (in)	Final Water Level (in)	Δ in Water Level (in)	Percolation Rate (min/inch)
1	8:49 AM	25	25	24.0	13.0	11.0	2.3
	9:14 AM						
2	9:14 AM	25	50	24.0	16.3	7.7	3.3
	9:39 AM						

Soil Criteria: Sandy

Percolation Test

Reading No.	Time	Time Interval (min)	Total Elapsed Time (min)	Initial Water Head (in)	Final Water Head (in)	Δ in Water Level (in)	Percolation Rate (min/inch)
1	11:01 AM	10	10	36.0	20.6	15.4	0.7
	11:11 AM						
2	11:11 AM	10	20	36.0	21.2	14.8	0.7
	11:21 AM						
3	11:21 AM	10	30	36.0	21.6	14.4	0.7
	11:31 AM						
4	11:31 AM	10	40	36.0	21.6	14.4	0.7
	11:41 AM						
5	11:41 AM	10	50	36.0	21.5	14.5	0.7
	11:51 AM						
6	11:51 AM	10	60	36.0	21.4	14.6	0.7
	12:01 PM						

Infiltration Rate (in/hr):	5.7	
Radius of test hole (in):	4	Figure A-16
Average Head (in):	28.7	

PERCOLATION TEST REPORT

Project Name:	Riverside Redevelopment	Project No.:	T2979-22-01
Test Hole No.:	P-4	Date Excavated:	5/13/2022
Length of Test Pipe:	54.0 inches	Soil Classification:	SM
Height of Pipe above Ground:	0.0 inches	Presoak Date:	5/13/2022
Depth of Test Hole:	54.0 inches	Perc Test Date:	5/16/2022
Check for Sandy Soil Criteria Tested by:	Weidman	Percolation Tested by:	Weidman

Water level measured from BOTTOM of hole

Sandy Soil Criteria Test

Trial No.	Time	Time Interval (min)	Total Elapsed Time (min)	Initial Water Level (in)	Final Water Level (in)	Δ in Water Level (in)	Percolation Rate (min/inch)
1	8:48 AM	25	25	24.0	15.2	8.8	2.9
	9:13 AM						
2	9:13 AM	25	50	24.0	17.9	6.1	4.1
	9:38 AM						

Soil Criteria: Sandy

Percolation Test

Reading No.	Time	Time Interval (min)	Total Elapsed Time (min)	Initial Water Head (in)	Final Water Head (in)	Δ in Water Level (in)	Percolation Rate (min/inch)
1	11:00 AM	10	10	36.0	21.8	14.2	0.7
	11:10 AM						
2	11:10 AM	10	20	36.0	22.1	13.9	0.7
	11:20 AM						
3	11:20 AM	10	30	36.0	22.3	13.7	0.7
	11:30 AM						
4	11:30 AM	10	40	36.0	22.7	13.3	0.8
	11:40 AM						
5	11:40 AM	10	50	36.0	23.0	13.0	0.8
	11:50 AM						
6	11:50 AM	10	60	36.0	23.4	12.6	0.8
	12:00 PM						

Infiltration Rate (in/hr):	4.8	
Radius of test hole (in):	4	Figure A-17
Average Head (in):	29.7	

PERCOLATION TEST REPORT

Project Name:	Riverside Redevelopment	Project No.:	T2979-22-01
Test Hole No.:	P-5	Date Excavated:	5/13/2022
Length of Test Pipe:	54.0 inches	Soil Classification:	SM
Height of Pipe above Ground:	0.0 inches	Presoak Date:	5/13/2022
Depth of Test Hole:	54.0 inches	Perc Test Date:	5/16/2022
Check for Sandy Soil Criteria Tested by:	Weidman	Percolation Tested by:	Weidman

Water level measured from BOTTOM of hole

Sandy Soil Criteria Test

Trial No.	Time	Time Interval (min)	Total Elapsed Time (min)	Initial Water Level (in)	Final Water Level (in)	Δ in Water Level (in)	Percolation Rate (min/inch)
1	8:46 AM	25	25	24.0	15.0	9.0	2.8
	9:11 AM						
2	9:11 AM	25	50	24.0	18.0	6.0	4.2
	9:36 AM						

Soil Criteria: Sandy

Percolation Test

Reading No.	Time	Time Interval (min)	Total Elapsed Time (min)	Initial Water Head (in)	Final Water Head (in)	Δ in Water Level (in)	Percolation Rate (min/inch)
1	9:46 AM	10	10	36.0	10.2	25.8	0.4
	9:56 AM						
2	9:56 AM	10	20	36.0	10.6	25.4	0.4
	10:06 AM						
3	10:06 AM	10	30	36.0	10.8	25.2	0.4
	10:16 AM						
4	10:16 AM	10	40	36.0	10.9	25.1	0.4
	10:26 AM						
5	10:26 AM	10	50	36.0	10.9	25.1	0.4
	10:36 AM						
6	10:36 AM	10	60	36.0	10.9	25.1	0.4
	10:46 AM						

Infiltration Rate (in/hr):	11.8		
Radius of test hole (in):	4		Figure A-18
Average Head (in):	23.5		

PERCOLATION TEST REPORT

Project Name:	Riverside Redevelopment	Project No.:	T2979-22-01
Test Hole No.:	P-6	Date Excavated:	5/13/2022
Length of Test Pipe:	54.0 inches	Soil Classification:	SM
Height of Pipe above Ground:	0.0 inches	Presoak Date:	5/13/2022
Depth of Test Hole:	54.0 inches	Perc Test Date:	5/16/2022
Check for Sandy Soil Criteria Tested by:	Weidman	Percolation Tested by:	Weidman

Water level measured from BOTTOM of hole

Sandy Soil Criteria Test

Trial No.	Time	Time Interval (min)	Total Elapsed Time (min)	Initial Water Level (in)	Final Water Level (in)	Δ in Water Level (in)	Percolation Rate (min/inch)
1	8:45 AM	25	25	24.0	16.4	7.6	3.3
	9:10 AM						
2	9:10 AM	25	50	24.0	18.0	6.0	4.2
	9:35 AM						

Soil Criteria: Sandy

Percolation Test

Reading No.	Time	Time Interval (min)	Total Elapsed Time (min)	Initial Water Head (in)	Final Water Head (in)	Δ in Water Level (in)	Percolation Rate (min/inch)
1	9:45 AM	10	10	36.0	21.6	14.4	0.7
	9:55 AM						
2	9:55 AM	10	20	36.0	21.7	14.3	0.7
	10:05 AM						
3	10:05 AM	10	30	36.0	22.0	14.0	0.7
	10:15 AM						
4	10:15 AM	10	40	36.0	22.2	13.8	0.7
	10:25 AM						
5	10:25 AM	10	50	36.0	22.4	13.6	0.7
	10:35 AM						
6	10:35 AM	10	60	36.0	22.6	13.4	0.7
	10:45 AM						

Infiltration Rate (in/hr):	5.2	
Radius of test hole (in):	4	Figure A-19
Average Head (in):	29.3	

Sample No:

B4@0-5'	Poorly Graded SAND with Silt (SP-SM), olive brown
----------------	---

TEST NO.		1	2	3	4	5	6
Wt. Compacted Soil + Mold	(g)	6468	6490	6469	6407		
Weight of Mold	(g)	4265	4265	4265	4265	4265	
Net Weight of Soil	(g)	2203	2225	2204	2142	-4265	
Wet Weight of Soil + Cont.	(g)	693.9	723.1	633.4	621.5		
Dry Weight of Soil + Cont.	(g)	671.6	690.3	601.2	610.0		
Weight of Container	(g)	259.3	256.1	259.9	257.7		
Moisture Content	(%)	5.4	7.6	9.4	3.3		
Wet Density	(pcf)	146.3	147.7	146.4	142.2	-283.2	
Dry Density	(pcf)	138.8	137.4	133.7	137.7		

Maximum Dry Density (pcf)	139.0
Bulk Specific Gravity (dry)	2.66
Corrected Maximum Dry Density (pcf)	142.0

Optimum Moisture Content (%)	6.0
Oversized Fraction (%)	12.0
Corrected Moisture Content (%)	5.5

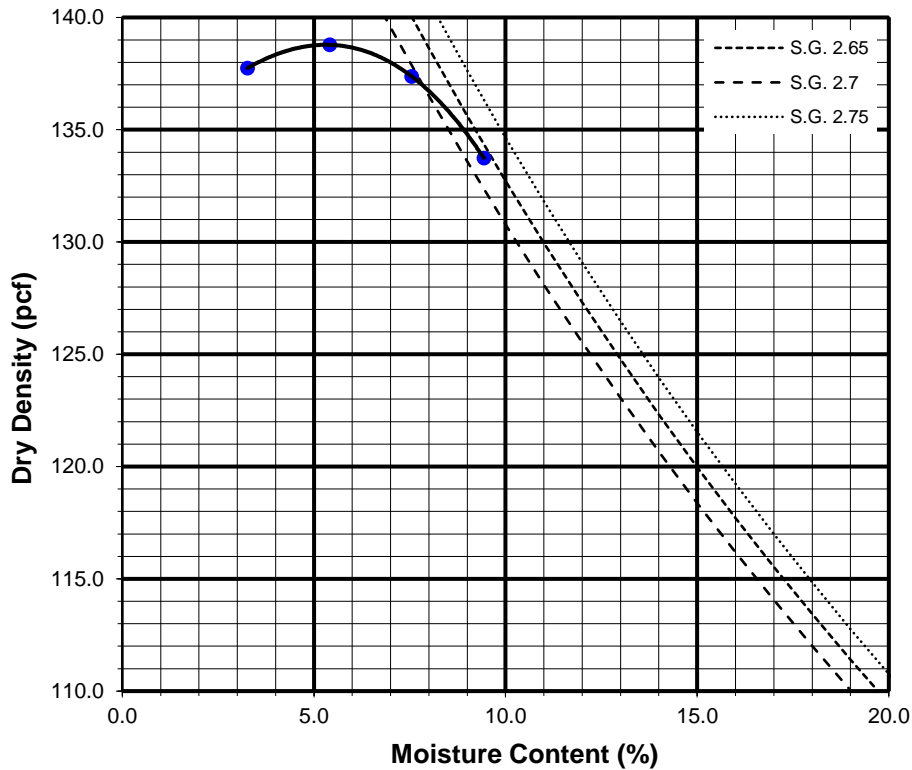

Preparation Method: A



**COMPACTION CHARACTERISTICS USING
MODIFIED EFFORT TEST RESULTS**

ASTM D-1557

Checked by:

Project No.: T2979-22-01

MISSION GROVE REDEVELOPMENT
375 EAST ALESSANDRO BOULEVARD
RIVERSIDE, CALIFORNIA

Jun 22

Figure B-1

Sample No:

B7@2-7'	Poorly Graded SAND with Silt (SP-SM), dark yellowish brown
----------------	--

TEST NO.		1	2	3	4	5	6
Wt. Compacted Soil + Mold	(g)	6448	6418	6417	6322		
Weight of Mold	(g)	4265	4265	4265	4265	4265	
Net Weight of Soil	(g)	2183	2153	2152	2057	-4265	
Wet Weight of Soil + Cont.	(g)	613.0	734.6	613.0	743.4		
Dry Weight of Soil + Cont.	(g)	586.3	691.1	592.4	724.2		
Weight of Container	(g)	254.4	257.5	253.5	257.6		
Moisture Content	(%)	8.0	10.0	6.1	4.1		
Wet Density	(pcf)	145.0	143.0	142.9	136.6	-283.2	
Dry Density	(pcf)	134.2	129.9	134.7	131.2		

Maximum Dry Density (pcf)	135.5
Bulk Specific Gravity (dry)	2.57
Corrected Maximum Dry Density (pcf)	137.0

Optimum Moisture Content (%)	7.0
Oversized Fraction (%)	8.0
Corrected Moisture Content (%)	6.5

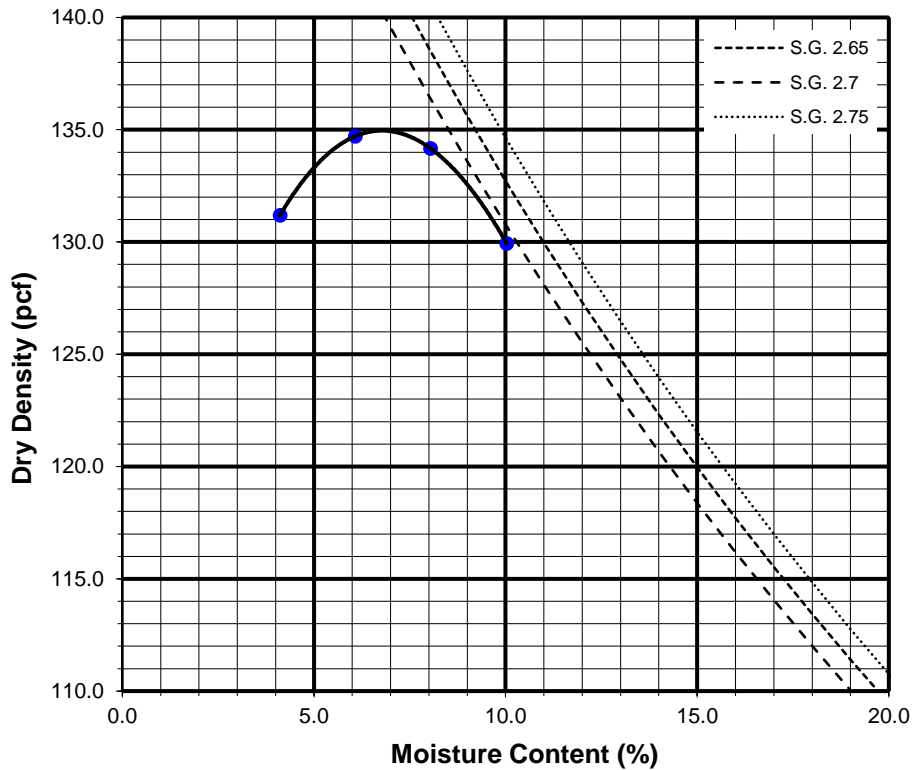

Preparation Method: A



**COMPACTION CHARACTERISTICS USING
MODIFIED EFFORT TEST RESULTS**

ASTM D-1557

Checked by:

Project No.: T2979-22-01

MISSION GROVE REDEVELOPMENT
375 EAST ALESSANDRO BOULEVARD
RIVERSIDE, CALIFORNIA

Jun 22

Figure B-2

B-2@5-10

MOLDED SPECIMEN		BEFORE TEST	AFTER TEST
Specimen Diameter	(in.)	4.0	4.0
Specimen Height	(in.)	1.0	1.0
Wt. Comp. Soil + Mold	(gm)	613.4	635.0
Wt. of Mold	(gm)	202.0	202.0
Specific Gravity	(Assumed)	2.7	2.7
Wet Wt. of Soil + Cont.	(gm)	556.0	635.0
Dry Wt. of Soil + Cont.	(gm)	532.5	379.2
Wt. of Container	(gm)	256.0	202.0
Moisture Content	(%)	8.5	14.2
Wet Density	(pcf)	124.1	130.4
Dry Density	(pcf)	114.4	114.2
Void Ratio		0.5	0.5
Total Porosity		0.3	0.3
Pore Volume	(cc)	66.6	66.4
Degree of Saturation	(%) [S_{meas}]	48.8	81.1

Date	Time	Pressure (psi)	Elapsed Time (min)	Dial Readings (in.)
6/1/2022	10:00	1.0	0	0.3775
6/1/2022	10:10	1.0	10	0.3774
Add Distilled Water to the Specimen				
6/2/2022	10:00	1.0	1430	0.3765
6/2/2022	11:00	1.0	1490	0.3765

Expansion Index (EI meas) =	-0.9
Expansion Index (Report) =	0

Expansion Index, EI_{50}	CBC CLASSIFICATION *	UBC CLASSIFICATION **
0-20	Non-Expansive	Very Low
21-50	Expansive	Low
51-90	Expansive	Medium
91-130	Expansive	High
>130	Expansive	Very High

* Reference: 2019 California Building Code, Section 1803.5.3

** Reference: 1997 Uniform Building Code, Table 18-I-B.



EXPANSION INDEX TEST RESULTS

ASTM D-4829

Checked by:

Project No.: T2979-22-01

MISSION GROVE REDEVELOPMENT
375 EAST ALESSANDRO BOULEVARD
RIVERSIDE, CALIFORNIA

Jun 22

Figure B-3

SUMMARY OF LABORATORY
 POTENTIAL OF HYDROGEN (pH) AND RESISTIVITY TEST RESULTS
 AASHTO T289 ASTM D4972 and AASHTO T288 ASTM G187

Sample No.	pH	Resistivity (ohm centimeters)
B2@44691	8.4	8000

SUMMARY OF LABORATORY CHLORIDE CONTENT TEST RESULTS
 AASHTO T291 ASTM C1218

Sample No.	Chloride Ion Content (%)
B2@5-10	0.002

SUMMARY OF LABORATORY WATER SOLUBLE SULFATE TEST RESULTS
 AASHTO T290 ASTM C1580

Sample No.	Water Soluble Sulfate (% SO ₄)	Sulfate Exposure
B2@5-10	0.000	S0

 GEOCON	CORROSIVITY TEST RESULTS	Project No.: T2979-22-01
	Checked by:	MISSION GROVE REDEVELOPMENT 375 EAST ALESSANDRO BOULEVARD RIVERSIDE, CALIFORNIA
		Jun 22 Figure B-4

GRAVEL		SAND			SILT AND CLAY
COARSE	FINE	COARSE	MEDIUM	FINE	

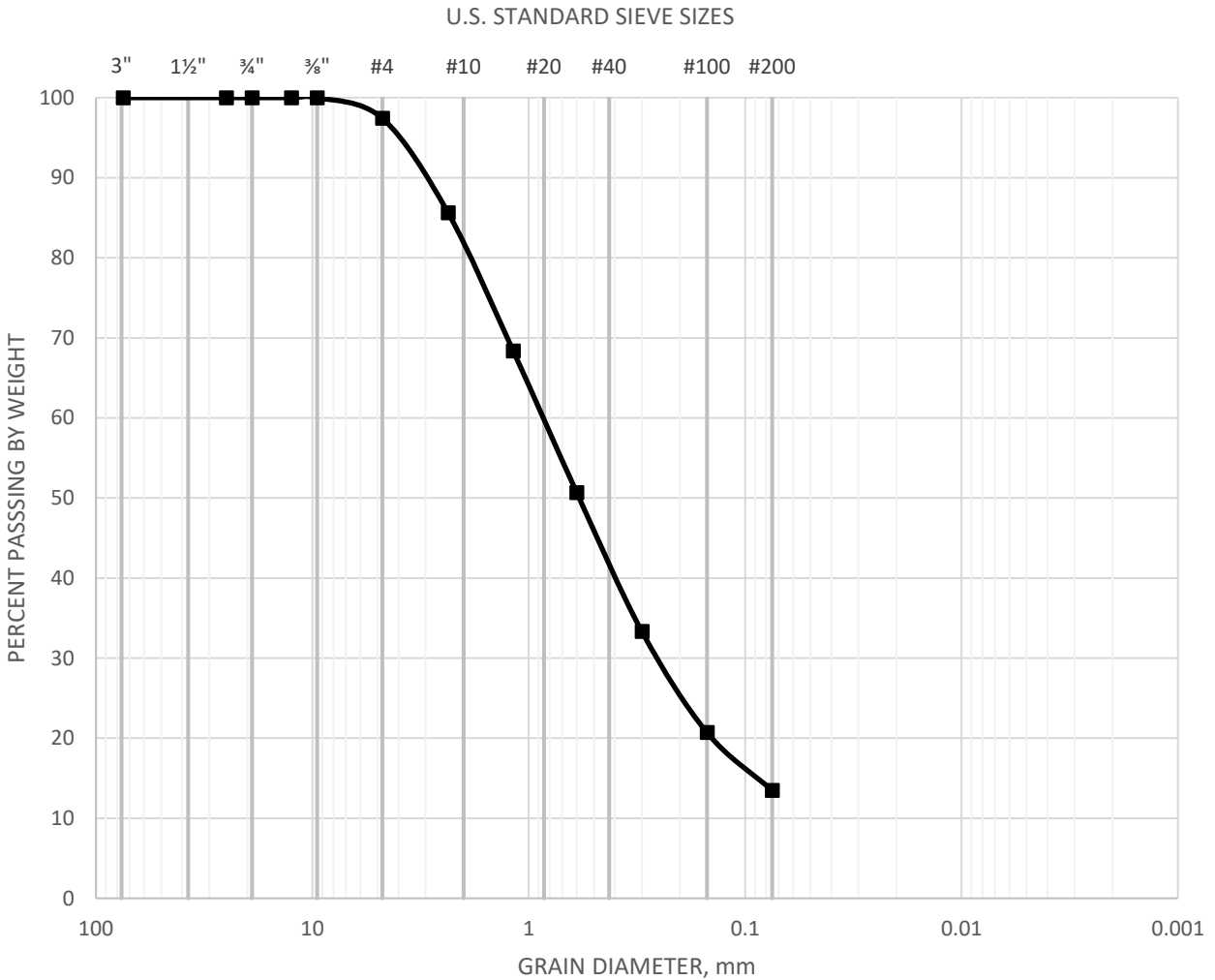

SAMPLE	CLASSIFICATION	D60	D30	D10
P-1@3	Silty SAND (SM), olive	0.87	0.25	0.073



GRAIN SIZE DISTRIBUTION

ASTM D 6913

Checked by:

Project No.: T2979-22-01

MISSION GROVE REDEVELOPMENT
375 EAST ALESSANDRO BOULEVARD
RIVERSIDE, CALIFORNIA

Jun 22

Figure B-5

GRAVEL		SAND			SILT AND CLAY
COARSE	FINE	COARSE	MEDIUM	FINE	

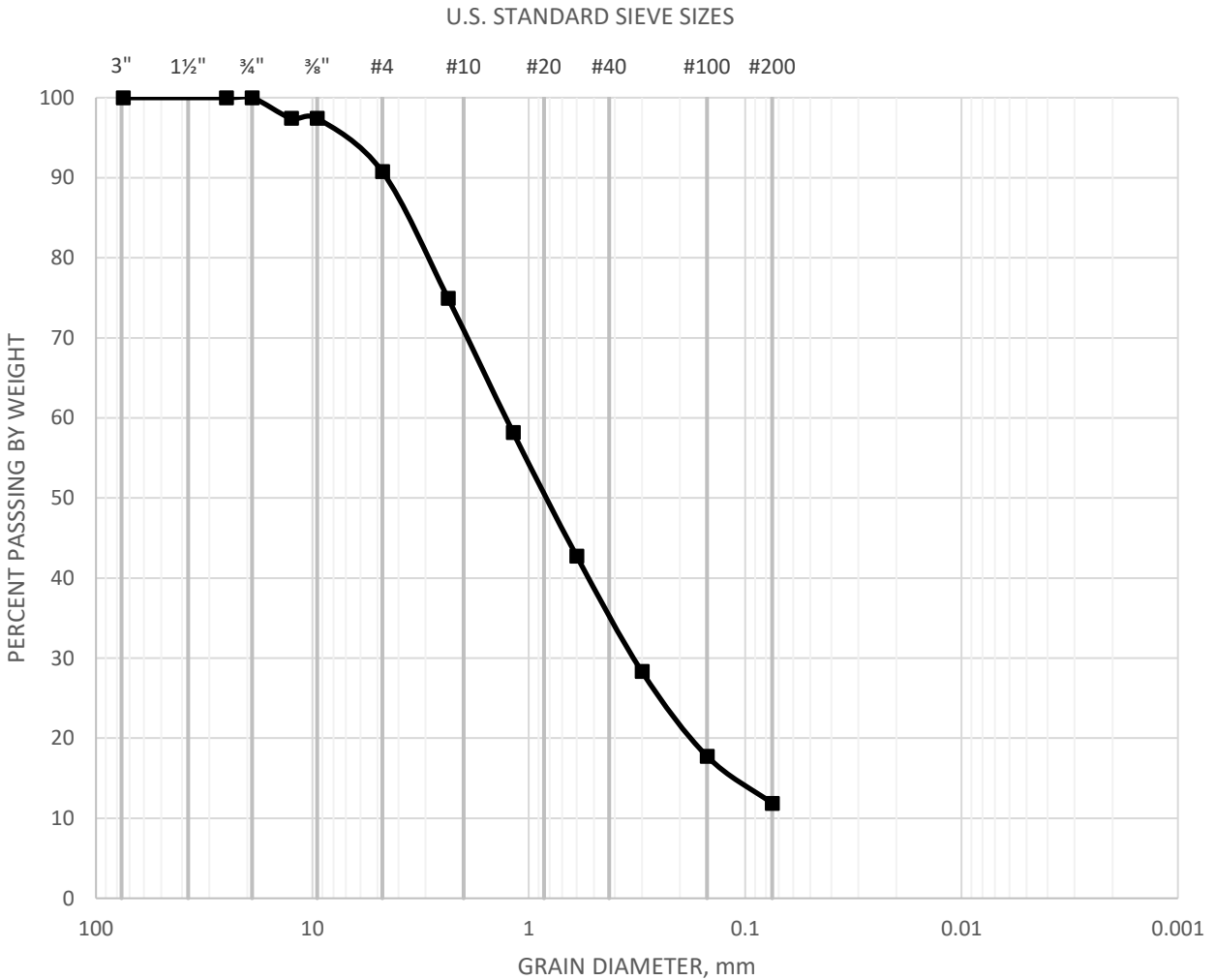

SAMPLE	CLASSIFICATION	D60	D30	D10
P-3@4.5	Well Graded SAND with Silt (SW-SM), olive brown	1.2	0.31	0.073



GRAIN SIZE DISTRIBUTION

ASTM D 6913

Checked by:

Project No.: T2979-22-01

MISSION GROVE REDEVELOPMENT
375 EAST ALESSANDRO BOULEVARD
RIVERSIDE, CALIFORNIA

Jun 22

Figure B-6

GRAVEL		SAND			SILT AND CLAY
COARSE	FINE	COARSE	MEDIUM	FINE	

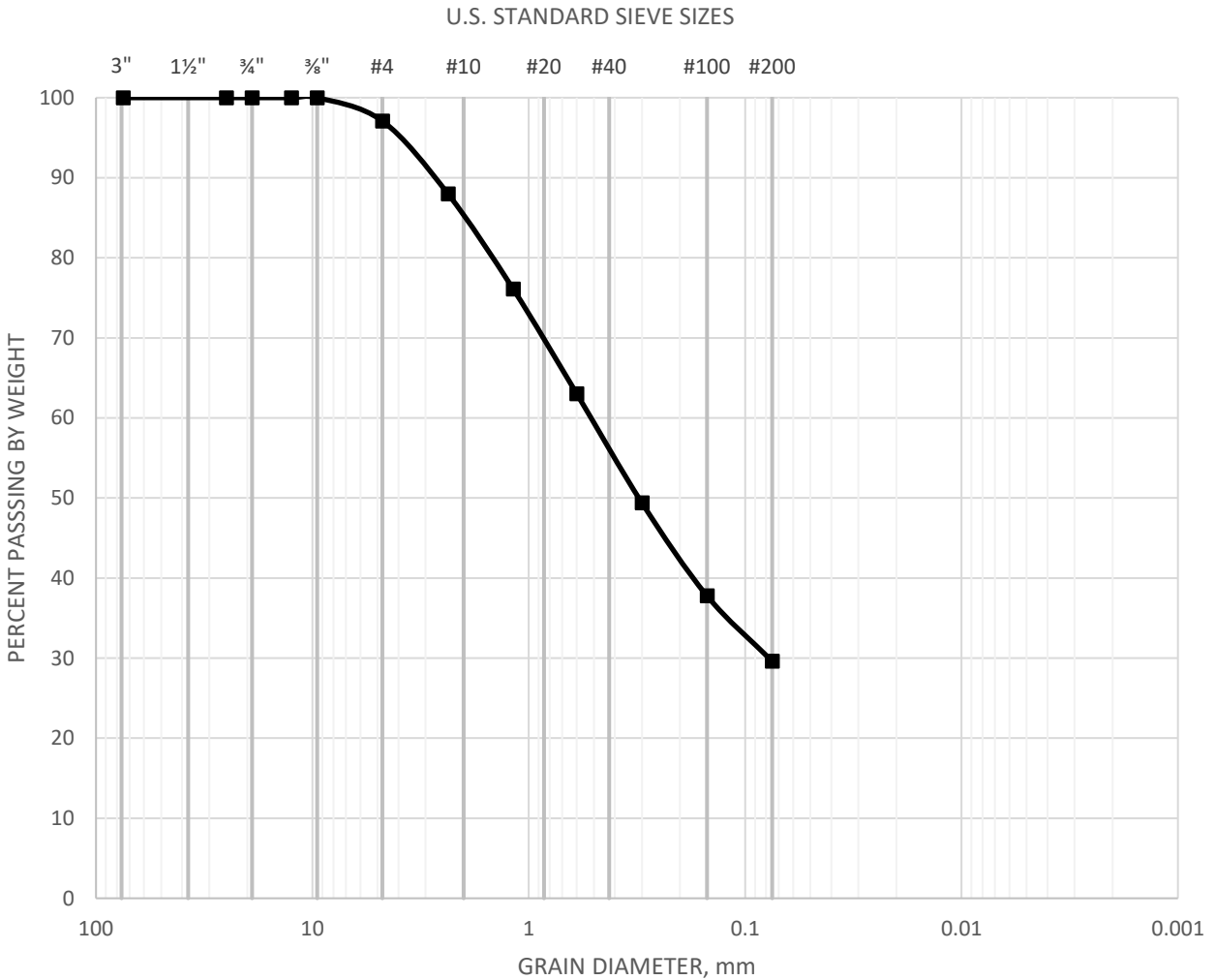

SAMPLE	CLASSIFICATION	D60	D30	D10
P-5@4.5	Silty SAND (SM), dark yellowish brown	0.5	0.073	0.073



GRAIN SIZE DISTRIBUTION

ASTM D 6913

Checked by:

Project No.: T2979-22-01

MISSION GROVE REDEVELOPMENT
375 EAST ALESSANDRO BOULEVARD
RIVERSIDE, CALIFORNIA

Jun 22

Figure B-7

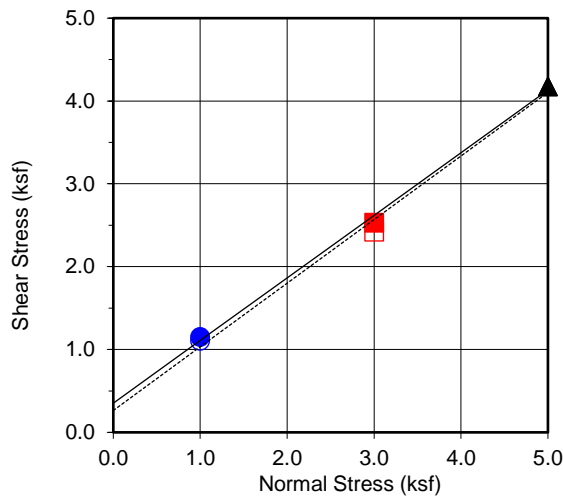
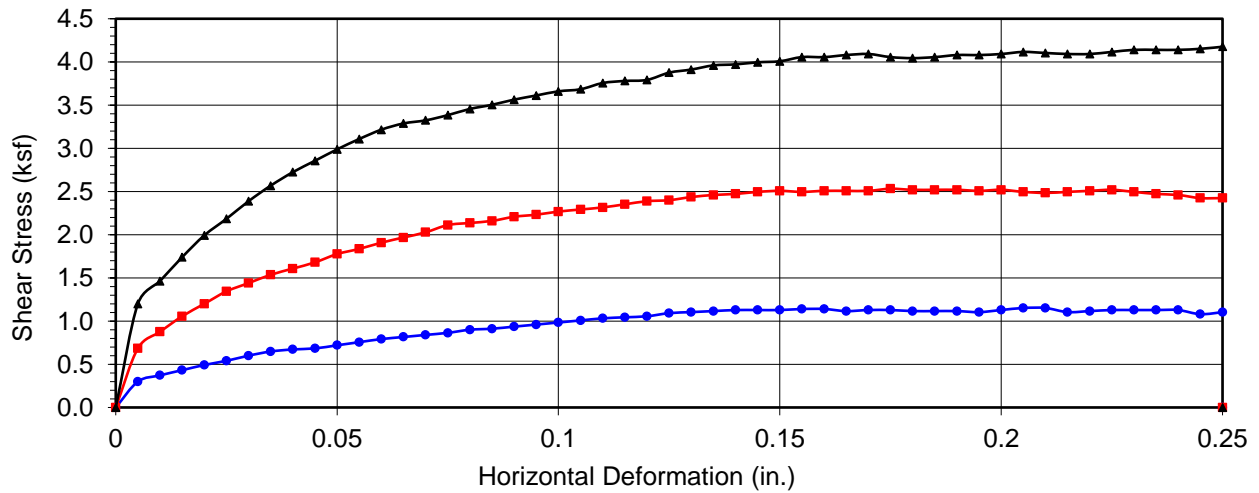

Boring No.	B1
Sample No.	B-1@5
Depth (ft)	5
Sample Type:	ring

<u>Soil Identification:</u>		
Silty SAND with Gravel (SM)g, light grayish brown		
Strength Parameters		
	C (psf)	ϕ (°)
Peak	352	37.1
Ultimate	264	37.5

Normal Stress (kip/ft ²)	1	3	5
Peak Shear Stress (kip/ft ²)	● 1.15	■ 2.53	▲ 4.18
Shear Stress @ End of Test (ksf)	○ 1.10	□ 2.42	△ 4.18
Deformation Rate (in./min.)	0.05	0.05	0.05
Initial Sample Height (in.)	1.0	1.0	1.0
Ring Inside Diameter (in.)	2.375	2.375	2.375
Initial Moisture Content (%)	5.9	6.1	7.8
Initial Dry Density (pcf)	112.8	109.5	113.8
Initial Degree of Saturation (%)	32.1	30.4	44.0
Soil Height Before Shearing (in.)	1.2	1.2	1.2
Final Moisture Content (%)	15.9	15.6	11.4



DIRECT SHEAR TEST RESULTS

Consolidated Drained ASTM D-3080

Checked by:

Project No.: T2979-22-01

MISSION GROVE REDEVELOPMENT
375 EAST ALESSANDRO BOULEVARD
RIVERSIDE, CALIFORNIA

Jun 22

Figure B-8

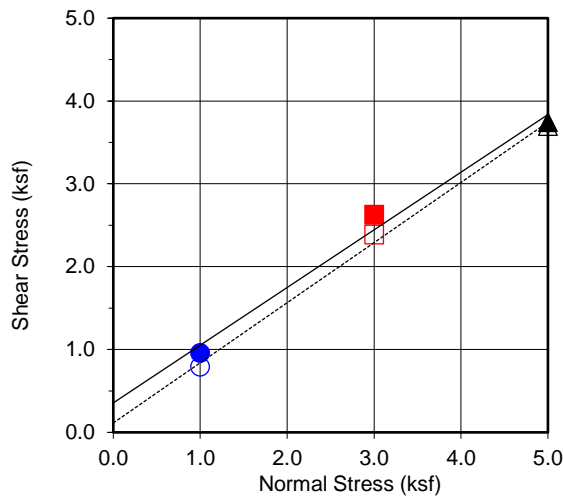
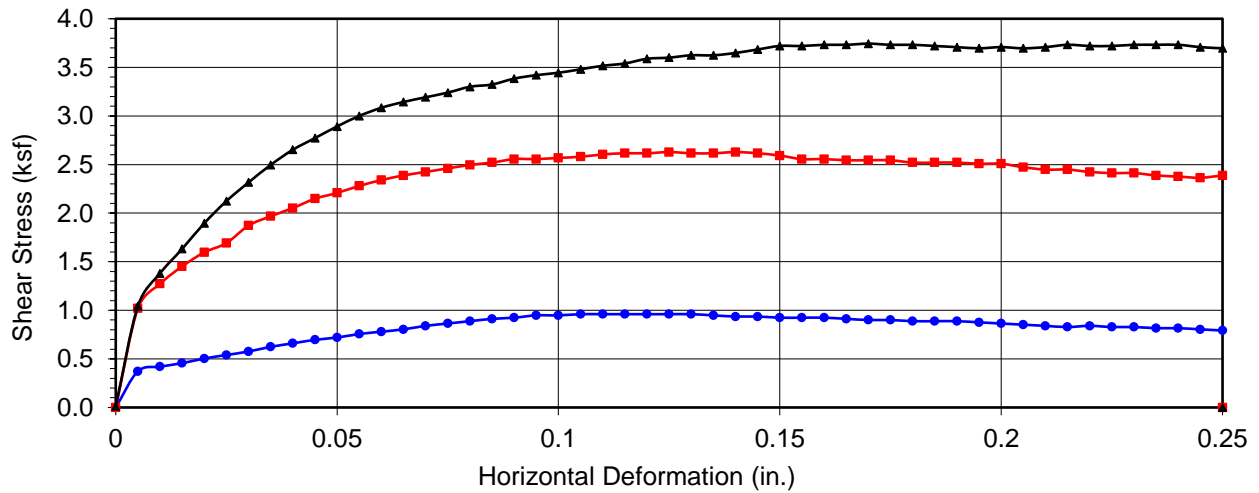

Boring No.	B4
Sample No.	B-4@0-5
Depth (ft)	0-5
<u>Sample Type:</u>	Bulk

<u>Soil Identification:</u>		
Poorly Graded SAND with Silt (SP-SM), olive brown		
Strength Parameters		
	C (psf)	ϕ (°)
Peak	356	34.8
Ultimate	114	36.0

Normal Stress (kip/ft ²)	1	3	5
Peak Shear Stress (kip/ft ²)	● 0.96	■ 2.63	▲ 3.74
Shear Stress @ End of Test (ksf)	○ 0.79	□ 2.39	△ 3.70
Deformation Rate (in./min.)	0.05	0.05	0.05
Initial Sample Height (in.)	1.0	1.0	1.0
Ring Inside Diameter (in.)	2.375	2.375	2.375
Initial Moisture Content (%)	5.9	5.9	5.9
Initial Dry Density (pcf)	124.9	124.9	125.1
Initial Degree of Saturation (%)	45.7	45.4	46.1
Soil Height Before Shearing (in.)	1.2	1.2	1.2
Final Moisture Content (%)	12.9	13.1	12.5



DIRECT SHEAR TEST RESULTS

Consolidated Drained ASTM D-3080

Checked by:

Project No.: T2979-22-01

MISSION GROVE REDEVELOPMENT
375 EAST ALESSANDRO BOULEVARD
RIVERSIDE, CALIFORNIA

Jun 22

Figure B-9

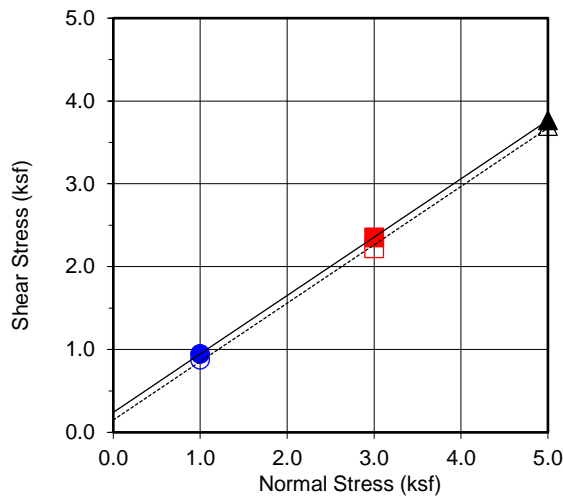
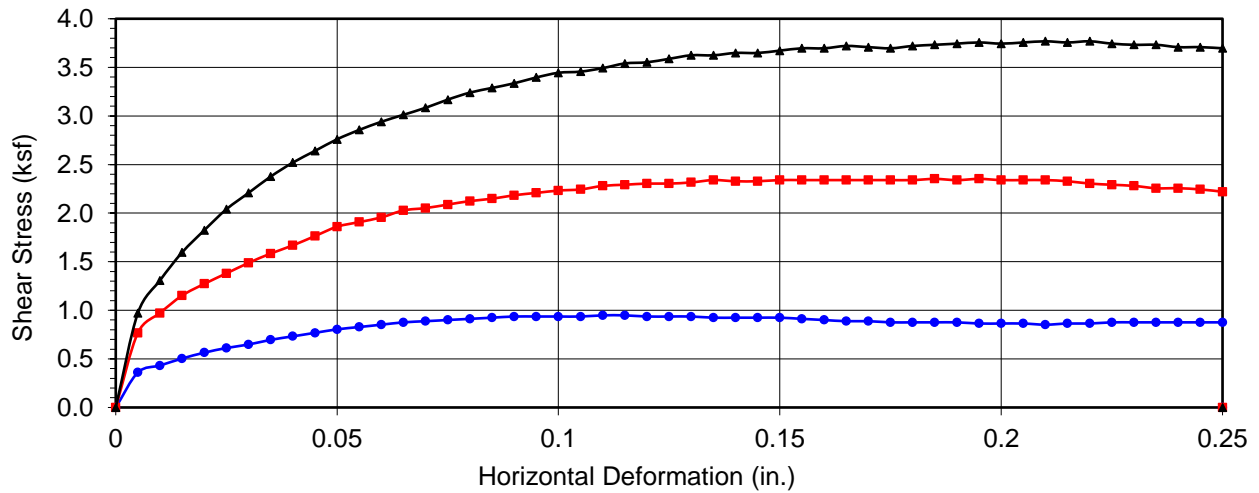

Boring No.	B7
Sample No.	B-7@2-7
Depth (ft)	44599
<u>Sample Type:</u>	Bulk

<u>Soil Identification:</u>		
fly Graded SAND with Silt (SP-SM), dark yellowish br		
Strength Parameters		
	C (psf)	ϕ (°)
Peak	241	35.2
Ultimate	149	35.2

Normal Stress (kip/ft ²)	1	3	5
Peak Shear Stress (kip/ft ²)	● 0.95	■ 2.35	▲ 3.77
Shear Stress @ End of Test (ksf)	○ 0.88	□ 2.22	△ 3.70
Deformation Rate (in./min.)	0.05	0.05	0.05
Initial Sample Height (in.)	1.0	1.0	1.0
Ring Inside Diameter (in.)	2.375	2.375	2.375
Initial Moisture Content (%)	6.9	6.9	6.9
Initial Dry Density (pcf)	122.1	122.0	122.1
Initial Degree of Saturation (%)	48.8	48.9	49.0
Soil Height Before Shearing (in.)	1.2	1.2	1.2
Final Moisture Content (%)	13.1	12.9	10.8



DIRECT SHEAR TEST RESULTS

Consolidated Drained ASTM D-3080

Checked by:

Project No.: T2979-22-01

MISSION GROVE REDEVELOPMENT
375 EAST ALESSANDRO BOULEVARD
RIVERSIDE, CALIFORNIA

Jun 22

Figure B-10

APPENDIX

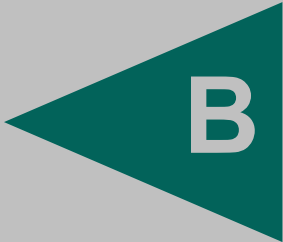

B

APPENDIX B

GEOTECHNICAL INVESTIGATION REPORT DATED

JUNE 13, 2022

FOR

MISSION GROVE REDEVELOPMENT
375 EAST ALESSANDRO BOULEVARD
RIVERSIDE, CALIFORNIA

PROJECT NO. T2979-22-01

**DUE DILIGENCE GEOTECHNICAL
INVESTIGATION**

**MISSION GROVE REDEVELOPMENT
375 EAST ALESSANDRO BOULEVARD
RIVERSIDE, CALIFORNIA**



GEOCON
WEST, INC.

GEOTECHNICAL
ENVIRONMENTAL
MATERIALS

PREPARED FOR

**ANTON MISSION GROVE, LLC.
WALNUT CREEK, CALIFORNIA**

**JUNE 13, 2022
PROJECT NO. T2979-22-01**



Project No. T2979-22-01
June 13, 2022

Anton Mission Grove, LLC.
1676 N California Boulevard, Suite 250
Walnut Creek, California 94596

Attention: Ms. Vanessa Garza, Development Manager

Subject: DUE DILIGENCE GEOTECHNICAL INVESTIGATION
MISSION GROVE REDEVELOPMENT
375 EAST ALESSANDRO BOULEVARD
RIVERSIDE, CALIFORNIA

Dear Ms. Garza:

In accordance with your authorization of Proposal No. IE-2891, Geocon West Inc. (Geocon) herein submits the results of our due diligence geotechnical investigation for the subject site. The accompanying report presents the results of our study and conclusions and recommendations pertaining to the geotechnical aspects of the proposed redevelopment project. The site is considered suitable for development provided the recommendations of this report are followed.

Should you have questions regarding this report, or if we may be of further service, please contact the undersigned at your convenience.

Very truly yours,

GEOCON WEST, INC.

Luke C. Weidman
Staff Geologist, GIT 891

Lisa A. Battiato
CEG 2316



Petrina Zen
PE 87489



Joseph J. Vettel
GE 2401



LCW:LAB:PZ:JIV:hd

TABLE OF CONTENTS

1.	PURPOSE AND SCOPE	1
2.	SITE AND PROJECT DESCRIPTION	2
3.	GEOLOGIC SETTING.....	2
4.	SOIL AND GEOLOGIC CONDITIONS	3
4.1	Asphaltic Concrete Pavement and Aggregate Base.....	3
4.2	Previously Placed Fill.....	3
4.3	Quartz Diorite (qdi)	3
5.	GROUNDWATER	3
6.	GEOLOGIC HAZARDS	4
6.1	Surface Fault Rupture.....	4
6.2	Seismicity	5
6.3	Liquefaction.....	6
6.4	Expansive Soil.....	6
6.5	Hydrocompression.....	7
6.6	Seiches and Tsunamis.....	7
6.7	Inundation.....	7
6.8	Landslides.....	7
6.9	Rock Fall Hazards.....	7
6.10	Slope Stability.....	7
7.	SITE INFILTRATION.....	8
8.	CONCLUSIONS AND RECOMMENDATIONS.....	9
8.1	General.....	9
8.2	Excavation and Soil Characteristics	10
8.3	Grading	12
8.4	Earthwork Grading Factors.....	13
8.5	Utility Trench Backfill.....	14
8.6	Seismic Design Criteria	14
8.7	Shallow Foundation and Concrete Slabs-On-Grade.....	16
8.8	Miscellaneous Foundations	18
8.9	Concrete Flatwork	19
8.10	Conventional Retaining Walls.....	20
8.11	Elevator Pit Design.....	21
8.12	Elevator Piston.....	21
8.13	Swimming Pool	22
8.14	Lateral Loading.....	23
8.15	Preliminary Pavement Recommendations.....	23
8.16	Temporary Excavations	26
8.17	Site Drainage and Moisture Protection.....	27
8.18	Grading and Foundation Plan Review	27

LIMITATIONS AND UNIFORMITY OF CONDITIONS

LIST OF REFERENCES

TABLE OF CONTENTS (Concluded)

MAPS AND ILLUSTRATIONS

- Figure 1, Vicinity Map
- Figure 2, Geologic Map

APPENDIX A

FIELD INVESTIGATION

- Figures A-1 through A-7, Logs of Borings
- Figures A-8 through A-13, Logs of Percolation Borings
- Figures A-14 through A-19, Percolation Test Report Data

APPENDIX B

LABORATORY TESTING

- Figures B-1 and B-2, Compaction Characteristics Using Modified Effort Test Results
- Figure B-3, Expansion Index Test Results
- Figure B-4, Corrosivity Test Results
- Figures B-5 through B-7, Grain Size Distribution
- Figure B-8 through B-10, Direct Shear Test Results

APPENDIX C

RECOMMENDED GRADING SPECIFICATIONS

DUE DILIGENCE GEOTECHNICAL INVESTIGATION

1. PURPOSE AND SCOPE

The purpose of the investigation was to evaluate the subsurface soil and geologic conditions at the site and, based on the conditions encountered and geotechnical analyses performed, provide remedial grading recommendations and geotechnical parameters for project design and construction.

The scope of our investigation included review of published geologic information and aerial photographs, subsurface utility location, subsurface exploration and sample collection, percolation testing, laboratory testing, engineering analyses, and preparation of this report. A summary of the information and documentation reviewed for this study is presented in the *List of References*.

Our field investigation was conducted on May 13 and 16, 2022. Work on May 13 included the drilling of seven geotechnical borings to depths of 15 feet 2 inches to 26 feet 3 inches and six percolation test borings to depths between 2 and 4½ feet below the existing ground surface. The purpose was to observe the subsurface geological and groundwater conditions at the site, and to collect undisturbed and disturbed samples for laboratory testing. Work on May 16 included performing percolation tests at the proposed infiltration basin locations as indicated by the project civil engineer.

A detailed discussion of the field investigation, boring logs and the percolation test results are presented in *Appendix A*. Laboratory tests were performed on select soil samples obtained to evaluate the physical and chemical soil properties for use in engineering analysis. *Appendix B* presents a summary of the laboratory test results.

2. SITE AND PROJECT DESCRIPTION

The site is located at 375 East Alessandro Boulevard in Riverside, California. The property consists of a previous K-mart store with asphalt drive isles and parking spaces, landscaped medians, and landscaped lawn areas between the former K-mart and the roadways to the east and south. The subject site is bounded on the north and west by the active Mission Grove Shopping Center, on the east by Mission Grove Parkway, and on the south by Mission Village Drive. The shopping center was developed before 1994 and after 1985. Aerial photographs taken in 1974 show a gently sloping erosion plain was present at the site prior to development. Val Verde tonalite is geologically mapped at the site. The existing grades range from approximately elevation 1,588 feet above mean sea level (MSL) to the west to 1,598 feet above MSL to the east. The site is at latitude 33.9135 and longitude -117.3256.

Grading plans were not available for our review at the time of this due diligence investigation. The *Infiltration Testing Location* map prepared by Rick Engineering was used as the base for our *Geologic Map*, Figure 2. The site will be redeveloped into a multi-family residential development at or near current grades.

We expect the redevelopment will include cuts and fills of less than 5 feet to reach planned finish grades. Structural plans were not provided for the buildings; however, we assume that the residential structures will be one to four stories, lightly loaded wood and/or metal stud framed buildings. For the purpose of our geotechnical evaluation, we assume that column loads for the proposed residential structures will be up to 400 kips, and wall loads will be up to 5 kips per linear foot. Once the design phase and foundation loading configuration proceeds to a more finalized plan, the recommendations within this report should be reviewed and revised, if necessary.

The locations and descriptions provided herein are based on a site reconnaissance, our field exploration, and project information provided by the client. If project details differ significantly from those described herein, Geocon should be contacted for review and possible revision to this report.

3. GEOLOGIC SETTING

The subject site is located within a seismically active region near the margin between the North American and Pacific tectonic plates. The property is located within the Peninsular Ranges Geomorphic Province which is bounded on the north by the Cucamonga and Sierra Madre faults along the Transverse Ranges, the east by the San Jacinto Fault and the Colorado Desert Geomorphic Province. The Peninsular Ranges extend west off the coast of California and south to the tip of Baja California. Specifically, the site is located on a Perris Erosion Surface in the Woodcrest area of Riverside. The major faults within this area include the San Jacinto Valley (Casa Loma and Claremont branches) and San Bernardino segments of the San Jacinto fault, and the Glen Ivy and Wildomar segments of the Elsinore fault.

4. SOIL AND GEOLOGIC CONDITIONS

Site geologic materials encountered consist of asphalt pavement over aggregate base and previously placed artificial fill to depths of 0 to 2½ feet overlying quartz diorite bedrock. Descriptions of the soil and geologic conditions are shown on the boring logs located in *Appendix A* and are described herein in order of increasing age. The soil and geologic units encountered at the site are discussed below with the geologic nomenclature following that of Dibblee, 2003.

4.1 Asphaltic Concrete Pavement and Aggregate Base

Asphalt and aggregate base were measured at thicknesses of 3 to 6 inches of asphalt over 4 to 8 inches of aggregate base.

4.2 Previously Placed Fill

Previously placed fill was encountered to depths of 0 to 2.5 feet. The fill, as encountered, consists of poorly graded to silty sand which is brown to red brown, moist, and medium dense. Deeper fill is likely present beneath the building due to the common practice of over excavating bedrock to create a fill pad on which to perform construction of buildings. This fill was likely placed during grading of the shopping center between 1985 and 1994.

4.3 Quartz Diorite (qdi)

Quartz diorite was encountered below the pavement sections and previously placed fill and underlies the site at depth. The bedrock consists of white and black granitic rock with oxidized zones of brown. It excavated as well-graded sand. The rock is moderately strong and highly to moderately weathered and moist to wet. We did not encounter refusal during drilling to depths of up to 26 feet 3 inches. However, core stones are common in granitic bedrock and difficult excavations and possible blasting cannot be ruled out between borings.

5. GROUNDWATER

We encountered perched groundwater in the weathered zone of the bedrock in our borings B-1 at 16.5 feet, B-2 at 11.5 feet, B-3 at 11 feet, B-4 at 13.5 feet, B-5 at 15 feet, and B-6 at 15 feet. We did not encounter perched groundwater in B-7 to depths of 15 feet 2 inches. The perched water is likely the result of surficial infiltration in the vicinity of the site moving through the subsurface above the impenetrable bedrock below. The California Department of Water Resources, does not show any wells located on the Perris Erosional Surface within several miles of the site.

It is not uncommon for seepage conditions to develop where none previously existed. Groundwater and seepage are dependent on seasonal precipitation, irrigation, land use, among other factors, and varies as a result. Proper surface drainage will be important to future performance of the project.

6. GEOLOGIC HAZARDS

6.1 Surface Fault Rupture

The numerous faults in southern California include active, potentially active, and inactive faults. The criteria for these major groups are based on criteria developed by the California Geological Survey (CGS, formerly known as CDMG) for the Alquist-Priolo Earthquake Fault Zone Program (Bryant and Hart, 2007). By definition, an active fault is one that has had surface displacement within Holocene time (about the last 11,700 years). A potentially active fault has demonstrated surface displacement during Quaternary time (approximately the last 1.6 million years) but has had no known Holocene movement. Faults that have not moved in the last 1.6 million years are considered inactive.

The site is not within a currently established State of California Alquist-Priolo Earthquake Fault Zone or a Riverside County Fault Hazard Zone for surface fault rupture hazards. No active or potentially active faults with the potential for surface fault rupture are known to pass directly beneath the site.

The closest surface traces of an active faults to the site are the Glen Ivy North branch of the Elsinore Fault Zone and the San Jacinto Valley segment of the San Jacinto Fault, both located 12 miles from the site to the southwest and northeast, respectively. Other nearby active faults are listed in Table 6.1, below.

**TABLE 6.1
ACTIVE FAULTS WITHIN 50 MILES OF THE SITE**

Fault Name	Maximum Magnitude (Mw)	Distance from Site (mi)	Direction from Site
Glen Ivy Fault	6.8	12	SW
San Jacinto-Valley Segment	6.9	12	NE
Chino Fault	6.7	13	W
Casa Loma Fault	6.9	16	SE
Claremont Fault	6.9	18	SE
Glen Helen Fault	6.7	18	N
Whittier Fault	6.8	18	W
Wildomar Fault	6.8	19	W
San Andreas Fault	7.5	19	NE
Cucamonga Fault	6.9	19	N
San Geronio Pass Fault	n/a	26	E
Clark Fault	7.2	29	SE
North Frontal Fault	6.7	38	NE
Newport-Inglewood	7.1	38	W
Pinto Mtn/Morongó Vly	7.2	40	E
Sand Andreas – South Branch	7.5	42	E
Helendale	7.3	44	NE

Geometry: BT = blind thrust, LL = left lateral, N = normal, O = oblique, R = reverse, RL = right lateral, SS = strike slip.

Information Sources: a = Cao, T., Bryant, W.A., Rowshandel, B., Branum, D., and Wills, C.J., 2003, The Revised 2002 California Probabilistic Seismic Hazard Maps, including Appendices A, B, and C, dated June; b = online Fault Activity Map of California website, maps.conservation.ca.gov/cgs/fam/, as of 1/2017.

n/a = data not available.

6.2 Seismicity

As with all of southern California, the site has experienced historic earthquakes from various regional faults. The seismicity of the region surrounding the site was formulated based on research of an electronic database of earthquake data. A number of earthquakes of moderate to major magnitude have occurred in the southern California area within the last 100 years. A partial list of these earthquakes is included in the following table.

**TABLE 6.2
HISTORIC EARTHQUAKE EVENTS WITH RESPECT TO THE SITE**

Earthquake (Oldest to Youngest)	Date of Earthquake	Magnitude	Distance to Epicenter (Miles)	Direction to Epicenter
Near Redlands	July 23, 1923	6.3	31	N
Long Beach	March 10, 1933	6.4	37	W
Tehachapi	July 21, 1952	7.5	139	NW
San Fernando	February 9, 1971	6.6	85	NW
Whittier Narrows	October 1, 1987	5.9	56	NW
Sierra Madre	June 28, 1991	5.8	62	NW
Landers	June 28, 1992	7.3	68	NE
Big Bear	June 28, 1992	6.4	53	NE
Northridge	January 17, 1994	6.7	83	WNW
Hector Mine	October 16, 1999	7.1	94	NE
Ridgecrest China Lake Fault	July 5, 2019	7.1	153	N

6.3 Liquefaction

Liquefaction is a phenomenon in which loose, saturated, relatively cohesionless soil deposits lose shear strength during strong ground motions. Primary factors controlling liquefaction include intensity and duration of ground motion, gradation characteristics of the subsurface soils, in-situ stress conditions, and the depth to groundwater. Liquefaction is typified by a loss of shear strength in the liquefied layers due to rapid increases in pore water pressure generated by earthquake accelerations. Seismically induced “dry-sand” settlement may occur whether the potential for liquefaction exists or not.

Liquefaction typically occurs in areas where the soils below the water table are composed of poorly consolidated, fine to medium-grained, primarily sandy soil. In addition to the requisite soil conditions, the ground acceleration and duration of the earthquake must also be of a sufficient level to induce liquefaction.

The site is underlain at shallow depths by granitic bedrock; therefore, the potential for liquefaction induced settlement or seismic “dry-sand” settlement to occur beneath the site is considered low.

6.4 Expansive Soil

The onsite soils encountered include sands and decomposed granitic rock. Clay develops as granitic rock weathers; therefore, we would also expect some clay to be present within the soils at the site. Laboratory testing result indicates a sample of the near surface soil exhibits a “very low” expansion potential (expansion index [EI] of 20 or less) with test results showing an expansion index of 0.

6.5 Hydrocompression

Hydrocompression is the tendency of unsaturated soil structure to collapse upon wetting resulting in the overall settlement of the affected soil and overlying foundations or improvements supported thereon. Potentially compressible soils underlying the site are typically removed and recompacted during remedial site grading. However, if compressible soil is left in-place, a potential for settlement due to hydrocompression of the soil exists.

Remedial grading will remove and reprocess the site soils resulting in compacted fill overlying granitic bedrock. Therefore, hydrocompression is not a design consideration for this site.

6.6 Seiches and Tsunamis

Seiches are caused by the movement of an inland body of water due to the movement from seismic forces. There are no bodies of water near the site. Therefore, flooding due a seiche is not a design consideration.

A tsunami is a series of long-period waves generated in the ocean by a sudden displacement of large volumes of water. Causes of tsunamis include underwater earthquakes, volcanic eruptions, or offshore slope failures. The site is located approximately 37 miles from the Pacific Ocean at an elevation greater than 1,500 feet MSL. Therefore, the risk of tsunamis affecting the site is negligible and not a design consideration.

6.7 Inundation

According to the State of California, Department of Water Resources, the site is not within an inundation zone due to dam failure. Therefore, inundation due to dam failure is not a design consideration.

6.8 Landslides

Landslides are not mapped on or near the site. Due to the relatively level topography at the site, we opine that landslides are not present at the property or at a location that could impact the subject site.

6.9 Rock Fall Hazards

Rock falls are not a design consideration due to the lack of natural bedrock slopes above and adjacent to the site.

6.10 Slope Stability

Graded slopes are not proposed on the site at this time, therefore slope stability is not a design consideration.

7. SITE INFILTRATION

Percolation testing was performed in accordance with the procedures outlined in *Riverside County Flood Control and Water Conservation District LID BMP, Appendix A* for infiltration basins. The percolation test locations are depicted on the *Geologic Map* (see Figure 2).

Percolation test holes were excavated to a depth of 2 to 4½ feet below existing grades. Approximately two inches of gravel was placed at the bottom of each test hole and a perforated pipe was placed atop the gravel to keep the test hole open. Gravel was placed around the bottom of the test hole to support the test pipe. The test locations were pre-saturated prior to testing. Percolation testing began within 24 hours after the holes were presaturated. Percolation data sheets are presented in *Appendix A* of this report. Percolation test rates were converted to infiltration test rates using the Porchet Method and the results are presented in Table 7.0 below. Test locations are shown on the *Geologic Map* (see Figure 2).

**TABLE 7.0
INFILTRATION TEST RATES FOR PERCOLATION AREAS**

Parameter	P-1	P-2	P-3	P-4	P-5	P-6
Depth (inches)	36	24	54	54	54	54
Test Type	Sandy	Sandy	Sandy	Sandy	Sandy	Sandy
Change in head over time: ΔH (inches)	28.9	28.8	14.6	12.6	25.1	13.4
Average head: Havg (inches)	21.5	21.6	28.7	29.7	23.5	29.3
Time Interval (minutes): Δt (minutes)	10	10	10	10	10	10
Radius of test hole: r (inches)	4	4	4	4	4	4
Tested Infiltration Rate: It (inches/hour)	14.7	4.6	5.7	4.8	11.8	5.2

The results of the infiltration testing indicate that infiltration at the site ranges from 4.6 to 14.7 inches per hour. The appropriate factor of safety should be applied to these values per the Handbook.

The in-situ field percolation tests performed provide short-term infiltration rates, which apply mainly to the initiation of the infiltration process due to the short time of the test (hours instead of days) and the amount of water used. Where appropriate the short-term infiltration rates shall be converted to long-term infiltration rates using reduction factors depending upon the degree of infiltrate quality, maintenance access and frequency, site variability, subsurface stratigraphy variation, and other factors. The small-scale percolation testing cannot model the complexity of the effect of interbedded layers of different soil composition, and our test results should be considered only as index values of infiltration rates.

8. CONCLUSIONS AND RECOMMENDATIONS

8.1 General

- 8.1.1 From a geotechnical engineering standpoint, the site is suitable for redevelopment and construction of the proposed multi-family development, provided the recommendations presented herein are implemented in design and construction of the project.
- 8.1.2 Potential geologic hazards at the site include seismic shaking and compressible near surface previously placed fill.
- 8.1.3 The site is located approximately 12 miles from the nearest active fault. Based on our background research and previous investigation, it is our opinion active, potentially active, or inactive faults do not extend across the site. Risks associated with seismic activity consist of the potential for moderate to strong seismic shaking.
- 8.1.4 The previously placed fill is not considered suitable for the support of compacted fill and settlement-sensitive structures. Remedial grading of the soil will be required as discussed herein. The existing site soils are suitable for re-use as engineered fill provided the recommendations in the *Grading* section of this report are followed.
- 8.1.5 Based on our field investigation, granitic bedrock is present directly below the paving section to 2½ feet below ground surface and may be deeper below the existing retail building. Although not encountered in our exploration, grading operations may encounter zones of hard bedrock, particularly at depth which may require heavy ripping, the use of breakers, or blasting.
- 8.1.6 We recommended that the previously placed fill within the proposed building footprint areas be excavated and properly compacted for foundation and slab support. Areas where structures are proposed should be over excavated to a depth of three feet below planned finished grades or 1 foot below footings, whichever is deeper. Fill should then be placed and compacted in layers to provide a fill mat on which to construct the proposed buildings. Deeper excavations should be conducted as needed to remove existing fill or loose soils at the direction of the Geotechnical Engineer (a representative of Geocon). The overexcavation should extend beyond the building footprint at least 3 feet or a distance equal to the fill depth at a 1:1 (horizontal:vertical) projection from the edge of the building.
- 8.1.7 Grading operations are expected to generate oversize rock which will require special placement. Oversize rock placement recommendations are provided in the *Recommended Grading Specifications in Appendix C*.

- 8.1.8 Some granular on-site soils may have little to no cohesion and are thus subject to caving in unshored excavations. It is the responsibility of the contractor to ensure that excavations and trenches are properly laid back and/or shored and maintained in accordance with OSHA rules and regulations to maintain the stability of adjacent existing improvements and life-safety.
- 8.1.9 The laboratory tests indicate that the site soils are non-expansive and have a “very low” expansion potential. If medium to highly expansive soils are encountered at the site, they should be exported from the site or selectively graded and placed in the deeper fill areas to allow for the placement of low expansion material at the finish pad grade.
- 8.1.10 Grading plans were not available to review at the time of this report. However, based on the existing grades and anticipated grades, cuts and fills of up to 5 feet are expected, not including remedial grading.
- 8.1.11 An existing structure, flatwork, and asphalt concrete parking lots at the site will be demolished as part of the redevelopment. The asphalt concrete can be pulverized, blended with soil, and used as fill or as a subbase within the site roadways and walkway areas, provided it is processed to meet the requirements for use as roadway fill or subbase material. Portland cement concrete (PCC) can be crushed to 6-inch minus with the rebar or other foreign matter removed and can be mixed with soil for use in the fill.
- 8.1.12 Seepage may be encountered during grading and construction of utilities.
- 8.1.13 Proper drainage should be maintained to preserve the design properties of the engineered fill in the sheet-graded pad areas.
- 8.1.14 Once grading and foundation plans become available, they should be reviewed by this office to evaluate the necessity for review and possible revision of this report.

8.2 Excavation and Soil Characteristics

- 8.2.1 Excavation of the previously placed fill and upper portion of the granitic bedrock should be possible with moderate effort using conventional heavy-duty equipment in proper functioning order. Excavation of deeper areas of granitic bedrock, or core stones, if encountered, should be possible with moderate difficulty but is expected to increase in difficulty with depth; zones of hard bedrock may be encountered during grading operations, particularly at depth which may require heavy ripping, the use of breakers, or blasting. Areas where deep excavations are expected should be evaluated via a rippability investigation once final grading and utility plans are available. Excavations in the bedrock are expected to generate oversize rock and may encounter core stones which will require special placement in accordance with the *Recommended Grading Specifications in Appendix C*.

8.2.2 The soil encountered in the field investigation is “non-expansive” (expansion index [EI] of less than 20) as defined by 2019 California Building Code (CBC) Section 1803.5.3. Table 8.2.2 presents soil classifications based on the expansion index. Based on the laboratory test results, we expect a majority of the soil encountered will possess a “very low” expansion potential (EI between 0 and 20). Although unlikely, any medium to highly expansive soils encountered at the site should not be placed within 4 feet of the proposed foundations, flatwork or paving improvements.

**TABLE 8.2.2
EXPANSION CLASSIFICATION BASED ON EXPANSION INDEX**

Expansion Index (EI)	ASTM D 4829 Expansion Classification	2019 CBC Expansion Classification
0 – 20	Very Low	Non-Expansive
21 – 50	Low	Expansive
51 – 90	Medium	
91 – 130	High	
Greater Than 130	Very High	

8.2.3 Additional testing for expansion potential should be performed during finish grading along with plasticity index testing on soils with expansion indices of more than 20.

8.2.4 Laboratory tests performed on samples of the site materials indicate that the on-site materials possess a sulfate content of 0.000 percent (0 parts per million [ppm]) equating to a S0 sulfate exposure to concrete structures as defined by 2019 CBC Section 1904.3 and ACI 318. Table 8.2.3 presents a summary of concrete requirements set forth by 2019 CBC Section 1904.3 and ACI 318. The presence of water-soluble sulfates is not a visually discernible characteristic; therefore, other soil samples from the site could yield different concentrations. Additionally, over time landscaping activities (i.e., addition of fertilizers and other soil nutrients) may affect the concentration.

**TABLE 8.2.4
REQUIREMENTS FOR CONCRETE EXPOSED TO
SULFATE-CONTAINING SOLUTIONS**

Exposure Class	Water-Soluble Sulfate (SO ₄) Percent by Weight	Cement Type (ASTM C 150)	Maximum Water to Cement Ratio by Weight ¹	Minimum Compressive Strength (psi)
S0	SO ₄ <0.10	No Type Restriction	n/a	2,500
S1	0.10≤SO ₄ <0.20	II	0.50	4,000
S2	0.20≤SO ₄ ≤2.00	V	0.45	4,500
S3	SO ₄ >2.00	V+Pozzolan or Slag	0.45	4,500

¹ Maximum water to cement ratio limits do not apply to lightweight concrete.

8.2.5 Laboratory testing indicates the site soils have a minimum electrical resistivity of 8,000 ohm-cm, possess 20 ppm chloride, 0 ppm sulfate, and a pH of 8.4. As shown in Table 8.2.5 below, the site would **not** be classified as “corrosive” to buried improvements, in accordance with the Caltrans Corrosion Guidelines (Caltrans, 2021).

**TABLE 8.2.5
CALTRANS CORROSION GUIDELINES**

Corrosion Exposure	Resistivity (ohm-cm)	Chloride (ppm)	Sulfate (ppm)	pH
Corrosive	<1,500	500 or greater	1,500 or greater	5.5 or less

8.2.6 Geocon does not practice in the field of corrosion engineering. Therefore, further evaluation by a corrosion engineer may be performed if improvements that could be susceptible to corrosion are planned.

8.3 Grading

8.3.1 Grading should be performed in accordance with the *Recommended Grading Specifications of Appendix C* and the grading ordinances of the City of Riverside.

8.3.2 Prior to commencing grading, a preconstruction conference should be held at the site with the City Inspector, Owner or Developer, Grading Contractor, Civil Engineer, and Geotechnical Engineer in attendance. Special soil handling and/or the grading plans can be discussed at that time.

8.3.3 Site preparation should begin with the removal of existing improvements, deleterious material, debris and vegetation. The depth of removal should be such that material exposed in cut areas or soil to be used as fill is relatively free of organic matter. Material generated during stripping and/or site demolition should be exported from the site.

8.3.4 Remedial grading should entail the removal of the previously placed fill to expose granitic bedrock. Based on our investigation, removals will be 1 to 3 feet deep; however, deeper removals could be required if deeper fill is located beneath the existing building. Areas where structures are proposed should be over excavated to a depth of three feet below planned finished grades or 1 foot below footings, whichever is deeper. The actual depth of remedial grading should be evaluated by the Engineering Geologist during grading operations. Removals should extend laterally a minimum of 3 feet or for a distance equal to the depth of the removal, whichever is greater, so as to maintain a 1:1 (h:v) projection from the outside bottom edge of footings. The bottom of the excavations in soil should be scarified to a depth of at least 1 foot, moisture conditioned at or slightly above optimum moisture content, and compacted to 90 percent of the laboratory maximum dry density, as determined by ASTM D1557, prior to fill placement.

- 8.3.5 The site should be brought to finish grade elevations with engineered fill compacted in layers. Layers of fill should be no thicker than will allow for adequate bonding and compaction. Fill, including backfill and scarified ground surfaces, should be compacted to a dry density of at least 90 percent of the laboratory maximum dry density at or slightly above optimum moisture content (as determined by ASTM D1557). Fill materials placed below optimum moisture content may require additional moisture conditioning prior to placing additional fill.
- 8.3.6 The fill placed within 4 feet of proposed finish grade should possess a “low” to “very low” expansion potential (EI of 50 or less), where practical.
- 8.3.7 Over excavation of cut fill transition lots and cut lots should be performed in accordance with the appended *Recommended Grading Specifications*.
- 8.3.8 Oversized rock (i.e. rock greater than 12-inches in maximum dimension) will be encountered and generated during grading operations. The oversize rock will require special handling and placement. Rocks greater than 3 inches in maximum dimensions should not be placed within utility trench backfill. Rocks greater than 6 inches in maximum dimension should not be placed in soil fill within the upper 3 feet of finish grade. Rocks 6 to 12 inches in maximum dimension should be placed deeper than 3 feet below finished grade elevations. Rocks 12 inches or larger in maximum dimension should be exported from the site or placed at specified depths in accordance with the *Recommended Grading Specifications* in *Appendix C*.
- 8.3.9 Import fill (if necessary) should consist of granular materials with a “low” expansion potential (EI of 50 or less), generally free of deleterious material and rock fragments larger than 6 inches and should be compacted as recommended herein. Geocon should be notified of the import soil source and should perform laboratory testing of import soil prior to its arrival at the site to evaluate its suitability as fill material.

8.4 Earthwork Grading Factors

- 8.4.1 Estimates of shrinkage factors are based on empirical judgments comparing the material in its existing or natural state as encountered in the exploratory excavations to a compacted state. Variations in natural soil density and in compacted fill density render shrinkage value estimates very approximate. As an example, the contractor can compact the fill to a dry density of 90 percent or higher of the laboratory maximum dry density. Thus, the contractor has an approximately 10 percent range of control over the fill volume. Due to the variations in the actual shrinkage/bulking factors, a balance area should be provided to accommodate variations.

8.5 Utility Trench Backfill

- 8.5.1 Utility trenches should be properly backfilled in accordance with the requirements of the City of Riverside and the latest edition of the *Standard Specifications for Public Works Construction* (Greenbook). The pipes should be bedded with well-graded crushed rock or clean sand (Sand Equivalent greater than 30) to a depth of at least one foot over the pipe. If open graded rock is used it should be wrapped in filter fabric to prevent finer soils from migrating into the rock voids. The remainder of the trench backfill may be derived from onsite soil or approved import soil. Backfill of utility trenches should not contain rocks greater than 3 inches in diameter. The use of 2-sack slurry and controlled low strength material (CLSM) are also acceptable as backfill. However, consideration should be given to the possibility of differential settlement where the slurry ends and earthen backfill begins. These transitions should be minimized, and additional stabilization should be considered at these transitions.
- 8.5.2 Utility trench backfill should be placed in layers no thicker than will allow for adequate bonding and compaction. Utility backfill should be compacted to a dry density of at least 90 percent of the laboratory maximum dry density and moisture conditioned at or slightly above optimum moisture content (as determined by ASTM D1557). Backfill at the finish subgrade elevation of new pavements should be compacted to at least 95 percent of the maximum dry density. Backfill materials placed below the recommended moisture content may require additional moisture conditioning prior to placing additional fill.

8.6 Seismic Design Criteria

- 8.6.1 The following table summarizes site-specific design criteria obtained from the 2019 California Building Code (CBC; Based on the 2018 International Building Code [IBC] and ASCE 7-16), Chapter 16 Structural Design, Section 1613 Earthquake Loads. We used the computer program *Seismic Design Maps*, provided by the Structural Engineers Association (SEA) to calculate the seismic design parameters. The short spectral response uses a period of 0.2 second. We evaluated the Site Class based on the discussion in Section 1613.2.2 of the 2019 CBC and Table 20.3-1 of ASCE 7-16. The values presented herein are for the risk-targeted maximum considered earthquake (MCE_R).

**TABLE 8.6.1
2019 CBC SEISMIC DESIGN PARAMETERS**

Parameter	Value	2019 CBC Reference
Site Class	B	Section 1613.3.2
MCE _R Ground Motion Spectral Response Acceleration – Class B (short), S _S	1.5g	Figure 1613.3.1(1)
MCE _R Ground Motion Spectral Response Acceleration – Class B (1 sec), S ₁	0.594g	Figure 1613.3.1(2)
Site Coefficient, F _A	0.9	Table 1613.3.3(1)
Site Coefficient, F _V	0.8	Table 1613.3.3(2)
Site Class Modified MCE _R Spectral Response Acceleration (short), S _{MS}	1.35g	Section 1613.3.3 (Eqn 16-37)
Site Class Modified MCE _R Spectral Response Acceleration (1 sec), S _{M1}	0.476g	Section 1613.3.3 (Eqn 16-38)
5% Damped Design Spectral Response Acceleration (short), S _{DS}	0.9g	Section 1613.3.4 (Eqn 16-39)
5% Damped Design Spectral Response Acceleration (1 sec), S _{D1}	0.317g	Section 1613.3.4 (Eqn 16-40)

8.6.2 The table below presents the mapped maximum considered geometric mean (MCE_G) seismic design parameters for projects located in Seismic Design Categories of D through F in accordance with ASCE 7-16.

**TABLE 8.6.2
ASCE 7-16 PEAK GROUND ACCELERATION**

Parameter	Value	ASCE 7-16 Reference
Mapped MCE _G Peak Ground Acceleration, PGA	0.5g	Figure 22-9
Site Coefficient, F _{PGA}	0.9	Table 11.8-1
Site Class Modified MCE _G Peak Ground Acceleration, PGA _M	0.45g	Section 11.8.3 (Eqn 11.8-1)

8.6.3 Conformance to the criteria in the above tables for seismic design does not constitute any kind of guarantee or assurance that significant structural damage or ground failure will not occur if a large earthquake occurs. The primary goal of seismic design is to protect life, not to avoid all damage, since such design may be economically prohibitive.

8.7 Shallow Foundation and Concrete Slabs-On-Grade

- 8.7.1 The foundation recommendations presented herein are for the proposed residential buildings subsequent to the recommended grading. We understand that future buildings will be supported on a conventional shallow foundation with concrete slabs-on-grade, deriving support in newly placed engineered fill.
- 8.7.2 The foundation for structures may consist of either continuous strip footings and/or isolated spread footings. Conventionally reinforced continuous footings should be at least 12 inches wide and extend at least 18 inches below lowest adjacent pad grade; isolated spread footings should have a minimum width of 24 inches and should extend at least 18 inches below lowest adjacent pad grade. A graphic depicting the foundation embedment is provided below.

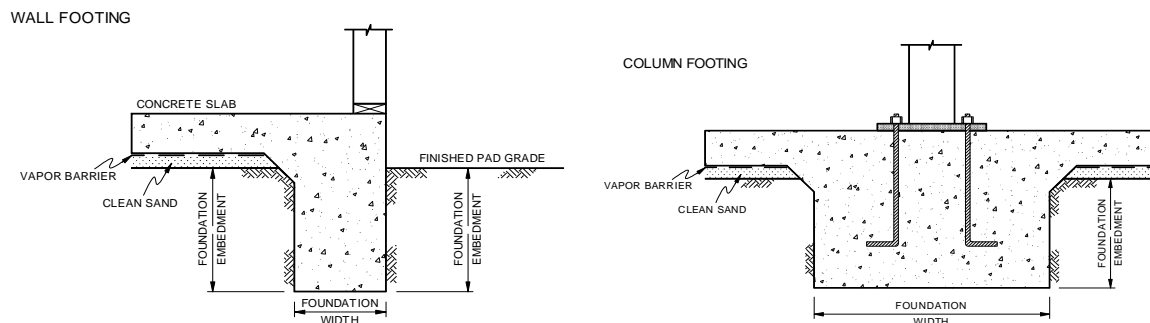

Wall/Column Footing Detail

- 8.7.3 From a geotechnical engineering standpoint, concrete slabs-on-grade for the structure should be at least 4 inches thick and be reinforced with at least No. 3 steel reinforcing bars placed 18 inches on center in both directions. The concrete slab-on-grade recommendations are based on soil support characteristics only. The project structural engineer should evaluate the structural requirements of the concrete slab for supporting equipment and storage loads. A thicker concrete slab may be required for heavier loading conditions. To reduce the effects of differential settlement on the foundation system, thickened slabs and/or an increase in steel reinforcement can provide a benefit to reduce concrete cracking.
- 8.7.4 Reinforcing steel for continuous footings should consist of at least four No. 4 steel reinforcing bars placed horizontally in the footings, two near the top and two near the bottom for the warehouse and commercial buildings; and at least two No. 4 steel bars placed horizontally in the footings, one near the top and one near the bottom for the residential buildings. Reinforcing steel for the spread footings should be designed by the project structural engineer.

- 8.7.5 Following remedial grading, foundations for the buildings may be designed for an allowable soil bearing pressure of 2,500 psf (dead plus live load). The soil bearing pressure may be increased by 250 psf and 500 psf for each additional foot of foundation width and depth, respectively, up to a maximum allowable soil bearing pressure of 4,500 psf. The allowable bearing pressure may be increased by one-third for transient loads due to wind or seismic forces.
- 8.7.6 The maximum expected static settlement for the planned structures, supported on conventional foundation systems with the above allowable bearing pressures and deriving support in engineered fill, is estimated to be on the order of ½ inch and to occur below the heaviest loaded structural element, with differential static settlement to be on the order of ¼ inch over a horizontal distance of 40 feet. Settlement of the foundation system is expected to occur on initial application of loading.
- 8.7.7 Once the design and foundation loading configuration proceeds to a more finalized plan, the estimated settlements within this report should be reviewed and revised, if necessary.
- 8.7.8 Foundation excavation bottoms must be observed and approved in writing by a qualified representative of Geocon, prior to placement of reinforcing steel or concrete.
- 8.7.9 Slabs that may receive moisture-sensitive floor coverings or may be used to store moisture-sensitive materials should be underlain by a vapor retarder. The vapor retarder design should be consistent with the guidelines presented in the American Concrete Institute's (ACI) Guide for Concrete Slabs that Receive Moisture-Sensitive Flooring Materials (ACI 302.2R-06). The vapor retarder used should be specified by the project architect or developer based on the type of floor covering that will be installed and if the structure will possess a humidity-controlled environment.
- 8.7.10 The bedding sand thickness should be evaluated by the project foundation engineer, architect, and/or developer. However, we should be contacted to provide recommendations if the bedding sand is thicker than 4 inches. Placement of 4 inches of sand is common practice in Southern California for 5 4-inch-thick slabs. The foundation engineer should provide appropriate concrete mix design criteria and curing measures that may be utilized to assure proper curing of the slab to reduce the potential for rapid moisture loss and subsequent cracking and/or slab curl. We suggest that the foundation design engineer present the concrete mix design and proper curing methods on the foundation plans. It is critical that the foundation contractor understands and follows the recommendations presented on the foundation plans.

- 8.7.11 Special subgrade presaturation is not deemed necessary prior to placing concrete; however, the exposed foundation and slab subgrade soil should be moisturized to maintain a moist condition between 0 and 2 percent above optimum moisture content.
- 8.7.12 The recommendations of this report are intended to reduce the potential for cracking of slabs due to expansive soil (if present), differential settlement of existing soil or soil with varying thicknesses. However, even with the incorporation of the recommendations presented herein, foundations, walls, and slabs-on-grade placed on such conditions may still exhibit some cracking due to soil movement and/or shrinkage. The occurrence of concrete shrinkage cracks is independent of the supporting soil characteristics. Their occurrence may be reduced and/or controlled by limiting the slump of the concrete, proper concrete placement and curing, and by the placement of crack control joints at periodic intervals, in particular where re-entrant slab corners occur.
- 8.7.13 Geocon should be consulted to provide additional design parameters as required by the structural engineer.

8.8 Miscellaneous Foundations

- 8.8.1 Foundations for small outlying structures, such as block walls up to 6 feet in height, planter walls or trash enclosures which will not be tied to the proposed structures may be supported on conventional foundations bearing on a minimum of 12 inches of newly placed engineered fill which extends laterally at least 12 inches beyond the foundation area. Where excavation and compaction cannot be performed, such as adjacent to property lines, foundations may derive support in the undisturbed granitic bedrock, and should be deepened as necessary to maintain a minimum 12-inch embedment into undisturbed granitic bedrock and must be observed and approved by a Geocon representative.
- 8.8.2 If soils exposed in the footing excavations are loose or soft, subgrade stabilization will be required prior to placing steel or concrete. Miscellaneous foundations may be designed for an allowable bearing value of 1,500 psf, and should be a minimum of 12 inches in width, 18 inches in depth below the lowest adjacent grade and 12 inches into the recommended bearing material. The allowable bearing pressure may be increased by up to one-third for transient loads due to wind or seismic forces.
- 8.8.3 Foundation excavations should be observed and approved in writing by the geotechnical engineer, prior to the placement of reinforcing steel and concrete to verify that the excavations and exposed soil conditions are consistent with those anticipated.

8.9 Concrete Flatwork

- 8.9.1 Exterior concrete flatwork not subject to vehicular traffic should be constructed in accordance with the recommendations herein assuming the subgrade materials possess an Expansion Index of 50 or less. Subgrade soils should be compacted to 90 percent relative compaction at or slightly above optimum moisture content. Slab panels should be a minimum of 4 inches thick and when in excess of 8 feet square should be reinforced with No. 3 reinforcing bars spaced 18 inches center-to-center in both directions to reduce the potential for cracking. In addition, concrete flatwork should be provided with crack control joints to reduce and/or control shrinkage cracking. Crack control spacing should be determined by the project structural engineer based upon the slab thickness and intended usage. Criteria of the American Concrete Institute (ACI) should be taken into consideration when establishing crack control spacing. Subgrade soil for exterior slabs not subjected to vehicle loads should be compacted in accordance with criteria presented in the *Grading* section prior to concrete placement. Subgrade soil should be properly compacted, and the moisture content of subgrade soil should be verified prior to placing concrete. Base materials will not be required below concrete improvements.
- 8.9.2 Even with the incorporation of the recommendations of this report, the exterior concrete flatwork has a potential to experience some uplift due to expansive soil beneath grade. The reinforcement steel should overlap continuously in flatwork to reduce the potential for vertical offsets within flatwork. Additionally, flatwork should be structurally connected to the curbs, where possible, to reduce the potential for offsets between the curbs and the flatwork.
- 8.9.3 Where exterior flatwork abuts the structure at entrant or exit points, the exterior slab should be dowelled into the structure's foundation stem wall. This recommendation is intended to reduce the potential for differential elevations that could result from differential settlement or minor heave of the flatwork. Dowelling details should be designed by the project structural engineer.
- 8.9.4 The recommendations presented herein are intended to reduce the potential for cracking of exterior slabs as a result of differential movement. However, even with the incorporation of the recommendations presented herein, slabs-on-grade will still crack. The occurrence of concrete shrinkage cracks is independent of the soil supporting characteristics. Their occurrence may be reduced and/or controlled by limiting the slump of the concrete, the use of crack control joints and proper concrete placement and curing. Crack control joints should be spaced at intervals no greater than 12 feet. Literature provided by the Portland Concrete Association (PCA) and American Concrete Institute (ACI) present recommendations for proper concrete mix, construction, and curing practices, and should be incorporated into project construction.

8.10 Conventional Retaining Walls

- 8.10.1 The recommendations presented herein are generally applicable to the design of rigid concrete or masonry retaining walls having a maximum height of 5 feet. In the event that walls higher than 5 feet or other types of walls are planned, Geocon should be consulted for additional recommendations.
- 8.10.2 Retaining wall foundations may be designed in accordance with the recommendations provided in the *Foundation and Concrete Slabs-On-Grade Recommendations* section of this report.
- 8.10.3 Retaining walls that are allowed to rotate more than $0.001H$ (where H equals the height of the retaining portion of the wall in feet) at the top of the wall with a level backfill surface should be designed utilizing a triangular distribution of pressure (active pressure) of 30 psf/ft. Where walls are restrained from movement at the top and are retaining a level soil backfill, walls may be designed utilizing a triangular distribution of pressure (at-rest pressure) of 53 pcf.
- 8.10.4 The wall pressures provided above assume that the retaining wall will be properly drained preventing the buildup of hydrostatic pressure. If retaining wall drainage is not implemented, the equivalent fluid pressure to be used in design of undrained walls is 89 pcf. The value includes hydrostatic pressures plus buoyant lateral earth pressures.
- 8.10.5 Retaining walls not designed for hydrostatic pressures should be provided with a drainage system adequate to prevent the buildup of hydrostatic forces and waterproofed as required by the project architect. The soil immediately adjacent to the backfilled retaining wall should be composed of free draining material completely wrapped in Mirafi 140 (or equivalent) filter fabric for a lateral distance of 1 foot for the bottom two-thirds of the height of the retaining wall. The upper one-third should be backfilled with less permeable compacted fill to reduce water infiltration. The use of drainage openings through the base of the wall (weep holes) is not recommended where the seepage could be a nuisance or otherwise adversely affect the property adjacent to the base of the wall. The recommendations herein assume a properly compacted backfill (EI of 50 or less) with no hydrostatic forces or imposed surcharge load. If conditions different than those described are expected or if specific drainage details are desired, Geocon should be contacted for additional recommendations. A graphic depicting typical retaining wall drainage is provided below.

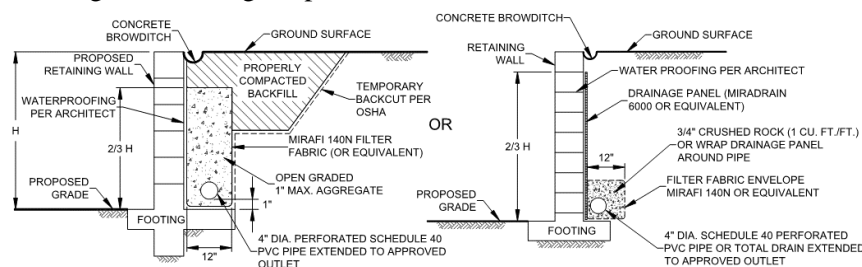

Typical Retaining Wall Drainage Detail

- 8.10.6 The wall pressures provided above assume that the proposed retaining walls will support relatively undisturbed soils or engineered fill derived from onsite soils, with an EI of 50 or less. If imported soil will be used to backfill proposed retaining walls, revised earth pressures may be required to account for the geotechnical properties of the import soil used as engineered fill. This should be evaluated once the use of import soil is established. All imported fills shall be observed, tested, and approved by Geocon West, Inc. prior to bringing soil to the site.
- 8.10.7 Additional active pressure should be added for a surcharge condition due to sloping ground, vehicular traffic, or adjacent structures. Once the design becomes more finalized, an addendum letter can be prepared revising recommendations and addressing specific surcharge conditions throughout the project, if necessary.
- 8.10.8 Unrestrained walls will move laterally when backfilled and loading is applied. The amount of lateral deflection is dependent on the wall height, the type of soil used for backfill, and loads acting on the wall. The retaining walls and improvements above the retaining walls should be designed to incorporate an appropriate amount of lateral deflection as determined by the structural engineer.

8.11 Elevator Pit Design

- 8.11.1 The elevator pit slab and retaining wall should be designed by the project structural engineer. Elevator pit walls may be designed in accordance with the recommendations in the *Shallow Foundation and Concrete Slabs-On-Grade* and *Conventional Retaining Walls* sections of this report.
- 8.11.2 Additional active pressure should be added for a surcharge condition due to sloping ground, vehicular traffic or adjacent foundations and should be designed for each condition as the project progresses.
- 8.11.3 If retaining wall drainage is to be provided, the drainage system should be designed in accordance with the *Conventional Retaining Walls* section of this report.
- 8.11.4 We recommend that the elevator pit walls and slab be waterproofed to prevent excessive moisture inside of the elevator pit. Waterproofing design and installation is not the responsibility of the geotechnical engineer.

8.12 Elevator Piston

- 8.12.1 If a plunger-type elevator piston is installed for this project, a deep drilled excavation will be required. It is important to verify that the drilled excavation is not situated immediately adjacent to a foundation, or the drilled excavation could compromise the existing foundation, especially if the drilling is performed subsequent to the foundation construction.

- 8.12.2 Casing may be required if caving is experienced in the drilled excavation. The contractor should be prepared to use casing and should have it readily available at the commencement of drilling activities. Continuous observation of the drilling and installation of the elevator piston by the Geotechnical Engineer (a representative of Geocon West, Inc.) is required.
- 8.12.3 The annular space between the piston casing and drilled excavation wall should be filled with a minimum of 1½-sack slurry pumped from the bottom up. As an alternative, pea gravel may be utilized. The use of soil to backfill the annular space is not acceptable.

8.13 Swimming Pool

- 8.13.1 For the proposed pools, the shell bottoms should be designed as a free-standing structure and may derive support on undisturbed granitic bedrock or a minimum of 2 feet of engineered fill compacted to a dry density of at least 90 percent of the laboratory maximum dry density at 0 to 2 percent above optimum moisture content as determined by ASTM D1557.
- 8.13.2 Swimming pool foundations and walls may be designed in accordance with the *Shallow Foundation and Concrete Slabs-On-Grade* and *Conventional Retaining Walls* sections of this report. A hydrostatic relief valve should be considered as part of the swimming pool design unless a gravity drain system can be placed beneath the pool shell.
- 8.13.3 Surface drainage around the pool/spa should be designed to prevent water from ponding and seeping into the ground. Surface water should be collected and conducted through non-erosive devices to the street, storm drain or other approved water course or disposal area. Leakage from the proposed pool/spa could create an artificial groundwater condition that will likely create instability problems. Therefore, all plumbing and the pool/spa should be leak free.
- 8.13.4 The deck for the swimming pool/spa should be cast separately of the swimming pool/spa, and water stops should be provided between the bond beam and the deck. Jointing for concrete flatwork should be provided in accordance with the recommendations of the American Concrete Institute. The joints should be sealed with an approved flexible sealant to reduce the potential for introduction of surface water into the underlying soil.
- 8.13.5 Consideration should be given to installing a subdrain system for the pool area. The subgrade surface should be graded to slope a minimum of 1 percent away from the pool. An impermeable liner (e.g. High-density polyethylene, HDPE, with a thickness of about 30 mil or equivalent PVC liner) could be placed over the subgrade soil. The liner, if installed, should overlap by at least 12 inches and sealed in accordance with manufacturer's recommendations.

- 8.13.6 To mitigate the potential for moisture infiltration into the subgrade soils beneath the pool deck, we recommend the construction of a deepened footing along the outside edge of the pool deck flatwork. A subdrain consisting of 4-inch diameter perforated PVC pipe should be installed inside the deepened footing and sloped to drain into an approved outlet. The pipe should be surrounded by $\frac{3}{4}$ inch open-graded gravel and wrapped with filter fabric.
- 8.13.7 If the proposed pools are in proximity to a proposed or existing structure, consideration should be given to the construction sequence. If the proposed pool is to be constructed near an existing structure, or a proposed structure that is constructed before the pool's construction, the excavation required for the pool could remove a critical component of lateral support from the structure's foundations and would therefore require shoring to safeguard the structure's foundations. Once information regarding the pool locations and depth becomes available, this information should be provided to Geocon for review and possible revision of these recommendations.

8.14 Lateral Loading

- 8.14.1 To resist lateral loads, a passive pressure exerted by an equivalent fluid density of 310 pounds per cubic foot (pcf) should be used for the design of footings or shear keys. The allowable passive pressure assumes a horizontal surface extending at least 5 feet, or three times the surface generating the passive pressure, whichever is greater. The upper 12 inches of material in areas not protected by floor slabs or pavement should not be included in design for passive resistance.
- 8.14.2 If friction is to be used to resist lateral loads, an allowable coefficient of friction between soil and concrete of 0.4 should be used for design. The friction coefficient may be reduced depending on the vapor barrier or waterproofing material used for construction in accordance with the manufacturer's recommendations.
- 8.14.3 The passive and frictional resistant loads can be combined for design purposes. The lateral passive pressures may be increased by one-third when considering transient loads due to wind or seismic forces.

8.15 Preliminary Pavement Recommendations

- 8.15.1 We calculated the flexible pavement sections in general conformance with the *Caltrans Method of Flexible Pavement Design* (Highway Design Manual, Section 608.4) and the County of Riverside's *Road Improvement Standards & Specifications* (Ordinance No. 461) using a range of Traffic Indices. The project civil engineer and owner should evaluate the final Traffic Index for the pavements and review the pavement designations to determine appropriate locations for pavement thickness. For the purpose of our preliminary analysis, an R-value test result of 70 was determined from a sample of near surface soils

from the site. However, Caltrans allows a maximum R-value of 50 to be used for pavement design. The final pavement sections should be based on the R-value of the subgrade soil encountered at final subgrade elevation. Table 8.15.1 presents the preliminary flexible pavement sections with various roadway traffic demands.

**TABLE 8.15.1
PRELIMINARY FLEXIBLE PAVEMENT SECTION**

Road Classification	Assumed Traffic Index	Preliminary Subgrade R-Value	Asphalt Concrete (inches)	Aggregate Base (inches)
Local Street/Access Road	5.5	50	3.0	4.0
Enhanced Local Street at School or Park	6.5		3.5	4.5
Collector	7.0		4.0	5.0
Industrial Collector	8.0		4.5	6.0

8.15.2 The upper 12 inches of the roadway subgrade soil should be compacted to a dry density of at least 95 percent of the laboratory maximum dry density at 0 to 2 percent above optimum moisture content as determined by ASTM D1557.

8.15.3 The aggregate base and asphalt concrete materials should conform to Section 200-2.4 and Section 203-6, respectively, of the latest edition of the California *Greenbook* and County of Riverside’s *Road Improvement Standards & Specifications* (Ordinance No. 461). Base materials should be compacted to a dry density of at least 95 percent of the laboratory maximum dry density at or slightly above optimum moisture content as determined by ASTM D1557. Asphalt concrete should be compacted to a density of 95 percent of the laboratory Hveem density as determined by ASTM D1561.

8.15.4 A rigid Portland cement concrete (PCC) pavement section should be placed in driveway aprons and cross gutters, and may be used in driveways and parking areas where desired. We calculated the rigid pavement section in general conformance with the procedure recommended by the American Concrete Institute, Report ACI 330R-08, *Guide for Design and Construction of Concrete Parking Lots* using the parameters presented in Table 8.15.4.

**TABLE 8.15.4
RIGID PAVEMENT DESIGN PARAMETERS**

Design Parameter	Design Value
Modulus of subgrade reaction, k	150 pci
Modulus of rupture for concrete, M_R	500 psi
Traffic Category, TC	C and D
Average daily truck traffic, ADTT	300 and 700

8.15.5 Based on the criteria presented herein, the PCC pavement sections should have a minimum thickness as presented in Table 8.15.5.

**TABLE 8.15.5
RIGID PAVEMENT RECOMMENDATIONS**

Location	Portland Cement Concrete (inches)
Light Truck Traffic (TC = C, ADTT = 300)	7.0
Medium and Heavy Truck Traffic (TC = D, ADTT = 700)	7.5

8.15.6 The PCC pavement should be placed over subgrade soil that is compacted to a dry density of at least 95 percent of the laboratory maximum dry density at 0 to 2 percent above optimum moisture content. This pavement section is based on a minimum concrete compressive strength of approximately 3,500 psi (pounds per square inch).

8.15.7 A thickened edge or integral curb should be constructed on the outside of concrete slabs subjected to wheel loads. The thickened edge should be 1.2 times the slab thickness or a minimum thickness of 2 inches, whichever results in a thicker edge, and taper back to the recommended slab thickness 4 feet behind the face of the slab (e.g., 7.5-inch-thick slabs would have a 9.5-inch-thick edge). Reinforcing steel will not be necessary within the concrete for geotechnical purposes with the possible exception of dowels at construction joints as discussed herein.

8.15.8 In order to control the location and spread of concrete shrinkage cracks, crack-control joints (weakened plane joints) should be included in the design of the concrete pavement slab in accordance with the referenced ACI report.

8.15.9 The performance of pavements is highly dependent on providing positive surface drainage away from the edge of the pavement. Ponding of water on or adjacent to the pavement surfaces will likely result in pavement distress and subgrade failure. Drainage from landscaped areas should be directed to controlled drainage structures. Landscape areas adjacent to the edge of asphalt pavements are not recommended due to the potential for surface or irrigation water to infiltrate the underlying permeable aggregate base and cause distress. Where such a condition cannot be avoided, consideration should be given to incorporating measures that will significantly reduce the potential for subsurface water migration into the aggregate base. If planter islands are planned, the perimeter curb should extend at least 6 inches below the level of the base materials.

8.16 Temporary Excavations

- 8.16.1 The recommendations included herein are provided for temporary excavations. It is the responsibility of the contractor to provide a safe excavation during the construction of the proposed project.
- 8.16.2 Excavations of up to 10 feet in vertical height are expected during utility installation. The contractor's competent person should evaluate the necessity for lay back of vertical cut areas. Vertical excavations up to 5 feet may be attempted where loose soils or caving sands are not present, and where not surcharged by existing structures or vehicle/construction equipment loads.
- 8.16.3 Vertical excavations greater than 5 feet will require sloping measures in order to provide a stable excavation. Where sufficient space is available, temporary unsurcharged embankments should be designed by the contractor's competent person in accordance with OSHA regulations.
- 8.16.4 Where sufficient space is available, temporary unsurcharged embankments in soil may be sloped back at a uniform 1.5:1 (h:v) slope gradient or flatter. Excavations in bedrock may be steepened per Cal OSHA requirements. Note, a uniform slope does not have a vertical portion.
- 8.4.5 Where there is insufficient space for sloped excavations, shoring or trench shields should be used to support excavations. Shoring may also be necessary where sloped excavation could remove vertical or lateral support of existing improvements, including existing utilities and adjacent structures. Recommendations for temporary shoring can be provided in an addendum if needed.
- 8.16.5 Where temporary construction slopes are utilized, the top of the slope should be barricaded to prevent vehicles and storage loads at the top of the slope within a horizontal distance equal to the height of the slope. If the temporary construction slopes are to be maintained during the rainy season, berms are suggested along the tops of the slopes where necessary to prevent runoff water from entering the excavation and eroding the slope faces. The contractor's personnel should inspect the soil exposed in the cut slopes during excavation so that modifications of the slopes can be made if variations in the soil conditions occur. Excavations should be stabilized within 30 days of initial excavation.

8.17 Site Drainage and Moisture Protection

- 8.17.1 Adequate site drainage is critical to reduce the potential for differential soil movement, erosion and subsurface seepage. Under no circumstances should water be allowed to pond adjacent to footings. The site should be graded and maintained such that surface drainage is directed away from structures in accordance with 2019 CBC 1804.4 or other applicable standards. In addition, surface drainage should be directed away from the top of slopes into swales or other controlled drainage devices. Roof and pavement drainage should be directed into conduits that carry runoff away from the proposed structure.
- 8.17.2 Underground utilities should be leak free. Utility and irrigation lines should be checked periodically for leaks and detected leaks should be repaired promptly. Detrimental soil movement could occur if water can infiltrate the soil for prolonged periods of time.
- 8.17.3 Storm water mitigation systems should be offset a minimum of 20 feet from the outside edge of structural footings, so as to reduce the occurrence of water migrating within the structures' load projection.
- 8.17.4 Landscaping planters adjacent to paved areas are not recommended due to the potential for surface or irrigation water to infiltrate the pavement's subgrade and base course. We recommend that area drains to collect excess irrigation water and transmit it to drainage structures or impervious above-grade planter boxes be used. In addition, where landscaping is planned adjacent to the pavement, we recommend construction of a cutoff wall or the use of an impermeable geosynthetic along the edge of the pavement that extends at least 6 inches below the bottom of the base material.
- 8.17.5 If not properly constructed, there is a potential for distress to improvements and properties located hydrologically down gradient or adjacent to infiltration areas. Factors such as the amount of water to be detained, its residence time, and soil permeability have an important effect on seepage transmission and the potential adverse impacts that may occur if the storm water management features are not properly designed and constructed. We have not performed a hydrogeology study at the site. Downgradient and adjacent structures may be subjected to seeps, movement of foundations and slabs, or other impacts as a result of water infiltration.

8.18 Grading and Foundation Plan Review

- 8.18.1 Geocon should review the project grading and foundation plans prior to final design submittal to verify that the plans have been prepared in substantial conformance with the recommendations of this report and to provide additional analyses or recommendations, if necessary.

LIMITATIONS AND UNIFORMITY OF CONDITIONS

The recommendations of this report pertain only to the site investigated and are based upon the assumption that the soil conditions do not deviate from those disclosed in this investigation. If any variations or undesirable conditions are encountered during construction, or if the proposed construction will differ from that expected herein, Geocon West, Inc. should be notified so that supplemental recommendations can be given. The evaluation or identification of the potential presence of hazardous materials was not part of the scope of services provided by Geocon West, Inc.

This report is issued with the understanding that it is the responsibility of the owner, or of their representative, to ensure that the information and recommendations contained herein are brought to the attention of the architect and engineer for the project and incorporated into the plans, and the necessary steps are taken to see that the contractor and subcontractors carry out such recommendations in the field.

The requirements for concrete and steel reinforcement presented in this report are preliminary recommendations from a geotechnical perspective. The Structural Engineer should provide the final recommendations for structural design of concrete and steel reinforcement for foundation systems, floor slabs, exterior concrete, or other systems where concrete and steel reinforcement are utilized, in accordance with the latest version of applicable codes.

The findings of this report are valid as of the present date. However, changes in the conditions of a property can occur with the passage of time, whether they are due to natural processes or the works of man on this or adjacent properties. In addition, changes in applicable or appropriate standards may occur, whether they result from legislation or the broadening of knowledge. Accordingly, the findings of this report may be invalidated wholly or partially by changes outside our control. Therefore, this report is subject to review and should not be relied upon after a period of three years.

The firm that performed the geotechnical investigation for the project should be retained to provide testing and observation services during construction to provide continuity of geotechnical interpretation and to check that the recommendations presented for geotechnical aspects of site development are incorporated during site grading, construction of improvements, and excavation of foundations. If another geotechnical firm is selected to perform the testing and observation services during construction operations, that firm should prepare a letter indicating their intent to assume the responsibilities of project Geotechnical Engineer of Record. A copy of the letter should be provided to the regulatory agency for their records. In addition, that firm should provide revised recommendations concerning the geotechnical aspects of the proposed development, or a written acknowledgement of their concurrence with the recommendations presented in our report. They should also perform additional analyses deemed necessary to assume the role of Geotechnical Engineer of Record.

LIST OF REFERENCES

1. American Concrete Institute, 2011, *Building Code Requirements for Structural Concrete*, Report by ACI Committee 318.
2. American Concrete Institute, 2008, *Guide for Design and Construction of Concrete Parking Lots*, Report by ACI Committee 330.
3. ASCE 7-16, 2019, *Minimum Design Loads for Buildings and Other Structures*.
4. California Building Standards Commission, 2019, *California Building Code (CBC)*, California Code of Regulations Title 24, Part 2.
5. California Department of Transportation (Caltrans), 2021, Division of Engineering Services, Materials Engineering and Testing Services, *Corrosion Guidelines, Version 3.2*, dated March.
6. California Department of Water Resources, *Water Data Library* website, <https://wdl.water.ca.gov/>; accessed May 2022.
7. California Geological Survey (CGS), 2003, *Earthquake Shaking Potential for California*, from USGS/CGS Seismic Hazards Model, CSSC No. 03-02
8. California Geological Survey, 2002, *Seismic Shaking Hazards in California*, Based on the USGS/CGS Probabilistic Seismic Hazards Assessment (PSHA) Model, (revised April 2003). 10% probability of being exceeded in 50 years, <http://redirect.conservation.ca.gov/cgs/rghm/pshamap/pshamain.html>
9. California Geologic Survey, 2008, Special Publication 117A, *Guidelines for Evaluating and Mitigating Seismic Hazards in California*, Revised and Re-adopted September 11.
10. Dibblee, T.W. and Minch, J.A., 2003, *Geologic Map of the Riverside East/south 1/2 of San Bernardino South quadrangles, San Bernardino and Riverside County, California*, DF-109, Scale 1:24,000.
11. Google Earth Pro, 2022, accessed May 2022.
12. Harden, Deborah R., 1998, *California Geology*, Prentice Hall Publishing.
13. Historic Aerials, Aerial Photographs of the site from 1966 through 2018, historicaerials.com, accessed June 2022.
14. Jennings, C. W., 2010, California Division of Mines and Geology, *Fault Activity Map of California and Adjacent Areas*, California Geologic Data Map Series Map No. 6.
15. Legg, M. R., J. C. Borrero, and C. E. Synolakis, *Evaluation of Tsunami Risk to Southern California Coastal Cities*, 2002 NEHRP Professional Fellowship Report, dated January 2003.
16. OSPD, 2018, *Seismic Design Maps*, <https://seismicmaps.org> Accessed May 2022.
17. Public Works Standards, Inc., 2021, *Standard Specifications for Public Works Construction "Greenbook"*, Published by BNi Building News.
18. Riverside County, *Map My County Website*, accessed May 2022.
19. Riverside County Flood Control and Water Conservation District, 2011, *Design Handbook for Low Impact Development Best Management Practices*, September.
20. Riverside County, Transportation Department, 2007, *Road Improvement Standards & Specifications*, Ordinance No. 461, dated December 20.



SITE

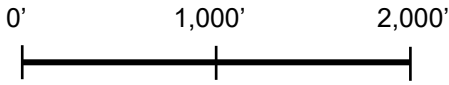

SCALE: 1" = 1,000'



SOURCE: Google Earth 2022

VICINITY MAP

GEOCON
WEST, INC.



GEOTECHNICAL, ENVIRONMENTAL, MATERIALS
41571 CORNING PLACE #101, MURRIETA, CALIFORNIA 92562
PHONE 951-304-2300 FAX 951-304-2392

MISSION GROVE REDEVELOPMENT
375 EAST ALESSANDRO BOULEVARD
RIVERSIDE, CALIFORNIA

HD

JUNE 2022

PROJECT NO. T2979-22-01

FIG. 1



GEOCON LEGEND

Locations are approximate

- B-7 GEOTECHNICAL BORING LOCATION
- 3 REMEDIAL REMOVAL DEPTHS IN FEET
- P-6 PERCOLATION TEST LOCATION
- LIMITS OF THIS STUDY
- GEOLOGIC CONTACT
- afu PREVIOUSLY PLACED FILL
- qdi QUARTZ DIORITE BEDROCK



SCALE: 1" = 100'



Source: Rick Engineering Company, Infiltration Testing Locations, Plot Date April 27, 2022

GEOCON
 WEST, INC.
 GEOTECHNICAL, ENVIRONMENTAL, MATERIALS
 41571 CORNING PLACE #101, MURRIETA, CALIFORNIA 92562
 PHONE 951-304-2300 FAX 951-304-2392



GEOLOGIC MAP

MISSION GOVE REDEVELOPMENT
 375 EAST ALESSANDRO BOULEVARD
 RIVERSIDE, CALIFORNIA

APPENDIX



APPENDIX A

FIELD INVESTIGATION

The field investigation was performed on May 13 and 16, 2022, and consisted of excavation of seven geotechnical borings and six percolation borings utilizing a truck-mounted hollow-stem auger drilling rig. The borings were drilled to depths of 2 to 26 feet 3 inches below existing grades. Representative and relatively undisturbed samples were obtained by driving a 3-inch O. D., California Modified Sampler into the “undisturbed” soil mass with blows from a 140-pound auto hammer falling 30 inches. The California Modified Sampler was equipped with 1-inch high by 2³/₈-inch diameter brass sampler rings to facilitate removal and testing.

The geotechnical conditions encountered in the excavations were visually examined, classified and logged in general accordance with ASTM International (ASTM) practice for Description and Identification of Soils (Visual-Manual Procedure D 2488).

Logs of the geotechnical and percolation borings are presented on Figures A-1 through A-13. The logs depict the soil and geologic conditions encountered and the depth at which samples were obtained. The approximate locations of the exploratory borings are shown on the *Geologic Map*, Figure 2. Percolation test results are presented in Figures A-14 through A-19. Percolation testing was performed in accordance with *Riverside County Flood Control and Water Conservation District, LID BMP Manual, Appendix A*.

DEPTH IN FEET	SAMPLE NO.	LITHOLOGY	GROUNDWATER	SOIL CLASS (USCS)	BORING B-1		PENETRATION RESISTANCE (BLOWS/FT.)	DRY DENSITY (P.C.F.)	MOISTURE CONTENT (%)
					ELEV. (MSL.) 1584	DATE COMPLETED 5/13/2022			
					EQUIPMENT CME 75 HSA BY: L. WEIDMAN				
MATERIAL DESCRIPTION									
0	B-1@0-5'			SP	PAVEMENT SECTION 3" AC, 4" BASE				
2	B-1@2.5'				PREVIOUSLY PLACED FILL (afu) Poorly-graded SAND, medium dense, slightly moist, golden brown; medium sand; some coarse sand		50-3.5"		
4	B-1@20'				QUARTZ DIORITE BEDROCK (qdi) White black brown; hard, moist, mica rich; excavates as Well-graded SAND with Silt; dry; friable; slightly oxidized; coarse grained		50-3"		
8	B-1@7.5'				-Becomes fine grained; hornblend rich		50-3"		
10	B-1@10'						50-4"		
16	B-1@15'				-Becomes more flesic		88-9"		
20	B-1@20'				-Becomes wet		50-2"		
26	B-1@25'						50-3"		
					Total Depth = 26'3" Groundwater encountered at 16'6" Penetration resistance for 140-lb hammer falling 30 inches by auto hammer Backfilled with cuttings 5/13/2022				

Figure A-1,
Log of Boring B-1, Page 1 of 1

T2979-22-01 BORING LOGS.GPJ

SAMPLE SYMBOLS		... SAMPLING UNSUCCESSFUL		... STANDARD PENETRATION TEST		... DRIVE SAMPLE (UNDISTURBED)
		... DISTURBED OR BAG SAMPLE		... CHUNK SAMPLE		... WATER TABLE OR SEEPAGE

NOTE: THE LOG OF SUBSURFACE CONDITIONS SHOWN HEREON APPLIES ONLY AT THE SPECIFIC BORING OR TRENCH LOCATION AND AT THE DATE INDICATED. IT IS NOT WARRANTED TO BE REPRESENTATIVE OF SUBSURFACE CONDITIONS AT OTHER LOCATIONS AND TIMES.

















DEPTH IN FEET	SAMPLE NO.	LITHOLOGY	GROUNDWATER	SOIL CLASS (USCS)	BORING B-2		PENETRATION RESISTANCE (BLOWS/FT.)	DRY DENSITY (P.C.F.)	MOISTURE CONTENT (%)
					ELEV. (MSL.) 1583	DATE COMPLETED 5/13/2022			
					EQUIPMENT CME 75 HSA	BY: L. WEIDMAN			
MATERIAL DESCRIPTION									
0					PAVEMENT SECTION 4" AC, 6" BASE				
2	B-2@2.5'				QUARTZ DIORITE BEDROCK (qdi) White black brown; hard, moist, mica rich; excavates as Well-graded SAND with Silt; slightly moist; friable; coarse grained; slightly oxidized		50-3"		
4									
6	B-2@20' B-2@5-10'				-Becomes moist; fine to coarse grained		50-2"		
8	B-2@7.5'				-Becomes wet		50-5"		
10	B-2@10'						50-4"		
12									
14	B-2@12.5'						50-3.5"		
16	B-2@15'						50-5"		
18	B-2@17.5'						50-4.5"		
20	B-2@20'				-NO RECOVERY		50-1"		
					Total Depth = 20'1" Groundwater encountered at 11'6" Penetration resistance for 140-lb hammer falling 30 inches by auto hammer Backfilled with cuttings 5/13/2022				

Figure A-2,
Log of Boring B-2, Page 1 of 1

T2979-22-01 BORING LOGS.GPJ







SAMPLE SYMBOLS	 ... SAMPLING UNSUCCESSFUL	 ... STANDARD PENETRATION TEST	 ... DRIVE SAMPLE (UNDISTURBED)
	 ... DISTURBED OR BAG SAMPLE	 ... CHUNK SAMPLE	 ... WATER TABLE OR SEEPAGE

NOTE: THE LOG OF SUBSURFACE CONDITIONS SHOWN HEREON APPLIES ONLY AT THE SPECIFIC BORING OR TRENCH LOCATION AND AT THE DATE INDICATED. IT IS NOT WARRANTED TO BE REPRESENTATIVE OF SUBSURFACE CONDITIONS AT OTHER LOCATIONS AND TIMES.

DEPTH IN FEET	SAMPLE NO.	LITHOLOGY	GROUNDWATER	SOIL CLASS (USCS)	BORING B-3		PENETRATION RESISTANCE (BLOWS/FT.)	DRY DENSITY (P.C.F.)	MOISTURE CONTENT (%)
					ELEV. (MSL.) 1588	DATE COMPLETED 5/13/2022			
					EQUIPMENT CME 75 HSA		BY: L. WEIDMAN		
MATERIAL DESCRIPTION									
0					PAVEMENT SECTION 3.5" AC, 4" BASE				
2					QUARTZ DIORITE BEDROCK (qdi) White black brown; hard, moist, mica rich; excavates as Well-graded SAND with Silt; moist; friable; slightly oxidized; micaceous		50-3"		
4	B-3@2.5'								
6	B-3@20' B-3@5-10'				-Becomes moist; fine to coarse grained		50-3"		
8	B-3@7.5'				-Becomes wet		50-3"		
10	B-3@10'						50-2"		
12									
14	B-3@15'				-NO RECOVERY		50-2"		
					Total Depth = 15'2" Groundwater encountered at 11' Penetration resistance for 140-lb hammer falling 30 inches by auto hammer Backfilled with cuttings 5/13/2022				

Figure A-3,
Log of Boring B-3, Page 1 of 1

T2979-22-01 BORING LOGS.GPJ

SAMPLE SYMBOLS		... SAMPLING UNSUCCESSFUL		... STANDARD PENETRATION TEST		... DRIVE SAMPLE (UNDISTURBED)
		... DISTURBED OR BAG SAMPLE		... CHUNK SAMPLE		... WATER TABLE OR SEEPAGE

NOTE: THE LOG OF SUBSURFACE CONDITIONS SHOWN HEREON APPLIES ONLY AT THE SPECIFIC BORING OR TRENCH LOCATION AND AT THE DATE INDICATED. IT IS NOT WARRANTED TO BE REPRESENTATIVE OF SUBSURFACE CONDITIONS AT OTHER LOCATIONS AND TIMES.













DEPTH IN FEET	SAMPLE NO.	LITHOLOGY	GROUNDWATER	SOIL CLASS (USCS)	BORING B-4 ELEV. (MSL.) 1584 DATE COMPLETED 5/13/2022 EQUIPMENT CME 75 HSA BY: L. WEIDMAN	PENETRATION RESISTANCE (BLOWS/FT.)	DRY DENSITY (P.C.F.)	MOISTURE CONTENT (%)
MATERIAL DESCRIPTION								
0	B-4@0-5'			SM	PAVEMENT SECTION 6" AC, 4" BASE			
2	B-4@2.5'				PREVIOUSLY PLACED FILL (afu) Silty SAND, medium dense, slightly moist, brown; medium to coarse sand; some mica	50-3"		
4	B-4@20"				QUARTZ DIORITE BEDROCK (qdi) White black brown; hard, moist, mica rich; excavates as Well-graded SAND with Silt; medium to coarse sand; slightly oxidized; micaceous; friable	50-2"		
8	B-4@7.5'				-Becomes hornblend rich	50-5"		
10	B-4@10'				-Becomes wet	50-5"		
14	B-4@15'				-NO RECOVERY Total Depth = 15'4" Groundwater encountered at 13'6" Penetration resistance for 140-lb hammer falling 30 inches by auto hammer Backfilled with cuttings 5/13/2022	50-4"		

Figure A-4,
Log of Boring B-4, Page 1 of 1

T2979-22-01 BORING LOGS.GPJ

SAMPLE SYMBOLS	 ... SAMPLING UNSUCCESSFUL	 ... STANDARD PENETRATION TEST	 ... DRIVE SAMPLE (UNDISTURBED)
	 ... DISTURBED OR BAG SAMPLE	 ... CHUNK SAMPLE	 ... WATER TABLE OR SEEPAGE

NOTE: THE LOG OF SUBSURFACE CONDITIONS SHOWN HEREON APPLIES ONLY AT THE SPECIFIC BORING OR TRENCH LOCATION AND AT THE DATE INDICATED. IT IS NOT WARRANTED TO BE REPRESENTATIVE OF SUBSURFACE CONDITIONS AT OTHER LOCATIONS AND TIMES.













DEPTH IN FEET	SAMPLE NO.	LITHOLOGY	GROUNDWATER	SOIL CLASS (USCS)	BORING B-5		PENETRATION RESISTANCE (BLOWS/FT.)	DRY DENSITY (P.C.F.)	MOISTURE CONTENT (%)
					ELEV. (MSL.) 1585	DATE COMPLETED 5/13/2022			
					EQUIPMENT CME 75 HSA BY: L. WEIDMAN				
MATERIAL DESCRIPTION									
0	B-5@0-5'			SM	PAVEMENT SECTION 4" AC, 4" BASE				
2	B-5@2.5'				PREVIOUSLY PLACED FILL (afu) Silty SAND, medium dense, slightly moist, golden brown; fine to coarse sand; little mica		50-5"		
4	B-5@20'				QUARTZ DIORITE BEDROCK (qdi) White black brown; hard, moist, mica rich; excavates as Well-graded SAND with Silt; coarse grained; slightly oxidized; micaceous; friable		50-4"		
8	B-5@7.5'				-Becomes fine grained; felsic		50-4"		
10	B-5@10'				-Becomes wet		50-3"		
14	B-5@15'				-NO RECOVERY Total Depth = 15'4" Groundwater encountered at 15' Penetration resistance for 140-lb hammer falling 30 inches by auto hammer Backfilled with cuttings 5/13/2022		50-4"		

Figure A-5,
Log of Boring B-5, Page 1 of 1

T2979-22-01 BORING LOGS.GPJ







SAMPLE SYMBOLS		... SAMPLING UNSUCCESSFUL		... STANDARD PENETRATION TEST		... DRIVE SAMPLE (UNDISTURBED)
		... DISTURBED OR BAG SAMPLE		... CHUNK SAMPLE		... WATER TABLE OR SEEPAGE

NOTE: THE LOG OF SUBSURFACE CONDITIONS SHOWN HEREON APPLIES ONLY AT THE SPECIFIC BORING OR TRENCH LOCATION AND AT THE DATE INDICATED. IT IS NOT WARRANTED TO BE REPRESENTATIVE OF SUBSURFACE CONDITIONS AT OTHER LOCATIONS AND TIMES.

DEPTH IN FEET	SAMPLE NO.	LITHOLOGY	GROUNDWATER	SOIL CLASS (USCS)	BORING B-6 ELEV. (MSL.) <u>1584</u> DATE COMPLETED <u>5/13/2022</u> EQUIPMENT <u>CME 75 HSA</u> BY: <u>L. WEIDMAN</u>	PENETRATION RESISTANCE (BLOWS/FT.)	DRY DENSITY (P.C.F.)	MOISTURE CONTENT (%)	
MATERIAL DESCRIPTION									
0					PAVEMENT SECTION 5" AC, 4" BASE				
2	B-6@2.5'			SM	PREVIOUSLY PLACED FILL (afu) Silty SAND, medium dense, moist, dark yellow brown; fine to coarse sand; little mica	50-6"			
4	B-6@20'				QUARTZ DIORITE BEDROCK (qdi) White black brown; hard, moist, mica rich; excavates as Well-graded SAND with Silt; slightly oxidized; micaceous; friable -Becomes moist -Becomes fine grained -Becomes wet	50-5"			
6	B-6@5-10'								
8	B-6@7.5'						50-4"		
10	B-6@10'						50-4"		
12									
14	B-6@15'		▼			50-4.5"			
					Total Depth = 15'4" Groundwater encountered at 15' Penetration resistance for 140-lb hammer falling 30 inches by auto hammer Backfilled with cuttings 5/13/2022				

Figure A-6,
Log of Boring B-6, Page 1 of 1

T2979-22-01 BORING LOGS.GPJ

SAMPLE SYMBOLS	 ... SAMPLING UNSUCCESSFUL	 ... STANDARD PENETRATION TEST	 ... DRIVE SAMPLE (UNDISTURBED)
	 ... DISTURBED OR BAG SAMPLE	 ... CHUNK SAMPLE	 ... WATER TABLE OR SEEPAGE

NOTE: THE LOG OF SUBSURFACE CONDITIONS SHOWN HEREON APPLIES ONLY AT THE SPECIFIC BORING OR TRENCH LOCATION AND AT THE DATE INDICATED. IT IS NOT WARRANTED TO BE REPRESENTATIVE OF SUBSURFACE CONDITIONS AT OTHER LOCATIONS AND TIMES.













DEPTH IN FEET	SAMPLE NO.	LITHOLOGY	GROUNDWATER	SOIL CLASS (USCS)	BORING B-7 ELEV. (MSL.) <u>1585</u> DATE COMPLETED <u>5/13/2022</u> EQUIPMENT <u>CME 75 HSA</u> BY: <u>L. WEIDMAN</u>	PENETRATION RESISTANCE (BLOWS/FT.)	DRY DENSITY (P.C.F.)	MOISTURE CONTENT (%)
MATERIAL DESCRIPTION								
0					PAVEMENT SECTION 4" AC, 8" BASE			
2	B-7@2-7' B-7@2.5'			SM	PREVIOUSLY PLACED FILL (afu) Silty SAND, medium dense, moist, dark red brown; fine to coarse sand; little mica	61-8"		
4	B-7@20'				QUARTZ DIORITE BEDROCK (qdi) White black brown; hard, moist, mica rich; excavates as Well-graded SAND with Silt; slightly oxidized; micaceous; friable -Becomes fine grained	50-3"		
8	B-7@7.5'				-Poor recovery	50-2"		
10	B-7@10'					50-2"		
14	B-7@15'				-Poor recovery	50-2"		
Total Depth = 15'2" Groundwater not encountered Penetration resistance for 140-lb hammer falling 30 inches by auto hammer Backfilled with cuttings 5/16/2022								

Figure A-7,
Log of Boring B-7, Page 1 of 1

T2979-22-01 BORING LOGS.GPJ

SAMPLE SYMBOLS	 ... SAMPLING UNSUCCESSFUL	 ... STANDARD PENETRATION TEST	 ... DRIVE SAMPLE (UNDISTURBED)
	 ... DISTURBED OR BAG SAMPLE	 ... CHUNK SAMPLE	 ... WATER TABLE OR SEEPAGE

NOTE: THE LOG OF SUBSURFACE CONDITIONS SHOWN HEREON APPLIES ONLY AT THE SPECIFIC BORING OR TRENCH LOCATION AND AT THE DATE INDICATED. IT IS NOT WARRANTED TO BE REPRESENTATIVE OF SUBSURFACE CONDITIONS AT OTHER LOCATIONS AND TIMES.

DEPTH IN FEET	SAMPLE NO.	LITHOLOGY	GROUNDWATER	SOIL CLASS (USCS)	BORING P-1		PENETRATION RESISTANCE (BLOWS/FT.)	DRY DENSITY (P.C.F.)	MOISTURE CONTENT (%)
					ELEV. (MSL.) 1582	DATE COMPLETED 5/13/2022			
					EQUIPMENT CME 75 HSA BY: L. WEIDMAN				
0					MATERIAL DESCRIPTION				
				SP	PAVEMENT SECTION 3" AC, 4" BASE				
2					PREVIOUSLY PLACED FILL (afu) Poorly-graded SAND, medium dense, slightly moist, golden brown; medium sand; some coarse sand; few mica				
4	P-1@3'				QUARTZ DIORITE BEDROCK (qdi) White black brown; hard, moist, mica rich; excavates as Well-graded SAND with Silt; dry; friable; slightly oxidized				
					Total Depth = 4.5' No Groundwater encountered Percolation Test Equipment set Presaturated with 5 gallons of water Backfilled with cuttings 5/16/2022				

Figure A-8,
Log of Boring P-1, Page 1 of 1

T2979-22-01 BORING LOGS.GPJ

SAMPLE SYMBOLS	<input type="checkbox"/>	... SAMPLING UNSUCCESSFUL	<input type="checkbox"/>	... STANDARD PENETRATION TEST	<input checked="" type="checkbox"/>	... DRIVE SAMPLE (UNDISTURBED)
	<input checked="" type="checkbox"/>	... DISTURBED OR BAG SAMPLE	<input checked="" type="checkbox"/>	... CHUNK SAMPLE	<input type="checkbox"/>	... WATER TABLE OR SEEPAGE

NOTE: THE LOG OF SUBSURFACE CONDITIONS SHOWN HEREON APPLIES ONLY AT THE SPECIFIC BORING OR TRENCH LOCATION AND AT THE DATE INDICATED. IT IS NOT WARRANTED TO BE REPRESENTATIVE OF SUBSURFACE CONDITIONS AT OTHER LOCATIONS AND TIMES.

DEPTH IN FEET	SAMPLE NO.	LITHOLOGY	GROUNDWATER	SOIL CLASS (USCS)	BORING P-2		PENETRATION RESISTANCE (BLOWS/FT.)	DRY DENSITY (P.C.F.)	MOISTURE CONTENT (%)
					ELEV. (MSL.) 1582	DATE COMPLETED 5/13/2022			
					EQUIPMENT CME 75 HSA BY: L. WEIDMAN				
0					MATERIAL DESCRIPTION				
				SP	PAVEMENT SECTION 3" AC, 4" BASE				
2	P-2@2'				PREVIOUSLY PLACED FILL (afu) Poorly-graded SAND, medium dense, slightly moist, golden brown; medium sand; some coarse sand; few mica				
					QUARTZ DIORITE BEDROCK (qdi) White black brown; hard, moist, mica rich; excavates as Well-graded SAND with Silt; dry; friable; slightly oxidized				
					Total Depth = 3.5' No Groundwater encountered Percolation Test Equipment set Presaturated with 5 gallons of water Backfilled with cuttings 5/16/2022				

Figure A-9,
Log of Boring P-2, Page 1 of 1

T2979-22-01 BORING LOGS.GPJ

SAMPLE SYMBOLS	<input type="checkbox"/>	... SAMPLING UNSUCCESSFUL	<input type="checkbox"/>	... STANDARD PENETRATION TEST	<input type="checkbox"/>	... DRIVE SAMPLE (UNDISTURBED)
	<input checked="" type="checkbox"/>	... DISTURBED OR BAG SAMPLE	<input checked="" type="checkbox"/>	... CHUNK SAMPLE	<input checked="" type="checkbox"/>	... WATER TABLE OR SEEPAGE

NOTE: THE LOG OF SUBSURFACE CONDITIONS SHOWN HEREON APPLIES ONLY AT THE SPECIFIC BORING OR TRENCH LOCATION AND AT THE DATE INDICATED. IT IS NOT WARRANTED TO BE REPRESENTATIVE OF SUBSURFACE CONDITIONS AT OTHER LOCATIONS AND TIMES.



DEPTH IN FEET	SAMPLE NO.	LITHOLOGY	GROUNDWATER	SOIL CLASS (USCS)	BORING P-3 ELEV. (MSL.) <u>1585</u> DATE COMPLETED <u>5/13/2022</u> EQUIPMENT <u>CME 75 HSA</u> BY: <u>L. WEIDMAN</u>	PENETRATION RESISTANCE (BLOWS/FT.)	DRY DENSITY (P.C.F.)	MOISTURE CONTENT (%)
0					MATERIAL DESCRIPTION			
					PAVEMENT SECTION 4" AC, 5" BASE			
2					QUARTZ DIORITE BEDROCK (qdi) White black brown; hard, moist, mica rich; excavates as Well-graded SAND with Silt; dry; friable; slightly oxidized; micaceous			
4	P-3@4.5'							
6					Total Depth = 6' No Groundwater encountered Percolation Test Equipment set Presaturated with 5 gallons of water Backfilled with cuttings 5/16/2022			

Figure A-10,
Log of Boring P-3, Page 1 of 1

T2979-22-01 BORING LOGS.GPJ

SAMPLE SYMBOLS	<input type="checkbox"/> ... SAMPLING UNSUCCESSFUL	<input type="checkbox"/> ... STANDARD PENETRATION TEST	<input type="checkbox"/> ... DRIVE SAMPLE (UNDISTURBED)
	<input checked="" type="checkbox"/> ... DISTURBED OR BAG SAMPLE	<input checked="" type="checkbox"/> ... CHUNK SAMPLE	<input type="checkbox"/> ... WATER TABLE OR SEEPAGE

NOTE: THE LOG OF SUBSURFACE CONDITIONS SHOWN HEREON APPLIES ONLY AT THE SPECIFIC BORING OR TRENCH LOCATION AND AT THE DATE INDICATED. IT IS NOT WARRANTED TO BE REPRESENTATIVE OF SUBSURFACE CONDITIONS AT OTHER LOCATIONS AND TIMES.









DEPTH IN FEET	SAMPLE NO.	LITHOLOGY	GROUNDWATER	SOIL CLASS (USCS)	BORING P-4 ELEV. (MSL.) <u>1585</u> DATE COMPLETED <u>5/13/2022</u> EQUIPMENT <u>CME 75 HSA</u> BY: <u>L. WEIDMAN</u>	PENETRATION RESISTANCE (BLOWS/FT.)	DRY DENSITY (P.C.F.)	MOISTURE CONTENT (%)
0					MATERIAL DESCRIPTION			
					PAVEMENT SECTION 4" AC, 5" BASE			
2					QUARTZ DIORITE BEDROCK (qdi) White black brown; hard, moist, mica rich; excavates as Well-graded SAND with Silt; dry; friable; slightly oxidized; micaceous			
4	P-4@4.5'							
6					Total Depth = 6' No Groundwater encountered Percolation Test Equipment set Presaturated with 5 gallons of water Backfilled with cuttings 5/16/2022			

Figure A-11,
Log of Boring P-4, Page 1 of 1

T2979-22-01 BORING LOGS.GPJ

SAMPLE SYMBOLS	 ... SAMPLING UNSUCCESSFUL	 ... STANDARD PENETRATION TEST	 ... DRIVE SAMPLE (UNDISTURBED)
	 ... DISTURBED OR BAG SAMPLE	 ... CHUNK SAMPLE	 ... WATER TABLE OR SEEPAGE

NOTE: THE LOG OF SUBSURFACE CONDITIONS SHOWN HEREON APPLIES ONLY AT THE SPECIFIC BORING OR TRENCH LOCATION AND AT THE DATE INDICATED. IT IS NOT WARRANTED TO BE REPRESENTATIVE OF SUBSURFACE CONDITIONS AT OTHER LOCATIONS AND TIMES.

DEPTH IN FEET	SAMPLE NO.	LITHOLOGY	GROUNDWATER	SOIL CLASS (USCS)	BORING P-5		PENETRATION RESISTANCE (BLOWS/FT.)	DRY DENSITY (P.C.F.)	MOISTURE CONTENT (%)
					ELEV. (MSL.) 1588	DATE COMPLETED 5/13/2022			
					EQUIPMENT CME 75 HSA BY: L. WEIDMAN				
0					MATERIAL DESCRIPTION				
				SM	PAVEMENT SECTION 3" AC, 5" BASE				
2					PREVIOUSLY PLACED FILL (afu) Silty SAND, medium dense, moist, dark red brown; fine to coarse sand; few mica				
4	P-5@4.5'				QUARTZ DIORITE BEDROCK (qdi) White black brown; hard, moist, mica rich; excavates as Well-graded SAND with Silt; dry; friable; slightly oxidized				
6					Total Depth = 6' No Groundwater encountered Percolation Test Equipment set Presaturated with 5 gallons of water Backfilled with cuttings 5/16/2022				

Figure A-12,
Log of Boring P-5, Page 1 of 1

T2979-22-01 BORING LOGS.GPJ

SAMPLE SYMBOLS	... SAMPLING UNSUCCESSFUL	... STANDARD PENETRATION TEST	... DRIVE SAMPLE (UNDISTURBED)
	... DISTURBED OR BAG SAMPLE	... CHUNK SAMPLE	... WATER TABLE OR SEEPAGE

NOTE: THE LOG OF SUBSURFACE CONDITIONS SHOWN HEREON APPLIES ONLY AT THE SPECIFIC BORING OR TRENCH LOCATION AND AT THE DATE INDICATED. IT IS NOT WARRANTED TO BE REPRESENTATIVE OF SUBSURFACE CONDITIONS AT OTHER LOCATIONS AND TIMES.

DEPTH IN FEET	SAMPLE NO.	LITHOLOGY	GROUNDWATER	SOIL CLASS (USCS)	BORING P-6 ELEV. (MSL.) <u>1588</u> DATE COMPLETED <u>5/13/2022</u> EQUIPMENT <u>CME 75 HSA</u> BY: <u>L. WEIDMAN</u>	PENETRATION RESISTANCE (BLOWS/FT.)	DRY DENSITY (P.C.F.)	MOISTURE CONTENT (%)
0					MATERIAL DESCRIPTION			
0				SM	PAVEMENT SECTION 3" AC, 5" BASE			
2					PREVIOUSLY PLACED FILL (afu) Silty SAND, medium dense, moist, dark red brown; fine to coarse sand; few mica			
4	P-6@4.5'				QUARTZ DIORITE BEDROCK (qdi) White black brown; hard, moist, mica rich; excavates as Well-graded SAND with Silt; dry; friable; slightly oxidized			
6					Total Depth = 6' No Groundwater encountered Percolation Test Equipment set Presaturated with 5 gallons of water Backfilled with cuttings 5/16/2022			

Figure A-13,
Log of Boring P-6, Page 1 of 1

T2979-22-01 BORING LOGS.GPJ

SAMPLE SYMBOLS	... SAMPLING UNSUCCESSFUL	... STANDARD PENETRATION TEST	... DRIVE SAMPLE (UNDISTURBED)
	... DISTURBED OR BAG SAMPLE	... CHUNK SAMPLE	... WATER TABLE OR SEEPAGE

NOTE: THE LOG OF SUBSURFACE CONDITIONS SHOWN HEREON APPLIES ONLY AT THE SPECIFIC BORING OR TRENCH LOCATION AND AT THE DATE INDICATED. IT IS NOT WARRANTED TO BE REPRESENTATIVE OF SUBSURFACE CONDITIONS AT OTHER LOCATIONS AND TIMES.

PERCOLATION TEST REPORT

Project Name:	Riverside Redevelopment	Project No.:	T2979-22-01
Test Hole No.:	P-1	Date Excavated:	5/13/2022
Length of Test Pipe:	36.0 inches	Soil Classification:	SM
Height of Pipe above Ground:	0.0 inches	Presoak Date:	5/13/2022
Depth of Test Hole:	36.0 inches	Perc Test Date:	5/16/2022
Check for Sandy Soil Criteria Tested by:	Weidman	Percolation Tested by:	Weidman

Water level measured from BOTTOM of hole

Sandy Soil Criteria Test

Trial No.	Time	Time Interval (min)	Total Elapsed Time (min)	Initial Water Level (in)	Final Water Level (in)	Δ in Water Level (in)	Percolation Rate (min/inch)
1	8:52 AM	25	25	12.0	0.0	12.0	2.1
	9:17 AM						
2	9:17 AM	25	50	12.0	4.8	7.2	3.5
	9:42 AM						

Soil Criteria: Sandy

Percolation Test

Reading No.	Time	Time Interval (min)	Total Elapsed Time (min)	Initial Water Head (in)	Final Water Head (in)	Δ in Water Level (in)	Percolation Rate (min/inch)
1	12:16 AM	10	10	36.0	3.8	32.2	0.3
	12:26 AM						
2	12:26 AM	10	20	36.0	4.9	31.1	0.3
	12:36 AM						
3	12:36 AM	10	30	36.0	5.4	30.6	0.3
	12:46 AM						
4	12:46 AM	10	40	36.0	5.8	30.2	0.3
	12:56 AM						
5	12:56 AM	10	50	36.0	6.5	29.5	0.3
	1:06 AM						
6	1:06 AM	10	60	36.0	7.1	28.9	0.3
	1:16 AM						

Infiltration Rate (in/hr):	14.7	
Radius of test hole (in):	4	Figure A-14
Average Head (in):	21.5	

PERCOLATION TEST REPORT

Project Name:	Riverside Redevelopment	Project No.:	T2979-22-01
Test Hole No.:	P-2	Date Excavated:	5/13/2022
Length of Test Pipe:	24.0 inches	Soil Classification:	SM
Height of Pipe above Ground:	0.0 inches	Presoak Date:	5/13/2022
Depth of Test Hole:	24.0 inches	Perc Test Date:	5/16/2022
Check for Sandy Soil Criteria Tested by:	Weidman	Percolation Tested by:	Weidman

Water level measured from BOTTOM of hole

Sandy Soil Criteria Test

Trial No.	Time	Time Interval (min)	Total Elapsed Time (min)	Initial Water Level (in)	Final Water Level (in)	Δ in Water Level (in)	Percolation Rate (min/inch)
1	8:51 AM	25	25	8.4	0.8	7.6	3.3
	9:16 AM						
2	9:16 AM	25	50	8.4	3.6	4.8	5.2
	9:41 AM						

Soil Criteria: Sandy

Percolation Test

Reading No.	Time	Time Interval (min)	Total Elapsed Time (min)	Initial Water Head (in)	Final Water Head (in)	Δ in Water Level (in)	Percolation Rate (min/inch)
1	12:15 AM	10	10	36.0	6.4	29.6	0.3
	12:25 AM						
2	12:25 AM	10	20	36.0	6.7	29.3	0.3
	12:35 AM						
3	12:35 AM	10	30	36.0	6.8	29.2	0.3
	12:45 AM						
4	12:45 AM	10	40	36.0	7.0	29.0	0.3
	12:55 AM						
5	12:55 AM	10	50	36.0	7.1	28.9	0.3
	1:05 AM						
6	1:05 AM	10	60	36.0	7.2	28.8	0.3
	1:15 AM						

Infiltration Rate (in/hr):	14.6		
Radius of test hole (in):	4		Figure A-15
Average Head (in):	21.6		

PERCOLATION TEST REPORT

Project Name:	Riverside Redevelopment	Project No.:	T2979-22-01
Test Hole No.:	P-3	Date Excavated:	5/13/2022
Length of Test Pipe:	54.0 inches	Soil Classification:	SM
Height of Pipe above Ground:	0.0 inches	Presoak Date:	5/13/2022
Depth of Test Hole:	54.0 inches	Perc Test Date:	5/16/2022
Check for Sandy Soil Criteria Tested by:	Weidman	Percolation Tested by:	Weidman

Water level measured from BOTTOM of hole

Sandy Soil Criteria Test

Trial No.	Time	Time Interval (min)	Total Elapsed Time (min)	Initial Water Level (in)	Final Water Level (in)	Δ in Water Level (in)	Percolation Rate (min/inch)
1	8:49 AM	25	25	24.0	13.0	11.0	2.3
	9:14 AM						
2	9:14 AM	25	50	24.0	16.3	7.7	3.3
	9:39 AM						

Soil Criteria: Sandy

Percolation Test

Reading No.	Time	Time Interval (min)	Total Elapsed Time (min)	Initial Water Head (in)	Final Water Head (in)	Δ in Water Level (in)	Percolation Rate (min/inch)
1	11:01 AM	10	10	36.0	20.6	15.4	0.7
	11:11 AM						
2	11:11 AM	10	20	36.0	21.2	14.8	0.7
	11:21 AM						
3	11:21 AM	10	30	36.0	21.6	14.4	0.7
	11:31 AM						
4	11:31 AM	10	40	36.0	21.6	14.4	0.7
	11:41 AM						
5	11:41 AM	10	50	36.0	21.5	14.5	0.7
	11:51 AM						
6	11:51 AM	10	60	36.0	21.4	14.6	0.7
	12:01 PM						

Infiltration Rate (in/hr):	5.7	
Radius of test hole (in):	4	Figure A-16
Average Head (in):	28.7	

PERCOLATION TEST REPORT

Project Name:	Riverside Redevelopment	Project No.:	T2979-22-01
Test Hole No.:	P-4	Date Excavated:	5/13/2022
Length of Test Pipe:	54.0 inches	Soil Classification:	SM
Height of Pipe above Ground:	0.0 inches	Presoak Date:	5/13/2022
Depth of Test Hole:	54.0 inches	Perc Test Date:	5/16/2022
Check for Sandy Soil Criteria Tested by:	Weidman	Percolation Tested by:	Weidman

Water level measured from BOTTOM of hole

Sandy Soil Criteria Test

Trial No.	Time	Time Interval (min)	Total Elapsed Time (min)	Initial Water Level (in)	Final Water Level (in)	Δ in Water Level (in)	Percolation Rate (min/inch)
1	8:48 AM	25	25	24.0	15.2	8.8	2.9
	9:13 AM						
2	9:13 AM	25	50	24.0	17.9	6.1	4.1
	9:38 AM						

Soil Criteria: Sandy

Percolation Test

Reading No.	Time	Time Interval (min)	Total Elapsed Time (min)	Initial Water Head (in)	Final Water Head (in)	Δ in Water Level (in)	Percolation Rate (min/inch)
1	11:00 AM	10	10	36.0	21.8	14.2	0.7
	11:10 AM						
2	11:10 AM	10	20	36.0	22.1	13.9	0.7
	11:20 AM						
3	11:20 AM	10	30	36.0	22.3	13.7	0.7
	11:30 AM						
4	11:30 AM	10	40	36.0	22.7	13.3	0.8
	11:40 AM						
5	11:40 AM	10	50	36.0	23.0	13.0	0.8
	11:50 AM						
6	11:50 AM	10	60	36.0	23.4	12.6	0.8
	12:00 PM						

Infiltration Rate (in/hr):	4.8	
Radius of test hole (in):	4	Figure A-17
Average Head (in):	29.7	

PERCOLATION TEST REPORT

Project Name:	Riverside Redevelopment	Project No.:	T2979-22-01
Test Hole No.:	P-5	Date Excavated:	5/13/2022
Length of Test Pipe:	54.0 inches	Soil Classification:	SM
Height of Pipe above Ground:	0.0 inches	Presoak Date:	5/13/2022
Depth of Test Hole:	54.0 inches	Perc Test Date:	5/16/2022
Check for Sandy Soil Criteria Tested by:	Weidman	Percolation Tested by:	Weidman

Water level measured from BOTTOM of hole

Sandy Soil Criteria Test

Trial No.	Time	Time Interval (min)	Total Elapsed Time (min)	Initial Water Level (in)	Final Water Level (in)	Δ in Water Level (in)	Percolation Rate (min/inch)
1	8:46 AM	25	25	24.0	15.0	9.0	2.8
	9:11 AM						
2	9:11 AM	25	50	24.0	18.0	6.0	4.2
	9:36 AM						

Soil Criteria: Sandy

Percolation Test

Reading No.	Time	Time Interval (min)	Total Elapsed Time (min)	Initial Water Head (in)	Final Water Head (in)	Δ in Water Level (in)	Percolation Rate (min/inch)
1	9:46 AM	10	10	36.0	10.2	25.8	0.4
	9:56 AM						
2	9:56 AM	10	20	36.0	10.6	25.4	0.4
	10:06 AM						
3	10:06 AM	10	30	36.0	10.8	25.2	0.4
	10:16 AM						
4	10:16 AM	10	40	36.0	10.9	25.1	0.4
	10:26 AM						
5	10:26 AM	10	50	36.0	10.9	25.1	0.4
	10:36 AM						
6	10:36 AM	10	60	36.0	10.9	25.1	0.4
	10:46 AM						

Infiltration Rate (in/hr):	11.8	
Radius of test hole (in):	4	Figure A-18
Average Head (in):	23.5	

PERCOLATION TEST REPORT

Project Name:	Riverside Redevelopment	Project No.:	T2979-22-01
Test Hole No.:	P-6	Date Excavated:	5/13/2022
Length of Test Pipe:	54.0 inches	Soil Classification:	SM
Height of Pipe above Ground:	0.0 inches	Presoak Date:	5/13/2022
Depth of Test Hole:	54.0 inches	Perc Test Date:	5/16/2022
Check for Sandy Soil Criteria Tested by:	Weidman	Percolation Tested by:	Weidman

Water level measured from BOTTOM of hole

Sandy Soil Criteria Test

Trial No.	Time	Time Interval (min)	Total Elapsed Time (min)	Initial Water Level (in)	Final Water Level (in)	Δ in Water Level (in)	Percolation Rate (min/inch)
1	8:45 AM	25	25	24.0	16.4	7.6	3.3
	9:10 AM						
2	9:10 AM	25	50	24.0	18.0	6.0	4.2
	9:35 AM						

Soil Criteria: Sandy

Percolation Test

Reading No.	Time	Time Interval (min)	Total Elapsed Time (min)	Initial Water Head (in)	Final Water Head (in)	Δ in Water Level (in)	Percolation Rate (min/inch)
1	9:45 AM	10	10	36.0	21.6	14.4	0.7
	9:55 AM						
2	9:55 AM	10	20	36.0	21.7	14.3	0.7
	10:05 AM						
3	10:05 AM	10	30	36.0	22.0	14.0	0.7
	10:15 AM						
4	10:15 AM	10	40	36.0	22.2	13.8	0.7
	10:25 AM						
5	10:25 AM	10	50	36.0	22.4	13.6	0.7
	10:35 AM						
6	10:35 AM	10	60	36.0	22.6	13.4	0.7
	10:45 AM						

Infiltration Rate (in/hr):	5.2	
Radius of test hole (in):	4	Figure A-19
Average Head (in):	29.3	

APPENDIX

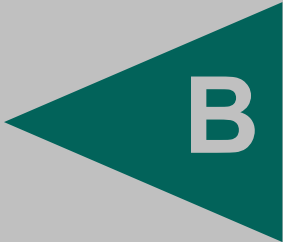

B

APPENDIX B

LABORATORY TESTING

We performed laboratory tests in accordance with current, generally accepted test methods of ASTM International (ASTM) or other suggested procedures. We analyzed selected soil samples for maximum dry density and optimum moisture content, expansion index, corrosivity, grain size distribution, and direct shear strength. The results of the laboratory tests are presented on Figures B-1 through B-10. The in-place dry density and moisture content are presented on the boring logs in *Appendix A*.

Sample No:

B4@0-5'	Poorly Graded SAND with Silt (SP-SM), olive brown
----------------	---

TEST NO.		1	2	3	4	5	6
Wt. Compacted Soil + Mold	(g)	6468	6490	6469	6407		
Weight of Mold	(g)	4265	4265	4265	4265	4265	
Net Weight of Soil	(g)	2203	2225	2204	2142	-4265	
Wet Weight of Soil + Cont.	(g)	693.9	723.1	633.4	621.5		
Dry Weight of Soil + Cont.	(g)	671.6	690.3	601.2	610.0		
Weight of Container	(g)	259.3	256.1	259.9	257.7		
Moisture Content	(%)	5.4	7.6	9.4	3.3		
Wet Density	(pcf)	146.3	147.7	146.4	142.2	-283.2	
Dry Density	(pcf)	138.8	137.4	133.7	137.7		

Maximum Dry Density (pcf)	139.0
Bulk Specific Gravity (dry)	2.66
Corrected Maximum Dry Density (pcf)	142.0

Optimum Moisture Content (%)	6.0
Oversized Fraction (%)	12.0
Corrected Moisture Content (%)	5.5

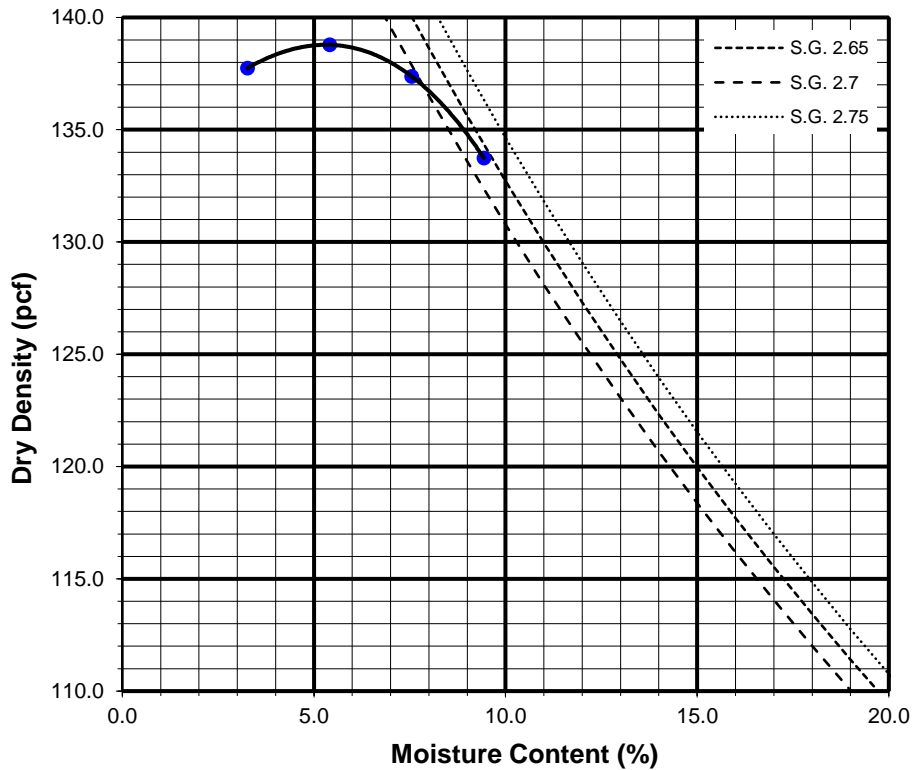

Preparation Method: A



**COMPACTION CHARACTERISTICS USING
MODIFIED EFFORT TEST RESULTS**

ASTM D-1557

Checked by:

Project No.: T2979-22-01

MISSION GROVE REDEVELOPMENT
375 EAST ALESSANDRO BOULEVARD
RIVERSIDE, CALIFORNIA

Jun 22

Figure B-1

Sample No:

B7@2-7'	Poorly Graded SAND with Silt (SP-SM), dark yellowish brown
----------------	--

TEST NO.		1	2	3	4	5	6
Wt. Compacted Soil + Mold	(g)	6448	6418	6417	6322		
Weight of Mold	(g)	4265	4265	4265	4265	4265	
Net Weight of Soil	(g)	2183	2153	2152	2057	-4265	
Wet Weight of Soil + Cont.	(g)	613.0	734.6	613.0	743.4		
Dry Weight of Soil + Cont.	(g)	586.3	691.1	592.4	724.2		
Weight of Container	(g)	254.4	257.5	253.5	257.6		
Moisture Content	(%)	8.0	10.0	6.1	4.1		
Wet Density	(pcf)	145.0	143.0	142.9	136.6	-283.2	
Dry Density	(pcf)	134.2	129.9	134.7	131.2		

Maximum Dry Density (pcf)	135.5
Bulk Specific Gravity (dry)	2.57
Corrected Maximum Dry Density (pcf)	137.0

Optimum Moisture Content (%)	7.0
Oversized Fraction (%)	8.0
Corrected Moisture Content (%)	6.5

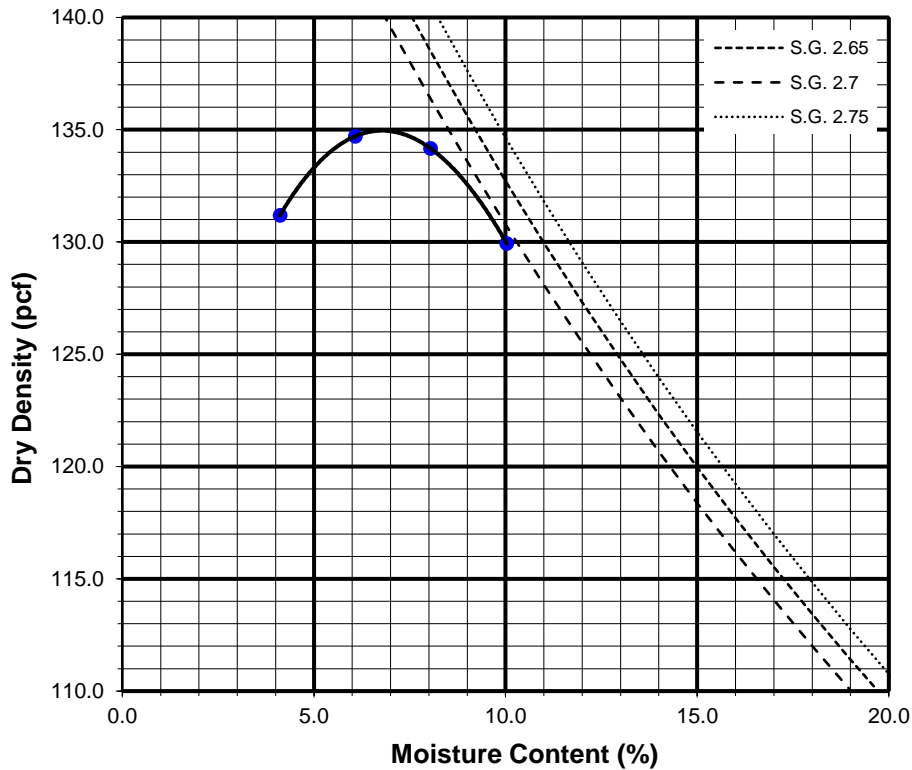

Preparation Method: A



**COMPACTION CHARACTERISTICS USING
MODIFIED EFFORT TEST RESULTS**

ASTM D-1557

Checked by:

Project No.: T2979-22-01

MISSION GROVE REDEVELOPMENT
375 EAST ALESSANDRO BOULEVARD
RIVERSIDE, CALIFORNIA

Jun 22

Figure B-2

B-2@5-10

MOLDED SPECIMEN		BEFORE TEST	AFTER TEST
Specimen Diameter	(in.)	4.0	4.0
Specimen Height	(in.)	1.0	1.0
Wt. Comp. Soil + Mold	(gm)	613.4	635.0
Wt. of Mold	(gm)	202.0	202.0
Specific Gravity	(Assumed)	2.7	2.7
Wet Wt. of Soil + Cont.	(gm)	556.0	635.0
Dry Wt. of Soil + Cont.	(gm)	532.5	379.2
Wt. of Container	(gm)	256.0	202.0
Moisture Content	(%)	8.5	14.2
Wet Density	(pcf)	124.1	130.4
Dry Density	(pcf)	114.4	114.2
Void Ratio		0.5	0.5
Total Porosity		0.3	0.3
Pore Volume	(cc)	66.6	66.4
Degree of Saturation	(%) [S_{meas}]	48.8	81.1

Date	Time	Pressure (psi)	Elapsed Time (min)	Dial Readings (in.)
6/1/2022	10:00	1.0	0	0.3775
6/1/2022	10:10	1.0	10	0.3774
Add Distilled Water to the Specimen				
6/2/2022	10:00	1.0	1430	0.3765
6/2/2022	11:00	1.0	1490	0.3765

Expansion Index (EI meas) =	-0.9
Expansion Index (Report) =	0

Expansion Index, EI_{50}	CBC CLASSIFICATION *	UBC CLASSIFICATION **
0-20	Non-Expansive	Very Low
21-50	Expansive	Low
51-90	Expansive	Medium
91-130	Expansive	High
>130	Expansive	Very High

* Reference: 2019 California Building Code, Section 1803.5.3

** Reference: 1997 Uniform Building Code, Table 18-1-B.



EXPANSION INDEX TEST RESULTS

ASTM D-4829

Checked by:

Project No.: T2979-22-01

MISSION GROVE REDEVELOPMENT
375 EAST ALESSANDRO BOULEVARD
RIVERSIDE, CALIFORNIA

Jun 22

Figure B-3

SUMMARY OF LABORATORY
 POTENTIAL OF HYDROGEN (pH) AND RESISTIVITY TEST RESULTS
 AASHTO T289 ASTM D4972 and AASHTO T288 ASTM G187

Sample No.	pH	Resistivity (ohm centimeters)
B2@44691	8.4	8000

SUMMARY OF LABORATORY CHLORIDE CONTENT TEST RESULTS
 AASHTO T291 ASTM C1218

Sample No.	Chloride Ion Content (%)
B2@5-10	0.002

SUMMARY OF LABORATORY WATER SOLUBLE SULFATE TEST RESULTS
 AASHTO T290 ASTM C1580

Sample No.	Water Soluble Sulfate (% SO ₄)	Sulfate Exposure
B2@5-10	0.000	S0

 GEOCON	CORROSIVITY TEST RESULTS	Project No.: T2979-22-01
	Checked by:	MISSION GROVE REDEVELOPMENT 375 EAST ALESSANDRO BOULEVARD RIVERSIDE, CALIFORNIA
		Jun 22 Figure B-4

GRAVEL		SAND			SILT AND CLAY
COARSE	FINE	COARSE	MEDIUM	FINE	

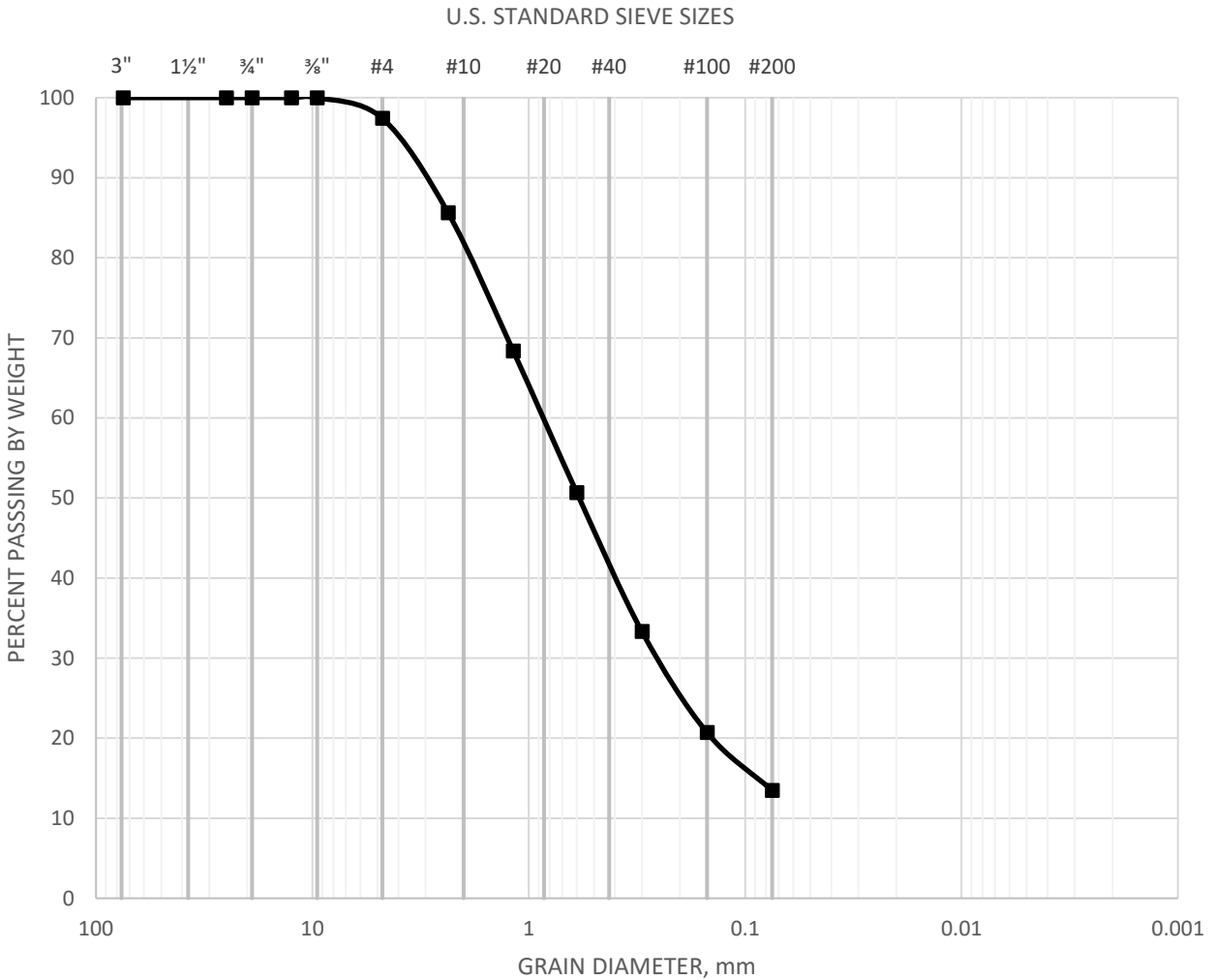

SAMPLE	CLASSIFICATION	D60	D30	D10
P-1@3	Silty SAND (SM), olive	0.87	0.25	0.073



GRAIN SIZE DISTRIBUTION

ASTM D 6913

Checked by:

Project No.: T2979-22-01

MISSION GROVE REDEVELOPMENT
375 EAST ALESSANDRO BOULEVARD
RIVERSIDE, CALIFORNIA

Jun 22

Figure B-5

GRAVEL		SAND			SILT AND CLAY
COARSE	FINE	COARSE	MEDIUM	FINE	

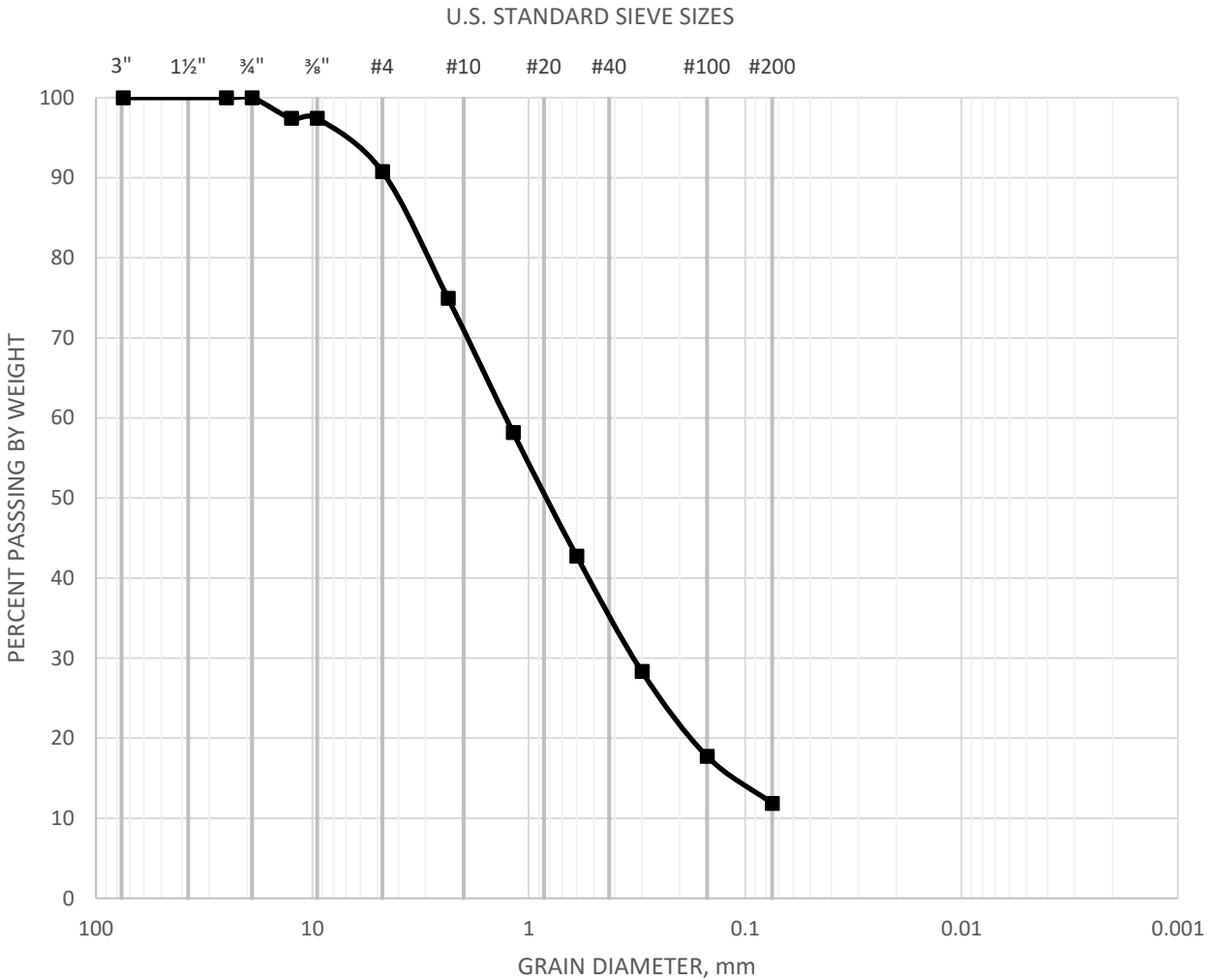

SAMPLE	CLASSIFICATION	D60	D30	D10
P-3@4.5	Well Graded SAND with Silt (SW-SM), olive brown	1.2	0.31	0.073



GRAIN SIZE DISTRIBUTION

ASTM D 6913

Checked by:

Project No.: T2979-22-01

MISSION GROVE REDEVELOPMENT
375 EAST ALESSANDRO BOULEVARD
RIVERSIDE, CALIFORNIA

Jun 22

Figure B-6

GRAVEL		SAND			SILT AND CLAY
COARSE	FINE	COARSE	MEDIUM	FINE	

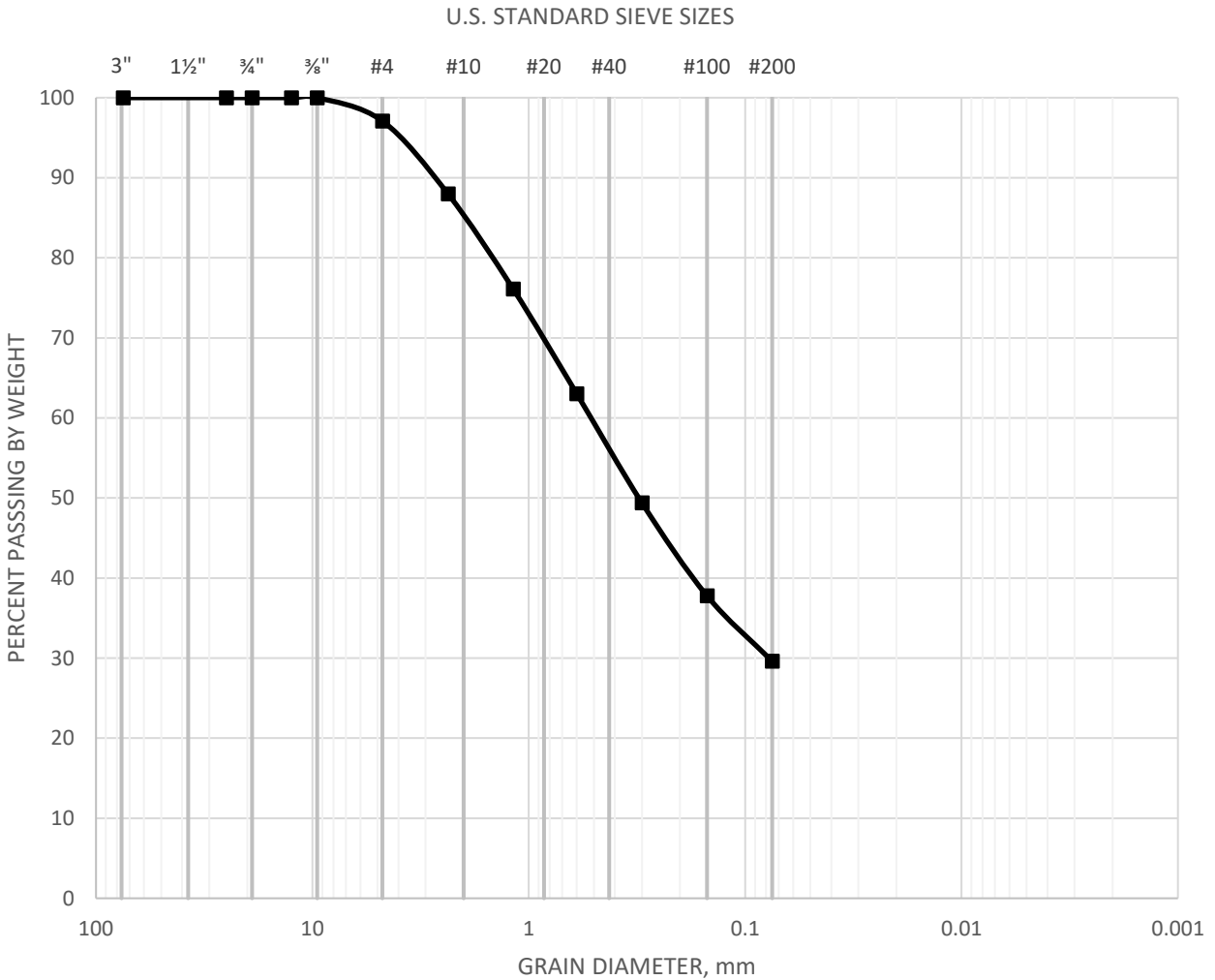

SAMPLE	CLASSIFICATION	D60	D30	D10
P-5@4.5	Silty SAND (SM), dark yellowish brown	0.5	0.073	0.073



GRAIN SIZE DISTRIBUTION

ASTM D 6913

Checked by:

Project No.: T2979-22-01

MISSION GROVE REDEVELOPMENT
375 EAST ALESSANDRO BOULEVARD
RIVERSIDE, CALIFORNIA

Jun 22

Figure B-7

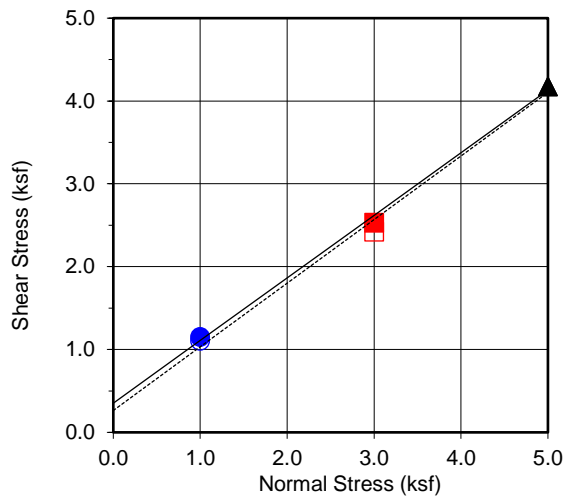
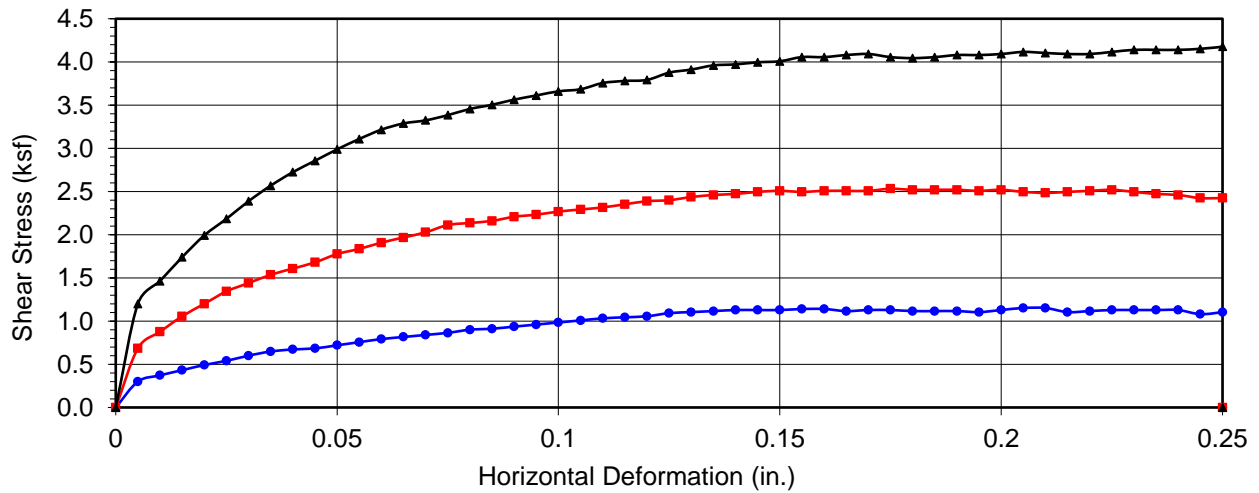

Boring No.	B1
Sample No.	B-1@5
Depth (ft)	5
Sample Type:	ring

<u>Soil Identification:</u>		
Silty SAND with Gravel (SM)g, light grayish brown		
Strength Parameters		
	C (psf)	ϕ (°)
Peak	352	37.1
Ultimate	264	37.5

Normal Stress (kip/ft ²)	1	3	5
Peak Shear Stress (kip/ft ²)	● 1.15	■ 2.53	▲ 4.18
Shear Stress @ End of Test (ksf)	○ 1.10	□ 2.42	△ 4.18
Deformation Rate (in./min.)	0.05	0.05	0.05
Initial Sample Height (in.)	1.0	1.0	1.0
Ring Inside Diameter (in.)	2.375	2.375	2.375
Initial Moisture Content (%)	5.9	6.1	7.8
Initial Dry Density (pcf)	112.8	109.5	113.8
Initial Degree of Saturation (%)	32.1	30.4	44.0
Soil Height Before Shearing (in.)	1.2	1.2	1.2
Final Moisture Content (%)	15.9	15.6	11.4



DIRECT SHEAR TEST RESULTS

Consolidated Drained ASTM D-3080

Checked by:

Project No.: T2979-22-01

MISSION GROVE REDEVELOPMENT
375 EAST ALESSANDRO BOULEVARD
RIVERSIDE, CALIFORNIA

Jun 22

Figure B-8

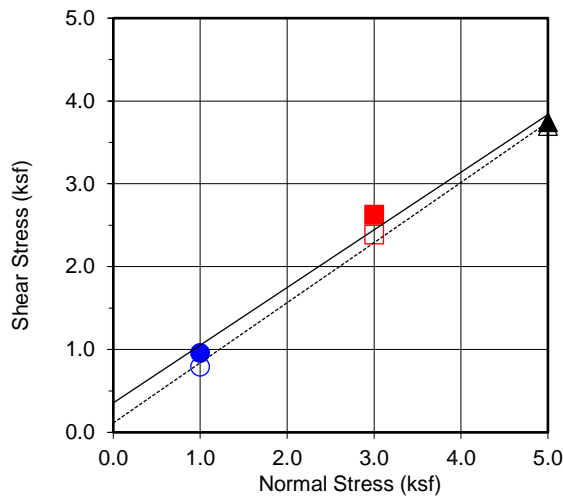
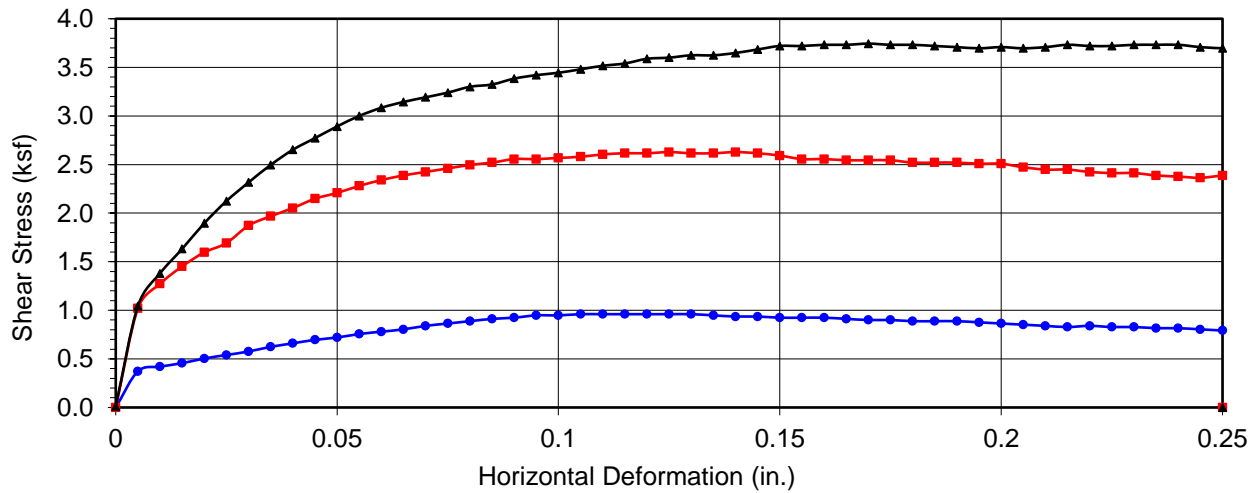

Boring No.	B4
Sample No.	B-4@0-5
Depth (ft)	0-5
<u>Sample Type:</u>	Bulk

<u>Soil Identification:</u>		
Poorly Graded SAND with Silt (SP-SM), olive brown		
Strength Parameters		
	C (psf)	ϕ ($^{\circ}$)
Peak	356	34.8
Ultimate	114	36.0

Normal Stress (kip/ft ²)	1	3	5
Peak Shear Stress (kip/ft ²)	● 0.96	■ 2.63	▲ 3.74
Shear Stress @ End of Test (ksf)	○ 0.79	□ 2.39	△ 3.70
Deformation Rate (in./min.)	0.05	0.05	0.05
Initial Sample Height (in.)	1.0	1.0	1.0
Ring Inside Diameter (in.)	2.375	2.375	2.375
Initial Moisture Content (%)	5.9	5.9	5.9
Initial Dry Density (pcf)	124.9	124.9	125.1
Initial Degree of Saturation (%)	45.7	45.4	46.1
Soil Height Before Shearing (in.)	1.2	1.2	1.2
Final Moisture Content (%)	12.9	13.1	12.5



DIRECT SHEAR TEST RESULTS

Consolidated Drained ASTM D-3080

Checked by:

Project No.: T2979-22-01

MISSION GROVE REDEVELOPMENT
375 EAST ALESSANDRO BOULEVARD
RIVERSIDE, CALIFORNIA

Jun 22

Figure B-9

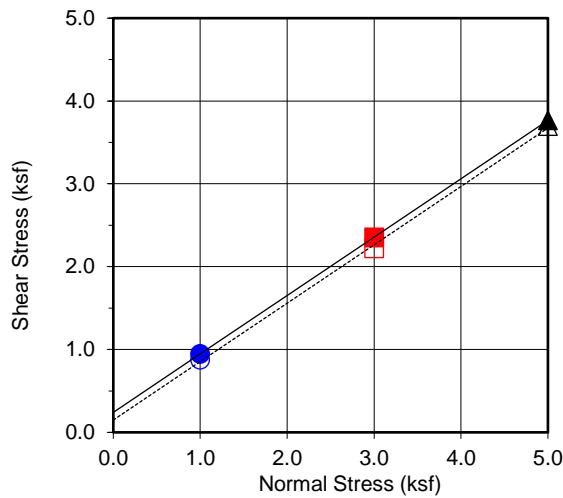
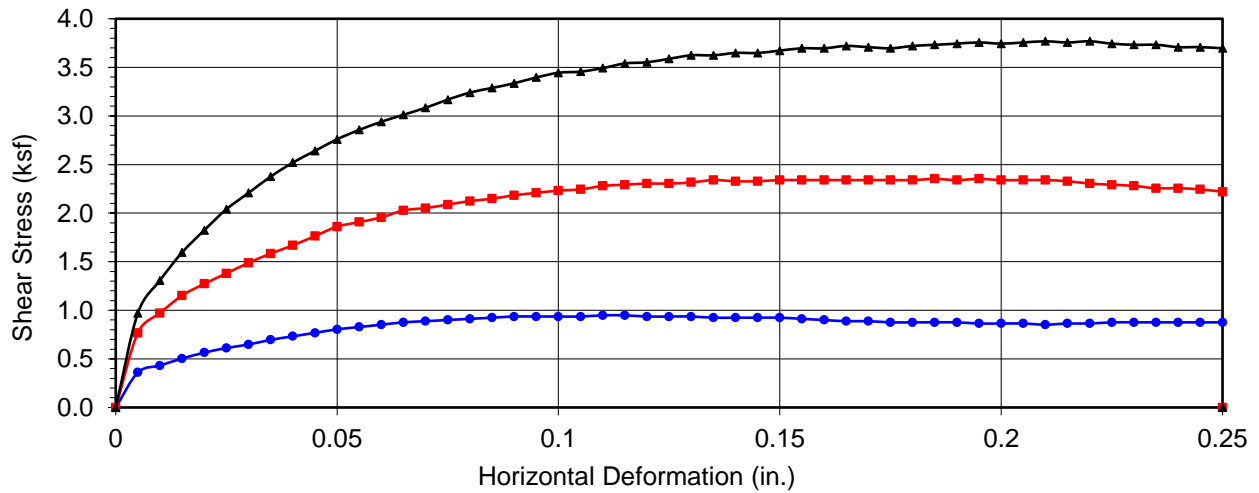

Boring No.	B7
Sample No.	B-7@2-7
Depth (ft)	44599
<u>Sample Type:</u>	Bulk

<u>Soil Identification:</u>		
Highly Graded SAND with Silt (SP-SM), dark yellowish brown		
Strength Parameters		
	C (psf)	ϕ (°)
Peak	241	35.2
Ultimate	149	35.2

Normal Stress (kip/ft ²)	1	3	5
Peak Shear Stress (kip/ft ²)	● 0.95	■ 2.35	▲ 3.77
Shear Stress @ End of Test (ksf)	○ 0.88	□ 2.22	△ 3.70
Deformation Rate (in./min.)	0.05	0.05	0.05
Initial Sample Height (in.)	1.0	1.0	1.0
Ring Inside Diameter (in.)	2.375	2.375	2.375
Initial Moisture Content (%)	6.9	6.9	6.9
Initial Dry Density (pcf)	122.1	122.0	122.1
Initial Degree of Saturation (%)	48.8	48.9	49.0
Soil Height Before Shearing (in.)	1.2	1.2	1.2
Final Moisture Content (%)	13.1	12.9	10.8



DIRECT SHEAR TEST RESULTS

Consolidated Drained ASTM D-3080

Checked by:

Project No.: T2979-22-01

MISSION GROVE REDEVELOPMENT
375 EAST ALESSANDRO BOULEVARD
RIVERSIDE, CALIFORNIA

Jun 22

Figure B-10

APPENDIX



C

APPENDIX C

RECOMMENDED GRADING SPECIFICATIONS

FOR

MISSION GROVE REDEVELOPMENT
375 EAST ALESSANDRO BOULEVARD
RIVERSIDE, CALIFORNIA

PROJECT NO. T2979-22-01

RECOMMENDED GRADING SPECIFICATIONS

1. GENERAL

- 1.1 These Recommended Grading Specifications shall be used in conjunction with the Geotechnical Report for the project prepared by Geocon. The recommendations contained in the text of the Geotechnical Report are a part of the earthwork and grading specifications and shall supersede the provisions contained hereinafter in the case of conflict.
- 1.2 Prior to the commencement of grading, a geotechnical consultant (Consultant) shall be employed for the purpose of observing earthwork procedures and testing the fills for substantial conformance with the recommendations of the Geotechnical Report and these specifications. The Consultant should provide adequate testing and observation services so that they may assess whether, in their opinion, the work was performed in substantial conformance with these specifications. It shall be the responsibility of the Contractor to assist the Consultant and keep them apprised of work schedules and changes so that personnel may be scheduled accordingly.
- 1.3 It shall be the sole responsibility of the Contractor to provide adequate equipment and methods to accomplish the work in accordance with applicable grading codes or agency ordinances, these specifications and the approved grading plans. If, in the opinion of the Consultant, unsatisfactory conditions such as questionable soil materials, poor moisture condition, inadequate compaction, and/or adverse weather result in a quality of work not in conformance with these specifications, the Consultant will be empowered to reject the work and recommend to the Owner that grading be stopped until the unacceptable conditions are corrected.

2. DEFINITIONS

- 2.1 **Owner** shall refer to the owner of the property or the entity on whose behalf the grading work is being performed and who has contracted with the Contractor to have grading performed.
- 2.2 **Contractor** shall refer to the Contractor performing the site grading work.
- 2.3 **Civil Engineer** or **Engineer of Work** shall refer to the California licensed Civil Engineer or consulting firm responsible for preparation of the grading plans, surveying and verifying as-graded topography.
- 2.4 **Consultant** shall refer to the soil engineering and engineering geology consulting firm retained to provide geotechnical services for the project.

- 2.5 **Soil Engineer** shall refer to a California licensed Civil Engineer retained by the Owner, who is experienced in the practice of geotechnical engineering. The Soil Engineer shall be responsible for having qualified representatives on-site to observe and test the Contractor's work for conformance with these specifications.
- 2.6 **Engineering Geologist** shall refer to a California licensed Engineering Geologist retained by the Owner to provide geologic observations and recommendations during the site grading.
- 2.7 **Geotechnical Report** shall refer to a soil report (including all addenda) which may include a geologic reconnaissance or geologic investigation that was prepared specifically for the development of the project for which these Recommended Grading Specifications are intended to apply.

3. MATERIALS

- 3.1 Materials for compacted fill shall consist of any soil excavated from the cut areas or imported to the site that, in the opinion of the Consultant, is suitable for use in construction of fills. In general, fill materials can be classified as *soil* fills, *soil-rock* fills or *rock* fills, as defined below.
- 3.1.1 **Soil fills** are defined as fills containing no rocks or hard lumps greater than 12 inches in maximum dimension and containing at least 40 percent by weight of material smaller than $\frac{3}{4}$ inch in size.
- 3.1.2 **Soil-rock fills** are defined as fills containing no rocks or hard lumps larger than 4 feet in maximum dimension and containing a sufficient matrix of soil fill to allow for proper compaction of soil fill around the rock fragments or hard lumps as specified in Paragraph 6.2. **Oversize rock** is defined as material greater than 12 inches.
- 3.1.3 **Rock fills** are defined as fills containing no rocks or hard lumps larger than 3 feet in maximum dimension and containing little or no fines. Fines are defined as material smaller than $\frac{3}{4}$ inch in maximum dimension. The quantity of fines shall be less than approximately 20 percent of the rock fill quantity.
- 3.2 Material of a perishable, spongy, or otherwise unsuitable nature as determined by the Consultant shall not be used in fills.
- 3.3 Materials used for fill, either imported or on-site, shall not contain hazardous materials as defined by the California Code of Regulations, Title 22, Division 4, Chapter 30, Articles 9

and 10; 40CFR; and any other applicable local, state or federal laws. The Consultant shall not be responsible for the identification or analysis of the potential presence of hazardous materials. However, if observations, odors or soil discoloration cause Consultant to suspect the presence of hazardous materials, the Consultant may request from the Owner the termination of grading operations within the affected area. Prior to resuming grading operations, the Owner shall provide a written report to the Consultant indicating that the suspected materials are not hazardous as defined by applicable laws and regulations.

- 3.4 The outer 15 feet of *soil-rock* fill slopes, measured horizontally, should be composed of properly compacted *soil* fill materials approved by the Consultant. *Rock* fill may extend to the slope face, provided that the slope is not steeper than 2:1 (horizontal:vertical) and a soil layer no thicker than 12 inches is track-walked onto the face for landscaping purposes. This procedure may be utilized provided it is acceptable to the governing agency, Owner and Consultant.
- 3.5 Samples of soil materials to be used for fill should be tested in the laboratory by the Consultant to determine the maximum density, optimum moisture content, and, where appropriate, shear strength, expansion, and gradation characteristics of the soil.
- 3.6 During grading, soil or groundwater conditions other than those identified in the Geotechnical Report may be encountered by the Contractor. The Consultant shall be notified immediately to evaluate the significance of the unanticipated condition

4. CLEARING AND PREPARING AREAS TO BE FILLED

- 4.1 Areas to be excavated and filled shall be cleared and grubbed. Clearing shall consist of complete removal above the ground surface of trees, stumps, brush, vegetation, man-made structures, and similar debris. Grubbing shall consist of removal of stumps, roots, buried logs and other unsuitable material and shall be performed in areas to be graded. Roots and other projections exceeding 1½ inches in diameter shall be removed to a depth of 3 feet below the surface of the ground. Borrow areas shall be grubbed to the extent necessary to provide suitable fill materials.
- 4.2 Asphalt pavement material removed during clearing operations should be properly disposed at an approved off-site facility or in an acceptable area of the project evaluated by Geocon and the property owner. Concrete fragments that are free of reinforcing steel may be placed in fills, provided they are placed in accordance with Section 6.2 or 6.3 of this document.

- 4.3 After clearing and grubbing of organic matter and other unsuitable material, loose or porous soils shall be removed to the depth recommended in the Geotechnical Report. The depth of removal and compaction should be observed and approved by a representative of the Consultant. The exposed surface shall then be plowed or scarified to a minimum depth of 6 inches and until the surface is free from uneven features that would tend to prevent uniform compaction by the equipment to be used.
- 4.4 Where the slope ratio of the original ground is steeper than 5:1 (horizontal:vertical), or where recommended by the Consultant, the original ground should be benched in accordance with the following illustration.

TYPICAL BENCHING DETAIL

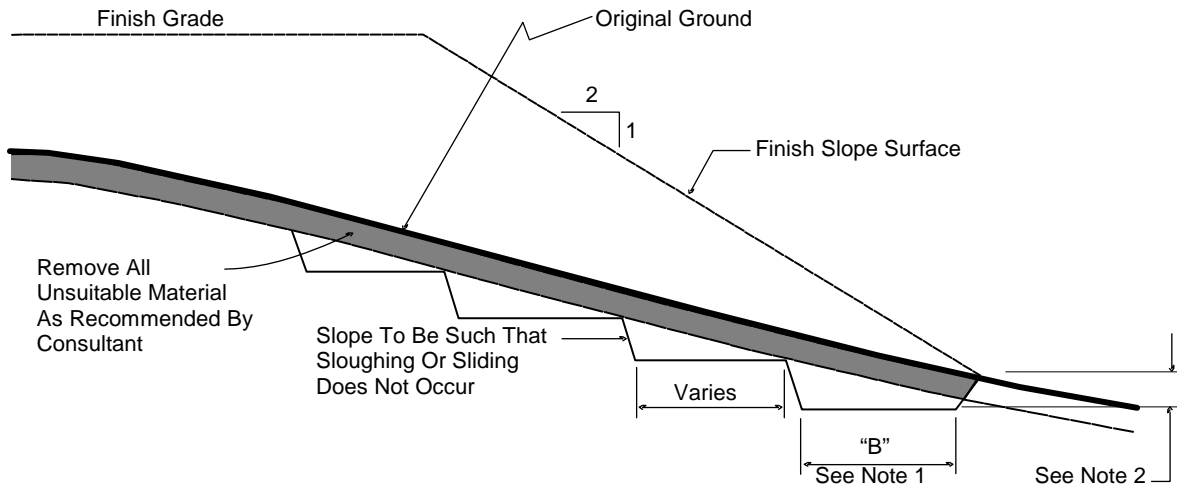

No Scale

- DETAIL NOTES:
- (1) Key width "B" should be a minimum of 10 feet, or sufficiently wide to permit complete coverage with the compaction equipment used. The base of the key should be graded horizontal, or inclined slightly into the natural slope.
 - (2) The outside of the key should be below the topsoil or unsuitable surficial material and at least 2 feet into dense formational material. Where hard rock is exposed in the bottom of the key, the depth and configuration of the key may be modified as approved by the Consultant.

- 4.5 After areas to receive fill have been cleared and scarified, the surface should be moisture conditioned to achieve the proper moisture content, and compacted as recommended in Section 6 of these specifications.

5. COMPACTION EQUIPMENT

- 5.1 Compaction of *soil* or *soil-rock* fill shall be accomplished by sheepsfoot or segmented-steel wheeled rollers, vibratory rollers, multiple-wheel pneumatic-tired rollers, or other types of acceptable compaction equipment. Equipment shall be of such a design that it will be capable of compacting the *soil* or *soil-rock* fill to the specified relative compaction at the specified moisture content.
- 5.2 Compaction of *rock* fills shall be performed in accordance with Section 6.3.

6. PLACING, SPREADING AND COMPACTION OF FILL MATERIAL

- 6.1 *Soil* fill, as defined in Paragraph 3.1.1, shall be placed by the Contractor in accordance with the following recommendations:
- 6.1.1 *Soil* fill shall be placed by the Contractor in layers that, when compacted, should generally not exceed 8 inches. Each layer shall be spread evenly and shall be thoroughly mixed during spreading to obtain uniformity of material and moisture in each layer. The entire fill shall be constructed as a unit in nearly level lifts. Rock materials greater than 12 inches in maximum dimension shall be placed in accordance with Section 6.2 or 6.3 of these specifications.
- 6.1.2 In general, the *soil* fill shall be compacted at a moisture content at or above the optimum moisture content as determined by ASTM D 1557.
- 6.1.3 When the moisture content of *soil* fill is below that specified by the Consultant, water shall be added by the Contractor until the moisture content is in the range specified.
- 6.1.4 When the moisture content of the *soil* fill is above the range specified by the Consultant or too wet to achieve proper compaction, the *soil* fill shall be aerated by the Contractor by blading/mixing, or other satisfactory methods until the moisture content is within the range specified.
- 6.1.5 After each layer has been placed, mixed, and spread evenly, it shall be thoroughly compacted by the Contractor to a relative compaction of at least 90 percent. Relative compaction is defined as the ratio (expressed in percent) of the in-place dry density of the compacted fill to the maximum laboratory dry density as determined in accordance with ASTM D 1557. Compaction shall be continuous over the entire area, and compaction equipment shall make sufficient passes so that the specified minimum relative compaction has been achieved throughout the entire fill.

- 6.1.6 Where practical, soils having an Expansion Index greater than 50 should be placed at least 3 feet below finish pad grade and should be compacted at a moisture content generally 2 to 4 percent greater than the optimum moisture content for the material.
 - 6.1.7 Properly compacted *soil* fill shall extend to the design surface of fill slopes. To achieve proper compaction, it is recommended that fill slopes be over-built by at least 3 feet and then cut to the design grade. This procedure is considered preferable to track-walking of slopes, as described in the following paragraph.
 - 6.1.8 As an alternative to over-building of slopes, slope faces may be back-rolled with a heavy-duty loaded sheepsfoot or vibratory roller at maximum 4-foot fill height intervals. Upon completion, slopes should then be track-walked with a D-8 dozer or similar equipment, such that a dozer track covers all slope surfaces at least twice.
- 6.2 *Soil-rock* fill, as defined in Paragraph 3.1.2, shall be placed by the Contractor in accordance with the following recommendations:
- 6.2.1 Rocks larger than 12 inches but less than 4 feet in maximum dimension may be incorporated into the compacted *soil* fill, but shall be limited to the area measured 15 feet minimum horizontally from the slope face and 5 feet below finish grade or 3 feet below the deepest utility, whichever is deeper.
 - 6.2.2 Rocks or rock fragments up to 4 feet in maximum dimension may either be individually placed or placed in windrows. Under certain conditions, rocks or rock fragments up to 10 feet in maximum dimension may be placed using similar methods. The acceptability of placing rock materials greater than 4 feet in maximum dimension shall be evaluated during grading as specific cases arise and shall be approved by the Consultant prior to placement.
 - 6.2.3 For individual placement, sufficient space shall be provided between rocks to allow for passage of compaction equipment.
 - 6.2.4 For windrow placement, the rocks should be placed in trenches excavated in properly compacted *soil* fill. Trenches should be approximately 5 feet wide and 4 feet deep in maximum dimension. The voids around and beneath rocks should be filled with approved granular soil having a Sand Equivalent of 30 or greater and should be compacted by flooding. Windrows may also be placed utilizing an "open-face" method in lieu of the trench procedure, however, this method should first be approved by the Consultant.

- 6.2.5 Windrows should generally be parallel to each other and may be placed either parallel to or perpendicular to the face of the slope depending on the site geometry. The minimum horizontal spacing for windrows shall be 12 feet center-to-center with a 5-foot stagger or offset from lower courses to next overlying course. The minimum vertical spacing between windrow courses shall be 2 feet from the top of a lower windrow to the bottom of the next higher windrow.
- 6.2.6 Rock placement, fill placement and flooding of approved granular soil in the windrows should be continuously observed by the Consultant.
- 6.3 *Rock* fills, as defined in Section 3.1.3, shall be placed by the Contractor in accordance with the following recommendations:
- 6.3.1 The base of the *rock* fill shall be placed on a sloping surface (minimum slope of 2 percent). The surface shall slope toward suitable subdrainage outlet facilities. The *rock* fills shall be provided with subdrains during construction so that a hydrostatic pressure buildup does not develop. The subdrains shall be permanently connected to controlled drainage facilities to control post-construction infiltration of water.
- 6.3.2 *Rock* fills shall be placed in lifts not exceeding 3 feet. Placement shall be by rock trucks traversing previously placed lifts and dumping at the edge of the currently placed lift. Spreading of the *rock* fill shall be by dozer to facilitate *seating* of the rock. The *rock* fill shall be watered heavily during placement. Watering shall consist of water trucks traversing in front of the current rock lift face and spraying water continuously during rock placement. Compaction equipment with compactive energy comparable to or greater than that of a 20-ton steel vibratory roller or other compaction equipment providing suitable energy to achieve the required compaction or deflection as recommended in Paragraph 6.3.3 shall be utilized. The number of passes to be made should be determined as described in Paragraph 6.3.3. Once a *rock* fill lift has been covered with *soil* fill, no additional *rock* fill lifts will be permitted over the *soil* fill.
- 6.3.3 Plate bearing tests, in accordance with ASTM D 1196, may be performed in both the compacted *soil* fill and in the *rock* fill to aid in determining the required minimum number of passes of the compaction equipment. If performed, a minimum of three plate bearing tests should be performed in the properly compacted *soil* fill (minimum relative compaction of 90 percent). Plate bearing tests shall then be performed on areas of *rock* fill having two passes, four passes and six passes of the compaction equipment, respectively. The number of passes required for the *rock* fill shall be determined by comparing the results of the plate bearing tests for the *soil* fill and the *rock* fill and by evaluating the deflection

variation with number of passes. The required number of passes of the compaction equipment will be performed as necessary until the plate bearing deflections are equal to or less than that determined for the properly compacted *soil* fill. In no case will the required number of passes be less than two.

- 6.3.4 A representative of the Consultant should be present during *rock* fill operations to observe that the minimum number of “passes” have been obtained, that water is being properly applied and that specified procedures are being followed. The actual number of plate bearing tests will be determined by the Consultant during grading.
- 6.3.5 Test pits shall be excavated by the Contractor so that the Consultant can state that, in their opinion, sufficient water is present and that voids between large rocks are properly filled with smaller rock material. In-place density testing will not be required in the *rock* fills.
- 6.3.6 To reduce the potential for “piping” of fines into the *rock* fill from overlying *soil* fill material, a 2-foot layer of graded filter material shall be placed above the uppermost lift of *rock* fill. The need to place graded filter material below the *rock* should be determined by the Consultant prior to commencing grading. The gradation of the graded filter material will be determined at the time the *rock* fill is being excavated. Materials typical of the *rock* fill should be submitted to the Consultant in a timely manner, to allow design of the graded filter prior to the commencement of *rock* fill placement.
- 6.3.7 *Rock* fill placement should be continuously observed during placement by the Consultant.

7. SUBDRAINS

- 7.1 The geologic units on the site may have permeability characteristics and/or fracture systems that could be susceptible under certain conditions to seepage. The use of canyon subdrains may be necessary to mitigate the potential for adverse impacts associated with seepage conditions. Canyon subdrains with lengths in excess of 500 feet or extensions of existing offsite subdrains should use 8-inch-diameter pipes. Canyon subdrains less than 500 feet in length should use 6-inch-diameter pipes.

TYPICAL CANYON DRAIN DETAIL

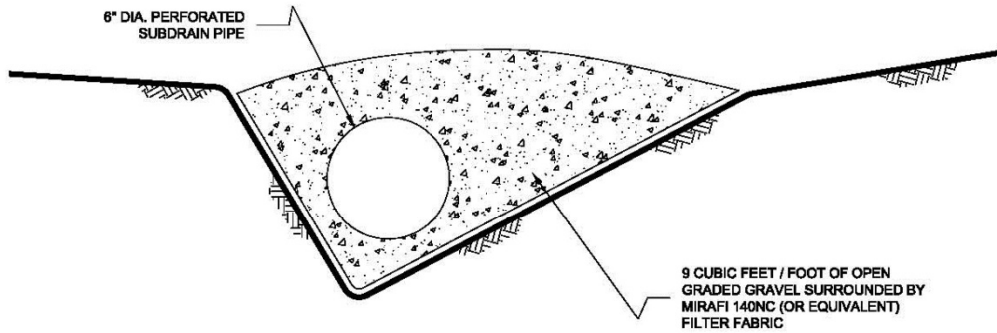
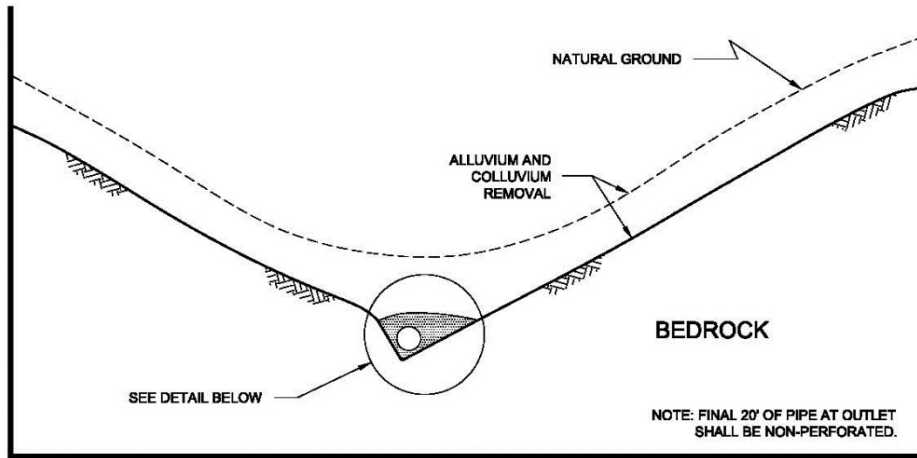

NOTES:

- 1.....8-INCH DIAMETER, SCHEDULE 80 PVC PERFORATED PIPE FOR FILLS IN EXCESS OF 100-FEET IN DEPTH OR A PIPE LENGTH OF LONGER THAN 500 FEET.
- 2.....6-INCH DIAMETER, SCHEDULE 40 PVC PERFORATED PIPE FOR FILLS LESS THAN 100-FEET IN DEPTH OR A PIPE LENGTH SHORTER THAN 500 FEET.

NO SCALE

7.2 Slope drains within stability fill keyways should use 4-inch-diameter (or larger) pipes.

TYPICAL STABILITY FILL DETAIL

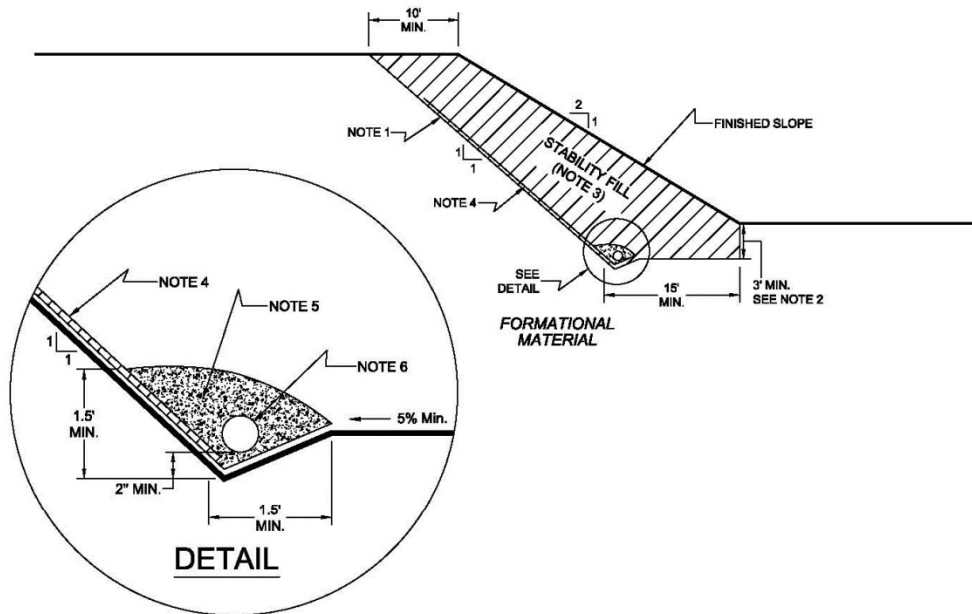

NOTES:

- 1.....EXCAVATE BACKCUT AT 1:1 INCLINATION (UNLESS OTHERWISE NOTED).
- 2.....BASE OF STABILITY FILL TO BE 3 FEET INTO FORMATIONAL MATERIAL, SLOPING A MINIMUM 5% INTO SLOPE.
- 3.....STABILITY FILL TO BE COMPOSED OF PROPERLY COMPACTED GRANULAR SOIL.
- 4.....CHIMNEY DRAINS TO BE APPROVED PREFABRICATED CHIMNEY DRAIN PANELS (MIRADRAIN G200N OR EQUIVALENT) SPACED APPROXIMATELY 20 FEET CENTER TO CENTER AND 4 FEET WIDE. CLOSER SPACING MAY BE REQUIRED IF SEEPAGE IS ENCOUNTERED.
- 5.....FILTER MATERIAL TO BE 3/4-INCH, OPEN-GRADED CRUSHED ROCK ENCLOSED IN APPROVED FILTER FABRIC (MIRAFI 140NC).
- 6.....COLLECTOR PIPE TO BE 4-INCH MINIMUM DIAMETER, PERFORATED, THICK-WALLED PVC SCHEDULE 40 OR EQUIVALENT, AND SLOPED TO DRAIN AT 1 PERCENT MINIMUM TO APPROVED OUTLET.

NO SCALE

7.3 The actual subdrain locations will be evaluated in the field during the remedial grading operations. Additional drains may be necessary depending on the conditions observed and the requirements of the local regulatory agencies. Appropriate subdrain outlets should be evaluated prior to finalizing 40-scale grading plans.

7.4 *Rock fill* or *soil-rock fill* areas may require subdrains along their down-slope perimeters to mitigate the potential for buildup of water from construction or landscape irrigation. The subdrains should be at least 6-inch-diameter pipes encapsulated in gravel and filter fabric. *Rock fill* drains should be constructed using the same requirements as canyon subdrains.

7.5 Prior to outletting, the final 20-foot segment of a subdrain that will not be extended during future development should consist of non-perforated drainpipe. At the non-perforated/perforated interface, a seepage cutoff wall should be constructed on the downslope side of the pipe.

TYPICAL CUT OFF WALL DETAIL

FRONT VIEW

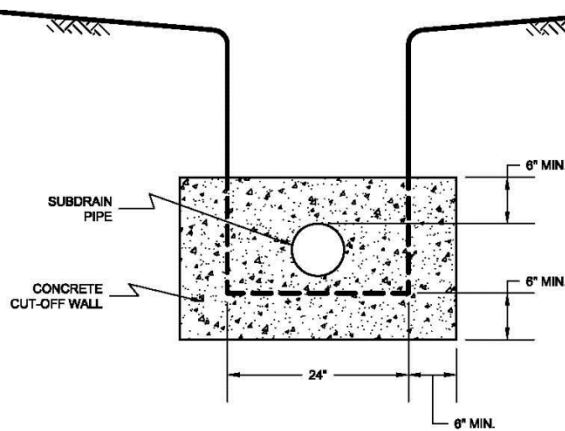

NO SCALE

SIDE VIEW

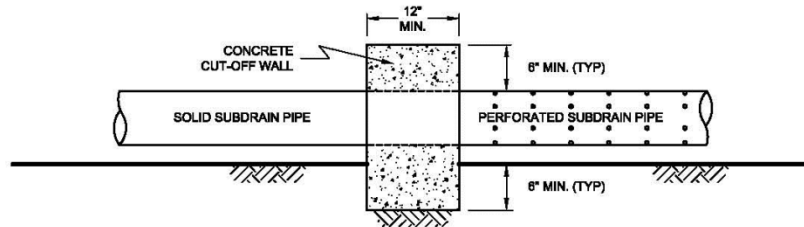

NO SCALE

7.6 Subdrains that discharge into a natural drainage course or open space area should be provided with a permanent headwall structure.

TYPICAL HEADWALL DETAIL

FRONT VIEW

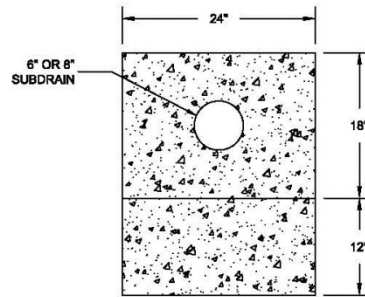

NO SCALE

SIDE VIEW

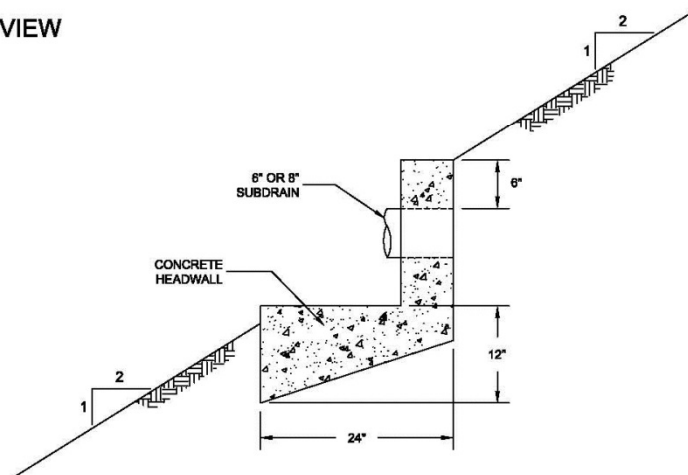

NOTE: HEADWALL SHOULD OUTLET AT TOE OF FILL SLOPE
OR INTO CONTROLLED SURFACE DRAINAGE

NO SCALE

- 7.7 The final grading plans should show the location of the proposed subdrains. After completion of remedial excavations and subdrain installation, the project civil engineer should survey the drain locations and prepare an “as-built” map showing the drain locations. The final outlet and connection locations should be determined during grading operations. Subdrains that will be extended on adjacent projects after grading can be placed on formational material and a vertical riser should be placed at the end of the subdrain. The grading contractor should consider videoing the subdrains shortly after burial to check proper installation and functionality. The contractor is responsible for the performance of the drains.

8. OBSERVATION AND TESTING

- 8.1 The Consultant shall be the Owner's representative to observe and perform tests during clearing, grubbing, filling, and compaction operations. In general, no more than 2 feet in vertical elevation of *soil* or *soil-rock* fill should be placed without at least one field density test being performed within that interval. In addition, a minimum of one field density test should be performed for every 2,000 cubic yards of *soil* or *soil-rock* fill placed and compacted.
- 8.2 The Consultant should perform a sufficient distribution of field density tests of the compacted *soil* or *soil-rock* fill to provide a basis for expressing an opinion whether the fill material is compacted as specified. Density tests shall be performed in the compacted materials below any disturbed surface. When these tests indicate that the density of any layer of fill or portion thereof is below that specified, the particular layer or areas represented by the test shall be reworked until the specified density has been achieved.
- 8.3 During placement of *rock* fill, the Consultant should observe that the minimum number of passes have been obtained per the criteria discussed in Section 6.3.3. The Consultant should request the excavation of observation pits and may perform plate bearing tests on the placed *rock* fills. The observation pits will be excavated to provide a basis for expressing an opinion as to whether the *rock* fill is properly seated and sufficient moisture has been applied to the material. When observations indicate that a layer of *rock* fill or any portion thereof is below that specified, the affected layer or area shall be reworked until the *rock* fill has been adequately seated and sufficient moisture applied.
- 8.4 A settlement monitoring program designed by the Consultant may be conducted in areas of *rock* fill placement. The specific design of the monitoring program shall be as recommended in the Conclusions and Recommendations section of the project Geotechnical Report or in the final report of testing and observation services performed during grading.
- 8.5 We should observe the placement of subdrains, to check that the drainage devices have been placed and constructed in substantial conformance with project specifications.
- 8.6 Testing procedures shall conform to the following Standards as appropriate:

8.6.1 Soil and Soil-Rock Fills:

- 8.6.1.1 Field Density Test, ASTM D 1556, *Density of Soil In-Place By the Sand-Cone Method.*

- 8.6.1.2 Field Density Test, Nuclear Method, ASTM D 6938, *Density of Soil and Soil-Aggregate In-Place by Nuclear Methods (Shallow Depth)*.
- 8.6.1.3 Laboratory Compaction Test, ASTM D 1557, *Moisture-Density Relations of Soils and Soil-Aggregate Mixtures Using 10-Pound Hammer and 18-Inch Drop*.
- 8.6.1.4 Expansion Index Test, ASTM D 4829, *Expansion Index Test*.

9. PROTECTION OF WORK

- 9.1 During construction, the Contractor shall properly grade all excavated surfaces to provide positive drainage and prevent ponding of water. Drainage of surface water shall be controlled to avoid damage to adjoining properties or to finished work on the site. The Contractor shall take remedial measures to prevent erosion of freshly graded areas until such time as permanent drainage and erosion control features have been installed. Areas subjected to erosion or sedimentation shall be properly prepared in accordance with the Specifications prior to placing additional fill or structures.
- 9.2 After completion of grading as observed and tested by the Consultant, no further excavation or filling shall be conducted except in conjunction with the services of the Consultant.

10. CERTIFICATIONS AND FINAL REPORTS

- 10.1 Upon completion of the work, Contractor shall furnish Owner a certification by the Civil Engineer stating that the lots and/or building pads are graded to within 0.1 foot vertically of elevations shown on the grading plan and that all tops and toes of slopes are within 0.5 foot horizontally of the positions shown on the grading plans. After installation of a section of subdrain, the project Civil Engineer should survey its location and prepare an *as-built* plan of the subdrain location. The project Civil Engineer should verify the proper outlet for the subdrains and the Contractor should ensure that the drain system is free of obstructions.
- 10.2 The Owner is responsible for furnishing a final as-graded soil and geologic report satisfactory to the appropriate governing or accepting agencies. The as-graded report should be prepared and signed by a California licensed Civil Engineer experienced in geotechnical engineering and by a California Certified Engineering Geologist, indicating that the geotechnical aspects of the grading were performed in substantial conformance with the Specifications or approved changes to the Specifications.