

APPENDIX F

PRELIMINARY HYDROLOGY AND HYDRAULICS STUDY



Preliminary Hydrology and Hydraulics Study

for

Shapell Norwalk Apartments

South-east Corner of Alondra Blvd. & Maidstone Ave.

Norwalk, CA

OCTOBER 18, 2022 | PRELIMINARY

Prepared for:

Shapell Properties

11200 Corbin Ave. Suite 201

Porter Ranch, CA 91326

Prepared By:

Kimley»»Horn

KHA Project # 094896004

© 2022 Kimley-Horn and Associates, Inc.

Contents

Introduction	4
Project Description and purpose.....	4
Project site conditions	5
Existing site (pre-development) conditions.....	5
Proposed site (post-development) conditions	5
Low Impact Development (LID)	6
Precipitaiton	6
Watershed description.....	6
Soil Types.....	6
Land Use	6
Groundwater	7
FEMA Mapping	7
Hydrologic Analysis.....	7
Methodology	7
Results and Conclusions.....	7
Appendix A	10
Appendix B	11
Appendix C	12
Appendix D	13
Appendix E	14
Appendix F.....	15

Figures

Figure 1: Project Site Location	4
---------------------------------------	---

Tables

Table 1. Pipe Sizing Table	7
Table 2. Existing vs Proposed Condition Flow Comparison:.....	7
Table 3. Inlet Sizing Table:.....	7

INTRODUCTION

PROJECT DESCRIPTION AND PURPOSE

The Shapell Norwalk Apartments (hereinafter referenced as the Project) is located on the South-east corner of Alondra Boulevard and Maidstone Avenue. The Project is bound to the north by Alondra Boulevard, to the west by Maidstone Avenue, to the south by single family residential and an existing parking lot to the east. The Project consists of 215 residential units making up 103,400 SF of building area, courtyards, landscape and parking lots with a total site area of 8.1 acres. The project is currently zoned as restricted commercial (C1) and parking. Pursuant to the City of Norwalk's Zoning Code, Table 17-A, residential is conditionally permitted within C1 Zoning in conjunction with commercial development. The portion of the site that is parking will be rezoned to restricted commercial (C1).

Figure 1: Project Site Location

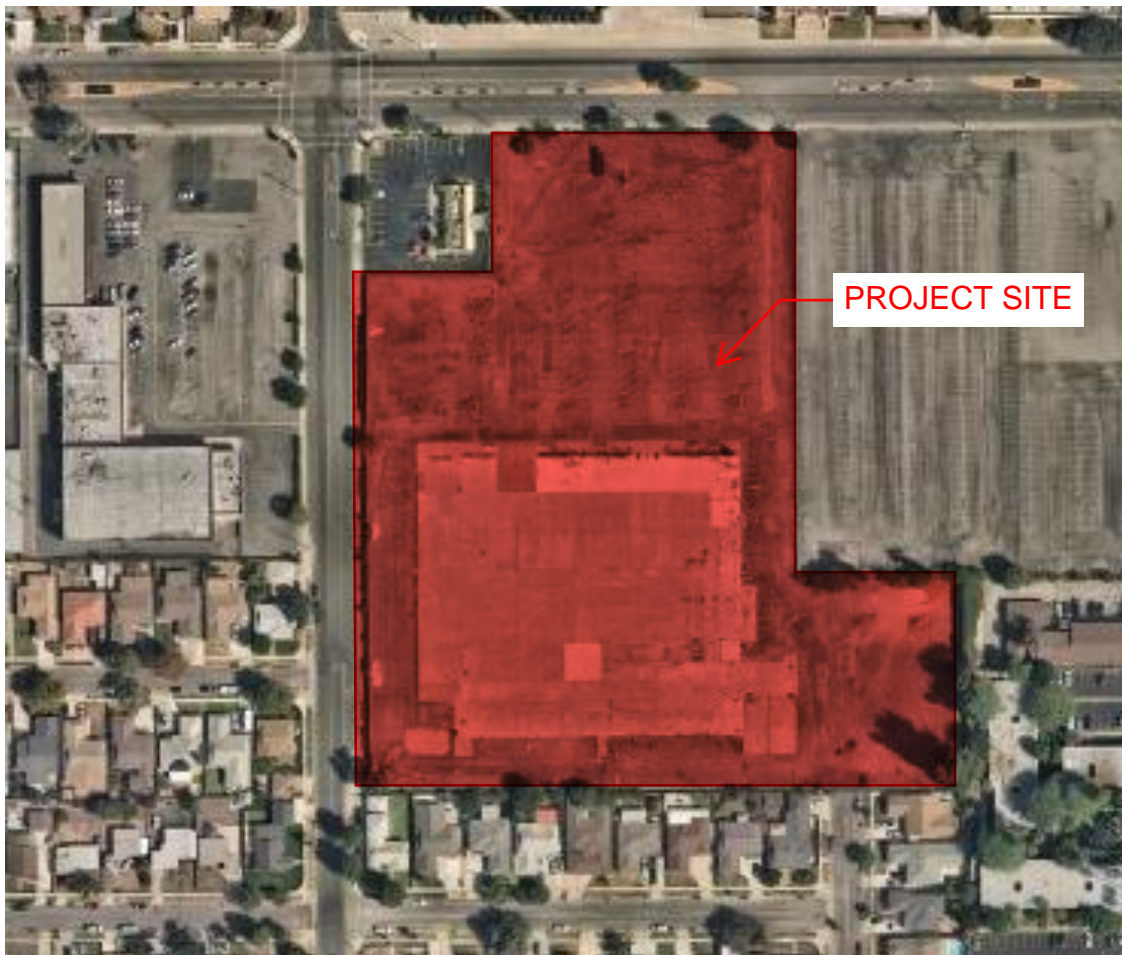

PROJECT SITE CONDITIONS

EXISTING SITE (PRE-DEVELOPMENT) CONDITIONS

In the existing condition, the site is made up of a building pad from a past development and parking stalls. Other than the flat building pad, the site generally slopes from North to south via surface flow and gutter flow. The existing site is approximately 95% impervious. The existing flow is not treated prior to leaving entering the public right of way and there is no public storm drain system in Maidstone Avenue. There is a LACFCD owned storm drain located on the northside of Alondra Boulevard west of the Alondra-Maidstone intersection. In the existing condition, the southerly half of Alondra Boulevard along the project frontage drains west and down into Maidstone Ave. From there, flow travels south down Maidstone via curb and gutter. It then flows east down College Dr. and then south along Flallon Ave. Flow from the existing site discharges into the public right of way in two locations, half flows south west and discharges into Maidstone, and the other half flows south east and discharges into Flallon Ave. The two flow paths meet at the intersection of College Dr. and Flallon Ave. and continue south approximately 1,700 feet where it joins with street flow on 166th St. and enters a LACFCD curb opening catch basin to the west. Flow travels through the public storm drain system to the County Channel Project No 21, until it eventually discharges into Coyote Creek. Coyote Creek confluences with The San Gabriel River and flows to the Pacific Ocean.

PROPOSED SITE (POST-DEVELOPMENT) CONDITIONS

The proposed site development includes 215 Units of multi-family building with parking lots, hardscape and landscape and is approximately 85% impervious. Under proposed conditions, the entire site will drain to the south-east. Where-as in the existing condition only half of the site drained to the south east and the other half drained to Maidstone. Although the drainage patterns vary, in both the existing and proposed condition, all onsite flow either directly or indirectly ends up in Flallon Ave. In the proposed condition, an underground storm drain system will connect a network of surface inlets and convey flow to various Modular Wetland Units placed across the site. Here the 85th percentile storm flow will be treated. Project site flow then continues to the low point in the system on the southeast side of the site. Low flows will exit the site via a proposed pump system that will discharge flow into Flallon Ave. During the peak storm event, the on-site storm drain system will fill up and overflow out of the lowest area drain at the low point in the system and surface flow offsite into Flallon Ave. In the existing condition, off site storm water flow does not enter the project site. Flow from the existing Weiner schnitzel, the neighboring property at the North-west corner, discharges site flow directly into the public right of way. Flow from the neighboring property to the east is prevented from entering the site via an existing retaining wall, and an existing screen wall along the south side of the site prevents offsite flow from entering the project site. Therefore, all offsite flow is kept separate from the project site flow in the proposed condition just as it was in the existing condition.

Proposed proprietary biotreatment devices, Modular Wetlands, will treat up to the 85th percentile storm event as required by the County. The 85th percentile storm event will be treated by 9 proposed Modular wetlands across the site, each of which treating one or more drainage management areas (See SUSMP Site plan for Drainage Management Area breakdown and MWS unit location). After treatment, flow is then discharged into Flallon Ave. and enters the county owned storm drain system on 166th St.

LOW IMPACT DEVELOPMENT (LID)

A separate LID report was prepared by Kimley-Horn and Associates. Per the report, *the proposed (LID) system stormwater quality control measures and structural source measures are adequately designed and sized to accomplish the following:*

- *Capture and mitigate the SQWDv volume from the 85th percentile, 24-hour storm;*
- *Prevent pollutants from contacting stormwater run-off and/or prevent discharge of contaminated stormwater run-off to stormdrain system*

Precise Grading Plans prepared By Kimley-Horn includes the implementation of source control BMPs and water treatment devices. Bioclean Modular Wetland units are placed throughout the project downstream of inlets to treat the site's Design Storm before being discharged onto Flallon Ave.

PRECIPITATION

Precipitation values for the hydrologic analysis were determined from site specific precipitation frequency estimates per the LACDPW Whittier 1-H1.21, 50-yr, 24 -hr isohyet. For this site, the 25 year, 24-hr storm precipitation depth of 4.94 inches was used taking into account the 0.878 reduction factor for the 25-year storm. See **Appendix A**.

WATERSHED DESCRIPTION

The project is relatively flat and the regional topography slopes to the southeast. Run-off from the project site drains to the public Right of Way, where it flows south before entering the public storm drain system. Flow continues in the public storm drain system until it discharges into Coyote Creek and ultimately out into the Pacific Ocean.

SOIL TYPES

The type of soil and its conditions are major factors affecting infiltration and resultant storm water runoff. The Natural Resources Conservation Service (NRCS) has classified soils into four general hydrologic groups for comparing infiltration and runoff rates. This Project Site has a hydrologic soil group classification of B. Group B Soils have a moderate infiltration rate when thoroughly wet and consist largely of sand and sandy loam with minimal amounts of clay. These soils have a moderately low runoff potential. Soil Type 6 underlies the Site based on the County 50-Year 24-Hour Isohyet map. It is assumed that infiltration will be infeasible on this project due to the Geotechnical Engineering Investigation by Salem Engineering Group, dated June 10, 2021 that was performed on the neighboring site on the other side of Maidstone Ave.

LAND USE

The existing site was utilized for commercial use and will be redeveloped to Multi-family residential in the proposed condition. The project site is zoned for restricted commercial (C1). Pursuant to the City of Norwalk's Zoning Code, Table 17-A, residential is conditionally permitted within C1 Zoning in conjunction with commercial development. The portion of the site that is parking will be rezoned to restricted commercial (C1).

GROUNDWATER

According to the Geotechnical Engineering Investigation Performed by Salem Engineering Group, Inc., performed on the neighboring site on the other side of Maidstone Ave., free ground water was encountered at approximately 35 feet below ground level.

FEMA MAPPING

The project site is covered by FEMA Flood Insurance Rate Map (FIRM) Number 06037C1839F. The project area does not fall within a FEMA-mapped special flood hazard area. The site is classified as Zone X, which is an area with a reduced risk of flooding do to a Levee. The effective FIRMETTE is dated September 26, 2008 and is provided in **Appendix C**.

HYDROLOGIC ANALYSIS

METHODOLOGY

The design criteria for the hydrologic calculations for this project have been conducted per requirements as outlined in the Los Angeles County Department of Publics Works Hydrology Manual (January 2006).

A 25-year storm event (the Urban Flood level of protection) was used to model the peak flow rates since the site does not fall under the capital Flood protection conditions necessary to treat the 50-year storm. The proposed Project was modeled using a C value based on the calculated impervious/pervious areas of the site. The County's HydroCalc software was utilized to determine the peak flow rates and time of concentration for the project. The site has been modeled with detailed drainage sub areas to obtain accurate, final levels results. The HydroCalc calculations are included in this report as **Appendix E**.

A new on-site storm drain system, designed for the 25-yr 24-hr storm, will be installed to collect surface runoff at designated storm inlet locations across the site and convey flows downstream. Each inlet has been sized to limit ponding depths to 8 inches or less.

Hydraulic calculations were performed for the main storm drains, utilizing Flowmaster, a software program developed by Bentley. The software utilizes Manning's equation to determine flow based on friction slopes for design. A friction slope of 0.4% was used to determine the full flow capacity each storm drain assuming they are run at a minimum slope. See **Table 1** below. The onsite storm drains were sized based on the calculated 25-yr flows being conveyed compared to the pipe capacity.

Inlet sizing calculations were preformed using weir/orifice equations to determine the maximum capacity for the various sizes of inlets. See **Table 3** below for a summary of the max allowable CFS of each type of inlet. The drop inlets were modeled to have a maximum ponding depth of 6 inches. The inlet calculations are located in **Appendix F**. Each inlet on the project will be sized based on the maximum capacity of the inlet and the calculated 25-yr flows upon final hydrologic analysis. Refer to Hydrology Exhibit in **Appendix D** for tributary areas.

RESULTS AND CONCLUSIONS

Table 1. Pipe Sizing Table

Pipe Size	Material	Capacity at 0.4% Friction Slope
8"	HDPE (n=0.011)	0.99 CFS
12"	HDPE (n=0.011)	2.93 CFS
18"	HDPE (n=0.011)	8.64 CFS
24"	HDPE (n=0.011)	16.91 CFS

Table 2. Existing vs Proposed Condition Flow Comparison

Scenario	Area	% Impervious	Tc	Q25
Existing Condition	8.07 AC	95%	10 min	16.77 CFS
Proposed Condition	8.07 AC	85%	13 min	13.26 CFS

Table 3. Inlet Sizing Table:

Subarea ID	Area (AC)	% IMP	Peak Flow (CFS)	Type	Full Capacity	Clogging Factor(%)	Clogged Capacity
DA-1	0.67	85	1.754	12x12 Grate Inlet(2)	5.70 CFS	50	2.82 CFS
DA-2	0.19	85	0.500	Curb Inlet 3.5' Sag	5.72 CFS	25	4.29 CFS
DA-3	0.18	85	0.471	Curb Inlet 3.5' Sag	5.72 CFS	25	4.29 CFS
DA-4	0.24	85	0.628	Curb Inlet 3.5' Sag	5.72 CFS	25	4.29 CFS
DA-5	1.31	85	3.430	12x12 Grate Inlet	2.85 CFS	50	1.42 CFS
DA-6	0.08	85	0.210	12x12 Grate Inlet	2.85 CFS	50	1.42 CFS
DA-7	0.18	85	0.471	12x12 Grate Inlet	2.85 CFS	50	1.42 CFS
DA-8	0.23	85	0.602	Curb Inlet 3.5' Sag	5.72 CFS	25	4.29 CFS
DA-9	0.51	85	1.335	12x12 Grate Inlet	2.85 CFS	50	1.42 CFS
DA-10	0.49	85	1.283	12x12 Grate Inlet	2.85 CFS	50	1.42 CFS
DA-11	0.28	85	0.733	Curb Inlet 3.5' Sag	5.72 CFS	25	4.29 CFS
DA-12	0.65	85	1.702	12x12 Grate Inlet	2.85 CFS	50	1.42 CFS
DA-13	1.16	85	3.037	Curb Inlet 3.5' Sag	5.72 CFS	25	4.29 CFS
DA-14	0.75	85	1.964	Curb Inlet 3.5' Sag	5.72 CFS	25	4.29 CFS
DA-15	0.29	85	0.759	Curb Inlet 3.5' Sag	5.72 CFS	25	4.29 CFS
DA-16	0.45	85	1.178	12x12 Grate Inlet	2.85 CFS	50	1.42 CFS
DA-17	0.25	85	0.655	Curb Inlet 3.5' Sag	5.72 CFS	25	4.29 CFS
DA-18	0.16	85	0.419	Curb Inlet 3.5' Sag	5.72 CFS	25	4.29 CFS

The purpose of this study is to analyze the existing versus the proposed runoff that exits the site into the public right-of-way. Although the existing condition drains to Maidstone and Flallon Ave, the east side of Maidstone flows into College Dr. continues east, and confluences at Flallon Avenue. Therefore, the overall site can be compared between the existing and proposed condition to verify that the project does not increase the amount of flow leaving the site. Table 2 compares the flows of the existing versus proposed condition obtained through HydroCalc. The proposed condition has more pervious area and a higher Tc than the existing condition, which results in the proposed site peak flow that is less than in the existing condition. Therefore, stormwater peak flow detention is not required. Pipe sizing and peak flow calculations are located in **Appendix E**. Table 3 breaks down the site peak flow based on the fractional area that is tributary to each inlet.

ISOHYET MAP

34° 00' 00"

EL MONTE 1-H1.20

-118° 07' 30"

SOUTH GATE 1-H1.9

LA HABRA 1-H1.11

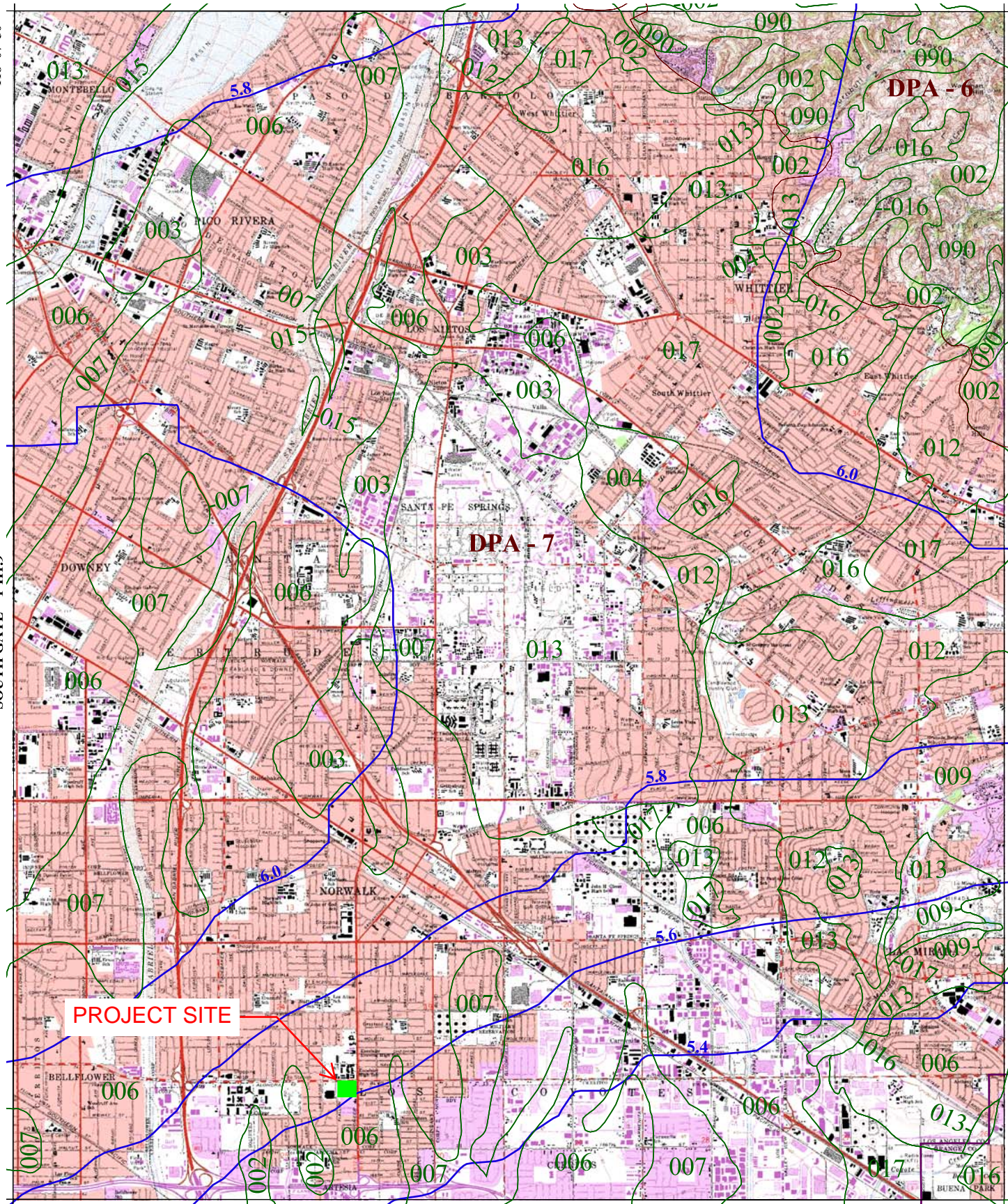

-118° 00' 00"

LOS ALAMITOS 1-H1.6

33° 52' 30"



016 SOIL CLASSIFICATION AREA

 7.2 INCHES OF RAINFALL

DPA - 6 DEBRIS POTENTIAL AREA

1 0 1 2 Miles

25-YEAR 24-HOUR ISOHYET REDUCTION FACTOR: 0.878
10-YEAR 24-HOUR ISOHYET REDUCTION FACTOR: 0.714

WHITTIER 50-YEAR 24-HOUR ISOHYET

1-H1.10



SOIL TYPE

Soil Map—Los Angeles County, California, Southeastern Part



Soil Map may not be valid at this scale.

Map Scale: 1:1,590 if printed on A portrait (8.5" x 11") sheet.

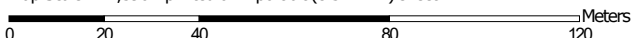

Map projection: Web Mercator Corner coordinates: WGS84 Edge tics: UTM Zone 11N WGS84



MAP LEGEND

Area of Interest (AOI)

 Area of Interest (AOI)

Soils

 Soil Map Unit Polygons

 Soil Map Unit Lines

 Soil Map Unit Points

Special Point Features



Blowout



Borrow Pit



Clay Spot



Closed Depression



Gravel Pit



Gravelly Spot



Landfill



Lava Flow



Marsh or swamp



Mine or Quarry



Miscellaneous Water



Perennial Water



Rock Outcrop



Saline Spot



Sandy Spot



Severely Eroded Spot



Sinkhole



Slide or Slip



Sodic Spot



Spoil Area



Stony Spot



Very Stony Spot



Wet Spot



Other



Special Line Features

Water Features



Streams and Canals

Transportation



Rails



Interstate Highways



US Routes



Major Roads



Local Roads

Background



Aerial Photography

MAP INFORMATION

The soil surveys that comprise your AOI were mapped at 1:24,000.

Warning: Soil Map may not be valid at this scale.

Enlargement of maps beyond the scale of mapping can cause misunderstanding of the detail of mapping and accuracy of soil line placement. The maps do not show the small areas of contrasting soils that could have been shown at a more detailed scale.

Please rely on the bar scale on each map sheet for map measurements.

Source of Map: Natural Resources Conservation Service

Web Soil Survey URL:

Coordinate System: Web Mercator (EPSG:3857)

Maps from the Web Soil Survey are based on the Web Mercator projection, which preserves direction and shape but distorts distance and area. A projection that preserves area, such as the Albers equal-area conic projection, should be used if more accurate calculations of distance or area are required.

This product is generated from the USDA-NRCS certified data as of the version date(s) listed below.

Soil Survey Area: Los Angeles County, California, Southeastern Part

Survey Area Data: Version 8, Sep 13, 2021

Soil map units are labeled (as space allows) for map scales 1:50,000 or larger.

Date(s) aerial images were photographed: Nov 19, 2020—Dec 5, 2020

The orthophoto or other base map on which the soil lines were compiled and digitized probably differs from the background imagery displayed on these maps. As a result, some minor shifting of map unit boundaries may be evident.

Map Unit Legend

Map Unit Symbol	Map Unit Name	Acres in AOI	Percent of AOI
1000	Urban land-Hueneme, drained-San Emigdio complex, 0 to 2 percent slopes	11.1	100.0%
Totals for Area of Interest		11.1	100.0%

Los Angeles County, California, Southeastern Part

1000—Urban land-Hueneme, drained-San Emigdio complex, 0 to 2 percent slopes

Map Unit Setting

National map unit symbol: 2lts5

Elevation: 10 to 300 feet

Mean annual precipitation: 12 to 16 inches

Mean annual air temperature: 64 to 66 degrees F

Frost-free period: 350 to 365 days

Farmland classification: Prime farmland if irrigated and drained

Map Unit Composition

Urban land: 45 percent

Hueneme, drained, and similar soils: 20 percent

San emigdio and similar soils: 15 percent

Minor components: 20 percent

Estimates are based on observations, descriptions, and transects of the mapunit.

Description of Urban Land

Setting

Landform: Alluvial fans

Properties and qualities

Slope: 0 to 2 percent

Depth to restrictive feature: 0 inches to manufactured layer

Runoff class: Very high

Frequency of flooding: RareNone

Interpretive groups

Land capability classification (irrigated): None specified

Land capability classification (nonirrigated): 8

Ecological site: R019XG911CA - Loamy Fan

Hydric soil rating: No

Description of Hueneme, Drained

Setting

Landform: Alluvial fans

Landform position (three-dimensional): Talf

Down-slope shape: Linear

Across-slope shape: Linear

Parent material: Discontinuous human-transported material over mixed alluvium derived from granite and/or sedimentary rock

Typical profile

A - 0 to 5 inches: sandy loam

C1 - 5 to 16 inches: sandy loam

C2 - 16 to 22 inches: loamy fine sand

C3 - 22 to 31 inches: very fine sandy loam

C4 - 31 to 53 inches: fine sandy loam

C5 - 53 to 77 inches: silt loam

C6 - 77 to 79 inches: loamy sand

Properties and qualities

Slope: 0 to 2 percent

Depth to restrictive feature: More than 80 inches

Drainage class: Somewhat poorly drained

Runoff class: Very low

Capacity of the most limiting layer to transmit water

(Ksat): Moderately high to high (0.57 to 1.98 in/hr)

Depth to water table: More than 80 inches

Frequency of flooding: RareNone

Frequency of ponding: None

Calcium carbonate, maximum content: 5 percent

Maximum salinity: Very slightly saline to slightly saline (2.0 to 4.0 mmhos/cm)

Sodium adsorption ratio, maximum: 8.0

Available water supply, 0 to 60 inches: Moderate (about 8.0 inches)

Interpretive groups

Land capability classification (irrigated): None specified

Land capability classification (nonirrigated): 3w

Hydrologic Soil Group: B

Ecological site: R019XG911CA - Loamy Fan

Hydric soil rating: No

Description of San Emigdio

Setting

Landform: Alluvial fans

Landform position (three-dimensional): Rise

Down-slope shape: Linear

Across-slope shape: Linear

Parent material: Discontinuous human-transported material over mixed alluvium derived from granite and/or sedimentary rock

Typical profile

A - 0 to 4 inches: fine sandy loam

C1 - 4 to 16 inches: fine sandy loam

C2 - 16 to 20 inches: silt loam

C3 - 20 to 39 inches: sandy loam

C4 - 39 to 67 inches: loamy sand

Properties and qualities

Slope: 0 to 2 percent

Depth to restrictive feature: More than 80 inches

Drainage class: Well drained

Runoff class: Very low

Capacity of the most limiting layer to transmit water

(Ksat): Moderately high to high (0.57 to 1.98 in/hr)

Depth to water table: More than 80 inches

Frequency of flooding: RareNone

Frequency of ponding: None
Calcium carbonate, maximum content: 5 percent
Maximum salinity: Nonsaline to very slightly saline (0.0 to 2.0 mmhos/cm)
Available water supply, 0 to 60 inches: Moderate (about 6.5 inches)

Interpretive groups

Land capability classification (irrigated): None specified
Land capability classification (nonirrigated): 3e
Hydrologic Soil Group: B
Ecological site: R019XG911CA - Loamy Fan
Hydric soil rating: No

Minor Components

Pico

Percent of map unit: 10 percent
Landform: Alluvial fans
Landform position (three-dimensional): Talf
Down-slope shape: Linear
Across-slope shape: Linear
Hydric soil rating: No

Xerorthents

Percent of map unit: 5 percent
Landform: Alluvial fans
Landform position (three-dimensional): Rise
Down-slope shape: Linear
Across-slope shape: Linear
Hydric soil rating: No

Metz

Percent of map unit: 5 percent
Landform: Alluvial fans
Landform position (three-dimensional): Talf
Down-slope shape: Linear
Across-slope shape: Linear
Hydric soil rating: No

Data Source Information

Soil Survey Area: Los Angeles County, California, Southeastern Part
Survey Area Data: Version 8, Sep 13, 2021

FIRMette

National Flood Hazard Layer FIRMette



118°5'28"W 33°53'26"N

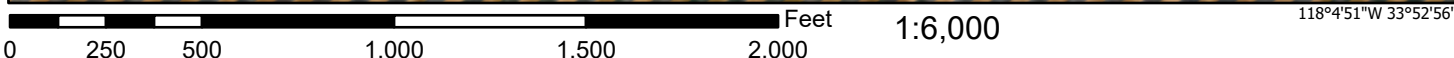
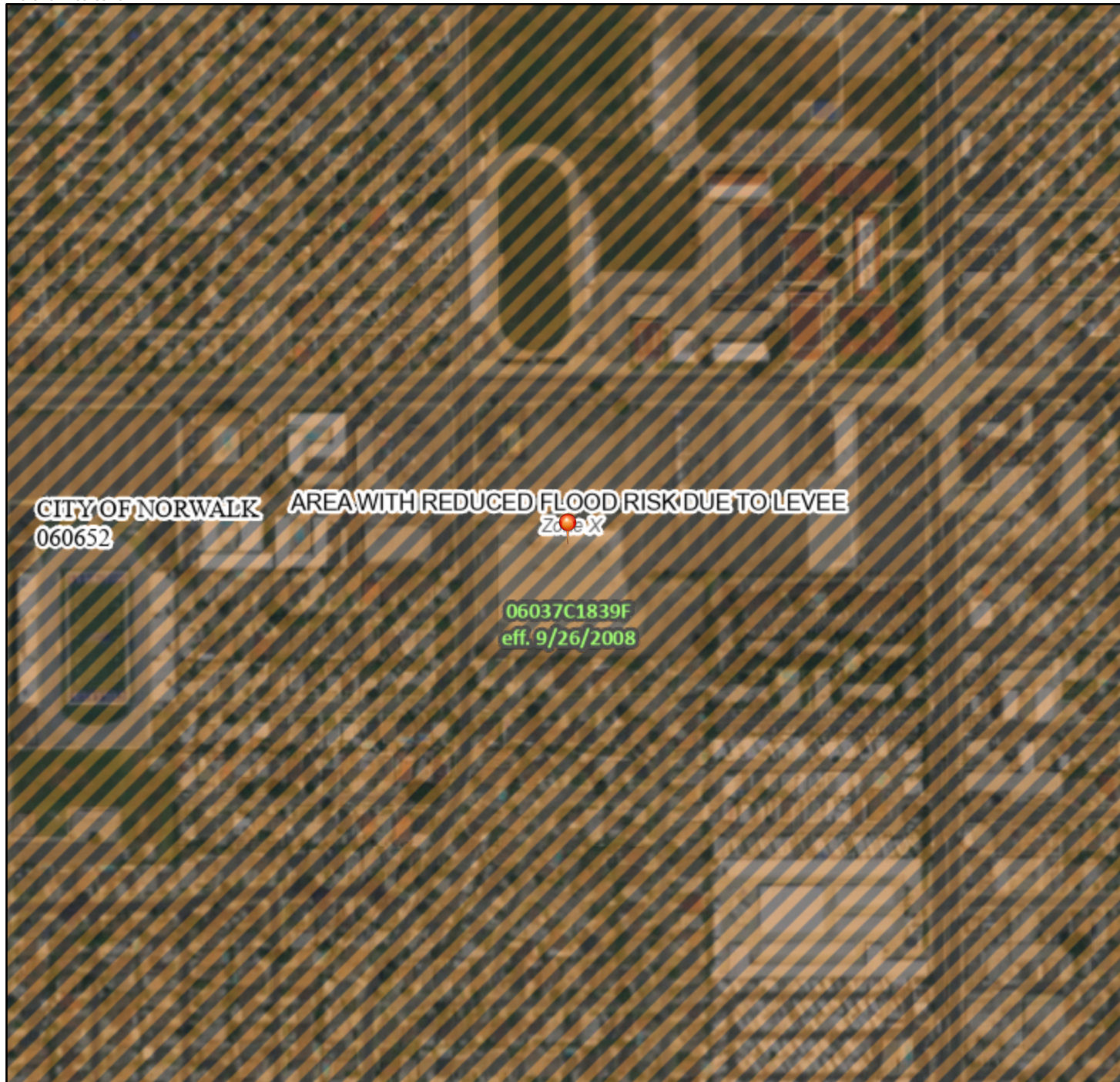

Basemap: USGS National Map: Orthoimagery: Data refreshed October, 2020

Legend

SEE FIS REPORT FOR DETAILED LEGEND AND INDEX MAP FOR FIRM PANEL LAYOUT

SPECIAL FLOOD HAZARD AREAS	Without Base Flood Elevation (BFE) <i>Zone A, V, A99</i> With BFE or Depth <i>Zone AE, AO, AH, VE, AR</i> Regulatory Floodway
OTHER AREAS OF FLOOD HAZARD	0.2% Annual Chance Flood Hazard, Areas of 1% annual chance flood with average depth less than one foot or with drainage areas of less than one square mile <i>Zone X</i> Future Conditions 1% Annual Chance Flood Hazard <i>Zone X</i> Area with Reduced Flood Risk due to Levee. See Notes. <i>Zone X</i> Area with Flood Risk due to Levee <i>Zone D</i>
OTHER AREAS	NO SCREEN Area of Minimal Flood Hazard <i>Zone X</i> Effective LOMRs Area of Undetermined Flood Hazard <i>Zone D</i>
GENERAL STRUCTURES	Channel, Culvert, or Storm Sewer Levee, Dike, or Floodwall
OTHER FEATURES	Cross Sections with 1% Annual Chance Water Surface Elevation Coastal Transect Base Flood Elevation Line (BFE) Limit of Study Jurisdiction Boundary Coastal Transect Baseline Profile Baseline Hydrographic Feature
MAP PANELS	Digital Data Available No Digital Data Available Unmapped

The pin displayed on the map is an approximate point selected by the user and does not represent an authoritative property location.

This map complies with FEMA's standards for the use of digital flood maps if it is not void as described below. The basemap shown complies with FEMA's basemap accuracy standards

The flood hazard information is derived directly from the authoritative NFHL web services provided by FEMA. This map was exported on **12/14/2021 at 4:12 PM** and does not reflect changes or amendments subsequent to this date and time. The NFHL and effective information may change or become superseded by new data over time.

This map image is void if the one or more of the following map elements do not appear: basemap imagery, flood zone labels, legend, scale bar, map creation date, community identifiers, FIRM panel number, and FIRM effective date. Map images for unmapped and unmodernized areas cannot be used for regulatory purposes.

HYDROLOGY MAPS

Plotted By: Lieberman, Cameron. Sheet Set: KHA_Layout11 January 04, 2022 08:58:55am K:\ORA_LDEV\094896004 - Shopell Norwalk Apartments\Hydrology\Hydrology Exhibits\2021.12 - Existing Drainage Map.dwg
 This document, together with the concepts and designs presented herein, is intended only for the specific purpose and client for which it was prepared. Reuse of and improper reliance on this document without written authorization and adaptation by Kimley-Horn and Associates, Inc. shall be without liability to Kimley-Horn and Associates, Inc.



HYDROLOGY SUMMARY TABLE				
SUBAREA ID	AREA (AC)	% IMP	Tc(MIN)	PEAK Q (CFS)
DA-1	3.74	100	7	8.48
DA-2	4.33	100	10	8.30

LEGEND	
	RIGHT-OF-WAY
	PROPERTY LINE
	CENTER LINE
	EASEMENT
	FLOW LINE
	DRAINAGE AREA BOUNDARY
	DRAINAGE AREA ID
	TOTAL ACREAGE

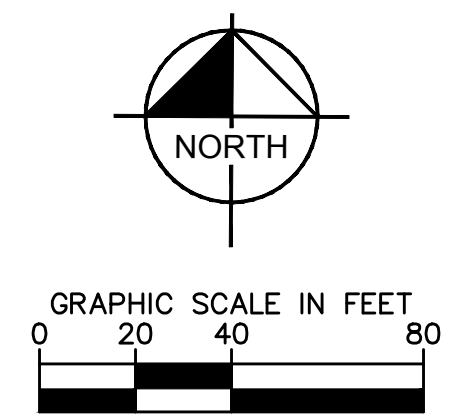
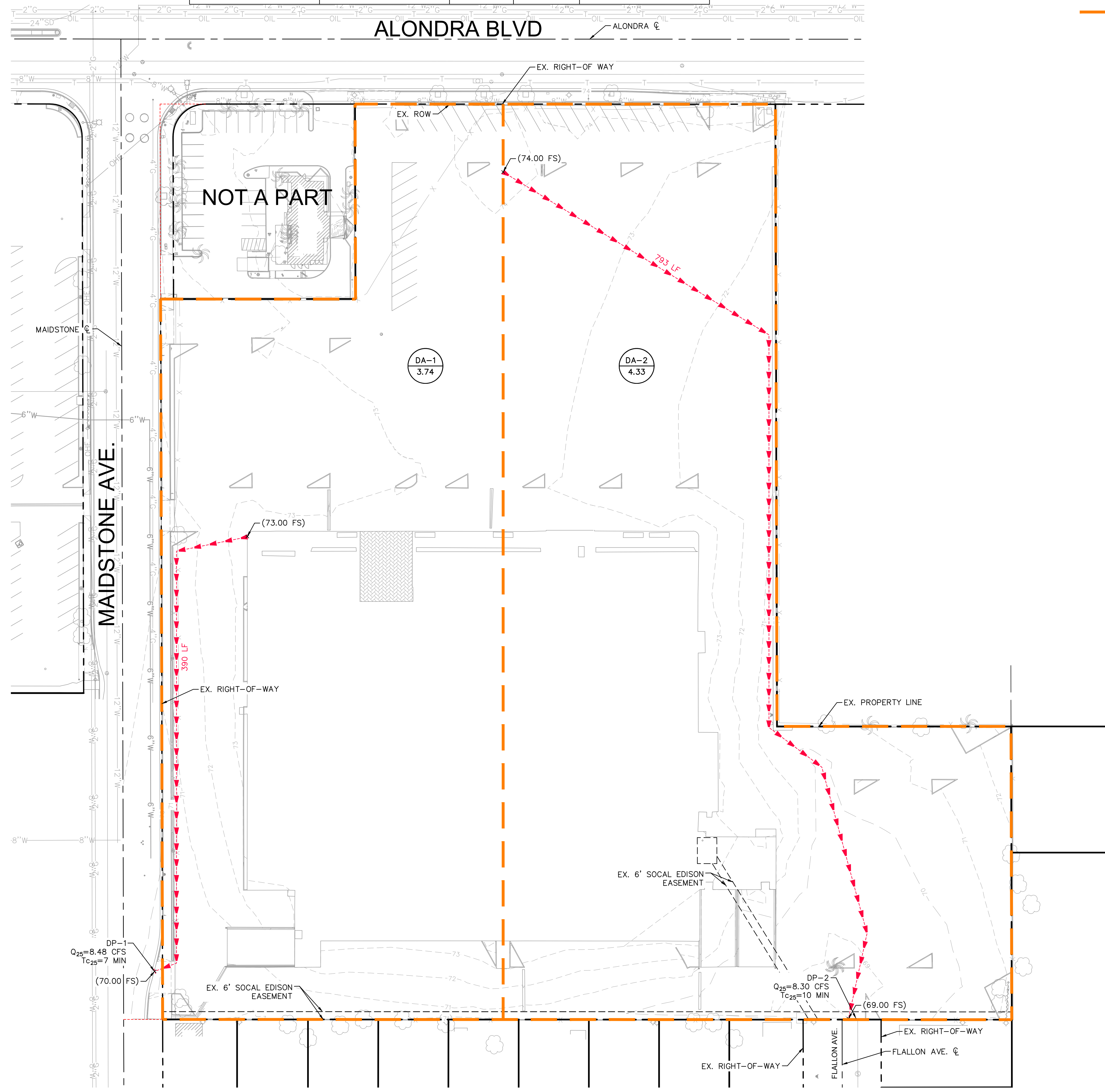

NO.	REVISIONS	DATE	BY

Kimley-Horn
 © 2022 KIMLEY-HORN AND ASSOCIATES, INC.
 1100 W TOWN AND COUNTRY ROAD, SUITE 700,
 ORANGE, CA 92668
 PHONE: 714-939-1030 FAX: 714-938-9488
 WWW.KIMLEY-HORN.COM



KHA PROJECT	094896004
PLOT DATE	1/4/2022
SCALE	AS SHOWN
DESIGNED BY	ML
DRAWN BY	CL
CHECKED BY	JM

EXISTING DRAINAGE MAP

NORWALK APARTMENTS
 PREPARED FOR SHAPELL

NORWALK
 SHEET NUMBER

Plotted By: Lieberman, Cameron. Sheet Set: KNO_Layout1. September 01, 2022. 09:33:17am. K:\ORA_LOEVA\094896004 - Shopell Norwalk Apartments\Reports\Hydrology\Hydrology_2021.12 - Overall-Prop_Drainage_Map.dwg
 This document, together with the concepts and designs presented herein, is intended only for the specific purpose and client for which it was prepared. Reuse of and improper reliance on this document without written authorization and adaptation by Kimley-Horn and Associates, Inc. shall be without liability to Kimley-Horn and Associates, Inc.

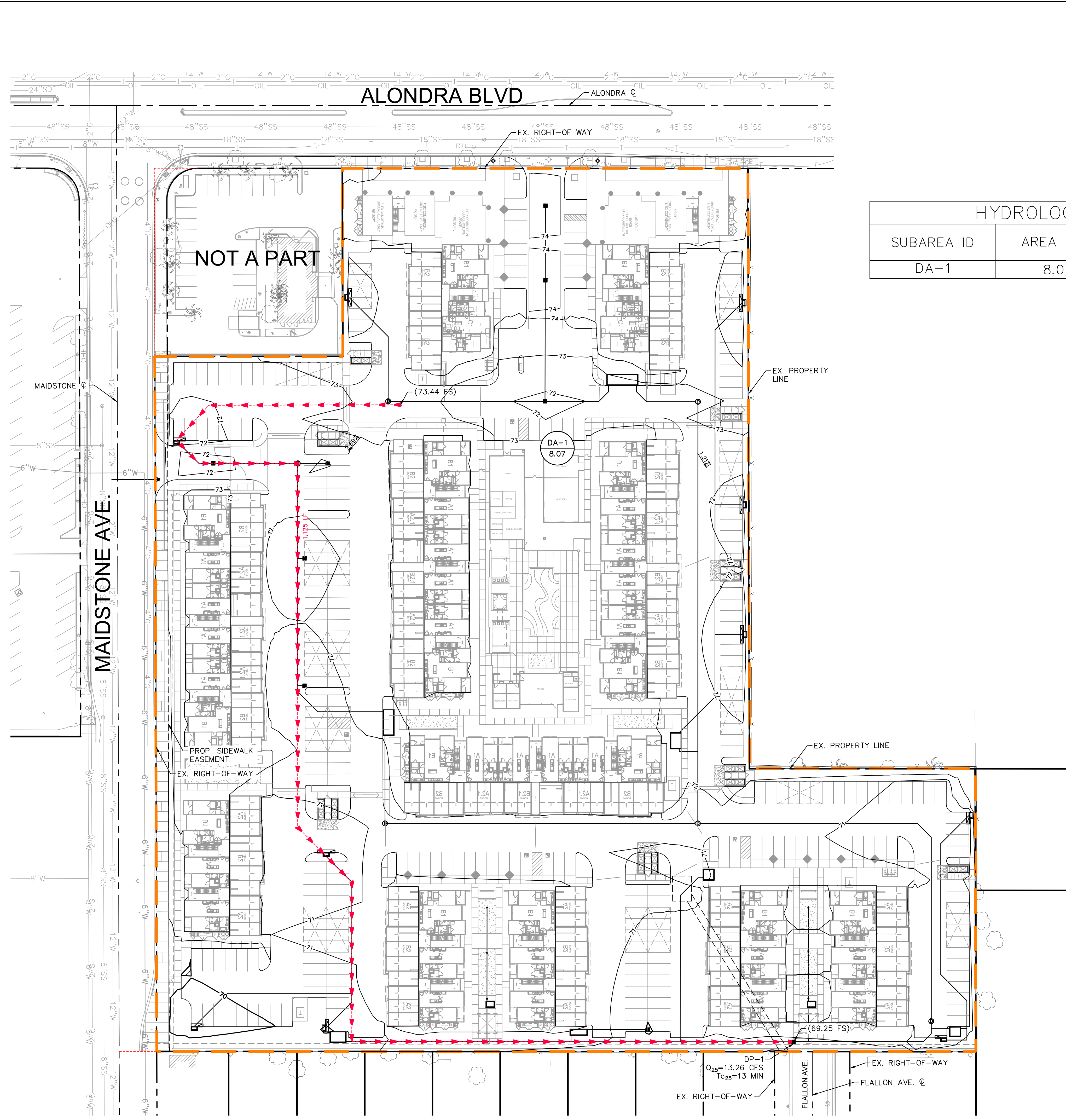

LEGEND

- RIGHT-OF-WAY
- PROPERTY LINE
- CENTER LINE
- EASEMENT
- FLOW LINE
- DRAINAGE AREA BOUNDARY
- DRAINAGE AREA ID
- TOTAL ACREAGE
- PROP. MODULAR WETLAND UNIT

HYDROLOGY SUMMARY TABLE

SUBAREA ID	AREA (AC)	% IMP	T _c (MIN)	PEAK FLOW (CFS)
DA-1	8.07	85	13	13.26

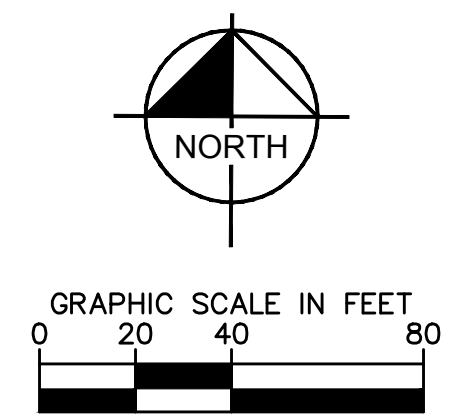

NORWALK APARTMENTS
 PREPARED FOR SHAPELL

PROPOSED DRAINAGE MAP

Kimley-Horn
 © 2022 KIMLEY-HORN AND ASSOCIATES, INC.
 1100 W TOWN AND COUNTRY ROAD, SUITE 700,
 ORANGE, CA 92668
 PHONE: 714-939-1030 FAX: 714-938-9488
 WWW.KIMLEY-HORN.COM

REGISTERED PROFESSIONAL ENGINEER
 WITTHAL J. LEVINE
 No. 90239
 Exp. 9-30-23
 CIVIL
 STATE OF CALIFORNIA

KHA PROJECT 094896004
 PLOT DATE 9/1/2022
 SCALE AS SHOWN
 DESIGNED BY ML
 DRAWN BY CL
 CHECKED BY JM

NORWALK CA

SHEET NUMBER

REVISIONS

No.	DATE	BY

Plotted By: Lieberman, Cameron. Sheet Set: KHA - Layout: 01 - 2022. 09:42:25am. K:\ORA_LOEVA\094896004 - Shopell, Norwalk Apartments_Hydrology\Hydrology\Hydrology Exhibits\2021.12 - Prop. Drainage Map.dwg
 This document, together with the concepts and designs presented herein, is intended only for the specific purpose and client for which it was prepared. Reuse of and improper reliance on this document without written authorization and adaptation by Kimley-Horn and Associates, Inc. shall be without liability to Kimley-Horn and Associates, Inc.

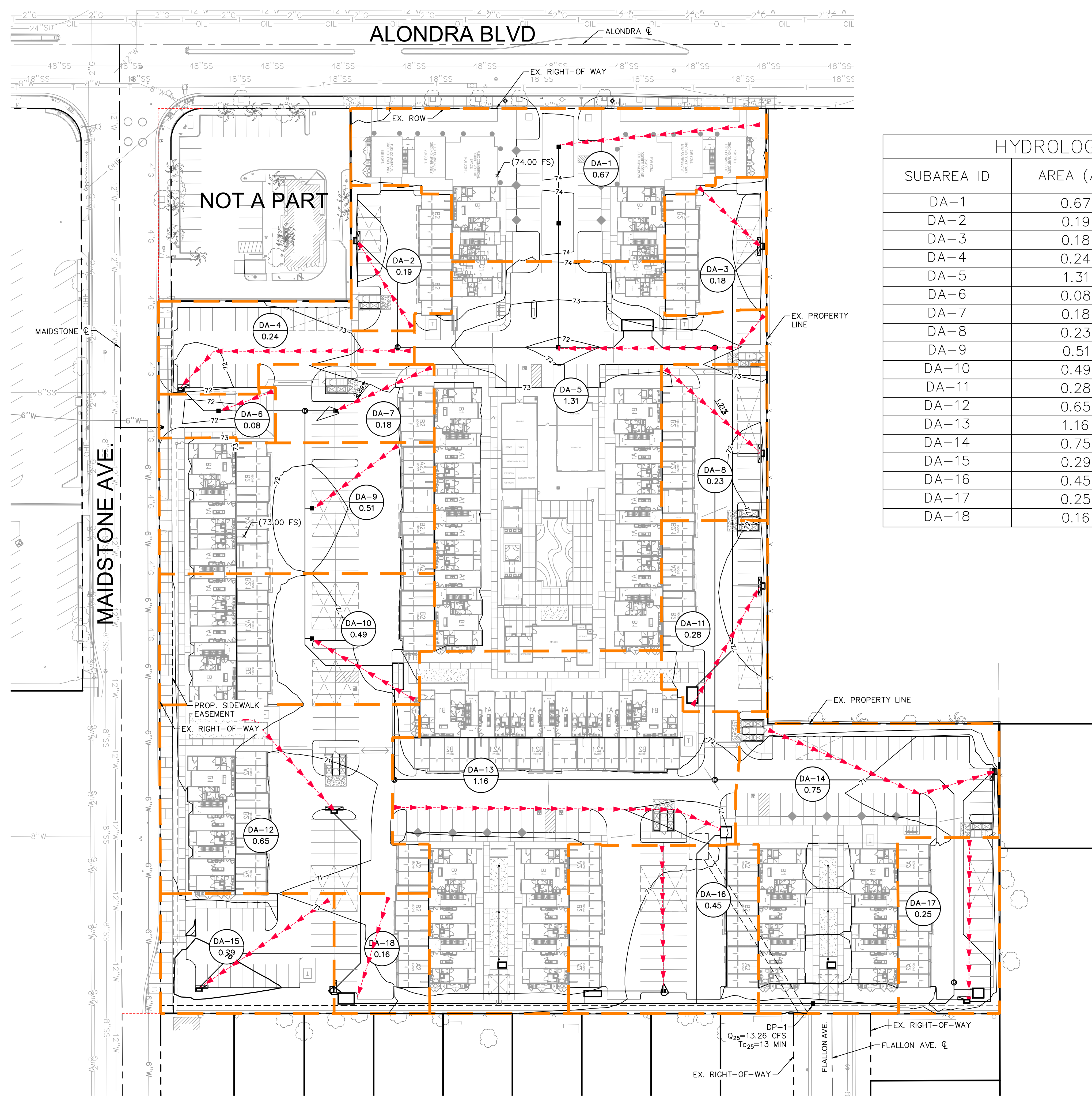

LEGEND

- RIGHT-OF-WAY
- PROPERTY LINE
- CENTER LINE
- EASEMENT
- FLOW LINE
- DRAINAGE AREA BOUNDARY
- DRAINAGE AREA ID
- TOTAL ACREAGE
- PROP. MODULAR WETLAND UNIT

HYDROLOGY SUMMARY TABLE

SUBAREA ID	AREA (AC)	% IMP	T _c	PEAK FLOW (CFS)
DA-1	0.67	85	6	1.754
DA-2	0.19	85	6	0.500
DA-3	0.18	85	6	0.471
DA-4	0.24	85	6	0.628
DA-5	1.31	85	6	3.430
DA-6	0.08	85	6	0.210
DA-7	0.18	85	6	0.471
DA-8	0.23	85	6	0.602
DA-9	0.51	85	6	1.335
DA-10	0.49	85	6	1.283
DA-11	0.28	85	6	0.733
DA-12	0.65	85	6	1.702
DA-13	1.16	85	6	3.307
DA-14	0.75	85	6	1.964
DA-15	0.29	85	6	0.759
DA-16	0.45	85	6	1.178
DA-17	0.25	85	6	0.655
DA-18	0.16	85	6	0.419

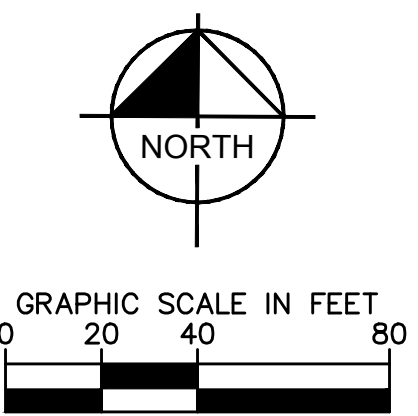

NORWALK APARTMENTS
 PREPARED FOR SHAPELL

INLET SIZING EXHIBIT

Kimley-Horn
 © 2023 KIMLEY-HORN AND ASSOCIATES, INC.
 1100 W TOWN AND COUNTRY ROAD, SUITE 700,
 ORANGE, CA 92668
 PHONE: 714-939-1030 FAX: 714-938-9488
 WWW.KIMLEY-HORN.COM

REGISTERED PROFESSIONAL ENGINEER
 WITSPAL J. LEVINE
 No. 90239
 Exp. 9-30-23
 CIVIL
 STATE OF CALIFORNIA

KHA PROJECT	094896004	DESIGNED BY	ML	CL	JM
PLOT DATE	9/1/2022	DRAWN BY	ML	CL	JM
SCALE	AS SHOWN	CHECKED BY	ML	CL	JM

SHEET NUMBER

NORWALK

REVISIONS

No.	DATE	BY

HYDROCALC CALCULATIONS

Worksheet for Circular Pipe - 8"

Project Description	
Friction Method	Manning Formula
Solve For	Discharge
Input Data	
Roughness Coefficient	0.010
Channel Slope	0.004 ft/ft
Normal Depth	8.0 in
Diameter	8.0 in
Results	
Discharge	0.99 cfs
Flow Area	0.3 ft ²
Wetted Perimeter	2.1 ft
Hydraulic Radius	2.0 in
Top Width	0.00 ft
Critical Depth	5.7 in
Percent Full	100.0 %
Critical Slope	0.006 ft/ft
Velocity	2.85 ft/s
Velocity Head	0.13 ft
Specific Energy	0.79 ft
Froude Number	(N/A)
Maximum Discharge	1.07 cfs
Discharge Full	0.99 cfs
Slope Full	0.004 ft/ft
Flow Type	Subcritical
GVF Input Data	
Downstream Depth	0.0 in
Length	0.0 ft
Number Of Steps	0
GVF Output Data	
Upstream Depth	0.0 in
Profile Description	N/A
Profile Headloss	0.00 ft
Average End Depth Over Rise	0.0 %
Normal Depth Over Rise	66.7 %
Downstream Velocity	Infinity ft/s
Upstream Velocity	Infinity ft/s
Normal Depth	8.0 in
Critical Depth	5.7 in
Channel Slope	0.004 ft/ft
Critical Slope	0.006 ft/ft

Worksheet for Circular Pipe - 12"

Project Description	
Friction Method	Manning Formula
Solve For	Discharge
Input Data	
Roughness Coefficient	0.010
Channel Slope	0.004 ft/ft
Normal Depth	12.0 in
Diameter	12.0 in
Results	
Discharge	2.93 cfs
Flow Area	0.8 ft ²
Wetted Perimeter	3.1 ft
Hydraulic Radius	3.0 in
Top Width	0.00 ft
Critical Depth	8.8 in
Percent Full	100.0 %
Critical Slope	0.005 ft/ft
Velocity	3.73 ft/s
Velocity Head	0.22 ft
Specific Energy	1.22 ft
Froude Number	(N/A)
Maximum Discharge	3.15 cfs
Discharge Full	2.93 cfs
Slope Full	0.004 ft/ft
Flow Type	Subcritical
GVF Input Data	
Downstream Depth	0.0 in
Length	0.0 ft
Number Of Steps	0
GVF Output Data	
Upstream Depth	0.0 in
Profile Description	N/A
Profile Headloss	0.00 ft
Average End Depth Over Rise	0.0 %
Normal Depth Over Rise	66.7 %
Downstream Velocity	Infinity ft/s
Upstream Velocity	Infinity ft/s
Normal Depth	12.0 in
Critical Depth	8.8 in
Channel Slope	0.004 ft/ft
Critical Slope	0.005 ft/ft

Worksheet for Circular Pipe - 18"

Project Description	
Friction Method	Manning Formula
Solve For	Discharge
Input Data	
Roughness Coefficient	0.010
Channel Slope	0.004 ft/ft
Normal Depth	18.0 in
Diameter	18.0 in
Results	
Discharge	8.64 cfs
Flow Area	1.8 ft ²
Wetted Perimeter	4.7 ft
Hydraulic Radius	4.5 in
Top Width	0.00 ft
Critical Depth	13.7 in
Percent Full	100.0 %
Critical Slope	0.005 ft/ft
Velocity	4.89 ft/s
Velocity Head	0.37 ft
Specific Energy	1.87 ft
Froude Number	(N/A)
Maximum Discharge	9.29 cfs
Discharge Full	8.64 cfs
Slope Full	0.004 ft/ft
Flow Type	Subcritical
GVF Input Data	
Downstream Depth	0.0 in
Length	0.0 ft
Number Of Steps	0
GVF Output Data	
Upstream Depth	0.0 in
Profile Description	N/A
Profile Headloss	0.00 ft
Average End Depth Over Rise	0.0 %
Normal Depth Over Rise	66.7 %
Downstream Velocity	Infinity ft/s
Upstream Velocity	Infinity ft/s
Normal Depth	18.0 in
Critical Depth	13.7 in
Channel Slope	0.004 ft/ft
Critical Slope	0.005 ft/ft

Worksheet for Circular Pipe - 24"

Project Description	
Friction Method	Manning Formula
Solve For	Discharge
Input Data	
Roughness Coefficient	0.011
Channel Slope	0.004 ft/ft
Normal Depth	24.0 in
Diameter	24.0 in
Results	
Discharge	16.91 cfs
Flow Area	3.1 ft ²
Wetted Perimeter	6.3 ft
Hydraulic Radius	6.0 in
Top Width	0.00 ft
Critical Depth	17.8 in
Percent Full	100.0 %
Critical Slope	0.005 ft/ft
Velocity	5.38 ft/s
Velocity Head	0.45 ft
Specific Energy	2.45 ft
Froude Number	(N/A)
Maximum Discharge	18.19 cfs
Discharge Full	16.91 cfs
Slope Full	0.004 ft/ft
Flow Type	Undefined
GVF Input Data	
Downstream Depth	0.0 in
Length	0.0 ft
Number Of Steps	0
GVF Output Data	
Upstream Depth	0.0 in
Profile Description	N/A
Profile Headloss	0.00 ft
Average End Depth Over Rise	0.0 %
Normal Depth Over Rise	0.0 %
Downstream Velocity	0.00 ft/s
Upstream Velocity	0.00 ft/s
Normal Depth	24.0 in
Critical Depth	17.8 in
Channel Slope	0.004 ft/ft
Critical Slope	0.005 ft/ft

Peak Flow Hydrologic Analysis

File location: K:/ORA_LDEV/094896004 - Shapell Norwalk Apartments/Reports/Hydrology Hydraulics/Calculations/Hydrocalc/Existing/Norwalk Apartments
Version: HydroCalc 1.0.3

Input Parameters

Project Name	Norwalk Apartments
Subarea ID	EX-DA1
Area (ac)	3.74
Flow Path Length (ft)	390.0
Flow Path Slope (vft/hft)	0.01
50-yr Rainfall Depth (in)	5.63
Percent Impervious	1.0
Soil Type	6
Design Storm Frequency	25-yr
Fire Factor	0
LID	False

Output Results

Modeled (25-yr) Rainfall Depth (in)	4.9431
Peak Intensity (in/hr)	2.5178
Undeveloped Runoff Coefficient (Cu)	0.7884
Developed Runoff Coefficient (Cd)	0.9
Time of Concentration (min)	7.0
Clear Peak Flow Rate (cfs)	8.475
Burned Peak Flow Rate (cfs)	8.475
24-Hr Clear Runoff Volume (ac-ft)	1.3751
24-Hr Clear Runoff Volume (cu-ft)	59899.0301

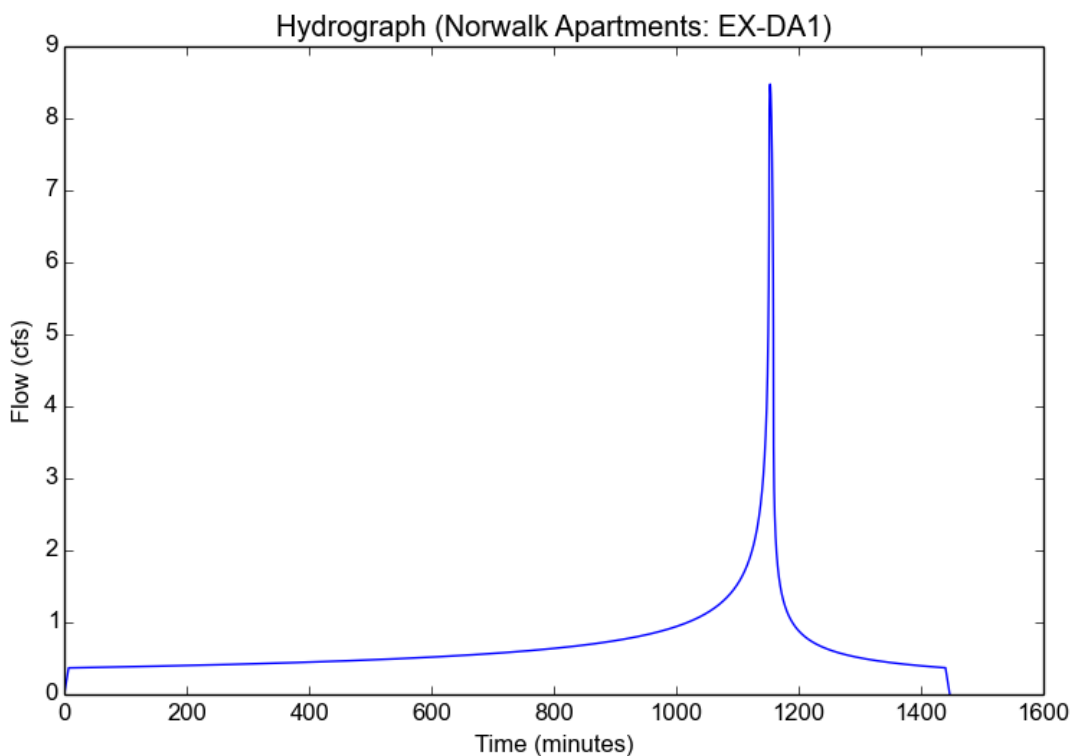

Peak Flow Hydrologic Analysis

File location: K:/ORA_LDEV/094896004 - Shapell Norwalk Apartments/Reports/Hydrology Hydraulics/Calculations/Hydrocalc/Existing/Norwalk Apartments
Version: HydroCalc 1.0.3

Input Parameters

Project Name	Norwalk Apartments
Subarea ID	EX-DA2
Area (ac)	4.33
Flow Path Length (ft)	793.0
Flow Path Slope (vft/hft)	0.01
50-yr Rainfall Depth (in)	5.63
Percent Impervious	1.0
Soil Type	6
Design Storm Frequency	25-yr
Fire Factor	0
LID	False

Output Results

Modeled (25-yr) Rainfall Depth (in)	4.9431
Peak Intensity (in/hr)	2.1292
Undeveloped Runoff Coefficient (Cu)	0.7465
Developed Runoff Coefficient (Cd)	0.9
Time of Concentration (min)	10.0
Clear Peak Flow Rate (cfs)	8.2976
Burned Peak Flow Rate (cfs)	8.2976
24-Hr Clear Runoff Volume (ac-ft)	1.592
24-Hr Clear Runoff Volume (cu-ft)	69348.387

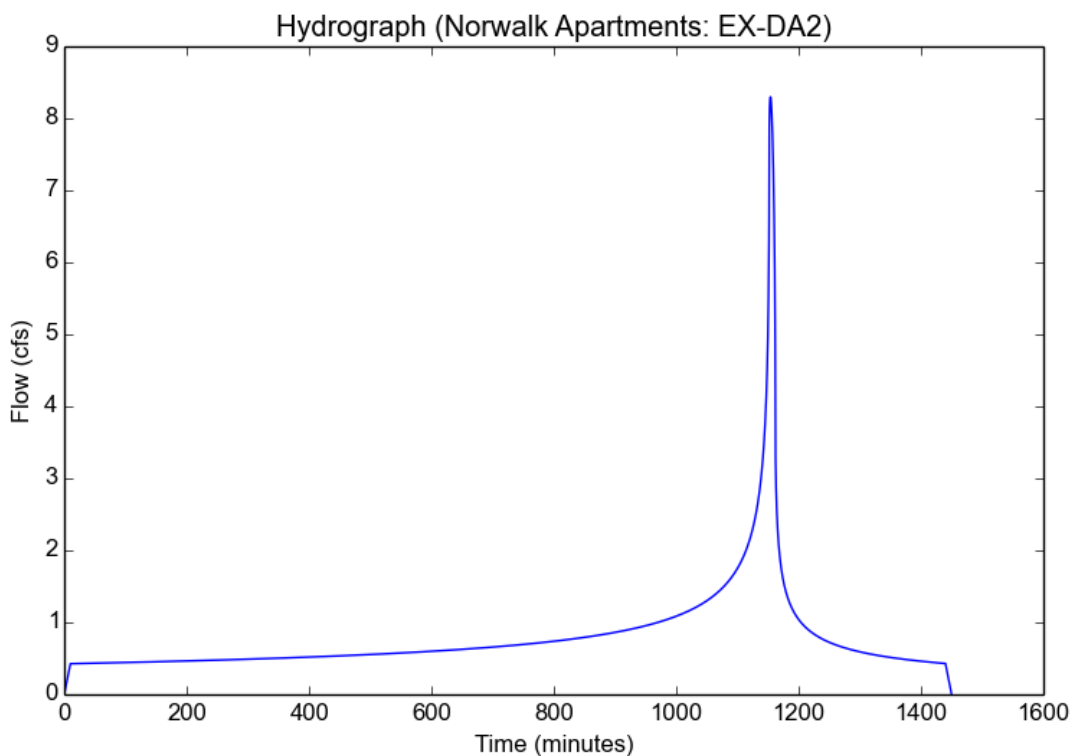

Peak Flow Hydrologic Analysis

File location: K:/ORA_LDEV/094896004 - Shapell Norwalk Apartments/Reports/Hydrology Hydraulics/Calculations/Hydrocalc/Proposed/25-yrApartments
Version: HydroCalc 1.0.3

Input Parameters

Project Name	Norwalk Apartments Overall
Subarea ID	DA-1
Area (ac)	8.07
Flow Path Length (ft)	1125.0
Flow Path Slope (vft/hft)	0.01
50-yr Rainfall Depth (in)	5.63
Percent Impervious	0.85
Soil Type	6
Design Storm Frequency	25-yr
Fire Factor	0
LID	False

Output Results

Modeled (25-yr) Rainfall Depth (in)	4.9431
Peak Intensity (in/hr)	1.8822
Undeveloped Runoff Coefficient (Cu)	0.7194
Developed Runoff Coefficient (Cd)	0.8729
Time of Concentration (min)	13.0
Clear Peak Flow Rate (cfs)	13.2589
Burned Peak Flow Rate (cfs)	13.2589
24-Hr Clear Runoff Volume (ac-ft)	2.6166
24-Hr Clear Runoff Volume (cu-ft)	113979.8147

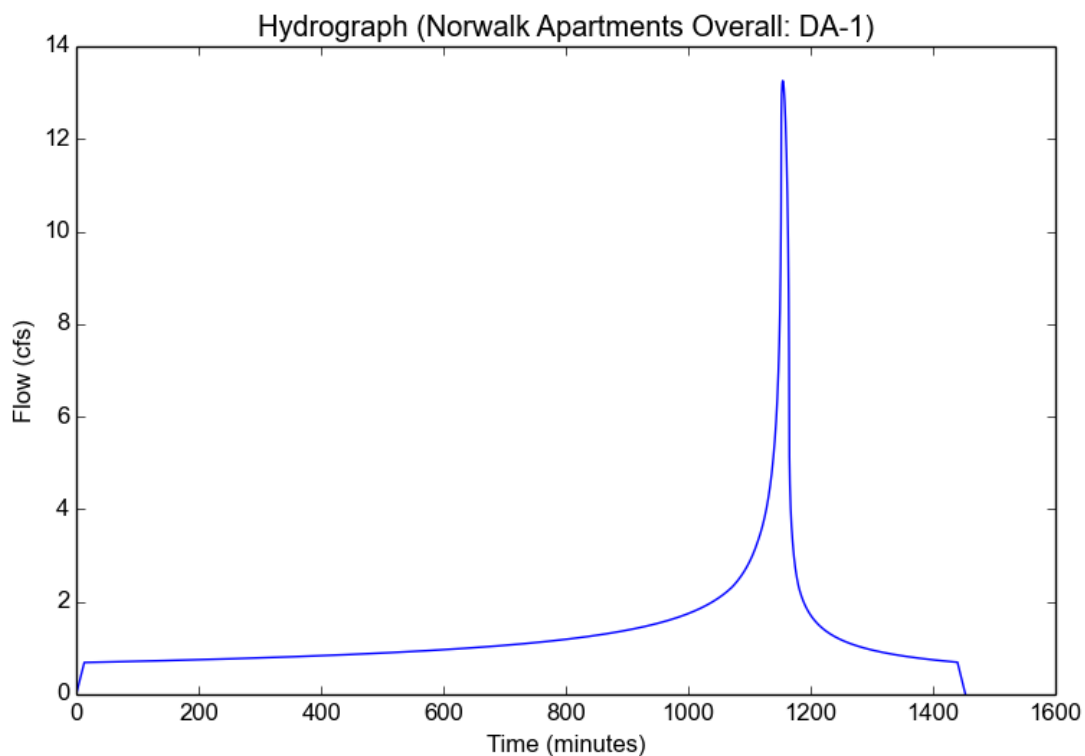

HYDRAULIC CALCULATIONS

INLET CAPACITY CALCULATIONS

PROJECT: Shapell Norwalk Apartments
 JOB No: 094896004
 DATE: 01/04/2022

Weir Equation

Catch Basin Number	Type	Width/Perimeter (ft)	Ponded Depth (in)	% Opening of Grate	Full Capacity (cfs)	Clogging Factor (%)	Clogged Capacity (cfs)
1	12"x12" Grate	4	6	100	4.24	75	3.18
2	18"x18" Grate	6	6	100	6.36	75	4.77
3	24"x24" Grate	8	6	100	8.49	75	6.36
4	30"x30" Grate	10	6	100	10.61	75	7.95
5	36"x36" Grate	12	6	100	12.73	75	9.55
6	48"x48" Grate	16	6	100	16.97	75	12.73
7	3.5' Curb Inlet	3.5	8	100	5.72	75	4.29
8	7' Curb Inlet	7	8	100	11.43	100	11.43
9	10' Curb Inlet	10	8	100	16.33	100	16.33
10	14' Curb Inlet	14	8	100	22.86	100	22.86

Orifice Equation

Catch Basin Number	Type	Area (sq. ft.)*	Ponded Depth (in)*	% Opening of Grate	Full Capacity (cfs)	Clogging Factor (%)	Clogged Capacity (cfs)
1	12"x12" Grate	1	6	75	2.85	50	1.42
2	18"x18" Grate	2.25	6	75	6.41	50	3.20
3	24"x24" Grate	4	6	75	11.39	50	5.70
4	30"x30" Grate	6.25	6	75	17.80	50	8.90
5	36"x36" Grate	9	6	75	25.63	50	12.82
6	48"x48" Grate	16	6	75	45.57	50	22.78
7	3.5' Curb Inlet	2.33	8	100	10.22	100	10.22
8	7' Curb Inlet	4.67	8	100	20.48	100	20.48
9	10' Curb Inlet	6.67	8	100	29.25	100	29.25
10	14' Curb Inlet	9.33	8	100	40.91	100	40.91

*Assumes 8" CF for curb inlet due to local sump



PRELIMINARY LOW IMPACT DEVELOPMENT (LID) REPORT

Norwalk Apartments
11600 Alondra Blvd.
Norwalk, CA 90650

August, 2022

PREPARED FOR:

Shapell Properties, Inc.
11200 Corbin Ave. Suite 201
Porter Ranch, CA 91326
Phone: 323.988.7594
Attn: Andrew Dewar

PREPARED BY:

Kimley»Horn

1100 W Town and Country Road, Suite 700
Orange, CA 92868
(714) 939-1030

Copyright © 2022 Kimley-Horn and Associates, Inc.
January 2017 - KHA Project #094896001

This document, together with the concepts and designs presented herein, as an instrument of service, is intended only for the specific purpose and client for which it was prepared. Reuse of and improper reliance on this document without written authorization and adaptation by Kimley-Horn and Associates, Inc. shall be without liability to Kimley-Horn and Associates, Inc.

ABLE OF CONTENTS

SECTION		PAGE
I.	INTRODUCTION	3
	LEGAL DESCRIPTION:.....	3
II.	EXISTING SITE CONDITIONS	4
III.	PROPOSED SITE CONDITIONS	5
IV.	BMP SUMMARY	6
	SOURCE CONTROL BMPS	6
	LID SITE DESIGN BMPS.....	8
	LID TREATMENT CONTROL BMPS.....	8
	DESIGN STANDARDS FOR TREATMENT CONTROL BMPS	10
V.	HYDROMODIFICATION DISCUSSION	111
VI.	INSPECTION/MAINTENANCE RESPONSIBILITY.....	12
	LONG-TERM FUNDING FOR BMP MAINTENANCE.....	12
	RESPONSIBLE PARTY CONTACT INFORMATION	12
VII.	OPERATION & MAINTENANCE PLAN.....	13
VIII.	APPENDICES	15
	<i>Appendix 1: LID and Drainage Area Exhibit, Treatment Control BMP Details</i>	
	<i>Appendix 2: Q25 and LID Calculations and Backup Documents</i>	
	<i>Appendix 3: Stormwater Observation Report Form</i>	
	<i>Appendix 4: Master Covenant and Agreement</i>	
	<i>Appendix 5: Treatment Control BMP Operation & Maintenance Plan Supplement</i>	
	<i>Appendix 6: Record of Inspection</i>	
	<i>Appendix 7: Source Control BMP Fact Sheets</i>	
	<i>Appendix 8: Public Education Materials</i>	
	<i>Appendix 9: Geotechnical Information</i>	
	<i>Appendix 10: Storm Drain As-Builts</i>	



OWNER CERTIFICATION

FINAL LOW IMPACT DEVELOPMENT PLAN

This Low Impact Development Plan (LID) has been prepared for Shapell Properties by Kimley-Horn and Associates, Inc. It is intended to comply with the requirements of the County of Los Angeles National Pollution Discharge Elimination Permit (Order No. R4-2012-0175, NPDES Permit No CAS004001), issued by the Los Angeles Regional Water Quality Control Board, of which the City of Los Angeles is a copermittee. The undersigned is authorized to approve implementation of the provisions of this plan as appropriate and will strive to have the plan carried out by successors consistent with the City of Los Angeles LID/SUSMP for Stormwater Management and the intent of the NPDES storm water program requirements.

Signature

Date

Name

Title

Shapell Properties, Inc.
11200 Corbin Ave. Suite 201
Porter Ranch, CA 91326
Phone: 323.988.7594

I. INTRODUCTION

Prior to issuance of any grading or building permit, the applicant shall submit a Low Impact Development (LID) Plan acceptable to the City Engineer to comply with the latest National Pollutant Discharge Elimination System (NPDES) Stormwater Regulations. The project shall incorporate both construction and operational Best Management Practices (BMPs) to minimize construction and urban pollutants in stormwater runoff. If required, the applicant shall obtain a State Water Resources Board General Construction Activities Storm Water Permit. The Engineering Department shall monitor compliance.

This LID Plan covers the post-construction operations on the tenant and site improvements, in the City of Los Angeles, California (see Figure 1, Vicinity Map, on the next page). It has been developed as mandated by the California Regional Water Quality Control Board, Los Angeles Region (RWQCB) for the City of Los Angeles and in accordance with good engineering practices.

This LID Plan shall identify, at a minimum, applicable BMPs, the assignment of long-term maintenance responsibilities, and illustrate the site-specific Plan that will be implemented in order to mitigate post-construction stormwater runoff pollution.

LEGAL DESCRIPTION:

The land referred to herein below is situated in the city of Norwalk in the county of Los Angeles, state of California, and is described as follows:

LOTS 1,2,3 AND 4 OF TRACT NO. 25798, IN THE CITY OF NORWALK, COUNTY OF LOS ANGELES, STATE OF CALIFORNIA, AS PER MAP RECORDED IN BOOK 668 PAGES 69 AND 70 OF MAPS, IN THE OFFICE OF THE COUNTY RECORDER OF SAID COUNTY, TOGETHER WITH THAT PORTION OF THE ALLEY SHOWN ON SAID MAP THAT WAS VACATED BY RESOLUTION NO. 1160 OF THE CITY COUNCIL OF THE CITY OF NORWALK, A CERTIFIED COPY OF WHICH RECORDED SEPTEMBER 25, 1963 AS INSTRUMENT NO. 5375, OF OFFICIAL RECORDS.

APN: 27014-013-016

II. EXISTING SITE CONDITIONS

The proposed multi-family project site consists of an 8.1-acre site located in the City of Norwalk, CA. The project site is bounded by Alondra Blvd. to the north, Maidstone Ave. to the west, an existing parking lot and multi-family residential to the east, and single-family residential to the south.

In the existing condition, the site is made up of a building pad and parking stalls. The site generally slopes on the north portion to the southeast via surface flow, and slopes on the south portion both southwest and southeast away from the building pad. There is no public storm drain system in Maidstone Avenue or Flallon Avenue. A LACFCD owned storm drain is located on the west side of the Alondra Blvd.-Maidstone Ave. intersection. In the existing condition onsite flow is not treated prior to leaving the site. Onsite flow that releases out into Maidstone flows south via curb and gutter until College Dr. where it then runs east over to Flallon Ave. Flow in Flallon Ave travels south via curb and gutter all the way down to 166th St. until it enters the public storm drain system via city owned catch basin just west of the 166th St.-Flallon Ave intersection. Flow travels through the public storm drain system to the County Channel Project No 21, until it eventually discharges into Coyote Creek. Coyote Creek confluences with The San Gabriel River and flows to the Pacific Ocean.

The project site is located within the Artesia-Norwalk Drain (LACFCD Project No. 21) tributary area. Artesia-Norwalk Drain is a tributary to the San Gabriel River Estuary, which ultimately drains into the Los Angeles Harbor. According to the 2018 303(d) List of Impaired Water Bodies, the Artesia-Norwalk Drain is listed for indicator bacteria and selenium. The San Gabriel Estuary, is listed for Dioxin, indicator bacteria, copper, nickel and dissolved oxygen.

No storm water quality improvements currently exist on the Site. LA County Flood Control District requires that the stormwater treatment requirement is the 85th Percentile Storm event.

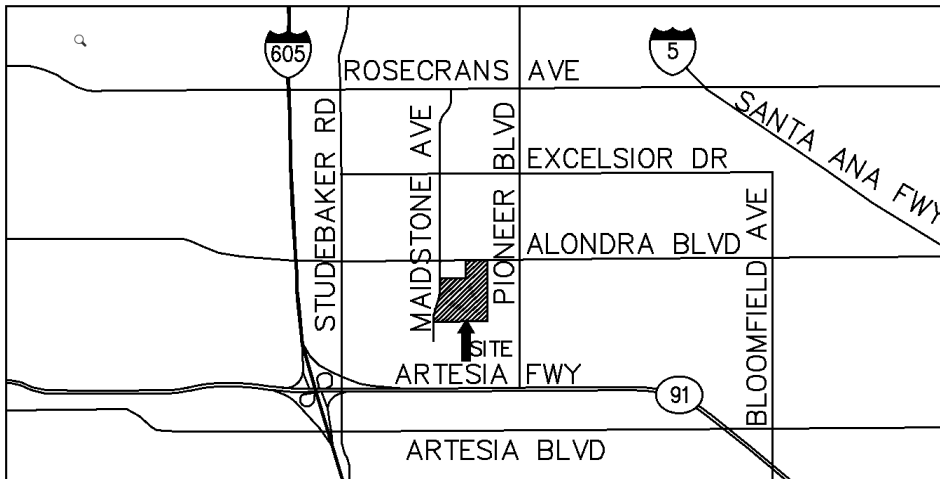

Figure 1: Vicinity Map

III. PROPOSED SITE CONDITIONS

The proposed site development includes 215 Units of multi-family building with parking lots, hardscape and landscape and is approximately 85% impervious. Under proposed conditions, the entire site will drain to the south-east, Where-as in the existing condition only half of the site drained to the south east and the other half drained to Maidstone. Although the drainage patterns vary, in both the existing and proposed condition, all onsite flow either directly or indirectly ends up in Flallon Ave. In the proposed condition, an underground storm drain system will connect a network of surface inlets and convey flow to the low point in the system on the southeast side of the site above Flallon Ave. During the peak storm event, the on-site storm drain system will fill up and overflow out of the lowest area drain at the low point in the system and continue offsite into Flallon Ave. Project stormwater will be kept separate from the offsite stormwater flow to the maximum extent practicable.

Proposed proprietary biotreatment devices, Modular Wetlands, will treat up to the 85th percentile storm event as required by the County. Treatment flow will enter the proposed Modular wetlands prior to leaving the site and entering the public storm drain system on Flallon Ave.

Refer to **Appendix 1** for the project's SUSMP Exhibit and Treatment Control BMP Detail Sheets.

IV. BMP SUMMARY

There are applicable, required or suggested treatment and source control BMPs based on the pollutants that are anticipated to be generated when the proposed redevelopment is completed and in use. This report is responsible for determining, evaluating, and selecting the appropriate and applicable measures to treat the targeted pollutants to the MEP standard.

The proposed project is a multi-family redevelopment. The expected pollutants of concern for this project include oil and grease, trash and debris, sediment, nutrients and solvents.

Although there has been no geotechnical investigation performed for the project. The geotechnical investigation performed by Salem Engineering Group, Inc. for the site on the other side of Maidstone Ave. stated that the underlying soils do not have the capacity to infiltrate. Therefore, infiltration is assumed to be considered infeasible. A Modular Wetland Bio-filtration unit will be implemented to treat the 85th percentile storm event. The larger storm events will burp out of a proposed grate inlet at the south east side of the site and will discharge out to Flallon Avenue

SOURCE CONTROL BMPS

Source control BMPs are required to be incorporated in all new development and redevelopment projects unless not applicable. The table below indicates all BMPs to be incorporated in the project. For those designated as not applicable (N/A), a brief explanation why is provided.

The specific source control BMPs for the tenant improvement project include:

INCORPORATED SOURCE CONTROL BMP:	YES	N/A	DESCRIPTION
Peak Stormwater Runoff Discharge Rates	<input type="checkbox"/>	<input checked="" type="checkbox"/>	The proposed condition peak flow rate is less than that of the existing condition therefore the project site's peak discharges will not cause or contribute to downstream erosion. Project runoff will discharge into the City's street and into the City's storm drain system, which has been approved by the City. Because $Q_{prop} < Q_{ex}$, peak flow mitigation is not required on site.
Conserve Natural Areas	<input type="checkbox"/>	<input checked="" type="checkbox"/>	Under existing conditions, the project site is fully developed. No natural areas will be preserved.
Minimize Stormwater Pollutants of Concern	<input checked="" type="checkbox"/>	<input type="checkbox"/>	The Modular Wetland water treatment unit will provide treatment of stormwater runoff. Additional source control BMPs will further minimize pollutants of concern.
Protect Slopes & Channels	<input type="checkbox"/>	<input checked="" type="checkbox"/>	There are no existing channels or slopes to be protected.

INCORPORATED SOURCE CONTROL BMP:	YES	N/A	DESCRIPTION
Provide Storm Drain System Stenciling & Signage	<input checked="" type="checkbox"/>	<input type="checkbox"/>	The phrase “No Dumping – Drains to Ocean” or equally effective phrase will be stenciled on catch basins and/or area drains to alert the public as to the destination of pollutants discharged into the stormwater.
Properly Design Outdoor Material Storage Areas	<input type="checkbox"/>	<input checked="" type="checkbox"/>	There are no outdoor storage areas proposed for the project site.
Properly Design Trash Storage Areas	<input checked="" type="checkbox"/>	<input type="checkbox"/>	The trash containers will be completely enclosed in a gate enclosure.
Provide Proof of Ongoing BMP Maintenance	<input checked="" type="checkbox"/>	<input type="checkbox"/>	The property owner will be responsible for the maintenance of the BMPs onsite, and ensure that they are in good working order.
Properly Design Loading/Unloading Dock Areas	<input type="checkbox"/>	<input checked="" type="checkbox"/>	There is no loading dock areas proposed for the project site.
Properly Design Repair/Maintenance Bays	<input type="checkbox"/>	<input checked="" type="checkbox"/>	There are no repair/maintenance bays proposed for the project site.
Properly Design Vehicle/ Equipment/ Accessory Wash Areas	<input type="checkbox"/>	<input checked="" type="checkbox"/>	There are no vehicle or equipment wash areas proposed for the project site.
Design Standards for Treatment Control BMPs	<input checked="" type="checkbox"/>	<input type="checkbox"/>	Post-construction structural BMP design will accommodate the 85 th percentile rainfall requirement.

The following source control BMP fact sheets taken from the 2019 California BMP Handbook are provided in **Appendix 7** of this report as a reference to the design plans and/or specifications for new multi-family improvements:

- SC-30 Outdoor Loading/Unloading
- SC-34 Waste Handling & Disposal
- SC-41 Building & Grounds Maintenance
- SC-43 Parking/Storage Area Maintenance
- SC-44 Drainage System Maintenance
- SD-13 Storm Drainage Signage
- SD-32 Trash Storage Areas

LID SITE DESIGN BMPS

The following table describes the Low Impact Development site design BMPs used in this project and the methods used to incorporate them. Careful consideration of site design is a critical first step in stormwater pollution prevention from new developments and redevelopments.

INCORPORATED LID SITE DESIGN BMP:	YES	NO	DESCRIPTION
Conserve natural areas.	<input type="checkbox"/>	<input checked="" type="checkbox"/>	Not applicable. The project is a fully developed site, and there are no natural areas to conserve.
Minimizing disturbances to natural drainage patterns.	<input type="checkbox"/>	<input checked="" type="checkbox"/>	No natural drainage patterns are present. The project will maintain the existing developed drainage patterns.
Minimizing and disconnecting impervious surfaces.	<input type="checkbox"/>	<input checked="" type="checkbox"/>	The project runoff will be directed to the proposed water treatment device. This will accomplish the same goals as minimizing and disconnecting impervious surfaces.
Minimizing soil compaction.	<input type="checkbox"/>	<input checked="" type="checkbox"/>	The previously developed site is already compacted in the existing condition.
Directing runoff from impervious areas to pervious areas.	<input type="checkbox"/>	<input checked="" type="checkbox"/>	The project runoff will be directed to the proposed water treatment device. This will accomplish the same goals as minimizing and disconnecting impervious surfaces by directing the low flows to landscaped areas as irrigation.

LID TREATMENT CONTROL BMPS

The water quality design for the Project complies with the 2002 Los Angeles County SUSMP Manual and the 2014 City of Los Angeles – Low Impact Development (LID) Manual. The LID goals of increasing groundwater recharge, enhancing water quality, and preventing degradation to downstream natural drainage courses, as outlined in LID Manual, were used in considering treatment method alternatives.

The LID manual outlines Implement LID and maximize in priority order:

1. Infiltrate
2. Capture and Use
3. High efficiency Bio-Filtration/Retention System BMP
4. Combination of above

The LID manual outlines Implement SUSMP and maximize in priority order:

1. Infiltrate
2. Capture and Use
3. Biofiltration
4. Mechanical Device
5. Combination of above.

The highest level on the priority list is to use Infiltration unless it is technically infeasible to do so. In this case, infiltration cannot be accomplished because of the very low infiltration rates

obtained from the Geotechnical recommendations found in **Appendix 9**. In lieu of infiltration, Biofiltration is proposed to treat the 85th percentile storm event.

INCORPORATED LID TREATMENT CONTROL BMP:	YES	NO	DESCRIPTION
Bioretention facility	<input type="checkbox"/>	<input checked="" type="checkbox"/>	-
Cisterns/Rain Barrels	<input type="checkbox"/>	<input checked="" type="checkbox"/>	-
Dry Ponds	<input type="checkbox"/>	<input checked="" type="checkbox"/>	-
Dry Wells	<input type="checkbox"/>	<input checked="" type="checkbox"/>	-
Engineered Wetlands	<input type="checkbox"/>	<input checked="" type="checkbox"/>	-
Green Roofs	<input type="checkbox"/>	<input checked="" type="checkbox"/>	-
Infiltration Basin	<input type="checkbox"/>	<input checked="" type="checkbox"/>	-
Infiltration Trenches	<input type="checkbox"/>	<input checked="" type="checkbox"/>	-
Landscape Irrigation	<input type="checkbox"/>	<input checked="" type="checkbox"/>	-
Biofiltration	<input checked="" type="checkbox"/>	<input type="checkbox"/>	-Modular Wetland unit proposed for water treatment
Porous pavements	<input type="checkbox"/>	<input checked="" type="checkbox"/>	-
Sand Filters	<input type="checkbox"/>	<input checked="" type="checkbox"/>	-
Vegetated Buffers	<input type="checkbox"/>	<input checked="" type="checkbox"/>	-
Vegetated Swales	<input type="checkbox"/>	<input checked="" type="checkbox"/>	-
Wet Ponds	<input type="checkbox"/>	<input checked="" type="checkbox"/>	-

DESIGN STANDARDS FOR TREATMENT CONTROL BMPS

Treatment Control BMPs must incorporate, at a minimum, either a flow- or volume-based treatment control design standard, or both, to mitigate (infiltrate, filter, or treat) stormwater runoff. The project site is utilizing both flow-based and volume-based treatments to mitigate the storm water runoff.

Hydrology calculations are based on a 25-year storm event. The calculated flows associated with the 25-year storm are based on the Rational Method as outlined by the Los Angeles County Public Works Department “Hydrology Manual”, January 2006.

Proposed peak mitigated discharge values and volumes have been calculated using the City of Los Angeles Watershed Protection Division’s “Development Best Management Practices Handbook, Low Impact Design Manual, Part B, Planning Activities, 4th Edition”, June 2011.

Input parameters, applicable equations, and detailed hydrology and peak mitigation calculations are provided in **Appendix 2**. Refer to the Drainage Area Exhibit within **Appendix 2** for the delineation of the project’s drainage areas.

As illustrated in the table below, all treatment control BMPs selected for the project are adequately sized:

Treatment Control BMP	BMP ID	Sub-Areas	Calculated Q _{PM} (cfs)	Selected BMP Size	Provided Q _{PM} (cfs)
Modular Wetland	1	1,2,5	0.640	MWS-L-8-24	0.693
Modular Wetland	2	3,8,11	0.233	MWS-L-8-12	0.346
Modular Wetland	3	4,6,7,9,10	0.484	MWS-L-8-20	0.577
Modular Wetland	4	13	0.191	MWS-L-8-8	0.230
Modular Wetland	5	12,15,18	0.329	MWS-L-8-12	0.346
Modular Wetland	6	19	0.088	MWS-L-4-8	0.115
Modular Wetland	7	16	0.135	MWS-L-4-13	0.144
Modular Wetland	8	20	0.085	MWS-L-4-8	0.115
Modular Wetland	9	14,17	0.171	MWS-L-8-8	0.230

V. HYDROMODIFICATION DISCUSSION

The site connects to a City-approved storm drain system that discharges to the Artesia-Norwalk Drain and subsequently to the Coyote Creek. Both drainage courses are improved and not susceptible to hydromodification.

VI. INSPECTION/MAINTENANCE RESPONSIBILITY

It has been determined that the property owner (Shapell Properties) shall assume all BMP inspection and maintenance responsibilities for the new tenant improvements. Shapell Properties will be responsible for maintenance of all storm drain inlets, collectors, v-ditches or any other related flood control or stormwater control devices. Furthermore, all interior streets and/or roadways, landscape, recreation areas, facilities and/or open space within the project limits will be maintained by the Owner. A Covenant and Agreement regarding on-site stormwater treatment devices maintenance shall be completed prior to completion and release of the project by the City of Los Angeles (see **Appendix 4**).

LONG-TERM FUNDING FOR BMP MAINTENANCE

Long-term funding for BMP maintenance shall be funded by Shapell Properties.

RESPONSIBLE PARTY CONTACT INFORMATION

Shapell Properties, Inc.
11200 Corbin Ave. Suite 201
Porter Ranch, CA 91326
Phone: 323.988.7594

VII. OPERATION & MAINTENANCE PLAN

Proper O&M is an important element of a stormwater mitigation plan to ensure BMPs remove pollution effectively. Routine maintenance or service also contributes to the efficiency and continuous operation of a system. The post development BMP maintenance responsibility and frequency matrix provided in this section detail the specific party to perform the inspection and maintenance of each BMP for the tenant Improvements and details the maintenance and inspection activities to be performed, and the frequency with which each shall be performed. Further Operations and Maintenance details can be found in **Appendix 5**.

Structural BMP Maintenance Responsibility / Frequency Matrix

BMP		RESPONSIBILITY	MAINTENANCE FREQUENCY
SD-13	Storm Drainage Signage	Shapell Properties	Storm drain stencils shall be inspected for legibility, at minimum, once prior to the storm season, no later than October 1 st each year. Those determined to be illegible should be re-stenciled as soon as possible. Frequency: ANNUALLY
SD-32	Trash Storage Areas	Shapell Properties	Sweep trash area at least once per week and before October 1 st each year. Maintain area clean of trash and debris at all times. Frequency: WEEKLY
SC-34	Waste Handling & Disposal	Shapell Properties	Train employees to clean regularly to remove potential sources of pollutants. Sweep area to be performed at least once per month and before Oct 1 of each year. Frequency: MONTHLY
SD-41	Building and Grounds Maintenance	Shapell Properties	Sweep paved areas regularly to collect loose particles, and wipe up spills with rags and other absorbent material immediately, DO NOT hose down the area to a storm drain. Frequency: WEEKLY

BMP		RESPONSIBILITY	MAINTENANCE FREQUENCY
SC-43	Parking/Storage Area Maintenance	Shapell Properties	<p>Parking lots must be swept at least quarterly (every 3 months), including prior to the start of the rainy season (October 1st).</p> <p>Frequency: QUARTERLY</p>
Modular Wetland Units		Shapell Properties	<p>Units must be serviced at least twice per year. Manufacturer's specifications may recommend additional maintenance.</p> <p>Frequency: MANUFACTURER'S RECOMMENDATIONS</p>



VIII. APPENDICES

- Appendix 1: LID and Drainage Area Exhibit, Treatment Control BMP Details
- Appendix 2: Q25 and LID Calculations and Backup Documents
- Appendix 3: Stormwater Observation Report Form
- Appendix 4: Master Covenant and Agreement
- Appendix 5: Treatment Control BMP Operation & Maintenance Plan Supplement
- Appendix 6: Record of Inspections
- Appendix 7: Source Control BMP Fact Sheets
- Appendix 8: Public Education Materials
- Appendix 9: Public Education Materials

APPENDIX 1

LID and Drainage Area Exhibit, Treatment Control BMP
Details

Plotted By: Lieberman, Cameron. Sheet Set: Kns Layout: Layout1. September 01, 2022. 09:38:19am. K:\ORA_LOEVA\094896004 - Shopell Norwalk Apartments\Reports_LID_Exhibits\2021.12 - LID Exhibit.dwg
 This document, together with the concepts and designs presented herein, is intended only for the specific purpose and client for which it was prepared. Reuse of and improper reliance on this document without written authorization and adaptation by Kimley-Horn and Associates, Inc. shall be without liability to Kimley-Horn and Associates, Inc.

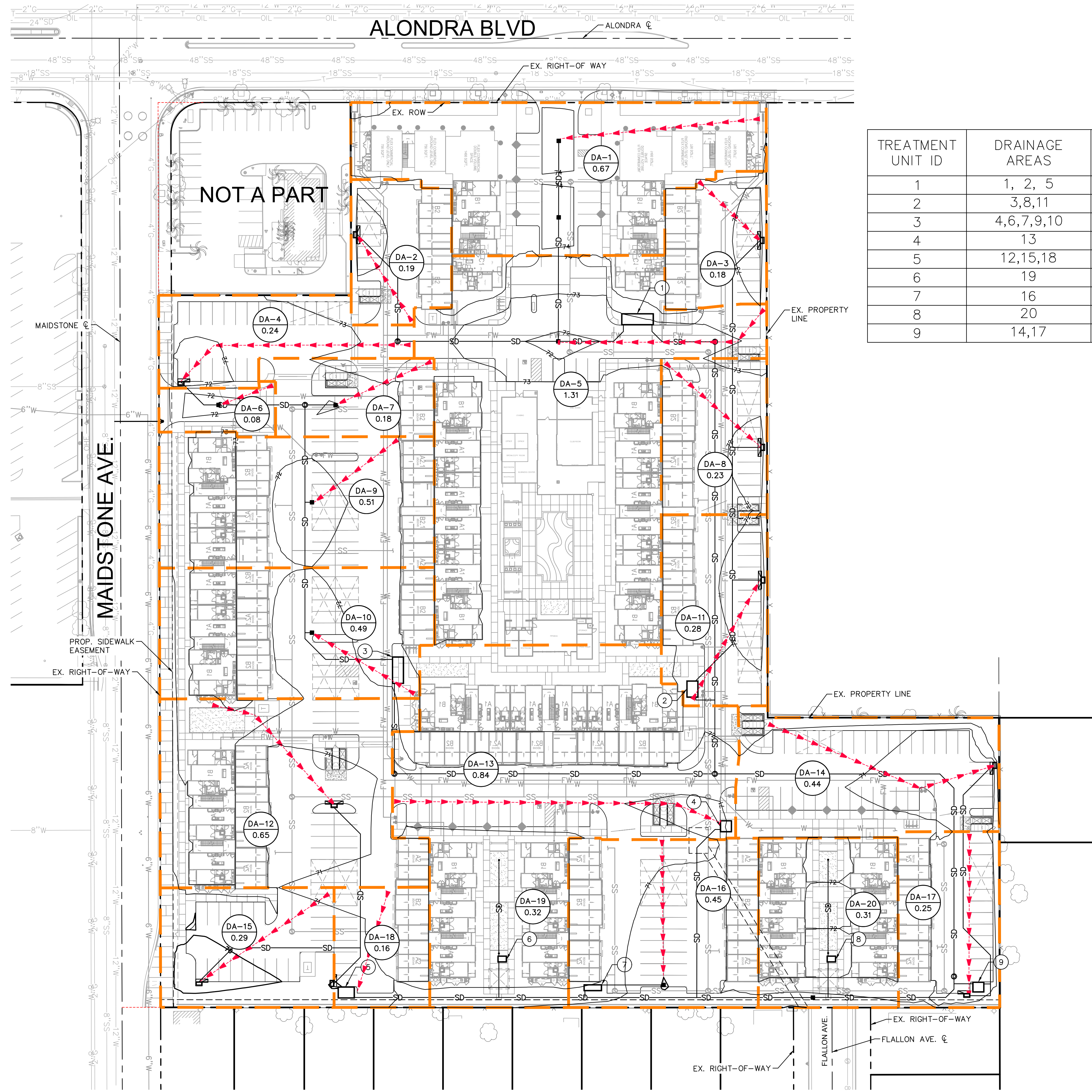

LEGEND

- RIGHT-OF-WAY
- PROPERTY LINE
- CENTER LINE
- EASEMENT
- FLOW LINE
- DRAINAGE AREA BOUNDARY
- DA-#
AC DRAINAGE AREA ID
- X MWS ID
- TOTAL ACREAGE

TREATMENT UNIT ID	DRAINAGE AREAS	TRIBUTARY AREA(AC)	BMP MWS MODEL	TREATMENT FLOW RATE (CFS)	TREATMENT FLOWRATE PROVIDED
1	1, 2, 5	2.17	MWS-L-8-24	0.640	0.693
2	3,8,11	0.69	MWS-L-8-12	0.233	0.346
3	4,6,7,9,10	1.5	MWS-L-8-20	0.484	0.577
4	13	0.84	MWS-L-8-8	0.191	0.230
5	12,15,18	1.10	MWS-L-8-12	0.329	0.346
6	19	0.32	MWS-L-4-8	0.088	0.115
7	16	0.45	MWS-L-4-13	0.135	0.144
8	20	0.31	MWS-L-4-8	0.085	0.115
9	14,17	0.69	MWS-L-8-8	0.171	0.230

No.	REVISIONS	DATE	BY

Kimley-Horn
 © 2023 KIMLEY-HORN AND ASSOCIATES, INC.
 1100 W TOWN AND COUNTRY ROAD, SUITE 700,
 ORANGE, CA 92668
 PHONE: 714-939-1030 FAX: 714-938-9488
 WWW.KIMLEY-HORN.COM



KHA PROJECT 094896004	PLOT DATE 9/1/2022	SCALE AS SHOWN	DESIGNED BY ML	DRAWN BY CL	CHECKED BY JM
--------------------------	-----------------------	-------------------	-------------------	----------------	------------------

LID EXHIBIT

NORWALK APARTMENTS
 PREPARED FOR
SHAPELL

NORWALK
 SHEET NUMBER

SITE SPECIFIC DATA			
PROJECT NUMBER			
PROJECT NAME			
PROJECT LOCATION			
STRUCTURE ID			
TREATMENT REQUIRED			
VOLUME BASED (CF)		FLOW BASED (CFS)	
N/A			
PEAK BYPASS REQUIRED (CFS) – IF APPLICABLE			
PIPE DATA	I.E.	MATERIAL	DIAMETER
INLET PIPE 1			
INLET PIPE 2			
OUTLET PIPE			
	PRETREATMENT	BIOFILTRATION	DISCHARGE
RIM ELEVATION			
SURFACE LOAD			
FRAME & COVER	36" X 36"		N/A
NOTES:			

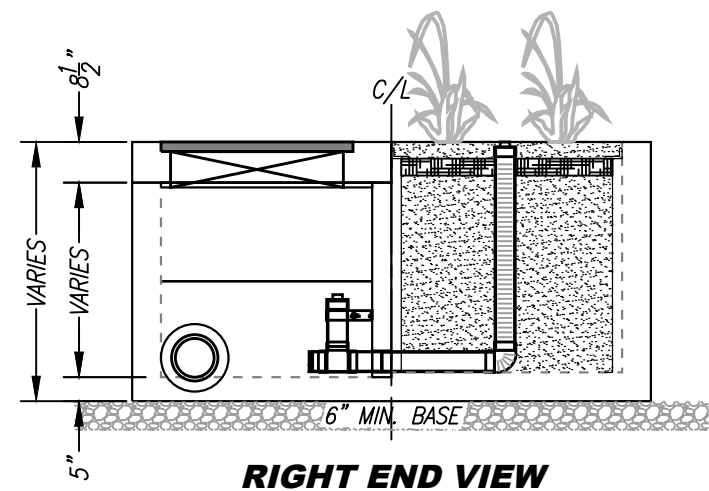
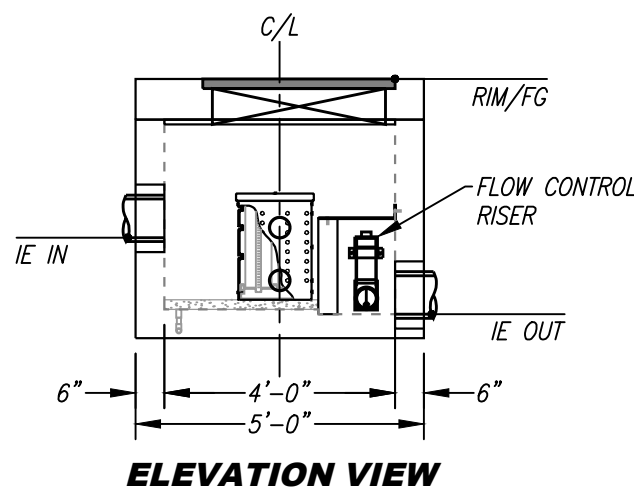
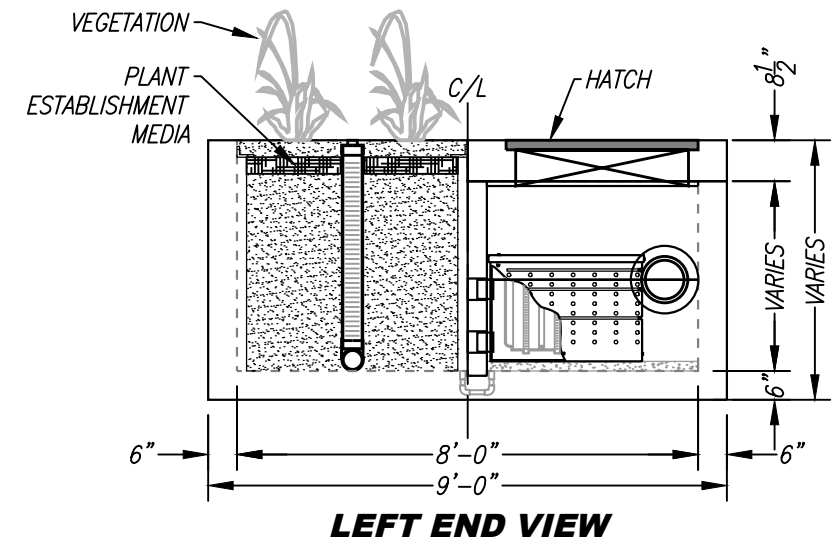
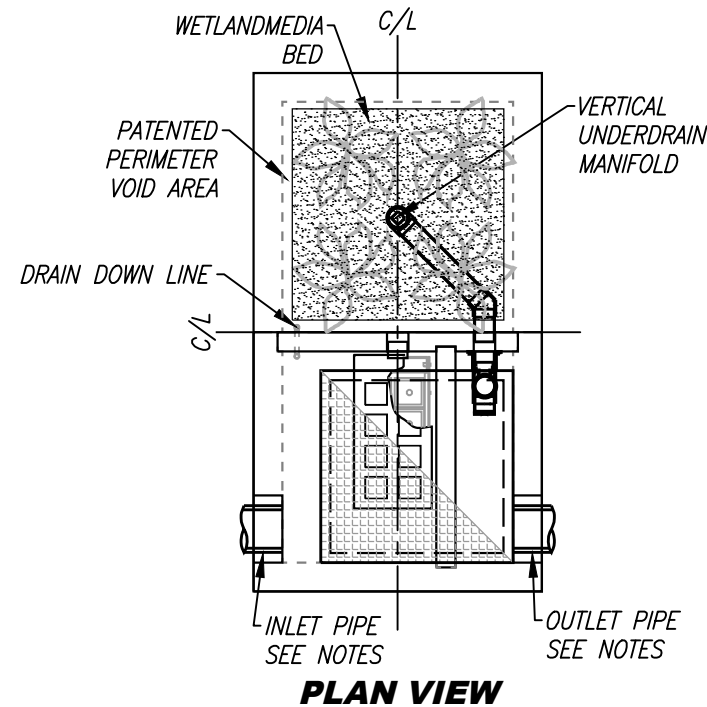

INSTALLATION NOTES

1. CONTRACTOR TO PROVIDE ALL LABOR, EQUIPMENT, MATERIALS AND INCIDENTALS REQUIRED TO OFFLOAD AND INSTALL THE SYSTEM AND APPURTENANCES IN ACCORDANCE WITH THIS DRAWING AND THE MANUFACTURERS SPECIFICATIONS, UNLESS OTHERWISE STATED IN MANUFACTURERS CONTRACT.
2. UNIT MUST BE INSTALLED ON LEVEL BASE. MANUFACTURER RECOMMENDS A MINIMUM 6" LEVEL ROCK BASE UNLESS SPECIFIED BY THE PROJECT ENGINEER. CONTRACTOR IS RESPONSIBLE TO VERIFY PROJECT ENGINEERS RECOMMENDED BASE SPECIFICATIONS.
4. CONTRACTOR TO SUPPLY AND INSTALL ALL EXTERNAL CONNECTING PIPES. ALL PIPES MUST BE FLUSH WITH INSIDE SURFACE OF CONCRETE. (PIPES CANNOT INTRUDE BEYOND FLUSH). INVERT OF OUTFLOW PIPE MUST BE FLUSH WITH DISCHARGE CHAMBER FLOOR. ALL PIPES SHALL BE SEALED WATER TIGHT PER MANUFACTURERS STANDARD CONNECTION DETAIL.
5. CONTRACTOR RESPONSIBLE FOR INSTALLATION OF ALL RISERS, MANHOLES, AND HATCHES. CONTRACTOR TO GROUT ALL MANHOLES AND HATCHES TO MATCH FINISHED SURFACE UNLESS SPECIFIED OTHERWISE.
6. VEGETATION SUPPLIED AND INSTALLED BY OTHERS. ALL UNITS WITH VEGETATION MUST HAVE DRIP OR SPRAY IRRIGATION SUPPLIED AND INSTALLED BY OTHERS.
7. CONTRACTOR RESPONSIBLE FOR CONTACTING BIO CLEAN FOR ACTIVATION OF UNIT. MANUFACTURERS WARRANTY IS VOID WITH OUT PROPER ACTIVATION BY A BIO CLEAN REPRESENTATIVE.

GENERAL NOTES

1. MANUFACTURER TO PROVIDE ALL MATERIALS UNLESS OTHERWISE NOTED.
2. ALL DIMENSIONS, ELEVATIONS, SPECIFICATIONS AND CAPACITIES ARE SUBJECT TO CHANGE. FOR PROJECT SPECIFIC DRAWINGS DETAILING EXACT DIMENSIONS, WEIGHTS AND ACCESSORIES PLEASE CONTACT BIO CLEAN.

TREATMENT FLOW (CFS)	
OPERATING HEAD (FT)	
PRETREATMENT LOADING RATE (GPM/SF)	
WETLAND MEDIA LOADING RATE (GPM/SF)	



PROPRIETARY AND CONFIDENTIAL:
 THE INFORMATION CONTAINED IN THIS DOCUMENT IS THE SOLE PROPERTY OF FORTERRA AND ITS COMPANIES. THIS DOCUMENT, NOR ANY PART THEREOF, MAY BE USED, REPRODUCED OR MODIFIED IN ANY MANNER WITH OUT THE WRITTEN CONSENT OF FORTERRA.



MWS-L-4-8-V
STORMWATER BIOFILTRATION SYSTEM
STANDARD DETAIL

5/23/19TOLF

SITE SPECIFIC DATA			
PROJECT NUMBER			
PROJECT NAME			
PROJECT LOCATION			
STRUCTURE ID			
TREATMENT REQUIRED			
VOLUME BASED (CF)		FLOW BASED (CFS)	
N/A			
PEAK BYPASS REQUIRED (CFS) – IF APPLICABLE			
PIPE DATA	I.E.	MATERIAL	DIAMETER
INLET PIPE 1			
INLET PIPE 2			
OUTLET PIPE			
	PRETREATMENT	BIOFILTRATION	DISCHARGE
RIM ELEVATION			
SURFACE LOAD			
FRAME & COVER	ø30"		ø24"
NOTES:			

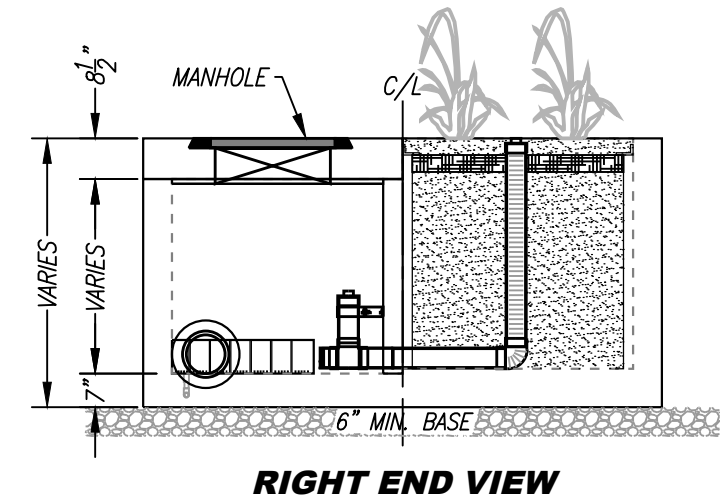
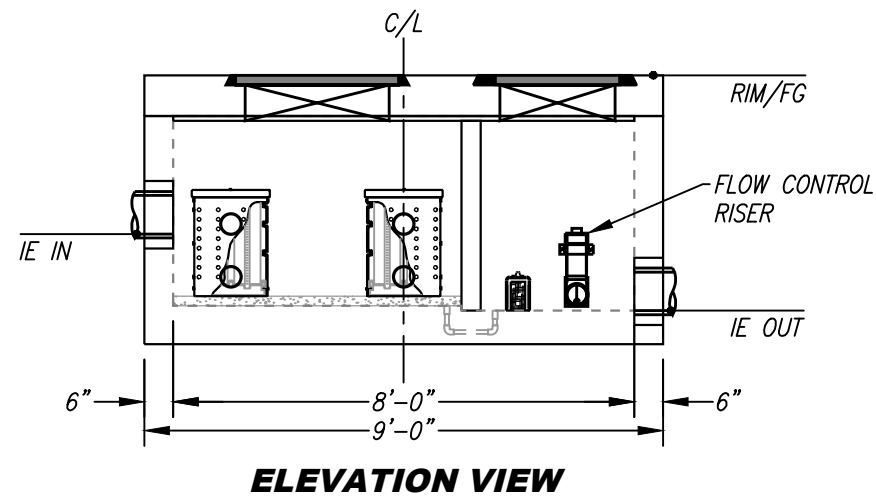
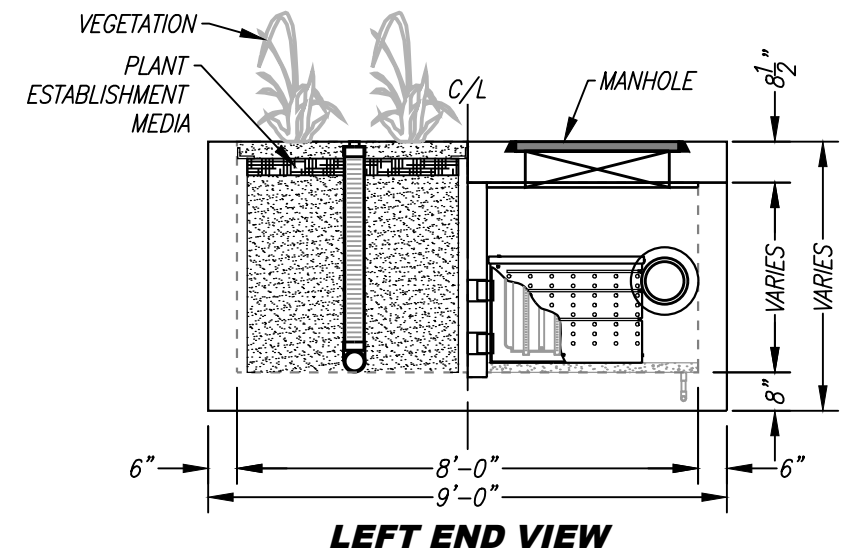
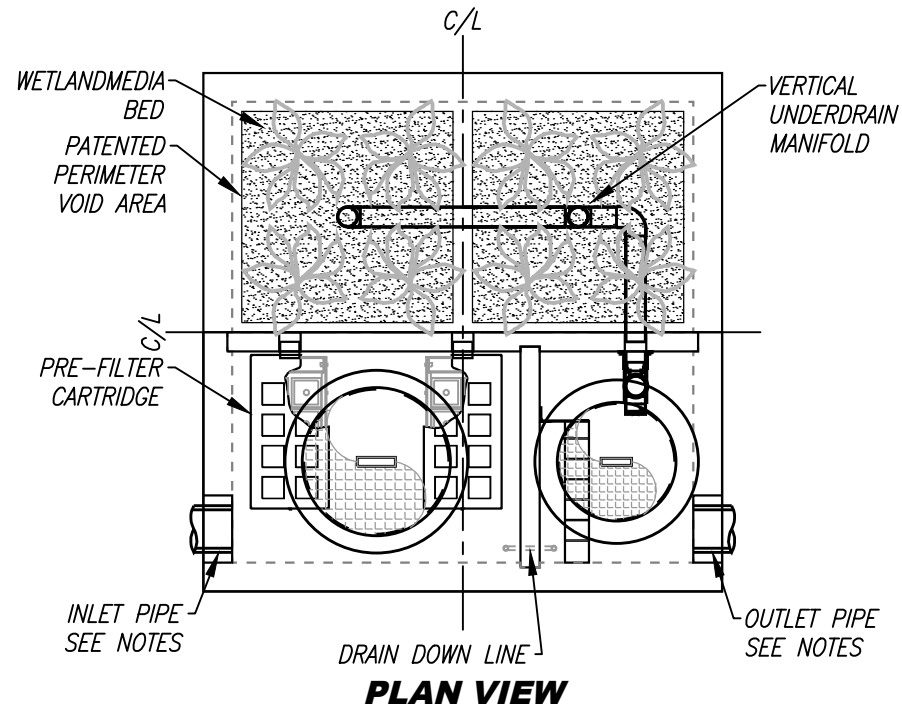

INSTALLATION NOTES

1. CONTRACTOR TO PROVIDE ALL LABOR, EQUIPMENT, MATERIALS AND INCIDENTALS REQUIRED TO OFFLOAD AND INSTALL THE SYSTEM AND APPURTENANCES IN ACCORDANCE WITH THIS DRAWING AND THE MANUFACTURERS SPECIFICATIONS, UNLESS OTHERWISE STATED IN MANUFACTURERS CONTRACT.
2. UNIT MUST BE INSTALLED ON LEVEL BASE. MANUFACTURER RECOMMENDS A MINIMUM 6" LEVEL ROCK BASE UNLESS SPECIFIED BY THE PROJECT ENGINEER. CONTRACTOR IS RESPONSIBLE TO VERIFY PROJECT ENGINEERS RECOMMENDED BASE SPECIFICATIONS.
4. CONTRACTOR TO SUPPLY AND INSTALL ALL EXTERNAL CONNECTING PIPES. ALL PIPES MUST BE FLUSH WITH INSIDE SURFACE OF CONCRETE. (PIPES CANNOT INTRUDE BEYOND FLUSH). INVERT OF OUTFLOW PIPE MUST BE FLUSH WITH DISCHARGE CHAMBER FLOOR. ALL PIPES SHALL BE SEALED WATER TIGHT PER MANUFACTURERS STANDARD CONNECTION DETAIL.
5. CONTRACTOR RESPONSIBLE FOR INSTALLATION OF ALL RISERS, MANHOLES, AND HATCHES. CONTRACTOR TO GROUT ALL MANHOLES AND HATCHES TO MATCH FINISHED SURFACE UNLESS SPECIFIED OTHERWISE.
6. VEGETATION SUPPLIED AND INSTALLED BY OTHERS. ALL UNITS WITH VEGETATION MUST HAVE DRIP OR SPRAY IRRIGATION SUPPLIED AND INSTALLED BY OTHERS.
7. CONTRACTOR RESPONSIBLE FOR CONTACTING BIO CLEAN FOR ACTIVATION OF UNIT. MANUFACTURERS WARRANTY IS VOID WITH OUT PROPER ACTIVATION BY A BIO CLEAN REPRESENTATIVE.

GENERAL NOTES

1. MANUFACTURER TO PROVIDE ALL MATERIALS UNLESS OTHERWISE NOTED.
2. ALL DIMENSIONS, ELEVATIONS, SPECIFICATIONS AND CAPACITIES ARE SUBJECT TO CHANGE. FOR PROJECT SPECIFIC DRAWINGS DETAILING EXACT DIMENSIONS, WEIGHTS AND ACCESSORIES PLEASE CONTACT BIO CLEAN.

TREATMENT FLOW (CFS)	
OPERATING HEAD (FT)	
PRETREATMENT LOADING RATE (GPM/SF)	
WETLAND MEDIA LOADING RATE (GPM/SF)	



PROPRIETARY AND CONFIDENTIAL:
 THE INFORMATION CONTAINED IN THIS DOCUMENT IS THE SOLE PROPERTY OF FORTERRA AND ITS COMPANIES. THIS DOCUMENT, NOR ANY PART THEREOF, MAY BE USED, REPRODUCED OR MODIFIED IN ANY MANNER WITH OUT THE WRITTEN CONSENT OF FORTERRA.



MWS-L-8-8-V
STORMWATER BIOFILTRATION SYSTEM
STANDARD DETAIL

SITE SPECIFIC DATA			
PROJECT NUMBER			
PROJECT NAME			
PROJECT LOCATION			
STRUCTURE ID			
TREATMENT REQUIRED			
VOLUME BASED (CF)		FLOW BASED (CFS)	
N/A			
PEAK BYPASS REQUIRED (CFS) – IF APPLICABLE			
PIPE DATA	I.E.	MATERIAL	DIAMETER
INLET PIPE 1			
INLET PIPE 2			
OUTLET PIPE			
	PRETREATMENT	BIOFILTRATION	DISCHARGE
RIM ELEVATION			
SURFACE LOAD			
FRAME & COVER	3EA Ø30"		Ø24"
NOTES:			

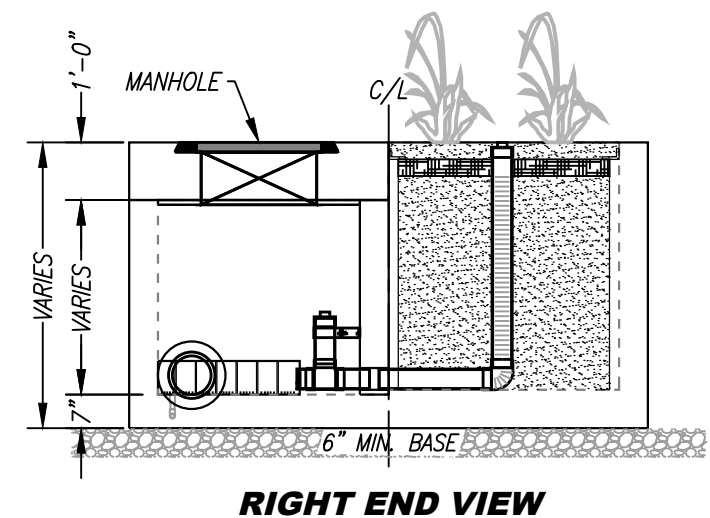
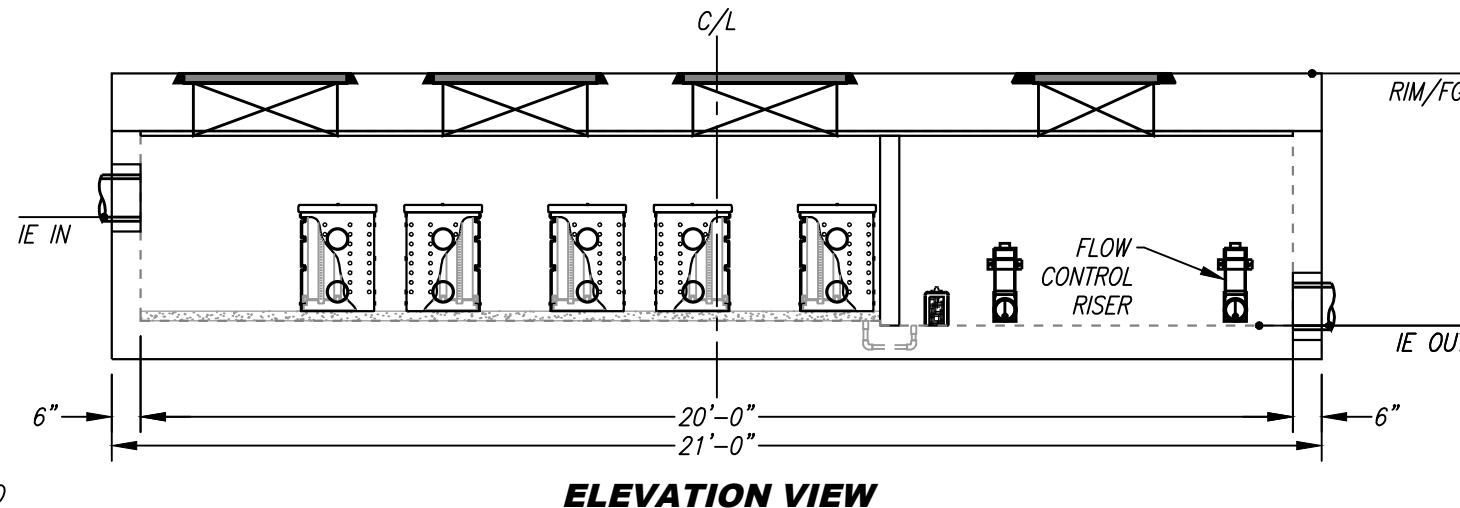
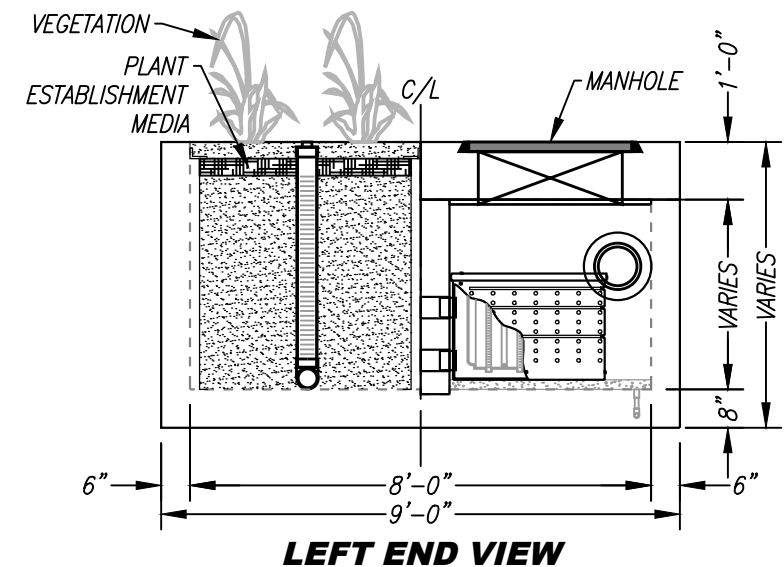
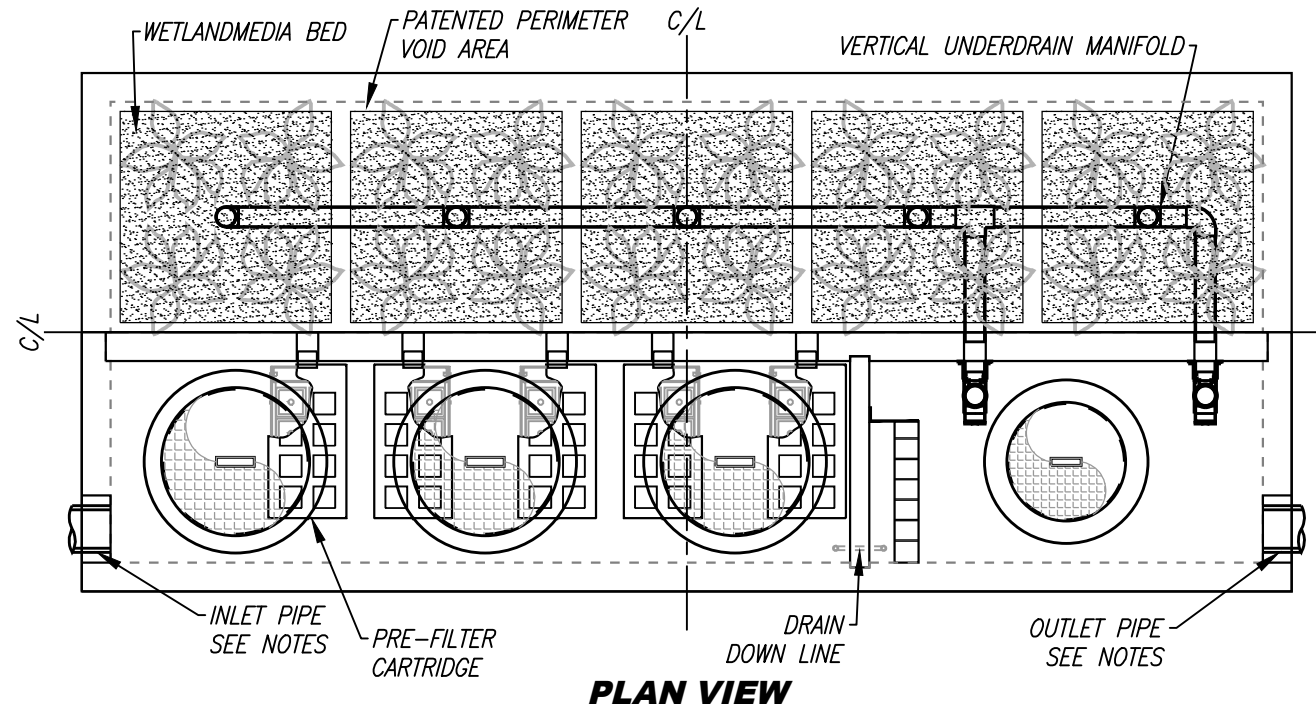

INSTALLATION NOTES

1. CONTRACTOR TO PROVIDE ALL LABOR, EQUIPMENT, MATERIALS AND INCIDENTALS REQUIRED TO OFFLOAD AND INSTALL THE SYSTEM AND APPURTENANCES IN ACCORDANCE WITH THIS DRAWING AND THE MANUFACTURERS SPECIFICATIONS, UNLESS OTHERWISE STATED IN MANUFACTURERS CONTRACT.
2. UNIT MUST BE INSTALLED ON LEVEL BASE. MANUFACTURER RECOMMENDS A MINIMUM 6" LEVEL ROCK BASE UNLESS SPECIFIED BY THE PROJECT ENGINEER. CONTRACTOR IS RESPONSIBLE TO VERIFY PROJECT ENGINEERS RECOMMENDED BASE SPECIFICATIONS.
4. CONTRACTOR TO SUPPLY AND INSTALL ALL EXTERNAL CONNECTING PIPES. ALL PIPES MUST BE FLUSH WITH INSIDE SURFACE OF CONCRETE. (PIPES CANNOT INTRUDE BEYOND FLUSH). INVERT OF OUTFLOW PIPE MUST BE FLUSH WITH DISCHARGE CHAMBER FLOOR. ALL PIPES SHALL BE SEALED WATER TIGHT PER MANUFACTURERS STANDARD CONNECTION DETAIL.
5. CONTRACTOR RESPONSIBLE FOR INSTALLATION OF ALL RISERS, MANHOLES, AND HATCHES. CONTRACTOR TO GROUT ALL MANHOLES AND HATCHES TO MATCH FINISHED SURFACE UNLESS SPECIFIED OTHERWISE.
6. VEGETATION SUPPLIED AND INSTALLED BY OTHERS. ALL UNITS WITH VEGETATION MUST HAVE DRIP OR SPRAY IRRIGATION SUPPLIED AND INSTALLED BY OTHERS.
7. CONTRACTOR RESPONSIBLE FOR CONTACTING BIO CLEAN FOR ACTIVATION OF UNIT. MANUFACTURERS WARRANTY IS VOID WITH OUT PROPER ACTIVATION BY A BIO CLEAN REPRESENTATIVE.

GENERAL NOTES

1. MANUFACTURER TO PROVIDE ALL MATERIALS UNLESS OTHERWISE NOTED.
2. ALL DIMENSIONS, ELEVATIONS, SPECIFICATIONS AND CAPACITIES ARE SUBJECT TO CHANGE. FOR PROJECT SPECIFIC DRAWINGS DETAILING EXACT DIMENSIONS, WEIGHTS AND ACCESSORIES PLEASE CONTACT BIO CLEAN.

TREATMENT FLOW (CFS)	
OPERATING HEAD (FT)	
PRETREATMENT LOADING RATE (GPM/SF)	
WETLAND MEDIA LOADING RATE (GPM/SF)	

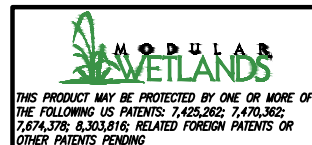

PROPRIETARY AND CONFIDENTIAL:
 THE INFORMATION CONTAINED IN THIS DOCUMENT IS THE SOLE PROPERTY OF FORTERRA AND ITS COMPANIES. THIS DOCUMENT, NOR ANY PART THEREOF, MAY BE USED, REPRODUCED OR MODIFIED IN ANY MANNER WITH OUT THE WRITTEN CONSENT OF FORTERRA.



MWS-L-8-20-V
STORMWATER BIOFILTRATION SYSTEM
STANDARD DETAIL

SITE SPECIFIC DATA			
PROJECT NUMBER			
PROJECT NAME			
PROJECT LOCATION			
STRUCTURE ID			
TREATMENT REQUIRED			
VOLUME BASED (CF)		FLOW BASED (CFS)	
N/A			
PEAK BYPASS REQUIRED (CFS) – IF APPLICABLE			
PIPE DATA	I.E.	MATERIAL	DIAMETER
INLET PIPE 1			
INLET PIPE 2			
OUTLET PIPE			
	PRETREATMENT	BIOFILTRATION	DISCHARGE
RIM ELEVATION			
SURFACE LOAD			
FRAME & COVER	2EA $\phi 30"$		$\phi 24"$
NOTES:			

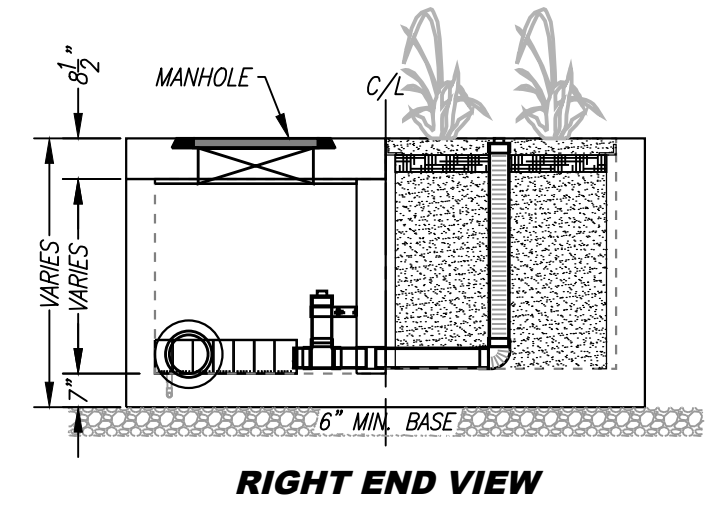
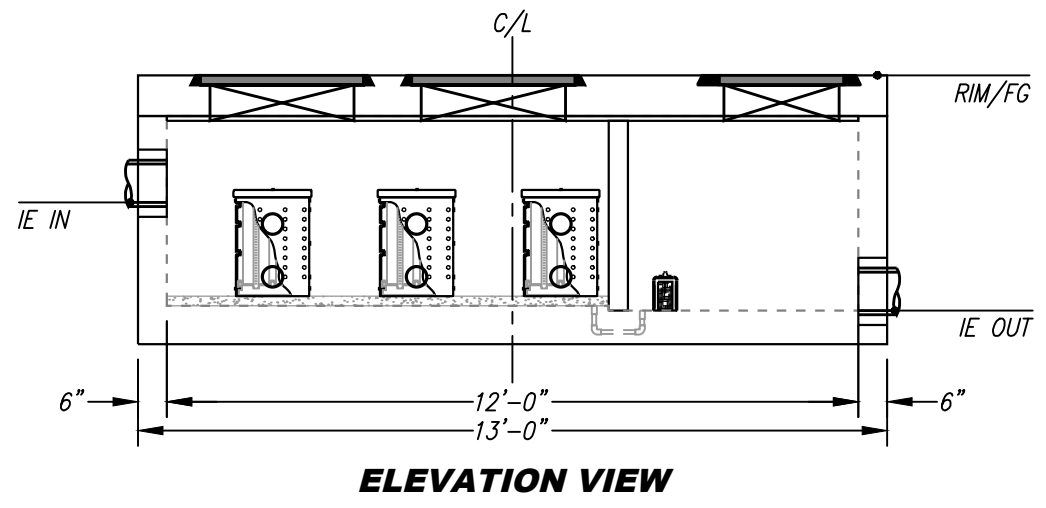
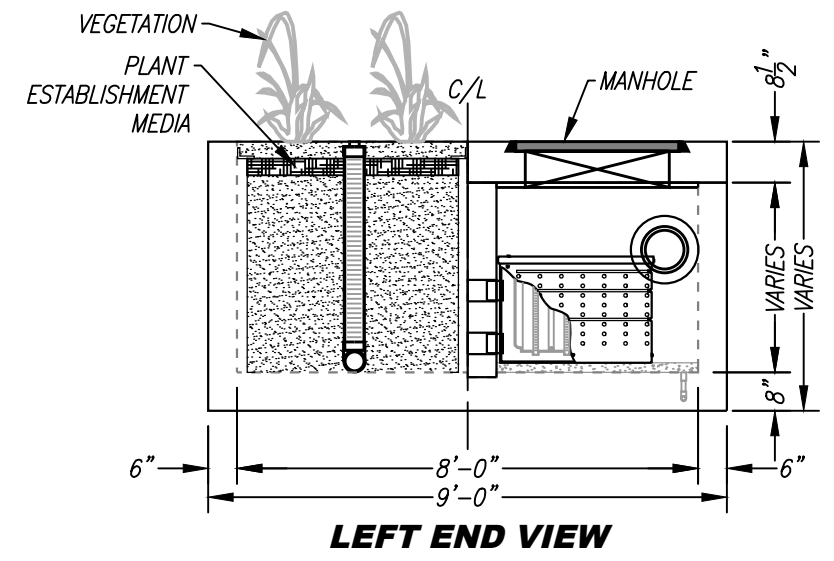
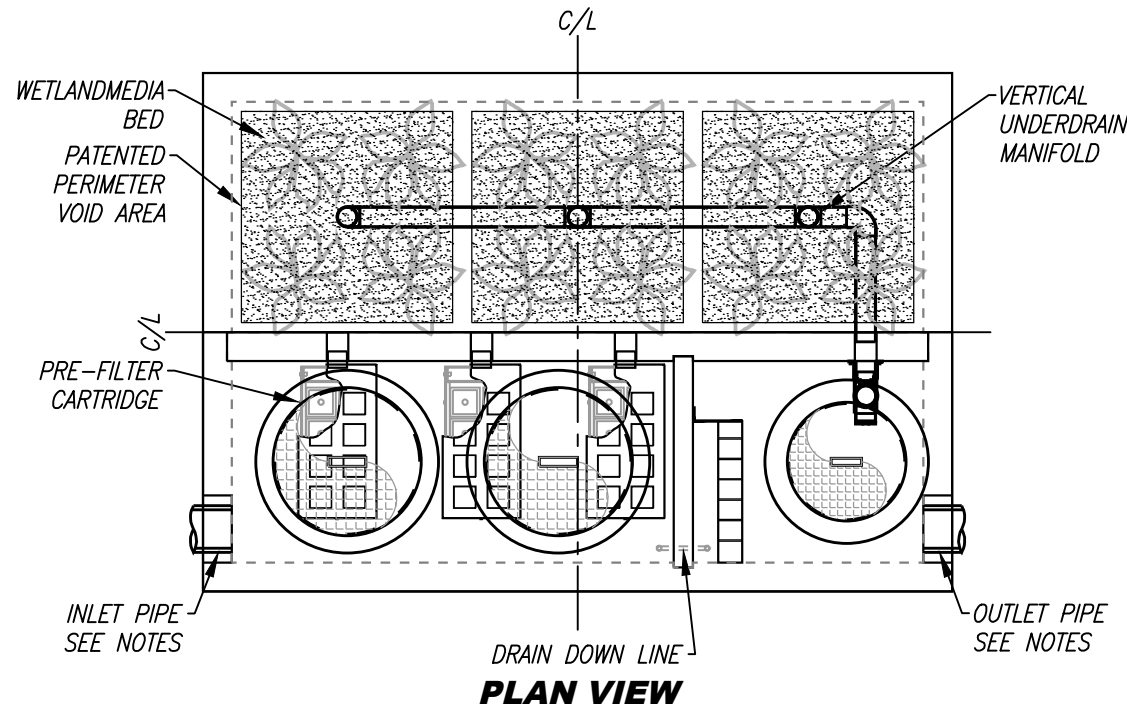

INSTALLATION NOTES

1. CONTRACTOR TO PROVIDE ALL LABOR, EQUIPMENT, MATERIALS AND INCIDENTALS REQUIRED TO OFFLOAD AND INSTALL THE SYSTEM AND APPURTENANCES IN ACCORDANCE WITH THIS DRAWING AND THE MANUFACTURERS SPECIFICATIONS, UNLESS OTHERWISE STATED IN MANUFACTURERS CONTRACT.
2. UNIT MUST BE INSTALLED ON LEVEL BASE. MANUFACTURER RECOMMENDS A MINIMUM 6" LEVEL ROCK BASE UNLESS SPECIFIED BY THE PROJECT ENGINEER. CONTRACTOR IS RESPONSIBLE TO VERIFY PROJECT ENGINEERS RECOMMENDED BASE SPECIFICATIONS.
4. CONTRACTOR TO SUPPLY AND INSTALL ALL EXTERNAL CONNECTING PIPES. ALL PIPES MUST BE FLUSH WITH INSIDE SURFACE OF CONCRETE. (PIPES CANNOT INTRUDE BEYOND FLUSH). INVERT OF OUTFLOW PIPE MUST BE FLUSH WITH DISCHARGE CHAMBER FLOOR. ALL PIPES SHALL BE SEALED WATER TIGHT PER MANUFACTURERS STANDARD CONNECTION DETAIL.
5. CONTRACTOR RESPONSIBLE FOR INSTALLATION OF ALL RISERS, MANHOLES, AND HATCHES. CONTRACTOR TO GROUT ALL MANHOLES AND HATCHES TO MATCH FINISHED SURFACE UNLESS SPECIFIED OTHERWISE.
6. VEGETATION SUPPLIED AND INSTALLED BY OTHERS. ALL UNITS WITH VEGETATION MUST HAVE DRIP OR SPRAY IRRIGATION SUPPLIED AND INSTALLED BY OTHERS.
7. CONTRACTOR RESPONSIBLE FOR CONTACTING BIO CLEAN FOR ACTIVATION OF UNIT. MANUFACTURERS WARRANTY IS VOID WITH OUT PROPER ACTIVATION BY A BIO CLEAN REPRESENTATIVE.

GENERAL NOTES

1. MANUFACTURER TO PROVIDE ALL MATERIALS UNLESS OTHERWISE NOTED.
2. ALL DIMENSIONS, ELEVATIONS, SPECIFICATIONS AND CAPACITIES ARE SUBJECT TO CHANGE. FOR PROJECT SPECIFIC DRAWINGS DETAILING EXACT DIMENSIONS, WEIGHTS AND ACCESSORIES PLEASE CONTACT BIO CLEAN.

TREATMENT FLOW (CFS)	
OPERATING HEAD (FT)	
PRETREATMENT LOADING RATE (GPM/SF)	
WETLAND MEDIA LOADING RATE (GPM/SF)	



PROPRIETARY AND CONFIDENTIAL:
 THE INFORMATION CONTAINED IN THIS DOCUMENT IS THE SOLE PROPERTY OF FORTERRA AND ITS COMPANIES. THIS DOCUMENT, NOR ANY PART THEREOF, MAY BE USED, REPRODUCED OR MODIFIED IN ANY MANNER WITH OUT THE WRITTEN CONSENT OF FORTERRA.



MWS-L-8-12-V
STORMWATER BIOFILTRATION SYSTEM
STANDARD DETAIL

5/23/19TOLF

SITE SPECIFIC DATA			
PROJECT NUMBER			
PROJECT NAME			
PROJECT LOCATION			
STRUCTURE ID			
TREATMENT REQUIRED			
VOLUME BASED (CF)		FLOW BASED (CFS)	
N/A			
PEAK BYPASS REQUIRED (CFS) – IF APPLICABLE			
PIPE DATA	I.E.	MATERIAL	DIAMETER
INLET PIPE 1			
INLET PIPE 2			
OUTLET PIPE			
	PRETREATMENT	BIOFILTRATION	DISCHARGE
RIM ELEVATION			
SURFACE LOAD			
FRAME & COVER	3EA Ø30"		2EA Ø24"
NOTES:			

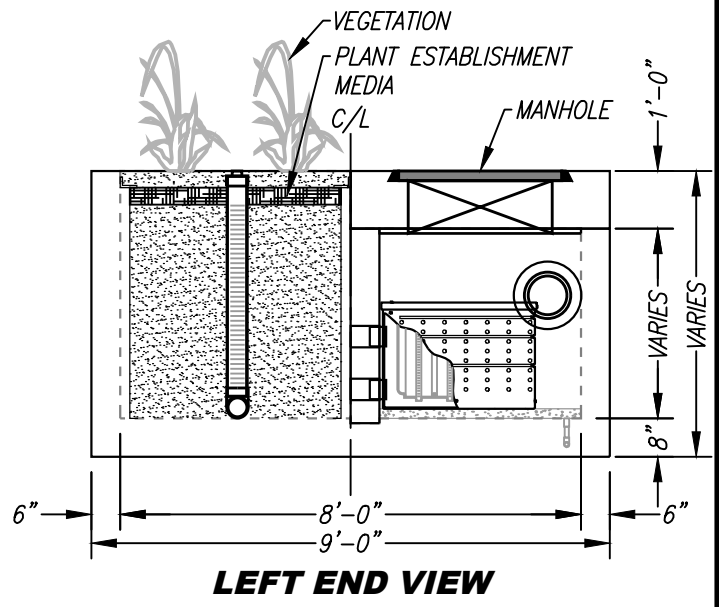
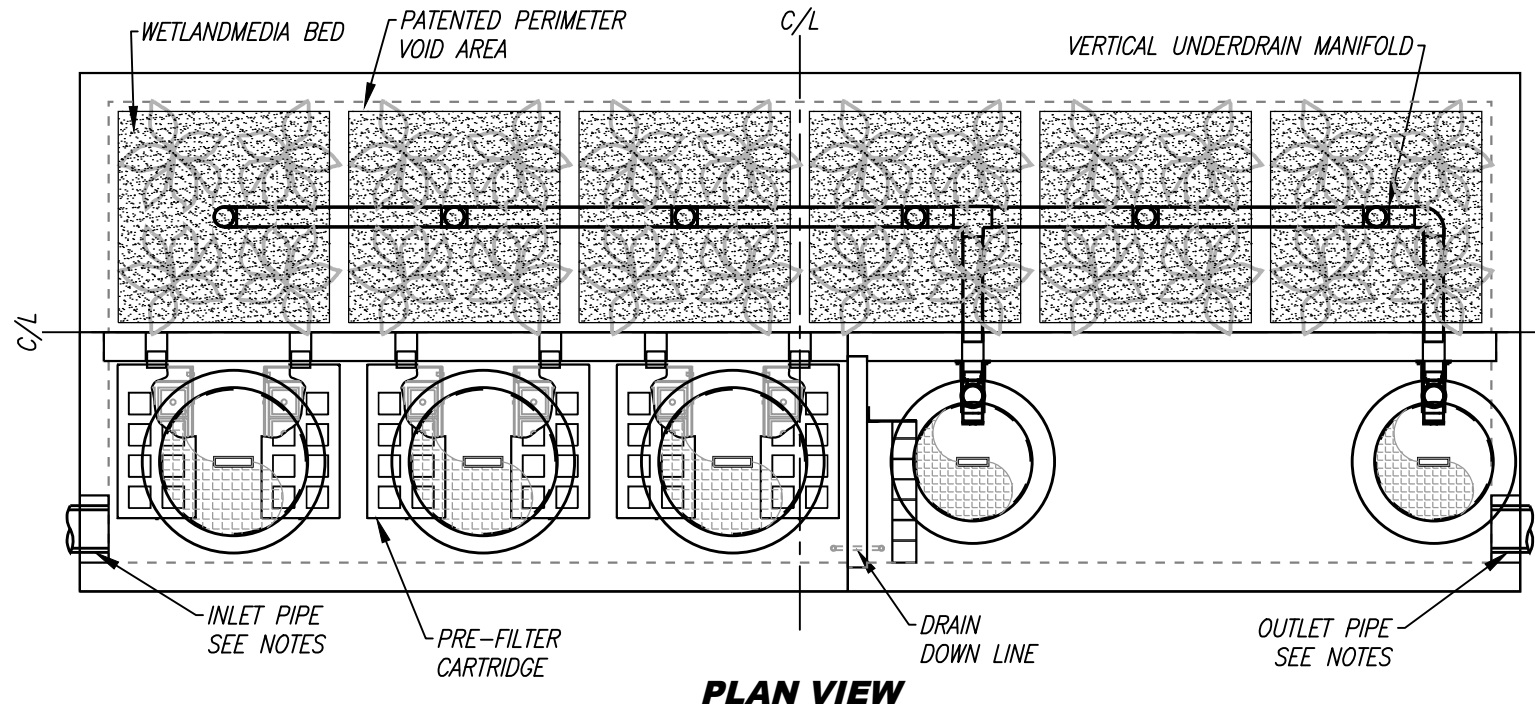

INSTALLATION NOTES

1. CONTRACTOR TO PROVIDE ALL LABOR, EQUIPMENT, MATERIALS AND INCIDENTALS REQUIRED TO OFFLOAD AND INSTALL THE SYSTEM AND APPURTENANCES IN ACCORDANCE WITH THIS DRAWING AND THE MANUFACTURERS SPECIFICATIONS, UNLESS OTHERWISE STATED IN MANUFACTURERS CONTRACT.
2. UNIT MUST BE INSTALLED ON LEVEL BASE. MANUFACTURER RECOMMENDS A MINIMUM 6" LEVEL ROCK BASE UNLESS SPECIFIED BY THE PROJECT ENGINEER. CONTRACTOR IS RESPONSIBLE TO VERIFY PROJECT ENGINEERS RECOMMENDED BASE SPECIFICATIONS.
4. CONTRACTOR TO SUPPLY AND INSTALL ALL EXTERNAL CONNECTING PIPES. ALL PIPES MUST BE FLUSH WITH INSIDE SURFACE OF CONCRETE. (PIPES CANNOT INTRUDE BEYOND FLUSH). INVERT OF OUTFLOW PIPE MUST BE FLUSH WITH DISCHARGE CHAMBER FLOOR. ALL PIPES SHALL BE SEALED WATER TIGHT PER MANUFACTURERS STANDARD CONNECTION DETAIL.
5. CONTRACTOR RESPONSIBLE FOR INSTALLATION OF ALL RISERS, MANHOLES, AND HATCHES. CONTRACTOR TO GROUT ALL MANHOLES AND HATCHES TO MATCH FINISHED SURFACE UNLESS SPECIFIED OTHERWISE.
6. VEGETATION SUPPLIED AND INSTALLED BY OTHERS. ALL UNITS WITH VEGETATION MUST HAVE DRIP OR SPRAY IRRIGATION SUPPLIED AND INSTALLED BY OTHERS.
7. CONTRACTOR RESPONSIBLE FOR CONTACTING BIO CLEAN FOR ACTIVATION OF UNIT. MANUFACTURERS WARRANTY IS VOID WITH OUT PROPER ACTIVATION BY A BIO CLEAN REPRESENTATIVE.

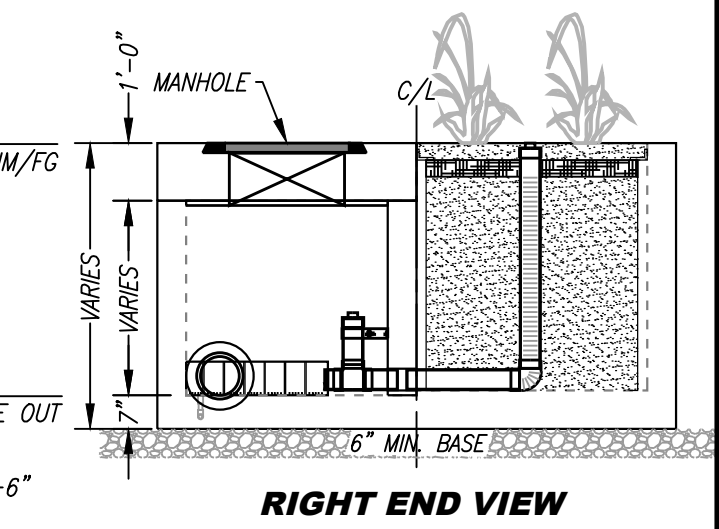
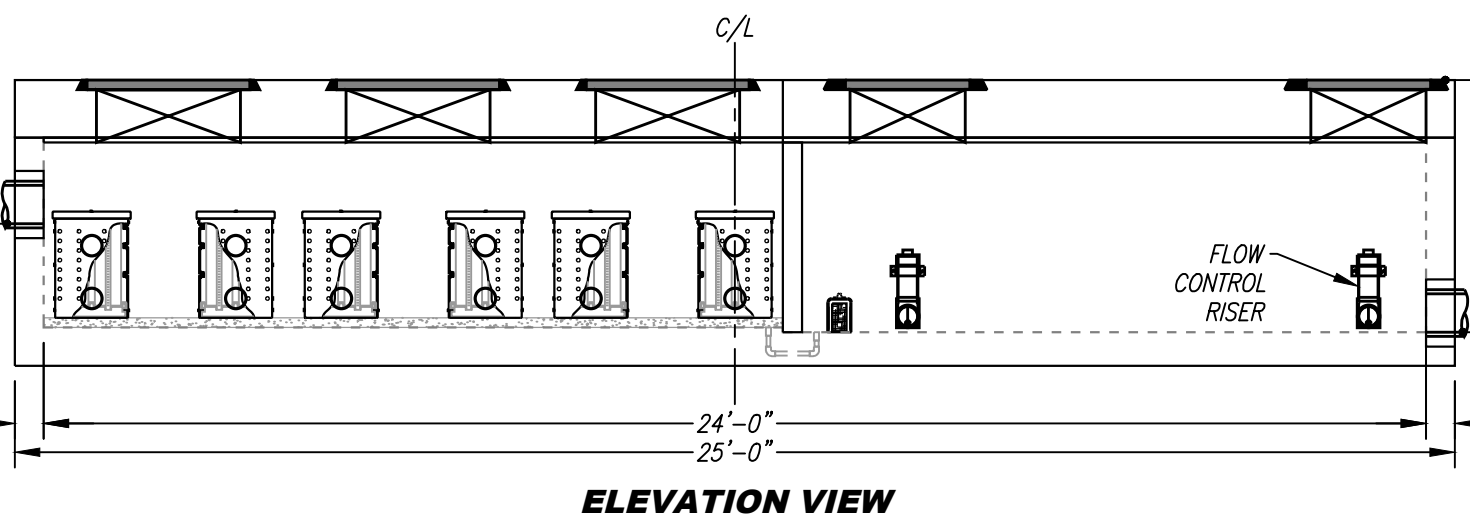

GENERAL NOTES

1. MANUFACTURER TO PROVIDE ALL MATERIALS UNLESS OTHERWISE NOTED.
2. ALL DIMENSIONS, ELEVATIONS, SPECIFICATIONS AND CAPACITIES ARE SUBJECT TO CHANGE. FOR PROJECT SPECIFIC DRAWINGS DETAILING EXACT DIMENSIONS, WEIGHTS AND ACCESSORIES PLEASE CONTACT BIO CLEAN.

TREATMENT FLOW (CFS)	
OPERATING HEAD (FT)	
PRETREATMENT LOADING RATE (GPM/SF)	
WETLAND MEDIA LOADING RATE (GPM/SF)	



PROPRIETARY AND CONFIDENTIAL:
 THE INFORMATION CONTAINED IN THIS DOCUMENT IS THE SOLE PROPERTY OF FORTERRA AND ITS COMPANIES. THIS DOCUMENT, NOR ANY PART THEREOF, MAY BE USED, REPRODUCED OR MODIFIED IN ANY MANNER WITH OUT THE WRITTEN CONSENT OF FORTERRA.



MWS-L-8-24-V
STORMWATER BIOFILTRATION SYSTEM
STANDARD DETAIL

5/23/19TOL/EE

SITE SPECIFIC DATA			
PROJECT NUMBER			
ORDER NUMBER			
PROJECT NAME			
PROJECT LOCATION			
STRUCTURE ID			
TREATMENT REQUIRED			
VOLUME BASED (CF)		FLOW BASED (CFS)	
TREATMENT HGL AVAILABLE (FT)			
PEAK BYPASS REQUIRED (CFS) – IF APPLICABLE			
PIPE DATA	I.E.	MATERIAL	DIAMETER
INLET PIPE 1			
INLET PIPE 2			
OUTLET PIPE			
	PRETREATMENT	BIOFILTRATION	DISCHARGE
RIM ELEVATION			
SURFACE LOAD	PEDESTRIAN	OPEN PLANTER	PEDESTRIAN
FRAME & COVER	ø30"	N/A	ø24"
WETLAND MEDIA VOLUME (CY)			TBD
ORIFICE SIZE (DIA. INCHES)			TBD
NOTES: PRELIMINARY NOT FOR CONSTRUCTION.			

INSTALLATION NOTES

1. CONTRACTOR TO PROVIDE ALL LABOR, EQUIPMENT, MATERIALS AND INCIDENTALS REQUIRED TO OFFLOAD AND INSTALL THE SYSTEM AND APPURTENANCES IN ACCORDANCE WITH THIS DRAWING AND THE MANUFACTURERS SPECIFICATIONS, UNLESS OTHERWISE STATED IN MANUFACTURERS CONTRACT.
2. UNIT MUST BE INSTALLED ON LEVEL BASE. MANUFACTURER RECOMMENDS A MINIMUM 6" LEVEL ROCK BASE UNLESS SPECIFIED BY THE PROJECT ENGINEER. CONTRACTOR IS RESPONSIBLE TO VERIFY PROJECT ENGINEERS RECOMMENDED BASE SPECIFICATIONS.
4. CONTRACTOR TO SUPPLY AND INSTALL ALL EXTERNAL CONNECTING PIPES. ALL PIPES MUST BE FLUSH WITH INSIDE SURFACE OF CONCRETE. (PIPES CANNOT INTRUDE BEYOND FLUSH). INVERT OF OUTFLOW PIPE MUST BE FLUSH WITH DISCHARGE CHAMBER FLOOR. ALL PIPES SHALL BE SEALED WATER TIGHT PER MANUFACTURERS STANDARD CONNECTION DETAIL.
5. CONTRACTOR RESPONSIBLE FOR INSTALLATION OF ALL RISERS, MANHOLES, AND HATCHES. CONTRACTOR TO GROUT ALL MANHOLES AND HATCHES TO MATCH FINISHED SURFACE UNLESS SPECIFIED OTHERWISE.
6. VEGETATION SUPPLIED AND INSTALLED BY OTHERS. ALL UNITS WITH VEGETATION MUST HAVE DRIP OR SPRAY IRRIGATION SUPPLIED AND INSTALLED BY OTHERS.
7. CONTRACTOR RESPONSIBLE FOR CONTACTING BIO CLEAN FOR ACTIVATION OF UNIT. MANUFACTURERS WARRANTY IS VOID WITH OUT PROPER ACTIVATION BY A BIO CLEAN REPRESENTATIVE.

GENERAL NOTES

1. MANUFACTURER TO PROVIDE ALL MATERIALS UNLESS OTHERWISE NOTED.
2. ALL DIMENSIONS, ELEVATIONS, SPECIFICATIONS AND CAPACITIES ARE SUBJECT TO CHANGE. FOR PROJECT SPECIFIC DRAWINGS DETAILING EXACT DIMENSIONS, WEIGHTS AND ACCESSORIES PLEASE CONTACT BIO CLEAN.

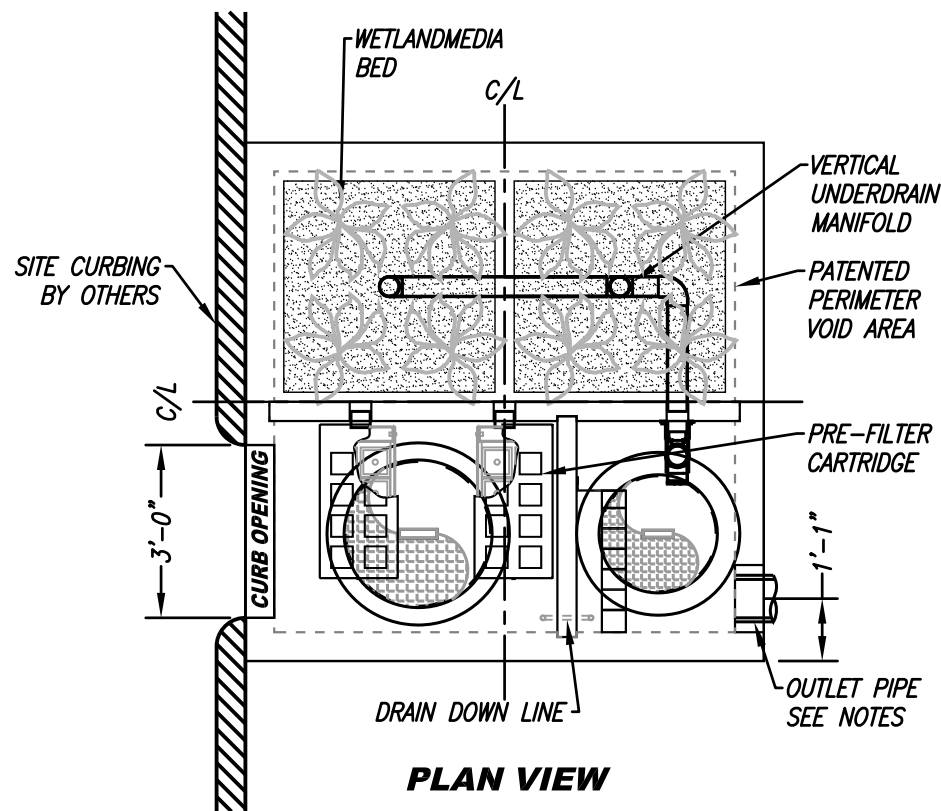

PLAN VIEW

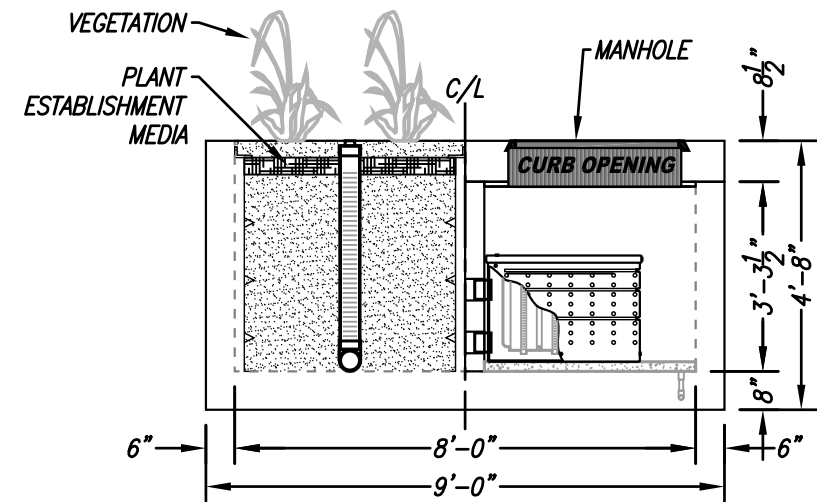

LEFT END VIEW

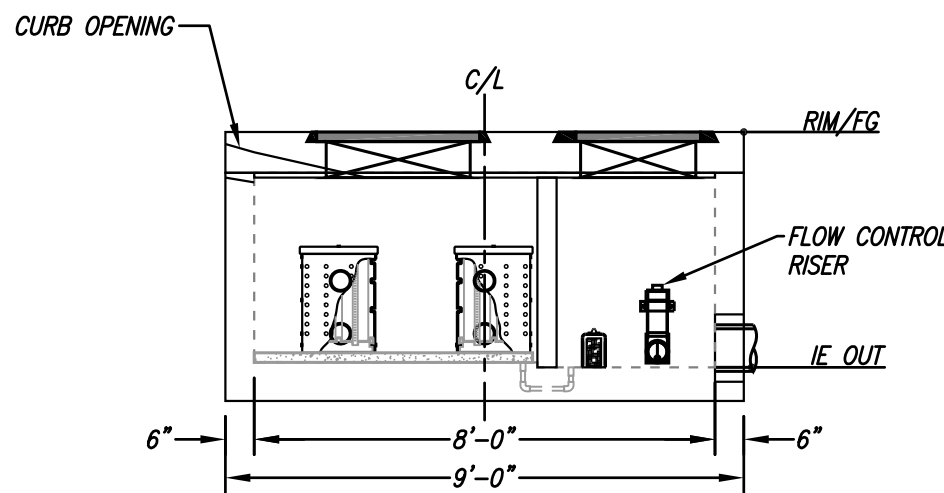

ELEVATION VIEW

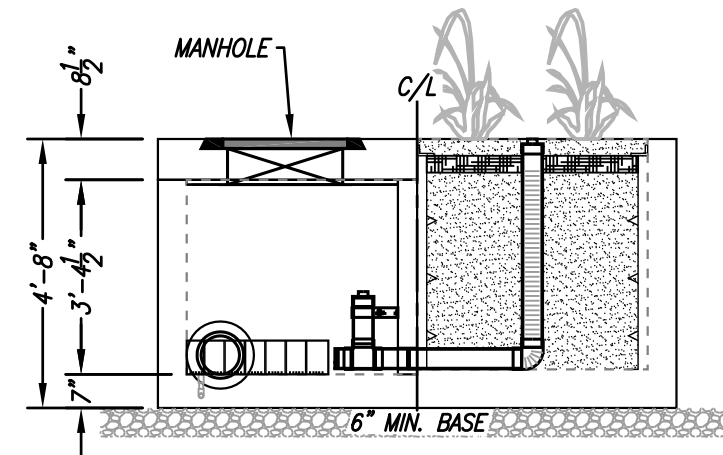

RIGHT END VIEW

TREATMENT FLOW (CFS)	0.231
OPERATING HEAD (FT)	3.4
PRETREATMENT LOADING RATE (GPM/SF)	2.0
WETLAND MEDIA LOADING RATE (GPM/SF)	1.0

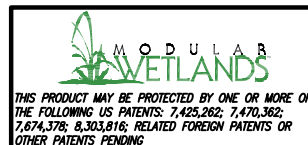

PROPRIETARY AND CONFIDENTIAL:
THE INFORMATION CONTAINED IN THIS DOCUMENT IS THE SOLE PROPERTY OF FORTERRA AND ITS COMPANIES. THIS DOCUMENT, NOR ANY PART THEREOF, MAY BE USED, REPRODUCED OR MODIFIED IN ANY MANNER WITH OUT THE WRITTEN CONSENT OF FORTERRA.



MWS-L-8-8-C
STORMWATER BIOFILTRATION SYSTEM
STANDARD DETAIL

APPENDIX 2

Q25 and LID Calculations and Backup Documents

Peak Flow Hydrologic Analysis

File location: K:/ORA_LDEV/094896004 - Shapell Norwalk Apartments/Reports/Hydrology Hydraulics/Calculations/Hydrocalc/Proposed/25YR/DA-1.pdf
Version: HydroCalc 1.0.3

Input Parameters

Project Name	Norwalk Apartments
Subarea ID	DA-1
Area (ac)	0.67
Flow Path Length (ft)	156.0
Flow Path Slope (vft/hft)	0.007
50-yr Rainfall Depth (in)	5.63
Percent Impervious	0.85
Soil Type	6
Design Storm Frequency	25-yr
Fire Factor	0
LID	False

Output Results

Modeled (25-yr) Rainfall Depth (in)	4.9431
Peak Intensity (in/hr)	2.9492
Undeveloped Runoff Coefficient (Cu)	0.8187
Developed Runoff Coefficient (Cd)	0.8878
Time of Concentration (min)	5.0
Clear Peak Flow Rate (cfs)	1.7543
Burned Peak Flow Rate (cfs)	1.7543
24-Hr Clear Runoff Volume (ac-ft)	0.2173
24-Hr Clear Runoff Volume (cu-ft)	9466.3696

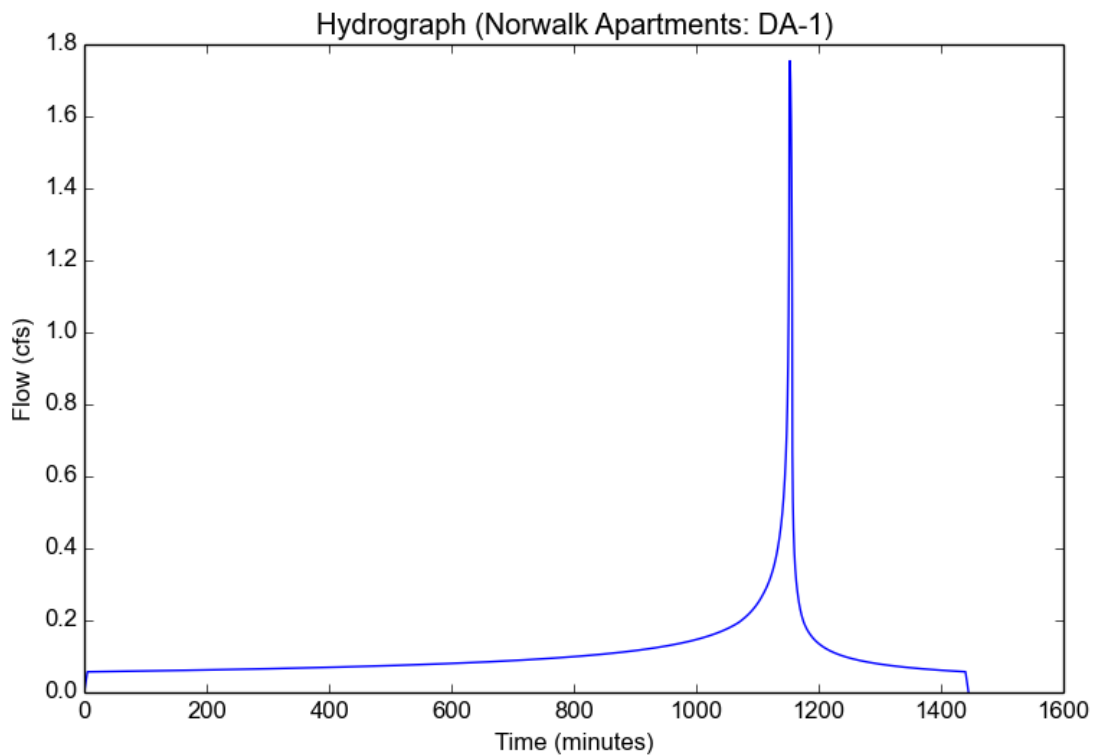

Peak Flow Hydrologic Analysis

File location: K:/ORA_LDEV/094896004 - Shapell Norwalk Apartments/Reports/Hydrology Hydraulics/Calculations/Hydrocalc/Proposed/25YR/Norwalk A
Version: HydroCalc 1.0.3

Input Parameters

Project Name	Norwalk Apartments
Subarea ID	DA-2
Area (ac)	0.19
Flow Path Length (ft)	80.0
Flow Path Slope (vft/hft)	0.015
50-yr Rainfall Depth (in)	5.63
Percent Impervious	0.85
Soil Type	6
Design Storm Frequency	25-yr
Fire Factor	0
LID	False

Output Results

Modeled (25-yr) Rainfall Depth (in)	4.9431
Peak Intensity (in/hr)	2.9492
Undeveloped Runoff Coefficient (Cu)	0.8187
Developed Runoff Coefficient (Cd)	0.8878
Time of Concentration (min)	5.0
Clear Peak Flow Rate (cfs)	0.4975
Burned Peak Flow Rate (cfs)	0.4975
24-Hr Clear Runoff Volume (ac-ft)	0.0616
24-Hr Clear Runoff Volume (cu-ft)	2684.4929

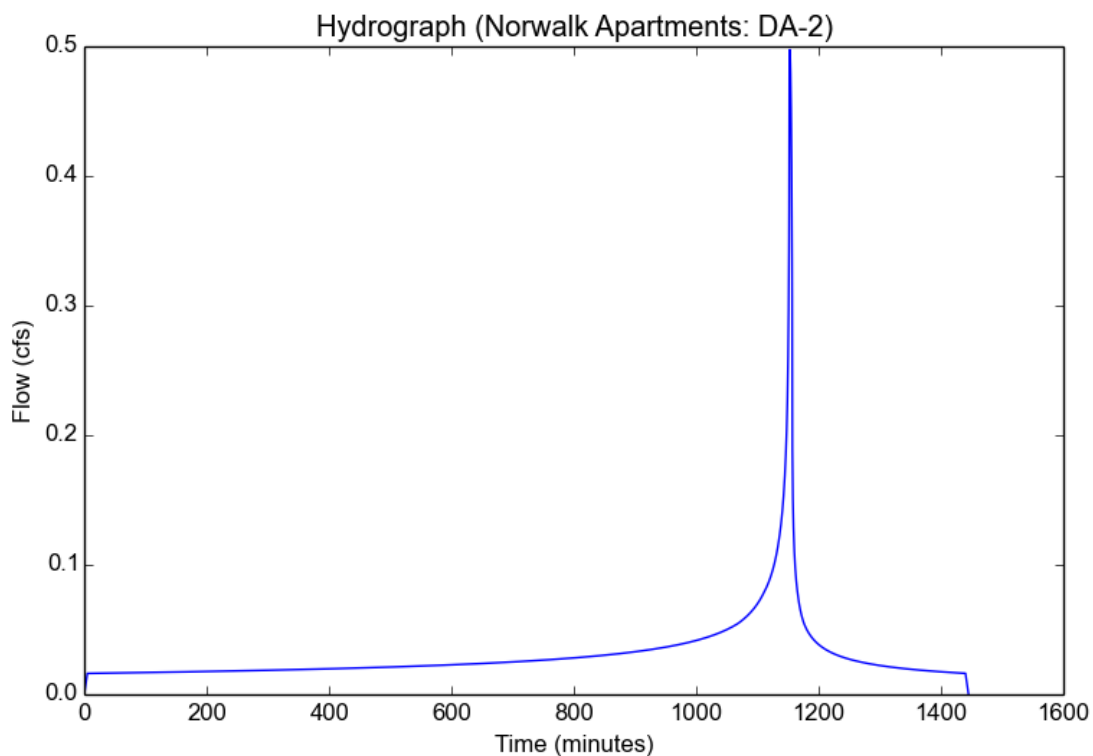

Peak Flow Hydrologic Analysis

File location: K:/ORA_LDEV/094896004 - Shapell Norwalk Apartments/Reports/Hydrology Hydraulics/Calculations/Hydrocalc/Proposed/25YR/Norwalk A
Version: HydroCalc 1.0.3

Input Parameters

Project Name	Norwalk Apartments
Subarea ID	DA-3
Area (ac)	0.18
Flow Path Length (ft)	65.0
Flow Path Slope (vft/hft)	0.021
50-yr Rainfall Depth (in)	5.63
Percent Impervious	0.85
Soil Type	6
Design Storm Frequency	25-yr
Fire Factor	0
LID	False

Output Results

Modeled (25-yr) Rainfall Depth (in)	4.9431
Peak Intensity (in/hr)	2.9492
Undeveloped Runoff Coefficient (Cu)	0.8187
Developed Runoff Coefficient (Cd)	0.8878
Time of Concentration (min)	5.0
Clear Peak Flow Rate (cfs)	0.4713
Burned Peak Flow Rate (cfs)	0.4713
24-Hr Clear Runoff Volume (ac-ft)	0.0584
24-Hr Clear Runoff Volume (cu-ft)	2543.2038

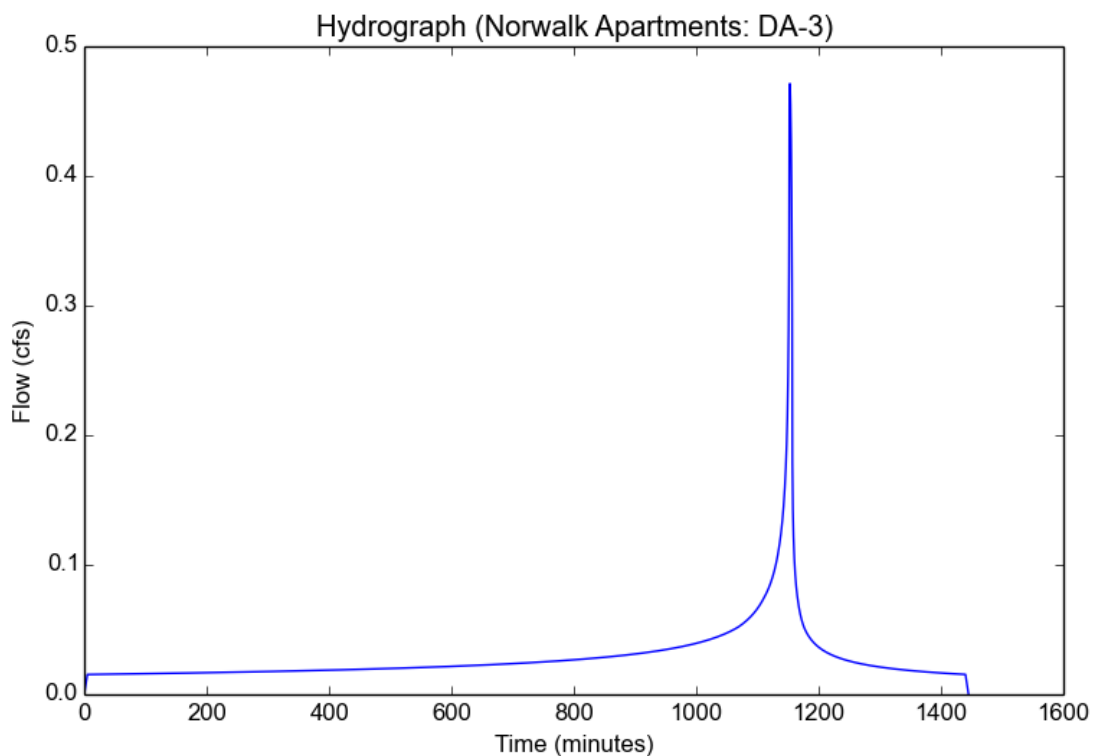

Peak Flow Hydrologic Analysis

File location: K:/ORA_LDEV/094896004 - Shapell Norwalk Apartments/Reports/Hydrology Hydraulics/Calculations/Hydrocalc/Proposed/25YR/Norwalk A
Version: HydroCalc 1.0.3

Input Parameters

Project Name	Norwalk Apartments
Subarea ID	DA-4
Area (ac)	0.24
Flow Path Length (ft)	190.0
Flow Path Slope (vft/hft)	0.012
50-yr Rainfall Depth (in)	5.63
Percent Impervious	0.85
Soil Type	6
Design Storm Frequency	25-yr
Fire Factor	0
LID	False

Output Results

Modeled (25-yr) Rainfall Depth (in)	4.9431
Peak Intensity (in/hr)	2.9492
Undeveloped Runoff Coefficient (Cu)	0.8187
Developed Runoff Coefficient (Cd)	0.8878
Time of Concentration (min)	5.0
Clear Peak Flow Rate (cfs)	0.6284
Burned Peak Flow Rate (cfs)	0.6284
24-Hr Clear Runoff Volume (ac-ft)	0.0778
24-Hr Clear Runoff Volume (cu-ft)	3390.9384

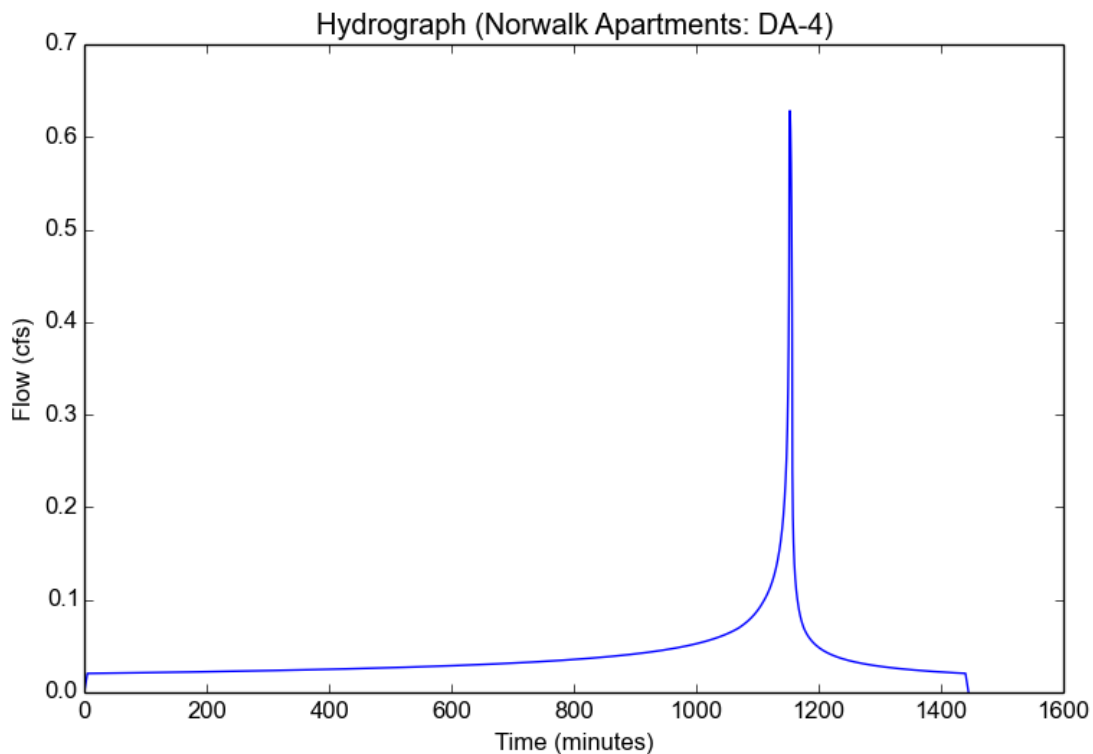

Peak Flow Hydrologic Analysis

File location: K:/ORA_LDEV/094896004 - Shapell Norwalk Apartments/Reports/Hydrology Hydraulics/Calculations/Hydrocalc/Proposed/25YR/Norwalk A
Version: HydroCalc 1.0.3

Input Parameters

Project Name	Norwalk Apartments
Subarea ID	DA-5
Area (ac)	1.31
Flow Path Length (ft)	170.0
Flow Path Slope (vft/hft)	0.012
50-yr Rainfall Depth (in)	5.63
Percent Impervious	0.85
Soil Type	6
Design Storm Frequency	25-yr
Fire Factor	0
LID	False

Output Results

Modeled (25-yr) Rainfall Depth (in)	4.9431
Peak Intensity (in/hr)	2.9492
Undeveloped Runoff Coefficient (Cu)	0.8187
Developed Runoff Coefficient (Cd)	0.8878
Time of Concentration (min)	5.0
Clear Peak Flow Rate (cfs)	3.43
Burned Peak Flow Rate (cfs)	3.43
24-Hr Clear Runoff Volume (ac-ft)	0.4249
24-Hr Clear Runoff Volume (cu-ft)	18508.872

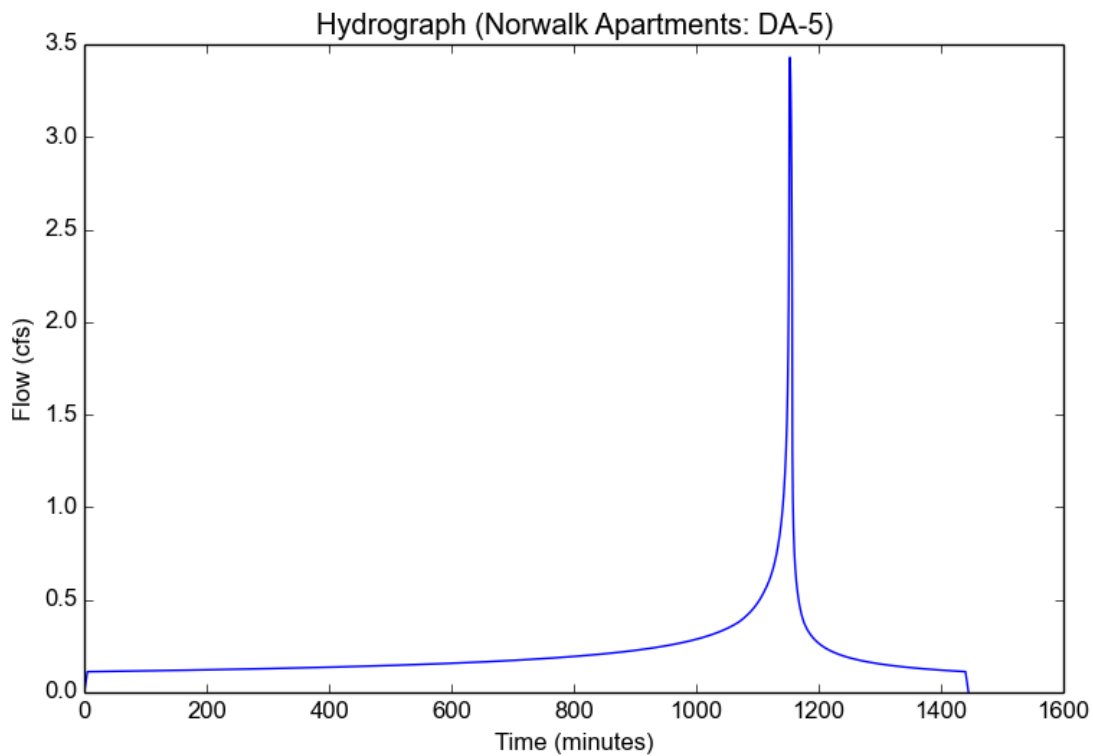

Peak Flow Hydrologic Analysis

File location: K:/ORA_LDEV/094896004 - Shapell Norwalk Apartments/Reports/Hydrology Hydraulics/Calculations/Hydrocalc/Proposed/25YR/Norwalk A
Version: HydroCalc 1.0.3

Input Parameters

Project Name	Norwalk Apartments
Subarea ID	DA-6
Area (ac)	0.08
Flow Path Length (ft)	45.0
Flow Path Slope (vft/hft)	0.025
50-yr Rainfall Depth (in)	5.63
Percent Impervious	0.85
Soil Type	6
Design Storm Frequency	25-yr
Fire Factor	0
LID	False

Output Results

Modeled (25-yr) Rainfall Depth (in)	4.9431
Peak Intensity (in/hr)	2.9492
Undeveloped Runoff Coefficient (Cu)	0.8187
Developed Runoff Coefficient (Cd)	0.8878
Time of Concentration (min)	5.0
Clear Peak Flow Rate (cfs)	0.2095
Burned Peak Flow Rate (cfs)	0.2095
24-Hr Clear Runoff Volume (ac-ft)	0.0259
24-Hr Clear Runoff Volume (cu-ft)	1130.3128

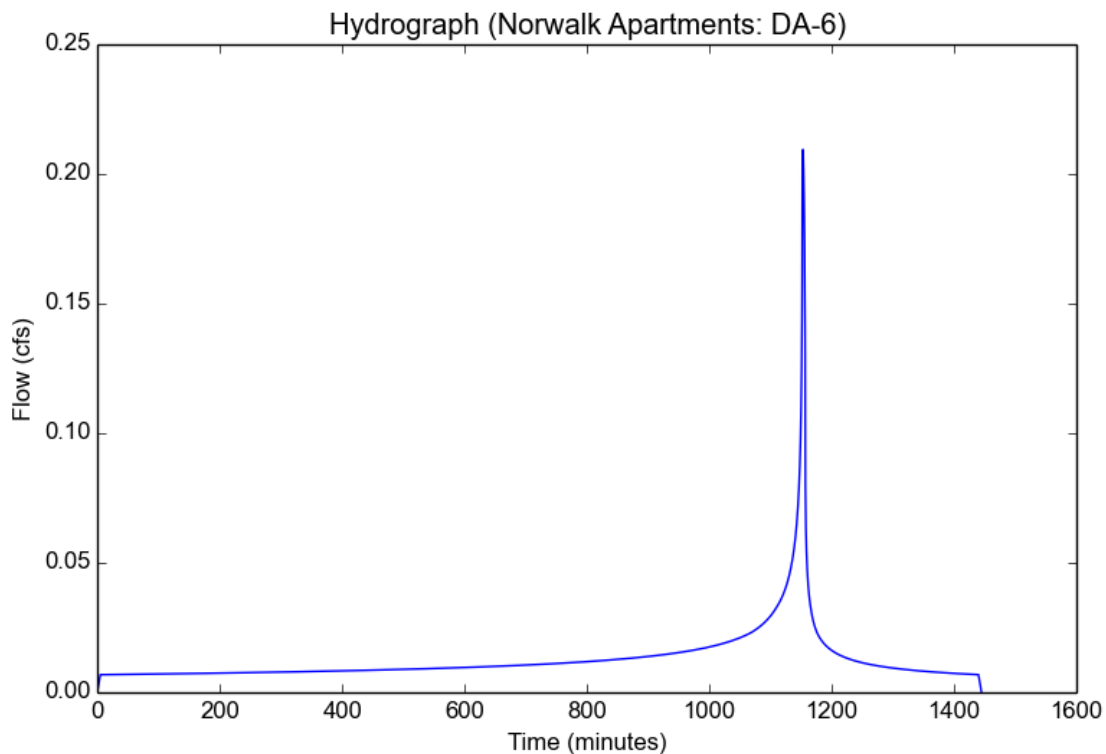

Peak Flow Hydrologic Analysis

File location: K:/ORA_LDEV/094896004 - Shapell Norwalk Apartments/Reports/Hydrology Hydraulics/Calculations/Hydrocalc/Proposed/25YR/Norwalk A
Version: HydroCalc 1.0.3

Input Parameters

Project Name	Norwalk Apartments
Subarea ID	DA-7
Area (ac)	0.18
Flow Path Length (ft)	80.0
Flow Path Slope (vft/hft)	0.019
50-yr Rainfall Depth (in)	5.63
Percent Impervious	0.85
Soil Type	6
Design Storm Frequency	25-yr
Fire Factor	0
LID	False

Output Results

Modeled (25-yr) Rainfall Depth (in)	4.9431
Peak Intensity (in/hr)	2.9492
Undeveloped Runoff Coefficient (Cu)	0.8187
Developed Runoff Coefficient (Cd)	0.8878
Time of Concentration (min)	5.0
Clear Peak Flow Rate (cfs)	0.4713
Burned Peak Flow Rate (cfs)	0.4713
24-Hr Clear Runoff Volume (ac-ft)	0.0584
24-Hr Clear Runoff Volume (cu-ft)	2543.2038

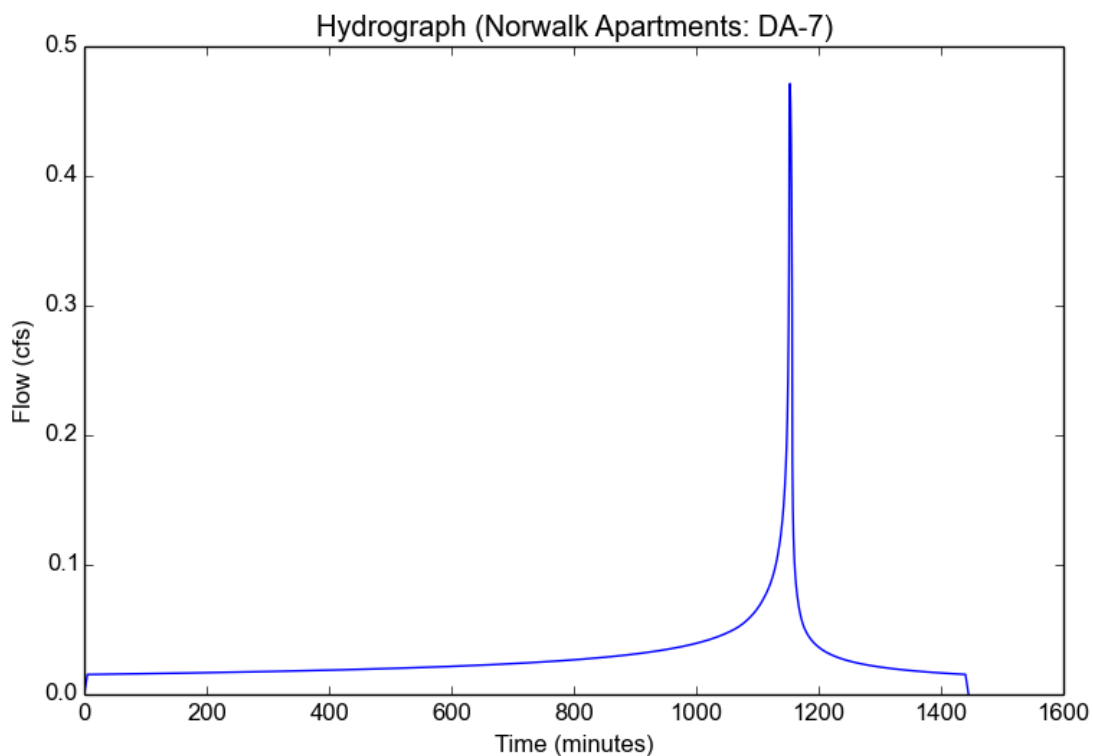

Peak Flow Hydrologic Analysis

File location: K:/ORA_LDEV/094896004 - Shapell Norwalk Apartments/Reports/Hydrology Hydraulics/Calculations/Hydrocalc/Proposed/25YR/Norwalk A
Version: HydroCalc 1.0.3

Input Parameters

Project Name	Norwalk Apartments
Subarea ID	DA-8
Area (ac)	0.23
Flow Path Length (ft)	100.0
Flow Path Slope (vft/hft)	0.025
50-yr Rainfall Depth (in)	5.63
Percent Impervious	0.85
Soil Type	6
Design Storm Frequency	25-yr
Fire Factor	0
LID	False

Output Results

Modeled (25-yr) Rainfall Depth (in)	4.9431
Peak Intensity (in/hr)	2.9492
Undeveloped Runoff Coefficient (Cu)	0.8187
Developed Runoff Coefficient (Cd)	0.8878
Time of Concentration (min)	5.0
Clear Peak Flow Rate (cfs)	0.6022
Burned Peak Flow Rate (cfs)	0.6022
24-Hr Clear Runoff Volume (ac-ft)	0.0746
24-Hr Clear Runoff Volume (cu-ft)	3249.6493

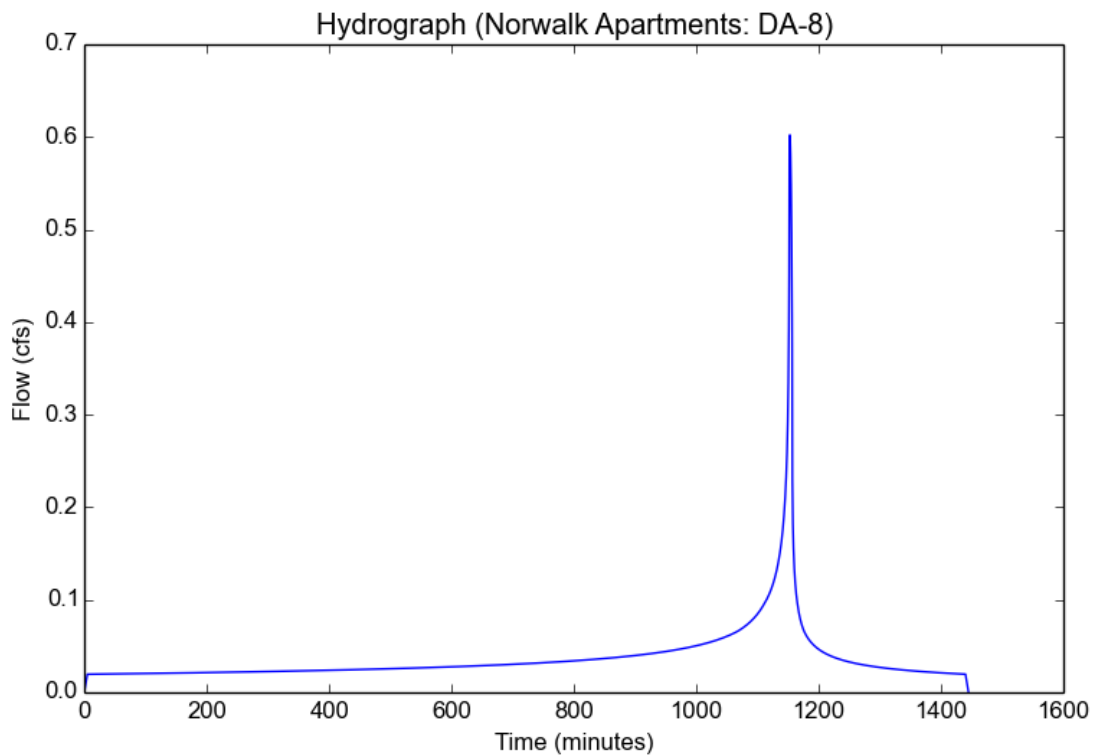

Peak Flow Hydrologic Analysis

File location: K:/ORA_LDEV/094896004 - Shapell Norwalk Apartments/Reports/Hydrology Hydraulics/Calculations/Hydrocalc/Proposed/25YR/Norwalk A
Version: HydroCalc 1.0.3

Input Parameters

Project Name	Norwalk Apartments
Subarea ID	DA-9
Area (ac)	0.51
Flow Path Length (ft)	80.0
Flow Path Slope (vft/hft)	0.018
50-yr Rainfall Depth (in)	5.63
Percent Impervious	0.85
Soil Type	6
Design Storm Frequency	25-yr
Fire Factor	0
LID	False

Output Results

Modeled (25-yr) Rainfall Depth (in)	4.9431
Peak Intensity (in/hr)	2.9492
Undeveloped Runoff Coefficient (Cu)	0.8187
Developed Runoff Coefficient (Cd)	0.8878
Time of Concentration (min)	5.0
Clear Peak Flow Rate (cfs)	1.3353
Burned Peak Flow Rate (cfs)	1.3353
24-Hr Clear Runoff Volume (ac-ft)	0.1654
24-Hr Clear Runoff Volume (cu-ft)	7205.7441

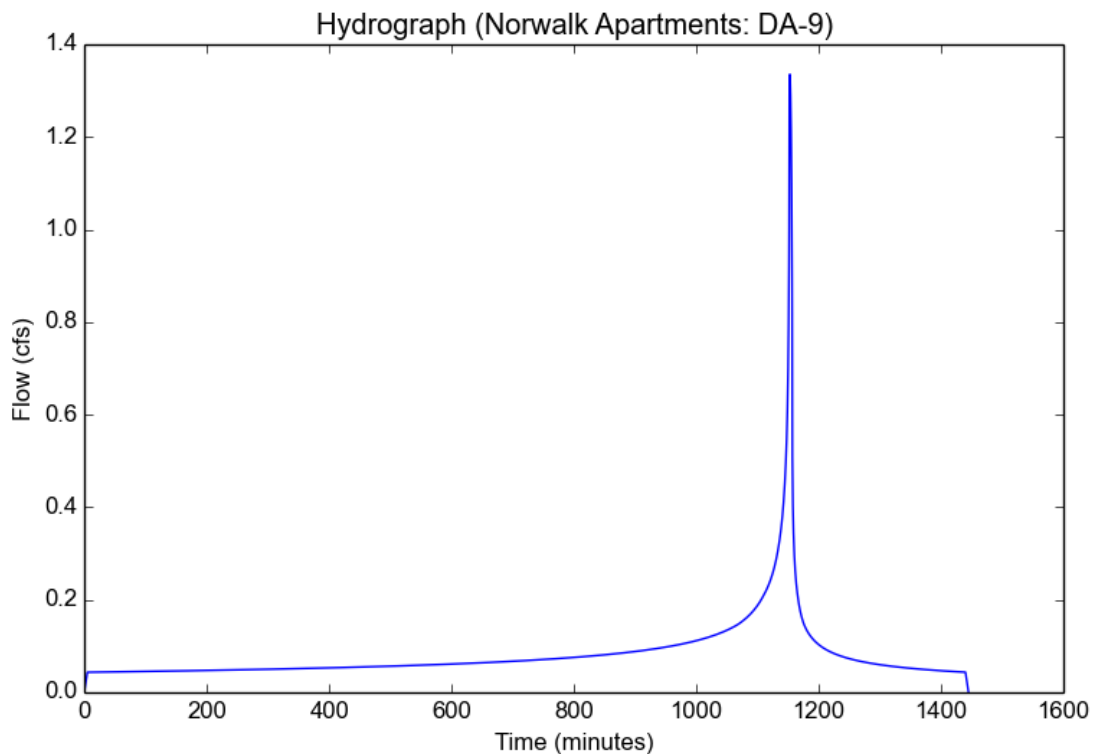

Peak Flow Hydrologic Analysis

File location: K:/ORA_LDEV/094896004 - Shapell Norwalk Apartments/Reports/Hydrology Hydraulics/Calculations/Hydrocalc/Proposed/25YR/Norwalk A
Version: HydroCalc 1.0.3

Input Parameters

Project Name	Norwalk Apartments
Subarea ID	DA-10
Area (ac)	0.49
Flow Path Length (ft)	91.0
Flow Path Slope (vft/hft)	0.013
50-yr Rainfall Depth (in)	5.63
Percent Impervious	0.85
Soil Type	6
Design Storm Frequency	25-yr
Fire Factor	0
LID	False

Output Results

Modeled (25-yr) Rainfall Depth (in)	4.9431
Peak Intensity (in/hr)	2.9492
Undeveloped Runoff Coefficient (Cu)	0.8187
Developed Runoff Coefficient (Cd)	0.8878
Time of Concentration (min)	5.0
Clear Peak Flow Rate (cfs)	1.283
Burned Peak Flow Rate (cfs)	1.283
24-Hr Clear Runoff Volume (ac-ft)	0.1589
24-Hr Clear Runoff Volume (cu-ft)	6923.1659

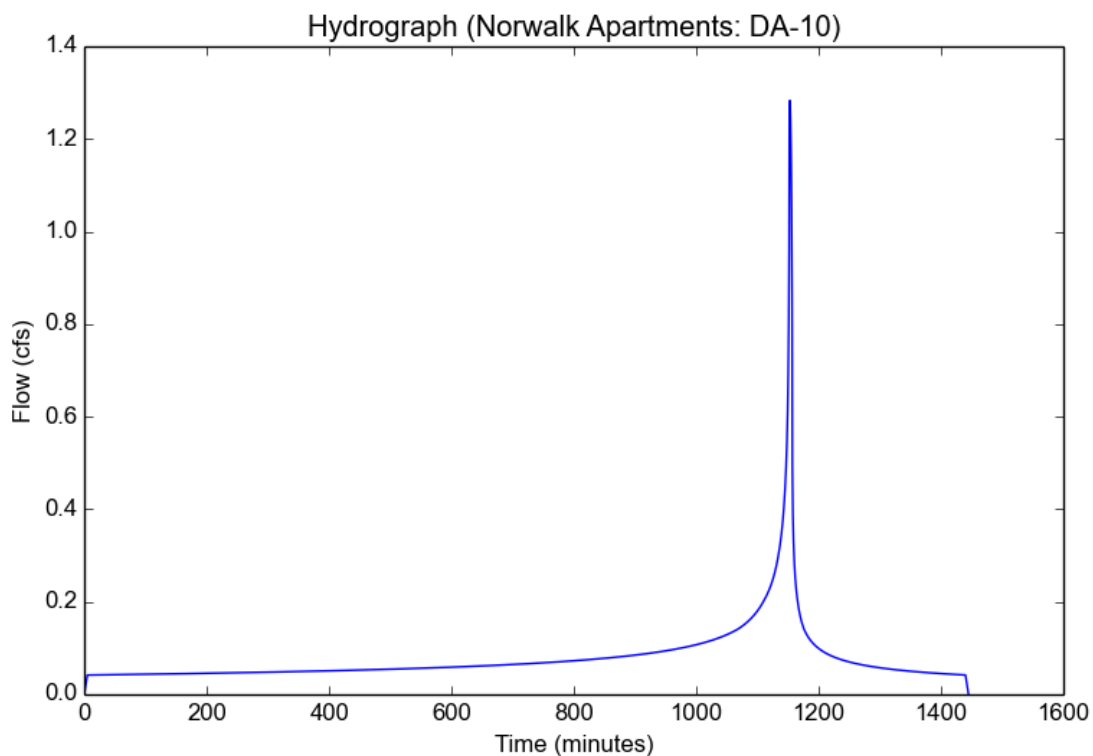

Peak Flow Hydrologic Analysis

File location: K:/ORA_LDEV/094896004 - Shapell Norwalk Apartments/Reports/Hydrology Hydraulics/Calculations/Hydrocalc/Proposed/25YR/Norwalk A
Version: HydroCalc 1.0.3

Input Parameters

Project Name	Norwalk Apartments
Subarea ID	DA-11
Area (ac)	0.28
Flow Path Length (ft)	106.0
Flow Path Slope (vft/hft)	0.012
50-yr Rainfall Depth (in)	5.63
Percent Impervious	0.85
Soil Type	6
Design Storm Frequency	25-yr
Fire Factor	0
LID	False

Output Results

Modeled (25-yr) Rainfall Depth (in)	4.9431
Peak Intensity (in/hr)	2.9492
Undeveloped Runoff Coefficient (Cu)	0.8187
Developed Runoff Coefficient (Cd)	0.8878
Time of Concentration (min)	5.0
Clear Peak Flow Rate (cfs)	0.7331
Burned Peak Flow Rate (cfs)	0.7331
24-Hr Clear Runoff Volume (ac-ft)	0.0908
24-Hr Clear Runoff Volume (cu-ft)	3956.0948

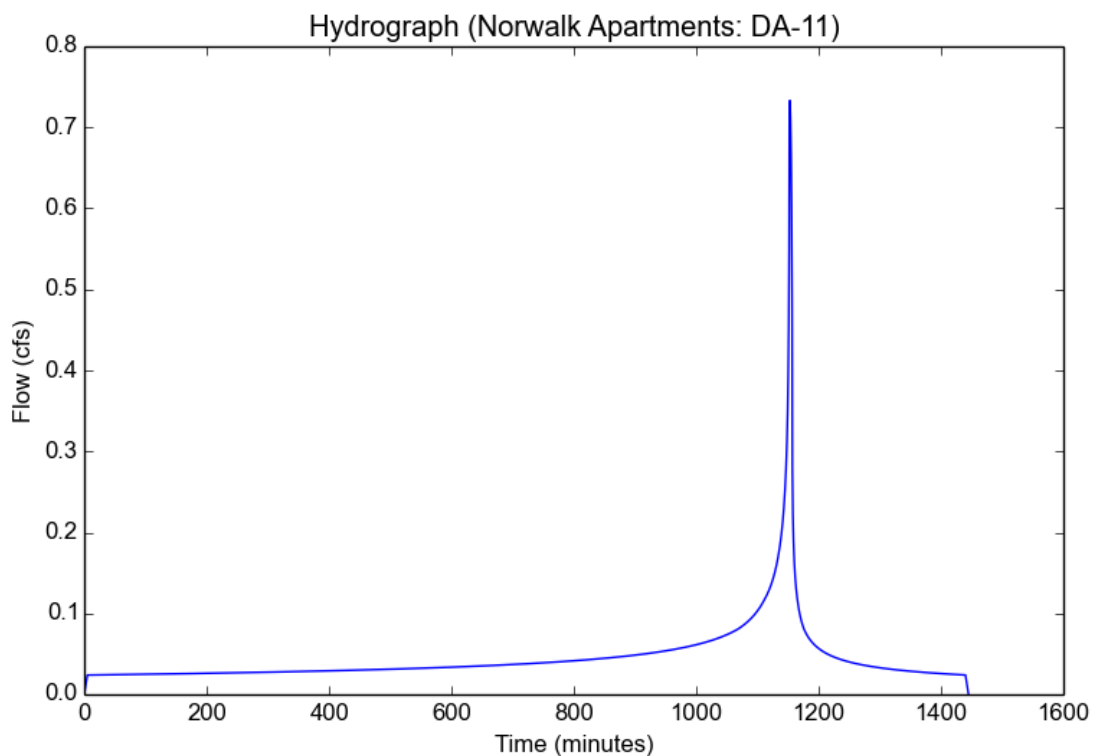

Peak Flow Hydrologic Analysis

File location: K:/ORA_LDEV/094896004 - Shapell Norwalk Apartments/Reports/Hydrology Hydraulics/Calculations/Hydrocalc/Proposed/25YR/Norwalk A
Version: HydroCalc 1.0.3

Input Parameters

Project Name	Norwalk Apartments
Subarea ID	DA-12
Area (ac)	0.65
Flow Path Length (ft)	126.0
Flow Path Slope (vft/hft)	0.02
50-yr Rainfall Depth (in)	5.63
Percent Impervious	0.85
Soil Type	6
Design Storm Frequency	25-yr
Fire Factor	0
LID	False

Output Results

Modeled (25-yr) Rainfall Depth (in)	4.9431
Peak Intensity (in/hr)	2.9492
Undeveloped Runoff Coefficient (Cu)	0.8187
Developed Runoff Coefficient (Cd)	0.8878
Time of Concentration (min)	5.0
Clear Peak Flow Rate (cfs)	1.7019
Burned Peak Flow Rate (cfs)	1.7019
24-Hr Clear Runoff Volume (ac-ft)	0.2108
24-Hr Clear Runoff Volume (cu-ft)	9183.7914

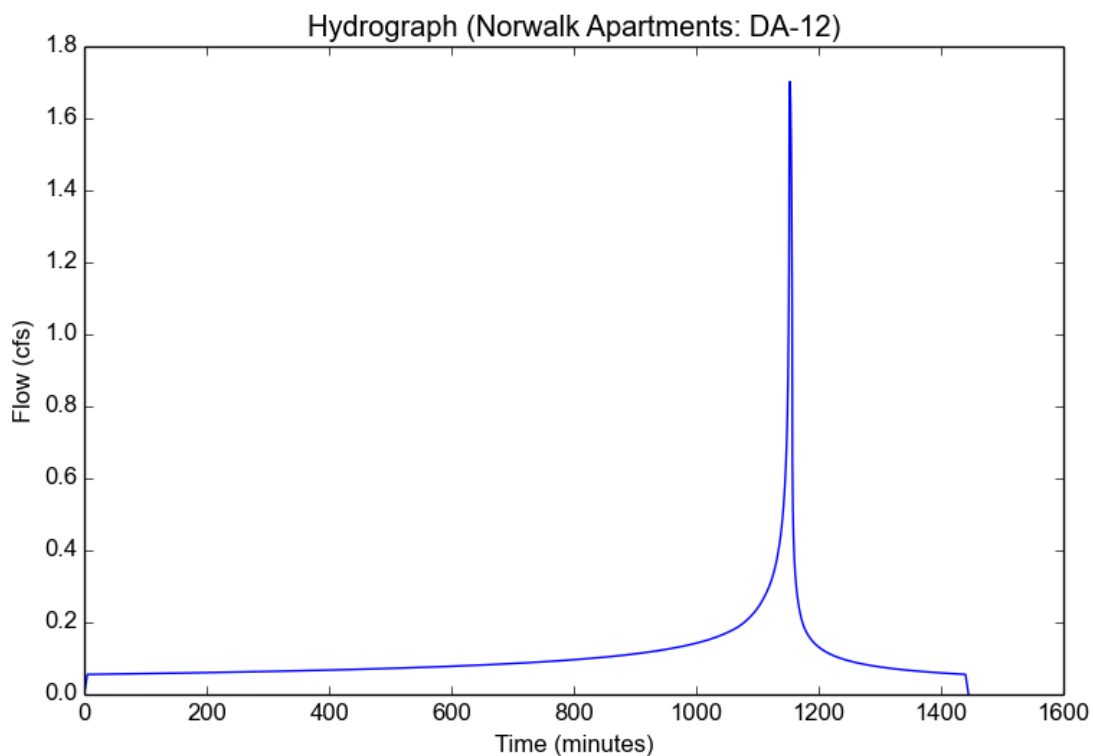

Peak Flow Hydrologic Analysis

File location: K:/ORA_LDEV/094896004 - Shapell Norwalk Apartments/Reports/Hydrology Hydraulics/Calculations/Hydrocalc/Proposed/25YR/Norwalk A
Version: HydroCalc 1.0.3

Input Parameters

Project Name	Norwalk Apartments
Subarea ID	DA-13
Area (ac)	0.84
Flow Path Length (ft)	208.0
Flow Path Slope (vft/hft)	0.005
50-yr Rainfall Depth (in)	5.63
Percent Impervious	0.85
Soil Type	6
Design Storm Frequency	25-yr
Fire Factor	0
LID	False

Output Results

Modeled (25-yr) Rainfall Depth (in)	4.9431
Peak Intensity (in/hr)	2.9492
Undeveloped Runoff Coefficient (Cu)	0.8187
Developed Runoff Coefficient (Cd)	0.8878
Time of Concentration (min)	5.0
Clear Peak Flow Rate (cfs)	2.1994
Burned Peak Flow Rate (cfs)	2.1994
24-Hr Clear Runoff Volume (ac-ft)	0.2725
24-Hr Clear Runoff Volume (cu-ft)	11868.2843

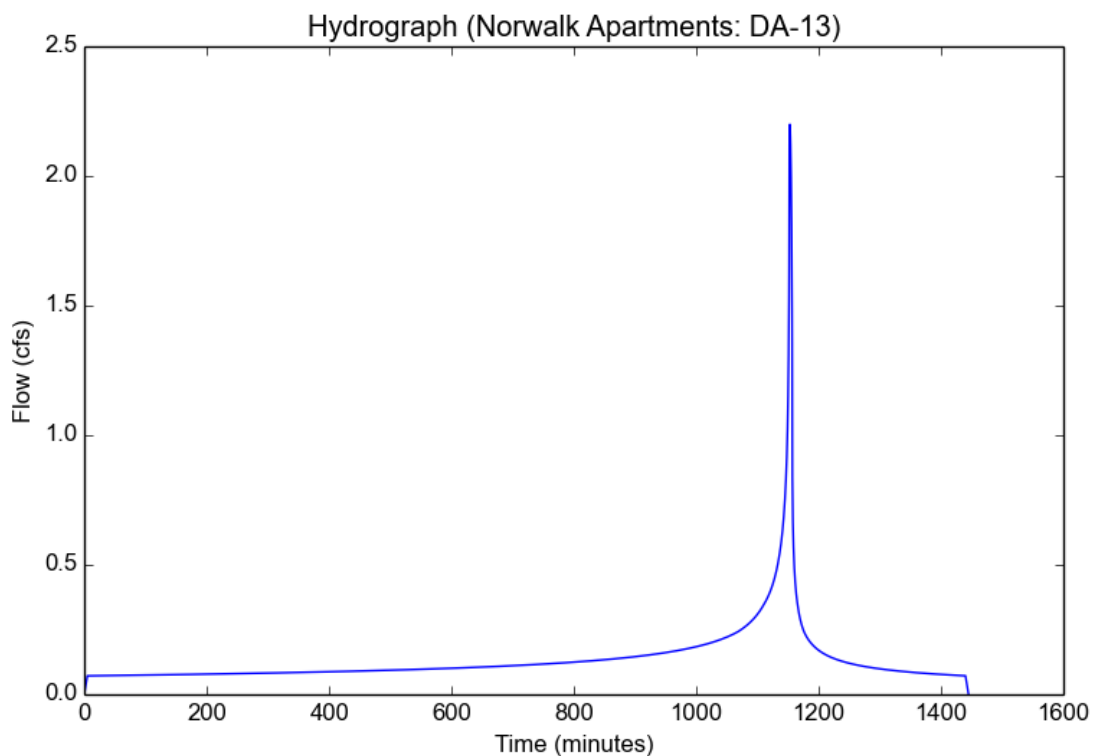

Peak Flow Hydrologic Analysis

File location: K:/ORA_LDEV/094896004 - Shapell Norwalk Apartments/Reports/Hydrology Hydraulics/Calculations/Hydrocalc/Proposed/25YR/Norwalk A
Version: HydroCalc 1.0.3

Input Parameters

Project Name	Norwalk Apartments
Subarea ID	DA-14
Area (ac)	0.44
Flow Path Length (ft)	205.0
Flow Path Slope (vft/hft)	0.01
50-yr Rainfall Depth (in)	5.63
Percent Impervious	0.85
Soil Type	6
Design Storm Frequency	25-yr
Fire Factor	0
LID	False

Output Results

Modeled (25-yr) Rainfall Depth (in)	4.9431
Peak Intensity (in/hr)	2.9492
Undeveloped Runoff Coefficient (Cu)	0.8187
Developed Runoff Coefficient (Cd)	0.8878
Time of Concentration (min)	5.0
Clear Peak Flow Rate (cfs)	1.1521
Burned Peak Flow Rate (cfs)	1.1521
24-Hr Clear Runoff Volume (ac-ft)	0.1427
24-Hr Clear Runoff Volume (cu-ft)	6216.7204

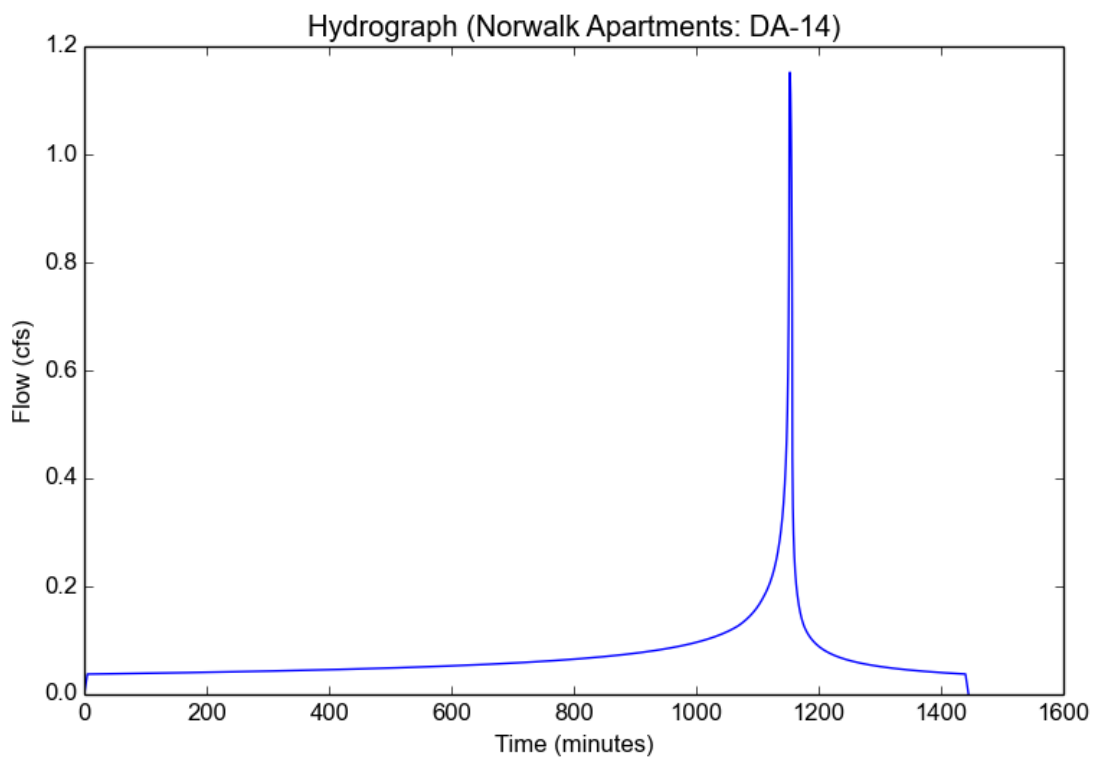

Peak Flow Hydrologic Analysis

File location: K:/ORA_LDEV/094896004 - Shapell Norwalk Apartments/Reports/Hydrology Hydraulics/Calculations/Hydrocalc/Proposed/25YR/Norwalk A
Version: HydroCalc 1.0.3

Input Parameters

Project Name	Norwalk Apartments
Subarea ID	DA-15
Area (ac)	0.29
Flow Path Length (ft)	120.0
Flow Path Slope (vft/hft)	0.01
50-yr Rainfall Depth (in)	5.63
Percent Impervious	0.85
Soil Type	6
Design Storm Frequency	25-yr
Fire Factor	0
LID	False

Output Results

Modeled (25-yr) Rainfall Depth (in)	4.9431
Peak Intensity (in/hr)	2.9492
Undeveloped Runoff Coefficient (Cu)	0.8187
Developed Runoff Coefficient (Cd)	0.8878
Time of Concentration (min)	5.0
Clear Peak Flow Rate (cfs)	0.7593
Burned Peak Flow Rate (cfs)	0.7593
24-Hr Clear Runoff Volume (ac-ft)	0.0941
24-Hr Clear Runoff Volume (cu-ft)	4097.3839

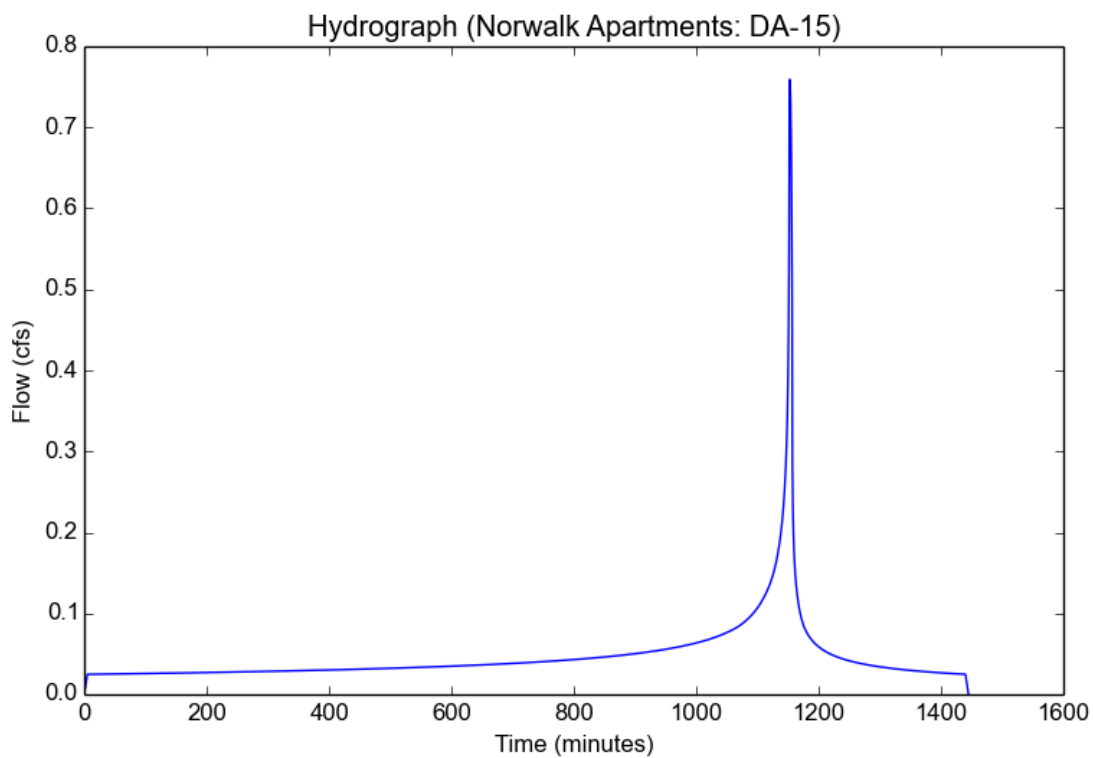

Peak Flow Hydrologic Analysis

File location: K:/ORA_LDEV/094896004 - Shapell Norwalk Apartments/Reports/Hydrology Hydraulics/Calculations/Hydrocalc/Proposed/25YR/Norwalk A
Version: HydroCalc 1.0.3

Input Parameters

Project Name	Norwalk Apartments
Subarea ID	DA-16
Area (ac)	0.45
Flow Path Length (ft)	114.0
Flow Path Slope (vft/hft)	0.015
50-yr Rainfall Depth (in)	5.63
Percent Impervious	0.85
Soil Type	6
Design Storm Frequency	25-yr
Fire Factor	0
LID	False

Output Results

Modeled (25-yr) Rainfall Depth (in)	4.9431
Peak Intensity (in/hr)	2.9492
Undeveloped Runoff Coefficient (Cu)	0.8187
Developed Runoff Coefficient (Cd)	0.8878
Time of Concentration (min)	5.0
Clear Peak Flow Rate (cfs)	1.1782
Burned Peak Flow Rate (cfs)	1.1782
24-Hr Clear Runoff Volume (ac-ft)	0.146
24-Hr Clear Runoff Volume (cu-ft)	6358.0095

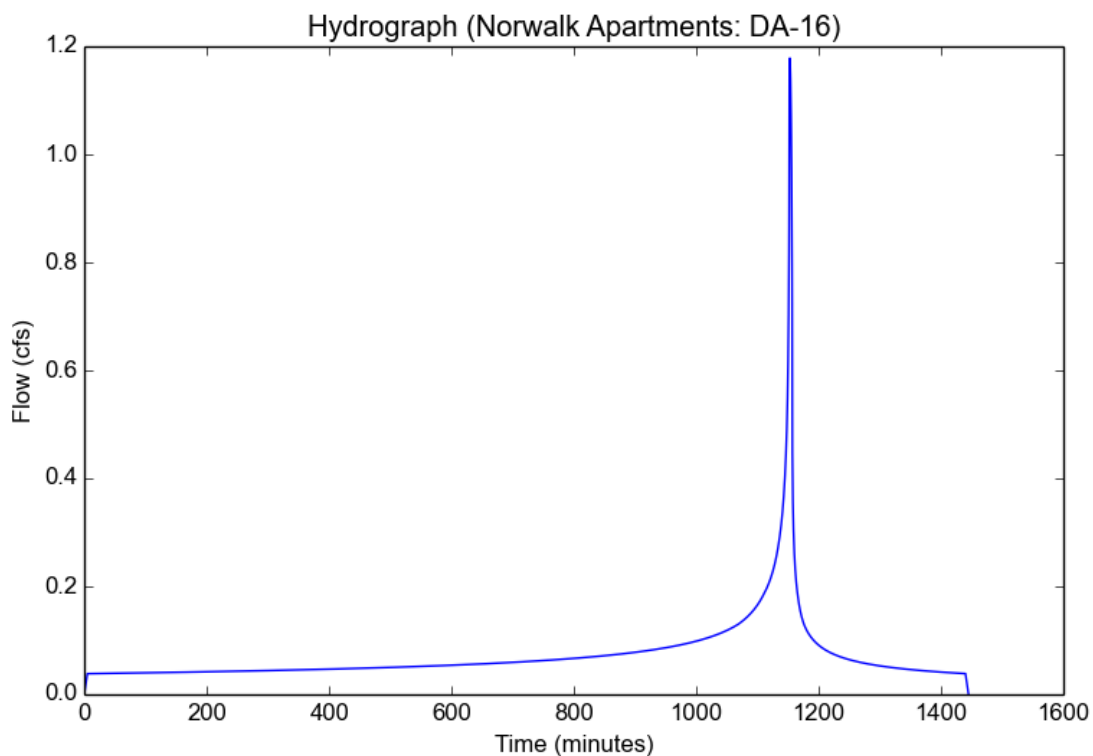

Peak Flow Hydrologic Analysis

File location: K:/ORA_LDEV/094896004 - Shapell Norwalk Apartments/Reports/Hydrology Hydraulics/Calculations/Hydrocalc/Proposed/25YR/Norwalk A
Version: HydroCalc 1.0.3

Input Parameters

Project Name	Norwalk Apartments
Subarea ID	DA-17
Area (ac)	0.25
Flow Path Length (ft)	124.0
Flow Path Slope (vft/hft)	0.005
50-yr Rainfall Depth (in)	5.63
Percent Impervious	0.85
Soil Type	6
Design Storm Frequency	25-yr
Fire Factor	0
LID	False

Output Results

Modeled (25-yr) Rainfall Depth (in)	4.9431
Peak Intensity (in/hr)	2.9492
Undeveloped Runoff Coefficient (Cu)	0.8187
Developed Runoff Coefficient (Cd)	0.8878
Time of Concentration (min)	5.0
Clear Peak Flow Rate (cfs)	0.6546
Burned Peak Flow Rate (cfs)	0.6546
24-Hr Clear Runoff Volume (ac-ft)	0.0811
24-Hr Clear Runoff Volume (cu-ft)	3532.2275

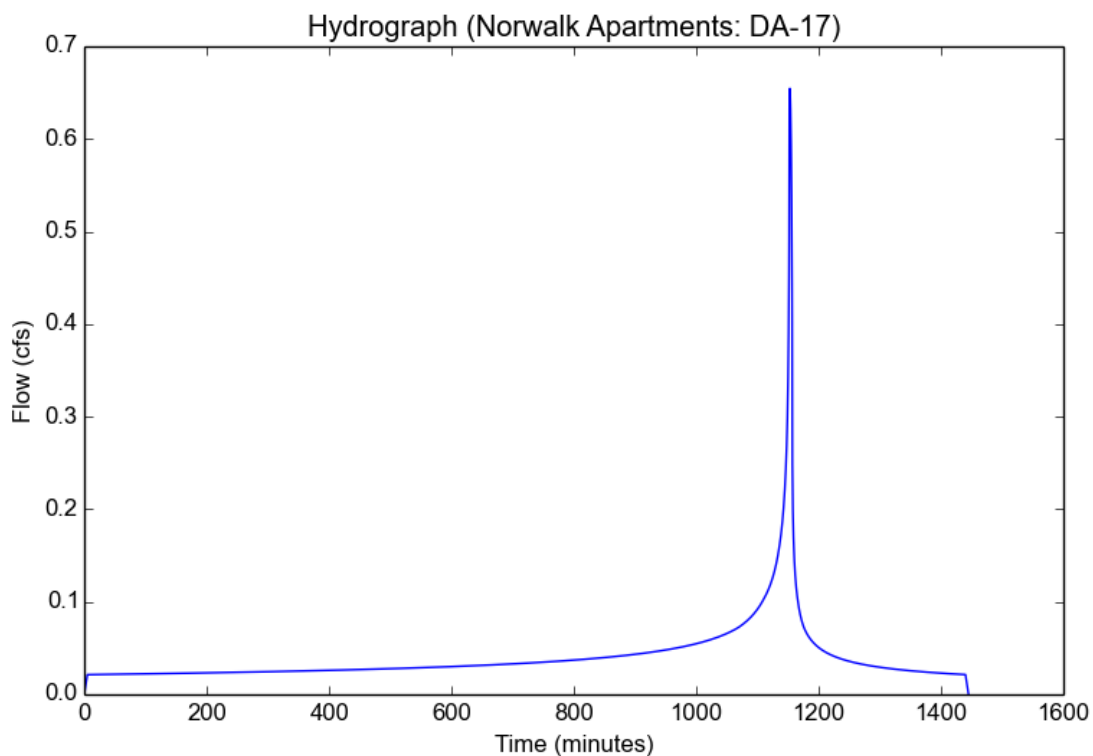

Peak Flow Hydrologic Analysis

File location: K:/ORA_LDEV/094896004 - Shapell Norwalk Apartments/Reports/Hydrology Hydraulics/Calculations/Hydrocalc/Proposed/25YR/Norwalk A
Version: HydroCalc 1.0.3

Input Parameters

Project Name	Norwalk Apartments
Subarea ID	DA-18
Area (ac)	0.16
Flow Path Length (ft)	83.0
Flow Path Slope (vft/hft)	0.01
50-yr Rainfall Depth (in)	5.63
Percent Impervious	0.85
Soil Type	6
Design Storm Frequency	25-yr
Fire Factor	0
LID	False

Output Results

Modeled (25-yr) Rainfall Depth (in)	4.9431
Peak Intensity (in/hr)	2.9492
Undeveloped Runoff Coefficient (Cu)	0.8187
Developed Runoff Coefficient (Cd)	0.8878
Time of Concentration (min)	5.0
Clear Peak Flow Rate (cfs)	0.4189
Burned Peak Flow Rate (cfs)	0.4189
24-Hr Clear Runoff Volume (ac-ft)	0.0519
24-Hr Clear Runoff Volume (cu-ft)	2260.6256

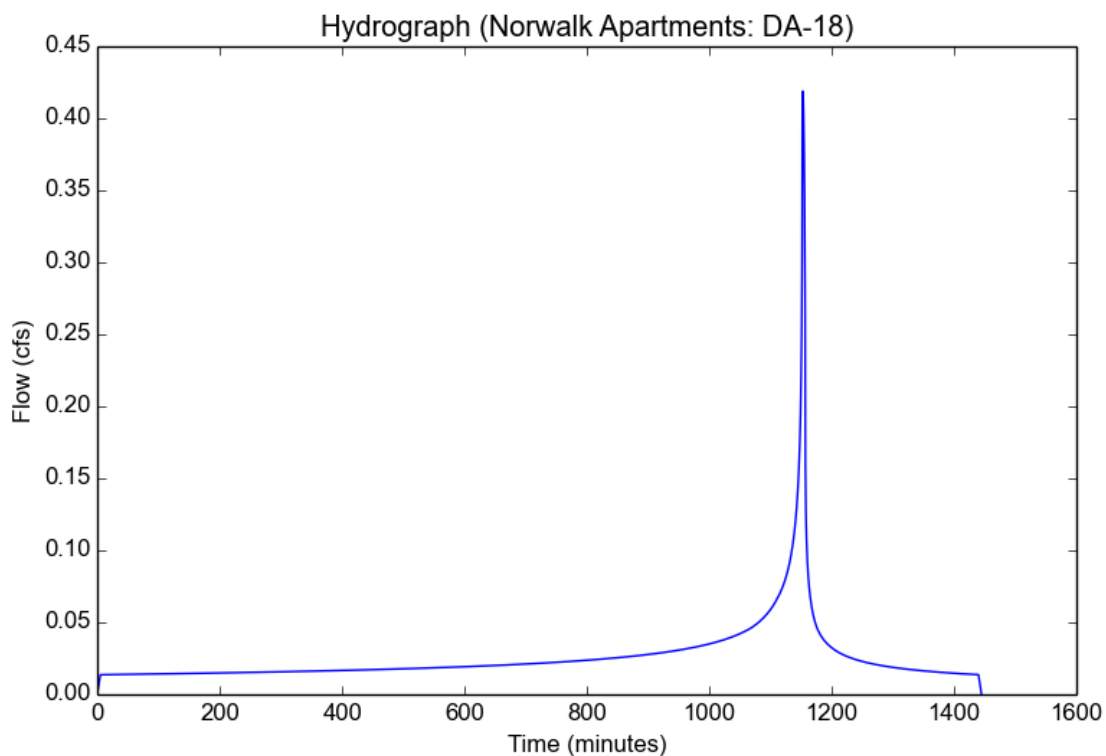

Peak Flow Hydrologic Analysis

File location: K:/ORA_LDEV/094896004 - Shapell Norwalk Apartments/Reports/Hydrology Hydraulics/Calculations/Hydrocalc/Proposed/25YR/Norwalk A
Version: HydroCalc 1.0.3

Input Parameters

Project Name	Norwalk Apartments
Subarea ID	DA-19
Area (ac)	0.32
Flow Path Length (ft)	140.0
Flow Path Slope (vft/hft)	0.01
50-yr Rainfall Depth (in)	5.63
Percent Impervious	0.85
Soil Type	6
Design Storm Frequency	25-yr
Fire Factor	0
LID	False

Output Results

Modeled (25-yr) Rainfall Depth (in)	4.9431
Peak Intensity (in/hr)	2.9492
Undeveloped Runoff Coefficient (Cu)	0.8187
Developed Runoff Coefficient (Cd)	0.8878
Time of Concentration (min)	5.0
Clear Peak Flow Rate (cfs)	0.8379
Burned Peak Flow Rate (cfs)	0.8379
24-Hr Clear Runoff Volume (ac-ft)	0.1038
24-Hr Clear Runoff Volume (cu-ft)	4521.2512

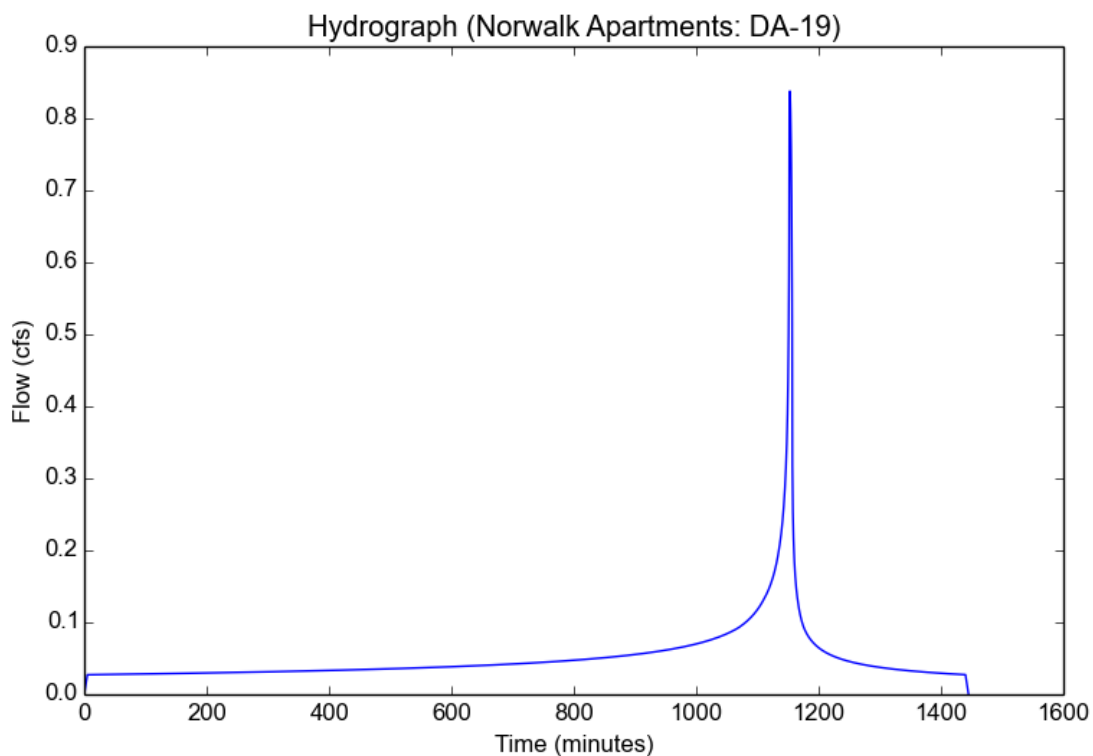

Peak Flow Hydrologic Analysis

File location: K:/ORA_LDEV/094896004 - Shapell Norwalk Apartments/Reports/Hydrology Hydraulics/Calculations/Hydrocalc/Proposed/25YR/Norwalk A
Version: HydroCalc 1.0.3

Input Parameters

Project Name	Norwalk Apartments
Subarea ID	DA-20
Area (ac)	0.31
Flow Path Length (ft)	140.0
Flow Path Slope (vft/hft)	0.01
50-yr Rainfall Depth (in)	5.63
Percent Impervious	0.85
Soil Type	6
Design Storm Frequency	25-yr
Fire Factor	0
LID	False

Output Results

Modeled (25-yr) Rainfall Depth (in)	4.9431
Peak Intensity (in/hr)	2.9492
Undeveloped Runoff Coefficient (Cu)	0.8187
Developed Runoff Coefficient (Cd)	0.8878
Time of Concentration (min)	5.0
Clear Peak Flow Rate (cfs)	0.8117
Burned Peak Flow Rate (cfs)	0.8117
24-Hr Clear Runoff Volume (ac-ft)	0.1006
24-Hr Clear Runoff Volume (cu-ft)	4379.9621

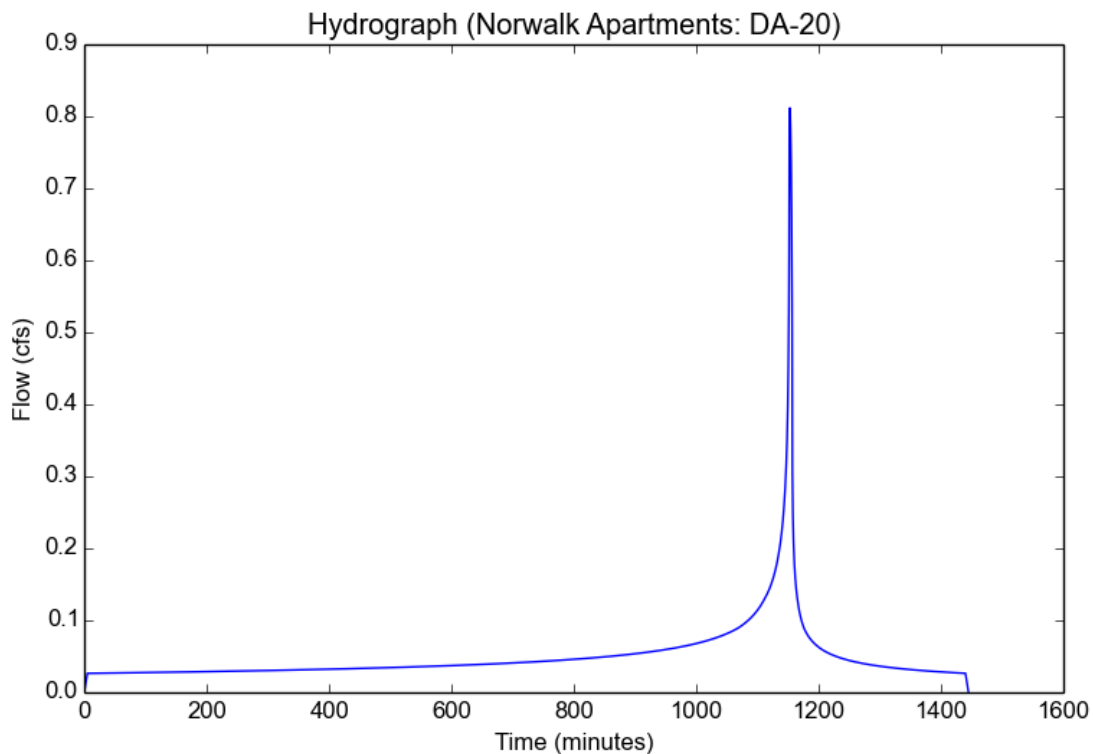

TREATMENT FLOW HYDROLOGIC ANALYSIS

File location: K:/ORA_LDEV/094896004 - Shapell Norwalk Apartments/Reports/Hydrology Hydraulics/Calculations/Hydrocalc/Proposed/Norwalk Apartments
Version: HydroCalc 1.0.3

Input Parameters

Project Name	Norwalk Apartments
Subarea ID	DA-1
Area (ac)	0.67
Flow Path Length (ft)	156.0
Flow Path Slope (vft/hft)	0.007
85th Percentile Rainfall Depth (in)	0.89
Percent Impervious	0.85
Soil Type	6
Design Storm Frequency	85th percentile storm
Fire Factor	0
LID	True

Output Results

Modeled (85th percentile storm) Rainfall Depth (in)	0.89
Peak Intensity (in/hr)	0.3273
Undeveloped Runoff Coefficient (Cu)	0.1
Developed Runoff Coefficient (Cd)	0.78
Time of Concentration (min)	14.0
Clear Peak Flow Rate (cfs)	0.171
Burned Peak Flow Rate (cfs)	0.171
24-Hr Clear Runoff Volume (ac-ft)	0.0384
24-Hr Clear Runoff Volume (cu-ft)	1674.4145

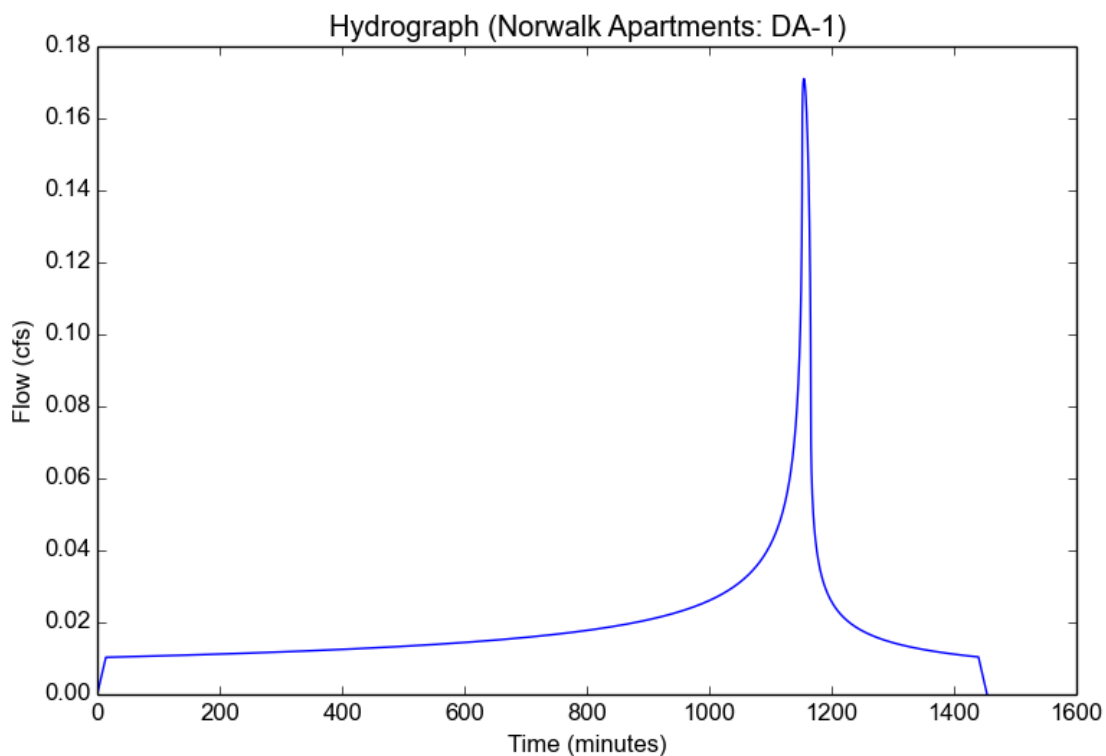

TREATMENT FLOW HYDROLOGIC ANALYSIS

File location: K:/ORA_LDEV/094896004 - Shapell Norwalk Apartments/Reports/Hydrology Hydraulics/Calculations/Hydrocalc/Proposed/Norwalk Apartments
Version: HydroCalc 1.0.3

Input Parameters

Project Name	Norwalk Apartments
Subarea ID	DA-2
Area (ac)	0.19
Flow Path Length (ft)	80.0
Flow Path Slope (vft/hft)	0.015
85th Percentile Rainfall Depth (in)	0.89
Percent Impervious	0.85
Soil Type	6
Design Storm Frequency	85th percentile storm
Fire Factor	0
LID	True

Output Results

Modeled (85th percentile storm) Rainfall Depth (in)	0.89
Peak Intensity (in/hr)	0.4258
Undeveloped Runoff Coefficient (Cu)	0.1958
Developed Runoff Coefficient (Cd)	0.7944
Time of Concentration (min)	8.0
Clear Peak Flow Rate (cfs)	0.0643
Burned Peak Flow Rate (cfs)	0.0643
24-Hr Clear Runoff Volume (ac-ft)	0.0109
24-Hr Clear Runoff Volume (cu-ft)	475.1027

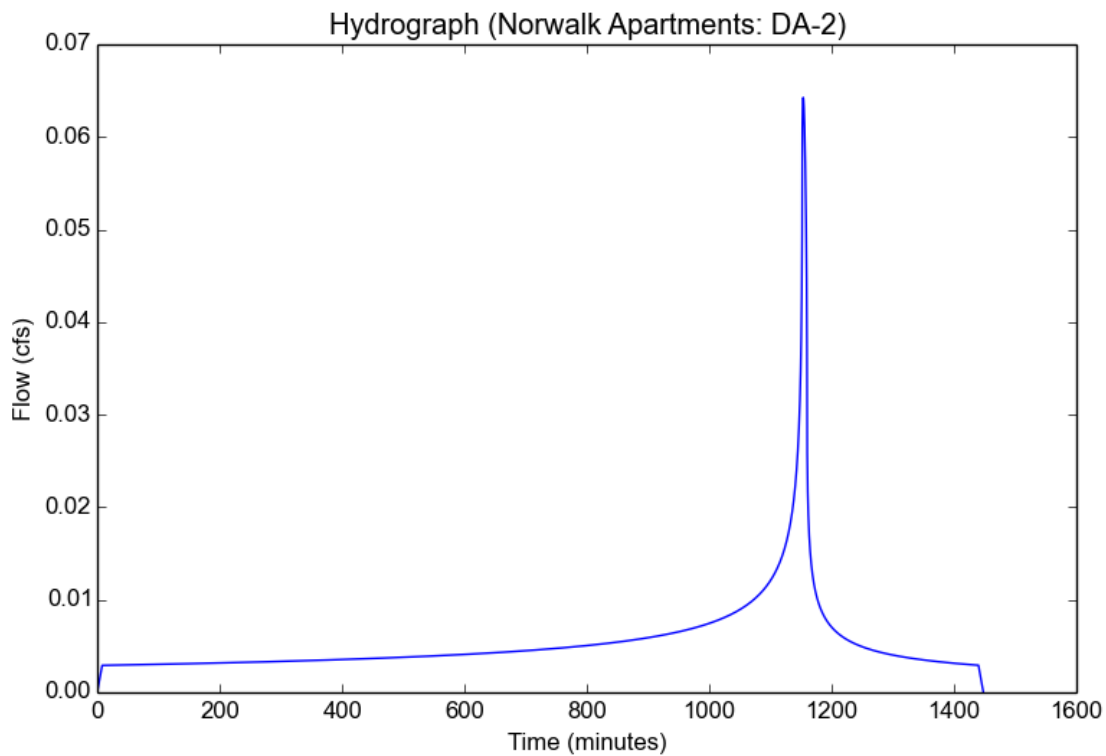

TREATMENT FLOW HYDROLOGIC ANALYSIS

File location: K:/ORA_LDEV/094896004 - Shapell Norwalk Apartments/Reports/Hydrology Hydraulics/Calculations/Hydrocalc/Proposed/Norwalk Apartments
Version: HydroCalc 1.0.3

Input Parameters

Project Name	Norwalk Apartments
Subarea ID	DA-3
Area (ac)	0.18
Flow Path Length (ft)	65.0
Flow Path Slope (vft/hft)	0.021
85th Percentile Rainfall Depth (in)	0.89
Percent Impervious	0.85
Soil Type	6
Design Storm Frequency	85th percentile storm
Fire Factor	0
LID	True

Output Results

Modeled (85th percentile storm) Rainfall Depth (in)	0.89
Peak Intensity (in/hr)	0.4874
Undeveloped Runoff Coefficient (Cu)	0.3017
Developed Runoff Coefficient (Cd)	0.8103
Time of Concentration (min)	6.0
Clear Peak Flow Rate (cfs)	0.0711
Burned Peak Flow Rate (cfs)	0.0711
24-Hr Clear Runoff Volume (ac-ft)	0.0103
24-Hr Clear Runoff Volume (cu-ft)	450.4216

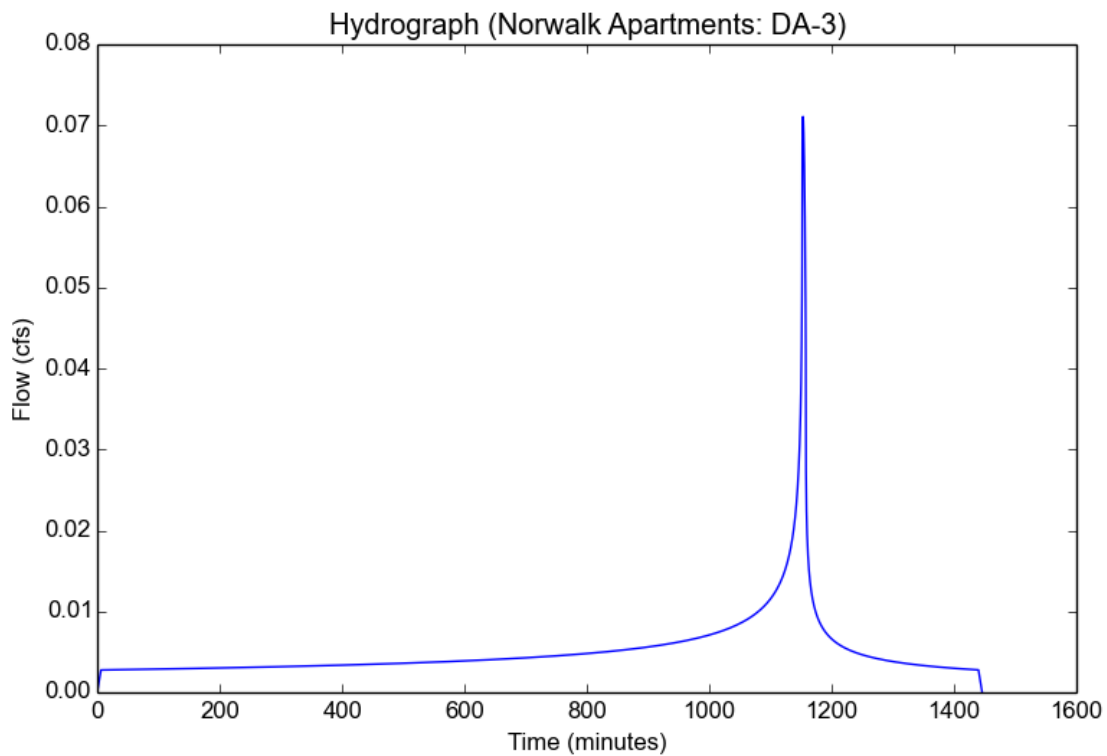

TREATMENT FLOW HYDROLOGIC ANALYSIS

File location: K:/ORA_LDEV/094896004 - Shapell Norwalk Apartments/Reports/Hydrology Hydraulics/Calculations/Hydrocalc/Proposed/Norwalk Apartments
Version: HydroCalc 1.0.3

Input Parameters

Project Name	Norwalk Apartments
Subarea ID	DA-4
Area (ac)	0.24
Flow Path Length (ft)	190.0
Flow Path Slope (vft/hft)	0.012
85th Percentile Rainfall Depth (in)	0.89
Percent Impervious	0.85
Soil Type	6
Design Storm Frequency	85th percentile storm
Fire Factor	0
LID	True

Output Results

Modeled (85th percentile storm) Rainfall Depth (in)	0.89
Peak Intensity (in/hr)	0.3168
Undeveloped Runoff Coefficient (Cu)	0.1
Developed Runoff Coefficient (Cd)	0.78
Time of Concentration (min)	15.0
Clear Peak Flow Rate (cfs)	0.0593
Burned Peak Flow Rate (cfs)	0.0593
24-Hr Clear Runoff Volume (ac-ft)	0.0138
24-Hr Clear Runoff Volume (cu-ft)	599.7905

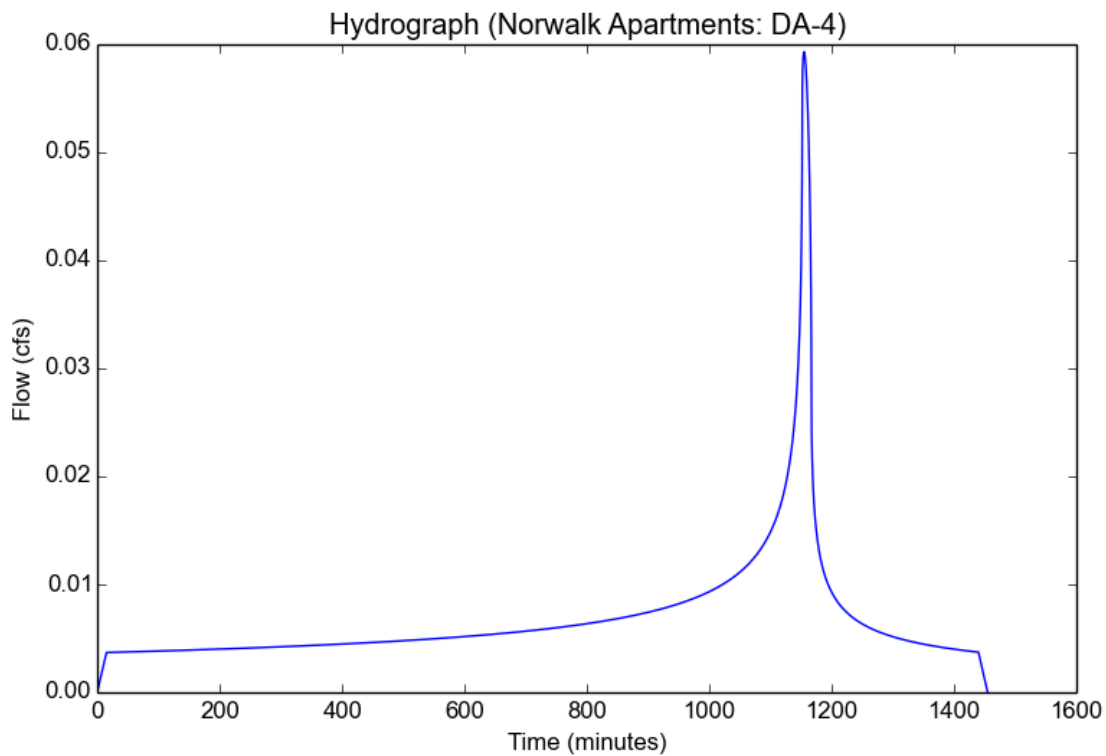

TREATMENT FLOW HYDROLOGIC ANALYSIS

File location: K:/ORA_LDEV/094896004 - Shapell Norwalk Apartments/Reports/Hydrology Hydraulics/Calculations/Hydrocalc/Proposed/Norwalk Apartments
Version: HydroCalc 1.0.3

Input Parameters

Project Name	Norwalk Apartments
Subarea ID	DA-5
Area (ac)	1.31
Flow Path Length (ft)	170.0
Flow Path Slope (vft/hft)	0.012
85th Percentile Rainfall Depth (in)	0.89
Percent Impervious	0.85
Soil Type	6
Design Storm Frequency	85th percentile storm
Fire Factor	0
LID	True

Output Results

Modeled (85th percentile storm) Rainfall Depth (in)	0.89
Peak Intensity (in/hr)	0.3273
Undeveloped Runoff Coefficient (Cu)	0.1
Developed Runoff Coefficient (Cd)	0.78
Time of Concentration (min)	14.0
Clear Peak Flow Rate (cfs)	0.3344
Burned Peak Flow Rate (cfs)	0.3344
24-Hr Clear Runoff Volume (ac-ft)	0.0752
24-Hr Clear Runoff Volume (cu-ft)	3273.8553

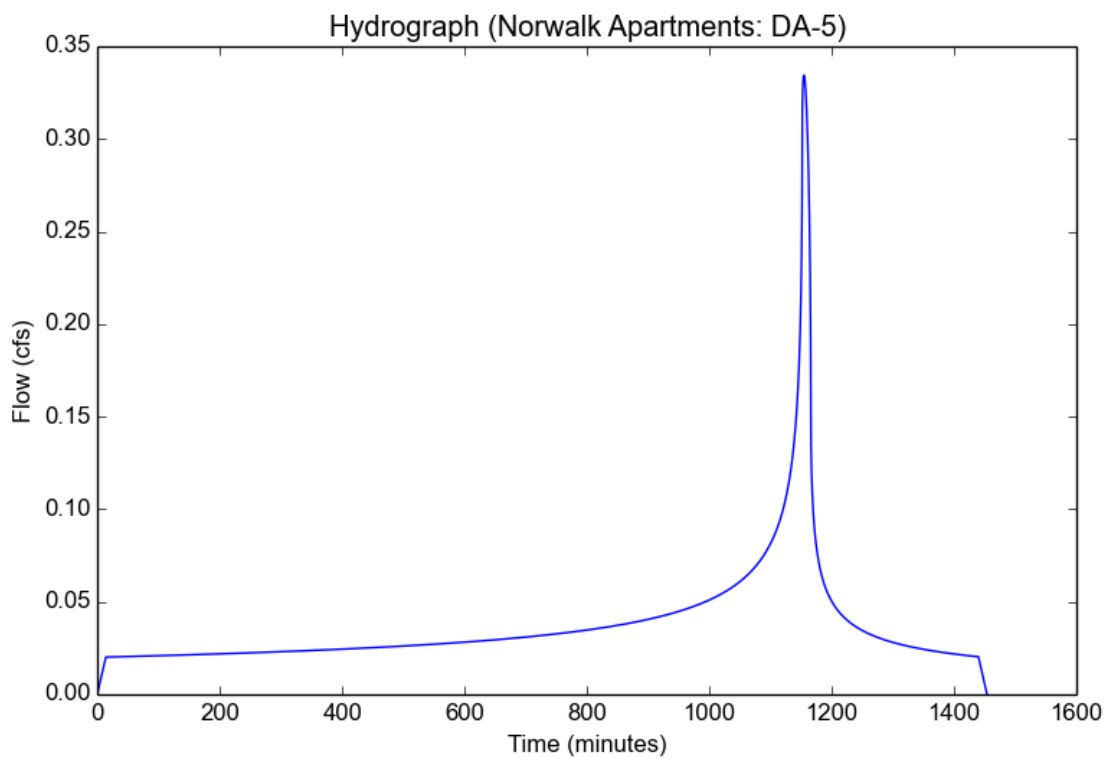

TREATMENT FLOW HYDROLOGIC ANALYSIS

File location: K:/ORA_LDEV/094896004 - Shapell Norwalk Apartments/Reports/Hydrology Hydraulics/Calculations/Hydrocalc/Proposed/Norwalk Apartments
Version: HydroCalc 1.0.3

Input Parameters

Project Name	Norwalk Apartments
Subarea ID	DA-6
Area (ac)	0.08
Flow Path Length (ft)	45.0
Flow Path Slope (vft/hft)	0.025
85th Percentile Rainfall Depth (in)	0.89
Percent Impervious	0.85
Soil Type	6
Design Storm Frequency	85th percentile storm
Fire Factor	0
LID	True

Output Results

Modeled (85th percentile storm) Rainfall Depth (in)	0.89
Peak Intensity (in/hr)	0.531
Undeveloped Runoff Coefficient (Cu)	0.3453
Developed Runoff Coefficient (Cd)	0.8168
Time of Concentration (min)	5.0
Clear Peak Flow Rate (cfs)	0.0347
Burned Peak Flow Rate (cfs)	0.0347
24-Hr Clear Runoff Volume (ac-ft)	0.0046
24-Hr Clear Runoff Volume (cu-ft)	200.2582

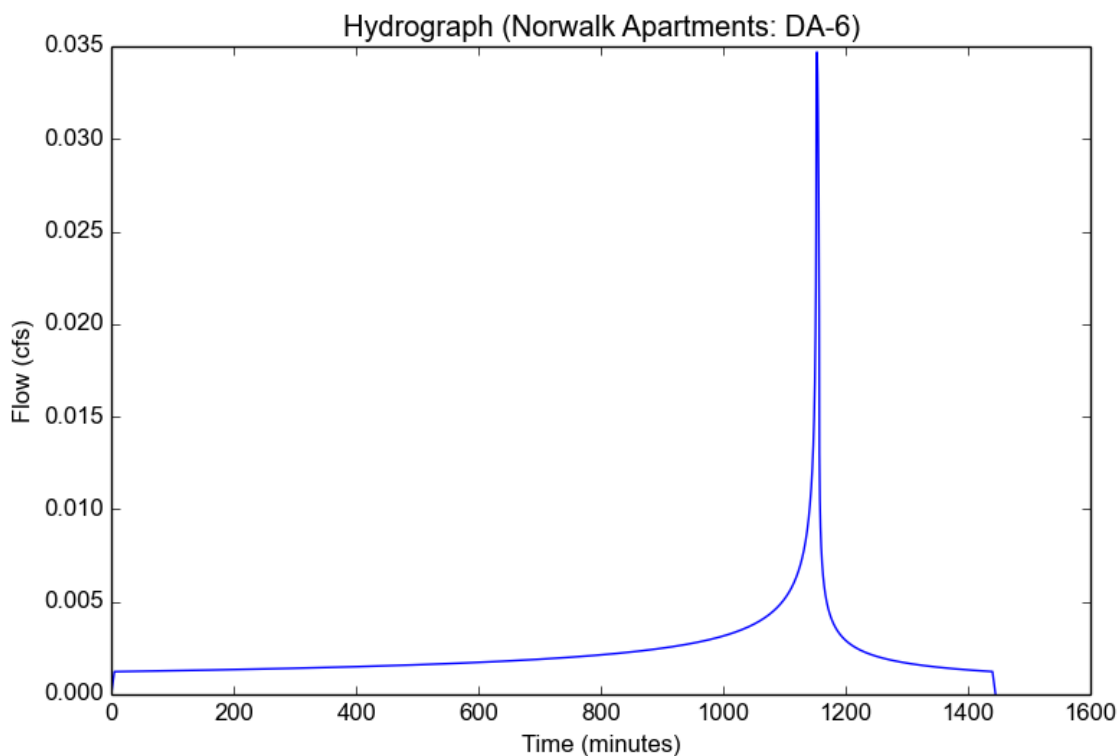

TREATMENT FLOW HYDROLOGIC ANALYSIS

File location: K:/ORA_LDEV/094896004 - Shapell Norwalk Apartments/Reports/Hydrology Hydraulics/Calculations/Hydrocalc/Proposed/Norwalk Apartments
Version: HydroCalc 1.0.3

Input Parameters

Project Name	Norwalk Apartments
Subarea ID	DA-7
Area (ac)	0.18
Flow Path Length (ft)	80.0
Flow Path Slope (vft/hft)	0.019
85th Percentile Rainfall Depth (in)	0.89
Percent Impervious	0.85
Soil Type	6
Design Storm Frequency	85th percentile storm
Fire Factor	0
LID	True

Output Results

Modeled (85th percentile storm) Rainfall Depth (in)	0.89
Peak Intensity (in/hr)	0.4258
Undeveloped Runoff Coefficient (Cu)	0.1958
Developed Runoff Coefficient (Cd)	0.7944
Time of Concentration (min)	8.0
Clear Peak Flow Rate (cfs)	0.0609
Burned Peak Flow Rate (cfs)	0.0609
24-Hr Clear Runoff Volume (ac-ft)	0.0103
24-Hr Clear Runoff Volume (cu-ft)	450.0973

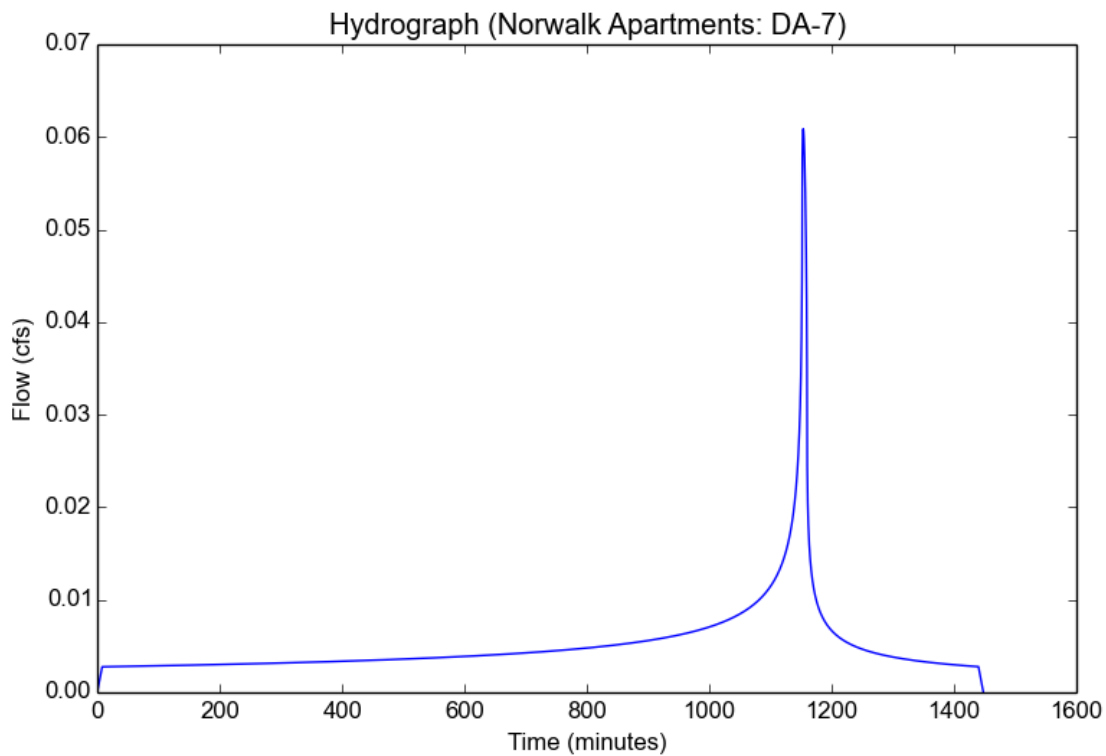

TREATMENT FLOW HYDROLOGIC ANALYSIS

File location: K:/ORA_LDEV/094896004 - Shapell Norwalk Apartments/Reports/Hydrology Hydraulics/Calculations/Hydrocalc/Proposed/Norwalk Apartments
Version: HydroCalc 1.0.3

Input Parameters

Project Name	Norwalk Apartments
Subarea ID	DA-8
Area (ac)	0.23
Flow Path Length (ft)	100.0
Flow Path Slope (vft/hft)	0.025
85th Percentile Rainfall Depth (in)	0.89
Percent Impervious	0.85
Soil Type	6
Design Storm Frequency	85th percentile storm
Fire Factor	0
LID	True

Output Results

Modeled (85th percentile storm) Rainfall Depth (in)	0.89
Peak Intensity (in/hr)	0.4258
Undeveloped Runoff Coefficient (Cu)	0.1958
Developed Runoff Coefficient (Cd)	0.7944
Time of Concentration (min)	8.0
Clear Peak Flow Rate (cfs)	0.0778
Burned Peak Flow Rate (cfs)	0.0778
24-Hr Clear Runoff Volume (ac-ft)	0.0132
24-Hr Clear Runoff Volume (cu-ft)	575.1243

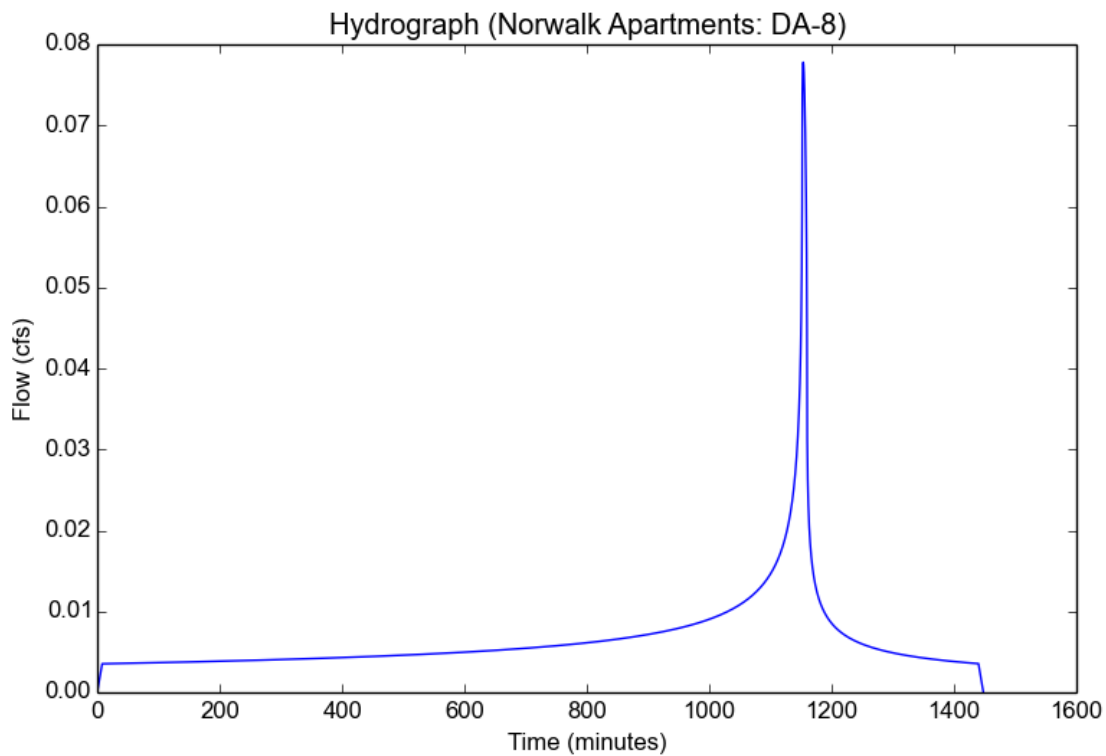

TREATMENT FLOW HYDROLOGIC ANALYSIS

File location: K:/ORA_LDEV/094896004 - Shapell Norwalk Apartments/Reports/Hydrology Hydraulics/Calculations/Hydrocalc/Proposed/Norwalk Apartments
Version: HydroCalc 1.0.3

Input Parameters

Project Name	Norwalk Apartments
Subarea ID	DA-9
Area (ac)	0.51
Flow Path Length (ft)	80.0
Flow Path Slope (vft/hft)	0.018
85th Percentile Rainfall Depth (in)	0.89
Percent Impervious	0.85
Soil Type	6
Design Storm Frequency	85th percentile storm
Fire Factor	0
LID	True

Output Results

Modeled (85th percentile storm) Rainfall Depth (in)	0.89
Peak Intensity (in/hr)	0.4258
Undeveloped Runoff Coefficient (Cu)	0.1958
Developed Runoff Coefficient (Cd)	0.7944
Time of Concentration (min)	8.0
Clear Peak Flow Rate (cfs)	0.1725
Burned Peak Flow Rate (cfs)	0.1725
24-Hr Clear Runoff Volume (ac-ft)	0.0293
24-Hr Clear Runoff Volume (cu-ft)	1275.2757

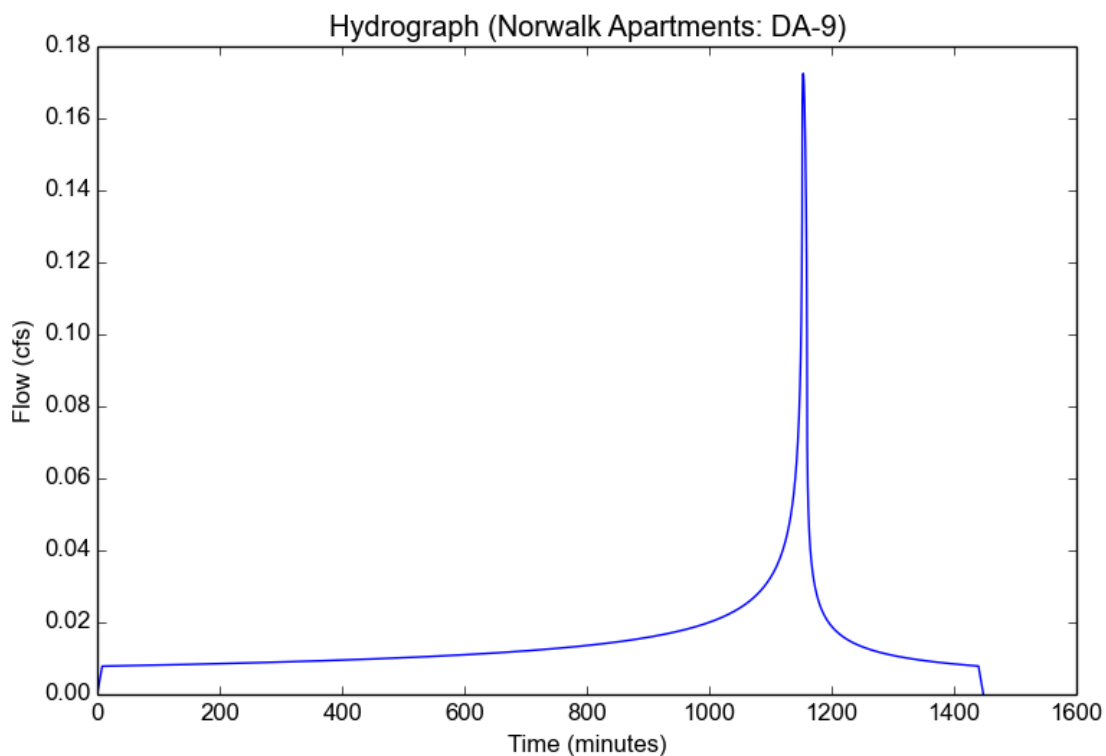

TREATMENT FLOW HYDROLOGIC ANALYSIS

File location: K:/ORA_LDEV/094896004 - Shapell Norwalk Apartments/Reports/Hydrology Hydraulics/Calculations/Hydrocalc/Proposed/Norwalk Apartments
Version: HydroCalc 1.0.3

Input Parameters

Project Name	Norwalk Apartments
Subarea ID	DA-10
Area (ac)	0.49
Flow Path Length (ft)	91.0
Flow Path Slope (vft/hft)	0.013
85th Percentile Rainfall Depth (in)	0.89
Percent Impervious	0.85
Soil Type	6
Design Storm Frequency	85th percentile storm
Fire Factor	0
LID	True

Output Results

Modeled (85th percentile storm) Rainfall Depth (in)	0.89
Peak Intensity (in/hr)	0.4028
Undeveloped Runoff Coefficient (Cu)	0.1564
Developed Runoff Coefficient (Cd)	0.7885
Time of Concentration (min)	9.0
Clear Peak Flow Rate (cfs)	0.1556
Burned Peak Flow Rate (cfs)	0.1556
24-Hr Clear Runoff Volume (ac-ft)	0.0281
24-Hr Clear Runoff Volume (cu-ft)	1224.9293

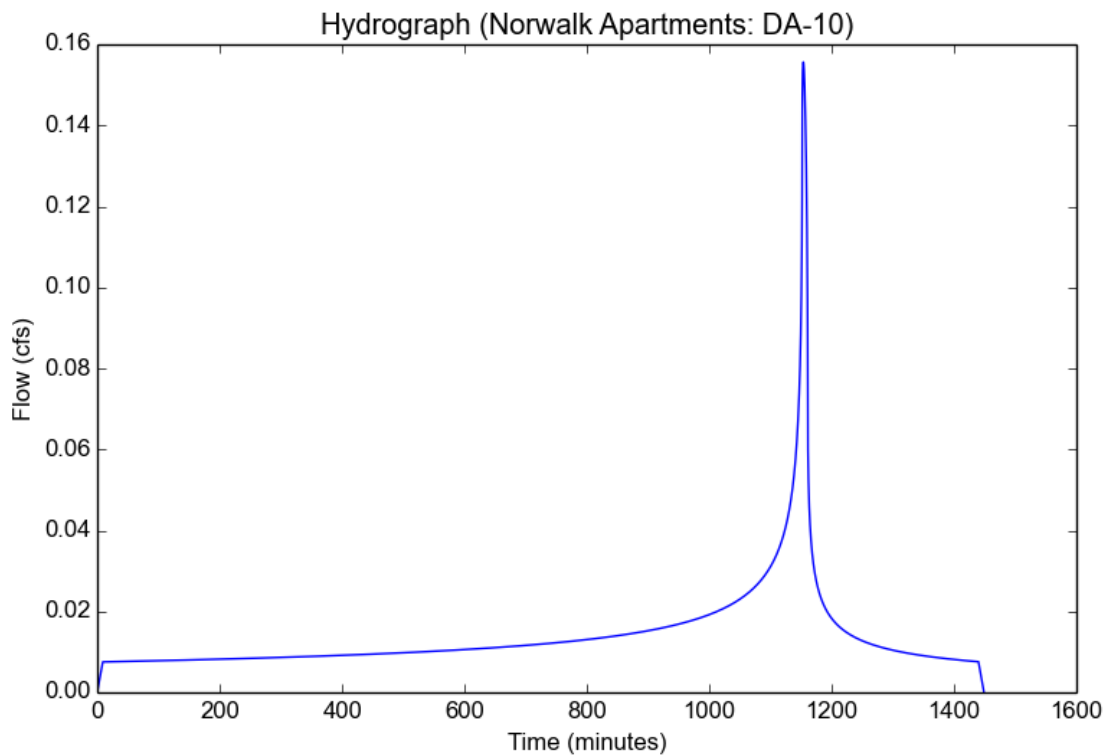

TREATMENT FLOW HYDROLOGIC ANALYSIS

File location: K:/ORA_LDEV/094896004 - Shapell Norwalk Apartments/Reports/Hydrology Hydraulics/Calculations/Hydrocalc/Proposed/Norwalk Apartments
Version: HydroCalc 1.0.3

Input Parameters

Project Name	Norwalk Apartments
Subarea ID	DA-11
Area (ac)	0.28
Flow Path Length (ft)	106.0
Flow Path Slope (vft/hft)	0.012
85th Percentile Rainfall Depth (in)	0.89
Percent Impervious	0.85
Soil Type	6
Design Storm Frequency	85th percentile storm
Fire Factor	0
LID	True

Output Results

Modeled (85th percentile storm) Rainfall Depth (in)	0.89
Peak Intensity (in/hr)	0.3834
Undeveloped Runoff Coefficient (Cu)	0.123
Developed Runoff Coefficient (Cd)	0.7834
Time of Concentration (min)	10.0
Clear Peak Flow Rate (cfs)	0.0841
Burned Peak Flow Rate (cfs)	0.0841
24-Hr Clear Runoff Volume (ac-ft)	0.0161
24-Hr Clear Runoff Volume (cu-ft)	699.815

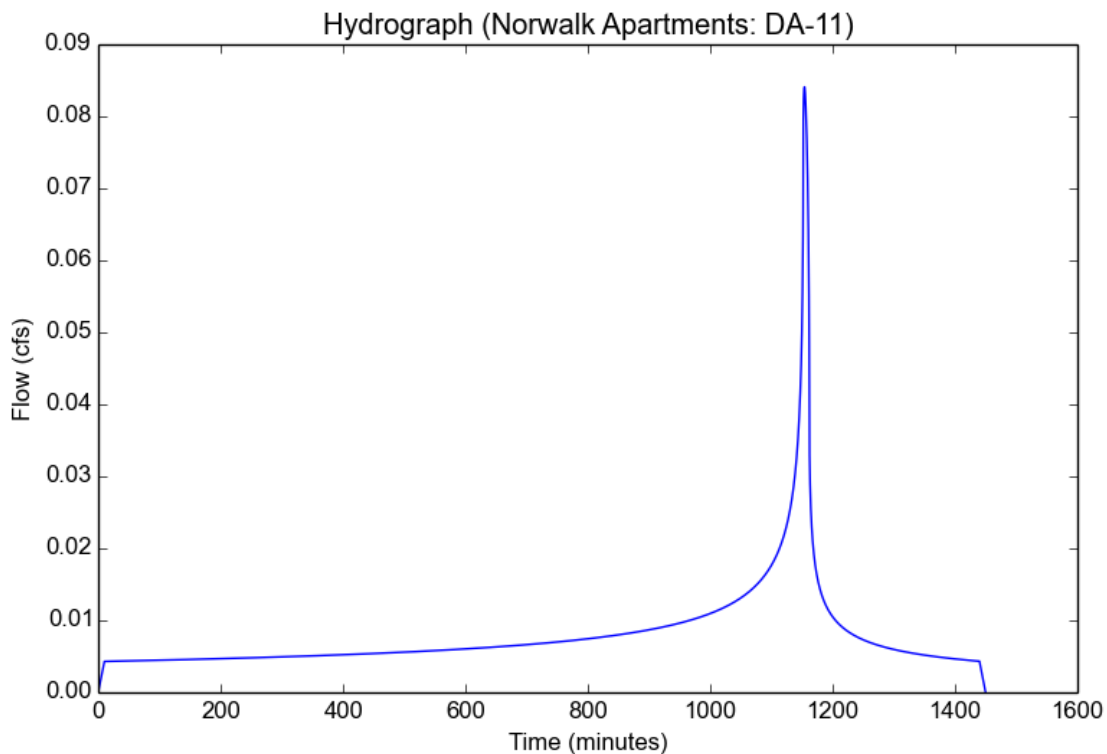

TREATMENT FLOW HYDROLOGIC ANALYSIS

File location: K:/ORA_LDEV/094896004 - Shapell Norwalk Apartments/Reports/Hydrology Hydraulics/Calculations/Hydrocalc/Proposed/Norwalk Apartments
Version: HydroCalc 1.0.3

Input Parameters

Project Name	Norwalk Apartments
Subarea ID	DA-12
Area (ac)	0.65
Flow Path Length (ft)	126.0
Flow Path Slope (vft/hft)	0.02
85th Percentile Rainfall Depth (in)	0.89
Percent Impervious	0.85
Soil Type	6
Design Storm Frequency	85th percentile storm
Fire Factor	0
LID	True

Output Results

Modeled (85th percentile storm) Rainfall Depth (in)	0.89
Peak Intensity (in/hr)	0.3834
Undeveloped Runoff Coefficient (Cu)	0.123
Developed Runoff Coefficient (Cd)	0.7834
Time of Concentration (min)	10.0
Clear Peak Flow Rate (cfs)	0.1952
Burned Peak Flow Rate (cfs)	0.1952
24-Hr Clear Runoff Volume (ac-ft)	0.0373
24-Hr Clear Runoff Volume (cu-ft)	1624.5704

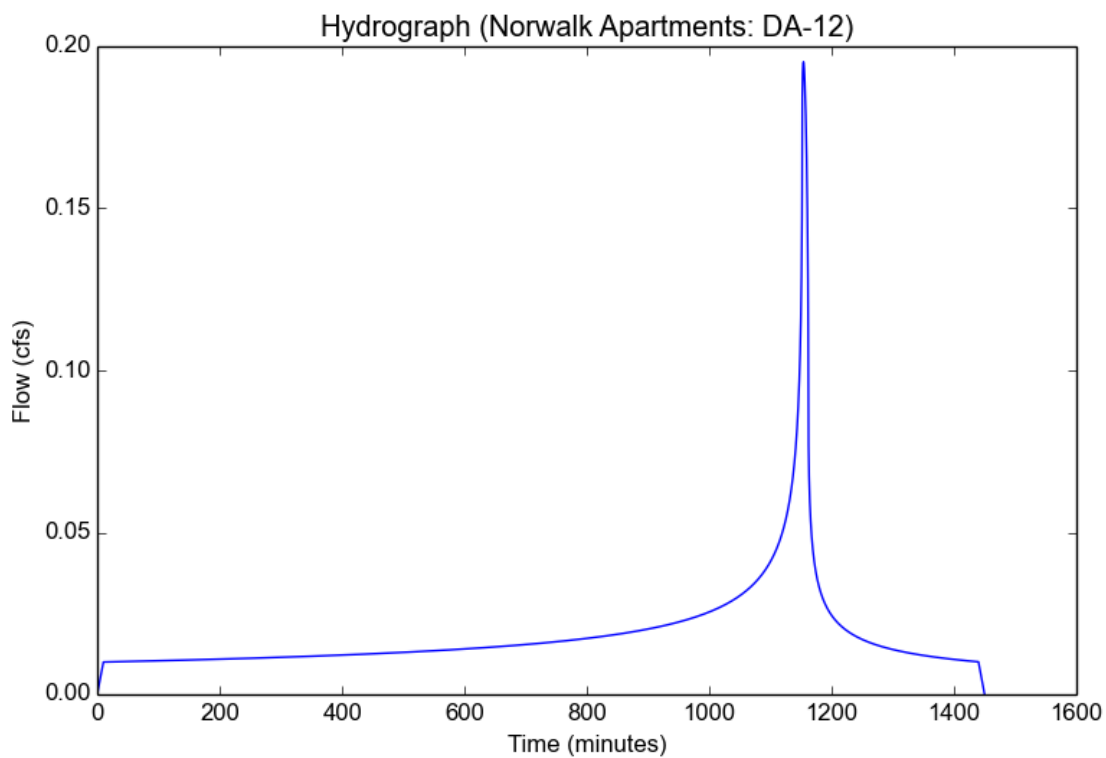

TREATMENT FLOW HYDROLOGIC ANALYSIS

File location: C:/Users/Cameron.Liederman/Desktop/Norwalk Apartments - DA-13.pdf
Version: HydroCalc 1.0.3

Input Parameters

Project Name	Norwalk Apartments
Subarea ID	DA-13
Area (ac)	0.84
Flow Path Length (ft)	208.0
Flow Path Slope (vft/hft)	0.005
85th Percentile Rainfall Depth (in)	0.89
Percent Impervious	0.85
Soil Type	6
Design Storm Frequency	85th percentile storm
Fire Factor	0
LID	True

Output Results

Modeled (85th percentile storm) Rainfall Depth (in)	0.89
Peak Intensity (in/hr)	0.2908
Undeveloped Runoff Coefficient (Cu)	0.1
Developed Runoff Coefficient (Cd)	0.78
Time of Concentration (min)	18.0
Clear Peak Flow Rate (cfs)	0.1905
Burned Peak Flow Rate (cfs)	0.1905
24-Hr Clear Runoff Volume (ac-ft)	0.0482
24-Hr Clear Runoff Volume (cu-ft)	2099.2694

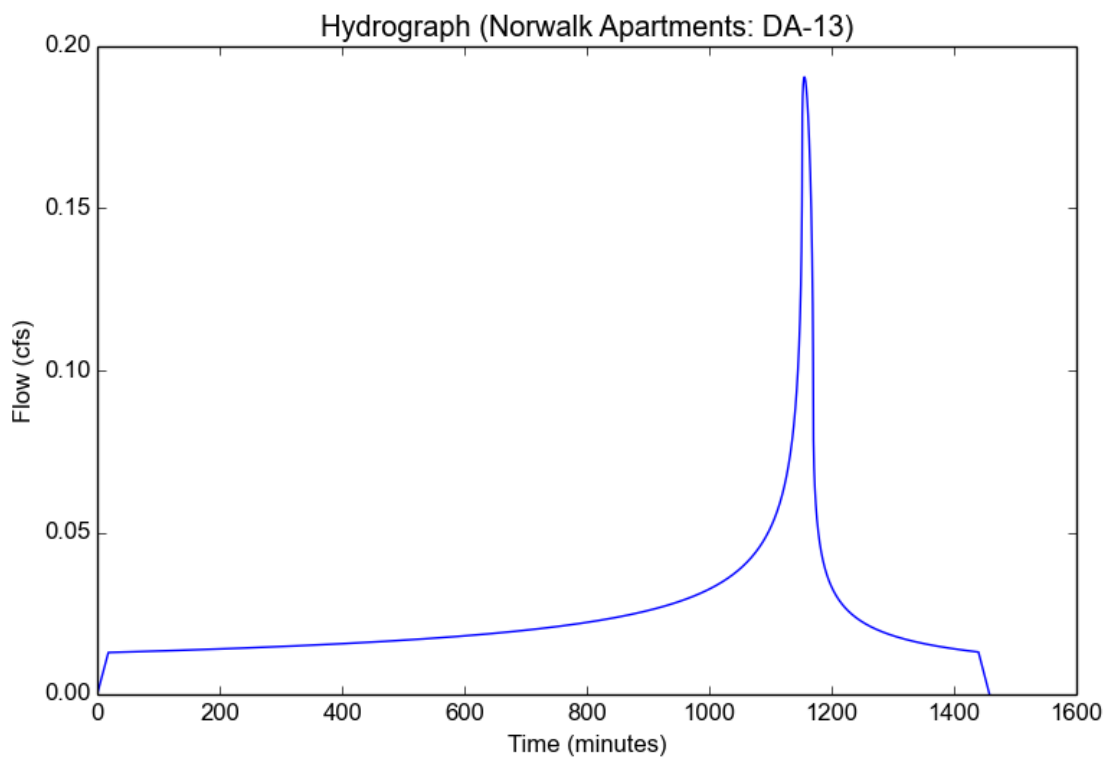

TREATMENT FLOW HYDROLOGIC ANALYSIS

File location: C:/Users/Cameron.Liederman/Desktop/Norwalk Apartments - DA-14.pdf
Version: HydroCalc 1.0.3

Input Parameters

Project Name	Norwalk Apartments
Subarea ID	DA-14
Area (ac)	0.44
Flow Path Length (ft)	205.0
Flow Path Slope (vft/hft)	0.01
85th Percentile Rainfall Depth (in)	0.89
Percent Impervious	0.85
Soil Type	6
Design Storm Frequency	85th percentile storm
Fire Factor	0
LID	True

Output Results

Modeled (85th percentile storm) Rainfall Depth (in)	0.89
Peak Intensity (in/hr)	0.3074
Undeveloped Runoff Coefficient (Cu)	0.1
Developed Runoff Coefficient (Cd)	0.78
Time of Concentration (min)	16.0
Clear Peak Flow Rate (cfs)	0.1055
Burned Peak Flow Rate (cfs)	0.1055
24-Hr Clear Runoff Volume (ac-ft)	0.0252
24-Hr Clear Runoff Volume (cu-ft)	1099.6164

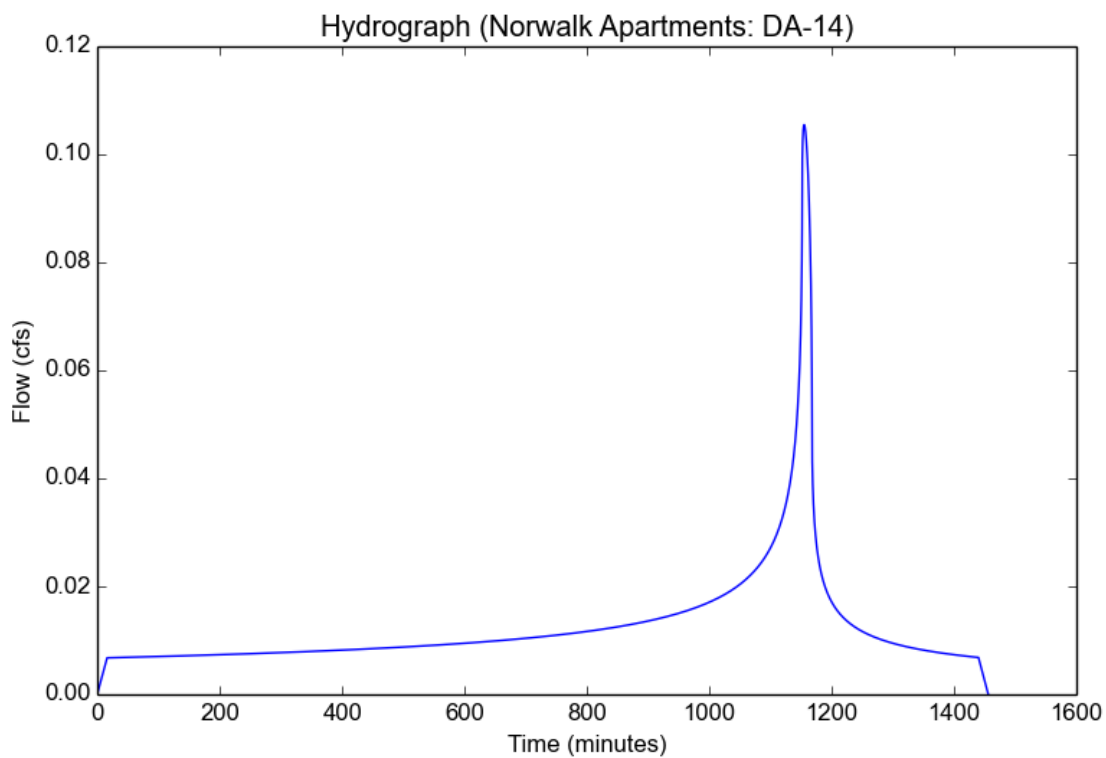

TREATMENT FLOW HYDROLOGIC ANALYSIS

File location: C:/Users/Cameron.Liederman/Desktop/Norwalk Apartments - DA-15.pdf
Version: HydroCalc 1.0.3

Input Parameters

Project Name	Norwalk Apartments
Subarea ID	DA-15
Area (ac)	0.29
Flow Path Length (ft)	120.0
Flow Path Slope (vft/hft)	0.01
85th Percentile Rainfall Depth (in)	0.89
Percent Impervious	0.85
Soil Type	6
Design Storm Frequency	85th percentile storm
Fire Factor	0
LID	True

Output Results

Modeled (85th percentile storm) Rainfall Depth (in)	0.89
Peak Intensity (in/hr)	0.3666
Undeveloped Runoff Coefficient (Cu)	0.1
Developed Runoff Coefficient (Cd)	0.78
Time of Concentration (min)	11.0
Clear Peak Flow Rate (cfs)	0.0829
Burned Peak Flow Rate (cfs)	0.0829
24-Hr Clear Runoff Volume (ac-ft)	0.0166
24-Hr Clear Runoff Volume (cu-ft)	724.7459

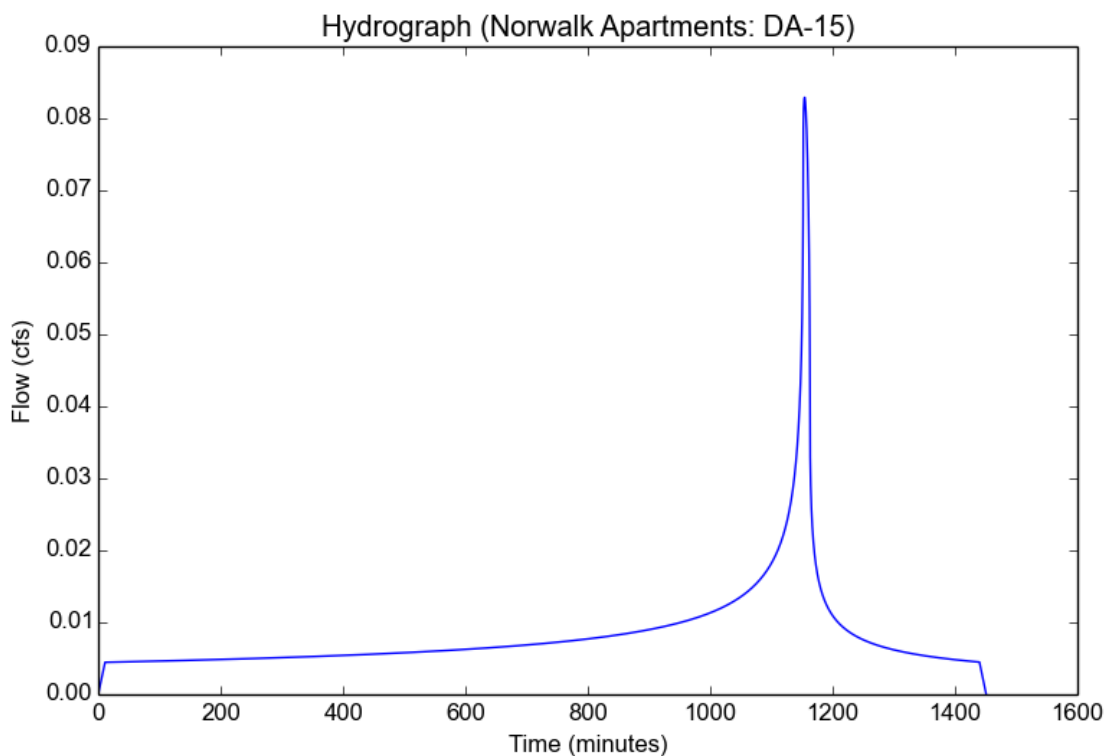

TREATMENT FLOW HYDROLOGIC ANALYSIS

File location: K:/ORA_LDEV/094896004 - Shapell Norwalk Apartments/Reports/Hydrology Hydraulics/Calculations/Hydrocalc/Proposed/Norwalk Apartments
Version: HydroCalc 1.0.3

Input Parameters

Project Name	Norwalk Apartments
Subarea ID	DA-16
Area (ac)	0.45
Flow Path Length (ft)	114.0
Flow Path Slope (vft/hft)	0.015
85th Percentile Rainfall Depth (in)	0.89
Percent Impervious	0.85
Soil Type	6
Design Storm Frequency	85th percentile storm
Fire Factor	0
LID	True

Output Results

Modeled (85th percentile storm) Rainfall Depth (in)	0.89
Peak Intensity (in/hr)	0.3834
Undeveloped Runoff Coefficient (Cu)	0.123
Developed Runoff Coefficient (Cd)	0.7834
Time of Concentration (min)	10.0
Clear Peak Flow Rate (cfs)	0.1352
Burned Peak Flow Rate (cfs)	0.1352
24-Hr Clear Runoff Volume (ac-ft)	0.0258
24-Hr Clear Runoff Volume (cu-ft)	1124.7026

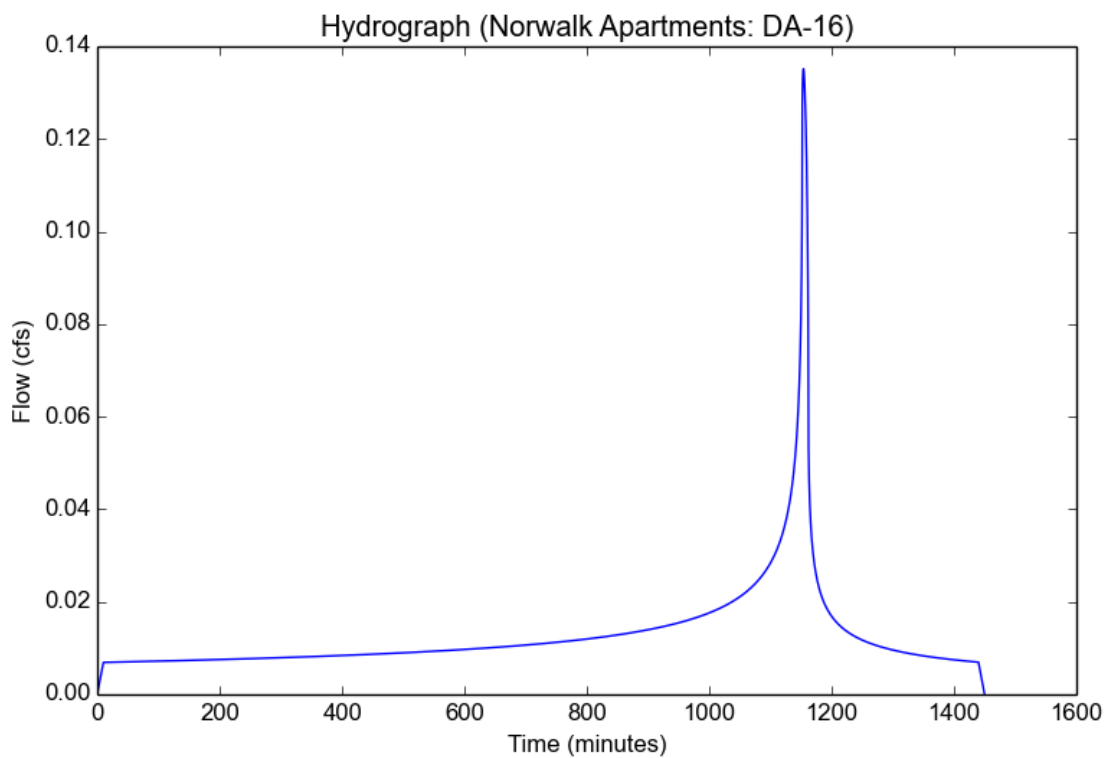

TREATMENT FLOW HYDROLOGIC ANALYSIS

File location: K:/ORA_LDEV/094896004 - Shapell Norwalk Apartments/Reports/Hydrology Hydraulics/Calculations/Hydrocalc/Proposed/Norwalk Apartments
Version: HydroCalc 1.0.3

Input Parameters

Project Name	Norwalk Apartments
Subarea ID	DA-17
Area (ac)	0.25
Flow Path Length (ft)	124.0
Flow Path Slope (vft/hft)	0.005
85th Percentile Rainfall Depth (in)	0.89
Percent Impervious	0.85
Soil Type	6
Design Storm Frequency	85th percentile storm
Fire Factor	0
LID	True

Output Results

Modeled (85th percentile storm) Rainfall Depth (in)	0.89
Peak Intensity (in/hr)	0.3389
Undeveloped Runoff Coefficient (Cu)	0.1
Developed Runoff Coefficient (Cd)	0.78
Time of Concentration (min)	13.0
Clear Peak Flow Rate (cfs)	0.0661
Burned Peak Flow Rate (cfs)	0.0661
24-Hr Clear Runoff Volume (ac-ft)	0.0143
24-Hr Clear Runoff Volume (cu-ft)	624.7813

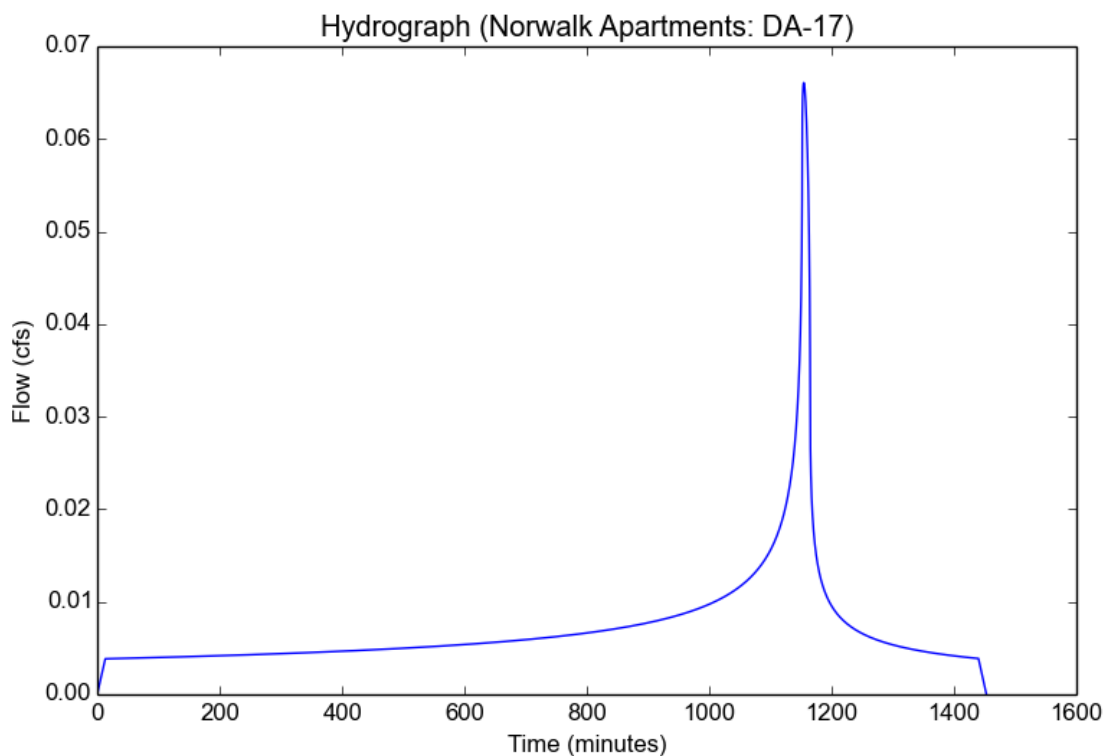

TREATMENT FLOW HYDROLOGIC ANALYSIS

File location: C:/Users/Cameron.Liederman/Desktop/Norwalk Apartments - DA-18.pdf
Version: HydroCalc 1.0.3

Input Parameters

Project Name	Norwalk Apartments
Subarea ID	DA-18
Area (ac)	0.16
Flow Path Length (ft)	83.0
Flow Path Slope (vft/hft)	0.01
85th Percentile Rainfall Depth (in)	0.89
Percent Impervious	0.85
Soil Type	6
Design Storm Frequency	85th percentile storm
Fire Factor	0
LID	True

Output Results

Modeled (85th percentile storm) Rainfall Depth (in)	0.89
Peak Intensity (in/hr)	0.4028
Undeveloped Runoff Coefficient (Cu)	0.1564
Developed Runoff Coefficient (Cd)	0.7885
Time of Concentration (min)	9.0
Clear Peak Flow Rate (cfs)	0.0508
Burned Peak Flow Rate (cfs)	0.0508
24-Hr Clear Runoff Volume (ac-ft)	0.0092
24-Hr Clear Runoff Volume (cu-ft)	399.9769

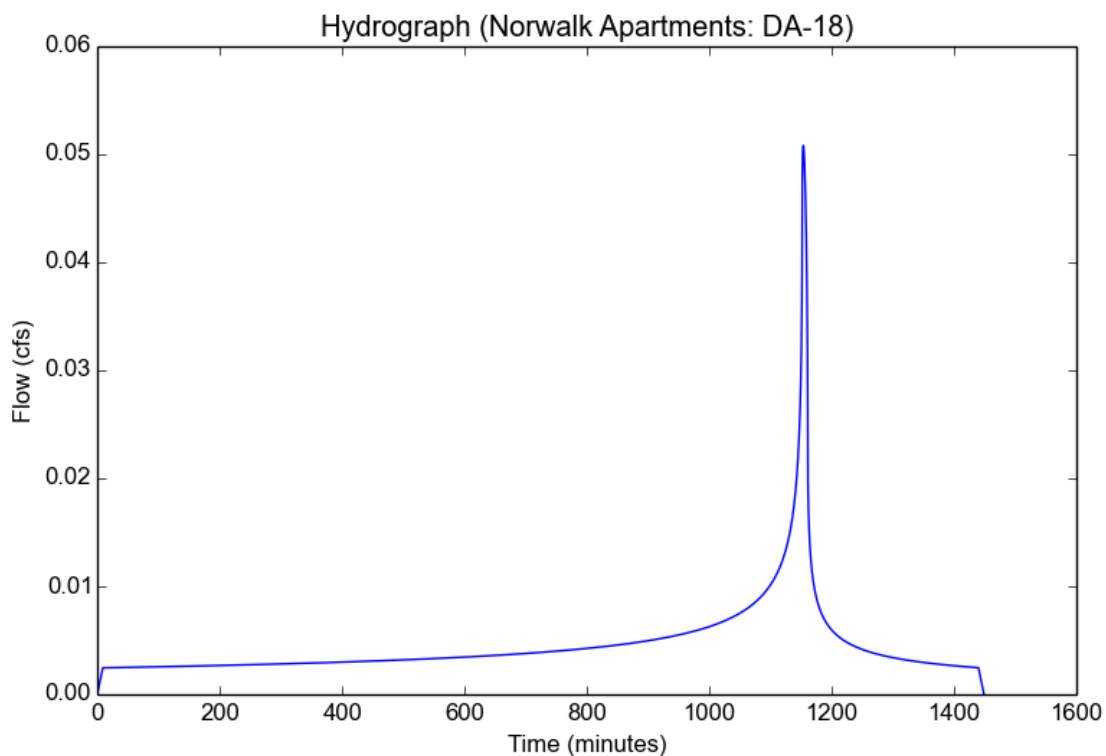

TREATMENT FLOW HYDROLOGIC ANALYSIS

File location: C:/Users/Cameron.Liederman/Desktop/Norwalk Apartments - DA-19.pdf
Version: HydroCalc 1.0.3

Input Parameters

Project Name	Norwalk Apartments
Subarea ID	DA-19
Area (ac)	0.32
Flow Path Length (ft)	140.0
Flow Path Slope (vft/hft)	0.01
85th Percentile Rainfall Depth (in)	0.89
Percent Impervious	0.85
Soil Type	6
Design Storm Frequency	85th percentile storm
Fire Factor	0
LID	True

Output Results

Modeled (85th percentile storm) Rainfall Depth (in)	0.89
Peak Intensity (in/hr)	0.3519
Undeveloped Runoff Coefficient (Cu)	0.1
Developed Runoff Coefficient (Cd)	0.78
Time of Concentration (min)	12.0
Clear Peak Flow Rate (cfs)	0.0878
Burned Peak Flow Rate (cfs)	0.0878
24-Hr Clear Runoff Volume (ac-ft)	0.0184
24-Hr Clear Runoff Volume (cu-ft)	799.7199

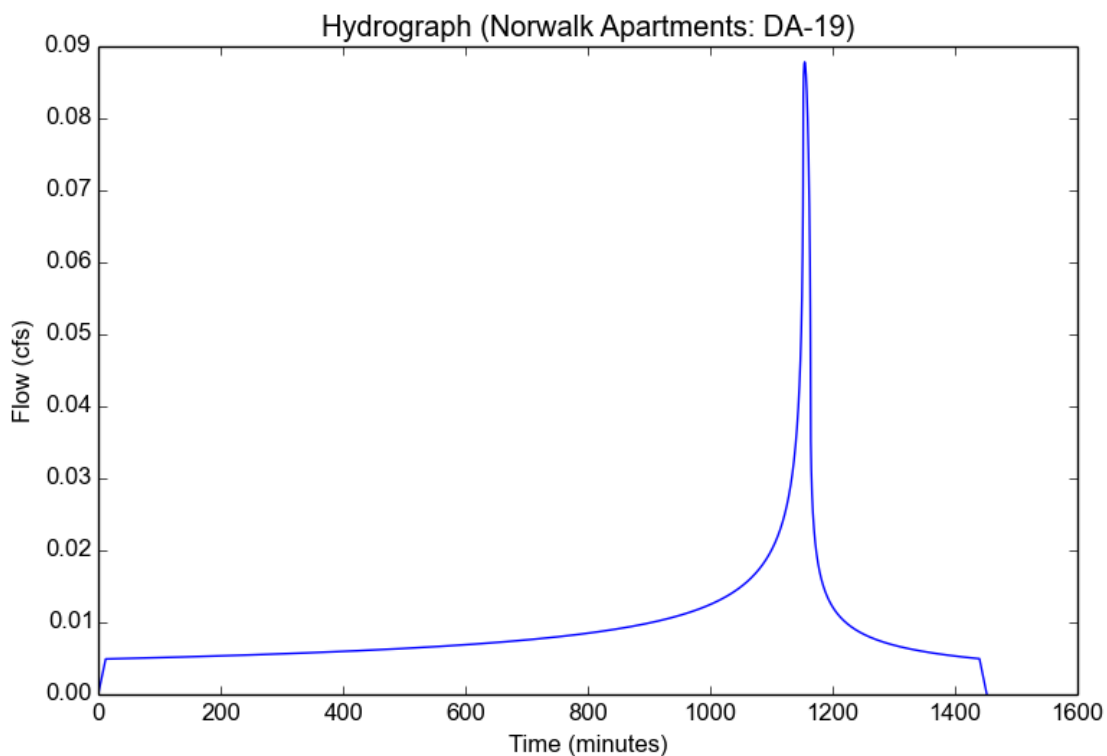

TREATMENT FLOW HYDROLOGIC ANALYSIS

File location: C:/Users/Cameron.Liederman/Desktop/Norwalk Apartments - DA-20.pdf
Version: HydroCalc 1.0.3

Input Parameters

Project Name	Norwalk Apartments
Subarea ID	DA-20
Area (ac)	0.31
Flow Path Length (ft)	140.0
Flow Path Slope (vft/hft)	0.01
85th Percentile Rainfall Depth (in)	0.89
Percent Impervious	0.85
Soil Type	6
Design Storm Frequency	85th percentile storm
Fire Factor	0
LID	True

Output Results

Modeled (85th percentile storm) Rainfall Depth (in)	0.89
Peak Intensity (in/hr)	0.3519
Undeveloped Runoff Coefficient (Cu)	0.1
Developed Runoff Coefficient (Cd)	0.78
Time of Concentration (min)	12.0
Clear Peak Flow Rate (cfs)	0.0851
Burned Peak Flow Rate (cfs)	0.0851
24-Hr Clear Runoff Volume (ac-ft)	0.0178
24-Hr Clear Runoff Volume (cu-ft)	774.7286

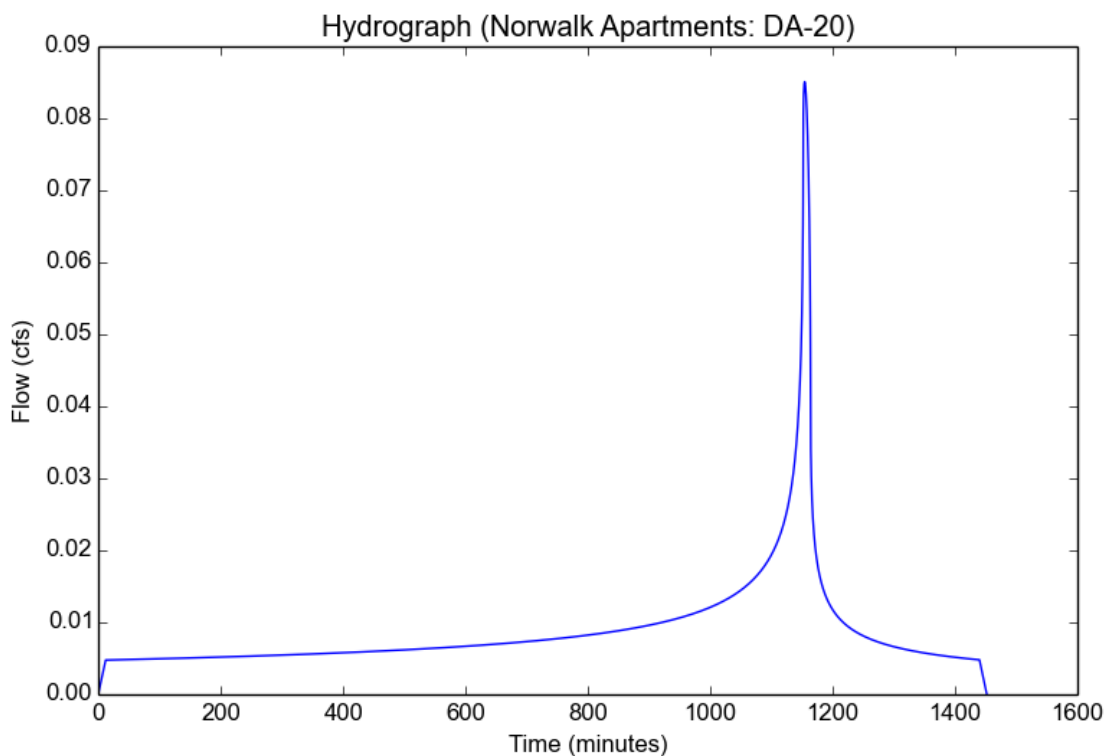

APPENDIX 3

STORMWATER OBSERVATION REPORT FORM

STORMWATER OBSERVATION REPORT FORM

(Residential ≥ 5 units & All other Development)



LOW IMPACT DEVELOPMENT

IN THE EVENT THAT THE APPROVED STORMWATER BMP CANNOT BE BUILT PER PLANS (OR ANY MODIFICATION), CONSULT WITH BUREAU OF SANITATION STAFF PRIOR TO ANY PLAN MODIFICATIONS. FAILURE TO DO SO MAY DELAY OBTAINING A FINAL APPROVAL AND CERTIFICATE OF OCCUPANCY (C OF O).

STORMWATER OBSERVATION means the visual observation of the stormwater related Best Management Practices (BMPs) for conformance with the approved LID Plan at significant construction stages and at completion of the project. Stormwater observation does not include or waive the responsibility for the inspections required by Section 108 or other sections of the City of Los Angeles Building Code.

STORMWATER OBSERVATION must be performed by the engineer or architect responsible for the approved LID Plan or designated staff in their employment. As part of the observation, provide photos of the BMPs taken during various construction phases.

STORMWATER OBSERVATION REPORT must be signed and stamped (see below) by the engineer or architect responsible for the approved LID Plan and submitted to the city prior to the issuance to the certificate of occupancy. PRIOR TO CERTIFICATE OF OCCUPANCY (C of O), SOR FORM, PRINTED PHOTOS OF THE BMPS TAKEN DURING VARIOUS CONSTRUCTION PHASES AND APPROVED STAMPED PLANS BY THE BUREAU OF SANITATION MUST BE SUBMITTED TO THE PUBLIC COUNTER FOR STAFF APPROVAL.

Project Address:	Building Permit No.:
Name of Engineer/Architect responsible for the approved LID Plan:	Phone Number:

List all BMPs installed as part of the project: Coordinates of the most significant (or typical) BMPs:

BMP Type: _____ # of units: _____ Lat: _____ ; Long: _____ <i>Ex: Lat: 34.04152; Long: -118.25962 (5 sig digits)</i>	BMP Type: _____ # of units: _____ Lat: _____ ; Long: _____
BMP Type: _____ # of units: _____ Lat: _____ ; Long: _____	BMP Type: _____ # of units: _____ Lat: _____ ; Long: _____

I DECLARE THAT THE FOLLOWING STATEMENTS ARE TRUE TO THE BEST OF MY KNOWLEDGE:

1. I am the engineer or architect responsible for the approved LID Plan, and;
2. I, or designated staff under my responsible charge, has preformed the required site visits at each significant construction stage and at the completion to verify that the Best Management Practices (BMPs) as shown on approved plans have been constructed and installed in accordance with the approved LID Plan.

Wet Stamp of Engineer or Architect

Signature _____

Date _____

STORMWATER OBSERVATION REPORT FORM

(Residential ≥ 5 units & All other Development)



LOW IMPACT DEVELOPMENT

IN THE EVENT THAT THE APPROVED STORMWATER BMP CANNOT BE BUILT PER PLANS (OR ANY MODIFICATION), CONSULT WITH BUREAU OF SANITATION STAFF PRIOR TO ANY PLAN MODIFICATIONS. FAILURE TO DO SO MAY DELAY OBTAINING A FINAL APPROVAL AND CERTIFICATE OF OCCUPANCY (C OF O).

STORMWATER OBSERVATION means the visual observation of the stormwater related Best Management Practices (BMPs) for conformance with the approved LID Plan at significant construction stages and at completion of the project. Stormwater observation does not include or waive the responsibility for the inspections required by Section 108 or other sections of the City of Los Angeles Building Code.

STORMWATER OBSERVATION must be performed by the engineer or architect responsible for the approved LID Plan or designated staff in their employment. As part of the observation, provide photos of the BMPs taken during various construction phases.

STORMWATER OBSERVATION REPORT must be signed and stamped (see below) by the engineer or architect responsible for the approved LID Plan and submitted to the city prior to the issuance to the certificate of occupancy. PRIOR TO CERTIFICATE OF OCCUPANCY (C of O), SOR FORM, PRINTED PHOTOS OF THE BMPs TAKEN DURING VARIOUS CONSTRUCTION PHASES AND APPROVED STAMPED PLANS BY THE BUREAU OF SANITATION MUST BE SUBMITTED TO THE PUBLIC COUNTER FOR STAFF APPROVAL.

Project Address: 20200 W. Rinaldi St. Porter Ranch, Ca 91326	Building Permit No.: 16010 - 10000 - 05339
Name of Engineer/Architect responsible for the approved LID Plan: Jason Marechal	Phone Number: 714-705-1305

List all BMPs installed as part of the project: Coordinates of the most significant (or typical) BMPs:

BMP Type: <u>CDS UNIT CDS2025-5-C</u> # of units: <u>1</u> Lat: <u>34.27478</u> ; Long: <u>-118.57154</u> <i>Ex: Lat: 34.04152; Long: -118.25962 (5 sig digits)</i>	URBAN GREEN SRPE BMP Type: <u>CISTERN</u> # of units: <u>7</u> Lat: <u>34.27469</u> ; Long: <u>-118.57147</u>
BMP Type: _____ # of units: _____ Lat: _____ ; Long: _____	BMP Type: _____ # of units: _____ Lat: _____ ; Long: _____

I DECLARE THAT THE FOLLOWING STATEMENTS ARE TRUE TO THE BEST OF MY KNOWLEDGE:

1. I am the engineer or architect responsible for the approved LID Plan, and;
2. I, or designated staff under my responsible charge, has preformed the required site visits at each significant construction stage and at the completion to verify that the Best Management Practices (BMPs) as shown on approved plans have been constructed and installed in accordance with the approved LID Plan.

Wet Stamp of Engineer or Architect

Signature Date

APPENDIX 4

MASTER COVENANT AND AGREEMENT

Recording requested by and mail to:

Name: SHAPELL PROPERTIES, INC.

Address: 11200 CORBIN AVE. SUITE 201

PORTER RANCH, CA 91326

***** Space Above This Line For Recorder's Use *****

MASTER COVENANT AND AGREEMENT
REGARDING ON-SITE STORMWATER MITIGATION MEASURES AND MAINTENANCE

I (We), the undersigned, hereby certify that I am (we are) the owner(s) of the hereinafter legally described real property ("Property") located in the City of Los Angeles, County of Los Angeles, State of California (please give the legal description):

LEGAL DESCRIPTION

ASSESSOR'S ID# 7014-013-016 TRACT NO. _____ BLOCK NO. _____ LOT NO _____

Site Address 11522 W Alondra Blvd., Norwalk, CA 90650

In consideration of the City of Los Angeles allowing SHAPELL PROPERTIES, INC. development on said Property, I (we) do hereby covenant and agree to install, operate and maintain in a good operable condition at all times, at my (our) sole cost, all on-site stormwater Best Management Practices (BMPs) per approved plans. The location and type of each BMP feature installed on the Subject Property is identified on the site diagram attached hereto as Exhibit 1. I (we) shall maintain, in accordance with the attached Operation & Maintenance Plan (Attachment 1), the following on-site stormwater BMPs:

- Rain Tank (min 55 gal): # of barrels _____; _____ total gallons, with minimum of _____ Sq. Ft of vegetated landscaping
- Rain Tank / Cistern: # of tanks / cistern _____; _____ total gallons, with minimum of _____ Sq. Ft of vegetated landscaping
- Porous pavement/pavers: _____ Sq. Ft (for incidental rainfall); and / or _____ Sq. Ft. with _____ ft sub base
- Rain Garden (lined): # of rain gardens _____; _____ total Sq. Ft. Dry Well: _____ Cu. Ft.
- Rain Garden (unlined): # of rain gardens _____; _____ total Sq. Ft. Infiltration Trench: _____ Cu. Ft.
- Flow Thru Planter: # of planters _____; _____ total Sq. Ft. Green Roof: _____ Sq. Ft.
- Other: Bio-Filtration (Wetland Mod Unit)

Owner further covenants and agrees that the above-described stormwater device(s) shall not be removed from the Subject Property unless a revised Plan is approved by the Bureau of Sanitation. In the event that any portion of the above-specified on-site stormwater pollution removal device(s) or BMPs is modified, I (we) shall immediately provide the Bureau of Sanitation of the City of Los Angeles with a revised Plan for their approval, and sign and record a Supplemental Covenant and Agreement, specifying all of the on-site stormwater pollution removal device(s) and BMPs, as modified (along with a modified O&M Plan). No Supplemental Covenant and Agreement shall, in any way, limit or diminish my (our) General Maintenance Obligation.

This Master Covenant and Agreement, and all obligations herein, shall run with the Property and shall be binding upon any future owners, encumbrancers, their successors, heirs or assigns and shall continue in effect until the Bureau of Sanitation approves the termination hereof.

Owner further covenants and agrees that if Owner hereafter sells the Subject Property, Owner shall provide printed educational materials to the buyer regarding the stormwater device(s) that are located on the Subject Property, including the type(s) and location(s) of all such devices, and instructions for properly maintaining all such devices.

(Print Name of Property Owner)

(Print Name of Property Owner)

(Signature of Property Owner)

(Signature of Property Owner)

Dated this _____ day of _____ 20____.

Dated this _____ day of _____ 20____.

(PLEASE ATTACH NOTARY ACKNOWLEDGEMENT)

***** Space Below This Line For Bureau Internal Use *****

Permit No. _____

Approved for recording by: Department of Public Works, Bureau of Sanitation

(Print Name) Engineering Associate

(Signature)

Date: _____

Easterly 40 feet of lot 10 and lot 11 of Tract No. 11670, City and County of Los Angeles, California

APPENDIX 5

TREATMENT CONTROL BMP OPERATION AND
MAINTENANCE PLAN SUPPLEMENT



Modular Wetlands[®] Linear

A Stormwater Biofiltration Solution



OVERVIEW

The Modular Wetlands® Linear is the only biofiltration system to utilize patented horizontal flow, allowing for a smaller footprint, higher treatment capacity, and a wide range of adaptability. The Modular Wetlands® is also the only pre-packaged subsurface flow wetland for stormwater treatment. While most biofilters use little or no pretreatment, the Modular Wetlands Linear incorporates an advanced pretreatment chamber that includes separation and pre-filter boxes. In this chamber, sediment and hydrocarbons are removed from runoff before entering the biofiltration chamber, reducing maintenance costs and improving performance.

Horizontal flow also gives the system the unique ability to adapt to the environment through a variety of configurations, bypass orientations, and diversion applications.

The Urban Impact

For hundreds of years, natural wetlands surrounding our shores have played an integral role as nature's stormwater treatment system. But as cities grow and develop, our environment's natural filtration systems are blanketed with impervious roads, rooftops, and parking lots.

Bio Clean understands this loss and has spent years re-establishing nature's presence in urban areas, and rejuvenating waterways with the Modular Wetlands Linear.

*Also known as: Modular Wetlands®, Modular Wetlands® System Linear, Modwet™, or MWS Linear™.

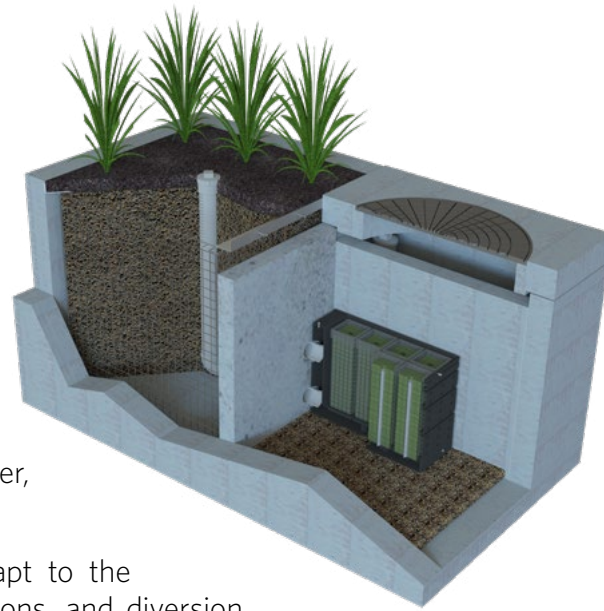

APPROVALS

The Modular Wetlands® Linear has successfully met years of challenging technical reviews and testing from some of the most prestigious and demanding agencies in the nation and perhaps the world. Here is a list of some of the most high-profile approvals, certifications, and verifications from around the country.



Washington State Department of Ecology TAPE Approved

The Modular Wetlands Linear (MWS-Linear) is approved for General Use Level Designation (GULD) for Basic, Enhanced, and Phosphorus treatment at 1 gpm/ft² loading rate. The highest performing BMP on the market for all main pollutant categories.



California Water Resources Control Board, Full Capture Certification

The Modular Wetlands® Linear is the first biofiltration system to receive certification as a full capture trash treatment control device.



Virginia Department of Environmental Quality, Assignment

The Virginia Department of Environmental Quality assigned the Modular Wetlands Linear the highest phosphorus removal rating for manufactured treatment devices to meet the new Virginia Stormwater Management Program (VSMP) regulation technical criteria.



Maryland Department of the Environment, Approved ESD

Granted Environmental Site Design (ESD) status for new construction, redevelopment, and retrofitting when designed in accordance with the design manual.



MASTEP Evaluation

The University of Massachusetts at Amherst - Water Resources Research Center issued a technical evaluation report noting removal rates up to 84% TSS, 70% total phosphorus, 68.5% total zinc, and more.



Rhode Island Department of Environmental Management BMP Approval



Texas Commission on Environmental Quality (TCEQ) Approval



Atlanta Regional Commission Certification

PERFORMANCE

The Modular Wetlands Linear continues to outperform other treatment methods with superior pollutant removal for TSS, heavy metals, nutrients, hydrocarbons, and bacteria. The Modular Wetlands Linear is field-tested on numerous sites across the country and is proven to effectively remove pollutants through a combination of physical, chemical, and biological filtration processes.

66%
REMOVAL
OF
DISSOLVED
ZINC

69%
REMOVAL
OF TOTAL
ZINC

38%
REMOVAL
OF
DISSOLVED
COPPER

85%
REMOVAL
OF TSS

100%
REMOVAL
OF TRASH

45%
REMOVAL
OF
NITROGEN

50%
REMOVAL
OF TOTAL
COPPER

95%
REMOVAL
OF MOTOR
OIL

67%
REMOVAL
OF ORTHO
PHOSPHORUS

64%
REMOVAL
OF TOTAL
PHOSPHORUS

ADVANTAGES

- HORIZONTAL FLOW BIOFILTRATION
- GREATER FILTER SURFACE AREA
- PRETREATMENT CHAMBER
- PATENTED PERIMETER VOID AREA
- FLOW CONTROL
- NO DEPRESSED PLANTER AREA
- AUTO DRAINDOWN MEANS NO MOSQUITO VECTOR

DIAGRAMS

The Modular Wetlands® Linear biofilter supports superior root penetration and plant uptake of metals and nutrients with treatment that includes both aerobic and anaerobic zones.

Modular Wetlands Linear Display Unit - 4x8 Vault Type Unit

Top View

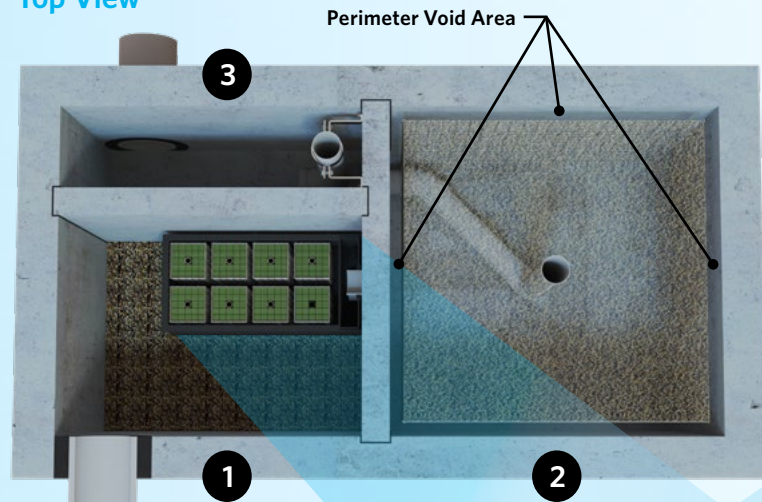

End View



- 1 Pretreatment Chamber
- 2 Biofiltration Chamber
- 3 Discharge Chamber

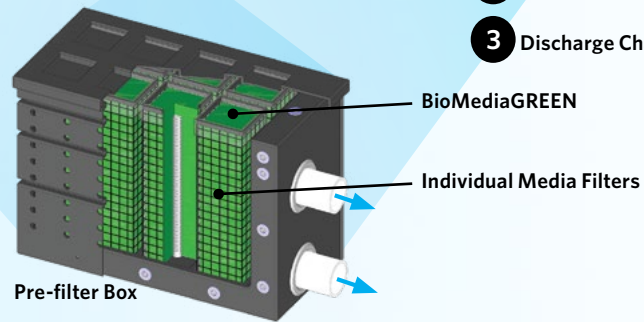

Side Cutaway View



- 1 Pretreatment Chamber
- 2 Biofiltration Chamber

Side Cutaway View

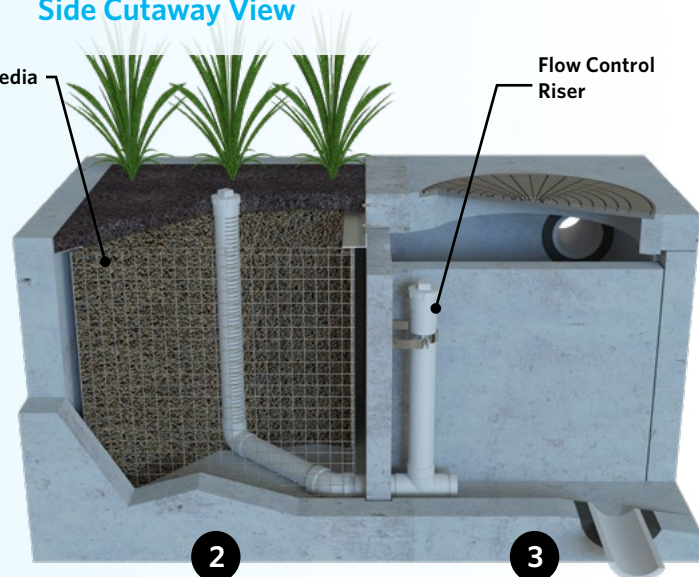

- 2 Biofiltration Chamber
- 3 Discharge Chamber

OPERATION

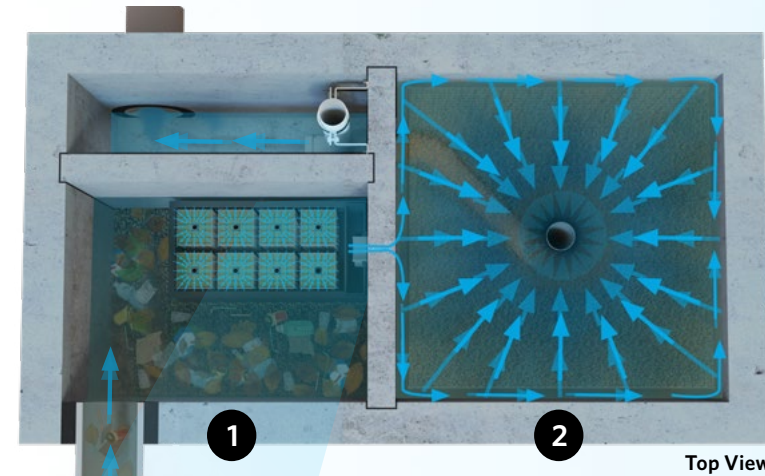

1 Pretreatment

Stormwater and other pollutants all enter the pretreatment chamber first. The larger material remains contained within the pretreatment stage as stormwater travels through the pre-filter boxes and on to the biofiltration chamber. This design enhances treatment, prevents clogging, and expedites the maintenance process.

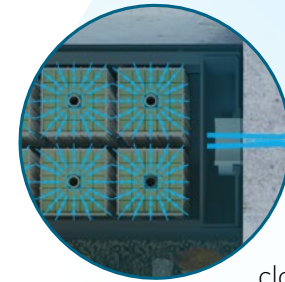

2 Biofiltration

As water leaves the pre-filter box and enters the biofiltration chamber, it initially fills the void space at the perimeter of the biofiltration chamber. The water's horizontal force grows, pushing it inward toward the centrally located vertical drain pipe, and out to discharge.

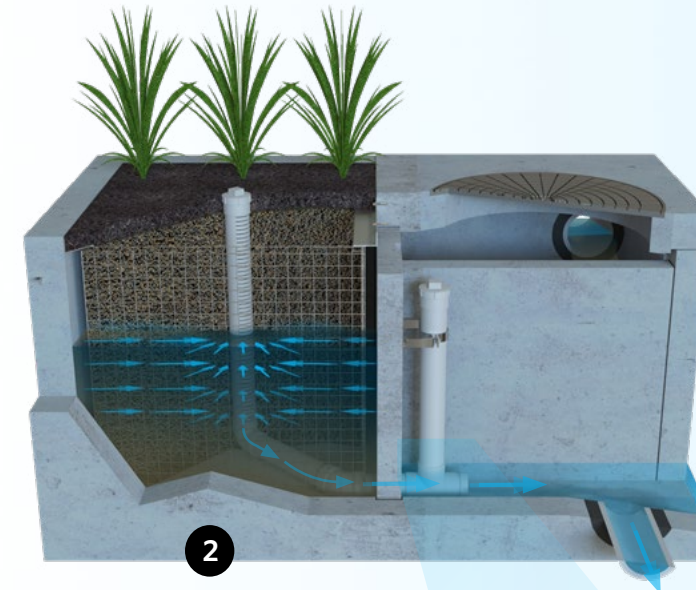
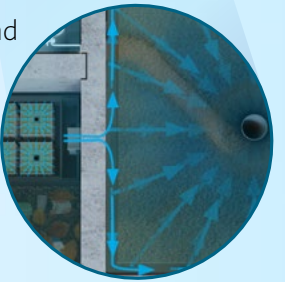

3 Discharge

In the final stage or discharge chamber, the flow control riser (shown in the close-up) and the orifice plate, control the flow of water through the media to a level lower than the media's capacity. This extends the life of the media and improves performance.



4 Bypass

In a side-by-side Modular Wetlands unit, the pretreatment and discharge chambers are adjacent to each other. Another unique advantage of horizontal flow. This allows unusually large flows to bypass the system to avoid flooding.



SIZING CHART

FLOW-BASED DESIGNS

The Modular Wetlands® Linear can be used in stand-alone applications to meet treatment flow requirements, and since it is the only biofiltration system that can accept inflow pipes several feet below the surface, it can be used in decentralized design applications as well as large central end-of-the-line applications.

Model #	Dimensions	WetlandMEDIA Surface Area (sq.ft.)	Treatment Flow Rate (cfs)
TIER 1: EXPRESS MODELS			
Express model options give our customers an opportunity to benefit from optimal lead times, pricing, and the industry's leading MTD.			
MWS-L-4-8	4'x8'	50	0.115
MWS-L-8-8	8'x8'	100	0.230
TIER 2: PREFERRED MODELS			
Preferred model sizes give our customers a dependable selection with favorable lead times and dependable pricing.			
MWS-L-4-4	4'x4'	23	0.052
MWS-L-4-6	4'x6'	32	0.073
MWS-L-4-8	4'x8'	50	0.115
MWS-L-8-8	8'x8'	100	0.230
MWS-L-8-12	8'x12'	151	0.346
MWS-L-8-16	8'x16'	201	0.462
MWS-L-8-20	8'x20'	252	0.577
MWS-L-8-24	8'x24'	302	0.693
TIER 3: CUSTOM			
Custom sizes and applications are always available upon project review, but they may include supplemental lead times and pricing.			

APPLICATIONS



The Modular Wetlands® Linear has been successfully used on numerous new construction and retrofit projects. The system's superior versatility makes it beneficial for a wide range of stormwater and waste water applications.

INDUSTRIAL

The Modular Wetlands has helped various sites meet difficult EPA-mandated effluent limits for dissolved metals and other pollutants.

RESIDENTIAL

Low to high density developments can benefit from the versatile design of the Modular Wetlands. The system can be used in both decentralized LID design and cost-effective end-of-the-line configurations.

STREETS

The Modular Wetlands is extremely space efficient, and adept to meeting special constraints of existing utilities on retrofit projects.

PARKING LOTS

Parking lots are designed to maximize space and the Modular Wetlands' 4 ft. standard planter width allows for easy integration into parking lot islands and other landscape medians.

COMMERCIAL

Compared to bioretention systems, the Modular Wetlands can treat far more area in less space, meeting treatment and volume control requirements.

More applications include:

- Agriculture
- Reuse
- Low Impact Development
- Waste Water
- Mixed Use

HORIZONTAL FLOW ADVANTAGES

VOLUME-BASED DESIGNS



URBANPOND™ PRESTORAGE

In the example above, the Modular Wetlands Linear is installed downstream of the UrbanPond storage system. The Modular Wetlands Linear is designed for the water quality volume and will treat and discharge the required volume within local draindown time requirements.

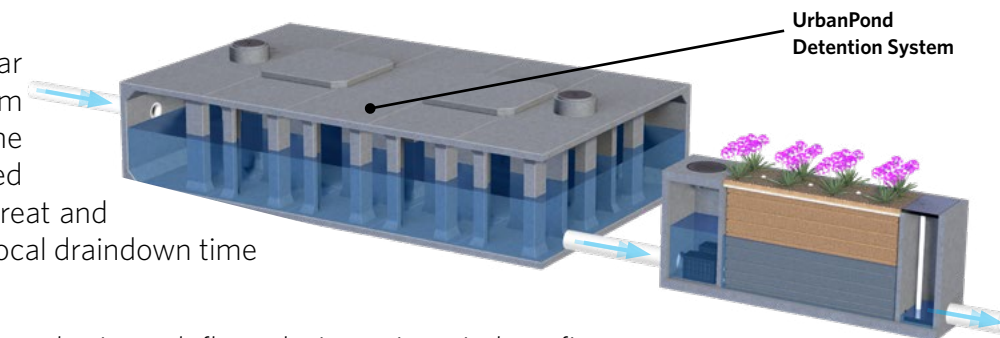

The Modular Wetlands Linear's unique horizontal flow design, gives it benefits no other biofilter has - the ability to be placed downstream of detention ponds, extended dry detention basins, underground storage systems and permeable paver reservoirs. The system's horizontal flow configuration and built-in orifice control allows it to be installed with just 6" of fall between inlet and outlet pipe for a simple connection to projects with shallow downstream tie-in points.

DESIGN SUPPORT

Volume control and hydromodification regulations are expanding the need to decrease the cost and size of your biofiltration system. Bio Clean will help you realize these cost savings with the Modular Wetlands Linear. Bio Clean engineers are aware of state and local regulations, and they are trained to provide you with superior support, so they can optimize a system to maximize feasibility.

ADVANTAGES

- LOWER COST THAN FLOW-BASED DESIGN
- BUILT-IN ORIFICE CONTROL STRUCTURE
- MEETS LID REQUIREMENTS
- WORKS WITH DEEP INSTALLATIONS

CONFIGURATIONS

The Modular Wetlands® Linear is the preferred biofiltration system of civil engineers across the country due to its versatile design. This highly versatile system has available “pipe-in” options on most models, along with built-in curb or grated inlets for simple integration into your storm drain design.

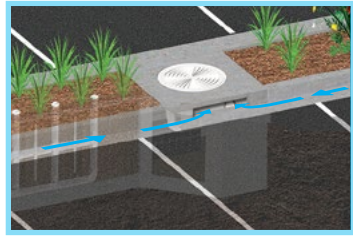

CURB TYPE

The Curb Type configuration accepts sheet flow through a curb opening and is commonly used along roadways and parking lots. It can be used in sump or flow-by conditions. Length of curb opening varies based on model and size.

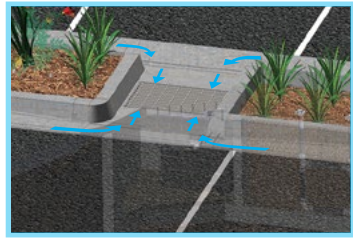

GRATE TYPE

The Grate Type configuration offers the same features and benefits as the Curb Type but with a grated/drop inlet above the system's pretreatment chamber. It has the added benefit of allowing pedestrian access over the inlet. The Grate Type can also be used in scenarios where runoff needs to be intercepted on both sides of landscape islands.

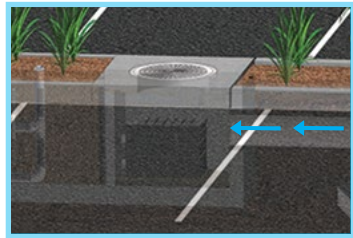

VAULT TYPE

Modular Wetlands® can be used in end-of-the-line installations. This greatly improves feasibility over typical decentralized designs that are required with other biofiltration/bioretention systems. Another benefit of the “pipe-in” design is the ability to install the system downstream of underground detention systems to meet water quality volume requirements, or for traffic-rated designs (no plants).



DOWNSPOUT TYPE

The Downspout Type is a variation of the Vault Type and is designed to accept a vertical downspout pipe from rooftop and podium areas. Some models have the option of utilizing an internal bypass, simplifying the overall design. The system can be installed as a raised planter, and the exterior can be stuccoed or covered with other finishes to match the look of adjacent buildings.

ORIENTATIONS

Side-by-Side (Internal Bypass)

The Side-by-Side orientation places the pretreatment and discharge chamber adjacent to one another with the biofiltration chamber running parallel on either side.



End-to-End

The End-To-End orientation places the pretreatment and discharge chambers on opposite ends of the biofiltration chamber, therefore minimizing the width of the system to 5 ft. (outside dimension).

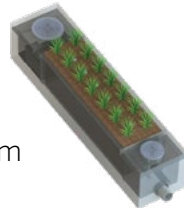

Dvert Low-Flow Diversion

A simple diversion trough can be installed in existing or new curb and grate inlets to divert the first flush to the Modular Wetlands Linear, and then back to the catch basin outlet.

External Diversion Weir Structure

This traditional offline diversion method can be used with the Modular Wetlands® Linear in scenarios where runoff is being piped to the system.

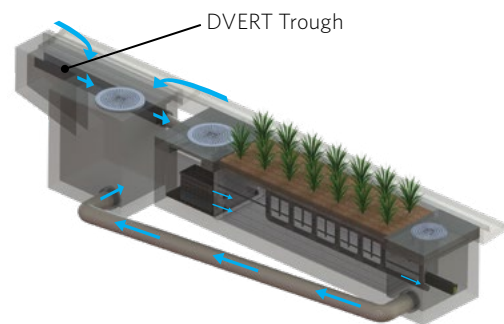

PLANT SELECTION

Abundant plants, trees, and grasses bring value and an aesthetic benefit to any urban setting, but those in the Modular Wetlands® System Linear do even more - they increase pollutant removal. What's not seen, but very important, is that below grade, the stormwater runoff/flow is being subjected to nature's secret weapon: a dynamic physical, chemical, and biological process working to break down and remove non-point source pollutants. The flow rate is controlled in the Modular Wetlands®, giving the plants more contact time so that pollutants are more successfully decomposed, volatilized, and incorporated into the biomass of the Modular Wetlands'® micro/macro flora and fauna.



A wide range of plants are suitable for use in the Modular Wetlands®, but selections vary by location and climate. View suitable plants by visiting biocleanenvironmental.com/plants.

INSTALLATION



The Modular Wetlands® is simple, easy to install, and has a space-efficient design that offers lower excavation and installation costs compared to traditional tree-box type systems. The structure of the system resembles precast catch basin or utility vaults and is installed in a similar fashion.

The system is delivered fully assembled for quick installation. Generally, the structure can be unloaded and set in place in 15 minutes. Our experienced team of field technicians is available to supervise installations and provide technical support.

MAINTENANCE

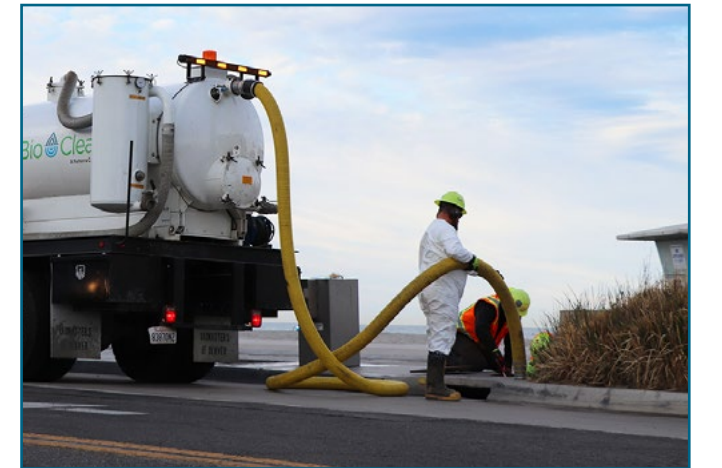

Reduce your maintenance costs, man hours, and materials with the Modular Wetlands®. Unlike other biofiltration systems that provide no pretreatment, the Modular Wetlands® is a self-contained treatment train which incorporates simple and effective pretreatment.

Maintenance requirements for the biofilter itself are almost completely eliminated, as the pretreatment chamber removes and isolates trash, sediments, and hydrocarbons. What's left is the simple maintenance of an easily accessible pretreatment chamber that can be cleaned by hand or with a standard vac truck. Only periodic replacement of low-cost media in the pre-filter cartridges is required for long-term operation, and there is absolutely no need to replace expensive biofiltration media.





Bio  Clean
A Forterra Company

398 Via El Centro
Oceanside, CA 92058
855.566.3938
stormwater@forterrabp.com
biocleanenvironmental.com

SITE SPECIFIC DATA			
PROJECT NUMBER			
PROJECT NAME			
PROJECT LOCATION			
STRUCTURE ID			
TREATMENT REQUIRED			
VOLUME BASED (CF)		FLOW BASED (CFS)	
N/A			
PEAK BYPASS REQUIRED (CFS) – IF APPLICABLE			
PIPE DATA	I.E.	MATERIAL	DIAMETER
INLET PIPE 1			
INLET PIPE 2			
OUTLET PIPE			
	PRETREATMENT	BIOFILTRATION	DISCHARGE
RIM ELEVATION			
SURFACE LOAD			
FRAME & COVER	36" X 36"		N/A
NOTES:			

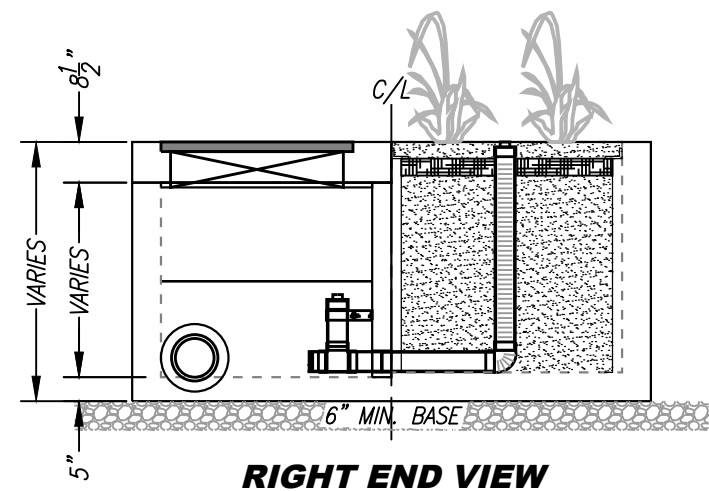
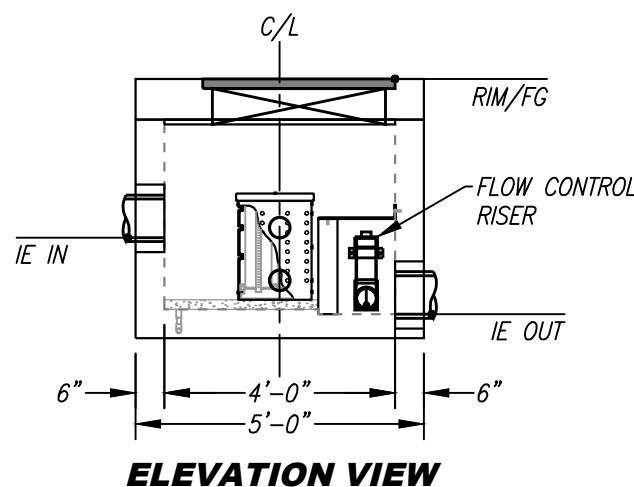
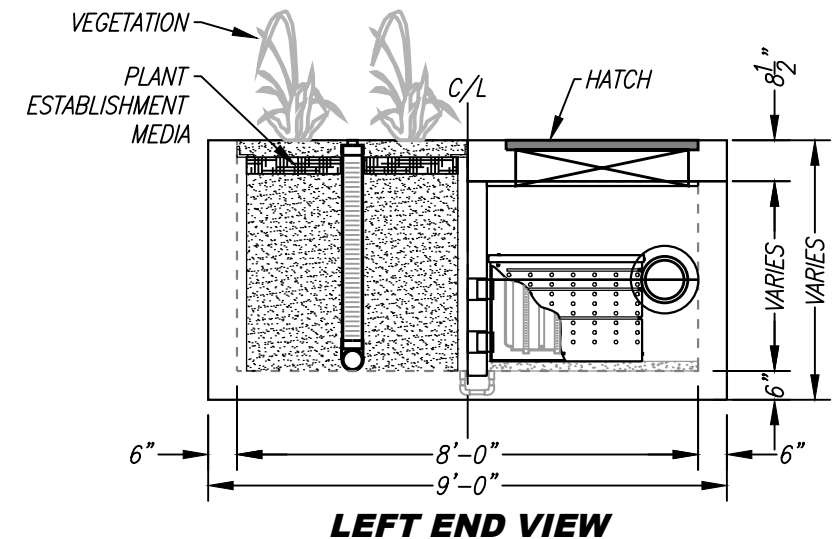
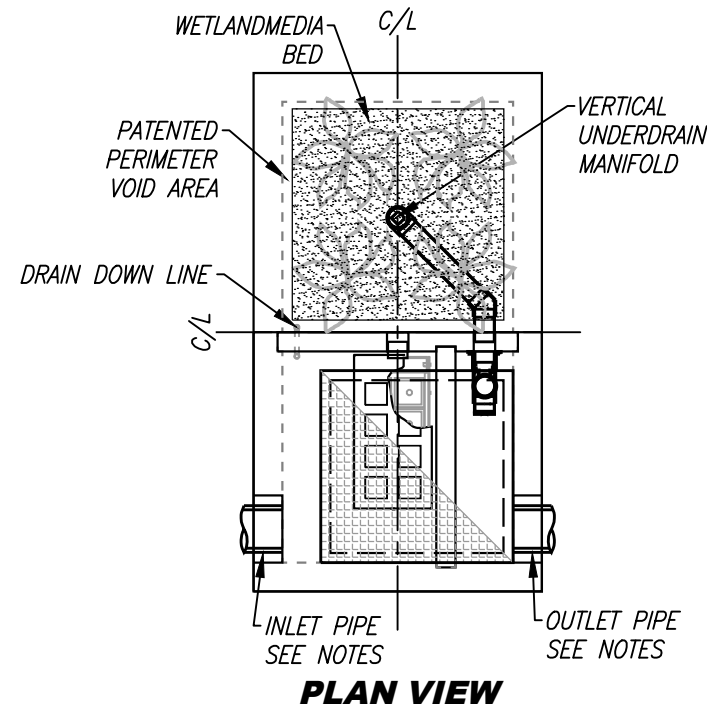

INSTALLATION NOTES

1. CONTRACTOR TO PROVIDE ALL LABOR, EQUIPMENT, MATERIALS AND INCIDENTALS REQUIRED TO OFFLOAD AND INSTALL THE SYSTEM AND APPURTENANCES IN ACCORDANCE WITH THIS DRAWING AND THE MANUFACTURERS SPECIFICATIONS, UNLESS OTHERWISE STATED IN MANUFACTURERS CONTRACT.
2. UNIT MUST BE INSTALLED ON LEVEL BASE. MANUFACTURER RECOMMENDS A MINIMUM 6" LEVEL ROCK BASE UNLESS SPECIFIED BY THE PROJECT ENGINEER. CONTRACTOR IS RESPONSIBLE TO VERIFY PROJECT ENGINEERS RECOMMENDED BASE SPECIFICATIONS.
4. CONTRACTOR TO SUPPLY AND INSTALL ALL EXTERNAL CONNECTING PIPES. ALL PIPES MUST BE FLUSH WITH INSIDE SURFACE OF CONCRETE. (PIPES CANNOT INTRUDE BEYOND FLUSH). INVERT OF OUTFLOW PIPE MUST BE FLUSH WITH DISCHARGE CHAMBER FLOOR. ALL PIPES SHALL BE SEALED WATER TIGHT PER MANUFACTURERS STANDARD CONNECTION DETAIL.
5. CONTRACTOR RESPONSIBLE FOR INSTALLATION OF ALL RISERS, MANHOLES, AND HATCHES. CONTRACTOR TO GROUT ALL MANHOLES AND HATCHES TO MATCH FINISHED SURFACE UNLESS SPECIFIED OTHERWISE.
6. VEGETATION SUPPLIED AND INSTALLED BY OTHERS. ALL UNITS WITH VEGETATION MUST HAVE DRIP OR SPRAY IRRIGATION SUPPLIED AND INSTALLED BY OTHERS.
7. CONTRACTOR RESPONSIBLE FOR CONTACTING BIO CLEAN FOR ACTIVATION OF UNIT. MANUFACTURERS WARRANTY IS VOID WITH OUT PROPER ACTIVATION BY A BIO CLEAN REPRESENTATIVE.

GENERAL NOTES

1. MANUFACTURER TO PROVIDE ALL MATERIALS UNLESS OTHERWISE NOTED.
2. ALL DIMENSIONS, ELEVATIONS, SPECIFICATIONS AND CAPACITIES ARE SUBJECT TO CHANGE. FOR PROJECT SPECIFIC DRAWINGS DETAILING EXACT DIMENSIONS, WEIGHTS AND ACCESSORIES PLEASE CONTACT BIO CLEAN.

TREATMENT FLOW (CFS)	
OPERATING HEAD (FT)	
PRETREATMENT LOADING RATE (GPM/SF)	
WETLAND MEDIA LOADING RATE (GPM/SF)	



PROPRIETARY AND CONFIDENTIAL:
 THE INFORMATION CONTAINED IN THIS DOCUMENT IS THE SOLE PROPERTY OF FORTERRA AND ITS COMPANIES. THIS DOCUMENT, NOR ANY PART THEREOF, MAY BE USED, REPRODUCED OR MODIFIED IN ANY MANNER WITH OUT THE WRITTEN CONSENT OF FORTERRA.



MWS-L-4-8-V
STORMWATER BIOFILTRATION SYSTEM
STANDARD DETAIL

5/23/19TOLF

SITE SPECIFIC DATA			
PROJECT NUMBER			
PROJECT NAME			
PROJECT LOCATION			
STRUCTURE ID			
TREATMENT REQUIRED			
VOLUME BASED (CF)		FLOW BASED (CFS)	
N/A			
PEAK BYPASS REQUIRED (CFS) – IF APPLICABLE			
PIPE DATA	I.E.	MATERIAL	DIAMETER
INLET PIPE 1			
INLET PIPE 2			
OUTLET PIPE			
	PRETREATMENT	BIOFILTRATION	DISCHARGE
RIM ELEVATION			
SURFACE LOAD			
FRAME & COVER	ø30"		ø24"
NOTES:			

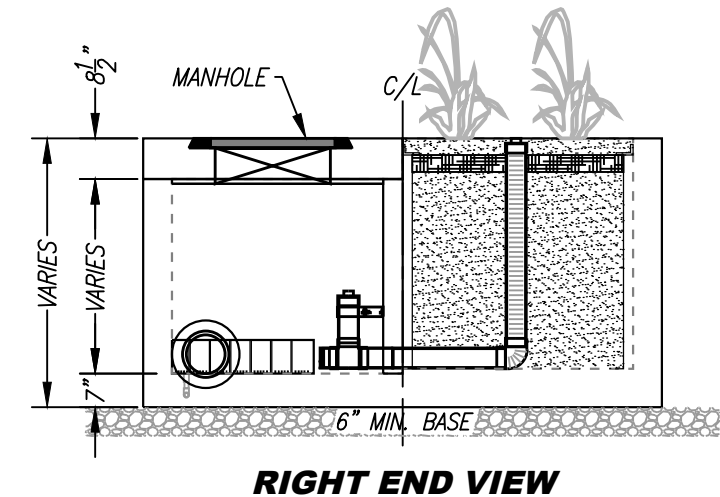
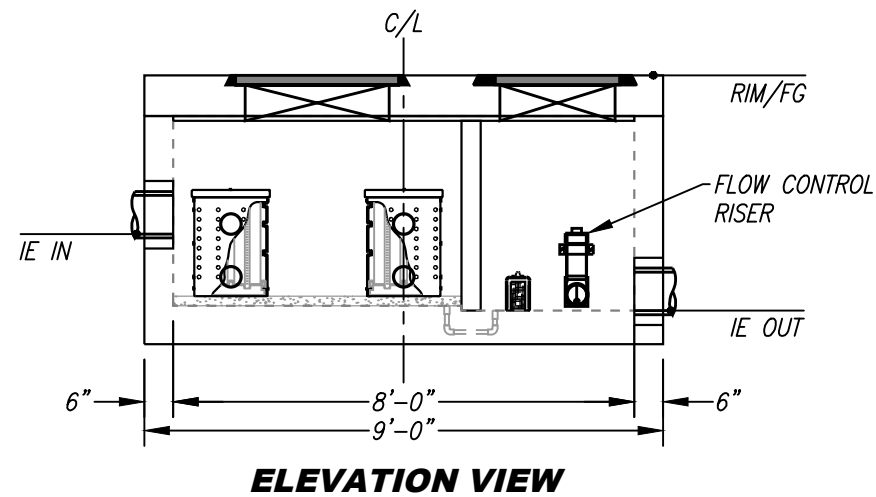
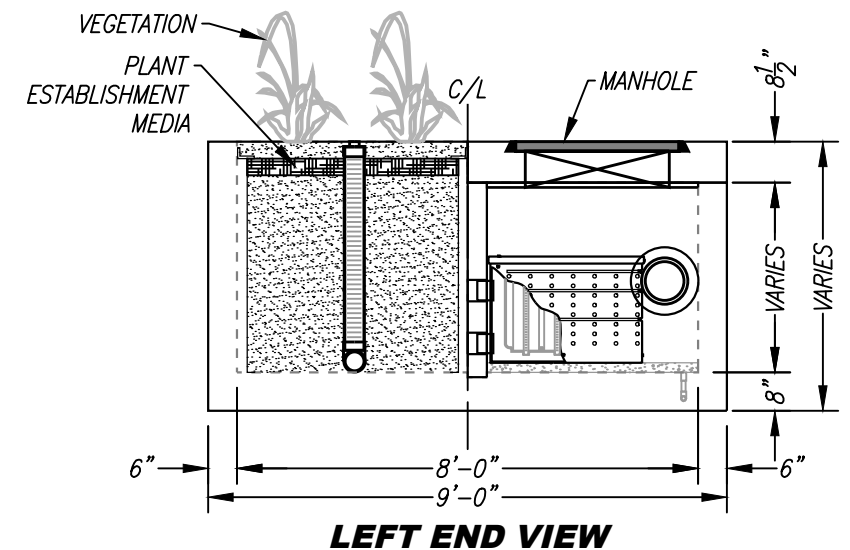
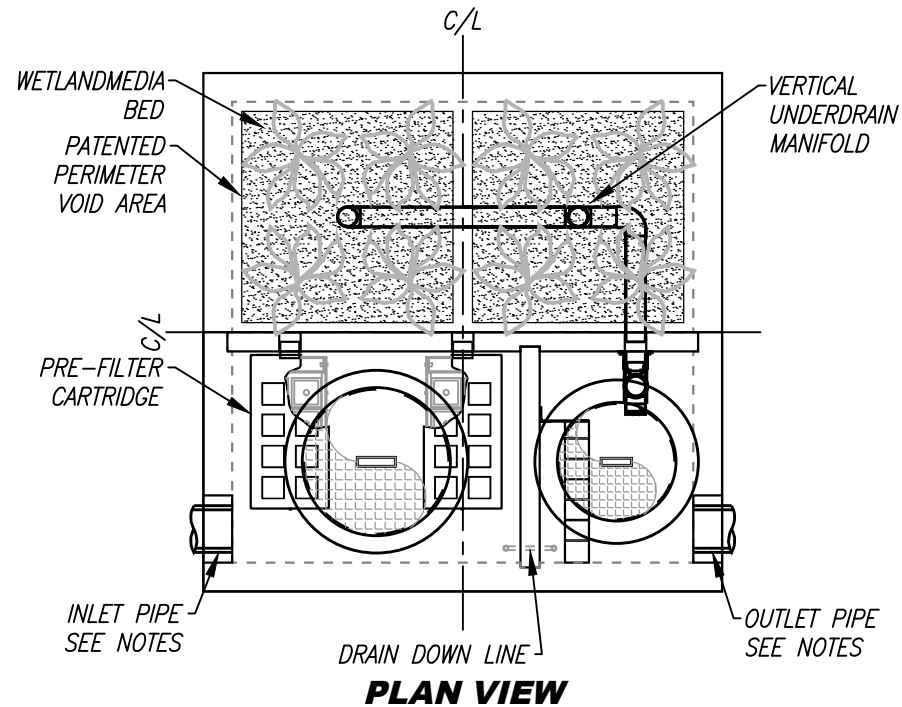

INSTALLATION NOTES

1. CONTRACTOR TO PROVIDE ALL LABOR, EQUIPMENT, MATERIALS AND INCIDENTALS REQUIRED TO OFFLOAD AND INSTALL THE SYSTEM AND APPURTENANCES IN ACCORDANCE WITH THIS DRAWING AND THE MANUFACTURERS SPECIFICATIONS, UNLESS OTHERWISE STATED IN MANUFACTURERS CONTRACT.
2. UNIT MUST BE INSTALLED ON LEVEL BASE. MANUFACTURER RECOMMENDS A MINIMUM 6" LEVEL ROCK BASE UNLESS SPECIFIED BY THE PROJECT ENGINEER. CONTRACTOR IS RESPONSIBLE TO VERIFY PROJECT ENGINEERS RECOMMENDED BASE SPECIFICATIONS.
4. CONTRACTOR TO SUPPLY AND INSTALL ALL EXTERNAL CONNECTING PIPES. ALL PIPES MUST BE FLUSH WITH INSIDE SURFACE OF CONCRETE. (PIPES CANNOT INTRUDE BEYOND FLUSH). INVERT OF OUTFLOW PIPE MUST BE FLUSH WITH DISCHARGE CHAMBER FLOOR. ALL PIPES SHALL BE SEALED WATER TIGHT PER MANUFACTURERS STANDARD CONNECTION DETAIL.
5. CONTRACTOR RESPONSIBLE FOR INSTALLATION OF ALL RISERS, MANHOLES, AND HATCHES. CONTRACTOR TO GROUT ALL MANHOLES AND HATCHES TO MATCH FINISHED SURFACE UNLESS SPECIFIED OTHERWISE.
6. VEGETATION SUPPLIED AND INSTALLED BY OTHERS. ALL UNITS WITH VEGETATION MUST HAVE DRIP OR SPRAY IRRIGATION SUPPLIED AND INSTALLED BY OTHERS.
7. CONTRACTOR RESPONSIBLE FOR CONTACTING BIO CLEAN FOR ACTIVATION OF UNIT. MANUFACTURERS WARRANTY IS VOID WITH OUT PROPER ACTIVATION BY A BIO CLEAN REPRESENTATIVE.

GENERAL NOTES

1. MANUFACTURER TO PROVIDE ALL MATERIALS UNLESS OTHERWISE NOTED.
2. ALL DIMENSIONS, ELEVATIONS, SPECIFICATIONS AND CAPACITIES ARE SUBJECT TO CHANGE. FOR PROJECT SPECIFIC DRAWINGS DETAILING EXACT DIMENSIONS, WEIGHTS AND ACCESSORIES PLEASE CONTACT BIO CLEAN.

TREATMENT FLOW (CFS)	
OPERATING HEAD (FT)	
PRETREATMENT LOADING RATE (GPM/SF)	
WETLAND MEDIA LOADING RATE (GPM/SF)	



PROPRIETARY AND CONFIDENTIAL:
 THE INFORMATION CONTAINED IN THIS DOCUMENT IS THE SOLE PROPERTY OF FORTERRA AND ITS COMPANIES. THIS DOCUMENT, NOR ANY PART THEREOF, MAY BE USED, REPRODUCED OR MODIFIED IN ANY MANNER WITH OUT THE WRITTEN CONSENT OF FORTERRA.



MWS-L-8-8-V
STORMWATER BIOFILTRATION SYSTEM
STANDARD DETAIL

5/23/19TOLF

SITE SPECIFIC DATA			
PROJECT NUMBER			
PROJECT NAME			
PROJECT LOCATION			
STRUCTURE ID			
TREATMENT REQUIRED			
VOLUME BASED (CF)		FLOW BASED (CFS)	
N/A			
PEAK BYPASS REQUIRED (CFS) – IF APPLICABLE			
PIPE DATA	I.E.	MATERIAL	DIAMETER
INLET PIPE 1			
INLET PIPE 2			
OUTLET PIPE			
	PRETREATMENT	BIOFILTRATION	DISCHARGE
RIM ELEVATION			
SURFACE LOAD			
FRAME & COVER	3EA Ø30"		Ø24"
NOTES:			

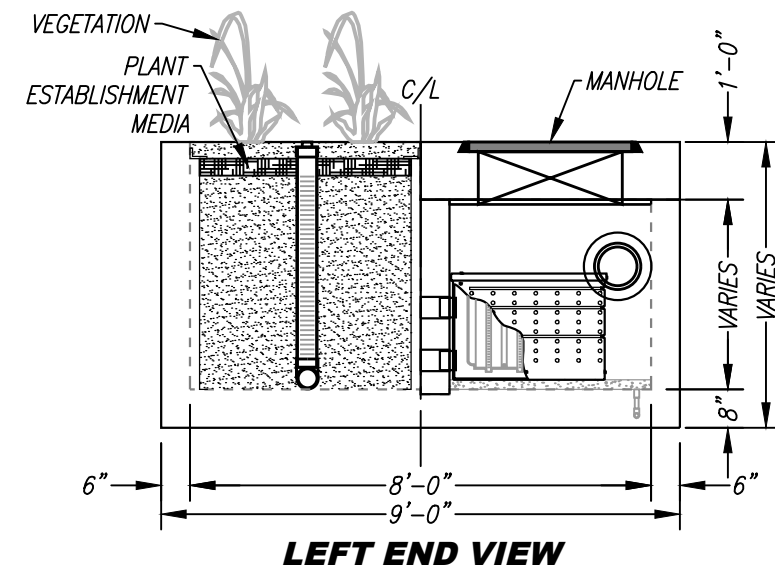
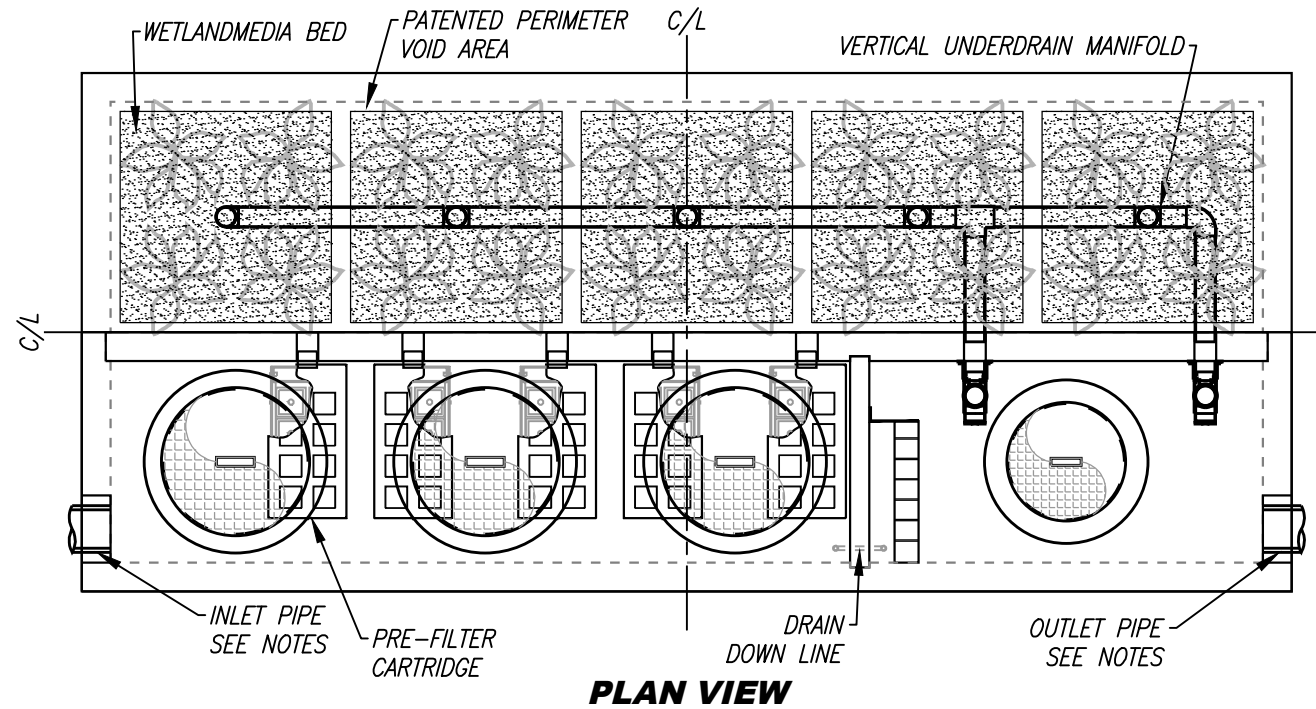

INSTALLATION NOTES

1. CONTRACTOR TO PROVIDE ALL LABOR, EQUIPMENT, MATERIALS AND INCIDENTALS REQUIRED TO OFFLOAD AND INSTALL THE SYSTEM AND APPURTENANCES IN ACCORDANCE WITH THIS DRAWING AND THE MANUFACTURERS SPECIFICATIONS, UNLESS OTHERWISE STATED IN MANUFACTURERS CONTRACT.
2. UNIT MUST BE INSTALLED ON LEVEL BASE. MANUFACTURER RECOMMENDS A MINIMUM 6" LEVEL ROCK BASE UNLESS SPECIFIED BY THE PROJECT ENGINEER. CONTRACTOR IS RESPONSIBLE TO VERIFY PROJECT ENGINEERS RECOMMENDED BASE SPECIFICATIONS.
4. CONTRACTOR TO SUPPLY AND INSTALL ALL EXTERNAL CONNECTING PIPES. ALL PIPES MUST BE FLUSH WITH INSIDE SURFACE OF CONCRETE. (PIPES CANNOT INTRUDE BEYOND FLUSH). INVERT OF OUTFLOW PIPE MUST BE FLUSH WITH DISCHARGE CHAMBER FLOOR. ALL PIPES SHALL BE SEALED WATER TIGHT PER MANUFACTURERS STANDARD CONNECTION DETAIL.
5. CONTRACTOR RESPONSIBLE FOR INSTALLATION OF ALL RISERS, MANHOLES, AND HATCHES. CONTRACTOR TO GROUT ALL MANHOLES AND HATCHES TO MATCH FINISHED SURFACE UNLESS SPECIFIED OTHERWISE.
6. VEGETATION SUPPLIED AND INSTALLED BY OTHERS. ALL UNITS WITH VEGETATION MUST HAVE DRIP OR SPRAY IRRIGATION SUPPLIED AND INSTALLED BY OTHERS.
7. CONTRACTOR RESPONSIBLE FOR CONTACTING BIO CLEAN FOR ACTIVATION OF UNIT. MANUFACTURERS WARRANTY IS VOID WITH OUT PROPER ACTIVATION BY A BIO CLEAN REPRESENTATIVE.

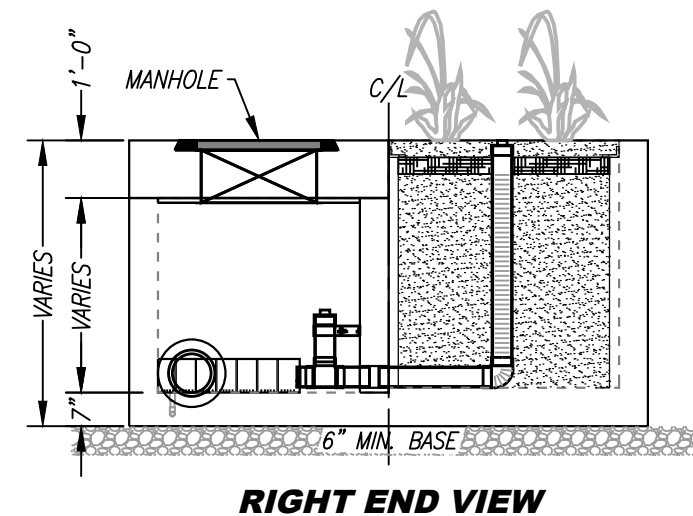
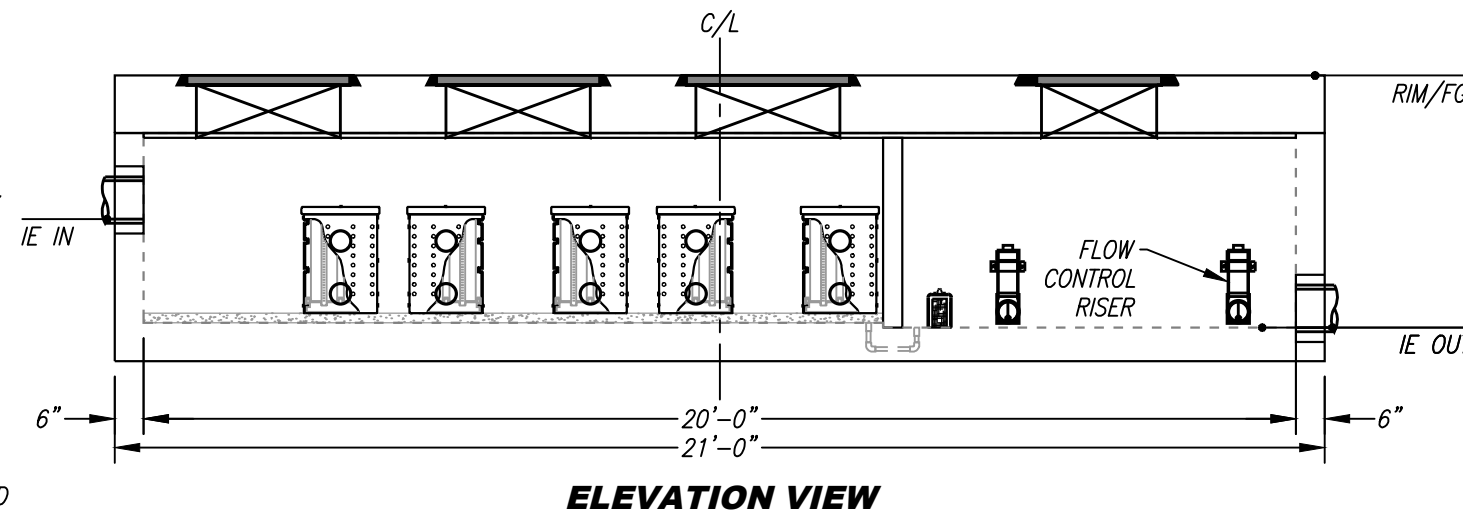

GENERAL NOTES

1. MANUFACTURER TO PROVIDE ALL MATERIALS UNLESS OTHERWISE NOTED.
2. ALL DIMENSIONS, ELEVATIONS, SPECIFICATIONS AND CAPACITIES ARE SUBJECT TO CHANGE. FOR PROJECT SPECIFIC DRAWINGS DETAILING EXACT DIMENSIONS, WEIGHTS AND ACCESSORIES PLEASE CONTACT BIO CLEAN.

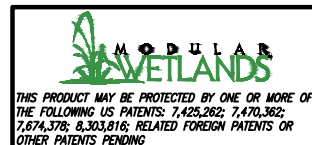

PROPRIETARY AND CONFIDENTIAL:
 THE INFORMATION CONTAINED IN THIS DOCUMENT IS THE SOLE PROPERTY OF FORTERRA AND ITS COMPANIES. THIS DOCUMENT, NOR ANY PART THEREOF, MAY BE USED, REPRODUCED OR MODIFIED IN ANY MANNER WITH OUT THE WRITTEN CONSENT OF FORTERRA.

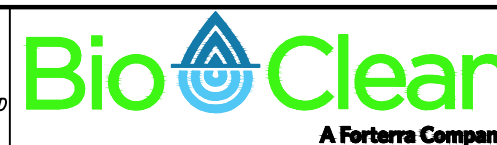

TREATMENT FLOW (CFS)	
OPERATING HEAD (FT)	
PRETREATMENT LOADING RATE (GPM/SF)	
WETLAND MEDIA LOADING RATE (GPM/SF)	

MWS-L-8-20-V
STORMWATER BIOFILTRATION SYSTEM
STANDARD DETAIL

SITE SPECIFIC DATA			
PROJECT NUMBER			
PROJECT NAME			
PROJECT LOCATION			
STRUCTURE ID			
TREATMENT REQUIRED			
VOLUME BASED (CF)		FLOW BASED (CFS)	
N/A			
PEAK BYPASS REQUIRED (CFS) – IF APPLICABLE			
PIPE DATA	I.E.	MATERIAL	DIAMETER
INLET PIPE 1			
INLET PIPE 2			
OUTLET PIPE			
	PRETREATMENT	BIOFILTRATION	DISCHARGE
RIM ELEVATION			
SURFACE LOAD			
FRAME & COVER	2EA ϕ 30"		ϕ 24"
NOTES:			

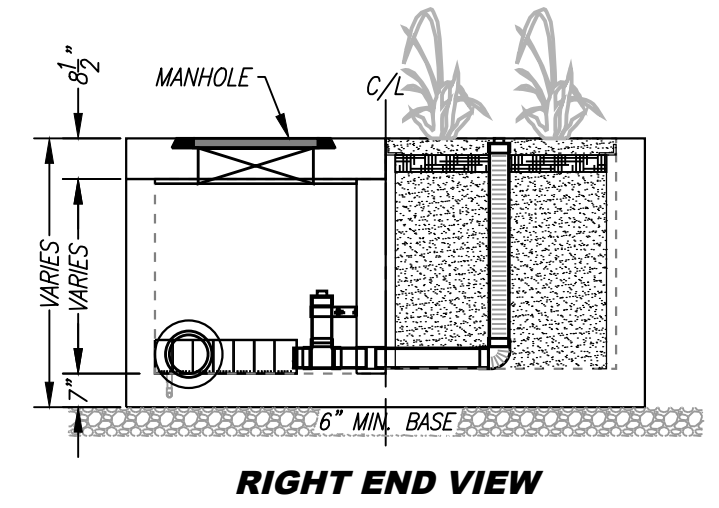
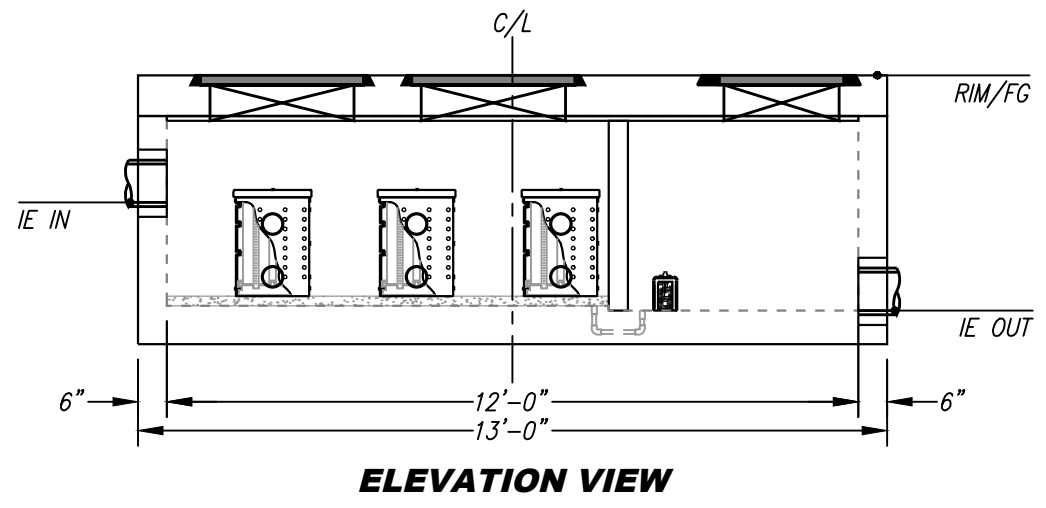
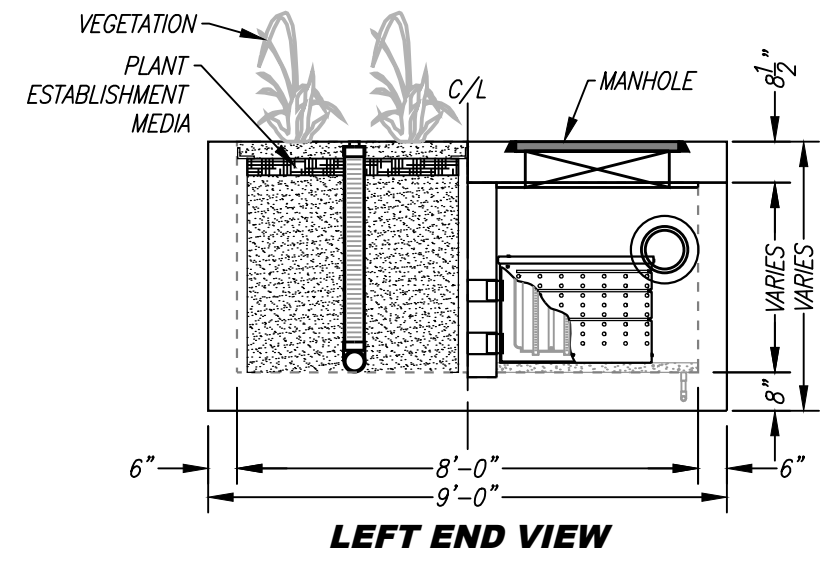
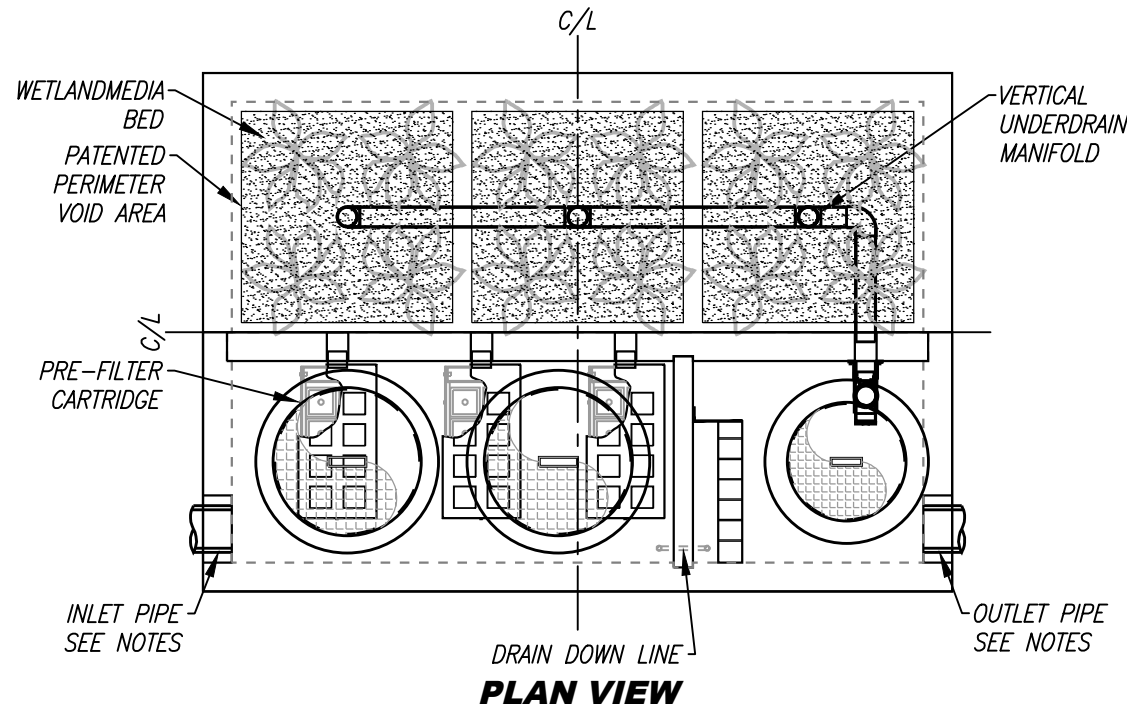

INSTALLATION NOTES

1. CONTRACTOR TO PROVIDE ALL LABOR, EQUIPMENT, MATERIALS AND INCIDENTALS REQUIRED TO OFFLOAD AND INSTALL THE SYSTEM AND APPURTENANCES IN ACCORDANCE WITH THIS DRAWING AND THE MANUFACTURERS SPECIFICATIONS, UNLESS OTHERWISE STATED IN MANUFACTURERS CONTRACT.
2. UNIT MUST BE INSTALLED ON LEVEL BASE. MANUFACTURER RECOMMENDS A MINIMUM 6" LEVEL ROCK BASE UNLESS SPECIFIED BY THE PROJECT ENGINEER. CONTRACTOR IS RESPONSIBLE TO VERIFY PROJECT ENGINEERS RECOMMENDED BASE SPECIFICATIONS.
4. CONTRACTOR TO SUPPLY AND INSTALL ALL EXTERNAL CONNECTING PIPES. ALL PIPES MUST BE FLUSH WITH INSIDE SURFACE OF CONCRETE. (PIPES CANNOT INTRUDE BEYOND FLUSH). INVERT OF OUTFLOW PIPE MUST BE FLUSH WITH DISCHARGE CHAMBER FLOOR. ALL PIPES SHALL BE SEALED WATER TIGHT PER MANUFACTURERS STANDARD CONNECTION DETAIL.
5. CONTRACTOR RESPONSIBLE FOR INSTALLATION OF ALL RISERS, MANHOLES, AND HATCHES. CONTRACTOR TO GROUT ALL MANHOLES AND HATCHES TO MATCH FINISHED SURFACE UNLESS SPECIFIED OTHERWISE.
6. VEGETATION SUPPLIED AND INSTALLED BY OTHERS. ALL UNITS WITH VEGETATION MUST HAVE DRIP OR SPRAY IRRIGATION SUPPLIED AND INSTALLED BY OTHERS.
7. CONTRACTOR RESPONSIBLE FOR CONTACTING BIO CLEAN FOR ACTIVATION OF UNIT. MANUFACTURERS WARRANTY IS VOID WITH OUT PROPER ACTIVATION BY A BIO CLEAN REPRESENTATIVE.

GENERAL NOTES

1. MANUFACTURER TO PROVIDE ALL MATERIALS UNLESS OTHERWISE NOTED.
2. ALL DIMENSIONS, ELEVATIONS, SPECIFICATIONS AND CAPACITIES ARE SUBJECT TO CHANGE. FOR PROJECT SPECIFIC DRAWINGS DETAILING EXACT DIMENSIONS, WEIGHTS AND ACCESSORIES PLEASE CONTACT BIO CLEAN.

TREATMENT FLOW (CFS)	
OPERATING HEAD (FT)	
PRETREATMENT LOADING RATE (GPM/SF)	
WETLAND MEDIA LOADING RATE (GPM/SF)	



PROPRIETARY AND CONFIDENTIAL:
 THE INFORMATION CONTAINED IN THIS DOCUMENT IS THE SOLE PROPERTY OF FORTERRA AND ITS COMPANIES. THIS DOCUMENT, NOR ANY PART THEREOF, MAY BE USED, REPRODUCED OR MODIFIED IN ANY MANNER WITH OUT THE WRITTEN CONSENT OF FORTERRA.



MWS-L-8-12-V
STORMWATER BIOFILTRATION SYSTEM
STANDARD DETAIL

5/23/19TOLF

SITE SPECIFIC DATA			
PROJECT NUMBER			
PROJECT NAME			
PROJECT LOCATION			
STRUCTURE ID			
TREATMENT REQUIRED			
VOLUME BASED (CF)		FLOW BASED (CFS)	
N/A			
PEAK BYPASS REQUIRED (CFS) – IF APPLICABLE			
PIPE DATA	I.E.	MATERIAL	DIAMETER
INLET PIPE 1			
INLET PIPE 2			
OUTLET PIPE			
	PRETREATMENT	BIOFILTRATION	DISCHARGE
RIM ELEVATION			
SURFACE LOAD			
FRAME & COVER	3EA ϕ 30"		2EA ϕ 24"
NOTES:			

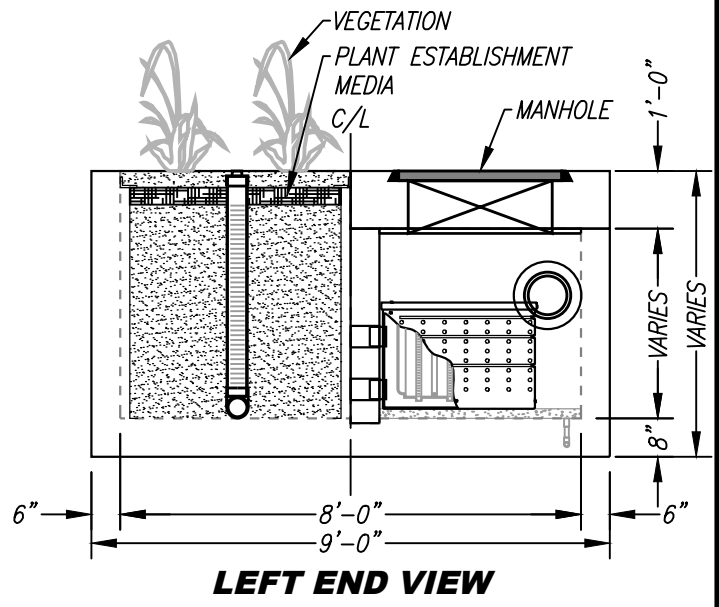
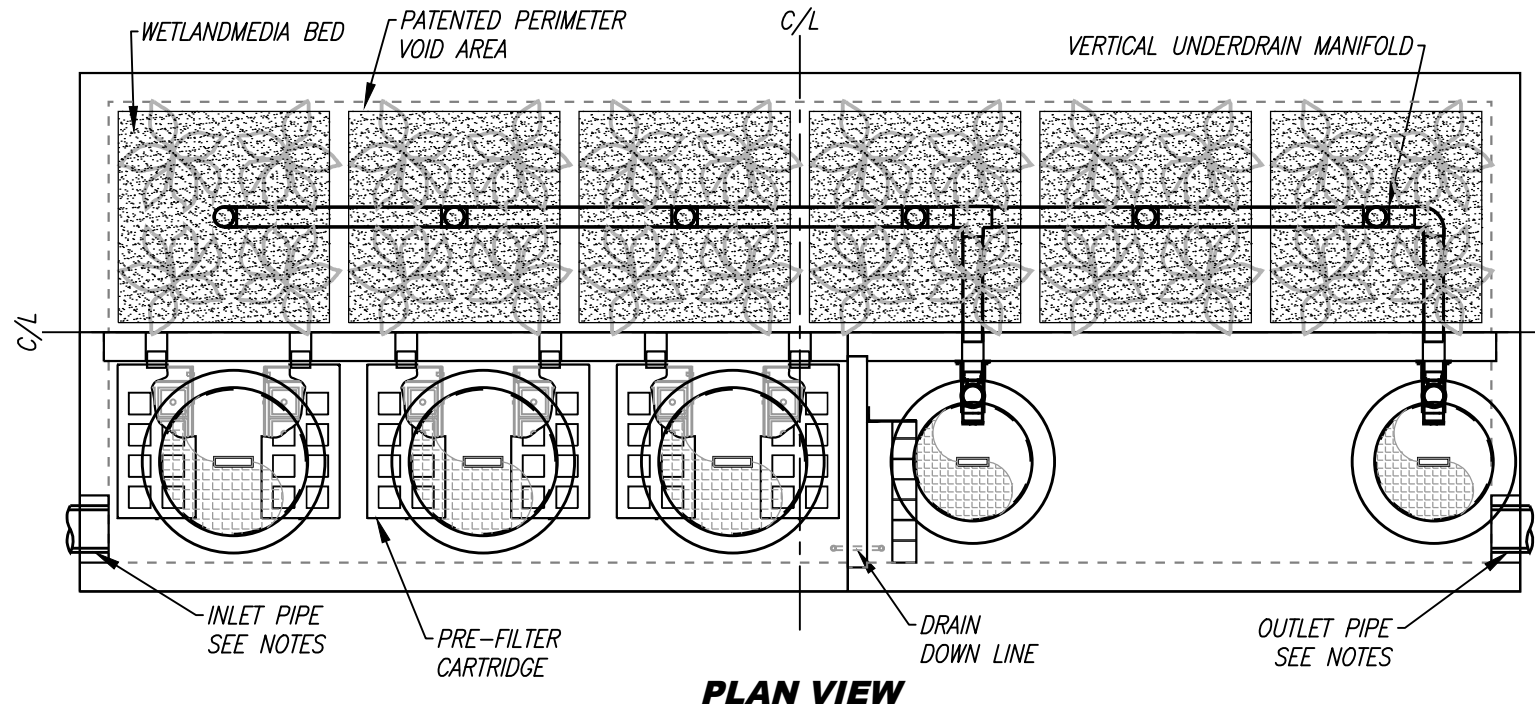

INSTALLATION NOTES

1. CONTRACTOR TO PROVIDE ALL LABOR, EQUIPMENT, MATERIALS AND INCIDENTALS REQUIRED TO OFFLOAD AND INSTALL THE SYSTEM AND APPURTENANCES IN ACCORDANCE WITH THIS DRAWING AND THE MANUFACTURERS SPECIFICATIONS, UNLESS OTHERWISE STATED IN MANUFACTURERS CONTRACT.
2. UNIT MUST BE INSTALLED ON LEVEL BASE. MANUFACTURER RECOMMENDS A MINIMUM 6" LEVEL ROCK BASE UNLESS SPECIFIED BY THE PROJECT ENGINEER. CONTRACTOR IS RESPONSIBLE TO VERIFY PROJECT ENGINEERS RECOMMENDED BASE SPECIFICATIONS.
4. CONTRACTOR TO SUPPLY AND INSTALL ALL EXTERNAL CONNECTING PIPES. ALL PIPES MUST BE FLUSH WITH INSIDE SURFACE OF CONCRETE. (PIPES CANNOT INTRUDE BEYOND FLUSH). INVERT OF OUTFLOW PIPE MUST BE FLUSH WITH DISCHARGE CHAMBER FLOOR. ALL PIPES SHALL BE SEALED WATER TIGHT PER MANUFACTURERS STANDARD CONNECTION DETAIL.
5. CONTRACTOR RESPONSIBLE FOR INSTALLATION OF ALL RISERS, MANHOLES, AND HATCHES. CONTRACTOR TO GROUT ALL MANHOLES AND HATCHES TO MATCH FINISHED SURFACE UNLESS SPECIFIED OTHERWISE.
6. VEGETATION SUPPLIED AND INSTALLED BY OTHERS. ALL UNITS WITH VEGETATION MUST HAVE DRIP OR SPRAY IRRIGATION SUPPLIED AND INSTALLED BY OTHERS.
7. CONTRACTOR RESPONSIBLE FOR CONTACTING BIO CLEAN FOR ACTIVATION OF UNIT. MANUFACTURERS WARRANTY IS VOID WITH OUT PROPER ACTIVATION BY A BIO CLEAN REPRESENTATIVE.

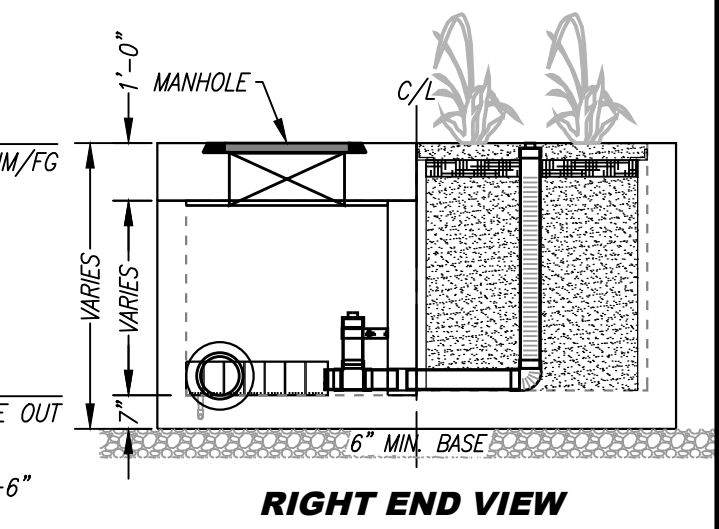
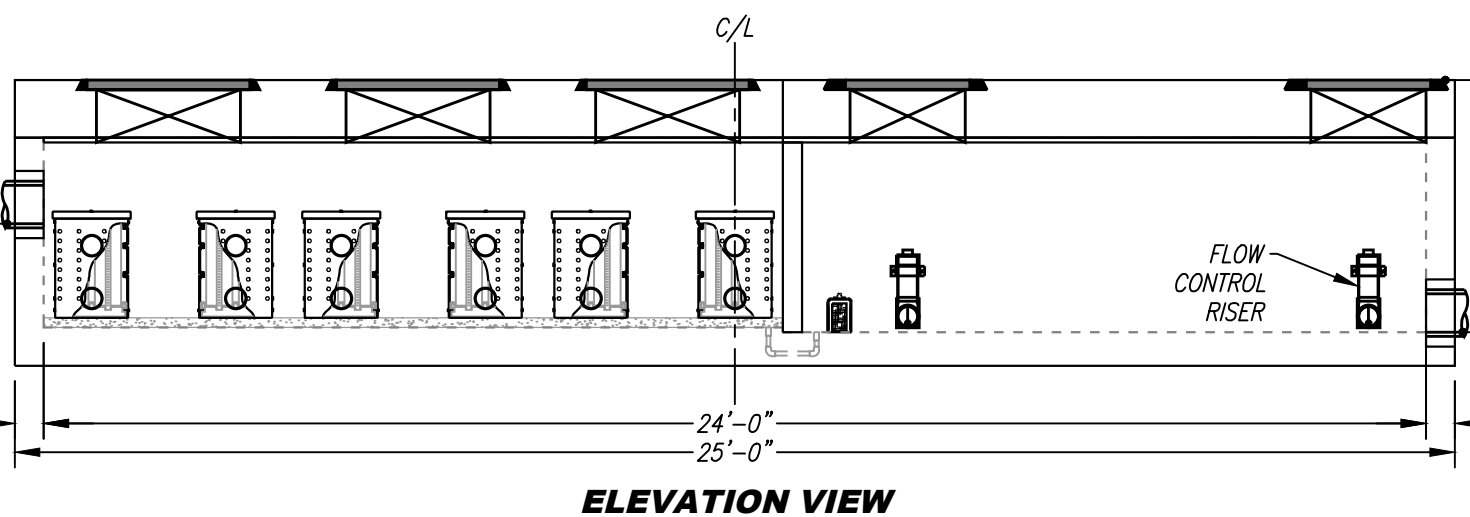

GENERAL NOTES

1. MANUFACTURER TO PROVIDE ALL MATERIALS UNLESS OTHERWISE NOTED.
2. ALL DIMENSIONS, ELEVATIONS, SPECIFICATIONS AND CAPACITIES ARE SUBJECT TO CHANGE. FOR PROJECT SPECIFIC DRAWINGS DETAILING EXACT DIMENSIONS, WEIGHTS AND ACCESSORIES PLEASE CONTACT BIO CLEAN.

TREATMENT FLOW (CFS)	
OPERATING HEAD (FT)	
PRETREATMENT LOADING RATE (GPM/SF)	
WETLAND MEDIA LOADING RATE (GPM/SF)	



PROPRIETARY AND CONFIDENTIAL:
THE INFORMATION CONTAINED IN THIS DOCUMENT IS THE SOLE PROPERTY OF FORTERRA AND ITS COMPANIES. THIS DOCUMENT, NOR ANY PART THEREOF, MAY BE USED, REPRODUCED OR MODIFIED IN ANY MANNER WITH OUT THE WRITTEN CONSENT OF FORTERRA.



MWS-L-8-24-V
STORMWATER BIOFILTRATION SYSTEM
STANDARD DETAIL

5/23/19TOL/EE

SITE SPECIFIC DATA			
PROJECT NUMBER			
ORDER NUMBER			
PROJECT NAME			
PROJECT LOCATION			
STRUCTURE ID			
TREATMENT REQUIRED			
VOLUME BASED (CF)		FLOW BASED (CFS)	
TREATMENT HGL AVAILABLE (FT)			
PEAK BYPASS REQUIRED (CFS) – IF APPLICABLE			
PIPE DATA	I.E.	MATERIAL	DIAMETER
INLET PIPE 1			
INLET PIPE 2			
OUTLET PIPE			
	PRETREATMENT	BIOFILTRATION	DISCHARGE
RIM ELEVATION			
SURFACE LOAD	PEDESTRIAN	OPEN PLANTER	PEDESTRIAN
FRAME & COVER	ø30"	N/A	ø24"
WETLAND MEDIA VOLUME (CY)		TBD	
ORIFICE SIZE (DIA. INCHES)		TBD	
NOTES: PRELIMINARY NOT FOR CONSTRUCTION.			

INSTALLATION NOTES

1. CONTRACTOR TO PROVIDE ALL LABOR, EQUIPMENT, MATERIALS AND INCIDENTALS REQUIRED TO OFFLOAD AND INSTALL THE SYSTEM AND APPURTENANCES IN ACCORDANCE WITH THIS DRAWING AND THE MANUFACTURERS SPECIFICATIONS, UNLESS OTHERWISE STATED IN MANUFACTURERS CONTRACT.
2. UNIT MUST BE INSTALLED ON LEVEL BASE. MANUFACTURER RECOMMENDS A MINIMUM 6" LEVEL ROCK BASE UNLESS SPECIFIED BY THE PROJECT ENGINEER. CONTRACTOR IS RESPONSIBLE TO VERIFY PROJECT ENGINEERS RECOMMENDED BASE SPECIFICATIONS.
4. CONTRACTOR TO SUPPLY AND INSTALL ALL EXTERNAL CONNECTING PIPES. ALL PIPES MUST BE FLUSH WITH INSIDE SURFACE OF CONCRETE. (PIPES CANNOT INTRUDE BEYOND FLUSH). INVERT OF OUTFLOW PIPE MUST BE FLUSH WITH DISCHARGE CHAMBER FLOOR. ALL PIPES SHALL BE SEALED WATER TIGHT PER MANUFACTURERS STANDARD CONNECTION DETAIL.
5. CONTRACTOR RESPONSIBLE FOR INSTALLATION OF ALL RISERS, MANHOLES, AND HATCHES. CONTRACTOR TO GROUT ALL MANHOLES AND HATCHES TO MATCH FINISHED SURFACE UNLESS SPECIFIED OTHERWISE.
6. VEGETATION SUPPLIED AND INSTALLED BY OTHERS. ALL UNITS WITH VEGETATION MUST HAVE DRIP OR SPRAY IRRIGATION SUPPLIED AND INSTALLED BY OTHERS.
7. CONTRACTOR RESPONSIBLE FOR CONTACTING BIO CLEAN FOR ACTIVATION OF UNIT. MANUFACTURERS WARRANTY IS VOID WITH OUT PROPER ACTIVATION BY A BIO CLEAN REPRESENTATIVE.

GENERAL NOTES

1. MANUFACTURER TO PROVIDE ALL MATERIALS UNLESS OTHERWISE NOTED.
2. ALL DIMENSIONS, ELEVATIONS, SPECIFICATIONS AND CAPACITIES ARE SUBJECT TO CHANGE. FOR PROJECT SPECIFIC DRAWINGS DETAILING EXACT DIMENSIONS, WEIGHTS AND ACCESSORIES PLEASE CONTACT BIO CLEAN.

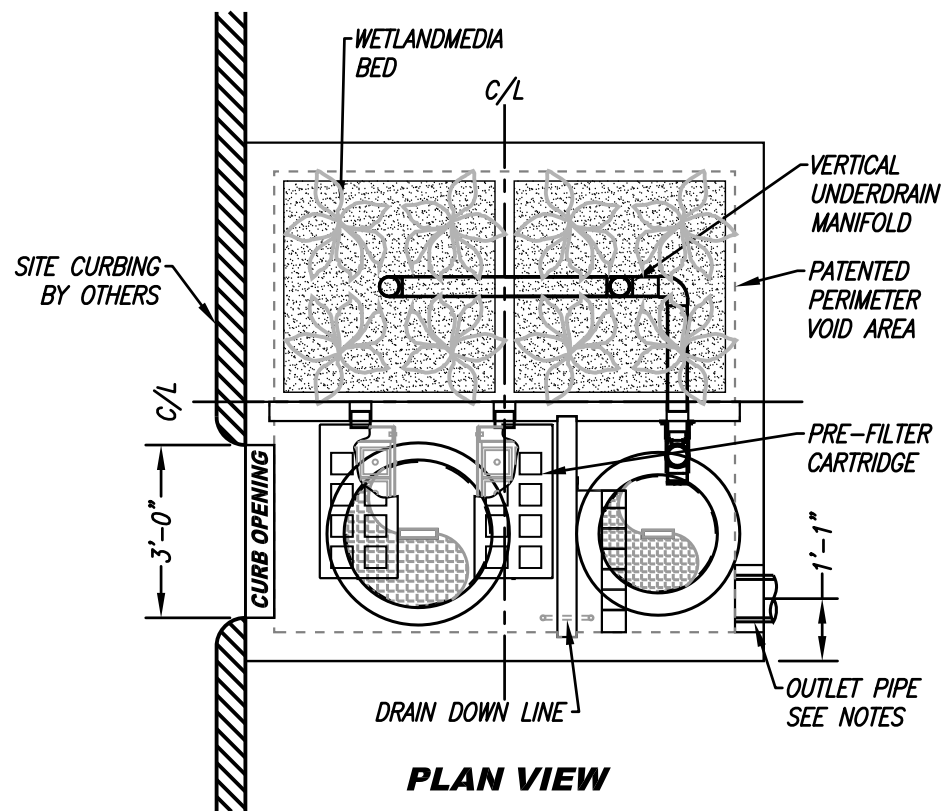

PLAN VIEW

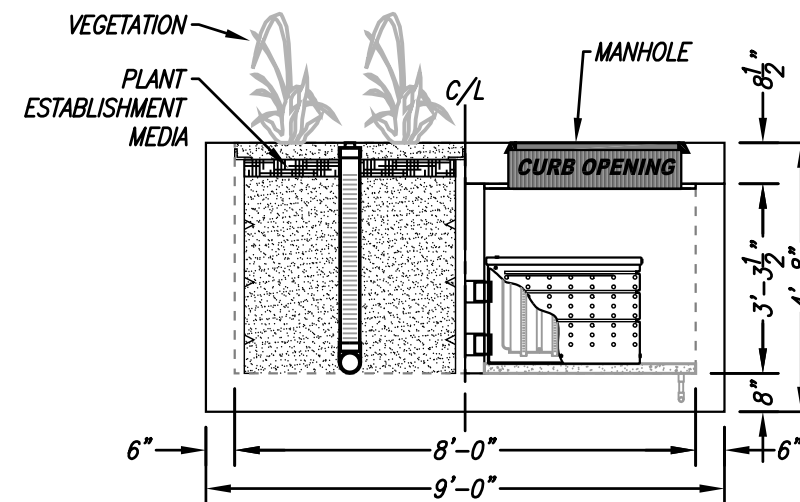

LEFT END VIEW

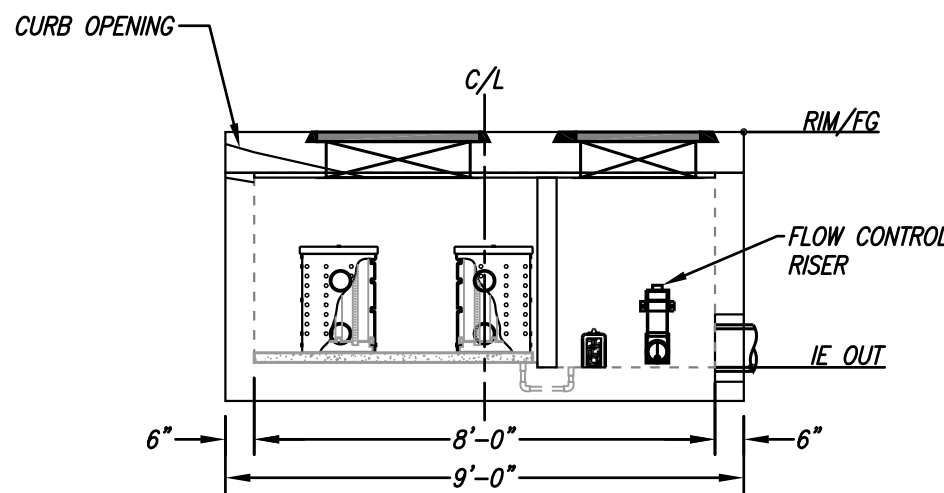

ELEVATION VIEW

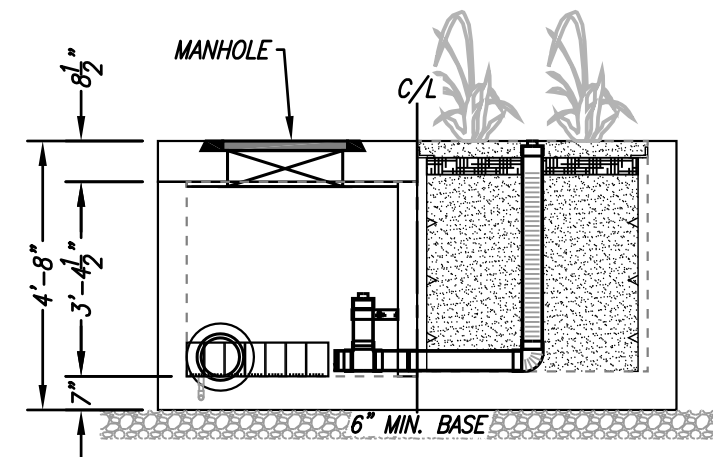

RIGHT END VIEW

TREATMENT FLOW (CFS)	0.231
OPERATING HEAD (FT)	3.4
PRETREATMENT LOADING RATE (GPM/SF)	2.0
WETLAND MEDIA LOADING RATE (GPM/SF)	1.0

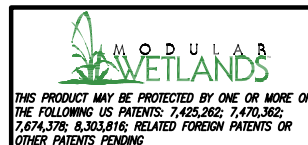

PROPRIETARY AND CONFIDENTIAL:
THE INFORMATION CONTAINED IN THIS DOCUMENT IS THE SOLE PROPERTY OF FORTERRA AND ITS COMPANIES. THIS DOCUMENT, NOR ANY PART THEREOF, MAY BE USED, REPRODUCED OR MODIFIED IN ANY MANNER WITH OUT THE WRITTEN CONSENT OF FORTERRA.

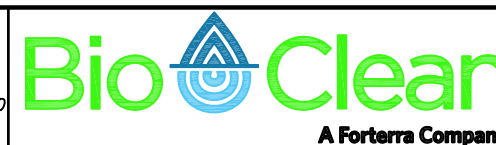

MWS-L-8-8-C
STORMWATER BIOFILTRATION SYSTEM
STANDARD DETAIL

APPENDIX 6

RECORD OF INSPECTION

APPENDIX 7

SOURCE CONTROL BMP FACT SHEETS



Objectives

- Cover
- Contain
- Educate
- Reduce/Minimize
- Product Substitution

Description

Improper storage and handling of solid wastes can allow toxic compounds, oils and greases, heavy metals, nutrients, suspended solids, and other pollutants to enter stormwater runoff. The discharge of pollutants to stormwater from waste handling and disposal can be prevented and reduced by tracking waste generation, storage, and disposal; reducing waste generation and disposal through source reduction, re-use, and recycling; and preventing runoff and runoff.

Approach

Pollution Prevention

- Reduction in the amount of waste generated can be accomplished using the following source controls such as:
 - Production planning and sequencing
 - Process or equipment modification
 - Raw material substitution or elimination
 - Loss prevention and housekeeping
 - Waste segregation and separation
 - Close loop recycling
- Establish a material tracking system to increase awareness about material usage. This may reduce spills and minimize contamination, thus reducing the amount of waste produced.
- Recycle materials whenever possible.

Targeted Constituents

Sediment	<input checked="" type="checkbox"/>
Nutrients	<input checked="" type="checkbox"/>
Trash	<input checked="" type="checkbox"/>
Metals	<input checked="" type="checkbox"/>
Bacteria	<input checked="" type="checkbox"/>
Oil and Grease	<input checked="" type="checkbox"/>
Organics	<input checked="" type="checkbox"/>
Oxygen Demanding	<input checked="" type="checkbox"/>



Suggested Protocols*General*

- Cover storage containers with leak proof lids or some other means. If waste is not in containers, cover all waste piles (plastic tarps are acceptable coverage) and prevent stormwater runoff and runoff with a berm. The waste containers or piles must be covered except when in use.
- Use drip pans or absorbent materials whenever grease containers are emptied by vacuum trucks or other means. Grease cannot be left on the ground. Collected grease must be properly disposed of as garbage.
- Check storage containers weekly for leaks and to ensure that lids are on tightly. Replace any that are leaking, corroded, or otherwise deteriorating.
- Sweep and clean the storage area regularly. If it is paved, do not hose down the area to a storm drain.
- Dispose of rinse and wash water from cleaning waste containers into a sanitary sewer if allowed by the local sewer authority. Do not discharge wash water to the street or storm drain.
- Transfer waste from damaged containers into safe containers.
- Take special care when loading or unloading wastes to minimize losses. Loading systems can be used to minimize spills and fugitive emission losses such as dust or mist. Vacuum transfer systems can minimize waste loss.

Controlling Litter

- Post “No Littering” signs and enforce anti-litter laws.
- Provide a sufficient number of litter receptacles for the facility.
- Clean out and cover litter receptacles frequently to prevent spillage.

Waste Collection

- Keep waste collection areas clean.
- Inspect solid waste containers for structural damage or leaks regularly. Repair or replace damaged containers as necessary.
- Secure solid waste containers; containers must be closed tightly when not in use.
- Place waste containers under cover if possible.
- Do not fill waste containers with washout water or any other liquid.
- Ensure that only appropriate solid wastes are added to the solid waste container. Certain wastes such as hazardous wastes, appliances, fluorescent lamps, pesticides, etc. may not be

disposed of in solid waste containers (see chemical/ hazardous waste collection section below).

- Do not mix wastes; this can cause chemical reactions, make recycling impossible, and complicate disposal.

Good Housekeeping

- Use all of the product before disposing of the container.
- Keep the waste management area clean at all times by sweeping and cleaning up spills immediately.
- Use dry methods when possible (e.g. sweeping, use of absorbents) when cleaning around restaurant/food handling dumpster areas. If water must be used after sweeping/using absorbents, collect water and discharge through grease interceptor to the sewer.
- Stencil storm drains on the facility's property with prohibitive message regarding waste disposal.

Chemical/Hazardous Wastes

- Select designated hazardous waste collection areas on-site.
- Store hazardous materials and wastes in covered containers protected from vandalism, and in compliance with fire and hazardous waste codes.
- Place hazardous waste containers in secondary containment.
- Make sure that hazardous waste is collected, removed, and disposed of only at authorized disposal areas.

Runon/Runoff Prevention

- Prevent stormwater runon from entering the waste management area by enclosing the area or building a berm around the area.
- Prevent the waste materials from directly contacting rain.
- Cover waste piles with temporary covering material such as reinforced tarpaulin, polyethylene, polyurethane, polypropylene or hypalon.
- Cover the area with a permanent roof if feasible.
- Cover dumpsters to prevent rain from washing waste out of holes or cracks in the bottom of the dumpster.
- Move the activity indoor after ensuring all safety concerns such as fire hazard and ventilation are addressed.

Inspection

- Inspect and replace faulty pumps or hoses regularly to minimize the potential of releases and spills.
- Check waste management areas for leaking containers or spills.
- Repair leaking equipment including valves, lines, seals, or pumps promptly.

Training

- Train staff pollution prevention measures and proper disposal methods.
- Train employees and contractors proper spill containment and cleanup. The employee should have the tools and knowledge to immediately begin cleaning up a spill if one should occur.
- Train employees and subcontractors in proper hazardous waste management.

Spill Response and Prevention

- Refer to SC-11, Spill Prevention, Control & Cleanup.
- Keep your Spill Prevention Control and countermeasure (SPCC) plan up-to-date, and implement accordingly.
- Have spill cleanup materials readily available and in a known location.
- Cleanup spills immediately and use dry methods if possible.
- Properly dispose of spill cleanup material.
- Vehicles transporting waste should have spill prevention equipment that can prevent spills during transport. The spill prevention equipment includes:
 - Vehicles equipped with baffles for liquid waste
 - Trucks with sealed gates and spill guards for solid waste

Other Considerations

- Hazardous waste cannot be re-used or recycled; it must be disposed of by a licensed hazardous waste hauler.

Requirements***Costs***

- Capital and operation and maintenance costs will vary substantially depending on the size of the facility and the types of waste handled. Costs should be low if there is an inventory program in place.

Maintenance

- None except for maintaining equipment for material tracking program.

Supplemental Information

Further Detail of the BMP

Land Treatment System

- Minimize the runoff of polluted stormwater from land application of municipal waste on-site by:
 - Choosing a site where slopes are under 6%, the soil is permeable, there is a low water table, it is located away from wetlands or marshes, there is a closed drainage system.
 - Avoiding application of waste to the site when it is raining or when the ground is saturated with water.
 - Growing vegetation on land disposal areas to stabilize soils and reduce the volume of surface water runoff from the site.
 - Maintaining adequate barriers between the land application site and the receiving waters. Planted strips are particularly good.
 - Using erosion control techniques such as mulching and matting, filter fences, straw bales, diversion terracing, and sediment basins.
 - Performing routine maintenance to ensure the erosion control or site stabilization measures are working.

References and Resources

King County Stormwater Pollution Control Manual - <http://dnr.metrokc.gov/wlr/dss/spcm.htm>

Orange County Stormwater Program

http://www.ocwatersheds.com/StormWater/swp_introduction.asp

Pollution from Surface Cleaning Folder. 1996. Bay Area Stormwater Management Agencies Associations (BASMAA). On-line: <http://www.basmaa.org>



Objectives

- Cover
- Contain
- Educate
- Reduce/Minimize
- Product Substitution

Description

Stormwater runoff from building and grounds maintenance activities can be contaminated with toxic hydrocarbons in solvents, fertilizers and pesticides, suspended solids, heavy metals, and abnormal pH. Utilizing the following protocols will prevent or reduce the discharge of pollutants to stormwater from building and grounds maintenance activities by washing and cleaning up with as little water as possible, following good landscape management practices, preventing and cleaning up spills immediately, keeping debris from entering the storm drains, and maintaining the stormwater collection system.

Approach

Pollution Prevention

- Switch to non-toxic chemicals for maintenance when possible.
- Choose cleaning agents that can be recycled.
- Encourage proper lawn management and landscaping, including use of native vegetation.
- Encourage use of Integrated Pest Management techniques for pest control.
- Encourage proper onsite recycling of yard trimmings.
- Recycle residual paints, solvents, lumber, and other material as much as possible.

Targeted Constituents

Sediment	<input checked="" type="checkbox"/>
Nutrients	<input checked="" type="checkbox"/>
Trash	<input checked="" type="checkbox"/>
Metals	<input checked="" type="checkbox"/>
Bacteria	<input checked="" type="checkbox"/>
Oil and Grease	<input checked="" type="checkbox"/>
Organics	<input checked="" type="checkbox"/>
Oxygen Demanding	<input checked="" type="checkbox"/>



SC-41 Building & Grounds Maintenance

Suggested Protocols

Pressure Washing of Buildings, Rooftops, and Other Large Objects

- In situations where soaps or detergents are used and the surrounding area is paved, pressure washers must use a waste water collection device that enables collection of wash water and associated solids. A sump pump, wet vacuum or similarly effective device must be used to collect the runoff and loose materials. The collected runoff and solids must be disposed of properly.
- If soaps or detergents are not used, and the surrounding area is paved, wash water runoff does not have to be collected but must be screened. Pressure washers must use filter fabric or some other type of screen on the ground and/or in the catch basin to trap the particles in wash water runoff.
- If you are pressure washing on a grassed area (with or without soap), runoff must be dispersed as sheet flow as much as possible, rather than as a concentrated stream. The wash runoff must remain on the grass and not drain to pavement. Ensure that this practice does not kill grass.

Landscaping Activities

- Do not apply any chemicals (insecticide, herbicide, or fertilizer) directly to surface waters, unless the application is approved and permitted by the state.
- Dispose of grass clippings, leaves, sticks, or other collected vegetation as garbage, or by composting. Do not dispose of collected vegetation into waterways or storm drainage systems.
- Use mulch or other erosion control measures on exposed soils.
- Check irrigation schedules so pesticides will not be washed away and to minimize non-stormwater discharge.

Building Repair, Remodeling, and Construction

- Do not dump any toxic substance or liquid waste on the pavement, the ground, or toward a storm drain.
- Use ground or drop cloths underneath outdoor painting, scraping, and sandblasting work, and properly dispose of collected material daily.
- Use a ground cloth or oversized tub for activities such as paint mixing and tool cleaning.
- Clean paint brushes and tools covered with water-based paints in sinks connected to sanitary sewers or in portable containers that can be dumped into a sanitary sewer drain. Brushes and tools covered with non-water-based paints, finishes, or other materials must be cleaned in a manner that enables collection of used solvents (e.g., paint thinner, turpentine, etc.) for recycling or proper disposal.

- Use a storm drain cover, filter fabric, or similarly effective runoff control mechanism if dust, grit, wash water, or other pollutants may escape the work area and enter a catch basin. The containment device(s) must be in place at the beginning of the work day, and accumulated dirty runoff and solids must be collected and disposed of before removing the containment device(s) at the end of the work day.
- If you need to de-water an excavation site, you may need to filter the water before discharging to a catch basin or off-site. In which case you should direct the water through hay bales and filter fabric or use other sediment filters or traps.
- Store toxic material under cover with secondary containment during precipitation events and when not in use. A cover would include tarps or other temporary cover material.

Mowing, Trimming, and Planting

- Dispose of leaves, sticks, or other collected vegetation as garbage, by composting or at a permitted landfill. Do not dispose of collected vegetation into waterways or storm drainage systems.
- Use mulch or other erosion control measures when soils are exposed.
- Place temporarily stockpiled material away from watercourses and drain inlets, and berm or cover stockpiles to prevent material releases to the storm drain system.
- Consider an alternative approach when bailing out muddy water; do not put it in the storm drain, pour over landscaped areas.
- Use hand or mechanical weeding where practical.

Fertilizer and Pesticide Management

- Follow all federal, state, and local laws and regulations governing the use, storage, and disposal of fertilizers and pesticides and training of applicators and pest control advisors.
- Follow manufacturers' recommendations and label directions. Pesticides must never be applied if precipitation is occurring or predicted. Do not apply insecticides within 100 feet of surface waters such as lakes, ponds, wetlands, and streams.
- Use less toxic pesticides that will do the job, whenever possible. Avoid use of copper-based pesticides if possible.
- Do not use pesticides if rain is expected.
- Do not mix or prepare pesticides for application near storm drains.
- Use the minimum amount needed for the job.
- Calibrate fertilizer distributors to avoid excessive application.
- Employ techniques to minimize off-target application (e.g. spray drift) of pesticides, including consideration of alternative application techniques.

SC-41 Building & Grounds Maintenance

- Apply pesticides only when wind speeds are low.
- Work fertilizers into the soil rather than dumping or broadcasting them onto the surface.
- Irrigate slowly to prevent runoff and then only as much as is needed.
- Clean pavement and sidewalk if fertilizer is spilled on these surfaces before applying irrigation water.
- Dispose of empty pesticide containers according to the instructions on the container label.
- Use up the pesticides. Rinse containers, and use rinse water as product. Dispose of unused pesticide as hazardous waste.
- Implement storage requirements for pesticide products with guidance from the local fire department and County Agricultural Commissioner. Provide secondary containment for pesticides.

Inspection

- Inspect irrigation system periodically to ensure that the right amount of water is being applied and that excessive runoff is not occurring. Minimize excess watering, and repair leaks in the irrigation system as soon as they are observed.

Training

- Educate and train employees on use of pesticides and in pesticide application techniques to prevent pollution.
- Train employees and contractors in proper techniques for spill containment and cleanup.
- Be sure the frequency of training takes into account the complexity of the operations and the nature of the staff.

Spill Response and Prevention

- Refer to SC-11, Spill Prevention, Control & Cleanup
- Keep your Spill Prevention Control and countermeasure (SPCC) plan up-to-date, and implement accordingly.
- Have spill cleanup materials readily available and in a known location.
- Cleanup spills immediately and use dry methods if possible.
- Properly dispose of spill cleanup material.

Other Considerations

- Alternative pest/weed controls may not be available, suitable, or effective in many cases.

Requirements

Costs

- Overall costs should be low in comparison to other BMPs.

Maintenance

- Sweep paved areas regularly to collect loose particles, and wipe up spills with rags and other absorbent material immediately, do not hose down the area to a storm drain.

Supplemental Information

Further Detail of the BMP

Fire Sprinkler Line Flushing

Building fire sprinkler line flushing may be a source of non-stormwater runoff pollution. The water entering the system is usually potable water though in some areas it may be non-potable reclaimed wastewater. There are subsequent factors that may drastically reduce the quality of the water in such systems. Black iron pipe is usually used since it is cheaper than potable piping but it is subject to rusting and results in lower quality water. Initially the black iron pipe has an oil coating to protect it from rusting between manufacture and installation; this will contaminate the water from the first flush but not from subsequent flushes. Nitrates, poly-phosphates and other corrosion inhibitors, as well as fire suppressants and antifreeze may be added to the sprinkler water system. Water generally remains in the sprinkler system a long time, typically a year, between flushes and may accumulate iron, manganese, lead, copper, nickel and zinc. The water generally becomes anoxic and contains living and dead bacteria and breakdown products from chlorination. This may result in a significant BOD problem and the water often smells. Consequently dispose fire sprinkler line flush water into the sanitary sewer. Do not allow discharge to storm drain or infiltration due to potential high levels of pollutants in fire sprinkler line water.

References and Resources

California's Nonpoint Source Program Plan <http://www.swrcb.ca.gov/nps/index.html>

King County - <ftp://dnr.metrokc.gov/wlr/dss/spcm/Chapter%203.PDF>

Orange County Stormwater Program

http://www.ocwatersheds.com/StormWater/swp_introduction.asp

Mobile Cleaners Pilot Program: Final Report. 1997. Bay Area Stormwater Management Agencies Association (BASSMA) <http://www.basmaa.org/>

Pollution from Surface Cleaning Folder. 1996. Bay Area Stormwater Management Agencies Association (BASMAA) <http://www.basmaa.org/>

San Diego Stormwater Co-permittees Jurisdictional Urban Runoff Management Program (URMP) -

<http://www.projectcleanwater.org/pdf/Model%20Program%20Municipal%20Facilities.pdf>

Parking/Storage Area Maintenance SC-43



Description

Parking lots and storage areas can contribute a number of substances, such as trash, suspended solids, hydrocarbons, oil and grease, and heavy metals that can enter receiving waters through stormwater runoff or non-stormwater discharges. The following protocols are intended to prevent or reduce the discharge of pollutants from parking/storage areas and include using good housekeeping practices, following appropriate cleaning BMPs, and training employees.

Approach

Pollution Prevention

- Encourage alternative designs and maintenance strategies for impervious parking lots. (See New Development and Redevelopment BMP Handbook).
- Keep accurate maintenance logs to evaluate BMP implementation.

Suggested Protocols

General

- Keep the parking and storage areas clean and orderly. Remove debris in a timely fashion.
- Allow sheet runoff to flow into biofilters (vegetated strip and swale) and/or infiltration devices.
- Utilize sand filters or oleophilic collectors for oily waste in low concentrations.

Objectives

- Cover
- Contain
- Educate
- Reduce/Minimize
- Product Substitution

Targeted Constituents

Sediment	<input checked="" type="checkbox"/>
Nutrients	<input checked="" type="checkbox"/>
Trash	<input checked="" type="checkbox"/>
Metals	<input checked="" type="checkbox"/>
Bacteria	<input checked="" type="checkbox"/>
Oil and Grease	<input checked="" type="checkbox"/>
Organics	<input checked="" type="checkbox"/>
Oxygen Demanding	<input checked="" type="checkbox"/>



SC-43 Parking/Storage Area Maintenance

- Arrange rooftop drains to prevent drainage directly onto paved surfaces.
- Design lot to include semi-permeable hardscape.

Controlling Litter

- Post “No Littering” signs and enforce anti-litter laws.
- Provide an adequate number of litter receptacles.
- Clean out and cover litter receptacles frequently to prevent spillage.
- Provide trash receptacles in parking lots to discourage litter.
- Routinely sweep, shovel and dispose of litter in the trash.

Surface cleaning

- Use dry cleaning methods (e.g. sweeping or vacuuming) to prevent the discharge of pollutants into the stormwater conveyance system.
- Establish frequency of public parking lot sweeping based on usage and field observations of waste accumulation.
- Sweep all parking lots at least once before the onset of the wet season.
- If water is used follow the procedures below:
 - Block the storm drain or contain runoff.
 - Wash water should be collected and pumped to the sanitary sewer or discharged to a pervious surface, do not allow wash water to enter storm drains.
 - Dispose of parking lot sweeping debris and dirt at a landfill.
- When cleaning heavy oily deposits:
 - Use absorbent materials on oily spots prior to sweeping or washing.
 - Dispose of used absorbents appropriately.

Surface Repair

- Pre-heat, transfer or load hot bituminous material away from storm drain inlets.
- Apply concrete, asphalt, and seal coat during dry weather to prevent contamination from contacting stormwater runoff.
- Cover and seal nearby storm drain inlets (with waterproof material or mesh) and manholes before applying seal coat, slurry seal, etc., where applicable. Leave covers in place until job is complete and until all water from emulsified oil sealants has drained or evaporated. Clean any debris from these covered manholes and drains for proper disposal.

Parking/Storage Area Maintenance SC-43

- Use only as much water as necessary for dust control, to avoid runoff.
- Catch drips from paving equipment that is not in use with pans or absorbent material placed under the machines. Dispose of collected material and absorbents properly.

Inspection

- Have designated personnel conduct inspections of the parking facilities and stormwater conveyance systems associated with them on a regular basis.
- Inspect cleaning equipment/sweepers for leaks on a regular basis.

Training

- Provide regular training to field employees and/or contractors regarding cleaning of paved areas and proper operation of equipment.
- Train employees and contractors in proper techniques for spill containment and cleanup.

Spill Response and Prevention

- Refer to SC-11, Spill Prevention, Control & Cleanup.
- Keep your Spill Prevention Control and countermeasure (SPCC) plan up-to-date, and implement accordingly.
- Have spill cleanup materials readily available and in a known location.
- Cleanup spills immediately and use dry methods if possible.
- Properly dispose of spill cleanup material.

Other Considerations

- Limitations related to sweeping activities at large parking facilities may include high equipment costs, the need for sweeper operator training, and the inability of current sweeper technology to remove oil and grease.

Requirements

Costs

Cleaning/sweeping costs can be quite large, construction and maintenance of stormwater structural controls can be quite expensive as well.

Maintenance

- Sweep parking lot to minimize cleaning with water.
- Clean out oil/water/sand separators regularly, especially after heavy storms.
- Clean parking facilities on a regular basis to prevent accumulated wastes and pollutants from being discharged into conveyance systems during rainy conditions.

SC-43 Parking/Storage Area Maintenance

Supplemental Information

Further Detail of the BMP

Surface Repair

Apply concrete, asphalt, and seal coat during dry weather to prevent contamination from contacting stormwater runoff. Where applicable, cover and seal nearby storm drain inlets (with waterproof material or mesh) and manholes before applying seal coat, slurry seal, etc. Leave covers in place until job is complete and until all water from emulsified oil sealants has drained or evaporated. Clean any debris from these covered manholes and drains for proper disposal. Use only as much water as necessary for dust control, to avoid runoff.

References and Resources

<http://www.stormwatercenter.net/>

California's Nonpoint Source Program Plan <http://www.swrcb.ca.gov/nps/index.html>

Model Urban Runoff Program: A How-To Guide for Developing Urban Runoff Programs for Small Municipalities. Prepared by City of Monterey, City of Santa Cruz, California Coastal Commission, Monterey Bay National Marine Sanctuary, Association of Monterey Bay Area Governments, Woodward-Clyde, Central Coast Regional Water Quality Control Board. July 1998 (Revised February 2002 by the California Coastal Commission).

Orange County Stormwater Program

http://www.ocwatersheds.com/StormWater/swp_introduction.asp

Oregon Association of Clean Water Agencies. Oregon Municipal Stormwater Toolbox for Maintenance Practices. June 1998.

Pollution from Surface Cleaning Folder. 1996. Bay Area Stormwater Management Agencies Association (BASMAA) <http://www.basma.org>

San Diego Stormwater Co-permittees Jurisdictional Urban Runoff Management Program (URMP)

<http://www.projectcleanwater.org/pdf/Model%20Program%20Municipal%20Facilities.pdf>



Objectives

- Cover
- Contain
- Educate
- Reduce/Minimize

Description

As a consequence of its function, the stormwater conveyance system collects and transports urban runoff and stormwater that may contain certain pollutants. The protocols in this fact sheet are intended to reduce pollutants reaching receiving waters through proper conveyance system operation and maintenance.

Approach

Pollution Prevention

Maintain catch basins, stormwater inlets, and other stormwater conveyance structures on a regular basis to remove pollutants, reduce high pollutant concentrations during the first flush of storms, prevent clogging of the downstream conveyance system, restore catch basins' sediment trapping capacity, and ensure the system functions properly hydraulically to avoid flooding.

Suggested Protocols

Catch Basins/Inlet Structures

- Staff should regularly inspect facilities to ensure compliance with the following:
 - Immediate repair of any deterioration threatening structural integrity.
 - Cleaning before the sump is 40% full. Catch basins should be cleaned as frequently as needed to meet this standard.
 - Stenciling of catch basins and inlets (see SC34 Waste Handling and Disposal).

Targeted Constituents

Sediment	✓
Nutrients	
Trash	✓
Metals	
Bacteria	✓
Oil and Grease	
Organics	



SC-44 Drainage System Maintenance

- Clean catch basins, storm drain inlets, and other conveyance structures before the wet season to remove sediments and debris accumulated during the summer.
- Conduct inspections more frequently during the wet season for problem areas where sediment or trash accumulates more often. Clean and repair as needed.
- Keep accurate logs of the number of catch basins cleaned.
- Store wastes collected from cleaning activities of the drainage system in appropriate containers or temporary storage sites in a manner that prevents discharge to the storm drain.
- Dewater the wastes if necessary with outflow into the sanitary sewer if permitted. Water should be treated with an appropriate filtering device prior to discharge to the sanitary sewer. If discharge to the sanitary sewer is not allowed, water should be pumped or vacuumed to a tank and properly disposed. Do not dewater near a storm drain or stream.

Storm Drain Conveyance System

- Locate reaches of storm drain with deposit problems and develop a flushing schedule that keeps the pipe clear of excessive buildup.
- Collect and pump flushed effluent to the sanitary sewer for treatment whenever possible.

Pump Stations

- Clean all storm drain pump stations prior to the wet season to remove silt and trash.
- Do not allow discharge to reach the storm drain system when cleaning a storm drain pump station or other facility.
- Conduct routine maintenance at each pump station.
- Inspect, clean, and repair as necessary all outlet structures prior to the wet season.

Open Channel

- Modify storm channel characteristics to improve channel hydraulics, increase pollutant removals, and enhance channel/creek aesthetic and habitat value.
- Conduct channel modification/improvement in accordance with existing laws. Any person, government agency, or public utility proposing an activity that will change the natural (emphasis added) state of any river, stream, or lake in California, must enter into a Stream or Lake Alteration Agreement with the Department of Fish and Game. The developer-applicant should also contact local governments (city, county, special districts), other state agencies (SWRCB, RWQCB, Department of Forestry, Department of Water Resources), and Federal Corps of Engineers and USFWS.

Illicit Connections and Discharges

- Look for evidence of illegal discharges or illicit connections during routine maintenance of conveyance system and drainage structures:
 - Is there evidence of spills such as paints, discoloring, etc?

- Are there any odors associated with the drainage system?
- Record locations of apparent illegal discharges/illicit connections?
- Track flows back to potential dischargers and conduct aboveground inspections. This can be done through visual inspection of upgradient manholes or alternate techniques including zinc chloride smoke testing, fluorometric dye testing, physical inspection testing, or television camera inspection.
- Eliminate the discharge once the origin of flow is established.
- Stencil or demarcate storm drains, where applicable, to prevent illegal disposal of pollutants. Storm drain inlets should have messages such as “Dump No Waste Drains to Stream” stenciled next to them to warn against ignorant or intentional dumping of pollutants into the storm drainage system.
- Refer to fact sheet SC-10 Non-Stormwater Discharges.

Illegal Dumping

- Inspect and clean up hot spots and other storm drainage areas regularly where illegal dumping and disposal occurs.
- Establish a system for tracking incidents. The system should be designed to identify the following:
 - Illegal dumping hot spots
 - Types and quantities (in some cases) of wastes
 - Patterns in time of occurrence (time of day/night, month, or year)
 - Mode of dumping (abandoned containers, “midnight dumping” from moving vehicles, direct dumping of materials, accidents/spills)
 - Responsible parties
- Post “No Dumping” signs in problem areas with a phone number for reporting dumping and disposal. Signs should also indicate fines and penalties for illegal dumping.
- Refer to fact sheet SC-10 Non-Stormwater Discharges.

Training

- Train crews in proper maintenance activities, including record keeping and disposal.
- Allow only properly trained individuals to handle hazardous materials/wastes.
- Have staff involved in detection and removal of illicit connections trained in the following:
 - OSHA-required Health and Safety Training (29 CFR 1910.120) plus annual refresher training (as needed).

- OSHA Confined Space Entry training (Cal-OSHA Confined Space, Title 8 and Federal OSHA 29 CFR 1910.146).
- Procedural training (field screening, sampling, smoke/dye testing, TV inspection).

Spill Response and Prevention

- Investigate all reports of spills, leaks, and/or illegal dumping promptly.
- Clean up all spills and leaks using “dry” methods (with absorbent materials and/or rags) or dig up, remove, and properly dispose of contaminated soil.
- Refer to fact sheet SC-11 Spill Prevention, Control, and Cleanup.

Other Considerations (Limitations and Regulations)

- Clean-up activities may create a slight disturbance for local aquatic species. Access to items and material on private property may be limited. Trade-offs may exist between channel hydraulics and water quality/riparian habitat. If storm channels or basins are recognized as wetlands, many activities, including maintenance, may be subject to regulation and permitting.
- Storm drain flushing is most effective in small diameter pipes (36-inch diameter pipe or less, depending on water supply and sediment collection capacity). Other considerations associated with storm drain flushing may include the availability of a water source, finding a downstream area to collect sediments, liquid/sediment disposal, and prohibition against disposal of flushed effluent to sanitary sewer in some areas.
- Regulations may include adoption of substantial penalties for illegal dumping and disposal.
- Local municipal codes may include sections prohibiting discharge of soil, debris, refuse, hazardous wastes, and other pollutants into the storm drain system.

Requirements***Costs***

- An aggressive catch basin cleaning program could require a significant capital and O&M budget.
- The elimination of illegal dumping is dependent on the availability, convenience, and cost of alternative means of disposal. The primary cost is for staff time. Cost depends on how aggressively a program is implemented. Other cost considerations for an illegal dumping program include:
 - Purchase and installation of signs.
 - Rental of vehicle(s) to haul illegally-disposed items and material to landfills.
 - Rental of heavy equipment to remove larger items (e.g., car bodies) from channels.
 - Purchase of landfill space to dispose of illegally-dumped items and material.

- Methods used for illicit connection detection (smoke testing, dye testing, visual inspection, and flow monitoring) can be costly and time-consuming. Site-specific factors, such as the level of impervious area, the density and ages of buildings, and type of land use will determine the level of investigation necessary.

Maintenance

- Two-person teams may be required to clean catch basins with vacuor trucks.
- Teams of at least two people plus administrative personnel are required to identify illicit discharges, depending on the complexity of the storm sewer system.
- Arrangements must be made for proper disposal of collected wastes.
- Technical staff are required to detect and investigate illegal dumping violations.

Supplemental Information

Further Detail of the BMP

Storm Drain Flushing

Flushing is a common maintenance activity used to improve pipe hydraulics and to remove pollutants in storm drainage systems. Flushing may be designed to hydraulically convey accumulated material to strategic locations, such as an open channel, another point where flushing will be initiated, or the sanitary sewer and the treatment facilities, thus preventing resuspension and overflow of a portion of the solids during storm events. Flushing prevents “plug flow” discharges of concentrated pollutant loadings and sediments. Deposits can hinder the designed conveyance capacity of the storm drain system and potentially cause backwater conditions in severe cases of clogging.

Storm drain flushing usually takes place along segments of pipe with grades that are too flat to maintain adequate velocity to keep particles in suspension. An upstream manhole is selected to place an inflatable device that temporarily plugs the pipe. Further upstream, water is pumped into the line to create a flushing wave. When the upstream reach of pipe is sufficiently full to cause a flushing wave, the inflated device is rapidly deflated with the assistance of a vacuum pump, thereby releasing the backed up water and resulting in the cleaning of the storm drain segment.

To further reduce impacts of stormwater pollution, a second inflatable device placed well downstream may be used to recollect the water after the force of the flushing wave has dissipated. A pump may then be used to transfer the water and accumulated material to the sanitary sewer for treatment. In some cases, an interceptor structure may be more practical or required to recollect the flushed waters.

It has been found that cleansing efficiency of periodic flush waves is dependent upon flush volume, flush discharge rate, sewer slope, sewer length, sewer flow rate, sewer diameter, and population density. As a rule of thumb, the length of line to be flushed should not exceed 700 feet. At this maximum recommended length, the percent removal efficiency ranges between 65-75% for organics and 55-65% for dry weather grit/inorganic material. The percent removal efficiency drops rapidly beyond that. Water is commonly supplied by a water truck, but fire hydrants can also supply water. To make the best use of water, it is recommended that reclaimed water be used or that fire hydrant line flushing coincide with storm sewer flushing.

SC-44 Drainage System Maintenance

References and Resources

California's Nonpoint Source Program Plan <http://www.swrcb.ca.gov/nps/index.html>

Clark County Storm Water Pollution Control Manual
<http://www.co.clark.wa.us/pubworks/bmpman.pdf>

Ferguson, B.K. 1991. Urban Stream Reclamation, p. 324-322, Journal of Soil and Water Conservation.

King County Storm Water Pollution Control Manual <http://dnr.metrokc.gov/wlr/dss/spcm.htm>

Oregon Association of Clean Water Agencies. Oregon Municipal Stormwater Toolbox for Maintenance Practices. June 1998.

Santa Clara Valley Urban Runoff Pollution Prevention Program <http://www.scvurppp.org>

The Storm Water Managers Resource Center <http://www.stormwatercenter.net>

United States Environmental Protection Agency (USEPA). 2002. Pollution Prevention/Good Housekeeping for Municipal Operations Storm Drain System Cleaning. On line:
http://www.epa.gov/npdes/menuofbmps/poll_16.htm

Site Design & Landscape Planning SD-10



Design Objectives

- Maximize Infiltration
 - Provide Retention
 - Slow Runoff
 - Minimize Impervious Land Coverage
 - Prohibit Dumping of Improper Materials
 - Contain Pollutants
 - Collect and Convey
-

Description

Each project site possesses unique topographic, hydrologic, and vegetative features, some of which are more suitable for development than others. Integrating and incorporating appropriate landscape planning methodologies into the project design is the most effective action that can be done to minimize surface and groundwater contamination from stormwater.

Approach

Landscape planning should couple consideration of land suitability for urban uses with consideration of community goals and projected growth. Project plan designs should conserve natural areas to the extent possible, maximize natural water storage and infiltration opportunities, and protect slopes and channels.

Suitable Applications

Appropriate applications include residential, commercial and industrial areas planned for development or redevelopment.

Design Considerations

Design requirements for site design and landscapes planning should conform to applicable standards and specifications of agencies with jurisdiction and be consistent with applicable General Plan and Local Area Plan policies.



SD-10 Site Design & Landscape Planning

Designing New Installations

Begin the development of a plan for the landscape unit with attention to the following general principles:

- Formulate the plan on the basis of clearly articulated community goals. Carefully identify conflicts and choices between retaining and protecting desired resources and community growth.
- Map and assess land suitability for urban uses. Include the following landscape features in the assessment: wooded land, open unwooded land, steep slopes, erosion-prone soils, foundation suitability, soil suitability for waste disposal, aquifers, aquifer recharge areas, wetlands, floodplains, surface waters, agricultural lands, and various categories of urban land use. When appropriate, the assessment can highlight outstanding local or regional resources that the community determines should be protected (e.g., a scenic area, recreational area, threatened species habitat, farmland, fish run). Mapping and assessment should recognize not only these resources but also additional areas needed for their sustenance.

Project plan designs should conserve natural areas to the extent possible, maximize natural water storage and infiltration opportunities, and protect slopes and channels.

Conserve Natural Areas during Landscape Planning

If applicable, the following items are required and must be implemented in the site layout during the subdivision design and approval process, consistent with applicable General Plan and Local Area Plan policies:

- Cluster development on least-sensitive portions of a site while leaving the remaining land in a natural undisturbed condition.
- Limit clearing and grading of native vegetation at a site to the minimum amount needed to build lots, allow access, and provide fire protection.
- Maximize trees and other vegetation at each site by planting additional vegetation, clustering tree areas, and promoting the use of native and/or drought tolerant plants.
- Promote natural vegetation by using parking lot islands and other landscaped areas.
- Preserve riparian areas and wetlands.

Maximize Natural Water Storage and Infiltration Opportunities Within the Landscape Unit

- Promote the conservation of forest cover. Building on land that is already deforested affects basin hydrology to a lesser extent than converting forested land. Loss of forest cover reduces interception storage, detention in the organic forest floor layer, and water losses by evapotranspiration, resulting in large peak runoff increases and either their negative effects or the expense of countering them with structural solutions.
- Maintain natural storage reservoirs and drainage corridors, including depressions, areas of permeable soils, swales, and intermittent streams. Develop and implement policies and

Site Design & Landscape Planning SD-10

regulations to discourage the clearing, filling, and channelization of these features. Utilize them in drainage networks in preference to pipes, culverts, and engineered ditches.

- Evaluating infiltration opportunities by referring to the stormwater management manual for the jurisdiction and pay particular attention to the selection criteria for avoiding groundwater contamination, poor soils, and hydrogeological conditions that cause these facilities to fail. If necessary, locate developments with large amounts of impervious surfaces or a potential to produce relatively contaminated runoff away from groundwater recharge areas.

Protection of Slopes and Channels during Landscape Design

- Convey runoff safely from the tops of slopes.
- Avoid disturbing steep or unstable slopes.
- Avoid disturbing natural channels.
- Stabilize disturbed slopes as quickly as possible.
- Vegetate slopes with native or drought tolerant vegetation.
- Control and treat flows in landscaping and/or other controls prior to reaching existing natural drainage systems.
- Stabilize temporary and permanent channel crossings as quickly as possible, and ensure that increases in run-off velocity and frequency caused by the project do not erode the channel.
- Install energy dissipaters, such as riprap, at the outlets of new storm drains, culverts, conduits, or channels that enter unlined channels in accordance with applicable specifications to minimize erosion. Energy dissipaters shall be installed in such a way as to minimize impacts to receiving waters.
- Line on-site conveyance channels where appropriate, to reduce erosion caused by increased flow velocity due to increases in tributary impervious area. The first choice for linings should be grass or some other vegetative surface, since these materials not only reduce runoff velocities, but also provide water quality benefits from filtration and infiltration. If velocities in the channel are high enough to erode grass or other vegetative linings, riprap, concrete, soil cement, or geo-grid stabilization are other alternatives.
- Consider other design principles that are comparable and equally effective.

Redeveloping Existing Installations

Various jurisdictional stormwater management and mitigation plans (SUSMP, WQMP, etc.) define “redevelopment” in terms of amounts of additional impervious area, increases in gross floor area and/or exterior construction, and land disturbing activities with structural or impervious surfaces. The definition of “redevelopment” must be consulted to determine whether or not the requirements for new development apply to areas intended for redevelopment. If the definition applies, the steps outlined under “designing new installations” above should be followed.

SD-10 Site Design & Landscape Planning

Redevelopment may present significant opportunity to add features which had not previously been implemented. Examples include incorporation of depressions, areas of permeable soils, and swales in newly redeveloped areas. While some site constraints may exist due to the status of already existing infrastructure, opportunities should not be missed to maximize infiltration, slow runoff, reduce impervious areas, disconnect directly connected impervious areas.

Other Resources

A Manual for the Standard Urban Stormwater Mitigation Plan (SUSMP), Los Angeles County Department of Public Works, May 2002.

Stormwater Management Manual for Western Washington, Washington State Department of Ecology, August 2001.

Model Standard Urban Storm Water Mitigation Plan (SUSMP) for San Diego County, Port of San Diego, and Cities in San Diego County, February 14, 2002.

Model Water Quality Management Plan (WQMP) for County of Orange, Orange County Flood Control District, and the Incorporated Cities of Orange County, Draft February 2003.

Ventura Countywide Technical Guidance Manual for Stormwater Quality Control Measures, July 2002.



Design Objectives

- Maximize Infiltration
- Provide Retention
- Slow Runoff
- Minimize Impervious Land Coverage
- Prohibit Dumping of Improper Materials
- Contain Pollutants
- Collect and Convey

Description

Waste materials dumped into storm drain inlets can have severe impacts on receiving and ground waters. Posting notices regarding discharge prohibitions at storm drain inlets can prevent waste dumping. Storm drain signs and stencils are highly visible source controls that are typically placed directly adjacent to storm drain inlets.

Approach

The stencil or affixed sign contains a brief statement that prohibits dumping of improper materials into the urban runoff conveyance system. Storm drain messages have become a popular method of alerting the public about the effects of and the prohibitions against waste disposal.

Suitable Applications

Stencils and signs alert the public to the destination of pollutants discharged to the storm drain. Signs are appropriate in residential, commercial, and industrial areas, as well as any other area where contributions or dumping to storm drains is likely.

Design Considerations

Storm drain message markers or placards are recommended at all storm drain inlets within the boundary of a development project. The marker should be placed in clear sight facing toward anyone approaching the inlet from either side. All storm drain inlet locations should be identified on the development site map.

Designing New Installations

The following methods should be considered for inclusion in the project design and show on project plans:

- Provide stenciling or labeling of all storm drain inlets and catch basins, constructed or modified, within the project area with prohibitive language. Examples include “NO DUMPING



– DRAINS TO OCEAN” and/or other graphical icons to discourage illegal dumping.

- Post signs with prohibitive language and/or graphical icons, which prohibit illegal dumping at public access points along channels and creeks within the project area.

Note - Some local agencies have approved specific signage and/or storm drain message placards for use. Consult local agency stormwater staff to determine specific requirements for placard types and methods of application.

Redeveloping Existing Installations

Various jurisdictional stormwater management and mitigation plans (SUSMP, WQMP, etc.) define “redevelopment” in terms of amounts of additional impervious area, increases in gross floor area and/or exterior construction, and land disturbing activities with structural or impervious surfaces. If the project meets the definition of “redevelopment”, then the requirements stated under “designing new installations” above should be included in all project design plans.

Additional Information

Maintenance Considerations

- Legibility of markers and signs should be maintained. If required by the agency with jurisdiction over the project, the owner/operator or homeowner’s association should enter into a maintenance agreement with the agency or record a deed restriction upon the property title to maintain the legibility of placards or signs.

Placement

- Signage on top of curbs tends to weather and fade.
- Signage on face of curbs tends to be worn by contact with vehicle tires and sweeper brooms.

Supplemental Information

Examples

- Most MS4 programs have storm drain signage programs. Some MS4 programs will provide stencils, or arrange for volunteers to stencil storm drains as part of their outreach program.

Other Resources

A Manual for the Standard Urban Stormwater Mitigation Plan (SUSMP), Los Angeles County Department of Public Works, May 2002.

Model Standard Urban Storm Water Mitigation Plan (SUSMP) for San Diego County, Port of San Diego, and Cities in San Diego County, February 14, 2002.

Model Water Quality Management Plan (WQMP) for County of Orange, Orange County Flood Control District, and the Incorporated Cities of Orange County, Draft February 2003.

Ventura Countywide Technical Guidance Manual for Stormwater Quality Control Measures, July 2002.

Description

Trash storage areas are areas where a trash receptacle (s) are located for use as a repository for solid wastes. Stormwater runoff from areas where trash is stored or disposed of can be polluted. In addition, loose trash and debris can be easily transported by water or wind into nearby storm drain inlets, channels, and/or creeks. Waste handling operations that may be sources of stormwater pollution include dumpsters, litter control, and waste piles.

Approach

This fact sheet contains details on the specific measures required to prevent or reduce pollutants in stormwater runoff associated with trash storage and handling. Preventative measures including enclosures, containment structures, and impervious pavements to mitigate spills, should be used to reduce the likelihood of contamination.

Suitable Applications

Appropriate applications include residential, commercial and industrial areas planned for development or redevelopment. (Detached residential single-family homes are typically excluded from this requirement.)

Design Considerations

Design requirements for waste handling areas are governed by Building and Fire Codes, and by current local agency ordinances and zoning requirements. The design criteria described in this fact sheet are meant to enhance and be consistent with these code and ordinance requirements. Hazardous waste should be handled in accordance with legal requirements established in Title 22, California Code of Regulation.

Wastes from commercial and industrial sites are typically hauled by either public or commercial carriers that may have design or access requirements for waste storage areas. The design criteria in this fact sheet are recommendations and are not intended to be in conflict with requirements established by the waste hauler. The waste hauler should be contacted prior to the design of your site trash collection areas. Conflicts or issues should be discussed with the local agency.

Designing New Installations

Trash storage areas should be designed to consider the following structural or treatment control BMPs:

- Design trash container areas so that drainage from adjoining roofs and pavement is diverted around the area(s) to avoid run-on. This might include berming or grading the waste handling area to prevent run-on of stormwater.
- Make sure trash container areas are screened or walled to prevent off-site transport of trash.

Design Objectives

- Maximize Infiltration
- Provide Retention
- Slow Runoff
- Minimize Impervious Land Coverage
- Prohibit Dumping of Improper Materials
- Contain Pollutants
- Collect and Convey



- Use lined bins or dumpsters to reduce leaking of liquid waste.
- Provide roofs, awnings, or attached lids on all trash containers to minimize direct precipitation and prevent rainfall from entering containers.
- Pave trash storage areas with an impervious surface to mitigate spills.
- Do not locate storm drains in immediate vicinity of the trash storage area.
- Post signs on all dumpsters informing users that hazardous materials are not to be disposed of therein.

Redeveloping Existing Installations

Various jurisdictional stormwater management and mitigation plans (SUSMP, WQMP, etc.) define “redevelopment” in terms of amounts of additional impervious area, increases in gross floor area and/or exterior construction, and land disturbing activities with structural or impervious surfaces. The definition of “redevelopment” must be consulted to determine whether or not the requirements for new development apply to areas intended for redevelopment. If the definition applies, the steps outlined under “designing new installations” above should be followed.

Additional Information

Maintenance Considerations

The integrity of structural elements that are subject to damage (i.e., screens, covers, and signs) must be maintained by the owner/operator. Maintenance agreements between the local agency and the owner/operator may be required. Some agencies will require maintenance deed restrictions to be recorded of the property title. If required by the local agency, maintenance agreements or deed restrictions must be executed by the owner/operator before improvement plans are approved.

Other Resources

A Manual for the Standard Urban Stormwater Mitigation Plan (SUSMP), Los Angeles County Department of Public Works, May 2002.

Model Standard Urban Storm Water Mitigation Plan (SUSMP) for San Diego County, Port of San Diego, and Cities in San Diego County, February 14, 2002.

Model Water Quality Management Plan (WQMP) for County of Orange, Orange County Flood Control District, and the Incorporated Cities of Orange County, Draft February 2003.

Ventura Countywide Technical Guidance Manual for Stormwater Quality Control Measures, July 2002.

APPENDIX 8

PUBLIC EDUCATION MATERIALS

Storm Drains are for Rain...

More than 200,000 times each month,



lawns and gardens throughout LA County are sprayed with pesticides. Overwatering or rain causes pesticides on leaves and grass to flow into the storm drain and to the ocean — untreated.

Please use pesticides wisely, not before a rain, and water carefully.

...not pesticides.

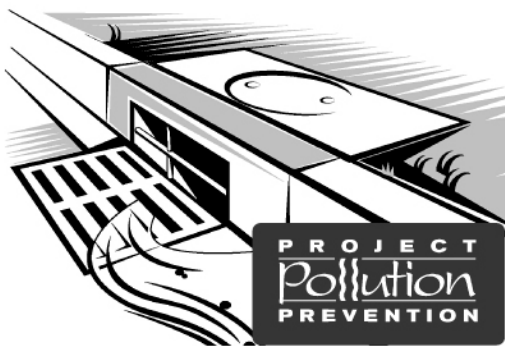

1(888)CLEAN LA
www.888CleanLA.com

Storm Drains are for Rain...

More than 200,000 times each month,



lawns and gardens throughout LA County are sprayed with pesticides. Overwatering or rain causes pesticides on leaves and grass to flow into the storm drain and to the ocean — untreated.

Please use pesticides wisely, not before a rain, and water carefully.

...not pesticides.

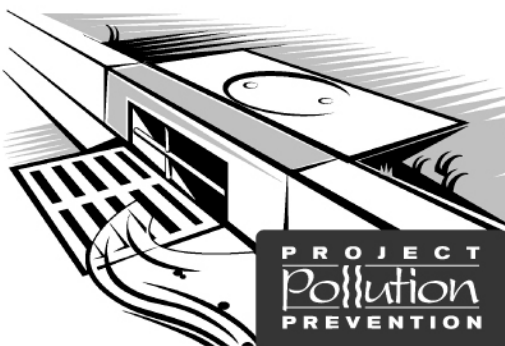

1(888)CLEAN LA
www.888CleanLA.com

Pesticide Tips:

You can keep your lawn and garden green and at the same time solve the pollution problem by taking these easy steps...

- Never dispose of lawn or garden chemicals in storm drains. This is called illegal dumping. Take them to a household hazardous waste roundup. Call 1(888)CLEAN LA or visit www.888CleanLA.com to locate a roundup or collection facility near you.
- More is not better. Use pesticides sparingly. "Spot" apply, rather than "blanket" apply.
- Read labels! Use only as directed.
- Use non-toxic products for your garden and lawn whenever possible.
- If you must store pesticides, make sure they are in a sealed, water-proof container that cannot leak.
- When watering your lawn, use the least amount of water possible so it doesn't run into the street and carry pesticide chemicals with it. Don't use pesticides before a rain storm. You will not only lose the pesticide, but also will be harming the environment.



Printed on recycled paper

PROJECT
Pollution
PREVENTION

Pesticide Tips:

You can keep your lawn and garden green and at the same time solve the pollution problem by taking these easy steps...

- Never dispose of lawn or garden chemicals in storm drains. This is called illegal dumping. Take them to a household hazardous waste roundup. Call 1(888)CLEAN LA or visit www.888CleanLA.com to locate a roundup or collection facility near you.
- More is not better. Use pesticides sparingly. "Spot" apply, rather than "blanket" apply.
- Read labels! Use only as directed.
- Use non-toxic products for your garden and lawn whenever possible.
- If you must store pesticides, make sure they are in a sealed, water-proof container that cannot leak.
- When watering your lawn, use the least amount of water possible so it doesn't run into the street and carry pesticide chemicals with it. Don't use pesticides before a rain storm. You will not only lose the pesticide, but also will be harming the environment.



Printed on recycled paper

PROJECT
Pollution
PREVENTION

Don't Paint the Town Red!

Storm drains are for rain...
they're not for paint disposal.

More than **197,000** times each month, L.A. County residents wash their dirty paint brushes under an outdoor faucet.

This dirty rinse water flows into the street, down the storm drain and straight to the ocean — **untreated.**

Remember to clean water-based paint brushes in the sink, rinse oil-based paint brushes with paint thinner, and take old paint and paint-related products to a Household Hazardous Waste/E-Waste collection event.

1 (888) CLEAN LA
www.888CleanLA.com



Tips for Paint Clean-Up:

L.A. County residents can help solve the stormwater pollution problem by taking these easy steps when working with paint and paint-related products...

- Never dispose of paint or paint-related products in the gutters or storm drains. This is called illegal dumping. Take them to a Household Hazardous Waste/E-Waste collection event. Call 1 (888) CLEAN LA or visit www.888CleanLA.com to locate an event near you.
- Buy only what you need. Reuse leftover paint for touch-ups or donate it to a local graffiti abatement program. Recycle or use excess paint.
- Clean water-based paint brushes in the sink.
- Oil-based paints should be cleaned with paint thinner. Filter and reuse paint thinner. Set the used thinner aside in a closed jar to settle-out paint particles.
- Store paints and paint-related products in rigid, durable and watertight containers with tight-fitting covers.

PROJECT
Pollution
PREVENTION

A message from the County of Los Angeles Department of Public Works.
Printed on recycled paper.

Are You a Litter Bug and Don't Know It?

Take our quiz!

Have you ever...

- Dropped a cigarette butt or trash on the ground?
- Failed to pick up after your dog while out on a walk?
- Overwatered your lawn after applying fertilizers/pesticides?
- Disposed of used motor oil in the street, gutter or garbage?

If you answered **yes** to any of these actions, then
YOU ARE A LITTER BUG!

Each of these behaviors contribute to stormwater pollution, which contaminates our ocean and waterways, kills marine life and causes beach closures.

You can become part of the solution!

To find out how, flip this card over.

For more information, call or visit:

1 (888) CLEAN LA
www.888CleanLA.com

Follow these simple steps to prevent stormwater pollution:

- Put your garbage where it belongs — in the trash can.
- Pick up after your dog when out on a walk.
- Reduce pesticide and fertilizer use; don't overwater after application or apply if rain is forecast.
- Dispose of used motor oil at an oil recycling center or at a free Household Hazardous Waste/E-Waste collection event.

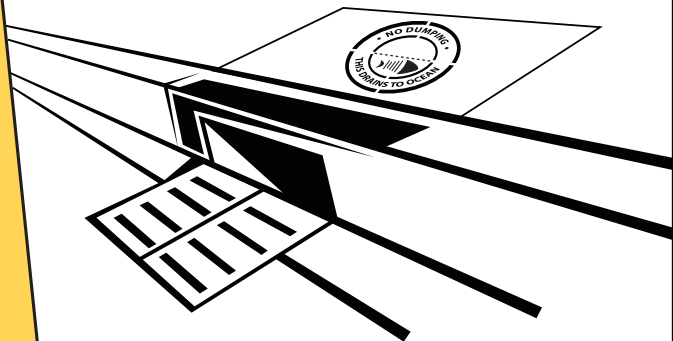

A message from the County of Los Angeles Department of Public Works.
Printed on recycled paper.

Storm Drains are for Rain...

More than 50% of the automotive oil sold to do-it-

yourself oil changers is not recycled. There are more than 600 State-certified used oil collection centers within Los Angeles County.

Never dispose of automotive fluids in the street or gutter. Take them to your local auto parts store, gas station or repair shop, or a household hazardous waste Roundup for recycling.

...not automotive fluids.

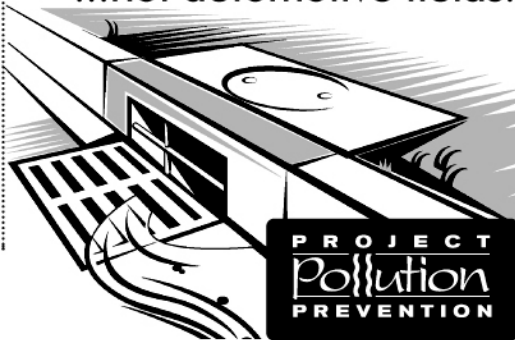

1 (888)CLEAN LA
www.888CleanLA.com

Storm Drains are for Rain...

More than 50% of the automotive oil sold to do-it-

yourself oil changers is not recycled. There are more than 600 State-certified used oil collection centers within Los Angeles County.

Never dispose of automotive fluids in the street or gutter. Take them to your local auto parts store, gas station or repair shop, or a household hazardous waste Roundup for recycling.

...not automotive fluids.



1 (888)CLEAN LA
www.888CleanLA.com

Car Care Tips:

You can keep your car running smoothly and efficiently, and at the same time help prevent stormwater pollution by taking these easy steps...

- When changing vehicle fluids — motor oil, transmission, brake and radiator fluids — drain them into separate drip pans to avoid spills. Do not combine these fluids. Do not dispose of these fluids in the street, gutter or garbage. It is illegal.
- If a spill occurs, use kitty litter, sawdust or cornmeal for cleanup. Do not hose or rinse with water.
- Regularly check and maintain your car to keep it running safely and efficiently. Water runoff from streets, parking lots and driveways picks up oil and grease drippings, asbestos from brake linings, zinc from tires and organic compounds and metals from spilled fuels and carries them to the ocean.
- Recycle all used vehicle fluids. Call 1(888)CLEAN LA or visit www.888CleanLA.com for the location of an auto parts store or gas station that recycles these fluids, or for the location of a local household hazardous waste Roundup.



Printed on recycled paper

Car Care Tips:

You can keep your car running smoothly and efficiently, and at the same time help prevent stormwater pollution by taking these easy steps...

- When changing vehicle fluids — motor oil, transmission, brake and radiator fluids — drain them into separate drip pans to avoid spills. Do not combine these fluids. Do not dispose of these fluids in the street, gutter or garbage. It is illegal.
- If a spill occurs, use kitty litter, sawdust or cornmeal for cleanup. Do not hose or rinse with water.
- Regularly check and maintain your car to keep it running safely and efficiently. Water runoff from streets, parking lots and driveways picks up oil and grease drippings, asbestos from brake linings, zinc from tires and organic compounds and metals from spilled fuels and carries them to the ocean.
- Recycle all used vehicle fluids. Call 1(888)CLEAN LA or visit www.888CleanLA.com for the location of an auto parts store or gas station that recycles these fluids, or for the location of a local household hazardous waste Roundup.



Printed on recycled paper

A Yard is a Terrible Thing to Waste!

Storm drains are for rain...**not yard waste.**

Residential yard waste represents about **13 percent** of the total waste generated in L.A. County.

Pesticides, fertilizer and yard waste such as leaves and mowed grass wash from the ground and streets into storm drains and flow straight to the ocean — **untreated.**

Remember to use pesticides and fertilizer wisely and pick-up yard waste.



1 (888) CLEAN LA
www.888CleanLA.com

Tips For Yard Care:

L.A. County residents can help solve the stormwater pollution problem by taking these easy steps...

- Do not over-fertilize and do not use fertilizer or pesticides near ditches, gutters or storm drains.
- Do not use fertilizer or pesticides before a rain.
- Follow the directions on the label carefully.
- Use pesticides sparingly — more is not better. “Spot” apply, rather than “blanket” apply.
- When watering your lawn, use the least amount of water possible so it doesn't run into the street carrying pesticides and other chemicals with it.
- Use non-toxic products for your garden and lawn whenever possible.
- If you must store pesticides or fertilizer, make sure they are in a sealed, water-proof container in a covered area to prevent runoff.
- Do not blow, sweep, hose or rake leaves or other yard trimmings into the street, gutter or storm drain.



A message from the County of Los Angeles Department of Public Works.
Printed on recycled paper.

Pick Up After Your Pooch!

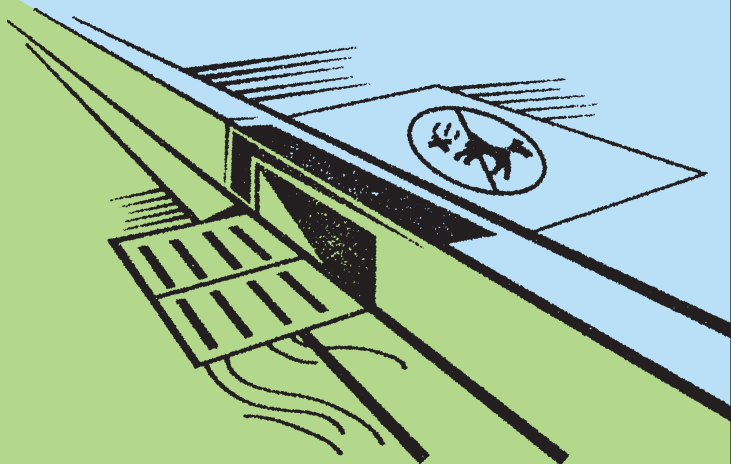

Storm drains are for rain...
they're not pooper scoopers.

L.A. County residents walk a dog without picking up the droppings more than **62,000** times per month.

Disease-causing dog waste washes from the ground and streets into storm drains and flows straight to the ocean — untreated.

Remember to bring a bag and clean up after your dog.

1 (888) CLEAN LA
www.888CleanLA.com

Tips for Dog Owners:

Dog owners can help solve the stormwater pollution problem by taking these easy steps...

- Clean up after your dog every single time.
- Take advantage of the complimentary waste bags offered in dispensers at local parks.
- Ensure you always have extra bags in your car so you are prepared when you travel with your dog.
- Carry extra bags when walking your dog and make them available to other pet owners who are without.
- Teach children how to properly clean up after a pet. Encourage them to throw the used bags in the nearest trash receptacle if they are away from home.
- Put a friendly message on the bulletin board at the local dog park to remind pet owners to clean up after their dogs.
- Tell friends and neighbors about the ill effects of animal waste on the environment. Encourage them to clean up after their pets as well.

PROJECT
Pollution
PREVENTION

Storm Drains are for Rain...

More than 50% of the automotive oil sold to do-it-



yourself oil changers is not recycled. There are more than 600 State-certified used oil collection centers within Los Angeles County.

Never dispose of automotive fluids, recyclable products, or household hazardous wastes into the street or gutter. Take them to your local auto repair station, recycling center or a household hazardous waste roundup.

...they're not recycling centers.



1(888)CLEAN LA
www.888CleanLA.com

Storm Drains are for Rain...

More than 50% of the automotive oil sold to do-it-



yourself oil changers is not recycled. There are more than 600 State-certified used oil collection centers within Los Angeles County.

Never dispose of automotive fluids, recyclable products, or household hazardous wastes into the street or gutter. Take them to your local auto repair station, recycling center or a household hazardous waste roundup.

...they're not recycling centers.

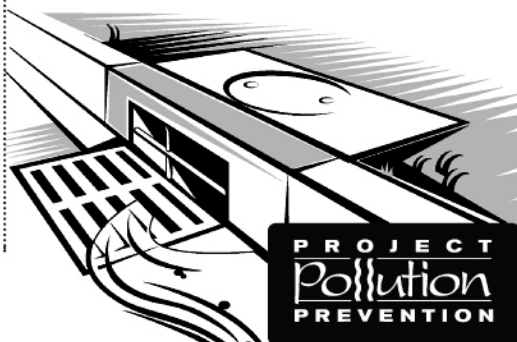

1(888)CLEAN LA
www.888CleanLA.com

Recycling Tips:

You can help keep your community clean, protect our area waterways and make the beaches safe for ocean swimmers by putting recyclable materials where they belong — at a recycling center or household hazardous waste roundup. Never throw or pour anything into the streets or gutters...

- When changing vehicle fluids – transmission, hydraulic and motor oil, brake and radiator fluid – drain them into a drip pan to avoid spills. Do not combine these fluids. Do not dispose of them in the street, gutter or in the garbage. It is illegal.
- Recycle all used vehicle fluids. Call 1(888)CLEAN LA or visit www.888CleanLA.com for the location of a center that recycles these fluids, or for the location of a local household hazardous waste Roundup.
- Other materials that should be taken to a household hazardous waste Roundup are: paint and paint-related materials, household cleaners, batteries, pesticides and fertilizers, pool chemicals, and aerosol products.
- Aluminum, glass, plastic and newspapers should be placed in your curbside recycling bin or taken to a local recycling center.



Printed on recycled paper



Recycling Tips:

You can help keep your community clean, protect our area waterways and make the beaches safe for ocean swimmers by putting recyclable materials where they belong — at a recycling center or household hazardous waste roundup. Never throw or pour anything into the streets or gutters...

- When changing vehicle fluids – transmission, hydraulic and motor oil, brake and radiator fluid – drain them into a drip pan to avoid spills. Do not combine these fluids. Do not dispose of them in the street, gutter or in the garbage. It is illegal.
- Recycle all used vehicle fluids. Call 1(888)CLEAN LA or visit www.888CleanLA.com for the location of a center that recycles these fluids, or for the location of a local household hazardous waste Roundup.
- Other materials that should be taken to a household hazardous waste Roundup are: paint and paint-related materials, household cleaners, batteries, pesticides and fertilizers, pool chemicals, and aerosol products.
- Aluminum, glass, plastic and newspapers should be placed in your curbside recycling bin or taken to a local recycling center.



Printed on recycled paper



APPENDIX 9

GEOTECHNICAL INFORMATION

*This Geotechnical Report is for the proposed commercial site on the west side of Maidstone Ave. The assumption was made that this project has the same soil characteristics as the neighboring project. A site specific Geotechnical investigation will be provided when available.



SALEM
engineering group, inc.

GEOTECHNICAL ENGINEERING INVESTIGATION

**PROPOSED COMMERCIAL DEVELOPMENT
ALONDRA BOULEVARD & MAIDSTONE AVENUE
NORWALK, CALIFORNIA**

SALEM PROJECT NO. 3-221-0428

JUNE 10, 2021

**THIS GEOTECHNICAL INVESTIGATION WAS PERFORMED FOR THE PROPOSED
COMMERCIAL SITE ON THE WEST SIDE OF MAIDSTONE AVE. REPORT IS
INCLUDED FOR REFERENCE ONLY BECAUSE OF THE ASSUMED SIMILAR SOIL
CONDITIONS.**

PREPARED FOR:

**MR. ANDREW DEWAR
SHAPELL PROPERTIES, INC.
11200 CORBIN AVENUE, SUITE 201
PORTER RANCH, CA 91326**

PREPARED BY:

**SALEM ENGINEERING GROUP, INC.
8711 MONROE COURT, SUITE A
RANCHO CUCAMONGA, CA 91730
P: (909) 980-6455
F: (909) 980-6435
www.salem.net**



SALEM
engineering group, inc.

8711 Monroe Court, Suite A
Rancho Cucamonga, CA 91730
Phone (909) 980-6455
Fax (909) 980-6435

June 10, 2021

Project No. 3-221-0428

Mr. Andrew Dewar
Shapell Properties, Inc.
11200 Corbin Avenue, Suite 201
Porter Ranch, CA 91326

**SUBJECT: GEOTECHNICAL ENGINEERING INVESTIGATION
PROPOSED COMMERCIAL DEVELOPMENT
ALONDRA BOULEVARD & MAIDSTONE AVENUE
NORWALK, CALIFORNIA**

Dear Mr. Dewar:

At your request and authorization, SALEM Engineering Group, Inc. (SALEM) has prepared this Geotechnical Engineering Investigation report for the Proposed Commercial Development to be located at the subject site.

The accompanying report presents our findings, conclusions, and recommendations regarding the geotechnical aspects of designing and constructing the project as presently proposed. In our opinion, the proposed project is feasible from a geotechnical viewpoint provided our recommendations are incorporated into the design and construction of the project.

We appreciate the opportunity to assist you with this project. Should you have questions regarding this report or need additional information, please contact the undersigned at (909) 980-6455.

Respectfully Submitted,

SALEM ENGINEERING GROUP, INC.

A handwritten signature in black ink, appearing to read 'Ibrahim Foud Ibrahim'.

Ibrahim Foud Ibrahim, PE
Senior Managing Engineer
RCE 86724

A handwritten signature in blue ink, appearing to read 'Clarence Jiang'.

Clarence Jiang, GE
Senior Geotechnical Engineer
RGE 2477

TABLE OF CONTENTS

1. PURPOSE AND SCOPE.....	1
2. PROJECT DESCRIPTION.....	1
3. SITE LOCATION AND DESCRIPTION	2
4. FIELD EXPLORATION	2
5. LABORATORY TESTING	3
6. GEOLOGIC SETTING	3
7. GEOLOGIC HAZARDS	3
7.1 Faulting and Seismicity	3
7.2 Surface Fault Rupture	4
7.3 Ground Shaking.....	4
7.4 Liquefaction.....	5
7.5 Lateral Spreading.....	5
7.6 Landslides.....	5
7.7 Tsunamis and Seiches.....	6
8. SOIL AND GROUNDWATER CONDITIONS	6
8.1 Subsurface Conditions	6
8.2 Groundwater	6
8.3 Soil Corrosion Screening	7
8.4 Percolation Testing	7
9. CONCLUSIONS AND RECOMMENDATIONS.....	9
9.1 General	9
9.2 Seismic Design Criteria	11
9.3 Soil and Excavation Characteristics	12
9.4 Materials for Fill.....	12
9.5 Grading.....	13
9.6 Option 1 - Shallow Foundations with Geogrid.....	16
9.7 Option 2 – Structural Slabs	18
9.8 Concrete Slabs-on-Grade	19
9.9 Lateral Earth Pressures and Frictional Resistance	20
9.10 Retaining Walls	21
9.11 Temporary Excavations	22
9.12 Underground Utilities	23
9.13 Surface Drainage	23
9.14 Pavement Design	24
10. PLAN REVIEW, CONSTRUCTION OBSERVATION AND TESTING.....	25
10.1 Plan and Specification Review.....	25
10.2 Construction Observation and Testing Services	25
11. LIMITATIONS AND CHANGED CONDITIONS	25

TABLE OF CONTENTS (cont.)

FIGURES

Figure 1, Vicinity Map

Figure 2, Site Plan

APPENDIX A – FIELD INVESTIGATION

Figures A-1 through A-7, Logs of Exploratory Soil Borings B-1 through B-7

Percolation Testing Results, P-1 and P-2

Liquefaction Analysis

APPENDIX B – LABORATORY TESTING

Consolidation Results

Direct Shear Results

Gradation Curves

Expansion Index Results

Corrosivity Results

Maximum Density and Optimum Moisture Proctor Results

APPENDIX C – EARTHWORK AND PAVEMENT SPECIFICATIONS

**GEOTECHNICAL ENGINEERING INVESTIGATION
PROPOSED COMMERCIAL DEVELOPMENT
ALONDRA BOULEVARD & MAIDSTONE AVENUE
NORWALK, CALIFORNIA**

1. PURPOSE AND SCOPE

This report presents the results of our Geotechnical Engineering Investigation for the proposed Commercial Development to be located at the subject site in the City of Norwalk, California (see Figure 1, Vicinity Map).

The purpose of our geotechnical engineering investigation was to observe and sample the subsurface conditions encountered at the site, and provide conclusions and recommendations relative to the geotechnical aspects of constructing the project as presently proposed.

The scope of this investigation included a field exploration, percolation testing, laboratory testing, engineering analysis and the preparation of this report. Our field exploration was performed on May 18, 2021 and included the drilling of seven (7) small-diameter soil borings to a maximum depth of 51½ feet at the site. Additionally, two (2) percolation tests were performed at depth of 5 and 10 feet below existing ground surface to determine the infiltration rates of the subsurface soil. The locations of the soil borings and percolation tests are depicted on Figure 2, Site Plan. A detailed discussion of our field investigation and exploratory boring logs are presented in Appendix A.

Laboratory tests were performed on selected soil samples obtained during the investigation to evaluate pertinent physical properties for engineering analyses. Appendix B presents the laboratory test results in tabular and graphic format. The recommendations presented herein are based on analysis of the data obtained during the investigation and our experience with similar soil and geologic conditions. If project details vary significantly from those described herein, SALEM should be contacted to determine the necessity for review and possible revision of this report.

Earthwork and Pavement Specifications are presented in Appendix C. If text of the report conflict with the specifications in Appendix C, the recommendations in the text of the report have precedence.

2. PROJECT DESCRIPTION

Based on the Site Plan provided to us, we understand that the proposed development of the site will include demolition of existing commercial buildings and construction of a 23,256 square-foot market (Building A) and a 4,900 square-foot building pad (Pad 1). The Pad 1 building will have 3 suites consisting of a 2,500 square-foot fast food with drive-thru, a 1,200 square-foot food use, and a 1,200 square-foot Retail. Maximum wall load is expected to be on the order of 5 kips per linear foot. Maximum column load is

expected to be on the order of 80 kips. Floor slab soil bearing pressure is expected to be on the order of 150 psf. Parking and landscaping are also planned to be associated with the proposed development.

Based on available information, the northeast corner of the site was occupied by a former P&M Service Station (11520 Alondra Boulevard E) and is a Leaking Underground Storage Tank (LUST) site with monitoring wells. The cleanup status is currently open.

A grading plan was not available at the time of preparation of this report. As the site area is relatively flat, we anticipate that cuts and fills during the earthwork will be minimal and limited to providing a level building pad and positive site drainage. In the event that changes occur in the nature or design of the project, the conclusions and recommendations contained in this report will not be considered valid unless the changes are reviewed and the conclusions of our report are modified. The site configuration and locations of proposed improvements are shown on the Site Plan, Figure 2.

3. SITE LOCATION AND DESCRIPTION

The subject site is rectangular in shape and encompasses approximately 3 acres. The site is located at the southwest corner of the intersection of Alondra Boulevard and Maidstone Avenue in the City of Norwalk, California (see Vicinity Plan, Figure 1).

The site is currently occupied by commercial buildings with associated asphalt-paved parking and landscaping. The northeast corner of the site was occupied by a Gas Station with underground storage tanks and is currently a Leaking Underground Storage Tank (LUST) site with monitoring wells. Monitoring Wells are located throughout the site but are predominately located within the northern area of the site.

The site is relatively flat with no major changes in grade. The average ground elevation of the site is approximately 70 feet above mean sea level based on Google Earth imagery.

4. FIELD EXPLORATION

Our field exploration consisted of site surface reconnaissance and subsurface exploration. The exploratory test borings (B-1 through B-7) were drilled on May 18, 2021 in the locations shown on the Site Plan, Figure 2. The test borings were advanced with 6½-inch diameter hollow stem augers rotated by a truck-mounted CME 55 drill rig. The test borings were extended to a maximum depth of 51½ feet below existing grade.

The materials encountered in the test borings were visually classified in the field, and logs were recorded by a field engineer and stratification lines were approximated on the basis of observations made at the time of drilling. Visual classification of the materials encountered in the test borings were generally made in accordance with the Unified Soil Classification System (ASTM D2488).

A soil classification chart and key to sampling is presented on the Unified Soil Classification Chart, in Appendix "A." The logs of the test borings are presented in Appendix "A." The Boring Logs include the soil type, color, moisture content, dry density, and the applicable Unified Soil Classification System symbol. The location of the test borings were determined by measuring from features shown on the Site Plan, provided to us. Hence, accuracy can be implied only to the degree that this method warrants.

The actual boundaries between different soil types may be gradual and soil conditions may vary. For a more detailed description of the materials encountered, the Boring Logs in Appendix "A" should be consulted. Soil samples were obtained from the test borings at the depths shown on the logs of borings. The MCS samples were recovered and capped at both ends to preserve the samples at their natural moisture content; SPT samples were recovered and placed in a sealed bag to preserve their natural moisture content. The borings were backfilled with bentonite grout/cement, and patched with cold asphalt after completion of the drilling.

5. LABORATORY TESTING

Laboratory tests were performed on selected soil samples to evaluate their physical characteristics and engineering properties. The laboratory-testing program was formulated with emphasis on the evaluation of natural moisture and density, shear strength, consolidation potential, expansion index, maximum density and optimum moisture determination, and gradation of the materials encountered.

In addition, chemical tests were performed to evaluate the corrosivity of the soils to buried concrete and metal. Details of the laboratory test program and the results of laboratory test are summarized in Appendix "B." This information, along with the field observations, was used to prepare the final boring logs in Appendix "A."

6. GEOLOGIC SETTING

The subject site is located in an area termed the central plain of the Los Angeles Basin between the Los Angeles River and San Gabriel River within the Peninsular Range of Southern California. This plain has been formed by deposition of alluvium within the flood plain of the Los Angeles and San Gabriel Rivers, which flows generally southward from the hills and mountains to the north. Published reports indicate that the Quaternary Age alluvium is from 600-800 feet thick in the area, and is underlain by Tertiary Age marine sedimentary rocks several thousand feet in thickness. These deposits are generally fine to coarse grained, consisting primarily of mixtures of silts, sands and clays. Tectonism of the region is dominated by the interaction of the East Pacific Plate and the North American Plate along a transform boundary. Deposits encountered on the subject site during exploratory drilling are discussed in detail in this report.

7. GEOLOGIC HAZARDS

7.1 Faulting and Seismicity

Based on the proximity of several dominant active faults and seismogenic structures, as well as the historic seismic record, the area of the subject site is considered subject to relatively high seismicity. The seismic hazard most likely to impact the site is ground-shaking due to a large earthquake on one of the major active regional faults. Moderate to large earthquakes have affected the area of the subject site within historic time.

There are no known active fault traces in the project vicinity. The project area is not within an Alquist-Priolo Earthquake Fault (Special Studies) Zone and will not require a special site investigation by an Engineering Geologist. Soils on site are classified as **Site Class E** in accordance with the California Building Code. The proposed structures are determined to be in Seismic Design Category D.

To determine the distance of known active faults within 100 miles of the site, we used the United States Geological Survey (USGS) web-based application *2008 National Seismic Hazard Maps - Fault Parameters*. Site latitude is 33.8865° North; site longitude is 118.0875° West. The ten closest active faults are summarized below in Table 7.1.

**TABLE 7.1
REGIONAL FAULT SUMMARY**

Fault Name	Distance to Site (miles)	Maximum Earthquake Magnitude, M_w
Puente Hills (Santa Fe Springs)	1.9	6.7
Puente Hills (Coyote Hills)	2.5	6.9
Puente Hills (LA)	6.1	7.0
Newport Inglewood Connected alt 2	7.5	7.5
Newport Inglewood Connected alt 1	7.5	7.5
Elsinore; W+GI+T+J+CM	7.7	7.9
Elysian Park (Upper)	12.3	6.7
Palos Verdes Connected	13.6	7.7
San Joaquin Hills	15.9	7.1
San Jose	15.9	6.7

The faults tabulated above and numerous other faults in the region are sources of potential ground motion. However, earthquakes that might occur on other faults throughout California are also potential generators of significant ground motion and could subject the site to intense ground shaking.

7.2 Surface Fault Rupture

The site is not within a currently established State of California Earthquake Fault Zone for surface fault rupture hazards. No active faults with the potential for surface fault rupture are known to pass directly beneath the site. Therefore, the potential for surface rupture due to faulting occurring beneath the site during the design life of the proposed development is considered low.

7.3 Ground Shaking

Seismic coefficients and spectral response acceleration values were developed based on the 2019 California Building Code (CBC). The CBC methodology for determining design ground motion values is based on the Office of Statewide Health Planning and Development (OSHPD) Seismic Design Maps, which incorporate both probabilistic and deterministic seismic ground motion.

A table providing the recommended design acceleration parameters for the project site, based on a Site Class E designation, is included in Section 9.2.1 of this report. Based on the Office of Statewide Health Planning and Development (OSHPD) Seismic Design Maps, the estimated design peak ground acceleration adjusted for site class effects (PGAM) was determined to be 0.738g (based on both probabilistic and deterministic seismic ground motion).

7.4 Liquefaction

Soil liquefaction is a state of soil particles suspension caused by a complete loss of strength when the effective stress drops to zero. Liquefaction normally occurs under saturated conditions in soils such as sand in which the strength is purely frictional. Primary factors that trigger liquefaction are: moderate to strong ground shaking (seismic source), relatively clean, loose granular soils (primarily poorly graded sands and silty sands), and saturated soil conditions (shallow groundwater). Due to the increasing overburden pressure with depth, liquefaction of granular soils is generally limited to the upper 50 feet of a soil profile. However, liquefaction has occurred in soils other than clean sand.

Groundwater was encountered at a depth of approximately 35 feet below ground surface during this investigation. Based on the State of California Seismic Hazard Zone Report 037, Whittier Quadrangle, Plate 1.2, Open-File Report 98-28, the historically highest groundwater level within the site's vicinity is estimated to be at a depth of approximately 8 feet below ground surface.

The soils encountered within the depth of 51½ feet on the project site consisted predominately of soft to very stiff sandy clayey silt, loose to medium dense silty sand, well-graded sand with silt, and clayey sand. Low to very low cohesion strength is associated with the sandy soil. A seismic hazard, which could cause damage to the proposed development during seismic shaking, is the post-liquefaction settlement of the liquefied sands.

Based on the State of California, Seismic Hazard Zone Map, Whittier Quadrangle, Dated March 25, 1999, the site is located within a liquefaction potential zone. The potential for soil liquefaction during a seismic event was evaluated using LiqIT computer program (version 7.4.5) developed by GeoLogismiki of Greece. For the analysis, a maximum earthquake magnitude of 7.9 M_w , a peak horizontal ground surface acceleration of 0.74g (based on both probabilistic and deterministic seismic ground motion) and a groundwater depth of 8 feet were considered appropriate for the liquefaction analysis.

The liquefaction analysis indicated that the site soils has a high potential for liquefaction under seismic conditions and the total liquefaction-induced settlement was calculated to be 3½ inches. Differential settlement is estimated to be 1¾ inches over a horizontal distance of 30 feet. The liquefaction analysis is included in Appendix A. The proposed site preparation methods recommended on our geotechnical report should address these geotechnical issues.

7.5 Lateral Spreading

Lateral spreading is a phenomenon in which soils move laterally during seismic shaking and is often associated with liquefaction. The amount of movement depends on the soil strength, duration and intensity of seismic shaking, topography, and free face geometry. Due to relatively flat site topography, we judge the likelihood of lateral spreading to be low.

7.6 Landslides

There are no known landslides at the site, nor is the site in the path of any known or potential landslides. We do not consider the potential for a landslide to be a hazard to this project.

7.7 Tsunamis and Seiches

The site is not located within a coastal area. Therefore, tsunamis (seismic sea waves) are not considered a significant hazard at the site. Seiches are large waves generated in enclosed bodies of water in response to ground shaking. No major water-retaining structures are located immediately up gradient from the project site. Flooding from a seismically-induced seiche is considered unlikely.

8. SOIL AND GROUNDWATER CONDITIONS

8.1 Subsurface Conditions

The subsurface conditions encountered appear typical of those found in the geologic region of the site. In general, the soils within the depth of exploration consisted of up to 6 feet of potential fill and alluvial deposits of soft to very stiff sandy clayey silt, loose to medium dense silty sand, well-graded sand with silt, and clayey sand. The exterior pavement within our test boring locations consisted of approximately 2 to 4 inches of asphaltic concrete (AC) underlain by 1 to 3 inches of asphalt millings or oil dirt. No aggregate base (AB) was encountered.

Thicker fill soils are anticipated to be present on site between our test boring locations since the site was occupied by a gas station and was graded for the current development. Verification of the extent of fill should be determined during site grading.

Undocumented fill material are not suitable to support any future structures and should be replaced with Engineered Fill. The extent and consistency of the fills should be verified during site construction. Prior to fill placement, Salem Engineering Group, Inc. should inspect the bottom of the excavation to verify the fill condition.

Petroleum (volatile organic compound or VOC) odor was noticed in our borings. The scope of services of this report does not include environmental services, such as chemical analyses of soil and groundwater for possible environmental contaminants.

The soils were classified in the field during the drilling and sampling operations. The stratification lines were approximated by the field engineer on the basis of observations made at the time of drilling. The actual boundaries between different soil types may be gradual and soil conditions may vary. For a more detailed description of the materials encountered, the Boring Logs in Appendix "A" should be consulted. The Boring Logs include the soil type, color, moisture content, dry density, and the applicable Unified Soil Classification System symbol. The locations of the test borings were determined by measuring from feature shown on the Site Plan, provided to us. Hence, accuracy can be implied only to the degree that this method warrants.

8.2 Groundwater

The test boring locations were checked for the presence of groundwater during and after the drilling operations. Free groundwater was encountered at a depth of approximately 35 feet below ground surface during this investigation. In accordance with Seismic Hazard Zone Report 037, Whittier 7.5-Minute Quadrangle, Open-File Report 98-28, Plate 1.2, the historically highest groundwater depth is approximately 8 feet below ground surface.

It should be recognized that water table elevations may fluctuate with time, being dependent upon seasonal precipitation, irrigation, land use, localized pumping, and climatic conditions as well as other factors. Therefore, water level observations at the time of the field investigation may vary from those encountered during the construction phase of the project. The evaluation of such factors is beyond the scope of this report.

8.3 Soil Corrosion Screening

Excessive sulfate in either the soil or native water may result in an adverse reaction between the cement in concrete and the soil. The 2014 Edition of ACI 318 (ACI 318) has established criteria for evaluation of sulfate and chloride levels and how they relate to cement reactivity with soil and/or water.

A soil sample was obtained from the project site and was tested for the evaluation of the potential for concrete deterioration or steel corrosion due to attack by soil-borne soluble salts and soluble chloride.

The water-soluble sulfate concentration in the saturation extract from the soil sample was detected to be 100 mg/kg. ACI 318 Tables 19.3.1.1 and 19.3.2.1 outline exposure categories, classes, and concrete requirements by exposure class. ACI 318 requirements for site concrete based upon soluble sulfate are summarized in Table 8.3 below.

**TABLE 8.3
WATER SOLUBLE SULFATE EXPOSURE REQUIREMENTS**

Water Soluble Sulfate (SO₄) in Soil, % by Weight	Exposure Severity	Exposure Class	Maximum w/cm Ratio	Minimum Concrete Compressive Strength	Cementations Materials Type
0.01	Not Severe	S0	N/A	2,500 psi	No Restriction

The water-soluble chloride concentration detected in saturation extract from the soil samples was 26 mg/kg. This level of chloride concentration is considered to be mildly corrosive. It is recommended that a qualified corrosion engineer be consulted regarding protection of buried steel or ductile iron piping and conduit or, at a minimum, applicable manufacturer’s recommendations for corrosion protection of buried metal pipe be closely followed.

8.4 Percolation Testing

Two (2) percolation tests (P-1 and P-2) were performed at the proposed infiltration system areas and were conducted in accordance with the criteria set in the Low Impact Development BMP Guideline of the County of Los Angeles, Department of Public Works. Results of the falling head tests are presented in the attachments to this report. The approximate locations of the percolation tests are shown on the attached Site Plan, Figure 2.

The holes were pre-saturated before percolation testing commenced. Percolation rates were measured by filling the test holes with clean water and measuring the water drops at a certain time interval. The percolation rate data are presented in tabular format at the end of this Report. The difference in the

percolation rates are reflected by the varied type of soil materials at the bottom of the test holes. The test results are shown in the table below.

**TABLE 8.4
PERCOLATION TEST RESULTS**

Test No.	Depth (feet)	Measured Percolation Rate (inch/hour)	Total Reduction Factor*	Design Infiltration Rate (inch/hour)**	Soil Type***
P-1	10	0.04	4	0.01	Sandy Clayey SILT (ML)
P-2	5	3.27	4	0.82	Well-graded Sand with SILT (SW-SM)

* $RF_t = 2, RF_v = 1, RF_s = 2$, Total Reduction Factor, $RF = RF_t \times RF_v \times RF_s = 4$

**Design Infiltration Rate = Measured Percolation Rate / RF

*** At bottom of drilled holes

$RF_s = 1$ to 3 which is based on the specified levels of pre-treatment and maintenance requirements. The value should be verified by the project Civil Engineer.

The soil infiltration or percolation rates are based on tests conducted with clear water. The infiltration/percolation rates may vary with time as a result of soil clogging from water impurities. The infiltration/percolation rates will deteriorate over time due to the soil conditions. Additional percolation tests should be conducted at bottom of the drainage system during construction to verify the infiltration/percolation rate.

The scope of our services did not include a groundwater study and was limited to the performance of percolation testing and soil profile description, and the submitted data only. Our services did not include those associated with septic system design. Neither did services include an Environmental Site Assessment for the presence or absence of hazardous and/or toxic materials in the soil, groundwater, or atmosphere; or the presence of wetlands. Any statements, or absence of statements, in this report or on any boring logs regarding odors, unusual or suspicious items, or conditions observed, are strictly for descriptive purposes and are not intended to convey engineering judgment regarding potential hazardous and/or toxic assessment.

The geotechnical engineering information presented herein is based upon professional interpretation utilizing standard engineering practices. The work conducted through the course of this investigation, including the preparation of this report, has been performed in accordance with the generally accepted standards of geotechnical engineering practice, which existed in the geographic area at the time the report was written. No other warranty, express or implied, is made.

Please be advised that when performing percolation testing services in relatively small diameter borings, that the testing may not fully model the actual full scale long term performance of a given site. This is particularly true where percolation test data is to be used in the design of large infiltration system such as may be proposed for the site. The measured percolation rate includes dispersion of the water at the sidewalls of the boring as well as into the underlying soils. Subsurface conditions, including percolation rates, can change over time as fine-grained soils migrate. It is not warranted that such information and interpretation cannot be superseded by future geotechnical engineering developments. We emphasize that this report is valid for the project outlined above and should not be used for any other sites.

9. CONCLUSIONS AND RECOMMENDATIONS

9.1 General

- 9.1.1 Based upon the data collected during this investigation, and from a geotechnical engineering standpoint, it is our opinion that the site is suitable for the proposed construction of improvements at the site as planned, provided the recommendations contained in this report are incorporated into the project design and construction. Conclusions and recommendations provided in this report are based on our review of available literature, analysis of data obtained from our field exploration and laboratory testing program, and our understanding of the proposed development at this time.
- 9.1.2 The primary geotechnical constraints identified in our investigation is the presence of potential fill soils, liquefiable material, and potentially compressible material at the site. Recommendations to mitigate the effects of these soils are provided in this report.
- 9.1.3 Up to 6 feet of potential fill soils were encountered in our borings. Thicker fill soils are anticipated to be present on site between our test boring locations since the site was occupied by a gas station and was graded for the current development. Undocumented/uncertified fill materials are not suitable to support any future structures and should be replaced with engineered fill in accordance with section 9.5 of this report. The extent and consistency of the fills should be verified during site construction. Prior to fill placement, Salem Engineering Group, Inc. should inspect the bottom of the excavation to verify the fill condition.
- 9.1.4 The scope of this investigation did not include subsurface exploration within the existing structural areas (i.e. buildings, etc.) during field exploration. As such, subsurface soil conditions and materials present below the existing site structures are unknown and may be different than those noted within this report. The presence of potentially unacceptable fill materials, undocumented fill, and/or loose soil material that may be present below existing site features shall be taken into consideration. Our firm shall be present at the time of demolition activities to verify soil conditions are consistent with those identified as part of this investigation.
- 9.1.5 The site is a current leaking underground storage tank (LUST) cleanup site (case currently open). A Soil Management Plan (SMP) should be prepared and distributed to construction personnel. The SMP will establish protocols for handling, sampling, storage, and disposal of any suspected hydrocarbon-affected soils generated during grading and construction activities.
- 9.1.6 Petroleum/gasoline (volatile organic compound or VOC) odor was noticed in our borings. The scope of services of this report does not include environmental services, such as chemical analyses of soil and groundwater for possible environmental contaminants.
- 9.1.7 Site demolition activities shall include removal of all surface obstructions not intended to be incorporated into final site design. In addition, all underground structures and/or utility lines should be properly removed and the resulting excavations backfilled with Engineered Fill. It is suspected that possible demolition activities of the existing structures may disturb the upper soils. After demolition activities, it is recommended that disturbed soils be removed and/or recompacted.

- 9.1.8 Surface vegetation consisting of grasses and other similar vegetation should be removed by stripping to a sufficient depth to remove organic-rich topsoil. The upper 4 to 6 inches of the soils containing vegetation, roots, and other objectionable organic matter encountered at the time of grading should be stripped and removed from the surface. Deeper stripping may be required in localized areas. The stripped vegetation will not be suitable for use as Engineered Fill or within 5 feet of building pads or within pavement areas. However, stripped topsoil may be stockpiled and reused in landscape or non-structural areas or exported from the site.
- 9.1.9 Loose sandy soils were encountered within the soil borings at the project site. A seismic hazard, which could cause damage to the proposed development during seismic shaking, is the post-liquefaction settlement of liquefied sands. Liquefaction potential at the site was evaluated using the “LiqIT” computer program. Based on our evaluation, the potential for liquefaction at the site is moderately high. Mitigation measures are recommended to minimize structural damage due to the liquefaction. The potential for structural damage at the site can be minimized by using geogrid (see Section 9.6), a structural slab system (see Section 9.7), stone columns, or supporting the building on a deep foundation system.
- 9.1.10 Geogrid is a commonly and economically method to reduce structural damage due to liquefaction. This method has been accepted by cities and counties throughout California, and implemented into design and construction of many retail buildings. However, this method may not be accepted by some local jurisdictions. We have no control for the acceptance of this method for this project. To use the geogrid method, it’s recommended the proposed building be designed and the structural drawings be prepared after this report is approved by the City of Norwalk.
- 9.1.11 Recommendations for the geogrid system (option 1) are provided herein. As an alternative to the use of geogrid, the proposed structure may be supported by a structural slab system. A structural slab system will help reduce structural damage caused by liquefaction. Recommendations for a structural slab system (option 2) are provided in the Foundation’s section of this report.
- 9.1.12 In lieu of the geogrid reinforcement method or the structural slab system, the building may be supported on deep foundations or by utilizing stone columns. Recommendations for a deep foundation system or the stone column method may be provided to the client by Salem Engineering Group, Inc. upon request.
- 9.1.13 SALEM shall review the project grading and foundation plans prior to final design submittal to assess whether our recommendations have been properly implemented and evaluate if additional analysis and/or recommendations are required. If SALEM is not provided plans and specifications for review, we cannot assume any responsibility for the future performance of the project.
- 9.1.14 SALEM shall be present at the site during site demolition and preparation to observe site clearing/demolition, preparation of exposed surfaces after clearing, and placement, treatment and compaction of fill material.

9.1.15 SALEM's observations should be supplemented with periodic compaction tests to establish substantial conformance with these recommendations. Moisture content of footings and slab subgrade should be tested immediately prior to concrete placement. SALEM should observe foundation excavations prior to placement of reinforcing steel or concrete to assess whether the actual bearing conditions are compatible with the conditions anticipated during the preparation of this report.

9.2 Seismic Design Criteria

9.2.1 For seismic design of the structures, and in accordance with the seismic provisions of the 2019 CBC, our recommended parameters are shown below. These parameters are based on Probabilistic Ground Motion of 2% Probability of Exceedance in 50 years. The Site Class was determined based on the results of our field exploration.

**TABLE 9.2.1
SEISMIC DESIGN PARAMETERS**

Seismic Item	Symbol	Value	ASCE 7-16 or 2019 CBC Reference
Site Coordinates (Datum = NAD 83)		33.8865 Lat -118.0875 Lon	
Site Class	--	E	ASCE 7 Table 20.3-1
Soil Profile Name	--	Soft Clay Soil	ASCE 7 Table 20.3-1
Risk Category	--	II	Table 1604.5
Site Coefficient for PGA	F_{PGA}	1.1	ASCE 7 Table 11.8-1
Peak Ground Acceleration (adjusted for Site Class effects)	PGA_M	0.738 g	ASCE 7 Equation 11.8-1
Seismic Design Category	SDC	D	Table 1613.2.5
Mapped Spectral Acceleration (Short period - 0.2 sec)	S_S	1.573 g	Figure 1613.2.1(1-8)
Mapped Spectral Acceleration (1.0 sec. period)	S_1	0.563 g	Figure 1613.2.1(1-8)
Site Class Modified Site Coefficient	F_a	1.2	Table 1613.2.3(1)
Site Class Modified Site Coefficient	F_v	*2.074	Table 1613.2.3(2)
MCE Spectral Response Acceleration (Short period - 0.2 sec) $S_{MS} = F_a S_S$	S_{MS}	1.888 g	Equation 16-36
MCE Spectral Response Acceleration (1.0 sec. period) $S_{M1} = F_v S_1$	S_{M1}	*1.168 g	Equation 16-37
Design Spectral Response Acceleration $S_{DS} = \frac{2}{3} S_{MS}$ (short period - 0.2 sec)	S_{DS}	1.258 g	Equation 16-38
Design Spectral Response Acceleration $S_{D1} = \frac{2}{3} S_{M1}$ (1.0 sec. period)	S_{D1}	*0.778 g	Equation 16-39
Short Term Transition Period (S_{D1}/S_{DS}), Seconds	T_S	0.619	ASCE 7-16, Section 11.4.6
Long Period Transition Period (seconds)	T_L	8	ASCE 7-16, Figure 22-14

* Determined per ASCE Table 11.4-2 for use in calculating T_S only.

9.2.2 Site Specific Ground Motion Analysis was not included in the scope of this investigation. Per ASCE 11.4.8, structures on Site Class E with S_s greater than or equal to 1.0 and/or with S_1 greater than or equal to 0.2 may require Site Specific Ground Motion Analysis. However, a site specific motion analysis may not be required based on Exceptions listed in ASCE 11.4.8. The Structural Engineer should verify whether Exceptions No.1 and/or No. 3 of ASCE 7-16, Section 11.4.8, is valid for the site. In the event that a site specific ground motion analysis is required, SALEM should be contacted for these services.

9.2.3 Conformance to the criteria in the above table for seismic design does not constitute any kind of guarantee or assurance that significant structural damage or ground failure will not occur if a large earthquake occurs. The primary goal of seismic design is to protect life, not to avoid all damage, since such design may be economically prohibitive.

9.3 Soil and Excavation Characteristics

9.3.1 Based on the soil conditions encountered in our soil borings, the onsite soils can be excavated with moderate to laborious effort using conventional excavation and earthmoving equipment.

9.3.2 It is the responsibility of the contractor to ensure that all excavations and trenches are properly shored and maintained in accordance with applicable Occupational Safety and Health Administration (OSHA) rules and regulations to maintain safety and maintain the stability of adjacent existing improvements.

9.3.3 The near surface soils identified as part of our investigation are, generally, slightly moist to very moist due to the absorption characteristics of the soil. Earthwork operations may encounter very moist unstable soils which may require removal to a stable bottom. Exposed native soils exposed as part of site grading operations shall not be allowed to dry out and should be kept continuously moist prior to placement of subsequent fill.

9.4 Materials for Fill

9.4.1 Excavated soils generated from cut operations at the site are suitable for use as general Engineered Fill in structural areas provided they do not have an Expansion Index greater than 20 ($EI \leq 20$) and do not contain deleterious matter, debris, organic material, or rock material larger than 3 inches in maximum dimension.

9.4.2 The preferred materials specified for Engineered Fill are suitable for most applications with the exception of exposure to erosion. Project site winterization and protection of exposed soils during the construction phase should be the sole responsibility of the Contractor, since they have complete control of the project site.

9.4.3 Environmental characteristics and corrosion potential of import soil materials should also be considered.

9.4.4 Proposed import materials should be sampled, tested, and approved by SALEM prior to its transportation to the site.

9.4.5 Import soil shall be well-graded, slightly cohesive silty fine sand or sandy silt, with relatively impervious characteristics when compacted. A clean sand or very sandy soil is not acceptable for this purpose. This material should be approved by the Engineer prior to use and should typically possess the soil characteristics summarized below in Table 9.4.5.

**TABLE 9.4.5
IMPORT FILL REQUIREMENTS**

Minimum Percent Passing No. 200 Sieve	15
Maximum Percent Passing No. 200 Sieve	50
Minimum Percent Passing No. 4 Sieve	80
Maximum Particle Size	3"
Maximum Plasticity Index	12
Maximum CBC Expansion Index	20

9.5 Grading

- 9.5.1 A representative of our firm should be present during all site clearing and grading operations to test and observe earthwork construction. This testing and observation is an integral part of our service as acceptance of earthwork construction is dependent upon compaction of the material and the stability of the material. The Geotechnical Engineer may reject any material that does not meet compaction and stability requirements. Further recommendations of this report are predicated upon the assumption that earthwork construction will conform to recommendations set forth in this section as well as other portions of this report.
- 9.5.2 A preconstruction conference should be held at the site prior to the beginning of grading operations with the owner, contractor, civil engineer and geotechnical engineer in attendance.
- 9.5.3 Site preparation should begin with removal of existing surface/subsurface structures, underground utilities and storage tanks, any existing uncertified fill, and debris. Excavations or depressions resulting from site clearing operations, or other existing excavations or depressions, should be restored with Engineered Fill in accordance with the recommendations of this report.
- 9.5.4 Surface vegetation consisting of grasses and other similar vegetation should be removed by stripping to a sufficient depth to remove organic-rich topsoil. The upper 2 to 4 inches of the soils containing, vegetation, roots and other objectionable organic matter encountered at the time of grading should be stripped and removed from the surface. Deeper stripping may be required in localized areas. In addition, existing concrete and asphalt materials shall be removed from areas of proposed improvements and stockpiled separately from excavated soil material. The stripped vegetation, asphalt and concrete materials will not be suitable for use as Engineered Fill or within 5 feet of building pads or within pavement areas. However, stripped topsoil may be stockpiled and reused in landscape or non-structural areas or exported from the site.

- 9.5.5 Tree root systems in proposed improvement areas should be removed to a minimum depth of 3 feet and to such an extent which would permit removal of all roots greater than ½ inch in diameter. Tree roots removed in parking areas may be limited to the upper 1½ feet of the ground surface. Backfill of tree root excavations is not permitted until all exposed surfaces have been inspected and the Soils Engineer is present for the proper control of backfill placement and compaction. Burning in areas which are to receive fill materials shall not be permitted.
- 9.5.6 Up to 6 feet of potential fill soils were encountered during this investigation. Any undocumented and uncertified fill materials encountered during grading should be removed and replaced with engineered fill. The actual depth of the overexcavation and recompaction should be determined by our field representative during construction.
- 9.5.7 Within pavement areas, it is recommended that overexcavation and recompaction be performed to a minimum depth of **12 inches** below existing grade or finish grade, whichever is deeper. The overexcavation and recompaction should also extend laterally to a minimum of 2 feet beyond the outer edges of the proposed pavement.
- 9.5.8 Prior to placement of fill soils, the upper 10 to 12 inches of native subgrade soils should be scarified, moisture-conditioned to slightly higher than the optimum moisture content and recompacted to a minimum of 90% (95% for granular non-cohesive soils) of the maximum dry density based on ASTM D1557-07 Test Method.
- 9.5.9 The consistency of the existing fill materials below the overexcavation should be verified during site construction. Prior to fill placement, Salem Engineering Group, Inc. should inspect the bottom of the excavation to verify no additional excavation will be required.
- 9.5.10 All Engineered Fill (including scarified ground surfaces and backfill) should be placed in thin lifts to allow for adequate bonding and compaction (typically 6 to 8 inches in loose thickness).
- 9.5.11 Engineered Fill should be placed, moisture conditioned to slightly higher than the optimum moisture content, and compacted to at least 90% (95% for granular non-cohesive soils) relative compaction.
- 9.5.12 Granular non-cohesive Engineered Fill should be placed, moisture conditioned to slightly higher than the optimum moisture content, and compacted to at least 95% relative compaction.
- 9.5.13 An integral part of satisfactory fill placement is the stability of the placed lift of soil. If placed materials exhibit excessive instability as determined by a SALEM field representative, the lift will be considered unacceptable and shall be remedied prior to placement of additional fill material. Additional lifts should not be placed if the previous lift did not meet the required dry density or if soil conditions are not stable.
- 9.5.14 Final pavement subgrade should be finished to a smooth, unyielding surface. We further recommend proof-rolling the subgrade with a loaded water truck (or similar equipment with high contact pressure) to verify the stability of the subgrade prior to placing aggregate base.

9.5.15 The most effective site preparation alternatives will depend on site conditions prior to grading. We should evaluate site conditions and provide supplemental recommendations immediately prior to grading, if necessary.

9.5.16 We do not anticipate groundwater or seepage to adversely affect construction if conducted during the drier months of the year (typically summer and fall). However, groundwater and soil moisture conditions could be significantly different during the wet season (typically winter and spring) as surface soil becomes wet; perched groundwater conditions may develop. Grading during this time period will likely encounter wet materials resulting in possible excavation and fill placement difficulties.

Project site winterization consisting of placement of aggregate base and protecting exposed soils during construction should be performed. If the construction schedule requires grading operations during the wet season, we can provide additional recommendations as conditions warrant.

9.5.17 Wet soils may become non conducive to site grading as the upper soils yield under the weight of the construction equipment. Therefore, mitigation measures should be performed for stabilization.

Typical remedial measures include: discing and aerating the soil during dry weather; mixing the soil with dryer materials; removing and replacing the soil with an approved fill material or placement of slurry, crushed rocks or aggregate base material; or mixing the soil with an approved lime or cement product. The most common remedial measure of stabilizing the bottom of the excavation due to wet soil condition is to reduce the moisture of the soil to near the optimum moisture content by having the subgrade soils scarified and aerated or mixed with drier soils prior to compacting. However, the drying process may require an extended period of time and delay the construction operation.

To expedite the stabilizing process, slurry or crushed rock may be utilized for stabilization provided this method is approved by the owner for the cost purpose. If the use of slurry, crushed rock is considered, it is recommended that the upper soft and wet soils be replaced by 6 to 24 inches of 2-sack slurry or $\frac{3}{4}$ -inch to 1-inch crushed rocks. The thickness of the slurry or rock layer depends on the severity of the soil instability. The recommended 6 to 24 inches of crushed rock material will provide a stable platform.

It is further recommended that lighter compaction equipment be utilized for compacting the crushed rock. A layer of geofabric is recommended to be placed on top of the compacted crushed rock to minimize migration of soil particles into the voids of the crushed rock, resulting in soil movement. Although it is not required, the use of geogrid (e.g. Tensar TX7) below the slurry or crushed rock will enhance stability and reduce the required thickness of crushed rock necessary for stabilization. Our firm should be consulted prior to implementing remedial measures to provide appropriate recommendations.

9.6 Option 1 - Shallow Foundations with Geogrid

- 9.6.1 The site is suitable for use of conventional shallow foundations consisting of continuous strip footings in combination with isolated spread footings bearing on geogrid reinforced Engineered Fill.
- 9.6.2 Subsurface soils within the site are prone to liquefaction under high ground shaking acceleration during an earthquake. Our preliminary calculations indicated that the building areas, and at least 5 feet beyond, should be over-excavated to a depth of **six (6) feet** below existing grade, **four (4) feet** below proposed footings, or to a bottom of any undocumented fills, whichever is greater, and the resulting excavation should be backfilled with a layered system of Engineered Fill and geogrid reinforcing fabric.
- 9.6.3 The proposed Pad 1 building will be located within the former gas station area. Therefore, deeper overexcavation is anticipated to remove all undocumented fill materials and underground structures.
- 9.6.4 Any undocumented and uncompacted fills encountered during grading should be removed and replaced with engineered fill. The depth of the over-excavation should be measured from existing ground or rough pad grade, whichever is greater. A preliminary design procedure is provided below. Final design will be provided by the geogrid manufacturer along with our office. Global seismic induced settlement of the site is still anticipated when liquefaction occurs.
- 9.6.5 Prior to placing the geogrid, The bottom of the excavation (subgrade) should be scarified to a depth of 8 inches, moisture conditioned to near optimum moisture, and recompacted to a minimum of 90 percent (95% for granular non-cohesive soils) relative compaction based on ASTM D 1557 (Latest Edition).
- 9.6.6 The first layer of geogrid reinforcement will be placed directly on the prepared subgrade at a depth of **6 feet** below existing grade or **4 feet** below proposed footings, whichever is deeper. The geogrid material should be overlapped a minimum of 3 feet in all directions. The interlock between the geogrid and Engineered Fill will provide load transfer. No vehicles may traverse the geogrid prior to placement of the Engineered Fill cover.
- 9.6.7 The next layer of geogrid should be placed on top of the compacted Engineered Fill. This and subsequent layers need only be overlapped a minimum of 1 foot on all sides. The fill soils excavated from the area beneath the structure may be moisture conditioned and recompacted between geogrid layers as reinforced fill. The reinforced fill should be moisture conditioned to near optimum moisture content and recompacted to a minimum of 90 percent (95% for granular non-cohesive soils) of the maximum dry density based on ASTM D 1557 Test Method.
- 9.6.8 A total of **three (3)** geogrid layers, including the layer at the base of the excavation should be installed at vertical increments of 1 foot. The geogrid layers should extend to a minimum of 5 feet beyond the exterior footing perimeter of the structure. The geogrid reinforcement fabric

should consist of Tensar® TX7 Geogrid. Any additional unstable soils within building areas should be excavated and backfilled with Engineered Fill.

- 9.6.9 It is recommended that the entire site be excavated at once, and soils be stockpiled on adjacent or nearby properties. The geogrid and excavated soil may then be placed and recompacted as recommended herein. Alternatively, the contractor may elect to excavate the site in two stages, where excavated soil can be stockpiled over one-half of the site while the other half is mitigated. However, if the contractor elects the option of two stages over the preferred option of using one stage, a minimum of 5 feet of geogrid from the first half should overlap the second half. Furthermore, the overlapping geogrid should be protected from damages, which may be caused by operating equipment. It is further recommended that flexible utility connections be used for the project.
- 9.6.10 It is recommended that continuous bearing wall footings to be utilized for the building have a minimum width of 15 inches, and a minimum embedment depth of 18 inches below lowest adjacent pad grade. Isolated column footings should have a minimum width of 24 inches, and a minimum embedment depth of 18 inches below lowest adjacent pad grade.
- 9.6.11 Footing concrete should be placed into neat excavation. The footing bottoms shall be maintained free of loose and disturbed soil.
- 9.6.12 Footings proportioned as recommended above may be designed for the maximum allowable soil bearing pressures shown in the table below.

Loading Condition	Allowable Bearing
Dead Load Only	2,000 psf
Dead-Plus-Live Load	2,500 psf
Total Load, Including Wind or Seismic Loads	3,325psf

- 9.6.13 For design purposes, total static settlement not exceeding ½ inches may be assumed for shallow foundations. Differential static settlement should not exceed ¼ inches (with geogrid) over 30 feet. Most of the settlement is expected to occur during construction as the loads are applied. However, additional post-construction settlement may occur if the foundation soils are flooded or saturated. The footing excavations should not be allowed to dry out any time prior to pouring concrete. The total settlement due to severe seismic loads is expected to be on the order of 3½ inches. With the geogrid reinforcement, the seismic induced differential settlement is expected to be reduced to approximately ½ inches over 30 feet.
- 9.6.14 Resistance to lateral footing displacement can be computed using an allowable coefficient of friction factor of 0.35 acting between the base of foundations and the supporting native subgrade.
- 9.6.15 Lateral resistance for footings can alternatively be developed using an equivalent fluid passive pressure of 300 pounds per cubic foot acting against the appropriate vertical native footing faces. The frictional and passive resistance of the soil may be combined without reduction in

determining the total lateral resistance. An increase of one-third is permitted when using the alternate load combination in CBC that includes wind or earthquake loads.

- 9.6.16 Underground utilities running parallel to footings should not be constructed in the zone of influence of footings. The zone of influence may be taken to be the area beneath the footing and within a 1:1 plane extending out and down from the bottom edge of the footing.
- 9.6.17 The foundation subgrade should be sprinkled as necessary to maintain a moist condition without significant shrinkage cracks as would be expected in any concrete placement. Prior to placing rebar reinforcement, foundation excavations should be evaluated by a representative of SALEM for appropriate support characteristics and moisture content. Moisture conditioning may be required for the materials exposed at footing bottom, particularly if foundation excavations are left open for an extended period.

9.7 Option 2 – Structural Slabs

- 9.7.1 As an alternative to the geogrid method, the building may be supported on a reinforced structural slab foundation system (e.g. mat foundation, modified mat foundation, post-tensioned slab or stiffened footings with rigid grade beams) to resist damage due to seismic-induced differential settlement.
- 9.7.2 The foundation can be designed utilizing allowable bearing pressure of 1,500 pounds per square foot for dead-plus-live loads. This value may be increased by 1/3 for short duration loads such as wind or seismic. The thickness and reinforcement of the structural slab should be determined by the Structural Engineer.
- 9.7.3 The structural slab should have a minimum depth of 12 inches below the lowest adjacent exterior grade. The structural slab should be supported by at least 2 feet of Engineered Fill. Any undocumented and uncompacted fills encountered during grading should be removed and replaced with engineered fill.
- 9.7.4 The total settlement due to foundation loads (static) is not expected to exceed 1 inch. Differential settlement due to static loads should be less than ½ inches over 30 feet. Most of the settlement is expected to occur during construction as the loads are applied. However, additional post-construction settlement may occur if the foundation soils are flooded or saturated.
- 9.7.5 The seismic-induced total and differential settlements are expected to be on the order of 3½ inches and 1¾ inches over 30 feet, respectively. It is further recommended that flexible utility connectors be used for this project.
- 9.7.6 Resistance to lateral footing displacement can be computed using an allowable friction factor of 0.35 acting between the base of foundations and the supporting subgrade. Lateral resistance for footings can alternatively be developed using an equivalent fluid passive pressure of 300 pounds per cubic foot acting against the appropriate vertical slab faces. The frictional and passive resistance of the soil may be combined without reduction in determining the total lateral resistance.

9.8 Concrete Slabs-on-Grade

- 9.8.1 Slab thickness and reinforcement should be determined by the structural engineer based on the anticipated loading. We recommend that non-structural slabs-on-grade be at least 4 inches thick and underlain by six (6) inches of compacted clean granular aggregate subbase material compacted to at least 95% relative compaction.
- 9.8.2 Granular aggregate subbase material shall conform to ASTM D-2940, Latest Edition (Table 1, bases) with at least 95 percent passing a 1½-inch sieve and not more than 8% passing a No. 200 sieve or clean crushed aggregate base (CAB) to prevent capillary moisture rise. Crushed Miscellaneous Base (CMB) containing recycled materials should not be used as granular aggregate subbase within the building pad areas.
- 9.8.3 We recommend reinforcing slabs, at a minimum, with No. 4 reinforcing bars placed 18 inches on center, each way.
- 9.8.4 Slabs subject to structural loading may be designed utilizing a modulus of subgrade reaction K of 120 pounds per square inch per inch. The K value was approximated based on inter-relationship of soil classification and bearing values (Portland Cement Association, Rocky Mountain Northwest).
- 9.8.5 The spacing of crack control joints should be designed by the project structural engineer. In order to regulate cracking of the slabs, we recommend that construction joints or control joints be provided at a maximum spacing of 15 feet in each direction for 5-inch thick slabs and 12 feet for 4-inch thick slabs.
- 9.8.6 Crack control joints should extend a minimum depth of one-fourth the slab thickness and should be constructed using saw-cuts or other methods as soon as practical after concrete placement. The exterior floors should be poured separately in order to act independently of the walls and foundation system.
- 9.8.7 It is recommended that the utility trenches within the structure be compacted, as specified in our report, to minimize the transmission of moisture through the utility trench backfill. Special attention to the immediate drainage and irrigation around the structures is recommended.
- 9.8.8 Moisture within the structure may be derived from water vapors, which were transformed from the moisture within the soils. This moisture vapor penetration can affect floor coverings and produce mold and mildew in the structure. To minimize moisture vapor intrusion, it is recommended that a vapor retarder be installed in accordance with manufacturer's recommendations and/or ASTM guidelines, whichever is more stringent. In addition, ventilation of the structure is recommended to reduce the accumulation of interior moisture.
- 9.8.9 In areas where it is desired to reduce floor dampness where moisture-sensitive coverings are anticipated, construction should have a suitable waterproof vapor retarder (a minimum of 15 mils thick polyethylene vapor retarder sheeting, Raven Industries "VaporBlock 15, Stego Industries 15 mil "StegoWrap" or W.R. Meadows Sealtight 15 mil "Perminator") incorporated into the floor slab design. The water vapor retarder should be decay resistant material complying with ASTM

E96 not exceeding 0.04 perms, ASTM E154 and ASTM E1745 Class A. The vapor barrier should be placed between the concrete slab and the compacted granular aggregate subbase material. The water vapor retarder (vapor barrier) should be installed in accordance with ASTM Specification E 1643-94.

- 9.8.10 The concrete may be placed directly on vapor retarder. The vapor retarder should be inspected prior to concrete placement. Cut or punctured retarder should be repaired using vapor retarder material lapped 6 inches beyond damaged areas and taped.
- 9.8.11 The recommendations of this report are intended to reduce the potential for cracking of slabs due to soil movement. However, even with the incorporation of the recommendations presented herein, foundations, stucco walls, and slabs-on-grade may exhibit some cracking due to soil movement. This is common for project areas that contain expansive soils since designing to eliminate potential soil movement is cost prohibitive. The occurrence of concrete shrinkage cracks is independent of the supporting soil characteristics. Their occurrence may be reduced and/or controlled by limiting the slump of the concrete, proper concrete placement and curing, and by the placement of crack control joints at periodic intervals, in particular, where re-entrant slab corners occur.
- 9.8.12 Proper finishing and curing should be performed in accordance with the latest guidelines provided by the American Concrete Institute, Portland Cement Association, and ASTM.

9.9 Lateral Earth Pressures and Frictional Resistance

9.9.1 Active, at-rest and passive unit lateral earth pressures against footings and walls are summarized in the table below:

Lateral Pressure Level Backfill and Drained Conditions	Equivalent Fluid Pressure, pcf
Active Pressure	42
At-Rest Pressure	62
Passive Pressure	300
Related Parameters	
Allowable Coefficient of Friction	0.35
In-Place Soil Density (lbs/ft ³)	120

9.9.2 Active pressure applies to walls, which are free to rotate. At-rest pressure applies to walls, which are restrained against rotation. The preceding lateral earth pressures assume sufficient drainage behind retaining walls to prevent the build-up of hydrostatic pressure.

9.9.3 The top one-foot of adjacent subgrade should be deleted from the passive pressure computation.

- 9.9.4 The foregoing values of lateral earth pressures represent allowable soil values and a safety factor consistent with the design conditions should be included in their usage.
- 9.9.5 For stability against lateral sliding, which is resisted solely by the passive pressure, we recommend a minimum safety factor of 1.5.
- 9.9.6 For stability against lateral sliding, which is resisted by the combined passive and frictional resistance, a minimum safety factor of 2.0 is recommended.
- 9.9.7 For lateral stability against seismic loading conditions, we recommend a minimum safety factor of 1.1.
- 9.9.8 For dynamic seismic lateral loading the following equation shall be used:

Dynamic Seismic Lateral Loading Equation
Dynamic Seismic Lateral Load = $\frac{3}{8}\gamma K_h H^2$
Where: γ = In-Place Soil Density
K_h = Horizontal Acceleration = $\frac{2}{3}PGA_M$
H = Wall Height

9.10 Retaining Walls

- 9.10.1 Retaining and/or below grade walls should be drained with either perforated pipe encased in free-draining gravel or a prefabricated drainage system. The gravel zone should have a minimum width of 12 inches wide and should extend upward to within 12 inches of the top of the wall. The upper 12 inches of backfill should consist of native soils, concrete, asphaltic-concrete or other suitable backfill to minimize surface drainage into the wall drain system. The gravel should conform to Class II permeable materials graded in accordance with the current CalTrans Standard Specifications.
- 9.10.2 Prefabricated drainage systems, such as Miradrain®, Enkadrain®, or an equivalent substitute, are acceptable alternatives in lieu of gravel provided they are installed in accordance with the manufacturer’s recommendations. If a prefabricated drainage system is proposed, our firm should review the system for final acceptance prior to installation.
- 9.10.3 Drainage pipes should be placed with perforations down and should discharge in a non-erosive manner away from foundations and other improvements. The top of the perforated pipe should be placed at or below the bottom of the adjacent floor slab or pavements. The pipe should be placed in the center line of the drainage blanket and should have a minimum diameter of 4 inches. Slots should be no wider than 1/8-inch in diameter, while perforations should be no more than 1/4-inch in diameter.
- 9.10.4 If retaining walls are less than 5 feet in height, the perforated pipe may be omitted in lieu of weep holes on 4 feet maximum spacing. The weep holes should consist of 2-inch minimum diameter

holes (concrete walls) or unmortared head joints (masonry walls) and placed no higher than 18 inches above the lowest adjacent grade. Two 8-inch square overlapping patches of geotextile fabric (conforming to the CalTrans Standard Specifications for "edge drains") should be affixed to the rear wall opening of each weep hole to retard soil piping.

9.10.5 During grading and backfilling operations adjacent to any walls, heavy equipment should not be allowed to operate within a lateral distance of 5 feet from the wall, or within a lateral distance equal to the wall height, whichever is greater, to avoid developing excessive lateral pressures. Within this zone, only hand operated equipment ("whackers," vibratory plates, or pneumatic compactors) should be used to compact the backfill soils.

9.11 Temporary Excavations

9.11.1 We anticipate that the majority of the near surface site soils will be classified as Cal-OSHA “Type C” soil when encountered in excavations during site development and construction. Excavation sloping, benching, the use of trench shields, and the placement of trench spoils should conform to the latest applicable Cal-OSHA standards. The contractor should have a Cal-OSHA-approved “competent person” onsite during excavation to evaluate trench conditions and make appropriate recommendations where necessary.

9.11.2 It is the contractor’s responsibility to provide sufficient and safe excavation support as well as protecting nearby utilities, structures, and other improvements which may be damaged by earth movements. All onsite excavations must be conducted in such a manner that potential surcharges from existing structures, construction equipment, and vehicle loads are resisted. The surcharge area may be defined by a 1:1 projection down and away from the bottom of an existing foundation or vehicle load.

9.11.3 Temporary excavations and slope faces should be protected from rainfall and erosion. Surface runoff should be directed away from excavations and slopes.

9.11.4 Open, unbraced excavations in undisturbed soils should be made according to the slopes presented in the following table:

RECOMMENDED EXCAVATION SLOPES

Depth of Excavation (ft)	Slope (Horizontal : Vertical)
0-5	1:1
5-10	2:1

9.11.5 If, due to space limitation, excavations near property lines or existing structures are performed in a vertical position, slot cuts, braced shorings or shields may be used for supporting vertical excavations. Therefore, in order to comply with the local and state safety regulations, a properly designed and installed shoring system would be required to accomplish planned excavations and installation. A Specialty Shoring Contractor should be responsible for the design and installation of such a shoring system during construction.

- 9.11.6 Braced shorings should be designed for a maximum pressure distribution of $30H$, (where H is the depth of the excavation in feet). The foregoing does not include excess hydrostatic pressure or surcharge loading. Fifty percent of any surcharge load, such as construction equipment weight, should be added to the lateral load given herein. Equipment traffic should concurrently be limited to an area at least 3 feet from the shoring face or edge of the slope.
- 9.11.7 The excavation and shoring recommendations provided herein are based on soil characteristics derived from the borings within the area. Variations in soil conditions will likely be encountered during the excavations. SALEM Engineering Group, Inc. should be afforded the opportunity to provide field review to evaluate the actual conditions and account for field condition variations not otherwise anticipated in the preparation of this recommendation. Slope height, slope inclination, or excavation depth should in no case exceed those specified in local, state, or federal safety regulation, (e.g. OSHA) standards for excavations, 29 CFR part 1926, or Assessor's regulations.

9.12 Underground Utilities

- 9.12.1 Underground utility trenches should be backfilled with properly compacted material. The material excavated from the trenches should be adequate for use as backfill provided it does not contain deleterious matter, vegetation or rock larger than 3 inches in maximum dimension. Trench backfill should be placed in loose lifts not exceeding 8 inches and compacted to at least 90% (95% for granular non-cohesive soils) relative compaction at slightly above the optimum moisture content.
- 9.12.2 Bedding and pipe zone backfill typically extends from the bottom of the trench excavations to approximately 6 to 12 inches above the crown of the pipe. Pipe bedding and backfill material should conform to the requirements of the governing utility agency.
- 9.12.3 It is suggested that underground utilities crossing beneath new or existing structures be plugged at entry and exit locations to the buildings or structures to prevent water migration. Trench plugs can consist of on-site clay soils, if available, or sand cement slurry. The trench plugs should extend 2 feet beyond each side of individual perimeter foundations.
- 9.12.4 The contractor is responsible for removing all water-sensitive soils from the trench regardless of the backfill location and compaction requirements. The contractor should use appropriate equipment and methods to avoid damage to the utilities and/or structures during fill placement and compaction.

9.13 Surface Drainage

- 9.13.1 Proper surface drainage is critical to the future performance of the project. Uncontrolled infiltration of irrigation excess and storm runoff into the soils can adversely affect the performance of the planned improvements. Saturation of a soil can cause it to lose internal shear strength and increase its compressibility, resulting in a change to important engineering properties. Proper drainage should be maintained at all times.

- 9.13.2 The ground immediately adjacent to the foundation shall be sloped away from the building at a slope of not less than 5 percent for a minimum distance of 10 feet.
- 9.13.3 Impervious surfaces within 10 feet of the building foundation shall be sloped a minimum of 2 percent away from the building and drainage gradients maintained to carry all surface water to collection facilities and off site. These grades should be maintained for the life of the project. Ponding of water should not be allowed adjacent to the structure. Over-irrigation within landscaped areas adjacent to the structure should not be performed.
- 9.13.4 Roof drains should be installed with appropriate downspout extensions out-falling on splash blocks so as to direct water a minimum of 5 feet away from the structures or be connected to the storm drain system for the development.

9.14 Pavement Design

- 9.14.1 Based on site soil conditions, an R-value of 20 was used for the preliminary flexible asphaltic concrete pavement design. The R-value may be verified during grading of the pavement areas.
- 9.14.2 The asphaltic concrete (flexible pavement) is based on a 20-year pavement life. The pavement is designed based on traffic loading provided in the table below. If higher traffic loading is anticipated, SALEM should be contacted to provide revised pavement thickness recommendations.

**TABLE 9.14.2
ASPHALT CONCRETE PAVEMENT**

Traffic Index	Asphaltic Concrete	Clean Class II Aggregate Base*	Compacted Subgrade**
5.0 (Vehicle Parking and Drive Areas)	3.0"	7.0"	12.0"
6.0 (Heavy Truck Areas)	4.0"	8.5"	12.0"

*95% compaction based on ASTM D1557-07 Test Method
** 90% (95% for granular non-cohesive soils) compaction based on ASTM D1557-07 Test Method

- 9.14.3 The following recommendations are for light-duty and heavy-duty Portland Cement Concrete pavement sections.

**TABLE 9.14.3
PORTLAND CEMENT CONCRETE PAVEMENT**

Traffic Index	Portland Cement Concrete*	Clean Class II Aggregate Base**	Compacted Subgrade***
5.0 (Light Duty)	5.0"	6.0"	12.0"
6.0 (Heavy Duty)	6.0"	6.0"	12.0"

* Min. Compressive Strength of 4,000 psi; Min. Reinforcement of No. 4 bars at 18 inches O.C. each way
** 95% compaction based on ASTM D1557-07 Test Method
*** 90% (95% for granular non-cohesive soils) compaction based on ASTM D1557-07 Test Method

10. PLAN REVIEW, CONSTRUCTION OBSERVATION AND TESTING

10.1 Plan and Specification Review

10.1.1 SALEM should review the project plans and specifications prior to final design submittal to assess whether our recommendations have been properly implemented and evaluate if additional analysis and/or recommendations are required.

10.2 Construction Observation and Testing Services

10.2.1 The recommendations provided in this report are based on the assumption that we will continue as Geotechnical Engineer of Record throughout the construction phase. It is important to maintain continuity of geotechnical interpretation and confirm that field conditions encountered are similar to those anticipated during design. If we are not retained for these services, we cannot assume any responsibility for others interpretation of our recommendations, and therefore the future performance of the project.

10.2.2 SALEM should be present at the site during site preparation to observe site clearing, preparation of exposed surfaces after clearing, and placement, treatment and compaction of fill material.

10.2.3 SALEM's observations should be supplemented with periodic compaction tests to establish substantial conformance with these recommendations. Moisture content of footings and slab subgrade should be tested immediately prior to concrete placement. SALEM should observe foundation excavations prior to placement of reinforcing steel or concrete to assess whether the actual bearing conditions are compatible with the conditions anticipated during the preparation of this report.

11. LIMITATIONS AND CHANGED CONDITIONS

The analyses and recommendations submitted in this report are based upon the data obtained from the test borings drilled at the approximate locations shown on the Site Plan, Figure 2. The report does not reflect variations which may occur between boring locations. The nature and extent of such variations may not become evident until construction is initiated. If variations then appear, a re-evaluation of the recommendations of this report will be necessary after performing on-site observations during the excavation period and noting the characteristics of such variations. The findings and recommendations presented in this report are valid as of the present and for the proposed construction.

If site conditions change due to natural processes or human intervention on the property or adjacent to the site, or changes occur in the nature or design of the project, or if there is a substantial time lapse between the submission of this report and the start of the work at the site, the conclusions and recommendations contained in our report will not be considered valid unless the changes are reviewed by SALEM and the conclusions of our report are modified or verified in writing. The validity of the recommendations contained in this report is also dependent upon an adequate testing and observations program during the construction phase. Our firm assumes no responsibility for construction compliance with the design concepts or recommendations unless we have been retained to perform the on-site testing and review during construction. SALEM has prepared this report for the exclusive use of the owner and project design consultants.

SALEM does not practice in the field of corrosion engineering. It is recommended that a qualified corrosion engineer be consulted regarding protection of buried steel or ductile iron piping and conduit or, at a minimum, that manufacturer's recommendations for corrosion protection be closely followed. Further, a corrosion engineer may be needed to incorporate the necessary precautions to avoid premature corrosion of concrete slabs and foundations in direct contact with native soil. The importation of soil and or aggregate materials to the site should be screened to determine the potential for corrosion to concrete and buried metal piping. The report has been prepared in accordance with generally accepted geotechnical engineering practices in the area. No other warranties, either express or implied, are made as to the professional advice provided under the terms of our agreement and included in this report.

If you have any questions, or if we may be of further assistance, please do not hesitate to contact our office at (909) 980-6455.

Respectfully Submitted,

SALEM ENGINEERING GROUP, INC.



Jared Christiansen, EIT
Geotechnical Staff Engineer



Ibrahim Foud Ibrahim, PE
Senior Managing Engineer
RCE 86724



Clarence Jiang, GE
Senior Geotechnical Engineer
RGE 2477



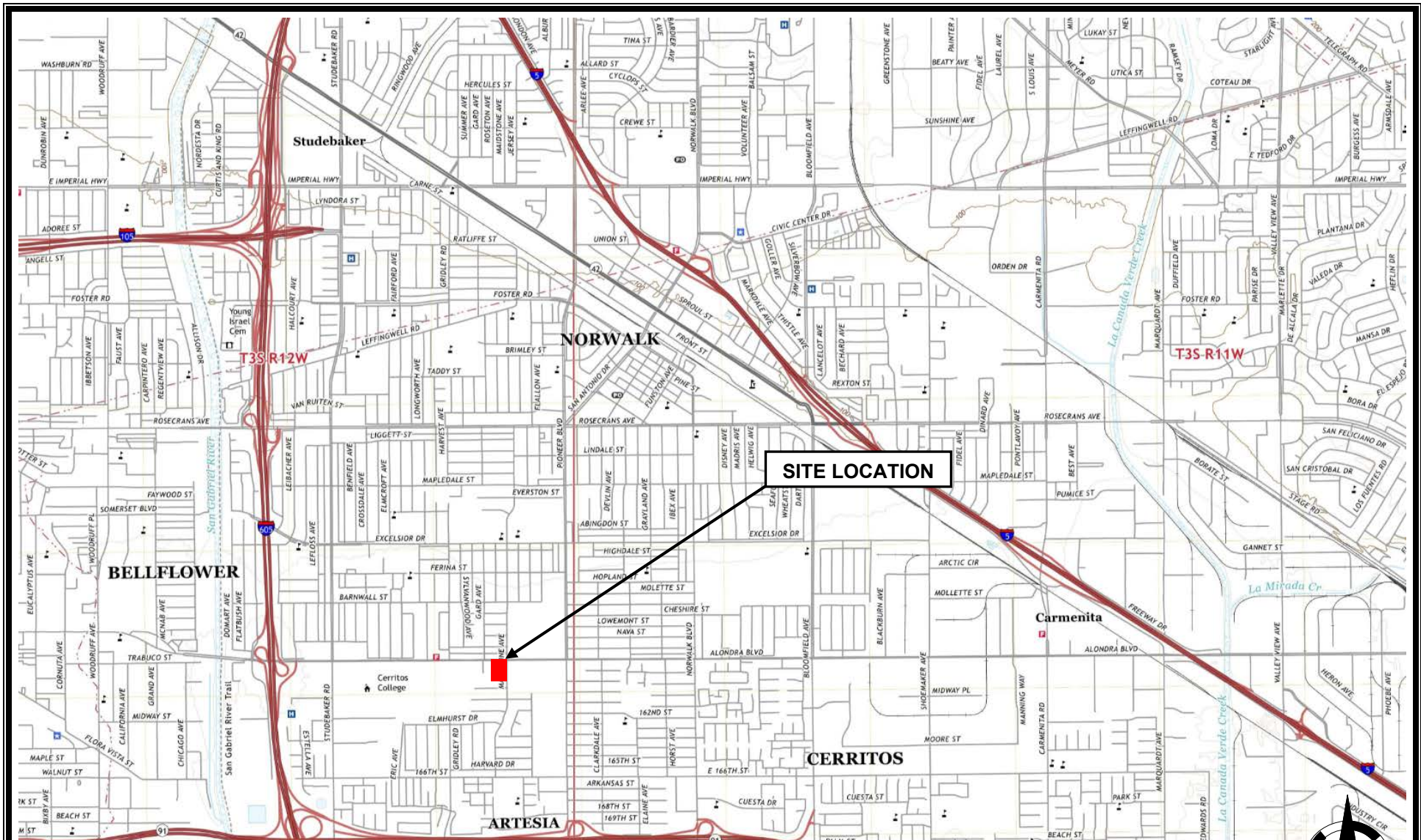

Source Image: U.S. Geological Survey, Whittier, California, <https://ngmdb.usgs.gov/topoview> (2018)

VICINITY MAP
GEOTECHNICAL ENGINEERING INVESTIGATION
Proposed Commercial Development
SWC Alondra Boulevard & Maidstone Avenue
Norwalk, California

SCALE: NOT TO SCALE	DATE: 06/2021
DRAWN BY: JC	APPROVED BY: CJ
PROJECT NO. 3-221-0428	FIGURE NO. 1



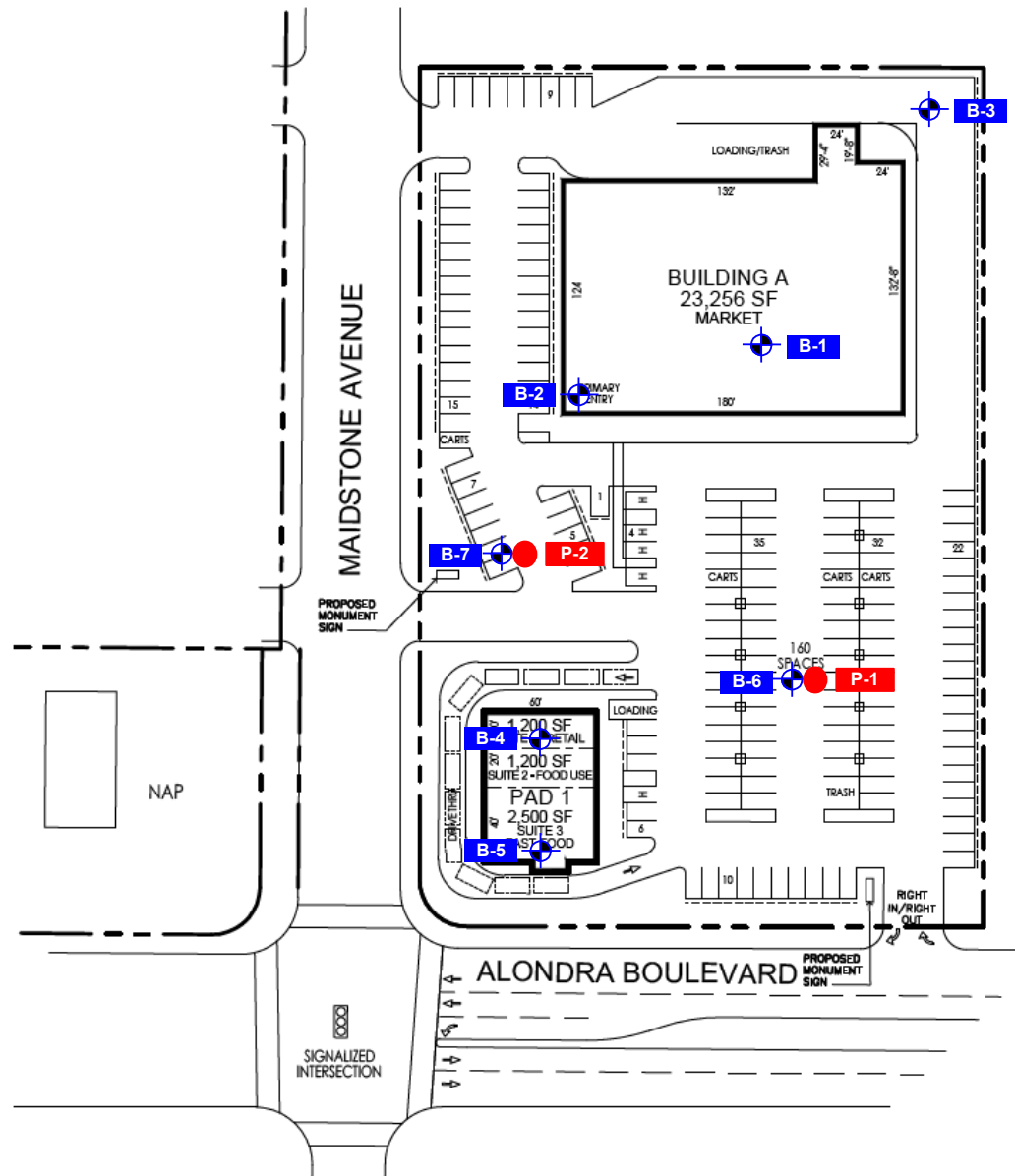



SITE PLAN

GEOTECHNICAL ENGINEERING INVESTIGATION
Proposed Commercial Development
SWC of Alondra Boulevard & Maidstone Avenue
Norwalk, California

SCALE:
 NOT TO SCALE
 DRAWN BY:
 JC
 PROJECT NO.
 3-221-0428

DATE:
 05/2021
 APPROVED BY:
 CJ
 FIGURE NO.
 2

LEGEND:
 **B-1** Soil Boring Locations
 **P-1** Percolation Locations
 All Locations Approximate



A



APPENDIX A FIELD EXPLORATION

Fieldwork for our investigation (drilling) was conducted on May 18, 2021 and included a site visit, subsurface exploration, percolation testing, and soil sampling. The locations of the exploratory borings and percolation tests are shown on the Site Plan, Figure 2. Boring logs for our exploration are presented in figures following the text in this appendix. Borings were located in the field using existing reference points. Therefore, actual boring locations may deviate slightly.

In general, our borings were performed using a truck-mounted CME 55 drill rig equipped with 6½-inch diameter hollow stem augers. Sampling in the borings was accomplished using a hydraulic 140-pound hammer with a 30-inch drop. Samples were obtained with a 3-inch outside-diameter (OD), split spoon (California Modified) sampler, and a 2-inch OD, Standard Penetration Test (SPT) sampler. The number of blows required to drive the sampler the last 12 inches (or fraction thereof) of the 18-inch sampling interval were recorded on the boring logs. The blow counts shown on the boring logs should not be interpreted as standard SPT “N” values; corrections have not been applied. Upon completion, the borings were backfilled with bentonite grout/cement and were patched with cold asphalt. Soil cuttings were placed in 55-gallon drums.

Subsurface conditions encountered in the exploratory borings were visually examined, classified and logged in general accordance with the American Society for Testing and Materials (ASTM) Practice for Description and Identification of Soils (Visual-Manual Procedure D2488). This system uses the Unified Soil Classification System (USCS) for soil designations. The logs depict soil and geologic conditions encountered and depths at which samples were obtained. The logs also include our interpretation of the conditions between sampling intervals. Therefore, the logs contain both observed and interpreted data. We determined the lines designating the interface between soil materials on the logs using visual observations, drill rig penetration rates, excavation characteristics and other factors. The transition between materials may be abrupt or gradual. Where applicable, the field logs were revised based on subsequent laboratory testing.



Project: Proposed Commercial Development

Location: SWC Alondra Boulevard & Maidstone Avenue, Norwalk, California

Drilled By: SALEM

Logged By: JC

Drill Type: CME 55

Elevation: 70'

Auger Type: 6.5 in. Hollow Stem Auger

Initial Depth to Groundwater: 35'

Hammer Type: Automatic Trip - 140 lb/30 in

Final Depth to Groundwater: 30.5'

ELEVATION/ DEPTH (feet)	SOIL SYMBOLS SAMPLER SYMBOLS AND FIELD TEST DATA	USCS	Soil Description	N-Values blows/ft.	Moisture Content %	Dry Density, PCF	Remarks
70 - 0		AC	Asphalt Concrete = 3 in.				
		FILL	Asphalt Millings = 1 in.				
	5/6 6/6 7/6	ML	Sandy Clayey SILT Stiff; moist; olive; fine grain sand.	13	16.4	98.5	
65 - 5	3/6 5/6 6/6		Grades as above; very moist; grayish brown.	11	19.1	96.3	
60 - 10	2/6 1/6 3/6		Grades as above; soft.	4	21.8	-	
55 - 15	3/6 2/6 4/6		Grades as above; firm.	6	27.3	-	
50 - 20	2/6 3/6 4/6		Grades as above.	7	21.3	-	
45 - 25	3/6 4/6 4/6		Grades as above; wet; grayish olive.	8	31.7	-	

Notes:

Figure Number A-1



SALEM
engineering group, inc.

Project Number: 3-221-0428

Date: 05/18/2021

Test Boring: B-1

ELEVATION/ DEPTH (feet)	SOIL SYMBOLS SAMPLER SYMBOLS AND FIELD TEST DATA	USCS	Soil Description	N-Values blows/ft.	Moisture Content %	Dry Density, PCF	Remarks
40 - 30		SM	Silty SAND Loose; very moist; dark gray; fine grain sand; trace clay.	7	20.0	-	Strong VOC odor beginning at 29 feet.
35 - 35			Grades as above; saturated; more sand.	7	35.5	-	
30 - 40		ML	Sandy Clayey SILT Very stiff; saturated; dark gray; fine grain sand.	18	32.5	-	
25 - 45			Grades as above; less silt.	29	26.3	-	
20 - 50			Grades as above; more silt.	13	34.4	-	
			End of boring at 51.5 feet BSG.				
15 - 55							
10 - 60							

Notes:

Figure Number A-1



Project: Proposed Commercial Development

Location: SWC Alondra Boulevard & Maidstone Avenue, Norwalk, California

Drilled By: SALEM

Logged By: JC

Drill Type: CME 55

Elevation: 70'

Auger Type: 6.5 in. Hollow Stem Auger

Initial Depth to Groundwater: N/A

Hammer Type: Automatic Trip - 140 lb/30 in

Final Depth to Groundwater: N/A

ELEVATION/ DEPTH (feet)	SOIL SYMBOLS SAMPLER SYMBOLS AND FIELD TEST DATA	USCS	Soil Description	N-Values blows/ft.	Moisture Content %	Dry Density, PCF	Remarks
70 0		AC	Asphalt Concrete = 3.5 in.				
		FILL	Asphalt Millings = 1 in.				
	4/6 5/6 7/6	ML	Sandy Clayey SILT Stiff; moist; grayish brown; fine grain sand.	12	13.3	98.7	
65 5	4/6 6/6 9/6		Grades as above.	15	15.4	93.7	
60 10	2/6 2/6 2/6		Grades as above; soft; olive brown; less sand. SAND lense at 11 feet.	4	22.2	-	
55 15	4/6 2/6 3/6	ML	Sandy Clayey SILT Firm; very moist; brown.	5	36.8	-	
50 20	2/6 4/6 6/6		Grades as above; stiff; grayish brown; with sand.	10	20.4	-	
			End of boring at 21.5 feet BSG.				
45 25							

Notes:

Figure Number A-2



Project: Proposed Commercial Development

Location: SWC Alondra Boulevard & Maidstone Avenue, Norwalk, California

Drilled By: SALEM

Logged By: JC

Drill Type: CME 55

Elevation: 71'

Auger Type: 6.5 in. Hollow Stem Auger

Initial Depth to Groundwater: N/A

Hammer Type: Automatic Trip - 140 lb/30 in

Final Depth to Groundwater: N/A

ELEVATION/ DEPTH (feet)	SOIL SYMBOLS SAMPLER SYMBOLS AND FIELD TEST DATA	USCS	Soil Description	N-Values blows/ft.	Moisture Content %	Dry Density, PCF	Remarks
0		AC	Asphalt Concrete = 2 in.				
70		FILL	Asphalt Millings = 1 in.				
	3/6 5/6 8/6	SC	Clayey SAND Medium dense; very moist; dark gray; fine to medium grain sand; with silt.	13	23.2	98.4	
5	5/6 6/6 8/6	ML	Sandy Clayey SILT Stiff; very moist; grayish brown; fine grain sand; trace clay.	14	17.9	97.4	
65	2/6 2/6 2/6	ML	Sandy Clayey SILT Soft; very moist; grayish brown; trace clay; some sand.	4	25.5	-	
10	2/6 3/6 4/6		Grades as above; firm; olive brown; no clay or sand.	7	29.9	-	
15			End of boring at 16.5 feet BSG.				
20							
50							
25							
45							

Notes:

Figure Number A-3



Project: Proposed Commercial Development

Location: SWC Alondra Boulevard & Maidstone Avenue, Norwalk, California

Drilled By: SALEM

Logged By: JC

Drill Type: CME 55

Elevation: 70'

Auger Type: 6.5 in. Hollow Stem Auger

Initial Depth to Groundwater: N/A

Hammer Type: Automatic Trip - 140 lb/30 in

Final Depth to Groundwater: N/A

ELEVATION/ DEPTH (feet)	SOIL SYMBOLS SAMPLER SYMBOLS AND FIELD TEST DATA	USCS	Soil Description	N-Values blows/ft.	Moisture Content %	Dry Density, PCF	Remarks
70 0		AC	Asphalt Concrete = 4 in.				
		FILL	Asphalt Millings = 2 in.				
	4/6 7/6 9/6	SM	POTENTIAL FILL Silty SAND Medium dense; moist; brown; fine to medium grain sand.	16	6.4	102.6	
65 5	4/6 4/6 5/6	ML	Sandy Clayey SILT Firm; moist; brown; fine grain sand.	9	16.1	93.5	
60 10	2/6 2/6 2/6		Grades as above; soft; very moist; grayish brown; with clay. Strong VOC odor at 11 feet.	4	22.4	-	
55 15	5/6 4/6 3/6	SM	Silty SAND Loose; very moist; brown; fine to coarse grain sand.	7	22.1	-	
		ML	Sandy Clayey SILT Firm very moist; gray.				
50 20	2/6 3/6 3/6		Grades as above; grayish brown; no clay; with fine sand.	6	22.9	-	
			End of boring at 21.5 feet BSG.				
45 25							

Notes:

Figure Number A-4



Project: Proposed Commercial Development

Location: SWC Alondra Boulevard & Maidstone Avenue, Norwalk, California

Drilled By: SALEM

Logged By: JC

Drill Type: CME 55

Elevation: 70'

Auger Type: 6.5 in. Hollow Stem Auger

Initial Depth to Groundwater: N/A

Hammer Type: Automatic Trip - 140 lb/30 in

Final Depth to Groundwater: N/A

ELEVATION/ DEPTH (feet)	SOIL SYMBOLS SAMPLER SYMBOLS AND FIELD TEST DATA	USCS	Soil Description	N-Values blows/ft.	Moisture Content %	Dry Density, PCF	Remarks
70 0		AC	Asphalt Concrete = 2 in.				
		FILL	Asphalt Millings = 1 in.				
		SM	POTENTIAL FILL Silty SAND	11	8.4	101.3	
65 5		ML	Loose; moist; grayish brown; fine to coarse grain sand. Sandy Clayey SILT	8	23.3	99.0	
			Firm; very moist; olive; fine grain sand; trace clay.				
60 10		ML	Grades as above; soft; grayish brown.	3	21.1	-	
55 15		SM	Silty SAND Loose; moist; gray; fine to coarse grain sand.	8	6.0	-	
			End of boring at 16.5 feet BSG.				Strong VOC odor beginning at 12 feet.
50 20							
45 25							

Notes:

Figure Number A-5



Project: Proposed Commercial Development

Location: SWC Alondra Boulevard & Maidstone Avenue, Norwalk, California

Drilled By: SALEM

Logged By: JC

Drill Type: CME 55

Elevation: 71'

Auger Type: 6.5 in. Hollow Stem Auger

Initial Depth to Groundwater: N/A

Hammer Type: Automatic Trip - 140 lb/30 in

Final Depth to Groundwater: N/A

ELEVATION/ DEPTH (feet)	SOIL SYMBOLS SAMPLER SYMBOLS AND FIELD TEST DATA	USCS	Soil Description	N-Values blows/ft.	Moisture Content %	Dry Density, PCF	Remarks
0							
70		AC	Asphalt Concrete = 2.5 in.				
		FILL	Asphalt Millings = 3 in.				
	6/6	ML	Sandy Clayey SILT	13	16.9	98.9	
	6/6		Stiff; moist; olive gray; fine grain				
	7/6	SM	sand.				
5			Silty SAND				
65	3/6		Loose; very moist; olive; fine grain	12	16.3	92.8	
	5/6		sand.				
	7/6						
10	3/6	ML	Sandy Clayey SILT	5	18.5	-	
	2/6		Firm; very moist; olive brown; fine				
	3/6		grain sand.				
60			End of boring at 10 feet BSG.				
15							
55							
20							
50							
25							
45							

Notes:

Figure Number A-6



Project: Proposed Commercial Development

Location: SWC Alondra Boulevard & Maidstone Avenue, Norwalk, California

Drilled By: SALEM

Logged By: JC

Drill Type: CME 55

Elevation: 70'

Auger Type: 6.5 in. Hollow Stem Auger

Initial Depth to Groundwater: N/A

Hammer Type: Automatic Trip - 140 lb/30 in

Final Depth to Groundwater: N/A

ELEVATION/ DEPTH (feet)	SOIL SYMBOLS SAMPLER SYMBOLS AND FIELD TEST DATA	USCS	Soil Description	N-Values blows/ft.	Moisture Content %	Dry Density, PCF	Remarks
70	0						
		AC	Asphalt Concrete = 2 in.				
		FILL	Asphalt Millings = 1 in.	32	7.5	113.2	
		SM	Silty SAND				
		SW-SM	Medium dense; moist; grayish brown; fine to medium grain sand.	10	4.0	-	
65	5		Well-graded SAND with Silt Loose; slightly moist; yellowish, grayish brown; fine to coarse grain sand.				
			End of boring at 5 feet BSG.				
60	10						
55	15						
50	20						
45	25						

Notes:

KEY TO SYMBOLS

Symbol Description

Strata symbols

 Asphaltic Concrete

 Fill

 Silt

 Silty sand

 Clayey sand

 Well graded sand
with silt

Misc. Symbols

 Boring continues

 Water table during
drilling

Soil Samplers

 California sampler

 Standard penetration test

Notes:

Granular Soils

Blows Per Foot (Uncorrected)

	MCS	SPT
Very loose	<5	<4
Loose	5-15	4-10
Medium dense	16-40	11-30
Dense	41-65	31-50
Very dense	>65	>50

Cohesive Soils

Blows Per Foot (Uncorrected)

	MCS	SPT
Very soft	<3	<2
Soft	3-5	2-4
Firm	6-10	5-8
Stiff	11-20	9-15
Very Stiff	21-40	16-30
Hard	>40	>30

MCS = Modified California Sampler

SPT = Standard Penetration Test Sampler

Percolation Test Worksheet

Project: Proposed Commercial Development
SWC Alondra Blvd. & Maidstone Ave.
Norwalk, California

Job No.: 3-221-0428
Date Drilled: 5/18/2021
Soil Classification: Sandy Clayey SILT (ML)

Vol. in 1" Wtr Col. (in³): 50.3

Hole Dia.: 8 in.

Pipe Dia.: 3 in.

Test Hole No.: P-1
Tested by: JC
Drilled Hole Depth: 10.0 ft.

Presoaking Date: 5/18/2021
Test Date: 5/18/2021

Pipe stickup: 0.25 ft

Time Start	Time Finish	Depth of Test Hole (ft) [#]	Refill- Yes or No	Elapsed Time (hrs:min)	Initial Water Level [#] (ft)	Final Water Level [#] (ft)	Δ Water Level (in.)	Δ Min.	Volume of Water Discharged (in ³)	Test Area (sidewalls & bottom) (in ²)	Measured Perc Rate (in/hr)	
7:37	8:07	10.25	Y	0:30	9.04	9.12	0.96	30	48.25	403.1	0.24	
8:07	8:37	10.25	N	0:30	9.12	9.17	0.60	30	30.16	383.5	0.16	
8:37	9:07	10.25	N	0:30	9.17	9.22	0.60	30	30.16	368.4	0.16	
9:07	9:37	10.25	N	0:30	9.22	9.26	0.48	30	24.13	354.9	0.14	
9:37	10:07	10.25	N	0:30	9.26	9.30	0.48	30	24.13	342.8	0.14	
10:07	10:37	10.25	N	0:30	9.30	9.33	0.36	30	18.10	332.3	0.11	
10:37	11:07	10.25	N	0:30	9.33	9.35	0.24	30	12.06	324.7	0.07	
11:07	11:37	10.25	N	0:30	9.35	9.36	0.12	30	6.03	320.2	0.04	
11:37	12:07	10.25	N	0:30	9.36	9.37	0.12	30	6.03	317.2	0.04	
12:07	12:37	10.25	N	0:30	9.37	9.38	0.12	30	6.03	314.2	0.04	
Recommended for Design:									Percolation Rate*	6.03		0.04

* Average of last 3 readings

Percolation Test Worksheet

Project: Proposed Commercial Development
SWC Alondra Blvd. & Maidstone Ave.
Norwalk, California

Job No.: 3-221-0428

Date Drilled: 5/18/2021

Soil Classification: Well-graded sand with silt
SW-SM

Vol. in 1" Wtr Col. (in³): 50.3

Hole Dia.: 8 in.

Pipe Dia.: 3 in.

Test Hole No.: P-2

Tested by: JC

Drilled Hole Depth: 5.0 ft.

Presoaking Date: 5/18/2021

Test Date: 5/18/2021

Pipe stickup: 1.7 ft

Time Start	Time Finish	Depth of Test Hole (ft) [#]	Refill- Yes or No	Elapsed Time (hrs:min)	Initial Water Level [#] (ft)	Final Water Level [#] (ft)	Δ Water Level (in.)	Δ Min.	Volume of Water Discharged (in ³)	Test Area (sidewalls & bottom) (in ²)	Measured Perc Rate (in/hr)
7:45	7:55	6.7	Y	0:10	5.60	6.10	6.00	10	301.59	306.6	5.90
7:55	8:14	6.7	N	0:19	6.10	drained		19			
water remained in the hole after 10 minutes but drained before 30 minutes, the time interval between readings is 10 minutes											
8:17	8:27	6.7	Y	0:10	5.65	5.99	4.08	10	205.08	315.7	3.90
8:29	8:39	6.7	Y	0:10	5.63	5.95	3.84	10	193.02	324.7	3.57
8:41	8:51	6.7	Y	0:10	5.75	6.03	3.36	10	168.89	294.6	3.44
8:53	9:03	6.7	Y	0:10	5.65	5.95	3.60	10	180.96	321.7	3.38
9:05	9:15	6.7	Y	0:10	5.66	5.95	3.48	10	174.92	320.2	3.28
9:17	9:27	6.7	Y	0:10	5.74	6.01	3.24	10	162.86	299.1	3.27
9:29	9:39	6.7	Y	0:10	5.70	5.98	3.36	10	168.89	309.6	3.27
9:41	9:51	6.7	Y	0:10	5.66	5.95	3.48	10	174.92	320.2	3.28
Recommended for Design:									Percolation Rate*	168.89	3.27

* Average of last 3 readings

LIQUEFACTION ANALYSIS REPORT

Project title : 3-221-0428

Project subtitle : Norwalk

Input parameters and analysis data

In-situ data type:	Standard Penetration Test	Depth to water table:	8.00 ft
Analysis type:	Deterministic	Earthquake magnitude M_w :	7.90
Analysis method:	NCEER 1998	Peak ground acceleration:	0.74 g
Fines correction method:	Robertson & Wride	User defined F.S.:	1.30

SPT data graph

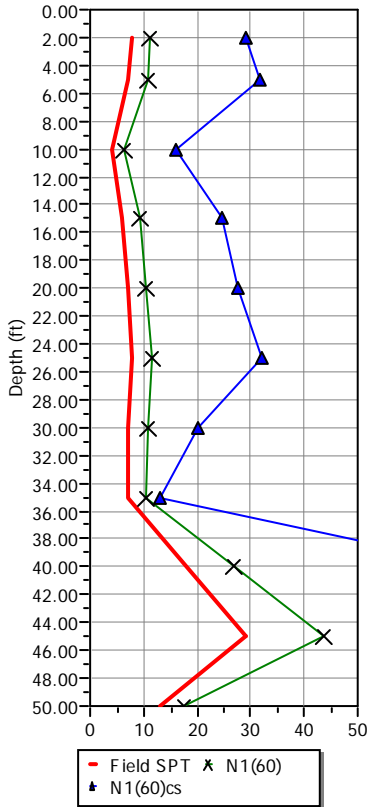

Shear stress ratio

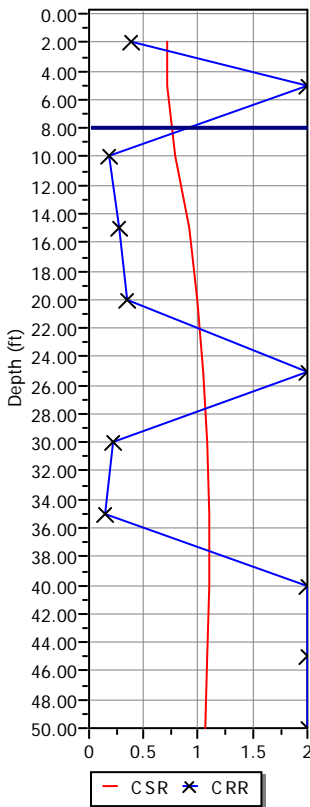

Factor of safety

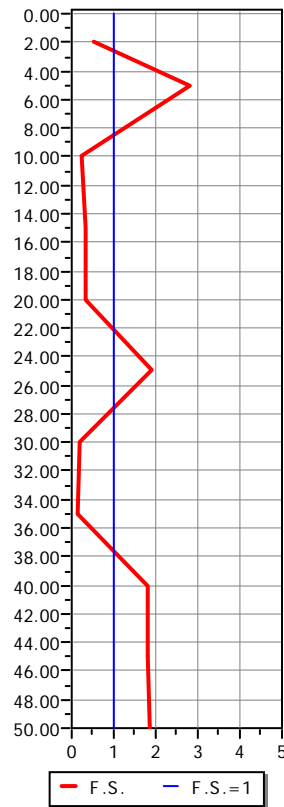

Settlements (in)

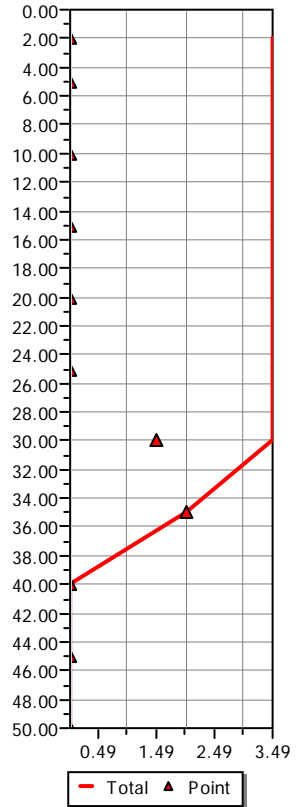

$M_w = 7^{1/2}$, $\sigma'_v = 1$ atm base curve

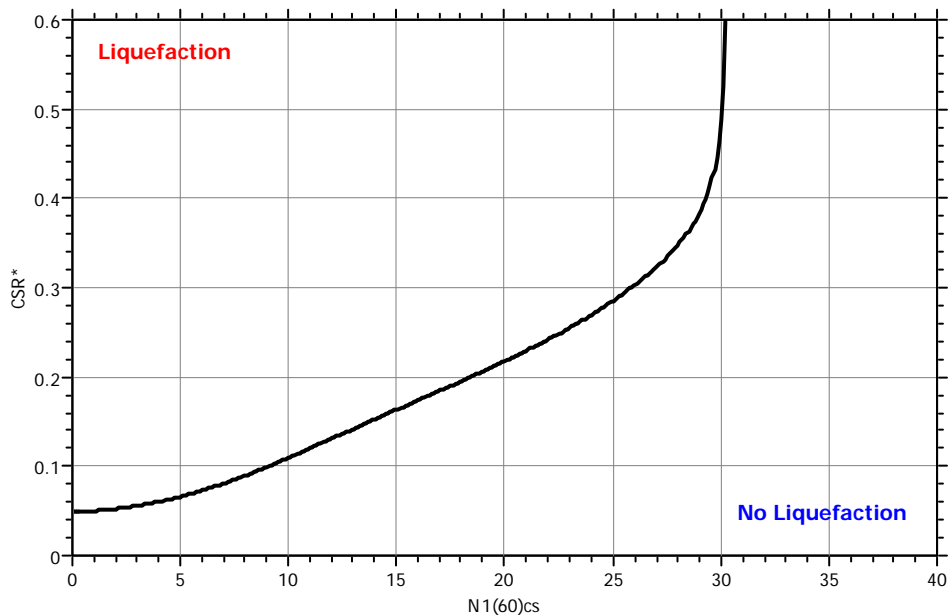

:: Field input data ::

Point ID	Depth (ft)	Field N _{SPT} (blows/feet)	Unit weight (pcf)	Fines content (%)
1	2.00	8.00	120.00	70.00
2	5.00	7.00	120.00	82.00
3	10.00	4.00	120.00	70.00
4	15.00	6.00	120.00	69.00
5	20.00	7.00	120.00	70.00
6	25.00	8.00	120.00	74.00
7	30.00	7.00	120.00	41.00
8	35.00	7.00	120.00	15.00
9	40.00	18.00	120.00	72.00
10	45.00	29.00	120.00	70.00
11	50.00	13.00	120.00	83.00

Depth : Depth from free surface, at which SPT was performed (ft)
 Field SPT : SPT blows measured at field (blows/feet)
 Unit weight : Bulk unit weight of soil at test depth (pcf)
 Fines content : Percentage of fines in soil (%)

:: Cyclic Stress Ratio calculation (CSR fully adjusted and normalized) ::

Point ID	Depth (ft)	Sigma (tsf)	u (tsf)	Sigma' (tsf)	r _d	CSR	MSF	CSR _{eq,M=7.5}	K _{sigma}	CSR*
1	2.00	0.12	0.00	0.12	1.00	0.48	0.88	0.55	1.00	0.55
2	5.00	0.30	0.00	0.30	0.99	0.48	0.88	0.54	1.00	0.54
3	10.00	0.60	0.06	0.54	0.98	0.52	0.88	0.60	1.00	0.60
4	15.00	0.90	0.22	0.68	0.97	0.61	0.88	0.70	1.00	0.70
5	20.00	1.20	0.37	0.83	0.95	0.67	0.88	0.76	1.00	0.76
6	25.00	1.50	0.53	0.97	0.94	0.70	0.88	0.80	1.00	0.80
7	30.00	1.80	0.69	1.11	0.93	0.72	0.88	0.83	0.99	0.84
8	35.00	2.10	0.84	1.26	0.89	0.72	0.88	0.82	0.96	0.85
9	40.00	2.40	1.00	1.40	0.85	0.70	0.88	0.80	0.94	0.85
10	45.00	2.70	1.16	1.54	0.81	0.68	0.88	0.78	0.92	0.84
11	50.00	3.00	1.31	1.69	0.77	0.66	0.88	0.75	0.91	0.83

Depth : Depth from free surface, at which SPT was performed (ft)
 Sigma : Total overburden pressure at test point, during earthquake (tsf)
 u : Water pressure at test point, during earthquake (tsf)
 Sigma' : Effective overburden pressure, during earthquake (tsf)
 r_d : Nonlinear shear mass factor
 CSR : Cyclic Stress Ratio
 MSF : Magnitude Scaling Factor
 CSR_{eq,M=7.5} : CSR adjusted for M=7.5
 K_{sigma} : Effective overburden stress factor
 CSR* : CSR fully adjusted

:: Cyclic Resistance Ratio calculation CRR_{7.5} ::

Point ID	Field SPT	C _n	C _e	C _b	C _r	C _s	N ₁₍₆₀₎	DeltaN	N _{1(60)cs}	CRR _{7.5}
1	8.00	1.70	0.86	1.05	0.75	1.20	11.07	17.98	29.05	0.39
2	7.00	1.70	0.90	1.05	0.80	1.20	10.83	20.84	31.67	2.00
3	4.00	1.48	0.97	1.05	0.85	1.20	6.17	10.03	16.21	0.18
4	6.00	1.26	1.04	1.05	0.95	1.20	9.45	15.12	24.56	0.28
5	7.00	1.13	1.11	1.05	0.95	1.20	10.55	17.14	27.69	0.34
6	8.00	1.04	1.18	1.05	0.95	1.20	11.74	20.26	32.00	2.00
7	7.00	0.97	1.25	1.05	1.00	1.20	10.65	9.58	20.23	0.22
8	7.00	0.91	1.32	1.05	1.00	1.20	10.53	2.63	13.16	0.14
9	18.00	0.89	1.33	1.05	1.00	1.20	27.02	45.25	72.27	2.00
10	29.00	0.90	1.33	1.05	1.00	1.20	43.77	71.13	114.91	2.00
11	13.00	0.80	1.33	1.05	1.00	1.20	17.49	34.10	51.58	2.00

:: Cyclic Resistance Ratio calculation CRR_{7.5} ::

Point ID	Field SPT	C _n	C _e	C _b	C _r	C _s	N ₁₍₆₀₎	DeltaN	N _{1(60)cs}	CRR _{7.5}
C _n :	Overburden correction factor									
C _e :	Energy correction factor									
C _b :	Borehole diameter correction factor									
C _r :	Rod length correction factor									
C _s :	Liner correction factor									
N ₁₍₆₀₎ :	Corrected N _{SPT}									
DeltaN :	Addition to corrected N _{SPT} value due to the presence of fines									
N _{1(60)cs} :	Corrected N ₁₍₆₀₎ value for fines									
CRR _{7.5} :	Cyclic resistance ratio for M=7.5									

:: Settlements calculation for saturated sands ::

Point ID	N ₁₍₆₀₎	N ₁	FS _L	e _v (%)	Settle. (in)
1	29.05	24.21	0.54	1.77	0.00
2	31.67	26.39	2.83	0.00	0.00
3	16.21	13.51	0.23	2.89	0.00
4	24.56	20.47	0.31	2.11	0.00
5	27.69	23.08	0.34	1.87	0.00
6	32.00	26.67	1.92	0.01	0.00
7	20.23	16.86	0.20	2.49	1.49
8	13.16	10.97	0.13	3.33	2.00
9	72.27	60.22	1.81	0.01	0.00
10	114.91	95.76	1.83	0.01	0.00
11	51.58	42.98	1.86	0.01	0.00

Total settlement : 3.49

N ₁₍₆₀₎ :	Stress normalized and corrected SPT blow count
N ₁ :	Japanese equivalent corrected value
FS _L :	Calculated factor of safety
e _v :	Post-liquefaction volumetric strain (%)
Settle.:	Calculated settlement (in)

:: Liquefaction potential according to Iwasaki ::

Point ID	F	w _z	I _L
1	0.46	9.70	2.70
2	0.00	9.24	0.00
3	0.77	8.48	9.99
4	0.69	7.71	8.17
5	0.66	6.95	6.96
6	0.00	6.19	0.00
7	0.80	5.43	6.60
8	0.87	4.67	6.18
9	0.00	3.90	0.00
10	0.00	3.14	0.00
11	0.00	2.38	0.00

Overall potential I_L : 40.61

I_L = 0.00 - No liquefaction
 I_L between 0.00 and 5 - Liquefaction not probable
 I_L between 5 and 15 - Liquefaction probable
 I_L > 15 - Liquefaction certain

APPENDIX

B



APPENDIX B LABORATORY TESTING

Laboratory tests were performed in accordance with generally accepted test methods of the American Society for Testing and Materials (ASTM), Caltrans, or other suggested procedures. Selected samples were tested for in-situ dry density and moisture content, corrosivity, consolidation, shear strength, expansion index, maximum density and optimum moisture content, and grain size distribution. The results of the laboratory tests are summarized in the following figures.

CONSOLIDATION - PRESSURE TEST DATA ASTM D2435

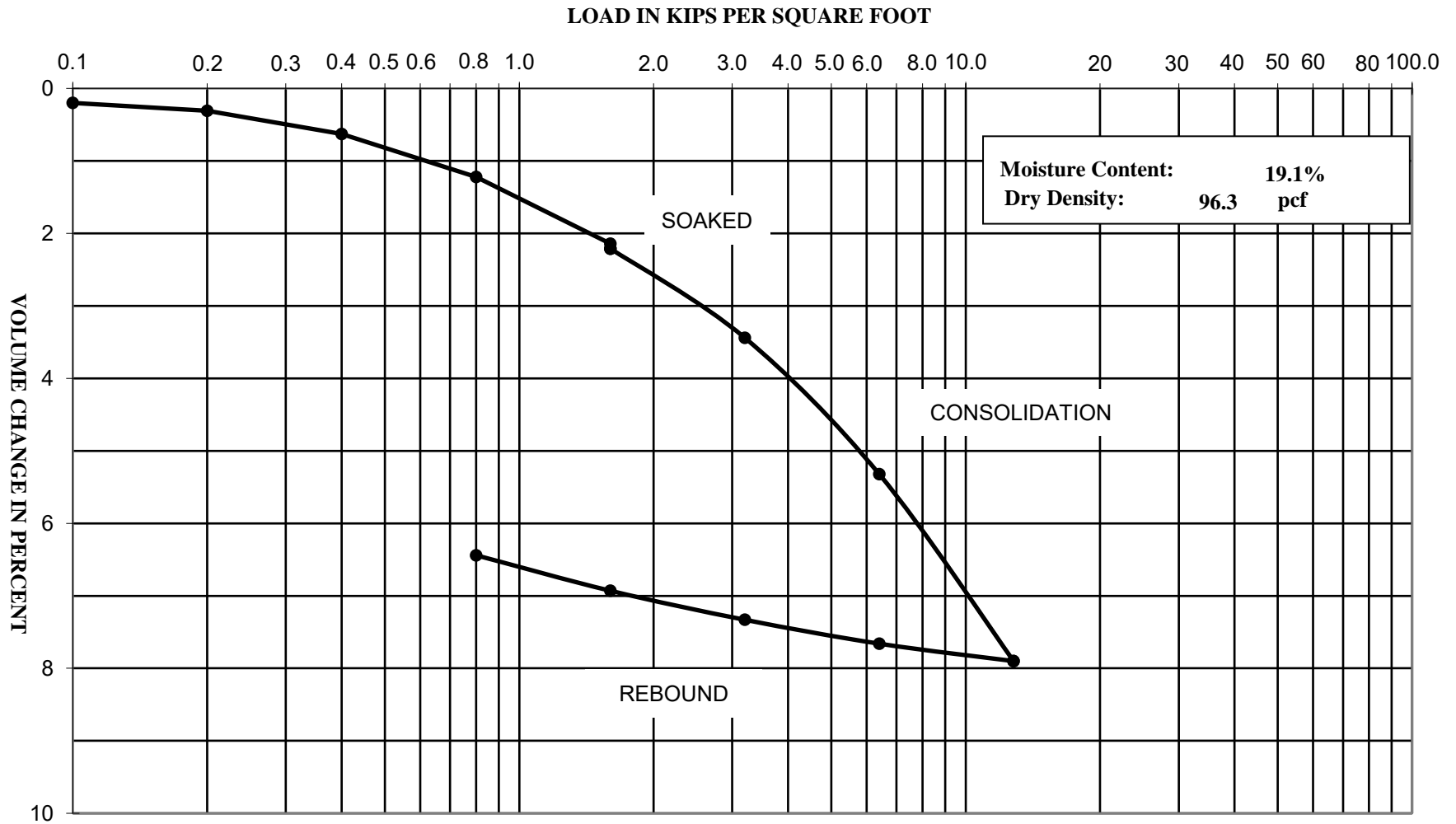

Project Name: Proposed Commercial Development - Norwalk, CA

Project Number: 3-221-0428

Boring: B-1 @ 5'



CONSOLIDATION - PRESSURE TEST DATA ASTM D2435

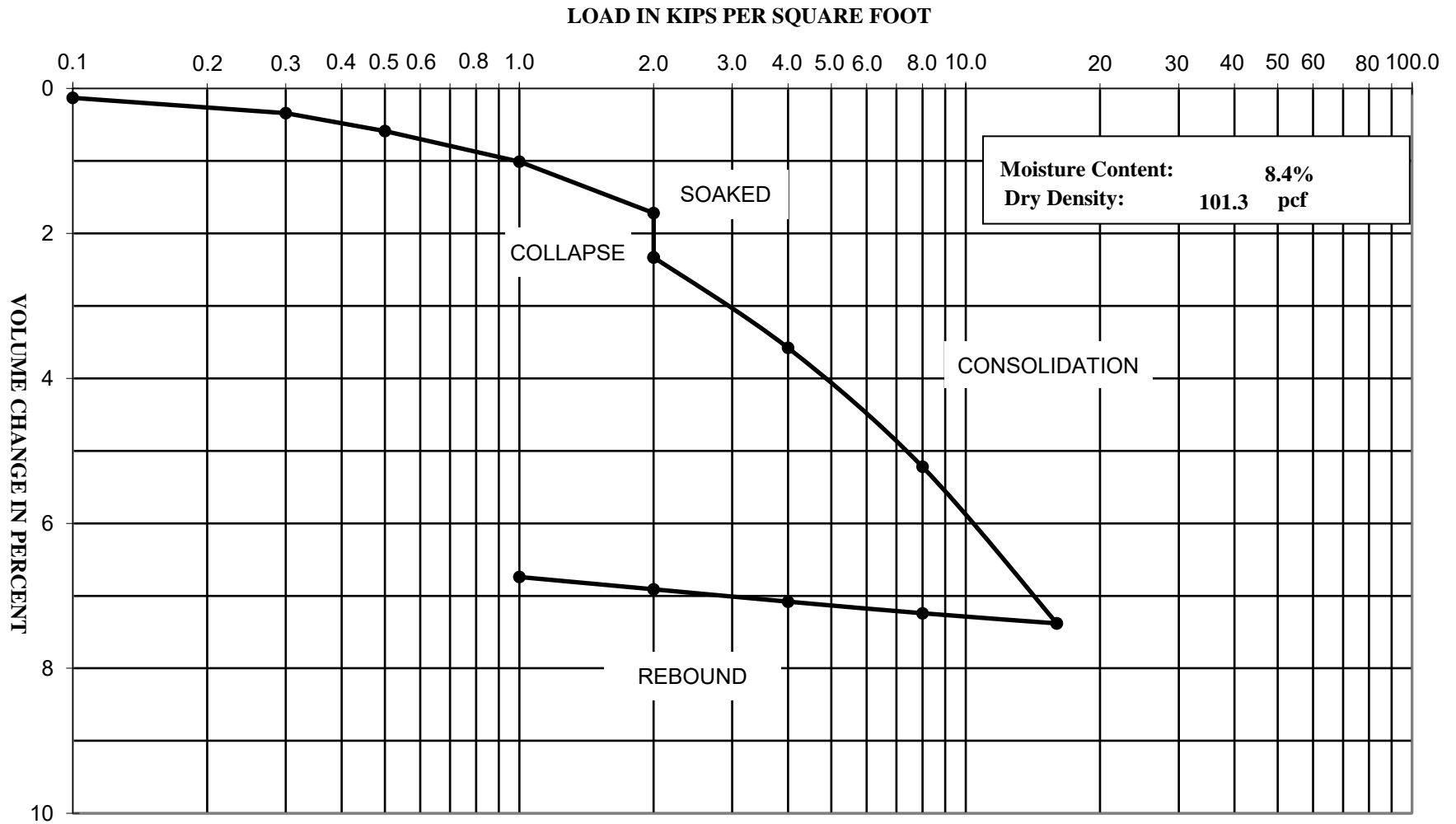

Project Name: Proposed Commercial Development - Norwalk, CA

Project Number: 3-221-0428

Boring: B-5 @ 2'

Direct Shear Test (ASTM D3080)

Project Name: Proposed Commercial Development - Norwalk, CA
Project Number: 3-221-0428
Client: Shapell Properties, Inc.
Sample Location: B-1 @ 2'
Sample Type: Undisturbed Ring
Soil Classification: Sandy Clayey SILT (ML)
Tested By: M. Noorzay
Reviewed By: CJ
Date: 5/27/2021
Equipment Used: Geomatic Direct Shear Machine

	Sample 1	Sample 2	Sample 3
Normal Stress (ksf)	1.000	2.000	3.000
Shear Rate (in/min)	0.004		
Peak Shear Stress (ksf)	0.948	1.536	2.064
Residual Shear Stress (ksf)	0.000	0.000	0.000

Initial Height of Sample (in)	1.000	1.000	1.000
Height of Sample before Shear (in.)	1	1	1
Diameter of Sample (in)	2.416	2.416	2.416
Initial Moisture Content (%)	15.8		
Final Moisture Content (%)	25.8	26.3	25.9
Dry Density (pcf)	98.7	96.4	98.0

Peak Shear Strength Values	
Slope	0.56
Friction Angle	29.2
Cohesion (psf)	400

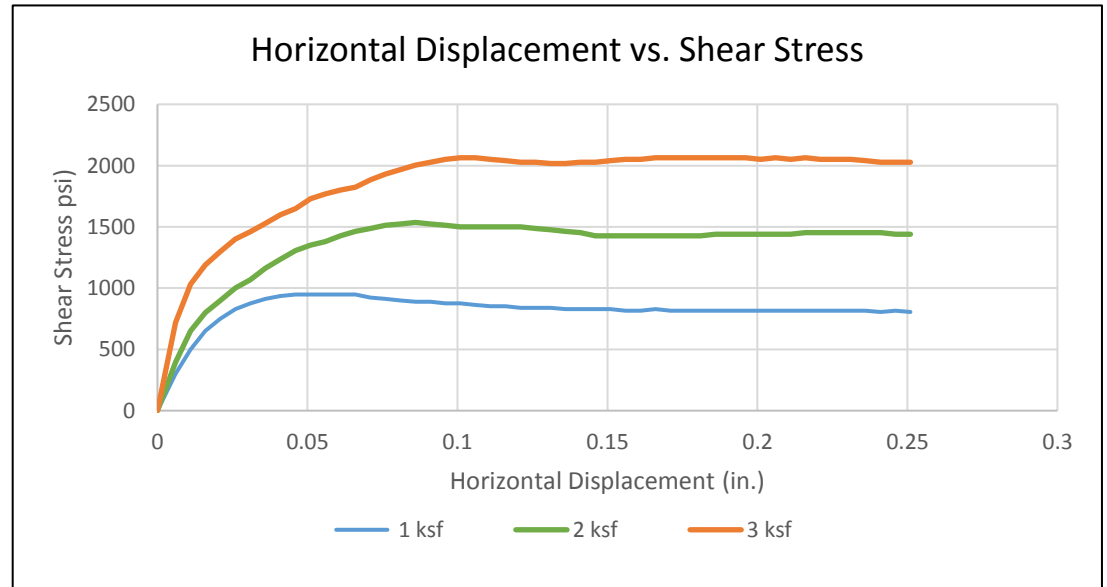
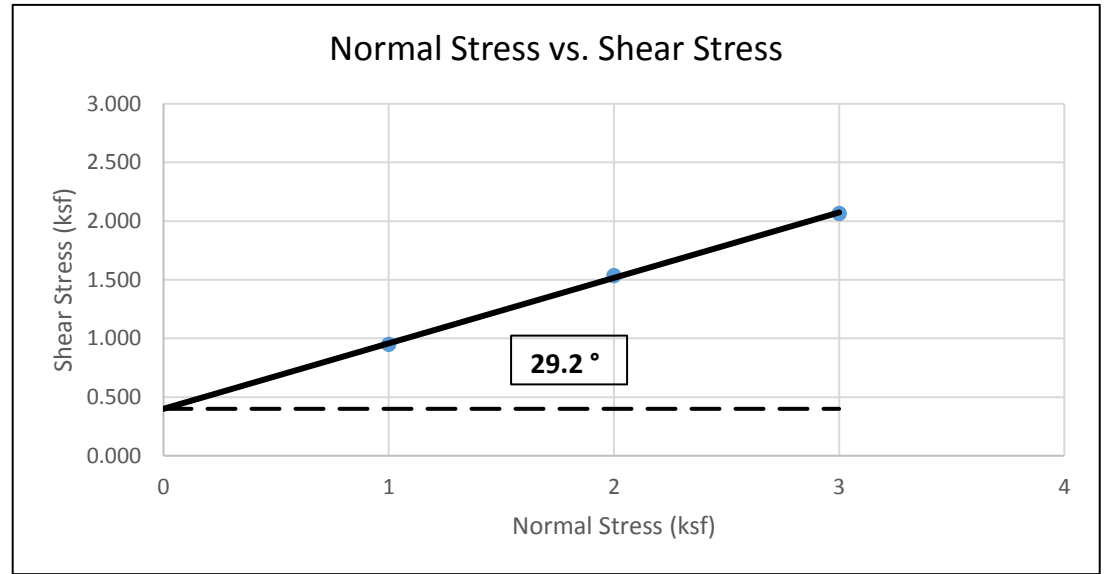

Direct Shear Test (ASTM D3080)

Project Name: Proposed Commercial Development - Norwalk, CA
Project Number: 3-221-0428
Client: Shapell Properties, Inc.
Sample Location: B-5 @ 5'
Sample Type: Undisturbed Ring
Soil Classification: Sandy Clayey SILT (ML)
Tested By: M. Noorzay
Reviewed By: CJ
Date: 5/28/2021
Equipment Used: Geomatic Direct Shear Machine

	Sample 1	Sample 2	Sample 3
Normal Stress (ksf)	1.000	2.000	3.000
Shear Rate (in/min)	0.004		
Peak Shear Stress (ksf)	0.936	1.536	2.184
Residual Shear Stress (ksf)	0.000	0.000	0.000

Initial Height of Sample (in)	1.000	1.000	1.000
Height of Sample before Shear (in.)	1	1	1
Diameter of Sample (in)	2.416	2.416	2.416
Initial Moisture Content (%)	22.4		
Final Moisture Content (%)	25.2	25.4	24.3
Dry Density (pcf)	98.3	97.4	99.6

Peak Shear Strength Values	
Slope	0.62
Friction Angle	32.0
Cohesion (psf)	304

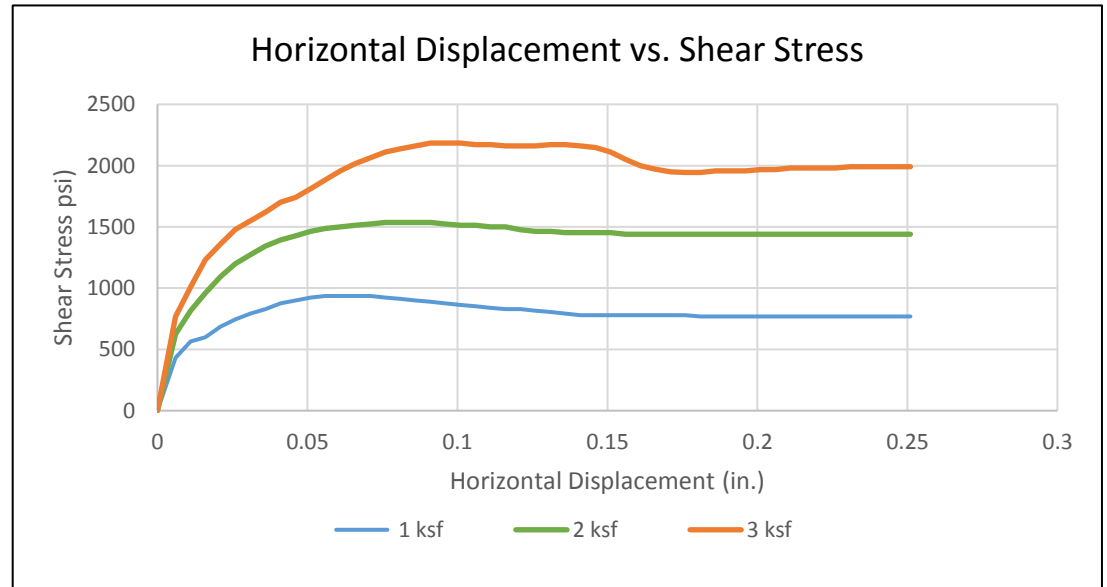
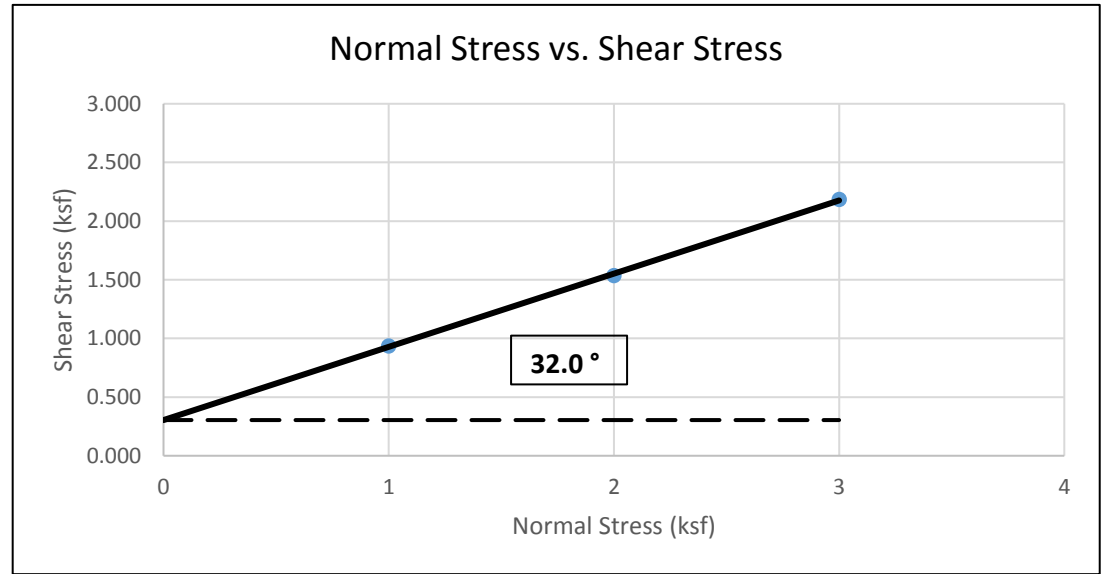

PARTICLE SIZE DISTRIBUTION DIAGRAM
GRADATION TEST - ASTM C136

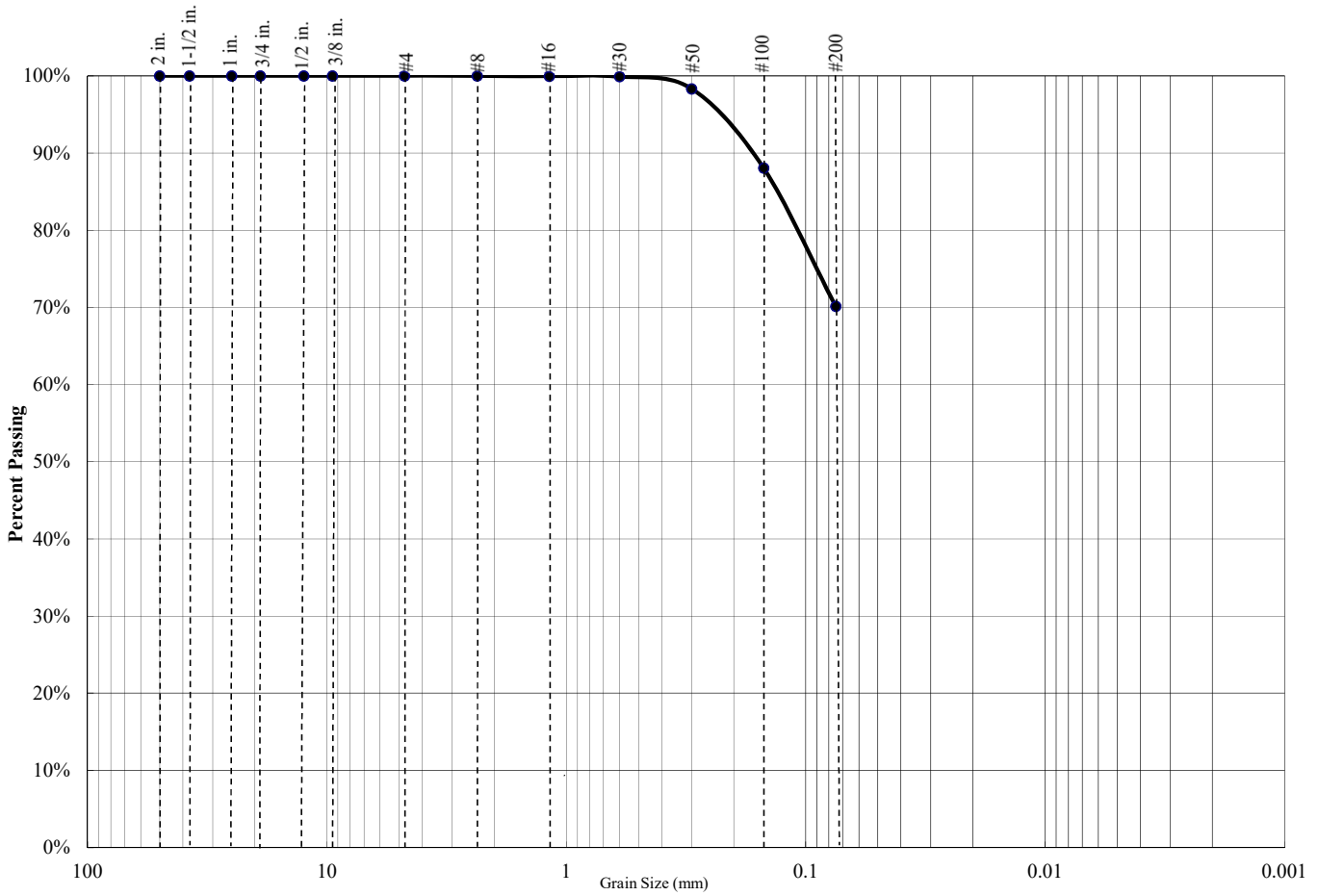

Percent Gravel	Percent Sand	Percent Silt/Clay
0%	30%	70%

Sieve Size	Percent Passing
3/4 inch	100.0%
1/2 inch	100.0%
3/8 inch	100.0%
#4	100.0%
#8	100.0%
#16	100.0%
#30	99.9%
#50	98.3%
#100	88.1%
#200	70.1%

Atterberg Limits		
PL=	LL=	PI=

Coefficients		
D85=	D60=	D50=
D30=	D15=	D10=
C_u= N/A	C_c= N/A	

USCS CLASSIFICATION
Sandy Clayey SILT (ML)

Project Name: Proposed Commercial Development - Norwalk, CA

Project Number: 3-221-0428

Boring: B-1 @ 2'



PARTICLE SIZE DISTRIBUTION DIAGRAM
GRADATION TEST - ASTM C136

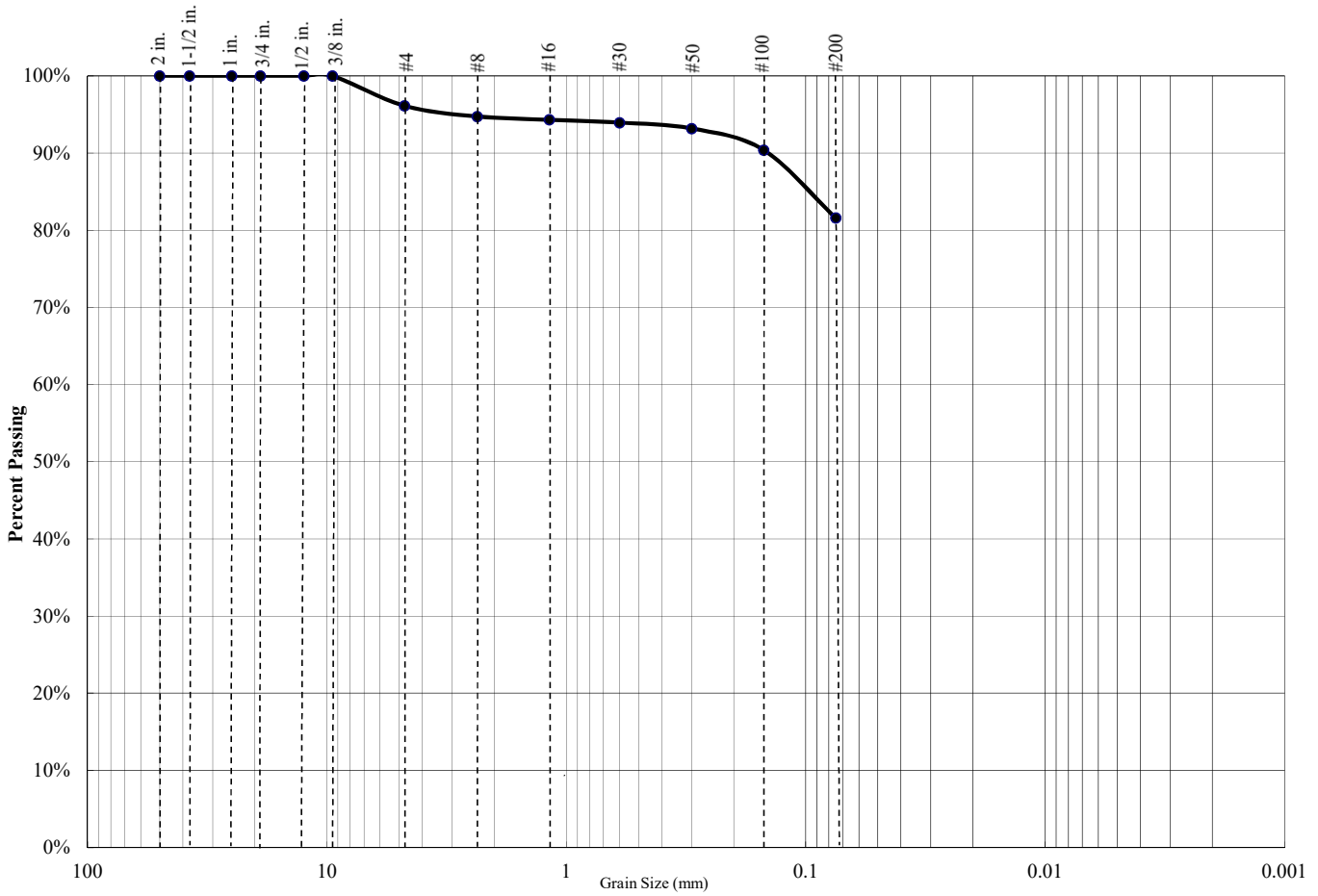

Percent Gravel	Percent Sand	Percent Silt/Clay
4%	15%	82%

Sieve Size	Percent Passing
3/4 inch	100.0%
1/2 inch	100.0%
3/8 inch	100.0%
#4	96.1%
#8	94.7%
#16	94.3%
#30	93.9%
#50	93.2%
#100	90.4%
#200	81.6%

Atterberg Limits		
PL=	LL=	PI=

Coefficients		
D85=	D60=	D50=
D30=	D15=	D10=
C_u=	N/A	C_c= N/A

USCS CLASSIFICATION
Sandy Clayey SILT (ML)

Project Name: Proposed Commercial Development - Norwalk, CA

Project Number: 3-221-0428

Boring: B-1 @ 5'



PARTICLE SIZE DISTRIBUTION DIAGRAM
GRADATION TEST - ASTM C136

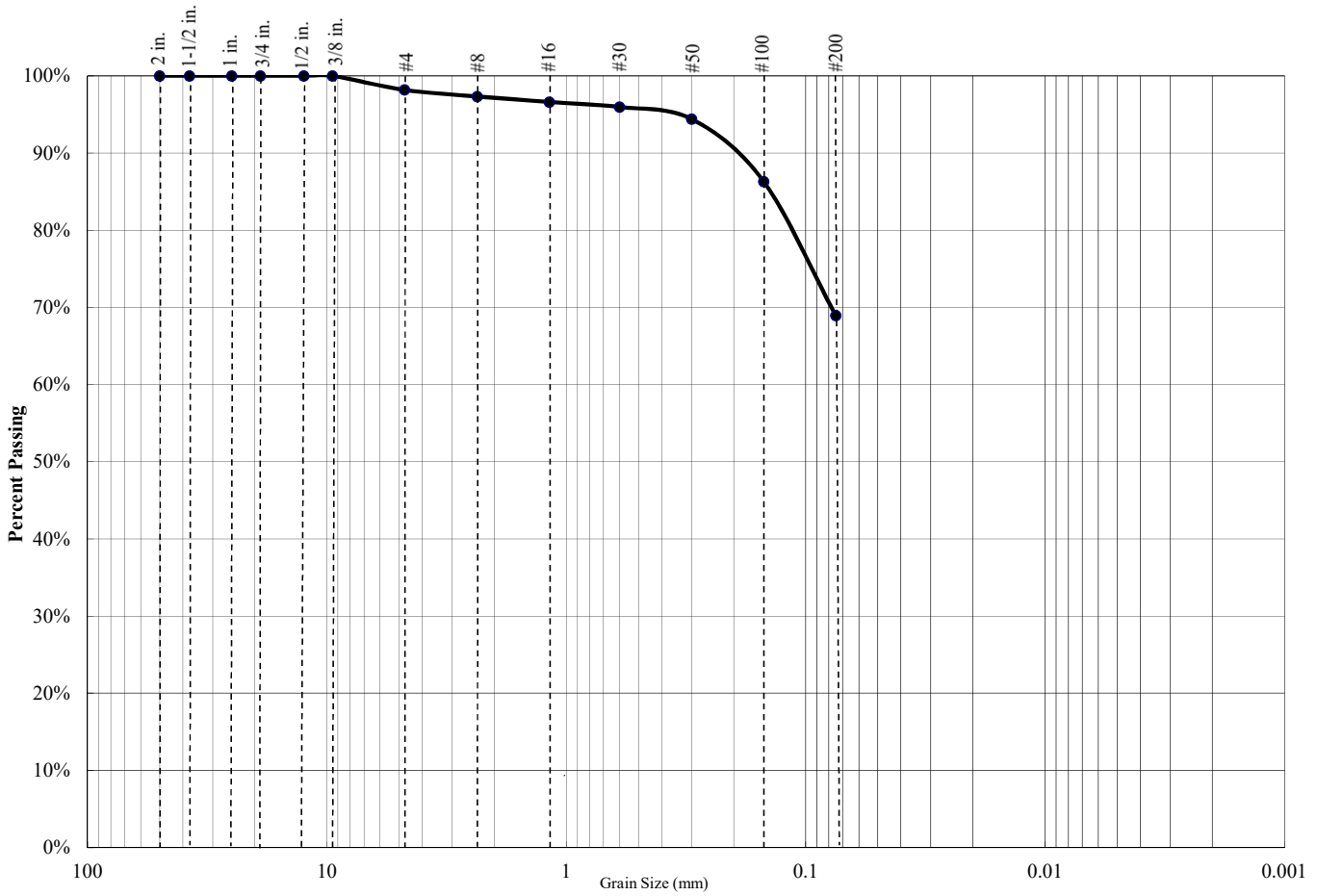

Percent Gravel	Percent Sand	Percent Silt/Clay
2%	29%	69%

Sieve Size	Percent Passing
3/4 inch	100.0%
1/2 inch	100.0%
3/8 inch	100.0%
#4	98.2%
#8	97.3%
#16	96.6%
#30	96.0%
#50	94.4%
#100	86.3%
#200	69.0%

Atterberg Limits		
PL=	LL=	PI=

Coefficients		
D85=	D60=	D50=
D30=	D15=	D10=
C _u =	N/A	C _c = N/A

USCS CLASSIFICATION
Sandy Clayey SILT (ML)

Project Name: Proposed Commercial Development - Norwalk, CA

Project Number: 3-221-0428

Boring: B-1 @ 15'



PARTICLE SIZE DISTRIBUTION DIAGRAM
GRADATION TEST - ASTM C136

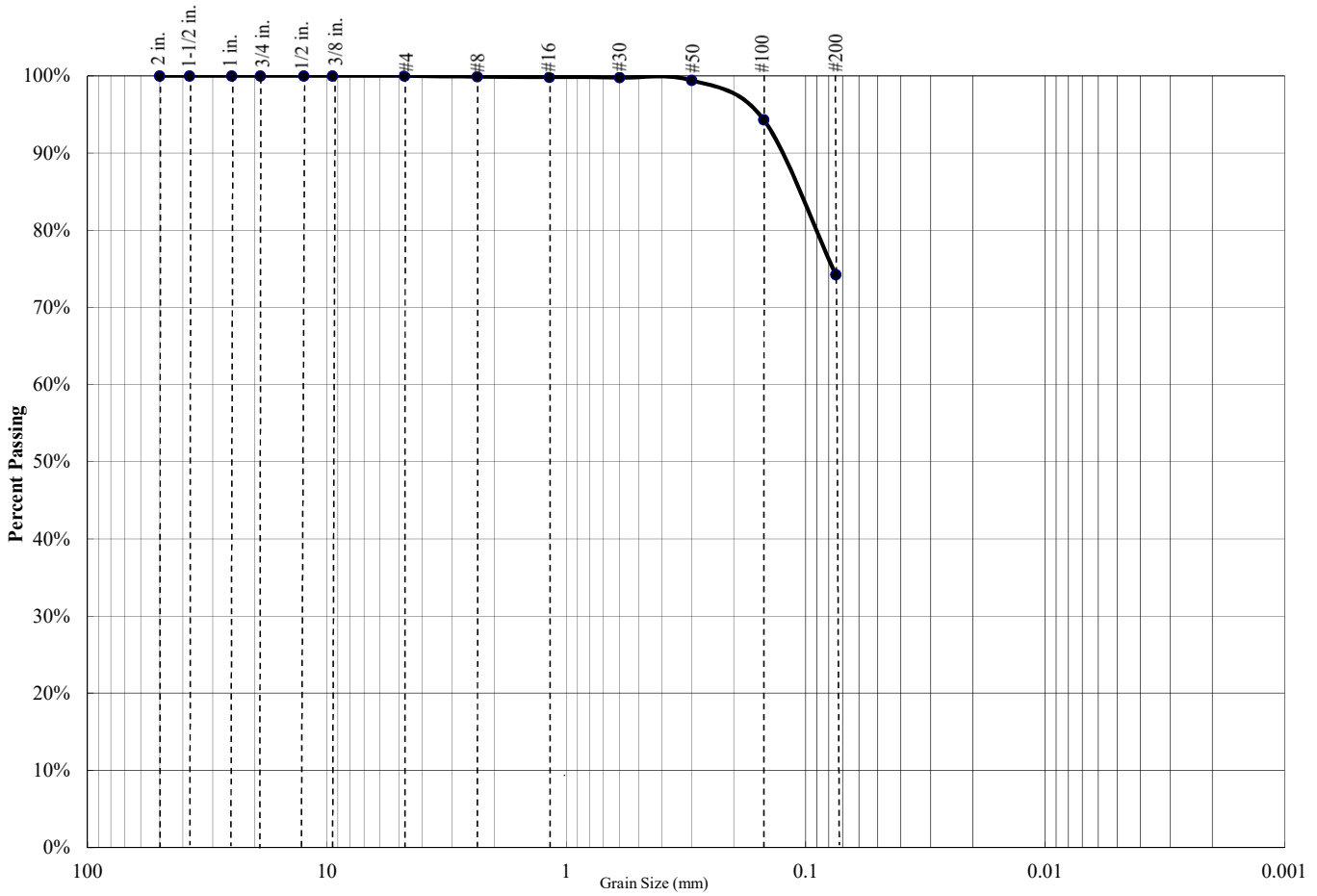

Percent Gravel	Percent Sand	Percent Silt/Clay
0%	26%	74%

Sieve Size	Percent Passing
3/4 inch	100.0%
1/2 inch	100.0%
3/8 inch	100.0%
#4	100.0%
#8	99.9%
#16	99.8%
#30	99.8%
#50	99.4%
#100	94.3%
#200	74.2%

Atterberg Limits		
PL=	LL=	PI=

Coefficients		
D85=	D60=	D50=
D30=	D15=	D10=
C _u =	N/A	C _c = N/A

USCS CLASSIFICATION
Sandy Clayey SILT (ML)

Project Name: Proposed Commercial Development - Norwalk, CA

Project Number: 3-221-0428

Boring: B-1 @ 25'



**PARTICLE SIZE DISTRIBUTION DIAGRAM
GRADATION TEST - ASTM C136**

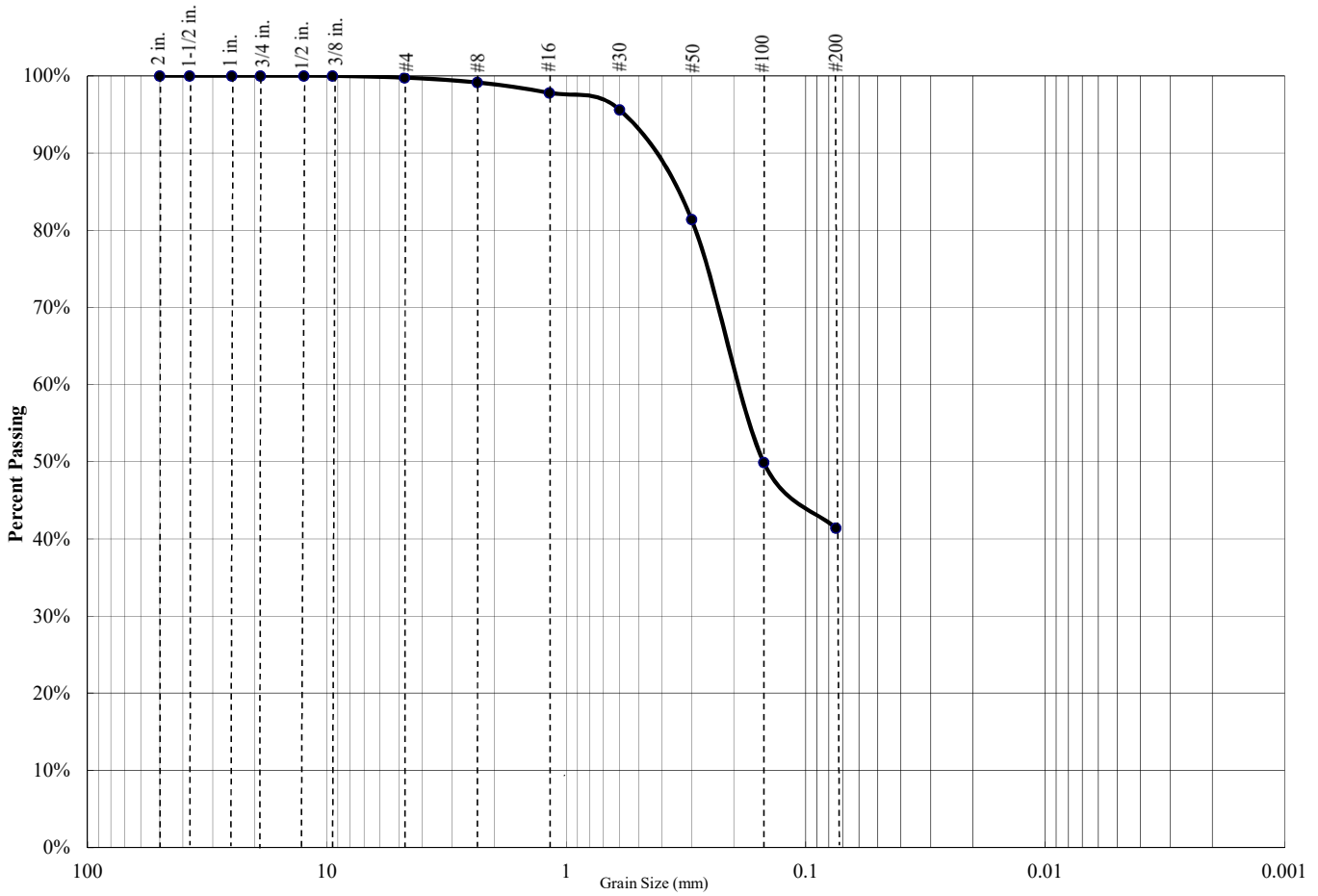

Percent Gravel	Percent Sand	Percent Silt/Clay
0%	58%	41%

Sieve Size	Percent Passing
3/4 inch	100.0%
1/2 inch	100.0%
3/8 inch	100.0%
#4	99.8%
#8	99.1%
#16	97.8%
#30	95.6%
#50	81.4%
#100	49.9%
#200	41.4%

Atterberg Limits		
PL=	LL=	PI=

Coefficients		
D85=	D60=	D50=
D30=	D15=	D10=
C_u=	N/A	C_c= N/A

USCS CLASSIFICATION
Silty SAND (SM)

Project Name: Proposed Commercial Development - Norwalk, CA

Project Number: 3-221-0428

Boring: B-1 @ 30'



PARTICLE SIZE DISTRIBUTION DIAGRAM
GRADATION TEST - ASTM C136

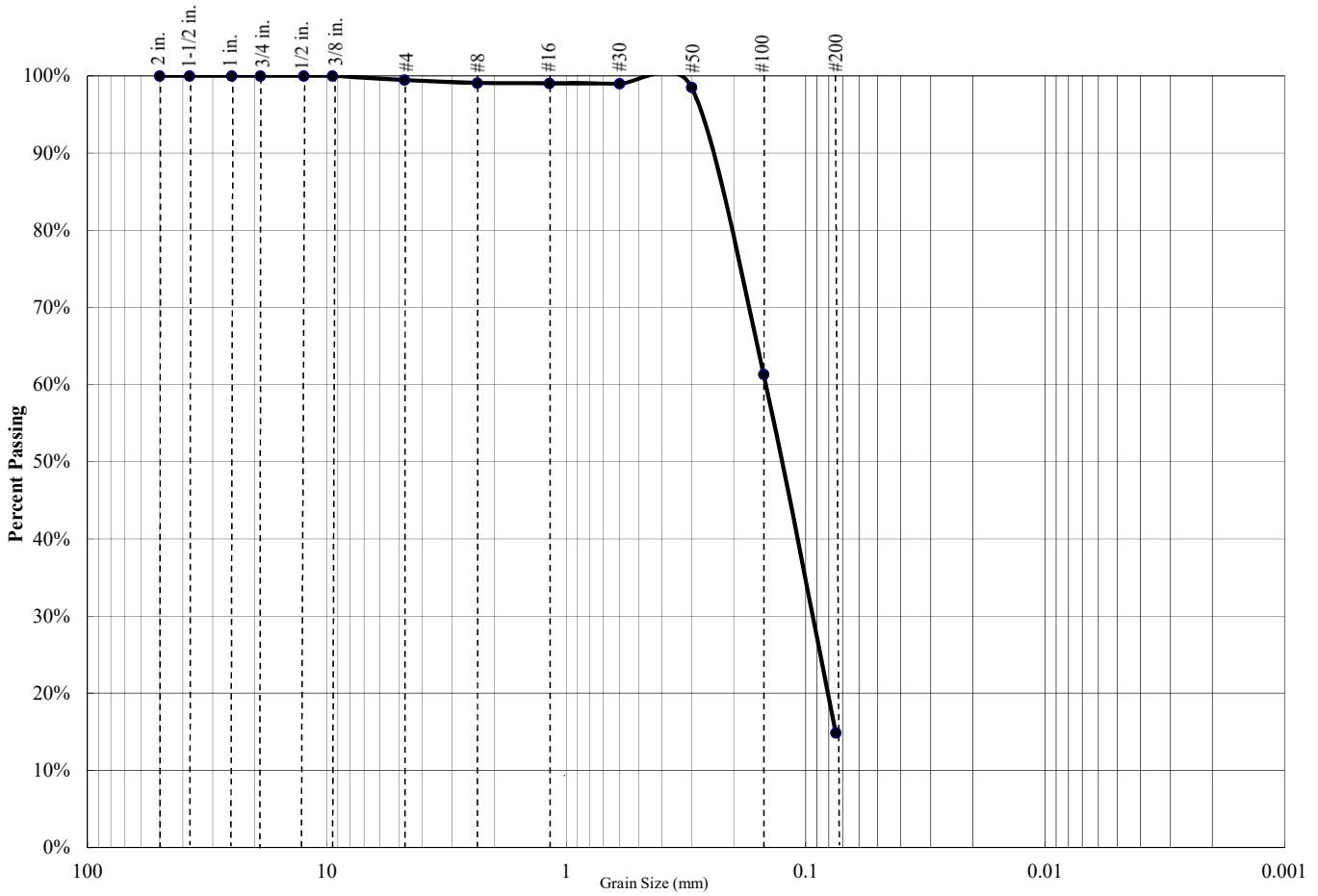

Percent Gravel	Percent Sand	Percent Silt/Clay
1%	85%	15%

Sieve Size	Percent Passing
3/4 inch	100.0%
1/2 inch	100.0%
3/8 inch	100.0%
#4	99.5%
#8	99.1%
#16	99.0%
#30	99.0%
#50	98.5%
#100	61.3%
#200	14.9%

Atterberg Limits		
PL=	LL=	PI=

Coefficients		
D85=	D60=	D50=
D30=	D15=	D10=
C _u =	N/A	C _c = N/A

USCS CLASSIFICATION
Silty SAND (SM)

Project Name: Proposed Commercial Development - Norwalk, CA

Project Number: 3-221-0428

Boring: B-1 @ 35'



PARTICLE SIZE DISTRIBUTION DIAGRAM
GRADATION TEST - ASTM C136

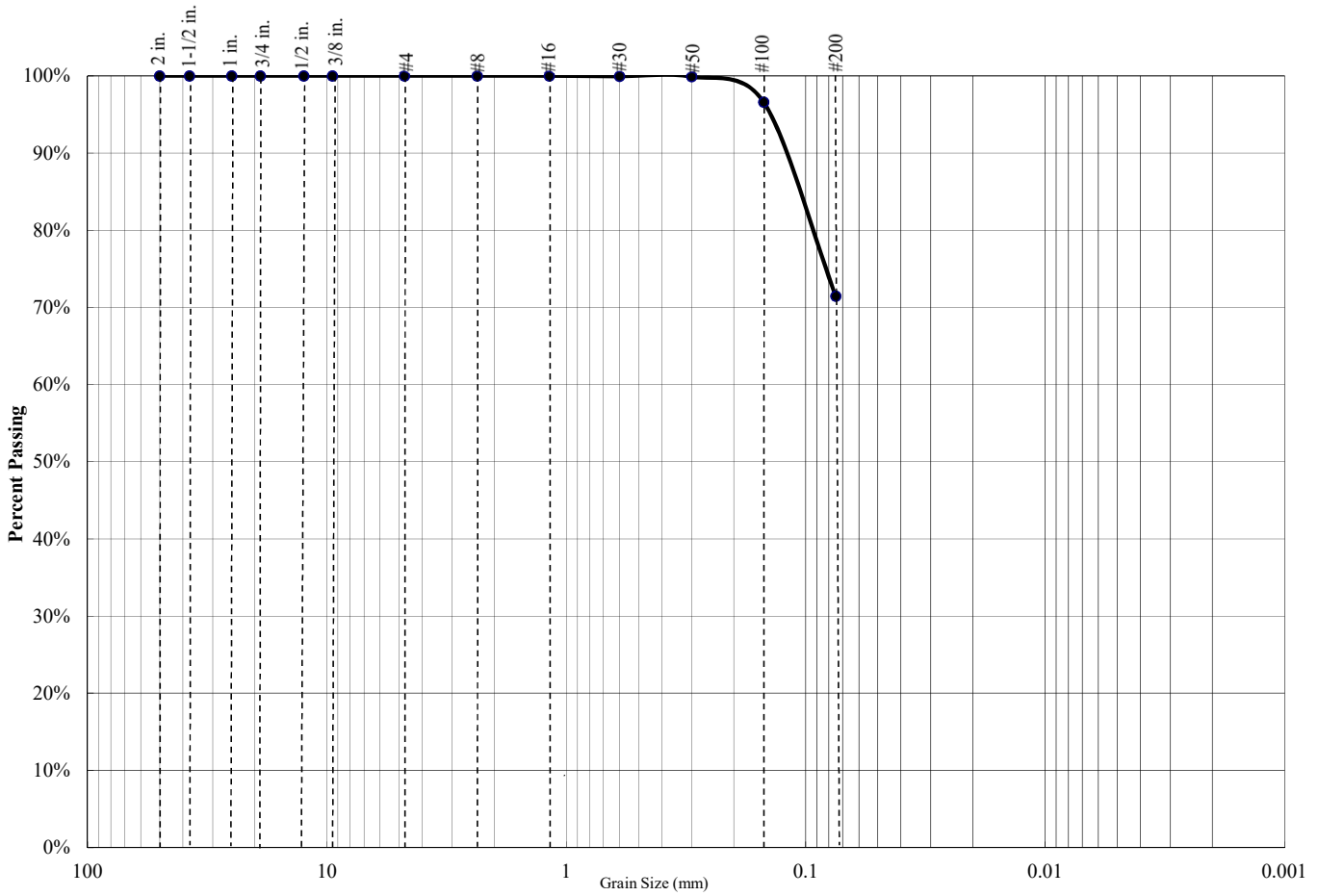

Percent Gravel	Percent Sand	Percent Silt/Clay
0%	29%	71%

Sieve Size	Percent Passing
3/4 inch	100.0%
1/2 inch	100.0%
3/8 inch	100.0%
#4	100.0%
#8	100.0%
#16	100.0%
#30	99.9%
#50	99.9%
#100	96.6%
#200	71.5%

Atterberg Limits		
PL=	LL=	PI=

Coefficients		
D85=	D60=	D50=
D30=	D15=	D10=
C _u =	N/A	C _c = N/A

USCS CLASSIFICATION
Sandy Clayey SILT (ML)

Project Name: Proposed Commercial Development - Norwalk, CA

Project Number: 3-221-0428

Boring: B-1 @ 40'



PARTICLE SIZE DISTRIBUTION DIAGRAM
GRADATION TEST - ASTM C136

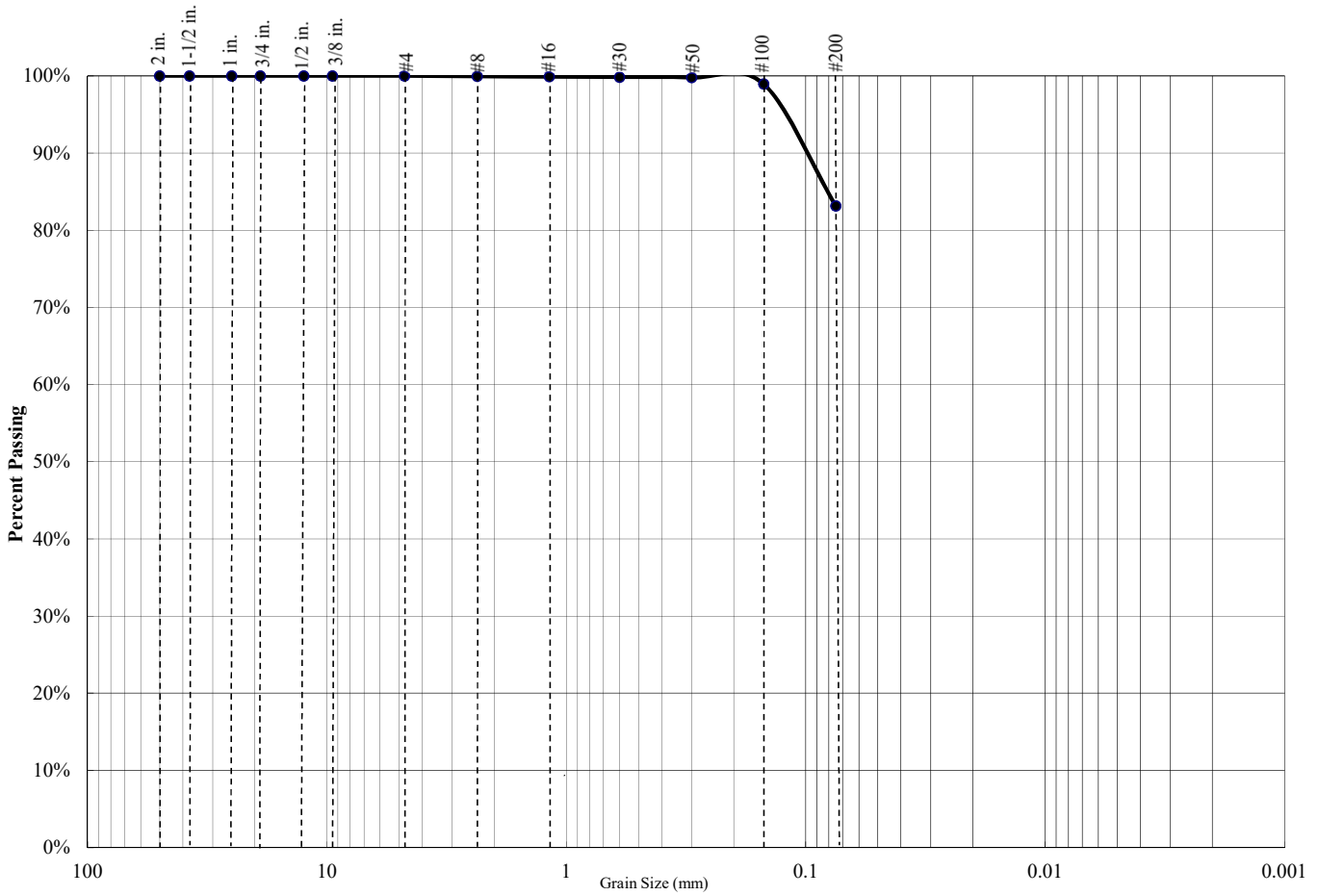

Percent Gravel	Percent Sand	Percent Silt/Clay
0%	17%	83%

Sieve Size	Percent Passing
3/4 inch	100.0%
1/2 inch	100.0%
3/8 inch	100.0%
#4	100.0%
#8	99.9%
#16	99.9%
#30	99.8%
#50	99.8%
#100	98.9%
#200	83.1%

Atterberg Limits		
PL=	LL=	PI=

Coefficients		
D85=	D60=	D50=
D30=	D15=	D10=
C _u =	N/A	C _c = N/A

USCS CLASSIFICATION
Sandy Clayey SILT (ML)

Project Name: Proposed Commercial Development - Norwalk, CA

Project Number: 3-221-0428

Boring: B-1 @ 50'



PARTICLE SIZE DISTRIBUTION DIAGRAM
GRADATION TEST - ASTM C136

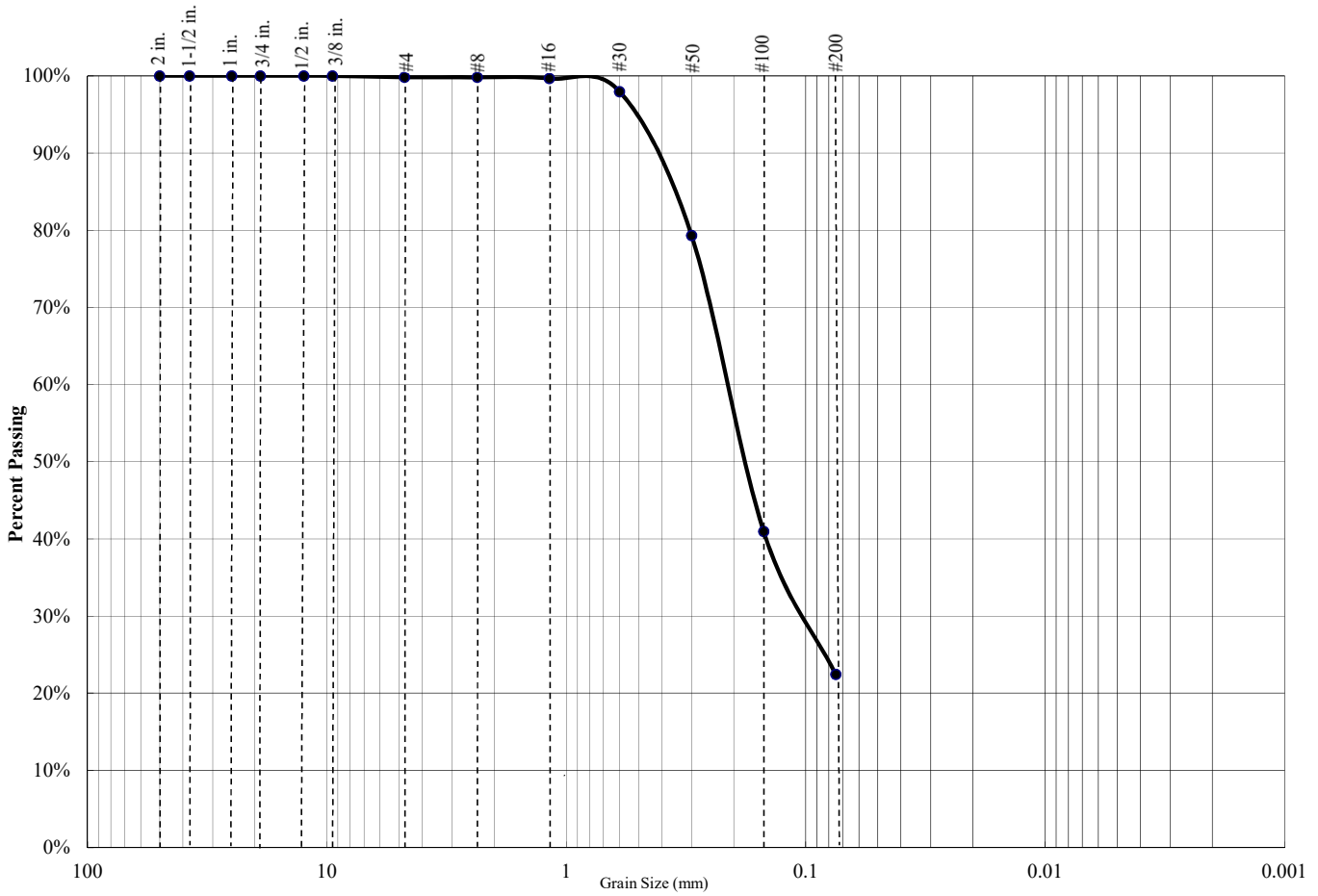

Percent Gravel	Percent Sand	Percent Silt/Clay
0%	77%	22%

Sieve Size	Percent Passing
3/4 inch	100.0%
1/2 inch	100.0%
3/8 inch	100.0%
#4	99.8%
#8	99.8%
#16	99.7%
#30	98.0%
#50	79.3%
#100	41.0%
#200	22.4%

Atterberg Limits		
PL=	LL=	PI=

Coefficients		
D85=	D60=	D50=
D30=	D15=	D10=
C _u =	N/A	C _c = N/A

USCS CLASSIFICATION
Silty SAND (SM)

Project Name: Proposed Commercial Development - Norwalk, CA

Project Number: 3-221-0428

Boring: B-5 @ 2'



PARTICLE SIZE DISTRIBUTION DIAGRAM
GRADATION TEST - ASTM C136

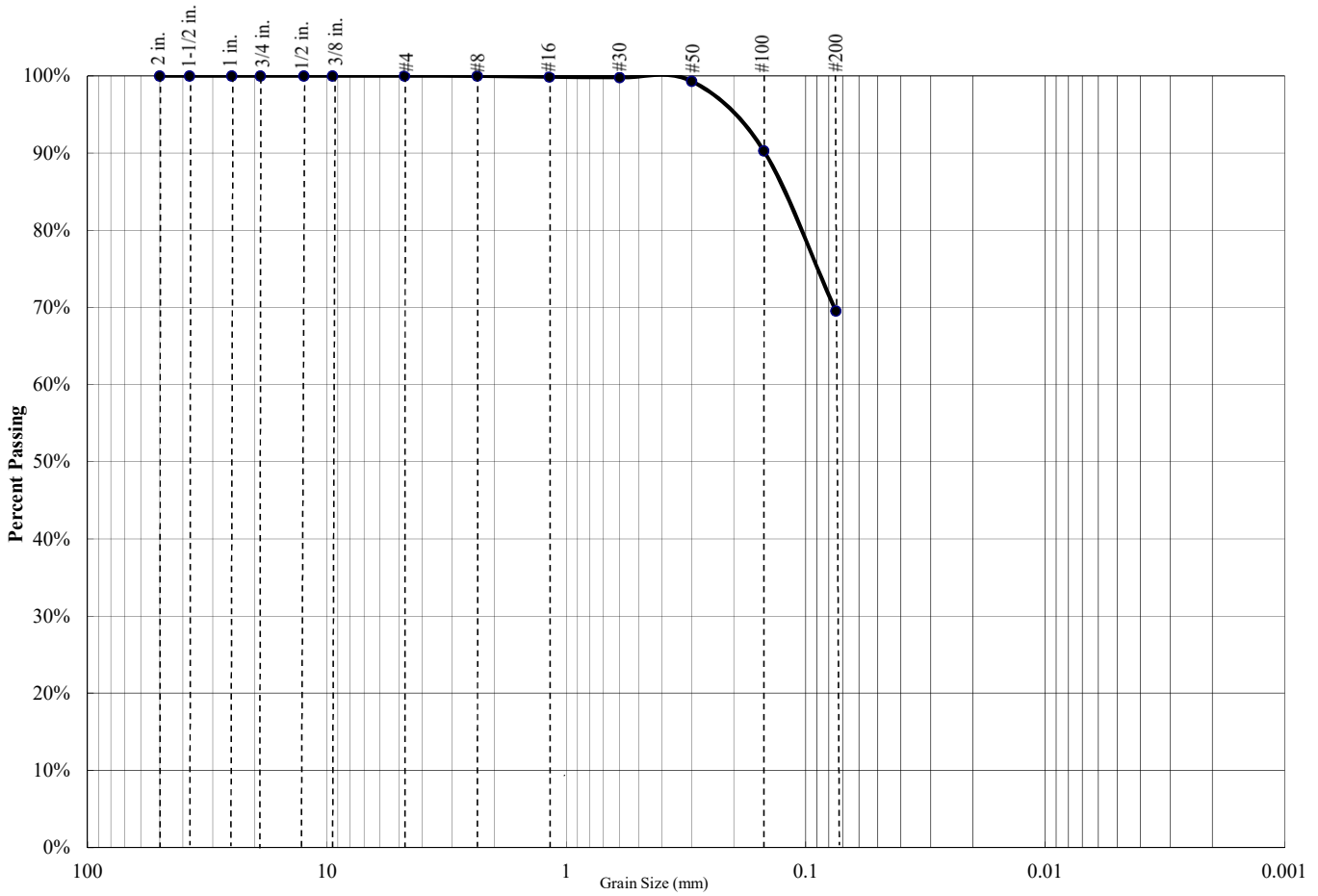

Percent Gravel	Percent Sand	Percent Silt/Clay
0%	30%	70%

Sieve Size	Percent Passing
3/4 inch	100.0%
1/2 inch	100.0%
3/8 inch	100.0%
#4	100.0%
#8	100.0%
#16	99.9%
#30	99.8%
#50	99.3%
#100	90.3%
#200	69.6%

Atterberg Limits		
PL=	LL=	PI=

Coefficients		
D85=	D60=	D50=
D30=	D15=	D10=
C _u =	N/A	C _c = N/A

USCS CLASSIFICATION
Sandy Clayey SILT (ML)

Project Name: Proposed Commercial Development - Norwalk, CA

Project Number: 3-221-0428

Boring: B-5 @ 5'



EXPANSION INDEX TEST

ASTM D4829

Project Name: Proposed Commercial Development - Norwalk, CA

Project Number: 3-221-0428

Date Sampled: 5/18/2021

Date Tested: 5/26/2021

Sampled By: JC

Tested By: Mass Noorzay

Sample Location: B-1 @ 1'-4'

Soil Description: Grayish Brown Sandy Clayey SILT (ML)

Trial #	1	2	3
Weight of Soil & Mold, g.	777.6		
Weight of Mold, g.	368.5		
Weight of Soil, g.	409.1		
Wet Density, pcf	123.4		
Weight of Moisture Sample (Wet), g.	800.0		
Weight of Moisture Sample (Dry), g.	736.0		
Moisture Content, %	8.7		
Dry Density, pcf	113.5		
Specific Gravity of Soil	2.7		
Degree of Saturation, %	48.5		

Time	Initial	30 min	1 hr	6 hrs	12 hrs	24 hrs
Dial Reading	0	0.008	0.009	--	--	0.009

Expansion Index_{measured} = 9
 Expansion Index₅₀ = 8.3

Expansion Index = 8

Expansion Potential Table	
Exp. Index	Potential Exp.
0 - 20	Very Low
21 - 50	Low
51 - 90	Medium
91 - 130	High
>130	Very High

CHEMICAL ANALYSIS

SO₄ - Modified CTM 417 & Cl - Modified CTM 417/422

Project Name: Proposed Commercial Development - Norwalk, CA

Project Number: 3-221-0428

Date Sampled: 5/18/2021

Date Tested: 6/3/2021

Sampled By: JC

Tested By: Mass Noorzay

Soil Description: Grayish Brown Sandy Clayey SILT (ML)

Sample Number	Sample Location	Soluble Sulfate SO ₄ -S	Soluble Chloride Cl	pH
1a.	B-1 @ 1'-4'	100 mg/kg	27 mg/kg	7.2
1b.	B-1 @ 1'-4'	100 mg/kg	25 mg/kg	7.2
1c.	B-1 @ 1'-4'	100 mg/kg	26 mg/kg	7.2
Average:		100 mg/kg	26 mg/kg	7.2

Laboratory Compaction Curve

ASTM D1557

Project Name: Proposed Commercial Development - Norwalk, CA

Project Number: 3-221-0428

Date Sampled: 5/18/2021

Date Tested: 5/28/2021

Sampled By: JC

Tested By: Mobin Noorzay

Sample Location: B-1 @ 1'-4'

Soil Description: Grayish Brown Sandy Clayey SILT (ML)

Test Method: Method A

	1	2	3	4
Weight of Moist Specimen & Mold, (g)	6208.4	6296.5	6375.8	6335.2
Weight of Compaction Mold, (g)	4290.9	4290.9	4290.9	4290.9
Weight of Moist Specimen, (g)	1917.5	2005.6	2084.9	2044.3
Volume of Mold, (ft ³)	0.0333	0.0333	0.0333	0.0333
Wet Density, (pcf)	126.8	132.6	137.9	135.2
Weight of Wet (Moisture) Sample, (g)	200.0	200.0	200.0	200.0
Weight of Dry (Moisture) Sample, (g)	187.9	184.6	181.4	178.0
Moisture Content, (%)	6.4%	8.3%	10.3%	12.4%
Dry Density, (pcf)	119.1	122.4	125.1	120.3

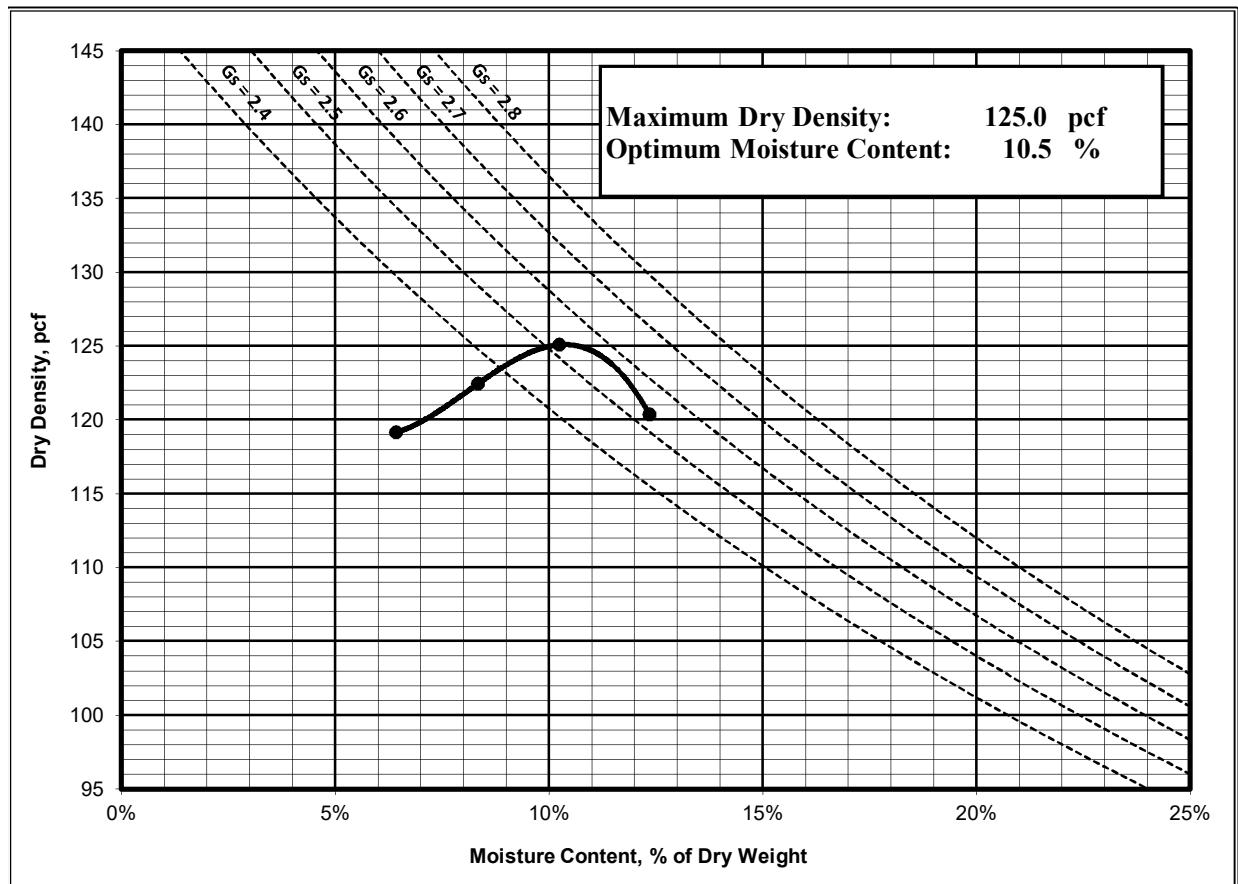

APPENDIX

C



APPENDIX C

GENERAL EARTHWORK AND PAVEMENT SPECIFICATIONS

When the text of the report conflicts with the general specifications in this appendix, the recommendations in the report have precedence.

1.0 SCOPE OF WORK: These specifications and applicable plans pertain to and include all earthwork associated with the site rough grading, including, but not limited to, the furnishing of all labor, tools and equipment necessary for site clearing and grubbing, stripping, preparation of foundation materials for receiving fill, excavation, processing, placement and compaction of fill and backfill materials to the lines and grades shown on the project grading plans and disposal of excess materials.

2.0 PERFORMANCE: The Contractor shall be responsible for the satisfactory completion of all earthwork in accordance with the project plans and specifications. This work shall be inspected and tested by a representative of SALEM Engineering Group, Incorporated, hereinafter referred to as the Soils Engineer and/or Testing Agency. Attainment of design grades, when achieved, shall be certified by the project Civil Engineer. Both the Soils Engineer and the Civil Engineer are the Owner's representatives. If the Contractor should fail to meet the technical or design requirements embodied in this document and on the applicable plans, he shall make the necessary adjustments until all work is deemed satisfactory as determined by both the Soils Engineer and the Civil Engineer. No deviation from these specifications shall be made except upon written approval of the Soils Engineer, Civil Engineer, or project Architect. No earthwork shall be performed without the physical presence or approval of the Soils Engineer. The Contractor shall notify the Soils Engineer at least 2 working days prior to the commencement of any aspect of the site earthwork.

The Contractor shall assume sole and complete responsibility for job site conditions during the course of construction of this project, including safety of all persons and property; that this requirement shall apply continuously and not be limited to normal working hours; and that the Contractor shall defend, indemnify and hold the Owner and the Engineers harmless from any and all liability, real or alleged, in connection with the performance of work on this project, except for liability arising from the sole negligence of the Owner or the Engineers.

3.0 TECHNICAL REQUIREMENTS: All compacted materials shall be densified to no less than 95 percent of relative compaction (90% for silty or clayey soil) based on ASTM D1557 Test Method (latest edition), UBC or CAL-216, or as specified in the technical portion of the Soil Engineer's report. The location and frequency of field density tests shall be determined by the Soils Engineer. The results of these tests and compliance with these specifications shall be the basis upon which satisfactory completion of work will be judged by the Soils Engineer.

4.0 SOILS AND FOUNDATION CONDITIONS: The Contractor is presumed to have visited the site and to have familiarized himself with existing site conditions and the contents of the data presented in the Geotechnical Engineering Report. The Contractor shall make his own interpretation of the data contained in the Geotechnical Engineering Report and the Contractor shall not be relieved of liability for any loss sustained as a result of any variance between conditions indicated by or deduced from said report and the actual conditions encountered during the progress of the work.

5.0 DUST CONTROL: The work includes dust control as required for the alleviation or prevention of any dust nuisance on or about the site or the borrow area, or off-site if caused by the Contractor's operation either during the performance of the earthwork or resulting from the conditions in which the Contractor leaves the site. The Contractor shall assume all liability, including court costs of codefendants, for all claims related to dust or wind-blown materials attributable to his work. Site preparation shall consist of site clearing and grubbing and preparation of foundation materials for receiving fill.

6.0 CLEARING AND GRUBBING: The Contractor shall accept the site in this present condition and shall demolish and/or remove from the area of designated project earthwork all structures, both surface and subsurface, trees, brush, roots, debris, organic matter and all other matter determined by the Soils Engineer to be deleterious. Such materials shall become the property of the Contractor and shall be removed from the site.

Tree root systems in proposed improvement areas should be removed to a minimum depth of 3 feet and to such an extent which would permit removal of all roots greater than 1 inch in diameter. Tree roots removed in parking areas may be limited to the upper 1½ feet of the ground surface. Backfill of tree root excavations is not permitted until all exposed surfaces have been inspected and the Soils Engineer is present for the proper control of backfill placement and compaction. Burning in areas which are to receive fill materials shall not be permitted.

7.0 SUBGRADE PREPARATION: Surfaces to receive Engineered Fill and/or building or slab loads shall be prepared as outlined above, scarified to a minimum of 12 inches, moisture-conditioned as necessary, and recompacted to 95 percent relative compaction (90% for silty or clayey soil).

Loose soil areas and/or areas of disturbed soil shall be moisture-conditioned as necessary and recompacted to 95 percent relative compaction (90% for silty or clayey soil). All ruts, hummocks, or other uneven surface features shall be removed by surface grading prior to placement of any fill materials. All areas which are to receive fill materials shall be approved by the Soils Engineer prior to the placement of any fill material.

8.0 EXCAVATION: All excavation shall be accomplished to the tolerance normally defined by the Civil Engineer as shown on the project grading plans. All over-excavation below the grades specified shall be backfilled at the Contractor's expense and shall be compacted in accordance with the applicable technical requirements.

9.0 FILL AND BACKFILL MATERIAL: No material shall be moved or compacted without the presence or approval of the Soils Engineer. Material from the required site excavation may be utilized for construction site fills, provided prior approval is given by the Soils Engineer. All materials utilized for constructing site fills shall be free from vegetation or other deleterious matter as determined by the Soils Engineer.

10.0 PLACEMENT, SPREADING AND COMPACTION: The placement and spreading of approved fill materials and the processing and compaction of approved fill and native materials shall be the responsibility of the Contractor. Compaction of fill materials by flooding, ponding, or jetting shall not be permitted unless specifically approved by local code, as well as the Soils Engineer. Both cut and fill shall be surface-compacted to the satisfaction of the Soils Engineer prior to final acceptance.

11.0 SEASONAL LIMITS: No fill material shall be placed, spread, or rolled while it is frozen or thawing, or during unfavorable wet weather conditions. When the work is interrupted by heavy rains, fill

operations shall not be resumed until the Soils Engineer indicates that the moisture content and density of previously placed fill is as specified.

12.0 DEFINITIONS - The term "pavement" shall include asphaltic concrete surfacing, untreated aggregate base, and aggregate subbase. The term "subgrade" is that portion of the area on which surfacing, base, or subbase is to be placed. The term "Standard Specifications": hereinafter referred to, is the most recent edition of the Standard Specifications of the State of California, Department of Transportation. The term "relative compaction" refers to the field density expressed as a percentage of the maximum laboratory density as determined by ASTM D1557 Test Method (latest edition) or California Test Method 216 (CAL-216), as applicable.

13.0 PREPARATION OF THE SUBGRADE - The Contractor shall prepare the surface of the various subgrades receiving subsequent pavement courses to the lines, grades, and dimensions given on the plans. The upper 12 inches of the soil subgrade beneath the pavement section shall be compacted to a minimum relative compaction of 95 percent (90% for silty or clayey soil) based upon ASTM D1557. The finished subgrades shall be tested and approved by the Soils Engineer prior to the placement of additional pavement courses.

14.0 AGGREGATE BASE - The aggregate base material shall be spread and compacted on the prepared subgrade in conformity with the lines, grades, and dimensions shown on the plans. The aggregate base material shall conform to the requirements of Section 26 of the Standard Specifications for Class II material, ¾-inch or 1½-inches maximum size. The aggregate base material shall be compacted to a minimum relative compaction of 95 percent based upon CAL-216. The aggregate base material shall be spread in layers not exceeding 6 inches and each layer of aggregate material course shall be tested and approved by the Soils Engineer prior to the placement of successive layers.

15.0 AGGREGATE SUBBASE - The aggregate subbase shall be spread and compacted on the prepared subgrade in conformity with the lines, grades, and dimensions shown on the plans. The aggregate subbase material shall conform to the requirements of Section 25 of the Standard Specifications for Class II Subbase material. The aggregate subbase material shall be compacted to a minimum relative compaction of 95 percent based upon CAL-216, and it shall be spread and compacted in accordance with the Standard Specifications. Each layer of aggregate subbase shall be tested and approved by the Soils Engineer prior to the placement of successive layers.

16.0 ASPHALTIC CONCRETE SURFACING - Asphaltic concrete surfacing shall consist of a mixture of mineral aggregate and paving grade asphalt, mixed at a central mixing plant and spread and compacted on a prepared base in conformity with the lines, grades, and dimensions shown on the plans. The viscosity grade of the asphalt shall be PG 64-10, unless otherwise stipulated or local conditions warrant more stringent grade. The mineral aggregate shall be Type A or B, ½ inch maximum size, medium grading, and shall conform to the requirements set forth in Section 39 of the Standard Specifications. The drying, proportioning, and mixing of the materials shall conform to Section 39. The prime coat, spreading and compacting equipment, and spreading and compacting the mixture shall conform to the applicable chapters of Section 39, with the exception that no surface course shall be placed when the atmospheric temperature is below 50 degrees F. The surfacing shall be rolled with a combination steel-wheel and pneumatic rollers, as described in the Standard Specifications. The surface course shall be placed with an approved self-propelled mechanical spreading and finishing machine.

APPENDIX 10

STORM DRAIN AS-BUILTS

