



Appendix 4.3

CalEEMod Air Quality Output Sheets

4200 N. University Parkway Project - San Bernardino-South Coast County, Summer

EMFAC Off-Model Adjustment Factors for Gasoline Light Duty Vehicle to Account for the SAFE Vehicle Rule Not Applied

**4200 N. University Parkway Project
San Bernardino-South Coast County, Summer**

1.0 Project Characteristics

1.1 Land Usage

Land Uses	Size	Metric	Lot Acreage	Floor Surface Area	Population
Parking Lot	215.00	Space	1.93	86,000.00	0
Fast Food Restaurant with Drive Thru	14.46	1000sqft	0.33	14,458.00	0

1.2 Other Project Characteristics

Urbanization	Urban	Wind Speed (m/s)	2.2	Precipitation Freq (Days)	32
Climate Zone	10			Operational Year	2025
Utility Company	Southern California Edison				
CO2 Intensity (lb/MW hr)	531.98	CH4 Intensity (lb/MW hr)	0.033	N2O Intensity (lb/MW hr)	0.004

1.3 User Entered Comments & Non-Default Data

Project Characteristics - Based on 2019 Reported Factors

Land Use - Retail land use includes fast food restaurant with drive-through, coffee/donut shop with drive-through and automated car wash (with tunne)

Construction Phase - Based on preliminary construction schedule of April 2023 through February 2024

Grading - Conservative assumption of 7,600 cubic yards of import, based on current topography and pavement section.

Vehicle Trips - Based on total gross proposed project trip generation forecast of 5,196. Total net trips results in 3,896 (-1,300 pass-by trips).

Construction Off-road Equipment Mitigation - Fugitive Dust (Rule 403) Minimum requirements

Area Mitigation -

Water Mitigation -

Trips and VMT -

Table Name	Column Name	Default Value	New Value
tblAreaMitigation	UseLowVOCPaintParkingCheck	False	True

4200 N. University Parkway Project - San Bernardino-South Coast County, Summer

EMFAC Off-Model Adjustment Factors for Gasoline Light Duty Vehicle to Account for the SAFE Vehicle Rule Not Applied

tblConstDustMitigation	WaterUnpavedRoadVehicleSpeed	0	15
tblGrading	MaterialImported	0.00	7,600.00
tblLandUse	LandUseSquareFeet	14,460.00	14,458.00
tblProjectCharacteristics	CO2IntensityFactor	390.98	531.98
tblVehicleTrips	ST_TR	616.12	470.17
tblVehicleTrips	SU_TR	472.58	360.63
tblVehicleTrips	WD_TR	470.95	359.39

2.0 Emissions Summary

2.1 Overall Construction (Maximum Daily Emission)

Unmitigated Construction

	ROG	NOx	CO	SO2	Fugitive PM10	Exhaust PM10	PM10 Total	Fugitive PM2.5	Exhaust PM2.5	PM2.5 Total	Bio- CO2	NBio- CO2	Total CO2	CH4	N2O	CO2e
Year	lb/day										lb/day					
2023	1.8965	31.9052	16.0296	0.1105	10.1103	0.7881	10.8984	4.2364	0.7317	4.9681	0.0000	11,789.2369	11,789.2369	1.0614	1.5388	12,274.3203
2024	19.1744	22.8475	30.1214	0.0550	0.8291	1.0023	1.8313	0.2222	0.9485	1.1707	0.0000	5,220.8622	5,220.8622	1.0065	0.0592	5,263.6624
Maximum	19.1744	31.9052	30.1214	0.1105	10.1103	1.0023	10.8984	4.2364	0.9485	4.9681	0.0000	11,789.2369	11,789.2369	1.0614	1.5388	12,274.3203

Mitigated Construction

	ROG	NOx	CO	SO2	Fugitive PM10	Exhaust PM10	PM10 Total	Fugitive PM2.5	Exhaust PM2.5	PM2.5 Total	Bio- CO2	NBio- CO2	Total CO2	CH4	N2O	CO2e
--	-----	-----	----	-----	---------------	--------------	------------	----------------	---------------	-------------	----------	-----------	-----------	-----	-----	------

4200 N. University Parkway Project - San Bernardino-South Coast County, Summer

EMFAC Off-Model Adjustment Factors for Gasoline Light Duty Vehicle to Account for the SAFE Vehicle Rule Not Applied

Year	lb/day										lb/day					
2023	1.8965	31.9052	16.0296	0.1105	5.7026	0.7881	6.4906	2.1341	0.7317	2.8658	0.0000	11,789.2369	11,789.2369	1.0614	1.5388	12,274.3203
2024	19.1744	22.8475	30.1214	0.0550	0.8291	1.0023	1.8313	0.2222	0.9485	1.1707	0.0000	5,220.8622	5,220.8622	1.0065	0.0592	5,263.6624
Maximum	19.1744	31.9052	30.1214	0.1105	5.7026	1.0023	6.4906	2.1341	0.9485	2.8658	0.0000	11,789.2369	11,789.2369	1.0614	1.5388	12,274.3203

	ROG	NOx	CO	SO2	Fugitive PM10	Exhaust PM10	PM10 Total	Fugitive PM2.5	Exhaust PM2.5	PM2.5 Total	Bio- CO2	NBio-CO2	Total CO2	CH4	N2O	CO2e
Percent Reduction	0.00	0.00	0.00	0.00	40.29	0.00	34.63	47.15	0.00	34.25	0.00	0.00	0.00	0.00	0.00	0.00

2.2 Overall Operational
Unmitigated Operational

	ROG	NOx	CO	SO2	Fugitive PM10	Exhaust PM10	PM10 Total	Fugitive PM2.5	Exhaust PM2.5	PM2.5 Total	Bio- CO2	NBio- CO2	Total CO2	CH4	N2O	CO2e
Category	lb/day										lb/day					
Area	0.3622	2.1000e-004	0.0234	0.0000		8.0000e-005	8.0000e-005		8.0000e-005	8.0000e-005		0.0502	0.0502	1.3000e-004		0.0535
Energy	0.1165	1.0589	0.8894	6.3500e-003		0.0805	0.0805		0.0805	0.0805		1,270.6264	1,270.6264	0.0244	0.0233	1,278.1771
Mobile	15.0579	12.1998	85.3835	0.1534	15.1069	0.1269	15.2338	4.0290	0.1185	4.1475		15,648.6525	15,648.6525	1.2295	0.9557	15,964.1843
Total	15.5366	13.2589	86.2964	0.1597	15.1069	0.2074	15.3143	4.0290	0.1991	4.2280		16,919.3291	16,919.3291	1.2539	0.9790	17,242.4148

Mitigated Operational

4200 N. University Parkway Project - San Bernardino-South Coast County, Summer

EMFAC Off-Model Adjustment Factors for Gasoline Light Duty Vehicle to Account for the SAFE Vehicle Rule Not Applied

	ROG	NOx	CO	SO2	Fugitive PM10	Exhaust PM10	PM10 Total	Fugitive PM2.5	Exhaust PM2.5	PM2.5 Total	Bio- CO2	NBio- CO2	Total CO2	CH4	N2O	CO2e
Category	lb/day										lb/day					
Area	0.3622	2.1000e-004	0.0234	0.0000		8.0000e-005	8.0000e-005		8.0000e-005	8.0000e-005		0.0502	0.0502	1.3000e-004		0.0535
Energy	0.1165	1.0589	0.8894	6.3500e-003		0.0805	0.0805		0.0805	0.0805		1,270.6264	1,270.6264	0.0244	0.0233	1,278.1771
Mobile	15.0579	12.1998	85.3835	0.1534	15.1069	0.1269	15.2338	4.0290	0.1185	4.1475		15,648.6525	15,648.6525	1.2295	0.9557	15,964.1843
Total	15.5366	13.2589	86.2964	0.1597	15.1069	0.2074	15.3143	4.0290	0.1991	4.2280		16,919.3291	16,919.3291	1.2539	0.9790	17,242.4148

	ROG	NOx	CO	SO2	Fugitive PM10	Exhaust PM10	PM10 Total	Fugitive PM2.5	Exhaust PM2.5	PM2.5 Total	Bio- CO2	NBio- CO2	Total CO2	CH4	N2O	CO2e
Percent Reduction	0.00	0.00	0.00	0.00	0.00	0.00	0.00	0.00	0.00	0.00	0.00	0.00	0.00	0.00	0.00	0.00

3.0 Construction Detail

Construction Phase

Phase Number	Phase Name	Phase Type	Start Date	End Date	Num Days Week	Num Days	Phase Description
1	Grading	Grading	4/3/2023	4/10/2023	5	6	
2	Building Construction	Building Construction	4/11/2023	2/12/2024	5	220	
3	Paving	Paving	1/30/2024	2/12/2024	5	10	
4	Architectural Coating	Architectural Coating	1/30/2024	2/12/2024	5	10	

Acres of Grading (Site Preparation Phase): 0

Acres of Grading (Grading Phase): 6

Acres of Paving: 1.93

4200 N. University Parkway Project - San Bernardino-South Coast County, Summer

EMFAC Off-Model Adjustment Factors for Gasoline Light Duty Vehicle to Account for the SAFE Vehicle Rule Not Applied

Residential Indoor: 0; Residential Outdoor: 0; Non-Residential Indoor: 21,687; Non-Residential Outdoor: 7,229; Striped Parking Area: 5,160 (Architectural

OffRoad Equipment

Phase Name	Offroad Equipment Type	Amount	Usage Hours	Horse Power	Load Factor
Grading	Graders	1	8.00	187	0.41
Grading	Rubber Tired Dozers	1	8.00	247	0.40
Grading	Tractors/Loaders/Backhoes	2	7.00	97	0.37
Building Construction	Cranes	1	8.00	231	0.29
Building Construction	Forklifts	2	7.00	89	0.20
Building Construction	Generator Sets	1	8.00	84	0.74
Building Construction	Tractors/Loaders/Backhoes	1	6.00	97	0.37
Building Construction	Welders	3	8.00	46	0.45
Paving	Cement and Mortar Mixers	1	8.00	9	0.56
Paving	Pavers	1	8.00	130	0.42
Paving	Paving Equipment	1	8.00	132	0.36
Paving	Rollers	2	8.00	80	0.38
Paving	Tractors/Loaders/Backhoes	1	8.00	97	0.37
Architectural Coating	Air Compressors	1	6.00	78	0.48

Trips and VMT

Phase Name	Offroad Equipment Count	Worker Trip Number	Vendor Trip Number	Hauling Trip Number	Worker Trip Length	Vendor Trip Length	Hauling Trip Length	Worker Vehicle Class	Vendor Vehicle Class	Hauling Vehicle Class
Grading	4	10.00	0.00	950.00	14.70	6.90	20.00	LD_Mix	HDT_Mix	HHDT
Building Construction	8	42.00	16.00	0.00	14.70	6.90	20.00	LD_Mix	HDT_Mix	HHDT
Paving	6	15.00	0.00	0.00	14.70	6.90	20.00	LD_Mix	HDT_Mix	HHDT
Architectural Coating	1	8.00	0.00	0.00	14.70	6.90	20.00	LD_Mix	HDT_Mix	HHDT

3.1 Mitigation Measures Construction

Water Exposed Area

Reduce Vehicle Speed on Unpaved Roads

4200 N. University Parkway Project - San Bernardino-South Coast County, Summer

EMFAC Off-Model Adjustment Factors for Gasoline Light Duty Vehicle to Account for the SAFE Vehicle Rule Not Applied

3.2 Grading - 2023

Unmitigated Construction On-Site

	ROG	NOx	CO	SO2	Fugitive PM10	Exhaust PM10	PM10 Total	Fugitive PM2.5	Exhaust PM2.5	PM2.5 Total	Bio- CO2	NBio- CO2	Total CO2	CH4	N2O	CO2e
Category	lb/day										lb/day					
Fugitive Dust					7.2258	0.0000	7.2258	3.4464	0.0000	3.4464			0.0000			0.0000
Off-Road	1.3330	14.4676	8.7038	0.0206		0.6044	0.6044		0.5560	0.5560		1,995.6147	1,995.6147	0.6454		2,011.7503
Total	1.3330	14.4676	8.7038	0.0206	7.2258	0.6044	7.8302	3.4464	0.5560	4.0024		1,995.6147	1,995.6147	0.6454		2,011.7503

Unmitigated Construction Off-Site

	ROG	NOx	CO	SO2	Fugitive PM10	Exhaust PM10	PM10 Total	Fugitive PM2.5	Exhaust PM2.5	PM2.5 Total	Bio- CO2	NBio- CO2	Total CO2	CH4	N2O	CO2e
Category	lb/day										lb/day					
Hauling	0.3815	17.4140	5.3041	0.0889	2.7727	0.1832	2.9559	0.7603	0.1752	0.9355		9,692.7210	9,692.7210	0.4136	1.5364	10,160.8920
Vendor	0.0000	0.0000	0.0000	0.0000	0.0000	0.0000	0.0000	0.0000	0.0000	0.0000		0.0000	0.0000	0.0000	0.0000	0.0000
Worker	0.0391	0.0236	0.3761	1.0000e-003	0.1118	5.5000e-004	0.1123	0.0296	5.1000e-004	0.0302		100.9011	100.9011	2.4400e-003	2.4000e-003	101.6781
Total	0.4206	17.4376	5.6802	0.0899	2.8845	0.1837	3.0682	0.7899	0.1757	0.9657		9,793.6221	9,793.6221	0.4160	1.5388	10,262.5700

4200 N. University Parkway Project - San Bernardino-South Coast County, Summer

EMFAC Off-Model Adjustment Factors for Gasoline Light Duty Vehicle to Account for the SAFE Vehicle Rule Not Applied

Mitigated Construction On-Site

	ROG	NOx	CO	SO2	Fugitive PM10	Exhaust PM10	PM10 Total	Fugitive PM2.5	Exhaust PM2.5	PM2.5 Total	Bio- CO2	NBio- CO2	Total CO2	CH4	N2O	CO2e
Category	lb/day										lb/day					
Fugitive Dust					2.8181	0.0000	2.8181	1.3441	0.0000	1.3441			0.0000			0.0000
Off-Road	1.3330	14.4676	8.7038	0.0206		0.6044	0.6044		0.5560	0.5560	0.0000	1,995.6147	1,995.6147	0.6454		2,011.7503
Total	1.3330	14.4676	8.7038	0.0206	2.8181	0.6044	3.4224	1.3441	0.5560	1.9001	0.0000	1,995.6147	1,995.6147	0.6454		2,011.7503

Mitigated Construction Off-Site

	ROG	NOx	CO	SO2	Fugitive PM10	Exhaust PM10	PM10 Total	Fugitive PM2.5	Exhaust PM2.5	PM2.5 Total	Bio- CO2	NBio- CO2	Total CO2	CH4	N2O	CO2e
Category	lb/day										lb/day					
Hauling	0.3815	17.4140	5.3041	0.0889	2.7727	0.1832	2.9559	0.7603	0.1752	0.9355		9,692.7210	9,692.7210	0.4136	1.5364	10,160.8920
Vendor	0.0000	0.0000	0.0000	0.0000	0.0000	0.0000	0.0000	0.0000	0.0000	0.0000		0.0000	0.0000	0.0000	0.0000	0.0000
Worker	0.0391	0.0236	0.3761	1.0000e-003	0.1118	5.5000e-004	0.1123	0.0296	5.1000e-004	0.0302		100.9011	100.9011	2.4400e-003	2.4000e-003	101.6781
Total	0.4206	17.4376	5.6802	0.0889	2.8845	0.1837	3.0682	0.7899	0.1757	0.9657		9,793.6221	9,793.6221	0.4160	1.5388	10,262.5700

3.3 Building Construction - 2023

Unmitigated Construction On-Site

4200 N. University Parkway Project - San Bernardino-South Coast County, Summer

EMFAC Off-Model Adjustment Factors for Gasoline Light Duty Vehicle to Account for the SAFE Vehicle Rule Not Applied

	ROG	NOx	CO	SO2	Fugitive PM10	Exhaust PM10	PM10 Total	Fugitive PM2.5	Exhaust PM2.5	PM2.5 Total	Bio- CO2	NBio- CO2	Total CO2	CH4	N2O	CO2e
Category	lb/day										lb/day					
Off-Road	1.7136	13.6239	14.2145	0.0250		0.6136	0.6136		0.5880	0.5880		2,289.5233	2,289.5233	0.4330		2,300.3479
Total	1.7136	13.6239	14.2145	0.0250		0.6136	0.6136		0.5880	0.5880		2,289.5233	2,289.5233	0.4330		2,300.3479

Unmitigated Construction Off-Site

	ROG	NOx	CO	SO2	Fugitive PM10	Exhaust PM10	PM10 Total	Fugitive PM2.5	Exhaust PM2.5	PM2.5 Total	Bio- CO2	NBio- CO2	Total CO2	CH4	N2O	CO2e
Category	lb/day										lb/day					
Hauling	0.0000	0.0000	0.0000	0.0000	0.0000	0.0000	0.0000	0.0000	0.0000	0.0000		0.0000	0.0000	0.0000	0.0000	0.0000
Vendor	0.0187	0.5612	0.2355	2.8600e-003	0.1025	4.2200e-003	0.1067	0.0295	4.0300e-003	0.0336		307.0691	307.0691	8.0300e-003	0.0454	320.7827
Worker	0.1641	0.0990	1.5796	4.1900e-003	0.4695	2.3100e-003	0.4718	0.1245	2.1300e-003	0.1266		423.7847	423.7847	0.0103	0.0101	427.0479
Total	0.1829	0.6602	1.8151	7.0500e-003	0.5720	6.5300e-003	0.5785	0.1540	6.1600e-003	0.1602		730.8538	730.8538	0.0183	0.0554	747.8306

Mitigated Construction On-Site

4200 N. University Parkway Project - San Bernardino-South Coast County, Summer

EMFAC Off-Model Adjustment Factors for Gasoline Light Duty Vehicle to Account for the SAFE Vehicle Rule Not Applied

	ROG	NOx	CO	SO2	Fugitive PM10	Exhaust PM10	PM10 Total	Fugitive PM2.5	Exhaust PM2.5	PM2.5 Total	Bio- CO2	NBio- CO2	Total CO2	CH4	N2O	CO2e
Category	lb/day										lb/day					
Off-Road	1.7136	13.6239	14.2145	0.0250		0.6136	0.6136		0.5880	0.5880	0.0000	2,289.5233	2,289.5233	0.4330		2,300.3479
Total	1.7136	13.6239	14.2145	0.0250		0.6136	0.6136		0.5880	0.5880	0.0000	2,289.5233	2,289.5233	0.4330		2,300.3479

Mitigated Construction Off-Site

	ROG	NOx	CO	SO2	Fugitive PM10	Exhaust PM10	PM10 Total	Fugitive PM2.5	Exhaust PM2.5	PM2.5 Total	Bio- CO2	NBio- CO2	Total CO2	CH4	N2O	CO2e
Category	lb/day										lb/day					
Hauling	0.0000	0.0000	0.0000	0.0000	0.0000	0.0000	0.0000	0.0000	0.0000	0.0000		0.0000	0.0000	0.0000	0.0000	0.0000
Vendor	0.0187	0.5612	0.2355	2.8600e-003	0.1025	4.2200e-003	0.1067	0.0295	4.0300e-003	0.0336		307.0691	307.0691	8.0300e-003	0.0454	320.7827
Worker	0.1641	0.0990	1.5796	4.1900e-003	0.4695	2.3100e-003	0.4718	0.1245	2.1300e-003	0.1266		423.7847	423.7847	0.0103	0.0101	427.0479
Total	0.1829	0.6602	1.8151	7.0500e-003	0.5720	6.5300e-003	0.5785	0.1540	6.1600e-003	0.1602		730.8538	730.8538	0.0183	0.0554	747.8306

3.3 Building Construction - 2024

Unmitigated Construction On-Site

	ROG	NOx	CO	SO2	Fugitive PM10	Exhaust PM10	PM10 Total	Fugitive PM2.5	Exhaust PM2.5	PM2.5 Total	Bio- CO2	NBio- CO2	Total CO2	CH4	N2O	CO2e
Category	lb/day										lb/day					

4200 N. University Parkway Project - San Bernardino-South Coast County, Summer

EMFAC Off-Model Adjustment Factors for Gasoline Light Duty Vehicle to Account for the SAFE Vehicle Rule Not Applied

Off-Road	1.5971	12.8235	14.1002	0.0250		0.5381	0.5381		0.5153	0.5153		2,289.6541	2,289.6541	0.4265		2,300.3154
Total	1.5971	12.8235	14.1002	0.0250		0.5381	0.5381		0.5153	0.5153		2,289.6541	2,289.6541	0.4265		2,300.3154

Unmitigated Construction Off-Site

	ROG	NOx	CO	SO2	Fugitive PM10	Exhaust PM10	PM10 Total	Fugitive PM2.5	Exhaust PM2.5	PM2.5 Total	Bio- CO2	NBio- CO2	Total CO2	CH4	N2O	CO2e
Category	lb/day										lb/day					
Hauling	0.0000	0.0000	0.0000	0.0000	0.0000	0.0000	0.0000	0.0000	0.0000	0.0000		0.0000	0.0000	0.0000	0.0000	0.0000
Vendor	0.0183	0.5662	0.2316	2.8200e-003	0.1025	4.1500e-003	0.1067	0.0295	3.9700e-003	0.0335		302.8390	302.8390	7.7800e-003	0.0447	316.3587
Worker	0.1524	0.0879	1.4685	4.0700e-003	0.4695	2.2200e-003	0.4717	0.1245	2.0400e-003	0.1265		411.4182	411.4182	9.2700e-003	9.3500e-003	414.4374
Total	0.1707	0.6541	1.7001	6.8900e-003	0.5720	6.3700e-003	0.5783	0.1540	6.0100e-003	0.1600		714.2572	714.2572	0.0171	0.0541	730.7961

Mitigated Construction On-Site

	ROG	NOx	CO	SO2	Fugitive PM10	Exhaust PM10	PM10 Total	Fugitive PM2.5	Exhaust PM2.5	PM2.5 Total	Bio- CO2	NBio- CO2	Total CO2	CH4	N2O	CO2e
Category	lb/day										lb/day					
Off-Road	1.5971	12.8235	14.1002	0.0250		0.5381	0.5381		0.5153	0.5153	0.0000	2,289.6541	2,289.6541	0.4265		2,300.3154
Total	1.5971	12.8235	14.1002	0.0250		0.5381	0.5381		0.5153	0.5153	0.0000	2,289.6541	2,289.6541	0.4265		2,300.3154

4200 N. University Parkway Project - San Bernardino-South Coast County, Summer

EMFAC Off-Model Adjustment Factors for Gasoline Light Duty Vehicle to Account for the SAFE Vehicle Rule Not Applied

Mitigated Construction Off-Site

	ROG	NOx	CO	SO2	Fugitive PM10	Exhaust PM10	PM10 Total	Fugitive PM2.5	Exhaust PM2.5	PM2.5 Total	Bio- CO2	NBio- CO2	Total CO2	CH4	N2O	CO2e
Category	lb/day										lb/day					
Hauling	0.0000	0.0000	0.0000	0.0000	0.0000	0.0000	0.0000	0.0000	0.0000	0.0000		0.0000	0.0000	0.0000	0.0000	0.0000
Vendor	0.0183	0.5662	0.2316	2.8200e-003	0.1025	4.1500e-003	0.1067	0.0295	3.9700e-003	0.0335		302.8390	302.8390	7.7800e-003	0.0447	316.3587
Worker	0.1524	0.0879	1.4685	4.0700e-003	0.4695	2.2200e-003	0.4717	0.1245	2.0400e-003	0.1265		411.4182	411.4182	9.2700e-003	9.3500e-003	414.4374
Total	0.1707	0.6541	1.7001	6.8900e-003	0.5720	6.3700e-003	0.5783	0.1540	6.0100e-003	0.1600		714.2572	714.2572	0.0171	0.0541	730.7961

3.4 Paving - 2024

Unmitigated Construction On-Site

	ROG	NOx	CO	SO2	Fugitive PM10	Exhaust PM10	PM10 Total	Fugitive PM2.5	Exhaust PM2.5	PM2.5 Total	Bio- CO2	NBio- CO2	Total CO2	CH4	N2O	CO2e
Category	lb/day										lb/day					
Off-Road	0.8425	8.1030	11.7069	0.0179		0.3957	0.3957		0.3652	0.3652		1,710.2024	1,710.2024	0.5420		1,723.7529
Paving	0.5057					0.0000	0.0000		0.0000	0.0000			0.0000			0.0000
Total	1.3481	8.1030	11.7069	0.0179		0.3957	0.3957		0.3652	0.3652		1,710.2024	1,710.2024	0.5420		1,723.7529

4200 N. University Parkway Project - San Bernardino-South Coast County, Summer

EMFAC Off-Model Adjustment Factors for Gasoline Light Duty Vehicle to Account for the SAFE Vehicle Rule Not Applied

Unmitigated Construction Off-Site

	ROG	NOx	CO	SO2	Fugitive PM10	Exhaust PM10	PM10 Total	Fugitive PM2.5	Exhaust PM2.5	PM2.5 Total	Bio- CO2	NBio- CO2	Total CO2	CH4	N2O	CO2e
Category	lb/day										lb/day					
Hauling	0.0000	0.0000	0.0000	0.0000	0.0000	0.0000	0.0000	0.0000	0.0000	0.0000		0.0000	0.0000	0.0000	0.0000	0.0000
Vendor	0.0000	0.0000	0.0000	0.0000	0.0000	0.0000	0.0000	0.0000	0.0000	0.0000		0.0000	0.0000	0.0000	0.0000	0.0000
Worker	0.0544	0.0314	0.5245	1.4500e-003	0.1677	7.9000e-004	0.1685	0.0445	7.3000e-004	0.0452		146.9351	146.9351	3.3100e-003	3.3400e-003	148.0134
Total	0.0544	0.0314	0.5245	1.4500e-003	0.1677	7.9000e-004	0.1685	0.0445	7.3000e-004	0.0452		146.9351	146.9351	3.3100e-003	3.3400e-003	148.0134

Mitigated Construction On-Site

	ROG	NOx	CO	SO2	Fugitive PM10	Exhaust PM10	PM10 Total	Fugitive PM2.5	Exhaust PM2.5	PM2.5 Total	Bio- CO2	NBio- CO2	Total CO2	CH4	N2O	CO2e
Category	lb/day										lb/day					
Off-Road	0.8425	8.1030	11.7069	0.0179		0.3957	0.3957		0.3652	0.3652	0.0000	1,710.2024	1,710.2024	0.5420		1,723.7529
Paving	0.5057					0.0000	0.0000		0.0000	0.0000			0.0000			0.0000
Total	1.3481	8.1030	11.7069	0.0179		0.3957	0.3957		0.3652	0.3652	0.0000	1,710.2024	1,710.2024	0.5420		1,723.7529

4200 N. University Parkway Project - San Bernardino-South Coast County, Summer

EMFAC Off-Model Adjustment Factors for Gasoline Light Duty Vehicle to Account for the SAFE Vehicle Rule Not Applied

Mitigated Construction Off-Site

	ROG	NOx	CO	SO2	Fugitive PM10	Exhaust PM10	PM10 Total	Fugitive PM2.5	Exhaust PM2.5	PM2.5 Total	Bio- CO2	NBio- CO2	Total CO2	CH4	N2O	CO2e
Category	lb/day										lb/day					
Hauling	0.0000	0.0000	0.0000	0.0000	0.0000	0.0000	0.0000	0.0000	0.0000	0.0000		0.0000	0.0000	0.0000	0.0000	0.0000
Vendor	0.0000	0.0000	0.0000	0.0000	0.0000	0.0000	0.0000	0.0000	0.0000	0.0000		0.0000	0.0000	0.0000	0.0000	0.0000
Worker	0.0544	0.0314	0.5245	1.4500e-003	0.1677	7.9000e-004	0.1685	0.0445	7.3000e-004	0.0452		146.9351	146.9351	3.3100e-003	3.3400e-003	148.0134
Total	0.0544	0.0314	0.5245	1.4500e-003	0.1677	7.9000e-004	0.1685	0.0445	7.3000e-004	0.0452		146.9351	146.9351	3.3100e-003	3.3400e-003	148.0134

3.5 Architectural Coating - 2024

Unmitigated Construction On-Site

	ROG	NOx	CO	SO2	Fugitive PM10	Exhaust PM10	PM10 Total	Fugitive PM2.5	Exhaust PM2.5	PM2.5 Total	Bio- CO2	NBio- CO2	Total CO2	CH4	N2O	CO2e
Category	lb/day										lb/day					
Archit. Coating	15.7942					0.0000	0.0000		0.0000	0.0000			0.0000			0.0000
Off-Road	0.1808	1.2188	1.8101	2.9700e-003		0.0609	0.0609		0.0609	0.0609		281.4481	281.4481	0.0159		281.8443
Total	15.9750	1.2188	1.8101	2.9700e-003		0.0609	0.0609		0.0609	0.0609		281.4481	281.4481	0.0159		281.8443

Unmitigated Construction Off-Site

4200 N. University Parkway Project - San Bernardino-South Coast County, Summer

EMFAC Off-Model Adjustment Factors for Gasoline Light Duty Vehicle to Account for the SAFE Vehicle Rule Not Applied

	ROG	NOx	CO	SO2	Fugitive PM10	Exhaust PM10	PM10 Total	Fugitive PM2.5	Exhaust PM2.5	PM2.5 Total	Bio- CO2	NBio- CO2	Total CO2	CH4	N2O	CO2e
Category	lb/day										lb/day					
Hauling	0.0000	0.0000	0.0000	0.0000	0.0000	0.0000	0.0000	0.0000	0.0000	0.0000		0.0000	0.0000	0.0000	0.0000	0.0000
Vendor	0.0000	0.0000	0.0000	0.0000	0.0000	0.0000	0.0000	0.0000	0.0000	0.0000		0.0000	0.0000	0.0000	0.0000	0.0000
Worker	0.0290	0.0167	0.2797	7.8000e-004	0.0894	4.2000e-004	0.0898	0.0237	3.9000e-004	0.0241		78.3654	78.3654	1.7700e-003	1.7800e-003	78.9405
Total	0.0290	0.0167	0.2797	7.8000e-004	0.0894	4.2000e-004	0.0898	0.0237	3.9000e-004	0.0241		78.3654	78.3654	1.7700e-003	1.7800e-003	78.9405

Mitigated Construction On-Site

	ROG	NOx	CO	SO2	Fugitive PM10	Exhaust PM10	PM10 Total	Fugitive PM2.5	Exhaust PM2.5	PM2.5 Total	Bio- CO2	NBio- CO2	Total CO2	CH4	N2O	CO2e
Category	lb/day										lb/day					
Archit. Coating	15.7942					0.0000	0.0000		0.0000	0.0000			0.0000			0.0000
Off-Road	0.1808	1.2188	1.8101	2.9700e-003		0.0609	0.0609		0.0609	0.0609	0.0000	281.4481	281.4481	0.0159		281.8443
Total	15.9750	1.2188	1.8101	2.9700e-003		0.0609	0.0609		0.0609	0.0609	0.0000	281.4481	281.4481	0.0159		281.8443

Mitigated Construction Off-Site

4200 N. University Parkway Project - San Bernardino-South Coast County, Summer

EMFAC Off-Model Adjustment Factors for Gasoline Light Duty Vehicle to Account for the SAFE Vehicle Rule Not Applied

	ROG	NOx	CO	SO2	Fugitive PM10	Exhaust PM10	PM10 Total	Fugitive PM2.5	Exhaust PM2.5	PM2.5 Total	Bio- CO2	NBio- CO2	Total CO2	CH4	N2O	CO2e
Category	lb/day										lb/day					
Hauling	0.0000	0.0000	0.0000	0.0000	0.0000	0.0000	0.0000	0.0000	0.0000	0.0000		0.0000	0.0000	0.0000	0.0000	0.0000
Vendor	0.0000	0.0000	0.0000	0.0000	0.0000	0.0000	0.0000	0.0000	0.0000	0.0000		0.0000	0.0000	0.0000	0.0000	0.0000
Worker	0.0290	0.0167	0.2797	7.8000e-004	0.0894	4.2000e-004	0.0898	0.0237	3.9000e-004	0.0241		78.3654	78.3654	1.7700e-003	1.7800e-003	78.9405
Total	0.0290	0.0167	0.2797	7.8000e-004	0.0894	4.2000e-004	0.0898	0.0237	3.9000e-004	0.0241		78.3654	78.3654	1.7700e-003	1.7800e-003	78.9405

4.0 Operational Detail - Mobile

4.1 Mitigation Measures Mobile

	ROG	NOx	CO	SO2	Fugitive PM10	Exhaust PM10	PM10 Total	Fugitive PM2.5	Exhaust PM2.5	PM2.5 Total	Bio- CO2	NBio- CO2	Total CO2	CH4	N2O	CO2e
Category	lb/day										lb/day					
Mitigated	15.0579	12.1998	85.3835	0.1534	15.1069	0.1269	15.2338	4.0290	0.1185	4.1475		15,648.652	15,648.652	1.2295	0.9557	15,964.184
Unmitigated	15.0579	12.1998	85.3835	0.1534	15.1069	0.1269	15.2338	4.0290	0.1185	4.1475		15,648.652	15,648.652	1.2295	0.9557	15,964.184

4.2 Trip Summary Information

	Average Daily Trip Rate	Unmitigated	Mitigated
--	-------------------------	-------------	-----------

4200 N. University Parkway Project - San Bernardino-South Coast County, Summer

EMFAC Off-Model Adjustment Factors for Gasoline Light Duty Vehicle to Account for the SAFE Vehicle Rule Not Applied

Land Use	Weekday	Saturday	Sunday	Annual VMT	Annual VMT
Fast Food Restaurant with Drive Thru	5,196.78	6,798.66	5214.71	5,712,550	5,712,550
Parking Lot	0.00	0.00	0.00		
Total	5,196.78	6,798.66	5,214.71	5,712,550	5,712,550

4.3 Trip Type Information

Land Use	Miles			Trip %			Trip Purpose %		
	H-W or C-W	H-S or C-C	H-O or C-NW	H-W or C-W	H-S or C-C	H-O or C-NW	Primary	Diverted	Pass-by
Fast Food Restaurant with Drive Thru	16.60	8.40	6.90	2.20	78.80	19.00	29	21	50
Parking Lot	16.60	8.40	6.90	0.00	0.00	0.00	0	0	0

4.4 Fleet Mix

Land Use	LDA	LDT1	LDT2	MDV	LHD1	LHD2	MHD	HHD	OBUS	UBUS	MCY	SBUS	MH
Fast Food Restaurant with Drive Thru	0.543085	0.056300	0.173085	0.134258	0.025645	0.007009	0.011926	0.017481	0.000552	0.000248	0.024848	0.000956	0.004606
Parking Lot	0.543085	0.056300	0.173085	0.134258	0.025645	0.007009	0.011926	0.017481	0.000552	0.000248	0.024848	0.000956	0.004606

5.0 Energy Detail

Historical Energy Use: N

5.1 Mitigation Measures Energy

Category	ROG	NOx	CO	SO2	Fugitive PM10	Exhaust PM10	PM10 Total	Fugitive PM2.5	Exhaust PM2.5	PM2.5 Total	Bio- CO2	NBio- CO2	Total CO2	CH4	N2O	CO2e
NaturalGas Mitigated	0.1165	1.0589	0.8894	6.3500e-003		0.0805	0.0805		0.0805	0.0805		1,270.6264	1,270.6264	0.0244	0.0233	1,278.1771
NaturalGas Unmitigated	0.1165	1.0589	0.8894	6.3500e-003		0.0805	0.0805		0.0805	0.0805		1,270.6264	1,270.6264	0.0244	0.0233	1,278.1771

4200 N. University Parkway Project - San Bernardino-South Coast County, Summer

EMFAC Off-Model Adjustment Factors for Gasoline Light Duty Vehicle to Account for the SAFE Vehicle Rule Not Applied

5.2 Energy by Land Use - NaturalGas

Unmitigated

	NaturalGas Use	ROG	NOx	CO	SO2	Fugitive PM10	Exhaust PM10	PM10 Total	Fugitive PM2.5	Exhaust PM2.5	PM2.5 Total	Bio- CO2	NBio- CO2	Total CO2	CH4	N2O	CO2e
Land Use	kBTU/yr	lb/day										lb/day					
Fast Food Restaurant with Drive-Thru Parking Lot	10800.3	0.1165	1.0589	0.8894	6.3500e-003		0.0805	0.0805		0.0805	0.0805		1,270.6264	1,270.6264	0.0244	0.0233	1,278.1771
	0	0.0000	0.0000	0.0000	0.0000		0.0000	0.0000		0.0000	0.0000		0.0000	0.0000	0.0000	0.0000	0.0000
Total		0.1165	1.0589	0.8894	6.3500e-003		0.0805	0.0805		0.0805	0.0805		1,270.6264	1,270.6264	0.0244	0.0233	1,278.1771

Mitigated

	NaturalGas Use	ROG	NOx	CO	SO2	Fugitive PM10	Exhaust PM10	PM10 Total	Fugitive PM2.5	Exhaust PM2.5	PM2.5 Total	Bio- CO2	NBio- CO2	Total CO2	CH4	N2O	CO2e
Land Use	kBTU/yr	lb/day										lb/day					
Fast Food Restaurant with Drive-Thru Parking Lot	10.8003	0.1165	1.0589	0.8894	6.3500e-003		0.0805	0.0805		0.0805	0.0805		1,270.6264	1,270.6264	0.0244	0.0233	1,278.1771
	0	0.0000	0.0000	0.0000	0.0000		0.0000	0.0000		0.0000	0.0000		0.0000	0.0000	0.0000	0.0000	0.0000
Total		0.1165	1.0589	0.8894	6.3500e-003		0.0805	0.0805		0.0805	0.0805		1,270.6264	1,270.6264	0.0244	0.0233	1,278.1771

4200 N. University Parkway Project - San Bernardino-South Coast County, Summer

EMFAC Off-Model Adjustment Factors for Gasoline Light Duty Vehicle to Account for the SAFE Vehicle Rule Not Applied

6.0 Area Detail

6.1 Mitigation Measures Area

- Use Low VOC Paint - Residential Interior
- Use Low VOC Paint - Residential Exterior
- Use Low VOC Paint - Non-Residential Interior
- Use Low VOC Paint - Non-Residential Exterior
- Use Low VOC Cleaning Supplies

	ROG	NOx	CO	SO2	Fugitive PM10	Exhaust PM10	PM10 Total	Fugitive PM2.5	Exhaust PM2.5	PM2.5 Total	Bio- CO2	NBio- CO2	Total CO2	CH4	N2O	CO2e	
Category	lb/day										lb/day						
Mitigated	0.3622	2.1000e-004	0.0234	0.0000		8.0000e-005	8.0000e-005		8.0000e-005	8.0000e-005		0.0502	0.0502	1.3000e-004			0.0535
Unmitigated	0.3622	2.1000e-004	0.0234	0.0000		8.0000e-005	8.0000e-005		8.0000e-005	8.0000e-005		0.0502	0.0502	1.3000e-004			0.0535

6.2 Area by SubCategory

Unmitigated

	ROG	NOx	CO	SO2	Fugitive PM10	Exhaust PM10	PM10 Total	Fugitive PM2.5	Exhaust PM2.5	PM2.5 Total	Bio- CO2	NBio- CO2	Total CO2	CH4	N2O	CO2e
SubCategory	lb/day										lb/day					
Architectural Coating	0.0433					0.0000	0.0000		0.0000	0.0000			0.0000			0.0000

4200 N. University Parkway Project - San Bernardino-South Coast County, Summer

EMFAC Off-Model Adjustment Factors for Gasoline Light Duty Vehicle to Account for the SAFE Vehicle Rule Not Applied

Consumer Products	0.3167					0.0000	0.0000		0.0000	0.0000			0.0000			0.0000
Landscaping	2.1500e-003	2.1000e-004	0.0234	0.0000		8.0000e-005	8.0000e-005		8.0000e-005	8.0000e-005		0.0502	0.0502	1.3000e-004		0.0535
Total	0.3622	2.1000e-004	0.0234	0.0000		8.0000e-005	8.0000e-005		8.0000e-005	8.0000e-005		0.0502	0.0502	1.3000e-004		0.0535

Mitigated

	ROG	NOx	CO	SO2	Fugitive PM10	Exhaust PM10	PM10 Total	Fugitive PM2.5	Exhaust PM2.5	PM2.5 Total	Bio- CO2	NBio- CO2	Total CO2	CH4	N2O	CO2e
SubCategory	lb/day										lb/day					
Architectural Coating	0.0433					0.0000	0.0000		0.0000	0.0000			0.0000			0.0000
Consumer Products	0.3167					0.0000	0.0000		0.0000	0.0000			0.0000			0.0000
Landscaping	2.1500e-003	2.1000e-004	0.0234	0.0000		8.0000e-005	8.0000e-005		8.0000e-005	8.0000e-005		0.0502	0.0502	1.3000e-004		0.0535
Total	0.3622	2.1000e-004	0.0234	0.0000		8.0000e-005	8.0000e-005		8.0000e-005	8.0000e-005		0.0502	0.0502	1.3000e-004		0.0535

7.0 Water Detail

7.1 Mitigation Measures Water

- Install Low Flow Bathroom Faucet
- Install Low Flow Kitchen Faucet
- Install Low Flow Toilet
- Install Low Flow Shower
- Use Water Efficient Irrigation System

4200 N. University Parkway Project - San Bernardino-South Coast County, Summer

EMFAC Off-Model Adjustment Factors for Gasoline Light Duty Vehicle to Account for the SAFE Vehicle Rule Not Applied

8.0 Waste Detail

8.1 Mitigation Measures Waste

9.0 Operational Offroad

Equipment Type	Number	Hours/Day	Days/Year	Horse Power	Load Factor	Fuel Type
----------------	--------	-----------	-----------	-------------	-------------	-----------

10.0 Stationary Equipment

Fire Pumps and Emergency Generators

Equipment Type	Number	Hours/Day	Hours/Year	Horse Power	Load Factor	Fuel Type
----------------	--------	-----------	------------	-------------	-------------	-----------

Boilers

Equipment Type	Number	Heat Input/Day	Heat Input/Year	Boiler Rating	Fuel Type
----------------	--------	----------------	-----------------	---------------	-----------

User Defined Equipment

Equipment Type	Number
----------------	--------

11.0 Vegetation

4200 N. University Parkway Project - San Bernardino-South Coast County, Winter

EMFAC Off-Model Adjustment Factors for Gasoline Light Duty Vehicle to Account for the SAFE Vehicle Rule Not Applied

**4200 N. University Parkway Project
San Bernardino-South Coast County, Winter**

1.0 Project Characteristics

1.1 Land Usage

Land Uses	Size	Metric	Lot Acreage	Floor Surface Area	Population
Parking Lot	215.00	Space	1.93	86,000.00	0
Fast Food Restaurant with Drive Thru	14.46	1000sqft	0.33	14,458.00	0

1.2 Other Project Characteristics

Urbanization	Urban	Wind Speed (m/s)	2.2	Precipitation Freq (Days)	32
Climate Zone	10			Operational Year	2025
Utility Company	Southern California Edison				
CO2 Intensity (lb/MW hr)	531.98	CH4 Intensity (lb/MW hr)	0.033	N2O Intensity (lb/MW hr)	0.004

1.3 User Entered Comments & Non-Default Data

Project Characteristics - Based on 2019 Reported Factors

Land Use - Retail land use includes fast food restaurant with drive-through, coffee/donut shop with drive-through and automated car wash (with tunne)

Construction Phase - Based on preliminary construction schedule of April 2023 through February 2024

Grading - Conservative assumption of 7,600 cubic yards of import, based on current topography and pavement section.

Vehicle Trips - Based on total gross proposed project trip generation forecast of 5,196. Total net trips results in 3,896 (-1,300 pass-by trips).

Construction Off-road Equipment Mitigation - Fugitive Dust (Rule 403) Minimum requirements

Area Mitigation -

Water Mitigation -

Trips and VMT -

Table Name	Column Name	Default Value	New Value
tblAreaMitigation	UseLowVOCPaintParkingCheck	False	True

4200 N. University Parkway Project - San Bernardino-South Coast County, Winter

EMFAC Off-Model Adjustment Factors for Gasoline Light Duty Vehicle to Account for the SAFE Vehicle Rule Not Applied

tblConstDustMitigation	WaterUnpavedRoadVehicleSpeed	0	15
tblGrading	MaterialImported	0.00	7,600.00
tblLandUse	LandUseSquareFeet	14,460.00	14,458.00
tblProjectCharacteristics	CO2IntensityFactor	390.98	531.98
tblVehicleTrips	ST_TR	616.12	470.17
tblVehicleTrips	SU_TR	472.58	360.63
tblVehicleTrips	WD_TR	470.95	359.39

2.0 Emissions Summary

2.1 Overall Construction (Maximum Daily Emission)

Unmitigated Construction

	ROG	NOx	CO	SO2	Fugitive PM10	Exhaust PM10	PM10 Total	Fugitive PM2.5	Exhaust PM2.5	PM2.5 Total	Bio- CO2	NBio- CO2	Total CO2	CH4	N2O	CO2e
Year	lb/day										lb/day					
2023	1.8892	32.8497	15.7573	0.1106	10.1103	0.7884	10.8987	4.2364	0.7320	4.9684	0.0000	11,794.3759	11,794.3759	1.0600	1.5411	12,280.1358
2024	19.1650	22.8862	29.7286	0.0544	0.8291	1.0023	1.8314	0.2222	0.9485	1.1707	0.0000	5,161.8660	5,161.8660	1.0064	0.0598	5,204.8440
Maximum	19.1650	32.8497	29.7286	0.1106	10.1103	1.0023	10.8987	4.2364	0.9485	4.9684	0.0000	11,794.3759	11,794.3759	1.0600	1.5411	12,280.1358

Mitigated Construction

	ROG	NOx	CO	SO2	Fugitive PM10	Exhaust PM10	PM10 Total	Fugitive PM2.5	Exhaust PM2.5	PM2.5 Total	Bio- CO2	NBio- CO2	Total CO2	CH4	N2O	CO2e
--	-----	-----	----	-----	---------------	--------------	------------	----------------	---------------	-------------	----------	-----------	-----------	-----	-----	------

4200 N. University Parkway Project - San Bernardino-South Coast County, Winter

EMFAC Off-Model Adjustment Factors for Gasoline Light Duty Vehicle to Account for the SAFE Vehicle Rule Not Applied

Year	lb/day										lb/day					
2023	1.8892	32.8497	15.7573	0.1106	5.7026	0.7884	6.4909	2.1341	0.7320	2.8661	0.0000	11,794.3759	11,794.3759	1.0600	1.5411	12,280.1358
2024	19.1650	22.8862	29.7286	0.0544	0.8291	1.0023	1.8314	0.2222	0.9485	1.1707	0.0000	5,161.8660	5,161.8660	1.0064	0.0598	5,204.8440
Maximum	19.1650	32.8497	29.7286	0.1106	5.7026	1.0023	6.4909	2.1341	0.9485	2.8661	0.0000	11,794.3759	11,794.3759	1.0600	1.5411	12,280.1358

	ROG	NOx	CO	SO2	Fugitive PM10	Exhaust PM10	PM10 Total	Fugitive PM2.5	Exhaust PM2.5	PM2.5 Total	Bio- CO2	NBio-CO2	Total CO2	CH4	N2O	CO2e
Percent Reduction	0.00	0.00	0.00	0.00	40.29	0.00	34.62	47.15	0.00	34.24	0.00	0.00	0.00	0.00	0.00	0.00

2.2 Overall Operational
Unmitigated Operational

	ROG	NOx	CO	SO2	Fugitive PM10	Exhaust PM10	PM10 Total	Fugitive PM2.5	Exhaust PM2.5	PM2.5 Total	Bio- CO2	NBio- CO2	Total CO2	CH4	N2O	CO2e
Category	lb/day										lb/day					
Area	0.3622	2.1000e-004	0.0234	0.0000		8.0000e-005	8.0000e-005		8.0000e-005	8.0000e-005		0.0502	0.0502	1.3000e-004		0.0535
Energy	0.1165	1.0589	0.8894	6.3500e-003		0.0805	0.0805		0.0805	0.0805		1,270.6264	1,270.6264	0.0244	0.0233	1,278.1771
Mobile	12.3874	12.9789	82.0019	0.1430	15.1069	0.1271	15.2340	4.0290	0.1187	4.1477		14,600.3736	14,600.3736	1.3204	0.9835	14,926.4595
Total	12.8660	14.0380	82.9148	0.1494	15.1069	0.2077	15.3146	4.0290	0.1993	4.2282		15,871.0502	15,871.0502	1.3449	1.0068	16,204.6901

Mitigated Operational

4200 N. University Parkway Project - San Bernardino-South Coast County, Winter

EMFAC Off-Model Adjustment Factors for Gasoline Light Duty Vehicle to Account for the SAFE Vehicle Rule Not Applied

	ROG	NOx	CO	SO2	Fugitive PM10	Exhaust PM10	PM10 Total	Fugitive PM2.5	Exhaust PM2.5	PM2.5 Total	Bio- CO2	NBio- CO2	Total CO2	CH4	N2O	CO2e
Category	lb/day										lb/day					
Area	0.3622	2.1000e-004	0.0234	0.0000		8.0000e-005	8.0000e-005		8.0000e-005	8.0000e-005		0.0502	0.0502	1.3000e-004		0.0535
Energy	0.1165	1.0589	0.8894	6.3500e-003		0.0805	0.0805		0.0805	0.0805		1,270.6264	1,270.6264	0.0244	0.0233	1,278.1771
Mobile	12.3874	12.9789	82.0019	0.1430	15.1069	0.1271	15.2340	4.0290	0.1187	4.1477		14,600.3736	14,600.3736	1.3204	0.9835	14,926.4595
Total	12.8660	14.0380	82.9148	0.1494	15.1069	0.2077	15.3146	4.0290	0.1993	4.2282		15,871.0502	15,871.0502	1.3449	1.0068	16,204.6901

	ROG	NOx	CO	SO2	Fugitive PM10	Exhaust PM10	PM10 Total	Fugitive PM2.5	Exhaust PM2.5	PM2.5 Total	Bio- CO2	NBio- CO2	Total CO2	CH4	N2O	CO2e
Percent Reduction	0.00	0.00	0.00	0.00	0.00	0.00	0.00	0.00	0.00	0.00	0.00	0.00	0.00	0.00	0.00	0.00

3.0 Construction Detail

Construction Phase

Phase Number	Phase Name	Phase Type	Start Date	End Date	Num Days Week	Num Days	Phase Description
1	Grading	Grading	4/3/2023	4/10/2023	5	6	
2	Building Construction	Building Construction	4/11/2023	2/12/2024	5	220	
3	Paving	Paving	1/30/2024	2/12/2024	5	10	
4	Architectural Coating	Architectural Coating	1/30/2024	2/12/2024	5	10	

Acres of Grading (Site Preparation Phase): 0

Acres of Grading (Grading Phase): 6

Acres of Paving: 1.93

4200 N. University Parkway Project - San Bernardino-South Coast County, Winter

EMFAC Off-Model Adjustment Factors for Gasoline Light Duty Vehicle to Account for the SAFE Vehicle Rule Not Applied

Residential Indoor: 0; Residential Outdoor: 0; Non-Residential Indoor: 21,687; Non-Residential Outdoor: 7,229; Striped Parking Area: 5,160 (Architectural

OffRoad Equipment

Phase Name	Offroad Equipment Type	Amount	Usage Hours	Horse Power	Load Factor
Grading	Graders	1	8.00	187	0.41
Grading	Rubber Tired Dozers	1	8.00	247	0.40
Grading	Tractors/Loaders/Backhoes	2	7.00	97	0.37
Building Construction	Cranes	1	8.00	231	0.29
Building Construction	Forklifts	2	7.00	89	0.20
Building Construction	Generator Sets	1	8.00	84	0.74
Building Construction	Tractors/Loaders/Backhoes	1	6.00	97	0.37
Building Construction	Welders	3	8.00	46	0.45
Paving	Cement and Mortar Mixers	1	8.00	9	0.56
Paving	Pavers	1	8.00	130	0.42
Paving	Paving Equipment	1	8.00	132	0.36
Paving	Rollers	2	8.00	80	0.38
Paving	Tractors/Loaders/Backhoes	1	8.00	97	0.37
Architectural Coating	Air Compressors	1	6.00	78	0.48

Trips and VMT

Phase Name	Offroad Equipment Count	Worker Trip Number	Vendor Trip Number	Hauling Trip Number	Worker Trip Length	Vendor Trip Length	Hauling Trip Length	Worker Vehicle Class	Vendor Vehicle Class	Hauling Vehicle Class
Grading	4	10.00	0.00	950.00	14.70	6.90	20.00	LD_Mix	HDT_Mix	HHDT
Building Construction	8	42.00	16.00	0.00	14.70	6.90	20.00	LD_Mix	HDT_Mix	HHDT
Paving	6	15.00	0.00	0.00	14.70	6.90	20.00	LD_Mix	HDT_Mix	HHDT
Architectural Coating	1	8.00	0.00	0.00	14.70	6.90	20.00	LD_Mix	HDT_Mix	HHDT

3.1 Mitigation Measures Construction

Water Exposed Area

Reduce Vehicle Speed on Unpaved Roads

4200 N. University Parkway Project - San Bernardino-South Coast County, Winter

EMFAC Off-Model Adjustment Factors for Gasoline Light Duty Vehicle to Account for the SAFE Vehicle Rule Not Applied

3.2 Grading - 2023

Unmitigated Construction On-Site

	ROG	NOx	CO	SO2	Fugitive PM10	Exhaust PM10	PM10 Total	Fugitive PM2.5	Exhaust PM2.5	PM2.5 Total	Bio- CO2	NBio- CO2	Total CO2	CH4	N2O	CO2e
Category	lb/day										lb/day					
Fugitive Dust					7.2258	0.0000	7.2258	3.4464	0.0000	3.4464			0.0000			0.0000
Off-Road	1.3330	14.4676	8.7038	0.0206		0.6044	0.6044		0.5560	0.5560		1,995.6147	1,995.6147	0.6454		2,011.7503
Total	1.3330	14.4676	8.7038	0.0206	7.2258	0.6044	7.8302	3.4464	0.5560	4.0024		1,995.6147	1,995.6147	0.6454		2,011.7503

Unmitigated Construction Off-Site

	ROG	NOx	CO	SO2	Fugitive PM10	Exhaust PM10	PM10 Total	Fugitive PM2.5	Exhaust PM2.5	PM2.5 Total	Bio- CO2	NBio- CO2	Total CO2	CH4	N2O	CO2e
Category	lb/day										lb/day					
Hauling	0.3527	18.3573	5.3999	0.0891	2.7727	0.1835	2.9562	0.7603	0.1755	0.9358		9,707.3468	9,707.3468	0.4121	1.5387	10,176.1711
Vendor	0.0000	0.0000	0.0000	0.0000	0.0000	0.0000	0.0000	0.0000	0.0000	0.0000		0.0000	0.0000	0.0000	0.0000	0.0000
Worker	0.0376	0.0248	0.3096	9.0000e-004	0.1118	5.5000e-004	0.1123	0.0296	5.1000e-004	0.0302		91.4144	91.4144	2.4400e-003	2.4800e-003	92.2144
Total	0.3904	18.3821	5.7095	0.0900	2.8845	0.1840	3.0685	0.7899	0.1760	0.9660		9,798.7612	9,798.7612	0.4146	1.5411	10,268.3855

4200 N. University Parkway Project - San Bernardino-South Coast County, Winter

EMFAC Off-Model Adjustment Factors for Gasoline Light Duty Vehicle to Account for the SAFE Vehicle Rule Not Applied

Mitigated Construction On-Site

	ROG	NOx	CO	SO2	Fugitive PM10	Exhaust PM10	PM10 Total	Fugitive PM2.5	Exhaust PM2.5	PM2.5 Total	Bio- CO2	NBio- CO2	Total CO2	CH4	N2O	CO2e
Category	lb/day										lb/day					
Fugitive Dust					2.8181	0.0000	2.8181	1.3441	0.0000	1.3441			0.0000			0.0000
Off-Road	1.3330	14.4676	8.7038	0.0206		0.6044	0.6044		0.5560	0.5560	0.0000	1,995.6147	1,995.6147	0.6454		2,011.7503
Total	1.3330	14.4676	8.7038	0.0206	2.8181	0.6044	3.4224	1.3441	0.5560	1.9001	0.0000	1,995.6147	1,995.6147	0.6454		2,011.7503

Mitigated Construction Off-Site

	ROG	NOx	CO	SO2	Fugitive PM10	Exhaust PM10	PM10 Total	Fugitive PM2.5	Exhaust PM2.5	PM2.5 Total	Bio- CO2	NBio- CO2	Total CO2	CH4	N2O	CO2e
Category	lb/day										lb/day					
Hauling	0.3527	18.3573	5.3999	0.0891	2.7727	0.1835	2.9562	0.7603	0.1755	0.9358		9,707.3468	9,707.3468	0.4121	1.5387	10,176.1711
Vendor	0.0000	0.0000	0.0000	0.0000	0.0000	0.0000	0.0000	0.0000	0.0000	0.0000		0.0000	0.0000	0.0000	0.0000	0.0000
Worker	0.0376	0.0248	0.3096	9.0000e-004	0.1118	5.5000e-004	0.1123	0.0296	5.1000e-004	0.0302		91.4144	91.4144	2.4400e-003	2.4800e-003	92.2144
Total	0.3904	18.3821	5.7095	0.0900	2.8845	0.1840	3.0685	0.7899	0.1760	0.9660		9,798.7612	9,798.7612	0.4146	1.5411	10,268.3855

3.3 Building Construction - 2023

Unmitigated Construction On-Site

4200 N. University Parkway Project - San Bernardino-South Coast County, Winter

EMFAC Off-Model Adjustment Factors for Gasoline Light Duty Vehicle to Account for the SAFE Vehicle Rule Not Applied

	ROG	NOx	CO	SO2	Fugitive PM10	Exhaust PM10	PM10 Total	Fugitive PM2.5	Exhaust PM2.5	PM2.5 Total	Bio- CO2	NBio- CO2	Total CO2	CH4	N2O	CO2e
Category	lb/day										lb/day					
Off-Road	1.7136	13.6239	14.2145	0.0250		0.6136	0.6136		0.5880	0.5880		2,289.5233	2,289.5233	0.4330		2,300.3479
Total	1.7136	13.6239	14.2145	0.0250		0.6136	0.6136		0.5880	0.5880		2,289.5233	2,289.5233	0.4330		2,300.3479

Unmitigated Construction Off-Site

	ROG	NOx	CO	SO2	Fugitive PM10	Exhaust PM10	PM10 Total	Fugitive PM2.5	Exhaust PM2.5	PM2.5 Total	Bio- CO2	NBio- CO2	Total CO2	CH4	N2O	CO2e
Category	lb/day										lb/day					
Hauling	0.0000	0.0000	0.0000	0.0000	0.0000	0.0000	0.0000	0.0000	0.0000	0.0000		0.0000	0.0000	0.0000	0.0000	0.0000
Vendor	0.0174	0.5928	0.2428	2.8700e-003	0.1025	4.2300e-003	0.1067	0.0295	4.0500e-003	0.0336		307.8138	307.8138	7.9600e-003	0.0455	321.5678
Worker	0.1581	0.1041	1.3001	3.8000e-003	0.4695	2.3100e-003	0.4718	0.1245	2.1300e-003	0.1266		383.9404	383.9404	0.0103	0.0104	387.3005
Total	0.1755	0.6969	1.5429	6.6700e-003	0.5720	6.5400e-003	0.5785	0.1540	6.1800e-003	0.1602		691.7542	691.7542	0.0182	0.0559	708.8683

Mitigated Construction On-Site

4200 N. University Parkway Project - San Bernardino-South Coast County, Winter

EMFAC Off-Model Adjustment Factors for Gasoline Light Duty Vehicle to Account for the SAFE Vehicle Rule Not Applied

	ROG	NOx	CO	SO2	Fugitive PM10	Exhaust PM10	PM10 Total	Fugitive PM2.5	Exhaust PM2.5	PM2.5 Total	Bio- CO2	NBio- CO2	Total CO2	CH4	N2O	CO2e
Category	lb/day										lb/day					
Off-Road	1.7136	13.6239	14.2145	0.0250		0.6136	0.6136		0.5880	0.5880	0.0000	2,289.5233	2,289.5233	0.4330		2,300.3479
Total	1.7136	13.6239	14.2145	0.0250		0.6136	0.6136		0.5880	0.5880	0.0000	2,289.5233	2,289.5233	0.4330		2,300.3479

Mitigated Construction Off-Site

	ROG	NOx	CO	SO2	Fugitive PM10	Exhaust PM10	PM10 Total	Fugitive PM2.5	Exhaust PM2.5	PM2.5 Total	Bio- CO2	NBio- CO2	Total CO2	CH4	N2O	CO2e
Category	lb/day										lb/day					
Hauling	0.0000	0.0000	0.0000	0.0000	0.0000	0.0000	0.0000	0.0000	0.0000	0.0000		0.0000	0.0000	0.0000	0.0000	0.0000
Vendor	0.0174	0.5928	0.2428	2.8700e-003	0.1025	4.2300e-003	0.1067	0.0295	4.0500e-003	0.0336		307.8138	307.8138	7.9600e-003	0.0455	321.5678
Worker	0.1581	0.1041	1.3001	3.8000e-003	0.4695	2.3100e-003	0.4718	0.1245	2.1300e-003	0.1266		383.9404	383.9404	0.0103	0.0104	387.3005
Total	0.1755	0.6969	1.5429	6.6700e-003	0.5720	6.5400e-003	0.5785	0.1540	6.1800e-003	0.1602		691.7542	691.7542	0.0182	0.0559	708.8683

3.3 Building Construction - 2024

Unmitigated Construction On-Site

	ROG	NOx	CO	SO2	Fugitive PM10	Exhaust PM10	PM10 Total	Fugitive PM2.5	Exhaust PM2.5	PM2.5 Total	Bio- CO2	NBio- CO2	Total CO2	CH4	N2O	CO2e
Category	lb/day										lb/day					

4200 N. University Parkway Project - San Bernardino-South Coast County, Winter

EMFAC Off-Model Adjustment Factors for Gasoline Light Duty Vehicle to Account for the SAFE Vehicle Rule Not Applied

Off-Road	1.5971	12.8235	14.1002	0.0250		0.5381	0.5381		0.5153	0.5153		2,289.6541	2,289.6541	0.4265		2,300.3154
Total	1.5971	12.8235	14.1002	0.0250		0.5381	0.5381		0.5153	0.5153		2,289.6541	2,289.6541	0.4265		2,300.3154

Unmitigated Construction Off-Site

	ROG	NOx	CO	SO2	Fugitive PM10	Exhaust PM10	PM10 Total	Fugitive PM2.5	Exhaust PM2.5	PM2.5 Total	Bio- CO2	NBio- CO2	Total CO2	CH4	N2O	CO2e
Category	lb/day										lb/day					
Hauling	0.0000	0.0000	0.0000	0.0000	0.0000	0.0000	0.0000	0.0000	0.0000	0.0000		0.0000	0.0000	0.0000	0.0000	0.0000
Vendor	0.0170	0.5980	0.2388	2.8300e-003	0.1025	4.1700e-003	0.1067	0.0295	3.9900e-003	0.0335		303.5792	303.5792	7.7200e-003	0.0449	317.1383
Worker	0.1472	0.0924	1.2100	3.6900e-003	0.4695	2.2200e-003	0.4717	0.1245	2.0400e-003	0.1265		372.8193	372.8193	9.3000e-003	9.6500e-003	375.9279
Total	0.1642	0.6903	1.4488	6.5200e-003	0.5720	6.3900e-003	0.5784	0.1540	6.0300e-003	0.1600		676.3985	676.3985	0.0170	0.0545	693.0662

Mitigated Construction On-Site

	ROG	NOx	CO	SO2	Fugitive PM10	Exhaust PM10	PM10 Total	Fugitive PM2.5	Exhaust PM2.5	PM2.5 Total	Bio- CO2	NBio- CO2	Total CO2	CH4	N2O	CO2e
Category	lb/day										lb/day					
Off-Road	1.5971	12.8235	14.1002	0.0250		0.5381	0.5381		0.5153	0.5153	0.0000	2,289.6541	2,289.6541	0.4265		2,300.3154
Total	1.5971	12.8235	14.1002	0.0250		0.5381	0.5381		0.5153	0.5153	0.0000	2,289.6541	2,289.6541	0.4265		2,300.3154

4200 N. University Parkway Project - San Bernardino-South Coast County, Winter

EMFAC Off-Model Adjustment Factors for Gasoline Light Duty Vehicle to Account for the SAFE Vehicle Rule Not Applied

Mitigated Construction Off-Site

	ROG	NOx	CO	SO2	Fugitive PM10	Exhaust PM10	PM10 Total	Fugitive PM2.5	Exhaust PM2.5	PM2.5 Total	Bio- CO2	NBio- CO2	Total CO2	CH4	N2O	CO2e
Category	lb/day										lb/day					
Hauling	0.0000	0.0000	0.0000	0.0000	0.0000	0.0000	0.0000	0.0000	0.0000	0.0000		0.0000	0.0000	0.0000	0.0000	0.0000
Vendor	0.0170	0.5980	0.2388	2.8300e-003	0.1025	4.1700e-003	0.1067	0.0295	3.9900e-003	0.0335		303.5792	303.5792	7.7200e-003	0.0449	317.1383
Worker	0.1472	0.0924	1.2100	3.6900e-003	0.4695	2.2200e-003	0.4717	0.1245	2.0400e-003	0.1265		372.8193	372.8193	9.3000e-003	9.6500e-003	375.9279
Total	0.1642	0.6903	1.4488	6.5200e-003	0.5720	6.3900e-003	0.5784	0.1540	6.0300e-003	0.1600		676.3985	676.3985	0.0170	0.0545	693.0662

3.4 Paving - 2024

Unmitigated Construction On-Site

	ROG	NOx	CO	SO2	Fugitive PM10	Exhaust PM10	PM10 Total	Fugitive PM2.5	Exhaust PM2.5	PM2.5 Total	Bio- CO2	NBio- CO2	Total CO2	CH4	N2O	CO2e
Category	lb/day										lb/day					
Off-Road	0.8425	8.1030	11.7069	0.0179		0.3957	0.3957		0.3652	0.3652		1,710.2024	1,710.2024	0.5420		1,723.7529
Paving	0.5057					0.0000	0.0000		0.0000	0.0000			0.0000			0.0000
Total	1.3481	8.1030	11.7069	0.0179		0.3957	0.3957		0.3652	0.3652		1,710.2024	1,710.2024	0.5420		1,723.7529

4200 N. University Parkway Project - San Bernardino-South Coast County, Winter

EMFAC Off-Model Adjustment Factors for Gasoline Light Duty Vehicle to Account for the SAFE Vehicle Rule Not Applied

Unmitigated Construction Off-Site

	ROG	NOx	CO	SO2	Fugitive PM10	Exhaust PM10	PM10 Total	Fugitive PM2.5	Exhaust PM2.5	PM2.5 Total	Bio- CO2	NBio- CO2	Total CO2	CH4	N2O	CO2e
Category	lb/day										lb/day					
Hauling	0.0000	0.0000	0.0000	0.0000	0.0000	0.0000	0.0000	0.0000	0.0000	0.0000		0.0000	0.0000	0.0000	0.0000	0.0000
Vendor	0.0000	0.0000	0.0000	0.0000	0.0000	0.0000	0.0000	0.0000	0.0000	0.0000		0.0000	0.0000	0.0000	0.0000	0.0000
Worker	0.0526	0.0330	0.4321	1.3200e-003	0.1677	7.9000e-004	0.1685	0.0445	7.3000e-004	0.0452		133.1498	133.1498	3.3200e-003	3.4500e-003	134.2600
Total	0.0526	0.0330	0.4321	1.3200e-003	0.1677	7.9000e-004	0.1685	0.0445	7.3000e-004	0.0452		133.1498	133.1498	3.3200e-003	3.4500e-003	134.2600

Mitigated Construction On-Site

	ROG	NOx	CO	SO2	Fugitive PM10	Exhaust PM10	PM10 Total	Fugitive PM2.5	Exhaust PM2.5	PM2.5 Total	Bio- CO2	NBio- CO2	Total CO2	CH4	N2O	CO2e
Category	lb/day										lb/day					
Off-Road	0.8425	8.1030	11.7069	0.0179		0.3957	0.3957		0.3652	0.3652	0.0000	1,710.2024	1,710.2024	0.5420		1,723.7529
Paving	0.5057					0.0000	0.0000		0.0000	0.0000			0.0000			0.0000
Total	1.3481	8.1030	11.7069	0.0179		0.3957	0.3957		0.3652	0.3652	0.0000	1,710.2024	1,710.2024	0.5420		1,723.7529

4200 N. University Parkway Project - San Bernardino-South Coast County, Winter

EMFAC Off-Model Adjustment Factors for Gasoline Light Duty Vehicle to Account for the SAFE Vehicle Rule Not Applied

Mitigated Construction Off-Site

	ROG	NOx	CO	SO2	Fugitive PM10	Exhaust PM10	PM10 Total	Fugitive PM2.5	Exhaust PM2.5	PM2.5 Total	Bio- CO2	NBio- CO2	Total CO2	CH4	N2O	CO2e
Category	lb/day										lb/day					
Hauling	0.0000	0.0000	0.0000	0.0000	0.0000	0.0000	0.0000	0.0000	0.0000	0.0000		0.0000	0.0000	0.0000	0.0000	0.0000
Vendor	0.0000	0.0000	0.0000	0.0000	0.0000	0.0000	0.0000	0.0000	0.0000	0.0000		0.0000	0.0000	0.0000	0.0000	0.0000
Worker	0.0526	0.0330	0.4321	1.3200e-003	0.1677	7.9000e-004	0.1685	0.0445	7.3000e-004	0.0452		133.1498	133.1498	3.3200e-003	3.4500e-003	134.2600
Total	0.0526	0.0330	0.4321	1.3200e-003	0.1677	7.9000e-004	0.1685	0.0445	7.3000e-004	0.0452		133.1498	133.1498	3.3200e-003	3.4500e-003	134.2600

3.5 Architectural Coating - 2024

Unmitigated Construction On-Site

	ROG	NOx	CO	SO2	Fugitive PM10	Exhaust PM10	PM10 Total	Fugitive PM2.5	Exhaust PM2.5	PM2.5 Total	Bio- CO2	NBio- CO2	Total CO2	CH4	N2O	CO2e
Category	lb/day										lb/day					
Archit. Coating	15.7942					0.0000	0.0000		0.0000	0.0000			0.0000			0.0000
Off-Road	0.1808	1.2188	1.8101	2.9700e-003		0.0609	0.0609		0.0609	0.0609		281.4481	281.4481	0.0159		281.8443
Total	15.9750	1.2188	1.8101	2.9700e-003		0.0609	0.0609		0.0609	0.0609		281.4481	281.4481	0.0159		281.8443

Unmitigated Construction Off-Site

4200 N. University Parkway Project - San Bernardino-South Coast County, Winter

EMFAC Off-Model Adjustment Factors for Gasoline Light Duty Vehicle to Account for the SAFE Vehicle Rule Not Applied

	ROG	NOx	CO	SO2	Fugitive PM10	Exhaust PM10	PM10 Total	Fugitive PM2.5	Exhaust PM2.5	PM2.5 Total	Bio- CO2	NBio- CO2	Total CO2	CH4	N2O	CO2e
Category	lb/day										lb/day					
Hauling	0.0000	0.0000	0.0000	0.0000	0.0000	0.0000	0.0000	0.0000	0.0000	0.0000		0.0000	0.0000	0.0000	0.0000	0.0000
Vendor	0.0000	0.0000	0.0000	0.0000	0.0000	0.0000	0.0000	0.0000	0.0000	0.0000		0.0000	0.0000	0.0000	0.0000	0.0000
Worker	0.0280	0.0176	0.2305	7.0000e-004	0.0894	4.2000e-004	0.0898	0.0237	3.9000e-004	0.0241		71.0132	71.0132	1.7700e-003	1.8400e-003	71.6053
Total	0.0280	0.0176	0.2305	7.0000e-004	0.0894	4.2000e-004	0.0898	0.0237	3.9000e-004	0.0241		71.0132	71.0132	1.7700e-003	1.8400e-003	71.6053

Mitigated Construction On-Site

	ROG	NOx	CO	SO2	Fugitive PM10	Exhaust PM10	PM10 Total	Fugitive PM2.5	Exhaust PM2.5	PM2.5 Total	Bio- CO2	NBio- CO2	Total CO2	CH4	N2O	CO2e
Category	lb/day										lb/day					
Archit. Coating	15.7942					0.0000	0.0000		0.0000	0.0000			0.0000			0.0000
Off-Road	0.1808	1.2188	1.8101	2.9700e-003		0.0609	0.0609		0.0609	0.0609	0.0000	281.4481	281.4481	0.0159		281.8443
Total	15.9750	1.2188	1.8101	2.9700e-003		0.0609	0.0609		0.0609	0.0609	0.0000	281.4481	281.4481	0.0159		281.8443

Mitigated Construction Off-Site

4200 N. University Parkway Project - San Bernardino-South Coast County, Winter

EMFAC Off-Model Adjustment Factors for Gasoline Light Duty Vehicle to Account for the SAFE Vehicle Rule Not Applied

	ROG	NOx	CO	SO2	Fugitive PM10	Exhaust PM10	PM10 Total	Fugitive PM2.5	Exhaust PM2.5	PM2.5 Total	Bio- CO2	NBio- CO2	Total CO2	CH4	N2O	CO2e
Category	lb/day										lb/day					
Hauling	0.0000	0.0000	0.0000	0.0000	0.0000	0.0000	0.0000	0.0000	0.0000	0.0000		0.0000	0.0000	0.0000	0.0000	0.0000
Vendor	0.0000	0.0000	0.0000	0.0000	0.0000	0.0000	0.0000	0.0000	0.0000	0.0000		0.0000	0.0000	0.0000	0.0000	0.0000
Worker	0.0280	0.0176	0.2305	7.0000e-004	0.0894	4.2000e-004	0.0898	0.0237	3.9000e-004	0.0241		71.0132	71.0132	1.7700e-003	1.8400e-003	71.6053
Total	0.0280	0.0176	0.2305	7.0000e-004	0.0894	4.2000e-004	0.0898	0.0237	3.9000e-004	0.0241		71.0132	71.0132	1.7700e-003	1.8400e-003	71.6053

4.0 Operational Detail - Mobile

4.1 Mitigation Measures Mobile

	ROG	NOx	CO	SO2	Fugitive PM10	Exhaust PM10	PM10 Total	Fugitive PM2.5	Exhaust PM2.5	PM2.5 Total	Bio- CO2	NBio- CO2	Total CO2	CH4	N2O	CO2e
Category	lb/day										lb/day					
Mitigated	12.3874	12.9789	82.0019	0.1430	15.1069	0.1271	15.2340	4.0290	0.1187	4.1477		14,600.373	14,600.373	1.3204	0.9835	14,926.459
Unmitigated	12.3874	12.9789	82.0019	0.1430	15.1069	0.1271	15.2340	4.0290	0.1187	4.1477		14,600.373	14,600.373	1.3204	0.9835	14,926.459

4.2 Trip Summary Information

	Average Daily Trip Rate	Unmitigated	Mitigated
--	-------------------------	-------------	-----------

4200 N. University Parkway Project - San Bernardino-South Coast County, Winter

EMFAC Off-Model Adjustment Factors for Gasoline Light Duty Vehicle to Account for the SAFE Vehicle Rule Not Applied

Land Use	Weekday	Saturday	Sunday	Annual VMT	Annual VMT
Fast Food Restaurant with Drive Thru	5,196.78	6,798.66	5214.71	5,712,550	5,712,550
Parking Lot	0.00	0.00	0.00		
Total	5,196.78	6,798.66	5,214.71	5,712,550	5,712,550

4.3 Trip Type Information

Land Use	Miles			Trip %			Trip Purpose %		
	H-W or C-W	H-S or C-C	H-O or C-NW	H-W or C-W	H-S or C-C	H-O or C-NW	Primary	Diverted	Pass-by
Fast Food Restaurant with Drive Thru	16.60	8.40	6.90	2.20	78.80	19.00	29	21	50
Parking Lot	16.60	8.40	6.90	0.00	0.00	0.00	0	0	0

4.4 Fleet Mix

Land Use	LDA	LDT1	LDT2	MDV	LHD1	LHD2	MHD	HHD	OBUS	UBUS	MCY	SBUS	MH
Fast Food Restaurant with Drive Thru	0.543085	0.056300	0.173085	0.134258	0.025645	0.007009	0.011926	0.017481	0.000552	0.000248	0.024848	0.000956	0.004606
Parking Lot	0.543085	0.056300	0.173085	0.134258	0.025645	0.007009	0.011926	0.017481	0.000552	0.000248	0.024848	0.000956	0.004606

5.0 Energy Detail

Historical Energy Use: N

5.1 Mitigation Measures Energy

Category	ROG	NOx	CO	SO2	Fugitive PM10	Exhaust PM10	PM10 Total	Fugitive PM2.5	Exhaust PM2.5	PM2.5 Total	Bio- CO2	NBio- CO2	Total CO2	CH4	N2O	CO2e
NaturalGas Mitigated	0.1165	1.0589	0.8894	6.3500e-003		0.0805	0.0805		0.0805	0.0805		1,270.6264	1,270.6264	0.0244	0.0233	1,278.1771
NaturalGas Unmitigated	0.1165	1.0589	0.8894	6.3500e-003		0.0805	0.0805		0.0805	0.0805		1,270.6264	1,270.6264	0.0244	0.0233	1,278.1771

4200 N. University Parkway Project - San Bernardino-South Coast County, Winter

EMFAC Off-Model Adjustment Factors for Gasoline Light Duty Vehicle to Account for the SAFE Vehicle Rule Not Applied

5.2 Energy by Land Use - NaturalGas

Unmitigated

	NaturalGas Use	ROG	NOx	CO	SO2	Fugitive PM10	Exhaust PM10	PM10 Total	Fugitive PM2.5	Exhaust PM2.5	PM2.5 Total	Bio- CO2	NBio- CO2	Total CO2	CH4	N2O	CO2e
Land Use	kBTU/yr	lb/day										lb/day					
Fast Food Restaurant with Drive-Thru Parking Lot	10800.3	0.1165	1.0589	0.8894	6.3500e-003		0.0805	0.0805		0.0805	0.0805		1,270.6264	1,270.6264	0.0244	0.0233	1,278.1771
	0	0.0000	0.0000	0.0000	0.0000		0.0000	0.0000		0.0000	0.0000		0.0000	0.0000	0.0000	0.0000	0.0000
Total		0.1165	1.0589	0.8894	6.3500e-003		0.0805	0.0805		0.0805	0.0805		1,270.6264	1,270.6264	0.0244	0.0233	1,278.1771

Mitigated

	NaturalGas Use	ROG	NOx	CO	SO2	Fugitive PM10	Exhaust PM10	PM10 Total	Fugitive PM2.5	Exhaust PM2.5	PM2.5 Total	Bio- CO2	NBio- CO2	Total CO2	CH4	N2O	CO2e
Land Use	kBTU/yr	lb/day										lb/day					
Fast Food Restaurant with Drive-Thru Parking Lot	10.8003	0.1165	1.0589	0.8894	6.3500e-003		0.0805	0.0805		0.0805	0.0805		1,270.6264	1,270.6264	0.0244	0.0233	1,278.1771
	0	0.0000	0.0000	0.0000	0.0000		0.0000	0.0000		0.0000	0.0000		0.0000	0.0000	0.0000	0.0000	0.0000
Total		0.1165	1.0589	0.8894	6.3500e-003		0.0805	0.0805		0.0805	0.0805		1,270.6264	1,270.6264	0.0244	0.0233	1,278.1771

4200 N. University Parkway Project - San Bernardino-South Coast County, Winter

EMFAC Off-Model Adjustment Factors for Gasoline Light Duty Vehicle to Account for the SAFE Vehicle Rule Not Applied

6.0 Area Detail

6.1 Mitigation Measures Area

- Use Low VOC Paint - Residential Interior
- Use Low VOC Paint - Residential Exterior
- Use Low VOC Paint - Non-Residential Interior
- Use Low VOC Paint - Non-Residential Exterior
- Use Low VOC Cleaning Supplies

	ROG	NOx	CO	SO2	Fugitive PM10	Exhaust PM10	PM10 Total	Fugitive PM2.5	Exhaust PM2.5	PM2.5 Total	Bio- CO2	NBio- CO2	Total CO2	CH4	N2O	CO2e	
Category	lb/day										lb/day						
Mitigated	0.3622	2.1000e-004	0.0234	0.0000		8.0000e-005	8.0000e-005		8.0000e-005	8.0000e-005		0.0502	0.0502	1.3000e-004			0.0535
Unmitigated	0.3622	2.1000e-004	0.0234	0.0000		8.0000e-005	8.0000e-005		8.0000e-005	8.0000e-005		0.0502	0.0502	1.3000e-004			0.0535

6.2 Area by SubCategory

Unmitigated

	ROG	NOx	CO	SO2	Fugitive PM10	Exhaust PM10	PM10 Total	Fugitive PM2.5	Exhaust PM2.5	PM2.5 Total	Bio- CO2	NBio- CO2	Total CO2	CH4	N2O	CO2e
SubCategory	lb/day										lb/day					
Architectural Coating	0.0433					0.0000	0.0000		0.0000	0.0000			0.0000			0.0000

4200 N. University Parkway Project - San Bernardino-South Coast County, Winter

EMFAC Off-Model Adjustment Factors for Gasoline Light Duty Vehicle to Account for the SAFE Vehicle Rule Not Applied

Consumer Products	0.3167					0.0000	0.0000		0.0000	0.0000			0.0000			0.0000
Landscaping	2.1500e-003	2.1000e-004	0.0234	0.0000		8.0000e-005	8.0000e-005		8.0000e-005	8.0000e-005		0.0502	0.0502	1.3000e-004		0.0535
Total	0.3622	2.1000e-004	0.0234	0.0000		8.0000e-005	8.0000e-005		8.0000e-005	8.0000e-005		0.0502	0.0502	1.3000e-004		0.0535

Mitigated

	ROG	NOx	CO	SO2	Fugitive PM10	Exhaust PM10	PM10 Total	Fugitive PM2.5	Exhaust PM2.5	PM2.5 Total	Bio- CO2	NBio- CO2	Total CO2	CH4	N2O	CO2e
SubCategory	lb/day										lb/day					
Architectural Coating	0.0433					0.0000	0.0000		0.0000	0.0000			0.0000			0.0000
Consumer Products	0.3167					0.0000	0.0000		0.0000	0.0000			0.0000			0.0000
Landscaping	2.1500e-003	2.1000e-004	0.0234	0.0000		8.0000e-005	8.0000e-005		8.0000e-005	8.0000e-005		0.0502	0.0502	1.3000e-004		0.0535
Total	0.3622	2.1000e-004	0.0234	0.0000		8.0000e-005	8.0000e-005		8.0000e-005	8.0000e-005		0.0502	0.0502	1.3000e-004		0.0535

7.0 Water Detail

7.1 Mitigation Measures Water

- Install Low Flow Bathroom Faucet
- Install Low Flow Kitchen Faucet
- Install Low Flow Toilet
- Install Low Flow Shower
- Use Water Efficient Irrigation System

4200 N. University Parkway Project - San Bernardino-South Coast County, Winter

EMFAC Off-Model Adjustment Factors for Gasoline Light Duty Vehicle to Account for the SAFE Vehicle Rule Not Applied

8.0 Waste Detail

8.1 Mitigation Measures Waste

9.0 Operational Offroad

Equipment Type	Number	Hours/Day	Days/Year	Horse Power	Load Factor	Fuel Type
----------------	--------	-----------	-----------	-------------	-------------	-----------

10.0 Stationary Equipment

Fire Pumps and Emergency Generators

Equipment Type	Number	Hours/Day	Hours/Year	Horse Power	Load Factor	Fuel Type
----------------	--------	-----------	------------	-------------	-------------	-----------

Boilers

Equipment Type	Number	Heat Input/Day	Heat Input/Year	Boiler Rating	Fuel Type
----------------	--------	----------------	-----------------	---------------	-----------

User Defined Equipment

Equipment Type	Number
----------------	--------

11.0 Vegetation

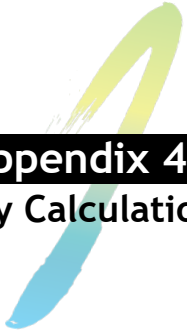

Appendix 4.6
Energy Calculations

Table 1. Summary of Energy Use During Construction	
Fuel Type	Quantity
Diesel	
Off-Road Construction Equipment	23,440 Gallons
On-Road Motor Vehicles	19,922 Gallons
Total	43,361 Gallons
Gasoline	
Off-Road Construction Equipment	0 Gallons
On-Road Motor Vehicles	5,320 Gallons
Total	5,320 Gallons
Electricity	
Total	176.3 kWh

Table 2. Summary of Annual Energy Use During Operation		
Source	Units	Buildout
Electricity		
Fast Food	kWh/yr	667,381
Parking	kWh/yr	30,100
Water Conveyance	kWh/yr	60,263
<i>Total Electricity</i>	<i>kWh/yr</i>	<i>757,744</i>
Natural Gas		
Fast Food	kBTU/yr	3,942,120
<i>Total Natural Gas</i>	<i>kBTU/yr</i>	<i>3,942,120</i>
Transportation/On-Site Sources		
Diesel	gallons	74,769
Gasoline	gallons	202,534
Total	gallons	277,302

Table 3. Water by Land Use				
Land Use	Units	Project		
		Indoor/Outdoor Use	Indoor Use	Outdoor Use
Buildout	Mgal	4.3891 / 0.280155	4.3891	0.280155

Water and Wastewater Electricity Intensity (kWh/gallon)

Supply Water	0.009727
Treat Water	0.000111
Distribute Water	0.001272
Wastewater Treatment	0.001911

Source: CalEEMod User's Guide, Appendix D, Table 9.2

Indoor Water Factor	0.013021 kWh/gallon (supply, treat, distribute, wastewater treatment)
Outdoor Water Factor	0.01111 kWh/gallon (supply, treat, and distribute)

Notes:

Electricity and Natural Gas for the Proposed Project is total operational usage. Electricity, natural gas, and mobile usage was calculated from CalEEMod. Indoor water factor used for entire Project Site for conservative analysis.

Table 4. Off-Road Equipment Fuel Usage During Construction

Phase Name	Off-road Equipment Type	Amount	Hours per Day	Horsepower	Load Factor	Number of Days	Diesel Fuel Usage (Gallons per Project)
Grading	Graders	1	8	187	0.41	6	184
Grading	Rubber Tired Dozers	1	8	247	0.4	6	237
Grading	Tractors/Loaders/Backhoes	2	7	97	0.37	6	151
Building Construction	Cranes	1	8	231	0.29	220	5,895
Building Construction	Forklifts	2	7	89	0.2	220	2,741
Building Construction	Generator Sets	1	8	84	0.74	220	5,470
Building Construction	Tractors/Loaders/Backhoes	1	6	97	0.37	220	2,369
Building Construction	Welders	3	8	46	0.45	220	5,465
Paving	Cement and Mortar Mixers	1	8	9	0.56	10	20
Paving	Pavers	1	8	130	0.42	10	218
Paving	Paving Equipment	1	8	132	0.36	10	190
Paving	Rollers	2	8	80	0.38	10	243
Paving	Tractors/Loaders/Backhoes	1	8	97	0.37	10	144
Architectural Coating	Air Compressors	1	6	78	0.48	10	112
Project Total							23,440

Notes:

Equipment assumptions from CalEEMod.

Fuel usage estimate of 0.05 gallons per horsepower-hour is from the SCAQMD CEQA Air Quality Handbook, Table A9-3 E.

Table 5. On-Road Vehicle Fuel Usage During Construction

Sub Area 1	Days	Daily Trips		Total			Trip Length (Miles)			Total Length (Miles)			Fuel Consumption (Gallons)	
		Worker	Vendor	Worker Trips	Vendor Trips	Haul Trips	Worker	Vendor	Hauling	Worker	Vendor	Hauling	Gasoline	Diesel
Grading	6	10	0	60	0	0	14.7	6.9	20	882	0	0	33	25
Building Construction	220	42	64	9,240	14,080	16	14.7	6.9	20	135,828	97,152	320	5,159	19,800
Architectural Coating	10	8	0	80	0	0	14.7	6.9	20	1,176	0	0	45	34
Paving	10	15	0	150	0	0	14.7	6.9	20	2,205	0	0	84	63
Total	246	75	64	9,530	14,080	16	n/a	n/a	n/a	140,091	97,152	320	5,320	19,922

Fuel Efficiency	Gas	DSL
Workers	26.33	34.88
Vendor/Haul Trucks	0	6.13

Notes:
 Fuel efficiency calculated in **Table 7: EMFAC2021 Results - Construction.**

Table 6. Water Usage for Control of Fugitive Dust During Construction			
Phase Name	Total Acres	Gallons for Project	Electricity (kWh)
Project	6.0	18,120	176.3

Notes:

Total acres graded based on CalEEMod output sheets.

Water Usage

3,020 gallons per acre per day

Source: Air & Waste Management Association, Air Pollution Engineering Manual, 1992 Edition

Supply Water Electricity Intensity

0.009727 kWh/gallons (CalEEMod default)

Table 7. EMFAC2021 Results - Construction								
Vehicle Class	Fuel	VMT (miles per day)	Fuel (1,000 gal per day)	Fuel Efficiency (miles per gallon)	Fuel	VMT (miles per day)	Fuel (1,000 gal per day)	Fuel Efficiency (miles per gallon)
LDA	GAS	33,073,440	1,140.88	28.99	DSL	77,366	1.85	41.87
LDT1	GAS	2,503,906	104.67	23.92	DSL	424	0.02	23.82
LDT2	GAS	13,160,213	561.87	23.42	DSL	39,572	1.24	31.97
Average (LDA, LDT1, LDT2)				26.33				34.88
T7 Tractor Construction	DSL	405,659	66.20	6.13				

Construction Worker Fleet Mix

LDA	50%
LDT1	25%
LDT2	25%

Vendor and Delivery/Haul Truck Fleet Mix

HHDT	100%
------	------

Source: EMFAC2021 (v1.0.2) Emissions Inventory

Region Type: County

Region: San Bernardino

Calendar Year: 2023

Season: Annual

Vehicle Classification: EMFAC202x Categories

Units: miles/day for CVMT and EVMT, trips/day for Trips, kWh/day for Energy Consumption, tons/day for Emissions, 1000 gallons/day for Fuel Consumption

Region	CalYr	VehClass	MdlYr	Speed	Fuel	Population	VMT	Trips	Fuel_Consumption
San Bernardino	2023	LDA	Aggregate	Aggregate	Gasoline	773664.0019	33073440.07	3594279.083	1140.883797
San Bernardino	2023	LDA	Aggregate	Aggregate	Diesel	2221.377014	77366.16142	9541.620731	1.847726849
San Bernardino	2023	LDA	Aggregate	Aggregate	Electricity	27031.11036	1265339.001	136160.7131	0
San Bernardino	2023	LDT1	Aggregate	Aggregate	Gasoline	73981.30063	2503906.499	318282.9673	104.6712544
San Bernardino	2023	LDT1	Aggregate	Aggregate	Diesel	29.71832479	424.1576698	86.28629252	0.01780751
San Bernardino	2023	LDT1	Aggregate	Aggregate	Electricity	77.71161154	3326.268317	378.6150268	0
San Bernardino	2023	LDT2	Aggregate	Aggregate	Gasoline	323145.0561	13160212.62	1508164.1	561.8657302
San Bernardino	2023	LDT2	Aggregate	Aggregate	Diesel	896.7674867	39572.03037	4322.633894	1.237774667
San Bernardino	2023	T7 Tractor Class	Aggregate	Aggregate	Diesel	4976.679984	405658.6311	72311.16017	66.19692331
									1876.721014
									1876721.014
		Gas		1807.420782	1807420.782	659708585.3	35,378,625.00		
		Diesel		69.30023233	69300.23233	25294584.8	10,548,851.00	685,003,170.11	
							45,927,476.00		

Table 8. On road Vehicles - Operational				
Scenario	Annual VMT	Fuel Consumption (gal)		
		Gasoline	Diesel	Total
Project	5,712,495	202,534	74,769	277,302

Table 9. Fuel Consumption Summary		
Project		
Fuel	Fuel Efficiency (MPG)	%Fleet
Gasoline	25.4	90.0%
Diesel	7.6	10.0%

Notes:

Percent fleet and fuel efficiency based on

Table 10: EMFAC2021 Emissions

Inventory-Operations

Annual VMT obtained from the CalEEMod Output files.

Table 10. EMFAC2021 Emissions Inventory - Operations

Fuel	VMT (miles/day)	Fuel Consumption (1,000 gal/day)	Fuel Efficiency (miles per gallon)	Fuel Percentage		Existing VMT	Fuel Consumption	Fuel Efficiency	Fuel Percentage
GAS	60,825,054	2,396	25.4	90		0	0	#DIV/0!	#DIV/0!
DSL	6,859,924	898	7.6	10		0	0	#DIV/0!	#DIV/0!

Note: Fuel percentage based on VMT.

Fuel efficiency calculated using fuel consumption and VMT from EMFAC2021.

Buildout

Source: EMFAC2021 (v1.0.1) Emissions Inventory

Region Type: County

Region: Los Angeles

Calendar Year: 2025

Season: Annual

Vehicle Classification: EMFAC202x Categories

Units: miles/day for VMT, trips/day for Trips, tons/day for Emissions, 1000 gallons/day for Fuel Consumption.

Region	CalYr	VehClass	MdYr	Speed	Fuel	Population	VMT	Trips	Fuel_Consumption	
San Bernardino	2025	All Other Buses	Aggregate	Aggregate	Diesel	229.2663691	12009.68797	2040.4707	1.25553978	
San Bernardino	2025	LDA	Aggregate	Aggregate	Diesel	1948.632535	66018.2217	8282.7365	1.55166875	
San Bernardino	2025	LDT1	Aggregate	Aggregate	Diesel	23.9948137	327.746725	67.113633	0.01375278	
San Bernardino	2025	LDT2	Aggregate	Aggregate	Diesel	1014.177039	44885.5334	4886.2048	1.34399814	
San Bernardino	2025	LHD1	Aggregate	Aggregate	Diesel	22260.03392	835207.0437	280003.22	40.5951999	
San Bernardino	2025	LHD2	Aggregate	Aggregate	Diesel	9589.889589	365990.3703	120628.75	21.2926898	
San Bernardino	2025	MDV	Aggregate	Aggregate	Diesel	3599.10134	143983.9356	16571.675	6.03242322	
San Bernardino	2025	MH	Aggregate	Aggregate	Diesel	2582.96196	22618.02796	258.2962	2.18761345	
San Bernardino	2025	Motor Coach	Aggregate	Aggregate	Diesel	61.58652159	8233.656181	1415.2583	1.4638549	
San Bernardino	2025	PTO	Aggregate	Aggregate	Diesel		0	47346.73289	0	9.4207087
San Bernardino	2025	SBUS	Aggregate	Aggregate	Diesel	993.6115615	22107.22281	14387.495	2.9387344	
San Bernardino	2025	T6 CAIRP Class 4	Aggregate	Aggregate	Diesel	25.74244438	1725.447195	591.56137	0.18953633	
San Bernardino	2025	T6 CAIRP Class 5	Aggregate	Aggregate	Diesel	34.057475	2370.93749	782.64078	0.26058578	
San Bernardino	2025	T6 CAIRP Class 6	Aggregate	Aggregate	Diesel	115.5681422	6153.527192	2655.7559	0.66601268	
San Bernardino	2025	T6 CAIRP Class 7	Aggregate	Aggregate	Diesel	190.6542161	39002.35893	4381.2339	3.92277661	
San Bernardino	2025	T6 Instate Delivery	Aggregate	Aggregate	Diesel	707.0166141	23941.01677	10089.127	2.69146176	
San Bernardino	2025	T6 Instate Delivery	Aggregate	Aggregate	Diesel	816.7867353	27972.65803	11655.547	3.1881776	
San Bernardino	2025	T6 Instate Delivery	Aggregate	Aggregate	Diesel	3325.261264	113323.7374	47451.478	12.7616546	
San Bernardino	2025	T6 Instate Delivery	Aggregate	Aggregate	Diesel	606.0934599	33126.7465	8648.9537	3.6239185	
San Bernardino	2025	T6 Instate Other Cl	Aggregate	Aggregate	Diesel	1498.012687	62555.99708	17317.027	7.06756122	
San Bernardino	2025	T6 Instate Other Cl	Aggregate	Aggregate	Diesel	3535.008245	153544.2521	40864.695	17.4106334	
San Bernardino	2025	T6 Instate Other Cl	Aggregate	Aggregate	Diesel	3080.91431	131734.1102	35615.369	14.8211157	
San Bernardino	2025	T6 Instate Other Cl	Aggregate	Aggregate	Diesel	1802.07051	85487.3607	20831.935	9.39828143	
San Bernardino	2025	T6 Instate Tractor C	Aggregate	Aggregate	Diesel	30.54824032	1558.619193	353.13766	0.17282843	
San Bernardino	2025	T6 Instate Tractor C	Aggregate	Aggregate	Diesel	972.6087021	58049.71699	11243.357	6.06888256	
San Bernardino	2025	T6 OOS Class 4	Aggregate	Aggregate	Diesel	14.94198121	994.4297168	343.36673	0.10791364	
San Bernardino	2025	T6 OOS Class 5	Aggregate	Aggregate	Diesel	19.67045504	1364.178749	452.02706	0.14831488	
San Bernardino	2025	T6 OOS Class 6	Aggregate	Aggregate	Diesel	67.24701381	3564.638101	1545.3364	0.37975745	
San Bernardino	2025	T6 OOS Class 7	Aggregate	Aggregate	Diesel	101.6902872	25919.35159	2336.8428	2.58377029	
San Bernardino	2025	T6 Public Class 4	Aggregate	Aggregate	Diesel	128.9173743	4399.872528	661.34613	0.51111658	
San Bernardino	2025	T6 Public Class 5	Aggregate	Aggregate	Diesel	220.2082047	8091.095734	1129.6681	0.9437338	
San Bernardino	2025	T6 Public Class 6	Aggregate	Aggregate	Diesel	178.7216757	6305.097815	916.8422	0.7315082	
San Bernardino	2025	T6 Public Class 7	Aggregate	Aggregate	Diesel	378.3348979	17331.51656	1940.858	1.96835606	
San Bernardino	2025	T6 Utility Class 5	Aggregate	Aggregate	Diesel	199.1426152	8065.517768	2549.0255	0.86907812	
San Bernardino	2025	T6 Utility Class 6	Aggregate	Aggregate	Diesel	37.6515772	1518.845525	481.94019	0.16300845	
San Bernardino	2025	T6 Utility Class 7	Aggregate	Aggregate	Diesel	42.51279132	2106.033036	544.16373	0.22487686	

San Bernardino	2025 T7 CAIRP Class 8	Aggregate	Aggregate	Diesel	6291.890692	1297926.413	144587.65	207.621524
San Bernardino	2025 T7 NNOOS Class 8	Aggregate	Aggregate	Diesel	5671.722041	1555338.065	130336.17	241.968368
San Bernardino	2025 T7 NOOS Class 8	Aggregate	Aggregate	Diesel	2397.626352	564943.1449	55097.454	89.9468394
San Bernardino	2025 T7 POLA Class 8	Aggregate	Aggregate	Diesel	2675.463778	337668.5003	43770.587	56.640109
San Bernardino	2025 T7 Public Class 8	Aggregate	Aggregate	Diesel	818.9945036	33635.41037	4201.4418	5.74967285
San Bernardino	2025 T7 Single Concrete/	Aggregate	Aggregate	Diesel	443.7187082	30488.04486	4179.8302	5.01947789
San Bernardino	2025 T7 Single Dump Cla	Aggregate	Aggregate	Diesel	864.0082301	49118.8343	8138.9575	8.27555771
San Bernardino	2025 T7 Single Other Cla	Aggregate	Aggregate	Diesel	2633.848671	143251.9063	24810.854	23.7142078
San Bernardino	2025 T7 SWCV Class 8	Aggregate	Aggregate	Diesel	454.4429298	29500.61207	2090.4375	10.7415271
San Bernardino	2025 T7 Tractor Class 8	Aggregate	Aggregate	Diesel	5586.973126	421956.3074	81178.72	68.0995666
San Bernardino	2025 T7 Utility Class 8	Aggregate	Aggregate	Diesel	145.5915619	6464.216242	1863.572	1.04559552
San Bernardino	2025 UBUS	Aggregate	Aggregate	Diesel	7.060472311	697.8011686	28.241889	0.07489277
San Bernardino	2025 LDA	Aggregate	Aggregate	Gasoline	764579.6112	32810289.96	3545081.6	1088.4083
San Bernardino	2025 LDT1	Aggregate	Aggregate	Gasoline	70144.44426	2409958.695	302020.18	97.0981129
San Bernardino	2025 LDT2	Aggregate	Aggregate	Gasoline	337644.2202	13929503.44	1577536.2	564.18984
San Bernardino	2025 LHD1	Aggregate	Aggregate	Gasoline	29713.01675	1108490.991	442679.68	80.8854393
San Bernardino	2025 LHD2	Aggregate	Aggregate	Gasoline	4518.553278	161855.7997	67319.711	13.3415026
San Bernardino	2025 MCY	Aggregate	Aggregate	Gasoline	38855.32162	226907.5585	77710.643	5.44912767
San Bernardino	2025 MDV	Aggregate	Aggregate	Gasoline	251167.1745	9921872.959	1145571.7	498.692277
San Bernardino	2025 MH	Aggregate	Aggregate	Gasoline	6121.22242	53536.5282	612.36709	11.0826071
San Bernardino	2025 OBUS	Aggregate	Aggregate	Gasoline	619.7772438	30637.70864	12400.503	5.98324118
San Bernardino	2025 SBUS	Aggregate	Aggregate	Gasoline	398.9536056	20420.71668	1595.8144	2.25047579
San Bernardino	2025 T6TS	Aggregate	Aggregate	Gasoline	2309.446886	140687.5982	46207.413	26.8652499
San Bernardino	2025 T7IS	Aggregate	Aggregate	Gasoline	6.102009755	351.9069674	122.08901	0.0888095
San Bernardino	2025 UBUS	Aggregate	Aggregate	Gasoline	110.1157443	10540.07679	440.46298	1.7997065

	VMT Sum	Fuel Sum	Fuel Sum/Year
Diesel	6859924.498	897.8683833	327,721,960
Gas	60825053.94	2396.134689	874,589,162
			1,202,311,122



Appendix 4.8

CalEEMod Greenhouse Gas Output Sheets

4200 N. University Parkway Project - San Bernardino-South Coast County, Annual

EMFAC Off-Model Adjustment Factors for Gasoline Light Duty Vehicle to Account for the SAFE Vehicle Rule Not Applied

**4200 N. University Parkway Project
San Bernardino-South Coast County, Annual**

1.0 Project Characteristics

1.1 Land Usage

Land Uses	Size	Metric	Lot Acreage	Floor Surface Area	Population
Parking Lot	215.00	Space	1.93	86,000.00	0
Fast Food Restaurant with Drive Thru	14.46	1000sqft	0.33	14,458.00	0

1.2 Other Project Characteristics

Urbanization	Urban	Wind Speed (m/s)	2.2	Precipitation Freq (Days)	32
Climate Zone	10			Operational Year	2025
Utility Company	Southern California Edison				
CO2 Intensity (lb/MW hr)	531.98	CH4 Intensity (lb/MW hr)	0.033	N2O Intensity (lb/MW hr)	0.004

1.3 User Entered Comments & Non-Default Data

Project Characteristics - Based on 2019 Reported Factors

Land Use - Retail land use includes fast food restaurant with drive-through, coffee/donut shop with drive-through and automated car wash (with tunne)

Construction Phase - Based on preliminary construction schedule of April 2023 through February 2024

Grading - Conservative assumption of 7,600 cubic yards of import, based on current topography and pavement section.

Vehicle Trips - Based on total gross proposed project trip generation forecast of 5,196. Total net trips results in 3,896 (-1,300 pass-by trips).

Construction Off-road Equipment Mitigation - Fugitive Dust (Rule 403) Minimum requirements

Area Mitigation -

Water Mitigation -

Trips and VMT -

Table Name	Column Name	Default Value	New Value
tblAreaMitigation	UseLowVOCPaintParkingCheck	False	True

4200 N. University Parkway Project - San Bernardino-South Coast County, Annual

EMFAC Off-Model Adjustment Factors for Gasoline Light Duty Vehicle to Account for the SAFE Vehicle Rule Not Applied

tblConstDustMitigation	WaterUnpavedRoadVehicleSpeed	0	15
tblGrading	MaterialImported	0.00	7,600.00
tblLandUse	LandUseSquareFeet	14,460.00	14,458.00
tblProjectCharacteristics	CO2IntensityFactor	390.98	531.98
tblVehicleTrips	ST_TR	616.12	470.17
tblVehicleTrips	SU_TR	472.58	360.63
tblVehicleTrips	WD_TR	470.95	359.39

2.0 Emissions Summary

2.1 Overall Construction

Unmitigated Construction

	ROG	NOx	CO	SO2	Fugitive PM10	Exhaust PM10	PM10 Total	Fugitive PM2.5	Exhaust PM2.5	PM2.5 Total	Bio- CO2	NBio- CO2	Total CO2	CH4	N2O	CO2e
Year	tons/yr										MT/yr					
2023	0.1827	1.4523	1.5378	3.3300e-003	0.0832	0.0610	0.1442	0.0270	0.0584	0.0853	0.0000	288.2789	288.2789	0.0416	9.0100e-003	292.0027
2024	0.1141	0.2564	0.3129	6.0000e-004	9.9600e-003	0.0107	0.0207	2.6800e-003	0.0102	0.0129	0.0000	51.7828	51.7828	8.7900e-003	7.9000e-004	52.2395
Maximum	0.1827	1.4523	1.5378	3.3300e-003	0.0832	0.0610	0.1442	0.0270	0.0584	0.0853	0.0000	288.2789	288.2789	0.0416	9.0100e-003	292.0027

Mitigated Construction

	ROG	NOx	CO	SO2	Fugitive PM10	Exhaust PM10	PM10 Total	Fugitive PM2.5	Exhaust PM2.5	PM2.5 Total	Bio- CO2	NBio- CO2	Total CO2	CH4	N2O	CO2e
--	-----	-----	----	-----	---------------	--------------	------------	----------------	---------------	-------------	----------	-----------	-----------	-----	-----	------

4200 N. University Parkway Project - San Bernardino-South Coast County, Annual

EMFAC Off-Model Adjustment Factors for Gasoline Light Duty Vehicle to Account for the SAFE Vehicle Rule Not Applied

Year	tons/yr										MT/yr					
2023	0.1827	1.4523	1.5378	3.3300e-003	0.0700	0.0610	0.1310	0.0207	0.0584	0.0790	0.0000	288.2786	288.2786	0.0416	9.0100e-003	292.0024
2024	0.1141	0.2564	0.3129	6.0000e-004	9.9600e-003	0.0107	0.0207	2.6800e-003	0.0102	0.0129	0.0000	51.7828	51.7828	8.7900e-003	7.9000e-004	52.2394
Maximum	0.1827	1.4523	1.5378	3.3300e-003	0.0700	0.0610	0.1310	0.0207	0.0584	0.0790	0.0000	288.2786	288.2786	0.0416	9.0100e-003	292.0024

	ROG	NOx	CO	SO2	Fugitive PM10	Exhaust PM10	PM10 Total	Fugitive PM2.5	Exhaust PM2.5	PM2.5 Total	Bio- CO2	NBio-CO2	Total CO2	CH4	N2O	CO2e
Percent Reduction	0.00	0.00	0.00	0.00	14.18	0.00	8.02	21.24	0.00	6.42	0.00	0.00	0.00	0.00	0.00	0.00

Quarter	Start Date	End Date	Maximum Unmitigated ROG + NOX (tons/quarter)	Maximum Mitigated ROG + NOX (tons/quarter)
1	4-3-2023	7-2-2023	0.5758	0.5758
2	7-3-2023	10-2-2023	0.5317	0.5317
3	10-3-2023	1-2-2024	0.5319	0.5319
4	1-3-2024	4-2-2024	0.3576	0.3576
		Highest	0.5758	0.5758

2.2 Overall Operational

Unmitigated Operational

	ROG	NOx	CO	SO2	Fugitive PM10	Exhaust PM10	PM10 Total	Fugitive PM2.5	Exhaust PM2.5	PM2.5 Total	Bio- CO2	NBio- CO2	Total CO2	CH4	N2O	CO2e
Category	tons/yr										MT/yr					
Area	0.0660	3.0000e-005	2.9200e-003	0.0000		1.0000e-005	1.0000e-005		1.0000e-005	1.0000e-005	0.0000	5.6900e-003	5.6900e-003	1.0000e-005	0.0000	6.0600e-003
Energy	0.0213	0.1932	0.1623	1.1600e-003		0.0147	0.0147		0.0147	0.0147	0.0000	378.6701	378.6701	0.0145	5.1200e-003	380.5584
Mobile	1.7645	1.9020	12.3133	0.0210	2.1538	0.0184	2.1723	0.5753	0.0172	0.5925	0.0000	1,948.7108	1,948.7108	0.1757	0.1308	1,992.0826

4200 N. University Parkway Project - San Bernardino-South Coast County, Annual

EMFAC Off-Model Adjustment Factors for Gasoline Light Duty Vehicle to Account for the SAFE Vehicle Rule Not Applied

Waste						0.0000	0.0000		0.0000	0.0000	33.8102	0.0000	33.8102	1.9981	0.0000	83.7633
Water						0.0000	0.0000		0.0000	0.0000	1.3925	14.5416	15.9340	0.1439	3.4900e-003	20.5710
Total	1.8517	2.0952	12.4785	0.0222	2.1538	0.0331	2.1870	0.5753	0.0319	0.6072	35.2026	2,341.9282	2,377.1308	2.3322	0.1394	2,476.9812

Mitigated Operational

	ROG	NOx	CO	SO2	Fugitive PM10	Exhaust PM10	PM10 Total	Fugitive PM2.5	Exhaust PM2.5	PM2.5 Total	Bio- CO2	NBio- CO2	Total CO2	CH4	N2O	CO2e
Category	tons/yr										MT/yr					
Area	0.0660	3.0000e-005	2.9200e-003	0.0000		1.0000e-005	1.0000e-005		1.0000e-005	1.0000e-005	0.0000	5.6900e-003	5.6900e-003	1.0000e-005	0.0000	6.0600e-003
Energy	0.0213	0.1932	0.1623	1.1600e-003		0.0147	0.0147		0.0147	0.0147	0.0000	378.6701	378.6701	0.0145	5.1200e-003	380.5584
Mobile	1.7645	1.9020	12.3133	0.0210	2.1538	0.0184	2.1723	0.5753	0.0172	0.5925	0.0000	1,948.7108	1,948.7108	0.1757	0.1308	1,992.0826
Waste						0.0000	0.0000		0.0000	0.0000	33.8102	0.0000	33.8102	1.9981	0.0000	83.7633
Water						0.0000	0.0000		0.0000	0.0000	1.1140	11.7377	12.8516	0.1151	2.7900e-003	16.5616
Total	1.8517	2.0952	12.4785	0.0222	2.1538	0.0331	2.1870	0.5753	0.0319	0.6072	34.9241	2,339.1243	2,374.0484	2.3034	0.1387	2,472.9718

	ROG	NOx	CO	SO2	Fugitive PM10	Exhaust PM10	PM10 Total	Fugitive PM2.5	Exhaust PM2.5	PM2.5 Total	Bio- CO2	NBio- CO2	Total CO2	CH4	N2O	CO2e
Percent Reduction	0.00	0.00	0.00	0.00	0.00	0.00	0.00	0.00	0.00	0.00	0.79	0.12	0.13	1.23	0.50	0.16

3.0 Construction Detail

Construction Phase

4200 N. University Parkway Project - San Bernardino-South Coast County, Annual

EMFAC Off-Model Adjustment Factors for Gasoline Light Duty Vehicle to Account for the SAFE Vehicle Rule Not Applied

Phase Number	Phase Name	Phase Type	Start Date	End Date	Num Days Week	Num Days	Phase Description
1	Grading	Grading	4/3/2023	4/10/2023	5	6	
2	Building Construction	Building Construction	4/11/2023	2/12/2024	5	220	
3	Paving	Paving	1/30/2024	2/12/2024	5	10	
4	Architectural Coating	Architectural Coating	1/30/2024	2/12/2024	5	10	

Acres of Grading (Site Preparation Phase): 0

Acres of Grading (Grading Phase): 6

Acres of Paving: 1.93

Residential Indoor: 0; Residential Outdoor: 0; Non-Residential Indoor: 21,687; Non-Residential Outdoor: 7,229; Striped Parking Area: 5,160 (Architectural

OffRoad Equipment

Phase Name	Offroad Equipment Type	Amount	Usage Hours	Horse Power	Load Factor
Grading	Graders	1	8.00	187	0.41
Grading	Rubber Tired Dozers	1	8.00	247	0.40
Grading	Tractors/Loaders/Backhoes	2	7.00	97	0.37
Building Construction	Cranes	1	8.00	231	0.29
Building Construction	Forklifts	2	7.00	89	0.20
Building Construction	Generator Sets	1	8.00	84	0.74
Building Construction	Tractors/Loaders/Backhoes	1	6.00	97	0.37
Building Construction	Welders	3	8.00	46	0.45
Paving	Cement and Mortar Mixers	1	8.00	9	0.56
Paving	Pavers	1	8.00	130	0.42
Paving	Paving Equipment	1	8.00	132	0.36
Paving	Rollers	2	8.00	80	0.38
Paving	Tractors/Loaders/Backhoes	1	8.00	97	0.37
Architectural Coating	Air Compressors	1	6.00	78	0.48

Trips and VMT

4200 N. University Parkway Project - San Bernardino-South Coast County, Annual

EMFAC Off-Model Adjustment Factors for Gasoline Light Duty Vehicle to Account for the SAFE Vehicle Rule Not Applied

Phase Name	Offroad Equipment Count	Worker Trip Number	Vendor Trip Number	Hauling Trip Number	Worker Trip Length	Vendor Trip Length	Hauling Trip Length	Worker Vehicle Class	Vendor Vehicle Class	Hauling Vehicle Class
Grading	4	10.00	0.00	950.00	14.70	6.90	20.00	LD_Mix	HDT_Mix	HHDT
Building Construction	8	42.00	16.00	0.00	14.70	6.90	20.00	LD_Mix	HDT_Mix	HHDT
Paving	6	15.00	0.00	0.00	14.70	6.90	20.00	LD_Mix	HDT_Mix	HHDT
Architectural Coating	1	8.00	0.00	0.00	14.70	6.90	20.00	LD_Mix	HDT_Mix	HHDT

3.1 Mitigation Measures Construction

Water Exposed Area

Reduce Vehicle Speed on Unpaved Roads

3.2 Grading - 2023

Unmitigated Construction On-Site

	ROG	NOx	CO	SO2	Fugitive PM10	Exhaust PM10	PM10 Total	Fugitive PM2.5	Exhaust PM2.5	PM2.5 Total	Bio- CO2	NBio- CO2	Total CO2	CH4	N2O	CO2e
Category	tons/yr										MT/yr					
Fugitive Dust					0.0217	0.0000	0.0217	0.0103	0.0000	0.0103	0.0000	0.0000	0.0000	0.0000	0.0000	0.0000
Off-Road	4.0000e-003	0.0434	0.0261	6.0000e-005		1.8100e-003	1.8100e-003		1.6700e-003	1.6700e-003	0.0000	5.4312	5.4312	1.7600e-003	0.0000	5.4751
Total	4.0000e-003	0.0434	0.0261	6.0000e-005	0.0217	1.8100e-003	0.0235	0.0103	1.6700e-003	0.0120	0.0000	5.4312	5.4312	1.7600e-003	0.0000	5.4751

Unmitigated Construction Off-Site

4200 N. University Parkway Project - San Bernardino-South Coast County, Annual

EMFAC Off-Model Adjustment Factors for Gasoline Light Duty Vehicle to Account for the SAFE Vehicle Rule Not Applied

	ROG	NOx	CO	SO2	Fugitive PM10	Exhaust PM10	PM10 Total	Fugitive PM2.5	Exhaust PM2.5	PM2.5 Total	Bio- CO2	NBio- CO2	Total CO2	CH4	N2O	CO2e
Category	tons/yr										MT/yr					
Hauling	1.1100e-003	0.0553	0.0160	2.7000e-004	8.1800e-003	5.5000e-004	8.7300e-003	2.2500e-003	5.3000e-004	2.7700e-003	0.0000	26.3960	26.3960	1.1200e-003	4.1800e-003	27.6709
Vendor	0.0000	0.0000	0.0000	0.0000	0.0000	0.0000	0.0000	0.0000	0.0000	0.0000	0.0000	0.0000	0.0000	0.0000	0.0000	0.0000
Worker	1.0000e-004	8.0000e-005	9.7000e-004	0.0000	3.3000e-004	0.0000	3.3000e-004	9.0000e-005	0.0000	9.0000e-005	0.0000	0.2537	0.2537	1.0000e-005	1.0000e-005	0.2560
Total	1.2100e-003	0.0553	0.0170	2.7000e-004	8.5100e-003	5.5000e-004	9.0600e-003	2.3400e-003	5.3000e-004	2.8600e-003	0.0000	26.6497	26.6497	1.1300e-003	4.1900e-003	27.9269

Mitigated Construction On-Site

	ROG	NOx	CO	SO2	Fugitive PM10	Exhaust PM10	PM10 Total	Fugitive PM2.5	Exhaust PM2.5	PM2.5 Total	Bio- CO2	NBio- CO2	Total CO2	CH4	N2O	CO2e
Category	tons/yr										MT/yr					
Fugitive Dust					8.4500e-003	0.0000	8.4500e-003	4.0300e-003	0.0000	4.0300e-003	0.0000	0.0000	0.0000	0.0000	0.0000	0.0000
Off-Road	4.0000e-003	0.0434	0.0261	6.0000e-005		1.8100e-003	1.8100e-003		1.6700e-003	1.6700e-003	0.0000	5.4312	5.4312	1.7600e-003	0.0000	5.4751
Total	4.0000e-003	0.0434	0.0261	6.0000e-005	8.4500e-003	1.8100e-003	0.0103	4.0300e-003	1.6700e-003	5.7000e-003	0.0000	5.4312	5.4312	1.7600e-003	0.0000	5.4751

Mitigated Construction Off-Site

	ROG	NOx	CO	SO2	Fugitive PM10	Exhaust PM10	PM10 Total	Fugitive PM2.5	Exhaust PM2.5	PM2.5 Total	Bio- CO2	NBio- CO2	Total CO2	CH4	N2O	CO2e
--	-----	-----	----	-----	---------------	--------------	------------	----------------	---------------	-------------	----------	-----------	-----------	-----	-----	------

4200 N. University Parkway Project - San Bernardino-South Coast County, Annual

EMFAC Off-Model Adjustment Factors for Gasoline Light Duty Vehicle to Account for the SAFE Vehicle Rule Not Applied

Vendor	1.7000e-003	0.0558	0.0226	2.7000e-004	9.5400e-003	4.0000e-004	9.9400e-003	2.7500e-003	3.8000e-004	3.1300e-003	0.0000	26.3516	26.3516	6.9000e-004	3.8900e-003	27.5292
Worker	0.0138	0.0103	0.1288	3.7000e-004	0.0435	2.2000e-004	0.0437	0.0116	2.0000e-004	0.0118	0.0000	33.5679	33.5679	8.9000e-004	9.2000e-004	33.8651
Total	0.0155	0.0661	0.1514	6.4000e-004	0.0531	6.2000e-004	0.0537	0.0143	5.8000e-004	0.0149	0.0000	59.9195	59.9195	1.5800e-003	4.8100e-003	61.3943

Mitigated Construction On-Site

	ROG	NOx	CO	SO2	Fugitive PM10	Exhaust PM10	PM10 Total	Fugitive PM2.5	Exhaust PM2.5	PM2.5 Total	Bio- CO2	NBio- CO2	Total CO2	CH4	N2O	CO2e
Category	tons/yr										MT/yr					
Off-Road	0.1619	1.2875	1.3433	2.3600e-003		0.0580	0.0580		0.0556	0.0556	0.0000	196.2782	196.2782	0.0371	0.0000	197.2062
Total	0.1619	1.2875	1.3433	2.3600e-003		0.0580	0.0580		0.0556	0.0556	0.0000	196.2782	196.2782	0.0371	0.0000	197.2062

Mitigated Construction Off-Site

	ROG	NOx	CO	SO2	Fugitive PM10	Exhaust PM10	PM10 Total	Fugitive PM2.5	Exhaust PM2.5	PM2.5 Total	Bio- CO2	NBio- CO2	Total CO2	CH4	N2O	CO2e
Category	tons/yr										MT/yr					
Hauling	0.0000	0.0000	0.0000	0.0000	0.0000	0.0000	0.0000	0.0000	0.0000	0.0000	0.0000	0.0000	0.0000	0.0000	0.0000	0.0000
Vendor	1.7000e-003	0.0558	0.0226	2.7000e-004	9.5400e-003	4.0000e-004	9.9400e-003	2.7500e-003	3.8000e-004	3.1300e-003	0.0000	26.3516	26.3516	6.9000e-004	3.8900e-003	27.5292
Worker	0.0138	0.0103	0.1288	3.7000e-004	0.0435	2.2000e-004	0.0437	0.0116	2.0000e-004	0.0118	0.0000	33.5679	33.5679	8.9000e-004	9.2000e-004	33.8651

4200 N. University Parkway Project - San Bernardino-South Coast County, Annual

EMFAC Off-Model Adjustment Factors for Gasoline Light Duty Vehicle to Account for the SAFE Vehicle Rule Not Applied

Total	0.0155	0.0661	0.1514	6.4000e-004	0.0531	6.2000e-004	0.0537	0.0143	5.8000e-004	0.0149	0.0000	59.9195	59.9195	1.5800e-003	4.8100e-003	61.3943
--------------	---------------	---------------	---------------	--------------------	---------------	--------------------	---------------	---------------	--------------------	---------------	---------------	----------------	----------------	--------------------	--------------------	----------------

3.3 Building Construction - 2024

Unmitigated Construction On-Site

	ROG	NOx	CO	SO2	Fugitive PM10	Exhaust PM10	PM10 Total	Fugitive PM2.5	Exhaust PM2.5	PM2.5 Total	Bio- CO2	NBio- CO2	Total CO2	CH4	N2O	CO2e
Category	tons/yr										MT/yr					
Off-Road	0.0248	0.1988	0.2186	3.9000e-004		8.3400e-003	8.3400e-003		7.9900e-003	7.9900e-003	0.0000	32.1957	32.1957	6.0000e-003	0.0000	32.3456
Total	0.0248	0.1988	0.2186	3.9000e-004		8.3400e-003	8.3400e-003		7.9900e-003	7.9900e-003	0.0000	32.1957	32.1957	6.0000e-003	0.0000	32.3456

Unmitigated Construction Off-Site

	ROG	NOx	CO	SO2	Fugitive PM10	Exhaust PM10	PM10 Total	Fugitive PM2.5	Exhaust PM2.5	PM2.5 Total	Bio- CO2	NBio- CO2	Total CO2	CH4	N2O	CO2e
Category	tons/yr										MT/yr					
Hauling	0.0000	0.0000	0.0000	0.0000	0.0000	0.0000	0.0000	0.0000	0.0000	0.0000	0.0000	0.0000	0.0000	0.0000	0.0000	0.0000
Vendor	2.7000e-004	9.2300e-003	3.6400e-003	4.0000e-005	1.5600e-003	6.0000e-005	1.6300e-003	4.5000e-004	6.0000e-005	5.1000e-004	0.0000	4.2627	4.2627	1.1000e-004	6.3000e-004	4.4531
Worker	2.1100e-003	1.5000e-003	0.0197	6.0000e-005	7.1400e-003	3.0000e-005	7.1700e-003	1.9000e-003	3.0000e-005	1.9300e-003	0.0000	5.3461	5.3461	1.3000e-004	1.4000e-004	5.3912
Total	2.3800e-003	0.0107	0.0233	1.0000e-004	8.7000e-003	9.0000e-005	8.8000e-003	2.3500e-003	9.0000e-005	2.4400e-003	0.0000	9.6088	9.6088	2.4000e-004	7.7000e-004	9.8443

4200 N. University Parkway Project - San Bernardino-South Coast County, Annual

EMFAC Off-Model Adjustment Factors for Gasoline Light Duty Vehicle to Account for the SAFE Vehicle Rule Not Applied

Mitigated Construction On-Site

	ROG	NOx	CO	SO2	Fugitive PM10	Exhaust PM10	PM10 Total	Fugitive PM2.5	Exhaust PM2.5	PM2.5 Total	Bio- CO2	NBio- CO2	Total CO2	CH4	N2O	CO2e
Category	tons/yr										MT/yr					
Off-Road	0.0248	0.1988	0.2186	3.9000e-004		8.3400e-003	8.3400e-003		7.9900e-003	7.9900e-003	0.0000	32.1956	32.1956	6.0000e-003	0.0000	32.3455
Total	0.0248	0.1988	0.2186	3.9000e-004		8.3400e-003	8.3400e-003		7.9900e-003	7.9900e-003	0.0000	32.1956	32.1956	6.0000e-003	0.0000	32.3455

Mitigated Construction Off-Site

	ROG	NOx	CO	SO2	Fugitive PM10	Exhaust PM10	PM10 Total	Fugitive PM2.5	Exhaust PM2.5	PM2.5 Total	Bio- CO2	NBio- CO2	Total CO2	CH4	N2O	CO2e
Category	tons/yr										MT/yr					
Hauling	0.0000	0.0000	0.0000	0.0000	0.0000	0.0000	0.0000	0.0000	0.0000	0.0000	0.0000	0.0000	0.0000	0.0000	0.0000	0.0000
Vendor	2.7000e-004	9.2300e-003	3.6400e-003	4.0000e-005	1.5600e-003	6.0000e-005	1.6300e-003	4.5000e-004	6.0000e-005	5.1000e-004	0.0000	4.2627	4.2627	1.1000e-004	6.3000e-004	4.4531
Worker	2.1100e-003	1.5000e-003	0.0197	6.0000e-005	7.1400e-003	3.0000e-005	7.1700e-003	1.9000e-003	3.0000e-005	1.9300e-003	0.0000	5.3461	5.3461	1.3000e-004	1.4000e-004	5.3912
Total	2.3800e-003	0.0107	0.0233	1.0000e-004	8.7000e-003	9.0000e-005	8.8000e-003	2.3500e-003	9.0000e-005	2.4400e-003	0.0000	9.6088	9.6088	2.4000e-004	7.7000e-004	9.8443

3.4 Paving - 2024

Unmitigated Construction On-Site

4200 N. University Parkway Project - San Bernardino-South Coast County, Annual

EMFAC Off-Model Adjustment Factors for Gasoline Light Duty Vehicle to Account for the SAFE Vehicle Rule Not Applied

	ROG	NOx	CO	SO2	Fugitive PM10	Exhaust PM10	PM10 Total	Fugitive PM2.5	Exhaust PM2.5	PM2.5 Total	Bio- CO2	NBio- CO2	Total CO2	CH4	N2O	CO2e
Category	tons/yr										MT/yr					
Off-Road	4.2100e-003	0.0405	0.0585	9.0000e-005		1.9800e-003	1.9800e-003		1.8300e-003	1.8300e-003	0.0000	7.7574	7.7574	2.4600e-003	0.0000	7.8188
Paving	2.5300e-003					0.0000	0.0000		0.0000	0.0000	0.0000	0.0000	0.0000	0.0000	0.0000	0.0000
Total	6.7400e-003	0.0405	0.0585	9.0000e-005		1.9800e-003	1.9800e-003		1.8300e-003	1.8300e-003	0.0000	7.7574	7.7574	2.4600e-003	0.0000	7.8188

Unmitigated Construction Off-Site

	ROG	NOx	CO	SO2	Fugitive PM10	Exhaust PM10	PM10 Total	Fugitive PM2.5	Exhaust PM2.5	PM2.5 Total	Bio- CO2	NBio- CO2	Total CO2	CH4	N2O	CO2e
Category	tons/yr										MT/yr					
Hauling	0.0000	0.0000	0.0000	0.0000	0.0000	0.0000	0.0000	0.0000	0.0000	0.0000	0.0000	0.0000	0.0000	0.0000	0.0000	0.0000
Vendor	0.0000	0.0000	0.0000	0.0000	0.0000	0.0000	0.0000	0.0000	0.0000	0.0000	0.0000	0.0000	0.0000	0.0000	0.0000	0.0000
Worker	2.4000e-004	1.7000e-004	2.2600e-003	1.0000e-005	8.2000e-004	0.0000	8.3000e-004	2.2000e-004	0.0000	2.2000e-004	0.0000	0.6159	0.6159	2.0000e-005	2.0000e-005	0.6211
Total	2.4000e-004	1.7000e-004	2.2600e-003	1.0000e-005	8.2000e-004	0.0000	8.3000e-004	2.2000e-004	0.0000	2.2000e-004	0.0000	0.6159	0.6159	2.0000e-005	2.0000e-005	0.6211

Mitigated Construction On-Site

4200 N. University Parkway Project - San Bernardino-South Coast County, Annual

EMFAC Off-Model Adjustment Factors for Gasoline Light Duty Vehicle to Account for the SAFE Vehicle Rule Not Applied

	ROG	NOx	CO	SO2	Fugitive PM10	Exhaust PM10	PM10 Total	Fugitive PM2.5	Exhaust PM2.5	PM2.5 Total	Bio- CO2	NBio- CO2	Total CO2	CH4	N2O	CO2e
Category	tons/yr										MT/yr					
Off-Road	4.2100e-003	0.0405	0.0585	9.0000e-005		1.9800e-003	1.9800e-003		1.8300e-003	1.8300e-003	0.0000	7.7573	7.7573	2.4600e-003	0.0000	7.8188
Paving	2.5300e-003					0.0000	0.0000		0.0000	0.0000	0.0000	0.0000	0.0000	0.0000	0.0000	0.0000
Total	6.7400e-003	0.0405	0.0585	9.0000e-005		1.9800e-003	1.9800e-003		1.8300e-003	1.8300e-003	0.0000	7.7573	7.7573	2.4600e-003	0.0000	7.8188

Mitigated Construction Off-Site

	ROG	NOx	CO	SO2	Fugitive PM10	Exhaust PM10	PM10 Total	Fugitive PM2.5	Exhaust PM2.5	PM2.5 Total	Bio- CO2	NBio- CO2	Total CO2	CH4	N2O	CO2e
Category	tons/yr										MT/yr					
Hauling	0.0000	0.0000	0.0000	0.0000	0.0000	0.0000	0.0000	0.0000	0.0000	0.0000	0.0000	0.0000	0.0000	0.0000	0.0000	0.0000
Vendor	0.0000	0.0000	0.0000	0.0000	0.0000	0.0000	0.0000	0.0000	0.0000	0.0000	0.0000	0.0000	0.0000	0.0000	0.0000	0.0000
Worker	2.4000e-004	1.7000e-004	2.2600e-003	1.0000e-005	8.2000e-004	0.0000	8.3000e-004	2.2000e-004	0.0000	2.2000e-004	0.0000	0.6159	0.6159	2.0000e-005	2.0000e-005	0.6211
Total	2.4000e-004	1.7000e-004	2.2600e-003	1.0000e-005	8.2000e-004	0.0000	8.3000e-004	2.2000e-004	0.0000	2.2000e-004	0.0000	0.6159	0.6159	2.0000e-005	2.0000e-005	0.6211

3.5 Architectural Coating - 2024

Unmitigated Construction On-Site

4200 N. University Parkway Project - San Bernardino-South Coast County, Annual

EMFAC Off-Model Adjustment Factors for Gasoline Light Duty Vehicle to Account for the SAFE Vehicle Rule Not Applied

	ROG	NOx	CO	SO2	Fugitive PM10	Exhaust PM10	PM10 Total	Fugitive PM2.5	Exhaust PM2.5	PM2.5 Total	Bio- CO2	NBio- CO2	Total CO2	CH4	N2O	CO2e
Category	tons/yr										MT/yr					
Archit. Coating	0.0790					0.0000	0.0000		0.0000	0.0000	0.0000	0.0000	0.0000	0.0000	0.0000	0.0000
Off-Road	9.0000e-004	6.0900e-003	9.0500e-003	1.0000e-005		3.0000e-004	3.0000e-004		3.0000e-004	3.0000e-004	0.0000	1.2766	1.2766	7.0000e-005	0.0000	1.2784
Total	0.0799	6.0900e-003	9.0500e-003	1.0000e-005		3.0000e-004	3.0000e-004		3.0000e-004	3.0000e-004	0.0000	1.2766	1.2766	7.0000e-005	0.0000	1.2784

Unmitigated Construction Off-Site

	ROG	NOx	CO	SO2	Fugitive PM10	Exhaust PM10	PM10 Total	Fugitive PM2.5	Exhaust PM2.5	PM2.5 Total	Bio- CO2	NBio- CO2	Total CO2	CH4	N2O	CO2e
Category	tons/yr										MT/yr					
Hauling	0.0000	0.0000	0.0000	0.0000	0.0000	0.0000	0.0000	0.0000	0.0000	0.0000	0.0000	0.0000	0.0000	0.0000	0.0000	0.0000
Vendor	0.0000	0.0000	0.0000	0.0000	0.0000	0.0000	0.0000	0.0000	0.0000	0.0000	0.0000	0.0000	0.0000	0.0000	0.0000	0.0000
Worker	1.3000e-004	9.0000e-005	1.2100e-003	0.0000	4.4000e-004	0.0000	4.4000e-004	1.2000e-004	0.0000	1.2000e-004	0.0000	0.3285	0.3285	1.0000e-005	1.0000e-005	0.3313
Total	1.3000e-004	9.0000e-005	1.2100e-003	0.0000	4.4000e-004	0.0000	4.4000e-004	1.2000e-004	0.0000	1.2000e-004	0.0000	0.3285	0.3285	1.0000e-005	1.0000e-005	0.3313

Mitigated Construction On-Site

4200 N. University Parkway Project - San Bernardino-South Coast County, Annual

EMFAC Off-Model Adjustment Factors for Gasoline Light Duty Vehicle to Account for the SAFE Vehicle Rule Not Applied

	ROG	NOx	CO	SO2	Fugitive PM10	Exhaust PM10	PM10 Total	Fugitive PM2.5	Exhaust PM2.5	PM2.5 Total	Bio- CO2	NBio- CO2	Total CO2	CH4	N2O	CO2e
Category	tons/yr										MT/yr					
Archit. Coating	0.0790					0.0000	0.0000		0.0000	0.0000	0.0000	0.0000	0.0000	0.0000	0.0000	0.0000
Off-Road	9.0000e-004	6.0900e-003	9.0500e-003	1.0000e-005		3.0000e-004	3.0000e-004		3.0000e-004	3.0000e-004	0.0000	1.2766	1.2766	7.0000e-005	0.0000	1.2784
Total	0.0799	6.0900e-003	9.0500e-003	1.0000e-005		3.0000e-004	3.0000e-004		3.0000e-004	3.0000e-004	0.0000	1.2766	1.2766	7.0000e-005	0.0000	1.2784

Mitigated Construction Off-Site

	ROG	NOx	CO	SO2	Fugitive PM10	Exhaust PM10	PM10 Total	Fugitive PM2.5	Exhaust PM2.5	PM2.5 Total	Bio- CO2	NBio- CO2	Total CO2	CH4	N2O	CO2e
Category	tons/yr										MT/yr					
Hauling	0.0000	0.0000	0.0000	0.0000	0.0000	0.0000	0.0000	0.0000	0.0000	0.0000	0.0000	0.0000	0.0000	0.0000	0.0000	0.0000
Vendor	0.0000	0.0000	0.0000	0.0000	0.0000	0.0000	0.0000	0.0000	0.0000	0.0000	0.0000	0.0000	0.0000	0.0000	0.0000	0.0000
Worker	1.3000e-004	9.0000e-005	1.2100e-003	0.0000	4.4000e-004	0.0000	4.4000e-004	1.2000e-004	0.0000	1.2000e-004	0.0000	0.3285	0.3285	1.0000e-005	1.0000e-005	0.3313
Total	1.3000e-004	9.0000e-005	1.2100e-003	0.0000	4.4000e-004	0.0000	4.4000e-004	1.2000e-004	0.0000	1.2000e-004	0.0000	0.3285	0.3285	1.0000e-005	1.0000e-005	0.3313

4.0 Operational Detail - Mobile

4.1 Mitigation Measures Mobile

4200 N. University Parkway Project - San Bernardino-South Coast County, Annual

EMFAC Off-Model Adjustment Factors for Gasoline Light Duty Vehicle to Account for the SAFE Vehicle Rule Not Applied

	ROG	NOx	CO	SO2	Fugitive PM10	Exhaust PM10	PM10 Total	Fugitive PM2.5	Exhaust PM2.5	PM2.5 Total	Bio- CO2	NBio- CO2	Total CO2	CH4	N2O	CO2e
Category	tons/yr										MT/yr					
Mitigated	1.7645	1.9020	12.3133	0.0210	2.1538	0.0184	2.1723	0.5753	0.0172	0.5925	0.0000	1,948.7108	1,948.7108	0.1757	0.1308	1,992.0826
Unmitigated	1.7645	1.9020	12.3133	0.0210	2.1538	0.0184	2.1723	0.5753	0.0172	0.5925	0.0000	1,948.7108	1,948.7108	0.1757	0.1308	1,992.0826

4.2 Trip Summary Information

Land Use	Average Daily Trip Rate			Unmitigated	Mitigated
	Weekday	Saturday	Sunday	Annual VMT	Annual VMT
Fast Food Restaurant with Drive Thru	5,196.78	6,798.66	5,214.71	5,712,550	5,712,550
Parking Lot	0.00	0.00	0.00		
Total	5,196.78	6,798.66	5,214.71	5,712,550	5,712,550

4.3 Trip Type Information

Land Use	Miles			Trip %			Trip Purpose %		
	H-W or C-W	H-S or C-C	H-O or C-NW	H-W or C-W	H-S or C-C	H-O or C-NW	Primary	Diverted	Pass-by
Fast Food Restaurant with Drive Thru	16.60	8.40	6.90	2.20	78.80	19.00	29	21	50
Parking Lot	16.60	8.40	6.90	0.00	0.00	0.00	0	0	0

4.4 Fleet Mix

Land Use	LDA	LDT1	LDT2	MDV	LHD1	LHD2	MHD	HHD	OBUS	UBUS	MCY	SBUS	MH
Fast Food Restaurant with Drive Thru	0.543085	0.056300	0.173085	0.134258	0.025645	0.007009	0.011926	0.017481	0.000552	0.000248	0.024848	0.000956	0.004606
Parking Lot	0.543085	0.056300	0.173085	0.134258	0.025645	0.007009	0.011926	0.017481	0.000552	0.000248	0.024848	0.000956	0.004606

4200 N. University Parkway Project - San Bernardino-South Coast County, Annual

EMFAC Off-Model Adjustment Factors for Gasoline Light Duty Vehicle to Account for the SAFE Vehicle Rule Not Applied

Total		0.0213	0.1932	0.1623	1.1600e-003		0.0147	0.0147		0.0147	0.0147	0.0000	210.3664	210.3664	4.0300e-003	3.8600e-003	211.6166
-------	--	--------	--------	--------	-------------	--	--------	--------	--	--------	--------	--------	----------	----------	-------------	-------------	----------

Mitigated

	Natural Gas Use	ROG	NOx	CO	SO2	Fugitive PM10	Exhaust PM10	PM10 Total	Fugitive PM2.5	Exhaust PM2.5	PM2.5 Total	Bio- CO2	NBio- CO2	Total CO2	CH4	N2O	CO2e
Land Use	kBTU/yr	tons/yr										MT/yr					
Fast Food Restaurant with Drive-Thru Parking Lot	3.94212e+006	0.0213	0.1932	0.1623	1.1600e-003		0.0147	0.0147		0.0147	0.0147	0.0000	210.3664	210.3664	4.0300e-003	3.8600e-003	211.6166
Drive-Thru Parking Lot	0	0.0000	0.0000	0.0000	0.0000		0.0000	0.0000		0.0000	0.0000	0.0000	0.0000	0.0000	0.0000	0.0000	0.0000
Total		0.0213	0.1932	0.1623	1.1600e-003		0.0147	0.0147		0.0147	0.0147	0.0000	210.3664	210.3664	4.0300e-003	3.8600e-003	211.6166

5.3 Energy by Land Use - Electricity

Unmitigated

	Electricity Use	Total CO2	CH4	N2O	CO2e
Land Use	kWh/yr	MT/yr			
Fast Food Restaurant with Drive-Thru Parking Lot	667381	161.0405	9.9900e-003	1.2100e-003	161.6511
Drive-Thru Parking Lot	30100	7.2632	4.5000e-004	5.0000e-005	7.2907
Total		168.3037	0.0104	1.2600e-003	168.9418

4200 N. University Parkway Project - San Bernardino-South Coast County, Annual

EMFAC Off-Model Adjustment Factors for Gasoline Light Duty Vehicle to Account for the SAFE Vehicle Rule Not Applied

Mitigated

	Electricity Use	Total CO2	CH4	N2O	CO2e
Land Use	kWh/yr	MT/yr			
Fast Food Restaurant with Drive Thru	667381	161.0405	9.9900e-003	1.2100e-003	161.6511
Parking Lot	30100	7.2632	4.5000e-004	5.0000e-005	7.2907
Total		168.3037	0.0104	1.2600e-003	168.9418

6.0 Area Detail

6.1 Mitigation Measures Area

- Use Low VOC Paint - Residential Interior
- Use Low VOC Paint - Residential Exterior
- Use Low VOC Paint - Non-Residential Interior
- Use Low VOC Paint - Non-Residential Exterior
- Use Low VOC Cleaning Supplies

ROG	NOx	CO	SO2	Fugitive PM10	Exhaust PM10	PM10 Total	Fugitive PM2.5	Exhaust PM2.5	PM2.5 Total	Bio- CO2	NBio- CO2	Total CO2	CH4	N2O	CO2e
-----	-----	----	-----	---------------	--------------	------------	----------------	---------------	-------------	----------	-----------	-----------	-----	-----	------

4200 N. University Parkway Project - San Bernardino-South Coast County, Annual

EMFAC Off-Model Adjustment Factors for Gasoline Light Duty Vehicle to Account for the SAFE Vehicle Rule Not Applied

Consumer Products	0.0578					0.0000	0.0000		0.0000	0.0000	0.0000	0.0000	0.0000	0.0000	0.0000	0.0000
Landscaping	2.7000e-004	3.0000e-005	2.9200e-003	0.0000		1.0000e-005	1.0000e-005		1.0000e-005	1.0000e-005	0.0000	5.6900e-003	5.6900e-003	1.0000e-005	0.0000	6.0600e-003
Total	0.0660	3.0000e-005	2.9200e-003	0.0000		1.0000e-005	1.0000e-005		1.0000e-005	1.0000e-005	0.0000	5.6900e-003	5.6900e-003	1.0000e-005	0.0000	6.0600e-003

7.0 Water Detail

7.1 Mitigation Measures Water

- Install Low Flow Bathroom Faucet
- Install Low Flow Kitchen Faucet
- Install Low Flow Toilet
- Install Low Flow Shower
- Use Water Efficient Irrigation System

	Total CO2	CH4	N2O	CO2e
Category	MT/yr			
Mitigated	12.8516	0.1151	2.7900e-003	16.5616
Unmitigated	15.9340	0.1439	3.4900e-003	20.5710

7.2 Water by Land Use

Unmitigated

4200 N. University Parkway Project - San Bernardino-South Coast County, Annual

EMFAC Off-Model Adjustment Factors for Gasoline Light Duty Vehicle to Account for the SAFE Vehicle Rule Not Applied

Indoor/Outdoor Use		Total CO2	CH4	N2O	CO2e
Land Use	Mgal	MT/yr			
Fast Food Restaurant with Drive-Thru	4.3891 / 0.280155	15.9340	0.1439	3.4900e-003	20.5710
Parking Lot	0 / 0	0.0000	0.0000	0.0000	0.0000
Total		15.9340	0.1439	3.4900e-003	20.5710

Mitigated

Indoor/Outdoor Use		Total CO2	CH4	N2O	CO2e
Land Use	Mgal	MT/yr			
Fast Food Restaurant with Drive-Thru	3.51128 / 0.263066	12.8516	0.1151	2.7900e-003	16.5616
Parking Lot	0 / 0	0.0000	0.0000	0.0000	0.0000
Total		12.8516	0.1151	2.7900e-003	16.5616

8.0 Waste Detail

8.1 Mitigation Measures Waste

4200 N. University Parkway Project - San Bernardino-South Coast County, Annual

EMFAC Off-Model Adjustment Factors for Gasoline Light Duty Vehicle to Account for the SAFE Vehicle Rule Not Applied

Category/Year

	Total CO2	CH4	N2O	CO2e
	MT/yr			
Mitigated	33.8102	1.9981	0.0000	83.7633
Unmitigated	33.8102	1.9981	0.0000	83.7633

8.2 Waste by Land Use

Unmitigated

	Waste Disposed	Total CO2	CH4	N2O	CO2e
Land Use	tons	MT/yr			
Fast Food Restaurant with Drive-Thru	166.56	33.8102	1.9981	0.0000	83.7633
Parking Lot	0	0.0000	0.0000	0.0000	0.0000
Total		33.8102	1.9981	0.0000	83.7633

Mitigated

4200 N. University Parkway Project - San Bernardino-South Coast County, Annual

EMFAC Off-Model Adjustment Factors for Gasoline Light Duty Vehicle to Account for the SAFE Vehicle Rule Not Applied

	Waste Disposed	Total CO2	CH4	N2O	CO2e
Land Use	tons	MT/yr			
Fast Food Restaurant with Drive-Thru Parking Lot	166.56	33.8102	1.9981	0.0000	83.7633
	0	0.0000	0.0000	0.0000	0.0000
Total		33.8102	1.9981	0.0000	83.7633

9.0 Operational Offroad

Equipment Type	Number	Hours/Day	Days/Year	Horse Power	Load Factor	Fuel Type
----------------	--------	-----------	-----------	-------------	-------------	-----------

10.0 Stationary Equipment

Fire Pumps and Emergency Generators

Equipment Type	Number	Hours/Day	Hours/Year	Horse Power	Load Factor	Fuel Type
----------------	--------	-----------	------------	-------------	-------------	-----------

Boilers

Equipment Type	Number	Heat Input/Day	Heat Input/Year	Boiler Rating	Fuel Type
----------------	--------	----------------	-----------------	---------------	-----------

User Defined Equipment

Equipment Type	Number
----------------	--------

11.0 Vegetation



Appendix 4.13
Noise Outputs

Monitoring Location: Site 1
Monitoring Date: 7/12/2022

Monitoring Period

Time	LAeq	LASmax	LASmin
11:21:10	63.0	67.1	61.0
11:22:10	63.4	65.9	60.9
11:23:10	65.1	69.4	61.5
11:24:10	63.1	66.8	61.0
11:25:10	72.2	75.1	63.1
11:26:10	71.6	75.1	62.6
11:27:10	62.5	64.7	60.4
11:28:10	66.5	72.3	61.3
11:29:10	64.0	68.5	61.2
11:30:10	63.4	66.1	60.8
11:31:10	64.4	68.3	62.2
11:32:10	63.2	65.6	60.8
11:33:10	63.8	66.2	62.2
11:34:10	62.2	65.4	60.6
11:35:10	64.3	67.2	61.6
11:36:10	62.1	64.7	60.7

15-minute LAeq

66.2

Monitoring Location: Site 2
Monitoring Date: 7/12/2022

Monitoring Period

Time	LAeq	LASmax	LASmin
10:16:15	57.6	60.8	53.3
10:17:15	56.0	59.9	52.9
10:18:15	56.3	61.5	52.7
10:19:15	56.2	59.0	52.2
10:20:15	54.3	57.7	50.8
10:21:15	53.7	57.2	50.3
10:22:15	55.9	59.9	52.3
10:23:15	55.0	59.7	52.0
10:24:15	55.2	56.7	53.4
10:25:15	57.6	61.9	54.0
10:26:15	58.0	62.5	53.7
10:27:15	59.4	63.9	54.6
10:28:15	57.4	60.9	53.7
10:29:15	56.2	60.3	53.4
10:30:15	55.1	60.0	52.5
10:31:15	57.5	60.0	58.4

15-minute LAeq

56.6

Monitoring Location: Site 3
Monitoring Date: 7/12/2022

Monitoring Period

Time	LAeq	LASmax	LASmin
10:59:15	57.1	62.8	49.0
11:00:15	69.3	81.7	49.8
11:01:15	61.7	74.7	48.7
11:02:15	57.8	63.5	49.7
11:03:15	63.4	72.8	51.5
11:04:15	59.7	70.2	50.5
11:05:15	64.9	75.8	50.2
11:06:15	63.1	74.0	52.5
11:07:15	60.2	67.4	50.4
11:08:15	61.7	66.9	55.1
11:09:15	60.4	66.1	53.0
11:10:15	66.1	71.9	53.6
11:11:15	58.6	68.1	50.8
11:12:15	61.4	71.2	51.9
11:13:15	66.4	76.1	52.0
11:14:15	63.5	62.7	61.9

15-minute LAeq

63.5

Monitoring Location: Site 4

Monitoring Date: 7/12/2022

Monitoring Period

Time	LAeq	LASmax	LASmin
10:38:02	59.8	67.9	52.1
10:39:02	57.6	63.3	51.3
10:40:02	56.7	63.3	50.5
10:41:02	57.8	61.8	49.4
10:42:02	58.0	64.0	50.2
10:43:02	56.7	64.2	49.8
10:44:02	57.8	62.8	51.5
10:45:02	56.1	62.2	50.8
10:46:02	58.3	63.6	49.8
10:47:02	56.9	60.7	52.5
10:48:02	59.7	70.0	49.7
10:49:02	54.4	59.0	50.6
10:50:02	60.2	63.2	56.3
10:51:02	57.9	60.8	53.1
10:52:02	58.8	67.7	52.9
10:53:02	62.4	64.4	63.6

15-minute LAeq

58.5

Monitoring Location: Site 5
Monitoring Date: 7/12/2022

Monitoring Period

Time	LAeq	LASmax	LASmin
11:42:01	69.5	74.4	65.2
11:43:01	66.3	69.4	63.2
11:44:01	71.3	75.5	65.5
11:45:01	69.8	74.6	64.6
11:46:01	69.5	73.4	63.9
11:47:01	66.6	69.9	63.3
11:48:01	69.0	75.4	63.7
11:49:01	71.0	76.9	62.8
11:50:01	67.6	71.2	62.1
11:51:01	70.5	76.0	64.7
11:52:01	69.2	75.2	64.1
11:53:01	71.1	81.6	63.5
11:54:01	69.7	73.6	65.0
11:55:01	68.8	75.9	61.5
11:56:01	69.8	77.9	64.5
11:57:01	71.3	72.0	70.5



15-minute LAeq

69.7

Roadway Construction Noise Model (RCNM),Version 1.1

Report date: 7/12/2022

Case Description: Grading

---- Receptor #1 ----

Description	Land Use	Baselines (dBA)		
		Daytime	Evening	Night
Site 2	Residential	56.6	56.6	56.6

Description	Impact Device	Usage(%)	Equipment		Receptor Distance (feet)	Estimated Shielding (dBA)
			Spec Lmax (dBA)	Actual Lmax (dBA)		
Grader	No	40	85		100	5
Dozer	No	40		81.7	100	5
Tractor	No	40	84		100	5
Tractor	No	40	84		100	5

Calculated (dBA)

Equipment	*Lmax	Leq
Grader	74	70
Dozer	70.6	66.7
Tractor	73	69
Tractor	73	69
Total	74	74.8

*Calculated Lmax is the Loudest value.

---- Receptor #2 ----

Description	Land Use	Baselines (dBA)		
		Daytime	Evening	Night
Site 3	Residential	63.5	63.5	63.5

Description	Impact Device	Usage(%)	Equipment		Receptor Distance (feet)	Estimated Shielding (dBA)
			Spec Lmax (dBA)	Actual Lmax (dBA)		
Grader	No	40	85		950	5
Dozer	No	40		81.7	950	5
Tractor	No	40	84		950	5
Tractor	No	40	84		950	5

Calculated (dBA)

Equipment	*Lmax	Leq
Grader	54.4	50.4
Dozer	51.1	47.1
Tractor	53.4	49.4
Tractor	53.4	49.4
Total	54.4	55.3

*Calculated Lmax is the Loudest value.

---- Receptor #3 ----

Description	Land Use	Baselines (dBA)		
		Daytime	Evening	Night
Site 4	Residential	58.5	58.5	58.5

Description	Device	Impact	Equipment				
			Usage(%)	Spec	Actual	Receptor	Estimated
				Lmax (dBA)	Lmax (dBA)	Distance (feet)	Shielding (dBA)
Grader	No		40	85	750	5	
Dozer	No		40		81.7	750	5
Tractor	No		40	84	750	5	
Tractor	No		40	84	750	5	

Calculated (dBA)

Equipment	*Lmax	Leq
Grader	56.5	52.5
Dozer	53.1	49.2
Tractor	55.5	51.5
Tractor	55.5	51.5
Total	56.5	57.3

*Calculated Lmax is the Loudest value.

---- Receptor #4 ----

Description	Land Use	Baselines (dBA)		
		Daytime	Evening	Night
Site 5	Residential	69.7	69.7	69.7

Description	Device	Impact	Equipment				
			Usage(%)	Spec	Actual	Receptor	Estimated
				Lmax (dBA)	Lmax (dBA)	Distance (feet)	Shielding (dBA)
Grader	No		40	85	835	0	
Dozer	No		40		81.7	835	0
Tractor	No		40	84	835	0	
Tractor	No		40	84	835	0	

Calculated (dBA)

Equipment	*Lmax	Leq
Grader	60.5	56.6
Dozer	57.2	53.2
Tractor	59.5	55.6
Tractor	59.5	55.6
Total	60.5	61.4

*Calculated Lmax is the Loudest value.

Roadway Construction Noise Model (RCNM),Version 1.1

Report date: 7/12/2022
 Case Description: Building Construction

---- Receptor #1 ----

Description	Land Use	Baselines (dBA)		
		Daytime	Evening	Night
Site 2	Residential	56.6	56.6	56.6

Description	Impact Device	Usage(%)	Equipment			
			Spec Lmax (dBA)	Actual Lmax (dBA)	Receptor Distance (feet)	Estimated Shielding (dBA)
Crane	No	16		80.6	100	5
Forklift	No	40	85		100	5
Forklift	No	40	85		100	5
Generator	No	50		80.6	100	5
Tractor	No	40	84		100	5
Welder / Torch	No	40		74	100	5

Calculated (dBA)

Equipment	*Lmax	Leq
Crane	69.5	61.6
Forklift	74	70
Forklift	74	70
Generator	69.6	66.6
Tractor	73	69
Welder / Torch	63	59
Total	74	75.4

*Calculated Lmax is the Loudest value.

---- Receptor #2 ----

Description	Land Use	Baselines (dBA)		
		Daytime	Evening	Night
Site 3	Residential	63.5	63.5	63.5

Description	Impact Device	Usage(%)	Equipment			
			Spec Lmax (dBA)	Actual Lmax (dBA)	Receptor Distance (feet)	Estimated Shielding (dBA)
Crane	No	16		80.6	950	5
Forklift	No	40	85		950	5
Forklift	No	40	85		950	5
Generator	No	50		80.6	950	5
Tractor	No	40	84		950	5
Welder / Torch	No	40		74	950	5

Calculated (dBA)

Equipment	*Lmax	Leq
Crane	50	42
Forklift	-30.6	-34.6
Forklift	-30.6	-34.6
Generator	50.1	47
Tractor	53.4	49.4
Welder / Torch	43.4	39.4
Total	53.4	52.1

*Calculated Lmax is the Loudest value.

---- Receptor #3 ----

Description	Land Use	Baselines (dBA)			Equipment			
		Daytime	Evening	Night	Spec Lmax (dBA)	Actual Lmax (dBA)	Receptor Distance (feet)	Estimated Shielding (dBA)
Site 4	Residential	58.5	58.5	58.5				
Description		Impact Device	Usage(%)					
Crane		No	16		80.6	750	5	
Forklift		No	40	85		750	5	
Forklift		No	40	85		750	5	
Generator		No	50		80.6	750	5	
Tractor		No	40	84		750	5	
Welder / Torch		No	40		74	750	5	

Calculated (dBA)

Equipment	*Lmax	Leq
Crane	52	44.1
Forklift	56.5	52.5
Forklift	56.5	52.5
Generator	52.1	49.1
Tractor	55.5	51.5
Welder / Torch	45.5	41.5
Total	56.5	57.9

*Calculated Lmax is the Loudest value.

---- Receptor #4 ----

Description	Land Use	Baselines (dBA)			Equipment		
		Daytime	Evening	Night	Spec Lmax (dBA)	Actual Lmax (dBA)	Receptor Distance (feet)
Site 5	Residential	69.7	69.7	69.7			
Description		Impact Device	Usage(%)				
Crane		No	16		80.6	835	0
Forklift		No	40	85		835	0
Forklift		No	40	85		835	0
Generator		No	50		80.6	835	0
Tractor		No	40	84		835	0
Welder / Torch		No	40		74	835	0

Calculated (dBA)

Equipment	*Lmax	Leq
Crane	56.1	48.1
Forklift	60.5	56.6
Forklift	60.5	56.6
Generator	56.2	53.2
Tractor	59.5	55.6
Welder / Torch	49.5	45.6
Total	60.5	62

*Calculated Lmax is the Loudest value.

Roadway Construction Noise Model (RCNM),Version 1.1

Report date: 7/12/2022
 Case Description: Paving

---- Receptor #1 ----

Description	Land Use	Baselines (dBA)		
		Daytime	Evening	Night
Site 2	Residential	56.6	56.6	56.6

Description	Impact Device	Usage(%)	Equipment			
			Spec Lmax (dBA)	Actual Lmax (dBA)	Receptor Distance (feet)	Estimated Shielding (dBA)
Concrete Mixer Truck	No	40		78.8	100	5
Paver	No	50		77.2	100	5
Paver	No	50		77.2	100	5
Roller	No	20		80	100	5
Roller	No	20		80	100	5
Tractor	No	40	84		100	5

Calculated (dBA)

Equipment	*Lmax	Leq
Concrete Mixer Truck	67.8	63.8
Paver	66.2	63.2
Paver	66.2	63.2
Roller	69	62
Roller	69	62
Tractor	73	69
Total	73	72.5

*Calculated Lmax is the Loudest value.

---- Receptor #2 ----

Description	Land Use	Baselines (dBA)		
		Daytime	Evening	Night
Site 3	Residential	63.5	63.5	63.5

Description	Impact Device	Usage(%)	Equipment			
			Spec Lmax (dBA)	Actual Lmax (dBA)	Receptor Distance (feet)	Estimated Shielding (dBA)
Concrete Mixer Truck	No	40		78.8	950	5
Paver	No	50		77.2	950	5
Paver	No	50		77.2	950	5
Roller	No	20		80	950	5
Roller	No	20		80	950	5
Tractor	No	40	84		950	5

Calculated (dBA)

Equipment	*Lmax	Leq
Concrete Mixer Truck	48.2	44.2
Paver	46.6	43.6
Paver	46.6	43.6
Roller	49.4	42.4
Roller	49.4	42.4
Tractor	53.4	49.4
Total	53.4	52.9

*Calculated Lmax is the Loudest value.

---- Receptor #3 ----

Description	Land Use	Baselines (dBA)		
		Daytime	Evening	Night
Site 4	Residential	58.5	58.5	58.5

Description	Impact Device	Usage(%)	Equipment			
			Spec Lmax (dBA)	Actual Lmax (dBA)	Receptor Distance (feet)	Estimated Shielding (dBA)
Concrete Mixer Truck	No	40		78.8	750	5
Paver	No	50		77.2	750	5
Paver	No	50		77.2	750	5
Roller	No	20		80	750	5
Roller	No	20		80	750	5
Tractor	No	40	84		750	5

Calculated (dBA)

Equipment	*Lmax	Leq
Concrete Mixer Truck	50.3	46.3
Paver	48.7	45.7
Paver	48.7	45.7
Roller	51.5	44.5
Roller	51.5	44.5
Tractor	55.5	51.5
Total	55.5	55

*Calculated Lmax is the Loudest value.

---- Receptor #4 ----

Description	Land Use	Baselines (dBA)		
		Daytime	Evening	Night
Site 5	Residential	69.7	69.7	69.7

Description	Impact Device	Usage(%)	Equipment			
			Spec Lmax (dBA)	Actual Lmax (dBA)	Receptor Distance (feet)	Estimated Shielding (dBA)
Concrete Mixer Truck	No	40		78.8	835	0
Paver	No	50		77.2	835	0
Paver	No	50		77.2	835	0
Roller	No	20		80	835	0
Roller	No	20		80	835	0
Tractor	No	40	84		835	0

Calculated (dBA)

Equipment	*Lmax	Leq
Concrete Mixer Truck	54.3	50.4
Paver	52.8	49.8
Paver	52.8	49.8
Roller	55.5	48.6
Roller	55.5	48.6
Tractor	59.5	55.6
Total	59.5	59

*Calculated Lmax is the Loudest value.

Roadway Construction Noise Model (RCNM),Version 1.1

Report date: 7/12/2022
 Case Description: Architectural Coating

---- Receptor #1 ----

Description	Land Use	Baselines (dBA)			Equipment			
		Daytime	Evening	Night	Spec Lmax (dBA)	Actual Lmax (dBA)	Receptor Distance (feet)	Estimated Shielding (dBA)
Site 2	Residential	56.6	56.6	56.6				
Description		Impact Device	Usage(%)					
Compressor (air)		No	40		77.7	100	5	

Calculated (dBA)

Equipment	*Lmax	Leq
Compressor (air)	66.6	62.7
Total	66.6	62.7

*Calculated Lmax is the Loudest value.

---- Receptor #2 ----

Description	Land Use	Baselines (dBA)			Equipment			
		Daytime	Evening	Night	Spec Lmax (dBA)	Actual Lmax (dBA)	Receptor Distance (feet)	Estimated Shielding (dBA)
Site 3	Residential	63.5	63.5	63.5				
Description		Impact Device	Usage(%)					
Compressor (air)		No	40		77.7	950	5	

Calculated (dBA)

Equipment	*Lmax	Leq
Compressor (air)	47.1	43.1
Total	47.1	43.1

*Calculated Lmax is the Loudest value.

---- Receptor #3 ----

Description	Land Use	Baselines (dBA)		
		Daytime	Evening	Night
Site 4	Residential	58.5	58.5	58.5

Description	Device	Impact	Usage(%)	Equipment			
				Spec Lmax (dBA)	Actual Lmax (dBA)	Receptor Distance (feet)	Estimated Shielding (dBA)
Compressor (air)	No		40		77.7	750	5

Calculated (dBA)

Equipment	*Lmax	Leq
Compressor (air)	49.1	45.2
Total	49.1	45.2

*Calculated Lmax is the Loudest value.

---- Receptor #4 ----

Description	Land Use	Baselines (dBA)		
		Daytime	Evening	Night
Site 5	Residential	69.7	69.7	69.7

Description	Device	Impact	Usage(%)	Equipment			
				Spec Lmax (dBA)	Actual Lmax (dBA)	Receptor Distance (feet)	Estimated Shielding (dBA)
Compressor (air)	No		40		77.7	835	0

Calculated (dBA)

Equipment	*Lmax	Leq
Compressor (air)	53.2	49.2
Total	53.2	49.2

*Calculated Lmax is the Loudest value.

**4400 N. University Parkway
Construction Vibration Model
(Site 2)**

Equipment		Pieces of Equipment	PPV at 25 feet (in/sec)	Distance from Equipment	PPV at adjusted distance	RMS velocity amplitude in in/sec at adjusted distance ^a	RMS Vibration level in VdB at adjusted distance
Caisson drilling		1	0.089	100	0.011	0.003	69
Jackhammer		1	0.035	100	0.004	0.001	61
Large bulldozer		1	0.089	100	0.011	0.003	69
Loaded trucks		1	0.076	100	0.010	0.002	68
Pile Drive (impact)		1	0.644	100	0.081	0.020	86
Vibratory Roller		1	0.210	100	0.026	0.007	76
Small bulldozer		1	0.003	100	0.000	0.000	39

*** Suggested Vibration Thresholds per the Federal Transit Administration, United States Department of Transportation, Transit Noise and Vibration Impact Assessment**

**4400 N. University Parkway
Construction Vibration Model
(Site 3)**

Equipment		Pieces of Equipment	PPV at 25 feet (in/sec)	Distance from Equipment	PPV at adjusted distance	RMS velocity amplitude in in/sec at adjusted distance ^a	RMS Vibration level in VdB at adjusted distance
Caisson drilling		1	0.089	950	0.000	0.000	40
Jackhammer		1	0.035	950	0.000	0.000	31
Large bulldozer		1	0.089	950	0.000	0.000	40
Loaded trucks		1	0.076	950	0.000	0.000	38
Pile Drive (impact)		1	0.644	950	0.003	0.001	57
Vibratory Roller		1	0.210	950	0.001	0.000	47
Small bulldozer		1	0.003	950	0.000	0.000	10

*** Suggested Vibration Thresholds per the Federal Transit Administration, United States Department of Transportation, Transit Noise and Vibration Impact Assessment**

**4400 N. University Parkway
Construction Vibration Model
(Site 4)**

Equipment		Pieces of Equipment	PPV at 25 feet (in/sec)	Distance from Equipment	PPV at adjusted distance	RMS velocity amplitude in in/sec at adjusted distance ^a	RMS Vibration level in VdB at adjusted distance
Caisson drilling		1	0.089	750	0.001	0.000	43
Jackhammer		1	0.035	750	0.000	0.000	35
Large bulldozer		1	0.089	750	0.001	0.000	43
Loaded trucks		1	0.076	750	0.000	0.000	41
Pile Drive (impact)		1	0.644	750	0.004	0.001	60
Vibratory Roller		1	0.210	750	0.001	0.000	50
Small bulldozer		1	0.003	750	0.000	0.000	13

*** Suggested Vibration Thresholds per the Federal Transit Administration, United States Department of Transportation, Transit Noise and Vibration Impact Assessment**

**4400 N. University Parkway
Construction Vibration Model
(Site 5)**

Equipment		Pieces of Equipment	PPV at 25 feet (in/sec)	Distance from Equipment	PPV at adjusted distance	RMS velocity amplitude in in/sec at adjusted distance ^a	RMS Vibration level in VdB at adjusted distance
Caisson drilling		1	0.089	835	0.000	0.000	41
Jackhammer		1	0.035	835	0.000	0.000	33
Large bulldozer		1	0.089	835	0.000	0.000	41
Loaded trucks		1	0.076	835	0.000	0.000	40
Pile Drive (impact)		1	0.644	835	0.003	0.001	58
Vibratory Roller		1	0.210	835	0.001	0.000	49
Small bulldozer		1	0.003	835	0.000	0.000	12

*** Suggested Vibration Thresholds per the Federal Transit Administration, United States Department of Transportation, Transit Noise and Vibration Impact Assessment**



Appendix 4.17
Traffic Impact Analysis



TRAFFIC IMPACT ANALYSIS REPORT
4400 VARSITY AVENUE COMMERCIAL CENTER
San Bernardino, California
December 5, 2022
(Revision of October 13, 2022 Report)

Prepared for:

PCG South Shores, LLC
133 Penn Street
El Segundo, CA 90245

LLG Ref. 2-21-4502-1



Prepared by:
Angela Besa, P.E.
Transportation Engineer II
and
Daniel A. Kloos, P.E.
Associate Principal



Under the Supervision of:
Keil D. Maberry, P.E.
Principal

TABLE OF CONTENTS

SECTION	PAGE
Executive Summary	vii
1.0 Introduction.....	1
1.1 Study Area.....	2
1.1.1 Intersections	2
1.1.2 Roadway Segments.....	2
1.2 Traffic Impact Analysis Components.....	2
1.3 Traffic Impact Analysis Scenarios	3
2.0 Project Description and Location.....	4
2.1 Site Access	4
3.0 Analysis Conditions and Methodology	5
3.1 Existing Street Network	5
3.2 Existing Public Transit	5
3.3 Bicycle and Pedestrian Facilities.....	6
3.4 Existing Traffic Volumes	7
3.5 Level of Service (LOS) Analysis Methodologies	7
3.5.1 Highway Capacity Manual 6 (HCM 6) Method of Analysis (Signalized Intersections).....	8
3.5.2 Highway Capacity Manual 6 (HCM 6) Method of Analysis (Unsignalized Intersections).....	8
3.5.2.1 Two-Way Stop-Controlled Intersections	8
3.5.2.2 All-Way Stop-Controlled Intersections	8
3.5.3 Volume to Capacity (V/C) Ratio Method of Analysis (Roadway Segments)	8
3.6 Impact Criteria and Thresholds	9
3.6.1 Intersections	9
3.6.2 Roadway Segments.....	9
4.0 Traffic Forecasting Methodology	14
5.0 Project Traffic Characteristics	15
5.1 Project Trip Generation Forecast	15
5.2 Project Trip Distribution and Assignment.....	15
6.0 Future Traffic Conditions	17
6.1 Existing With Project Traffic Volumes.....	17
6.2 Year 2024 Without Project Traffic Volumes	17
6.2.1 Ambient Growth Traffic	17
6.2.2 Cumulative Projects Traffic.....	17

TABLE OF CONTENTS (CONTINUED)

SECTION	PAGE
6.3	Year 2024 With Project Traffic Volumes 18
6.4	Buildout Traffic Conditions 18
6.4.1	Volume Adjustment 18
6.4.2	B-turn Methodology 18
6.5	Buildout Traffic Volumes 19
7.0	Existing Conditions Traffic Impact Analysis 22
7.1	Existing Conditions Intersection Capacity Analysis 22
7.1.1	Existing Traffic Conditions 22
7.1.2	Existing With Project Traffic Conditions 22
7.2	Existing Conditions Roadway Segment Analysis 25
7.2.1	Existing Traffic Conditions 25
7.2.2	Existing With Project Traffic Conditions 25
8.0	Year 2024 With Project Analysis 28
8.1	Year 2024 Conditions Intersection Capacity Analysis 28
8.1.1	Year 2024 Without Project Traffic Conditions 28
8.1.2	Year 2024 With Project Traffic Conditions 28
8.2	Year 2024 Conditions Roadway Segment Analysis 32
8.2.1	Year 2024 Without Project Traffic Conditions 32
8.2.2	Year 2024 With Project Traffic Conditions 32
9.0	Buildout Analysis 35
9.1	Buildout Conditions Intersection Capacity Analysis 35
9.1.1	Buildout Without Project Traffic Conditions 35
9.1.2	Buildout With Project Traffic Conditions 35
9.2	Buildout Conditions Roadway Segment Analysis 39
9.2.1	Buildout Without Project Traffic Conditions 39
9.2.2	Buildout With Project Traffic Conditions 39
10.0	Site Access and Internal Circulation Evaluation 42
10.1	Site Access 42
10.2	Project Driveway Queuing Analysis 42
10.3	Internal Circulation Evaluation 43
10.4	Drive-Through Queuing Analysis 43
10.4.1	Chick-fil-A Drive-Through 43
10.4.2	Dutch Brothers Coffee 47
10.4.3	Express Car Wash 47
10.4.4	Pad B – Fast Food Restaurant With Drive-Through 47
11.0	State of California (Caltrans) Methodology 51

TABLE OF CONTENTS (CONTINUED)

SECTION	PAGE
11.1 Ramp Intersection Capacity Analysis	51
11.2 Vehicle Miles Traveled Analysis	51
11.3 Off-Ramp Vehicle Queuing Analysis	52
11.3.1 Existing With Project Traffic Conditions	53
11.3.2 Year 2024 With Project Traffic Conditions.....	53
11.3.3 Buildout With Project Traffic Conditions.....	53
11.4 Pedestrian Circulation	53
12.0 Planned and Recommended Improvements.....	57
12.1 Planned Improvements	57
12.1.1 Intersections	57
12.1.2 Roadway Segments.....	57
12.2 Existing With Project Traffic Conditions Recommended Improvements.....	57
12.2.1 Intersections	57
12.2.2 Roadway Segments.....	58
12.3 Year 2024 With Project Traffic Conditions Recommended Improvements	58
12.3.1 Intersections	58
12.3.2 Roadway Segments.....	58
12.4 Buildout With Project Traffic Conditions Recommended Improvements	58
12.4.1 Intersections	58
12.4.2 Roadway Segments.....	59
13.0 Project Fair Share Analysis	60
13.1 Year 2024 With Project Traffic Conditions	60
13.2 Buildout With Project Traffic Conditions	60
14.0 Vehicle Miles Traveled (VMT) Analysis.....	63
14.1 VMT Analysis Conclusion.....	64

APPENDICES

APPENDIX

- A. Traffic Study Scope of Work**
- B. Existing Traffic Count Data**
- C. Modeling Worksheets**
- D. Existing Traffic Conditions Intersection Level of Service Calculation Worksheets**
 - D-I Existing Traffic Conditions
 - D-II Existing With Project Traffic Conditions
 - D-III Existing With Project Traffic Conditions With Improvements
- E. Year 2024 Traffic Conditions Intersection Level of Service Calculation Worksheets**
 - E-I Year 2024 Without Project Traffic Conditions
 - E-II Year 2024 With Project Traffic Conditions
 - E-III Year 2024 With Project Traffic Conditions With Improvements
- F. Buildout Traffic Conditions Intersection Level of Service Calculation Worksheets**
 - F-I Buildout Without Project Traffic Conditions
 - F-II Buildout With Project Traffic Conditions
 - F-III Buildout With Project Traffic Conditions With Improvements
- G. Project Driveway Level of Service Calculation Worksheets**
 - G-I Year 2024 With Project Traffic Conditions
 - G-II Buildout With Project Traffic Conditions
- H. Drive-Through Queuing Study Data**
- I. SBCTA VMT Screening Tool Data**

LIST OF FIGURES

SECTION – FIGURE #	FOLLOWING PAGE
1–1 Vicinity Map	3
2–1 Existing Site Aerial	4
2–2 Proposed Site Plan.....	4
3–1 Existing Roadway Conditions and Intersection Controls	5
3–2 Existing AM Peak Hour Traffic Volumes.....	7
3–3 Existing PM Peak Hour and Daily Traffic Volumes	7
5–1 Project Traffic Distribution Pattern	16
5–2 AM Peak Hour Project Traffic Volumes.....	16
5–3 PM Peak Hour and Daily Project Traffic Volumes	16
6–1 Existing With Project AM Peak Hour Traffic Volumes	21
6–2 Existing With Project PM Peak Hour and Daily Traffic Volumes.....	21
6–3 Location of Cumulative Projects	21
6–4 AM Peak Hour Cumulative Projects Traffic Volumes.....	21
6–5 PM Peak Hour Cumulative Projects Traffic Volumes.....	21
6–6 Year 2024 Without Project AM Peak Hour Traffic Volumes.....	21
6–7 Year 2024 Without Project PM Peak Hour and Daily Traffic Volumes.....	21
6–8 Year 2024 With Project AM Peak Hour Traffic Volumes.....	21
6–9 Year 2024 With Project PM Peak Hour and Daily Traffic Volumes	21
6–10 Buildout Without Project AM Peak Hour Traffic Volumes	21
6–11 Buildout Without Project PM Peak Hour and Daily Traffic Volumes.....	21
6–12 Buildout With Project AM Peak Hour Traffic Volumes.....	21
6–13 Buildout With Project PM Peak Hour and Daily Traffic Volumes	21
12–1 Existing With Project Recommended Improvements	59
12–2 Year 2024 With Project Recommended Improvements.....	59
12–3 Buildout With Project Planned and Recommended Improvements	59

LIST OF TABLES

SECTION-TABLE#	PAGE
3-1	Level of Service Criteria For Signalized Intersections (HCM 6 Methodology)..... 10
3-2	Level of Service Criteria For Unsignalized Intersections (HCM 6 Methodology) 11
3-3	Level of Service Criteria For Roadway Segments (V/C Methodology)..... 12
3-4	Daily Roadway Segment Capacities 13
5-1	Project Trip Generation Rates and Forecast 16
6-1	Location and Description of Cumulative Projects 20
6-2	Cumulative Projects Traffic Generation Forecast..... 21
7-1	Existing With Project Conditions Peak Hour Intersection Capacity Analysis Summary.....23-24
7-2	Existing With Project Conditions Daily Roadway Segment Analysis Summary..... 26
7-3	Existing With Project Conditions Peak Hour Roadway Segment Analysis Summary 27
8-1	Year 2024 With Project Conditions Peak Hour Intersection Capacity Analysis Summary30-31
8-2	Year 2024 With Project Conditions Daily Roadway Segment Analysis Summary 33
8-3	Year 2024 With Project Conditions Peak Hour Roadway Segment Analysis Summary 34
9-1	Buildout With Project Conditions Peak Hour Intersection Capacity Analysis Summary37-38
9-2	Buildout With Project Conditions Daily Roadway Segment Analysis Summary 40
9-3	Buildout With Project Conditions Peak Hour Roadway Segment Analysis Summary..... 41
10-1	Project Driveway Peak Hour Levels of Service Summary 44
10-2	Project Driveway Peak Hour Queuing Analysis 45
10-3	Weekday (Thursday) Queuing Analysis Summary..... 48
10-4	Weekday (Friday) Queuing Analysis Summary 49
10-5	Weekend (Saturday) Queuing Analysis Summary..... 50
11-1	Existing With Project Peak Hour Freeway Off-Ramp Queuing Analysis 54
11-2	Year 2024 With Project Peak Hour Freeway Off-Ramp Queuing Analysis 55
11-3	Buildout With Project Peak Hour Freeway Off-Ramp Queuing Analysis 56
13-1	Year 2024 With Project Traffic Conditions Fair Share Contribution 61
13-2	Buildout With Project Traffic Conditions Fair Share Contribution..... 62

EXECUTIVE SUMMARY

Project Description

- The Project site is located at 4400 Varsity Avenue and is generally located on the southwest quadrant of University Parkway and Varsity Avenue in the City of San Bernardino, California. The proposed Project will consist of a 4,761 SF Chick-fil-A Restaurant with drive-through window (the drive-through will provide storage for 75 vehicles), a 5,137 SF automated carwash (1 wash tunnel; 21 vehicles of storage from the pay station), a 950 SF Dutch Brothers Coffee (the drive-through will provide storage for 33 vehicles) and a 3,610 SF fast food restaurant with drive-through window (the drive-through will provide storage for 12 vehicles). The proposed Project is anticipated to be completed by the Year 2024. Access to the Project will be provided via two full access unsignalized driveways located along Varsity Avenue (i.e. Project Driveways No. 1 and No. 2) and via one right-turn in/right-turn out only driveway located along University Parkway (i.e. Project Driveway No. 3).
- The proposed Project is forecast to generate approximately 3,896 daily trips, with 285 trips (145 inbound, 140 outbound) produced in the AM peak hour and 211 trips (108 inbound, 103 outbound) produced in the PM peak hour on a “typical” weekday.

Study Area

- Ten (10) key study intersections and five (5) key roadway segments were selected for evaluation based on discussions with City of San Bernardino Public Works Department staff. The intersections and roadway segments listed below provide local access to the study area and define the extent of the boundaries for this traffic impact investigation.

Key Study Intersections

1. University Parkway at Northpark Boulevard
2. University Parkway at Kendall Drive
3. Varsity Avenue at College Avenue
4. University Parkway at College Avenue
5. State Street at College Avenue
6. University Parkway at Varsity Avenue/State Street
7. University Parkway at I-215 NB Ramps
8. University Parkway at I-215 SB Ramps
9. University Parkway at Hallmark Parkway
10. State Street at Nolan Street/Short Street

Key Roadway Segments

- A. University Parkway between Northpark Boulevard and Kendall Drive
- B. University Parkway between Kendall Drive and College Avenue
- C. University Parkway between College Avenue and Varsity Avenue
- D. University Parkway between Varsity Avenue and I-215 NB Ramps

E. University Parkway between I-215 SB Ramps and Hallmark Parkway

Cumulative Projects Description

- The nine (9) cumulative projects are expected to generate 5,627 daily trips (one half arriving, one half departing), with 485 trips (297 inbound and 188 outbound) forecast during the AM peak hour and 568 trips (233 inbound and 335 outbound) forecast during the PM peak hour on a “typical” weekday.

Traffic Impact Analysis

Existing Traffic Conditions

- For Existing traffic conditions, two (2) of the ten (10) key study intersections currently operate at an unacceptable LOS E during the AM peak hour (i.e. University Parkway at Varsity Avenue/State Street and University Parkway at I-215 NB Ramps) when compared to the LOS standards defined in this report. The remaining eight (8) key study intersections currently operate at acceptable LOS D or better during the AM and PM peak hours.
- One (1) of the five (5) the key roadway segments currently operates at an adverse level of service on a daily basis (i.e. Roadway Segment D – University Parkway between Varsity Avenue and I-215 NB Ramps). The remaining four (4) key roadway segments currently operate at acceptable levels of service on a daily basis.

Existing With Project Traffic Conditions

- The Project will adversely impact one (1) of the ten (10) key study intersections when compared to the LOS criteria defined in this report (i.e. Intersection #7 – University Parkway at I-215 NB Ramps). Although the intersection of University Parkway at Varsity Avenue/State Street is forecast to operate at an adverse LOS E during the AM peak hour with the addition of Project traffic, the proposed Project is expected to add only 0.01 to the V/C value, which does not exceed the allowable threshold. The remaining eight (8) key study intersections currently operate and are forecast to continue to operate at an acceptable LOS during the AM and PM peak hours with the addition of Project generated traffic to existing traffic. The implementation of recommended improvements at the one (1) deficient location improves the intersection to acceptable service levels and offsets the impact of Project traffic.
- For Existing With Project traffic conditions, one (1) of the five (5) key study roadway segments is forecast to operate at an adverse level of service on a daily basis (i.e. Roadway Segment D – University Parkway between Varsity Avenue and I-215 NB Ramps). The remaining four (4) key study roadway segments are forecast to operate at acceptable levels of service on a daily basis with the addition of Project generated traffic to existing traffic. To determine if the Project creates a deficiency, this adverse roadway segment is further analyzed under peak hour conditions to determine if there are any peak hour deficiencies.

Based on this evaluation, the one (1) adverse study roadway segment is forecast to operate at an acceptable level of service during the AM and PM peak hours.

Year 2024 With Project Traffic Conditions

- The proposed Project will adversely impact two (2) of the ten (10) key study intersections when compared to the LOS criteria defined in this report (i.e. Intersection #6 – University Parkway at Varsity Avenue/State Street and Intersection #7 – University Parkway at I-215 NB Ramps). The remaining eight (8) key study intersections are forecast to continue to operate at an acceptable LOS during the AM and PM peak hours with the addition of Project generated traffic in the horizon Year 2024. The implementation of recommended improvements at the two (2) deficient locations improves the intersections to acceptable service levels and offsets the impact of Project traffic.
- For Year 2024 With Project traffic conditions, one (1) of the five (5) key roadway segments is forecast to operate at an adverse level of service on a daily basis (i.e. Roadway Segment D – University Parkway between Varsity Avenue and I-215 NB Ramps). The remaining four (4) key roadway segments are forecast to continue to operate at acceptable levels of service on a daily basis with the addition of Project generated traffic in the Year 2024 traffic condition. To determine if the Project creates a deficiency, this adverse roadway segment is further analyzed under peak hour conditions to determine if there are any peak hour deficiencies. Based on this evaluation, the one (1) adverse study roadway segment is forecast to operate at an acceptable level of service during the AM and PM peak hours.

Buildout With Project Traffic Conditions

- The proposed Project will adversely impact one (1) of the ten (10) key study intersections when compared to the LOS criteria defined in this report (i.e. Intersection #6 – University Parkway at Varsity Avenue/State Street). Although the intersection of University Parkway at Hallmark Parkway is forecast to operate at an adverse LOS E during the PM peak hour with the addition of Project traffic, the proposed Project is expected to add only 0.01 to the V/C value, which does not exceed the allowable threshold. The remaining eight (8) key study intersections are forecast to continue to operate at an acceptable LOS during the AM and PM peak hours with the addition of Project generated traffic in the Buildout traffic condition. The implementation of recommended improvements at the one (1) deficient location improves this intersection to acceptable service levels and offsets the impact of Project traffic.
- For Buildout With Project traffic conditions, two (2) of the five (5) key roadway segments are forecast to operate at an adverse level of service on a daily basis (i.e. Roadway Segment D – University Parkway between Varsity Avenue and I-215 NB Ramps and Roadway Segment E – University Parkway between I-215 SB Ramps and Hallmark Parkway). The remaining three (3) key roadway segments are forecast to continue to operate at acceptable levels of service on a daily basis with the addition of Project generated traffic in the Buildout

traffic condition. To determine if the Project creates a deficiency, these adverse roadway segments are further analyzed under peak hour conditions to determine if there are any peak hour deficiencies. Based on this evaluation, the two (2) adverse study roadway segments are forecast to operate at an acceptable level of service during the AM and PM peak hours.

Site Access and Internal Circulation Evaluation

- The two project driveways on Varsity Avenue (i.e. Project Driveways No. 1 and No. 2) are forecast to operate at an acceptable level of service during the AM and PM peak hours under Year 2024 With Project traffic conditions and Buildout With Project traffic conditions. The project driveway on University Parkway (i.e. Project Driveway No. 3) is forecast to operate at acceptable LOS D during the AM peak hour and unacceptable LOS E during the PM peak hour under Year 2024 With Project traffic conditions and Buildout With Project traffic conditions.

It should be noted that it is not uncommon for private unsignalized driveways, such as Project Driveway No. 3, to experience a longer delay due to the heavy traffic volumes on the major street, such as University Parkway. Furthermore, due to the proposed project driveway being located south of the signalized intersection of University Parkway at Varsity Avenue/State Street, it is expected that gaps in traffic would occur and the actual vehicular delay experienced exiting the project driveway would be lower than what is being reported by the HCM methodology. Lastly, the expected 95th percentile vehicular queue experienced for the eastbound right-turn for Project Driveway No. 3 at University Parkway would not exceed 3 vehicles, further validating that the forecast adverse LOS at this driveway is insignificant.

- Adequate storage is provided to accommodate the forecast 95th percentile queues under Year 2024 With Project and Buildout With Project traffic conditions for all outbound movements at the three (3) project driveways. In addition, the 95th percentile queue for the southbound shared through/right-turn lane on University Parkway at Project Driveway No. 3 is nominal (essentially zero), but 25 feet is reported in the table to indicate a conservative result, which reflects one vehicle slowing to enter the driveway with nominal delay. Lastly, a right turn deceleration is not recommended at the Project driveway along University Parkway given the proximity of the driveway to the adjacent driveway to the north and exclusive southbound right turn lane at the I-215 NB On-ramp to the south, which can create a confusing and unsafe condition for southbound right turn movements at both driveways.
- The on-site circulation layout of the proposed Project as illustrated in *Figure 2-2* on an overall basis is adequate. Curb return radii appear adequate for passenger cars, service/delivery trucks and trash trucks. Based on our review of the project site plan, the overall layout does not create significant vehicle-pedestrian conflict points and project traffic is not anticipated to cause significant internal queuing/stacking at the Project driveways. Lastly, it is not anticipated that any vehicular traffic at the internal project driveways located

along the project's main east-west drive aisle (i.e. located along the northerly boundary of the project site) will queue onto either University Parkway or Varsity Avenue as the parking area configuration and circulation pattern is typical for retail centers.

- Based on drive-through queuing observations, service times and processing rates, adequate storage is provided for the Chick-fil-A drive-through lane, the proposed Dutch Brothers Coffee drive-through lane, the Express Car Wash and the proposed Pad B – Fast-Food Restaurant drive-through lane. Vehicles are not anticipated to queue back to Varsity Avenue and/or University Parkway. Refer to Section 10.4 for further details regarding the Drive-Through Queuing Analysis, including Chick-fil-A's drive-through operations plan.

State of California (Caltrans) Methodology

- The intersection of University Parkway at I-215 NB Ramps is forecast to operate at unacceptable levels of service during the AM peak hour under Existing With Project and Year 2024 With Project traffic conditions. However, the implementation of recommended improvements at the deficient location improves this intersection to acceptable service levels and offsets the impact of Project traffic. Under Buildout traffic conditions, the intersection of University Parkway at I-215 NB Ramps is forecast to operate at an acceptable level of service during the AM peak hour and PM peak hour. The intersection of University Parkway at I-215 SB Ramps is forecast to operate at acceptable levels of service during the AM peak hour and PM peak hour without and with the proposed Project for all analyzed traffic conditions.

Caltrans' TISG references the *Technical Advisory on Evaluating Transportation Impacts In California Environmental Quality Act (CEQA)*, dated December 2018, prepared by the State of California Governor's Office of Planning and Research (OPR) as the basis for its guidance on VMT assessment. The City of San Bernardino recently adopted new traffic impact criteria in August 2020 to be consistent with the CEQA revisions and OPR recommendations. These new guidelines are contained within the *City of San Bernardino Traffic Impact Analysis Guidelines*, dated August 2020 and provide screening criteria and methodology for VMT analysis. Since the City's guidelines are generally consistent with OPR guidelines, no separate VMT analysis has been prepared for Caltrans' review of the proposed project.

An analysis of the project's effect on off-ramp queuing was prepared in order to determine if the project would cause, or contribute towards, slowing or stopped traffic on mainline travel lanes resulting in unsafe speed differentials between adjacent lanes. Adequate storage is provided to accommodate the forecast 95th percentile queues under Existing, Existing With Project, Year 2024 Without Project, Year 2024 With Project, Buildout Without Project and Buildout With Project traffic conditions at the two (2) off-ramp locations. The proposed project is expected to neither cause nor contribute towards vehicle queuing which extends back into the I-215 Freeway mainline travel lanes under all analyzed traffic conditions.

Therefore, the proposed project is not anticipated to negatively influence safety on the State Highway System.

Pedestrian circulation will be provided via the existing public sidewalk along University Parkway within the vicinity of the Project frontage, which will connect to the Project's internal walkways. The project will construct sidewalk along the Project frontage on Varsity Avenue, which will connect to the existing sidewalk on Varsity Avenue to the east. The Project will protect the existing sidewalk along Project frontage and if necessary, repair or reconstruct sidewalks along the project frontage per the City's request. The existing sidewalk system within the Project vicinity provides direct connectivity to the surrounding commercial, office and residential developments, as well as nearby public transit stops, along University Parkway.

Planned Improvements

The following planned improvements listed below have been included under Buildout Without Project and Buildout With Project traffic conditions:

- Intersection 7 – University Parkway at I-215 NB Ramps: Reconstruct the I-215 Freeway Interchange at University Parkway to a Diverging Diamond Interchange as designed by Caltrans.
- Intersection 8 – University Parkway at I-215 SB Ramps: Reconstruct the I-215 Freeway Interchange at University Parkway to a Diverging Diamond Interchange as designed by Caltrans.

Recommended Improvements

Existing With Project Traffic Conditions

- The results of the Existing With Project intersection capacity analysis indicates that the proposed Project will adversely impact one (1) of the ten (10) key study intersections. The following recommended improvements listed below have been identified to improve the impacted key study intersections under Existing With Project traffic conditions:
 - Intersection 7 – University Parkway at I-215 NB Ramps: Widen and/or restripe to provide a third exclusive westbound right-turn turn lane. Modify the existing traffic signal, as necessary. It should be noted that this improvement is consistent with the future Diverging Diamond Interchange Plan.
- The results of the Existing With Project roadway segment analysis indicates that the proposed Project ***will not*** adversely impact any of the five (5) key study roadway segments. As such, no improvement measures have been recommended.

Year 2024 With Project Traffic Conditions

- The results of the Year 2024 With Project intersection capacity analysis indicates that the proposed Project will adversely impact two (2) of the ten (10) key study intersections. The following recommended improvements listed below have been identified to improve the impacted key study intersections under Year 2024 With Project traffic conditions:
 - Intersection 6 – University Parkway at Varsity Avenue/State Street: Modify the existing traffic signal from five-phase to eight-phase operation with protected/permissive phasing for eastbound left turns on Varsity Avenue/State Street and protected phasing for westbound left turns on Varsity Avenue/State Street. The eastbound left-turn pocket on Varsity Avenue will also be lengthened to provide additional storage. Provide a northbound right-turn overlap from University Parkway to State Street.
 - Intersection 7 – University Parkway at I-215 NB Ramps: Widen and/or restripe to provide a third exclusive westbound right-turn turn lane. Modify the existing traffic signal, as necessary. It should be noted that this improvement is consistent with the future Diverging Diamond Interchange Plan.
- The results of the Year 2024 With Project roadway segment analysis indicates that the proposed Project ***will not*** adversely impact any of the five (5) key study roadway segments. As such, no improvement measures have been recommended.

Buildout With Project Traffic Conditions

- The results of the Buildout With Project intersection capacity analysis indicates that the proposed Project will adversely impact one (1) of the ten (10) key study intersections. The following recommended improvements listed below have been identified to improve the impacted key study intersections under Buildout With Project traffic conditions:
 - Intersection 6 – University Parkway at Varsity Avenue/State Street: Restripe to provide a second exclusive westbound left-turn lane. Modify the existing traffic signal from five-phase to eight-phase operation with protected/permissive phasing for eastbound left turns on Varsity Avenue/State Street and protected phasing for westbound left turns on Varsity Avenue/State Street. The eastbound left-turn pocket on Varsity Avenue will also be lengthened to provide additional storage. Provide a northbound right-turn overlap from University Parkway to State Street.
- The results of the Buildout With Project roadway segment analysis indicates that the proposed Project ***will not*** adversely impact any of the five (5) key study roadway segments. As such, no improvement measures have been recommended.

Project Fair Share Analysis

- The Project fair share percentages (most adverse time period) for the impacted intersections for Year 2024 With Project traffic conditions that require physical improvements are shown below:
 - 6. University Parkway at Varsity Avenue/State Street 21.24%
 - 7. University Parkway at I-215 NB Ramps 29.80%

- The Project fair share percentages (most adverse time period) for the impacted intersection for Buildout With Project traffic conditions that require physical improvements is shown below:
 - 6. University Parkway at Varsity Avenue/State Street 20.53%

Vehicle Miles Traveled (VMT) Analysis

- Based on the SBCTA screening tool, the project site is not located within a Transit Priority Area (TPA). Therefore, Project Screening Step 1: Transit Priority Area (TPA) Screening is not satisfied.

- Based on the SBCTA screening tool, the project site is located within Traffic Analysis Zone (TAZ) #53771301. Per the SBCTA screening tool, the Project TAZ VMT/service population is 26.3 VMT per service population and the City average VMT/service population is 31.6 VMT per service population. Comparison of the two VMT values indicates that the Project TAZ VMT is lower than the City VMT average. Therefore, Project Screening Step 2: Low VMT Area Screening is satisfied.

- The proposed Project will consist of a 4,761 SF Chick-fil-A Restaurant with drive-through window, a 5,137 SF automated carwash (1 wash tunnel), a 950 SF Dutch Brothers Coffee and a 3,610 SF fast food restaurant with drive-through window. Therefore, based on the Step 3: Project Type Screening criteria, this project could be screened from a VMT analysis, and could be presumed to have a less than significant impact on VMT per the City's guidelines.

- Based on the City's guidelines, the proposed Project satisfies Step 2: Low VMT Area Screening and Step 3: Project Type Screening. Therefore, this project could be screened from a VMT analysis, and could be presumed to have a less than significant impact on VMT per the City's guidelines.

TRAFFIC IMPACT ANALYSIS REPORT
4400 VARSITY AVENUE COMMERCIAL CENTER

San Bernardino, California

December 5, 2022

(Revision of October 13, 2022 Report)

1.0 INTRODUCTION

This traffic impact analysis evaluates the potential traffic impacts and circulation needs associated with the proposed 4400 Varsity Avenue Commercial Center (hereinafter referred to as Project). The proposed Project site is located at 4400 Varsity Avenue and is generally located on the southwest corner of University Parkway and Varsity Avenue in the City of San Bernardino, California. The proposed Project will consist of a 4,761 square-foot (SF) Chick-fil-A Restaurant with drive-through window, a 5,137 SF automated carwash (1 wash tunnel), a 950 SF Dutch Brothers Coffee and a 3,610 SF fast food restaurant with drive-through window. The proposed Project is anticipated to be completed by the Year 2024. Access to the proposed Project will be provided via two full access unsignalized driveways located along Varsity Avenue (i.e. Project Driveways No. 1 and No. 2) and via one right-turn in/right-turn out only driveway located along University Parkway (i.e. Project Driveway No. 3).

This report documents the findings and recommendations of a traffic impact analysis conducted by Linscott, Law & Greenspan, Engineers (LLG) to determine the potential traffic impacts that the Project may have on the local and/or regional transportation network in the vicinity of the Project site. The traffic impact analysis evaluates the operating conditions at ten (10) key study intersections and five (5) key roadway segments within the Project vicinity, estimates the trip generation potential of the Project and forecasts future (near-term and buildout) operating conditions without and with the Project.

This traffic report satisfies the *City of San Bernardino Traffic Impact Analysis Guidelines*, dated August 2020, and is consistent with the most current *Congestion Management Program (CMP) for San Bernardino County*. The Scope of Work for this traffic study, which is included in **Appendix A**, was developed in conjunction with City of San Bernardino Public Works Department staff.

The project site has been visited and an inventory of adjacent area roadways and intersections was performed. Existing traffic information has been collected at ten (10) key study intersections and five (5) key roadway segments on a “typical” weekday for use in the preparation of intersection level of service calculations. Information concerning cumulative projects (planned and/or approved) in the vicinity of the proposed Project has been researched at the City of San Bernardino and the County of San Bernardino. Based on our research, there are five (5) cumulative projects in the City of San Bernardino and four (4) cumulative projects in the County of San Bernardino within the vicinity of the subject site. These nine (9) planned and/or approved cumulative projects were considered in the cumulative traffic analysis for this project.

This traffic report analyzes existing and future weekday daily, AM peak hour and PM peak hour traffic conditions for a near-term (Year 2024 – Project Opening Year) and long-term (Buildout) traffic setting upon completion of the proposed Project. Peak hour traffic forecasts for the Year 2024 horizon year have been projected by increasing existing traffic volumes by an annual growth rate of three percent (3.0%) per year and adding traffic volumes generated by nine (9) cumulative projects. Long-term (Buildout) peak hour traffic forecasts were projected based on modeled traffic projections utilizing the San Bernardino Traffic Analysis Model (SBTAM).

1.1 Study Area

1.1.1 Intersections

Ten (10) key study intersections were selected for evaluation based on discussions with City of San Bernardino Public Works Department staff. The intersections listed below provide local access to the study area and define the extent of the boundaries for this traffic impact investigation.

Key Study Intersections:

1. University Parkway at Northpark Boulevard
2. University Parkway at Kendall Drive
3. Varsity Avenue at College Avenue
4. University Parkway at College Avenue
5. State Street at College Avenue
6. University Parkway at Varsity Avenue/State Street
7. University Parkway at I-215 NB Ramps
8. University Parkway at I-215 SB Ramps
9. University Parkway at Hallmark Parkway
10. State Street at Nolan Street/Short Street

1.1.2 Roadway Segments

The following five (5) key roadway segments were selected for evaluation based on discussions with City of San Bernardino Public Works Department staff.

- A. University Parkway between Northpark Boulevard and Kendall Drive
- B. University Parkway between Kendall Drive and College Avenue
- C. University Parkway between College Avenue and Varsity Avenue
- D. University Parkway between Varsity Avenue and I-215 NB Ramps
- E. University Parkway between I-215 SB Ramps and Hallmark Parkway

1.2 Traffic Impact Analysis Components

The Highway Capacity Manual (HCM) Delay, Volume to Capacity (V/C) ratio and corresponding Level of Service (LOS) calculations at the key study locations were used to evaluate the potential traffic-related impacts associated with area growth, cumulative projects and the Project. When necessary, this report recommends intersection improvements that may be required to accommodate future traffic volumes and restore/maintain an acceptable Level of Service and/or addresses the impact of the Project.

Included in this Traffic Impact Analysis are:

- Existing Traffic Counts,
- Estimated Project traffic generation/distribution/assignment,
- Estimated Cumulative Projects traffic generation/distribution/assignment,
- Daily, AM and PM peak hour LOS analyses for Existing (i.e. Baseline) Conditions,
- Daily, AM and PM peak hour for Existing (i.e. Baseline) Conditions with Project traffic,
- Daily, AM and PM peak hour LOS analyses for Near-Term (Year 2024) Conditions without and with Project traffic,
- Daily, AM and PM peak hour LOS analyses for Buildout Conditions without and with Project traffic,
- Site Access and Internal Circulation Evaluation,
- Drive-Through Queuing Evaluation,
- Caltrans Facilities Analysis,
- Recommended Improvements,
- Project Fair-Share Contribution, and
- Vehicle Miles Traveled (VMT) Assessment.

Figure 1-1 presents a Vicinity Map, which illustrates the general location of the Project and depicts the study locations and surrounding street system.

1.3 Traffic Impact Analysis Scenarios

The following scenarios are those for which volume/capacity and corresponding LOS calculations have been performed at the key study intersections and key roadway segments for existing, near-term, and buildout traffic conditions:

1. Existing (i.e. Baseline) Traffic Conditions,
2. Existing (i.e. Baseline) With Project Traffic Conditions,
3. Scenario (2) with Recommended Improvements, if any,
4. Year 2024 Without Project Traffic Conditions,
5. Year 2024 With Project Traffic Conditions,
6. Scenario (5) With Recommended Improvements, if any.
7. Buildout Without Project Traffic Conditions,
8. Buildout With Project Traffic Conditions, and
9. Scenario (8) With Recommended Improvements, if any.

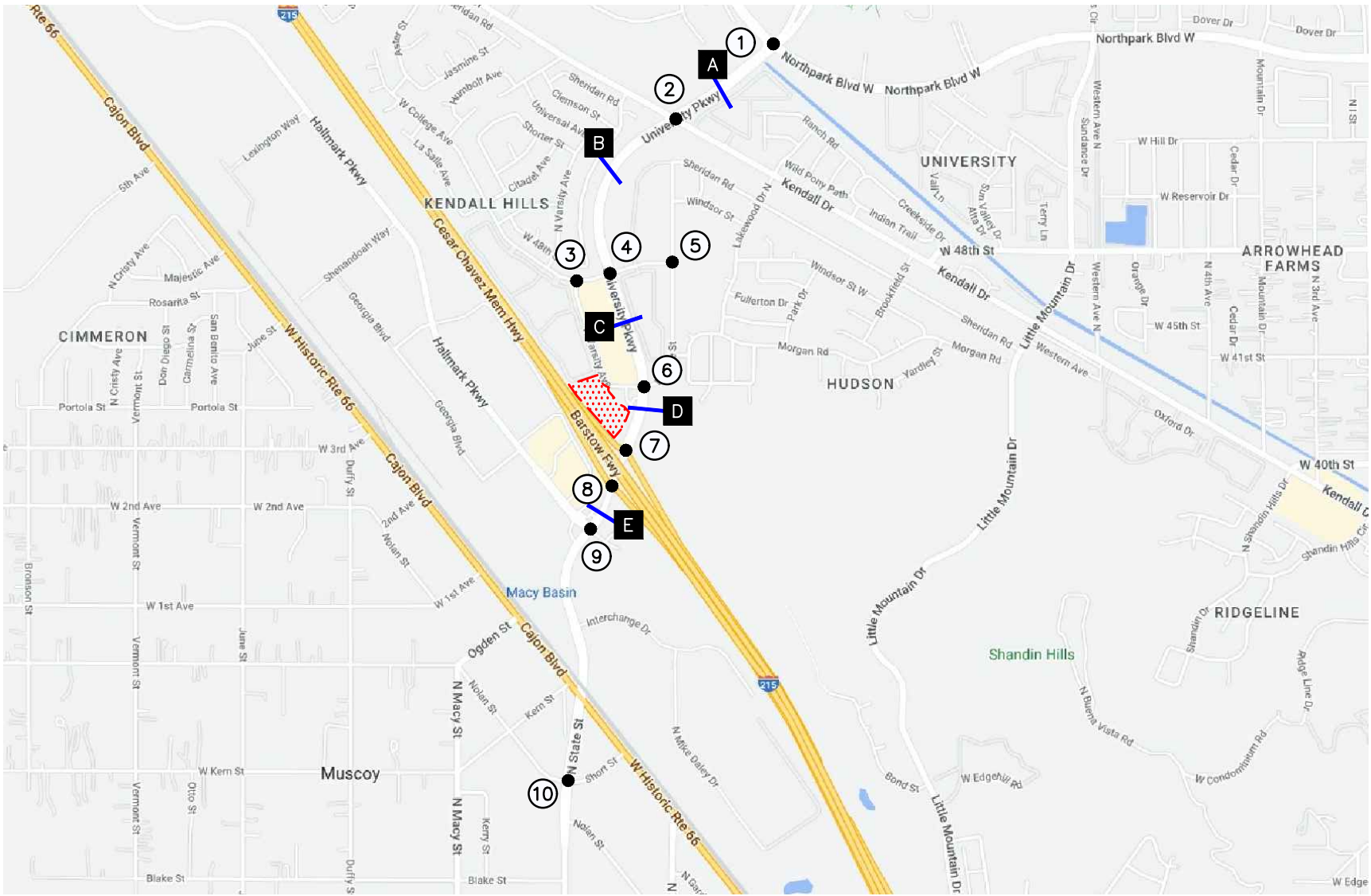

n:\4500\2224555 - 4400 varsity ave commercial center, san bernardino.dwg\4555 f1-1.dwg LDP 13:14:52 06-28-2022 kopulsky

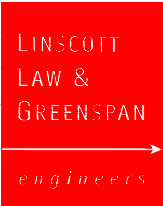

SOURCE: GOOGLE

KEY

- = STUDY INTERSECTION
- = STUDY ROADWAY SEGMENT
- = PROJECT SITE

FIGURE 1-1

VICINITY MAP

4400 VARSITY AVE COMMERCIAL CENTER, SAN BERNARDINO

2.0 PROJECT DESCRIPTION AND LOCATION

The proposed Project site is located at 4400 Varsity Avenue and is generally located on the southwest corner of University Parkway and Varsity Avenue in the City of San Bernardino, California. The proposed Project will consist of a 4,761 SF Chick-fil-A Restaurant with drive-through window (the drive-through will provide storage for 75 vehicles), a 5,137 SF automated carwash (1 wash tunnel; 21 vehicles of storage from the pay station), a 950 SF Dutch Brothers Coffee (the drive-through will provide storage for 33 vehicles) and a 3,610 SF fast food restaurant with drive-through window (the drive-through will provide storage for 12 vehicles). The proposed Project is anticipated to be completed by the Year 2024.

Figure 2-1 presents an aerial image of the existing site for the proposed Project. *Figure 2-2* presents the site plan for the proposed Project. Although not shown specifically on *Figure 2-2*, it should be noted that red curb with no parking signs will be installed along both sides of the project's main east-west drive aisle (i.e. located at the north end of the project site) between Varsity Avenue and University Parkway.

2.1 Site Access

Access to the proposed Project will be provided via two full access unsignalized driveways located along Varsity Avenue (i.e. Project Driveways No. 1 and No. 2) and via one right-turn in/right-turn out only driveway located along University Parkway (i.e. Project Driveway No. 3).



n:\4500\2224555 - 4400 varsity ave commercial center, san bernardino.dwg\4555 f2-1.dwg LDP 10:02:27 05-13-2022 aguilera

LINSCOTT
LAW &
GREENSPAN
engineers



NO SCALE

KEY

 = PROJECT SITE

FIGURE 2-1

EXISTING SITE AERIAL

4400 VARSITY AVE COMMERCIAL CENTER, SAN BERNARDINO

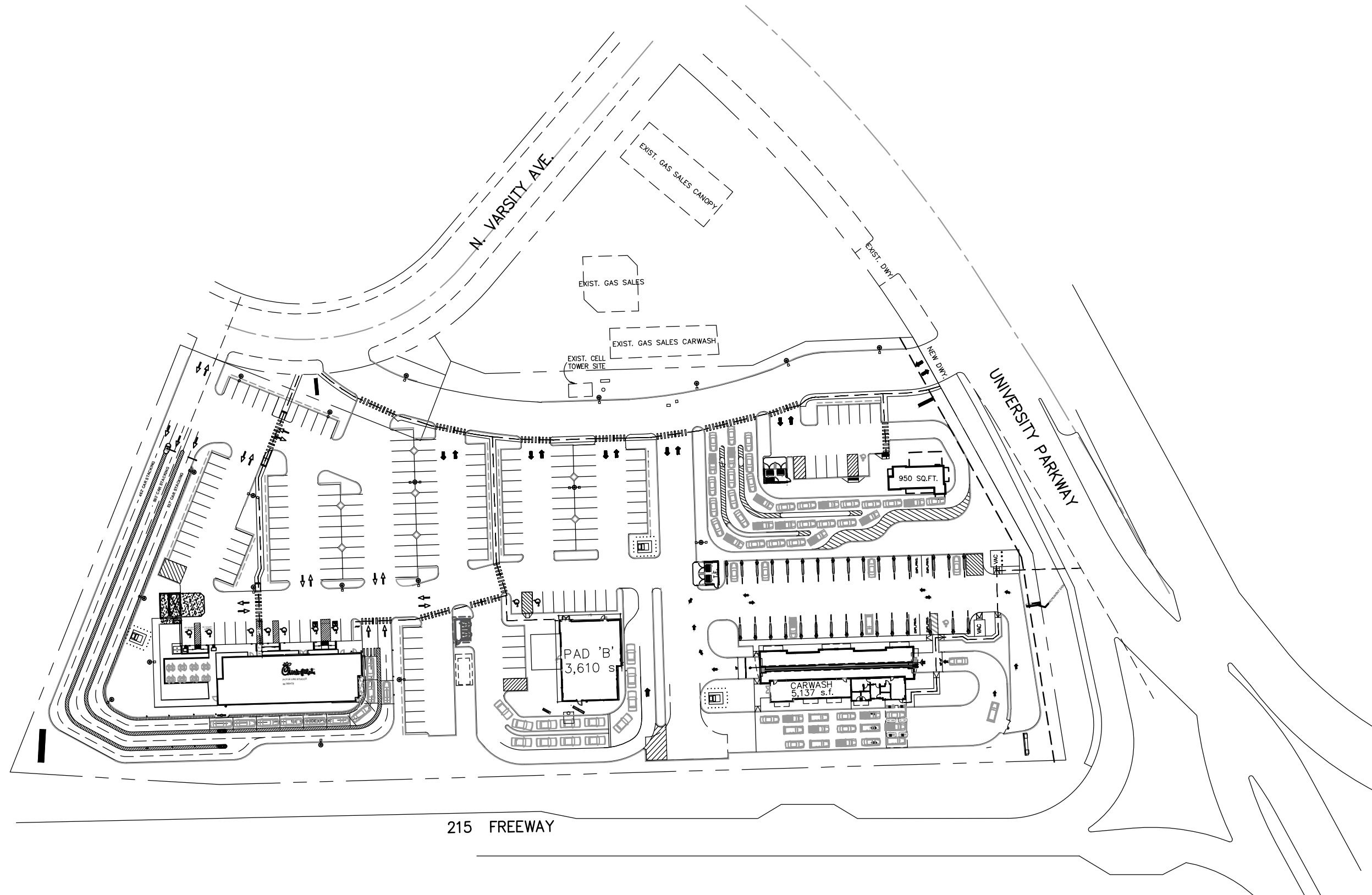

n:\miscellaneous\bases\autocad planning standards\11x17 landscape.dwg LDP 16:44:23 06-17-2020 agular

SOURCE: NADEL STUDIO ONE, INC.

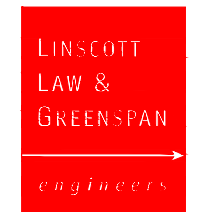

NO SCALE

FIGURE 2-2

PROPOSED SITE PLAN
4400 VARSITY AVE COMMERCIAL CENTER, SAN BERNARDINO

3.0 ANALYSIS CONDITIONS AND METHODOLOGY

3.1 Existing Street Network

Regional access to the project site is provided via the I-215 Freeway, which is located immediately south of the project site. The principal local network of streets serving the project site includes University Parkway and Varsity Avenue. The following discussion provides a brief synopsis of these key area streets.

University Parkway is generally a six-lane, divided roadway north of the I-215 Freeway and generally a four-lane, divided roadway south of the I-215 Freeway, oriented in the north-south direction that borders the project site to the east. The posted speed limit on University Parkway is 50 miles per hour (mph) within the vicinity of the Project. On-street parking is generally not permitted along either side of the roadway within the vicinity of the Project site. Traffic signals control the study intersections of University Parkway at Northpark Boulevard, Kendall Drive, College Avenue, Varsity Avenue/State Street, I-215 Northbound Ramps, I-215 Southbound Ramps, Hallmark Parkway and Nolan Street/Short Street. A traffic signal also controls the intersection of University Parkway and Interchange Drive. University Parkway is classified as a Major Arterial in the City of San Bernardino General Plan.

Varsity Avenue is generally a two-lane, undivided roadway, oriented in the north-south and east-west direction that borders a portion of the project site to the north. On-street parking is generally not permitted along either side of the roadway within the vicinity of the Project site. A traffic signal controls the study intersection of Varsity Avenue/State Street at University Parkway. The study intersection of Varsity Avenue at College Avenue is stop-controlled (Varsity Avenue approach has a stop sign). Varsity Avenue is classified as a Local Street in the City of San Bernardino General Plan.

Figure 3-1 presents an inventory of the existing roadway conditions within the study area evaluated in this report. The number of travel lanes and intersection controls for the key area study intersections are identified.

3.2 Existing Public Transit

OmniTrans operates several bus lines within the study area. A description of the transit services within the Project vicinity are as follows:

OmniTrans

sbX Green Line:

- The sbX Green Line provides service along the E Street Corridor, from Cal State University San Bernardino at the north to Loma Linda University & Medical Center at the south.
- Most notably, the sbX Green Line provides service to Cal State University San Bernardino and Loma Linda University & Medical Center.
- The route traverses the cities of San Bernardino and Loma Linda.

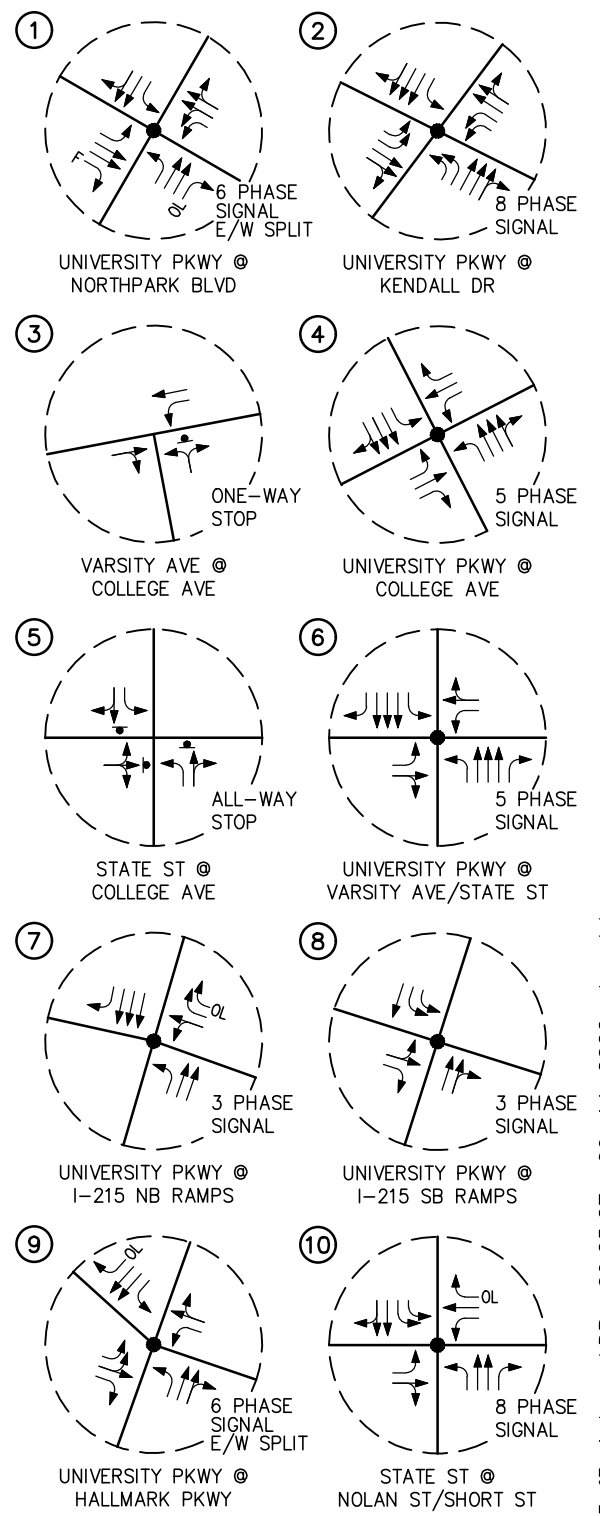
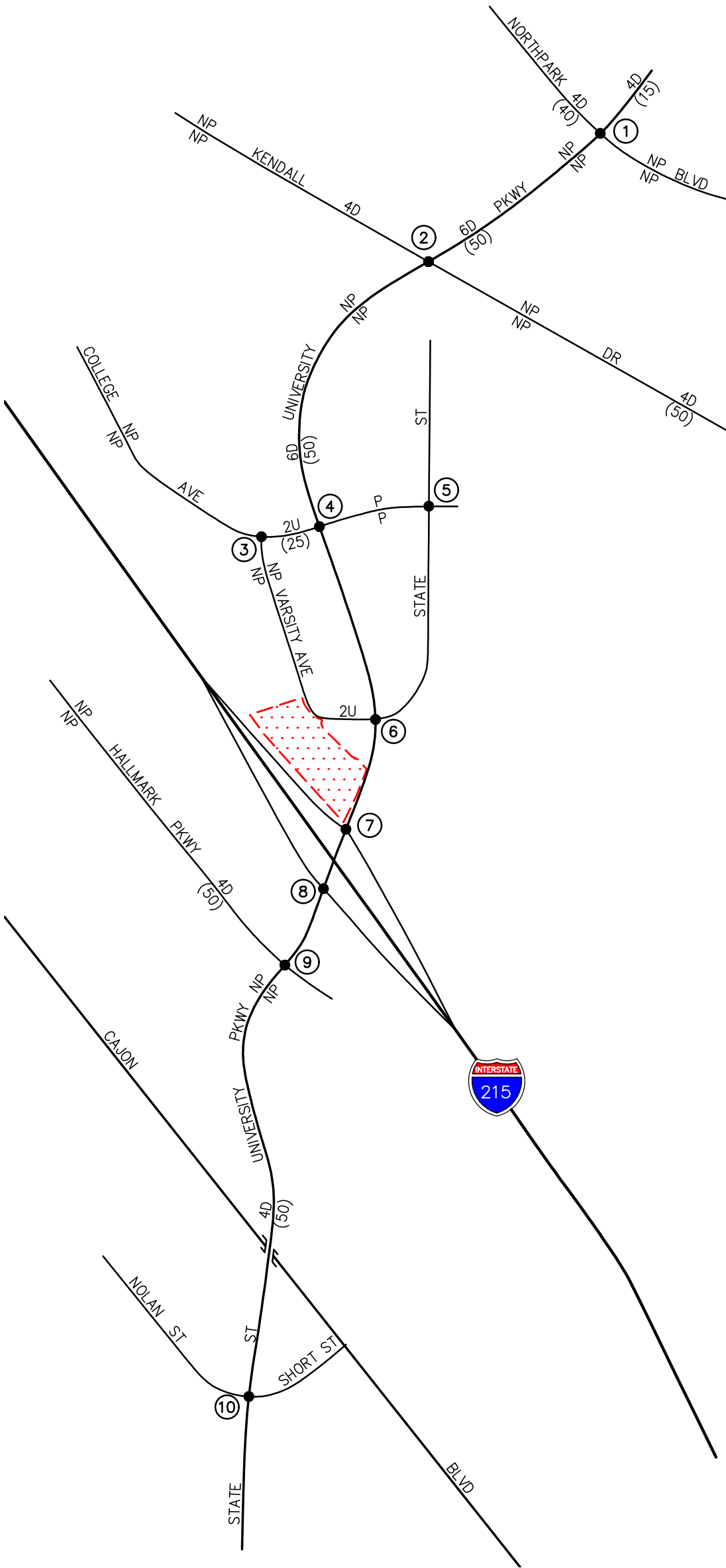

n:\4500\2224555 - 4400 varsity ave commercial center, san bernardino\dwg\4555 f3-1.dwg LDP 09:25:27 09-14-2022 kopulsky

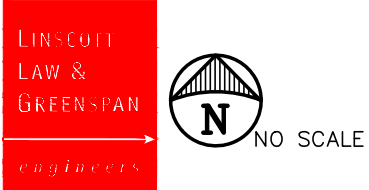

- KEY**
- ← = APPROACH LANE ASSIGNMENT
 - = TRAFFIC SIGNAL, ▣ = STOP SIGN
 - P = PARKING, NP = NO PARKING
 - U = UNDIVIDED, D = DIVIDED
 - 2 = NUMBER OF TRAVEL LANES
 - (XX) = POSTED SPEED LIMIT (MPH)
 - F = FREE-RIGHT
 - OL = OVERLAP
 - [Red Hatched Box] = PROJECT SITE

FIGURE 3-1

EXISTING ROADWAY CONDITIONS AND INTERSECTION CONTROLS

4400 VARSITY AVE COMMERCIAL CENTER, SAN BERNARDINO

- During the AM and PM peak hour, the sbX Green Line has approximate headways of 20-30 minutes in the northbound and southbound directions.

Route 2:

- Route 2 provides service from Cal State San Bernardino to Loma Linda via Kendall, E Street, Hospitality Lane, and Tippecanoe/Anderson.
- Most notably, Route 2 provides service to Cal State University San Bernardino and Loma Linda University & Medical Center.
- The route traverses the cities of San Bernardino and Loma Linda.
- During the AM and PM peak hour, Route 2 has approximate headways of 75 minutes in the northbound and southbound directions.

Route 6:

- Route 6 provides service from Cal State University San Bernardino to San Bernardino Transit Center; via 21st & Kenwood and 40th & Sierra Way.
- Most notably, Route 6 provides service Cal State University San Bernardino and San Bernardino Transit Center.
- The route traverses the city of San Bernardino.
- During the AM and PM peak hour, Route 6 has approximate headways of 60 minutes in the eastbound and westbound directions.

Route 312:

- Route 312 provides service from Cal State University San Bernardino to Fontana Metrolink Transit Center; via Linden & Renaissance Parkway and 16th & Medical Center.
- Most notably, Route 312 provides service to Cal State University San Bernardino and Fontana Metrolink Transit Center.
- The route traverses the cities of Fontana, Rialto, Muscoy, and San Bernardino.
- During the AM and PM peak hour, Route 312 has approximate headways of 60 minutes in the eastbound and westbound directions.

3.3 Bicycle and Pedestrian Facilities

The Federal and State transportation system recognizes three primary bikeway facilities: Bicycle Paths (Class I), Bicycle Lanes (Class II), and Bicycle Routes (Class III). Bicycle Paths (Class I) are exclusive car free facilities that are typically not located within a roadway area. Bicycle Lanes (Class II) are part of the street design that is dedicated only for bicycles and identified by a striped lane separating vehicle lanes from bicycle lanes. Bicycle Routes (Class III) are preferably located on collector and lower volume arterial streets. The following bicycle facilities are located within the vicinity of the project site.

- A Class II Bike Lane currently exists along University Parkway (i.e. on both sides of the street), north of Varsity Avenue/State Street. A Class II Bike Lane also currently exists along

Northpark Boulevard (i.e. on both sides of the street) and Kendall Drive (i.e. on both sides of the street), east and west of University Parkway.

Pedestrian connection to the surrounding commercial, residential, university developments, as well as nearby public transit stops, is provided via existing sidewalks along the Project frontage on University Parkway. Sidewalks are also existing along most streets within the Project vicinity and the project will construct sidewalk along the Project frontage on Varsity Avenue.

3.4 Existing Traffic Volumes

Ten (10) key study intersections and five (5) key roadway segments have been identified as the locations at which to evaluate existing and future traffic operating conditions. Some portion of potential project-related traffic will pass through each of these intersections/roadway segments, and their analysis will reveal the expected relative impacts of the project. These key intersections and roadway segments were selected for evaluation based on coordination with City of San Bernardino staff.

Existing daily, AM peak hour and PM peak hour traffic volumes for the ten (10) key study intersections and five (5) key roadway segments evaluated in this report were conducted by Counts Unlimited in August 2022, when local area schools were in session. **Figures 3-2** and **3-3** illustrate the existing AM and PM peak hour traffic volumes at the ten (10) key study intersections evaluated in this report, respectively. *Figure 3-3* also presents the existing average daily traffic volumes for the five (5) key roadway segments in the vicinity of the proposed Project.

Appendix B contains the detailed peak hour traffic count sheets for the key intersections and roadway segments evaluated in this report.

3.5 Level of Service (LOS) Analysis Methodologies

AM and PM peak hour operating conditions for the key study intersections were evaluated using the methodology outlined in *Chapter 19 of the Highway Capacity Manual 6 (HCM 6)* for signalized intersections, the methodology outlined in *Chapter 20 of the HCM 6* for two-way stop-controlled intersections and the methodology outlined in *Chapter 21 of the HCM 6* for all-way stop-controlled intersections.

It should be noted that *Synchro 11.0* does not report a V/C value for the HCM 6 methodology for signalized intersections. Therefore, the V/C values reported in this traffic analysis are referenced from the *Synchro 11.0* HCM 2000 methodology in order to be consistent with the City of San Bernardino's traffic impact criteria, which requires a V/C ratio. It should be further noted that the intersection of University Parkway at I-215 NB Ramps (i.e. key study intersection #7) currently operates with non-NEMA phasing due to the westbound right-turn overlap phasing for the I-215 NB off-ramp that stops the northbound through movement on University Parkway. *Synchro 11.0* does not calculate the HCM 6 methodology for non-NEMA phasing intersections. Therefore, HCM 2000 is reported for key study intersection #7.

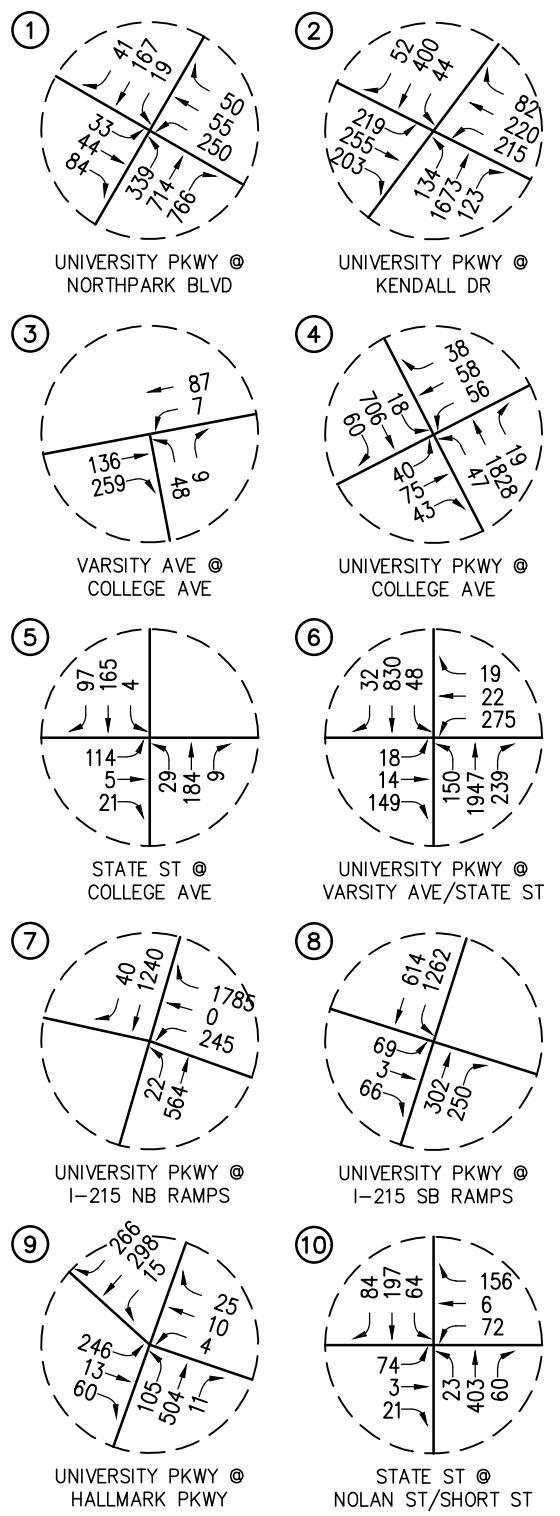
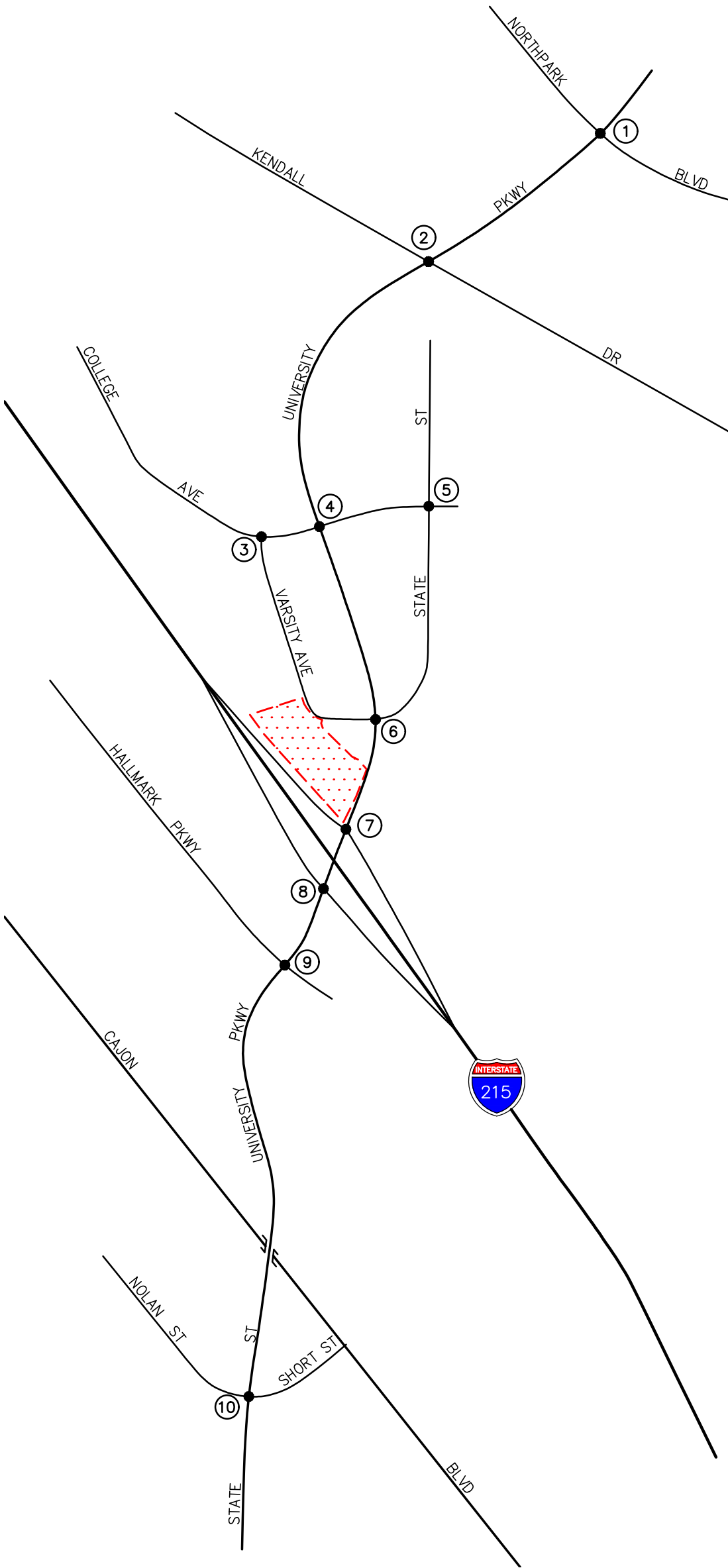

n:\4500\2224555 - 4400 varsity ave commercial center, san bernardino\dwg\4555 f3-2.dwg LDP 12:04:07 09-14-2022 kopulsky

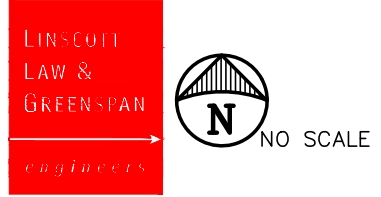

KEY
 # = STUDY INTERSECTION
 [Red Hatched Box] = PROJECT SITE

FIGURE 3-2

EXISTING AM PEAK HOUR TRAFFIC VOLUMES
 4400 VARSITY AVE COMMERCIAL CENTER, SAN BERNARDINO

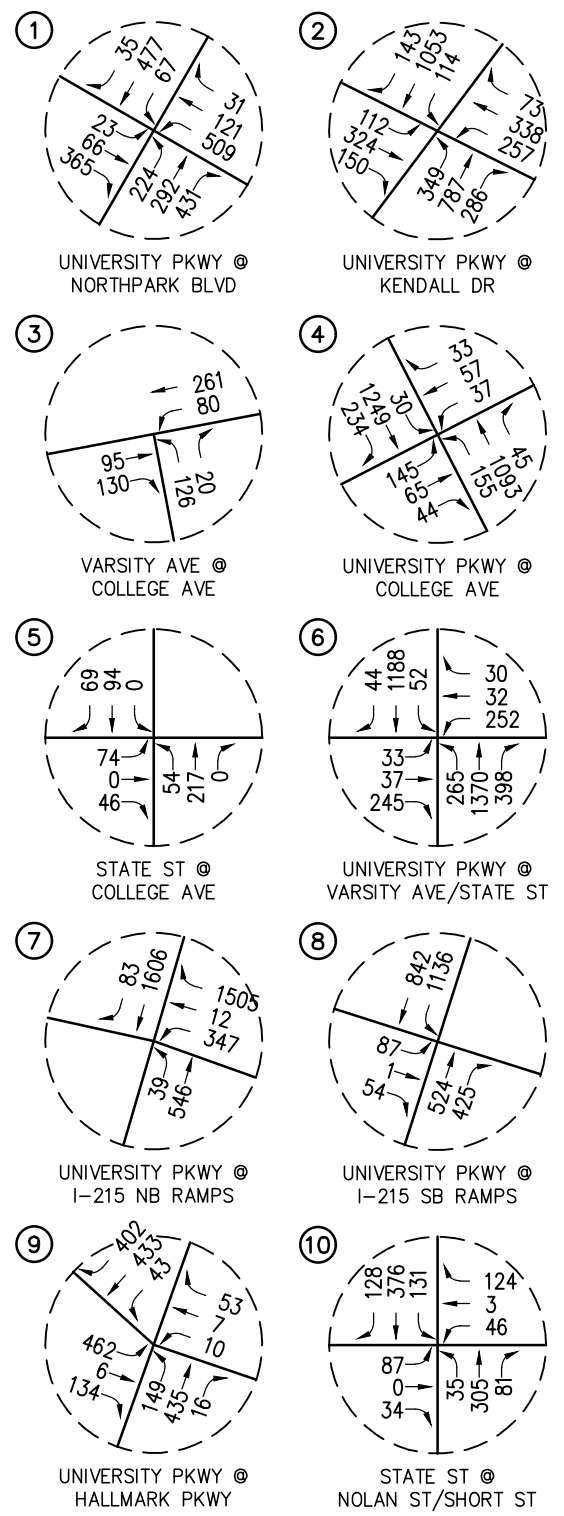
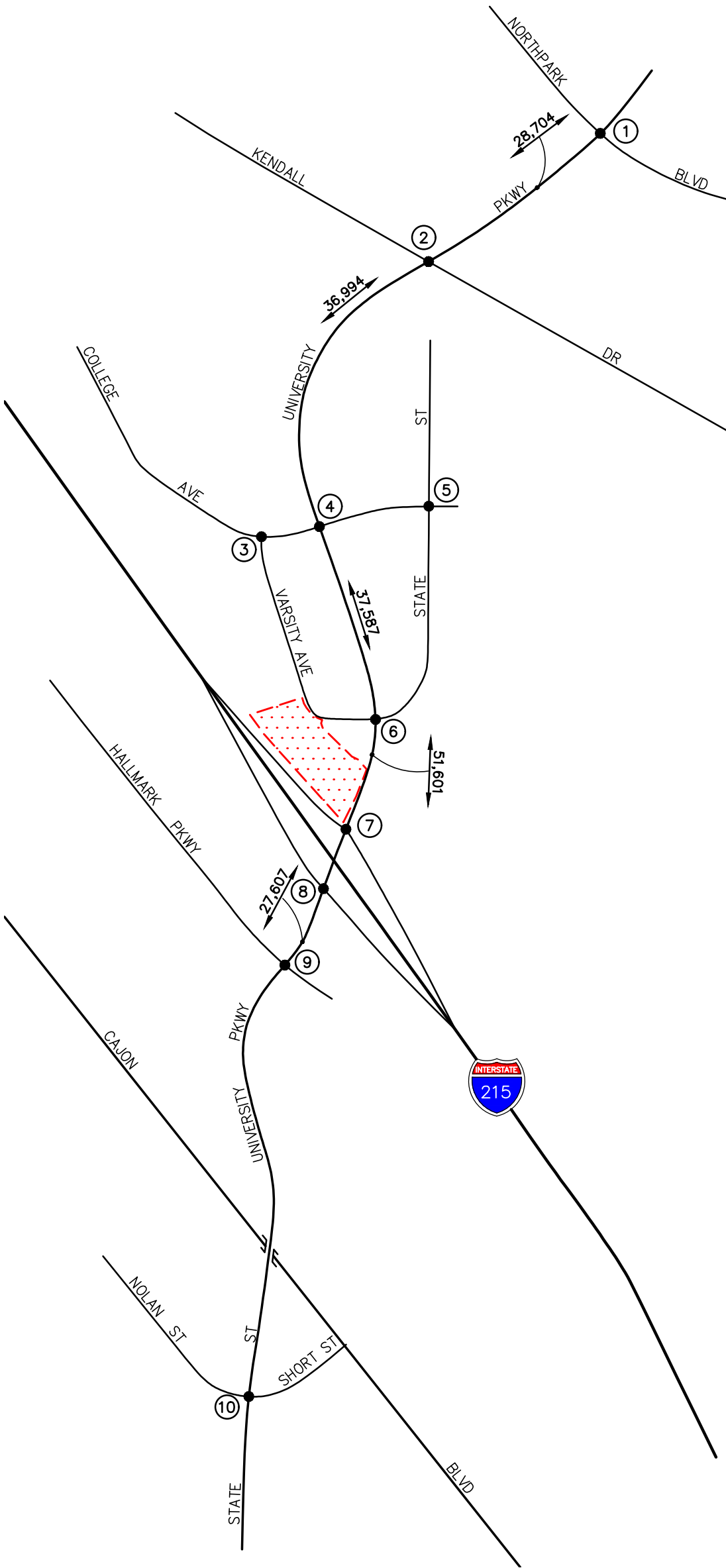

n:\4500\2224555 - 4400 varsity ave commercial center, san bernardino\dwg\4555 f3-3.dwg LDP 13:09:04 09-14-2022 kopulsky

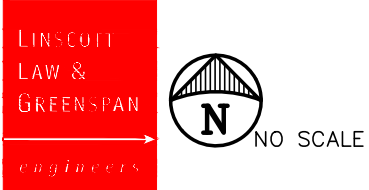

KEY
 # = STUDY INTERSECTION
 XX,XXX = DAILY TRAFFIC VOLUMES
 [Red Hatched Box] = PROJECT SITE

FIGURE 3-3
EXISTING PM PEAK HOUR
AND DAILY TRAFFIC VOLUMES

4400 VARSITY AVE COMMERCIAL CENTER, SAN BERNARDINO

3.5.1 Highway Capacity Manual 6 (HCM 6) Method of Analysis (Signalized Intersections)

Based on the HCM operations method of analysis, level of service for signalized intersections and approaches is defined in terms of control delay, which is a measure of the increase in travel time due to traffic signal control, driver discomfort and fuel consumption. Control delay includes the delay associated with vehicles slowing in advance of an intersection, the time spent stopped on an intersection approach, the time spent as vehicles move up in the queue and the time needed for vehicles to accelerate to their desired speed. LOS criteria for traffic signals are stated in terms of the control delay in seconds per vehicle. The LOS thresholds established for the automobile mode at a signalized intersection are shown in *Table 3-1*.

3.5.2 Highway Capacity Manual 6 (HCM 6) Method of Analysis (Unsignalized Intersections)

The HCM unsignalized methodology for stop-controlled intersections was utilized for the analysis of the unsignalized intersections. LOS criteria for unsignalized intersections differ from LOS criteria for signalized intersections as signalized intersections are designed for heavier traffic and therefore a greater delay. Unsignalized intersections are also associated with more uncertainty for users, as delays are less predictable, which can reduce users' delay tolerance.

3.5.2.1 Two-Way Stop-Controlled Intersections

Two-way stop-controlled intersections are comprised of a major street, which is uncontrolled and a minor street, which is controlled by stop signs. Level of service for a two-way stop-controlled intersection is determined by the computed or measured control delay. The control delay by movement, by approach and for the intersection as a whole is estimated by the computed capacity for each movement. LOS is determined for each minor-street movement (or shared movement) as well as major-street left turns. The worst side street approach delay is reported. LOS is not defined for the intersection as a whole or for major-street approaches, as it is assumed that major-street through vehicles experience zero delay. The HCM control delay value ranges for two-way stop-controlled intersections are shown in *Table 3-2*.

3.5.2.2 All-Way Stop-Controlled Intersections

All-way stop-controlled intersections require every vehicle to stop at the intersection before proceeding. Because each driver must stop, the decision to proceed into the intersection is a function of traffic conditions on the other approaches. The time between subsequent vehicle departures depends on the degree of conflict that results between the vehicles and vehicles on the other approaches. This methodology determines the control delay for each lane on the approach, computes a weighted average for the whole approach and computes a weighted average for the intersection as a whole. Level of service (LOS) at the approach and intersection levels is based solely on control delay. The HCM control delay value ranges for all-way stop-controlled intersections are shown in *Table 3-2*.

3.5.3 Volume to Capacity (V/C) Ratio Method of Analysis (Roadway Segments)

Daily operating conditions for the key study roadway segments have been investigated according to the Volume to Capacity (V/C) ratio of each roadway segment. The V/C relationship is used to estimate the LOS of the roadway segment with the volume based on the 24-hour traffic volumes and

the capacity based on the City’s classification of each roadway. The six qualitative categories of Level of Service have been defined along with the corresponding Volume to Capacity (V/C) value range and are shown in **Table 3-3**. The roadway segments’ daily capacities of each street classification according to the *City of San Bernardino General Plan Appendix 14* are presented in **Table 3-4**.

Although the arterial segment V/C analysis provides a general assessment of overall system performance, the performance is measured on the ability to serve peak hour traffic demands. To identify deficient arterial segments, the segments that are identified as deficient under daily conditions are evaluated under peak hour conditions to evaluate the capability of serving forecast peak hour throughput. Arterial segments that operate deficiently under peak hour conditions are candidates for improvements.

3.6 Impact Criteria and Thresholds

3.6.1 Intersections

According to the *City of San Bernardino Traffic Impact Analysis Guidelines*, dated August 2020, LOS D is the minimum acceptable condition that should be maintained during the peak commute hours. Therefore, any intersection operating at LOS E or LOS F is considered deficient/unsatisfactory.

- For signalized intersections, intersection operations are considered to be deficient when any of the following changes in the volume to capacity (V/C) ratios occur between the “without project” and the “with project” conditions:

<u>LOS Without Project</u>	<u>V/C Difference</u>
C	> 0.0400
D	> 0.0200
E, F	> 0.0100

Given that the City of San Bernardino does not have specific impact criteria for unsignalized intersections, this report defines the following impact criteria for unsignalized intersections.

- An unsignalized intersection is considered to be deficient if the project causes an intersection at LOS D or better to degrade to LOS E or LOS F, and the traffic signal warrant analysis determines that a traffic signal is justified.

3.6.2 Roadway Segments

The City of San Bernardino considers LOS C to be the minimum acceptable LOS for all roadway segments. Given that the City of San Bernardino does not have specific impact criteria for roadway segments, this report defines the following impact criteria for roadway segments.

- A roadway segment is deemed to have a significant impact if the project results in deterioration of the daily LOS to an unacceptable LOS (i.e. LOS D, E, or F) coupled with a continued deficiency under peak hour conditions.

**TABLE 3-1
LEVEL OF SERVICE CRITERIA FOR SIGNALIZED INTERSECTIONS (HCM 6 METHODOLOGY)¹**

Level of Service (LOS)	Control Delay Per Vehicle (seconds/vehicle)	Level of Service Description
A	≤ 10.0	This level of service occurs when progression is extremely favorable and most vehicles arrive during the green phase. Most vehicles do not stop at all. Short cycle lengths may also contribute to low delay.
B	> 10.0 and ≤ 20.0	This level generally occurs with good progression, short cycle lengths, or both. More vehicles stop than with LOS A, causing higher levels of average delay.
C	> 20.0 and ≤ 35.0	Average traffic delays. These higher delays may result from fair progression, longer cycle lengths, or both. Individual cycle failures may begin to appear at this level. The number of vehicles stopping is significant at this level, though many still pass through the intersection without stopping.
D	> 35.0 and ≤ 55.0	Long traffic delays At level D, the influence of congestion becomes more noticeable. Longer delays may result from some combination of unfavorable progression, long cycle lengths, or high v/c ratios. Many vehicles stop and the proportion of vehicles not stopping declines. Individual cycle failures are noticeable.
E	> 55.0 and ≤ 80.0	Very long traffic delays This level is considered by many agencies to be the limit of acceptable delay. These high delay values generally indicate poor progression, long cycle lengths and high v/c ratios. Individual cycle failures are frequent occurrences.
F	≥ 80.0	Severe congestion This level, considered to be unacceptable to most drivers, often occurs with over saturation, that is, when arrival flow rates exceed the capacity of the intersection. It may also occur at high v/c ratios below 1.0 with many individual cycle failures. Poor progression and long cycle lengths may also be major contributing factors to such delay levels.

¹ Source: *Highway Capacity Manual 6*, Chapter 19: Signalized Intersections.

TABLE 3-2

LEVEL OF SERVICE CRITERIA FOR UNSIGNALIZED INTERSECTIONS (HCM 6 METHODOLOGY)^{2,3}

Level of Service (LOS)	Highway Capacity Manual (HCM) Delay Per Vehicle (seconds/vehicle)	Level of Service Description
A	≤ 10.0	Little or no delay
B	> 10.0 and ≤ 15.0	Short traffic delays
C	> 15.0 and ≤ 25.0	Average traffic delays
D	> 25.0 and ≤ 35.0	Long traffic delays
E	> 35.0 and ≤ 50.0	Very long traffic delays
F	> 50.0	Severe congestion

² Source: *Highway Capacity Manual 6*, Chapter 20: Two-Way Stop-Controlled Intersections. The LOS criteria apply to each lane on a given approach and to each approach on the minor street. LOS is not calculated for major-street approaches or for the intersection as a whole.

³ Source: *Highway Capacity Manual 6*, Chapter 21: All-Way Stop-Controlled Intersections. For approaches and intersection-wide assessment, LOS is defined solely by control delay.

TABLE 3-3
LEVEL OF SERVICE CRITERIA FOR ROADWAY SEGMENTS (V/C METHODOLOGY)⁴

Level of Service (LOS)	Volume to Capacity Ratio (V/C)	Level of Service Description
A	≤ 0.600	EXCELLENT. Describes primarily free flow operations at average travel speeds, usually about 90% of the free flow speed for the arterial class. Vehicles are completely unimpeded in their ability to maneuver within the traffic stream. Stopped delay at signalized intersections is minimal.
B	0.601 – 0.700	VERY GOOD. Represents reasonably unimpeded operations at average travel speeds, usually about 70% of the free flow speed for the arterial class. The ability to maneuver within the traffic stream is only slightly restricted and stopped delays are not bothersome. Drivers are not generally subjected to appreciable tension.
C	0.701 – 0.800	GOOD. Represents stable conditions; however, ability to maneuver and change lanes in mid-block location may be more restricted than in LOS B, and longer queues and/or adverse signal coordination may contribute to lower average travel speeds of about 50% of the average free flow speed for the arterial class. Motorists will experience appreciable tension while driving.
D	0.801 – 0.900	FAIR. Borders on a range in which small increases in flow may cause substantial increases in approach delay and, hence, decreases in arterial speed. This may be due to adverse signal progression, inappropriate signal timing, high volumes, or some combination of these. Average travel speeds are about 40% of free flow speed.
E	0.901 – 1.000	POOR. Characterized by significant approach delays and average travel speeds of one-third the free flow speed or lower. Such operations are caused by some combination of adverse progression, high signal density, extensive queuing at critical intersections, and inappropriate signal timing.
F	> 1.000	FAILURE. Characterizes arterial flow at extremely low speeds below one-third to one-quarter of the free flow speed. Intersection congestion is likely at critical signalized locations, with resultant high approach delays. Adverse progression is frequently a contributor to this condition.

⁴ Source: *Transportation Research Board (TRB) 2000.*

**TABLE 3-4
DAILY ROADWAY SEGMENT CAPACITIES⁵**

Roadway Classification	Maximum Two-Way Traffic Volume (ADT) Level of Service
6-lane Major Arterial	60,000
4-lane Major Arterial	40,000
2-lane Major Arterial	15,000
4-lane Secondary Arterial	30,000
2-lane Secondary Arterial	12,000
4-lane Collector Street	25,000
2-lane Collector Street	10,000

⁵ Source: *City of San Bernardino General Plan, Appendix 14.*

4.0 TRAFFIC FORECASTING METHODOLOGY

In order to estimate the traffic impact characteristics of the Project, a multi-step process has been utilized. The first step is traffic generation, which estimates the total arriving and departing traffic on a peak hour and daily basis. The traffic generation potential is forecast by applying the appropriate vehicle trip generation equations and/or rates to the Project development tabulation.

The second step of the forecasting process is traffic distribution, which identifies the origins and destinations of inbound and outbound Project traffic. These origins and destinations are typically based on demographics and existing/expected future travel patterns in the study area.

The third step is traffic assignment, which involves the allocation of Project traffic to study area streets and intersections. Traffic assignment is typically based on minimization of travel time, which may or may not involve the shortest route, depending on prevailing operating conditions and travel speeds.

Traffic distribution patterns are indicated by general percentage orientation, while traffic assignment allocates specific volume forecasts to individual roadway segments and intersection turning movements throughout the study area.

With the forecasting process complete and Project traffic assignments developed, the impact of the Project is isolated by comparing operational (LOS) conditions at selected key intersections using expected future traffic volumes with and without forecast Project traffic. If necessary, the need for site-specific and/or cumulative local area improvements can then be evaluated.

5.0 PROJECT TRAFFIC CHARACTERISTICS

5.1 Project Trip Generation Forecast

Traffic generation is expressed in vehicle trip ends, defined as one-way vehicular movements, either entering or exiting the generating land use. Generation equations and/or rates used in the traffic forecasting procedure are found in the 11th Edition of *Trip Generation*, published by the Institute of Transportation Engineers (ITE) [Washington D.C., 2021].

Table 5-1 summarizes the trip generation rates used in forecasting the vehicular trips generated by the proposed Project and presents the forecast daily and peak hour project traffic volumes for a “typical” weekday. As shown in the upper portion of **Table 5-1**, the trip generation potential of the proposed Project has been estimated using ITE Land Use 934: Fast-Food Restaurant with Drive-Through Window trip rates, ITE Land Use 937: Coffee/Donut Shop with Drive-Through Window trip rates and ITE Land Use 948: Automated Car Wash trip rates.

A review of the last row of **Table 5-1** indicates that the proposed Project is forecast to generate approximately 3,896 daily trips, with 285 trips (145 inbound, 140 outbound) produced in the AM peak hour and 211 trips (108 inbound, 103 outbound) produced in the PM peak hour on a “typical” weekday. It should be noted that the aforementioned overall trip generation includes adjustments for pass-by per the *Trip Generation Manual, 11th Edition*, published by ITE, to account for trips that are already in the everyday traffic stream on the adjoining streets (i.e. University Parkway, Varsity Avenue) and will stop as they pass by the Project site as a matter of convenience on their path to another destination. The pass-by reduction factors utilized are summarized in the footnotes of **Table 5-1**. It should also be noted that the trip generation methodology and forecasts were approved by City of San Bernardino staff prior to proceeding with further analysis.

5.2 Project Trip Distribution and Assignment

The Project directional trip distribution pattern is presented in **Figure 5-1**. Project traffic volumes both entering and exiting the site have been distributed and assigned to the adjacent street system based on the following considerations:

- the site's proximity to major traffic carriers (i.e. University Parkway, I-215 Freeway, etc.),
- expected localized traffic flow patterns based on adjacent street channelization and presence of traffic signals, and
- ingress/egress availability at the Project site.

It should be noted that the Project trip distribution pattern was submitted to City staff for their review and approval prior to proceeding with further analyses.

The anticipated AM and PM peak hour Project traffic volumes at the ten (10) key study intersections are presented in **Figures 5-2** and **5-3**, respectively. **Figure 5-3** also presents the daily Project traffic volumes. The traffic volume assignments presented in the above-mentioned figures reflect the Project trip distribution characteristics shown in **Figure 5-1** and the Project trip generation forecast presented in the **Table 5-1**.

**TABLE 5-1
PROJECT TRIP GENERATION RATES AND FORECAST⁶**

ITE Land Use Code / Project Description	Daily 2-Way	AM Peak Hour			PM Peak Hour		
		Enter	Exit	Total	Enter	Exit	Total
<u>Generation Rates:</u>							
▪ 934: Fast Food Restaurant With Drive-Through Window (TE/TSF)	467.48	51%	49%	44.61	52%	48%	33.03
▪ 937: Coffee/Donut Shop With Drive-Through Window (TE/TSF)	533.57	51%	49%	85.88	50%	50%	38.99
▪ 948: Automated Car Wash (TE/Car Wash Tunnel) [a]	775.00	50%	50%	77.50	50%	50%	77.50
<u>Proposed Project Generation Forecast:</u>							
▪ Chick-fil-A (4,761 SF)	2,226	108	104	212	82	75	157
Pass-By (Daily: 25%, AM: 50%, PM: 55%) ⁷	<u>-557</u>	<u>-54</u>	<u>-52</u>	<u>-106</u>	<u>-45</u>	<u>-41</u>	<u>-86</u>
Subtotal	1,669	54	52	106	37	34	71
▪ Automated Car Wash (1 Wash Tunnel)	775	39	39	78	39	39	78
Pass-By (Daily: 25%, AM: 25%, PM: 25%) ⁷	<u>-194</u>	<u>-10</u>	<u>-10</u>	<u>-20</u>	<u>-10</u>	<u>-10</u>	<u>-20</u>
Subtotal	581	29	29	58	29	29	58
▪ Dutch Brothers Coffee (950 SF)	507	42	40	82	19	18	37
Pass-By (Daily: 25%, AM: 50%, PM: 25%) ⁷	<u>-127</u>	<u>-21</u>	<u>-20</u>	<u>-41</u>	<u>-5</u>	<u>-4</u>	<u>-9</u>
Subtotal	380	21	20	41	14	14	28
▪ Fast Food Restaurant with Drive Through (3,610 SF)	1,688	82	79	161	62	57	119
Pass-By (Daily: 25%, AM: 50%, PM: 55%) ⁷	<u>-422</u>	<u>-41</u>	<u>-40</u>	<u>-81</u>	<u>-34</u>	<u>-31</u>	<u>-65</u>
Subtotal	1,266	41	39	80	28	26	54
Total Gross Proposed Project Trip Generation Forecast	5,196	271	262	533	202	189	391
Total Pass-by	-1,300	-126	-122	-248	-94	-86	-180
Total Net Proposed Project Trip Generation Forecast	3,896	145	140	285	108	103	211

Note:

[a] = Trip Generation, 11th Edition does not provide daily and AM peak hour trip rates for ITE Land Use 948: Automated Car Wash. As such, the daily rate was assumed to be ten times the PM peak hour rate and the AM peak hour rate was assumed to be identical to the PM peak hour rate to provide a conservative trip generation forecast for this project component.

⁶ Source: Trip Generation, 11th Edition, Institute of Transportation Engineers, (ITE) [Washington, D.C. (2021)].

⁷ Pass-By Trips are trips made as intermediate stops on the way from an origin to a primary trip destination. Pass-by trips are attracted from traffic passing the site on adjacent streets, which contain direct access to the generator. For this analysis, the following pass-by reduction factors were used (Source: Trip Generation Manual, 11th Edition, ITE 2021):

- 934: Fast Food Restaurant With Drive-Through Window: Daily/AM peak hour/PM peak hour – 25% (assumed)/50%/55%
- 948: Automated Car Wash: Daily/AM peak hour/PM peak hour – 25% (assumed)/25% (assumed)/25% (assumed)
- 937: Coffee/Donut Shop With Drive-Through Window: Daily/AM peak hour/PM peak hour – 25% (assumed)/50% (assumed)/25% (assumed)

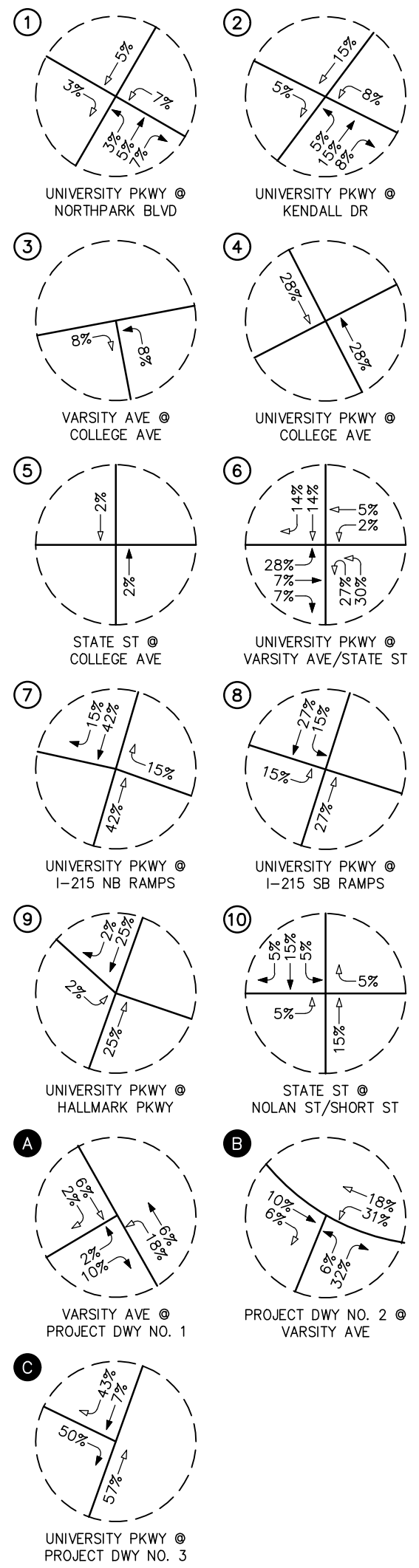
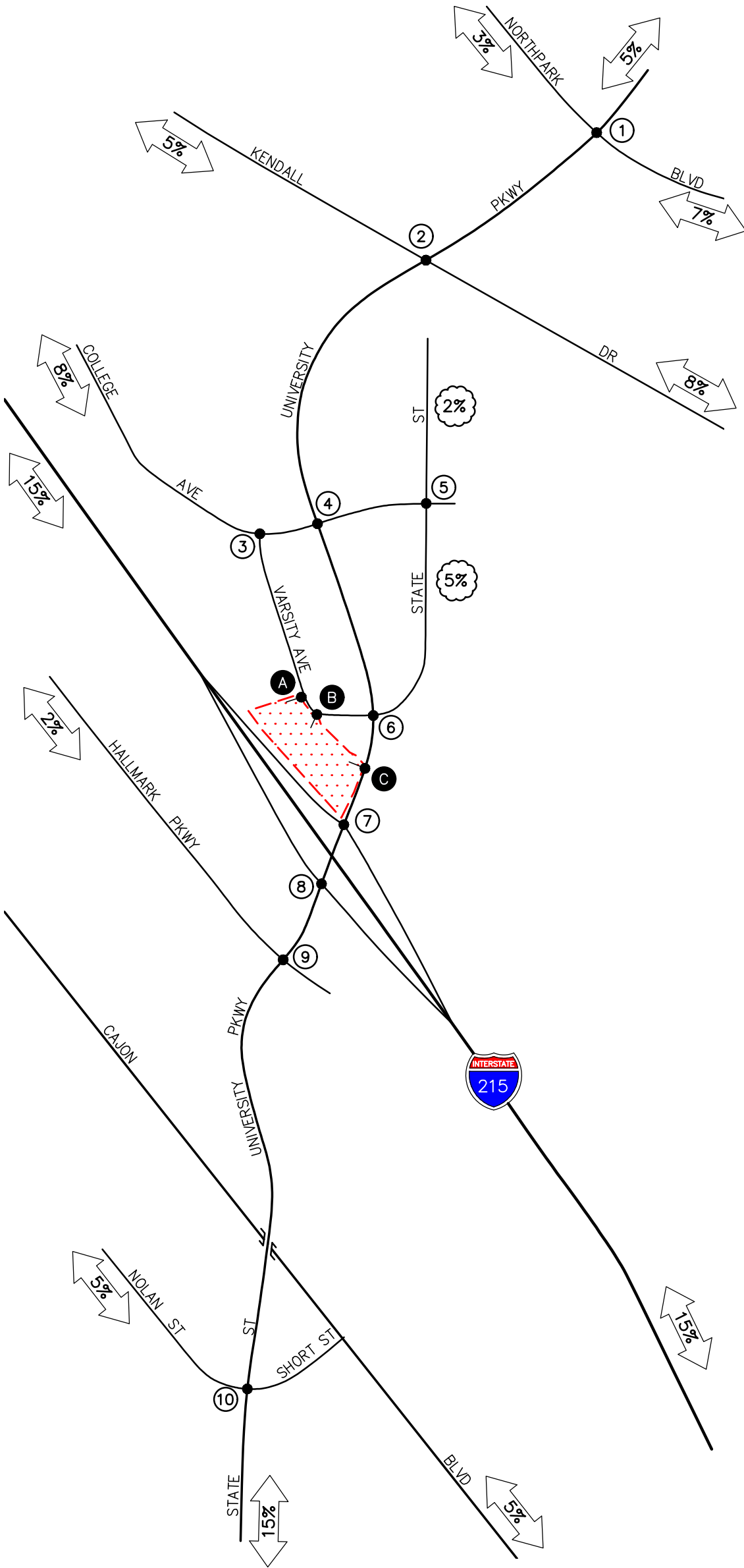

n:\4500\2224555 - 4400 varsity ave commercial center, san bernardino\dwg\4555 f5-1.dwg LDP 11:19:52 05-19-2022 aguilera

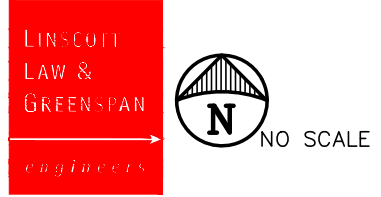

KEY
 # = STUDY INTERSECTION
 ← = INBOUND PERCENTAGE
 → = OUTBOUND PERCENTAGE
 [Red Hatched] = PROJECT SITE

FIGURE 5-1

PROJECT TRAFFIC DISTRIBUTION PATTERN

4400 VARSITY AVE COMMERCIAL CENTER, SAN BERNARDINO

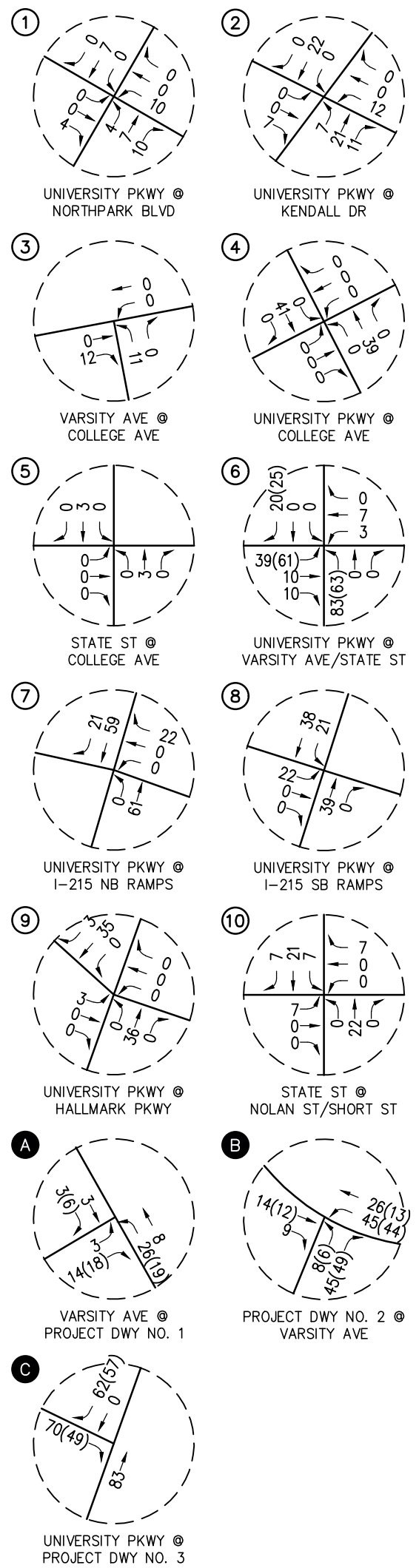
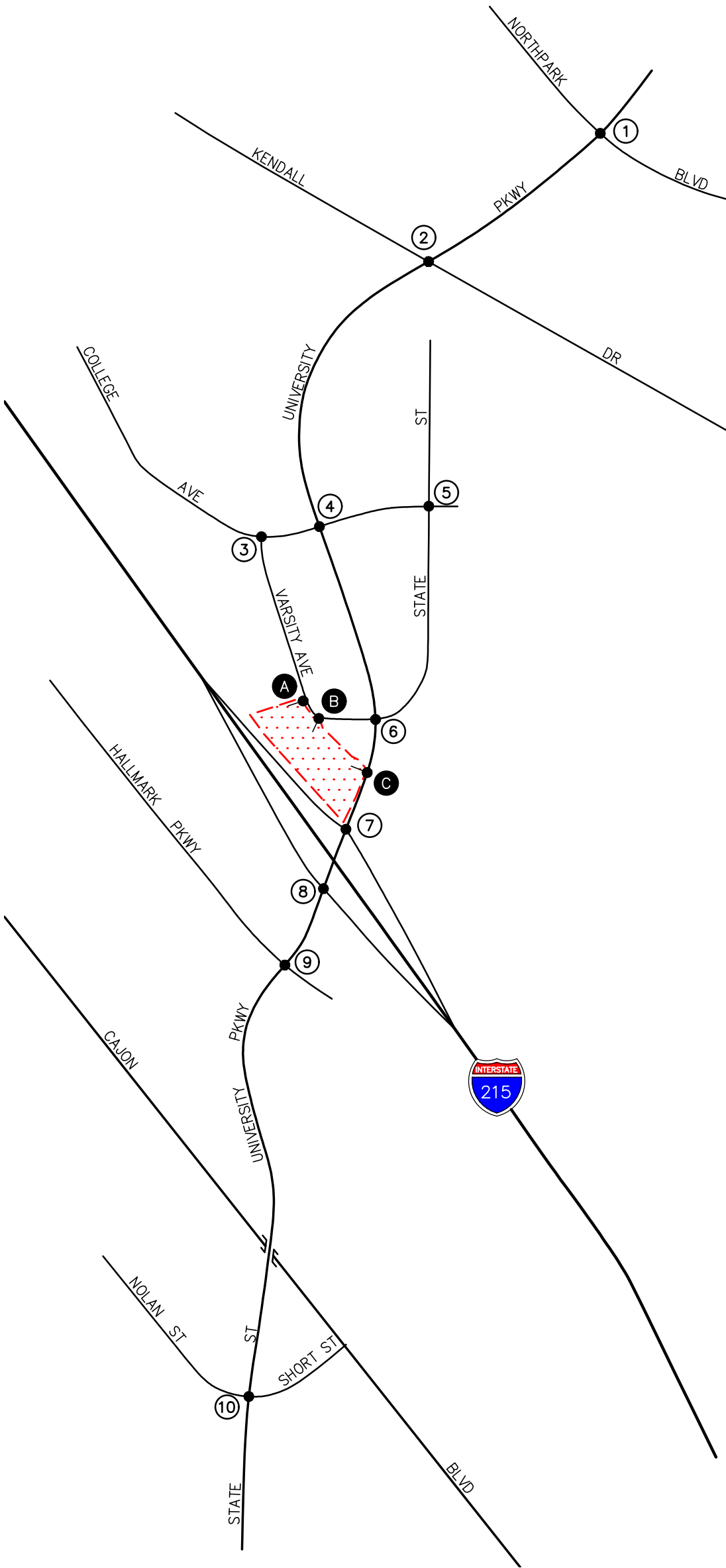

n:\4500\2224555 - 4400 varsity ave commercial center, san bernardino\dwg\4555 f5-2.dwg LDP 10:42:30 09-23-2022 kopulsky

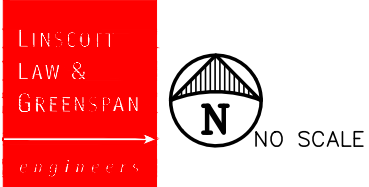

KEY

① = STUDY INTERSECTION

(XX) = PASS-BY TRIPS

[Hatched Box] = PROJECT SITE

FIGURE 5-2

AM PEAK HOUR PROJECT TRAFFIC VOLUMES
4400 VARSITY AVE COMMERCIAL CENTER, SAN BERNARDINO

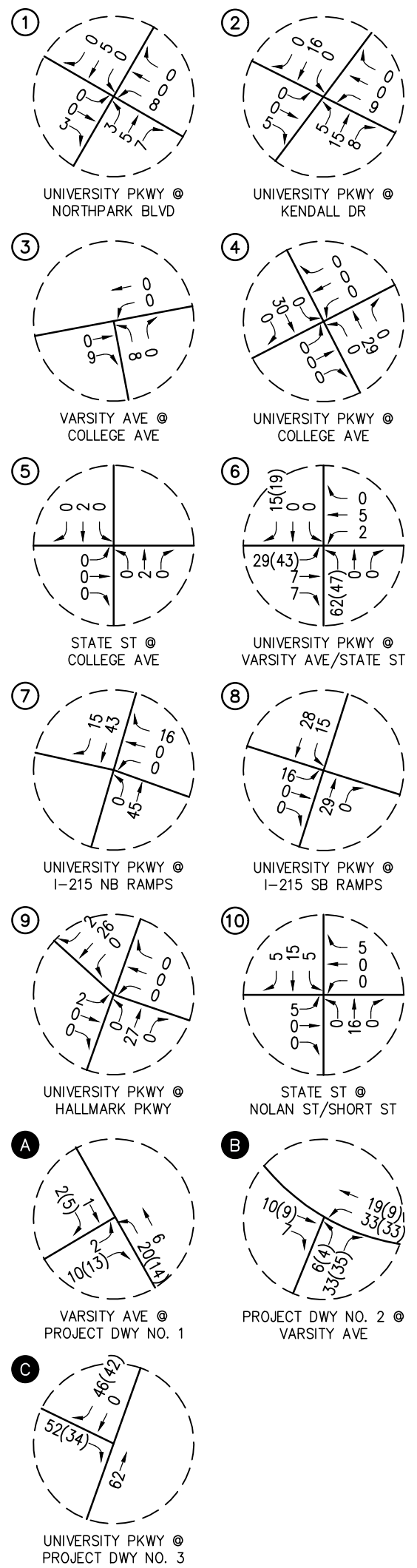
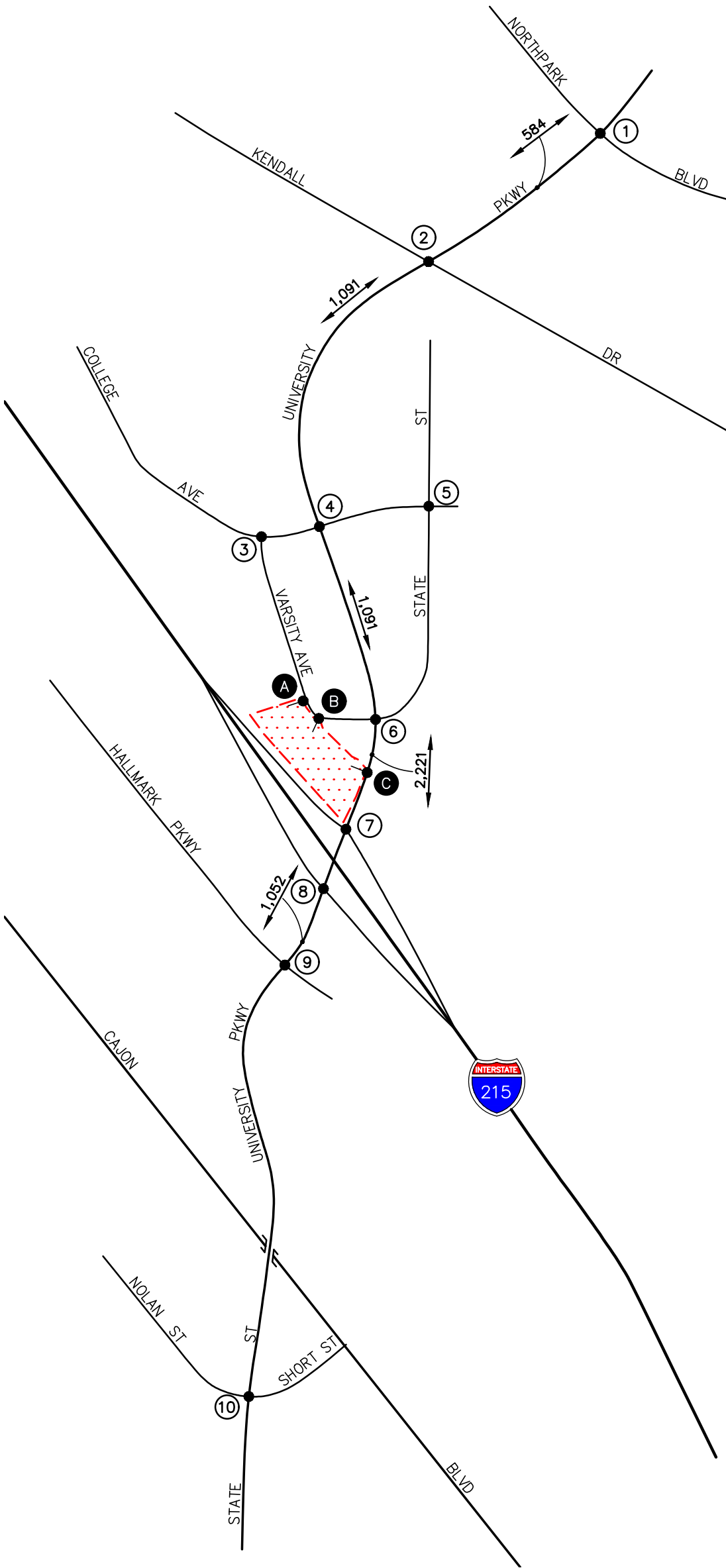

n:\4500\2224555 - 4400 varsity ave commercial center, san bernardino\dwg\4555 f5-3.dwg LDP 09:48:10 09-23-2022 besa

6.0 FUTURE TRAFFIC CONDITIONS

6.1 Existing With Project Traffic Volumes

The estimates of Project generated traffic volumes were added to the Existing traffic conditions to develop traffic projections for Existing With Project traffic conditions. *Figures 6-1* and *6-2* present the anticipated AM and PM peak hour Existing With Project traffic volumes, respectively, at the ten (10) key study intersections. *Figure 6-2* also presents the Existing With Project daily traffic volumes at the five (5) key study roadway segments.

6.2 Year 2024 Without Project Traffic Volumes

6.2.1 Ambient Growth Traffic

Near-term horizon year, traffic growth estimates have been calculated using an ambient growth factor. The ambient growth factor is intended to include unknown and future cumulative projects in the study area, as well as account for regular growth in traffic volumes due to the development of projects outside the study area. The application of the three percent (3.0%) annual growth rate to baseline traffic volumes results in a six percent (6.0%) growth in existing baseline volumes at the ten (10) key study intersections and five (5) key roadway segments to horizon Year 2024.

6.2.2 Cumulative Projects Traffic

In order to make a realistic estimate of future on-street conditions prior to implementation of the proposed Project, the status of other known development projects (cumulative projects) in the vicinity of the proposed Project has been researched at the City of San Bernardino and the County of San Bernardino. With this information, the potential impact of the proposed Project can be evaluated within the context of the cumulative impact of all ongoing development. Based on our research, there are five (5) cumulative projects in the City of San Bernardino and four (4) cumulative projects in the County of San Bernardino within the vicinity of the Project site. These nine (9) planned and/or approved cumulative projects have been included as part of the cumulative background setting. The locations of the nine (9) cumulative projects are presented in *Figure 6-3*.

Table 6-1 presents the jurisdiction, description, and development totals for each of the nine (9) cumulative projects. *Table 6-2* presents the resultant trip generation for the nine (9) cumulative projects. As shown in *Table 6-2*, the cumulative projects are expected to generate 5,627 daily trips (one half arriving, one half departing), with 485 trips (297 inbound and 188 outbound) forecast during the AM peak hour and 568 trips (233 inbound and 335 outbound) forecast during the PM peak hour on a “typical” weekday.

The anticipated AM and PM peak hour cumulative projects traffic volumes at the ten (10) key study intersections are presented in *Figures 6-4* and *6-5*, respectively. *Figure 6-5* also presents the daily cumulative projects traffic volumes at the five (5) key study roadway segments.

Figures 6-6 and *6-7* present Year 2024 Without Project AM and PM peak hour traffic volumes at the ten (10) key study intersections, respectively. *Figure 6-7* also presents the daily Year 2024 Without Project traffic volumes at the five (5) key study roadway segments. It should be noted that

the Year 2024 Without Project traffic volumes include ambient traffic growth as well as the traffic from the nine (9) cumulative projects.

It should again be emphasized that because this traffic impact analysis utilizes both an ambient growth factor along with a list of cumulative projects approach to analyze cumulative impacts, this traffic impact analysis is highly conservative and would tend to overstate cumulative traffic impacts.

6.3 Year 2024 With Project Traffic Volumes

The estimates of Project generated traffic volumes were added to the Year 2024 Without Project traffic conditions to develop traffic projections for Year 2024 With Project traffic conditions. *Figures 6-8* and *6-9* present the anticipated AM and PM peak hour Year 2024 With Project traffic volumes at the ten (10) key study intersections, respectively. *Figure 6-9* also presents the Year 2024 With Project daily traffic volumes at the five (5) key study roadway segments.

6.4 Buildout Traffic Conditions

As directed by City of San Bernardino staff, long-term (Buildout) traffic volume forecasts for the ten (10) key study intersections and five (5) key roadway segments were determined through utilization of the San Bernardino Traffic Analysis Model (SBTAM). The future traffic volumes were post-processed based on the relationship of base year validation model run output to the base year ground traffic counts. The projected volumes were reviewed carefully and adjustments were applied as warranted based on local conditions and professional judgment. It should be noted that the Buildout traffic volume projections include the reconstruction of the I-215 Freeway Interchange at University Parkway to a Diverging Diamond Interchange as designed by Caltrans.

Copies of the traffic model post-processing worksheets for Buildout traffic conditions are contained in *Appendix C*.

6.4.1 Volume Adjustment

Using the SBTAM, projected traffic volumes were obtained for each intersection. The first step is to obtain the approach and departure volumes from the model for each leg of the analyzed intersections. The next step is to determine the difference between the base year peak hour model volumes and the build-out peak hour model volumes. This “difference” represents the projected growth in traffic on each approach from the base year to the build-out using the SBTAM.

6.4.2 B-turn Methodology

The base year turning movement counts for each intersection must be converted to approach and departure volumes for each leg of the intersection. Once the base counts are in this format, the difference between the build-out model and base model are then added to the base year counts for each corresponding approach and departure volume. This step provides the adjusted volumes that will be used to determine the build-out turning movement volumes. The next process in the forecasting of future turning volumes applies the B-turn methodology. The B-turn methodology is generally described in the “*National Cooperative Highway Research Program Report (NCHRP) 255: Highway Traffic Data for Urbanized Area Project Planning and Design*”, Chapter 8. The B-

turn method uses the base year turning percentages (from traffic counts) and proceeds through an iterative computational technique to produce a final set of future year turning volumes. The computations involve alternatively balancing the rows (approaches) and the columns (departures) of a turning movement matrix until an acceptable convergence is obtained. Future year link volumes are fixed using this method and the turning movements are adjusted to match. The results must be checked for reasonableness and manual adjustments are sometimes necessary.

Projected volumes were reviewed carefully and adjustments were applied as warranted based on local conditions and professional engineering judgment. Please note that the post-processing methodology utilized in this report is consistent with SCAG/SANBAG requirements.

6.5 Buildout Traffic Volumes

The anticipated AM and PM peak hour traffic volumes at the ten (10) key study intersections associated with Buildout traffic conditions are presented in *Figures 6-10* and *6-11*, respectively. *Figure 6-11* also presents the daily Buildout Without Project traffic volumes at the five (5) key study roadway segments.

Figures 6-12 and *6-13* illustrate the Buildout With Project Traffic Conditions at the ten (10) key study intersections during the AM peak hour and PM peak hour, respectively. *Figure 6-13* also presents the daily Buildout With Project traffic volumes at the five (5) key study roadway segments.

**TABLE 6-1
LOCATION AND DESCRIPTION OF CUMULATIVE PROJECTS⁸**

No.	Cumulative Project	Location/Address	Description
<i>City of San Bernardino</i>			
1.	CUP 22-10	Southwest corner of West Kendall Drive and North Shandin Hills Drive	3,596 SF automated car wash
2.	DCA (ZMA) 21-03 & DP-D 21-15	5770 North Industrial Parkway	52,160 SF truck terminal
3.	DP-D 21-12	North side of West Hallmark Parkway, at the intersection of South Shenandoah Way	105 Spaces truck and trailer parking
4.	DP-D 22-13	Southwest corner of North Medical Center Drive and West 27 th Street	1,700 SF office and 2,500 SF warehouse
5.	SUB 22-06 & DP-D 22-14	5705 North Industrial Parkway	105,500 SF industrial warehouse
<i>County of San Bernardino</i>			
6.	PREA-2021-00314	South of 4180 North 4 th Avenue	77,101 SF behavioral health facility
7.	PREA-2022-00195	746 West 44 th Street	90 DU multifamily residential
8.	PREA-2022-00157	1163 West 41 st Street	8 DU multifamily residential and 1 DU attached single-family
9.	PREA-2022-00120	South side of Darby Street, at the intersection of Arizona Avenue	49 DU single family residential

Notes:

- SF = Square-feet
- DU = Dwelling units

⁸ Source: City of San Bernardino and County of San Bernardino Planning Department staff.

**TABLE 6-2
CUMULATIVE PROJECTS TRAFFIC GENERATION FORECAST⁹**

Cumulative Project Description	Daily 2-Way	AM Peak Hour			PM Peak Hour		
		In	Out	Total	In	Out	Total
1. CUP 22-10	383	19	19	38	19	19	38
2. DCA (ZMA) 21-03 & DP-D 21-15	975	48	55	103	51	47	98
3. DP-D 21-12	161	5	6	11	5	6	11
4. DP-D 22-13	22	3	0	3	0	2	2
5. SUB 22-06 & DP-D 22-14	180	14	4	18	5	14	19
6. PREA-2021-00314	2,776	189	50	239	91	212	303
7. PREA-2022-00195	607	9	27	36	29	17	46
8. PREA-2022-00157	61	1	2	3	4	1	5
9. PREA-2022-00120	462	9	25	34	29	17	46
Cumulative Projects Total Trip Generation Potential	5,627	297	188	485	233	335	568

⁹ Unless otherwise noted, Source: *Trip Generation, 11th Editions*, Institute of Transportation Engineers (ITE) [Washington, D.C. (2021)].

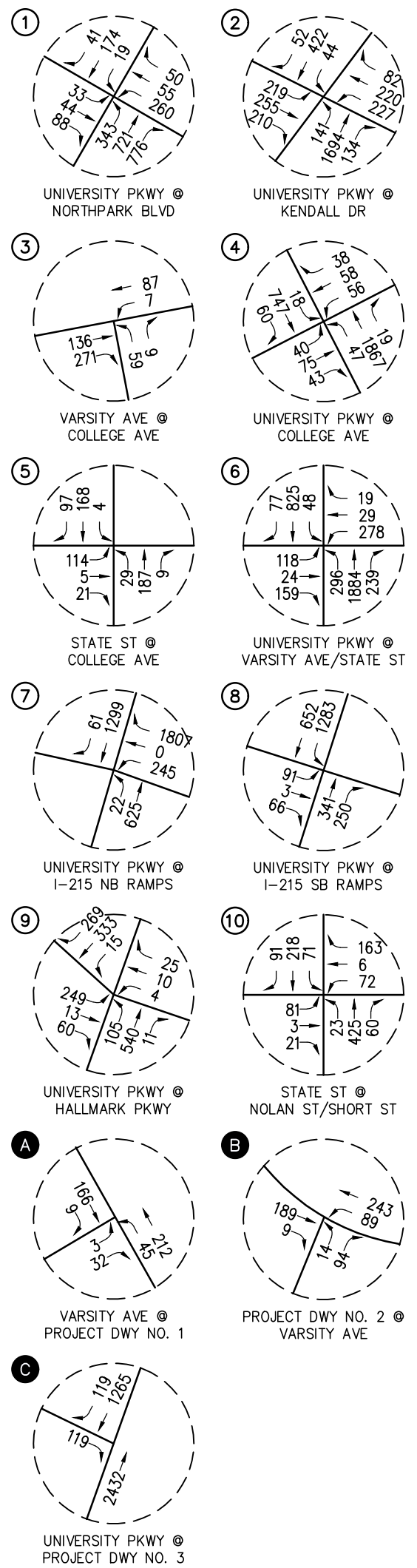
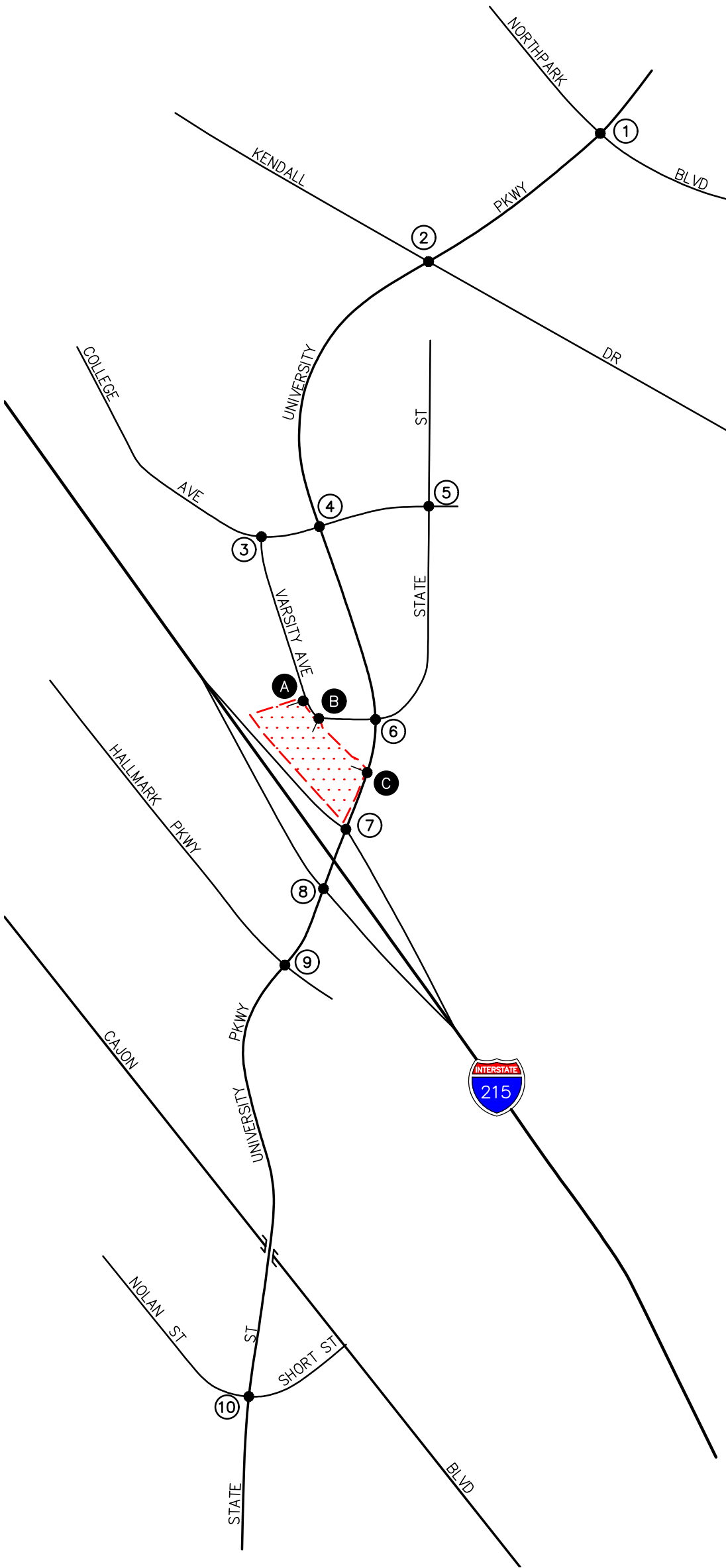

n:\4500\2224555 - 4400 varsity ave commercial center, san bernardino\dwg\4555 f6-1.dwg LDP 10:49:19 09-23-2022 kopulsky

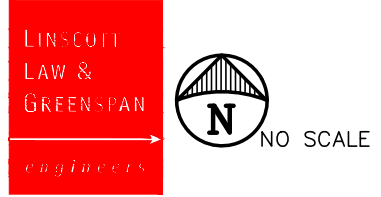

KEY
 # = STUDY INTERSECTION
 [Red Hatched Box] = PROJECT SITE

FIGURE 6-1

EXISTING WITH PROJECT AM PEAK HOUR TRAFFIC VOLUMES

4400 VARSITY AVE COMMERCIAL CENTER, SAN BERNARDINO

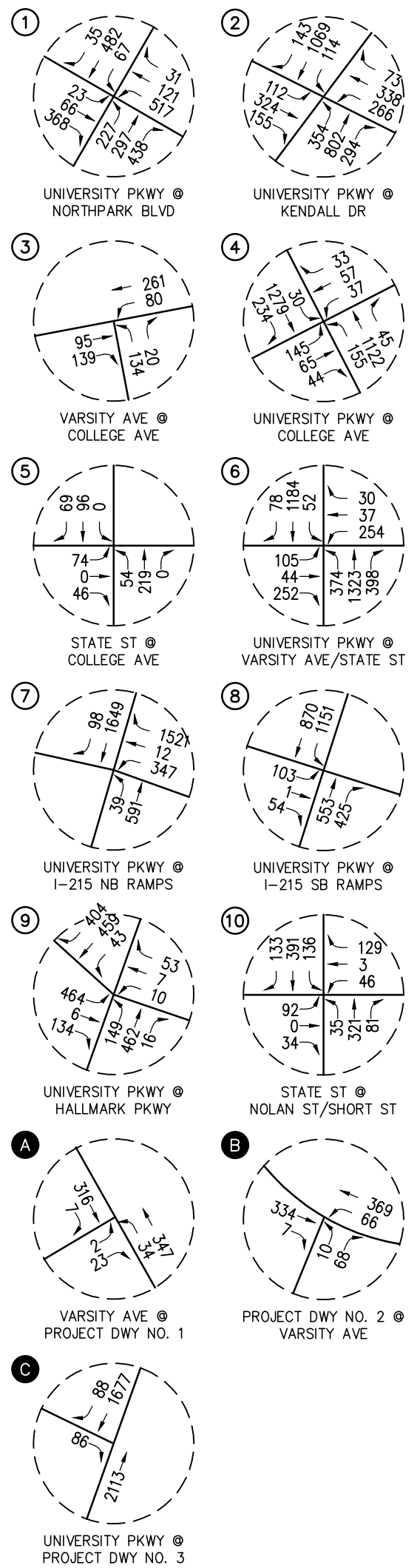
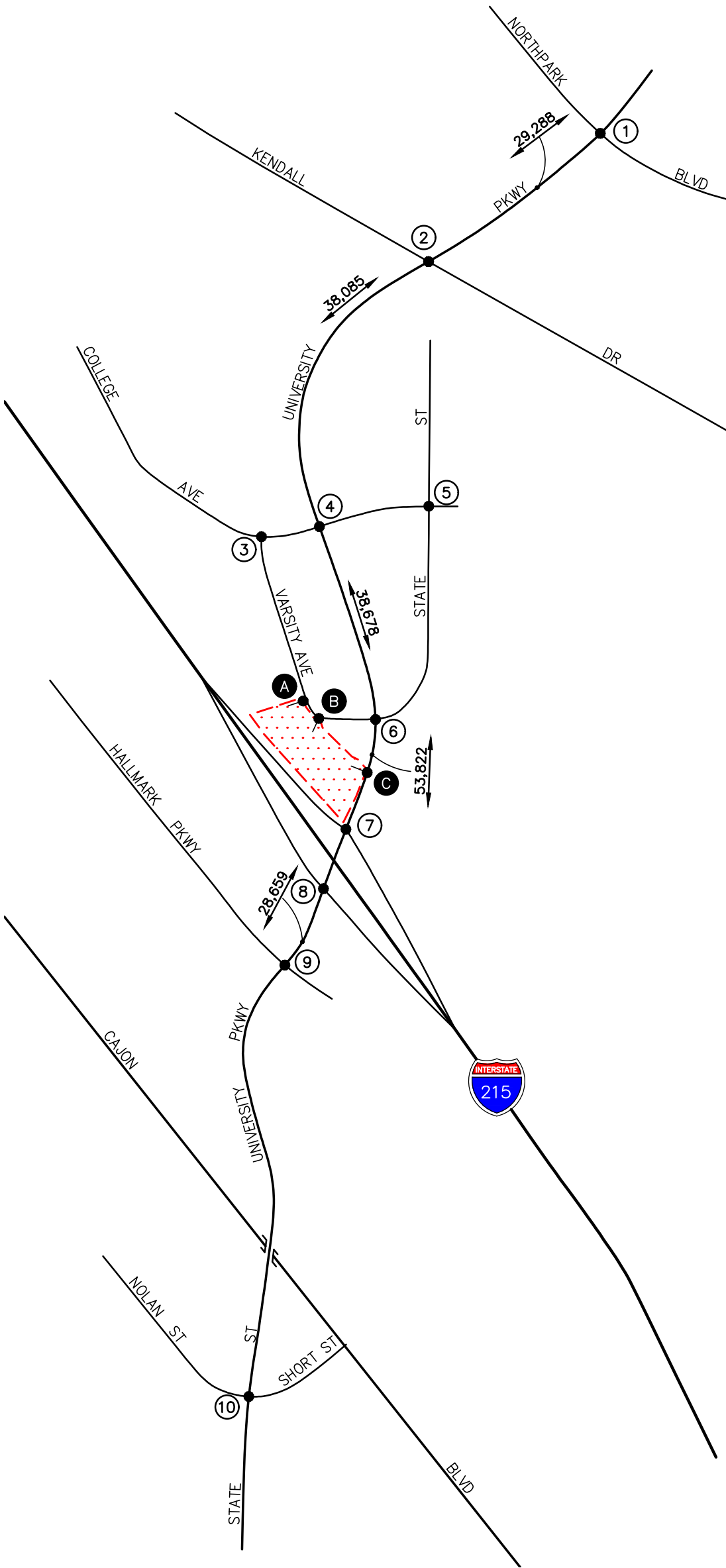

n:\4500\2224555 - 4400 varsity ave commercial center, san bernardino\dwg\4555 f6-2.dwg LDP 10:54:49 09-23-2022 kopulsky

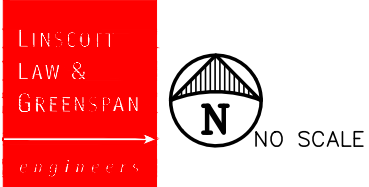

KEY
 # = STUDY INTERSECTION
 XX,XXX = DAILY TRAFFIC VOLUMES
 [Red Hatched Box] = PROJECT SITE

FIGURE 6-2

EXISTING WITH PROJECT PM PEAK HOUR AND DAILY TRAFFIC VOLUMES

4400 VARSITY AVE COMMERCIAL CENTER, SAN BERNARDINO

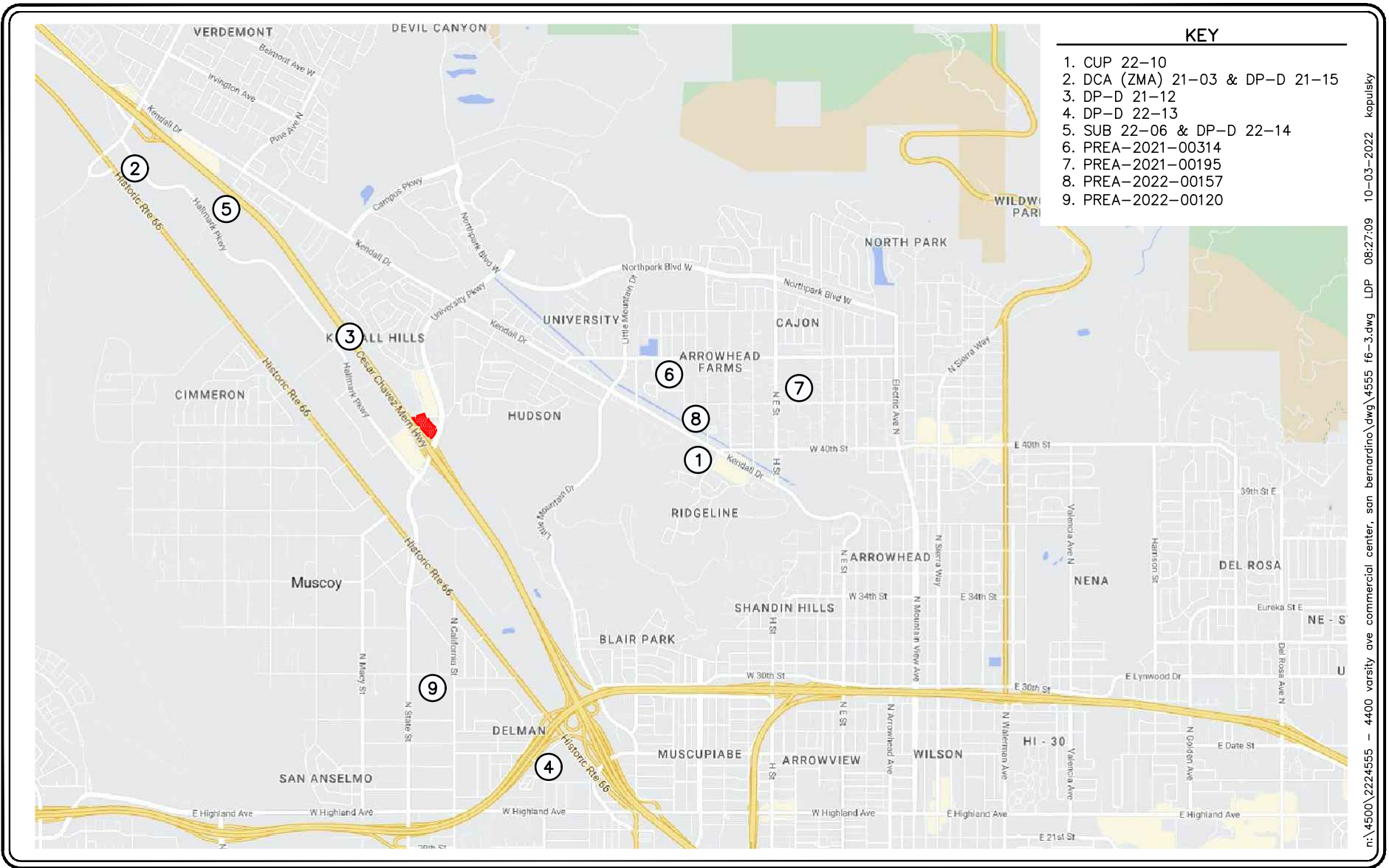

- KEY**
1. CUP 22-10
 2. DCA (ZMA) 21-03 & DP-D 21-15
 3. DP-D 21-12
 4. DP-D 22-13
 5. SUB 22-06 & DP-D 22-14
 6. PREA-2021-00314
 7. PREA-2021-00195
 8. PREA-2022-00157
 9. PREA-2022-00120

n:\4500\2224555 - 4400 varsity ave commercial center, san bernardino.dwg\4555 f6-3.dwg LDP 08:27:09 10-03-2022 kopulsky

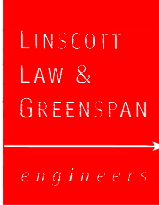



NO SCALE

SOURCE: GOOGLE

KEY

⊕ = CUMULATIVE PROJECTS LOCATION

▨ = PROJECT SITE

FIGURE 6-3

LOCATION OF CUMULATIVE PROJECTS

4400 VARSITY AVE COMMERCIAL CENTER, SAN BERNARDINO

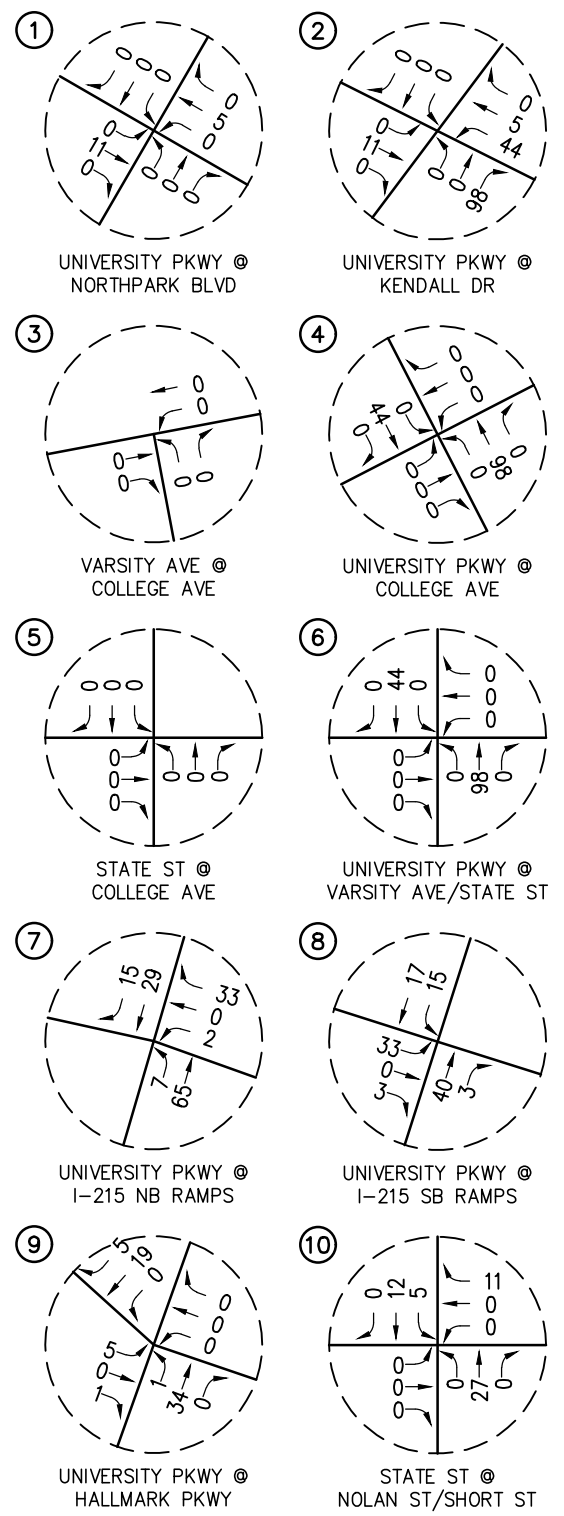
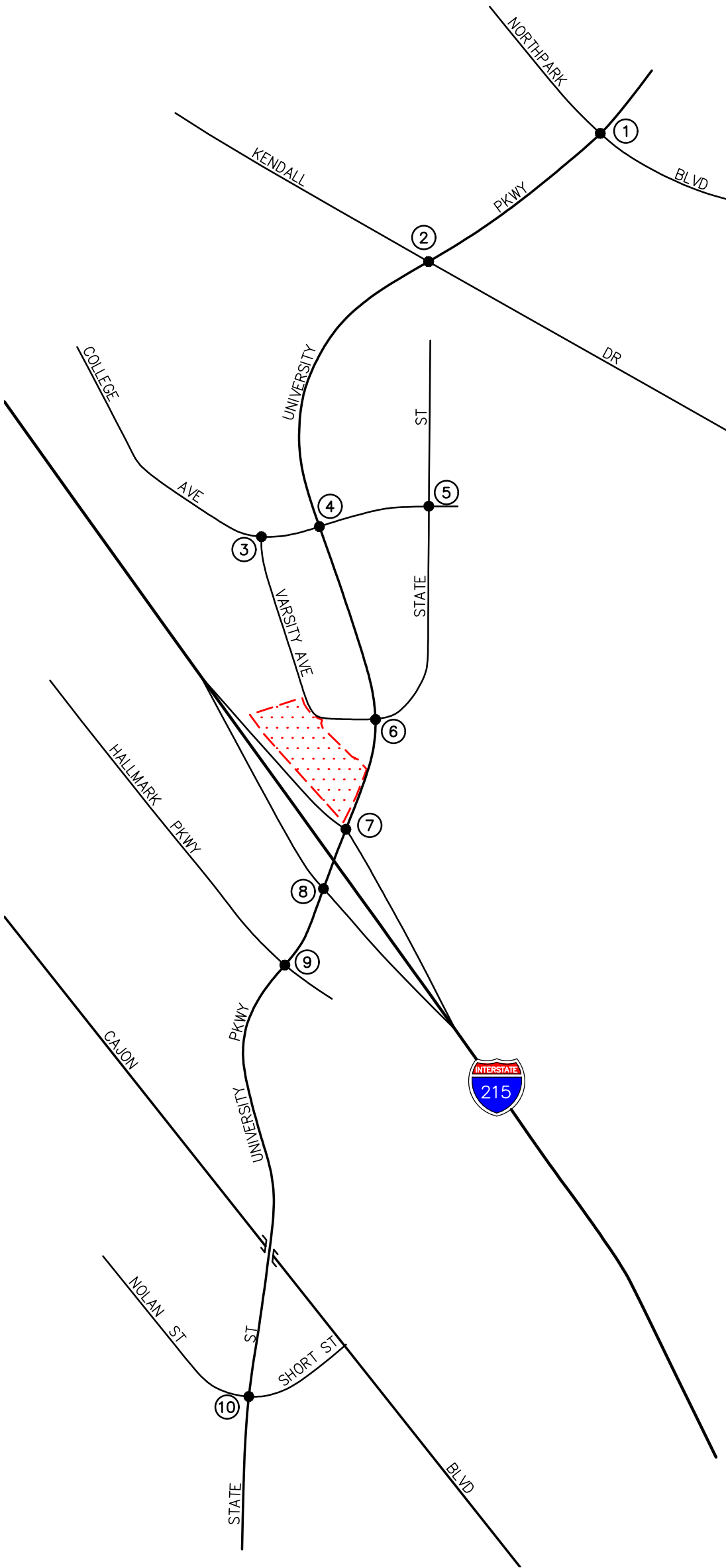

n:\4500\2224555 - 4400 varsity ave commercial center, san bernardino\dwg\4555 f6-4.dwg LDP 11:20:15 09-23-2022 kopulsky

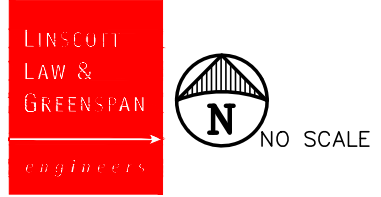

KEY
 # = STUDY INTERSECTION
 [Red Hatched Box] = PROJECT SITE

FIGURE 6-4
AM PEAK HOUR CUMULATIVE PROJECTS TRAFFIC VOLUMES
 4400 VARSITY AVE COMMERCIAL CENTER, SAN BERNARDINO

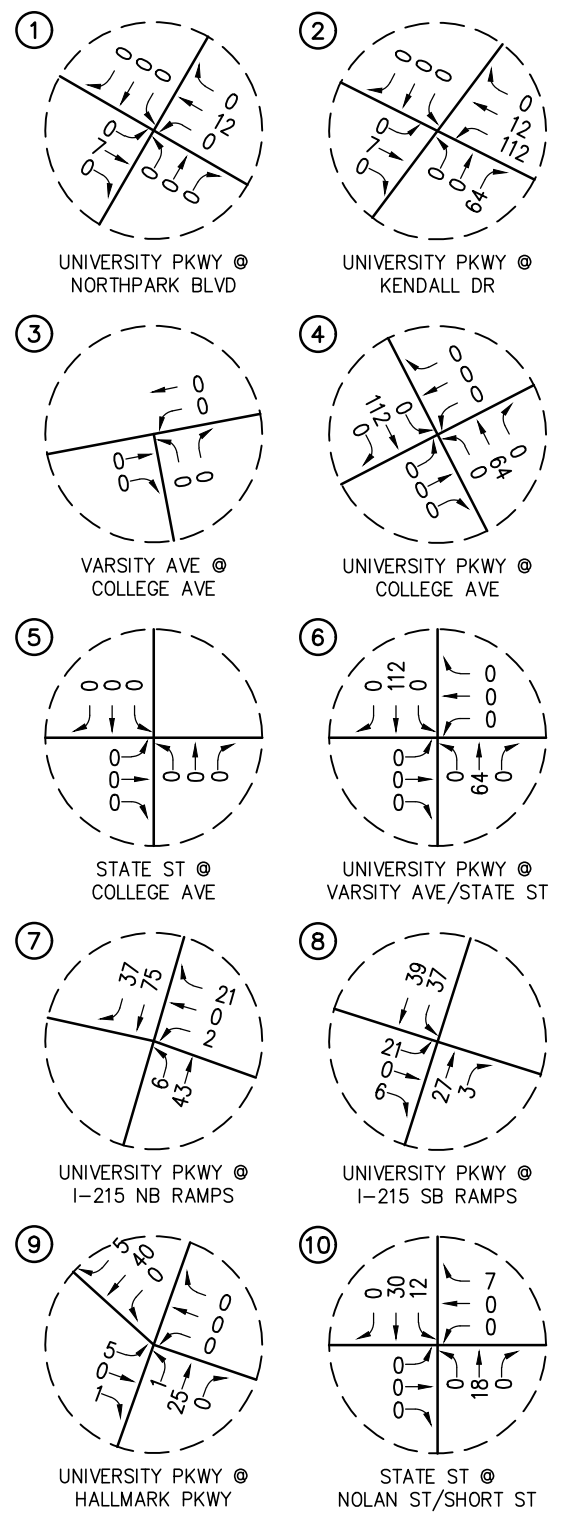
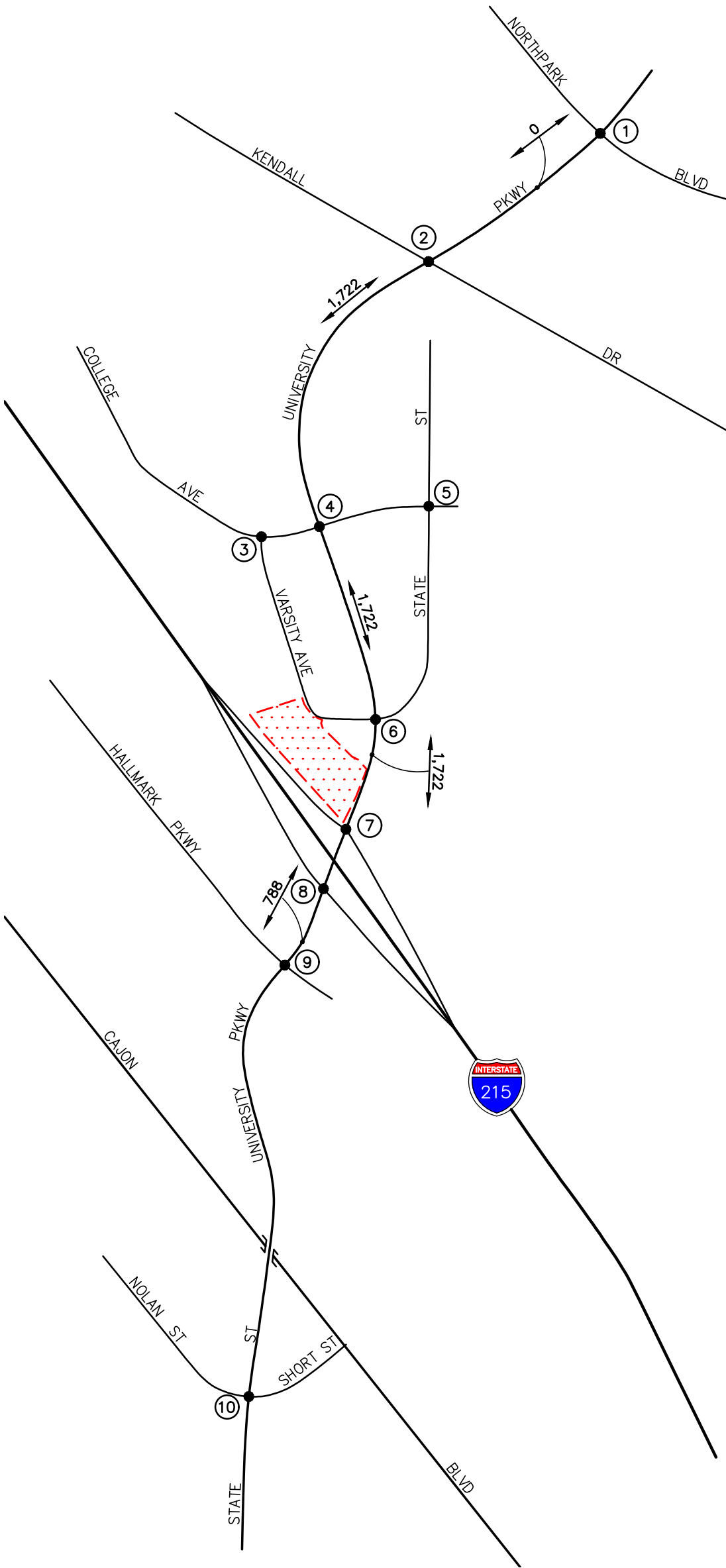

n:\4500\2224555 - 4400 varsity ave commercial center, san bernardino\dwg\4555 f6-5.dwg LDP 11:05:08 09-23-2022 kopulsky

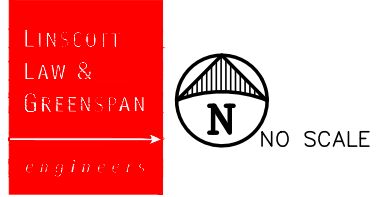

KEY
 # = STUDY INTERSECTION
 XX,XXX = DAILY TRAFFIC VOLUMES
 [Red Hatched Box] = PROJECT SITE

FIGURE 6-5
PM PEAK HOUR AND DAILY CUMULATIVE PROJECTS TRAFFIC VOLUMES
 4400 VARSITY AVE COMMERCIAL CENTER, SAN BERNARDINO

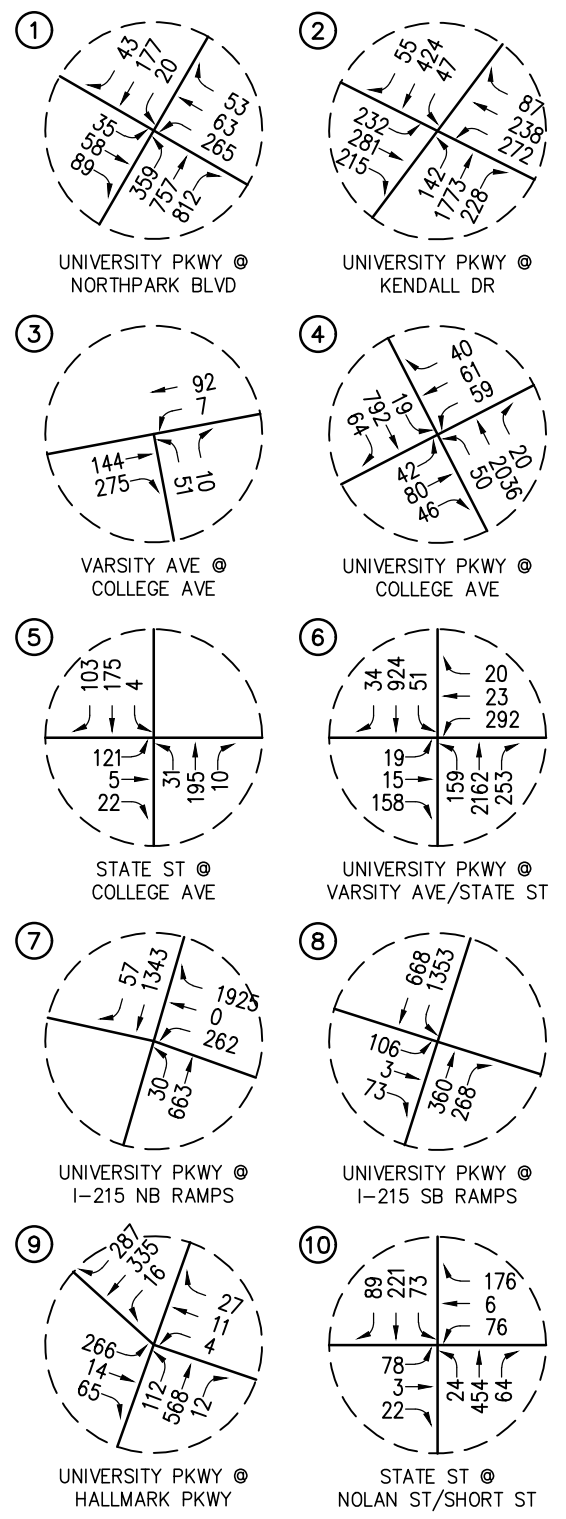
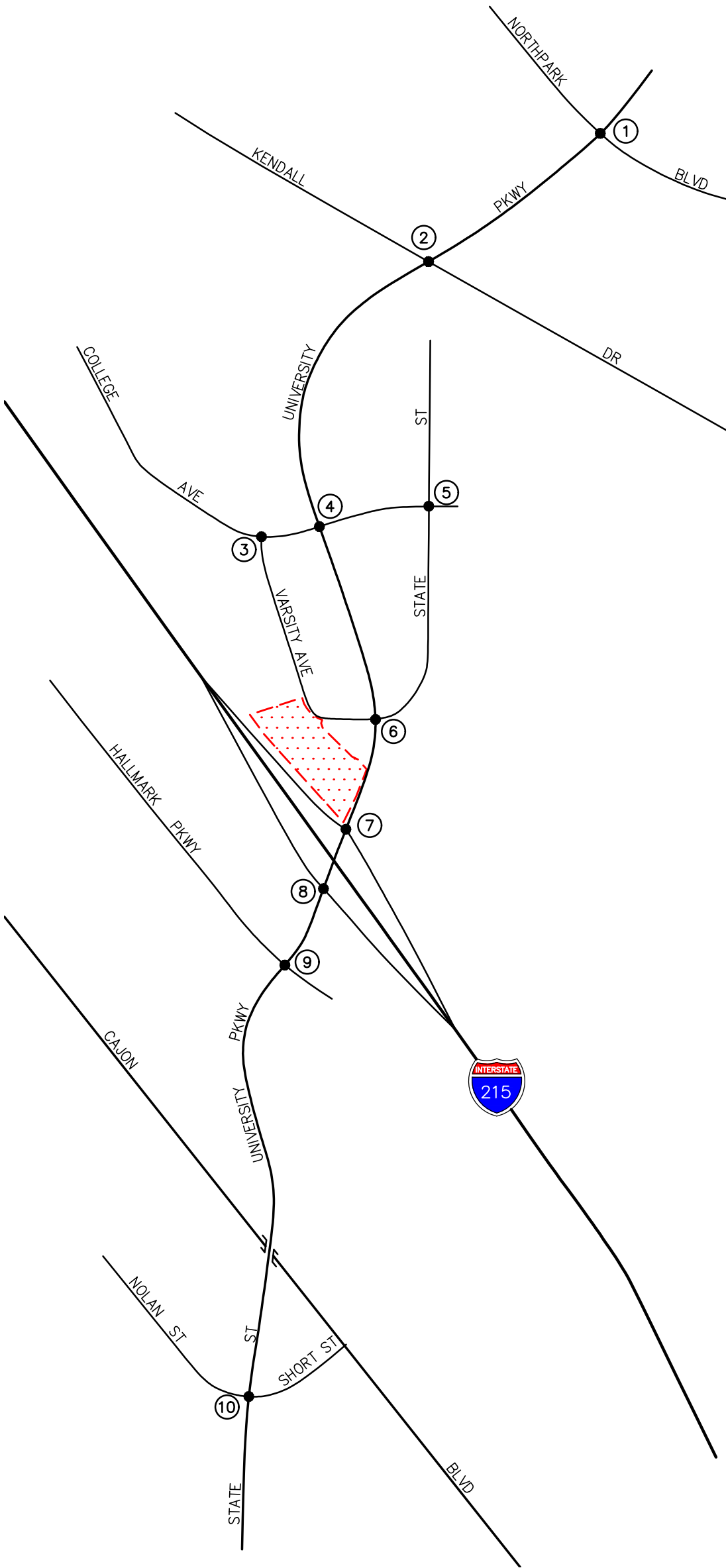

n:\4500\2224555 - 4400 varsity ave commercial center, san bernardino\dwg\4555 f6-6.dwg LDP 11:09:55 09-23-2022 kopulsky

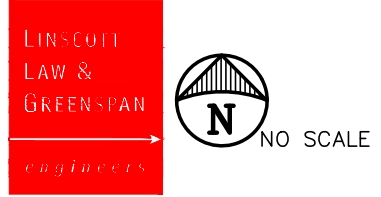

KEY
 # = STUDY INTERSECTION
 [Red Hatched Box] = PROJECT SITE

FIGURE 6-6

YEAR 2024 WITHOUT PROJECT AM PEAK HOUR TRAFFIC VOLUMES

4400 VARSITY AVE COMMERCIAL CENTER, SAN BERNARDINO

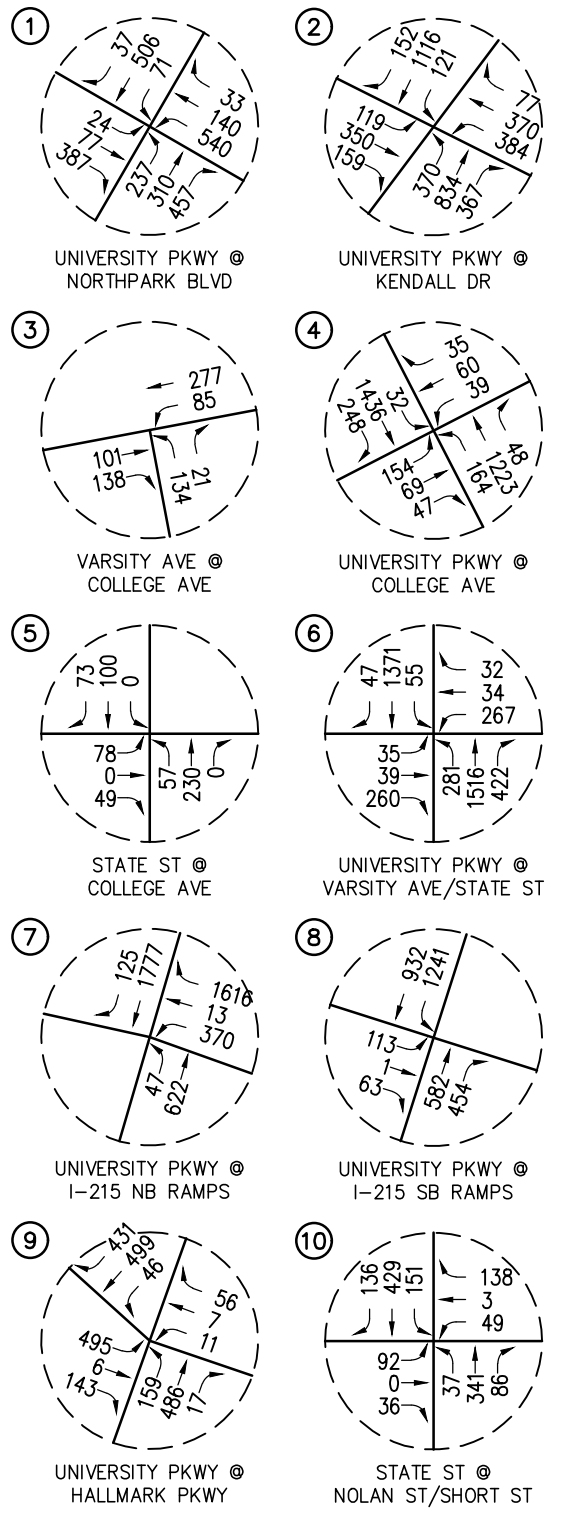
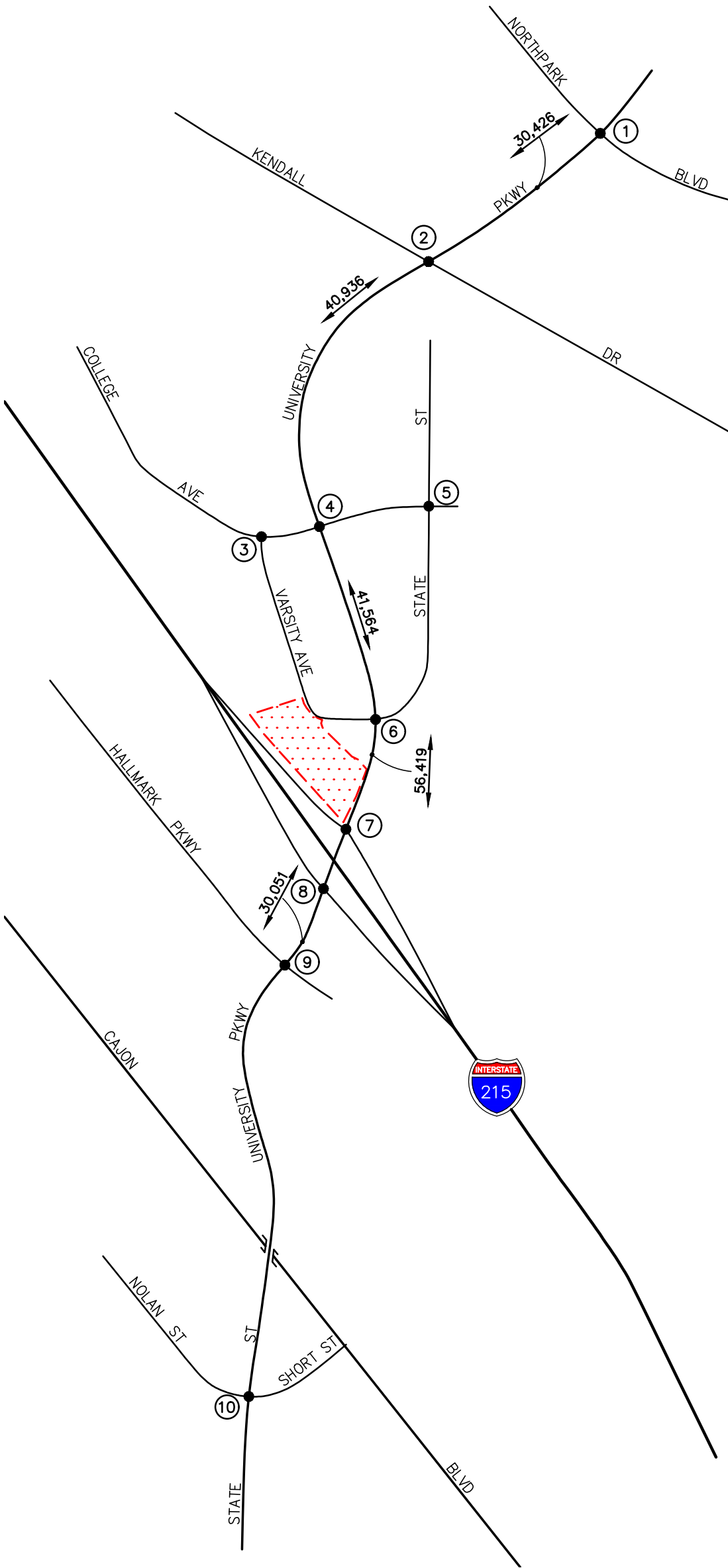

n:\4500\2224555 - 4400 varsity ave commercial center, san bernardino\dwg\4555 f6-7.dwg LDP 11:12:51 09-23-2022 kopulsky

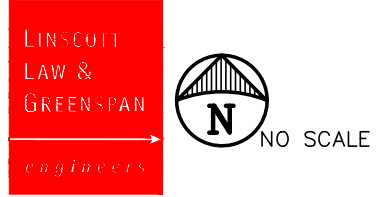

KEY
 # = STUDY INTERSECTION
 XX,XXX = DAILY TRAFFIC VOLUMES
 [Red Hatched Box] = PROJECT SITE

FIGURE 6-7

**YEAR 2024 WITHOUT PROJECT PM
 PEAK HOUR AND DAILY TRAFFIC VOLUMES**
 4400 VARSITY AVE COMMERCIAL CENTER, SAN BERNARDINO

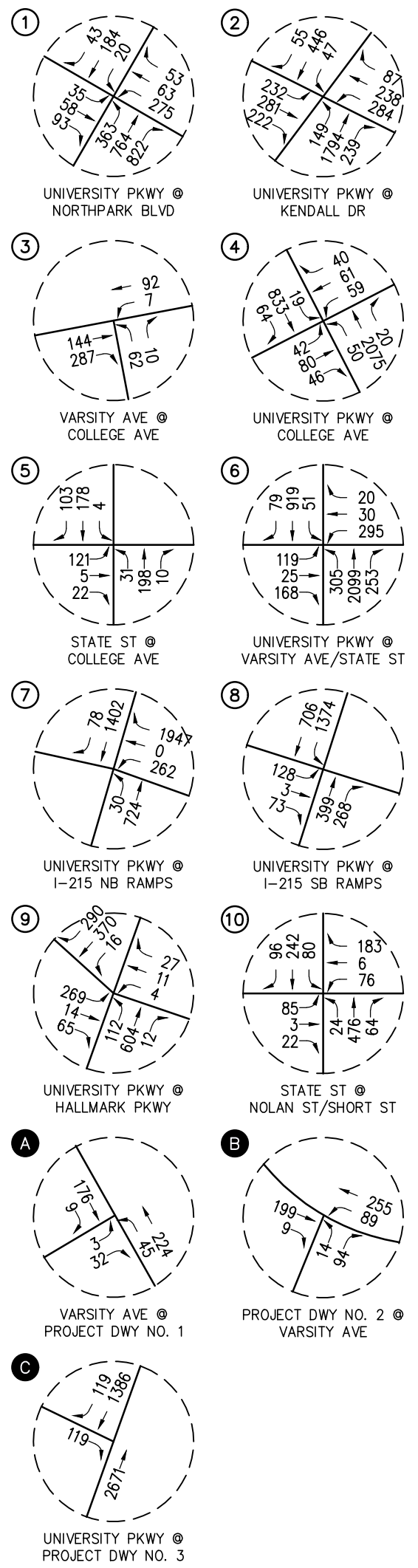
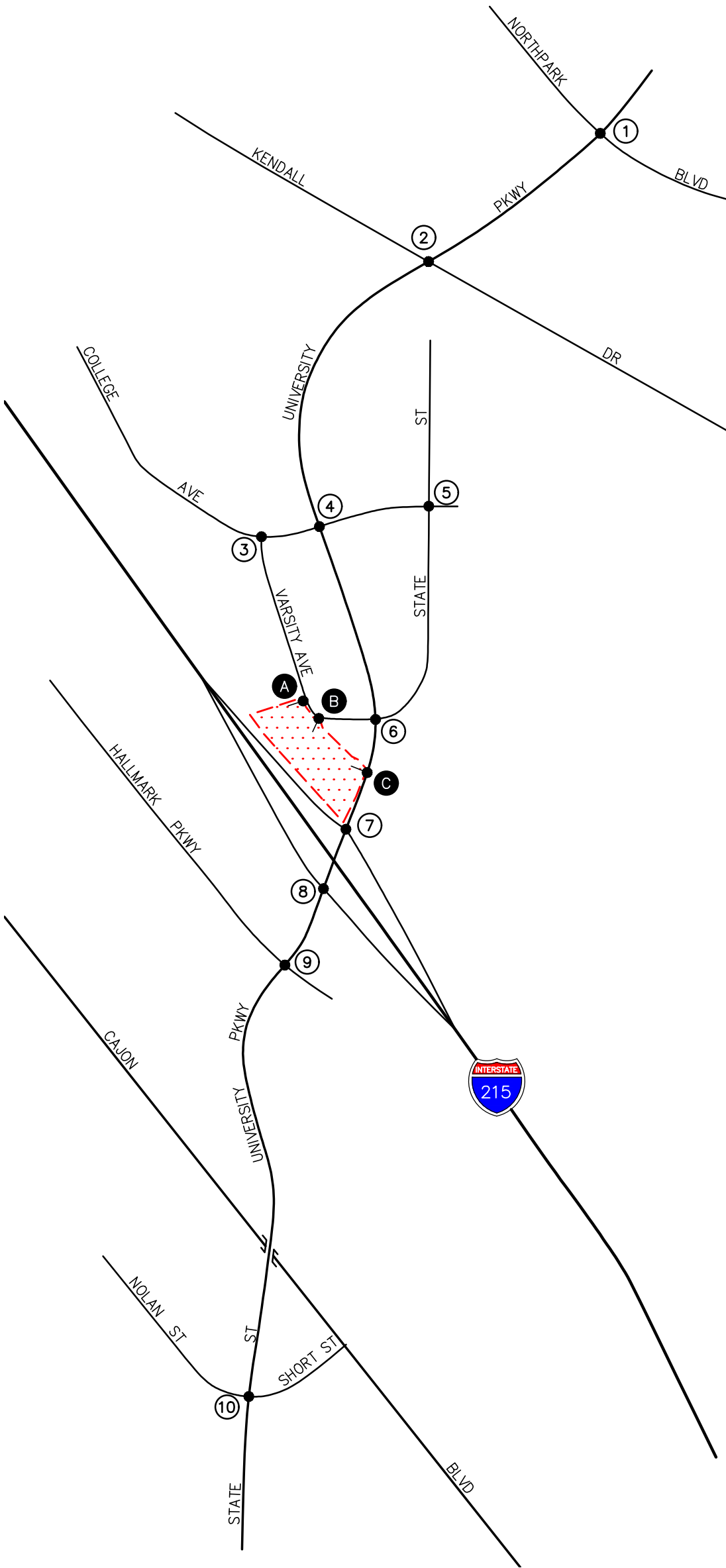

n:\4500\2224555 - 4400 varsity ave commercial center, san bernardino\dwg\4555 f6-8.dwg LDP 11:15:48 09-23-2022 kopulsky

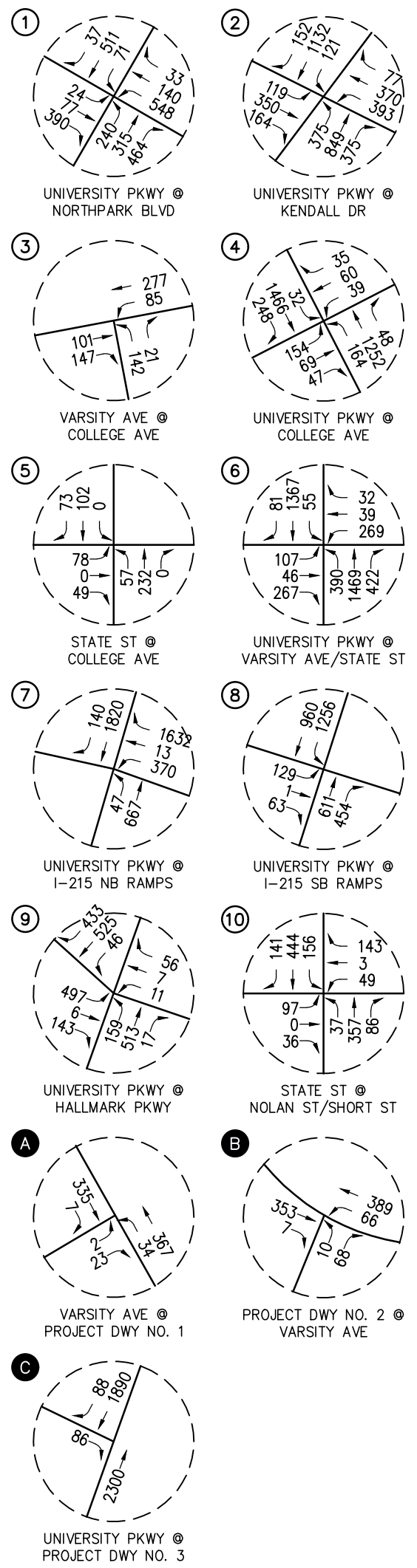
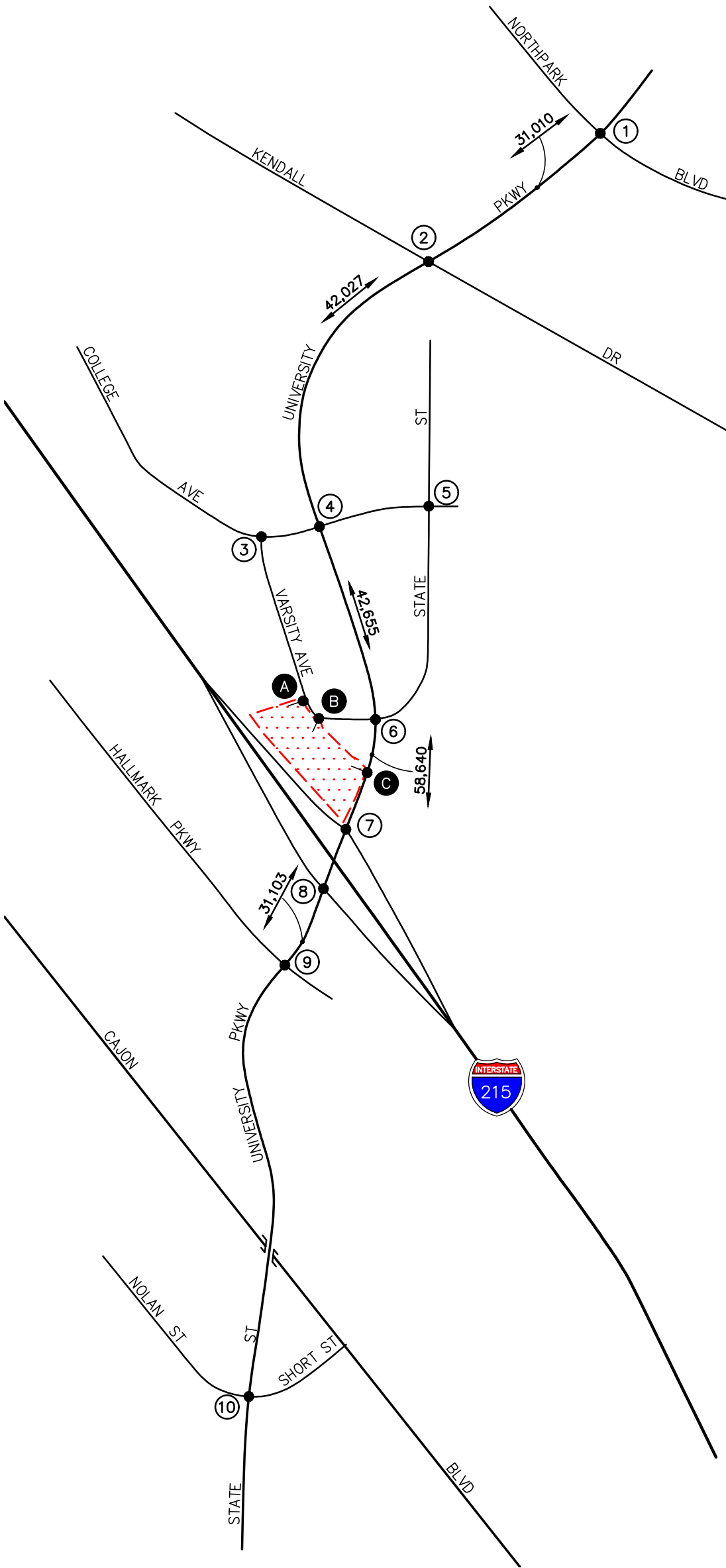

n:\4500\2224555 - 4400 varsity ave commercial center, san bernardino\dwg\4555 f6-9.dwg LDP 11:17:20 09-23-2022 kopulsky

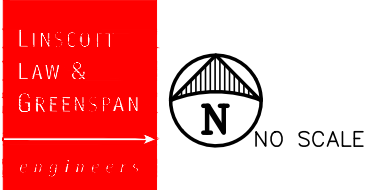

KEY
 # = STUDY INTERSECTION
 XX,XXX = DAILY TRAFFIC VOLUMES
 [Red Hatched Box] = PROJECT SITE

FIGURE 6-9

YEAR 2024 WITH PROJECT PM PEAK HOUR AND DAILY TRAFFIC VOLUMES

4400 VARSITY AVE COMMERCIAL CENTER, SAN BERNARDINO

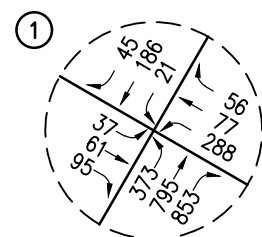
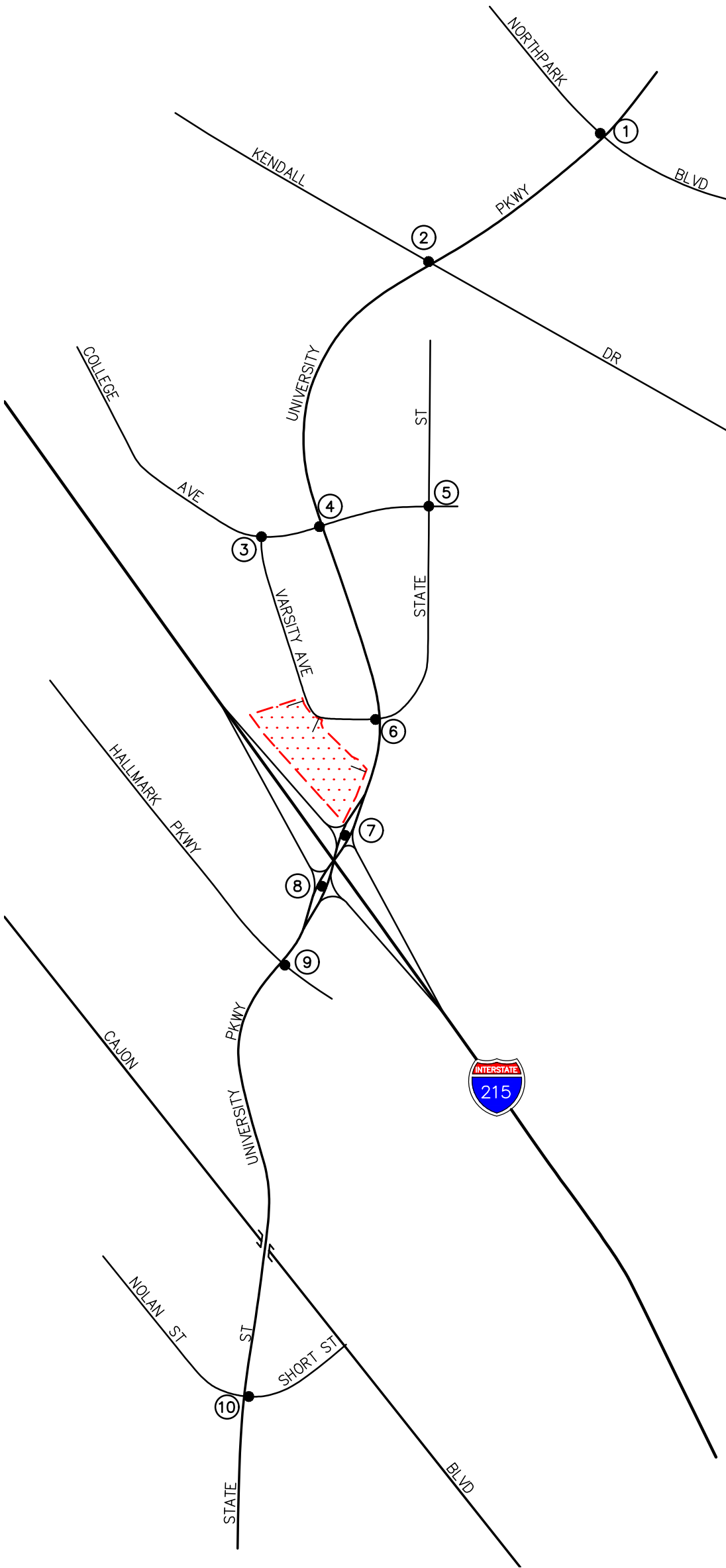

UNIVERSITY PKWY @ NORTH PARK BLVD

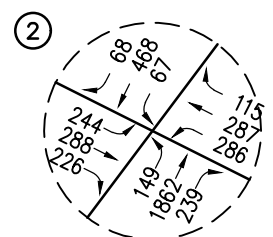

UNIVERSITY PKWY @ KENDALL DR

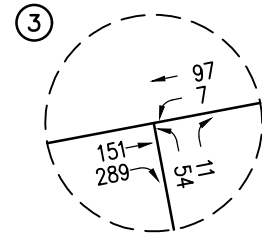

VARSITY AVE @ COLLEGE AVE

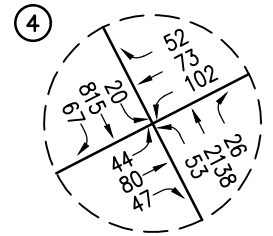

UNIVERSITY PKWY @ COLLEGE AVE

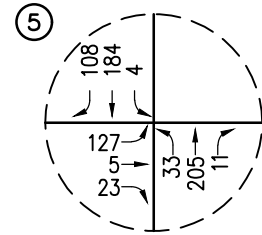

STATE ST @ COLLEGE AVE

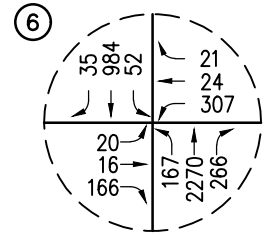

UNIVERSITY PKWY @ VARSITY AVE/STATE ST

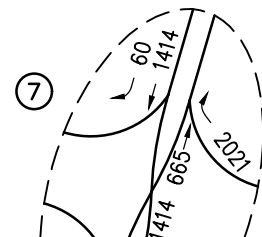

UNIVERSITY PKWY @ I-215 NB RAMPS

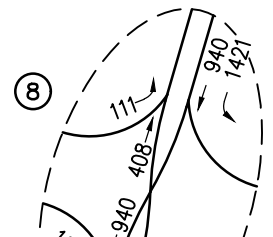

UNIVERSITY PKWY @ I-215 SB RAMPS

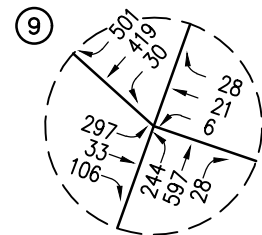

UNIVERSITY PKWY @ HALLMARK PKWY

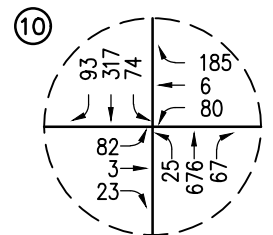

STATE ST @ NOLAN ST/SHORT ST

n:\4500\2224555 - 4400 varsity ave commercial center, san bernardino\dwg\4555 f6-10.dwg LDP 15:55:54 09-27-2022 aguilera

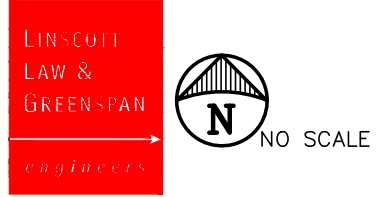

KEY
 # = STUDY INTERSECTION
 [Red Dotted Box] = PROJECT SITE

FIGURE 6-10
BUILDOUT WITHOUT PROJECT
AM PEAK HOUR TRAFFIC VOLUMES
 4400 VARSITY AVE COMMERCIAL CENTER, SAN BERNARDINO

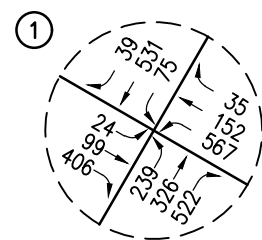
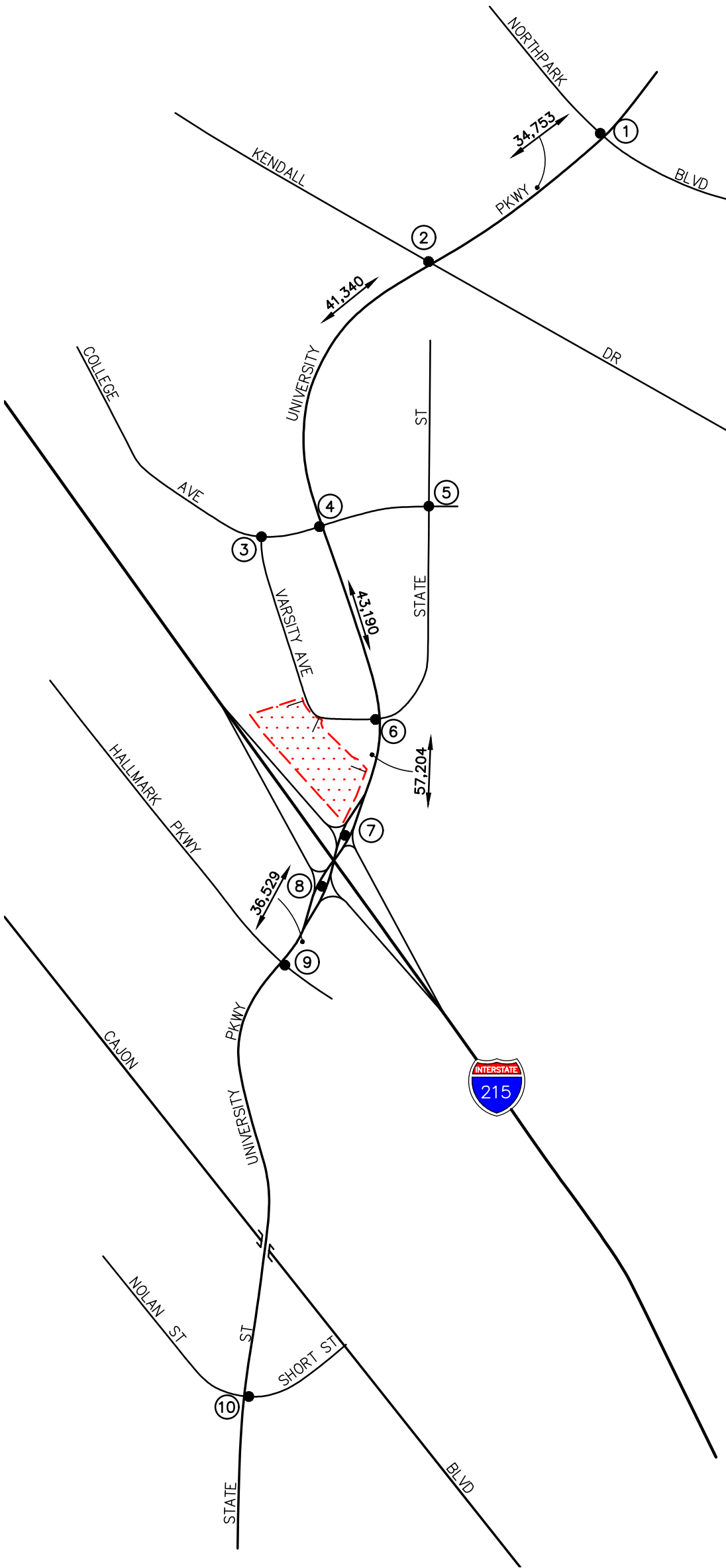

1 UNIVERSITY PKWY @ NORTHPARK BLVD

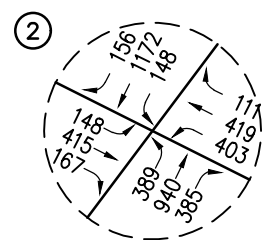

2 UNIVERSITY PKWY @ KENDALL DR

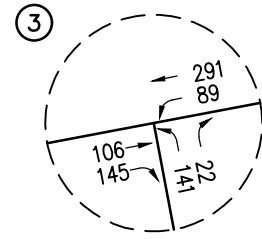

3 VARSITY AVE @ COLLEGE AVE

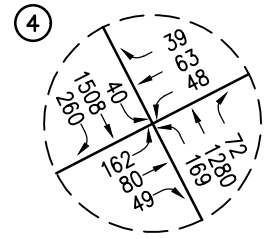

4 UNIVERSITY PKWY @ COLLEGE AVE

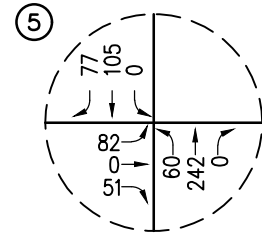

5 STATE ST @ COLLEGE AVE

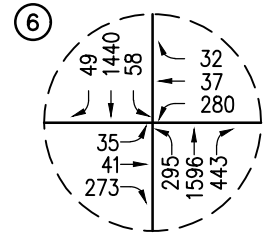

6 UNIVERSITY PKWY @ VARSITY AVE/STATE ST

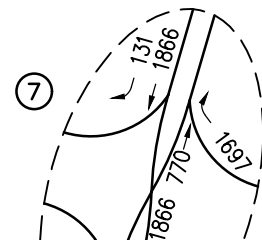

7 UNIVERSITY PKWY @ I-215 NB RAMP

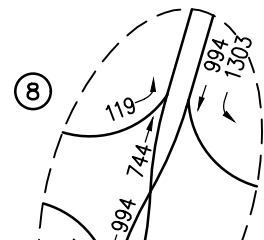

8 UNIVERSITY PKWY @ I-215 SB RAMP

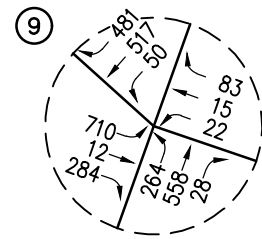

9 UNIVERSITY PKWY @ HALLMARK PKWY

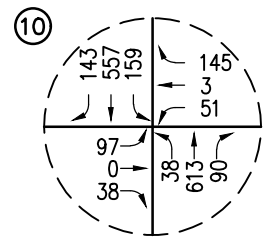

10 STATE ST @ NOLAN ST/SHORT ST

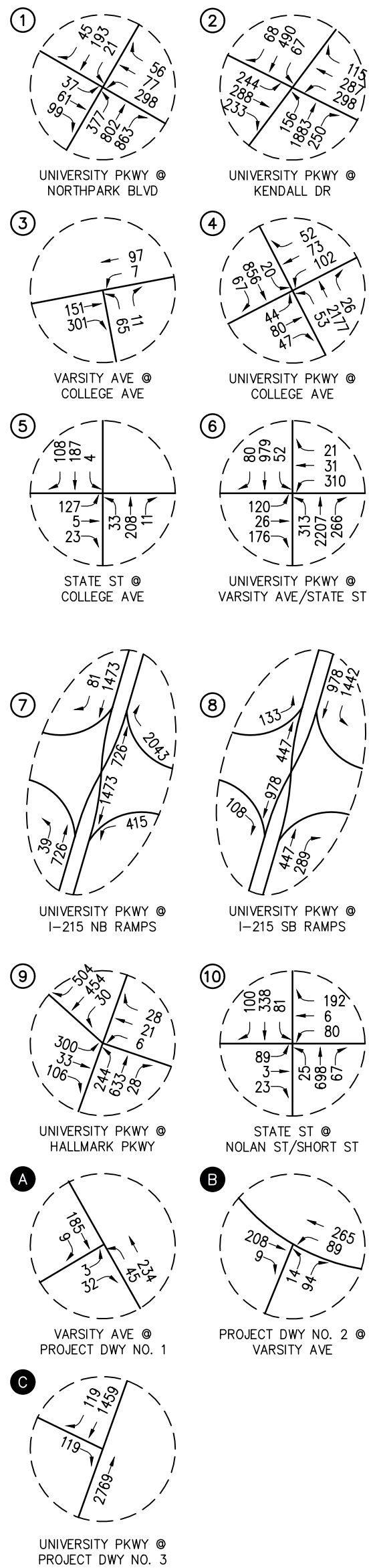
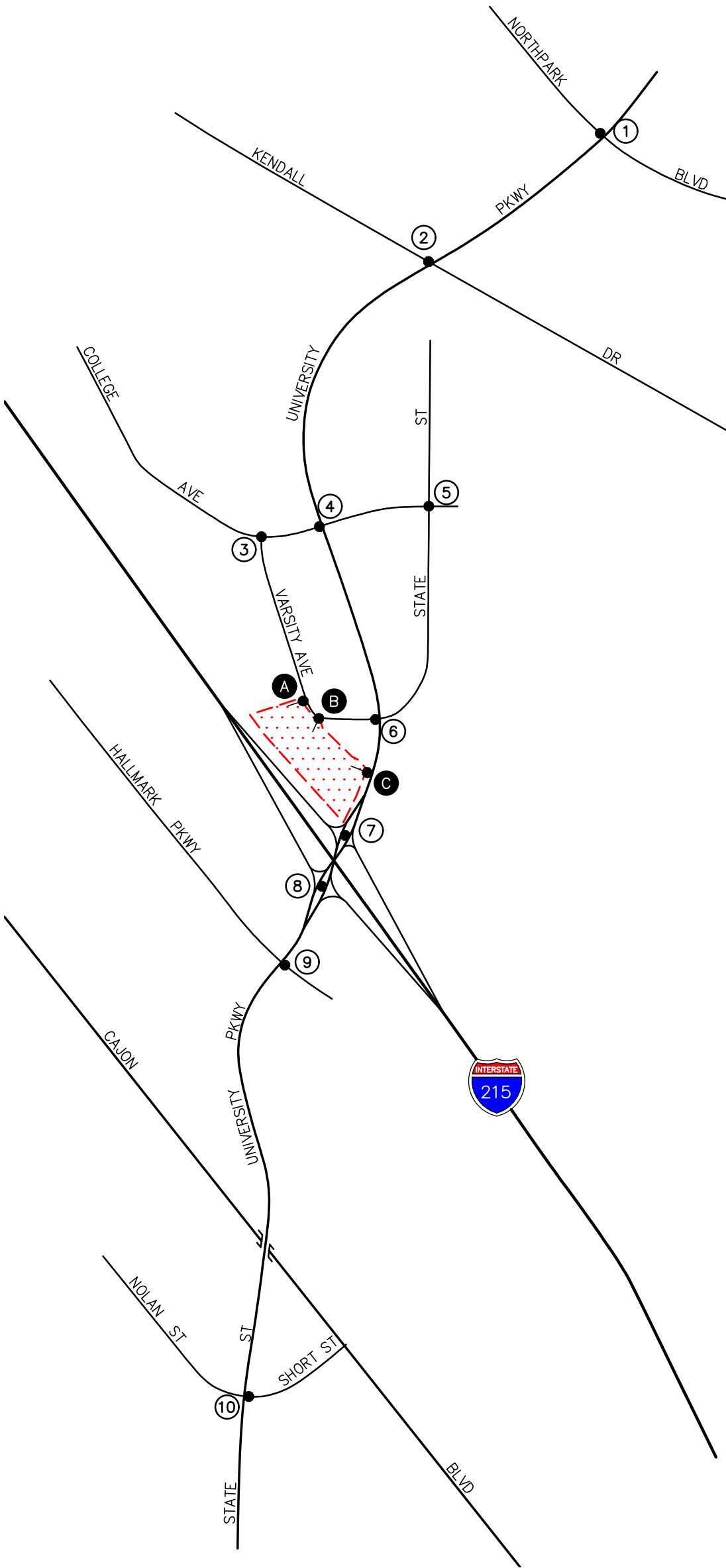

n:\4500\2224555 - 4400 varsity ave commercial center, san bernardino\dwg\4555 f6-12.dwg LDP 15:57:32 09-27-2022 aguilar

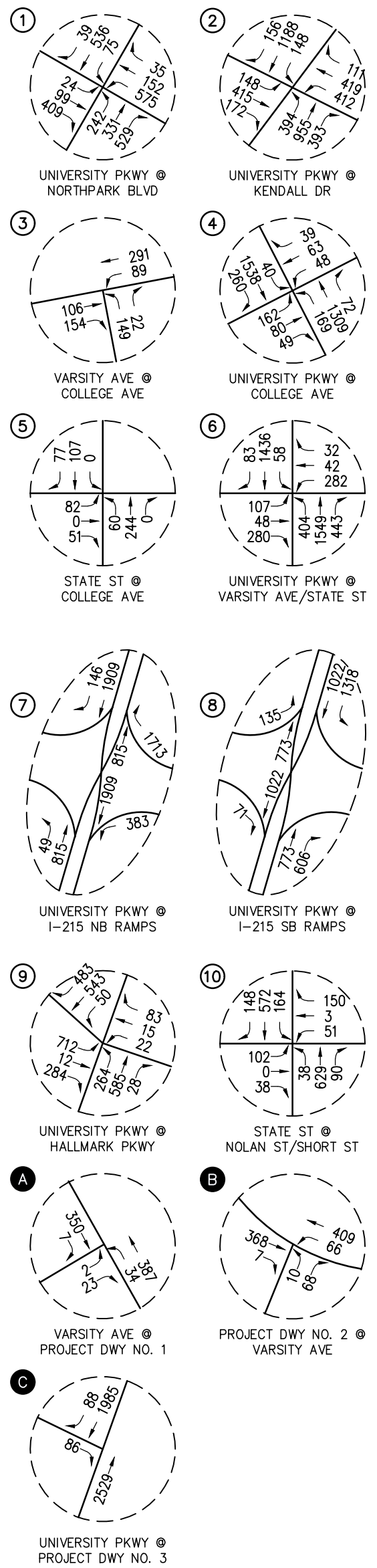
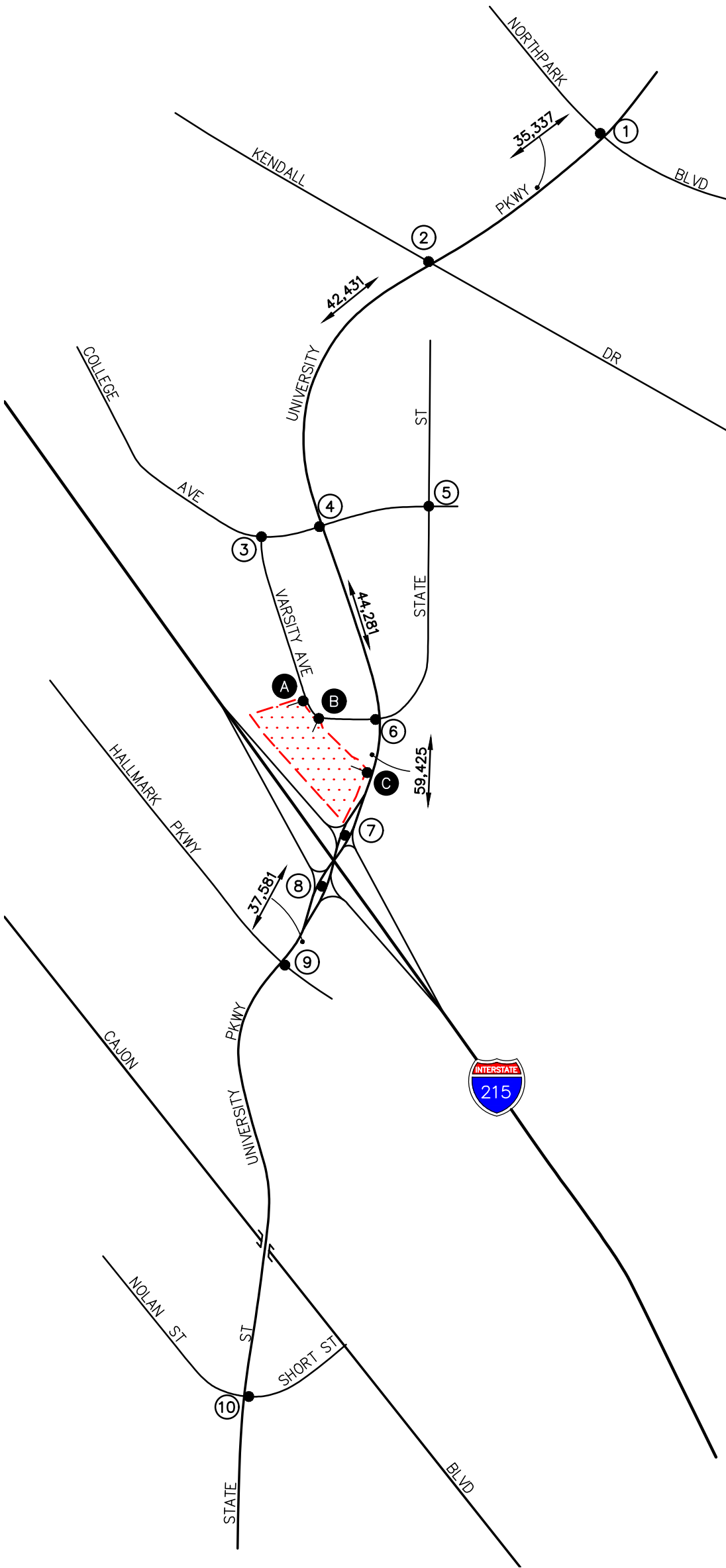

n:\4500\2224555 - 4400 varsity ave commercial center, san bernardino\dwg\4555 f6-13.dwg LDP 15:58:01 09-27-2022 aguilera

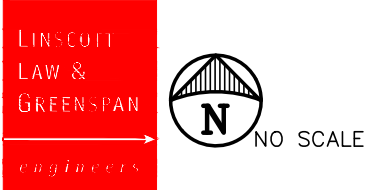

KEY

= STUDY INTERSECTION

XX,XXX = DAILY TRAFFIC VOLUMES

[Red Dotted Box] = PROJECT SITE

FIGURE 6-13

BUILDOUT WITH PROJECT PM PEAK HOUR AND DAILY TRAFFIC VOLUMES

4400 VARSITY AVE COMMERCIAL CENTER, SAN BERNARDINO

7.0 EXISTING CONDITIONS TRAFFIC IMPACT ANALYSIS

The existing conditions analysis establishes the basis for the future forecasts for the Project. This analysis was based on existing intersection and roadway segment counts. The existing conditions analysis reflects these counts as well as existing lane configurations for all analyzed intersections and roadway segments.

7.1 Existing Conditions Intersection Capacity Analysis

Table 7-1 summarizes the peak hour Level of Service results at the ten (10) key study intersections for existing traffic conditions, without and with the proposed Project. The first column (1) of Delay/LOS values in *Table 7-1* presents a summary of Existing AM and PM peak hour traffic conditions. The second column (2) presents forecast Existing With Project traffic conditions. The third column (3) indicates whether the traffic associated with the Project will cause an operational deficiency based on the LOS criteria defined in this report. The fourth column (4) indicates the anticipated operating conditions with implementation of recommended improvements.

7.1.1 Existing Traffic Conditions

Review of column (1) of *Table 7-1* indicates that for Existing traffic conditions, two (2) of the ten (10) key study intersections currently operate at an unacceptable LOS E during the AM peak hour (i.e. University Parkway at Varsity Avenue/State Street and University Parkway at I-215 NB Ramps) when compared to the LOS standards defined in this report. The remaining eight (8) key study intersections currently operate at acceptable LOS D or better during the AM and PM peak hours.

7.1.2 Existing With Project Traffic Conditions

Review of columns (2) and (3) of *Table 7-1* indicates that traffic associated with the proposed Project will adversely impact one (1) of the ten (10) key study intersections when compared to the LOS criteria defined in this report. Although the intersection of University Parkway at Varsity Avenue/State Street is forecast to operate at an adverse LOS E during the AM peak hour with the addition of Project traffic, the proposed Project is expected to add only 0.01 to the V/C value, which does not exceed the allowable threshold. The remaining eight (8) key study intersections currently operate and are forecast to continue to operate at an acceptable LOS during the AM and PM peak hours with the addition of Project generated traffic to existing traffic. The location that will be adversely impacted is as follows:

<u>Key Intersection</u>	<u>AM Peak Hour</u>			<u>PM Peak Hour</u>		
	<u>Delay</u>	<u>LOS</u>	<u>V/C</u>	<u>Delay</u>	<u>LOS</u>	<u>V/C</u>
7. University Parkway at I-215 NB Ramps	70.0 s/v	E	1.17	--	--	--

As shown in column (4) of *Table 7-1*, the implementation of recommended improvements at the one (1) deficient location improves the intersection to acceptable service levels and offsets the impact of Project traffic.

Appendix D contains the Delay/LOS calculation worksheets for Existing and Existing With Project Traffic Conditions.

TABLE 7-1
EXISTING WITH PROJECT CONDITIONS PEAK HOUR INTERSECTION CAPACITY ANALYSIS SUMMARY

Key Intersection	Minimum Acceptable LOS	Control Type	Time Period	(1) Existing Traffic Conditions			(2) Existing With Project Traffic Conditions			(3) Operational Deficiency		(4) Existing With Project With Improvements		
				Delay	LOS	V/C	Delay	LOS	V/C	V/C Inc.	Yes/No	Delay	LOS	V/C
1. University Parkway at Northpark Boulevard	D	6Ø Traffic Signal	AM	19.4 s/v	B	0.64	19.7 s/v	B	0.64	0.00	No	--	--	--
			PM	36.2 s/v	D	0.65	36.3 s/v	D	0.66	0.01	No	--	--	--
2. University Parkway at Kendall Drive	D	8Ø Traffic Signal	AM	44.1 s/v	D	0.72	44.8 s/v	D	0.73	0.01	No	--	--	--
			PM	36.9 s/v	D	0.68	37.2 s/v	D	0.69	0.01	No	--	--	--
3. Varsity Avenue at College Avenue	D	One-Way Stop	AM	11.5 s/v	B	--	11.8 s/v	B	--	--	No	--	--	--
			PM	21.9 s/v	C	--	23.3 s/v	C	--	--	No	--	--	--
4. University Parkway at College Avenue	D	5Ø Traffic Signal	AM	9.8 s/v	A	0.55	9.9 s/v	A	0.56	0.01	No	--	--	--
			PM	21.5 s/v	C	0.60	21.5 s/v	C	0.61	0.01	No	--	--	--
5. State Street at College Avenue	D	All-Way Stop	AM	11.7 s/v	B	--	11.8 s/v	B	--	--	No	--	--	--
			PM	9.7 s/v	A	--	9.7 s/v	A	--	--	No	--	--	--
6. University Parkway at Varsity Ave/State St	D	5Ø Traffic Signal	AM	71.0 s/v	E	0.87	63.4 s/v	E	0.88	0.01	No	--	--	--
			PM	18.7 s/v	B	0.80	24.0 s/v	C	0.88	0.08	No	--	--	--
7. University Parkway at I-215 NB Ramps ¹⁰	D	3Ø Traffic Signal	AM	66.3 s/v	E	1.13	70.0 s/v	E	1.17	0.04	Yes	36.3 s/v	D	0.92
			PM	26.6 s/v	C	0.94	28.9 s/v	C	0.96	0.02	No	35.7 s/v	D	0.81
8. University Parkway at I-215 SB Ramps	D	3Ø Traffic Signal	AM	21.9 s/v	C	0.69	22.6 s/v	C	0.73	0.04	No	--	--	--
			PM	32.2 s/v	C	0.75	34.7 s/v	C	0.78	0.03	No	--	--	--

Notes:

- s/v = seconds per vehicle (delay)
- LOS = Level of Service
- **Bold Delay/LOS values** indicate adverse service levels based on the LOS standards as defined in this report

¹⁰ The delay reported for this location is based on *HCM 2000* due to non-typical signal timing at this intersection.

TABLE 7-1 (CONTINUED)
EXISTING WITH PROJECT CONDITIONS PEAK HOUR INTERSECTION CAPACITY ANALYSIS SUMMARY

Key Intersection	Minimum Acceptable LOS	Control Type	Time Period	(1) Existing Traffic Conditions			(2) Existing With Project Traffic Conditions			(3) Operational Deficiency		(4) Existing With Project With Improvements		
				Delay	LOS	V/C	Delay	LOS	V/C	V/C Inc.	Yes/No	Delay	LOS	V/C
9. University Parkway at Hallmark Parkway	D	6Ø Traffic Signal	AM	17.1 s/v	B	0.38	17.1 s/v	B	0.39	0.01	No	--	--	--
			PM	40.7 s/v	D	0.45	40.7 s/v	D	0.45	0.00	No	--	--	--
10. State Street at Nolan St/Short St	D	8Ø Traffic Signal	AM	16.8 s/v	B	0.36	17.2 s/v	B	0.39	0.03	No	--	--	--
			PM	24.3 s/v	C	0.33	24.4 s/v	C	0.34	0.01	No	--	--	--

Notes:

- s/v = seconds per vehicle (delay)
- LOS = Level of Service
- **Bold Delay/LOS values** indicate adverse service levels based on the LOS standards as defined in this report

7.2 Existing Conditions Roadway Segment Analysis

Table 7-2 summarizes the roadway segment level of service results at the five (5) key roadway segments for existing traffic conditions without and with the Project. The first column (1) shows the number of lanes, the second column (2) shows the arterial classification, and the third column (3) shows the existing LOS “E” capacity. The fourth column (4) presents a summary of existing daily traffic conditions. The fifth column (5) lists existing with project daily traffic conditions. Column 5 also shows the increase in V/C ratio value due to the added daily project trips and indicates whether the traffic associated with the Project will result in an adverse level of service based on the LOS standards defined in this report.

7.2.1 Existing Traffic Conditions

Review of column (4) of *Table 7-2* indicates that one (1) of the five (5) key roadway segments currently operates at an adverse level of service on a daily basis when compared to the LOS standards defined in this report. The remaining four (4) key roadway segments currently operate at acceptable levels of service on a daily basis. The roadway segment operating at an adverse level of service is as follows:

<u>Key Roadway Segment</u>	<u>Volume</u>	<u>Daily</u>	
		<u>V/C Ratio</u>	<u>LOS</u>
D. University Parkway between Varsity Avenue and I-215 NB Ramps	51,601	0.860	D

7.2.2 Existing With Project Traffic Conditions

Review of column (5) of *Table 7-2* indicates that for Existing With Project traffic conditions, one (1) of the five (5) key study roadway segments is forecast to operate at an adverse level of service on a daily basis when compared to the LOS standards defined in this report. The remaining four (4) key study roadway segments are forecast to operate at acceptable levels of service on a daily basis with the addition of Project generated traffic to existing traffic. The roadway segment forecast to operate at an adverse level of service is:

<u>Key Roadway Segment</u>	<u>Volume</u>	<u>Daily</u>	
		<u>V/C Ratio</u>	<u>LOS</u>
D. University Parkway between Varsity Avenue and I-215 NB Ramps	53,822	0.897	D

To determine if the Project creates a deficiency, this adverse roadway segment is further analyzed under peak hour conditions to determine if there are any peak hour deficiencies. As presented in *Table 7-3*, the one (1) adverse study roadway segment is forecast to operate at an acceptable level of service during the AM and PM peak hours.

**TABLE 7-2
EXISTING WITH PROJECT CONDITIONS DAILY ROADWAY SEGMENT ANALYSIS SUMMARY**

Key Roadway Segment	(1) Lanes	(2) Type of Arterial	(3) LOS E Capacity (VPD)	(4) Existing Traffic Conditions			(5) Existing With Project Traffic Conditions				
				Daily Volume	V/C Ratio	LOS	Daily Volume	V/C Ratio	LOS	Increase	Adverse (Yes/No)
				A. <u>University Parkway</u> , between Northpark Boulevard and Kendall Drive	6D	Major	60,000	28,704	0.478	A	29,288
B. <u>University Parkway</u> , between Kendall Drive and College Avenue	6D	Major	60,000	36,994	0.617	B	38,085	0.635	B	0.018	No
C. <u>University Parkway</u> , between College Avenue and Varsity Avenue	6D	Major	60,000	37,587	0.626	B	38,678	0.645	B	0.019	No
D. <u>University Parkway</u> , between Varsity Avenue and I-215 NB Ramps	6D	Major	60,000	51,601	0.860	D	53,822	0.897	D	0.037	Yes
E. <u>University Parkway</u> , between I-215 SB Ramps and Hallmark Parkway	4D	Major	40,000	27,607	0.690	B	28,659	0.716	C	0.026	No

Notes:

- VPD = Vehicles Per Day
- D = Divided
- U = Undivided
- V/C = Volume to Capacity Ratio
- LOS = Level of Service, please refer to *Table 3-3* for the LOS definitions.
- **Bold V/C ratios** and **LOS values** indicate unacceptable service levels.

**TABLE 7-3
EXISTING WITH PROJECT CONDITIONS PEAK HOUR ROADWAY SEGMENT ANALYSIS SUMMARY**

Key Roadway Segment	Type of Arterial	Approach	Time Period	(1)	(2)					(3)
				Link Capacity (VPHPL)	Existing With Project Traffic Conditions					Deficient
					Lanes	Total Link Capacity (VPH)	Peak Hour Volume	V/C Ratio	LOS	
D. <u>University Parkway</u> , between Varsity Avenue and I-215 NB Ramps	Major	Northbound	AM	1,600	3	4,800	2,432	0.507	A	No
			PM	1,600	3	4,800	2,112	0.440	A	No
		Southbound	AM	1,600	3	4,800	1,360	0.283	A	No
			PM	1,600	3	4,800	1,747	0.364	A	No

Notes:

- VPHPL = Vehicles Per Hour Per Lane
- VPH = Vehicles Per Hour
- V/C = Volume to Capacity Ratio
- LOS = Level of Service, please refer to *Table 3-3* for the LOS definitions

8.0 YEAR 2024 WITH PROJECT ANALYSIS

The relative impacts of the added Project traffic volumes generated by the proposed Project during the AM and PM peak hours, was evaluated based on analysis of future Year 2024 operating conditions at the ten (10) key study intersections and five (5) key roadway segments, without and with the proposed Project. The previously discussed capacity analysis procedures were utilized to investigate the future HCM and V/C relationships and service level characteristics at each study intersection and roadway segment. The potential impacts of the Project at each key intersection and roadway segment was then evaluated using the traffic impact criteria mentioned in this report.

8.1 Year 2024 Conditions Intersection Capacity Analysis

Table 8-1 summarizes the AM and PM peak hour Level of Service results at the ten (10) key study intersections for Year 2024 traffic conditions. The first column (1) of Delay/LOS values in *Table 8-1* presents forecast Year 2024 Without Project traffic conditions. The second column (2) identifies forecast Year 2024 With Project traffic conditions. The third column (3) indicates whether the traffic associated with the Project will cause an operational deficiency based on the LOS criteria defined in this report. The fourth column (4) indicates the anticipated operating conditions with implementation of recommended improvements.

8.1.1 Year 2024 Without Project Traffic Conditions

An analysis of future (Year 2024) cumulative traffic conditions indicates that one (1) of the ten (10) key study intersections are forecast to operate at an adverse level of service, based on the LOS criteria mentioned in this report. The remaining nine (9) key study intersections are forecast to continue to operate at acceptable levels of service during the AM and PM peak hours with the addition of ambient traffic growth and cumulative projects traffic. The location forecast to operate at an adverse LOS is as follows:

<u>Key Intersection</u>	<u>AM Peak Hour</u>			<u>PM Peak Hour</u>		
	<u>Delay (s/v)</u>	<u>LOS</u>	<u>V/C</u>	<u>Delay (s/v)</u>	<u>LOS</u>	<u>V/C</u>
7. University Parkway at I-215 NB Ramps	69.8 s/v	E	1.19	--	--	--

8.1.2 Year 2024 With Project Traffic Conditions

Review of columns (2) and (3) of *Table 8-1* indicates that traffic associated with the proposed Project will adversely impact two (2) of the ten (10) key study intersections when compared to the LOS criteria defined in this report. The remaining eight (8) key study intersections are forecast to continue to operate at an acceptable LOS during the AM and PM peak hours with the addition of Project generated traffic in the horizon Year 2024. The locations that will be adversely impacted are as follows:

<u>Key Intersection</u>	<u>AM Peak Hour</u>			<u>PM Peak Hour</u>		
	<u>Delay (s/v)</u>	<u>LOS</u>	<u>V/C</u>	<u>Delay (s/v)</u>	<u>LOS</u>	<u>V/C</u>
6. University Parkway at Varsity Avenue/State Street	--	--	--	27.3 s/v	C	0.96
7. University Parkway at I-215 NB Ramps	73.3 s/v	E	1.22	--	--	--

As shown in column (4) of *Table 8-1*, the implementation of recommended improvements at the two (2) deficient locations improves the intersections to acceptable service levels and offsets the impact of Project traffic.

Appendix E contains the Delay/LOS calculation worksheets for Year 2024 Traffic Conditions and Year 2024 With Project Traffic Conditions.

TABLE 8-1
YEAR 2024 WITH PROJECT CONDITIONS PEAK HOUR INTERSECTION CAPACITY ANALYSIS SUMMARY

Key Intersection	Min. Accept. LOS	Control Type	Time Period	(1) Year 2024 Without Project Traffic Conditions			(2) Year 2024 With Project Traffic Conditions			(3) Operational Deficiency		(4) Year 2024 With Project With Improvements		
				Delay	LOS	V/C	Delay	LOS	V/C	V/C Inc.	Yes/No	Delay	LOS	V/C
				1. University Parkway at Northpark Boulevard	D	6Ø Traffic Signal	AM PM	16.1 s/v 35.2 s/v	B D	0.68 0.71	16.2 s/v 35.3 s/v	B D	0.69 0.71	0.01 0.00
2. University Parkway at Kendall Drive	D	8Ø Traffic Signal	AM PM	41.4 s/v 44.6 s/v	D D	0.82 0.78	43.1 s/v 45.6 s/v	D D	0.83 0.79	0.01 0.01	No No	-- --	-- --	-- --
3. Varsity Avenue at College Avenue	D	One-Way Stop	AM PM	11.8 s/v 25.4 s/v	B D	-- --	12.1 s/v 26.9 s/v	B D	-- --	-- --	No No	-- --	-- --	-- --
4. University Parkway at College Avenue	D	5Ø Traffic Signal	AM PM	10.1 s/v 30.2 s/v	B C	0.58 0.67	10.2 s/v 30.3 s/v	B C	0.59 0.68	0.01 0.01	No No	-- --	-- --	-- --
5. State Street at College Avenue	D	All-Way Stop	AM PM	12.5 s/v 9.9 s/v	B A	-- --	12.6 s/v 9.9 s/v	B A	-- --	-- --	No No	-- --	-- --	-- --
6. University Parkway at Varsity Ave/State St	D	5Ø Traffic Signal	AM PM	27.8 s/v 20.1 s/v	C C	0.94 0.88	36.3 s/v 27.3 s/v	D C	0.96 0.96	0.02 0.08	No Yes	48.3 s/v 49.6 s/v	D D	0.88 0.82
7. University Parkway at I-215 NB Ramps ¹¹	D	3Ø Traffic Signal	AM PM	69.8 s/v 48.9 s/v	E D	1.19 1.06	73.3 s/v 53.8 s/v	E D	1.22 1.08	0.03 0.02	Yes No	42.9 s/v 38.6 s/v	D D	1.01 0.90
8. University Parkway at I-215 SB Ramps	D	3Ø Traffic Signal	AM PM	23.7 s/v 42.7 s/v	C D	0.76 0.84	27.3 s/v 46.3 s/v	C D	0.80 0.86	0.04 0.02	No No	-- --	-- --	-- --

Notes:

- s/v = seconds per vehicle (delay)
- LOS = Level of Service
- **Bold Delay/LOS values** indicate adverse service levels based on the LOS standards as defined in this report

¹¹ The delay reported for this location is based on *HCM 2000* due to non-typical signal timing at this intersection.

TABLE 8-1 (CONTINUED)
YEAR 2024 WITH PROJECT CONDITIONS PEAK HOUR INTERSECTION CAPACITY ANALYSIS SUMMARY

Key Intersection	Min. Accept. LOS	Control Type	Time Period	(1) Year 2024 Without Project Traffic Conditions			(2) Year 2024 With Project Traffic Conditions			(3) Operational Deficiency		(4) Year 2024 With Project With Improvements		
				Delay	LOS	V/C	Delay	LOS	V/C	V/C Inc.	Yes/No	Delay	LOS	V/C
9. University Parkway at Hallmark Parkway	D	6Ø Traffic	AM	27.1 s/v	C	0.38	27.0 s/v	C	0.40	0.02	No	--	--	--
		Signal	PM	41.3 s/v	D	0.49	41.4 s/v	D	0.50	0.01	No	--	--	--
10. State Street at Nolan St/Short St	D	8Ø Traffic	AM	28.6 s/v	C	0.34	29.0 s/v	C	0.35	0.01	No	--	--	--
		Signal	PM	24.4 s/v	C	0.36	24.5 s/v	C	0.37	0.01	No	--	--	--

Notes:

- s/v = seconds per vehicle (delay)
- LOS = Level of Service
- **Bold Delay/LOS values** indicate adverse service levels based on the LOS standards as defined in this report

8.2 Year 2024 Conditions Roadway Segment Analysis

Table 8-2 summarizes the roadway segment level of service results at the five (5) key roadway segments for Year 2024 traffic conditions. The first column (1) shows the number of lanes, the second column (2) shows the arterial classification, and the third column (3) shows the existing LOS “E” capacity. The fourth column (4) presents a summary of existing daily traffic conditions. The fifth column (5) presents a summary of projected Year 2024 cumulative daily traffic conditions. The sixth column (6) lists Year 2024 plus project daily traffic conditions. Column 6 also shows the increase in V/C ratio value due to the added daily project trips and indicates whether the traffic associated with the Project will result in an adverse level of service based on the LOS standards defined in this report.

8.2.1 Year 2024 Without Project Traffic Conditions

Review of column (5) of *Table 8-2* indicates that for Year 2024 Without Project traffic conditions, one (1) of the five (5) key roadway segments is forecast to operate at an adverse level of service on a daily basis when compared to the LOS standards defined in this report. The remaining four (4) key study roadway segments are forecast to continue to operate at acceptable levels of service on a daily basis with the addition of ambient traffic growth and cumulative projects traffic. The roadway segment forecast to operate at an adverse level of service is:

<u>Key Roadway Segment</u>	<u>Volume</u>	<u>Daily</u>	
		<u>V/C Ratio</u>	<u>LOS</u>
D. University Parkway between Varsity Avenue and I-215 NB Ramps	56,419	0.940	E

8.2.2 Year 2024 With Project Traffic Conditions

Review of column (6) of *Table 8-2* indicates that for Year 2024 With Project traffic conditions, one (1) of the five (5) key roadway segments is forecast to operate at an adverse level of service on a daily basis when compared to the LOS standards defined in this report. The remaining four (4) key roadway segments are forecast to continue to operate at acceptable levels of service on a daily basis with the addition of Project generated traffic in the Year 2024 traffic condition. The roadway segment forecast to operate at an adverse level of service is:

<u>Key Roadway Segment</u>	<u>Volume</u>	<u>Daily</u>	
		<u>V/C Ratio</u>	<u>LOS</u>
D. University Parkway between Varsity Avenue and I-215 NB Ramps	58,640	0.977	E

To determine if the Project creates a deficiency, this adverse roadway segment is further analyzed under peak hour conditions to determine if there are any peak hour deficiencies. As presented in **Table 8-3**, the one (1) adverse study roadway segment is forecast to operate at an acceptable level of service during the AM and PM peak hours.

TABLE 8-2
YEAR 2024 WITH PROJECT CONDITIONS DAILY ROADWAY SEGMENT ANALYSIS SUMMARY

Key Roadway Segment	(1) Lanes	(2) Type of Arterial	(3) LOS E Capacity (VPD)	(4) Existing Traffic Conditions			(5) Year 2024 Without Project Traffic Conditions			(6) Year 2024 With Project Traffic Conditions				
				Daily Volume	V/C Ratio	LOS	Daily Volume	V/C Ratio	LOS	Daily Volume	V/C Ratio	LOS	Inc.	Adverse (Yes/No)
A. <u>University Parkway</u> between Northpark Boulevard and Kendall Drive	6D	Major	60,000	28,704	0.478	A	30,426	0.507	A	31,010	0.517	A	0.010	No
B. <u>University Parkway</u> between Kendall Drive and College Avenue	6D	Major	60,000	36,994	0.617	B	40,936	0.682	B	42,027	0.700	C	0.018	No
C. <u>University Parkway</u> between College Avenue and Varsity Avenue	6D	Major	60,000	37,587	0.626	B	41,564	0.693	B	42,655	0.711	C	0.018	No
D. <u>University Parkway</u> between Varsity Avenue and I-215 NB Ramps	6D	Major	60,000	51,601	0.860	D	56,419	0.940	E	58,640	0.977	E	0.037	Yes
E. <u>University Parkway</u> between I-215 SB Ramps and Hallmark Parkway	4D	Major	40,000	27,607	0.690	B	30,051	0.751	C	31,103	0.778	C	0.027	No

Notes:

- VPD = Vehicles Per Day
- D = Divided
- U = Undivided
- V/C = Volume to Capacity Ratio
- LOS = Level of Service, please refer to *Table 3-3* for the LOS definitions.
- **Bold V/C ratios and LOS values** indicate unacceptable service levels.

**TABLE 8-3
YEAR 2024 WITH PROJECT CONDITIONS PEAK HOUR ROADWAY SEGMENT ANALYSIS SUMMARY**

Key Roadway Segment	Type of Arterial	Approach	Time Period	(1)	(2)					(3)
				Link Capacity (VPHPL)	Year 2024 With Project Traffic Conditions					Deficient
					Lanes	Total Link Capacity (VPH)	Peak Hour Volume	V/C Ratio	LOS	
D. <u>University Parkway</u> , between Varsity Avenue and I-215 NB Ramps	Major	Northbound	AM	1,600	3	4,800	2,671	0.556	A	No
			PM	1,600	3	4,800	2,299	0.479	A	No
		Southbound	AM	1,600	3	4,800	1,480	0.308	A	No
			PM	1,600	3	4,800	1,960	0.408	A	No

Notes:

- VPHPL = Vehicles Per Hour Per Lane
- VPH = Vehicles Per Hour
- V/C = Volume to Capacity Ratio
- LOS = Level of Service, please refer to *Table 3-3* for the LOS definitions

9.0 BUILDOUT ANALYSIS

The relative impacts of the added Project traffic volumes generated by the proposed Project during the AM and PM peak hours, was evaluated based on analysis of buildout operating conditions at the ten (10) key study intersections and five (5) key roadway segments, without and with the proposed Project. The previously discussed capacity analysis procedures were utilized to investigate the future HCM and V/C relationships and service level characteristics at each study intersection and roadway segment. The potential impacts of the Project at each key intersection and roadway segment was then evaluated using the traffic impact criteria mentioned in this report. It should be noted that the Buildout Without Project and Buildout With Project Buildout traffic analysis includes the planned reconstruction of the I-215 Freeway Interchange at University Parkway to a Diverging Diamond Interchange as designed by Caltrans.

9.1 Buildout Conditions Intersection Capacity Analysis

Table 9-1 summarizes the AM and PM peak hour Level of Service results at the ten (10) key study intersections for buildout traffic conditions. The first column (1) presents forecast Buildout Without Project traffic conditions and the second column (2) identifies forecast Buildout With Project traffic conditions. The third column (3) indicates whether the traffic associated with the Project will cause an operational deficiency based on the LOS criteria defined in this report. The fourth column (4) indicates the anticipated operating conditions with implementation of recommended improvements.

9.1.1 Buildout Without Project Traffic Conditions

An analysis of future Buildout traffic conditions indicates that one (1) of the ten (10) key study intersections are forecast to operate at an adverse level of service, based on the LOS criteria defined in this report. The remaining nine (9) key study intersections are forecast to continue to operate at acceptable levels of service during the AM and PM peak hours under future Buildout traffic conditions. The location forecast to operate at an adverse LOS is as follows:

<u>Key Intersection</u>	<u>AM Peak Hour</u>			<u>PM Peak Hour</u>		
	<u>Delay (s/v)</u>	<u>LOS</u>	<u>V/C</u>	<u>Delay (s/v)</u>	<u>LOS</u>	<u>V/C</u>
9. University Parkway at Hallmark Parkway	--	--	--	55.6 s/v	E	0.67

9.1.2 Buildout With Project Traffic Conditions

Review of columns (2) and (3) of *Table 9-1* indicates that traffic associated with the proposed Project will adversely impact one (1) of the ten (10) key study intersections when compared to the LOS criteria defined in this report. Although the intersection of University Parkway at Hallmark Parkway is forecast to operate at an adverse LOS E during the PM peak hour with the addition of Project traffic, the proposed Project is expected to add only 0.01 to the V/C value, which does not exceed the allowable threshold. The remaining eight (8) key study intersections are forecast to continue to operate at an acceptable LOS during the AM and PM peak hours with the addition of Project generated traffic in the Buildout traffic condition. The location that will be adversely impacted is as follows:

<u>Key Intersection</u>	<u>AM Peak Hour</u>			<u>PM Peak Hour</u>		
	<u>Delay (s/v)</u>	<u>LOS</u>	<u>V/C</u>	<u>Delay (s/v)</u>	<u>LOS</u>	<u>V/C</u>
6. University Parkway at Varsity Avenue/State Street	41.9 s/v	D	0.97	46.8 s/v	D	1.04

As shown in column (4) of *Table 9-1*, the implementation of recommended improvements at the one (1) deficient location improves this intersection to acceptable service levels and offsets the impact of Project traffic.

Appendix F contains the Delay/LOS calculation worksheets for Buildout Traffic Conditions and Buildout With Project Traffic Conditions.

TABLE 9-1
BUILDOUT WITH PROJECT CONDITIONS PEAK HOUR INTERSECTION CAPACITY ANALYSIS SUMMARY

Key Intersection	Minimum Acceptable LOS	Control Type	Time Period	(1) Buildout Without Project Traffic Conditions			(2) Buildout With Project Traffic Conditions			(3) Operational Deficiency		(4) Buildout With Project With Improvements		
				Delay	LOS	V/C	Delay	LOS	V/C	V/C Inc.	Yes/No	Delay	LOS	V/C
1. University Parkway at Northpark Boulevard	D	6Ø Traffic Signal	AM	22.7 s/v	C	0.65	22.9 s/v	C	0.65	0.00	No	--	--	--
			PM	30.5 s/v	C	0.64	30.5 s/v	C	0.64	0.00	No	--	--	--
2. University Parkway at Kendall Drive	D	8Ø Traffic Signal	AM	41.7 s/v	D	0.81	43.0 s/v	D	0.83	0.02	No	--	--	--
			PM	40.1 s/v	D	0.83	41.7 s/v	D	0.85	0.02	No	--	--	--
3. Varsity Avenue at College Avenue	D	One-Way Stop	AM	11.8 s/v	B	--	12.0 s/v	B	--	--	No	--	--	--
			PM	19.6 s/v	C	--	20.3 s/v	C	--	--	No	--	--	--
4. University Parkway at College Avenue	D	5Ø Traffic Signal	AM	10.9 s/v	B	0.63	11.2 s/v	B	0.64	0.01	No	--	--	--
			PM	36.9 s/v	D	0.69	37.1 s/v	D	0.69	0.00	No	--	--	--
5. State Street at College Avenue	D	All-Way Stop	AM	10.8 s/v	B	--	10.8 s/v	B	--	--	No	--	--	--
			PM	9.8 s/v	A	--	9.8 s/v	A	--	--	No	--	--	--
6. University Parkway at Varsity Ave/State St	D	5Ø Traffic Signal	AM	41.7 s/v	D	0.93	41.9 s/v	D	0.97	0.04	Yes	41.6 s/v	D	0.77
			PM	45.4 s/v	D	0.94	46.8 s/v	D	1.04	0.10	Yes	46.4 s/v	D	0.79

Notes:

- s/v = seconds per vehicle (delay)
- LOS = Level of Service
- **Bold Delay/LOS values** indicate adverse service levels based on the LOS standards as defined in this report

TABLE 9-1 (CONTINUED)
BUILDOUT WITH PROJECT CONDITIONS PEAK HOUR INTERSECTION CAPACITY ANALYSIS SUMMARY

Key Intersection	Minimum Acceptable LOS	Control Type	Time Period	(1) Buildout Without Project Traffic Conditions			(2) Buildout With Project Traffic Conditions			(3) Operational Deficiency		(4) Buildout With Project With Improvements		
				Delay	LOS	V/C	Delay	LOS	V/C	V/C Inc.	Yes/No	Delay	LOS	V/C
				7a. University Parkway at I-215 NB Ramps ¹²	D	2Ø Traffic Signal	AM PM	13.5 s/v 13.6 s/v	B B	0.53 0.66	13.7 s/v 16.3 s/v	B B	0.56 0.68	0.03 0.02
7b. University Parkway (SB) at I-215 NB Off-Ramp	D	2Ø Traffic Signal	AM PM	15.1 s/v 16.4 s/v	B B	0.69 0.79	16.2 s/v 16.8 s/v	B B	0.71 0.81	0.02 0.02	No No	-- --	-- --	-- --
7c. University Parkway (NB) at I-215 NB Off-Ramp	D	2Ø Traffic Signal	AM PM	20.1 s/v 16.0 s/v	C B	0.84 0.78	19.3 s/v 16.8 s/v	B B	0.87 0.80	0.03 0.02	No No	-- --	-- --	-- --
8a. University Parkway at I-215 SB Ramps ¹²	D	2Ø Traffic Signal	AM PM	14.5 s/v 18.2 s/v	B B	0.43 0.55	14.5 s/v 16.4 s/v	B B	0.45 0.57	0.02 0.02	No No	-- --	-- --	-- --
8b. University Parkway (SB) at I-215 SB Off-Ramp	D	2Ø Traffic Signal	AM PM	4.5 s/v 3.9 s/v	A A	0.35 0.34	4.6 s/v 3.7 s/v	A A	0.36 0.35	0.01 0.01	No No	-- --	-- --	-- --
8c. University Parkway (NB) at I-215 SB Off-Ramp	D	2Ø Traffic Signal	AM PM	19.8 s/v 19.9 s/v	B B	0.14 0.21	20.6 s/v 22.4 s/v	C C	0.15 0.21	0.01 0.00	No No	-- --	-- --	-- --
9. University Parkway at Hallmark Parkway	D	6Ø Traffic Signal	AM PM	38.5 s/v 55.6 s/v	D E	0.47 0.67	41.9 s/v 57.9 s/v	D E	0.48 0.68	0.01 0.01	No No	-- --	-- --	-- --
10. State Street at Nolan Street/Short Street	D	8Ø Traffic Signal	AM PM	30.5 s/v 24.4 s/v	C C	0.35 0.39	30.8 s/v 24.6 s/v	C C	0.38 0.40	0.03 0.01	No No	-- --	-- --	-- --

Notes:

- s/v = seconds per vehicle (delay)
- LOS = Level of Service
- Bold Delay/LOS values indicate adverse service levels based on the LOS standards as defined in this report

¹² The delay reported for this location is based on *HCM 2000* due to non-typical signal timing at this intersection.

9.2 Buildout Conditions Roadway Segment Analysis

Table 9-2 summarizes the roadway segment level of service results at the five (5) key roadway segments for buildout traffic conditions. The first column (1) shows the number of lanes, the second column (2) shows the arterial classification, and the third column (3) shows the existing LOS “E” capacity. The fourth column (4) presents a summary of existing daily traffic conditions. The fifth column (5) presents a summary of projected buildout without project daily traffic conditions. The sixth column (6) lists buildout plus project daily traffic conditions. Column 6 also shows the increase in V/C ratio value due to the added daily project trips and indicates whether the traffic associated with the Project will result in an adverse level of service based on the LOS standards defined in this report.

9.2.1 Buildout Without Project Traffic Conditions

Review of column (5) of *Table 9-2* indicates that for Buildout Without Project traffic conditions, two (2) of the five (5) key roadway segments are forecast to operate at an adverse level of service on a daily basis when compared to the LOS standards defined in this report. The remaining three (3) key study roadway segments are forecast to continue to operate at acceptable levels of service on a daily basis under buildout traffic conditions. The roadway segments forecast to operate at an adverse level of service are:

<u>Key Roadway Segment</u>	<u>Volume</u>	<u>Daily</u>	
		<u>V/C Ratio</u>	<u>LOS</u>
D. University Parkway between Varsity Avenue and I-215 NB Ramps	57,204	0.953	E
E. University Parkway between I-215 SB Ramps and Hallmark Parkway	36,529	0.913	E

9.2.2 Buildout With Project Traffic Conditions

Review of column (6) of *Table 9-2* indicates that for Buildout With Project traffic conditions, two (2) of the five (5) key roadway segments are forecast to operate at an adverse level of service on a daily basis when compared to the LOS standards defined in this report. The remaining three (3) key roadway segments are forecast to continue to operate at acceptable levels of service on a daily basis with the addition of Project generated traffic in the Buildout traffic condition. The roadway segments forecast to operate at an adverse level of service are:

<u>Key Roadway Segment</u>	<u>Volume</u>	<u>Daily</u>	
		<u>V/C Ratio</u>	<u>LOS</u>
D. University Parkway between Varsity Avenue and I-215 NB Ramps	59,425	0.990	E
E. University Parkway between I-215 SB Ramps and Hallmark Parkway	37,581	0.940	E

To determine if the Project creates a deficiency, these adverse roadway segments are further analyzed under peak hour conditions to determine if there are any peak hour deficiencies. As presented in **Table 9-3**, the two (2) adverse study roadway segments are forecast to operate at an acceptable level of service during the AM and PM peak hours.

**TABLE 9-2
BUILDOUT WITH PROJECT CONDITIONS DAILY ROADWAY SEGMENT ANALYSIS SUMMARY**

Key Roadway Segment	(1) Lanes	(2) Type of Arterial	(3) LOS E Capacity (VPD)	(4) Existing Traffic Conditions			(5) Buildout Without Project Traffic Conditions			(6) Buildout With Project Traffic Conditions				
				Daily Volume	V/C Ratio	LOS	Daily Volume	V/C Ratio	LOS	Daily Volume	V/C Ratio	LOS	Inc.	Adverse (Yes/No)
A. <u>University Parkway</u> between Northpark Boulevard and Kendall Drive	6D	Major	60,000	28,704	0.478	A	34,753	0.579	A	35,337	0.589	A	0.010	No
B. <u>University Parkway</u> between Kendall Drive and College Avenue	6D	Major	60,000	36,994	0.617	B	41,340	0.689	B	42,431	0.707	C	0.018	No
C. <u>University Parkway</u> between College Avenue and Varsity Avenue	6D	Major	60,000	37,587	0.626	B	43,190	0.720	C	44,281	0.738	C	0.018	No
D. <u>University Parkway</u> between Varsity Avenue and I-215 NB Ramps	6D	Major	60,000	51,601	0.860	D	57,204	0.953	E	59,425	0.990	E	0.037	Yes
E. <u>University Parkway</u> between I-215 SB Ramps and Hallmark Parkway	4D	Major	40,000	27,607	0.690	B	36,529	0.913	E	37,581	0.940	E	0.027	Yes

Notes:

- VPD = Vehicles Per Day
- D = Divided
- U = Undivided
- V/C = Volume to Capacity Ratio
- LOS = Level of Service, please refer to *Table 3-3* for the LOS definitions.
- **Bold V/C ratios and LOS values** indicate unacceptable service levels.

**TABLE 9-3
BUILDOUT WITH PROJECT CONDITIONS PEAK HOUR ROADWAY SEGMENT ANALYSIS SUMMARY**

Key Roadway Segment	Type of Arterial	Approach	Time Period	(1)	(2)					(3)
				Link Capacity (VPHPL)	Buildout With Project Traffic Conditions					Deficient
					Lanes	Total Link Capacity (VPH)	Peak Hour Volume	V/C Ratio	LOS	
D. <u>University Parkway</u> , between Varsity Avenue and I-215 NB Ramps	Major	Northbound	AM	1,600	3	4,800	2,769	0.577	A	No
			PM	1,600	3	4,800	2,528	0.527	A	No
		Southbound	AM	1,600	3	4,800	1,554	0.324	A	No
			PM	1,600	3	4,800	2,055	0.428	A	No
E. <u>University Parkway</u> , between I-215 SB Ramps and Hallmark Parkway	Major	Northbound	AM	1,600	2	3,200	736	0.230	A	No
			PM	1,600	2	3,200	1,086	0.339	A	No
		Southbound	AM	1,600	2	3,200	1,379	0.431	A	No
			PM	1,600	2	3,200	1,093	0.342	A	No

Notes:

- VPHPL = Vehicles Per Hour Per Lane
- VPH = Vehicles Per Hour
- V/C = Volume to Capacity Ratio
- LOS = Level of Service, please refer to *Table 3-3* for the LOS definitions

10.0 SITE ACCESS AND INTERNAL CIRCULATION EVALUATION

10.1 Site Access

As shown previously in *Figure 2-2*, access to the proposed Project will be provided via two full access unsignalized driveways located along Varsity Avenue (i.e. Project Driveways No. 1 and No. 2) and via one right-turn in/right-turn out only driveway located along University Parkway (i.e. Project Driveway No. 3).

Table 10-1 summarizes the levels of service at the three (3) project driveways for Year 2024 With Project traffic conditions and Buildout With Project traffic conditions. The operations analysis for the three (3) project driveways is based on the *Highway Capacity Manual 6* (HCM 6) Method of Analysis for unsignalized intersections. Column one (1) presents the level of service results for Year 2024 With Project traffic conditions and column two (2) presents the level of service results for Buildout With Project traffic conditions. As shown in *Table 10-1*, the two project driveways on Varsity Avenue (i.e. Project Driveways No. 1 and No. 2) are forecast to operate at an acceptable level of service during the AM and PM peak hours under Year 2024 With Project traffic conditions and Buildout With Project traffic conditions. The project driveway on University Parkway (i.e. Project Driveway No. 3) is forecast to operate at acceptable LOS D during the AM peak hour and unacceptable LOS E during the PM peak hour under Year 2024 With Project traffic conditions and Buildout With Project traffic conditions.

It should be noted that it is not uncommon for private unsignalized driveways, such as Project Driveway No. 3, to experience a longer delay due to the heavy traffic volumes on the major street, such as University Parkway. Furthermore, due to the proposed project driveway being located south of the signalized intersection of University Parkway at Varsity Avenue/State Street, it is expected that gaps in traffic would occur and the actual vehicular delay experienced exiting the project driveway would be lower than what is being reported by the HCM methodology. Lastly, the expected 95th percentile vehicular queue experienced for the eastbound right-turn for Project Driveway No. 3 at University Parkway would not exceed 3 vehicles, further validating that the forecast adverse LOS at this driveway is insignificant.

Appendix G contains the Delay/LOS calculation worksheets for the Year 2024 With Project and Buildout With Project Traffic Conditions.

10.2 Project Driveway Queuing Analysis

Table 10-2 presents the project driveway queuing analysis results for Year 2024 With Project traffic conditions and Buildout With Project traffic conditions. Review of *Table 10-2* indicates that adequate storage is provided to accommodate the forecast 95th percentile queues under Year 2024 With Project and Buildout With Project traffic conditions for all outbound movements at the three (3) project driveways. In addition, as shown in *Table 10-2*, the 95th percentile queue for the southbound shared through/right-turn lane on University Parkway at Project Driveway No. 3 is nominal (essentially zero), but 25 feet is reported in the table to indicate a conservative result, which reflects one vehicle slowing to enter the driveway with nominal delay.

As requested by City staff, the need for a southbound right-turn deceleration lane at the intersection of University Parkway/Project Driveway No. 3 was evaluated. Based on review of the peak hour level of service calculations for Project Driveway No. 3, the southbound through vehicles along University Parkway at Project Driveway No. 3 are forecast to have nominal delay, indicating that a deceleration lane is not needed. Furthermore, given the proximity of the driveway to the adjacent driveway to the north and exclusive southbound right turn lane at the I-215 NB On-ramp to the south, which can create a confusing and unsafe condition for southbound right turn movements at both driveways, a right turn deceleration is not recommended at the Project driveway along University Parkway.

10.3 Internal Circulation Evaluation

The on-site circulation layout of the proposed Project as illustrated in *Figure 2-2* on an overall basis is adequate. Curb return radii appear adequate for passenger cars, service/delivery trucks and trash trucks. Based on our review of the project site plan, the overall layout does not create significant vehicle-pedestrian conflict points and project traffic is not anticipated to cause significant internal queuing/stacking at the Project driveways. Lastly, it is not anticipated that any vehicular traffic at the internal project driveways located along the project's main east-west drive aisle (i.e. located along the northerly boundary of the project site) will queue onto either University Parkway or Varsity Avenue as the parking area configuration and circulation pattern is typical for retail centers.

10.4 Drive-Through Queuing Analysis

The following sections evaluate the adequacy of storage provided for the Chick-fil-A drive-through lane, the proposed Dutch Brothers Coffee drive-through lane, the Express Car Wash and the proposed Pad B – Fast-Food Restaurant drive-through lane.

10.4.1 Chick-fil-A Drive-Through

To confirm the adequacy of storage provided for the proposed Chick-fil-A drive-through lane, existing queuing observations were conducted at the following three (3) existing Chick-fil-A restaurants.

- Chick-fil-A Irvine, located at 4127 Campus Drive
- Chick-fil-A San Juan Capistrano, located at 31872 Del Obispo Street
- Chick-fil-A Yucaipa, located at 31479 Avenue E

Drive-through queuing observations were conducted at the three (3) locations on two weekdays (Thursday and Friday) and on a Saturday during the morning, mid-day and evening service periods, generally between the hours of 7:00 AM and 9:00 AM, 11:00 AM and 2:00 PM, and 4:00 PM and 7:00 PM. The queuing observations for the Irvine Chick-fil-A and San Juan Capistrano Chick-fil-A were conducted by Transportation Studies Inc. (TSI) on Thursday December 9, 2021, Friday December 10, 2021 and Saturday December 11, 2021. The queuing observations for the Yucaipa Chick-fil-A were conducted by TSI on Thursday December 16, 2021, Friday December 17, 2021 and Saturday December 18, 2021. The vehicular queues observed at the three (3) sites were recorded at 5-minute intervals.

TABLE 10-1
PROJECT DRIVEWAY PEAK HOUR LEVELS OF SERVICE SUMMARY

Key Intersection	Time Period	Intersection Control	(1) Year 2024 With Project Traffic Conditions		(2) Buildout With Project Traffic Conditions	
			Delay	LOS	Delay	LOS
A. Varsity Avenue at Project Driveway No. 1	AM	One-Way	9.7 s/v	A	9.8 s/v	A
	PM	Stop	10.9 s/v	B	11.1 s/v	B
B. Project Driveway No. 2 at Varsity Avenue	AM	One-Way	10.9 s/v	B	11.1 s/v	B
	PM	Stop	12.4 s/v	B	12.7 s/v	B
C. University Parkway at Project Driveway No. 3	AM	One-Way	27.2 s/v	D	29.5 s/v	D
	PM	Stop	38.5 s/v	E	43.7 s/v	E

Note:

s/v = seconds per vehicle

TABLE 10-2
PROJECT DRIVEWAY PEAK HOUR QUEUING ANALYSIS¹³

Key Ramp Intersection	Year 2024 With Project Traffic Conditions				Buildout With Project Traffic Conditions			
	AM Peak Hour		PM Peak Hour		AM Peak Hour		PM Peak Hour	
	Max. Queue (feet)	Adequate Storage (Yes / No)	Max Queue (feet)	Adequate Storage (Yes / No)	Max. Queue (feet)	Adequate Storage (Yes / No)	Max. Queue (feet)	Adequate Storage (Yes / No)
A. Varsity Avenue at Project Driveway No. 1 <i>Eastbound Shared Left/Right-Turn</i>	25'	Yes	25'	Yes	25'	Yes	25'	Yes
B. Project Driveway No. 2 at Varsity Avenue <i>Northbound Shared Left/Right-Turn</i>	25'	Yes	25'	Yes	25'	Yes	25'	Yes
C. University Parkway at Project Driveway No. 3 <i>Southbound Shared Through/Right-Turn</i>	25' [a]	Yes	25' [a]	Yes	25' [a]	Yes	25' [a]	Yes
	<i>Eastbound Right-Turn</i> 53'	Yes	55'	Yes	58'	Yes	63'	Yes

Note:

[a] = It should be noted that the right turn movement delay is nominal and the queue reported for this uncontrolled movement is also nominal, but 25 feet is reported in the table to indicate a conservative result, which reflects one vehicle slowing to enter the driveway.

¹³ Queue is based on the 95th Percentile Queue and is reported in total queue length (feet) per lane for unsignalized intersections.

Tables 10-3, 10-4 and 10-5 summarize the Queue Frequency that was observed at the three sites for the weekday (Thursday), weekday (Friday) and weekend (Saturday) peak periods, respectively. Our evaluation of this data indicates that on average during the weekday (Thursday) peak periods, an average queue of 12 vehicles in the drive-through lane can be expected, with an 85th percentile queue of approximately 19 vehicles, a 95th percentile queue of approximately 23 vehicles and a max queue of approximately 27 vehicles. Similarly, our evaluation of this data indicates that on average during the weekday (Friday) peak periods, an average queue of 12 vehicles in the drive-through lane can be expected, with an 85th percentile queue of approximately 18 vehicles, a 95th percentile queue of approximately 22 vehicles and a max queue of approximately 31 vehicles. In addition, our evaluation of this data also indicates that on average during the weekend (Saturday) peak periods, an average queue of 9 vehicles in the drive-through lane can be expected, with an 85th percentile queue of approximately 15 vehicles, a 95th percentile queue of approximately 18 vehicles and a max queue of approximately 27 vehicles. It should be noted that the 85th percentile queue is generally utilized when designing/sizing the length of the proposed drive-through lane.

In conclusion, the three (3) study sites experienced an 85th percentile queue range between 15 vehicles and 19 vehicles. As stated previously, the proposed Project will provide storage for up to 75 vehicles within the proposed drive-through lane without encroaching into the drive aisle. Therefore, the 85th percentile expected queues can be accommodated without interfering with internal circulation or causing congestion to the drive aisles. It should be noted that the proposed 75 vehicle storage drive-through lane can also accommodate the observed 95th percentile queues (i.e. queue range between 18 vehicles and 23 vehicles). Lastly, it should be noted that the proposed 75 vehicle storage drive-through lane can also accommodate the observed maximum queue of 31 vehicles, which only occurred one time and only at one site throughout the survey days.

Even though it is anticipated that the proposed drive-through lane will accommodate all potential queues on site, Chick-fil-A staff will implement the following program, on an as-needed basis during their peak operating times, to further ensure that vehicles will not queue back onto the public streets. The program consists of the following as provided by Chick-fil-A management staff:

- “Our restaurants are staffed so that if the drive-thru queuing begins stacking onto the street, team members go out and assist with ordering via Chick-fil-A’s iPad ordering system. Our operators use the iPad ordering during our peak hours of 11:30 am to 1:30 pm and any additional time when needed. The iPad ordering system allows team members to take orders, receive payment, and assist with traffic movement within the parking lot.
- Based on data from our other comparable stores, the iPad ordering system increases the Chick-fil-A drive thru speed of service by 30% than the typical speaker box. Putting people forward in the drive-through is one of our biggest competitive advantages in the market because it personally connects our team members with our valued guest. We want to continue this momentum by building a platform to supporting current and future

innovations that increase capacity and put our people forward to care for our guest in every interaction. Our customers enjoy the face to face ordering over the standard drive-thru experience.”

- Along with face-to-face ordering, Chick-fil-A implemented a dual drive-through concept from the entrance of the drive-through to the pick-up window. The outer drive-through lane can be used for full order take and meal delivery, mobile pick up lane, or for a pickup point for smaller orders. The Operator has the flexibility to use the second lane as they see fit (during peak demand). Chick-fil-A team members will take orders and deliver orders in both lanes, hence the importance of the canopies to provide shade for the team members. Appropriate safety signage and protocols are placed throughout the drive-thru.
- It should be noted that Chick-fil-A team members will control the drive-through area after the pick-up window ensuring that only one vehicle will leave at a time after they receive their order.

Appendix H presents the drive-through queuing study data for the three (3) existing sites.

10.4.2 Dutch Brothers Coffee

The drive-through lane for Dutch Brothers Coffee will provide storage for up to thirty-three (33) vehicles without encroaching into the internal drive aisles. Based on information provided by Dutch Brothers, the drive-through storage design exceeds the minimum corporate standard of fifteen (15) vehicles, which allows the store to achieve their average service times of 45-seconds per vehicle. Therefore, we conclude that adequate storage is provided for the Dutch Brothers Coffee drive-through and vehicles are not anticipated to queue back to Varsity Avenue and/or University Parkway.

10.4.3 Express Car Wash

The Express Wash will have the capacity to stack twenty-one (21) vehicles from the pay station without encroaching into the internal drive aisles. Based on information provided by the operator, the express wash can process up to 120 vehicles per hour. Given the trip generation demand forecasted during the peak hours and the processing rate, minimal queuing is anticipated. Therefore, we conclude that adequate storage is provided for the Express Wash and vehicles are not anticipated to interfere with internal circulation.

10.4.4 Pad B – Fast Food Restaurant With Drive-Through

The Pad B – Fast Food Restaurant With Drive-Through will provide storage for up to twelve (12) vehicles without encroaching into the internal drive aisles and also includes an additional outside storage lane for approximately eight (8) more vehicles. Although the specific tenant has not been identified at this time, we conclude that adequate storage is provided and vehicles are not anticipated to interfere with internal circulation.

**TABLE 10-3
WEEKDAY (THURSDAY) QUEUING ANALYSIS SUMMARY**

Queue Length (Vehicles)	Queue Frequency of Vehicles Observed				Cumulative	
	Site #1 4127 Campus Dr, Irvine, CA	Site #2 31872 Del Obispo St, San Juan Cap, CA	Site #3 31479 Avenue E, Yucaipa, CA	Total	Frequency	Percentage
0	5	3	0	8	8	2.5%
1	5	2	0	7	15	4.6%
2	0	5	0	5	20	6.2%
3	6	5	2	13	33	10.2%
4	6	5	8	19	52	16.0%
5	3	0	2	5	57	17.6%
6	3	4	8	15	72	22.2%
7	1	8	3	12	84	25.9%
8	3	5	6	14	98	30.2%
9	2	10	7	19	117	36.1%
10	2	12	7	21	138	42.6%
11	1	10	12	23	161	49.7%
12	4	4	7	15	176	54.3%
13	6	10	5	21	197	60.8%
14	4	6	8	18	215	66.4%
15	4	4	4	12	227	70.1%
16	4	4	9	17	244	75.3%
17	9	5	3	17	261	80.6%
18	7	2	2	11	272	84.0%
19	8	1	4	13	285	88.0%
20	4	0	3	7	292	90.1%
21	4	2	0	6	298	92.0%
22	3	1	2	6	304	93.8%
23	5	0	3	8	312	96.3%
24	6	0	1	7	319	98.5%
25	1	0	0	1	320	98.8%
26	0	0	1	1	321	99.1%
27	2	0	1	3	324	100.0%
Total	108	108	108	324	--	--
Average	14.0	10.0	12.0	12.0	--	--
85th Percentile	22.0	15.0	18.0	19.0	--	--
95th Percentile	24.0	18.0	23.0	23.0	--	--
Max	27.0	22.0	27.0	27.0	--	--

**TABLE 10-4
WEEKDAY (FRIDAY) QUEUING ANALYSIS SUMMARY**

Queue Length (Vehicles)	Queue Frequency of Vehicles Observed				Cumulative	
	Site #1 4127 Campus Dr, Irvine, CA	Site #2 31872 Del Obispo St, San Juan Cap, CA	Site #3 31479 Avenue E, Yucaipa, CA	Total	Frequency	Percentage
0	0	3	0	3	3	0.9%
1	0	1	0	1	4	1.2%
2	0	5	2	7	11	3.4%
3	2	4	2	8	19	5.9%
4	1	2	2	5	24	7.4%
5	0	2	6	8	32	9.9%
6	2	5	3	10	42	13.0%
7	4	5	8	17	59	18.2%
8	5	10	5	20	79	24.4%
9	0	10	6	16	95	29.3%
10	6	9	8	23	118	36.4%
11	4	9	9	22	140	43.2%
12	10	7	6	23	163	50.3%
13	6	4	13	23	186	57.4%
14	6	5	6	17	203	62.7%
15	8	7	4	19	222	68.5%
16	5	8	8	21	243	75.0%
17	10	1	4	15	258	79.6%
18	15	2	4	21	279	86.1%
19	6	1	3	10	289	89.2%
20	1	2	0	3	292	90.1%
21	8	1	2	11	303	93.5%
22	3	1	2	6	309	95.4%
23	2	3	1	6	315	97.2%
24	0	0	2	2	317	97.8%
25	1	0	0	1	318	98.1%
26	1	1	0	2	320	98.8%
27	2	0	0	2	322	99.4%
28	0	0	1	1	323	99.7%
29	0	0	0	0	323	99.7%
30	0	0	0	0	323	99.7%
31	0	0	1	1	324	100.0%
Total	108	108	108	324	--	--
Average	15.0	11.0	12.0	12.0	--	--
85th Percentile	21.0	16.0	17.0	18.0	--	--
95th Percentile	23.0	21.0	22.0	22.0	--	--
Max	27.0	26.0	31.0	31.0	--	--

**TABLE 10-5
WEEKEND (SATURDAY) QUEUING ANALYSIS SUMMARY**

Queue Length (Vehicles)	Queue Frequency of Vehicles Observed				Cumulative	
	Site #1 4127 Campus Dr, Irvine, CA	Site #2 31872 Del Obispo St, San Juan Cap, CA	Site #3 31479 Avenue E, Yucaipa, CA	Total	Frequency	Percentage
0	0	6	0	6	6	1.9%
1	3	1	3	7	13	4.0%
2	2	9	1	12	25	7.7%
3	3	4	5	12	37	11.4%
4	2	7	7	16	53	16.4%
5	4	7	7	18	71	21.9%
6	6	6	12	24	95	29.3%
7	4	7	20	31	126	38.9%
8	10	13	4	27	153	47.2%
9	2	3	10	15	168	51.9%
10	6	6	7	19	187	57.7%
11	7	10	5	22	209	64.5%
12	7	9	5	21	230	71.0%
13	10	9	6	25	255	78.7%
14	8	4	5	17	272	84.0%
15	7	2	2	11	283	87.3%
16	4	2	5	11	294	90.7%
17	6	2	1	9	303	93.5%
18	4	1	0	5	308	95.1%
19	3	0	1	4	312	96.3%
20	3	0	1	4	316	97.5%
21	3	0	0	3	319	98.5%
22	2	0	1	3	322	99.4%
23	0	0	0	0	322	99.4%
24	1	0	0	1	323	99.7%
25	0	0	0	0	323	99.7%
26	0	0	0	0	323	99.7%
27	1	0	0	1	324	100.0%
Total	108	108	108	324	--	--
Average	12.0	8.0	9.0	9.0	--	--
85th Percentile	18.0	13.0	13.0	15.0	--	--
95th Percentile	21.0	15.0	16.0	18.0	--	--
Max	27.0	18.0	22.0	27.0	--	--

11.0 STATE OF CALIFORNIA (CALTRANS) METHODOLOGY

Caltrans requires the use of analysis methods provided in the Highway Capacity Manual 6 (*HCM 6*) for the analysis of ramp intersections. Caltrans “endeavors to maintain a target LOS at the transition between LOS “C” and LOS “D” on State highway facilities; it does not require that LOS “D” (shall) be maintained. However, Caltrans acknowledges that this may not always be feasible and recommends that the lead agency consult with Caltrans to determine the appropriate target LOS. For this analysis, LOS D is the target level of service standard, consistent with City of San Bernardino requirements and will be utilized to assess the Project impacts at the state-controlled study intersections.

Ramp Intersection Capacity Analyses were conducted for the following two (2) state-controlled key study intersections:

7. University Parkway at I-215 Northbound Ramps
8. University Parkway at I-215 Southbound Ramps

11.1 Ramp Intersection Capacity Analysis

As shown in *Tables 7-1, 8-1, and 9-1*, presented previously in *Sections 7.0, 8.0 and 9.0*, the intersection of University Parkway at I-215 NB Ramps is forecast to operate at unacceptable levels of service during the AM peak hour under Existing With Project and Year 2024 With Project traffic conditions. However, the implementation of recommended improvements at the deficient location improves this intersection to acceptable service levels and offsets the impact of Project traffic. Under Buildout traffic conditions, the intersection of University Parkway at I-215 NB Ramps is forecast to operate at an acceptable level of service during the AM peak hour and PM peak hour.

The intersection of University Parkway at I-215 SB Ramps is forecast to operate at acceptable levels of service during the AM peak hour and PM peak hour without and with the proposed Project for all analyzed traffic conditions.

11.2 Vehicle Miles Traveled Analysis

The Department of Transportation (Caltrans) has also formally adopted VMT as the metric for reviewing the transportation impacts of a land use development project. Caltrans has released the Vehicle Miles Traveled-Focused *Transportation Impact Study Guide (TISG)*, dated May 20, 2020, and the *Caltrans Interim Land Development and Intergovernmental Review (LDIGR) Safety Review Practitioners Guidance*, dated July 2020, in order to provide guidance on Caltrans’ review of land use projects.

Caltrans’ TISG references the *Technical Advisory on Evaluating Transportation Impacts In California Environmental Quality Act (CEQA)*, dated December 2018, prepared by the State of California Governor’s Office of Planning and Research (OPR) as the basis for its guidance on VMT assessment. The City of San Bernardino recently adopted new traffic impact criteria in August 2020 to be consistent with the CEQA revisions and OPR recommendations. These new guidelines are contained within the *City of San Bernardino Traffic Impact Analysis Guidelines*, dated August 2020.

and provide screening criteria and methodology for VMT analysis. Since the City's guidelines are generally consistent with OPR guidelines, no separate VMT analysis has been prepared for Caltrans' review of the proposed project. The VMT analysis for this project is contained within **Section 14.0** later in this TIA.

11.3 Off-Ramp Vehicle Queuing Analysis

The *Caltrans Interim Land Development and Intergovernmental Review (LDIGR) Safety Review Practitioners Guidance*, dated July 2020, provides direction on a simplified safety analysis approach that reduces the risk to all road users and that focuses on multi-modal conflict analysis as well as access management issues. District traffic safety staff are encouraged to consider the proposed project's potential influence on safety on state roadways, including the following factors:

- Increased presence of pedestrians and bicyclists
- Degradation of the walking and bicycling environment and experience
- New pedestrian and bicyclist connection desires
- Multimodal conflict points, especially at intersections and project access locations
- Change in traffic mix such as an increase in bicyclists or pedestrians where features such as shoulders or sidewalks may not exist or are inconsistent with facility design (sidewalks, bike and multi-user paths, multimodal roadways, etc.)
- Increased vehicular speeds
- Transition between free flow and metered flow
- Increased traffic volumes
- Queuing at off-ramps resulting in slow or stopped traffic on the mainline or speed differentials between adjacent lanes
- Queuing exceeding turn pocket length that impedes through-traffic

The proposed Project does not take direct access from a State facility; therefore, the project has not been reviewed for factors pertaining to site access or local roadways. However, the proposed project is expected to generate new project trips at the I-215 Freeway ramps along University Parkway (i.e. key study intersections #7 and #8). Therefore, an analysis of the project's effect on off-ramp queuing was prepared in order to determine if the project would cause, or contribute towards, slowing or stopped traffic on mainline travel lanes resulting in unsafe speed differentials between adjacent lanes.

Pursuant to prior direction from Caltrans staff, off-ramp queuing was analyzed using the Highway Capacity Manual (HCM) method for signalized intersections. As described in **Section 3.0** above, the off-ramp queuing calculations were prepared utilizing the HCM 6 operational methodology for signalized intersections. A *Synchro* network was created based on existing conditions field reviews at the two (2) ramp intersections. In addition, specifics such as traffic volume data, lane configurations, available vehicle storage lengths, crosswalk locations, posted speed limits, traffic signal timing and phasing, etc., were coded to complete the existing network. The corresponding weekday AM peak hour and PM peak hour HCM 6 worksheets for purposes of determining the 95th percentile vehicle queues are contained in *Appendices D, E and F*.

The queuing analysis was prepared for Existing, Existing With Project, Year 2024 Without Project, Year 2024 With Project, Buildout Without Project, and Buildout With Project traffic conditions. Both of the freeway off-ramp intersection approaches were reviewed in terms of expected maximum vehicle queues (i.e. 95th percentile queues) which represent the maximum back of vehicle queues with 95th percentile traffic volumes. The corresponding maximum vehicle queue lengths were then compared to the total ramp storage lengths (i.e. the available storage length as measured from the applicable off-ramp/frontage road lane striping to the respective off-ramp approach limit lines/merge points).

11.3.1 Existing With Project Traffic Conditions

As shown in *Table 11-1*, adequate storage is provided to accommodate the forecast 95th percentile queues under Existing and Existing With Project traffic conditions at the two (2) off-ramp locations. The Project is expected to neither cause nor contribute towards vehicle queuing which extends back into the I-215 Freeway mainline travel lanes for Existing and Existing With Project traffic conditions. Therefore, the proposed project is not anticipated to negatively influence safety on the State Highway System.

11.3.2 Year 2024 With Project Traffic Conditions

As shown in *Table 11-2*, adequate storage is provided to accommodate the forecast 95th percentile queues under Year 2024 Without Project and Year 2024 With Project traffic conditions at the two (2) off-ramp locations. The Project is expected to neither cause nor contribute towards vehicle queuing which extends back into the I-215 Freeway mainline travel lanes for Year 2024 Without Project and Year 2024 With Project traffic conditions. Therefore, the proposed project is not anticipated to negatively influence safety on the State Highway System.

11.3.3 Buildout With Project Traffic Conditions

As shown in *Table 11-3*, adequate storage is provided to accommodate the forecast 95th percentile queues under Buildout Without Project and Buildout With Project traffic conditions at the two (2) off-ramp locations, which includes the planned reconstruction of the I-215 Freeway Interchange at University Parkway to a Diverging Diamond Interchange. The Project is expected to neither cause nor contribute towards vehicle queuing which extends back into the I-215 Freeway mainline travel lanes for Buildout Without Project and Buildout With Project traffic conditions. Therefore, the proposed project is not anticipated to negatively influence safety on the State Highway System.

11.4 Pedestrian Circulation

Pedestrian circulation will be provided via the existing public sidewalk along University Parkway within the vicinity of the Project frontage, which will connect to the Project's internal walkways. The project will construct sidewalk along the Project frontage on Varsity Avenue, which will connect to the existing sidewalk on Varsity Avenue to the east. The Project will protect the existing sidewalk along Project frontage and if necessary, repair or reconstruct sidewalks along the project frontage per the City's request. The existing sidewalk system within the Project vicinity provides direct connectivity to the surrounding commercial, office and residential developments, as well as nearby public transit stops, along University Parkway.

**TABLE 11-1
EXISTING WITH PROJECT PEAK HOUR FREEWAY OFF-RAMP QUEUING ANALYSIS¹⁴**

Key Ramp Intersection	Estimated Storage Provided Per Lane (feet)	Existing Traffic Conditions				Existing With Project Traffic Conditions			
		AM Peak Hour		PM Peak Hour		AM Peak Hour		PM Peak Hour	
		Max. Queue (feet)	Adequate Storage (Yes / No)	Max Queue (feet)	Adequate Storage (Yes / No)	Max. Queue (feet)	Adequate Storage (Yes / No)	Max. Queue (feet)	Adequate Storage (Yes / No)
7. University Parkway at I-215 Northbound Ramps <i>Westbound Shared Left-Turn/Through</i> <i>Westbound Right-Turns</i>	650'	158'	Yes	287'	Yes	158'	Yes	287'	Yes
	1,380' ¹⁵	896'	Yes	756'	Yes	926'	Yes	791'	Yes
8. University Parkway at I-215 Southbound Ramps <i>Eastbound Shared Left-Turn/Through</i> <i>Eastbound Right-Turn</i>	1,460'	69'	Yes	109'	Yes	85'	Yes	125'	Yes
	290'	31'	Yes	30'	Yes	31'	Yes	30'	Yes

¹⁴ Queue is based on the 95th Percentile Queue and is reported in total queue length (feet) per lane for signalized intersections.

¹⁵ The westbound right-turn consists of dual lanes, the storage reported is the average of both lanes.

TABLE 11-2
YEAR 2024 WITH PROJECT PEAK HOUR FREEWAY OFF-RAMP QUEUING ANALYSIS¹⁶

Key Ramp Intersection	Estimated Storage Provided (feet)	Year 2024 Without Project Traffic Conditions				Year 2024 With Project Traffic Conditions			
		AM Peak Hour		PM Peak Hour		AM Peak Hour		PM Peak Hour	
		Max. Queue (feet)	Adequate Storage (Yes / No)	Max Queue (feet)	Adequate Storage (Yes / No)	Max. Queue (feet)	Adequate Storage (Yes / No)	Max. Queue (feet)	Adequate Storage (Yes / No)
7. University Parkway at I-215 Northbound Ramps <i>Westbound Shared Left-Turn/Through</i> <i>Westbound Right-Turns</i>	650'	175'	Yes	305'	Yes	175'	Yes	305'	Yes
	1,380' ¹⁷	1,250'	Yes	890'	Yes	1,276'	Yes	920'	Yes
8. University Parkway at I-215 Southbound Ramps <i>Eastbound Shared Left-Turn/Through</i> <i>Eastbound Right-Turn</i>	1,460'	135'	Yes	136'	Yes	158'	Yes	152'	Yes
	290'	41'	Yes	38'	Yes	41'	Yes	38'	Yes

¹⁶ Queue is based on the 95th Percentile Queue and is reported in total queue length (feet) per lane for signalized intersections.

¹⁷ The westbound right-turn consists of dual lanes, the storage reported is the average of both lanes.

**TABLE 11-3
BUILDOUT WITH PROJECT PEAK HOUR FREEWAY OFF-RAMP QUEUING ANALYSIS¹⁸**

Key Ramp Intersection	Estimated Storage Provided Per Lane (feet) ¹⁹	Buildout Without Project Traffic Conditions				Buildout With Project Traffic Conditions			
		AM Peak Hour		PM Peak Hour		AM Peak Hour		PM Peak Hour	
		Max. Queue (feet)	Adequate Storage (Yes / No)	Max Queue (feet)	Adequate Storage (Yes / No)	Max. Queue (feet)	Adequate Storage (Yes / No)	Max. Queue (feet)	Adequate Storage (Yes / No)
7b. University Parkway (SB) at I-215 Northbound Off-Ramp <i>Westbound Left-Turn</i>	675'	464'	Yes	361'	Yes	489'	Yes	361'	Yes
7c. University Parkway (NB) at I-215 Northbound Off-Ramp <i>Westbound Right-Turns</i>	685' ²⁰	651'	Yes	497'	Yes	630'	Yes	507'	Yes
8b. University Parkway (SB) at I-215 Southbound Off-Ramp <i>Eastbound Right-Turn</i>	535'	69'	Yes	34'	Yes	69'	Yes	39'	Yes
8c. University Parkway (NB) at I-215 Southbound Off-Ramp <i>Eastbound Left-Turn</i>	540'	60'	Yes	79'	Yes	70'	Yes	76'	Yes

¹⁸ Queue is based on the 95th Percentile Queue and is reported in total queue length (feet) per lane for signalized intersections.

¹⁹ Estimated storage taken from I-215 University Parkway project plans.

²⁰ The westbound right-turn consists of triple lanes, the storage reported is the most conservative storage of the three lanes.

12.0 PLANNED AND RECOMMENDED IMPROVEMENTS

For those intersections where projected traffic volumes are expected to result in deficiencies, this report recommends traffic improvements that change the intersection geometry to increase capacity. These capacity improvements involve roadway widening and/or re-striping to reconfigure (add lanes) roadways to specific approaches of a key intersection. The identified improvements are expected to:

- Address the impact of existing traffic, Project traffic and future non-project (ambient traffic growth and cumulative) traffic, and
- Improve Levels of Service to an acceptable range and/or to pre-project conditions.

Figures 12-1, 12-2 and 12-3 present the planned and recommended improvements at the key study intersections for Existing With Project, Year 2024 With Project and Buildout With Project traffic conditions, respectively. These recommended improvements are discussed in more detail in the sections below.

12.1 Planned Improvements

12.1.1 Intersections

The following planned improvements listed below have been included under Buildout Without Project and Buildout With Project traffic conditions:

- Intersection 7 – University Parkway at I-215 NB Ramps: Reconstruct the I-215 Freeway Interchange at University Parkway to a Diverging Diamond Interchange as designed by Caltrans.
- Intersection 8 – University Parkway at I-215 SB Ramps: Reconstruct the I-215 Freeway Interchange at University Parkway to a Diverging Diamond Interchange as designed by Caltrans.

12.1.2 Roadway Segments

There are no planned improvements for any of the five (5) key roadway segments.

12.2 Existing With Project Traffic Conditions Recommended Improvements

12.2.1 Intersections

The results of the Existing With Project intersection capacity analysis indicates that the proposed Project will adversely impact one (1) of the ten (10) key study intersections. The following recommended improvements listed below have been identified to improve the impacted key study intersections under Existing With Project traffic conditions:

- Intersection 7 – University Parkway at I-215 NB Ramps: Widen and/or restripe to provide a third exclusive westbound right-turn turn lane. Modify the existing traffic signal, as necessary. It should be noted that this improvement is consistent with the future Diverging Diamond Interchange Plan.

12.2.2 Roadway Segments

The results of the Existing With Project roadway segment analysis indicates that the proposed Project ***will not*** adversely impact any of the five (5) key study roadway segments. As such, no improvement measures have been recommended.

12.3 Year 2024 With Project Traffic Conditions Recommended Improvements

12.3.1 Intersections

The results of the Year 2024 With Project intersection capacity analysis indicates that the proposed Project will adversely impact two (2) of the ten (10) key study intersections. The following recommended improvements listed below have been identified to improve the impacted key study intersections under Year 2024 With Project traffic conditions:

- Intersection 6 – University Parkway at Varsity Avenue/State Street: Modify the existing traffic signal from five-phase to eight-phase operation with protected/permissive phasing for eastbound left turns on Varsity Avenue/State Street and protected phasing for westbound left turns on Varsity Avenue/State Street. The eastbound left-turn pocket on Varsity Avenue will also be lengthened to provide additional storage. Provide a northbound right-turn overlap from University Parkway to State Street.
- Intersection 7 – University Parkway at I-215 NB Ramps: Widen and/or restripe to provide a third exclusive westbound right-turn turn lane. Modify the existing traffic signal, as necessary. It should be noted that this improvement is consistent with the future Diverging Diamond Interchange Plan.

12.3.2 Roadway Segments

The results of the Year 2024 With Project roadway segment analysis indicates that the proposed Project ***will not*** adversely impact any of the five (5) key study roadway segments. As such, no improvement measures have been recommended.

12.4 Buildout With Project Traffic Conditions Recommended Improvements

12.4.1 Intersections

The results of the Buildout With Project intersection capacity analysis indicates that the proposed Project will adversely impact one (1) of the ten (10) key study intersections. The following recommended improvements listed below have been identified to improve the impacted key study intersections under Buildout With Project traffic conditions:

- Intersection 6 – University Parkway at Varsity Avenue/State Street: Restripe to provide a second exclusive westbound left-turn lane. Modify the existing traffic signal from five-phase to eight-phase operation with protected/permissive phasing for eastbound left turns on Varsity Avenue/State Street and protected phasing for westbound left turns on Varsity Avenue/State Street. The eastbound left-turn pocket on Varsity Avenue will also be lengthened to provide additional storage. Provide a northbound right-turn overlap from University Parkway to State Street.

12.4.2 Roadway Segments

The results of the Buildout With Project roadway segment analysis indicates that the proposed Project ***will not*** adversely impact any of the five (5) key study roadway segments. As such, no improvement measures have been recommended.

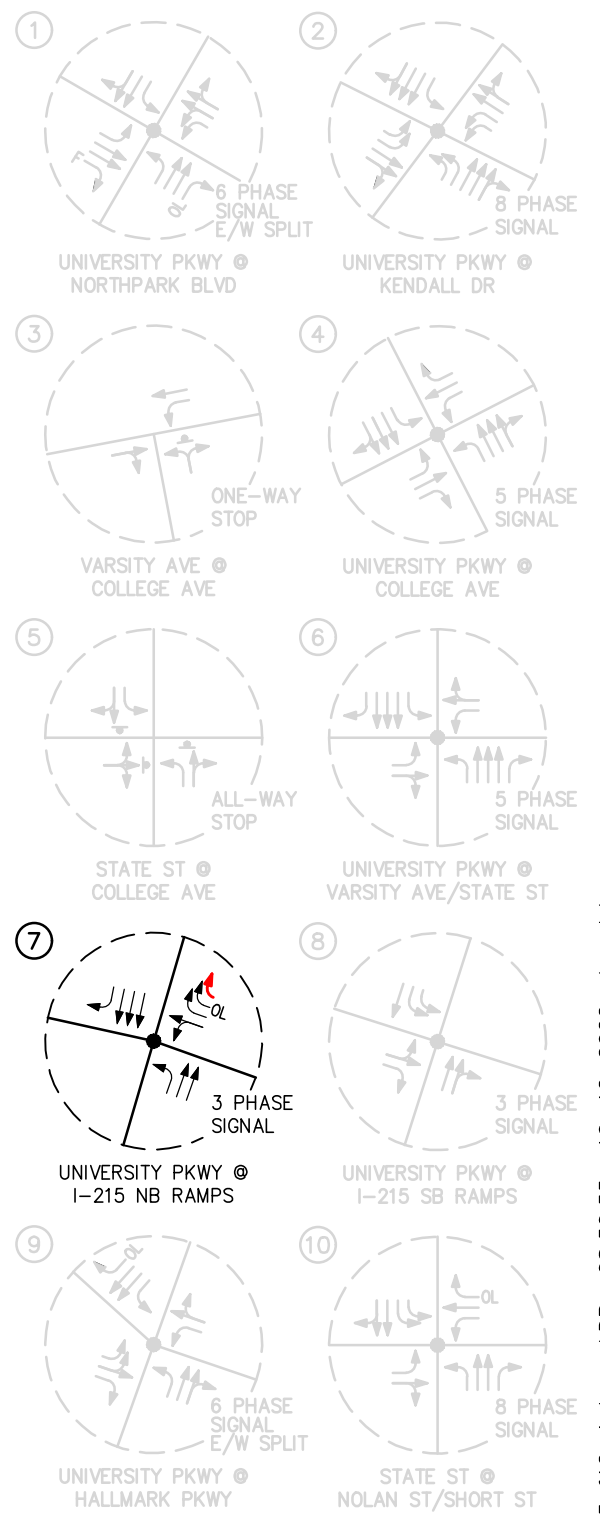
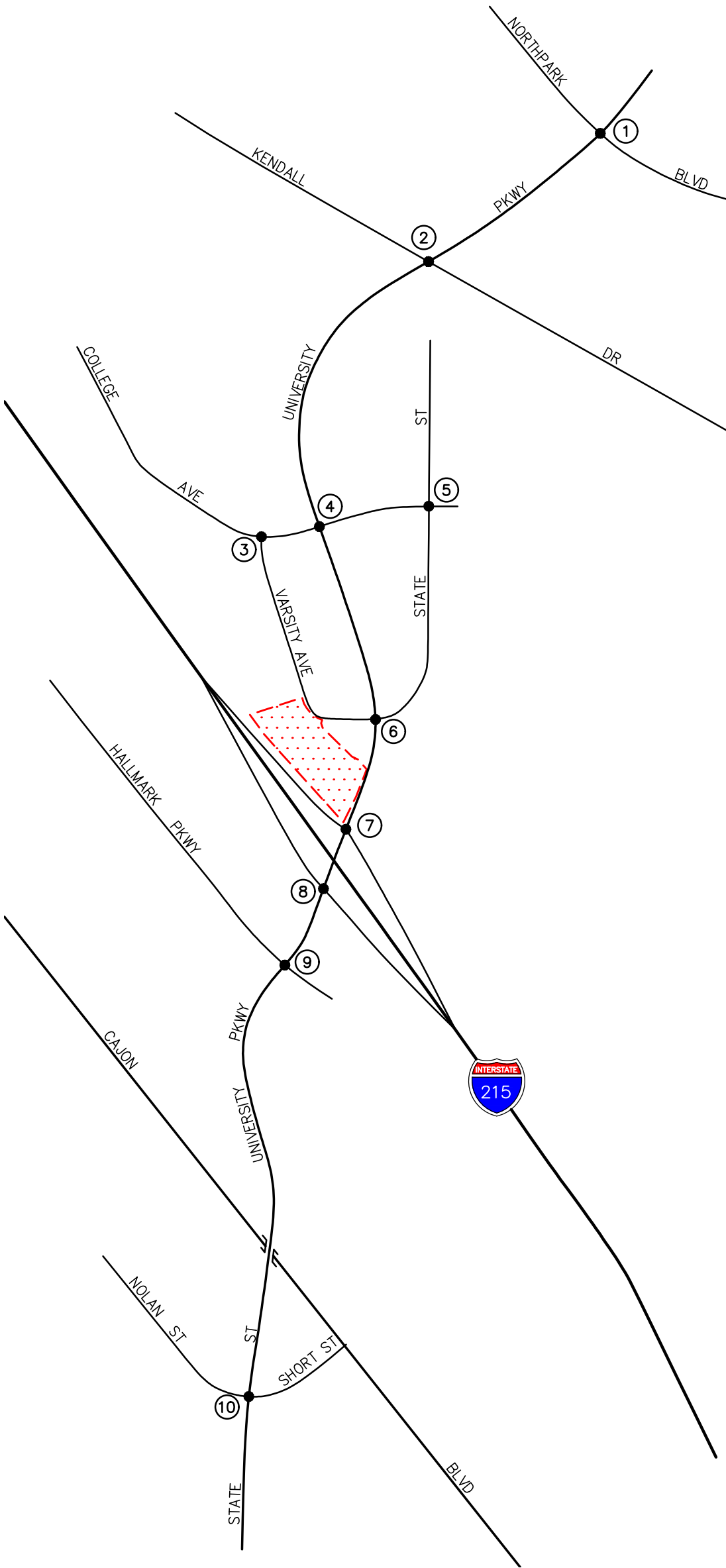

n:\4500\2224555 - 4400 varsity ave commercial center, san bernardino\dwg\4555 f12-1.dwg LDP 08:50:55 10-12-2022 kopulsky

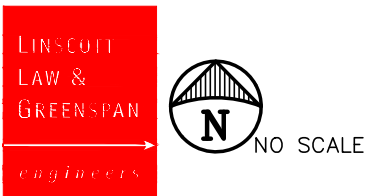

KEY
 = RECOMMENDED IMPROVEMENT
 = PROJECT SITE

FIGURE 12-1
EXISTING WITH PROJECT
RECOMMENDED IMPROVEMENTS

4400 VARSITY AVE COMMERCIAL CENTER, SAN BERNARDINO

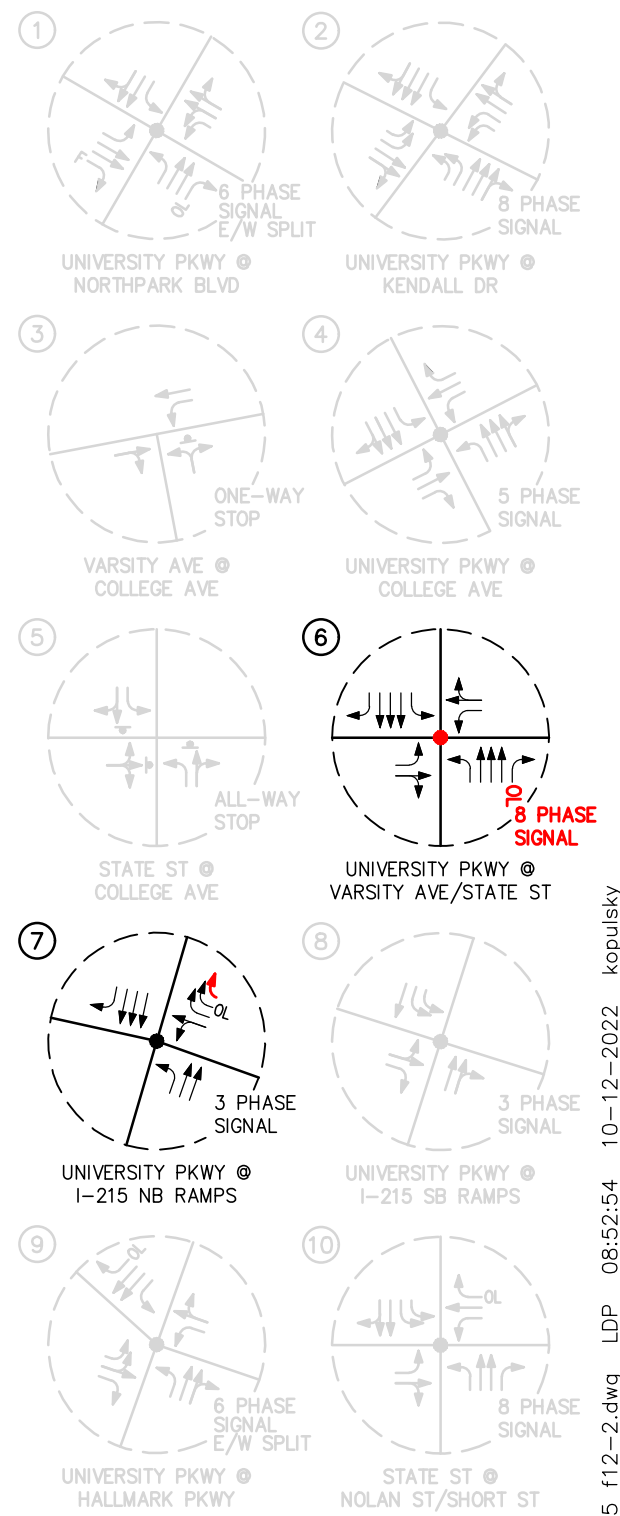
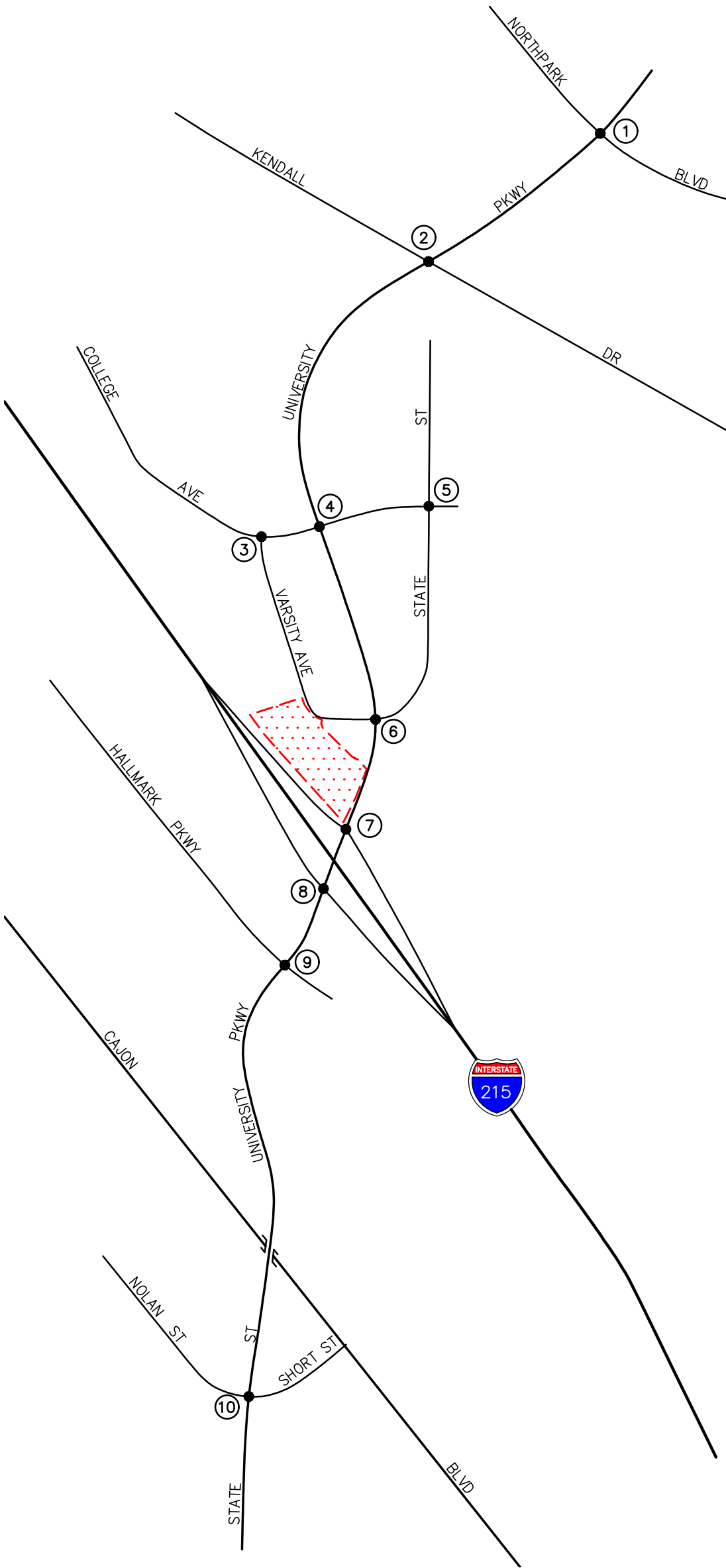

n:\4500\2224555 - 4400 varsity ave commercial center, san bernardino\dwg\4555 f12-2.dwg LDP 08:52:54 10-12-2022 kopulsky

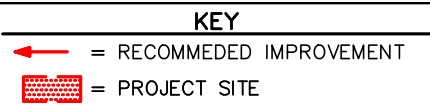
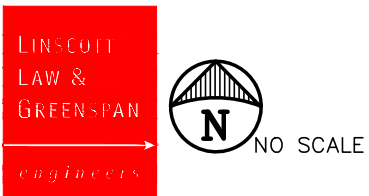
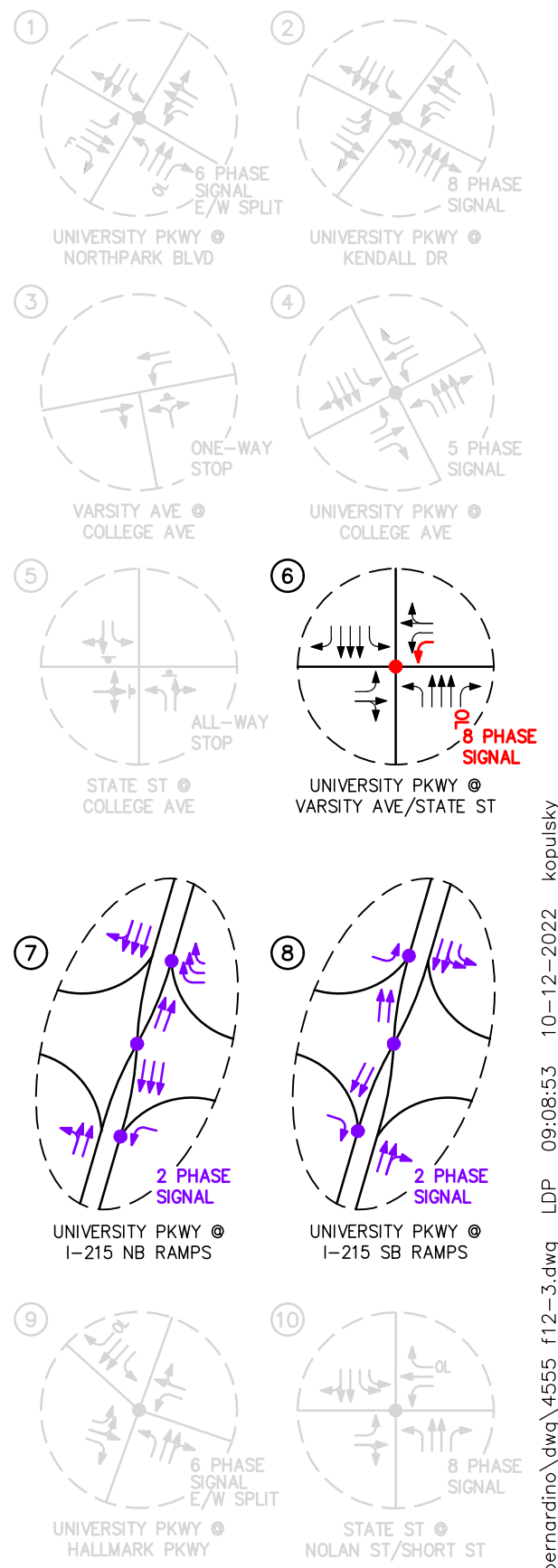
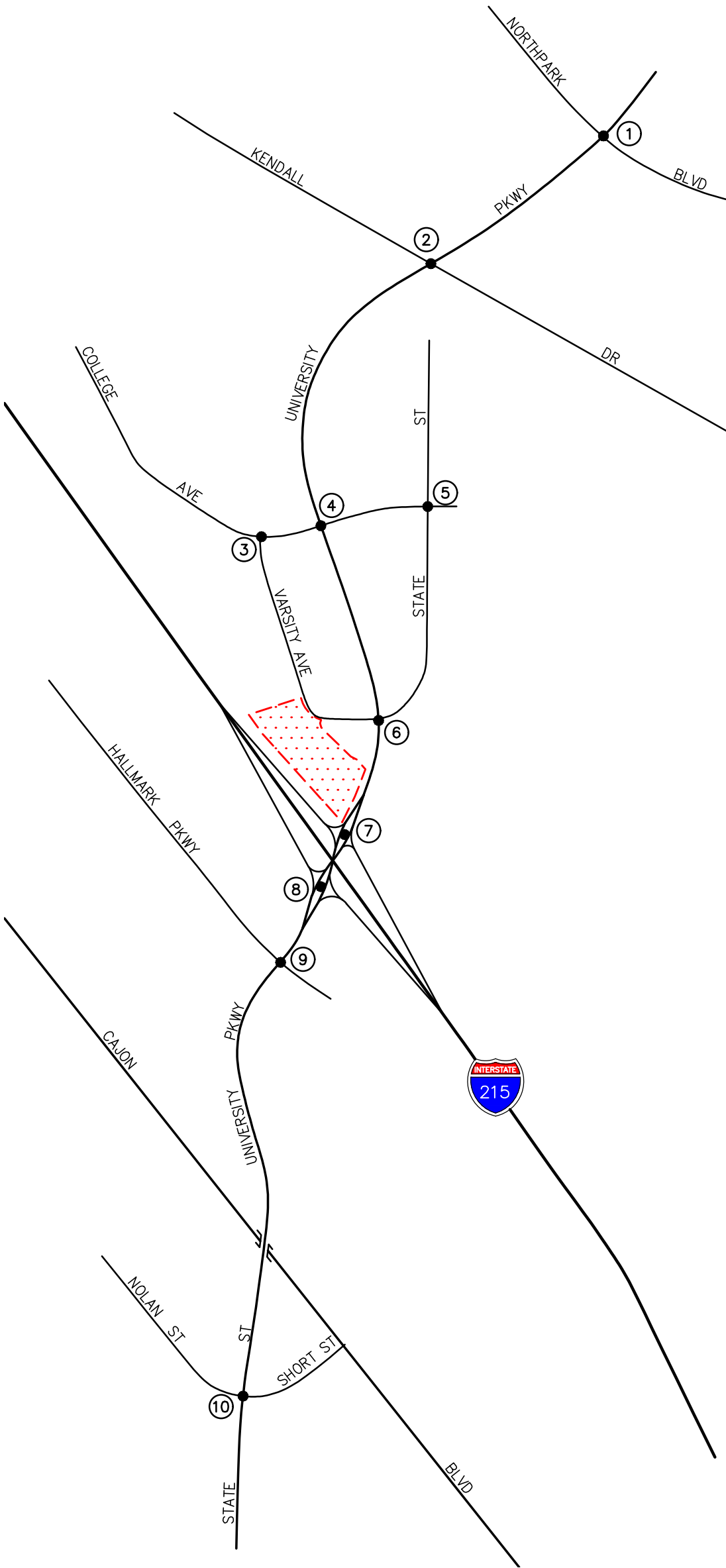

FIGURE 12-2

YEAR 2024 WITH PROJECT RECOMMENDED IMPROVEMENTS

4400 VARSITY AVE COMMERCIAL CENTER, SAN BERNARDINO



n:\4500\2224555 - 4400 varsity ave commercial center, san bernardino\dwg\4555 f12-3.dwg LDP 09:08:53 10-12-2022 kopulsky

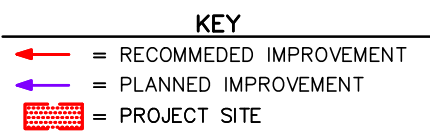
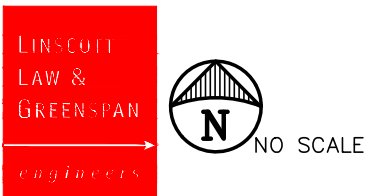

FIGURE 12-3

BUILDOUT WITH PROJECT PLANNED AND RECOMMENDED IMPROVEMENTS

4400 VARSITY AVE COMMERCIAL CENTER, SAN BERNARDINO

13.0 PROJECT FAIR SHARE ANALYSIS

The transportation impacts associated with the development of the proposed Project were determined based on the future conditions analysis with the proposed Project. The key study locations forecast to operate at adverse levels of service are discussed previously in *Section 12.0*. As such, the proposed Project’s “fair share” of the recommended improvements has been calculated for the key study locations that are adversely impacted.

13.1 Year 2024 With Project Traffic Conditions

Table 13-1 presents the AM and PM peak hours Project fair share percentages at the key study intersections that are forecast to operate at adverse levels of service in Year 2024 With Project traffic conditions. The first column (1) of *Table 13-1* presents the Project only traffic volumes. The second column (2) presents the existing traffic volumes at the intersection. The third column (3) presents the Year 2024 With Project traffic volumes. The fourth column (4) represents the Project fair share based on the following formula:

- Project Fair Share (4) = Column (1)/[Column (3) – Column (2)]*100

The Project fair share percentages (most adverse time period) for the impacted intersections for Year 2024 With Project traffic conditions that require physical improvements are shown below:

- 6. University Parkway at Varsity Avenue/State Street 21.24%
- 7. University Parkway at I-215 NB Ramps 29.80%

13.2 Buildout With Project Traffic Conditions

Table 13-2 presents the AM and PM peak hours Project fair share percentages at the key study intersections that are forecast to operate at adverse levels of service in Buildout With Project traffic conditions. The structure of this table is similar to the near-term (Year 2024) fair-share contribution summary presented in *Table 13-1*.

The Project fair share percentages (most adverse time period) for the impacted intersection for Buildout With Project traffic conditions that require physical improvements is shown below:

- 6. University Parkway at Varsity Avenue/State Street 20.53%

TABLE 13-1
YEAR 2024 WITH PROJECT TRAFFIC CONDITIONS FAIR SHARE CONTRIBUTION

Key Intersection	Impacted Time Period	(1) Project Only Volume	(2) Existing Volume	(3) Year 2024 With Project Volume	(4) Project Fair Share Responsibility
6. University Parkway at Varsity Avenue/State Street	AM	--	--	--	--
	PM	127	3,946	4,544	21.24%
7. University Parkway at I-215 NB Ramps	AM	163	3,896	4,443	29.80%
	PM	--	--	--	--

Notes:

- Project Fair Share (4) = Column (1) / [Column (3) – Column (2)]
- **Project Fair Share Responsibility** is based on worse case

TABLE 13-2
BUILDOUT WITH PROJECT TRAFFIC CONDITIONS FAIR SHARE CONTRIBUTION

Key Intersection	Impacted Time Period	(1) Project Only Volume	(2) Existing Volume	(3) Buildout With Project Volume	(4) Project Fair Share Responsibility
6. University Parkway at	AM	172	3,743	4,581	20.53%
Varsity Avenue/State Street	PM	127	3,946	4,764	15.53%

Notes:

- Project Fair Share (4) = Column (1) / [Column (3) – Column (2)]
- **Project Fair Share Responsibility** is based on worse case

14.0 VEHICLE MILES TRAVELED (VMT) ANALYSIS

On December 28, 2018, the California Natural Resources Agency adopted revised CEQA Guidelines. Among the changes to the guidelines was the removal of vehicle delay and LOS from consideration for transportation impacts under CEQA. With the adopted guidelines, transportation impacts are to be evaluated based on a project's effect on vehicle miles traveled. Lead agencies are allowed to continue using their current impact criteria, or to opt into the revised transportation guidelines. However, the new guidelines must be used starting July 1, 2020, as required in CEQA section 15064.3. The City of San Bernardino recently adopted new traffic impact criteria in August 2020 to be consistent with the CEQA revisions. These new guidelines are contained within the *City of San Bernardino Traffic Impact Analysis Guidelines*, dated August 2020 and provide screening criteria and methodology for VMT analysis.

Per the *City of San Bernardino Traffic Impact Analysis Guidelines*, there are three types of screening to screen projects from project-level VMT assessments. The three screening steps are described below. The results of each screening step applied to the proposed Project is also discussed. It should be noted that the project only needs to satisfy one of the three screening steps.

Step 1: Transit Priority Area (TPA) Screening

Projects located within a transit priority area (TPA) may be presumed to have a less than significant impact absent substantial evidence to the contrary. This presumption may **NOT** be appropriate if the project:

1. Has a Floor Area Ratio (FAR) of less than 0.75;
2. Includes more parking for use by residents, customers, or employees of the project than required by the City (if the City requires the project to supply parking);
3. Is inconsistent with the applicable Sustainable Communities Strategy (as determined by the lead agency, with input from the Metropolitan Planning Organization); or
4. Replaces affordable residential units with a smaller number of moderate- or high-income residential units.

➤ *Based on the SBCTA screening tool, the project site is not located within a Transit Priority Area (TPA). Therefore, Project Screening Step 1: Transit Priority Area (TPA) Screening is not satisfied.*

Step 2: Low VMT Area Screening

Residential and office projects located within a low VMT-generating area may be presumed to have a less than significant impact absent substantial evidence to the contrary. In addition, other employment-related and mixed-use land use projects may qualify for the use of screening if the project can reasonably be expected to generate VMT per resident, per worker, or per service population that is similar to the existing land uses in the low VMT area. A low VMT area is defined as an individual traffic analysis zone (TAZ) where total daily Origin/Destination VMT per service population is lower than the City average total daily Origin/Destination VMT per service population.

- *Based on the SBCTA screening tool, the project site is located within Traffic Analysis Zone (TAZ) #53771301. Per the SBCTA screening tool, the Project TAZ VMT/service population is 26.3 VMT per service population and the City average VMT/service population is 31.6 VMT per service population. Comparison of the two VMT values indicates that the Project TAZ VMT is lower than the City VMT average. Therefore, Project Screening Step 2: Low VMT Area Screening is satisfied.*

Appendix I contains the SBCTA VMT Screening Tool Data.

Step 3: Project Type Screening

Local serving retail projects less than 50,000 square feet may be presumed to have a less than significant impact absent substantial evidence to the contrary. Local serving retail generally improves the convenience of shopping close to home and has the effect of reducing vehicle travel.

- *As stated in Section 2.0, the proposed Project will consist of a 4,761 SF Chick-fil-A Restaurant with drive-through window, a 5,137 SF automated carwash (1 wash tunnel), a 950 SF Dutch Brothers Coffee and a 3,610 SF fast food restaurant with drive-through window. Therefore, based on the Step 3: Project Type Screening criteria, this project could be screened from a VMT analysis, and could be presumed to have a less than significant impact on VMT per the City's guidelines.*

14.1 VMT Analysis Conclusion

Based on the City's guidelines, the proposed Project satisfies Step 2: Low VMT Area Screening and Step 3: Project Type Screening. Therefore, this project could be screened from a VMT analysis, and could be presumed to have a less than significant impact on VMT per the City's guidelines.