

DRAFT FOCUSED ENVIRONMENTAL IMPACT REPORT

CITY OF HANFORD TENTATIVE TRACT 938



APRIL 2023



DRAFT FOCUSED ENVIRONMENTAL IMPACT REPORT

TENTATIVE TRACT MAP 938

Prepared for:



City of Hanford - Community Development Department
317 North Douty Street
Hanford, CA 93230
Contact Person: Gabrielle de Silva Myers
Phone: (559) 585-2500

Consultant:



5080 California Avenue, Suite 220
Bakersfield, CA 93309
Contact: Jaymie L. Brauer
Phone: (661) 616-2600

April 2023

Table of Contents

List of Acronyms and Abbreviations v

CHAPTER 1 - Executive Summary 1-1

1.1 - Introduction 1-1

1.2 - Project Summary 1-1

 1.2.1 - Project Location 1-1

 1.2.2 - Project Description 1-1

1.3 - Lead Agency, Responsible Agency, and Trustee Agencies 1-2

1.4 - Summary of Project Objectives 1-2

1.5 - Scope of the Environmental Impact Report 1-2

1.6 - Notice of Preparation 1-3

1.7 - Public Review of the Draft EIR 1-4

1.8 - Environmental Impacts 1-4

 1.8.1 - Impacts Not Further Considered in This EIR 1-5

 1.8.2 - Impacts of the Proposed Project 1-5

1.9 - Summary of Project Alternatives 1-15

 1.9.1 - Alternatives Considered and Rejected 1-15

 1.9.2 - Alternatives Considered and Evaluated 1-15

1.10 - Environmentally Superior Alternative 1-15

1.11 - Growth Inducement 1-17

1.12 - Irreversible Impacts 1-17

1.13 - Areas of Controversy 1-18

1.14 - Issues to be Resolved 1-18

1.15 - Executive Summary Matrix 1-18

CHAPTER 2 - Introduction 2-1

2.1 - Overview 2-1

2.2 - Purpose of This Environmental Impact Report 2-1

 2.2.1 - Issues to be Resolved 2-2

2.3 - Terminology 2-2

2.4 - Decision-Making Process 2-4

 2.4.1 - Notice of Preparation (NOP) 2-5

 2.4.2 - Scoping Meeting 2-5

2.5 - Availability of the Draft EIR 2-10

2.6 - Format and Content 2-10

 2.6.1 - Required EIR Content and Organization 2-10

2.7 - Responsible and Trustee Agencies 2-11

 2.7.1 - Local Agencies 2-12

 2.7.2 - State Agencies 12

 2.7.3 - Federal Agencies 12

2.8 - Incorporation by Reference	2-13
2.9 - Sources	2-13

CHAPTER 3 - Project Description 3-1

3.1 - Project Overview	3-1
3.2 - Project Location and Environmental Setting	3-1
3.2.1 - Regional Setting	3-1
3.2.2 - Local Setting	3-1
3.2.3 - Project Location	3-4
3.3 - Project Objectives	3-4
3.4 - Proposed Project	3-4
3.5 - Entitlements Required	3-6
3.5.1 - Other Responsible Agencies	3-6
3.6 - Cumulative Projects	3-7

CHAPTER 4 - Environmental Impact Analyses 4-1

4.1 - Approach to Environmental Analysis	4-1
4.2 - Environmental Topics	4-1
4.3 - Organization of Issue Areas	4-2
4.4 - Level of Significance	4-2
4.5 - Format Used for Impact Analysis and Mitigation Measures	4-3
4.6 - Transportation	4-5
4.6.1 - Introduction	4-5
4.6.2 - Environmental Setting	4-5
4.6.3 - Regulatory Setting	4-10
4.6.4 - Impacts and Mitigation Measures	4-18

CHAPTER 5 - Consequences of Project Implementation 5-1

5.1 - Environmental Effects Found to be Less than Significant	5-1
5.1.1 - Potential for Less than Significant Impacts to Occur	5-1
5.1.2 - Potential for Less than Significant Impacts to Occur with Incorporation of Mitigation Measures	5-5
5.2 - Significant Environmental Effects that Cannot be Avoided	5-8
5.3 - Growth Inducing Impacts	5-9
5.4 - Significant Irreversible Changes	5-10

CHAPTER 6 - Alternatives 6-1

6.1 - Introduction	6-1
6.1.1 - Significant Impacts of the Project	6-2
6.1.2 - Other Impacts of the Project	6-11
6.2 - Project Objectives	6-11
6.3 - Alternatives Considered but Rejected	6-12

6.4 - Alternatives Considered and Evaluated	6-12
6.4.1 - Alternative A - No Project Alternative	6-12
6.4.2 - Alternative B - Reduced Project Alternative.....	6-12
6.4.3 - Alternative C – Multi-Family Alternative	6-12
6.4.4 - Alternative D – Different Sites Alternative	6-13
6.5 - Environmentally Superior Alternative	6-13
CHAPTER 7 - Responses to Comments.....	7-1
CHAPTER 8 - Organizations and Persons Consulted.....	8-1
8.1 - Federal Agencies	8-1
8.2 - State Agencies.....	8-1
8.3 - Regional and Local.....	8-1
8.4 - Native American Consultation	8-2
CHAPTER 9 - Preparers.....	9-3
9.1 - Lead Agency	9-3
City of Hanford.....	9-3
9.2 - Technical Assistance.....	9-3
QK.....	9-3
JLB Traffic Engineering, Inc.	9-3
CHAPTER 10 - Bibliography.....	10-1
List of Appendices	
Appendix A- Notice of Preparation/Initial Study and Response to	
Comments Appendix B- Revised Traffic Impact Analysis & VMT	
List of Figures	
Figure 3-1 Regional Location	3-2
Figure 3-2 Project Location.....	3-3
Figure 3-3 Vesting Tentative Tract Map #938.....	3-5
List of Tables	
Table 1-1 Summary of Significant Impacts of the Project.....	1-14
Table 1-2 Comparison of Alternatives' Impacts.....	1-16
Table 1-3 Summary for Mitigation	1-19
Table 2-1 Summary of Written Comments on Notice of Preparation	2-6
Table 2-2 Summary of Oral Comments on Notice of Preparation.....	2-9
Table 4.6-1 Existing Arterial Streets.....	4-5

Table 4.6-2 Existing Collector Streets.....	4-6
Table 4.6-3 Existing Plus Project Intersection LOS Results.....	4-20
Table 4.6-4 Existing Plus Project Segment LOS Results.....	4-20
Table 4.6-5 Near-term Plus Project Intersection LOS Results.....	4-21
Table 4.6-6 Near-term Plus Project Segment LOS Results.....	4-21
Table 4.6-7 Cumulative Year 2042 plus Project Intersection LOS Results.....	4-22
Table 4.6-8 Cumulative Year 2042 plus Project Segment LOS Results.....	4-22
Table 5-1 Summary of Significant Impacts of the Proposed Project.....	5-9

List of Acronyms and Abbreviations

APN	Assessor Parcel Number
AWSC	All-way Stop Controls
Caltrans	California Department of Transportation
CAPCOA	California Air Pollution Control Officers Association
CARB	California Air Resources Board
CCR	California Code of Regulations
CDFW	California Department of Fish and Wildlife
CDPH	California Department of Public Health
CEQA	California Environmental Quality Act
CTC	California Transportation Commission
EIR	Environmental Impact Report
GP	General Plan
HJO	Hanford Municipal Airport
HST	High-Speed Train
ITE	Institute of Transportation Engineers
KART	Kings Area Rural Transit
KCAG	Kings County Association of Governments
KCAPTA	Kings County Area Public Transit Agency
LOS	level of service
MDB&M	Mount Diablo Base and Meridian
NOA	Notice of Availability
NOC	Notice of Completion
NOP	Notice of Preparation
NWS	National Weather Service
OPR	Office of Planning and Research
PRC	Public Resources Code
RHNA	Regional Housing Needs Allocation
ROW	right of way
RTIP	Regional Transportation Improvement Program
RTP	Regional Transportation Plan
RTPA	Regional Transportation Planning Agency
RWQCB	Regional Water Quality Control Board
SDR	site development review
SJVAPCD	San Joaquin Valley Air Pollution Control District
SOI	Sphere of Influence
SOV	single-occupant vehicle
STIP	State Transportation Improvement Program
TA	Technical Advisory
TIA	Traffic Impact Analysis
TWSC	Two-way Stop Controlled
USFWS	U.S. Fish and Wildlife Service
VMT	vehicle miles traveled

CHAPTER 1 - EXECUTIVE SUMMARY

1.1 - Introduction

This Draft Environmental Impact Report (EIR) has been prepared in accordance with the California Environmental Quality Act (CEQA) to evaluate the potential environmental impacts associated with the construction of 457 single-family residences, internal roads, a drainage retention basin, and a 5.82-acre park on an approximately 95-acre site (Project). The Project is located in the incorporated City of Hanford, California. Access to the proposed subdivision will be from 10 ½ Avenue. The development will build 10 ½ Avenue with a minimum 34-foot road right of way (ROW).

The purpose of this Draft EIR is to inform public agency decision-makers, representatives of affected and responsible agencies, the public, and other interested parties of the potential environmental effects that may result from the Project. In addition to identifying potential environmental effects, this Draft EIR also identifies methods by which these impacts can be mitigated, reduced, minimized, or avoided.

The study area for the analysis of the Project and cumulative impacts is the Hanford city limits, the portions of Kings County located adjacent to the City. The applicable cumulative projections include growth projections from the Hanford General Plan and the Kings County General Plan.

1.2 - Project Summary

1.2.1 - PROJECT LOCATION

The Project is located in the incorporated City of Hanford, California. The Project site is adjacent to 10 ½ Avenue to the west and between Hanford-Armona Road and Houston Avenue in the City of Hanford, Kings County, CA. The Project is on Assessor Parcel Numbers (APN) 011-440-015 and 011-440-014, within Section 1, Township 19S, Range 21E, Mount Diablo Base and Meridian (MDB&M).

1.2.2 - PROJECT DESCRIPTION

The Applicant proposes the construction of 457 single-family residences, internal roads, a drainage retention basin, and a 5.82-acre park on an approximately 95-acre site (Project). Access to the proposed subdivision will be from 10 ½ Avenue. The development will build 10 ½ Avenue with a minimum 34-foot ROW.

In order for the Project to be constructed, approval of the following actions is required:

- Tentative Tract Map 938 (Figure 3-5)

Construction will take approximately 24 months, with a total buildout of the homes by Q4 2025. There will be six phases, with the following lots constructed per phase:

- Phase 1 – 106 lots
- Phase 2 – 65 lots
- Phase 3 – 78 lots
- Phase 4 – 67 lots
- Phase 5 – 67 lots
- Phase 6 – 69 lots

1.3 - Lead Agency, Responsible Agency, and Trustee Agencies

The Project Applicant and Lead Agency for the proposed Project is the City of Hanford. The City is the public agency that has the principal responsibility for carrying out or disapproving the Project.

The responsible agencies are State and local public agencies other than the Lead Agency that have the authority to carry out or approve a project or that are required to approve a portion of a project for which the Lead Agency is preparing or has prepared an EIR or Negative Declaration. A complete list of agencies that may have authority as a responsible or trustee agency is listed in Chapter 2, *Introduction*.

1.4 - Summary of Project Objectives

The Project has the following objectives:

- Provide a variety of housing opportunities with a range of styles, sizes, and values that will be designed to satisfy existing and future demand for quality housing in the area.
- Provide a sense of community and walkability within the development through the use of street patterns, parks/open space areas, landscaping, and other Project amenities.
- Create a successful and financially feasible Project by meeting the housing needs of the area.
- Provide a residential development that assists the City in meeting its General Plan and Housing Element requirements and objectives.

1.5 - Scope of the Environmental Impact Report

The scope of this EIR is based on the Project description outlined in Chapter 2, *Project Description* and the Notice of Preparation (NOP) (Appendix A), focusing review of environmental resources that could result in potentially significant impacts on environmental resources. Chapter 4, *Environmental Impact Analysis*, identifies one resource related to the Project, which was determined to be subject to potentially significant impacts in the NOP scoping process, and these are addressed in the following sections:

- 4.17 – Transportation and Traffic

Section 4.1 provides detailed discussions of the environmental setting, regulatory setting, methodology for impact assessment for the resource, impacts associated with the Project, and mitigation measures designed to reduce significant impacts where required and when feasible. Cumulative impacts also are discussed.

This EIR examines the potential direct and cumulative impacts of the proposed Project. These impacts were determined through a rigorous process mandated by CEQA in which existing conditions are compared and contrasted with conditions that would exist once the Project is implemented. The significance of each identified impact was determined using CEQA thresholds informed by local thresholds of significance. The following categories are used for classifying impacts.

- **Significant and Unavoidable:** Significant impacts that cannot be feasibly mitigated or avoided. No measures could be taken to avoid or reduce these adverse effects to achieve insignificant or negligible levels. Even after the application of feasible mitigation measures, the residual impact would be significant. If the Project is approved with significant and unavoidable impacts, decision-makers are required to adopt a Statement of Overriding Considerations pursuant to CEQA Section 15093 explaining why the benefits of the Project outweigh the potential damage caused by these significant unavoidable impacts.
- **Less than Significant with Mitigation:** Such impacts can be reduced to a less-than-significant level with feasible mitigation, which can include incorporating changes to the Project. If the proposed Project is approved with significant but mitigable impacts, decision-makers are required to make findings pursuant to CEQA Section 15091, stating that impacts have been mitigated to the maximum extent feasible and the residual impact would not be significant.
- **Less than Significant:** These adverse but less-than-significant impacts do not require mitigation, nor do they require findings to be made.
- **No Impact:** Such impacts are considered to not exist with the implementation of the proposed Project or have been found to not apply to the proposed Project.

1.6 - Notice of Preparation

The contents of this EIR were established based on the findings in the Notice of Preparation (NOP) and attached materials, as well as public and agency input during the scoping period. The City of Hanford prepared and circulated a Notice of Preparation (NOP) to responsible, trustee, and local agencies for review and comment on February 2, 2023. The NOP and responses to the NOP are included in Appendix A of this EIR. In conjunction with this public notice, a scoping meeting was held on February 14, 2023, at Hanford City Council Chambers, located in CIVIC CENTER BUILDING, 315 N DOUTY ST, HANFORD, CA 93230. (CEQA Guidelines §15082). A copy of the NOP and comments received during the NOP review period are included in Appendix A.

1.7 - Public Review of the Draft EIR

Upon completion of this Draft EIR, the City of Hanford prepared and filed a Notice of Completion (NOC) with the California Office of Planning and Research/State Clearinghouse to begin the public review period (Public Resources Code, Section 21161). Concurrent with the NOC, the City of Hanford distributed a Notice of Availability (NOA) in accordance with Section 15087 of the CEQA Guidelines. The NOA was mailed to the organizations and individuals who previously requested such a notice to comply with Public Resources Code Section 21092(b)(3). This Draft EIR was distributed to the California Office of Planning and Research/State Clearinghouse, published in the Hanford Sentinel newspaper to comply with Section 15087 of the State CEQA Guidelines, and was distributed to affected agencies, surrounding cities and municipalities, and all interested parties. During the public review period, this Draft EIR, including the appendices, will be available for review at the following location:

City of Hanford Community Development Department
317 N Douty St, Hanford, CA 93230

In addition, the Draft EIR, including the appendices, will be available for review at the following City of Hanford website: <https://www.cityofhanfordca.com/1236/Current-Projects>.

Agencies, organizations, individuals, and all other interested parties not previously contacted or who did not respond to the NOP or attended the scoping meeting currently have the opportunity to comment on this Draft EIR during the 45-day public review period. Written comments on this Draft EIR should be addressed to:

Attn: Gabrielle de Silva Myers
City of Hanford Community Development Department
317 N Douty St, Hanford, CA 93230

email: gdesilva@cityofhanfordca.com

1.8 - Environmental Impacts

Section 15128 of the California Environmental Quality Act (CEQA) Guidelines requires that an EIR contain a statement briefly indicating the reasons that various, possible, new significant effects of a project were determined not to be significant and were therefore not discussed in detail in the EIR. The County has engaged the public to participate in the scoping of the environmental document.

The contents of this Draft EIR were established based on the NOP prepared in accordance with the CEQA Guidelines, as well as public and agency input that was received during the scoping process. The comments to the NOP are found in Appendix A of this document. Based on the findings of the NOP and the results of scoping, a determination was made that this EIR

must contain a comprehensive analysis of all environmental issues identified in Appendix G of the CEQA Guidelines.

1.8.1 - IMPACTS NOT FURTHER CONSIDERED IN THIS EIR

As discussed in Appendix A, the Project was determined to have impacts with regard to each of the impact thresholds. Therefore, all environmental issues as they are presented in Appendix G of the CEQA Guidelines are analyzed further in this EIR.

1.8.2 - IMPACTS OF THE PROPOSED PROJECT

No Potential for Impacts to Occur

The potential environmental effects of the Project and mitigation measures are discussed in detail in Chapter 4 of this EIR. After a full analysis, the following effects were determined to have no potential for impacts to occur:

Aesthetics

- Impact 4.1-1: Have a substantial adverse effect on a scenic vista
- Impact 4.1-2: Substantially damage scenic resources, including, but not limited to, trees, rock outcroppings, and historic buildings within a state scenic highway

Agriculture and Forest Resources

- Impact 4.2-1: Convert Prime Farmland, Unique Farmland, or Farmland of Statewide Importance (Farmland), as shown on the maps prepared pursuant to the Farmland Mapping and Monitoring Program of the California Resources Agency, to non-agricultural use
- Impact 4.2-2: Conflict with existing zoning for agricultural use or a Williamson Act contract
- Impact 4.2-3: Conflict with existing zoning for, or cause rezoning of, forest land (as defined in Public Resources Code Section 12220(g)), or timberland (as defined by Public Resources Code Section 4526), or timberland zoned Timberland Productions (as defined in Government Code Section 51104(g))
- Impact 4.2-4: Result in the loss of forest land or conversion of forest land to non-forest use

Biological Resources

- Impact 4.4-5: Conflict with any local policies or ordinances protecting biological resources, such as a tree preservation policy or ordinance
- Impact 4.4-6: Conflict with provisions of an adopted habitat conservation plan, natural communities conservation plan, or other approved local, regional, or State habitat conservation plan

Geology and Soils

- Impact 4.7-8: Have soils incapable of adequately supporting the use of septic tanks or alternative wastewater disposal systems where sewers are not available for the disposal of wastewater

Hazards and Hazardous Materials

- Impact 4.9-7: Expose people or structures, either directly or indirectly, to a significant risk of loss, injury, or death involving wildland fires

Hydrology and Water Quality

- Impact 4.10-4: In flood hazard, tsunami, or seiche zones, risk release of pollutants due to Project inundation

Land Use and Planning

- Impact 4.11-1: Physically divide an established community
- Impact 4.11-2: Cause a significant environmental impact due to a conflict with any land use plan, policy, or regulation adopted for the purpose of avoiding or mitigating an environmental effect

Mineral Resources

- Impact 4.12-1: Result in the loss of availability of a known mineral resource that would be of value to the region and the residents of the State
- Impact 4.12-2: Result in the loss of availability of a locally important mineral resource recovery site delineated on a local general plan, specific plan, or other land use plan

Population and Housing

- Impact 4.14-2: Displace a substantial number of existing people or housing necessitating the construction

Recreation

- Impact 4.16-2: Include recreational facilities or require construction or expansion of recreational facilities that might have an adverse physical effect on the environment

Potential for Less than Significant Impacts

Potential environmental effects of the Project and mitigation measures are discussed in detail in Chapter 4 of this EIR. After a full analysis, the following effects were determined to have less-than-significant impacts to occur:

Aesthetics

- Impact 4.1-3: Substantially degrade the existing visual character or quality of public views of the site and its surroundings. (Public views are those that are experienced from a publicly accessible vantage point). If the project is in an urbanized area, would the project conflict with applicable zoning and other regulations governing scenic quality
- Impact 4.1-4: Create a new source of substantial light or glare which would adversely affect day or nighttime views in the area

Agriculture and Forest Resources

- Impact 4.2-5: Involve other changes in the existing environment which, because of their location or nature, could result in conversion of Farmland to non-agricultural use or conversion of forest land to non-forest use

Air Quality

- Impact 4.3-1: Conflict with or obstruct implementation of the applicable air quality plan
- Impact 4.3-2: Result in a cumulatively considerable net increase of any criteria pollutant for which the Project region is non-attainment under an applicable federal or State ambient air quality standard
- Impact 4.3-3: Expose sensitive receptors to substantial pollutant concentrations
- Impact 4.3-4: Result in other emissions (such as those leading to odors) adversely affecting a substantial number of people

Biological Resources

- Impact 4.4-1: Have a substantial adverse effect, either directly or through habitat modifications, on any species identified as a candidate, sensitive, or special-status

species in local or regional plans, policies, or regulations, or by the California Department of Fish and Wildlife or U.S. Fish and Wildlife Service

- Impact 4.4-2: Have a substantial adverse effect on any riparian habitat or other sensitive natural community identified in local or regional plans, policies, regulations, or by the California Department of Fish and Wildlife or U.S. Fish and Wildlife Service
- Impact 4.4-3: Have a substantial adverse effect on State or federally Protected wetlands (including, but not limited to, marsh, vernal pool, coastal, etc.) through direct removal, filling, hydrological interruption, or other means
- Impact 4.4-4: Interfere substantially with the movement of any native resident or migratory fish or wildlife species or with established native resident or migratory wildlife corridors, or impede the use of native wildlife nursery sites

Cultural Resources

- Impact 4.5-1: Cause a substantial adverse change in the significance of a historical resource pursuant to Section 15064.5
- Impact 4.5-2: Cause a substantial adverse change in the significance of an archaeological resource pursuant to Section 15064.5
- Impact 4.5-3: Disturb any human remains, including those interred outside of dedicated cemeteries

Energy

- Impact 4.6-1: Result in potentially significant environmental impact due to wasteful, inefficient, or unnecessary consumption of energy resources, during Project construction or operation
- Impact 4.6-2: Conflict with or obstruct a State or local plan for renewable energy or energy efficiency

Geology and Soils

- Impact 4.7-1: Directly or indirectly cause potential substantial adverse effects, including the risk of loss, injury, or death involving the rupture of a known earthquake fault
- Impact 4.7-2: Directly or indirectly cause potential substantial adverse effects, including the risk of loss, injury, or death involving strong seismic ground shaking
- Impact 4.7-3: Directly or indirectly cause potential substantial adverse effects, including the risk of loss, injury, or death involving seismic-related ground failure, including liquefaction

- Impact 4.7-4: Directly or indirectly cause potentially substantial adverse effects, including the risk of loss, injury, or death involving landslides
- Impact 4.7-5: Result in substantial soil erosion or loss of topsoil
- Impact 4.7-6: Be located on a geologic unit or soil that is unstable, or that would become unstable as a result of the Project, and potentially result in on- or off-site landslide, lateral spreading, subsidence, liquefaction, or collapse
- Impact 4.7-7: Be located on expansive soil, as defined in Table 18-1-B of the Uniform Building Code (1994), creating substantial direct or indirect risks to life or property
- Impact 4.7-9: Directly or indirectly destroy a unique paleontological resource or site or unique geologic feature

Greenhouse Gas Emissions

- Impact 4.8.1: Generate greenhouse gas emissions, either directly or indirectly, that may have a significant impact on the environment
- Impact 4.8.2: Conflict with any applicable plan, policy, or regulation of an agency adopted for the purpose of reducing the emissions of greenhouse gases

Hazards and Hazardous Materials

- Impact 4.9-1: Create a significant hazard to the public or the environment through the routine transport, use, or disposal of hazardous materials
- Impact 4.9-2: Create a significant hazard to the public or the environment through reasonably foreseeable upset and accident conditions involving the release of hazardous materials into the environment
- Impact 4.9-3: Emit hazardous emissions or handle hazardous or acutely hazardous materials, substances, or waste within one-quarter mile of an existing or proposed school
- Impact 4.9-4: Create a hazard to the public or the environment as a result of being located on a site that is included on a list of hazardous material sites compiled pursuant to Government Code Section 65962.5
- Impact 4.9-5: For a project located within an airport land use plan or, where such a plan has not been adopted, within two miles of a public airport or public use airport, would the Project result in a safety hazard or excessive noise for people residing or working in the Project area
- Impact 4.9-6: Impair implementation of, or physically interfere with, an adopted emergency response plan or emergency evacuation plan

Hydrology and Water Quality

- Impact 4.10-1: Violate any water quality standards or waste discharge requirements or otherwise substantially degrade surface or groundwater quality
- Impact 4.10-2: Substantially decrease groundwater supplies or interfere substantially with groundwater recharge such that the Project may impede sustainable groundwater management of the basin
- Impact 4.10-3(i): Substantially alter the existing drainage pattern of the site or area, including through the alteration of the course of a stream or river, or through the addition of impervious surfaces, in a manner which would result in substantial erosion or siltation on- or off-site
- Impact 4.10-3(ii): Substantially alter the existing drainage pattern of the site or area, including the alteration of the course of a stream or river or through the addition of impervious surfaces, or substantially increase the rate or amount of surface runoff in a manner which would result in flooding on- or off-site
- Impact 4.10-3(iii): Substantially alter the existing drainage pattern of the site or area, including through the alteration of the course of a stream or river or through the addition of impervious surfaces, in a manner which would create or contribute runoff water which would exceed the capacity of existing or planned stormwater drainage systems or provide substantially additional sources of polluted runoff
- Impact 4.10-3(iv): Substantially alter the existing drainage pattern of the site or area, including through the alteration of the course of a stream or river or through the addition of impervious surfaces, in a manner which would impede or redirect flood flows
- Impact 4.10-5: Conflict with or obstruct implementation of a water quality control plan or sustainable groundwater management plan

Noise

- Impact 4.13-1: Generation of a substantial temporary or permanent increase in ambient noise levels in the vicinity of the Project in excess of standards established in the local general plan or noise ordinance or applicable standards of other agencies
- Impact 4.13-2: Generation of excessive ground-borne vibration or ground-borne noise levels
- Impact 4.13-3: For a project located within the vicinity of a private airstrip or an airport land use plan or, where such a plan has not been adopted, within two miles of a public airport or public use airport, would the Project expose people residing or working in the Project area to excessive noise levels

Population and Housing

- Impact 4.14-1: Induce substantial unplanned population growth in an area, either directly or indirectly

Public Services

- Impact 4.15-1: Result in substantial adverse physical impacts associated with the provision of new or physically altered governmental facilities, need for new or physically altered governmental facilities, the construction of which could cause significant environmental impacts in order to maintain acceptable service ratios, response times, or other performance objectives for fire protection
- Impact 4.15-2: Result in substantial adverse physical impacts associated with the provision of new or physically altered governmental facilities, need for new or physically altered governmental facilities, the construction of which could cause significant environmental impacts in order to maintain acceptable service ratios, response times, or other performance objectives for police protection services
- Impact 4.15-3: Result in substantial adverse physical impacts associated with the provision of new or physically altered governmental facilities, need for new or physically altered governmental facilities, the construction of which could cause significant environmental impacts in order to maintain acceptable service Ratios, response times, or other performance objectives for school services
- Impact 4.15-4: Result in substantial adverse physical impacts associated with the provision of new or physically altered governmental facilities, need for new or physically altered governmental facilities, the construction of which could cause significant environmental impacts in order to maintain acceptable service ratios, response times, or other performance objectives for park services
- Impact 4.15-5: Result in substantial adverse physical impacts associated with the provision of new or physically altered governmental facilities, need for new or physically altered governmental facilities, the construction of which could cause significant environmental impacts in order to maintain acceptable service ratios, response times, or other performance objectives for other public facilities

Recreation

- Impact 4.16-1: Result in increased use of existing neighborhood and regional parks or other recreational facilities such that substantial physical deterioration would occur or be accelerated

Transportation

- Impact 4.17-1: Conflict with a program plan, ordinance or policy addressing the circulation system, including transit, roadway, bicycle and pedestrian facilities
- Impact 4.17-2: Conflict or be inconsistent with CEQA Guidelines 15064.3, Subdivision (b)
- Impact 4.17-3: Substantially increase hazards due to a geometric design feature or incompatible uses
- Impact 4.17-4: Result in inadequate emergency access

Tribal Cultural Resources

- Impact 4.18-1: Cause a substantial adverse change in the significance of a tribal cultural resource, defined in Public Resources Code Section 21074 as either a site, feature, place, cultural landscape that is geographically defined in terms of the size and scope of the landscape, sacred place, or object with cultural value to a California Native American tribe, and that is listed or eligible for listing in the California register of historical resources, or in a local register of historical resources as defined in Public Resources Code Section 5020.1(k)
- Impact 4.18-2: Cause a substantial adverse change in the significance of a tribal cultural resource, defined in Public Resources Code Section 21074 as either a site, feature, place, cultural landscape that is geographically defined in terms of the size and scope of the landscape, sacred place, or object with cultural value to a California Native American tribe, and that is a resource determined by the lead agency, in its discretion and supported by substantial evidence, to be significant pursuant to criteria set forth in Subdivision (c) of Public Resources Code Section 5024.1.

Utilities and Service Systems

- Impact 4.19-1: Require or result in the relocation or construction of new or expanded water, wastewater treatment or stormwater drainage, electric power, natural gas, or telecommunications facilities, the construction or relocation of which could cause significant environmental effects
- Impact 4.19-2: Have sufficient water supplies available to serve the Project from existing entitlements and resources, or are new or expanded entitlements needed
- Impact 4.19-3: Result in a determination by the wastewater treatment provider which serves or may serve the Project that it has adequate capacity to serve the Project's projected demand in addition to the provider's existing commitments

- Impact 4.19-4: Generate solid waste in excess of State or local standards, or in excess of the capacity of local infrastructure, or otherwise impair the attainment of solid waste reduction goals
- Impact 4.19-5: Comply with federal, State, and local management and reduction statutes and regulations related to solid waste

Wildfire

- Impact 4.20-1: Substantially impair an adopted emergency response plan or emergency evacuation plan
- Impact 4.20-2: Due to slope, prevailing winds, and other factors, exacerbate wildfire risks, and thereby expose Project occupants to, pollutant concentrations from a wildfire or the uncontrolled spread of a wildfire
- Impact 4.20-3: Require the installation or maintenance of associated infrastructure (such as roads, fuel breaks, emergency water sources, power lines, or other utilities) that may exacerbate fire risk or that may result in temporary or ongoing impacts to the environment
- Impact 4.20-4: Expose people or structures to significant risks, including downslope or downstream flooding or landslides, as a result of runoff, post-fire slope instability, or drainage changes

Potential for Less-than-Significant Impacts to Occur with Incorporation of Mitigation Measures

The potential environmental effects of the Project and mitigation measures are discussed in detail in Chapter 4 of this EIR. After a full analysis, no effects were determined to be less than significant with the incorporation of mitigation measures.

None

Unavoidable Significant Adverse Impacts

Section 15126.2(b) of the CEQA Guidelines requires that the EIR describe any significant impacts, including those that can be mitigated but not reduced to less-than-significant levels. The potential environmental effects of the Project and proposed mitigation measures are discussed in detail in Chapter 4 of this EIR. The following environmental impacts were

determined to be significant and unavoidable impacts (refer to Table 1-1, *Summary of Significant Impacts of the Project*).

Table 1-1
Summary of Significant Impacts of the Project

Resources	Project Impacts	Cumulative Impacts
Transportation and Traffic Impact 4-17.2	The Project's VMT would exceed the Kings County baseline average. Although implementation of Mitigation Measure 4.1-1 is expected to reduce VMT for the Project, the amount of reduction would not bring the Project below the Kings County baseline average.; therefore, impacts are considered significant and unavoidable .	Project impacts are considered <i>significant and unavoidable</i> , even with feasible mitigation. This is in large part due to the lack of VMT-adopted thresholds for the City of Hanford. The only recognized VMT standard is from the County of Kings as it relates to greenhouse gas reductions. Due to the proposed Project being significant and unavoidable and no adopted thresholds for VMT, the cumulative impacts for the City of Hanford would be considered significant and unavoidable .

Significant Cumulative Impacts

According to Section 15355 of the CEQA Guidelines, the term *cumulative impacts* "refers to two or more individual effects which, when considered together, are considerable or which compound or increase other environmental impacts." Individual effects that may contribute to a cumulative impact may be from a single project or a number of separate projects. Individually, the impacts of a project may be relatively minor, but when considered along with impacts of other closely related or nearby projects, including newly proposed projects, the effects could be cumulatively considerable.

This EIR has considered the potential cumulative effects of the proposed Project. Impacts for the following issue areas have been found to be cumulatively considerable:

- Transportation and Traffic

This significant cumulative impact is discussed in the applicable section of Chapter 4, *Environmental Analysis*, of this EIR.

1.9 - Summary of Project Alternatives

Below is a summary of the alternatives to the proposed Project, that have been considered but rejected as well as those alternatives that have been considered and evaluated in Chapter 6, *Alternatives to the Proposed Project*.

1.9.1 - ALTERNATIVES CONSIDERED AND REJECTED

There are no Project alternatives that were considered and rejected.

1.9.2 - ALTERNATIVES CONSIDERED AND EVALUATED

- *No Project Alternative*. Under the No Project Alternative, the Project area would remain unchanged, and there would be no residential units or parks constructed.
- *Alternative B – Reduced Project Alternative*. This alternative would decrease the number of single-family residential houses from 457 to 228.
- *Alternative C – Multi-Family Alternative*. This alternative would replace the proposed single-family residential with multi-family apartments at a density of at least 20 dwelling units per gross acre (1,196 units).
- *Alternative D– Different Sites Alternative*. This alternative would relocate the Project to one of two different sites in order to be located nearer to regional commercial. This alternative would place the Project on the west side of the City, along Hanford-Armona Road, west of South 12th Avenue, or on the southeast corner of 9 ¼ Avenue and Grangeville Boulevard.

1.10 - Environmentally Superior Alternative

CEQA requires that the City identify an Environmentally Superior Alternative. If the No Project Alternative is the Environmentally Superior Alternative, the City must identify an Environmentally Superior Alternative among the other alternatives considered in the EIR (CEQA Guidelines, Section 15126.6). This alternatives analysis includes three other Project alternatives –Alternative B - Reduced Project, Alternative C - Multi-Family, and Alternative D - Different Sites. Based on the evaluation of the three alternatives, Alternative C – Multi-Family would reduce significant and unavoidable environmental impacts relating to VMT while fulfilling most of the objectives of the proposed Project and is therefore the Environmentally Superior Alternative.

**Table 1-2
Comparison of Alternatives' Impacts**

Environmental Resource	Project	Alternative A	Alternative B	Alternative C	Alternative D
Transportation and Traffic: Conflict or be Inconsistent with CEQA Guidelines Section 15064.3, Subdivision (b)	Significant / Unavoidable	Fewer	Similar	Fewer	Similar
Transportation and Traffic: Cumulative Impacts associated with VMT	Significant / Unavoidable	Fewer	Similar	Fewer	Similar
Meet Project Objectives?	Yes	No	Yes	Yes	Yes
Reduce Any Significant and Unavoidable Impacts to No Impact or Less than Significant?	—	Yes	No	Yes	No

1.11 - Growth Inducement

The City of Hanford General Plan recognizes that certain forms of growth are beneficial, both economically and socially. Section 15126.2(d) of the CEQA Guidelines provides the following guidance on growth-inducing impacts: a project is identified as growth-inducing if it “could foster economic or population growth, or the construction of additional housing, either directly or indirectly, in the surrounding environment.”

A key consideration in evaluating growth inducement is whether the activity in question constitutes “planned growth.” A project that is consistent with the underlying General Plan and zoning designations would generally be considered planned growth because it was previously contemplated by these long-range documents, and, thus, would not be deemed to have a significant growth-inducing effect. Likewise, a project that requires a General Plan Amendment may be considered to have a substantial growth-inducing effect because such intensity was not contemplated by the applicable long-range documents. It should be noted that these are hypothetical examples, and conclusions about the potential for growth inducement will vary on a case-by-case basis.

With respect to residential land uses, the Project does not include a General Plan Amendment or a change in Zone District. The existing General Plan designation for the Project is Low Density Residential and the existing Zoning is Low Density Residential (5,000 SF min.). The Project would accordingly not directly result in unplanned population growth of the City.

With respect to employment during construction, the jobs created by the Project will primarily employ persons living within the area. It is anticipated that the majority of the jobs will be filled by existing City or County residents; some employees would come from the region and commute, while a small number would relocate to the City. This small number of new residents is anticipated by the General Plan.

Therefore, this Project would not result in a large increase in new residential units or employment. In addition, the Project is situated in urbanized areas within the City of Hanford, where existing public services exist. The Project would accordingly accommodate planned growth and not induce unplanned growth.

With respect to removing barriers to development, such as by providing access to previously undeveloped areas, the Project is not anticipated to result in significant growth inducement. The Project does not include the construction of infrastructure that could remove barriers to off-site development.

Although the Project accommodates planned residential growth, the net increase in population on the Project site would be less than significant.

1.12 - Irreversible Impacts

Section 15126.2(c) of the CEQA Guidelines defines an irreversible impact as an impact that uses nonrenewable resources during the initial and continued phases of a project.

Irreversible impacts can also result from damage caused by environmental accidents associated with a project. Irretrievable commitments of resources should be evaluated to ensure that such consumption is justified. Buildout of a project would commit nonrenewable resources during project construction and ongoing utility services during project operations. During project operations, oil, gas, and other nonrenewable resources would be consumed. Therefore, an irreversible commitment of nonrenewable resources would occur as a result of long-term project operations. However, assuming that those commitments occur in accordance with the adopted goals, policies, and implementation measures of the City of Hanford General Plan, as a matter of public policy, those commitments have been determined to be acceptable. The City of Hanford General Plan ensures that any irreversible environmental changes associated with those commitments will be minimized.

1.13 - Areas of Controversy

No areas of controversy were identified through written agency, and three public comments received during the scoping period. Public comments received during scoping are provided in Appendix A and summarized in Section 2.4 of Chapter 2, *Introduction*. In summary, the following issues were identified during scoping and are addressed in the appropriate sections of Chapter 4, *Environmental Analysis*:

- Transportation
 - Vehicle Miles Travelled (VMT)
 - Evaluate local and cumulative impacts

1.14 - Issues to be Resolved

Section 15123(b)(3) of the CEQA Guidelines requires that an EIR contain issues to be resolved, which includes the choices among alternatives and whether or how to mitigate significant impacts. The major issues to be resolved regarding the Project include decisions by the Lead Agency as to whether or not:

- The Draft EIR adequately describes the environmental impacts of the Project.
- The recommended mitigation measures should be adopted or modified.
- Additional mitigation measures need to be applied.

1.15 - Executive Summary Matrix

Table 1-3 below summarizes the impacts, mitigation measures, and the resulting level of significance after mitigation for the relevant environmental issue areas evaluated for the proposed Project. Table 1-3 is intended to provide an overview; narrative discussions for the issue areas are included in the corresponding sections of this Draft EIR.

**Table 1-3
Summary for Mitigation**

Impacts	Mitigation Measures	Level of Significance
Section 4.6 Transportation		
4.6-1: Conflict with a program, plan, ordinance, or policy addressing the circulation system, including transit, roadway, bicycle, and pedestrian facilities?	No mitigation is required.	Less than significant
4.6-2: Conflict or be inconsistent with CEQA Guidelines Section 15064.3, Subdivision (b)?	MM 4.6-1: Prior to the recordation of the final map, the design shall include Class II Bikeways along the Project frontages to 10 ½ Avenue and Orchard Avenue	Significant and Unavoidable

CHAPTER 2 - INTRODUCTION

2.1 - Overview

The City of Hanford (City) will be the Lead Agency pursuant to the requirements of the California Environmental Quality Act (CEQA) and will be responsible for preparing an Environmental Impact Report (EIR) pursuant to CEQA (Public Resources Code (PRC) Section 21000 et seq.) and the CEQA Guidelines. In accordance with Section 15082 of the CEQA Guidelines, the City published a Notice of Preparation (NOP). This EIR will be used by the City to evaluate the potential environmental impacts that could result from implementation of the Project and develop changes in the proposed Project and/or adopt mitigation measures that would address those impacts.

This EIR has been prepared pursuant to the following relevant State statutes and guidelines:

- CEQA (Public Resources Code, Section 21000 et seq.).
- CEQA Guidelines (California Code of Regulations, Title 14, Chapter 3, Section 15000 et seq.).

The overall purposes of the CEQA process are to:

- Identify the significant effects to the environment of a project, identify alternatives, and indicate the manner in which those significant effects can be avoided or mitigated.
- Provide for full disclosure of the project's environmental effects to the public, the agency decision-makers who will approve or deny the project, and responsible and trustee agencies charged with managing resources (e.g., wildlife, air quality) that may be affected by the project.
- Provide a forum for public participation in the decision-making process with respect to environmental effects.

2.2 - Purpose of This Environmental Impact Report

An EIR is a public informational document used in the planning and decision-making process. This project-level EIR will analyze the environmental impacts of the Project. The City of Hanford Planning Commission and City Council will consider the information in the EIR, including the public comments and staff response to those comments, during the public hearing process. As a legislative action, the final decision is made by the Board of Supervisors, who may approve, conditionally approve, or deny the Project. The purpose of an EIR is to identify:

- The significant potential impacts of a project on the environment and indicate the manner in which those significant impacts can be avoided or mitigated.
- Any unavoidable adverse impacts that cannot be mitigated.

- Reasonable and feasible alternatives to the project that would eliminate any significant adverse environmental impacts or reduce the impacts to a less-than-significant level.

An EIR also discloses growth-inducing impacts; impacts found not to be significant; and significant cumulative impacts of the project when taken into consideration with past, present, and reasonably anticipated future projects.

CEQA requires an EIR that reflects the independent judgment of the Lead Agency regarding the impacts, the level of significance of the impacts both before and after mitigation, and mitigation measures proposed to reduce the impacts. A Draft EIR is circulated to responsible agencies, trustee agencies with resources affected by the project, and interested agencies and individuals. The purposes of public and agency review of a Draft EIR include sharing expertise, disclosing agency analyses, checking for accuracy, detecting omissions, discovering public concerns, and soliciting mitigation measures and alternatives capable of avoiding or reducing the significant effects of the project, while still attaining most of the basic objectives of the project.

Reviewers of a Draft EIR are requested to focus on the sufficiency of the document in identifying and analyzing the possible impacts on the environment and ways in which the significant effects of the project might be avoided or mitigated. Comments are most helpful when they suggest additional specific alternatives or mitigation measures that would provide better ways to avoid or mitigate significant environmental effects.

2.2.1 - ISSUES TO BE RESOLVED

Section 15123(b)(3) of the CEQA Guidelines requires that an EIR contain issues to be resolved, which includes the choices among alternatives and whether or how to mitigate significant impacts. The major issues to be resolved regarding the Project include decisions by the Lead agency as to whether or not:

- The Draft EIR adequately describes the environmental impacts of the Project.
- The recommended mitigation measures should be adopted or modified.
- Additional mitigation measures need to be applied.

2.3 - Terminology

To assist reviewers in understanding this EIR, the following terms are defined:

- *Project* means the whole of an action that has the potential for resulting in a direct physical change in the environment. or a reasonably foreseeable indirect physical change in the environment.
- *Environment* means the physical conditions that exist in the area and which will be affected by the proposed Project, including land, air, water, minerals, flora, fauna, ambient noise, and objects of historical or aesthetic significance. The area involved is

where significant direct or indirect impacts would occur as a result of the Project. The environment includes both natural and manmade (artificial) conditions.

- *Impacts* analyzed under CEQA must be related to a physical change. Impacts are:
 - Direct or primary impacts that would be caused by the proposed Project and would occur at the same time and place.
 - Indirect or secondary impacts that would be caused by the proposed Project and would be later in time or farther removed in distance but would still be reasonably foreseeable. Indirect or secondary impacts may include growth-inducing impacts and other effects related to induced changes in the pattern of land use, population density or growth rate, and related effects on air and water and other natural systems, including ecosystems.
 - The California Supreme Court recently ruled that the environment's impact on a project fall outside the scope of CEQA except to the extent that impacts from a project exacerbate such impacts. This EIR includes the environment's impacts on the Project for informational purposes and addresses the exacerbation component of the Court's decision.
- *Significant impact on the environment* means a substantial, or potentially substantial, adverse change in any of the physical conditions in the area affected by the proposed Project, including land, air, water, minerals, flora, fauna, ambient noise, and objects of historical or aesthetic significance. An economic or social change by itself is not considered a significant impact on the environment. A social or economic change related to a physical change may be considered in determining whether the physical change is significant.
- *Mitigation* consists of measures that avoid or substantially reduce the proposed Project's significant environmental impacts by:
 - Avoiding the impact altogether by not taking a certain action or parts of an action.
 - Minimizing impacts by limiting the degree or magnitude of the action and its implementation.
 - Rectifying the impact by repairing, rehabilitating, or restoring the affected environment.
 - Reducing or eliminating the impact over time by preservation and maintenance operations during the life of the action.
 - Compensating for the impact by replacing or providing substitute resources or environments.
- *Cumulative impacts* are two or more individual impacts that, when considered together, are considerable or that compound or increase other environmental impacts. The following statements also apply when considering cumulative impacts:
 - The individual impacts may be changes resulting from a single project or separate projects.

- The cumulative impact from several projects is the change in the environment that results from the incremental impact of the Project when added to other closely related past, present, and reasonably foreseeable probable future projects. Cumulative impacts can result from individually minor but collectively significant projects taking place over time.

This EIR uses a variety of terms to describe the level of significance of adverse impacts. These terms are defined as follows:

- *Less than significant.* An impact that is adverse but that does not exceed the defined thresholds of significance. Less-than-significant impacts do not require mitigation.
- *Significant.* An impact that exceeds the defined thresholds of significance and would or could cause a substantial adverse change in the environment. Mitigation measures are recommended to eliminate the impact or reduce it to a less-than-significant level.
- *Significant and unavoidable.* An impact that exceeds the defined thresholds of significance and cannot be eliminated or reduced to a less-than-significant level through the implementation of mitigation measures.

2.4 - Decision-Making Process

CEQA requires Lead Agencies to solicit and consider input from other interested agencies, citizen groups, and individual members of the public. CEQA also requires a project to be monitored after it has been permitted to ensure that mitigation measures are carried out.

CEQA requires the Lead Agency to provide the public with full disclosure of the expected environmental consequences of a proposed project and with an opportunity to provide comments. In accordance with CEQA, the following is the process for public participation in the decision-making process:

- **Notice of Preparation.** The City of Hanford prepared and circulated a Notice of Preparation (NOP) to responsible, trustee, and local agencies for review and comment on February 2, 2023. The NOP and responses to the NOP are included in Appendix A of this EIR. In conjunction with this public notice, a scoping meeting was held on February 14, 2023, at Hanford City Council Chambers, located in Civic Auditorium, 400 North Douty Street, Hanford, CA 93230.
- **Draft EIR Preparation.** A Draft EIR is prepared, incorporating public and agency responses to the NOP and scoping process. The Draft EIR is circulated for review and comment to appropriate agencies and additional individuals and interest groups who have requested to be notified of EIR projects. Per Section 15105 of the CEQA Guidelines, the City of Hanford will provide for a 45-day public review period on the Draft EIR. The City will subsequently respond to each comment on the Draft EIR received in writing through a Response to Comments chapter in the Final EIR. The Response to Comments will be provided to each agency or person who provided

written comments on the EIR a minimum of 10 business days before the scheduled City Council hearing on the Final EIR.

- **Preparation and Certification of Final EIR.** The City of Hanford will consider the Final EIR and the Project, acting in an advisory capacity to the City Council. Upon receipt of the Planning Commission's recommendation, the City Council will also consider the Final EIR, and all public comments and take final action on the Project. At least one public hearing will be held by both the Planning Commission and City Council to consider the Final EIR, take public testimony, and then approve, conditionally approve, or deny the Project.

2.4.1 - NOTICE OF PREPARATION (NOP)

Pursuant to Section 15082 of the CEQA Guidelines, as amended, the City of Hanford circulated a NOP to the State Clearinghouse, public agencies, special districts, and members of the public for a public review period beginning February 2, 2023, and ended March 4, 2023. The purpose of the NOP is to formally convey that the City, as the Lead Agency, solicited input regarding the scope and proposed content of the EIR. The NOP and all comment letters are provided in Appendix A of this EIR.

2.4.2 - SCOPING MEETING

Pursuant to Section 15206 of the CEQA Guidelines, the Lead Agency is required to conduct at least one scoping meeting for all projects of Statewide, regional, or area-wide significance. The scoping meeting is for jurisdictional agencies and interested persons or groups to provide comments regarding, but not limited to, the range of actions, alternatives, mitigation measures, and environmental effects to be analyzed. The City of Hanford hosted a scoping meeting at 5:30 p.m. February 14, 2023, at Hanford City Council Chambers, located in Civic Auditorium, 400 North Douty Street, Hanford, CA 93230.

NOP and Scoping Meeting Results

One individual was present during the February 14, 2023, scoping meeting. No comment letters were submitted during the scoping meeting. Additional comments were made by Planning Commissioner Dennis Ham. These comments are summarized in Table 2-2, below.

NOP Written Comments

The City received three letters with comments in response to the NOP. Specific concerns raised in written comments received during the 30-day NOP public review period are discussed below. The NOP and all comments received are included in Appendix A, along with the Summary of Proceedings from the scoping meeting. The comments are also summarized in Table 2-1, *Summary of Written Comments on Notice of Preparation/Initial Study*.

Table 2-1
Summary of Written Comments on Notice of Preparation

Commenter	Summary of Comment
Federal Agencies	No federal agencies submitted comments in response to the NOP.
State Agencies	
Office Planning (letter dated February 8, 2023)	Notifies reviewing agencies of their ability to review and provide comments on the NOP within 30 days of its receipt from the Lead Agency.
California Native American Heritage Commission	The NHAC recommends consultation with California Native American tribes that are traditionally and culturally affiliated with the geographic area of the proposed Project as early as possible in order to avoid inadvertent discoveries of Native American human remains and best protect tribal cultural resources and compliance with tribal consultation requirements of SB18 and AB52.
California Department of Fish and Wildlife (CDFW) (March 3, 2023)	<ol style="list-style-type: none"> 1. CDFW recommends assessing presence/absence of San Joaquin Kit Fox (SJKF) by conducting focused den surveys as part of the biological technical studies conducted in support of the CEQA document. CDFW also recommends a qualified biologist conduct on-site worker awareness training and inspect all construction materials for SJKF before use. Any pits or trenches created shall be sloped or covered to prevent inadvertent take. 2. If suitable Crotch Bumblebee (CBB) habitat exists in areas of planned Project-related ground disturbance, equipment staging, or materials laydown, CDFW recommends a qualified biologist conduct a habitat assessment and surveys as part of the biological technical studies conducted in support of the CEQA document to determine if the Project area or its immediate vicinity contain habitat suitable to support CBB. If surveys cannot be completed, CDFW recommends avoiding disturbing potential CBB habitat. 3. To evaluate potential Project-related impacts, CDFW recommends that a qualified biologist conduct a habitat assessment as part of the biological technical studies conducted in support of

Commenter	Summary of Comment
	<p>the CEQA document, to determine if the Project site or the immediate vicinity contains suitable habitat for Swainson’s Hawk (SWHA). If suitable foraging or nesting habitat is present, CDFW recommends that a qualified biologist conduct surveys for nesting SWHA.</p> <p>4. Burrowing owl and American badger have the potential to occur in the Project area. These species have been documented to occur in the vicinity of the Project site, which supports requisite habitat elements (CDFW 2023). CDFW recommends that a qualified biologist conduct a habitat assessment as part of the biological technical studies conducted in support of the CEQA document, to determine if Project areas or their immediate vicinity contain potential habitat for the species mentioned above. If potential habitat is present, CDFW recommends that various measures be implemented prior to and during any ground-disturbing activities.</p>
<p>Department of Toxic Substances Control (DTSC) (February 17, 2023)</p>	<p>DTSC recommends that the following issues be evaluated in the Hazards and Hazardous Materials section of the EIR:</p> <ol style="list-style-type: none"> 1. Provide regulatory concurrence that the Project site is safe for construction and the proposed use. 2. Acknowledge the potential for historic or future activities on or near the Project site to result in the release of hazardous wastes/substances on the Project site. <p>Also, identify the mechanism(s) to initiate any required investigation and/or remediation and the government agency that will be responsible for providing appropriate regulatory oversight.</p> <ol style="list-style-type: none"> 3. Due to the potential for ADL-contaminated soil DTSC, recommends collecting soil samples for lead analysis prior to performing any intrusive activities for the Project described in the EIR.

Commenter	Summary of Comment
	<ol style="list-style-type: none"> <li data-bbox="716 212 1422 548">4. If structures ae to be demolished surveys should be conducted for the presence of lead-based paints or products, mercury, asbestos-containing materials, and polychlorinated biphenyl caulk. Removal, demolition, and disposal of any of the above-mentioned chemicals should be conducted in compliance with California environmental regulations and policies. <li data-bbox="716 590 1422 810">5. Proper sampling should be conducted to ensure that the imported soil is free of contamination. DTSC recommends the imported materials be characterized according to DTSC’s 2001 Information Advisory Clean Imported Fill Material. <li data-bbox="716 852 1422 1115">6. Conduct a proper investigation for organochlorinated pesticides should be discussed in the EIR. DTSC recommends the current and former agricultural lands be evaluated in accordance with DTSC’s 2008 Interim Guidance for Sampling Agricultural Properties (Third Revision).
Local Agencies	No local agencies submitted comments in response to the NOP.
Members of the Public	No written comments were received

IS/NOP Oral Comments

The City received no oral comments in response to the NOP at the scoping meeting. The comments are summarized in Table 2-2, *Summary of Oral Comments on Notice of Preparation*.

Table 2-2
Summary of Oral Comments on Notice of Preparation

Commenter	Summary of Comment
Federal Agencies	No federal agencies commented in response to the NOP during the scoping meeting.
State Agencies	No local agencies commented in response to the NOP during the scoping meeting.
Local Agencies	No local agencies commented in response to the NOP during the scoping meeting.
Interested Parties	<p>Onan Champi - property owner. Mr. Champi had two questions:</p> <ol style="list-style-type: none"> 1. Will any roads connect to 10th Avenue? 2. Wants property owner to be aware of Heavy Industrial zoning owned by Onan Champi on 10th Avenue <p>Additional comments were made by Planning Commissioner Dennis Ham:</p> <ol style="list-style-type: none"> 1. street name concerns 2. lot numbering and phasing concerns 3. Echo Ln naming concern; Orchard Ave naming concern 4. Concern about traffic flow into the project, inability for emergency services to get to site quickly, due to turn movements 5. Public Service environmental review concerns 6. Doesn't think map will be able to be constructed within 2 years 7. Believes air quality would be an issue 8. Concerns about water availability

2.5 - Availability of the Draft EIR

This Draft EIR is being distributed directly to agencies, organizations, and interested groups and persons for comment during a 45-day formal review period in accordance with Section 15087 of the CEQA Guidelines. This Draft EIR and the full administrative record for the Project, including all studies, is available for review during normal business hours Monday through Friday at the City of Hanford Community Development Department, located at:

City of Hanford Community Development Department
City Hall
317 North Douty Street, Hanford, CA 93230

2.6 - Format and Content

This Draft EIR addresses the potential environmental effects of the Project and was prepared following input from the public and the responsible and affected agencies, through the EIR scoping process, as discussed previously. The contents of this Draft EIR were established based on the findings in the NOP and public and agency input. Based on the findings of the NOP, a determination was made that an EIR was required to address potentially significant environmental effects on the following resources:

- Transportation

2.6.1 - REQUIRED EIR CONTENT AND ORGANIZATION

The content and organization of this Draft EIR are designed to meet the requirements of CEQA, the CEQA Guidelines, and the Kern County CEQA Implementation Document, as well as to present issues, analysis, mitigation, and other information in a logical and understandable way. This Draft EIR is organized into the following sections:

- Chapter 1, *“Executive Summary,”* provides a Project description and a summary of the environmental impacts and mitigation measures.
- Chapter 2, *“Introduction,”* provides CEQA compliance information, an overview of the decision-making process, organization of the EIR, and a responsible and trustee agency list.
- Chapter 3, *“Project Description,”* provides a description of the location, characteristics, objectives, and the relationship of the Project to other plans and policies.
- Chapter 4, *“Environmental Setting, Impacts, and Mitigation Measures,”* contains a detailed environmental analysis of the existing conditions, project impacts, mitigation measures, and unavoidable adverse impacts.
- Chapter 5, *“Consequences of Project Implementation (Mandatory CEQA Sections),”* presents an analysis of the Project’s cumulative and growth-inducing impacts and

other CEQA requirements, including significant and unavoidable impacts and irreversible commitment of resources.

- Chapter 6, *“Alternatives,”* describes a reasonable range of alternatives to the Project that could reduce the significant environmental effects that cannot be avoided.
- Chapter 7, *“Responses to Comments,”* is reserved for responses to comments on this Draft EIR.
- Chapter 8, *“Organizations and Persons Consulted,”* lists the organizations and persons contacted during the preparation of this Draft EIR.
- Chapter 9, *“Preparers,”* identifies persons involved in the preparation of the Draft EIR.
- Chapter 10, *“Bibliography,”* identifies reference sources for the Draft EIR.
- *“Appendices”* provide information and technical studies that support the environmental analysis contained within the Draft EIR.

The analysis of each environmental category in Chapter 4 is organized as follows:

- *“Introduction”* provides a brief overview of the purpose of the section being analyzed with regard to the Project.
- *“Environmental Setting”* describes the physical conditions that exist at this time and that may influence or affect the topic being analyzed.
- *“Regulatory Setting”* provides State and federal laws, the City of Hanford General Plan (GP) goals, policies, and implementation measures that apply to the topic being analyzed.
- *“Impacts and Mitigation Measures”* discusses the impacts of the Project in each category, including direct, indirect, and cumulative impacts, presents the determination of the level of significance, and provides a discussion of feasible mitigation measures to reduce any impacts.

2.7 - Responsible and Trustee Agencies

Projects or actions undertaken by the Lead Agency, in this case, the City of Hanford, may require subsequent oversight, approvals, or permits from other public agencies in order to be implemented. Other such agencies are referred to as *“responsible agencies”* and *“trustee agencies.”* Pursuant to Sections 15381 and 15386 of the CEQA Guidelines, as amended, responsible agencies and trustee agencies are defined as follows:

- A *“responsible agency”* is a public agency that proposes to carry out or approve a project, for which a Lead Agency is preparing or has prepared an EIR or Negative Declaration. For the purposes of CEQA, the term *“responsible agency”* includes all

public agencies other than the Lead Agency that have discretionary approval power over a project (Section 15381).

- A “trustee agency” is a State agency having jurisdiction by law over natural resources affected by a project that is held in trust for the people of the State of California (Section 15386).

The various public, private, and political agencies and jurisdictions with a particular interest in the Project include, but are not limited to, the following:

2.7.1 - LOCAL AGENCIES

- San Joaquin Valley Air Pollution Control District (SJVAPCD)
- County of Kings

2.7.2 - STATE AGENCIES

- California Air Resources Board (CARB)
- California Department of Transportation (Caltrans)
- California Department of Fish and Wildlife (CDFW)
- California Integrated Waste Management Board
- Department of Toxic Substances Control
- Department of Water Resources
- Governor’s Office of Planning and Research
- Regional Water Quality Control Board (RWQCB), Central Valley Region

2.7.3 - FEDERAL AGENCIES

- U.S. Fish and Wildlife Service (USFWS)

2.8 - Incorporation by Reference

In accordance with Section 15150 of the CEQA Guidelines to reduce the size of the report, the following documents are hereby incorporated by reference into this Draft EIR and are available for public review at the City of Hanford Community Development Department.

- City of Hanford 2035 General Plan Update
- City of Hanford 2035 General Plan Update Master EIR
- City of Hanford Subdivision Ordinance
- City of Hanford Zoning Ordinance
- City of Hanford Housing Element

2.9 - Sources

This Draft EIR is dependent upon information from many sources. Some sources are studies or reports that have been prepared specifically for this document. Other sources provide background information related to one or more issue areas that are discussed in this document. The sources and references used in the preparation of this Draft EIR are listed in Chapter 10, *Bibliography*, and are available for review during normal business hours at the:

City of Hanford Community Development Department
City Hall
317 North Douty Street, Hanford, CA 93230

CHAPTER 3 - PROJECT DESCRIPTION

3.1 - Project Overview

This Environmental Impact Report (EIR) has been prepared to identify and evaluate potential environmental impacts associated with the construction of 457 single-family residences, internal roads, a drainage retention basin, and a 5.82-acre park on an approximately 95-acre site (Project). Access to the proposed subdivision will be from 10 ½ Avenue. The development will build 10 ½ Avenue with a minimum 34-foot road right of way (ROW).

The Project is located in the incorporated City of Hanford, California (Figure 3-1 - *Regional Location*; Figure 3-2 - *Project Location*).

3.2 - Project Location and Environmental Setting

3.2.1 - REGIONAL SETTING

The City of Hanford (City) is located 30 miles south of the City of Fresno and 20 miles west of the City of Visalia in the northern portion of Kings County, California. Kings County is one of eight counties that comprise the San Joaquin Valley, which is bound on the west by the Coast Range Mountains, on the east by the Sierra Nevada, on the south by the Tehachapi Mountains, and on the north by the Sacramento River Delta area. Kings County is bordered by Monterey County to the west, Tulare County to the east, Kern County to the south, and Fresno County to the north. Like much of the greater San Joaquin Valley, Kings County has remained predominantly an agricultural area. There are four incorporated cities in Kings County. Hanford is the largest of the four cities in physical size and population. Figure 3-1 provides the regional location of Hanford.

3.2.2 - LOCAL SETTING

The City has a total area of approximately 17 square miles and, on January 1, 2020, had a population of 57,339 residents, which was about 38 percent of the total population of Kings County. The City's elevation is approximately 249 feet above mean sea level, and the topography of Hanford is relatively flat, indicative of the floor of the San Joaquin Valley where the City resides. Armona, Home Garden, and Grangeville are unincorporated communities located near Hanford. The Naval Air Station Lemoore is located 16 miles west of Hanford. Santa Rosa Rancheria, the reservation of the Santa Rosa Indian Community, is located eight miles southwest of Hanford.

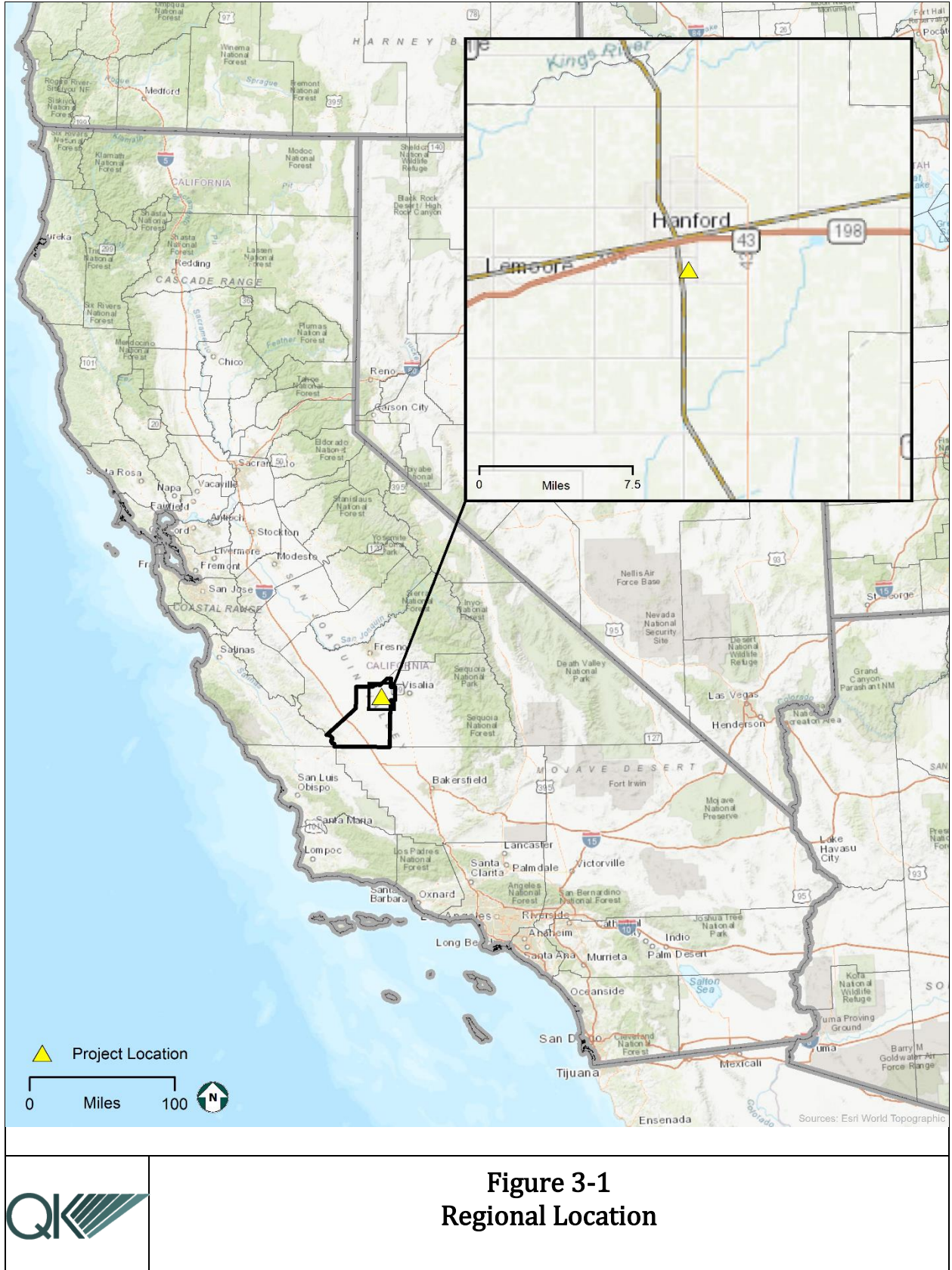

Figure 3-1
Regional Location

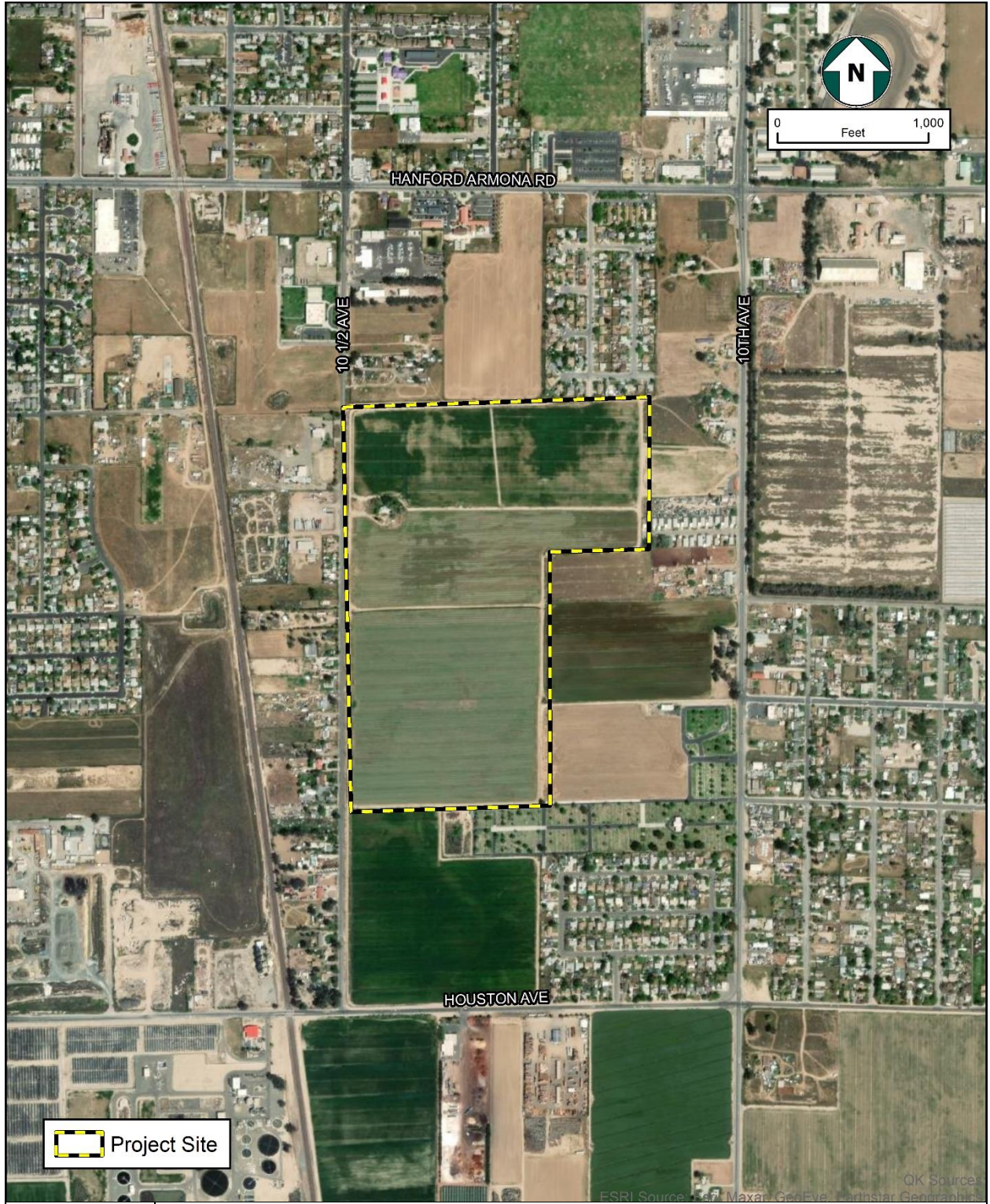

Figure 3-2
Project Location

3.2.3 - PROJECT LOCATION

The Project site is adjacent to 10 ½ Avenue to the west and between Hanford-Armona Road and Houston Avenue in the City of Hanford, Kings County, CA. The Project is on Assessor Parcel Numbers (APN) 011-440-015 and 011-440-014, within Section 1, Township 19S, Range 21E, Mount Diablo Base and Meridian (MDB&M).

3.3 - Project Objectives

State CEQA Guidelines require that the EIR project description include a statement of the objectives of the proposed Project. The primary objectives of the Project are to:

- Provide a variety of housing opportunities with a range of styles, sizes, and values that will be designed to satisfy existing and future demand for quality housing in the area.
- Provide a sense of community and walkability within the development through the use of street patterns, parks/open space areas, landscaping, and other Project amenities.
- Create a successful and financially feasible Project by meeting the housing needs of the area.
- Provide a residential development that assists the City in meeting its General Plan and Housing Element requirements and objectives.

3.4 - Proposed Project

The Applicant proposes the construction of 457 single-family residences, internal roads, a drainage retention basin, and a 5.82-acre park on an approximately 95-acre site (Project). Access to the proposed subdivision will be from 10 ½ Avenue. The development will build 10 ½ Avenue with a minimum 34-foot road ROW.

In order for the Project to be constructed, approval of the following actions is required:

- Tentative Tract Map 938 (Figure 3-3)

Construction will take approximately 24 months, with a total buildout of the homes by Q4 2025. There will be six phases, with the following lots constructed per phase:

- Phase 1 – 106 lots
- Phase 2 – 65 lots
- Phase 3 – 78 lots
- Phase 4 – 67 lots
- Phase 5 – 67 lots
- Phase 6 – 69 lots

VESTING TENTATIVE SUBDIVISION MAP TRACT #938

PORTION OF THE NORTHEAST QUARTER AND SOUTHWEST QUARTER OF SECTION 1, T.19S., R.21E., MOUNT DIABLO
BASE AND MERIDIAN, IN THE CITY OF HANFORD, COUNTY OF KINGS, STATE OF CALIFORNIA.

PROJECT SITE INFORMATION

APNs: 011-440-014 & 011-440-015



RECORD OWNERS:
DANIEL W. FANDERRECHT AND BETTY FANDERRECHT TRUST OF DECEMBER 15, 1963
6827 E. MCKENZIE AVENUE
FRESNO, CA 93727

SUBDIVIDER/APPLICANT:
D.R. HORTON CA3, INC.
419 W. MURRAY AVENUE
VESALIA, CA 93221
(559) 636-9850

LEGAL DESCRIPTION

PER PRELIMINARY TITLE REPORT ORDER NO. 018-024682ALA DATED SEPTEMBER 24, 2021 AND UPDATED ON OCTOBER 6, 2022:
REAL PROPERTY IN THE CITY OF HANFORD, COUNTY OF KINGS, STATE OF CALIFORNIA, DESCRIBED AS FOLLOWS:

- PARCEL 1:
THE NORTHWEST QUARTER OF THE SOUTHWEST QUARTER OF SECTION 1, TOWNSHIP 19 SOUTH, RANGE 21 EAST, MOUNT DIABLO BASE AND MERIDIAN, IN THE COUNTY OF KINGS, STATE OF CALIFORNIA, ACCORDING TO THE OFFICIAL PLAT THEREOF.
EXCEPTING THEREFROM AN UNDIVIDED 1/2 INTEREST IN AND TO ALL OIL, GAS, MINERALS, MINERAL RIGHTS AND OTHER HYDROCARBON SUBSTANCES WITHIN UNDERLYING SAID LAND AS RESERVED BY DORIAN E. SMITH AND LAVONNE L. SMITH, IN THAT CERTAIN DEED DATED NOVEMBER 19, 1966 AND RECORDED NOVEMBER 24, 1966 IN BOOK 881, PAGE 889 OF OFFICIAL RECORDS, AS DOCUMENT NO. 15317.
- PARCEL 2:
THE NORTHWEST QUARTER OF THE SOUTHWEST QUARTER OF THE NORTHEAST QUARTER AND THE NORTH HALF OF THE SOUTHWEST QUARTER OF THE SOUTHWEST QUARTER OF THE NORTHEAST QUARTER OF SECTION 1, TOWNSHIP 19 SOUTH, RANGE 21 EAST, MOUNT DIABLO BASE AND MERIDIAN.
EXCEPTING THEREFROM ALL OIL, GAS AND OTHER HYDROCARBONS AND MINERALS HERETOFORE CONVEYED.
- PARCEL 3:
THE SOUTHWEST QUARTER OF THE NORTHEAST QUARTER OF SECTION 1, TOWNSHIP 19 SOUTH, RANGE 21 EAST, MOUNT DIABLO BASE AND MERIDIAN.
APN: 011-440-014-000 (AFFECTS: PARCEL 1) AND 011-440-015-000 (AFFECTS: PARCELS 2 AND 3)

NOTES

- DATE OF PREPARATION: JANUARY 27, 2021
- ZONE: RL-5.
- ALL DISTANCES SHOWN ARE IN FEET & DECIMALS THEREOF AND ARE APPROXIMATE
- PROPOSED LAND USE: SINGLE FAMILY RESIDENTIAL (100% OF SITE)
- IMPROVEMENTS TO CONFORM TO APPLICABLE ORDINANCES & STATUTES
- EASEMENTS FOR PUBLIC UTILITIES TO BE PROVIDED AS REQUIRED
- NOT SUBJECT TO INUNDATION OR OVERFLOW, UNLESS OTHERWISE NOTED
- NATURAL GAS BY: THE GAS COMPANY
- TELEPHONE BY: AT&T
- POWER BY: SOUTHERN CALIFORNIA EDISON CO
- CABLE T.V. BY: COMCAST
- DOMESTIC WATER BY: CITY OF HANFORD
- SEWAGE DISPOSAL BY: CITY OF HANFORD
- REFUSE COLLECTION BY: CITY OF HANFORD
- DRAINAGE: ON-SITE BASIN
- OFF STREET PARKING: NONE
- UTILITY LOCATIONS ARE ESTIMATED AND BASED ON AN ABOVE GROUND FIELD SURVEY
- ENTITLEMENTS: TENTATIVE SUBDIVISION MAP

FLOOD ZONE NOTE

THE SUBJECT SITE IS NOT WITHIN A FLOOD ZONE AS SHOWN ON FEMA FIRM PANEL 06031C0185C, EFFECTIVE 6/16/2009.

ACREAGE AND LAND USE

	NO. OF UNITS	GROSS ACRES	GROSS DENSITY	PROPOSED ZONE
5,000 SF LOTS:	457	59.86	N/A	RL-5
OUTLOT - PARK (PUBLIC):	1	5.82	N/A	P-F
OUTLOT - STORM BASIN:	1	4.40	N/A	P-F
RIGHT OF WAY:		26.14	N/A	RL-5
TOTALS:	459	96.22	4.75	

SETBACKS

- FRONT: 15' TO LIVING
20' TO GARAGE
- SIDE: 10' FOR STREET SIDE
CORNER LOTS
5' EVERYWHERE ELSE
- REAR: 15' 1 STORY HOUSE
25' 2 STORY HOUSE

PHASING & LOT INFORMATION

THE APPLICANT RESERVES THE RIGHT TO FILE MULTIPLE FINAL MAPS PURSUANT TO SECTION 66456.1 OF THE SUBDIVISION MAP ACT. PHASE LOTS SHOWN HEREON ARE PLANNED, AND SUBJECT TO CHANGE.

PHASE 1	PHASE 2	PHASE 3
5,000+ SF - 107	5,000+ SF - 65	5,000+ SF - 79
PHASE 4	PHASE 5	PHASE 6
5,000+ SF - 65	5,000+ SF - 72	5,000+ SF - 69

TOTAL LOTS - 457

LEGEND

- PP POWER POLE
- SP STAND PIPE
- TP TELEPHONE POLE
- TREE
- A.P.N. ASSESSOR'S PARCEL NUMBER
- D.N. DOCUMENT NUMBER PER OFFICIAL RECORDS OF TULARE COUNTY
- TULARE COUNTY RECORDS
- SUBDIVISION BOUNDARY
- PROPOSED PARCEL LINE
- PROPOSED CENTER LINE
- EXISTING RIGHT OF WAY LINE
- ADJACENT PARCEL LINES
- LANDSCAPE EASEMENT
- PUBLIC UTILITY EASEMENT
- PHASE LINE
- PROPOSED SANITARY SEWER LINE
- PROPOSED WATER LINE
- EXISTING CONTOUR
- EXISTING EDGE OF DIRT ROAD
- EXISTING EDGE OF PAVEMENT
- EXISTING OVERHEAD ELECTRIC LINE
- FENCE, BARBED WIRE
- FENCE, WIRE
- FENCE, CHAINLINK
- FENCE, WOOD
- ELECTRICAL LINE (OVERHEAD)
- IRRIGATION LINE
- SANITARY SEWER LINE

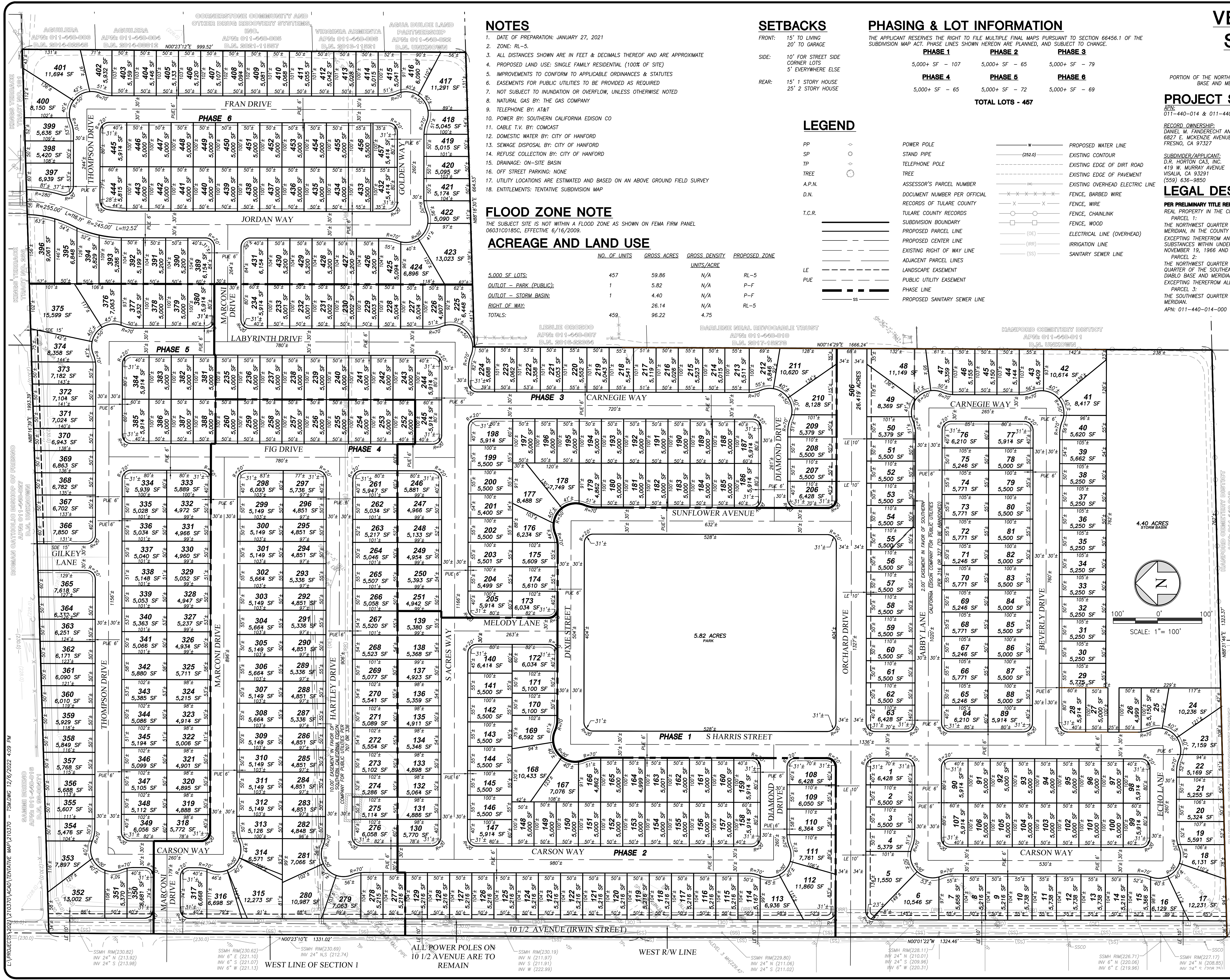

10 1/2 AVENUE

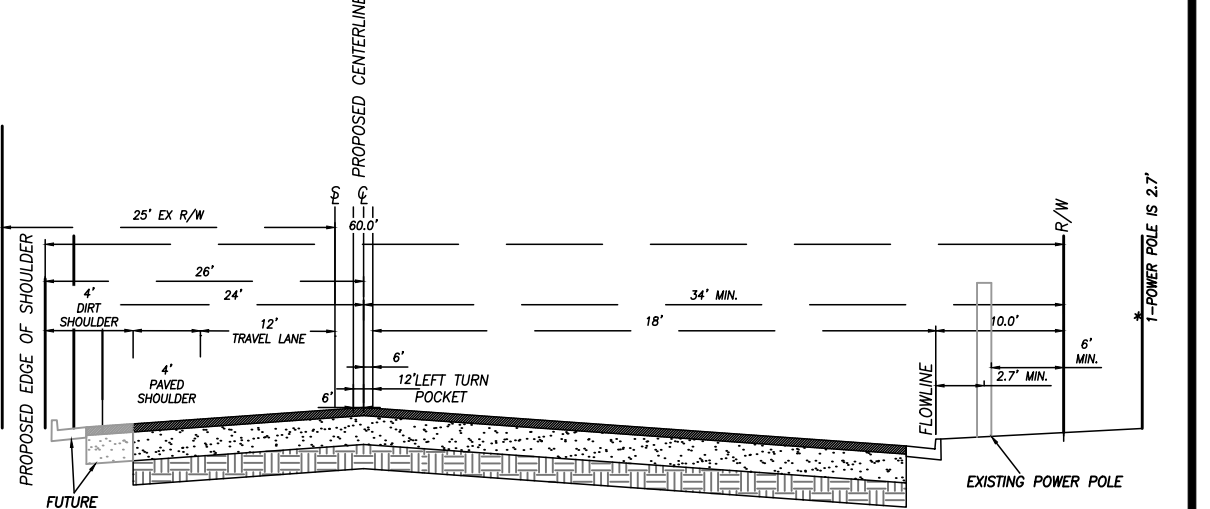

ORCHARD AVENUE

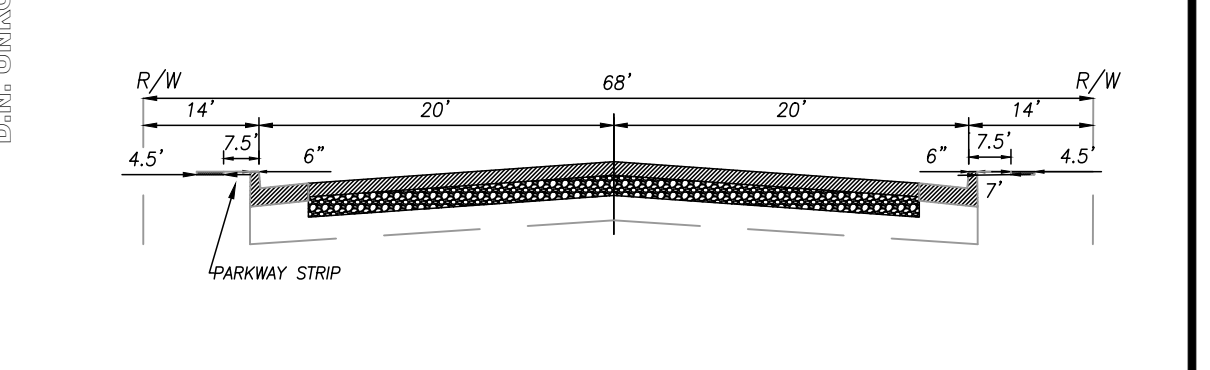

INTERIOR STREETS

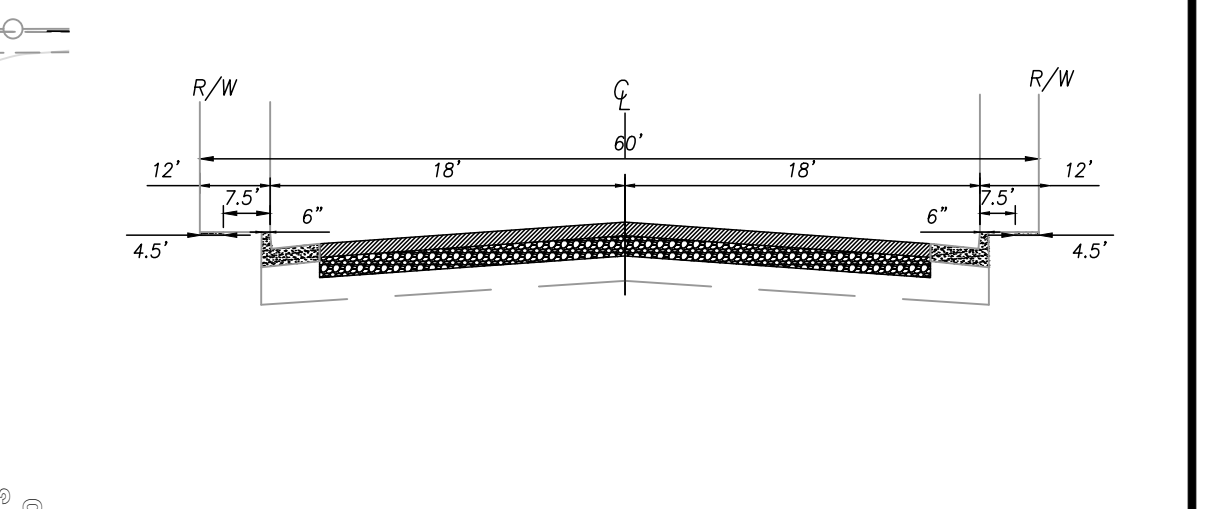

LOCATION MAP

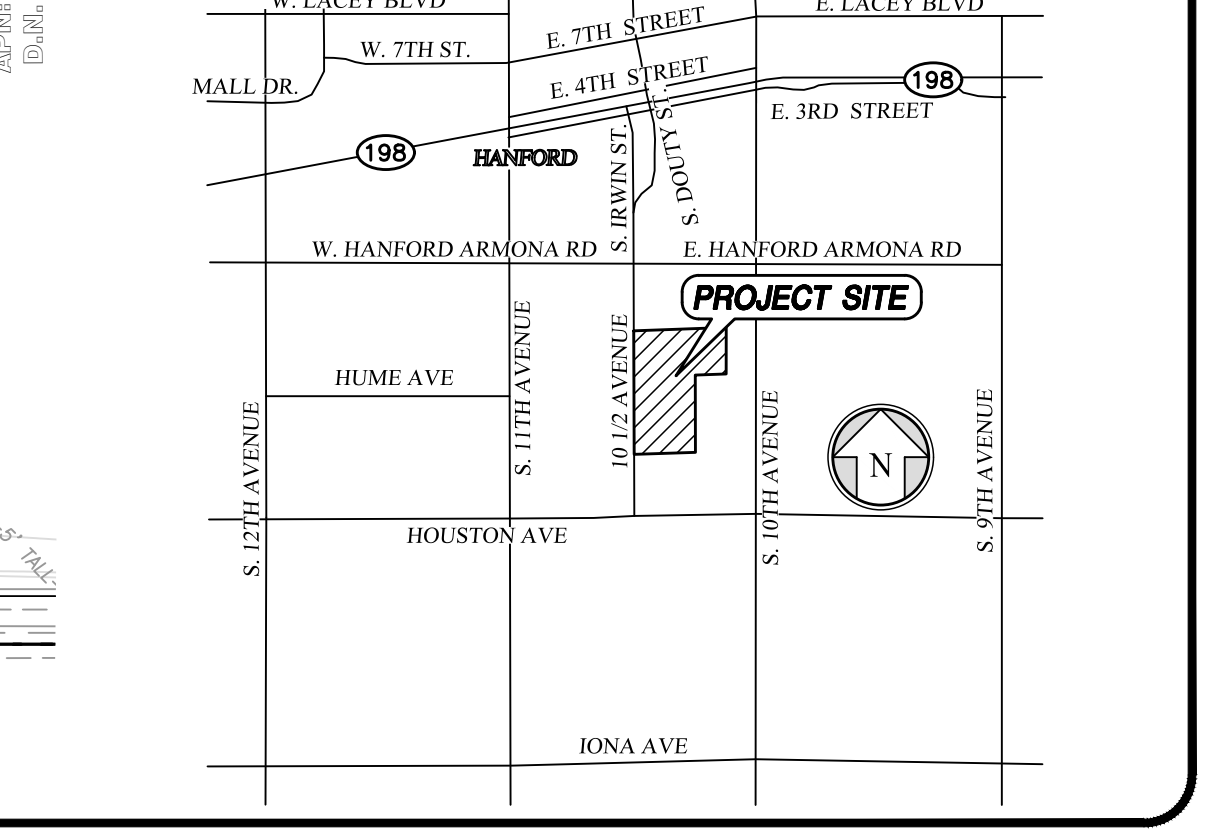

FIGURE 3-3

It is anticipated that the following pieces of equipment will be used during construction activities:

- Roller
- Large bulldozer
- Loaded trucks
- Excavator
- Generator
- Service truck
- Air compressor

3.5 - Entitlements Required

The City is the Lead Agency for the proposed Project, consistent with State CEQA Guidelines Section 15065(b). As such, this EIR will be used by the City to evaluate the potential environmental impacts that could result from implementation of the Project and develop changes in the proposed Project, and/or adopt mitigation measures that would address those impacts.

The Hanford Planning Commission will consider the adoption of the Project after certification of the Final EIR. Pursuant to CEQA Guidelines Section 15093, the decision-makers must *“balance, as applicable, the economic, legal, social, technological, or other benefits of a proposed project against its unavoidable environmental risks when determining whether to approve the project. If the specific economic, legal, social, technological, or other benefits of a proposed project outweigh the unavoidable adverse environmental effects, the adverse environmental effects may be considered ‘acceptable.’”*

If the City, as the Lead Agency, approves the proposed Project and significant, unavoidable environmental impacts have been documented, a Statement of Overriding Considerations must be written, which shall state the specific reasons to support the approval based on the Final EIR and/or other information in the record.

Implementation of the proposed Project would require the following regulatory and/or legislative actions by the Hanford City Council, following the recommendation from the Planning Commission:

- Certify the Final EIR.
- Consider and adopt Findings and a Statement of Overriding Considerations, as necessary.
- Approve Tentative Tract Map 938.

3.5.1 - OTHER RESPONSIBLE AGENCIES

- Future activities related to cannabis businesses may require consideration and approval from a variety of agencies, who will be CEQA responsible or trustee agencies in this environmental process. The specific responsible agencies may vary depending

upon the nature of the planned activity, location, and the resources impacted by cultivation, manufacturing, distribution, testing, and retail activities. A preliminary list of potentially responsible and trustee agencies is provided below:

- California Department of Fish and Wildlife (CDFW)
- San Joaquin Valley Air Pollution Control District (SJVAPCD)
- California Department of Public Health (CDPH)
- Central Valley Regional Water Quality Control Board (RWQCB)
- State Water Resources Board

3.6 - Cumulative Projects

CEQA requires that an EIR evaluate cumulative impacts. Cumulative impacts are the Project's impacts combined with the impacts of other related past, present, and reasonably foreseeable future projects. As set forth in the CEQA Guidelines, the discussion of cumulative impacts must reflect the severity of the impacts, as well as the likelihood of their occurrence; however, the discussion need not be as detailed as the discussion of environmental impacts attributable to the Project alone. As stated in CEQA, Public Resources Code, Section 21083(b) (2), "a project may have a significant effect on the environment if the possible effects of a project are individually limited but cumulatively considerable."

According to the CEQA Guidelines:

Cumulative impacts refer to two or more individual effects, which, when considered together, are considerable and compound or increase other environmental impacts.

- The individual effects may be changes resulting from a single project or a number of separate projects.
- The cumulative impact from several projects is the change in the environment, which results from the incremental impact of a project when added to other closely related past, present, and reasonably foreseeable probable future projects. Cumulative impacts can result from individually minor but collectively significant projects taking place over a period of time (California Code of Regulations (CCR), Title 14, Division 6, Chapter 3, §15355).

In addition, as stated in the CEQA Guidelines, it should be noted that:

The mere existence of significant cumulative impacts caused by other projects alone shall not constitute substantial evidence that the proposed Project's incremental effects are cumulatively considerable (CCR, Title 14, Division 6, Chapter 3, Section 15064(I)(5)).

Cumulative impact discussions for each environmental topic area are provided at the end of each technical analysis contained within Chapter 4, under *Impacts and Mitigation Measures*. The cumulative impacts discussions explain the geographic scope of the area affected by each cumulative effect (e.g., immediate project vicinity, city, county, watershed, or air basin). The geographic area considered for each cumulative impact depends upon the impact that is

being analyzed. For example, in assessing aesthetic impacts, the pertinent geographic study area is the vicinity of the areas of new development under the proposed plan from which the new development can be publicly viewed and may contribute to a significant cumulative visual effect. In assessing macro-scale air quality impacts, on the other hand, all development within the air basin contributes to regional emissions of criteria pollutants, and basin-wide projections of emissions are the best tool for determining the cumulative effect.

Section 15130 of the CEQA Guidelines permits two different methodologies for the completion of the cumulative impact analysis:

- The 'list' approach permits the use of a list of past, present, and probable future projects producing related or cumulative impacts, including projects both within and outside the city.
- The 'projections' approach allows the use of a summary of projections contained in an adopted plan or related planning document, such as a regional transportation plan, or in an EIR prepared for such a plan. The projections may be supplemented with additional information such as regional modeling.

This EIR uses the projections approach and takes into account growth from the proposed plan within the Hanford City boundary and Sphere of Influence, in combination with impacts from projected growth in the "Non-District County" portions of Kings County. The following provides a summary of the cumulative impact scope for each impact area:

- **Transportation and Traffic:** The analysis of the proposed Project addresses cumulative impacts to the transportation network in Hanford and the surrounding area.

CHAPTER 4 - ENVIRONMENTAL IMPACT ANALYSES

4.1 - Approach to Environmental Analysis

Section 4.1 of this Draft EIR contains discussions of the environmental setting, regulatory setting, thresholds of significance, and potential environmental impacts related to the construction and operation of the proposed Project. These sections also include a discussion of mitigation measures and the level of significance after the implementation of mitigation measures.

Section 15125(a) of the CEQA Guidelines identifies that an EIR includes a description of the physical environmental conditions in the vicinity of the project. This environmental setting will normally constitute the baseline physical conditions by which a Lead Agency determines whether an impact is significant.

The study area for the analysis of the Project and cumulative impacts is the Hanford city limits, the portions of Kings County located adjacent to the City. The applicable cumulative projections include growth projections from the Hanford General Plan and the Kings County General Plan.

The regulatory setting includes a discussion of the regulatory environment as it existed prior to the implementation of the Project. There are federal, State, regional, and local regulations identified within each environmental issue discussion, where appropriate. It is acknowledged that although the existing City of Hanford development codes currently guide development within the City, the proposed Project will add new standards and regulations to provide new guidance for the future development of cannabis-related activities.

The impact analysis contains a discussion of Project-specific impacts as well as cumulative impacts. The Project that is evaluated is the construction of 457 single-family residences, internal roads, a drainage retention basin, and a 5.82-acre park on an approximately 95-acre site (Project). Access to the proposed subdivision will be from 10 ½ Avenue. The development will build 10 ½ Avenue with a minimum 34-foot road right of way (ROW). Specific components of the Project are not separately evaluated; however, the Project, as a whole, is evaluated. The Project, as a whole, is referred to as the proposed Project or Project, throughout this EIR.

The impacts within the impact analysis section are identified as *no impact*, *less-than-significant impact*, *potentially significant impact*, or *significant impact*. The project-specific impacts address the potential environmental impacts that could occur under the development activity anticipated to occur with the proposed Project.

4.2 - Environmental Topics

The potential environmental effects associated with the implementation of the proposed Project are analyzed in the following topical environmental issue areas:

- Transportation
- Mandatory Findings of Significance

4.3 - Organization of Issue Areas

Each environmental issue section contains the following components:

- Introduction - includes a brief discussion of the information used for the analysis.
- Environmental Setting - identifies and describes the existing physical environmental conditions of the Project area associated with each of the impact sections.
- Regulatory Setting - provides an understanding of the regulatory environment that exists prior to the implementation of the Project. This discussion includes the applicable goals, objectives, and policies from the City of Hanford 2035 General Plan as well as other regulations that currently exist.
- Methodology – identifies which criteria, technical documents, or formulas were used to analyze specific environmental impacts.
- Thresholds of Significance - identifies thresholds from Appendix G of the CEQA Guidelines that assist in determining the significance of an impact. Some thresholds include a more detailed discussion to address the City of Hanford’s or other local agency’s specific significance criteria for the Project area.
- Project Impacts - describes environmental changes to the existing physical conditions that may occur if the proposed Project is implemented and evaluates these changes with respect to the CEQA thresholds of significance. This section includes a Project-specific impact analysis and a cumulative impact analysis. Mitigation measures are identified for the potentially significant project and cumulative impacts, if determined feasible. The mitigation measures are those measures that could avoid, minimize, or reduce an environmental impact. This section also includes a discussion of the level of significance after mitigation that describes the level of impact significance remaining after mitigation measures are implemented.

4.4 - Level of Significance

Determining the severity of project and cumulative impacts is fundamental to achieving the objectives of CEQA. CEQA Guidelines Section 15091 requires that decision-makers mitigate, as completely as is feasible, the significant impacts identified in the Project EIR. If the Project EIR identifies any significant unmitigated impacts, CEQA Guidelines Section 15093 requires decision-makers in approving a project to adopt a Statement of Overriding Considerations that explains why the benefits of the project outweigh the adverse environmental consequences identified in the EIR.

The level of significance for each impact examined in this EIR is determined by considering the predicted magnitude of the impact against the applicable threshold. Thresholds are developed using criteria from the CEQA Guidelines and checklist; federal, State, and local regulatory schemes; local/regional plans and ordinances; accepted practice; consultation with agencies and recognized experts; and other professional opinions. When adopting or using thresholds of significance, a Lead Agency may consider thresholds of significance previously adopted or recommended by other public agencies or recommended by experts, provided the decision of the lead agency to adopt such thresholds is supported by substantial evidence.

4.5 - Format Used for Impact Analysis and Mitigation Measures

The format adopted in this EIR to present the evaluation of impacts is described and illustrated below.

Summary Heading of Impact

Impact 4.1-1: An impact summary heading appears immediately preceding the impact description (Summary Heading of Impact in this example). The impact number correlates to the section of the report (4.1 for Aesthetics in this example) and the sequential order of the impact (1 in this example) within that section. To the right of the impact number is the impact statement, which identifies the potential impact, corresponding to CEQA thresholds.

Project Impact Analysis

A narrative analysis follows the impact statement. The analysis identifies the significant environmental effects of the proposed Project on the environment, based on an examination of the changes in the existing physical conditions in the affected area as they exist at the time the Notice of Preparation is published. Direct and indirect significant effects of the Project on the environment are identified and described for both the short-term and long-term effects. The analysis includes relevant specifics of the area, the resources involved, physical changes, alterations to ecological systems, and changes induced in population distribution, population concentration, the human use of the land (including commercial and residential development), health and safety problems caused by the physical changes, and other aspects of the resource base such as water, historical resources, scenic quality, and public services.

Cumulative Impact Analysis

A narrative analysis of cumulative impacts follows the project impacts section. The cumulative impacts analysis includes a discussion of the level of impact that would occur if the proposed Project, in combination with cumulative development, as described in Chapter 1 - *Executive Summary* of this EIR, is implemented. If the combined level of impact is *no impact* or *less-than-significant* impact, the Project's incremental effect would be less than cumulatively considerable. If the combined level of impact is *significant*, the Project's incremental effect is determined to be cumulatively considerable. The discussion of cumulative impacts is guided by the standards of practicality and reasonableness and should

focus on the cumulative impact to which the identified other projects contribute rather than the attributes of other projects which do not contribute to the cumulative impact.

Mitigation Measures

Mitigation measures to reduce potential project-specific and cumulative impacts include a summary heading and description using the format presented below:

MM 4.4-1: Project-specific or cumulative mitigation is identified that would reduce the impact to the lowest degree feasible. The mitigation number links the particular mitigation to the impact section with which it is associated (Impact 4.4-1 in this example).

Level of Significance After Mitigation

This section identifies the resulting level of significance of the project-specific or cumulative impact following mitigation.

4.6 - Transportation

4.6.1 - INTRODUCTION

This section describes potential impacts to the transportation system associated with the proposed TTM 938 (Lunaria) Project (Project). The impact analysis examines the roadway, transit, bicycle, pedestrian, rail, and aviation components of the transportation system in the City of Hanford. To provide a context for the impact analysis, this section begins with the environmental setting, which describes the existing physical and operational conditions of the transportation system. Followed by the relevant regulatory framework, which influences the transportation system and provides the basis for impact significance thresholds that are used in the impact analysis findings and recommended mitigation measures.

4.6.2 - ENVIRONMENTAL SETTING

Roadway Network

The roadway network in the City is a traditional grid-based network of north/south and east/west streets, except for portions of the downtown area, whose grid-based network of streets is angled, consistent with the northeast/southwest railroad alignment. Almost all of the major streets in the City are regularly spaced at half-mile intervals. The grid system provides high levels of accessibility (i.e., travel choices) for residents. The road network is divided into five categories: State Highways, Arterial Streets, Collector Streets, Local Streets, and Alleys (see Tables 4.6-1 and 4.6-2). Hanford has five north/south arterials, 14 east/west arterials, 12 north/south collectors, seven east/west collectors, and numerous local and alleyway streets. Freeways are under the jurisdiction of the State and are outside of City control but have been assessed for the purposes of this EIR section due to their location within the Project area.

**Table 4.6-1
Existing Arterial Streets**

North/South Arterial Streets	
Street Name	Limits
13th Avenue	Houston Avenue to Fargo Avenue
12th Avenue	Idaho Avenue to Flint Avenue
11th Avenue Jackson	Avenue to Flint Avenue
10th Avenue Jackson	Avenue to Hwy 43
9th Avenue	Houston Avenue to Lacey Boulevard
East/West Arterial Streets	
Street Name	Limits
Jackson Avenue	11th Avenue to 10th Avenue
Idaho Avenue	12th Avenue to 10th Avenue
Iona Avenue	12th Avenue to 10th Avenue

East/West Arterial Streets	
Houston Avenue	13th Avenue to SR 43
Hanford-Armona Road	13th Avenue to 10th Avenue, 9th Avenue to SR 43
3rd Street (one way)	11th Avenue to 10th Avenue
4th Street (one way)	11th Avenue to 10th Avenue
6th Street	11th Avenue to 10th Avenue
7th Street	Mall Drive to 10th Avenue
E. Lacey Boulevard	10th Avenue to SR 43
W. Lacey Boulevard	13th Avenue to Irwin Street
Grangeville Boulevard	13th Avenue to SR 43
Fargo Avenue	13th Avenue to SR 43
Flint Avenue	12th Avenue to SR 43

**Table 4.6-2
Existing Collector Streets**

North/South Collector Streets	
Street Name	Limits
Campus University	6th Street to Grangeville Boulevard
Greenfield Street	Lacey Boulevard to Centennial Drive
Rodgers Street	11th Avenue to Mallard Way (potentially to Cortner Street)
Redington Street	4th Street to Grangeville Boulevard
Irwin Street	4th Street to Grangeville Boulevard
Harris Street	6th Street to Grangeville Boulevard
Fitzgerald Lane	Grangeville Boulevard to Fargo Avenue
Douty Street	Hanford-Armona Road to Flint Avenue
Kensington Street	Grangeville Boulevard to Fargo Avenue
9 ¼ Avenue	Lacey Boulevard to Leland Way
Centennial Drive	Lacey Boulevard to Heather Lane
Glacier Way	Fargo Avenue to Flint Avenue

East/West Collector Streets	
Street Name	Limits
Hume Street	12th Avenue to 11th Avenue
3rd Street	10th Avenue to 9th Avenue
Garner Street	Lacey Boulevard to 11th Avenue
Ivy Street	10th Avenue to 11th Avenue
Florinda Street	11th Avenue to 9 ¼ Avenue
Malone Street	Douty Street to 10th Avenue
McCreary Street	11th Avenue to Douty Street

State Facilities

The State facilities in the City of Hanford are listed below and are operated and maintained by Caltrans.

- SR 198 is an east-west State highway that begins at U.S. Route 101 (US 101) south of King City and ends in Sequoia National Park. It connects the California Central Coast to the San Joaquin Valley, running through Hanford and Visalia. SR 198 intersects the major north-south routes in the Central Valley, including Interstate 5 (I-5) and State Routes 41, 43, 33, and 99. The portion of SR 198 through Hanford was upgraded to a four-lane freeway in the 1960s. In 2012, the portion from Hanford to SR 99 was upgraded to a four-lane expressway. Interchanges within the Planning Area are located at Highway 43, 10th Avenue, 11th Avenue, 12th Avenue, and 13th Avenue.
- SR 43 is a north-south State highway running roughly parallel to SR 99, connecting Shafter, Wasco, Corcoran, Hanford, and Selma. Arterial access is limited within the Planning Area to intersections at Flint Avenue, Fargo Avenue, 10th Avenue, Grangeville Boulevard, Lacey Boulevard, Hanford-Armona Road, and Houston Avenue.

Public Transportation

The largest provider of public transit services within Kings County is the Kings County Area Public Transit Agency (KCAPTA). KCAPTA is an intra-governmental agency with representatives from Avenal, Kings County, Hanford, and Lemoore and is responsible for the operation of the Kings Area Rural Transit (KART). KART offers a scheduled daily bus service from Hanford to Armona, Lemoore, the Lemoore Naval Air Station, Visalia, Corcoran, Stratford, Kettleman City, and Avenal.

There are currently eight fixed routes that circulate throughout the City and operate as early as 6:30 a.m. until as late as 9:00 p.m. The Fresno route, with service every Monday, Wednesday, and Friday, includes stops at Children's Hospital, Veterans Hospital, Community Regional Medical Center, St. Agnes Medical Center, and Kaiser Permanente Medical Center, as well as access to the downtown area with a stop at Fulton Mall. KART also offers limited service on Saturdays. In addition, KART provides regular transportation service to Visalia Monday through Friday.

KART began a scheduled fixed route bus service for Hanford in July of 1991. The scheduled bus service operates Monday through Friday from 7:30 a.m. to 11:00 p.m. Expansion of the service is planned as new retail developments are built. West Hills College in Lemoore is served by the system, as are educational institutions in Visalia, including the College of Sequoias, Galen College, San Joaquin Business College, and Chapman College.

Dial-A-Ride is an origin-to-destination service available to eligible residents of Hanford, Lemoore, Armona, and Avenal. The KART dial-a-ride operates from 7:00 a.m. to 11:00 p.m. Monday through Friday and, on Saturday, from 9:00 a.m. to 4:00 p.m.

Park-and-Ride lots provide a meeting place where drivers can safely park and join carpools or vanpools or utilize existing public transit. Park-and-Ride lots are generally located near community entrances, major highways, or local arterials where conveniently scheduled transit service is provided. Lots are designed exclusively for commuters, or they can consist

of an area of parking spaces in complementary land uses such as shopping centers and churches. Hanford has one Park-and-Ride facility located at the northeastern entrance of the City at 10th Avenue and SR 43. There are a number of informal Park-and-Ride lots located in various communities throughout Kings County and served by KCAPTA vanpools. One of the largest is the old Wal-Mart parking lot located on the northwest corner of 12th Avenue and Lacey Avenue in Hanford.

The San Joaquin Valley Air Pollution Control District provides funding for public transportation kiosks and the construction of Park-and-Ride lots. The purpose of this program is to encourage commuter rideshare activities as an alternative to single-occupant vehicle (SOV) commutes. Funds are available for eligible projects that meet specific program criteria on a first-come, first-served basis until the program funds are exhausted.

KART defines vanpooling as 7 to 15 persons who commute together in a van-type vehicle and who share the operating expenses. The KART vanpool program provides passengers with reliable transportation to and from work. The vanpool program is not only to provide safe travel to work but to provide alternative transportation options, which would ultimately reduce the number of vehicles on the road. Vanpooling is somewhat different from carpooling, though it is based upon the same principle: reducing single-occupant commuting. KART established a vanpool program for riders to the Corcoran and Avenal State prisons in 2001 and has purchased additional vans to implement new vanpools. The program has become very successful with 180 vans in service in 2009 and extends to the areas of Tulare, Kings, Kern, Madera, Ventura, Monterey, and Fresno counties. CalVans has grown to include more than 200 vanpools tailored to meet the needs of commuters, plus nearly 150 vans specially designed for farm workers. The San Joaquin Valley Air Pollution Control District (SJVAPCD) offers Vanpool Voucher Incentive Programs. The program is meant to encourage commuter rideshare practices among frequent long-distance riders in the San Joaquin Valley.

Bicycle and Pedestrian Circulation

Nearly all arterials in the city limits have been designated as bikeways except 13th Avenue, Houston Avenue, and Lacey Boulevard. Some collector streets have been identified as bikeways, including Pepper Drive, Glacier Way, Irwin Street, and Rodgers Street. Encore Drive, Nell Way, Leland Way, Fitzgerald Lane, Centennial Drive, Florinda Street, McCreary Avenue, Mall Drive, Liberty Street, Sanfioveser Street, University Avenue, Greenfield Avenue, and Hume Drive.

The San Joaquin Valley Railroad has also been designated as a location for an east-west bike path. The railway corridor is not abandoned, and currently, there are no plans to abandon it. Any possible bike path will need to be located within an easement adjacent to the railroad line but not in the railway easement.

The adopted Hanford Downtown East Precise Plan recognizes the potential for an east-west connection from the 10th Avenue bike lane to Harris Street. That section has been designated with a Class II bike lane.

Rail/Highway Freight

Almost 87 percent of the total freight tonnage is moved out of the Valley by truck, while rail accounts for 11 percent. BNSF and SJVR railroads provide freight service to the Hanford area. The BNSF mainline is double-tracked through the entire Planning Area. Over time, it is expected that the number of trains using the system will increase as demand for rail service increases. The BNSF Railroad currently operates between 25 and 30 trains per day on the system. SJVR has a limited schedule of one train per day. Development of new industry along the SJVR right of way has prompted renewed investment in the east/west service. SJVR anticipates an increase to three round trips per week and in the speed of trains using this route. Planning for improvements must include identifying future surface crossings that are needed to implement the City's circulation system. In the process of improving the SJVR trackage, existing street crossings need to be modernized to ensure safety and adequate operational standards for both rail and vehicular traffic.

Amtrak Passenger Service

Amtrak provides passenger rail service from Hanford to the San Francisco Bay Area and Sacramento and service to Southern California by a combination of rail and bus. Freight service is available from both the BNSF Railway and the San Joaquin Valley Railroad. The Amtrak San Joaquin passenger train provides regularly scheduled intercity passenger rail service to Kings County. Stops are made daily at the Hanford and Corcoran stations for each northbound and southbound train. Stops along the San Joaquin line also include Bakersfield, Wasco, Fresno, Madera, Merced, Turlock, Modesto, Stockton, Antioch, Martinez, Richmond, Emeryville, and Oakland, with connecting bus service to Los Angeles, Sacramento, San Francisco, and many other points in Northern and Southern California. Passengers can transfer to the Amtrak Coast Starlight, which continues north to Portland and Seattle. Trains are accessible to the disabled and provide onboard bicycle racks, checked baggage, and food services.

High-Speed Train

In addition to the airport, train, and bus travel mentioned above, the California High-Speed Train (HST) will also serve as a regional transportation system for Fresno and surrounding communities. The proposed HST line, if approved and funded, would ultimately extend through the San Joaquin Valley, linking San Francisco with Los Angeles. The initial construction section is planned to start in Madera County just north of Bakersfield, with a station located in Fresno's downtown, aligned with Mariposa Street. In November 2013, the California High-Speed Rail Commission identified the preferred route through the Planning Area. The selected route, which runs along the eastern edge of Hanford, roughly follows a north-south route near the high-voltage power lines between 7th and Avenue 8th Avenue.

Aviation

Hanford Municipal Airport (HJO) is the only public aviation facility in Kings County. The airport does not offer commercial flights. The airport is located on the southeast edge of

Hanford and is owned and operated by the City of Hanford. The airport enforces City, State, and federal aviation regulations and administers airport leases, tie-downs, hangars, shelters, fueling, and their overall maintenance.

At present, airport property totals approximately 295 acres. Airport acreage consists of a runway and full-length parallel taxiway, transient and based tie-down aprons, and aircraft storage areas. The runway's current length is 5,180 feet, 75 feet wide, and oriented roughly north-south. The runway is designed to accommodate aircraft with wingspans of up to 79 feet and speeds of up to 121 knots. The runway can accommodate larger aircraft on an occasional basis. Currently, the aircraft parking capacity totals 116 spaces and includes 37 hangar units, 30 shade hangar units, and 49 tie-downs.

Hanford Municipal Airport also serves as a base for the National Weather Service (NWS). The primary function of the NWS is to provide current and forecasted weather conditions in the area (e.g., humidity, wind speed, barometer, dewpoint, temperature, and visibility).

4.6.3 - REGULATORY SETTING

This section summarizes the transportation policies, laws, and regulations that apply to the proposed Project. This information provides context for the impact discussion related to the Project's consistency with applicable regulatory conditions.

Federal

No federal plans, policies, regulations, or laws pertaining to transportation are applicable.

State

CALIFORNIA DEPARTMENT OF TRANSPORTATION

The California Department of Transportation (Caltrans) is responsible for operating and maintaining the State highway system. In the Project vicinity, State Routes 43 and 198, along with all the freeway ramp terminal intersections, fall under Caltrans jurisdiction. Caltrans provides administrative support for transportation programming decisions made by the California Transportation Commission (CTC) for State funding programs. The State Transportation Improvement Program (STIP) is a multi-year Capital Improvement Program that sets priorities and funds transportation projects envisioned in long-range transportation plans.

SENATE BILL 743

Senate Bill 743, passed in 2013, required the California Governor's Office of Planning and Research (OPR) to develop new CEQA Guidelines that address traffic metrics under CEQA. As stated in the legislation, upon adoption of the new guidelines, "automobile delay, as described solely by the level of service (LOS) or similar measures of vehicular capacity or

traffic congestion shall not be considered a significant impact on the environment pursuant to this division, except in locations specifically identified in the guidelines, if any.”

In December 2018, OPR and the State Natural Resources Agency submitted the updated CEQA Guidelines to the Office of Administrative Law for final approval to implement SB 743. The Office of Administrative Law subsequently approved the updated CEQA Guidelines, thus, implementing SB 743 and making vehicle miles traveled (VMT) the primary metric used to analyze transportation impacts.

COMPLETE STREETS

The California Complete Streets Act (Act) requires general plans updated after January 30, 2011, to develop a plan for a multi-modal transportation system. The goal of the Act is to encourage cities to rethink policies that emphasize automobile circulation and prioritize motor vehicle improvements and come up with creative solutions that emphasize all modes of transportation. Complete Streets design has many advantages. When people have more transportation options, there are fewer traffic jams, and the overall capacity of the transportation network increases. Additionally, increased transit ridership, walking, and biking can reduce air pollution, energy consumption, and greenhouse gas emissions while improving the overall travel experience for road users. Providing more transportation options will allow the City to meet its future travel demands without solely relying on motorized vehicles.

While there is no standard design template for a Complete Street, it generally includes one or more of the following features: bicycle lanes, wide shoulders, well-designed and well-placed crosswalks, crossing islands in appropriate midblock locations, bus pullouts or special bus lanes, audible and accessible pedestrian signals, sidewalk bulb-outs, center medians, street trees, planter strips, and ground cover. Complete Streets create a sense of place and improve public safety due to their emphasis on comprehensively encouraging pedestrian activity. The Act is implemented through the City’s ATP and General Plan.

Regional

KINGS COUNTY ASSOCIATION OF GOVERNMENTS (KCAG)

The KCAG is the State-designated Regional Transportation Planning Agency (RTPA) recognized by the State’s Business, Transportation, and Housing Agency. KCAG is responsible for:

- Administering the Regional Transportation Plan.
- Preparing a Regional Transportation Improvement Program and the Federal Transportation Improvement Program.
- Reviewing the State Transportation Improvement Program and other State transportation programs.
- Monitoring local public transit operations.
- Overseeing federal transportation grant proposals.

- Administering the Local Transportation Fund and State Transit Assistance funds.

Other objectives of KCAG include facilitating planning on a regional scale with an emphasis on transportation, finding and researching problems in urban growth, and considering common concerns of its constituent agencies. KCAG aims to tackle the issues that the members have in common but could not otherwise handle individually.

2018 KINGS COUNTY REGIONAL TRANSPORTATION PLAN

The 2018 Regional Transportation Plan (RTP) is a comprehensive assessment of all forms of transportation available in Kings County and the needs for travel and goods movement through the year 2042. The 2018 RTP update was accomplished within the framework of the KCAG, with assistance from Avenal, Corcoran, Hanford, Lemoore, and Kings County. The Santa Rosa Tachi-Yokut Tribe was also consulted during the development of the RTP. Caltrans District 6 and the San Joaquin Valley Air Pollution Control District staff provided invaluable service by furnishing helpful information, comments, and general support (KCAG, 2022).

2022 REGIONAL TRANSPORTATION IMPROVEMENT PROGRAM (2022 RTIP)

The Regional Transportation Improvement Program (RTIP) is a list of transportation projects and programs to be funded and implemented over the next three years. KCAG submits this document to Caltrans and amends the program on a quarterly cycle (KCAG, 2022).

Local

CITY OF HANFORD GENERAL PLAN

The Hanford General Plan serves as the community's guide for the continued development, enhancement, and revitalization of the City of Hanford. The General Plan includes the following policies related to transportation and circulation that are relevant to this analysis:

Policy T1 Coordination of Circulation and Land Use

Develop a circulation network that reinforces the desired land use pattern for Hanford, as identified in the Land Use Element.

Policy T2 Street Classification System

Designate a functional street classification system that includes Highways, Major Arterials, Arterials, Collectors, Minor Collectors, and Local Streets.

Policy T3 Circulation Map

Identify the locations of existing and future Highways, Major Arterials, Arterials, Collectors, and Minor Collectors with the Planned Area Boundary on the Circulation Map. Locations

shown shall be fixed, with allowance for slight variation from the depicted alignments of new Collectors and Minor Collectors.

Policy T4 Regional System Improvements

Identify and support improvements to regional transportation system improvements both within and outside the Planning Area that will improve mobility to and from Hanford. Policy T5 Funding Sources and Improvements coordinate with Caltrans and Kings County Association of Governments (KCAG) for funding and timely construction of programmed State highway and interchange improvements.

Policy T6 Highway Improvements

Coordinate with Caltrans to identify needed improvements to highway facilities in the City.

Policy T7 Highway 198 and 9th Avenue

Identify any program improvements necessary to maintain LOS standards at the intersection of SR 198 and 9th Avenue.

Policy T8 Highway 43 Access Limitations

Limit new direct access to Highway 43, and require building setbacks and offers of dedication to accommodate future widening.

Policy T9 Highway 43 Intersection Limitations

Limit roadway intersections with Highway 43 to Flint Avenue, 10th Avenue, Fargo Avenue, future 9th Avenue, Grangeville Boulevard, Lacey Boulevard, Hanford-Armona Road, Houston Avenue, Iona Avenue, Idaho Avenue, and Jackson Avenue.

Policy T10 Purpose of Major Arterials

Major Arterials shall provide for through-traffic movement around the edge of Hanford on continuous routes with very limited access to abutting property and local streets.

Policy T11 Designation of Major Arterials

Major Arterials shall be designated on Flint Avenue between 13th Avenue and SR 43, on 13th Avenue between Flint Avenue and Houston Avenue, and on Houston Avenue between 13th Avenue and SR 43.

Policy T12 Access to Major Arterials

New access to Major Arterials shall be limited to new intersections with Arterials and Collectors, and where the Major Arterial is a property's only legal access to a public right of way.

Policy T13 Purpose of Arterials

Arterials shall provide for through-traffic movement on continuous routes through Hanford with limited access to abutting property.

Policy T14 Designation of Arterials

Arterials shall be designated generally on the one-mile grid of streets within the Planned Area Boundary. The specific streets designated are Flint Avenue, Fargo Avenue, Grangeville Boulevard, Lacey Boulevard, Hanford-Armona Road, Houston Avenue, Iona Avenue, Idaho Avenue, 7th Avenue, 9th Avenue, 10th Avenue, 11th Avenue, 12th Avenue, and 13th Avenue.

Policy T15 Access to Major Arterials

New access to Arterials from new local streets and new driveways shall be limited to maximize through-traffic movements.

Policy T16 Consolidation of Arterial Access Points

Encourage the consolidation or elimination of driveways, access points, and curb cuts along existing Arterials.

Policy T17 Purpose of Collectors

Collectors shall provide traffic movement within a limited area and connect local roads to the Arterial street system.

Policy T18 Designation of Collectors

Collectors shall be designated generally at half-mile intervals between Arterials in new growth areas and on selected existing through streets that connect to two or more Arterials.

Policy T19 Access to Collectors

New access to Collectors from new local streets and abutting property is generally permitted but may be limited in some cases depending on planned roadway capacity and adjacent land use development patterns.

Policy T20 Purpose of Minor Collectors

Minor Collectors shall provide internal traffic movement within a neighborhood and connect local roads to Collectors and/or Arterials.

Policy T21 Designation of Collectors

Minor Collectors shall be designated in developed areas without a half-mile Collector interval and/or where the street is not wide enough to be designated a Collector.

Policy T22 Access to Collectors

Minor Collectors shall have no access limitations.

Policy T23 Purpose of Local Streets

Local streets shall provide internal traffic movement within a neighborhood and direct access to abutting property.

Policy T24 Block Lengths

Adopt standards for block lengths for new local streets to promote ease of movement and connectivity.

Policy T25 Cul-de-sacs

Construct cul-de-sacs on all permanent dead-end streets. New cul-de-sacs shall be discouraged in commercial and industrial developments. Adopt maximum lengths of new local streets with cul-de-sacs.

Policy T26 Cul-de-sac

Non-motorized connectivity encourages sidewalks and breaks in perimeter walls to allow pedestrian, bicycle, and visual access from cul-de-sac streets to other nearby streets.

Policy T27 Maintenance of Local Streets

Adopt policies that incorporate the use of maintenance districts to fund local street maintenance.

Policy T28 Alleys

Generally discourage new alleys, but allow them in limited cases when effectively incorporated into the overall neighborhood design. Fund the maintenance of new alleys with maintenance districts.

Policy T29 Maximum Level of Service

Maintain a peak hour LOS E on streets and intersections within the area bounded by Highway 198, 10th Avenue, 11th Avenue, and Florinda Avenue, inclusive of these streets. Maintain a peak hour LOS D on all other streets and intersections with the Planned Growth Boundary.

Policy T30 Capital Improvement Program

Include the acquisition of right of way and the construction and maintenance of streets in the City Capital Improvement Program.

Policy T31 Coordination with Development Approvals

Coordinate additions and modifications to the roadway system with land development approvals.

Policy T32 Ultimate Rights-of-Way

Acquire control of land within ultimate right of way of Arterial and Collector streets during early stages of development.

Policy T33 Street Improvements and Priorities

Prioritize street improvements with emphasis on current and forecasted service levels.

Policy T34 Kings County Regional Transportation Plan

Local circulation system improvements shall be consistent with the goals and objectives stated in the Kings County Regional Transportation Plan.

Policy T35 Caltrans Coordination

Coordinate with Caltrans to identify needed improvements to its highway facilities in the City and implement necessary programs to assist in improving State Route 43 and 198 and its interchanges/intersections with local roadways.

Policy T36 Traffic Impact Fees

Periodically review and update the traffic impact fee program to ensure new development contributes its fair share of funding for new streets, intersections, and highway improvements.

Policy T37 Shade Trees in Planter Strips

Where adequate space permits, include street trees planted in planter strips between the curb and sidewalk to shade paved street surfaces.

Policy T38 Operational Improvements First

Maximize operational improvements before widening existing streets even when they do not meet current width standards.

Policy T39 Accommodating All Modes of Traffic

Plan, design, and construct new transportation improvement projects to safely accommodate the needs of pedestrians, bicyclists, transit riders, motorists, and persons of all abilities.

Policy T40 Pedestrian and Bicycle Placemaking

Promote pedestrian and bicycle improvements that improve connectivity between neighborhoods, provide opportunities for distinctive neighborhood features, and foster a greater sense of community.

Policy T41 Streetscape Enhancements

Strive to improve the visual character of roadway corridors by improving streetscapes with amenities such as street trees, pedestrian-scaled lighting, underground utilities, water-efficient landscaping, and streetscape furniture.

Policy T42 Existing Sound Walls and Fences

Encourage landscaping improvements along walls and fences adjacent to major streets to discourage graffiti and enhance visual character.

Policy T43 Safe Routes to Schools Programs

Promote Safe Routes to Schools Programs for all schools serving the City.

Policy T44 Funding

Seek outside funding for Safe Routes to Schools projects.

Policy T45 Truck Routes

Minimize the adverse impact of truck traffic on the community by designating, maintaining, and enforcing a system of designated truck routes.

Policy T46 Good Movement Strategies

Coordinate with regional transportation agencies to plan and implement goods movement strategies, including those that improve mobility, deliver goods efficiently, and minimize negative environmental impacts.

Policy T47 Truck Parking

Identify locations where heavy truck parking is acceptable and where it is prohibited based on adjacent land use designations.

Policy T48 Traffic Calming

Consider the use of traffic-calming designs such as roundabouts, bulb-outs, and other traffic-calming designs, which will improve the operation or LOS of a street.

Policy T49 Subdivision Connectivity

Design subdivisions to maximize connectivity both internally and with other surrounding development.

Policy T50 Carpool Programs

Encourage the use of carpooling, vanpooling, and flexible employment hours.

Policy T51 Alternative Design Standards

Consider alternative roadway design standards for new residential and mixed-use development for future streets that may include:

- Narrower street widths on local roadways.
- Smaller turning radii geometrics on street intersections to improve safety for pedestrians.
- Tree-lined streets in parkways between the curb and sidewalk.
- Roundabouts in lieu of traffic signals where appropriate conditions exist to maximize intersection efficiency, maintain continuous traffic flow, and reduce accident severity.

4.6.4 - IMPACTS AND MITIGATION MEASURES**Methodology**

As stated above, SB 743 requires all CEQA analyses relating to transportation impacts to be conducted using the vehicle miles traveled (VMT) metric. In December 2022, the City of Hanford adopted *VMT Thresholds and Implementation Guidelines* for VMT Analyses. A VMT and a revised Traffic Impact Analysis (TIA) Report were prepared for this Project (see Appendix B).

Thresholds of Significance

The following criteria, as established in Appendix G of the CEQA Guidelines, will be utilized to determine if a project could potentially have a significant impact:

- a) Conflict with a program, plan, ordinance, or policy addressing the circulation system, including transit, roadway, bicycle, and pedestrian facilities?*
- b) Conflict or be inconsistent with CEQA Guidelines Section 15064.3, Subdivision (b)?*

Project Impacts

Impact 4.6-1 - Conflict with a program, plan, ordinance, or policy addressing the circulation system, including transit, roadway, bicycle, and pedestrian facilities.

The first step to determining Project trip generation is to assess the impacts that the Project may have on the surrounding roadway network in the City of Hanford. The trip generation

rates for the proposed Project were obtained from the 11th Edition of the Trip Generation Manual published by the Institute of Transportation Engineers (ITE). At build-out, the Project is estimated to generate a maximum of 4,315 daily trips, 320 AM peak hour trips, and 431 PM peak hour trips.

As noted in the regulatory section above, the Hanford General Plan has policies related to traffic systems. The General Plan has established LOS E as the acceptable level on streets and intersections within the area bounded by Highway 198, 10th Avenue, 11th Avenue, and Florinda Avenue, and a peak hour LOS D on all other streets and intersections within the Planned Growth Boundary. The County of Kings has established LOS D as the acceptable level of traffic congestion on County roads. Since all the study facilities for this Project lie outside of the SR 198, 10th Avenue, 11th Avenue, and Florinda Avenue boundary, the LOS D threshold was utilized to evaluate the potential significance of LOS impacts to the City of Hanford roadway facilities and the County of Kings facilities.

Existing Level of Service Analysis

The following roadways and corresponding intersections were analyzed in the TIA:

- 11th Avenue
- 10 ½ Avenue
- Douty Street
- Jordan Way
- 10th Avenue
- 4th Street
- 3rd Street
- Hanford-Armona Road
- Orchard Avenue
- Houston Avenue

As noted in the TIA for this Project (Appendix XX), all study intersections operate at an acceptable LOS during both AM and PM peak periods.

Existing Plus Project Traffic Conditions

Access to and from the Project site will be from six access points. One access point will be from the existing local street of Jordan Way. Two access points will be located along the east side of 10 ½ Avenue. The Project will be constructing Orchard Avenue within the Project limits. The Project will have three access points to Orchard Avenue.

The TIA analyzed the location of the existing and proposed roadways and access points relative to those in the vicinity of the Project site. Based on this review, all proposed roadways and access points are proposed in locations that minimize traffic-operational impacts to existing and future roadway networks.

Tables 4.6-3 and 4.6-4 summarize the Existing Plus Project Peak Hour LOS for study area intersections and roadway segments. Based on the analysis prepared, all study intersections are projected to operate at an acceptable LOS.

**Table 4.6-3
Existing Plus Project Intersection LOS Results**

ID	Intersection	Intersection Control	AM (7-9) Peak Hour		PM (4-6) Peak Hour	
			Average Delay (sec/veh)	LOS	Average Delay (sec/veh)	LOS
3	10 ½ Avenue/Hanford-Armona Road	Traffic Signal	17.9	B	15.9	B
4	Jordan Way/Hanford-Armona Road	Two-Way Stop	12.7	B	13.3	B
5	10th Avenue/Hanford-Armona Road	Traffic Signal	20.9	C	19.8	B
6	10 ½ Avenue/Orchard Avenue	Two-Way Stop	9.5	A	9.7	A
7	11th Avenue/Houston Avenue	Traffic Signal	20.7	C	22.4	C
8	Houston Avenue/10 ½ Avenue	Two-Way Stop	10.0	B	10.7	B
9	10th Avenue/Houston Avenue	All-Way Stop	8.9	A	9.0	A

Note: LOS = Level of Service based on average delay on signalized intersections and All-Way Stop Controls (AWSC)

LOS for two-way stop-controlled (TWSC) and one-way stop-controlled intersections are based on the worst approach/movement of the minor street.

**Table 4.6-4
Existing Plus Project Segment LOS Results**

ID	Segment	Limits	24-hour Lanes	AM Peak Volume	AM Peak LOS	PM Peak Volume	PM Peak LOS
1	Hanford-Armona Road	11th Avenue and 10 ½ Avenue	2	10,350	C	542	D
2	Hanford-Armona Road	10 ½ Avenue and Jordan Way	2	6,940	C	350	C
3	Hanford-Armona Road	Jordan Way and 10th Avenue	2	6,280	B	346	B
4	10 ½ Avenue	Hanford-Armona Road and Orchard Avenue	2	3,290	B	188	B
5	10 ½ Avenue	Orchard Avenue and Houston Avenue	2	1,900	A	115	B
6	Houston Avenue	11th Avenue and 10 ½ Avenue	2	4,250	A	223	A
7	Houston Avenue	10 ½ Avenue and 10th Avenue	2	3,880	A	223	B

Note: LOS = Level of Service per HCM 6th Edition methodologies in HCS7 software. Peak hour volumes are from the highest directional volume.

Near-Term Plus Project Traffic Conditions

Near-term projects are approved and/or known projects that are either under construction, built but not fully occupied, are not built but have final site development review (SDR) approval, or are for which the Lead Agency or responsible agencies know.

The following near-term projects were analyzed in the TIA:

- Live Oak
- Billingsley Ranch
- Tract 927
- Tract 922
- Tract 929
- Tract 928
- Tract 912
- Tract 919

Tables 4.6-5 and 4.6-6 summarize the Near-term Plus Project Intersection LOS for study area intersections and roadway segments. Based on the analysis prepared, all study intersections are projected to operate at an acceptable LOS.

**Table 4.6-5
Near-term Plus Project Intersection LOS Results**

ID	Intersection	Intersection Control	AM (7-9) Peak Hour		PM (4-6) Peak Hour	
			Average Delay (sec/veh)	LOS	Average Delay (sec/veh)	LOS
3	10 ½ Avenue/Hanford-Armona Road	Traffic Signal	18.0	B	16.0	B
4	Jordan Way/Hanford-Armona Road	Two-Way Stop	12.7	B	13.4	B
5	10th Avenue/Hanford-Armona Road	Traffic Signal	21.5	C	19.9	B
6	10 ½ Avenue/Orchard Avenue	Two-Way Stop	9.6	A	9.8	A
7	11th Avenue/Houston Avenue	Traffic Signal	22.3	C	19.2	B
8	Houston Avenue/10 ½ Avenue	Two-Way Stop	10.2	B	11.7	B
9	10th Avenue/Houston Avenue	All-Way Stop	9.1	A	9.6	A

Note: LOS = Level of Service based on average delay on signalized intersections and All-Way STOP Controls

LOS for two-way and one-way stop-controlled intersections are based on the worst approach/movement of the minor street.

**Table 4.6-6
Near-term Plus Project Segment LOS Results**

ID	Segment	Limits	Lanes	24-hour Volume	AM Peak		PM Peak	
					Volume	LOS	Volume	LOS
1	Hanford-Armona Road	11th Avenue and 10 ½ Avenue	2	10,490	398	C	546	D
2	Hanford-Armona Road	10 ½ Avenue and Jordan Way	2	7,020	271	C	355	C
3	Hanford-Armona Road	Jordan Way and 10th Avenue	2	6,340	258	B	351	B
4	10 ½ Avenue	Hanford-Armona Road and Orchard Avenue	2	3,550	196	C	197	B
5	10 ½ Avenue	Orchard Avenue and Houston Avenue	2	2,160	70	A	132	B
6	Houston Avenue	11th Avenue and 10 ½ Avenue	2	4,800	193	B	269	B
7	Houston Avenue	10 ½ Avenue and 10th Avenue	2	4,890	197	A	295	B

Note: LOS =Level of Service per HCM 6th Edition methodologies in HCS7 software. Peak hour volumes are from the highest directional volume.

Cumulative Year 2042 Plus Project Traffic Conditions

The Cumulative Year 2042 Plus Project Traffic Conditions scenario assumes the same roadway geometrics and traffic controls as those assumed in the near-term plus Project traffic conditions scenario. Additionally, this scenario assumes Orchard Avenue will be fully constructed easterly to 10th Avenue. As a result, the Project only trips have been revised to allow access to 10th Avenue from Orchard Avenue.

Tables 4.6-7 and 4.6-8 summarize the Cumulative Year 2042 Plus Project Intersection LOS for study area intersections and roadway segments. Based on the analysis prepared, all study intersections are projected to operate at an acceptable LOS.

**Table 4.6-7
Cumulative Year 2042 plus Project Intersection LOS Results**

ID	Intersection	Intersection Control	AM (7-9) Peak Hour		PM (4-6) Peak Hour	
			Average Delay (sec/veh)	LOS	Average Delay (sec/veh)	LOS
3	10 ½ Avenue/Hanford-Armona Road	Traffic Signal	16.6	B	19.4	B
4	Jordan Way/Hanford-Armona Road	Two-Way Stop	11.6	B	14.5	B
5	10th Avenue/Hanford-Armona Road	Traffic Signal	18.8	B	21.9	C
6	10 ½ Avenue/Orchard Avenue	Two-Way Stop	9.4	A	9.7	A
7	11th Avenue/Houston Avenue	Traffic Signal	22.2	C	24.7	C
8	Houston Avenue/10 ½ Avenue	Two-Way Stop	10.1	B	12.1	B
9	10th Avenue/Houston Avenue	All-Way Stop	9.9	A	14.8	B

Note: LOS = Level of Service based on average delay on signalized intersections and All-Way Stop Controls (AWSC)

LOS for two-way stop-controlled (TWSC) and one-way stop-controlled intersections are based on the worst approach/movement of the minor street.

**Table 4.6-8
Cumulative Year 2042 plus Project Segment LOS Results**

ID	Segment	Limits	24-hour Lanes	AM Peak		PM Peak		
				Volume	Volume	LOS	Volume	LOS
1	Hanford-Armona Road	11th Avenue and 10 ½ Avenue	2	11,750	400	C	591	D
2	Hanford-Armona Road	10 ½ Avenue and Jordan Way	2	7,330	261	C	394	C
3	Hanford-Armona Road	Jordan Way and 10th Avenue	2	7,820	252	B	455	C
4	10 ½ Avenue	Hanford-Armona Road and Orchard Avenue	2	4,930	190	B	276	C
5	10 ½ Avenue	Orchard Avenue and Houston Avenue	2	2,080	74	A	128	B
6	Houston Avenue	11th Avenue and 10 ½ Avenue	2	6,300	224	B	408	C
7	Houston Avenue	10 ½ Avenue and 10th Avenue	2	5,840	197	A	319	B

Note: LOS = Level of Service per HCM 6th Edition methodologies in HCS7 software. Peak hour volumes are from the highest directional volume.

MITIGATION MEASURES

None

LEVEL OF SIGNIFICANCE

Impacts would be *less than significant*.

Impact 4.6-2 - Conflict or be inconsistent with CEQA Guidelines Section 15064.3, Subdivision (b)

The VMT Analysis prepared for this Project (Appendix B) follows the guide of the December 2018 *Technical Advisory on Evaluating Transportation Impacts in CEQA* (TA) published by the Governor's Office of Planning and Research (OPR) and the August 2010 *Quantifying Greenhouse Gas Mitigation Measures* published by the California Air Pollution Control Officers Association (CAPCOA) to analyze the Project's VMT. In December 2022, the City of Hanford adopted *VMT Thresholds and Implementation Guidelines* for VMT Analyses pursuant to Senate Bill 743 effective July 1, 2020. This document is referred to herein as the City of Hanford VMT Guidelines. The City of Hanford VMT Guidelines were prepared and adopted consistent with the requirements of CEQA Guidelines Sections 15064.3 and 15064.7. The December 2018 *Technical Advisory on Evaluating Transportation Impacts in CEQA* (TA) published by the Governor's Office Planning and Research (OPR), was utilized as a reference and guidance document in the preparation of the City of Hanford VMT Guidelines.

The City of Hanford VMT Guidelines contains screening standard and criteria that can be used to screen out qualified development projects that meet the adopted criteria from needing to prepare a detailed VMT Analysis. These criteria may be size, location, proximity to transit or trip making potential. Development projects that are consistent with the City's General Plan and Zoning that meet one or more of the criteria can be screened out from a quantitative VMT analysis. In this case, the Project does not meet any of the screening criteria.

1. Project Located in a Transit Priority Area/High Quality Transit Corridor (within 0.5 miles of a transit stop).
2. Project is Local-serving Retail of less than 50,000 square feet.
3. Project is a Low Trip Generator (Less than 500 daily Trips).
4. Project has a High Level of Affordable Housing Units.
5. Project is an institutional/Government and Public Service Uses.
6. Project is located in a Low VMT Zone

For projects that are not screened out, a quantitative analysis of VMT impacts must be prepared and compared against the adopted VMT thresholds of significance. The City of Hanford VMT Guidelines include thresholds of significance that were developed using Kings County as the applicable region. The required reduction of VMT (as adopted in the City of Hanford VMT Guidelines) corresponds to Kings County's contribution to the statewide greenhouse gas (GHG) emission reduction target. In order to reach the statewide GHG

reduction target of 15%, Kings County must reduce its GHG emissions by 13%. The method of reducing GHG by 13% is to reduce VMT by 13% as well.

Baseline VMT

The first step in a VMT analysis is to establish the baseline average VMT, which requires the definition of a region. The established region for the Project is Kings County, which is modeled by the Kings County Association of Governments (KCAG).

Based on the KCAG Model, the King's County average VMT per Capita is 10.33. Therefore, the target VMT for residential land uses is a maximum of $(10.33 \times (1.00 - 0.13) = 8.99)$ 8.99 VMT per capita. The Project's trip generation, number of residential units, and square footages of non-residential uses were provided to KCAG in order to conduct a Project-specific VMT analysis using the KCAG model for specific Project components. Based on KCAG VMT results, Project components containing residential land uses are projected to yield an average VMT per capita of 9.78. This exceeds the City's VMT threshold for residential uses of 8.99 VMT per capita. As a result, it is recommended that the Project implement VMT mitigation measures for the residential component to reduce VMT per Capita.

In order to reduce VMTs, a project must decrease the number of vehicle miles travels to and from the Project site. The single greatest reduction in VMT is through alternative methods of transportation. Due to the proposed Project being located 1.7 miles from downtown Hanford, 3.28 miles from the existing major shopping center on Lacey Boulevard at 12th Avenue, and 4.0 miles from the proposed major shopping center on Lacey Boulevard at State Route 43, increasing bicycle use would have an impact on the amount of VMT generated. In order to increase multi-modal accessibility, it is recommended that Class II Bikeways get added along the Project frontages to 10 ½ Avenue and Orchard Avenue.

Per the VMT analysis in Appendix B, the mitigation measure, above, is projected to reduce the residential VMT per capita from 9.78 to 9.72. However, this reduced residential VMT per capita is short of meeting the City's default threshold of 8.99 VMT per capita.

Incorporation of MM 4.6-1 would reduce VMT; however, impacts would still be considered significant and unavoidable.

MITIGATION MEASURES

MM 4.6-1: Prior to the recordation of the final map, the design shall include Class II Bikeways along the Project frontages to 10 ½ Avenue and Orchard Avenue.

LEVEL OF SIGNIFICANCE

Impacts would be *significant and unavoidable*.

Cumulative Setting Impacts and Mitigation Measures

CUMULATIVE SETTING

The study area for the analysis of cumulative impacts is the City of Hanford and the unincorporated portions of Kings County located adjacent to the city limits. The applicable cumulative projections include growth projections from the City of Hanford General Plan and the Kings County General Plan.

The City of Hanford General Plan was last adopted in the year 2017. Anticipated development within the General Plan includes 15,695 residential units needed between 2013 and 2035. The County of Kings General Plan was last adopted in the year 2010. The County General Plan was prepared to accommodate population growth through the year 2035. The General Plan estimates an additional 1,464 residential units to be constructed in the “Non-District County” area.

CUMULATIVE IMPACTS

As noted above, impacts related to LOS would be less than significant for the proposed Project and for the cumulative year 2042. Based on the analysis in the TIA (Appendix X), cumulative impacts would be less than significant.

As for VMT, Project impacts are considered significant and unavoidable, even with feasible mitigation. This is in large part due to the lack of VMT-adopted thresholds for the City of Hanford. As noted above, the only recognized standard is from the County of Kings as it relates to greenhouse gas reductions. Due to the proposed Project being significant and unavoidable and no adopted thresholds for VMT, the cumulative impacts for the City of Hanford would be considered significant and unavoidable.

MITIGATION MEASURES

Implementation of MM 4.1-1.

CUMULATIVE LEVEL OF SIGNIFICANCE

Cumulative impacts for LOS would be *less than significant*.

Cumulative impacts for VMT would be *significant and unavoidable*.

CHAPTER 5 - CONSEQUENCES OF PROJECT IMPLEMENTATION

5.1 - Environmental Effects Found to be Less than Significant

Section 15128 of the California Environmental Quality Act (CEQA) Guidelines requires that an Environmental Impact Report (EIR) “contain a statement briefly indicating the reasons that various possible significant effects of a project were determined not to be significant and were therefore not discussed in detail in the EIR.”

The City of Hanford has engaged the public in the scoping of the environmental document. Comments received during scoping have been considered in the process of identifying issue areas that should receive attention in the EIR. The contents of this EIR were established based on the Notice of Preparation (NOP) prepared in accordance with the CEQA Guidelines and on public and agency input received during the scoping process.

After further study and environmental review in this EIR, direct and indirect impacts of the proposed Project (not including cumulative impacts) would be less than significant or could be reduced to less-than-significant levels with mitigation measures for the resource areas listed below.

5.1.1 - POTENTIAL FOR LESS THAN SIGNIFICANT IMPACTS TO OCCUR

Aesthetics

- Impact 4.1-1: Have a substantial adverse effect on a scenic vista
- Impact 4.1-2: Substantially damage scenic resources, including, but not limited to, trees, rock outcroppings, and historic buildings within a State scenic highway
- Impact 4.1-3: Substantially degrade the existing visual character or quality of public views of the site and its surroundings. (Public views are those that are experienced from publicly accessible vantage point). If the Project is in an urbanized area, would the Project conflict with applicable zoning and other regulations governing scenic quality
- Impact 4.1-4: Create a new source of substantial light or glare which would adversely affect day or nighttime views in the area

Air Quality

- Impact 4.3-3: Expose sensitive receptor to substantial pollutant concentrations

Biological Resources

- Impact 4.4-4: Interfere substantially with the movement of any native resident or migratory fish or wildlife species or with established native resident or migratory wildlife corridors, or impede the use of native wildlife nursery sites

Geology and Soils

- Impact 4.7-1: Directly or indirectly cause potential substantial adverse effects, including the risk of loss, injury, or death involving the rupture of a known earthquake fault
- Impact 4.7-2: Directly or indirectly cause potential substantial adverse effects, including the risk of loss, injury, or death involving strong seismic ground shaking
- Impact 4.7-3: Directly or indirectly cause potential substantial adverse effects, including the risk of loss, injury, or death involving seismic-related ground failure, including liquefaction
- Impact 4.7-4: Directly or indirectly cause potentially substantial adverse effects, including the risk of loss, injury, or death involving landslides
- Impact 4.7-5: Result in substantial soil erosion or loss of topsoil
- Impact 4.7-6: Be located on a geologic unit or soil that is unstable, or that would become unstable as a result of the Project, and potentially result in on- or off-site landslide, lateral spreading, subsidence, liquefaction, or collapse
- Impact 4.7-7: Be located on expansive soil, as defined in Table 18-1-B of the Uniform Building Code (1994), creating substantial direct or indirect risks to life or property
- Impact 4.7-8: Have soils incapable of adequately supporting the use of septic tanks or alternative wastewater disposal systems where sewers are not available for the disposal of wastewater

Hazards and Hazardous Materials

- Impact 4.9-5: For a project located within an airport land use plan or, where such a plan has not been adopted, within two miles of a public airport or public use airport, would the Project result in a safety hazard or excessive noise for people residing or working in the Project area
- Impact 4.9-6: Impair implementation of, or physically interfere with, an adopted emergency response plan or emergency evacuation plan
- Impact 4.9-7: Expose people or structures, either directly or indirectly, to a significant risk of loss, injury, or death involving wildland fires

Hydrology and Water Quality

- Impact 4.10-3(i): Substantially alter the existing drainage pattern of the site or area, including through the alteration of the course of a stream or river, or through the addition of impervious surfaces, in a manner which would result in substantial erosion or siltation on- or off-site
- Impact 4.10-3(ii): Substantially alter the existing drainage pattern of the site or area, including the alteration of the course of a stream or river or through the addition of impervious surfaces, or substantially increase the rate or amount of surface runoff in a manner which would result in flooding on- or off-site
- Impact 4.10-4: In flood hazard, tsunami, or seiche zones, risk release of pollutants due to Project inundation
- Impact 4.10-5: Conflict with or obstruct implementation of a water quality control plan or sustainable groundwater management plan

Land Use and Planning

- Impact 4.11-1: Physically divide an established community
- Impact 4.11-2: Cause a significant environmental impact due to a conflict with any land use plan, policy, or regulation adopted for the purpose of avoiding or mitigating an environmental effect

Mineral Resources

- Impact 4.12-1: Result in the loss of availability of a known mineral resource that would be of value to the region and the residents of the State
- Impact 4.12-2: Result in the loss of availability of a locally important mineral resource recovery site delineated on a local general plan, specific plan, or other land use plan

Noise

- Impact 4.13-2: Generation of excessive ground-borne vibration or ground-borne noise levels
- Impact 4.13-3: For a project located within the vicinity of a private airstrip or an airport land use plan or, where such a plan has not been adopted, within two miles of a public airport or public use airport, would the Project expose people residing or working in the Project area to excessive noise levels

Population and Housing

- Impact 4.14-1: Induce substantial unplanned population growth in an area, either directly or indirectly
- Impact 4.14-2: Displace substantial number of existing people or housing necessitating the construction

Public Services

- Impact 4.15-2: Result in substantial adverse physical impacts associated with the provision of new or physically altered governmental facilities, need for new or physically altered governmental facilities, the construction of which could cause significant environmental impacts in order to maintain acceptable service ratios, response times, or other performance objectives for police protection services
- Impact 4.15-3: Result in substantial adverse physical impacts associated with the provision of new or physically altered governmental facilities, need for new or physically altered governmental facilities, the construction of which could cause significant environmental impacts in order to maintain acceptable service Ratios, response times, or other performance objectives for school services
- Impact 4.15-4: Result in substantial adverse physical impacts associated with the provision of new or physically altered governmental facilities, need for new or physically altered governmental facilities, the construction of which could cause significant environmental impacts in order to maintain acceptable service ratios, response times, or other performance objectives for park services

Utilities and Service Systems

- Impact 4.19-2: Have sufficient water supplies available to serve the Project from existing entitlements and resources, or are new or expanded entitlements needed

Wildfire

- Impact 4.20-1: Substantially impair an adopted emergency response plan or emergency evacuation plan
- Impact 4.20-2: Due to slope, prevailing winds, and other factors, exacerbate wildfire risks, and thereby expose Project occupants to, pollutant concentrations from a wildfire or the uncontrolled spread of a wildfire
- Impact 4.20-3: Require the installation or maintenance of associated infrastructure (such as roads, fuel breaks, emergency water sources, power lines, or other utilities) that may exacerbate fire risk or that may result in temporary or ongoing impacts to the environment

5.1.2 - POTENTIAL FOR LESS THAN SIGNIFICANT IMPACTS TO OCCUR WITH INCORPORATION OF MITIGATION MEASURES

Potential environmental effects of the Project and mitigation measures are discussed in detail in Chapter 4 of this EIR. After a full analysis, the following effects were determined to be less than significant with the incorporation of mitigation measures.

Agriculture and Forest Resources

- Impact 4.2-1: Convert Prime Farmland, Unique Farmland, or Farmland of Statewide Importance (Farmland), as shown on the maps prepared pursuant to the Farmland Mapping and Monitoring Program of the California Resources Agency, to non-agricultural use
- Impact 4.2-5: Involve other changes in the existing environment which, because of their location or nature, could result in conversion of Farmland to non-agricultural use or conversion of forest land to non-forest use

Air Quality

- Impact 4.3-4: Result in other emissions (such as those leading to odors) adversely affecting a substantial number of people

Biological Resources

- Impact 4.4-1: Have a substantial adverse effect, either directly or through habitat modifications, on any species identified as a candidate, sensitive, or special-status species in local or regional plans, policies, or regulations, or by the California Department of Fish and Wildlife or U.S. Fish and Wildlife Service
- Impact 4.4-5: Conflict with any local policies or ordinances protecting biological resources, such as a tree preservation policy or ordinance

Cultural Resources

- Impact 4.5-1: Cause a substantial adverse change in the significance of a historical resource pursuant to Section 15064.5
- Impact 4.5-2: Cause a substantial adverse change in the significance of an archaeological resource pursuant to Section 15064.5
- Impact 4.5-3: Disturb any human remains, including those interred outside of dedicated cemeteries

Energy

- Impact 4.6-1: Result in potentially significant environmental impact due to wasteful, inefficient, or unnecessary consumption of energy resources, during Project construction or operation
- Impact 4.6-2: Conflict with or obstruct a State or local plan for renewable energy or energy efficiency

Geology and Soils

- Impact 4.7-9: Directly or indirectly destroy a unique paleontological resource or site or unique geologic feature

Greenhouse Gas Emissions

- Impact 4.8.2: Conflict with any applicable plan, policy, or regulation of an agency adopted for the purpose of reducing the emissions of greenhouse gases

Hazards and Hazardous Materials

- Impact 4.9-1: Create a significant hazard to the public or the environment through the routine transport, use, or disposal of hazardous materials
- Impact 4.9-2: Create a significant hazard to the public or the environment through reasonably foreseeable upset and accident conditions involving the release of hazardous materials into the environment
- Impact 4.9-3 Emit hazardous emissions or handle hazardous or acutely hazardous materials, substances, or waste within one-quarter mile of an existing or proposed school
- Impact 4.9-4: Create a hazard to the public or the environment as a result of being located on a site that is included on a list of hazardous material sites compiled pursuant to Government Code Section 65962.5

Hydrology and Water Quality

- Impact 4.10-1: Violate any water quality standards or waste discharge requirements or otherwise substantially degrade surface or groundwater quality
- Impact 4.10-2: Substantially decrease groundwater supplies or interfere substantially with groundwater recharge such that the Project may impede sustainable groundwater management of the basin
- Impact 4.10-3(iii): Substantially alter the existing drainage pattern of the site or area, including through the alteration of the course of a stream or river or through the

addition of impervious surfaces, in a manner which would create or contribute runoff water which would exceed the capacity of existing or planned stormwater drainage systems or provide substantially additional sources of polluted runoff

- Impact 4.10-3(iv): Substantially alter the existing drainage pattern of the site or area, including through the alteration of the course of a stream or river or through the addition of impervious surfaces, in a manner which would impede or redirect flood flows

Noise

- Impact 4.13-1: Generation of a substantial temporary or permanent increase in ambient noise levels in the vicinity of the Project in excess of standards established in the local general plan or noise ordinance or applicable standards of other agencies

Public Services

- Impact 4.15-1: Result in substantial adverse physical impacts associated with the provision of new or physically altered governmental facilities, need for new or physically altered governmental facilities, the construction of which could cause significant environmental impacts in order to maintain acceptable service ratios, response times, or other performance objectives for fire protection
- Impact 4.15-5: Result in substantial adverse physical impacts associated with the provision of new or physically altered governmental facilities, need for new or physically altered governmental facilities, the construction of which could cause significant environmental impacts in order to maintain acceptable service ratios, response times, or other performance objectives for other public facilities

Transportation

- Impact 4.17-1: Conflict with a program plan, ordinance or policy addressing the circulation system, including transit, roadway, bicycle and pedestrian facilities
- Impact 4.17-2: Conflict or be inconsistent with CEQA Guidelines 15064.3, Subdivision (b)
- Impact 4.17-3: Substantially increase hazards due to a geometric design feature or incompatible uses
- Impact 4.17-4: Result in inadequate emergency access

Tribal Cultural Resources

- Impact 4.18-1: Cause a substantial adverse change in the significance of a tribal cultural resource, defined in Public Resources Code Section 21074 as either a site, feature, place, cultural landscape that is geographically defined in terms of the size

and scope of the landscape, sacred place, or object with cultural value to a California Native American tribe, and that is listed or eligible for listing in the California register of historical resources, or in a local register of historical resources as defined in Public Resources Code Section 5020.1(k)

- Impact 4.18-2: Cause a substantial adverse change in the significance of a tribal cultural resource, defined in Public Resources Code Section 21074 as either a site, feature, place, cultural landscape that is geographically defined in terms of the size and scope of the landscape, sacred place, or object with cultural value to a California Native American tribe, and that is a resource determined by the lead agency, in its discretion and supported by substantial evidence, to be significant pursuant to criteria set forth in Subdivision (c) of Public Resources Code Section 5024.1

Utilities and Service Systems

- Impact 4.19-1: Require or result in the relocation or construction of new or expanded water, wastewater treatment or stormwater drainage, electric power, natural gas, or telecommunications facilities, the construction or relocation of which could cause significant environmental effects
- Impact 4.19-3: Result in a determination by the wastewater treatment provider which serves or may serve the Project that it has adequate capacity to serve the Project's projected demand in addition to the provider's existing commitments
- Impact 4.19-4: Generate solid waste in excess of State or local standards, or in excess of the capacity of local infrastructure, or otherwise impair the attainment of solid waste reduction goals
- Impact 4.19-5: Comply with federal, State, and local management and reduction statutes and regulations related to solid waste

Wildfire

- Impact 4.20-4: Expose people or structures to significant risks, including downslope or downstream flooding or landslides, as a result of runoff, post-fire slope instability, or drainage changes

5.2 - Significant Environmental Effects that Cannot be Avoided

Section 15126.2(b) of the CEQA Guidelines requires that the EIR describe any significant impacts, including those that can be mitigated but not reduced to less-than-significant levels. Potential environmental effects of the Project and proposed mitigation measures are discussed in detail in Chapter 4, *Environmental Analysis*, of this EIR.

The environmental impacts determined to be significant and unavoidable and described in Table 5-1, *Summary of Significant Impacts of the Proposed Project*.

**Table 5-1
Summary of Significant Impacts of the Proposed Project**

Resources	Project Impacts	Cumulative Impacts
Traffic Impact 4.6-2	Conflict or be inconsistent with CEQA Guidelines Section 15064.3, Subdivision (b). Since the Project would conflict with the Hanford adopted Vehicle Miles Traveled standards, impacts are considered significant and unavoidable.	Although implementation of Mitigation Measure 4.6-1 would reduce VMT for the Project, the total amount needed to reduce the impact to less than significant levels is not achievable through feasible measures. For these reasons, the proposed Project would have a significant and unavoidable impact.

5.3 - Growth Inducing Impacts

The City of Hanford General Plan recognizes that certain forms of growth are beneficial, both economically and socially. Section 15126.2(d) of the CEQA Guidelines provides the following guidance on growth-inducing impacts: a project is identified as growth-inducing if it “could foster economic or population growth, or the construction of additional housing, either directly or indirectly, in the surrounding environment.”

A key consideration in evaluating growth inducement is whether the activity in question constitutes “planned growth.” A project that is consistent with the underlying General Plan and zoning designations would generally be considered planned growth because it was previously contemplated by these long-range documents, and, thus, would not be deemed to have a significant growth-inducing effect. Likewise, a project that requires a General Plan Amendment may be considered to have a substantial growth-inducing effect because such intensity was not contemplated by the applicable long-range documents. It should be noted that these are hypothetical examples, and conclusions about the potential for growth inducement will vary on a case-by-case basis.

With respect to residential land uses, the Project does not include a General Plan Amendment or a change in Zone District. The existing General Plan designation for the Project is Low Density Residential and the existing Zoning is Low Density Residential (5,000 SF min.). The Project would accordingly not directly result in unplanned population growth of the City.

With respect to employment during construction, the jobs created by the Project will primarily employ persons living within the area. It is anticipated that the majority of the jobs will be filled by existing City or County residents; some employees would come from the region and commute, while a small number would relocate to the City. This small number of new residents is anticipated by the General Plan.

Therefore, this Project would not result in a large increase in new residential units or employment. In addition, the Project is situated in urbanized areas within the City of Hanford, where existing public services exist. The Project would accordingly accommodate planned growth and not induce unplanned growth.

With respect to removing barriers to development, such as by providing access to previously undeveloped areas, the Project is not anticipated to result in significant growth inducement. The Project does not include the construction of infrastructure that could remove barriers to off-site development.

Although the Project accommodates planned residential growth, the net increase in population on the Project site would be less than significant.

5.4 - Significant Irreversible Changes

As stated in the CEQA Guidelines, an EIR must address any significant irreversible environmental change that would result from project implementation. According to Section 15126.2(c) of the CEQA Guidelines, such a change would occur if one of the following scenarios occurs:

- The Project would involve a large commitment of nonrenewable resources.
- Irreversible damage can result from environmental accidents associated with the Project.
- The proposed consumption of resources is not justified (e.g., the Project would result in the wasteful use of energy).

The environmental effects of the proposed Project are thoroughly discussed in Chapter 4, *Environmental Impact Analysis*, of this EIR and summarized in the Executive Summary. Implementation of the proposed Project would commit nonrenewable resources during any construction activities and operations. Future operations of the Project will commit oil, gas, and other nonrenewable resources. Therefore, an irreversible commitment of nonrenewable resources would occur as a result of the proposed Project. However, assuming that those commitments occur in accordance with the adopted goals, policies, and implementation measures of the Hanford General Plan, as a matter of public policy, those commitments have been determined to be acceptable. The policies of the Hanford General Plan ensure that any irreversible environmental changes associated with those commitments will be minimized.

CHAPTER 6 - ALTERNATIVES

6.1 - Introduction

The California Environmental Quality Act (CEQA) requires that an Environmental Impact Report (EIR) describe a range of reasonable alternatives to the Project or to the location of the Project site that could feasibly avoid or lessen any significant environmental impacts of the Project while attaining most of the Project's basic objectives. An EIR also must compare and evaluate the environmental effects and comparative merits of the alternatives. This chapter describes alternatives considered but eliminated from further consideration, including the reasons for elimination, and compares the environmental impacts of several alternatives retained with those of the Project.

The following are key provisions of the CEQA Guidelines (Section 15126.6):

- The discussion of alternatives shall focus on alternatives to the Project or its location that are capable of avoiding or substantially lessening any significant effects of the Project, even if these alternatives would impede to some degree the attainment of the Project objectives or would be costlier.
- The No Project Alternative shall be evaluated, along with its impacts. The no project analysis shall discuss the existing conditions at the time the Notice of Preparation was published, as well as what would be reasonably expected to occur in the foreseeable future if the Project were not approved, based on current plans and consistent with available infrastructure and community services.
- The range of alternatives required in an EIR is governed by a "rule of reason;" therefore, the EIR must evaluate only those alternatives necessary to permit a reasoned choice. The alternatives shall be limited to ones that would avoid or substantially lessen any of the significant effects of the Project.
- For alternative locations, only locations that would avoid or substantially lessen any of the significant effects of the Project need to be considered for inclusion in the EIR.
- An EIR need not consider an alternative whose effects cannot be reasonably ascertained and whose implementation is remote and speculative.

The range of feasible alternatives is selected and discussed in a manner to foster meaningful public participation and informed decision-making. Among the factors that may be taken into account when addressing the feasibility of alternatives, as described in Section 15126.6(f)(1) of the CEQA Guidelines, are environmental impacts, site suitability, economic viability, availability of infrastructure, general plan consistency, regulatory limitations, jurisdictional boundaries, and whether the Project proponent could reasonably acquire, control, or otherwise have access to an alternative site. An EIR need not consider an alternative whose effects could not be reasonably identified, whose implementation is remote or speculative, and that would not achieve the basic project objectives.

Under case law and CEQA Section 15126.6(f), the discussion of alternatives need not be exhaustive and is subject to a rule of reason. CEQA Section 15126.6(d) states that "if an

alternative would cause one or more significant effects in addition to those that would be caused by the project as proposed, the significant effects of the alternatives shall be discussed, but in less detail than the significant effects of the project as proposed.” Determining factors that may be used to eliminate alternatives from detailed consideration in an EIR are (a) failure to meet most of the basic project objectives, (b) infeasibility, or (c) inability to avoid significant environmental impacts. CEQA Section 15364 defines “feasibility” as “Capable of being accomplished in a successful manner within a reasonable period of time, taking into account economic, environmental, legal, social, and technological factors.”

The Project has the potential to have significant adverse effects, at either a project level or cumulative level, on aesthetics, agriculture, air quality, biological resources, greenhouse gas emissions, noise, population, and housing at the Project site. Even with the mitigation measures described in Chapter 4, *Environmental Analysis*, of this EIR, impacts in these issue areas would be significant and unavoidable. Therefore, per the CEQA Guidelines, this section discusses alternatives that are capable of avoiding or substantially lessening the effects on these resources. Significant, unavoidable impacts of the Project are summarized below. Following these summaries, Section 6.2, *Project Objectives*, restates the Project proponent’s objectives. Section 6.3, *Alternatives Eliminated from Further Consideration*, presents alternatives to the Project that were considered but eliminated for further analysis. Section 6.4, *Alternatives Analyzed in This EIR*, presents alternatives fully analyzed in this EIR, provides a comparison of alternatives, and makes a determination about the environmentally superior alternative.

6.1.1 - SIGNIFICANT IMPACTS OF THE PROJECT

The implementation of the proposed Project would result in significant and unavoidable impacts and significant impacts prior to mitigation incorporated. These potential significant and unavoidable impacts and less-than-significant impacts with mitigation incorporated are evaluated for each of the alternatives that are considered and evaluated as discussed below.

No Potential for Impacts to Occur

Potential environmental effects of the Project and mitigation measures are discussed in detail in Chapter 4 of this EIR. After a full analysis, the following effects were determined to have no potential for impacts to occur:

Aesthetics

- Impact 4.1-1: Have a substantial adverse effect on a scenic vista
- Impact 4.1-2: Substantially damage scenic resources, including, but not limited to, trees, rock outcroppings, and historic buildings within a state scenic highway

Agriculture and Forest Resources

- Impact 4.2-1: Convert Prime Farmland, Unique Farmland, or Farmland of Statewide Importance (Farmland), as shown on the maps prepared pursuant to the Farmland Mapping and Monitoring Program of the California Resources Agency, to non-agricultural use
- Impact 4.2-2: Conflict with existing zoning for agricultural use or a Williamson Act contract
- Impact 4.2-3: Conflict with existing zoning for, or cause rezoning of, forest land (as defined in Public Resources Code Section 12220(g)), or timberland (as defined by Public Resources Code Section 4526), or timberland zoned Timberland Productions (as defined in Government Code Section 51104(g))
- Impact 4.2-4: Result in the loss of forest land or conversion of forest land to non-forest use

Biological Resources

- Impact 4.4-5: Conflict with any local policies or ordinances protecting biological resources, such as a tree preservation policy or ordinance
- Impact 4.4-6: Conflict with provisions of an adopted habitat conservation plan, natural communities conservation plan, or other approved local, regional, or State habitat conservation plan

Geology and Soils

- Impact 4.7-8: Have soils incapable of adequately supporting the use of septic tanks or alternative wastewater disposal systems where sewers are not available for the disposal of wastewater

Hazards and Hazardous Materials

- Impact 4.9-7: Expose people or structures, either directly or indirectly, to a significant risk of loss, injury, or death involving wildland fires

Hydrology and Water Quality

- Impact 4.10-4: In flood hazard, tsunami, or seiche zones, risk release of pollutants due to Project inundation

Land Use and Planning

- Impact 4.11-1: Physically divide an established community

- Impact 4.11-2: Cause a significant environmental impact due to a conflict with any land use plan, policy, or regulation adopted for the purpose of avoiding or mitigating an environmental effect

Mineral Resources

- Impact 4.12-1: Result in the loss of availability of a known mineral resource that would be of value to the region and the residents of the State
- Impact 4.12-2: Result in the loss of availability of a locally important mineral resource recovery site delineated on a local general plan, specific plan, or other land use plan

Population and Housing

- Impact 4.14-2: Displace substantial number of existing people or housing necessitating the construction

Recreation

- Impact 4.16-2: Include recreational facilities or require construction or expansion of recreational facilities that might have an adverse physical effect on the environment

Potential for Less than Significant Impacts

Potential environmental effects of the Project and mitigation measures are discussed in detail in Chapter 4 of this EIR. After a full analysis, the following effects were determined to have less than significant impacts to occur:

Aesthetics

- Impact 4.1-3: Substantially degrade the existing visual character or quality of public views of the site and its surroundings. (Public views are those that are experienced from a publicly accessible vantage point). If the project is in an urbanized area, would the project conflict with applicable zoning and other regulations governing scenic quality
- Impact 4.1-4: Create a new source of substantial light or glare which would adversely affect day or nighttime views in the area

Agriculture and Forest Resources

- Impact 4.2-5: Involve other changes in the existing environment which, because of their location or nature, could result in conversion of Farmland to non-agricultural use or conversion of forest land to non-forest use

Air Quality

- Impact 4.3-1: Conflict with or obstruct implementation of the applicable air quality plan
- Impact 4.3-2: Result in a cumulatively considerable net increase of any criteria pollutant for which the Project region is non-attainment under an applicable federal or State ambient air quality standard
- Impact 4.3-3: Expose sensitive receptors to substantial pollutant concentrations
- Impact 4.3-4: Result in other emissions (such as those leading to odors) adversely affecting a substantial number of people

Biological Resources

- Impact 4.4-1: Have a substantial adverse effect, either directly or through habitat modifications, on any species identified as a candidate, sensitive, or special-status species in local or regional plans, policies, or regulations, or by the California Department of Fish and Wildlife or U.S. Fish and Wildlife Service
- Impact 4.4-2: Have a substantial adverse effect on any riparian habitat or other sensitive natural community identified in local or regional plans, policies, regulations, or by the California Department of Fish and Wildlife or U.S. Fish and Wildlife Service
- Impact 4.4-3: Have a substantial adverse effect on State or federally Protected wetlands (including, but not limited to, marsh, vernal pool, coastal, etc.) through direct removal, filling, hydrological interruption, or other means
- Impact 4.4-4: Interfere substantially with the movement of any native resident or migratory fish or wildlife species or with established native resident or migratory wildlife corridors, or impede the use of native wildlife nursery sites

Cultural Resources

- Impact 4.5-1: Cause a substantial adverse change in the significance of a historical resource pursuant to Section 15064.5
- Impact 4.5-2: Cause a substantial adverse change in the significance of an archaeological resource pursuant to Section 15064.5
- Impact 4.5-3: Disturb any human remains, including those interred outside of dedicated cemeteries

Energy

- Impact 4.6-1: Result in potentially significant environmental impact due to wasteful, inefficient, or unnecessary consumption of energy resources, during Project construction or operation
- Impact 4.6-2: Conflict with or obstruct a State or local plan for renewable energy or energy efficiency

Geology and Soils

- Impact 4.7-1: Directly or indirectly cause potential substantial adverse effects, including the risk of loss, injury, or death involving the rupture of a known earthquake fault
- Impact 4.7-2: Directly or indirectly cause potential substantial adverse effects, including the risk of loss, injury, or death involving strong seismic ground shaking
- Impact 4.7-3: Directly or indirectly cause potential substantial adverse effects, including the risk of loss, injury, or death involving seismic-related ground failure, including liquefaction
- Impact 4.7-4: Directly or indirectly cause potentially substantial adverse effects, including the risk of loss, injury, or death involving landslides
- Impact 4.7-5: Result in substantial soil erosion or loss of topsoil
- Impact 4.7-6: Be located on a geologic unit or soil that is unstable, or that would become unstable as a result of the Project, and potentially result in on- or off-site landslide, lateral spreading, subsidence, liquefaction, or collapse
- Impact 4.7-7: Be located on expansive soil, as defined in Table 18-1-B of the Uniform Building Code (1994), creating substantial direct or indirect risks to life or property
- Impact 4.7-9: Directly or indirectly destroy a unique paleontological resource or site or unique geologic feature

Greenhouse Gas Emissions

- Impact 4.8.1: Generate greenhouse gas emissions, either directly or indirectly, that may have a significant impact on the environment
- Impact 4.8.2: Conflict with any applicable plan, policy, or regulation of an agency adopted for the purpose of reducing the emissions of greenhouse gases

Hazards and Hazardous Materials

- Impact 4.9-1: Create a significant hazard to the public or the environment through the routine transport, use, or disposal of hazardous materials
- Impact 4.9-2: Create a significant hazard to the public or the environment through reasonably foreseeable upset and accident conditions involving the release of hazardous materials into the environment
- Impact 4.9-3: Emit hazardous emissions or handle hazardous or acutely hazardous materials, substances, or waste within one-quarter mile of an existing or proposed school
- Impact 4.9-4: Create a hazard to the public or the environment as a result of being located on a site that is included on a list of hazardous material sites compiled pursuant to Government Code Section 65962.5
- Impact 4.9-5: For a project located within an airport land use plan or, where such a plan has not been adopted, within two miles of a public airport or public use airport, would the Project result in a safety hazard or excessive noise for people residing or working in the Project area
- Impact 4.9-6: Impair implementation of, or physically interfere with, an adopted emergency response plan or emergency evacuation plan

Hydrology and Water Quality

- Impact 4.10-1: Violate any water quality standards or waste discharge requirements or otherwise substantially degrade surface or groundwater quality
- Impact 4.10-2: Substantially decrease groundwater supplies or interfere substantially with groundwater recharge such that the Project may impede sustainable groundwater management of the basin
- Impact 4.10-3(i): Substantially alter the existing drainage pattern of the site or area, including through the alteration of the course of a stream or river, or through the addition of impervious surfaces, in a manner which would result in substantial erosion or siltation on- or off-site
- Impact 4.10-3(ii): Substantially alter the existing drainage pattern of the site or area, including the alteration of the course of a stream or river or through the addition of impervious surfaces, or substantially increase the rate or amount of surface runoff in a manner which would result in flooding on- or off-site
- Impact 4.10-3(iii): Substantially alter the existing drainage pattern of the site or area, including through the alteration of the course of a stream or river or through the

addition of impervious surfaces, in a manner which would create or contribute runoff water which would exceed the capacity of existing or planned stormwater drainage systems or provide substantially additional sources of polluted runoff

- Impact 4.10-3(iv): Substantially alter the existing drainage pattern of the site or area, including through the alteration of the course of a stream or river or through the addition of impervious surfaces, in a manner which would impede or redirect flood flows
- Impact 4.10-5: Conflict with or obstruct implementation of a water quality control plan or sustainable groundwater management plan

Noise

- Impact 4.13-1: Generation of a substantial temporary or permanent increase in ambient noise levels in the vicinity of the Project in excess of standards established in the local general plan or noise ordinance or applicable standards of other agencies
- Impact 4.13-2: Generation of excessive ground-borne vibration or ground-borne noise levels
- Impact 4.13-3: For a project located within the vicinity of a private airstrip or an airport land use plan or, where such a plan has not been adopted, within two miles of a public airport or public use airport, would the Project expose people residing or working in the Project area to excessive noise levels

Population and Housing

- Impact 4.14-1: Induce substantial unplanned population growth in an area, either directly or indirectly

Public Services

- Impact 4.15-1: Result in substantial adverse physical impacts associated with the provision of new or physically altered governmental facilities, need for new or physically altered governmental facilities, the construction of which could cause significant environmental impacts in order to maintain acceptable service ratios, response times, or other performance objectives for fire protection
- Impact 4.15-2: Result in substantial adverse physical impacts associated with the provision of new or physically altered governmental facilities, need for new or physically altered governmental facilities, the construction of which could cause significant environmental impacts in order to maintain acceptable service ratios, response times, or other performance objectives for police protection services
- Impact 4.15-3: Result in substantial adverse physical impacts associated with the provision of new or physically altered governmental facilities, need for new or

physically altered governmental facilities, the construction of which could cause significant environmental impacts in order to maintain acceptable service Ratios, response times, or other performance objectives for school services

- Impact 4.15-4: Result in substantial adverse physical impacts associated with the provision of new or physically altered governmental facilities, need for new or physically altered governmental facilities, the construction of which could cause significant environmental impacts in order to maintain acceptable service ratios, response times, or other performance objectives for park services
- Impact 4.15-5: Result in substantial adverse physical impacts associated with the provision of new or physically altered governmental facilities, need for new or physically altered governmental facilities, the construction of which could cause significant environmental impacts in order to maintain acceptable service ratios, response times, or other performance objectives for other public facilities

Recreation

- Impact 4.16-1: Result in increased use of existing neighborhood and regional parks or other recreational facilities such that substantial physical deterioration would occur or be accelerated

Transportation

- Impact 4.17-1: Conflict with a program plan, ordinance or policy addressing the circulation system, including transit, roadway, bicycle and pedestrian facilities
- Impact 4.17-3: Substantially increase hazards due to a geometric design feature or incompatible uses
- Impact 4.17-4: Result in inadequate emergency access

Tribal Cultural Resources

- Impact 4.18-1: Cause a substantial adverse change in the significance of a tribal cultural resource, defined in Public Resources Code Section 21074 as either a site, feature, place, cultural landscape that is geographically defined in terms of the size and scope of the landscape, sacred place, or object with cultural value to a California Native American tribe, and that is listed or eligible for listing in the California register of historical resources, or in a local register of historical resources as defined in Public Resources Code Section 5020.1(k)
- Impact 4.18-2: Cause a substantial adverse change in the significance of a tribal cultural resource, defined in Public Resources Code Section 21074 as either a site, feature, place, cultural landscape that is geographically defined in terms of the size and scope of the landscape, sacred place, or object with cultural value to a California

Native American tribe, and that is a resource determined by the lead agency, in its discretion and supported by substantial evidence, to be significant pursuant to criteria set forth in Subdivision (c) of Public Resources Code Section 5024.1

Utilities and Service Systems

- Impact 4.19-1: Require or result in the relocation or construction of new or expanded water, wastewater treatment or stormwater drainage, electric power, natural gas, or telecommunications facilities, the construction or relocation of which could cause significant environmental effects
- Impact 4.19-2: Have sufficient water supplies available to serve the Project from existing entitlements and resources, or are new or expanded entitlements needed
- Impact 4.19-3: Result in a determination by the wastewater treatment provider which serves or may serve the Project that it has adequate capacity to serve the Project's projected demand in addition to the provider's existing commitments
- Impact 4.19-4: Generate solid waste in excess of State or local standards, or in excess of the capacity of local infrastructure, or otherwise impair the attainment of solid waste reduction goals
- Impact 4.19-5: Comply with federal, State, and local management and reduction statutes and regulations related to solid waste

Wildfire

- Impact 4.20-1: Substantially impair an adopted emergency response plan or emergency evacuation plan
- Impact 4.20-2: Due to slope, prevailing winds, and other factors, exacerbate wildfire risks, and thereby expose Project occupants to, pollutant concentrations from a wildfire or the uncontrolled spread of a wildfire
- Impact 4.20-3: Require the installation or maintenance of associated infrastructure (such as roads, fuel breaks, emergency water sources, power lines, or other utilities) that may exacerbate fire risk or that may result in temporary or ongoing impacts to the environment
- Impact 4.20-4: Expose people or structures to significant risks, including downslope or downstream flooding or landslides, as a result of runoff, post-fire slope instability, or drainage changes

Potential for Less than Significant Impacts to Occur with Incorporation of Mitigation Measures

Potential environmental effects of the Project and mitigation measures are discussed in detail in Chapter 4 of this EIR. After a full analysis, the no effects were determined to be less than significant with the incorporation of mitigation measures.

Potential for Significant and Unavoidable Impacts to Occur

Potential environmental effects of the Project and mitigation measures are discussed in detail in Chapter 4 of this EIR. After a full analysis, the following effects were determined to have potential for significant and unavoidable impacts to occur:

Transportation

- Impact 4.17-2: Conflict or be inconsistent with CEQA Guidelines 15064.3, Subdivision (b)

6.1.2 - OTHER IMPACTS OF THE PROJECT

Impacts of the Project on the other resources evaluated in this EIR were found to be either less than significant or less than significant after mitigation. Therefore, consideration of alternatives that would further reduce impacts on these resources is not required by CEQA. Only alternatives that reduce or substantially lessen the Project's impacts on aesthetics, agriculture, air quality, biological resources, greenhouse gas emissions, noise, or population and housing are considered in this EIR. If one of the alternatives would cause a greater adverse impact on another resource, these impacts are disclosed in Section 6.4, *Alternatives Analyzed in this EIR*. Otherwise, impacts to the remaining resources evaluated in this EIR are not discussed further in this section.

6.2 - Project Objectives

The Project has the following objectives:

1. Provide a variety of housing opportunities with a range of styles, sizes, and values that will be designed to satisfy existing and future demand for quality housing in the area.
2. Provide a sense of community and walkability within the development through the use of street patterns, parks/open space areas, landscaping, and other Project amenities.
3. Create a successful and financially feasible Project by meeting the housing needs of the area.
4. Provide a residential development that assists the City in meeting its General Plan and Housing Element requirements and objectives.

CEQA requires that an EIR describe a reasonable range of alternatives to the Project, or to the location of the Project, that would avoid or substantially lessen any of the significant effects of the Project and that would feasibly attain most of the basic Project objectives (Title 14, Section 15126.6). Attainment of the Project objectives is discussed for each retained alternative in Section 6.4.

6.3 - Alternatives Considered but Rejected

There are no Project alternatives that were considered and rejected.

6.4 - Alternatives Considered and Evaluated

An evaluation of three alternatives that were considered and evaluated are provided below. These alternatives represent a reasonable range of alternatives to the proposed Project. This analysis includes alternatives that could feasibly accomplish some of the basic objectives of the proposed Project and could potentially avoid or substantially lessen one or more of the significant effects. The following is an evaluation of each of the alternatives to the proposed Project that were further considered for analysis.

6.4.1 - ALTERNATIVE A - NO PROJECT ALTERNATIVE

Under the No Project Alternative, the Project area would remain unchanged and there would be no residential units or parks constructed. The No Project Alternative would reduce the significant and unavoidable impact relating to VMT; however, the City is required to meet the State Regional Housing Needs Allocation (RHNA) for new housing in the City. The No Project Alternative would not fulfill the objectives of the Project or assist the City in meeting RHNA.

6.4.2 - ALTERNATIVE B - REDUCED PROJECT ALTERNATIVE

This alternative would decrease the number of single-family residential houses from 457 to 228. This alternative will meet all Project objectives but would have a reduced positive effect of assisting the City in meeting regional housing needs. Under **Alternative B**, the overall VMT for the Project would decrease; however, per capita, VMT would remain the same as the proposed Project. Impacts would continue to be *significant and unavoidable*.

6.4.3 - ALTERNATIVE C – MULTI-FAMILY ALTERNATIVE

This alternative would replace the proposed single-family residential with multi-family apartments at a density of at least 20 dwelling units per gross acre (1,196 units). The Project site is currently zoned and designated by the General Plan for low-density residential. The proposed Project request would need to be modified to include a General Plan Amendment and a Zone Change to multi-family. Under **Alternative C**, the overall VMT for the Project would decrease to the 8.13 threshold used in the Kings County greenhouse gas emissions calculations and would be considered less than significant.

6.4.4 - ALTERNATIVE D – DIFFERENT SITES ALTERNATIVE

This alternative would relocate the Project to one of two different sites in order to be located nearer to regional commercial. This alternative would place the Project on the west side of the City, along Hanford-Armona Road, west of South 12th Avenue, or on the southeast corner of 9 ¼ Avenue and Grangeville Boulevard. This alternative will meet all Project objectives and would assist the City in meeting its regional housing needs. Under **Alternative D**, the overall VMT for the Project would decrease slightly; however, per capita, VMT would remain the same as the proposed Project. Impacts would continue to be *significant and unavoidable*. In addition, the applicant does not currently own either of these properties and it is not known if the current owners are willing to sell these properties.

6.5 - Environmentally Superior Alternative

CEQA requires that the City identify an Environmentally Superior Alternative. If the No Project Alternative is the Environmentally Superior Alternative, the City must identify an Environmentally Superior Alternative among the other alternatives considered in the EIR (CEQA Guidelines, Section 15126.6). This alternatives analysis includes three other Project alternatives –Alternative B - Reduced Project, Alternative C - Multi-Family, and Alternative D - Different Sites. Based on the evaluation of the three alternatives, Alternative C – Multi-Family would reduce significant and unavoidable environmental impacts relating to VMT while fulfilling most of the objectives of the proposed Project and is therefore the Environmentally Superior Alternative.

**Table 6-1
Summary of Alternatives' Impacts**

Environmental Resource	Project	Alternative A	Alternative B	Alternative C	Alternative D
Transportation and Traffic: Conflict or be Inconsistent with CEQA Guidelines Section 15064.3, Subdivision (b)	Significant / Unavoidable	Fewer	Similar	Fewer	Similar
Transportation and Traffic: Cumulative Impacts associated with VMT	Significant / Unavoidable	Fewer	Similar	Fewer	Similar
Meet Project Objectives?	Yes	No	Yes	Yes	Yes
Reduce Any Significant and Unavoidable Impacts to No Impact or Less than Significant?	—	Yes	No	Yes	No

CHAPTER 7 - RESPONSES TO COMMENTS

This chapter is being reserved for and will be included with the Final Environmental Impact Report (EIR).

CHAPTER 8 - ORGANIZATIONS AND PERSONS CONSULTED

Note: All of the below entities were either notified or contacted directly to ask for or directly receive consultation on their applicable area of expertise with respect to this proposed Project. This may not be an all-inclusive list.

8.1 - Federal Agencies

- U.S. Bureau of Land Management
- U.S. Department of Agriculture/Natural Resources Conservation Service
- U.S. Environmental Protection Agency - Region IX
- U.S. Fish and Wildlife Service

8.2 - State Agencies

- California Air Resources Board
- California Highway Patrol
- Department of Conservation
- Department of Parks and Recreation
- Department of Water Resources
- Department of Fish and Wildlife
- Department of Forestry and Fire Protection
- Department of Health Services
- Department of Corrections
- Native American Heritage Commission
- Office of Historic Preservation
- Public Utilities Commission
- Department of Transportation Division of Aeronautics
- Department of Transportation District
- Regional Water Quality Control Board / Central Valley Region
- State Clearinghouse Office of Planning and Research

8.3 - Regional and Local

- Kings County Public Works Department
- Kings County Sheriff's Department
- City of Hanford Public Works Department
- City of Hanford Community Development Department
- City of Hanford Parks & Recreation Department
- City of Hanford Police Department
- City of Hanford Airport Department
- Hanford Elementary School District
- Hanford Joint Union High School District
- Pacific Gas & Electric Company

- San Joaquin Valley Unified Air Pollution Control District
- Southern San Joaquin Valley Information Center
- Southern California Gas Company
- Southern California Edison

8.4 - Native American Consultation

In accordance with Assembly Bill (AB) 52 and the California Tribal Consultation guidelines, the appropriate native groups were consulted with respect to the Project's potential impacts on Native American places, features, and objects. As of the writing of this report, staff has not received any comments from consulted tribes regarding the department's AB 52 request. Staff notes consultation with appropriate Native American groups per AB 52 requirements has occurred.

CHAPTER 9 - PREPARERS

9.1 - Lead Agency

CITY OF HANFORD

Mr. Jason Waters – Director of Community Development
Ms. Gabriele Myers – Senior Planner, Community Development Department

9.2 - Technical Assistance

QK

Mr. Christopher Mynk, AICP, Principal Planner
Ms. Jaymie Brauer, Principal Planner

JLB TRAFFIC ENGINEERING, INC.

Mr. Jose Luis Benavides, PE, TE Project Manager
Mr. Carlos Ayala-Magaña, EIT Engineer I/II
Mr. Matthew Arndt, EIT Engineer I/II
Mr. Jove Alcazar, EIT Engineer I/II
Mr. Javier Rios Engineer I/II
Mr. Dennis Wynn Sr. Engineering Technician
Mr. Adrian Benavides Engineering Aide
Mr. Christian Sanchez Engineering Aide

CHAPTER 10 - BIBLIOGRAPHY

City of Clovis. (2014). *General Plan and Development Code Update Draft EIR*.

KCAG. (2022). *KCAG 2018 RTP*. Retrieved from https://www.kingscog.org/rtp_adopted

KCAG. (2022). *KCAG RTIP*. Retrieved from <https://www.kingscog.org/rtip>

Appendix A-
Notice of Preparation/Initial Study and Response to Comments

Notice of Preparation/Initial Study for a Focused Environmental Impact Report

City of Hanford

To: Agencies and Interested Parties

Date: February 2, 2023

Subject: Notice of Preparation of a Focused Environmental Impact Report for Vesting Tentative Tract 938.

Notice is hereby given that the City of Hanford will be the Lead Agency and will prepare a focused Environmental Impact Report (EIR) for the proposed Lunaria Residential Development Project (TTM 938; Project). An Initial Study has been prepared along with this Notice of Preparation (NOP), which scopes out environmental topics for further review. The focused EIR will address the potential physical environmental effects of the proposed projects that have not been scoped out, as outlined in the California Environmental Quality Act (CEQA). The City is requesting comments on the scope and content of this focused EIR. A scoping session will be held on February 14, 2023 at 5:30 p.m. in the Council Chambers of the Civic Auditorium, 400 N. Douty Street, Hanford, CA 93230.

The scoping session, which is part of the focused EIR process, is the time when the City solicits input from the public and agencies on specific topics they believe should be addressed in the environmental analysis. The scoping process is designed to enable the City to determine the scope and content of the focused EIR, identify the range of actions, and identify potentially significant environmental effects, alternatives, and mitigation measures to be analyzed in the focused EIR.

Project Location

The Project site is adjacent to 10 ½ Avenue to the west and between Hanford Armona Road and Houston Avenue in the City of Hanford, Kings County, CA. The Project is on Assessor Parcel Numbers (APN) 011-440-015 and 011-440-014, within Section 1, Township 19S, Range 21E, Mount Diablo Base and Meridian (MDB&M).

Project Description

The Applicant proposes the construction of 457 single-family residences, internal roads, a drainage retention basin, and a 5.82-acre park on an approximately 95-acre site (Project). Access to the proposed subdivision will be from 10 1/2 Avenue. The development will build 10 ½ Avenue with a minimum 34-foot road right of way (ROW).

In order for the Project to be constructed, approval of the following actions is required:
Tentative Tract Map 938 – Planning Commission Approval

Construction will take approximately 24 months, with a total buildout of the homes by Q4 2025. There will be six phases, with the following lots constructed per phase:

Phase 1 – 106 lots

Phase 2 – 65 lots
Phase 3 – 78 lots
Phase 4 – 67 lots
Phase 5 – 67 lots
Phase 6 – 69 lots

As mandated by the California Environmental Quality Act (CEQA), the public review period for this document is 30 days (CEQA Section 15073[b]). The public review period begins on February 2 and ends on March 4, 2023. For further information, please contact Gabrielle de Silva Myers, 317 N. Douty Street, Hanford, CA 93230. (559) 585-2500

**DRAFT NOTICE OF PREPARATION/INITIAL STUDY FOR
A FOCUSED ENVIRONMENTAL IMPACT REPORT**

CITY OF HANFORD

TENTATIVE TRACT MAP 938



OCTOBER 2022



DRAFT NOTICE OF PREPARATION/INITIAL STUDY FOR A FOCUSED ENVIRONMENTAL IMPACT REPORT

TENTATIVE TRACT MAP 938

Prepared for:



City of Hanford - Community Development Department
317 N. Douty Street
Hanford, CA 93230
Contact Person: Gabrielle de Silva Myers
Phone: (559) 585-2500

Consultant:



5080 California Avenue, Suite 220
Bakersfield, CA 93309
Contact: Jaymie L. Brauer
Phone: (661) 616-2600

October 2022

Table of Contents

SECTION 1 - Introduction	1-1
1.1 - Overview	1-1
1.2 - California Environmental Quality Act	1-1
1.3 - Impact Terminology.....	1-2
1.4 - Document Organization and Contents	1-2
1.5 - Incorporated by Reference	1-3
SECTION 2 - Project Description	2-1
2.1 - Introduction.....	2-1
2.2 - Project Location	2-1
2.3 - Surrounding Land Uses	2-1
2.4 - Proposed Project.....	2-1
2.4.1 - Project Description.....	2-1
SECTION 3 - Initial Study	3-1
3.1 - Environmental Checklist.....	3-1
3.2 - Environmental Factors Potentially Affected	3-7
3.3 - Determination.....	3-8
3.4 - Evaluation of Environmental Impacts.....	3-9
3.4.1 - Aesthetics	3-11
3.4.2 - Agriculture and Forestry Resources.....	3-14
3.4.3 - Air Quality	3-17
3.4.4 - Biological Resources.....	3-24
3.4.5 - Cultural Resources	3-29
3.4.6 - Energy.....	3-32
3.4.7 - Geology and Soils	3-35
3.4.8 - Greenhouse Gas Emissions.....	3-41
3.4.9 - Hazards and Hazardous Materials.....	3-45
3.4.10 - Hydrology and Water Quality	3-51
3.4.11 - Land Use and Planning.....	3-57
3.4.12 - Mineral Resources	3-59
3.4.13 - Noise	3-61
3.4.14 - Population and Housing.....	3-65
3.4.15 - Public Services.....	3-67
3.4.16 - Recreation	3-71
3.4.17 - Transportation and Traffic.....	3-73
3.4.18 - Tribal Cultural Resources.....	3-75

3.4.19 - Utilities and Service Systems	3-78
3.4.20 - Wildfire	3-83
3.4.21 - Mandatory Findings of Significance	3-85
SECTION 4 - List of Preparers.....	4-1
4.1 - Lead Agency.....	4-1
4.2 - QK.....	4-1
SECTION 5 - Bibliography.....	5-1

Appendices

- Appendix A – Air Quality and Greenhouse Gas Study
- Appendix B – Biological Resources Evaluation
- Appendix C – Cultural Technical Memo
- Appendix D – Traffic Impact Analysis

List of Figures

Figure 3-1 Regional Map	3-4
Figure 3-2 Project Site Area.....	3-5
Figure 3-3 Tract Map	3-6

List of Tables

Table 3.4.3-1 SJVAPCD Pollutant Thresholds of Significance.....	3-19
Table 3.4.3-2 Project Construction Emissions.....	3-20
Table 3.4.3-3 Project Operational Emissions (tons/year)	3-20
Table 3.4.3-5 Screening Levels for Potential Odor Sources	3-23
Table 3.4.6-1 Project Operational Natural Gas and Electricity Usage	3-33
Table 3.4.8-1 Project Operational Greenhouse Gas Emissions.....	3-42
Table 3.4.13-1 Different Levels of Groundborne Vibration	3-63
Table 3.4.13-2 Typical Vibration Levels for Construction Equipment.....	3-63
Table 3.4.14-1 Regional Housing Needs 2014-2024 (Hanford)	3-65

NOTICE OF PREPARATION/INITIAL STUDY FOR A FOCUSED ENVIRONMENTAL IMPACT REPORT

Notice is hereby given that the City of Hanford will be the Lead Agency and will prepare a focused Environmental Impact Report (EIR) for the proposed Lunaria Residential Development Project (TTM 938; Project). An Initial Study has been prepared along with this Notice of Preparation (NOP), which scopes out environmental topics for further review. The focused EIR will address the potential physical environmental effects of the proposed projects that have not been scoped out, as outlined in the California Environmental Quality Act (CEQA). The City is requesting comments on the scope and content of this focused EIR.

A scoping session will be held on February 14, 2023 at 5:30 p.m. in the Council Chambers of the Civic Auditorium, 400 N. Douty Street, Hanford, CA 93230. The scoping session, which is part of the focused EIR process, is the time when the City solicits input from the public and agencies on specific topics they believe should be addressed in the environmental analysis. The scoping process is designed to enable the City to determine the scope and content of the focused EIR, identify the range of actions, and identify potentially significant environmental effects, alternatives, and mitigation measures to be analyzed in the focused EIR.

Project Location

The Project site is adjacent to 10 ½ Avenue to the west and between Hanford Armona Road and Houston Avenue in the City of Hanford, Kings County, CA. The Project is on Assessor Parcel Numbers (APN) 011-440-015 and 011-440-014, within Section 1, Township 19S, Range 21E, Mount Diablo Base and Meridian (MDB&M).

Project Description

The Applicant proposes the construction of 457 single-family residences, internal roads, a drainage retention basin, and a 5.82-acre park on an approximately 95-acre site (Project). Access to the proposed subdivision will be from 10 1/2 Avenue. The development will build 10 ½ Avenue with a minimum 34-foot road right of way (ROW).

In order for the Project to be constructed, approval of the following actions is required:

- Tentative Tract Map 938

Construction will take approximately 24 months, with a total buildout of the homes by Q4 2025. There will be six phases, with the following lots constructed per phase:

- Phase 1 – 106 lots
- Phase 2 – 65 lots
- Phase 3 – 78 lots
- Phase 4 – 67 lots
- Phase 5 – 67 lots
- Phase 6 – 69 lots

As mandated by the California Environmental Quality Act (CEQA), the public review period for this document was 30 days (CEQA Section 15073[b]). The public review period began on February 2 and ends on March 4, 2023. For further information, please contact Gabrielle de Silva Myers, 317 N. Douty Street, Hanford, CA 93230. (559) 585-2500

Mailing Address and Phone Number of Contact Person

Mel Mercado
Forward Planning and Land Development Manager
D.R. Horton, America’s Builder – South
419 W Murray Avenue
Visalia, CA 93291

Findings

As Lead Agency, the City of Hanford finds that the Project will have a significant effect on the environment. The Environmental Checklist (CEQA Guidelines Appendix G) or Initial Study (IS) (see *Section 3 - Environmental Checklist*) has identified one or more potentially significant effects on the environment. Pursuant to CEQA Guidelines Section 115064 (a)(1), an Environmental Impact Report (EIR) must be prepared if there is substantial evidence in light of the whole record that the proposed Project under review may have a significant effect on the environment and should be further analyzed to determine mitigation measures or project alternatives that might avoid or reduce project impacts to less-than-significant levels. The City of Hanford has determined that preparation of a focused Environmental Impact Report for the Project is necessary.

SECTION 1 - INTRODUCTION

1.1 - Overview

D.R. Horton (the Applicant) proposes to develop 457 residential units on approximately 95 acres as well as a park and appurtenant infrastructure consistent with the City of Hanford General Plan Designation R-L-5, Low Density Residential.

1.2 - California Environmental Quality Act

The City of Hanford is the Lead Agency for this Project pursuant to the CEQA Guidelines (Public Resources Code Section 15000 et seq.). The Environmental Checklist (CEQA Guidelines Appendix G) or Initial Study (IS) (see *Section 3 – Initial Study*) provides an analysis that examines the potential environmental effects of the construction and operation of the Project. Section 15063 of the CEQA Guidelines requires the Lead Agency to prepare an IS to determine whether a discretionary project will have a significant effect on the environment. A Mitigated Negative Declaration (MND) is appropriate when an IS has been prepared, and a determination can be made that no significant environmental effects will occur because revisions to the Project have been made or mitigation measures will be implemented that reduce all potentially significant impacts to less-than-significant levels. Section 15064 (a)(1) states that an Environmental Impact Report (EIR) must be prepared if there is substantial evidence in light of the whole record that the proposed Project under review may have a significant effect on the environment and should be further analyzed to determine mitigation measures or project alternatives that might avoid or reduce project impacts to less-than-significant levels. A Negative Declaration (ND) may be prepared instead if the Lead Agency finds that there is no substantial evidence in light of the whole record that the project may have a significant effect on the environment. An ND is a written statement describing the reasons why the proposed Project, not otherwise exempt from CEQA, would not have a significant effect on the environment and, therefore, why it would not require the preparation of an EIR (CEQA Guidelines Section 15371). According to CEQA Guidelines Section 15070, an ND or MND shall be prepared for a project subject to CEQA when either:

- The IS shows there is no substantial evidence in light of the whole record before the agency that the proposed Project may have a significant effect on the environment; or
- The IS identified potentially significant effects, but:
 - Revisions in the project plans or proposals made by or agreed to by the Applicant before the proposed MND and IS are released for public review would avoid the effects or mitigate the effects to a point where clearly no significant effects would occur is prepared, and
 - There is no substantial evidence in light of the whole record before the agency that the proposed Project as revised may have a significant effect on the environment.

Based on the IS, the Lead Agency has determined that the environmental review for the proposed application can potentially result in a significant impact and requires that a focused EIR be prepared.

1.3 - Impact Terminology

The following terminology is used to describe the level of significance of impacts.

- A finding of “no impact” is appropriate if the analysis concludes that the Project would not affect a topic area in any way.
- An impact is considered “less than significant” if the analysis concludes that it would cause no substantial adverse change to the environment and requires no mitigation.
- An impact is considered “less than significant with mitigation incorporated” if the analysis concludes that it would cause no substantial adverse change to the environment with the inclusion of environmental commitments that have been agreed to by the Applicant.
- An impact is considered “potentially significant” if the analysis concludes that it could have a substantial adverse effect on the environment.

1.4 - Document Organization and Contents

The content and format of this IS/MND is designed to meet the requirements of CEQA. The report contains the following sections:

- *Section 1 – Introduction:* This section provides an overview of CEQA requirements, intended uses of the IS/MND, document organization, and a list of regulations that have been incorporated by reference.
- *Section 2 – Project Description:* This section describes the Project and provides data on the site’s location.
- *Section 3 – Environmental Checklist:* This section contains the evaluation of 21 different environmental resource factors contained in Appendix G of the CEQA Guidelines. Each environmental resource factor is analyzed to determine whether the proposed Project would have an impact. One of four findings is made: no impact, less-than-significant impact, less than significant with mitigation, or significant and unavoidable. If the evaluation results in a finding of significant and unavoidable for any of the 21 environmental resource factors, then an Environmental Impact Report will be required.
- *Section 4 – List of Preparers:* This section identifies the individuals who prepared the IS.
- *Section 5 – Bibliography:* This section contains a full list of references that were used in the preparation of this IS.

1.5 - Incorporated by Reference

The following documents and/or regulations are incorporated into this IS/MND by reference:

- City of Hanford 2035 General Plan (2017)
- City of Hanford 2016-2024 Adopted Housing Element
- City of Hanford Urban Water Management Plan
- City of Hanford Water Information (2021)
- City of Hanford Recycling & Green Waste
- Cal Recycle (2022)
- Hanford Emergency Management Plan
- Kings County Airport Land Use Compatibility Plan
- Hanford Municipal Code
- California Building Code Title 24
- Kings County Safety Element

SECTION 2 - PROJECT DESCRIPTION

2.1 - Introduction

D.R. Horton (the Applicant) proposes to develop 457 residential units on approximately 95 acres as well as a park and appurtenant infrastructure consistent with the City of Hanford General Plan Designation R-L-5, Low Density Residential.

2.2 - Project Location

The Project area is primarily located in the southern portion of Hanford's city limit, located between Hanford Armona Road and Houston Avenue, adjacent to the west of 10 ½ Avenue, and approximately one mile south of SR 198 (see Figure 2-1).

The Project is on Assessor Parcel Numbers (APN) 011-440-015 and 011-440-014, within Section 1, Township 19S, Range 21E, Mount Diablo Base and Meridian (MDB&M).

2.3 - Surrounding Land Uses

Surrounding land uses consist of undeveloped and residential development to the north, a mix of commercial and undeveloped agricultural land to the east, agricultural land to the south, and residential land to the west.

2.4 - Proposed Project

2.4.1 - PROJECT DESCRIPTION

The Applicant proposes the construction of 457 single-family residences, internal roads, a drainage retention basin, and a 5.82-acre park on an approximately 95-acre site (Project). Access to the proposed subdivision will be from 10 ½ Avenue. Since 10 ½ Avenue is not already fully built out, as a part of the project, the development will be required to build 10 ½ Avenue with a minimum 34-foot road right of way (ROW). This will include two travel lanes and a sidewalk, curb, and gutter. There is an existing residence on the property that will be demolished.

In order for the Project to be constructed, approval of the following actions is required:

- Tentative Tract Map 938

Construction will take approximately 24 months, with total buildout of the homes by Q4 2025. There will be six phases, with the following lots constructed per phase:

- Phase 1 – 106 lots
- Phase 2 – 65 lots
- Phase 3 – 78 lots
- Phase 4 – 67 lots

- Phase 5 – 67 lots
- Phase 6 – 69 lots

It is anticipated that the following pieces of equipment will be used during construction activities:

- Roller
- Large bulldozer
- Loaded trucks
- Excavator
- Generator
- Service truck
- Air compressor

As mandated by the California Environmental Quality Act (CEQA), the public review period for this document was 30 days (CEQA Section 15073[b]). The public review period began on February 2 and ended on March 4, 2023. For further information, please Gabrielle de Silva Myers, 317 N. Douty Street, Hanford, CA 93230, (559) 585-2500.

SECTION 3 - INITIAL STUDY

3.1 - Environmental Checklist

1. Project Title:

Tentative Tract Map 938: Lunaria Residential Development Project

2. Lead Agency Name and Address:

City of Hanford
317 N. Douty Street
Hanford, CA 93230

3. Contact Person and Phone Number:

Gabrielle de Siva Myers – (559) 585-2578

4. Project Location:

The Project site is adjacent to 10 1/2 Avenue to the west and between Hanford Armona Road and Houston Avenue in the City of Hanford, Kings County, CA. The Project is on Assessor Parcel Numbers (APN) 011-440-015 and 011-440-014, within Section 1, Township 19S, Range 21E, Mount Diablo Base and Meridian (MDB&M).

5. Project Sponsor's Name and Address:

Mel Mercado
D.R. Horton
419 West Murray Avenue
Visalia, CA 93291

6. General Plan Designation:

Existing: City of Hanford – Low Density Residential

7. Zoning:

Existing: City of Hanford – Residential Low Density (R-L-5, 5,000 square feet)

8. Description of Project:

The Applicant proposes the construction of 457 single-family residences, internal roads, a drainage retention basin, and a 5.82-acre park on an approximately 95-acre site (Project). Access to the proposed subdivision will be from 10 1/2 Avenue. 10 1/2 Avenue is not already fully built out; as a part of the project, the development will be required to build 10 1/2 Avenue with a minimum 34-foot road right of way (ROW). This will include

two travel lanes and a sidewalk, curb, and gutter. There is an existing residence on the property that will be demolished.

In order for the Project to be constructed, approval of the following actions is required:

- Tentative Tract Map (TTM) 938

Construction will take approximately 24 months, with total buildout of the homes by Q4 2025. There will be six phases, with the following lots constructed per phase:

- Phase 1 – 106 lots
- Phase 2 – 65 lots
- Phase 3 – 78 lots
- Phase 4 – 67 lots
- Phase 5 – 67 lots
- Phase 6 – 69 lots

It is anticipated that the following pieces of equipment will be used during construction activities:

- Roller
- Large bulldozer
- Loaded trucks
- Excavator
- Generator
- Service truck
- Air compressor

9. Surrounding Land Uses and Setting:

Surrounding land uses consist of undeveloped and residential development to the north, a mix of commercial and undeveloped agricultural land to the east, agricultural land to the south, and residential land to the west.

10. Other Public Agencies Whose Approval is Required:

- San Joaquin Valley Air Pollution Control District

11. Have California Native American tribes traditionally and culturally affiliated with the Project area requested consultation pursuant to Public Resources Code Section 21080.3.1? If so, is there a plan for consultation that includes, for example, the determination of significance of impacts to tribal cultural resources, procedures regarding confidentiality, etc.?

The State requires lead agencies to consider the potential effects of proposed projects and consult with California Native American tribes during the local planning process for the purpose of protecting Traditional Tribal Cultural Resources through the California Environmental Quality Act (CEQA) Guidelines. Pursuant to PRC Section 21080.3.1, the Lead Agency shall begin consultation with the California Native American tribe that is traditionally and culturally affiliated with the geographical area of the proposed Project. Such significant cultural resources are either sites, features, places, cultural landscapes, sacred places, and objects with cultural value to a tribe which is either on or eligible for inclusion in the California Historic Register or local historic register, or the Lead Agency, at its discretion, and support by substantial evidence, choose to treat the resources as a Tribal Cultural Resources (PRC Section 21074(a)(1-2)). According to the most recent census data, California is home to 109 currently recognized Indian tribes. Tribes in California currently have nearly 100 separate reservations or rancherias. Kings County has a number of tribal groups in the area.

Conducting consultation early in the CEQA process allows tribal governments, lead agencies, and project proponents to discuss the level of environmental review, identify and address potential adverse impacts to tribal cultural resources, and reduce the potential for delay and conflict in the environmental review process. (See PRC Section 21083.3.2.) Information may also be available from the California Native American Heritage Commission's Sacred Lands File per PRC Section 5097.96 and the California Historical Resources Information System administered by the California Office of Historic Preservation. Please also note that PRC Section 21082.3(c) contains provisions specific to confidentiality.

1 tribe has requested to be notified pursuant to Assembly Bill 52 (AB 52). A certified letter was mailed to the above-mentioned tribes on March 1, 2022. The 30-day comment period ended on April 1, 2022.

NOTE: Conducting consultation early in the CEQA process allows tribal governments, lead agencies, and Project proponents to discuss the level of environmental review, identify and address potential adverse impacts to tribal cultural resources, and reduce the potential for delay and conflict in the environmental review process. (See Public Resources Code Section 21083.3.2.) Information may also be available from the California Native American Heritage Commission's Sacred Lands File per Public Resources Code Section 5097.96 and the California Historical Resources Information System administered by the California Office of Historic Preservation. Please also note that Public Resources Code Section 21082.3(c) contains provisions specific to confidentiality.

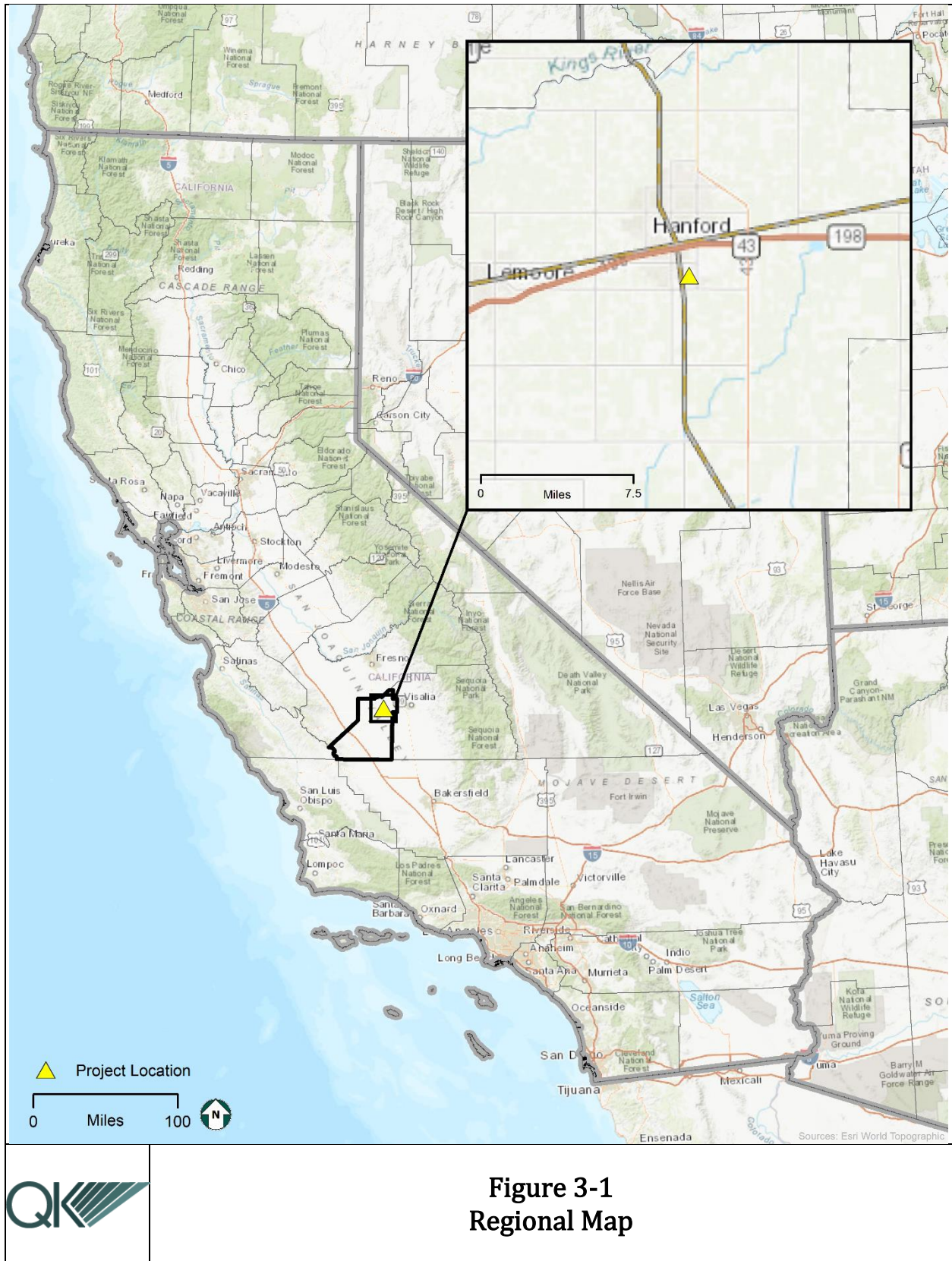

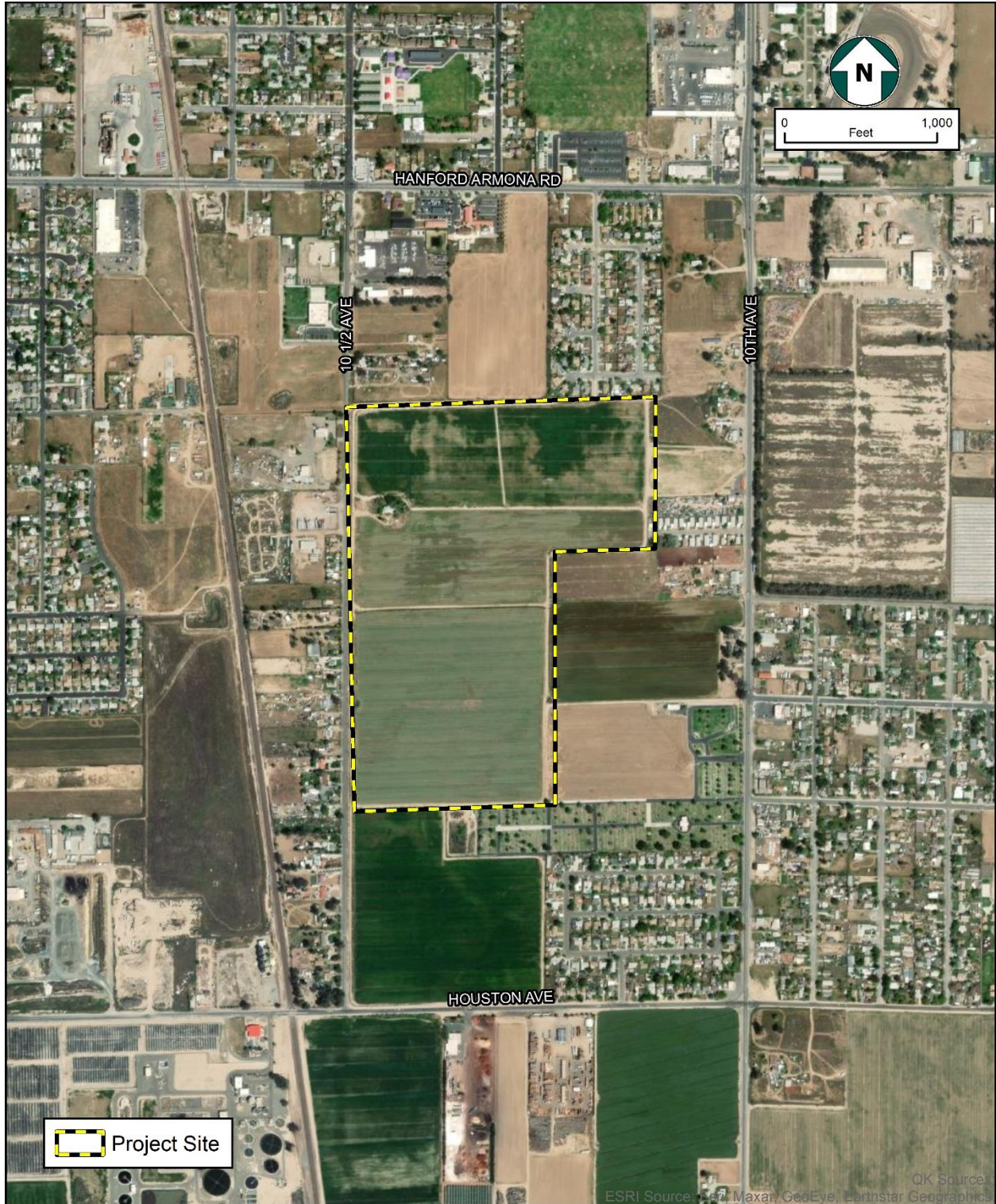

Figure 3-2
Project Site Area

3.2 - Environmental Factors Potentially Affected

The environmental factors checked below would be potentially affected by this Project, involving at least one impact that is a "Potentially Significant Impact" as indicated by the checklist on the following pages.

- | | | |
|--|---|---|
| <input type="checkbox"/> Aesthetics | <input type="checkbox"/> Agriculture and Forestry Resources | <input type="checkbox"/> Air Quality |
| <input type="checkbox"/> Biological Resources | <input type="checkbox"/> Cultural Resources | <input type="checkbox"/> Energy |
| <input type="checkbox"/> Geology and Soils | <input type="checkbox"/> Greenhouse Gas Emissions | <input type="checkbox"/> Hazards and Hazardous Materials |
| <input type="checkbox"/> Hydrology and Water Quality | <input type="checkbox"/> Land Use and Planning | <input type="checkbox"/> Mineral Resources |
| <input type="checkbox"/> Noise | <input type="checkbox"/> Population and Housing | <input type="checkbox"/> Public Services |
| <input type="checkbox"/> Recreation | <input checked="" type="checkbox"/> Transportation | <input type="checkbox"/> Tribal Cultural Resources |
| <input type="checkbox"/> Utilities and Service Systems | <input type="checkbox"/> Wildfire | <input type="checkbox"/> Mandatory Findings of Significance |

3.3 - Determination

On the basis of this initial evaluation:

- I find that the proposed Project COULD NOT have a significant effect on the environment, and a NEGATIVE DECLARATION will be prepared.
- I find that although the proposed Project could have a significant effect on the environment, there will not be a significant effect in this case because revisions in the project have been made by or agreed to by the project proponent. A MITIGATED NEGATIVE DECLARATION will be prepared.
- I find that the proposed Project MAY have a significant effect on the environment, and an ENVIRONMENTAL IMPACT REPORT is required.
- I find that the proposed Project MAY have a “potentially significant impact” or “potentially significant unless mitigated” impact on the environment, but at least one effect (a) has been adequately analyzed in an earlier document pursuant to applicable legal standards, and (b) has been addressed by mitigation measures based on the earlier analysis as described on attached sheets. An ENVIRONMENT IMPACT REPORT is required, but it must analyze only the effects that remain to be addressed.
- I find that although the proposed Project could have a significant effect on the environment, because all potentially significant effects (a) have been analyzed adequately in an earlier EIR or NEGATIVE DECLARATION pursuant to applicable standards, and (b) have been avoided or mitigated pursuant to that earlier EIR or NEGATIVE DECLARATION, including revisions or mitigation measures that are imposed upon the proposed Project, nothing further is required.

Signature

Gabrielle Myers

Printed Name

Date

For

3.4 - Evaluation of Environmental Impacts

1. A brief explanation is required for all answers except "No Impact" answers that are adequately supported by the information sources a Lead Agency cites in the parentheses following each question. A "No Impact" answer is adequately supported if the referenced information sources show that the impact simply does not apply to projects like the one involved (e.g., the project falls outside a fault rupture zone). A "No Impact" answer should be explained where it is based on project-specific factors as well as general standards (e.g., the project will not expose sensitive receptors to pollutants, based on a project-specific screening analysis).
2. All answers must take account of the whole action involved, including off-site as well as on-site, cumulative as well as project-level, indirect as well as direct, and construction as well as operational impacts.
3. Once the Lead Agency has determined that a particular physical impact may occur, then the checklist answers must indicate whether the impact is potentially significant, less than significant with mitigation, or less than significant. "Potentially Significant Impact" is appropriate if there is substantial evidence that an effect may be significant. If there are one or more "Potentially Significant Impact" entries when the determination is made, an EIR is required.
4. "Negative Declaration: Less Than Significant With Mitigation Incorporated" applies where the incorporation of mitigation measures has reduced an effect from "Potentially Significant Impact" to a "Less-Than-Significant Impact." The Lead Agency must describe the mitigation measures and briefly explain how they reduce the effect to a less-than-significant level (mitigation measures from "Earlier Analyses," as described in (5) below, may be cross-referenced).
5. Earlier analyses may be used where, pursuant to the tiering, program EIR, or other CEQA process, an effect has been adequately analyzed in an earlier EIR or negative declaration. Section 15063(c)(3)(D). In this case, a brief discussion should identify the following:
 - a. Earlier Analysis Used. Identify and state where they are available for review.
 - b. Impacts Adequately Addressed. Identify which effects from the above checklist were within the scope of and adequately analyzed in an earlier document pursuant to applicable legal standards, and state whether such effects were addressed by mitigation measures based on the earlier analysis.
 - c. Mitigation Measures. For effects that are "Less than Significant with Mitigation Measures Incorporated," describe the mitigation measures which were incorporated or refined from the earlier document and the extent to which they address site-specific conditions for the project.

6. Lead agencies are encouraged to incorporate into the checklist references to information sources for potential impacts (e.g., general plans, zoning ordinances). Reference to a previously prepared or outside document should, where appropriate, include a reference to the page or pages where the statement is substantiated.
7. Supporting Information Sources: A source list should be attached, and other sources used or individuals contacted should be cited in the discussion.
8. This is only a suggested form, and lead agencies are free to use different formats; however, lead agencies should normally address the questions from this checklist that are relevant to a project's environmental effects in whatever format is selected.
9. The explanation of each issue should identify:
 - a. The significance criteria or threshold, if any, used to evaluate each question.
 - b. The mitigation measure identified, if any, to reduce the impact to less than significance.

	Potentially Significant Impact	Less than Significant with Mitigation Incorporated	Less-than-Significant Impact	No Impact
--	--------------------------------	--	------------------------------	-----------

3.4.1 - AESTHETICS

Except as provided in Public Resources Code Section 21099, would the Project:

- | | | | | | |
|----|--|--------------------------|--------------------------|-------------------------------------|-------------------------------------|
| a. | Have a substantial adverse effect on a scenic vista? | <input type="checkbox"/> | <input type="checkbox"/> | <input type="checkbox"/> | <input checked="" type="checkbox"/> |
| b. | Substantially damage scenic resources, including, but not limited to, trees, rock outcroppings, and historic buildings within a state scenic highway? | <input type="checkbox"/> | <input type="checkbox"/> | <input type="checkbox"/> | <input checked="" type="checkbox"/> |
| c. | In non-urbanized areas, substantially degrade the existing visual character or quality of public views of the site and its surroundings? (Public views are those that are experienced from publicly accessible vantage point.) If the Project is in an urbanized area, would the Project conflict with applicable zoning and other regulations governing scenic quality? | <input type="checkbox"/> | <input type="checkbox"/> | <input checked="" type="checkbox"/> | <input type="checkbox"/> |
| d. | Create a new source of substantial light or glare that would adversely affect day or nighttime views in the area? | <input type="checkbox"/> | <input type="checkbox"/> | <input checked="" type="checkbox"/> | <input type="checkbox"/> |

Discussion

Impact #3.4.1a – Would the Project have a substantial adverse effect on a scenic vista?

A scenic vista is an area identified or known for high scenic quality. Scenic vistas may be designated by a federal, State, or local agency and may also include an area that is designated, signed, and accessible to the public for the express purposes of viewing and sightseeing. The City of Hanford does not designate any scenic vistas within its jurisdiction. There are very few scenic vistas within the Central Valley. The Coastal Range Mountains and the Sierra Nevada can be considered scenic vistas. The proposed Project is located approximately 40 miles from the Coastal Range and approximately 45 miles from the Sierra Nevada. Since there are no scenic vistas in the immediate proximity of the proposed Project site, there would be no impacts related to a scenic vista. Therefore, no impacts are anticipated, and no further analysis in the EIR is warranted

Impact #3.4.1b - Would the Project substantially damage scenic resources, including, but not limited to, trees, rock outcroppings, and historic buildings within a state scenic highway?

The proposed Project is not in the vicinity of a scenic highway as identified by the City of Hanford or Caltrans. The closest eligible scenic highway is a portion of State Route (SR) 198 that runs from SR 99 east through Visalia (California Department of Transportation, 2022). This portion of SR 198 is more than 14 miles east of the Project site and will not be visible or impacted by the Project. The site is flat with little topography and no trees or rock outcroppings. There would be no impacts related to these types of scenic resources.

Downtown Hanford is identified as the City's historic center (City of Hanford, 2017). Three buildings are listed on the National Registry of Historic Places and the State Register of Historic Places. The Kings County Courthouse is approximately five miles to the northwest, and the Carnegie Library and the Taoist Temple are approximately four miles to the northwest. Therefore, the Project would not have an impact on any of these historic buildings. There will be no impact, and no further analysis in the EIR is warranted.

Impact #3.4.1c - Would the Project in non-urbanized areas substantially degrade the existing visual character or quality of public views of the site and its surroundings? (Public views are those that are experienced from publicly accessible vantage point.) If the Project is in an urbanized area, would the Project conflict with applicable zoning and other regulations governing scenic quality?

The area surrounding the Project site consists of urban development and undeveloped agricultural land.

Several sections of the Hanford Municipal Code regulate physical development by controlling the appearance of new development and the placement of new development with consideration for surrounding uses. The Project development will comply with the General Plan, as the Project area is currently zoned R-L-5 Low Density Residential.

There are no scenic vistas within the surrounding area and existing urban areas near the Project site; therefore, the proposed Project will not substantially degrade the existing characteristics of the area. Therefore, impacts from the Project are considered to be less than significant, and no further analysis in the EIR is warranted.

Impact #3.4.1d - Except as provided in Public Resources Code Section 21099, would the Project create a new source of substantial light or glare that would adversely affect day or nighttime views in the area?

The Project would create a new source of light and glare, which may affect day and nighttime views of the area. Construction of the proposed Project would generally occur during daytime hours, typically from 7:00 a.m. to 8:00 p.m, per General Plan section 9.10.060 A.10. Lighting needed during construction would be directed downward and shielded to focus illumination on the desired work areas and prevent light spillage onto adjacent properties. Because lighting used to illuminate work areas would be shielded, focused downward, and turned off by

8:00 p.m., the potential for lighting to affect any residents adversely is minimal. Security lighting would also be shielded and focused downward to minimize light spill onto neighboring properties. Increased truck traffic and the transport of construction materials to the Project site would temporarily increase glare conditions during construction. However, this increase in glare would be minimal and of short duration. Construction activity would focus on specific areas on the sites, and any sources of glare would not be stationary for a prolonged period. Therefore, the proposed Project's construction would not create a new source of substantial glare that would affect daytime views in the area.

Operational impacts would be limited to residential lighting, including homes and streetlights. The Project exterior streetlights and residential lighting will be designed to minimize reflective glare and light scatter. The Project will comply with the applicable provisions of the Hanford Municipal Code Development Standards, such as Section 17.50.140 – Outdoor Lighting Standards (City of Hanford, 2022). Additionally, the California Building Code Title 24 contains standards for outdoor lighting that are intended to reduce light pollution and glare by regulating light power and brightness, shielding, and sensor controls. These requirements would substantially reduce potential nuisances from light or glare. Therefore, impacts resulting from the Project are considered to be less than significant, and no further analysis in the EIR is warranted.

Potentially Significant Impact	Less than Significant with Mitigation Incorporated	Less-than- Significant Impact	No Impact
--------------------------------------	--	-------------------------------------	--------------

3.4.2 - AGRICULTURE AND FORESTRY RESOURCES

In determining whether impacts to agricultural resources are significant environmental effects, lead agencies may refer to the California Agricultural Land Evaluation and Site Assessment Model (1997) prepared by the California Department of Conservation as an optional model to use in assessing impacts on agriculture and farmland. In determining whether impacts to forest resources, including timberland, are significant environmental effects, lead agencies may refer to information compiled by the California Department of Forestry and Fire Protection regarding the state’s inventory of forest land, including the Forest and Range Assessment Project and the Forest Legacy Assessment Project; and forest carbon measurement methodology provided in Forest Protocols adopted by the California Air Resources Board. Would the Project:

- | | | | | | |
|----|---|--------------------------|--------------------------|-------------------------------------|-------------------------------------|
| a. | Convert Prime Farmland, Unique Farmland, or Farmland of Statewide Importance (Farmland), as shown on the maps prepared pursuant to the Farmland Mapping and Monitoring Program of the California Resources Agency, to non-agricultural use? | <input type="checkbox"/> | <input type="checkbox"/> | <input checked="" type="checkbox"/> | <input type="checkbox"/> |
| b. | Conflict with existing zoning for agricultural use or a Williamson Act contract? | <input type="checkbox"/> | <input type="checkbox"/> | <input type="checkbox"/> | <input checked="" type="checkbox"/> |
| c. | Conflict with existing zoning for, or cause rezoning of, forest land (as defined in Public Resources Code Section 12220[g]), timberland (as defined by Public Resources Code Section 4526), or timberland zoned Timberland Production (as defined by Government Code Section 51104[g])? | <input type="checkbox"/> | <input type="checkbox"/> | <input type="checkbox"/> | <input checked="" type="checkbox"/> |
| d. | Result in the loss of forest land or conversion of forest land to non-forest use? | <input type="checkbox"/> | <input type="checkbox"/> | <input type="checkbox"/> | <input checked="" type="checkbox"/> |
| e. | Involve other changes in the existing environment which, due to their location or nature, could result in conversion of Farmland, to non-agricultural use or conversion of forest land to non-forest use? | <input type="checkbox"/> | <input type="checkbox"/> | <input checked="" type="checkbox"/> | <input type="checkbox"/> |

Discussion

Impact #3.4.2a – Would the Project convert Prime Farmland, Unique Farmland, or Farmland of Statewide Importance (Farmland), as shown on the maps prepared pursuant to the Farmland Mapping and Monitoring Program of the California Resources Agency, to non-agricultural use?

CEQA uses the California Department of Conservation Division of Land Resource Protection's Farmland Mapping and Monitoring Program (FMMP) categories of "Prime Farmland," "Farmland of Statewide Importance," and "Unique Farmland" to define "agricultural land" for the purposes of assessing environmental impacts (PRC Section 21060.1[a]). According to the California Department of Conservation Important Farmland Finder, the Project site is designated as approximately 88 acres of Prime Farmland, 6 acres of Farmland of Statewide Importance, and 0.20 acres of Unique Farmland (California Department of Conservation, 2022).

The City General Plan noted that over the 2014 to 2035 planning period, approximately 877 acres of Prime Farmland, 1,724 acres of Farmland of Statewide Importance, and 105 acres of Unique Farmland would be converted to non-agricultural use. Future development would have to adhere to the Hanford Municipal Code Chapter 16.40.110 (Right to Farm) and proposed goals and policies of the General Plan Update related to agriculture. However, the loss of this farmland due to the General Plan Update would be a significant and unavoidable impact, as there is no feasible mitigation to reduce impacts to a less-than-significant level (City of Hanford, 2016).

The City has not established a threshold of significance for the conversion of farmland to non-agricultural use. The loss of 88 acres of Prime Farmland represents approximately 10 percent loss, a 0.35 percent loss of Farmland of Statewide Importance, and 0.2 percent reduction in Unique Farmland within the City.

The most recent data available indicates that there is approximately 107,913 acres of Prime Farmland, 320,053 acres of Farmland of Statewide Importance and 20,531 acres of Unique Farmland available within the County of Kings (County of Kings, 2020). Based on the farmland designations within the Project site, the Project would result in the conversion of approximately 0.082% of Prime Farmland, 0.001% of Farmland of Statewide Importance, and 0.001% of Unique Farmland to residential use. The Project represents a very small loss of available farmland on a county-wide basis.

Therefore, in consideration of the Project's small conversion of agricultural land to a non-agricultural use and the current land use designation of residential development, impacts resulting from this conversion would be less than significant, and no further analysis in the EIR is warranted.

Impact #3.4.2b – Would the Project conflict with existing zoning for agricultural use or a Williamson Act contract?

The Project site is not subject to a Williamson Act Land Use contract. The Project area is zoned and designated for Low Density Residential by the City of Hanford Zoning Ordinance and is anticipated to have a non-agricultural land use. Therefore, there is no impact, and no further analysis in the EIR is warranted.

Impact #3.4.2c – Would the Project conflict with existing zoning for, or cause rezoning of, forest land (as defined in Public Resources Code Section 12220(g)), timberland (as defined

by Public Resources Code Section 4526), or timberland zoned Timberland Production (as defined by Government Code Section 51104(g))?

The Project site is not considered forest land or timberland. Therefore, the proposed Project will not conflict with any forest land or Timberland Production or result in any loss of forest land. Therefore, the Project will have no impact, and no further analysis in the EIR is warranted.

Impact #3.4.2d – Would the Project result in the loss of forest land or conversion of forest land to non-forest use?

See Impacts #3.4.2a-c. There will be no impact on forest land, and no further analysis in the EIR is warranted.

Impact #3.4.2e – Would the Project involve other changes in the existing environment which, due to their location or nature, could result in conversion of Farmland, to non-agricultural use or conversion of forest land to non-forest use?

As noted above, the City has not established a threshold of significance for the conversion of farmland to non-agricultural use. Within City limits, the loss of 88 acres of Prime Farmland represents approximately 10 percent reduction in available farmland, a 0.35 percent loss of Statewide Importance, and 0.2 percent reduction in Unique Farmland. Additionally, when comparing the Project's conversion of Farmland to non-agricultural use within the County is considered a less than significant impact. As such, no further analysis in the EIR is warranted.

	Potentially Significant Impact	Less than Significant with Mitigation Incorporated	Less-than-Significant Impact	No Impact
--	--------------------------------	--	------------------------------	-----------

3.4.3 - AIR QUALITY

Where available, the significance criteria established by the applicable air quality management district or air pollution control district may be relied upon to make the following determinations. Would the Project:

a. Conflict with or obstruct implementation of the applicable air quality plan?	<input type="checkbox"/>	<input type="checkbox"/>	<input checked="" type="checkbox"/>	<input type="checkbox"/>
b. Result in a cumulatively considerable net increase of any criteria pollutant for which the Project region is non-attainment under an applicable federal or State ambient air quality standard?	<input type="checkbox"/>	<input type="checkbox"/>	<input checked="" type="checkbox"/>	<input type="checkbox"/>
c. Expose sensitive receptors to substantial pollutant concentrations?	<input type="checkbox"/>	<input type="checkbox"/>	<input checked="" type="checkbox"/>	<input type="checkbox"/>
d. Result in other emissions (such as those leading to odors) adversely affecting a substantial number of people?	<input type="checkbox"/>	<input type="checkbox"/>	<input checked="" type="checkbox"/>	<input type="checkbox"/>

The impact analyses in this section are based on an *Air Quality & Greenhouse Gas Impact Assessment* (VRPA Technologies, Inc., 2022) prepared for the Project, which is included in Appendix A.

Discussion

Impact #3.4.3a – Would the Project conflict with or obstruct implementation of the applicable air quality plan?

The proposed Project lies within the San Joaquin Valley Air Basin (SJVAB) and is under the San Joaquin Valley Air Pollution Control District (SJVAPCD) jurisdiction. Kings County is located in a non-attainment area for the 8-hour ozone standard, PM_{2.5} standard, and PM₁₀. The SJVAB is designated non-attainment of State PM₁₀. To meet Federal Clean Air Act (CAA) requirements, the SJVAPCD has multiple Air Quality Attainment Plan (AQAP) documents, including:

- 2016 Ozone Plan.
- 2007 PM₁₀ Maintenance Plan and Request for Redesignation.
- 2016 PM_{2.5} Plan.

As discussed below, emissions of ROG, NO_x, PM₁₀, and PM_{2.5} associated with the construction and operation of the Project would not exceed the District’s significance thresholds. As

shown in impact (b) below, the Project would not result in CO hotspots that would violate CO standards. Therefore, the Project would not contribute to air quality violations.

Compliance with Applicable Control Measures

The AQP contains a number of control measures, which are enforceable requirements through the adoption of rules and regulations. The rules and regulations that apply to this Project are provided below.

SJVAPCD Rule 9510 – Indirect Source Review (ISR) is a control measure in the 2006 PM₁₀ Plan that requires NO_x and PM₁₀ emission reductions from development projects in the San Joaquin Valley. The NO_x emission reductions help reduce the secondary formation of PM₁₀ in the atmosphere (primarily ammonium nitrate and ammonium sulfate) and reduce the formation of ozone. Reductions in directly emitted PM₁₀ reduce particles such as dust, soot, and aerosols. Rule 9510 is also a control measure in the 2016 Plan for the 2008 8-hour ozone standard. Developers of projects subject to Rule 9510 must reduce emissions occurring during construction and operational phases through on-site measures or pay off-site mitigation fees. The Project is required to comply with Rule 9510.

Rule 8011 – General Requirements for Fugitive Dust Emission Sources. Fugitive dust regulations are applicable to outdoor fugitive dust sources. Operations, including construction operations, must control fugitive dust emissions in accordance with SJVAPCD Regulation VIII. According to Rule 8011, the SJVAPCD requires the implementation of control measures for fugitive dust emission sources. For projects in which construction-related activities would disturb equal to or greater than one acre of surface area, the SJVAPCD recommends that demonstration of receipt of an SJVAPCD approved Dust Control Plan or Construction Notification Form before issuance of the first grading permit be made a condition of approval of TTM 938, and a note outlining the requirement be placed on all plans and specs. The Project is required to comply by preparing a Dust Control Plan or Construction Notification Form before issuance of the first grading permit.

Regulation VIII – Fugitive PM₁₀ Prohibitions. Rules 8011-8081 are designed to reduce PM₁₀ emissions (predominantly dust/dirt) generated by human activity, including construction and demolition activities, road construction, bulk materials storage, paved and unpaved roads, carryout and track out, etc. All development projects that involve soil disturbance are subject to at least one provision of the Regulation VIII series of rules. The Project is required to prepare a Dust Control Plan to comply with Regulation VIII.

Other control measures that apply to the Project are Rule 4641 - Cutback, Slow Cure, and Emulsified Asphalt, Paving and Maintenance Operation, which requires reductions in VOC emissions during paving, and Rule 4601 - Architectural Coatings, which limits the VOC content of all types of paints and coatings sold in the San Joaquin Valley. These measures apply at the point of sale of the asphalt and the coatings, so project compliance is ensured.

The Project would comply with all applicable SJVAPCD rules and regulations and applicable control measures of the AQP. The Project complies with this criterion and would not conflict

with or obstruct the implementation of the applicable Air Quality Attainment Plan. As discussed under III. AIR QUALITY (b) and (c), the Project's emissions are less than significant for all criteria pollutants and would not result in inconsistency with the applicable air quality plan and will comply with applicable control measures of the air quality plan. Therefore, the Project is consistent with the applicable air quality plan.

The Project is consistent with the currently adopted General Plan for the City of Hanford and is therefore consistent with the population growth and VMT applied in the plan. Therefore, the Project is consistent with the growth assumptions used in the applicable AQPs. As a result, the Project will not conflict with or obstruct the implementation of any air quality plans. Therefore, no mitigation is needed. The impacts of the Project would be less than significant, and no further analysis in the EIR is warranted.

Impact #3.4.3b – Would the Project result in a cumulatively considerable net increase of any criteria pollutant for which the Project region is non-attainment under an applicable federal or State ambient air quality standard?

The SJVAPCD also prepared the *Guide for Assessing and Mitigation Air Quality Impacts* (GAMAQI), dated March 19, 2015. The GAMAQI is an advisory document that provides lead agencies, consultants, and project applicants with analysis guidance and uniform procedures for addressing air quality impacts in environmental documents. Local jurisdictions are not required to utilize the methodology outlined therein. This document describes the criteria that SJVAPCD uses when reviewing and commenting on the adequacy of environmental documents. It recommends thresholds for determining whether or not projects would have significant adverse environmental impacts, identifies methodologies for predicting project emissions and impacts, and identifies measures that can be used to avoid or reduce air quality impacts.

The SJVAPCD has established thresholds of significance for determining environmental significance, which are provided in Table 3.4.3-1 below. Project-specific emissions that exceed the thresholds of significance for criteria pollutants would be expected to result in a cumulatively considerable net increase of any criteria pollutant for which the County is in non-attainment under applicable federal or State ambient air quality standards. It should be noted that a project is not characterized as cumulatively insignificant when project emissions fall below thresholds of significance.

**Table 3.4.3-1
SJVAPCD Pollutant Thresholds of Significance**

Criteria Pollutant	Significance Level	
	Construction (tons/year)	Operational (tons/year)
CO	100 tons/yr	100
NO _x	10	10
ROG	10	10
SO _x	27	27
PM ₁₀	15	15

PM_{2.5}

15

15

Short-Term Impacts

The annual emissions from the Project's construction phase will be less than the applicable SJVAPCD emission thresholds for criteria pollutants, as shown in Table 3.4.3-2 below. Therefore, construction emissions associated with the Project are considered less than significant.

**Table 3.4.3-2
Project Construction Emissions**

Pollutant	CO	NO _x	ROG	SO _x	PM ₁₀	PM _{2.5}	CO _{2e}
Construction Emissions	5.65	6.66	7.20	0.01	1.70	0.61	1011.80
SJVAPCD Level of Significance	100	10	10	27	15	15	None
Does the Project Exceed Standard?	No	No	No	No	No	No	No

Long-Term Impacts

Emissions from long-term operations generally represent a project's most substantial air quality impact. Long-term emissions from the Project are generated primarily by mobile source (vehicle) emissions from the Project site and area sources such as lawn maintenance equipment. Table 3.4.3-3 below summarizes the Project's operational impacts by criteria pollutants.

**Table 3.4.3-3
Project Operational Emissions (tons/year)**

Pollutant	CO	NO _x	ROG	SO _x	PM ₁₀	PM _{2.5}	CO _{2e}
Project Operational Emissions	23.72	4.86	6.18	0.05	4.57	1.30	5999.30
SJVAPCD Level of Significance	100	10	10	27	15	15	None
Does the Project Exceed Standard?	No	No	No	No	No	No	No

Results from Table 3.4.3-3 indicate that the annual operational emissions from the Project will be less than the SJVAPCD emission thresholds for criteria pollutants. Therefore, operational emissions associated with the Project are considered less than significant. Results of the analysis show that emissions generated from the construction and operation of the Project will be less than the applicable SJVAPCD emission thresholds for criteria pollutants. Therefore, the Project will have a less-than-significant impact. No further analysis in the EIR is warranted.

Impact #3.4.3c – Would the Project expose sensitive receptors to substantial pollutant concentrations?

Sensitive receptors refer to those segments of the population most susceptible to poor air quality (i.e., children, the elderly, and those with pre-existing serious health problems affected by air quality). Land uses with the greatest potential to attract these sensitive receptors include

schools, parks, playgrounds, daycare centers, nursing homes, hospitals, and residential communities.

Short Term Construction

Short-term impacts are mainly related to the construction phase of a project and are recognized to be short in duration. Construction air quality impacts are generally attributable to dust and exhaust pollutants generated by equipment and vehicles. Fugitive dust is emitted both during construction activity and as a result of wind erosion over exposed earth surfaces. Clearing and earth-moving activities comprise major sources of construction dust emissions, but traffic and general disturbances of soil surfaces also generate significant dust emissions. Further, dust generation is dependent on soil type and soil moisture. Exhaust pollutants are the non-useable gaseous waste products produced during the combustion process. Engine exhaust contains CO, HC, and NO_x pollutants that are harmful to the environment. As noted in Table 3.4.3-2, the Project's impacts from construction emissions will be less than the SJVAPCD emission thresholds for criteria pollutants and are considered less than significant.

Long term Operations

Emissions from long-term operations generally represent a project's most substantial air quality impact. Long-term emissions from the Project are generated primarily by mobile source (vehicle) emissions from the Project site and area sources such as lawn maintenance equipment. As noted in Table 3.4.3-3, the Project's operational impacts annual operational emissions will be less than the SJVAPCD emission thresholds for criteria pollutants. Therefore, operational emissions associated with the Project are considered less than significant.

Toxic Air Contaminant (TAC)/Hazardous Air Pollutants (HAP) Impacts

Existing air quality concerns within Hanford and the entire SJVAB are related to increases in regional criteria air pollutants (e.g., ozone and particulate matter), exposure to toxic air contaminants, odors, and increases in greenhouse gas emissions contributing to climate change. The primary source of ozone (smog) pollution is motor vehicles. Particulate matter is caused by dust, primarily dust generated from construction and grading activities, and smoke which is emitted from fireplaces, wood-burning stoves, and agricultural burning.

From a health risk perspective, the Project is a Type B project in that it may potentially place sensitive receptors in the vicinity of existing sources. The Project is located one mile from SR 198 and more than 4,000 feet from SR 41. The SJVAPCD recommends that new sensitive land uses shouldn't be sited within 500 feet of a freeway/urban roads with 100,000 vehicles/day or rural roads with 50,000 vehicles/day. Therefore, impacts related to exposure to criteria pollutants are considered less than significant.

Based on the analysis presented, impacts are anticipated to be less than significant with implementation of the Project. However, further analysis is warranted in the EIR.

Impact #3.4.3d – Would the Project result in other emissions (such as those leading to odors) adversely affecting a substantial number of people?

Odor impacts on residential areas and other sensitive receptors, such as hospitals, day-care centers, schools, etc., warrant the closest scrutiny, but consideration should also be given to other land uses where people may congregate, such as recreational facilities, worksites, and commercial areas.

The proposed Project is a residential community located near other residential neighborhoods and agricultural land uses. The Project will not generate odorous emissions given the nature or characteristics of the Project. The intensity of an odor source's operations and its proximity to sensitive receptors influence the potential significance of odor emissions.

Two situations create a potential for odor impact. The first occurs when a new odor source is located near an existing sensitive receptor. The second occurs when a new sensitive receptor locates near an existing source of odor. According to the *CBIA v. BAAQMD* ruling (Alameda Superior Court Case No. RGI0548693), impacts of existing sources of odors on the Project are not subject to CEQA review (*California Building Industry Association v. Bay Area Air Quality Management District*, 2015). Therefore, the analysis to determine if the Project would locate new sensitive receptors near an existing source of odor is provided for information only. The SJVAPCD has determined the common land use types that are known to produce odors in the SJVAB.

The Project will not generate odorous emissions, given the nature or characteristics of residential developments. The intensity of an odor source's operations and its proximity to sensitive receptors influence odor emissions' potential significance. The SJVAPCD has identified some common types of facilities that have been known to produce odors in the SJVAB. The types of facilities that are known to produce odors are shown in Table 3.4.3-5, along with a reasonable distance from the source within which the degree of odors could possibly be significant. None of the facilities shown in Table 3.4.3-5 are located within the vicinity of the Project. Therefore, no mitigation is needed.

Table 3.4.3-3 shows that operational emissions will be less than the SJVAPCD level of significance thresholds. The Project is not within SJVACPD potential odor sources shown in Table 3.4.3-5. Long-term potential odors in the area would be limited to vehicular and lawn equipment emissions once the Project site is operational. Therefore, the Project will have a less-than-significant impact, and no further analysis in the EIR is warranted.

**Table 3.4.3-4
Screening Levels for Potential Odor Sources**

Type of Facility	Distance
Wastewater Treatment Facility	2 miles
Sanitary Landfill	1 mile
Transfer Station	1 mile
Composting Facility	1 mile
Petroleum Refinery	2 miles
Asphalt Batch Plant	1 mile
Chemical Manufacturing	1 mile
Fiberglass Manufacturing	1 mile
Painting/Coating Operations (e.g., auto body shops)	1 mile
Food Processing Facility	1 mile
Feed Lot/Dairy	1 mile
Rendering Plant	1 mile

	Potentially Significant Impact	Less than Significant with Mitigation Incorporated	Less-than-Significant Impact	No Impact
--	--------------------------------	--	------------------------------	-----------

3.4.4 - BIOLOGICAL RESOURCES

Would the Project:

- | | | | | |
|---|--------------------------|--------------------------|-------------------------------------|-------------------------------------|
| a. Have a substantial adverse effect, either directly or through habitat modifications, on any species identified as a candidate, sensitive, or special-status species in local or regional plans, policies, or regulations or by the California Department of Fish and Wildlife or U.S. Fish and Wildlife Service? | <input type="checkbox"/> | <input type="checkbox"/> | <input checked="" type="checkbox"/> | <input type="checkbox"/> |
| b. Have a substantial adverse effect on any riparian habitat or other sensitive natural community identified in local or regional plans, policies, regulations, or by the California Department of Fish and Wildlife or U.S. Fish and Wildlife Service? | <input type="checkbox"/> | <input type="checkbox"/> | <input checked="" type="checkbox"/> | <input type="checkbox"/> |
| c. Have a substantial adverse effect on state or federally protected wetlands (including, but not limited to, marsh, vernal pool, coastal, etc.) through direct removal, filling, hydrological interruption, or other means? | <input type="checkbox"/> | <input type="checkbox"/> | <input checked="" type="checkbox"/> | <input type="checkbox"/> |
| d. Interfere substantially with the movement of any native resident or migratory fish or wildlife species, or with established native resident or migratory wildlife corridors, or impede the use of native wildlife nursery sites? | <input type="checkbox"/> | <input type="checkbox"/> | <input checked="" type="checkbox"/> | <input type="checkbox"/> |
| e. Conflict with any local policies or ordinances protecting biological resources, such as a tree preservation policy or ordinance? | <input type="checkbox"/> | <input type="checkbox"/> | <input type="checkbox"/> | <input checked="" type="checkbox"/> |
| f. Conflict with the provisions of an adopted habitat conservation plan, natural community conservation plan, or other approved local, regional, or state habitat conservation plan? | <input type="checkbox"/> | <input type="checkbox"/> | <input type="checkbox"/> | <input checked="" type="checkbox"/> |

The impact analyses in this section is based on a Biological Resources Evaluation prepared for the Project (QK, 2022a), included in Appendix B.

Discussion

Impact #3.4.4a – Would the Project have a substantial adverse effect, either directly or through habitat modifications, on any species identified as a candidate, sensitive, or special-status species in local or regional plans, policies, or regulations or by the California Department of Fish and Wildlife or U.S. Fish and Wildlife Service?

Project activities have the potential to affect biological resources. A reconnaissance survey of the Project and a 250-foot buffer (Biological Survey Area, or BSA), where feasible, was conducted on March 18, 2022.

QK conducted a review of the literature and agency databases to obtain information on the occurrences of natural communities and special-status species known from the vicinity of the Project site. The California Natural Diversity Database (CDFW 2022a), California Native Plant Society (CNPS) Database (CNPS 2022), and U.S. Fish and Wildlife Service (USFWS) Threatened and Endangered Species List (USFWS 2022a) were reviewed in March 2022 to assess whether occurrences of sensitive natural communities, federally-listed species, State-listed species, other species of special concern, or USFWS Critical Habitat Units that have been documented within the *Remnoy, Guernsey, Waukena, Burris Park, Hanford, Lemoore, Riverdale, Laton, and Stratford* U.S. Geological Survey (USGS) 7.5-minute quadrangles that encompass the Project site. To satisfy other standard search criteria, CNDDDB records within a 10-mile radius of the Project site were queried separately from the broader database search.

No natural plant communities occur within the BSA. The majority of the Project site was actively used for agricultural purposes. The Project site was actively being disked at the time of the survey. Patches of ruderal vegetation were observed along the edges of the Project site that included fiddleneck (*Amsinckia menziesii*), ripgut brome (*Bromus diandrus*), and wild oat (*Avena fatua*).

Only two special-status wildlife species, San Joaquin kit fox and Swainson's hawk, have the potential to occur within the BSA from time to time as transients.

Swainson's Hawk

The Swainson's hawk (*Buteo swainsoni*) has the potential to occur within the BSA. The nearest Swainson's hawk CNDDDB occurrence is approximately three miles northeast of the BSA, where nesting observations have been recorded since 2012. There is suitable nesting habitat within the BSA in the nearby residential properties to the west and east that could be used by a Swainson's hawk. The site provides a small area of foraging opportunities when the crops are harvested.

Impacts to nesting Swainson's hawks could occur during construction due to noise, vibration, and the presence of construction workers if the species is nesting near the Project.

San Joaquin Kit Fox

There is no evidence that the San Joaquin kit fox is present within the BSA. Surrounding land use and habitat conditions make it unlikely that the San Joaquin kit fox would be present other than as a transient forager. Direct impacts resulting in injury, death, or entrapment in trenches or pipes could occur if a fox travels into the construction area. Construction activities could result in crushing or destroying a den with a kit fox inside. Noise, vibration, and the presence of construction workers may alter normal behaviors, which could affect reproductive success.

Nesting Birds

The BSA contains suitable habitat for a wide variety of nesting bird species. No active or inactive bird nests were observed during the site survey. There is potential for birds to nest within the BSA in existing structures and trees and trees and utility poles in the surrounding urban areas. If there are active nests present during Project activities, nests could be destroyed, and Project activities could interfere with normal breeding behaviors, which could discourage breeding or lead to nest abandonment or failure.

Although it is unlikely that either of these species would be present on the Project site, to protect biological resources, avoidance and minimization measures will be included as a condition of approval of TTM 938 and added to all engineered plans and specs that would outline necessary steps to be taken prior to the start of construction. This includes a pre-activity survey for San Joaquin kit fox, American badger, Swainson's hawk nesting birds, and other special-status species be conducted within 14 days of the start of construction activities by a qualified biologist knowledgeable in the identification of these species. If no evidence of these special-status species is detected, no further action is required. If evidence of special-status species is observed, the qualified biologist would determine the appropriate actions to be taken, including monitoring during construction or additional protocol level surveys, to reduce impacts to the species. Measures also include actions to be taken such as limiting on-site speeds to 20 miles per hour, covering trenches, capping pipes, removing trash on a daily basis, prohibiting pets on site, etc., and these measures will be placed on all plans and specs.

With the implementation of these avoidance and minimization measures, impacts are considered to be less than significant, and no further analysis in the EIR is warranted.

Impact #3.4.4b – Would the Project have a substantial adverse effect on any riparian habitat or other sensitive natural community identified in local or regional plans, policies, regulations, or by the California Department of Fish and Wildlife or U.S. Fish and Wildlife Service?

Sensitive natural communities are designated by various resource agencies, including the CDFW, USFWS, Bureau of Land Management, U.S. Forest Service, or are designated by local agencies through policies, ordinances, and regulations.

There is no riparian habitat or sensitive natural communities within the Project boundaries, and no protected species were observed during the survey. Therefore, the Project's impacts would be less than significant, and no further analysis in the EIR is warranted.

Impact #3.4.4c – Would the Project have a substantial adverse effect on State or federally protected wetlands (including, but not limited to, marsh, vernal pool, coastal, etc.) through direct removal, filling, hydrological interruption, or other means?

The United States Army Corps of Engineers (USACE) has regulatory authority over the Clean Water Act (CWA), as provided for by the EPA. The USACE has established specific criteria for the determination of wetlands based upon the presence of wetland hydrology, hydric soils, and hydrophilic vegetation. There are no federally protected wetlands or vernal pools that occur within the Project.

Wetlands, streams, reservoirs, sloughs, and ponds typically meet the criteria for federal jurisdiction under Section 404 of the CWA and State jurisdiction under the Porter-Cologne Water Quality Control Act. Streams and ponds typically meet the criteria for State jurisdiction under Section 1602 of the California Fish and Game Code.

A review of the National Hydrography Dataset (NHD) and National Wetlands Inventory (NWI) identifies a historic water feature that runs within the Project site. The feature is classified by the NHD as a canal ditch. The NWI identifies it as a perennial-flow, semi-permanently flooded streambed with an unconsolidated bottom that is anthropogenic in origin. The drainage is shown on the NHD and NWI as northwest to south, traversing and crossing through the western half of the Project site. However, this feature was not present during the survey (QK, 2022a). There are no other identified water features, federal waters, or wetlands located on or near the Project. Therefore, the Project's impacts would be less than significant, and no further analysis in the EIR is warranted.

Impact #3.4.4d – Would the Project interfere substantially with the movement of any native resident or migratory fish or wildlife species, or with established native resident or migratory wildlife corridors, or impede the use of native wildlife nursery sites?

Wildlife movement corridors also referred to as dispersal corridors or landscape linkages, are generally defined as linear features along which animals can travel from one habitat or resource area to another. Wildlife movement corridors can be large tracts of land connecting regionally important habitats that support wildlife in general, such as stop-over habitat that supports migrating birds or large contiguous natural habitats that support animals with large home ranges (e.g., coyotes, mule deer). They can also be small-scale movement corridors, such as riparian zones, that provide connectivity and cover to support the movement at a local scale.

There are no known wildlife movement corridors or habitat linkages that intersect the BSA. The Project is situated within an area developed for urban and agricultural use and does not provide a linkage between suitable natural habitats for most wildlife species. Due to the disturbed condition of the Project, there is no substantial movement of wildlife onto or off of

the Project site. Therefore, the Project's impacts would be less than significant, and no further analysis in the EIR is warranted.

Impact #3.4.4e – Would the Project conflict with any local policies or ordinances protecting biological resources, such as a tree preservation policy or ordinance?

The City of Hanford General Plan contains policies aimed at the preservation of biological resources and promotes coordination with federal and State resource agencies. The General Plan outlines a work plan with implementation measures to uphold these policies, including biological resource review for proposed projects and development of mitigation measures for these projects. The City of Hanford Valley Oak Ordinance establishes policies for care, trimming, and removal of Valley Oaks.

However, there are no Valley Oaks on the Project site. The Project is consistent with the General Plan, the Valley Oak Tree Ordinance, and any other local ordinances or policies related to biological resources. The Project would have no impact, and no further analysis in the EIR is warranted.

Impact #3.4.4f – Would the Project conflict with the provisions of an adopted habitat conservation plan, natural community conservation plan, or other approved local, regional, or State habitat conservation plan?

The Project is located within an area covered by the PG&E San Joaquin Valley Operation and Maintenance Habitat Conservation Plan (HCP). That HCP only applies to maintenance and operations of PG&E facilities and does not apply to this Project. There are no other pertinent HCP or NCCP within the Project area. The Project would have no impact, and no further analysis in the EIR is warranted.

	Potentially Significant Impact	Less than Significant with Mitigation Incorporated	Less-than-Significant Impact	No Impact
--	--------------------------------	--	------------------------------	-----------

3.4.5 - CULTURAL RESOURCES

Would the Project:

- | | | | | |
|--|--------------------------|--------------------------|-------------------------------------|--------------------------|
| a. Cause a substantial adverse change in the significance of a historical resource pursuant to CEQA Guidelines Section 15064.5? | <input type="checkbox"/> | <input type="checkbox"/> | <input checked="" type="checkbox"/> | <input type="checkbox"/> |
| b. Cause a substantial adverse change in the significance of an archaeological resource pursuant to CEQA Guidelines Section 15064.5? | <input type="checkbox"/> | <input type="checkbox"/> | <input checked="" type="checkbox"/> | <input type="checkbox"/> |
| c. Disturb any human remains, including those interred outside of formal cemeteries? | <input type="checkbox"/> | <input type="checkbox"/> | <input checked="" type="checkbox"/> | <input type="checkbox"/> |

The discussion below is based on the Cultural Resources Technical Memo completed for the Project, attached as Appendix C (QK, 2022b).

Discussion

Impact #3.4.5a – Would the Project cause a substantial adverse change in the significance of a historical resource pursuant to CEQA Guidelines Section 15064.5?

The City maintains a Local Register of Historic Structures within its General Plan, which features approximately 340 buildings, including residential, commercial, civic, and religious structures. These are categorized into exceptional, focus, and background structures. Exceptional structures or sites are those having preeminent historical, cultural, architectural, archaeological, or aesthetic significance, considered candidates for nomination to the National Register of Historic Places. Currently, four of these buildings have national and State historic designations: the Bank of Italy Building on East Main Street; the U.S. Post Office on West Acequia Avenue; Hyde House on South Court Street; and the Pioneer statue in Mooney Grove Park. None of these are located near the Project, and therefore, there would be no impact.

A cultural resources records search (RS #22-164) was conducted at the Southern San Joaquin Valley Information Center, CSU Bakersfield, to determine whether the proposed Project would impact cultural resources. The records search covered an area within one-half mile of the Project and included a review of the National Register of Historic Places, California Points of Historical Interest, California Registry of Historic Resources, California Historical Landmarks, California State Historic Resources Inventory, and a review of cultural resource reports on file.

The records search indicated that, although it was included in a brief cultural resource assessment of the general area, the subject property had never been surveyed for cultural resources. Four cultural resource studies have been conducted within one-half mile of the Project (QK, 2022b).

One historic cultural resource, the People's Ditch (P-16-000246), passes through the property. This is an active irrigation ditch that was originally constructed in the 1870s. However, this drainage is no longer observable on the property due to previous agricultural activities and, therefore, will not be impacted by the Project (QK, 2022a).

One cultural resource, the historic route of the AT&SF Railroad (P-16-000120), is located within one-half mile of the Project but will not be impacted.

A Sacred Lands File request was also submitted to the Native American Heritage Commission. A response dated June 20, 2022, indicates negative results.

Based on the results of cultural records search findings and the lack of historical or archaeological resources previously identified within a half-mile radius of the proposed Project, the potential to encounter subsurface cultural, historical, or archaeological resources is minimal.

Although there is no obvious evidence of historical or archaeological resources on the Project site, there is the potential during construction for the discovery of cultural resources. Grading, trenching, and other ground-disturbing actions can damage or destroy these previously unidentified and potentially significant cultural resources within the Project area, including historical resources.

In the unlikely event construction of the Project inadvertently uncovers previously unknown cultural resources, avoidance and minimization measures will be added to all engineered plans and specs that would outline necessary steps to be taken prior to the start of construction. These measures require all work in the immediate vicinity of the discovery of cultural resources find would halt until a qualified archaeologist can evaluate the find and make recommendations. In addition, prior to any ground disturbance, if the City of Hanford receives a request from a Native American tribal group, a surface inspection of the site will be conducted by a tribal monitor, and the tribe will have the opportunity to provide a Native American Monitor during ground-disturbing activities, dependent upon the availability and interest of the tribe.

With the implementation of these measures, impacts are considered to be less than significant, and no further analysis in the EIR is warranted.

Impact #3.4.5b – Would the Project cause a substantial adverse change in the significance of an archaeological resource pursuant to CEQA Guidelines Section 15064.5?

See Impact #3.4.5a above.

Based on the results of cultural records search findings and the lack of historical or archaeological resources previously identified within a half-mile radius of the proposed Project, the potential to encounter subsurface cultural resources is minimal. However, there is still a possibility that historical or archaeological materials may be exposed during construction. Grading, trenching, and other ground-disturbing actions can damage or destroy these previously unidentified and potentially significant cultural resources within the Project area, including historical or archaeological resources. As noted above, avoidance and minimization measures will be included as conditions of approval of TTM 938, and added to all engineered plans and specs that would outline the required steps to be taken to reduce potential impacts to cultural resources. No further analysis in the EIR is warranted.

Impact #3.4.5c – Would the Project disturb any human remains, including those interred outside of formal cemeteries?

There are no known cemeteries or burials on or near the Project. Although unlikely, subsurface construction activities, such as trenching and grading, associated with the proposed Project could potentially disturb previously undiscovered human burial sites. Accordingly, this is a potentially significant impact. However, considered unlikely, subsurface construction activities could cause a potentially significant impact to previously undiscovered human burial sites. The cultural resources and Sacred Lands File records searches did not indicate the presence of human remains, burials, or cemeteries within or in the vicinity of the Project site. No human remains have been discovered at the Project site, and no burials or cemeteries are known to occur within the area of the site. However, construction would involve earth-disturbing activities, and it is still possible that human remains may be discovered, possibly in association with archaeological sites.

Avoidance and minimization measures will be added to all engineered plans and specs that would outline necessary steps to be taken in the unlikely event construction of the Project inadvertently uncovers previously unknown human remains. This measure will be in accordance with Section 7050.5 of the Health and Safety Code, Section 5097.98 of the Public Resources Code (Chapter 1492, Statutes of 1982, Senate Bill 297), Senate Bill 447 (Chapter 44, Statutes of 1987 and \Section 7050.5(c), in the event of the discovery of human remains, at the direction of the county coroner. With the implementation of this condition of approval, impacts would be less than significant, and no further analysis in the EIR is warranted.

	Potentially Significant Impact	Less than Significant with Mitigation Incorporated	Less-than-Significant Impact	No Impact
--	--------------------------------	--	------------------------------	-----------

3.4.6 - ENERGY

Would the Project:

- | | | | | |
|--|--------------------------|--------------------------|-------------------------------------|--------------------------|
| a. Result in potentially significant environmental impact due to wasteful, inefficient, or unnecessary consumption of energy resources during Project construction or operation? | <input type="checkbox"/> | <input type="checkbox"/> | <input checked="" type="checkbox"/> | <input type="checkbox"/> |
| b. Conflict with or obstruct a state or local plan for renewable energy or energy efficiency? | <input type="checkbox"/> | <input type="checkbox"/> | <input checked="" type="checkbox"/> | <input type="checkbox"/> |

The impact analyses in this section are based on *available data and the Air Quality & Greenhouse Gas Impact Assessment (VRPA Technologies, Inc., 2022)* prepared for the Project, which is included in Appendix A.

Discussion

Impact #3.4.6a – Would the Project result in potentially significant environmental impact due to wasteful, inefficient, or unnecessary consumption of energy resources during Project construction or operation?

CEQA Guidelines require consideration of the potentially significant energy implications of a project. CEQA requires mitigation measures to reduce “wasteful, inefficient, and unnecessary” energy usage (Public Resources Code Section 21100, subdivision [b][3]). The means to conserve energy include decreasing overall energy consumption, decreasing reliance on natural gas and oil, and increasing reliance on renewable energy sources.

Construction

ON-ROAD VEHICLES (CONSTRUCTION)

Due to the nature of the Project, construction of the Project would be limited to the Project site and would only generate on-site (off-road) construction trips and would not contribute to on-road vehicle trips during Project construction (from construction workers and vendors).

OFF-ROAD VEHICLES (CONSTRUCTION)

Off-road construction vehicles would use diesel fuel during the proposed Project's construction phase. Based on the total amount of CO₂ emissions expected to be generated by the proposed Project (as provided by the CalEEMod output) and a CO₂ to diesel fuel

conversion factor (provided by the U.S. Environmental Protection Agency), the proposed Project would use a total of approximately 100,054 gallons of diesel fuel for off-road construction vehicles for the entirety of the Project’s construction (United States Environmental Protection Agency, 2022). A non-exhaustive list of constructive off-road vehicles expected to be used during the proposed Project's construction phase includes cranes, forklifts, generator sets, tractors, excavators, and dozers.

Short-term energy use during the construction phase would be in the form of fuel consumption (e.g., gasoline and diesel fuel) to operate heavy equipment, light-duty vehicles, and machinery. Energy demand during the construction phase would be the result of transportation of materials, construction equipment, and construction worker vehicle trips. Compliance with local and regional regulations during construction would minimize fuel consumption. Energy-saving strategies will be implemented where possible to further reduce the Project’s energy consumption during the construction phase. Strategies being implemented include those recommended by the CARB that may reduce the Project’s energy consumption, including diesel anti-idling measures, light-duty vehicle technology, alternative fuels such as biodiesel blends and ethanol, and heavy-duty vehicle design measures to reduce energy consumption.

Operations

CalEEMod uses the California Commercial End-Use Survey (CEUS) database to develop energy intensity values for non-residential buildings. The energy use from residential land uses is calculated based on the Residential Appliance Saturation Survey (RASS). Similar to CEUS, this is a comprehensive energy use assessment that includes the end-use for various climate zones in California. As shown in Table 3.4.6-1, the Project would use approximately 1.06486e+007 (10,548,600) of natural gas per year and approximately 3,532,460 kWh of electricity per year.

**Table 3.4.6-1
Project Operational Natural Gas and Electricity Usage**

Emissions^(a)	Natural Gas (kBTU/year)	Electricity (kWh/year)
Single-Family Housing	10,548,600	3,532,460

Source: (VRPA Technologies, Inc., 2022)

Long-term operation of the proposed includes electricity and natural gas service to power internal and exterior building lighting and heating and cooling systems.

ELECTRICITY AND NATURAL GAS

Electricity and natural gas used by the proposed Project would be used primarily to power residential homes. Total annual electricity (kWh) and natural gas (kBTU) usage associated with the operation of the proposed Project are shown in Table 3.4.6-1.

The Project would be required to comply with California's Title 24 energy efficiency requirements and other applicable City development standards. That would include the installation of solar panels on each home's rooftop, which would provide energy from a renewable power source to offset energy generated by fossil fuel-run. The Project will be required to comply with all applicable standards and building codes included in the 2019 California Green Building Standards Code regarding the use of energy-efficient appliances and lighting, low-flow toilets and faucets, drip irrigation, etc. Therefore, the Project will have a less-than-significant impact, and no further analysis in the EIR is warranted.

Impact #3.4.6b – Would the Project Conflict with or obstruct a State or local plan for renewable energy or energy efficiency?

See Impact #3.4.6a above.

The construction and the operation of the Project would comply with State and local plans and regulations. The proposed Project would be in compliance with all applicable federal, State, and local regulations regulating energy usage. The Project will comply with Title 24 Energy Efficiency Standards and CalGreen Code requirements for solar-ready roofs, electric vehicle charging, and water conservation. Energy would also be indirectly conserved through water-efficient landscaping requirements consistent with the City Landscaping Ordinance.

Stringent solid waste recycling requirements applicable to Project construction and operation would reduce energy consumed in solid waste disposal. In summary, the Project will implement all mandatory federal, State, and local conservation measures, project design features, and voluntary energy conservation measures to reduce energy demands further. Therefore, the Project will not conflict with or obstruct a State or local plan for renewable energy or energy efficiency. Project-related impacts are less than significant, and no further analysis in the EIR is warranted.

	Potentially Significant Impact	Less than Significant with Mitigation Incorporated	Less-than-Significant Impact	No Impact
--	--------------------------------	--	------------------------------	-----------

3.4.7 - GEOLOGY AND SOILS

Would the Project:

- | | | | | |
|--|--------------------------|--------------------------|-------------------------------------|-------------------------------------|
| a. Directly or indirectly cause potential substantial adverse effects, including the risk of loss, injury, or death involving: | | | | |
| i. Rupture of a known earthquake fault, as delineated on the most recent Alquist-Priolo Earthquake Fault Zoning Map issued by the State Geologist for the area or based on other substantial evidence of a known fault? Refer to Division of Mines and Geology Special Publication 42. | <input type="checkbox"/> | <input type="checkbox"/> | <input checked="" type="checkbox"/> | <input type="checkbox"/> |
| ii. Strong seismic ground shaking? | <input type="checkbox"/> | <input type="checkbox"/> | <input checked="" type="checkbox"/> | <input type="checkbox"/> |
| iii. Seismic-related ground failure, including liquefaction? | <input type="checkbox"/> | <input type="checkbox"/> | <input checked="" type="checkbox"/> | <input type="checkbox"/> |
| iv. Landslides? | <input type="checkbox"/> | <input type="checkbox"/> | <input checked="" type="checkbox"/> | <input type="checkbox"/> |
| b. Result in substantial soil erosion or the loss of topsoil? | <input type="checkbox"/> | <input type="checkbox"/> | <input checked="" type="checkbox"/> | <input type="checkbox"/> |
| c. Be located on a geologic unit or soil that is unstable, or that would become unstable as a result of the project, and potentially result in on- or off-site landslide, lateral spreading, subsidence, liquefaction, or collapse? | <input type="checkbox"/> | <input type="checkbox"/> | <input checked="" type="checkbox"/> | <input type="checkbox"/> |
| d. Be located on expansive soil, as defined in Table 18-1-B of the Uniform Building Code (1994), creating substantial direct or indirect risks to life or property? | <input type="checkbox"/> | <input type="checkbox"/> | <input checked="" type="checkbox"/> | <input type="checkbox"/> |
| e. Have soils incapable of adequately supporting the use of septic tanks or alternative wastewater disposal systems in areas where sewers are not available for the disposal of wastewater? | <input type="checkbox"/> | <input type="checkbox"/> | <input type="checkbox"/> | <input checked="" type="checkbox"/> |
| f. Directly or indirectly destroy a unique paleontological resource or site or unique geologic feature? | <input type="checkbox"/> | <input type="checkbox"/> | <input checked="" type="checkbox"/> | <input type="checkbox"/> |

Discussion

Impact #3.4.7a(i) – Would the Project directly or indirectly cause potential substantial adverse effects, including the risk of loss, injury, or death involving rupture of a known earthquake fault, as delineated on the most recent Alquist-Priolo Earthquake Fault Zoning Map issued by the State Geologist for the area or based on other substantial evidence of a known fault?

The Alquist-Priolo Earthquake Fault Zoning Act (formerly the Alquist-Priolo Special Studies Zone Act) requires the delineation of zones along active faults in California. Within these zones, cities, and counties must regulate certain development, including withholding permits until geologic investigations demonstrate that development sites are not threatened by future surface displacement. The purpose of the Alquist-Priolo Act is to regulate development on or near active fault traces to reduce the hazard of fault rupture; however, surface fault rupture is not necessarily restricted to the area within the Alquist-Priolo Zone. The Alquist-Priolo Act prohibits the location of most structures for human occupancy across active fault traces.

There are no designated Alquist-Priolo zones in the City of Hanford according to the General Plan (City of Hanford, 2017). No portion of the proposed Project is located within an earthquake fault zone, as defined by the Alquist-Priolo Earthquake Fault Zoning Act. Therefore, the proposed Project's development would not expose people or structures to potential substantial adverse effects, including risk of loss, injury, or death involving rupture of a known earthquake fault.

All new structures are required to conform to current seismic protection standards in the California Building Code. By adhering to the 2019 California Building Code and City development standards, the Project will have a less-than-significant impact of endangering people and structures associated with earthquakes. No further analysis in the EIR is warranted.

Impact #3.4.7a(ii) – Would the Project expose people or structures to potential substantial adverse effects, including the risk of loss, injury, or death involving strong seismic groundshaking?

See discussion of Impact #3.4.7a(i) above.

The greatest potential for seismic activity in the City is posed by the San Andreas Fault, which is located approximately 45 miles southwest of the proposed Project. The White Wolf Fault, located near Arvin and Bakersfield to the southwest of Kern County, has the potential to cause seismic hazards for the County to a much lesser degree than the San Andreas Fault. Kings County does not have any major fault system within its boundaries.

The Uniform Building Code has four seismic zones in the US, ranging from I to IV; the higher the number, the higher the earthquake danger. All of California lies within Zone III or IV, and Kings County is within Zone III, which equates to the potential to experience 0.3

meters/second squared ground acceleration, which would result in very strong to severe perceived shaking and a moderate to heavy potential.

Secondary hazards from earthquakes include ground shaking/rupture. Since there are no known faults within the immediate area, ground shaking/rupture from surface faulting, seiches, and landslides would not be hazards in the area. While such seismic shaking would be less severe from an earthquake that originates at a greater distance from the Project site, the side effects could potentially be damaging to residential buildings and supporting infrastructure. The Project is required to design residential buildings and associated infrastructure to withstand substantial ground shaking in accordance with all applicable State law and applicable codes included in the California Building Code (CBC) Title 24 for earthquake construction standards and building standards code including those relating to soil characteristics (California Building Standards Commission, 2019). The Project will adhere to all applicable local and State regulations to reduce any potentially significant impacts to structures resulting from strong seismic ground shaking at the Project site. Therefore, Project impacts would be less than significant, and no further analysis on the EIR is warranted.

Impact #3.4.7a(iii) – Would the Project expose people or structures to potential substantial adverse effects, including the risk of loss, injury, or death involving seismic-related ground failure, including liquefaction?

See discussion of Impacts #3.4.7a(i) and a(ii) above.

Liquefaction occurs when saturated, loose materials are weakened and transformed from a solid to a near-liquid state as a result of increased pore water pressure. For liquefaction to occur, surface and near-surface soil must be saturated and relatively loose. Liquefaction occurs more often in areas under young alluvium where the groundwater table is above 50 feet below the ground surface. In the City, the range is generally between 120 feet to 160 feet below ground surface; therefore, the potential for liquefaction at the proposed Project site is unlikely.

According to the Kings County Safety Element, the risk of liquefaction within the County is considered minimal. The Project would not directly or indirectly cause potential substantial adverse effects, including the risk of loss, injury, or death involving seismic-related ground failure, including liquefaction. The proposed Project would comply with all applicable mitigation measures to avoid any potential impacts to structures resulting from liquefaction at the proposed Project site. Because the Project site is within an area of low seismic activity, and the soils associated with the Project are not suitable for liquefaction, impacts will be less than significant, and no further analysis in the EIR is warranted.

Impact #3.4.7a(iv) – Would the Project expose people or structures to potential substantial adverse effects, including the risk of loss, injury, or death involving landslides?

See discussion of Impacts #3.4.7a(i) through a(iii) above.

Landslides include rockfalls, deep slope failure, and shallow slope failure. Factors such as the geological conditions, drainage, slope, vegetation, and others directly affect the potential for landslides.

The entire City of Hanford is located within an area of low landslide incidence, but there is still a possibility that landslides could occur within the City as a result of erosion, slope weakening through saturation, or stresses by earthquakes that make slopes fail. Geotechnical and soil studies that identify potential hazards, including landslides, would be required prior to grading activities as part of the plan check and development review process for the physical development of the area. Such technical studies would provide structural design, as needed, pursuant to the California Building Code requirements to reduce hazards to people and structures as a result of landslides.

Additionally, Kings County is listed to have “Low” to “Moderate” risk landslide areas located in the remote uninhabited sections of southwest Kings County. The Project site is within the Landslide Incidence Low (less than 1.5 percent of the area involved), and the development will have a less-than-significant impact (Kings County, 2009). As impacts are anticipated to be less than significant, no further analysis in the EIR is warranted.

Impact #3.4.7b – Would the Project result in substantial soil erosion or the loss of topsoil?

See discussion of Impacts #3.4.7a(i) through a(iv) above.

The Project site is underlain by four soil types, Nord complex, Nord fine sandy loam, Kimberlina fine sandy loam, saline-alkali, and Wasco sandy loam (QK, 2022a). Construction activities associated with the proposed Project will disturb surface vegetation and soils during construction and expose these disturbed areas to erosion by wind and water. To reduce the potential for soil erosion and loss of topsoil during construction, the Project would comply with the National Pollutant Discharge Elimination System (NPDES) General Construction Permit from the State of California Central Valley Regional Water Quality Control Board (RWQCB) during construction. Under the NPDES, the preparation and implementation of a Stormwater Pollution Prevention Plan (SWPPP) are required for construction activities that would disturb an area of one acre or more. An SWPPP must identify potential sources of erosion or sedimentation and identify and implement best management practices (BMPs) that ensure reduced erosion. If an SWPPP was not required, the Project would implement the standard BMPs. Typical BMPs intended to control erosion include sandbags, silt fencing, street sweeping, etc. Compliance with local grading and erosion control ordinances would also help minimize adverse effects associated with erosion and sedimentation. Any stockpiled soils would be watered and/or covered to prevent loss due to wind erosion as part of the SWPPP during construction.

The Project will comply with all the City's grading requirements outlined in Title 24 and Appendix J of the California Building Code. The Project is not expected to result in substantial soil erosion or the loss of topsoil.

Once constructed, the Project will have both impermeable surfaces as well as permeable surfaces. Impermeable surfaces would include existing roadways, driveways, and structures. Permeable surfaces would include open areas of the site and any landscaped areas. Overall, the development of the Project would not result in conditions where substantial surface soils would be exposed to wind and water erosion. Therefore, within implementation of the mitigation measures, the project is expected to result in a less-than-significant impact, and no further analysis in the EIR is warranted.

Impact #3.4.7c – Would the Project be located on a geologic unit or soil that is unstable, or that would become unstable as a result of the Project, and potentially result in on- or off-site landslide, lateral spreading, subsidence, liquefaction, or collapse?

See discussion in Impact #3.4.7a(iii) and 3.4.7a(iv) above.

There are no slopes on or near the property, and the Project would not expose the people or structures to significant risks from landslides.

The proposed Project will comply with all City and State regulations pertaining to construction, including the Hanford Municipal Code. In addition, the California Geologic Society, in implementing the CA Seismic Hazards Mapping Program, has not identified any seismically induced landslide hazard zones in Hanford (City of Hanford, 2017). Therefore, complying with the existing regulatory framework would be adequate to reduce any potential impacts to less-than-significant levels. No further analysis in the EIR is warranted.

Impact #3.4.7d – Would the Project be located on expansive soil, as defined in Table 18-1-B of the Uniform Building Code (1994), creating substantial direct or indirect risks to life or property?

See Impact #3.4.7a(iii), 3.4.7a(iv) and Impact #3.4.7c above.

Expansive soils are fine-grained soils that can undergo a significant increase in volume with an increase in water content, as well as a significant decrease in volume with a decrease in water content. The City and surrounding area's soils contain percentages of clay that generally range between 7-27 percent. When a soil has 35 percent or more clay content, it is considered clayey soil. Since the soils types in the City generally do not contain 35 percent clay content, the potential for expansive soils within the City of Hanford and its surrounding is low (City of Hanford, 2017). The soils found within the Project site are sandy and loamy and not considered to have a high clay content.

Additionally, the Project would comply with all applicable California Code of Regulations and the most recent California Building Standards Code, which provides criteria for the appropriate design of buildings. The proposed Project would not be located on any identified

expansive soils, as defined in the California Building Code. No further analysis in the EIR is warranted.

Impact #3.4.7e – Would the Project have soils incapable of adequately supporting the use of septic tanks or alternative wastewater disposal systems in areas where sewers are not available for the disposal of wastewater?

The proposed Project would not include septic tanks or alternative wastewater disposal systems. The dwelling units will be required to connect to the existing City sewer system. Therefore, there would be no impact related to the use of septic systems, and no further analysis in the EIR is warranted.

Impact #3.4.7f – Would the Project directly or indirectly destroy a unique paleontological resource or site or unique geologic feature?

The Project site does not have any known paleontological resources or unique geologic features. There is no evidence that cultural resources of any type (including historical, archaeological, paleontological, or unique geologic features) exist on the Project site. Nevertheless, there is some possibility that a buried site may exist in the area and be obscured by vegetation, fill, or other historical activities, leaving no surface evidence.

However, the City's 2035 General Plan Goal 06 requires the protection of paleontological resources. Avoidance and minimization measures will be added to all engineered plans and specs that would outline necessary steps to be taken in the unlikely event construction of the Project inadvertently uncovers previously unknown paleontological resources. These measures require all work in the immediate vicinity of the discovery of paleontological resources find would halt until a qualified professional can evaluate the find and make recommendations. With the implementation of these measures, impacts are considered to be less than significant, and no further analysis in the EIR is warranted.

	Potentially Significant Impact	Less than Significant with Mitigation Incorporated	Less-than-Significant Impact	No Impact
--	--------------------------------	--	------------------------------	-----------

3.4.8 - GREENHOUSE GAS EMISSIONS

Would the Project:

- | | | | | |
|--|--------------------------|--------------------------|-------------------------------------|--------------------------|
| a. Generate greenhouse gas emissions, either directly or indirectly, that may have a significant impact on the environment? | <input type="checkbox"/> | <input type="checkbox"/> | <input checked="" type="checkbox"/> | <input type="checkbox"/> |
| b. Conflict with any applicable plan, policy, or regulation adopted for the purpose of reducing the emissions of greenhouse gases? | <input type="checkbox"/> | <input type="checkbox"/> | <input checked="" type="checkbox"/> | <input type="checkbox"/> |

The impact analyses in this section are based on an *Air Quality & Greenhouse Impact Assessment* (VRPA Technologies, Inc., 2022), which is attached as Appendix A.

Discussion

There have been legislative and regulatory activities that directly and indirectly affect climate change and GHGs in California. The primary climate change legislation in California is AB 32, the California Global Warming Solutions Act of 2006. AB 32 focuses on reducing greenhouse gases (GHG) emissions in California. GHGs, as defined under AB 32, include carbon dioxide, methane, nitrous oxide, hydrofluorocarbons, perfluorocarbons, sulfur hexafluoride, and nitrogen trifluoride. AB 32 requires that GHGs emitted in California be reduced to 1990 levels by the year 2020. The California Air Resources Board is the State agency charged with monitoring and regulating sources of emissions of GHGs that cause global warming in order to reduce emissions of GHGs. SB 32 was signed by the Governor in 2016, which would require the State Board to ensure that statewide greenhouse gas emissions are reduced to 40 percent below the 1990 level by 2030.

Impact #3.4.8a – Would the Project generate greenhouse gas emissions, either directly or indirectly, that may have a significant impact on the environment?

The SJVAPCD acknowledges the current absence of numerical thresholds and recommends a tiered approach to establish the significance of the GHG impacts on the environment.

- i. If a project complies with an approved GHG emission reduction plan or GHG mitigation program which avoids or substantially reduces GHG emissions within the geographic area in which the project is located, then the project would be determined to have a less-than-significant individual and cumulative impact for GHG emissions.
- ii. If a project does not comply with an approved GHG emission reduction plan or mitigation program, it would be required to implement best performance standards (BPS).

- iii. If a project is not implementing BPS, it should demonstrate that its GHG emissions would be reduced or mitigated by at least 29 percent compared to Business as Usual (BAU).

The South Coast Air Quality Management District (SCAQMD) guidance identifies a threshold of 10,000 MTCO₂eq./year for GHG for construction emissions amortized over a 30-year project lifetime, plus annual operation emissions. Although the Project is under SJVAPCD jurisdiction, the SCAQMD GHG threshold provides some perspective on the GHG emissions generated by the Project. Table 3.4.8-1 shows the yearly GHG emissions generated by the Project as determined by the CalEEMod model, which is approximately 38 percent less than the threshold identified by the SCAQMD (VRPA Technologies, Inc., 2022).

**Table 3.4.8-1
Project Operational Greenhouse Gas Emissions**

Summary Report	CO₂e
Project operation Emissions Per Year	6,206.03 MT/yr

The proposed Project would emit greenhouse gases such as carbon dioxide (CO₂), methane, and nitrous oxide from the exhaust of construction equipment and the exhaust of vehicles for residents and construction equipment and delivery trips during construction. The increased rate of greenhouse gas emissions would not be considered cumulatively significant per the California Global Warming Solutions Act of 2006. As stated in the SJVAPCD's GAMAQI, projects whose emissions have been reduced or mitigated, consistent with AB 32 – California Global Warming Solutions Act of 2006, should be considered to have a less-than-significant impact on global climate change. Although project-related activities of the proposed Project could result in temporary emissions of GHGs, the proposed Project as a whole is not expected to generate greenhouse gas emissions, either directly or indirectly, that may have a significant impact on the environment.

Implementation of the Project will not result in Project-specific or site-specific significant adverse impacts from greenhouse gas emissions. Therefore, no mitigation is required, impacts are less than significant, and no further analysis in the EIR is warranted.

Impact #3.4.8b – Would the Project conflict with any applicable plan, policy, or regulation adopted for the purpose of reducing the emissions of greenhouse gases?

On December 11, 2008, CARB adopted its initial Scoping Plan, which functions as a roadmap of CARB's plans to achieve GHG reductions in California required by AB 32 through subsequently enacted regulations. CARB's 2017 Climate Change Scoping Plan builds on the efforts and plans encompassed in the initial Scoping Plan.

Senate Bill (SB) 375 aligns regional transportation planning efforts, regional GHG reduction targets, and land use and housing allocation. CARB has provided each affected region with reduction targets for GHGs emitted by passenger cars and light trucks in the region 2020 and 2035.

There is no proposed long-term use of large pieces of stationary source equipment or use of diesel-powered vehicles that generate GHG emissions. Once site preparation has been completed, there will be minimal use of any large construction equipment. Because the proposed Project will be consistent with the applicable General Plan land use designation of High Density Residential, it can be concluded that the proposed Project would not conflict with the approved General Plan. Therefore, the Project is consistent with the growth assumptions used in the applicable AQPs. As a result, the Project will not conflict with or obstruct implementation of any air quality plans. Therefore, no mitigation is needed.

CARB's 2017 Climate Change Scoping Plan builds on the efforts and plans encompassed in the initial Scoping Plan. The current plan has identified new policies and actions to accomplish the State's 2030 GHG limit. Below is a list of applicable strategies in the Scoping Plan and the Project's consistency with those strategies.

- California Light-Duty Vehicle GHG Standards – Implement adopted standards and planned second phase of the program. Align zero-emission vehicles, alternative and renewable fuel, and vehicle technology programs for long-term climate change goals.
- The Project is consistent with this reduction measure. This measure cannot be implemented by a particular project or Lead Agency since it is a statewide measure. When this measure is implemented, standards would be applicable to light-duty vehicles that would access the residential development. The Project would not conflict with or obstruct this reduction measure.
- Energy Efficiency – Pursuit of a comparable investment in energy efficiency from all retail providers of electricity in California. Maximize energy efficiency building and appliance standards.
- The Project is consistent with this reduction measure. Though this measure applies to the State to increase its energy standards, the Project would comply with this measure through existing regulations. The Project would not conflict with or obstruct this reduction measure.
- Low Carbon Fuel – Development and adoption of the low carbon fuel standard.
- The Project is consistent with this reduction measure. This measure cannot be implemented by a particular project or Lead Agency since it is a statewide measure. When this measure is implemented, standards would be applicable to the fuel used by vehicles that would access the residential development. The Project would not conflict with or obstruct this reduction measure.

The SJVAPCD does not have thresholds or guidance regarding the significance of construction-related emissions. Overall, the impacts during the construction phase would be short-term and temporary. Since there are no current significance thresholds and because construction-related impacts are considered temporary, they are generally considered less than significant. In addition, the construction of the proposed Project would still have to

comply with the SJVAPCD's regulations and requirements, as discussed in the air quality section. The Project will not generate significant long-term emissions over the life of the Project. Based on the assessment above, the Project will not conflict with an applicable plan, policy, or regulation adopted to reduce the emissions of greenhouse gases. Therefore, any impacts would be less than significant, and no further analysis in the EIR is warranted.

	Potentially Significant Impact	Less than Significant with Mitigation Incorporated	Less-than-Significant Impact	No Impact
--	--------------------------------	--	------------------------------	-----------

3.4.9 - HAZARDS AND HAZARDOUS MATERIALS

Would the Project:

- | | | | | |
|---|--------------------------|--------------------------|-------------------------------------|-------------------------------------|
| a. Create a significant hazard to the public or the environment through the routine transport, use, or disposal of hazardous materials? | <input type="checkbox"/> | <input type="checkbox"/> | <input checked="" type="checkbox"/> | <input type="checkbox"/> |
| b. Create a significant hazard to the public or the environment through reasonably foreseeable upset and accident conditions involving the release of hazardous materials into the environment? | <input type="checkbox"/> | <input type="checkbox"/> | <input checked="" type="checkbox"/> | <input type="checkbox"/> |
| c. Emit hazardous emissions or involve handling hazardous or acutely hazardous materials, substances, or waste within one-quarter mile of an existing or proposed school? | <input type="checkbox"/> | <input type="checkbox"/> | <input checked="" type="checkbox"/> | <input type="checkbox"/> |
| d. Be located on a site that is included on a list of hazardous materials sites compiled pursuant to Government Code Section 65962.5 and, as a result, would it create a significant hazard to the public or the environment? | <input type="checkbox"/> | <input type="checkbox"/> | <input checked="" type="checkbox"/> | <input type="checkbox"/> |
| e. For a Project located within an airport land use plan or, where such a plan has not been adopted, within two miles of a public airport or public use airport, would the Project result in a safety hazard or excessive noise for people residing or working in the Project area? | <input type="checkbox"/> | <input type="checkbox"/> | <input checked="" type="checkbox"/> | <input type="checkbox"/> |
| f. Impair implementation of, or physically interfere with, an adopted emergency response plan or emergency evacuation plan? | <input type="checkbox"/> | <input type="checkbox"/> | <input checked="" type="checkbox"/> | <input type="checkbox"/> |
| g. Expose people or structures, either directly or indirectly, to a significant risk of loss, injury, or death involving wildland fires? | <input type="checkbox"/> | <input type="checkbox"/> | <input type="checkbox"/> | <input checked="" type="checkbox"/> |

Discussion

Impact #3.4.9a – Would the Project create a significant hazard to the public or the environment through the routine transport, use, or disposal of hazardous materials?

A material is considered hazardous if it appears on a list of hazardous materials prepared by a federal, State, or local agency or if it has characteristics defined as hazardous by such an agency. The California Code of Regulation (CCR) defines a hazardous material as a substance that, because of physical or chemical properties, quantity, concentration, or other characteristics, may either (1) cause an increase in mortality or an increase in serious, irreversible, or incapacitating illness, or (2) pose a substantial present or potential hazard to human health or environment when improperly treated, stored, transported, or disposed of, or otherwise managed (CCR, Title 22, Division 4.5, Chapter 10, Article 2, Section 66260.10). Hazardous materials have been and are commonly used in commercial, agricultural, and industrial applications and, to a limited extent, in residential areas. Hazardous wastes are defined in the same manner.

Project Construction

Project construction-related activities may involve the use and transport of hazardous materials. These materials may include fuels, oils, mechanical fluids, and other chemicals used during construction-related activities. These materials could expose human health or the environment to undue risks associated with their use, and no significant impacts will occur during construction activities.

Transportation, storage, use, and disposal of hazardous materials during construction activities will be required to comply with applicable federal, State, and local statutes and regulations. U.S. Department of Transportation and Caltrans regulate the transportation of hazardous materials. Additionally, the City's routes that have been designated for hazardous materials transport would be used. Any hazardous waste or debris that is generated during the construction of the proposed Project would be collected and transported away from the site and disposed of at an approved off-site landfill or other such facilities. In addition, sanitary waste generated during construction would be managed through portable toilets located at reasonably accessible on-site locations.

Hazardous materials such as paint, bleach, water treatment chemicals, gasoline, oil, etc., may be used during construction. These materials are stored in appropriate storage locations and containers in the manner specified by the manufacturer and disposed of in accordance with local, federal, and State regulations. Residential construction generally uses fewer hazardous chemicals or chemicals in relatively small quantities and concentrations compared to commercial or industrial uses. No significant hazard to the public or the environment through the routine transport, use, or disposal of hazardous waste during construction or operation of the new residential development would occur.

Project Operation

Once constructed, the use of such materials as paint, bleach, etc., is considered common for residential developments. It would be unlikely for such materials to be stored or used in such quantities that would be considered a significant hazard. The Project will not generate or use hazardous materials outside health department requirements. Operation activities will

comply with the California Building Code, local building codes, and applicable safety measures.

Based on the analysis above, Project construction and operation are not anticipated to result in significant impacts due to the transportation, use, or disposal of hazardous materials. Therefore, impacts would be less than significant, and no further analysis in the EIR is warranted.

Impact #3.4.9b – Would the Project create a significant hazard to the public or the environment through reasonably foreseeable upset and accident conditions involving the release of hazardous materials into the environment?

Hazardous materials handling on the Project site over the long-term construction of the Project may result in soil and groundwater contamination from accidental spills. Construction of the Project would require preparing and implementing an SWPPP, as noted in Impact #3.4.7b. An SWPPP is a State requirement under the National Pollution Discharge Elimination System (NPDES) general permit for construction sites over one acre. The SWPPP identifies potential sources of pollution from the Project that may affect the stormwater discharge quality and requires that best management practices (BMPs) be implemented to prevent contamination at the source. Implementing BMPs during construction would contain accidental spills of hazardous materials, and soil and groundwater contamination would be minimized or prevented. Due to the size of the Project, each construction phase would be required to prepare and implement an SWPPP.

Valley Fever or coccidioidomycosis is prevalent in the Central San Joaquin Valley of California. This disease, which affects both humans and animals, is caused by the inhalation of arthroconidia (spores) of the fungus *Coccidioides immitis* (CI). CI spores are found in the top few inches of soil, and the fungus's existence in most soil areas is temporary. The proposed Project can generate fugitive dust and suspend Valley Fever spores with the dust that could then reach nearby sensitive receptors. It is possible that on-site workers could be exposed to valley fever as fugitive dust is generated during construction. Implementation of dust control measures throughout the construction period would reduce fugitive dust emissions. Therefore, the exposure to Valley Fever would be minimized by implementing these dust control measures as required by the Air District. Dust from the construction of the proposed Project would not add significantly to the existing exposure level of people to this fungus, including construction workers, and impacts would be reduced to less-than-significant levels.

All Project plans would comply with State and local codes and regulations. Construction and operational activities will also be required to comply with the California fire code to reduce the risk of potential fire hazards. The City's Fire Department will be responsible for enforcing provisions of the fire code.

A review of the State of California Department of Toxic Substances Control (DTSC) Envirostor database available via the DTSC's internet website indicated that no sites, including State response sites, voluntary cleanup sites, school cleanup sites, or military or

school evaluation sites are listed for the subject site or adjacent properties. Additionally, no Federal Superfund – National Priorities List (NPL) sites were determined to be located within a one-mile radius of the subject site (Department of Toxic Substances Control, 2022).

Review of State of California Department of Conservation, Geological Energy Management Division (CalGEM, formerly DOGGR) Online Mapping System indicated that no plugged and abandoned or producing oil wells are located on or adjacent to the subject site (CalGEM, 2022).

As noted in Impact #3.4.9a above, if there is a use of hazardous materials during the Project's construction phase, the safe handling and storage of hazardous materials consistent with applicable local and State regulations will be required.

The proposed Project is not anticipated to create a significant hazard to the public or the environment; as mentioned previously in Impact #3.4.9a above, the residential Project would not routinely transport, use, dispose of, or discharge hazardous materials into the environment, and impacts would be less than significant. No further analysis in the EIR is warranted.

Impact #3.4.9c – Would the Project emit hazardous emissions or involve handling hazardous or acutely hazardous materials, substances, or waste within one-quarter mile of an existing or proposed school?

The nearest schools to the site are the Kings Community School, approximately 700 feet northwest, and Lincoln Elementary School, approximately 2,500 feet north of the Project site. Construction activities for residential development could temporarily use hazardous materials and or substances, such as lubricant and diesel fuel, during construction. Exhaust from construction and related activities are expected to be of short duration, minimal, and not significant (VRPA Technologies, Inc., 2022). All future construction-related activities resulting from the proposed Project would be subject to local, State, and federal laws related to hazardous materials and substances emissions. However, construction of the Project would require the use of minimal hazardous materials and require implementation of BMPs when handling any hazardous materials, substances, or waste. As noted in Impact #3.4.9a, emissions from construction and related activities are expected to be minimal and not significant. Once constructed, residential development is not expected to result in hazardous emissions; therefore, the Project would have a less-than-significant impact, and no further analysis in the EIR is warranted.

Impact #3.4.9d – Would the Project be located on a site that is included on a list of hazardous materials sites compiled pursuant to Government Code Section 65962.5, and, as a result, would it create a significant hazard to the public or the environment?

As noted in Impact #3.4.9b, there are no known existing hazardous material conditions on the Project property. The property is not included on a list of hazardous materials sites compiled pursuant to Government Code Section 65962.5 and the Department of Toxic

Substances Control (DTSC). The Project itself will not generate or use hazardous materials outside health department requirements.

Therefore, because the Project is not located on a site that is included on a list of hazardous materials sites compiled pursuant to Government Code Section 65962.5, it can be seen there is a less-than-significant impact of hazards to the public or environment. Therefore, a less-than-significant impact is seen, and no further analysis in the EIR is warranted.

Impact #3.4.9e – Would the Project for a Project located within an airport land use plan or, where such a plan has not been adopted, within two miles of a public airport or public use airport, would the Project result in a safety hazard or excessive noise for people residing or working in the Project area?

The Project site is located approximately one mile southwest of the Hanford Municipal Airport, which is included in the adopted Kings County Airport Land Use Compatibility Plan (ALUCP). The eastern portion of the Project site is within the Airport Land Use Compatibility Overlay District (City of Hanford, 2017b). According to the County General Plan, residential developments are not permitted within the Aviation Land Use Compatibility Overlay Zone if the noise contour is 70 Community Noise Equivalent Level (CNEL) or higher. The Project is not within the Airport's Noise Contour zones, and the highest noise level from the airport is 65 CNEL (City of Hanford, 2010). Therefore, there would not be excessive noise or create a safety hazard for the people residing or working in the Project area.

The construction and operation of the Project would not result in the generation of noise levels beyond those that exist in the surrounding area. The construction and operation of the Project would not result in the generation of noise levels beyond those that exist in the surrounding area. Therefore, impacts would be less than significant, and no further analysis in the EIR is warranted.

Impact #3.4.9f – Would the Project impair implementation of, or physically interfere with, an adopted emergency response plan or emergency evacuation plan?

The 2015 Kings County Emergency Operations Plan (EOP) establishes emergency procedures and policies and identifies responsible parties for emergency response in the County, including the incorporated City of Hanford (Kings County, 2015). The EOP includes policies that would prevent new development from interfering with the emergency response of evacuation plans.

Development of the proposed Project has the potential to strain the emergency response and recovery capabilities of federal, State, and local government. Compliance with the General Plan policies to ensure adequate emergency response and maintain current plans reduces the impact of the development. The proposed Project is consistent with the policy of the General Plan. Additionally, the proposed Project would not inhibit the ability of local roadways to continue to accommodate emergency response and evacuation activities. The proposed Project would not interfere with the City's adopted emergency response plan, and there would be no impact.

The Project site and surrounding area are relatively flat, with little to no topography that might obscure visibility to motorists. Additionally, roadway improvements have been proposed to maintain traffic safety with the anticipated increase in vehicle trips. Therefore, impacts would be less than significant, and no further analysis in the EIR is warranted.

Impact #3.4.9g – Would the Project expose people or structures, either directly or indirectly, to a significant risk of loss, injury, or death involving wildland fires?

The majority of the City is located within a zone considered by Cal Fire to have low to no potential for wildland fires. Additionally, the proposed Project site is not located within proximity of a wildland area (City of Hanford, 2017).

The Hanford City Fire Department Station #2, located approximately 0.25 miles away, would provide fire protection services to the proposed Project. Kings County Fire Station #4 is approximately 2.5 miles east. Given that the Project is not surrounded by wildland areas and is in proximity to existing fire services, the Project would not expose people or structures to a significant risk of loss, injury, or death involving wildland fires. There would be no impact related to wildfires, and further analysis in the EIR is not warranted.

	Potentially Significant Impact	Less than Significant with Mitigation Incorporated	Less-than-Significant Impact	No Impact
--	--------------------------------	--	------------------------------	-----------

3.4.10 - HYDROLOGY AND WATER QUALITY

Would the Project:

- | | | | | |
|--|--------------------------|--------------------------|-------------------------------------|-------------------------------------|
| a. Violate any water quality standards or waste discharge requirements or otherwise substantially degrade surface or ground water quality? | <input type="checkbox"/> | <input type="checkbox"/> | <input checked="" type="checkbox"/> | <input type="checkbox"/> |
| b. Substantially decrease groundwater supplies or interfere substantially with groundwater recharge such that the Project may impede sustainable groundwater management of the basin? | <input type="checkbox"/> | <input type="checkbox"/> | <input checked="" type="checkbox"/> | <input type="checkbox"/> |
| c. Substantially alter the existing drainage pattern of the site or area, including through the alteration of the course of a stream or river or through the addition of impervious surfaces, in a manner which would? | | | | |
| i. Result in substantial erosion or siltation on- or off-site; | <input type="checkbox"/> | <input type="checkbox"/> | <input checked="" type="checkbox"/> | <input type="checkbox"/> |
| ii. Substantially increase the rate or amount of surface runoff in a manner that would result in flooding on- or off-site; | <input type="checkbox"/> | <input type="checkbox"/> | <input checked="" type="checkbox"/> | <input type="checkbox"/> |
| iii. Create or contribute runoff water that would exceed the capacity of existing or planned stormwater drainage systems or provide substantial additional sources of polluted runoff; or | <input type="checkbox"/> | <input type="checkbox"/> | <input checked="" type="checkbox"/> | <input type="checkbox"/> |
| iv. Impede or redirect flood flows? | <input type="checkbox"/> | <input type="checkbox"/> | <input checked="" type="checkbox"/> | <input type="checkbox"/> |
| d. In flood hazard, tsunami, or seiche zones, risk release of pollutants due to Project inundation? | <input type="checkbox"/> | <input type="checkbox"/> | <input type="checkbox"/> | <input checked="" type="checkbox"/> |
| e. Conflict with or obstruct implementation of a water quality control plan or sustainable groundwater management plan? | <input type="checkbox"/> | <input type="checkbox"/> | <input checked="" type="checkbox"/> | <input type="checkbox"/> |

Discussion

Impact #3.4.10a – Would the Project violate any water quality standards or waste discharge requirements or otherwise substantially degrade surface or groundwater quality?

See Impact #3.4.7b.

During construction, potential impacts on water quality arising from erosion and sedimentation are expected to be temporary conditions during the construction of new development. The proposed development must draft and comply with an approved SWPPP that specifies BMPs to prevent construction pollutants from contacting stormwater to keep all erosion products from moving off-site and into receiving waters during construction. In addition, prior to the commencement of construction activities, the Project proponent would be required to adhere to the requirements of the City Grading Code. The intention is to eliminate or reduce non-stormwater discharge to storm sewer systems and other waters of the United States.

Furthermore, as shown in Figure 3-3, TTM 938 includes an approximately four-acre stormwater retention that has been designed to control stormwater runoff and erosion, both during and after construction. Project-specific drainage improvements would reduce the proposed Project's potential to violate water quality standards during construction to a less-than-significant impact, and no further analysis in the EIR is warranted.

Impact #3.4.10b – Would the Project substantially decrease groundwater supplies or interfere substantially with groundwater recharge such that the Project may impede sustainable groundwater management of the basin?

The Project site is located within the Tulare Lake Subbasin, which is identified as being critically over-drafted and subject to Sustainable Groundwater Management Act (SGMA) requirements. The proposed Project site is located within the South Fork Kings Groundwater Sustainability Agency (GSA), Basin ID No. 5-022.12, "exclusive local agency" per Water Code §10723(c). In compliance with the Sustainable Groundwater Management Act (SGMA), a Groundwater Sustainability Plan (GSP) was submitted by the GSA to the Department of Water Resources (DWR), but it is not yet certified.

The City currently utilizes local groundwater as its sole source of municipal water supply. The City's municipal water system extracts its water supply from underground aquifers via 14 active groundwater wells within the city limits. In corporation with the Peoples Ditch Company and the Kings County Water District, excess Kings River water and stormwater flows are conveyed to 125 acres of drainage and slough basins located throughout the City to help replenish groundwater. The basins account for approximately 586 acre-feet of available water retention. The City plans to add approximately 317 acre-feet of additional basins located along major drainage channels for groundwater recharge and flood protection.

The current and future efforts of the City and Kings County Water District, coupled with the requirement to comply with the Sustainable Groundwater Management Act through the Groundwater Sustainability Plan process, ensure that future development as an implementation of the General Plan would not substantially deplete groundwater supplies or interfere substantially with groundwater recharge such that there be a net deficit in aquifer volume or a lowering of the local groundwater table level.

Construction

The City currently uses groundwater pumped from the Tulare Lake Basin to meet its water demand. Like any activity in Hanford, groundwater would be used for construction. Water would be used for dust control during grading and construction and for minor activities such as washing construction equipment and vehicles. Water demands generated by the Project during the construction phase would be temporary and not substantial. It is anticipated that groundwater supplies would be adequate to meet construction water demands generated by the Project without depleting the underlying aquifer or lowering the local groundwater table. Therefore, Project construction would not deplete groundwater supplies, and impacts would be less than significant.

Project construction would not substantially prevent or inhibit incidental groundwater recharge on-site during precipitation events. As the Project is constructed, portions of the site would remain pervious and would allow infiltration that presently occurs during precipitation events to continue to occur. Therefore, Project construction would not substantially deplete area groundwater supplies or interfere substantially with groundwater recharge, and impacts would be less than significant.

Operation

The proposed Project consists of 457 dwelling units, and the average household size in Hanford is 3.0 (U.S. Census Bureau, 2022); therefore, the Project will house approximately 1,371 people. According to the City's 2015 Urban Water Management Plan (UWMP), the actual water used in 2015 was 219 gallons per capita per day (gpcd) (City of Hanford, 2015); therefore, the proposed Project would result in estimated water demand of 63,304.14 gallons per day (1,371 people x 219 gallons/day = 300,249 gallons/day) or 336.3 acre-feet per year.

The Project will follow requirements as applicable in the City of Hanford and Kings County Groundwater Sustainability Plan (Greater Kaweah Groundwater Sustainability Agency, 2020). Given that the water needed for the Project's construction and operations are nominal, the Project's construction and operations would not substantially deplete groundwater supplies or conflict with any future adopted groundwater management plan.

Since the Project is consistent with the General Plan designation, the Project's water usage has been accounted for in the EIR for the most current General Plan Update. This Project's groundwater usage would not change the baseline condition of groundwater water supplies in the basin beyond the baseline condition already analyzed in the current General Plan EIR.

Therefore, the Project's construction and operations would not substantially deplete groundwater supplies or interfere significantly with groundwater recharge such that there would be a net deficit in aquifer volume or a lowering of the local groundwater table level. Impacts would be less than significant, and no further analysis in the EIR is warranted.

Impact #3.4.10c(i) – Would the Project substantially alter the existing drainage pattern of the site or area, including through the alteration of the course of a stream or river or through the addition of impervious surfaces, in a manner that would result in substantial erosion or siltation on- or off-site?

The Project site is relatively flat, and grading would be minimal. The topography of the site would not appreciably change because of grading activities. The site does not contain any blue-line water features, including streams or rivers. The Project has a proposed stormwater retention basin that will collect and maintain stormwater runoff on the site, allowing for percolation of the captured water back into the underlying aquifer.

However, the Project would develop areas of impervious surfaces that would reduce the rate of percolation at the site, but areas of open space would allow for the percolation of stormwater to recharge the aquifer. Water would also be directed into the City's existing stormwater sewer system. The Project would comply with applicable City development standards and codes. Therefore, the Project would have a less-than-significant impact on drainage patterns or cause substantial erosion or siltation on or off the site.

As discussed in Impact #3.4.10a above, potential impacts on water quality from erosion and sedimentation are expected to be localized and temporary during construction. Construction-related erosion and sedimentation impacts due to soil disturbance would be less than significant after implementing the SWPPP and BMPs required by the NPDES. No drainages or other water bodies are present on the Project site, and therefore, the proposed Project would not change the course of any such drainages.

The existing drainage pattern of the site and area would be affected by Project development because of the increase in impervious surfaces at the site. The Project design includes natural features such as landscaping and vegetation that would allow for the percolation of stormwater. However, there will be an addition in impervious surfaces that could increase the potential for stormwater runoff and soil erosion. The Project would connect to existing City stormwater sewer infrastructure. The Project will comply with all applicable local building codes and regulations to minimize impacts during construction and post-construction, and impacts related to erosion or siltation on- or off-site are less than significant. No further analysis in the EIR is warranted.

Impact #3.4.10c(ii) – Would the Project substantially alter the existing drainage pattern of the site or area, including through the alteration of the course of a stream or river or through the addition of impervious surfaces, in a manner that would substantially increase the rate or amount of surface runoff in a manner which would result in flooding on- or off-site?

See also Impact #3.4.10c(i) above.

The Project site is flat, and no drainages or other water bodies are present. Therefore, the development of the site would not change the course of any such drainages that may potentially result in on- or off-site flooding. Water would be used during the temporary construction phase of the Project (e.g., for dust suppression). However, any water used for dust control would be mechanically and precisely applied and generally infiltrate or evaporate before running off.

With the construction of the Project, runoff patterns and concentrations could be altered by grading activities associated with the Project. Improper design of the access road or building pads could alter drainage patterns that would cause flooding on- or off-site. The potential for the construction of the proposed Project to alter existing drainage patterns would be minimized through compliance with the preparation of an SWPPP and compliance with City development standards and codes. With the implementation of such measures, the Project would not substantially increase the amount of runoff to result in flooding on- or off-site. Impacts would be reduced to less-than-significant levels.

Additionally, with the approval of grading plans and site development requirements by the City Building Division that incorporates BMPs and design standards, the new development operations would not substantially increase the rate or amount of surface runoff in a manner that would result in flooding on- or off-site. Impacts would be less than significant, and no further analysis in the EIR is warranted.

Impact #3.4.10c(iii) – Would the Project substantially alter the existing drainage pattern of the site or area, including through the alteration of the course of a stream or river or through the addition of impervious surfaces, in a manner that would create or contribute runoff water which would exceed the capacity of existing or planned stormwater drainage systems or provide substantial additional sources of polluted runoff?

Please see Impact #3.4.10c(i)-(ii) above.

Water would be used during the temporary construction phase of the proposed Project (e.g., for dust suppression). However, any water used for dust control would be mechanically and precisely applied and would generally infiltrate or evaporate prior to running off.

The Project would comply with all applicable State and City codes and regulations. The Project will construct a stormwater retention basin on-site to capture stormwater, and engineering calculations will support the storm drainage plan to ensure that the Project does not create or contribute runoff water that would exceed the capacity of existing or planned stormwater drainage systems or provide substantial additional sources of polluted runoff. Therefore, the Project would not create or contribute runoff water that would exceed the capacity of existing or planned stormwater drainage systems or provide substantial additional sources of polluted runoff. Impacts would be less than significant, and no further analysis in the EIR is warranted.

Impact #3.4.10c(iv) – Would the Project substantially alter the existing drainage pattern of the site or area, including through the alteration of the course of a stream or river or through

the addition of impervious surfaces, in a manner which would impede or redirect flood flows?

Please see response #3.4.10a through c(iii) above.

The Project would comply with all applicable State and City codes and regulations. The Project will construct a stormwater retention basin on-site to capture stormwater. Engineering calculations will support the storm drainage plan to ensure that the Project does not create or contribute runoff water that would exceed the capacity of existing or planned stormwater drainage systems or provide substantial additional sources of polluted runoff. Therefore, the Project would not create or contribute runoff water that would exceed the capacity of existing or planned stormwater drainage systems or provide substantial additional sources of polluted runoff.

The Project site is within an area of minimal flood hazard. There are no development restrictions associated since these are areas determined to be outside the 0.2 percent annual chance floodplain. Impacts would be less than significant, and no further analysis in the EIR is warranted.

Impact #3.4.10d – Would the Project in flood hazard, tsunami, or seiche zones, risk release of pollutants due to Project inundation?

The Project site is not located near the ocean or a steep topographic feature (i.e., mountain, hill, bluff, etc.), nor is it located by the ocean or lake large enough to be inundated by tsunami or seiches. The Project area is flat and does not contain slopes steep enough to cause a mudflow, avalanche, or significant ground-related risks. The Project site is not located within the 100-year floodplain, and there do not appear to be any significant levees that could potentially affect people or structures if they were to fail.

There is no potential for the inundation of the Project site by seiche. Therefore, the Project would not contribute to inundation by seiche, tsunami, or mudflow. There would be no impact from the Project, and no further analysis in the EIR is warranted.

Impact #3.4.10e – Would the Project conflict with or obstruct implementation of a water quality control plan or sustainable groundwater management plan?

See response #3.4.10b above.

The water demand from this Project would not result in a significant impact due to depleted groundwater resources or interference with groundwater recharge. Per the City's 2015 UWMP, the City's existing system has a total supply capacity of 32 million gallons per day with an average daily demand of 30.2 million gallons (City of Hanford, 2015). Therefore, impacts would be less than significant, and no further analysis in the EIR is warranted.

	Potentially Significant Impact	Less than Significant with Mitigation Incorporated	Less-than-Significant Impact	No Impact
--	--------------------------------	--	------------------------------	-----------

3.4.11 - LAND USE AND PLANNING

Would the Project:

- | | | | | |
|---|--------------------------|--------------------------|--------------------------|-------------------------------------|
| a. Physically divide an established community? | <input type="checkbox"/> | <input type="checkbox"/> | <input type="checkbox"/> | <input checked="" type="checkbox"/> |
| b. Cause a significant environmental impact due to a conflict with any land use plan, policy or regulation adopted for the purpose of avoiding or mitigating an environmental effect? | <input type="checkbox"/> | <input type="checkbox"/> | <input type="checkbox"/> | <input checked="" type="checkbox"/> |

Discussion

Impact #3.4.11a – Would the Project physically divide an established community?

The Project is surrounded by undeveloped property and residential developments. Furthermore, where the Project abuts an existing subdivision’s stub street or un-subdivided land, a stub street intended for connection is proposed to increase connectivity between communities.

The Project would increase an established community within the area and promote orderly land use development by providing the ability to develop the 95 acres, which is a supported goal under the General Plan, and, therefore, would have no impact. The Project proposes connecting to existing roadways, providing future connectivity access, and not dividing an established or future community. Future development would not be built in a pre-existing community area and would not create any physical barrier between an established community. Therefore, the Project would not result in an impact, and no further analysis in the EIR is warranted.

Impact #3.4.11b – Would the Project cause a significant environmental impact due to a conflict with any land use plan, policy, or regulation adopted for the purpose of avoiding or mitigating an environmental effect?

The Project is consistent with the General Plan and has a Low Density Residential land use designation. The Project proposes a gross density of 4.81 per acre, within the allowable density between two and 10 units per acre.

The subdivision TTM 938 is also consistent with the R-L-5 Low Density Residential zoning for the site. All parcels meet the required lot size, frontage, width, and depth of the R-L-5 Low Density Residential zone district. The proposed residential use is allowed within this land

use designation, and the Project does not exceed the maximum density; therefore, the Project is consistent with applicable land use plans and policies. No further analysis in the EIR is warranted.

	Potentially Significant Impact	Less than Significant with Mitigation Incorporated	Less-than-Significant Impact	No Impact
--	--------------------------------	--	------------------------------	-----------

3.4.12 - MINERAL RESOURCES

Would the Project:

- | | | | | |
|--|--------------------------|--------------------------|--------------------------|-------------------------------------|
| a. Result in the loss of availability of a known mineral resource that would be of value to the region and the residents of the state? | <input type="checkbox"/> | <input type="checkbox"/> | <input type="checkbox"/> | <input checked="" type="checkbox"/> |
| b. Result in the loss of availability of a locally important mineral resource recovery site delineated on a local general plan, specific plan, or other land use plan? | <input type="checkbox"/> | <input type="checkbox"/> | <input type="checkbox"/> | <input checked="" type="checkbox"/> |

Discussion

Impact #3.4.12a – Would the Project result in the loss of availability of a known mineral resource that would be of value to the region and the residents of the State?

The California Department of Conservation, Geological Survey classifies lands into Aggregate and Mineral Resource Zones (MRZs) based on guidelines adopted by the California State Mining and Geology Board, as mandated by the Surface Mining and Reclamation Act of 1974. These MRZs identify whether known or inferred significant mineral resources are present in areas. Lead agencies are required to incorporate identified MRZs resource areas delineated by the State into their General Plans. Neither the Project site nor the surrounding area is designated as a Mineral Resources Zone in the City of Hanford General Plan or Zoning Ordinance, nor is it currently being utilized for mineral extraction. The Project site is also not within a California Geologic Energy Management (CalGEM) identified oilfield or gas field.

The Project design does not include mineral extraction. The Project would not result in the loss of availability of a known mineral resource that would be of value to the region and the residents of the State and would therefore have no impact. No further analysis in the EIR is warranted.

Impact #3.4.12b – Would the Project result in the loss of availability of a locally important mineral resource recovery site delineated on a local general plan, specific plan, or other land use plan?

See Impact #3.4.12a above.

No portion of the City or nearby vicinity is designated for mineral resources or zoned for mineral resources (City of Hanford, 2017). Therefore, the Project would not result in the loss of availability of a locally important mineral resources recovery site delineated on a local

general plan, specific plan, or any other land use, and there would be no impact. No further analysis in the EIR is warranted.

	Potentially Significant Impact	Less than Significant with Mitigation Incorporated	Less-than-Significant Impact	No Impact
--	--------------------------------	--	------------------------------	-----------

3.4.13 - NOISE

Would the Project result in:

a. Generation of a substantial temporary or permanent increase in ambient noise levels in the vicinity of the Project in excess of standards established in the local general plan or noise ordinance, or applicable standards of other agencies?	<input type="checkbox"/>	<input type="checkbox"/>	<input checked="" type="checkbox"/>	<input type="checkbox"/>
b. Generation of excessive groundborne vibration or groundborne noise levels?	<input type="checkbox"/>	<input type="checkbox"/>	<input checked="" type="checkbox"/>	<input type="checkbox"/>
c. For a Project located within the vicinity of a private airstrip or an airport land use plan or, where such a plan has not been adopted, within two miles of a public airport or public use airport, would the Project expose people residing or working in the Project area to excessive noise levels?	<input type="checkbox"/>	<input type="checkbox"/>	<input checked="" type="checkbox"/>	<input type="checkbox"/>

Discussion

Impact #3.4.13a – Would the Project result in generation of a substantial temporary or permanent increase in ambient noise levels in the vicinity of the Project in excess of standards established in the local general plan or noise ordinance, or applicable standards of other agencies?

Land uses deemed sensitive receptors include schools, hospitals, rest homes, and long-term care and mental care facilities, which are considered to be more sensitive to ambient noise levels than others. The nearest sensitive land uses include widely spaced residential homes to the south and west.

Stationary noise sources can also influence the population, and unlike mobile, transportation-related noise sources, these sources generally have a more permanent and consistent impact on people. These stationary noise sources involve various industrial uses, commercial operations, agricultural production, school playgrounds, high school football games, HVAC units, generators, lawn maintenance equipment, and swimming pool pumps.

During the Project's construction phase, noise-generating activities will be present; however, it will be temporary, and any machinery used as a part of the construction of the Project will be muffled. Construction activities would be temporary in nature and are

anticipated to occur during normal daytime working hours. Construction is anticipated to take approximately 24 months to complete.

The operation of the facility would not generate noise levels significantly higher than the existing levels in the Project area. This generated noise is not anticipated to exceed thresholds consistent with the City's General Plan Noise Element or Municipal Code. Short-term noise-related impacts would be temporary and require compliance with applicable regulations and policies of the General Plan to ensure further that construction-related impacts would be handled to the greatest extent feasible.

There are no specific construction noise thresholds established by the City other than the noise-generating construction activities that are only allowed to occur between the hours of 7:00 a.m. and 8:00 p.m. However, the proposed Project's construction would be temporary and would occur between 7:00 a.m. to 8:00 p.m., five days a week for approximately 24 months (City of Hanford, 2022). No demolition or pile-driving will occur during the construction phase of the Project.

Once constructed, the Project would not significantly increase traffic on local roadways. Residential activities could also increase ambient noise levels in the immediate Project vicinity. Activities that could be expected to generate noise include cars entering and exiting the development and mechanical systems related to heating, ventilation, and air conditioning systems located on residential buildings. However, this noise would be similar to those generated by the nearby existing residential development and would not be of a level that exceeds thresholds. Therefore, these increases in ambient noise are considered less than significant and consistent with applicable standards. No further analysis in the EIR is warranted.

Impact #3.4.13b – Would the Project result in generation of excessive groundborne vibration or groundborne noise levels?

The proposed Project is expected to create temporary groundborne vibration as a result of the construction activities (during site preparation and grading). According to the U.S. Department of Transportation, Federal Railroad Administration, vibration is sound radiated through the ground. The rumbling sound caused by the vibration is called groundborne noise. The ground motion caused by vibration is measured as particle velocity in inches per second and is referenced as vibration decibels (VdB). The background vibration velocity level in residential areas is usually around 50 VdB. A list of typical vibration-generating equipment is shown in Table 3.4.13-1. However, the Project does not propose to use this specific equipment. The table is meant to illustrate typical vibration levels for various pieces of equipment.

The vibration velocity level threshold of perception for humans is approximately 65 VdB. A vibration velocity level of 75 VdB is the approximate dividing line between barely perceptible and distinctly perceptible levels for many people.

**Table 3.4.13-1
Different Levels of Groundborne Vibration**

Vibration Velocity Level	Equipment Type
94 VdB	Vibratory roller
87 VdB	Large bulldozer
87 VdB	Caisson drilling
86 VdB	Loaded trucks
79 VdB	Jackhammer
58 VdB	Small bulldozer

Source: (Federal Transit Administration, 2006) Note: 25 feet from the corresponding equipment.

The Federal Transit Administration (FTA) has published standard vibration velocities for construction equipment operations (Federal Highway Administration (FHWA), U.S. Department of Transportation, 2017). In general, the FTA architectural damage criterion for continuous vibrations (i.e., 0.2 inch/second) appears to be conservative even for sustained pile driving. Building damage can be cosmetic or structural. Ordinary buildings that are not particularly fragile would not experience any cosmetic damage (e.g., plaster cracks) at distances beyond 30 feet. This distance can vary substantially depending on the soil composition and underground geological layer between vibration source and receiver. In addition, not all buildings respond similarly to vibration generated by construction equipment. The typical vibration produced by construction equipment is illustrated in Table 3.4.13-2.

**Table 3.4.13-2
Typical Vibration Levels for Construction Equipment**

Equipment	Reference peak particle velocity at 25 feet (inches/second)¹	Approximate peak particle velocity at 100 feet (inches/second)²
Large Bulldozer	0.089	0.011
Loaded Trucks	0.076	0.010
Small Bulldozer	0.003	0.000
Auger/drill Rigs	0.089	0.011
Jackhammer	0.035	0.004
Vibratory Hammer	0.070	0.009
Vibratory Compactor/roller	0.210	0.026

Notes:

1 - Federal Transit Administration, Transit Noise and Vibration Impact Assessment Guidelines, May 2006. Table 12-2.

2 - Calculated using the following formula: $PPV_{equip} = PPV_{ref} \times (25/D)^{1.5}$

where: $PPV_{(equip)}$ = the peak particle velocity in/sec of the equipment adjusted for the distance $PPV_{(ref)}$ = the reference vibration level in/sec from Table 12-2 of the FTA Transit Noise and Vibration Impact Assessment Guidelines
 D = the distance from the equipment to the receiver

With regard to the proposed Project, groundborne vibration would be generated during site clearing and grading activities on-site facilitated by the implementation of the proposed Project. As indicated in Table 3.4.13-2, based on the FTA data, vibration velocities from typical heavy construction equipment that would be used during Project construction range from 0.076 to 0.210 inch-per-second peak particle velocity (PPV) at 25 feet from the source of activity. As demonstrated in Table 3.4.13-2, vibration levels at 100 feet would range from 0.010 to 0.026 PPV. Therefore, the anticipated vibration levels would not exceed the 0.2 inch-per-second PPV significance threshold during construction operations at the nearest receptors, approximately 100 feet to the east and south.

Typical outdoor sources of perceptible groundborne vibration are construction equipment and traffic on rough roads. For example, if a roadway is smooth, the groundborne vibration from traffic is barely perceptible.

Typically, groundborne vibration generated by construction activity attenuates rapidly with distance from the source of the vibration. Therefore, vibration issues are generally confined to distances of less than 500 feet (U.S. Department of Transportation, 2005). Potential sources of temporary vibration during construction of the proposed Project would be minimal and would include transportation of equipment to the site.

Construction activity would include various site preparation, grading, fabrication, and site cleanup work. Construction would not involve the use of equipment that would cause high groundborne vibration levels, such as pile-driving or blasting. Once constructed, the proposed Project would not have any components that would generate high vibration levels. Thus, the construction and operation of the proposed Project would not result in any vibration, and impacts would be less than significant, and no further analysis in the EIR is warranted.

Impact #3.4.13c – Would the Project result in for a Project located within the vicinity of a private airstrip or an airport land use plan or, where such a plan has not been adopted, within two miles of a public airport or public use airport, would the Project expose people residing or working in the Project area to excessive noise levels?

The Project site is approximately one mile west of the Hanford Municipal Airport. The site is partially located within any Compatibility Zone boundary identified for the Airport in the Kings County ALUCP (Kings County, 1994). The noise levels associated with the airport operations do not contribute significantly to the overall noise environment at the Project site as the Project is not within the noise contour impact map (City of Hanford, 2010). Therefore, the Project would not expose people residing or working in the Project area to excessive noise levels, and there would be no impact. No further analysis in the EIR is warranted.

	Potentially Significant Impact	Less than Significant with Mitigation Incorporated	Less-than Significant Impact	No Impact
--	--------------------------------	--	------------------------------	-----------

3.4.14 - POPULATION AND HOUSING

Would the Project:

- | | | | | |
|---|--------------------------|--------------------------|-------------------------------------|-------------------------------------|
| a. Induce substantial population unplanned growth in an area, either directly (for example, by proposing new homes and businesses) or indirectly (for example, through extension of roads or other infrastructure)? | <input type="checkbox"/> | <input type="checkbox"/> | <input checked="" type="checkbox"/> | <input type="checkbox"/> |
| b. Displace substantial numbers of existing people or housing, necessitating the construction of replacement housing elsewhere? | <input type="checkbox"/> | <input type="checkbox"/> | <input type="checkbox"/> | <input checked="" type="checkbox"/> |

Discussion

Impact #3.4.14a – Would the Project induce substantial population unplanned growth in an area, either directly (for example, by proposing new homes and businesses) or indirectly (for example, through extension of roads or other infrastructure)?

According to the 2019 U.S. Department of Finance population estimates, the population in Hanford is 57,990 people (United States Census Bureau, 2020). The City is expected to increase its population by 32,010 residents in the next 20 years. The City’s General Plan goals include encouraging residential developments to meet the future population growth needs. The Project proposed 457 new housing units, and the average number of persons per household is 3.0. Therefore, the Project will house approximately 1,371 people and would be within the range of projected growth within the City. Regional Housing Needs Allocation (RHNA) from the California Department of Housing and Community Development specifies the number of units, by affordability level, that needs to be accommodated.

**Table 3.4.14-1
Regional Housing Needs 2014-2024 (Hanford)**

Housing Type	Federal Standards
Extremely Low	549
Very Low	548
Low	821
Low Moderate	865
Above Moderate	2,049
Total	4,832

Source: (City of Hanford, 2022)

The Project directly induces population growth in an area by proposing new residential development. However, the population of the City is expected to grow by more than 50 percent over the next 20 years, furthering the need for additional dwelling units. The RHNA states that the City of Hanford will need to provide an additional 15,695 dwelling units by 2035. The proposed Project will provide an estimated additional 457 single-family units. The Project is also consistent with the density allowed in the General Plan planned for population growth. The Project will help the City of Hanford work toward attaining a sufficient housing supply for its residents. Therefore, impacts will be less than significant, and no further analysis in the EIR is warranted.

Impact #3.4.14b – Would the Project displace substantial numbers of existing people or housing, necessitating the construction of replacement housing elsewhere?

See Impact#3.4.14a above.

The Project site is undeveloped and does not necessitate the demolition of any existing houses. Construction of the Project is anticipated to last 24 months and would likely be completed by construction workers residing in the City or the surrounding area; they would not require new housing. Therefore, the Project will not displace existing people or housing, necessitating housing replacement elsewhere. The Project would have no impact, and no further analysis in the EIR is warranted.

	Potentially Significant Impact	Less than Significant with Mitigation Incorporated	Less-than-Significant Impact	No Impact
--	--------------------------------	--	------------------------------	-----------

3.4.15 - PUBLIC SERVICES

Would the Project:

a. Result in substantial adverse physical impacts associated with the provision of new or physically altered governmental facilities, need for new or physically altered governmental facilities, the construction of which could cause significant environmental impacts, in order to maintain acceptable service ratios, response times, or to other performance objectives for any of the public services:

i. Fire protection?	<input type="checkbox"/>	<input type="checkbox"/>	<input checked="" type="checkbox"/>	<input type="checkbox"/>
ii. Police protection?	<input type="checkbox"/>	<input type="checkbox"/>	<input checked="" type="checkbox"/>	<input type="checkbox"/>
iii. Schools?	<input type="checkbox"/>	<input type="checkbox"/>	<input checked="" type="checkbox"/>	<input type="checkbox"/>
iv. Parks?	<input type="checkbox"/>	<input type="checkbox"/>	<input checked="" type="checkbox"/>	<input type="checkbox"/>
v. Other public facilities?	<input type="checkbox"/>	<input type="checkbox"/>	<input checked="" type="checkbox"/>	<input type="checkbox"/>

Discussion

Impact #3.4.15a(i) – Would the Project result in substantial adverse physical impacts associated with the provision of new or physically altered governmental facilities, need for new or physically altered governmental facilities, the construction of which could cause significant environmental impacts, in order to maintain acceptable service ratios, response times, or to other performance objectives for any of the public services - Fire Protection?

The City of Hanford Fire Department Station #2 is located approximately 0.25 miles south of the Project site.

Prior to the recordation of the proposed TTM 938, the developer will be required to pay development impact fees. A portion of those funds will be specifically earmarked for the use of the Fire Department to maintain an adequate level of service within its service boundary. The entire Project, whether submitted in phases or not, will be subject to review by the City of Hanford Engineering, Public Works, and Fire Department in order to determine whether the Project’s infrastructure design is in compliance with City policies for development. The Project’s water system will be reviewed to verify that the system can supply the required fire

flow for fire protection purposes. The establishment of gallons-per-minute requirements for fire flow shall be based on the review of the City of Hanford Fire Department.

Development of the Project will increase the need for fire protection services and expand the service area and response times of the local City Fire Department. As previously mentioned, the Project will be required to adhere to any conditions/policies pertaining to the construction of infrastructure needed for the Hanford Fire Department to provide an adequate level of fire protection service.

According to the General Plan and the standard review procedures for development projects within the City of Hanford, the Project's plans and permits will be reviewed for input from the Fire Department. The Project's proposed construction would be located adjacent to existing residential areas, which the City Fire Department already serves. The developer will be required to pay development impact fees to offset growth in population in the area that would impact fire protection. Impacts would be less than significant, and no further analysis in the EIR is warranted.

Impact #3.4.15a(ii) – Would the Project result in substantial adverse physical impacts associated with the provision of new or physically altered governmental facilities, need for new or physically altered governmental facilities, the construction of which could cause significant environmental impacts, in order to maintain acceptable service ratios, response times, or to other performance objectives for any of the public services – Police Protection?

The Hanford Police Department (VPD) provides police protection in the City of Hanford and collaborates with other law enforcement agencies and the District Attorney's office on crime prevention. The City has approximately 143 sworn officers that are working out of two districts. The Project site is located approximately 1.4 miles south of the City of Hanford Police Station. The Project proposes development in an area adjacent to residential development and undeveloped agricultural land. The Project proposes additional residential development in a previously undeveloped location, which will increase the need for police services. However, the Project will pay appropriate development fees based on the adopted fee calculations and is responsible for constructing any infrastructure needed to serve the Project. Impacts would be less than significant, and no further analysis in the EIR is warranted.

Impact #3.4.15a(iii) – Would the Project result in substantial adverse physical impacts associated with the provision of new or physically altered governmental facilities, need for new or physically altered governmental facilities, the construction of which could cause significant environmental impacts, in order to maintain acceptable service ratios, response times, or to other performance objectives for any of the public services – Schools?

There are six elementary school districts and one high school district within the City of Hanford. The Martin Luther King Jr. Elementary School is approximately 0.5 miles southwest of the Project site; Roosevelt Elementary School is approximately 1 mile northwest, and Hanford West High School is approximately 1.7 miles northwest.

The increased population generated by the proposed Project would increase the number of students attending local schools and could significantly impact these facilities by requiring new facilities. The proposed Project would require the payment of developer fees for each new residential construction to offset the District's student classroom capacity. The developer will pay appropriate impact fees at the time of building permits. According to Government Code Section 65996, the development fees authorized by SB 50 are deemed "full and complete school facilities mitigation." School districts would utilize the General Plan and codes to establish new school sites and make decisions on school amenities and facility size. The development will be subject to school impact fees to mitigate any increased impacts on school facilities. The Project will result in a less-than-significant impact, and no further analysis in the EIR is warranted.

Impact #3.4.15a(iv) – Would the Project result in substantial adverse physical impacts associated with the provision of new or physically altered governmental facilities, need for new or physically altered governmental facilities, the construction of which could cause significant environmental impacts, in order to maintain acceptable service ratios, response times, or to other performance objectives for any of the public services – Parks?

The Project is within the boundaries of the Hanford Parks and Recreation District. The proposed Project includes uses that would increase the use of park and recreation facilities in the area. The City presently owns and maintains 24 parks.

A parks facilities development impact fee is established on the issuance of all residential building permits for development in the Hanford city area to pay for parks and recreational facilities improvements. Each developer will pay this development fee prior to issuance of a building permit or dedicate parkland as a part of their proposed project. The Project is proposing a centralized 5.8-acre public park to offset park impacts. The final determination will be made by the City of Hanford. With the proposed 5.8-acre public park being proposed to offset park impacts, the Project will result in a less-than-significant impact, and no further analysis in the EIR is warranted.

Impact #3.4.15a(v) – Would the Project result in substantial adverse physical impacts associated with the provision of new or physically altered governmental facilities, need for new or physically altered governmental facilities, the construction of which could cause significant environmental impacts, in order to maintain acceptable service ratios, response times, or to other performance objectives for any of the public services – Other Public Facilities?

The City provides a wide range of public services to the public besides those services previously mentioned above. The City also provides animal control services, refuse pick-up, library facilities, and drainage management. These services are generally funded through the general fund, usage fees, fines, penalties, or impact fee collection.

In the City of Hanford, all jurisdictions collect planning and building fees and impact fees for new development, as necessary. Since the demand for other public facilities is driven by population, the proposed Project would be required to pay fees to offset the demand for that

service. Therefore, the Project would have a less-than-significant impact, and no further analysis in the EIR is warranted.

	Potentially Significant Impact	Less than Significant with Mitigation Incorporated	Less-than-Significant Impact	No Impact
--	--------------------------------	--	------------------------------	-----------

3.4.16 - RECREATION

Would the Project:

a. Increase the use of existing neighborhood and regional parks or other recreational facilities such that substantial physical deterioration of the facility would occur or be accelerated?	<input type="checkbox"/>	<input type="checkbox"/>	<input checked="" type="checkbox"/>	<input type="checkbox"/>
b. Include recreational facilities or require the construction or expansion of recreational facilities that might have an adverse physical effect on the environment?	<input type="checkbox"/>	<input type="checkbox"/>	<input type="checkbox"/>	<input checked="" type="checkbox"/>

Discussion

Impact #3.4.16a – Would the Project increase the use of existing neighborhood and regional parks or other recreational facilities such that substantial physical deterioration of the facility would occur or be accelerated?

See Impact #3.4.15a(ii) above.

The City’s inventory of parks and recreation facilities ranges from a rose garden to softball and baseball fields to community centers. Park facilities are classified into nine categories: private recreational space, mine-park or pocket park, neighborhood parks, community parks, special use parks, dual-purpose stormwater basin park, indoor recreational facilities, school parks, and regional parks. Recreational facilities span from picnic shelters to sports fields. Hanford maintains 229.17 acres of park and grounds, including inspection of Landscape Assessment Districts and right of way and median landscaped acreage. Additionally, several elementary schools within Hanford provide public open space during non-school hours. The Project proposes to include the construction of a 5.8-acre park for use by the residents of the subdivision.

With the addition of the new 5.8-acre park, the Project would not require the construction of additional recreational facilities due to the existing ratio of at least 5.06 acres per 1,000 residents, where the City of Hanford 2035 General Plan, Goal 9 states that parks be provided at a combined ratio of 3.5 acres per 1,000 residents. Several City parks are nearby the Project, including Centennial and Home Garden Community Park. The Project is not expected to require the construction or expansion of additional City recreational facilities. However, the City of Hanford requires that the Project developer pay park impact fees for parkland,

community centers, recreational facilities, park amenities, vehicle equipment, and impact fee studies to offset any potential impacts from new development.

Although the proposed Project would increase the use of park and recreation facilities in the area, it will not result in the physical deterioration of existing parks or recreational facilities. There would be a less-than-significant impact with the payment of the impact fees and the construction of the 5.8-acre subdivision park. No further analysis in the EIR is warranted.

Impact #3.4.16b – Would the Project include recreational facilities or require the construction or expansion of recreational facilities that might have an adverse physical effect on the environment?

See Impact #3.4.16a.

The Project proposes to construct and dedicate a 5.8-acre park to be utilized by the immediate community and public. The Project does not propose the construction or expansion of any recreational facilities. There will be no impact, and no further analysis in the EIR is warranted.

	Potentially Significant Impact	Less than Significant with Mitigation Incorporated	Less-than-Significant Impact	No Impact
--	--------------------------------	--	------------------------------	-----------

3.4.17 - TRANSPORTATION AND TRAFFIC

Would the Project:

- | | | | | |
|--|-------------------------------------|--------------------------|-------------------------------------|--------------------------|
| a. Conflict with a program plan, ordinance or policy addressing the circulation system, including transit, roadway, bicycle and pedestrian facilities? | <input checked="" type="checkbox"/> | <input type="checkbox"/> | <input type="checkbox"/> | <input type="checkbox"/> |
| b. Conflict or be inconsistent with CEQA Guidelines Section 15064.3, Subdivision (b)? | <input checked="" type="checkbox"/> | <input type="checkbox"/> | <input type="checkbox"/> | <input type="checkbox"/> |
| c. Substantially increase hazards due to a geometric design feature (e.g., sharp curves or dangerous intersections) or incompatible uses (e.g., farm equipment)? | <input type="checkbox"/> | <input type="checkbox"/> | <input checked="" type="checkbox"/> | <input type="checkbox"/> |
| d. Result in inadequate emergency access? | <input type="checkbox"/> | <input type="checkbox"/> | <input checked="" type="checkbox"/> | <input type="checkbox"/> |

Impact #3.4.17a – Would the Project conflict with a program plan, ordinance or policy addressing the circulation system, including transit, roadway, bicycle and pedestrian facilities?

The subject Project site is located along Avenue 10 1/2 between Hanford Armona Road and Houston Avenue. The Project could potentially significantly impact the local circulation system and level of service at nearby intersections. A Traffic Impact Analysis will be prepared, and impacts to the circulation system will be analyzed within the EIR.

Impact #3.4.17b – Would the Project conflict or be inconsistent with CEQA Guidelines Section 15064.3, Subdivision (b)?

CEQA Guidelines Section 15064.3 subdivision (b) was adopted in December 2018 by the California Natural Resources Agency. These revisions to the CEQA Guidelines criteria for determining the significance of transportation impacts shift the focus from driver delay to a reduction of vehicular greenhouse gas emissions through the creation of multimodal vehicle trips. Vehicle miles traveled (VMT) is a measure of the total number of miles driven for various purposes and is sometimes expressed as an average per trip or per person.

In the case of this Project, the anticipated VMT impacts could potentially exceed established significance thresholds. As such, an in-depth VMT analysis is required and will be further analyzed in the EIR.

Impact #3.4.17c – Would the Project substantially increase hazards due to a geometric design feature (e.g., sharp curves or dangerous intersections) or incompatible uses (e.g., farm equipment)?

The Project will be designed to meet current standards and safety regulations. All intersections will be constructed to comply with the City and Caltrans regulations and design and safety standards of Chapter 33 of the California Building Code (CBC) and the guidelines of Title 24 to create safe and accessible roadways.

Vehicles exiting the subdivision will be provided with a clear view of the roadway without obstructions. Landscaping associated with the entry driveways could impede such views if improperly installed. Specific circulation patterns and roadway designs will incorporate all applicable safety measures to ensure that hazardous design features or inadequate emergency access to the site or other areas surrounding the Project area would not occur.

Therefore, the Project will have a less-than-significant impact with the incorporated design features and all applicable rules and regulations. No further analysis in the EIR is warranted.

Impact #3.4.17d – Would the Project result in inadequate emergency access?

See the discussion in Impact #3.4.9f

State and City fire codes establish standards by which emergency access may be determined. The proposed Project would have to provide adequate unobstructed space for fire trucks to turn around. The proposed Project site would have adequate internal circulation capacity, including entrance and exit routes to provide adequate unobstructed space for fire trucks and other emergency vehicles to gain access and to turn around. The proposed Project would not inhibit the ability of local roadways to continue to accommodate emergency response and evacuation activities. Therefore, the Project would result in a less-than-significant impact associated with emergency access. No further analysis in the EIR is warranted.

Potentially Significant Impact	Less than Significant with Mitigation Incorporated	Less-than-Significant Impact	No Impact
--------------------------------	--	------------------------------	-----------

3.4.18 - TRIBAL CULTURAL RESOURCES

Would the Project:

a. Would the Project cause a substantial adverse change in the significance of a tribal cultural resource, defined in Public Resources Code Section 21074 as either a site, feature, place, cultural landscape that is geographically defined in terms of the size and scope of the landscape, sacred place, or object with cultural value to a California Native American tribe, and that is:

i. Listed or eligible for listing in the California Register of Historical Resources, or in a local register of historical resources as defined in Public Resources Code Section 5020.1(k), or	<input type="checkbox"/>	<input type="checkbox"/>	<input checked="" type="checkbox"/>	<input type="checkbox"/>
ii. A resource determined by the Lead Agency, in its discretion and supported by substantial evidence, to be significant pursuant to criteria set forth in subdivision (c) of Public Resources Code Section 5024.1. In applying the criteria set forth in subdivision (c) of Public Resource Code Section 5024.1, the Lead Agency shall consider the significance of the resource to a California Native American tribe.	<input type="checkbox"/>	<input type="checkbox"/>	<input checked="" type="checkbox"/>	<input type="checkbox"/>

Discussion

Impact #3.4.18a(i) – Would the Project cause a substantial adverse change in the significance of a tribal cultural resource, defined in Public Resources Code Section 21074 as either a site, feature, place, cultural landscape that is geographically defined in terms of the size and scope of the landscape, sacred place, or object with cultural value to a California Native American tribe, and that is listed or eligible for listing in the California Register of Historical Resources, or in a local register of historical resources as defined in Public Resources Code Section 5020.1(k)?

See also *Section 3.4.5 - Cultural Resources*.

Native American Tribal Consultation was completed for the Project in compliance with Assembly Bill 52 (AB 52), CEQA, and the Public Resources Code.

A Sacred Land Files search was requested from the Native American Heritage Commission (NAHC) to identify previously recorded sacred sites or cultural resources of special importance to tribes and provide contact information for local Native American representatives who may have information about the Project area. A response was received on June 20, 2022, indicating negative results that did not indicate the presence of any cultural places within the Project site and within a half-mile buffer around the Project site. The City of Hanford, as Lead Agency, sent consultation request letters pursuant AB 52 to the tribal groups on the NAHC list.

The Lead Agency has not received information from a local tribal group indicating that the Project would impact tribal cultural resources.

Although there is no obvious evidence of historical or archaeological resources on the Project site, there is the potential during construction for the discovery of cultural resources. Grading, trenching, and other ground-disturbing actions can damage or destroy these previously unidentified and potentially significant cultural resources within the Project area, including historical resources.

The General Plan EIR determined that new development could affect known and previously unknown archaeological resources. The EIR also included policies that specifically address sensitive archaeological resources and their protection, which includes:

- Policy 045—Consult with appropriate Native American associations about potential archaeological sites in the beginning stages of the development review process.
- Policy 046—Require archaeological studies by a certified archeologist in areas of archeological potential significance prior to approval of development projects.
- Policy 047—Consult with the California Archaeological Inventory Southern San Joaquin Valley at California State University, Bakersfield about potential cultural sites on projects that could have an impact on cultural resources.
- Policy 048—Halt construction at a development site if cultural resources are encountered.

An inventory was conducted for the General Plan Update and this site was not listed as having a potential cultural resource. Consultation was conducted with the Santa Rosa Tachi Yokut Tribe for this project, a response was not received. Compliance with General Plan Policy 048, set forth above is required as a condition of approval of TTM 938 and these measures will be added to all engineered plans and specs that would outline the necessary steps to be taken. The condition of approval will require the project proponent to adhere to the policies set forth in the Hanford General Plan pertaining to preservation of Cultural Resources, including Policy 048.

Due to the prior meeting with the Tachi Yokut Tribe on January 10, 2017, the lead agency is requiring as a Condition of Approval that a Burial Treatment Plan be entered into by the applicant/developer prior to any earth disturbing activities. This condition was requested by the Tachi Yokut Tribe for all projects requiring an initial study

These measures will be added to all engineered plans and specs that outline the necessary steps to be taken prior to the start of construction in the unlikely event construction of the Project inadvertently uncovers previously unknown tribal cultural resources. These measures require all work in the immediate vicinity of the discovery of cultural resources find would halt until a qualified archaeologist can evaluate the find and make recommendations. In addition, prior to any ground disturbance, if the City of Hanford receives a request from a Native American tribal group, a surface inspection of the site will be conducted by a tribal monitor, and the tribe will have the opportunity to provide a Native American Monitor during ground-disturbing activities, dependent upon the availability and interest of the tribe.

With the implementation of these measures, impacts are considered to be less than significant, and no further analysis in the EIR is warranted.

Impact #3.4.18a(ii) – Would the Project cause a substantial adverse change in the significance of a tribal cultural resource, defined in Public Resources Code Section 21074 as either a site, feature, place, cultural landscape that is geographically defined in terms of the size and scope of the landscape, sacred place, or object with cultural value to a California Native American tribe, and that is a resource determined by the Lead Agency, in its discretion and supported by substantial evidence, to be significant pursuant to criteria set forth in subdivision (c) of Public Resources Code Section 5024.1. In applying the criteria set forth in subdivision (c) of Public Resource Code Section 5024.1, the Lead Agency shall consider the significance of the resource to a California Native American tribe?

See discussion in *Section 3.4.5 - Cultural Resources* and Impact #3.14.18(i) above.

With the implementation of these measures, the Project would not cause a substantial adverse change in the significance of a tribal cultural resource that is a resource determined by the Lead Agency, in its discretion and supported by substantial evidence, to be significant pursuant to criteria set forth in subdivision (c) of Public Resources Code Section 5024.1. The Project would result in a less-than-significant impact, and no further analysis in the EIR is warranted.

	Potentially Significant Impact	Less than Significant with Mitigation Incorporated	Less-than-Significant Impact	No Impact
--	--------------------------------	--	------------------------------	-----------

3.4.19 - UTILITIES AND SERVICE SYSTEMS

Would the Project:

a. Require or result in the relocation or construction of new or expanded water, wastewater treatment or stormwater drainage, electric power, natural gas, or telecommunications facilities, the construction or relocation of which would cause significant environmental effects?	<input type="checkbox"/>	<input type="checkbox"/>	<input checked="" type="checkbox"/>	<input type="checkbox"/>
b. Have sufficient water supplies available to serve the Project and reasonably foreseeable future development during normal, dry, and multiple dry years?	<input type="checkbox"/>	<input type="checkbox"/>	<input checked="" type="checkbox"/>	<input type="checkbox"/>
c. Result in a determination by the wastewater treatment provider that serves or may serve the Project that it has adequate capacity to serve the Project's projected demand in addition to the provider's existing commitments?	<input type="checkbox"/>	<input type="checkbox"/>	<input checked="" type="checkbox"/>	<input type="checkbox"/>
d. Generate solid waste in excess of State or local standards, or in excess of the capacity of local infrastructure, or otherwise impair the attainment of solid waste reduction goals?	<input type="checkbox"/>	<input type="checkbox"/>	<input checked="" type="checkbox"/>	<input type="checkbox"/>
e. Comply with federal, state, and local management and reduction statutes and regulations related to solid waste?	<input type="checkbox"/>	<input type="checkbox"/>	<input checked="" type="checkbox"/>	<input type="checkbox"/>

Discussion

Impact #3.4.19a – Would the Project require or result in the relocation or construction of new or expanded water, wastewater treatment or stormwater drainage, electric power, natural gas, or telecommunications facilities, the construction or relocation of which would cause significant environmental effects?

The proposed Project would be developed on land that has already been designated for residential development in the General Plan. The City has indicated that the infrastructure necessary to serve the Project is available and sufficient.

The proposed Project is located within the planned service area for the City services. The Project proposes to construct new wet and dry utility infrastructure to connect to the existing City and private service provider infrastructure. Services that will be installed during the construction of the Project include water, wastewater, storm drain drainage connections, natural gas, electric power, and telecommunications facilities. The proper sizing and placement of the utilities will be designed per the City and other utility development design standards.

See *Section 3.4.10 - Hydrology and Water Quality* for a discussion of wastewater disposal. The Project will not require the construction of new water or wastewater treatment facilities. The City's Wastewater Treatment Facility is currently up to date with all wastewater treatment requirements set forth by the Central Valley Regional Water Quality Control Board. The City's WWTF would continue to comply with the requirements set forth by the Central Valley Regional Water Quality Control Board, as required by law. Therefore, the proposed Project would have a less-than-significant impact.

The proposed Project would be subject to the payment of any applicable connection charges and/or fees and extension of services in a manner that is compliant with the City's development standards, specifications, and policies. All applicable local, State, and federal requirements and best management practices will be incorporated into the construction and operation of the Project. Therefore, impacts would be considered less than significant, and no further analysis in the EIR is warranted.

Impact #3.4.19b – Would the Project have sufficient water supplies available to serve the Project and reasonably foreseeable future development during normal, dry, and multiple dry years?

As noted in Impact #3.4.10b, the water demand for the proposed Project would result in 300,249 gallons per day (1,371 people x 219 gallons/day = 300,249 gallons/day) or 336.3 acre-feet per year). Water usage for construction is minimal to that required for occupancy of constructed land uses. Even on a short-term basis, such usage does not require the water volumes required for human occupancy of residences and other structures, waste disposal, and year-round landscaping. Water usage for construction dust control, trench and roadway soils compaction, landscaping, and related activities and usage is sporadic rather than long-term. Its quantification for analysis is difficult, but it clearly does not approximate or approach long-term water demand.

Future population growth in the area would create an increase in water usage. Water supply demand was addressed under the Urban Water Management Plan, which concluded that the Tulare Lake Groundwater Subbasin would continue to supply water to meet the City's projected water demands through the year 2035.

It is important to note that the water usage was considered and analyzed in the certified General Plan EIR. Such water usage is approximately the same as that required for Project implementation. The Project will obtain its water from the City of Hanford's municipal water system. The site is within the City of Hanford Water Management Plan service area (City of

Hanford, 2020). The City's groundwater has historically been capable of reliably meeting the City's water demands. It is projected that with the expected population growth when the Project is completed, the supply of water will meet the demand (City of Hanford, 2020). Based on these estimates, the Project's construction and operations would not substantially deplete groundwater supplies or interfere substantially with groundwater recharge such that there would be a net deficit in aquifer volume or a lowering of the local groundwater table level. Impacts would be less than significant, and no further analysis in the EIR is warranted.

Impact #3.4.19c – Would the Project result in a determination by the wastewater treatment provider that serves or may serve the Project that it has adequate capacity to serve the Project's projected demand in addition to the provider's existing commitments?

Under the General Plan Update, it was determined that planned improvements and expansion development through various goals and policies would assist in providing wastewater services to the study area as development continues (City of Hanford, 2017). The current capacity of the WWTF is designed to accommodate 8.0 mgd, which is expected to provide adequate services to population growth for the foreseeable future, as planned in the General Plan.

Hanford's existing wastewater system includes a treatment facility south of Houston Avenue and east of 11th Avenue and 21 sanitary sewer lift stations at various locations throughout the City. The City has plans for pump replacements or upgrades at each of its locations within the next several years. The City's wastewater treatment facility provides for treatment, disposal, and reuse of effluent, which meets all of the State's discharge requirements for Hanford. The City's plant treats nearly 1.75 billion gallons of sewage each year. The facility is a major part of the City's effort to keep the environment clean and to provide a water resource for agricultural irrigation and reuse.

The proposed Project will be reviewed by the Department of Public Works, and any applicable fees will be determined. The payment of the fees would help reduce the impacts of the Project related to wastewater treatment. It is anticipated that an increase of 457 homes would result in a less-than-significant impact, and no further analysis in the EIR is warranted.

Impact #3.4.19d – Would the Project Generate solid waste in excess of State or local standards, or in excess of the capacity of local infrastructure, or otherwise impair the attainment of solid waste reduction goals?

The 1989 California Integrated Waste Management Act (AB 939) requires California counties to attain specific waste diversion goals. In addition, the California Solid Waste Reuse and Recycling Access Act of 1991, as amended, requires expanded or new development projects to incorporate storage areas for recycling bins into the proposed project design. Reusing and recycling construction debris would reduce operating expenses and save valuable landfill space.

When developed, the City of Hanford would provide for solid waste collection and disposal for the proposed Project site. The City has achieved a 50 percent diversion rate from the landfill and has incorporated a green waste program and recycling at the Materials Recycling Facility. Project development is subject to payment of Refuse and Recycling Impact Fee and compliance with all statutes and regulations related to solid waste. Therefore, impacts would be less than significant.

Kings Waste Recycling Authority (KWRA) will remove solid waste produced from construction and operation. The KWRA is a key element that helps the City of Hanford meet the State's recycling goals. Refuse from both municipal and commercial haulers is sorted at the KWRA facility to recover recyclable materials, including wood/green waste processed for compost, ferrous/metallic items, plastic and glass, newspaper, scrap paper, junk mail, magazines, paperboard, and cardboard. The KWRA does not operate an active landfill. Waste is hauled by transfer trucks from the Material Recover Facility (MRF) to the State permitted 320-acre Chemical Waste Management Landfill site in Kettleman Hills, approximately 45 miles west of the MRF. A combined MRF and Transfer Station (TS) was constructed near the old landfill southeast of Hanford. The MRF and TS facility includes a small but complete Household Hazardous Waste collection station. KWRA operates the MFR and TS as an enterprise function, with all revenue coming from solid waste disposal fees and the sale of recovered recyclable materials and compost. Responsibilities of the KWRA include the siting, permitting, financing, construction, and operation of landfills, and an MRF and TS. Additional responsibilities include all activities and waste diversion goals required by the State and the closure, post-closure monitoring, and liabilities of all identified former landfills in Kings County.

Construction

Non-hazardous construction refuse and solid waste would be collected and recycled or disposed of at the KWRA facility (City of Hanford, 2017). Any hazardous waste generated during construction would be disposed of at an approved location.

The Kettleman Hills Landfill has a maximum permit capacity of 18.4 million cubic yards (mcy) and a remaining capacity of 17.4 mcy and is expected to remain operational until at least 2030 (Cal Recycle, 2022).

The solid waste generated by construction activities is not expected to exceed the capacity of the landfill. Additionally, the construction period for the Project is expected to be up to 24 months, and the landfill that would serve the Project will be in operation during the construction period.

Operation

The Project would produce waste that would be collected and disposed of at the local landfill by a licensed waste hauler. Workers would generate small amounts of typical household refuse during maintenance visits. Some refuse will be sent for recycling as a part of the City's recycling efforts.

In compliance with federal, State, and local statutes and regulations related to solid waste, the Project would dispose of all waste generated on-site at an approved solid waste facility. The Project does not conflict with federal, State, or local regulations related to solid waste. The proposed Project would be served by a landfill with the sufficient permitted capacity to accommodate the Project's solid waste disposal needs in compliance with federal, State, and local statutes and regulations related to solid waste. Therefore, the Project would have a less-than-significant impact, and no further analysis in the EIR is warranted.

Impact #3.4.19e – Would the Project comply with federal, state, and local statutes and regulations related to solid waste?

See Impact #3.4.19d.

The Project would result in a less-than-significant impact, and no further analysis in the EIR is warranted.

	Potentially Significant Impact	Less than Significant with Mitigation Incorporated	Less-than-Significant Impact	No Impact
3.4.20 - WILDFIRE				
Would the Project:				
a. Substantially impair an adopted emergency response plan or emergency evacuation plan?	<input type="checkbox"/>	<input type="checkbox"/>	<input checked="" type="checkbox"/>	<input type="checkbox"/>
b. Due to slope, prevailing winds, and other factors, exacerbate wildfire risks, and thereby expose Project occupants to, pollutant concentrations from a wildfire or the uncontrolled spread of a wildfire?	<input type="checkbox"/>	<input type="checkbox"/>	<input checked="" type="checkbox"/>	<input type="checkbox"/>
c. Require the installation or maintenance of associated infrastructure (such as roads, fuel breaks, emergency water sources, power lines or other utilities) that may exacerbate fire risk or that may result in temporary or ongoing impacts to the environment?	<input type="checkbox"/>	<input type="checkbox"/>	<input checked="" type="checkbox"/>	<input type="checkbox"/>
d. Expose people or structures to significant risks, including downslope or downstream flooding or landslides, as a result of runoff, post-fire slope instability, or drainage changes?	<input type="checkbox"/>	<input type="checkbox"/>	<input checked="" type="checkbox"/>	<input type="checkbox"/>

Discussion

Impact #3.4.20a – Would the Project substantially impair an adopted emergency response plan or emergency evacuation plan?

See Impact #3.4.9f regarding emergency response.

Access to the site for emergency vehicles to the site would be maintained throughout the construction period. The Project would not interfere with any local or regional emergency response or evacuation plans and would not result in a substantial alteration to the adjacent and area circulation system. Impacts related to fire hazards and emergency response plans would be less than significant. No further analysis in the EIR is warranted.

Impact #3.4.20b – Would the Project due to slope, prevailing winds, and other factors, exacerbate wildfire risks, and thereby expose Project occupants to, pollutant concentrations from a wildfire or the uncontrolled spread of a wildfire?

The risk of wildfire is related to a variety of parameters, including fuel loading (vegetation), fire weather (winds, temperatures, humidity levels, and fuel moisture contents), and topography (degree of slope). Fuels such as grass are highly flammable because they have a high surface area to mass ratio and require less heat to reach the ignition point. Steep slopes contribute to fire hazards by intensifying the effects of wind and making fire suppression difficult.

The Project site and surrounding area are relatively flat and without steep slopes. The site is located in a predominately urban area with some ongoing agricultural activities, which is not considered at significant risk of wildfire. Therefore, impacts would be less than significant, and no further analysis in the EIR is warranted.

Impact #3.4.20c – Would the Project require the installation or maintenance of associated infrastructure (such as roads, fuel breaks, emergency water sources, power lines or other utilities) that may exacerbate fire risk or that may result in temporary or ongoing impacts to the environment?

See discussion in Impact #3.4.20a-b.

The Project proposes to construct 457 single-family residences and includes the development of infrastructure (water, sewer, electrical power lines, and storm drainage) required to support the proposed residential uses. The Project would require installing or maintaining additional electrical distribution lines and natural gas lines to connect the residences to the existing utility grid. However, the Project would be constructed in accordance with all local, State, and federal regulations regarding power lines and other related infrastructure, as well as fire suppression requirements. The design of all proposed utilities will be subject to the review and approval of the City. The Project will also be subject to payment of development fees to offset impacts on City services. It will ensure the viability of the utility infrastructure's ability for fire protection and suppression activities. Therefore, impacts for the Project would be considered less than significant, and no further analysis in the EIR is warranted.

Impact #3.4.20d – Would the Project expose people or structures to significant risks, including downslope or downstream flooding or landslides, as a result of runoff, post-fire slope instability, or drainage changes?

The Project site is not located in or near an SRA or an LRA Fire Hazard Severity Zone. Thus, the proposed Project would not expose people or structures to significant risks, including downslope or downstream flooding or landslides, as a result of runoff, post-fire slope instability, or drainage changes. The Project site is within the Federal Emergency Management Agency (FEMA) Area of Minimal Flood Hazard. Therefore, the proposed Project would have no impact, and no further analysis in the EIR is warranted.

	Potentially Significant Impact	Less than Significant with Mitigation Incorporated	Less than Significant Impact	No Impact
--	--------------------------------	--	------------------------------	-----------

3.4.21 - MANDATORY FINDINGS OF SIGNIFICANCE

- | | | | | |
|---|-------------------------------------|--------------------------|-------------------------------------|--------------------------|
| a. Does the Project have the potential to substantially degrade the quality of the environment, substantially reduce the habitat of a fish or wildlife species, cause a fish or wildlife population to drop below self-sustaining levels, threaten to eliminate a plant or animal community, substantially reduce the number or restrict the range of a rare or endangered plant or animal, or eliminate important examples of the major periods of California history or prehistory? | <input type="checkbox"/> | <input type="checkbox"/> | <input checked="" type="checkbox"/> | <input type="checkbox"/> |
| b. Does the Project have impacts that are individually limited, but cumulatively considerable? ("Cumulatively considerable" means that the incremental effects of a Project are significant when viewed in connection with the effects of past Projects, the effects of other current Projects, and the effects of probable future Projects.) | <input checked="" type="checkbox"/> | <input type="checkbox"/> | <input type="checkbox"/> | <input type="checkbox"/> |
| c. Does the Project have environmental effects that would cause substantial adverse effects on human beings, either directly or indirectly? | <input checked="" type="checkbox"/> | <input type="checkbox"/> | <input type="checkbox"/> | <input type="checkbox"/> |

Discussion

Impact #3.4.21a – Does the Project have the potential to degrade the quality of the environment, substantially reduce the habitat of a fish or wildlife species, cause a fish or wildlife population to drop below self-sustaining levels, threaten to eliminate a plant or animal community, substantially reduce the number or restrict the range of a rare or endangered plant or animal, or eliminate important examples of the major periods of California history or prehistory?

As evaluated in this IS, the Project would not substantially degrade the quality of the environment; substantially reduce the habitat of a fish or wildlife species; cause a fish or wildlife population to drop below self-sustaining levels; threaten to eliminate a plant or animal community; reduce the number or restrict the range of an endangered, rare, or threatened species; or eliminate important examples of the major periods of California history or prehistory including paleontological resources. Avoidance and minimization

measures have been recommended to be added to all engineered plans and specs. By implementing these measures related to cultural, paleontological, and biological resources. The incremental effects of the proposed Project would not contribute to a cumulative adverse impact on these resources. Therefore, the Project would have a less-than-significant impact. No further analysis in the EIR is warranted.

Impact #3.4.21b - Does the Project have impacts that are individually limited, but cumulatively considerable? (“Cumulatively considerable” means that the incremental effects of a Project are significant when viewed in connection with the effects of past Projects, the effects of other current Projects, and the effects of probable future Projects.)?

The Project has the potential to contribute a cumulatively significant impact on the City’s circulation system and impacts related to VMT, as identified in this Initial Study. Such impacts could occur as a result of full buildout of the Project. Therefore, the preparation of a focused EIR is warranted to evaluate the Project’s contribution to transportation impacts related to the City’s circulation system and VMT. The EIR will evaluate the proposed Project’s contribution to cumulative impacts in this area.

Impact #3.4.21c - Does the Project have environmental effects that would cause substantial adverse effects on human beings, either directly or indirectly?

The ways in which people can be subject to substantial adverse effects from projects include potential exposure to significant levels of local air pollutants; potential exposure to seismic and flooding hazards; potential exposure to hazardous materials; potential exposure to contamination from hazardous materials; and potential exposure to excessive noise levels. The risks from these potential hazards would be avoided or reduced to less-than-significant levels through compliance with existing laws, regulations, or avoidance and minimization measures placed on all engineered plans and specs. All direct and indirect impacts attributable to the Project were identified and determined to be less than significant, except for the Project’s contribution to transportation impacts related to the City’s circulation system and VMT.

The EIR will evaluate the proposed Project’s contribution to impacts in this area, and preparation of a focused EIR is warranted for this Project.

SECTION 4 - LIST OF PREPARERS

4.1 - Lead Agency

- Jason Waters – Community Development Director
- Gabrielle de Silva Myers, Senior Planner

4.2 - QK

- Jaymie Brauer – Principal Planner
- Thomas Kobayashi – Senior Associate Planner

SECTION 5 - BIBLIOGRAPHY

- Cal Recycle. (2022, Jan). *Visalia Disposal Site (54-AA-0009)*. Retrieved from SWIS Facility/Site Activity Details :
<https://www2.calrecycle.ca.gov/SolidWaste/SiteActivity/Details/822?siteID=3839>
- CalGEM. (2022). *State of California Department of Conservation, Geological Energy Management Division*. Retrieved from Online Mapping System:
<https://maps.conservation.ca.gov/doggr/wellfinder/#openModal/-119.63622/36.31040/15>
- (2015). *California Building Industry Association v. Bay Area Air Quality Management District*.
- California Building Standards Commission. (2019). *California Code of Regulations*.
- California Department of Conservation. (2022, January). *Farmland Mapping and Monitoring Program*. Retrieved from Important Farmland Finder- 2018:
<https://maps.conservation.ca.gov/DLRP/CIFF/>
- California Department of Transportation. (2022, January). *California State Scenic Highway System Map*. Retrieved from State Scenic Highway System ARC GIS On Line.:
<https://www.arcgis.com/apps/webappviewer/index.html?id=465dfd3d807c46cc8e8057116f1aaca>
- City of Hanford. (2010). *Hanford Municipal Airport Master Plan*.
- City of Hanford. (2015). *2015 Urban Water Management Plan*.
- City of Hanford. (2016). *Draft EIR- City of Hanford 2035 General Plan Update*.
- City of Hanford. (2017). *2035 General Plan Update*.
- City of Hanford. (2017b). *Planning Division*. Retrieved from Zoning Map:
https://cms6.revize.com/revize/hanfordca/document_center/Planning/Plans/Final%20Zoning%20Map%20Effective%2006-01-2017.pdf
- City of Hanford. (2020). *Urban Water Management Plan*.
- City of Hanford. (2022, January). *Hanford Municipal Code*. Retrieved from Title 17 Zoning, Chapt 17.50 Development Standards: <http://qcode.us/codes/hanford/>
- City of Hanford. (2022, January). *Hanford Municipal Code*. Retrieved from Title 17 Zoning, Chapt 17.50 Development Standards: <http://qcode.us/codes/hanford/>

- City of Hanford. (2022). *Housing Element (2016 - 2024)*.
[https://cms6.revize.com/revize/hanfordca/document_center/Planning/General%20Plan/Adopted%20Housing%20Element%20\(03-31-2016\).pdf](https://cms6.revize.com/revize/hanfordca/document_center/Planning/General%20Plan/Adopted%20Housing%20Element%20(03-31-2016).pdf).
- Department of Toxic Substances Control. (2022). EnviroStor. California, United States of America.
- Federal Highway Administration (FHWA), U.S. Department of Transportation. (2017). *Highway Traffic Noise Analysis and Abatement Policy and Guidance*.
https://www.fhwa.dot.gov/environMent/noise/regulations_and_guidance/.
- Federal Transit Administration. (2006). *Transit Noise and Vibration Impact Assessment*.
- Greater Kaweah Groundwater Sustainability Agency. (2020). *Groundwater Sustainability Plan*.
- Kings County. (1994). *Kings County Airport Compatibility Plan*.
- Kings County. (2009). *2035 General Plan*.
- Kings County. (2015). *Kings County Emergency Ooperations Plan*.
- QK. (2022a). *Biological Resources Evaluation- Lunaria Residential Development Project*.
- QK. (2022b). *Cultural Resources Technical Memo- Lunaria Residential Development*.
- SJVAPCD. (2015). *Guidance for Assessing and Mitigating Air Quality Impacts*.
- U.S. Census Bureau. (2022). *Census*. Retrieved from Hanford, CA:
<https://www.census.gov/quickfacts/hanfordcitycalifornia>
- U.S. Department of Energy. (2014). *Hanford Emergency Management Plan*.
- U.S. Department of Transportation, F. R. (2005). *High-Speed Ground Transportation Noise and Vibration Impact Assessment*.
- United States Census Bureau. (2020). *Quick Facts*. Retrieved from Tulare County:
<https://www.census.gov/quickfacts/tularecountycalifornia>
- United States Environmental Protection Agency. (2022). *Energy and the Environment*. Retrieved from Greenhouse Gas Equivalencies Calculator:
<https://www.epa.gov/energy/greenhouse-gas-equivalencies-calculator#results>
- VRPA Technologies, Inc. (2022). *Air Quality & Greenhouse Gas Impact Assessment: Lunaria Development Project*.

1.0 Introduction

1.1 Description of the Region/Project

The Project Applicant is proposing to develop a 443-unit single-family residential tract via tentative subdivision map (Project) on two APN's 011-440-015 and 011-440-014 with total land area of 95 acres in the City of Hanford, CA. The Project site is located in the southern portion of Hanford's city limit located between Hanford Armona Road and Houston Avenue adjacent to west of 10 ½ Avenue and approximately 1 mile south of SR198.

This Air Quality & Greenhouse Gas Impact Assessment has been prepared for the purpose of identifying potential project-specific or site-specific air quality impacts that may result from the Project. Figures 1 and 2 show the location of the Project along with major roadways and highways.

The City of Hanford is located in Kings County one of the most polluted air basins in the country – the San Joaquin Valley Air Basin (SJVAB). The surrounding topography includes foothills and mountains to the east and west. These mountain ranges direct air circulation and dispersion patterns. Temperature inversions can trap air within the Valley, thereby preventing the vertical dispersal of air pollutants. In addition to topographic conditions, the local climate can also contribute to air quality problems. Climate in Hanford is characterized by hot, dry summers and cool winters with the notable presence of Tule fog.

1.2 Regulatory

Air quality within the Project area is addressed through the efforts of various federal, state, regional, and local government agencies. These agencies work jointly, as well as individually, to improve air quality through legislation, regulations, planning, policymaking, education, and a variety of programs. The agencies primarily responsible for improving the air quality within the City of Hanford and Kings County are discussed below along with their individual responsibilities.

1.2.1 Federal Agencies

✓ U.S. Environmental Protection Agency (EPA)

The Federal Clean Air Bill first adopted in 1967 and periodically amended since then, established federal ambient air quality standards. A 1987 amendment to the Bill set a deadline for the attainment of these standards. That deadline has since passed. The other Clean Air Act (CAA) Bill Amendments, passed in 1990, share responsibility with the State in reducing emissions from mobile sources. The U.S. Environmental Protection Agency (EPA) is responsible for enforcing the 1990 amendments.

The CAA and the national ambient air quality standards identify levels of air quality for six "criteria" pollutants, which are considered the maximum levels of ambient air pollutants

considered safe, with an adequate margin of safety, to protect public health and welfare. The six criteria pollutants include ozone, carbon monoxide (CO), nitrogen dioxide, sulfur dioxide, particulate matter, and lead.

CAA Section 176(c) (42 U.S.C. 7506(c)) and EPA transportation conformity regulations (40 CFR 93 Subpart A) require that each new RTP and Transportation Improvement Program (TIP) be demonstrated to conform to the State Implementation Plan (SIP) before the RTP and TIP are approved by the Metropolitan planning organization (MPO) or accepted by the U.S. Department of Transportation (DOT). The conformity analysis is a federal requirement designed to demonstrate compliance with the National Ambient Air Quality Standards (NAAQS). However, because the State Implementation Plan (SIP) for particulate matter 10 microns or less in diameter (PM₁₀), particulate matter 2.5 microns or less in diameter (PM_{2.5}), and Ozone address attainment of both the State and federal standards, for these pollutants, demonstrating conformity to the federal standards is also an indication of progress toward attainment of the State standards. Compliance with the State air quality standards is provided on the pages following this federal conformity discussion.

The EPA approved San Joaquin Valley reclassification of the ozone (8-hour) designation to extreme nonattainment in the Federal Register on May 5, 2010, even though the San Joaquin Valley was initially classified as serious nonattainment for the 1997 8-hour ozone standard. In accordance with the CAA, EPA uses the design value at the time of standard promulgation to assign nonattainment areas to one of several classes that reflect the severity of the nonattainment problem; classifications range from marginal nonattainment to extreme nonattainment. In the Federal Register on October 26, 2015, the EPA revised the primary and secondary standard to 0.070 parts per million (ppm) to provide increased public health protection against health effects associated with long- and short-term exposures. The previous ozone standard was set in 2010 at 0.075 ppm.

Kings County is located in a nonattainment area for the 8-hour ozone standard, PM_{2.5} standard, and PM₁₀ standard.

**Lunaria Project Development AQ/GHG&HRA
Regional Location**

**Figure
1**

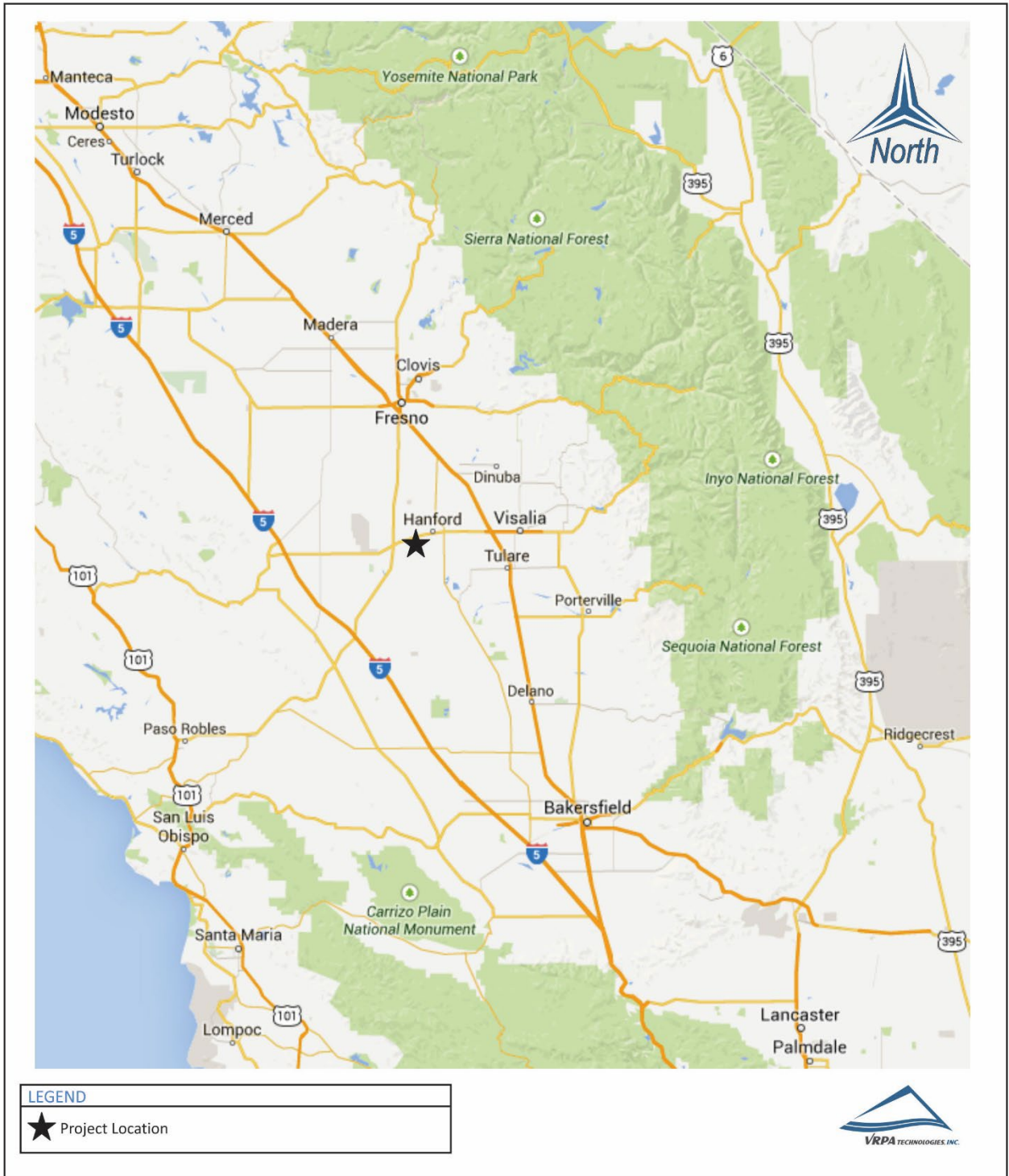

**Lunaria Project Development AQ/GHG&HRA
Project Location**

**Figure
2**

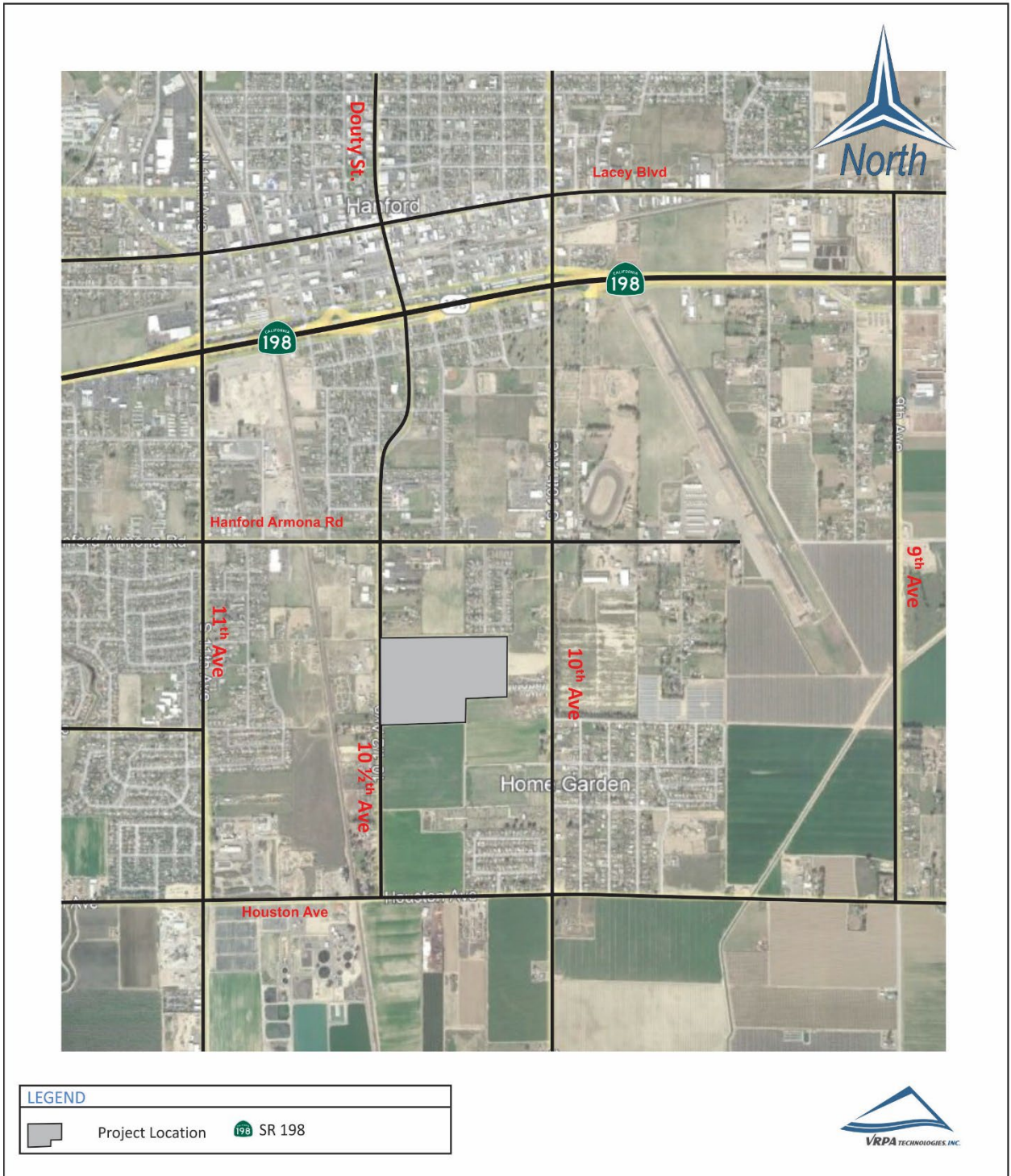

1.2.2 Federal Regulations

✓ National Environmental Policy Act (NEPA)

NEPA provides general information on the effects of federally funded projects. The Act was implemented by regulations included in the Code of Federal Regulations (40CFR6). The code requires careful consideration concerning environmental impacts of federal actions or plans, including projects that receive federal funds. The regulations address impacts on land uses and conflicts with state, regional, or local plans and policies, among others. They also require that projects requiring NEPA review seek to avoid or minimize adverse effects of proposed actions and to restore and enhance environmental quality as much as possible.

✓ State Implementation Plan (SIP)/ Air Quality Management Plans (AQMPs)

To ensure compliance with the NAAQS, EPA requires states to adopt SIP aimed at improving air quality in areas of nonattainment or a Maintenance Plan aimed at maintaining air quality in areas that have attained a given standard. New and previously submitted plans, programs, district rules, state regulations, and federal controls are included in the SIPs. Amendments made in 1990 to the federal CAA established deadlines for attainment based on an area's current air pollution levels. States must enact additional regulatory programs for nonattainment's areas in order to adhere with the CAA Section 172. In California, the SIPs must adhere to both the NAAQS and the California Ambient Air Quality Standards (CAAQS).

To ensure that State and federal air quality regulations are being met, Air Quality Management Plans (AQMPs) are required. AQMPs present scientific information and use analytical tools to identify a pathway towards attainment of NAAQS and CAAQS. The San Joaquin Valley Air Pollution Control District (SJVAPCD) develops the AQMPs for the region where the Kings County Association of Governments (KCAG) operates. The regional air districts begin the SIP process by submitting their AQMPs to the California Air Resources Board (CARB). CARB is responsible for revising the SIP and submitting it to EPA for approval. EPA then acts on the SIP in the Federal Register. The items included in the California SIP are listed in the Code of Federal Regulations Title 40, Chapter 1, Part 52, Subpart 7, Section 52.220.

✓ Transportation Control Measures

One particular aspect of the SIP development process is the assessment of available transportation control measures (TCMs) as a part of making progress towards clean air goals. TCMs are defined in Section 108(f)(1) of the CAA and are strategies designed to reduce vehicle miles traveled, vehicle idling, and associated air pollution. These goals are generally achieved by developing attractive and convenient alternatives to single-occupant vehicle use. Examples of TCMs include ridesharing programs, transportation infrastructure improvements such as adding bicycle and carpool lanes, and expansion of public transit.

✓ **Energy Policy Act of 1992 (EPAAct)**

The Energy Policy Act of 1992 (EPAAct) was passed to reduce the country's dependence on foreign petroleum and improve air quality. EPAAct includes several parts intended to build an inventory of alternative fuel vehicles (AFVs) in large, centrally fueled fleets in metropolitan areas. EPAAct requires certain federal, state, and local government and private fleets to purchase a percentage of light duty AFVs capable of running on alternative fuels each year. In addition, financial incentives are included in EPAAct. Federal tax deductions will be allowed for businesses and individuals to cover the incremental cost of alternative fueled vehicles (AFVs). States are also required by the act to consider a variety of incentive programs to help promote AFVs.

1.2.3 *State Agencies*

✓ **California Air Resources Board (CARB)**

CARB is the agency responsible for coordination and oversight of State and local air pollution control programs in California and for implementing its own air quality legislation called the California Clean Air Act (CCAA), adopted in 1988. CARB was created in 1967 from the merging of the California Motor Vehicle Pollution Control Board and the Bureau of Air Sanitation and its Laboratory.

CARB has primary responsibility in California to develop and implement air pollution control plans designed to achieve and maintain the NAAQS established by the EPA. Whereas CARB has primary responsibility and produces a major part of the SIP for pollution sources that are statewide in scope, it relies on the local air districts to provide additional strategies for sources under their jurisdiction. CARB combines its data with all local district data and submits the completed SIP to the EPA. The SIP consists of the emissions standards for vehicular sources and consumer products set by CARB, and attainment plans adopted by the Air Pollution Control Districts (APCDs) and Air Quality Management District's (AQMDs) and approved by CARB.

States may establish their own standards, provided the State standards are at least as stringent as the NAAQS. California has established California Ambient Air Quality Standards (CAAQS) pursuant to California Health and Safety Code (CH&SC) [§39606(b)] and its predecessor statutes.

The CH&SC [§39608] requires CARB to "identify" and "classify" each air basin in the State on a pollutant-by-pollutant basis. Subsequently, CARB designated areas in California as nonattainment based on violations of the CAAQSs. Designations and classifications specific to the SJVAB can be found in the next section of this document. Areas in the State were also classified based on severity of air pollution problems. For each nonattainment class, the CCAA specifies air quality management strategies that must be adopted. For all nonattainment categories, attainment plans are required to demonstrate a five percent-per-

year reduction in nonattainment air pollutants or their precursors, averaged every consecutive three-year period, unless an approved alternative measure of progress is developed. In addition, air districts in violation of CAAQS are required to prepare an Air Quality Attainment Plan (AQAP) that lays out a program to attain and maintain the CCAA mandates.

CARB, in consultation with MPOs, has provided each affected region with reduction targets for GHGs emitted by passenger cars and light trucks in the region for the years 2020 and 2035. For the Kings County Association of Governments (KCAG) region, CARB set targets at five (5) percent per capita decrease in 2020 and a ten (10) percent per capita decrease in 2035 from a base year of 2005. KCAG's 2018 Regional Transportation Plan/Sustainable Communities Strategy (RTP/SCS), which was adopted in August 2018, projects that the Kings County region would achieve the prescribed emissions targets.

Other CARB duties include monitoring air quality. CARB has established and maintains, in conjunction with local APCDs and AQMDs, a network of sampling stations (called the State and Local Air Monitoring [SLAMS] network), which monitor the present pollutant levels in the ambient air.

Kings County is in the CARB-designated, SJVAB. A map of the SJVAB is provided in Figure 3. In addition to Kings County, the SJVAB includes Fresno, Kern, Madera, Merced, San Joaquin, Stanislaus, and Tulare Counties. Federal and State standards for criteria pollutants are provided in Table 1.

Lunaria Project Development AQ/GHG&HRA
San Joaquin Valley Air Basin

Figure 3

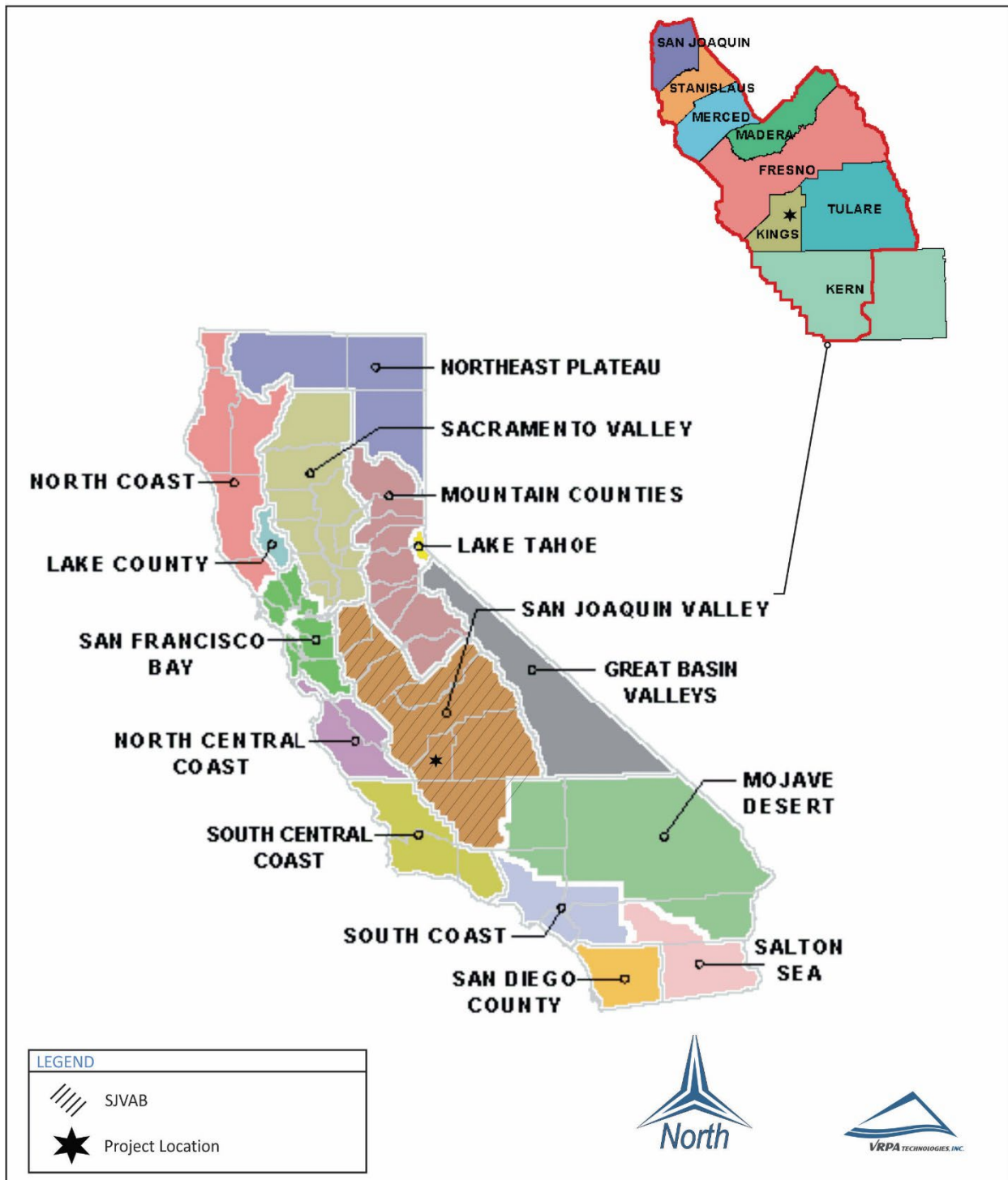

Table 1
Ambient Air Quality Standards

Pollutant	Averaging Time	California Standards ¹		National Standards ²		
		Concentration ³	Method ⁴	Primary ^{3,5}	Secondary ^{3,6}	Method ⁷
Ozone (O ₃) ⁸	1 Hour	0.09 ppm (180 µg/m ³)	Ultraviolet Photometry	--	Same as Primary Standard	Ultraviolet Photometry
	8 Hour	0.070 ppm (137 µg/m ³)		0.070 ppm (137 µg/m ³)		
Respirable Particulate Matter (PM ₁₀) ⁹	24 Hour	50 µg/m ³	Gravimetric or Beta Attenuation	150 µg/m ³	Same as Primary Standard	Inertial Separation and Gravimetric Analysis
	Annual Arithmetic Mean	20 µg/m ³		--		
Fine Particulate Matter (PM _{2.5}) ⁹	24 Hour	--	--	35 µg/m ³	Same as Primary Standard	Inertial Separation and Gravimetric Analysis
	Annual Arithmetic Mean	12 µg/m ³	Gravimetric or Beta Attenuation	12.0 µg/m ³		
Carbon Monoxide (CO)	1 Hour	20 ppm (23 mg/m ³)	Non-Dispersive Infrared Photometry (NDIR)	35 ppm (40 mg/m ³)	--	Non-Dispersive Infrared Photometry (NDIR)
	8 Hour	9.0 ppm (10 mg/m ³)		9 ppm (10 mg/m ³)	--	
	8 Hour (Lake Tahoe)	6 ppm (7 mg/m ³)		--	--	
Nitrogen Dioxide (NO ₂) ¹⁰	1 Hour	0.18 ppm (339 µg/m ³)	Gas Phase Chemiluminescence	100 ppb (188 µg/m ³)	--	Gas Phase Chemiluminescence
	Annual Arithmetic Mean	0.030 ppm (57 µg/m ³)		0.053 ppm (100 µg/m ³)	Same as Primary Standard	
Sulfur Dioxide (SO ₂) ¹¹	1 Hour	0.25 ppm (655 µg/m ³)	Ultraviolet Fluorescence	75 ppb (196 µg/m ³)	--	Ultraviolet Fluorescence; Spectrophotometry (Pararosaniline Method)
	3 Hour	--		--	0.5 ppm (1300 µg/m ³)	
	24 Hour	0.04 ppm (105 µg/m ³)		0.14 ppm (for certain areas) ¹¹	--	
	Annual Arithmetic Mean	--		0.030 ppm (for certain areas) ¹¹	--	
Lead ^{12,13}	30 Day Average	1.5 µg/m ³	Atomic Absorption	--	--	High Volume Sampler and Atomic Absorption
	Calendar Quarter	--		1.5 µg/m ³ (for certain areas) ¹¹	Same as Primary Standard	
	Rolling 3-Month Average	--		0.15 µg/m ³		
Visibility Reducing Particles ¹⁴	8 Hour	See footnote 14	Beta Attenuation and Transmittance through Filter Tape	No National Standards		
Sulfates	24 Hour	25 µg/m ³	Ion Chromatography			
Hydrogen Sulfide	1 Hour	0.03 ppm (42 µg/m ³)	Ultraviolet Fluorescence			
Vinyl Chloride ¹²	24 Hour	0.01 ppm (26 µg/m ³)	Gas Chromatography			

See footnotes on next page ...

Footnotes:

1. California standards for ozone, carbon monoxide (except 8-hour Lake Tahoe), sulfur dioxide (1 and 24 hour), nitrogen dioxide, and particulate matter (PM10, PM2.5, and visibility reducing particles), are values that are not to be exceeded. All others are not to be equaled or exceeded. California ambient air quality standards are listed in the Table of Standards in Section 70200 of Title 17 of the California Code of Regulations.
 2. National standards (other than ozone, particulate matter, and those based on annual arithmetic mean) are not to be exceeded more than once a year. The ozone standard is attained when the fourth highest 8-hour concentration measured at each site in a year, averaged over three years, is equal to or less than the standard. For PM10, the 24 hour standard is attained when the expected number of days per calendar year with a 24-hour average concentration above 150 µg/m³ is equal to or less than one. For PM2.5, the 24 hour standard is attained when 98 percent of the daily concentrations, averaged over three years, are equal to or less than the standard. Contact the U.S. EPA for further clarification and current national policies.
 3. Concentration expressed first in units in which it was promulgated. Equivalent units given in parentheses are based upon a reference temperature of 25°C and a reference pressure of 760 torr. Most measurements of air quality are to be corrected to a reference temperature of 25°C and a reference pressure of 760 torr; ppm in this table refers to ppm by volume, or micromoles of pollutant per mole of gas.
 4. Any equivalent measurement method which can be shown to the satisfaction of the ARB to give equivalent results at or near the level of the air quality standard may be used.
 5. National Primary Standards: The levels of air quality necessary, with an adequate margin of safety to protect the public health.
 6. National Secondary Standards: The levels of air quality necessary to protect the public welfare from any known or anticipated adverse effects of a pollutant.
 7. Reference method as described by the U.S. EPA. An "equivalent method" of measurement may be used but must have a "consistent relationship to the reference method" and must be approved by the U.S. EPA.
 8. On October 1, 2015, the national 8-hour ozone primary and secondary standards were lowered from 0.075 to 0.070 ppm.
 9. On December 14, 2012, the national annual PM2.5 primary standard was lowered from 15 µg/m³ to 12.0 µg/m³. The existing national 24-hour PM2.5 standards (primary and secondary) were retained at 35 µg/m³, as was the annual secondary standard of 15 µg/m³. The existing 24-hour PM10 standards (primary and secondary) of 150 µg/m³ also were retained. The form of the annual primary and secondary standards is the annual mean, averaged over 3 years.
 10. To attain the 1-hour national standard, the 3-year average of the annual 98th percentile of the 1-hour daily maximum concentrations at each site must not exceed 100 ppb. Note that the national 1-hour standard is in units of parts per billion (ppb). California standards are in units of parts per million (ppm). To directly compare the national 1-hour standard to the California standards the units can be converted from ppb to ppm. In this case, the national standard of 100 ppb is identical to 0.100 ppm.
 11. On June 2, 2010, a new 1-hour SO₂ standard was established and the existing 24-hour and annual primary standards were revoked. To attain the 1-hour national standard, the 3-year average of the annual 99th percentile of the 1-hour daily maximum concentrations at each site must not exceed 75 ppb. The 1971 SO₂ national standards (24-hour and annual) remain in effect until one year after an area is designated for the 2010 standard, except that in areas designated nonattainment for the 1971 standards, the 1971 standards remain in effect until implementation plans to attain or maintain the 2010 standards are approved.
- Note that the 1-hour national standard is in units of parts per billion (ppb). California standards are in units of parts per million (ppm). To directly compare the 1-hour national standard to the California standard the units can be converted to ppm. In this case, the national standard of 75 ppb is identical to 0.075 ppm.
12. The ARB has identified lead and vinyl chloride as 'toxic air contaminants' with no threshold level of exposure for adverse health effects determined. These actions allow for the implementation of control measures at levels below the ambient concentrations specified for these pollutants.
 13. The national standard for lead was revised on October 15, 2008 to a rolling 3-month average. The 1978 lead standard (1.5 µg/m³ as a quarterly average) remains in effect until one year after an area is designated for the 2008 standard, except that in areas designated nonattainment for the 1978 standard, the 1978 standard remains in effect until implementation plans to attain or maintain the 2008 standard are approved.
 14. In 1989, the ARB converted both the general statewide 10-mile visibility standard and the Lake Tahoe 30-mile visibility standard to instrumental equivalents, which are "extinction of 0.23 per kilometer" and "extinction of 0.07 per kilometer" for the statewide and Lake Tahoe Air Basin standards, respectively.

1.2.4 State Regulations

✓ CARB Mobile-Source Regulation

The State of California is responsible for controlling emissions from the operation of motor vehicles in the State. Rather than mandating the use of specific technology or the reliance on a specific fuel, CARB's motor vehicle standards specify the allowable grams of pollutant per mile driven. In other words, the regulations focus on the reductions needed rather than on the manner in which they are achieved.

✓ California Clean Air Act

The CCAA was first signed into law in 1988. The CCAA provides a comprehensive framework for air quality planning and regulation, and spells out, in statute, the state's air quality goals, planning and regulatory strategies, and performance. The CCAA establishes more stringent ambient air quality standards than those included in the Federal CAA. CARB is the agency responsible for administering the CCAA. CARB established ambient air quality standards pursuant to the CH&SC [§39606(b)], which are similar to the federal standards. The SJVAPCD is one of 35 AQMDs that have prepared air quality management plans to accomplish a five percent (5%) annual reduction in emissions documenting progress toward the State ambient air quality standards.

✓ Tanner Air Toxics Act

California regulates Toxic Air Contaminants (TACs) primarily through the Tanner Air Toxics Act (AB 1807) and the Air Toxics Hot Spots Information and Assessment Act of 1987 (AB 2588). The Tanner Act sets forth a formal procedure for CARB to designate substances as TACs. This includes research, public participation, and scientific peer review before CARB can designate a substance as a TAC. To date, CARB has identified more than 21 TACs and has adopted EPA's list of Hazardous Air Pollutants (HAPs) as TACs. Once a TAC is identified, CARB then adopts an Airborne Toxics Control Measure (ATCM) for sources that emit that particular TAC. If there is a safe threshold for a substance at which there is no toxic effect, the control measure must reduce exposure below that threshold. If there is no safe threshold, the measure must incorporate Best Available Control Technology (BACT) to minimize emissions.

AB 2588 requires that existing facilities that emit toxic substances above a specified level prepare a toxic-emission inventory, prepare a risk assessment if emissions are significant, notify the public of significant risk levels, and prepare and implement risk reduction measures. CARB has adopted diesel exhaust control measures and more stringent emission standards for various on-road mobile sources of emissions, including transit buses and off-road diesel equipment (e.g., tractors, generators).

These rules and standards provide for:

- More stringent emission standards for some new urban bus engines, beginning with 2002 model year engines.
- Zero-emission bus demonstration and purchase requirements applicable to transit agencies
- Reporting requirements under which transit agencies must demonstrate compliance with the urban transit bus fleet rule.

✓ **AB 1493 (Pavley)**

AB 1493 (Pavley) enacted on July 22, 2002, required CARB to develop and adopt regulations that reduce greenhouse gases emitted by passenger vehicles and light duty trucks. Regulations adopted by CARB would apply to 2009 and later model year vehicles. CARB estimated that the regulation would reduce climate change emissions from light duty passenger vehicles by an estimated 18 percent in 2020 and by 27 percent in 2030 [Association of Environmental Professionals (AEP) 2007)]. In 2005, the CARB requested a waiver from U.S. EPA to enforce the regulation, as required under the CAA. Despite the fact that no waiver had ever been denied over a 40-year period, the then Administrator of the EPA sent Governor Schwarzenegger a letter in December 2007, indicating he had denied the waiver. On March 6, 2008, the waiver denial was formally issued in the Federal Register. Governor Schwarzenegger and several other states immediately filed suit against the federal government to reverse that decision. On January 21, 2009, CARB requested that EPA reconsider denial of the waiver. EPA scheduled a re-hearing on March 5, 2009. On June 30, 2009, EPA granted a waiver of CAA preemption to California for its greenhouse gas emission standards for motor vehicles beginning with the 2009 model year.

✓ **Assembly Bill 32 (California Global Warming Solutions Act of 2006)**

California passed the California Global Warming Solutions Act of 2006 (AB 32; California Health and Safety Code Division 25.5, Sections 38500 - 38599). AB 32 establishes regulatory, reporting, and market mechanisms to achieve quantifiable reductions in GHG emissions and establishes a cap on statewide GHG emissions. AB 32 required that statewide GHG emissions be reduced to 1990 levels by 2020. December 31, 2020 is the deadline for achieving the 2020 GHG emissions cap. To effectively implement the cap, AB 32 directs CARB to develop and implement regulations to reduce statewide GHG emissions from stationary sources. AB 32 specifies that regulations adopted in response to AB 1493 should be used to address GHG emissions from vehicles. However, AB 32 also includes language stating that if the AB 1493 regulations cannot be implemented, then CARB should develop new regulations to control vehicle GHG emissions under the authorization of AB 32.

AB 32 requires CARB to adopt a quantified cap on GHG emissions representing 1990 emissions levels and disclose how it arrived at the cap; institute a schedule to meet the emissions cap; and develop tracking, reporting, and enforcement mechanisms to ensure that the state reduces GHG emissions enough to meet the cap. AB 32 also includes guidance on instituting emissions reductions in an economically efficient manner, along with conditions

to ensure that businesses and consumers are not unfairly affected by the reductions. Using these criteria to reduce statewide GHG emissions to 1990 levels by 2020 would represent an approximate 25 to 30 percent reduction in current emissions levels. However, CARB has discretionary authority to seek greater reductions in more significant and growing GHG sectors, such as transportation, as compared to other sectors that are not anticipated to significantly increase emissions.

CARB's 2017 Climate Change Scoping Plan builds on the efforts and plans encompassed in the initial Scoping Plan adopted in December of 2008. The current plan has identified new policies and actions to accomplish the State's 2030 GHG limit.

✓ **Senate Bill 375**

SB 375, signed in September 2008 (Chapter 728, Statutes of 2008), aligns regional transportation planning efforts, regional GHG reduction targets, and land use and housing allocation. SB 375 requires Metropolitan Planning Organizations (MPOs) to adopt a sustainable communities strategy (SCS) or alternative planning strategy (APS) that will prescribe land use allocation in that MPO's regional transportation plan. CARB, in consultation with MPOs, has provided each affected region with reduction targets for GHGs emitted by passenger cars and light trucks in the region for the years 2020 and 2035. For the Kings County Association of Government (KCAG), CARB set targets at five (5) percent per capita decrease in 2020 and a ten (10) percent per capita decrease in 2035 from a base year of 2005. KCAG 2018 Regional Transportation Plan/Sustainable Communities Strategy (RTP/SCS), which was adopted in August 2018, projects that the Kings County region would achieve the prescribed emissions targets.

This law also extends the minimum time period for the regional housing needs allocation cycle from five years to eight years for local governments located within an MPO that meets certain requirements. City or county land use policies (including general plans) are not required to be consistent with the regional transportation plan (and associated SCS or APS). However, new provisions of CEQA incentivize (through streamlining and other provisions) qualified projects that are consistent with an approved SCS or APS, categorized as "transit priority projects."

✓ **Executive Order B-30-15**

Executive Order B-30-15, which was signed by Governor Brown in 2016, establishes a California greenhouse gas reduction target of 40 percent below 1990 levels by 2030 to ensure California meets its target of reducing greenhouse gas emissions to 80 percent below 1990 levels by 2050. Executive Order B-30-15 requires MPO's to implement measures that will achieve reductions of greenhouse gas emissions to meet the 2030 and 2050 greenhouse gas emissions reductions targets.

✓ **California Global Warming Solutions Act of 2006: emissions limit, or SB 32**

SB 32 is a California Senate bill expanding upon AB 32 to reduce greenhouse gas (GHG) emissions. The lead author is Senator Fran Pavley and the principal co-author is Assembly member Eduardo Garcia. SB 32 was signed into law on September 8, 2016, by Governor Brown. SB 32 sets into law the mandated reduction target in GHG emissions as written into Executive Order B-30-15. SB 32 requires that there be a reduction in GHG emissions to 40% below the 1990 levels by 2030. Greenhouse gas emissions include carbon dioxide, methane, nitrous oxide, sulfur hexafluoride, hydrofluorocarbons, and perfluorocarbons. The California Air Resources Board (CARB) is responsible for ensuring that California meets this goal. The provisions of SB 32 were added to Section 38566 of the Health and Safety Code subsequent to the bill's approval. The bill went into effect January 1, 2017. SB 32 builds onto Assembly Bill (AB) 32 written by Senator Fran Pavley and Assembly Speaker Fabian Nunez passed into law on September 27, 2006. AB 32 required California to reduce greenhouse gas emissions to 1990 levels by 2020 and SB 32 continues that timeline to reach the targets set in Executive Order B-30-15. SB 32 provides another intermediate target between the 2020 and 2050 targets set in Executive Order S-3-05.

1.2.5 Regional Agencies

✓ **San Joaquin Valley Air Pollution Control District**

The SJVAPCD is the agency responsible for monitoring and regulating air pollutant emissions from stationary, area, and indirect sources within Kings County and throughout the SJVAB. The District also has responsibility for monitoring air quality and setting and enforcing limits for source emissions. CARB is the agency with the legal responsibility for regulating mobile source emissions. The District is precluded from such activities under State law.

The District was formed in mid-1991 and prepared and adopted the San Joaquin Valley Air Quality Attainment Plan (AQAP), dated January 30, 1992, in response to the requirements of the State CCAA. The CCAA requires each non-attainment district to reduce pertinent air contaminants by at least five percent (5%) per year until new, more stringent, 1988 State air quality standards are met.

Activities of the SJVAPCD include the preparation of plans for the attainment of ambient air quality standards, adoption and enforcement of rules and regulations concerning sources of air pollution, issuance of permits for stationary sources of air pollution, inspection of stationary sources of air pollution and response to citizen complaints, monitoring of ambient air quality and meteorological conditions, and implementation of programs and regulations required by the FCAA and CCAA.

The SJVAPCD has prepared the following State Implementation Plans to address ozone, PM-10 and PM2.5 that currently apply to non-attainment areas:

- The 2016 Ozone Plan (2008 standard) was adopted by SJVAPCD on June 16, 2016 and

subsequently adopted by ARB on July 21, 2016.

- The 2013 1-Hour Ozone Plan (revoked 1997 standard) was adopted by the SJVAPCD on September 19, 2013. EPA withdrew its approval of the plan due to litigation. The District plans to submit a “redesignation substitute” to EPA to maintain its attainment status for this revoked ozone standard.
- The 2007 PM-10 Maintenance Plan (as revised in 2015) was approved by EPA on July 8, 2016 (effective September 30, 2016).
- The 2012 PM2.5 Plan (as revised in 2015) was approved by EPA on August 16, 2016 (effective September 30, 2016).

The SJVAPCD Plans identified above represent SJVAPCD’s plan to achieve both state and federal air quality standards. The regulations and incentives contained in these documents must be legally enforceable and permanent. These plans break emissions reductions and compliance into different emissions source categories.

The SJVAPCD also prepared the *Guide for Assessing and Mitigation Air Quality Impacts* (GAMAQI), dated March 19, 2015. The GAMAQI is an advisory document that provides Lead Agencies, consultants, and project applicants with analysis guidance and uniform procedures for addressing air quality impacts in environmental documents. Local jurisdictions are not required to utilize the methodology outlined therein. This document describes the criteria that SJVAPCD uses when reviewing and commenting on the adequacy of environmental documents. It recommends thresholds for determining whether or not projects would have significant adverse environmental impacts, identifies methodologies for predicting project emissions and impacts, and identifies measures that can be used to avoid or reduce air quality impacts.

1.2.6 Regional Regulations

The SJVAPCD has adopted numerous rules and regulations to implement its air quality plans. Following, are significant rules that will apply to the Project.

✓ Regulation VIII – Fugitive PM10 Prohibitions

Regulation VIII is comprised of District Rules 8011 through 8081, which are designed to reduce PM₁₀ emissions (predominantly dust/dirt) generated by human activity, including construction and demolition activities, road construction, bulk materials storage, paved and unpaved roads, carryout and track out, landfill operations, etc. The proposed Project will be required to comply with this regulation. Regulation VIII control measures are provided below:

1. *All disturbed areas, including storage piles, which are not being actively utilized for construction purposes, shall be effectively stabilized of dust emissions using water, chemical stabilizer/suppressant, covered with a tarp or other suitable cover or vegetative ground cover.*

2. *All on-site unpaved roads and off-site unpaved access roads shall be effectively stabilized of dust emissions using water or chemical stabilizer/suppressant.*
3. *All land clearing, grubbing, scraping, excavation, land leveling, grading, cut & fill, and demolition activities shall be effectively controlled of fugitive dust emissions utilizing application of water or by presoaking.*
4. *When materials are transported off-site, all material shall be covered, or effectively wetted to limit visible dust emissions, and at least six inches of freeboard space from the top of the container shall be maintained.*
5. *All operations shall limit or expeditiously remove the accumulation of mud or dirt from adjacent public streets at the end of each workday. The use of dry rotary brushes is expressly prohibited except where preceded or accompanied by sufficient wetting to limit the visible dust emissions. Use of blower devices is expressly forbidden.*
6. *Following the addition of materials to, or the removal of materials from, the surface of outdoor storage piles, said piles shall be effectively stabilized of fugitive dust emissions utilizing sufficient water or chemical stabilizer/suppressant.*
7. *Within urban areas, track out shall be immediately removed when it extends 50 or more feet from the site and at the end of each workday.*

✓ **Rule 8021 – Construction, Demolition, Excavation, and Other Earthmoving Activities**

District Rule 8021 requires owners or operators of construction projects to submit a Dust Control Plan to the District if at any time the project involves non-residential developments of five or more acres of disturbed surface area or moving, depositing, or relocating of more than 2,500 cubic yards per day of bulk materials on at least three days of the project. The proposed Project will meet these criteria and will be required to submit a Dust Control Plan to the District in order to comply with this rule.

✓ **Rule 4641 – Cutback, Slow Cure, and Emulsified Asphalt, Paving and Maintenance Operations**

If asphalt paving will be used, then paving operations of the proposed Project will be subject to Rule 4641. This rule applies to the manufacture and use of cutback asphalt, slow cure asphalt and emulsified asphalt for paving and maintenance operations.

✓ **Rule 9510 – Indirect Source Review (ISR)**

The purpose of this rule is to fulfill the District's emission reduction commitments in the PM10 and Ozone Attainment Plans, achieve emission reductions from construction activities, and to provide a mechanism for reducing emissions from the construction of and use of development projects through off-site measures. The rule is expected to reduce nitrogen oxides and particulates throughout the San Joaquin Valley by more than 10 tons per day.

1.2.7 *Local Plans*

✓ **City of Hanford General Plan**

California State Law requires every city and county to adopt a comprehensive General Plan to guide its future development. The General Plan essentially serves as a “constitution for development”— the document that serves as the foundation for all land use decisions. The City of Hanford 2035 General Plan Update (2018) includes various elements, including air quality and greenhouse gases, that address local concerns and provides goals and policies to achieve its development goals.

2.0 Environmental Setting

This section describes existing air quality within the San Joaquin Valley Air Basin and in Kings County, including the identification of air pollutant standards, meteorological and topological conditions affecting air quality, and current air quality conditions. Air quality is described in relation to ambient air quality standards for criteria pollutants such as, ozone, carbon monoxide, and particulate matter. Air quality can be directly affected by the type and density of land use change and population growth in urban and rural areas.

2.1 Geographical Location

The SJVAB is comprised of eight counties: Fresno, Kern, Kings, Madera, Merced, San Joaquin, Stanislaus, and Tulare. Encompassing 24,840 square miles, the San Joaquin Valley is the second largest air basin in California. Cumulatively, counties within the Air Basin represent approximately 16 percent of the State's geographic area. The Air Basin is bordered by the Sierra Nevada Mountains on the east (8,000 to 14,492 feet in elevation), the Coastal Range on the west (4,500 feet in elevation), and the Tehachapi Mountains on the south (9,000 feet elevation). The San Joaquin Valley is open to the north extending to the Sacramento Valley Air Basin.

2.2 Topographic Conditions

Kings County is located within the San Joaquin Valley Air Basin [as determined by the California Air Resources Board (CARB)]. Air basins are geographic areas sharing a common "air shed." A description of the Air Basin in the County, as designated by CARB, is provided in the paragraph below. Air pollution is directly related to the region's topographic features, which impact air movement within the Basin.

Wind patterns within the SJVAB result from marine air that generally flows into the Basin from the San Joaquin River Delta. The Coastal Range hinders wind access into the Valley from the west, the Tehachapi's prevent southerly passage of airflow, and the high Sierra Nevada Mountain Range provides a significant barrier to the east. These topographic features result in weak airflow that becomes restricted vertically by high barometric pressure over the Valley. As a result, the SJVAB is highly susceptible to pollutant accumulation over time. Most of the surrounding mountains are above the normal height of summer inversion layers (1,500-3,000 feet).

2.3 Climate Conditions

Hanford is located in one of the most polluted air basins in the country. Temperature inversions can trap air within the Valley, thereby preventing the vertical dispersal of air pollutants. In addition to topographic conditions, the local climate can also contribute to air quality problems. Climate in Hanford is characterized by warm, dry summers and cool winters with significant Tule fog.

Ozone, classified as a “regional” pollutant, often afflicts areas downwind of the original source of precursor emissions. Ozone can be easily transported by winds from a source area. Peak ozone levels tend to be higher in the southern portion of the Valley, as the prevailing summer winds sweep precursors downwind of northern source areas before concentrations peak. The separate designations reflect the fact that ozone precursor transport depends on daily meteorological conditions.

Other primary pollutants, carbon monoxide (CO), for example, may form high concentrations when wind speed is low. During the winter, Hanford experiences cold temperatures and calm conditions that increase the likelihood of a climate conducive to high CO concentrations.

Precipitation and fog tend to reduce or limit some pollutant concentrations. Ozone needs sunlight for its formation, and clouds and fog block the required radiation. CO is slightly water-soluble, so precipitation and fog tends to “reduce” CO concentrations in the atmosphere. PM10 is somewhat “washed” from the atmosphere with precipitation. Precipitation in the San Joaquin Valley is strongly influenced by the position of the semi-permanent subtropical high-pressure belt located off the Pacific coast. In the winter, this high- pressure system moves southward, allowing Pacific storms to move through the San Joaquin Valley. These storms bring in moist, maritime air that produces considerable precipitation on the western, upslope side of the Coast Ranges. Significant precipitation also occurs on the western side of the Sierra Nevada. On the valley floor, however, there is some down slope flow from the Coast Ranges and the resultant evaporation of moisture from associated warming results in a minimum of precipitation. Nevertheless, the majority of the precipitation falling in the San Joaquin Valley is produced by those storms during the winter. Precipitation during the summer months is in the form of convective rain showers and is rare. It is usually associated with an influx of moisture into the San Joaquin Valley through the San Francisco area during an anomalous flow pattern in the lower layers of the atmosphere. Although the hourly rates of precipitation from these storms may be high, their rarity keeps monthly totals low.

Precipitation on the San Joaquin Valley floor and in the Sierra Nevada decreases from north to south. Stockton in the north receives about 20 inches of precipitation per year, Fresno in the center, receives about 10 inches per year, and Bakersfield at the southern end of the valley receives less than 6 inches per year. This is primarily because the Pacific storm track often passes through the northern part of the state while the southern part of the state remains protected by the Pacific High. Precipitation in the San Joaquin Valley Air Basin (SJVAB) is confined primarily to the winter months with some also occurring in late summer and fall. Average annual rainfall for the entire San Joaquin Valley is approximately 5 to 16 inches. Snowstorms, hailstorms, and ice storms occur infrequently in the San Joaquin Valley and severe occurrences of any of these are very rare.

The winds and unstable air conditions experienced during the passage of storms result in periods of low pollutant concentrations and excellent visibility. Between winter storms, high pressure and light winds allow cold moist air to pool on the San Joaquin Valley floor. This creates strong

low-level temperature inversions and very stable air conditions. This situation leads to the San Joaquin Valley's famous Tule Fogs. The formation of natural fog is caused by local cooling of the atmosphere until it is saturated (dew point temperature). This type of fog, known as radiation fog, is more likely to occur inland. Cooling may also be accomplished by heat radiation losses or by horizontal movement of a mass of air over a colder surface. This second type of fog, known as advection fog, generally occurs along the coast.

Conditions favorable to fog formation are also conditions favorable to high concentrations of CO and PM10. Ozone levels are low during these periods because of the lack of sunlight to drive the photochemical reaction. Maximum CO concentrations tend to occur on clear, cold nights when a strong surface inversion is present and large numbers of fireplaces are in use. A secondary peak in CO concentrations occurs during morning commute hours when a large number of motorists are on the road and the surface inversion has not yet broken.

The water droplets in fog, however, can act as a sink for CO and nitrogen oxides (NO_x), lowering pollutant concentrations. At the same time, fog could help in the formation of secondary particulates such as ammonium sulfate. These secondary particulates are believed to be a significant contributor of winter season violations of the PM10 and PM2.5 standards.

2.4 Anthropogenic (Man-made) Sources

In addition to climatic conditions (wind, lack of rain, etc.), air pollution can be caused by anthropogenic or man-made sources. Air pollution in the SJVAB can be directly attributed to human activities, which cause air pollutant emissions. Human causes of air pollution in the Valley consist of population growth, urbanization (gas-fired appliances, residential wood heaters, etc.), mobile sources (i.e., cars, trucks, airplanes, trains, etc.), oil production, agriculture, and other socioeconomic activities. The most significant factors, which are accelerating the decline of air quality in the SJVAB, are the Valley's rapid population growth and its associated increases in traffic, urbanization, and industrial activity.

Carbon monoxide emissions overwhelmingly come from mobile sources in the San Joaquin Valley; on-road vehicles contributed 34 percent, while other mobile vehicles, such as trains, planes, and off-road vehicles, contribute another 20 percent in 2012 according to emission projections from the CARB. Motor vehicles account for significant portions of regional gaseous and particulate emissions. Local large employers such as industrial plants can also generate substantial regional gaseous and particulate emissions. In addition, construction and agricultural activities can generate significant temporary gaseous and particulate emissions (dust, ash, smoke, etc.).

Ozone is the result of a photochemical reaction between Oxides of nitrogen (NO_x) and Reactive Organic Gases (ROG). Mobile sources contribute 84 percent of all NO_x emitted from anthropogenic sources based on data provided in Appendix B of the Air District's 2016 Ozone

Plan. In addition, mobile sources contribute 26 percent of all the ROG emitted from sources within the San Joaquin Valley.

The principal factors that affect air quality in and around Hanford are:

1. The sink effect, climatic subsidence and temperature inversions and low wind speeds
2. Automobile and truck travel
3. Increases in mobile and stationary pollutants generated by local urban growth

Automobiles, trucks, buses and other vehicles using hydrocarbon (HC) fuels release exhaust products into the air. Each vehicle by itself does not release large quantities; however, when considered as a group, the cumulative effect is significant.

Other sources may not seem to fit into any one of the major categories or they may seem to fit in a number of them. These could include agricultural uses, dirt roads, animal shelters; animal feed lots, chemical plants and industrial waste disposal, which may be a source of dust, odors, or other pollutants. For Kings County, this category includes several agriculturally related activities, such as plowing, harvesting, dusting with herbicides and pesticides and other related activities. Finally, industrial contaminants and their potential to produce various effects depend on the size and type of industry, pollution controls, local topography, and meteorological conditions. Major sources of industrial emissions in Kings County consist of agricultural production and processing operations.

The primary contributors of PM10 emissions in the San Joaquin Valley are farming activities (22%) and road dust, both paved and unpaved (35%) in 2020 according to emission projections from the CARB. Fugitive windblown dust from “open” fields contributed 14 percent of the PM10.

The four major sources of air pollutant emissions in the SJVAB include industrial plants, motor vehicles, construction activities, and agricultural activities. Industrial plants account for significant portions of regional gaseous and particulate emissions. Motor vehicles, including those from large employers, generate substantial regional gaseous and particulate emissions. Finally, construction and agricultural activities can generate significant temporary gaseous and particulate emissions (dust, ash, smoke, etc.). In addition to these primary sources of air pollution, urban areas upwind from Kings County including areas north and west of the San Joaquin Valley, can cause or generate emissions that are transported into Kings County. All four of the major pollutant sources affect ambient air quality throughout the Air Basin.

2.4.1 Motor Vehicles

Automobiles, trucks, buses and other vehicles using hydrocarbon fuels release exhaust products into the air. Each vehicle by itself does not release large quantities; however, when considered as a group, the cumulative effect is significant.

2.4.2 *Agricultural and Other Miscellaneous Activities*

Other sources may not seem to fit into any one of the major categories or they may seem to fit in a number of them. These could include agricultural uses, dirt roads, animal shelters, animal feed lots, chemical plants and industrial waste disposal, which may be a source of dust, odors, or other pollutants. For Hanford, this category includes several agriculturally related activities, such as plowing, harvesting, dusting with herbicides and pesticides and other related activities.

2.4.3 *Industrial Plants*

Industrial contaminants and their potential to produce various effects depend on the size and type of industry, pollution controls, local topography, and meteorological conditions. Major sources of industrial emissions in Kings County consist of agricultural production and processing operations.

2.5 San Joaquin Valley Air Basin Monitoring

SJVAPCD and the CARB maintain numerous air quality monitoring sites throughout each County in the Air Basin to measure ozone, PM_{2.5}, and PM₁₀. It is important to note that the federal ozone 1-hour standard was revoked by the EPA and is no longer applicable for federal standards. The closest monitoring station to the Project is located at Hanford-S Irwin Monitoring station. The station monitors particulates, ozone, carbon monoxide, and nitrogen dioxide. Monitoring data for the past three years is summarized in Table 2.

Table 3 identifies the Kings County's attainment status. As indicated, the SJVAB is nonattainment for Ozone (1 hour and 8 hour) and PM. In accordance with the FCAA, EPA uses the design value at the time of standard promulgation to assign nonattainment areas to one of several classes that reflect the severity of the nonattainment problem; classifications range from marginal nonattainment to extreme nonattainment. The FCAA contains provisions for changing the classifications using factors such as clean air progress rates and requests from States to move areas to a higher classification.

On April 16, 2004 EPA issued a final rule classifying the SJVAB as extreme nonattainment for Ozone, effective May 17, 2004 (69 FR 20550). The (federal) 1-hour ozone standard was revoked on June 6, 2005. However, many of the requirements in the 1-hour attainment plan (SIP) continue to apply to the SJVAB. The current ozone plan is the (federal) 8-hour ozone plan adopted in 2007. The SJVAB was reclassified from a "serious" nonattainment area for the 8-hour ozone standard to "extreme" effective June 4, 2010.

Table 2
Maximum Pollutant Levels at
Hanford-S Irwin Monitoring Station

Pollutant	Time Averaging	2018	2019	2020	Standards	
		Maximums	Maximums	Maximums	National	State
Ozone (O ₃)	1 hour	0.108 ppm	0.093 ppm	0.103 ppm	0.099 ppm	0.101 ppm
Ozone (O ₃)(70 ppm)	8 hour	0.082 ppm	0.076 ppm	0.088 ppm	0.070 ppm	0.070 ppm
Nitrogen Dioxide (NO ₂)	1 hour	56.3 ppm	62.9 ppm	51.9 ppm	48 ppm	60 ppm
Nitrogen Dioxide (NO ₂)	Annual Average	9 ppm	8 ppm	9 ppm	8 ppm	8 ppm
Particulates (PM ₁₀)	24 hour	174.2 µg/m ³	211.7 µg/m ³	180.4 µg/m ³	48 µg/m ³	48 µg/m ³
Particulates (PM ₁₀)	Federal Annual Arithmetic Mean	47.3 µg/m ³	44.8 µg/m ³	51.5 µg/m ³	48 µg/m ³	48 µg/m ³
Particulates (PM _{2.5})	24 hour	107.8 µg/m ³	48.2 µg/m ³	147 µg/m ³	35 µg/m ³	100.4 µg/m ³
Particulates (PM _{2.5})	Federal Annual Arithmetic Mean	17.7 µg/m ³	12.1 µg/m ³	19.8 µg/m ³	65 µg/m ³	16 µg/m ³

Source: California Air Resources Board (ADAM) Air Pollution Summaries

* Means there was insufficient data available to determine the value.

Table 3
Kings County Attainment Status

Pollutant	Designation/Classification	
	Federal Standards	State Standards
Ozone - 1 Hour	Revoked in 2005	Nonattainment
Ozone - 8 Hour	Nonattainment/Extreme ^a	No State Standard
PM10	Attainment	Nonattainment
PM2.5	Nonattainment	Nonattainment
Carbon Monoxide	Unclassified/Attainment	Unclassified
Nitrogen Dioxide	Unclassified/Attainment	Attainment
Sulfur Dioxide	Unclassified/Attainment	Attainment
Lead (Particulate)	Unclassified/Attainment	Attainment
Hydrogen Sulfide	No Federal Standard	Unclassified
Sulfates	No Federal Standard	Attainment
Visibility Reducing Particles	No Federal Standard	Unclassified

Source: CARB Website, 2022

a. Though the Valley was initially classified as serious nonattainment for the 1997 8-hour ozone standard, EPA approved Valley reclassification to extreme nonattainment in the Federal Register on May 5, 2010 (effective June 4, 2010).

Notes:

National Designation Categories

Non-Attainment Area: Any area that does not meet (or that contributes to ambient air quality in a nearby area that does not meet) the national primary or secondary ambient air quality standard for the pollutant.

Unclassified/Attainment Area: Any area that cannot be classified on the basis of available information as meeting or not meeting the national primary or secondary ambient air quality standard for the pollutant or meets the national primary or secondary ambient air quality standard for the pollutant.

State Designation Categories

Unclassified: A pollutant is designated unclassified if the data are incomplete and do not support a designation of attainment or non-attainment.

Attainment: A pollutant is designated attainment if the State standard for that pollutant was not violated at any site in the area during a three-year period.

Non-attainment: A pollutant is designated non-attainment if there was at least one violation of a State standard for that pollutant in the area.

Non-Attainment/Transitional: A subcategory of the non-attainment designation. An area is designated non-attainment/transitional to signify that the area is close to attaining the standard for the pollutant.

2.6 Air Quality Standards

The FCAA, first adopted in 1963, and periodically amended since then, established National Ambient Air Quality Standards (NAAQS). A set of 1977 amendments determined a deadline for the attainment of these standards. That deadline has since passed. Other CAA amendments, passed in 1990, share responsibility with the State in reducing emissions from mobile sources.

In 1988, the State of California passed the CCAA (State 1988 Statutes, Chapter 568), which set forth a program for achieving more stringent California Ambient Air Quality Standards. The CARB implements State ambient air quality standards, as required in the CCAA, and cooperates with the federal government in implementing pertinent sections of the FCAA Amendments (FCAAA). Further, CARB regulates vehicular emissions throughout the State. The SJVAPCD regulates stationary sources, as well as some mobile sources. Attainment of the more stringent State PM10 Air Quality Standards is not currently required.

The EPA uses six "criteria pollutants" as indicators of air quality and has established for each of them a maximum concentration above which adverse effects on human health may occur. These threshold concentrations are called the NAAQS.

The SJVAPCD operates regional air quality monitoring networks that provide information on average concentrations of pollutants for which State or federal agencies have established ambient air quality standards. Descriptions of nine pollutants of importance in Kings County follow.

2.6.1 Ozone (1-hour and 8-hour)

The most severe air quality problem in the Air Basin is the high level of ozone. Ozone occurs in two layers of the atmosphere. The layer surrounding the earth's surface is the troposphere. Here, ground level, or "bad" ozone, is an air pollutant that damages human health, vegetation, and many common materials. It is a key ingredient of urban smog. The troposphere extends to a level about 10 miles up, where it meets the second layer, the stratosphere. The stratospheric, or "good" ozone layer, extends upward from about 10 to 30 miles and protects life on earth from the sun's harmful ultraviolet rays.

"Bad" ozone is what is known as a photochemical pollutant. It needs reactive organic gases (ROG), NO_x, and sunlight. ROG and NO_x are emitted from various sources throughout Kings County. In order to reduce ozone concentrations, it is necessary to control the emissions of these ozone precursors.

Significant ozone formation generally requires an adequate amount of precursors in the atmosphere and several hours in a stable atmosphere with strong sunlight. High ozone concentrations can form over large regions when emissions from motor vehicles and stationary sources are carried hundreds of miles from their origins.

Ozone is a regional air pollutant. It is generated over a large area and is transported and spread by wind. Ozone, the primary constituent of smog, is the most complex, difficult to control, and pervasive of the criteria pollutants. Unlike other pollutants, ozone is not emitted directly into the air by specific sources. Ozone is created by sunlight acting on other air pollutants (called precursors), specifically NO_x and ROG. Sources of precursor gases to the photochemical reaction that form ozone number in the thousands. Common sources include consumer products, gasoline vapors, chemical solvents, and combustion products of various fuels. Originating from gas stations, motor vehicles, large industrial facilities, and small businesses such as bakeries and dry cleaners, the ozone-forming chemical reactions often take place in another location, catalyzed by sunlight and heat. High ozone concentrations can form over large regions when emissions from motor vehicles and stationary sources are carried hundreds of miles from their origins. Approximately 50 million people lived in counties with air quality levels above the EPA's health-based national air quality standard in 1994. The highest levels of ozone were recorded in Los Angeles, closely followed by the San Joaquin Valley. High levels also persist in other heavily populated areas, including the Texas Gulf Coast and much of the Northeast.

While the ozone in the upper atmosphere absorbs harmful ultraviolet light, ground-level ozone is damaging to the tissues of plants, animals, and humans, as well as to a wide variety of inanimate materials such as plastics, metals, fabrics, rubber, and paints. Societal costs from ozone damage include increased medical costs, the loss of human and animal life, accelerated replacement of industrial equipment, and reduced crop yields.

✓ **Health Effects**

While ozone in the upper atmosphere protects the earth from harmful ultraviolet radiation, high concentrations of ground-level ozone can adversely affect the human respiratory system. Many respiratory ailments, as well as cardiovascular disease, are aggravated by exposure to high ozone levels. Ozone also damages natural ecosystems, such as: forests and foothill communities; agricultural crops; and some man-made materials, such as rubber, paint, and plastic. High levels of ozone may negatively affect immune systems, making people more susceptible to respiratory illnesses, including bronchitis and pneumonia. Ozone accelerates aging and exacerbates pre-existing asthma and bronchitis and, in cases with high concentrations, can lead to the development of asthma in active children. Active people, both children and adults, appear to be more at risk from ozone exposure than those with a low level of activity. Additionally, the elderly and those with respiratory disease are also considered sensitive populations for ozone.

People who work or play outdoors are at a greater risk for harmful health effects from ozone. Children and adolescents are also at greater risk because they are more likely than adults to spend time engaged in vigorous activities. Research indicates that children under 12 years of age spend nearly twice as much time outdoors daily than adults. Teenagers spend at least twice as much time as adults in active sports and outdoor activities. In addition, children

inhale more air per pound of body weight than adults, and they breathe more rapidly than adults. Children are less likely than adults to notice their own symptoms and avoid harmful exposures.

Ozone is a powerful oxidant—it can be compared to household bleach, which can kill living cells (such as germs or human skin cells) upon contact. Ozone can damage the respiratory tract, causing inflammation and irritation, and it can induce symptoms such as coughing, chest tightness, shortness of breath, and worsening of asthmatic symptoms. Ozone in sufficient doses increases the permeability of lung cells, rendering them more susceptible to toxins and microorganisms. Exposure to levels of ozone above the current ambient air quality standard leads to lung inflammation and lung tissue damage and a reduction in the amount of air inhaled into the lungs.

The CARB found ozone standards in Kings County nonattainment of Federal and State standards.

2.6.2 *Suspended PM (PM10 and PM2.5)*

Particulate matter pollution consists of very small liquid and solid particles that remain suspended in the air for long periods. Some particles are large or concentrated enough to be seen as soot or smoke. Others are so small they can be detected only with an electron microscope. Particulate matter is a mixture of materials that can include smoke, soot, dust, salt, acids, and metals. Particulate matter is emitted from stationary and mobile sources, including diesel trucks and other motor vehicles; power plants; industrial processes; wood-burning stoves and fireplaces; wildfires; dust from roads, construction, landfills, and agriculture; and fugitive windblown dust. PM10 refers to particles less than or equal to 10 microns in aerodynamic diameter. PM2.5 refers to particles less than or equal to 2.5 microns in aerodynamic diameter and are a subset of PM10. Particulates of concern are those that are 10 microns or less in diameter. These are small enough to be inhaled, pass through the respiratory system and lodge in the lungs, possibly leading to adverse health effects.

In the western United States, there are sources of PM10 in both urban and rural areas. Because particles originate from a variety of sources, their chemical and physical compositions vary widely. The composition of PM10 and PM2.5 can also vary greatly with time, location, the sources of the material and meteorological conditions. Dust, sand, salt spray, metallic and mineral particles, pollen, smoke, mist, and acid fumes are the main components of PM10 and PM2.5. In addition to those listed previously, secondary particles can also be formed as precipitates from chemical and photochemical reactions of gaseous sulfur dioxide (SO₂) and NO_x in the atmosphere to create sulfates (SO₄) and nitrates (NO₃). Secondary particles are of greatest concern during the winter months where low inversion layers tend to trap the precursors of secondary particulates.

The District's 2008 PM2.5 Plan built upon the aggressive emission reduction strategy adopted in

the 2007 Ozone Plan and strives to bring the valley into attainment status for the 1997 NAAQS for PM2.5. The District's 2012 PM2.5 Plan provides multiple control strategies to reduce emissions of PM2.5 and other pollutants that form PM2.5. The plan's comprehensive control strategy includes regulatory actions, incentive programs, technology advancement, policy and legislative positions, public outreach, participation and communication, and additional strategies.

✓ **Health Effects**

PM10 and PM2.5 particles are small enough—about one-seventh the thickness of a human hair, or smaller—to be inhaled and lodged in the deepest parts of the lung where they evade the respiratory system's natural defenses. Health problems begin as the body reacts to these foreign particles. Acute and chronic health effects associated with high particulate levels include the aggravation of chronic respiratory diseases, heart and lung disease, and coughing, bronchitis, and respiratory illnesses in children. Recent mortality studies have shown a statistically significant direct association between mortality and daily concentrations of particulate matter in the air. Non-health-related effects include reduced visibility and soiling of buildings. PM10 can increase the number and severity of asthma attacks, cause or aggravate bronchitis and other lung diseases, and reduce the body's ability to fight infections. PM10 and PM2.5 can aggravate respiratory disease and cause lung damage, cancer, and premature death.

Although particulate matter can cause health problems for everyone, certain people are especially vulnerable to adverse health effects of PM10. These "sensitive populations" include children, the elderly, exercising adults, and those suffering from chronic lung disease such as asthma or bronchitis. Of greatest concern are recent studies that link PM10 exposure to the premature death of people who already have heart and lung disease, especially the elderly. Acidic PM10 can also damage manmade materials and is a major cause of reduced visibility in many parts of the United States.

The CARB found PM10 standards in Kings County in attainment of Federal standards and nonattainment for State standards. The CARB found PM2.5 standards in Kings County nonattainment of Federal and State standards.

2.6.3 Carbon Monoxide (CO)

Carbon monoxide (CO) is emitted by mobile and stationary sources as a result of incomplete combustion of hydrocarbons or other carbon-based fuels. CO is an odorless, colorless, poisonous gas that is highly reactive. CO is a byproduct of motor vehicle exhaust, contributes more than two thirds of all CO emissions nationwide. In cities, automobile exhaust can cause as much as 95 percent of all CO emissions. These emissions can result in high concentrations of CO, particularly in local areas with heavy traffic congestion. Other sources of CO emissions include industrial processes and fuel combustion in sources such as boilers and incinerators. Despite an overall

downward trend in concentrations and emissions of CO, some metropolitan areas still experience high levels of CO.

✓ **Health Effects**

CO enters the bloodstream and binds more readily to hemoglobin than oxygen, reducing the oxygen-carrying capacity of blood and thus reducing oxygen delivery to organs and tissues. The health threat from CO is most serious for those who suffer from cardiovascular disease. Healthy individuals are also affected but only at higher levels of exposure. At high concentrations, CO can cause heart difficulties in people with chronic diseases and can impair mental abilities. Exposure to elevated CO levels is associated with visual impairment, reduced work capacity, reduced manual dexterity, poor learning ability, difficulty performing complex tasks, and in prolonged, enclosed exposure, death.

The adverse health effects associated with exposure to ambient and indoor concentrations of CO are related to the concentration of carboxyhemoglobin (COHb) in the blood. Health effects observed may include an early onset of cardiovascular disease; behavioral impairment; decreased exercise performance of young, healthy men; reduced birth weight; sudden infant death syndrome (SIDS); and increased daily mortality rate.

Most of the studies evaluating adverse health effects of CO on the central nervous system examine high-level poisoning. Such poisoning results in symptoms ranging from common flu and cold symptoms (shortness of breath on mild exertion, mild headaches, and nausea) to unconsciousness and death.

The CARB found CO standards in Kings County as unclassified/attainment of Federal standards and attainment for State standards.

2.6.4 Nitrogen Dioxide (NO₂)

Nitrogen oxides (NO_x) is a family of highly reactive gases that are primary precursors to the formation of ground-level ozone and react in the atmosphere to form acid rain. NO_x is emitted from combustion processes in which fuel is burned at high temperatures, principally from motor vehicle exhaust and stationary sources such as electric utilities and industrial boilers. A brownish gas, NO_x is a strong oxidizing agent that reacts in the air to form corrosive nitric acid, as well as toxic organic nitrates. EPA regulates only nitrogen dioxide (NO₂) as a surrogate for this family of compounds because it is the most prevalent form of NO_x in the atmosphere that is generated by anthropogenic (human) activities.¹

✓ **Health Effects**

NO_x is an ozone precursor that combines with Reactive Organic Gases (ROG) to form ozone.

¹ United States Environmental Protection Agency (EPA), Nitrogen Oxides (NO_x). Why and How They Are Controlled, 456/F-99-006R, November 2019

See the ozone section above for a discussion of the health effects of ozone.

Direct inhalation of NO_x can also cause a wide range of health effects. NO_x can irritate the lungs, cause lung damage, and lower resistance to respiratory infections such as influenza. Short-term exposures (e.g., less than 3 hours) to low levels of nitrogen dioxide (NO₂) may lead to changes in airway responsiveness and lung function in individuals with preexisting respiratory illnesses. These exposures may also increase respiratory illnesses in children. Long-term exposures to NO₂ may lead to increased susceptibility to respiratory infection and may cause irreversible alterations in lung structure. Other health effects associated with NO_x are an increase in the incidence of chronic bronchitis and lung irritation. Chronic exposure to NO₂ may lead to eye and mucus membrane aggravation, along with pulmonary dysfunction. NO_x can cause fading of textile dyes and additives, deterioration of cotton and nylon, and corrosion of metals due to production of particulate nitrates. Airborne NO_x can also impair visibility. NO_x is a major component of acid deposition in California. NO_x may affect both terrestrial and aquatic ecosystems. NO_x in the air is a potentially significant contributor to a number of environmental effects such as acid rain and eutrophication in coastal waters. Eutrophication occurs when a body of water suffers an increase in nutrients that reduce the amount of oxygen in the water, producing an environment that is destructive to fish and other animal life.

NO₂ is toxic to various animals as well as to humans. Its toxicity relates to its ability to combine with water to form nitric acid in the eye, lung, mucus membranes, and skin. Studies of the health impacts of NO₂ include experimental studies on animals, controlled laboratory studies on humans, and observational studies.

In animals, long-term exposure to NO_x increases susceptibility to respiratory infections, lowering their resistance to such diseases as pneumonia and influenza. Laboratory studies show susceptible humans, such as asthmatics, exposed to high concentrations of NO₂, can suffer lung irritation and, potentially, lung damage. Epidemiological studies have also shown associations between NO₂ concentrations and daily mortality from respiratory and cardiovascular causes as well as hospital admissions for respiratory conditions.

NO_x contributes to a wide range of environmental effects both directly and when combined with other precursors in acid rain and ozone. Increased nitrogen inputs to terrestrial and wetland systems can lead to changes in plant species composition and diversity. Similarly, direct nitrogen inputs to aquatic ecosystems such as those found in estuarine and coastal waters can lead to eutrophication as discussed above. Nitrogen, alone or in acid rain, also can acidify soils and surface waters. Acidification of soils causes the loss of essential plant nutrients and increased levels of soluble aluminum, which is toxic to plants. Acidification of surface waters creates conditions of low pH and levels of aluminum that are toxic to fish and other aquatic organisms.

The CARB found NO₂ standards in Kings County as unclassified/attainment of Federal standards and attainment for State standards.

2.6.5 Sulfur Dioxide (SO₂)

The major source of sulfur dioxide (SO₂) is the combustion of high-sulfur fuels for electricity generation, petroleum refining and shipping. High concentrations of SO₂ can result in temporary breathing impairment for asthmatic children and adults who are active outdoors. Short-term exposures of asthmatic individuals to elevated SO₂ levels during moderate activity may result in breathing difficulties that can be accompanied by symptoms such as wheezing, chest tightness, or shortness of breath. Other effects that have been associated with longer-term exposures to high concentrations of SO₂, in conjunction with high levels of PM, include aggravation of existing cardiovascular disease, respiratory illness, and alterations in the lungs' defenses. SO₂ also is a major precursor to PM_{2.5}, which is a significant health concern and a main contributor to poor visibility. In humid atmospheres, sulfur oxides can react with vapor to produce sulfuric acid, a component of acid rain.

The CARB found SO₂ standards in the Kings County as unclassified for Federal standards and attainment for State standards.

2.6.6 Lead (Pb)

Lead, a naturally occurring metal, can be a constituent of air, water, and the biosphere. Lead is neither created nor destroyed in the environment, so it essentially persists forever. Lead was used until recently to increase the octane rating in automobile fuel. Since the 1980s, lead has been phased out in gasoline, reduced in drinking water, reduced in industrial air pollution, and banned or limited in consumer products. Gasoline-powered automobile engines were a major source of airborne lead through the use of leaded fuels; however, the use of leaded fuel has been mostly phased out. Since this has occurred the ambient concentrations of lead have dropped dramatically.

Exposure to lead occurs mainly through inhalation of air and ingestion of lead in food, water, soil, or dust. It accumulates in the blood, bones, and soft tissues and can adversely affect the kidneys, liver, nervous system, and other organs. Excessive exposure to lead may cause neurological impairments such as seizures, mental retardation, and behavioral disorders. Even at low doses, lead exposure is associated with damage to the nervous systems of fetuses and young children. Effects on the nervous systems of children are one of the primary health risk concerns from lead. In high concentrations, children can even suffer irreversible brain damage and death. Children 6 years old and under are most at risk, because their bodies are growing quickly.

The CARB found Lead standards in Kings County as unclassified/attainment of Federal standards and attainment for State standards.

2.6.7 Toxic Air Contaminants (TAC)

In addition to the criteria pollutants discussed above, Toxic Air Contaminants (TAC) are another

group of pollutants of concern. TAC are injurious in small quantities and are regulated despite the absence of criteria documents. The identification, regulation and monitoring of TAC is relatively recent compared to that for criteria pollutants. Unlike criteria pollutants, TAC are regulated on the basis of risk rather than specification of safe levels of contamination. The ten TAC are acetaldehyde, benzene, 1,3-butadiene, carbon tetrachloride, hexavalent chromium, para-dichlorobenzene, formaldehyde, methylene chloride, perchloroethylene, and diesel particulate matter (diesel PM). Caltrans' guidance for transportation studies references the Federal Highway Administration (FHWA) memorandum titled "Interim Guidance on Air Toxic Analysis in NEPA Documents" which discusses emissions quantification of six "priority" compounds of 21 Mobile Source Air Toxics (MSAT) identified by the United States Environmental Protection Agency (USEPA). The six "priority" compounds are diesel exhaust (particulate matter and organic gases), benzene, 1,3-butadiene, acetaldehyde, formaldehyde, and acrolein.

Some studies indicate that diesel PM poses the greatest health risk among the TAC listed above. A 10-year research program (California Air Resources Board 1998) demonstrated that diesel PM from diesel-fueled engines is a human carcinogen and that chronic (long-term) inhalation exposure to diesel PM poses a chronic health risk. In addition to increasing the risk of lung cancer, exposure to diesel exhaust can have other health effects. Diesel exhaust can irritate the eyes, nose, throat, and lungs, and it can cause coughs, headaches, lightheadedness, and nausea. Diesel exhaust is a major source of fine particulate pollution as well, and studies have linked elevated particle levels in the air to increased hospital admissions, emergency room visits, asthma attacks, and premature deaths among those suffering from respiratory problems.

Diesel PM differs from other TAC in that it is not a single substance but a complex mixture of hundreds of substances. Although diesel PM is emitted by diesel-fueled, internal combustion engines, the composition of the emissions varies, depending on engine type, operating conditions, fuel composition, lubricating oil, and whether an emission control system is present. Unlike the other TAC, however, no ambient monitoring data are available for diesel PM because no routine measurement method currently exists. The CARB has made preliminary concentration estimates based on a diesel PM exposure method. This method uses the CARB emissions inventory's PM10 database, ambient PM10 monitoring data, and the results from several studies to estimate concentrations of diesel PM. Table 4 depicts the CARB Handbook's recommended buffer distances associated with various types of common sources.

Existing air quality concerns within Hanford and the entire SJVAB are related to increases of regional criteria air pollutants (e.g., ozone and particulate matter), exposure to toxic air contaminants, odors, and increases in greenhouse gas emissions contributing to climate change. The primary source of ozone (smog) pollution is motor vehicles. Particulate matter is caused by dust, primarily dust generated from construction and grading activities, and smoke which is emitted from fireplaces, wood-burning stoves, and agricultural burning.

TABLE 4
Recommendations on Siting New Sensitive Land Uses Such As Residences, Schools, Daycare Centers, Playgrounds, or Medical Facilities*

SOURCE CATEGORY	ADVISORY RECOMMENDATIONS
Freeways and High-Traffic Roads ¹	- Avoid siting new sensitive land uses within 500 feet of a freeway, urban roads with 100,000 vehicles/day, or rural roads with 50,000 vehicles/day.
Distribution Centers	- Avoid siting new sensitive land uses within 1,000 feet of a distribution center (that accommodates more than 100 trucks per day, more than 40 trucks with operating transport refrigeration units (TRUs) per day, or where TRU unit operations exceed 300 hours per week). - Take into account the configuration of existing distribution centers and avoid locating residences and other new sensitive land uses near entry and exit points.
Rail Yards	- Avoid siting new sensitive land uses within 1,000 feet of a major service and maintenance rail yard. - Within one mile of a rail yard, consider possible siting limitations and mitigation approaches.
Ports	- Avoid siting of new sensitive land uses immediately downwind of ports in the most heavily impacted zones. Consult local air districts or the ARB on the status of pending analyses of health risks.
Refineries	- Avoid siting new sensitive land uses immediately downwind of petroleum refineries. Consult with local air districts and other local agencies to determine an appropriate separation.
Chrome Platers	- Avoid siting new sensitive land uses within 1,000 feet of a chrome plater.
Dry Cleaners Using Perchloroethylene	- Avoid siting new sensitive land uses within 300 feet of any dry cleaning operation. For operations with two or more machines, provide 500 feet. For operations with 3 or more machines, consult with the local air district. - Do not site new sensitive land uses in the same building with perchloroethylene dry cleaning operations.
Gasoline Dispensing Facilities	- Avoid siting new sensitive land uses within 300 feet of a large gas station (defined as a facility with a throughput of 3.6 million gallons per year or greater). A 50 foot separation is recommended for typical gas dispensing facilities.

1: The recommendation to avoid siting new sensitive land uses within 500 feet of a freeway was identified in CARB’s Air Quality and Land Use Handbook published in 2005. CARB recently published a technical advisory to the Air Quality and Land Use Handbook indicating that new research has demonstrated promising strategies to reduce pollution exposure along transportation corridors.

***Notes:**

- These recommendations are advisory. Land use agencies have to balance other considerations, including housing and transportation needs, economic development priorities, and other quality of life issues.
- Recommendations are based primarily on data showing that the air pollution exposures addressed here (i.e., localized) can be reduced as much as 80% with the recommended separation.
- The relative risk for these categories varies greatly (see Table 1-2). To determine the actual risk near a particular facility, a site-specific analysis would be required. Risk from diesel PM will decrease over time as cleaner technology phases in.
- These recommendations are designed to fill a gap where information about existing facilities may not be readily available and are not designed to substitute for more specific information if it exists. The recommended distances take into account other factors in addition to available health risk data (see individual category descriptions).
- Site-specific project design improvements may help reduce air pollution exposures and should also be considered when siting new sensitive land uses.
- This table does not imply that mixed residential and commercial development in general is incompatible. Rather it focuses on known problems like dry cleaners using perchloroethylene that can be addressed with reasonable preventative actions.
- A summary of the basis for the distance recommendations can be found in the ARB Handbook: Air Quality and Land Use Handbook: A Community Health Perspective.

Source: SJVAPCD 2022

2.6.8 Odors

Typically, odors are regarded as an annoyance rather than a health hazard. However, manifestations of a person's reaction to foul odors can range from psychological (e.g., irritation, anger, or anxiety) to physiological (e.g., circulatory and respiratory effects, nausea, vomiting, and headache).

With respect to odors, the human nose is the sole sensing device. The ability to detect odors varies considerably among the population and overall is quite subjective. Some individuals have the ability to smell minute quantities of specific substances; others may not have the same sensitivity but may have sensitivities to odors of other substances. In addition, people may have different reactions to the same odor; in fact, an odor that is offensive to one person (e.g., from a fast-food restaurant) may be perfectly acceptable to another. It is also important to note that an unfamiliar odor is more easily detected and is more likely to cause complaints than a familiar one. This is because of the phenomenon known as odor fatigue, in which a person can become desensitized to almost any odor and recognition only occurs with an alteration in the intensity.

Quality and intensity are two properties present in any odor. The quality of an odor indicates the nature of the smell experience. For instance, if a person describes an odor as flowery or sweet, then the person is describing the quality of the odor. Intensity refers to the strength of the odor. For example, a person may use the word "strong" to describe the intensity of an odor. Odor intensity depends on the odorant concentration in the air.

When an odorous sample is progressively diluted, the odorant concentration decreases. As this occurs, the odor intensity weakens and eventually becomes so low that the detection or recognition of the odor is quite difficult. At some point during dilution, the concentration of the odorant reaches a detection threshold. An odorant concentration below the detection threshold means that the concentration in the air is not detectable by the average human.

The intensity of an odor source's operations and its proximity to sensitive receptors influences the potential significance of odor emissions. The SJVAPCD has identified some common types of facilities that have been known to produce odors in the SJVAB. The types of facilities that are known to produce odors are shown in Table 5 along with a reasonable distance from the source within which, the degree of odors could possibly be significant. The Project does not propose any uses that would be potential odor sources; however, the information presented in Table 5 will be used as a screening level analysis to determine if the Project would be impacted by existing odor sources in the study area. Such information is presented for informational purposes, but it is noted that the environment's effect on the Project, including exposure to potential odors, would not be an impact for CEQA purposes.

TABLE 5
Screening Levels for Potential Odor Sources

Type of Facility	Distance
Wastewater Treatment Facilities	2 miles
Sanitary Landfill	1 mile
Transfer Station	1 mile
Compositing Facility	1 mile
Petroleum Refinery	2 miles
Asphalt Batch Plant	1 mile
Chemical Manufacturing	1 mile
Fiberglass Manufacturing	1 mile
Painting/Coating Operations (e.g. auto body shops)	1 mile
Food Processing Facility	1 mile
Feed Lot/Dairy	1 mile
Rendering Plant	1 mile

Source: SJVAPCD 2022

2.6.9 Naturally Occurring Asbestos (NOA)

Asbestos is a term used for several types of naturally occurring fibrous minerals found in many parts of California. The most common type of asbestos is chrysotile, but other types are also found in California. Asbestos is commonly found in ultramafic rock and near fault zones. The amount of asbestos that is typically present in these rocks’ ranges from less than 1% up to approximately 25% and sometimes more. It is released from ultramafic rock when it is broken or crushed. This can happen when cars drive over unpaved roads or driveways, which are surfaced with these rocks, when land is graded for building purposes, or at quarrying operations. Asbestos is also released naturally through weathering and erosion. Once released from the rock, asbestos can become airborne and may stay in the air for long periods of time. Asbestos is hazardous and can cause lung disease and cancer dependent upon the level of exposure. The longer a person is exposed to asbestos and the greater the intensity of the exposure, the greater the chances for a health problem.

The proposed Project’s construction phase may cause asbestos to become airborne due to the construction activities that will occur on site. The Project would be required to submit a Dust Control Plan under the SJVAPCD’s Rule 8021.

2.6.10 Greenhouse Gas Emissions

Gases that trap heat in the atmosphere are often called greenhouse gases. Some greenhouse gases such as carbon dioxide occur naturally and are emitted to the atmosphere through natural processes and human activities. Other greenhouse gases (e.g., fluorinated gases) are created and emitted solely through human activities. The principal greenhouse gases that enter the

atmosphere because of human activities are:

- ✓ **Carbon Dioxide (CO₂):** Carbon dioxide enters the atmosphere through the burning of fossil fuels (oil, natural gas, and coal), solid waste, trees and wood products, and also as a result of other chemical reactions (e.g., manufacture of cement, asphalt paving, truck trips). Carbon dioxide is also removed from the atmosphere (or "sequestered") when it is absorbed by plants as part of the biological carbon cycle.
- ✓ **Methane (CH₄):** Methane is emitted during the production and transport of coal, natural gas, and oil. Methane emissions also result from livestock and other agricultural practices and by the decay of organic waste in municipal solid waste landfills.
- ✓ **Nitrous Oxide (N₂O):** Nitrous oxide is emitted during agricultural and industrial activities, as well as during combustion of fossil fuels and solid waste.
- ✓ **Fluorinated Gases:** Hydrofluorocarbons, perfluorocarbons, and sulfur hexafluoride are synthetic, powerful greenhouse gases that are emitted from a variety of industrial processes. Fluorinated gases are sometimes used as substitutes for ozone-depleting substances (i.e., CFCs, HCFCs, and halons). These gases are typically emitted in smaller quantities, but because they are potent greenhouse gases, they are sometimes referred to as High Global Warming Potential gases ("High GWP gases").

3.0 Air-Quality Impacts

3.1 Methodology

The impact assessment for air quality focuses on potential effects the Project might have on air quality within the Hanford region. The SJVAPCD has established thresholds of significance for determining environmental significance. These thresholds separate a project’s short-term emissions from its long-term emissions. The short-term emissions are mainly related to the construction phase of a project, which are recognized to be short in duration. The long-term emissions are primarily related to the activities that will occur indefinitely as a result of Project operations. Impacts will be evaluated both on the basis of CEQA Appendix G criteria and SJVAPCD significance criteria. The impacts to be evaluated will be those involving construction and operational emissions of criteria pollutants. The SJVAPCD has established thresholds for certain pollutants shown in Table 6.

Table 6
SJVAPCD Air Quality Thresholds of Significance

Project Type	Ozone Precursor Emissions (tons/year)					
	CO	NO _x	ROG	SO _x	PM ₁₀	PM _{2.5}
Construction Emissions	100	10	10	27	15	15
Operational Emissions (Permitted Equipment and Activities)	100	10	10	27	15	15
Operational Emissions (Non-Permitted Equipment and Activities)	100	10	10	27	15	15

Source: SJVAPCD 2022

3.1.1 CalEEMod

CalEEMod is a statewide land use emissions computer model designed to provide a uniform platform for government agencies, land use planners, and environmental professionals to quantify potential criteria pollutant and greenhouse gas (GHG) emissions associated with both construction and operations from a variety of land use projects. The model quantifies direct emissions from construction and operations (including vehicle use), as well as indirect emissions, such as GHG emissions from energy use, solid waste disposal, vegetation planting and/or removal, and water use.

The model is an accurate and comprehensive tool for quantifying air quality impacts from land use projects throughout California. The model can be used for a variety of situations where an air quality analysis is necessary or desirable such as CEQA and NEPA documents, pre-project planning, compliance with local air quality rules and regulations, etc.

3.2 Short-Term Impacts

Short-term impacts are mainly related to the construction phase of a project and are recognized to be short in duration. Construction air quality impacts are generally attributable to dust and exhaust pollutants generated by equipment and vehicles. Fugitive dust is emitted both during construction activity and as a result of wind erosion over exposed earth surfaces. Clearing and earth moving activities do comprise major sources of construction dust emissions, but traffic and general disturbances of soil surfaces also generate significant dust emissions. Further, dust generation is dependent on soil type and soil moisture. Exhaust pollutants are the non-useable gaseous waste products produced during the combustion process. Engine exhaust contains CO, HC, and NO_x pollutants which are harmful to the environment.

Adverse effects of construction activities cause increased dust-fall and locally elevated levels of total suspended particulate. Dust-fall can be a nuisance to neighboring properties or previously completed developments surrounding or within the Project area and may require frequent washing during the construction period.

PM₁₀ emissions can result from construction activities of the Project. The SJVAPCD has determined that compliance with Regulation VIII and other control measures will constitute sufficient mitigation to reduce PM₁₀ impacts to a level considered less-than significant for most development projects. Even with implementation of District Regulation VIII and District Rule 9510, large development projects may not be able to reduce project specific construction impacts below District thresholds of significance.

Ozone precursor emissions are also an impact of construction activities and can be quantified through calculations. Numerous variables factored into estimating total construction emission include: level of activity, length of construction period, number of pieces and types of equipment in use, site characteristics, weather conditions, number of construction personnel, and amount of materials to be transported onsite or offsite. Additional exhaust emissions would be associated with the transport of workers and materials. Because the specific mix of construction equipment is not presently known for this Project, construction emissions were estimated using CalEEMod Model defaults for construction equipment.

Table 7 shows the CalEEMod estimated construction emissions that would be generated from construction of the Project. Results of the analysis show that emissions generated from construction of the Project will not exceed the SJVAPCD emission thresholds.

Table 7
Project Construction Emissions (tons/year)

Summary Report	CO	NO _x	ROG	SO ₂	PM ₁₀	PM _{2.5}	CO ₂ e
Project Construction Emissions	5.65	6.66	7.20	0.01	1.70	0.61	1011.80
SJVAPCD Level of Significance	100	10	10	27	15	15	None
Does the Project Exceed Standard?	No	No	No	No	No	No	No

Source: CalEEMod

3.3 Long-Term Emissions

Long-Term emissions from the Project would be generated primarily by mobile source (vehicle) emissions from the Project site and area sources such as lawn maintenance equipment.

3.3.1 Localized Operational Emissions – Ozone/Particulate Matter

The Kings County area is nonattainment for Federal and State air quality standards for ozone, attainment of Federal standards for PM10 and nonattainment for State standards, and nonattainment for Federal and State standards for PM2.5. Nitrogen oxides and reactive organic gases are regulated as ozone precursors. Significance criteria have been established for criteria pollutant emissions as documented in Section 3.1. Operational emissions have been estimated for the Project using the CalEEMod Model and detailed results are included in Appendix A of this report.

Results of the CalEEMod analysis are shown in Table 8. Results indicate that the annual operational emissions from the Project will be less than the SJVAPCD emission thresholds for criteria pollutants.

Table 8
Project Operational Emissions (tons/year)

Summary Report	CO	NO _x	ROG	SO ₂	PM ₁₀	PM _{2.5}	CO ₂ e
Project Operational Emissions	23.72	4.86	6.18	0.05	4.57	1.30	5992.30
SJVAPCD Level of Significance	100	10	10	27	15	15	None
Does the Project Exceed Standard?	No	No	No	No	No	No	No

Source: CalEEMod

3.3.2 Localized Operational Emissions

✓ Carbon Monoxide

The SJVAPCD is currently in unclassified/attainment for Federal standards and unclassified for State standards for CO. An analysis of localized CO concentrations is typically warranted

to ensure that standards are maintained. Also, an analysis is required to ensure that localized concentrations don't reach potentially unhealthy levels that could affect sensitive receptors (residents, school children, hospital patients, the elderly, etc.).

Typically, high CO concentrations are associated with roadways or intersections operating at an unacceptable Level of Service (LOS). CO "Hot Spot" modeling is required if a traffic study reveals that the project will reduce the LOS on one or more streets to E or F or if the project will worsen an existing LOS F.

To analyze the Cumulative Year 2042 Plus Project "worst case" CO concentrations at study roadway segments, the analysis methodology considered the highest annual maximum CO concentration reported in 2013, using 1.0 PPM as an estimate of the background concentration for the 8-hour standard and 2.2 PPM for the 1-hour standard (source: CARB annual publications). Other modeling assumptions include a wind speed of .5 m/s, flat topography, 1,000-meter mixing height, and a 5 degree wind deviation.

✓ Toxic Air Contaminants (TAC)

The SJVAPCD's Guidance Document, Guidance for Assessing and Mitigating Air Quality Impacts – 2015, identifies the need for projects to analyze the potential for adverse air quality impacts to sensitive receptors. Sensitive receptors refer to those segments of the population most susceptible to poor air quality (i.e., children, the elderly, and those with pre-existing serious health problems affected by air quality). Land uses that have the greatest potential to attract these types of sensitive receptors include schools, parks, playgrounds, daycare centers, nursing homes, hospitals, and residential communities. From a health risk perspective, the Project is a Type Project in that it may potentially place sensitive receptors in the vicinity of existing sources.

The first step in evaluating the potential for impacts to sensitive receptors for TAC's from the Project is to perform a screening level analysis. For Type B Projects, one type of screening tool is found in the CARB Handbook: Air Quality and Land Use Handbook: A Community Perspective. This handbook includes a table (depicted in Table 4) with recommended buffer distances associated with various types of common sources. The screening level analysis for the Project shows that TAC's are not a concern based upon the recommendations provided in Table 4. An evaluation of nearby land uses considering CARB's Pollution Mapping Tool shows that the Project will not place sensitive receptors in the vicinity of existing toxic sources. The Project is located a half mile from the State Route (SR) 198 freeway. Table 4 indicates that new sensitive land uses shouldn't be sited within 500 feet of a freeway/urban roads with 100,000 vehicles/day, or rural roads with 50,000 vehicles/day. The Project is located more than 1 miles from the SR 198 freeway. As a result, a health risk assessment is not needed at this time

✓ **Odors**

Typically, odors are regarded as an annoyance rather than a health hazard. However, manifestations of a person's reaction to foul odors can range from psychological (e.g., irritation, anger, or anxiety) to physiological (e.g., circulatory and respiratory effects, nausea, vomiting, and headache).

Quality and intensity are two properties present in any odor. The quality of an odor indicates the nature of the smell experience. For instance, if a person describes an odor as flowery or sweet, then the person is describing the quality of the odor. Intensity refers to the strength of the odor. For example, a person may use the word "strong" to describe the intensity of an odor. Odor intensity depends on the odorant concentration in the air.

When an odorous sample is progressively diluted, the odorant concentration decreases. As this occurs, the odor intensity weakens and eventually becomes so low that the detection or recognition of the odor is quite difficult. At some point during dilution, the concentration of the odorant reaches a detection threshold. An odorant concentration below the detection threshold means that the concentration in the air is not detectable by the average human.

While offensive odors rarely cause any physical harm, they can be very unpleasant, leading to considerable distress among the public and often generating citizen complaints to local governments and the SJVAPCD. Any project with the potential to frequently expose members of the public to objectionable odors should be deemed to have a significant impact.

The SJVAPCD requires that an analysis of potential odor impacts be conducted for the following two situations:

- Generators – projects that would potentially generate odorous emissions proposed to be located near existing sensitive receptors or other land uses where people may congregate, and
- Receivers – residential or other sensitive receptor projects or other projects built for the intent of attracting people locating near existing odor sources.

The Project will not generate odorous emissions given the nature or characteristics of the Project. The intensity of an odor source's operations and its proximity to sensitive receptors influences the potential significance of odor emissions. The SJVAPCD has identified some common types of facilities that have been known to produce odors in the SJV Air Basin. The types of facilities that are known to produce odors are shown in Table 5 above along with a reasonable distance from the source within which, the degree of odors could possibly be significant. None of the facilities shown in Table 5 are located within two (2) miles of the Project.

✓ **Naturally Occurring Asbestos (NOA)**

Asbestos is a term used for several types of naturally occurring fibrous minerals found in many parts of California. The most common type of asbestos is chrysotile, but other types are also found in California. Construction of the Project may cause asbestos to become airborne due to the construction activities that will occur on site. The Project would be required to submit a Dust Control Plan under the SJVAPCD's Rule 8021. Compliance with Rule 8021 would limit fugitive dust emissions from construction, demolition, excavation, extraction, and other earthmoving activities associated with the Project.

The Dust Control Plan may include the following measures:

1. Water wetting of road surfaces
2. Rinse vehicles and equipment
3. Wet loads of excavated material, and
4. Cover loads of excavated material

✓ Greenhouse Gas Emissions

CARB, in consultation with MPOs, has provided each affected region with reduction targets for GHGs emitted by passenger cars and light trucks in the region for the years 2020 and 2035. For the Kings County Association of Governments (KCAG) region, CARB set targets at five (5) percent per capita decrease in 2020 and a ten (10) percent per capita decrease in 2035 from a base year of 2005. KCAG's 2018 Regional Transportation Plan/Sustainable Communities Strategy (RTP/SCS), which was adopted in August 2018, projects that the Kings County region would achieve the prescribed emissions targets.

In 2009, the SJVAPCD adopted the following guidance documents applicable to projects within the San Joaquin Valley:

- ✓ Guidance for Valley Land-use Agencies in Addressing GHG Emission Impacts for New Projects under CEQA (SJVAPCD 2009), and
- ✓ District Policy: Addressing GHG Emission Impacts for Stationary Source Projects Under CEQA When Serving as the Lead Agency (SJVAPCD 2009).

This guidance and policy are the reference documents referenced in the SJVAPCD's Guidance for Assessing and Mitigating Air Quality Impacts adopted in March 2015 (SJVAPCD 2015). Consistent with the District Guidance and District Policy above, SJVAPCD (2015) acknowledges the current absence of numerical thresholds, and recommends a tiered approach to establish the significance of the GHG impacts on the environment:

- i. If a project complies with an approved GHG emission reduction plan or GHG mitigation program which avoids or substantially reduces GHG emissions within the geographic area in which the project is located, then the project would be determined to have a less than significant individual and cumulative impact for GHG emissions;
- ii. If a project does not comply with an approved GHG emission reduction plan or mitigation program, then it would be required to implement Best Performance

- Standards (BPS); and
- iii. If a project is not implementing BPS, then it should demonstrate that its GHG emissions would be reduced or mitigated by at least 29 percent compared to Business as Usual (BAU).

As shown in Table 9, the Project would generate 7637.11 Metric Tons of Carbon Dioxide Equivalent per year (MTCO₂eq./year) using an operational year of 2005, which includes area, energy, mobile, waste, and water sources. “Business as usual” (BAU) is referenced in CARB’s AB 32 Scoping Plan as emissions projected to occur in 2020 if the average baseline emissions during the 2002-2004 period grew to 2020 levels, without control or Best Performance Standards (BPS) offsets. As a result, an estimate of the Project’s operational emissions in 2005 were compared to operational emissions in 2020 in order to determine if the Project meets the 29% emission reduction. The SJVAPCD has reviewed relevant scientific information related to GHG emissions and has determined that they are not able to determine a specific quantitative level of GHG emissions increase, above which a project would have a significant impact on the environment, and below which would have an insignificant impact. As a result, the SJVAPCD has determined that projects achieving at least a 29% GHG emission reduction compared to BAU would be determined to have a less than significant individual and cumulative impact for GHG. Results of the analysis show that the Project’s GHG emissions in the year 2020 is 6410.55 MTCO₂eq./year. This represents an achievement of 16% GHG emission reduction on the basis of BAU, which does not meet the 29% GHG emission reduction target.

In the event that a local air district’s guidance for addressing GHG impacts does not use numerical GHG emissions thresholds, at the lead agency’s discretion, a neighboring air district’s GHG threshold may be used to determine impacts. In December 2008, the South Coast Air Quality Management District (SCAQMD) Governing Board adopted the staff proposal for an interim GHG significance threshold for projects where the SCAQMD is lead agency. The SCAQMD guidance identifies a threshold of 10,000 MTCO₂eq./year for GHG for construction emissions amortized over a 30-year project lifetime, plus annual operation emissions. This threshold is often used by agencies, such as the California Public Utilities Commission, to evaluate GHG impacts in areas that do not have specific thresholds (CPUC 2015)². Therefore, because this threshold has been established by the SCAQMD in an effort to control GHG emissions in the largest metropolitan area in the State of California, this threshold is considered a conservative approach for evaluating the significance of GHG emissions in a more rural area, such as Kings County. Though the Project is under SJVAPCD jurisdiction, the SCAQMD GHG threshold provides some perspective on the GHG emissions generated by the Project. Table 10 shows the yearly GHG emissions generated by the Project as determined by the CalEEMod model, which is approximately 38% less than the threshold identified by the SCAQMD. Though the Project is under SJVAPCD jurisdiction, the SCAQMD

² California Public Utilities Commission (CPUC). 2015. Section 4.7, “Greenhouse Gases.” Final Environmental Impact Report for the Santa Barbara County Reliability Project. May 2015. Accessed January 18, 2018. http://www.cpuc.ca.gov/environment/info/ene/sbcpr/SBCRP_FEIR.html.

GHG threshold provides some perspective on the GHG emissions generated by the Project. Table 10 shows the yearly GHG emissions generated by the Project as determined by the CalEEMod model.

Table 9
2005/2020 Operational greenhouse Gas Emissions

Summary Report	CO ₂ e
Operational Emissions Per Year (2005)	7637.11 MT/yr
Operational Emissions Per Year (2020)	6410.55 MT/yr
SJVAPCD Level of Significance	29% Reduction Compared to BAU
Does the Project Meet the Standard	No

Source: CalEEMod Emissions Model

Table 10
Project Operational Greenhouse Gas Emissions

Summary Report	CO ₂ e
Project Operational Emissions Per Year	6206.03 MT/yr

Source: CalEEMod

3.3.3 Indirect Source Review

The proposed Project is subject to the SJVAPCD’s ISR program since there are more than 250 residential units, which is also known as Rule 9510. Rule 9510 and the Administrative ISR Fee Rule (Rule 3180) are the result of state requirements outlined in the California Health and Safety Code, Section 40604 and the State Implementation Plan (SIP). The purpose of the SJVAPCD’s ISR program is to reduce emissions of NOx and PM10 from new projects. In general, new development contributes to the air-pollution problem in the Valley by increasing the number of vehicles and vehicle miles traveled.

Utilizing the ISR Fee Estimator calculator available on the SJVAPCD website, it was determined that the Project’s total cost for emission reductions is \$352,404.00 without implementation of emission reduction measures. The ISR Fee Estimator worksheets are included in Appendix B. The fee noted above may be reduced dependent upon the formal ISR review process.

4.0 Impact Determinations and Recommended Mitigation

In accordance with CEQA, when a proposed project is consistent with a General Plan for which an EIR has been certified, the effects of that project are evaluated to determine if they will result in project-specific significant adverse impacts on the environment. The criteria used to determine the significance of an air quality or greenhouse gas impact are based on the following thresholds of significance, which come from Appendix G of the CEQA Guidelines and the General Plan EIR. Accordingly, air quality or greenhouse gas impacts resulting from the Project are considered significant if the Project would:

Air Quality

- a) Conflict with or obstruct implementation of the applicable air quality plan?
- b) Result in a cumulatively considerable net increase of any criteria pollutant for which the project region is non-attainment under an applicable federal or state ambient air quality standard?
- c) Expose sensitive receptors to substantial pollutant concentrations?
- d) Result in other emissions such as those leading to odors adversely affecting a substantial number of people?

Greenhouse Gas Emissions

- a) Generate greenhouse gas emissions, either directly or indirectly, that may have a significant impact on the environment?
- b) Conflict with an applicable plan, policy or regulation adopted for the purpose of reducing the emissions of greenhouse gases?

4.1 Air Quality

4.1.1 *Conflict with or obstruct implementation of the applicable air quality plan*

The primary way of determining consistency with the air quality plan's (AQP's) assumptions is determining consistency with the applicable General Plan to ensure that the Project's population density and land use are consistent with the growth assumptions used in the AQPs for the air basin.

As required by California law, city and county General Plans contain a Land Use Element that details the types and quantities of land uses that the city or county estimates will be needed for future growth, and that designate locations for land uses to regulate growth. KCAG uses the growth projections and land use information in adopted general plans to estimate future average daily trips and then VMT, which are then provided to SJVAPCD to estimate future emissions in

the AQPs. Existing and future pollutant emissions computed in the AQP are based on land uses from area general plans. AQPs detail the control measures and emission reductions required for reaching attainment of the air standards.

The applicable General Plan for the project is the City of Hanford 2035 General Plan Update, which was adopted in 2018. The Project is consistent with the currently adopted General Plan for the City of Hanford and is therefore consistent with the population growth and VMT applied in the plan. Therefore, the Project is consistent with the growth assumptions used in the applicable AQPs. As a result, the Project will not conflict with or obstruct implementation of any air quality plans. Therefore, no mitigation is needed.

4.1.2 Result in a cumulatively considerable net increase of any criteria pollutant for which the project region is non-attainment under an applicable federal or state ambient air quality standard

The Kings County area is nonattainment for Federal and State air quality standards for ozone, in attainment of Federal standards and nonattainment for State standards for PM10, and nonattainment for Federal and State standards for PM2.5. The SJVAPCD has prepared the 2016 and 2013 Ozone Plans, 2007 PM10 Maintenance Plan, and 2012 PM2.5 Plan to achieve Federal and State standards for improved air quality in the SJVAB regarding ozone and PM. Inconsistency with any of the plans would be considered a cumulatively adverse air quality impact. As discussed in Section 4.1.1, the Project is consistent with the currently adopted General Plan for the City of Hanford and is therefore consistent with the population growth and VMT applied in the plan. Therefore, the Project is consistent with the growth assumptions used in the 2016 and 2013 Ozone Plan, 2007 PM10 Maintenance Plan, and 2012 PM2.5 Plan.

Project specific emissions that exceed the thresholds of significance for criteria pollutants would be expected to result in a cumulatively considerable net increase of any criteria pollutant for which the County is in non-attainment under applicable federal or state ambient air quality standards. It should be noted that a project is not characterized as cumulatively insignificant when project emissions fall below thresholds of significance. As discussed in Section 3.1, the SJVAPCD has established thresholds of significance for determining environmental significance which are provided in Table 6.

As discussed above in Section 3.2 and 3.3, results of the analysis show that emissions generated from construction and operation of the Project will be less than the applicable SJVAPCD emission thresholds for criteria pollutants. Therefore, no mitigation is needed.

4.1.3 Expose sensitive receptors to substantial pollutant concentrations

Sensitive receptors refer to those segments of the population most susceptible to poor air quality (i.e., children, the elderly, and those with pre-existing serious health problems affected by air quality). Land uses that have the greatest potential to attract these types of sensitive receptors

include schools, parks, playgrounds, daycare centers, nursing homes, hospitals, and residential communities. From a health risk perspective, the Project is a Type B project in that it may potentially place sensitive receptors in the vicinity of existing sources.

The first step in evaluating the potential for impacts to sensitive receptors for TAC's from the Project is to perform a screening level analysis. For Type B Projects, one type of screening tool is found in the CARB Handbook: Air Quality and Land Use Handbook: A Community Perspective. This handbook includes a table (depicted in Table 4) with recommended buffer distances associated with various types of common sources. The screening level analysis for the Project shows that TAC's are not a concern based upon the recommendations provided in Table 4. An evaluation of nearby land uses considering CARB's Pollution Mapping Tool shows that the Project will not place sensitive receptors in the vicinity of existing toxic sources. The Project is located a one mile from the State Route (SR) 198 freeway. Table 4 indicates that new sensitive land uses shouldn't be sited within 500 feet of a freeway/urban roads with 100,000 vehicles/day, or rural roads with 50,000 vehicles/day. The Project is located more than 4000 feet from the SR 41 freeway. Therefore, no mitigation is needed.

Short-Term Impacts

The annual emissions from the construction phase of the Project will be less than the applicable SJVAPCD emission thresholds for criteria pollutants as shown in Table 8. The construction emissions are therefore considered less than significant with the implementation of the SJVAPCD applicable Regulation VIII control measures, which are provided below.

1. *All disturbed areas, including storage piles, which are not being actively utilized for construction purposes, shall be effectively stabilized of dust emissions using water, chemical stabilizer/suppressant, covered with a tarp or other suitable cover or vegetative ground cover.*
2. *All on-site unpaved roads and off-site unpaved access roads shall be effectively stabilized of dust emissions using water or chemical stabilizer/suppressant.*
3. *All land clearing, grubbing, scraping, excavation, land leveling, grading, cut & fill, and demolition activities shall be effectively controlled of fugitive dust emissions utilizing application of water or by presoaking.*
4. *When materials are transported off-site, all material shall be covered, or effectively wetted to limit visible dust emissions, and at least six inches of freeboard space from the top of the container shall be maintained.*
5. *All operations shall limit or expeditiously remove the accumulation of mud or dirt from adjacent public streets at the end of each workday. The use of dry rotary brushes is expressly prohibited except where preceded or accompanied by sufficient wetting to limit the visible dust emissions. Use of blower devices is expressly forbidden.*
6. *Following the addition of materials to, or the removal of materials from, the surface of outdoor storage piles, said piles shall be effectively stabilized of fugitive dust emissions*

utilizing sufficient water or chemical stabilizer/suppressant.

7. *Within urban areas, track out shall be immediately removed when it extends 50 or more feet from the site and at the end of each workday.*

Naturally Occurring Asbestos (NOA)

The proposed Project's construction phase may cause asbestos to become airborne due to the construction activities that will occur on site. In order to control naturally-occurring asbestos dust, the Project will be required to submit a Dust Control Plan under the SJVAPCD's Rule 8021. The Dust Control Plan may include the following measures:

1. Water wetting of road surfaces
2. Rinse vehicles and equipment
3. Wet loads of excavated material, and
4. Cover loads of excavated material

Long-Term Impacts

Long-Term emissions from the Project are generated primarily by mobile source (vehicle) emissions from the project site and area sources such as lawn maintenance equipment. Emissions from long-term operations generally represent a project's most substantial air quality impact. Table 8 summarizes the Project's operational impacts by pollutant. Results indicate that operational emissions from the Project will exceed the SJVAPCD emissions threshold for NOx emissions by 4.43 tons/year. Compliance with Rule 9510 will reduce Project Operational NOx Emissions by 33.3% and PM10 emissions by 50% according to the SJVAPCD's Guidance for Assessing and Mitigating Air Quality Impacts adopted in March 2015 (SJVAPCD 2015). This reduction will alleviate Project impacts to the SJVAPCD's threshold for NOx emissions as noted in Table 11 below.

Table 11
Project Operational Emissions with Rule 9510 (tons/year)

Summary Report	CO	NO _x	ROG	SO ₂	PM ₁₀	PM _{2.5}	CO _{2e}
Project Operational Emissions	23.72	4.86	6.18	0.05	4.57	1.30	5992.30
SJVAPCD Level of Significance	100	10	10	27	15	15	None
Does the Project Exceed Standard?	No	No	No	No	No	No	No

Source: CalEEMod

4.1.4 Result in other emissions such as those leading to odors adversely affecting a substantial number of people

The SJVAPCD requires that an analysis of potential odor impacts be conducted for the following

two situations:

- ✓ Generators – projects that would potentially generate odorous emissions proposed to be located near existing sensitive receptors or other land uses where people may congregate, and
- ✓ Receivers – residential or other sensitive receptor projects or other projects built for the intent of attracting people located near existing odor sources.

The proposed Project will not generate odorous emissions given the nature or characteristics of residential developments. The intensity of an odor source's operations and its proximity to sensitive receptors influences the potential significance of odor emissions. The SJVAPCD has identified some common types of facilities that have been known to produce odors in the SJV Air Basin. The types of facilities that are known to produce odors are shown in Table 5 above along with a reasonable distance from the source within which, the degree of odors could possibly be significant. None of the facilities shown in Table 5 are located within two (2) miles of the Project. Therefore, no mitigation is needed.

4.2 Greenhouse Gas Emissions

4.2.1 *Generate greenhouse gas emissions, either directly or indirectly, that may have a significant impact on the environment*

In 2009, the SJVAPCD adopted the following guidance documents applicable to projects within the San Joaquin Valley:

- ✓ Guidance for Valley Land-use Agencies in Addressing GHG Emission Impacts for New Projects under CEQA (SJVAPCD 2009), and
- ✓ District Policy: Addressing GHG Emission Impacts for Stationary Source Projects Under CEQA When Serving as the Lead Agency (SJVAPCD 2009).

As shown in Table 9, the Project would generate 7637.11 Metric Tons of Carbon Dioxide Equivalent per year (MTCO₂eq./year) using an operational year of 2005, which includes area, energy, mobile, waste, and water sources. "Business as usual" (BAU) is referenced in CARB's AB 32 Scoping Plan as emissions projected to occur in 2020 if the average baseline emissions during the 2002-2004 period grew to 2020 levels, without control or Best Performance Standards (BPS) offsets. As a result, an estimate of the Project's operational emissions in 2005 were compared to operational emissions in 2020 in order to determine if the Project meets the 29% emission reduction. The SJVAPCD has reviewed relevant scientific information related to GHG emissions and has determined that they are not able to determine a specific quantitative level of GHG emissions increase, above which a project would have a significant impact on the environment, and below which would have an insignificant impact. As a result, the SJVAPCD has determined that projects achieving at least a 29% GHG emission reduction

compared to BAU would be determined to have a less than significant individual and cumulative impact for GHG. Results of the analysis show that the Project's GHG emissions in the year 2020 is 6410.55 MTCO₂eq./year. This represents an achievement of 16% GHG emission reduction on the basis of BAU, which does not meet the 29% GHG emission reduction target.

In the event that a local air district's guidance for addressing GHG impacts does not use numerical GHG emissions thresholds, at the lead agency's discretion, a neighboring air district's GHG threshold may be used to determine impacts. In December 2008, the South Coast Air Quality Management District (SCAQMD) Governing Board adopted the staff proposal for an interim GHG significance threshold for projects where the SCAQMD is lead agency. The SCAQMD guidance identifies a threshold of 10,000 MTCO₂eq./year for GHG for construction emissions amortized over a 30-year project lifetime, plus annual operation emissions. This threshold is often used by agencies, such as the California Public Utilities Commission, to evaluate GHG impacts in areas that do not have specific thresholds (CPUC 2015)³. Therefore, because this threshold has been established by the SCAQMD in an effort to control GHG emissions in the largest metropolitan area in the State of California, this threshold is considered a conservative approach for evaluating the significance of GHG emissions in a more rural area, such as Kings County. Though the Project is under SJVAPCD jurisdiction, the SCAQMD GHG threshold provides some perspective on the GHG emissions generated by the Project. Table 10 shows the yearly GHG emissions generated by the Project as determined by the CalEEMod model, which is approximately 38% less than the threshold identified by the SCAQMD.

CARB's California GHG Emissions Inventory provides estimates of anthropogenic GHG emissions within California, as well as emissions associated with imported electricity; natural sources are not included in the inventory. California's GHG emissions for 2018 totaled approximately 418.2 million MTCO₂eq. The proposed Project's GHG emissions represents less than 0.001% of the total GHG emissions for the state of California when compared to year 2018 emissions data.

Based on the assessment above, the Project will not generate greenhouse gas emissions, either directly or indirectly, that may have a significant impact on the environment. Therefore, any impacts would be less than significant.

4.2.2 Conflict with an applicable plan, policy or regulation adopted for the purpose of reducing the emissions of greenhouse gases

California passed the California Global Warming Solutions Act of 2006. AB 32 requires that

³ California Public Utilities Commission (CPUC). 2015. Section 4.7, "Greenhouse Gases." Final Environmental Impact Report for the Santa Barbara County Reliability Project. May 2015. Accessed January 18, 2018. http://www.cpuc.ca.gov/environment/info/ene/sbcpr/SBCRP_FEIR.html.

statewide GHG emissions be reduced to 1990 levels by 2020. Under AB 32, CARB must adopt regulations by January 1, 2011 to achieve reductions in GHGs to meet the 1990 emission cap by 2020. On December 11, 2008, CARB adopted its initial Scoping Plan, which functions as a roadmap of CARB's plans to achieve GHG reductions in California required by AB 32 through subsequently enacted regulations. CARB's 2017 Climate Change Scoping Plan builds on the efforts and plans encompassed in the initial Scoping Plan.

SB 375 requires MPOs to adopt a SCS or APS that will prescribe land use allocation in that MPO's regional transportation plan. CARB, in consultation with MPOs, has provided each affected region with reduction targets for GHGs emitted by passenger cars and light trucks in the region for the years 2020 and 2035. For the KCAG region, CARB set targets at five (5) percent per capita decrease in 2020 and a ten (10) percent per capita decrease in 2035 from a base year of 2005. KCAG's 2018 RTP/SCS, which was adopted in August 2018, projects that the Kings County region would achieve the prescribed emissions targets.

Executive Order B-30-15 establishes a California greenhouse gas reduction target of 40 percent below 1990 levels by 2030 to ensure California meets its target of reducing greenhouse gas emissions to 80 percent below 1990 levels by 2050. Executive Order B-30-15 requires MPO's to implement measures that will achieve reductions of greenhouse gas emissions to meet the 2030 and 2050 greenhouse gas emissions reductions targets.

As required by California law, city and county General Plans contain a Land Use Element that details the types and quantities of land uses that the city or county estimates will be needed for future growth, and that designate locations for land uses to regulate growth. KCAG uses the growth projections and land use information in adopted general plans to estimate future average daily trips and then VMT, which are then provided to SJVAPCD to estimate future emissions in the AQPs. The applicable General Plan for the project is City of Hanford 2035 General Plan Update, which was adopted in 2018.

The Project is consistent with the currently adopted General Plan for the City of Hanford and the adopted KCAG 2018 RTP/SCS and is therefore consistent with the population growth and VMT applied in those plan documents. Therefore, the Project is consistent with the growth assumptions used in the applicable AQP. It should also be noted that yearly GHG emissions generated by the Project (Table 9) are approximately 38% less than the threshold identified by the SCAQMD (see the discussion for Impact 4.2.1 above).

CARB's 2017 Climate Change Scoping Plan builds on the efforts and plans encompassed in the initial Scoping Plan. The current plan has identified new policies and actions to accomplish the State's 2030 GHG limit. Below is a list of applicable strategies in the Scoping Plan and the Project's consistency with those strategies.

- ✓ California Light-Duty Vehicle GHG Standards – Implement adopted standards and planned second phase of the program. Align zero-emission vehicle, alternative and renewable fuel and vehicle technology programs for long-term climate change goals.

- The Project is consistent with this reduction measure. This measure cannot be implemented by a particular project or lead agency since it is a statewide measure. When this measure is implemented, standards would be applicable to light-duty vehicles that would access the Project. The Project would not conflict or obstruct this reduction measure.
- ✓ Energy Efficiency – Pursuit of comparable investment in energy efficiency from all retail providers of electricity in California. Maximize energy efficiency building and appliance standards.
 - The Project is consistent with this reduction measure. Though this measure applies to the State to increase its energy standards, the Project would comply with this measure through existing regulation. The Project would not conflict or obstruct this reduction measure.
- ✓ Low Carbon Fuel – Development and adoption of the low carbon fuel standard.
 - The Project is consistent with this reduction measure. This measure cannot be implemented by a particular project or lead agency since it is a statewide measure. When this measure is implemented, standards would be applicable to the fuel used by vehicles that would access the Project. The Project would not conflict or obstruct this reduction measure.

Based on the assessment above, the Project will not conflict with an applicable plan, policy or regulation adopted for the purpose of reducing the emissions of greenhouse gases. Therefore, any impacts would be less than significant.

BIOLOGICAL RESOURCE EVALUATION

D.R. HORTON, AMERICA'S BUILDER LUNARIA RESIDENTIAL DEVELOPMENT PROJECT



APRIL 2022



BIOLOGICAL RESOURCE EVALUATION

LUNARIA RESIDENTIAL PROJECT

Prepared for:

D.R. Horton, America's Builder
419 Murray Avenue
Visalia, CA 93291

Contact Person: Mel Mercado, Forward Planning and Land Development Manager

Consultant:



5080 California Avenue, Suite 220
Bakersfield, CA 93309
Contact: Jaymie Brauer
Phone: (661) 616-2600

April 2022

TABLE OF CONTENTS

<i>Table of Contents</i>	<i>i</i>
<i>Executive Summary</i>	<i>1</i>
<i>SECTION 1 - Introduction</i>	<i>2</i>
1.1 - Project Location.....	2
1.2 - Project Description.....	2
1.3 - Purpose, Goals, and Objectives for this Report.....	2
<i>SECTION 2 - Methods</i>	<i>5</i>
2.1 - Definition of Biological Study Area	5
2.2 - Literature Review and Database Analysis.....	5
2.3 - Reconnaissance-Level Field Surveys.....	7
<i>SECTION 3 - Environmental Setting</i>	<i>8</i>
3.1 - Topography	8
3.2 - Climate.....	8
3.3 - Land Use	8
3.4 - Soils	8
3.5 - Hydrology.....	11
3.6 - General Biological Conditions	14
<i>SECTION 4 - Findings</i>	<i>15</i>
4.1 - Sensitive Natural Communities	15
4.1.1 - Results of Literature Review and Database Searches.....	15
4.1.2 - Presence of Sensitive Natural Communities.....	15
4.2 - Special-Status Plants.....	15
4.2.1 - Results of Literature Review and Database Searches.....	15
4.2.2 - Presence of Special-Status Plants	16
4.3 - Special-Status Wildlife	16
4.3.1 - Results of Literature Review and Database Searches.....	16
4.3.2 - Presence of Special-Status Wildlife	18
4.4 - Nesting Migratory Birds and Raptors	19
4.5 - Critical Habitat, Movement Corridors, and Linkages.....	20
4.5.1 - Presence of Critical Habitat.....	20
4.5.2 - Presence of Movement Corridors and Linkages	20
4.6 - Wetlands and Other Waters.....	20
<i>SECTION 5 - Potential Project Impacts</i>	<i>22</i>
5.1 - Potential Impacts to Sensitive Vegetation Communities.....	22

5.2 - Potential Impacts to Special-Status Plant Species.....	22
5.3 - Potential Impacts to Special-Status Wildlife Species	22
5.4 - Potential Impacts to Nesting Birds and Raptors.....	22
5.5 - Potential Impacts to Critical Habitat, Movement Corridors and Linkages	23
5.5.1 - Potential Impacts to Critical Habitat	23
5.5.2 - Potential Impacts to Movement Corridors and Linkages	23
5.6 - Potential Impacts to Wetlands and Waters	23
SECTION 6 - Recommendations	24
SECTION 7 - Summary and Conclusions	24
SECTION 8 - References	26

Appendices

- Appendix A CNDDDB, CNPS, and iPac Database Results
- Appendix B Representative Photographs
- Appendix C Plants and Animals Observed On-Site

List of Figures

Figure 1-1 Regional Map	3
Figure 1-2 Project Location Map.....	4
Figure 2-1 Biological Study Area.....	6
Figure 3-1 Soils Mapped within the BSA.....	10
Figure 3-2 NWI and NHD Records of Aquatic Resources	12
Figure 3-3 FEMA Flood Zone Map	13
Figure 4-1 Mapped Critical Habitat in the Project Vicinity.....	21

List of Tables

Table 3-1 Field Survey Personnel and Timing.....	8
Table 3-2 Soil Acreages On-Site and within the BSA.....	9
Table 4-1 Special-Status Plant Species Occurring in the Region of the.....	15
Table 4-2 Special-Status Wildlife Species Occurring in the Region of the Lunaria Residential Development Project.....	17

EXECUTIVE SUMMARY

This Biological Resource Evaluation (BRE) report provides the results of a biological survey conducted by QK for the Lunaria Residential Development Project (Project). In order to comply with the California Environmental Quality Act (CEQA) and requirements for approval of a Vesting Tentative Subdivision Map by the City of Hanford (City), a biological evaluation was conducted to identify the potential for sensitive biological resources to occur on or near the Project site.

The Project site is adjacent to 10 ½ Avenue to the west and between Hanford Armona Road and Houston Avenue in the City of Hanford, Kings County, California. The Project is on Assessor Parcel Numbers (APN) 011-440-015 and 011-440-014. D.R. Horton (the Applicant) proposes to construct a tract with the approval of Tentative Tract Map 938. The development would include single-story homes of three to five bedrooms, with a minimum lot size of 5,000 square feet, and the associated road and utility improvements. The 457-lot single-family subdivision includes an approximately 30,000-square-foot stormwater retention basin and a 5.8-acre recreational park. The Project site has been used for agricultural purposes for many years, and at the time of the survey was actively being disked. The Project site is currently surrounded mostly by urban development.

A review of available literature and agency databases was conducted to obtain information of the occurrences of natural communities and special-status plant and wildlife species known to occur in the vicinity of the Project site. QK conducted a biological reconnaissance survey on March 18, 2022, to determine the locations and extent of land use, natural vegetation communities, determine the potential for occurrences of special-status plant and wildlife species, and verify the presence of wetlands and State and or federal jurisdictional waters. No special-status species plant or diagnostic sign of special-status wildlife species were observed, and no wetlands or other sensitive biological resources were observed on or near the Project site.

Based on the literature and database search and the results of the survey, there is a potential for two special-status wildlife species to occur on the Project site: San Joaquin kit fox (*Vulpes macrotis mutica*), and Swainson's hawk (*Buteo swainsoni*). Because of the historical disturbance and required environmental requirements and conditions for habitation of these species, direct impacts to these species are not expected to occur. San Joaquin kit foxes may pass through as transients, and Swainson's hawk could nest in the vicinity of the Project site. There is potential for nesting migratory birds and other raptors species to occur on or near the Project site and surrounding areas. With the implementation of Best Management Practices and recommended avoidance measures, the Project will likely have limited impacts to special-status wildlife species and migratory birds and raptors. There is expected to be no impact to special-status plant species, sensitive natural communities, wetlands or water features, or any other sensitive biological resources.

SECTION 1 - INTRODUCTION

D.R. Horton, America's Builder proposes to construct a new residential development in the City of Hanford (City), Kings County, California. The Lunaria Residential Development Project (Project) will provide additional housing within the City. To comply with the California Environmental Quality Act (CEQA), a biological evaluation was conducted to identify the potential for sensitive biological resources to occur on or near the Project site. This Biological Resource Evaluation (BRE) provides the basic biological information requested by D.R. Horton.

1.1 - Project Location

The Project is within the boundaries of the City of Hanford, Kings County, California. It covers approximately 95 acres and is located on the east side of 10 ½ Avenue, south of Hanford Armona Road and north of Houston Avenue (Figures 1-1 and 1-2). It is approximately 0.95 mile south of Highway 198. The Project site is situated on two Assessor Parcel Numbers (APNs), 011-440-015 and 011-440-014. It is within the *Hanford* United States Geological Survey (USGS) 7.5-minute quadrangle in Section 1, Township 19 South, Range 21 East, Mount Diablo Base and Meridian.

1.2 - Project Description

D.R. Horton proposes to the construction of 457 single-family residences along with paved roads, a drainage retention basin, and a 5.8-acre recreational park. Improvements would also occur on 10 ½ Avenue that would include the construction of a sidewalk, curb, and gutter.

1.3 - Purpose, Goals, and Objectives for this Report

The Biological Resource Evaluation (BRE) report includes the results of a biological reconnaissance survey QK conducted at the Lunaria Property (Project) site. This report is consistent with the requirements for an analysis of impacts to biological resources needed of an Initial Study/ Mitigated Negative Declaration following guidelines established by the California Environmental Quality Act.

The primary focus of this report is to provide information about the presence of sensitive biological resources on the Project and develop measures to avoid and minimize impacts of the Project on those resources. To accomplish that goal, the BRE provides information on the condition and sensitivity of the sensitive biological resources present and potentially present on and adjacent to the Project site and evaluates Project impacts to those resources. This BRE focuses on providing information and sensitive natural communities, special-status species, wildlife movement corridors, and wetlands and waters by conducting a desktop analysis of site conditions and verifying those findings with an on-site biological survey.

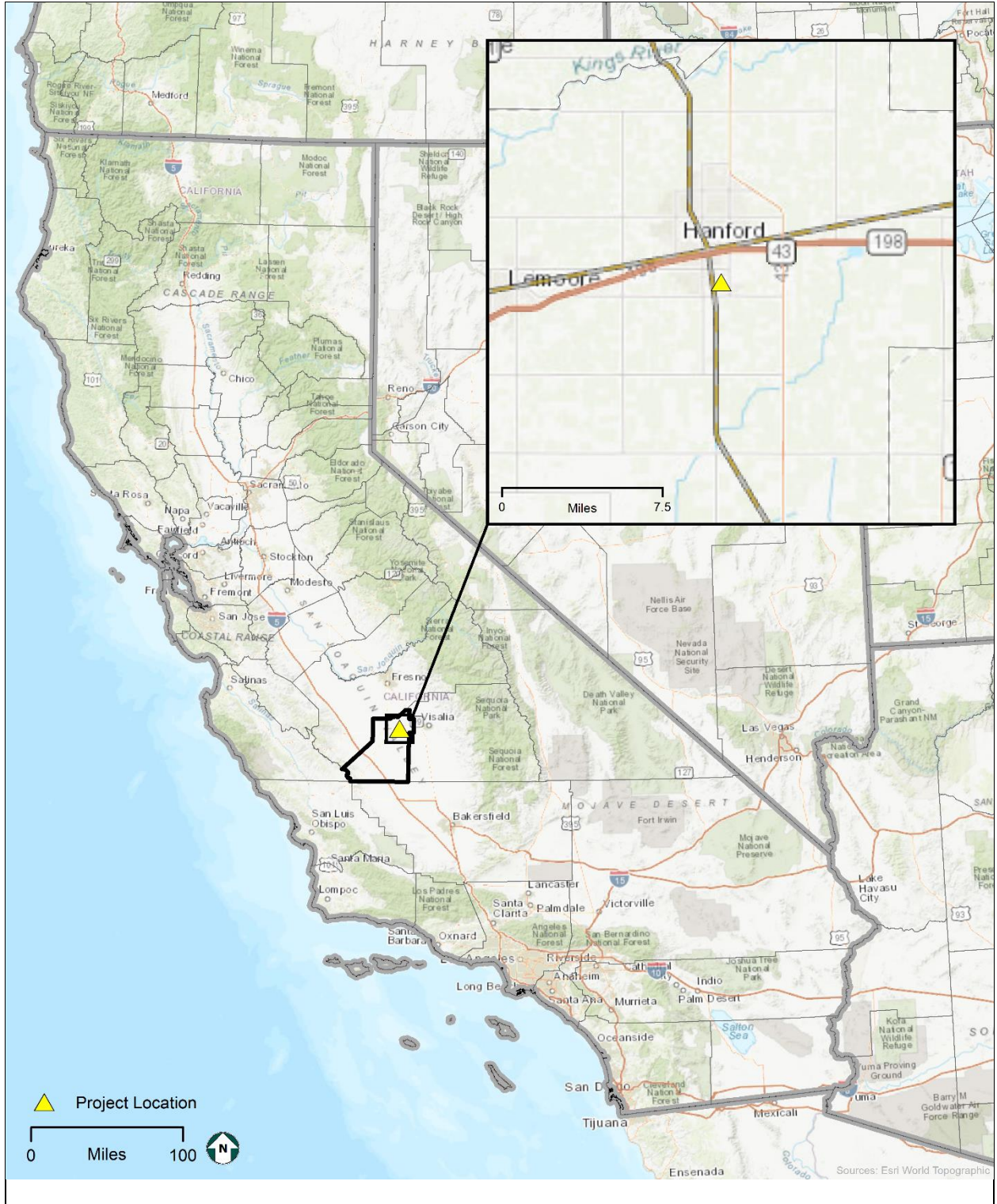

 **Figure 1-1**
Regional Map
Lunaria Residential Development Project, Kings County, California



 **Figure 1-2**
Project Location Map
Lunaria Residential Development Project, Kings County, California

SECTION 2 - METHODS

2.1 - Definition of Biological Study Area

The Biological Study Area (BSA) is a 250-foot buffer surrounding the Project disturbance footprint (Figure 2-1).

2.2 - Literature Review and Database Analysis

The following sources were reviewed for information on special-status biological resources in the Project vicinity:

- CDFW's California Natural Diversity Database (CDFW 2022a)
- CDFW's Biogeographic Information and Observation System (CDFW 2022b)
- CDFW's Special Animals List (CDFW 2022c)
- CDFW's California Wildlife Habitat Relationships (CWHR) System (Mayer and Laudenslayer 1988)
- California Native Plant Society (CNPS) Inventory of Rare and Endangered Plants of California (CNPS 2022)
- USFWS Information for Planning and Consultation system (USFWS 2022a)
- USFWS Critical Habitat Mapper (USFWS 2022b)
- USFWS National Wetlands Inventory (USFWS 2022c)
- USGS National Hydrography Dataset (USGS 2022)
- Federal Emergency Management Agency (FEMA) flood zone maps (FEMA 2022)
- U.S. Department of Agriculture (USDA), Natural Resources Conservation Service (NRCS) Web Soil Survey (USDA, NRCS 2022)
- Current and historical aerial imagery (Google LLC 2022)

QK conducted a review of the literature and agency databases to obtain information on the occurrences of natural communities and special-status species known from the vicinity of the Project site. The California Natural Diversity Database (CDFW 2022a), California Native Plant Society (CNPS) Database (CNPS 2022), and U.S. Fish and Wildlife Service (USFWS) Threatened and Endangered Species List (USFWS 2022a) were reviewed in March 2022 to assess whether occurrences of sensitive natural communities, federally-listed species, State-listed species, other species of special concern, or USFWS Critical Habitat Units that have been documented within the *Remnoy, Guernsey, Waukena, Burris Park, Hanford, Lemoore, Riverdale, Laton, and Stratford* U.S. Geological Survey (USGS) 7.5-minute quadrangles that encompass the Project site. To satisfy other standard search criteria, CNDDDB records within a 10-mile radius of the project site were queried separately from the broader database search.

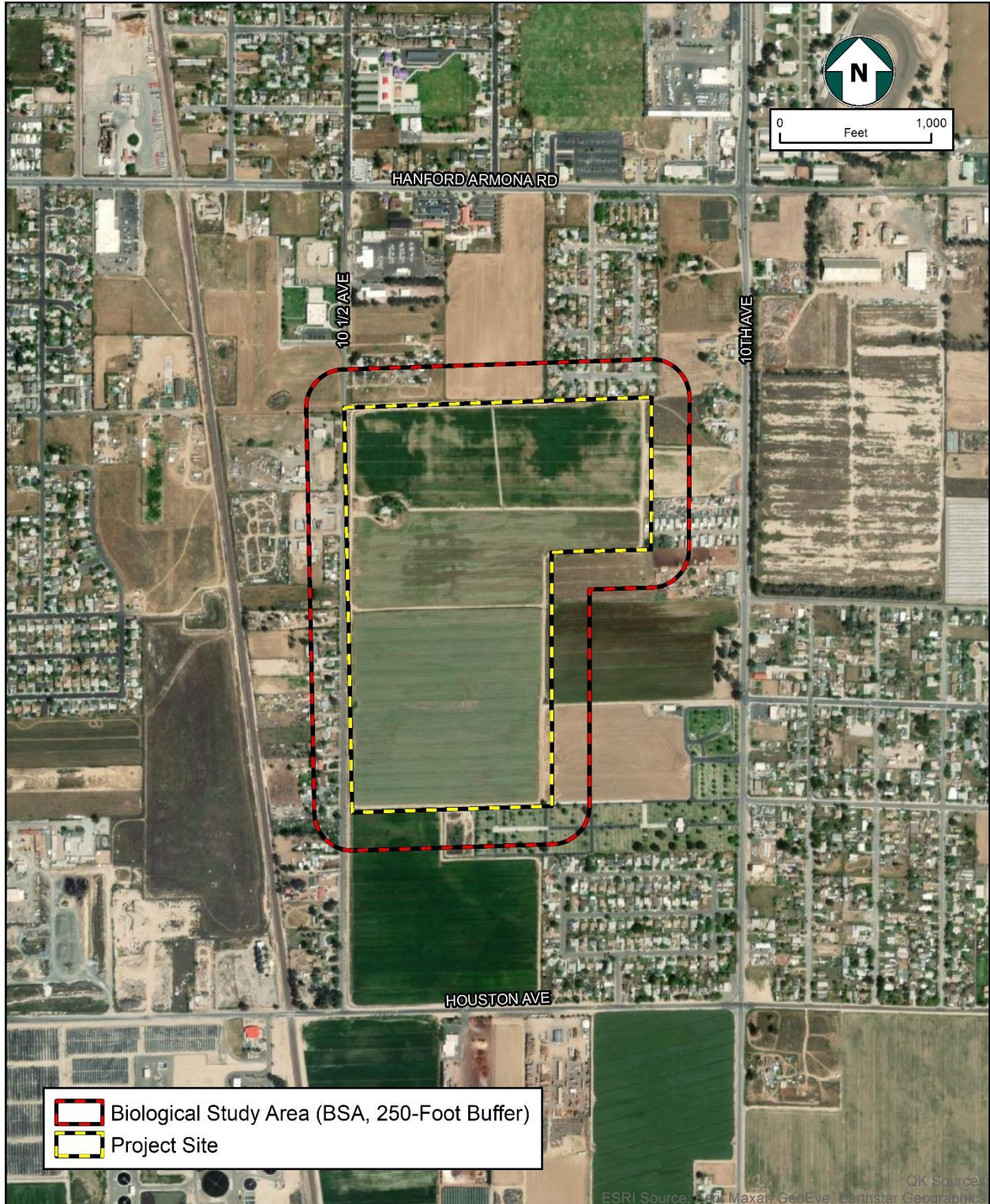

 **Figure 2-1**
Biological Study Area
Lunaria Residential Development Project, Kings County, California

The CNDDDB provides element-specific spatial information on individual documented occurrences of special-status species and sensitive natural vegetation communities. The CNPS database provides similar information, but at a much lower spatial resolution, for additional sensitive plant species tracked by the CNPS. The USFWS query generates a list of federally protected species known to potentially occur within individual USGS quadrangles. Wildlife species designated as “Fully Protected” by California Fish and Game Code Sections 5050 (Fully Protected reptiles and amphibians), 3511 (Fully Protected birds), and 4700 (Fully Protected mammals) are also included on the final list. Both database search results can be found in Appendix A.

A review of the National Wetlands Inventory (NWI, USFWS 2022c) was completed to identify whether wetlands had previously been documented on or adjacent to the Project site. The NWI, which is operated by the USFWS, is a collection of wetland and riparian maps that depicts graphic representations of the type, size, and location of wetland, deep water, and riparian habitats in the United States. In addition to the NWI, regional hydrologic information was obtained from the USGS to evaluate the potential occurrence of blueline streams within the Project area.

Soils data were obtained from the Natural Resource Conservation District, United States Department of Agriculture (USDA, NRCS 2022a), climate information was obtained from Weather Underground, and land use information was obtained from available aerial imagery. Information about flood zones were obtained from the Federal Emergency Management Agency, Department of Homeland Security (FEMA 2022).

The results of the database inquiries were subsequently reviewed to extract pertinent information on site conditions and evaluate the potential for sensitive biological resources to occur within or near the proposed Project site. Only those resources with the potential to be present and affected by the project were included and considered in this document. The potential presence of natural communities and special-status species was based on distributional ranges overlapping the Project site and the presence of habitat and/or primary constituent habitat elements.

2.3 - Reconnaissance-Level Field Surveys

A biological reconnaissance survey was conducted by QK Environmental Scientists Shannon Gleason and Karissa Denney on March 18, 2022. The reconnaissance survey was conducted within the Project site and included a 250-foot buffer. Together, these areas define the Biological Survey Area (BSA; Figure 2-1). Information gathered during the survey included locations and extent of land use and natural vegetation communities, observations and locations of diagnostic signs of special-status species, the potential for presence of special-status plant and wildlife species based upon existing conditions, and locations and extent of wetlands and waters. The reconnaissance surveys consisted of a pedestrian and windshield survey. A list of plants, wildlife, and wildlife sign (e.g., scat, burrows, feather, tracks, etc.) encountered was generated. Representative photographs were taken at key areas to document conditions at the Project site (Appendix B).

SECTION 3 - ENVIRONMENTAL SETTING

This section identifies the regional and local environmental setting of the Project and describes existing baseline conditions. The environmental setting of the BSA was obtained from various sources of literature, databases, and aerial photographs. Site conditions were verified and updated during the site reconnaissance survey conducted by QK Environmental Scientists (Table 4-1).

Table 3-1
Field Survey Personnel and Timing

Date	Personnel	Time	Weather Conditions	Temperature
03/18/2022	Karissa Denney, Shannon Gleason	1045 - 1140	Clear	64-67F

3.1 - Topography

The BSA is on the eastern floor of the Central Valley in the northeastern portion of Kings County. The topography of the BSA is relatively flat with an elevation of about 233 feet above mean sea level.

3.2 - Climate

The BSA is within an area that has a Mediterranean climate of hot summers and mild, wet winters. Average high temperatures range from 54.7°F in January to 97.8°F in July, with daily temperatures often exceeding 100°F several days in the summer (WRCC 2022). Average low temperatures range from 34.6°F in December to 62.5°F in July. Precipitation occurs primarily as rain, most of which falls from November to April, with an average of 8.38 inches of rainfall per year. Precipitation may also occur as a dense fog during the winter known as Tule fog. Rain rarely falls during the summer months.

3.3 - Land Use

The Project site is predominantly cropland with one occupied residential property located on site. The BSA is comprised of residential properties with some grazing properties. Historical imagery shows that the Project site has been used for agricultural practices since at least 1994 (Google LLC 2022, Netronline 2022).

3.4 - Soils

The BSA and Project site is underlain by four soil types, Nord complex, Nord fine sandy loam, Kimberlina fine sandy loam, saline-alkali, and Wasco sandy loam (Table 3-2, Figure 3-3, NRCS 2022). A complex consists of two or more similar soils or miscellaneous areas in such an intricate pattern or in such small areas that they cannot be shown separately on soil maps. These soil series are described by the NRCS and are listed below.

Table 3-2
Soil Acreages On-Site and within the BSA

<i>Soil Type</i>	<i>Acreages</i>	
	<i>BSA</i>	<i>Project</i>
<i>Nord complex</i>	78.49	51.63
<i>Nord fine sandy loam</i>	48.70	37.58
<i>Kimberlina fine sandy loam, saline-alkali</i>	16.98	6.93
<i>Wasco sandy loam</i>	6.13	0.73

The Nord complex soil series is characterized by very deep and well drained soils (NRCS 2022a). This soil series has a negligible to low rate of runoff and moderate permeability; however, in saline-sodic phases the permeability is moderate. They are formed of mixed alluvium from granitic and sedimentary rock. Nord can be found in alluvial fans and flood plains areas. Slopes range between 0 to 2 percent. This soil series can be used for irrigated crops including wheat (*Triticum* sp.), sugar beets (*Beta vulgaris*), corn (*Zea mays*), cotton (*Gossypium* sp.), alfalfa, walnuts (*Juglans* sp.), peaches and other fruit or nut trees. Natural vegetation that can grow on this soil type includes annual grasses and forbs and valley oak (*Quercus lobata*). Nord soil types that are found in Kings County include Nord complex and Nord fine sandy loam.

The Kimberlina series consists of very deep, well-drained soils on flood plains and recent alluvial fans (NRCS 2022a). These soils are formed in mixed alluvium derived primarily from igneous and/or sedimentary rock sources. Slopes range from 0 to 9 percent at elevations from 125 to 2,250 feet. The climate is arid with hot, dry summers and cool winters. Mean precipitation is 4 to 8 inches annually and the mean annual air temperature ranges from 59 to 62 °F. Kimberlina soils are used for irrigated field, forage, and row crops, and for livestock grazing. When undisturbed these soils support annual grasses, forbs, and saltbush (*Atriplex* sp.).

The Wasco series consists of very deep, well-drained soils on recent alluvial fans and flood plains on slopes between 0 and 5 percent (NRCS 2022a). Wasco sandy loam soils are formed in mixed alluvium derived mainly from igneous and/or sedimentary rock sources. These soils can be found between 225 and 1,000 feet in the southern San Joaquin Valley, and as high as 3,700 feet in the Mojave Desert; the series is of large extent. The climate is arid to semiarid, with hot, dry summers and cool, somewhat moist winters. Mean annual precipitation is 4 to 7 inches and mean annual temperature is between 59 and 62 °F in the Mojave Desert and 62 and 65 °F in the San Joaquin Valley. Wasco soils are used primarily for growing field, forage, and row crops; some areas are used for livestock grazing, wildlife habitat, recreation, and homesites. Natural vegetation is saltbush (*Atriplex* sp.) and annual grasses and forbs. Wasco series soils are not hydric (NRCS 2022a).

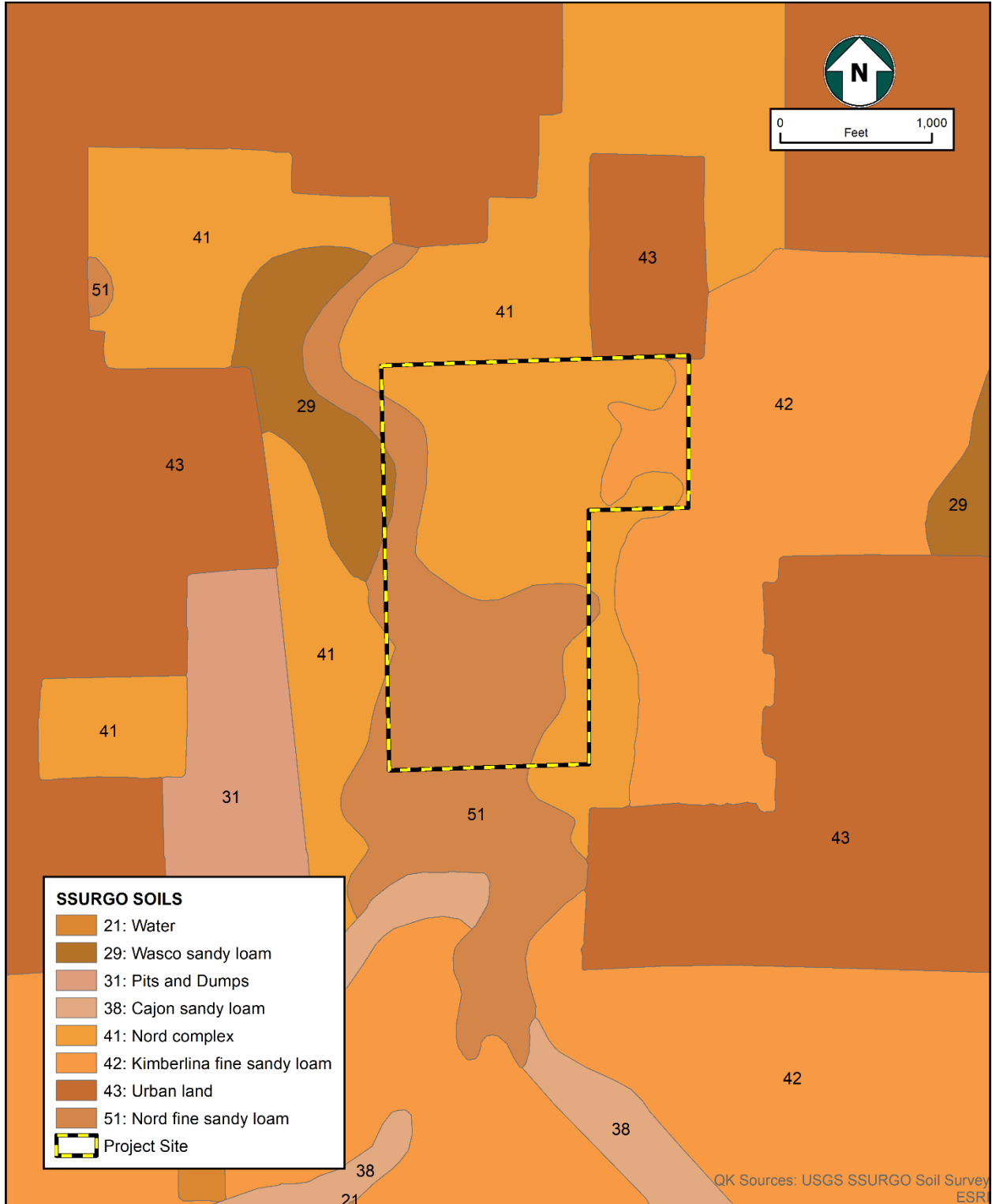

Figure 3-1
Soils Mapped within the BSA
Lunaria Residential Development Project, Kings County, California

3.5 - Hydrology

The Project site is in the South Valley Floor Hydrologic Unit, within the Tulare Lake Hydrologic Region (CDWR 2022). The Tulare Lake Hydrologic Region encompasses approximately 10.5 million acres and includes the drainage area south of the San Joaquin River within the San Joaquin Valley. The Kings, Kaweah, Tule, and Kern rivers, which drain the west face of the Sierra Nevada Mountains, provide the bulk of the surface water supply native to the basin. Imported surface waters enter the basin through the San Luis Canal/California Aqueduct System, the Friant-Kern Canal, and the Delta-Mendota Canal.

The NHD and NWI identify one water feature, either as a riverine or canal ditch, within the BSA (Figure 3-2). This feature is classified by the NHD as a canal ditch and the NWI identifies it as Cowardin code R5UBFx; a perennial-flow, semi-permanently flooded streambed with an unconsolidated bottom that is anthropogenic in origin (USFWS 2022c, USGS 2022). The canal is shown on the NHD and NWI as northwest to south traversing and crossing through the western half of the Project site. This feature was not present during the survey.

According to FEMA, the BSA is within an Area of Minimal Flood Hazard (Figure 3-3).

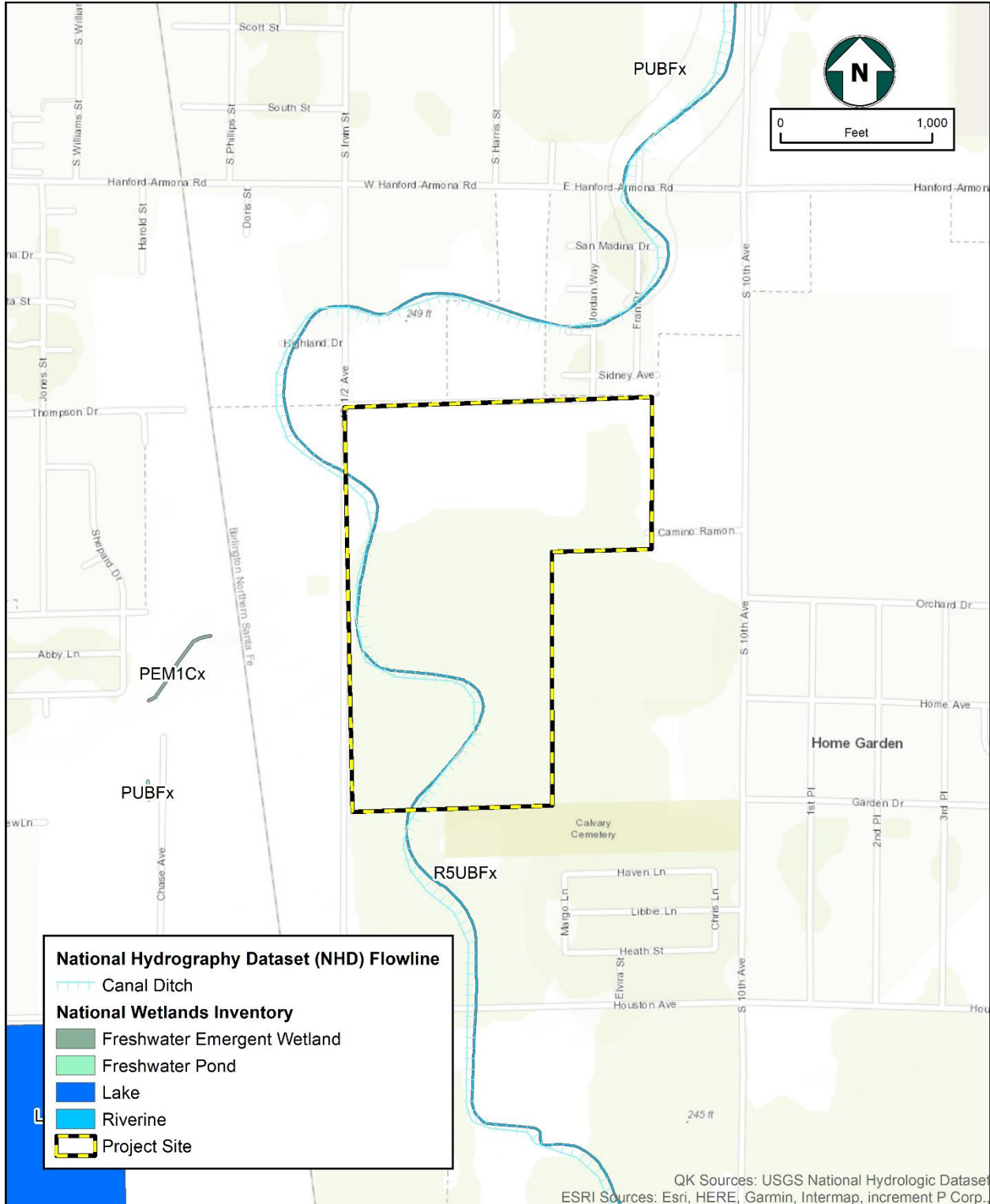

Figure 3-2
NWI and NHD Records of Aquatic Resources
Lunaria Residential Development Project, Kings County, California

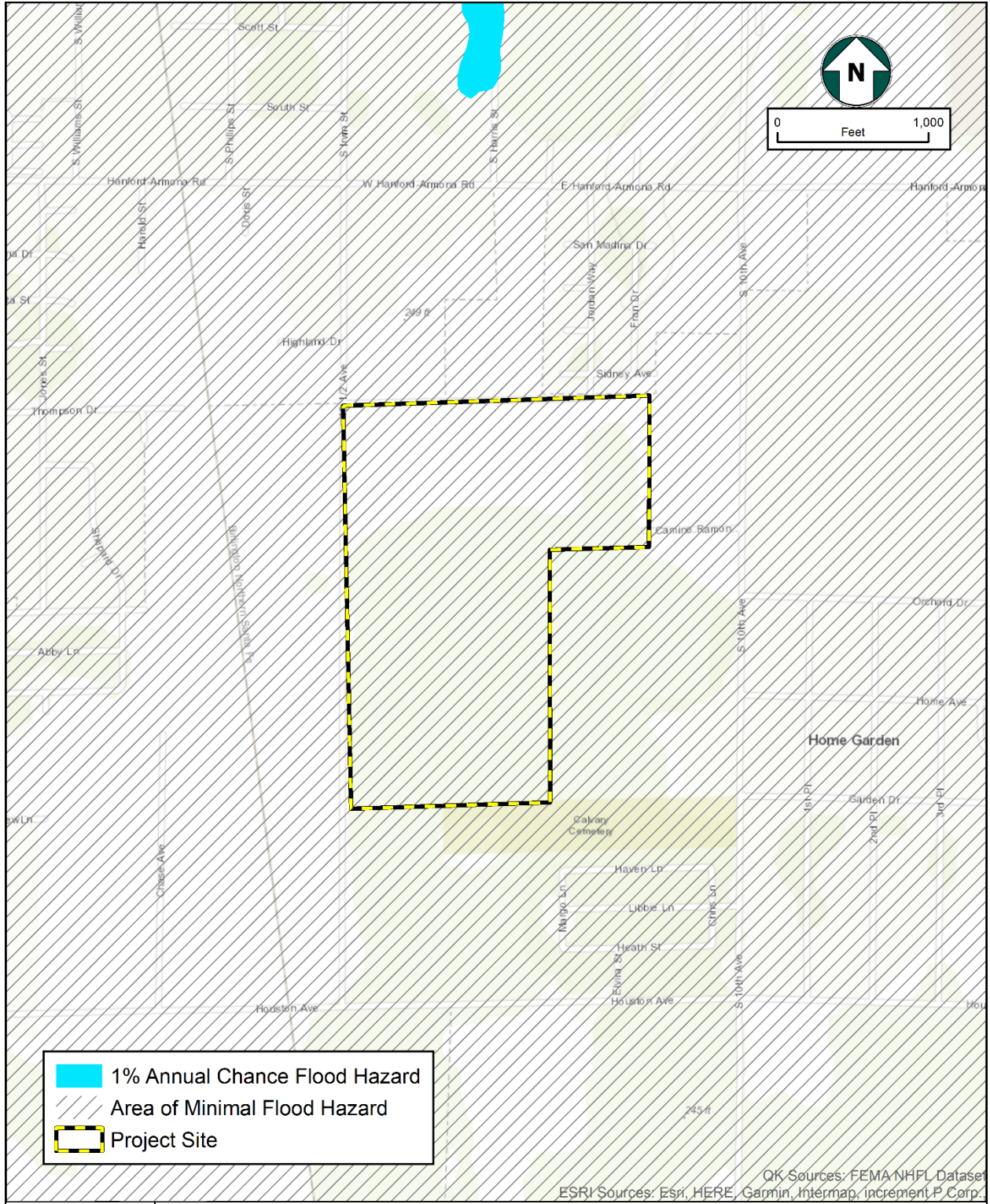

Figure 3-3
FEMA Flood Zone Map
Lunaria Residential Development Project, Kings County, California

3.6 - General Biological Conditions

The BSA is situated within Kings County, California, just south of the City of Hanford, and is surrounded by agricultural and residential properties. The Project site is bordered by residential and industrial properties, and open grazing pastures to the west, north, and east, and active agriculture and the Calvary Cemetery to the south.

No natural plant communities occur within the BSA. The majority of the Project site was actively used for agricultural purposes. The Project site was actively being disked at the time of the survey. Patches of ruderal vegetation was observed along the edges of the Project site that included: fiddleneck (*Amsinckia menziesii*), riggut brome (*Bromus diandrus*), and wild oat (*Avena fatua*). One private residence is located on the Project site and supports a variety of ornamental plants.

No nests on the Project site were observed during the survey. White-crowned sparrows (*Zonotrichia leucophrys*) were observed foraging near the Project site. The ornamental trees located on nearby residential properties that may support nesting birds or raptors did not contain nests during the survey though the survey coincided within the peak nesting season.

Small mammal burrows were observed along the western boundary of the Project site. Based on their size, configuration, and scat remains, these burrows were determined to be occupied by California ground squirrels (*Otospermophilus beecheyi*).

One overflow irrigation trench was observed along the Project site boundary that is not connected to any jurisdictional water feature or mapped on the NWI or NHD datasets. This ditch is contained to the active agricultural fields within the Project site. Most of the overflow irrigation ditch was dry; however, some stagnant water was present in the northern section of the BSA outside of the Project site boundary.

A complete list of plant and wildlife species observed during the biological reconnaissance survey is included in Appendix C.

SECTION 4 - FINDINGS

4.1 - Sensitive Natural Communities

4.1.1 - RESULTS OF LITERATURE REVIEW AND DATABASE SEARCHES

Literature results from the 9-quadrangle queries for the Project site revealed two sensitive natural vegetation communities: Valley Sacaton Grassland and Valley Sink Scrub.

4.1.2 - PRESENCE OF SENSITIVE NATURAL COMMUNITIES

Valley Sacaton Grassland and Valley Sink Scrub communities were not observed within the BSA during the survey. In addition, the BSA does not provide habitat that would support these communities.

4.2 - Special-Status Plants

4.2.1 - RESULTS OF LITERATURE REVIEW AND DATABASE SEARCHES

There were 10 special-status plant species identified in the CNDDDB, CNPS, and USFWS databases that occur in the Project region (Table 4-1). There are 6 special-status plant species with historical occurrence records within 10-miles of the BSA.

Table 4-1
Special-Status Plant Species Occurring in the Region of the,
Lunaria Residential Development Project
 (Source: CNDDDB 2022, CNPS 2022, and USFWS 2022)

	Scientific Name	Common Name	Status
	<i>Atriplex cordulata</i> var. <i>cordulata</i>	heartscale	1B.2
	<i>Atriplex cordulata</i> var. <i>erecticaulis</i>	Earlimart orache	1B.2
	<i>Atriplex depressa</i>	brittlescale	1B.2
	<i>Atriplex minuscula</i>	lesser saltscale	1B.1
	<i>Atriplex subtilis</i>	subtle orache	1B.2
	<i>Delphinium recurvatum</i>	recurved larkspur	1B.2
	<i>Lasthenia chrysantha</i>	alkali-sink goldfields	1B.1
	<i>Lepidium jaredii</i> ssp. <i>album</i>	Panoche pepper-grass	1B.2
	<i>Nama stenocarpa</i>	mud nama	2B.2
	<i>Puccinellia simplex</i>	California alkali grass	1B.2

1A	California Native Plant Society List 1A Species- Plants Presumed Extinct in California
1B.1	California Native Plant Society List 1B Species-Plants Categorized as Rare, Threatened, or Endangered in California and Elsewhere; Seriously Endangered in California
1B.2	California Native Plant Society List 1B Species-Plants Categorized as Rare, Threatened, or Endangered in California and Elsewhere; Fairly Endangered in California.
1B.3	California Native Plant Society List 1B Species-Plants Categorized as Rare, Threatened, or Endangered in California and Elsewhere; Not Very Endangered in California

FE Federal Endangered Species
FT Federal Threatened Species

4.2.2 - PRESENCE OF SPECIAL-STATUS PLANTS

No special-status plant species were observed within the BSA. The field survey coincided with the optimal blooming period of some, but not all of the special-status plant species identified in the database queries. However, there is no habitat present on the Project site or within the BSA that would support any special-status plant species. The Project site is degraded from historical land use, mainly for agricultural operations and residential development, and the adjacent lands have been equally disturbed for agricultural and residential uses. A complete list of plant species observed during the biological reconnaissance survey is included in Appendix C.

4.3 - Special-Status Wildlife

4.3.1 - RESULTS OF LITERATURE REVIEW AND DATABASE SEARCHES

There were 24 special-status wildlife species identified in the CNDDDB, and USFWS databases that occur in the Project region (Table 4-2). There are 14 special-status wildlife species with historical occurrence records within 10-miles of the BSA.

Table 4-2
Special-Status Wildlife Species Occurring in the Region of the
Lunaria Residential Development Project
 (Source: CNDDDB 2022, and USFWS 2022)

Scientific Name	Common Name	Status
Invertebrates		
<i>Cicindela tranquebarica joaquinensis</i>	San Joaquin tiger beetle	-, -
<i>Desmocerus californicus dimorphus</i>	valley elderberry longhorn beetle	FT, -
<i>Danaus plexippus</i>	monarch butterfly	FC
Crustaceans		
<i>Branchinecta lynchi</i>	vernal pool fairy shrimp	FT, -
<i>Gonidea angulata</i>	western ridged mussel	-, -
<i>Lepidurus packardii</i>	vernal pool tadpole shrimp	FE, -
<i>Linderiella occidentalis</i>	California linderiella	-, -
Fish		
<i>Hypomesus transpacificus</i>	Delta smelt	FT, -
Amphibians		
<i>Ambystoma californiense</i> pop 1	California tiger salamander – central California DPS	FT, CT
<i>Spea hammondi</i>	western spadefoot	-, SSC
<i>Rana draytonii</i>	California red-legged frog	FT, -
Reptiles		
<i>Arizona elegans occidentalis</i>	California glossy snake	-, SSC
<i>Emys marmorata</i>	western pond turtle	-, SSC
<i>Gambelia sila</i>	blunt-nosed leopard lizard	FE, CE, FP
<i>Thamnophis gigas</i>	giant garter snake	FT, -
Birds		
<i>Agelaius tricolor</i>	tricolored blackbird	ST, SSC
<i>Athene cunicularia</i>	burrowing owl	-, SSC
<i>Buteo swainsoni</i>	Swainson's hawk	-, CT
<i>Charadrius nivosus nivosus</i>	western snowy plover	FT, SSC
<i>Xanthocephalus xanthocephalus</i>	yellow-headed blackbird	SSC
Mammals		
<i>Dipodomys nitratooides exilis</i>	Fresno kangaroo rat	FE, -
<i>Dipodomys nitratooides nitratooides</i>	Tipton kangaroo rat	FE, CE
<i>Lasiurus cinereus</i>	hoary bat	-,
<i>Vulpes macrotis mutica</i>	San Joaquin kit fox	FE, CT

Sources:

- California Department of Fish and Wildlife. 2022. California Natural Diversity Data Base, California Department of Fish and Wildlife Sacramento, CA. Quads: Academy, Clovis, Friant, Lanes Bridge, Malaga, Round Mountain, Sanger, Fresno North, and Fresno South.
- California Native Plant Society (CNPS). 2022. Inventory of Rare and Endangered Plants (online edition, v6-05b 4-11-05). Rare Plant Scientific Advisory Committee. California Native Plant Society. Sacramento, CA. Quads: Academy, Clovis, Friant, Lanes Bridge, Malaga, Round Mountain, Sanger, Fresno North, and Fresno South.
- United States Fish and Wildlife Service. 2022. Federal Endangered and Threatened Species that Occur in or may be Affected by Projects in the Merced U.S.G.S 7 ½ Minute Quad. USFWS. Sacramento, CA.

Abbreviations:

FC	Federal Candidate
FE	Federal Endangered Species
FT	Federal Threatened Species
FP	Fully Protected Animal, CDFW
MBTA	Species Protected Under the Auspices of the Migratory Bird Treaty Act
CE	California Endangered Species
CT	California Threatened Species
SSC	California Department of Fish and Game Species of Special Concern

4.3.2 - PRESENCE OF SPECIAL-STATUS WILDLIFE

No special-status wildlife species or their sign were observed within the BSA. The Project site is highly disturbed and contains no habitat capable of supporting most of the special-status wildlife species listed in Table 4-2. A complete list of wildlife species observed during the biological reconnaissance survey is included in Appendix C.

There is no roosting habitat for monarch butterfly (*Danaus plexippus*) present within the BSA, although it may travel through the BSA as a transient. Additionally, no milkweed (*Asclepias* sp.) was observed within the BSA, which is a required food source for larval monarch butterflies. There are no elderberry shrubs within the BSA to support the valley elderberry longhorn beetle (*Desmocerus californicus*). The remaining insect species, San Joaquin tiger beetle (*Cicindela tranquebarica joaquinensis*), has no formal protection under the CESA or the ESA.

There are no pooled water features within the BSA capable of supporting crustaceans such as vernal pool fairy shrimp (*Branchinecta lynchi*), vernal pool tadpole shrimp (*Lepidurus packardii*), or California linderiella (*Linderiella occidentalis*).

There are no creeks, streams, or wetland features within the BSA capable of supporting several species including: western ridged mussel (*Gonidea angulate*), California tiger salamander (*Ambystoma californiense*), western spadefoot (*Spea hammondi*), California red-legged frog (*Rana draytonii*). In addition, the BSA lacks the necessary hydrology and vegetation necessary to support western pond turtle (*Emys marmorata*), or giant garter snake (*Thamophis gigas*). There are no water features present capable of supporting fish species such as the delta smelt (*Hypomesus transpacificus*).

There are no grasslands or native shrub habitats within the BSA that would support California glossy snake (*Arizona elegans occidentalis*) or blunt-nosed leopard lizard (*Gambelia sila*), Except for a few active California ground squirrel (*Otospermophilus beecheyi*) burrows located on the western boundary of the Project site there were no small

mammal burrows observed to provide shelter for California glossy snake or blunt-nosed leopard lizard.

No wetland or riparian habitat exists on-site that would support nesting or foraging tricolored blackbird (*Agelaius tricolor*), or yellow-headed blackbird (*Xanthocephalus xanthocephalus*). The BSA lacks grassland habitat that would support nesting and foraging western snowy plover (*Charadrius nivosus nivosus*). Burrowing owl (*Athene cunicularia*) also inhabits grassland and open bare ground and utilizes existing small mammal burrows, typically created by California ground squirrel, for breeding and shelter. While a few California ground squirrel burrows were observed there was no sign (e.g., whitewash, tracks, prey remains) to indicate burrowing owl may be occupying these burrows. In addition, burrowing owl are not typically associated with active agricultural fields because they prefer isolation from people and loud noises.

There are no rocky outcroppings, mines or caves, cliff faces, tree hollows, or bridges within the BSA that would support the hoary bat (*Lasiurus cinereus*). Due to the historic disturbance and absence of small mammal burrows, the BSA does not support the Fresno kangaroo rat (*Dipodomys nitratoides exilis*) or Tipton kangaroo rat (*Dipodomys nitratoides nitratoides*).

The San Joaquin kit fox is unlikely to habituate within the BSA. The nearest San Joaquin kit fox CNDDDB occurrence (EONDX 66435) is approximately 1.0-mile southwest of the BSA, where one adult was observed in a walnut (*Juglans* sp.) orchard in 2000. The BSA consists of active agricultural fields and common ornamental grasses, shrubs, and trees located on occupied residential properties. No San Joaquin kit fox or diagnostic signs of the species (e.g., tracks, dens, scat, prey remains) were found during the field survey, and there is a very limited prey base. Surrounding land use and habitat conditions make it unlikely that the San Joaquin kit fox would be present, other than as a transient forager.

The Swainson's hawk (*Buteo swainsoni*) has the potential to nest outside of the Project site in the vicinity of ornamental trees and powerline structures. No nests suitable for Nesting Swainson's hawks were observed within the BSA. The nearest CNDDDB occurrence (EONDX 91345) for nesting Swainson's hawk is approximately 3.0-miles northeast of the BSA, where nesting observations have been recorded since 2012. There is suitable nesting habitat within the vicinity on residential properties to the west and east. The site currently does provide foraging habitat during low growing agricultural crops.

4.4 - Nesting Migratory Birds and Raptors

No active or inactive migratory bird or raptor nests were observed during the survey, which was conducted during the breeding season (February 1 through September 15). There are a variety of man-made structures, transmission towers, and trees within the BSA and in the vicinity of the Project which could support a variety of nesting bird species, including larger species such as raptors and common raven (*Corvus corax*). Due to the active agricultural production and seasonal disking of the site, it is unlikely that ground nesting species would nest on the Project.

4.5 - Critical Habitat, Movement Corridors, and Linkages

4.5.1 - PRESENCE OF CRITICAL HABITAT

No designated critical habitat occurs within the BSA. The nearest USFWS designated critical habitat is for vernal pool fairy shrimp, California tiger salamander, and vernal pool tadpole shrimp located approximately 8.5-miles northeast of the BSA (Figure 4-1).

4.5.2 - PRESENCE OF MOVEMENT CORRIDORS AND LINKAGES

There are no known wildlife movement corridors or habitat linkages that intersect the BSA. The Project is situated within an area developed for urban and agricultural use and does not provide a linkage between suitable natural habitats for most wildlife species. Due to the disturbed condition of the Project, there is no substantial movement of wildlife onto or off of the BSA.

4.6 - Wetlands and Other Waters

No wetland features are known to exist at the Project site (Figure 3-4). The NHD and NWI identified one water feature that intersected the BSA, crossing the northwest corner and traversing through the western half of the Project site and exiting at the southern boundary. The NHD classified the feature as a canal ditch and NWI classified the feature as a riverine, R5UBFx. This water feature was not present during the site survey and is not visible on historical aerial imagery.

One water feature was observed during the survey that was not identified by NHD or NWI. An irrigation overflow trench located on the northern and western boundaries was predominately dry with some stagnant water located outside of the Project site in the northern portion of the BSA. The irrigation trench does not appear to connect to any outside source and appears to be contained to the existing Project site.

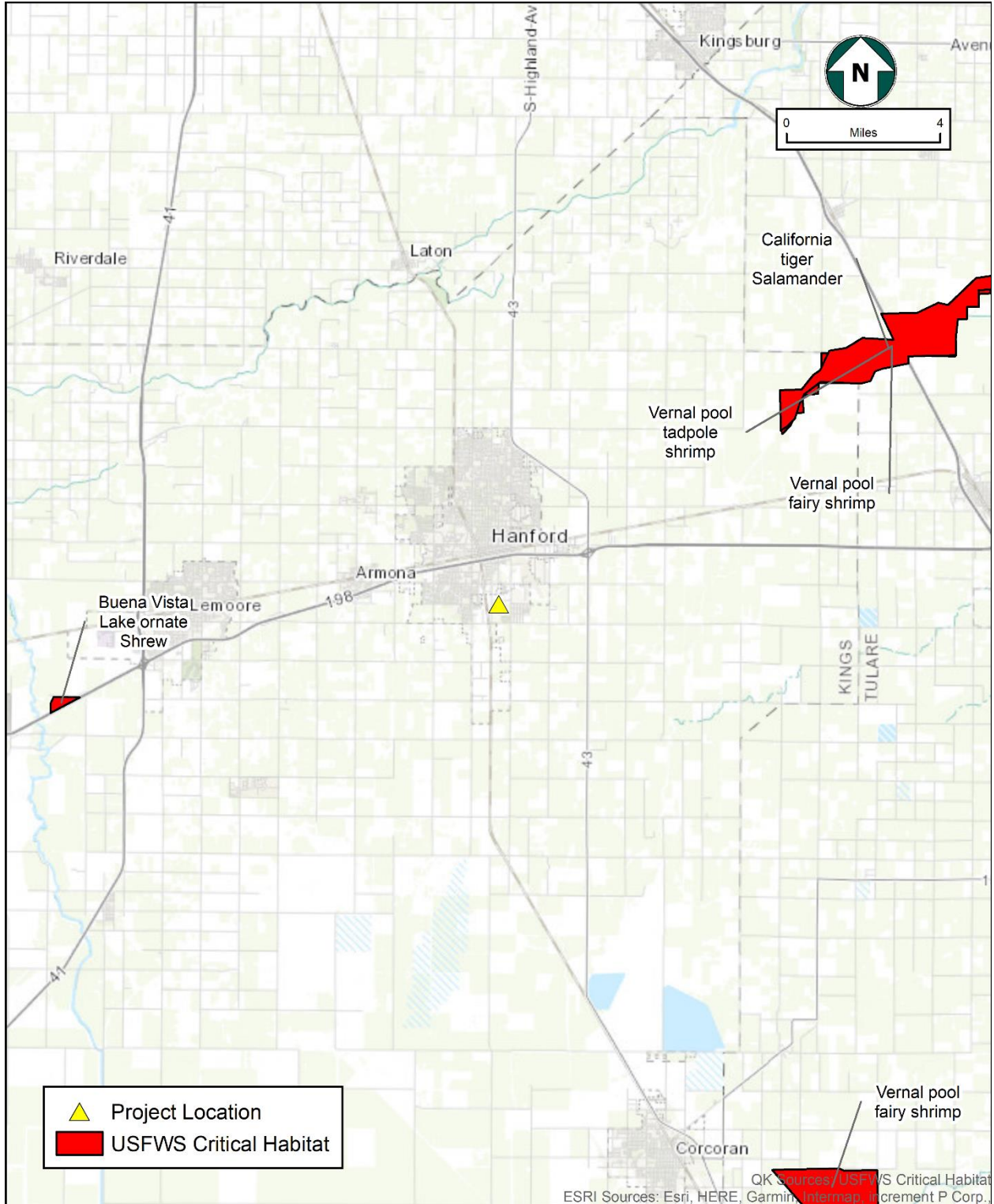

Figure 4-1
Mapped Critical Habitat in the Project Vicinity
Lunaria Residential Development Project, Kings County, California



SECTION 5 - POTENTIAL PROJECT IMPACTS

The purpose of this section is to present an evaluation of the potential for Project-related impacts to sensitive biological resources to occur resulting from Project construction activities. Although the potential for impacts of the Project is anticipated to be minor because the Project will be constructed on active agricultural fields, there are some risks of Project impacts. These are discussed below.

5.1 - Potential Impacts to Sensitive Vegetation Communities

No sensitive vegetation communities occur within the BSA. The Project would not impact sensitive natural communities

5.2 - Potential Impacts to Special-Status Plant Species

No special-status plant species occur within the BSA and there is no suitable habitat for any special-status plant species or near the BSA. The Project would not impact any special-status plant species.

5.3 - Potential Impacts to Special-Status Wildlife Species

Only two special-status wildlife species, San Joaquin kit fox and Swainson's hawk, have the potential to occur within the BSA from time to time. The available habitat for is very limited on fulfilling the necessary foraging requirements for San Joaquin kit fox and Swainson's hawk. No San Joaquin kit fox dens were observed on or near the Project site and habitation for foxes is very limited. Several trees outside of the Project site but within the BSA could support nests; however, the shortage of prey, and lack of local foraging habitat makes the presence of the Swainson's hawk very unlikely.

Any special-status species that use the Project as a movement corridor could be indirectly impacted because of Project activities, though little wildlife was observed in or near BSA during the reconnaissance survey conducted for the Project.

5.4 - Potential Impacts to Nesting Birds and Raptors

No active or inactive bird nests were observed during the site survey. There is potential for birds to nest outside of the Project site but within the BSA in existing structures and trees, and in trees and utility poles in the surrounding urban areas. If there are active nests present during Project activities, nests could be destroyed, and Project activities could interfere with normal breeding behaviors, which could discourage breeding or lead to nest abandonment or failure.

5.5 - Potential Impacts to Critical Habitat, Movement Corridors and Linkages

5.5.1 - POTENTIAL IMPACTS TO CRITICAL HABITAT

The Project would not impact any designated critical habitat.

5.5.2 - POTENTIAL IMPACTS TO MOVEMENT CORRIDORS AND LINKAGES

Project activities would not impact any movement corridors or habitat linkages.

5.6 - Potential Impacts to Wetlands and Waters

No wetland features exist on or near the BSA, and there would be no impacts to wetland resources. One ditch canal or riverine was identified via the NHD and NWI. This feature was not present during the reconnaissance survey and is not visible on historical aerial imagery. An irrigation ditch was identified during the survey on the northern and western boundary; however, it was not identified by NHD or NWI. This feature will not be impacted by the construction of this project. There would be no impacts to any wetlands or water features.

SECTION 6 - RECOMMENDATIONS

The Project is anticipated to have no impacts to sensitive natural communities, special-status plants, wetlands and water features, Critical Habitat, or migratory corridors. There is potential for Project activities to result in impacts to some of the special-status wildlife species listed in Sections 4 and 5. While the potential for impacts to San Joaquin kit fox and Swainson's hawk is low, to avoid these species and other wildlife species, we recommend that the following measures be implemented as Best Management Practices (BMPs) during Project activities:

- A pre-construction survey of the Project and a 500-foot buffer surrounding the Project footprint should be conducted for San Joaquin kit fox. The survey should occur no less than 14 days prior to the start of construction activities and no more than 30 days prior to the start of construction activities. If construction is delayed beyond 30 days from the time of the survey, then another survey would need to be conducted. The survey should be conducted by a biologist with adequate training and prior experience conducting surveys for special-status wildlife species.
- A worker environmental Awareness Training Program should be prepared and presented to all workers that will be on-site during construction activities.
- Project-related vehicles should observe a 20 mph speed limit in all Project areas, except on county roads and state and federal highways; this is particularly important at night when kit foxes, and other animals are most active. To the extent possible, nighttime construction should be minimized. Off-road traffic outside of designated project areas should be prohibited.
- To prevent inadvertent entrapment of kit foxes, and other animals during work being conducted, the contractor should cover all excavated, steep-walled holes or trenches more than 2 feet deep at the close of each working day with plywood or similar materials or provide one or more escape ramps constructed of earth fill or wooden planks. Before such holes or trenches are filled, the contractor should thoroughly inspect them for trapped animals.
- Kit foxes and other wildlife species are attracted to den-like structures such as pipes and may enter stored pipes, becoming trapped or injured. All construction pipes, culverts, or similar structures with a diameter of 4 inches or greater that are stored at a construction site for one or more overnight periods should be thoroughly inspected for kit foxes before the pipe is subsequently buried, capped, or otherwise used or moved in any way. If a kit fox is discovered inside a pipe, that section of pipe should not be moved until the designated biologist has been consulted. If necessary, and under the direct supervision of the biologist, the pipe may be moved once to remove it from the path of construction activity until the fox has escaped.
- All trash and food items should be discarded into closed containers and properly disposed of at the end of each workday.
- To prevent harassment or mortality of listed species, no pets should be permitted on the Project site.

To protect nesting migratory birds and raptors, it is recommended that:

- If Project activities are scheduled during the breeding bird season, from February 1 through September 15, then a preconstruction survey for nesting birds should be conducted within the Project site and within a 250-foot radius surrounding the Project site for active nesting sites. A 0.5-mile radius surrounding the Project site should be used to survey for nesting Swainson's hawks. Construction activities should not be conducted within 250 feet of an active bird nest, within 500 feet of an active raptor nest and within 0.5 mile of an active Swainson's hawk nest. These avoidance distances may be reduced if the qualified biologist determines that activities are not affecting the breeding success of the nesting birds.

SECTION 7 - SUMMARY AND CONCLUSIONS

Land within the Project site is highly disturbed and contains no habitat that would support special-status plant species or sensitive natural communities. There are no designated Critical Habitats, movement corridors, wetlands, or water features that would be impacted by the Project.

Based on the literature and database searches and results of the site survey, there is potential for two special-status species to occur on the site: the San Joaquin kit fox, and Swainson's hawk. Because of the disturbed nature of the Project and its situation within an area developed for agriculture and urban use, impacts to the San Joaquin kit fox are not expected. San Joaquin kit foxes would likely be only transient visitors to the Project site. If Swainson's hawks were to nest in the vicinity of the Project, impacts to the species could occur. The Project and surrounding areas provide suitable nesting habitat for other nesting migratory birds as well and impacts to these species may also occur. Implementation of the recommended BMPs and avoidance measures outlined in Section 6 would minimize any Project impacts to these species.

This Biological Resource Evaluation report has been performed in accordance with professionally accepted biological investigation practices conducted at this time and in this geographic area. The findings and opinions conveyed in this report are based on findings derived from specified historical and literary sources and a biological survey of the Project site and surrounding area. The biological investigation was limited by the scope of work performed. The biological survey may not have been performed during blooming periods or periods of seasonal or daily wildlife activity that would provide positive identification if resources were present, and therefore the findings of this report might not be definitive. The biological survey was also limited by the environmental conditions present at the time of the survey. In addition, general biological (or protocol) surveys do not guarantee that the organisms are not present and would not be discovered in the future within the site. Mobile animal species could occupy the site on a transient basis or re-establish populations in the future. No other guarantees or warranties, expressed or implied, are provided.

SECTION 8 - REFERENCES

- California Department of Fish and Wildlife (CDFW). 2022a. California Natural Diversity Database (CNDDDB), from <https://map.dfg.ca.gov/rarefind/view/RareFind.aspx>.
- California Department of Fish and Wildlife (CDFW). 2022b. Biogeographic Information and Observation System (BIOS). www.wildlife.ca.gov/data/BIOS
- California Department of Fish and Wildlife (CDFW). 2022c. CDFW's Special Animals List
- California Department of Water Resources Water Management Planning Tool (CDWR). 2022. <https://gis.water.ca.gov/app/boundaries/>
- California Native Plant Society (CNPS). 2022. Inventory of Rare and Endangered Plants. Updated online and accessed via: www.rareplants.cnps.org.
- Federal Emergency Management Agency (FEMA) 2022. On-line Map Service Center.
- Google LLC. 2022. Google Earth Pro.
- Mayer, K.E. and W.F. Laudenslayer, Jr. 1988. *A guide to wildlife habitats of California. State of California*. Resources Agency, Department of Fish and Game. Sacramento, CA. 166 pp. As updated online at: <https://www.wildlife.ca.gov/Data/CWHR/Wildlife-Habitats>
- Netronline. 2022. Historic Aerials Viewer. Accessed via: www.historicaerials.com/viewer
- United States Department of Agriculture, Natural Resources Conservation Service (NRCS). 2022a. Web Soil Survey. <http://websoilsurvey.nrcs.usda.gov/app/WebSoilSurvey.aspx>
- United States Department of Agriculture, Natural Resources Conservation Service (NRCS). 2022b. Lists of Hydric Soils. National Cooperative Soil Survey, U.S. Department of Agriculture. Accessed via: <https://www.nrcs.usda.gov/wps/portal/nrcs/main/soils/use/hydric/>.
- United States Fish and Wildlife Service (USFWS). 2022a. Information for Planning and Consultation online project planning tool. Available at: <https://ecos.fws.gov/ipac/>
- United States Fish and Wildlife Service (USFWS). 2022b. Critical Habitat Portal. Available at: <https://ecos.fws.gov/ecp/report/table/critical-habitat.html>
- United States Fish and Wildlife Service (USFWS). 2022c. National Wetlands Inventory Wetlands Mapper (NWI). U.S. Geological Survey.
- United States Geological Survey (USGS). 2022. National Hydrography Dataset (NHD). <https://www.usgs.gov/core-science-systems/ngp/national-hydrography>

Western Regional Climate Center (WRCC). 2021. Cooperative Climatological Data Summaries, NOAA Cooperative Station Hanford, California (043747).
<https://wrcc.dri.edu/cgi-bin/cliMAIN.pl?ca9367>

APPENDIX A

**SPECIAL-STATUS SPECIES DATABASE SEARCH RESULTS
FOR THE LUNARIA RESIDENTIAL DEVELOPMENT PROJECT**



Selected Elements by Scientific Name
California Department of Fish and Wildlife
California Natural Diversity Database



Query Criteria: Quad<IS> <(Hanford (3611936)> OR <Lemoore (3611937)> OR <Riverdale (3611947)> OR <Remnoy (3611935)> OR <Stratford (3611927)> OR <Burris Park (3611945)> OR <Waukena (3611925)> OR <Guernsey (3611926)> OR <Laton (3611946)>

Species	Element Code	Federal Status	State Status	Global Rank	State Rank	Rare Plant Rank/CDFW SSC or FP
<i>Agelaius tricolor</i> tricolored blackbird	ABPBXB0020	None	Threatened	G1G2	S1S2	SSC
<i>Ambystoma californiense pop. 1</i> California tiger salamander - central California DPS	AAAAA01181	Threatened	Threatened	G2G3	S3	WL
<i>Arizona elegans occidentalis</i> California glossy snake	ARADB01017	None	None	G5T2	S2	SSC
<i>Athene cunicularia</i> burrowing owl	ABNSB10010	None	None	G4	S3	SSC
<i>Atriplex cordulata var. erecticaulis</i> Earlilmart orache	PDCHE042V0	None	None	G3T1	S1	1B.2
<i>Atriplex depressa</i> brittlescale	PDCHE042L0	None	None	G2	S2	1B.2
<i>Atriplex minuscula</i> lesser saltscale	PDCHE042M0	None	None	G2	S2	1B.1
<i>Atriplex subtilis</i> subtle orache	PDCHE042T0	None	None	G1	S1	1B.2
<i>Branchinecta lynchi</i> vernal pool fairy shrimp	ICBRA03030	Threatened	None	G3	S3	
<i>Buteo swainsoni</i> Swainson's hawk	ABNKC19070	None	Threatened	G5	S3	
<i>Charadrius nivosus nivosus</i> western snowy plover	ABNNB03031	Threatened	None	G3T3	S2	SSC
<i>Cicindela tranquebarica joaquinensis</i> San Joaquin tiger beetle	IICOL0220E	None	None	G5T1	S1	
<i>Delphinium recurvatum</i> recurved larkspur	PDRAN0B1J0	None	None	G2?	S2?	1B.2
<i>Desmocerus californicus dimorphus</i> valley elderberry longhorn beetle	IICOL48011	Threatened	None	G3T2	S3	
<i>Dipodomys nitratoides nitratoides</i> Tipton kangaroo rat	AMAFD03152	Endangered	Endangered	G3T1T2	S1S2	
<i>Emys marmorata</i> western pond turtle	ARAAD02030	None	None	G3G4	S3	SSC
<i>Gambelia sila</i> blunt-nosed leopard lizard	ARACF07010	Endangered	Endangered	G1	S1	FP
<i>Gonidea angulata</i> western ridged mussel	IMBIV19010	None	None	G3	S1S2	
<i>Lasiurus cinereus</i> hoary bat	AMACC05030	None	None	G3G4	S4	



Selected Elements by Scientific Name
California Department of Fish and Wildlife
California Natural Diversity Database



Species	Element Code	Federal Status	State Status	Global Rank	State Rank	Rare Plant Rank/CDFW SSC or FP
<i>Lasthenia chrysantha</i> alkali-sink goldfields	PDAST5L030	None	None	G2	S2	1B.1
<i>Lepidium jaredii ssp. album</i> Panoche pepper-grass	PDBRA1M0G2	None	None	G2G3T2T3	S2S3	1B.2
<i>Lepidurus packardii</i> vernal pool tadpole shrimp	ICBRA10010	Endangered	None	G4	S3S4	
<i>Linderiella occidentalis</i> California linderiella	ICBRA06010	None	None	G2G3	S2S3	
<i>Nama stenocarpa</i> mud nama	PDHYD0A0H0	None	None	G4G5	S1S2	2B.2
<i>Puccinellia simplex</i> California alkali grass	PMPOA53110	None	None	G3	S2	1B.2
<i>Spea hammondi</i> western spadefoot	AAABF02020	None	None	G2G3	S3	SSC
<i>Valley Sacaton Grassland</i> Valley Sacaton Grassland	CTT42120CA	None	None	G1	S1.1	
<i>Valley Sink Scrub</i> Valley Sink Scrub	CTT36210CA	None	None	G1	S1.1	
<i>Vulpes macrotis mutica</i> San Joaquin kit fox	AMAJA03041	Endangered	Threatened	G4T2	S2	
<i>Xanthocephalus xanthocephalus</i> yellow-headed blackbird	ABPBXB3010	None	None	G5	S3	SSC

Record Count: 30



United States Department of the Interior

FISH AND WILDLIFE SERVICE

Sacramento Fish And Wildlife Office

Federal Building

2800 Cottage Way, Room W-2605

Sacramento, CA 95825-1846

Phone: (916) 414-6600 Fax: (916) 414-6713



In Reply Refer To:
Project Code: 2022-0021728
Project Name: Lunaria

March 18, 2022

Subject: List of threatened and endangered species that may occur in your proposed project location or may be affected by your proposed project

To Whom It May Concern:

The enclosed species list identifies threatened, endangered, proposed and candidate species, as well as proposed and final designated critical habitat, that may occur within the boundary of your proposed project and/or may be affected by your proposed project. The species list fulfills the requirements of the U.S. Fish and Wildlife Service (Service) under section 7(c) of the Endangered Species Act (Act) of 1973, as amended (16 U.S.C. 1531 *et seq.*).

New information based on updated surveys, changes in the abundance and distribution of species, changed habitat conditions, or other factors could change this list. Please feel free to contact us if you need more current information or assistance regarding the potential impacts to federally proposed, listed, and candidate species and federally designated and proposed critical habitat. Please note that under 50 CFR 402.12(e) of the regulations implementing section 7 of the Act, the accuracy of this species list should be verified after 90 days. This verification can be completed formally or informally as desired. The Service recommends that verification be completed by visiting the ECOS-IPaC website at regular intervals during project planning and implementation for updates to species lists and information. An updated list may be requested through the ECOS-IPaC system by completing the same process used to receive the enclosed list.

The purpose of the Act is to provide a means whereby threatened and endangered species and the ecosystems upon which they depend may be conserved. Under sections 7(a)(1) and 7(a)(2) of the Act and its implementing regulations (50 CFR 402 *et seq.*), Federal agencies are required to utilize their authorities to carry out programs for the conservation of threatened and endangered species and to determine whether projects may affect threatened and endangered species and/or designated critical habitat.

A Biological Assessment is required for construction projects (or other undertakings having similar physical impacts) that are major Federal actions significantly affecting the quality of the human environment as defined in the National Environmental Policy Act (42 U.S.C. 4332(2))

(c). For projects other than major construction activities, the Service suggests that a biological evaluation similar to a Biological Assessment be prepared to determine whether the project may affect listed or proposed species and/or designated or proposed critical habitat. Recommended contents of a Biological Assessment are described at 50 CFR 402.12.

If a Federal agency determines, based on the Biological Assessment or biological evaluation, that listed species and/or designated critical habitat may be affected by the proposed project, the agency is required to consult with the Service pursuant to 50 CFR 402. In addition, the Service recommends that candidate species, proposed species and proposed critical habitat be addressed within the consultation. More information on the regulations and procedures for section 7 consultation, including the role of permit or license applicants, can be found in the "Endangered Species Consultation Handbook" at:

<http://www.fws.gov/endangered/esa-library/pdf/TOC-GLOS.PDF>

Migratory Birds: In addition to responsibilities to protect threatened and endangered species under the Endangered Species Act (ESA), there are additional responsibilities under the Migratory Bird Treaty Act (MBTA) and the Bald and Golden Eagle Protection Act (BGEPA) to protect native birds from project-related impacts. Any activity, intentional or unintentional, resulting in take of migratory birds, including eagles, is prohibited unless otherwise permitted by the U.S. Fish and Wildlife Service (50 C.F.R. Sec. 10.12 and 16 U.S.C. Sec. 668(a)). For more information regarding these Acts see <https://www.fws.gov/birds/policies-and-regulations.php>.

The MBTA has no provision for allowing take of migratory birds that may be unintentionally killed or injured by otherwise lawful activities. It is the responsibility of the project proponent to comply with these Acts by identifying potential impacts to migratory birds and eagles within applicable NEPA documents (when there is a federal nexus) or a Bird/Eagle Conservation Plan (when there is no federal nexus). Proponents should implement conservation measures to avoid or minimize the production of project-related stressors or minimize the exposure of birds and their resources to the project-related stressors. For more information on avian stressors and recommended conservation measures see <https://www.fws.gov/birds/bird-enthusiasts/threats-to-birds.php>.

In addition to MBTA and BGEPA, Executive Order 13186: *Responsibilities of Federal Agencies to Protect Migratory Birds*, obligates all Federal agencies that engage in or authorize activities that might affect migratory birds, to minimize those effects and encourage conservation measures that will improve bird populations. Executive Order 13186 provides for the protection of both migratory birds and migratory bird habitat. For information regarding the implementation of Executive Order 13186, please visit <https://www.fws.gov/birds/policies-and-regulations/executive-orders/e0-13186.php>.

We appreciate your concern for threatened and endangered species. The Service encourages Federal agencies to include conservation of threatened and endangered species into their project planning to further the purposes of the Act. Please include the Consultation Code in the header of this letter with any request for consultation or correspondence about your project that you submit to our office.

Attachment(s):

- Official Species List

Official Species List

This list is provided pursuant to Section 7 of the Endangered Species Act, and fulfills the requirement for Federal agencies to "request of the Secretary of the Interior information whether any species which is listed or proposed to be listed may be present in the area of a proposed action".

This species list is provided by:

Sacramento Fish And Wildlife Office

Federal Building

2800 Cottage Way, Room W-2605

Sacramento, CA 95825-1846

(916) 414-6600

Project Summary

Project Code: 2022-0021728

Event Code: None

Project Name: Lunaria

Project Type: Residential Construction

Project Description: Tentative track map for residential housing

Project Location:

Approximate location of the project can be viewed in Google Maps: <https://www.google.com/maps/@36.30591325,-119.64361626829984,14z>



Counties: Kings County, California

Endangered Species Act Species

There is a total of 10 threatened, endangered, or candidate species on this species list.

Species on this list should be considered in an effects analysis for your project and could include species that exist in another geographic area. For example, certain fish may appear on the species list because a project could affect downstream species.

IPaC does not display listed species or critical habitats under the sole jurisdiction of NOAA Fisheries⁴, as USFWS does not have the authority to speak on behalf of NOAA and the Department of Commerce.

See the "Critical habitats" section below for those critical habitats that lie wholly or partially within your project area under this office's jurisdiction. Please contact the designated FWS office if you have questions.

1. [NOAA Fisheries](#), also known as the National Marine Fisheries Service (NMFS), is an office of the National Oceanic and Atmospheric Administration within the Department of Commerce.

Mammals

NAME	STATUS
Fresno Kangaroo Rat <i>Dipodomys nitratooides exilis</i> There is final critical habitat for this species. The location of the critical habitat is not available. Species profile: https://ecos.fws.gov/ecp/species/5150	Endangered
San Joaquin Kit Fox <i>Vulpes macrotis mutica</i> No critical habitat has been designated for this species. Species profile: https://ecos.fws.gov/ecp/species/2873	Endangered
Tipton Kangaroo Rat <i>Dipodomys nitratooides nitratooides</i> No critical habitat has been designated for this species. Species profile: https://ecos.fws.gov/ecp/species/7247	Endangered

Reptiles

NAME	STATUS
Blunt-nosed Leopard Lizard <i>Gambelia silus</i> No critical habitat has been designated for this species. Species profile: https://ecos.fws.gov/ecp/species/625	Endangered
Giant Garter Snake <i>Thamnophis gigas</i> No critical habitat has been designated for this species. Species profile: https://ecos.fws.gov/ecp/species/4482	Threatened

Amphibians

NAME	STATUS
California Red-legged Frog <i>Rana draytonii</i> There is final critical habitat for this species. The location of the critical habitat is not available. Species profile: https://ecos.fws.gov/ecp/species/2891	Threatened

Fishes

NAME	STATUS
Delta Smelt <i>Hypomesus transpacificus</i> There is final critical habitat for this species. The location of the critical habitat is not available. Species profile: https://ecos.fws.gov/ecp/species/321	Threatened

Insects

NAME	STATUS
Monarch Butterfly <i>Danaus plexippus</i> No critical habitat has been designated for this species. Species profile: https://ecos.fws.gov/ecp/species/9743	Candidate

Crustaceans

NAME	STATUS
Vernal Pool Fairy Shrimp <i>Branchinecta lynchi</i> There is final critical habitat for this species. The location of the critical habitat is not available. Species profile: https://ecos.fws.gov/ecp/species/498	Threatened
Vernal Pool Tadpole Shrimp <i>Lepidurus packardii</i> There is final critical habitat for this species. The location of the critical habitat is not available. Species profile: https://ecos.fws.gov/ecp/species/2246	Endangered

Critical habitats

THERE ARE NO CRITICAL HABITATS WITHIN YOUR PROJECT AREA UNDER THIS OFFICE'S JURISDICTION.

IPaC User Contact Information

Agency: QK, Inc.
Name: Karissa Denney
Address: 5080 California Avenue
Address Line 2: Suite 220
City: Bakersfield
State: CA
Zip: 93309
Email: karissa.denney@qkinc.com
Phone: 6616162600

Search Results

12 matches found. Click on scientific name for details

Search Criteria: 9-Quad include [3611935:3611926:3611925:3611945:3611936:3611937:3611947:3611946:3611927]

▲ SCIENTIFIC NAME	COMMON NAME	FAMILY	LIFEFORM	BLOOMING PERIOD	FED LIST	STATE LIST	GLOBAL RANK	STATE RANK	CA RARE PLANT RANK	PHOTO
Atriplex cordulata var. cordulata	heartscale	Chenopodiaceae	annual herb	Apr-Oct	None	None	G3T2	S2	1B.2	 © 1994 Robert E. Preston, Ph.D.
Atriplex cordulata var. erecticaulis	Earlilmart orache	Chenopodiaceae	annual herb	Aug-Sep(Nov)	None	None	G3T1	S1	1B.2	 © 2009 Robert E. Preston, Ph.D.
Atriplex dioecia	brittlescale	Chenopodiaceae	annual herb	Apr-Oct	None	None	G2	S2	1B.2	 © 2009 Zoey Akulova
Atriplex minuscula	lesser saltscale	Chenopodiaceae	annual herb	May-Oct	None	None	G2	S2	1B.1	 © 2000 Robert E. Preston, Ph.D.
Atriplex subtilis	subtle orache	Chenopodiaceae	annual herb	(Apr)Jun-Sep(Oct)	None	None	G1	S1	1B.2	 © 2000 Robert E. Preston, Ph.D.
Delphinium recurvatum	recurved larkspur	Ranunculaceae	perennial herb	Mar-Jun	None	None	G27	S27	1B.2	No Photo Available
Lasthenia chrysantha	alkali-stnk goldfields	Asteraceae	annual herb	Feb-Apr	None	None	G2	S2	1B.1	 © 2009 California State University, Stanislaus
Lasthenia fernisiae	Ferris' goldfields	Asteraceae	annual herb	Feb-May	None	None	G3	S3	4.2	 © 2009 Zoey Akulova
Lepidium jaredii ssp. album	Panoche peppergrass	Brassicaceae	annual herb	Feb-Jun	None	None	G2G3T2T3	S2S3	1B.2	 © 2015 Debra L. Cook
Nema stenocarpa	mud nama	Namaceae	annual/perennial herb	Jan-Jul	None	None	G4G5	S1S2	2B.2	No Photo Available
Puccinellia simplex	California alkali grass	Poaceae	annual herb	Mar-May	None	None	G3	S2	1B.2	No Photo Available
Sagittaria sanfordii	Sanford's arrowhead	Alismataceae	perennial rhizomatous herb (emergent)	May-Oct(Nov)	None	None	G3	S3	1B.2	 ©2013 Debra L. Cook

Showing 1 to 12 of 12 entries

Suggested Citation:

California Native Plant Society, Rare Plant Program. 2022. Rare Plant Inventory (online edition, v9-01 1.5). Website <https://www.rareplants.cnps.org> [accessed 6 April 2022].

CONTACT US

Send questions and comments to
rareplants@cnps.org.



Developed by
Rincon Consultants, Inc.

ABOUT THIS WEBSITE

[About the Inventory](#)
[Release Notes](#)
[Advanced Search](#)
[Glossary](#)

ABOUT CNPS

[About the Rare Plant Program](#)
[CNPS Home Page](#)
[About CNPS](#)
[Join CNPS](#)

CONTRIBUTORS

[The California Database](#)
[The California Lichen Society](#)
[California Natural Diversity Database](#)
[The Jepson Flora Project](#)
[The Consortium of California Herbaria](#)
[CalPhotos](#)

Copyright © 2010-2022 California Native Plant Society. All rights reserved.

APPENDIX B

REPRESENTATIVE PHOTOGRAPHS OF THE

LUNARIA RESIDENTIAL DEVELOPMENT PROJECT



Photograph 1: Southwest corner of the Project site, facing north.
GPS Coordinates: 36.302287°N, -119.645731°W.
Photograph taken by Karissa Denney on March 18, 2022.



Photograph 2: Southern boundary of the Project site, facing north.
GPS Coordinates: 36.302279°N, -119.643724°W.
Photograph taken by Karissa Denney on March 18, 2022.



Photograph 3: Northwest corner of the Project site with the irrigation ditch, facing east.
GPS Coordinates: 36.309347°N, -119.645745°W.
Photograph taken by Karissa Denney on March 18, 2022.



Photograph 4: Northwest corner of the Project site with the irrigation ditch, facing south.
GPS Coordinates: 36.309347°N, -119.645745°W.
Photograph taken by Karissa Denney on March 18, 2022.



Photograph 5: Northeast corner of the Project site with a tractor disking the field, facing south.
GPS Coordinates: 36.309501°N, -119.639220°W.
Photograph taken by Karissa Denney on March 18, 2022.



Photograph 6: Center of the Project site, facing north.
GPS Coordinates: 36.305801°N, -119.643459°W.
Photograph taken by Karissa Denney on March 18, 2022.



Photograph 7: Center of the Project site, facing south.
GPS Coordinates: 36.305801°N, -119.643459°W.
Photograph taken by Karissa Denney on March 18, 2022.



Photograph 8: Representative California ground squirrel along the irrigation ditch on the western boundary of the BSA, facing west.
GPS Coordinates: 36.305875°N, -119.645784°W.
Photograph taken by Karissa Denney on March 18, 2022.

APPENDIX C
PLANT AND WILDLIFE SPECIES OBSERVED
ON THE LUNARIA RESIDENTIAL DEVELOPMENT PROJECT

Table C - 1
Plant and Wildlife Species Observed on the Project Site
Lunaria Residential Development Project

Scientific Name	Common Name	Status
Plants		
<i>Amsinckia menziesii</i>	fiddleneck	None
<i>Avena fatua</i>	wild oat	None
<i>Bromus diandrus</i>	ripgut brome	None
<i>Capsella bursa-pastoris</i>	Shepard's purse	None
<i>Digitaria</i> sp.	crabgrass	None
<i>Erodium cicutarium</i>	red-stemmed filaree	None
<i>Eucalyptus</i> sp.	eucalyptus	None
<i>Heterotheca grandiflora</i>	telegraph weed	None
<i>Hordeum murinum</i>	foxtail barley	None
<i>Malva parviflora</i>	cheeseweed	None
<i>Matricaria discoidea</i>	pineapple weed	None
<i>Matricaria recutita</i>	German chamomile	None
<i>Medicago sativa</i>	alfalfa	None
<i>Raphanus raphanistrum</i>	wild radish	None
<i>Salsola tragus</i>	Russian thistle	None
<i>Senecio vulgaris</i>	common groundsel	None
<i>Sisymbrium irio</i>	London rocket	None
<i>Sisymbrium sophia</i>	tansy mustard	None
<i>Triticum</i> sp.	wheat	None
Reptiles		
<i>Uta stansburiana</i>	side-blotched lizard	None
Birds		
<i>Aphelocoma californica</i>	California scrub jay	None
<i>Carpodacus mexicanus</i>	house finch	None
<i>Corvus brachyrhynchos</i>	American crow	None
<i>Gallus gallus domesticus</i>	rooster	None
<i>Mimus polyglottos</i>	Northern mockingbird	None
<i>Sayornis nigricans</i>	black phoebe	None
<i>Zenaida macroura</i>	mourning dove	None
<i>Zonotrichia leucophrys</i>	white-crowned sparrow	None
Mammals		
<i>Bos</i> sp.	cattle	None
<i>Otospermophilus beecheyi</i>	California ground squirrel*	None
<i>Geomyidae</i>	gopher*	None
<i>Canis lupus familiaris</i>	domestic dog	None
<i>Equus ferus caballus</i>	horse	None

* Indicates that only sign (e.g., tracks, scat, burrows, dens, vocalizations) of the species was observed.



TECHNICAL MEMORANDUM

Date: June 20, 2022

Project: Cultural resources records search- Lunaria Residential Development Project, City of Hanford, Kings County, CA

To: Jaymie Brauer, Principal Planner

From: Robert Parr, MS, RPA, Senior Archaeologist

Subject: Cultural Resources Records Search Results (RS#22-164)

Background

A cultural resources records search (#22-164) was conducted at the Southern San Joaquin Valley Information Center (IC), CSU Bakersfield for the above referenced Project in the City of Hanford, Kings County to determine whether the proposed project would impact cultural resources.

Project Location

The Project is located in Kings County, California (Attachment A: Figures 1-4). The Project site is within the northwest $\frac{1}{4}$ of the southeast $\frac{1}{4}$ of Section 1, T.19S, R.21E. (Figures 1-4).

Project Description

The Project intends to create residential lots and the appurtenant infrastructure consistent with the General Plan designation of Residential Low Density. The applicant (D.R. Horton) proposes constructing a tract, a 457-lot single-family subdivision with an approximate 4.4-acre square foot storm basin, and a 5.82-acre park (Tract 938). The development would include single-story homes of three to five bedrooms, with a minimum lot size of 5,000 square feet, and the associated road and utility improvements. The Project will also include landscaping.

Results

The records search covered an area within one-half mile of the Project and included a review of the *National Register of Historic Places*, *California Points of Historical Interest*, *California Registry of Historic Resources*, *California Historical Landmarks*, *California State Historic Resources Inventory*, and a review of cultural resource reports on file.

The records search indicated that, although it was included in a brief cultural resource assessment of the general area (Davis 1977), the subject property had never been surveyed for cultural resources. Four cultural resource studies have been conducted within a half mile of the project (Varner 1975, 2005; Mason and Shepard 2000; Nelson 2000).



TECHNICAL MEMORANDUM

One historic cultural resource, the People's Ditch (P-16-000246), passes through the property. This is an active irrigation ditch that originally was constructed in the 1870s. However, aerial photography indicates this feature is no longer present on the site, and there would be no impact. Since the property has never been surveyed for cultural resources, it is not known if any others exist on it.

One cultural resource, the historic route of the AT&SF Railroad (P-16-000120) is located within one half mile of the project. This historic resource will not be impacted by the project.

A Sacred Lands File request was also submitted to the Native American Heritage Commission. A response dated June 20, 2022 indicates negative results (see Attachment C).

Conclusions

Based on the results of cultural records search findings and the lack of historical or archaeological resources previously identified within a half mile radius of the proposed Project, the potential to encounter subsurface cultural resources is minimal. Additionally, the Project construction would be conducted within the partially developed and previously disturbed parcel. The potential to uncover subsurface historical or archaeological deposits would be considered unlikely.

However, there is still a possibility that historical or archaeological materials may be exposed during construction. Grading and trenching, as well as other ground-disturbing actions have the potential to damage or destroy these previously unidentified and potentially significant cultural resources within the project area, including historical or archaeological resources. Disturbance of any deposits that have the potential to provide significant cultural data would be considered a significant impact. To reduce the potential impacts of the Project on cultural resources, the following measures are recommended to be included as Conditions of Approval. With implementation of CUL-1 and CUL-2, the Project would have a less than significant impact related to cultural resources.

CUL-1: If prehistoric or historic-era cultural materials are encountered during construction activities, all work in the immediate vicinity of the find shall halt until a qualified archaeologist can evaluate the find and make recommendations. Cultural resource materials may include prehistoric resources such as flaked and ground stone tools and debris, shell, bone, ceramics, and fire-affected rock as well as historic resources such as glass, metal, wood, brick, or structural remnants. If the qualified archaeologist determines that the discovery represents a potentially significant cultural resource, additional investigations may be required to mitigate adverse impacts from Project implementation. These additional studies may include avoidance, testing, and evaluation or data recovery excavation. Implementation of the mitigation measure below would ensure that the proposed Project would not cause a substantial adverse change in the significance of a historical resource.



TECHNICAL MEMORANDUM

CUL-2: If human remains are discovered during construction or operational activities, further excavation or disturbance shall be prohibited pursuant to Section 7050.5 of the California Health and Safety Code. The specific protocol, guidelines, and channels of communication outlined by the Native American Heritage Commission, in accordance with Section 7050.5 of the Health and Safety Code, Section 5097.98 of the Public Resources Code (Chapter 1492, Statutes of 1982, Senate Bill 297), and Senate Bill 447 (Chapter 44, Statutes of 1987), shall be followed. Section 7050.5(c) shall guide the potential Native American involvement, in the event of discovery of human remains, at the direction of the county coroner.

A handwritten signature in black ink, appearing to read 'Robert E. Parr', written in a cursive style.

Robert E. Parr, MS, RPA
Senior Archaeologist

Attachment A- Figures

Attachment B- Sacred Lands File Response by the Native American Heritage Commission



TECHNICAL MEMORANDUM

References

(all reports on file at the Southern San Joaquin Valley Information Center, California State University, Bakersfield)

Bonner, Wayne H., Marnie Aislin-Kay, and Alynne Loupe
2005 Cultural Resources Records Search and Site Visit Results for Cingular Telecommunications Facility Candidate ES-0006-01 (Sprint Barstow Road), 260 Virginia Way, Barstow, San Bernardino County, California. (SB-04893)

Bonner, Wayne H., and Sarah A. Williams
2012 Cultural Resources Records Search and Site Visit Results for T-Mobile West, LLC Candidate IE04396A (Barstow Fire Department), 861 Barstow Road, Barstow, San Bernardino County, California. (SB-07158)

Dice, Michael
2000 Records Search for Sprint PCS Facility SB40XC715B (Barstow Museum), City of Barstow, San Bernardino County, CA. (SB-04210)

Hearn, Joseph E., and Ruth D. Simpson
1976 Archaeological – Historical Resources Assessment of Area Selected for Proposed Barstow Fire District Headquarters Facility. (SB-00425)



TECHNICAL MEMORANDUM

Attachment A-
Figures

Lunaria Residential Development Project



Lunaria Residential Development Project

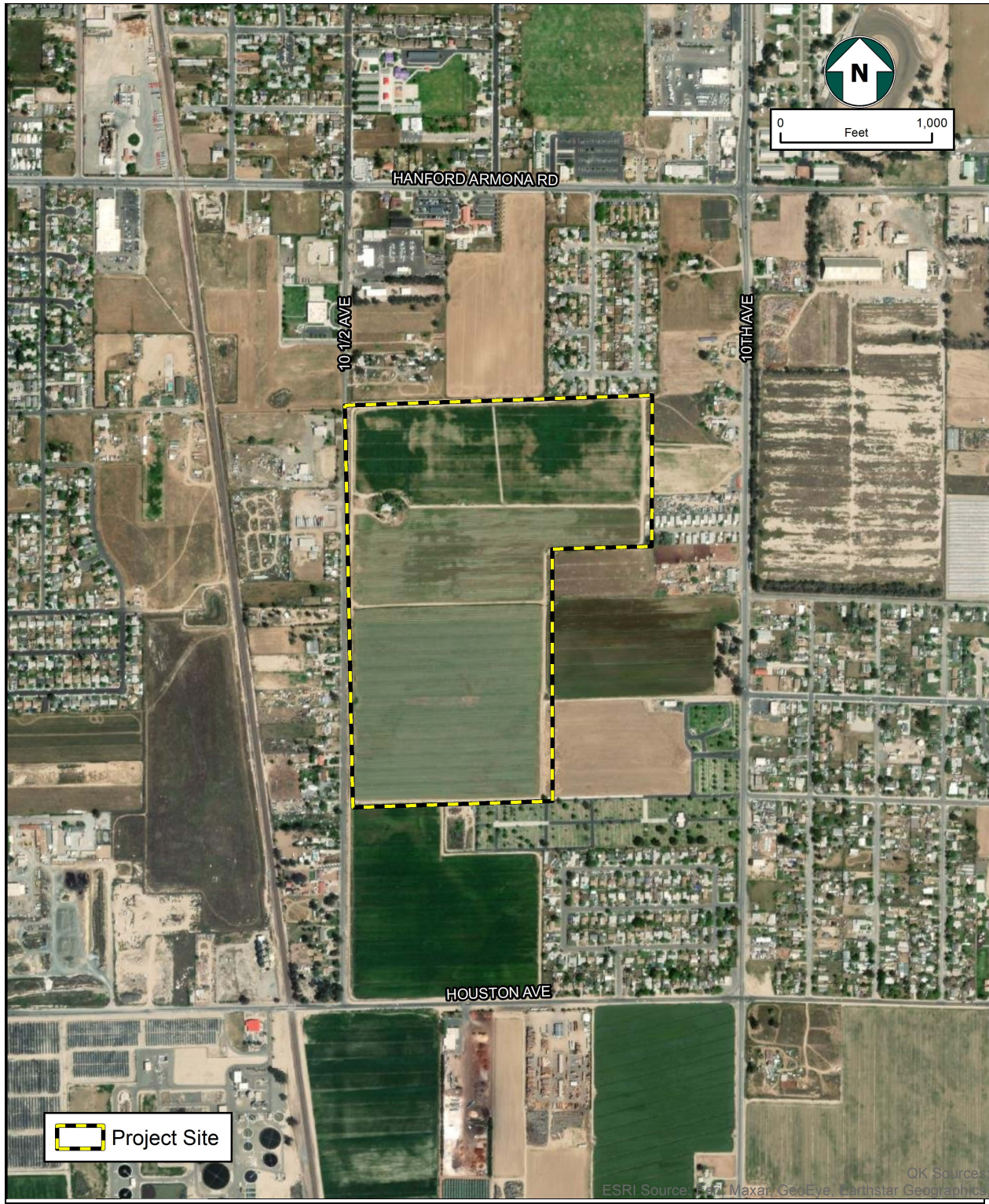

Figure - 2
Project Area

Lunaria Residential Development Project

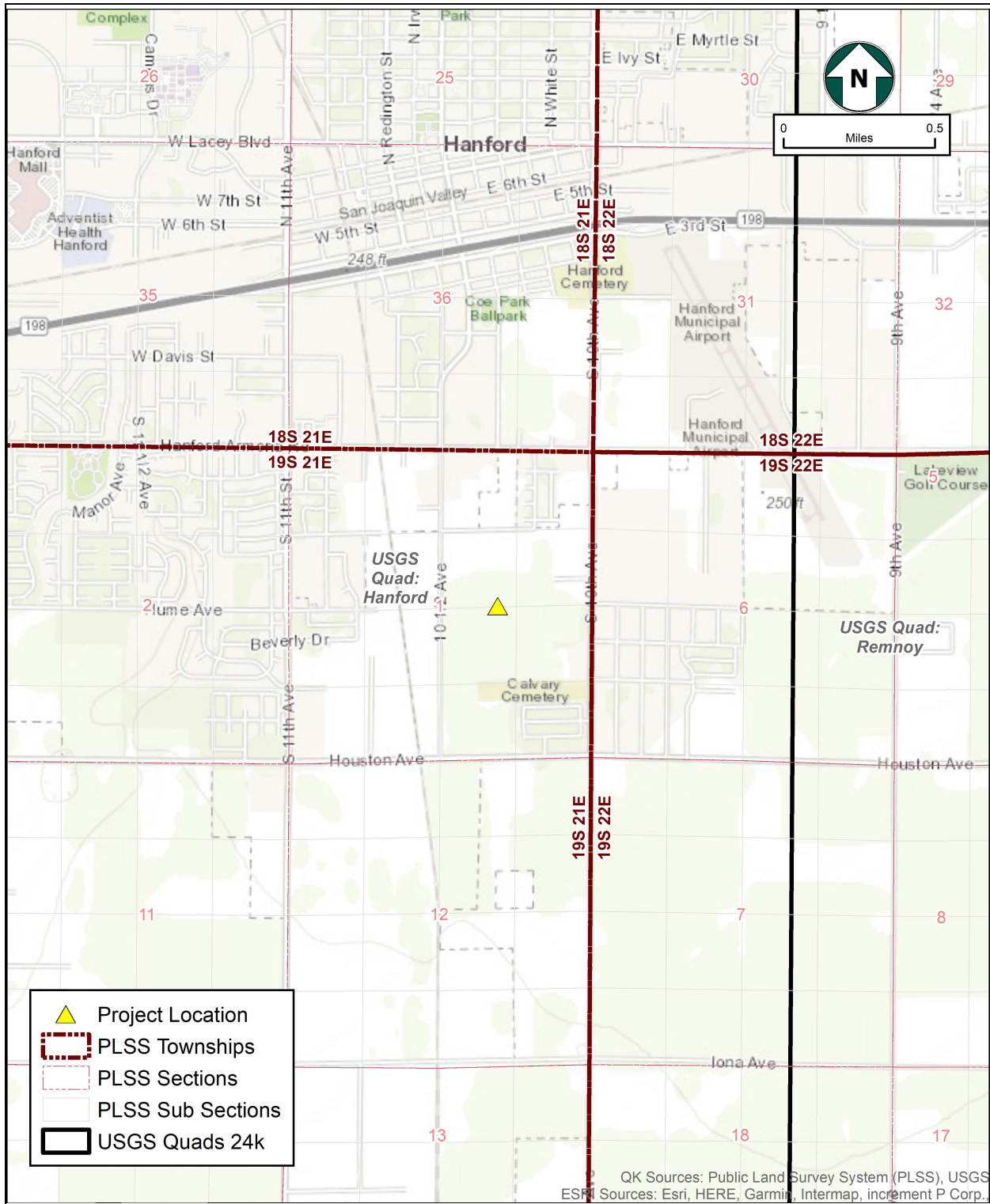

Figure - 3
PLSS/USGS Quad

Lunaria Residential Development Project



Figure - 4
Topo



TECHNICAL MEMORANDUM

Attachment B-
Sacred Lands File Response by the
Native American Heritage Commission

NATIVE AMERICAN HERITAGE COMMISSION

June 20, 2022

Jaymie Brauer
QK Inc.

Via Email to: jaymie.brauer@qkinc.com

Re: Native American Tribal Consultation, Pursuant to the Assembly Bill 52 (AB 52), Amendments to the California Environmental Quality Act (CEQA) (Chapter 532, Statutes of 2014), Public Resources Code Sections 5097.94 (m), 21073, 21074, 21080.3.1, 21080.3.2, 21082.3, 21083.09, 21084.2 and 21084.3, Lunaria Residential Development Project, Kings County

Dear Mr. Brauer:

Pursuant to Public Resources Code section 21080.3.1 (c), attached is a consultation list of tribes that are traditionally and culturally affiliated with the geographic area of the above-listed project. Please note that the intent of the AB 52 amendments to CEQA is to avoid and/or mitigate impacts to tribal cultural resources, (Pub. Resources Code §21084.3 (a)) ("Public agencies shall, when feasible, avoid damaging effects to any tribal cultural resource.")

Public Resources Code sections 21080.3.1 and 21084.3(c) require CEQA lead agencies to consult with California Native American tribes that have requested notice from such agencies of proposed projects in the geographic area that are traditionally and culturally affiliated with the tribes on projects for which a Notice of Preparation or Notice of Negative Declaration or Mitigated Negative Declaration has been filed on or after July 1, 2015. Specifically, Public Resources Code section 21080.3.1 (d) provides:

Within 14 days of determining that an application for a project is complete or a decision by a public agency to undertake a project, the lead agency shall provide formal notification to the designated contact of, or a tribal representative of, traditionally and culturally affiliated California Native American tribes that have requested notice, which shall be accomplished by means of at least one written notification that includes a brief description of the proposed project and its location, the lead agency contact information, and a notification that the California Native American tribe has 30 days to request consultation pursuant to this section.

The AB 52 amendments to CEQA law does not preclude initiating consultation with the tribes that are culturally and traditionally affiliated within your jurisdiction prior to receiving requests for notification of projects in the tribe's areas of traditional and cultural affiliation. The Native American Heritage Commission (NAHC) recommends, but does not require, early consultation as a best practice to ensure that lead agencies receive sufficient information about cultural resources in a project area to avoid damaging effects to tribal cultural resources.

The NAHC also recommends, but does not require that agencies should also include with their notification letters, information regarding any cultural resources assessment that has been completed on the area of potential effect (APE), such as:

1. The results of any record search that may have been conducted at an Information Center of the California Historical Resources Information System (CHRIS), including, but not limited to:



CHAIRPERSON
Laura Miranda
Luiseño

VICE CHAIRPERSON
Reginald Pagaling
Chumash

PARLIAMENTARIAN
Russell Attebery
Karuk

SECRETARY
Sara Dutschke
Miwok

COMMISSIONER
William Mungary
Paiute/White Mountain
Apache

COMMISSIONER
Isaac Bojorquez
Ohlone-Costanoan

COMMISSIONER
Buffy McQuillen
Yokayo Pomo, Yuki,
Nomlaki

COMMISSIONER
Wayne Nelson
Luiseño

COMMISSIONER
Stanley Rodriguez
Kumeyaay

EXECUTIVE SECRETARY
Raymond C. Hitchcock
Miwok/Nisenan

NAHC HEADQUARTERS
1550 Harbor Boulevard
Suite 100
West Sacramento,
California 95691
(916) 373-3710
nahc@nahc.ca.gov

- A listing of any and all known cultural resources that have already been recorded on or adjacent to the APE, such as known archaeological sites;
- Copies of any and all cultural resource records and study reports that may have been provided by the Information Center as part of the records search response;
- Whether the records search indicates a low, moderate, or high probability that unrecorded cultural resources are located in the APE; and
- If a survey is recommended by the Information Center to determine whether previously unrecorded cultural resources are present.

2. The results of any archaeological inventory survey that was conducted, including:

- Any report that may contain site forms, site significance, and suggested mitigation measures.

All information regarding site locations, Native American human remains, and associated funerary objects should be in a separate confidential addendum, and not be made available for public disclosure in accordance with Government Code section 6254.10.

3. The result of any Sacred Lands File (SLF) check conducted through the Native American Heritage Commission was negative.

4. Any ethnographic studies conducted for any area including all or part of the APE; and

5. Any geotechnical reports regarding all or part of the APE.

Lead agencies should be aware that records maintained by the NAHC and CHRIS are not exhaustive and a negative response to these searches does not preclude the existence of a tribal cultural resource. A tribe may be the only source of information regarding the existence of a tribal cultural resource.

This information will aid tribes in determining whether to request formal consultation. In the event that they do, having the information beforehand will help to facilitate the consultation process.

If you receive notification of change of addresses and phone numbers from tribes, please notify the NAHC. With your assistance, we can assure that our consultation list remains current.

If you have any questions, please contact me at my email address: Cameron.vela@nahc.ca.gov.

Sincerely,

Cameron Vela

Cameron Vela
Cultural Resources Analyst

Attachment

**Native American Heritage Commission
Tribal Consultation List
Kings County
6/20/2022**

***Kings River Choinumni Farm
Tribe***

Stan Alec,
3515 East Fedora Avenue Foothill Yokut
Fresno, CA, 93726
Phone: (559) 647 - 3227

***Santa Rosa Rancheria Tachi
Yokut Tribe***

Leo Sisco, Chairperson
P.O. Box 8 Southern Valley
Lemoore, CA, 93245 Yokut
Phone: (559) 924 - 1278
Fax: (559) 924-3583

Table Mountain Rancheria

Brenda Lavell, Chairperson
P.O. Box 410 Yokut
Friant, CA, 93626
Phone: (559) 822 - 2587
Fax: (559) 822-2693
rpennell@tmr.org

Tule River Indian Tribe

Neil Peyron, Chairperson
P.O. Box 589 Yokut
Porterville, CA, 93258
Phone: (559) 781 - 4271
Fax: (559) 781-4610
neil.peyron@tulerivertribe-nsn.gov

***Wuksache Indian Tribe/Eshom
Valley Band***

Kenneth Woodrow, Chairperson
1179 Rock Haven Ct. Foothill Yokut
Salinas, CA, 93906 Mono
Phone: (831) 443 - 9702
kwood8934@aol.com

This list is current only as of the date of this document. Distribution of this list does not relieve any person of statutory responsibility as defined in Section 7050.5 of the Health and Safety Code, Section 5097.94 of the Public Resources Code and section 5097.98 of the Public Resources Code.

This list is only applicable for consultation with Native American tribes under Public Resources Code Sections 21080.3.1 for the proposed Lunaria Residential Development Project, Kings County.

Traffic Impact Analysis Report

Lunaria (Single-Family Detached Housing)

Located on the Southeast Quadrant of Hanford-
Armona Road and 10 ½ Avenue

In the City of Hanford, California

Prepared for

Quad Knopf, Inc.
601 Pollasky Avenue, Suite 301
Clovis, CA 93612

August 24, 2022

Project No. 047-002



Traffic Engineering, Transportation Planning, & Parking Solutions

516 W. Shaw Ave., Ste. 103

Fresno, CA 93710

Phone: (559) 570-8991

www.JLBtraffic.com



Traffic Engineering, Transportation Planning, & Parking Solutions

Traffic Impact Analysis Report

**For Lunaria located on the Southeast Quadrant of Hanford-Armona Road and
10 ½ Avenue**

In the City of Hanford, California

August 24, 2022

This Traffic Impact Analysis Report has been prepared under the direction of a licensed Traffic Engineer. The licensed Traffic Engineer attests to the technical information contained therein and has judged the qualifications of any technical specialists providing engineering data from which recommendations, conclusions and decisions are based.

Prepared by:

A handwritten signature in black ink that reads 'Jose L Benavides'. The signature is written over a horizontal line.

Jose Luis Benavides, PE, TE
President



Traffic Engineering, Transportation Planning, & Parking Solutions

516 W. Shaw Ave., Ste. 103
Fresno, CA 93704
Phone: (559) 570-8991
www.JLBtraffic.com

Table of Contents

Introduction and Summary.....	1
Introduction	1
Summary	1
Existing Traffic Conditions.....	1
Existing plus Project Traffic Conditions.....	1
Near Term plus Project Traffic Conditions.....	2
Cumulative Year 2042 plus Project Traffic Conditions.....	2
Scope of Work	3
Study Facilities	3
Study Intersections	4
Study Segments.....	4
Project Only Trips to State Facilities	4
Study Scenarios.....	4
Existing Traffic Conditions.....	4
Existing plus Project Traffic Conditions.....	4
Near Term plus Project Traffic Conditions.....	5
Cumulative Year 2042 plus Project Traffic Conditions.....	5
LOS Methodology	5
LOS Thresholds	6
Operational Analysis Assumptions and Defaults	6
Existing Traffic Conditions	7
Roadway Network.....	7
Traffic Signal Warrants.....	8
Results of Existing Level of Service Analysis	8
Existing plus Project Traffic Conditions	12
Project Description.....	12
Project Access	12
Trip Generation.....	12
Trip Distribution	13
Bikeways	14

Walkways 14

Transit 14

Traffic Signal Warrants..... 15

Results of Existing plus Project Level of Service Analysis 15

Near Term plus Project Traffic Conditions.....19

 Description of Near Term Projects..... 19

 Traffic Signal Warrants..... 20

 Results of Near Term plus Project Level of Service Analysis..... 20

Cumulative Year 2042 plus Project Traffic Conditions.....23

 Traffic Signal Warrants..... 23

 Results of Cumulative Year 2042 plus Project Level of Service Analysis 23

 Latest Site Plan Project Trips..... 24

 Project Only Trip Assignment to State Facilities 24

Queuing Analysis30

Conclusions and Recommendations.....34

 Existing Traffic Conditions..... 34

 Existing plus Project Traffic Conditions..... 34

 Near Term plus Project Traffic Conditions..... 34

 Cumulative Year 2042 plus Project Traffic Conditions..... 35

 Queuing Analysis..... 35

Study Participants.....36

References.....37



List of Figures

Figure 1: Vicinity Map	10
Figure 2: Existing - Traffic Volumes, Geometrics and Controls.....	11
Figure 3: Project Site Plan	16
Figure 4: 2027 Project Only Trips	17
Figure 5: Existing plus Project - Traffic Volumes, Geometrics and Controls	18
Figure 6: 2027 Near Term Projects' Trip Assignment	21
Figure 7: Near Term plus Project - Traffic Volumes, Geometrics and Controls.....	22
Figure 8: 2042 Project Only Trips	25
Figure 9: 2042 Near Term Projects' Trip Assignment	26
Figure 10: Cumulative Year 2042 plus Project - Traffic Volumes, Geometrics and Controls	27
Figure 11: Project Only Trips to State Route 198 at 11 th Avenue	28
Figure 12: Project Only Trips to State Route 198 at 10 th Avenue	29

List of Tables

Table I: Existing Intersection LOS Results	9
Table II: Existing Segment LOS Results	9
Table III: Original Project Site Plan Trip Generation	13
Table IV: Latest Project Site Plan Trip Generation	13
Table V: Difference in Net Trip Generation	13
Table VI: Existing plus Project Intersection LOS Results	15
Table VII: Existing plus Project Segment LOS Results	15
Table VIII: Near Term Projects' Trip Generation	19
Table IX: Near Term plus Project Intersection LOS Results	20
Table X: Near Term plus Project Segment LOS Results	20
Table XI: Cumulative Year 2042 plus Project Intersection LOS Results	23
Table XII: Cumulative Year 2042 plus Project Segment LOS Results	24
Table XIII: Cumulative Year 2042 plus Latest Project Site Plan Intersection LOS Results	24
Table XIV: Queuing Analysis	31

List of Appendices

Appendix A: Scope of Work
Appendix B: Traffic Counts
Appendix C: Traffic Modeling
Appendix D: Methodology
Appendix E: Existing Traffic Conditions
Appendix F: Existing plus Project Traffic Conditions
Appendix G: Near Term plus Project Traffic Conditions
Appendix H: Cumulative Year 2042 plus Project Traffic Conditions
Appendix I: Traffic Signal Warrants

Introduction and Summary

Introduction

This Report describes a **Traffic Impact Analysis Report (TIA)** prepared by **JLB Traffic Engineering, Inc. (JLB)** for the proposed **Lunaria (Project)** located in the City of Hanford. Specifically, the Project proposes to develop 457 single family residential units and a 5.8-acre public park on the Southeast Quadrant of Hanford-Armona Road and 10 ½ Avenue. Based on information provided to JLB, the Project is consistent with the City's General Plan. Figure 1 shows the location of the proposed Project site relative to the surrounding roadway network.

The purpose of the TIA is to evaluate the potential on-site and off-site traffic impacts, identify short-term and long-term roadway and circulation needs, determine potential roadway improvement measures and identify any critical traffic issues that should be addressed in the on-going planning process. The TIA primarily focused on evaluating traffic conditions at study intersections that may potentially be impacted by the proposed Project. The Scope of Work was prepared via consultation with City of Hanford, Kings County and Caltrans staff.

Summary

The potential traffic impacts of the proposed Project were evaluated in accordance with the standards set forth by the Level of Service (LOS) policies of the City of Hanford, Kings County and Caltrans.

Existing Traffic Conditions

- At present, all study intersections operate at an acceptable LOS during both peak periods.
- At present, all study segments operate at an acceptable LOS.

Existing plus Project Traffic Conditions

- Based on the original site plan, the Project is estimated to generate a maximum of 4,181 daily trips, 310 AM peak hour trips and 418 PM peak hour trips at build-out.
- Based on the latest site plan, the Project is estimated to generate a maximum of 4,315 daily trips, 320 AM peak hour trips and 431 PM peak hour trips at build-out.
- Compared to the original site plan, the latest site plan is estimated to yield a greater trip generation by 134 daily trips, 10 AM peak hour trips and 13 PM peak hour trips. These are an increase of 3.20%, 3.23% and 3.11% of the Daily, AM peak hour and PM peak hour, respectively.
- LOS studies were completed using the trip generated by the original site plan. To account for the additional trips produced by the latest site plan, all additional trips (10 AM Peak hour trips and 13 PM peak hour trips) were routed to the worst performing intersection during the worst performing scenario. This was determined to be the intersection of Houston Avenue at 11th Avenue during the Cumulative Year 2042 plus Project Scenario. Based on this analysis, it was determined that that all study intersections and segments would continue to operate within the acceptable LOS for all study scenarios.

- JLB analyzed the location of the existing and proposed roadways and access points. This review revealed that all access points are located at points that minimize traffic operational impacts to existing and future roadway networks.
- It is recommended that the Project implement ADA compliant sidewalks along its frontages to 10 ½ Avenue and Orchard Avenue.
- It is recommended that the Project implement Class II Bike Lanes along its frontage to 10 ½ Avenue and Orchard Avenue.
- Under this scenario, all study intersections are projected to operate at an acceptable LOS during both peak periods.
- Under this scenario, all study segments are projected to operate at an acceptable LOS.

Near Term plus Project Traffic Conditions

- The total trip generation for the Near Term Projects by 2027 is projected as 20,410 daily trips, 1,600 AM peak hour trips and 2,141 PM peak hour trips.
- The total trip generation for the Near Term Projects by 2042 is projected as 25,413 daily trips, 1,992 AM peak hour trips and 2,665 PM peak hour trips.
- Under this scenario, all study intersections are projected to operate at an acceptable LOS during both peak periods.
- Under this scenario, all study segments are projected to operate at an acceptable LOS.

Cumulative Year 2042 plus Project Traffic Conditions

- Under this scenario, all study intersections are projected to operate at an acceptable LOS during both peak periods.
- Under this scenario, all study segments are projected to operate at an acceptable LOS.
- To account for the difference in trip generation between the original and latest site plan, all additional trips (10 AM Peak hour trips and 13 PM peak hour trips) were routed to the worst performing intersection during the worst performing scenario. This intersection was determined to be Houston Avenue at 11th Avenue during the Cumulative Year 2042 plus Project. Even with all additional project trips routed to this intersection, it continues to operate at an acceptable LOS. Therefore, it is the opinion of JLB that all study intersections would continue to operate within the acceptable LOS for all study scenarios if the additional trips were distributed throughout the roadway network and the LOS studies were redone. As a result, JLB does not recommend that this TIA be redone and that the City of Hanford, County of Kings and Caltrans can utilize this TIA to determine the Projects impacts to the study intersections and segments.

Scope of Work

The TIA focuses on evaluating traffic conditions at study intersections that may potentially be impacted by the proposed Project. On January 20, 2022, a Draft Scope of Work for the preparation of a TIA and VMT analysis for this Project was provided to City of Hanford, Kings County and Caltrans staff for their review and comment. The Draft Scope of Work was based on the Traffic Impact Analysis Guidelines of lead and responsible agencies.

On January 27, 2022, City of Hanford staff responded to the Draft Scope of Work. The City of Hanford requested that the intersection of 10th Avenue at Houston Avenue and the segments of Hanford-Armona Road between 11th Avenue and 10th Avenue and Houston Avenue between 11th Avenue and 10th Avenue be added to the study facilities.

On February 3, 2022, King's County staff responded to the Draft Scope of Work. King's County requested that the intersections of 10th Avenue at Houston Avenue and 11th Avenue at Houston Avenue and the segment of Houston Avenue between 11th Avenue and 10th Avenue be added to the study facilities.

On January 28, 2022, Caltrans staff responded to the Draft Scope of Work. Caltrans requested that the following be added to the study facilities 1) SR 198 at Avenue 10 both on/off ramps, 2) SR 198 at Douty Street eastbound off-ramp and 3) SR 198 at Avenue 11 westbound on-ramp. On February 3, 2022, after coordinating with Caltrans, Caltrans revised their comments as follows; a queuing analysis for 1) SR 198 at Avenue 10 westbound off-ramp and 2) SR 198 at Douty St (on 3rd Street) eastbound off-ramp and trip trace analysis at 1) SR 198 at Avenue 11 westbound on-ramp and 2) SR 198 at Avenue 10 (on 3rd Street) eastbound on-ramp.

Based on the comments received, the TIA includes the study intersections of 10th Avenue at Houston Avenue and 11th Avenue at Houston Avenue, the study segments of Hanford-Armona Road between 11th Avenue and 10th Avenue and Houston Avenue between 11th Avenue and 10th Avenue, the queuing analysis of SR 198 at Avenue 10 westbound off-ramp and SR 198 at Douty St (on 3rd Street) eastbound off-ramp and the trip trace analysis at SR 198 at Avenue 11 westbound on-ramp and SR 198 at Avenue 10 (on 3rd Street) eastbound on-ramp. JLB also coordinated with the City of Hanford Planning Department to verify the list of pending/approved projects. The Draft Scope of Work and the comments received from the lead agency and responsible agencies are included in Appendix A.

Study Facilities

The existing intersection peak hour turning movement counts were conducted at the study intersections and segments between January 2022 and March 2022, while schools in the vicinity of the Project site were in session. The intersection turning movement counts included pedestrian and bicycle volumes. As proposed in the Draft Scope of Work, traffic conditions have normalized to the new normal and therefore no escalation rate was applied to the collected traffic counts due to Covid-19. The traffic counts for the existing study intersections are contained in Appendix B. The existing intersection turning movement volumes, intersection geometrics and traffic controls are illustrated in Figure 2.

Study Intersections

Location

1. State Route 198 Eastbound Off-Ramp at Douty Street (Queuing Analysis Only)
2. State Route 198 Westbound Off-Ramp at 10th Avenue (Queuing Analysis Only)
3. Hanford-Armona Road / 10 ½ Avenue
4. Hanford-Armona Road / Jordan Way
5. Hanford-Armona Road / 10th Avenue
6. Orchard Avenue / 10 ½ Avenue (Future Intersection)
7. Houston Avenue / 11th Avenue
8. Houston Avenue / 10 ½ Avenue
9. Houston Avenue / 10th Avenue

Study Segments

Location

1. Hanford-Armona Road Between 11th Avenue and 10 ½ Avenue
2. Hanford-Armona Road Between 10 ½ Avenue and Jordan Way
3. Hanford-Armona Road Between Jordan Way and 10th Avenue
4. 10 ½ Avenue Between Hanford-Armona Road and Orchard Avenue
5. 10 ½ Avenue Between Orchard Avenue and Houston Avenue
6. Houston Avenue Between 11th Avenue and 10 ½ Avenue
7. Houston Avenue Between 10 ½ Avenue and 10th Avenue

Project Only Trips to State Facilities

Location

1. State Route 198 at 11th Avenue Westbound On-Ramp
2. State Route 198 at 10th Avenue (on 3rd Street) Eastbound On-Ramp

Study Scenarios

Existing Traffic Conditions

This scenario evaluates the Existing Traffic Conditions based on existing traffic volumes and roadway conditions from traffic counts and field surveys conducted in between January 2022 and March 2022.

Existing plus Project Traffic Conditions

This scenario evaluates total traffic volumes and roadway conditions based on the Existing plus Project Traffic Conditions. The Existing plus Project traffic volumes were obtained by adding the Project Only Trips to the Existing Traffic Conditions scenario. The Project Only Trips to the study facilities were developed based on existing travel patterns, the Kings County Association of Governments (KCAG) Project Select Zone, the existing roadway network, data provided by the developer, knowledge of the study area, engineering judgment, existing residential and commercial densities and the City of Hanford *General Plan* Background Report in the vicinity of the Project site. The KCAG Project only trip output was lower than the Project's trip generation, so the volumes were manually increased and proportionally distributed through the study intersections. The KCAG Project Select Zone results are contained in Appendix C.

Near Term plus Project Traffic Conditions

This scenario evaluates total traffic volumes and roadway conditions based on the Near Term plus Project Traffic Conditions. Since not all the Near Term Projects are projected to be fully built out in the next five (5) years, we estimated a percentage of what could be constructed within this period. This percentage was determined to be 67%, therefore 67% of the Project's Near Term trips were included in this scenario. The Near Term plus Project traffic volumes were obtained by adding the 2027 Near Term related trips to the Existing plus Project Traffic Conditions scenario.

Cumulative Year 2042 plus Project Traffic Conditions

This scenario evaluates total traffic volumes and roadway conditions based on the Cumulative Year 2042 plus Project Traffic Conditions. The Cumulative Year 2042 plus Project traffic volumes were obtained by using a combination of the KCAG traffic model runs (Base Year 2021 and Cumulative Year 2042) and existing traffic counts. Based on the *City of Hanford 2035 General Plan Circulation Map*, Orchard Avenue is planned to connect 10 ½ Avenue and 10th Avenue. Therefore, the 2042 Project Only trips were modified to allow access to 10th Avenue from Orchard Avenue. The Near Term Projects are also projected to be fully built prior to this scenario, therefore 100% of the Near Term trips were included. Under this scenario, the increment method was utilized to determine the Cumulative Year 2042 traffic volumes. The KCAG Activity Based-Model (ABM) results provided by KCAG modeler Kittelson & Associates are contained in Appendix C.

LOS Methodology

LOS is a qualitative index of the performance of an element of the transportation system. LOS is a rating scale running from "A" to "F", with "A" indicating no congestion of any kind and "F" indicating unacceptable congestion and delays. LOS in this study describes the operating conditions for signalized and unsignalized intersections.

The *Highway Capacity Manual (HCM)* 6th Edition is the standard reference published by the Transportation Research Board and contains the specific criteria and methods to be used in assessing LOS. U-turn movements were analyzed using HCM 2000 methodologies and would yield more accurate results for the reason that HCM 6th Edition methodologies do not allow the analysis of U-turns. Lane configurations not reflective of existing conditions are a result of software limitations and thus represent a worst-case scenario. Synchro software was used to define LOS in this study. Details regarding these calculations are included in Appendix D.

While LOS is no longer the criteria of significance for traffic impacts in the state of California, the City of Hanford continues to apply congestion-related conditions or requirements for land development projects through planning approval processes outside of CEQA guidelines in order to continue the implementation of *Hanford General Plan* policies.

LOS Thresholds

The City of Hanford *2035 General Plan Policy Document* has established LOS E as the acceptable level on streets and intersections within the area bounded by Highway 198, 10th Avenue, 11th Avenue, and Florinda Avenue, inclusive of these streets and a peak hour LOS D on all other streets and intersections within the Planned Growth Boundary. All the study facilities lie outside of the SR 198, 10th Avenue, 11th Avenue and Florinda Avenue boundary, therefore, the LOS D threshold was utilized to evaluate the potential significance of LOS impacts to City of Hanford roadway facilities.

The County of Kings has established LOS D as the acceptable level of traffic congestion on county roads. Therefore, LOS D is used to evaluate the potential significance of LOS impacts to King's County intersections. In this case, since the LOS threshold for the City and County is the same, LOS D was utilized as the criteria of significance for this TIA.

Operational Analysis Assumptions and Defaults

The following operational analysis values, assumptions and defaults were used in this study to ensure a consistent analysis of LOS among the various scenarios.

- Yellow time consistent with the *California Manual on Uniform Traffic Control Devices (CA MUTCD)* based on approach speeds (Caltrans 2021)
- Yellow time of 3.2 seconds for left-turn phases
- All-red clearance intervals of 1.0 second for all phases
- Walk intervals of 7.0 seconds
- Flashing Don't Walk based on 3.5 feet/second walking speed with yellow plus all-red clearance subtracted and 2.0 seconds added
- The number of observed pedestrians at existing intersections was utilized under all study scenarios
- All new or modified signals utilize protective left-turn phasing
- A 3 percent Heavy Vehicle Factor (HVF), or the existing HVF if higher, was utilized under all study scenarios
- An average of 10 pedestrian calls per hour at signalized study intersections
- At existing intersections, the observed Peak Hour Factor (PHF) is utilized in the Existing, Existing plus Project and Near Term plus Project Traffic Conditions scenarios.
- For the Cumulative Year 2042 scenario, the PHF's were increased to reflect traffic operations and an increase in future traffic volumes. As roadways start to reach their saturated flow rates, PHF's tend to increase to 0.92 or higher in urban settings. A PHF of 0.92, or the existing PHF if higher, is utilized for under this scenario.
 - For the intersection of 10½ Avenue and Hanford-Armona Road, the following PHF's were utilized in order to reflect general peak hour factors near the proximity of a school:
 - A PHF of 0.86, or the existing if higher, is utilized during the AM peak.
 - A PHF of 0.90, or the existing if higher, is utilized during the PM peak.
 - A PHF of 0.92, or the existing if higher, is utilized for all remaining study intersections.

Existing Traffic Conditions

Roadway Network

The Project site and surrounding study area are illustrated in Figure 1. Important roadways serving the Project are discussed below.

11th Avenue is an existing north-south four-lane divided arterial in the vicinity of the proposed Project site. In this area, 11th Avenue exists between Dover Avenue and Kansas Avenue. The *City of Hanford 2035 General Plan Circulation Map* designates 11th Avenue as an arterial between Flint Avenue and Jackson Avenue.

10 ½ Avenue is an existing north-south two-lane undivided collector adjacent to the proposed Project site. In this area, 10 ½ Avenue exists between Scott Street and Houston Avenue. The *City of Hanford 2035 General Plan Circulation Map* designates 10 ½ Avenue as a collector.

Douty Street is an existing north-south two-lane undivided collector in the vicinity of the proposed Project site. In this area, Douty Street exists between Flint Avenue and Scott Street. The *City of Hanford 2035 General Plan Circulation Map* designates Douty Street as a collector.

Jordan Way is an existing north-south two-lane undivided local street adjacent to the proposed Project site. In this area, Jordan Way currently exists between Hanford-Armona Road and Sydney Court. As part of the project, Jordan Way is expected to be extended further South approximately 850 feet.

10th Avenue is an existing north-south two-lane undivided arterial in the vicinity of the proposed Project site. In this area, 10th Avenue currently exists between State Route 43 and Lansing Avenue. The *City of Hanford 2035 General Plan Circulation Map* designates 10th Avenue as an arterial.

4th Street is an existing east-west two-lane collector in the vicinity of the proposed Project site. In this area, 4th Street currently exists between 11th Avenue and 10th Avenue. 4th Street is a one-way street with traffic flowing westbound. The *City of Hanford 2035 General Plan Circulation Map* designates 4th Street as a collector.

3rd Street is an existing east-west two-lane collector in the vicinity of the proposed Project site. In this area, 3rd Street currently exists between 11th Avenue and approximately half a mile east of 8 ¾ Avenue. Between 11th Avenue and 10th Avenue, 3rd Street is a one-way street with traffic flowing eastbound. The *City of Hanford 2035 General Plan Circulation Map* designates 3rd Street as a collector.

Hanford-Armona Road is an existing east-west two-lane undivided arterial in the vicinity of the proposed Project site. Hanford-Armona Road currently extends throughout King's County. The *City of Hanford 2035 General Plan Circulation Map* designates Hanford-Armona Road as an arterial between 13th Avenue and 8th Avenue.

Orchard Avenue is a future east-west two-lane undivided collector street that will be partially constructed with the Project. The Project will only be constructing Orchard Avenue within the Project limits. The *City of Hanford 2035 General Plan Circulation Map* designates Orchard Avenue as a collector between 10 ½

Avenue and 10th Avenue. Therefore, it is assumed Orchard Avenue will be fully constructed to 10th Avenue prior to 2035.

Houston Avenue is an existing east-west two-lane undivided major arterial in the vicinity of the proposed Project site. In this area, Houston Avenue exists between State Route 198 and the eastern King's County Limits. The *City of Hanford 2035 General Plan Circulation Map* designates Houston Avenue as a major arterial between 13th Avenue and 8th Avenue.

Traffic Signal Warrants

The CA MUTCD indicates that an engineering study of traffic conditions, pedestrian characteristics and physical features of an intersection shall be conducted to determine whether installation of traffic signal controls are justified. The CA MUTCD provides a total of nine (9) warrants to evaluate the need for traffic signal controls. These warrants include 1) Eight-Hour Vehicular Volume, 2) Four-Hour Vehicular Volume, 3) Peak Hour, 4) Pedestrian Volume, 5) School Crossing, 6) Coordinated Signal System, 7) Crash Experience, 8) Roadway Network and 9) Intersection Near a Grade Crossing. Signalization of an intersection may be appropriate if one or more of the signal warrants is satisfied. However, the CA MUTCD also states that "[t]he satisfaction of a signal warrant or warrants shall not in itself require the installation of a traffic control signal" (Caltrans 2021).

If traffic signal warrants are satisfied when a LOS threshold impact is identified at an unsignalized intersection, then installation of a traffic signal control may serve as an improvement measure. For instances where traffic signal warrants are satisfied, a traffic signal control is not considered to be the default improvement measure. Prior to assuming that an intersection will be signalized, an attempt is made to improve the intersection approach lane geometrics in order to improve its LOS while maintaining the existing intersection controls. If the additional lanes did not result in acceptable LOS at the intersection, then in those cases implementation of a traffic signal control would be considered.

Warrant 3 was prepared for the unsignalized intersections under the Existing Traffic Conditions scenario. These warrants are contained in Appendix I. Under this scenario, no unsignalized study intersection satisfies Warrant 3. Based on the traffic signal warrants, operational analysis and engineering judgment, it is not recommended that the City consider implementing traffic signal controls at any of the unsignalized study intersections especially since these operate at an acceptable LOS during both peak periods under stop sign control.

Results of Existing Level of Service Analysis

Figure 2 illustrates the Existing Traffic Conditions turning movement volumes, intersection geometrics and traffic controls. LOS worksheets for the Existing Traffic Conditions scenario are provided in Appendix E. Table I presents a summary of the Existing peak hour LOS at the study intersections, while Table II presents a summary of the Existing LOS for the study segments.

At present, all study intersections operate at an acceptable LOS during both peak periods.

Table I: Existing Intersection LOS Results

ID	Intersection	Intersection Control	AM (7-9) Peak Hour		PM (4-6) Peak Hour	
			Average Delay (sec/veh)	LOS	Average Delay (sec/veh)	LOS
3	10 1/2 Avenue / Hanford Armona Road	Traffic Signal	14.4	B	13.1	B
4	Jordan Way / Hanford Armona Road	Two-Way Stop	11.6	B	12.2	B
5	10th Avenue / Hanford Armona Road	Traffic Signal	18.2	B	17.7	B
6	10 ½ Avenue / Orchard Avenue	Does Not Exist	-	-	-	-
7	11th Avenue / Houston Avenue	Traffic Signal	26.5	C	24.8	C
8	Houston Avenue / 10 1/2 Avenue	Two-Way Stop	9.6	A	10.0	B
9	10th Avenue / Houston Avenue	All-Way Stop	8.8	A	8.8	A

Note: LOS = Level of Service based on average delay on signalized intersections and All-Way STOP Controls
 LOS for two-way and one-way STOP controlled intersections are based on the worst approach/movement of the minor street.

At present, all study segments operate at an acceptable LOS during both peak periods.

Table II: Existing Segment LOS Results

ID	Segment	Limits	Lanes	24-hour Volume	AM Peak Volume	AM LOS	PM Peak Volume	PM LOS
1	Hanford-Armona Road	11 th Avenue and 10 ½ Avenue	2	8,480	298	C	429	C
2	Hanford-Armona Road	10 ½ Avenue and Jordan Way	2	6,320	248	C	318	C
3	Hanford-Armona Road	Jordan Way and 10 th Avenue	2	5,560	220	B	296	B
4	10 ½ Avenue	Hanford-Armona Road and Orchard Avenue	2	990	55	A	50	A
5	10 ½ Avenue	Orchard Avenue and Houston Avenue	2	850	40	A	45	A
6	Houston Avenue	11 th Avenue and 10 ½ Avenue	2	3,490	143	A	178	A
7	Houston Avenue	10 ½ Avenue and 10 th Avenue	2	3,590	165	A	205	A

Note: LOS =Level of Service per HCM 6th Edition methodologies in HCS7 software. Peak hour volumes are from the highest directional volume.

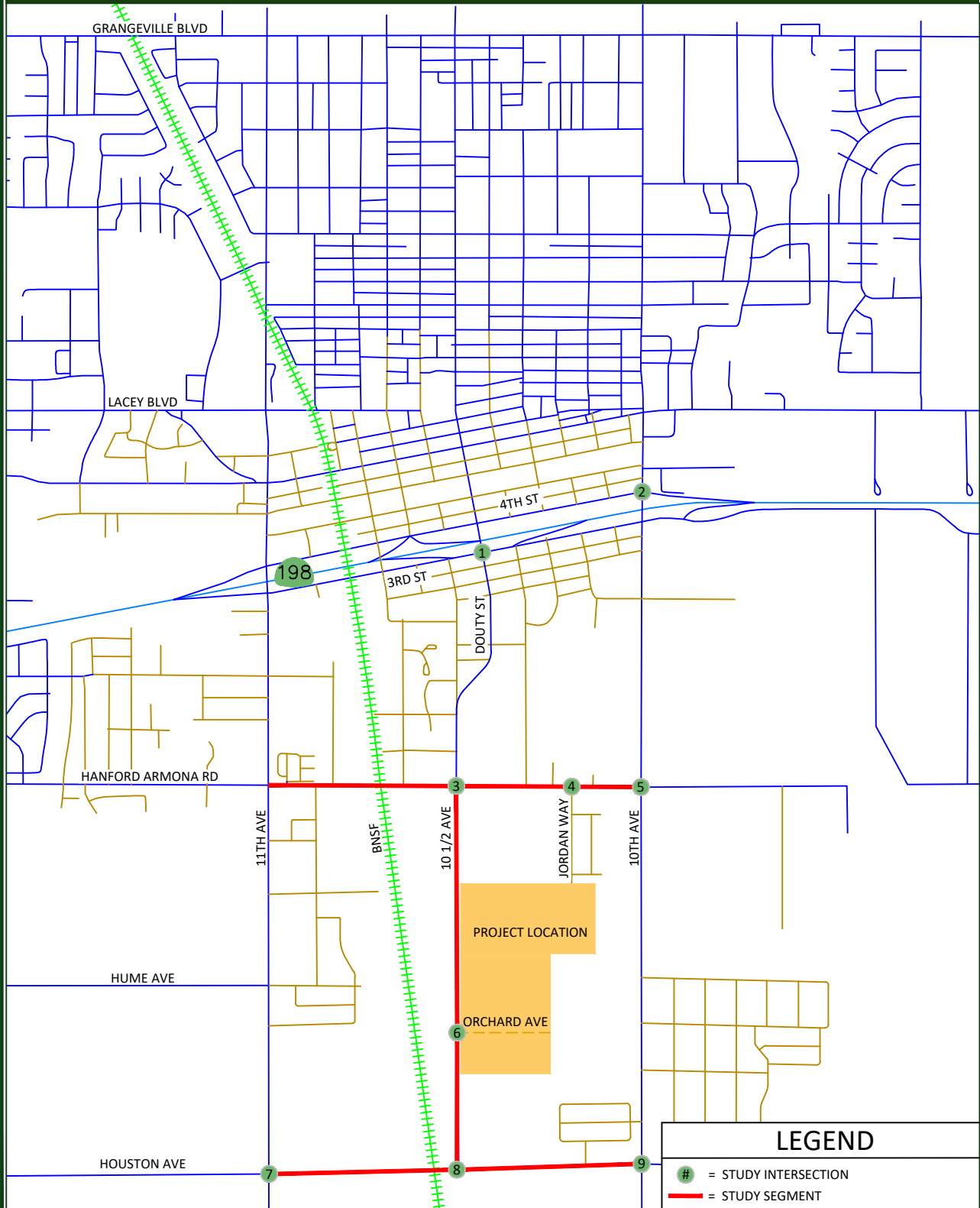

LEGEND

- # = STUDY INTERSECTION
- = STUDY SEGMENT
- - - = FUTURE ROADWAY



Not To Scale



516 W. Shaw Ave., Ste. 103, Fresno, CA 93704
PHONE: (559) 570-8991, EMAIL: info@JLBtraffic.com, www.JLBtraffic.com

Lunaria TIA - City of Hanford Existing - Traffic Volumes, Geometrics and Controls

Figure 2

<p>1. SR 198 EB Off Ramp/3rd St & Douty St</p>	<p>2. SR 198 WB Off Ramp/4th St & 10th Ave</p>	<p>3. 10 1/2 Ave & Hanford-Armona Rd</p>	<p>4. Jordan Way & Hanford-Armona Rd</p>
<p>5. 10th Ave & Hanford-Armona Rd</p>	<p>6. 10 1/2 Ave & Orchard Ave</p> <p style="color: red; font-size: 2em; transform: rotate(-45deg);">DOES NOT EXIST</p>	<p>7. 11th Ave & Houston Ave</p>	<p>8. 10 1/2 Ave & Houston Ave</p>

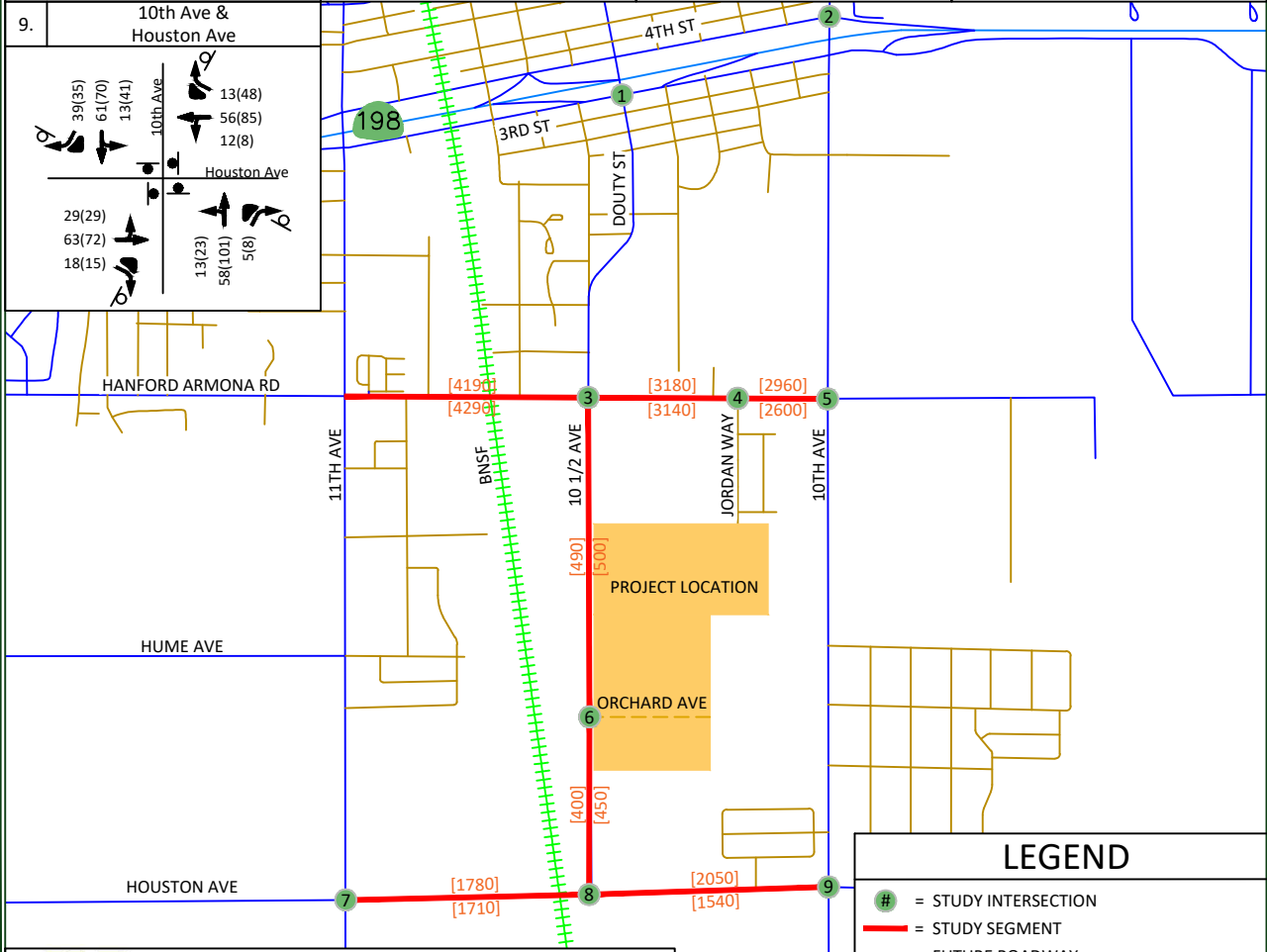

LEGEND

- # = STUDY INTERSECTION
- = STUDY SEGMENT
- = FUTURE ROADWAY
- XX = AM PEAK HOUR TRIPS
- (XX) = PM PEAK HOUR TRIPS
- [XX] = DAILY VOLUMES
- = STOP SIGN
- = YIELD SIGN
- = TRAFFIC SIGNAL

516 W. Shaw Ave., Ste. 103, Fresno, CA 93704
 PHONE: (559) 570-8991, EMAIL: info@JLBtraffic.com, www.JLBtraffic.com



Existing plus Project Traffic Conditions

Project Description

At the time of the preparation of this TIA, the Project proposed to develop approximately 96.22 gross acres with 443 single-family housing units and a 4.9-acre park. Once all the LOS studies for this TIA were completed, the site plan was revised to include 457 single-family housing units and a 5.8-acre park within the same 96.22 gross acres. Based on information provided to JLB, the Project is consistent with the City's General Plan. Figure 3 illustrates the latest Project Site Plan.

Project Access

Based on the latest Project Site Plan, access to and from the Project site will be from six (6) access points. One (1) access point will be from the existing local street of Jordan Way. Two (2) access points will be located along the east side of 10 ½ Avenue. The Project will be constructing Orchard Avenue within the Project limits. The Project will have three (3) access points to Orchard Avenue.

JLB analyzed the location of the existing and proposed roadways and access points relative to those in the vicinity of the Project site. A review of the existing and proposed roadways and access points indicates that they are located at points that minimize traffic operational impacts to existing and future roadway networks. A Project Site Plan can be found in Figure 3.

Trip Generation

The trip generation rates for the proposed Project were obtained from the 11th Edition of the Trip Generation Manual published by the Institute of Transportation Engineers (ITE). Table III presents the trip generation for the original project site plan for 443 Single-Family Detached Housing units and a 4.9-acre public park. At build-out, the Project is estimated to generate a maximum of 4,181 daily trips, 310 AM peak hour trips and 418 PM peak hour trips. Once all LOS studies for this TIA were completed using the total trips generated by the original site plan, the site plan was slightly revised to increase the number of lots and acreage of park. Table IV presents the trip generation for the latest project site plan for 457 Single-Family Detached Housing units and a 5.8-acre public park. At build-out, the Project is estimated to generate a maximum of 4,315 daily trips, 320 AM peak hour trips and 431 PM peak hour trips. The difference in trip generation between the original site plan and the latest site plan is summarized in Table V. Compared to the original site plan, the latest site plan is estimated to generate an increase of 134 daily trips, 10 AM peak hour trips and 13 PM peak hour trips. These are an increase of 3.20%, 3.23% and 3.11% of the daily, AM peak hour and PM peak hour, respectively. Since the increases are very minor, JLB kept the original LOS studies and only analyzed the worst performing study facility during the worst scenario. This was determined to be the intersection of Houston Avenue at 11th Avenue during the Cumulative Year 2042 plus Project Scenario. Based on this analysis, it was determined that that all study intersections and segments would continue to operate within the acceptable LOS for all study scenarios. The detailed results of this analysis will be discussed later in the Report under the Cumulative Year plus Project scenario.

Table III: Original Project Site Plan Trip Generation

Land Use (ITE Code)	Size	Unit	Daily		AM (7-9) Peak Hour					PM (4-6) Peak Hour						
			Rate	Total	Trip Rate	In	Out	In	Out	Total	Trip Rate	In	Out	In	Out	Total
						%						%				
Single-Family Detached Housing (210)	443	d.u.	9.43	4,177	0.70	26	74	80	230	310	0.94	63	37	262	155	417
Public Park (411)	4.9	Acres	0.78	4	0.02	59	41	0	0	0	0.11	55	45	1	0	1
Total Project Trips				4,181				80	230	310				263	155	418

Note: d.u. = Dwelling Units

Table IV: Latest Project Site Plan Trip Generation

Land Use (ITE Code)	Size	Unit	Daily		AM (7-9) Peak Hour					PM (4-6) Peak Hour						
			Rate	Total	Trip Rate	In	Out	In	Out	Total	Trip Rate	In	Out	In	Out	Total
						%						%				
Single-Family Detached Housing (210)	457	d.u.	9.43	4,310	0.70	26	74	83	237	320	0.94	63	37	271	159	430
Public Park (411)	5.8	Acres	0.78	5	0.02	59	41	0	0	0	0.11	55	45	1	0	1
Total Project Trips				4,315				83	237	320				272	159	431

Note: d.u. = Dwelling Units

Table V: Difference in Net Trip Generation

	Daily	AM (7-9) Peak Hour			PM (4-6) Peak Hour		
	Total	In	Out	Total	In	Out	Total
Original Project Site Plan	4,181	80	230	310	263	155	418
Latest Project Site Plan	4,315	83	237	320	272	159	431
Difference in Trip Generation	134	3	7	10	9	4	13
Percent Difference in Trip Generation	3.20%	3.75%	3.04%	3.23%	3.42%	2.58%	3.11%

Trip Distribution

The trip distribution assumptions were developed based on existing travel patterns, the KCAG Project Select Zone, the existing roadway network, engineering judgment, data provided by the developer, knowledge of the study area, existing residential and commercial densities and the City of Hanford 2035 General Plan Transportation and Circulation Element in the vicinity of the Project site. The Project's trip generation data was provided to KCAG in order to conduct a Project-specific Traffic Analysis Zone (TAZ) analysis using the KCAG ABM (Cumulative Year 2042). The KCAG Project only trip output was lower than the Project's trip generation, so the volumes were manually increased and proportionally distributed through the study intersections. The KCAG Project Select Zone results are contained in Appendix C. Figure 4 illustrates the 2027 Project Only Trips at the study intersections.

Bikeways

The *City of Hanford Pedestrian and Bicycle Master Plan* classifies bicycle facilities three categories: Class II (Bike Lanes), Class III (Bike Routes), and Class III (Bike Routes with Stripes). In the vicinity of the Project, Class II (Bike Lanes) currently exist on Hanford-Armona Road between Greenbrier Drive and 10th Avenue, while Class III (Bike Routes) exist on Douty Street between Cortner Street and Scott Street and 10 ½ Avenue between Scott Street and Hanford-Armona Road and Class III (Bike Routes with Stripes) exist on 10th Avenue between Houston Avenue and Hanford-Armona Road. In the vicinity of the Project, Class II (Bike Lanes) are planned on 10 ½ Avenue between Hanford-Armona Road and Houston Avenue, 10th Avenue between State Route 43 and Houston Avenue, Hanford-Armona Road between 10th Avenue and 9 ¾ Avenue, Orchard Avenue between 10 ½ Avenue and 10th Avenue and Houston Avenue between 13th Avenue and 9th Avenue. Class III (Bike Routes) are planned on 11th Avenue between 6th Street and Jackson Avenue. Therefore, it is recommended that the Project implement Class II Bike Lanes along its frontages to 10 ½ Avenue and Orchard Avenue.

Walkways

Currently, walkways exist in the vicinity of the proposed Project site along Jordan Way and Hanford-Armona Road. Douty Street between Grangeville Boulevard and Scott Street, 10 ½ Avenue between Scott Street and Hanford-Armona Road, 10th Avenue between State Route 43 and Hanford-Armona Road and Hanford-Armona Road between 13th Avenue and 9 ¾ Avenue are dedicated as Walking Corridors. The *City of Hanford Pedestrian and Bicycle Master Plan* states curb, gutter and sidewalk are required for all new developments. Therefore, it is recommended that the Project implement walkways that are ADA compliant along its frontages to 10 ½ Avenue and Orchard Avenue.

Transit

Kings Area Rural Transit (KART) is the transit operator in the City of Hanford. At present, there are two (2) KART routes, Route 4 and Route 8, that operate and have stops in the vicinity of the Project. KART Route 4, which runs along 10th Avenue from Downtown Hanford to 10th Avenue at Home Avenue, operates at 30-minute intervals on weekdays from 6:30 AM - 7:30 PM and 60-minute intervals on Saturday's from 9:30 AM to 4:30 PM. The closest stop to the Project on Route 4 is located on the north side of Hanford-Armona Road 150 feet east of 10 ½ Avenue. This route provides a direct connection to the Cole Park, Longfield Center, Lincoln Elementary School, Hanford Soccer Complex, Downtown Hanford and the KART Transit Center. KART Route 8, which runs along 11th Avenue, 10th Avenue, Hanford-Armona Road and Houston Avenue operates at 30-minute intervals on weekdays from 6:45 AM – 7: 15 PM and 60-minute intervals on Saturday's from 10:00 AM to 4:00 PM. The closest stop to the Project on Route 8 is located on the north side of Hanford-Armona Road 150 feet east of 10 ½ Avenue. This route provides a direct connection to the Home Garden Park, Martin Luther King Jr. Elementary School, Hanford DMV, Roosevelt Elementary School, Downtown Hanford and the KART Transit Center. Retention of the existing and expansion of future transit routes is dependent on transit ridership demand and available funding.

Traffic Signal Warrants

Warrant 3 was prepared for the unsignalized intersections under the Existing plus Project Traffic Conditions scenario. These warrants are found in Appendix I. Under this scenario, none of the unsignalized intersections are projected to satisfy Warrant 3. Based on the traffic signal warrants, operational analysis and engineering judgement, signalization of any of the study intersections is not recommended.

Results of Existing plus Project Level of Service Analysis

The Existing plus Project Traffic Conditions scenario assumes the existing roadway geometrics and traffic controls will remain in place. Figure 5 illustrates the Existing plus Project turning movement volumes, intersection geometrics and traffic controls. LOS worksheets for the Existing plus Project Traffic Conditions scenario are provided in Appendix F. Table VI presents a summary of the Existing plus Project peak hour LOS at the study intersections, while Table VII presents a summary of the Existing plus Project LOS for the study segment.

Under this scenario, all study intersections are projected to operate at an acceptable LOS.

Table VI: Existing plus Project Intersection LOS Results

ID	Intersection	Intersection Control	AM (7-9) Peak Hour		PM (4-6) Peak Hour	
			Average Delay (sec/veh)	LOS	Average Delay (sec/veh)	LOS
3	10 1/2 Avenue / Hanford Armona Road	Traffic Signal	17.9	B	15.9	B
4	Jordan Way / Hanford Armona Road	Two-Way Stop	12.7	B	13.3	B
5	10th Avenue / Hanford Armona Road	Traffic Signal	20.9	C	19.8	B
6	10 ½ Avenue / Orchard Avenue	Two-Way Stop	9.5	A	9.7	A
7	11th Avenue / Houston Avenue	Traffic Signal	20.7	C	22.4	C
8	Houston Avenue / 10 1/2 Avenue	Two-Way Stop	10.0	B	10.7	B
9	10th Avenue / Houston Avenue	All-Way Stop	8.9	A	9.0	A

Note: LOS = Level of Service based on average delay on signalized intersections and All-Way STOP Controls (AWSC)
 LOS for two-way stop controlled (TWSC) and one-way STOP controlled intersections are based on the worst approach/movement of the minor street.

Under this scenario, all study segments are projected to operate at an acceptable LOS.

Table VII: Existing plus Project Segment LOS Results

ID	Segment	Limits	Lanes	24-hour Volume	AM Peak Volume	AM LOS	PM Peak Volume	PM LOS
1	Hanford-Armona Road	11 th Avenue and 10 ½ Avenue	2	10,350	394	C	542	D
2	Hanford-Armona Road	10 ½ Avenue and Jordan Way	2	6,940	268	C	350	C
3	Hanford-Armona Road	Jordan Way and 10 th Avenue	2	6,280	255	B	346	B
4	10 ½ Avenue	Hanford-Armona Road and Orchard Avenue	2	3,290	184	B	188	B
5	10 ½ Avenue	Orchard Avenue and Houston Avenue	2	1,900	65	A	115	B
6	Houston Avenue	11 th Avenue and 10 ½ Avenue	2	4,250	177	A	223	A
7	Houston Avenue	10 ½ Avenue and 10 th Avenue	2	3,880	174	A	223	B

Note: LOS =Level of Service per HCM 6th Edition methodologies in HCS7 software. Peak hour volumes are from the highest directional volume.

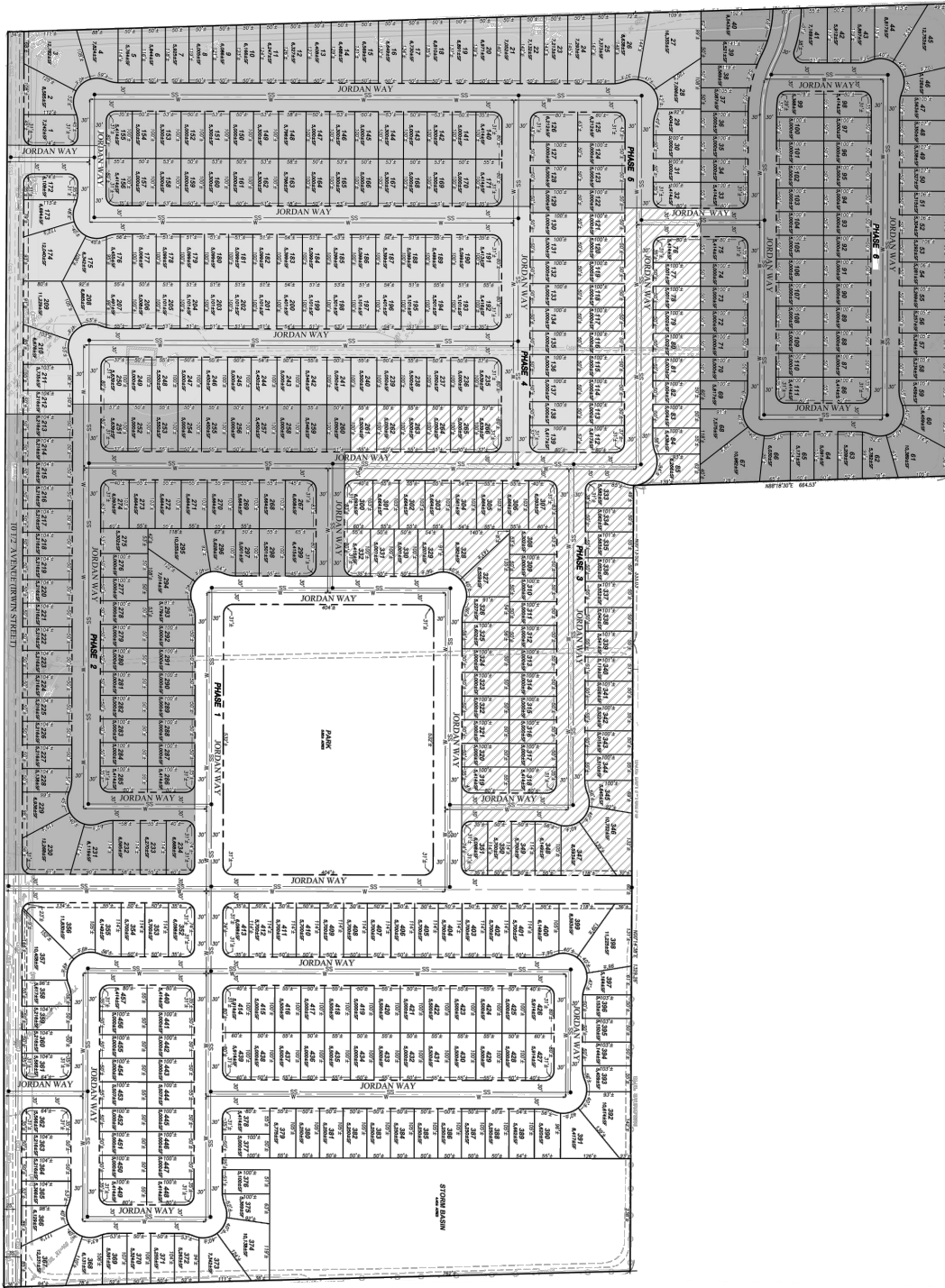

516 W. Shaw Ave., Ste. 103, Fresno, CA 93704
PHONE: (559) 570-8991, EMAIL: info@JLBtraffic.com, www.JLBtraffic.com



Not To Scale

Lunaria TIA - City of Hanford 2027 Project Only Trips

Figure 4

<p>1. SR 198 EB Off Ramp/3rd St & Douty St</p>	<p>2. SR 198 WB Off Ramp/4th St & 10th Ave</p>	<p>3. 10 1/2 Ave & Hanford-Armona Rd</p>	<p>4. Jordan Way & Hanford-Armona Rd</p>
<p>5. 10th Ave & Hanford-Armona Rd</p>	<p>6. 10 1/2 Ave & Orchard Ave</p>	<p>7. 11th Ave & Houston Ave</p>	<p>8. 10 1/2 Ave & Houston Ave</p>

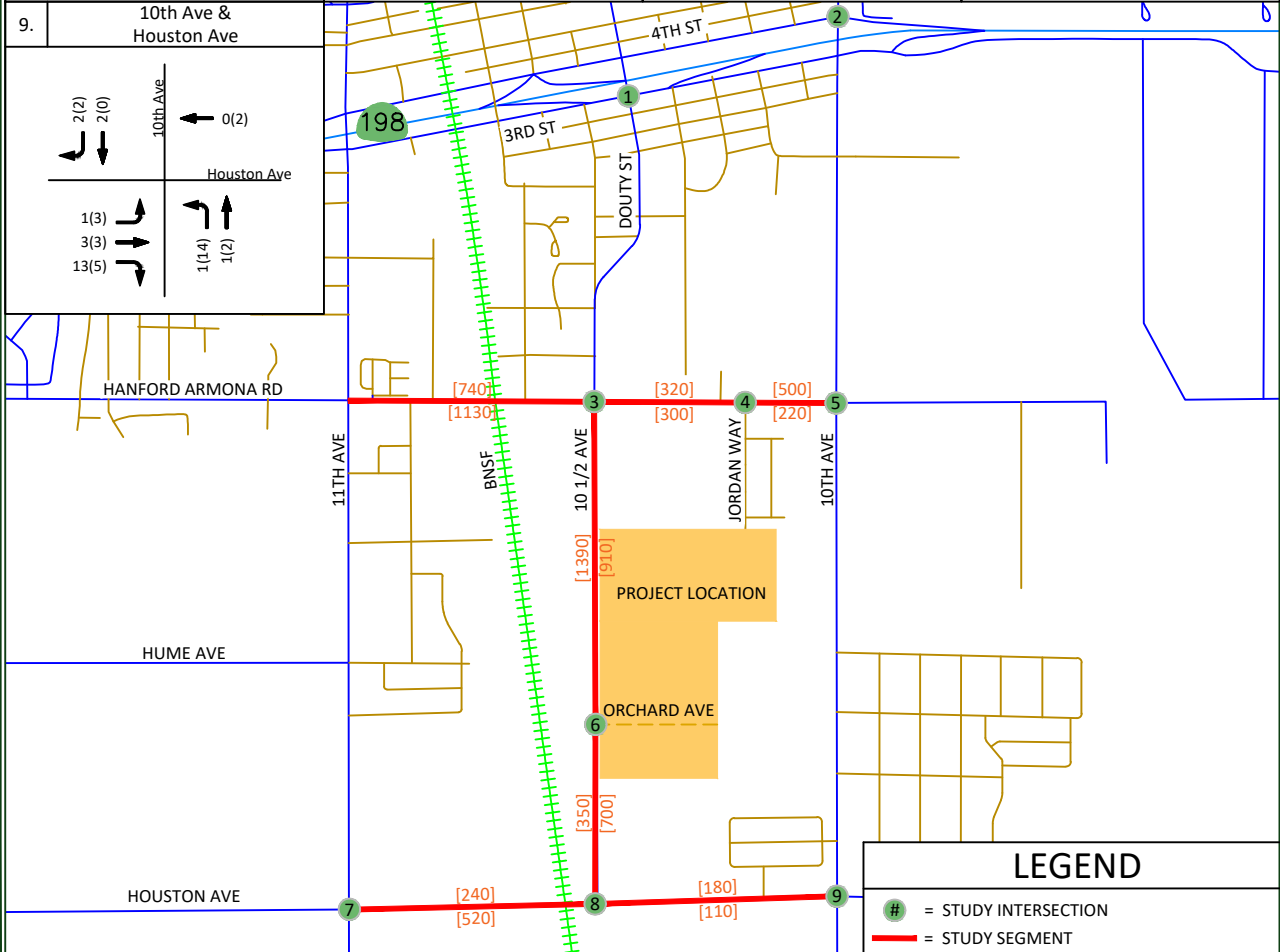

LEGEND

- = STUDY INTERSECTION
- = STUDY SEGMENT
- = FUTURE ROADWAY
- XX = AM PROJECT ONLY TRIPS
- (XX) = PM PROJECT ONLY TRIPS
- [XX] = DAILY VOLUMES

Not To Scale

516 W. Shaw Ave., Ste. 103, Fresno, CA 93704
 PHONE: (559) 570-8991, EMAIL: info@JLBtraffic.com, www.JLBtraffic.com

Lunaria TIA - City of Hanford Existing plus Project - Traffic Volumes, Geometrics and Controls

Figure 5

<p>1. SR 198 EB Off Ramp/3rd St & Douty St</p>	<p>2. SR 198 WB Off Ramp/4th St & 10th Ave</p>	<p>3. 10 1/2 Ave & Hanford-Armona Rd</p>	<p>4. Jordan Way & Hanford-Armona Rd</p>
<p>5. 10th Ave & Hanford-Armona Rd</p>	<p>6. 10 1/2 Ave & Orchard Ave</p>	<p>7. 11th Ave & Houston Ave</p>	<p>8. 10 1/2 Ave & Houston Ave</p>

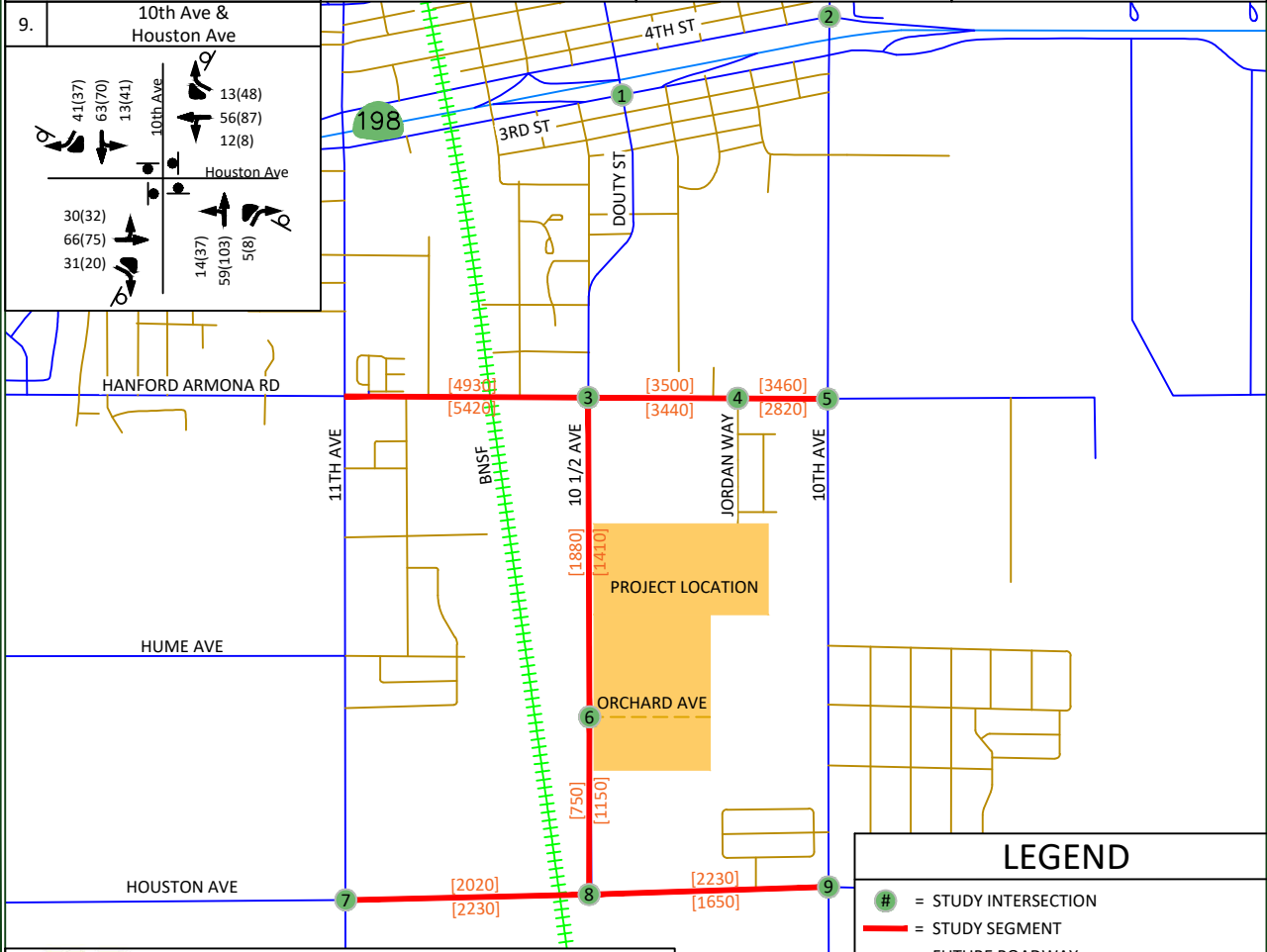

LEGEND

- # = STUDY INTERSECTION
- = STUDY SEGMENT
- = FUTURE ROADWAY
- XX = AM PEAK HOUR TRIPS
- (XX) = PM PEAK HOUR TRIPS
- [XX] = DAILY VOLUMES
- = STOP SIGN
- = YIELD SIGN
- = TRAFFIC SIGNAL

516 W. Shaw Ave., Ste. 103, Fresno, CA 93704
 PHONE: (559) 570-8991, EMAIL: info@JLBtraffic.com, www.JLBtraffic.com



Near Term plus Project Traffic Conditions

Description of Near Term Projects

Near Term Projects are approved and/or known Projects that are either under construction, built but not fully occupied, are not built but have final site development review (SDR) approval or for which the lead agency or responsible agencies have knowledge of. The City of Hanford staff were consulted throughout the preparation of this Report regarding approved and/or known projects that could potentially impact the study intersections and study segment. JLB staff conducted a reconnaissance of the surrounding area to confirm the Near Term Projects. Therefore, the Near Term Projects listed in Table VIII were approved, near approval, or in the pipeline within the proximity of the proposed Project.

Table VIII: Near Term Projects' Trip Generation

<i>Near Term Project ID</i>	<i>Near Term Project Name</i>	<i>Daily Trips</i>	<i>AM Peak Hour</i>	<i>PM Peak Hour</i>
A	Live Oak ¹	14,726	1,154	1,544
B	Billingsley Ranch ²	916	72	96
C	Tract 927 ³	1256	98	132
D	Tract 922 ³	1831	144	192
E	Tract 929 ³	1492	117	156
F	Tract 928 ³	2672	209	280
G	Tract 912 ³	1340	105	141
H	Tract 919 ³	1180	93	124
2027 Near Term Project Trips		20,410	1,600	2,141
2042 Near Term Project Trips		25,413	1,992	2,665

Note: 1 = Trip Generation prepared by KD Anderson Traffic Impact Analysis Report
 2= Trip Generation prepared by VRPA Traffic Impact Analysis Report
 3= Trip Generation prepared by JLB Traffic Engineering, Inc. based on readily available information

The trip generation listed in Table VIII is that which is anticipated to be added to the roadway network by the Near Term Projects. Since the entire Live Oak Project is not projected to be fully built out in the next five (5) years, we estimated a percentage of what could be constructed within this period. This percentage was determined to be approximately two thirds, or 67%, therefore 67% of the Live Oak Project trips were included in this scenario. As shown in Table VIII, the total trip generation for the 2027 Near Term Projects is 20,410 daily trips, 1,600 AM peak hour trips and 2,141 PM peak hour trips, while the total trip generation for the 2042 Near Term Projects is 25,413 daily trips, 1,992 AM peak hour trips and 2,665 PM peak hour trips. The Near Term plus Project traffic volumes were obtained by adding the 2027 Near Term related trips to the Existing plus Project Traffic Conditions scenario. Figure 6 illustrates the location of the 2027 Near Term Projects and their combined trip assignment to the study intersections under this scenario.

Traffic Signal Warrants

Warrant 3 was prepared for the unsignalized intersections under the Near Term plus Project Traffic Conditions scenario. These warrants are found in Appendix I. Under this scenario, none of the unsignalized intersections are projected to satisfy Warrant 3. Based on the traffic signal warrants, operational analysis and engineering judgement, signalization of any of the study intersections is not recommended.

Results of Near Term plus Project Level of Service Analysis

The Near Term plus Project Traffic Conditions scenario assumes the same roadway geometrics and traffic controls as those assumed in the Existing plus Project Traffic Conditions scenario. Figure 7 illustrates the Near Term plus Project turning movement volumes, intersection geometrics and traffic controls. LOS worksheets for the Near Term plus Project Traffic Conditions scenario are provided in Appendix G. Table IX presents a summary of the Near Term plus Project intersection LOS intersections, while Table X presents a summary of the Near Term plus Project LOS for the study segment.

Under this scenario, all study intersections are projected to operate at an acceptable LOS.

Table IX: Near Term plus Project Intersection LOS Results

ID	Intersection	Intersection Control	AM (7-9) Peak Hour		PM (4-6) Peak Hour	
			Average Delay (sec/veh)	LOS	Average Delay (sec/veh)	LOS
3	10 1/2 Avenue / Hanford Armona Road	Traffic Signal	18.0	B	16.0	B
4	Jordan Way / Hanford Armona Road	Two-Way Stop	12.7	B	13.4	B
5	10th Avenue / Hanford Armona Road	Traffic Signal	21.5	C	19.9	B
6	10 ½ Avenue / Orchard Avenue	Two-Way Stop	9.6	A	9.8	A
7	11th Avenue / Houston Avenue	Traffic Signal	22.3	C	19.2	B
8	Houston Avenue / 10 1/2 Avenue	Two-Way Stop	10.2	B	11.7	B
9	10th Avenue / Houston Avenue	All-Way Stop	9.1	A	9.6	A

Note: LOS = Level of Service based on average delay on signalized intersections and All-Way STOP Controls
 LOS for two-way and one-way STOP controlled intersections are based on the worst approach/movement of the minor street.

Under this scenario, all study segments are projected to operate at an acceptable LOS.

Table X: Near Term plus Project Segment LOS Results

ID	Segment	Limits	Lanes	24-hour Volume	AM Peak Volume	AM LOS	PM Peak Volume	PM LOS
1	Hanford-Armona Road	11 th Avenue and 10 ½ Avenue	2	10,490	398	C	546	D
2	Hanford-Armona Road	10 ½ Avenue and Jordan Way	2	7,020	271	C	355	C
3	Hanford-Armona Road	Jordan Way and 10 th Avenue	2	6,340	258	B	351	B
4	10 ½ Avenue	Hanford-Armona Road and Orchard Avenue	2	3,550	196	C	197	B
5	10 ½ Avenue	Orchard Avenue and Houston Avenue	2	2,160	70	A	132	B
6	Houston Avenue	11 th Avenue and 10 ½ Avenue	2	4,800	193	B	269	B
7	Houston Avenue	10 ½ Avenue and 10 th Avenue	2	4,890	197	A	295	B

Note: LOS=Level of Service per HCM 6th Edition methodologies in HCS7 software. Peak hour volumes are from the highest directional volume.

Lunaria TIA - City of Hanford 2027 Near Term Projects' Trip Assignment

Figure 6

<p>1. SR 198 EB Off Ramp/3rd St & Douty St</p>	<p>2. SR 198 WB Off Ramp/4th St & 10th Ave</p>	<p>3. 10 1/2 Ave & Hanford-Armona Rd</p>	<p>4. Jordan Way & Hanford-Armona Rd</p>
<p>5. 10th Ave & Hanford-Armona Rd</p>	<p>6. 10 1/2 Ave & Orchard Ave</p>	<p>7. 11th Ave & Houston Ave</p>	<p>8. 10 1/2 Ave & Houston Ave</p>

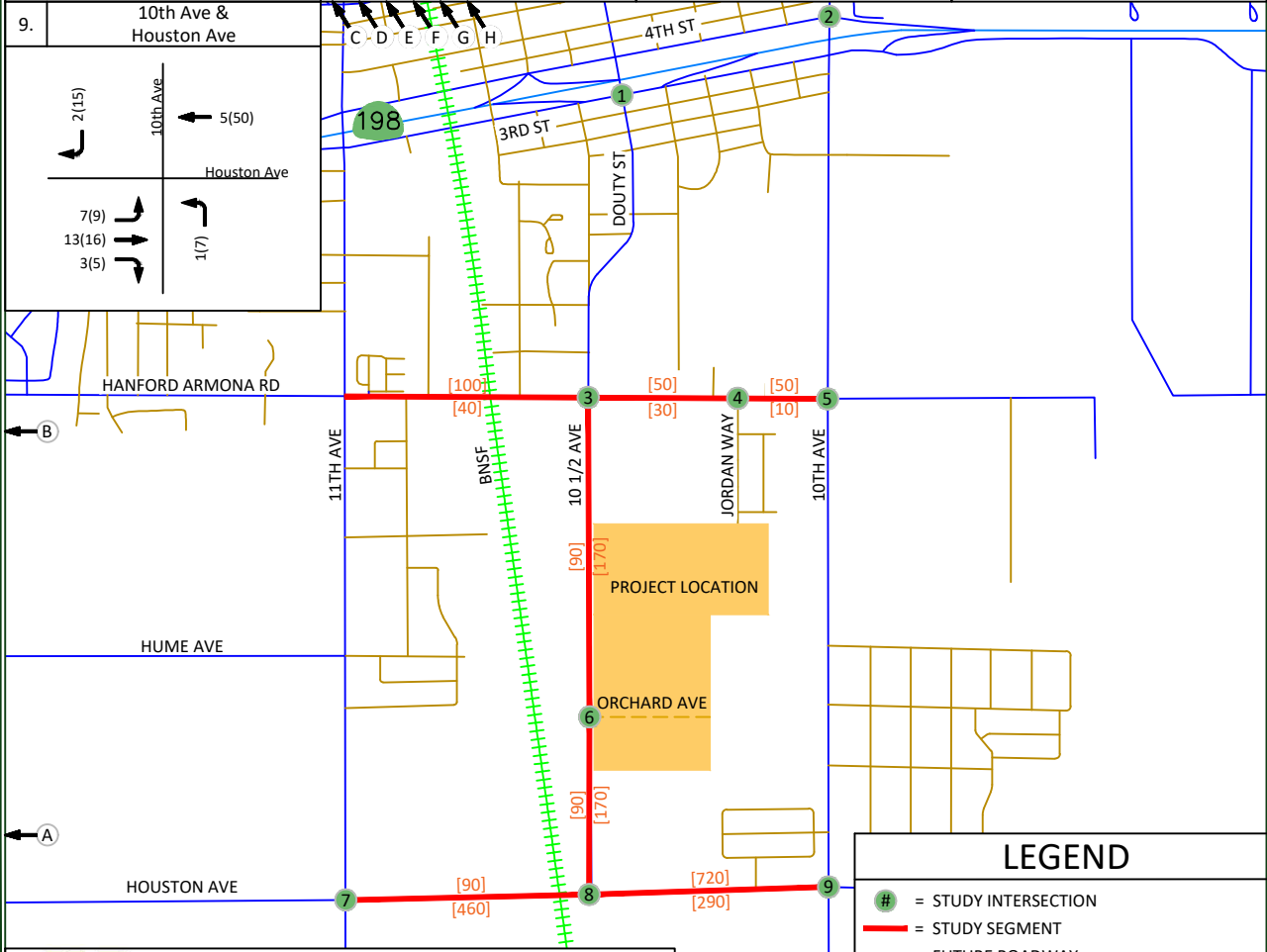

JLB TRAFFIC
ENGINEERING, INC.

516 W. Shaw Ave., Ste. 103, Fresno, CA 93704
PHONE: (559) 570-8991, EMAIL: info@JLBtraffic.com, www.JLBtraffic.com



Lunaria TIA - City of Hanford Near Term plus Project - Traffic Volumes, Geometrics and Controls

Figure 7

<p>1. SR 198 EB Off Ramp/3rd St & Douty St</p>	<p>2. SR 198 WB Off Ramp/4th St & 10th Ave</p>	<p>3. 10 1/2 Ave & Hanford-Armona Rd</p>	<p>4. Jordan Way & Hanford-Armona Rd</p>
<p>5. 10th Ave & Hanford-Armona Rd</p>	<p>6. 10 1/2 Ave & Orchard Ave</p>	<p>7. 11th Ave & Houston Ave</p>	<p>8. 10 1/2 Ave & Houston Ave</p>

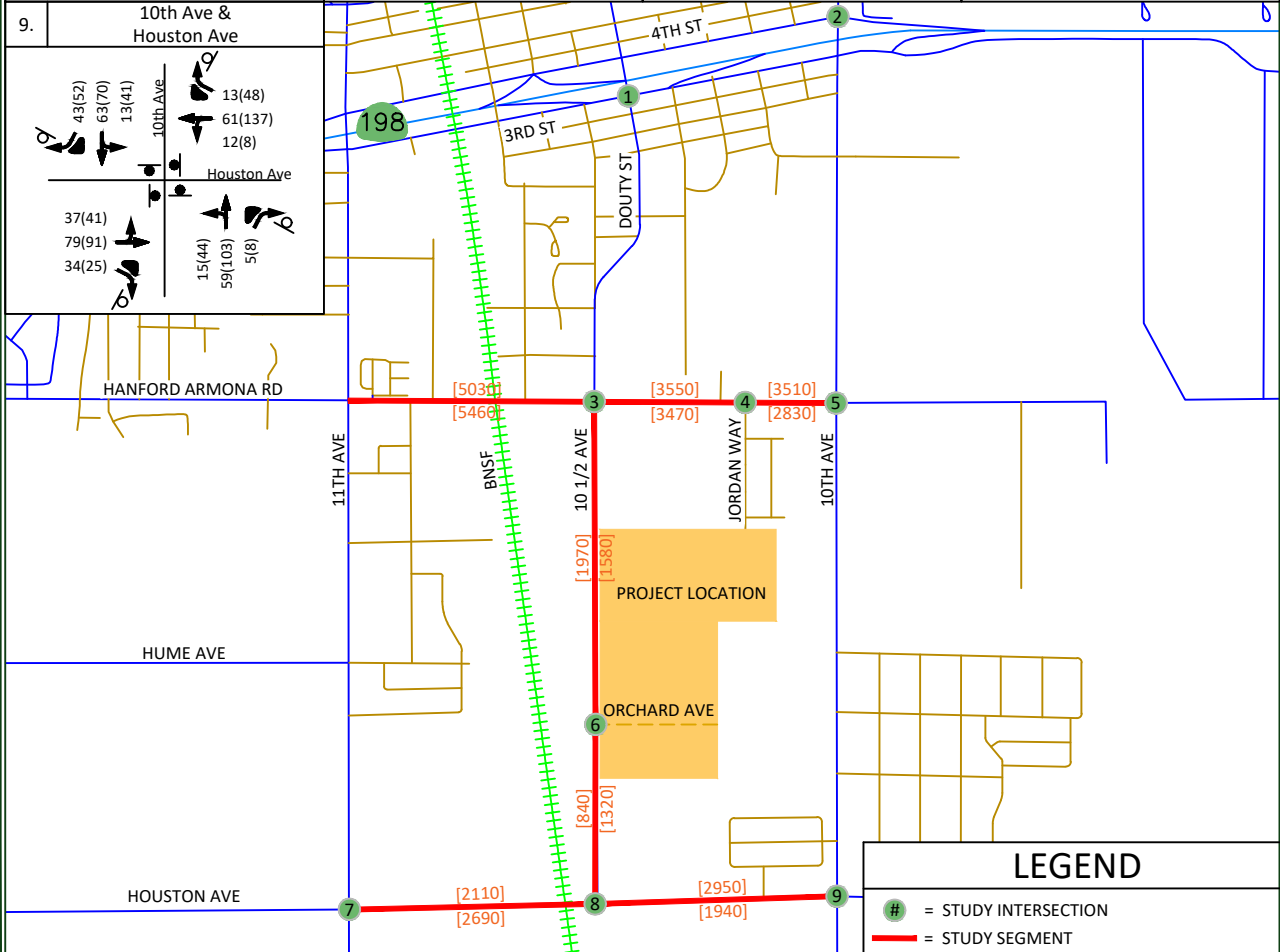

LEGEND

- # = STUDY INTERSECTION
- = STUDY SEGMENT
- = FUTURE ROADWAY
- XX = AM PEAK HOUR TRIPS
- (XX) = PM PEAK HOUR TRIPS
- [XX] = DAILY VOLUMES
- = STOP SIGN
- = YIELD SIGN
- = TRAFFIC SIGNAL

Not To Scale

516 W. Shaw Ave., Ste. 103, Fresno, CA 93704
 PHONE: (559) 570-8991, EMAIL: info@JLBtraffic.com, www.JLBtraffic.com

Cumulative Year 2042 plus Project Traffic Conditions

Traffic Signal Warrants

Warrant 3 was prepared for the unsignalized intersections under the Cumulative Year 2042 plus Project Traffic Conditions scenario. These warrants are contained in Appendix I. Under this scenario, the intersection of 10th Avenue at Houston Avenue is projected to satisfy Warrant 3 in the PM peak period only. Based on the traffic signal warrants, operational analysis and engineering judgement, signalization of this intersection is not recommended.

Results of Cumulative Year 2042 plus Project Level of Service Analysis

The Cumulative Year 2042 plus Project Traffic Conditions scenario assumes the same roadway geometrics and traffic controls as those assumed in the Near Term Plus Project Traffic Conditions scenario. Additionally, this scenario assumes Orchard Avenue will be fully constructed easterly to 10th Avenue. As a result, the Project Only trips have been revised to allow access to 10th Avenue from Orchard Avenue. Figure 8 illustrates the 2042 Project Only Trip to the study intersections. This scenario also assumes the Live Oak Project will be fully built, as a result the 2042 Near Term Trips were used instead of the 2027 Near Term Trips. Figure 9 illustrates the 2042 Near Term Trips. Figure 10 illustrates the Cumulative Year 2042 plus Project turning movement volumes, intersection geometrics and traffic controls. LOS worksheets for the Cumulative Year 2042 plus Project Traffic Conditions scenario are provided in Appendix H. Table XI presents a summary of the Cumulative Year 2042 plus Project peak hour LOS at the study intersections, while Table XII presents a summary of the Cumulative Year 2042 plus Project LOS for the study segments.

Under this scenario, all study intersections are projected to operate at an acceptable LOS.

Table XI: Cumulative Year 2042 plus Project Intersection LOS Results

ID	Intersection	Intersection Control	AM (7-9) Peak Hour		PM (4-6) Peak Hour	
			Average Delay (sec/veh)	LOS	Average Delay (sec/veh)	LOS
3	10 1/2 Avenue / Hanford Armona Road	Traffic Signal	16.6	B	19.4	B
4	Jordan Way / Hanford Armona Road	Two-Way Stop	11.6	B	14.5	B
5	10th Avenue / Hanford Armona Road	Traffic Signal	18.8	B	21.9	C
6	10 ½ Avenue / Orchard Avenue	Two-Way Stop	9.4	A	9.7	A
7	11th Avenue / Houston Avenue	Traffic Signal	22.2	C	24.7	C
8	Houston Avenue / 10 1/2 Avenue	Two-Way Stop	10.1	B	12.1	B
9	10th Avenue / Houston Avenue	All-Way Stop	9.9	A	14.8	B

Note: LOS = Level of Service based on average delay on signalized intersections and All-Way STOP Controls (AWSC)
 LOS for two-way stop controlled (TWSC) and one-way STOP controlled intersections are based on the worst approach/movement of the minor street.

Under this scenario, all study segments are projected to operate at an acceptable LOS.

Table XII: Cumulative Year 2042 plus Project Segment LOS Results

ID	Segment	Limits	Lanes	24-hour Volume	AM Peak Volume	AM LOS	PM Peak Volume	PM LOS
1	Hanford-Armona Road	11 th Avenue and 10 ½ Avenue	2	11,750	400	C	591	D
2	Hanford-Armona Road	10 ½ Avenue and Jordan Way	2	7,330	261	C	394	C
3	Hanford-Armona Road	Jordan Way and 10 th Avenue	2	7,820	252	B	455	C
4	10 ½ Avenue	Hanford-Armona Road and Orchard Avenue	2	4,930	190	B	276	C
5	10 ½ Avenue	Orchard Avenue and Houston Avenue	2	2,080	74	A	128	B
6	Houston Avenue	11 th Avenue and 10 ½ Avenue	2	6,300	224	B	408	C
7	Houston Avenue	10 ½ Avenue and 10 th Avenue	2	5,840	197	A	319	B

Note: LOS = Level of Service per HCM 6th Edition methodologies in HCS7 software. Peak hour volumes are from the highest directional volume.

Latest Site Plan Project Trips

The LOS studies were completed using the trips generated by the original Project site plan. The revised project site plan added 10 AM peak hour trips and 13 PM peak hour trips. Since all intersections fall well within the LOS threshold in all scenarios, the additional project trips were all distributed to the worst performing intersection during the worst scenario in an effort to represent a worst-case scenario and determine if the LOS results of this TIA, which were based on the original site plan that contained 14 less single-family residential lots and 0.9 less acres of park, would result in unacceptable LOS thresholds. The critical intersection was determined to be that of Houston Avenue and 11th Avenue during the Cumulative Year 2042 plus Project scenario. LOS worksheets for this scenario are provided in Appendix H. Table XIII presents a summary of the Cumulative Year 2042 plus Project peak hour LOS for the intersection of Houston Avenue and 11th Avenue. Under this scenario, this intersection is projected to operate at an acceptable LOS. Therefore, it is the opinion of JLB that all study intersections and segments would continue to operate within the acceptable LOS for all study scenarios if the additional trips were distributed throughout the roadway network and the LOS studies were redone. As a result, JLB does not recommend that this LOS analysis be redone and that the City of Hanford, County of Kings and Caltrans can utilize this TIA to determine the Projects impacts to the study intersections and segments.

Table XIII: Cumulative Year 2042 plus Latest Project Site Plan Intersection LOS Results

ID	Intersection	Intersection Control	AM (7-9) Peak Hour		PM (4-6) Peak Hour	
			Average Delay (sec/veh)	LOS	Average Delay (sec/veh)	LOS
7	11th Avenue / Houston Avenue	Traffic Signal	22.3	C	24.8	C

Note: LOS = Level of Service based on average delay on signalized intersections and All-Way STOP Controls
 LOS for two-way and one-way STOP controlled intersections are based on the worst approach/movement of the minor street.

Project Only Trip Assignment to State Facilities

Figure 11 illustrates the Project Only Trips to State Route 198 at 11th Avenue. Similarly, Figure 12 illustrates the Project Only Trips to State Route 198 at 10th Avenue. The project only trips from both of these figures also include the trips from the added lots and park acreage from the latest Project site plan.

Lunaria TIA - City of Hanford 2042 Project Only Trips

Figure 8

<p>1. SR 198 EB Off Ramp/3rd St & Douty St</p>	<p>2. SR 198 WB Off Ramp/4th St & 10th Ave</p>	<p>3. 10 1/2 Ave & Hanford-Armona Rd</p>	<p>4. Jordan Way & Hanford-Armona Rd</p>
<p>5. 10th Ave & Hanford-Armona Rd</p>	<p>6. 10 1/2 Ave & Orchard Ave</p>	<p>7. 11th Ave & Houston Ave</p>	<p>8. 10 1/2 Ave & Houston Ave</p>

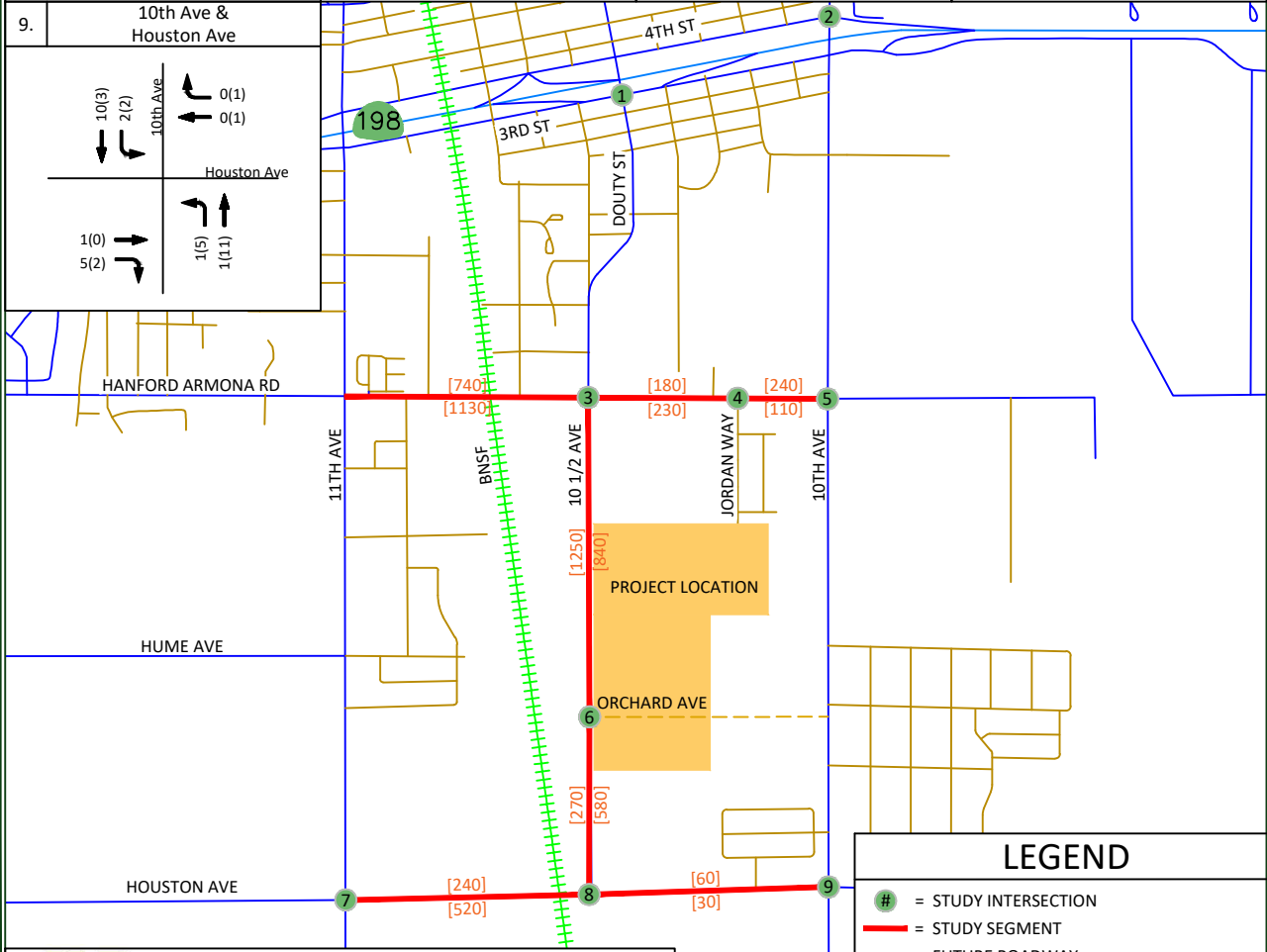

JLB TRAFFIC
ENGINEERING, INC.

516 W. Shaw Ave., Ste. 103, Fresno, CA 93704
PHONE: (559) 570-8991, EMAIL: info@JLBtraffic.com, www.JLBtraffic.com

LEGEND

- # = STUDY INTERSECTION
- = STUDY SEGMENT
- - - = FUTURE ROADWAY
- XX = AM PROJECT ONLY TRIPS
- (XX) = PM PROJECT ONLY TRIPS
- [XX] = DAILY VOLUMES

Not To Scale

Lunaria TIA - City of Hanford 2042 Near Term Projects' Trip Assignment

Figure 9

1. SR 198 EB Off Ramp/3rd St & Douty St	2. SR 198 WB Off Ramp/4th St & 10th Ave	3. 10 1/2 Ave & Hanford-Armona Rd	4. Jordan Way & Hanford-Armona Rd
5. 10th Ave & Hanford-Armona Rd	6. 10 1/2 Ave & Orchard Ave	7. 11th Ave & Houston Ave	8. 10 1/2 Ave & Houston Ave
9. 10th Ave & Houston Ave			

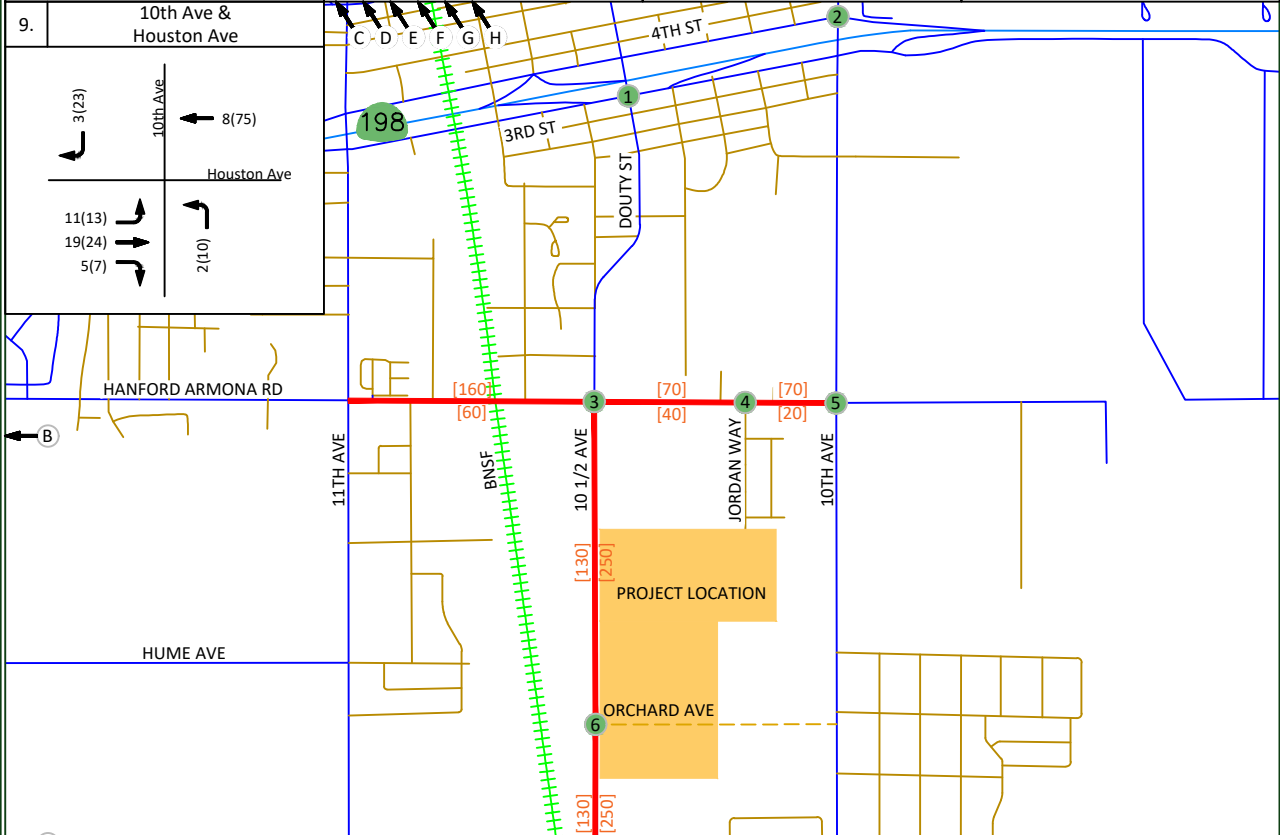

LEGEND

- = STUDY INTERSECTION
- = STUDY SEGMENT
- = FUTURE ROADWAY
- XX = AM NEAR TERM TRIPS
- (XX) = PM NEAR TERM TRIPS
- [XX] = DAILY VOLUMES
- Ⓝ = NEAR TERM PROJECT LOCATION

Not To Scale

JLB TRAFFIC
ENGINEERING, INC.

516 W. Shaw Ave., Ste. 103, Fresno, CA 93704
PHONE: (559) 570-8991, EMAIL: info@JLBtraffic.com, www.JLBtraffic.com

Lunaria TIA - City of Hanford Cumulative Year 2042 plus Project - Traffic Volumes, Geometrics and Controls

Figure 10

<p>1. SR 198 EB Off Ramp/3rd St & Douty St</p>	<p>2. SR 198 WB Off Ramp/4th St & 10th Ave</p>	<p>3. 10 1/2 Ave & Hanford-Armona Rd</p>	<p>4. Jordan Way & Hanford-Armona Rd</p>
<p>5. 10th Ave & Hanford-Armona Rd</p>	<p>6. 10 1/2 Ave & Orchard Ave</p>	<p>7. 11th Ave & Houston Ave</p>	<p>8. 10 1/2 Ave & Houston Ave</p>

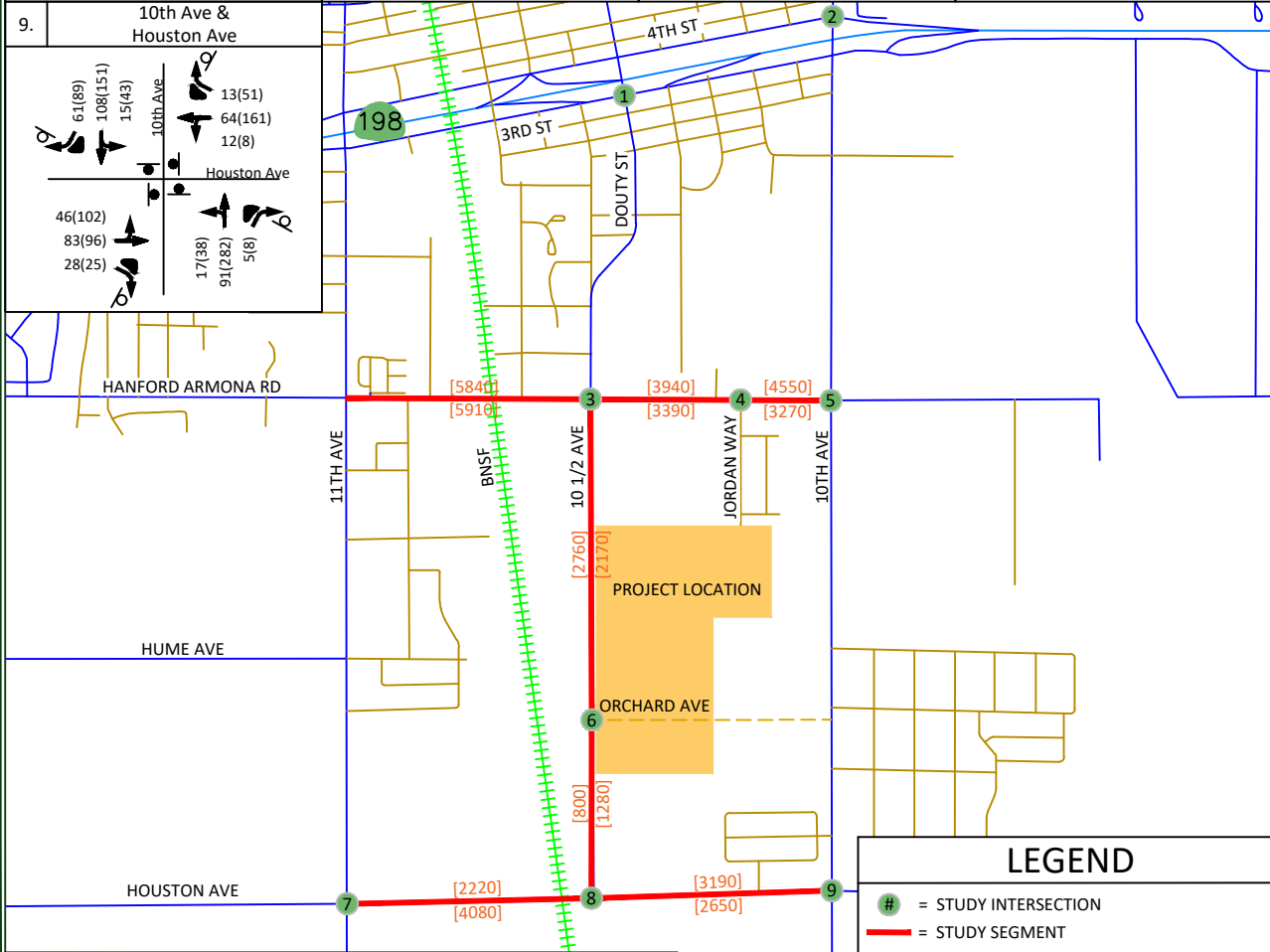

LEGEND

- # = STUDY INTERSECTION
- = STUDY SEGMENT
- - - = FUTURE ROADWAY
- XX = AM PEAK HOUR TRIPS
- (XX) = PM PEAK HOUR TRIPS
- [XX] = DAILY VOLUMES
- = STOP SIGN
- ⓪ = YIELD SIGN
- = TRAFFIC SIGNAL

Not To Scale

516 W. Shaw Ave., Ste. 103, Fresno, CA 93704
PHONE: (559) 570-8991, EMAIL: info@JLBtraffic.com, www.JLBtraffic.com

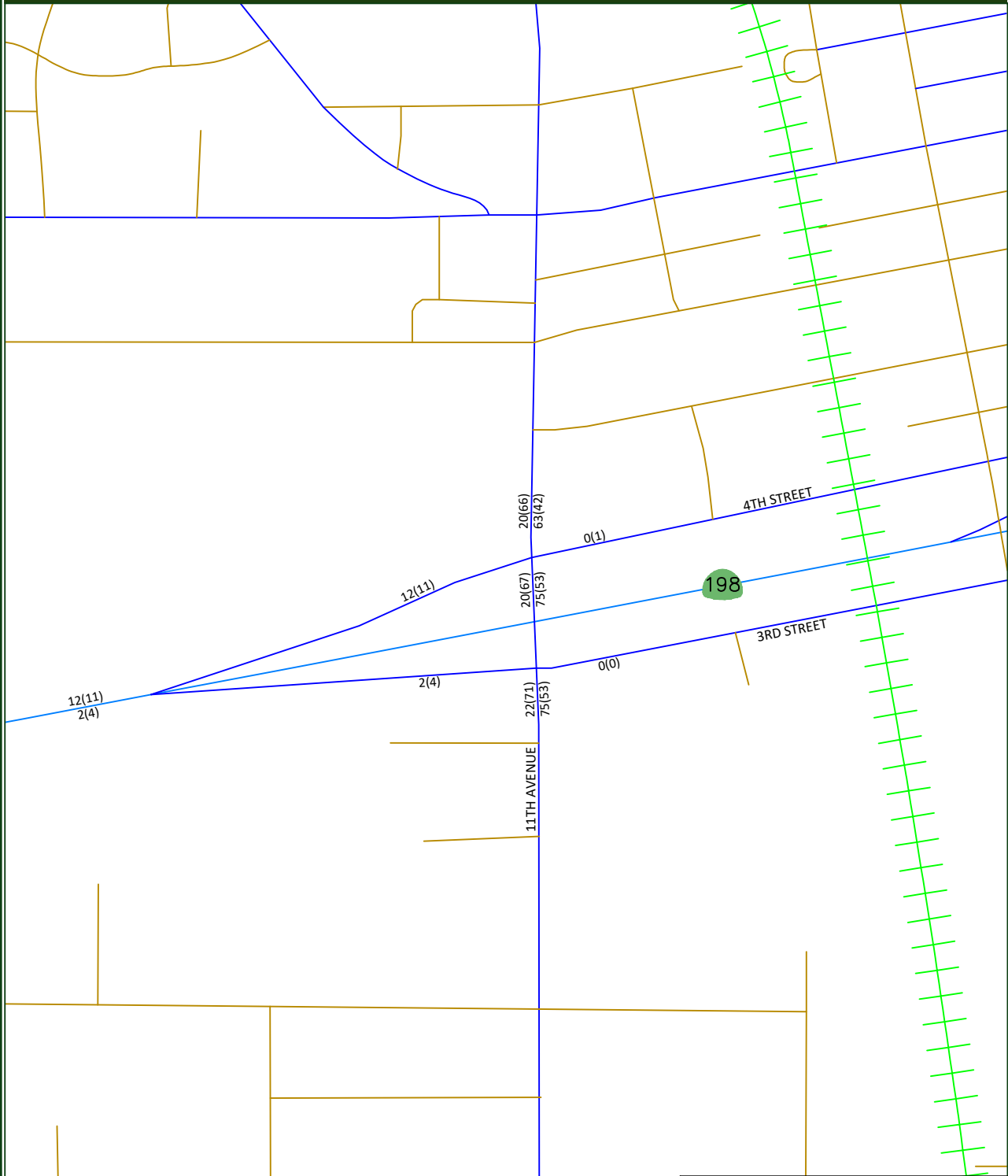

JLB TRAFFIC
 ENGINEERING, INC.

516 W. Shaw Ave., Ste. 103, Fresno, CA 93704
 PHONE: (559) 570-8991, EMAIL: info@JLBtraffic.com, www.JLBtraffic.com

LEGEND

XX = AM PROJECT ONLY TRIPS
 (XX) = PM PROJECT ONLY TRIPS



Not To Scale

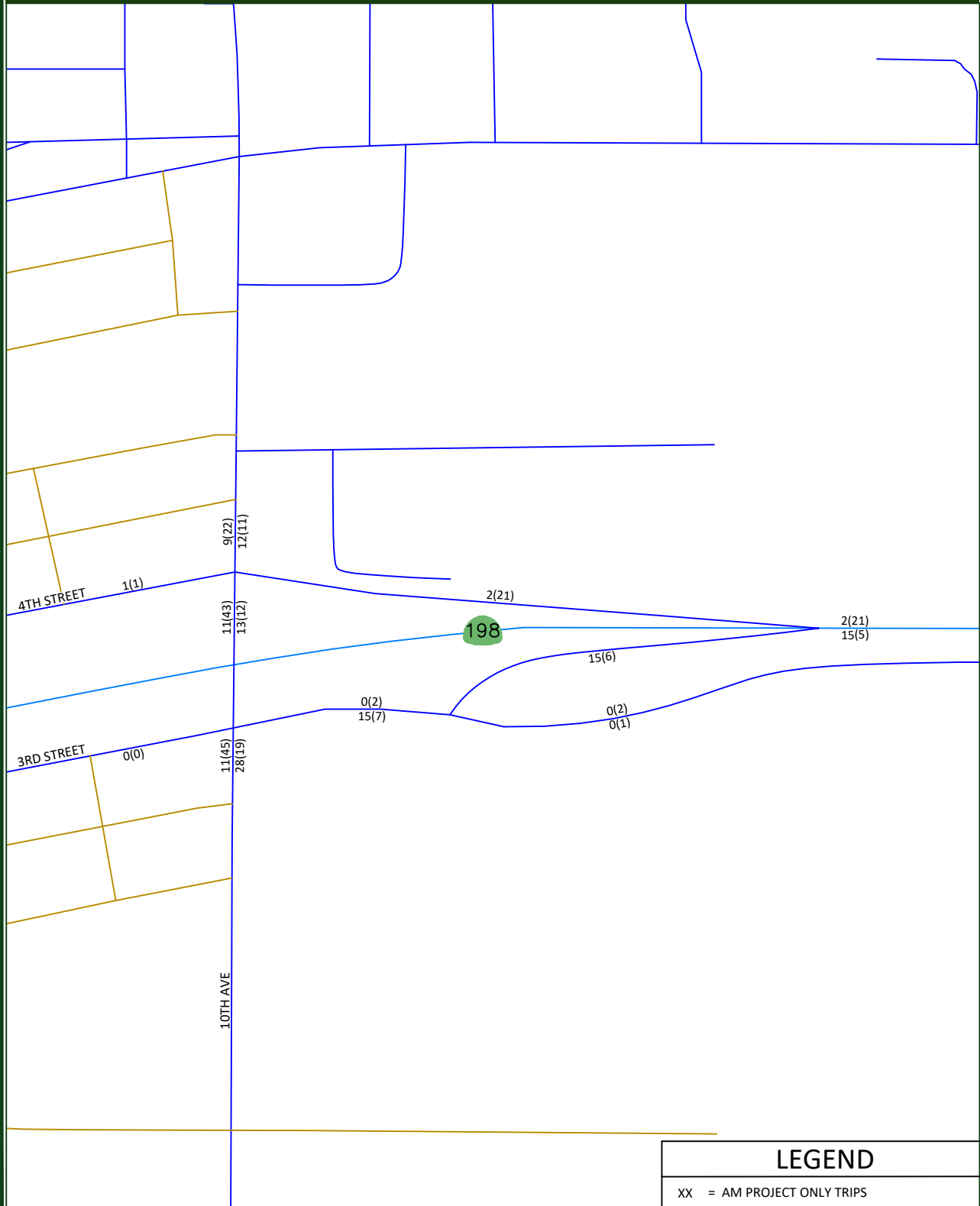

LEGEND

XX = AM PROJECT ONLY TRIPS
 (XX) = PM PROJECT ONLY TRIPS



Not To Scale



516 W. Shaw Ave., Ste. 103, Fresno, CA 93704
 PHONE: (559) 570-8991, EMAIL: info@JLBtraffic.com, www.JLBtraffic.com

Queuing Analysis

Table XIV provides a queue length summary for left-turn and right-turn lanes at the study intersections under all study scenarios. The queuing analyses for the study intersections are contained in the LOS worksheets for the respective scenarios. Appendix D contains the methodologies used to evaluate these intersections. Queuing analyses were completed using SimTraffic output information. Synchro provides both 50th and 95th percentile maximum queue lengths (in feet). According to the *Synchro Studio 11 User Guide*, “the 50th percentile maximum queue is the maximum back of queue on a typical cycle and the 95th percentile queue is the maximum back of queue with 95th percentile volumes” (Cubic ITS, Inc., 2019). The queues shown on Table XIV are the 95th percentile queue lengths for the respective lane movements.

The *California Highway Design Manual* (CA HDM) provides guidance for determining deceleration lengths for the left-turn and right-turn lanes based on design speeds. According to the CA HDM, tapers for right-turn lanes are “usually unnecessary since main line traffic need not be shifted laterally to provide space for the right-turn lane. If, in some rare instances, a lateral shift were needed, the approach taper would use the same formula as for a left-turn lane” (Caltrans 2019). Therefore, a bay taper length pursuant to the CA HDM would need to be added, as necessary, to the recommended storage lengths presented in Table XIV.

The storage capacity for the Cumulative Year 2042 plus Project Traffic Conditions shall be based on the SimTraffic output files and engineering judgement. The values in bold presented in Table XIV are the projected queue lengths that will likely need to be accommodated by the Cumulative Year 2042 plus Project Traffic Conditions scenario. At the remaining approaches of the study intersections, the existing storage capacity will be sufficient to accommodate the maximum queue.

Table XIV: Queuing Analysis

ID	Intersection	Existing Queue Storage Length (ft.)		Existing		Existing plus Project		Near Term plus Project		Cumulative Year 2042 plus Project	
				AM	PM	AM	PM	AM	PM	AM	PM
1	Douty Street / 3rd Street (State Route 198 Eastbound Off Ramp)	EB L	100	81	86	87	92	103	95	90	123
		EB T	>300	81	89	72	92	68	92	81	153
		EB TR	>300	71	97	62	85	68	82	78	139
		NB T	>300	59	59	54	59	54	57	58	60
		NB T	>300	65	72	67	58	62	70	64	64
		NB R	90	43	37	43	54	55	53	55	54
		SB LT	>300	69	118	83	146	75	133	88	177
		SB T	>300	0	35	28	56	10	34	0	53
2	10th Avenue / SR-99 WB Off Ramp	WB LTR	>500	84	126	103	115	92	104	156	156
		NB L	295	52	85	53	87	49	110	76	421
		NB T	295	101	124	110	110	125	114	136	561
		NB T	295	102	121	142	121	120	106	144	381
		SB T	>300	161	170	151	210	151	219	195	327
		SB T	>300	121	99	101	159	36	142	144	278
		SB R	105	64	67	59	68	55	73	82	135
3	10 1/2 Avenue / Hanford Armona Road	EB L	150	48	56	77	61	81	81	73	143
		EB TR	>500	105	85	106	198	144	203	128	324
		WB L	95	22	25	27	41	50	45	49	140
		WB TR	>500	82	133	113	138	135	158	139	186
		NB L	150	55	49	109	99	121	84	112	149
		NB T	>500	38	32	79	61	61	60	66	108
		NB R	95	26	25	37	33	50	22	47	29
		SB L	150	28	53	33	47	41	53	32	49
		SB T	>500	47	36	38	53	56	66	61	72
		SB R	100	49	57	45	57	45	56	37	57
4	Jordan Way / Hanford Armona Road	EB TR	>500	0	0	0	10	0	0	0	0
		WB L	75	28	23	22	46	19	40	22	52
		WB T	>500	0	0	0	0	0	0	0	0
		NB LR	>300	61	55	71	68	69	72	65	71

Note: * = Does not exist or is not projected to exist

Table XIV: Queuing Analysis (Continued)

ID	Intersection	Existing Queue Storage Length (ft.)		Existing		Existing plus Project		Near Term plus Project		Cumulative Year 2042 plus Project	
				AM	PM	AM	PM	AM	PM	AM	PM
5	10th Avenue / Hanford Armona Road	EB L	105	127	112	146	156	157	151	140	153
		EB T	>500	32	20	27	21	15	64	28	79
		EB R	55	31	44	38	71	39	73	44	57
		WB L	155	18	19	10	8	13	22	19	41
		WB TR	>500	37	36	33	39	40	41	46	91
		NB L	155	58	92	61	116	75	108	77	134
		NB T	>500	86	107	111	130	82	149	130	198
		NB R	130	0	0	0	7	7	10	0	22
		SB L	110	24	42	23	49	28	37	29	99
		SB T	>500	97	85	115	111	123	111	130	258
	SB R	265	58	76	70	78	85	91	95	187	
6	10 ½ Avenue / Orchard Avenue	WB LR	*	*	*	66	52	53	46	59	42
		NB TR	*	*	*	0	0	0	0	0	0
		SB LT	*	*	*	0	22	9	39	9	19
7	11th Avenue / Houston Avenue	EB L	165	49	38	59	35	103	49	94	76
		EB T	>500	45	60	53	77	66	78	117	162
		EB R	150	32	18	24	22	37	20	45	36
		WB L	175	49	33	44	34	55	34	47	50
		WB T	>500	66	78	74	83	70	90	111	165
		WB R	175	38	37	39	32	38	47	31	38
		NB L	175	34	50	49	52	45	60	77	83
		NB T	>300	50	58	47	57	38	56	67	149
		NB T	>300	45	41	32	36	25	46	82	143
		NB R	100	25	20	31	25	17	25	39	43
		SB L	250	49	52	57	67	51	56	71	70
	SB T	>500	29	58	53	62	49	56	82	172	
	SB R	>300	34	18	47	23	29	24	27	25	
8	Houston Avenue / 10 1/2 Avenue	EB LT	>500	0	0	0	31	22	30	36	45
		WB TR	>500	0	0	0	0	0	0	0	0
		SB LR	>500	36	41	68	44	67	59	62	58
9	10th Avenue / Houston Avenue	EB LTR	>500	75	55	83	57	77	55	93	84
		WB LTR	>500	65	60	80	72	86	66	62	119
		NB LTR	>500	69	52	66	58	67	68	70	119
		SB LTR	>500	67	66	77	57	70	70	100	138

Note: * = Does not exist or is not projected to exist

Table XIV: Queuing Analysis (Continued)

10	3 rd Street / SR-198	EB T	>500	10	0	10	43	20	14	0	40
	EB Off Ramp	SB L	>500	52	98	65	71	77	96	66	204

Note: * = Does not exist or is not projected to exist

Conclusions and Recommendations

Conclusions and recommendations regarding the proposed Project are presented below.

Existing Traffic Conditions

- At present, all study intersections operate at an acceptable LOS during both peak periods.
- At present, all study segments operate at an acceptable LOS.

Existing plus Project Traffic Conditions

- Based on the original site plan, the Project is estimated to generate a maximum of 4,181 daily trips, 310 AM peak hour trips and 418 PM peak hour trips at build-out.
- Based on the latest site plan, the Project is estimated to generate a maximum of 4,315 daily trips, 320 AM peak hour trips and 431 PM peak hour trips at build-out.
- Compared to the original site plan, the latest site plan is estimated to yield a greater trip generation by 134 daily trips, 10 AM peak hour trips and 13 PM peak hour trips. These are an increase of 3.20%, 3.23% and 3.11% of the Daily, AM peak hour and PM peak hour respectively.
- LOS studies were completed using the trip generated by the original site plan. To account for the additional trips produced by the latest site plan, all additional trips (10 AM Peak hour trips and 13 PM peak hour trips) were routed to the worst performing intersection during the worst performing scenario. This was determined to be the intersection of Houston Avenue at 11th Avenue during the Cumulative Year 2042 plus Project Scenario. Based on this analysis, it was determined that that all study intersections and segments would continue to operate within the acceptable LOS for all study scenarios.
- JLB analyzed the location of the existing and proposed roadways and access points. This review revealed that all access points are located at points that minimize traffic operational impacts to existing and future roadway networks.
- It is recommended that the Project implement ADA compliant sidewalks along its frontages to 10 ½ Avenue and Orchard Avenue.
- It is recommended that the Project implement Class II Bike Lanes along its frontage to 10 ½ Avenue and Orchard Avenue.
- Under this scenario, all study intersections are projected to operate at an acceptable LOS during both peak periods.
- Under this scenario, all study segments are projected to operate at an acceptable LOS.

Near Term plus Project Traffic Conditions

- The total trip generation for the Near Term Projects by 2027 is projected as 20,410 daily trips, 1,600 AM peak hour trips and 2,141 PM peak hour trips.
- The total trip generation for the Near Term Projects by 2042 is projected as 25,413 daily trips, 1,992 AM peak hour trips and 2,665 PM peak hour trips.
- Under this scenario, all study intersections are projected to operate at an acceptable LOS during both peak periods.
- Under this scenario, all study segments are projected to operate at an acceptable LOS.

Cumulative Year 2042 plus Project Traffic Conditions

- Under this scenario, all study intersections are projected to operate at an acceptable LOS during both peak periods.
- Under this scenario, all study segments are projected to operate at an acceptable LOS.
- To account for the difference in trip generation between the original and latest site plan, all additional trips (10 AM Peak hour trips and 13 PM peak hour trips) were routed to the worst performing intersection during the worst performing scenario. This intersection was determined to be Houston Avenue at 11th Avenue during the Cumulative Year 2042 plus Project. Even with all additional project trips routed to this intersection, it continues to operate at an acceptable LOS. Therefore, it is the opinion of JLB that all study intersections would continue to operate within the acceptable LOS for all study scenarios if the additional trips were distributed throughout the roadway network and the LOS studies were redone. As a result, JLB does not recommend that this TIA be redone and that the City of Hanford, County of Kings and Caltrans can utilize this TIA to determine the Projects impacts to the study intersections and segments.

Queuing Analysis

- It is recommended that the City consider left-turn and right-turn lane storage lengths as indicated in the Queuing Analysis.

Study Participants

JLB Traffic Engineering, Inc. Personnel:

Jose Luis Benavides, PE, TE	Project Manager
Carlos Ayala-Magaña, EIT	Engineer I/II
Matthew Arndt, EIT	Engineer I/II
Jove Alcazar, EIT	Engineer I/II
Javier Rios	Engineer I/II
Dennis Wynn	Sr. Engineering Technician
Adrian Benavides	Engineering Aide
Christian Sanchez	Engineering Aide

Persons Consulted:

Ernie Escobedo	QK Inc.
Mary Beatie	City of Hanford
John Doyel	City of Hanford
Dominic Tyburski	County of Kings
Chuck Kinney	County of Kings
David Padilla	Caltrans
Christopher Xiong	Caltrans
Mike Aronson	Kittleson & Associates, Inc.
Miao Gao	Kittleson & Associates, Inc.

References

- Caltrans. 2002. "Guide for The Preparation of Traffic Impact Studies." State of California.
- Caltrans. 2019. "Highway Design Manual". Sacramento: State of California.
- Caltrans. 2021. "California Manual on Uniform Traffic Control Devices". Sacramento: State of California.
- City of Hanford. 2014. "General Plan Background Report." Hanford: City of Hanford.
- City of Hanford. 2017. "General Plan Circulation Map." Hanford: City of Hanford.
- City of Hanford. 2017. "2035 General Plan Policy Document." Hanford: City of Hanford.
- City of Hanford. 2016. "Pedestrian and Bicycle Master Plan." Hanford: City of Hanford.
- County of Kings. 2010. "2035 General Plan Circulation Element". King's County.
- Institute of Transportation Engineers. 2017. "Trip Generation Manual". Washington: Institute of Transportation Engineers.
- Cubic ITS, Inc. 2019. "Synchro Studio 11 User Guide". Sugar Land: Trafficware, LLC.
- Transportation Research Board. 2016. "Highway Capacity Manual". Washington: The National Academy of Sciences.

Appendix A: Scope of Work



www.JLBtraffic.com
info@JLBtraffic.com

516 W. Shaw Ave., Ste. 103
Fresno, CA 93704
(559) 570-8991

App | A

January 20, 2022

Gabrielle de Silva Myers
Senior Planner
City of Hanford
317 N. Douty Street
Hanford, CA 93230

Via Email Only: gmyers@cityofhanfordca.com

Subject: Proposed Scope of Work for the Preparation of a Traffic Impact Analysis and Vehicle Miles Traveled Analysis for the Lunaria Project in the City of Hanford (JLB Project 047-002)

Dear Ms. Myers,

JLB Traffic Engineering, Inc. (JLB) hereby submits this Draft Scope of Work for the preparation of a Traffic Impact Analysis (TIA) and Vehicle Miles Traveled (VMT) Analysis for the Lunaria Project (Project) located at the southeast quadrant of Hanford-Armona Road and Avenue 10 ½ in the City of Hanford. The Project proposes to develop the site with 443 single family residential units and a 4.9-acre public park. Based on information provided to JLB, the Project is consistent with the City's General Plan. An aerial of the Project vicinity and Project Site Plan are shown in Exhibits A and Exhibit B, respectively.

The purpose of the TIA and VMT Analysis is to evaluate the potential on-site and off-site traffic impacts, identify short-term roadway and circulation needs, determine potential mitigation measures and identify any critical traffic issues that should be addressed in the on-going planning process. To evaluate the on-site and off-site traffic impacts of the proposed Project, JLB proposes the following Scope of Work.

Scope of Work

- JLB will obtain new traffic counts at the study facility(ies) when schools in the vicinity are in session. These counts will include pedestrians and vehicles. Schools in the proximity of these intersections are in sessions and have had in-person learning this academic year, unless students opt out for at-home learning. According to VMT data on the Transportation Injury Mapping System (TIMS) database, VMT has been normalizing to pre-Covid numbers. As a result of VMT data normalizing and schools being in session, JLB proposes that no escalation be applied to the traffic counts due to Covid.
- JLB will request a Kings County Association of Governments (Kings CAG) traffic forecasting modeling for the Project. The Kings CAG traffic forecasting model will be used to forecast traffic volumes for the Base Year and Cumulative Year 2042 scenarios.
- JLB will perform a site visit to observe existing traffic conditions, especially during the AM and PM peak hours. Existing roadway conditions including speed limits, lane geometrics, turn prohibitions and traffic controls will be verified.



www.JLBtraffic.com

info@JLBtraffic.com

516 W. Shaw Ave., Ste. 103

Fresno, CA 93704

(559) 570-8991

Page | 1

- JLB will evaluate on-site circulation and provide recommendations as necessary to improve circulation to and within the Project site.
- JLB will qualitatively analyze existing and planned transit routes in the vicinity of the Project.
- JLB will qualitatively analyze existing and planned walkways in the vicinity of the Project.
- JLB will qualitatively analyze existing and planned bikeways in the vicinity of the Project.
- JLB will prepare CA MUTCD Warrant 3 “Peak Hour” for unsignalized study intersections under all study scenarios.
- JLB will forecast trip distribution based on turn count information and knowledge of the existing and planned circulation network in the vicinity of the Project.
- JLB will evaluate existing and forecasted levels of service (LOS) at the study intersection(s). JLB will use HCM 6th or HCM 2000 methodologies (as appropriate) within Synchro to perform this analysis for the AM and PM peak hours. JLB will identify the causes of poor LOS.

Study Scenarios

1. Existing Traffic Conditions with needed improvements (if any);
2. Existing plus Project Buildout Traffic Conditions with proposed improvements (if any);
3. Near Term plus Project Buildout Traffic Conditions with proposed improvements (if any); and
4. Cumulative Year 2042 plus Project Buildout Traffic Conditions with proposed improvements (if any).

Weekday peak hours to be analyzed (Tuesday or Thursday only)

1. 7 - 9 AM peak hour
2. 4 - 6 PM peak hour

Study Intersections

1. Hanford-Armona Road / Avenue 10 1/2
2. Hanford-Armona Road / Jordan Way
3. Hanford-Armona Road / Avenue 10
4. Orchard Avenue / Avenue 10 1/2 (Future Intersection)
5. Houston Avenue / Avenue 10 1/2

Queuing analysis is included in the proposed Scope of Work for the study intersection(s) listed above under all study scenarios. This analysis will be utilized to recommend minimum storage lengths for left-turn and right-turn lanes at all study intersections.

Study Segments

1. Avenue 10 1/2 between Hanford Armona Road and Orchard Avenue alignment
2. Avenue 10 1/2 between Orchard Avenue alignment and Houston Avenue

Project Only Trip Assignment to State Facilities

1. State Route 198 at Douty Street
2. State Route 198 at 10th Avenue

Access to the Project

Access to and from the Project site will be from four (4) access points. Three of these access points will connect directly to 10 1/2 Avenue, while the fourth will tie into existing local street Jordan Way. Jordan Way connects to Hanford Armona Road.



Project Trip Generation

The trip generation rates for the proposed Project were obtained from the 11th Edition of the Trip Generation Manual published by the Institute of Transportation Engineers (ITE). Table I presents the trip generation for the proposed Project with trip generation rates for 443 Single-Family Detached Housing units and a 4.9-acre public park. At buildout, the proposed Project is estimated to generate a maximum of 4,181 daily trips, 310 AM peak hour trips and 418 PM peak hour trips.

Table I: Project Trip Generation

Land Use (ITE Code)	Size	Unit	Daily		AM (7-9) Peak Hour					PM (4-6) Peak Hour						
			Rate	Total	Trip Rate	In	Out	In	Out	Total	Trip Rate	In	Out	In	Out	Total
						%	%									
Single-Family Detached Housing (210)	443	d.u.	9.43	4,177	0.70	26	74	80	230	310	0.94	63	37	262	155	417
Public Park (411)	4.9	Acres	0.78	4	0.02	59	41	0	0	0	0.11	55	54	1	0	1
Total Project Trips				4,181				80	230	310				263	155	418

Note: d.u. = Dwelling Units

Near Term Projects to be Included

JLB will be consulting with City of Hanford Planning Department and Engineering staff to determine which Projects should be included in the Near Term plus Project analysis. JLB will include Near Term Projects in the vicinity of the proposed Project under the Near Term plus Project analysis for which the City, County or Caltrans has knowledge of and for which it is anticipated that said project(s) is/are projected to be whole or partially built by the Near-Term Project year 2025. City of Hanford, County of Kings and Caltrans, as appropriate, would provide JLB with Near Term Project details such as a project description, location, proposed land uses with breakdowns and type of residential units and amount of square footages for non-residential uses.

The Scope of Work is based on our understanding of this Project and our experience with similar TIAs. In the absence of comments by January 31, 2022 it will be assumed that the Scope of Work is acceptable to the agency(ies) that have not submitted any comments. If you have any questions or require additional information, please contact via email at cayala@JLBtraffic.com.

Sincerely,



Carlos Ayala-Magana, EIT
 Engineer I/II

cc: John Doyle, City of Hanford
 Dominic Tyburski, County of Kings
 David Padilla, Caltrans
 Jose Benavides, JLB Traffic Engineering, Inc.

Z:\01 Projects\047 Hanford\047-002 Lunaria TIA & VMT\Scope of Work\01 Draft Scope of Work\L01202022 Lunaria Project TIA Draft Scope of Work.docx



www.JLBtraffic.com

info@JLBtraffic.com

516 W. Shaw Ave., Ste. 103

Fresno, CA 93704

(559) 570-8991

Exhibit A – Project Vicinity

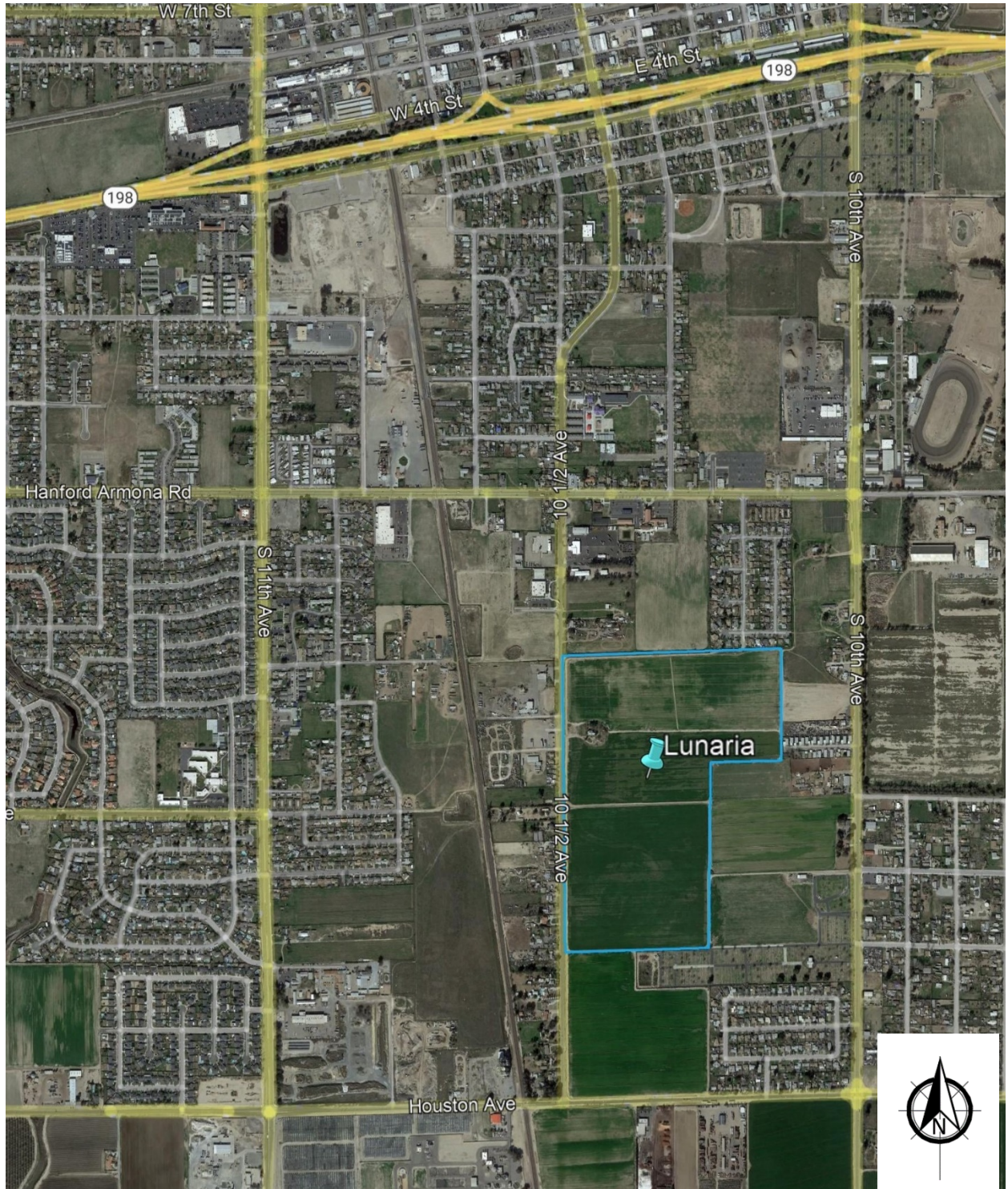
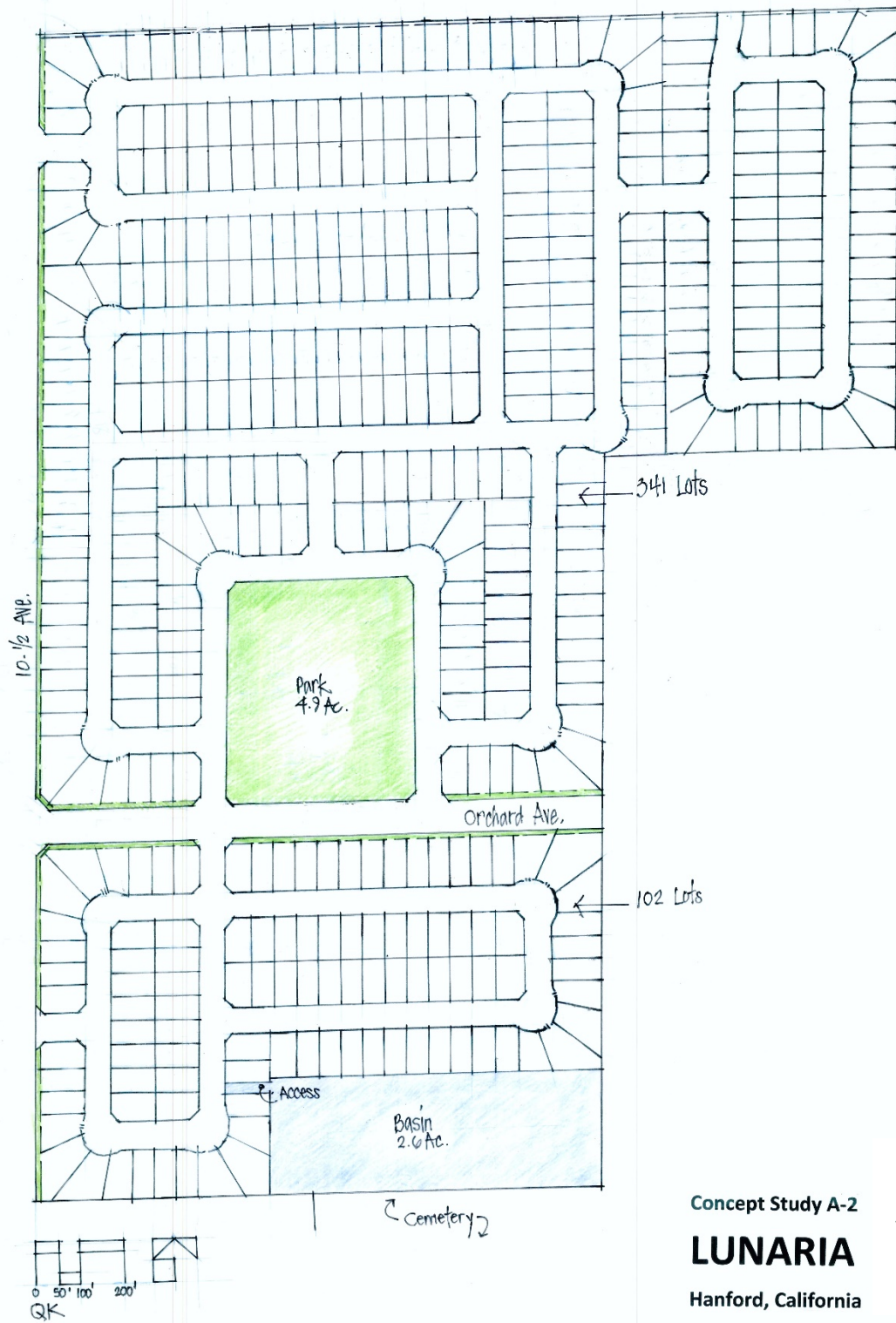

Exhibit B – Project Site Plan



Concept Study A-2
LUNARIA
Hanford, California



- JLB will evaluate on-site circulation and provide recommendations as necessary to improve circulation to and within the Project site.
- JLB will qualitatively analyze existing and planned transit routes in the vicinity of the Project.
- JLB will qualitatively analyze existing and planned walkways in the vicinity of the Project.
- JLB will qualitatively analyze existing and planned bikeways in the vicinity of the Project.
- JLB will prepare CA MUTCD Warrant 3 “Peak Hour” for unsignalized study intersections under all study scenarios.
- JLB will forecast trip distribution based on turn count information and knowledge of the existing and planned circulation network in the vicinity of the Project.
- JLB will evaluate existing and forecasted levels of service (LOS) at the study intersection(s). JLB will use HCM 6th or HCM 2000 methodologies (as appropriate) within Synchro to perform this analysis for the AM and PM peak hours. JLB will identify the causes of poor LOS.

Study Scenarios

1. Existing Traffic Conditions with needed improvements (if any);
2. Existing plus Project Buildout Traffic Conditions with proposed improvements (if any);
3. Near Term plus Project Buildout Traffic Conditions with proposed improvements (if any); and
4. Cumulative Year 2042 plus Project Buildout Traffic Conditions with proposed improvements (if any).

Weekday peak hours to be analyzed (Tuesday or Thursday only)

1. 7 - 9 AM peak hour
2. 4 - 6 PM peak hour

Study Intersections

1. Hanford-Armona Road / Avenue 10 1/2
2. Hanford-Armona Road / Jordan Way 
3. Hanford-Armona Road / Avenue 10
4. Orchard Avenue / Avenue 10 1/2 (Future Intersection)
5. Houston Avenue / Avenue 10 1/2

Queuing analysis is included in the proposed Scope of Work for the study intersection(s) listed above under all study scenarios. This analysis will be utilized to recommend minimum storage lengths for left-turn and right-turn lanes at all study intersections.

Study Segments

1. Avenue 10 1/2 between Hanford Armona Road and Orchard Avenue alignment 
2. Avenue 10 1/2 between Orchard Avenue alignment and Houston Avenue

Project Only Trip Assignment to State Facilities

1. State Route 198 at Dotty Street
2. State Route 198 at 10th Avenue

Access to the Project

Access to and from the Project site will be from four (4) access points. Three of these access points will connect directly to 10 1/2 Avenue, while the fourth will tie into existing local street Jordan Way. Jordan Way connects to Hanford Armona Road.

Carlos Ayala

From: Jose Benavides
Sent: Thursday, February 3, 2022 4:44 PM
To: Kinney, Chuck; Tyburski, Dominic
Cc: Carlos Ayala
Subject: RE: Lunaria Hanford TIA: Scope of Work

Thanks Chuck for the very quick response.

We will include your comments to the TIA scope of work within the appendix of the TIA. I believe that your reply to me will suffice, but feel free to provide your comments directly to the City of Hanford if that is the County's protocol.

Once the TIA and VMT reports have been completed, we will be sending these to you and Dominic in PDF format for your review and comment. We will also be providing the TIA and VMT reports to the City and Caltrans.

Sincerely,

Jose Luis Benavides, P.E., T.E.
President



Traffic Engineering, Transportation Planning and Parking Solutions
Certified Disadvantaged Business Enterprise (DBE) and Small Business Enterprise (SBE)

516 W. Shaw Ave., Ste. 103
Fresno, CA 93704
Direct: (559) 317-6249
Main: (559) 570-8991
Cell: (559) 694-6000
Fax: (559) 317-6854
www.JLBtraffic.com

From: Kinney, Chuck <Chuck.Kinney@co.kings.ca.us>
Sent: Thursday, February 3, 2022 4:21 PM
To: Tyburski, Dominic <Dominic.Tyburski@co.kings.ca.us>
Cc: Jose Benavides <jbenavides@jlbtraffic.com>
Subject: RE: Lunaria Hanford TIA: Scope of Work

Hi Dominic and Jose,

Based upon the project scope, in addition to the LOS study intersections proposed it would probably also be a good idea to study the following intersections:

- a. 10 Ave. and Houston Ave. (included as a City of Hanford addition in the email below)
- b. 11th Ave. and Houston Ave.

I also concur with the City of Hanford on analyzing the segment of Houston Avenue from 10th Avenue to 11th Avenue. With the addition of the 443 new homes it is likely to generate significant new traffic along Houston Avenue as it is an arterial street which can connect that new area to the 12th Avenue shopping centers (Walmart/Target) and it would be prudent to calculate the impact on those intersections and roadways so that recommendations can be developed offsetting any negative impacts to LOS.

Jose, would you confirm if I need to send this information to Mary Beatie (acting Community Development Director for Hanford) since Gabrielle is on her extended leave or am I good just submitting this information to you? Thank you for your assistance on this.

Sincerely,
Chuck K.

Chuck Kinney, Director
Kings County Community Development Agency
1400 W. Lacey Blvd.
Hanford, CA 93230
559-852-2674

From: Tyburski, Dominic <Dominic.Tyburski@co.kings.ca.us>
Sent: Thursday, February 3, 2022 3:37 PM
To: Kinney, Chuck <Chuck.Kinney@co.kings.ca.us>
Cc: 'Jose Benavides' <jbenavides@jlbtraffic.com>
Subject: FW: Lunaria Hanford TIA: Scope of Work

Hi Chuck,

Does CDA have any comments on the attached TIA scope of work? Thank you.

Dominic Tyburski, P.E.
Director | Public Works

County of Kings | Public Works Department
1400 W. Lacey Blvd. | Hanford, CA 93230

Direct 559-852-2698 | Fax 559-582-2506
Dominic.Tyburski@co.kings.ca.us | www.countyofkings.com



From: Jose Benavides <jbenavides@jlbtraffic.com>
Sent: Thursday, February 3, 2022 3:27 PM
To: Tyburski, Dominic <Dominic.Tyburski@co.kings.ca.us>
Cc: Carlos Ayala <cayala@jlbtraffic.com>
Subject: FW: Lunaria Hanford TIA: Scope of Work

Good afternoon Dominic,

Sorry that I missed your call this afternoon.

Anyway, attached you will find the proposed scope of work for the preparation of a TIA in the City of Hanford. Furthermore, the City of Hanford has recently requested that we also include in the TIA analysis the following study segments and intersections.

Segment LOS:

- Hanford Armona Road between 11th Avenue and 10 ½ Avenue
- Hanford Armona Road between 10 1/2 Avenue and 10th Avenue
- Houston Avenue between 11th Avenue and 10 ½ Avenue
- Houston Avenue between 10 1/2 Avenue and 10th Avenue

Intersection LOS:

- Houston Avenue and 10th Avenue

Can you please share this with Chuck or provide me with his email so that we can send this to him so that we may get comments if any from the County?

Sincerely,

Jose Luis Benavides, P.E., T.E.
President



Traffic Engineering, Transportation Planning and Parking Solutions
Certified Disadvantaged Business Enterprise (DBE) and Small Business Enterprise (SBE)

516 W. Shaw Ave., Ste. 103
Fresno, CA 93704
Direct: (559) 317-6249
Main: (559) 570-8991
Cell: (559) 694-6000
Fax: (559) 317-6854
www.JLBtraffic.com

From: Carlos Ayala <cayala@jlbtraffic.com>
Sent: Thursday, February 3, 2022 9:37 AM
To: Jose Benavides <jbenavides@jlbtraffic.com>
Subject: FW: Lunaria Hanford TIA: Scope of Work

Initial Lunaria SOW email.

Thank you,

Carlos Ayala-Magana
Engineer I/II



Traffic Engineering, Transportation Planning and Parking Solutions
Certified Disadvantaged Business Enterprise (DBE) and Small Business Enterprise (SBE)

516 W. Shaw Ave., Ste. 103
Fresno, CA 93704
Office: (559) 570-8991
Direct: (559) 869-4514
Fax: (559) 317-6854
www.JLBtraffic.com

From: Carlos Ayala
Sent: Thursday, January 20, 2022 10:44 AM
To: Gabrielle de Silva Myers (gmyers@cityofhanfordca.com) <gmyers@cityofhanfordca.com>
Cc: John Doyel (JDoyel@cityofhanfordca.com) <JDoyel@cityofhanfordca.com>; Dominic Tyburski (dominic.tyburski@co.kings.ca.us) <dominic.tyburski@co.kings.ca.us>; David Padilla (dave.padilla@dot.ca.gov) <dave.padilla@dot.ca.gov>; Jose Benavides <jbenavides@jlbtraffic.com>
Subject: Lunaria Hanford TIA: Scope of Work

Hello Gabrielle,

Attached you will find a Draft Scope of Work for the preparation of a Traffic Impact Analysis for a Project in the City of Hanford/County of Kings.

We kindly ask that you take a moment to review and comment on the proposed Scope of Work. In the absence of comments by January 31, 2022, it will be assumed that the proposed Scope of Work is acceptable to the agency(ies) that have not submitted any comments.

If you have any questions or require additional information, please contact me by phone at 559.869.4514 or by e-mail at cayala@JLBtraffic.com. We appreciate your time and attention to this matter and look forward to hearing from you soon.

Thank you,

Carlos Ayala-Magana
Engineer I/II



Traffic Engineering, Transportation Planning and Parking Solutions
Certified Disadvantaged Business Enterprise (DBE) and Small Business Enterprise (SBE)

516 W. Shaw Ave., Ste. 103

Carlos Ayala

From: Xiong, Christopher@DOT <Christopher.Xiong@dot.ca.gov>
Sent: Thursday, February 3, 2022 2:42 PM
To: Carlos Ayala
Cc: Padilla, Dave@DOT; gmyers@cityofhanfordca.com; JDoyel@cityofhanfordca.com; dominic.tyburski@co.kings.ca.us; Jose Benavides
Subject: RE: Lunaria Hanford TIA: Scope of Work
Attachments: KIN-198-R18.373_Proposed Scope of Work for Traffic Impact Analysis - Lunaria Project_revised_response.pdf

Hello Carlos,

Attached is our revised comment letter regarding the proposed scope of work, which supersedes our previous letter.

Please let me know if you have any questions.

Best regards,

Christopher Xiong

Associate Transportation Planner
Caltrans District 6
1352 W. Olive Avenue
Fresno, CA 93728
Christopher.Xiong@dot.ca.gov
(559) 908-7064

From: Xiong, Christopher@DOT
Sent: Friday, January 28, 2022 3:58 PM
To: cayala@jlbtraffic.com
Cc: Padilla, Dave@DOT <dave.padilla@dot.ca.gov>; gmyers@cityofhanfordca.com; JDoyel@cityofhanfordca.com; dominic.tyburski@co.kings.ca.us; jbenavides@jlbtraffic.com
Subject: RE: Lunaria Hanford TIA: Scope of Work

Hello Carlos,

Attached are our comments regarding the proposed Scope of Work and project.

Please let me know if you have any questions.

Best regards,

Christopher Xiong

Associate Transportation Planner
Caltrans District 6
1352 W. Olive Avenue
Fresno, CA 93728
Christopher.Xiong@dot.ca.gov
(559) 908-7064

From: Carlos Ayala <cayala@jlbtraffic.com>
Sent: Thursday, January 20, 2022 10:44 AM
To: Gabrielle de Silva Myers (gmyers@cityofhanfordca.com) <gmyers@cityofhanfordca.com>
Cc: John Doyel (JDoyel@cityofhanfordca.com) <JDoyel@cityofhanfordca.com>; Dominic Tyburski (dominic.tyburski@co.kings.ca.us) <dominic.tyburski@co.kings.ca.us>; Padilla, Dave@DOT <dave.padilla@dot.ca.gov>; Jose Benavides <jbenavides@jlbtraffic.com>
Subject: Lunaria Hanford TIA: Scope of Work

EXTERNAL EMAIL. Links/attachments may not be safe.

Hello Gabrielle,

Attached you will find a Draft Scope of Work for the preparation of a Traffic Impact Analysis for a Project in the City of Hanford/County of Kings.

We kindly ask that you take a moment to review and comment on the proposed Scope of Work. In the absence of comments by January 31, 2022, it will be assumed that the proposed Scope of Work is acceptable to the agency(ies) that have not submitted any comments.

If you have any questions or require additional information, please contact me by phone at 559.869.4514 or by e-mail at cayala@JLBtraffic.com. We appreciate your time and attention to this matter and look forward to hearing from you soon.

Thank you,

Carlos Ayala-Magana
Engineer I/II



Traffic Engineering, Transportation Planning and Parking Solutions
Certified Disadvantaged Business Enterprise (DBE) and Small Business Enterprise (SBE)

516 W. Shaw Ave., Ste. 103
Fresno, CA 93704
Office: (559) 570-8991
Direct: (559) 869-4514
Fax: (559) 317-6854
www.JLBtraffic.com

California Department of Transportation

DISTRICT 6 OFFICE
1352 WEST OLIVE AVENUE | P.O. BOX 12616 | FRESNO, CA 93778-2616
(559) 981-1041 | FAX (559) 488-4195 | TTY 711
www.dot.ca.gov



February 3, 2022

KIN-198-R18.373
Lunaria Project
Proposed Scope of Work for Traffic Impact Analysis
Revised
<https://ld-igr-gts.dot.ca.gov/district/6/report/25306>

SENT VIA EMAIL

Carlos Ayala-Magana,
JLB Traffic Engineering, Inc.
516 W. Shaw Ave., Ste. 103
Fresno, CA 93704

Dear Mr. Ayala-Magana,

This comment letter supersedes our previous letter dated January 28, 2022 for the Proposed Scope of Work for the Preparations of a Traffic Impact Analysis (TIA) and Vehicle Miles Traveled (VMT) Analysis for the Lunaria Project, proposing to develop 443 single-family residential units and a 4.9-acre public park. The project site is located at the southeast quadrant of Hanford-Armona Road and 10-1/2 Avenue in the City of Hanford, approximately one mile south of the State Route (SR) 198 / Douty Street ramps, southwest of the SR 198 / 10th Avenue ramps, and southeast of the SR 198 / 11th Avenue ramps.

General Comments

The submitted Scope of Work (SOW) for the Preparation of a Traffic Impact Analysis and VMT Analysis proposes to study (including queuing analysis) for the following 5 intersections:

1. Hanford-Armona Road / Avenue 10 1/2
2. Hanford-Armona Road / Jordan Way
3. Hanford-Armona Road / Avenue 10
4. Orchard Avenue / Avenue 10 1/2 (Future Intersection)
5. Houston Avenue / Avenue 10 1/2

While the proposed SOW is satisfactory, Caltrans recommends a queuing analysis for the following facilities be included in the study:

1. SR 198 / Avenue 10 – Westbound off-ramp
2. SR 198 / Douty Street (on 3rd Street) – Eastbound off-ramp

This is due to the potential project trips from the 443 single-family residential units and public park that would utilize the State facilities, which were not designed as high capacity ramps. In addition, please include a trip trace to the following locations:

1. SR 198 / Avenue 11 – Westbound on-ramp
2. SR 198 / Avenue 10 (on 3rd Street) – Eastbound on-ramp

Caltrans provides the following additional comments to better support the State's smart mobility goals that support a vibrant economy and sustainable communities:

1. Caltrans recommends the project proponents(s) consider working with the City to convert a portion of the units to affordable housing units.
2. Caltrans concurs with the project proponent(s) conducting a vehicle miles traveled (VMT) study. The preparer should refer to the *Caltrans Vehicle Miles Traveled Transportation Impact Study Guide*, dated May 20, 2020. Improvements for existing/future bike and pedestrian facilities on roads in the vicinity of the Project and connectivity between home to work/home to shops should be considered and included in the VMT mitigation plan.
3. Caltrans recommends the City consider creating a VMT Mitigation Impact Fee to help reduce impacts on the State Highway System.
4. According to the City of Hanford's Pedestrian and Bicycle Master Plan (2016), 10-1/2 Avenue is proposed as Class III bike lane as part of the 2016 Initial Stage Bikeway Plan (see page 3-22) and as a Class II bike lane in the 2035 Bikeway Plan (see page 3-23). Therefore, Caltrans recommends the project proponent(s) coordinate with the City regarding these alternative transportation measures.

Carlos Ayala-Magana, Lunaria Project – Proposed Scope of Work for Traffic Impact Analysis

February 3, 2022

Page 3

5. Active Transportation Plans and Smart Growth efforts support the state's 2050 Climate goals. Caltrans supports reducing VMT and GHG emissions in ways that increase the likelihood people will use and benefit from a multimodal transportation network.

If you have any other questions, please call or email Christopher Xiong at (559) 908-7064 or Christopher.Xiong@dot.ca.gov.

Sincerely,

A handwritten signature in blue ink, appearing to read 'David Padilla', with a long horizontal flourish extending to the right.

DAVID PADILLA, Branch Chief
Transportation Planning – North

Appendix B: Traffic Counts



www.JLBtraffic.com
info@JLBtraffic.com

516 W. Shaw Ave., Ste. 103
Fresno, CA 93704
(559) 570-8991



Metro Traffic Data Inc.
 310 N. Irwin Street - Suite 20
 Hanford, CA 93230
 800-975-6938 Phone/Fax
 www.metrotrafficedata.com

Turning Movement Report

Prepared For:

JLB Traffic Engineering, Inc.
 516 W. Shaw Ave, Suite 103
 Fresno, CA 93704

LOCATION 3rd St @ Douy St LATITUDE 36.3225
 COUNTY Kings LONGITUDE -119.6447
 COLLECTION DATE Tuesday, March 1, 2022 WEATHER Clear

Time	Northbound					Southbound					Eastbound					Westbound				
	U-Turn	Left	Thru	Right	Trucks	U-Turn	Left	Thru	Right	Trucks	U-Turn	Left	Thru	Right	Trucks	U-Turn	Left	Thru	Right	Trucks
7:00 AM - 7:15 AM	0	0	15	2	0	0	12	5	0	1	0	30	60	3	11	0	0	0	0	0
7:15 AM - 7:30 AM	0	0	22	6	3	0	10	9	0	0	0	41	67	5	5	0	0	0	0	0
7:30 AM - 7:45 AM	0	0	34	7	1	0	17	15	0	2	0	48	91	3	2	0	0	0	0	0
7:45 AM - 8:00 AM	0	0	43	12	2	0	19	29	0	0	0	103	104	9	11	0	0	0	0	0
8:00 AM - 8:15 AM	0	0	41	7	2	0	16	34	0	3	0	75	87	6	4	0	0	0	0	0
8:15 AM - 8:30 AM	0	0	37	5	2	0	19	25	0	3	0	65	79	8	5	0	0	0	0	0
8:30 AM - 8:45 AM	0	0	30	8	1	0	13	24	0	2	0	59	70	6	17	0	0	0	0	0
8:45 AM - 9:00 AM	0	0	42	3	2	0	16	10	0	1	0	66	67	7	4	0	0	0	0	0
TOTAL	0	0	264	50	13	0	122	151	0	12	0	487	625	47	59	0	0	0	0	0

Time	Northbound					Southbound					Eastbound					Westbound				
	U-Turn	Left	Thru	Right	Trucks	U-Turn	Left	Thru	Right	Trucks	U-Turn	Left	Thru	Right	Trucks	U-Turn	Left	Thru	Right	Trucks
4:00 PM - 4:15 PM	0	0	33	7	0	0	38	33	0	2	0	81	126	12	9	0	0	0	0	0
4:15 PM - 4:30 PM	0	0	36	5	3	0	32	33	0	1	0	76	121	14	5	0	0	0	0	0
4:30 PM - 4:45 PM	0	0	31	8	0	0	47	36	0	1	0	72	128	11	4	0	0	0	0	0
4:45 PM - 5:00 PM	0	0	45	10	1	0	28	48	0	0	0	75	118	10	2	0	0	0	0	0
5:00 PM - 5:15 PM	0	0	30	8	0	0	54	43	0	3	0	63	132	21	3	0	0	0	0	0
5:15 PM - 5:30 PM	0	0	39	5	1	0	31	34	0	0	0	60	129	19	3	0	0	0	0	0
5:30 PM - 5:45 PM	0	0	28	5	0	0	26	22	0	2	0	69	113	14	6	0	0	0	0	0
5:45 PM - 6:00 PM	0	0	35	3	1	0	29	32	0	0	0	58	95	10	0	0	0	0	0	0
TOTAL	0	0	277	51	6	0	285	281	0	9	0	554	962	111	32	0	0	0	0	0

PEAK HOUR	Northbound					Southbound					Eastbound					Westbound				
	U-Turn	Left	Thru	Right	Trucks	U-Turn	Left	Thru	Right	Trucks	U-Turn	Left	Thru	Right	Trucks	U-Turn	Left	Thru	Right	Trucks
7:30 AM - 8:30 AM	0	0	155	31	7	0	71	103	0	8	0	291	361	26	22	0	0	0	0	0
4:15 PM - 5:15 PM	0	0	142	31	4	0	161	160	0	5	0	286	499	56	14	0	0	0	0	0

	PHF	Trucks
AM	0.813	3.6%
PM	0.951	1.7%

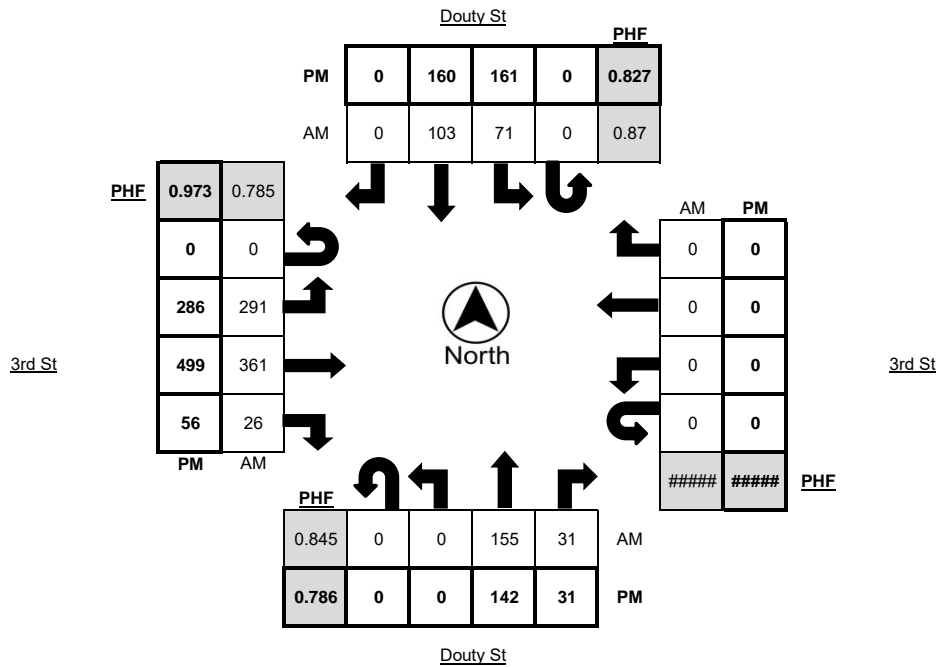



Metro Traffic Data Inc.
 310 N. Irwin Street - Suite 20
 Hanford, CA 93230
 800-975-6938 Phone/Fax
 www.metrotrafficdata.com

Turning Movement Report

Prepared For:

JLB Traffic Engineering, Inc.
 516 W. Shaw Ave, Suite 103
 Fresno, CA 93704

LOCATION 3rd St @ Douty St

LATITUDE 36.3225

COUNTY Kings

LONGITUDE -119.6447

COLLECTION DATE Tuesday, March 1, 2022

WEATHER Clear

Time	Northbound Bikes			N.Leg Peds	Southbound Bikes			S.Leg Peds	Eastbound Bikes			E.Leg Peds	Westbound Bikes			W.Leg Peds
	Left	Thru	Right		Left	Thru	Right		Left	Thru	Right		Left	Thru	Right	
7:00 AM - 7:15 AM	0	0	0	0	0	0	0	0	0	0	0	0	0	0	0	0
7:15 AM - 7:30 AM	0	0	0	0	0	0	0	0	0	0	0	0	0	0	0	0
7:30 AM - 7:45 AM	0	0	0	0	0	0	0	0	0	0	0	0	0	0	0	0
7:45 AM - 8:00 AM	0	1	0	0	0	0	0	0	0	0	0	0	0	0	0	0
8:00 AM - 8:15 AM	0	0	0	0	0	0	0	0	0	0	0	0	0	0	0	0
8:15 AM - 8:30 AM	0	1	0	0	0	0	0	0	0	0	0	0	0	0	0	0
8:30 AM - 8:45 AM	0	0	0	0	0	0	1	0	0	0	0	0	0	0	0	0
8:45 AM - 9:00 AM	0	0	0	0	0	0	0	0	0	0	0	0	0	0	0	2
TOTAL	0	2	0	0	0	0	1	0	0	0	0	0	0	0	0	2

Time	Northbound Bikes			N.Leg Peds	Southbound Bikes			S.Leg Peds	Eastbound Bikes			E.Leg Peds	Westbound Bikes			W.Leg Peds
	Left	Thru	Right		Left	Thru	Right		Left	Thru	Right		Left	Thru	Right	
4:00 PM - 4:15 PM	0	0	0	0	0	0	0	0	0	0	0	0	0	0	0	0
4:15 PM - 4:30 PM	0	2	0	0	0	0	0	0	0	0	0	1	0	0	0	0
4:30 PM - 4:45 PM	0	0	0	0	0	0	0	0	0	0	0	0	0	0	0	0
4:45 PM - 5:00 PM	0	0	0	0	0	3	0	0	0	0	0	0	0	0	0	4
5:00 PM - 5:15 PM	0	1	0	0	0	0	0	0	0	0	0	0	0	0	0	0
5:15 PM - 5:30 PM	0	1	0	0	0	2	0	0	0	0	0	0	0	0	0	0
5:30 PM - 5:45 PM	0	1	0	0	0	4	0	0	0	0	0	0	0	0	0	0
5:45 PM - 6:00 PM	0	0	0	0	0	1	0	0	0	0	0	1	0	0	0	0
TOTAL	0	5	0	0	0	10	0	0	0	0	0	2	0	0	0	4

PEAK HOUR	Northbound Bikes			N.Leg Peds	Southbound Bikes			S.Leg Peds	Eastbound Bikes			E.Leg Peds	Westbound Bikes			W.Leg Peds
	Left	Thru	Right		Left	Thru	Right		Left	Thru	Right		Left	Thru	Right	
7:30 AM - 8:30 AM	0	2	0	0	0	0	0	0	0	0	0	0	0	0	0	0
4:15 PM - 5:15 PM	0	3	0	0	0	3	0	0	0	0	0	1	0	0	0	4

	Bikes	Peds
AM Peak Total	2	0
PM Peak Total	6	5

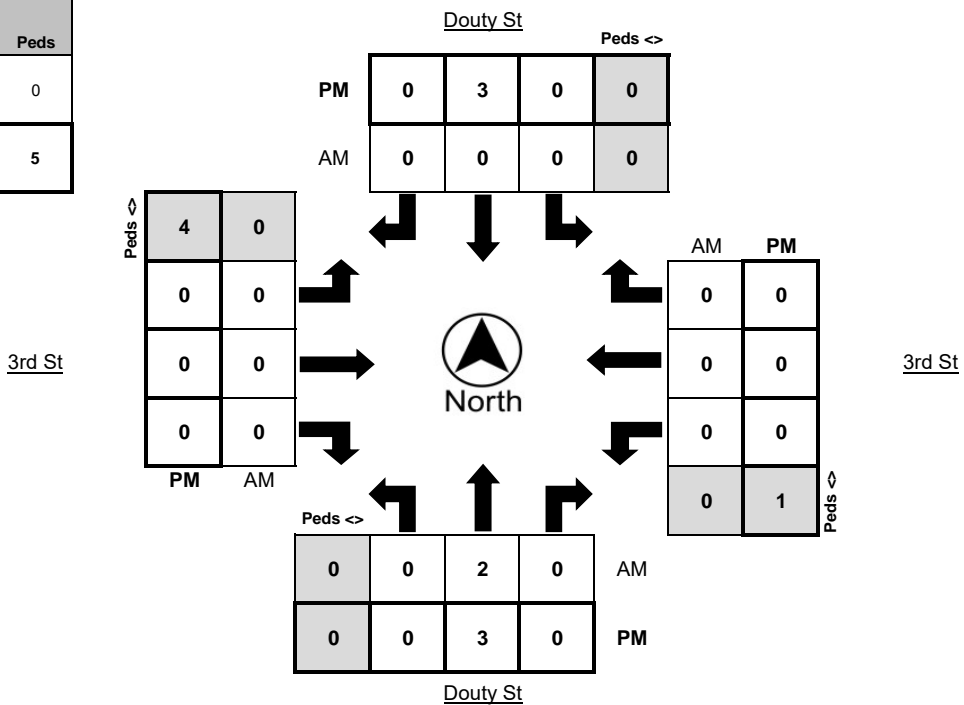



Metro Traffic Data Inc.
 310 N. Irwin Street - Suite 20
 Hanford, CA 93230
 800-975-6938 Phone/Fax
 www.metrotrafficdata.com

24 Hour Volume Report

Prepared For: **JLB Traffic Engineering, Inc.**
 516 W. Shaw Ave, Suite 103
 Fresno, CA 93704

LOCATION SR 198 EB Off-ramp @ Douy St **LATITUDE** 36.3221936
COUNTY Kings **LONGITUDE** -119.6463439
COLLECTION DATE Thursday, March 3, 2022 **WEATHER** Clear
NUMBER OF LANES 1

Hour	Eastbound					Westbound					Hourly Totals
	1st	2nd	3rd	4th	Total	1st	2nd	3rd	4th	Total	
12:00 AM	0	0	0	0	0	0	0	0	0	0	0
1:00 AM	0	0	0	0	0	0	0	0	0	0	0
2:00 AM	0	0	0	0	0	0	0	0	0	0	0
3:00 AM	0	0	0	0	0	0	0	0	0	0	0
4:00 AM	0	0	0	0	0	0	0	0	0	0	0
5:00 AM	0	0	0	0	0	0	0	0	0	0	0
6:00 AM	0	0	0	0	0	0	0	0	0	0	0
7:00 AM	37	72	82	148	339	0	0	0	0	0	339
8:00 AM	112	100	79	60	351	0	0	0	0	0	351
9:00 AM	0	0	0	0	0	0	0	0	0	0	0
10:00 AM	0	0	0	0	0	0	0	0	0	0	0
11:00 AM	0	0	0	0	0	0	0	0	0	0	0
12:00 PM	0	0	0	0	0	0	0	0	0	0	0
1:00 PM	0	0	0	0	0	0	0	0	0	0	0
2:00 PM	0	0	0	0	0	0	0	0	0	0	0
3:00 PM	0	0	0	0	0	0	0	0	0	0	0
4:00 PM	104	105	87	109	405	0	0	0	0	0	405
5:00 PM	91	92	83	94	360	0	0	0	0	0	360
6:00 PM	0	0	0	0	0	0	0	0	0	0	0
7:00 PM	0	0	0	0	0	0	0	0	0	0	0
8:00 PM	0	0	0	0	0	0	0	0	0	0	0
9:00 PM	0	0	0	0	0	0	0	0	0	0	0
10:00 PM	0	0	0	0	0	0	0	0	0	0	0
11:00 PM	0	0	0	0	0	0	0	0	0	0	0
Total	100.0%				1455	0.0%				0	1455

AM% 47.4% **AM Peak** 442 **7:30 am to 8:30 am** **AM P.H.F.** 0.75
PM% 52.6% **PM Peak** 405 **4:00 pm to 5:00 pm** **PM P.H.F.** 0.93

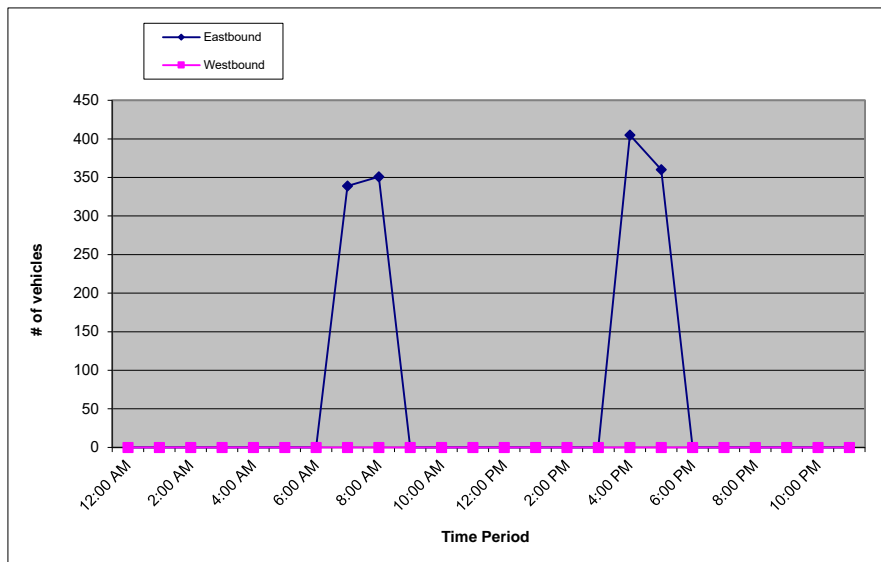



Metro Traffic Data Inc.
 310 N. Irwin Street - Suite 20
 Hanford, CA 93230
 800-975-6938 Phone/Fax
 www.metrotrafficdata.com

Turning Movement Report

Prepared For:

JLB Traffic Engineering, Inc.
 516 W. Shaw Ave, Suite 103
 Fresno, CA 93704

LOCATION 4th St / SR 198 WB Off-ramp @ 10th Ave

LATITUDE 36.3248

COUNTY Kings

LONGITUDE -119.6370

COLLECTION DATE Tuesday, March 1, 2022

WEATHER Clear

Time	Northbound					Southbound					Eastbound					Westbound				
	U-Turn	Left	Thru	Right	Trucks	U-Turn	Left	Thru	Right	Trucks	U-Turn	Left	Thru	Right	Trucks	U-Turn	Left	Thru	Right	Trucks
7:00 AM - 7:15 AM	0	6	78	0	6	0	0	68	40	2	0	0	0	0	0	0	12	5	19	4
7:15 AM - 7:30 AM	0	12	82	0	3	0	0	80	48	4	0	0	0	0	0	0	8	3	32	1
7:30 AM - 7:45 AM	0	11	103	0	2	0	0	91	49	1	0	0	0	0	0	0	10	3	18	0
7:45 AM - 8:00 AM	0	10	150	0	4	0	0	137	62	5	0	0	0	0	0	0	15	14	39	2
8:00 AM - 8:15 AM	0	13	162	0	5	0	0	102	56	7	0	0	0	0	0	0	13	14	14	2
8:15 AM - 8:30 AM	0	3	130	0	6	0	0	86	35	14	0	0	0	0	0	0	9	7	29	1
8:30 AM - 8:45 AM	0	9	57	0	3	0	0	83	41	6	0	0	0	0	0	0	9	6	22	3
8:45 AM - 9:00 AM	0	9	82	0	7	0	0	69	32	8	0	0	0	0	0	0	4	5	26	2
TOTAL	0	73	844	0	36	0	0	716	363	47	0	0	0	0	0	0	80	57	199	15

Time	Northbound					Southbound					Eastbound					Westbound				
	U-Turn	Left	Thru	Right	Trucks	U-Turn	Left	Thru	Right	Trucks	U-Turn	Left	Thru	Right	Trucks	U-Turn	Left	Thru	Right	Trucks
4:00 PM - 4:15 PM	0	13	165	0	4	0	0	135	69	3	0	0	0	0	0	0	15	7	25	3
4:15 PM - 4:30 PM	0	39	172	0	6	0	0	132	49	8	0	0	0	0	0	0	11	11	31	3
4:30 PM - 4:45 PM	0	33	190	0	7	0	0	145	52	2	0	0	0	0	0	0	14	10	23	5
4:45 PM - 5:00 PM	0	16	141	0	5	0	0	107	41	1	0	0	0	0	0	0	14	5	23	2
5:00 PM - 5:15 PM	0	26	158	0	3	0	0	132	42	3	0	0	0	0	0	0	17	4	24	1
5:15 PM - 5:30 PM	0	16	111	0	4	0	0	111	41	2	0	0	0	0	0	0	10	9	27	1
5:30 PM - 5:45 PM	0	8	110	0	1	0	0	86	55	7	0	0	0	0	0	0	16	3	28	2
5:45 PM - 6:00 PM	0	9	96	0	0	0	0	91	46	4	0	0	0	0	0	0	14	6	17	0
TOTAL	0	160	1143	0	30	0	0	939	395	30	0	0	0	0	0	0	111	55	198	17

PEAK HOUR	Northbound					Southbound					Eastbound					Westbound				
	U-Turn	Left	Thru	Right	Trucks	U-Turn	Left	Thru	Right	Trucks	U-Turn	Left	Thru	Right	Trucks	U-Turn	Left	Thru	Right	Trucks
7:30 AM - 8:30 AM	0	37	545	0	17	0	0	416	202	27	0	0	0	0	0	0	47	38	100	5
4:00 PM - 5:00 PM	0	101	668	0	22	0	0	519	211	14	0	0	0	0	0	0	54	33	102	13

	PHF	Trucks
AM	0.811	3.5%
PM	0.904	2.9%

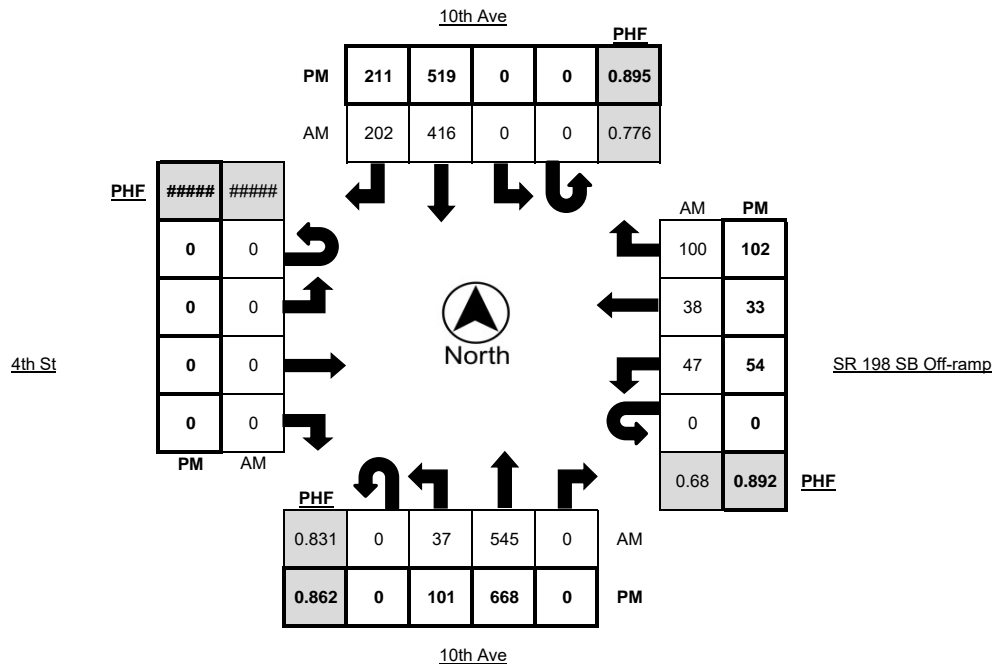



Metro Traffic Data Inc.
 310 N. Irwin Street - Suite 20
 Hanford, CA 93230
 800-975-6938 Phone/Fax
 www.metrotrafficdata.com

Turning Movement Report

Prepared For:

JLB Traffic Engineering, Inc.
 516 W. Shaw Ave, Suite 103
 Fresno, CA 93704

LOCATION 4th St / SR 198 WB Off-ramp @ 10th Ave

LATITUDE 36.3248

COUNTY Kings

LONGITUDE -119.6370

COLLECTION DATE Tuesday, March 1, 2022

WEATHER Clear

Time	Northbound Bikes			N.Leg Peds	Southbound Bikes			S.Leg Peds	Eastbound Bikes			E.Leg Peds	Westbound Bikes			W.Leg Peds	
	Left	Thru	Right		Left	Thru	Right		Left	Thru	Right		Left	Thru	Right		
7:00 AM - 7:15 AM	0	1	0	0	0	0	0	0	0	0	0	0	0	0	0	0	
7:15 AM - 7:30 AM	0	0	0	0	0	0	0	0	0	0	0	0	1	0	0	0	
7:30 AM - 7:45 AM	0	0	0	0	0	0	0	0	0	0	0	1	0	0	0	1	
7:45 AM - 8:00 AM	0	0	0	1	0	0	0	0	0	1	0	0	0	0	0	0	
8:00 AM - 8:15 AM	0	0	0	0	0	0	0	0	0	0	0	1	0	0	0	1	
8:15 AM - 8:30 AM	0	0	0	0	0	0	0	0	0	0	0	0	0	0	0	1	
8:30 AM - 8:45 AM	0	0	0	0	0	0	0	0	0	0	0	0	0	0	0	0	
8:45 AM - 9:00 AM	0	0	0	0	0	0	0	0	0	0	0	0	0	0	0	1	
TOTAL	0	1	0	1	0	0	0	0	0	1	0	1	2	0	0	0	4

Time	Northbound Bikes			N.Leg Peds	Southbound Bikes			S.Leg Peds	Eastbound Bikes			E.Leg Peds	Westbound Bikes			W.Leg Peds	
	Left	Thru	Right		Left	Thru	Right		Left	Thru	Right		Left	Thru	Right		
4:00 PM - 4:15 PM	0	1	0	0	0	0	0	0	0	0	0	0	0	0	0	0	1
4:15 PM - 4:30 PM	0	0	0	0	0	0	0	0	0	0	0	0	0	0	0	0	1
4:30 PM - 4:45 PM	0	0	0	0	0	2	0	0	0	0	0	0	0	0	0	0	0
4:45 PM - 5:00 PM	0	0	0	1	0	2	0	0	0	0	0	2	0	0	0	0	0
5:00 PM - 5:15 PM	0	0	0	0	0	0	0	0	0	0	0	0	0	0	0	0	0
5:15 PM - 5:30 PM	0	0	0	0	0	0	0	0	0	0	0	0	0	0	0	0	0
5:30 PM - 5:45 PM	0	1	0	0	0	0	0	0	0	0	0	0	0	0	0	0	0
5:45 PM - 6:00 PM	0	0	0	0	0	0	0	0	0	0	0	0	0	0	0	0	0
TOTAL	0	2	0	1	0	4	0	0	0	0	0	2	0	0	0	0	2

PEAK HOUR	Northbound Bikes			N.Leg Peds	Southbound Bikes			S.Leg Peds	Eastbound Bikes			E.Leg Peds	Westbound Bikes			W.Leg Peds
	Left	Thru	Right		Left	Thru	Right		Left	Thru	Right		Left	Thru	Right	
7:30 AM - 8:30 AM	0	0	0	1	0	0	0	0	1	0	1	1	0	0	0	3
4:00 PM - 5:00 PM	0	1	0	1	0	4	0	0	0	0	0	2	0	0	0	2

	Bikes	Peds
AM Peak Total	2	5
PM Peak Total	5	5

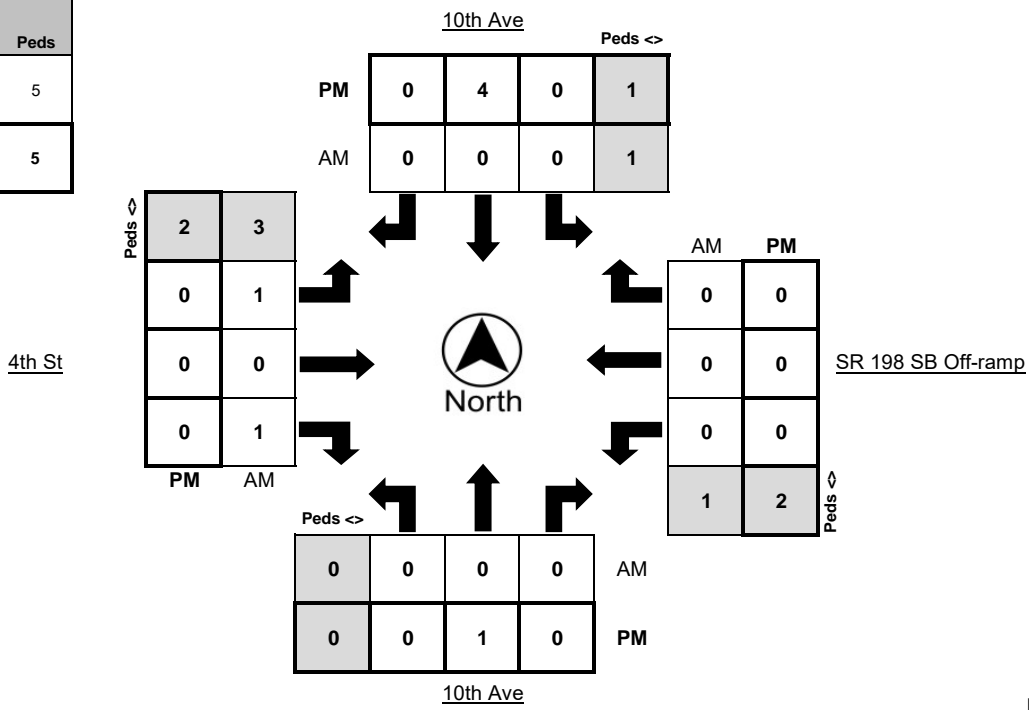



Metro Traffic Data Inc.
 310 N. Irwin Street - Suite 20
 Hanford, CA 93230
 800-975-6938 Phone/Fax
 www.metrotrafficdata.com

Turning Movement Report

Prepared For:

JLB Traffic Engineering, Inc.
 516 W. Shaw Ave, Suite 103
 Fresno, CA 93704

LOCATION Hanford Armona Rd @ 10 1/2 Ave

LATITUDE 36.3134

COUNTY Kings

LONGITUDE -119.6459

COLLECTION DATE Tuesday, January 25, 2022

WEATHER Clear

Time	Northbound					Southbound					Eastbound					Westbound				
	U-Turn	Left	Thru	Right	Trucks	U-Turn	Left	Thru	Right	Trucks	U-Turn	Left	Thru	Right	Trucks	U-Turn	Left	Thru	Right	Trucks
7:00 AM - 7:15 AM	0	0	5	0	1	0	1	1	5	1	0	3	16	3	4	0	6	25	5	4
7:15 AM - 7:30 AM	0	3	5	0	2	0	1	2	6	1	0	5	37	3	5	0	1	29	6	3
7:30 AM - 7:45 AM	0	9	7	6	6	0	1	4	4	0	0	14	48	3	4	0	4	40	5	3
7:45 AM - 8:00 AM	0	20	10	4	0	0	3	2	9	0	0	19	84	1	2	0	3	67	10	2
8:00 AM - 8:15 AM	0	5	3	0	1	0	3	2	11	0	0	14	54	5	2	0	2	65	5	1
8:15 AM - 8:30 AM	0	5	11	1	1	0	4	4	10	2	0	8	40	8	4	0	3	30	2	2
8:30 AM - 8:45 AM	0	10	1	2	1	0	3	5	6	2	0	7	35	4	1	0	3	38	6	1
8:45 AM - 9:00 AM	0	3	4	2	0	0	6	4	7	0	0	10	21	3	2	0	2	25	8	2
TOTAL	0	55	46	15	12	0	22	24	58	6	0	80	335	30	24	0	24	319	47	18

Time	Northbound					Southbound					Eastbound					Westbound				
	U-Turn	Left	Thru	Right	Trucks	U-Turn	Left	Thru	Right	Trucks	U-Turn	Left	Thru	Right	Trucks	U-Turn	Left	Thru	Right	Trucks
4:00 PM - 4:15 PM	0	5	7	3	0	0	9	5	14	1	0	11	62	7	0	0	0	64	8	3
4:15 PM - 4:30 PM	0	2	6	3	1	0	7	3	15	0	0	11	66	6	2	0	0	53	7	1
4:30 PM - 4:45 PM	0	10	5	1	0	0	7	6	14	1	0	13	66	5	2	0	2	63	9	3
4:45 PM - 5:00 PM	0	8	1	0	0	0	8	3	13	0	0	11	91	2	1	0	1	72	9	3
5:00 PM - 5:15 PM	0	2	4	2	0	0	3	2	16	0	0	8	67	5	3	0	2	87	5	0
5:15 PM - 5:30 PM	0	7	6	2	0	0	5	7	13	0	0	12	62	3	2	0	1	63	4	1
5:30 PM - 5:45 PM	0	1	2	0	0	0	4	4	15	0	0	14	65	3	0	0	0	57	11	1
5:45 PM - 6:00 PM	0	4	3	1	0	0	5	6	10	0	0	10	58	1	1	0	0	63	3	2
TOTAL	0	39	34	12	1	0	48	36	110	2	0	90	537	32	11	0	6	522	56	14

PEAK HOUR	Northbound					Southbound					Eastbound					Westbound				
	U-Turn	Left	Thru	Right	Trucks	U-Turn	Left	Thru	Right	Trucks	U-Turn	Left	Thru	Right	Trucks	U-Turn	Left	Thru	Right	Trucks
7:30 AM - 8:30 AM	0	39	31	11	8	0	11	12	34	2	0	55	226	17	12	0	12	202	22	8
4:30 PM - 5:30 PM	0	27	16	5	0	0	23	18	56	1	0	44	286	15	8	0	6	285	27	7

	PHF	Trucks
AM	0.724	4.5%
PM	0.922	2.0%

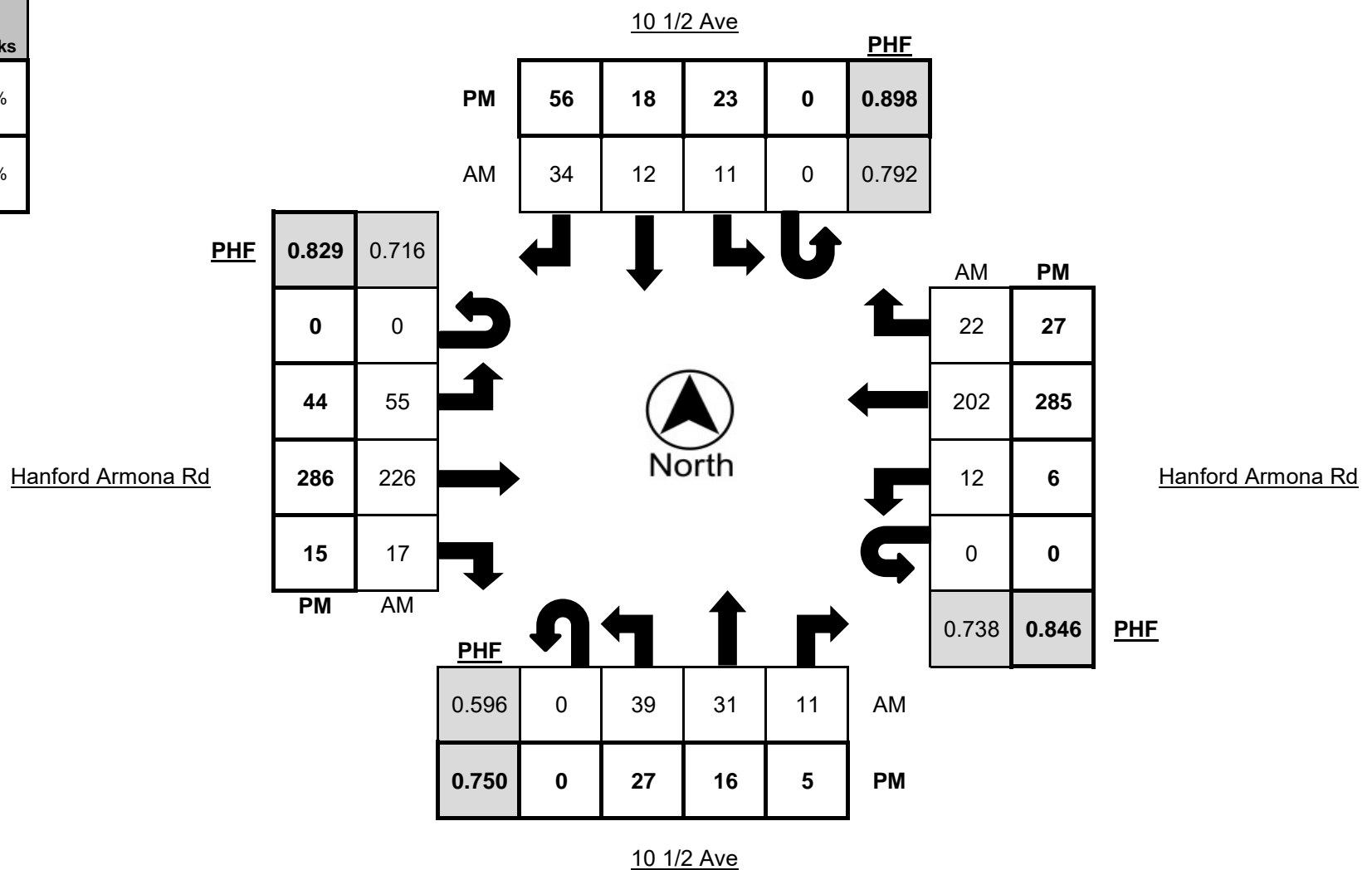



Metro Traffic Data Inc.
 310 N. Irwin Street - Suite 20
 Hanford, CA 93230
 800-975-6938 Phone/Fax
 www.metrotrafficdata.com

Turning Movement Report

Prepared For:

JLB Traffic Engineering, Inc.
 516 W. Shaw Ave, Suite 103
 Fresno, CA 93704

LOCATION Hanford Armona Rd @ 10 1/2 Ave

LATITUDE 36.3134

COUNTY Kings

LONGITUDE -119.6459

COLLECTION DATE Tuesday, January 25, 2022

WEATHER Clear

Time	Northbound Bikes			N.Leg Peds	Southbound Bikes			S.Leg Peds	Eastbound Bikes			E.Leg Peds	Westbound Bikes			W.Leg Peds
	Left	Thru	Right		Left	Thru	Right		Left	Thru	Right		Left	Thru	Right	
7:00 AM - 7:15 AM	0	1	0	0	0	0	0	0	0	0	0	0	0	0	0	0
7:15 AM - 7:30 AM	0	0	0	0	0	0	0	0	0	0	0	0	0	0	0	0
7:30 AM - 7:45 AM	0	0	0	0	0	0	0	0	0	0	0	0	0	0	0	0
7:45 AM - 8:00 AM	0	0	0	1	0	0	0	0	0	0	0	0	0	0	0	0
8:00 AM - 8:15 AM	0	0	0	0	0	0	0	0	0	0	0	0	0	0	0	0
8:15 AM - 8:30 AM	0	0	0	0	0	0	0	0	0	0	0	0	0	0	0	0
8:30 AM - 8:45 AM	0	0	0	3	0	0	0	0	0	0	0	0	0	0	0	0
8:45 AM - 9:00 AM	0	0	0	0	0	0	0	0	0	0	0	0	0	0	0	0
TOTAL	0	1	0	4	0	0	0	0	0	0	0	0	0	0	0	0

Time	Northbound Bikes			N.Leg Peds	Southbound Bikes			S.Leg Peds	Eastbound Bikes			E.Leg Peds	Westbound Bikes			W.Leg Peds
	Left	Thru	Right		Left	Thru	Right		Left	Thru	Right		Left	Thru	Right	
4:00 PM - 4:15 PM	0	0	0	0	0	0	0	0	0	0	0	4	0	0	0	0
4:15 PM - 4:30 PM	0	0	0	0	0	0	0	0	0	0	0	0	0	0	0	0
4:30 PM - 4:45 PM	0	0	0	1	0	1	0	1	0	0	0	0	0	0	0	0
4:45 PM - 5:00 PM	0	1	0	0	0	1	0	1	0	0	0	0	0	0	0	0
5:00 PM - 5:15 PM	0	0	0	0	0	0	0	0	0	1	0	0	0	0	0	0
5:15 PM - 5:30 PM	0	0	0	0	0	0	1	0	0	0	0	0	0	0	0	0
5:30 PM - 5:45 PM	0	0	0	0	0	0	0	0	0	0	0	0	0	1	0	0
5:45 PM - 6:00 PM	0	0	0	0	0	0	0	0	0	1	0	0	0	1	0	0
TOTAL	0	1	0	1	0	2	1	2	0	2	0	4	0	2	0	0

PEAK HOUR	Northbound Bikes			N.Leg Peds	Southbound Bikes			S.Leg Peds	Eastbound Bikes			E.Leg Peds	Westbound Bikes			W.Leg Peds
	Left	Thru	Right		Left	Thru	Right		Left	Thru	Right		Left	Thru	Right	
7:30 AM - 8:30 AM	0	0	0	1	0	0	0	0	0	0	0	0	0	0	0	0
4:30 PM - 5:30 PM	0	1	0	1	0	2	1	2	0	1	0	0	0	0	0	0

	Bikes	Peds
AM Peak Total	0	1
PM Peak Total	5	3

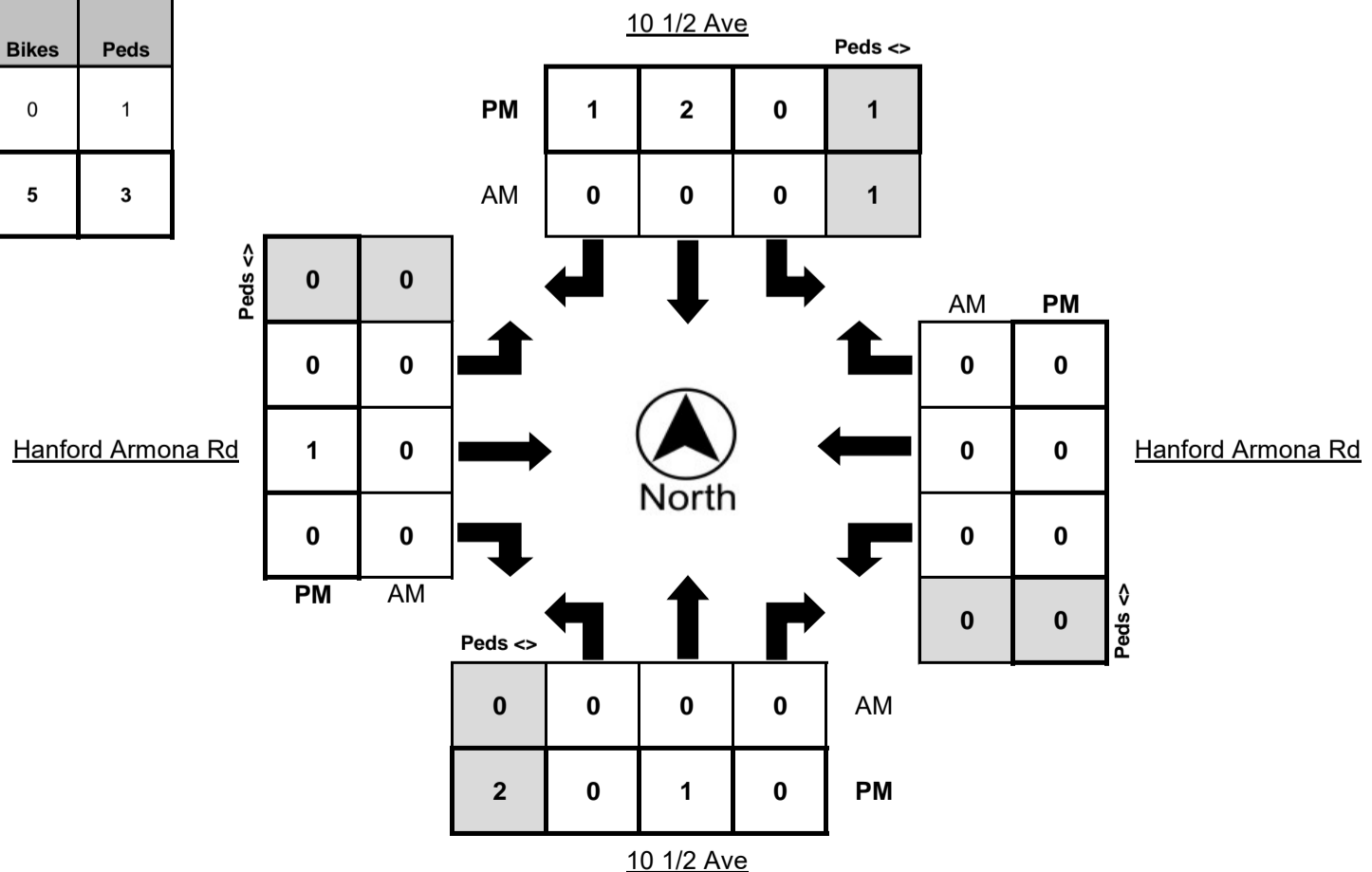



Metro Traffic Data Inc.
 310 N. Irwin Street - Suite 20
 Hanford, CA 93230
 800-975-6938 Phone/Fax
 www.metrotrafficdata.com

Turning Movement Report

Prepared For:

JLB Traffic Engineering, Inc.
 516 W. Shaw Ave, Suite 103
 Fresno, CA 93704

LOCATION Hanford Armona Rd @ Jordan Way

LATITUDE 36.3134

COUNTY Kings

LONGITUDE -119.6404

COLLECTION DATE Wednesday, January 26, 2022

WEATHER Clear

Time	Northbound					Southbound					Eastbound					Westbound				
	U-Turn	Left	Thru	Right	Trucks	U-Turn	Left	Thru	Right	Trucks	U-Turn	Left	Thru	Right	Trucks	U-Turn	Left	Thru	Right	Trucks
7:00 AM - 7:15 AM	0	4	0	1	0	0	0	0	0	0	0	0	13	1	2	0	1	30	0	6
7:15 AM - 7:30 AM	0	1	0	4	1	0	0	0	0	0	0	0	39	1	4	0	0	33	0	3
7:30 AM - 7:45 AM	0	7	0	5	0	0	0	0	0	0	0	0	49	1	5	0	3	40	0	5
7:45 AM - 8:00 AM	0	14	0	7	0	0	0	0	0	0	0	0	66	7	4	0	3	61	0	3
8:00 AM - 8:15 AM	0	6	0	2	0	0	0	0	0	0	0	0	46	9	2	0	5	51	0	2
8:15 AM - 8:30 AM	0	7	0	7	0	0	0	0	0	0	0	0	39	4	5	0	3	26	0	2
8:30 AM - 8:45 AM	0	3	0	4	0	0	0	0	0	0	0	0	34	4	3	0	2	34	0	3
8:45 AM - 9:00 AM	0	4	0	0	0	0	0	0	0	0	0	0	22	5	2	0	2	29	0	2
TOTAL	0	46	0	30	1	0	0	0	0	0	0	0	308	32	27	0	19	304	0	26

Time	Northbound					Southbound					Eastbound					Westbound				
	U-Turn	Left	Thru	Right	Trucks	U-Turn	Left	Thru	Right	Trucks	U-Turn	Left	Thru	Right	Trucks	U-Turn	Left	Thru	Right	Trucks
4:00 PM - 4:15 PM	0	6	0	8	0	0	0	0	0	0	0	0	56	12	0	0	4	61	0	2
4:15 PM - 4:30 PM	0	1	0	2	0	0	0	0	0	0	1	0	62	5	3	0	8	50	0	1
4:30 PM - 4:45 PM	0	9	0	3	0	0	0	0	0	0	0	0	59	6	2	0	3	72	0	5
4:45 PM - 5:00 PM	0	10	0	3	0	0	0	0	0	0	0	0	66	8	2	0	4	68	0	2
5:00 PM - 5:15 PM	0	13	0	6	0	0	0	0	0	0	0	0	70	12	3	0	9	68	0	1
5:15 PM - 5:30 PM	0	7	0	4	0	0	0	0	0	0	0	0	55	10	1	0	11	65	0	0
5:30 PM - 5:45 PM	0	7	0	7	0	0	0	0	0	0	0	0	61	7	0	0	5	57	0	2
5:45 PM - 6:00 PM	0	6	0	6	1	0	0	0	0	0	0	0	49	9	2	0	5	59	0	1
TOTAL	0	59	0	39	1	0	0	0	0	0	1	0	478	69	13	0	49	500	0	14

PEAK HOUR	Northbound					Southbound					Eastbound					Westbound				
	U-Turn	Left	Thru	Right	Trucks	U-Turn	Left	Thru	Right	Trucks	U-Turn	Left	Thru	Right	Trucks	U-Turn	Left	Thru	Right	Trucks
7:30 AM - 8:30 AM	0	34	0	21	0	0	0	0	0	0	0	0	200	21	16	0	14	178	0	12
4:30 PM - 5:30 PM	0	39	0	16	0	0	0	0	0	0	0	0	250	36	8	0	27	273	0	8

	PHF	Trucks
AM	0.741	6.0%
PM	0.900	2.5%

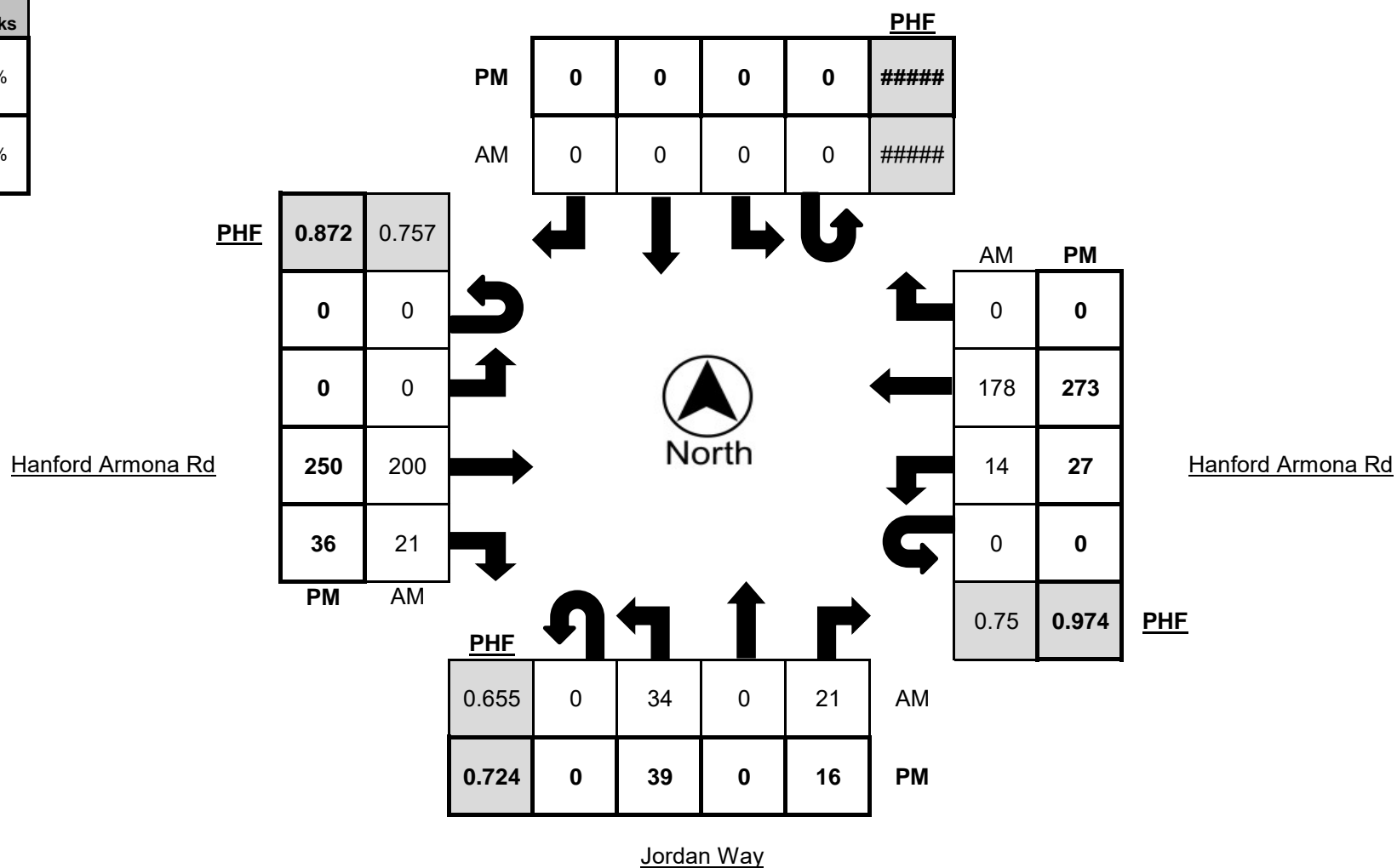



Metro Traffic Data Inc.
 310 N. Irwin Street - Suite 20
 Hanford, CA 93230
 800-975-6938 Phone/Fax
 www.metrotrafficdata.com

Turning Movement Report

Prepared For:

JLB Traffic Engineering, Inc.
 516 W. Shaw Ave, Suite 103
 Fresno, CA 93704

LOCATION Hanford Armona Rd @ Jordan Way

LATITUDE 36.3134

COUNTY Kings

LONGITUDE -119.6404

COLLECTION DATE Wednesday, January 26, 2022

WEATHER Clear

Time	Northbound Bikes			N.Leg Peds	Southbound Bikes			S.Leg Peds	Eastbound Bikes			E.Leg Peds	Westbound Bikes			W.Leg Peds
	Left	Thru	Right		Left	Thru	Right		Left	Thru	Right		Left	Thru	Right	
7:00 AM - 7:15 AM	0	0	0	0	0	0	0	0	0	0	0	0	0	0	0	0
7:15 AM - 7:30 AM	1	0	0	0	0	0	0	0	0	0	0	0	0	0	0	0
7:30 AM - 7:45 AM	0	0	0	0	0	0	0	0	0	0	0	0	0	0	0	0
7:45 AM - 8:00 AM	0	0	0	0	0	0	0	0	0	0	0	0	0	0	0	0
8:00 AM - 8:15 AM	0	0	0	0	0	0	0	0	0	0	0	0	0	0	0	0
8:15 AM - 8:30 AM	0	0	0	0	0	0	0	0	0	0	0	1	0	0	0	0
8:30 AM - 8:45 AM	0	0	0	0	0	0	0	0	0	0	0	0	0	0	0	0
8:45 AM - 9:00 AM	0	0	0	0	0	0	0	0	0	0	0	0	0	0	0	0
TOTAL	1	0	0	0	0	0	0	0	0	0	0	1	0	0	0	0

Time	Northbound Bikes			N.Leg Peds	Southbound Bikes			S.Leg Peds	Eastbound Bikes			E.Leg Peds	Westbound Bikes			W.Leg Peds
	Left	Thru	Right		Left	Thru	Right		Left	Thru	Right		Left	Thru	Right	
4:00 PM - 4:15 PM	0	0	0	0	0	0	0	0	0	0	0	0	0	0	0	0
4:15 PM - 4:30 PM	0	0	0	0	0	0	0	0	4	0	0	0	0	0	0	0
4:30 PM - 4:45 PM	0	0	0	0	0	0	0	0	0	0	0	0	0	0	0	0
4:45 PM - 5:00 PM	0	0	0	0	0	0	0	1	0	0	0	0	0	0	0	0
5:00 PM - 5:15 PM	0	0	0	0	0	0	0	0	0	0	0	0	0	0	0	0
5:15 PM - 5:30 PM	0	0	0	0	0	0	0	1	0	0	0	0	0	0	0	0
5:30 PM - 5:45 PM	0	0	0	0	0	0	0	0	0	0	0	0	0	0	0	0
5:45 PM - 6:00 PM	0	0	0	0	0	0	0	0	0	0	0	0	0	0	0	0
TOTAL	0	0	0	0	0	0	0	6	0	0	0	0	0	0	0	0

PEAK HOUR	Northbound Bikes			N.Leg Peds	Southbound Bikes			S.Leg Peds	Eastbound Bikes			E.Leg Peds	Westbound Bikes			W.Leg Peds
	Left	Thru	Right		Left	Thru	Right		Left	Thru	Right		Left	Thru	Right	
7:30 AM - 8:30 AM	0	0	0	0	0	0	0	0	0	0	0	1	0	0	0	0
4:30 PM - 5:30 PM	0	0	0	0	0	0	0	2	0	0	0	0	0	0	0	0

	Bikes	Peds
AM Peak Total	0	1
PM Peak Total	0	2

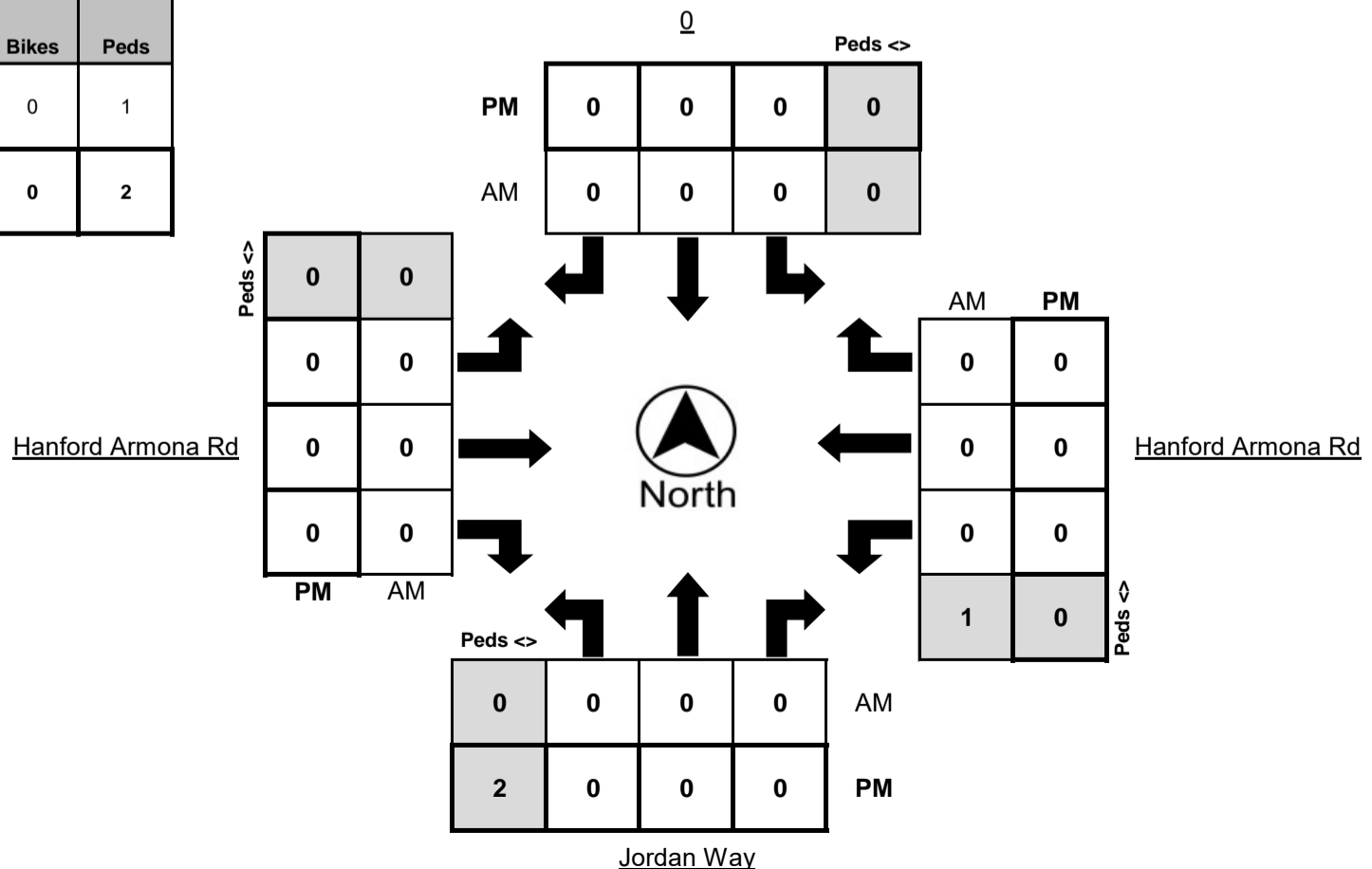



Metro Traffic Data Inc.
 310 N. Irwin Street - Suite 20
 Hanford, CA 93230
 800-975-6938 Phone/Fax
 www.metrotrafficdata.com

Turning Movement Report

Prepared For:

JLB Traffic Engineering, Inc.
 516 W. Shaw Ave, Suite 103
 Fresno, CA 93704

LOCATION Hanford Armona Rd @ 10th Ave

LATITUDE 36.3134

COUNTY Kings

LONGITUDE -119.6370

COLLECTION DATE Thursday, January 27, 2022

WEATHER Clear

Time	Northbound					Southbound					Eastbound					Westbound				
	U-Turn	Left	Thru	Right	Trucks	U-Turn	Left	Thru	Right	Trucks	U-Turn	Left	Thru	Right	Trucks	U-Turn	Left	Thru	Right	Trucks
7:00 AM - 7:15 AM	0	8	23	0	4	0	7	31	24	7	0	9	0	3	1	0	0	1	3	0
7:15 AM - 7:30 AM	0	7	30	1	3	0	5	19	24	3	0	33	2	10	6	0	0	1	4	0
7:30 AM - 7:45 AM	0	12	29	1	4	0	1	37	31	8	0	45	1	5	6	0	0	1	3	1
7:45 AM - 8:00 AM	0	20	39	0	4	0	4	44	47	5	0	58	0	20	3	0	0	0	5	1
8:00 AM - 8:15 AM	0	17	56	0	4	0	0	46	38	5	1	29	0	14	2	0	1	3	4	0
8:15 AM - 8:30 AM	0	5	43	0	2	0	1	27	27	3	0	33	3	11	3	0	2	0	0	0
8:30 AM - 8:45 AM	0	11	32	0	6	0	1	30	27	3	0	30	0	9	2	0	0	0	1	0
8:45 AM - 9:00 AM	0	11	39	1	3	0	1	25	17	5	0	12	0	9	2	0	1	1	1	0
TOTAL	0	91	291	3	30	0	20	259	235	39	1	249	6	81	25	0	4	7	21	2

Time	Northbound					Southbound					Eastbound					Westbound				
	U-Turn	Left	Thru	Right	Trucks	U-Turn	Left	Thru	Right	Trucks	U-Turn	Left	Thru	Right	Trucks	U-Turn	Left	Thru	Right	Trucks
4:00 PM - 4:15 PM	0	18	53	3	2	0	1	52	42	2	0	37	2	22	0	0	0	1	4	0
4:15 PM - 4:30 PM	0	23	53	1	2	0	2	29	31	2	0	37	5	23	2	0	1	3	2	0
4:30 PM - 4:45 PM	0	31	63	0	3	0	2	48	43	6	0	36	5	19	3	0	1	1	1	0
4:45 PM - 5:00 PM	0	27	48	0	1	0	3	33	41	1	0	43	4	19	2	0	1	1	2	0
5:00 PM - 5:15 PM	0	21	40	2	4	0	4	35	51	1	0	42	2	30	3	0	1	4	3	2
5:15 PM - 5:30 PM	0	33	52	3	2	0	7	38	41	0	0	28	4	28	1	0	1	2	2	0
5:30 PM - 5:45 PM	0	19	48	0	1	0	4	44	38	2	0	42	6	19	0	0	1	5	5	0
5:45 PM - 6:00 PM	0	24	31	1	3	0	5	23	35	0	0	27	4	28	1	0	1	8	3	0
TOTAL	0	196	388	10	18	0	28	302	322	14	0	292	32	188	12	0	7	25	22	2

PEAK HOUR	Northbound					Southbound					Eastbound					Westbound				
	U-Turn	Left	Thru	Right	Trucks	U-Turn	Left	Thru	Right	Trucks	U-Turn	Left	Thru	Right	Trucks	U-Turn	Left	Thru	Right	Trucks
7:30 AM - 8:30 AM	0	54	167	1	14	0	6	154	143	21	1	165	4	50	14	0	3	4	12	2
4:30 PM - 5:30 PM	0	112	203	5	10	0	16	154	176	8	0	149	15	96	9	0	4	8	8	2

	PHF	Trucks
AM	0.806	6.7%
PM	0.946	3.1%

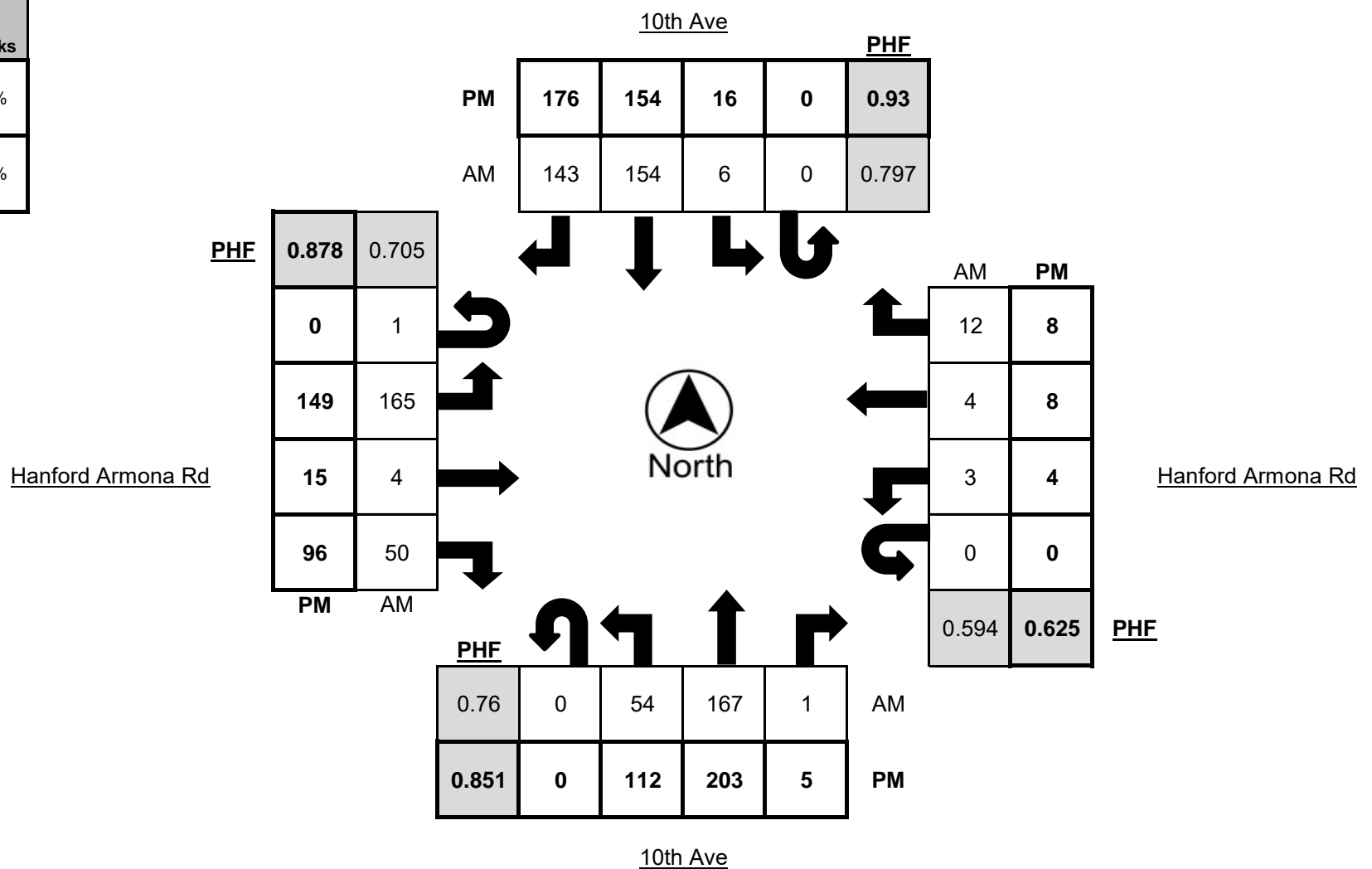



Metro Traffic Data Inc.
 310 N. Irwin Street - Suite 20
 Hanford, CA 93230
 800-975-6938 Phone/Fax
 www.metrotrafficdata.com

Turning Movement Report

Prepared For:

JLB Traffic Engineering, Inc.
 516 W. Shaw Ave, Suite 103
 Fresno, CA 93704

LOCATION Hanford Armona Rd @ 10th Ave

LATITUDE 36.3134

COUNTY Kings

LONGITUDE -119.6370

COLLECTION DATE Thursday, January 27, 2022

WEATHER Clear

Time	Northbound Bikes			N.Leg Peds	Southbound Bikes			S.Leg Peds	Eastbound Bikes			E.Leg Peds	Westbound Bikes			W.Leg Peds
	Left	Thru	Right		Left	Thru	Right		Left	Thru	Right		Left	Thru	Right	
7:00 AM - 7:15 AM	0	0	0	0	0	0	0	0	0	0	0	0	0	0	0	0
7:15 AM - 7:30 AM	0	0	0	0	0	0	0	0	0	0	0	0	0	0	0	0
7:30 AM - 7:45 AM	0	0	0	0	0	0	0	0	0	0	0	0	0	0	0	0
7:45 AM - 8:00 AM	0	0	0	0	0	0	0	0	0	0	0	0	0	0	0	0
8:00 AM - 8:15 AM	0	0	0	0	0	0	0	0	0	0	0	0	0	0	0	0
8:15 AM - 8:30 AM	0	0	0	0	0	0	0	0	0	0	0	0	0	0	0	0
8:30 AM - 8:45 AM	0	0	0	0	0	0	0	0	1	0	0	0	0	0	0	0
8:45 AM - 9:00 AM	1	0	0	0	0	0	0	0	0	0	0	0	0	0	0	0
TOTAL	1	0	0	0	0	0	0	0	1	0	0	0	0	0	0	0

Time	Northbound Bikes			N.Leg Peds	Southbound Bikes			S.Leg Peds	Eastbound Bikes			E.Leg Peds	Westbound Bikes			W.Leg Peds
	Left	Thru	Right		Left	Thru	Right		Left	Thru	Right		Left	Thru	Right	
4:00 PM - 4:15 PM	0	0	0	0	0	0	0	0	0	0	1	0	0	0	0	0
4:15 PM - 4:30 PM	0	0	0	0	0	0	0	2	0	0	0	0	0	0	0	0
4:30 PM - 4:45 PM	0	0	0	0	0	0	0	0	0	0	0	0	0	0	0	2
4:45 PM - 5:00 PM	0	0	0	0	0	0	0	0	0	0	0	0	0	0	0	0
5:00 PM - 5:15 PM	0	0	0	0	0	0	0	0	0	0	0	0	0	0	0	0
5:15 PM - 5:30 PM	0	0	0	0	0	0	2	2	0	0	0	0	0	0	0	1
5:30 PM - 5:45 PM	0	0	0	0	0	0	1	0	0	0	0	0	0	0	0	0
5:45 PM - 6:00 PM	0	0	0	0	0	0	0	0	0	0	0	0	0	0	0	0
TOTAL	0	0	0	0	0	0	3	4	0	0	1	0	0	0	0	3

PEAK HOUR	Northbound Bikes			N.Leg Peds	Southbound Bikes			S.Leg Peds	Eastbound Bikes			E.Leg Peds	Westbound Bikes			W.Leg Peds
	Left	Thru	Right		Left	Thru	Right		Left	Thru	Right		Left	Thru	Right	
7:30 AM - 8:30 AM	0	0	0	0	0	0	0	0	0	0	0	0	0	0	0	0
4:30 PM - 5:30 PM	0	0	0	0	0	0	2	2	0	0	0	0	0	0	0	3

	Bikes	Peds
AM Peak Total	0	0
PM Peak Total	2	5

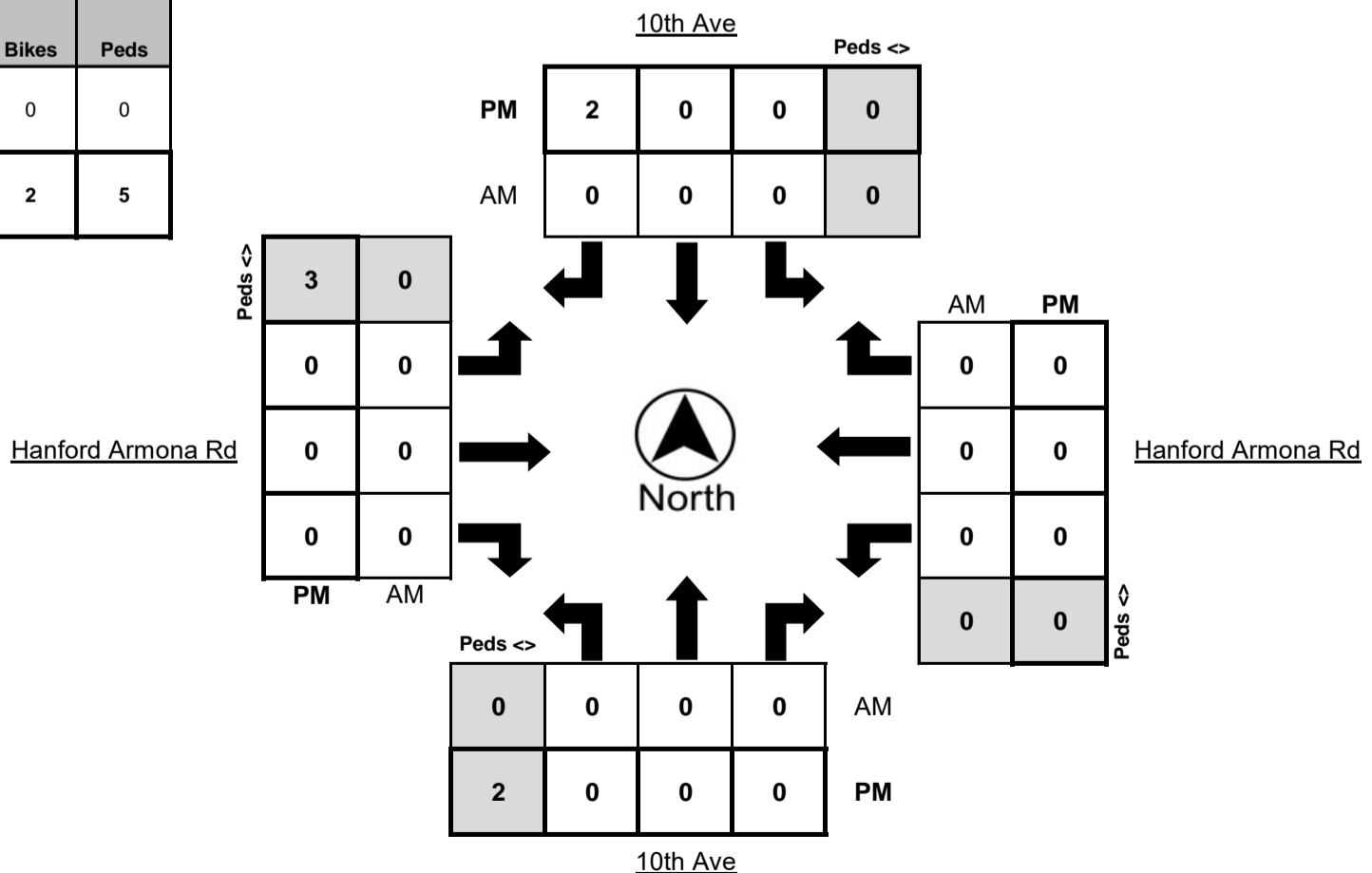



Metro Traffic Data Inc.
 310 N. Irwin Street - Suite 20
 Hanford, CA 93230
 800-975-6938 Phone/Fax
 www.metrotraffdata.com

Turning Movement Report

Prepared For:

JLB Traffic Engineering, Inc.
 516 W. Shaw Ave, Suite 103
 Fresno, CA 93704

LOCATION Houston Ave @ 11th Ave

LATITUDE 36.2983

COUNTY Kings

LONGITUDE -119.6548

COLLECTION DATE Thursday, March 3, 2022

WEATHER Clear

Time	Northbound					Southbound					Eastbound					Westbound				
	U-Turn	Left	Thru	Right	Trucks	U-Turn	Left	Thru	Right	Trucks	U-Turn	Left	Thru	Right	Trucks	U-Turn	Left	Thru	Right	Trucks
7:00 AM - 7:15 AM	0	2	19	6	2	0	5	14	3	1	0	0	6	6	2	0	6	10	9	7
7:15 AM - 7:30 AM	0	5	12	6	7	0	7	20	1	1	0	6	9	11	5	0	3	14	9	4
7:30 AM - 7:45 AM	0	0	20	5	3	0	12	18	8	1	0	8	18	4	1	0	5	15	7	5
7:45 AM - 8:00 AM	0	7	22	4	8	0	6	15	1	1	0	11	13	11	5	0	7	18	7	2
8:00 AM - 8:15 AM	0	6	16	4	7	0	11	12	5	1	0	6	20	5	2	0	9	12	16	7
8:15 AM - 8:30 AM	0	4	15	8	5	0	11	14	7	6	0	7	15	4	5	0	3	12	5	3
8:30 AM - 8:45 AM	0	7	17	4	6	0	9	14	2	2	0	4	11	6	4	0	4	13	8	8
8:45 AM - 9:00 AM	0	3	15	4	5	0	5	11	7	4	0	6	10	10	10	0	8	12	13	7
TOTAL	0	34	136	41	43	0	66	118	34	17	0	48	102	57	34	0	45	106	74	43

Time	Northbound					Southbound					Eastbound					Westbound				
	U-Turn	Left	Thru	Right	Trucks	U-Turn	Left	Thru	Right	Trucks	U-Turn	Left	Thru	Right	Trucks	U-Turn	Left	Thru	Right	Trucks
4:00 PM - 4:15 PM	0	9	31	5	3	0	15	12	13	0	0	4	14	4	2	0	3	21	17	3
4:15 PM - 4:30 PM	0	11	27	3	1	0	15	24	1	2	0	7	22	3	1	0	8	22	17	1
4:30 PM - 4:45 PM	0	6	43	2	5	0	10	8	6	0	0	2	28	7	2	0	1	20	26	2
4:45 PM - 5:00 PM	0	7	29	9	5	0	11	26	7	0	1	4	19	6	2	0	3	23	15	3
5:00 PM - 5:15 PM	0	9	60	10	6	0	12	20	6	0	0	8	24	2	0	0	6	31	16	1
5:15 PM - 5:30 PM	0	6	15	1	3	0	9	15	2	0	0	7	11	3	0	0	6	18	13	1
5:30 PM - 5:45 PM	0	5	19	2	1	0	6	14	7	0	0	4	16	4	0	0	1	13	10	1
5:45 PM - 6:00 PM	0	5	14	2	2	0	12	13	6	0	1	10	13	6	1	0	1	9	19	0
TOTAL	0	58	238	34	26	0	90	132	48	2	2	46	147	35	8	0	29	157	133	12

PEAK HOUR	Northbound					Southbound					Eastbound					Westbound				
	U-Turn	Left	Thru	Right	Trucks	U-Turn	Left	Thru	Right	Trucks	U-Turn	Left	Thru	Right	Trucks	U-Turn	Left	Thru	Right	Trucks
7:30 AM - 8:30 AM	0	17	73	21	23	0	40	59	21	9	0	32	66	24	13	0	24	57	35	17
4:15 PM - 5:15 PM	0	33	159	24	17	0	48	78	20	2	1	21	93	18	5	0	18	96	74	7

	PHF	Trucks
AM	0.961	13.2%
PM	0.837	4.5%

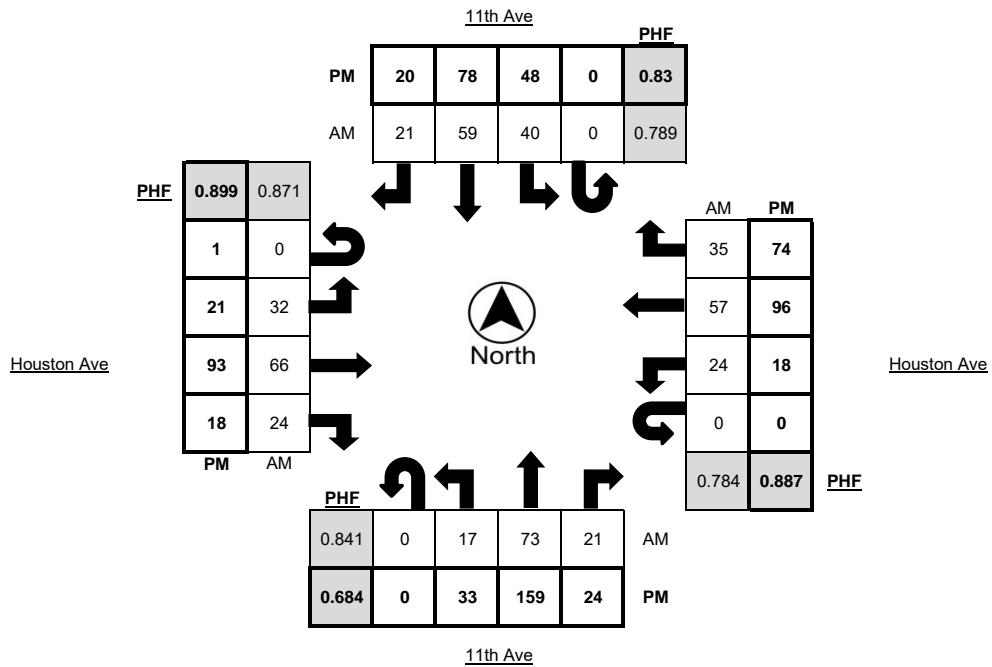



Metro Traffic Data Inc.
 310 N. Irwin Street - Suite 20
 Hanford, CA 93230
 800-975-6938 Phone/Fax
 www.metrotrafficdata.com

Turning Movement Report

Prepared For:

JLB Traffic Engineering, Inc.
 516 W. Shaw Ave, Suite 103
 Fresno, CA 93704

LOCATION Houston Ave @ 11th Ave

LATITUDE 36.2983

COUNTY Kings

LONGITUDE -119.6548

COLLECTION DATE Thursday, March 3, 2022

WEATHER Clear

Time	Northbound Bikes			N.Leg Peds	Southbound Bikes			S.Leg Peds	Eastbound Bikes			E.Leg Peds	Westbound Bikes			W.Leg Peds
	Left	Thru	Right		Left	Thru	Right		Left	Thru	Right		Left	Thru	Right	
7:00 AM - 7:15 AM	0	0	0	0	0	0	0	0	0	0	0	0	0	0	0	0
7:15 AM - 7:30 AM	0	0	0	0	0	0	0	0	0	0	0	0	0	0	0	0
7:30 AM - 7:45 AM	0	0	0	0	0	0	0	0	0	0	0	0	0	0	0	0
7:45 AM - 8:00 AM	0	0	0	0	0	0	0	0	0	0	0	0	0	0	0	0
8:00 AM - 8:15 AM	0	0	0	0	0	0	0	0	0	0	0	0	0	0	0	0
8:15 AM - 8:30 AM	0	0	0	0	0	0	0	0	0	0	0	0	0	0	0	0
8:30 AM - 8:45 AM	0	0	0	0	0	0	0	0	0	0	0	0	0	0	0	0
8:45 AM - 9:00 AM	0	0	0	0	0	0	0	0	0	0	0	0	0	0	0	0
TOTAL	0	0	0	0	0	0	0	0	0	0	0	0	0	0	0	0

Time	Northbound Bikes			N.Leg Peds	Southbound Bikes			S.Leg Peds	Eastbound Bikes			E.Leg Peds	Westbound Bikes			W.Leg Peds
	Left	Thru	Right		Left	Thru	Right		Left	Thru	Right		Left	Thru	Right	
4:00 PM - 4:15 PM	0	0	0	0	0	0	0	0	0	0	0	0	0	0	0	0
4:15 PM - 4:30 PM	0	0	0	0	0	0	0	0	0	0	0	0	0	0	0	0
4:30 PM - 4:45 PM	0	0	0	0	0	0	0	0	0	0	0	0	0	0	0	0
4:45 PM - 5:00 PM	0	0	0	0	0	0	0	0	0	0	0	0	0	0	0	0
5:00 PM - 5:15 PM	0	0	0	0	0	0	0	0	0	0	0	0	0	0	0	0
5:15 PM - 5:30 PM	0	0	0	0	0	0	0	0	0	0	0	0	0	0	0	0
5:30 PM - 5:45 PM	0	0	0	0	0	0	0	0	0	0	0	0	0	0	0	0
5:45 PM - 6:00 PM	0	0	0	0	0	0	0	0	0	0	0	0	0	0	0	0
TOTAL	0	0	0	0	0	0	0	0	0	0	0	0	0	0	0	0

PEAK HOUR	Northbound Bikes			N.Leg Peds	Southbound Bikes			S.Leg Peds	Eastbound Bikes			E.Leg Peds	Westbound Bikes			W.Leg Peds
	Left	Thru	Right		Left	Thru	Right		Left	Thru	Right		Left	Thru	Right	
7:30 AM - 8:30 AM	0	0	0	0	0	0	0	0	0	0	0	0	0	0	0	0
4:15 PM - 5:15 PM	0	0	0	0	0	0	0	0	0	0	0	0	0	0	0	0

	Bikes	Peds
AM Peak Total	0	0
PM Peak Total	0	0

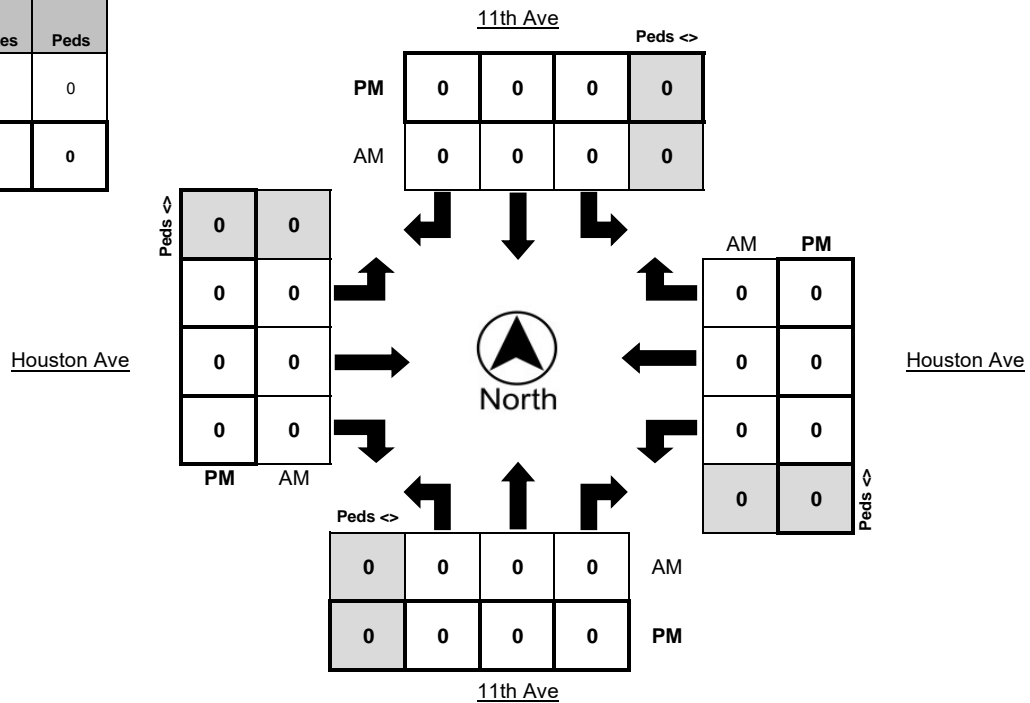



Metro Traffic Data Inc.
 310 N. Irwin Street - Suite 20
 Hanford, CA 93230
 800-975-6938 Phone/Fax
 www.metrotrafficdata.com

Turning Movement Report

Prepared For:

JLB Traffic Engineering, Inc.
 516 W. Shaw Ave, Suite 103
 Fresno, CA 93704

LOCATION Houston Ave @ 10 1/2 Ave

LATITUDE 36.2985

COUNTY Kings

LONGITUDE -119.6459

COLLECTION DATE Friday, January 28, 2022

WEATHER Clear

Time	Northbound					Southbound					Eastbound					Westbound				
	U-Turn	Left	Thru	Right	Trucks	U-Turn	Left	Thru	Right	Trucks	U-Turn	Left	Thru	Right	Trucks	U-Turn	Left	Thru	Right	Trucks
7:00 AM - 7:15 AM	0	0	0	0	0	0	1	0	4	1	0	2	20	0	5	0	0	28	2	5
7:15 AM - 7:30 AM	0	0	0	0	0	0	0	0	1	0	0	2	17	0	5	0	0	25	2	4
7:30 AM - 7:45 AM	0	0	0	0	0	0	1	0	4	0	0	3	6	0	0	0	0	19	6	6
7:45 AM - 8:00 AM	0	0	0	0	0	0	1	0	1	0	0	1	22	0	6	0	0	13	16	2
8:00 AM - 8:15 AM	0	0	0	0	0	0	1	0	1	0	0	1	17	0	5	0	0	26	3	6
8:15 AM - 8:30 AM	0	0	0	0	0	0	2	0	0	0	0	6	32	0	6	0	0	20	2	6
8:30 AM - 8:45 AM	0	0	0	0	0	0	4	0	5	2	0	1	23	0	5	0	0	21	1	4
8:45 AM - 9:00 AM	0	0	0	0	0	0	2	0	1	0	0	0	17	0	2	0	0	19	1	0
TOTAL	0	0	0	0	0	0	12	0	17	3	0	16	154	0	34	0	0	171	33	33

Time	Northbound					Southbound					Eastbound					Westbound				
	U-Turn	Left	Thru	Right	Trucks	U-Turn	Left	Thru	Right	Trucks	U-Turn	Left	Thru	Right	Trucks	U-Turn	Left	Thru	Right	Trucks
4:00 PM - 4:15 PM	0	0	0	0	0	0	3	0	4	0	0	4	24	0	1	0	0	37	5	3
4:15 PM - 4:30 PM	0	0	0	0	0	0	7	0	3	0	0	3	29	0	2	0	0	28	7	1
4:30 PM - 4:45 PM	0	0	0	0	0	0	4	0	2	0	0	2	26	0	0	0	0	39	4	2
4:45 PM - 5:00 PM	0	0	0	0	0	0	3	0	2	1	0	1	27	0	2	0	0	31	1	2
5:00 PM - 5:15 PM	0	0	0	0	0	0	3	0	1	0	0	3	28	0	0	0	0	36	4	0
5:15 PM - 5:30 PM	0	0	0	0	0	0	7	0	5	0	0	2	26	0	0	0	0	28	12	0
5:30 PM - 5:45 PM	0	0	0	0	0	0	2	0	3	0	0	1	28	0	0	0	0	25	1	2
5:45 PM - 6:00 PM	0	0	0	0	0	0	2	0	3	0	0	4	21	0	1	0	0	27	1	0
TOTAL	0	0	0	0	0	0	31	0	23	1	0	20	209	0	6	0	0	251	35	10

PEAK HOUR	Northbound					Southbound					Eastbound					Westbound				
	U-Turn	Left	Thru	Right	Trucks	U-Turn	Left	Thru	Right	Trucks	U-Turn	Left	Thru	Right	Trucks	U-Turn	Left	Thru	Right	Trucks
7:45 AM - 8:45 AM	0	0	0	0	0	0	8	0	7	2	0	9	94	0	22	0	0	80	22	18
4:30 PM - 5:30 PM	0	0	0	0	0	0	17	0	10	1	0	8	107	0	2	0	0	134	21	4

	PHF	Trucks
AM	0.887	19.1%
PM	0.928	2.4%

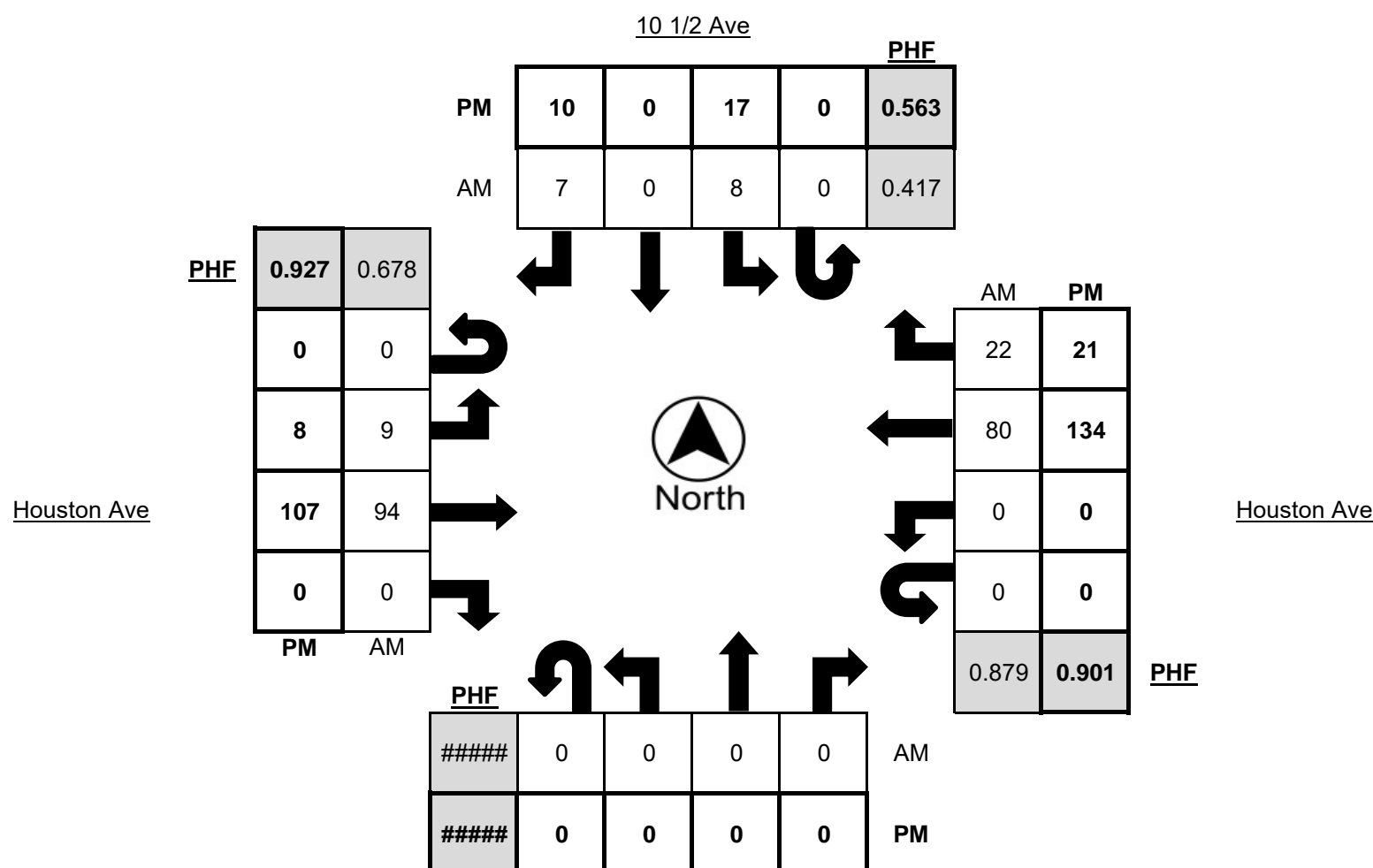



Metro Traffic Data Inc.
 310 N. Irwin Street - Suite 20
 Hanford, CA 93230
 800-975-6938 Phone/Fax
 www.metrotrafficdata.com

Turning Movement Report

Prepared For:

JLB Traffic Engineering, Inc.
 516 W. Shaw Ave, Suite 103
 Fresno, CA 93704

LOCATION Houston Ave @ 10 1/2 Ave

LATITUDE 36.2985

COUNTY Kings

LONGITUDE -119.6459

COLLECTION DATE Friday, January 28, 2022

WEATHER Clear

Time	Northbound Bikes			N.Leg Peds	Southbound Bikes			S.Leg Peds	Eastbound Bikes			E.Leg Peds	Westbound Bikes			W.Leg Peds
	Left	Thru	Right		Left	Thru	Right		Left	Thru	Right		Left	Thru	Right	
7:00 AM - 7:15 AM	0	0	0	0	0	0	0	0	0	0	0	0	0	0	0	0
7:15 AM - 7:30 AM	0	0	0	0	0	0	0	0	0	0	0	0	0	0	0	0
7:30 AM - 7:45 AM	0	0	0	0	0	0	0	0	0	0	0	0	0	0	0	0
7:45 AM - 8:00 AM	0	0	0	0	0	0	0	0	0	0	0	0	0	0	0	0
8:00 AM - 8:15 AM	0	0	0	0	0	0	0	0	0	0	0	0	0	0	0	0
8:15 AM - 8:30 AM	0	0	0	0	0	0	0	0	0	0	0	0	0	0	0	0
8:30 AM - 8:45 AM	0	0	0	0	0	0	0	0	0	0	0	0	0	0	0	0
8:45 AM - 9:00 AM	0	0	0	0	0	0	0	0	0	0	0	0	0	0	0	0
TOTAL	0	0	0	0	0	0	0	0	0	0	0	0	0	0	0	0

Time	Northbound Bikes			N.Leg Peds	Southbound Bikes			S.Leg Peds	Eastbound Bikes			E.Leg Peds	Westbound Bikes			W.Leg Peds
	Left	Thru	Right		Left	Thru	Right		Left	Thru	Right		Left	Thru	Right	
4:00 PM - 4:15 PM	0	0	0	1	0	0	0	0	0	0	0	0	0	0	0	0
4:15 PM - 4:30 PM	0	0	0	0	0	0	0	0	0	0	0	0	0	0	0	0
4:30 PM - 4:45 PM	0	0	0	0	0	0	0	0	0	0	0	0	0	0	0	0
4:45 PM - 5:00 PM	0	0	0	0	1	0	0	0	0	0	0	0	0	0	0	0
5:00 PM - 5:15 PM	0	0	0	0	0	0	0	0	0	0	0	0	0	0	0	0
5:15 PM - 5:30 PM	0	0	0	0	0	0	0	0	0	0	0	0	0	0	0	0
5:30 PM - 5:45 PM	0	0	0	0	0	0	0	0	0	0	0	0	0	0	0	0
5:45 PM - 6:00 PM	0	0	0	0	0	0	0	0	0	0	0	0	0	0	0	0
TOTAL	0	0	0	1	1	0	0	0	0	0	0	0	0	0	0	0

PEAK HOUR	Northbound Bikes			N.Leg Peds	Southbound Bikes			S.Leg Peds	Eastbound Bikes			E.Leg Peds	Westbound Bikes			W.Leg Peds
	Left	Thru	Right		Left	Thru	Right		Left	Thru	Right		Left	Thru	Right	
7:45 AM - 8:45 AM	0	0	0	0	0	0	0	0	0	0	0	0	0	0	0	0
4:30 PM - 5:30 PM	0	0	0	0	1	0	0	0	0	0	0	0	0	0	0	0

	Bikes	Peds
AM Peak Total	0	0
PM Peak Total	1	0

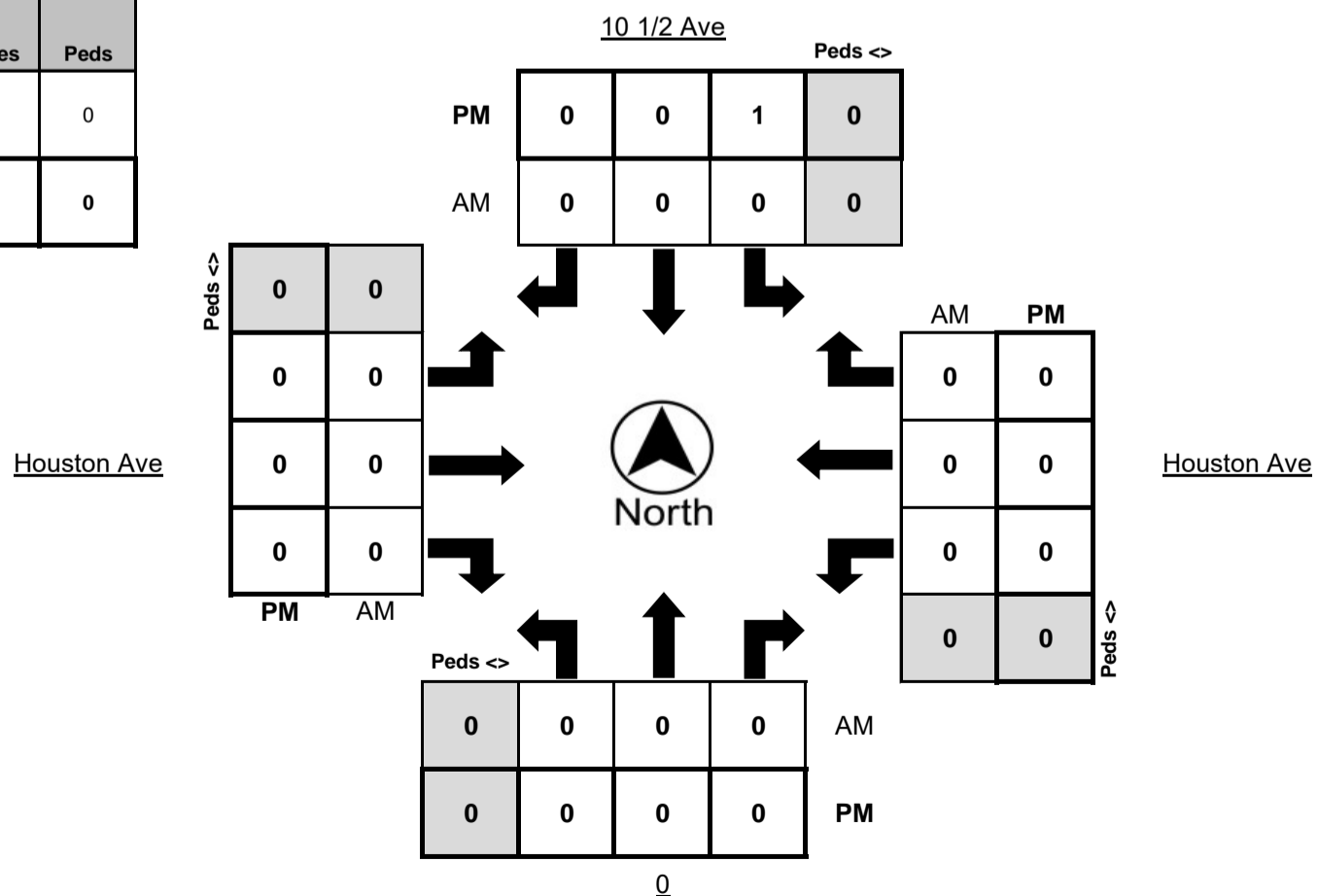



Metro Traffic Data Inc.
 310 N. Irwin Street - Suite 20
 Hanford, CA 93230
 800-975-6938 Phone/Fax
 www.metrotrafficdata.com

Turning Movement Report

Prepared For:

JLB Traffic Engineering, Inc.
 516 W. Shaw Ave, Suite 103
 Fresno, CA 93704

LOCATION Houston Ave @ 10th Ave

LATITUDE 36.2987

COUNTY Kings

LONGITUDE -119.6370

COLLECTION DATE Tuesday, February 1, 2022

WEATHER Clear

Time	Northbound					Southbound					Eastbound					Westbound				
	U-Turn	Left	Thru	Right	Trucks	U-Turn	Left	Thru	Right	Trucks	U-Turn	Left	Thru	Right	Trucks	U-Turn	Left	Thru	Right	Trucks
7:00 AM - 7:15 AM	0	0	11	3	1	0	8	14	9	3	0	3	7	2	2	0	2	11	1	4
7:15 AM - 7:30 AM	0	3	7	1	0	0	5	16	4	2	0	6	12	2	6	0	8	15	2	4
7:30 AM - 7:45 AM	0	0	11	1	2	0	0	18	13	7	0	8	18	3	13	0	5	12	2	3
7:45 AM - 8:00 AM	0	4	17	2	4	0	2	18	13	9	0	4	18	6	8	0	4	14	3	3
8:00 AM - 8:15 AM	0	7	15	1	1	0	5	14	7	7	0	10	15	7	12	0	1	18	1	6
8:15 AM - 8:30 AM	0	2	15	1	2	0	6	11	6	7	0	7	12	2	11	0	2	12	7	3
8:30 AM - 8:45 AM	0	1	5	0	0	0	4	15	7	6	0	5	11	4	9	0	3	13	3	8
8:45 AM - 9:00 AM	0	1	13	4	4	0	2	8	3	4	0	3	11	1	6	0	0	11	4	6
TOTAL	0	18	94	13	14	0	32	114	62	45	0	46	104	27	67	0	25	106	23	37

Time	Northbound					Southbound					Eastbound					Westbound				
	U-Turn	Left	Thru	Right	Trucks	U-Turn	Left	Thru	Right	Trucks	U-Turn	Left	Thru	Right	Trucks	U-Turn	Left	Thru	Right	Trucks
4:00 PM - 4:15 PM	0	3	27	3	3	0	10	12	11	3	0	10	22	2	5	0	1	19	13	4
4:15 PM - 4:30 PM	0	4	34	1	2	0	9	14	9	2	0	10	20	5	4	0	2	14	13	3
4:30 PM - 4:45 PM	0	12	19	2	2	0	15	15	6	1	0	7	18	3	0	0	3	22	11	4
4:45 PM - 5:00 PM	0	3	20	3	1	0	6	24	10	2	0	7	14	3	1	0	0	27	14	1
5:00 PM - 5:15 PM	0	4	28	2	2	0	11	17	10	0	0	5	20	4	4	0	3	22	10	0
5:15 PM - 5:30 PM	0	6	19	4	3	0	13	13	4	1	0	12	9	1	1	0	3	14	12	2
5:30 PM - 5:45 PM	0	6	20	1	3	0	7	10	6	0	0	4	9	3	1	0	1	17	4	3
5:45 PM - 6:00 PM	0	5	16	4	1	0	5	14	2	1	0	2	10	9	1	0	1	10	4	1
TOTAL	0	43	183	20	17	0	76	119	58	10	0	57	122	30	17	0	14	145	81	18

PEAK HOUR	Northbound					Southbound					Eastbound					Westbound				
	U-Turn	Left	Thru	Right	Trucks	U-Turn	Left	Thru	Right	Trucks	U-Turn	Left	Thru	Right	Trucks	U-Turn	Left	Thru	Right	Trucks
7:30 AM - 8:30 AM	0	13	58	5	9	0	13	61	39	30	0	29	63	18	44	0	12	56	13	15
4:15 PM - 5:15 PM	0	23	101	8	7	0	41	70	35	5	0	29	72	15	9	0	8	85	48	8

	PHF	Trucks
AM	0.905	25.8%
PM	0.983	5.4%

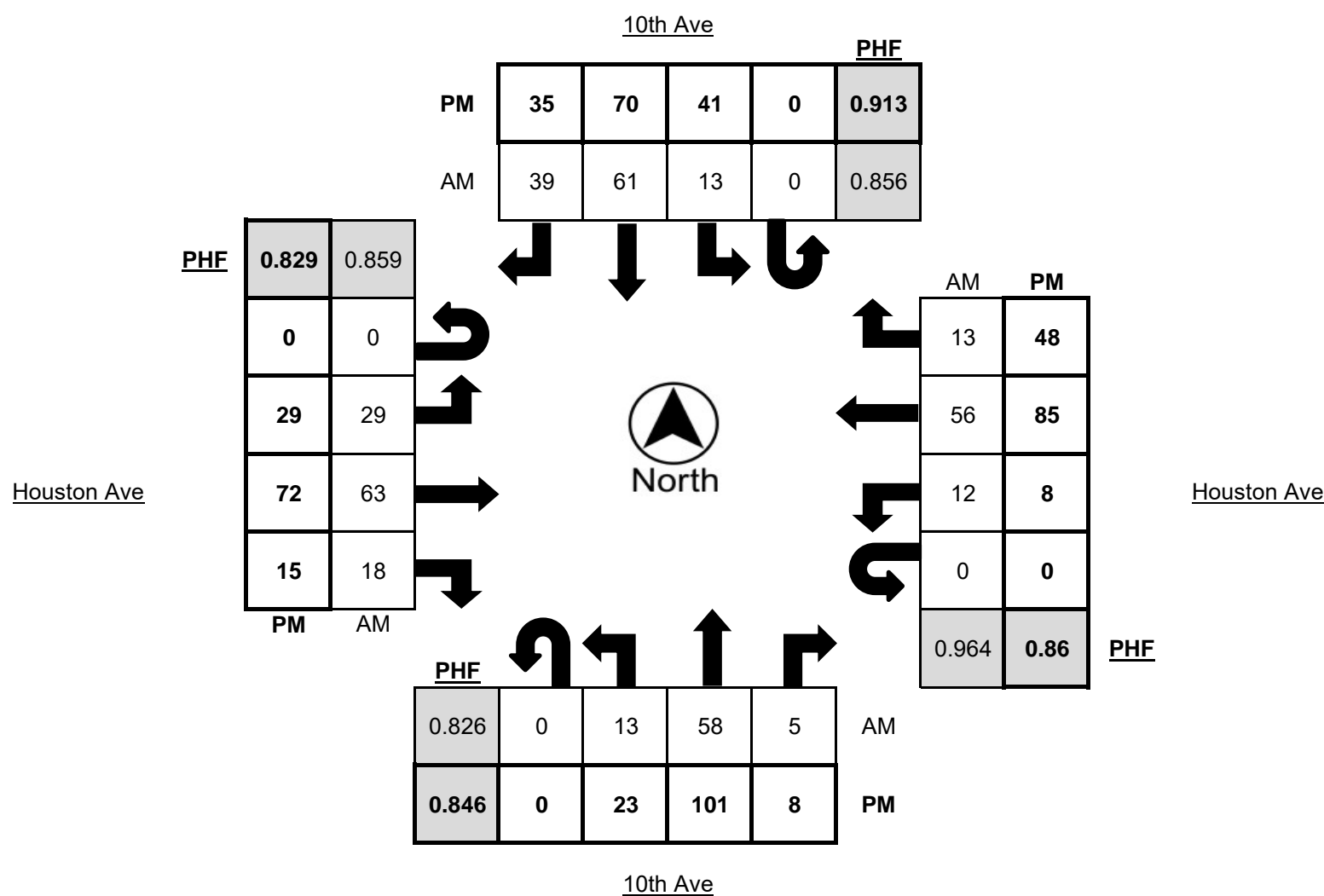



Metro Traffic Data Inc.
 310 N. Irwin Street - Suite 20
 Hanford, CA 93230
 800-975-6938 Phone/Fax
 www.metrotrafficdata.com

Turning Movement Report

Prepared For:

JLB Traffic Engineering, Inc.
 516 W. Shaw Ave, Suite 103
 Fresno, CA 93704

LOCATION Houston Ave @ 10th Ave

LATITUDE 36.2987

COUNTY Kings

LONGITUDE -119.6370

COLLECTION DATE Tuesday, February 1, 2022

WEATHER Clear

Time	Northbound Bikes			N.Leg Peds	Southbound Bikes			S.Leg Peds	Eastbound Bikes			E.Leg Peds	Westbound Bikes			W.Leg Peds
	Left	Thru	Right		Left	Thru	Right		Left	Thru	Right		Left	Thru	Right	
7:00 AM - 7:15 AM	0	0	0	0	0	0	0	0	0	0	0	0	0	0	0	0
7:15 AM - 7:30 AM	0	0	0	0	0	0	0	0	0	0	0	0	0	0	0	0
7:30 AM - 7:45 AM	0	0	0	0	0	0	0	0	0	0	0	0	0	0	0	0
7:45 AM - 8:00 AM	0	0	0	0	0	0	0	0	0	0	0	0	0	0	0	0
8:00 AM - 8:15 AM	0	0	0	0	0	0	0	0	0	0	0	0	0	0	0	0
8:15 AM - 8:30 AM	0	0	0	0	0	0	0	0	0	0	0	0	0	0	0	0
8:30 AM - 8:45 AM	0	0	0	0	0	0	0	0	0	0	0	0	0	0	0	0
8:45 AM - 9:00 AM	0	0	0	0	0	0	0	0	0	0	0	0	0	0	0	0
TOTAL	0	0	0	0	0	0	0	0	0	0	0	0	0	0	0	0

Time	Northbound Bikes			N.Leg Peds	Southbound Bikes			S.Leg Peds	Eastbound Bikes			E.Leg Peds	Westbound Bikes			W.Leg Peds
	Left	Thru	Right		Left	Thru	Right		Left	Thru	Right		Left	Thru	Right	
4:00 PM - 4:15 PM	0	0	0	4	0	0	0	0	0	0	0	1	0	0	0	0
4:15 PM - 4:30 PM	0	0	0	2	0	0	0	0	0	0	0	0	0	0	0	0
4:30 PM - 4:45 PM	0	0	0	0	0	0	0	0	0	0	0	0	0	0	0	1
4:45 PM - 5:00 PM	0	0	0	2	0	0	0	0	0	0	0	0	0	0	0	0
5:00 PM - 5:15 PM	0	0	0	0	0	0	0	0	0	0	0	0	0	0	0	0
5:15 PM - 5:30 PM	0	0	0	0	0	0	0	0	0	0	0	0	0	0	0	0
5:30 PM - 5:45 PM	0	0	0	0	0	0	0	0	0	0	0	0	0	0	0	0
5:45 PM - 6:00 PM	0	0	0	0	0	0	0	0	0	0	0	0	0	0	0	0
TOTAL	0	0	0	8	0	0	0	0	0	0	0	1	0	0	0	1

PEAK HOUR	Northbound Bikes			N.Leg Peds	Southbound Bikes			S.Leg Peds	Eastbound Bikes			E.Leg Peds	Westbound Bikes			W.Leg Peds
	Left	Thru	Right		Left	Thru	Right		Left	Thru	Right		Left	Thru	Right	
7:30 AM - 8:30 AM	0	0	0	0	0	0	0	0	0	0	0	0	0	0	0	0
4:15 PM - 5:15 PM	0	0	0	4	0	0	0	0	0	0	0	0	0	0	0	1

	Bikes	Peds
AM Peak Total	0	0
PM Peak Total	0	5

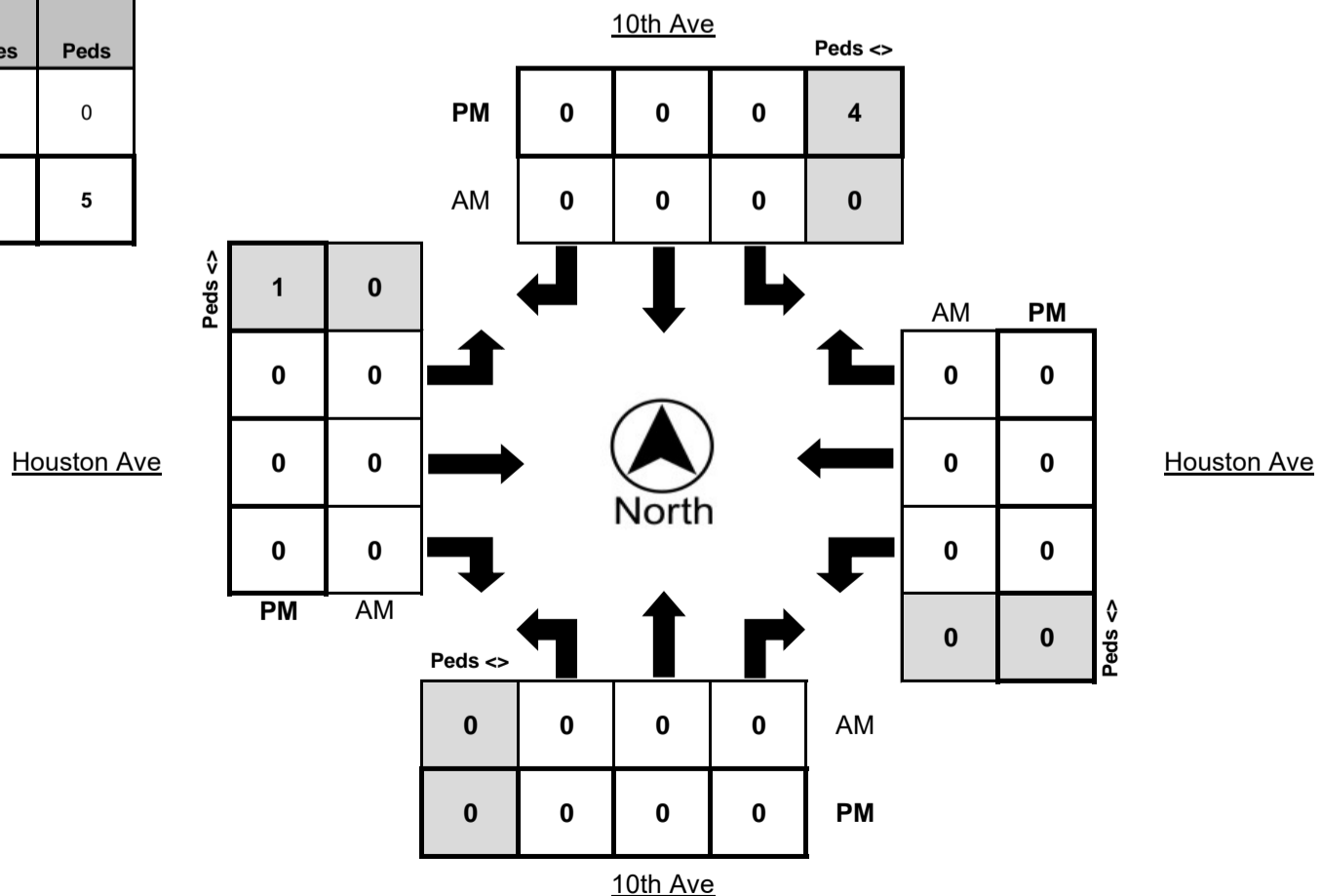



Metro Traffic Data Inc.
 310 N. Irwin Street - Suite 20
 Hanford, CA 93230
 800-975-6938 Phone/Fax
 www.metrotrafficdata.com

24 Hour Volume Report

Prepared For: **JLB Traffic Engineering, Inc.**
 516 W. Shaw Ave, Suite 103
 Fresno, CA 93704

LOCATION 10 1/2 Ave approx 400' south of Highland St

LATITUDE 36.309484

COUNTY Kings

LONGITUDE -119.6459607

DATE Tuesday, January 25, 2022

WEATHER Clear

NUMBER OF LANES 2

Hour	Northbound					Southbound					Hourly Totals
	1st	2nd	3rd	4th	Total	1st	2nd	3rd	4th	Total	
12:00 AM	1	0	0	0	1	1	0	0	2	3	4
1:00 AM	1	0	0	1	2	0	0	0	0	0	2
2:00 AM	6	4	1	2	13	4	1	0	1	6	19
3:00 AM	0	0	0	0	0	1	1	0	1	3	3
4:00 AM	0	2	5	1	8	0	0	2	3	5	13
5:00 AM	1	2	0	5	8	1	2	1	2	6	14
6:00 AM	4	1	4	4	13	1	2	11	6	20	33
7:00 AM	5	3	14	25	47	4	2	6	2	14	61
8:00 AM	7	9	4	2	22	4	4	11	6	25	47
9:00 AM	5	8	6	5	24	3	5	4	7	19	43
10:00 AM	3	7	6	6	22	6	6	6	4	22	44
11:00 AM	4	7	8	5	24	9	7	15	8	39	63
12:00 PM	4	6	9	6	25	5	2	9	11	27	52
1:00 PM	7	11	9	10	37	11	5	15	20	51	88
2:00 PM	6	11	13	16	46	3	8	6	9	26	72
3:00 PM	8	5	15	14	42	10	12	16	13	51	93
4:00 PM	11	10	12	6	39	12	8	10	4	34	73
5:00 PM	9	10	4	8	31	8	11	7	7	33	64
6:00 PM	1	6	2	0	9	9	5	5	4	23	32
7:00 PM	2	4	2	3	11	2	4	6	2	14	25
8:00 PM	0	1	0	0	1	4	4	2	4	14	15
9:00 PM	6	1	0	0	7	3	1	2	1	7	14
10:00 PM	0	0	0	1	1	1	1	2	1	5	6
11:00 PM	2	1	0	2	5	2	1	0	0	3	8
Total	49.3%				438	50.7%				450	888

AM% **39.0%** AM Peak **63** 11:00 am to 12:00 pm AM P.H.F. **0.68**
 PM% **61.0%** PM Peak **99** 3:30 pm to 4:30 pm PM P.H.F. **0.80**

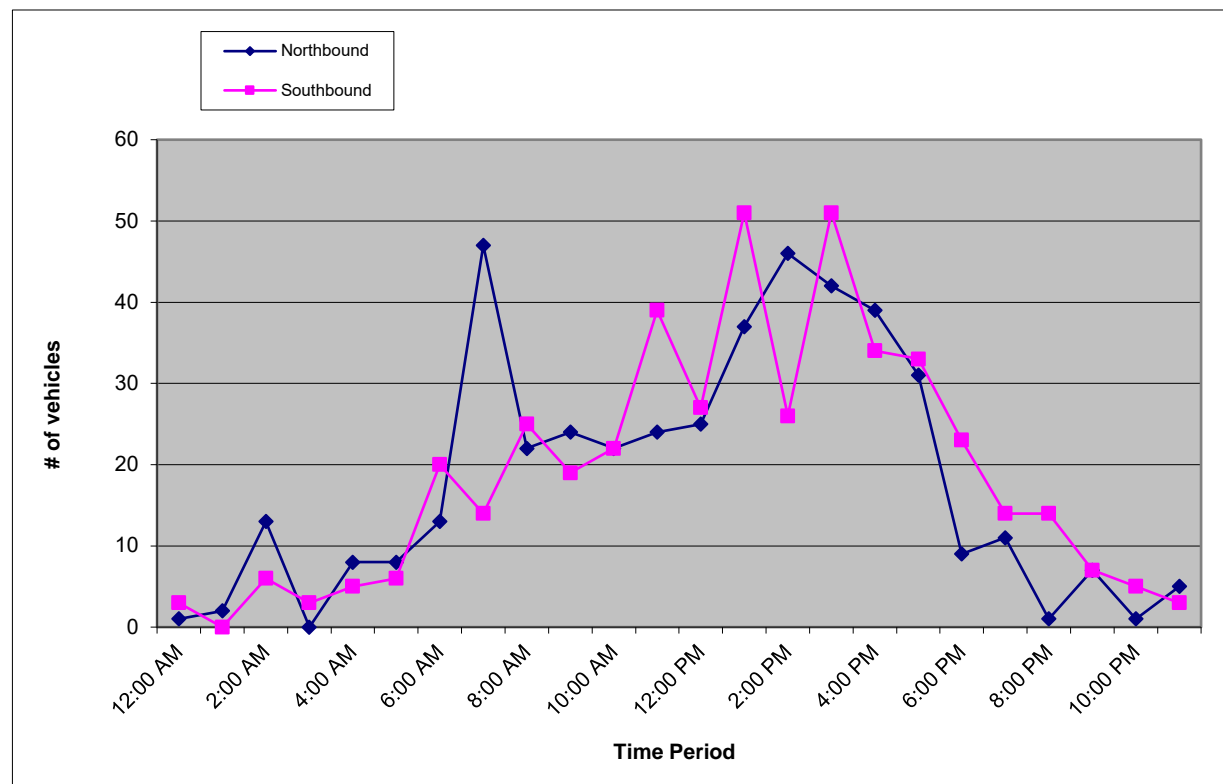



Metro Traffic Data Inc.
 310 N. Irwin Street - Suite 20
 Hanford, CA 93230
 800-975-6938 Phone/Fax
 www.metrotrafficdata.com

24 Hour Volume Report

Prepared For: **JLB Traffic Engineering, Inc.**
 516 W. Shaw Ave, Suite 103
 Fresno, CA 93704

LOCATION 10 1/2 Ave, approx 300' north of Houston Ave

LATITUDE 36.2990968

COUNTY Kings

LONGITUDE -119.6458958

DATE Tuesday, January 25, 2022

WEATHER Clear

NUMBER OF LANES 2

Hour	Northbound					Southbound					Hourly Totals	
	1st	2nd	3rd	4th	Total	1st	2nd	3rd	4th	Total		
12:00 AM	1	0	0	0	1	0	0	0	1	1	2	
1:00 AM	1	0	0	1	2	1	0	0	0	1	3	
2:00 AM	1	0	0	0	1	0	1	0	0	1	2	
3:00 AM	0	0	0	1	1	1	0	1	0	2	3	
4:00 AM	0	1	1	0	2	2	0	0	2	4	6	
5:00 AM	0	0	2	2	4	1	2	2	1	6	10	
6:00 AM	3	0	4	2	9	2	3	7	6	18	27	
7:00 AM	5	4	10	18	37	4	0	4	1	9	46	
8:00 AM	5	7	2	1	15	2	2	9	2	15	30	
9:00 AM	2	7	3	3	15	4	2	4	3	13	28	
10:00 AM	1	6	5	4	16	3	6	3	4	16	32	
11:00 AM	6	4	5	5	20	7	5	10	5	27	47	
12:00 PM	0	8	7	7	22	4	2	9	12	27	49	
1:00 PM	4	9	9	5	27	7	2	10	12	31	58	
2:00 PM	6	5	11	14	36	2	6	5	7	20	56	
3:00 PM	7	8	15	8	38	6	8	16	9	39	77	
4:00 PM	9	13	5	3	30	7	8	9	2	26	56	
5:00 PM	9	14	1	5	29	5	10	5	5	25	54	
6:00 PM	1	8	1	0	10	7	4	4	5	20	30	
7:00 PM	2	5	1	3	11	4	2	2	2	10	21	
8:00 PM	2	0	0	5	7	2	2	1	2	7	14	
9:00 PM	3	0	1	1	5	2	1	1	1	5	10	
10:00 PM	0	0	0	1	1	0	1	2	1	4	5	
11:00 PM	0	0	0	2	2	2	0	0	0	2	4	
Total	50.9%				341	49.1%				329	670	

AM% 35.2% **AM Peak** 47 **11:00 am to 12:00 pm** **AM P.H.F.** 0.78
PM% 64.8% **PM Peak** 85 **3:30 pm to 4:30 pm** **PM P.H.F.** 0.69

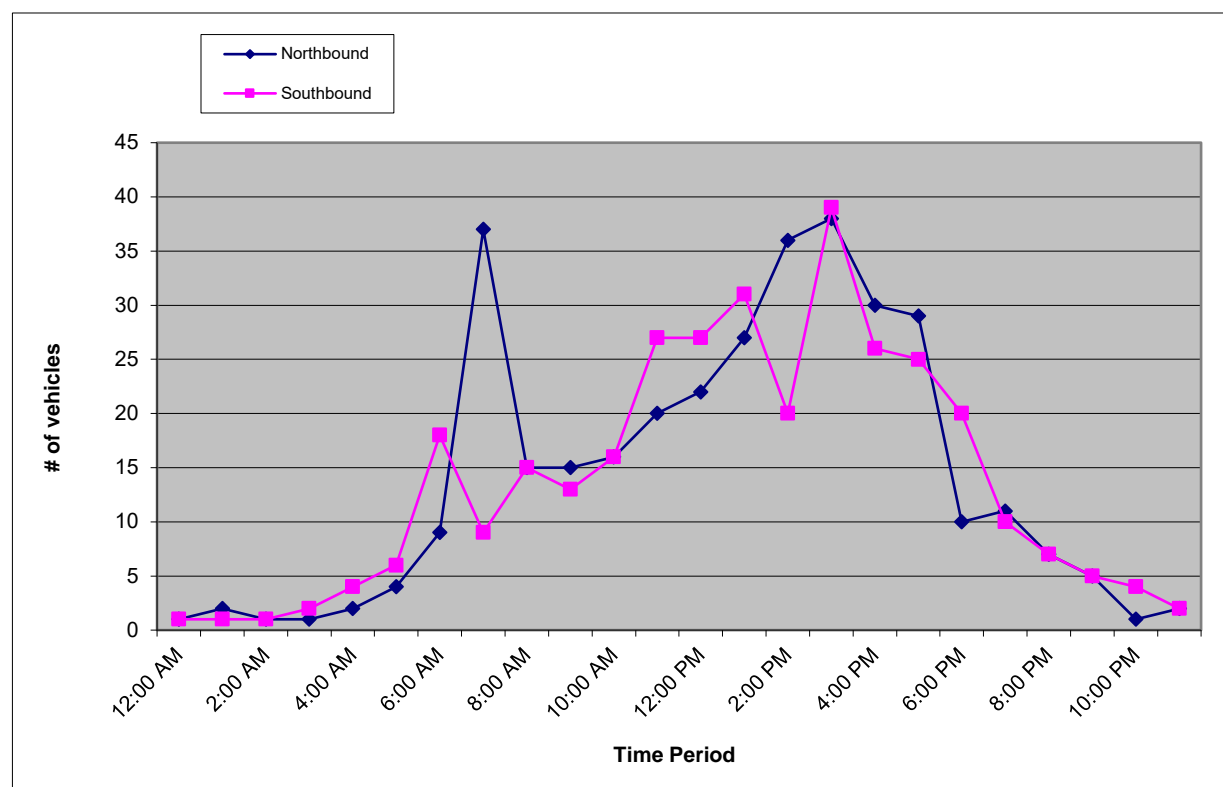



Metro Traffic Data Inc.
 310 N. Irwin Street - Suite 20
 Hanford, CA 93230
 800-975-6938 Phone/Fax
 www.metrotrafficdata.com

24 Hour Volume Report

Prepared For: **JLB Traffic Engineering, Inc.**
 516 W. Shaw Ave, Suite 103
 Fresno, CA 93704

LOCATION Hanford Armona Rd between BNSF RR and Phillips St **LATITUDE** 36.3134175
COUNTY Kings **LONGITUDE** -119.6490965
COLLECTION DATE Tuesday, February 1, 2022 **WEATHER** Clear
NUMBER OF LANES 3

Hour	Eastbound					Westbound					Hourly Totals
	1st	2nd	3rd	4th	Total	1st	2nd	3rd	4th	Total	
12:00 AM	4	12	4	4	24	7	2	2	6	17	41
1:00 AM	4	3	3	4	14	7	4	5	6	22	36
2:00 AM	1	8	6	8	23	2	4	11	5	22	45
3:00 AM	2	2	14	4	22	4	2	3	5	14	36
4:00 AM	5	9	16	17	47	5	9	9	12	35	82
5:00 AM	18	18	23	23	82	5	13	19	18	55	137
6:00 AM	30	32	27	42	131	16	14	32	32	94	225
7:00 AM	20	49	68	115	252	19	31	57	89	196	448
8:00 AM	60	55	51	54	220	93	54	55	58	260	480
9:00 AM	41	54	46	62	203	54	50	40	44	188	391
10:00 AM	57	62	60	59	238	47	55	59	49	210	448
11:00 AM	78	68	59	83	288	64	57	58	58	237	525
12:00 PM	52	75	50	78	255	73	71	53	68	265	520
1:00 PM	68	66	74	99	307	55	64	70	73	262	569
2:00 PM	74	81	94	105	354	83	85	86	84	338	692
3:00 PM	86	92	99	82	359	107	80	90	89	366	725
4:00 PM	95	118	111	104	428	117	97	94	103	411	839
5:00 PM	96	84	82	85	347	125	105	79	83	392	739
6:00 PM	74	107	68	65	314	84	65	75	62	286	600
7:00 PM	50	53	40	34	177	99	51	57	43	250	427
8:00 PM	41	46	28	28	143	35	35	46	25	141	284
9:00 PM	24	15	24	19	82	27	20	23	18	88	170
10:00 PM	19	10	14	14	57	20	17	11	13	61	118
11:00 PM	6	10	17	8	41	11	10	15	14	50	91
Total	50.9%				4408	49.1%				4260	8668

AM% 33.4% **AM Peak** 525 **11:00 am to 12:00 pm** **AM P.H.F.** 0.92
PM% 66.6% **PM Peak** 848 **4:15 pm to 5:15 pm** **PM P.H.F.** 0.96

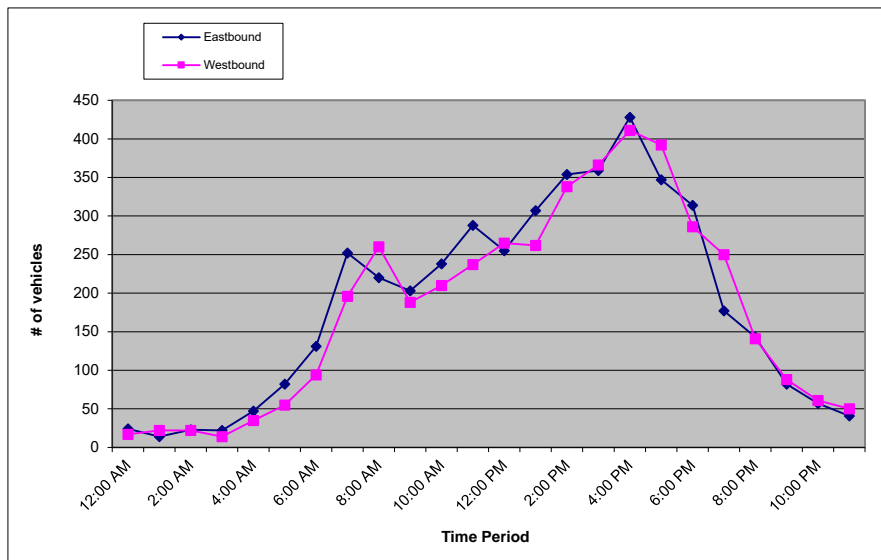



Metro Traffic Data Inc.
 310 N. Irwin Street - Suite 20
 Hanford, CA 93230
 800-975-6938 Phone/Fax
 www.metrotrafficdata.com

24 Hour Volume Report

Prepared For: **JLB Traffic Engineering, Inc.**
 516 W. Shaw Ave, Suite 103
 Fresno, CA 93704

LOCATION Hanford Armona Rd btwn Harris St / Gilkey Ln **LATITUDE** 36.3133991
COUNTY Kings **LONGITUDE** -119.6418133
COLLECTION DATE Tuesday, February 1, 2022 **WEATHER** Clear
NUMBER OF LANES 3

Hour	Eastbound					Westbound					Hourly Totals	
	1st	2nd	3rd	4th	Total	1st	2nd	3rd	4th	Total		
12:00 AM	3	11	2	4	20	8	2	3	1	14	34	
1:00 AM	2	3	2	5	12	4	2	6	5	17	29	
2:00 AM	1	6	2	6	15	1	1	5	2	9	24	
3:00 AM	5	2	11	4	22	3	2	3	5	13	35	
4:00 AM	6	5	12	14	37	4	9	6	12	31	68	
5:00 AM	17	17	17	22	73	8	11	18	20	57	130	
6:00 AM	21	19	27	20	87	17	25	34	34	110	197	
7:00 AM	18	39	46	73	176	29	27	57	70	183	359	
8:00 AM	47	40	43	36	166	70	33	41	44	188	354	
9:00 AM	30	41	35	49	155	35	42	34	30	141	296	
10:00 AM	42	46	42	40	170	35	48	50	38	171	341	
11:00 AM	55	51	48	59	213	52	41	50	47	190	403	
12:00 PM	49	58	45	57	209	43	45	41	62	191	400	
1:00 PM	48	47	53	72	220	47	41	45	48	181	401	
2:00 PM	55	63	70	75	263	73	69	58	69	269	532	
3:00 PM	63	76	63	79	281	96	72	62	63	293	574	
4:00 PM	67	75	75	53	270	102	60	58	85	305	575	
5:00 PM	80	65	74	70	289	78	76	82	55	291	580	
6:00 PM	51	57	64	45	217	74	56	41	48	219	436	
7:00 PM	43	47	35	28	153	62	44	46	36	188	341	
8:00 PM	27	35	17	25	104	24	25	34	14	97	201	
9:00 PM	22	15	16	12	65	19	11	18	15	63	128	
10:00 PM	11	4	11	6	32	11	9	6	11	37	69	
11:00 PM	6	7	12	7	32	4	7	11	10	32	64	
Total	49.9%					3281	50.1%					3290
6571												

AM% 34.5% **AM Peak** 403 **11:00 am to 12:00 pm** **AM P.H.F.** 0.94
PM% 65.5% **PM Peak** 593 **4:45 pm to 5:45 pm** **PM P.H.F.** 0.94

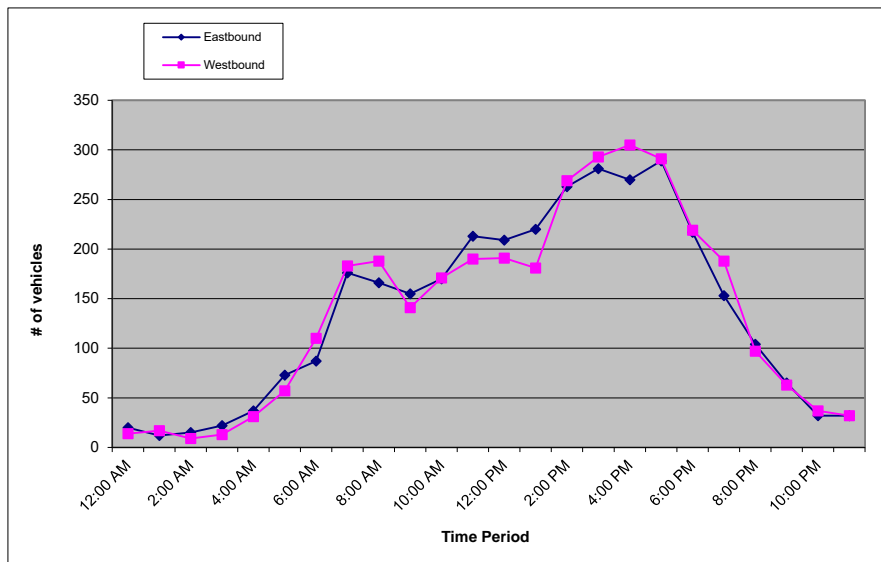



Metro Traffic Data Inc.
 310 N. Irwin Street - Suite 20
 Hanford, CA 93230
 800-975-6938 Phone/Fax
 www.metrotrafficdata.com

24 Hour Volume Report

Prepared For: **JLB Traffic Engineering, Inc.**
 516 W. Shaw Ave, Suite 103
 Fresno, CA 93704

LOCATION Houston Ave approx. 700' west of BNSF RR **LATITUDE** 36.2984308
COUNTY Kings **LONGITUDE** -119.6494196
COLLECTION DATE Tuesday, February 1, 2022 **WEATHER** Clear
NUMBER OF LANES 2

Hour	Eastbound					Westbound					Hourly Totals	
	1st	2nd	3rd	4th	Total	1st	2nd	3rd	4th	Total		
12:00 AM	2	2	2	1	7	0	0	1	4	5	12	
1:00 AM	2	5	0	3	10	5	2	4	3	14	24	
2:00 AM	6	3	4	0	13	2	0	4	0	6	19	
3:00 AM	1	0	7	7	15	3	1	3	5	12	27	
4:00 AM	6	6	13	8	33	9	9	5	7	30	63	
5:00 AM	12	13	19	9	53	9	13	10	12	44	97	
6:00 AM	20	24	37	35	116	10	17	10	36	73	189	
7:00 AM	17	27	33	41	118	29	25	30	33	117	235	
8:00 AM	38	31	29	24	122	46	30	32	20	128	250	
9:00 AM	27	27	26	26	106	31	29	30	28	118	224	
10:00 AM	27	25	28	29	109	22	31	31	36	120	229	
11:00 AM	32	30	33	31	126	32	38	46	30	146	272	
12:00 PM	25	29	29	29	112	38	25	35	30	128	240	
1:00 PM	31	29	33	33	126	35	35	35	32	137	263	
2:00 PM	27	32	33	37	129	23	39	47	38	147	276	
3:00 PM	33	21	40	47	141	47	47	58	41	193	334	
4:00 PM	45	39	37	35	156	35	44	50	32	161	317	
5:00 PM	29	23	28	35	115	40	39	37	28	144	259	
6:00 PM	21	13	14	18	66	32	19	26	8	85	151	
7:00 PM	24	6	15	10	55	18	14	14	11	57	112	
8:00 PM	10	7	10	7	34	11	9	10	9	39	73	
9:00 PM	10	7	7	5	29	14	8	5	6	33	62	
10:00 PM	9	4	5	3	21	9	7	12	8	36	57	
11:00 PM	1	5	2	6	14	11	2	4	0	17	31	
Total	47.9%				1826	52.1%				1990	3816	

AM% 43.0% **AM Peak** 276 **10:45 am to 11:45 am** **AM P.H.F.** 0.87
PM% 57.0% **PM Peak** 349 **3:30 pm to 4:30 pm** **PM P.H.F.** 0.89

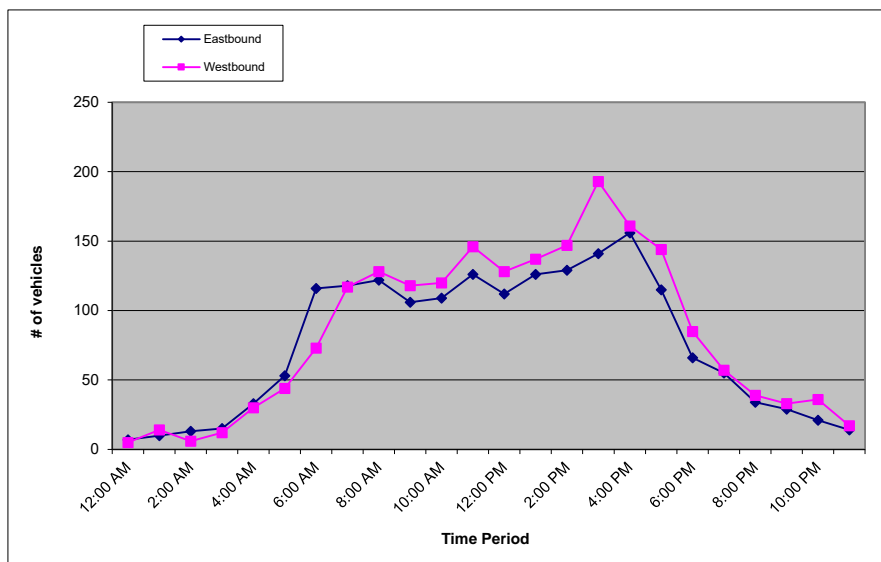



Metro Traffic Data Inc.
 310 N. Irwin Street - Suite 20
 Hanford, CA 93230
 800-975-6938 Phone/Fax
 www.metrotrafficdata.com

24 Hour Volume Report

Prepared For: **JLB Traffic Engineering, Inc.**
 516 W. Shaw Ave, Suite 103
 Fresno, CA 93704

LOCATION Houston Ave btwn Superior Soil / Valley Pallet Drives **LATITUDE** 36.2986037
COUNTY Kings **LONGITUDE** -119.6419416
COLLECTION DATE Tuesday, February 1, 2022 **WEATHER** Clear
NUMBER OF LANES 2

Hour	Eastbound					Westbound					Hourly Totals
	1st	2nd	3rd	4th	Total	1st	2nd	3rd	4th	Total	
12:00 AM	2	2	2	1	7	1	0	2	3	6	13
1:00 AM	1	3	0	3	7	3	2	4	4	13	20
2:00 AM	0	5	7	0	12	0	0	4	1	5	17
3:00 AM	1	0	5	9	15	3	1	3	3	10	25
4:00 AM	6	7	15	8	36	9	8	7	6	30	66
5:00 AM	12	13	17	14	56	8	16	11	9	44	100
6:00 AM	20	25	34	37	116	12	15	17	42	86	202
7:00 AM	14	24	37	43	118	29	25	38	42	134	252
8:00 AM	42	34	37	21	134	50	35	28	24	137	271
9:00 AM	26	30	28	36	120	33	32	32	32	129	249
10:00 AM	29	31	28	30	118	32	29	28	38	127	245
11:00 AM	30	38	36	37	141	36	38	48	25	147	288
12:00 PM	30	26	34	29	119	34	34	35	31	134	253
1:00 PM	36	31	32	29	128	36	30	35	32	133	261
2:00 PM	31	31	37	34	133	28	39	51	37	155	288
3:00 PM	43	22	42	47	154	45	61	55	44	205	359
4:00 PM	49	40	41	44	174	37	43	49	45	174	348
5:00 PM	31	31	21	34	117	37	33	38	25	133	250
6:00 PM	26	9	19	21	75	37	17	24	8	86	161
7:00 PM	20	9	14	11	54	18	18	17	10	63	117
8:00 PM	10	9	10	11	40	12	12	11	10	45	85
9:00 PM	10	7	7	4	28	13	8	5	6	32	60
10:00 PM	7	6	6	4	23	10	7	12	9	38	61
11:00 PM	1	3	2	6	12	11	6	4	2	23	35
Total	48.1%				1937	51.9%				2089	4026

AM% 43.4% **AM Peak 294** **10:45 am to 11:45 am** **AM P.H.F. 0.88**
PM% 56.6% **PM Peak 359** **3:00 pm to 4:00 pm** **PM P.H.F. 0.93**

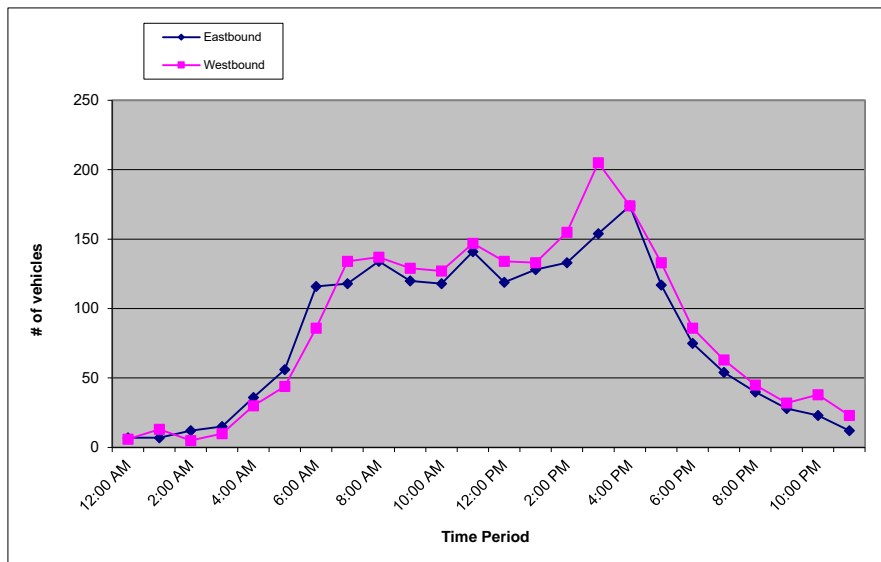

Appendix C: Traffic Modeling



www.JLBtraffic.com
info@JLBtraffic.com

516 W. Shaw Ave., Ste. 103
Fresno, CA 93704
(559) 570-8991

App | C

January 18, 2022

Mike Aronson, P.E.
Kittle son & Associates, Inc.
155 Grand Avenue, Suite 505
Oakland, CA 94612

Via Email Only: maronson@kittelson.com

Subject: Traffic Modeling Request for the Preparation of a Traffic Impact Analysis and Vehicle Miles Traveled Analysis for the Lunaria Project Located on the Southeast quadrant of Hanford-Armona Road and Avenue 10 ½ in the City of Hanford (JLB Project 047-002)

Dear Mr. Aronson,

JLB Traffic Engineering, Inc. (JLB) hereby requests traffic modeling for the preparation of a Traffic Impact Analysis (TIA) and Vehicle Miles Traveled (VMT) Analysis for the proposed Lunaria Project (Project) located on the southeast quadrant of Hanford-Armona Road and Avenue 10 ½ in the City of Hanford. The Project proposes to develop the site with 443 single family residential units and a 4.9-acre public park. Based on information provided to JLB, the Project is consistent with the City of Hanford General Plan. An aerial of the Project vicinity is shown in Exhibit A. The latest Project Site Plan is presented in Exhibit B.

The purpose of the TIA and VMT Analysis is to evaluate the potential on-site and off-site traffic impacts, identify short-term roadway and circulation needs, determine potential mitigation measures and identify any critical traffic issues that should be addressed in the on-going planning process.

Scenarios:

The following scenarios are requested:

1. Base Year 2021 (with Link and TAZ modifications)
2. Cumulative Year 2042 plus Project Select Zone (with Link and TAZ modifications)
3. Differences between model runs 2 and 1 above

Changes and/or additions to the Model Network or TAZ's

JLB reviewed the Kings CAG model network for the Base Year 2021 and Cumulative Year 2042. Based on this review, JLB requests the following link and TAZ network modifications. Details on the requested Link and TAZ modifications for Base Year 2021 and Cumulative Year 2042 are illustrated in Exhibit C.

LINK and TAZ MODIFICATIONS (Base Year 2021 Scenario Only):

1. Modify 10th Street as follows:
 - a. Between Hanford-Armona Avenue and 3rd Street
 - i. Decrease the number of lanes to 1 in each direction



www.JLBtraffic.com
info@JLBtraffic.com

516 W. Shaw Ave., Ste. 103
Fresno, CA 93704
(559) 570-8991

LINK and TAZ MODIFICATIONS (Base Year 2021 and Cumulative Year 2042 plus Project Select Zone Scenarios):

1. Eliminate existing TAZ connector between Node 752 and 10 ½ Avenue
2. Modify Hanford-Armona Avenue as follows:
 - a. Between Node 13557 and Node 10865
 - i. Decrease the speed limit to 40 MPH in both directions
 - b. Between Node 11294 and Node 11686
 - i. Decrease the speed limit to 40 MPH in both directions
3. Modify Houston Avenue as follows:
 - a. Between 12th Avenue and Node 11940
 - i. Increase the speed limit to 55 MPH in both directions
 - b. Between Node 11940 and Node 13572
 - i. Decrease the speed limit to 45 MPH in both directions
4. Modify 11th Avenue as follows:
 - a. Between Hume Avenue and Hanford-Armona Avenue
 - i. Decrease the speed limit to 40 MPH in both directions
5. Modify 10 ½ Avenue as follows:
 - a. Between Hanford-Armona Avenue and Node 10566
 - i. Decrease the speed limit to 35 MPH in both directions
6. Modify Irwin Avenue as follows:
 - a. Between Node 10566 and 3rd Street
 - i. Decrease the speed limit to 25 MPH in both directions
7. Modify Harris Street as follows:
 - a. Between Hanford-Armona Avenue and 3rd Street
 - i. Decrease the speed limit to 25 MPH in both directions
8. Modify 10th Street as follows:
 - a. Between Houston Avenue and Hanford-Armona Avenue
 - i. Increase the speed limit to 50 MPH in both directions
 - b. Between Hanford-Armona Avenue and 3rd Street
 - i. Increase the speed limit to 45 MPH in both directions

LINK and Project MODIFICATIONS (Cumulative Year 2042 plus Project Select Zone Scenario Only):

1. Modify Houston Avenue as follows:
 - a. Between 12th Avenue and 10th Avenue
 - i. Decrease the number of lanes to 1 in each direction
2. Create Orchard Avenue between 10 ½ Avenue and 10th Avenue.
 - a. Classification: Collector Roadway
 - b. Lanes: One lane in each direction
 - c. Speed: 35 mph

3. Create TAZ A (Northern Project) generally located on the southeast quadrant of Hanford-Armona Avenue and 10 ½ Avenue. Taz A shall have TAZ connectors to 10 ½ Avenue, Orchard Avenue and Hanford Armona Road.
4. Create TAZ B (Southern Project) generally located on the southeast quadrant of Hanford-Armona Avenue and 10 ½ Avenue. Taz B shall have TAZ connectors to 10 ½ Avenue and Orchard Avenue.

TAZ A (Northern Project) Trip Generation

The trip generation rates for the proposed Project were obtained from the 11th Edition of the Trip Generation Manual published by the Institute of Transportation Engineers (ITE). Table I presents the trip generation for TAZ A of the proposed Project with trip generation rates for 341 Single-Family Detached Housing units and a 4.9-acre public park. At buildout, TAZ A of proposed Project is estimated to generate 3,220 daily trips, 239 AM peak hour trips and 322 PM peak hour trips.

Table I: TAZ A (Northern Project) Trip Generation

Land Use (ITE Code)	Size	Unit	Daily		AM (7-9) Peak Hour					PM (4-6) Peak Hour						
			Rate	Total	Trip Rate	In	Out	In	Out	Total	Trip Rate	In	Out	In	Out	Total
						%	%									
Single-Family Detached Housing (210)	341	d.u.	9.43	3,216	0.70	26	74	62	177	239	0.94	63	37	202	119	321
Public Park (411)	4.9	Acres	0.78	4	0.02	59	41	0	0	0	0.11	55	54	1	0	1
Total Project Trips				3,220				62	177	239				203	119	322

Note: d.u. = Dwelling Units

TAZ B (Southern Project) Trip Generation

The trip generation rates for the proposed Project were obtained from the 11th Edition of the Trip Generation Manual published by the Institute of Transportation Engineers (ITE). Table II presents the trip generation for TAZ B of the proposed Project with trip generation rates for 102 Single-Family Detached Housing units. At buildout, TAZ B of the proposed Project is estimated to generate 961 daily trips, 71 AM peak hour trips and 96 PM peak hour trips.

Table II: TAZ B (Southern Project) Trip Generation

Land Use (ITE Code)	Size	Unit	Daily		AM (7-9) Peak Hour					PM (4-6) Peak Hour						
			Rate	Total	Trip Rate	In	Out	In	Out	Total	Trip Rate	In	Out	In	Out	Total
						%	%									
Single-Family Detached Housing (210)	102	d.u.	9.43	961	0.70	26	74	18	53	71	0.94	63	37	60	36	96
Total Project Trips				961				18	53	71				60	36	96

Note: d.u. = Dwelling Units

Vehicle Miles Traveled

It is requested that Kings CAG modeling consultant prepare a detailed VMT analysis for the Project. The proposed Project land use classification is Low Density Residential. Please report total regional VMT with the project and without the project in Word or Excel format.



Mr. Aronson – Kittelson & Associates, Inc.
Traffic Modeling Request (JLB Project No. 047-002)
January 18, 2022

Please feel welcome to contact me if you have any questions or require additional information. I can be reached by phone at (559) 869-4514, or via email at cayala@jlbtraffic.com.

Sincerely,



Carlos Ayala-Magana, EIT
JLB Traffic Engineering, Inc.

cc: Jose Luis Benavides, JLB Traffic Engineering, Inc.

Z:\01 Projects\047 Hanford\047-002 Lunaria TIA & VMT\Modeling\01 Model Request\L01182022 Model Request (047-002).docx



www.JLBtraffic.com
info@JLBtraffic.com

516 W. Shaw Ave., Ste. 103
Fresno, CA 93704
(559) 570-8991

Page | 4

Exhibit A – Project Site Aerial

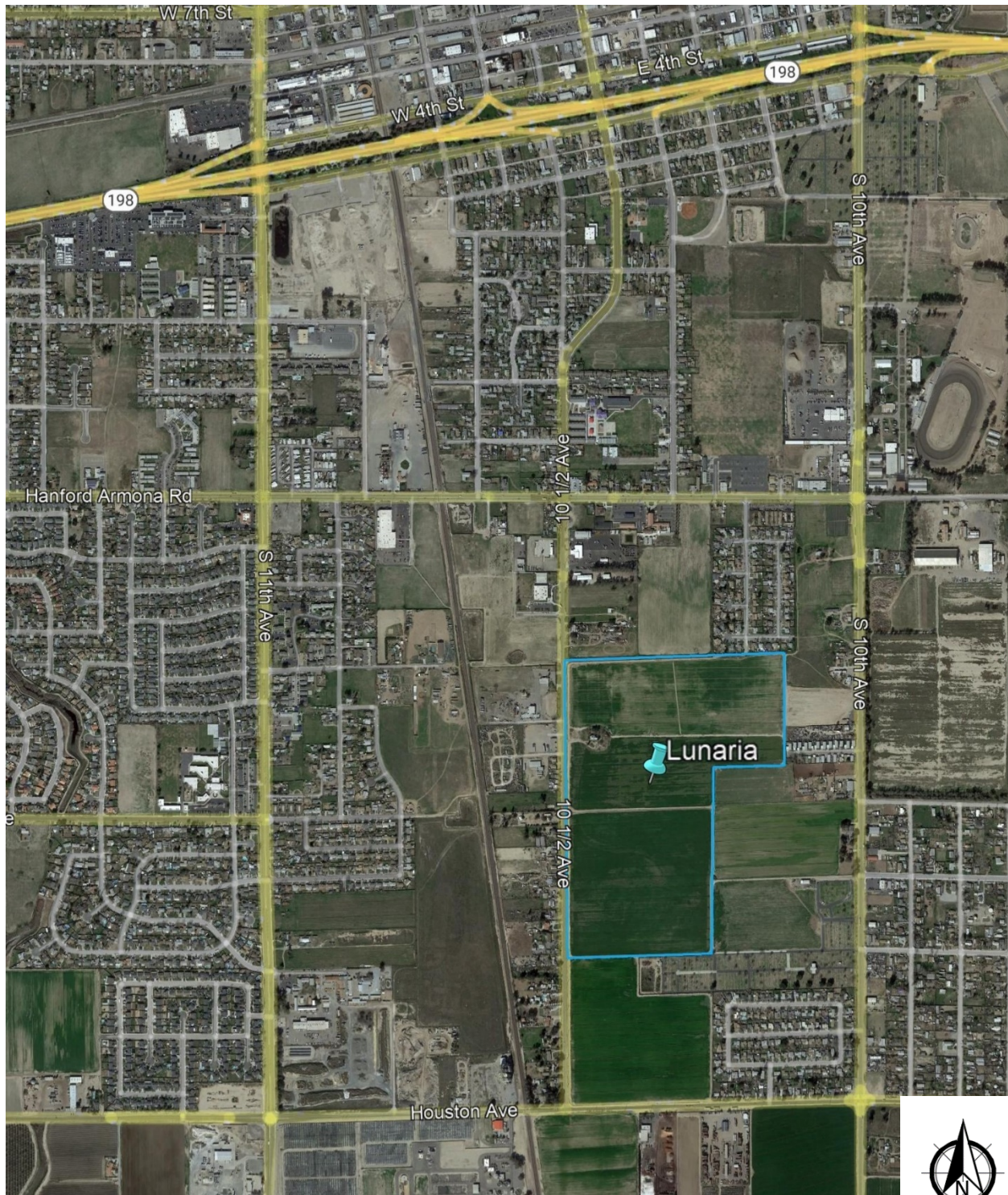
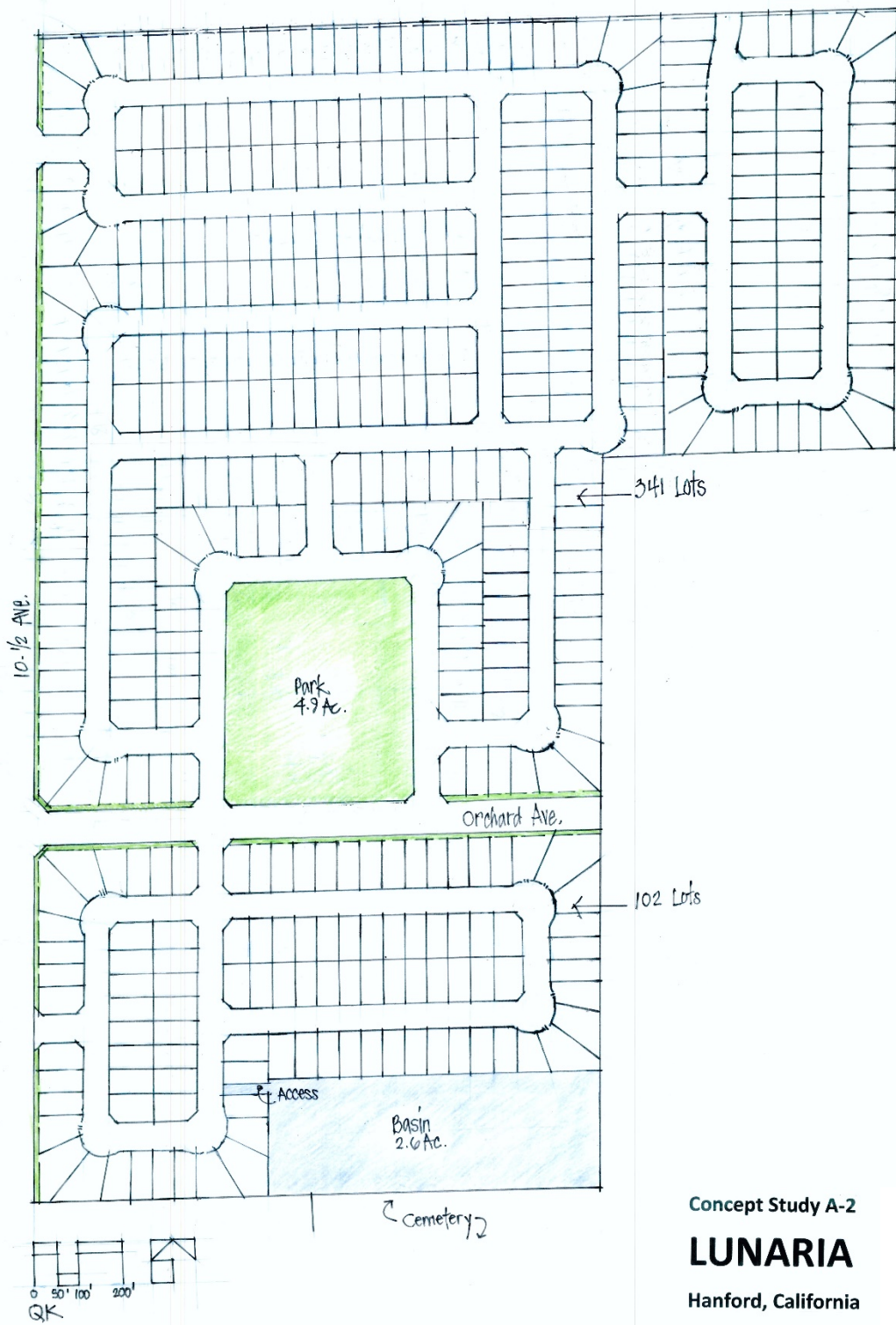

Exhibit B – Project Site Plan



Concept Study A-2

LUNARIA

Hanford, California



Exhibit C – Link and TAZ Modifications



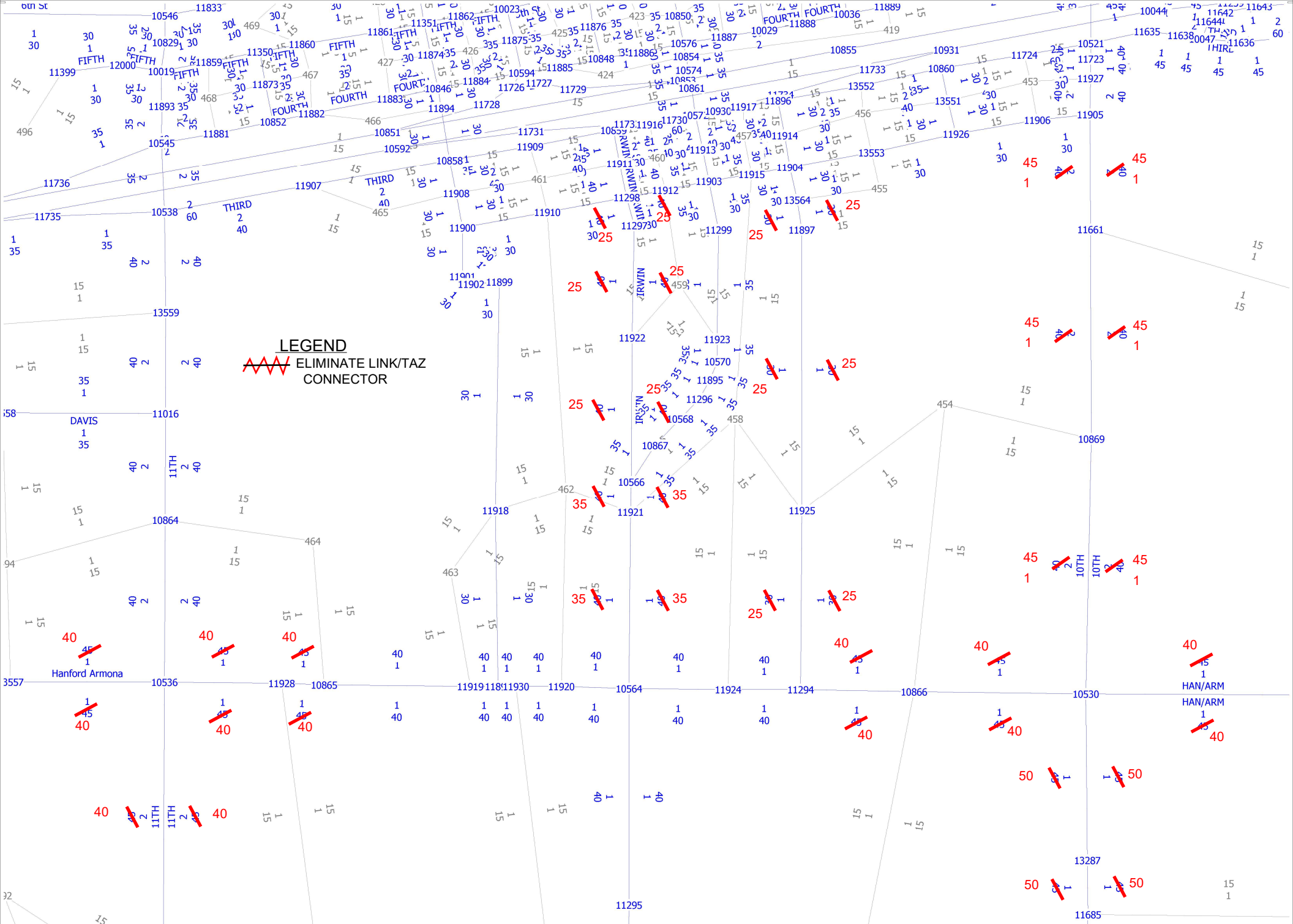

LEGEND
 ELIMINATE LINK/TAZ CONNECTOR

Base Year 2021
 Name, Lanes, Speed

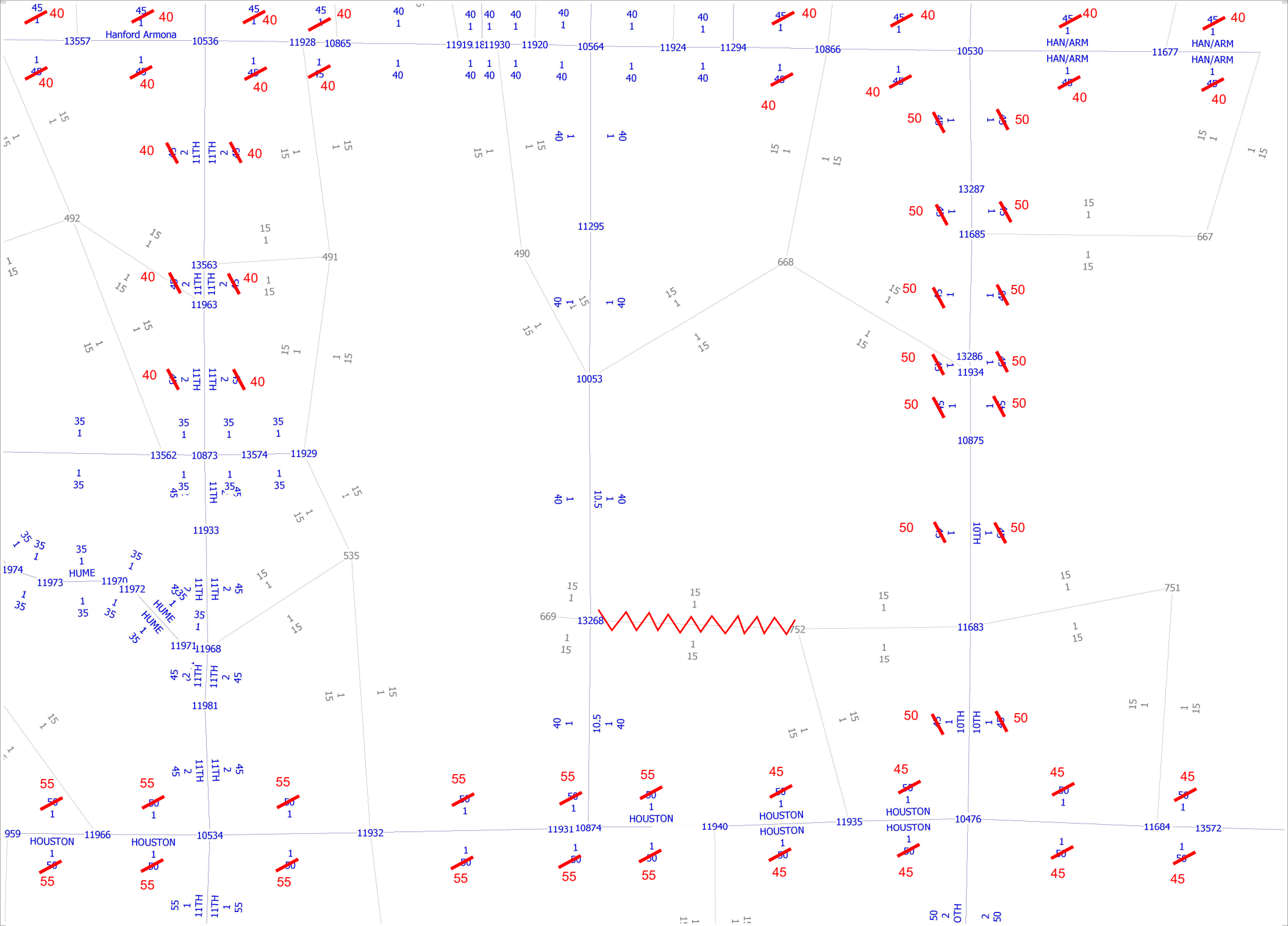

Base Year 2021
Name, Lanes, Speed

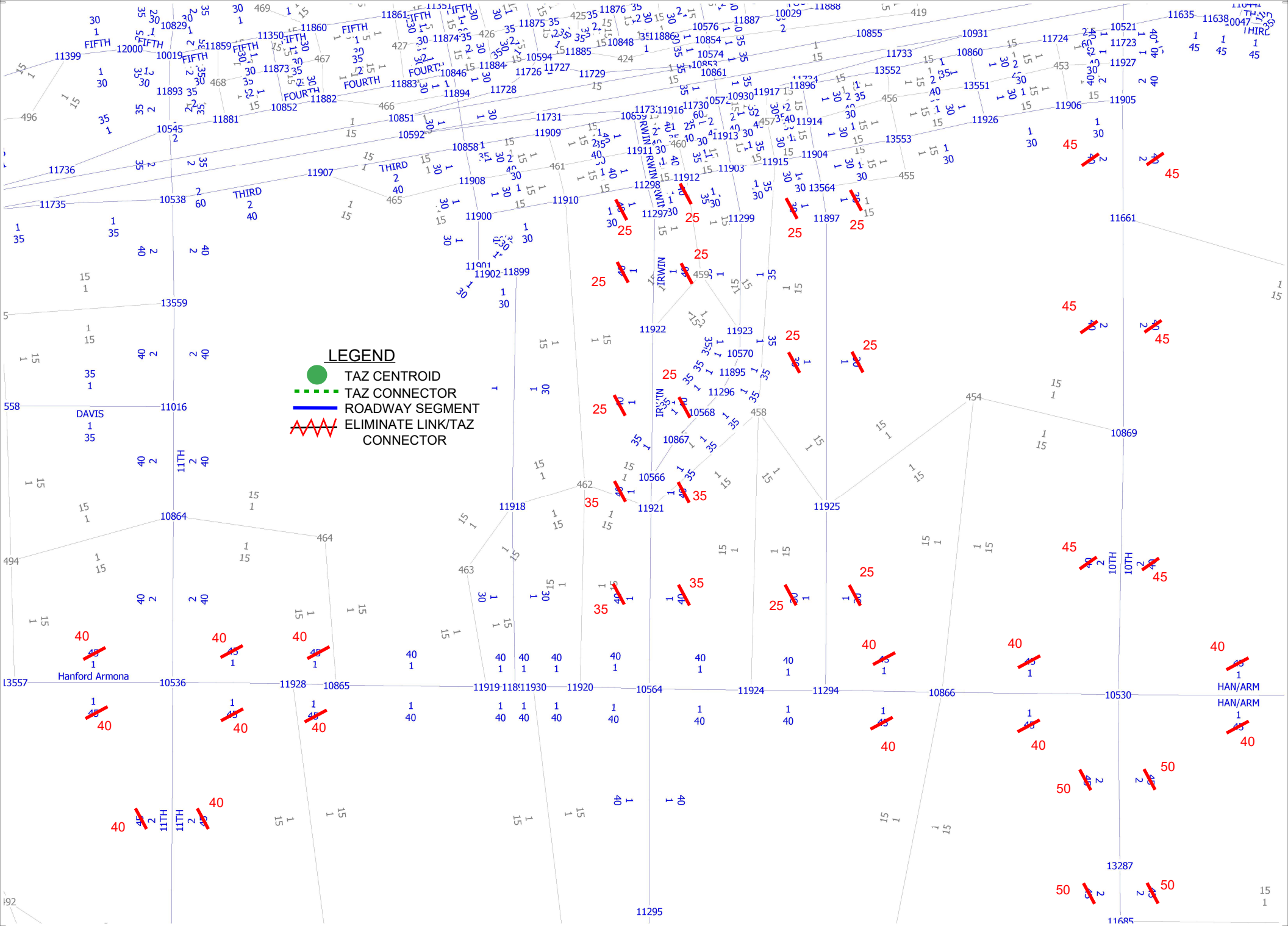

Cumulative Year 2042
Name, Lanes, Speed

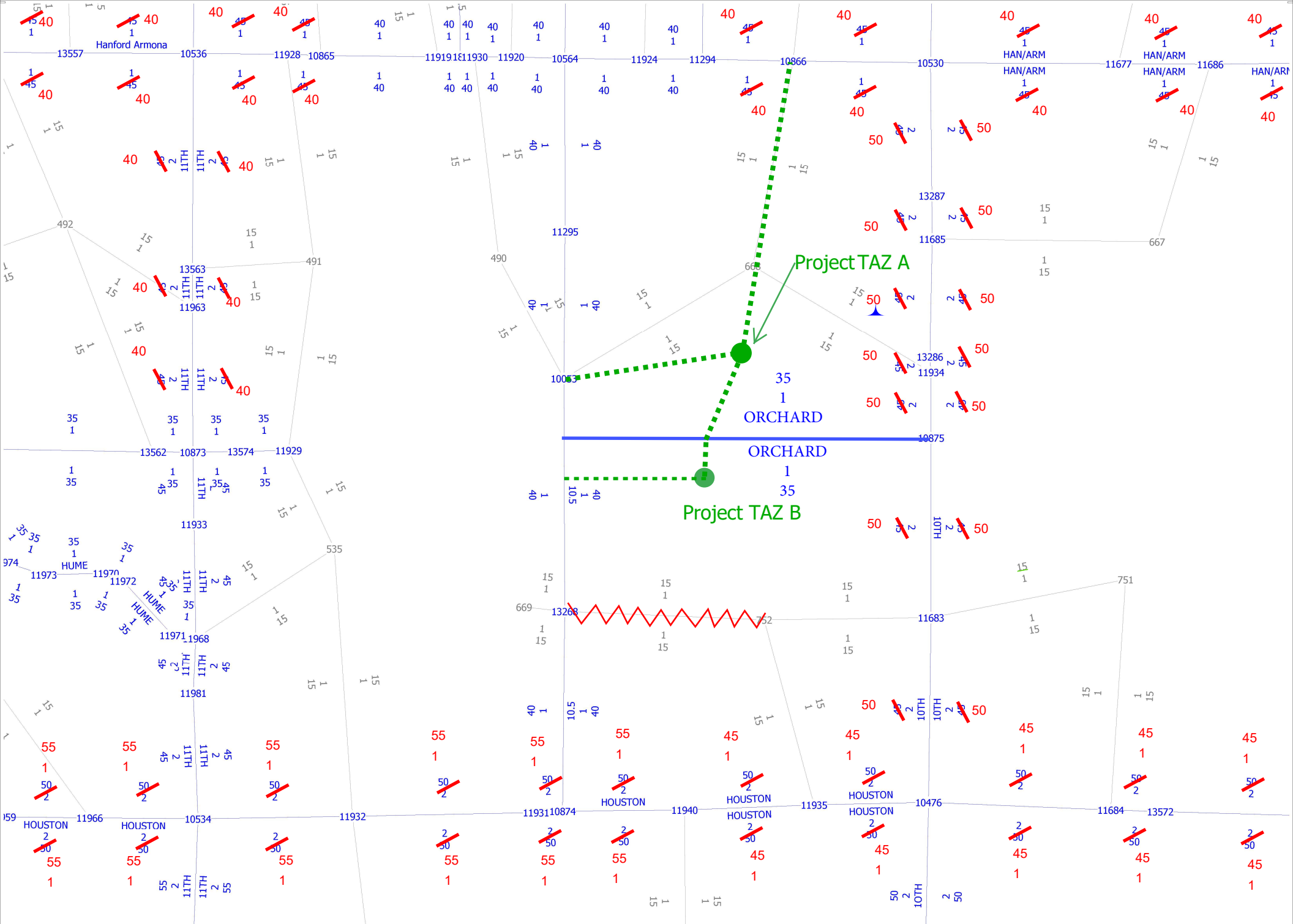

Cumulative Year 2042
Name, Lanes, Speed

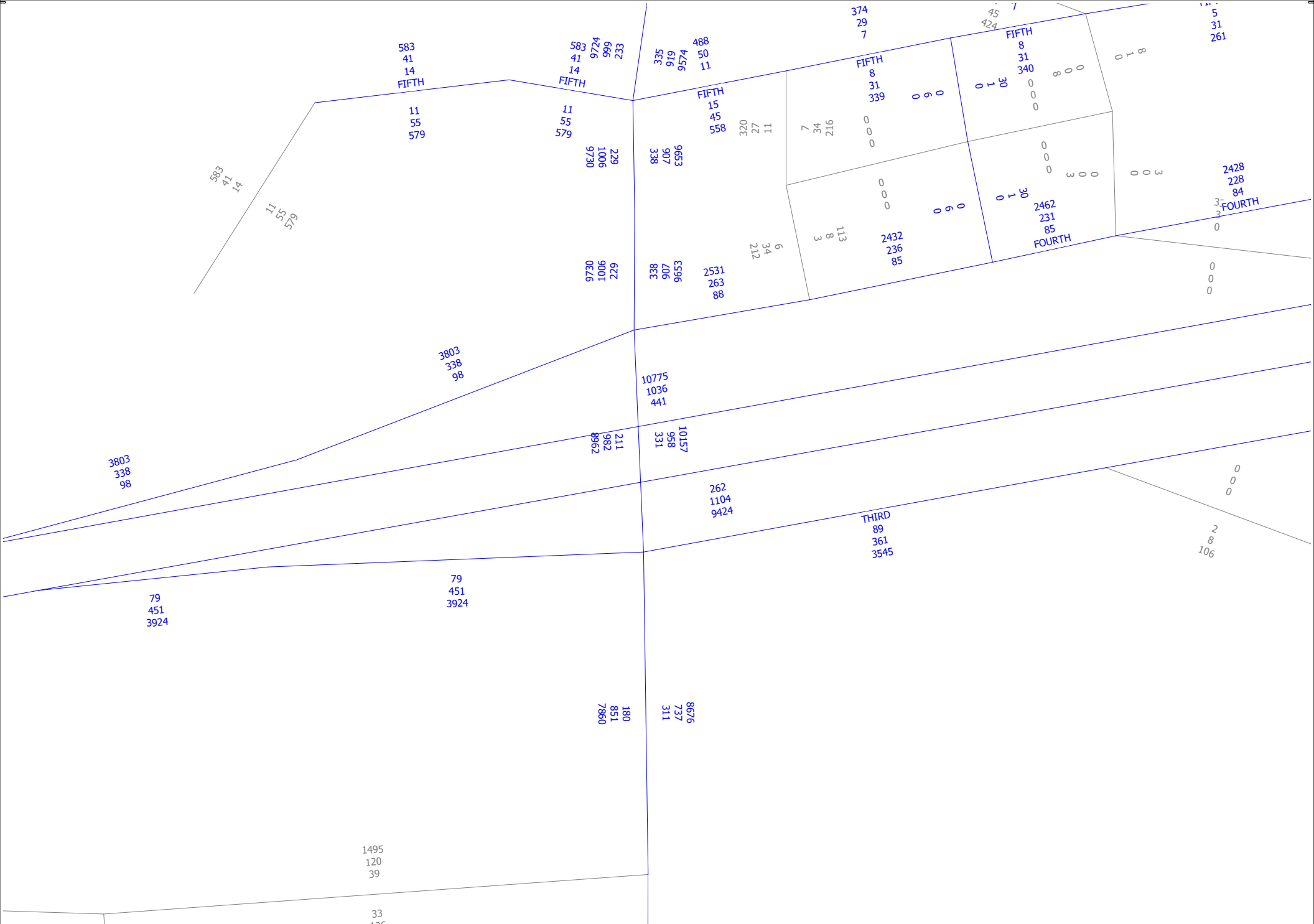

Lunaria TIA
 Base Year 2021
 AM, PM and Daily Volumes

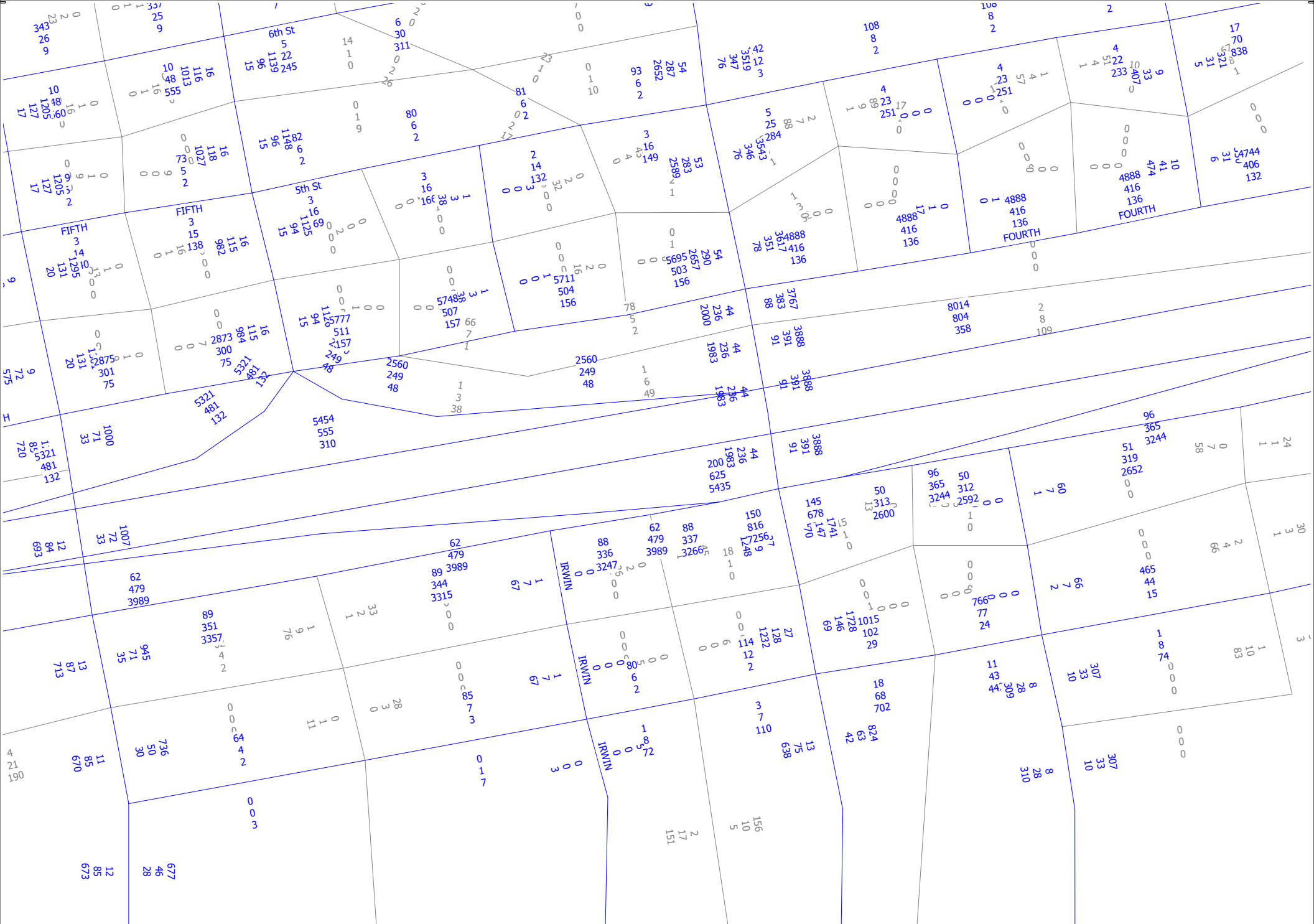

Lunaria TIA
 Base Year 2021
 AM, PM and Daily Volumes

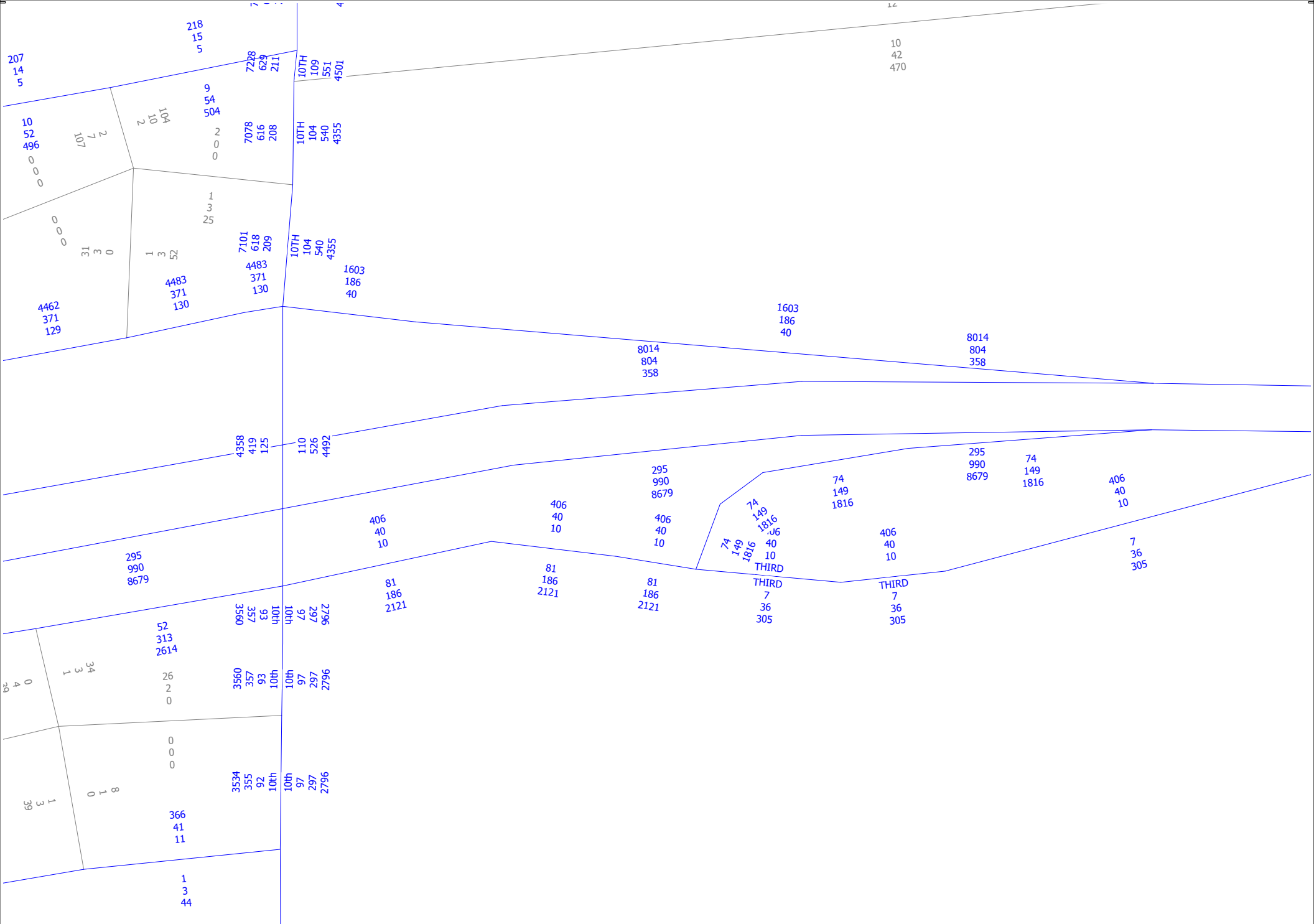

Lunaria TIA
 Base Year 2021
 AM, PM and Daily Volumes



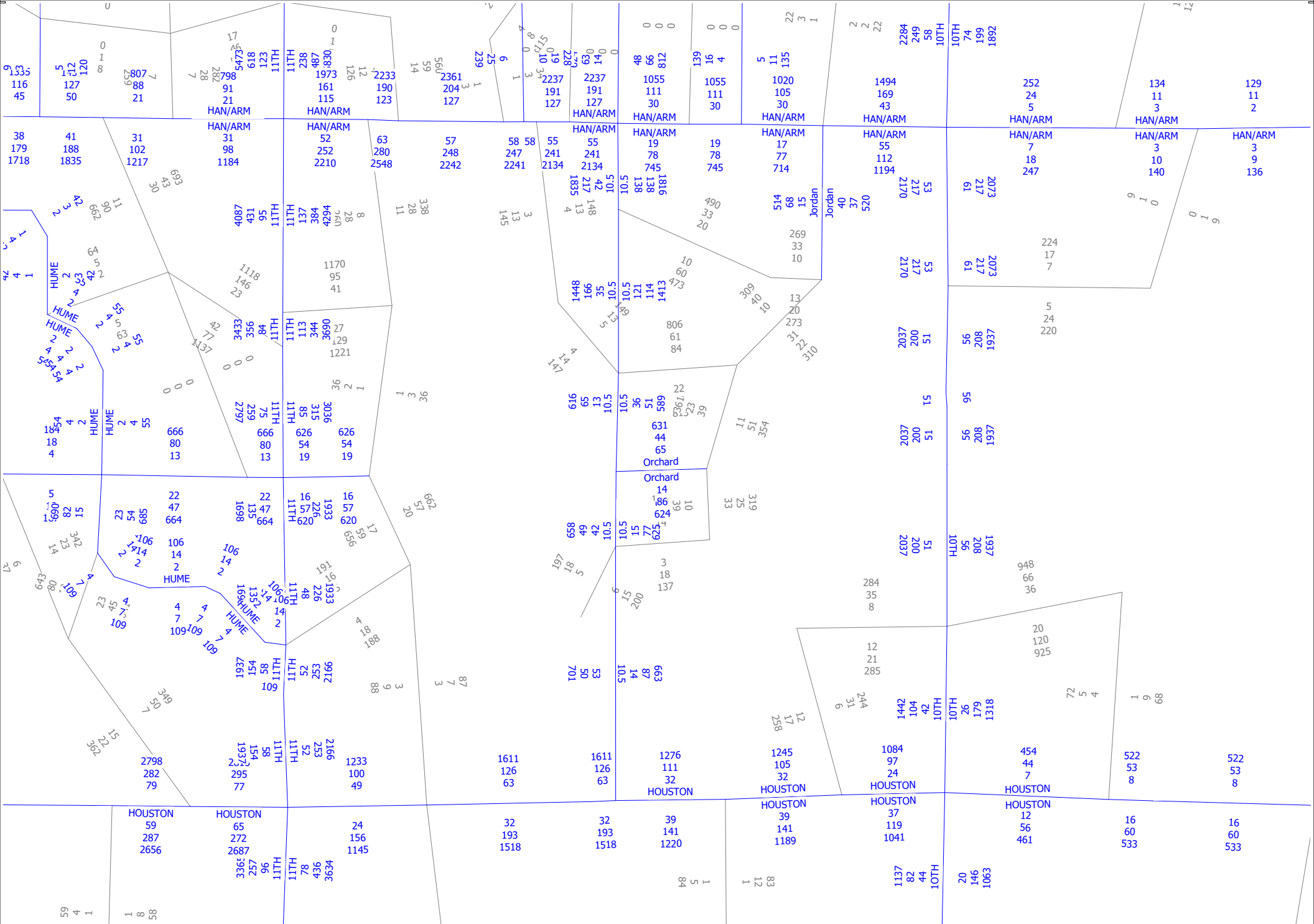

Lunaria TIA
 Base Year 2021
 AM, PM and Daily Volumes



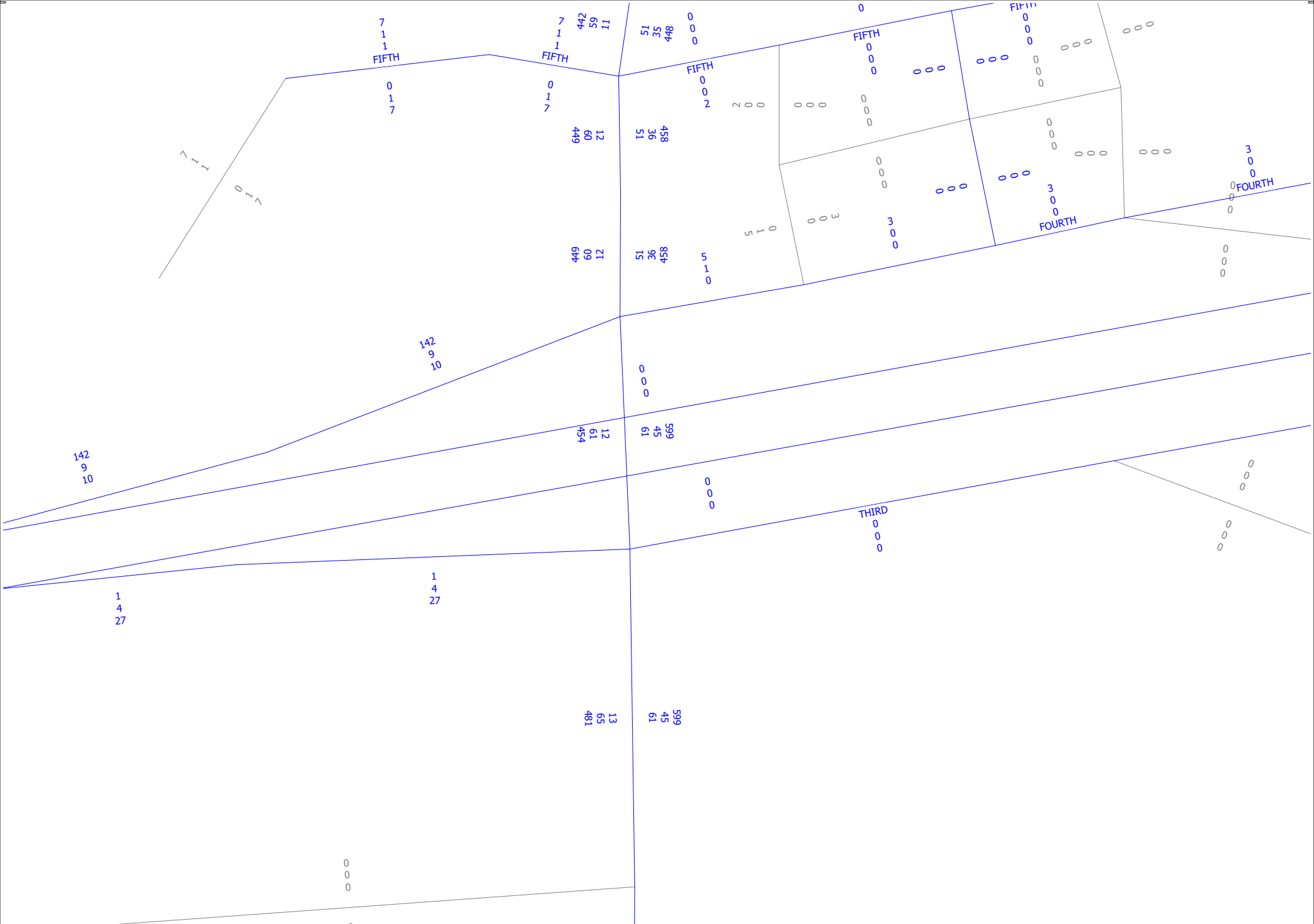

Lunaria TIA
 Project Only Trips (2021)
 AM, PM and Daily Volumes



Lunaria TIA
 Project Only Trips (2021)
 AM, PM and Daily Volumes

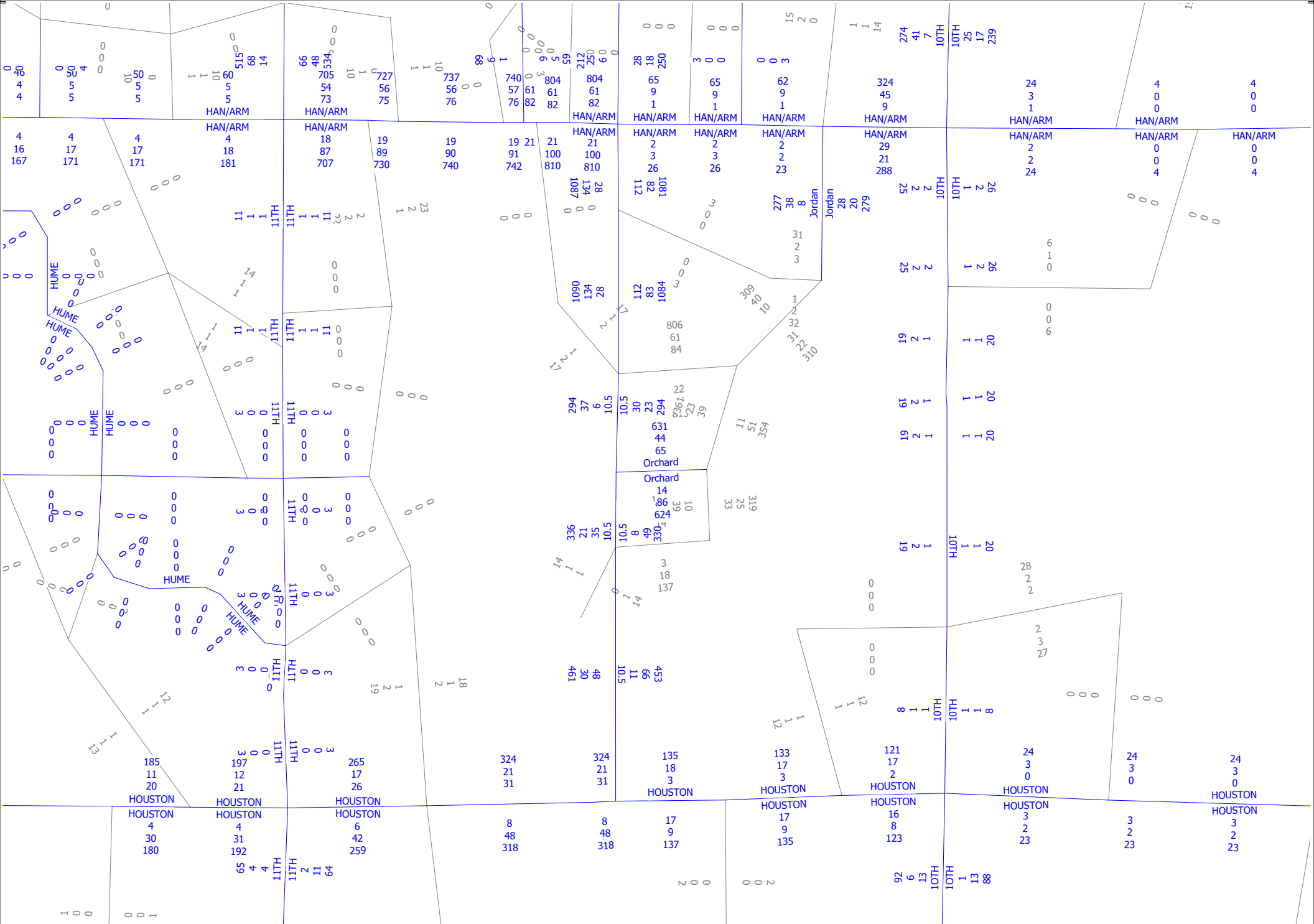

Lunaria TIA
 Project Only Trips (2021)
 AM, PM and Daily Volumes



Lunaria TIA
 Project Only Trips (2021)
 AM, PM and Daily Volumes

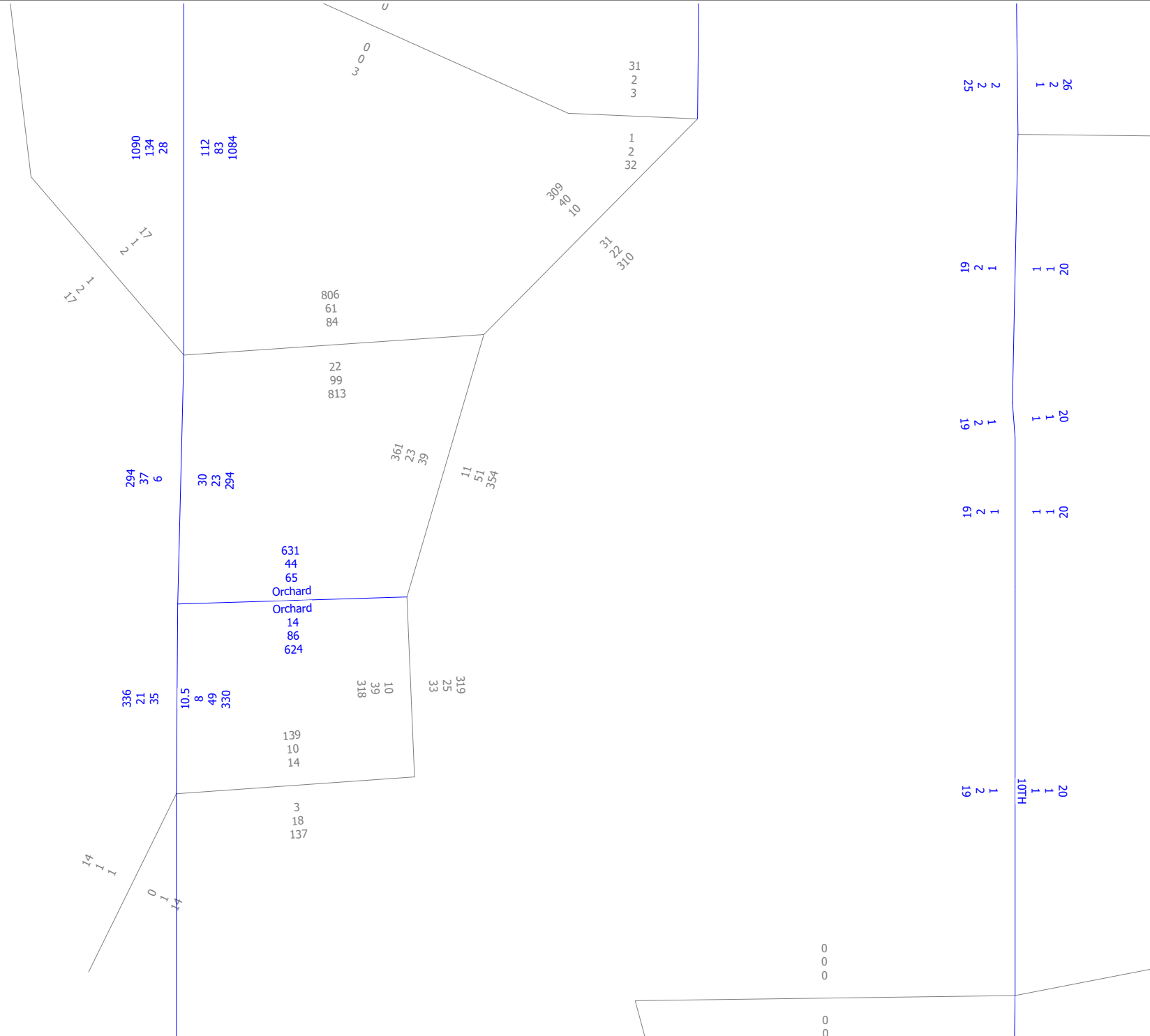

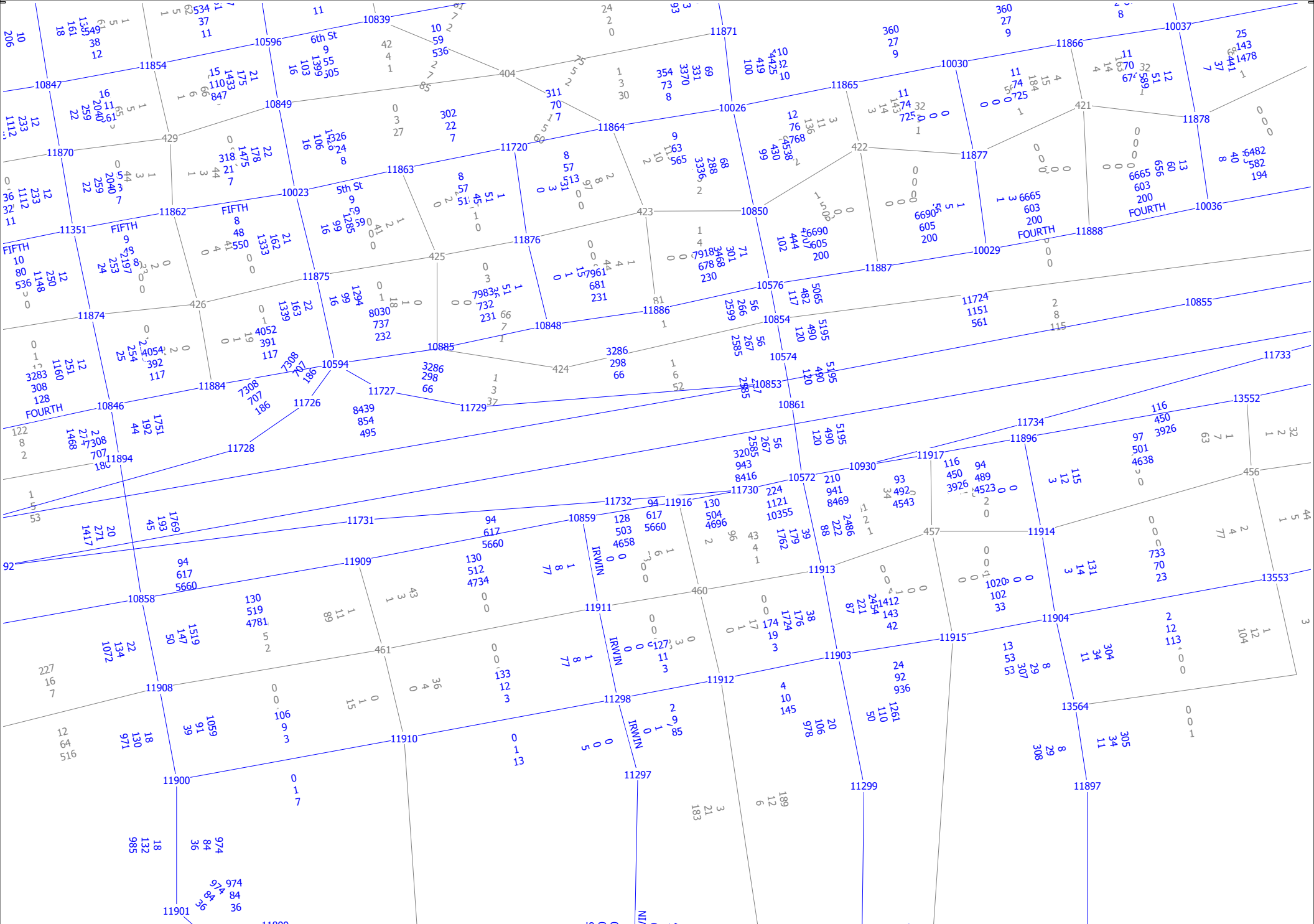

Lunaria TIA
 Cumulative Year 2042
 AM, PM and Daily Volumes

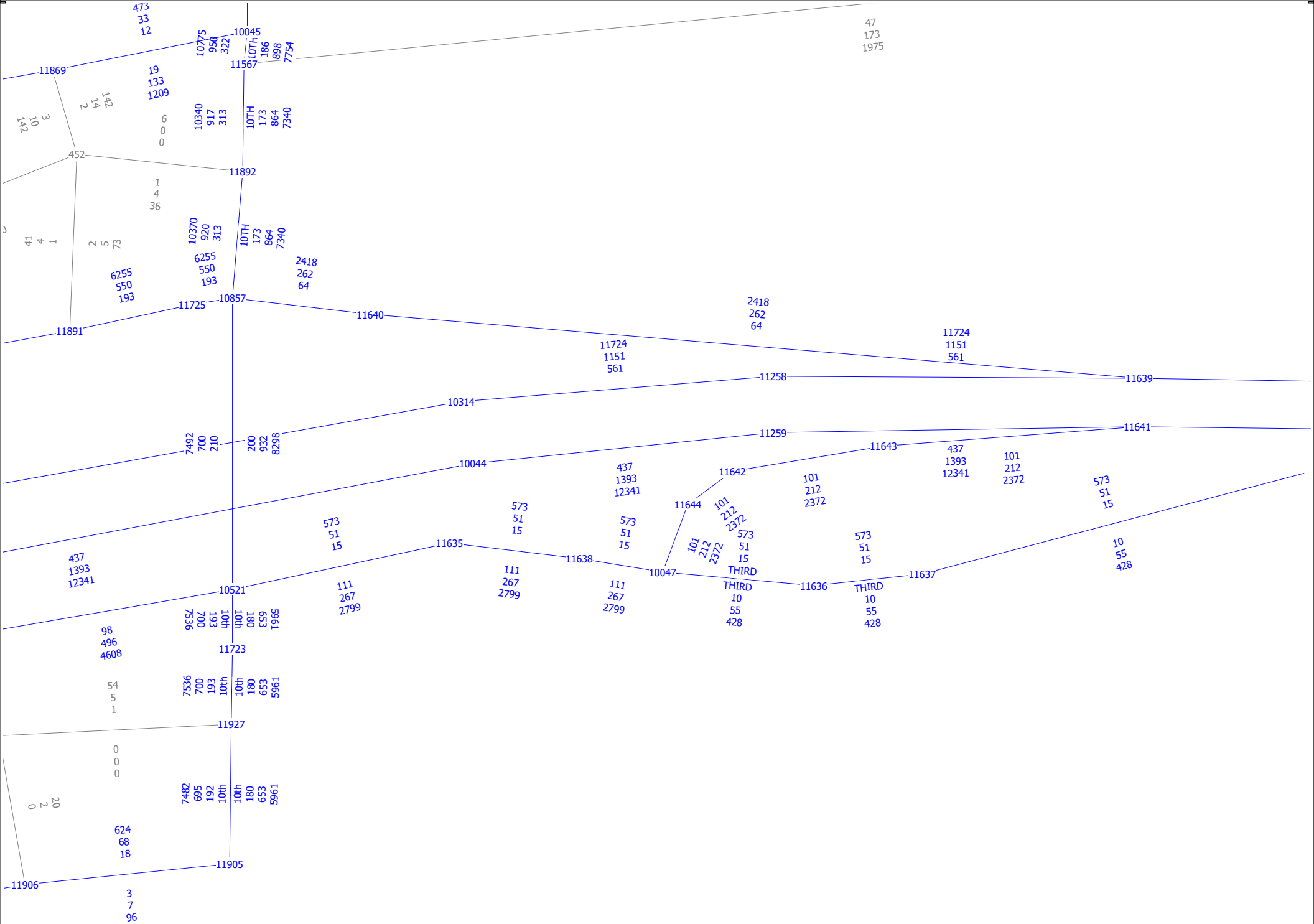

Lunaria TIA
 Cumulative Year 2042
 AM, PM and Daily Volumes



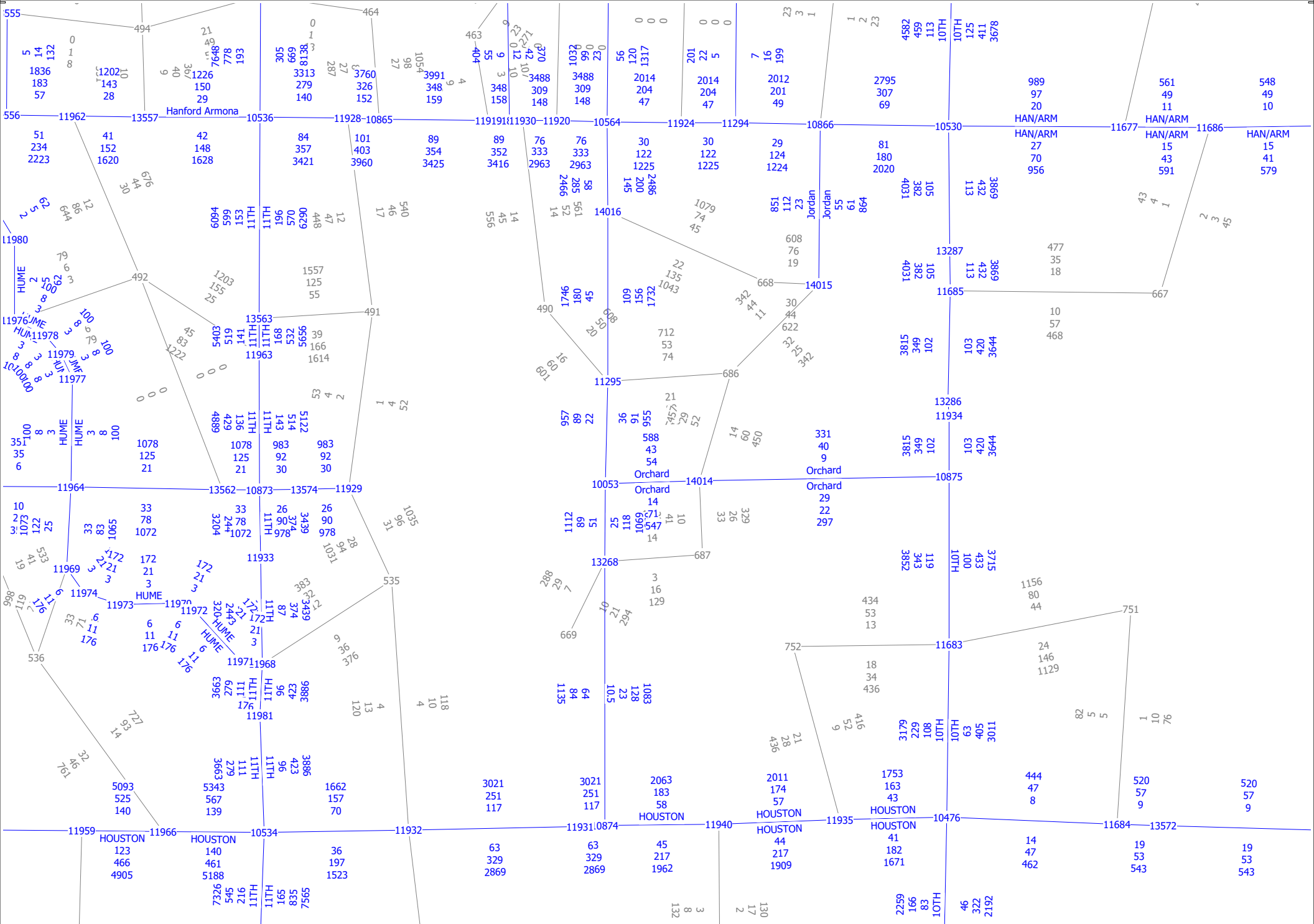

Lunaria TIA
 Cumulative Year 2042
 AM, PM and Daily Volumes



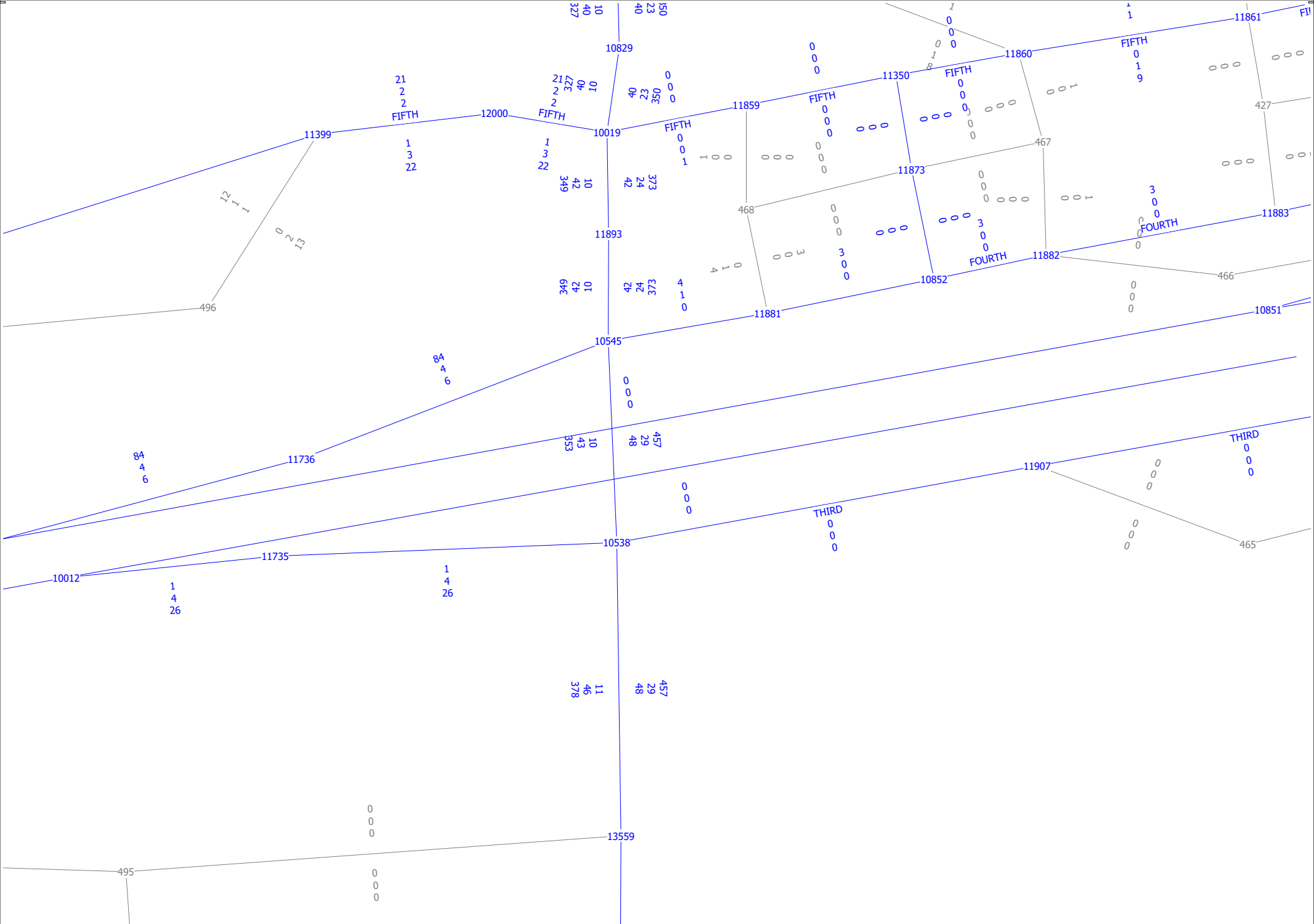

Lunaria TIA
 Project Only Trips (2042)
 AM, PM and Daily Volumes



Lunaria TIA
 Project Only Trips (2042)
 AM, PM and Daily Volumes

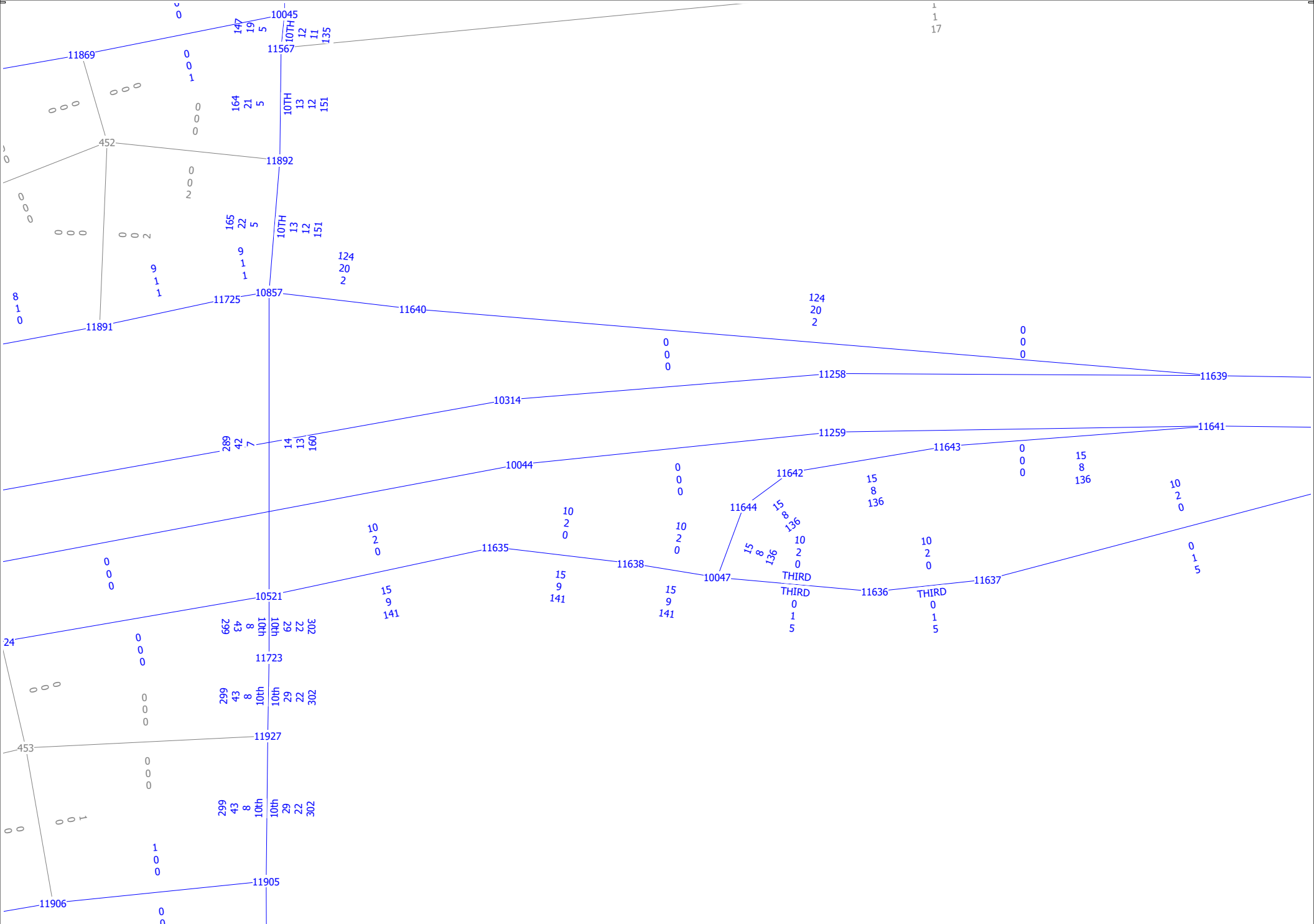

Lunaria TIA
Project Only Trips (2042)
AM, PM and Daily Volumes



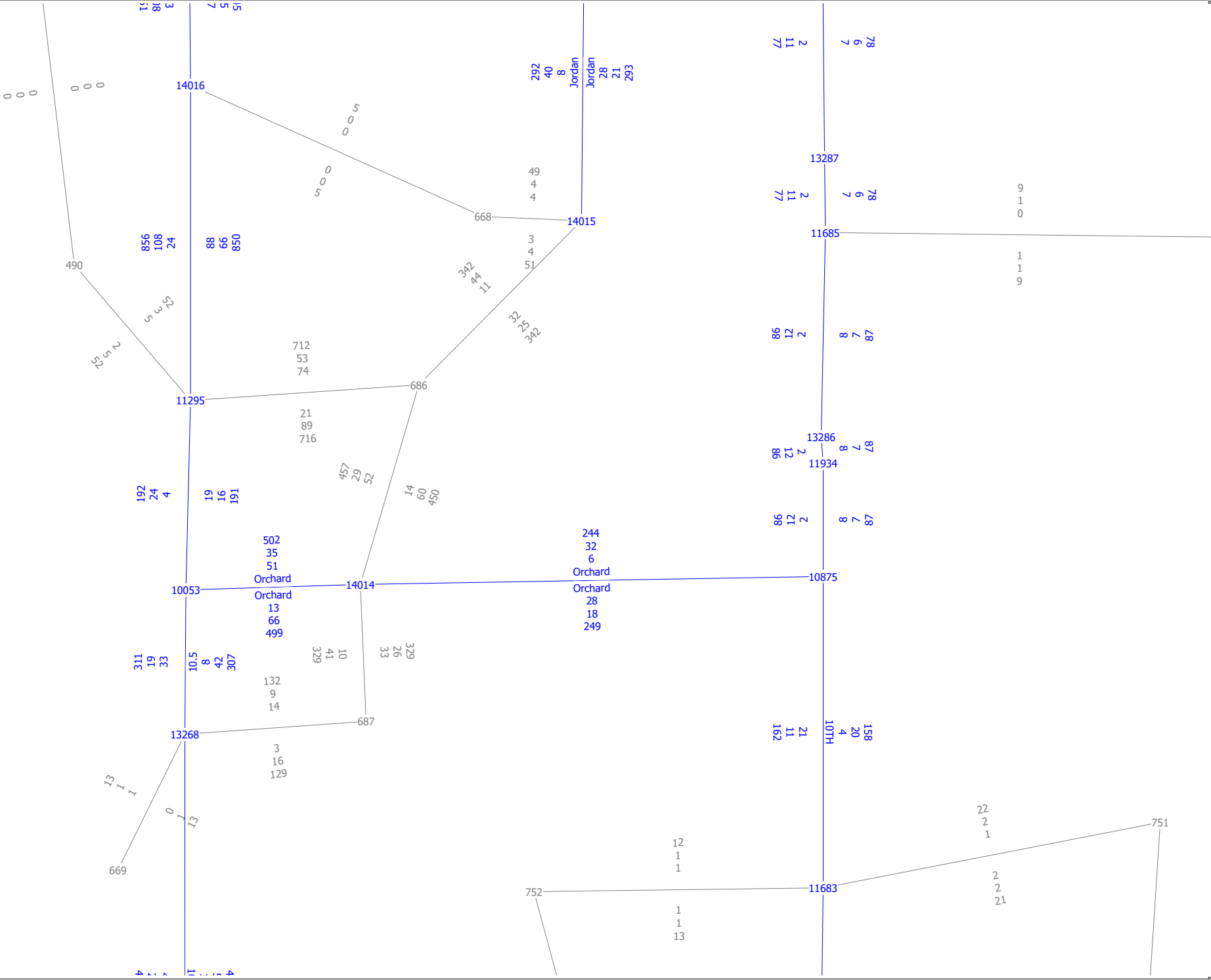

Lunaria TIA
 Project Only Trips (2042)
 AM, PM and Daily Volumes



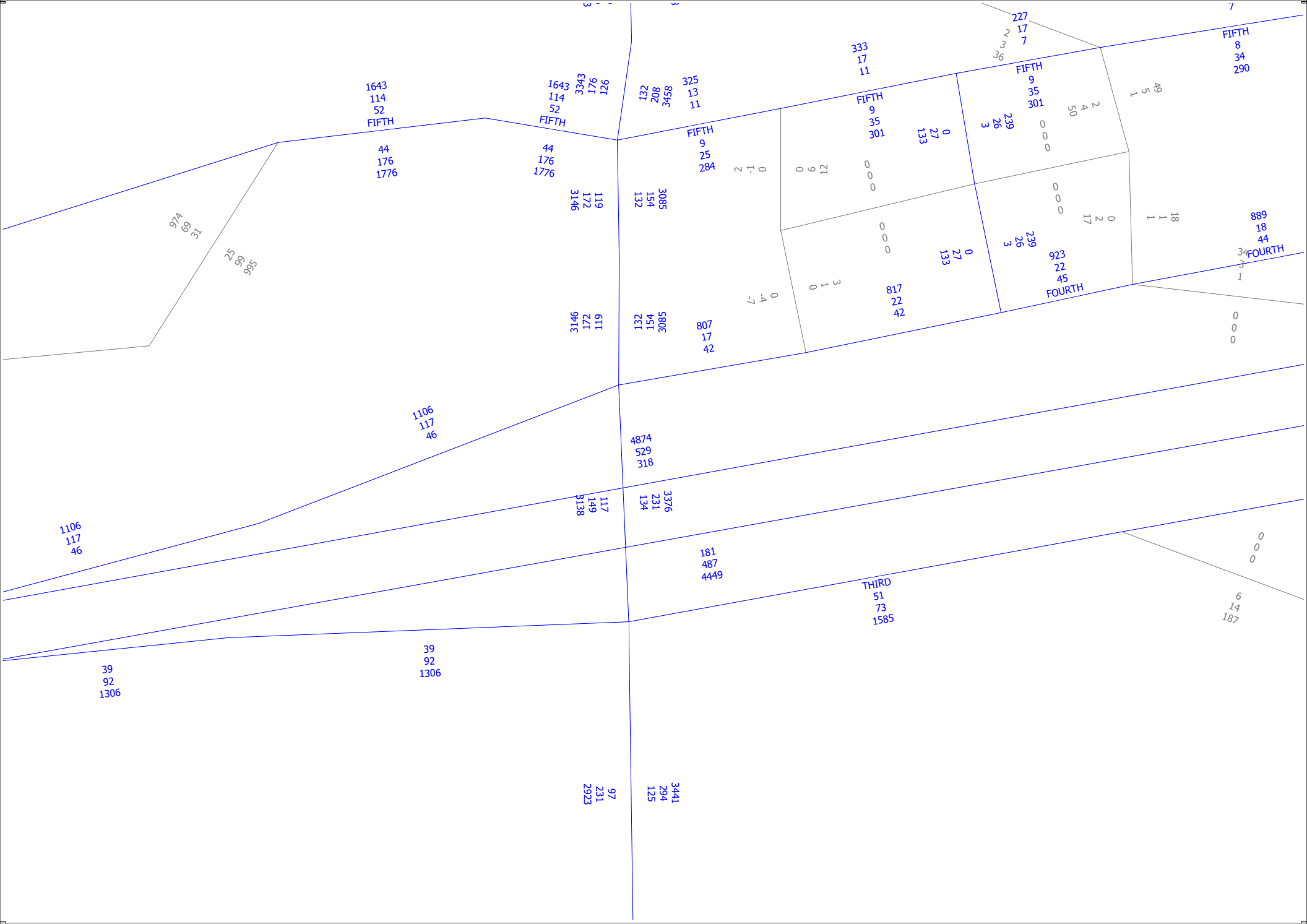

Lunaria TIA
 2042 Increment
 AM, PM and Daily Volumes



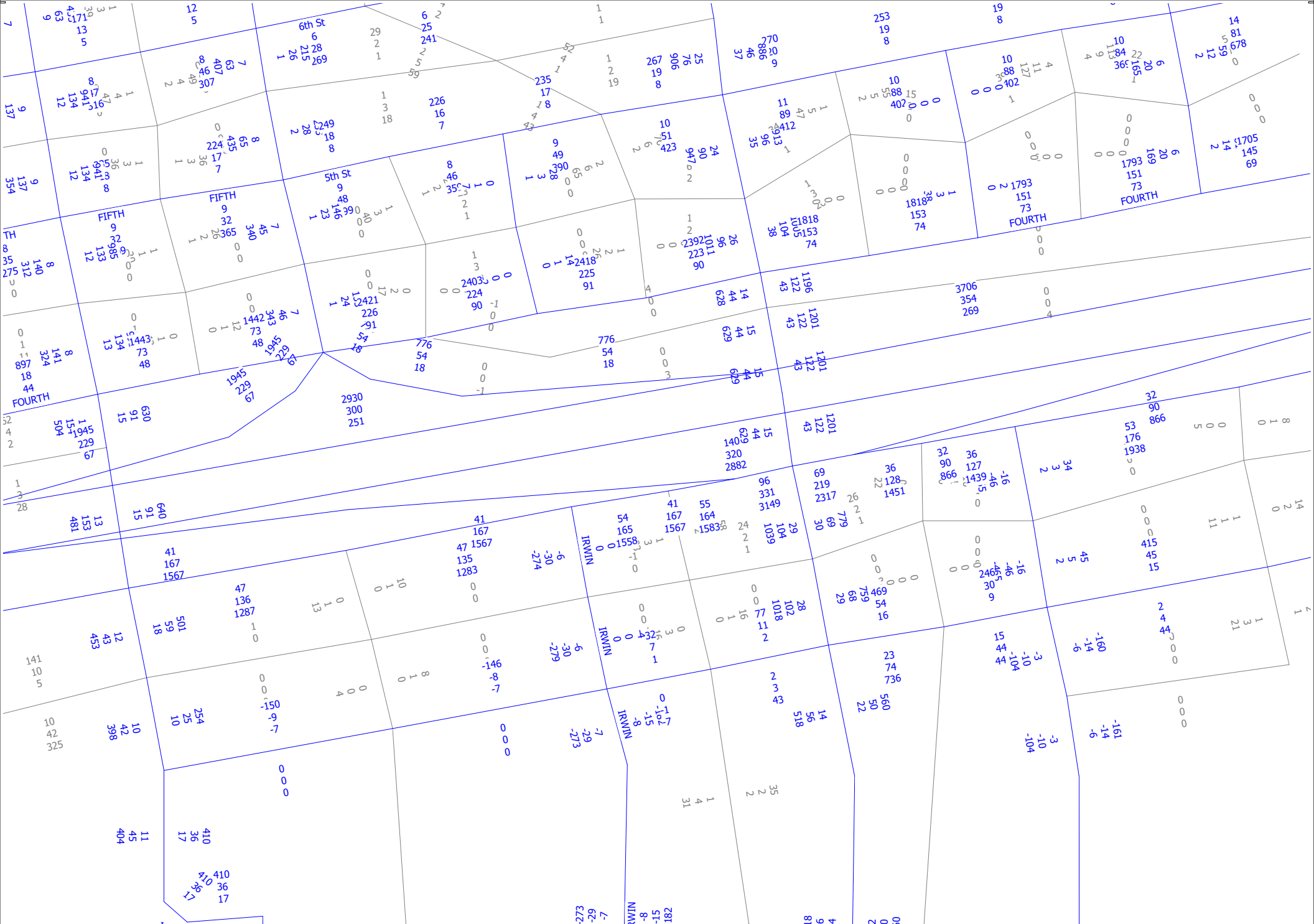

Lunaria TIA
 2042 Increment
 AM, PM and Daily Volumes

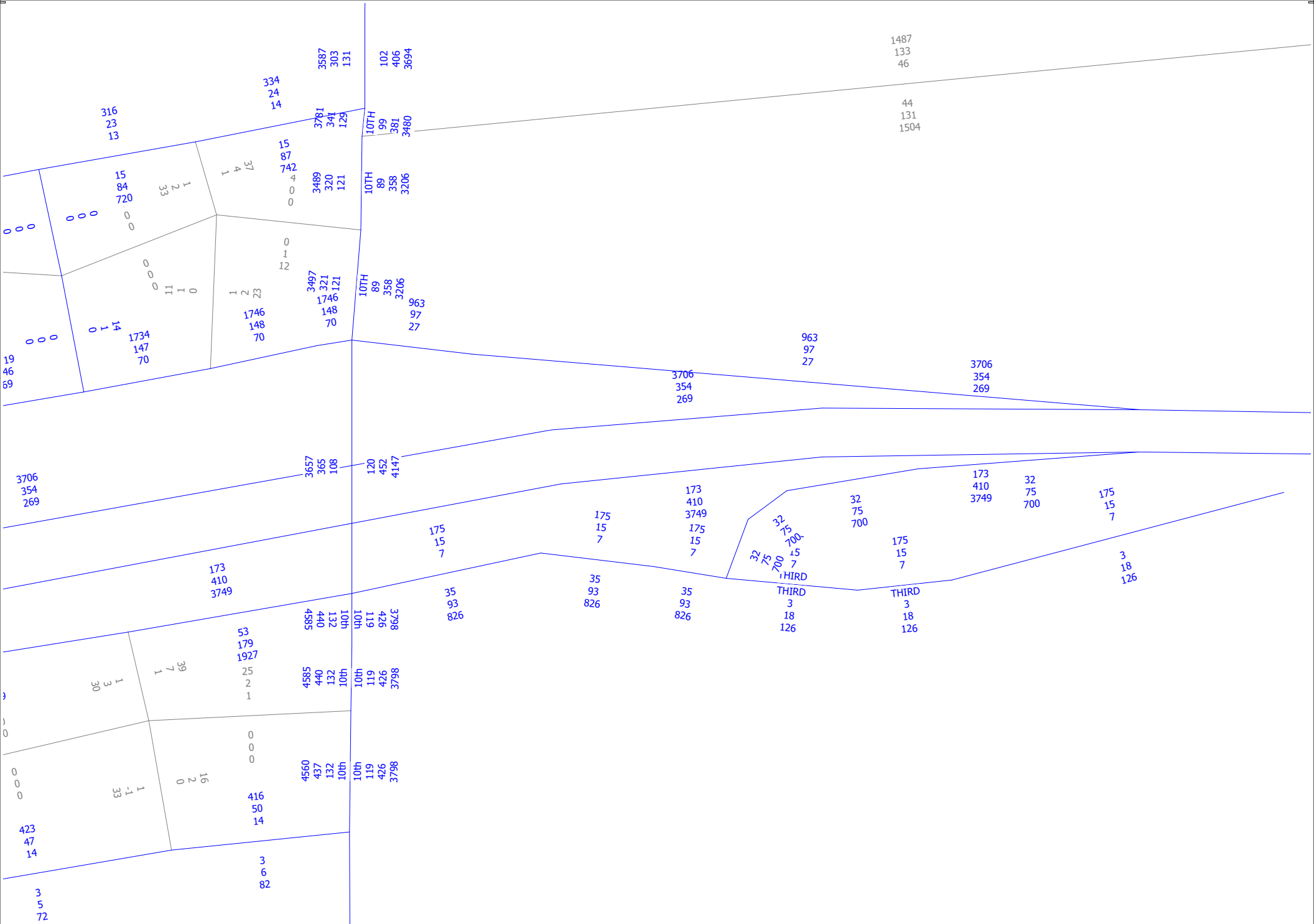

Lunaria TIA
 2042 Increment
 AM, PM and Daily Volumes



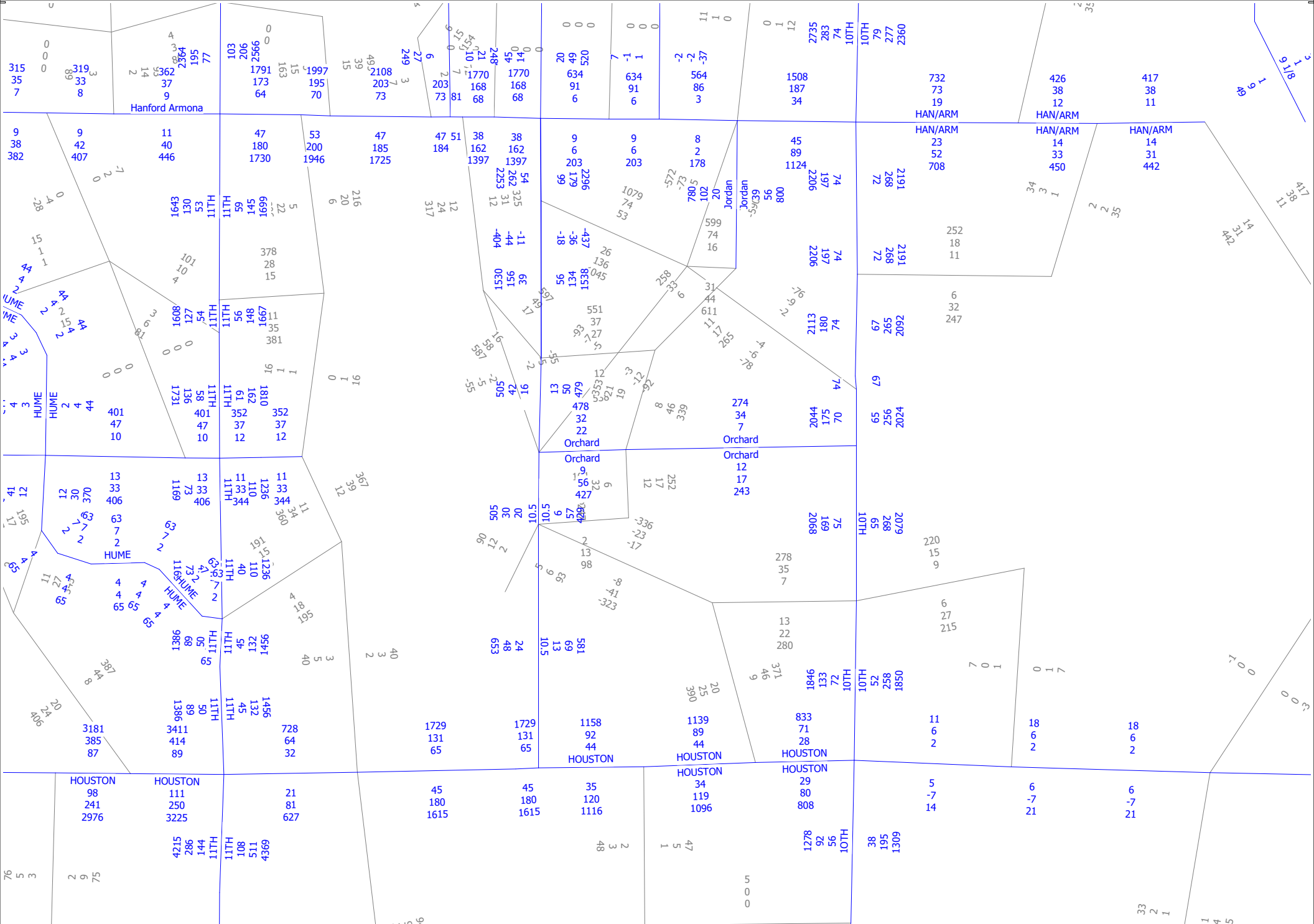

Lunaria TIA
 2042 Increment
 AM, PM and Daily Volumes



Appendix D: Methodology



www.JLBtraffic.com
info@JLBtraffic.com

516 W. Shaw Ave., Ste. 103
Fresno, CA 93704
(559) 570-8991

A p p | D

Levels of Service Methodology

The description and procedures for calculating capacity and level of service (LOS) are found in the Transportation Research Board, Highway Capacity Manual (HCM). The HCM 6th Edition represents the research on capacity and quality of service for transportation facilities.

Quality of service requires quantitative measures to characterize operational conditions within a traffic stream. Level of service is a quality measure describing operational conditions within a traffic stream, generally in terms of such service measures as speed and travel time, freedom to maneuver, traffic interruptions, comfort and convenience.

Six levels of service are defined for each type of facility that has analysis procedures available. Letters designate each level of service (LOS), from A to F, with LOS A representing the best operating conditions and LOS F the worst. Each LOS represents a range of operating conditions and the driver's perception of these conditions. Safety is not included in the measures that establish an LOS.

Intersection Levels of Service

One of the more important elements limiting and often interrupting the flow of traffic on a highway is the intersection. Flow on an interrupted facility is usually dominated by points of fixed operation such as traffic signals, stop signs and yield signs.

Signalized Intersections – Performance Measures

For signalized intersections, the performance measures include automobile volume-to-capacity ratio, automobile delay, queue storage length, ratio of pedestrian delay, pedestrian circulation area, pedestrian perception score, bicycle delay and bicycle perception score. LOS is also considered a performance measure. For the automobile mode, the average control delay per vehicle per approach is determined for the peak hour. A weighted average of control delay per vehicle is then determined for the intersection. An LOS designation is given to the weighted average control delay to better describe the level of operation. A description of LOS for signalized intersections is found in Table A-1.

Table A-1: Signalized Intersection Levels of Service Description (Automobile Mode)

<i>Level of Service</i>	<i>Description</i>	<i>Average Control Delay (Seconds per Vehicle)</i>
A	Operations with a control delay of 10 seconds/vehicle or less and a volume-to-capacity ratio no greater than 1.0. This level is typically assigned when the volume-to-capacity ratio is really low and either progression is exceptionally favorable or the cycle length is very short. If it's due to favorable progression, most vehicles arrive during the green indication and travel through the intersection without stopping.	≤10
B	Operations with control delay between 10.1 to 20.0 seconds/vehicle and a volume-to-capacity ratio no greater than 1.0. This level is typically assigned when the volume-to-capacity ratio is low and either progression is highly favorable or the cycle length is short. More vehicles stop than with LOS A.	>10.0 to 20.0
C	Operations with average control delays between 20.1 to 35.0 seconds/vehicle and a volume-to-capacity ratio no greater than 1.0. This level is typically assigned when the volume-to-capacity ratio no greater than 1.0, the progression is favorable or the cycle length is moderate. Individual cycle failures (i.e., one or more queued vehicles are not able to depart as a result of insufficient capacity during the cycle) may begin to appear at this level. The number of vehicles stopping is significant, although many vehicles still pass through the intersection without stopping.	>20 to 35
D	Operations with control delay between 35.1 to 55.0 seconds/vehicle and a volume-to-capacity ratio no greater than 1.0. This level is typically assigned when the volume-to-capacity ratio is high and either progression is ineffective or the cycle length is long. Many vehicles stop and individual cycle failures are noticeable.	>35 to 55
E	Operations with control delay between 55.1 to 80.0 seconds/vehicle and a volume-to-capacity ratio no greater than 1.0. This level is typically assigned when the volume-to-capacity ratio is high, progression is unfavorable and the cycle length is long. Individual cycle failures are frequent.	>55 to 80
F	Operations with unacceptable control delay exceeding 80.0 seconds/vehicle and a volume-to-capacity ratio greater than 1.0. This level is typically assigned when the volume-to-capacity ratio is very high, progression is very poor and the cycle length is long. Most cycles fail to clear the queue.	>80

Note: Source: Highway Capacity Manual 6th Edition

Unsignalized Intersections

The HCM 6th Edition procedures use control delay as a measure of effectiveness to determine level of service. Delay is a measure of driver discomfort, frustration, fuel consumption and increased travel time. The delay experienced by a motorist is made up of a number of factors that relate to control, traffic and incidents. Total delay is the difference between the travel time actually experienced and the reference travel time that would result during base conditions, i.e., in the absence of traffic control, geometric delay, any incidents and any other vehicles. Control delay is the increased time of travel for a vehicle approaching and passing through an unsignalized intersection, compared with a free-flow vehicle if it were not required to slow or stop at the intersection.



www.JLBtraffic.com
info@JLBtraffic.com

516 W. Shaw Ave., Ste. 103
Fresno, CA 93704
(559) 570-8991

All-Way Stop Controlled Intersections

All-way stop controlled intersections are a form of traffic controls in which all approaches to an intersection are required to stop. Similar to signalized intersections, at all-way stop controlled intersections the average control delay per vehicle per approach is determined for the peak hour. A weighted average of control delay per vehicle is then determined for the intersection as a whole. In other words, the delay measured for all-way stop controlled intersections is a measure of the average delay for all vehicles passing through the intersection during the peak hour. An LOS designation is given to the weighted average control delay to better describe the level of operation.

Two-Way Stop Controlled Intersections

Two-way stop controlled (TWSC) intersections in which stop signs are used to assign the right-of-way, are the most prevalent type of intersection in the United States. At TWSC intersections the stop-controlled approaches are referred to as the minor street approaches and can be either public streets or private driveways. The approaches that are not controlled by stop signs are referred to as the major street approaches.

The capacity of movements subject to delay are determined using the "critical gap" method of capacity analysis. Expected average control delay based on movement volume and movement capacity is calculated. An LOS for a TWSC intersection is determined by the computed or measured control delay for each minor movement. LOS is not defined for the intersection as a whole for three main reasons: (a) major-street through vehicles are assumed to experience zero delay; (b) the disproportionate number of major-street through vehicles at the typical TWSC intersection skews the weighted average of all movements, resulting in a very low overall average delay from all vehicles; and (c) the resulting low delay can mask important LOS deficiencies for minor movements. Table A-2 provides a description of LOS at unsignalized intersections.

Table A-2: Unsignalized Intersection Levels of Service Description (Automobile Mode)

<i>Control Delay (Seconds per Vehicle)</i>	<i>LOS by Volume-to-Capacity Ratio</i>	
	<i>v/c ≤ 1.0</i>	<i>v/c > 1.0</i>
≤10	A	F
>10 to 15	B	F
>15 to 25	C	F
>25 to 35	D	F
>35 to 50	E	F
>50	F	F

Note: Source: HCM 6th Edition, Exhibit 20-2.



www.JLBtraffic.com
info@JLBtraffic.com

516 W. Shaw Ave., Ste. 103
Fresno, CA 93704
(559) 570-8991

Roundabout Controlled Intersections

Roundabouts are intersections with a generally circular shape, characterized by yield on entry and circulation around a central island. Roundabouts have been used successfully throughout the world and are being used increasingly in the United States, especially since 1990. The procedure used to calculate LOS incorporates a combination of lane-based regression models and gap acceptance models for both single-lane and multi-lane roundabouts. As a result, the capacity models focus on one entry of a roundabout at a time. Table A-3 provides a description of LOS at roundabout intersections.

Table A-3: Roundabout Intersection Level of Service Description (Automobile Mode)

Control Delay (Seconds per Vehicle)	LOS by Volume-to-Capacity Ratio	
	$v/c \leq 1.0$	$v/c > 1.0$
≤10	A	F
>10 to 15	B	F
>15 to 25	C	F
>25 to 35	D	F
>35 to 50	E	F
>50	F	F

Note: Source: HCM 6th Edition, Exhibit 22-8.

Segment Levels of Service

Segments are portions of roads without any interruption of flow. These are typically studied as urban streets, basic freeways, multilane highways or two-lane highways. Each of these categories has further classification and the level of service analysis can differ between them.

Basic Freeway and Multilane Highway Segments

For segments of multilane highways and basic freeways outside the influence of merging, diverging and weaving maneuvers, LOS is defined by density. Density describes a motorist's proximity to other vehicles and is related to a motorist's freedom to maneuver within the traffic stream. Chapter 12 of the Highway Capacity Manual categorizes each LOS as follows:

LOS A describes free-flow operations. FFS prevails on the freeway or multilane highway, and vehicles are almost completely unimpeded in their ability to maneuver within the traffic stream. The effects of incidents or point breakdowns are easily absorbed.

LOS B represents reasonably free-flow operations, and FFS on the freeway or multilane highway is maintained. The ability to maneuver within the traffic stream is only slightly restricted, and the general level of physical and psychological comfort provided to drivers is still high. The effects of minor incidents are still easily absorbed.

LOS C provides for flow with speeds near the FFS of the freeway or multilane highway. Freedom to maneuver within the traffic stream is noticeably restricted, and lane changes require more care and vigilance on the part of the driver. Minor incidents may still be absorbed, but the local deterioration in service quality will be significant. Queues may be expected to form behind any significant blockages.

LOS D is the level at which speeds begin to decline with increasing flows, with density increasing more quickly. Freedom to maneuver within the traffic stream is seriously limited, and drivers experience reduced physical and psychological comfort levels. Even minor incidents can be expected to create queuing, because the traffic stream has little space to absorb disruptions.

LOS E describes operation at or near capacity. Operations on the freeway or multilane highway at this level are highly volatile because there are virtually no usable gaps within the traffic stream, leaving little room to maneuver within the traffic stream. Any disruption to the traffic stream, such as vehicles entering from a ramp or an access point or a vehicle changing lanes, can establish a disruption wave that propagates throughout the upstream traffic stream. Toward the upper boundary of LOS E, the traffic stream has no ability to dissipate even the most minor disruption, and any incident can be expected to produce a serious breakdown and substantial queuing. The physical and psychological comfort afforded to drivers is poor.

LOS F describes unstable flow. Such conditions exist within queues forming behind bottlenecks. Breakdowns occur for a number of reasons:

- Traffic incidents can temporarily reduce the capacity of a short segment so that the number of vehicles arriving at a point is greater than the number of vehicles that can move through it.
- Points of recurring congestion, such as merge or weaving segments and lane drops, experience very high demand in which the number of vehicles arriving is greater than the number of vehicles that can be discharged.
- In analyses using forecast volumes, the projected flow rate can exceed the estimated capacity of a given location.

Basic Freeway

Basic Freeway segments generally have four to eight lanes and posted speed limits between 50 and 75 mi/hr. The performance measures include capacity, free flow speed, demand and volume-to-capacity ratio, space mean speed, average density and LOS. The LOS is dependent on the number of lanes, base free-flow speed, lane width, right side lateral clearance, total ramp density, hourly demand volume, peak hour factor and total truck percentage. Table A-4 provides a description of LOS for Basic Freeway Segments.

Multilane Highway

Multilane Highway segments generally have four to six lanes and posted speed limits between 40 and 55 mi/hr. The performance measures include capacity, free flow speed, demand and volume-to-capacity ratio, space mean speed, average density and LOS. The LOS is dependent on the number of lanes, base free-flow speed, lane width, right side lateral clearance, left side lateral clearance, access point density, terrain type, median type, hourly demand volume, peak hour factor and total truck percentage. Table A-4 provides a description of LOS for Multilane Highway Segments.

Table A-4: Basic Freeway and Multilane Highway Segment Level of Service Description

<i>Level of Service</i>	<i>Density (Passenger Cars per Mile per Lane)</i>
A	≤11
B	>11 to 18
C	>18 to 26
D	>26 to 35
E	>35 to 45
F	>45 or Demand Exceeds Capacity

Note: Source: HCM 6th Edition, Exhibit 12-15.



www.JLBtraffic.com
info@JLBtraffic.com

516 W. Shaw Ave., Ste. 103
Fresno, CA 93704
(559) 570-8991

Two-Lane Highway Segments

Two-Lane Highways generally have one lane per direction and only allow passing maneuvers to take place in the opposing lane of traffic. If allowed, passing maneuvers are limited by the availability of gaps in the opposing traffic stream and by the availability of sufficient sight distance for a driver to discern the approach of an opposing vehicle safely. A principal measure of LOS is percent time spent following and follower density. This is the average percent of time that vehicles must travel in platoons behind slower vehicles due to the inability to pass. Chapter 15 of the Highway Capacity Manual categorizes each LOS as follows:

At **LOS A**, motorists experience high operating speeds on Class I highways and little difficulty in passing. Platoons of three or more vehicles are rare. On Class II highways, speed is controlled primarily by roadway conditions, but a small amount of platooning would be expected. On Class III highways, motorists can maintain operating speeds at or near the facility's FFS.

At **LOS B**, passing demand and passing capacity are balanced. On both Class I and Class II highways, the degree of platooning becomes noticeable. Some speed reductions are present on Class I highways. On Class III highways, maintenance of FFS operation becomes difficult, but the speed reduction is still relatively small.

At **LOS C**, most vehicles travel in platoons. Speeds are noticeably curtailed on all three classes of highways.

At **LOS D**, platooning increases significantly. Passing demand is high on both Class I and Class II facilities, but passing capacity approaches zero. A high percentage of vehicles travels in platoons, and PTSF is noticeable. On Class III highways, the fall-off from FFS is significant.

At **LOS E**, demand is approaching capacity. Passing on Class I and II highways is virtually impossible, and PTSF is more than 80%. Speeds are seriously curtailed. On Class III highways, speed is less than two-thirds of the FFS. The lower limit of LOSE represents capacity.

LOS F exists whenever demand flow in one or both directions exceeds the segment's capacity. Operating conditions are unstable and heavy congestion exists on all classes of two-lane highways.

Two-Lane Highway

The performance measures include average travel speed, segment travel time, percent followers, volume to capacity ratio, follower density and LOS. The LOS is dependent on Highway Class (I, II, or III), lane width, shoulder width, access point density, terrain type, free flow speed, passing lane length, demand flow rate, opposing demand flow rate peak hour factor and total truck percentage. Tables A-5 and A-6 provide a description of LOS for Two-Lane Highway Segments.

Table A-5: Two-Lane Highway Segment Level of Service Description

LOS	Class I Highways		Class II Highways	Class III Highways
	ATS (Mile per Hour)	PTSF (%)	PTSF (%)	PFFS (%)
A	>55	≤35	≤40	>91.7
B	>50 to 55	>35 to 50	>40 to 55	>83.3 to 91.7
C	>45 to 50	>50 to 65	>55 to 70	>75.0 to 83.3
D	>40 to 45	>65 to 80	>70 to 85	>66.7 to 75.0
E	≤40	>80	>85	≤66.7
F	Demand exceeds capacity			

Note: ATS = Average Travel Speed
 PTSF = Percent Time Spent Following
 PFFS = Percent of Free Flow Speed
 Source: HCM 6th Edition, Exhibit 15-3.

Table A-6: Two-Lane Highway Segment Level of Service Description

LOS	Follower Density (Followers per Mile per Lane)	
	High Speed Highways Posted Speed Limit ≥ 50 miles per hour	High Speed Highways Posted Speed Limit < 50 miles per hour
	A	≤2.0
B	>2.0 to 4.0	>2.5 to 5.0
C	>4.0 to 8.0	>5.0 to 10.0
D	>8.0 to 12.0	>10.0 to 15.0
E	>12.0	>15.0

Note: Source: NCHRP 'Improved Analysis of Two-Lane Highway Capacity and Operational Performance, Table 3-23.

Urban Streets (Automobile Mode)

The term “urban streets” refers to urban arterials and collectors, including those in downtown areas. Arterial streets are roads that primarily serve longer through trips. However, providing access to abutting commercial and residential land uses is also an important function of arterials. Collector streets provide both land access and traffic circulation within residential, commercial and industrial areas. Their access function is more important than that of arterials and unlike arterials their operation is not always dominated by traffic signals. Downtown streets are signalized facilities that often resemble arterials.

They not only move through traffic but also provide access to local businesses for passenger cars, transit buses and trucks. Pedestrian conflicts and lane obstructions created by stopping or standing taxicabs, buses, trucks and parking vehicles that cause turbulence in the traffic flow are typical of downtown streets.

Flow Characteristics

The speed of vehicles on urban streets is influenced by three main factors, street environment, interaction among vehicles and traffic control.

The street environment includes the geometric characteristics of the facility, the character of roadside activity and adjacent land uses. Thus, the environment reflects the number and width of lanes, type of median, driveway/access point density, spacing between signalized intersections, existence of parking, level of pedestrian and bicyclist activity and speed limit.

The interaction among vehicles is determined by traffic density, the proportion of trucks and buses and turning movements. This interaction affects the operation of vehicles at intersections and, to a lesser extent, between signals.

Traffic controls (including signals and signs) force a portion of all vehicles to slow or stop. The delays and speed changes caused by traffic control devices reduce vehicle speeds; however, such controls are needed to establish right-of-way.



www.JLBtraffic.com
info@JLBtraffic.com

516 W. Shaw Ave., Ste. 103
Fresno, CA 93704
(559) 570-8991

Urban Street Segments LOS

The average travel speed for through vehicles along an urban street is the determinant of the operating level of service (LOS). The travel speed along a segment, section or entire length of an urban street is dependent on the running speed between signalized intersections and the amount of control delay incurred at signalized intersections. Table A-7 provides a description of LOS for Urban Street Segments.

LOS A describes primarily free-flow operation. Vehicles are completely unimpeded in their ability to maneuver within the traffic stream. Control delay at signalized intersections is minimal. Travel speeds exceed 80 percent of the base free flow speed (FFS).

LOS B describes reasonably unimpeded operation. The ability to maneuver within the traffic stream is only slightly restricted and control delay at the boundary intersections is not significant. The travel speed is between 67 and 80 percent of the base FFS.

LOS C describes stable operations. The ability to maneuver and change lanes in midblock location may be more restricted than at LOS B. Longer queues at the boundary intersections may contribute to lower travel speeds. The travel speed is between 50 and 67 percent of the base FFS.

LOS D indicates a less stable condition in which small increases in flow may cause substantial increases in delay and decreases in travel speed. This operation may be due to adverse signal progression, high volumes or inappropriate signal timing at the boundary intersections. The travel speed is between 40 and 50 percent of the base FFS.

LOS E is characterized as an unstable operation and has significant delay. Such operations may be due to some combination of adverse progression, high volume and inappropriate signal timing at the boundary intersections. The travel speed is between 30 and 40 percent of the base FFS.

LOS F is characterized by street flow at extremely low speed. Congestion is likely occurring at the boundary intersections, as indicated by high delay and extensive queuing. The travel speed is 30 percent or less of the base FFS.

Table A-7: Urban Street Levels of Service (Automobile Mode)

LOS	Travel Speed Threshold by Base Free-Flow Speed (miles/hour)							Volume-to-Capacity Ratio
	55	50	45	40	35	30	25	
A	>44	>40	>36	>32	>28	>24	>20	≤ 1.0
B	>37	>34	>30	>27	>23	>20	>17	
C	>28	>25	>23	>20	>18	>15	>13	
D	>22	>20	>18	>16	>14	>12	>10	
E	>17	>15	>14	>12	>11	>9	>8	
F	≤17	≤15	≤14	≤12	≤11	≤9	≤8	
F	Any							> 1.0

Note: a = The Critical volume-to-capacity ratio is based on consideration of the through movement-to-capacity ratio at each boundary intersection in the subject direction of travel. The critical volume-to-capacity ratio is the largest ratio of those considered.
Source: Highway Capacity Manual 6th Edition, Exhibit 16-3.



www.JLBtraffic.com
info@JLBtraffic.com

516 W. Shaw Ave., Ste. 103
Fresno, CA 93704
(559) 570-8991

Appendix E: Existing Traffic Conditions



www.JLBtraffic.com
info@JLBtraffic.com

516 W. Shaw Ave., Ste. 103
Fresno, CA 93704
(559) 570-8991

App | E

HCM 6th Signalized Intersection Summary
 3: 10 1/2 Avenue & Hanford Armona Road

Existing AM Peak
 04/26/2022



Movement	EBL	EBT	EBR	WBL	WBT	WBR	NBL	NBT	NBR	SBL	SBT	SBR
Lane Configurations	↖	↗		↖	↗		↖	↗	↗	↖	↗	↖
Traffic Volume (veh/h)	55	226	17	12	202	22	39	31	11	11	12	34
Future Volume (veh/h)	55	226	17	12	202	22	39	31	11	11	12	34
Initial Q (Qb), veh	0	0	0	0	0	0	0	0	0	0	0	0
Ped-Bike Adj(A_pbT)	1.00		1.00	1.00		1.00	1.00		1.00	1.00		1.00
Parking Bus, Adj	1.00	1.00	1.00	1.00	1.00	1.00	1.00	1.00	1.00	1.00	1.00	1.00
Work Zone On Approach		No			No			No			No	
Adj Sat Flow, veh/h/ln	1826	1826	1826	1826	1826	1826	1826	1826	1826	1826	1826	1826
Adj Flow Rate, veh/h	76	314	24	17	281	31	54	43	15	15	17	47
Peak Hour Factor	0.72	0.72	0.72	0.72	0.72	0.72	0.72	0.72	0.72	0.72	0.72	0.72
Percent Heavy Veh, %	5	5	5	5	5	5	5	5	5	5	5	5
Cap, veh/h	128	523	40	38	420	46	101	259	220	34	189	160
Arrive On Green	0.07	0.31	0.31	0.02	0.26	0.26	0.06	0.14	0.14	0.02	0.10	0.10
Sat Flow, veh/h	1739	1675	128	1739	1615	178	1739	1826	1547	1739	1826	1547
Grp Volume(v), veh/h	76	0	338	17	0	312	54	43	15	15	17	47
Grp Sat Flow(s),veh/h/ln	1739	0	1803	1739	0	1793	1739	1826	1547	1739	1826	1547
Q Serve(g_s), s	1.5	0.0	5.7	0.3	0.0	5.6	1.1	0.7	0.3	0.3	0.3	1.0
Cycle Q Clear(g_c), s	1.5	0.0	5.7	0.3	0.0	5.6	1.1	0.7	0.3	0.3	0.3	1.0
Prop In Lane	1.00		0.07	1.00		0.10	1.00		1.00	1.00		1.00
Lane Grp Cap(c), veh/h	128	0	563	38	0	467	101	259	220	34	189	160
V/C Ratio(X)	0.59	0.00	0.60	0.45	0.00	0.67	0.54	0.17	0.07	0.45	0.09	0.29
Avail Cap(c_a), veh/h	376	0	1464	241	0	1317	280	1392	1179	241	1366	1158
HCM Platoon Ratio	1.00	1.00	1.00	1.00	1.00	1.00	1.00	1.00	1.00	1.00	1.00	1.00
Upstream Filter(I)	1.00	0.00	1.00	1.00	0.00	1.00	1.00	1.00	1.00	1.00	1.00	1.00
Uniform Delay (d), s/veh	16.2	0.0	10.5	17.4	0.0	11.9	16.5	13.6	13.4	17.5	14.6	15.0
Incr Delay (d2), s/veh	4.3	0.0	1.0	8.2	0.0	1.7	4.4	0.3	0.1	9.0	0.2	1.0
Initial Q Delay(d3),s/veh	0.0	0.0	0.0	0.0	0.0	0.0	0.0	0.0	0.0	0.0	0.0	0.0
%ile BackOfQ(50%),veh/ln	0.6	0.0	1.6	0.2	0.0	1.7	0.5	0.3	0.1	0.2	0.1	0.3
Unsig. Movement Delay, s/veh												
LnGrp Delay(d),s/veh	20.5	0.0	11.5	25.6	0.0	13.6	20.9	13.9	13.5	26.5	14.8	16.0
LnGrp LOS	C	A	B	C	A	B	C	B	B	C	B	B
Approach Vol, veh/h		414			329			112			79	
Approach Delay, s/veh		13.2			14.2			17.2			17.7	
Approach LOS		B			B			B			B	
Timer - Assigned Phs	1	2	3	4	5	6	7	8				
Phs Duration (G+Y+Rc), s	4.9	10.0	5.0	16.2	6.3	8.6	6.9	14.3				
Change Period (Y+Rc), s	* 4.2	4.9	* 4.2	4.9	* 4.2	* 4.9	* 4.2	4.9				
Max Green Setting (Gmax), s	* 5	27.5	* 5	29.3	* 5.8	* 27	* 7.8	26.5				
Max Q Clear Time (g_c+I1), s	2.3	2.7	2.3	7.7	3.1	3.0	3.5	7.6				
Green Ext Time (p_c), s	0.0	0.2	0.0	1.8	0.0	0.2	0.0	1.6				

Intersection Summary												
HCM 6th Ctrl Delay				14.4								
HCM 6th LOS				B								

Notes

* HCM 6th computational engine requires equal clearance times for the phases crossing the barrier.

Intersection

Int Delay, s/veh 1.6

Movement	EBT	EBR	WBL	WBT	NBL	NBR
Lane Configurations						
Traffic Vol, veh/h	200	21	14	178	34	21
Future Vol, veh/h	200	21	14	178	34	21
Conflicting Peds, #/hr	0	0	0	0	0	1
Sign Control	Free	Free	Free	Free	Stop	Stop
RT Channelized	-	None	-	None	-	None
Storage Length	-	-	75	-	0	-
Veh in Median Storage, #	0	-	-	0	0	-
Grade, %	0	-	-	0	0	-
Peak Hour Factor	74	74	74	74	74	74
Heavy Vehicles, %	6	6	6	6	6	6
Mvmt Flow	270	28	19	241	46	28

Major/Minor

	Major1	Major2	Minor1		
Conflicting Flow All	0	0	298	0	563
Stage 1	-	-	-	-	284
Stage 2	-	-	-	-	279
Critical Hdwy	-	-	4.16	-	6.46
Critical Hdwy Stg 1	-	-	-	-	5.46
Critical Hdwy Stg 2	-	-	-	-	5.46
Follow-up Hdwy	-	-	2.254	-	3.554
Pot Cap-1 Maneuver	-	-	1241	-	481
Stage 1	-	-	-	-	755
Stage 2	-	-	-	-	759
Platoon blocked, %	-	-	-	-	-
Mov Cap-1 Maneuver	-	-	1241	-	474
Mov Cap-2 Maneuver	-	-	-	-	559
Stage 1	-	-	-	-	755
Stage 2	-	-	-	-	748

Approach

	EB	WB	NB
HCM Control Delay, s	0	0.6	11.6
HCM LOS			B

Minor Lane/Major Mvmt

	NBLn1	EBT	EBR	WBL	WBT
Capacity (veh/h)	618	-	-	1241	-
HCM Lane V/C Ratio	0.12	-	-	0.015	-
HCM Control Delay (s)	11.6	-	-	7.9	-
HCM Lane LOS	B	-	-	A	-
HCM 95th %tile Q(veh)	0.4	-	-	0	-

HCM 6th Signalized Intersection Summary
5: 10th Avenue & Hanford Armona Road

Existing AM Peak
04/26/2022



Movement	EBL	EBT	EBR	WBL	WBT	WBR	NBL	NBT	NBR	SBL	SBT	SBR
Lane Configurations												
Traffic Volume (veh/h)	166	4	50	3	4	12	54	167	1	6	154	144
Future Volume (veh/h)	166	4	50	3	4	12	54	167	1	6	154	144
Initial Q (Qb), veh	0	0	0	0	0	0	0	0	0	0	0	0
Ped-Bike Adj(A_pbT)	1.00		1.00	1.00		1.00	1.00		1.00	1.00		1.00
Parking Bus, Adj	1.00	1.00	1.00	1.00	1.00	1.00	1.00	1.00	1.00	1.00	1.00	1.00
Work Zone On Approach		No			No			No			No	
Adj Sat Flow, veh/h/ln	1796	1796	1796	1796	1796	1796	1796	1796	1796	1796	1796	1796
Adj Flow Rate, veh/h	205	5	62	4	5	15	67	206	1	7	190	178
Peak Hour Factor	0.81	0.81	0.81	0.81	0.81	0.81	0.81	0.81	0.81	0.81	0.81	0.81
Percent Heavy Veh, %	7	7	7	7	7	7	7	7	7	7	7	7
Cap, veh/h	256	404	342	9	32	96	114	457	388	16	355	301
Arrive On Green	0.15	0.22	0.22	0.01	0.08	0.08	0.07	0.25	0.25	0.01	0.20	0.20
Sat Flow, veh/h	1711	1796	1522	1711	396	1187	1711	1796	1522	1711	1796	1522
Grp Volume(v), veh/h	205	5	62	4	0	20	67	206	1	7	190	178
Grp Sat Flow(s),veh/h/ln	1711	1796	1522	1711	0	1583	1711	1796	1522	1711	1796	1522
Q Serve(g_s), s	4.4	0.1	1.3	0.1	0.0	0.5	1.5	3.7	0.0	0.2	3.6	4.1
Cycle Q Clear(g_c), s	4.4	0.1	1.3	0.1	0.0	0.5	1.5	3.7	0.0	0.2	3.6	4.1
Prop In Lane	1.00		1.00	1.00		0.75	1.00		1.00	1.00		1.00
Lane Grp Cap(c), veh/h	256	404	342	9	0	128	114	457	388	16	355	301
V/C Ratio(X)	0.80	0.01	0.18	0.43	0.00	0.16	0.59	0.45	0.00	0.44	0.54	0.59
Avail Cap(c_a), veh/h	303	1741	1476	223	0	1443	223	1348	1142	223	1367	1158
HCM Platoon Ratio	1.00	1.00	1.00	1.00	1.00	1.00	1.00	1.00	1.00	1.00	1.00	1.00
Upstream Filter(I)	1.00	1.00	1.00	1.00	0.00	1.00	1.00	1.00	1.00	1.00	1.00	1.00
Uniform Delay (d), s/veh	15.8	11.6	12.0	19.0	0.0	16.4	17.4	12.0	10.7	18.9	13.8	14.0
Incr Delay (d2), s/veh	12.3	0.0	0.3	28.4	0.0	0.6	4.8	0.7	0.0	17.6	1.3	1.9
Initial Q Delay(d3),s/veh	0.0	0.0	0.0	0.0	0.0	0.0	0.0	0.0	0.0	0.0	0.0	0.0
%ile BackOfQ(50%),veh/ln	2.2	0.0	0.3	0.1	0.0	0.1	0.6	1.1	0.0	0.1	1.2	1.2
Unsig. Movement Delay, s/veh												
LnGrp Delay(d),s/veh	28.1	11.6	12.3	47.4	0.0	17.0	22.2	12.7	10.7	36.5	15.1	15.8
LnGrp LOS	C	B	B	D	A	B	C	B	B	D	B	B
Approach Vol, veh/h		272			24			274			375	
Approach Delay, s/veh		24.2			22.0			15.0			15.8	
Approach LOS		C			C			B			B	
Timer - Assigned Phs	1	2	3	4	5	6	7	8				
Phs Duration (G+Y+Rc), s	4.6	15.5	4.4	13.9	6.8	13.3	9.9	8.4				
Change Period (Y+Rc), s	* 4.2	5.7	* 4.2	* 5.3	* 4.2	* 5.7	* 4.2	5.3				
Max Green Setting (Gmax), s	* 5	28.8	* 5	* 37	* 5	* 29	* 6.8	35.0				
Max Q Clear Time (g_c+I1), s	2.2	5.7	2.1	3.3	3.5	6.1	6.4	2.5				
Green Ext Time (p_c), s	0.0	0.9	0.0	0.2	0.0	1.5	0.0	0.1				

Intersection Summary

HCM 6th Ctrl Delay	18.2
HCM 6th LOS	B

Notes

* HCM 6th computational engine requires equal clearance times for the phases crossing the barrier.

HCM Signalized Intersection Capacity Analysis

7: 11th Avenue & Houston Avenue

Existing AM Peak

04/26/2022



Movement	EBL	EBT	EBR	WBL	WBT	WBR	NBL	NBT	NBR	SBL	SBT	SBR
Lane Configurations												
Traffic Volume (vph)	32	66	24	24	57	35	17	73	21	40	59	21
Future Volume (vph)	32	66	24	24	57	35	17	73	21	40	59	21
Ideal Flow (vphp)	1900	1900	1900	1900	1900	1900	1900	1900	1900	1900	1900	1900
Total Lost time (s)	4.2	6.0	6.0	4.2	5.7	5.7	4.2	5.7	5.7	4.2	5.3	5.3
Lane Util. Factor	1.00	1.00	1.00	1.00	1.00	1.00	1.00	0.95	1.00	1.00	1.00	1.00
Frt	1.00	1.00	0.85	1.00	1.00	0.85	1.00	1.00	0.85	1.00	1.00	0.85
Flt Protected	0.95	1.00	1.00	0.95	1.00	1.00	0.95	1.00	1.00	0.95	1.00	1.00
Satd. Flow (prot)	1597	1681	1429	1597	1681	1429	1597	3195	1429	1597	1681	1429
Flt Permitted	0.95	1.00	1.00	0.95	1.00	1.00	0.95	1.00	1.00	0.95	1.00	1.00
Satd. Flow (perm)	1597	1681	1429	1597	1681	1429	1597	3195	1429	1597	1681	1429
Peak-hour factor, PHF	0.96	0.96	0.96	0.96	0.96	0.96	0.96	0.96	0.96	0.96	0.96	0.96
Adj. Flow (vph)	33	69	25	25	59	36	18	76	22	42	61	22
RTOR Reduction (vph)	0	0	21	0	0	31	0	0	13	0	0	12
Lane Group Flow (vph)	33	69	4	25	59	5	18	76	9	42	61	10
Heavy Vehicles (%)	13%	13%	13%	13%	13%	13%	13%	13%	13%	13%	13%	13%
Turn Type	Prot	NA	Perm	Prot	NA	Perm	Prot	NA	Perm	Prot	NA	Perm
Protected Phases	7	4		3	8		5	2		1	6	
Permitted Phases			4			8			2			6
Actuated Green, G (s)	3.0	9.9	9.9	1.0	8.2	8.2	1.0	22.3	22.3	3.0	24.7	24.7
Effective Green, g (s)	3.0	9.9	9.9	1.0	8.2	8.2	1.0	22.3	22.3	3.0	24.7	24.7
Actuated g/C Ratio	0.05	0.18	0.18	0.02	0.15	0.15	0.02	0.40	0.40	0.05	0.44	0.44
Clearance Time (s)	4.2	6.0	6.0	4.2	5.7	5.7	4.2	5.7	5.7	4.2	5.3	5.3
Vehicle Extension (s)	3.0	3.0	3.0	3.0	3.0	3.0	3.0	3.0	3.0	3.0	3.0	3.0
Lane Grp Cap (vph)	85	295	251	28	244	208	28	1265	566	85	737	626
v/s Ratio Prot	c0.02	c0.04		0.02	0.04		0.01	0.02		c0.03	c0.04	
v/s Ratio Perm			0.00			0.00			0.01			0.01
v/c Ratio	0.39	0.23	0.02	0.89	0.24	0.03	0.64	0.06	0.02	0.49	0.08	0.02
Uniform Delay, d1	25.8	19.9	19.2	27.6	21.3	20.6	27.5	10.5	10.3	25.9	9.2	8.9
Progression Factor	1.00	1.00	1.00	1.00	1.00	1.00	1.00	1.00	1.00	1.00	1.00	1.00
Incremental Delay, d2	2.9	0.4	0.0	123.8	0.5	0.0	40.9	0.0	0.0	4.5	0.0	0.0
Delay (s)	28.7	20.3	19.2	151.4	21.8	20.7	68.4	10.5	10.3	30.4	9.3	8.9
Level of Service	C	C	B	F	C	C	E	B	B	C	A	A
Approach Delay (s)		22.3			48.5			19.5			16.3	
Approach LOS		C			D			B			B	

Intersection Summary

HCM 2000 Control Delay	26.5	HCM 2000 Level of Service	C
HCM 2000 Volume to Capacity ratio	0.19		
Actuated Cycle Length (s)	56.3	Sum of lost time (s)	20.1
Intersection Capacity Utilization	30.9%	ICU Level of Service	A
Analysis Period (min)	15		
c Critical Lane Group			

Intersection

Int Delay, s/veh 1

Movement	EBL	EBT	WBT	WBR	SBL	SBR
Lane Configurations		↕	↕		↕	
Traffic Vol, veh/h	9	94	80	22	8	7
Future Vol, veh/h	9	94	80	22	8	7
Conflicting Peds, #/hr	0	0	0	0	0	0
Sign Control	Free	Free	Free	Free	Stop	Stop
RT Channelized	-	None	-	None	-	None
Storage Length	-	-	-	-	0	-
Veh in Median Storage, #	-	0	0	-	0	-
Grade, %	-	0	0	-	0	-
Peak Hour Factor	89	89	89	89	89	89
Heavy Vehicles, %	19	19	19	19	19	19
Mvmt Flow	10	106	90	25	9	8

Major/Minor	Major1	Major2	Minor2
Conflicting Flow All	115	0	0
Stage 1	-	-	103
Stage 2	-	-	126
Critical Hdwy	4.29	-	6.59
Critical Hdwy Stg 1	-	-	5.59
Critical Hdwy Stg 2	-	-	5.59
Follow-up Hdwy	2.371	-	3.671
Pot Cap-1 Maneuver	1375	-	723
Stage 1	-	-	880
Stage 2	-	-	859
Platoon blocked, %	-	-	-
Mov Cap-1 Maneuver	1375	-	717
Mov Cap-2 Maneuver	-	-	717
Stage 1	-	-	873
Stage 2	-	-	859

Approach	EB	WB	SB
HCM Control Delay, s	0.7	0	9.6
HCM LOS			A

Minor Lane/Major Mvmt	EBL	EBT	WBT	WBR	SBLn1
Capacity (veh/h)	1375	-	-	-	795
HCM Lane V/C Ratio	0.007	-	-	-	0.021
HCM Control Delay (s)	7.6	0	-	-	9.6
HCM Lane LOS	A	A	-	-	A
HCM 95th %tile Q(veh)	0	-	-	-	0.1

Intersection	
Intersection Delay, s/veh	8.8
Intersection LOS	A

Movement	EBL	EBT	EBR	WBL	WBT	WBR	NBL	NBT	NBR	SBL	SBT	SBR
Lane Configurations		↕			↕			↕			↕	
Traffic Vol, veh/h	29	63	18	12	56	13	13	58	5	13	61	39
Future Vol, veh/h	29	63	18	12	56	13	13	58	5	13	61	39
Peak Hour Factor	0.91	0.91	0.91	0.91	0.91	0.91	0.91	0.91	0.91	0.91	0.91	0.91
Heavy Vehicles, %	26	26	26	26	26	26	26	26	26	26	26	26
Mvmt Flow	32	69	20	13	62	14	14	64	5	14	67	43
Number of Lanes	0	1	0	0	1	0	0	1	0	0	1	0

Approach	EB	WB	NB	SB
Opposing Approach	WB	EB	SB	NB
Opposing Lanes	1	1	1	1
Conflicting Approach Left	SB	NB	EB	WB
Conflicting Lanes Left	1	1	1	1
Conflicting Approach Right	NB	SB	WB	EB
Conflicting Lanes Right	1	1	1	1
HCM Control Delay	8.9	8.7	8.7	8.8
HCM LOS	A	A	A	A

Lane	NBLn1	EBLn1	WBLn1	SBLn1
Vol Left, %	17%	26%	15%	12%
Vol Thru, %	76%	57%	69%	54%
Vol Right, %	7%	16%	16%	35%
Sign Control	Stop	Stop	Stop	Stop
Traffic Vol by Lane	76	110	81	113
LT Vol	13	29	12	13
Through Vol	58	63	56	61
RT Vol	5	18	13	39
Lane Flow Rate	84	121	89	124
Geometry Grp	1	1	1	1
Degree of Util (X)	0.116	0.165	0.122	0.165
Departure Headway (Hd)	5.021	4.927	4.947	4.795
Convergence, Y/N	Yes	Yes	Yes	Yes
Cap	714	729	725	749
Service Time	3.049	2.955	2.976	2.821
HCM Lane V/C Ratio	0.118	0.166	0.123	0.166
HCM Control Delay	8.7	8.9	8.7	8.8
HCM Lane LOS	A	A	A	A
HCM 95th-tile Q	0.4	0.6	0.4	0.6

HCM 6th Signalized Intersection Summary
3: 10 1/2 Avenue & Hanford Armona Road

Existing PM Peak
04/25/2022



Movement	EBL	EBT	EBR	WBL	WBT	WBR	NBL	NBT	NBR	SBL	SBT	SBR
Lane Configurations												
Traffic Volume (veh/h)	44	286	15	6	285	27	27	16	5	23	18	56
Future Volume (veh/h)	44	286	15	6	285	27	27	16	5	23	18	56
Initial Q (Qb), veh	0	0	0	0	0	0	0	0	0	0	0	0
Ped-Bike Adj(A_pbT)	1.00		1.00	1.00		1.00	1.00		1.00	1.00		1.00
Parking Bus, Adj	1.00	1.00	1.00	1.00	1.00	1.00	1.00	1.00	1.00	1.00	1.00	1.00
Work Zone On Approach		No			No			No			No	
Adj Sat Flow, veh/h/ln	1856	1856	1856	1856	1856	1856	1856	1856	1856	1856	1856	1856
Adj Flow Rate, veh/h	48	311	16	7	310	29	29	17	5	25	20	61
Peak Hour Factor	0.92	0.92	0.92	0.92	0.92	0.92	0.92	0.92	0.92	0.92	0.92	0.92
Percent Heavy Veh, %	3	3	3	3	3	3	3	3	3	3	3	3
Cap, veh/h	94	571	29	17	472	44	62	198	168	55	190	161
Arrive On Green	0.05	0.33	0.33	0.01	0.28	0.28	0.04	0.11	0.11	0.03	0.10	0.10
Sat Flow, veh/h	1767	1749	90	1767	1670	156	1767	1856	1572	1767	1856	1572
Grp Volume(v), veh/h	48	0	327	7	0	339	29	17	5	25	20	61
Grp Sat Flow(s),veh/h/ln	1767	0	1839	1767	0	1827	1767	1856	1572	1767	1856	1572
Q Serve(g_s), s	0.9	0.0	5.0	0.1	0.0	5.7	0.6	0.3	0.1	0.5	0.3	1.3
Cycle Q Clear(g_c), s	0.9	0.0	5.0	0.1	0.0	5.7	0.6	0.3	0.1	0.5	0.3	1.3
Prop In Lane	1.00		0.05	1.00		0.09	1.00		1.00	1.00		1.00
Lane Grp Cap(c), veh/h	94	0	600	17	0	516	62	198	168	55	190	161
V/C Ratio(X)	0.51	0.00	0.54	0.42	0.00	0.66	0.47	0.09	0.03	0.46	0.11	0.38
Avail Cap(c_a), veh/h	348	0	1549	256	0	1443	297	1455	1233	286	1461	1238
HCM Platoon Ratio	1.00	1.00	1.00	1.00	1.00	1.00	1.00	1.00	1.00	1.00	1.00	1.00
Upstream Filter(I)	1.00	0.00	1.00	1.00	0.00	1.00	1.00	1.00	1.00	1.00	1.00	1.00
Uniform Delay (d), s/veh	15.9	0.0	9.5	17.0	0.0	10.9	16.4	13.9	13.8	16.5	14.1	14.5
Incr Delay (d2), s/veh	4.2	0.0	0.8	16.0	0.0	1.4	5.4	0.2	0.1	5.9	0.2	1.5
Initial Q Delay(d3),s/veh	0.0	0.0	0.0	0.0	0.0	0.0	0.0	0.0	0.0	0.0	0.0	0.0
%ile BackOfQ(50%),veh/ln	0.4	0.0	1.4	0.1	0.0	1.7	0.3	0.1	0.0	0.2	0.1	0.4
Unsig. Movement Delay, s/veh												
LnGrp Delay(d),s/veh	20.1	0.0	10.3	33.1	0.0	12.4	21.7	14.1	13.9	22.3	14.3	16.0
LnGrp LOS	C	A	B	C	A	B	C	B	B	C	B	B
Approach Vol, veh/h		375			346			51			106	
Approach Delay, s/veh		11.6			12.8			18.4			17.2	
Approach LOS		B			B			B			B	
Timer - Assigned Phs	1	2	3	4	5	6	7	8				
Phs Duration (G+Y+Rc), s	5.3	8.6	4.5	16.2	5.4	8.4	6.0	14.7				
Change Period (Y+Rc), s	* 4.2	4.9	* 4.2	4.9	* 4.2	* 4.9	* 4.2	4.9				
Max Green Setting (Gmax), s	* 5.6	27.1	* 5	29.1	* 5.8	* 27	* 6.8	27.3				
Max Q Clear Time (g_c+I1), s	2.5	2.3	2.1	7.0	2.6	3.3	2.9	7.7				
Green Ext Time (p_c), s	0.0	0.0	0.0	1.8	0.0	0.2	0.0	1.8				

Intersection Summary

HCM 6th Ctrl Delay	13.1
HCM 6th LOS	B

Notes

* HCM 6th computational engine requires equal clearance times for the phases crossing the barrier.

Intersection

Int Delay, s/veh 1.4

Movement	EBT	EBR	WBL	WBT	NBL	NBR
Lane Configurations	↑		↑	↑	↑	↑
Traffic Vol, veh/h	250	36	27	273	39	16
Future Vol, veh/h	250	36	27	273	39	16
Conflicting Peds, #/hr	0	2	2	0	0	0
Sign Control	Free	Free	Free	Free	Stop	Stop
RT Channelized	-	None	-	None	-	None
Storage Length	-	-	75	-	0	-
Veh in Median Storage, #	0	-	-	0	0	-
Grade, %	0	-	-	0	0	-
Peak Hour Factor	90	90	90	90	90	90
Heavy Vehicles, %	3	3	3	3	3	3
Mvmt Flow	278	40	30	303	43	18

Major/Minor	Major1	Major2	Minor1
Conflicting Flow All	0	0	320
Stage 1	-	-	-
Stage 2	-	-	-
Critical Hdwy	-	-	4.13
Critical Hdwy Stg 1	-	-	-
Critical Hdwy Stg 2	-	-	-
Follow-up Hdwy	-	-	2.227
Pot Cap-1 Maneuver	-	-	1234
Stage 1	-	-	-
Stage 2	-	-	-
Platoon blocked, %	-	-	-
Mov Cap-1 Maneuver	-	-	1232
Mov Cap-2 Maneuver	-	-	-
Stage 1	-	-	-
Stage 2	-	-	-

Approach	EB	WB	NB
HCM Control Delay, s	0	0.7	12.2
HCM LOS			B

Minor Lane/Major Mvmt	NBLn1	EBT	EBR	WBL	WBT
Capacity (veh/h)	563	-	-	1232	-
HCM Lane V/C Ratio	0.109	-	-	0.024	-
HCM Control Delay (s)	12.2	-	-	8	-
HCM Lane LOS	B	-	-	A	-
HCM 95th %tile Q(veh)	0.4	-	-	0.1	-

HCM 6th Signalized Intersection Summary
5: 10th Avenue & Hanford Armona Road

Existing PM Peak
04/25/2022



Movement	EBL	EBT	EBR	WBL	WBT	WBR	NBL	NBT	NBR	SBL	SBT	SBR
Lane Configurations												
Traffic Volume (veh/h)	149	15	96	4	8	8	112	203	5	16	154	176
Future Volume (veh/h)	149	15	96	4	8	8	112	203	5	16	154	176
Initial Q (Qb), veh	0	0	0	0	0	0	0	0	0	0	0	0
Ped-Bike Adj(A_pbT)	1.00		1.00	1.00		1.00	1.00		0.99	1.00		0.99
Parking Bus, Adj	1.00	1.00	1.00	1.00	1.00	1.00	1.00	1.00	1.00	1.00	1.00	1.00
Work Zone On Approach		No			No			No			No	
Adj Sat Flow, veh/h/ln	1856	1856	1856	1856	1856	1856	1856	1856	1856	1856	1856	1856
Adj Flow Rate, veh/h	157	16	101	4	8	8	118	214	5	17	162	185
Peak Hour Factor	0.95	0.95	0.95	0.95	0.95	0.95	0.95	0.95	0.95	0.95	0.95	0.95
Percent Heavy Veh, %	3	3	3	3	3	3	3	3	3	3	3	3
Cap, veh/h	201	412	348	10	97	97	160	510	430	38	382	322
Arrive On Green	0.11	0.22	0.22	0.01	0.11	0.11	0.09	0.27	0.27	0.02	0.21	0.21
Sat Flow, veh/h	1767	1856	1565	1767	849	849	1767	1856	1564	1767	1856	1561
Grp Volume(v), veh/h	157	16	101	4	0	16	118	214	5	17	162	185
Grp Sat Flow(s),veh/h/ln	1767	1856	1565	1767	0	1698	1767	1856	1564	1767	1856	1561
Q Serve(g_s), s	3.5	0.3	2.2	0.1	0.0	0.3	2.7	3.9	0.1	0.4	3.1	4.4
Cycle Q Clear(g_c), s	3.5	0.3	2.2	0.1	0.0	0.3	2.7	3.9	0.1	0.4	3.1	4.4
Prop In Lane	1.00		1.00	1.00		0.50	1.00		1.00	1.00		1.00
Lane Grp Cap(c), veh/h	201	412	348	10	0	194	160	510	430	38	382	322
V/C Ratio(X)	0.78	0.04	0.29	0.42	0.00	0.08	0.74	0.42	0.01	0.45	0.42	0.58
Avail Cap(c_a), veh/h	295	1693	1429	217	0	1458	251	1311	1105	217	1293	1088
HCM Platoon Ratio	1.00	1.00	1.00	1.00	1.00	1.00	1.00	1.00	1.00	1.00	1.00	1.00
Upstream Filter(I)	1.00	1.00	1.00	1.00	0.00	1.00	1.00	1.00	1.00	1.00	1.00	1.00
Uniform Delay (d), s/veh	17.6	12.4	13.2	20.2	0.0	16.1	18.1	12.1	10.7	19.7	14.1	14.6
Incr Delay (d2), s/veh	8.0	0.0	0.5	26.3	0.0	0.2	6.5	0.5	0.0	8.1	0.7	1.6
Initial Q Delay(d3),s/veh	0.0	0.0	0.0	0.0	0.0	0.0	0.0	0.0	0.0	0.0	0.0	0.0
%ile BackOfQ(50%),veh/ln	1.6	0.1	0.6	0.1	0.0	0.1	1.1	1.1	0.0	0.2	1.0	1.3
Unsig. Movement Delay, s/veh												
LnGrp Delay(d),s/veh	25.5	12.5	13.6	46.5	0.0	16.3	24.6	12.7	10.8	27.8	14.8	16.2
LnGrp LOS	C	B	B	D	A	B	C	B	B	C	B	B
Approach Vol, veh/h		274			20			337			364	
Approach Delay, s/veh		20.4			22.4			16.8			16.1	
Approach LOS		C			C			B			B	
Timer - Assigned Phs	1	2	3	4	5	6	7	8				
Phs Duration (G+Y+Rc), s	5.1	16.9	4.4	14.4	7.9	14.1	8.8	9.9				
Change Period (Y+Rc), s	* 4.2	5.7	* 4.2	* 5.3	* 4.2	* 5.7	* 4.2	5.3				
Max Green Setting (Gmax), s	* 5	28.8	* 5	* 37	* 5.8	* 28	* 6.8	35.0				
Max Q Clear Time (g_c+I1), s	2.4	5.9	2.1	4.2	4.7	6.4	5.5	2.3				
Green Ext Time (p_c), s	0.0	1.0	0.0	0.4	0.0	1.4	0.0	0.0				

Intersection Summary

HCM 6th Ctrl Delay	17.7
HCM 6th LOS	B

Notes

* HCM 6th computational engine requires equal clearance times for the phases crossing the barrier.

HCM Signalized Intersection Capacity Analysis

7: 11th Avenue & Houston Avenue

Existing PM Peak
04/25/2022

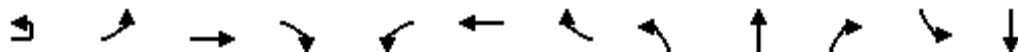

Movement	EBU	EBL	EBT	EBR	WBL	WBT	WBR	NBL	NBT	NBR	SBL	SBT
Lane Configurations		↔	↑	↗	↖	↑	↗	↖	↑↑	↗	↖	↑
Traffic Volume (vph)	1	21	93	18	18	96	74	33	159	24	48	78
Future Volume (vph)	1	21	93	18	18	96	74	33	159	24	48	78
Ideal Flow (vphp)	1900	1900	1900	1900	1900	1900	1900	1900	1900	1900	1900	1900
Total Lost time (s)		4.2	6.0	6.0	4.2	5.7	5.7	4.2	5.7	5.7	4.2	5.3
Lane Util. Factor		1.00	1.00	1.00	1.00	1.00	1.00	1.00	0.95	1.00	1.00	1.00
Frt		1.00	1.00	0.85	1.00	1.00	0.85	1.00	1.00	0.85	1.00	1.00
Flt Protected		0.95	1.00	1.00	0.95	1.00	1.00	0.95	1.00	1.00	0.95	1.00
Satd. Flow (prot)		1719	1810	1538	1719	1810	1538	1719	3438	1538	1719	1810
Flt Permitted		0.95	1.00	1.00	0.95	1.00	1.00	0.95	1.00	1.00	0.95	1.00
Satd. Flow (perm)		1719	1810	1538	1719	1810	1538	1719	3438	1538	1719	1810
Peak-hour factor, PHF	0.84	0.84	0.84	0.84	0.84	0.84	0.84	0.84	0.84	0.84	0.84	0.84
Adj. Flow (vph)	1	25	111	21	21	114	88	39	189	29	57	93
RTOR Reduction (vph)	0	0	0	17	0	0	71	0	0	19	0	0
Lane Group Flow (vph)	0	26	111	4	21	114	17	39	189	10	57	93
Heavy Vehicles (%)	5%	5%	5%	5%	5%	5%	5%	5%	5%	5%	5%	5%
Turn Type	Prot	Prot	NA	Perm	Prot	NA	Perm	Prot	NA	Perm	Prot	NA
Protected Phases	7	7	4		3	8		5	2		1	6
Permitted Phases				4			8			2		
Actuated Green, G (s)		0.9	10.2	10.2	0.9	10.5	10.5	3.1	18.8	18.8	5.4	21.5
Effective Green, g (s)		0.9	10.2	10.2	0.9	10.5	10.5	3.1	18.8	18.8	5.4	21.5
Actuated g/C Ratio		0.02	0.18	0.18	0.02	0.19	0.19	0.06	0.34	0.34	0.10	0.39
Clearance Time (s)		4.2	6.0	6.0	4.2	5.7	5.7	4.2	5.7	5.7	4.2	5.3
Vehicle Extension (s)		3.0	3.0	3.0	3.0	3.0	3.0	3.0	3.0	3.0	3.0	3.0
Lane Grp Cap (vph)		27	333	283	27	343	291	96	1166	521	167	702
v/s Ratio Prot		c0.02	0.06		0.01	c0.06		0.02	c0.05		c0.03	0.05
v/s Ratio Perm				0.00			0.01			0.01		
v/c Ratio		0.96	0.33	0.01	0.78	0.33	0.06	0.41	0.16	0.02	0.34	0.13
Uniform Delay, d1		27.2	19.6	18.5	27.2	19.4	18.4	25.3	12.8	12.2	23.3	10.9
Progression Factor		1.00	1.00	1.00	1.00	1.00	1.00	1.00	1.00	1.00	1.00	1.00
Incremental Delay, d2		156.3	0.6	0.0	81.9	0.6	0.1	2.8	0.1	0.0	1.2	0.1
Delay (s)		183.5	20.2	18.5	109.0	20.0	18.5	28.1	12.9	12.2	24.6	11.0
Level of Service		F	C	B	F	B	B	C	B	B	C	B
Approach Delay (s)			46.9			27.8			15.1			15.4
Approach LOS			D			C			B			B

Intersection Summary

HCM 2000 Control Delay	24.8	HCM 2000 Level of Service	C
HCM 2000 Volume to Capacity ratio	0.26		
Actuated Cycle Length (s)	55.4	Sum of lost time (s)	20.1
Intersection Capacity Utilization	30.6%	ICU Level of Service	A
Analysis Period (min)	15		
c Critical Lane Group			



Movement	SBR
Lane Configurations	7
Traffic Volume (vph)	20
Future Volume (vph)	20
Ideal Flow (vphpl)	1900
Total Lost time (s)	5.3
Lane Util. Factor	1.00
Frt	0.85
Flt Protected	1.00
Satd. Flow (prot)	1538
Flt Permitted	1.00
Satd. Flow (perm)	1538
Peak-hour factor, PHF	0.84
Adj. Flow (vph)	24
RTOR Reduction (vph)	15
Lane Group Flow (vph)	9
Heavy Vehicles (%)	5%
Turn Type	Perm
Protected Phases	
Permitted Phases	6
Actuated Green, G (s)	21.5
Effective Green, g (s)	21.5
Actuated g/C Ratio	0.39
Clearance Time (s)	5.3
Vehicle Extension (s)	3.0
Lane Grp Cap (vph)	596
v/s Ratio Prot	
v/s Ratio Perm	0.01
v/c Ratio	0.02
Uniform Delay, d1	10.4
Progression Factor	1.00
Incremental Delay, d2	0.0
Delay (s)	10.4
Level of Service	B
Approach Delay (s)	
Approach LOS	
Intersection Summary	

Intersection

Int Delay, s/veh 1.1

Movement	EBL	EBT	WBT	WBR	SBL	SBR
Lane Configurations		↔	↔		↔	
Traffic Vol, veh/h	8	107	134	21	17	10
Future Vol, veh/h	8	107	134	21	17	10
Conflicting Peds, #/hr	0	0	0	0	0	0
Sign Control	Free	Free	Free	Free	Stop	Stop
RT Channelized	-	None	-	None	-	None
Storage Length	-	-	-	-	0	-
Veh in Median Storage, #	-	0	0	-	0	-
Grade, %	-	0	0	-	0	-
Peak Hour Factor	93	93	93	93	93	93
Heavy Vehicles, %	3	3	3	3	3	3
Mvmt Flow	9	115	144	23	18	11

Major/Minor	Major1	Major2	Minor2
Conflicting Flow All	167	0	0 289 156
Stage 1	-	-	- 156 -
Stage 2	-	-	- 133 -
Critical Hdwy	4.13	-	- 6.43 6.23
Critical Hdwy Stg 1	-	-	- 5.43 -
Critical Hdwy Stg 2	-	-	- 5.43 -
Follow-up Hdwy	2.227	-	- 3.527 3.327
Pot Cap-1 Maneuver	1405	-	- 699 887
Stage 1	-	-	- 870 -
Stage 2	-	-	- 891 -
Platoon blocked, %		-	- -
Mov Cap-1 Maneuver	1405	-	- 694 887
Mov Cap-2 Maneuver	-	-	- 694 -
Stage 1	-	-	- 864 -
Stage 2	-	-	- 891 -

Approach	EB	WB	SB
HCM Control Delay, s	0.5	0	10
HCM LOS			B

Minor Lane/Major Mvmt	EBL	EBT	WBT	WBR	SBLn1
Capacity (veh/h)	1405	-	-	-	755
HCM Lane V/C Ratio	0.006	-	-	-	0.038
HCM Control Delay (s)	7.6	0	-	-	10
HCM Lane LOS	A	A	-	-	B
HCM 95th %tile Q(veh)	0	-	-	-	0.1

Intersection	
Intersection Delay, s/veh	8.8
Intersection LOS	A

Movement	EBL	EBT	EBR	WBL	WBT	WBR	NBL	NBT	NBR	SBL	SBT	SBR
Lane Configurations		↕			↕			↕			↕	
Traffic Vol, veh/h	29	72	15	8	85	48	23	101	8	41	70	35
Future Vol, veh/h	29	72	15	8	85	48	23	101	8	41	70	35
Peak Hour Factor	0.98	0.98	0.98	0.98	0.98	0.98	0.98	0.98	0.98	0.98	0.98	0.98
Heavy Vehicles, %	5	5	5	5	5	5	5	5	5	5	5	5
Mvmt Flow	30	73	15	8	87	49	23	103	8	42	71	36
Number of Lanes	0	1	0	0	1	0	0	1	0	0	1	0

Approach	EB	WB	NB	SB
Opposing Approach	WB	EB	SB	NB
Opposing Lanes	1	1	1	1
Conflicting Approach Left	SB	NB	EB	WB
Conflicting Lanes Left	1	1	1	1
Conflicting Approach Right	NB	SB	WB	EB
Conflicting Lanes Right	1	1	1	1
HCM Control Delay	8.8	8.7	8.9	8.9
HCM LOS	A	A	A	A

Lane	NBLn1	EBLn1	WBLn1	SBLn1
Vol Left, %	17%	25%	6%	28%
Vol Thru, %	77%	62%	60%	48%
Vol Right, %	6%	13%	34%	24%
Sign Control	Stop	Stop	Stop	Stop
Traffic Vol by Lane	132	116	141	146
LT Vol	23	29	8	41
Through Vol	101	72	85	70
RT Vol	8	15	48	35
Lane Flow Rate	135	118	144	149
Geometry Grp	1	1	1	1
Degree of Util (X)	0.179	0.158	0.184	0.194
Departure Headway (Hd)	4.787	4.808	4.616	4.686
Convergence, Y/N	Yes	Yes	Yes	Yes
Cap	748	743	774	764
Service Time	2.83	2.854	2.661	2.728
HCM Lane V/C Ratio	0.18	0.159	0.186	0.195
HCM Control Delay	8.9	8.8	8.7	8.9
HCM Lane LOS	A	A	A	A
HCM 95th-tile Q	0.6	0.6	0.7	0.7

Intersection: 1: Douty St & 3rd Street

Movement	EB	EB	EB	NB	NB	NB	SB
Directions Served	L	T	TR	T	T	R	LT
Maximum Queue (ft)	102	97	92	81	114	54	87
Average Queue (ft)	49	53	44	36	31	17	43
95th Queue (ft)	81	81	71	59	65	43	69
Link Distance (ft)	320	320	320	356	356		787
Upstream Blk Time (%)							
Queuing Penalty (veh)							
Storage Bay Dist (ft)						90	
Storage Blk Time (%)					0		
Queuing Penalty (veh)					0		

Intersection: 2: 10th Avenue & 4th Street/SR-198 WB Off Ramp

Movement	WB	NB	NB	NB	SB	SB	SB
Directions Served	LTR	L	T	T	T	T	R
Maximum Queue (ft)	133	52	114	113	185	206	90
Average Queue (ft)	43	27	52	47	97	36	39
95th Queue (ft)	84	52	101	102	161	121	64
Link Distance (ft)	775		759	759	758	758	
Upstream Blk Time (%)							
Queuing Penalty (veh)							
Storage Bay Dist (ft)		295					105
Storage Blk Time (%)						0	0
Queuing Penalty (veh)						0	0

Intersection: 3: 10 1/2 Avenue & Hanford Armona Road

Movement	EB	EB	WB	WB	NB	NB	NB	SB	SB	SB
Directions Served	L	TR	L	TR	L	T	R	L	T	R
Maximum Queue (ft)	50	142	25	101	53	53	31	31	91	53
Average Queue (ft)	26	48	6	38	28	11	7	8	12	22
95th Queue (ft)	48	105	22	82	55	38	26	28	47	49
Link Distance (ft)		1346		1547		396			386	
Upstream Blk Time (%)										
Queuing Penalty (veh)										
Storage Bay Dist (ft)	150		95		150		95	150		100
Storage Blk Time (%)		0		0					0	
Queuing Penalty (veh)		0		0					0	

Intersection: 4: Jordan Way & Hanford Armona Road

Movement	WB	NB
Directions Served	L	LR
Maximum Queue (ft)	47	79
Average Queue (ft)	7	35
95th Queue (ft)	28	61
Link Distance (ft)	1339	
Upstream Blk Time (%)		
Queuing Penalty (veh)		
Storage Bay Dist (ft)	75	
Storage Blk Time (%)		
Queuing Penalty (veh)		

Intersection: 5: 10th Avenue & Hanford Armona Road

Movement	EB	EB	EB	WB	WB	NB	NB	SB	SB	SB	
Directions Served	L	T	R	L	TR	L	T	L	T	R	
Maximum Queue (ft)	143	93	40	26	48	68	132	31	118	54	
Average Queue (ft)	70	4	13	4	12	27	37	6	49	31	
95th Queue (ft)	127	32	31	18	37	58	86	24	97	58	
Link Distance (ft)	936			372			448		399		
Upstream Blk Time (%)											
Queuing Penalty (veh)											
Storage Bay Dist (ft)	105		55		155		155		110		265
Storage Blk Time (%)	3	0		0				1	0		
Queuing Penalty (veh)	1	0		0				0	0		

Intersection: 6: 10 1/2 Avenue & Orchard Avenue

Movement
Directions Served
Maximum Queue (ft)
Average Queue (ft)
95th Queue (ft)
Link Distance (ft)
Upstream Blk Time (%)
Queuing Penalty (veh)
Storage Bay Dist (ft)
Storage Blk Time (%)
Queuing Penalty (veh)

Intersection: 7: 11th Avenue & Houston Avenue

Movement	EB	EB	EB	WB	WB	WB	NB	NB	NB	NB	SB	SB
Directions Served	UL	T	R	L	T	R	L	T	T	R	L	T
Maximum Queue (ft)	57	64	50	65	110	57	69	68	70	56	57	46
Average Queue (ft)	19	20	9	18	28	13	9	21	11	6	21	9
95th Queue (ft)	49	45	32	49	66	38	34	50	45	25	49	29
Link Distance (ft)		680			436			276	276			1524
Upstream Blk Time (%)												
Queuing Penalty (veh)												
Storage Bay Dist (ft)	165		150	175		175	175			100	250	
Storage Blk Time (%)												
Queuing Penalty (veh)												

Intersection: 7: 11th Avenue & Houston Avenue

Movement	SB
Directions Served	R
Maximum Queue (ft)	62
Average Queue (ft)	8
95th Queue (ft)	34
Link Distance (ft)	1524
Upstream Blk Time (%)	
Queuing Penalty (veh)	
Storage Bay Dist (ft)	
Storage Blk Time (%)	
Queuing Penalty (veh)	

Intersection: 8: Houston Avenue & 10 1/2 Avenue

Movement	SB
Directions Served	LR
Maximum Queue (ft)	51
Average Queue (ft)	12
95th Queue (ft)	36
Link Distance (ft)	2057
Upstream Blk Time (%)	
Queuing Penalty (veh)	
Storage Bay Dist (ft)	
Storage Blk Time (%)	
Queuing Penalty (veh)	

Intersection: 9: 10th Avenue & Houston Avenue

Movement	EB	WB	NB	SB
Directions Served	LTR	LTR	LTR	LTR
Maximum Queue (ft)	78	76	75	77
Average Queue (ft)	41	37	44	33
95th Queue (ft)	75	65	69	67
Link Distance (ft)	2557	1661	1092	4776
Upstream Blk Time (%)				
Queuing Penalty (veh)				
Storage Bay Dist (ft)				
Storage Blk Time (%)				
Queuing Penalty (veh)				

Intersection: 10: 3rd Street & SR-198 EB Off Ramp

Movement	EB	SE
Directions Served	T	L
Maximum Queue (ft)	30	53
Average Queue (ft)	1	26
95th Queue (ft)	10	52
Link Distance (ft)	361	209
Upstream Blk Time (%)		
Queuing Penalty (veh)		
Storage Bay Dist (ft)		
Storage Blk Time (%)		
Queuing Penalty (veh)		

Network Summary

Network wide Queuing Penalty: 3

Intersection: 1: Douty St & 3rd Street

Movement	EB	EB	EB	NB	NB	NB	SB	SB	
Directions Served	L	T	TR	T	T	R	LT	T	
Maximum Queue (ft)	97	96	112	72	79	31	154	56	
Average Queue (ft)	53	60	62	37	34	13	69	8	
95th Queue (ft)	86	89	97	59	72	37	118	35	
Link Distance (ft)	320	320	320	356	356		787	787	
Upstream Blk Time (%)									
Queuing Penalty (veh)									
Storage Bay Dist (ft)							90		
Storage Blk Time (%)					0				
Queuing Penalty (veh)					0				

Intersection: 2: 10th Avenue & 4th Street/SR-198 WB Off Ramp

Movement	WB	NB	NB	NB	SB	SB	SB
Directions Served	LTR	L	T	T	T	T	R
Maximum Queue (ft)	162	95	136	139	188	161	79
Average Queue (ft)	65	52	68	56	104	29	41
95th Queue (ft)	126	85	124	121	170	99	67
Link Distance (ft)	775		759	759	758	758	
Upstream Blk Time (%)							
Queuing Penalty (veh)							
Storage Bay Dist (ft)		295					105
Storage Blk Time (%)							
Queuing Penalty (veh)							

Intersection: 3: 10 1/2 Avenue & Hanford Armona Road

Movement	EB	EB	WB	WB	NB	NB	NB	SB	SB	SB
Directions Served	L	TR	L	TR	L	T	R	L	T	R
Maximum Queue (ft)	69	109	45	213	55	52	31	74	52	53
Average Queue (ft)	26	38	6	57	19	8	6	17	10	29
95th Queue (ft)	56	85	25	133	49	32	25	53	36	57
Link Distance (ft)		1346		1547		396			386	
Upstream Blk Time (%)										
Queuing Penalty (veh)										
Storage Bay Dist (ft)	150		95		150		95	150		100
Storage Blk Time (%)					3					
Queuing Penalty (veh)					0					

Intersection: 4: Jordan Way & Hanford Armona Road

Movement	WB	NB
Directions Served	L	LR
Maximum Queue (ft)	46	68
Average Queue (ft)	4	29
95th Queue (ft)	23	55
Link Distance (ft)	1339	
Upstream Blk Time (%)		
Queuing Penalty (veh)		
Storage Bay Dist (ft)	75	
Storage Blk Time (%)		
Queuing Penalty (veh)		

Intersection: 5: 10th Avenue & Hanford Armona Road

Movement	EB	EB	EB	WB	WB	NB	NB	SB	SB	SB	
Directions Served	L	T	R	L	TR	L	T	L	T	R	
Maximum Queue (ft)	140	44	60	25	52	117	125	53	96	102	
Average Queue (ft)	68	4	19	4	11	54	49	13	45	48	
95th Queue (ft)	112	20	44	19	36	92	107	42	85	76	
Link Distance (ft)	936			372			448		399		
Upstream Blk Time (%)											
Queuing Penalty (veh)											
Storage Bay Dist (ft)	105		55		155		155		110		265
Storage Blk Time (%)	3	0		0		0		0		0	
Queuing Penalty (veh)	4	0		0		0		0		0	

Intersection: 6: 10 1/2 Avenue & Orchard Avenue

Movement
Directions Served
Maximum Queue (ft)
Average Queue (ft)
95th Queue (ft)
Link Distance (ft)
Upstream Blk Time (%)
Queuing Penalty (veh)
Storage Bay Dist (ft)
Storage Blk Time (%)
Queuing Penalty (veh)

Intersection: 7: 11th Avenue & Houston Avenue

Movement	EB	EB	EB	WB	WB	WB	NB	NB	NB	NB	SB	SB
Directions Served	UL	T	R	L	T	R	L	T	T	R	L	T
Maximum Queue (ft)	63	67	20	47	113	45	75	65	68	32	70	66
Average Queue (ft)	14	30	6	12	37	16	17	28	13	7	23	22
95th Queue (ft)	38	60	18	33	78	37	50	58	41	20	52	58
Link Distance (ft)		680			436			276	276			1524
Upstream Blk Time (%)												
Queuing Penalty (veh)												
Storage Bay Dist (ft)	165		150	175		175	175			100	250	
Storage Blk Time (%)												
Queuing Penalty (veh)												

Intersection: 7: 11th Avenue & Houston Avenue

Movement	SB
Directions Served	R
Maximum Queue (ft)	35
Average Queue (ft)	4
95th Queue (ft)	18
Link Distance (ft)	1524
Upstream Blk Time (%)	
Queuing Penalty (veh)	
Storage Bay Dist (ft)	
Storage Blk Time (%)	
Queuing Penalty (veh)	

Intersection: 8: Houston Avenue & 10 1/2 Avenue

Movement	SB
Directions Served	LR
Maximum Queue (ft)	51
Average Queue (ft)	18
95th Queue (ft)	41
Link Distance (ft)	2057
Upstream Blk Time (%)	
Queuing Penalty (veh)	
Storage Bay Dist (ft)	
Storage Blk Time (%)	
Queuing Penalty (veh)	

Intersection: 9: 10th Avenue & Houston Avenue

Movement	EB	WB	NB	SB
Directions Served	LTR	LTR	LTR	LTR
Maximum Queue (ft)	75	78	72	77
Average Queue (ft)	32	36	34	39
95th Queue (ft)	55	60	52	66
Link Distance (ft)	2557	1661	1092	4776
Upstream Blk Time (%)				
Queuing Penalty (veh)				
Storage Bay Dist (ft)				
Storage Blk Time (%)				
Queuing Penalty (veh)				

Intersection: 10: 3rd Street & SR-198 EB Off Ramp

Movement	SE
Directions Served	L
Maximum Queue (ft)	123
Average Queue (ft)	48
95th Queue (ft)	98
Link Distance (ft)	209
Upstream Blk Time (%)	
Queuing Penalty (veh)	
Storage Bay Dist (ft)	
Storage Blk Time (%)	
Queuing Penalty (veh)	

Network Summary

Network wide Queuing Penalty: 4

HCS7 Two-Lane Highway Report

Project Information

Analyst	C. Ayala-Magana	Date	7/20/2022
Agency	JLB Traffic Engineering, Inc.	Analysis Year	2022
Jurisdiction	City of Hanford	Time Period Analyzed	Existing AM Peak
Project Description	01 Hanford-Armona Road Between 11th Avenue and 10 1/2 Avenue	Unit	United States Customary

Segment 1

Vehicle Inputs

Segment Type	Passing Constrained	Length, ft	2583
Lane Width, ft	12	Shoulder Width, ft	6
Speed Limit, mi/h	40	Access Point Density, pts/mi	34.8

Demand and Capacity

Directional Demand Flow Rate, veh/h	414	Opposing Demand Flow Rate, veh/h	-
Peak Hour Factor	0.72	Total Trucks, %	4.03
Segment Capacity, veh/h	1700	Demand/Capacity (D/C)	0.24

Intermediate Results

Segment Vertical Class	1	Free-Flow Speed, mi/h	36.8
Speed Slope Coefficient	2.52195	Speed Power Coefficient	0.41674
PF Slope Coefficient	-1.44139	PF Power Coefficient	0.67822
In Passing Lane Effective Length?	No	Total Segment Density, veh/mi/ln	6.4
%Improved % Followers	0.0	% Improved Avg Speed	0.0

Subsegment Data

#	Segment Type	Length, ft	Radius, ft	Superelevation, %	Average Speed, mi/h
1	Tangent	2583	-	-	35.2

Vehicle Results

Average Speed, mi/h	35.2	Percent Followers, %	54.7
Segment Travel Time, minutes	0.83	Follower Density, followers/mi/ln	6.4
Vehicle LOS	C		

Facility Results

T	Follower Density, followers/mi/ln	LOS
1	6.4	C

HCS7 Two-Lane Highway Report

Project Information

Analyst	C. Ayala-Magana	Date	7/20/2022
Agency	JLB Traffic Engineering, Inc.	Analysis Year	2022
Jurisdiction	City of Hanford	Time Period Analyzed	Existing AM Peak
Project Description	02 Hanford-Armona Road Between 10 1/2 Avenue and Jordan Way	Unit	United States Customary

Segment 1

Vehicle Inputs

Segment Type	Passing Constrained	Length, ft	1556
Lane Width, ft	12	Shoulder Width, ft	6
Speed Limit, mi/h	40	Access Point Density, pts/mi	67.9

Demand and Capacity

Directional Demand Flow Rate, veh/h	335	Opposing Demand Flow Rate, veh/h	-
Peak Hour Factor	0.74	Total Trucks, %	3.39
Segment Capacity, veh/h	1700	Demand/Capacity (D/C)	0.20

Intermediate Results

Segment Vertical Class	1	Free-Flow Speed, mi/h	35.5
Speed Slope Coefficient	2.43653	Speed Power Coefficient	0.41674
PF Slope Coefficient	-1.48329	PF Power Coefficient	0.66113
In Passing Lane Effective Length?	No	Total Segment Density, veh/mi/ln	5.0
%Improved % Followers	0.0	% Improved Avg Speed	0.0

Subsegment Data

#	Segment Type	Length, ft	Radius, ft	Superelevation, %	Average Speed, mi/h
1	Tangent	1556	-	-	34.2

Vehicle Results

Average Speed, mi/h	34.2	Percent Followers, %	51.3
Segment Travel Time, minutes	0.52	Follower Density, followers/mi/ln	5.0
Vehicle LOS	C		

Facility Results

T	Follower Density, followers/mi/ln	LOS
1	5.0	C

HCS7 Two-Lane Highway Report

Project Information

Analyst	C. Ayala-Magana	Date	7/20/2022
Agency	JLB Traffic Engineering, Inc.	Analysis Year	2022
Jurisdiction	City of Hanford	Time Period Analyzed	Existing AM Peak
Project Description	03 Hanford-Armona Road Between Jordan Way and 10th Avenue	Unit	United States Customary

Segment 1

Vehicle Inputs

Segment Type	Passing Constrained	Length, ft	901
Lane Width, ft	12	Shoulder Width, ft	6
Speed Limit, mi/h	40	Access Point Density, pts/mi	23.4

Demand and Capacity

Directional Demand Flow Rate, veh/h	293	Opposing Demand Flow Rate, veh/h	-
Peak Hour Factor	0.75	Total Trucks, %	6.25
Segment Capacity, veh/h	1700	Demand/Capacity (D/C)	0.17

Intermediate Results

Segment Vertical Class	1	Free-Flow Speed, mi/h	39.5
Speed Slope Coefficient	2.65189	Speed Power Coefficient	0.41674
PF Slope Coefficient	-1.50451	PF Power Coefficient	0.67582
In Passing Lane Effective Length?	No	Total Segment Density, veh/mi/ln	3.7
%Improved % Followers	0.0	% Improved Avg Speed	0.0

Subsegment Data

#	Segment Type	Length, ft	Radius, ft	Superelevation, %	Average Speed, mi/h
1	Tangent	901	-	-	38.2

Vehicle Results

Average Speed, mi/h	38.2	Percent Followers, %	48.1
Segment Travel Time, minutes	0.27	Follower Density, followers/mi/ln	3.7
Vehicle LOS	B		

Facility Results

T	Follower Density, followers/mi/ln	LOS
1	3.7	B

HCS7 Two-Lane Highway Report

Project Information

Analyst	C. Ayala-Magana	Date	7/20/2022
Agency	JLB Traffic Engineering, Inc.	Analysis Year	2022
Jurisdiction	City of Hanford	Time Period Analyzed	Existing AM Peak
Project Description	04 10.5 Avenue Between Hanford Armona Road and Orchard Avenue	Unit	United States Customary

Segment 1

Vehicle Inputs

Segment Type	Passing Constrained	Length, ft	2735
Lane Width, ft	12	Shoulder Width, ft	2
Speed Limit, mi/h	40	Access Point Density, pts/mi	50.2

Demand and Capacity

Directional Demand Flow Rate, veh/h	92	Opposing Demand Flow Rate, veh/h	-
Peak Hour Factor	0.60	Total Trucks, %	9.87
Segment Capacity, veh/h	1700	Demand/Capacity (D/C)	0.05

Intermediate Results

Segment Vertical Class	1	Free-Flow Speed, mi/h	32.5
Speed Slope Coefficient	2.29128	Speed Power Coefficient	0.41674
PF Slope Coefficient	-1.42068	PF Power Coefficient	0.65951
In Passing Lane Effective Length?	No	Total Segment Density, veh/mi/ln	0.7
%Improved % Followers	0.0	% Improved Avg Speed	0.0

Subsegment Data

#	Segment Type	Length, ft	Radius, ft	Superelevation, %	Average Speed, mi/h
1	Tangent	2735	-	-	32.5

Vehicle Results

Average Speed, mi/h	32.5	Percent Followers, %	25.6
Segment Travel Time, minutes	0.96	Follower Density, followers/mi/ln	0.7
Vehicle LOS	A		

Facility Results

T	Follower Density, followers/mi/ln	LOS
1	0.7	A

HCS7 Two-Lane Highway Report

Project Information

Analyst	C. Ayala-Magana	Date	7/20/2022
Agency	JLB Traffic Engineering, Inc.	Analysis Year	2022
Jurisdiction	City of Hanford	Time Period Analyzed	Existing AM Peak
Project Description	05 10.5 Avenue Between Orchard Avenue and Houston Avenue	Unit	United States Customary

Segment 1

Vehicle Inputs

Segment Type	Passing Constrained	Length, ft	2594
Lane Width, ft	12	Shoulder Width, ft	2
Speed Limit, mi/h	40	Access Point Density, pts/mi	52.9

Demand and Capacity

Directional Demand Flow Rate, veh/h	95	Opposing Demand Flow Rate, veh/h	-
Peak Hour Factor	0.42	Total Trucks, %	13.33
Segment Capacity, veh/h	1700	Demand/Capacity (D/C)	0.06

Intermediate Results

Segment Vertical Class	1	Free-Flow Speed, mi/h	32.4
Speed Slope Coefficient	2.28310	Speed Power Coefficient	0.41674
PF Slope Coefficient	-1.42395	PF Power Coefficient	0.65839
In Passing Lane Effective Length?	No	Total Segment Density, veh/mi/ln	0.8
%Improved % Followers	0.0	% Improved Avg Speed	0.0

Subsegment Data

#	Segment Type	Length, ft	Radius, ft	Superelevation, %	Average Speed, mi/h
1	Tangent	2594	-	-	32.4

Vehicle Results

Average Speed, mi/h	32.4	Percent Followers, %	26.1
Segment Travel Time, minutes	0.91	Follower Density, followers/mi/ln	0.8
Vehicle LOS	A		

Facility Results

T	Follower Density, followers/mi/ln	LOS
1	0.8	A

HCS7 Two-Lane Highway Report

Project Information

Analyst	C. Ayala-Magana	Date	7/20/2022
Agency	JLB Traffic Engineering, Inc.	Analysis Year	2022
Jurisdiction	City of Hanford	Time Period Analyzed	Existing AM Peak
Project Description	06 Houston Avenue Between 11th Avenue and 10 1/2 Avenue	Unit	United States Customary

Segment 1

Vehicle Inputs

Segment Type	Passing Constrained	Length, ft	2567
Lane Width, ft	12	Shoulder Width, ft	2
Speed Limit, mi/h	50	Access Point Density, pts/mi	20.6

Demand and Capacity

Directional Demand Flow Rate, veh/h	211	Opposing Demand Flow Rate, veh/h	-
Peak Hour Factor	0.68	Total Trucks, %	21.40
Segment Capacity, veh/h	1700	Demand/Capacity (D/C)	0.12

Intermediate Results

Segment Vertical Class	1	Free-Flow Speed, mi/h	48.3
Speed Slope Coefficient	3.14891	Speed Power Coefficient	0.41674
PF Slope Coefficient	-1.42118	PF Power Coefficient	0.72418
In Passing Lane Effective Length?	No	Total Segment Density, veh/mi/ln	1.7
%Improved % Followers	0.0	% Improved Avg Speed	0.0

Subsegment Data

#	Segment Type	Length, ft	Radius, ft	Superelevation, %	Average Speed, mi/h
1	Tangent	2567	-	-	47.1

Vehicle Results

Average Speed, mi/h	47.1	Percent Followers, %	36.9
Segment Travel Time, minutes	0.62	Follower Density, followers/mi/ln	1.7
Vehicle LOS	A		

Facility Results

T	Follower Density, followers/mi/ln	LOS
1	1.7	A

HCS7 Two-Lane Highway Report

Project Information

Analyst	C. Ayala-Magana	Date	7/20/2022
Agency	JLB Traffic Engineering, Inc.	Analysis Year	2022
Jurisdiction	City of Hanford	Time Period Analyzed	Existing AM Peak
Project Description	07 Houston Avenue Between 10 1/2 Avenue and 10th Avenue	Unit	United States Customary

Segment 1

Vehicle Inputs

Segment Type	Passing Constrained	Length, ft	2570
Lane Width, ft	12	Shoulder Width, ft	2
Speed Limit, mi/h	55	Access Point Density, pts/mi	45.2

Demand and Capacity

Directional Demand Flow Rate, veh/h	188	Opposing Demand Flow Rate, veh/h	-
Peak Hour Factor	0.88	Total Trucks, %	17.65
Segment Capacity, veh/h	1700	Demand/Capacity (D/C)	0.11

Intermediate Results

Segment Vertical Class	1	Free-Flow Speed, mi/h	49.3
Speed Slope Coefficient	3.20179	Speed Power Coefficient	0.41674
PF Slope Coefficient	-1.41674	PF Power Coefficient	0.72668
In Passing Lane Effective Length?	No	Total Segment Density, veh/mi/ln	1.3
%Improved % Followers	0.0	% Improved Avg Speed	0.0

Subsegment Data

#	Segment Type	Length, ft	Radius, ft	Superelevation, %	Average Speed, mi/h
1	Tangent	2570	-	-	48.2

Vehicle Results

Average Speed, mi/h	48.2	Percent Followers, %	34.3
Segment Travel Time, minutes	0.61	Follower Density, followers/mi/ln	1.3
Vehicle LOS	A		

Facility Results

T	Follower Density, followers/mi/ln	LOS
1	1.3	A

HCS7 Two-Lane Highway Report

Project Information

Analyst	C. Ayala-Magana	Date	7/20/2022
Agency	JLB Traffic Engineering, Inc.	Analysis Year	2022
Jurisdiction	City of Hanford	Time Period Analyzed	Existing PM Peak
Project Description	01 Hanford-Armona Road Between 11th Avenue and 10 1/2 Avenue	Unit	United States Customary

Segment 1

Vehicle Inputs

Segment Type	Passing Constrained	Length, ft	2583
Lane Width, ft	12	Shoulder Width, ft	6
Speed Limit, mi/h	40	Access Point Density, pts/mi	34.8

Demand and Capacity

Directional Demand Flow Rate, veh/h	517	Opposing Demand Flow Rate, veh/h	-
Peak Hour Factor	0.83	Total Trucks, %	3.00
Segment Capacity, veh/h	1700	Demand/Capacity (D/C)	0.30

Intermediate Results

Segment Vertical Class	1	Free-Flow Speed, mi/h	36.8
Speed Slope Coefficient	2.52381	Speed Power Coefficient	0.41674
PF Slope Coefficient	-1.44159	PF Power Coefficient	0.67823
In Passing Lane Effective Length?	No	Total Segment Density, veh/mi/ln	8.9
%Improved % Followers	0.0	% Improved Avg Speed	0.0

Subsegment Data

#	Segment Type	Length, ft	Radius, ft	Superelevation, %	Average Speed, mi/h
1	Tangent	2583	-	-	35.0

Vehicle Results

Average Speed, mi/h	35.0	Percent Followers, %	60.2
Segment Travel Time, minutes	0.84	Follower Density, followers/mi/ln	8.9
Vehicle LOS	C		

Facility Results

T	Follower Density, followers/mi/ln	LOS
1	8.9	C

HCS7 Two-Lane Highway Report

Project Information

Analyst	C. Ayala-Magana	Date	7/20/2022
Agency	JLB Traffic Engineering, Inc.	Analysis Year	2022
Jurisdiction	City of Hanford	Time Period Analyzed	Existing PM Peak
Project Description	02 Hanford-Armona Road Between 10 1/2 Avenue and Jordan Way	Unit	United States Customary

Segment 1

Vehicle Inputs

Segment Type	Passing Constrained	Length, ft	1556
Lane Width, ft	12	Shoulder Width, ft	6
Speed Limit, mi/h	40	Access Point Density, pts/mi	67.9

Demand and Capacity

Directional Demand Flow Rate, veh/h	374	Opposing Demand Flow Rate, veh/h	-
Peak Hour Factor	0.85	Total Trucks, %	3.00
Segment Capacity, veh/h	1700	Demand/Capacity (D/C)	0.22

Intermediate Results

Segment Vertical Class	1	Free-Flow Speed, mi/h	35.5
Speed Slope Coefficient	2.43724	Speed Power Coefficient	0.41674
PF Slope Coefficient	-1.48339	PF Power Coefficient	0.66114
In Passing Lane Effective Length?	No	Total Segment Density, veh/mi/ln	5.9
%Improved % Followers	0.0	% Improved Avg Speed	0.0

Subsegment Data

#	Segment Type	Length, ft	Radius, ft	Superelevation, %	Average Speed, mi/h
1	Tangent	1556	-	-	34.1

Vehicle Results

Average Speed, mi/h	34.1	Percent Followers, %	53.9
Segment Travel Time, minutes	0.52	Follower Density, followers/mi/ln	5.9
Vehicle LOS	C		

Facility Results

T	Follower Density, followers/mi/ln	LOS
1	5.9	C

HCS7 Two-Lane Highway Report

Project Information

Analyst	C. Ayala-Magana	Date	7/20/2022
Agency	JLB Traffic Engineering, Inc.	Analysis Year	2022
Jurisdiction	City of Hanford	Time Period Analyzed	Existing PM Peak
Project Description	03 Hanford-Armona Road Between Jordan Way and 10th Avenue	Unit	United States Customary

Segment 1

Vehicle Inputs

Segment Type	Passing Constrained	Length, ft	901
Lane Width, ft	12	Shoulder Width, ft	6
Speed Limit, mi/h	40	Access Point Density, pts/mi	17.6

Demand and Capacity

Directional Demand Flow Rate, veh/h	305	Opposing Demand Flow Rate, veh/h	-
Peak Hour Factor	0.97	Total Trucks, %	3.00
Segment Capacity, veh/h	1700	Demand/Capacity (D/C)	0.18

Intermediate Results

Segment Vertical Class	1	Free-Flow Speed, mi/h	41.1
Speed Slope Coefficient	2.73635	Speed Power Coefficient	0.41674
PF Slope Coefficient	-1.50445	PF Power Coefficient	0.68170
In Passing Lane Effective Length?	No	Total Segment Density, veh/mi/ln	3.8
%Improved % Followers	0.0	% Improved Avg Speed	0.0

Subsegment Data

#	Segment Type	Length, ft	Radius, ft	Superelevation, %	Average Speed, mi/h
1	Tangent	901	-	-	39.7

Vehicle Results

Average Speed, mi/h	39.7	Percent Followers, %	48.8
Segment Travel Time, minutes	0.26	Follower Density, followers/mi/ln	3.8
Vehicle LOS	B		

Facility Results

T	Follower Density, followers/mi/ln	LOS
1	3.8	B

HCS7 Two-Lane Highway Report

Project Information

Analyst	C. Ayala-Magana	Date	7/20/2022
Agency	JLB Traffic Engineering, Inc.	Analysis Year	2022
Jurisdiction	City of Hanford	Time Period Analyzed	Existing PM Peak
Project Description	04 10.5 Avenue Between Hanford Armona Road and Orchard Avenue	Unit	United States Customary

Segment 1

Vehicle Inputs

Segment Type	Passing Constrained	Length, ft	2735
Lane Width, ft	12	Shoulder Width, ft	2
Speed Limit, mi/h	40	Access Point Density, pts/mi	50.2

Demand and Capacity

Directional Demand Flow Rate, veh/h	67	Opposing Demand Flow Rate, veh/h	-
Peak Hour Factor	0.75	Total Trucks, %	3.00
Segment Capacity, veh/h	1700	Demand/Capacity (D/C)	0.04

Intermediate Results

Segment Vertical Class	1	Free-Flow Speed, mi/h	32.7
Speed Slope Coefficient	2.30368	Speed Power Coefficient	0.41674
PF Slope Coefficient	-1.42275	PF Power Coefficient	0.65971
In Passing Lane Effective Length?	No	Total Segment Density, veh/mi/ln	0.4
%Improved % Followers	0.0	% Improved Avg Speed	0.0

Subsegment Data

#	Segment Type	Length, ft	Radius, ft	Superelevation, %	Average Speed, mi/h
1	Tangent	2735	-	-	32.7

Vehicle Results

Average Speed, mi/h	32.7	Percent Followers, %	21.2
Segment Travel Time, minutes	0.95	Follower Density, followers/mi/ln	0.4
Vehicle LOS	A		

Facility Results

T	Follower Density, followers/mi/ln	LOS
1	0.4	A

HCS7 Two-Lane Highway Report

Project Information

Analyst	C. Ayala-Magana	Date	7/20/2022
Agency	JLB Traffic Engineering, Inc.	Analysis Year	2022
Jurisdiction	City of Hanford	Time Period Analyzed	Existing PM Peak
Project Description	05 10.5 Avenue Between Orchard Avenue and Houston Avenue	Unit	United States Customary

Segment 1

Vehicle Inputs

Segment Type	Passing Constrained	Length, ft	2594
Lane Width, ft	12	Shoulder Width, ft	2
Speed Limit, mi/h	40	Access Point Density, pts/mi	52.9

Demand and Capacity

Directional Demand Flow Rate, veh/h	80	Opposing Demand Flow Rate, veh/h	-
Peak Hour Factor	0.56	Total Trucks, %	3.70
Segment Capacity, veh/h	1700	Demand/Capacity (D/C)	0.05

Intermediate Results

Segment Vertical Class	1	Free-Flow Speed, mi/h	32.7
Speed Slope Coefficient	2.30048	Speed Power Coefficient	0.41674
PF Slope Coefficient	-1.42689	PF Power Coefficient	0.65868
In Passing Lane Effective Length?	No	Total Segment Density, veh/mi/ln	0.6
%Improved % Followers	0.0	% Improved Avg Speed	0.0

Subsegment Data

#	Segment Type	Length, ft	Radius, ft	Superelevation, %	Average Speed, mi/h
1	Tangent	2594	-	-	32.7

Vehicle Results

Average Speed, mi/h	32.7	Percent Followers, %	23.7
Segment Travel Time, minutes	0.90	Follower Density, followers/mi/ln	0.6
Vehicle LOS	A		

Facility Results

T	Follower Density, followers/mi/ln	LOS
1	0.6	A

HCS7 Two-Lane Highway Report

Project Information

Analyst	C. Ayala-Magana	Date	7/20/2022
Agency	JLB Traffic Engineering, Inc.	Analysis Year	2022
Jurisdiction	City of Hanford	Time Period Analyzed	Existing PM Peak
Project Description	06 Houston Avenue Between 11th Avenue and 10 1/2 Avenue	Unit	United States Customary

Segment 1

Vehicle Inputs

Segment Type	Passing Constrained	Length, ft	2567
Lane Width, ft	12	Shoulder Width, ft	2
Speed Limit, mi/h	50	Access Point Density, pts/mi	20.6

Demand and Capacity

Directional Demand Flow Rate, veh/h	200	Opposing Demand Flow Rate, veh/h	-
Peak Hour Factor	0.89	Total Trucks, %	3.75
Segment Capacity, veh/h	1700	Demand/Capacity (D/C)	0.12

Intermediate Results

Segment Vertical Class	1	Free-Flow Speed, mi/h	48.9
Speed Slope Coefficient	3.18076	Speed Power Coefficient	0.41674
PF Slope Coefficient	-1.42061	PF Power Coefficient	0.72351
In Passing Lane Effective Length?	No	Total Segment Density, veh/mi/ln	1.5
%Improved % Followers	0.0	% Improved Avg Speed	0.0

Subsegment Data

#	Segment Type	Length, ft	Radius, ft	Superelevation, %	Average Speed, mi/h
1	Tangent	2567	-	-	47.7

Vehicle Results

Average Speed, mi/h	47.7	Percent Followers, %	35.8
Segment Travel Time, minutes	0.61	Follower Density, followers/mi/ln	1.5
Vehicle LOS	A		

Facility Results

T	Follower Density, followers/mi/ln	LOS
1	1.5	A

HCS7 Two-Lane Highway Report

Project Information

Analyst	C. Ayala-Magana	Date	7/20/2022
Agency	JLB Traffic Engineering, Inc.	Analysis Year	2022
Jurisdiction	City of Hanford	Time Period Analyzed	Existing PM Peak
Project Description	07 Houston Avenue Between 10 1/2 Avenue and 10th Avenue	Unit	United States Customary

Segment 1

Vehicle Inputs

Segment Type	Passing Constrained	Length, ft	2570
Lane Width, ft	12	Shoulder Width, ft	2
Speed Limit, mi/h	55	Access Point Density, pts/mi	45.2

Demand and Capacity

Directional Demand Flow Rate, veh/h	228	Opposing Demand Flow Rate, veh/h	-
Peak Hour Factor	0.90	Total Trucks, %	3.00
Segment Capacity, veh/h	1700	Demand/Capacity (D/C)	0.13

Intermediate Results

Segment Vertical Class	1	Free-Flow Speed, mi/h	49.8
Speed Slope Coefficient	3.22823	Speed Power Coefficient	0.41674
PF Slope Coefficient	-1.41606	PF Power Coefficient	0.72608
In Passing Lane Effective Length?	No	Total Segment Density, veh/mi/ln	1.8
%Improved % Followers	0.0	% Improved Avg Speed	0.0

Subsegment Data

#	Segment Type	Length, ft	Radius, ft	Superelevation, %	Average Speed, mi/h
1	Tangent	2570	-	-	48.4

Vehicle Results

Average Speed, mi/h	48.4	Percent Followers, %	38.4
Segment Travel Time, minutes	0.60	Follower Density, followers/mi/ln	1.8
Vehicle LOS	A		

Facility Results

T	Follower Density, followers/mi/ln	LOS
1	1.8	A

Appendix F: Existing plus Project Traffic Conditions



www.JLBtraffic.com
info@JLBtraffic.com

516 W. Shaw Ave., Ste. 103
Fresno, CA 93704
(559) 570-8991

App | F

HCM 6th Signalized Intersection Summary
 3: 10 1/2 Avenue & Hanford Armona Road

Existing Plus Project AM Peak
 04/26/2022



Movement	EBL	EBT	EBR	WBL	WBT	WBR	NBL	NBT	NBR	SBL	SBT	SBR
Lane Configurations												
Traffic Volume (veh/h)	55	232	47	18	218	27	124	62	24	12	21	34
Future Volume (veh/h)	55	232	47	18	218	27	124	62	24	12	21	34
Initial Q (Qb), veh	0	0	0	0	0	0	0	0	0	0	0	0
Ped-Bike Adj(A_pbT)	1.00		1.00	1.00		1.00	1.00		1.00	1.00		1.00
Parking Bus, Adj	1.00	1.00	1.00	1.00	1.00	1.00	1.00	1.00	1.00	1.00	1.00	1.00
Work Zone On Approach		No			No			No			No	
Adj Sat Flow, veh/h/ln	1826	1826	1826	1826	1826	1826	1826	1826	1826	1826	1826	1826
Adj Flow Rate, veh/h	76	322	65	25	303	38	172	86	33	17	29	47
Peak Hour Factor	0.72	0.72	0.72	0.72	0.72	0.72	0.72	0.72	0.72	0.72	0.72	0.72
Percent Heavy Veh, %	5	5	5	5	5	5	5	5	5	5	5	5
Cap, veh/h	121	450	91	52	423	53	219	389	329	37	198	168
Arrive On Green	0.07	0.31	0.31	0.03	0.27	0.27	0.13	0.21	0.21	0.02	0.11	0.11
Sat Flow, veh/h	1739	1474	298	1739	1590	199	1739	1826	1547	1739	1826	1547
Grp Volume(v), veh/h	76	0	387	25	0	341	172	86	33	17	29	47
Grp Sat Flow(s),veh/h/ln	1739	0	1772	1739	0	1790	1739	1826	1547	1739	1826	1547
Q Serve(g_s), s	1.8	0.0	8.2	0.6	0.0	7.3	4.1	1.6	0.7	0.4	0.6	1.2
Cycle Q Clear(g_c), s	1.8	0.0	8.2	0.6	0.0	7.3	4.1	1.6	0.7	0.4	0.6	1.2
Prop In Lane	1.00		0.17	1.00		0.11	1.00		1.00	1.00		1.00
Lane Grp Cap(c), veh/h	121	0	541	52	0	476	219	389	329	37	198	168
V/C Ratio(X)	0.63	0.00	0.71	0.48	0.00	0.72	0.79	0.22	0.10	0.46	0.15	0.28
Avail Cap(c_a), veh/h	206	0	1143	206	0	1155	321	1273	1079	206	1165	988
HCM Platoon Ratio	1.00	1.00	1.00	1.00	1.00	1.00	1.00	1.00	1.00	1.00	1.00	1.00
Upstream Filter(I)	1.00	0.00	1.00	1.00	0.00	1.00	1.00	1.00	1.00	1.00	1.00	1.00
Uniform Delay (d), s/veh	19.1	0.0	13.1	20.2	0.0	14.1	17.9	13.8	13.4	20.5	17.1	17.3
Incr Delay (d2), s/veh	5.2	0.0	1.8	6.6	0.0	2.0	7.7	0.3	0.1	8.5	0.3	0.9
Initial Q Delay(d3),s/veh	0.0	0.0	0.0	0.0	0.0	0.0	0.0	0.0	0.0	0.0	0.0	0.0
%ile BackOfQ(50%),veh/ln	0.8	0.0	2.6	0.3	0.0	2.5	1.8	0.6	0.2	0.2	0.2	0.4
Unsig. Movement Delay, s/veh												
LnGrp Delay(d),s/veh	24.3	0.0	14.8	26.8	0.0	16.1	25.6	14.0	13.5	28.9	17.4	18.2
LnGrp LOS	C	A	B	C	A	B	C	B	B	C	B	B
Approach Vol, veh/h		463			366			291			93	
Approach Delay, s/veh		16.4			16.9			20.8			19.9	
Approach LOS		B			B			C			B	
Timer - Assigned Phs	1	2	3	4	5	6	7	8				
Phs Duration (G+Y+Rc), s	5.1	13.9	5.5	17.8	9.5	9.5	7.2	16.1				
Change Period (Y+Rc), s	* 4.2	4.9	* 4.2	4.9	* 4.2	* 4.9	* 4.2	4.9				
Max Green Setting (Gmax), s	* 5	29.5	* 5	27.3	* 7.8	* 27	* 5	27.3				
Max Q Clear Time (g_c+I1), s	2.4	3.6	2.6	10.2	6.1	3.2	3.8	9.3				
Green Ext Time (p_c), s	0.0	0.5	0.0	2.0	0.1	0.2	0.0	1.8				

Intersection Summary

HCM 6th Ctrl Delay	17.9
HCM 6th LOS	B

Notes

* HCM 6th computational engine requires equal clearance times for the phases crossing the barrier.

Intersection

Int Delay, s/veh 2.6

Movement	EBT	EBR	WBL	WBT	NBL	NBR
Lane Configurations						
Traffic Vol, veh/h	212	28	24	184	55	44
Future Vol, veh/h	212	28	24	184	55	44
Conflicting Peds, #/hr	0	0	0	0	0	1
Sign Control	Free	Free	Free	Free	Stop	Stop
RT Channelized	-	None	-	None	-	None
Storage Length	-	-	75	-	0	-
Veh in Median Storage, #	0	-	-	0	0	-
Grade, %	0	-	-	0	0	-
Peak Hour Factor	74	74	74	74	74	74
Heavy Vehicles, %	6	6	6	6	6	6
Mvmt Flow	286	38	32	249	74	59

Major/Minor

	Major1	Major2	Minor1		
Conflicting Flow All	0	0	324	0	618
Stage 1	-	-	-	-	305
Stage 2	-	-	-	-	313
Critical Hdwy	-	-	4.16	-	6.46
Critical Hdwy Stg 1	-	-	-	-	5.46
Critical Hdwy Stg 2	-	-	-	-	5.46
Follow-up Hdwy	-	-	2.254	-	3.554
Pot Cap-1 Maneuver	-	-	1214	-	446
Stage 1	-	-	-	-	739
Stage 2	-	-	-	-	732
Platoon blocked, %	-	-	-	-	-
Mov Cap-1 Maneuver	-	-	1214	-	434
Mov Cap-2 Maneuver	-	-	-	-	529
Stage 1	-	-	-	-	739
Stage 2	-	-	-	-	713

Approach

	EB	WB	NB
HCM Control Delay, s	0	0.9	12.7
HCM LOS			B

Minor Lane/Major Mvmt

	NBLn1	EBT	EBR	WBL	WBT
Capacity (veh/h)	601	-	-	1214	-
HCM Lane V/C Ratio	0.223	-	-	0.027	-
HCM Control Delay (s)	12.7	-	-	8	-
HCM Lane LOS	B	-	-	A	-
HCM 95th %tile Q(veh)	0.8	-	-	0.1	-

HCM 6th Signalized Intersection Summary
5: 10th Avenue & Hanford Armona Road

Existing Plus Project AM Peak

04/26/2022



Movement	EBL	EBT	EBR	WBL	WBT	WBR	NBL	NBT	NBR	SBL	SBT	SBR
Lane Configurations												
Traffic Volume (veh/h)	197	5	53	3	6	12	55	167	1	6	154	157
Future Volume (veh/h)	197	5	53	3	6	12	55	167	1	6	154	157
Initial Q (Qb), veh	0	0	0	0	0	0	0	0	0	0	0	0
Ped-Bike Adj(A_pbT)	1.00		1.00	1.00		1.00	1.00		1.00	1.00		1.00
Parking Bus, Adj	1.00	1.00	1.00	1.00	1.00	1.00	1.00	1.00	1.00	1.00	1.00	1.00
Work Zone On Approach		No			No			No			No	
Adj Sat Flow, veh/h/ln	1796	1796	1796	1796	1796	1796	1796	1796	1796	1796	1796	1796
Adj Flow Rate, veh/h	243	6	65	4	7	15	68	206	1	7	190	194
Peak Hour Factor	0.81	0.81	0.81	0.81	0.81	0.81	0.81	0.81	0.81	0.81	0.81	0.81
Percent Heavy Veh, %	7	7	7	7	7	7	7	7	7	7	7	7
Cap, veh/h	288	440	373	9	42	90	113	468	397	16	367	311
Arrive On Green	0.17	0.24	0.24	0.01	0.08	0.08	0.07	0.26	0.26	0.01	0.20	0.20
Sat Flow, veh/h	1711	1796	1522	1711	509	1091	1711	1796	1522	1711	1796	1522
Grp Volume(v), veh/h	243	6	65	4	0	22	68	206	1	7	190	194
Grp Sat Flow(s),veh/h/ln	1711	1796	1522	1711	0	1600	1711	1796	1522	1711	1796	1522
Q Serve(g_s), s	5.6	0.1	1.4	0.1	0.0	0.5	1.6	3.9	0.0	0.2	3.8	4.7
Cycle Q Clear(g_c), s	5.6	0.1	1.4	0.1	0.0	0.5	1.6	3.9	0.0	0.2	3.8	4.7
Prop In Lane	1.00		1.00	1.00		0.68	1.00		1.00	1.00		1.00
Lane Grp Cap(c), veh/h	288	440	373	9	0	131	113	468	397	16	367	311
V/C Ratio(X)	0.84	0.01	0.17	0.43	0.00	0.17	0.60	0.44	0.00	0.44	0.52	0.62
Avail Cap(c_a), veh/h	288	1652	1400	211	0	1385	211	1279	1084	211	1297	1099
HCM Platoon Ratio	1.00	1.00	1.00	1.00	1.00	1.00	1.00	1.00	1.00	1.00	1.00	1.00
Upstream Filter(I)	1.00	1.00	1.00	1.00	0.00	1.00	1.00	1.00	1.00	1.00	1.00	1.00
Uniform Delay (d), s/veh	16.3	11.6	12.0	20.0	0.0	17.3	18.4	12.5	11.1	19.9	14.3	14.7
Incr Delay (d2), s/veh	20.0	0.0	0.2	28.5	0.0	0.6	5.1	0.7	0.0	17.7	1.1	2.1
Initial Q Delay(d3),s/veh	0.0	0.0	0.0	0.0	0.0	0.0	0.0	0.0	0.0	0.0	0.0	0.0
%ile BackOfQ(50%),veh/ln	3.3	0.0	0.4	0.1	0.0	0.2	0.6	1.1	0.0	0.1	1.3	1.4
Unsig. Movement Delay, s/veh												
LnGrp Delay(d),s/veh	36.3	11.6	12.3	48.5	0.0	17.9	23.4	13.1	11.1	37.6	15.5	16.7
LnGrp LOS	D	B	B	D	A	B	C	B	B	D	B	B
Approach Vol, veh/h		314			26			275			391	
Approach Delay, s/veh		30.9			22.6			15.7			16.5	
Approach LOS		C			C			B			B	
Timer - Assigned Phs	1	2	3	4	5	6	7	8				
Phs Duration (G+Y+Rc), s	4.6	16.2	4.4	15.2	6.9	14.0	11.0	8.6				
Change Period (Y+Rc), s	* 4.2	5.7	* 4.2	* 5.3	* 4.2	* 5.7	* 4.2	5.3				
Max Green Setting (Gmax), s	* 5	28.8	* 5	* 37	* 5	* 29	* 6.8	35.0				
Max Q Clear Time (g_c+I1), s	2.2	5.9	2.1	3.4	3.6	6.7	7.6	2.5				
Green Ext Time (p_c), s	0.0	0.9	0.0	0.2	0.0	1.6	0.0	0.1				

Intersection Summary												
HCM 6th Ctrl Delay				20.9								
HCM 6th LOS				C								

Notes

* HCM 6th computational engine requires equal clearance times for the phases crossing the barrier.

Intersection						
Int Delay, s/veh	4.3					
Movement	WBL	WBR	NBT	NBR	SBL	SBT
Lane Configurations						
Traffic Vol, veh/h	32	53	71	8	18	39
Future Vol, veh/h	32	53	71	8	18	39
Conflicting Peds, #/hr	0	0	0	0	0	0
Sign Control	Stop	Stop	Free	Free	Free	Free
RT Channelized	-	None	-	None	-	None
Storage Length	0	-	-	-	-	-
Veh in Median Storage, #	0	-	0	-	-	0
Grade, %	0	-	0	-	-	0
Peak Hour Factor	88	88	88	88	88	88
Heavy Vehicles, %	5	5	5	5	5	5
Mvmt Flow	36	60	81	9	20	44

Major/Minor	Minor1	Major1	Major2		
Conflicting Flow All	170	86	0	0	90
Stage 1	86	-	-	-	-
Stage 2	84	-	-	-	-
Critical Hdwy	6.45	6.25	-	-	4.15
Critical Hdwy Stg 1	5.45	-	-	-	-
Critical Hdwy Stg 2	5.45	-	-	-	-
Follow-up Hdwy	3.545	3.345	-	-	2.245
Pot Cap-1 Maneuver	813	964	-	-	1486
Stage 1	930	-	-	-	-
Stage 2	932	-	-	-	-
Platoon blocked, %			-	-	-
Mov Cap-1 Maneuver	802	964	-	-	1486
Mov Cap-2 Maneuver	802	-	-	-	-
Stage 1	930	-	-	-	-
Stage 2	919	-	-	-	-

Approach	WB	NB	SB
HCM Control Delay, s	9.5	0	2.4
HCM LOS	A		

Minor Lane/Major Mvmt	NBT	NBRWBLn1	SBL	SBT
Capacity (veh/h)	-	-	896	1486
HCM Lane V/C Ratio	-	-	0.108	0.014
HCM Control Delay (s)	-	-	9.5	7.5
HCM Lane LOS	-	-	A	A
HCM 95th %tile Q(veh)	-	-	0.4	0

HCM Signalized Intersection Capacity Analysis
7: 11th Avenue & Houston Avenue

Existing Plus Project AM Peak
04/26/2022



Movement	EBL	EBT	EBR	WBL	WBT	WBR	NBL	NBT	NBR	SBL	SBT	SBR
Lane Configurations	↔	↑	↗	↖	↑	↗	↖	↑↑	↗	↖	↑	↗
Traffic Volume (vph)	32	76	24	30	85	39	17	73	23	41	59	21
Future Volume (vph)	32	76	24	30	85	39	17	73	23	41	59	21
Ideal Flow (vphp)	1900	1900	1900	1900	1900	1900	1900	1900	1900	1900	1900	1900
Total Lost time (s)	4.2	6.0	6.0	4.2	5.7	5.7	4.2	5.7	5.7	4.2	5.3	5.3
Lane Util. Factor	1.00	1.00	1.00	1.00	1.00	1.00	1.00	0.95	1.00	1.00	1.00	1.00
Frt	1.00	1.00	0.85	1.00	1.00	0.85	1.00	1.00	0.85	1.00	1.00	0.85
Flt Protected	0.95	1.00	1.00	0.95	1.00	1.00	0.95	1.00	1.00	0.95	1.00	1.00
Satd. Flow (prot)	1597	1681	1429	1597	1681	1429	1597	3195	1429	1597	1681	1429
Flt Permitted	0.95	1.00	1.00	0.95	1.00	1.00	0.95	1.00	1.00	0.95	1.00	1.00
Satd. Flow (perm)	1597	1681	1429	1597	1681	1429	1597	3195	1429	1597	1681	1429
Peak-hour factor, PHF	0.96	0.96	0.96	0.96	0.96	0.96	0.96	0.96	0.96	0.96	0.96	0.96
Adj. Flow (vph)	33	79	25	31	89	41	18	76	24	43	61	22
RTOR Reduction (vph)	0	0	22	0	0	35	0	0	15	0	0	12
Lane Group Flow (vph)	33	79	3	31	89	6	18	76	9	43	61	10
Heavy Vehicles (%)	13%	13%	13%	13%	13%	13%	13%	13%	13%	13%	13%	13%
Turn Type	Prot	NA	Perm	Prot	NA	Perm	Prot	NA	Perm	Prot	NA	Perm
Protected Phases	7	4		3	8		5	2		1	6	
Permitted Phases			4			8			2			6
Actuated Green, G (s)	3.0	7.5	7.5	3.0	7.8	7.8	1.0	21.6	21.6	3.0	24.0	24.0
Effective Green, g (s)	3.0	7.5	7.5	3.0	7.8	7.8	1.0	21.6	21.6	3.0	24.0	24.0
Actuated g/C Ratio	0.05	0.14	0.14	0.05	0.14	0.14	0.02	0.39	0.39	0.05	0.43	0.43
Clearance Time (s)	4.2	6.0	6.0	4.2	5.7	5.7	4.2	5.7	5.7	4.2	5.3	5.3
Vehicle Extension (s)	3.0	3.0	3.0	3.0	3.0	3.0	3.0	3.0	3.0	3.0	3.0	3.0
Lane Grp Cap (vph)	86	228	194	86	237	201	28	1250	559	86	730	621
v/s Ratio Prot	c0.02	0.05		0.02	c0.05		0.01	0.02		c0.03	c0.04	
v/s Ratio Perm			0.00			0.00			0.01			0.01
v/c Ratio	0.38	0.35	0.02	0.36	0.38	0.03	0.64	0.06	0.02	0.50	0.08	0.02
Uniform Delay, d1	25.2	21.6	20.7	25.2	21.5	20.4	26.9	10.5	10.3	25.4	9.1	8.9
Progression Factor	1.00	1.00	1.00	1.00	1.00	1.00	1.00	1.00	1.00	1.00	1.00	1.00
Incremental Delay, d2	2.8	0.9	0.0	2.6	1.0	0.1	40.9	0.0	0.0	4.5	0.0	0.0
Delay (s)	28.0	22.5	20.7	27.7	22.5	20.5	67.9	10.5	10.3	29.9	9.2	8.9
Level of Service	C	C	C	C	C	C	E	B	B	C	A	A
Approach Delay (s)		23.5			23.0			19.2			16.2	
Approach LOS		C			C			B			B	

Intersection Summary		
HCM 2000 Control Delay	20.7	HCM 2000 Level of Service C
HCM 2000 Volume to Capacity ratio	0.21	
Actuated Cycle Length (s)	55.2	Sum of lost time (s) 20.1
Intersection Capacity Utilization	30.9%	ICU Level of Service A
Analysis Period (min)	15	
c Critical Lane Group		

Intersection

Int Delay, s/veh 3

Movement	EBL	EBT	WBT	WBR	SBL	SBR
Lane Configurations		↶	↷		↶	↷
Traffic Vol, veh/h	22	94	80	26	26	45
Future Vol, veh/h	22	94	80	26	26	45
Conflicting Peds, #/hr	0	0	0	0	0	0
Sign Control	Free	Free	Free	Free	Stop	Stop
RT Channelized	-	None	-	None	-	None
Storage Length	-	-	-	-	0	-
Veh in Median Storage, #	-	0	0	-	0	-
Grade, %	-	0	0	-	0	-
Peak Hour Factor	89	89	89	89	89	89
Heavy Vehicles, %	19	19	19	19	19	19
Mvmt Flow	25	106	90	29	29	51

Major/Minor	Major1	Major2	Minor2
Conflicting Flow All	119	0	0
Stage 1	-	-	-
Stage 2	-	-	-
Critical Hdwy	4.29	-	-
Critical Hdwy Stg 1	-	-	-
Critical Hdwy Stg 2	-	-	-
Follow-up Hdwy	2.371	-	-
Pot Cap-1 Maneuver	1370	-	-
Stage 1	-	-	-
Stage 2	-	-	-
Platoon blocked, %	-	-	-
Mov Cap-1 Maneuver	1370	-	-
Mov Cap-2 Maneuver	-	-	-
Stage 1	-	-	-
Stage 2	-	-	-

Approach	EB	WB	SB
HCM Control Delay, s	1.5	0	10
HCM LOS			B

Minor Lane/Major Mvmt	EBL	EBT	WBT	WBR	SBLn1
Capacity (veh/h)	1370	-	-	-	807
HCM Lane V/C Ratio	0.018	-	-	-	0.099
HCM Control Delay (s)	7.7	0	-	-	10
HCM Lane LOS	A	A	-	-	B
HCM 95th %tile Q(veh)	0.1	-	-	-	0.3

Intersection	
Intersection Delay, s/veh	8.9
Intersection LOS	A

Movement	EBL	EBT	EBR	WBL	WBT	WBR	NBL	NBT	NBR	SBL	SBT	SBR
Lane Configurations		↕			↕			↕			↕	
Traffic Vol, veh/h	30	66	31	12	56	13	14	59	5	13	63	41
Future Vol, veh/h	30	66	31	12	56	13	14	59	5	13	63	41
Peak Hour Factor	0.91	0.91	0.91	0.91	0.91	0.91	0.91	0.91	0.91	0.91	0.91	0.91
Heavy Vehicles, %	26	26	26	26	26	26	26	26	26	26	26	26
Mvmt Flow	33	73	34	13	62	14	15	65	5	14	69	45
Number of Lanes	0	1	0	0	1	0	0	1	0	0	1	0

Approach	EB	WB	NB	SB
Opposing Approach	WB	EB	SB	NB
Opposing Lanes	1	1	1	1
Conflicting Approach Left	SB	NB	EB	WB
Conflicting Lanes Left	1	1	1	1
Conflicting Approach Right	NB	SB	WB	EB
Conflicting Lanes Right	1	1	1	1
HCM Control Delay	9.1	8.7	8.8	8.9
HCM LOS	A	A	A	A

Lane	NBLn1	EBLn1	WBLn1	SBLn1
Vol Left, %	18%	24%	15%	11%
Vol Thru, %	76%	52%	69%	54%
Vol Right, %	6%	24%	16%	35%
Sign Control	Stop	Stop	Stop	Stop
Traffic Vol by Lane	78	127	81	117
LT Vol	14	30	12	13
Through Vol	59	66	56	63
RT Vol	5	31	13	41
Lane Flow Rate	86	140	89	129
Geometry Grp	1	1	1	1
Degree of Util (X)	0.121	0.19	0.123	0.173
Departure Headway (Hd)	5.078	4.895	4.991	4.842
Convergence, Y/N	Yes	Yes	Yes	Yes
Cap	705	733	717	741
Service Time	3.111	2.927	3.026	2.873
HCM Lane V/C Ratio	0.122	0.191	0.124	0.174
HCM Control Delay	8.8	9.1	8.7	8.9
HCM Lane LOS	A	A	A	A
HCM 95th-tile Q	0.4	0.7	0.4	0.6

HCM 6th Signalized Intersection Summary
 3: 10 1/2 Avenue & Hanford Armona Road

Existing Plus Project PM Peak

04/26/2022

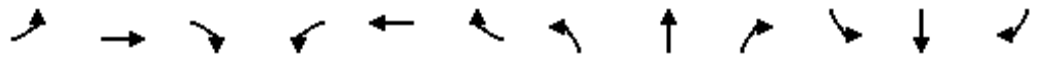

Movement	EBL	EBT	EBR	WBL	WBT	WBR	NBL	NBT	NBR	SBL	SBT	SBR
Lane Configurations												
Traffic Volume (veh/h)	44	303	111	24	297	29	89	36	14	27	43	56
Future Volume (veh/h)	44	303	111	24	297	29	89	36	14	27	43	56
Initial Q (Qb), veh	0	0	0	0	0	0	0	0	0	0	0	0
Ped-Bike Adj(A_pbT)	1.00		1.00	1.00		1.00	1.00		1.00	1.00		1.00
Parking Bus, Adj	1.00	1.00	1.00	1.00	1.00	1.00	1.00	1.00	1.00	1.00	1.00	1.00
Work Zone On Approach		No			No			No			No	
Adj Sat Flow, veh/h/ln	1856	1856	1856	1856	1856	1856	1856	1856	1856	1856	1856	1856
Adj Flow Rate, veh/h	48	329	121	26	323	32	97	39	15	29	47	61
Peak Hour Factor	0.92	0.92	0.92	0.92	0.92	0.92	0.92	0.92	0.92	0.92	0.92	0.92
Percent Heavy Veh, %	3	3	3	3	3	3	3	3	3	3	3	3
Cap, veh/h	91	439	162	55	531	53	144	287	243	61	199	169
Arrive On Green	0.05	0.34	0.34	0.03	0.32	0.32	0.08	0.15	0.15	0.03	0.11	0.11
Sat Flow, veh/h	1767	1293	475	1767	1661	165	1767	1856	1572	1767	1856	1572
Grp Volume(v), veh/h	48	0	450	26	0	355	97	39	15	29	47	61
Grp Sat Flow(s),veh/h/ln	1767	0	1768	1767	0	1825	1767	1856	1572	1767	1856	1572
Q Serve(g_s), s	1.1	0.0	9.3	0.6	0.0	6.8	2.2	0.8	0.3	0.7	1.0	1.5
Cycle Q Clear(g_c), s	1.1	0.0	9.3	0.6	0.0	6.8	2.2	0.8	0.3	0.7	1.0	1.5
Prop In Lane	1.00		0.27	1.00		0.09	1.00		1.00	1.00		1.00
Lane Grp Cap(c), veh/h	91	0	601	55	0	584	144	287	243	61	199	169
V/C Ratio(X)	0.53	0.00	0.75	0.47	0.00	0.61	0.68	0.14	0.06	0.48	0.24	0.36
Avail Cap(c_a), veh/h	214	0	1176	214	0	1214	325	1284	1088	244	1212	1027
HCM Platoon Ratio	1.00	1.00	1.00	1.00	1.00	1.00	1.00	1.00	1.00	1.00	1.00	1.00
Upstream Filter(I)	1.00	0.00	1.00	1.00	0.00	1.00	1.00	1.00	1.00	1.00	1.00	1.00
Uniform Delay (d), s/veh	19.1	0.0	12.1	19.7	0.0	11.9	18.5	15.1	14.9	19.6	16.9	17.1
Incr Delay (d2), s/veh	4.7	0.0	1.9	6.1	0.0	1.0	5.4	0.2	0.1	5.8	0.6	1.3
Initial Q Delay(d3),s/veh	0.0	0.0	0.0	0.0	0.0	0.0	0.0	0.0	0.0	0.0	0.0	0.0
%ile BackOfQ(50%),veh/ln	0.5	0.0	2.9	0.3	0.0	2.1	1.0	0.3	0.1	0.3	0.4	0.5
Unsig. Movement Delay, s/veh												
LnGrp Delay(d),s/veh	23.9	0.0	14.0	25.8	0.0	12.9	23.9	15.3	15.0	25.4	17.5	18.4
LnGrp LOS	C	A	B	C	A	B	C	B	B	C	B	B
Approach Vol, veh/h		498			381			151			137	
Approach Delay, s/veh		14.9			13.8			20.8			19.6	
Approach LOS		B			B			C			B	
Timer - Assigned Phs	1	2	3	4	5	6	7	8				
Phs Duration (G+Y+Rc), s	5.6	11.3	5.5	18.9	7.6	9.3	6.3	18.1				
Change Period (Y+Rc), s	* 4.2	4.9	* 4.2	4.9	* 4.2	* 4.9	* 4.2	4.9				
Max Green Setting (Gmax), s	* 5.7	28.6	* 5	27.5	* 7.6	* 27	* 5	27.5				
Max Q Clear Time (g_c+I1), s	2.7	2.8	2.6	11.3	4.2	3.5	3.1	8.8				
Green Ext Time (p_c), s	0.0	0.2	0.0	2.4	0.1	0.4	0.0	1.9				

Intersection Summary

HCM 6th Ctrl Delay	15.9
HCM 6th LOS	B

Notes

* HCM 6th computational engine requires equal clearance times for the phases crossing the barrier.

Intersection

Int Delay, s/veh 2.1

Movement	EBT	EBR	WBL	WBT	NBL	NBR
Lane Configurations						
Traffic Vol, veh/h	257	57	59	291	53	31
Future Vol, veh/h	257	57	59	291	53	31
Conflicting Peds, #/hr	0	2	2	0	0	0
Sign Control	Free	Free	Free	Free	Stop	Stop
RT Channelized	-	None	-	None	-	None
Storage Length	-	-	75	-	0	-
Veh in Median Storage, #	0	-	-	0	0	-
Grade, %	0	-	-	0	0	-
Peak Hour Factor	90	90	90	90	90	90
Heavy Vehicles, %	3	3	3	3	3	3
Mvmt Flow	286	63	66	323	59	34

Major/Minor	Major1	Major2	Minor1	Minor2	Minor3
Conflicting Flow All	0	0	351	0	775
Stage 1	-	-	-	-	320
Stage 2	-	-	-	-	455
Critical Hdwy	-	-	4.13	-	6.43
Critical Hdwy Stg 1	-	-	-	-	5.43
Critical Hdwy Stg 2	-	-	-	-	5.43
Follow-up Hdwy	-	-	2.227	-	3.527
Pot Cap-1 Maneuver	-	-	1202	-	365
Stage 1	-	-	-	-	734
Stage 2	-	-	-	-	637
Platoon blocked, %	-	-	-	-	-
Mov Cap-1 Maneuver	-	-	1200	-	344
Mov Cap-2 Maneuver	-	-	-	-	456
Stage 1	-	-	-	-	733
Stage 2	-	-	-	-	602

Approach	EB	WB	NB
HCM Control Delay, s	0	1.4	13.3
HCM LOS			B

Minor Lane/Major Mvmt	NBLn1	EBT	EBR	WBL	WBT
Capacity (veh/h)	527	-	-	1200	-
HCM Lane V/C Ratio	0.177	-	-	0.055	-
HCM Control Delay (s)	13.3	-	-	8.2	-
HCM Lane LOS	B	-	-	A	-
HCM 95th %tile Q(veh)	0.6	-	-	0.2	-

HCM 6th Signalized Intersection Summary
5: 10th Avenue & Hanford Armona Road

Existing Plus Project PM Peak
04/26/2022



Movement	EBL	EBT	EBR	WBL	WBT	WBR	NBL	NBT	NBR	SBL	SBT	SBR
Lane Configurations												
Traffic Volume (veh/h)	169	16	97	4	11	8	114	203	5	16	154	221
Future Volume (veh/h)	169	16	97	4	11	8	114	203	5	16	154	221
Initial Q (Qb), veh	0	0	0	0	0	0	0	0	0	0	0	0
Ped-Bike Adj(A_pbT)	1.00		1.00	1.00		0.99	1.00		0.99	1.00		0.99
Parking Bus, Adj	1.00	1.00	1.00	1.00	1.00	1.00	1.00	1.00	1.00	1.00	1.00	1.00
Work Zone On Approach		No			No			No			No	
Adj Sat Flow, veh/h/ln	1856	1856	1856	1856	1856	1856	1856	1856	1856	1856	1856	1856
Adj Flow Rate, veh/h	178	17	102	4	12	8	120	214	5	17	162	233
Peak Hour Factor	0.95	0.95	0.95	0.95	0.95	0.95	0.95	0.95	0.95	0.95	0.95	0.95
Percent Heavy Veh, %	3	3	3	3	3	3	3	3	3	3	3	3
Cap, veh/h	225	433	365	10	115	77	155	551	465	38	428	360
Arrive On Green	0.13	0.23	0.23	0.01	0.11	0.11	0.09	0.30	0.30	0.02	0.23	0.23
Sat Flow, veh/h	1767	1856	1566	1767	1036	691	1767	1856	1565	1767	1856	1562
Grp Volume(v), veh/h	178	17	102	4	0	20	120	214	5	17	162	233
Grp Sat Flow(s),veh/h/ln	1767	1856	1566	1767	0	1727	1767	1856	1565	1767	1856	1562
Q Serve(g_s), s	4.3	0.3	2.3	0.1	0.0	0.5	2.9	4.0	0.1	0.4	3.2	5.9
Cycle Q Clear(g_c), s	4.3	0.3	2.3	0.1	0.0	0.5	2.9	4.0	0.1	0.4	3.2	5.9
Prop In Lane	1.00		1.00	1.00		0.40	1.00		1.00	1.00		1.00
Lane Grp Cap(c), veh/h	225	433	365	10	0	192	155	551	465	38	428	360
V/C Ratio(X)	0.79	0.04	0.28	0.42	0.00	0.10	0.77	0.39	0.01	0.45	0.38	0.65
Avail Cap(c_a), veh/h	274	1576	1330	202	0	1380	202	1220	1029	202	1237	1041
HCM Platoon Ratio	1.00	1.00	1.00	1.00	1.00	1.00	1.00	1.00	1.00	1.00	1.00	1.00
Upstream Filter(I)	1.00	1.00	1.00	1.00	0.00	1.00	1.00	1.00	1.00	1.00	1.00	1.00
Uniform Delay (d), s/veh	18.5	13.0	13.8	21.7	0.0	17.5	19.6	12.2	10.9	21.2	14.2	15.2
Incr Delay (d2), s/veh	12.0	0.0	0.4	26.4	0.0	0.2	12.9	0.4	0.0	8.2	0.6	1.9
Initial Q Delay(d3),s/veh	0.0	0.0	0.0	0.0	0.0	0.0	0.0	0.0	0.0	0.0	0.0	0.0
%ile BackOfQ(50%),veh/ln	2.2	0.1	0.7	0.1	0.0	0.2	1.5	1.2	0.0	0.2	1.1	1.8
Unsig. Movement Delay, s/veh												
LnGrp Delay(d),s/veh	30.6	13.0	14.2	48.1	0.0	17.7	32.5	12.7	10.9	29.4	14.8	17.2
LnGrp LOS	C	B	B	D	A	B	C	B	B	C	B	B
Approach Vol, veh/h		297			24			339			412	
Approach Delay, s/veh		23.9			22.8			19.7			16.7	
Approach LOS		C			C			B			B	
Timer - Assigned Phs	1	2	3	4	5	6	7	8				
Phs Duration (G+Y+Rc), s	5.1	18.7	4.4	15.5	8.0	15.8	9.8	10.2				
Change Period (Y+Rc), s	* 4.2	5.7	* 4.2	* 5.3	* 4.2	* 5.7	* 4.2	5.3				
Max Green Setting (Gmax), s	* 5	28.8	* 5	* 37	* 5	* 29	* 6.8	35.0				
Max Q Clear Time (g_c+I1), s	2.4	6.0	2.1	4.3	4.9	7.9	6.3	2.5				
Green Ext Time (p_c), s	0.0	1.0	0.0	0.4	0.0	1.5	0.0	0.1				

Intersection Summary

HCM 6th Ctrl Delay	19.8
HCM 6th LOS	B

Notes

* HCM 6th computational engine requires equal clearance times for the phases crossing the barrier.

Intersection

Int Delay, s/veh 3.6

Movement WBL WBR NBT NBR SBL SBT

Lane Configurations						
Traffic Vol, veh/h	19	36	64	37	58	57
Future Vol, veh/h	19	36	64	37	58	57
Conflicting Peds, #/hr	0	0	0	0	0	0
Sign Control	Stop	Stop	Free	Free	Free	Free
RT Channelized	-	None	-	None	-	None
Storage Length	0	-	-	-	-	-
Veh in Median Storage, #	0	-	0	-	-	0
Grade, %	0	-	0	-	-	0
Peak Hour Factor	88	88	88	88	88	88
Heavy Vehicles, %	3	3	3	3	3	3
Mvmt Flow	22	41	73	42	66	65

Major/Minor Minor1 Major1 Major2

Conflicting Flow All	291	94	0	0	115	0
Stage 1	94	-	-	-	-	-
Stage 2	197	-	-	-	-	-
Critical Hdwy	6.43	6.23	-	-	4.13	-
Critical Hdwy Stg 1	5.43	-	-	-	-	-
Critical Hdwy Stg 2	5.43	-	-	-	-	-
Follow-up Hdwy	3.527	3.327	-	-	2.227	-
Pot Cap-1 Maneuver	698	960	-	-	1468	-
Stage 1	927	-	-	-	-	-
Stage 2	834	-	-	-	-	-
Platoon blocked, %			-	-		-
Mov Cap-1 Maneuver	665	960	-	-	1468	-
Mov Cap-2 Maneuver	665	-	-	-	-	-
Stage 1	927	-	-	-	-	-
Stage 2	795	-	-	-	-	-

Approach WB NB SB

HCM Control Delay, s	9.7	0	3.8
HCM LOS	A		

Minor Lane/Major Mvmt NBT NBRWBLn1 SBL SBT

Capacity (veh/h)	-	-	832	1468	-
HCM Lane V/C Ratio	-	-	0.075	0.045	-
HCM Control Delay (s)	-	-	9.7	7.6	0
HCM Lane LOS	-	-	A	A	A
HCM 95th %tile Q(veh)	-	-	0.2	0.1	-

HCM Signalized Intersection Capacity Analysis

7: 11th Avenue & Houston Avenue

Existing Plus Project PM Peak

04/26/2022

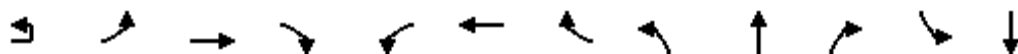

Movement	EBU	EBL	EBT	EBR	WBL	WBT	WBR	NBL	NBT	NBR	SBL	SBT
Lane Configurations		↔	↑	↗	↖	↑	↗	↖	↑↑	↗	↖	↑
Traffic Volume (vph)	1	21	129	18	24	112	76	33	159	38	50	78
Future Volume (vph)	1	21	129	18	24	112	76	33	159	38	50	78
Ideal Flow (vphp)	1900	1900	1900	1900	1900	1900	1900	1900	1900	1900	1900	1900
Total Lost time (s)		4.2	6.0	6.0	4.2	5.7	5.7	4.2	5.7	5.7	4.2	5.3
Lane Util. Factor		1.00	1.00	1.00	1.00	1.00	1.00	1.00	0.95	1.00	1.00	1.00
Frt		1.00	1.00	0.85	1.00	1.00	0.85	1.00	1.00	0.85	1.00	1.00
Flt Protected		0.95	1.00	1.00	0.95	1.00	1.00	0.95	1.00	1.00	0.95	1.00
Satd. Flow (prot)		1719	1810	1538	1719	1810	1538	1719	3438	1538	1719	1810
Flt Permitted		0.95	1.00	1.00	0.95	1.00	1.00	0.95	1.00	1.00	0.95	1.00
Satd. Flow (perm)		1719	1810	1538	1719	1810	1538	1719	3438	1538	1719	1810
Peak-hour factor, PHF	0.84	0.84	0.84	0.84	0.84	0.84	0.84	0.84	0.84	0.84	0.84	0.84
Adj. Flow (vph)	1	25	154	21	29	133	90	39	189	45	60	93
RTOR Reduction (vph)	0	0	0	17	0	0	69	0	0	30	0	0
Lane Group Flow (vph)	0	26	154	4	29	133	21	39	189	15	60	93
Heavy Vehicles (%)	5%	5%	5%	5%	5%	5%	5%	5%	5%	5%	5%	5%
Turn Type	Prot	Prot	NA	Perm	Prot	NA	Perm	Prot	NA	Perm	Prot	NA
Protected Phases	7	7	4		3	8		5	2		1	6
Permitted Phases				4			8			2		
Actuated Green, G (s)		1.0	11.8	11.8	2.7	13.8	13.8	2.7	19.1	19.1	5.1	21.9
Effective Green, g (s)		1.0	11.8	11.8	2.7	13.8	13.8	2.7	19.1	19.1	5.1	21.9
Actuated g/C Ratio		0.02	0.20	0.20	0.05	0.23	0.23	0.05	0.32	0.32	0.09	0.37
Clearance Time (s)		4.2	6.0	6.0	4.2	5.7	5.7	4.2	5.7	5.7	4.2	5.3
Vehicle Extension (s)		3.0	3.0	3.0	3.0	3.0	3.0	3.0	3.0	3.0	3.0	3.0
Lane Grp Cap (vph)		29	363	308	78	424	360	78	1116	499	149	674
v/s Ratio Prot		0.02	c0.09		c0.02	0.07		0.02	c0.05		c0.03	0.05
v/s Ratio Perm				0.00			0.01			0.01		
v/c Ratio		0.90	0.42	0.01	0.37	0.31	0.06	0.50	0.17	0.03	0.40	0.14
Uniform Delay, d1		28.8	20.5	18.8	27.2	18.6	17.5	27.4	14.2	13.5	25.4	12.2
Progression Factor		1.00	1.00	1.00	1.00	1.00	1.00	1.00	1.00	1.00	1.00	1.00
Incremental Delay, d2		122.2	0.8	0.0	3.0	0.4	0.1	5.0	0.1	0.0	1.8	0.1
Delay (s)		151.1	21.3	18.9	30.2	19.0	17.5	32.4	14.3	13.6	27.2	12.3
Level of Service		F	C	B	C	B	B	C	B	B	C	B
Approach Delay (s)			37.9			19.8			16.7			17.3
Approach LOS			D			B			B			B

Intersection Summary

HCM 2000 Control Delay	22.4	HCM 2000 Level of Service	C
HCM 2000 Volume to Capacity ratio	0.28		
Actuated Cycle Length (s)	58.8	Sum of lost time (s)	20.1
Intersection Capacity Utilization	40.2%	ICU Level of Service	A
Analysis Period (min)	15		
c Critical Lane Group			



Movement	SBR
Lane Configurations	7
Traffic Volume (vph)	20
Future Volume (vph)	20
Ideal Flow (vphpl)	1900
Total Lost time (s)	5.3
Lane Util. Factor	1.00
Frt	0.85
Flt Protected	1.00
Satd. Flow (prot)	1538
Flt Permitted	1.00
Satd. Flow (perm)	1538
Peak-hour factor, PHF	0.84
Adj. Flow (vph)	24
RTOR Reduction (vph)	15
Lane Group Flow (vph)	9
Heavy Vehicles (%)	5%
Turn Type	Perm
Protected Phases	
Permitted Phases	6
Actuated Green, G (s)	21.9
Effective Green, g (s)	21.9
Actuated g/C Ratio	0.37
Clearance Time (s)	5.3
Vehicle Extension (s)	3.0
Lane Grp Cap (vph)	572
v/s Ratio Prot	
v/s Ratio Perm	0.01
v/c Ratio	0.02
Uniform Delay, d1	11.6
Progression Factor	1.00
Incremental Delay, d2	0.0
Delay (s)	11.7
Level of Service	B
Approach Delay (s)	
Approach LOS	
Intersection Summary	

Intersection

Int Delay, s/veh 2.8

Movement EBL EBT WBT WBR SBL SBR

Lane Configurations		↕	↕		↕	
Traffic Vol, veh/h	60	107	134	39	28	34
Future Vol, veh/h	60	107	134	39	28	34
Conflicting Peds, #/hr	0	0	0	0	0	0
Sign Control	Free	Free	Free	Free	Stop	Stop
RT Channelized	-	None	-	None	-	None
Storage Length	-	-	-	-	0	-
Veh in Median Storage, #	-	0	0	-	0	-
Grade, %	-	0	0	-	0	-
Peak Hour Factor	93	93	93	93	93	93
Heavy Vehicles, %	3	3	3	3	3	3
Mvmt Flow	65	115	144	42	30	37

Major/Minor Major1 Major2 Minor2

Conflicting Flow All	186	0	-	0	410	165
Stage 1	-	-	-	-	165	-
Stage 2	-	-	-	-	245	-
Critical Hdwy	4.13	-	-	-	6.43	6.23
Critical Hdwy Stg 1	-	-	-	-	5.43	-
Critical Hdwy Stg 2	-	-	-	-	5.43	-
Follow-up Hdwy	2.227	-	-	-	3.527	3.327
Pot Cap-1 Maneuver	1382	-	-	-	596	877
Stage 1	-	-	-	-	862	-
Stage 2	-	-	-	-	793	-
Platoon blocked, %		-	-	-		
Mov Cap-1 Maneuver	1382	-	-	-	566	877
Mov Cap-2 Maneuver	-	-	-	-	566	-
Stage 1	-	-	-	-	819	-
Stage 2	-	-	-	-	793	-

Approach EB WB SB

HCM Control Delay, s	2.8	0	10.7
HCM LOS			B

Minor Lane/Major Mvmt EBL EBT WBT WBR SBLn1

Capacity (veh/h)	1382	-	-	-	703
HCM Lane V/C Ratio	0.047	-	-	-	0.095
HCM Control Delay (s)	7.7	0	-	-	10.7
HCM Lane LOS	A	A	-	-	B
HCM 95th %tile Q(veh)	0.1	-	-	-	0.3

Intersection	
Intersection Delay, s/veh	9
Intersection LOS	A

Movement	EBL	EBT	EBR	WBL	WBT	WBR	NBL	NBT	NBR	SBL	SBT	SBR
Lane Configurations		↕			↕			↕			↕	
Traffic Vol, veh/h	32	75	20	8	87	48	37	103	8	41	70	37
Future Vol, veh/h	32	75	20	8	87	48	37	103	8	41	70	37
Peak Hour Factor	0.98	0.98	0.98	0.98	0.98	0.98	0.98	0.98	0.98	0.98	0.98	0.98
Heavy Vehicles, %	5	5	5	5	5	5	5	5	5	5	5	5
Mvmt Flow	33	77	20	8	89	49	38	105	8	42	71	38
Number of Lanes	0	1	0	0	1	0	0	1	0	0	1	0

Approach	EB	WB	NB	SB
Opposing Approach	WB	EB	SB	NB
Opposing Lanes	1	1	1	1
Conflicting Approach Left	SB	NB	EB	WB
Conflicting Lanes Left	1	1	1	1
Conflicting Approach Right	NB	SB	WB	EB
Conflicting Lanes Right	1	1	1	1
HCM Control Delay	8.9	8.8	9.1	9
HCM LOS	A	A	A	A

Lane	NBLn1	EBLn1	WBLn1	SBLn1
Vol Left, %	25%	25%	6%	28%
Vol Thru, %	70%	59%	61%	47%
Vol Right, %	5%	16%	34%	25%
Sign Control	Stop	Stop	Stop	Stop
Traffic Vol by Lane	148	127	143	148
LT Vol	37	32	8	41
Through Vol	103	75	87	70
RT Vol	8	20	48	37
Lane Flow Rate	151	130	146	151
Geometry Grp	1	1	1	1
Degree of Util (X)	0.203	0.175	0.19	0.199
Departure Headway (Hd)	4.847	4.848	4.686	4.739
Convergence, Y/N	Yes	Yes	Yes	Yes
Cap	737	736	762	754
Service Time	2.9	2.9	2.737	2.791
HCM Lane V/C Ratio	0.205	0.177	0.192	0.2
HCM Control Delay	9.1	8.9	8.8	9
HCM Lane LOS	A	A	A	A
HCM 95th-tile Q	0.8	0.6	0.7	0.7

Intersection: 1: Douty St & 3rd Street

Movement	EB	EB	EB	NB	NB	NB	SB	SB
Directions Served	L	T	TR	T	T	R	LT	T
Maximum Queue (ft)	104	105	72	55	78	31	119	49
Average Queue (ft)	57	43	41	37	40	20	49	5
95th Queue (ft)	87	72	62	54	67	43	83	28
Link Distance (ft)	320	320	320	356	356		787	787
Upstream Blk Time (%)								
Queuing Penalty (veh)								
Storage Bay Dist (ft)						90		
Storage Blk Time (%)					0			
Queuing Penalty (veh)					0			

Intersection: 2: 10th Avenue & 4th Street/SR-198 WB Off Ramp

Movement	WB	NB	NB	NB	SB	SB	SB
Directions Served	LTR	L	T	T	T	T	R
Maximum Queue (ft)	151	52	115	162	179	174	75
Average Queue (ft)	48	23	64	68	88	24	35
95th Queue (ft)	103	53	110	142	151	101	59
Link Distance (ft)	775		759	759	758	758	
Upstream Blk Time (%)							
Queuing Penalty (veh)							
Storage Bay Dist (ft)		295					105
Storage Blk Time (%)							
Queuing Penalty (veh)							

Intersection: 3: 10 1/2 Avenue & Hanford Armona Road

Movement	EB	EB	WB	WB	NB	NB	NB	SB	SB	SB
Directions Served	L	TR	L	TR	L	T	R	L	T	R
Maximum Queue (ft)	107	106	47	154	141	116	50	31	31	53
Average Queue (ft)	34	62	7	55	61	33	12	10	14	18
95th Queue (ft)	77	106	27	113	109	79	37	33	38	45
Link Distance (ft)		1346		1547		396			386	
Upstream Blk Time (%)										
Queuing Penalty (veh)										
Storage Bay Dist (ft)	150		95		150		95	150		100
Storage Blk Time (%)				1	0	1				
Queuing Penalty (veh)				0	0	1				

Intersection: 4: Jordan Way & Hanford Armona Road

Movement	WB	NB
Directions Served	L	LR
Maximum Queue (ft)	30	75
Average Queue (ft)	5	42
95th Queue (ft)	22	71
Link Distance (ft)	1339	
Upstream Blk Time (%)		
Queuing Penalty (veh)		
Storage Bay Dist (ft)	75	
Storage Blk Time (%)		
Queuing Penalty (veh)		

Intersection: 5: 10th Avenue & Hanford Armona Road

Movement	EB	EB	EB	WB	WB	NB	NB	SB	SB	SB					
Directions Served	L	T	R	L	TR	L	T	L	T	R					
Maximum Queue (ft)	152	75	54	25	45	89	134	31	137	101					
Average Queue (ft)	86	4	16	1	10	34	47	5	56	36					
95th Queue (ft)	146	27	38	10	33	61	111	23	115	70					
Link Distance (ft)	936			372			448		399						
Upstream Blk Time (%)															
Queuing Penalty (veh)															
Storage Bay Dist (ft)	105		55		155		155		110		265				
Storage Blk Time (%)	7	0	0											0	2
Queuing Penalty (veh)	4	0	0											0	3

Intersection: 6: 10 1/2 Avenue & Orchard Avenue

Movement	WB
Directions Served	LR
Maximum Queue (ft)	78
Average Queue (ft)	40
95th Queue (ft)	66
Link Distance (ft)	862
Upstream Blk Time (%)	
Queuing Penalty (veh)	
Storage Bay Dist (ft)	
Storage Blk Time (%)	
Queuing Penalty (veh)	

Intersection: 7: 11th Avenue & Houston Avenue

Movement	EB	EB	EB	WB	WB	WB	NB	NB	NB	NB	SB	SB
Directions Served	UL	T	R	L	T	R	L	T	T	R	L	T
Maximum Queue (ft)	103	92	51	61	108	43	69	46	79	50	95	82
Average Queue (ft)	20	23	6	17	36	15	15	20	5	11	23	18
95th Queue (ft)	59	53	24	44	74	39	49	47	32	31	57	53
Link Distance (ft)		680			436			276	276			1524
Upstream Blk Time (%)												
Queuing Penalty (veh)												
Storage Bay Dist (ft)	165		150	175		175	175			100	250	
Storage Blk Time (%)												
Queuing Penalty (veh)												

Intersection: 7: 11th Avenue & Houston Avenue

Movement	SB
Directions Served	R
Maximum Queue (ft)	69
Average Queue (ft)	14
95th Queue (ft)	47
Link Distance (ft)	1524
Upstream Blk Time (%)	
Queuing Penalty (veh)	
Storage Bay Dist (ft)	
Storage Blk Time (%)	
Queuing Penalty (veh)	

Intersection: 8: Houston Avenue & 10 1/2 Avenue

Movement	SB
Directions Served	LR
Maximum Queue (ft)	73
Average Queue (ft)	37
95th Queue (ft)	68
Link Distance (ft)	2057
Upstream Blk Time (%)	
Queuing Penalty (veh)	
Storage Bay Dist (ft)	
Storage Blk Time (%)	
Queuing Penalty (veh)	

Intersection: 9: 10th Avenue & Houston Avenue

Movement	EB	WB	NB	SB
Directions Served	LTR	LTR	LTR	LTR
Maximum Queue (ft)	100	79	74	87
Average Queue (ft)	50	41	35	41
95th Queue (ft)	83	80	66	77
Link Distance (ft)	2557	1661	1092	4776
Upstream Blk Time (%)				
Queuing Penalty (veh)				
Storage Bay Dist (ft)				
Storage Blk Time (%)				
Queuing Penalty (veh)				

Intersection: 10: 3rd Street & SR-198 EB Off Ramp

Movement	EB	SE
Directions Served	T	L
Maximum Queue (ft)	31	73
Average Queue (ft)	1	24
95th Queue (ft)	10	65
Link Distance (ft)	361	209
Upstream Blk Time (%)		
Queuing Penalty (veh)		
Storage Bay Dist (ft)		
Storage Blk Time (%)		
Queuing Penalty (veh)		

Network Summary

Network wide Queuing Penalty: 9

Intersection: 1: Douty St & 3rd Street

Movement	EB	EB	EB	NB	NB	NB	SB	SB
Directions Served	L	T	TR	T	T	R	LT	T
Maximum Queue (ft)	99	108	94	79	77	54	162	92
Average Queue (ft)	64	63	54	37	35	25	80	15
95th Queue (ft)	92	92	85	59	58	54	146	56
Link Distance (ft)	320	320	320	356	356		787	787
Upstream Blk Time (%)								
Queuing Penalty (veh)								
Storage Bay Dist (ft)						90		
Storage Blk Time (%)					0			
Queuing Penalty (veh)					0			

Intersection: 2: 10th Avenue & 4th Street/SR-198 WB Off Ramp

Movement	WB	NB	NB	NB	SB	SB	SB
Directions Served	LTR	L	T	T	T	T	R
Maximum Queue (ft)	142	121	120	138	243	180	101
Average Queue (ft)	68	51	60	55	125	55	36
95th Queue (ft)	115	87	110	121	210	159	68
Link Distance (ft)	775		759	759	758	758	
Upstream Blk Time (%)							
Queuing Penalty (veh)							
Storage Bay Dist (ft)		295					105
Storage Blk Time (%)						1	0
Queuing Penalty (veh)						2	0

Intersection: 3: 10 1/2 Avenue & Hanford Armona Road

Movement	EB	EB	WB	WB	NB	NB	NB	SB	SB	SB
Directions Served	L	TR	L	TR	L	T	R	L	T	R
Maximum Queue (ft)	88	298	47	167	135	74	31	53	75	72
Average Queue (ft)	23	102	17	76	51	25	10	17	23	26
95th Queue (ft)	61	198	41	138	99	61	33	47	53	57
Link Distance (ft)		1346		1547		396			386	
Upstream Blk Time (%)										
Queuing Penalty (veh)										
Storage Bay Dist (ft)	150		95		150		95	150		100
Storage Blk Time (%)		2		4	0					
Queuing Penalty (veh)		1		1	0					

Intersection: 4: Jordan Way & Hanford Armona Road

Movement	EB	WB	NB
Directions Served	TR	L	LR
Maximum Queue (ft)	22	72	75
Average Queue (ft)	1	15	37
95th Queue (ft)	10	46	68
Link Distance (ft)	1547		1339
Upstream Blk Time (%)			
Queuing Penalty (veh)			
Storage Bay Dist (ft)		75	
Storage Blk Time (%)		0	
Queuing Penalty (veh)		0	

Intersection: 5: 10th Avenue & Hanford Armona Road

Movement	EB	EB	EB	WB	WB	NB	NB	NB	SB	SB	SB
Directions Served	L	T	R	L	TR	L	T	R	L	T	R
Maximum Queue (ft)	202	23	147	24	48	153	157	20	52	159	80
Average Queue (ft)	83	5	27	1	16	65	62	1	22	54	51
95th Queue (ft)	156	21	71	8	39	116	130	7	49	111	78
Link Distance (ft)		936			372		448			399	
Upstream Blk Time (%)											
Queuing Penalty (veh)											
Storage Bay Dist (ft)	105		55	155		155		130	110		265
Storage Blk Time (%)	6		0			1	2				2
Queuing Penalty (veh)	6		1			1	3				4

Intersection: 6: 10 1/2 Avenue & Orchard Avenue

Movement	WB	SB
Directions Served	LR	LT
Maximum Queue (ft)	54	52
Average Queue (ft)	30	4
95th Queue (ft)	52	22
Link Distance (ft)	862	2833
Upstream Blk Time (%)		
Queuing Penalty (veh)		
Storage Bay Dist (ft)		
Storage Blk Time (%)		
Queuing Penalty (veh)		

Intersection: 7: 11th Avenue & Houston Avenue

Movement	EB	EB	EB	WB	WB	WB	NB	NB	NB	NB	SB	SB
Directions Served	UL	T	R	L	T	R	L	T	T	R	L	T
Maximum Queue (ft)	60	150	39	51	88	42	61	79	60	37	94	82
Average Queue (ft)	12	34	6	11	42	17	20	29	11	10	30	23
95th Queue (ft)	35	77	22	34	83	32	52	57	36	25	67	62
Link Distance (ft)		680			436			276	276			1524
Upstream Blk Time (%)												
Queuing Penalty (veh)												
Storage Bay Dist (ft)	165		150	175		175	175			100	250	
Storage Blk Time (%)		0										
Queuing Penalty (veh)		0										

Intersection: 7: 11th Avenue & Houston Avenue

Movement	SB
Directions Served	R
Maximum Queue (ft)	42
Average Queue (ft)	6
95th Queue (ft)	23
Link Distance (ft)	1524
Upstream Blk Time (%)	
Queuing Penalty (veh)	
Storage Bay Dist (ft)	
Storage Blk Time (%)	
Queuing Penalty (veh)	

Intersection: 8: Houston Avenue & 10 1/2 Avenue

Movement	EB	SB
Directions Served	LT	LR
Maximum Queue (ft)	43	52
Average Queue (ft)	9	25
95th Queue (ft)	31	44
Link Distance (ft)	2076	2057
Upstream Blk Time (%)		
Queuing Penalty (veh)		
Storage Bay Dist (ft)		
Storage Blk Time (%)		
Queuing Penalty (veh)		

Intersection: 9: 10th Avenue & Houston Avenue

Movement	EB	WB	NB	SB
Directions Served	LTR	LTR	LTR	LTR
Maximum Queue (ft)	78	103	75	68
Average Queue (ft)	33	41	35	35
95th Queue (ft)	57	72	58	57
Link Distance (ft)	2557	1661	1092	4776
Upstream Blk Time (%)				
Queuing Penalty (veh)				
Storage Bay Dist (ft)				
Storage Blk Time (%)				
Queuing Penalty (veh)				

Intersection: 10: 3rd Street & SR-198 EB Off Ramp

Movement	EB	SE
Directions Served	T	L
Maximum Queue (ft)	99	94
Average Queue (ft)	7	35
95th Queue (ft)	43	71
Link Distance (ft)	361	209
Upstream Blk Time (%)		
Queuing Penalty (veh)		
Storage Bay Dist (ft)		
Storage Blk Time (%)		
Queuing Penalty (veh)		

Network Summary

Network wide Queuing Penalty: 19

HCS7 Two-Lane Highway Report

Project Information

Analyst	C. Ayala-Magana	Date	7/20/2022
Agency	JLB Traffic Engineering, Inc.	Analysis Year	2022
Jurisdiction	City of Hanford	Time Period Analyzed	Existing Plus Project AM Peak
Project Description	01 Hanford-Armona Road Between 11th Avenue and 10 1/2 Avenue	Unit	United States Customary

Segment 1

Vehicle Inputs

Segment Type	Passing Constrained	Length, ft	2583
Lane Width, ft	12	Shoulder Width, ft	6
Speed Limit, mi/h	40	Access Point Density, pts/mi	34.8

Demand and Capacity

Directional Demand Flow Rate, veh/h	547	Opposing Demand Flow Rate, veh/h	-
Peak Hour Factor	0.72	Total Trucks, %	4.03
Segment Capacity, veh/h	1700	Demand/Capacity (D/C)	0.32

Intermediate Results

Segment Vertical Class	1	Free-Flow Speed, mi/h	36.8
Speed Slope Coefficient	2.52195	Speed Power Coefficient	0.41674
PF Slope Coefficient	-1.44139	PF Power Coefficient	0.67822
In Passing Lane Effective Length?	No	Total Segment Density, veh/mi/ln	9.6
%Improved % Followers	0.0	% Improved Avg Speed	0.0

Subsegment Data

#	Segment Type	Length, ft	Radius, ft	Superelevation, %	Average Speed, mi/h
1	Tangent	2583	-	-	35.0

Vehicle Results

Average Speed, mi/h	35.0	Percent Followers, %	61.6
Segment Travel Time, minutes	0.84	Follower Density, followers/mi/ln	9.6
Vehicle LOS	C		

Facility Results

T	Follower Density, followers/mi/ln	LOS
1	9.6	C

HCS7 Two-Lane Highway Report

Project Information

Analyst	C. Ayala-Magana	Date	7/20/2022
Agency	JLB Traffic Engineering, Inc.	Analysis Year	2022
Jurisdiction	City of Hanford	Time Period Analyzed	Existing Plus Project AM Peak
Project Description	02 Hanford-Armona Road Between 10 1/2 Avenue and Jordan Way	Unit	United States Customary

Segment 1

Vehicle Inputs

Segment Type	Passing Constrained	Length, ft	1556
Lane Width, ft	12	Shoulder Width, ft	6
Speed Limit, mi/h	40	Access Point Density, pts/mi	67.9

Demand and Capacity

Directional Demand Flow Rate, veh/h	362	Opposing Demand Flow Rate, veh/h	-
Peak Hour Factor	0.74	Total Trucks, %	3.39
Segment Capacity, veh/h	1700	Demand/Capacity (D/C)	0.21

Intermediate Results

Segment Vertical Class	1	Free-Flow Speed, mi/h	35.5
Speed Slope Coefficient	2.43653	Speed Power Coefficient	0.41674
PF Slope Coefficient	-1.48329	PF Power Coefficient	0.66113
In Passing Lane Effective Length?	No	Total Segment Density, veh/mi/ln	5.6
%Improved % Followers	0.0	% Improved Avg Speed	0.0

Subsegment Data

#	Segment Type	Length, ft	Radius, ft	Superelevation, %	Average Speed, mi/h
1	Tangent	1556	-	-	34.1

Vehicle Results

Average Speed, mi/h	34.1	Percent Followers, %	53.1
Segment Travel Time, minutes	0.52	Follower Density, followers/mi/ln	5.6
Vehicle LOS	C		

Facility Results

T	Follower Density, followers/mi/ln	LOS
1	5.6	C

HCS7 Two-Lane Highway Report

Project Information

Analyst	C. Ayala-Magana	Date	7/20/2022
Agency	JLB Traffic Engineering, Inc.	Analysis Year	2022
Jurisdiction	City of Hanford	Time Period Analyzed	Existing Plus Project AM Peak
Project Description	03 Hanford-Armona Road Between Jordan Way and 10th Avenue	Unit	United States Customary

Segment 1

Vehicle Inputs

Segment Type	Passing Constrained	Length, ft	901
Lane Width, ft	12	Shoulder Width, ft	6
Speed Limit, mi/h	40	Access Point Density, pts/mi	23.4

Demand and Capacity

Directional Demand Flow Rate, veh/h	340	Opposing Demand Flow Rate, veh/h	-
Peak Hour Factor	0.75	Total Trucks, %	6.25
Segment Capacity, veh/h	1700	Demand/Capacity (D/C)	0.20

Intermediate Results

Segment Vertical Class	1	Free-Flow Speed, mi/h	39.5
Speed Slope Coefficient	2.65189	Speed Power Coefficient	0.41674
PF Slope Coefficient	-1.50451	PF Power Coefficient	0.67582
In Passing Lane Effective Length?	No	Total Segment Density, veh/mi/ln	4.6
%Improved % Followers	0.0	% Improved Avg Speed	0.0

Subsegment Data

#	Segment Type	Length, ft	Radius, ft	Superelevation, %	Average Speed, mi/h
1	Tangent	901	-	-	38.1

Vehicle Results

Average Speed, mi/h	38.1	Percent Followers, %	51.6
Segment Travel Time, minutes	0.27	Follower Density, followers/mi/ln	4.6
Vehicle LOS	B		

Facility Results

T	Follower Density, followers/mi/ln	LOS
1	4.6	B

HCS7 Two-Lane Highway Report

Project Information

Analyst	C. Ayala-Magana	Date	7/20/2022
Agency	JLB Traffic Engineering, Inc.	Analysis Year	2022
Jurisdiction	City of Hanford	Time Period Analyzed	Existing Plus Project AM Peak
Project Description	04 10.5 Avenue Between Hanford Armona Road and Orchard Avenue	Unit	United States Customary

Segment 1

Vehicle Inputs

Segment Type	Passing Constrained	Length, ft	2735
Lane Width, ft	12	Shoulder Width, ft	2
Speed Limit, mi/h	40	Access Point Density, pts/mi	50.2

Demand and Capacity

Directional Demand Flow Rate, veh/h	307	Opposing Demand Flow Rate, veh/h	-
Peak Hour Factor	0.60	Total Trucks, %	9.87
Segment Capacity, veh/h	1700	Demand/Capacity (D/C)	0.18

Intermediate Results

Segment Vertical Class	1	Free-Flow Speed, mi/h	32.5
Speed Slope Coefficient	2.29128	Speed Power Coefficient	0.41674
PF Slope Coefficient	-1.42068	PF Power Coefficient	0.65951
In Passing Lane Effective Length?	No	Total Segment Density, veh/mi/ln	4.7
%Improved % Followers	0.0	% Improved Avg Speed	0.0

Subsegment Data

#	Segment Type	Length, ft	Radius, ft	Superelevation, %	Average Speed, mi/h
1	Tangent	2735	-	-	31.3

Vehicle Results

Average Speed, mi/h	31.3	Percent Followers, %	47.9
Segment Travel Time, minutes	0.99	Follower Density, followers/mi/ln	4.7
Vehicle LOS	B		

Facility Results

T	Follower Density, followers/mi/ln	LOS
1	4.7	B

HCS7 Two-Lane Highway Report

Project Information

Analyst	C. Ayala-Magana	Date	7/20/2022
Agency	JLB Traffic Engineering, Inc.	Analysis Year	2022
Jurisdiction	City of Hanford	Time Period Analyzed	Existing Plus Project AM Peak
Project Description	05 10.5 Avenue Between Orchard Avenue and Houston Avenue	Unit	United States Customary

Segment 1

Vehicle Inputs

Segment Type	Passing Constrained	Length, ft	2594
Lane Width, ft	12	Shoulder Width, ft	2
Speed Limit, mi/h	40	Access Point Density, pts/mi	52.9

Demand and Capacity

Directional Demand Flow Rate, veh/h	155	Opposing Demand Flow Rate, veh/h	-
Peak Hour Factor	0.42	Total Trucks, %	13.33
Segment Capacity, veh/h	1700	Demand/Capacity (D/C)	0.09

Intermediate Results

Segment Vertical Class	1	Free-Flow Speed, mi/h	32.4
Speed Slope Coefficient	2.28310	Speed Power Coefficient	0.41674
PF Slope Coefficient	-1.42395	PF Power Coefficient	0.65839
In Passing Lane Effective Length?	No	Total Segment Density, veh/mi/ln	1.7
%Improved % Followers	0.0	% Improved Avg Speed	0.0

Subsegment Data

#	Segment Type	Length, ft	Radius, ft	Superelevation, %	Average Speed, mi/h
1	Tangent	2594	-	-	31.7

Vehicle Results

Average Speed, mi/h	31.7	Percent Followers, %	34.1
Segment Travel Time, minutes	0.93	Follower Density, followers/mi/ln	1.7
Vehicle LOS	A		

Facility Results

T	Follower Density, followers/mi/ln	LOS
1	1.7	A

HCS7 Two-Lane Highway Report

Project Information

Analyst	C. Ayala-Magana	Date	7/20/2022
Agency	JLB Traffic Engineering, Inc.	Analysis Year	2022
Jurisdiction	City of Hanford	Time Period Analyzed	Existing Plus Project AM Peak
Project Description	06 Houston Avenue Between 11th Avenue and 10 1/2 Avenue	Unit	United States Customary

Segment 1

Vehicle Inputs

Segment Type	Passing Constrained	Length, ft	2567
Lane Width, ft	12	Shoulder Width, ft	2
Speed Limit, mi/h	50	Access Point Density, pts/mi	20.6

Demand and Capacity

Directional Demand Flow Rate, veh/h	260	Opposing Demand Flow Rate, veh/h	-
Peak Hour Factor	0.68	Total Trucks, %	21.40
Segment Capacity, veh/h	1700	Demand/Capacity (D/C)	0.15

Intermediate Results

Segment Vertical Class	1	Free-Flow Speed, mi/h	48.3
Speed Slope Coefficient	3.14891	Speed Power Coefficient	0.41674
PF Slope Coefficient	-1.42118	PF Power Coefficient	0.72418
In Passing Lane Effective Length?	No	Total Segment Density, veh/mi/ln	2.3
%Improved % Followers	0.0	% Improved Avg Speed	0.0

Subsegment Data

#	Segment Type	Length, ft	Radius, ft	Superelevation, %	Average Speed, mi/h
1	Tangent	2567	-	-	46.9

Vehicle Results

Average Speed, mi/h	46.9	Percent Followers, %	41.5
Segment Travel Time, minutes	0.62	Follower Density, followers/mi/ln	2.3
Vehicle LOS	A		

Facility Results

T	Follower Density, followers/mi/ln	LOS
1	2.3	A

HCS7 Two-Lane Highway Report

Project Information

Analyst	C. Ayala-Magana	Date	7/20/2022
Agency	JLB Traffic Engineering, Inc.	Analysis Year	2022
Jurisdiction	City of Hanford	Time Period Analyzed	Existing Plus Project AM Peak
Project Description	07 Houston Avenue Between 10 1/2 Avenue and 10th Avenue	Unit	United States Customary

Segment 1

Vehicle Inputs

Segment Type	Passing Constrained	Length, ft	2570
Lane Width, ft	12	Shoulder Width, ft	2
Speed Limit, mi/h	55	Access Point Density, pts/mi	45.2

Demand and Capacity

Directional Demand Flow Rate, veh/h	198	Opposing Demand Flow Rate, veh/h	-
Peak Hour Factor	0.88	Total Trucks, %	17.65
Segment Capacity, veh/h	1700	Demand/Capacity (D/C)	0.12

Intermediate Results

Segment Vertical Class	1	Free-Flow Speed, mi/h	49.3
Speed Slope Coefficient	3.20179	Speed Power Coefficient	0.41674
PF Slope Coefficient	-1.41674	PF Power Coefficient	0.72668
In Passing Lane Effective Length?	No	Total Segment Density, veh/mi/ln	1.5
%Improved % Followers	0.0	% Improved Avg Speed	0.0

Subsegment Data

#	Segment Type	Length, ft	Radius, ft	Superelevation, %	Average Speed, mi/h
1	Tangent	2570	-	-	48.1

Vehicle Results

Average Speed, mi/h	48.1	Percent Followers, %	35.4
Segment Travel Time, minutes	0.61	Follower Density, followers/mi/ln	1.5
Vehicle LOS	A		

Facility Results

T	Follower Density, followers/mi/ln	LOS
1	1.5	A

HCS7 Two-Lane Highway Report

Project Information

Analyst	C. Ayala-Magana	Date	7/20/2022
Agency	JLB Traffic Engineering, Inc.	Analysis Year	2022
Jurisdiction	City of Hanford	Time Period Analyzed	Existing Plus Project PM Peak
Project Description	01 Hanford-Armona Road Between 11th Avenue and 10 1/2 Avenue	Unit	United States Customary

Segment 1

Vehicle Inputs

Segment Type	Passing Constrained	Length, ft	2583
Lane Width, ft	12	Shoulder Width, ft	6
Speed Limit, mi/h	40	Access Point Density, pts/mi	34.8

Demand and Capacity

Directional Demand Flow Rate, veh/h	653	Opposing Demand Flow Rate, veh/h	-
Peak Hour Factor	0.83	Total Trucks, %	3.00
Segment Capacity, veh/h	1700	Demand/Capacity (D/C)	0.38

Intermediate Results

Segment Vertical Class	1	Free-Flow Speed, mi/h	36.8
Speed Slope Coefficient	2.52381	Speed Power Coefficient	0.41674
PF Slope Coefficient	-1.44159	PF Power Coefficient	0.67823
In Passing Lane Effective Length?	No	Total Segment Density, veh/mi/ln	12.4
%Improved % Followers	0.0	% Improved Avg Speed	0.0

Subsegment Data

#	Segment Type	Length, ft	Radius, ft	Superelevation, %	Average Speed, mi/h
1	Tangent	2583	-	-	34.8

Vehicle Results

Average Speed, mi/h	34.8	Percent Followers, %	66.0
Segment Travel Time, minutes	0.84	Follower Density, followers/mi/ln	12.4
Vehicle LOS	D		

Facility Results

T	Follower Density, followers/mi/ln	LOS
1	12.4	D

HCS7 Two-Lane Highway Report

Project Information

Analyst	C. Ayala-Magana	Date	7/20/2022
Agency	JLB Traffic Engineering, Inc.	Analysis Year	2022
Jurisdiction	City of Hanford	Time Period Analyzed	Existing Plus Project PM Peak
Project Description	02 Hanford-Armona Road Between 10 1/2 Avenue and Jordan Way	Unit	United States Customary

Segment 1

Vehicle Inputs

Segment Type	Passing Constrained	Length, ft	1556
Lane Width, ft	12	Shoulder Width, ft	6
Speed Limit, mi/h	40	Access Point Density, pts/mi	67.9

Demand and Capacity

Directional Demand Flow Rate, veh/h	412	Opposing Demand Flow Rate, veh/h	-
Peak Hour Factor	0.85	Total Trucks, %	3.00
Segment Capacity, veh/h	1700	Demand/Capacity (D/C)	0.24

Intermediate Results

Segment Vertical Class	1	Free-Flow Speed, mi/h	35.5
Speed Slope Coefficient	2.43724	Speed Power Coefficient	0.41674
PF Slope Coefficient	-1.48339	PF Power Coefficient	0.66114
In Passing Lane Effective Length?	No	Total Segment Density, veh/mi/ln	6.8
%Improved % Followers	0.0	% Improved Avg Speed	0.0

Subsegment Data

#	Segment Type	Length, ft	Radius, ft	Superelevation, %	Average Speed, mi/h
1	Tangent	1556	-	-	34.0

Vehicle Results

Average Speed, mi/h	34.0	Percent Followers, %	56.2
Segment Travel Time, minutes	0.52	Follower Density, followers/mi/ln	6.8
Vehicle LOS	C		

Facility Results

T	Follower Density, followers/mi/ln	LOS
1	6.8	C

HCS7 Two-Lane Highway Report

Project Information

Analyst	C. Ayala-Magana	Date	7/20/2022
Agency	JLB Traffic Engineering, Inc.	Analysis Year	2022
Jurisdiction	City of Hanford	Time Period Analyzed	Existing Plus Project PM Peak
Project Description	03 Hanford-Armona Road Between Jordan Way and 10th Avenue	Unit	United States Customary

Segment 1

Vehicle Inputs

Segment Type	Passing Constrained	Length, ft	901
Lane Width, ft	12	Shoulder Width, ft	6
Speed Limit, mi/h	40	Access Point Density, pts/mi	17.6

Demand and Capacity

Directional Demand Flow Rate, veh/h	357	Opposing Demand Flow Rate, veh/h	-
Peak Hour Factor	0.97	Total Trucks, %	3.00
Segment Capacity, veh/h	1700	Demand/Capacity (D/C)	0.21

Intermediate Results

Segment Vertical Class	1	Free-Flow Speed, mi/h	41.1
Speed Slope Coefficient	2.73635	Speed Power Coefficient	0.41674
PF Slope Coefficient	-1.50445	PF Power Coefficient	0.68170
In Passing Lane Effective Length?	No	Total Segment Density, veh/mi/ln	4.7
%Improved % Followers	0.0	% Improved Avg Speed	0.0

Subsegment Data

#	Segment Type	Length, ft	Radius, ft	Superelevation, %	Average Speed, mi/h
1	Tangent	901	-	-	39.5

Vehicle Results

Average Speed, mi/h	39.5	Percent Followers, %	52.5
Segment Travel Time, minutes	0.26	Follower Density, followers/mi/ln	4.7
Vehicle LOS	B		

Facility Results

T	Follower Density, followers/mi/ln	LOS
1	4.7	B

HCS7 Two-Lane Highway Report

Project Information

Analyst	C. Ayala-Magana	Date	7/20/2022
Agency	JLB Traffic Engineering, Inc.	Analysis Year	2022
Jurisdiction	City of Hanford	Time Period Analyzed	Existing Plus Project PM Peak
Project Description	04 10.5 Avenue Between Hanford Armona Road and Orchard Avenue	Unit	United States Customary

Segment 1

Vehicle Inputs

Segment Type	Passing Constrained	Length, ft	2735
Lane Width, ft	12	Shoulder Width, ft	2
Speed Limit, mi/h	40	Access Point Density, pts/mi	50.2

Demand and Capacity

Directional Demand Flow Rate, veh/h	251	Opposing Demand Flow Rate, veh/h	-
Peak Hour Factor	0.75	Total Trucks, %	3.00
Segment Capacity, veh/h	1700	Demand/Capacity (D/C)	0.15

Intermediate Results

Segment Vertical Class	1	Free-Flow Speed, mi/h	32.7
Speed Slope Coefficient	2.30368	Speed Power Coefficient	0.41674
PF Slope Coefficient	-1.42275	PF Power Coefficient	0.65971
In Passing Lane Effective Length?	No	Total Segment Density, veh/mi/ln	3.4
%Improved % Followers	0.0	% Improved Avg Speed	0.0

Subsegment Data

#	Segment Type	Length, ft	Radius, ft	Superelevation, %	Average Speed, mi/h
1	Tangent	2735	-	-	31.7

Vehicle Results

Average Speed, mi/h	31.7	Percent Followers, %	43.5
Segment Travel Time, minutes	0.98	Follower Density, followers/mi/ln	3.4
Vehicle LOS	B		

Facility Results

T	Follower Density, followers/mi/ln	LOS
1	3.4	B

HCS7 Two-Lane Highway Report

Project Information

Analyst	C. Ayala-Magana	Date	7/20/2022
Agency	JLB Traffic Engineering, Inc.	Analysis Year	2022
Jurisdiction	City of Hanford	Time Period Analyzed	Existing Plus Project PM Peak
Project Description	05 10.5 Avenue Between Orchard Avenue and Houston Avenue	Unit	United States Customary

Segment 1

Vehicle Inputs

Segment Type	Passing Constrained	Length, ft	2594
Lane Width, ft	12	Shoulder Width, ft	2
Speed Limit, mi/h	40	Access Point Density, pts/mi	52.9

Demand and Capacity

Directional Demand Flow Rate, veh/h	205	Opposing Demand Flow Rate, veh/h	-
Peak Hour Factor	0.56	Total Trucks, %	3.70
Segment Capacity, veh/h	1700	Demand/Capacity (D/C)	0.12

Intermediate Results

Segment Vertical Class	1	Free-Flow Speed, mi/h	32.7
Speed Slope Coefficient	2.30048	Speed Power Coefficient	0.41674
PF Slope Coefficient	-1.42689	PF Power Coefficient	0.65868
In Passing Lane Effective Length?	No	Total Segment Density, veh/mi/ln	2.6
%Improved % Followers	0.0	% Improved Avg Speed	0.0

Subsegment Data

#	Segment Type	Length, ft	Radius, ft	Superelevation, %	Average Speed, mi/h
1	Tangent	2594	-	-	31.8

Vehicle Results

Average Speed, mi/h	31.8	Percent Followers, %	39.5
Segment Travel Time, minutes	0.93	Follower Density, followers/mi/ln	2.6
Vehicle LOS	B		

Facility Results

T	Follower Density, followers/mi/ln	LOS
1	2.6	B

HCS7 Two-Lane Highway Report

Project Information

Analyst	C. Ayala-Magana	Date	7/20/2022
Agency	JLB Traffic Engineering, Inc.	Analysis Year	2022
Jurisdiction	City of Hanford	Time Period Analyzed	Existing Plus Project PM Peak
Project Description	06 Houston Avenue Between 11th Avenue and 10 1/2 Avenue	Unit	United States Customary

Segment 1

Vehicle Inputs

Segment Type	Passing Constrained	Length, ft	2567
Lane Width, ft	12	Shoulder Width, ft	2
Speed Limit, mi/h	50	Access Point Density, pts/mi	20.6

Demand and Capacity

Directional Demand Flow Rate, veh/h	251	Opposing Demand Flow Rate, veh/h	-
Peak Hour Factor	0.89	Total Trucks, %	3.75
Segment Capacity, veh/h	1700	Demand/Capacity (D/C)	0.15

Intermediate Results

Segment Vertical Class	1	Free-Flow Speed, mi/h	48.9
Speed Slope Coefficient	3.18076	Speed Power Coefficient	0.41674
PF Slope Coefficient	-1.42061	PF Power Coefficient	0.72351
In Passing Lane Effective Length?	No	Total Segment Density, veh/mi/ln	2.1
%Improved % Followers	0.0	% Improved Avg Speed	0.0

Subsegment Data

#	Segment Type	Length, ft	Radius, ft	Superelevation, %	Average Speed, mi/h
1	Tangent	2567	-	-	47.5

Vehicle Results

Average Speed, mi/h	47.5	Percent Followers, %	40.7
Segment Travel Time, minutes	0.61	Follower Density, followers/mi/ln	2.1
Vehicle LOS	A		

Facility Results

T	Follower Density, followers/mi/ln	LOS
1	2.1	A

HCS7 Two-Lane Highway Report

Project Information

Analyst	C. Ayala-Magana	Date	7/20/2022
Agency	JLB Traffic Engineering, Inc.	Analysis Year	2022
Jurisdiction	City of Hanford	Time Period Analyzed	Existing Plus Project PM Peak
Project Description	07 Houston Avenue Between 10 1/2 Avenue and 10th Avenue	Unit	United States Customary

Segment 1

Vehicle Inputs

Segment Type	Passing Constrained	Length, ft	2570
Lane Width, ft	12	Shoulder Width, ft	2
Speed Limit, mi/h	55	Access Point Density, pts/mi	45.2

Demand and Capacity

Directional Demand Flow Rate, veh/h	248	Opposing Demand Flow Rate, veh/h	-
Peak Hour Factor	0.90	Total Trucks, %	3.00
Segment Capacity, veh/h	1700	Demand/Capacity (D/C)	0.15

Intermediate Results

Segment Vertical Class	1	Free-Flow Speed, mi/h	49.8
Speed Slope Coefficient	3.22823	Speed Power Coefficient	0.41674
PF Slope Coefficient	-1.41606	PF Power Coefficient	0.72608
In Passing Lane Effective Length?	No	Total Segment Density, veh/mi/ln	2.1
%Improved % Followers	0.0	% Improved Avg Speed	0.0

Subsegment Data

#	Segment Type	Length, ft	Radius, ft	Superelevation, %	Average Speed, mi/h
1	Tangent	2570	-	-	48.3

Vehicle Results

Average Speed, mi/h	48.3	Percent Followers, %	40.2
Segment Travel Time, minutes	0.60	Follower Density, followers/mi/ln	2.1
Vehicle LOS	B		

Facility Results

T	Follower Density, followers/mi/ln	LOS
1	2.1	B

Appendix G: Near Term plus Project Traffic Conditions



www.JLBtraffic.com
info@JLBtraffic.com

516 W. Shaw Ave., Ste. 103
Fresno, CA 93704
(559) 570-8991

App | G

HCM 6th Signalized Intersection Summary
 3: 10 1/2 Avenue & Hanford Armona Road

Near Term Plus Project AM Peak

04/26/2022



Movement	EBL	EBT	EBR	WBL	WBT	WBR	NBL	NBT	NBR	SBL	SBT	SBR
Lane Configurations												
Traffic Volume (veh/h)	58	235	47	18	220	27	124	74	24	12	22	36
Future Volume (veh/h)	58	235	47	18	220	27	124	74	24	12	22	36
Initial Q (Qb), veh	0	0	0	0	0	0	0	0	0	0	0	0
Ped-Bike Adj(A_pbT)	1.00		1.00	1.00		1.00	1.00		1.00	1.00		1.00
Parking Bus, Adj	1.00	1.00	1.00	1.00	1.00	1.00	1.00	1.00	1.00	1.00	1.00	1.00
Work Zone On Approach		No			No			No			No	
Adj Sat Flow, veh/h/ln	1826	1826	1826	1826	1826	1826	1826	1826	1826	1826	1826	1826
Adj Flow Rate, veh/h	81	326	65	25	306	38	172	103	33	17	31	50
Peak Hour Factor	0.72	0.72	0.72	0.72	0.72	0.72	0.72	0.72	0.72	0.72	0.72	0.72
Percent Heavy Veh, %	5	5	5	5	5	5	5	5	5	5	5	5
Cap, veh/h	126	457	91	52	425	53	219	391	331	37	200	170
Arrive On Green	0.07	0.31	0.31	0.03	0.27	0.27	0.13	0.21	0.21	0.02	0.11	0.11
Sat Flow, veh/h	1739	1478	295	1739	1592	198	1739	1826	1547	1739	1826	1547
Grp Volume(v), veh/h	81	0	391	25	0	344	172	103	33	17	31	50
Grp Sat Flow(s),veh/h/ln	1739	0	1772	1739	0	1790	1739	1826	1547	1739	1826	1547
Q Serve(g_s), s	1.9	0.0	8.4	0.6	0.0	7.5	4.1	2.0	0.7	0.4	0.7	1.3
Cycle Q Clear(g_c), s	1.9	0.0	8.4	0.6	0.0	7.5	4.1	2.0	0.7	0.4	0.7	1.3
Prop In Lane	1.00		0.17	1.00		0.11	1.00		1.00	1.00		1.00
Lane Grp Cap(c), veh/h	126	0	548	52	0	477	219	391	331	37	200	170
V/C Ratio(X)	0.64	0.00	0.71	0.48	0.00	0.72	0.79	0.26	0.10	0.46	0.15	0.29
Avail Cap(c_a), veh/h	203	0	1131	203	0	1143	317	1260	1067	203	1153	977
HCM Platoon Ratio	1.00	1.00	1.00	1.00	1.00	1.00	1.00	1.00	1.00	1.00	1.00	1.00
Upstream Filter(I)	1.00	0.00	1.00	1.00	0.00	1.00	1.00	1.00	1.00	1.00	1.00	1.00
Uniform Delay (d), s/veh	19.3	0.0	13.1	20.4	0.0	14.2	18.1	14.0	13.5	20.7	17.2	17.5
Incr Delay (d2), s/veh	5.4	0.0	1.7	6.6	0.0	2.1	7.9	0.4	0.1	8.5	0.4	1.0
Initial Q Delay(d3),s/veh	0.0	0.0	0.0	0.0	0.0	0.0	0.0	0.0	0.0	0.0	0.0	0.0
%ile BackOfQ(50%),veh/ln	0.8	0.0	2.7	0.3	0.0	2.6	1.8	0.7	0.2	0.2	0.3	0.4
Unsig. Movement Delay, s/veh												
LnGrp Delay(d),s/veh	24.7	0.0	14.8	27.1	0.0	16.3	26.1	14.4	13.6	29.2	17.6	18.5
LnGrp LOS	C	A	B	C	A	B	C	B	B	C	B	B
Approach Vol, veh/h		472			369			308			98	
Approach Delay, s/veh		16.5			17.0			20.8			20.1	
Approach LOS		B			B			C			C	
Timer - Assigned Phs	1	2	3	4	5	6	7	8				
Phs Duration (G+Y+Rc), s	5.1	14.1	5.5	18.1	9.6	9.6	7.3	16.3				
Change Period (Y+Rc), s	* 4.2	4.9	* 4.2	4.9	* 4.2	* 4.9	* 4.2	4.9				
Max Green Setting (Gmax), s	* 5	29.5	* 5	27.3	* 7.8	* 27	* 5	27.3				
Max Q Clear Time (g_c+I1), s	2.4	4.0	2.6	10.4	6.1	3.3	3.9	9.5				
Green Ext Time (p_c), s	0.0	0.6	0.0	2.0	0.1	0.2	0.0	1.8				

Intersection Summary

HCM 6th Ctrl Delay	18.0
HCM 6th LOS	B

Notes

* HCM 6th computational engine requires equal clearance times for the phases crossing the barrier.

Intersection

Int Delay, s/veh 2.6

Movement	EBT	EBR	WBL	WBT	NBL	NBR
Lane Configurations	↶		↷	↶	↷	
Traffic Vol, veh/h	215	28	24	186	55	44
Future Vol, veh/h	215	28	24	186	55	44
Conflicting Peds, #/hr	0	0	0	0	0	1
Sign Control	Free	Free	Free	Free	Stop	Stop
RT Channelized	-	None	-	None	-	None
Storage Length	-	-	75	-	0	-
Veh in Median Storage, #	0	-	-	0	0	-
Grade, %	0	-	-	0	0	-
Peak Hour Factor	74	74	74	74	74	74
Heavy Vehicles, %	6	6	6	6	6	6
Mvmt Flow	291	38	32	251	74	59

Major/Minor	Major1	Major2	Minor1		
Conflicting Flow All	0	0	329	0	625 311
Stage 1	-	-	-	-	310 -
Stage 2	-	-	-	-	315 -
Critical Hdwy	-	-	4.16	-	6.46 6.26
Critical Hdwy Stg 1	-	-	-	-	5.46 -
Critical Hdwy Stg 2	-	-	-	-	5.46 -
Follow-up Hdwy	-	-	2.254	-	3.554 3.354
Pot Cap-1 Maneuver	-	-	1208	-	442 720
Stage 1	-	-	-	-	735 -
Stage 2	-	-	-	-	731 -
Platoon blocked, %	-	-	-	-	-
Mov Cap-1 Maneuver	-	-	1208	-	431 719
Mov Cap-2 Maneuver	-	-	-	-	527 -
Stage 1	-	-	-	-	735 -
Stage 2	-	-	-	-	712 -

Approach	EB	WB	NB
HCM Control Delay, s	0	0.9	12.7
HCM LOS			B

Minor Lane/Major Mvmt	NBLn1	EBT	EBR	WBL	WBT
Capacity (veh/h)	598	-	-	1208	-
HCM Lane V/C Ratio	0.224	-	-	0.027	-
HCM Control Delay (s)	12.7	-	-	8.1	-
HCM Lane LOS	B	-	-	A	-
HCM 95th %tile Q(veh)	0.9	-	-	0.1	-

HCM 6th Signalized Intersection Summary
5: 10th Avenue & Hanford Armona Road

Near Term Plus Project AM Peak

04/26/2022



Movement	EBL	EBT	EBR	WBL	WBT	WBR	NBL	NBT	NBR	SBL	SBT	SBR
Lane Configurations												
Traffic Volume (veh/h)	200	5	53	3	6	12	55	173	2	6	156	159
Future Volume (veh/h)	200	5	53	3	6	12	55	173	2	6	156	159
Initial Q (Qb), veh	0	0	0	0	0	0	0	0	0	0	0	0
Ped-Bike Adj(A_pbT)	1.00		1.00	1.00		1.00	1.00		1.00	1.00		1.00
Parking Bus, Adj	1.00	1.00	1.00	1.00	1.00	1.00	1.00	1.00	1.00	1.00	1.00	1.00
Work Zone On Approach		No			No			No			No	
Adj Sat Flow, veh/h/ln	1796	1796	1796	1796	1796	1796	1796	1796	1796	1796	1796	1796
Adj Flow Rate, veh/h	247	6	65	4	7	15	68	214	2	7	193	196
Peak Hour Factor	0.81	0.81	0.81	0.81	0.81	0.81	0.81	0.81	0.81	0.81	0.81	0.81
Percent Heavy Veh, %	7	7	7	7	7	7	7	7	7	7	7	7
Cap, veh/h	287	439	372	9	42	89	113	471	399	16	369	313
Arrive On Green	0.17	0.24	0.24	0.01	0.08	0.08	0.07	0.26	0.26	0.01	0.21	0.21
Sat Flow, veh/h	1711	1796	1522	1711	509	1091	1711	1796	1522	1711	1796	1522
Grp Volume(v), veh/h	247	6	65	4	0	22	68	214	2	7	193	196
Grp Sat Flow(s),veh/h/ln	1711	1796	1522	1711	0	1600	1711	1796	1522	1711	1796	1522
Q Serve(g_s), s	5.7	0.1	1.4	0.1	0.0	0.5	1.6	4.0	0.0	0.2	3.9	4.8
Cycle Q Clear(g_c), s	5.7	0.1	1.4	0.1	0.0	0.5	1.6	4.0	0.0	0.2	3.9	4.8
Prop In Lane	1.00		1.00	1.00		0.68	1.00		1.00	1.00		1.00
Lane Grp Cap(c), veh/h	287	439	372	9	0	131	113	471	399	16	369	313
V/C Ratio(X)	0.86	0.01	0.17	0.43	0.00	0.17	0.60	0.45	0.01	0.44	0.52	0.63
Avail Cap(c_a), veh/h	287	1649	1397	211	0	1382	211	1276	1082	211	1294	1097
HCM Platoon Ratio	1.00	1.00	1.00	1.00	1.00	1.00	1.00	1.00	1.00	1.00	1.00	1.00
Upstream Filter(I)	1.00	1.00	1.00	1.00	0.00	1.00	1.00	1.00	1.00	1.00	1.00	1.00
Uniform Delay (d), s/veh	16.4	11.6	12.1	20.1	0.0	17.3	18.4	12.5	11.0	20.0	14.3	14.7
Incr Delay (d2), s/veh	22.3	0.0	0.2	28.5	0.0	0.6	5.1	0.7	0.0	17.7	1.1	2.1
Initial Q Delay(d3),s/veh	0.0	0.0	0.0	0.0	0.0	0.0	0.0	0.0	0.0	0.0	0.0	0.0
%ile BackOfQ(50%),veh/ln	3.5	0.0	0.4	0.1	0.0	0.2	0.6	1.2	0.0	0.1	1.3	1.4
Unsig. Movement Delay, s/veh												
LnGrp Delay(d),s/veh	38.7	11.6	12.3	48.6	0.0	17.9	23.5	13.2	11.0	37.7	15.5	16.7
LnGrp LOS	D	B	B	D	A	B	C	B	B	D	B	B
Approach Vol, veh/h		318			26			284			396	
Approach Delay, s/veh		32.8			22.6			15.7			16.5	
Approach LOS		C			C			B			B	
Timer - Assigned Phs	1	2	3	4	5	6	7	8				
Phs Duration (G+Y+Rc), s	4.6	16.3	4.4	15.2	6.9	14.0	11.0	8.6				
Change Period (Y+Rc), s	* 4.2	5.7	* 4.2	* 5.3	* 4.2	* 5.7	* 4.2	5.3				
Max Green Setting (Gmax), s	* 5	28.8	* 5	* 37	* 5	* 29	* 6.8	35.0				
Max Q Clear Time (g_c+I1), s	2.2	6.0	2.1	3.4	3.6	6.8	7.7	2.5				
Green Ext Time (p_c), s	0.0	1.0	0.0	0.2	0.0	1.6	0.0	0.1				

Intersection Summary

HCM 6th Ctrl Delay	21.5
HCM 6th LOS	C

Notes

* HCM 6th computational engine requires equal clearance times for the phases crossing the barrier.

Intersection

Int Delay, s/veh 4

Movement	WBL	WBR	NBT	NBR	SBL	SBT
Lane Configurations						
Traffic Vol, veh/h	32	53	84	8	18	40
Future Vol, veh/h	32	53	84	8	18	40
Conflicting Peds, #/hr	0	0	0	0	0	0
Sign Control	Stop	Stop	Free	Free	Free	Free
RT Channelized	-	None	-	None	-	None
Storage Length	0	-	-	-	-	-
Veh in Median Storage, #	0	-	0	-	-	0
Grade, %	0	-	0	-	-	0
Peak Hour Factor	88	88	88	88	88	88
Heavy Vehicles, %	5	5	5	5	5	5
Mvmt Flow	36	60	95	9	20	45

Major/Minor	Minor1	Major1	Major2		
Conflicting Flow All	185	100	0	0	104
Stage 1	100	-	-	-	-
Stage 2	85	-	-	-	-
Critical Hdwy	6.45	6.25	-	-	4.15
Critical Hdwy Stg 1	5.45	-	-	-	-
Critical Hdwy Stg 2	5.45	-	-	-	-
Follow-up Hdwy	3.545	3.345	-	-	2.245
Pot Cap-1 Maneuver	797	947	-	-	1469
Stage 1	917	-	-	-	-
Stage 2	931	-	-	-	-
Platoon blocked, %			-	-	-
Mov Cap-1 Maneuver	786	947	-	-	1469
Mov Cap-2 Maneuver	786	-	-	-	-
Stage 1	917	-	-	-	-
Stage 2	918	-	-	-	-

Approach	WB	NB	SB
HCM Control Delay, s	9.6	0	2.3
HCM LOS	A		

Minor Lane/Major Mvmt	NBT	NBRWBLn1	SBL	SBT
Capacity (veh/h)	-	-	879	1469
HCM Lane V/C Ratio	-	-	0.11	0.014
HCM Control Delay (s)	-	-	9.6	7.5
HCM Lane LOS	-	-	A	A
HCM 95th %tile Q(veh)	-	-	0.4	0

HCM Signalized Intersection Capacity Analysis

7: 11th Avenue & Houston Avenue

Near Term Plus Project AM Peak

04/26/2022



Movement	EBL	EBT	EBR	WBL	WBT	WBR	NBL	NBT	NBR	SBL	SBT	SBR
Lane Configurations	↔	↑	↗	↖	↑	↗	↖	↑↑	↗	↖	↑	↗
Traffic Volume (vph)	75	111	29	30	94	40	19	73	23	43	60	34
Future Volume (vph)	75	111	29	30	94	40	19	73	23	43	60	34
Ideal Flow (vphp)	1900	1900	1900	1900	1900	1900	1900	1900	1900	1900	1900	1900
Total Lost time (s)	4.2	6.0	6.0	4.2	5.7	5.7	4.2	5.7	5.7	4.2	5.3	5.3
Lane Util. Factor	1.00	1.00	1.00	1.00	1.00	1.00	1.00	0.95	1.00	1.00	1.00	1.00
Frt	1.00	1.00	0.85	1.00	1.00	0.85	1.00	1.00	0.85	1.00	1.00	0.85
Flt Protected	0.95	1.00	1.00	0.95	1.00	1.00	0.95	1.00	1.00	0.95	1.00	1.00
Satd. Flow (prot)	1597	1681	1429	1597	1681	1429	1597	3195	1429	1597	1681	1429
Flt Permitted	0.95	1.00	1.00	0.95	1.00	1.00	0.95	1.00	1.00	0.95	1.00	1.00
Satd. Flow (perm)	1597	1681	1429	1597	1681	1429	1597	3195	1429	1597	1681	1429
Peak-hour factor, PHF	0.96	0.96	0.96	0.96	0.96	0.96	0.96	0.96	0.96	0.96	0.96	0.96
Adj. Flow (vph)	78	116	30	31	98	42	20	76	24	45	62	35
RTOR Reduction (vph)	0	0	21	0	0	34	0	0	17	0	0	24
Lane Group Flow (vph)	78	116	9	31	98	8	20	76	7	45	63	11
Heavy Vehicles (%)	13%	13%	13%	13%	13%	13%	13%	13%	13%	13%	13%	13%
Turn Type	Prot	NA	Perm	Prot	NA	Perm	Prot	NA	Perm	Prot	NA	Perm
Protected Phases	7	4		3	8		5	2		1	6	
Permitted Phases			4			8			2			6
Actuated Green, G (s)	10.0	18.6	18.6	3.4	12.3	12.3	1.2	18.2	18.2	3.4	20.8	20.8
Effective Green, g (s)	10.0	18.6	18.6	3.4	12.3	12.3	1.2	18.2	18.2	3.4	20.8	20.8
Actuated g/C Ratio	0.16	0.29	0.29	0.05	0.19	0.19	0.02	0.29	0.29	0.05	0.33	0.33
Clearance Time (s)	4.2	6.0	6.0	4.2	5.7	5.7	4.2	5.7	5.7	4.2	5.3	5.3
Vehicle Extension (s)	3.0	3.0	3.0	3.0	3.0	3.0	3.0	3.0	3.0	3.0	3.0	3.0
Lane Grp Cap (vph)	250	490	417	85	324	275	30	912	408	85	548	466
v/s Ratio Prot	c0.05	0.07		0.02	c0.06		0.01	0.02		c0.03	c0.04	
v/s Ratio Perm			0.01			0.01			0.00			0.01
v/c Ratio	0.31	0.24	0.02	0.36	0.30	0.03	0.67	0.08	0.02	0.53	0.11	0.02
Uniform Delay, d1	23.8	17.2	16.1	29.1	22.0	20.9	31.1	16.6	16.3	29.4	15.0	14.6
Progression Factor	1.00	1.00	1.00	1.00	1.00	1.00	1.00	1.00	1.00	1.00	1.00	1.00
Incremental Delay, d2	0.7	0.3	0.0	2.6	0.5	0.0	44.1	0.0	0.0	5.8	0.1	0.0
Delay (s)	24.5	17.4	16.1	31.8	22.6	20.9	75.2	16.7	16.3	35.2	15.1	14.6
Level of Service	C	B	B	C	C	C	E	B	B	D	B	B
Approach Delay (s)		19.7			23.8			26.4			21.3	
Approach LOS		B			C			C			C	

Intersection Summary

HCM 2000 Control Delay	22.3	HCM 2000 Level of Service	C
HCM 2000 Volume to Capacity ratio	0.25		
Actuated Cycle Length (s)	63.7	Sum of lost time (s)	20.1
Intersection Capacity Utilization	33.3%	ICU Level of Service	A
Analysis Period (min)	15		
c Critical Lane Group			

Intersection

Int Delay, s/veh 3

Movement	EBL	EBT	WBT	WBR	SBL	SBR
Lane Configurations		↶	↷		↶	↷
Traffic Vol, veh/h	35	117	89	26	26	46
Future Vol, veh/h	35	117	89	26	26	46
Conflicting Peds, #/hr	0	0	0	0	0	0
Sign Control	Free	Free	Free	Free	Stop	Stop
RT Channelized	-	None	-	None	-	None
Storage Length	-	-	-	-	0	-
Veh in Median Storage, #	-	0	0	-	0	-
Grade, %	-	0	0	-	0	-
Peak Hour Factor	89	89	89	89	89	89
Heavy Vehicles, %	19	19	19	19	19	19
Mvmt Flow	39	131	100	29	29	52

Major/Minor	Major1	Major2	Minor2
Conflicting Flow All	129	0	0
Stage 1	-	-	-
Stage 2	-	-	-
Critical Hdwy	4.29	-	-
Critical Hdwy Stg 1	-	-	-
Critical Hdwy Stg 2	-	-	-
Follow-up Hdwy	2.371	-	-
Pot Cap-1 Maneuver	1358	-	-
Stage 1	-	-	-
Stage 2	-	-	-
Platoon blocked, %	-	-	-
Mov Cap-1 Maneuver	1358	-	-
Mov Cap-2 Maneuver	-	-	-
Stage 1	-	-	-
Stage 2	-	-	-

Approach	EB	WB	SB
HCM Control Delay, s	1.8	0	10.2
HCM LOS			B

Minor Lane/Major Mvmt	EBL	EBT	WBT	WBR	SBLn1
Capacity (veh/h)	1358	-	-	-	768
HCM Lane V/C Ratio	0.029	-	-	-	0.105
HCM Control Delay (s)	7.7	0	-	-	10.2
HCM Lane LOS	A	A	-	-	B
HCM 95th %tile Q(veh)	0.1	-	-	-	0.4

Intersection	
Intersection Delay, s/veh	9.1
Intersection LOS	A

Movement	EBL	EBT	EBR	WBL	WBT	WBR	NBL	NBT	NBR	SBL	SBT	SBR
Lane Configurations		↕			↕			↕			↕	
Traffic Vol, veh/h	37	79	34	12	61	13	15	59	5	13	63	43
Future Vol, veh/h	37	79	34	12	61	13	15	59	5	13	63	43
Peak Hour Factor	0.91	0.91	0.91	0.91	0.91	0.91	0.91	0.91	0.91	0.91	0.91	0.91
Heavy Vehicles, %	26	26	26	26	26	26	26	26	26	26	26	26
Mvmt Flow	41	87	37	13	67	14	16	65	5	14	69	47
Number of Lanes	0	1	0	0	1	0	0	1	0	0	1	0

Approach	EB	WB	NB	SB
Opposing Approach	WB	EB	SB	NB
Opposing Lanes	1	1	1	1
Conflicting Approach Left	SB	NB	EB	WB
Conflicting Lanes Left	1	1	1	1
Conflicting Approach Right	NB	SB	WB	EB
Conflicting Lanes Right	1	1	1	1
HCM Control Delay	9.4	8.9	9	9
HCM LOS	A	A	A	A

Lane	NBLn1	EBLn1	WBLn1	SBLn1
Vol Left, %	19%	25%	14%	11%
Vol Thru, %	75%	53%	71%	53%
Vol Right, %	6%	23%	15%	36%
Sign Control	Stop	Stop	Stop	Stop
Traffic Vol by Lane	79	150	86	119
LT Vol	15	37	12	13
Through Vol	59	79	61	63
RT Vol	5	34	13	43
Lane Flow Rate	87	165	95	131
Geometry Grp	1	1	1	1
Degree of Util (X)	0.125	0.226	0.132	0.179
Departure Headway (Hd)	5.167	4.929	5.042	4.919
Convergence, Y/N	Yes	Yes	Yes	Yes
Cap	693	727	710	728
Service Time	3.209	2.968	3.085	2.957
HCM Lane V/C Ratio	0.126	0.227	0.134	0.18
HCM Control Delay	9	9.4	8.9	9
HCM Lane LOS	A	A	A	A
HCM 95th-tile Q	0.4	0.9	0.5	0.6

HCM 6th Signalized Intersection Summary
3: 10 1/2 Avenue & Hanford Armona Road

Near Term Plus Project PM Peak
04/27/2022



Movement	EBL	EBT	EBR	WBL	WBT	WBR	NBL	NBT	NBR	SBL	SBT	SBR
Lane Configurations												
Traffic Volume (veh/h)	45	306	111	24	302	29	89	53	14	27	52	61
Future Volume (veh/h)	45	306	111	24	302	29	89	53	14	27	52	61
Initial Q (Qb), veh	0	0	0	0	0	0	0	0	0	0	0	0
Ped-Bike Adj(A_pbT)	1.00		1.00	1.00		1.00	1.00		1.00	1.00		1.00
Parking Bus, Adj	1.00	1.00	1.00	1.00	1.00	1.00	1.00	1.00	1.00	1.00	1.00	1.00
Work Zone On Approach		No			No			No			No	
Adj Sat Flow, veh/h/ln	1856	1856	1856	1856	1856	1856	1856	1856	1856	1856	1856	1856
Adj Flow Rate, veh/h	49	333	121	26	328	32	97	58	15	29	57	66
Peak Hour Factor	0.92	0.92	0.92	0.92	0.92	0.92	0.92	0.92	0.92	0.92	0.92	0.92
Percent Heavy Veh, %	3	3	3	3	3	3	3	3	3	3	3	3
Cap, veh/h	92	443	161	55	533	52	143	292	248	60	206	174
Arrive On Green	0.05	0.34	0.34	0.03	0.32	0.32	0.08	0.16	0.16	0.03	0.11	0.11
Sat Flow, veh/h	1767	1298	471	1767	1663	162	1767	1856	1572	1767	1856	1572
Grp Volume(v), veh/h	49	0	454	26	0	360	97	58	15	29	57	66
Grp Sat Flow(s),veh/h/ln	1767	0	1769	1767	0	1826	1767	1856	1572	1767	1856	1572
Q Serve(g_s), s	1.1	0.0	9.5	0.6	0.0	7.0	2.2	1.1	0.3	0.7	1.2	1.6
Cycle Q Clear(g_c), s	1.1	0.0	9.5	0.6	0.0	7.0	2.2	1.1	0.3	0.7	1.2	1.6
Prop In Lane	1.00		0.27	1.00		0.09	1.00		1.00	1.00		1.00
Lane Grp Cap(c), veh/h	92	0	603	55	0	585	143	292	248	60	206	174
V/C Ratio(X)	0.53	0.00	0.75	0.47	0.00	0.62	0.68	0.20	0.06	0.48	0.28	0.38
Avail Cap(c_a), veh/h	212	0	1165	212	0	1202	322	1271	1077	241	1200	1017
HCM Platoon Ratio	1.00	1.00	1.00	1.00	1.00	1.00	1.00	1.00	1.00	1.00	1.00	1.00
Upstream Filter(I)	1.00	0.00	1.00	1.00	0.00	1.00	1.00	1.00	1.00	1.00	1.00	1.00
Uniform Delay (d), s/veh	19.3	0.0	12.2	19.9	0.0	12.0	18.7	15.3	15.0	19.8	17.0	17.2
Incr Delay (d2), s/veh	4.8	0.0	1.9	6.1	0.0	1.1	5.5	0.3	0.1	5.8	0.7	1.4
Initial Q Delay(d3),s/veh	0.0	0.0	0.0	0.0	0.0	0.0	0.0	0.0	0.0	0.0	0.0	0.0
%ile BackOfQ(50%),veh/ln	0.5	0.0	2.9	0.3	0.0	2.2	1.0	0.4	0.1	0.3	0.5	0.5
Unsig. Movement Delay, s/veh												
LnGrp Delay(d),s/veh	24.1	0.0	14.1	26.0	0.0	13.1	24.2	15.6	15.1	25.6	17.7	18.6
LnGrp LOS	C	A	B	C	A	B	C	B	B	C	B	B
Approach Vol, veh/h		503			386			170			152	
Approach Delay, s/veh		15.1			13.9			20.5			19.6	
Approach LOS		B			B			C			B	
Timer - Assigned Phs	1	2	3	4	5	6	7	8				
Phs Duration (G+Y+Rc), s	5.6	11.5	5.5	19.1	7.6	9.5	6.4	18.3				
Change Period (Y+Rc), s	* 4.2	4.9	* 4.2	4.9	* 4.2	* 4.9	* 4.2	4.9				
Max Green Setting (Gmax), s	* 5.7	28.6	* 5	27.5	* 7.6	* 27	* 5	27.5				
Max Q Clear Time (g_c+I1), s	2.7	3.1	2.6	11.5	4.2	3.6	3.1	9.0				
Green Ext Time (p_c), s	0.0	0.3	0.0	2.4	0.1	0.4	0.0	1.9				

Intersection Summary

HCM 6th Ctrl Delay	16.0
HCM 6th LOS	B

Notes

* HCM 6th computational engine requires equal clearance times for the phases crossing the barrier.

Intersection

Int Delay, s/veh 2.2

Movement	EBT	EBR	WBL	WBT	NBL	NBR
Lane Configurations						
Traffic Vol, veh/h	258	57	59	296	53	31
Future Vol, veh/h	258	57	59	296	53	31
Conflicting Peds, #/hr	0	2	2	0	0	0
Sign Control	Free	Free	Free	Free	Stop	Stop
RT Channelized	-	None	-	None	-	None
Storage Length	-	-	75	-	0	-
Veh in Median Storage, #	0	-	-	0	0	-
Grade, %	0	-	-	0	0	-
Peak Hour Factor	90	90	90	90	90	90
Heavy Vehicles, %	3	3	3	3	3	3
Mvmt Flow	287	63	66	329	59	34

Major/Minor	Major1	Major2	Minor1	Minor2	Minor3
Conflicting Flow All	0	0	352	0	782
Stage 1	-	-	-	-	321
Stage 2	-	-	-	-	461
Critical Hdwy	-	-	4.13	-	6.43
Critical Hdwy Stg 1	-	-	-	-	5.43
Critical Hdwy Stg 2	-	-	-	-	5.43
Follow-up Hdwy	-	-	2.227	-	3.527
Pot Cap-1 Maneuver	-	-	1201	-	361
Stage 1	-	-	-	-	733
Stage 2	-	-	-	-	633
Platoon blocked, %	-	-	-	-	-
Mov Cap-1 Maneuver	-	-	1199	-	340
Mov Cap-2 Maneuver	-	-	-	-	452
Stage 1	-	-	-	-	732
Stage 2	-	-	-	-	598

Approach	EB	WB	NB
HCM Control Delay, s	0	1.4	13.4
HCM LOS			B

Minor Lane/Major Mvmt	NBLn1	EBT	EBR	WBL	WBT
Capacity (veh/h)	523	-	-	1199	-
HCM Lane V/C Ratio	0.178	-	-	0.055	-
HCM Control Delay (s)	13.4	-	-	8.2	-
HCM Lane LOS	B	-	-	A	-
HCM 95th %tile Q(veh)	0.6	-	-	0.2	-

HCM 6th Signalized Intersection Summary
5: 10th Avenue & Hanford Armona Road

Near Term Plus Project PM Peak

04/27/2022



Movement	EBL	EBT	EBR	WBL	WBT	WBR	NBL	NBT	NBR	SBL	SBT	SBR
Lane Configurations												
Traffic Volume (veh/h)	170	16	97	5	11	8	114	210	7	16	169	226
Future Volume (veh/h)	170	16	97	5	11	8	114	210	7	16	169	226
Initial Q (Qb), veh	0	0	0	0	0	0	0	0	0	0	0	0
Ped-Bike Adj(A_pbT)	1.00		1.00	1.00		0.99	1.00		1.00	1.00		0.99
Parking Bus, Adj	1.00	1.00	1.00	1.00	1.00	1.00	1.00	1.00	1.00	1.00	1.00	1.00
Work Zone On Approach		No			No			No			No	
Adj Sat Flow, veh/h/ln	1856	1856	1856	1856	1856	1856	1856	1856	1856	1856	1856	1856
Adj Flow Rate, veh/h	179	17	102	5	12	8	120	221	7	17	178	238
Peak Hour Factor	0.95	0.95	0.95	0.95	0.95	0.95	0.95	0.95	0.95	0.95	0.95	0.95
Percent Heavy Veh, %	3	3	3	3	3	3	3	3	3	3	3	3
Cap, veh/h	226	431	364	12	115	77	154	558	470	38	436	367
Arrive On Green	0.13	0.23	0.23	0.01	0.11	0.11	0.09	0.30	0.30	0.02	0.23	0.23
Sat Flow, veh/h	1767	1856	1566	1767	1036	691	1767	1856	1565	1767	1856	1562
Grp Volume(v), veh/h	179	17	102	5	0	20	120	221	7	17	178	238
Grp Sat Flow(s),veh/h/ln	1767	1856	1566	1767	0	1727	1767	1856	1565	1767	1856	1562
Q Serve(g_s), s	4.3	0.3	2.4	0.1	0.0	0.5	2.9	4.2	0.1	0.4	3.6	6.1
Cycle Q Clear(g_c), s	4.3	0.3	2.4	0.1	0.0	0.5	2.9	4.2	0.1	0.4	3.6	6.1
Prop In Lane	1.00		1.00	1.00		0.40	1.00		1.00	1.00		1.00
Lane Grp Cap(c), veh/h	226	431	364	12	0	192	154	558	470	38	436	367
V/C Ratio(X)	0.79	0.04	0.28	0.42	0.00	0.10	0.78	0.40	0.01	0.45	0.41	0.65
Avail Cap(c_a), veh/h	272	1562	1318	200	0	1368	200	1209	1020	200	1226	1032
HCM Platoon Ratio	1.00	1.00	1.00	1.00	1.00	1.00	1.00	1.00	1.00	1.00	1.00	1.00
Upstream Filter(I)	1.00	1.00	1.00	1.00	0.00	1.00	1.00	1.00	1.00	1.00	1.00	1.00
Uniform Delay (d), s/veh	18.7	13.1	13.9	21.9	0.0	17.7	19.8	12.3	10.9	21.4	14.3	15.3
Incr Delay (d2), s/veh	12.4	0.0	0.4	21.8	0.0	0.2	13.5	0.5	0.0	8.2	0.6	1.9
Initial Q Delay(d3),s/veh	0.0	0.0	0.0	0.0	0.0	0.0	0.0	0.0	0.0	0.0	0.0	0.0
%ile BackOfQ(50%),veh/ln	2.2	0.1	0.7	0.1	0.0	0.2	1.5	1.3	0.0	0.2	1.2	1.8
Unsig. Movement Delay, s/veh												
LnGrp Delay(d),s/veh	31.1	13.2	14.3	43.7	0.0	17.9	33.3	12.7	10.9	29.6	14.9	17.2
LnGrp LOS	C	B	B	D	A	B	C	B	B	C	B	B
Approach Vol, veh/h		298			25			348			433	
Approach Delay, s/veh		24.3			23.1			19.8			16.8	
Approach LOS		C			C			B			B	
Timer - Assigned Phs	1	2	3	4	5	6	7	8				
Phs Duration (G+Y+Rc), s	5.1	19.0	4.5	15.6	8.1	16.1	9.9	10.2				
Change Period (Y+Rc), s	* 4.2	5.7	* 4.2	* 5.3	* 4.2	* 5.7	* 4.2	5.3				
Max Green Setting (Gmax), s	* 5	28.8	* 5	* 37	* 5	* 29	* 6.8	35.0				
Max Q Clear Time (g_c+I1), s	2.4	6.2	2.1	4.4	4.9	8.1	6.3	2.5				
Green Ext Time (p_c), s	0.0	1.0	0.0	0.4	0.0	1.6	0.0	0.1				

Intersection Summary

HCM 6th Ctrl Delay	19.9
HCM 6th LOS	B

Notes

* HCM 6th computational engine requires equal clearance times for the phases crossing the barrier.

Intersection

Int Delay, s/veh 3.3

Movement WBL WBR NBT NBR SBL SBT

Lane Configurations						
Traffic Vol, veh/h	19	36	81	37	58	66
Future Vol, veh/h	19	36	81	37	58	66
Conflicting Peds, #/hr	0	0	0	0	0	0
Sign Control	Stop	Stop	Free	Free	Free	Free
RT Channelized	-	None	-	None	-	None
Storage Length	0	-	-	-	-	-
Veh in Median Storage, #	0	-	0	-	-	0
Grade, %	0	-	0	-	-	0
Peak Hour Factor	88	88	88	88	88	88
Heavy Vehicles, %	3	3	3	3	3	3
Mvmt Flow	22	41	92	42	66	75

Major/Minor Minor1 Major1 Major2

Conflicting Flow All	320	113	0	0	134	0
Stage 1	113	-	-	-	-	-
Stage 2	207	-	-	-	-	-
Critical Hdwy	6.43	6.23	-	-	4.13	-
Critical Hdwy Stg 1	5.43	-	-	-	-	-
Critical Hdwy Stg 2	5.43	-	-	-	-	-
Follow-up Hdwy	3.527	3.327	-	-	2.227	-
Pot Cap-1 Maneuver	671	937	-	-	1444	-
Stage 1	909	-	-	-	-	-
Stage 2	825	-	-	-	-	-
Platoon blocked, %			-	-	-	-
Mov Cap-1 Maneuver	639	937	-	-	1444	-
Mov Cap-2 Maneuver	639	-	-	-	-	-
Stage 1	909	-	-	-	-	-
Stage 2	785	-	-	-	-	-

Approach WB NB SB

HCM Control Delay, s	9.8	0	3.6
HCM LOS	A		

Minor Lane/Major Mvmt NBT NBRWBLn1 SBL SBT

Capacity (veh/h)	-	-	807	1444	-
HCM Lane V/C Ratio	-	-	0.077	0.046	-
HCM Control Delay (s)	-	-	9.8	7.6	0
HCM Lane LOS	-	-	A	A	A
HCM 95th %tile Q(veh)	-	-	0.3	0.1	-

HCM Signalized Intersection Capacity Analysis
7: 11th Avenue & Houston Avenue

Near Term Plus Project PM Peak

04/27/2022

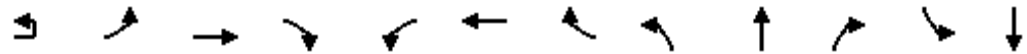

Movement	EBU	EBL	EBT	EBR	WBL	WBT	WBR	NBL	NBT	NBR	SBL	SBT
Lane Configurations												
Traffic Volume (vph)	1	36	172	21	24	190	80	39	159	38	53	78
Future Volume (vph)	1	36	172	21	24	190	80	39	159	38	53	78
Ideal Flow (vphp)	1900	1900	1900	1900	1900	1900	1900	1900	1900	1900	1900	1900
Total Lost time (s)		4.2	6.0	6.0	4.2	5.7	5.7	4.2	5.7	5.7	4.2	5.3
Lane Util. Factor		1.00	1.00	1.00	1.00	1.00	1.00	1.00	0.95	1.00	1.00	1.00
Frt		1.00	1.00	0.85	1.00	1.00	0.85	1.00	1.00	0.85	1.00	1.00
Flt Protected		0.95	1.00	1.00	0.95	1.00	1.00	0.95	1.00	1.00	0.95	1.00
Satd. Flow (prot)		1719	1810	1538	1719	1810	1538	1719	3438	1538	1719	1810
Flt Permitted		0.95	1.00	1.00	0.95	1.00	1.00	0.95	1.00	1.00	0.95	1.00
Satd. Flow (perm)		1719	1810	1538	1719	1810	1538	1719	3438	1538	1719	1810
Peak-hour factor, PHF	0.84	0.84	0.84	0.84	0.84	0.84	0.84	0.84	0.84	0.84	0.84	0.84
Adj. Flow (vph)	1	43	205	25	29	226	95	46	189	45	63	93
RTOR Reduction (vph)	0	0	0	17	0	0	68	0	0	35	0	0
Lane Group Flow (vph)	0	44	205	8	29	226	27	46	189	10	63	93
Heavy Vehicles (%)	5%	5%	5%	5%	5%	5%	5%	5%	5%	5%	5%	5%
Turn Type	Prot	Prot	NA	Perm	Prot	NA	Perm	Prot	NA	Perm	Prot	NA
Protected Phases	7	7	4		3	8		5	2		1	6
Permitted Phases				4			8			2		
Actuated Green, G (s)		4.7	18.2	18.2	2.8	16.6	16.6	4.7	12.9	12.9	4.7	13.3
Effective Green, g (s)		4.7	18.2	18.2	2.8	16.6	16.6	4.7	12.9	12.9	4.7	13.3
Actuated g/C Ratio		0.08	0.31	0.31	0.05	0.28	0.28	0.08	0.22	0.22	0.08	0.23
Clearance Time (s)		4.2	6.0	6.0	4.2	5.7	5.7	4.2	5.7	5.7	4.2	5.3
Vehicle Extension (s)		3.0	3.0	3.0	3.0	3.0	3.0	3.0	3.0	3.0	3.0	3.0
Lane Grp Cap (vph)		137	561	476	81	511	434	137	755	337	137	410
v/s Ratio Prot		c0.03	0.11		0.02	c0.12		0.03	c0.05		c0.04	0.05
v/s Ratio Perm				0.01			0.02			0.01		
v/c Ratio		0.32	0.37	0.02	0.36	0.44	0.06	0.34	0.25	0.03	0.46	0.23
Uniform Delay, d1		25.5	15.8	14.0	27.1	17.3	15.4	25.5	18.9	18.0	25.8	18.5
Progression Factor		1.00	1.00	1.00	1.00	1.00	1.00	1.00	1.00	1.00	1.00	1.00
Incremental Delay, d2		1.4	0.4	0.0	2.7	0.6	0.1	1.5	0.2	0.0	2.4	0.3
Delay (s)		26.9	16.2	14.1	29.8	17.9	15.4	27.0	19.1	18.0	28.2	18.8
Level of Service		C	B	B	C	B	B	C	B	B	C	B
Approach Delay (s)			17.7			18.2			20.2			21.4
Approach LOS			B			B			C			C

Intersection Summary		
HCM 2000 Control Delay	19.2	HCM 2000 Level of Service
HCM 2000 Volume to Capacity ratio	0.37	B
Actuated Cycle Length (s)	58.7	Sum of lost time (s)
Intersection Capacity Utilization	44.3%	20.1
Analysis Period (min)	15	ICU Level of Service
c Critical Lane Group		A



Movement	SBR
Lane Configurations	7
Traffic Volume (vph)	45
Future Volume (vph)	45
Ideal Flow (vphpl)	1900
Total Lost time (s)	5.3
Lane Util. Factor	1.00
Frt	0.85
Flt Protected	1.00
Satd. Flow (prot)	1538
Flt Permitted	1.00
Satd. Flow (perm)	1538
Peak-hour factor, PHF	0.84
Adj. Flow (vph)	54
RTOR Reduction (vph)	42
Lane Group Flow (vph)	12
Heavy Vehicles (%)	5%
Turn Type	Perm
Protected Phases	
Permitted Phases	6
Actuated Green, G (s)	13.3
Effective Green, g (s)	13.3
Actuated g/C Ratio	0.23
Clearance Time (s)	5.3
Vehicle Extension (s)	3.0
Lane Grp Cap (vph)	348
v/s Ratio Prot	
v/s Ratio Perm	0.01
v/c Ratio	0.04
Uniform Delay, d1	17.7
Progression Factor	1.00
Incremental Delay, d2	0.0
Delay (s)	17.7
Level of Service	B
Approach Delay (s)	
Approach LOS	
Intersection Summary	

Intersection

Int Delay, s/veh 2.7

Movement EBL EBT WBT WBR SBL SBR

Lane Configurations		↶	↷		↶	↷
Traffic Vol, veh/h	77	136	208	39	28	43
Future Vol, veh/h	77	136	208	39	28	43
Conflicting Peds, #/hr	0	0	0	0	0	0
Sign Control	Free	Free	Free	Free	Stop	Stop
RT Channelized	-	None	-	None	-	None
Storage Length	-	-	-	-	0	-
Veh in Median Storage, #	-	0	0	-	0	-
Grade, %	-	0	0	-	0	-
Peak Hour Factor	93	93	93	93	93	93
Heavy Vehicles, %	3	3	3	3	3	3
Mvmt Flow	83	146	224	42	30	46

Major/Minor Major1 Major2 Minor2

Conflicting Flow All	266	0	-	0	557	245
Stage 1	-	-	-	-	245	-
Stage 2	-	-	-	-	312	-
Critical Hdwy	4.13	-	-	-	6.43	6.23
Critical Hdwy Stg 1	-	-	-	-	5.43	-
Critical Hdwy Stg 2	-	-	-	-	5.43	-
Follow-up Hdwy	2.227	-	-	-	3.527	3.327
Pot Cap-1 Maneuver	1292	-	-	-	490	791
Stage 1	-	-	-	-	793	-
Stage 2	-	-	-	-	740	-
Platoon blocked, %		-	-	-		
Mov Cap-1 Maneuver	1292	-	-	-	456	791
Mov Cap-2 Maneuver	-	-	-	-	456	-
Stage 1	-	-	-	-	737	-
Stage 2	-	-	-	-	740	-

Approach EB WB SB

HCM Control Delay, s	2.9	0	11.7
HCM LOS			B

Minor Lane/Major Mvmt EBL EBT WBT WBR SBLn1

Capacity (veh/h)	1292	-	-	-	613
HCM Lane V/C Ratio	0.064	-	-	-	0.125
HCM Control Delay (s)	8	0	-	-	11.7
HCM Lane LOS	A	A	-	-	B
HCM 95th %tile Q(veh)	0.2	-	-	-	0.4

Intersection	
Intersection Delay, s/veh	9.6
Intersection LOS	A

Movement	EBL	EBT	EBR	WBL	WBT	WBR	NBL	NBT	NBR	SBL	SBT	SBR
Lane Configurations		↕			↕			↕			↕	
Traffic Vol, veh/h	41	91	25	8	137	48	44	103	8	41	70	52
Future Vol, veh/h	41	91	25	8	137	48	44	103	8	41	70	52
Peak Hour Factor	0.98	0.98	0.98	0.98	0.98	0.98	0.98	0.98	0.98	0.98	0.98	0.98
Heavy Vehicles, %	5	5	5	5	5	5	5	5	5	5	5	5
Mvmt Flow	42	93	26	8	140	49	45	105	8	42	71	53
Number of Lanes	0	1	0	0	1	0	0	1	0	0	1	0

Approach	EB	WB	NB	SB
Opposing Approach	WB	EB	SB	NB
Opposing Lanes	1	1	1	1
Conflicting Approach Left	SB	NB	EB	WB
Conflicting Lanes Left	1	1	1	1
Conflicting Approach Right	NB	SB	WB	EB
Conflicting Lanes Right	1	1	1	1
HCM Control Delay	9.5	9.7	9.7	9.5
HCM LOS	A	A	A	A

Lane	NBLn1	EBLn1	WBLn1	SBLn1
Vol Left, %	28%	26%	4%	25%
Vol Thru, %	66%	58%	71%	43%
Vol Right, %	5%	16%	25%	32%
Sign Control	Stop	Stop	Stop	Stop
Traffic Vol by Lane	155	157	193	163
LT Vol	44	41	8	41
Through Vol	103	91	137	70
RT Vol	8	25	48	52
Lane Flow Rate	158	160	197	166
Geometry Grp	1	1	1	1
Degree of Util (X)	0.224	0.222	0.266	0.228
Departure Headway (Hd)	5.099	4.999	4.858	4.927
Convergence, Y/N	Yes	Yes	Yes	Yes
Cap	697	711	733	722
Service Time	3.179	3.08	2.934	3.006
HCM Lane V/C Ratio	0.227	0.225	0.269	0.23
HCM Control Delay	9.7	9.5	9.7	9.5
HCM Lane LOS	A	A	A	A
HCM 95th-tile Q	0.9	0.8	1.1	0.9

Intersection: 1: Douty St & 3rd Street

Movement	EB	EB	EB	NB	NB	NB	SB	SB
Directions Served	L	T	TR	T	T	R	LT	T
Maximum Queue (ft)	142	75	79	54	74	54	87	30
Average Queue (ft)	63	48	40	38	35	28	48	1
95th Queue (ft)	103	68	68	54	62	55	75	10
Link Distance (ft)	320	320	320	356	356		787	787
Upstream Blk Time (%)								
Queuing Penalty (veh)								
Storage Bay Dist (ft)						90		
Storage Blk Time (%)					0			
Queuing Penalty (veh)					0			

Intersection: 2: 10th Avenue & 4th Street/SR-198 WB Off Ramp

Movement	WB	NB	NB	NB	SB	SB	SB
Directions Served	LTR	L	T	T	T	T	R
Maximum Queue (ft)	114	52	164	173	169	51	54
Average Queue (ft)	52	20	70	58	96	10	37
95th Queue (ft)	92	49	125	120	151	36	55
Link Distance (ft)	775		759	759	758	758	
Upstream Blk Time (%)							
Queuing Penalty (veh)							
Storage Bay Dist (ft)		295					105
Storage Blk Time (%)							
Queuing Penalty (veh)							

Intersection: 3: 10 1/2 Avenue & Hanford Armona Road

Movement	EB	EB	WB	WB	NB	NB	NB	SB	SB	SB
Directions Served	L	TR	L	TR	L	T	R	L	T	R
Maximum Queue (ft)	111	212	77	194	138	53	77	68	68	47
Average Queue (ft)	39	70	17	68	71	30	15	11	27	19
95th Queue (ft)	81	144	50	135	121	61	50	41	56	45
Link Distance (ft)		1346		1547		396			386	
Upstream Blk Time (%)										
Queuing Penalty (veh)										
Storage Bay Dist (ft)	150		95		150		95	150		100
Storage Blk Time (%)		1	0	2	0		0			
Queuing Penalty (veh)		1	0	0	0		0			

Intersection: 4: Jordan Way & Hanford Armona Road

Movement	WB	NB
Directions Served	L	LR
Maximum Queue (ft)	28	89
Average Queue (ft)	4	42
95th Queue (ft)	19	69
Link Distance (ft)	1339	
Upstream Blk Time (%)		
Queuing Penalty (veh)		
Storage Bay Dist (ft)	75	
Storage Blk Time (%)		
Queuing Penalty (veh)		

Intersection: 5: 10th Avenue & Hanford Armona Road

Movement	EB	EB	EB	WB	WB	NB	NB	NB	SB	SB	SB			
Directions Served	L	T	R	L	TR	L	T	R	L	T	R			
Maximum Queue (ft)	185	23	64	25	52	109	109	22	51	159	113			
Average Queue (ft)	93	3	14	2	13	35	45	1	6	59	49			
95th Queue (ft)	157	15	39	13	40	75	82	7	28	123	85			
Link Distance (ft)	936			372			448			399				
Upstream Blk Time (%)														
Queuing Penalty (veh)														
Storage Bay Dist (ft)	105		55		155		155		130		110		265	
Storage Blk Time (%)	8		0										1	
Queuing Penalty (veh)	5		0										2	

Intersection: 6: 10 1/2 Avenue & Orchard Avenue

Movement	WB	SB
Directions Served	LR	LT
Maximum Queue (ft)	70	29
Average Queue (ft)	36	1
95th Queue (ft)	53	9
Link Distance (ft)	862	2833
Upstream Blk Time (%)		
Queuing Penalty (veh)		
Storage Bay Dist (ft)		
Storage Blk Time (%)		
Queuing Penalty (veh)		

Intersection: 7: 11th Avenue & Houston Avenue

Movement	EB	EB	EB	WB	WB	WB	NB	NB	NB	NB	SB	SB
Directions Served	UL	T	R	L	T	R	L	T	T	R	L	T
Maximum Queue (ft)	153	69	60	68	77	69	69	44	64	17	84	108
Average Queue (ft)	47	31	11	26	40	14	15	17	5	6	21	12
95th Queue (ft)	103	66	37	55	70	38	45	38	25	17	51	49
Link Distance (ft)		680			436			276	276			1524
Upstream Blk Time (%)												
Queuing Penalty (veh)												
Storage Bay Dist (ft)	165		150	175		175	175			100	250	
Storage Blk Time (%)	0											
Queuing Penalty (veh)	0											

Intersection: 7: 11th Avenue & Houston Avenue

Movement	SB
Directions Served	R
Maximum Queue (ft)	62
Average Queue (ft)	9
95th Queue (ft)	29
Link Distance (ft)	1524
Upstream Blk Time (%)	
Queuing Penalty (veh)	
Storage Bay Dist (ft)	
Storage Blk Time (%)	
Queuing Penalty (veh)	

Intersection: 8: Houston Avenue & 10 1/2 Avenue

Movement	EB	SB
Directions Served	LT	LR
Maximum Queue (ft)	44	73
Average Queue (ft)	5	40
95th Queue (ft)	22	67
Link Distance (ft)	2076	2057
Upstream Blk Time (%)		
Queuing Penalty (veh)		
Storage Bay Dist (ft)		
Storage Blk Time (%)		
Queuing Penalty (veh)		

Intersection: 9: 10th Avenue & Houston Avenue

Movement	EB	WB	NB	SB
Directions Served	LTR	LTR	LTR	LTR
Maximum Queue (ft)	101	140	75	76
Average Queue (ft)	48	47	35	41
95th Queue (ft)	77	86	67	70
Link Distance (ft)	2557	1661	1092	4776
Upstream Blk Time (%)				
Queuing Penalty (veh)				
Storage Bay Dist (ft)				
Storage Blk Time (%)				
Queuing Penalty (veh)				

Intersection: 10: 3rd Street & SR-198 EB Off Ramp

Movement	EB	SE
Directions Served	T	L
Maximum Queue (ft)	31	141
Average Queue (ft)	4	28
95th Queue (ft)	20	77
Link Distance (ft)	361	209
Upstream Blk Time (%)		
Queuing Penalty (veh)		
Storage Bay Dist (ft)		
Storage Blk Time (%)		
Queuing Penalty (veh)		

Network Summary

Network wide Queuing Penalty: 9

Intersection: 1: Douty St & 3rd Street

Movement	EB	EB	EB	NB	NB	NB	SB	SB	
Directions Served	L	T	TR	T	T	R	LT	T	
Maximum Queue (ft)	122	100	78	56	77	55	158	54	
Average Queue (ft)	59	62	58	40	37	26	79	9	
95th Queue (ft)	95	92	82	57	70	53	133	34	
Link Distance (ft)	320	320	320	356	356		787	787	
Upstream Blk Time (%)									
Queuing Penalty (veh)									
Storage Bay Dist (ft)							90		
Storage Blk Time (%)					0				
Queuing Penalty (veh)					0				

Intersection: 2: 10th Avenue & 4th Street/SR-198 WB Off Ramp

Movement	WB	NB	NB	NB	SB	SB	SB
Directions Served	LTR	L	T	T	T	T	R
Maximum Queue (ft)	112	142	139	156	293	194	89
Average Queue (ft)	66	63	63	50	119	46	44
95th Queue (ft)	104	110	114	106	219	142	73
Link Distance (ft)	775		759	759	758	758	
Upstream Blk Time (%)							
Queuing Penalty (veh)							
Storage Bay Dist (ft)		295					105
Storage Blk Time (%)						1	0
Queuing Penalty (veh)						2	0

Intersection: 3: 10 1/2 Avenue & Hanford Armona Road

Movement	EB	EB	WB	WB	NB	NB	NB	SB	SB	SB
Directions Served	L	TR	L	TR	L	T	R	L	T	R
Maximum Queue (ft)	106	267	69	214	94	72	31	79	78	56
Average Queue (ft)	36	110	14	81	52	27	5	20	30	30
95th Queue (ft)	81	203	45	158	84	60	22	53	66	56
Link Distance (ft)		1346		1547		396			386	
Upstream Blk Time (%)										
Queuing Penalty (veh)										
Storage Bay Dist (ft)	150		95		150		95	150		100
Storage Blk Time (%)		4		6						
Queuing Penalty (veh)		2		1						

Intersection: 4: Jordan Way & Hanford Armona Road

Movement	WB	NB
Directions Served	L	LR
Maximum Queue (ft)	67	116
Average Queue (ft)	12	40
95th Queue (ft)	40	72
Link Distance (ft)	1339	
Upstream Blk Time (%)		
Queuing Penalty (veh)		
Storage Bay Dist (ft)	75	
Storage Blk Time (%)	0	
Queuing Penalty (veh)	0	

Intersection: 5: 10th Avenue & Hanford Armona Road

Movement	EB	EB	EB	WB	WB	NB	NB	NB	SB	SB	SB	
Directions Served	L	T	R	L	TR	L	T	R	L	T	R	
Maximum Queue (ft)	180	155	154	26	72	125	200	22	31	161	134	
Average Queue (ft)	84	16	29	5	13	57	66	1	14	60	53	
95th Queue (ft)	151	64	73	22	41	108	149	10	37	111	91	
Link Distance (ft)	936			372			448			399		
Upstream Blk Time (%)												
Queuing Penalty (veh)												
Storage Bay Dist (ft)	105		55	155		155		130	110		265	
Storage Blk Time (%)	5	0	0				2			1		
Queuing Penalty (veh)	5	0	0				3			2		

Intersection: 6: 10 1/2 Avenue & Orchard Avenue

Movement	WB	SB
Directions Served	LR	LT
Maximum Queue (ft)	54	74
Average Queue (ft)	27	9
95th Queue (ft)	46	39
Link Distance (ft)	862	2833
Upstream Blk Time (%)		
Queuing Penalty (veh)		
Storage Bay Dist (ft)		
Storage Blk Time (%)		
Queuing Penalty (veh)		

Intersection: 7: 11th Avenue & Houston Avenue

Movement	EB	EB	EB	WB	WB	WB	NB	NB	NB	NB	SB	SB
Directions Served	UL	T	R	L	T	R	L	T	T	R	L	T
Maximum Queue (ft)	71	86	32	48	109	91	71	65	63	42	81	81
Average Queue (ft)	23	39	7	11	54	18	29	32	19	9	26	25
95th Queue (ft)	49	78	20	34	90	47	60	56	46	25	56	56
Link Distance (ft)		680			436			276	276			1524
Upstream Blk Time (%)												
Queuing Penalty (veh)												
Storage Bay Dist (ft)	165		150	175		175	175			100	250	
Storage Blk Time (%)												
Queuing Penalty (veh)												

Intersection: 7: 11th Avenue & Houston Avenue

Movement	SB
Directions Served	R
Maximum Queue (ft)	33
Average Queue (ft)	11
95th Queue (ft)	24
Link Distance (ft)	1524
Upstream Blk Time (%)	
Queuing Penalty (veh)	
Storage Bay Dist (ft)	
Storage Blk Time (%)	
Queuing Penalty (veh)	

Intersection: 8: Houston Avenue & 10 1/2 Avenue

Movement	EB	SB
Directions Served	LT	LR
Maximum Queue (ft)	32	74
Average Queue (ft)	9	29
95th Queue (ft)	30	59
Link Distance (ft)	2076	2057
Upstream Blk Time (%)		
Queuing Penalty (veh)		
Storage Bay Dist (ft)		
Storage Blk Time (%)		
Queuing Penalty (veh)		

Intersection: 9: 10th Avenue & Houston Avenue

Movement	EB	WB	NB	SB
Directions Served	LTR	LTR	LTR	LTR
Maximum Queue (ft)	78	73	90	78
Average Queue (ft)	35	38	41	41
95th Queue (ft)	55	66	68	70
Link Distance (ft)	2557	1661	1092	4776
Upstream Blk Time (%)				
Queuing Penalty (veh)				
Storage Bay Dist (ft)				
Storage Blk Time (%)				
Queuing Penalty (veh)				

Intersection: 10: 3rd Street & SR-198 EB Off Ramp

Movement	EB	SE
Directions Served	T	L
Maximum Queue (ft)	30	117
Average Queue (ft)	2	45
95th Queue (ft)	14	96
Link Distance (ft)	361	209
Upstream Blk Time (%)		
Queuing Penalty (veh)		
Storage Bay Dist (ft)		
Storage Blk Time (%)		
Queuing Penalty (veh)		

Network Summary

Network wide Queuing Penalty: 15

HCS7 Two-Lane Highway Report

Project Information

Analyst	C. Ayala-Magana	Date	7/20/2022
Agency	JLB Traffic Engineering, Inc.	Analysis Year	2022
Jurisdiction	City of Hanford	Time Period Analyzed	Near Term Plus Project AM Peak
Project Description	01 Hanford-Armona Road Between 11th Avenue and 10 1/2 Avenue	Unit	United States Customary

Segment 1

Vehicle Inputs

Segment Type	Passing Constrained	Length, ft	2583
Lane Width, ft	12	Shoulder Width, ft	6
Speed Limit, mi/h	40	Access Point Density, pts/mi	34.8

Demand and Capacity

Directional Demand Flow Rate, veh/h	553	Opposing Demand Flow Rate, veh/h	-
Peak Hour Factor	0.72	Total Trucks, %	4.02
Segment Capacity, veh/h	1700	Demand/Capacity (D/C)	0.33

Intermediate Results

Segment Vertical Class	1	Free-Flow Speed, mi/h	36.8
Speed Slope Coefficient	2.52197	Speed Power Coefficient	0.41674
PF Slope Coefficient	-1.44139	PF Power Coefficient	0.67822
In Passing Lane Effective Length?	No	Total Segment Density, veh/mi/ln	9.8
%Improved % Followers	0.0	% Improved Avg Speed	0.0

Subsegment Data

#	Segment Type	Length, ft	Radius, ft	Superelevation, %	Average Speed, mi/h
1	Tangent	2583	-	-	35.0

Vehicle Results

Average Speed, mi/h	35.0	Percent Followers, %	61.9
Segment Travel Time, minutes	0.84	Follower Density, followers/mi/ln	9.8
Vehicle LOS	C		

Facility Results

T	Follower Density, followers/mi/ln	LOS
1	9.8	C

HCS7 Two-Lane Highway Report

Project Information

Analyst	C. Ayala-Magana	Date	7/20/2022
Agency	JLB Traffic Engineering, Inc.	Analysis Year	2022
Jurisdiction	City of Hanford	Time Period Analyzed	Near Term Plus Project AM Peak
Project Description	02 Hanford-Armona Road Between 10 1/2 Avenue and Jordan Way	Unit	United States Customary

Segment 1

Vehicle Inputs

Segment Type	Passing Constrained	Length, ft	1556
Lane Width, ft	12	Shoulder Width, ft	6
Speed Limit, mi/h	40	Access Point Density, pts/mi	67.9

Demand and Capacity

Directional Demand Flow Rate, veh/h	366	Opposing Demand Flow Rate, veh/h	-
Peak Hour Factor	0.74	Total Trucks, %	3.39
Segment Capacity, veh/h	1700	Demand/Capacity (D/C)	0.22

Intermediate Results

Segment Vertical Class	1	Free-Flow Speed, mi/h	35.5
Speed Slope Coefficient	2.43653	Speed Power Coefficient	0.41674
PF Slope Coefficient	-1.48329	PF Power Coefficient	0.66113
In Passing Lane Effective Length?	No	Total Segment Density, veh/mi/ln	5.7
%Improved % Followers	0.0	% Improved Avg Speed	0.0

Subsegment Data

#	Segment Type	Length, ft	Radius, ft	Superelevation, %	Average Speed, mi/h
1	Tangent	1556	-	-	34.1

Vehicle Results

Average Speed, mi/h	34.1	Percent Followers, %	53.4
Segment Travel Time, minutes	0.52	Follower Density, followers/mi/ln	5.7
Vehicle LOS	C		

Facility Results

T	Follower Density, followers/mi/ln	LOS
1	5.7	C

HCS7 Two-Lane Highway Report

Project Information

Analyst	C. Ayala-Magana	Date	7/20/2022
Agency	JLB Traffic Engineering, Inc.	Analysis Year	2022
Jurisdiction	City of Hanford	Time Period Analyzed	Near Term Plus Project AM Peak
Project Description	03 Hanford-Armona Road Between Jordan Way and 10th Avenue	Unit	United States Customary

Segment 1

Vehicle Inputs

Segment Type	Passing Constrained	Length, ft	901
Lane Width, ft	12	Shoulder Width, ft	6
Speed Limit, mi/h	40	Access Point Density, pts/mi	23.4

Demand and Capacity

Directional Demand Flow Rate, veh/h	344	Opposing Demand Flow Rate, veh/h	-
Peak Hour Factor	0.75	Total Trucks, %	6.25
Segment Capacity, veh/h	1700	Demand/Capacity (D/C)	0.20

Intermediate Results

Segment Vertical Class	1	Free-Flow Speed, mi/h	39.5
Speed Slope Coefficient	2.65189	Speed Power Coefficient	0.41674
PF Slope Coefficient	-1.50451	PF Power Coefficient	0.67582
In Passing Lane Effective Length?	No	Total Segment Density, veh/mi/ln	4.7
%Improved % Followers	0.0	% Improved Avg Speed	0.0

Subsegment Data

#	Segment Type	Length, ft	Radius, ft	Superelevation, %	Average Speed, mi/h
1	Tangent	901	-	-	38.1

Vehicle Results

Average Speed, mi/h	38.1	Percent Followers, %	51.9
Segment Travel Time, minutes	0.27	Follower Density, followers/mi/ln	4.7
Vehicle LOS	B		

Facility Results

T	Follower Density, followers/mi/ln	LOS
1	4.7	B

HCS7 Two-Lane Highway Report

Project Information

Analyst	C. Ayala-Magana	Date	7/20/2022
Agency	JLB Traffic Engineering, Inc.	Analysis Year	2022
Jurisdiction	City of Hanford	Time Period Analyzed	Near Term Plus Project AM Peak
Project Description	04 10.5 Avenue Between Hanford Armona Drive and Orchard Avenue	Unit	United States Customary

Segment 1

Vehicle Inputs

Segment Type	Passing Constrained	Length, ft	2735
Lane Width, ft	12	Shoulder Width, ft	2
Speed Limit, mi/h	40	Access Point Density, pts/mi	50.2

Demand and Capacity

Directional Demand Flow Rate, veh/h	327	Opposing Demand Flow Rate, veh/h	-
Peak Hour Factor	0.60	Total Trucks, %	9.87
Segment Capacity, veh/h	1700	Demand/Capacity (D/C)	0.19

Intermediate Results

Segment Vertical Class	1	Free-Flow Speed, mi/h	32.5
Speed Slope Coefficient	2.29128	Speed Power Coefficient	0.41674
PF Slope Coefficient	-1.42068	PF Power Coefficient	0.65951
In Passing Lane Effective Length?	No	Total Segment Density, veh/mi/ln	5.2
%Improved % Followers	0.0	% Improved Avg Speed	0.0

Subsegment Data

#	Segment Type	Length, ft	Radius, ft	Superelevation, %	Average Speed, mi/h
1	Tangent	2735	-	-	31.2

Vehicle Results

Average Speed, mi/h	31.2	Percent Followers, %	49.3
Segment Travel Time, minutes	0.99	Follower Density, followers/mi/ln	5.2
Vehicle LOS	C		

Facility Results

T	Follower Density, followers/mi/ln	LOS
1	5.2	C

HCS7 Two-Lane Highway Report

Project Information

Analyst	C. Ayala-Magana	Date	7/20/2022
Agency	JLB Traffic Engineering, Inc.	Analysis Year	2022
Jurisdiction	City of Hanford	Time Period Analyzed	Near Term Plus Project AM Peak
Project Description	05 10.5 Avenue Between Orchard Avenue and Houston Avenue	Unit	United States Customary

Segment 1

Vehicle Inputs

Segment Type	Passing Constrained	Length, ft	2594
Lane Width, ft	12	Shoulder Width, ft	2
Speed Limit, mi/h	40	Access Point Density, pts/mi	52.9

Demand and Capacity

Directional Demand Flow Rate, veh/h	167	Opposing Demand Flow Rate, veh/h	-
Peak Hour Factor	0.42	Total Trucks, %	13.33
Segment Capacity, veh/h	1700	Demand/Capacity (D/C)	0.10

Intermediate Results

Segment Vertical Class	1	Free-Flow Speed, mi/h	32.4
Speed Slope Coefficient	2.28310	Speed Power Coefficient	0.41674
PF Slope Coefficient	-1.42395	PF Power Coefficient	0.65839
In Passing Lane Effective Length?	No	Total Segment Density, veh/mi/ln	1.9
%Improved % Followers	0.0	% Improved Avg Speed	0.0

Subsegment Data

#	Segment Type	Length, ft	Radius, ft	Superelevation, %	Average Speed, mi/h
1	Tangent	2594	-	-	31.6

Vehicle Results

Average Speed, mi/h	31.6	Percent Followers, %	35.4
Segment Travel Time, minutes	0.93	Follower Density, followers/mi/ln	1.9
Vehicle LOS	A		

Facility Results

T	Follower Density, followers/mi/ln	LOS
1	1.9	A

HCS7 Two-Lane Highway Report

Project Information

Analyst	C. Ayala-Magana	Date	7/20/2022
Agency	JLB Traffic Engineering, Inc.	Analysis Year	2022
Jurisdiction	City of Hanford	Time Period Analyzed	Near Term Plus Project AM Peak
Project Description	06 Houston Avenue Between 11th Avenue and 10 1/2 Avenue	Unit	United States Customary

Segment 1

Vehicle Inputs

Segment Type	Passing Constrained	Length, ft	2567
Lane Width, ft	12	Shoulder Width, ft	2
Speed Limit, mi/h	50	Access Point Density, pts/mi	20.6

Demand and Capacity

Directional Demand Flow Rate, veh/h	284	Opposing Demand Flow Rate, veh/h	-
Peak Hour Factor	0.68	Total Trucks, %	21.40
Segment Capacity, veh/h	1700	Demand/Capacity (D/C)	0.17

Intermediate Results

Segment Vertical Class	1	Free-Flow Speed, mi/h	48.3
Speed Slope Coefficient	3.14891	Speed Power Coefficient	0.41674
PF Slope Coefficient	-1.42118	PF Power Coefficient	0.72418
In Passing Lane Effective Length?	No	Total Segment Density, veh/mi/ln	2.6
%Improved % Followers	0.0	% Improved Avg Speed	0.0

Subsegment Data

#	Segment Type	Length, ft	Radius, ft	Superelevation, %	Average Speed, mi/h
1	Tangent	2567	-	-	46.8

Vehicle Results

Average Speed, mi/h	46.8	Percent Followers, %	43.5
Segment Travel Time, minutes	0.62	Follower Density, followers/mi/ln	2.6
Vehicle LOS	B		

Facility Results

T	Follower Density, followers/mi/ln	LOS
1	2.6	B

HCS7 Two-Lane Highway Report

Project Information

Analyst	C. Ayala-Magana	Date	7/20/2022
Agency	JLB Traffic Engineering, Inc.	Analysis Year	2022
Jurisdiction	City of Hanford	Time Period Analyzed	Near Term Plus Project AM Peak
Project Description	07 Houston Avenue Between 10 1/2 Avenue and 10th Avenue	Unit	United States Customary

Segment 1

Vehicle Inputs

Segment Type	Passing Constrained	Length, ft	2570
Lane Width, ft	12	Shoulder Width, ft	2
Speed Limit, mi/h	55	Access Point Density, pts/mi	45.2

Demand and Capacity

Directional Demand Flow Rate, veh/h	224	Opposing Demand Flow Rate, veh/h	-
Peak Hour Factor	0.88	Total Trucks, %	17.65
Segment Capacity, veh/h	1700	Demand/Capacity (D/C)	0.13

Intermediate Results

Segment Vertical Class	1	Free-Flow Speed, mi/h	49.3
Speed Slope Coefficient	3.20179	Speed Power Coefficient	0.41674
PF Slope Coefficient	-1.41674	PF Power Coefficient	0.72668
In Passing Lane Effective Length?	No	Total Segment Density, veh/mi/ln	1.8
%Improved % Followers	0.0	% Improved Avg Speed	0.0

Subsegment Data

#	Segment Type	Length, ft	Radius, ft	Superelevation, %	Average Speed, mi/h
1	Tangent	2570	-	-	48.0

Vehicle Results

Average Speed, mi/h	48.0	Percent Followers, %	38.0
Segment Travel Time, minutes	0.61	Follower Density, followers/mi/ln	1.8
Vehicle LOS	A		

Facility Results

T	Follower Density, followers/mi/ln	LOS
1	1.8	A

HCS7 Two-Lane Highway Report

Project Information

Analyst	C. Ayala-Magana	Date	7/20/2022
Agency	JLB Traffic Engineering, Inc.	Analysis Year	2022
Jurisdiction	City of Hanford	Time Period Analyzed	Near Term Plus Project PM Peak
Project Description	01 Hanford-Armona Road Between 11th Avenue and 10 1/2 Avenue	Unit	United States Customary

Segment 1

Vehicle Inputs

Segment Type	Passing Constrained	Length, ft	2583
Lane Width, ft	12	Shoulder Width, ft	6
Speed Limit, mi/h	40	Access Point Density, pts/mi	34.8

Demand and Capacity

Directional Demand Flow Rate, veh/h	658	Opposing Demand Flow Rate, veh/h	-
Peak Hour Factor	0.83	Total Trucks, %	3.00
Segment Capacity, veh/h	1700	Demand/Capacity (D/C)	0.39

Intermediate Results

Segment Vertical Class	1	Free-Flow Speed, mi/h	36.8
Speed Slope Coefficient	2.52381	Speed Power Coefficient	0.41674
PF Slope Coefficient	-1.44159	PF Power Coefficient	0.67823
In Passing Lane Effective Length?	No	Total Segment Density, veh/mi/ln	12.5
%Improved % Followers	0.0	% Improved Avg Speed	0.0

Subsegment Data

#	Segment Type	Length, ft	Radius, ft	Superelevation, %	Average Speed, mi/h
1	Tangent	2583	-	-	34.8

Vehicle Results

Average Speed, mi/h	34.8	Percent Followers, %	66.2
Segment Travel Time, minutes	0.84	Follower Density, followers/mi/ln	12.5
Vehicle LOS	D		

Facility Results

T	Follower Density, followers/mi/ln	LOS
1	12.5	D

HCS7 Two-Lane Highway Report

Project Information

Analyst	C. Ayala-Magana	Date	7/20/2022
Agency	JLB Traffic Engineering, Inc.	Analysis Year	2022
Jurisdiction	City of Hanford	Time Period Analyzed	Near Term Plus Project PM Peak
Project Description	02 Hanford-Armona Road Between 10 1/2 Avenue and Jordan Way	Unit	United States Customary

Segment 1

Vehicle Inputs

Segment Type	Passing Constrained	Length, ft	1556
Lane Width, ft	12	Shoulder Width, ft	6
Speed Limit, mi/h	40	Access Point Density, pts/mi	67.9

Demand and Capacity

Directional Demand Flow Rate, veh/h	418	Opposing Demand Flow Rate, veh/h	-
Peak Hour Factor	0.85	Total Trucks, %	3.00
Segment Capacity, veh/h	1700	Demand/Capacity (D/C)	0.25

Intermediate Results

Segment Vertical Class	1	Free-Flow Speed, mi/h	35.5
Speed Slope Coefficient	2.43724	Speed Power Coefficient	0.41674
PF Slope Coefficient	-1.48339	PF Power Coefficient	0.66114
In Passing Lane Effective Length?	No	Total Segment Density, veh/mi/ln	6.9
%Improved % Followers	0.0	% Improved Avg Speed	0.0

Subsegment Data

#	Segment Type	Length, ft	Radius, ft	Superelevation, %	Average Speed, mi/h
1	Tangent	1556	-	-	34.0

Vehicle Results

Average Speed, mi/h	34.0	Percent Followers, %	56.5
Segment Travel Time, minutes	0.52	Follower Density, followers/mi/ln	6.9
Vehicle LOS	C		

Facility Results

T	Follower Density, followers/mi/ln	LOS
1	6.9	C

HCS7 Two-Lane Highway Report

Project Information

Analyst	C. Ayala-Magana	Date	7/20/2022
Agency	JLB Traffic Engineering, Inc.	Analysis Year	2022
Jurisdiction	City of Hanford	Time Period Analyzed	Near Term Plus Project PM Peak
Project Description	03 Hanford-Armona Road Between Jordan Way and 10th Avenue	Unit	United States Customary

Segment 1

Vehicle Inputs

Segment Type	Passing Constrained	Length, ft	901
Lane Width, ft	12	Shoulder Width, ft	6
Speed Limit, mi/h	40	Access Point Density, pts/mi	17.6

Demand and Capacity

Directional Demand Flow Rate, veh/h	362	Opposing Demand Flow Rate, veh/h	-
Peak Hour Factor	0.97	Total Trucks, %	3.00
Segment Capacity, veh/h	1700	Demand/Capacity (D/C)	0.21

Intermediate Results

Segment Vertical Class	1	Free-Flow Speed, mi/h	41.1
Speed Slope Coefficient	2.73635	Speed Power Coefficient	0.41674
PF Slope Coefficient	-1.50445	PF Power Coefficient	0.68170
In Passing Lane Effective Length?	No	Total Segment Density, veh/mi/ln	4.8
%Improved % Followers	0.0	% Improved Avg Speed	0.0

Subsegment Data

#	Segment Type	Length, ft	Radius, ft	Superelevation, %	Average Speed, mi/h
1	Tangent	901	-	-	39.5

Vehicle Results

Average Speed, mi/h	39.5	Percent Followers, %	52.9
Segment Travel Time, minutes	0.26	Follower Density, followers/mi/ln	4.8
Vehicle LOS	B		

Facility Results

T	Follower Density, followers/mi/ln	LOS
1	4.8	B

HCS7 Two-Lane Highway Report

Project Information

Analyst	C. Ayala-Magana	Date	7/20/2022
Agency	JLB Traffic Engineering, Inc.	Analysis Year	2022
Jurisdiction	City of Hanford	Time Period Analyzed	Near Term Plus Project PM Peak
Project Description	04 10.5 Avenue Between Hanford Armona Drive and Orchard Avenue	Unit	United States Customary

Segment 1

Vehicle Inputs

Segment Type	Passing Constrained	Length, ft	2735
Lane Width, ft	12	Shoulder Width, ft	2
Speed Limit, mi/h	40	Access Point Density, pts/mi	50.2

Demand and Capacity

Directional Demand Flow Rate, veh/h	263	Opposing Demand Flow Rate, veh/h	-
Peak Hour Factor	0.75	Total Trucks, %	3.00
Segment Capacity, veh/h	1700	Demand/Capacity (D/C)	0.15

Intermediate Results

Segment Vertical Class	1	Free-Flow Speed, mi/h	32.7
Speed Slope Coefficient	2.30368	Speed Power Coefficient	0.41674
PF Slope Coefficient	-1.42275	PF Power Coefficient	0.65971
In Passing Lane Effective Length?	No	Total Segment Density, veh/mi/ln	3.7
%Improved % Followers	0.0	% Improved Avg Speed	0.0

Subsegment Data

#	Segment Type	Length, ft	Radius, ft	Superelevation, %	Average Speed, mi/h
1	Tangent	2735	-	-	31.6

Vehicle Results

Average Speed, mi/h	31.6	Percent Followers, %	44.5
Segment Travel Time, minutes	0.98	Follower Density, followers/mi/ln	3.7
Vehicle LOS	B		

Facility Results

T	Follower Density, followers/mi/ln	LOS
1	3.7	B

HCS7 Two-Lane Highway Report

Project Information

Analyst	C. Ayala-Magana	Date	7/20/2022
Agency	JLB Traffic Engineering, Inc.	Analysis Year	2022
Jurisdiction	City of Hanford	Time Period Analyzed	Near Term Plus Project PM Peak
Project Description	05 10.5 Avenue Between Orchard Avenue and Houston Avenue	Unit	United States Customary

Segment 1

Vehicle Inputs

Segment Type	Passing Constrained	Length, ft	2594
Lane Width, ft	12	Shoulder Width, ft	2
Speed Limit, mi/h	40	Access Point Density, pts/mi	52.9

Demand and Capacity

Directional Demand Flow Rate, veh/h	236	Opposing Demand Flow Rate, veh/h	-
Peak Hour Factor	0.56	Total Trucks, %	3.70
Segment Capacity, veh/h	1700	Demand/Capacity (D/C)	0.14

Intermediate Results

Segment Vertical Class	1	Free-Flow Speed, mi/h	32.7
Speed Slope Coefficient	2.30048	Speed Power Coefficient	0.41674
PF Slope Coefficient	-1.42689	PF Power Coefficient	0.65868
In Passing Lane Effective Length?	No	Total Segment Density, veh/mi/ln	3.2
%Improved % Followers	0.0	% Improved Avg Speed	0.0

Subsegment Data

#	Segment Type	Length, ft	Radius, ft	Superelevation, %	Average Speed, mi/h
1	Tangent	2594	-	-	31.7

Vehicle Results

Average Speed, mi/h	31.7	Percent Followers, %	42.4
Segment Travel Time, minutes	0.93	Follower Density, followers/mi/ln	3.2
Vehicle LOS	B		

Facility Results

T	Follower Density, followers/mi/ln	LOS
1	3.2	B

HCS7 Two-Lane Highway Report

Project Information

Analyst	C. Ayala-Magana	Date	7/20/2022
Agency	JLB Traffic Engineering, Inc.	Analysis Year	2022
Jurisdiction	City of Hanford	Time Period Analyzed	Near Term Plus Project PM Peak
Project Description	06 Houston Avenue Between 11th Avenue and 10 1/2 Avenue	Unit	United States Customary

Segment 1

Vehicle Inputs

Segment Type	Passing Constrained	Length, ft	2567
Lane Width, ft	12	Shoulder Width, ft	2
Speed Limit, mi/h	50	Access Point Density, pts/mi	20.6

Demand and Capacity

Directional Demand Flow Rate, veh/h	302	Opposing Demand Flow Rate, veh/h	-
Peak Hour Factor	0.89	Total Trucks, %	3.75
Segment Capacity, veh/h	1700	Demand/Capacity (D/C)	0.18

Intermediate Results

Segment Vertical Class	1	Free-Flow Speed, mi/h	48.9
Speed Slope Coefficient	3.18076	Speed Power Coefficient	0.41674
PF Slope Coefficient	-1.42061	PF Power Coefficient	0.72351
In Passing Lane Effective Length?	No	Total Segment Density, veh/mi/ln	2.9
%Improved % Followers	0.0	% Improved Avg Speed	0.0

Subsegment Data

#	Segment Type	Length, ft	Radius, ft	Superelevation, %	Average Speed, mi/h
1	Tangent	2567	-	-	47.3

Vehicle Results

Average Speed, mi/h	47.3	Percent Followers, %	45.0
Segment Travel Time, minutes	0.62	Follower Density, followers/mi/ln	2.9
Vehicle LOS	B		

Facility Results

T	Follower Density, followers/mi/ln	LOS
1	2.9	B

HCS7 Two-Lane Highway Report

Project Information

Analyst	C. Ayala-Magana	Date	7/20/2022
Agency	JLB Traffic Engineering, Inc.	Analysis Year	2022
Jurisdiction	City of Hanford	Time Period Analyzed	Near Term Plus Project PM Peak
Project Description	07 Houston Avenue Between 10 1/2 Avenue and 10th Avenue	Unit	United States Customary

Segment 1

Vehicle Inputs

Segment Type	Passing Constrained	Length, ft	2570
Lane Width, ft	12	Shoulder Width, ft	2
Speed Limit, mi/h	55	Access Point Density, pts/mi	45.2

Demand and Capacity

Directional Demand Flow Rate, veh/h	328	Opposing Demand Flow Rate, veh/h	-
Peak Hour Factor	0.90	Total Trucks, %	3.00
Segment Capacity, veh/h	1700	Demand/Capacity (D/C)	0.19

Intermediate Results

Segment Vertical Class	1	Free-Flow Speed, mi/h	49.8
Speed Slope Coefficient	3.22823	Speed Power Coefficient	0.41674
PF Slope Coefficient	-1.41606	PF Power Coefficient	0.72608
In Passing Lane Effective Length?	No	Total Segment Density, veh/mi/ln	3.2
%Improved % Followers	0.0	% Improved Avg Speed	0.0

Subsegment Data

#	Segment Type	Length, ft	Radius, ft	Superelevation, %	Average Speed, mi/h
1	Tangent	2570	-	-	48.1

Vehicle Results

Average Speed, mi/h	48.1	Percent Followers, %	46.7
Segment Travel Time, minutes	0.61	Follower Density, followers/mi/ln	3.2
Vehicle LOS	B		

Facility Results

T	Follower Density, followers/mi/ln	LOS
1	3.2	B

Appendix H: Cumulative Year 2042 plus Project Traffic Conditions



www.JLBtraffic.com
info@JLBtraffic.com

516 W. Shaw Ave., Ste. 103
Fresno, CA 93704
(559) 570-8991

A p p | H

HCM 6th Signalized Intersection Summary
3: 10 1/2 Avenue & Hanford Armona Road

Cumulative Year 2042 Plus Project AM Peak

05/05/2022



Movement	EBL	EBT	EBR	WBL	WBT	WBR	NBL	NBT	NBR	SBL	SBT	SBR
Lane Configurations												
Traffic Volume (veh/h)	60	237	52	17	221	27	124	80	19	12	25	37
Future Volume (veh/h)	60	237	52	17	221	27	124	80	19	12	25	37
Initial Q (Qb), veh	0	0	0	0	0	0	0	0	0	0	0	0
Ped-Bike Adj(A_pbT)	1.00		1.00	1.00		1.00	1.00		1.00	1.00		1.00
Parking Bus, Adj	1.00	1.00	1.00	1.00	1.00	1.00	1.00	1.00	1.00	1.00	1.00	1.00
Work Zone On Approach		No			No			No			No	
Adj Sat Flow, veh/h/ln	1826	1826	1826	1826	1826	1826	1826	1826	1826	1826	1826	1826
Adj Flow Rate, veh/h	70	276	60	20	257	31	144	93	22	14	29	43
Peak Hour Factor	0.86	0.86	0.86	0.86	0.86	0.86	0.86	0.86	0.86	0.86	0.86	0.86
Percent Heavy Veh, %	5	5	5	5	5	5	5	5	5	5	5	5
Cap, veh/h	119	412	90	43	384	46	184	370	313	31	209	177
Arrive On Green	0.07	0.28	0.28	0.02	0.24	0.24	0.11	0.20	0.20	0.02	0.11	0.11
Sat Flow, veh/h	1739	1453	316	1739	1598	193	1739	1826	1547	1739	1826	1547
Grp Volume(v), veh/h	70	0	336	20	0	288	144	93	22	14	29	43
Grp Sat Flow(s),veh/h/ln	1739	0	1768	1739	0	1791	1739	1826	1547	1739	1826	1547
Q Serve(g_s), s	1.5	0.0	6.5	0.4	0.0	5.6	3.1	1.7	0.4	0.3	0.6	1.0
Cycle Q Clear(g_c), s	1.5	0.0	6.5	0.4	0.0	5.6	3.1	1.7	0.4	0.3	0.6	1.0
Prop In Lane	1.00		0.18	1.00		0.11	1.00		1.00	1.00		1.00
Lane Grp Cap(c), veh/h	119	0	501	43	0	430	184	370	313	31	209	177
V/C Ratio(X)	0.59	0.00	0.67	0.46	0.00	0.67	0.78	0.25	0.07	0.45	0.14	0.24
Avail Cap(c_a), veh/h	225	0	1236	225	0	1251	365	1408	1193	225	1276	1081
HCM Platoon Ratio	1.00	1.00	1.00	1.00	1.00	1.00	1.00	1.00	1.00	1.00	1.00	1.00
Upstream Filter(I)	1.00	0.00	1.00	1.00	0.00	1.00	1.00	1.00	1.00	1.00	1.00	1.00
Uniform Delay (d), s/veh	17.5	0.0	12.2	18.6	0.0	13.3	16.8	12.9	12.5	18.8	15.4	15.6
Incr Delay (d2), s/veh	4.6	0.0	1.6	7.4	0.0	1.8	7.0	0.4	0.1	9.6	0.3	0.7
Initial Q Delay(d3),s/veh	0.0	0.0	0.0	0.0	0.0	0.0	0.0	0.0	0.0	0.0	0.0	0.0
%ile BackOfQ(50%),veh/ln	0.6	0.0	2.0	0.2	0.0	1.9	1.3	0.5	0.1	0.2	0.2	0.3
Unsig. Movement Delay, s/veh												
LnGrp Delay(d),s/veh	22.0	0.0	13.8	26.0	0.0	15.1	23.8	13.3	12.6	28.4	15.7	16.3
LnGrp LOS	C	A	B	C	A	B	C	B	B	C	B	B
Approach Vol, veh/h		406			308			259				86
Approach Delay, s/veh		15.2			15.8			19.1				18.1
Approach LOS		B			B			B				B
Timer - Assigned Phs	1	2	3	4	5	6	7	8				
Phs Duration (G+Y+Rc), s	4.9	12.7	5.2	15.9	8.3	9.3	6.8	14.2				
Change Period (Y+Rc), s	* 4.2	4.9	* 4.2	4.9	* 4.2	* 4.9	* 4.2	4.9				
Max Green Setting (Gmax), s	* 5	29.8	* 5	27.0	* 8.1	* 27	* 5	27.0				
Max Q Clear Time (g_c+I1), s	2.3	3.7	2.4	8.5	5.1	3.0	3.5	7.6				
Green Ext Time (p_c), s	0.0	0.5	0.0	1.8	0.1	0.2	0.0	1.5				

Intersection Summary

HCM 6th Ctrl Delay	16.6
HCM 6th LOS	B

Notes

* HCM 6th computational engine requires equal clearance times for the phases crossing the barrier.

Intersection

Int Delay, s/veh 2.9

Movement	EBT	EBR	WBL	WBT	NBL	NBR
Lane Configurations	↶		↷	↶	↷	
Traffic Vol, veh/h	208	28	36	182	55	62
Future Vol, veh/h	208	28	36	182	55	62
Conflicting Peds, #/hr	0	0	0	0	0	1
Sign Control	Free	Free	Free	Free	Stop	Stop
RT Channelized	-	None	-	None	-	None
Storage Length	-	-	75	-	0	-
Veh in Median Storage, #	0	-	-	0	0	-
Grade, %	0	-	-	0	0	-
Peak Hour Factor	92	92	92	92	92	92
Heavy Vehicles, %	6	6	6	6	6	6
Mvmt Flow	226	30	39	198	60	67

Major/Minor	Major1	Major2	Minor1	Minor2	Minor3
Conflicting Flow All	0	0	256	0	517
Stage 1	-	-	-	-	241
Stage 2	-	-	-	-	276
Critical Hdwy	-	-	4.16	-	6.46
Critical Hdwy Stg 1	-	-	-	-	5.46
Critical Hdwy Stg 2	-	-	-	-	5.46
Follow-up Hdwy	-	-	2.254	-	3.554
Pot Cap-1 Maneuver	-	-	1286	-	511
Stage 1	-	-	-	-	790
Stage 2	-	-	-	-	761
Platoon blocked, %	-	-	-	-	-
Mov Cap-1 Maneuver	-	-	1286	-	496
Mov Cap-2 Maneuver	-	-	-	-	574
Stage 1	-	-	-	-	790
Stage 2	-	-	-	-	738

Approach	EB	WB	NB
HCM Control Delay, s	0	1.3	11.6
HCM LOS			B

Minor Lane/Major Mvmt	NBLn1	EBT	EBR	WBL	WBT
Capacity (veh/h)	670	-	-	1286	-
HCM Lane V/C Ratio	0.19	-	-	0.03	-
HCM Control Delay (s)	11.6	-	-	7.9	-
HCM Lane LOS	B	-	-	A	-
HCM 95th %tile Q(veh)	0.7	-	-	0.1	-

HCM 6th Signalized Intersection Summary
5: 10th Avenue & Hanford Armona Road

Cumulative Year 2042 Plus Project AM Peak

05/05/2022



Movement	EBL	EBT	EBR	WBL	WBT	WBR	NBL	NBT	NBR	SBL	SBT	SBR
Lane Configurations												
Traffic Volume (veh/h)	186	11	67	10	7	21	70	217	6	16	203	158
Future Volume (veh/h)	186	11	67	10	7	21	70	217	6	16	203	158
Initial Q (Qb), veh	0	0	0	0	0	0	0	0	0	0	0	0
Ped-Bike Adj(A_pbT)	1.00		1.00	1.00		1.00	1.00		1.00	1.00		1.00
Parking Bus, Adj	1.00	1.00	1.00	1.00	1.00	1.00	1.00	1.00	1.00	1.00	1.00	1.00
Work Zone On Approach		No			No			No			No	
Adj Sat Flow, veh/h/ln	1796	1796	1796	1796	1796	1796	1796	1796	1796	1796	1796	1796
Adj Flow Rate, veh/h	202	12	73	11	8	23	76	236	7	17	221	172
Peak Hour Factor	0.92	0.92	0.92	0.92	0.92	0.92	0.92	0.92	0.92	0.92	0.92	0.92
Percent Heavy Veh, %	7	7	7	7	7	7	7	7	7	7	7	7
Cap, veh/h	252	408	346	25	39	111	122	454	385	37	365	309
Arrive On Green	0.15	0.23	0.23	0.01	0.09	0.09	0.07	0.25	0.25	0.02	0.20	0.20
Sat Flow, veh/h	1711	1796	1522	1711	409	1176	1711	1796	1522	1711	1796	1522
Grp Volume(v), veh/h	202	12	73	11	0	31	76	236	7	17	221	172
Grp Sat Flow(s),veh/h/ln	1711	1796	1522	1711	0	1585	1711	1796	1522	1711	1796	1522
Q Serve(g_s), s	4.6	0.2	1.6	0.3	0.0	0.7	1.7	4.5	0.1	0.4	4.5	4.1
Cycle Q Clear(g_c), s	4.6	0.2	1.6	0.3	0.0	0.7	1.7	4.5	0.1	0.4	4.5	4.1
Prop In Lane	1.00		1.00	1.00		0.74	1.00		1.00	1.00		1.00
Lane Grp Cap(c), veh/h	252	408	346	25	0	150	122	454	385	37	365	309
V/C Ratio(X)	0.80	0.03	0.21	0.45	0.00	0.21	0.62	0.52	0.02	0.46	0.61	0.56
Avail Cap(c_a), veh/h	290	1668	1414	214	0	1384	214	1291	1094	214	1309	1110
HCM Platoon Ratio	1.00	1.00	1.00	1.00	1.00	1.00	1.00	1.00	1.00	1.00	1.00	1.00
Upstream Filter(I)	1.00	1.00	1.00	1.00	0.00	1.00	1.00	1.00	1.00	1.00	1.00	1.00
Uniform Delay (d), s/veh	16.5	12.0	12.6	19.6	0.0	16.8	18.1	12.9	11.2	19.4	14.5	14.3
Incr Delay (d2), s/veh	13.2	0.0	0.3	12.2	0.0	0.7	5.1	0.9	0.0	8.8	1.6	1.6
Initial Q Delay(d3),s/veh	0.0	0.0	0.0	0.0	0.0	0.0	0.0	0.0	0.0	0.0	0.0	0.0
%ile BackOfQ(50%),veh/ln	2.3	0.1	0.4	0.2	0.0	0.2	0.7	1.3	0.0	0.2	1.5	1.2
Unsig. Movement Delay, s/veh												
LnGrp Delay(d),s/veh	29.8	12.1	12.9	31.8	0.0	17.4	23.2	13.8	11.3	28.1	16.1	15.9
LnGrp LOS	C	B	B	C	A	B	C	B	B	C	B	B
Approach Vol, veh/h		287			42			319			410	
Approach Delay, s/veh		24.7			21.2			16.0			16.5	
Approach LOS		C			C			B			B	
Timer - Assigned Phs	1	2	3	4	5	6	7	8				
Phs Duration (G+Y+Rc), s	5.1	15.8	4.8	14.4	7.1	13.8	10.1	9.1				
Change Period (Y+Rc), s	* 4.2	5.7	* 4.2	* 5.3	* 4.2	* 5.7	* 4.2	5.3				
Max Green Setting (Gmax), s	* 5	28.8	* 5	* 37	* 5	* 29	* 6.8	35.0				
Max Q Clear Time (g_c+I1), s	2.4	6.5	2.3	3.6	3.7	6.5	6.6	2.7				
Green Ext Time (p_c), s	0.0	1.1	0.0	0.3	0.0	1.7	0.0	0.1				

Intersection Summary

HCM 6th Ctrl Delay	18.8
HCM 6th LOS	B

Notes

* HCM 6th computational engine requires equal clearance times for the phases crossing the barrier.

Intersection

Int Delay, s/veh 3.4

Movement WBL WBR NBT NBR SBL SBT

Lane Configurations						
Traffic Vol, veh/h	23	42	89	6	17	39
Future Vol, veh/h	23	42	89	6	17	39
Conflicting Peds, #/hr	0	0	0	0	0	0
Sign Control	Stop	Stop	Free	Free	Free	Free
RT Channelized	-	None	-	None	-	None
Storage Length	0	-	-	-	-	-
Veh in Median Storage, #	0	-	0	-	-	0
Grade, %	0	-	0	-	-	0
Peak Hour Factor	92	92	92	92	92	92
Heavy Vehicles, %	5	5	5	5	5	5
Mvmt Flow	25	46	97	7	18	42

Major/Minor Minor1 Major1 Major2

Conflicting Flow All	179	101	0	0	104	0
Stage 1	101	-	-	-	-	-
Stage 2	78	-	-	-	-	-
Critical Hdwy	6.45	6.25	-	-	4.15	-
Critical Hdwy Stg 1	5.45	-	-	-	-	-
Critical Hdwy Stg 2	5.45	-	-	-	-	-
Follow-up Hdwy	3.545	3.345	-	-	2.245	-
Pot Cap-1 Maneuver	804	946	-	-	1469	-
Stage 1	916	-	-	-	-	-
Stage 2	938	-	-	-	-	-
Platoon blocked, %			-	-		-
Mov Cap-1 Maneuver	794	946	-	-	1469	-
Mov Cap-2 Maneuver	794	-	-	-	-	-
Stage 1	916	-	-	-	-	-
Stage 2	926	-	-	-	-	-

Approach WB NB SB

HCM Control Delay, s 9.4 0 2.3
HCM LOS A

Minor Lane/Major Mvmt NBT NBRWBLn1 SBL SBT

Capacity (veh/h)	-	-	886	1469	-
HCM Lane V/C Ratio	-	-	0.08	0.013	-
HCM Control Delay (s)	-	-	9.4	7.5	0
HCM Lane LOS	-	-	A	A	A
HCM 95th %tile Q(veh)	-	-	0.3	0	-

HCM Signalized Intersection Capacity Analysis
7: 11th Avenue & Houston Avenue

Cumulative Year 2042 Plus Project AM Peak

05/05/2022



Movement	EBL	EBT	EBR	WBL	WBT	WBR	NBL	NBT	NBR	SBL	SBT	SBR
Lane Configurations	↔	↑	↗	↖	↑	↗	↖	↑↑	↗	↖	↑	↗
Traffic Volume (vph)	96	128	46	37	99	40	34	144	41	44	99	40
Future Volume (vph)	96	128	46	37	99	40	34	144	41	44	99	40
Ideal Flow (vphp)	1900	1900	1900	1900	1900	1900	1900	1900	1900	1900	1900	1900
Total Lost time (s)	4.2	6.0	6.0	4.2	5.7	5.7	4.2	5.7	5.7	4.2	5.3	5.3
Lane Util. Factor	1.00	1.00	1.00	1.00	1.00	1.00	1.00	0.95	1.00	1.00	1.00	1.00
Frt	1.00	1.00	0.85	1.00	1.00	0.85	1.00	1.00	0.85	1.00	1.00	0.85
Flt Protected	0.95	1.00	1.00	0.95	1.00	1.00	0.95	1.00	1.00	0.95	1.00	1.00
Satd. Flow (prot)	1597	1681	1429	1597	1681	1429	1597	3195	1429	1597	1681	1429
Flt Permitted	0.95	1.00	1.00	0.95	1.00	1.00	0.95	1.00	1.00	0.95	1.00	1.00
Satd. Flow (perm)	1597	1681	1429	1597	1681	1429	1597	3195	1429	1597	1681	1429
Peak-hour factor, PHF	0.96	0.96	0.96	0.96	0.96	0.96	0.96	0.96	0.96	0.96	0.96	0.96
Adj. Flow (vph)	100	133	48	39	103	42	35	150	43	46	103	42
RTOR Reduction (vph)	0	0	35	0	0	34	0	0	30	0	0	28
Lane Group Flow (vph)	100	133	13	39	103	8	35	150	13	46	103	14
Heavy Vehicles (%)	13%	13%	13%	13%	13%	13%	13%	13%	13%	13%	13%	13%
Turn Type	Prot	NA	Perm	Prot	NA	Perm	Prot	NA	Perm	Prot	NA	Perm
Protected Phases	7	4		3	8		5	2		1	6	
Permitted Phases			4			8			2			6
Actuated Green, G (s)	9.7	18.3	18.3	3.6	12.5	12.5	3.6	20.3	20.3	6.0	23.1	23.1
Effective Green, g (s)	9.7	18.3	18.3	3.6	12.5	12.5	3.6	20.3	20.3	6.0	23.1	23.1
Actuated g/C Ratio	0.14	0.27	0.27	0.05	0.18	0.18	0.05	0.30	0.30	0.09	0.34	0.34
Clearance Time (s)	4.2	6.0	6.0	4.2	5.7	5.7	4.2	5.7	5.7	4.2	5.3	5.3
Vehicle Extension (s)	3.0	3.0	3.0	3.0	3.0	3.0	3.0	3.0	3.0	3.0	3.0	3.0
Lane Grp Cap (vph)	226	450	382	84	307	261	84	949	424	140	568	483
v/s Ratio Prot	c0.06	c0.08		0.02	0.06		0.02	0.05		c0.03	c0.06	
v/s Ratio Perm			0.01			0.01			0.01			0.01
v/c Ratio	0.44	0.30	0.03	0.46	0.34	0.03	0.42	0.16	0.03	0.33	0.18	0.03
Uniform Delay, d1	26.8	19.9	18.5	31.4	24.3	22.9	31.3	17.7	17.0	29.3	15.9	15.1
Progression Factor	1.00	1.00	1.00	1.00	1.00	1.00	1.00	1.00	1.00	1.00	1.00	1.00
Incremental Delay, d2	1.4	0.4	0.0	4.0	0.6	0.0	3.3	0.1	0.0	1.4	0.2	0.0
Delay (s)	28.2	20.2	18.5	35.4	24.9	23.0	34.7	17.8	17.0	30.6	16.1	15.1
Level of Service	C	C	B	D	C	C	C	B	B	C	B	B
Approach Delay (s)		22.8			26.7			20.2			19.4	
Approach LOS		C			C			C			B	

Intersection Summary		
HCM 2000 Control Delay	22.2	HCM 2000 Level of Service
HCM 2000 Volume to Capacity ratio	0.30	C
Actuated Cycle Length (s)	68.3	Sum of lost time (s)
Intersection Capacity Utilization	40.2%	ICU Level of Service
Analysis Period (min)	15	A
c	Critical Lane Group	

Intersection

Int Delay, s/veh 2.5

Movement EBL EBT WBT WBR SBL SBR

Lane Configurations		↶	↷		↶	↷
Traffic Vol, veh/h	42	129	122	23	14	47
Future Vol, veh/h	42	129	122	23	14	47
Conflicting Peds, #/hr	0	0	0	0	0	0
Sign Control	Free	Free	Free	Free	Stop	Stop
RT Channelized	-	None	-	None	-	None
Storage Length	-	-	-	-	0	-
Veh in Median Storage, #	-	0	0	-	0	-
Grade, %	-	0	0	-	0	-
Peak Hour Factor	92	92	92	92	92	92
Heavy Vehicles, %	19	19	19	19	19	19
Mvmt Flow	46	140	133	25	15	51

Major/Minor Major1 Major2 Minor2

Conflicting Flow All	158	0	-	0	378	146
Stage 1	-	-	-	-	146	-
Stage 2	-	-	-	-	232	-
Critical Hdwy	4.29	-	-	-	6.59	6.39
Critical Hdwy Stg 1	-	-	-	-	5.59	-
Critical Hdwy Stg 2	-	-	-	-	5.59	-
Follow-up Hdwy	2.371	-	-	-	3.671	3.471
Pot Cap-1 Maneuver	1324	-	-	-	592	858
Stage 1	-	-	-	-	841	-
Stage 2	-	-	-	-	768	-
Platoon blocked, %		-	-	-		
Mov Cap-1 Maneuver	1324	-	-	-	570	858
Mov Cap-2 Maneuver	-	-	-	-	570	-
Stage 1	-	-	-	-	809	-
Stage 2	-	-	-	-	768	-

Approach EB WB SB

HCM Control Delay, s	1.9	0	10.1
HCM LOS			B

Minor Lane/Major Mvmt EBL EBT WBT WBR SBLn1

Capacity (veh/h)	1324	-	-	-	769
HCM Lane V/C Ratio	0.034	-	-	-	0.086
HCM Control Delay (s)	7.8	0	-	-	10.1
HCM Lane LOS	A	A	-	-	B
HCM 95th %tile Q(veh)	0.1	-	-	-	0.3

Intersection	
Intersection Delay, s/veh	9.9
Intersection LOS	A

Movement	EBL	EBT	EBR	WBL	WBT	WBR	NBL	NBT	NBR	SBL	SBT	SBR
Lane Configurations		↕			↕			↕			↕	
Traffic Vol, veh/h	46	83	28	12	64	13	17	91	5	15	108	61
Future Vol, veh/h	46	83	28	12	64	13	17	91	5	15	108	61
Peak Hour Factor	0.92	0.92	0.92	0.92	0.92	0.92	0.92	0.92	0.92	0.92	0.92	0.92
Heavy Vehicles, %	26	26	26	26	26	26	26	26	26	26	26	26
Mvmt Flow	50	90	30	13	70	14	18	99	5	16	117	66
Number of Lanes	0	1	0	0	1	0	0	1	0	0	1	0

Approach	EB	WB	NB	SB
Opposing Approach	WB	EB	SB	NB
Opposing Lanes	1	1	1	1
Conflicting Approach Left	SB	NB	EB	WB
Conflicting Lanes Left	1	1	1	1
Conflicting Approach Right	NB	SB	WB	EB
Conflicting Lanes Right	1	1	1	1
HCM Control Delay	10.1	9.3	9.6	10.1
HCM LOS	B	A	A	B

Lane	NBLn1	EBLn1	WBLn1	SBLn1
Vol Left, %	15%	29%	13%	8%
Vol Thru, %	81%	53%	72%	59%
Vol Right, %	4%	18%	15%	33%
Sign Control	Stop	Stop	Stop	Stop
Traffic Vol by Lane	113	157	89	184
LT Vol	17	46	12	15
Through Vol	91	83	64	108
RT Vol	5	28	13	61
Lane Flow Rate	123	171	97	200
Geometry Grp	1	1	1	1
Degree of Util (X)	0.181	0.249	0.144	0.28
Departure Headway (Hd)	5.317	5.256	5.35	5.035
Convergence, Y/N	Yes	Yes	Yes	Yes
Cap	671	679	666	710
Service Time	3.386	3.322	3.423	3.095
HCM Lane V/C Ratio	0.183	0.252	0.146	0.282
HCM Control Delay	9.6	10.1	9.3	10.1
HCM Lane LOS	A	B	A	B
HCM 95th-tile Q	0.7	1	0.5	1.1

HCM 6th Signalized Intersection Summary
3: 10 1/2 Avenue & Hanford Armona Road

Cumulative Year 2042 Project PM Peak

05/05/2022



Movement	EBL	EBT	EBR	WBL	WBT	WBR	NBL	NBT	NBR	SBL	SBT	SBR
Lane Configurations												
Traffic Volume (veh/h)	46	307	154	65	330	29	146	61	16	27	61	64
Future Volume (veh/h)	46	307	154	65	330	29	146	61	16	27	61	64
Initial Q (Qb), veh	0	0	0	0	0	0	0	0	0	0	0	0
Ped-Bike Adj(A_pbT)	1.00		1.00	1.00		1.00	1.00		1.00	1.00		1.00
Parking Bus, Adj	1.00	1.00	1.00	1.00	1.00	1.00	1.00	1.00	1.00	1.00	1.00	1.00
Work Zone On Approach		No			No			No			No	
Adj Sat Flow, veh/h/ln	1856	1856	1856	1856	1856	1856	1856	1856	1856	1856	1856	1856
Adj Flow Rate, veh/h	50	334	167	71	359	32	159	66	17	29	66	70
Peak Hour Factor	0.92	0.92	0.92	0.92	0.92	0.92	0.92	0.92	0.92	0.92	0.92	0.92
Percent Heavy Veh, %	3	3	3	3	3	3	3	3	3	3	3	3
Cap, veh/h	89	414	207	111	618	55	203	333	282	59	182	154
Arrive On Green	0.05	0.36	0.36	0.06	0.37	0.37	0.11	0.18	0.18	0.03	0.10	0.10
Sat Flow, veh/h	1767	1166	583	1767	1679	150	1767	1856	1572	1767	1856	1572
Grp Volume(v), veh/h	50	0	501	71	0	391	159	66	17	29	66	70
Grp Sat Flow(s),veh/h/ln	1767	0	1749	1767	0	1828	1767	1856	1572	1767	1856	1572
Q Serve(g_s), s	1.4	0.0	12.8	1.9	0.0	8.5	4.3	1.5	0.4	0.8	1.6	2.1
Cycle Q Clear(g_c), s	1.4	0.0	12.8	1.9	0.0	8.5	4.3	1.5	0.4	0.8	1.6	2.1
Prop In Lane	1.00		0.33	1.00		0.08	1.00		1.00	1.00		1.00
Lane Grp Cap(c), veh/h	89	0	621	111	0	673	203	333	282	59	182	154
V/C Ratio(X)	0.56	0.00	0.81	0.64	0.00	0.58	0.78	0.20	0.06	0.49	0.36	0.45
Avail Cap(c_a), veh/h	179	0	965	179	0	1008	283	1088	922	204	1016	861
HCM Platoon Ratio	1.00	1.00	1.00	1.00	1.00	1.00	1.00	1.00	1.00	1.00	1.00	1.00
Upstream Filter(I)	1.00	0.00	1.00	1.00	0.00	1.00	1.00	1.00	1.00	1.00	1.00	1.00
Uniform Delay (d), s/veh	22.9	0.0	14.4	22.5	0.0	12.5	21.2	17.2	16.8	23.4	20.8	21.0
Incr Delay (d2), s/veh	5.5	0.0	2.9	5.9	0.0	0.8	9.2	0.3	0.1	6.3	1.2	2.1
Initial Q Delay(d3),s/veh	0.0	0.0	0.0	0.0	0.0	0.0	0.0	0.0	0.0	0.0	0.0	0.0
%ile BackOfQ(50%),veh/ln	0.6	0.0	4.3	0.9	0.0	2.8	2.1	0.6	0.1	0.4	0.7	0.7
Unsig. Movement Delay, s/veh												
LnGrp Delay(d),s/veh	28.4	0.0	17.3	28.5	0.0	13.3	30.5	17.5	16.9	29.7	22.0	23.1
LnGrp LOS	C	A	B	C	A	B	C	B	B	C	C	C
Approach Vol, veh/h		551			462			242			165	
Approach Delay, s/veh		18.3			15.7			26.0			23.8	
Approach LOS		B			B			C			C	
Timer - Assigned Phs	1	2	3	4	5	6	7	8				
Phs Duration (G+Y+Rc), s	5.8	13.7	7.3	22.4	9.9	9.7	6.7	23.0				
Change Period (Y+Rc), s	* 4.2	4.9	* 4.2	4.9	* 4.2	* 4.9	* 4.2	4.9				
Max Green Setting (Gmax), s	* 5.7	28.9	* 5	27.2	* 7.9	* 27	* 5	27.2				
Max Q Clear Time (g_c+I1), s	2.8	3.5	3.9	14.8	6.3	4.1	3.4	10.5				
Green Ext Time (p_c), s	0.0	0.3	0.0	2.5	0.1	0.5	0.0	2.0				

Intersection Summary

HCM 6th Ctrl Delay	19.4
HCM 6th LOS	B

Notes

* HCM 6th computational engine requires equal clearance times for the phases crossing the barrier.

Intersection

Int Delay, s/veh 3.2

Movement EBT EBR WBL WBT NBL NBR

Lane Configurations	↶		↷	↶	↷	
Traffic Vol, veh/h	261	57	117	349	53	83
Future Vol, veh/h	261	57	117	349	53	83
Conflicting Peds, #/hr	0	2	2	0	0	0
Sign Control	Free	Free	Free	Free	Stop	Stop
RT Channelized	-	None	-	None	-	None
Storage Length	-	-	75	-	0	-
Veh in Median Storage, #	0	-	-	0	0	-
Grade, %	0	-	-	0	0	-
Peak Hour Factor	92	92	92	92	92	92
Heavy Vehicles, %	3	3	3	3	3	3
Mvmt Flow	284	62	127	379	58	90

Major/Minor Major1 Major2 Minor1

Conflicting Flow All	0	0	348	0	950	317
Stage 1	-	-	-	-	317	-
Stage 2	-	-	-	-	633	-
Critical Hdwy	-	-	4.13	-	6.43	6.23
Critical Hdwy Stg 1	-	-	-	-	5.43	-
Critical Hdwy Stg 2	-	-	-	-	5.43	-
Follow-up Hdwy	-	-	2.227	-	3.527	3.327
Pot Cap-1 Maneuver	-	-	1205	-	287	721
Stage 1	-	-	-	-	736	-
Stage 2	-	-	-	-	527	-
Platoon blocked, %	-	-	-	-	-	-
Mov Cap-1 Maneuver	-	-	1203	-	256	720
Mov Cap-2 Maneuver	-	-	-	-	369	-
Stage 1	-	-	-	-	735	-
Stage 2	-	-	-	-	471	-

Approach EB WB NB

HCM Control Delay, s	0	2.1	14.5
HCM LOS			B

Minor Lane/Major Mvmt NBLn1 EBT EBR WBL WBT

Capacity (veh/h)	525	-	-	1203	-
HCM Lane V/C Ratio	0.282	-	-	0.106	-
HCM Control Delay (s)	14.5	-	-	8.3	-
HCM Lane LOS	B	-	-	A	-
HCM 95th %tile Q(veh)	1.1	-	-	0.4	-

HCM 6th Signalized Intersection Summary
5: 10th Avenue & Hanford Armona Road

Cumulative Year 2042 Project PM Peak

05/05/2022



Movement	EBL	EBT	EBR	WBL	WBT	WBR	NBL	NBT	NBR	SBL	SBT	SBR
Lane Configurations												
Traffic Volume (veh/h)	197	25	127	21	28	42	176	397	15	48	302	277
Future Volume (veh/h)	197	25	127	21	28	42	176	397	15	48	302	277
Initial Q (Qb), veh	0	0	0	0	0	0	0	0	0	0	0	0
Ped-Bike Adj(A_pbT)	1.00		1.00	1.00		0.99	1.00		1.00	1.00		0.99
Parking Bus, Adj	1.00	1.00	1.00	1.00	1.00	1.00	1.00	1.00	1.00	1.00	1.00	1.00
Work Zone On Approach		No			No			No			No	
Adj Sat Flow, veh/h/ln	1856	1856	1856	1856	1856	1856	1856	1856	1856	1856	1856	1856
Adj Flow Rate, veh/h	207	26	134	22	29	44	185	418	16	51	318	292
Peak Hour Factor	0.95	0.95	0.95	0.95	0.95	0.95	0.95	0.95	0.95	0.95	0.95	0.95
Percent Heavy Veh, %	3	3	3	3	3	3	3	3	3	3	3	3
Cap, veh/h	259	420	354	46	70	106	233	641	541	87	488	411
Arrive On Green	0.15	0.23	0.23	0.03	0.11	0.11	0.13	0.35	0.35	0.05	0.26	0.26
Sat Flow, veh/h	1767	1856	1566	1767	663	1005	1767	1856	1566	1767	1856	1564
Grp Volume(v), veh/h	207	26	134	22	0	73	185	418	16	51	318	292
Grp Sat Flow(s),veh/h/ln	1767	1856	1566	1767	0	1668	1767	1856	1566	1767	1856	1564
Q Serve(g_s), s	6.2	0.6	4.0	0.7	0.0	2.3	5.6	10.5	0.4	1.6	8.4	9.3
Cycle Q Clear(g_c), s	6.2	0.6	4.0	0.7	0.0	2.3	5.6	10.5	0.4	1.6	8.4	9.3
Prop In Lane	1.00		1.00	1.00		0.60	1.00		1.00	1.00		1.00
Lane Grp Cap(c), veh/h	259	420	354	46	0	177	233	641	541	87	488	411
V/C Ratio(X)	0.80	0.06	0.38	0.48	0.00	0.41	0.79	0.65	0.03	0.59	0.65	0.71
Avail Cap(c_a), veh/h	379	1404	1184	180	0	1061	347	1130	954	170	958	807
HCM Platoon Ratio	1.00	1.00	1.00	1.00	1.00	1.00	1.00	1.00	1.00	1.00	1.00	1.00
Upstream Filter(I)	1.00	1.00	1.00	1.00	0.00	1.00	1.00	1.00	1.00	1.00	1.00	1.00
Uniform Delay (d), s/veh	22.7	16.7	18.0	26.4	0.0	23.0	23.1	15.2	11.9	25.6	18.0	18.4
Incr Delay (d2), s/veh	7.4	0.1	0.7	7.6	0.0	1.5	7.3	1.1	0.0	6.1	1.5	2.3
Initial Q Delay(d3),s/veh	0.0	0.0	0.0	0.0	0.0	0.0	0.0	0.0	0.0	0.0	0.0	0.0
%ile BackOfQ(50%),veh/ln	2.8	0.2	1.3	0.3	0.0	0.8	2.4	3.6	0.1	0.7	3.2	3.0
Unsig. Movement Delay, s/veh												
LnGrp Delay(d),s/veh	30.1	16.8	18.7	34.0	0.0	24.5	30.5	16.3	11.9	31.7	19.5	20.7
LnGrp LOS	C	B	B	C	A	C	C	B	B	C	B	C
Approach Vol, veh/h		367			95			619			661	
Approach Delay, s/veh		25.0			26.7			20.4			21.0	
Approach LOS		C			C			C			C	
Timer - Assigned Phs	1	2	3	4	5	6	7	8				
Phs Duration (G+Y+Rc), s	6.9	24.7	5.6	17.7	11.5	20.2	12.3	11.1				
Change Period (Y+Rc), s	* 4.2	5.7	* 4.2	* 5.3	* 4.2	* 5.7	* 4.2	5.3				
Max Green Setting (Gmax), s	* 5.3	33.5	* 5.6	* 42	* 11	* 28	* 12	35.0				
Max Q Clear Time (g_c+I1), s	3.6	12.5	2.7	6.0	7.6	11.3	8.2	4.3				
Green Ext Time (p_c), s	0.0	2.2	0.0	0.6	0.1	2.5	0.2	0.3				

Intersection Summary

HCM 6th Ctrl Delay	21.9
HCM 6th LOS	C

Notes

* HCM 6th computational engine requires equal clearance times for the phases crossing the barrier.

Intersection

Int Delay, s/veh 2.6

Movement WBL WBR NBT NBR SBL SBT

Lane Configurations						
Traffic Vol, veh/h	13	31	105	28	47	81
Future Vol, veh/h	13	31	105	28	47	81
Conflicting Peds, #/hr	0	0	0	0	0	0
Sign Control	Stop	Stop	Free	Free	Free	Free
RT Channelized	-	None	-	None	-	None
Storage Length	0	-	-	-	-	-
Veh in Median Storage, #	0	-	0	-	-	0
Grade, %	0	-	0	-	-	0
Peak Hour Factor	92	92	92	92	92	92
Heavy Vehicles, %	3	3	3	3	3	3
Mvmt Flow	14	34	114	30	51	88

Major/Minor Minor1 Major1 Major2

Conflicting Flow All	319	129	0	0	144	0
Stage 1	129	-	-	-	-	-
Stage 2	190	-	-	-	-	-
Critical Hdwy	6.43	6.23	-	-	4.13	-
Critical Hdwy Stg 1	5.43	-	-	-	-	-
Critical Hdwy Stg 2	5.43	-	-	-	-	-
Follow-up Hdwy	3.527	3.327	-	-	2.227	-
Pot Cap-1 Maneuver	672	918	-	-	1432	-
Stage 1	894	-	-	-	-	-
Stage 2	840	-	-	-	-	-
Platoon blocked, %			-	-		
Mov Cap-1 Maneuver	647	918	-	-	1432	-
Mov Cap-2 Maneuver	647	-	-	-	-	-
Stage 1	894	-	-	-	-	-
Stage 2	809	-	-	-	-	-

Approach WB NB SB

HCM Control Delay, s	9.7	0	2.8
HCM LOS	A		

Minor Lane/Major Mvmt NBT NBRWBLn1 SBL SBT

Capacity (veh/h)	-	-	817	1432	-
HCM Lane V/C Ratio	-	-	0.059	0.036	-
HCM Control Delay (s)	-	-	9.7	7.6	0
HCM Lane LOS	-	-	A	A	A
HCM 95th %tile Q(veh)	-	-	0.2	0.1	-

HCM Signalized Intersection Capacity Analysis
7: 11th Avenue & Houston Avenue

Cumulative Year 2042 Project PM Peak
05/05/2022

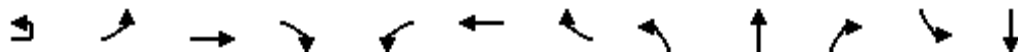

Movement	EBU	EBL	EBT	EBR	WBL	WBT	WBR	NBL	NBT	NBR	SBL	SBT
Lane Configurations		↔	↑	↗	↖	↑	↗	↖	↑↑	↗	↖	↑
Traffic Volume (vph)	1	61	269	52	35	229	82	114	529	83	55	155
Future Volume (vph)	1	61	269	52	35	229	82	114	529	83	55	155
Ideal Flow (vphp)	1900	1900	1900	1900	1900	1900	1900	1900	1900	1900	1900	1900
Total Lost time (s)		4.2	6.0	6.0	4.2	5.7	5.7	4.2	5.7	5.7	4.2	5.3
Lane Util. Factor		1.00	1.00	1.00	1.00	1.00	1.00	1.00	0.95	1.00	1.00	1.00
Frt		1.00	1.00	0.85	1.00	1.00	0.85	1.00	1.00	0.85	1.00	1.00
Flt Protected		0.95	1.00	1.00	0.95	1.00	1.00	0.95	1.00	1.00	0.95	1.00
Satd. Flow (prot)		1719	1810	1538	1719	1810	1538	1719	3438	1538	1719	1810
Flt Permitted		0.95	1.00	1.00	0.95	1.00	1.00	0.95	1.00	1.00	0.95	1.00
Satd. Flow (perm)		1719	1810	1538	1719	1810	1538	1719	3438	1538	1719	1810
Peak-hour factor, PHF	0.92	0.92	0.92	0.92	0.92	0.92	0.92	0.92	0.92	0.92	0.92	0.92
Adj. Flow (vph)	1	66	292	57	38	249	89	124	575	90	60	168
RTOR Reduction (vph)	0	0	0	40	0	0	65	0	0	63	0	0
Lane Group Flow (vph)	0	67	292	17	38	249	24	124	575	27	60	168
Heavy Vehicles (%)	5%	5%	5%	5%	5%	5%	5%	5%	5%	5%	5%	5%
Turn Type	Prot	Prot	NA	Perm	Prot	NA	Perm	Prot	NA	Perm	Prot	NA
Protected Phases	7	7	4		3	8		5	2		1	6
Permitted Phases				4			8			2		
Actuated Green, G (s)		7.3	22.4	22.4	4.9	20.3	20.3	8.0	21.9	21.9	4.9	19.2
Effective Green, g (s)		7.3	22.4	22.4	4.9	20.3	20.3	8.0	21.9	21.9	4.9	19.2
Actuated g/C Ratio		0.10	0.30	0.30	0.07	0.27	0.27	0.11	0.30	0.30	0.07	0.26
Clearance Time (s)		4.2	6.0	6.0	4.2	5.7	5.7	4.2	5.7	5.7	4.2	5.3
Vehicle Extension (s)		3.0	3.0	3.0	3.0	3.0	3.0	3.0	3.0	3.0	3.0	3.0
Lane Grp Cap (vph)		169	546	464	113	495	420	185	1014	453	113	468
v/s Ratio Prot		c0.04	c0.16		0.02	0.14		c0.07	c0.17		0.03	0.09
v/s Ratio Perm				0.01			0.02			0.02		
v/c Ratio		0.40	0.53	0.04	0.34	0.50	0.06	0.67	0.57	0.06	0.53	0.36
Uniform Delay, d1		31.4	21.6	18.3	33.1	22.7	19.9	31.8	22.1	18.8	33.5	22.5
Progression Factor		1.00	1.00	1.00	1.00	1.00	1.00	1.00	1.00	1.00	1.00	1.00
Incremental Delay, d2		1.5	1.0	0.0	1.8	0.8	0.1	9.2	0.7	0.1	4.7	0.5
Delay (s)		32.9	22.6	18.3	34.9	23.5	20.0	41.0	22.9	18.8	38.3	22.9
Level of Service		C	C	B	C	C	B	D	C	B	D	C
Approach Delay (s)			23.7			23.8			25.3			25.6
Approach LOS			C			C			C			C

Intersection Summary		
HCM 2000 Control Delay	24.7	HCM 2000 Level of Service C
HCM 2000 Volume to Capacity ratio	0.58	
Actuated Cycle Length (s)	74.2	Sum of lost time (s) 20.1
Intersection Capacity Utilization	62.2%	ICU Level of Service B
Analysis Period (min)	15	
c Critical Lane Group		



Movement	SBR
Lane Configurations	7
Traffic Volume (vph)	57
Future Volume (vph)	57
Ideal Flow (vphpl)	1900
Total Lost time (s)	5.3
Lane Util. Factor	1.00
Frt	0.85
Flt Protected	1.00
Satd. Flow (prot)	1538
Flt Permitted	1.00
Satd. Flow (perm)	1538
Peak-hour factor, PHF	0.92
Adj. Flow (vph)	62
RTOR Reduction (vph)	46
Lane Group Flow (vph)	16
Heavy Vehicles (%)	5%
Turn Type	Perm
Protected Phases	
Permitted Phases	6
Actuated Green, G (s)	19.2
Effective Green, g (s)	19.2
Actuated g/C Ratio	0.26
Clearance Time (s)	5.3
Vehicle Extension (s)	3.0
Lane Grp Cap (vph)	397
v/s Ratio Prot	
v/s Ratio Perm	0.01
v/c Ratio	0.04
Uniform Delay, d1	20.6
Progression Factor	1.00
Incremental Delay, d2	0.0
Delay (s)	20.6
Level of Service	C
Approach Delay (s)	
Approach LOS	
Intersection Summary	

Intersection

Int Delay, s/veh 2.4

Movement EBL EBT WBT WBR SBL SBR

Lane Configurations		↕	↕		↕	
Traffic Vol, veh/h	85	222	244	27	21	54
Future Vol, veh/h	85	222	244	27	21	54
Conflicting Peds, #/hr	0	0	0	0	0	0
Sign Control	Free	Free	Free	Free	Stop	Stop
RT Channelized	-	None	-	None	-	None
Storage Length	-	-	-	-	0	-
Veh in Median Storage, #	-	0	0	-	0	-
Grade, %	-	0	0	-	0	-
Peak Hour Factor	93	93	93	93	93	93
Heavy Vehicles, %	3	3	3	3	3	3
Mvmt Flow	91	239	262	29	23	58

Major/Minor Major1 Major2 Minor2

Conflicting Flow All	291	0	-	0	698	277
Stage 1	-	-	-	-	277	-
Stage 2	-	-	-	-	421	-
Critical Hdwy	4.13	-	-	-	6.43	6.23
Critical Hdwy Stg 1	-	-	-	-	5.43	-
Critical Hdwy Stg 2	-	-	-	-	5.43	-
Follow-up Hdwy	2.227	-	-	-	3.527	3.327
Pot Cap-1 Maneuver	1265	-	-	-	405	759
Stage 1	-	-	-	-	767	-
Stage 2	-	-	-	-	660	-
Platoon blocked, %		-	-	-		
Mov Cap-1 Maneuver	1265	-	-	-	371	759
Mov Cap-2 Maneuver	-	-	-	-	371	-
Stage 1	-	-	-	-	703	-
Stage 2	-	-	-	-	660	-

Approach EB WB SB

HCM Control Delay, s	2.2	0	12.1
HCM LOS			B

Minor Lane/Major Mvmt EBL EBT WBT WBR SBLn1

Capacity (veh/h)	1265	-	-	-	587
HCM Lane V/C Ratio	0.072	-	-	-	0.137
HCM Control Delay (s)	8.1	0	-	-	12.1
HCM Lane LOS	A	A	-	-	B
HCM 95th %tile Q(veh)	0.2	-	-	-	0.5

Intersection	
Intersection Delay, s/veh	14.8
Intersection LOS	B

Movement	EBL	EBT	EBR	WBL	WBT	WBR	NBL	NBT	NBR	SBL	SBT	SBR
Lane Configurations		↕			↕			↕			↕	
Traffic Vol, veh/h	102	96	25	8	161	51	38	282	8	43	151	89
Future Vol, veh/h	102	96	25	8	161	51	38	282	8	43	151	89
Peak Hour Factor	0.98	0.98	0.98	0.98	0.98	0.98	0.98	0.98	0.98	0.98	0.98	0.98
Heavy Vehicles, %	5	5	5	5	5	5	5	5	5	5	5	5
Mvmt Flow	104	98	26	8	164	52	39	288	8	44	154	91
Number of Lanes	0	1	0	0	1	0	0	1	0	0	1	0

Approach	EB	WB	NB	SB
Opposing Approach	WB	EB	SB	NB
Opposing Lanes	1	1	1	1
Conflicting Approach Left	SB	NB	EB	WB
Conflicting Lanes Left	1	1	1	1
Conflicting Approach Right	NB	SB	WB	EB
Conflicting Lanes Right	1	1	1	1
HCM Control Delay	13.8	13.4	16.6	14.5
HCM LOS	B	B	C	B

Lane	NBLn1	EBLn1	WBLn1	SBLn1
Vol Left, %	12%	46%	4%	15%
Vol Thru, %	86%	43%	73%	53%
Vol Right, %	2%	11%	23%	31%
Sign Control	Stop	Stop	Stop	Stop
Traffic Vol by Lane	328	223	220	283
LT Vol	38	102	8	43
Through Vol	282	96	161	151
RT Vol	8	25	51	89
Lane Flow Rate	335	228	224	289
Geometry Grp	1	1	1	1
Degree of Util (X)	0.562	0.406	0.392	0.48
Departure Headway (Hd)	6.049	6.426	6.287	5.986
Convergence, Y/N	Yes	Yes	Yes	Yes
Cap	596	560	572	601
Service Time	4.09	4.474	4.336	4.029
HCM Lane V/C Ratio	0.562	0.407	0.392	0.481
HCM Control Delay	16.6	13.8	13.4	14.5
HCM Lane LOS	C	B	B	B
HCM 95th-tile Q	3.5	2	1.9	2.6

Intersection: 1: Douty St & 3rd Street

Movement	EB	EB	EB	NB	NB	NB	SB
Directions Served	L	T	TR	T	T	R	LT
Maximum Queue (ft)	100	94	112	79	77	55	94
Average Queue (ft)	58	51	47	38	34	29	55
95th Queue (ft)	90	81	78	58	64	55	88
Link Distance (ft)	320	320	320	356	356		787
Upstream Blk Time (%)							
Queuing Penalty (veh)							
Storage Bay Dist (ft)						90	
Storage Blk Time (%)					0		
Queuing Penalty (veh)					0		

Intersection: 2: 10th Avenue & 4th Street/SR-198 WB Off Ramp

Movement	WB	NB	NB	NB	SB	SB	SB
Directions Served	LTR	L	T	T	T	T	R
Maximum Queue (ft)	230	93	180	175	235	188	93
Average Queue (ft)	74	40	77	78	121	49	49
95th Queue (ft)	156	76	136	144	195	144	82
Link Distance (ft)	775		759	759	758	758	
Upstream Blk Time (%)							
Queuing Penalty (veh)							
Storage Bay Dist (ft)		295					105
Storage Blk Time (%)						0	0
Queuing Penalty (veh)						0	0

Intersection: 3: 10 1/2 Avenue & Hanford Armona Road

Movement	EB	EB	WB	WB	NB	NB	NB	SB	SB	SB
Directions Served	L	TR	L	TR	L	T	R	L	T	R
Maximum Queue (ft)	89	169	58	212	137	75	65	31	89	52
Average Queue (ft)	36	71	18	66	65	35	18	9	18	12
95th Queue (ft)	73	128	49	139	112	66	47	32	61	37
Link Distance (ft)		1346		1547		396			386	
Upstream Blk Time (%)										
Queuing Penalty (veh)										
Storage Bay Dist (ft)	150		95		150		95	150		100
Storage Blk Time (%)		0		3	0				0	
Queuing Penalty (veh)		0		1	0				0	

Intersection: 4: Jordan Way & Hanford Armona Road

Movement	WB	NB
Directions Served	L	LR
Maximum Queue (ft)	31	74
Average Queue (ft)	5	43
95th Queue (ft)	22	65
Link Distance (ft)	1339	
Upstream Blk Time (%)		
Queuing Penalty (veh)		
Storage Bay Dist (ft)	75	
Storage Blk Time (%)		
Queuing Penalty (veh)		

Intersection: 5: 10th Avenue & Hanford Armona Road

Movement	EB	EB	EB	WB	WB	NB	NB	SB	SB	SB	
Directions Served	L	T	R	L	TR	L	T	L	T	R	
Maximum Queue (ft)	149	75	61	30	52	94	178	31	159	133	
Average Queue (ft)	86	5	21	4	19	37	59	8	65	46	
95th Queue (ft)	140	28	44	19	46	77	130	29	130	95	
Link Distance (ft)	936			372			448			399	
Upstream Blk Time (%)											
Queuing Penalty (veh)											
Storage Bay Dist (ft)	105		55		155		155		110		265
Storage Blk Time (%)	4	0	0				2	1			
Queuing Penalty (veh)	3	0	1				1	1			

Intersection: 6: 10 1/2 Avenue & Orchard Avenue

Movement	WB	SB
Directions Served	LR	LT
Maximum Queue (ft)	90	27
Average Queue (ft)	29	1
95th Queue (ft)	59	9
Link Distance (ft)	862	2833
Upstream Blk Time (%)		
Queuing Penalty (veh)		
Storage Bay Dist (ft)		
Storage Blk Time (%)		
Queuing Penalty (veh)		

Intersection: 7: 11th Avenue & Houston Avenue

Movement	EB	EB	EB	WB	WB	WB	NB	NB	NB	NB	SB	SB
Directions Served	UL	T	R	L	T	R	L	T	T	R	L	T
Maximum Queue (ft)	96	136	57	48	132	43	109	92	128	74	87	109
Average Queue (ft)	47	57	17	24	59	12	33	33	29	13	33	38
95th Queue (ft)	94	117	45	47	111	31	77	67	82	39	71	82
Link Distance (ft)		680			436			276	276			1524
Upstream Blk Time (%)												
Queuing Penalty (veh)												
Storage Bay Dist (ft)	165		150	175		175	175			100	250	
Storage Blk Time (%)		0							0			
Queuing Penalty (veh)		0							0			

Intersection: 7: 11th Avenue & Houston Avenue

Movement	SB
Directions Served	R
Maximum Queue (ft)	35
Average Queue (ft)	11
95th Queue (ft)	27
Link Distance (ft)	1524
Upstream Blk Time (%)	
Queuing Penalty (veh)	
Storage Bay Dist (ft)	
Storage Blk Time (%)	
Queuing Penalty (veh)	

Intersection: 8: Houston Avenue & 10 1/2 Avenue

Movement	EB	SB
Directions Served	LT	LR
Maximum Queue (ft)	62	70
Average Queue (ft)	9	35
95th Queue (ft)	36	62
Link Distance (ft)	2076	2057
Upstream Blk Time (%)		
Queuing Penalty (veh)		
Storage Bay Dist (ft)		
Storage Blk Time (%)		
Queuing Penalty (veh)		

Intersection: 9: 10th Avenue & Houston Avenue

Movement	EB	WB	NB	SB
Directions Served	LTR	LTR	LTR	LTR
Maximum Queue (ft)	117	79	74	124
Average Queue (ft)	59	40	44	59
95th Queue (ft)	93	62	70	100
Link Distance (ft)	2557	1661	1092	4776
Upstream Blk Time (%)				
Queuing Penalty (veh)				
Storage Bay Dist (ft)				
Storage Blk Time (%)				
Queuing Penalty (veh)				

Intersection: 10: 3rd Street & SR-198 EB Off Ramp

Movement	SE
Directions Served	L
Maximum Queue (ft)	75
Average Queue (ft)	34
95th Queue (ft)	66
Link Distance (ft)	209
Upstream Blk Time (%)	
Queuing Penalty (veh)	
Storage Bay Dist (ft)	
Storage Blk Time (%)	
Queuing Penalty (veh)	

Network Summary

Network wide Queuing Penalty: 9

Intersection: 1: Douty St & 3rd Street

Movement	EB	EB	EB	NB	NB	NB	SB	SB
Directions Served	L	T	TR	T	T	R	LT	T
Maximum Queue (ft)	146	209	181	74	77	78	243	56
Average Queue (ft)	75	91	89	39	40	26	104	20
95th Queue (ft)	123	153	139	60	64	54	177	53
Link Distance (ft)	320	320	320	356	356		787	787
Upstream Blk Time (%)								
Queuing Penalty (veh)								
Storage Bay Dist (ft)						90		
Storage Blk Time (%)					0	0		
Queuing Penalty (veh)					0	0		

Intersection: 2: 10th Avenue & 4th Street/SR-198 WB Off Ramp

Movement	WB	NB	NB	NB	SB	SB	SB
Directions Served	LTR	L	T	T	T	T	R
Maximum Queue (ft)	223	345	488	463	345	283	225
Average Queue (ft)	94	276	277	173	227	166	58
95th Queue (ft)	156	421	561	381	327	278	135
Link Distance (ft)	775		759	759	758	758	
Upstream Blk Time (%)							
Queuing Penalty (veh)							
Storage Bay Dist (ft)		295					105
Storage Blk Time (%)		51	0			3	
Queuing Penalty (veh)		256	0			6	

Intersection: 3: 10 1/2 Avenue & Hanford Armona Road

Movement	EB	EB	WB	WB	NB	NB	NB	SB	SB	SB
Directions Served	L	TR	L	TR	L	T	R	L	T	R
Maximum Queue (ft)	219	420	174	209	214	230	31	51	77	53
Average Queue (ft)	45	186	65	104	92	41	8	21	36	30
95th Queue (ft)	143	324	140	186	149	108	29	49	72	57
Link Distance (ft)		1346		1547		396			386	
Upstream Blk Time (%)										
Queuing Penalty (veh)										
Storage Bay Dist (ft)	150		95		150		95	150		100
Storage Blk Time (%)		14	2	9	2	0				
Queuing Penalty (veh)		6	8	6	2	0				

Intersection: 4: Jordan Way & Hanford Armona Road

Movement	WB	NB
Directions Served	L	LR
Maximum Queue (ft)	75	96
Average Queue (ft)	24	44
95th Queue (ft)	52	71
Link Distance (ft)	1339	
Upstream Blk Time (%)		
Queuing Penalty (veh)		
Storage Bay Dist (ft)	75	
Storage Blk Time (%)	0	
Queuing Penalty (veh)	0	

Intersection: 5: 10th Avenue & Hanford Armona Road

Movement	EB	EB	EB	WB	WB	NB	NB	NB	SB	SB	SB	
Directions Served	L	T	R	L	TR	L	T	R	L	T	R	
Maximum Queue (ft)	162	194	80	52	94	136	211	44	194	336	357	
Average Queue (ft)	93	21	28	17	44	86	111	4	42	133	86	
95th Queue (ft)	153	79	57	41	91	134	198	22	99	258	187	
Link Distance (ft)	936			372			448			399		
Upstream Blk Time (%)												
Queuing Penalty (veh)												
Storage Bay Dist (ft)	105		55	155		155		130	110		265	
Storage Blk Time (%)	8	0	1			0	5			11		
Queuing Penalty (veh)	13	0	2			0	10			35		

Intersection: 6: 10 1/2 Avenue & Orchard Avenue

Movement	WB	SB
Directions Served	LR	LT
Maximum Queue (ft)	31	31
Average Queue (ft)	27	4
95th Queue (ft)	42	19
Link Distance (ft)	862	2833
Upstream Blk Time (%)		
Queuing Penalty (veh)		
Storage Bay Dist (ft)		
Storage Blk Time (%)		
Queuing Penalty (veh)		

Intersection: 7: 11th Avenue & Houston Avenue

Movement	EB	EB	EB	WB	WB	WB	NB	NB	NB	NB	SB	SB
Directions Served	UL	T	R	L	T	R	L	T	T	R	L	T
Maximum Queue (ft)	112	219	44	69	187	43	104	152	171	62	69	216
Average Queue (ft)	37	90	16	19	77	20	50	89	83	21	33	78
95th Queue (ft)	76	162	36	50	165	38	83	149	143	43	70	172
Link Distance (ft)		680			436			276	276			1524
Upstream Blk Time (%)												
Queuing Penalty (veh)												
Storage Bay Dist (ft)	165		150	175		175	175			100	250	
Storage Blk Time (%)		2			1			5				
Queuing Penalty (veh)		2			1			4				

Intersection: 7: 11th Avenue & Houston Avenue

Movement	SB
Directions Served	R
Maximum Queue (ft)	33
Average Queue (ft)	12
95th Queue (ft)	25
Link Distance (ft)	1524
Upstream Blk Time (%)	
Queuing Penalty (veh)	
Storage Bay Dist (ft)	
Storage Blk Time (%)	
Queuing Penalty (veh)	

Intersection: 8: Houston Avenue & 10 1/2 Avenue

Movement	EB	SB
Directions Served	LT	LR
Maximum Queue (ft)	52	74
Average Queue (ft)	20	33
95th Queue (ft)	45	58
Link Distance (ft)	2076	2057
Upstream Blk Time (%)		
Queuing Penalty (veh)		
Storage Bay Dist (ft)		
Storage Blk Time (%)		
Queuing Penalty (veh)		

Intersection: 9: 10th Avenue & Houston Avenue

Movement	EB	WB	NB	SB
Directions Served	LTR	LTR	LTR	LTR
Maximum Queue (ft)	118	184	160	189
Average Queue (ft)	51	61	69	73
95th Queue (ft)	84	119	119	138
Link Distance (ft)	2557	1661	1092	4776
Upstream Blk Time (%)				
Queuing Penalty (veh)				
Storage Bay Dist (ft)				
Storage Blk Time (%)				
Queuing Penalty (veh)				

Intersection: 10: 3rd Street & SR-198 EB Off Ramp

Movement	EB	SE
Directions Served	T	L
Maximum Queue (ft)	75	243
Average Queue (ft)	9	95
95th Queue (ft)	40	204
Link Distance (ft)	361	209
Upstream Blk Time (%)		3
Queuing Penalty (veh)		0
Storage Bay Dist (ft)		
Storage Blk Time (%)		
Queuing Penalty (veh)		

Network Summary

Network wide Queuing Penalty: 351

HCS7 Two-Lane Highway Report

Project Information

Analyst	C. Ayala-Magana	Date	7/20/2022
Agency	JLB Traffic Engineering, Inc.	Analysis Year	2022
Jurisdiction	City of Hanford	Time Period Analyzed	Cumulative Year 2042 Plus Project AM Peak
Project Description	01 Hanford-Armona Road Between 11th Avenue and 10 1/2 Avenue	Unit	United States Customary

Segment 1

Vehicle Inputs

Segment Type	Passing Constrained	Length, ft	2583
Lane Width, ft	12	Shoulder Width, ft	6
Speed Limit, mi/h	40	Access Point Density, pts/mi	34.8

Demand and Capacity

Directional Demand Flow Rate, veh/h	556	Opposing Demand Flow Rate, veh/h	-
Peak Hour Factor	0.72	Total Trucks, %	4.02
Segment Capacity, veh/h	1700	Demand/Capacity (D/C)	0.33

Intermediate Results

Segment Vertical Class	1	Free-Flow Speed, mi/h	36.8
Speed Slope Coefficient	2.52197	Speed Power Coefficient	0.41674
PF Slope Coefficient	-1.44139	PF Power Coefficient	0.67822
In Passing Lane Effective Length?	No	Total Segment Density, veh/mi/ln	9.9
%Improved % Followers	0.0	% Improved Avg Speed	0.0

Subsegment Data

#	Segment Type	Length, ft	Radius, ft	Superelevation, %	Average Speed, mi/h
1	Tangent	2583	-	-	34.9

Vehicle Results

Average Speed, mi/h	34.9	Percent Followers, %	62.0
Segment Travel Time, minutes	0.84	Follower Density, followers/mi/ln	9.9
Vehicle LOS	C		

Facility Results

T	Follower Density, followers/mi/ln	LOS
1	9.9	C

HCS7 Two-Lane Highway Report

Project Information

Analyst	C. Ayala-Magana	Date	7/20/2022
Agency	JLB Traffic Engineering, Inc.	Analysis Year	2022
Jurisdiction	City of Hanford	Time Period Analyzed	Cumulative Year 2042 Plus Project AM Peak
Project Description	02 Hanford-Armona Road Between 10 1/2 Avenue and Jordan Way	Unit	United States Customary

Segment 1

Vehicle Inputs

Segment Type	Passing Constrained	Length, ft	1556
Lane Width, ft	12	Shoulder Width, ft	6
Speed Limit, mi/h	40	Access Point Density, pts/mi	67.9

Demand and Capacity

Directional Demand Flow Rate, veh/h	353	Opposing Demand Flow Rate, veh/h	-
Peak Hour Factor	0.74	Total Trucks, %	3.39
Segment Capacity, veh/h	1700	Demand/Capacity (D/C)	0.21

Intermediate Results

Segment Vertical Class	1	Free-Flow Speed, mi/h	35.5
Speed Slope Coefficient	2.43653	Speed Power Coefficient	0.41674
PF Slope Coefficient	-1.48329	PF Power Coefficient	0.66113
In Passing Lane Effective Length?	No	Total Segment Density, veh/mi/ln	5.4
%Improved % Followers	0.0	% Improved Avg Speed	0.0

Subsegment Data

#	Segment Type	Length, ft	Radius, ft	Superelevation, %	Average Speed, mi/h
1	Tangent	1556	-	-	34.1

Vehicle Results

Average Speed, mi/h	34.1	Percent Followers, %	52.5
Segment Travel Time, minutes	0.52	Follower Density, followers/mi/ln	5.4
Vehicle LOS	C		

Facility Results

T	Follower Density, followers/mi/ln	LOS
1	5.4	C

HCS7 Two-Lane Highway Report

Project Information

Analyst	C. Ayala-Magana	Date	7/20/2022
Agency	JLB Traffic Engineering, Inc.	Analysis Year	2022
Jurisdiction	City of Hanford	Time Period Analyzed	Cumulative Year 2042 Plus Project AM Peak
Project Description	03 Hanford-Armona Road Between Jordan Way and 10th Avenue	Unit	United States Customary

Segment 1

Vehicle Inputs

Segment Type	Passing Constrained	Length, ft	901
Lane Width, ft	12	Shoulder Width, ft	6
Speed Limit, mi/h	40	Access Point Density, pts/mi	23.4

Demand and Capacity

Directional Demand Flow Rate, veh/h	336	Opposing Demand Flow Rate, veh/h	-
Peak Hour Factor	0.75	Total Trucks, %	6.25
Segment Capacity, veh/h	1700	Demand/Capacity (D/C)	0.20

Intermediate Results

Segment Vertical Class	1	Free-Flow Speed, mi/h	39.5
Speed Slope Coefficient	2.65189	Speed Power Coefficient	0.41674
PF Slope Coefficient	-1.50451	PF Power Coefficient	0.67582
In Passing Lane Effective Length?	No	Total Segment Density, veh/mi/ln	4.5
%Improved % Followers	0.0	% Improved Avg Speed	0.0

Subsegment Data

#	Segment Type	Length, ft	Radius, ft	Superelevation, %	Average Speed, mi/h
1	Tangent	901	-	-	38.1

Vehicle Results

Average Speed, mi/h	38.1	Percent Followers, %	51.3
Segment Travel Time, minutes	0.27	Follower Density, followers/mi/ln	4.5
Vehicle LOS	B		

Facility Results

T	Follower Density, followers/mi/ln	LOS
1	4.5	B

HCS7 Two-Lane Highway Report

Project Information

Analyst	C. Ayala-Magana	Date	7/20/2022
Agency	JLB Traffic Engineering, Inc.	Analysis Year	2022
Jurisdiction	City of Hanford	Time Period Analyzed	Cumulative Year 2042 Plus Project AM Peak
Project Description	04 10.5 Avenue Between Hanford Armona Drive and Orchard Avenue	Unit	United States Customary

Segment 1

Vehicle Inputs

Segment Type	Passing Constrained	Length, ft	2735
Lane Width, ft	12	Shoulder Width, ft	2
Speed Limit, mi/h	40	Access Point Density, pts/mi	50.2

Demand and Capacity

Directional Demand Flow Rate, veh/h	317	Opposing Demand Flow Rate, veh/h	-
Peak Hour Factor	0.60	Total Trucks, %	9.87
Segment Capacity, veh/h	1700	Demand/Capacity (D/C)	0.19

Intermediate Results

Segment Vertical Class	1	Free-Flow Speed, mi/h	32.5
Speed Slope Coefficient	2.29128	Speed Power Coefficient	0.41674
PF Slope Coefficient	-1.42068	PF Power Coefficient	0.65951
In Passing Lane Effective Length?	No	Total Segment Density, veh/mi/ln	4.9
%Improved % Followers	0.0	% Improved Avg Speed	0.0

Subsegment Data

#	Segment Type	Length, ft	Radius, ft	Superelevation, %	Average Speed, mi/h
1	Tangent	2735	-	-	31.3

Vehicle Results

Average Speed, mi/h	31.3	Percent Followers, %	48.6
Segment Travel Time, minutes	0.99	Follower Density, followers/mi/ln	4.9
Vehicle LOS	B		

Facility Results

T	Follower Density, followers/mi/ln	LOS
1	4.9	B

HCS7 Two-Lane Highway Report

Project Information

Analyst	C. Ayala-Magana	Date	7/20/2022
Agency	JLB Traffic Engineering, Inc.	Analysis Year	2022
Jurisdiction	City of Hanford	Time Period Analyzed	Cumulative Year 2042 Plus Project AM Peak
Project Description	05 10.5 Avenue Between Orchard Avenue and Houston Avenue	Unit	United States Customary

Segment 1

Vehicle Inputs

Segment Type	Passing Constrained	Length, ft	2594
Lane Width, ft	12	Shoulder Width, ft	2
Speed Limit, mi/h	40	Access Point Density, pts/mi	52.9

Demand and Capacity

Directional Demand Flow Rate, veh/h	176	Opposing Demand Flow Rate, veh/h	-
Peak Hour Factor	0.42	Total Trucks, %	13.33
Segment Capacity, veh/h	1700	Demand/Capacity (D/C)	0.10

Intermediate Results

Segment Vertical Class	1	Free-Flow Speed, mi/h	32.4
Speed Slope Coefficient	2.28310	Speed Power Coefficient	0.41674
PF Slope Coefficient	-1.42395	PF Power Coefficient	0.65839
In Passing Lane Effective Length?	No	Total Segment Density, veh/mi/ln	2.0
%Improved % Followers	0.0	% Improved Avg Speed	0.0

Subsegment Data

#	Segment Type	Length, ft	Radius, ft	Superelevation, %	Average Speed, mi/h
1	Tangent	2594	-	-	31.6

Vehicle Results

Average Speed, mi/h	31.6	Percent Followers, %	36.5
Segment Travel Time, minutes	0.93	Follower Density, followers/mi/ln	2.0
Vehicle LOS	A		

Facility Results

T	Follower Density, followers/mi/ln	LOS
1	2.0	A

HCS7 Two-Lane Highway Report

Project Information

Analyst	C. Ayala-Magana	Date	7/20/2022
Agency	JLB Traffic Engineering, Inc.	Analysis Year	2022
Jurisdiction	City of Hanford	Time Period Analyzed	Cumulative Year 2042 Plus Project AM Peak
Project Description	06 Houston Avenue Between 11th Avenue and 10 1/2 Avenue	Unit	United States Customary

Segment 1

Vehicle Inputs

Segment Type	Passing Constrained	Length, ft	2567
Lane Width, ft	12	Shoulder Width, ft	2
Speed Limit, mi/h	50	Access Point Density, pts/mi	20.6

Demand and Capacity

Directional Demand Flow Rate, veh/h	329	Opposing Demand Flow Rate, veh/h	-
Peak Hour Factor	0.68	Total Trucks, %	21.40
Segment Capacity, veh/h	1700	Demand/Capacity (D/C)	0.19

Intermediate Results

Segment Vertical Class	1	Free-Flow Speed, mi/h	48.3
Speed Slope Coefficient	3.14891	Speed Power Coefficient	0.41674
PF Slope Coefficient	-1.42118	PF Power Coefficient	0.72418
In Passing Lane Effective Length?	No	Total Segment Density, veh/mi/ln	3.3
%Improved % Followers	0.0	% Improved Avg Speed	0.0

Subsegment Data

#	Segment Type	Length, ft	Radius, ft	Superelevation, %	Average Speed, mi/h
1	Tangent	2567	-	-	46.6

Vehicle Results

Average Speed, mi/h	46.6	Percent Followers, %	47.1
Segment Travel Time, minutes	0.63	Follower Density, followers/mi/ln	3.3
Vehicle LOS	B		

Facility Results

T	Follower Density, followers/mi/ln	LOS
1	3.3	B

HCS7 Two-Lane Highway Report

Project Information

Analyst	C. Ayala-Magana	Date	7/20/2022
Agency	JLB Traffic Engineering, Inc.	Analysis Year	2022
Jurisdiction	City of Hanford	Time Period Analyzed	Cumulative Year 2042 Plus Project AM Peak
Project Description	07 Houston Avenue Between 10 1/2 Avenue and 10th Avenue	Unit	United States Customary

Segment 1

Vehicle Inputs

Segment Type	Passing Constrained	Length, ft	2570
Lane Width, ft	12	Shoulder Width, ft	2
Speed Limit, mi/h	55	Access Point Density, pts/mi	45.2

Demand and Capacity

Directional Demand Flow Rate, veh/h	224	Opposing Demand Flow Rate, veh/h	-
Peak Hour Factor	0.88	Total Trucks, %	17.65
Segment Capacity, veh/h	1700	Demand/Capacity (D/C)	0.13

Intermediate Results

Segment Vertical Class	1	Free-Flow Speed, mi/h	49.3
Speed Slope Coefficient	3.20179	Speed Power Coefficient	0.41674
PF Slope Coefficient	-1.41674	PF Power Coefficient	0.72668
In Passing Lane Effective Length?	No	Total Segment Density, veh/mi/ln	1.8
%Improved % Followers	0.0	% Improved Avg Speed	0.0

Subsegment Data

#	Segment Type	Length, ft	Radius, ft	Superelevation, %	Average Speed, mi/h
1	Tangent	2570	-	-	48.0

Vehicle Results

Average Speed, mi/h	48.0	Percent Followers, %	38.0
Segment Travel Time, minutes	0.61	Follower Density, followers/mi/ln	1.8
Vehicle LOS	A		

Facility Results

T	Follower Density, followers/mi/ln	LOS
1	1.8	A

HCS7 Two-Lane Highway Report

Project Information

Analyst	C. Ayala-Magana	Date	7/20/2022
Agency	JLB Traffic Engineering, Inc.	Analysis Year	2022
Jurisdiction	City of Hanford	Time Period Analyzed	Cumulative Year 2042 Plus Project PM Peak
Project Description	01 Hanford-Armona Road Between 11th Avenue and 10 1/2 Avenue	Unit	United States Customary

Segment 1

Vehicle Inputs

Segment Type	Passing Constrained	Length, ft	2583
Lane Width, ft	12	Shoulder Width, ft	6
Speed Limit, mi/h	40	Access Point Density, pts/mi	34.8

Demand and Capacity

Directional Demand Flow Rate, veh/h	712	Opposing Demand Flow Rate, veh/h	-
Peak Hour Factor	0.83	Total Trucks, %	3.00
Segment Capacity, veh/h	1700	Demand/Capacity (D/C)	0.42

Intermediate Results

Segment Vertical Class	1	Free-Flow Speed, mi/h	36.8
Speed Slope Coefficient	2.52381	Speed Power Coefficient	0.41674
PF Slope Coefficient	-1.44159	PF Power Coefficient	0.67823
In Passing Lane Effective Length?	No	Total Segment Density, veh/mi/ln	14.0
%Improved % Followers	0.0	% Improved Avg Speed	0.0

Subsegment Data

#	Segment Type	Length, ft	Radius, ft	Superelevation, %	Average Speed, mi/h
1	Tangent	2583	-	-	34.7

Vehicle Results

Average Speed, mi/h	34.7	Percent Followers, %	68.2
Segment Travel Time, minutes	0.84	Follower Density, followers/mi/ln	14.0
Vehicle LOS	D		

Facility Results

T	Follower Density, followers/mi/ln	LOS
1	14.0	D

HCS7 Two-Lane Highway Report

Project Information

Analyst	C. Ayala-Magana	Date	7/20/2022
Agency	JLB Traffic Engineering, Inc.	Analysis Year	2022
Jurisdiction	City of Hanford	Time Period Analyzed	Cumulative Year 2042 Plus Project PM Peak
Project Description	02 Hanford-Armona Road Between 10 1/2 Avenue and Jordan Way	Unit	United States Customary

Segment 1

Vehicle Inputs

Segment Type	Passing Constrained	Length, ft	1556
Lane Width, ft	12	Shoulder Width, ft	6
Speed Limit, mi/h	40	Access Point Density, pts/mi	67.9

Demand and Capacity

Directional Demand Flow Rate, veh/h	464	Opposing Demand Flow Rate, veh/h	-
Peak Hour Factor	0.85	Total Trucks, %	3.00
Segment Capacity, veh/h	1700	Demand/Capacity (D/C)	0.27

Intermediate Results

Segment Vertical Class	1	Free-Flow Speed, mi/h	35.5
Speed Slope Coefficient	2.43724	Speed Power Coefficient	0.41674
PF Slope Coefficient	-1.48339	PF Power Coefficient	0.66114
In Passing Lane Effective Length?	No	Total Segment Density, veh/mi/ln	8.1
%Improved % Followers	0.0	% Improved Avg Speed	0.0

Subsegment Data

#	Segment Type	Length, ft	Radius, ft	Superelevation, %	Average Speed, mi/h
1	Tangent	1556	-	-	33.9

Vehicle Results

Average Speed, mi/h	33.9	Percent Followers, %	59.0
Segment Travel Time, minutes	0.52	Follower Density, followers/mi/ln	8.1
Vehicle LOS	C		

Facility Results

T	Follower Density, followers/mi/ln	LOS
1	8.1	C

HCS7 Two-Lane Highway Report

Project Information

Analyst	C. Ayala-Magana	Date	7/20/2022
Agency	JLB Traffic Engineering, Inc.	Analysis Year	2022
Jurisdiction	City of Hanford	Time Period Analyzed	Cumulative Year 2042 Plus Project PM Peak
Project Description	03 Hanford-Armona Road Between Jordan Way and 10th Avenue	Unit	United States Customary

Segment 1

Vehicle Inputs

Segment Type	Passing Constrained	Length, ft	901
Lane Width, ft	12	Shoulder Width, ft	6
Speed Limit, mi/h	40	Access Point Density, pts/mi	17.6

Demand and Capacity

Directional Demand Flow Rate, veh/h	469	Opposing Demand Flow Rate, veh/h	-
Peak Hour Factor	0.97	Total Trucks, %	3.00
Segment Capacity, veh/h	1700	Demand/Capacity (D/C)	0.28

Intermediate Results

Segment Vertical Class	1	Free-Flow Speed, mi/h	41.1
Speed Slope Coefficient	2.73635	Speed Power Coefficient	0.41674
PF Slope Coefficient	-1.50445	PF Power Coefficient	0.68170
In Passing Lane Effective Length?	No	Total Segment Density, veh/mi/ln	7.1
%Improved % Followers	0.0	% Improved Avg Speed	0.0

Subsegment Data

#	Segment Type	Length, ft	Radius, ft	Superelevation, %	Average Speed, mi/h
1	Tangent	901	-	-	39.3

Vehicle Results

Average Speed, mi/h	39.3	Percent Followers, %	59.3
Segment Travel Time, minutes	0.26	Follower Density, followers/mi/ln	7.1
Vehicle LOS	C		

Facility Results

T	Follower Density, followers/mi/ln	LOS
1	7.1	C

HCS7 Two-Lane Highway Report

Project Information

Analyst	C. Ayala-Magana	Date	7/20/2022
Agency	JLB Traffic Engineering, Inc.	Analysis Year	2022
Jurisdiction	City of Hanford	Time Period Analyzed	Cumulative Year 2042 Plus Project PM Peak
Project Description	04 10.5 Avenue Between Hanford Armona Drive and Orchard Avenue	Unit	United States Customary

Segment 1

Vehicle Inputs

Segment Type	Passing Constrained	Length, ft	2735
Lane Width, ft	12	Shoulder Width, ft	2
Speed Limit, mi/h	40	Access Point Density, pts/mi	50.2

Demand and Capacity

Directional Demand Flow Rate, veh/h	368	Opposing Demand Flow Rate, veh/h	-
Peak Hour Factor	0.75	Total Trucks, %	3.00
Segment Capacity, veh/h	1700	Demand/Capacity (D/C)	0.22

Intermediate Results

Segment Vertical Class	1	Free-Flow Speed, mi/h	32.7
Speed Slope Coefficient	2.30368	Speed Power Coefficient	0.41674
PF Slope Coefficient	-1.42275	PF Power Coefficient	0.65971
In Passing Lane Effective Length?	No	Total Segment Density, veh/mi/ln	6.1
%Improved % Followers	0.0	% Improved Avg Speed	0.0

Subsegment Data

#	Segment Type	Length, ft	Radius, ft	Superelevation, %	Average Speed, mi/h
1	Tangent	2735	-	-	31.4

Vehicle Results

Average Speed, mi/h	31.4	Percent Followers, %	52.1
Segment Travel Time, minutes	0.99	Follower Density, followers/mi/ln	6.1
Vehicle LOS	C		

Facility Results

T	Follower Density, followers/mi/ln	LOS
1	6.1	C

HCS7 Two-Lane Highway Report

Project Information

Analyst	C. Ayala-Magana	Date	7/20/2022
Agency	JLB Traffic Engineering, Inc.	Analysis Year	2022
Jurisdiction	City of Hanford	Time Period Analyzed	Cumulative Year 2042 Plus Project PM Peak
Project Description	05 10.5 Avenue Between Orchard Avenue and Houston Avenue	Unit	United States Customary

Segment 1

Vehicle Inputs

Segment Type	Passing Constrained	Length, ft	2594
Lane Width, ft	12	Shoulder Width, ft	2
Speed Limit, mi/h	40	Access Point Density, pts/mi	52.9

Demand and Capacity

Directional Demand Flow Rate, veh/h	229	Opposing Demand Flow Rate, veh/h	-
Peak Hour Factor	0.56	Total Trucks, %	3.70
Segment Capacity, veh/h	1700	Demand/Capacity (D/C)	0.13

Intermediate Results

Segment Vertical Class	1	Free-Flow Speed, mi/h	32.7
Speed Slope Coefficient	2.30048	Speed Power Coefficient	0.41674
PF Slope Coefficient	-1.42689	PF Power Coefficient	0.65868
In Passing Lane Effective Length?	No	Total Segment Density, veh/mi/ln	3.0
%Improved % Followers	0.0	% Improved Avg Speed	0.0

Subsegment Data

#	Segment Type	Length, ft	Radius, ft	Superelevation, %	Average Speed, mi/h
1	Tangent	2594	-	-	31.7

Vehicle Results

Average Speed, mi/h	31.7	Percent Followers, %	41.7
Segment Travel Time, minutes	0.93	Follower Density, followers/mi/ln	3.0
Vehicle LOS	B		

Facility Results

T	Follower Density, followers/mi/ln	LOS
1	3.0	B

HCS7 Two-Lane Highway Report

Project Information

Analyst	C. Ayala-Magana	Date	7/20/2022
Agency	JLB Traffic Engineering, Inc.	Analysis Year	2022
Jurisdiction	City of Hanford	Time Period Analyzed	Cumulative Year 2042 Plus Project PM Peak
Project Description	06 Houston Avenue Between 11th Avenue and 10 1/2 Avenue	Unit	United States Customary

Segment 1

Vehicle Inputs

Segment Type	Passing Constrained	Length, ft	2567
Lane Width, ft	12	Shoulder Width, ft	2
Speed Limit, mi/h	50	Access Point Density, pts/mi	20.6

Demand and Capacity

Directional Demand Flow Rate, veh/h	458	Opposing Demand Flow Rate, veh/h	-
Peak Hour Factor	0.89	Total Trucks, %	3.75
Segment Capacity, veh/h	1700	Demand/Capacity (D/C)	0.27

Intermediate Results

Segment Vertical Class	1	Free-Flow Speed, mi/h	48.9
Speed Slope Coefficient	3.18076	Speed Power Coefficient	0.41674
PF Slope Coefficient	-1.42061	PF Power Coefficient	0.72351
In Passing Lane Effective Length?	No	Total Segment Density, veh/mi/ln	5.4
%Improved % Followers	0.0	% Improved Avg Speed	0.0

Subsegment Data

#	Segment Type	Length, ft	Radius, ft	Superelevation, %	Average Speed, mi/h
1	Tangent	2567	-	-	46.9

Vehicle Results

Average Speed, mi/h	46.9	Percent Followers, %	55.4
Segment Travel Time, minutes	0.62	Follower Density, followers/mi/ln	5.4
Vehicle LOS	C		

Facility Results

T	Follower Density, followers/mi/ln	LOS
1	5.4	C

HCS7 Two-Lane Highway Report

Project Information

Analyst	C. Ayala-Magana	Date	7/20/2022
Agency	JLB Traffic Engineering, Inc.	Analysis Year	2022
Jurisdiction	City of Hanford	Time Period Analyzed	Cumulative Year 2042 Plus Project PM Peak
Project Description	07 Houston Avenue Between 10 1/2 Avenue and 10th Avenue	Unit	United States Customary

Segment 1

Vehicle Inputs

Segment Type	Passing Constrained	Length, ft	2570
Lane Width, ft	12	Shoulder Width, ft	2
Speed Limit, mi/h	55	Access Point Density, pts/mi	45.2

Demand and Capacity

Directional Demand Flow Rate, veh/h	354	Opposing Demand Flow Rate, veh/h	-
Peak Hour Factor	0.90	Total Trucks, %	3.00
Segment Capacity, veh/h	1700	Demand/Capacity (D/C)	0.21

Intermediate Results

Segment Vertical Class	1	Free-Flow Speed, mi/h	49.8
Speed Slope Coefficient	3.22823	Speed Power Coefficient	0.41674
PF Slope Coefficient	-1.41606	PF Power Coefficient	0.72608
In Passing Lane Effective Length?	No	Total Segment Density, veh/mi/ln	3.6
%Improved % Followers	0.0	% Improved Avg Speed	0.0

Subsegment Data

#	Segment Type	Length, ft	Radius, ft	Superelevation, %	Average Speed, mi/h
1	Tangent	2570	-	-	48.0

Vehicle Results

























Average Speed, mi/h	48.0	Percent Followers, %	48.7
Segment Travel Time, minutes	0.61	Follower Density, followers/mi/ln	3.6
Vehicle LOS	B		

Facility Results

T	Follower Density, followers/mi/ln	LOS
1	3.6	B

Cumulative Year 2042 Plus Project AM Peak W/ Additional Project Trips
 HCM Signalized Intersection Capacity Analysis
 7: 11th Avenue & Houston Avenue

08/04/2022

												
Movement	EBL	EBT	EBR	WBL	WBT	WBR	NBL	NBT	NBR	SBL	SBT	SBR
Lane Configurations												
Traffic Volume (vph)	96	131	46	38	104	41	34	144	41	44	99	40
Future Volume (vph)	96	131	46	38	104	41	34	144	41	44	99	40
Ideal Flow (vphpl)	1900	1900	1900	1900	1900	1900	1900	1900	1900	1900	1900	1900
Total Lost time (s)	4.2	6.0	6.0	4.2	5.7	5.7	4.2	5.7	5.7	4.2	5.3	5.3
Lane Util. Factor	1.00	1.00	1.00	1.00	1.00	1.00	1.00	0.95	1.00	1.00	1.00	1.00
Frt	1.00	1.00	0.85	1.00	1.00	0.85	1.00	1.00	0.85	1.00	1.00	0.85
Flt Protected	0.95	1.00	1.00	0.95	1.00	1.00	0.95	1.00	1.00	0.95	1.00	1.00
Satd. Flow (prot)	1597	1681	1429	1597	1681	1429	1597	3195	1429	1597	1681	1429
Flt Permitted	0.95	1.00	1.00	0.95	1.00	1.00	0.95	1.00	1.00	0.95	1.00	1.00
Satd. Flow (perm)	1597	1681	1429	1597	1681	1429	1597	3195	1429	1597	1681	1429
Peak-hour factor, PHF	0.96	0.96	0.96	0.96	0.96	0.96	0.96	0.96	0.96	0.96	0.96	0.96
Adj. Flow (vph)	100	136	48	40	108	43	35	150	43	46	103	42
RTOR Reduction (vph)	0	0	35	0	0	35	0	0	30	0	0	28
Lane Group Flow (vph)	100	136	13	40	108	8	35	150	13	46	103	14
Heavy Vehicles (%)	13%	13%	13%	13%	13%	13%	13%	13%	13%	13%	13%	13%
Turn Type	Prot	NA	Perm	Prot	NA	Perm	Prot	NA	Perm	Prot	NA	Perm
Protected Phases	7	4		3	8		5	2		1	6	
Permitted Phases			4			8			2			6
Actuated Green, G (s)	9.7	18.4	18.4	3.6	12.6	12.6	3.6	20.3	20.3	6.0	23.1	23.1
Effective Green, g (s)	9.7	18.4	18.4	3.6	12.6	12.6	3.6	20.3	20.3	6.0	23.1	23.1
Actuated g/C Ratio	0.14	0.27	0.27	0.05	0.18	0.18	0.05	0.30	0.30	0.09	0.34	0.34
Clearance Time (s)	4.2	6.0	6.0	4.2	5.7	5.7	4.2	5.7	5.7	4.2	5.3	5.3
Vehicle Extension (s)	3.0	3.0	3.0	3.0	3.0	3.0	3.0	3.0	3.0	3.0	3.0	3.0
Lane Grp Cap (vph)	226	452	384	84	309	263	84	948	424	140	567	482
v/s Ratio Prot	c0.06	c0.08		0.03	0.06		0.02	0.05		c0.03	c0.06	
v/s Ratio Perm			0.01			0.01			0.01			0.01
v/c Ratio	0.44	0.30	0.03	0.48	0.35	0.03	0.42	0.16	0.03	0.33	0.18	0.03
Uniform Delay, d1	26.9	19.9	18.4	31.5	24.3	22.9	31.4	17.7	17.1	29.3	16.0	15.2
Progression Factor	1.00	1.00	1.00	1.00	1.00	1.00	1.00	1.00	1.00	1.00	1.00	1.00
Incremental Delay, d2	1.4	0.4	0.0	4.2	0.7	0.0	3.3	0.1	0.0	1.4	0.2	0.0
Delay (s)	28.3	20.3	18.5	35.7	25.0	22.9	34.7	17.8	17.1	30.7	16.1	15.2
Level of Service	C	C	B	D	C	C	C	B	B	C	B	B
Approach Delay (s)		22.8			26.8			20.3			19.4	
Approach LOS		C			C			C			B	
Intersection Summary												
HCM 2000 Control Delay			22.3									C
HCM 2000 Volume to Capacity ratio			0.30									
Actuated Cycle Length (s)			68.4						20.1			
Intersection Capacity Utilization			40.7%									A
Analysis Period (min)			15									
c Critical Lane Group												

Cumulative Year 2042 Plus Project PM Peak W/ Additional Project Trips
 HCM Signalized Intersection Capacity Analysis
 7: 11th Avenue & Houston Avenue

08/04/2022

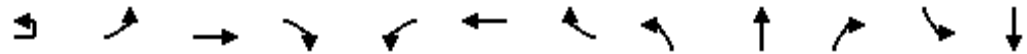

Movement	EBU	EBL	EBT	EBR	WBL	WBT	WBR	NBL	NBT	NBR	SBL	SBT
Lane Configurations		↔	↑	↗	↖	↑	↗	↖	↑↑	↗	↖	↑
Traffic Volume (vph)	1	61	275	52	36	232	82	114	529	85	56	155
Future Volume (vph)	1	61	275	52	36	232	82	114	529	85	56	155
Ideal Flow (vphpl)	1900	1900	1900	1900	1900	1900	1900	1900	1900	1900	1900	1900
Total Lost time (s)		4.2	6.0	6.0	4.2	5.7	5.7	4.2	5.7	5.7	4.2	5.3
Lane Util. Factor		1.00	1.00	1.00	1.00	1.00	1.00	1.00	0.95	1.00	1.00	1.00
Frt		1.00	1.00	0.85	1.00	1.00	0.85	1.00	1.00	0.85	1.00	1.00
Flt Protected		0.95	1.00	1.00	0.95	1.00	1.00	0.95	1.00	1.00	0.95	1.00
Satd. Flow (prot)		1719	1810	1538	1719	1810	1538	1719	3438	1538	1719	1810
Flt Permitted		0.95	1.00	1.00	0.95	1.00	1.00	0.95	1.00	1.00	0.95	1.00
Satd. Flow (perm)		1719	1810	1538	1719	1810	1538	1719	3438	1538	1719	1810
Peak-hour factor, PHF	0.92	0.92	0.92	0.92	0.92	0.92	0.92	0.92	0.92	0.92	0.92	0.92
Adj. Flow (vph)	1	66	299	57	39	252	89	124	575	92	61	168
RTOR Reduction (vph)	0	0	0	40	0	0	65	0	0	65	0	0
Lane Group Flow (vph)	0	67	299	17	39	252	24	124	575	27	61	168
Heavy Vehicles (%)	5%	5%	5%	5%	5%	5%	5%	5%	5%	5%	5%	5%
Turn Type	Prot	Prot	NA	Perm	Prot	NA	Perm	Prot	NA	Perm	Prot	NA
Protected Phases	7	7	4		3	8		5	2		1	6
Permitted Phases				4			8			2		
Actuated Green, G (s)		7.3	22.6	22.6	4.9	20.5	20.5	8.0	22.0	22.0	4.9	19.3
Effective Green, g (s)		7.3	22.6	22.6	4.9	20.5	20.5	8.0	22.0	22.0	4.9	19.3
Actuated g/C Ratio		0.10	0.30	0.30	0.07	0.28	0.28	0.11	0.30	0.30	0.07	0.26
Clearance Time (s)		4.2	6.0	6.0	4.2	5.7	5.7	4.2	5.7	5.7	4.2	5.3
Vehicle Extension (s)		3.0	3.0	3.0	3.0	3.0	3.0	3.0	3.0	3.0	3.0	3.0
Lane Grp Cap (vph)		168	549	466	113	498	423	184	1015	454	113	468
v/s Ratio Prot		c0.04	c0.17		0.02	0.14		c0.07	c0.17		0.04	0.09
v/s Ratio Perm				0.01			0.02			0.02		
v/c Ratio		0.40	0.54	0.04	0.35	0.51	0.06	0.67	0.57	0.06	0.54	0.36
Uniform Delay, d1		31.5	21.7	18.3	33.3	22.7	19.9	32.0	22.2	18.8	33.7	22.5
Progression Factor		1.00	1.00	1.00	1.00	1.00	1.00	1.00	1.00	1.00	1.00	1.00
Incremental Delay, d2		1.6	1.1	0.0	1.8	0.8	0.1	9.4	0.7	0.1	4.9	0.5
Delay (s)		33.1	22.8	18.3	35.1	23.5	19.9	41.3	22.9	18.9	38.6	23.0
Level of Service		C	C	B	D	C	B	D	C	B	D	C
Approach Delay (s)			23.8			23.9			25.4			25.8
Approach LOS			C			C			C			C

Intersection Summary		
HCM 2000 Control Delay	24.8	HCM 2000 Level of Service
HCM 2000 Volume to Capacity ratio	0.59	C
Actuated Cycle Length (s)	74.5	Sum of lost time (s)
Intersection Capacity Utilization	62.5%	ICU Level of Service
Analysis Period (min)	15	B
c Critical Lane Group		

Cumulative Year 2042 Plus Project PM Peak W/ Additional Project Trips
 HCM Signalized Intersection Capacity Analysis
 7: 11th Avenue & Houston Avenue

08/04/2022

Movement	SBR
Lane Configurations	
Traffic Volume (vph)	57
Future Volume (vph)	57
Ideal Flow (vphpl)	1900
Total Lost time (s)	5.3
Lane Util. Factor	1.00
Frt	0.85
Flt Protected	1.00
Satd. Flow (prot)	1538
Flt Permitted	1.00
Satd. Flow (perm)	1538
Peak-hour factor, PHF	0.92
Adj. Flow (vph)	62
RTOR Reduction (vph)	46
Lane Group Flow (vph)	16
Heavy Vehicles (%)	5%
Turn Type	Perm
Protected Phases	
Permitted Phases	6
Actuated Green, G (s)	19.3
Effective Green, g (s)	19.3
Actuated g/C Ratio	0.26
Clearance Time (s)	5.3
Vehicle Extension (s)	3.0
Lane Grp Cap (vph)	398
v/s Ratio Prot	
v/s Ratio Perm	0.01
v/c Ratio	0.04
Uniform Delay, d1	20.7
Progression Factor	1.00
Incremental Delay, d2	0.0
Delay (s)	20.7
Level of Service	C
Approach Delay (s)	
Approach LOS	
Intersection Summary	

Appendix I: Traffic Signal Warrants



www.JLBtraffic.com
info@JLBtraffic.com

516 W. Shaw Ave., Ste. 103
Fresno, CA 93704
(559) 570-8991

App | I

Warrant 3: Peak Hour (Urban)

Existing Traffic Conditions 4. Jordan Way / Hanford-Armona Road AM (PM) Peak Hour

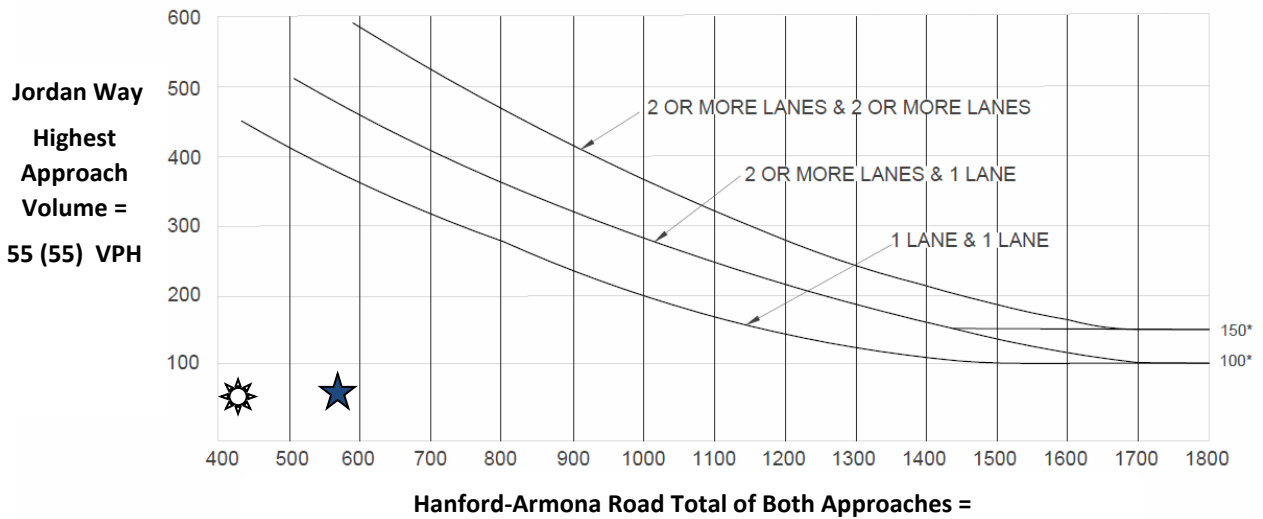

*Note: 150 vph applies as the lower threshold volume for a minor-street approach with two or more lanes and 100 vph applies as the lower threshold volume for a minor street approach with one lane.



AM Peak Hour – Signal Warrant is Not Met



PM Peak Hour – Signal Warrant is Not Met

Source: California Manual of Uniform Traffic Control Devices (CA MUTCD 2014 Edition)
Chapter 4C: Traffic Control Signal Needs Studies
Part 4: Highway Traffic Signals
November 7, 2014

Warrant 3: Peak Hour (Rural)

Existing Traffic Conditions
8. 10 1/2 Avenue / Houston Avenue
AM (PM) Peak Hour

(COMMUNITY LESS THAN 10,000 POPULATION OR ABOVE 40 MPH ON MAJOR STREET)

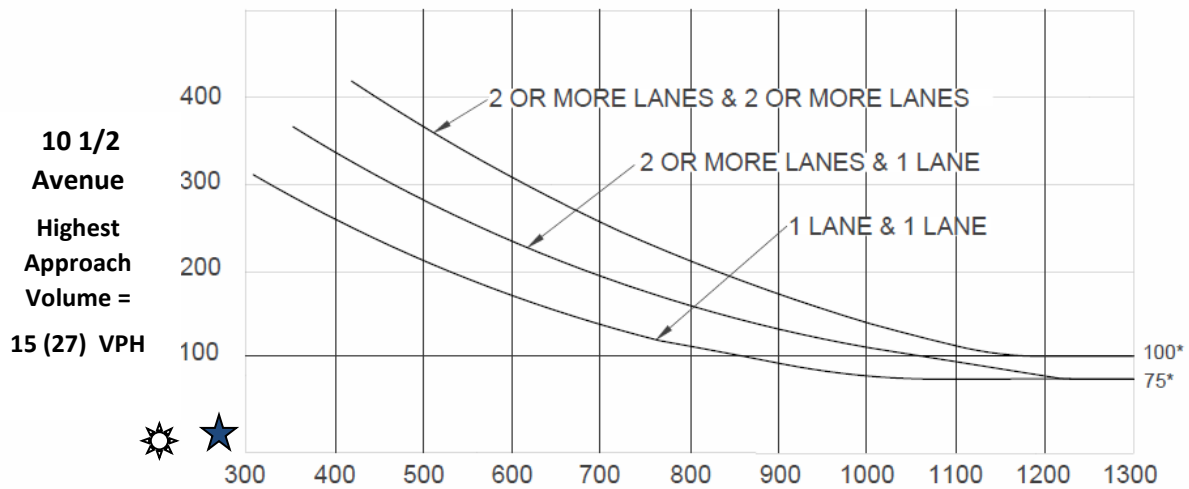

Houston Avenue Total of Both Approaches =
205 (270) VPH

*Note: 100 vph applies as the lower threshold volume for a minor-street approach with two or more lanes and 75 vph applies as the lower threshold volume for a minor street approach with one lane.

- AM Peak Hour – Signal Warrant is Not Met**
- PM Peak Hour – Signal Warrant is Not Met**

Source: California Manual of Uniform Traffic Control Devices (CA MUTCD 2014 Edition)
 Chapter 4C: Traffic Control Signal Needs Studies
 Part 4: Highway Traffic Signals
 November 7, 2014

Warrant 3: Peak Hour (Rural)

Existing Traffic Conditions
9. 10th Avenue / Houston Avenue
AM (PM) Peak Hour

(COMMUNITY LESS THAN 10,000 POPULATION OR ABOVE 40 MPH ON MAJOR STREET)

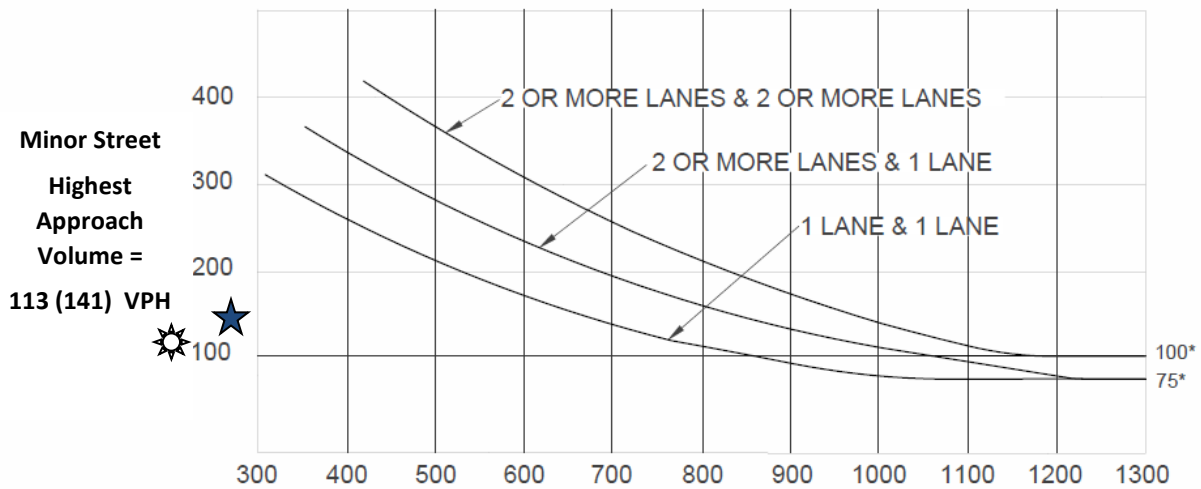

Major Street Total of Both Approaches =
191 (278) VPH

*Note: 100 vph applies as the lower threshold volume for a minor-street approach with two or more lanes and 75 vph applies as the lower threshold volume for a minor street approach with one lane.



AM Peak Hour – Signal Warrant is Not Met



PM Peak Hour – Signal Warrant is Not Met

Source: California Manual of Uniform Traffic Control Devices (CA MUTCD 2014 Edition)
Chapter 4C: Traffic Control Signal Needs Studies
Part 4: Highway Traffic Signals
November 7, 2014

Warrant 3: Peak Hour (Urban)

Existing plus Project Traffic Conditions 4. Jordan Way / Hanford-Armona Road AM (PM) Peak Hour

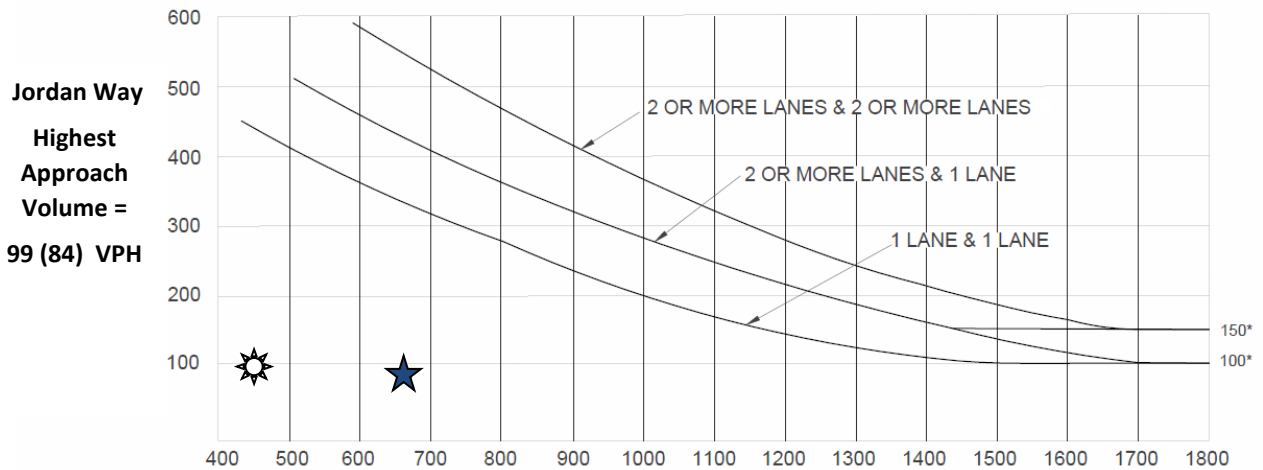

Hanford-Armona Road Total of Both Approaches =

448 (664) VPH

*Note: 150 vph applies as the lower threshold volume for a minor-street approach with two or more lanes and 100 vph applies as the lower threshold volume for a minor street approach with one lane.



AM Peak Hour – Signal Warrant is Not Met



PM Peak Hour – Signal Warrant is Not Met

Source: California Manual of Uniform Traffic Control Devices (CA MUTCD 2014 Edition)
Chapter 4C: Traffic Control Signal Needs Studies
Part 4: Highway Traffic Signals
November 7, 2014

Warrant 3: Peak Hour (Urban)

Existing plus Project Traffic Conditions
6. 10 1/2 Avenue / Orchard Avenue
AM (PM) Peak Hour

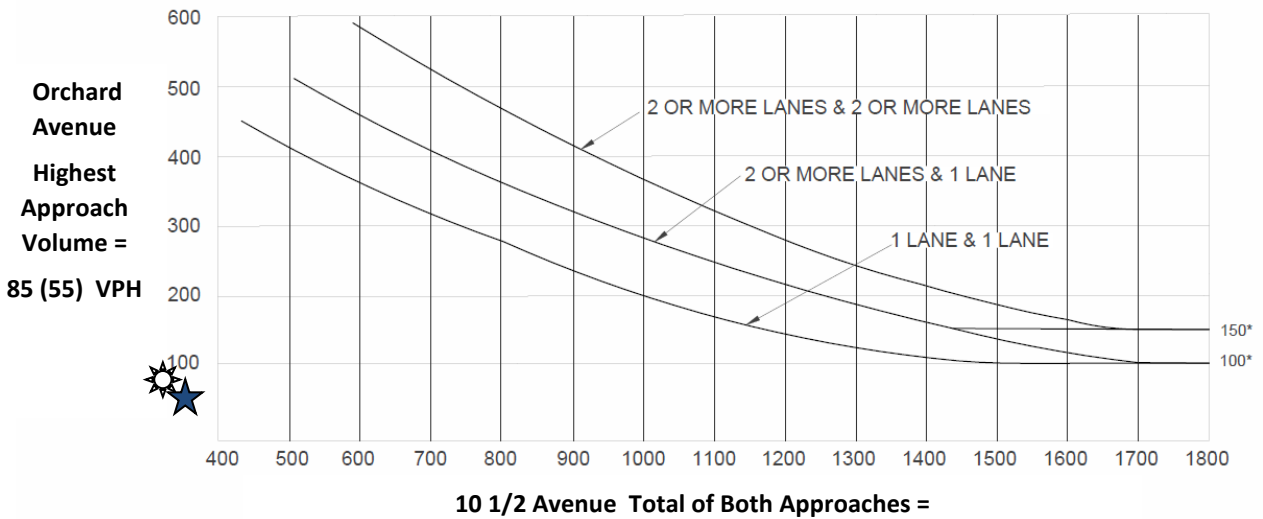

*Note: 150 vph applies as the lower threshold volume for a minor-street approach with two or more lanes and 100 vph applies as the lower threshold volume for a minor street approach with one lane.



AM Peak Hour – Signal Warrant is Not Met



PM Peak Hour – Signal Warrant is Not Met

Source: California Manual of Uniform Traffic Control Devices (CA MUTCD 2014 Edition)
Chapter 4C: Traffic Control Signal Needs Studies
Part 4: Highway Traffic Signals
November 7, 2014

Warrant 3: Peak Hour (Rural)

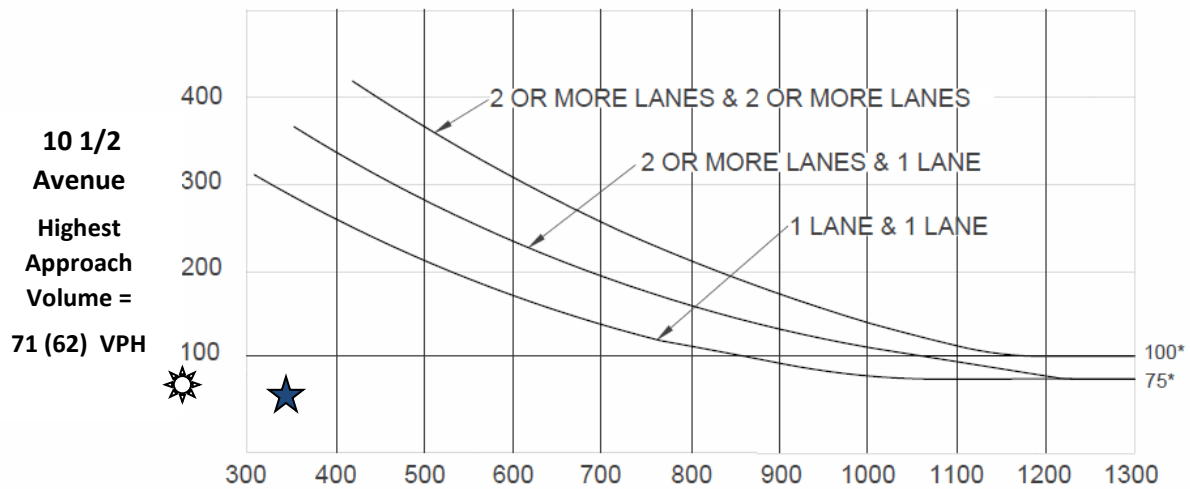

Existing plus Project Traffic Conditions
8. 10 1/2 Avenue / Houston Avenue
AM (PM) Peak Hour

(COMMUNITY LESS THAN 10,000 POPULATION OR ABOVE 40 MPH ON MAJOR STREET)



Houston Avenue Total of Both Approaches =
222 (340) VPH

*Note: 100 vph applies as the lower threshold volume for a minor-street approach with two or more lanes and 75 vph applies as the lower threshold volume for a minor street approach with one lane.

-  **AM Peak Hour – Signal Warrant is Not Met**
-  **PM Peak Hour – Signal Warrant is Not Met**

Source: California Manual of Uniform Traffic Control Devices (CA MUTCD 2014 Edition)
 Chapter 4C: Traffic Control Signal Needs Studies
 Part 4: Highway Traffic Signals
 November 7, 2014

Warrant 3: Peak Hour (Rural)

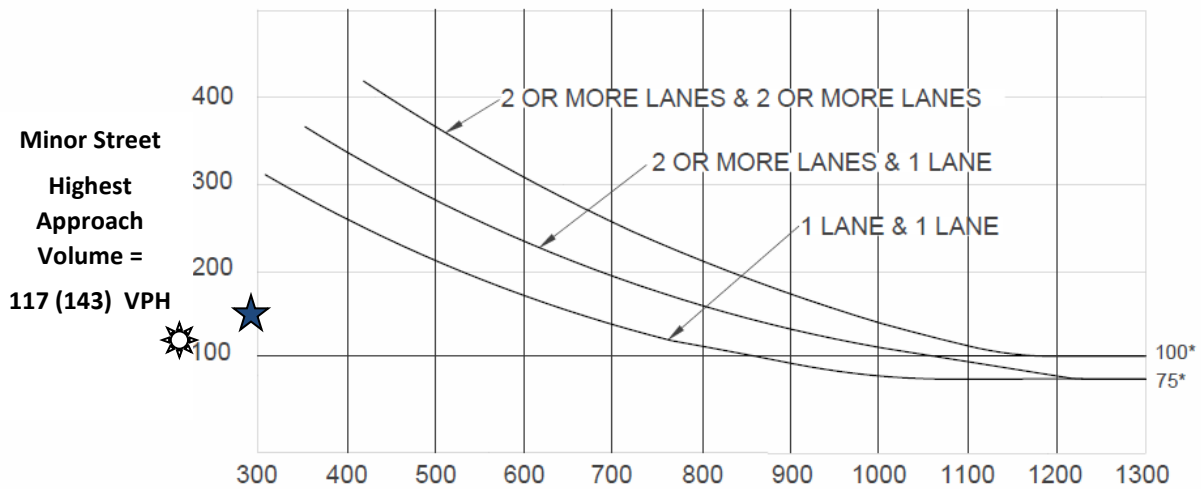

Existing plus Project Traffic Conditions
9. 10th Avenue / Houston Avenue
AM (PM) Peak Hour

(COMMUNITY LESS THAN 10,000 POPULATION OR ABOVE 40 MPH ON MAJOR STREET)



Major Street Total of Both Approaches =
208 (296) VPH

*Note: 100 vph applies as the lower threshold volume for a minor-street approach with two or more lanes and 75 vph applies as the lower threshold volume for a minor street approach with one lane.

-  AM Peak Hour – Signal Warrant is Not Met
-  PM Peak Hour – Signal Warrant is Not Met

Source: California Manual of Uniform Traffic Control Devices (CA MUTCD 2014 Edition)
Chapter 4C: Traffic Control Signal Needs Studies
Part 4: Highway Traffic Signals
November 7, 2014

Warrant 3: Peak Hour (Urban)

Near Term plus Project Traffic Conditions
4. Jordan Way / Hanford-Armona Road
AM (PM) Peak Hour

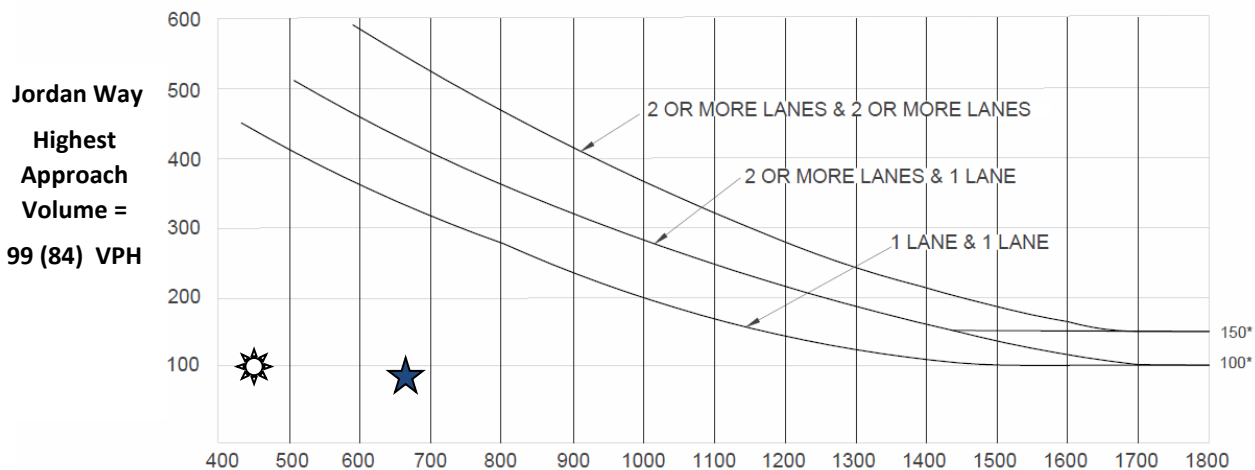

Hanford-Armona Road Total of Both Approaches =
453 (670) VPH

*Note: 150 vph applies as the lower threshold volume for a minor-street approach with two or more lanes and 100 vph applies as the lower threshold volume for a minor street approach with one lane.



AM Peak Hour – Signal Warrant is Not Met



PM Peak Hour – Signal Warrant is Not Met

Source: California Manual of Uniform Traffic Control Devices (CA MUTCD 2014 Edition)
 Chapter 4C: Traffic Control Signal Needs Studies
 Part 4: Highway Traffic Signals
 November 7, 2014

Warrant 3: Peak Hour (Urban)

Near Term plus Project Traffic Conditions

6. 10 1/2 Avenue / Orchard Avenue

AM (PM) Peak Hour

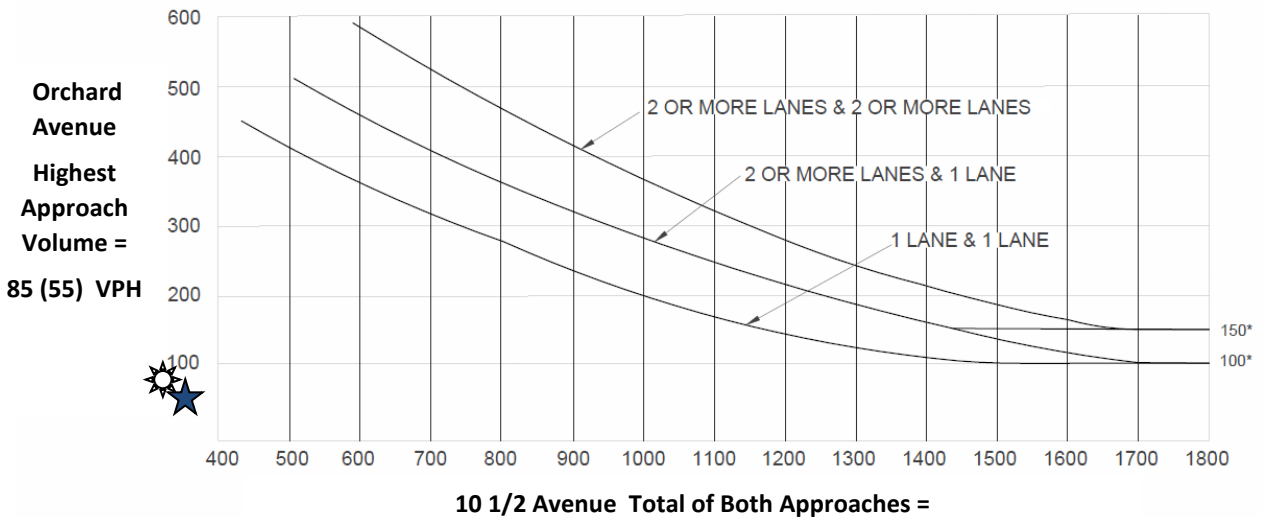

*Note: 150 vph applies as the lower threshold volume for a minor-street approach with two or more lanes and 100 vph applies as the lower threshold volume for a minor street approach with one lane.



AM Peak Hour – Signal Warrant is Not Met



PM Peak Hour – Signal Warrant is Not Met

Source: California Manual of Uniform Traffic Control Devices (CA MUTCD 2014 Edition)
Chapter 4C: Traffic Control Signal Needs Studies
Part 4: Highway Traffic Signals
November 7, 2014

Warrant 3: Peak Hour (Rural)

Near Term plus Project Traffic Conditions

8. 10 1/2 Avenue / Houston Avenue

AM (PM) Peak Hour

(COMMUNITY LESS THAN 10,000 POPULATION OR ABOVE 40 MPH ON MAJOR STREET)

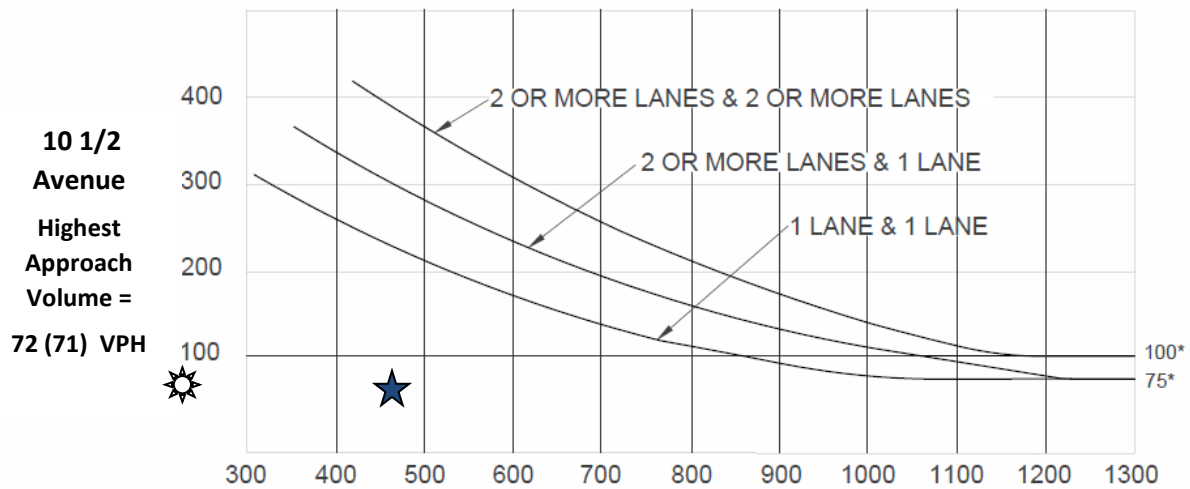

Houston Avenue Total of Both Approaches =

267 (460) VPH

*Note: 100 vph applies as the lower threshold volume for a minor-street approach with two or more lanes and 75 vph applies as the lower threshold volume for a minor street approach with one lane.



AM Peak Hour – Signal Warrant is Not Met



PM Peak Hour – Signal Warrant is Not Met

Source: California Manual of Uniform Traffic Control Devices (CA MUTCD 2014 Edition)
 Chapter 4C: Traffic Control Signal Needs Studies
 Part 4: Highway Traffic Signals
 November 7, 2014

Warrant 3: Peak Hour (Rural)

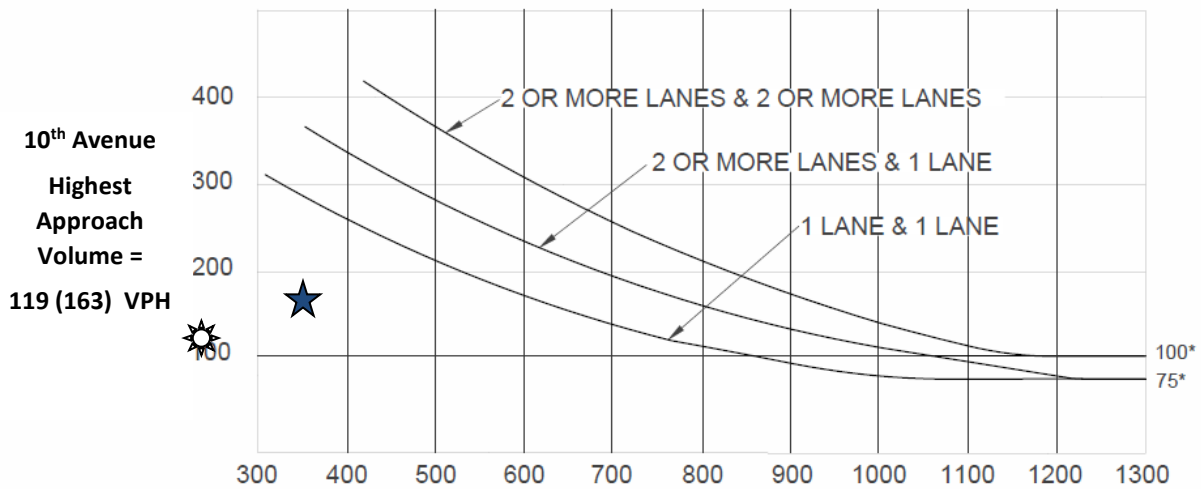

Near Term plus Project Traffic Conditions
9. 10th Avenue / Houston Avenue
AM (PM) Peak Hour

(COMMUNITY LESS THAN 10,000 POPULATION OR ABOVE 40 MPH ON MAJOR STREET)



Houston Avenue Total of Both Approaches =
236 (350) VPH

*Note: 100 vph applies as the lower threshold volume for a minor-street approach with two or more lanes and 75 vph applies as the lower threshold volume for a minor street approach with one lane.

-  **AM Peak Hour – Signal Warrant is Not Met**
-  **PM Peak Hour – Signal Warrant is Not Met**

Source: California Manual of Uniform Traffic Control Devices (CA MUTCD 2014 Edition)
 Chapter 4C: Traffic Control Signal Needs Studies
 Part 4: Highway Traffic Signals
 November 7, 2014

Warrant 3: Peak Hour (Urban)

Cumulative Year 2042 plus Project Traffic Conditions

4. Jordan Way / Hanford-Armona Road

AM (PM) Peak Hour

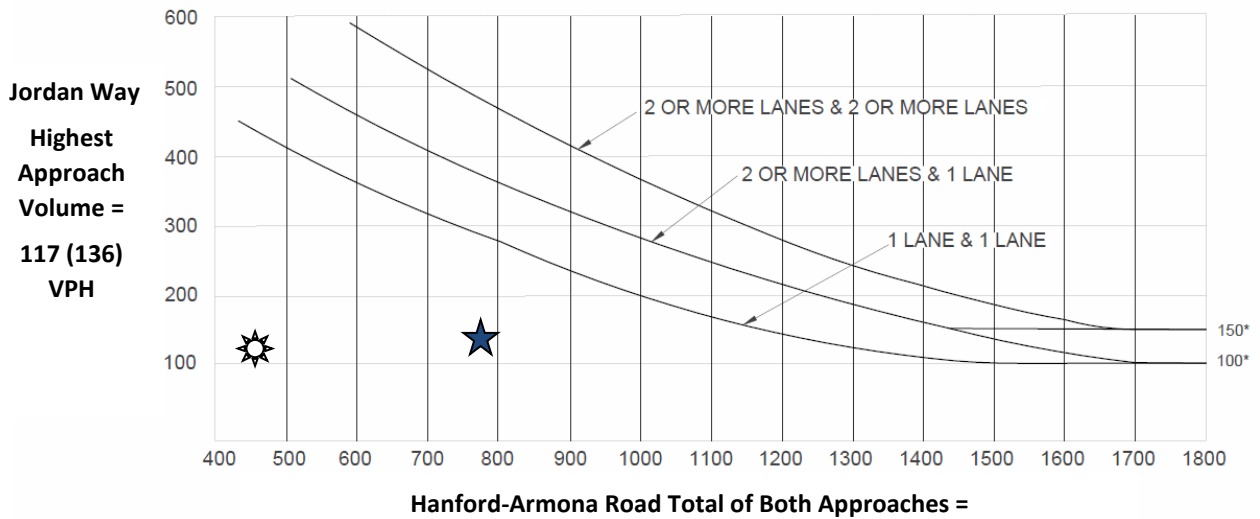

*Note: 150 vph applies as the lower threshold volume for a minor-street approach with two or more lanes and 100 vph applies as the lower threshold volume for a minor street approach with one lane.



AM Peak Hour – Signal Warrant is Not Met



PM Peak Hour – Signal Warrant is Not Met

Source: California Manual of Uniform Traffic Control Devices (CA MUTCD 2014 Edition)
Chapter 4C: Traffic Control Signal Needs Studies
Part 4: Highway Traffic Signals
November 7, 2014

Warrant 3: Peak Hour (Urban)

**Cumulative Year 2042 plus Project Traffic Conditions
6. 10 1/2 Avenue / Orchard Avenue
AM (PM) Peak Hour**

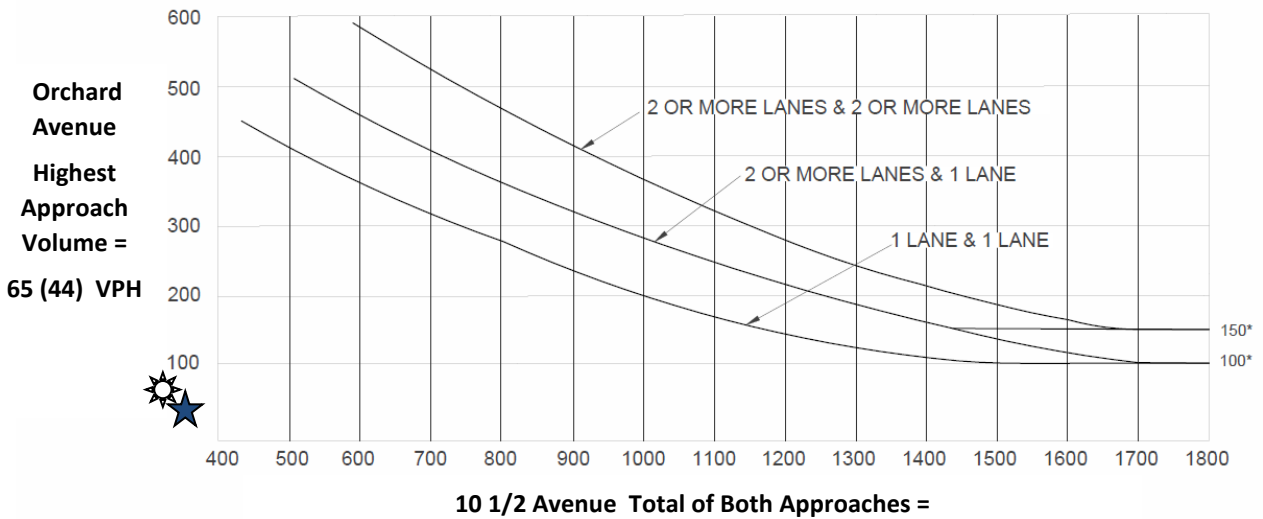

*Note: 150 vph applies as the lower threshold volume for a minor-street approach with two or more lanes and 100 vph applies as the lower threshold volume for a minor street approach with one lane.



AM Peak Hour – Signal Warrant is Not Met



PM Peak Hour – Signal Warrant is Not Met

Source: California Manual of Uniform Traffic Control Devices (CA MUTCD 2014 Edition)
Chapter 4C: Traffic Control Signal Needs Studies
Part 4: Highway Traffic Signals
November 7, 2014

Warrant 3: Peak Hour (Rural)

Cumulative Year 2042 plus Project Traffic Conditions

8. 10 1/2 Avenue / Houston Avenue

AM (PM) Peak Hour

(COMMUNITY LESS THAN 10,000 POPULATION OR ABOVE 40 MPH ON MAJOR STREET)

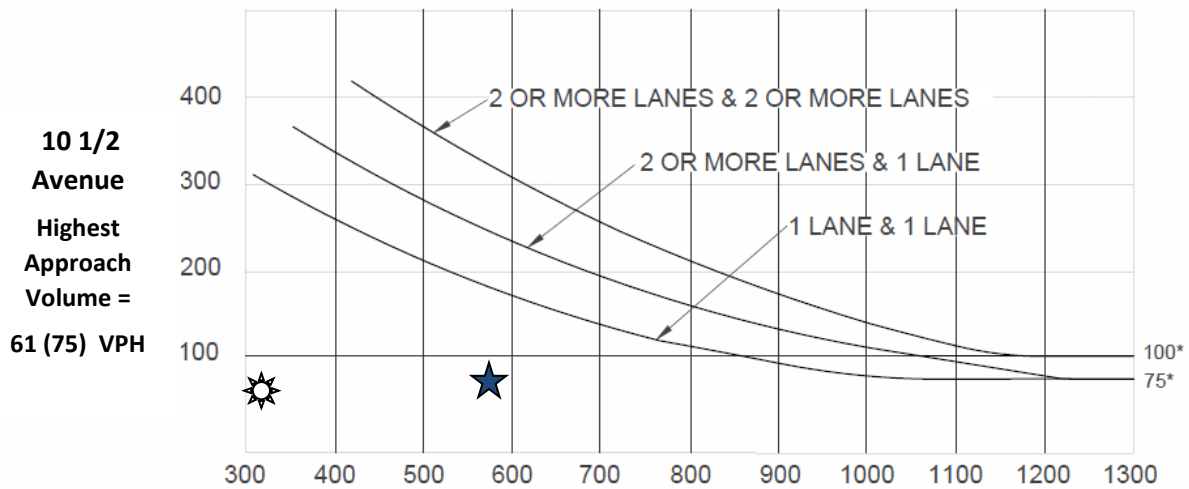

Houston Avenue Total of Both Approaches =

316 (578) VPH

*Note: 100 vph applies as the lower threshold volume for a minor-street approach with two or more lanes and 75 vph applies as the lower threshold volume for a minor street approach with one lane.



AM Peak Hour – Signal Warrant is Not Met



PM Peak Hour – Signal Warrant is Not Met

Source: California Manual of Uniform Traffic Control Devices (CA MUTCD 2014 Edition)
 Chapter 4C: Traffic Control Signal Needs Studies
 Part 4: Highway Traffic Signals
 November 7, 2014

Warrant 3: Peak Hour (Rural)

Cumulative Year 2042 plus Project Traffic Conditions
9. 10th Avenue / Houston Avenue
AM (PM) Peak Hour

(COMMUNITY LESS THAN 10,000 POPULATION OR ABOVE 40 MPH ON MAJOR STREET)

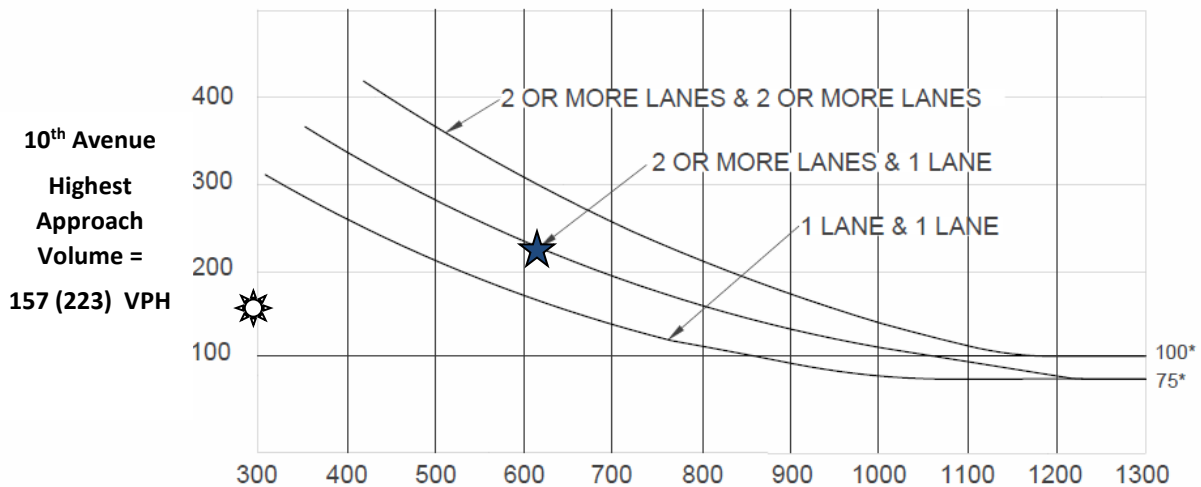

Houston Avenue Total of Both Approaches =
297 (611) VPH

*Note: 100 vph applies as the lower threshold volume for a minor-street approach with two or more lanes and 75 vph applies as the lower threshold volume for a minor street approach with one lane.



AM Peak Hour – Signal Warrant is Not Met



PM Peak Hour – Signal Warrant is Met

Source: California Manual of Uniform Traffic Control Devices (CA MUTCD 2014 Edition)
Chapter 4C: Traffic Control Signal Needs Studies
Part 4: Highway Traffic Signals
November 7, 2014



MEMO

Date: March 22, 2023 **Project No.:** 210079

To: Gabrielle Meyers- City of Hanford

From: Jaymie L. Brauer, Principal Planner/Project Manager

Subject: Notice of Preparation/Initial Study (NOP/IS) Response to Comments received for the proposed City of Hanford Tentative Tract Map 938 (Lunaria)

The City circulated a Notice of Preparation/Initial Study (NOP/IS) on February 2, 2023, for a 30 day public comment period. The City received the following comment letters, which are included as Attachment A to this memo:

1. Native American Heritage Commission (NAHC)- February 8, 2023
2. California Department of Toxic Substances Control (DTSC)-February 17, 2022
3. California Department of Fish and Wildlife (CDFW)- March 3, 2023

The comments and responses are as follows:

1. The Native American Heritage Commission (NAHC)

Comment #1-1:

The NAHC recommends consultation with California Native American tribes that are traditionally and culturally affiliated with the geographic area of the proposed Project as early as possible in order to avoid inadvertent discoveries of Native American human remains and best protect tribal cultural resources and compliance with tribal consultation requirements of SB18 and AB52.

Response:

Thank you for your comment. The NAHC is a recognized reviewing agency, and their comments are appreciated, and noted for the record.

The City has initiated the Tribe consultation as required by AB52. The project is consistent with the General Plan designation of Residential Low Density; therefore, a General Plan Amendment is not necessary, and compliance with SB 18 is not triggered.

A cultural resources records search (#22-164) was conducted at the Southern San Joaquin Valley Information Center (IC), CSU Bakersfield and a Cultural Technical Memo outlining the results of the records search was prepared for the project. A request for a Local Government Consultation List and Sacred Lands File database search to the Native American Heritage Commission (NAHC) was sent, and a negative response was received on June 20, 2022. A copy of the Cultural Resources Technical Memo and NAHC letter was included as Appendix C.



As was noted in the NOP/IS, in the unlikely event construction of the Project inadvertently uncovers previously unknown cultural resources, avoidance and minimization measures will be added to all engineered plans and specs that would outline necessary steps to be taken prior to the start of construction. These measures require all work in the immediate vicinity of the discovery of cultural resources find would halt until a qualified archaeologist can evaluate the find and make recommendations. In addition, prior to any ground disturbance, if the City receives a request from a Native American tribal group, a surface inspection of the site will be conducted by a tribal monitor, and the tribe will have the opportunity to provide a Native American Monitor during ground-disturbing activities, dependent upon the availability and interest of the tribe.

With implementation of applicable State and local regulations regarding cultural resources and based on the analysis presented in the NOP/IS prepared for the Project, impacts remain less than significant and no further analysis in the EIR is warranted.

2. California Department of Toxic Substances Control (DTSC)

Comment #2-1

The commenter states that DTSC is a regulatory agency that meets the requirements under health and Health and Safety Code section 101480 should provide regulatory concurrence that the Project site is safe for construction and the proposed use.

Response:

Thank you for your comments. The DTSC is a recognized regulatory agency, and their comments are appreciated. DTSC's comments are noted for the record.

Comment #2-2:

The commenter recommends that the EIR should acknowledge the potential for historic or future activities on or near the project site to result in the release of hazardous wastes/substances on the project site. In instances in which releases have occurred or may occur, further studies should be carried out to delineate the nature and extent of the contamination, and the potential threat to public health and/or the environment should be evaluated. The EIR should also identify the mechanism(s) to initiate any required investigation and/or remediation and the government agency who will be responsible for providing appropriate regulatory oversight.

Response:

The project is not located on a site that is included on a list of hazardous materials sites compiled pursuant to Government Code Section 65962.5 (Cortese List) and there are no hazardous or toxic sites in the vicinity (within one mile) of the project site.

The project site has previously been utilized for agricultural purposes, which may have utilized pesticides in association with agricultural operations and cultivation. However, the potential for elevated concentrations of environmentally persistent pesticides/herbicides to currently exist in the near-surface soils at concentrations that would require regulatory action appears to be low.



The site is relatively flat, and grading of the site will be minimal. As noted in the NOP/IS Section 3.4.3-*Air Quality*, an Air Quality Impact Analysis was prepared for the project, which was included in Appendix A of the NOP/IS. The study and IS/NOP noted that the project would comply with the San Joaquin Valley Air Pollution Control District (SJVAPCD) Regulation VIII (Fugitive PM₁₀ Prohibitions) Rules 8011-8081 and Rule 9510- Indirect Source Review (ISR), which require projects to employ various measures intended to reduce particulate matter, specifically PM_{2.5} and PM₁₀ emissions generated during construction and demolition activities. The Project is also required to prepare a Dust Control Plan to comply with Regulation VIII. Compliance with these requirements would be effective in limiting construction personnel to herbicide/pesticide exposure and impacts from potential pesticides in the soil during construction will be minimal. It was also noted that the project emissions of PM_{2.5} and PM₁₀ are well below the threshold established by the SJVAPCD and were considered to be less than significant.

Once the homes are constructed, there will be little to no areas of exposed dirt that might be dispersed into the air and create a health concern.

There is no reasonably foreseeable condition or incident involving the project that could result in release of hazardous materials into the environment, other than any potential accidental releases of standard fuels, solvents, or chemicals encountered during typical construction of a residential subdivision. Should an accidental hazardous release occur, or should the project encounter hazardous soils, existing regulations for handling hazardous materials require coordination with the DTSC for an appropriate plan of action, which can include studies or testing to determine the nature and extent of contamination, as well as handling and proper disposal.

Based on this analysis impacts remain less than significant, and no further analysis in the EIR is warranted.

Comment #2-3:

The commenter noted that leaded gasoline was used in California until 1992, and that tailpipe emissions from automobiles using leaded gasoline contained lead and resulted in aerially deposited lead (ADL) being deposited in and along roadways throughout the State. Due to the potential for ADL-contaminated soil DTSC, recommends collecting soil samples for lead analysis prior to performing any intrusive activities for the project described in the EIR.

See Response to Comment 2-1, above.

Based on this analysis impacts remain less than significant, and no further analysis in the EIR is warranted.

Comment #2-4:

The commenter notes if buildings or other structures are to be demolished on any project sites included in the proposed project, surveys should be conducted for the presence of lead-based paints or products, mercury, asbestos containing materials, and polychlorinated biphenyl caulk. Removal, demolition and disposal of any of the above-mentioned chemicals should be conducted in compliance with California environmental regulations and policies.

Response:

As noted in the NOP/IS Impact #3.4.14b, the project site is undeveloped and does not necessitate the demolition of any existing houses. Therefore, the determination remains the same, the project would have no impact, and no further analysis in the EIR is warranted.

Comment #2-5:

L:\Projects\2021\210370\PLANNING\Environmental\focused EIR\RTC memo to City.docx



The commenter notes if any projects initiated as part of the proposed project require the importation of soil to backfill any excavated areas, proper sampling should be conducted to ensure that the imported soil is free of contamination. DTSC recommends the imported materials be characterized according to DTSC's 2001 Information Advisory Clean Imported Fill Material.

Response:

The project does not propose to import fill for use on the site. Structures will be constructed in accordance with all applicable International Building Code (IBC), California Building Code (CBC) standards, and City development standards, relating to soils. Adherence to all applicable regulations would avoid any potential impacts related to uncovered hazardous materials. Impacts remain less than significant, and no further analysis in the EIR is necessary.

Comment #2-6:

The commenter states if any sites included as part of the proposed project have been used for agricultural, weed abatement or related activities, proper investigation for organochlorinated pesticides should be discussed in the MND. DTSC recommends the current and former agricultural lands be evaluated in accordance with DTSC's 2008 Interim Guidance for Sampling Agricultural Properties (Third Revision).

Response:

See Response to Comment #2-2, above.

3. California Department of Fish and Wildlife (CDFW)

Comment #3-1:

*The commenter advises that The Project area is within the geographic range of several special-status animal species including the State threatened and federally endangered San Joaquin kit fox (*Vulpes macrotis mutica*), the State candidate endangered Crotch bumblebee (*Bombus crotchii*), the State threatened Swainson's hawk (*Buteo swainsoni*), and the State species of special concern burrowing owl (*Athene cunicularia*) and American badger (*Taxidea taxus*).*

Response:

Thank you for your comments. The CDFW is a recognized regulatory agency, and their comments are appreciated. CDFW's comments are noted for the record.

The Project site has been previously used for agricultural purposes has been actively being disked. As noted in the NOP/IS, Section #3.4.4- *Biological Resources*, a *Biological Resources Evaluation (BRE)* was prepared for the project and was included in Appendix B. It was noted that project site is currently surrounded mostly by urban development a Project site has no native vegetation or suitable habitat. No special-status species plant or diagnostic sign of special-status wildlife species were observed, and no wetlands or other sensitive biological resources were observed on or near the project site.

Comment #3-2:

The commenter recommends The California Natural Diversity Database (CNDDDB) records show that San Joaquin Kit Fox (SJKF) has been documented near the project area and are known to occur near Hanford. Aerial records show that the area is comprised of agricultural and ruderal habitat. In addition to



grasslands, SJKF den in a variety of areas such as rights-of-way, vacant lots, agricultural and fallow or ruderal habitat, dry stream channels, and canal levees and populations can fluctuate over time. SJKF are also capable of occupying urban environments (Cypher and Frost 1999). SJKF may be attracted to the Project area due to the type and level of ground-disturbing activities and the loose, friable soils resulting from intensive ground disturbance. As a result, there is potential for SJKF to occupy the Project site and surrounding area.

Response:

As noted in the NOP/IS Impact #3.4.4a, based on the literature and database search and the results of the biological survey conducted on the site, there is a potential for two special-status wildlife species to occur on the Project site: San Joaquin kit fox (*Vulpes macrotis mutica*), and Swainson's hawk (*Buteo swainsoni*). However, there is no evidence that the San Joaquin kit fox is present within the BSA. Surrounding land use and habitat conditions make it unlikely that the San Joaquin kit fox would be present other than as a transient forager. Because of the historical disturbance and urbanized area conditions found in the area, direct impacts to these species are not expected to occur. The available habitat for is very limited to fulfill the necessary foraging requirements for San Joaquin kit fox.

Although Swainson's hawk could nest in the vicinity of the project site, no nests suitable for Swainson's hawks were observed within the survey area. The nearest CNDDDB occurrence (EONDX 91345) for nesting Swainson's hawk is approximately 3.0-miles northeast of the BSA, where nesting observations have been recorded since 2012. However, the site currently does provide foraging habitat during low growing agricultural crops. Due to a limited prey base, and lack of suitable habitat, the presence of the Swainson's hawk very unlikely.

As recommended in Impact #3.4.4a, Although it is unlikely that either of these species would be present on the project site, to protect biological resources, avoidance and minimization measures will be included as a condition of approval of TTM 938 and added to all engineered plans and specs that would outlines necessary steps to be taken prior to the start of construction. This includes a pre-construction survey for San Joaquin kit fox, American badger, Swainson's hawk nesting birds, and other special-status species be conducted within 14 days of the start of construction activities by a qualified biologist knowledgeable in the identification of these species. If no evidence of these special-status species is detected, no further action is required.

If evidence of special-status species is observed, the qualified biologist would determine the appropriate actions to be taken, including monitoring during construction or additional protocol level surveys, to reduce impacts to the species. Measures also include actions to be taken such as limiting on-site speeds to 20 miles per hour, covering trenches, capping pipes, removing trash on a daily basis, prohibiting pets on site, etc., and these measures will be placed on all plans and specs.

Based on this analysis impacts remain less than significant, and no further analysis in the EIR is warranted

Comment #3-3:

CNDDDB records indicate that the Project site is within the habitat range of Crotch bumblebees (CBB). Suitable CBB habitat includes areas of grasslands and upland scrub that contain requisite habitat elements, such as small mammal burrows. If suitable CBB habitat exists in areas of planned Project-related ground disturbance, equipment staging, or materials laydown, CDFW recommends a qualified biologist conduct a habitat assessment and surveys as part of the biological technical studies conducted in support of the CEQA



document to determine if the Project area or its immediate vicinity contain habitat suitable to support CBB. If surveys cannot be completed, CDFW recommends avoiding disturbing potential CBB habitat.

Response:

See Response to Comment #3-2, above.

There is no suitable habitat to support the CBB. The site is actively disked, has no suitable small mammal burrows nor any by of vegetation as described by the commenter. It is highly unlikely that CBB would inhabit or be found on the project site. As noted above, a pre-construction survey for special-status species including CBB would be conducted within 14 days of the start of construction activities by a qualified biologist. In the unlikely event any special status species was observed, appropriate measures would be taken to reduce impacts.

Based on this analysis impacts remain less than significant, and no further analysis in the EIR is warranted

Comment #3-4:

The commentor states other State Species of Special Concern, the burrowing owl and American badger have the potential to occur in the Project area. These species have been documented to occur in the vicinity of the Project site, which supports requisite habitat elements (CDFW 2023). The commentor recommends that a qualified biologist conduct a habitat assessment as part of the biological technical studies conducted in support of the CEQA document, to determine if project areas or their immediate vicinity contain potential habitat for the species mentioned above.

Response:

See Response to Comments #3-2 and #3-3, above.

As noted in the previously, the site is devoid of small mammal burrows that would support the use of the site by burrowing owl (*Athene cunicularia*). This is also noted in the BRE included as Appendix B of the IS/NOP. Burrowing owl inhabits grassland and open bare ground and utilizes existing small mammal burrows, typically created by California ground squirrel, for breeding and shelter. While a few California ground squirrel burrows were observed there was no sign (e.g., whitewash, tracks, prey remains) to indicate burrowing owl may be occupying these burrows. In addition, burrowing owl are not typically associated with active agricultural fields because they prefer isolation from people and loud noises. These conditions also make it unsuitable habitat for American badger.

As noted above, a pre-construction survey for special-status species including burrowing owl and badger would be conducted within 14 days of the start of construction activities by a qualified biologist. In the unlikely event any special status species was observed, appropriate measures would be taken to reduce impacts.

Based on this analysis impacts remain less than significant, and no further analysis in the EIR is warranted.

Comment #3-5:

The commentor recommends with US Fish and Wildlife Service regarding potential impacts to federally listed species including but not limited to SJKF to comply with the Federal Endangered Species Act (FESA).

Response:

See Response to Comments #3-2 through #3-4, above.



It is highly unlikely that any special status species, including those that are federally listed, would occur on the site for the reasons outlined above and in the BRE prepared for the project. The project will comply with the avoidance and minimization measures included as a condition of approval of TTM 938 and added to all engineered plans and specs that would outline necessary steps to be taken prior to the start of and during construction activities.

Based on this analysis impacts remain less than significant, and no further analysis in the EIR is warranted



Attachment A- Comment Letters Received



NATIVE AMERICAN HERITAGE COMMISSION

February 8, 2023

Gabrielle Myers
City of Hanford
317 N Douty Street
Hanford, CA 93230

CHAIRPERSON
Laura Miranda
Luiseño

VICE CHAIRPERSON
Reginald Pagaling
Chumash

SECRETARY
Sara Dutschke
Miwok

COMMISSIONER
Isaac Bojorquez
Ohlone-Costanoan

COMMISSIONER
Buffy McQuillen
Yokayo Pomo, Yuki,
Nomlaki

COMMISSIONER
Wayne Nelson
Luiseño

COMMISSIONER
Stanley Rodriguez
Kumeyaay

COMMISSIONER
[Vacant]

COMMISSIONER
[Vacant]

EXECUTIVE SECRETARY
**Raymond C.
Hitchcock**
Miwok/Nisenan

NAHC HEADQUARTERS
1550 Harbor Boulevard
Suite 100
West Sacramento,
California 95691
(916) 373-3710
nahc@nahc.ca.gov
NAHC.ca.gov

Re: 2023020035, Vesting Tentative Tract 938 Project, Kings County

Dear Ms. Myers:

The Native American Heritage Commission (NAHC) has received the Notice of Preparation (NOP), Draft Environmental Impact Report (DEIR) or Early Consultation for the project referenced above. The California Environmental Quality Act (CEQA) (Pub. Resources Code §21000 et seq.), specifically Public Resources Code §21084.1, states that a project that may cause a substantial adverse change in the significance of a historical resource, is a project that may have a significant effect on the environment. (Pub. Resources Code § 21084.1; Cal. Code Regs., tit.14, § 15064.5 (b) (CEQA Guidelines § 15064.5 (b)). If there is substantial evidence, in light of the whole record before a lead agency, that a project may have a significant effect on the environment, an Environmental Impact Report (EIR) shall be prepared. (Pub. Resources Code §21080 (d); Cal. Code Regs., tit. 14, § 5064 subd.(a)(1) (CEQA Guidelines § 15064 (a)(1)). In order to determine whether a project will cause a substantial adverse change in the significance of a historical resource, a lead agency will need to determine whether there are historical resources within the area of potential effect (APE).

CEQA was amended significantly in 2014. Assembly Bill 52 (Gatto, Chapter 532, Statutes of 2014) (AB 52) amended CEQA to create a separate category of cultural resources, "tribal cultural resources" (Pub. Resources Code §21074) and provides that a project with an effect that may cause a substantial adverse change in the significance of a tribal cultural resource is a project that may have a significant effect on the environment. (Pub. Resources Code §21084.2). Public agencies shall, when feasible, avoid damaging effects to any tribal cultural resource. (Pub. Resources Code §21084.3 (a)). **AB 52 applies to any project for which a notice of preparation, a notice of negative declaration, or a mitigated negative declaration is filed on or after July 1, 2015.** If your project involves the adoption of or amendment to a general plan or a specific plan, or the designation or proposed designation of open space, on or after March 1, 2005, it may also be subject to Senate Bill 18 (Burton, Chapter 905, Statutes of 2004) (SB 18). **Both SB 18 and AB 52 have tribal consultation requirements.** If your project is also subject to the federal National Environmental Policy Act (42 U.S.C. § 4321 et seq.) (NEPA), the tribal consultation requirements of Section 106 of the National Historic Preservation Act of 1966 (154 U.S.C. 300101, 36 C.F.R. §800 et seq.) may also apply.

The NAHC recommends consultation with California Native American tribes that are traditionally and culturally affiliated with the geographic area of your proposed project as early as possible in order to avoid inadvertent discoveries of Native American human remains and best protect tribal cultural resources. Below is a brief summary of portions of AB 52 and SB 18 as well as the NAHC's recommendations for conducting cultural resources assessments.

Consult your legal counsel about compliance with AB 52 and SB 18 as well as compliance with any other applicable laws.

[AB 52](#)

AB 52 has added to CEQA the additional requirements listed below, along with many other requirements:

- 1. Fourteen Day Period to Provide Notice of Completion of an Application/Decision to Undertake a Project:** Within fourteen (14) days of determining that an application for a project is complete or of a decision by a public agency to undertake a project, a lead agency shall provide formal notification to a designated contact of, or tribal representative of, traditionally and culturally affiliated California Native American tribes that have requested notice, to be accomplished by at least one written notice that includes:

 - a. A brief description of the project.
 - b. The lead agency contact information.
 - c. Notification that the California Native American tribe has 30 days to request consultation. (Pub. Resources Code §21080.3.1 (d)).
 - d. A "California Native American tribe" is defined as a Native American tribe located in California that is on the contact list maintained by the NAHC for the purposes of Chapter 905 of Statutes of 2004 (SB 18). (Pub. Resources Code §21073).

- 2. Begin Consultation Within 30 Days of Receiving a Tribe's Request for Consultation and Before Releasing a Negative Declaration, Mitigated Negative Declaration, or Environmental Impact Report:** A lead agency shall begin the consultation process within 30 days of receiving a request for consultation from a California Native American tribe that is traditionally and culturally affiliated with the geographic area of the proposed project. (Pub. Resources Code §21080.3.1, subds. (d) and (e)) and prior to the release of a negative declaration, mitigated negative declaration or Environmental Impact Report. (Pub. Resources Code §21080.3.1(b)).

 - a. For purposes of AB 52, "consultation shall have the same meaning as provided in Gov. Code § 65352.4 (SB 18). (Pub. Resources Code §21080.3.1 (b)).

- 3. Mandatory Topics of Consultation If Requested by a Tribe:** The following topics of consultation, if a tribe requests to discuss them, are mandatory topics of consultation:

 - a. Alternatives to the project.
 - b. Recommended mitigation measures.
 - c. Significant effects. (Pub. Resources Code §21080.3.2 (a)).

- 4. Discretionary Topics of Consultation:** The following topics are discretionary topics of consultation:

 - a. Type of environmental review necessary.
 - b. Significance of the tribal cultural resources.
 - c. Significance of the project's impacts on tribal cultural resources.
 - d. If necessary, project alternatives or appropriate measures for preservation or mitigation that the tribe may recommend to the lead agency. (Pub. Resources Code §21080.3.2 (a)).

- 5. Confidentiality of Information Submitted by a Tribe During the Environmental Review Process:** With some exceptions, any information, including but not limited to, the location, description, and use of tribal cultural resources submitted by a California Native American tribe during the environmental review process shall not be included in the environmental document or otherwise disclosed by the lead agency or any other public agency to the public, consistent with Government Code §6254 (r) and §6254.10. Any information submitted by a California Native American tribe during the consultation or environmental review process shall be published in a confidential appendix to the environmental document unless the tribe that provided the information consents, in writing, to the disclosure of some or all of the information to the public. (Pub. Resources Code §21082.3 (c)(1)).

- 6. Discussion of Impacts to Tribal Cultural Resources in the Environmental Document:** If a project may have a significant impact on a tribal cultural resource, the lead agency's environmental document shall discuss both of the following:

 - a. Whether the proposed project has a significant impact on an identified tribal cultural resource.
 - b. Whether feasible alternatives or mitigation measures, including those measures that may be agreed to pursuant to Public Resources Code §21082.3, subdivision (a), avoid or substantially lessen the impact on the identified tribal cultural resource. (Pub. Resources Code §21082.3 (b)).

- 7. Conclusion of Consultation:** Consultation with a tribe shall be considered concluded when either of the following occurs:
- a.** The parties agree to measures to mitigate or avoid a significant effect, if a significant effect exists, on a tribal cultural resource; or
 - b.** A party, acting in good faith and after reasonable effort, concludes that mutual agreement cannot be reached. (Pub. Resources Code §21080.3.2 (b)).
- 8. Recommending Mitigation Measures Agreed Upon in Consultation in the Environmental Document:** Any mitigation measures agreed upon in the consultation conducted pursuant to Public Resources Code §21080.3.2 shall be recommended for inclusion in the environmental document and in an adopted mitigation monitoring and reporting program, if determined to avoid or lessen the impact pursuant to Public Resources Code §21082.3, subdivision (b), paragraph 2, and shall be fully enforceable. (Pub. Resources Code §21082.3 (a)).
- 9. Required Consideration of Feasible Mitigation:** If mitigation measures recommended by the staff of the lead agency as a result of the consultation process are not included in the environmental document or if there are no agreed upon mitigation measures at the conclusion of consultation, or if consultation does not occur, and if substantial evidence demonstrates that a project will cause a significant effect to a tribal cultural resource, the lead agency shall consider feasible mitigation pursuant to Public Resources Code §21084.3 (b). (Pub. Resources Code §21082.3 (e)).
- 10. Examples of Mitigation Measures That, If Feasible, May Be Considered to Avoid or Minimize Significant Adverse Impacts to Tribal Cultural Resources:**
- a.** Avoidance and preservation of the resources in place, including, but not limited to:
 - i.** Planning and construction to avoid the resources and protect the cultural and natural context.
 - ii.** Planning greenspace, parks, or other open space, to incorporate the resources with culturally appropriate protection and management criteria.
 - b.** Treating the resource with culturally appropriate dignity, taking into account the tribal cultural values and meaning of the resource, including, but not limited to, the following:
 - i.** Protecting the cultural character and integrity of the resource.
 - ii.** Protecting the traditional use of the resource.
 - iii.** Protecting the confidentiality of the resource.
 - c.** Permanent conservation easements or other interests in real property, with culturally appropriate management criteria for the purposes of preserving or utilizing the resources or places.
 - d.** Protecting the resource. (Pub. Resource Code §21084.3 (b)).
 - e.** Please note that a federally recognized California Native American tribe or a non-federally recognized California Native American tribe that is on the contact list maintained by the NAHC to protect a California prehistoric, archaeological, cultural, spiritual, or ceremonial place may acquire and hold conservation easements if the conservation easement is voluntarily conveyed. (Civ. Code §815.3 (c)).
 - f.** Please note that it is the policy of the state that Native American remains and associated grave artifacts shall be repatriated. (Pub. Resources Code §5097.991).
- 11. Prerequisites for Certifying an Environmental Impact Report or Adopting a Mitigated Negative Declaration or Negative Declaration with a Significant Impact on an Identified Tribal Cultural Resource:** An Environmental Impact Report may not be certified, nor may a mitigated negative declaration or a negative declaration be adopted unless one of the following occurs:
- a.** The consultation process between the tribes and the lead agency has occurred as provided in Public Resources Code §21080.3.1 and §21080.3.2 and concluded pursuant to Public Resources Code §21080.3.2.
 - b.** The tribe that requested consultation failed to provide comments to the lead agency or otherwise failed to engage in the consultation process.
 - c.** The lead agency provided notice of the project to the tribe in compliance with Public Resources Code §21080.3.1 (d) and the tribe failed to request consultation within 30 days. (Pub. Resources Code §21082.3 (d)).

The NAHC's PowerPoint presentation titled, "Tribal Consultation Under AB 52: Requirements and Best Practices" may be found online at: http://nahc.ca.gov/wp-content/uploads/2015/10/AB52TribalConsultation_CalEPAPDF.pdf

SB 18

SB 18 applies to local governments and requires local governments to contact, provide notice to, refer plans to, and consult with tribes prior to the adoption or amendment of a general plan or a specific plan, or the designation of open space. (Gov. Code §65352.3). Local governments should consult the Governor's Office of Planning and Research's "Tribal Consultation Guidelines," which can be found online at: https://www.opr.ca.gov/docs/09_14_05_Updated_Guidelines_922.pdf.

Some of SB 18's provisions include:

1. **Tribal Consultation**: If a local government considers a proposal to adopt or amend a general plan or a specific plan, or to designate open space it is required to contact the appropriate tribes identified by the NAHC by requesting a "Tribal Consultation List." If a tribe, once contacted, requests consultation the local government must consult with the tribe on the plan proposal. **A tribe has 90 days from the date of receipt of notification to request consultation unless a shorter timeframe has been agreed to by the tribe.** (Gov. Code §65352.3 (a)(2)).
2. **No Statutory Time Limit on SB 18 Tribal Consultation**. There is no statutory time limit on SB 18 tribal consultation.
3. **Confidentiality**: Consistent with the guidelines developed and adopted by the Office of Planning and Research pursuant to Gov. Code §65040.2, the city or county shall protect the confidentiality of the information concerning the specific identity, location, character, and use of places, features and objects described in Public Resources Code §5097.9 and §5097.993 that are within the city's or county's jurisdiction. (Gov. Code §65352.3 (b)).
4. **Conclusion of SB 18 Tribal Consultation**: Consultation should be concluded at the point in which:
 - a. The parties to the consultation come to a mutual agreement concerning the appropriate measures for preservation or mitigation; or
 - b. Either the local government or the tribe, acting in good faith and after reasonable effort, concludes that mutual agreement cannot be reached concerning the appropriate measures of preservation or mitigation. (Tribal Consultation Guidelines, Governor's Office of Planning and Research (2005) at p. 18).

Agencies should be aware that neither AB 52 nor SB 18 precludes agencies from initiating tribal consultation with tribes that are traditionally and culturally affiliated with their jurisdictions before the timeframes provided in AB 52 and SB 18. For that reason, we urge you to continue to request Native American Tribal Contact Lists and "Sacred Lands File" searches from the NAHC. The request forms can be found online at: <http://nahc.ca.gov/resources/forms/>.

NAHC Recommendations for Cultural Resources Assessments

To adequately assess the existence and significance of tribal cultural resources and plan for avoidance, preservation in place, or barring both, mitigation of project-related impacts to tribal cultural resources, the NAHC recommends the following actions:

1. Contact the appropriate regional California Historical Research Information System (CHRIS) Center (https://ohp.parks.ca.gov/?page_id=30331) for an archaeological records search. The records search will determine:
 - a. If part or all of the APE has been previously surveyed for cultural resources.
 - b. If any known cultural resources have already been recorded on or adjacent to the APE.
 - c. If the probability is low, moderate, or high that cultural resources are located in the APE.
 - d. If a survey is required to determine whether previously unrecorded cultural resources are present.
2. If an archaeological inventory survey is required, the final stage is the preparation of a professional report detailing the findings and recommendations of the records search and field survey.
 - a. The final report containing site forms, site significance, and mitigation measures should be submitted immediately to the planning department. All information regarding site locations, Native American human remains, and associated funerary objects should be in a separate confidential addendum and not be made available for public disclosure.
 - b. The final written report should be submitted within 3 months after work has been completed to the appropriate regional CHRIS center.

3. Contact the NAHC for:
 - a. A Sacred Lands File search. Remember that tribes do not always record their sacred sites in the Sacred Lands File, nor are they required to do so. A Sacred Lands File search is not a substitute for consultation with tribes that are traditionally and culturally affiliated with the geographic area of the project's APE.
 - b. A Native American Tribal Consultation List of appropriate tribes for consultation concerning the project site and to assist in planning for avoidance, preservation in place, or, failing both, mitigation measures.

4. Remember that the lack of surface evidence of archaeological resources (including tribal cultural resources) does not preclude their subsurface existence.
 - a. Lead agencies should include in their mitigation and monitoring reporting program plan provisions for the identification and evaluation of inadvertently discovered archaeological resources per Cal. Code Regs., tit. 14, §15064.5(f) (CEQA Guidelines §15064.5(f)). In areas of identified archaeological sensitivity, a certified archaeologist and a culturally affiliated Native American with knowledge of cultural resources should monitor all ground-disturbing activities.
 - b. Lead agencies should include in their mitigation and monitoring reporting program plans provisions for the disposition of recovered cultural items that are not burial associated in consultation with culturally affiliated Native Americans.
 - c. Lead agencies should include in their mitigation and monitoring reporting program plans provisions for the treatment and disposition of inadvertently discovered Native American human remains. Health and Safety Code §7050.5, Public Resources Code §5097.98, and Cal. Code Regs., tit. 14, §15064.5, subdivisions (d) and (e) (CEQA Guidelines §15064.5, subs. (d) and (e)) address the processes to be followed in the event of an inadvertent discovery of any Native American human remains and associated grave goods in a location other than a dedicated cemetery.

If you have any questions or need additional information, please contact me at my email address:
Cameron.Vela@nahc.ca.gov.

Sincerely,

Cameron Vela

Cameron Vela
Cultural Resources Analyst

cc: State Clearinghouse



Yana Garcia
Secretary for
Environmental Protection



Department of Toxic Substances Control

Meredith Williams, Ph.D.
Director
8800 Cal Center Drive
Sacramento, California 95826-3200



Gavin Newsom
Governor

SENT VIA ELECTRONIC MAIL

February 17, 2023

Ms. Gabrielle Myers
City of Hanford
317 N Douty Street
Hanford, CA 93230
GMyers@cityofhanfordca.com

NOTICE OF PREPARATION OF AN ENVIRONMENTAL IMPACT REPORT FOR
TENTATIVE TRACT MAP 938 – DATED OCTOBER 2022 (STATE CLEARINGHOUSE
NUMBER: 2023020035)

Dear Ms. Myers:

The Department of Toxic Substances Control (DTSC) received a Notice of Preparation of an Environmental Impact Report (EIR) for the Vesting Tentative Tract Map 938 (Project). The Lead Agency is receiving this notice from DTSC because the Project includes one or more of the following: groundbreaking activities, work in close proximity to a roadway, presence of site buildings that may require demolition or modifications, importation of backfill soil, and/or work on or in close proximity to an agricultural or former agricultural site.

DTSC recommends that the following issues be evaluated in the Hazards and Hazardous Materials section of the EIR:

1. A State of California environmental regulatory agency such as DTSC, a Regional Water Quality Control Board (RWQCB), or a local agency that meets the requirements of [Health and Safety Code section 101480](#) should provide regulatory concurrence that the Project site is safe for construction and the proposed use.
2. The EIR should acknowledge the potential for historic or future activities on or near the project site to result in the release of hazardous wastes/substances on the project site. In instances in which releases have occurred or may occur, further studies should be carried out to delineate the nature and extent of the

contamination, and the potential threat to public health and/or the environment should be evaluated. The EIR should also identify the mechanism(s) to initiate any required investigation and/or remediation and the government agency who will be responsible for providing appropriate regulatory oversight.

3. Refiners in the United States started adding lead compounds to gasoline in the 1920s in order to boost octane levels and improve engine performance. This practice did not officially end until 1992 when lead was banned as a fuel additive in California. Tailpipe emissions from automobiles using leaded gasoline contained lead and resulted in aurally deposited lead (ADL) being deposited in and along roadways throughout the state. ADL-contaminated soils still exist along roadsides and medians and can also be found underneath some existing road surfaces due to past construction activities. Due to the potential for ADL-contaminated soil DTSC, recommends collecting soil samples for lead analysis prior to performing any intrusive activities for the project described in the EIR.
4. If buildings or other structures are to be demolished on any project sites included in the proposed project, surveys should be conducted for the presence of lead-based paints or products, mercury, asbestos containing materials, and polychlorinated biphenyl caulk. Removal, demolition and disposal of any of the above-mentioned chemicals should be conducted in compliance with California environmental regulations and policies. In addition, sampling near current and/or former buildings should be conducted in accordance with DTSC's 2006 [Interim Guidance Evaluation of School Sites with Potential Contamination from Lead Based Paint, Termiticides, and Electrical Transformers.](#)
5. If any projects initiated as part of the proposed project require the importation of soil to backfill any excavated areas, proper sampling should be conducted to ensure that the imported soil is free of contamination. DTSC recommends the imported materials be characterized according to DTSC's 2001 [Information Advisory Clean Imported Fill Material.](#)
6. If any sites included as part of the proposed project have been used for agricultural, weed abatement or related activities, proper investigation for organochlorinated pesticides should be discussed in the EIR. DTSC recommends the current and former agricultural lands be evaluated in accordance with DTSC's 2008 [Interim Guidance for Sampling Agricultural Properties \(Third Revision\).](#)



State of California – Natural Resources Agency
DEPARTMENT OF FISH AND WILDLIFE
Central Region
1234 East Shaw Avenue
Fresno, California 93710
(559) 243-4005
www.wildlife.ca.gov

GAVIN NEWSOM, Governor
CHARLTON H. BONHAM, Director



March 3, 2023

Gabrielle Meyers
City of Hanford
317 North Douty Street
Hanford California, 93230

Subject: **Vesting Tentative Tract 938- Lunaria
Notice of Preparation**

Dear Gabrielle Meyers:

The California Department of Fish and Wildlife (CDFW) received a notice of preparation from the City of Hanford, as Lead Agency, for the Project pursuant the California Environmental Quality Act (CEQA) and CEQA Guidelines.¹

Thank you for the opportunity to provide comments and recommendations regarding those activities involved in the Project that may affect California fish and wildlife. Likewise, CDFW appreciates the opportunity to provide comments regarding those aspects of the Project that CDFW, by law, may be required to carry out or approve through the exercise of its own regulatory authority under the Fish and Game Code.

CDFW ROLE

CDFW is California's **Trustee Agency** for fish and wildlife resources and holds those resources in trust by statute for all the people of the State (Fish & G. Code, §§ 711.7, subd. (a) & 1802; Pub. Resources Code, § 21070; CEQA Guidelines § 15386, subd. (a)). CDFW, in its trustee capacity, has jurisdiction over the conservation, protection, and management of fish, wildlife, native plants, and habitat necessary for biologically sustainable populations of those species (*Id.*, § 1802). Similarly, for purposes of CEQA, CDFW is charged by law to provide, as available, biological expertise during public agency environmental review efforts, focusing specifically on projects and related activities that have the potential to adversely affect fish and wildlife resources.

¹ CEQA is codified in the California Public Resources Code in section 21000 et seq. The "CEQA Guidelines" are found in Title 14 of the California Code of Regulations, commencing with section 15000.

Gabrielle Meyers
City of Hanford
March 3, 2023
Page 2

CDFW is also submitting comments as a **Responsible Agency** under CEQA (Pub. Resources Code, § 21069; CEQA Guidelines, § 15381). CDFW expects that it may need to exercise regulatory authority as provided by the Fish and Game Code. As proposed, for example, the Project may be subject to CDFW's lake and streambed alteration regulatory authority (Fish & G. Code, § 1600 et seq.). Likewise, to the extent implementation of the Project as proposed may result in "take" as defined by State law of any species protected under the California Endangered Species Act (CESA) (Fish & G. Code, § 2050 et seq.), related authorization as provided by the Fish and Game Code will be required.

PROJECT DESCRIPTION SUMMARY

Proponent: D.R. Horton

Objective: The Applicant proposes the construction of 457 single-family residences, internal roads, a drainage retention basin, and a 5.82-acre park on an approximately 95-acre site (Project). Access to the proposed subdivision will be from 10 ½ Avenue. The development will build 10 ½ Avenue with a minimum 34-foot road right of way (ROW).

In order for the Project to be constructed, approval of the following actions is required:

- Tentative Tract Map 938

Construction will take approximately 24 months, with a total buildout of the homes by Q4 2025. There will be six phases, with the following lots constructed per phase:

- Phase 1 – 106 lots
- Phase 2 – 65 lots
- Phase 3 – 78 lots
- Phase 4 – 67 lots
- Phase 5 – 67 lots
- Phase 6 – 69 lots

COMMENTS AND RECOMMENDATIONS

CDFW offers the comments and recommendations below to assist the City of Hanford in adequately identifying and/or mitigating the Project's significant, or potentially significant, direct, and indirect impacts on fish and wildlife (biological) resources. Editorial comments or other suggestions may also be included to improve the CEQA document.

The Project area is within the geographic range of several special-status animal species including the State threatened and federally endangered San Joaquin kit fox (*Vulpes*

Gabrielle Meyers
City of Hanford
March 3, 2023
Page 3

macrotis mutica), the State candidate endangered Crotch bumblebee (*Bombus crotchii*), the State threatened Swainson's hawk (*Buteo swainsoni*), and the State species of special concern burrowing owl (*Athene cunicularia*) and American badger (*Taxidea taxus*).

San Joaquin Kit Fox (SJKF)

The California Natural Diversity Database (CNDDDB) records show that SJKF have been documented near the project area and are known to occur near Hanford. Aerial records show that the area is comprised of agricultural and ruderal habitat. In addition to grasslands, SJKF den in a variety of areas such as rights-of-way, vacant lots, agricultural and fallow or ruderal habitat, dry stream channels, and canal levees and populations can fluctuate over time. SJKF are also capable of occupying urban environments (Cypher and Frost 1999). SJKF may be attracted to the Project area due to the type and level of ground-disturbing activities and the loose, friable soils resulting from intensive ground disturbance. As a result, there is potential for SJKF to occupy the Project site and surrounding area.

CDFW recommends assessing presence/absence of SJKF by conducting focused den surveys as part of the biological technical studies conducted in support of the CEQA document. CDFW also recommends a qualified biologist conduct on-site worker awareness training and inspect all construction materials for SJKF before use. Any pits or trenches created shall be sloped or covered to prevent inadvertent take.

SJKF detection warrants consultation with CDFW to discuss how to avoid take or, if avoidance is not feasible, to acquire an Incidental Take Permit (ITP) prior to ground-disturbing activities, pursuant to Fish and Game Code section 2081 subdivision (b).

Crotch Bumblebee (CBB)

CNDDDB records indicate that the Project site is within the habitat range of CBB. Suitable CBB habitat includes areas of grasslands and upland scrub that contain requisite habitat elements, such as small mammal burrows. CBB primarily nest in late February through late October underground in abandoned small mammal burrows but may also nest under perennial bunch grasses or thatched annual grasses, under brush piles, in old bird nests, and in dead trees or hollow logs (Williams et al. 2014, Hatfield et al. 2015). Overwintering sites utilized by CBB mated queens include soft, disturbed soil (Goulson 2010), or under leaf litter or other debris (Williams et al. 2014). Therefore, potential ground disturbance and vegetation removal associated with Project implementation may significantly impact local CBB populations.

Gabrielle Meyers
City of Hanford
March 3, 2023
Page 4

If suitable CBB habitat exists in areas of planned Project-related ground disturbance, equipment staging, or materials laydown, CDFW recommends a qualified biologist conduct a habitat assessment and surveys as part of the biological technical studies conducted in support of the CEQA document to determine if the Project area or its immediate vicinity contain habitat suitable to support CBB. If surveys cannot be completed, CDFW recommends avoiding disturbing potential CBB habitat.

CBB detection warrants consultation with CDFW to discuss how to avoid take or, if avoidance is not feasible, to acquire an ITP prior to ground disturbing activities, pursuant to Fish and Game Code section 2081 subdivision (b).

Swainson's Hawk (SWHA)

CNDDDB records indicate that SWHA have been documented to occur near the project site (CDFW 2022). The habitat types present at and surrounding the Project site all provide suitable foraging habitat for SWHA, increasing the likelihood of SWHA occurrence within the vicinity. In addition, any trees in the Project vicinity have the potential to provide suitable nesting habitat and any power poles may be utilized for perching. SWHA exhibit high nest-site fidelity year after year and lack of suitable nesting habitat limits their local distribution and abundance (CDFW 2016). If potential nest sites occur in the Project vicinity, approval of the Project may lead to subsequent ground-disturbing activities that involve noise, groundwork, construction of structures, and movement of workers that could affect nests and has the potential to result in nest abandonment and/or loss of foraging habitat, significantly impacting local nesting SWHA. In addition, conversion of undeveloped land can directly influence distribution and abundance of SWHA, due to the reduction in foraging habitat.

To evaluate potential Project-related impacts, CDFW recommends that a qualified biologist conduct a habitat assessment as part of the biological technical studies conducted in support of the CEQA document, to determine if the Project site or the immediate vicinity contain suitable habitat for SWHA. If suitable foraging or nesting habitat is present, CDFW recommends that a qualified biologist conduct surveys for nesting SWHA following the entire survey methodology developed by the SWHA Technical Advisory Committee (SWHA TAC 2000) prior to Project implementation (during CEQA analysis). The survey protocol includes early season surveys to assist the project proponent in implementing necessary avoidance and minimization measures, and in identifying active nest sites prior to initiating ground-disturbing activities. CDFW recommends a minimum no-disturbance buffer of ½ mile be delineated around active nests until the breeding season has ended or until a qualified biologist has determined that the birds have fledged and are no longer reliant upon the nest or parental care for survival. If an active SWHA nest is detected during surveys, consultation with CDFW is warranted to discuss how to

Gabrielle Meyers
City of Hanford
March 3, 2023
Page 5

implement the Project and avoid take. If take cannot be avoided, take authorization through the issuance of an ITP, pursuant to Fish and Game Code section 2081 subdivision (b) is necessary to comply with CESA.

State Species of Special Concern

Burrowing owl and American badger have the potential to occur in the Project area. These species have been documented to occur in the vicinity of the Project site, which supports requisite habitat elements (CDFW 2023).

CDFW recommends that a qualified biologist conduct a habitat assessment as part of the biological technical studies conducted in support of the CEQA document, to determine if project areas or their immediate vicinity contain potential habitat for the species mentioned above. If potential habitat is present, CDFW recommends that a qualified biologist conduct focused surveys for applicable species and their requisite habitat features to evaluate potential impacts resulting from ground and vegetation disturbance.

Avoidance whenever possible is encouraged via delineation and observance of a 50-foot no-disturbance buffer around dens of mammals like the American badger as well as the entrances of burrows that can provide refuge for special-status small mammals.

CDFW recommends assessing presence/absence of BUOW by having a qualified biologist conduct surveys as part of the biological technical studies conducted in support of the CEQA document following the California Burrowing Owl Consortium's Burrowing Owl Survey Protocol and Mitigation Guidelines (CBOC 1993) and CDFW's Staff Report on Burrowing Owl Mitigation (Staff Report) (CDFG 2012). Specifically, if suitable habitat is present at an individual Project site, CBOC and CDFW's Staff Report suggest three or more surveillance surveys conducted during daylight with each visit occurring at least three weeks apart during the peak breeding season (April 15 to July 15), when BUOW are most detectable.

If BUOW are detected, CDFW recommends no-disturbance buffers, as outlined in the Staff Report (CDFG 2012), be implemented prior to and during any ground-disturbing activities. Specifically, CDFW's Staff Report recommends that impacts to occupied burrows be avoided in accordance with the following table unless a qualified biologist approved by CDFW verifies through non-invasive methods that either: 1) the birds have not begun egg laying and incubation; or 2) that juveniles from the occupied burrows are foraging independently and are capable of independent survival.

Gabrielle Meyers
 City of Hanford
 March 3, 2023
 Page 6

Location	Time of Year	Level of Disturbance		
		Low	Med	High
Nesting sites	April 1-Aug 15	200 m*	500 m	500 m
Nesting sites	Aug 16-Oct 15	200 m	200 m	500 m
Nesting sites	Oct 16-Mar 31	50 m	100 m	500 m

* meters (m)

If BUOW are found within these recommended buffers and avoidance is not possible, it is important to note that according to the Staff Report (CDFG 2012), eviction is not a take avoidance, minimization, or mitigation method and is considered a potentially significant impact under CEQA. However, if necessary, CDFW recommends that burrow exclusion be conducted by qualified biologists and only during the non-breeding season, before breeding behavior is exhibited and after the burrow is confirmed unoccupied through non-invasive methods, such as surveillance. CDFW recommends replacement of occupied burrows with artificial burrows at a ratio of 1 burrow collapsed to 1 artificial burrow constructed (1:1) as mitigation for the potentially significant impact of evicting BUOW. BUOW may attempt to colonize or re-colonize an area that will be impacted; thus, CDFW recommends ongoing surveillance, at a rate that is sufficient to detect BUOW if they return.

Federally Listed Species: CDFW recommends consulting with USFWS regarding potential impacts to federally listed species including but not limited to SJKF. Take under the Federal Endangered Species Act (FESA) is more broadly defined than CESA; take under FESA also includes significant habitat modification or degradation that could result in death or injury to a listed species by interfering with essential behavioral patterns such as breeding, foraging, or nesting. Consultation with the USFWS in order to comply with FESA is advised well in advance of any Project activities.

CDFW appreciates the opportunity to comment to assist the City of Hanford in identifying and mitigating Project impacts on biological resources. If you have any questions, please contact Jaime Marquez, Environmental Scientist, at the address provided on this letterhead, by telephone at (559) 580-3200, or by electronic mail at Jaime.Marquez@wildlife.ca.gov.

Sincerely,

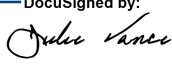
DocuSigned by:

 FA83F09FE08945A...
 Julie A. Vance
 Regional Manager

Gabrielle Meyers
City of Hanford
March 3, 2023
Page 7

REFERENCES

- California Burrowing Owl Consortium (CBOC). 1993. Burrowing owl survey protocol and mitigation guidelines. Pages 171-177 in Lincer, J. L. and K. Steenhof (editors). 1993. The burrowing owl, its biology and management. Raptor Research Report Number 9.
- CDFG. 2012. Staff Report on Burrowing Owl Mitigation. California Department of Fish and Game.
- California Department of Fish and Wildlife (CDFW), 2016. Five Year Status Review for Swainson's Hawk (*Buteo swainsoni*). California Department of Fish and Wildlife. April 11, 2016.
- CDFW. 2023. Biogeographic Information and Observation System (BIOS). <https://www.wildlife.ca.gov/Data/BIOS>. Accessed February 21, 2023.
- Cypher, B. and N. Frost. 1999. Condition of San Joaquin kit foxes in urban and exurban habitats. *Journal of Wildlife Management* 63: 930-938.
- Goulson, D. 2010. *Bumblebees: Behaviour, Ecology, and Conservation*. Oxford University Press, New York. 317pp.
- Hatfield, R., Jepsen, S., Thorp, R., Richardson, L. & Colla, S. 2015. *Bombus crotchii*. The IUCN Red List of Threatened Species.
- Swainson's Hawk Technical Advisory Committee (SWHA TAC). 2000. Recommended Timing and Methodology for Swainson's Hawk Nesting Surveys in the Central Valley of California. Swainson's Hawk Technical Advisory Committee. May 31, 2000.
- USFWS. 2011. Standard Recommendations for the Protection of the San Joaquin Kit Fox Prior to or During Ground Disturbance. United States Fish and Wildlife Service. January 2011.
- Williams, P. H., R. W. Thorp, L. L. Richardson, and S.R. Colla. 2014. *Bumble bees of North America: An Identification guide*. Princeton University Press, Princeton, New Jersey. 208pp.

Ms. Gabrielle Myers
February 17, 2023
Page 3

DTSC appreciates the opportunity to comment on the EIR. Should you need any assistance with an environmental investigation, please visit DTSC's [Site Mitigation and Restoration Program](#) page to apply for lead agency oversight. Additional information regarding voluntary agreements with DTSC can be found at [DTSC's Brownfield website](#).

If you have any questions, please contact me at (916) 255-3710 or via email at Gavin.McCreary@dtsc.ca.gov.

Sincerely,

A handwritten signature in blue ink that reads "Gavin McCreary". The signature is written in a cursive style.

Gavin McCreary
Project Manager
Site Evaluation and Remediation Unit
Site Mitigation and Restoration Program
Department of Toxic Substances Control

cc: (via email)

Governor's Office of Planning and Research
State Clearinghouse
State.Clearinghouse@opr.ca.gov

Mr. Dave Kereazis
Office of Planning & Environmental Analysis
Department of Toxic Substances Control
Dave.Kereazis@dtsc.ca.gov

Appendix B-
Revised Traffic Impact Analysis & VMT

Revised Traffic Impact Analysis Report

Lunaria (Single-Family Detached Housing)

Located on the Southeast Quadrant of Hanford-
Armona Road and 10 ½ Avenue

In the City of Hanford, California

Prepared for

Quad Knopf, Inc.
601 Pollasky Avenue, Suite 301
Clovis, CA 93612

February 24, 2023

Project No. 047-002



Traffic Engineering, Transportation Planning, & Parking Solutions

516 W. Shaw Ave., Ste. 103

Fresno, CA 93710

Phone: (559) 570-8991

www.JLBtraffic.com



Traffic Engineering, Transportation Planning, & Parking Solutions

Revised Traffic Impact Analysis Report

**For Lunaria located on the Southeast Quadrant of Hanford-Armona Road and
10 ½ Avenue**

In the City of Hanford, California

February 24, 2023

This Traffic Impact Analysis Report has been prepared under the direction of a licensed Traffic Engineer. The licensed Traffic Engineer attests to the technical information contained therein and has judged the qualifications of any technical specialists providing engineering data from which recommendations, conclusions and decisions are based.

Prepared by:

Jose Luis Benavides, PE, TE
President



Traffic Engineering, Transportation Planning, & Parking Solutions

516 W. Shaw Ave., Ste. 103
Fresno, CA 93704
Phone: (559) 570-8991
www.JLBtraffic.com

Table of Contents

Introduction and Summary.....	1
Introduction	1
Summary	1
Existing Traffic Conditions.....	1
Existing plus Project Traffic Conditions.....	1
Near Term plus Project Traffic Conditions.....	2
Cumulative Year 2042 plus Project Traffic Conditions.....	2
Scope of Work	3
Study Facilities	3
Study Intersections	4
Study Segments.....	4
Project Only Trips to State Facilities	4
Study Scenarios.....	4
Existing Traffic Conditions.....	4
Existing plus Project Traffic Conditions.....	4
Near Term plus Project Traffic Conditions.....	5
Cumulative Year 2042 plus Project Traffic Conditions.....	5
LOS Methodology	5
LOS Thresholds	6
Operational Analysis Assumptions and Defaults	6
Existing Traffic Conditions	7
Roadway Network.....	7
Traffic Signal Warrants.....	8
Results of Existing Level of Service Analysis	8
Existing plus Project Traffic Conditions	12
Project Description.....	12
Project Access	12
Trip Generation.....	12
Trip Distribution	13
Bikeways	14

Walkways 14

Transit 14

Traffic Signal Warrants..... 15

Results of Existing plus Project Level of Service Analysis 15

Near Term plus Project Traffic Conditions.....19

 Description of Near Term Projects..... 19

 Traffic Signal Warrants..... 20

 Results of Near Term plus Project Level of Service Analysis..... 20

Cumulative Year 2042 plus Project Traffic Conditions.....23

 Traffic Signal Warrants..... 23

 Results of Cumulative Year 2042 plus Project Level of Service Analysis 23

 Latest Site Plan Project Trips..... 24

 Project Only Trip Assignment to State Facilities 24

Queuing Analysis30

Conclusions and Recommendations.....34

 Existing Traffic Conditions..... 34

 Existing plus Project Traffic Conditions..... 34

 Near Term plus Project Traffic Conditions..... 34

 Cumulative Year 2042 plus Project Traffic Conditions..... 35

 Queuing Analysis..... 35

Study Participants.....36

References.....37



List of Figures

Figure 1: Vicinity Map	10
Figure 2: Existing - Traffic Volumes, Geometrics and Controls.....	11
Figure 3: Project Site Plan	16
Figure 4: 2027 Project Only Trips	17
Figure 5: Existing plus Project - Traffic Volumes, Geometrics and Controls	18
Figure 6: 2027 Near Term Projects' Trip Assignment	21
Figure 7: Near Term plus Project - Traffic Volumes, Geometrics and Controls.....	22
Figure 8: 2042 Project Only Trips	25
Figure 9: 2042 Near Term Projects' Trip Assignment	26
Figure 10: Cumulative Year 2042 plus Project - Traffic Volumes, Geometrics and Controls	27
Figure 11: Project Only Trips to State Route 198 at 11 th Avenue	28
Figure 12: Project Only Trips to State Route 198 at 10 th Avenue	29

List of Tables

Table I: Existing Intersection LOS Results	9
Table II: Existing Segment LOS Results	9
Table III: Original Project Site Plan Trip Generation	13
Table IV: Latest Project Site Plan Trip Generation	13
Table V: Difference in Net Trip Generation	13
Table VI: Existing plus Project Intersection LOS Results	15
Table VII: Existing plus Project Segment LOS Results	15
Table VIII: Near Term Projects' Trip Generation	19
Table IX: Near Term plus Project Intersection LOS Results	20
Table X: Near Term plus Project Segment LOS Results	20
Table XI: Cumulative Year 2042 plus Project Intersection LOS Results	23
Table XII: Cumulative Year 2042 plus Project Segment LOS Results	24
Table XIII: Cumulative Year 2042 plus Latest Project Site Plan Intersection LOS Results	24
Table XIV: Queuing Analysis	31

List of Appendices

Appendix A: Scope of Work
Appendix B: Traffic Counts
Appendix C: Traffic Modeling
Appendix D: Methodology
Appendix E: Existing Traffic Conditions
Appendix F: Existing plus Project Traffic Conditions
Appendix G: Near Term plus Project Traffic Conditions
Appendix H: Cumulative Year 2042 plus Project Traffic Conditions
Appendix I: Traffic Signal Warrants

Introduction and Summary

Introduction

This Report describes a **Revised Traffic Impact Analysis Report (TIA)** prepared by **JLB Traffic Engineering, Inc. (JLB)** for the proposed **Lunaria (Project)** located in the City of Hanford. Specifically, the Project proposes to develop 457 single family residential units and a 5.8-acre public park on the Southeast Quadrant of Hanford-Armona Road and 10 ½ Avenue. The TIA has been revised to address comments from the City of Hanford and to update the Project Only trips based on the latest site plan. Based on information provided to JLB, the Project is consistent with the City's General Plan. Figure 1 shows the location of the proposed Project site relative to the surrounding roadway network.

The purpose of the TIA is to evaluate the potential on-site and off-site traffic impacts, identify short-term and long-term roadway and circulation needs, determine potential roadway improvement measures and identify any critical traffic issues that should be addressed in the on-going planning process. The TIA primarily focused on evaluating traffic conditions at study intersections that may potentially be impacted by the proposed Project. The Scope of Work was prepared via consultation with City of Hanford, Kings County and Caltrans staff.

Summary

The potential traffic impacts of the proposed Project were evaluated in accordance with the standards set forth by the Level of Service (LOS) policies of the City of Hanford, Kings County and Caltrans.

Existing Traffic Conditions

- At present, all study intersections operate at an acceptable LOS during both peak periods.
- At present, all study segments operate at an acceptable LOS.

Existing plus Project Traffic Conditions

- Based on the original site plan, the Project is estimated to generate a maximum of 4,181 daily trips, 310 AM peak hour trips and 418 PM peak hour trips at build-out.
- Based on the latest site plan, the Project is estimated to generate a maximum of 4,315 daily trips, 320 AM peak hour trips and 431 PM peak hour trips at build-out.
- Compared to the original site plan, the latest site plan is estimated to yield a greater trip generation by 134 daily trips, 10 AM peak hour trips and 13 PM peak hour trips. These are an increase of 3.20%, 3.23% and 3.11% of the Daily, AM peak hour and PM peak hour, respectively.
- LOS studies were completed using the trip generated by the original site plan. To account for the additional trips produced by the latest site plan, all additional trips (10 AM Peak hour trips and 13 PM peak hour trips) were routed to the worst performing intersection during the worst performing scenario. This was determined to be the intersection of Houston Avenue at 11th Avenue during the Cumulative Year 2042 plus Project Scenario. Based on this analysis, it was determined that that all study intersections and segments would continue to operate within the acceptable LOS for all study scenarios.

- JLB analyzed the location of the existing and proposed roadways and access points. This review revealed that all access points are located at points that minimize traffic operational impacts to existing and future roadway networks.
- It is recommended that the Project implement ADA compliant sidewalks along its frontages to 10 ½ Avenue and Orchard Avenue.
- It is recommended that the Project implement Class II Bike Lanes along its frontage to 10 ½ Avenue and Orchard Avenue.
- Under this scenario, all study intersections are projected to operate at an acceptable LOS during both peak periods.
- Under this scenario, all study segments are projected to operate at an acceptable LOS.

Near Term plus Project Traffic Conditions

- The total trip generation for the Near Term Projects by 2027 is projected as 20,410 daily trips, 1,600 AM peak hour trips and 2,141 PM peak hour trips.
- The total trip generation for the Near Term Projects by 2042 is projected as 25,413 daily trips, 1,992 AM peak hour trips and 2,665 PM peak hour trips.
- Under this scenario, all study intersections are projected to operate at an acceptable LOS during both peak periods.
- Under this scenario, all study segments are projected to operate at an acceptable LOS.

Cumulative Year 2042 plus Project Traffic Conditions

- Under this scenario, all study intersections are projected to operate at an acceptable LOS during both peak periods.
- Under this scenario, all study segments are projected to operate at an acceptable LOS.
- To account for the difference in trip generation between the original and latest site plan, all additional trips (10 AM Peak hour trips and 13 PM peak hour trips) were routed to the worst performing intersection during the worst performing scenario. This intersection was determined to be Houston Avenue at 11th Avenue during the Cumulative Year 2042 plus Project. Even with all additional project trips routed to this intersection, it continues to operate at an acceptable LOS. Therefore, it is the opinion of JLB that all study intersections would continue to operate within the acceptable LOS for all study scenarios if the additional trips were distributed throughout the roadway network and the LOS studies were redone. As a result, JLB does not recommend that this TIA be redone and that the City of Hanford, County of Kings and Caltrans can utilize this TIA to determine the Projects impacts to the study intersections and segments.

Scope of Work

The TIA focuses on evaluating traffic conditions at study intersections that may potentially be impacted by the proposed Project. On January 20, 2022, a Draft Scope of Work for the preparation of a TIA and VMT analysis for this Project was provided to City of Hanford, Kings County and Caltrans staff for their review and comment. The Draft Scope of Work was based on the Traffic Impact Analysis Guidelines of lead and responsible agencies.

On January 27, 2022, City of Hanford staff responded to the Draft Scope of Work. The City of Hanford requested that the intersection of 10th Avenue at Houston Avenue and the segments of Hanford-Armona Road between 11th Avenue and 10th Avenue and Houston Avenue between 11th Avenue and 10th Avenue be added to the study facilities.

On February 3, 2022, King's County staff responded to the Draft Scope of Work. King's County requested that the intersections of 10th Avenue at Houston Avenue and 11th Avenue at Houston Avenue and the segment of Houston Avenue between 11th Avenue and 10th Avenue be added to the study facilities.

On January 28, 2022, Caltrans staff responded to the Draft Scope of Work. Caltrans requested that the following be added to the study facilities 1) SR 198 at Avenue 10 both on/off ramps, 2) SR 198 at Douty Street eastbound off-ramp and 3) SR 198 at Avenue 11 westbound on-ramp. On February 3, 2022, after coordinating with Caltrans, Caltrans revised their comments as follows; a queuing analysis for 1) SR 198 at Avenue 10 westbound off-ramp and 2) SR 198 at Douty St (on 3rd Street) eastbound off-ramp and trip trace analysis at 1) SR 198 at Avenue 11 westbound on-ramp and 2) SR 198 at Avenue 10 (on 3rd Street) eastbound on-ramp.

Based on the comments received, the TIA includes the study intersections of 10th Avenue at Houston Avenue and 11th Avenue at Houston Avenue, the study segments of Hanford-Armona Road between 11th Avenue and 10th Avenue and Houston Avenue between 11th Avenue and 10th Avenue, the queuing analysis of SR 198 at Avenue 10 westbound off-ramp and SR 198 at Douty St (on 3rd Street) eastbound off-ramp and the trip trace analysis at SR 198 at Avenue 11 westbound on-ramp and SR 198 at Avenue 10 (on 3rd Street) eastbound on-ramp. JLB also coordinated with the City of Hanford Planning Department to verify the list of pending/approved projects. The Draft Scope of Work and the comments received from the lead agency and responsible agencies are included in Appendix A.

Study Facilities

The existing intersection peak hour turning movement counts were conducted at the study intersections and segments between January 2022 and March 2022, while schools in the vicinity of the Project site were in session. The intersection turning movement counts included pedestrian and bicycle volumes. As proposed in the Draft Scope of Work, traffic conditions have normalized to the new normal and therefore no escalation rate was applied to the collected traffic counts due to Covid-19. The traffic counts for the existing study intersections are contained in Appendix B. The existing intersection turning movement volumes, intersection geometrics and traffic controls are illustrated in Figure 2.

Study Intersections

Location

1. State Route 198 Eastbound Off-Ramp at Douty Street (Queuing Analysis Only)
2. State Route 198 Westbound Off-Ramp at 10th Avenue (Queuing Analysis Only)
3. Hanford-Armona Road / 10 ½ Avenue
4. Hanford-Armona Road / Jordan Way
5. Hanford-Armona Road / 10th Avenue
6. Orchard Avenue / 10 ½ Avenue (Future Intersection)
7. Houston Avenue / 11th Avenue
8. Houston Avenue / 10 ½ Avenue
9. Houston Avenue / 10th Avenue

Study Segments

Location

1. Hanford-Armona Road Between 11th Avenue and 10 ½ Avenue
2. Hanford-Armona Road Between 10 ½ Avenue and Jordan Way
3. Hanford-Armona Road Between Jordan Way and 10th Avenue
4. 10 ½ Avenue Between Hanford-Armona Road and Orchard Avenue
5. 10 ½ Avenue Between Orchard Avenue and Houston Avenue
6. Houston Avenue Between 11th Avenue and 10 ½ Avenue
7. Houston Avenue Between 10 ½ Avenue and 10th Avenue

Project Only Trips to State Facilities

Location

1. State Route 198 at 11th Avenue Westbound On-Ramp
2. State Route 198 at 10th Avenue (on 3rd Street) Eastbound On-Ramp

Study Scenarios

Existing Traffic Conditions

This scenario evaluates the Existing Traffic Conditions based on existing traffic volumes and roadway conditions from traffic counts and field surveys conducted in between January 2022 and March 2022.

Existing plus Project Traffic Conditions

This scenario evaluates total traffic volumes and roadway conditions based on the Existing plus Project Traffic Conditions. The Existing plus Project traffic volumes were obtained by adding the Project Only Trips to the Existing Traffic Conditions scenario. The Project Only Trips to the study facilities were developed based on existing travel patterns, the Kings County Association of Governments (KCAG) Project Select Zone, the existing roadway network, data provided by the developer, knowledge of the study area, engineering judgment, existing residential and commercial densities and the City of Hanford *General Plan* Background Report in the vicinity of the Project site. The KCAG Project only trip output was lower than the Project's trip generation, so the volumes were manually increased and proportionally distributed through the study intersections. The KCAG Project Select Zone results are contained in Appendix C.

Near Term plus Project Traffic Conditions

This scenario evaluates total traffic volumes and roadway conditions based on the Near Term plus Project Traffic Conditions. Since not all the Near Term Projects are projected to be fully built out in the next five (5) years, we estimated a percentage of what could be constructed within this period. This percentage was determined to be 67%, therefore 67% of the Project's Near Term trips were included in this scenario. The Near Term plus Project traffic volumes were obtained by adding the 2027 Near Term related trips to the Existing plus Project Traffic Conditions scenario.

Cumulative Year 2042 plus Project Traffic Conditions

This scenario evaluates total traffic volumes and roadway conditions based on the Cumulative Year 2042 plus Project Traffic Conditions. The Cumulative Year 2042 plus Project traffic volumes were obtained by using a combination of the KCAG traffic model runs (Base Year 2021 and Cumulative Year 2042) and existing traffic counts. Based on the *City of Hanford 2035 General Plan Circulation Map*, Orchard Avenue is planned to connect 10 ½ Avenue and 10th Avenue. Therefore, the 2042 Project Only trips were modified to allow access to 10th Avenue from Orchard Avenue. The Near Term Projects are also projected to be fully built prior to this scenario, therefore 100% of the Near Term trips were included. Under this scenario, the increment method was utilized to determine the Cumulative Year 2042 traffic volumes. The KCAG Activity Based-Model (ABM) results provided by KCAG modeler Kittelson & Associates are contained in Appendix C.

LOS Methodology

LOS is a qualitative index of the performance of an element of the transportation system. LOS is a rating scale running from "A" to "F", with "A" indicating no congestion of any kind and "F" indicating unacceptable congestion and delays. LOS in this study describes the operating conditions for signalized and unsignalized intersections.

The *Highway Capacity Manual (HCM)* 6th Edition is the standard reference published by the Transportation Research Board and contains the specific criteria and methods to be used in assessing LOS. U-turn movements were analyzed using HCM 2000 methodologies and would yield more accurate results for the reason that HCM 6th Edition methodologies do not allow the analysis of U-turns. Lane configurations not reflective of existing conditions are a result of software limitations and thus represent a worst-case scenario. Synchro software was used to define LOS in this study. Details regarding these calculations are included in Appendix D.

While LOS is no longer the criteria of significance for traffic impacts in the state of California, the City of Hanford continues to apply congestion-related conditions or requirements for land development projects through planning approval processes outside of CEQA guidelines in order to continue the implementation of *Hanford General Plan* policies.

LOS Thresholds

The City of Hanford *2035 General Plan Policy Document* has established LOS E as the acceptable level on streets and intersections within the area bounded by Highway 198, 10th Avenue, 11th Avenue, and Florina Avenue, inclusive of these streets and a peak hour LOS D on all other streets and intersections within the Planned Growth Boundary. All the study facilities lie outside of the SR 198, 10th Avenue, 11th Avenue and Florina Avenue boundary, therefore, the LOS D threshold was utilized to evaluate the potential significance of LOS impacts to City of Hanford roadway facilities.

The County of Kings has established LOS D as the acceptable level of traffic congestion on county roads. Therefore, LOS D is used to evaluate the potential significance of LOS impacts to King's County intersections. In this case, since the LOS threshold for the City and County is the same, LOS D was utilized as the criteria of significance for this TIA.

Operational Analysis Assumptions and Defaults

The following operational analysis values, assumptions and defaults were used in this study to ensure a consistent analysis of LOS among the various scenarios.

- Yellow time consistent with the *California Manual on Uniform Traffic Control Devices (CA MUTCD)* based on approach speeds (Caltrans 2021)
- Yellow time of 3.2 seconds for left-turn phases
- All-red clearance intervals of 1.0 second for all phases
- Walk intervals of 7.0 seconds
- Flashing Don't Walk based on 3.5 feet/second walking speed with yellow plus all-red clearance subtracted and 2.0 seconds added
- The number of observed pedestrians at existing intersections was utilized under all study scenarios
- All new or modified signals utilize protective left-turn phasing
- A 3 percent Heavy Vehicle Factor (HVF), or the existing HVF if higher, was utilized under all study scenarios
- An average of 10 pedestrian calls per hour at signalized study intersections
- At existing intersections, the observed Peak Hour Factor (PHF) is utilized in the Existing, Existing plus Project and Near Term plus Project Traffic Conditions scenarios.
- For the Cumulative Year 2042 scenario, the PHF's were increased to reflect traffic operations and an increase in future traffic volumes. As roadways start to reach their saturated flow rates, PHF's tend to increase to 0.92 or higher in urban settings. A PHF of 0.92, or the existing PHF if higher, is utilized for under this scenario.
 - For the intersection of 10½ Avenue and Hanford-Armona Road, the following PHF's were utilized in order to reflect general peak hour factors near the proximity of a school:
 - A PHF of 0.86, or the existing if higher, is utilized during the AM peak.
 - A PHF of 0.90, or the existing if higher, is utilized during the PM peak.
 - A PHF of 0.92, or the existing if higher, is utilized for all remaining study intersections.

Existing Traffic Conditions

Roadway Network

The Project site and surrounding study area are illustrated in Figure 1. Important roadways serving the Project are discussed below.

11th Avenue is an existing north-south four-lane divided arterial in the vicinity of the proposed Project site. In this area, 11th Avenue exists between Dover Avenue and Kansas Avenue. The *City of Hanford 2035 General Plan Circulation Map* designates 11th Avenue as an arterial between Flint Avenue and Jackson Avenue.

10 ½ Avenue is an existing north-south two-lane undivided collector adjacent to the proposed Project site. In this area, 10 ½ Avenue exists between Scott Street and Houston Avenue. The *City of Hanford 2035 General Plan Circulation Map* designates 10 ½ Avenue as a collector.

Douty Street is an existing north-south two-lane undivided collector in the vicinity of the proposed Project site. In this area, Douty Street exists between Flint Avenue and Scott Street. The *City of Hanford 2035 General Plan Circulation Map* designates Douty Street as a collector.

Jordan Way is an existing north-south two-lane undivided local street adjacent to the proposed Project site. In this area, Jordan Way currently exists between Hanford-Armona Road and Sydney Court. As part of the project, Jordan Way is expected to be extended further South approximately 850 feet.

10th Avenue is an existing north-south two-lane undivided arterial in the vicinity of the proposed Project site. In this area, 10th Avenue currently exists between State Route 43 and Lansing Avenue. The *City of Hanford 2035 General Plan Circulation Map* designates 10th Avenue as an arterial.

4th Street is an existing east-west two-lane collector in the vicinity of the proposed Project site. In this area, 4th Street currently exists between 11th Avenue and 10th Avenue. 4th Street is a one-way street with traffic flowing westbound. The *City of Hanford 2035 General Plan Circulation Map* designates 4th Street as a collector.

3rd Street is an existing east-west two-lane collector in the vicinity of the proposed Project site. In this area, 3rd Street currently exists between 11th Avenue and approximately half a mile east of 8 ¾ Avenue. Between 11th Avenue and 10th Avenue, 3rd Street is a one-way street with traffic flowing eastbound. The *City of Hanford 2035 General Plan Circulation Map* designates 3rd Street as a collector.

Hanford-Armona Road is an existing east-west two-lane undivided arterial in the vicinity of the proposed Project site. Hanford-Armona Road currently extends throughout King's County. The *City of Hanford 2035 General Plan Circulation Map* designates Hanford-Armona Road as an arterial between 13th Avenue and 8th Avenue.

Orchard Avenue is a future east-west two-lane undivided collector street that will be partially constructed with the Project. The Project will only be constructing Orchard Avenue within the Project limits. The *City of Hanford 2035 General Plan Circulation Map* designates Orchard Avenue as a collector between 10 ½

Avenue and 10th Avenue. Therefore, it is assumed Orchard Avenue will be fully constructed to 10th Avenue prior to 2035.

Houston Avenue is an existing east-west two-lane undivided major arterial in the vicinity of the proposed Project site. In this area, Houston Avenue exists between State Route 198 and the eastern King's County Limits. The *City of Hanford 2035 General Plan Circulation Map* designates Houston Avenue as a major arterial between 13th Avenue and 8th Avenue.

Traffic Signal Warrants

The CA MUTCD indicates that an engineering study of traffic conditions, pedestrian characteristics and physical features of an intersection shall be conducted to determine whether installation of traffic signal controls are justified. The CA MUTCD provides a total of nine (9) warrants to evaluate the need for traffic signal controls. These warrants include 1) Eight-Hour Vehicular Volume, 2) Four-Hour Vehicular Volume, 3) Peak Hour, 4) Pedestrian Volume, 5) School Crossing, 6) Coordinated Signal System, 7) Crash Experience, 8) Roadway Network and 9) Intersection Near a Grade Crossing. Signalization of an intersection may be appropriate if one or more of the signal warrants is satisfied. However, the CA MUTCD also states that “[t]he satisfaction of a signal warrant or warrants shall not in itself require the installation of a traffic control signal” (Caltrans 2021).

If traffic signal warrants are satisfied when a LOS threshold impact is identified at an unsignalized intersection, then installation of a traffic signal control may serve as an improvement measure. For instances where traffic signal warrants are satisfied, a traffic signal control is not considered to be the default improvement measure. Prior to assuming that an intersection will be signalized, an attempt is made to improve the intersection approach lane geometrics in order to improve its LOS while maintaining the existing intersection controls. If the additional lanes did not result in acceptable LOS at the intersection, then in those cases implementation of a traffic signal control would be considered.

Warrant 3 was prepared for the unsignalized intersections under the Existing Traffic Conditions scenario. These warrants are contained in Appendix I. Under this scenario, no unsignalized study intersection satisfies Warrant 3. Based on the traffic signal warrants, operational analysis and engineering judgment, it is not recommended that the City consider implementing traffic signal controls at any of the unsignalized study intersections especially since these operate at an acceptable LOS during both peak periods under stop sign control.

Results of Existing Level of Service Analysis

Figure 2 illustrates the Existing Traffic Conditions turning movement volumes, intersection geometrics and traffic controls. LOS worksheets for the Existing Traffic Conditions scenario are provided in Appendix E. Table I presents a summary of the Existing peak hour LOS at the study intersections, while Table II presents a summary of the Existing LOS for the study segments.

At present, all study intersections operate at an acceptable LOS during both peak periods.

Table I: Existing Intersection LOS Results

ID	Intersection	Intersection Control	AM (7-9) Peak Hour		PM (4-6) Peak Hour	
			Average Delay (sec/veh)	LOS	Average Delay (sec/veh)	LOS
3	10 1/2 Avenue / Hanford Armona Road	Traffic Signal	14.4	B	13.1	B
4	Jordan Way / Hanford Armona Road	Two-Way Stop	11.6	B	12.2	B
5	10th Avenue / Hanford Armona Road	Traffic Signal	18.2	B	17.7	B
6	10 ½ Avenue / Orchard Avenue	Does Not Exist	-	-	-	-
7	11th Avenue / Houston Avenue	Traffic Signal	26.5	C	24.8	C
8	Houston Avenue / 10 1/2 Avenue	Two-Way Stop	9.6	A	10.0	B
9	10th Avenue / Houston Avenue	All-Way Stop	8.8	A	8.8	A

Note: LOS = Level of Service based on average delay on signalized intersections and All-Way STOP Controls
 LOS for two-way and one-way STOP controlled intersections are based on the worst approach/movement of the minor street.

At present, all study segments operate at an acceptable LOS during both peak periods.

Table II: Existing Segment LOS Results

ID	Segment	Limits	Lanes	24-hour Volume	AM Peak Volume	AM LOS	PM Peak Volume	PM LOS
1	Hanford-Armona Road	11 th Avenue and 10 ½ Avenue	2	8,480	298	C	429	C
2	Hanford-Armona Road	10 ½ Avenue and Jordan Way	2	6,320	248	C	318	C
3	Hanford-Armona Road	Jordan Way and 10 th Avenue	2	5,560	220	B	296	B
4	10 ½ Avenue	Hanford-Armona Road and Orchard Avenue	2	990	55	A	50	A
5	10 ½ Avenue	Orchard Avenue and Houston Avenue	2	850	40	A	45	A
6	Houston Avenue	11 th Avenue and 10 ½ Avenue	2	3,490	143	A	178	A
7	Houston Avenue	10 ½ Avenue and 10 th Avenue	2	3,590	165	A	205	A

Note: LOS = Level of Service per HCM 6th Edition methodologies in HCS7 software. Peak hour volumes are from the highest directional volume.

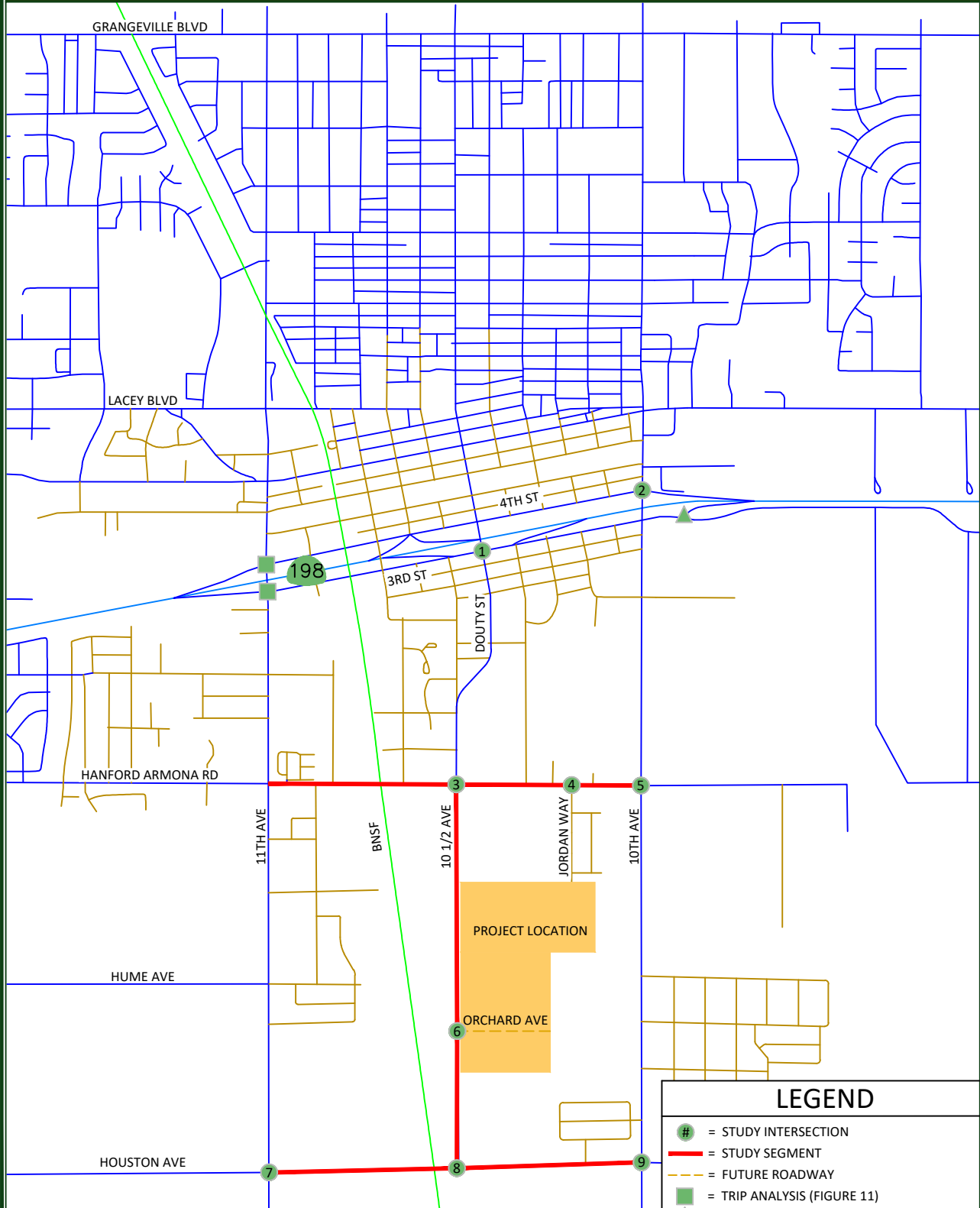

LEGEND

- = STUDY INTERSECTION
- = STUDY SEGMENT
- - - = FUTURE ROADWAY
- = TRIP ANALYSIS (FIGURE 11)
- ▲ = TRIP ANALYSIS (FIGURE 12)

JLB TRAFFIC
ENGINEERING, INC.

516 W. Shaw Ave., Ste. 103, Fresno, CA 93704
PHONE: (559) 570-8991, EMAIL: info@JLBtraffic.com, www.JLBtraffic.com



Lunaria TIA - City of Hanford Existing - Traffic Volumes, Geometrics and Controls

Figure 2

<p>1. SR 198 EB Off Ramp/3rd St & Douty St</p>	<p>2. SR 198 WB Off Ramp/4th St & 10th Ave</p>	<p>3. 10 1/2 Ave & Hanford-Armona Rd</p>	<p>4. Jordan Way & Hanford-Armona Rd</p>
<p>5. 10th Ave & Hanford-Armona Rd</p>	<p>6. 10 1/2 Ave & Orchard Ave</p> <p style="color: red; font-size: 2em; transform: rotate(-45deg);">DOES NOT EXIST</p>	<p>7. 11th Ave & Houston Ave</p>	<p>8. 10 1/2 Ave & Houston Ave</p>

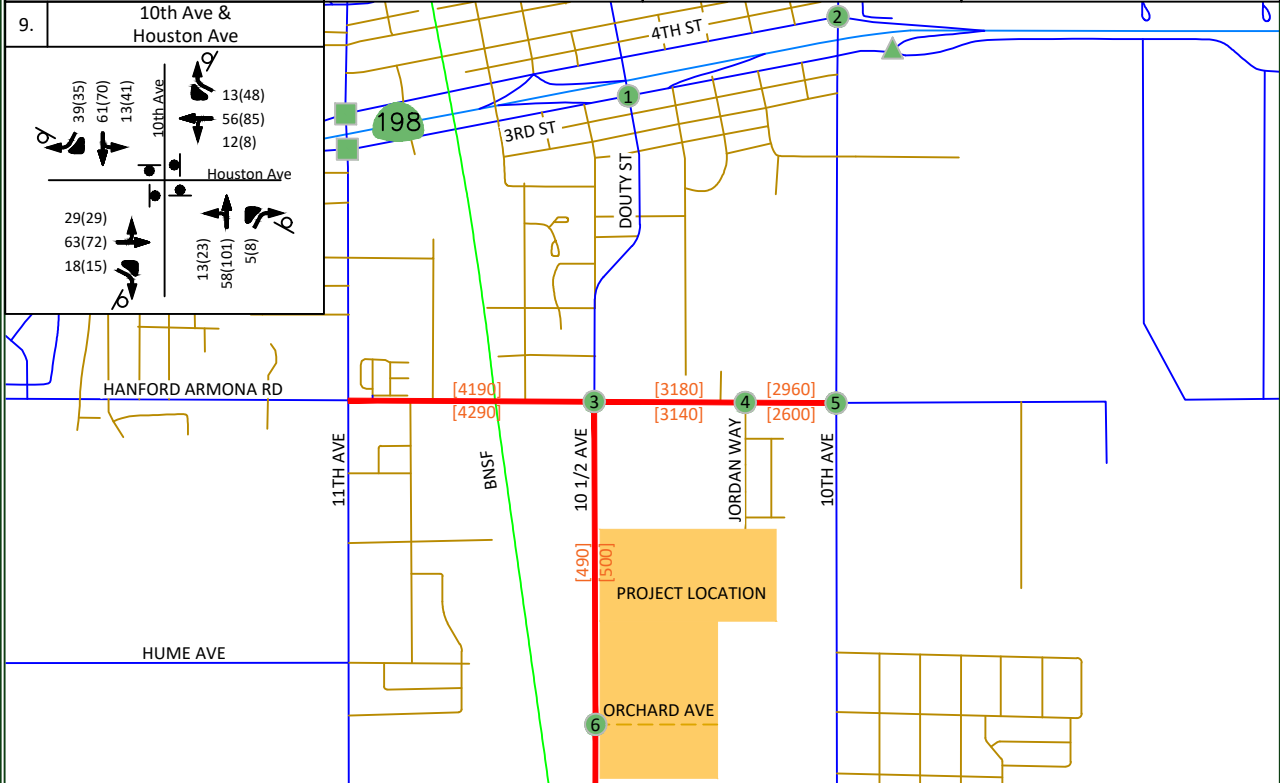

LEGEND

- = STUDY INTERSECTION
- = STUDY SEGMENT
- = FUTURE ROADWAY
- XX = AM PEAK HOUR TRIPS
- (XX) = PM PEAK HOUR TRIPS
- [XX] = DAILY VOLUMES
- = STOP SIGN
- ⊙ = YIELD SIGN
- 🚦 = TRAFFIC SIGNAL
- = TRIP ANALYSIS (FIGURE 11)
- ▲ = TRIP ANALYSIS (FIGURE 12)

Not To Scale

516 W. Shaw Ave., Ste. 103, Fresno, CA 93704
 PHONE: (559) 570-8991, EMAIL: info@JLBtraffic.com, www.JLBtraffic.com

Existing plus Project Traffic Conditions

Project Description

At the time of the preparation of this TIA, the Project proposed to develop approximately 96.22 gross acres with 443 single-family housing units and a 4.9-acre park. Once all the LOS studies for this TIA were completed, the site plan was revised to include 457 single-family housing units and a 5.8-acre park within the same 96.22 gross acres. Based on information provided to JLB, the Project is consistent with the City's General Plan. Figure 3 illustrates the latest Project Site Plan.

Project Access

Based on the latest Project Site Plan, access to and from the Project site will be from six (6) access points. One (1) access point will be from the existing local street of Jordan Way. Two (2) access points will be located along the east side of 10 ½ Avenue. The Project will be constructing Orchard Avenue within the Project limits. The Project will have three (3) access points to Orchard Avenue.

JLB analyzed the location of the existing and proposed roadways and access points relative to those in the vicinity of the Project site. A review of the existing and proposed roadways and access points indicates that they are located at points that minimize traffic operational impacts to existing and future roadway networks. A Project Site Plan can be found in Figure 3.

Trip Generation

The trip generation rates for the proposed Project were obtained from the 11th Edition of the Trip Generation Manual published by the Institute of Transportation Engineers (ITE). Table III presents the trip generation for the original project site plan for 443 Single-Family Detached Housing units and a 4.9-acre public park. At build-out, the Project is estimated to generate a maximum of 4,181 daily trips, 310 AM peak hour trips and 418 PM peak hour trips. Once all LOS studies for this TIA were completed using the total trips generated by the original site plan, the site plan was slightly revised to increase the number of lots and acreage of park. Table IV presents the trip generation for the latest project site plan for 457 Single-Family Detached Housing units and a 5.8-acre public park. At build-out, the Project is estimated to generate a maximum of 4,315 daily trips, 320 AM peak hour trips and 431 PM peak hour trips. The difference in trip generation between the original site plan and the latest site plan is summarized in Table V. Compared to the original site plan, the latest site plan is estimated to generate an increase of 134 daily trips, 10 AM peak hour trips and 13 PM peak hour trips. These are an increase of 3.20%, 3.23% and 3.11% of the daily, AM peak hour and PM peak hour, respectively. Since the increases are very minor, JLB kept the original LOS studies and only analyzed the worst performing study facility during the worst scenario. This was determined to be the intersection of Houston Avenue at 11th Avenue during the Cumulative Year 2042 plus Project Scenario. Based on this analysis, it was determined that that all study intersections and segments would continue to operate within the acceptable LOS for all study scenarios. The detailed results of this analysis will be discussed later in the Report under the Cumulative Year plus Project scenario.

Table III: Original Project Site Plan Trip Generation

Land Use (ITE Code)	Size	Unit	Daily		AM (7-9) Peak Hour						PM (4-6) Peak Hour					
			Rate	Total	Trip Rate	In	Out	In	Out	Total	Trip Rate	In	Out	In	Out	Total
						%						%				
Single-Family Detached Housing (210)	443	d.u.	9.43	4,177	0.70	26	74	80	230	310	0.94	63	37	262	155	417
Public Park (411)	4.9	Acres	0.78	4	0.02	59	41	0	0	0	0.11	55	45	1	0	1
Total Project Trips				4,181				80	230	310				263	155	418

Note: d.u. = Dwelling Units

Table IV: Latest Project Site Plan Trip Generation

Land Use (ITE Code)	Size	Unit	Daily		AM (7-9) Peak Hour						PM (4-6) Peak Hour					
			Rate	Total	Trip Rate	In	Out	In	Out	Total	Trip Rate	In	Out	In	Out	Total
						%						%				
Single-Family Detached Housing (210)	457	d.u.	9.43	4,310	0.70	26	74	83	237	320	0.94	63	37	271	159	430
Public Park (411)	5.8	Acres	0.78	5	0.02	59	41	0	0	0	0.11	55	45	1	0	1
Total Project Trips				4,315				83	237	320				272	159	431

Note: d.u. = Dwelling Units

Table V: Difference in Net Trip Generation

	Daily	AM (7-9) Peak Hour			PM (4-6) Peak Hour		
	Total	In	Out	Total	In	Out	Total
Original Project Site Plan	4,181	80	230	310	263	155	418
Latest Project Site Plan	4,315	83	237	320	272	159	431
Difference in Trip Generation	134	3	7	10	9	4	13
Percent Difference in Trip Generation	3.20%	3.75%	3.04%	3.23%	3.42%	2.58%	3.11%

Trip Distribution

The trip distribution assumptions were developed based on existing travel patterns, the KCAG Project Select Zone, the existing roadway network, engineering judgment, data provided by the developer, knowledge of the study area, existing residential and commercial densities and the City of Hanford 2035 General Plan Transportation and Circulation Element in the vicinity of the Project site. The Project's trip generation data was provided to KCAG in order to conduct a Project-specific Traffic Analysis Zone (TAZ) analysis using the KCAG ABM (Cumulative Year 2042). The KCAG Project only trip output was lower than the Project's trip generation, so the volumes were manually increased and proportionally distributed through the study intersections. The KCAG Project Select Zone results are contained in Appendix C. Figure 4 illustrates the 2027 Project Only Trips at the study intersections.

Bikeways

The *City of Hanford Pedestrian and Bicycle Master Plan* classifies bicycle facilities three categories: Class II (Bike Lanes), Class III (Bike Routes), and Class III (Bike Routes with Stripes). In the vicinity of the Project, Class II (Bike Lanes) currently exist on Hanford-Armona Road between Greenbrier Drive and 10th Avenue, while Class III (Bike Routes) exist on Douty Street between Cortner Street and Scott Street and 10 ½ Avenue between Scott Street and Hanford-Armona Road and Class III (Bike Routes with Stripes) exist on 10th Avenue between Houston Avenue and Hanford-Armona Road. In the vicinity of the Project, Class II (Bike Lanes) are planned on 10 ½ Avenue between Hanford-Armona Road and Houston Avenue, 10th Avenue between State Route 43 and Houston Avenue, Hanford-Armona Road between 10th Avenue and 9 ¾ Avenue, Orchard Avenue between 10 ½ Avenue and 10th Avenue and Houston Avenue between 13th Avenue and 9th Avenue. Class III (Bike Routes) are planned on 11th Avenue between 6th Street and Jackson Avenue. Therefore, it is recommended that the Project implement Class II Bike Lanes along its frontages to 10 ½ Avenue and Orchard Avenue.

Walkways

Currently, walkways exist in the vicinity of the proposed Project site along Jordan Way and Hanford-Armona Road. Douty Street between Grangeville Boulevard and Scott Street, 10 ½ Avenue between Scott Street and Hanford-Armona Road, 10th Avenue between State Route 43 and Hanford-Armona Road and Hanford-Armona Road between 13th Avenue and 9 ¾ Avenue are dedicated as Walking Corridors. The *City of Hanford Pedestrian and Bicycle Master Plan* states “Curb, gutter and sidewalk are required for all new development in the City.” Therefore, it is recommended that the Project implement walkways that are ADA compliant along its frontages to 10 ½ Avenue and Orchard Avenue.

Transit

Kings Area Rural Transit (KART) is the transit operator in the City of Hanford. At present, there are two (2) KART routes, Route 4 and Route 8, that operate and have stops in the vicinity of the Project. KART Route 4, which runs along 10th Avenue from Downtown Hanford to 10th Avenue at Home Avenue, operates at 30-minute intervals on weekdays from 6:30 AM - 7:30 PM and 60-minute intervals on Saturday's from 9:30 AM to 4:30 PM. The closest stop to the Project on Route 4 is located on the north side of Hanford-Armona Road 150 feet east of 10 ½ Avenue. This route provides a direct connection to Coe Park, Longfield Center, Lincoln Elementary School, Hanford Soccer Complex, Downtown Hanford and the KART Transit Center. KART Route 8, which runs along 11th Avenue, 10th Avenue, Hanford-Armona Road and Houston Avenue operates at 30-minute intervals on weekdays from 6:45 AM – 7: 15 PM and 60-minute intervals on Saturday's from 10:00 AM to 4:00 PM. The closest stop to the Project on Route 8 is located on the north side of Hanford-Armona Road 150 feet east of 10 ½ Avenue. This route provides a direct connection to the Home Garden Park, Martin Luther King Jr. Elementary School, Hanford DMV, Roosevelt Elementary School, Downtown Hanford and the KART Transit Center. Retention of the existing and expansion of future transit routes is dependent on transit ridership demand and available funding.

Traffic Signal Warrants

Warrant 3 was prepared for the unsignalized intersections under the Existing plus Project Traffic Conditions scenario. These warrants are found in Appendix I. Under this scenario, none of the unsignalized intersections are projected to satisfy Warrant 3. Based on the traffic signal warrants, operational analysis and engineering judgement, signalization of any of the study intersections is not recommended.

Results of Existing plus Project Level of Service Analysis

The Existing plus Project Traffic Conditions scenario assumes the existing roadway geometrics and traffic controls will remain in place. Figure 5 illustrates the Existing plus Project turning movement volumes, intersection geometrics and traffic controls. LOS worksheets for the Existing plus Project Traffic Conditions scenario are provided in Appendix F. Table VI presents a summary of the Existing plus Project peak hour LOS at the study intersections, while Table VII presents a summary of the Existing plus Project LOS for the study segment.

Under this scenario, all study intersections are projected to operate at an acceptable LOS.

Table VI: Existing plus Project Intersection LOS Results

ID	Intersection	Intersection Control	AM (7-9) Peak Hour		PM (4-6) Peak Hour	
			Average Delay (sec/veh)	LOS	Average Delay (sec/veh)	LOS
3	10 1/2 Avenue / Hanford Armona Road	Traffic Signal	17.9	B	15.9	B
4	Jordan Way / Hanford Armona Road	Two-Way Stop	12.7	B	13.3	B
5	10th Avenue / Hanford Armona Road	Traffic Signal	20.9	C	19.8	B
6	10 1/2 Avenue / Orchard Avenue	Two-Way Stop	9.5	A	9.8	A
7	11th Avenue / Houston Avenue	Traffic Signal	20.7	C	22.4	C
8	Houston Avenue / 10 1/2 Avenue	Two-Way Stop	10.0	B	10.7	B
9	10th Avenue / Houston Avenue	All-Way Stop	8.9	A	9.0	A

Note: LOS = Level of Service based on average delay on signalized intersections and All-Way STOP Controls (AWSC)
 LOS for two-way stop controlled (TWSC) and one-way STOP controlled intersections are based on the worst approach/movement of the minor street.

Under this scenario, all study segments are projected to operate at an acceptable LOS.

Table VII: Existing plus Project Segment LOS Results

ID	Segment	Limits	Lanes	24-hour Volume	AM Peak Volume	AM LOS	PM Peak Volume	PM LOS
1	Hanford-Armona Road	11 th Avenue and 10 1/2 Avenue	2	10,350	394	C	542	D
2	Hanford-Armona Road	10 1/2 Avenue and Jordan Way	2	6,940	268	C	350	C
3	Hanford-Armona Road	Jordan Way and 10 th Avenue	2	6,280	255	B	346	B
4	10 1/2 Avenue	Hanford-Armona Road and Orchard Avenue	2	3,290	184	B	188	B
5	10 1/2 Avenue	Orchard Avenue and Houston Avenue	2	1,900	65	A	115	B
6	Houston Avenue	11 th Avenue and 10 1/2 Avenue	2	4,250	177	A	223	A
7	Houston Avenue	10 1/2 Avenue and 10 th Avenue	2	3,880	174	A	223	B

Note: LOS =Level of Service per HCM 6th Edition methodologies in HCS7 software. Peak hour volumes are from the highest directional volume.

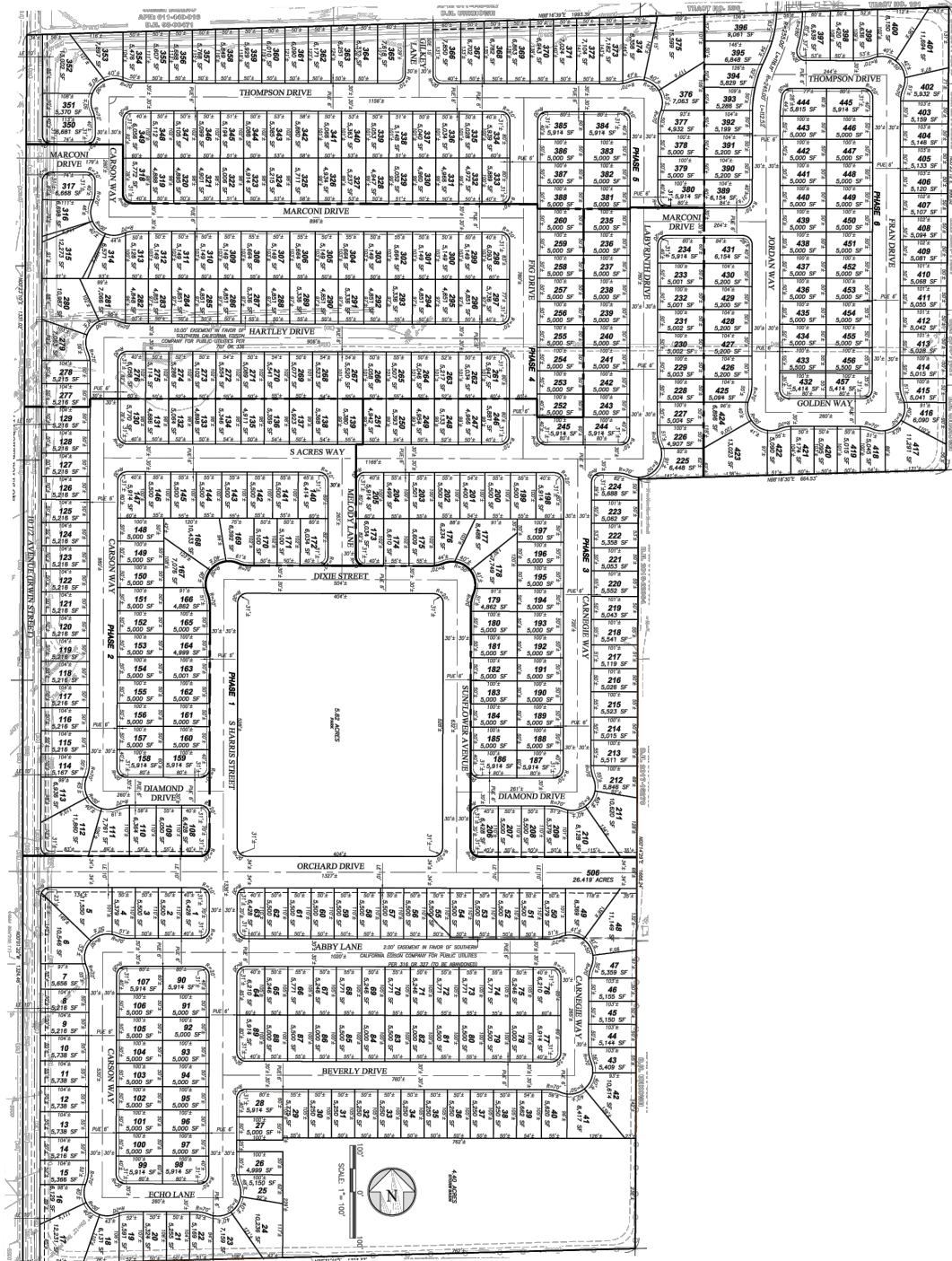

516 W. Shaw Ave., Ste. 103, Fresno, CA 93704
PHONE: (559) 570-8991, EMAIL: info@JLBtraffic.com, www.JLBtraffic.com



Not To Scale

Lunaria TIA - City of Hanford 2027 Project Only Trips

Figure 4

<p>1. SR 198 EB Off Ramp/3rd St & Douty St</p>	<p>2. SR 198 WB Off Ramp/4th St & 10th Ave</p>	<p>3. 10 1/2 Ave & Hanford-Armona Rd</p>	<p>4. Jordan Way & Hanford-Armona Rd</p>
<p>5. 10th Ave & Hanford-Armona Rd</p>	<p>6. 10 1/2 Ave & Orchard Ave</p>	<p>7. 11th Ave & Houston Ave</p>	<p>8. 10 1/2 Ave & Houston Ave</p>

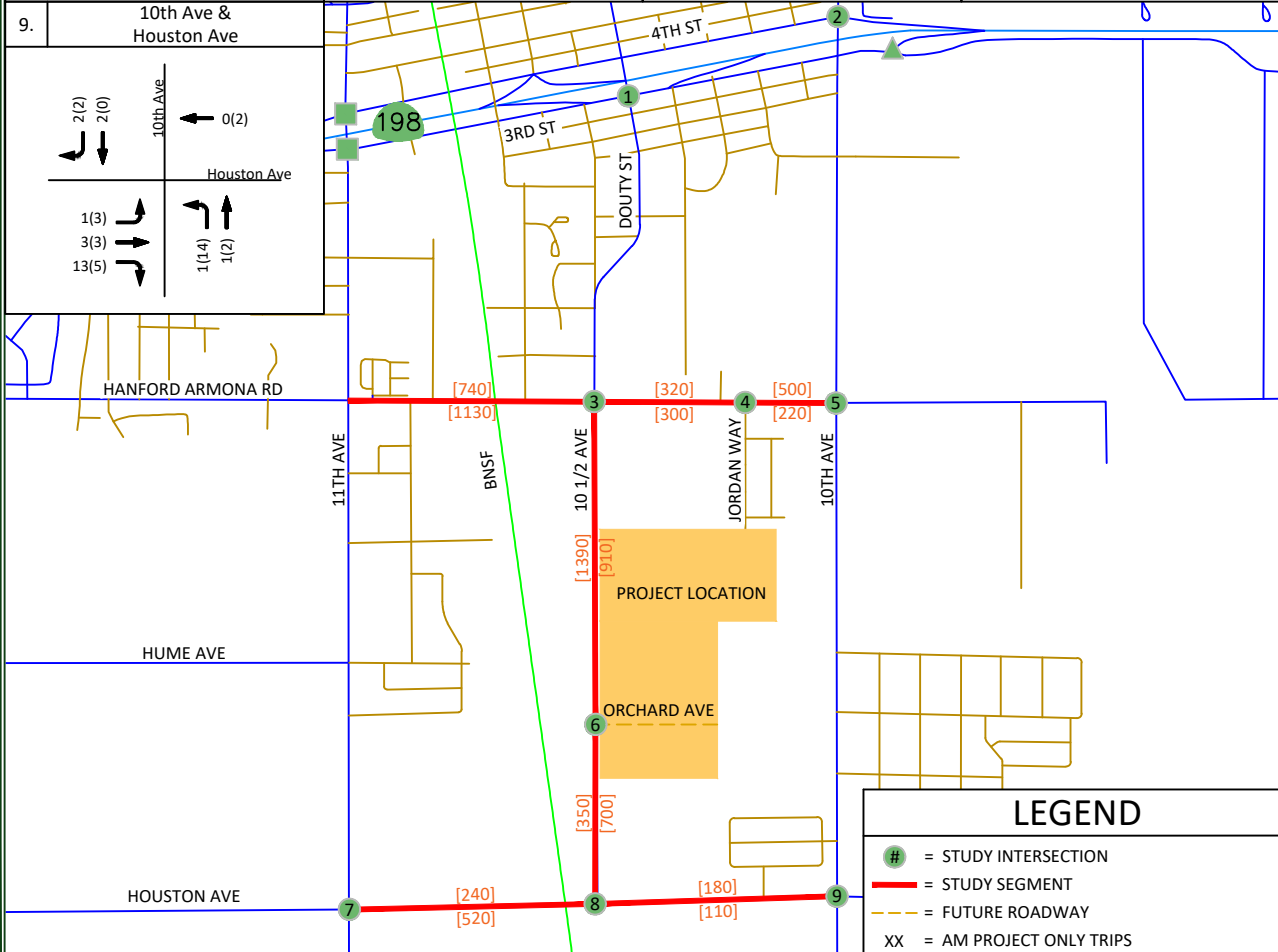

LEGEND

- = STUDY INTERSECTION
- = STUDY SEGMENT
- = FUTURE ROADWAY
- XX = AM PROJECT ONLY TRIPS
- (XX) = PM PROJECT ONLY TRIPS
- [XX] = DAILY VOLUMES
- = TRIP ANALYSIS (FIGURE 11)
- ▲ = TRIP ANALYSIS (FIGURE 12)

Not To Scale

516 W. Shaw Ave., Ste. 103, Fresno, CA 93704
 PHONE: (559) 570-8991, EMAIL: info@JLBtraffic.com, www.JLBtraffic.com

Lunaria TIA - City of Hanford Existing plus Project - Traffic Volumes, Geometrics and Controls

Figure 5

<p>1. SR 198 EB Off Ramp/3rd St & Douty St</p>	<p>2. SR 198 WB Off Ramp/4th St & 10th Ave</p>	<p>3. 10 1/2 Ave & Hanford-Armona Rd</p>	<p>4. Jordan Way & Hanford-Armona Rd</p>
<p>5. 10th Ave & Hanford-Armona Rd</p>	<p>6. 10 1/2 Ave & Orchard Ave</p>	<p>7. 11th Ave & Houston Ave</p>	<p>8. 10 1/2 Ave & Houston Ave</p>

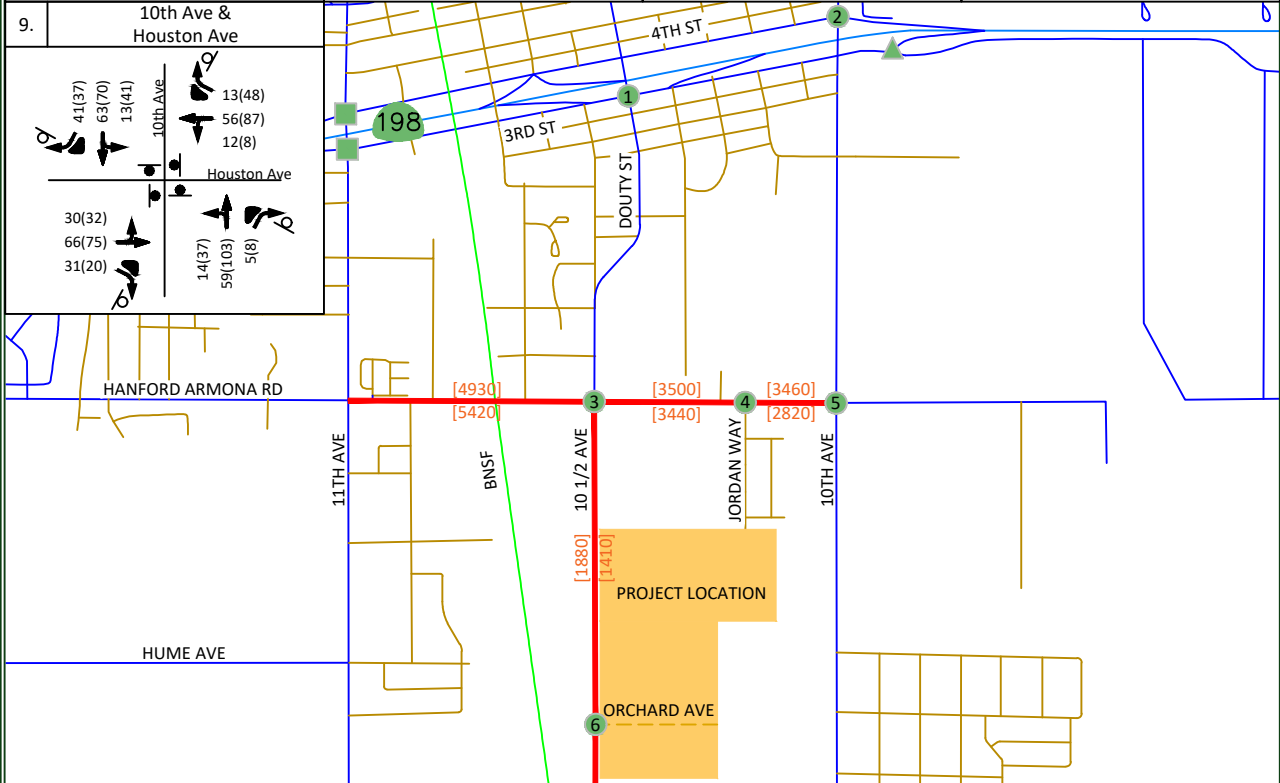

516 W. Shaw Ave., Ste. 103, Fresno, CA 93704
PHONE: (559) 570-8991, EMAIL: info@JLBtraffic.com, www.JLBtraffic.com

LEGEND

- = STUDY INTERSECTION
- = STUDY SEGMENT
- = FUTURE ROADWAY
- XX = AM PEAK HOUR TRIPS
- (XX) = PM PEAK HOUR TRIPS
- [XX] = DAILY VOLUMES
- = STOP SIGN
- = YIELD SIGN
- = TRAFFIC SIGNAL
- = TRIP ANALYSIS (FIGURE 11)
- ▲ = TRIP ANALYSIS (FIGURE 12)

Not To Scale

Near Term plus Project Traffic Conditions

Description of Near Term Projects

Near Term Projects are approved and/or known Projects that are either under construction, built but not fully occupied, are not built but have final site development review (SDR) approval or for which the lead agency or responsible agencies have knowledge of. The City of Hanford staff were consulted throughout the preparation of this Report regarding approved and/or known projects that could potentially impact the study intersections and study segment. JLB staff conducted a reconnaissance of the surrounding area to confirm the Near Term Projects. Therefore, the Near Term Projects listed in Table VIII were approved, near approval, or in the pipeline within the proximity of the proposed Project.

Table VIII: Near Term Projects' Trip Generation

<i>Near Term Project ID</i>	<i>Near Term Project Name</i>	<i>Daily Trips</i>	<i>AM Peak Hour</i>	<i>PM Peak Hour</i>
A	Live Oak ¹	14,726	1,154	1,544
B	Billingsley Ranch ²	916	72	96
C	Tract 927 ³	1256	98	132
D	Tract 922 ³	1831	144	192
E	Tract 929 ³	1492	117	156
F	Tract 928 ³	2672	209	280
G	Tract 912 ³	1340	105	141
H	Tract 919 ³	1180	93	124
2027 Near Term Project Trips		20,410	1,600	2,141
2042 Near Term Project Trips		25,413	1,992	2,665

Note: 1 = Trip Generation prepared by KD Anderson Traffic Impact Analysis Report
 2= Trip Generation prepared by VRPA Traffic Impact Analysis Report
 3= Trip Generation prepared by JLB Traffic Engineering, Inc. based on readily available information

The trip generation listed in Table VIII is that which is anticipated to be added to the roadway network by the Near Term Projects. Since the entire Live Oak Project is not projected to be fully built out in the next five (5) years, we estimated a percentage of what could be constructed within this period. This percentage was determined to be approximately two thirds, or 67%, therefore 67% of the Live Oak Project trips were included in this scenario. As shown in Table VIII, the total trip generation for the 2027 Near Term Projects is 20,410 daily trips, 1,600 AM peak hour trips and 2,141 PM peak hour trips, while the total trip generation for the 2042 Near Term Projects is 25,413 daily trips, 1,992 AM peak hour trips and 2,665 PM peak hour trips. The Near Term plus Project traffic volumes were obtained by adding the 2027 Near Term related trips to the Existing plus Project Traffic Conditions scenario. Figure 6 illustrates the location of the 2027 Near Term Projects and their combined trip assignment to the study intersections under this scenario.

Traffic Signal Warrants

Warrant 3 was prepared for the unsignalized intersections under the Near Term plus Project Traffic Conditions scenario. These warrants are found in Appendix I. Under this scenario, none of the unsignalized intersections are projected to satisfy Warrant 3. Based on the traffic signal warrants, operational analysis and engineering judgement, signalization of any of the study intersections is not recommended.

Results of Near Term plus Project Level of Service Analysis

The Near Term plus Project Traffic Conditions scenario assumes the same roadway geometrics and traffic controls as those assumed in the Existing plus Project Traffic Conditions scenario. Figure 7 illustrates the Near Term plus Project turning movement volumes, intersection geometrics and traffic controls. LOS worksheets for the Near Term plus Project Traffic Conditions scenario are provided in Appendix G. Table IX presents a summary of the Near Term plus Project intersection LOS intersections, while Table X presents a summary of the Near Term plus Project LOS for the study segment.

Under this scenario, all study intersections are projected to operate at an acceptable LOS.

Table IX: Near Term plus Project Intersection LOS Results

ID	Intersection	Intersection Control	AM (7-9) Peak Hour		PM (4-6) Peak Hour	
			Average Delay (sec/veh)	LOS	Average Delay (sec/veh)	LOS
3	10 1/2 Avenue / Hanford Armona Road	Traffic Signal	18.0	B	16.0	B
4	Jordan Way / Hanford Armona Road	Two-Way Stop	12.7	B	13.4	B
5	10th Avenue / Hanford Armona Road	Traffic Signal	21.5	C	19.9	B
6	10 ½ Avenue / Orchard Avenue	Two-Way Stop	9.6	A	10.0	B
7	11th Avenue / Houston Avenue	Traffic Signal	22.3	C	19.2	B
8	Houston Avenue / 10 1/2 Avenue	Two-Way Stop	10.2	B	11.7	B
9	10th Avenue / Houston Avenue	All-Way Stop	9.1	A	9.6	A

Note: LOS = Level of Service based on average delay on signalized intersections and All-Way STOP Controls
 LOS for two-way and one-way STOP controlled intersections are based on the worst approach/movement of the minor street.

Under this scenario, all study segments are projected to operate at an acceptable LOS.

Table X: Near Term plus Project Segment LOS Results

ID	Segment	Limits	Lanes	24-hour Volume	AM Peak Volume	AM LOS	PM Peak Volume	PM LOS
1	Hanford-Armona Road	11 th Avenue and 10 ½ Avenue	2	10,490	398	C	546	D
2	Hanford-Armona Road	10 ½ Avenue and Jordan Way	2	7,020	271	C	355	C
3	Hanford-Armona Road	Jordan Way and 10 th Avenue	2	6,340	258	B	351	B
4	10 ½ Avenue	Hanford-Armona Road and Orchard Avenue	2	3,550	196	C	197	B
5	10 ½ Avenue	Orchard Avenue and Houston Avenue	2	2,160	70	A	132	B
6	Houston Avenue	11 th Avenue and 10 ½ Avenue	2	4,800	193	B	269	B
7	Houston Avenue	10 ½ Avenue and 10 th Avenue	2	4,890	197	A	295	B

Note: LOS=Level of Service per HCM 6th Edition methodologies in HCS7 software. Peak hour volumes are from the highest directional volume.

Lunaria TIA - City of Hanford 2027 Near Term Projects' Trip Assignment

Figure 6

<p>1. SR 198 EB Off Ramp/3rd St & Douty St</p>	<p>2. SR 198 WB Off Ramp/4th St & 10th Ave</p>	<p>3. 10 1/2 Ave & Hanford-Armona Rd</p>	<p>4. Jordan Way & Hanford-Armona Rd</p>
<p>5. 10th Ave & Hanford-Armona Rd</p>	<p>6. 10 1/2 Ave & Orchard Ave</p>	<p>7. 11th Ave & Houston Ave</p>	<p>8. 10 1/2 Ave & Houston Ave</p>

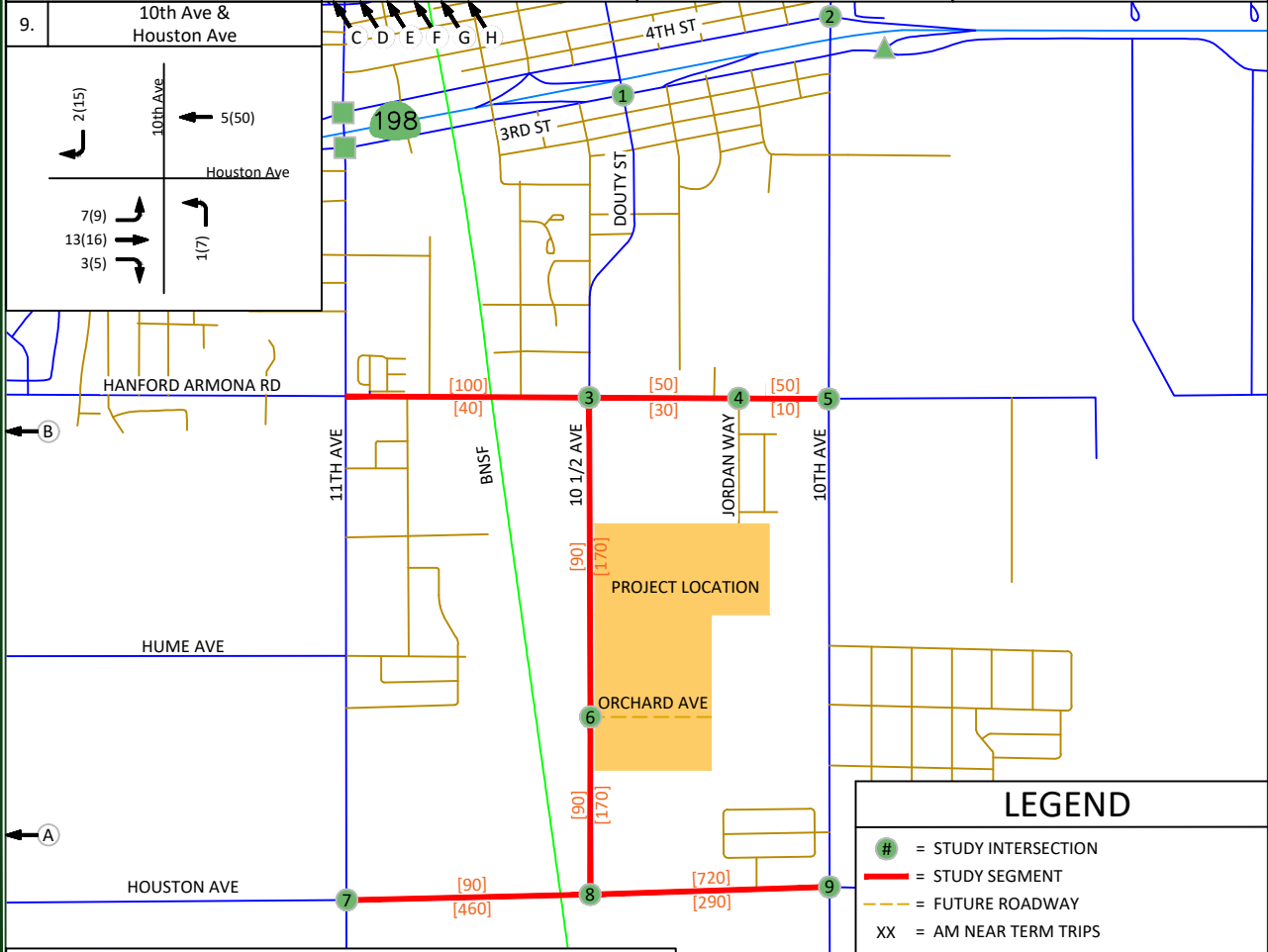

JLB TRAFFIC
ENGINEERING, INC.

516 W. Shaw Ave., Ste. 103, Fresno, CA 93704
PHONE: (559) 570-8991, EMAIL: info@JLBtraffic.com, www.JLBtraffic.com

LEGEND

- = STUDY INTERSECTION
- = STUDY SEGMENT
- - - = FUTURE ROADWAY
- XX = AM NEAR TERM TRIPS
- (XX) = PM NEAR TERM TRIPS
- [XX] = DAILY VOLUMES
- ⊕ = NEAR TERM PROJECT LOCATION
- = TRIP ANALYSIS (FIGURE 11)
- ▲ = TRIP ANALYSIS (FIGURE 12)

Not To Scale

Lunaria TIA - City of Hanford Near Term plus Project - Traffic Volumes, Geometrics and Controls

Figure 7

<p>1. SR 198 EB Off Ramp/3rd St & Douty St</p>	<p>2. SR 198 WB Off Ramp/4th St & 10th Ave</p>	<p>3. 10 1/2 Ave & Hanford-Armona Rd</p>	<p>4. Jordan Way & Hanford-Armona Rd</p>
<p>5. 10th Ave & Hanford-Armona Rd</p>	<p>6. 10 1/2 Ave & Orchard Ave</p>	<p>7. 11th Ave & Houston Ave</p>	<p>8. 10 1/2 Ave & Houston Ave</p>

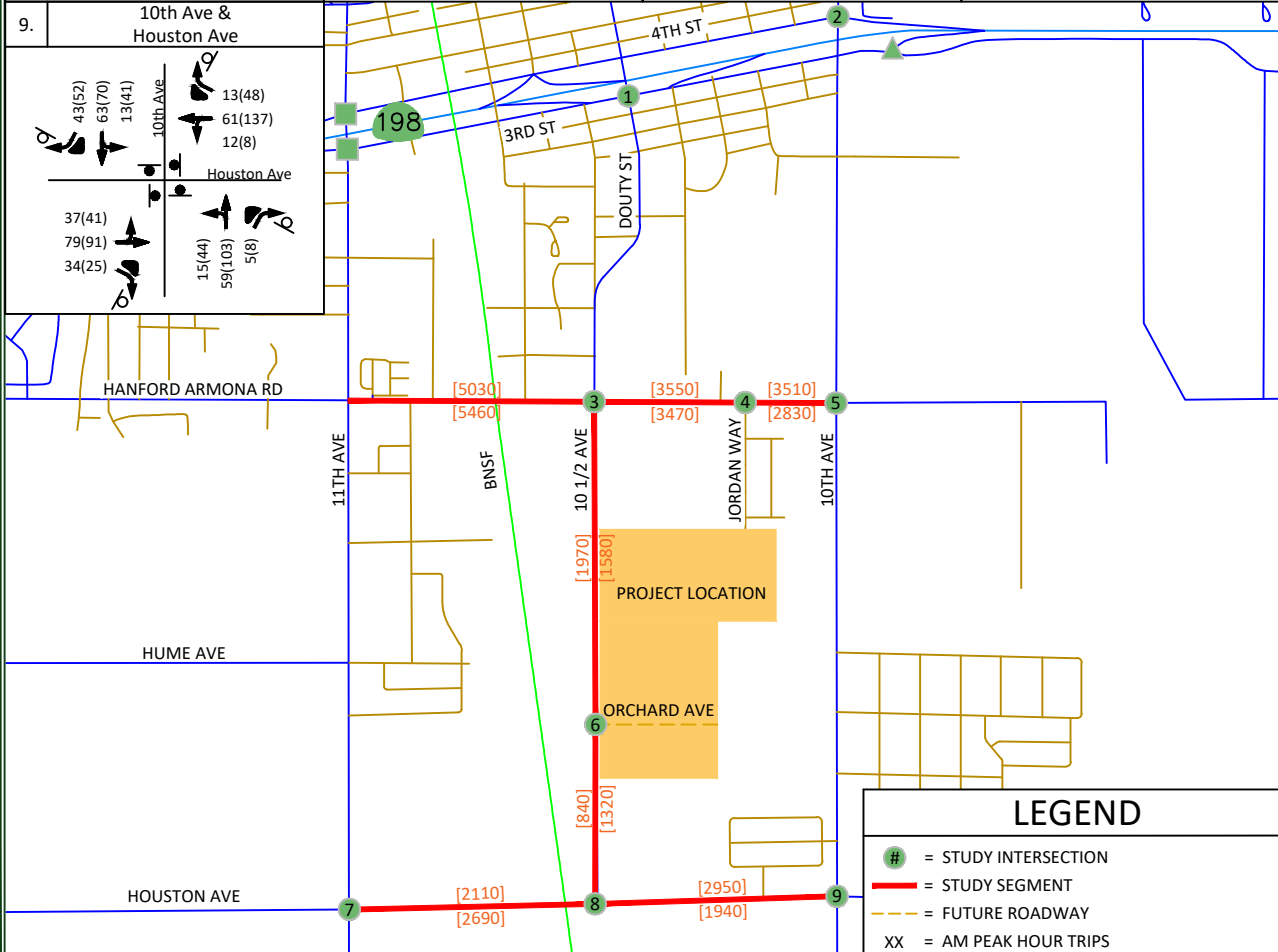

JLB TRAFFIC
ENGINEERING, INC.

516 W. Shaw Ave., Ste. 103, Fresno, CA 93704
PHONE: (559) 570-8991, EMAIL: info@JLBtraffic.com, www.JLBtraffic.com



Cumulative Year 2042 plus Project Traffic Conditions

Traffic Signal Warrants

Warrant 3 was prepared for the unsignalized intersections under the Cumulative Year 2042 plus Project Traffic Conditions scenario. These warrants are contained in Appendix I. Under this scenario, the intersection of 10th Avenue at Houston Avenue is projected to satisfy Warrant 3 in the PM peak period only. Based on the traffic signal warrants, operational analysis and engineering judgement, signalization of this intersection is not recommended.

Results of Cumulative Year 2042 plus Project Level of Service Analysis

The Cumulative Year 2042 plus Project Traffic Conditions scenario assumes the same roadway geometrics and traffic controls as those assumed in the Near Term Plus Project Traffic Conditions scenario. Additionally, this scenario assumes Orchard Avenue will be fully constructed easterly to 10th Avenue. As a result, the Project Only trips have been revised to allow access to 10th Avenue from Orchard Avenue. Figure 8 illustrates the 2042 Project Only Trip to the study intersections. This scenario also assumes the Live Oak Project will be fully built, as a result the 2042 Near Term Trips were used instead of the 2027 Near Term Trips. Figure 9 illustrates the 2042 Near Term Trips. Figure 10 illustrates the Cumulative Year 2042 plus Project turning movement volumes, intersection geometrics and traffic controls. LOS worksheets for the Cumulative Year 2042 plus Project Traffic Conditions scenario are provided in Appendix H. Table XI presents a summary of the Cumulative Year 2042 plus Project peak hour LOS at the study intersections, while Table XII presents a summary of the Cumulative Year 2042 plus Project LOS for the study segments.

Under this scenario, all study intersections are projected to operate at an acceptable LOS.

Table XI: Cumulative Year 2042 plus Project Intersection LOS Results

ID	Intersection	Intersection Control	AM (7-9) Peak Hour		PM (4-6) Peak Hour	
			Average Delay (sec/veh)	LOS	Average Delay (sec/veh)	LOS
3	10 1/2 Avenue / Hanford Armona Road	Traffic Signal	16.6	B	19.4	B
4	Jordan Way / Hanford Armona Road	Two-Way Stop	11.6	B	14.5	B
5	10th Avenue / Hanford Armona Road	Traffic Signal	18.8	B	21.9	C
6	10 ½ Avenue / Orchard Avenue	Two-Way Stop	9.5	A	9.9	A
7	11th Avenue / Houston Avenue	Traffic Signal	22.2	C	24.7	C
8	Houston Avenue / 10 1/2 Avenue	Two-Way Stop	10.1	B	12.1	B
9	10th Avenue / Houston Avenue	All-Way Stop	9.9	A	14.8	B

Note: LOS = Level of Service based on average delay on signalized intersections and All-Way STOP Controls (AWSC)
 LOS for two-way stop controlled (TWSC) and one-way STOP controlled intersections are based on the worst approach/movement of the minor street.

Under this scenario, all study segments are projected to operate at an acceptable LOS.

Table XII: Cumulative Year 2042 plus Project Segment LOS Results

ID	Segment	Limits	Lanes	24-hour Volume	AM Peak Volume	AM LOS	PM Peak Volume	PM LOS
1	Hanford-Armona Road	11 th Avenue and 10 ½ Avenue	2	11,750	400	C	591	D
2	Hanford-Armona Road	10 ½ Avenue and Jordan Way	2	7,330	261	C	394	C
3	Hanford-Armona Road	Jordan Way and 10 th Avenue	2	7,820	252	B	455	C
4	10 ½ Avenue	Hanford-Armona Road and Orchard Avenue	2	4,930	190	B	276	C
5	10 ½ Avenue	Orchard Avenue and Houston Avenue	2	2,080	74	A	128	B
6	Houston Avenue	11 th Avenue and 10 ½ Avenue	2	6,300	224	B	408	C
7	Houston Avenue	10 ½ Avenue and 10 th Avenue	2	5,840	197	A	319	B

Note: LOS = Level of Service per HCM 6th Edition methodologies in HCS7 software. Peak hour volumes are from the highest directional volume.

Latest Site Plan Project Trips

The LOS studies were completed using the trips generated by the original Project site plan. The revised project site plan added 10 AM peak hour trips and 13 PM peak hour trips. Since all intersections fall well within the LOS threshold in all scenarios, the additional project trips were all distributed to the worst performing intersection during the worst scenario in an effort to represent a worst-case scenario and determine if the LOS results of this TIA, which were based on the original site plan that contained 14 less single-family residential lots and 0.9 less acres of park, would result in unacceptable LOS thresholds. The critical intersection was determined to be that of Houston Avenue and 11th Avenue during the Cumulative Year 2042 plus Project scenario. LOS worksheets for this scenario are provided in Appendix H. Table XIII presents a summary of the Cumulative Year 2042 plus Project peak hour LOS for the intersection of Houston Avenue and 11th Avenue. Under this scenario, this intersection is projected to operate at an acceptable LOS. Therefore, it is the opinion of JLB that all study intersections and segments would continue to operate within the acceptable LOS for all study scenarios if the additional trips were distributed throughout the roadway network and the LOS studies were redone. As a result, JLB does not recommend that this LOS analysis be redone and that the City of Hanford, County of Kings and Caltrans can utilize this TIA to determine the Projects impacts to the study intersections and segments.

Table XIII: Cumulative Year 2042 plus Latest Project Site Plan Intersection LOS Results

ID	Intersection	Intersection Control	AM (7-9) Peak Hour		PM (4-6) Peak Hour	
			Average Delay (sec/veh)	LOS	Average Delay (sec/veh)	LOS
7	11th Avenue / Houston Avenue	Traffic Signal	22.3	C	24.8	C

Note: LOS = Level of Service based on average delay on signalized intersections and All-Way STOP Controls
 LOS for two-way and one-way STOP controlled intersections are based on the worst approach/movement of the minor street.

Project Only Trip Assignment to State Facilities

Figure 11 illustrates the Project Only Trips to State Route 198 at 11th Avenue. Similarly, Figure 12 illustrates the Project Only Trips to State Route 198 at 10th Avenue. The project only trips from both of these figures also include the trips from the added lots and park acreage from the latest Project site plan.

Lunaria TIA - City of Hanford 2042 Project Only Trips

Figure 8

<p>1. SR 198 EB Off Ramp/3rd St & Douty St</p>	<p>2. SR 198 WB Off Ramp/4th St & 10th Ave</p>	<p>3. 10 1/2 Ave & Hanford-Armona Rd</p>	<p>4. Jordan Way & Hanford-Armona Rd</p>
<p>5. 10th Ave & Hanford-Armona Rd</p>	<p>6. 10 1/2 Ave & Orchard Ave</p>	<p>7. 11th Ave & Houston Ave</p>	<p>8. 10 1/2 Ave & Houston Ave</p>

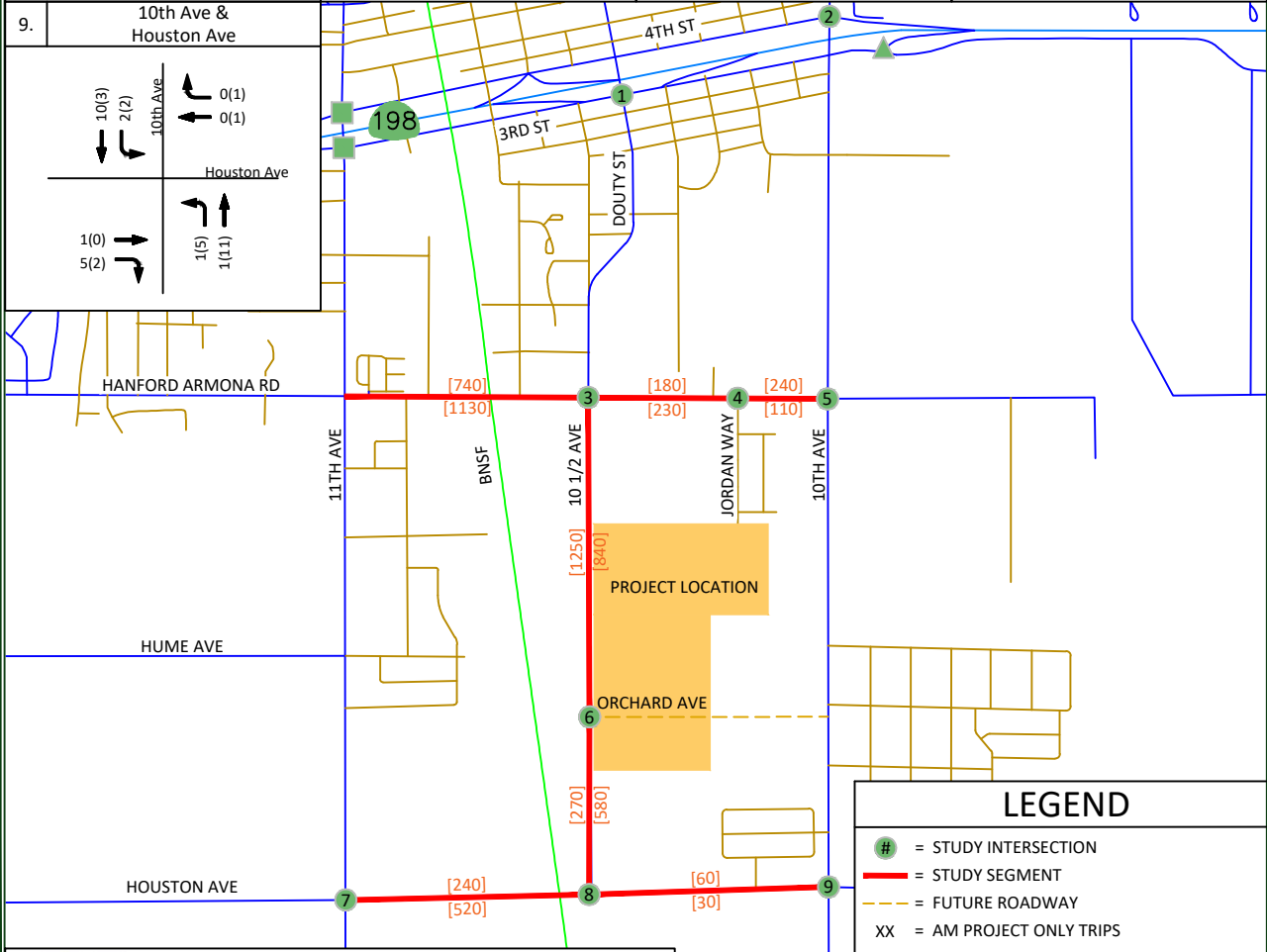

JLB TRAFFIC
ENGINEERING, INC.

516 W. Shaw Ave., Ste. 103, Fresno, CA 93704
PHONE: (559) 570-8991, EMAIL: info@JLBtraffic.com, www.JLBtraffic.com

LEGEND

- = STUDY INTERSECTION
- = STUDY SEGMENT
- - - = FUTURE ROADWAY
- XX = AM PROJECT ONLY TRIPS
- (XX) = PM PROJECT ONLY TRIPS
- [XX] = DAILY VOLUMES
- = TRIP ANALYSIS (FIGURE 11)
- ▲ = TRIP ANALYSIS (FIGURE 12)

Not To Scale

Lunaria TIA - City of Hanford 2042 Near Term Projects' Trip Assignment

Figure 9

<p>1. SR 198 EB Off Ramp/3rd St & Douty St</p>	<p>2. SR 198 WB Off Ramp/4th St & 10th Ave</p>	<p>3. 10 1/2 Ave & Hanford-Armona Rd</p>	<p>4. Jordan Way & Hanford-Armona Rd</p>
<p>5. 10th Ave & Hanford-Armona Rd</p>	<p>6. 10 1/2 Ave & Orchard Ave</p>	<p>7. 11th Ave & Houston Ave</p>	<p>8. 10 1/2 Ave & Houston Ave</p>

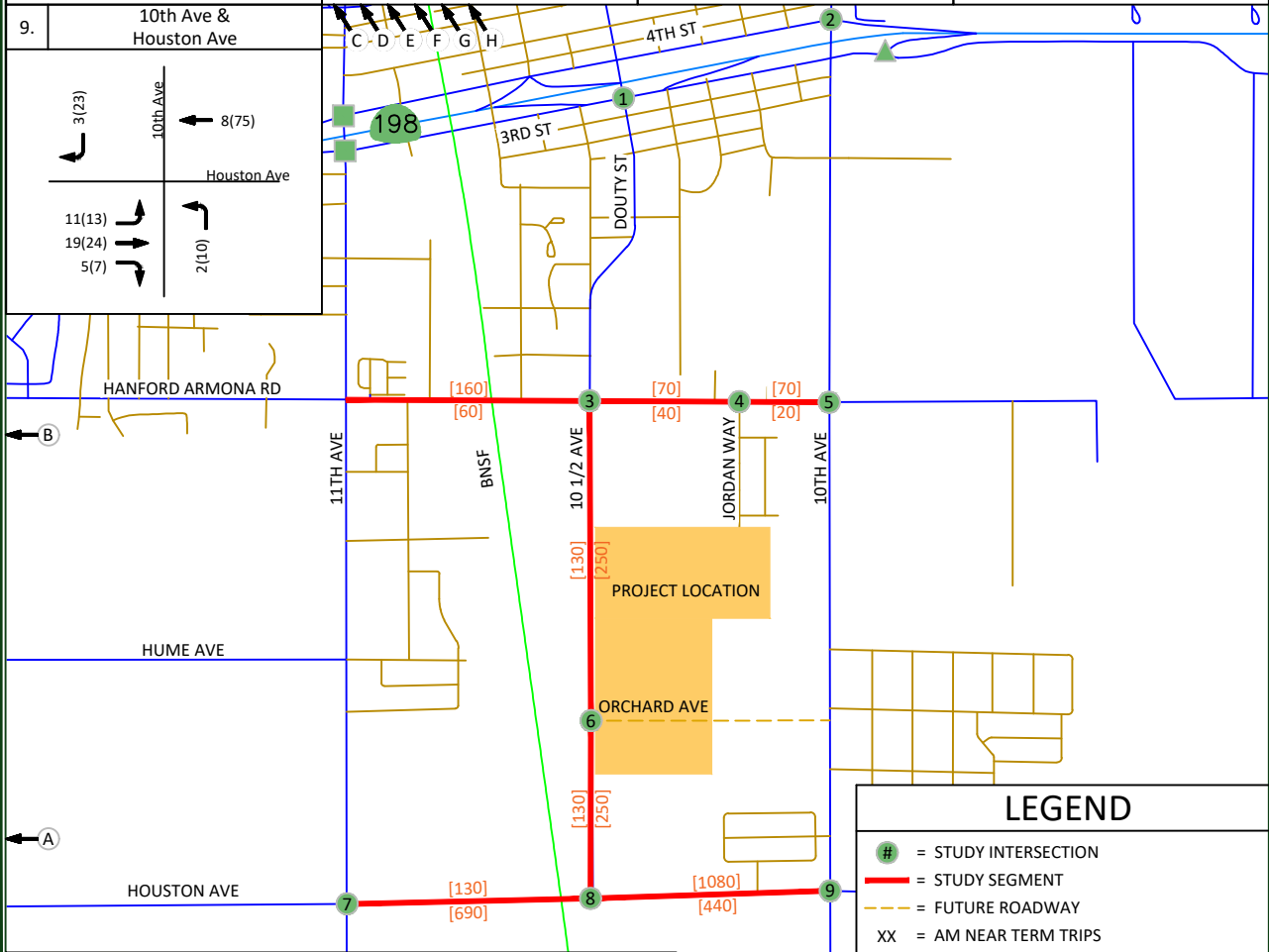

LEGEND

- = STUDY INTERSECTION
- = STUDY SEGMENT
- = FUTURE ROADWAY
- XX = AM NEAR TERM TRIPS
- (XX) = PM NEAR TERM TRIPS
- [XX] = DAILY VOLUMES
- ⊕ = NEAR TERM PROJECT LOCATION
- = TRIP ANALYSIS (FIGURE 11)
- ▲ = TRIP ANALYSIS (FIGURE 12)

Not To Scale

516 W. Shaw Ave., Ste. 103, Fresno, CA 93704
 PHONE: (559) 570-8991, EMAIL: info@JLBtraffic.com, www.JLBtraffic.com

Lunaria TIA - City of Hanford Cumulative Year 2042 plus Project - Traffic Volumes, Geometrics and Controls

Figure 10

1. SR 198 EB Off Ramp/3rd St & Douty St	2. SR 198 WB Off Ramp/4th St & 10th Ave	3. 10 1/2 Ave & Hanford-Armona Rd	4. Jordan Way & Hanford-Armona Rd
5. 10th Ave & Hanford-Armona Rd	6. 10 1/2 Ave & Orchard Ave	7. 11th Ave & Houston Ave	8. 10 1/2 Ave & Houston Ave

9. 10th Ave & Houston Ave			

LEGEND

- = STUDY INTERSECTION
- = STUDY SEGMENT
- = FUTURE ROADWAY
- XX = AM PEAK HOUR TRIPS
- (XX) = PM PEAK HOUR TRIPS
- [XX] = DAILY VOLUMES
- ⬛ = STOP SIGN
- ⊙ = YIELD SIGN
- 🚦 = TRAFFIC SIGNAL
- 🟩 = TRIP ANALYSIS (FIGURE 11)
- 🟩 = TRIP ANALYSIS (FIGURE 12)

Not To Scale

516 W. Shaw Ave., Ste. 103, Fresno, CA 93704
 PHONE: (559) 570-8991, EMAIL: info@JLBtraffic.com, www.JLBtraffic.com

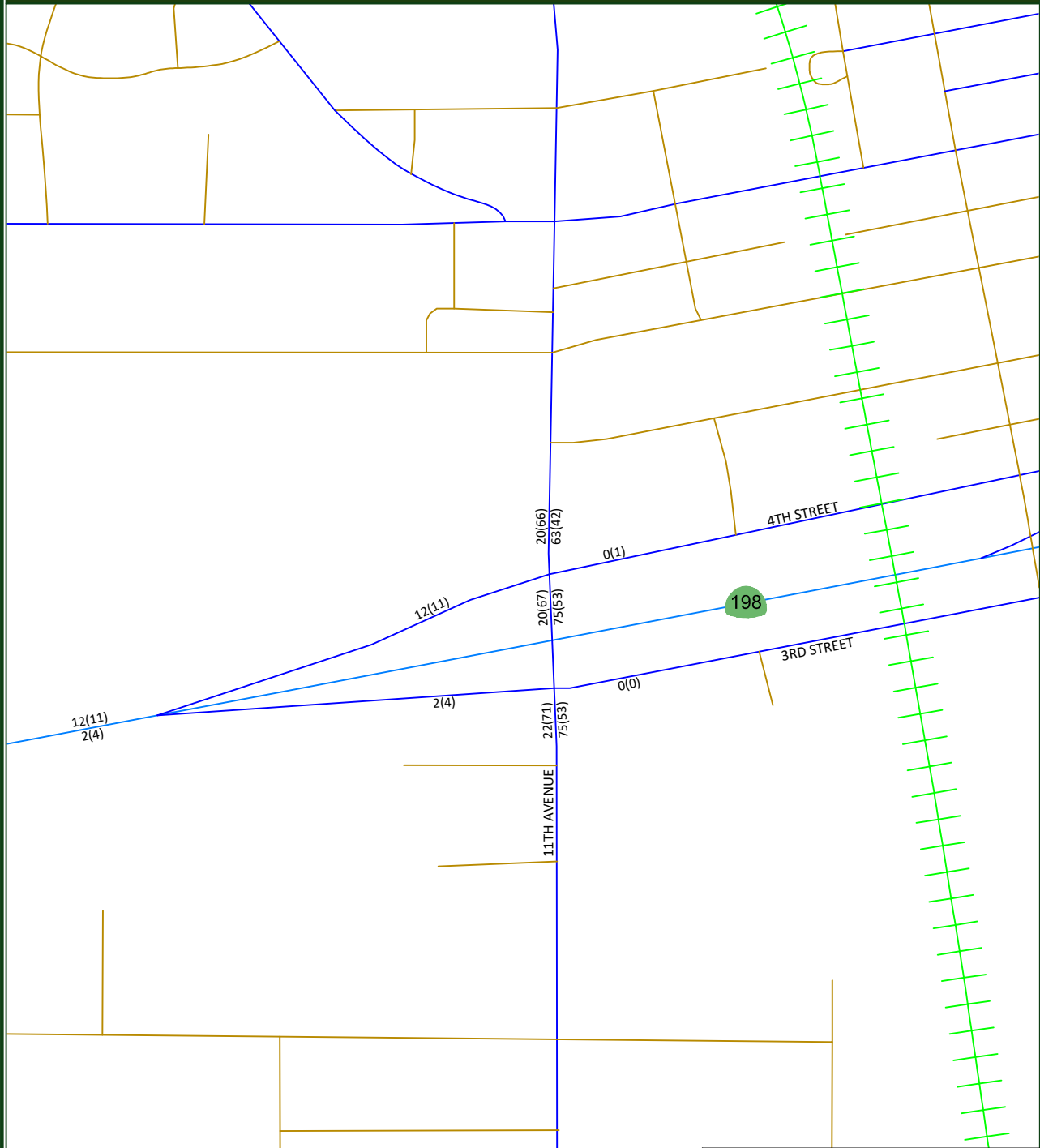

LEGEND

- XX = AM PROJECT ONLY TRIPS
- (XX) = PM PROJECT ONLY TRIPS



Not To Scale



516 W. Shaw Ave., Ste. 103, Fresno, CA 93704
 PHONE: (559) 570-8991, EMAIL: info@JLBtraffic.com, www.JLBtraffic.com

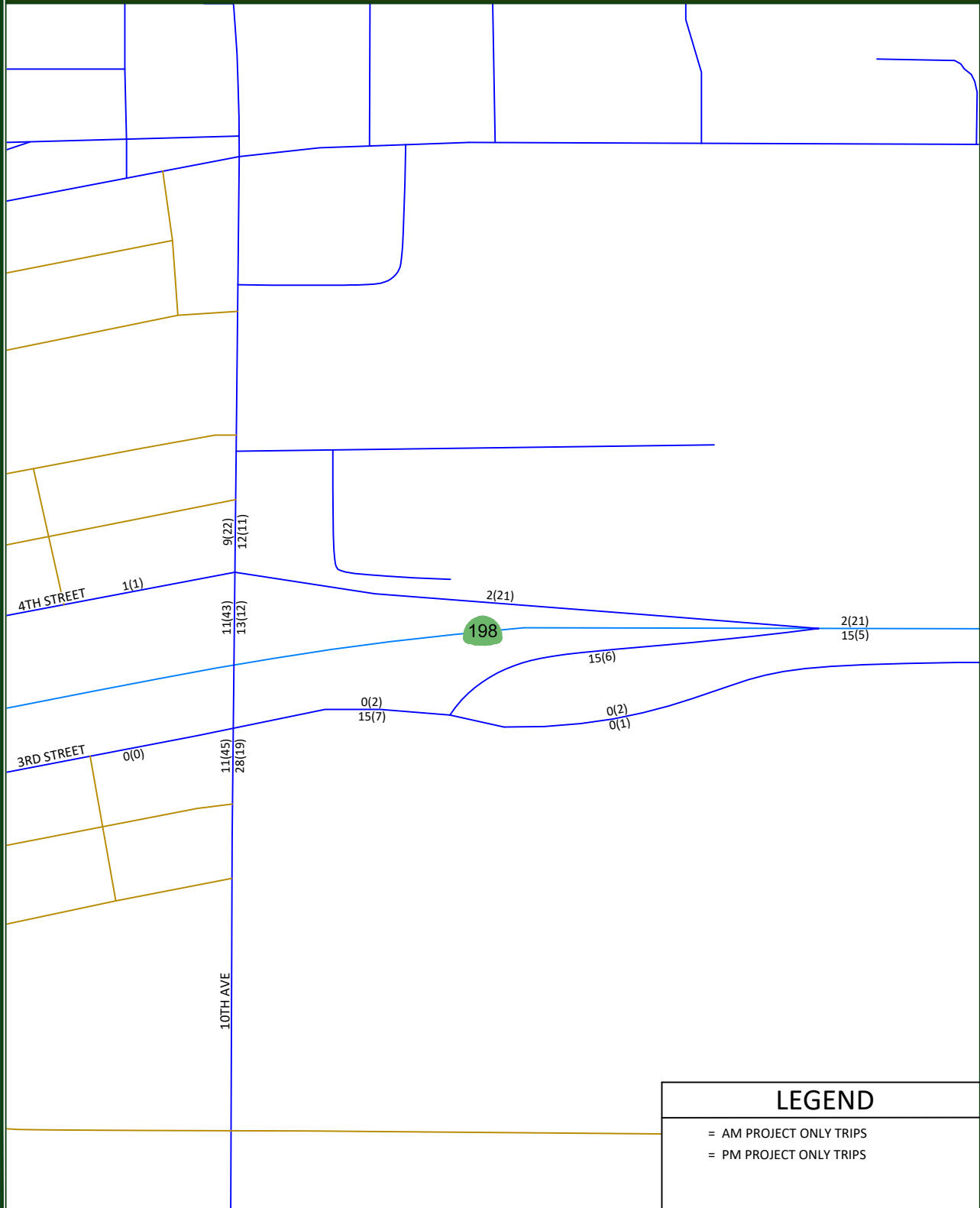

LEGEND

- = AM PROJECT ONLY TRIPS
- = PM PROJECT ONLY TRIPS



Not To Scale

JLB TRAFFIC
 ENGINEERING, INC.

516 W. Shaw Ave., Ste. 103, Fresno, CA 93704
 PHONE: (559) 570-8991, EMAIL: info@JLBtraffic.com, www.JLBtraffic.com

Queuing Analysis

Table XIV provides a queue length summary for left-turn and right-turn lanes at the study intersections under all study scenarios. The queuing analyses for the study intersections are contained in the LOS worksheets for the respective scenarios. Appendix D contains the methodologies used to evaluate these intersections. Queuing analyses were completed using SimTraffic output information. Synchro provides both 50th and 95th percentile maximum queue lengths (in feet). According to the *Synchro Studio 11 User Guide*, “the 50th percentile maximum queue is the maximum back of queue on a typical cycle and the 95th percentile queue is the maximum back of queue with 95th percentile volumes” (Cubic ITS, Inc., 2019). The queues shown on Table XIV are the 95th percentile queue lengths for the respective lane movements.

The *California Highway Design Manual* (CA HDM) provides guidance for determining deceleration lengths for the left-turn and right-turn lanes based on design speeds. According to the CA HDM, tapers for right-turn lanes are “usually unnecessary since main line traffic need not be shifted laterally to provide space for the right-turn lane. If, in some rare instances, a lateral shift were needed, the approach taper would use the same formula as for a left-turn lane” (Caltrans 2019). Therefore, a bay taper length pursuant to the CA HDM would need to be added, as necessary, to the recommended storage lengths presented in Table XIV.

The storage capacity for the Cumulative Year 2042 plus Project Traffic Conditions shall be based on the SimTraffic output files and engineering judgement. The values in bold presented in Table XIV are the projected queue lengths that will likely need to be accommodated by the Cumulative Year 2042 plus Project Traffic Conditions scenario. At the remaining approaches of the study intersections, the existing storage capacity will be sufficient to accommodate the maximum queue.

Table XIV: Queuing Analysis

ID	Intersection	Existing Queue Storage Length (ft.)		Existing		Existing plus Project		Near Term plus Project		Cumulative Year 2042 plus Project	
				AM	PM	AM	PM	AM	PM	AM	PM
1	Douty Street / 3rd Street	EB L	100	81	86	87	92	103	95	90	123
		EB T	>300	81	89	72	92	68	92	81	153
		EB TR	>300	71	97	62	85	68	82	78	139
		NB T	>300	59	59	54	59	54	57	58	60
		NB T	>300	65	72	67	58	62	70	64	64
		NB R	90	43	37	43	54	55	53	55	54
		SB LT	>300	69	118	83	146	75	133	88	177
		SB T	>300	0	35	28	56	10	34	0	53
2	10th Avenue / SR-198 WB Off Ramp	WB LTR	>500	84	126	103	115	92	104	156	156
		NB L	295	52	85	53	87	49	110	76	421
		NB T	295	101	124	110	110	125	114	136	561
		NB T	295	102	121	142	121	120	106	144	381
		SB T	>300	161	170	151	210	151	219	195	327
		SB T	>300	121	99	101	159	36	142	144	278
		SB R	105	64	67	59	68	55	73	82	135
3	10 1/2 Avenue / Hanford Armona Road	EB L	150	48	56	77	61	81	81	73	143
		EB TR	>500	105	85	106	198	144	203	128	324
		WB L	95	22	25	27	41	50	45	49	140
		WB TR	>500	82	133	113	138	135	158	139	186
		NB L	150	55	49	109	99	121	84	112	149
		NB T	>500	38	32	79	61	61	60	66	108
		NB R	95	26	25	37	33	50	22	47	29
		SB L	150	28	53	33	47	41	53	32	49
		SB T	>500	47	36	38	53	56	66	61	72
		SB R	100	49	57	45	57	45	56	37	57
4	Jordan Way / Hanford Armona Road	EB TR	>500	0	0	0	10	0	0	0	0
		WB L	75	28	23	22	46	19	40	22	52
		WB T	>500	0	0	0	0	0	0	0	0
		NB LR	>300	61	55	71	68	69	72	65	71

Note:

* = Does not exist or is not projected to exist

L = Left Turn Lane

LT = Left-Through Lane

T = Through Lane

TR = Through-Right Lane

R = Right Turn Lane

LTR = Left-Through-Right Lane

LR = Left-Right Lane

Table XIV: Queuing Analysis (Continued)

ID	Intersection	Existing Queue Storage Length (ft.)		Existing		Existing plus Project		Near Term plus Project		Cumulative Year 2042 plus Project	
				AM	PM	AM	PM	AM	PM	AM	PM
5	10th Avenue / Hanford Armona Road	EB L	105	127	112	146	156	157	151	140	153
		EB T	>500	32	20	27	21	15	64	28	79
		EB R	55	31	44	38	71	39	73	44	57
		WB L	155	18	19	10	8	13	22	19	41
		WB TR	>500	37	36	33	39	40	41	46	91
		NB L	155	58	92	61	116	75	108	77	134
		NB T	>500	86	107	111	130	82	149	130	198
		NB R	130	0	0	0	7	7	10	0	22
		SB L	110	24	42	23	49	28	37	29	99
		SB T	>500	97	85	115	111	123	111	130	258
	SB R	265	58	76	70	78	85	91	95	187	
6	10 ½ Avenue / Orchard Avenue	WB LR	*	*	*	65	54	53	51	58	58
		NB TR	*	*	*	0	0	0	0	0	0
		SB LT	*	*	*	20	28	16	38	14	28
7	11th Avenue / Houston Avenue	EB L	165	49	38	59	35	103	49	94	76
		EB T	>500	45	60	53	77	66	78	117	162
		EB R	150	32	18	24	22	37	20	45	36
		WB L	175	49	33	44	34	55	34	47	50
		WB T	>500	66	78	74	83	70	90	111	165
		WB R	175	38	37	39	32	38	47	31	38
		NB L	175	34	50	49	52	45	60	77	83
		NB T	>300	50	58	47	57	38	56	67	149
		NB T	>300	45	41	32	36	25	46	82	143
		NB R	100	25	20	31	25	17	25	39	43
		SB L	250	49	52	57	67	51	56	71	70
	SB T	>500	29	58	53	62	49	56	82	172	
	SB R	>300	34	18	47	23	29	24	27	25	
8	Houston Avenue / 10 1/2 Avenue	EB LT	>500	0	0	0	31	22	30	36	45
		WB TR	>500	0	0	0	0	0	0	0	0
		SB LR	>500	36	41	68	44	67	59	62	58

Note:

* = Does not exist or is not projected to exist
 L = Left Turn Lane
 LT = Left-Through Lane
 T = Through Lane
 TR = Through-Right Lane

R = Right Turn Lane
 LTR = Left-Through-Right Lane
 LR = Left-Right Lane



Table XIV: Queuing Analysis (Continued)

9	10th Avenue / Houston Avenue	EB LTR	>500	75	55	83	57	77	55	93	84
		WB LTR	>500	65	60	80	72	86	66	62	119
		NB LTR	>500	69	52	66	58	67	68	70	119
		SB LTR	>500	67	66	77	57	70	70	100	138
10	3 rd Street / SR-198 EB Off Ramp	EB T	>500	10	0	10	43	20	14	0	40
		SB L	>500	52	98	65	71	77	96	66	204

Note:

* = Does not exist or is not projected to exist

L = Left Turn Lane

LT = Left-Through Lane

T = Through Lane

TR = Through-Right Lane

R = Right Turn Lane

LTR = Left-Through-Right Lane

LR = Left-Right Lane

Conclusions and Recommendations

Conclusions and recommendations regarding the proposed Project are presented below.

Existing Traffic Conditions

- At present, all study intersections operate at an acceptable LOS during both peak periods.
- At present, all study segments operate at an acceptable LOS.

Existing plus Project Traffic Conditions

- Based on the original site plan, the Project is estimated to generate a maximum of 4,181 daily trips, 310 AM peak hour trips and 418 PM peak hour trips at build-out.
- Based on the latest site plan, the Project is estimated to generate a maximum of 4,315 daily trips, 320 AM peak hour trips and 431 PM peak hour trips at build-out.
- Compared to the original site plan, the latest site plan is estimated to yield a greater trip generation by 134 daily trips, 10 AM peak hour trips and 13 PM peak hour trips. These are an increase of 3.20%, 3.23% and 3.11% of the Daily, AM peak hour and PM peak hour respectively.
- LOS studies were completed using the trip generated by the original site plan. To account for the additional trips produced by the latest site plan, all additional trips (10 AM Peak hour trips and 13 PM peak hour trips) were routed to the worst performing intersection during the worst performing scenario. This was determined to be the intersection of Houston Avenue at 11th Avenue during the Cumulative Year 2042 plus Project Scenario. Based on this analysis, it was determined that that all study intersections and segments would continue to operate within the acceptable LOS for all study scenarios.
- JLB analyzed the location of the existing and proposed roadways and access points. This review revealed that all access points are located at points that minimize traffic operational impacts to existing and future roadway networks.
- It is recommended that the Project implement ADA compliant sidewalks along its frontages to 10 ½ Avenue and Orchard Avenue.
- It is recommended that the Project implement Class II Bike Lanes along its frontage to 10 ½ Avenue and Orchard Avenue.
- Under this scenario, all study intersections are projected to operate at an acceptable LOS during both peak periods.
- Under this scenario, all study segments are projected to operate at an acceptable LOS.

Near Term plus Project Traffic Conditions

- The total trip generation for the Near Term Projects by 2027 is projected as 20,410 daily trips, 1,600 AM peak hour trips and 2,141 PM peak hour trips.
- The total trip generation for the Near Term Projects by 2042 is projected as 25,413 daily trips, 1,992 AM peak hour trips and 2,665 PM peak hour trips.
- Under this scenario, all study intersections are projected to operate at an acceptable LOS during both peak periods.
- Under this scenario, all study segments are projected to operate at an acceptable LOS.

Cumulative Year 2042 plus Project Traffic Conditions

- Under this scenario, all study intersections are projected to operate at an acceptable LOS during both peak periods.
- Under this scenario, all study segments are projected to operate at an acceptable LOS.
- To account for the difference in trip generation between the original and latest site plan, all additional trips (10 AM Peak hour trips and 13 PM peak hour trips) were routed to the worst performing intersection during the worst performing scenario. This intersection was determined to be Houston Avenue at 11th Avenue during the Cumulative Year 2042 plus Project. Even with all additional project trips routed to this intersection, it continues to operate at an acceptable LOS. Therefore, it is the opinion of JLB that all study intersections would continue to operate within the acceptable LOS for all study scenarios if the additional trips were distributed throughout the roadway network and the LOS studies were redone. As a result, JLB does not recommend that this TIA be redone and that the City of Hanford, County of Kings and Caltrans can utilize this TIA to determine the Projects impacts to the study intersections and segments.

Queuing Analysis

- It is recommended that the City consider left-turn and right-turn lane storage lengths as indicated in the Queuing Analysis.

Study Participants

JLB Traffic Engineering, Inc. Personnel:

Jose Luis Benavides, PE, TE	Project Manager
Carlos Ayala-Magaña, EIT	Engineer I/II
Matthew Arndt, EIT	Engineer I/II
Jove Alcazar, EIT	Engineer I/II
Javier Rios	Engineer I/II
Dennis Wynn	Sr. Engineering Technician
Adrian Benavides	Engineering Aide
Christian Sanchez	Engineering Aide

Persons Consulted:

Ernie Escobedo	QK Inc.
Mary Beatie	City of Hanford
John Doyel	City of Hanford
Dominic Tyburski	County of Kings
Chuck Kinney	County of Kings
David Padilla	Caltrans
Christopher Xiong	Caltrans
Mike Aronson	Kittleson & Associates, Inc.
Miao Gao	Kittleson & Associates, Inc.

References

- Caltrans. 2002. "Guide for The Preparation of Traffic Impact Studies." State of California.
- Caltrans. 2019. "Highway Design Manual". Sacramento: State of California.
- Caltrans. 2021. "California Manual on Uniform Traffic Control Devices". Sacramento: State of California.
- City of Hanford. 2014. "General Plan Background Report." Hanford: City of Hanford.
- City of Hanford. 2017. "General Plan Circulation Map." Hanford: City of Hanford.
- City of Hanford. 2017. "2035 General Plan Policy Document." Hanford: City of Hanford.
- City of Hanford. 2016. "Pedestrian and Bicycle Master Plan." Hanford: City of Hanford.
- County of Kings. 2010. "2035 General Plan Circulation Element". King's County.
- Institute of Transportation Engineers. 2017. "Trip Generation Manual". Washington: Institute of Transportation Engineers.
- Cubic ITS, Inc. 2019. "Synchro Studio 11 User Guide". Sugar Land: Trafficware, LLC.
- Transportation Research Board. 2016. "Highway Capacity Manual". Washington: The National Academy of Sciences.

Appendix A: Scope of Work



www.JLBtraffic.com
info@JLBtraffic.com

516 W. Shaw Ave., Ste. 103
Fresno, CA 93704
(559) 570-8991

App | A

January 20, 2022

Gabrielle de Silva Myers
Senior Planner
City of Hanford
317 N. Douty Street
Hanford, CA 93230

Via Email Only: gmyers@cityofhanfordca.com

Subject: Proposed Scope of Work for the Preparation of a Traffic Impact Analysis and Vehicle Miles Traveled Analysis for the Lunaria Project in the City of Hanford (JLB Project 047-002)

Dear Ms. Myers,

JLB Traffic Engineering, Inc. (JLB) hereby submits this Draft Scope of Work for the preparation of a Traffic Impact Analysis (TIA) and Vehicle Miles Traveled (VMT) Analysis for the Lunaria Project (Project) located at the southeast quadrant of Hanford-Armona Road and Avenue 10 ½ in the City of Hanford. The Project proposes to develop the site with 443 single family residential units and a 4.9-acre public park. Based on information provided to JLB, the Project is consistent with the City's General Plan. An aerial of the Project vicinity and Project Site Plan are shown in Exhibits A and Exhibit B, respectively.

The purpose of the TIA and VMT Analysis is to evaluate the potential on-site and off-site traffic impacts, identify short-term roadway and circulation needs, determine potential mitigation measures and identify any critical traffic issues that should be addressed in the on-going planning process. To evaluate the on-site and off-site traffic impacts of the proposed Project, JLB proposes the following Scope of Work.

Scope of Work

- JLB will obtain new traffic counts at the study facility(ies) when schools in the vicinity are in session. These counts will include pedestrians and vehicles. Schools in the proximity of these intersections are in sessions and have had in-person learning this academic year, unless students opt out for at-home learning. According to VMT data on the Transportation Injury Mapping System (TIMS) database, VMT has been normalizing to pre-Covid numbers. As a result of VMT data normalizing and schools being in session, JLB proposes that no escalation be applied to the traffic counts due to Covid.
- JLB will request a Kings County Association of Governments (Kings CAG) traffic forecasting modeling for the Project. The Kings CAG traffic forecasting model will be used to forecast traffic volumes for the Base Year and Cumulative Year 2042 scenarios.
- JLB will perform a site visit to observe existing traffic conditions, especially during the AM and PM peak hours. Existing roadway conditions including speed limits, lane geometrics, turn prohibitions and traffic controls will be verified.



www.JLBtraffic.com

info@JLBtraffic.com

516 W. Shaw Ave., Ste. 103

Fresno, CA 93704

(559) 570-8991

Page | 1

- JLB will evaluate on-site circulation and provide recommendations as necessary to improve circulation to and within the Project site.
- JLB will qualitatively analyze existing and planned transit routes in the vicinity of the Project.
- JLB will qualitatively analyze existing and planned walkways in the vicinity of the Project.
- JLB will qualitatively analyze existing and planned bikeways in the vicinity of the Project.
- JLB will prepare CA MUTCD Warrant 3 “Peak Hour” for unsignalized study intersections under all study scenarios.
- JLB will forecast trip distribution based on turn count information and knowledge of the existing and planned circulation network in the vicinity of the Project.
- JLB will evaluate existing and forecasted levels of service (LOS) at the study intersection(s). JLB will use HCM 6th or HCM 2000 methodologies (as appropriate) within Synchro to perform this analysis for the AM and PM peak hours. JLB will identify the causes of poor LOS.

Study Scenarios

1. Existing Traffic Conditions with needed improvements (if any);
2. Existing plus Project Buildout Traffic Conditions with proposed improvements (if any);
3. Near Term plus Project Buildout Traffic Conditions with proposed improvements (if any); and
4. Cumulative Year 2042 plus Project Buildout Traffic Conditions with proposed improvements (if any).

Weekday peak hours to be analyzed (Tuesday or Thursday only)

1. 7 - 9 AM peak hour
2. 4 - 6 PM peak hour

Study Intersections

1. Hanford-Armona Road / Avenue 10 1/2
2. Hanford-Armona Road / Jordan Way
3. Hanford-Armona Road / Avenue 10
4. Orchard Avenue / Avenue 10 1/2 (Future Intersection)
5. Houston Avenue / Avenue 10 1/2

Queuing analysis is included in the proposed Scope of Work for the study intersection(s) listed above under all study scenarios. This analysis will be utilized to recommend minimum storage lengths for left-turn and right-turn lanes at all study intersections.

Study Segments

1. Avenue 10 1/2 between Hanford Armona Road and Orchard Avenue alignment
2. Avenue 10 1/2 between Orchard Avenue alignment and Houston Avenue

Project Only Trip Assignment to State Facilities

1. State Route 198 at Douty Street
2. State Route 198 at 10th Avenue

Access to the Project

Access to and from the Project site will be from four (4) access points. Three of these access points will connect directly to 10 1/2 Avenue, while the fourth will tie into existing local street Jordan Way. Jordan Way connects to Hanford Armona Road.



Project Trip Generation

The trip generation rates for the proposed Project were obtained from the 11th Edition of the Trip Generation Manual published by the Institute of Transportation Engineers (ITE). Table I presents the trip generation for the proposed Project with trip generation rates for 443 Single-Family Detached Housing units and a 4.9-acre public park. At buildout, the proposed Project is estimated to generate a maximum of 4,181 daily trips, 310 AM peak hour trips and 418 PM peak hour trips.

Table I: Project Trip Generation

Land Use (ITE Code)	Size	Unit	Daily		AM (7-9) Peak Hour					PM (4-6) Peak Hour						
			Rate	Total	Trip Rate	In	Out	In	Out	Total	Trip Rate	In	Out	In	Out	Total
						%	%									
Single-Family Detached Housing (210)	443	d.u.	9.43	4,177	0.70	26	74	80	230	310	0.94	63	37	262	155	417
Public Park (411)	4.9	Acres	0.78	4	0.02	59	41	0	0	0	0.11	55	54	1	0	1
Total Project Trips				4,181				80	230	310				263	155	418

Note: d.u. = Dwelling Units

Near Term Projects to be Included

JLB will be consulting with City of Hanford Planning Department and Engineering staff to determine which Projects should be included in the Near Term plus Project analysis. JLB will include Near Term Projects in the vicinity of the proposed Project under the Near Term plus Project analysis for which the City, County or Caltrans has knowledge of and for which it is anticipated that said project(s) is/are projected to be whole or partially built by the Near-Term Project year 2025. City of Hanford, County of Kings and Caltrans, as appropriate, would provide JLB with Near Term Project details such as a project description, location, proposed land uses with breakdowns and type of residential units and amount of square footages for non-residential uses.

The Scope of Work is based on our understanding of this Project and our experience with similar TIAs. In the absence of comments by January 31, 2022 it will be assumed that the Scope of Work is acceptable to the agency(ies) that have not submitted any comments. If you have any questions or require additional information, please contact via email at cayala@JLBtraffic.com.

Sincerely,



Carlos Ayala-Magana, EIT
 Engineer I/II

cc: John Doyle, City of Hanford
 Dominic Tyburski, County of Kings
 David Padilla, Caltrans
 Jose Benavides, JLB Traffic Engineering, Inc.

Z:\01 Projects\047 Hanford\047-002 Lunaria TIA & VMT\Scope of Work\01 Draft Scope of Work\L01202022 Lunaria Project TIA Draft Scope of Work.docx



www.JLBtraffic.com
 info@JLBtraffic.com

516 W. Shaw Ave., Ste. 103
 Fresno, CA 93704
 (559) 570-8991

Exhibit A – Project Vicinity

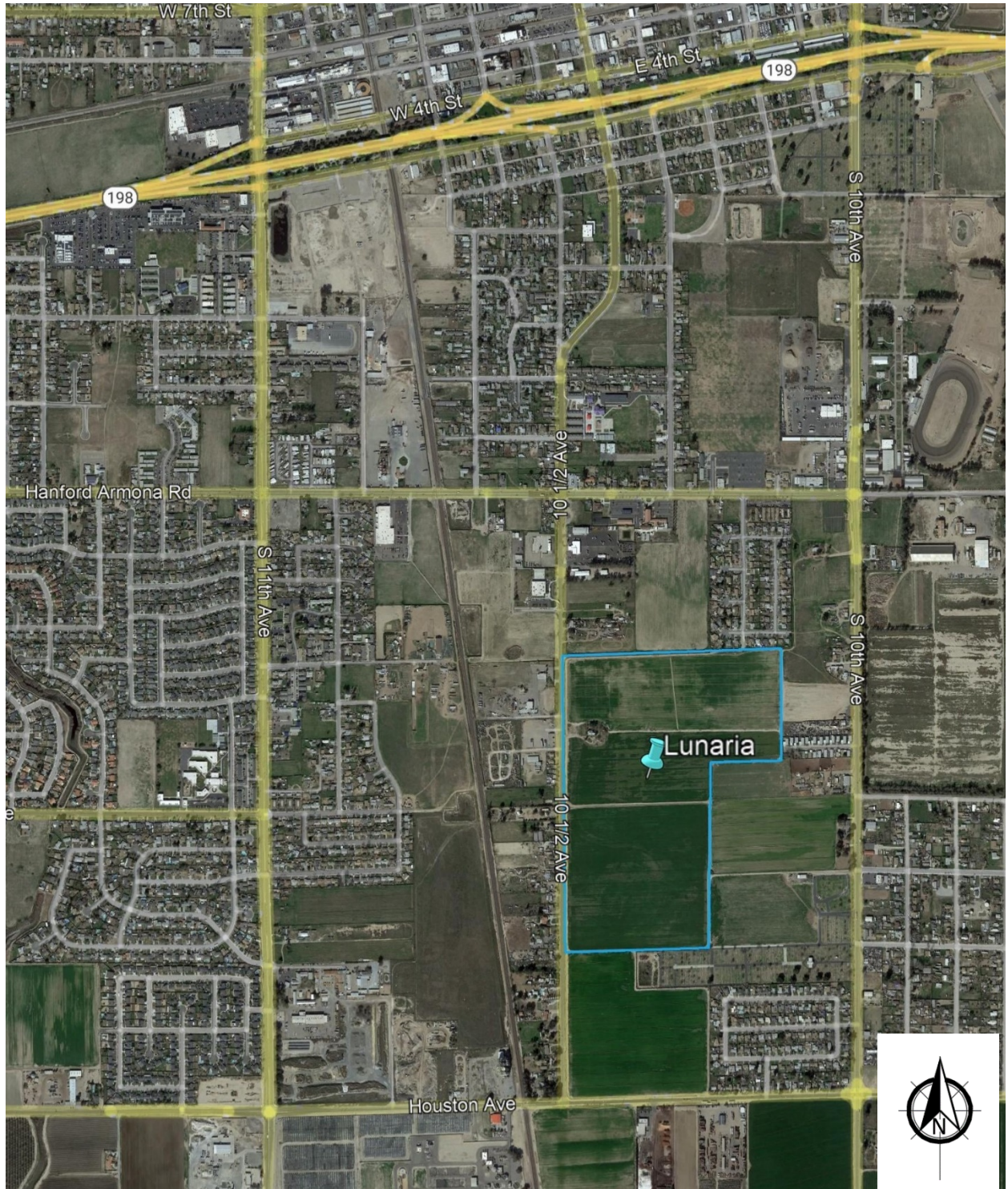
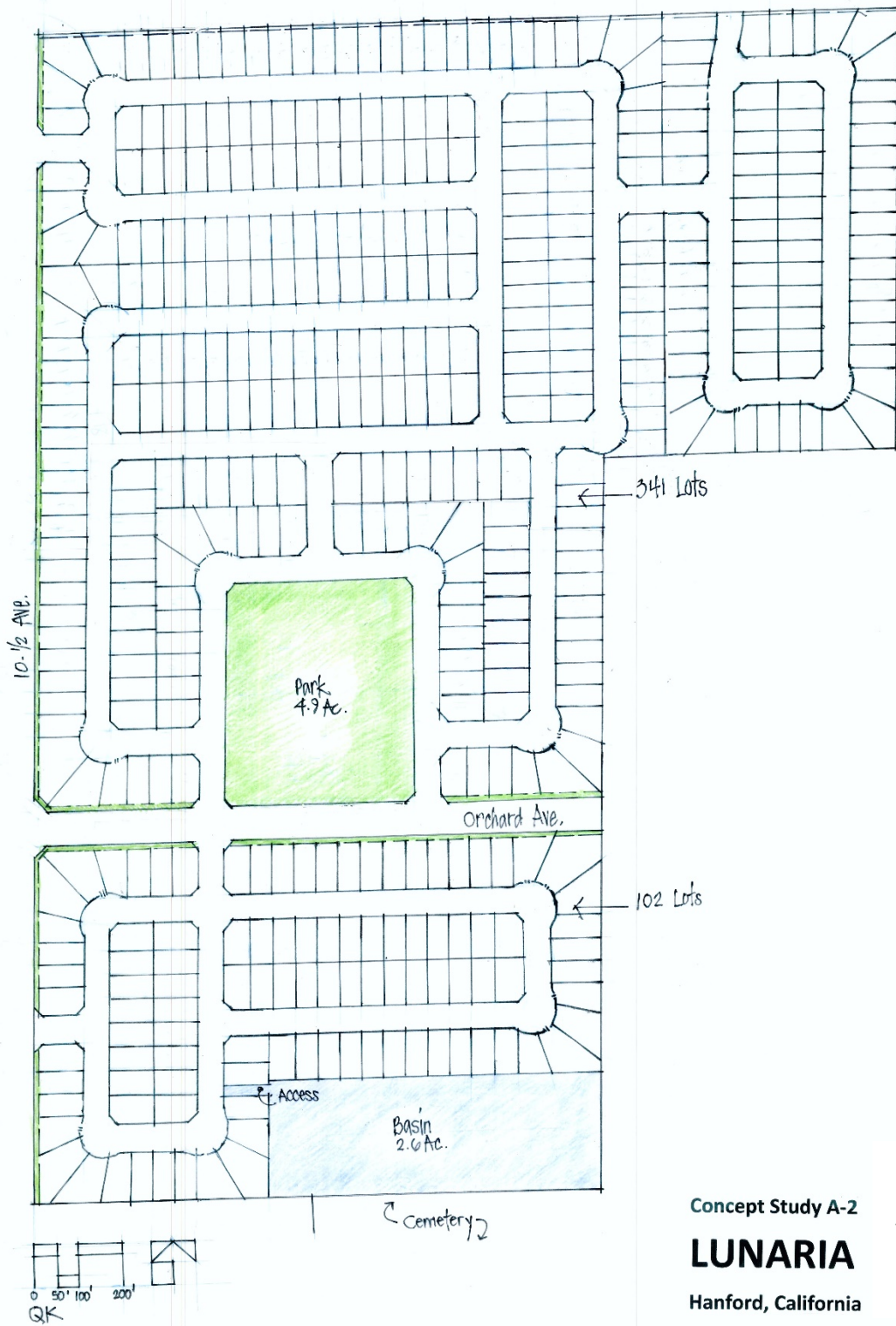

Exhibit B – Project Site Plan



Concept Study A-2
LUNARIA
Hanford, California



- JLB will evaluate on-site circulation and provide recommendations as necessary to improve circulation to and within the Project site.
- JLB will qualitatively analyze existing and planned transit routes in the vicinity of the Project.
- JLB will qualitatively analyze existing and planned walkways in the vicinity of the Project.
- JLB will qualitatively analyze existing and planned bikeways in the vicinity of the Project.
- JLB will prepare CA MUTCD Warrant 3 “Peak Hour” for unsignalized study intersections under all study scenarios.
- JLB will forecast trip distribution based on turn count information and knowledge of the existing and planned circulation network in the vicinity of the Project.
- JLB will evaluate existing and forecasted levels of service (LOS) at the study intersection(s). JLB will use HCM 6th or HCM 2000 methodologies (as appropriate) within Synchro to perform this analysis for the AM and PM peak hours. JLB will identify the causes of poor LOS.

Study Scenarios

1. Existing Traffic Conditions with needed improvements (if any);
2. Existing plus Project Buildout Traffic Conditions with proposed improvements (if any);
3. Near Term plus Project Buildout Traffic Conditions with proposed improvements (if any); and
4. Cumulative Year 2042 plus Project Buildout Traffic Conditions with proposed improvements (if any).

Weekday peak hours to be analyzed (Tuesday or Thursday only)

1. 7 - 9 AM peak hour
2. 4 - 6 PM peak hour

Study Intersections

1. Hanford-Armona Road / Avenue 10 1/2
2. Hanford-Armona Road / Jordan Way 
3. Hanford-Armona Road / Avenue 10
4. Orchard Avenue / Avenue 10 1/2 (Future Intersection)
5. Houston Avenue / Avenue 10 1/2

Queuing analysis is included in the proposed Scope of Work for the study intersection(s) listed above under all study scenarios. This analysis will be utilized to recommend minimum storage lengths for left-turn and right-turn lanes at all study intersections.

Study Segments

1. Avenue 10 1/2 between Hanford Armona Road and Orchard Avenue alignment 
2. Avenue 10 1/2 between Orchard Avenue alignment and Houston Avenue

Project Only Trip Assignment to State Facilities

1. State Route 198 at Douty Street
2. State Route 198 at 10th Avenue

Access to the Project

Access to and from the Project site will be from four (4) access points. Three of these access points will connect directly to 10 1/2 Avenue, while the fourth will tie into existing local street Jordan Way. Jordan Way connects to Hanford Armona Road.

Carlos Ayala

From: Jose Benavides
Sent: Thursday, February 3, 2022 4:44 PM
To: Kinney, Chuck; Tyburski, Dominic
Cc: Carlos Ayala
Subject: RE: Lunaria Hanford TIA: Scope of Work

Thanks Chuck for the very quick response.

We will include your comments to the TIA scope of work within the appendix of the TIA. I believe that your reply to me will suffice, but feel free to provide your comments directly to the City of Hanford if that is the County's protocol.

Once the TIA and VMT reports have been completed, we will be sending these to you and Dominic in PDF format for your review and comment. We will also be providing the TIA and VMT reports to the City and Caltrans.

Sincerely,

Jose Luis Benavides, P.E., T.E.
President



Traffic Engineering, Transportation Planning and Parking Solutions
Certified Disadvantaged Business Enterprise (DBE) and Small Business Enterprise (SBE)

516 W. Shaw Ave., Ste. 103
Fresno, CA 93704
Direct: (559) 317-6249
Main: (559) 570-8991
Cell: (559) 694-6000
Fax: (559) 317-6854
www.JLBtraffic.com

From: Kinney, Chuck <Chuck.Kinney@co.kings.ca.us>
Sent: Thursday, February 3, 2022 4:21 PM
To: Tyburski, Dominic <Dominic.Tyburski@co.kings.ca.us>
Cc: Jose Benavides <jbenavides@jlbtraffic.com>
Subject: RE: Lunaria Hanford TIA: Scope of Work

Hi Dominic and Jose,

Based upon the project scope, in addition to the LOS study intersections proposed it would probably also be a good idea to study the following intersections:

- a. 10 Ave. and Houston Ave. (included as a City of Hanford addition in the email below)
- b. 11th Ave. and Houston Ave.

I also concur with the City of Hanford on analyzing the segment of Houston Avenue from 10th Avenue to 11th Avenue. With the addition of the 443 new homes it is likely to generate significant new traffic along Houston Avenue as it is an arterial street which can connect that new area to the 12th Avenue shopping centers (Walmart/Target) and it would be prudent to calculate the impact on those intersections and roadways so that recommendations can be developed offsetting any negative impacts to LOS.

Jose, would you confirm if I need to send this information to Mary Beatie (acting Community Development Director for Hanford) since Gabrielle is on her extended leave or am I good just submitting this information to you? Thank you for your assistance on this.

Sincerely,
Chuck K.

Chuck Kinney, Director
Kings County Community Development Agency
1400 W. Lacey Blvd.
Hanford, CA 93230
559-852-2674

From: Tyburski, Dominic <Dominic.Tyburski@co.kings.ca.us>
Sent: Thursday, February 3, 2022 3:37 PM
To: Kinney, Chuck <Chuck.Kinney@co.kings.ca.us>
Cc: 'Jose Benavides' <jbenavides@jlbtraffic.com>
Subject: FW: Lunaria Hanford TIA: Scope of Work

Hi Chuck,

Does CDA have any comments on the attached TIA scope of work? Thank you.

Dominic Tyburski, P.E.
Director | Public Works

County of Kings | Public Works Department
1400 W. Lacey Blvd. | Hanford, CA 93230

Direct 559-852-2698 | Fax 559-582-2506
Dominic.Tyburski@co.kings.ca.us | www.countyofkings.com



From: Jose Benavides <jbenavides@jlbtraffic.com>
Sent: Thursday, February 3, 2022 3:27 PM
To: Tyburski, Dominic <Dominic.Tyburski@co.kings.ca.us>
Cc: Carlos Ayala <cayala@jlbtraffic.com>
Subject: FW: Lunaria Hanford TIA: Scope of Work

Good afternoon Dominic,

Sorry that I missed your call this afternoon.

Anyway, attached you will find the proposed scope of work for the preparation of a TIA in the City of Hanford. Furthermore, the City of Hanford has recently requested that we also include in the TIA analysis the following study segments and intersections.

Segment LOS:

- Hanford Armona Road between 11th Avenue and 10 ½ Avenue
- Hanford Armona Road between 10 1/2 Avenue and 10th Avenue
- Houston Avenue between 11th Avenue and 10 ½ Avenue
- Houston Avenue between 10 1/2 Avenue and 10th Avenue

Intersection LOS:

- Houston Avenue and 10th Avenue

Can you please share this with Chuck or provide me with his email so that we can send this to him so that we may get comments if any from the County?

Sincerely,

Jose Luis Benavides, P.E., T.E.
President



Traffic Engineering, Transportation Planning and Parking Solutions
Certified Disadvantaged Business Enterprise (DBE) and Small Business Enterprise (SBE)

516 W. Shaw Ave., Ste. 103
Fresno, CA 93704
Direct: (559) 317-6249
Main: (559) 570-8991
Cell: (559) 694-6000
Fax: (559) 317-6854
www.JLBtraffic.com

From: Carlos Ayala <cayala@jlbtraffic.com>
Sent: Thursday, February 3, 2022 9:37 AM
To: Jose Benavides <jbenavides@jlbtraffic.com>
Subject: FW: Lunaria Hanford TIA: Scope of Work

Initial Lunaria SOW email.

Thank you,

Carlos Ayala-Magana
Engineer I/II



Traffic Engineering, Transportation Planning and Parking Solutions
Certified Disadvantaged Business Enterprise (DBE) and Small Business Enterprise (SBE)

516 W. Shaw Ave., Ste. 103
Fresno, CA 93704
Office: (559) 570-8991
Direct: (559) 869-4514
Fax: (559) 317-6854
www.JLBtraffic.com

From: Carlos Ayala
Sent: Thursday, January 20, 2022 10:44 AM
To: Gabrielle de Silva Myers (gmyers@cityofhanfordca.com) <gmyers@cityofhanfordca.com>
Cc: John Doyel (JDoyel@cityofhanfordca.com) <JDoyel@cityofhanfordca.com>; Dominic Tyburski (dominic.tyburski@co.kings.ca.us) <dominic.tyburski@co.kings.ca.us>; David Padilla (dave.padilla@dot.ca.gov) <dave.padilla@dot.ca.gov>; Jose Benavides <jbenavides@jlbtraffic.com>
Subject: Lunaria Hanford TIA: Scope of Work

Hello Gabrielle,

Attached you will find a Draft Scope of Work for the preparation of a Traffic Impact Analysis for a Project in the City of Hanford/County of Kings.

We kindly ask that you take a moment to review and comment on the proposed Scope of Work. In the absence of comments by January 31, 2022, it will be assumed that the proposed Scope of Work is acceptable to the agency(ies) that have not submitted any comments.

If you have any questions or require additional information, please contact me by phone at 559.869.4514 or by e-mail at cayala@JLBtraffic.com. We appreciate your time and attention to this matter and look forward to hearing from you soon.

Thank you,

Carlos Ayala-Magana
Engineer I/II



Traffic Engineering, Transportation Planning and Parking Solutions
Certified Disadvantaged Business Enterprise (DBE) and Small Business Enterprise (SBE)

516 W. Shaw Ave., Ste. 103

Carlos Ayala

From: Xiong, Christopher@DOT <Christopher.Xiong@dot.ca.gov>
Sent: Thursday, February 3, 2022 2:42 PM
To: Carlos Ayala
Cc: Padilla, Dave@DOT; gmyers@cityofhanfordca.com; JDoyel@cityofhanfordca.com; dominic.tyburski@co.kings.ca.us; Jose Benavides
Subject: RE: Lunaria Hanford TIA: Scope of Work
Attachments: KIN-198-R18.373_Proposed Scope of Work for Traffic Impact Analysis - Lunaria Project_revised_response.pdf

Hello Carlos,

Attached is our revised comment letter regarding the proposed scope of work, which supersedes our previous letter.

Please let me know if you have any questions.

Best regards,

Christopher Xiong
Associate Transportation Planner
Caltrans District 6
1352 W. Olive Avenue
Fresno, CA 93728
Christopher.Xiong@dot.ca.gov
(559) 908-7064

From: Xiong, Christopher@DOT
Sent: Friday, January 28, 2022 3:58 PM
To: cayala@jlbtraffic.com
Cc: Padilla, Dave@DOT <dave.padilla@dot.ca.gov>; gmyers@cityofhanfordca.com; JDoyel@cityofhanfordca.com; dominic.tyburski@co.kings.ca.us; jbenavides@jlbtraffic.com
Subject: RE: Lunaria Hanford TIA: Scope of Work

Hello Carlos,

Attached are our comments regarding the proposed Scope of Work and project.

Please let me know if you have any questions.

Best regards,

Christopher Xiong
Associate Transportation Planner
Caltrans District 6
1352 W. Olive Avenue
Fresno, CA 93728
Christopher.Xiong@dot.ca.gov
(559) 908-7064

From: Carlos Ayala <cayala@jlbtraffic.com>
Sent: Thursday, January 20, 2022 10:44 AM
To: Gabrielle de Silva Myers (gmyers@cityofhanfordca.com) <gmyers@cityofhanfordca.com>
Cc: John Doyel (JDoyel@cityofhanfordca.com) <JDoyel@cityofhanfordca.com>; Dominic Tyburski (dominic.tyburski@co.kings.ca.us) <dominic.tyburski@co.kings.ca.us>; Padilla, Dave@DOT <dave.padilla@dot.ca.gov>; Jose Benavides <jbenavides@jlbtraffic.com>
Subject: Lunaria Hanford TIA: Scope of Work

EXTERNAL EMAIL. Links/attachments may not be safe.

Hello Gabrielle,

Attached you will find a Draft Scope of Work for the preparation of a Traffic Impact Analysis for a Project in the City of Hanford/County of Kings.

We kindly ask that you take a moment to review and comment on the proposed Scope of Work. In the absence of comments by January 31, 2022, it will be assumed that the proposed Scope of Work is acceptable to the agency(ies) that have not submitted any comments.

If you have any questions or require additional information, please contact me by phone at 559.869.4514 or by e-mail at cayala@JLBtraffic.com. We appreciate your time and attention to this matter and look forward to hearing from you soon.

Thank you,

Carlos Ayala-Magana
Engineer I/II



Traffic Engineering, Transportation Planning and Parking Solutions
Certified Disadvantaged Business Enterprise (DBE) and Small Business Enterprise (SBE)

516 W. Shaw Ave., Ste. 103
Fresno, CA 93704
Office: (559) 570-8991
Direct: (559) 869-4514
Fax: (559) 317-6854
www.JLBtraffic.com

California Department of Transportation

DISTRICT 6 OFFICE
1352 WEST OLIVE AVENUE | P.O. BOX 12616 | FRESNO, CA 93778-2616
(559) 981-1041 | FAX (559) 488-4195 | TTY 711
www.dot.ca.gov



February 3, 2022

KIN-198-R18.373
Lunaria Project
Proposed Scope of Work for Traffic Impact Analysis
Revised
<https://ld-igr-gts.dot.ca.gov/district/6/report/25306>

SENT VIA EMAIL

Carlos Ayala-Magana,
JLB Traffic Engineering, Inc.
516 W. Shaw Ave., Ste. 103
Fresno, CA 93704

Dear Mr. Ayala-Magana,

This comment letter supersedes our previous letter dated January 28, 2022 for the Proposed Scope of Work for the Preparations of a Traffic Impact Analysis (TIA) and Vehicle Miles Traveled (VMT) Analysis for the Lunaria Project, proposing to develop 443 single-family residential units and a 4.9-acre public park. The project site is located at the southeast quadrant of Hanford-Armona Road and 10-1/2 Avenue in the City of Hanford, approximately one mile south of the State Route (SR) 198 / Douty Street ramps, southwest of the SR 198 / 10th Avenue ramps, and southeast of the SR 198 / 11th Avenue ramps.

General Comments

The submitted Scope of Work (SOW) for the Preparation of a Traffic Impact Analysis and VMT Analysis proposes to study (including queuing analysis) for the following 5 intersections:

1. Hanford-Armona Road / Avenue 10 1/2
2. Hanford-Armona Road / Jordan Way
3. Hanford-Armona Road / Avenue 10
4. Orchard Avenue / Avenue 10 1/2 (Future Intersection)
5. Houston Avenue / Avenue 10 1/2

While the proposed SOW is satisfactory, Caltrans recommends a queuing analysis for the following facilities be included in the study:

1. SR 198 / Avenue 10 – Westbound off-ramp
2. SR 198 / Douty Street (on 3rd Street) – Eastbound off-ramp

This is due to the potential project trips from the 443 single-family residential units and public park that would utilize the State facilities, which were not designed as high capacity ramps. In addition, please include a trip trace to the following locations:

1. SR 198 / Avenue 11 – Westbound on-ramp
2. SR 198 / Avenue 10 (on 3rd Street) – Eastbound on-ramp

Caltrans provides the following additional comments to better support the State's smart mobility goals that support a vibrant economy and sustainable communities:

1. Caltrans recommends the project proponents(s) consider working with the City to convert a portion of the units to affordable housing units.
2. Caltrans concurs with the project proponent(s) conducting a vehicle miles traveled (VMT) study. The preparer should refer to the *Caltrans Vehicle Miles Traveled Transportation Impact Study Guide*, dated May 20, 2020. Improvements for existing/future bike and pedestrian facilities on roads in the vicinity of the Project and connectivity between home to work/home to shops should be considered and included in the VMT mitigation plan.
3. Caltrans recommends the City consider creating a VMT Mitigation Impact Fee to help reduce impacts on the State Highway System.
4. According to the City of Hanford's Pedestrian and Bicycle Master Plan (2016), 10-1/2 Avenue is proposed as Class III bike lane as part of the 2016 Initial Stage Bikeway Plan (see page 3-22) and as a Class II bike lane in the 2035 Bikeway Plan (see page 3-23). Therefore, Caltrans recommends the project proponent(s) coordinate with the City regarding these alternative transportation measures.

Carlos Ayala-Magana, Lunaria Project – Proposed Scope of Work for Traffic Impact Analysis

February 3, 2022

Page 3

5. Active Transportation Plans and Smart Growth efforts support the state's 2050 Climate goals. Caltrans supports reducing VMT and GHG emissions in ways that increase the likelihood people will use and benefit from a multimodal transportation network.

If you have any other questions, please call or email Christopher Xiong at (559) 908-7064 or Christopher.Xiong@dot.ca.gov.

Sincerely,

A handwritten signature in blue ink, appearing to read 'David Padilla', with a long horizontal flourish extending to the right.

DAVID PADILLA, Branch Chief
Transportation Planning – North

Appendix B: Traffic Counts



www.JLBtraffic.com
info@JLBtraffic.com

516 W. Shaw Ave., Ste. 103
Fresno, CA 93704
(559) 570-8991



Metro Traffic Data Inc.
 310 N. Irwin Street - Suite 20
 Hanford, CA 93230
 800-975-6938 Phone/Fax
 www.metrotrafficdata.com

Turning Movement Report

Prepared For:

JLB Traffic Engineering, Inc.
 516 W. Shaw Ave, Suite 103
 Fresno, CA 93704

LOCATION 3rd St @ Douy St

LATITUDE 36.3225

COUNTY Kings

LONGITUDE -119.6447

COLLECTION DATE Tuesday, March 1, 2022

WEATHER Clear

Time	Northbound					Southbound					Eastbound					Westbound					
	U-Turn	Left	Thru	Right	Trucks	U-Turn	Left	Thru	Right	Trucks	U-Turn	Left	Thru	Right	Trucks	U-Turn	Left	Thru	Right	Trucks	
7:00 AM - 7:15 AM	0	0	15	2	0	0	0	12	5	0	1	0	30	60	3	11	0	0	0	0	0
7:15 AM - 7:30 AM	0	0	22	6	3	0	0	10	9	0	0	0	41	67	5	5	0	0	0	0	0
7:30 AM - 7:45 AM	0	0	34	7	1	0	0	17	15	0	2	0	48	91	3	2	0	0	0	0	0
7:45 AM - 8:00 AM	0	0	43	12	2	0	0	19	29	0	0	0	103	104	9	11	0	0	0	0	0
8:00 AM - 8:15 AM	0	0	41	7	2	0	0	16	34	0	3	0	75	87	6	4	0	0	0	0	0
8:15 AM - 8:30 AM	0	0	37	5	2	0	0	19	25	0	3	0	65	79	8	5	0	0	0	0	0
8:30 AM - 8:45 AM	0	0	30	8	1	0	0	13	24	0	2	0	59	70	6	17	0	0	0	0	0
8:45 AM - 9:00 AM	0	0	42	3	2	0	0	16	10	0	1	0	66	67	7	4	0	0	0	0	0
TOTAL	0	0	264	50	13	0	0	122	151	0	12	0	487	625	47	59	0	0	0	0	0

Time	Northbound					Southbound					Eastbound					Westbound					
	U-Turn	Left	Thru	Right	Trucks	U-Turn	Left	Thru	Right	Trucks	U-Turn	Left	Thru	Right	Trucks	U-Turn	Left	Thru	Right	Trucks	
4:00 PM - 4:15 PM	0	0	33	7	0	0	0	38	33	0	2	0	81	126	12	9	0	0	0	0	0
4:15 PM - 4:30 PM	0	0	36	5	3	0	0	32	33	0	1	0	76	121	14	5	0	0	0	0	0
4:30 PM - 4:45 PM	0	0	31	8	0	0	0	47	36	0	1	0	72	128	11	4	0	0	0	0	0
4:45 PM - 5:00 PM	0	0	45	10	1	0	0	28	48	0	0	0	75	118	10	2	0	0	0	0	0
5:00 PM - 5:15 PM	0	0	30	8	0	0	0	54	43	0	3	0	63	132	21	3	0	0	0	0	0
5:15 PM - 5:30 PM	0	0	39	5	1	0	0	31	34	0	0	0	60	129	19	3	0	0	0	0	0
5:30 PM - 5:45 PM	0	0	28	5	0	0	0	26	22	0	2	0	69	113	14	6	0	0	0	0	0
5:45 PM - 6:00 PM	0	0	35	3	1	0	0	29	32	0	0	0	58	95	10	0	0	0	0	0	0
TOTAL	0	0	277	51	6	0	0	285	281	0	9	0	554	962	111	32	0	0	0	0	0

PEAK HOUR	Northbound					Southbound					Eastbound					Westbound					
	U-Turn	Left	Thru	Right	Trucks	U-Turn	Left	Thru	Right	Trucks	U-Turn	Left	Thru	Right	Trucks	U-Turn	Left	Thru	Right	Trucks	
7:30 AM - 8:30 AM	0	0	155	31	7	0	0	71	103	0	8	0	291	361	26	22	0	0	0	0	0
4:15 PM - 5:15 PM	0	0	142	31	4	0	0	161	160	0	5	0	286	499	56	14	0	0	0	0	0

	PHF	Trucks
AM	0.813	3.6%
PM	0.951	1.7%

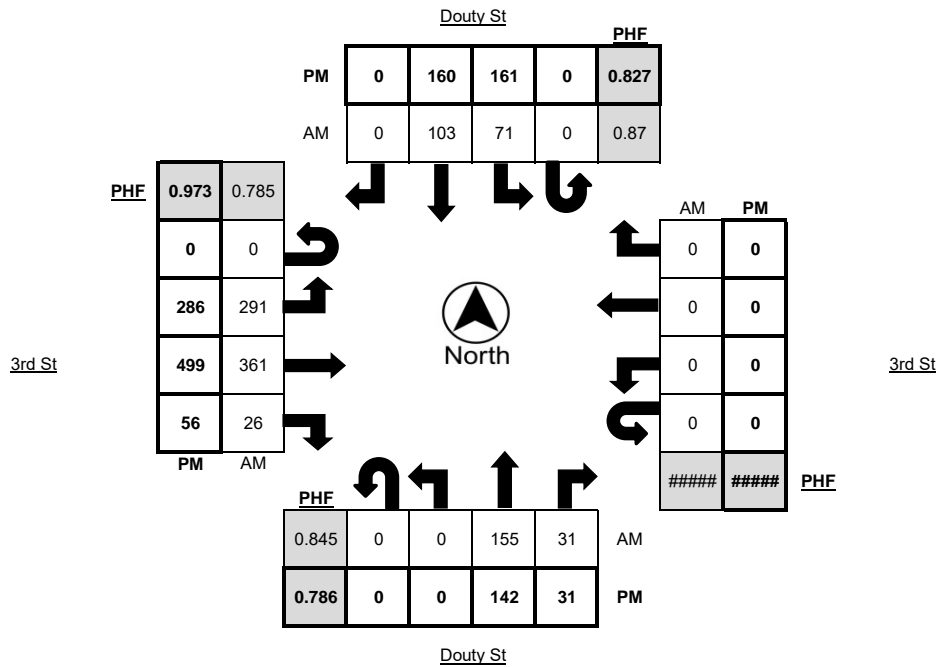



Metro Traffic Data Inc.
 310 N. Irwin Street - Suite 20
 Hanford, CA 93230
 800-975-6938 Phone/Fax
 www.metrotrafficdata.com

Turning Movement Report

Prepared For:

JLB Traffic Engineering, Inc.
 516 W. Shaw Ave, Suite 103
 Fresno, CA 93704

LOCATION 3rd St @ Douty St

LATITUDE 36.3225

COUNTY Kings

LONGITUDE -119.6447

COLLECTION DATE Tuesday, March 1, 2022

WEATHER Clear

Time	Northbound Bikes			N.Leg Peds	Southbound Bikes			S.Leg Peds	Eastbound Bikes			E.Leg Peds	Westbound Bikes			W.Leg Peds
	Left	Thru	Right		Left	Thru	Right		Left	Thru	Right		Left	Thru	Right	
7:00 AM - 7:15 AM	0	0	0	0	0	0	0	0	0	0	0	0	0	0	0	0
7:15 AM - 7:30 AM	0	0	0	0	0	0	0	0	0	0	0	0	0	0	0	0
7:30 AM - 7:45 AM	0	0	0	0	0	0	0	0	0	0	0	0	0	0	0	0
7:45 AM - 8:00 AM	0	1	0	0	0	0	0	0	0	0	0	0	0	0	0	0
8:00 AM - 8:15 AM	0	0	0	0	0	0	0	0	0	0	0	0	0	0	0	0
8:15 AM - 8:30 AM	0	1	0	0	0	0	0	0	0	0	0	0	0	0	0	0
8:30 AM - 8:45 AM	0	0	0	0	0	0	1	0	0	0	0	0	0	0	0	0
8:45 AM - 9:00 AM	0	0	0	0	0	0	0	0	0	0	0	0	0	0	0	2
TOTAL	0	2	0	0	0	0	1	0	0	0	0	0	0	0	0	2

Time	Northbound Bikes			N.Leg Peds	Southbound Bikes			S.Leg Peds	Eastbound Bikes			E.Leg Peds	Westbound Bikes			W.Leg Peds
	Left	Thru	Right		Left	Thru	Right		Left	Thru	Right		Left	Thru	Right	
4:00 PM - 4:15 PM	0	0	0	0	0	0	0	0	0	0	0	0	0	0	0	0
4:15 PM - 4:30 PM	0	2	0	0	0	0	0	0	0	0	0	1	0	0	0	0
4:30 PM - 4:45 PM	0	0	0	0	0	0	0	0	0	0	0	0	0	0	0	0
4:45 PM - 5:00 PM	0	0	0	0	0	3	0	0	0	0	0	0	0	0	0	4
5:00 PM - 5:15 PM	0	1	0	0	0	0	0	0	0	0	0	0	0	0	0	0
5:15 PM - 5:30 PM	0	1	0	0	0	2	0	0	0	0	0	0	0	0	0	0
5:30 PM - 5:45 PM	0	1	0	0	0	4	0	0	0	0	0	0	0	0	0	0
5:45 PM - 6:00 PM	0	0	0	0	0	1	0	0	0	0	0	1	0	0	0	0
TOTAL	0	5	0	0	0	10	0	0	0	0	0	2	0	0	0	4

PEAK HOUR	Northbound Bikes			N.Leg Peds	Southbound Bikes			S.Leg Peds	Eastbound Bikes			E.Leg Peds	Westbound Bikes			W.Leg Peds
	Left	Thru	Right		Left	Thru	Right		Left	Thru	Right		Left	Thru	Right	
7:30 AM - 8:30 AM	0	2	0	0	0	0	0	0	0	0	0	0	0	0	0	0
4:15 PM - 5:15 PM	0	3	0	0	0	3	0	0	0	0	0	1	0	0	0	4

	Bikes	Peds
AM Peak Total	2	0
PM Peak Total	6	5

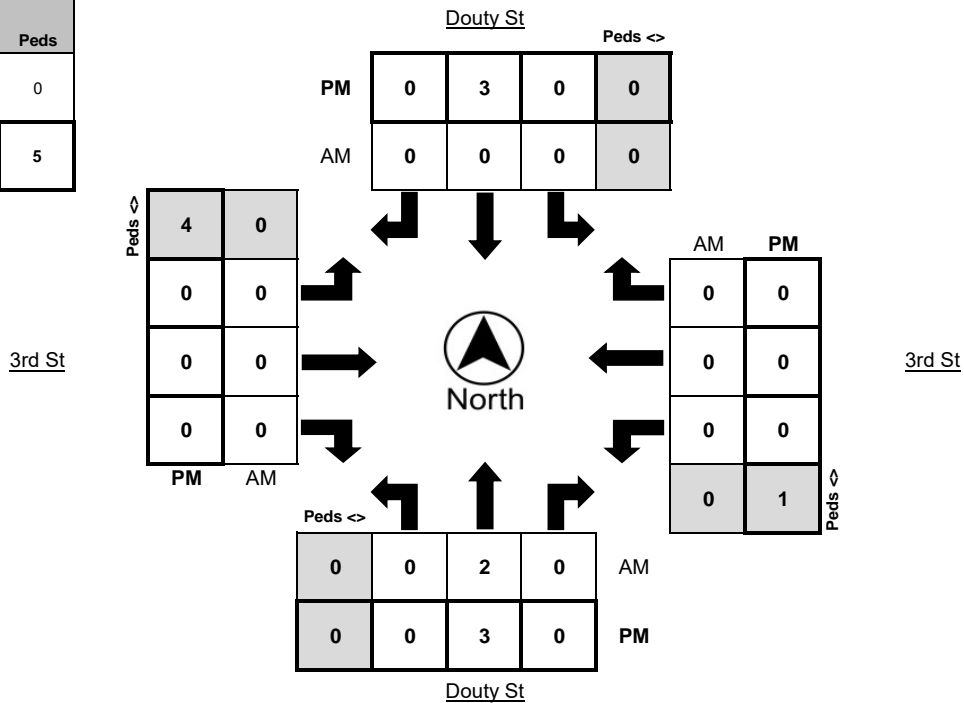



Metro Traffic Data Inc.
 310 N. Irwin Street - Suite 20
 Hanford, CA 93230
 800-975-6938 Phone/Fax
 www.metrotrafficdata.com

24 Hour Volume Report

Prepared For: **JLB Traffic Engineering, Inc.**
 516 W. Shaw Ave, Suite 103
 Fresno, CA 93704

LOCATION SR 198 EB Off-ramp @ Douty St **LATITUDE** 36.3221936
COUNTY Kings **LONGITUDE** -119.6463439
COLLECTION DATE Thursday, March 3, 2022 **WEATHER** Clear
NUMBER OF LANES 1

Hour	Eastbound					Westbound					Hourly Totals
	1st	2nd	3rd	4th	Total	1st	2nd	3rd	4th	Total	
12:00 AM	0	0	0	0	0	0	0	0	0	0	0
1:00 AM	0	0	0	0	0	0	0	0	0	0	0
2:00 AM	0	0	0	0	0	0	0	0	0	0	0
3:00 AM	0	0	0	0	0	0	0	0	0	0	0
4:00 AM	0	0	0	0	0	0	0	0	0	0	0
5:00 AM	0	0	0	0	0	0	0	0	0	0	0
6:00 AM	0	0	0	0	0	0	0	0	0	0	0
7:00 AM	37	72	82	148	339	0	0	0	0	0	339
8:00 AM	112	100	79	60	351	0	0	0	0	0	351
9:00 AM	0	0	0	0	0	0	0	0	0	0	0
10:00 AM	0	0	0	0	0	0	0	0	0	0	0
11:00 AM	0	0	0	0	0	0	0	0	0	0	0
12:00 PM	0	0	0	0	0	0	0	0	0	0	0
1:00 PM	0	0	0	0	0	0	0	0	0	0	0
2:00 PM	0	0	0	0	0	0	0	0	0	0	0
3:00 PM	0	0	0	0	0	0	0	0	0	0	0
4:00 PM	104	105	87	109	405	0	0	0	0	0	405
5:00 PM	91	92	83	94	360	0	0	0	0	0	360
6:00 PM	0	0	0	0	0	0	0	0	0	0	0
7:00 PM	0	0	0	0	0	0	0	0	0	0	0
8:00 PM	0	0	0	0	0	0	0	0	0	0	0
9:00 PM	0	0	0	0	0	0	0	0	0	0	0
10:00 PM	0	0	0	0	0	0	0	0	0	0	0
11:00 PM	0	0	0	0	0	0	0	0	0	0	0
Total	100.0%				1455	0.0%				0	1455

AM% 47.4% **AM Peak** 442 **7:30 am to 8:30 am** **AM P.H.F.** 0.75
PM% 52.6% **PM Peak** 405 **4:00 pm to 5:00 pm** **PM P.H.F.** 0.93

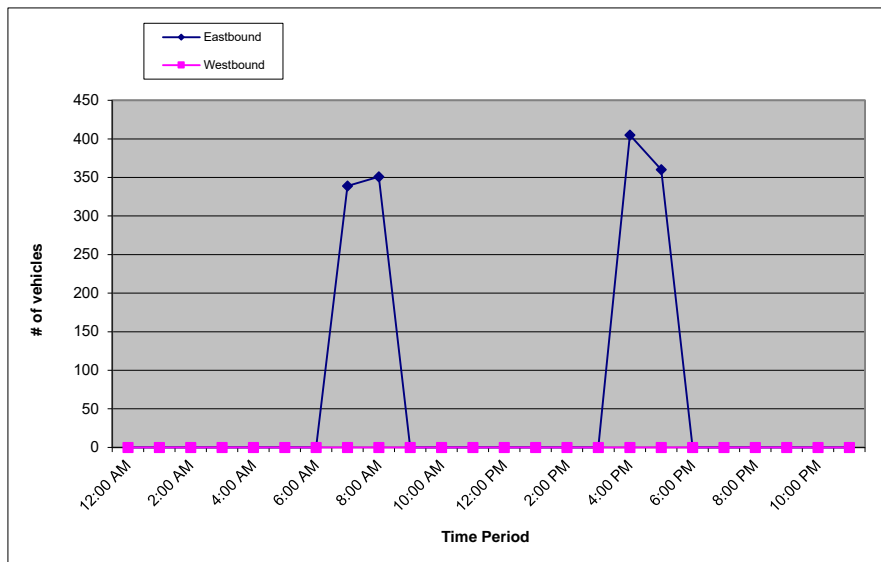



Metro Traffic Data Inc.
 310 N. Irwin Street - Suite 20
 Hanford, CA 93230
 800-975-6938 Phone/Fax
 www.metrotrafficdata.com

Turning Movement Report

Prepared For:

JLB Traffic Engineering, Inc.
 516 W. Shaw Ave, Suite 103
 Fresno, CA 93704

LOCATION 4th St / SR 198 WB Off-ramp @ 10th Ave

LATITUDE 36.3248

COUNTY Kings

LONGITUDE -119.6370

COLLECTION DATE Tuesday, March 1, 2022

WEATHER Clear

Time	Northbound					Southbound					Eastbound					Westbound				
	U-Turn	Left	Thru	Right	Trucks	U-Turn	Left	Thru	Right	Trucks	U-Turn	Left	Thru	Right	Trucks	U-Turn	Left	Thru	Right	Trucks
7:00 AM - 7:15 AM	0	6	78	0	6	0	0	68	40	2	0	0	0	0	0	0	12	5	19	4
7:15 AM - 7:30 AM	0	12	82	0	3	0	0	80	48	4	0	0	0	0	0	0	8	3	32	1
7:30 AM - 7:45 AM	0	11	103	0	2	0	0	91	49	1	0	0	0	0	0	0	10	3	18	0
7:45 AM - 8:00 AM	0	10	150	0	4	0	0	137	62	5	0	0	0	0	0	0	15	14	39	2
8:00 AM - 8:15 AM	0	13	162	0	5	0	0	102	56	7	0	0	0	0	0	0	13	14	14	2
8:15 AM - 8:30 AM	0	3	130	0	6	0	0	86	35	14	0	0	0	0	0	0	9	7	29	1
8:30 AM - 8:45 AM	0	9	57	0	3	0	0	83	41	6	0	0	0	0	0	0	9	6	22	3
8:45 AM - 9:00 AM	0	9	82	0	7	0	0	69	32	8	0	0	0	0	0	0	4	5	26	2
TOTAL	0	73	844	0	36	0	0	716	363	47	0	0	0	0	0	0	80	57	199	15

Time	Northbound					Southbound					Eastbound					Westbound				
	U-Turn	Left	Thru	Right	Trucks	U-Turn	Left	Thru	Right	Trucks	U-Turn	Left	Thru	Right	Trucks	U-Turn	Left	Thru	Right	Trucks
4:00 PM - 4:15 PM	0	13	165	0	4	0	0	135	69	3	0	0	0	0	0	0	15	7	25	3
4:15 PM - 4:30 PM	0	39	172	0	6	0	0	132	49	8	0	0	0	0	0	0	11	11	31	3
4:30 PM - 4:45 PM	0	33	190	0	7	0	0	145	52	2	0	0	0	0	0	0	14	10	23	5
4:45 PM - 5:00 PM	0	16	141	0	5	0	0	107	41	1	0	0	0	0	0	0	14	5	23	2
5:00 PM - 5:15 PM	0	26	158	0	3	0	0	132	42	3	0	0	0	0	0	0	17	4	24	1
5:15 PM - 5:30 PM	0	16	111	0	4	0	0	111	41	2	0	0	0	0	0	0	10	9	27	1
5:30 PM - 5:45 PM	0	8	110	0	1	0	0	86	55	7	0	0	0	0	0	0	16	3	28	2
5:45 PM - 6:00 PM	0	9	96	0	0	0	0	91	46	4	0	0	0	0	0	0	14	6	17	0
TOTAL	0	160	1143	0	30	0	0	939	395	30	0	0	0	0	0	0	111	55	198	17

PEAK HOUR	Northbound					Southbound					Eastbound					Westbound				
	U-Turn	Left	Thru	Right	Trucks	U-Turn	Left	Thru	Right	Trucks	U-Turn	Left	Thru	Right	Trucks	U-Turn	Left	Thru	Right	Trucks
7:30 AM - 8:30 AM	0	37	545	0	17	0	0	416	202	27	0	0	0	0	0	0	47	38	100	5
4:00 PM - 5:00 PM	0	101	668	0	22	0	0	519	211	14	0	0	0	0	0	0	54	33	102	13

	PHF	Trucks
AM	0.811	3.5%
PM	0.904	2.9%

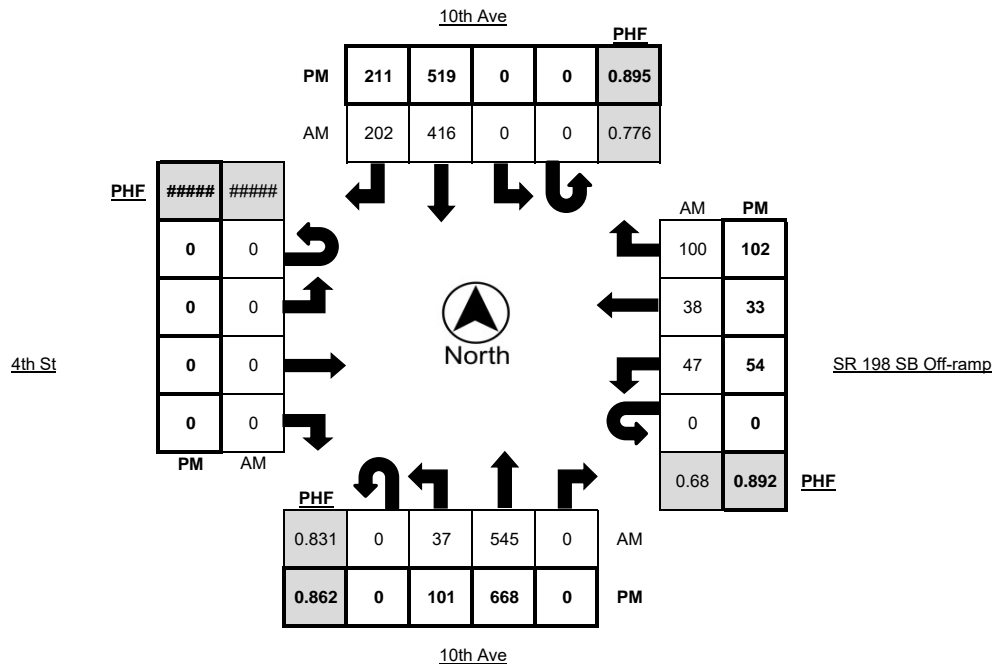



Metro Traffic Data Inc.
 310 N. Irwin Street - Suite 20
 Hanford, CA 93230
 800-975-6938 Phone/Fax
 www.metrotrafficdata.com

Turning Movement Report

Prepared For:

JLB Traffic Engineering, Inc.
 516 W. Shaw Ave, Suite 103
 Fresno, CA 93704

LOCATION 4th St / SR 198 WB Off-ramp @ 10th Ave

LATITUDE 36.3248

COUNTY Kings

LONGITUDE -119.6370

COLLECTION DATE Tuesday, March 1, 2022

WEATHER Clear

Time	Northbound Bikes			N.Leg Peds	Southbound Bikes			S.Leg Peds	Eastbound Bikes			E.Leg Peds	Westbound Bikes			W.Leg Peds
	Left	Thru	Right		Left	Thru	Right		Left	Thru	Right		Left	Thru	Right	
7:00 AM - 7:15 AM	0	1	0	0	0	0	0	0	0	0	0	0	0	0	0	0
7:15 AM - 7:30 AM	0	0	0	0	0	0	0	0	0	0	0	0	1	0	0	0
7:30 AM - 7:45 AM	0	0	0	0	0	0	0	0	0	0	0	1	0	0	0	1
7:45 AM - 8:00 AM	0	0	0	1	0	0	0	0	0	1	0	0	0	0	0	0
8:00 AM - 8:15 AM	0	0	0	0	0	0	0	0	0	0	0	1	0	0	0	1
8:15 AM - 8:30 AM	0	0	0	0	0	0	0	0	0	0	0	0	0	0	0	1
8:30 AM - 8:45 AM	0	0	0	0	0	0	0	0	0	0	0	0	0	0	0	0
8:45 AM - 9:00 AM	0	0	0	0	0	0	0	0	0	0	0	0	0	0	0	1
TOTAL	0	1	0	1	0	0	0	0	0	1	0	1	2	0	0	4

Time	Northbound Bikes			N.Leg Peds	Southbound Bikes			S.Leg Peds	Eastbound Bikes			E.Leg Peds	Westbound Bikes			W.Leg Peds
	Left	Thru	Right		Left	Thru	Right		Left	Thru	Right		Left	Thru	Right	
4:00 PM - 4:15 PM	0	1	0	0	0	0	0	0	0	0	0	0	0	0	0	1
4:15 PM - 4:30 PM	0	0	0	0	0	0	0	0	0	0	0	0	0	0	0	1
4:30 PM - 4:45 PM	0	0	0	0	0	2	0	0	0	0	0	0	0	0	0	0
4:45 PM - 5:00 PM	0	0	0	1	0	2	0	0	0	0	0	2	0	0	0	0
5:00 PM - 5:15 PM	0	0	0	0	0	0	0	0	0	0	0	0	0	0	0	0
5:15 PM - 5:30 PM	0	0	0	0	0	0	0	0	0	0	0	0	0	0	0	0
5:30 PM - 5:45 PM	0	1	0	0	0	0	0	0	0	0	0	0	0	0	0	0
5:45 PM - 6:00 PM	0	0	0	0	0	0	0	0	0	0	0	0	0	0	0	0
TOTAL	0	2	0	1	0	4	0	0	0	0	0	2	0	0	0	2

PEAK HOUR	Northbound Bikes			N.Leg Peds	Southbound Bikes			S.Leg Peds	Eastbound Bikes			E.Leg Peds	Westbound Bikes			W.Leg Peds
	Left	Thru	Right		Left	Thru	Right		Left	Thru	Right		Left	Thru	Right	
7:30 AM - 8:30 AM	0	0	0	1	0	0	0	0	1	0	1	1	0	0	0	3
4:00 PM - 5:00 PM	0	1	0	1	0	4	0	0	0	0	0	2	0	0	0	2

	Bikes	Peds
AM Peak Total	2	5
PM Peak Total	5	5

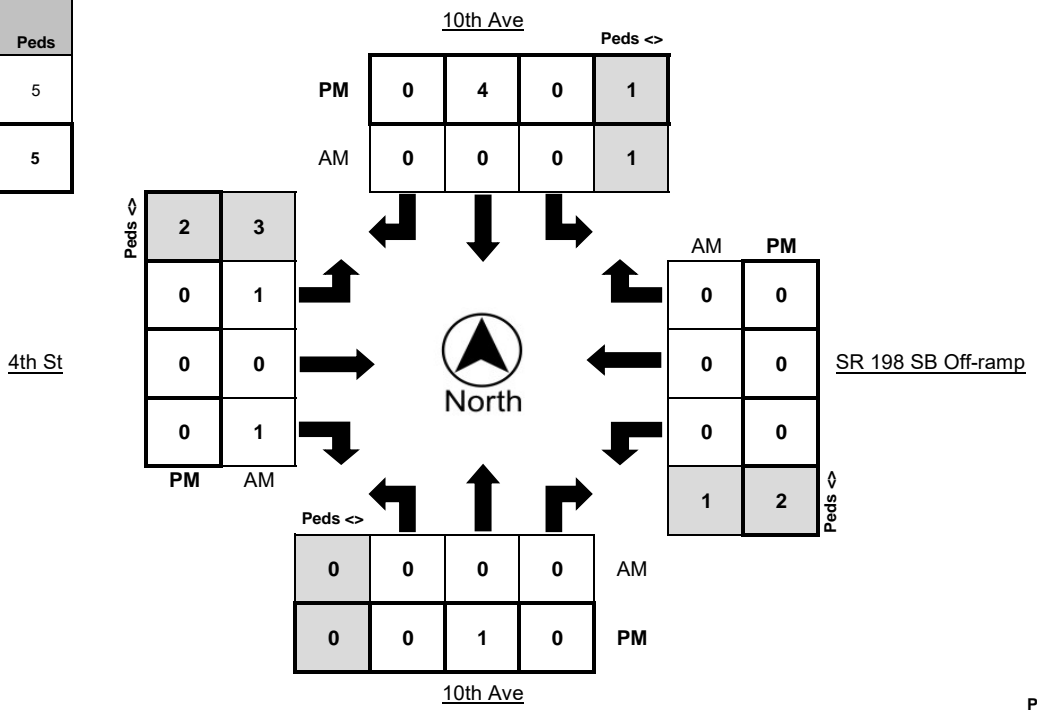



Metro Traffic Data Inc.
 310 N. Irwin Street - Suite 20
 Hanford, CA 93230
 800-975-6938 Phone/Fax
 www.metrotrafficdata.com

Turning Movement Report

Prepared For:

JLB Traffic Engineering, Inc.
 516 W. Shaw Ave, Suite 103
 Fresno, CA 93704

LOCATION Hanford Armona Rd @ 10 1/2 Ave

LATITUDE 36.3134

COUNTY Kings

LONGITUDE -119.6459

COLLECTION DATE Tuesday, January 25, 2022

WEATHER Clear

Time	Northbound					Southbound					Eastbound					Westbound				
	U-Turn	Left	Thru	Right	Trucks	U-Turn	Left	Thru	Right	Trucks	U-Turn	Left	Thru	Right	Trucks	U-Turn	Left	Thru	Right	Trucks
7:00 AM - 7:15 AM	0	0	5	0	1	0	1	1	5	1	0	3	16	3	4	0	6	25	5	4
7:15 AM - 7:30 AM	0	3	5	0	2	0	1	2	6	1	0	5	37	3	5	0	1	29	6	3
7:30 AM - 7:45 AM	0	9	7	6	6	0	1	4	4	0	0	14	48	3	4	0	4	40	5	3
7:45 AM - 8:00 AM	0	20	10	4	0	0	3	2	9	0	0	19	84	1	2	0	3	67	10	2
8:00 AM - 8:15 AM	0	5	3	0	1	0	3	2	11	0	0	14	54	5	2	0	2	65	5	1
8:15 AM - 8:30 AM	0	5	11	1	1	0	4	4	10	2	0	8	40	8	4	0	3	30	2	2
8:30 AM - 8:45 AM	0	10	1	2	1	0	3	5	6	2	0	7	35	4	1	0	3	38	6	1
8:45 AM - 9:00 AM	0	3	4	2	0	0	6	4	7	0	0	10	21	3	2	0	2	25	8	2
TOTAL	0	55	46	15	12	0	22	24	58	6	0	80	335	30	24	0	24	319	47	18

Time	Northbound					Southbound					Eastbound					Westbound				
	U-Turn	Left	Thru	Right	Trucks	U-Turn	Left	Thru	Right	Trucks	U-Turn	Left	Thru	Right	Trucks	U-Turn	Left	Thru	Right	Trucks
4:00 PM - 4:15 PM	0	5	7	3	0	0	9	5	14	1	0	11	62	7	0	0	0	64	8	3
4:15 PM - 4:30 PM	0	2	6	3	1	0	7	3	15	0	0	11	66	6	2	0	0	53	7	1
4:30 PM - 4:45 PM	0	10	5	1	0	0	7	6	14	1	0	13	66	5	2	0	2	63	9	3
4:45 PM - 5:00 PM	0	8	1	0	0	0	8	3	13	0	0	11	91	2	1	0	1	72	9	3
5:00 PM - 5:15 PM	0	2	4	2	0	0	3	2	16	0	0	8	67	5	3	0	2	87	5	0
5:15 PM - 5:30 PM	0	7	6	2	0	0	5	7	13	0	0	12	62	3	2	0	1	63	4	1
5:30 PM - 5:45 PM	0	1	2	0	0	0	4	4	15	0	0	14	65	3	0	0	0	57	11	1
5:45 PM - 6:00 PM	0	4	3	1	0	0	5	6	10	0	0	10	58	1	1	0	0	63	3	2
TOTAL	0	39	34	12	1	0	48	36	110	2	0	90	537	32	11	0	6	522	56	14

PEAK HOUR	Northbound					Southbound					Eastbound					Westbound				
	U-Turn	Left	Thru	Right	Trucks	U-Turn	Left	Thru	Right	Trucks	U-Turn	Left	Thru	Right	Trucks	U-Turn	Left	Thru	Right	Trucks
7:30 AM - 8:30 AM	0	39	31	11	8	0	11	12	34	2	0	55	226	17	12	0	12	202	22	8
4:30 PM - 5:30 PM	0	27	16	5	0	0	23	18	56	1	0	44	286	15	8	0	6	285	27	7

	PHF	Trucks
AM	0.724	4.5%
PM	0.922	2.0%

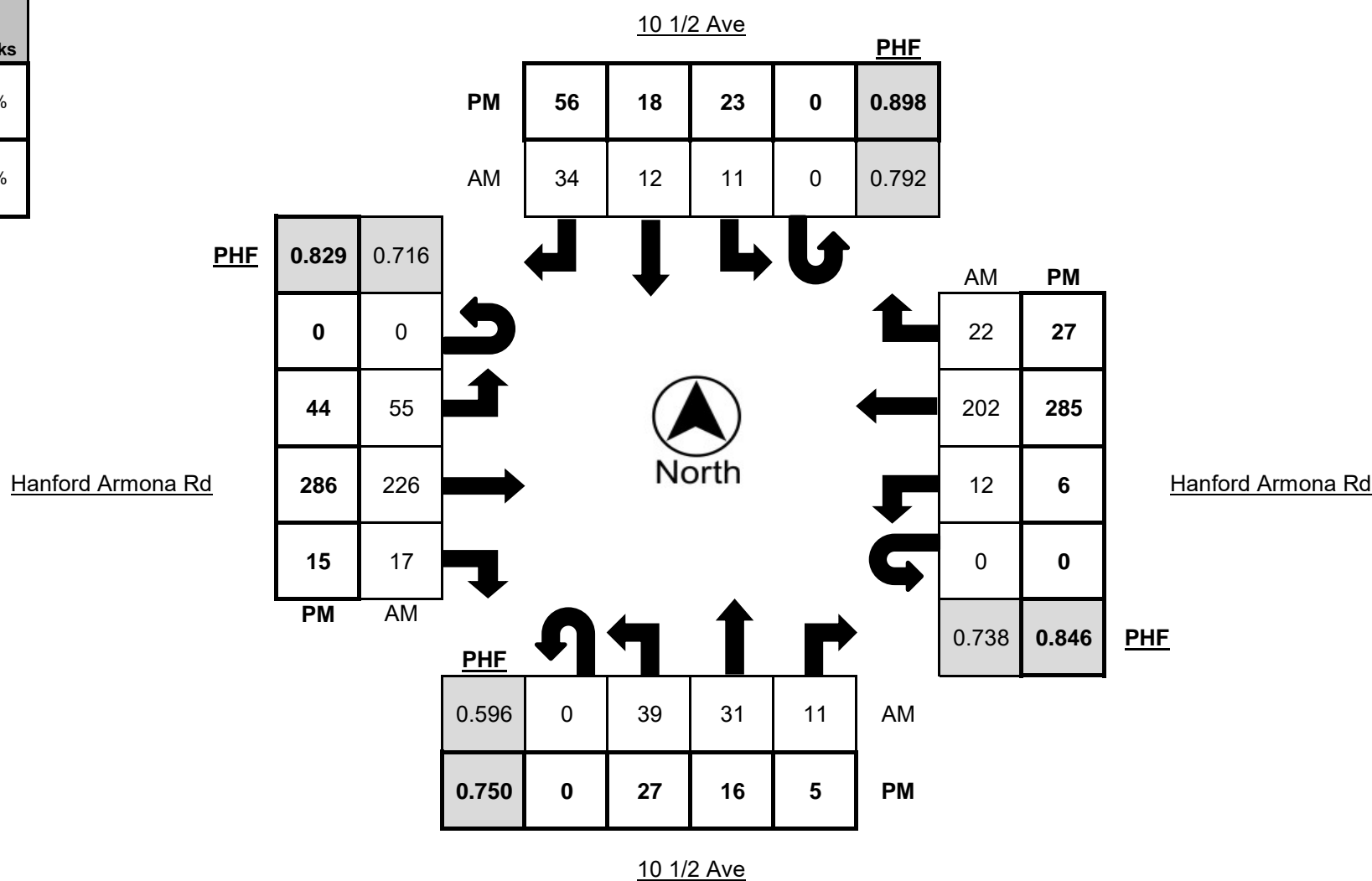



Metro Traffic Data Inc.
 310 N. Irwin Street - Suite 20
 Hanford, CA 93230
 800-975-6938 Phone/Fax
 www.metrotrafficdata.com

Turning Movement Report

Prepared For:

JLB Traffic Engineering, Inc.
 516 W. Shaw Ave, Suite 103
 Fresno, CA 93704

LOCATION Hanford Armona Rd @ 10 1/2 Ave

LATITUDE 36.3134

COUNTY Kings

LONGITUDE -119.6459

COLLECTION DATE Tuesday, January 25, 2022

WEATHER Clear

Time	Northbound Bikes			N.Leg Peds	Southbound Bikes			S.Leg Peds	Eastbound Bikes			E.Leg Peds	Westbound Bikes			W.Leg Peds
	Left	Thru	Right		Left	Thru	Right		Left	Thru	Right		Left	Thru	Right	
7:00 AM - 7:15 AM	0	1	0	0	0	0	0	0	0	0	0	0	0	0	0	0
7:15 AM - 7:30 AM	0	0	0	0	0	0	0	0	0	0	0	0	0	0	0	0
7:30 AM - 7:45 AM	0	0	0	0	0	0	0	0	0	0	0	0	0	0	0	0
7:45 AM - 8:00 AM	0	0	0	1	0	0	0	0	0	0	0	0	0	0	0	0
8:00 AM - 8:15 AM	0	0	0	0	0	0	0	0	0	0	0	0	0	0	0	0
8:15 AM - 8:30 AM	0	0	0	0	0	0	0	0	0	0	0	0	0	0	0	0
8:30 AM - 8:45 AM	0	0	0	3	0	0	0	0	0	0	0	0	0	0	0	0
8:45 AM - 9:00 AM	0	0	0	0	0	0	0	0	0	0	0	0	0	0	0	0
TOTAL	0	1	0	4	0	0	0	0	0	0	0	0	0	0	0	0

Time	Northbound Bikes			N.Leg Peds	Southbound Bikes			S.Leg Peds	Eastbound Bikes			E.Leg Peds	Westbound Bikes			W.Leg Peds
	Left	Thru	Right		Left	Thru	Right		Left	Thru	Right		Left	Thru	Right	
4:00 PM - 4:15 PM	0	0	0	0	0	0	0	0	0	0	0	4	0	0	0	0
4:15 PM - 4:30 PM	0	0	0	0	0	0	0	0	0	0	0	0	0	0	0	0
4:30 PM - 4:45 PM	0	0	0	1	0	1	0	1	0	0	0	0	0	0	0	0
4:45 PM - 5:00 PM	0	1	0	0	0	1	0	1	0	0	0	0	0	0	0	0
5:00 PM - 5:15 PM	0	0	0	0	0	0	0	0	0	1	0	0	0	0	0	0
5:15 PM - 5:30 PM	0	0	0	0	0	0	1	0	0	0	0	0	0	0	0	0
5:30 PM - 5:45 PM	0	0	0	0	0	0	0	0	0	0	0	0	0	1	0	0
5:45 PM - 6:00 PM	0	0	0	0	0	0	0	0	0	1	0	0	0	1	0	0
TOTAL	0	1	0	1	0	2	1	2	0	2	0	4	0	2	0	0

PEAK HOUR	Northbound Bikes			N.Leg Peds	Southbound Bikes			S.Leg Peds	Eastbound Bikes			E.Leg Peds	Westbound Bikes			W.Leg Peds
	Left	Thru	Right		Left	Thru	Right		Left	Thru	Right		Left	Thru	Right	
7:30 AM - 8:30 AM	0	0	0	1	0	0	0	0	0	0	0	0	0	0	0	0
4:30 PM - 5:30 PM	0	1	0	1	0	2	1	2	0	1	0	0	0	0	0	0

	Bikes	Peds
AM Peak Total	0	1
PM Peak Total	5	3

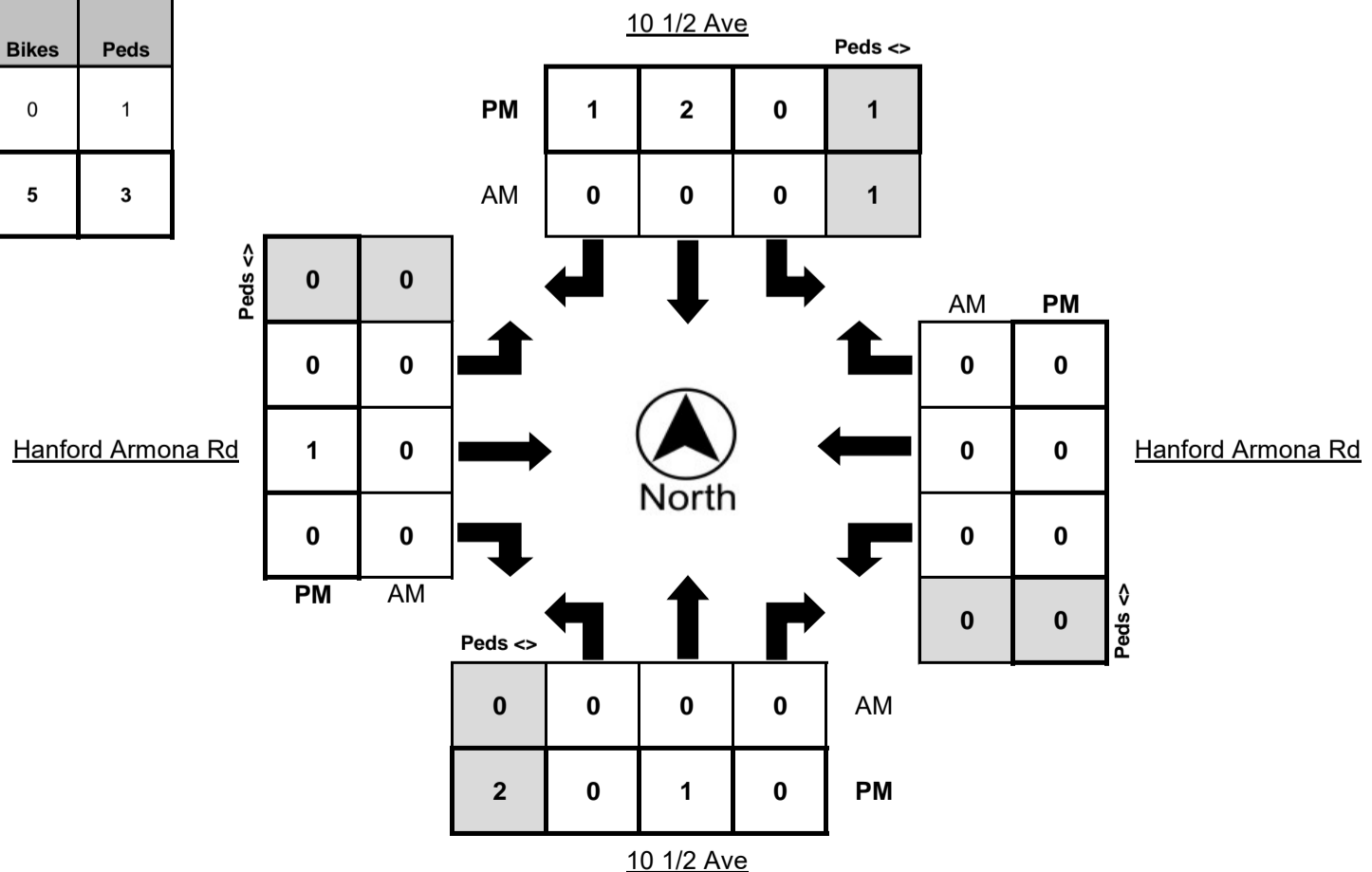



Metro Traffic Data Inc.
 310 N. Irwin Street - Suite 20
 Hanford, CA 93230
 800-975-6938 Phone/Fax
 www.metrotrafficdata.com

Turning Movement Report

Prepared For:

JLB Traffic Engineering, Inc.
 516 W. Shaw Ave, Suite 103
 Fresno, CA 93704

LOCATION Hanford Armona Rd @ Jordan Way

LATITUDE 36.3134

COUNTY Kings

LONGITUDE -119.6404

COLLECTION DATE Wednesday, January 26, 2022

WEATHER Clear

Time	Northbound					Southbound					Eastbound					Westbound				
	U-Turn	Left	Thru	Right	Trucks	U-Turn	Left	Thru	Right	Trucks	U-Turn	Left	Thru	Right	Trucks	U-Turn	Left	Thru	Right	Trucks
7:00 AM - 7:15 AM	0	4	0	1	0	0	0	0	0	0	0	0	13	1	2	0	1	30	0	6
7:15 AM - 7:30 AM	0	1	0	4	1	0	0	0	0	0	0	0	39	1	4	0	0	33	0	3
7:30 AM - 7:45 AM	0	7	0	5	0	0	0	0	0	0	0	0	49	1	5	0	3	40	0	5
7:45 AM - 8:00 AM	0	14	0	7	0	0	0	0	0	0	0	0	66	7	4	0	3	61	0	3
8:00 AM - 8:15 AM	0	6	0	2	0	0	0	0	0	0	0	0	46	9	2	0	5	51	0	2
8:15 AM - 8:30 AM	0	7	0	7	0	0	0	0	0	0	0	0	39	4	5	0	3	26	0	2
8:30 AM - 8:45 AM	0	3	0	4	0	0	0	0	0	0	0	0	34	4	3	0	2	34	0	3
8:45 AM - 9:00 AM	0	4	0	0	0	0	0	0	0	0	0	0	22	5	2	0	2	29	0	2
TOTAL	0	46	0	30	1	0	0	0	0	0	0	0	308	32	27	0	19	304	0	26

Time	Northbound					Southbound					Eastbound					Westbound				
	U-Turn	Left	Thru	Right	Trucks	U-Turn	Left	Thru	Right	Trucks	U-Turn	Left	Thru	Right	Trucks	U-Turn	Left	Thru	Right	Trucks
4:00 PM - 4:15 PM	0	6	0	8	0	0	0	0	0	0	0	0	56	12	0	0	4	61	0	2
4:15 PM - 4:30 PM	0	1	0	2	0	0	0	0	0	0	1	0	62	5	3	0	8	50	0	1
4:30 PM - 4:45 PM	0	9	0	3	0	0	0	0	0	0	0	0	59	6	2	0	3	72	0	5
4:45 PM - 5:00 PM	0	10	0	3	0	0	0	0	0	0	0	0	66	8	2	0	4	68	0	2
5:00 PM - 5:15 PM	0	13	0	6	0	0	0	0	0	0	0	0	70	12	3	0	9	68	0	1
5:15 PM - 5:30 PM	0	7	0	4	0	0	0	0	0	0	0	0	55	10	1	0	11	65	0	0
5:30 PM - 5:45 PM	0	7	0	7	0	0	0	0	0	0	0	0	61	7	0	0	5	57	0	2
5:45 PM - 6:00 PM	0	6	0	6	1	0	0	0	0	0	0	0	49	9	2	0	5	59	0	1
TOTAL	0	59	0	39	1	0	0	0	0	0	1	0	478	69	13	0	49	500	0	14

PEAK HOUR	Northbound					Southbound					Eastbound					Westbound				
	U-Turn	Left	Thru	Right	Trucks	U-Turn	Left	Thru	Right	Trucks	U-Turn	Left	Thru	Right	Trucks	U-Turn	Left	Thru	Right	Trucks
7:30 AM - 8:30 AM	0	34	0	21	0	0	0	0	0	0	0	0	200	21	16	0	14	178	0	12
4:30 PM - 5:30 PM	0	39	0	16	0	0	0	0	0	0	0	0	250	36	8	0	27	273	0	8

	PHF	Trucks
AM	0.741	6.0%
PM	0.900	2.5%

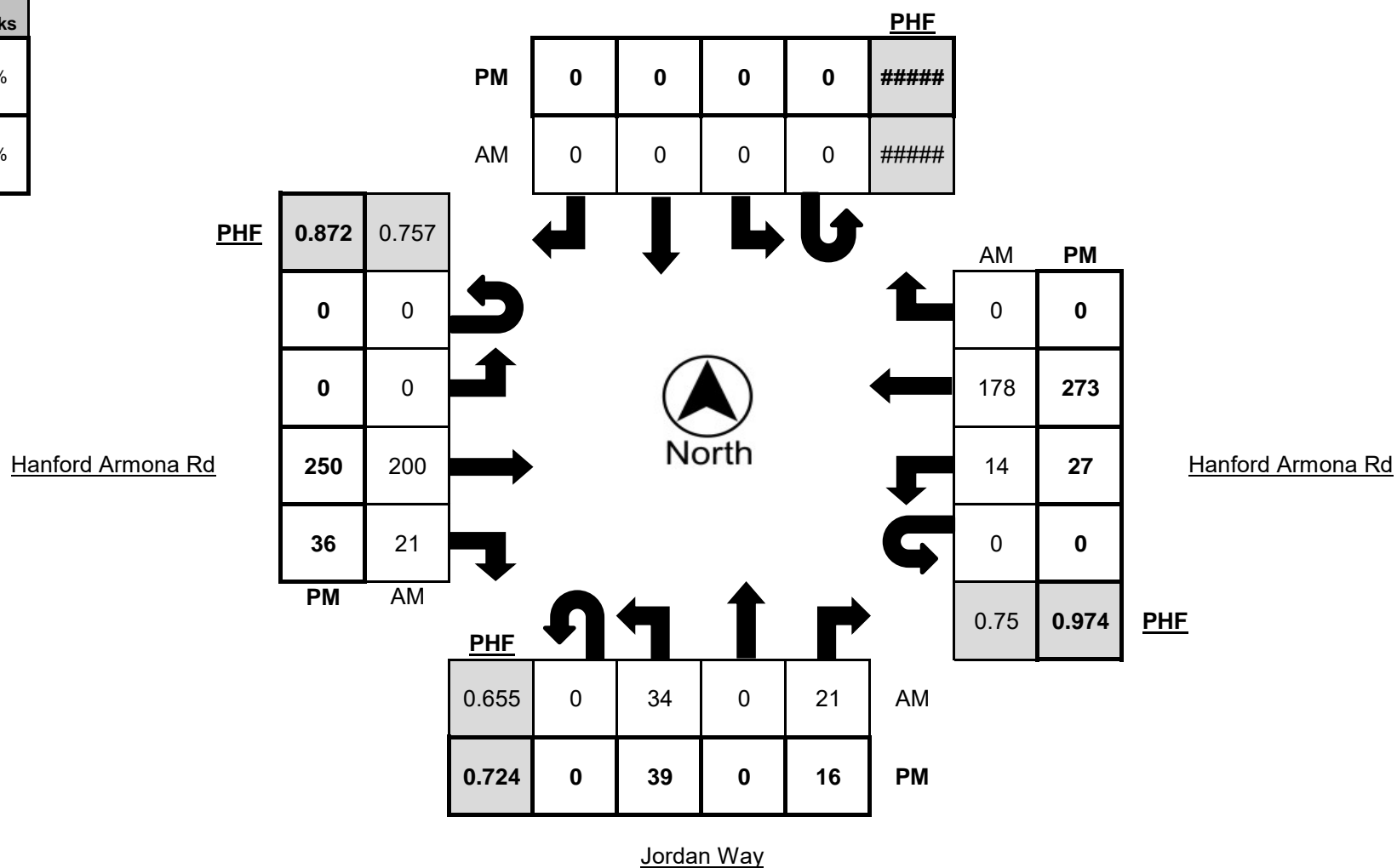



Metro Traffic Data Inc.
 310 N. Irwin Street - Suite 20
 Hanford, CA 93230
 800-975-6938 Phone/Fax
 www.metrotrafficdata.com

Turning Movement Report

Prepared For:

JLB Traffic Engineering, Inc.
 516 W. Shaw Ave, Suite 103
 Fresno, CA 93704

LOCATION Hanford Armona Rd @ Jordan Way

LATITUDE 36.3134

COUNTY Kings

LONGITUDE -119.6404

COLLECTION DATE Wednesday, January 26, 2022

WEATHER Clear

Time	Northbound Bikes			N.Leg Peds	Southbound Bikes			S.Leg Peds	Eastbound Bikes			E.Leg Peds	Westbound Bikes			W.Leg Peds
	Left	Thru	Right		Left	Thru	Right		Left	Thru	Right		Left	Thru	Right	
7:00 AM - 7:15 AM	0	0	0	0	0	0	0	0	0	0	0	0	0	0	0	0
7:15 AM - 7:30 AM	1	0	0	0	0	0	0	0	0	0	0	0	0	0	0	0
7:30 AM - 7:45 AM	0	0	0	0	0	0	0	0	0	0	0	0	0	0	0	0
7:45 AM - 8:00 AM	0	0	0	0	0	0	0	0	0	0	0	0	0	0	0	0
8:00 AM - 8:15 AM	0	0	0	0	0	0	0	0	0	0	0	0	0	0	0	0
8:15 AM - 8:30 AM	0	0	0	0	0	0	0	0	0	0	0	1	0	0	0	0
8:30 AM - 8:45 AM	0	0	0	0	0	0	0	0	0	0	0	0	0	0	0	0
8:45 AM - 9:00 AM	0	0	0	0	0	0	0	0	0	0	0	0	0	0	0	0
TOTAL	1	0	0	0	0	0	0	0	0	0	0	1	0	0	0	0

Time	Northbound Bikes			N.Leg Peds	Southbound Bikes			S.Leg Peds	Eastbound Bikes			E.Leg Peds	Westbound Bikes			W.Leg Peds
	Left	Thru	Right		Left	Thru	Right		Left	Thru	Right		Left	Thru	Right	
4:00 PM - 4:15 PM	0	0	0	0	0	0	0	0	0	0	0	0	0	0	0	0
4:15 PM - 4:30 PM	0	0	0	0	0	0	0	0	4	0	0	0	0	0	0	0
4:30 PM - 4:45 PM	0	0	0	0	0	0	0	0	0	0	0	0	0	0	0	0
4:45 PM - 5:00 PM	0	0	0	0	0	0	0	1	0	0	0	0	0	0	0	0
5:00 PM - 5:15 PM	0	0	0	0	0	0	0	0	0	0	0	0	0	0	0	0
5:15 PM - 5:30 PM	0	0	0	0	0	0	0	1	0	0	0	0	0	0	0	0
5:30 PM - 5:45 PM	0	0	0	0	0	0	0	0	0	0	0	0	0	0	0	0
5:45 PM - 6:00 PM	0	0	0	0	0	0	0	0	0	0	0	0	0	0	0	0
TOTAL	0	0	0	0	0	0	0	6	0	0	0	0	0	0	0	0

PEAK HOUR	Northbound Bikes			N.Leg Peds	Southbound Bikes			S.Leg Peds	Eastbound Bikes			E.Leg Peds	Westbound Bikes			W.Leg Peds
	Left	Thru	Right		Left	Thru	Right		Left	Thru	Right		Left	Thru	Right	
7:30 AM - 8:30 AM	0	0	0	0	0	0	0	0	0	0	0	1	0	0	0	0
4:30 PM - 5:30 PM	0	0	0	0	0	0	0	2	0	0	0	0	0	0	0	0

	Bikes	Peds
AM Peak Total	0	1
PM Peak Total	0	2

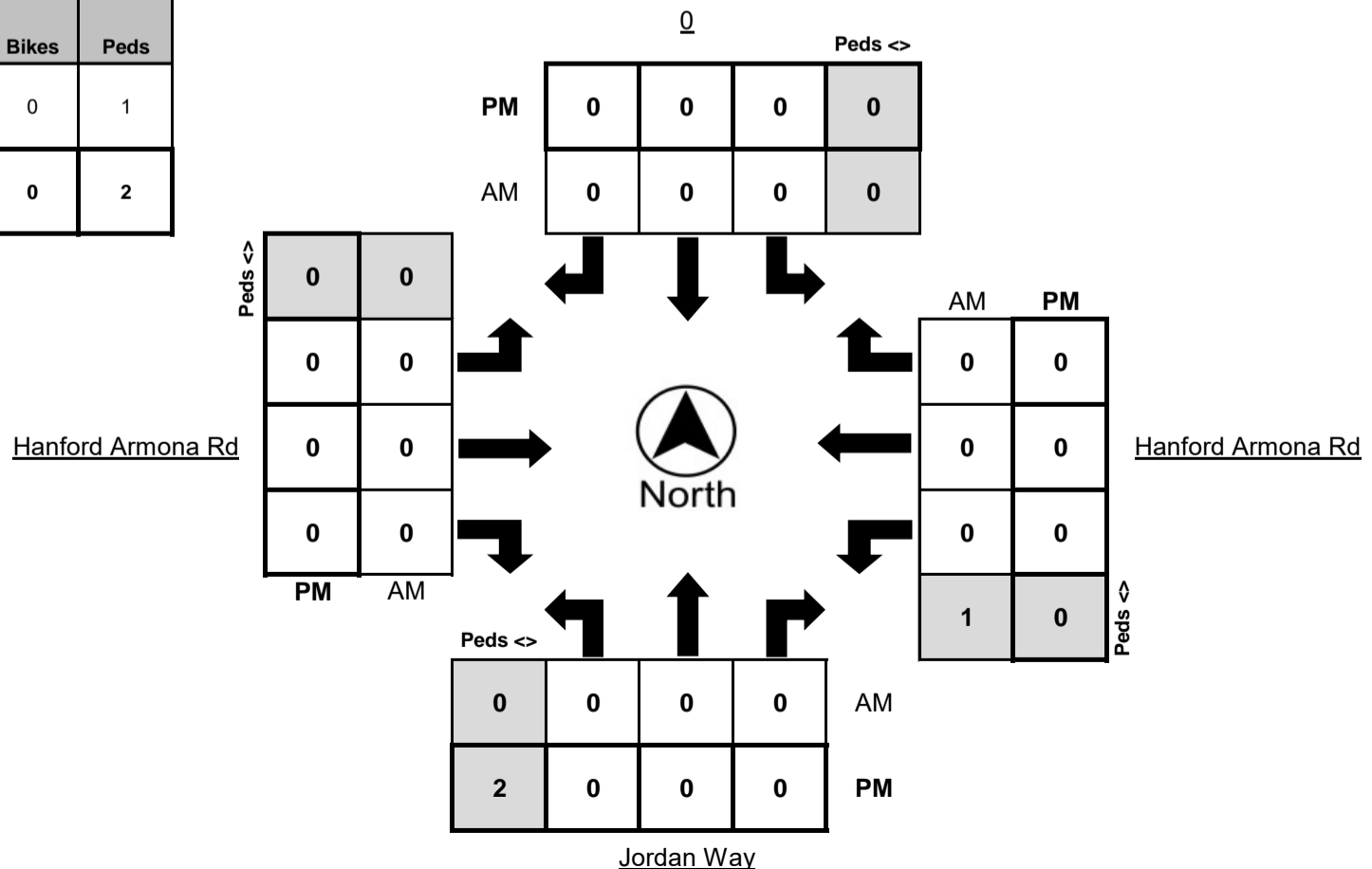



Metro Traffic Data Inc.
 310 N. Irwin Street - Suite 20
 Hanford, CA 93230
 800-975-6938 Phone/Fax
 www.metrotrafficdata.com

Turning Movement Report

Prepared For:

JLB Traffic Engineering, Inc.
 516 W. Shaw Ave, Suite 103
 Fresno, CA 93704

LOCATION Hanford Armona Rd @ 10th Ave

LATITUDE 36.3134

COUNTY Kings

LONGITUDE -119.6370

COLLECTION DATE Thursday, January 27, 2022

WEATHER Clear

Time	Northbound					Southbound					Eastbound					Westbound				
	U-Turn	Left	Thru	Right	Trucks	U-Turn	Left	Thru	Right	Trucks	U-Turn	Left	Thru	Right	Trucks	U-Turn	Left	Thru	Right	Trucks
7:00 AM - 7:15 AM	0	8	23	0	4	0	7	31	24	7	0	9	0	3	1	0	0	1	3	0
7:15 AM - 7:30 AM	0	7	30	1	3	0	5	19	24	3	0	33	2	10	6	0	0	1	4	0
7:30 AM - 7:45 AM	0	12	29	1	4	0	1	37	31	8	0	45	1	5	6	0	0	1	3	1
7:45 AM - 8:00 AM	0	20	39	0	4	0	4	44	47	5	0	58	0	20	3	0	0	0	5	1
8:00 AM - 8:15 AM	0	17	56	0	4	0	0	46	38	5	1	29	0	14	2	0	1	3	4	0
8:15 AM - 8:30 AM	0	5	43	0	2	0	1	27	27	3	0	33	3	11	3	0	2	0	0	0
8:30 AM - 8:45 AM	0	11	32	0	6	0	1	30	27	3	0	30	0	9	2	0	0	0	1	0
8:45 AM - 9:00 AM	0	11	39	1	3	0	1	25	17	5	0	12	0	9	2	0	1	1	1	0
TOTAL	0	91	291	3	30	0	20	259	235	39	1	249	6	81	25	0	4	7	21	2

Time	Northbound					Southbound					Eastbound					Westbound				
	U-Turn	Left	Thru	Right	Trucks	U-Turn	Left	Thru	Right	Trucks	U-Turn	Left	Thru	Right	Trucks	U-Turn	Left	Thru	Right	Trucks
4:00 PM - 4:15 PM	0	18	53	3	2	0	1	52	42	2	0	37	2	22	0	0	0	1	4	0
4:15 PM - 4:30 PM	0	23	53	1	2	0	2	29	31	2	0	37	5	23	2	0	1	3	2	0
4:30 PM - 4:45 PM	0	31	63	0	3	0	2	48	43	6	0	36	5	19	3	0	1	1	1	0
4:45 PM - 5:00 PM	0	27	48	0	1	0	3	33	41	1	0	43	4	19	2	0	1	1	2	0
5:00 PM - 5:15 PM	0	21	40	2	4	0	4	35	51	1	0	42	2	30	3	0	1	4	3	2
5:15 PM - 5:30 PM	0	33	52	3	2	0	7	38	41	0	0	28	4	28	1	0	1	2	2	0
5:30 PM - 5:45 PM	0	19	48	0	1	0	4	44	38	2	0	42	6	19	0	0	1	5	5	0
5:45 PM - 6:00 PM	0	24	31	1	3	0	5	23	35	0	0	27	4	28	1	0	1	8	3	0
TOTAL	0	196	388	10	18	0	28	302	322	14	0	292	32	188	12	0	7	25	22	2

PEAK HOUR	Northbound					Southbound					Eastbound					Westbound				
	U-Turn	Left	Thru	Right	Trucks	U-Turn	Left	Thru	Right	Trucks	U-Turn	Left	Thru	Right	Trucks	U-Turn	Left	Thru	Right	Trucks
7:30 AM - 8:30 AM	0	54	167	1	14	0	6	154	143	21	1	165	4	50	14	0	3	4	12	2
4:30 PM - 5:30 PM	0	112	203	5	10	0	16	154	176	8	0	149	15	96	9	0	4	8	8	2

	PHF	Trucks
AM	0.806	6.7%
PM	0.946	3.1%

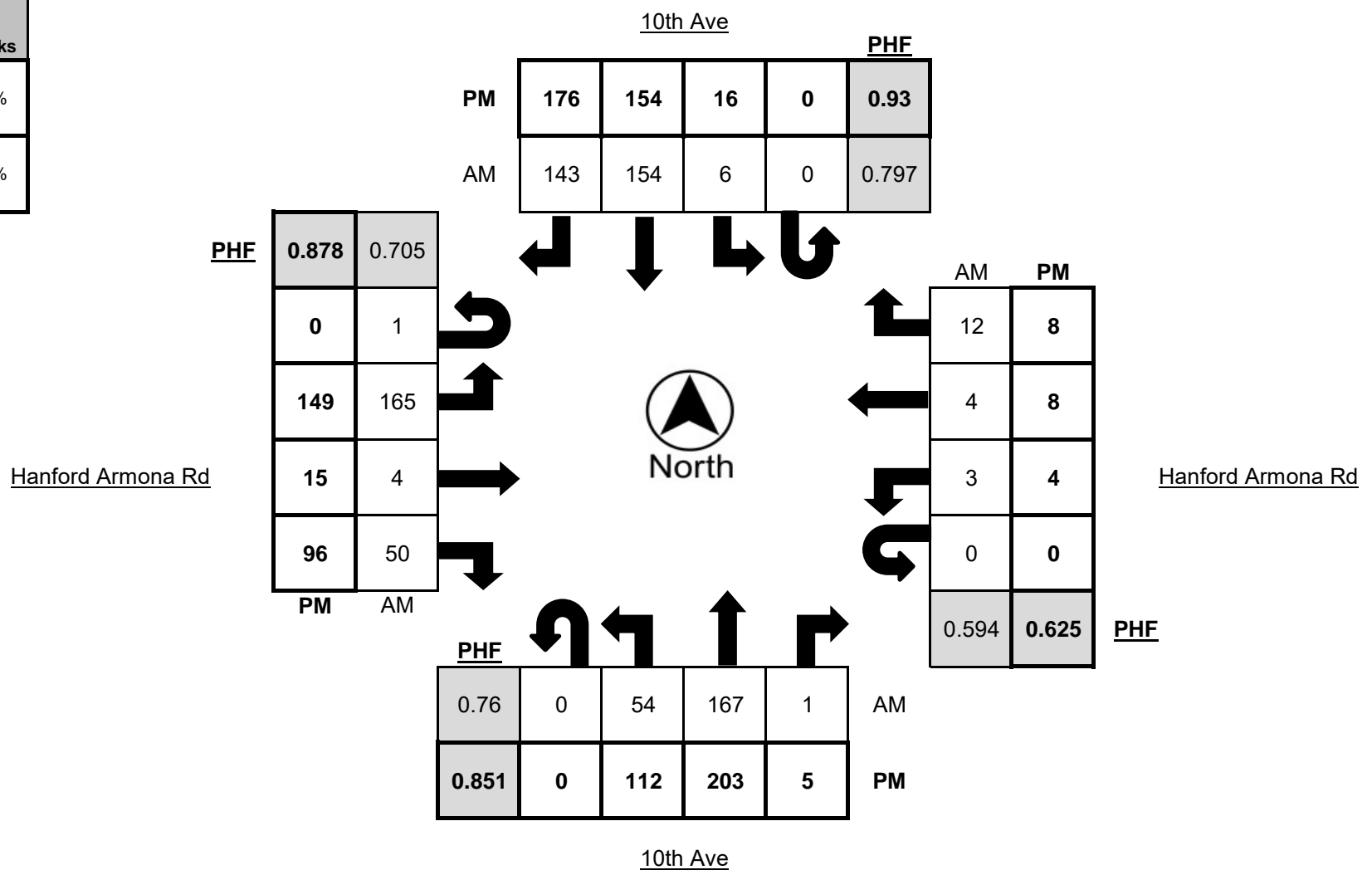



Metro Traffic Data Inc.
 310 N. Irwin Street - Suite 20
 Hanford, CA 93230
 800-975-6938 Phone/Fax
 www.metrotrafficdata.com

Turning Movement Report

Prepared For:

JLB Traffic Engineering, Inc.
 516 W. Shaw Ave, Suite 103
 Fresno, CA 93704

LOCATION Hanford Armona Rd @ 10th Ave

LATITUDE 36.3134

COUNTY Kings

LONGITUDE -119.6370

COLLECTION DATE Thursday, January 27, 2022

WEATHER Clear

Time	Northbound Bikes			N.Leg Peds	Southbound Bikes			S.Leg Peds	Eastbound Bikes			E.Leg Peds	Westbound Bikes			W.Leg Peds
	Left	Thru	Right		Left	Thru	Right		Left	Thru	Right		Left	Thru	Right	
7:00 AM - 7:15 AM	0	0	0	0	0	0	0	0	0	0	0	0	0	0	0	0
7:15 AM - 7:30 AM	0	0	0	0	0	0	0	0	0	0	0	0	0	0	0	0
7:30 AM - 7:45 AM	0	0	0	0	0	0	0	0	0	0	0	0	0	0	0	0
7:45 AM - 8:00 AM	0	0	0	0	0	0	0	0	0	0	0	0	0	0	0	0
8:00 AM - 8:15 AM	0	0	0	0	0	0	0	0	0	0	0	0	0	0	0	0
8:15 AM - 8:30 AM	0	0	0	0	0	0	0	0	0	0	0	0	0	0	0	0
8:30 AM - 8:45 AM	0	0	0	0	0	0	0	0	1	0	0	0	0	0	0	0
8:45 AM - 9:00 AM	1	0	0	0	0	0	0	0	0	0	0	0	0	0	0	0
TOTAL	1	0	0	0	0	0	0	0	1	0	0	0	0	0	0	0

Time	Northbound Bikes			N.Leg Peds	Southbound Bikes			S.Leg Peds	Eastbound Bikes			E.Leg Peds	Westbound Bikes			W.Leg Peds
	Left	Thru	Right		Left	Thru	Right		Left	Thru	Right		Left	Thru	Right	
4:00 PM - 4:15 PM	0	0	0	0	0	0	0	0	0	0	1	0	0	0	0	0
4:15 PM - 4:30 PM	0	0	0	0	0	0	0	2	0	0	0	0	0	0	0	0
4:30 PM - 4:45 PM	0	0	0	0	0	0	0	0	0	0	0	0	0	0	0	2
4:45 PM - 5:00 PM	0	0	0	0	0	0	0	0	0	0	0	0	0	0	0	0
5:00 PM - 5:15 PM	0	0	0	0	0	0	0	0	0	0	0	0	0	0	0	0
5:15 PM - 5:30 PM	0	0	0	0	0	0	2	2	0	0	0	0	0	0	0	1
5:30 PM - 5:45 PM	0	0	0	0	0	0	1	0	0	0	0	0	0	0	0	0
5:45 PM - 6:00 PM	0	0	0	0	0	0	0	0	0	0	0	0	0	0	0	0
TOTAL	0	0	0	0	0	0	3	4	0	0	1	0	0	0	0	3

PEAK HOUR	Northbound Bikes			N.Leg Peds	Southbound Bikes			S.Leg Peds	Eastbound Bikes			E.Leg Peds	Westbound Bikes			W.Leg Peds
	Left	Thru	Right		Left	Thru	Right		Left	Thru	Right		Left	Thru	Right	
7:30 AM - 8:30 AM	0	0	0	0	0	0	0	0	0	0	0	0	0	0	0	0
4:30 PM - 5:30 PM	0	0	0	0	0	0	2	2	0	0	0	0	0	0	0	3

	Bikes	Peds
AM Peak Total	0	0
PM Peak Total	2	5

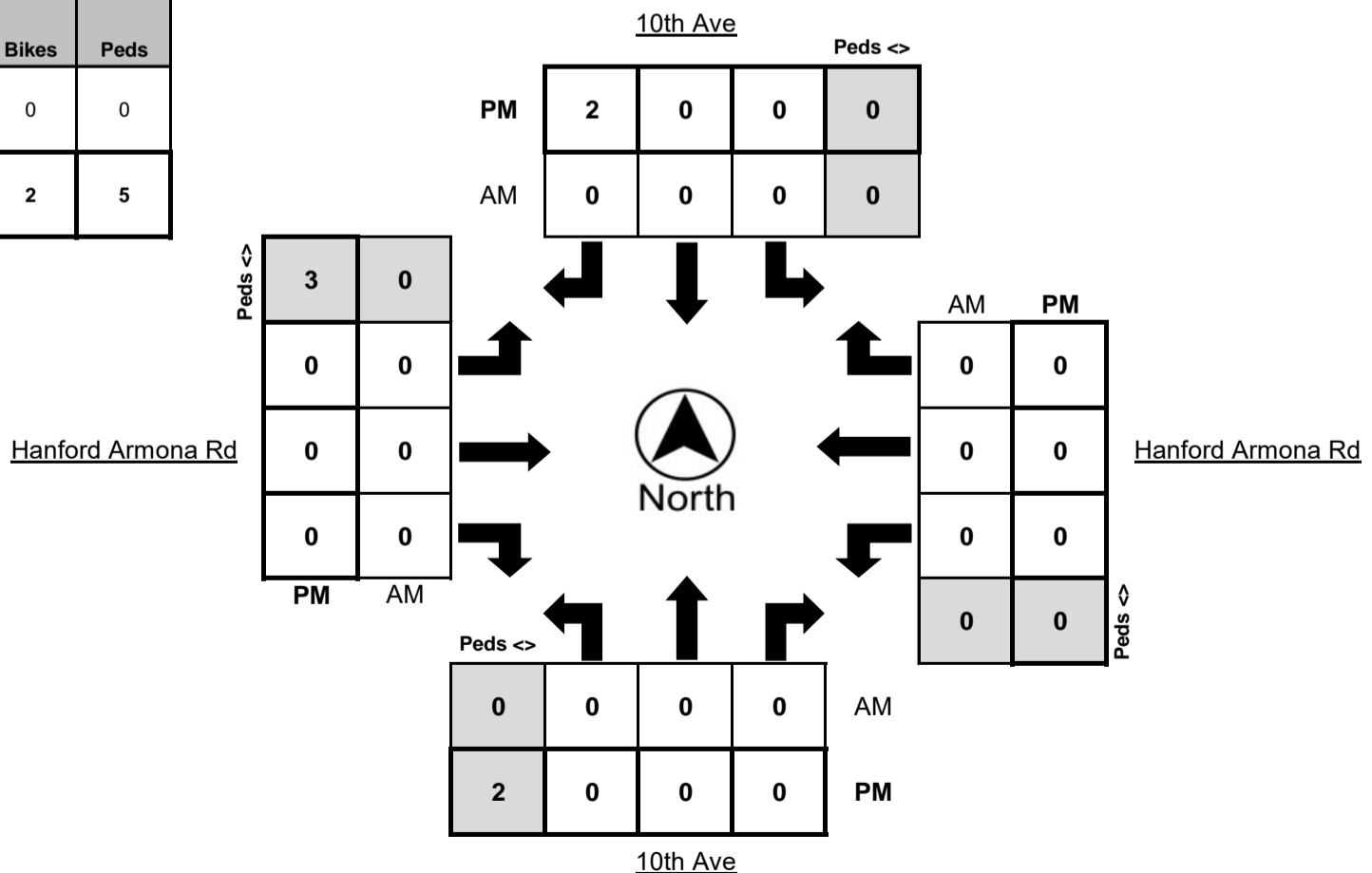



Metro Traffic Data Inc.
 310 N. Irwin Street - Suite 20
 Hanford, CA 93230
 800-975-6938 Phone/Fax
 www.metrotraffdata.com

Turning Movement Report

Prepared For:

JLB Traffic Engineering, Inc.
 516 W. Shaw Ave, Suite 103
 Fresno, CA 93704

LOCATION Houston Ave @ 11th Ave

LATITUDE 36.2983

COUNTY Kings

LONGITUDE -119.6548

COLLECTION DATE Thursday, March 3, 2022

WEATHER Clear

Time	Northbound					Southbound					Eastbound					Westbound				
	U-Turn	Left	Thru	Right	Trucks	U-Turn	Left	Thru	Right	Trucks	U-Turn	Left	Thru	Right	Trucks	U-Turn	Left	Thru	Right	Trucks
7:00 AM - 7:15 AM	0	2	19	6	2	0	5	14	3	1	0	0	6	6	2	0	6	10	9	7
7:15 AM - 7:30 AM	0	5	12	6	7	0	7	20	1	1	0	6	9	11	5	0	3	14	9	4
7:30 AM - 7:45 AM	0	0	20	5	3	0	12	18	8	1	0	8	18	4	1	0	5	15	7	5
7:45 AM - 8:00 AM	0	7	22	4	8	0	6	15	1	1	0	11	13	11	5	0	7	18	7	2
8:00 AM - 8:15 AM	0	6	16	4	7	0	11	12	5	1	0	6	20	5	2	0	9	12	16	7
8:15 AM - 8:30 AM	0	4	15	8	5	0	11	14	7	6	0	7	15	4	5	0	3	12	5	3
8:30 AM - 8:45 AM	0	7	17	4	6	0	9	14	2	2	0	4	11	6	4	0	4	13	8	8
8:45 AM - 9:00 AM	0	3	15	4	5	0	5	11	7	4	0	6	10	10	10	0	8	12	13	7
TOTAL	0	34	136	41	43	0	66	118	34	17	0	48	102	57	34	0	45	106	74	43

Time	Northbound					Southbound					Eastbound					Westbound				
	U-Turn	Left	Thru	Right	Trucks	U-Turn	Left	Thru	Right	Trucks	U-Turn	Left	Thru	Right	Trucks	U-Turn	Left	Thru	Right	Trucks
4:00 PM - 4:15 PM	0	9	31	5	3	0	15	12	13	0	0	4	14	4	2	0	3	21	17	3
4:15 PM - 4:30 PM	0	11	27	3	1	0	15	24	1	2	0	7	22	3	1	0	8	22	17	1
4:30 PM - 4:45 PM	0	6	43	2	5	0	10	8	6	0	0	2	28	7	2	0	1	20	26	2
4:45 PM - 5:00 PM	0	7	29	9	5	0	11	26	7	0	1	4	19	6	2	0	3	23	15	3
5:00 PM - 5:15 PM	0	9	60	10	6	0	12	20	6	0	0	8	24	2	0	0	6	31	16	1
5:15 PM - 5:30 PM	0	6	15	1	3	0	9	15	2	0	0	7	11	3	0	0	6	18	13	1
5:30 PM - 5:45 PM	0	5	19	2	1	0	6	14	7	0	0	4	16	4	0	0	1	13	10	1
5:45 PM - 6:00 PM	0	5	14	2	2	0	12	13	6	0	1	10	13	6	1	0	1	9	19	0
TOTAL	0	58	238	34	26	0	90	132	48	2	2	46	147	35	8	0	29	157	133	12

PEAK HOUR	Northbound					Southbound					Eastbound					Westbound				
	U-Turn	Left	Thru	Right	Trucks	U-Turn	Left	Thru	Right	Trucks	U-Turn	Left	Thru	Right	Trucks	U-Turn	Left	Thru	Right	Trucks
7:30 AM - 8:30 AM	0	17	73	21	23	0	40	59	21	9	0	32	66	24	13	0	24	57	35	17
4:15 PM - 5:15 PM	0	33	159	24	17	0	48	78	20	2	1	21	93	18	5	0	18	96	74	7

	PHF	Trucks
AM	0.961	13.2%
PM	0.837	4.5%

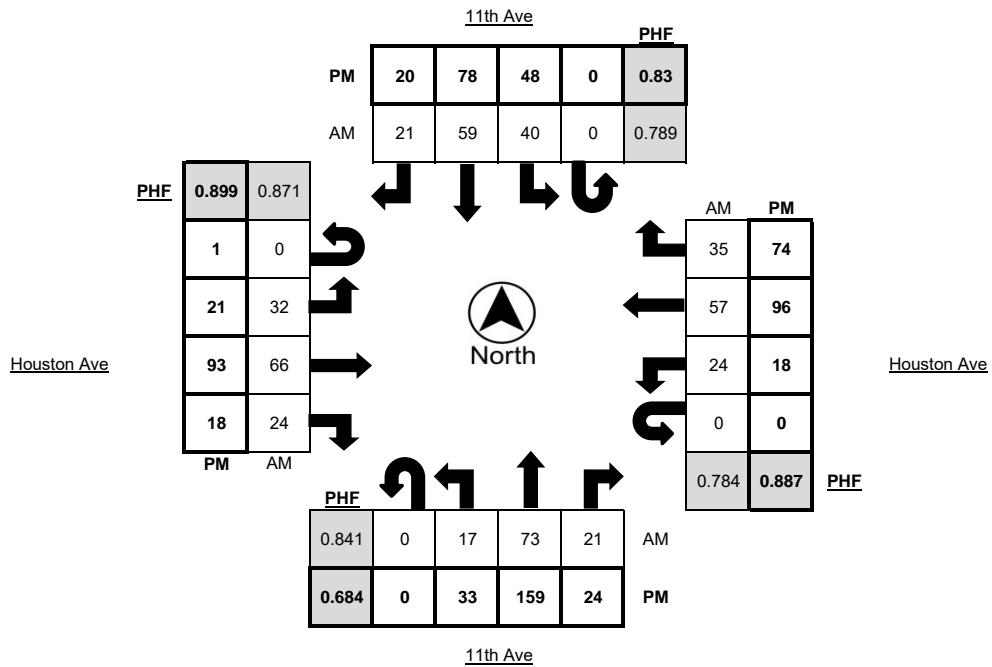



Metro Traffic Data Inc.
 310 N. Irwin Street - Suite 20
 Hanford, CA 93230
 800-975-6938 Phone/Fax
 www.metrotrafficdata.com

Turning Movement Report

Prepared For:

JLB Traffic Engineering, Inc.
 516 W. Shaw Ave, Suite 103
 Fresno, CA 93704

LOCATION Houston Ave @ 11th Ave

LATITUDE 36.2983

COUNTY Kings

LONGITUDE -119.6548

COLLECTION DATE Thursday, March 3, 2022

WEATHER Clear

Time	Northbound Bikes			N.Leg Peds	Southbound Bikes			S.Leg Peds	Eastbound Bikes			E.Leg Peds	Westbound Bikes			W.Leg Peds
	Left	Thru	Right		Left	Thru	Right		Left	Thru	Right		Left	Thru	Right	
7:00 AM - 7:15 AM	0	0	0	0	0	0	0	0	0	0	0	0	0	0	0	0
7:15 AM - 7:30 AM	0	0	0	0	0	0	0	0	0	0	0	0	0	0	0	0
7:30 AM - 7:45 AM	0	0	0	0	0	0	0	0	0	0	0	0	0	0	0	0
7:45 AM - 8:00 AM	0	0	0	0	0	0	0	0	0	0	0	0	0	0	0	0
8:00 AM - 8:15 AM	0	0	0	0	0	0	0	0	0	0	0	0	0	0	0	0
8:15 AM - 8:30 AM	0	0	0	0	0	0	0	0	0	0	0	0	0	0	0	0
8:30 AM - 8:45 AM	0	0	0	0	0	0	0	0	0	0	0	0	0	0	0	0
8:45 AM - 9:00 AM	0	0	0	0	0	0	0	0	0	0	0	0	0	0	0	0
TOTAL	0	0	0	0	0	0	0	0	0	0	0	0	0	0	0	0

Time	Northbound Bikes			N.Leg Peds	Southbound Bikes			S.Leg Peds	Eastbound Bikes			E.Leg Peds	Westbound Bikes			W.Leg Peds
	Left	Thru	Right		Left	Thru	Right		Left	Thru	Right		Left	Thru	Right	
4:00 PM - 4:15 PM	0	0	0	0	0	0	0	0	0	0	0	0	0	0	0	0
4:15 PM - 4:30 PM	0	0	0	0	0	0	0	0	0	0	0	0	0	0	0	0
4:30 PM - 4:45 PM	0	0	0	0	0	0	0	0	0	0	0	0	0	0	0	0
4:45 PM - 5:00 PM	0	0	0	0	0	0	0	0	0	0	0	0	0	0	0	0
5:00 PM - 5:15 PM	0	0	0	0	0	0	0	0	0	0	0	0	0	0	0	0
5:15 PM - 5:30 PM	0	0	0	0	0	0	0	0	0	0	0	0	0	0	0	0
5:30 PM - 5:45 PM	0	0	0	0	0	0	0	0	0	0	0	0	0	0	0	0
5:45 PM - 6:00 PM	0	0	0	0	0	0	0	0	0	0	0	0	0	0	0	0
TOTAL	0	0	0	0	0	0	0	0	0	0	0	0	0	0	0	0

PEAK HOUR	Northbound Bikes			N.Leg Peds	Southbound Bikes			S.Leg Peds	Eastbound Bikes			E.Leg Peds	Westbound Bikes			W.Leg Peds
	Left	Thru	Right		Left	Thru	Right		Left	Thru	Right		Left	Thru	Right	
7:30 AM - 8:30 AM	0	0	0	0	0	0	0	0	0	0	0	0	0	0	0	0
4:15 PM - 5:15 PM	0	0	0	0	0	0	0	0	0	0	0	0	0	0	0	0

	Bikes	Peds
AM Peak Total	0	0
PM Peak Total	0	0

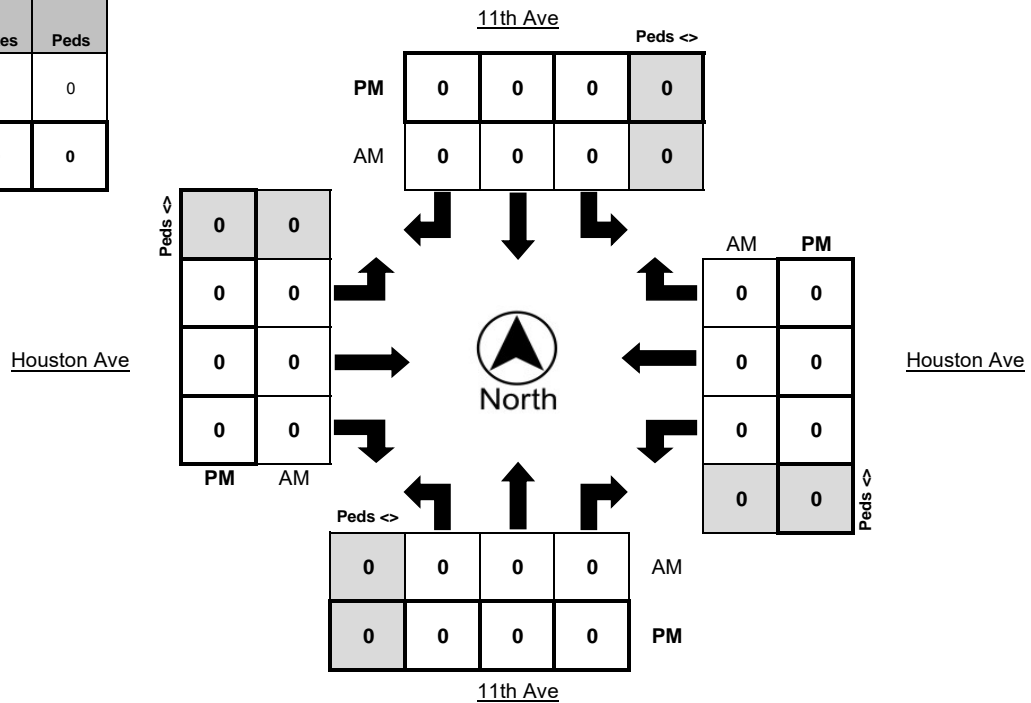



Metro Traffic Data Inc.
 310 N. Irwin Street - Suite 20
 Hanford, CA 93230
 800-975-6938 Phone/Fax
 www.metrotrafficdata.com

Turning Movement Report

Prepared For:

JLB Traffic Engineering, Inc.
 516 W. Shaw Ave, Suite 103
 Fresno, CA 93704

LOCATION Houston Ave @ 10 1/2 Ave

LATITUDE 36.2985

COUNTY Kings

LONGITUDE -119.6459

COLLECTION DATE Friday, January 28, 2022

WEATHER Clear

Time	Northbound					Southbound					Eastbound					Westbound				
	U-Turn	Left	Thru	Right	Trucks	U-Turn	Left	Thru	Right	Trucks	U-Turn	Left	Thru	Right	Trucks	U-Turn	Left	Thru	Right	Trucks
7:00 AM - 7:15 AM	0	0	0	0	0	0	1	0	4	1	0	2	20	0	5	0	0	28	2	5
7:15 AM - 7:30 AM	0	0	0	0	0	0	0	0	1	0	0	2	17	0	5	0	0	25	2	4
7:30 AM - 7:45 AM	0	0	0	0	0	0	1	0	4	0	0	3	6	0	0	0	0	19	6	6
7:45 AM - 8:00 AM	0	0	0	0	0	0	1	0	1	0	0	1	22	0	6	0	0	13	16	2
8:00 AM - 8:15 AM	0	0	0	0	0	0	1	0	1	0	0	1	17	0	5	0	0	26	3	6
8:15 AM - 8:30 AM	0	0	0	0	0	0	2	0	0	0	0	6	32	0	6	0	0	20	2	6
8:30 AM - 8:45 AM	0	0	0	0	0	0	4	0	5	2	0	1	23	0	5	0	0	21	1	4
8:45 AM - 9:00 AM	0	0	0	0	0	0	2	0	1	0	0	0	17	0	2	0	0	19	1	0
TOTAL	0	0	0	0	0	0	12	0	17	3	0	16	154	0	34	0	0	171	33	33

Time	Northbound					Southbound					Eastbound					Westbound				
	U-Turn	Left	Thru	Right	Trucks	U-Turn	Left	Thru	Right	Trucks	U-Turn	Left	Thru	Right	Trucks	U-Turn	Left	Thru	Right	Trucks
4:00 PM - 4:15 PM	0	0	0	0	0	0	3	0	4	0	0	4	24	0	1	0	0	37	5	3
4:15 PM - 4:30 PM	0	0	0	0	0	0	7	0	3	0	0	3	29	0	2	0	0	28	7	1
4:30 PM - 4:45 PM	0	0	0	0	0	0	4	0	2	0	0	2	26	0	0	0	0	39	4	2
4:45 PM - 5:00 PM	0	0	0	0	0	0	3	0	2	1	0	1	27	0	2	0	0	31	1	2
5:00 PM - 5:15 PM	0	0	0	0	0	0	3	0	1	0	0	3	28	0	0	0	0	36	4	0
5:15 PM - 5:30 PM	0	0	0	0	0	0	7	0	5	0	0	2	26	0	0	0	0	28	12	0
5:30 PM - 5:45 PM	0	0	0	0	0	0	2	0	3	0	0	1	28	0	0	0	0	25	1	2
5:45 PM - 6:00 PM	0	0	0	0	0	0	2	0	3	0	0	4	21	0	1	0	0	27	1	0
TOTAL	0	0	0	0	0	0	31	0	23	1	0	20	209	0	6	0	0	251	35	10

PEAK HOUR	Northbound					Southbound					Eastbound					Westbound				
	U-Turn	Left	Thru	Right	Trucks	U-Turn	Left	Thru	Right	Trucks	U-Turn	Left	Thru	Right	Trucks	U-Turn	Left	Thru	Right	Trucks
7:45 AM - 8:45 AM	0	0	0	0	0	0	8	0	7	2	0	9	94	0	22	0	0	80	22	18
4:30 PM - 5:30 PM	0	0	0	0	0	0	17	0	10	1	0	8	107	0	2	0	0	134	21	4

	PHF	Trucks
AM	0.887	19.1%
PM	0.928	2.4%

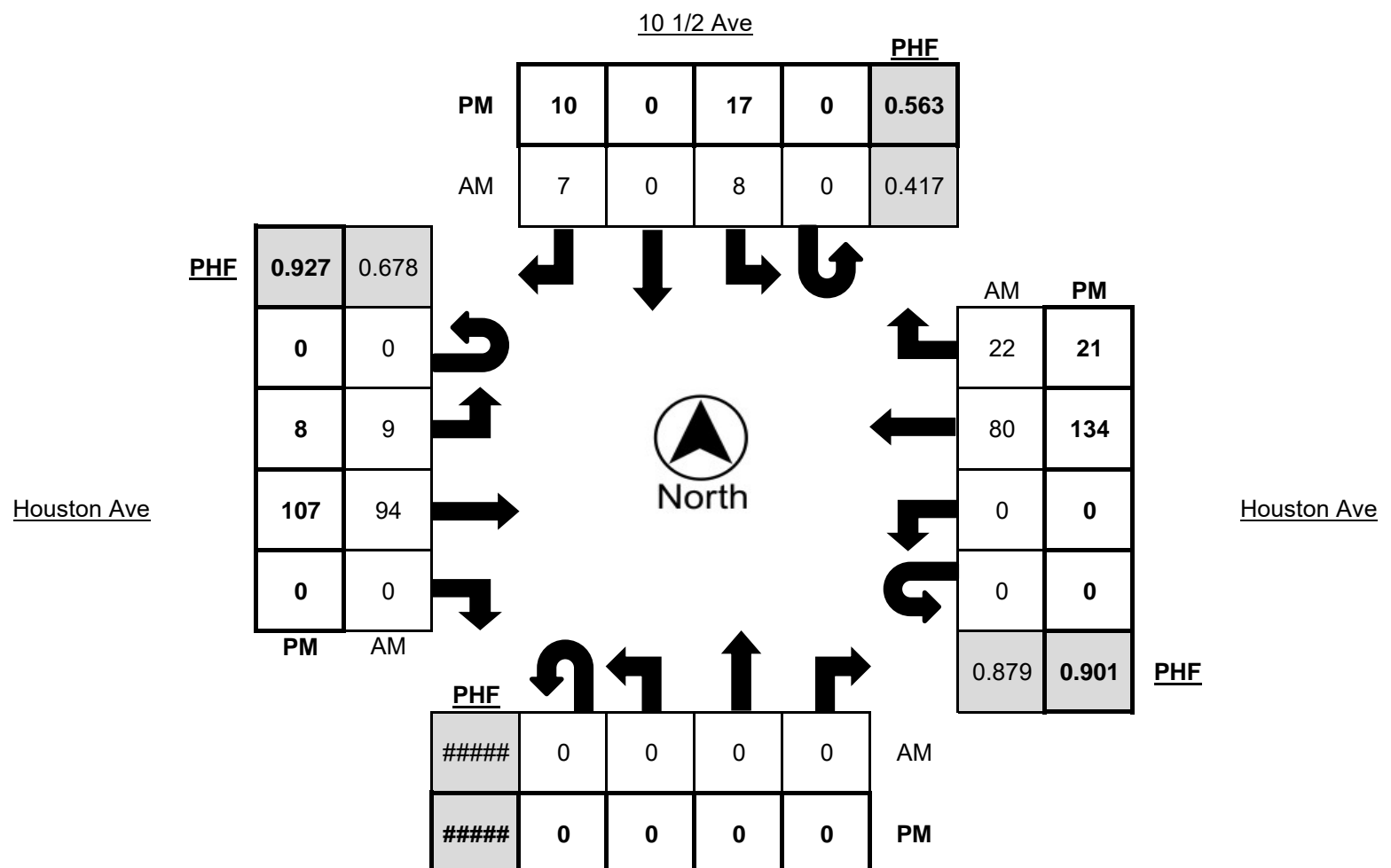



Metro Traffic Data Inc.
 310 N. Irwin Street - Suite 20
 Hanford, CA 93230
 800-975-6938 Phone/Fax
 www.metrotrafficdata.com

Turning Movement Report

Prepared For:

JLB Traffic Engineering, Inc.
 516 W. Shaw Ave, Suite 103
 Fresno, CA 93704

LOCATION Houston Ave @ 10 1/2 Ave

LATITUDE 36.2985

COUNTY Kings

LONGITUDE -119.6459

COLLECTION DATE Friday, January 28, 2022

WEATHER Clear

Time	Northbound Bikes			N.Leg Peds	Southbound Bikes			S.Leg Peds	Eastbound Bikes			E.Leg Peds	Westbound Bikes			W.Leg Peds
	Left	Thru	Right		Left	Thru	Right		Left	Thru	Right		Left	Thru	Right	
7:00 AM - 7:15 AM	0	0	0	0	0	0	0	0	0	0	0	0	0	0	0	0
7:15 AM - 7:30 AM	0	0	0	0	0	0	0	0	0	0	0	0	0	0	0	0
7:30 AM - 7:45 AM	0	0	0	0	0	0	0	0	0	0	0	0	0	0	0	0
7:45 AM - 8:00 AM	0	0	0	0	0	0	0	0	0	0	0	0	0	0	0	0
8:00 AM - 8:15 AM	0	0	0	0	0	0	0	0	0	0	0	0	0	0	0	0
8:15 AM - 8:30 AM	0	0	0	0	0	0	0	0	0	0	0	0	0	0	0	0
8:30 AM - 8:45 AM	0	0	0	0	0	0	0	0	0	0	0	0	0	0	0	0
8:45 AM - 9:00 AM	0	0	0	0	0	0	0	0	0	0	0	0	0	0	0	0
TOTAL	0	0	0	0	0	0	0	0	0	0	0	0	0	0	0	0

Time	Northbound Bikes			N.Leg Peds	Southbound Bikes			S.Leg Peds	Eastbound Bikes			E.Leg Peds	Westbound Bikes			W.Leg Peds
	Left	Thru	Right		Left	Thru	Right		Left	Thru	Right		Left	Thru	Right	
4:00 PM - 4:15 PM	0	0	0	1	0	0	0	0	0	0	0	0	0	0	0	0
4:15 PM - 4:30 PM	0	0	0	0	0	0	0	0	0	0	0	0	0	0	0	0
4:30 PM - 4:45 PM	0	0	0	0	0	0	0	0	0	0	0	0	0	0	0	0
4:45 PM - 5:00 PM	0	0	0	0	1	0	0	0	0	0	0	0	0	0	0	0
5:00 PM - 5:15 PM	0	0	0	0	0	0	0	0	0	0	0	0	0	0	0	0
5:15 PM - 5:30 PM	0	0	0	0	0	0	0	0	0	0	0	0	0	0	0	0
5:30 PM - 5:45 PM	0	0	0	0	0	0	0	0	0	0	0	0	0	0	0	0
5:45 PM - 6:00 PM	0	0	0	0	0	0	0	0	0	0	0	0	0	0	0	0
TOTAL	0	0	0	1	1	0	0	0	0	0	0	0	0	0	0	0

PEAK HOUR	Northbound Bikes			N.Leg Peds	Southbound Bikes			S.Leg Peds	Eastbound Bikes			E.Leg Peds	Westbound Bikes			W.Leg Peds
	Left	Thru	Right		Left	Thru	Right		Left	Thru	Right		Left	Thru	Right	
7:45 AM - 8:45 AM	0	0	0	0	0	0	0	0	0	0	0	0	0	0	0	0
4:30 PM - 5:30 PM	0	0	0	0	1	0	0	0	0	0	0	0	0	0	0	0

	Bikes	Peds
AM Peak Total	0	0
PM Peak Total	1	0

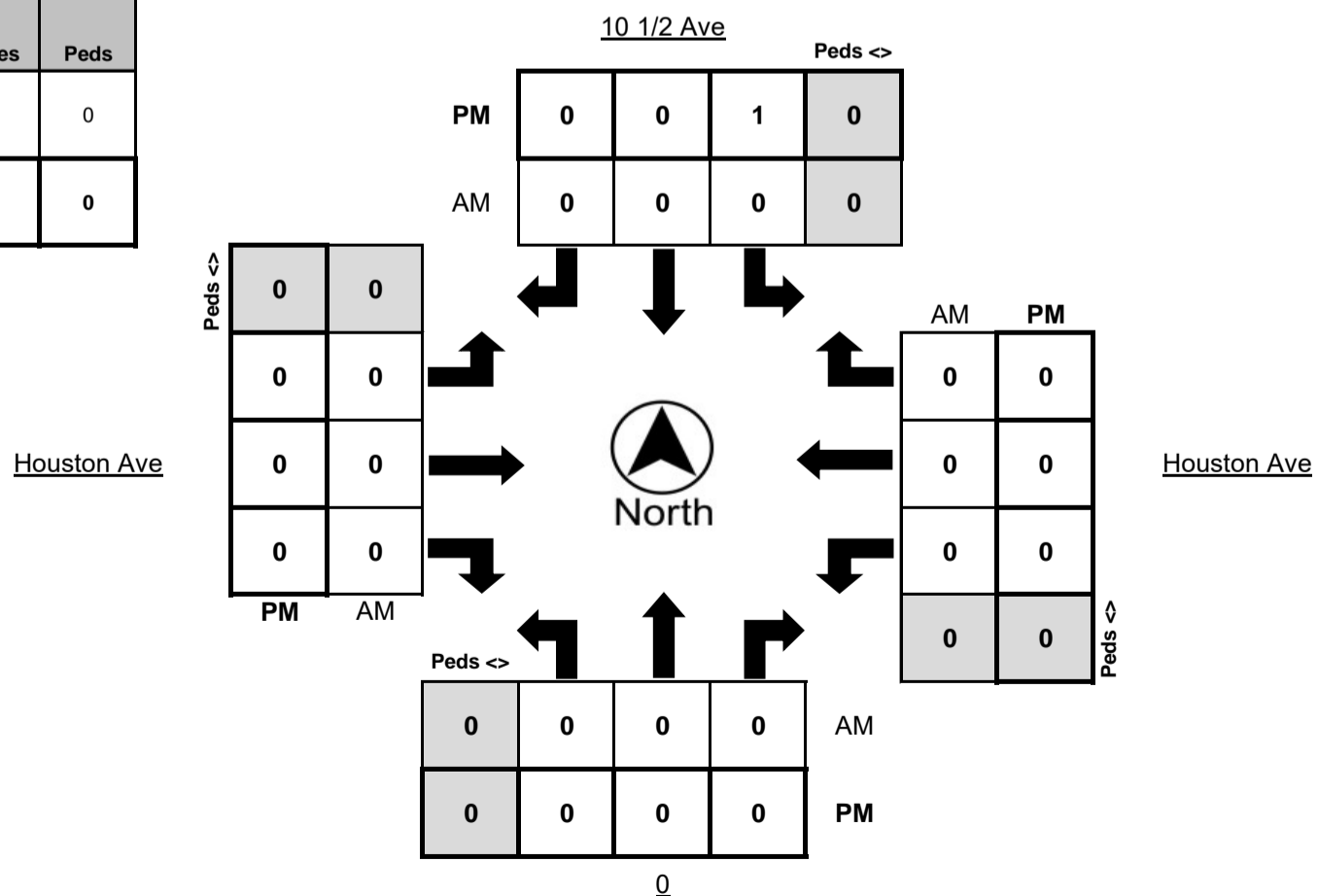



Metro Traffic Data Inc.
 310 N. Irwin Street - Suite 20
 Hanford, CA 93230
 800-975-6938 Phone/Fax
 www.metrotrafficdata.com

Turning Movement Report

Prepared For:

JLB Traffic Engineering, Inc.
 516 W. Shaw Ave, Suite 103
 Fresno, CA 93704

LOCATION Houston Ave @ 10th Ave

LATITUDE 36.2987

COUNTY Kings

LONGITUDE -119.6370

COLLECTION DATE Tuesday, February 1, 2022

WEATHER Clear

Time	Northbound					Southbound					Eastbound					Westbound				
	U-Turn	Left	Thru	Right	Trucks	U-Turn	Left	Thru	Right	Trucks	U-Turn	Left	Thru	Right	Trucks	U-Turn	Left	Thru	Right	Trucks
7:00 AM - 7:15 AM	0	0	11	3	1	0	8	14	9	3	0	3	7	2	2	0	2	11	1	4
7:15 AM - 7:30 AM	0	3	7	1	0	0	5	16	4	2	0	6	12	2	6	0	8	15	2	4
7:30 AM - 7:45 AM	0	0	11	1	2	0	0	18	13	7	0	8	18	3	13	0	5	12	2	3
7:45 AM - 8:00 AM	0	4	17	2	4	0	2	18	13	9	0	4	18	6	8	0	4	14	3	3
8:00 AM - 8:15 AM	0	7	15	1	1	0	5	14	7	7	0	10	15	7	12	0	1	18	1	6
8:15 AM - 8:30 AM	0	2	15	1	2	0	6	11	6	7	0	7	12	2	11	0	2	12	7	3
8:30 AM - 8:45 AM	0	1	5	0	0	0	4	15	7	6	0	5	11	4	9	0	3	13	3	8
8:45 AM - 9:00 AM	0	1	13	4	4	0	2	8	3	4	0	3	11	1	6	0	0	11	4	6
TOTAL	0	18	94	13	14	0	32	114	62	45	0	46	104	27	67	0	25	106	23	37

Time	Northbound					Southbound					Eastbound					Westbound				
	U-Turn	Left	Thru	Right	Trucks	U-Turn	Left	Thru	Right	Trucks	U-Turn	Left	Thru	Right	Trucks	U-Turn	Left	Thru	Right	Trucks
4:00 PM - 4:15 PM	0	3	27	3	3	0	10	12	11	3	0	10	22	2	5	0	1	19	13	4
4:15 PM - 4:30 PM	0	4	34	1	2	0	9	14	9	2	0	10	20	5	4	0	2	14	13	3
4:30 PM - 4:45 PM	0	12	19	2	2	0	15	15	6	1	0	7	18	3	0	0	3	22	11	4
4:45 PM - 5:00 PM	0	3	20	3	1	0	6	24	10	2	0	7	14	3	1	0	0	27	14	1
5:00 PM - 5:15 PM	0	4	28	2	2	0	11	17	10	0	0	5	20	4	4	0	3	22	10	0
5:15 PM - 5:30 PM	0	6	19	4	3	0	13	13	4	1	0	12	9	1	1	0	3	14	12	2
5:30 PM - 5:45 PM	0	6	20	1	3	0	7	10	6	0	0	4	9	3	1	0	1	17	4	3
5:45 PM - 6:00 PM	0	5	16	4	1	0	5	14	2	1	0	2	10	9	1	0	1	10	4	1
TOTAL	0	43	183	20	17	0	76	119	58	10	0	57	122	30	17	0	14	145	81	18

PEAK HOUR	Northbound					Southbound					Eastbound					Westbound				
	U-Turn	Left	Thru	Right	Trucks	U-Turn	Left	Thru	Right	Trucks	U-Turn	Left	Thru	Right	Trucks	U-Turn	Left	Thru	Right	Trucks
7:30 AM - 8:30 AM	0	13	58	5	9	0	13	61	39	30	0	29	63	18	44	0	12	56	13	15
4:15 PM - 5:15 PM	0	23	101	8	7	0	41	70	35	5	0	29	72	15	9	0	8	85	48	8

	PHF	Trucks
AM	0.905	25.8%
PM	0.983	5.4%

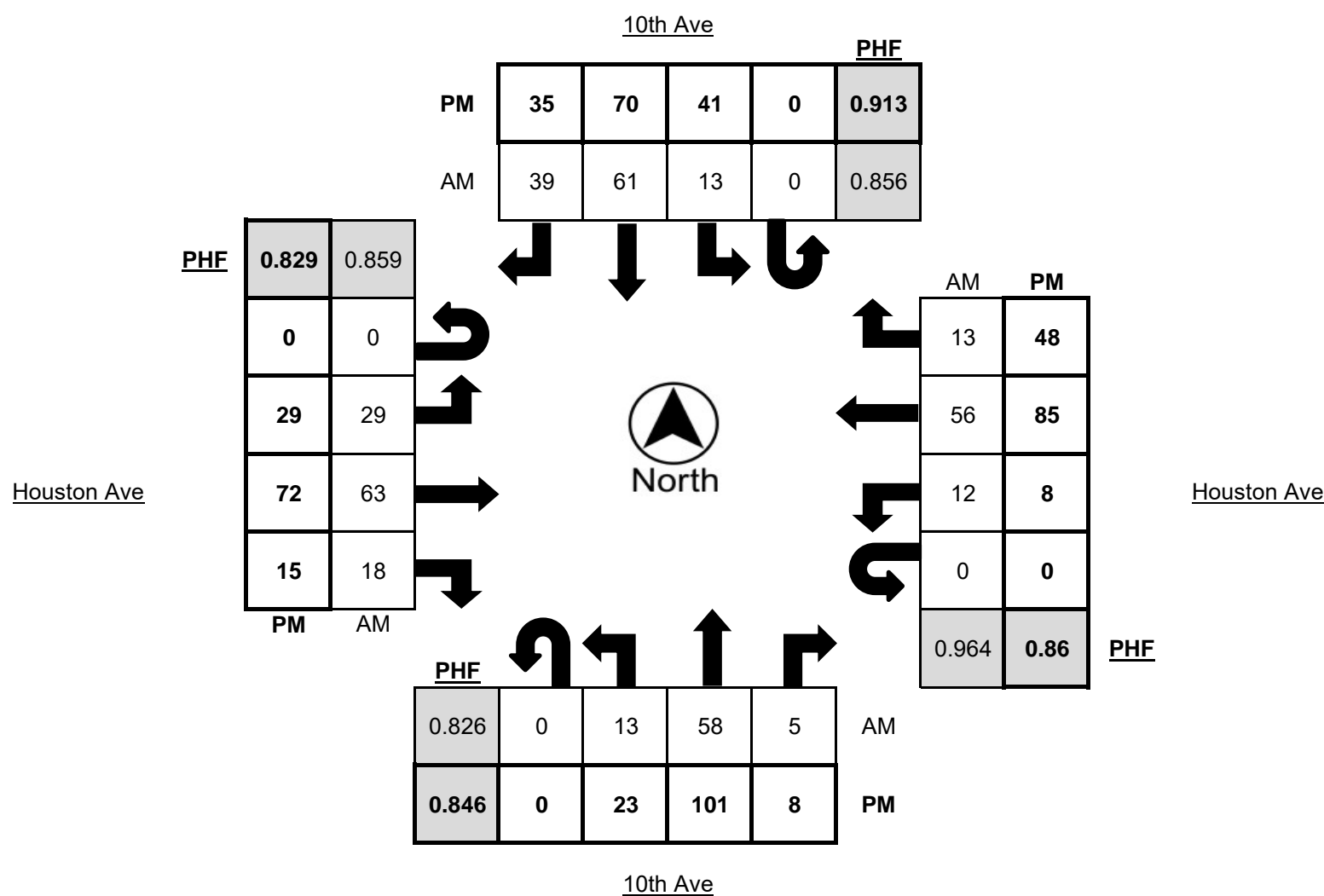



Metro Traffic Data Inc.
 310 N. Irwin Street - Suite 20
 Hanford, CA 93230
 800-975-6938 Phone/Fax
 www.metrotrafficdata.com

Turning Movement Report

Prepared For:

JLB Traffic Engineering, Inc.
 516 W. Shaw Ave, Suite 103
 Fresno, CA 93704

LOCATION Houston Ave @ 10th Ave

LATITUDE 36.2987

COUNTY Kings

LONGITUDE -119.6370

COLLECTION DATE Tuesday, February 1, 2022

WEATHER Clear

Time	Northbound Bikes			N.Leg Peds	Southbound Bikes			S.Leg Peds	Eastbound Bikes			E.Leg Peds	Westbound Bikes			W.Leg Peds
	Left	Thru	Right		Left	Thru	Right		Left	Thru	Right		Left	Thru	Right	
7:00 AM - 7:15 AM	0	0	0	0	0	0	0	0	0	0	0	0	0	0	0	0
7:15 AM - 7:30 AM	0	0	0	0	0	0	0	0	0	0	0	0	0	0	0	0
7:30 AM - 7:45 AM	0	0	0	0	0	0	0	0	0	0	0	0	0	0	0	0
7:45 AM - 8:00 AM	0	0	0	0	0	0	0	0	0	0	0	0	0	0	0	0
8:00 AM - 8:15 AM	0	0	0	0	0	0	0	0	0	0	0	0	0	0	0	0
8:15 AM - 8:30 AM	0	0	0	0	0	0	0	0	0	0	0	0	0	0	0	0
8:30 AM - 8:45 AM	0	0	0	0	0	0	0	0	0	0	0	0	0	0	0	0
8:45 AM - 9:00 AM	0	0	0	0	0	0	0	0	0	0	0	0	0	0	0	0
TOTAL	0	0	0	0	0	0	0	0	0	0	0	0	0	0	0	0

Time	Northbound Bikes			N.Leg Peds	Southbound Bikes			S.Leg Peds	Eastbound Bikes			E.Leg Peds	Westbound Bikes			W.Leg Peds
	Left	Thru	Right		Left	Thru	Right		Left	Thru	Right		Left	Thru	Right	
4:00 PM - 4:15 PM	0	0	0	4	0	0	0	0	0	0	0	1	0	0	0	0
4:15 PM - 4:30 PM	0	0	0	2	0	0	0	0	0	0	0	0	0	0	0	0
4:30 PM - 4:45 PM	0	0	0	0	0	0	0	0	0	0	0	0	0	0	0	1
4:45 PM - 5:00 PM	0	0	0	2	0	0	0	0	0	0	0	0	0	0	0	0
5:00 PM - 5:15 PM	0	0	0	0	0	0	0	0	0	0	0	0	0	0	0	0
5:15 PM - 5:30 PM	0	0	0	0	0	0	0	0	0	0	0	0	0	0	0	0
5:30 PM - 5:45 PM	0	0	0	0	0	0	0	0	0	0	0	0	0	0	0	0
5:45 PM - 6:00 PM	0	0	0	0	0	0	0	0	0	0	0	0	0	0	0	0
TOTAL	0	0	0	8	0	0	0	0	0	0	0	1	0	0	0	1

PEAK HOUR	Northbound Bikes			N.Leg Peds	Southbound Bikes			S.Leg Peds	Eastbound Bikes			E.Leg Peds	Westbound Bikes			W.Leg Peds
	Left	Thru	Right		Left	Thru	Right		Left	Thru	Right		Left	Thru	Right	
7:30 AM - 8:30 AM	0	0	0	0	0	0	0	0	0	0	0	0	0	0	0	0
4:15 PM - 5:15 PM	0	0	0	4	0	0	0	0	0	0	0	0	0	0	0	1

	Bikes	Peds
AM Peak Total	0	0
PM Peak Total	0	5

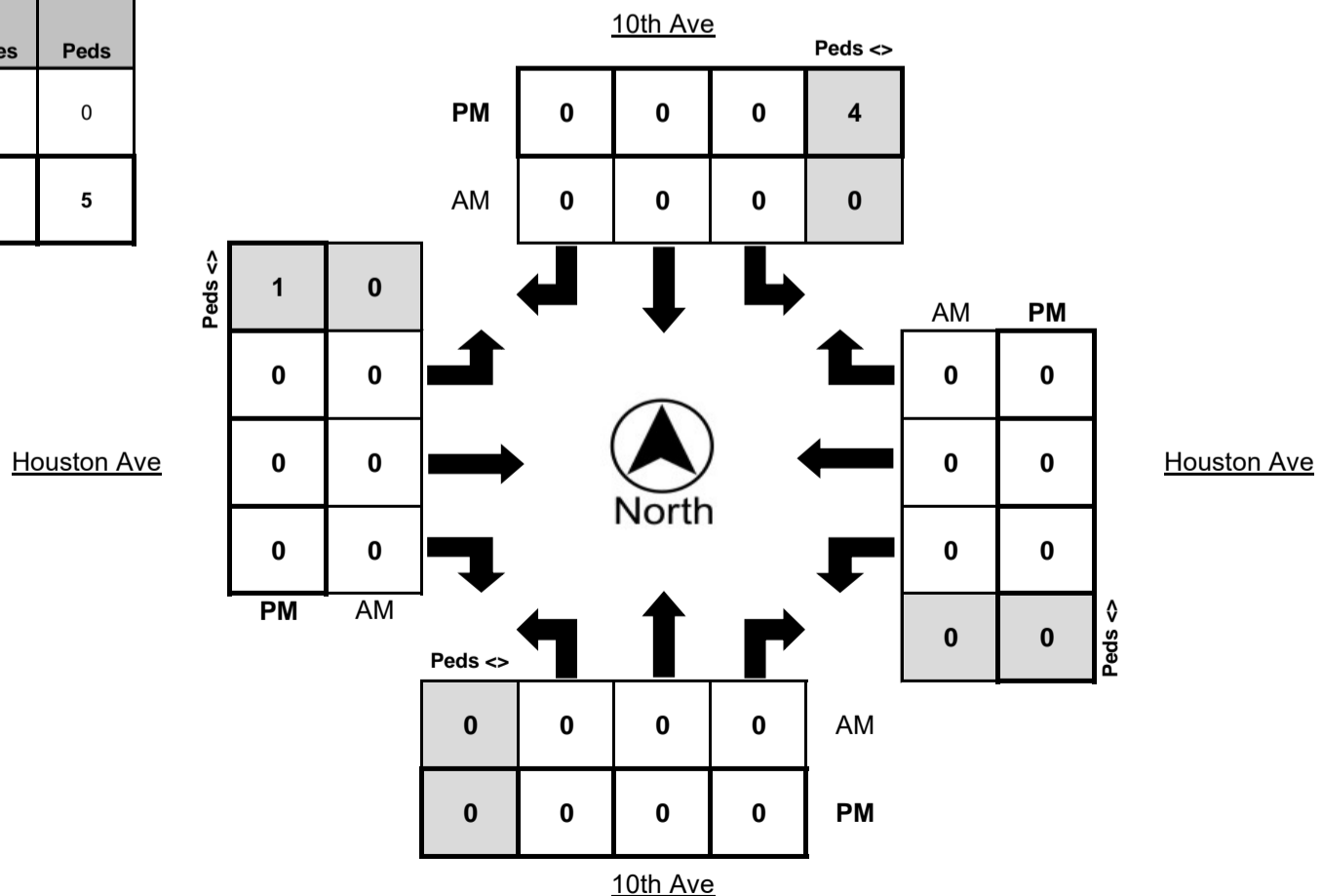



Metro Traffic Data Inc.
 310 N. Irwin Street - Suite 20
 Hanford, CA 93230
 800-975-6938 Phone/Fax
 www.metrotrafficdata.com

24 Hour Volume Report

Prepared For: **JLB Traffic Engineering, Inc.**
 516 W. Shaw Ave, Suite 103
 Fresno, CA 93704

LOCATION 10 1/2 Ave approx 400' south of Highland St

LATITUDE 36.309484

COUNTY Kings

LONGITUDE -119.6459607

DATE Tuesday, January 25, 2022

WEATHER Clear

NUMBER OF LANES 2

Hour	Northbound					Southbound					Hourly Totals
	1st	2nd	3rd	4th	Total	1st	2nd	3rd	4th	Total	
12:00 AM	1	0	0	0	1	1	0	0	2	3	4
1:00 AM	1	0	0	1	2	0	0	0	0	0	2
2:00 AM	6	4	1	2	13	4	1	0	1	6	19
3:00 AM	0	0	0	0	0	1	1	0	1	3	3
4:00 AM	0	2	5	1	8	0	0	2	3	5	13
5:00 AM	1	2	0	5	8	1	2	1	2	6	14
6:00 AM	4	1	4	4	13	1	2	11	6	20	33
7:00 AM	5	3	14	25	47	4	2	6	2	14	61
8:00 AM	7	9	4	2	22	4	4	11	6	25	47
9:00 AM	5	8	6	5	24	3	5	4	7	19	43
10:00 AM	3	7	6	6	22	6	6	6	4	22	44
11:00 AM	4	7	8	5	24	9	7	15	8	39	63
12:00 PM	4	6	9	6	25	5	2	9	11	27	52
1:00 PM	7	11	9	10	37	11	5	15	20	51	88
2:00 PM	6	11	13	16	46	3	8	6	9	26	72
3:00 PM	8	5	15	14	42	10	12	16	13	51	93
4:00 PM	11	10	12	6	39	12	8	10	4	34	73
5:00 PM	9	10	4	8	31	8	11	7	7	33	64
6:00 PM	1	6	2	0	9	9	5	5	4	23	32
7:00 PM	2	4	2	3	11	2	4	6	2	14	25
8:00 PM	0	1	0	0	1	4	4	2	4	14	15
9:00 PM	6	1	0	0	7	3	1	2	1	7	14
10:00 PM	0	0	0	1	1	1	1	2	1	5	6
11:00 PM	2	1	0	2	5	2	1	0	0	3	8
Total	49.3%				438	50.7%				450	888

AM% **39.0%** AM Peak **63** 11:00 am to 12:00 pm AM P.H.F. **0.68**
 PM% **61.0%** PM Peak **99** 3:30 pm to 4:30 pm PM P.H.F. **0.80**

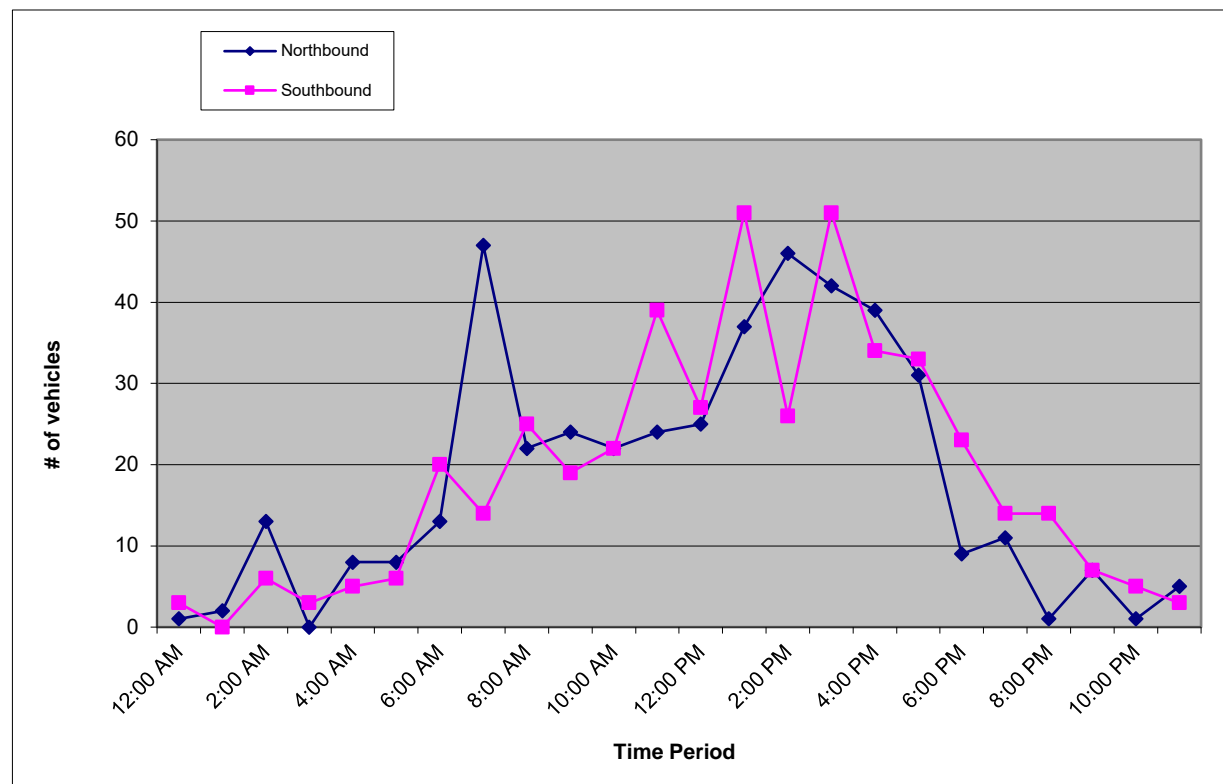



Metro Traffic Data Inc.
 310 N. Irwin Street - Suite 20
 Hanford, CA 93230
 800-975-6938 Phone/Fax
 www.metrotrafficdata.com

24 Hour Volume Report

Prepared For: **JLB Traffic Engineering, Inc.**
 516 W. Shaw Ave, Suite 103
 Fresno, CA 93704

LOCATION 10 1/2 Ave, approx 300' north of Houston Ave

LATITUDE 36.2990968

COUNTY Kings

LONGITUDE -119.6458958

DATE Tuesday, January 25, 2022

WEATHER Clear

NUMBER OF LANES 2

Hour	Northbound					Southbound					Hourly Totals
	1st	2nd	3rd	4th	Total	1st	2nd	3rd	4th	Total	
12:00 AM	1	0	0	0	1	0	0	0	1	1	2
1:00 AM	1	0	0	1	2	1	0	0	0	1	3
2:00 AM	1	0	0	0	1	0	1	0	0	1	2
3:00 AM	0	0	0	1	1	1	0	1	0	2	3
4:00 AM	0	1	1	0	2	2	0	0	2	4	6
5:00 AM	0	0	2	2	4	1	2	2	1	6	10
6:00 AM	3	0	4	2	9	2	3	7	6	18	27
7:00 AM	5	4	10	18	37	4	0	4	1	9	46
8:00 AM	5	7	2	1	15	2	2	9	2	15	30
9:00 AM	2	7	3	3	15	4	2	4	3	13	28
10:00 AM	1	6	5	4	16	3	6	3	4	16	32
11:00 AM	6	4	5	5	20	7	5	10	5	27	47
12:00 PM	0	8	7	7	22	4	2	9	12	27	49
1:00 PM	4	9	9	5	27	7	2	10	12	31	58
2:00 PM	6	5	11	14	36	2	6	5	7	20	56
3:00 PM	7	8	15	8	38	6	8	16	9	39	77
4:00 PM	9	13	5	3	30	7	8	9	2	26	56
5:00 PM	9	14	1	5	29	5	10	5	5	25	54
6:00 PM	1	8	1	0	10	7	4	4	5	20	30
7:00 PM	2	5	1	3	11	4	2	2	2	10	21
8:00 PM	2	0	0	5	7	2	2	1	2	7	14
9:00 PM	3	0	1	1	5	2	1	1	1	5	10
10:00 PM	0	0	0	1	1	0	1	2	1	4	5
11:00 PM	0	0	0	2	2	2	0	0	0	2	4
Total	50.9%				341	49.1%				329	
670											

AM% 35.2% **AM Peak** 47 **11:00 am to 12:00 pm** **AM P.H.F.** 0.78
PM% 64.8% **PM Peak** 85 **3:30 pm to 4:30 pm** **PM P.H.F.** 0.69

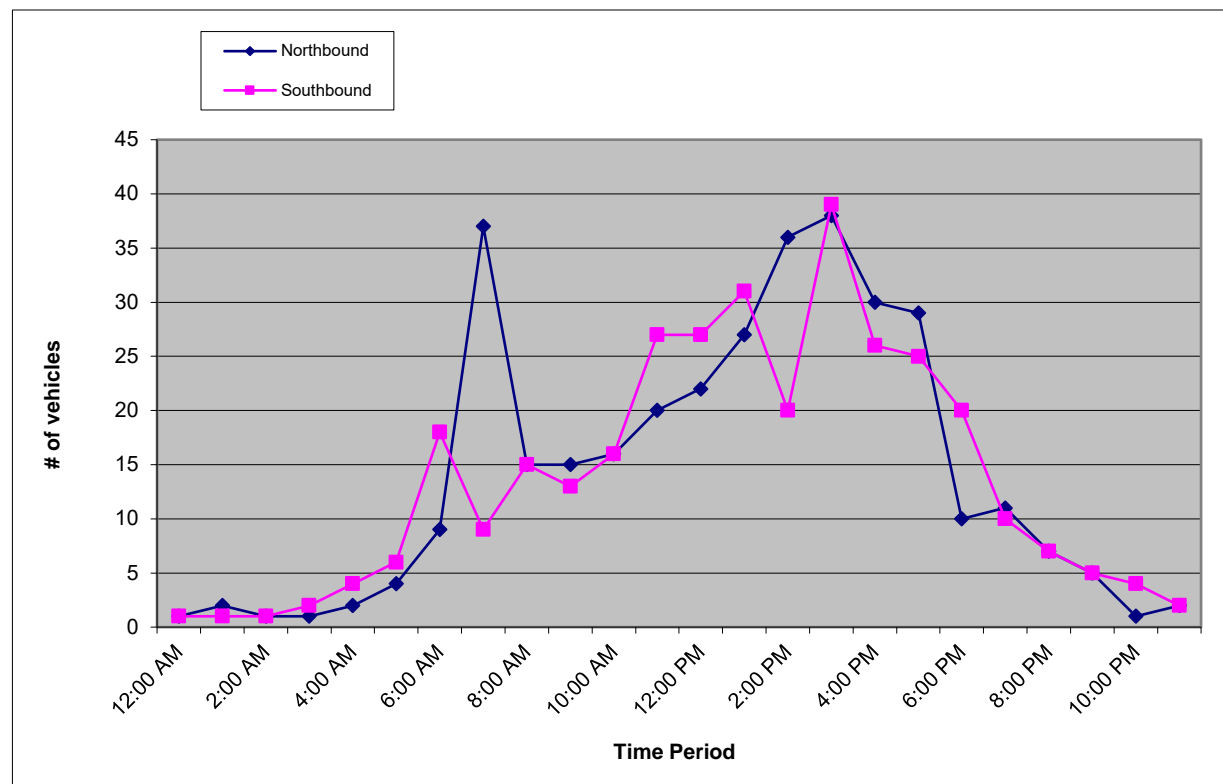



Metro Traffic Data Inc.
 310 N. Irwin Street - Suite 20
 Hanford, CA 93230
 800-975-6938 Phone/Fax
 www.metrotrafficdata.com

24 Hour Volume Report

Prepared For: **JLB Traffic Engineering, Inc.**
 516 W. Shaw Ave, Suite 103
 Fresno, CA 93704

LOCATION Hanford Armona Rd between BNSF RR and Phillips St **LATITUDE** 36.3134175
COUNTY Kings **LONGITUDE** -119.6490965
COLLECTION DATE Tuesday, February 1, 2022 **WEATHER** Clear
NUMBER OF LANES 3

Hour	Eastbound					Westbound					Hourly Totals
	1st	2nd	3rd	4th	Total	1st	2nd	3rd	4th	Total	
12:00 AM	4	12	4	4	24	7	2	2	6	17	41
1:00 AM	4	3	3	4	14	7	4	5	6	22	36
2:00 AM	1	8	6	8	23	2	4	11	5	22	45
3:00 AM	2	2	14	4	22	4	2	3	5	14	36
4:00 AM	5	9	16	17	47	5	9	9	12	35	82
5:00 AM	18	18	23	23	82	5	13	19	18	55	137
6:00 AM	30	32	27	42	131	16	14	32	32	94	225
7:00 AM	20	49	68	115	252	19	31	57	89	196	448
8:00 AM	60	55	51	54	220	93	54	55	58	260	480
9:00 AM	41	54	46	62	203	54	50	40	44	188	391
10:00 AM	57	62	60	59	238	47	55	59	49	210	448
11:00 AM	78	68	59	83	288	64	57	58	58	237	525
12:00 PM	52	75	50	78	255	73	71	53	68	265	520
1:00 PM	68	66	74	99	307	55	64	70	73	262	569
2:00 PM	74	81	94	105	354	83	85	86	84	338	692
3:00 PM	86	92	99	82	359	107	80	90	89	366	725
4:00 PM	95	118	111	104	428	117	97	94	103	411	839
5:00 PM	96	84	82	85	347	125	105	79	83	392	739
6:00 PM	74	107	68	65	314	84	65	75	62	286	600
7:00 PM	50	53	40	34	177	99	51	57	43	250	427
8:00 PM	41	46	28	28	143	35	35	46	25	141	284
9:00 PM	24	15	24	19	82	27	20	23	18	88	170
10:00 PM	19	10	14	14	57	20	17	11	13	61	118
11:00 PM	6	10	17	8	41	11	10	15	14	50	91
Total	50.9%				4408	49.1%				4260	8668

AM% 33.4% **AM Peak** 525 **11:00 am to 12:00 pm** **AM P.H.F.** 0.92
PM% 66.6% **PM Peak** 848 **4:15 pm to 5:15 pm** **PM P.H.F.** 0.96

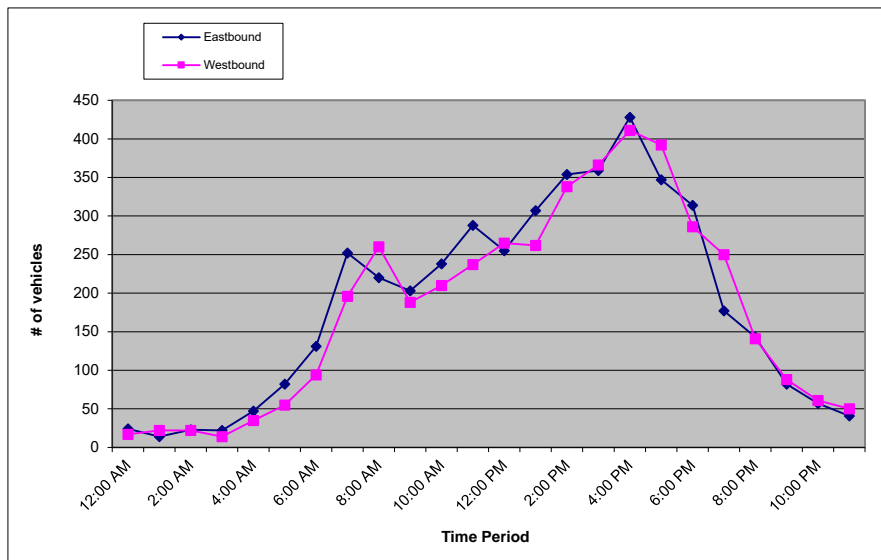



Metro Traffic Data Inc.
 310 N. Irwin Street - Suite 20
 Hanford, CA 93230
 800-975-6938 Phone/Fax
 www.metrotrafficdata.com

24 Hour Volume Report

Prepared For: **JLB Traffic Engineering, Inc.**
 516 W. Shaw Ave, Suite 103
 Fresno, CA 93704

LOCATION Hanford Armona Rd btwn Harris St / Gilkey Ln **LATITUDE** 36.3133991
COUNTY Kings **LONGITUDE** -119.6418133
COLLECTION DATE Tuesday, February 1, 2022 **WEATHER** Clear
NUMBER OF LANES 3

Hour	Eastbound					Westbound					Hourly Totals
	1st	2nd	3rd	4th	Total	1st	2nd	3rd	4th	Total	
12:00 AM	3	11	2	4	20	8	2	3	1	14	34
1:00 AM	2	3	2	5	12	4	2	6	5	17	29
2:00 AM	1	6	2	6	15	1	1	5	2	9	24
3:00 AM	5	2	11	4	22	3	2	3	5	13	35
4:00 AM	6	5	12	14	37	4	9	6	12	31	68
5:00 AM	17	17	17	22	73	8	11	18	20	57	130
6:00 AM	21	19	27	20	87	17	25	34	34	110	197
7:00 AM	18	39	46	73	176	29	27	57	70	183	359
8:00 AM	47	40	43	36	166	70	33	41	44	188	354
9:00 AM	30	41	35	49	155	35	42	34	30	141	296
10:00 AM	42	46	42	40	170	35	48	50	38	171	341
11:00 AM	55	51	48	59	213	52	41	50	47	190	403
12:00 PM	49	58	45	57	209	43	45	41	62	191	400
1:00 PM	48	47	53	72	220	47	41	45	48	181	401
2:00 PM	55	63	70	75	263	73	69	58	69	269	532
3:00 PM	63	76	63	79	281	96	72	62	63	293	574
4:00 PM	67	75	75	53	270	102	60	58	85	305	575
5:00 PM	80	65	74	70	289	78	76	82	55	291	580
6:00 PM	51	57	64	45	217	74	56	41	48	219	436
7:00 PM	43	47	35	28	153	62	44	46	36	188	341
8:00 PM	27	35	17	25	104	24	25	34	14	97	201
9:00 PM	22	15	16	12	65	19	11	18	15	63	128
10:00 PM	11	4	11	6	32	11	9	6	11	37	69
11:00 PM	6	7	12	7	32	4	7	11	10	32	64
Total	49.9%				3281	50.1%				3290	6571

AM% 34.5% **AM Peak** 403 **11:00 am to 12:00 pm** **AM P.H.F.** 0.94
PM% 65.5% **PM Peak** 593 **4:45 pm to 5:45 pm** **PM P.H.F.** 0.94

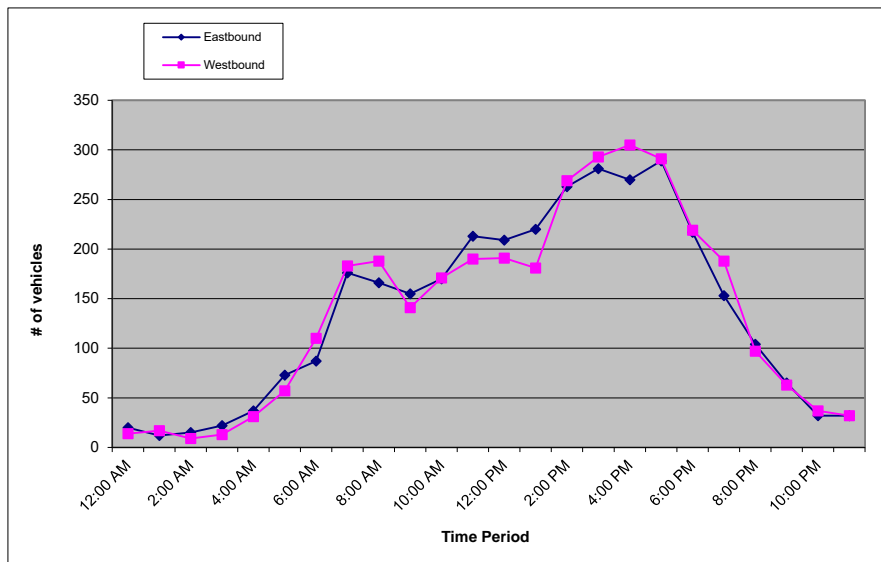



Metro Traffic Data Inc.
 310 N. Irwin Street - Suite 20
 Hanford, CA 93230
 800-975-6938 Phone/Fax
 www.metrotrafficdata.com

24 Hour Volume Report

Prepared For: **JLB Traffic Engineering, Inc.**
 516 W. Shaw Ave, Suite 103
 Fresno, CA 93704

LOCATION Houston Ave approx. 700' west of BNSF RR **LATITUDE** 36.2984308
COUNTY Kings **LONGITUDE** -119.6494196
COLLECTION DATE Tuesday, February 1, 2022 **WEATHER** Clear
NUMBER OF LANES 2

Hour	Eastbound					Westbound					Hourly Totals
	1st	2nd	3rd	4th	Total	1st	2nd	3rd	4th	Total	
12:00 AM	2	2	2	1	7	0	0	1	4	5	12
1:00 AM	2	5	0	3	10	5	2	4	3	14	24
2:00 AM	6	3	4	0	13	2	0	4	0	6	19
3:00 AM	1	0	7	7	15	3	1	3	5	12	27
4:00 AM	6	6	13	8	33	9	9	5	7	30	63
5:00 AM	12	13	19	9	53	9	13	10	12	44	97
6:00 AM	20	24	37	35	116	10	17	10	36	73	189
7:00 AM	17	27	33	41	118	29	25	30	33	117	235
8:00 AM	38	31	29	24	122	46	30	32	20	128	250
9:00 AM	27	27	26	26	106	31	29	30	28	118	224
10:00 AM	27	25	28	29	109	22	31	31	36	120	229
11:00 AM	32	30	33	31	126	32	38	46	30	146	272
12:00 PM	25	29	29	29	112	38	25	35	30	128	240
1:00 PM	31	29	33	33	126	35	35	35	32	137	263
2:00 PM	27	32	33	37	129	23	39	47	38	147	276
3:00 PM	33	21	40	47	141	47	47	58	41	193	334
4:00 PM	45	39	37	35	156	35	44	50	32	161	317
5:00 PM	29	23	28	35	115	40	39	37	28	144	259
6:00 PM	21	13	14	18	66	32	19	26	8	85	151
7:00 PM	24	6	15	10	55	18	14	14	11	57	112
8:00 PM	10	7	10	7	34	11	9	10	9	39	73
9:00 PM	10	7	7	5	29	14	8	5	6	33	62
10:00 PM	9	4	5	3	21	9	7	12	8	36	57
11:00 PM	1	5	2	6	14	11	2	4	0	17	31
Total	47.9%				1826	52.1%				1990	3816

AM% 43.0% **AM Peak** 276 **10:45 am to 11:45 am** **AM P.H.F.** 0.87
PM% 57.0% **PM Peak** 349 **3:30 pm to 4:30 pm** **PM P.H.F.** 0.89

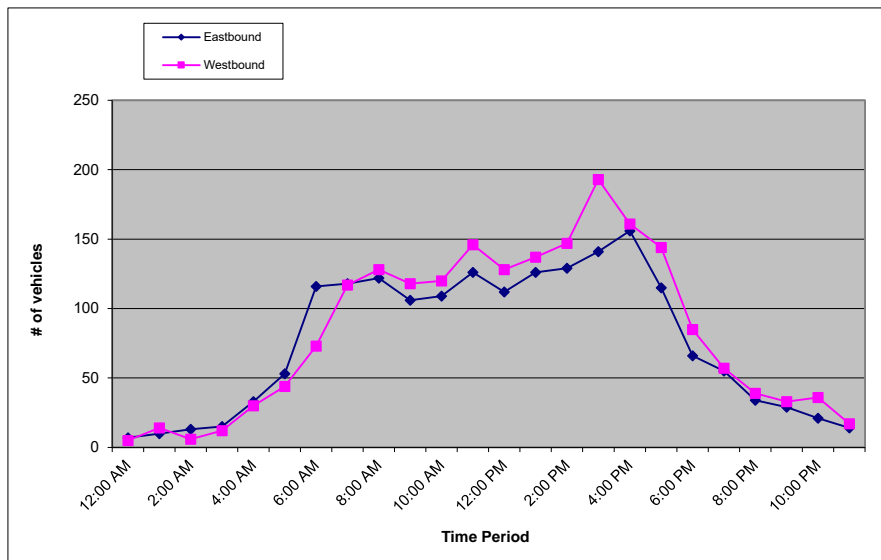



Metro Traffic Data Inc.
 310 N. Irwin Street - Suite 20
 Hanford, CA 93230
 800-975-6938 Phone/Fax
 www.metrotrafficdata.com

24 Hour Volume Report

Prepared For: **JLB Traffic Engineering, Inc.**
 516 W. Shaw Ave, Suite 103
 Fresno, CA 93704

LOCATION Houston Ave btwn Superior Soil / Valley Pallet Drives **LATITUDE** 36.2986037
COUNTY Kings **LONGITUDE** -119.6419416
COLLECTION DATE Tuesday, February 1, 2022 **WEATHER** Clear
NUMBER OF LANES 2

Hour	Eastbound					Westbound					Hourly Totals
	1st	2nd	3rd	4th	Total	1st	2nd	3rd	4th	Total	
12:00 AM	2	2	2	1	7	1	0	2	3	6	13
1:00 AM	1	3	0	3	7	3	2	4	4	13	20
2:00 AM	0	5	7	0	12	0	0	4	1	5	17
3:00 AM	1	0	5	9	15	3	1	3	3	10	25
4:00 AM	6	7	15	8	36	9	8	7	6	30	66
5:00 AM	12	13	17	14	56	8	16	11	9	44	100
6:00 AM	20	25	34	37	116	12	15	17	42	86	202
7:00 AM	14	24	37	43	118	29	25	38	42	134	252
8:00 AM	42	34	37	21	134	50	35	28	24	137	271
9:00 AM	26	30	28	36	120	33	32	32	32	129	249
10:00 AM	29	31	28	30	118	32	29	28	38	127	245
11:00 AM	30	38	36	37	141	36	38	48	25	147	288
12:00 PM	30	26	34	29	119	34	34	35	31	134	253
1:00 PM	36	31	32	29	128	36	30	35	32	133	261
2:00 PM	31	31	37	34	133	28	39	51	37	155	288
3:00 PM	43	22	42	47	154	45	61	55	44	205	359
4:00 PM	49	40	41	44	174	37	43	49	45	174	348
5:00 PM	31	31	21	34	117	37	33	38	25	133	250
6:00 PM	26	9	19	21	75	37	17	24	8	86	161
7:00 PM	20	9	14	11	54	18	18	17	10	63	117
8:00 PM	10	9	10	11	40	12	12	11	10	45	85
9:00 PM	10	7	7	4	28	13	8	5	6	32	60
10:00 PM	7	6	6	4	23	10	7	12	9	38	61
11:00 PM	1	3	2	6	12	11	6	4	2	23	35
Total	48.1%				1937	51.9%				2089	4026

AM% 43.4% **AM Peak** 294 **10:45 am to 11:45 am** **AM P.H.F.** 0.88
PM% 56.6% **PM Peak** 359 **3:00 pm to 4:00 pm** **PM P.H.F.** 0.93

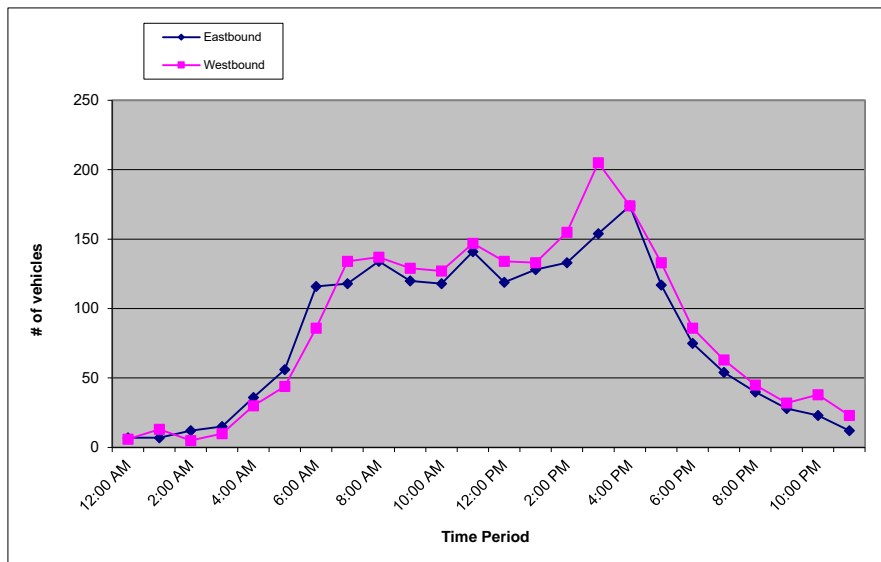

Appendix C: Traffic Modeling



www.JLBtraffic.com
info@JLBtraffic.com

516 W. Shaw Ave., Ste. 103
Fresno, CA 93704
(559) 570-8991

App | C

January 18, 2022

Mike Aronson, P.E.
Kittle son & Associates, Inc.
155 Grand Avenue, Suite 505
Oakland, CA 94612

Via Email Only: maronson@kittelson.com

Subject: Traffic Modeling Request for the Preparation of a Traffic Impact Analysis and Vehicle Miles Traveled Analysis for the Lunaria Project Located on the Southeast quadrant of Hanford-Armona Road and Avenue 10 ½ in the City of Hanford (JLB Project 047-002)

Dear Mr. Aronson,

JLB Traffic Engineering, Inc. (JLB) hereby requests traffic modeling for the preparation of a Traffic Impact Analysis (TIA) and Vehicle Miles Traveled (VMT) Analysis for the proposed Lunaria Project (Project) located on the southeast quadrant of Hanford-Armona Road and Avenue 10 ½ in the City of Hanford. The Project proposes to develop the site with 443 single family residential units and a 4.9-acre public park. Based on information provided to JLB, the Project is consistent with the City of Hanford General Plan. An aerial of the Project vicinity is shown in Exhibit A. The latest Project Site Plan is presented in Exhibit B.

The purpose of the TIA and VMT Analysis is to evaluate the potential on-site and off-site traffic impacts, identify short-term roadway and circulation needs, determine potential mitigation measures and identify any critical traffic issues that should be addressed in the on-going planning process.

Scenarios:

The following scenarios are requested:

1. Base Year 2021 (with Link and TAZ modifications)
2. Cumulative Year 2042 plus Project Select Zone (with Link and TAZ modifications)
3. Differences between model runs 2 and 1 above

Changes and/or additions to the Model Network or TAZ's

JLB reviewed the Kings CAG model network for the Base Year 2021 and Cumulative Year 2042. Based on this review, JLB requests the following link and TAZ network modifications. Details on the requested Link and TAZ modifications for Base Year 2021 and Cumulative Year 2042 are illustrated in Exhibit C.

LINK and TAZ MODIFICATIONS (Base Year 2021 Scenario Only):

1. Modify 10th Street as follows:
 - a. Between Hanford-Armona Avenue and 3rd Street
 - i. Decrease the number of lanes to 1 in each direction



www.JLBtraffic.com
info@JLBtraffic.com

516 W. Shaw Ave., Ste. 103
Fresno, CA 93704
(559) 570-8991

LINK and TAZ MODIFICATIONS (Base Year 2021 and Cumulative Year 2042 plus Project Select Zone Scenarios):

1. Eliminate existing TAZ connector between Node 752 and 10 ½ Avenue
2. Modify Hanford-Armona Avenue as follows:
 - a. Between Node 13557 and Node 10865
 - i. Decrease the speed limit to 40 MPH in both directions
 - b. Between Node 11294 and Node 11686
 - i. Decrease the speed limit to 40 MPH in both directions
3. Modify Houston Avenue as follows:
 - a. Between 12th Avenue and Node 11940
 - i. Increase the speed limit to 55 MPH in both directions
 - b. Between Node 11940 and Node 13572
 - i. Decrease the speed limit to 45 MPH in both directions
4. Modify 11th Avenue as follows:
 - a. Between Hume Avenue and Hanford-Armona Avenue
 - i. Decrease the speed limit to 40 MPH in both directions
5. Modify 10 ½ Avenue as follows:
 - a. Between Hanford-Armona Avenue and Node 10566
 - i. Decrease the speed limit to 35 MPH in both directions
6. Modify Irwin Avenue as follows:
 - a. Between Node 10566 and 3rd Street
 - i. Decrease the speed limit to 25 MPH in both directions
7. Modify Harris Street as follows:
 - a. Between Hanford-Armona Avenue and 3rd Street
 - i. Decrease the speed limit to 25 MPH in both directions
8. Modify 10th Street as follows:
 - a. Between Houston Avenue and Hanford-Armona Avenue
 - i. Increase the speed limit to 50 MPH in both directions
 - b. Between Hanford-Armona Avenue and 3rd Street
 - i. Increase the speed limit to 45 MPH in both directions

LINK and Project MODIFICATIONS (Cumulative Year 2042 plus Project Select Zone Scenario Only):

1. Modify Houston Avenue as follows:
 - a. Between 12th Avenue and 10th Avenue
 - i. Decrease the number of lanes to 1 in each direction
2. Create Orchard Avenue between 10 ½ Avenue and 10th Avenue.
 - a. Classification: Collector Roadway
 - b. Lanes: One lane in each direction
 - c. Speed: 35 mph

3. Create TAZ A (Northern Project) generally located on the southeast quadrant of Hanford-Armona Avenue and 10 ½ Avenue. Taz A shall have TAZ connectors to 10 ½ Avenue, Orchard Avenue and Hanford Armona Road.
4. Create TAZ B (Southern Project) generally located on the southeast quadrant of Hanford-Armona Avenue and 10 ½ Avenue. Taz B shall have TAZ connectors to 10 ½ Avenue and Orchard Avenue.

TAZ A (Northern Project) Trip Generation

The trip generation rates for the proposed Project were obtained from the 11th Edition of the Trip Generation Manual published by the Institute of Transportation Engineers (ITE). Table I presents the trip generation for TAZ A of the proposed Project with trip generation rates for 341 Single-Family Detached Housing units and a 4.9-acre public park. At buildout, TAZ A of proposed Project is estimated to generate 3,220 daily trips, 239 AM peak hour trips and 322 PM peak hour trips.

Table I: TAZ A (Northern Project) Trip Generation

Land Use (ITE Code)	Size	Unit	Daily		AM (7-9) Peak Hour					PM (4-6) Peak Hour						
			Rate	Total	Trip Rate	In	Out	In	Out	Total	Trip Rate	In	Out	In	Out	Total
						%	%									
Single-Family Detached Housing (210)	341	d.u.	9.43	3,216	0.70	26	74	62	177	239	0.94	63	37	202	119	321
Public Park (411)	4.9	Acres	0.78	4	0.02	59	41	0	0	0	0.11	55	54	1	0	1
Total Project Trips				3,220				62	177	239				203	119	322

Note: d.u. = Dwelling Units

TAZ B (Southern Project) Trip Generation

The trip generation rates for the proposed Project were obtained from the 11th Edition of the Trip Generation Manual published by the Institute of Transportation Engineers (ITE). Table II presents the trip generation for TAZ B of the proposed Project with trip generation rates for 102 Single-Family Detached Housing units. At buildout, TAZ B of the proposed Project is estimated to generate 961 daily trips, 71 AM peak hour trips and 96 PM peak hour trips.

Table II: TAZ B (Southern Project) Trip Generation

Land Use (ITE Code)	Size	Unit	Daily		AM (7-9) Peak Hour					PM (4-6) Peak Hour						
			Rate	Total	Trip Rate	In	Out	In	Out	Total	Trip Rate	In	Out	In	Out	Total
						%	%									
Single-Family Detached Housing (210)	102	d.u.	9.43	961	0.70	26	74	18	53	71	0.94	63	37	60	36	96
Total Project Trips				961				18	53	71				60	36	96

Note: d.u. = Dwelling Units

Vehicle Miles Traveled

It is requested that Kings CAG modeling consultant prepare a detailed VMT analysis for the Project. The proposed Project land use classification is Low Density Residential. Please report total regional VMT with the project and without the project in Word or Excel format.



Mr. Aronson – Kittelson & Associates, Inc.
Traffic Modeling Request (JLB Project No. 047-002)
January 18, 2022

Please feel welcome to contact me if you have any questions or require additional information. I can be reached by phone at (559) 869-4514, or via email at cayala@jlbtraffic.com.

Sincerely,



Carlos Ayala-Magana, EIT
JLB Traffic Engineering, Inc.

cc: Jose Luis Benavides, JLB Traffic Engineering, Inc.

Z:\01 Projects\047 Hanford\047-002 Lunaria TIA & VMT\Modeling\01 Model Request\L01182022 Model Request (047-002).docx



www.JLBtraffic.com
info@JLBtraffic.com

516 W. Shaw Ave., Ste. 103
Fresno, CA 93704
(559) 570-8991

Page | 4

Exhibit A – Project Site Aerial

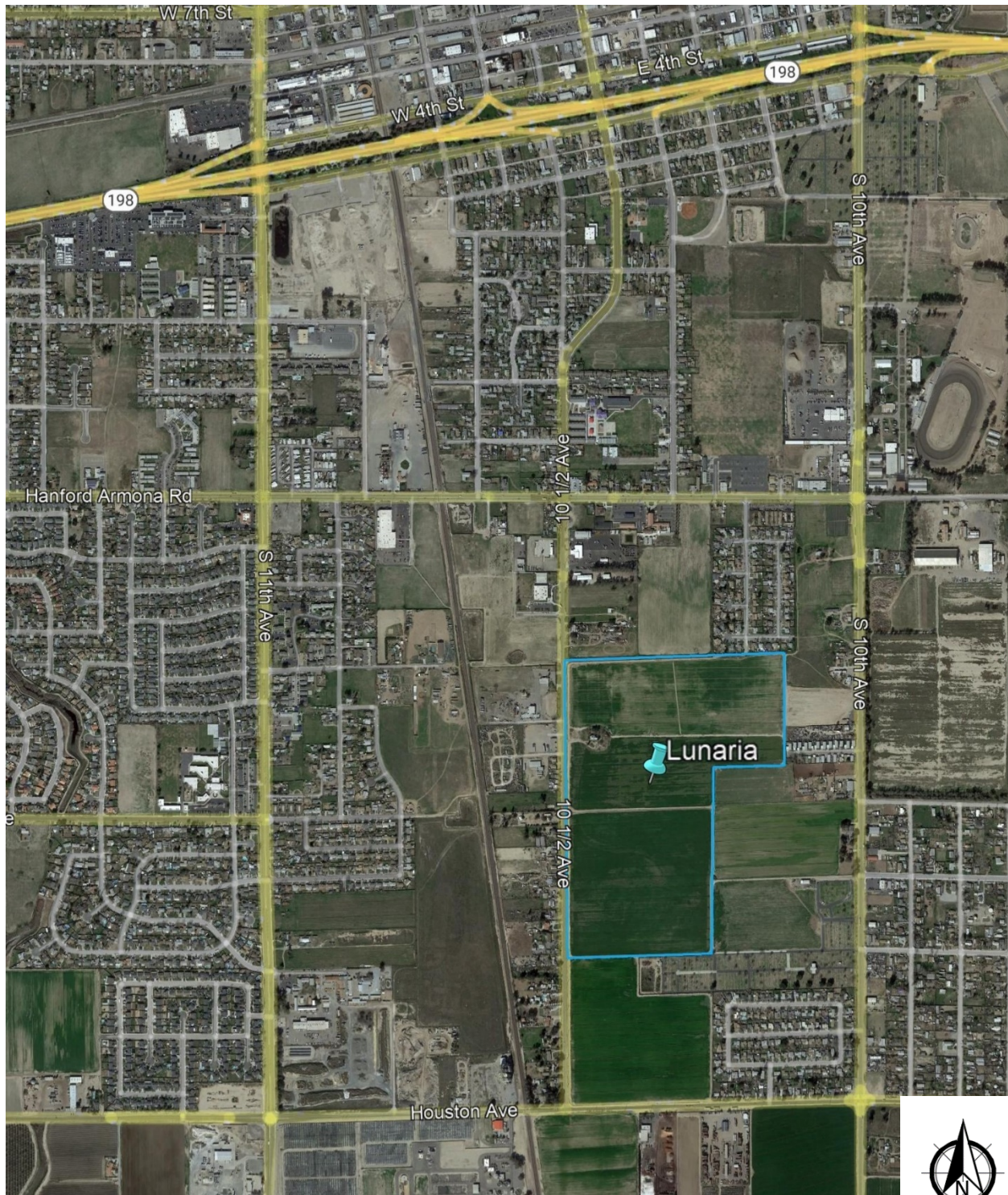
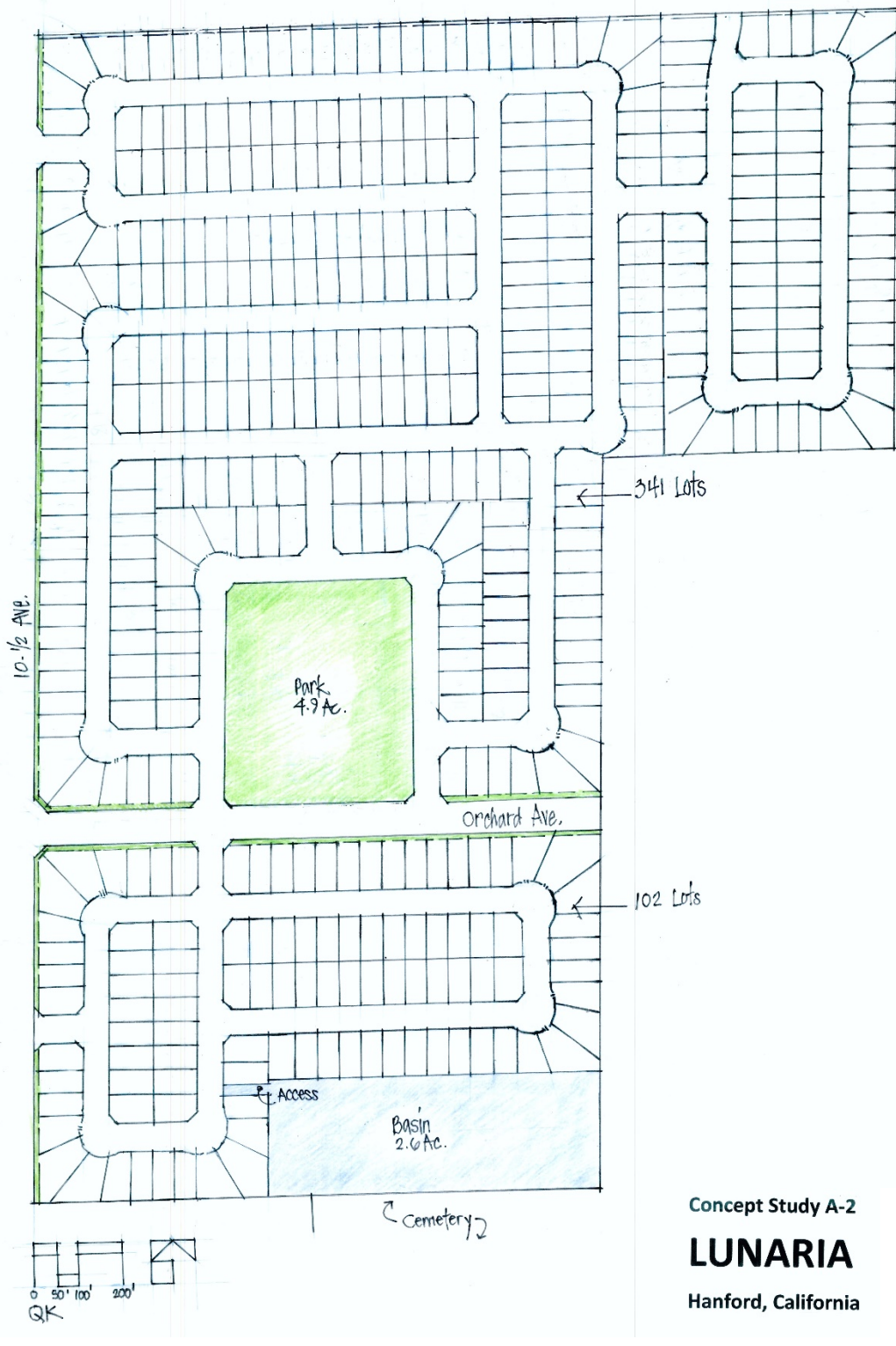

Exhibit B – Project Site Plan



Concept Study A-2

LUNARIA

Hanford, California



Exhibit C – Link and TAZ Modifications



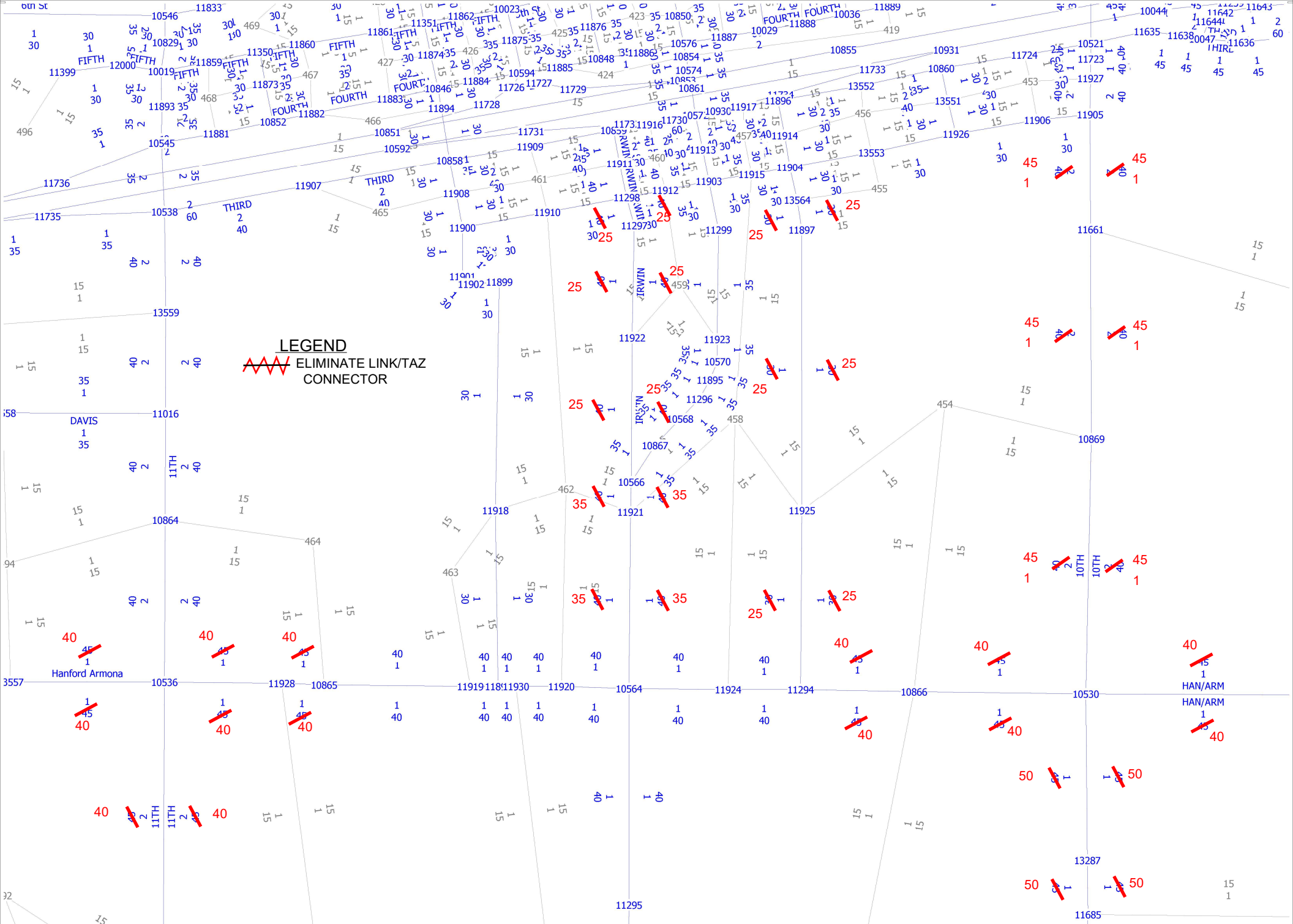

LEGEND
 ELIMINATE LINK/TAZ CONNECTOR

Base Year 2021
 Name, Lanes, Speed

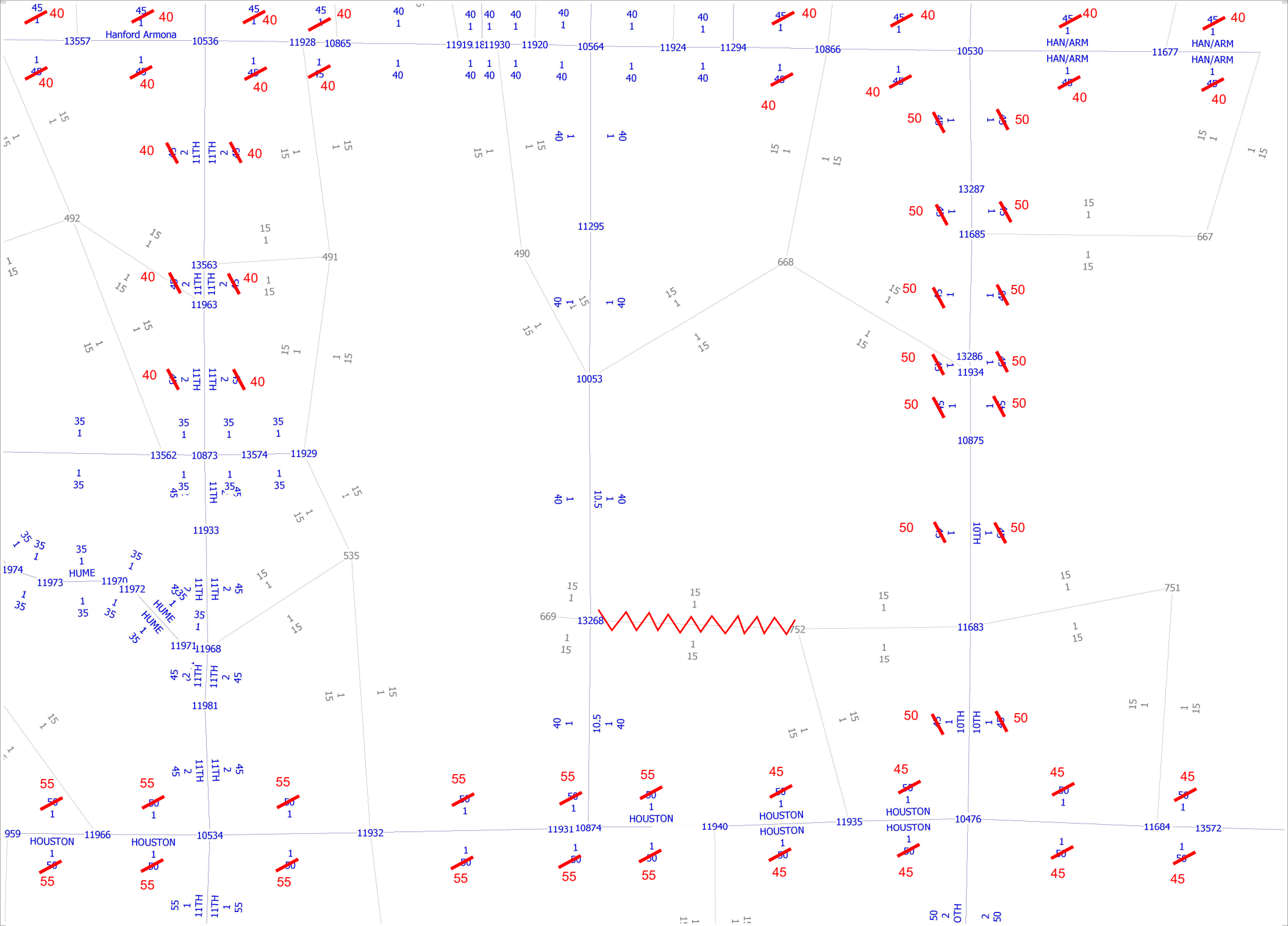

Base Year 2021
Name, Lanes, Speed



(Licensed to JLB Traffic Engineering, Inc)

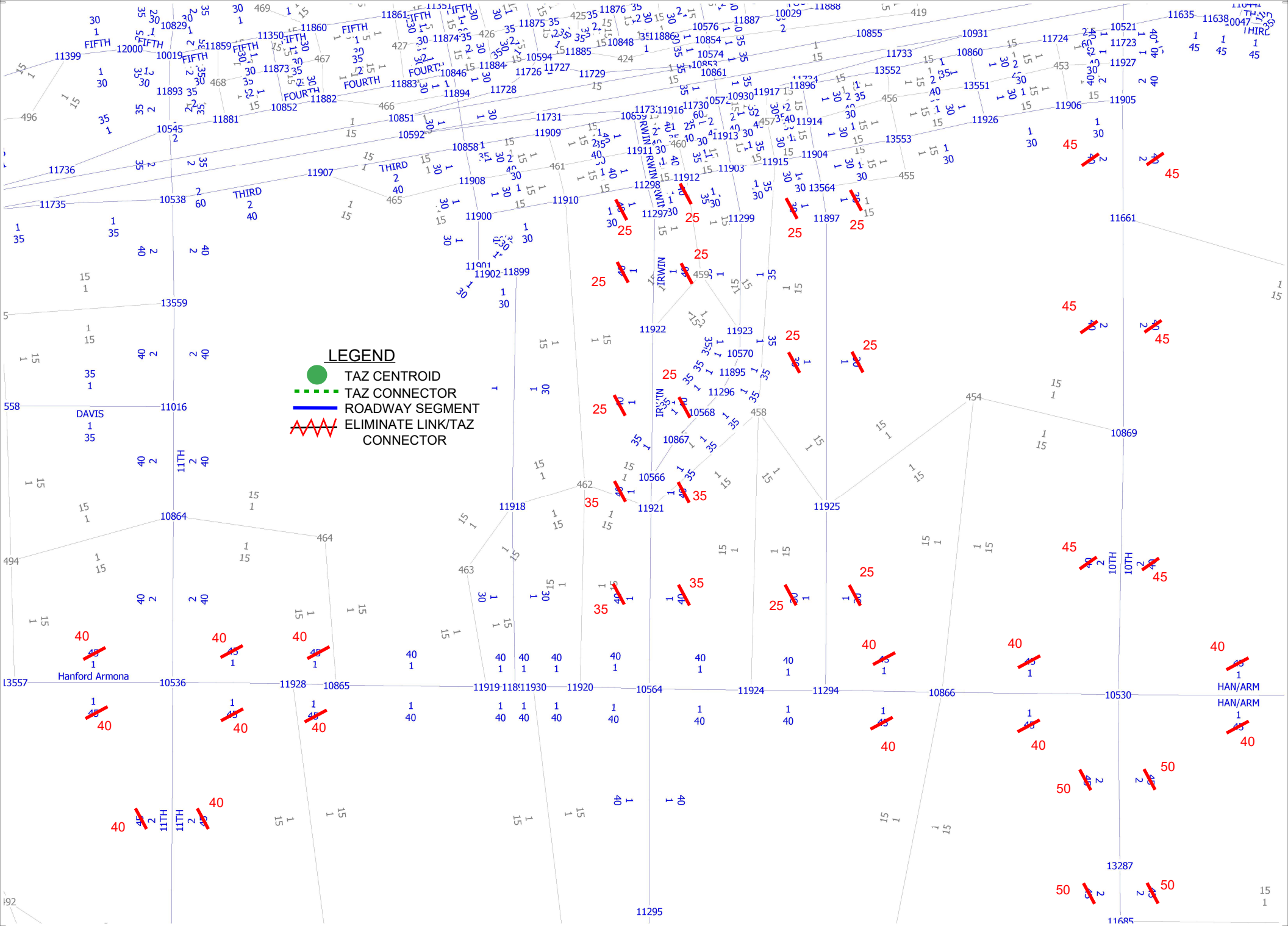

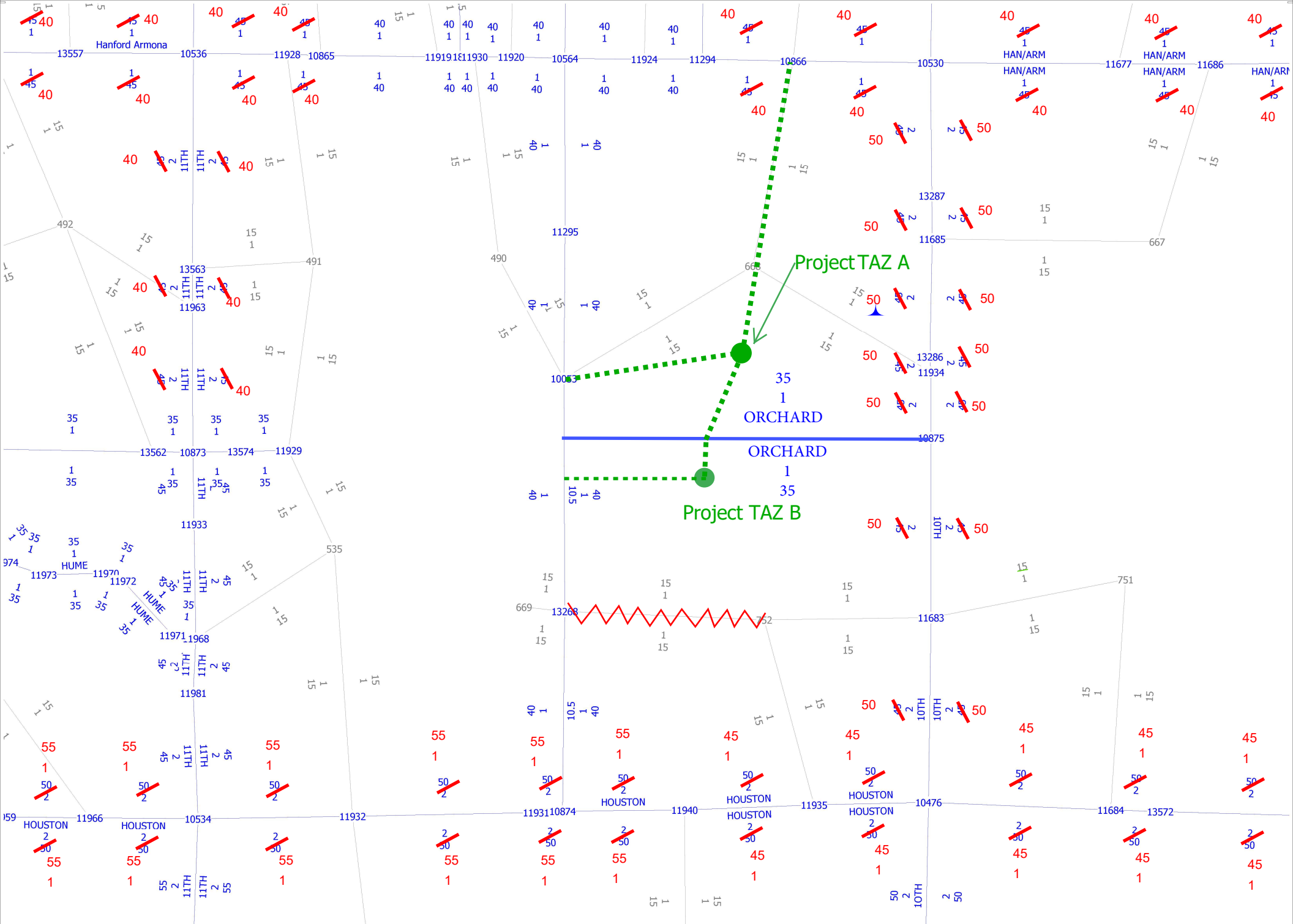

Cumulative Year 2042
Name, Lanes, Speed

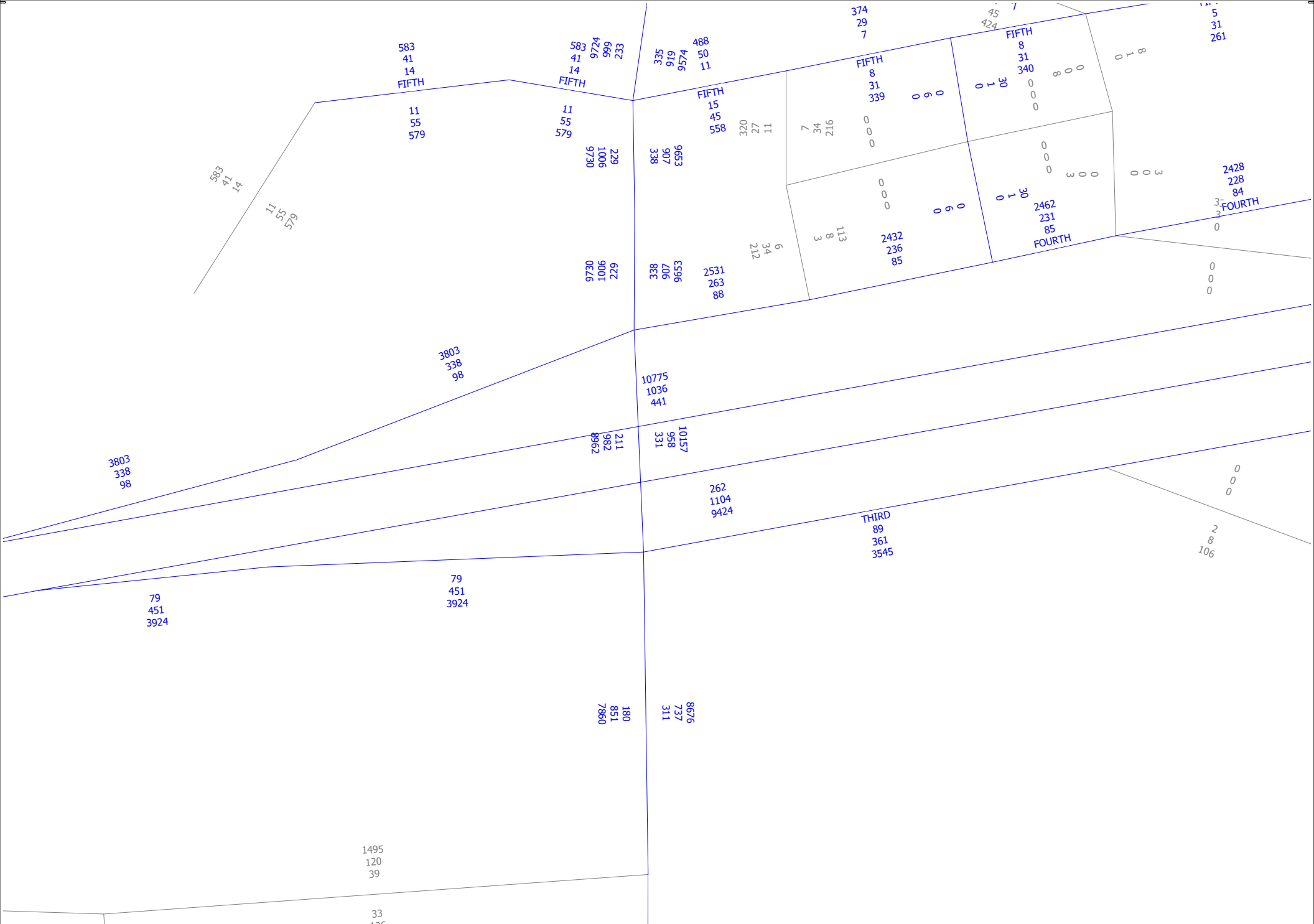

Lunaria TIA
 Base Year 2021
 AM, PM and Daily Volumes

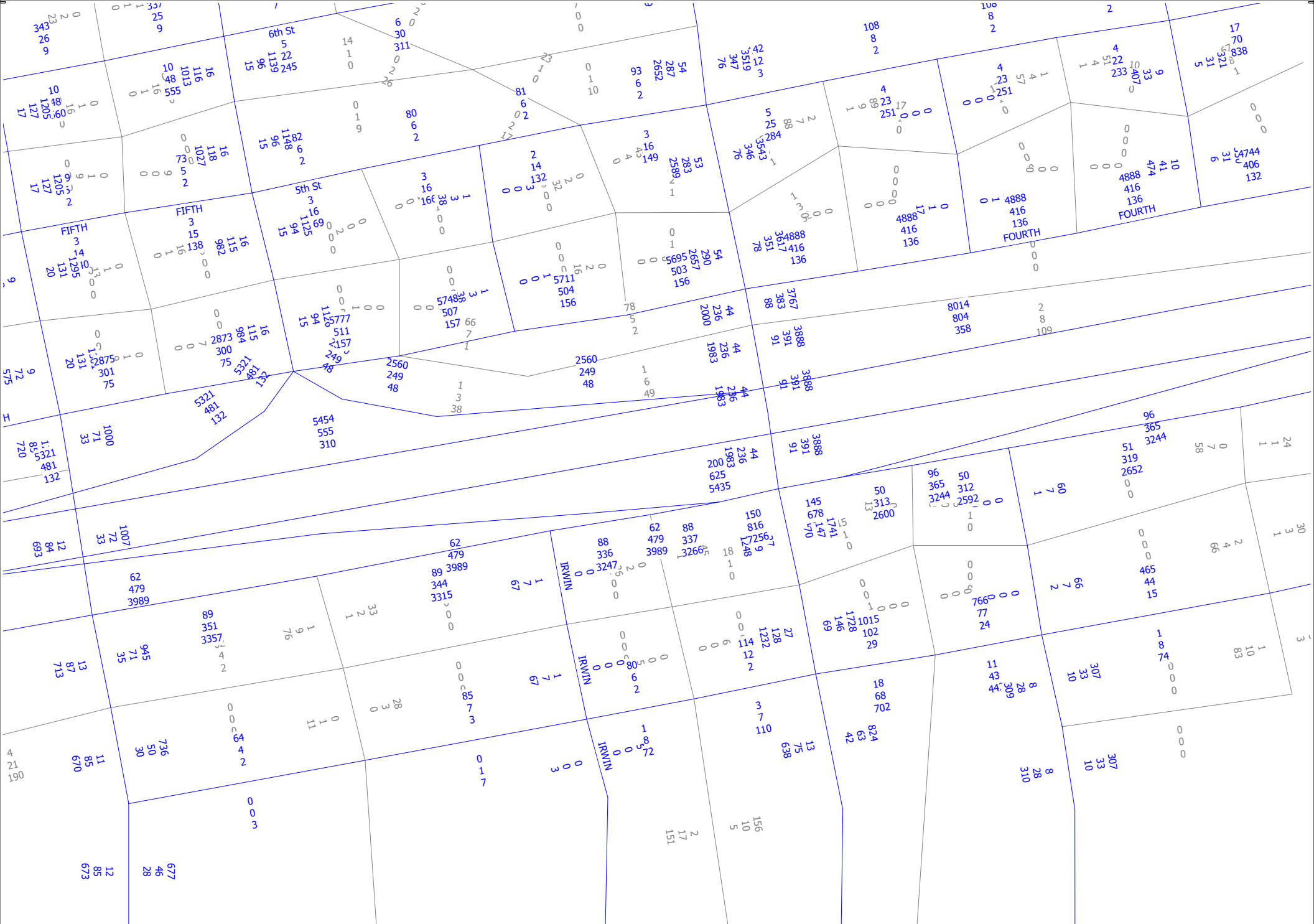

Lunaria TIA
 Base Year 2021
 AM, PM and Daily Volumes

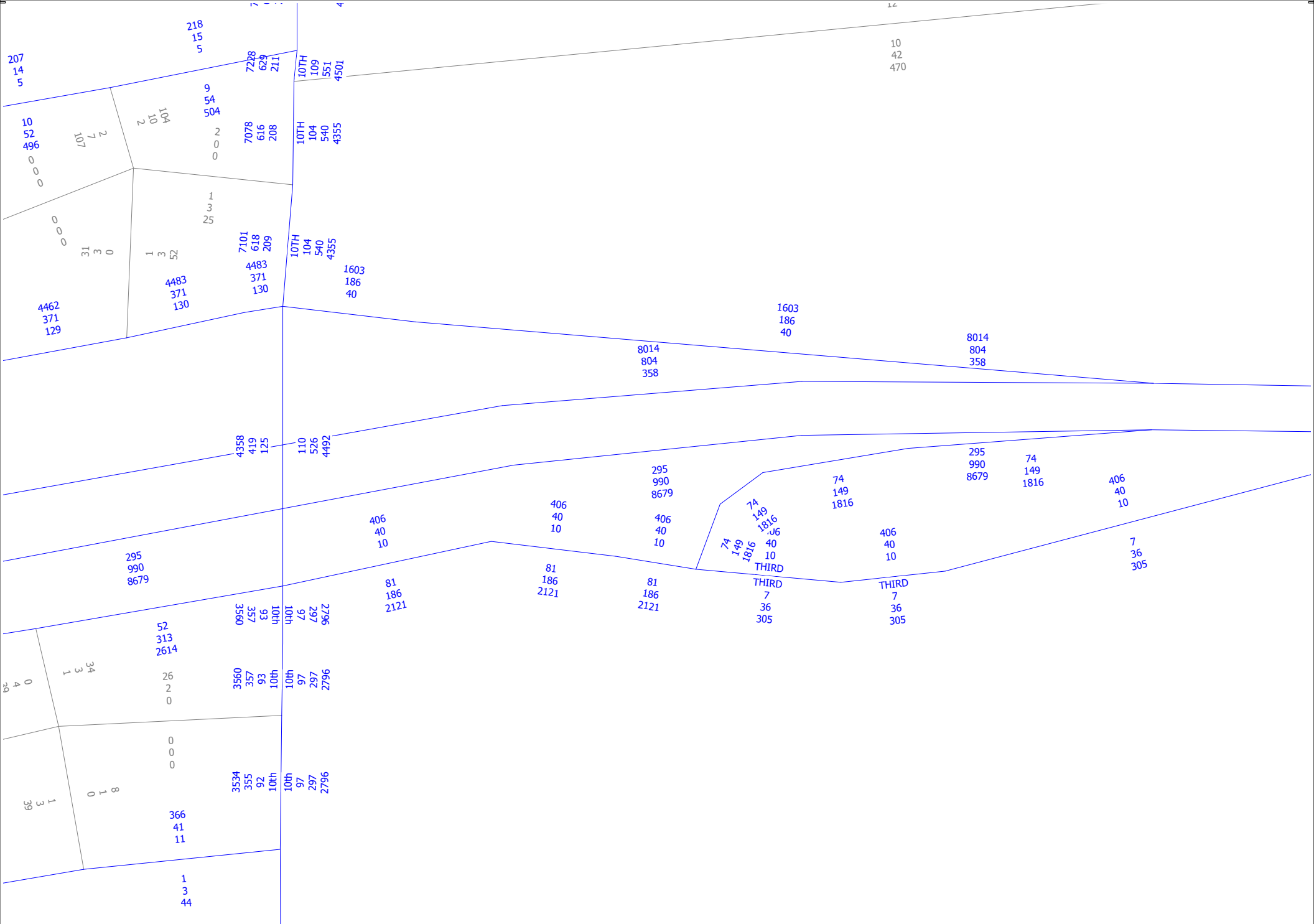

Lunaria TIA
 Base Year 2021
 AM, PM and Daily Volumes



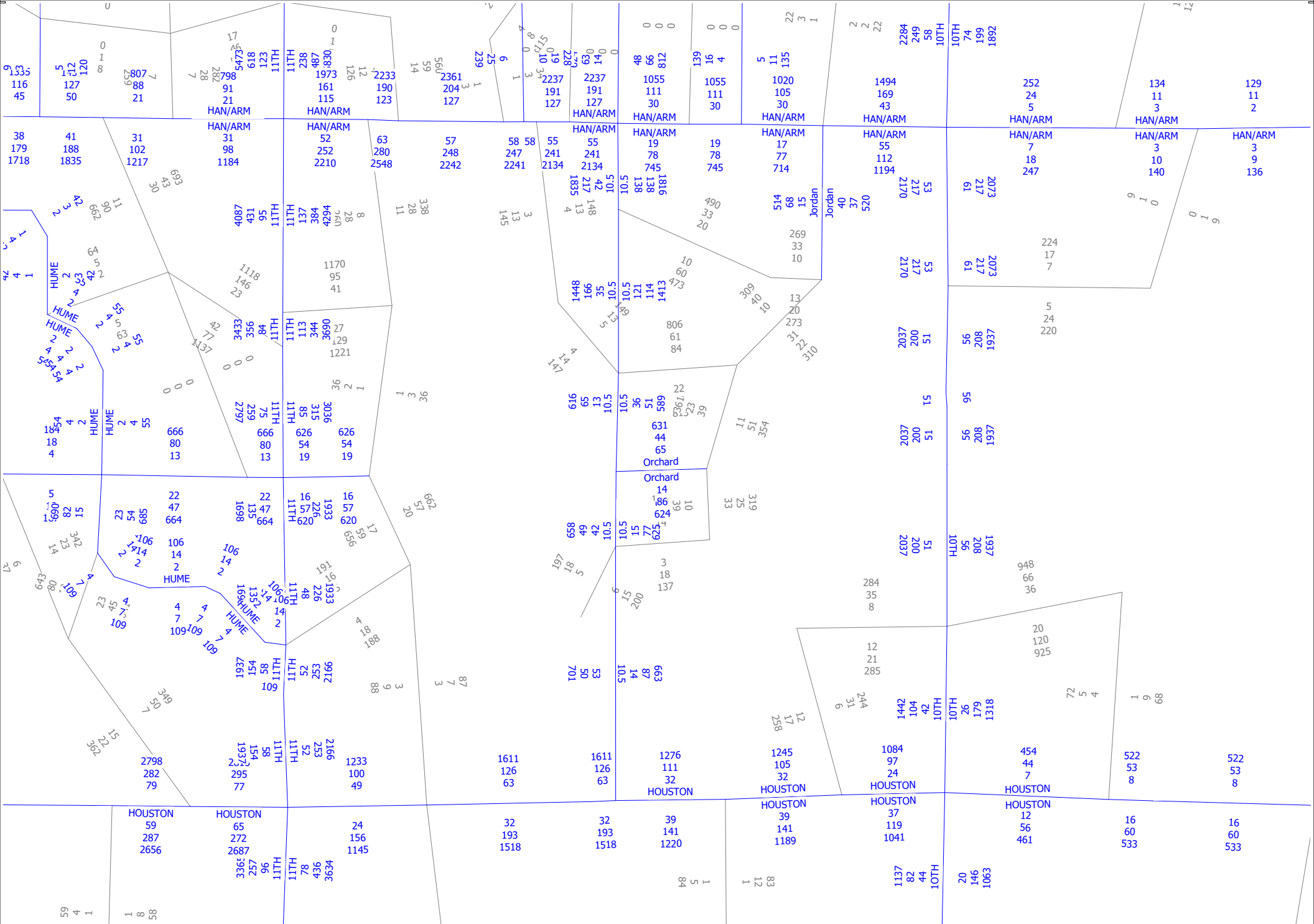

Lunaria TIA
 Base Year 2021
 AM, PM and Daily Volumes



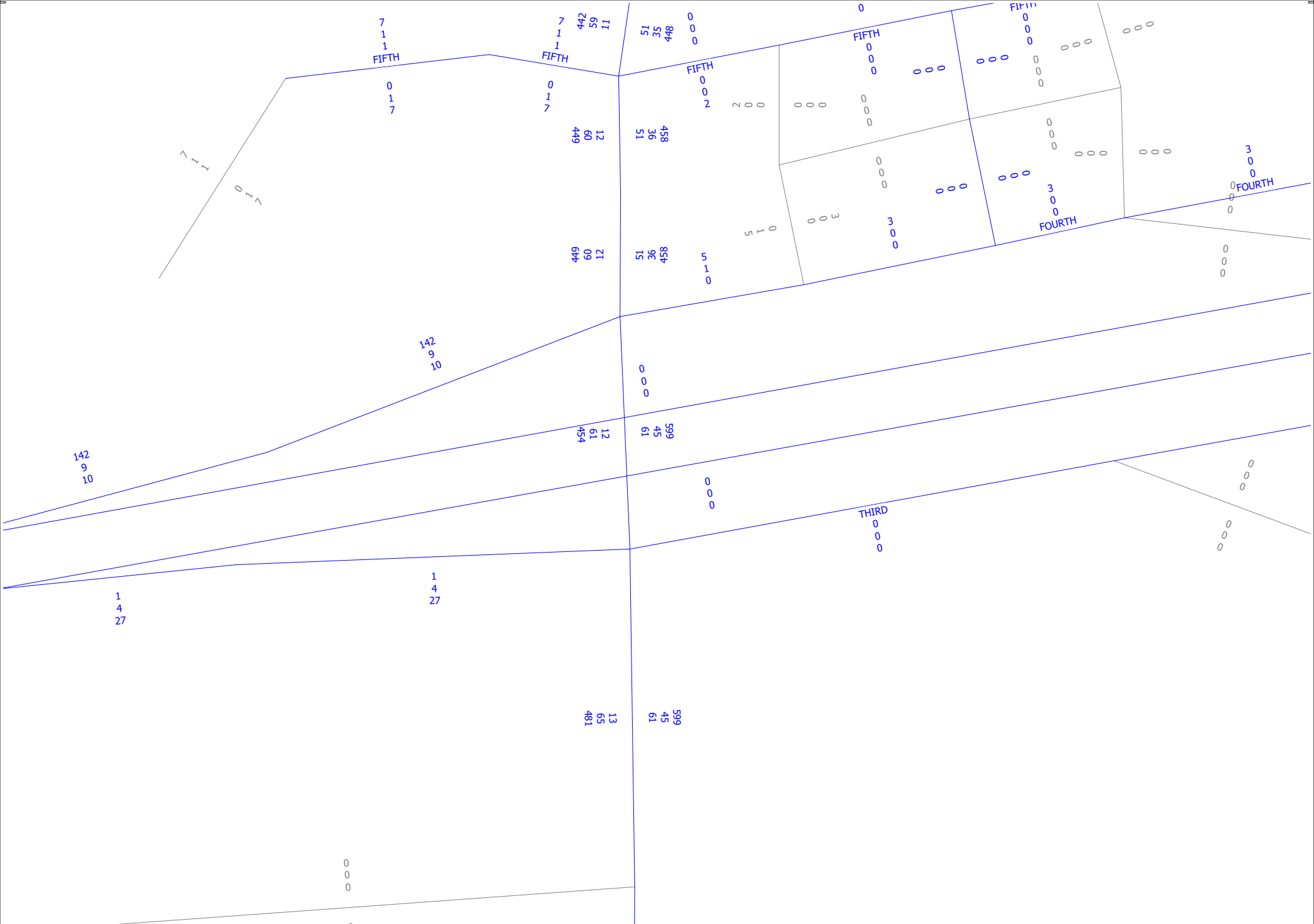

Lunaria TIA
 Project Only Trips (2021)
 AM, PM and Daily Volumes





Lunaria TIA
 Project Only Trips (2021)
 AM, PM and Daily Volumes

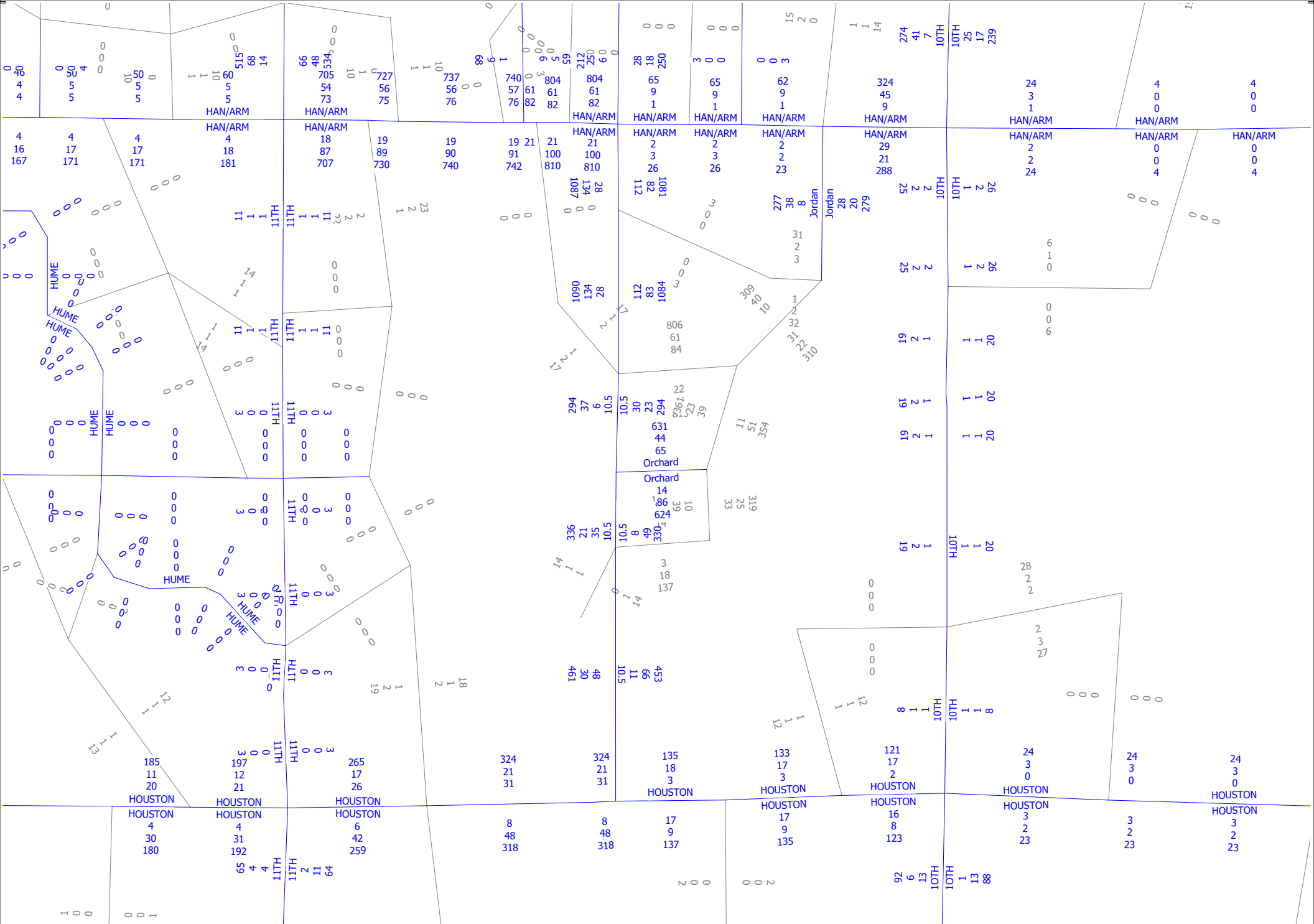

Lunaria TIA
 Project Only Trips (2021)
 AM, PM and Daily Volumes

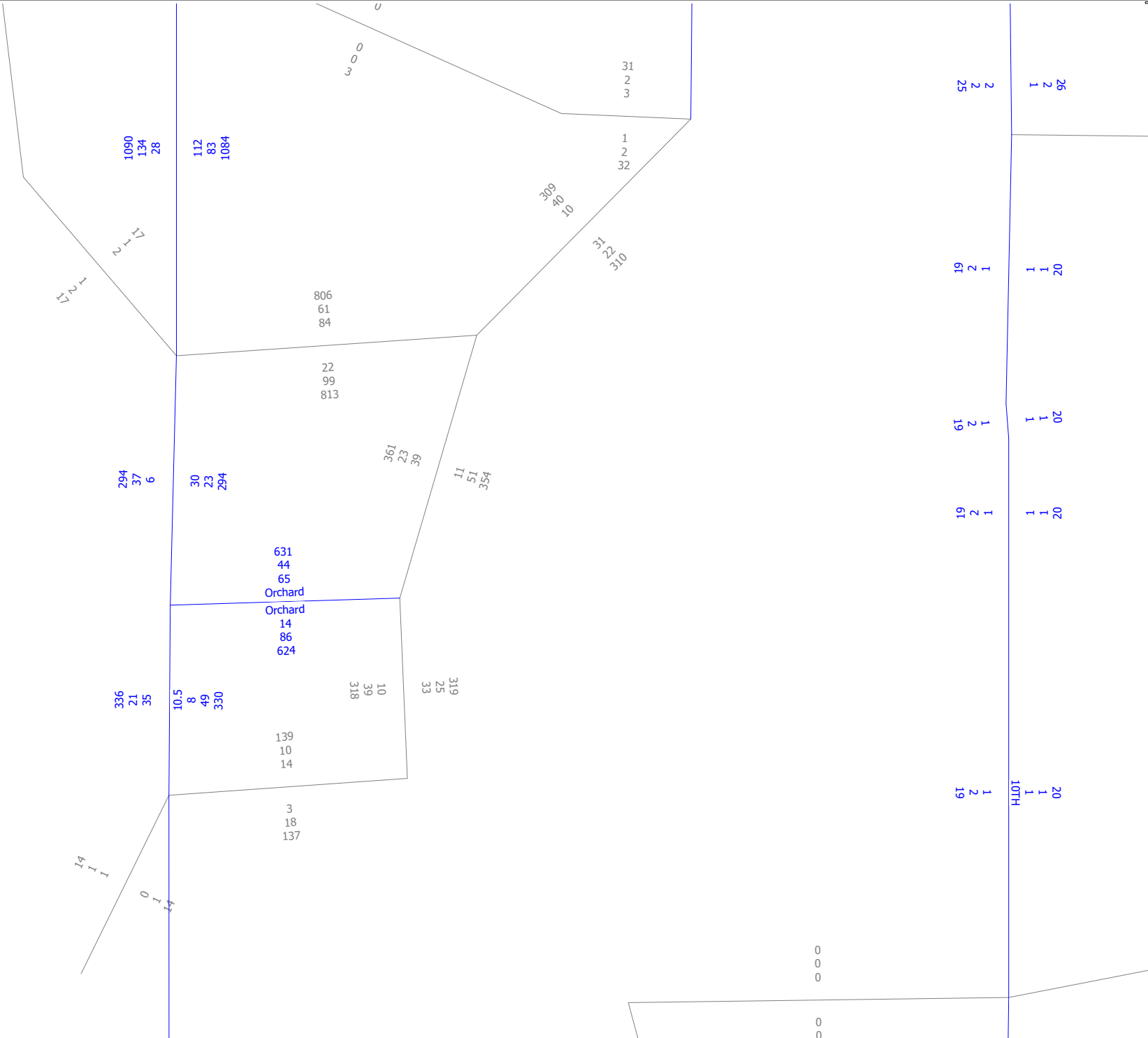

Lunaria TIA
 Project Only Trips (2021)
 AM, PM and Daily Volumes



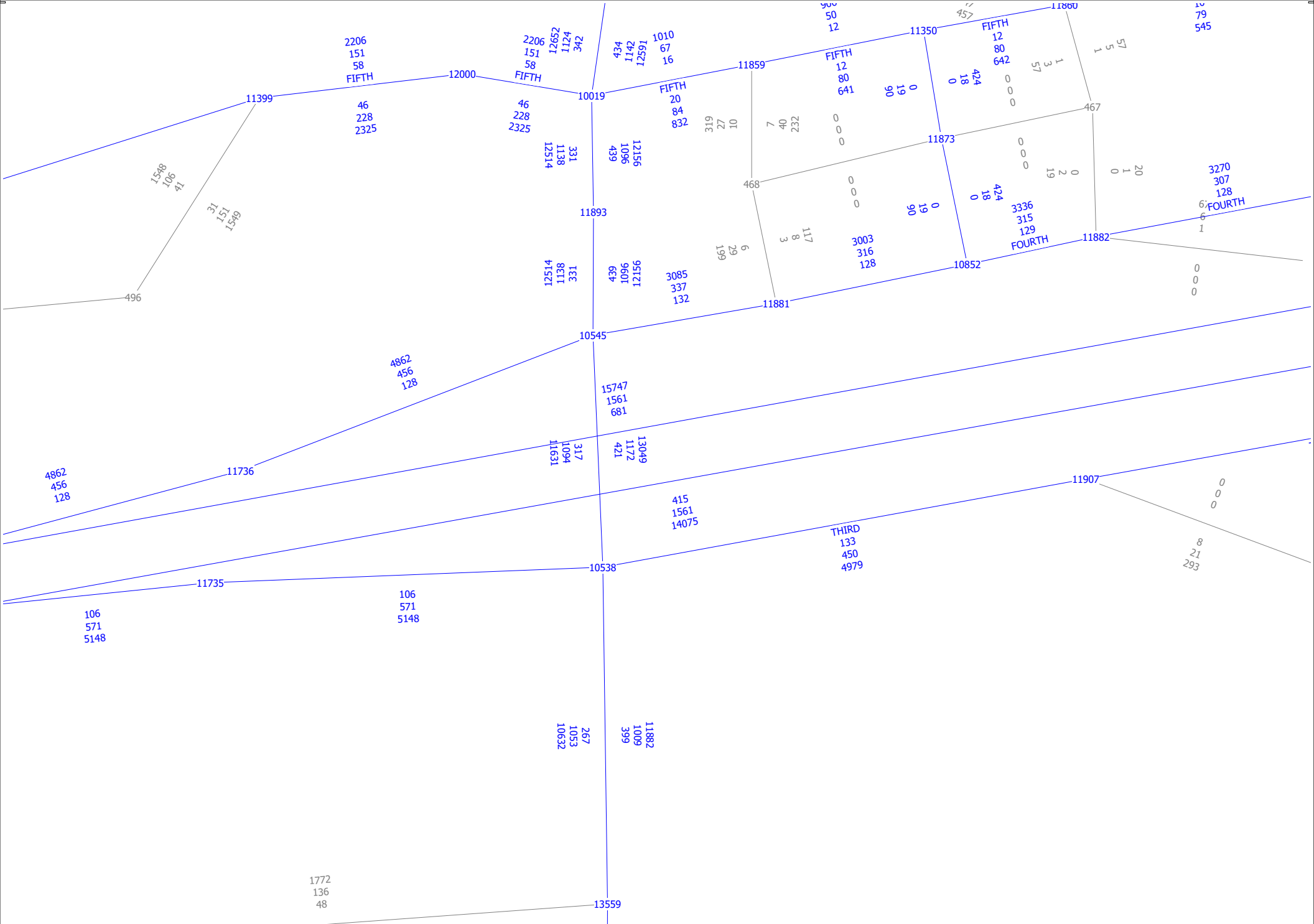

Lunaria TIA
 Cumulative Year 2042
 AM, PM and Daily Volumes



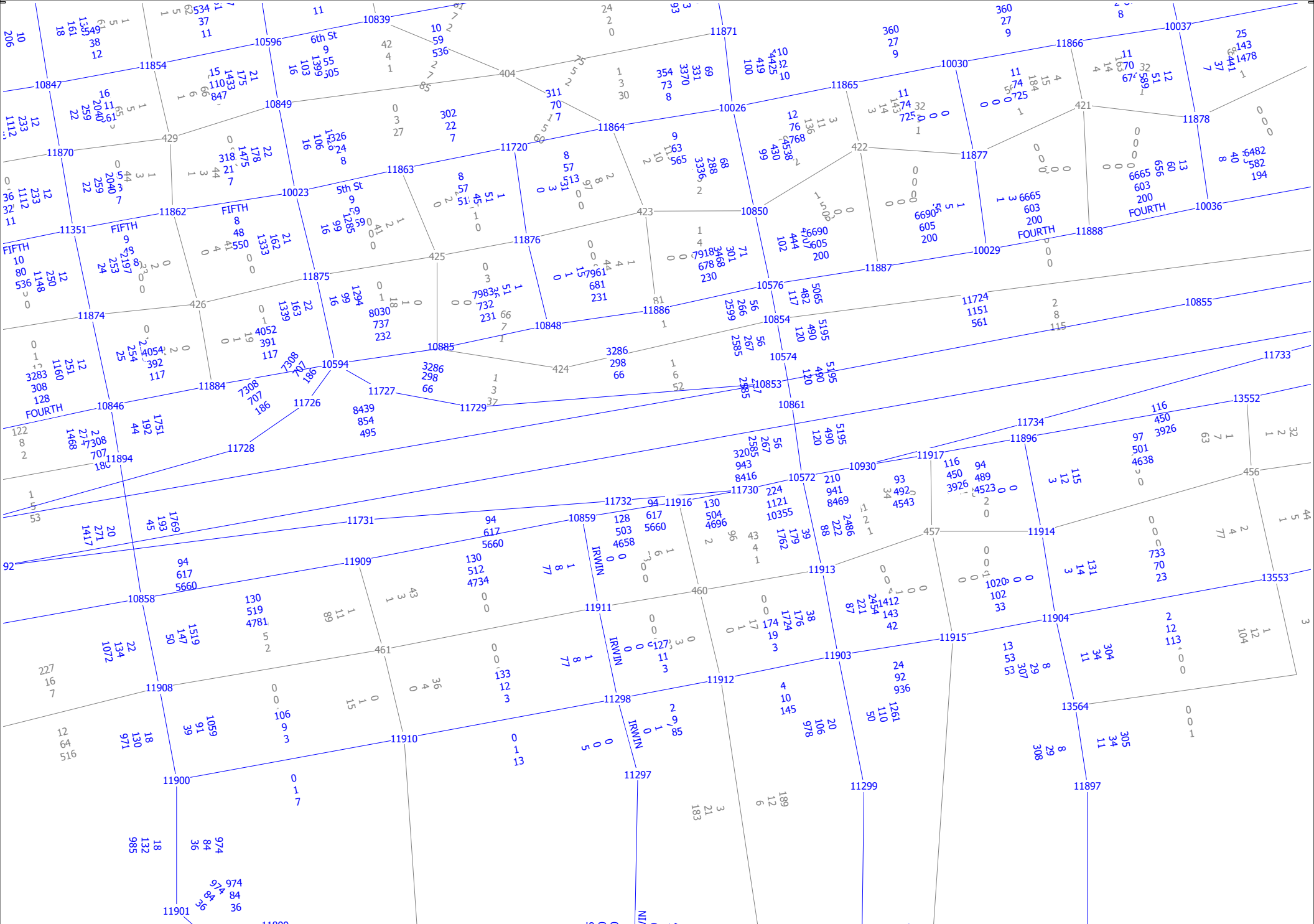

Lunaria TIA
 Cumulative Year 2042
 AM, PM and Daily Volumes

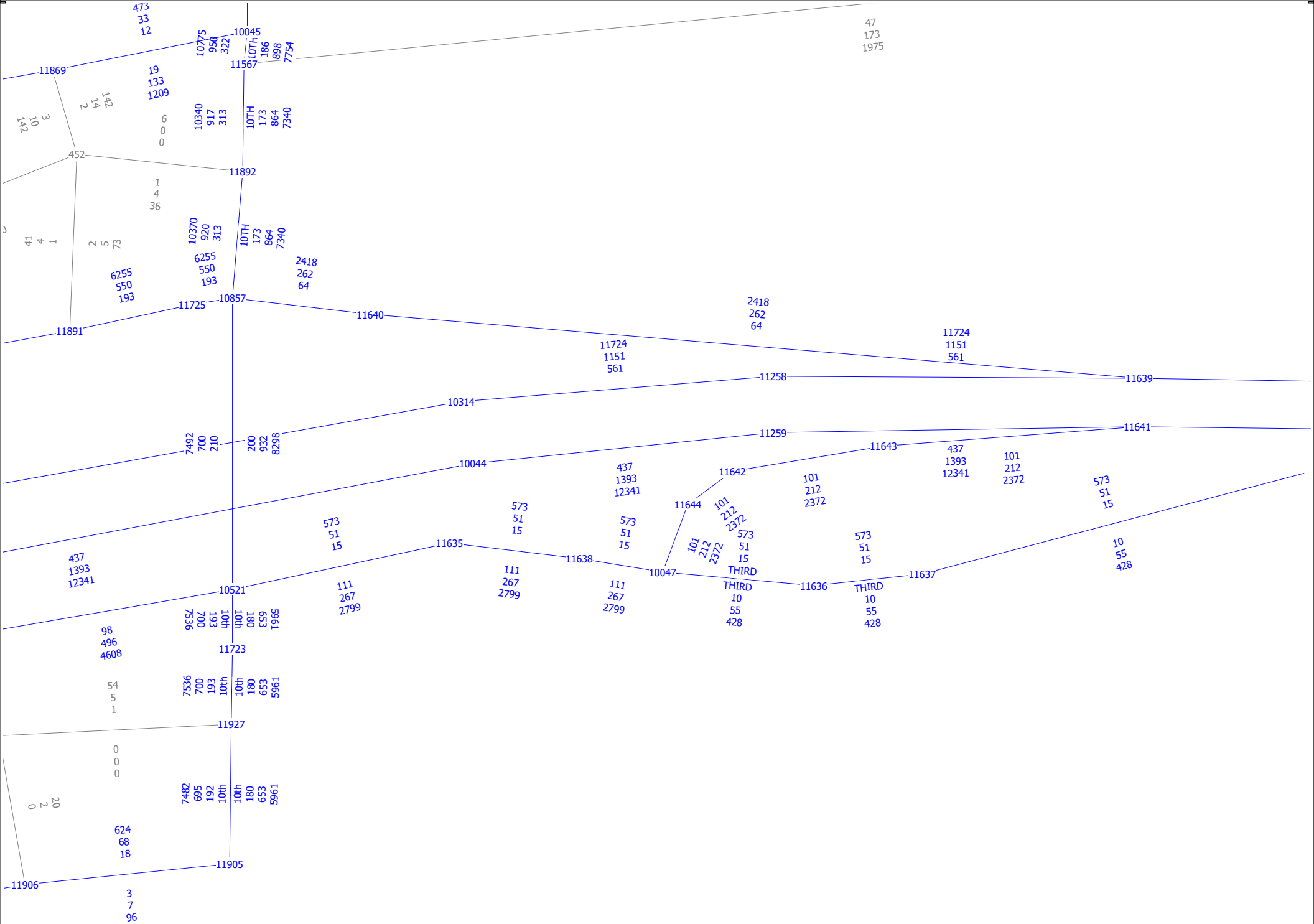

Lunaria TIA
 Cumulative Year 2042
 AM, PM and Daily Volumes



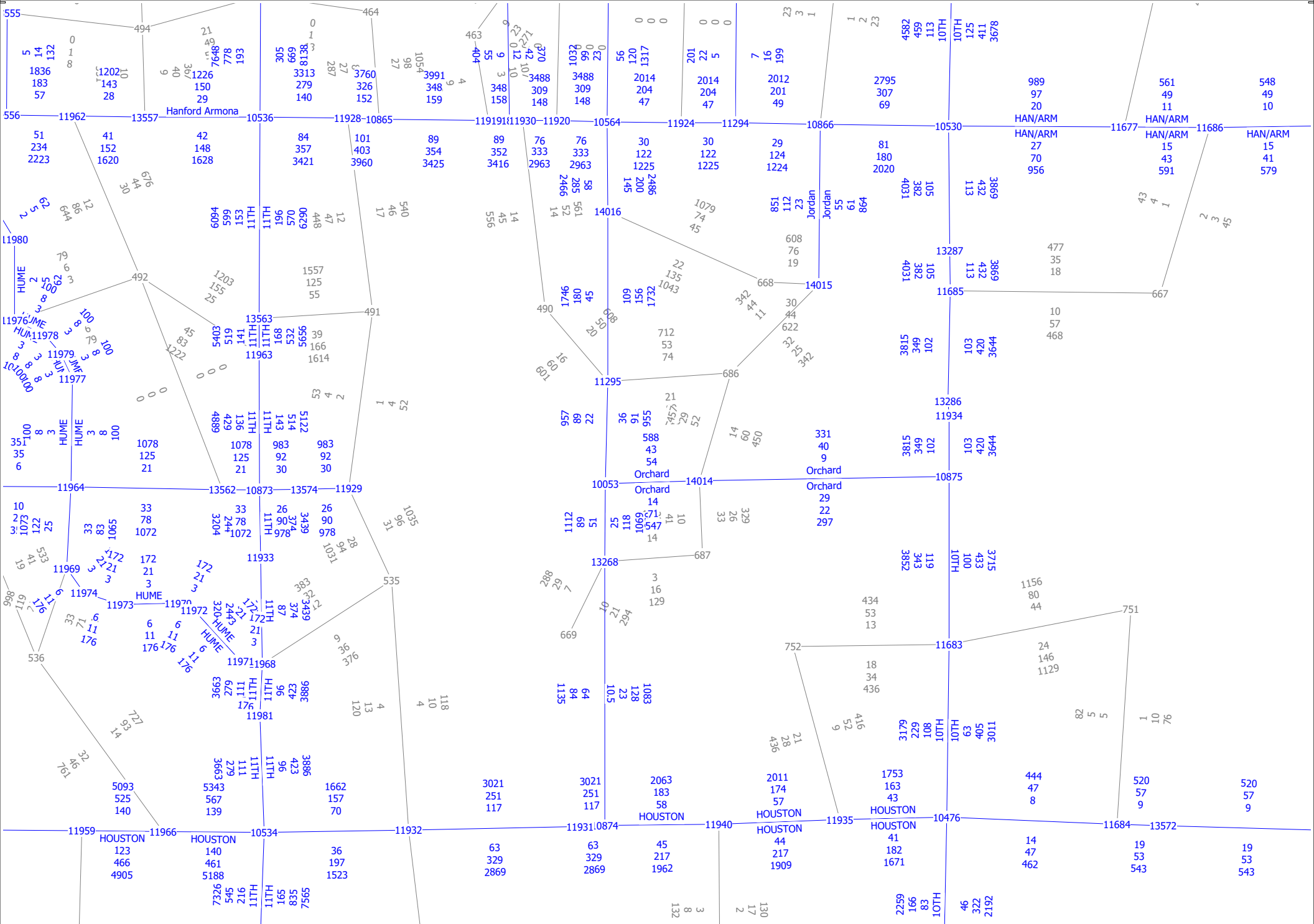

Lunaria TIA
 Cumulative Year 2042
 AM, PM and Daily Volumes

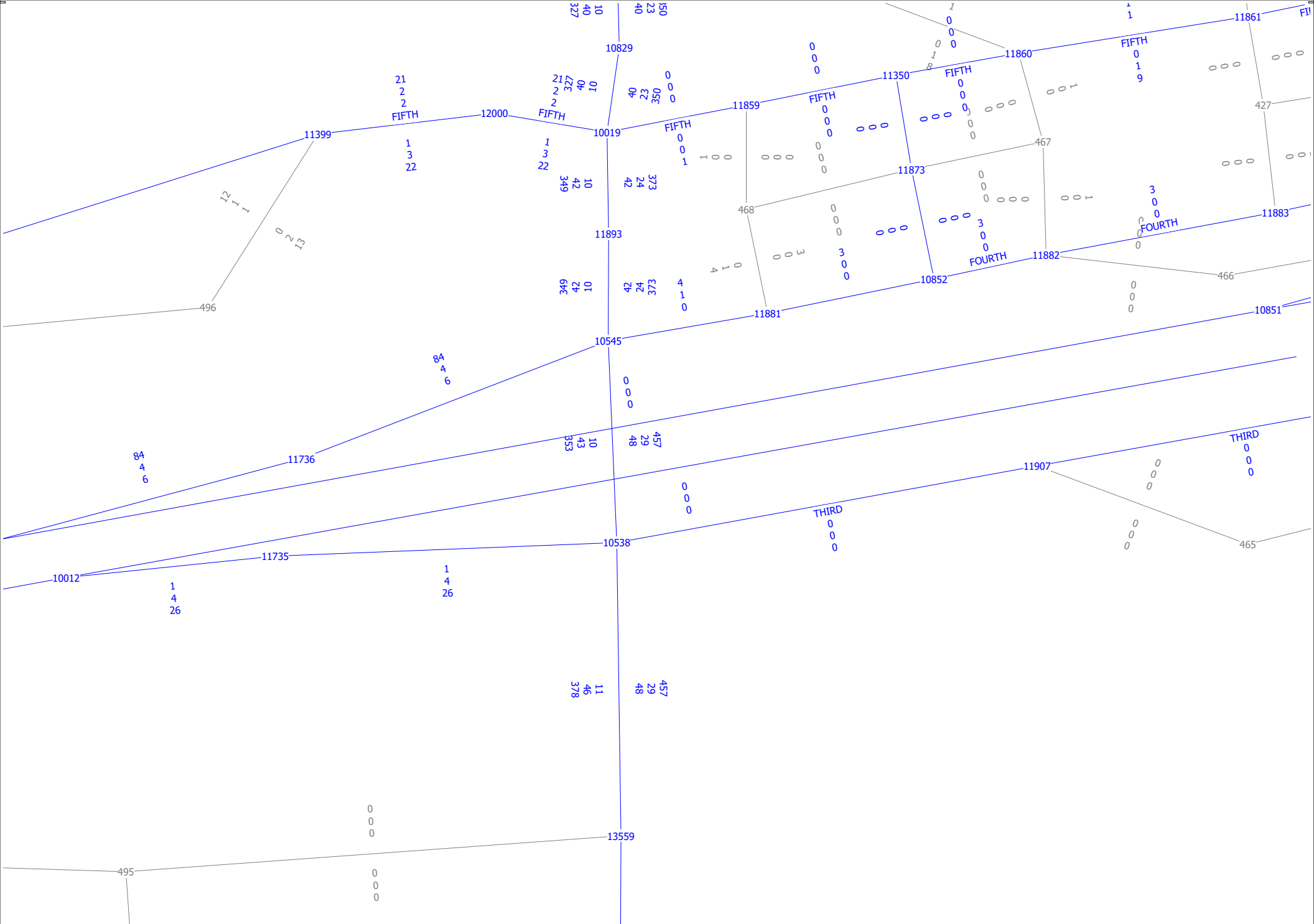

Lunaria TIA
 Project Only Trips (2042)
 AM, PM and Daily Volumes



Lunaria TIA
Project Only Trips (2042)
AM, PM and Daily Volumes



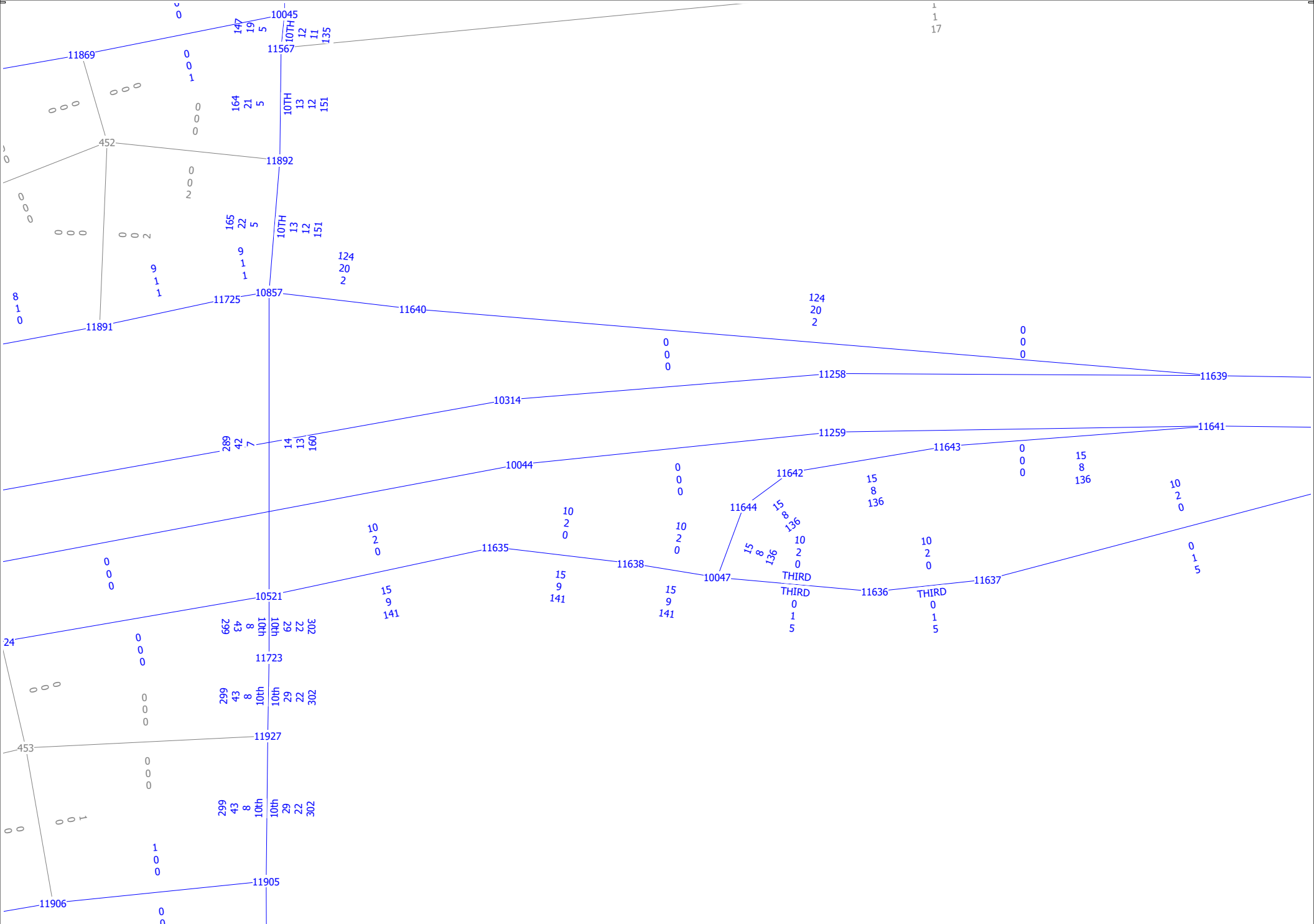

Lunaria TIA
 Project Only Trips (2042)
 AM, PM and Daily Volumes



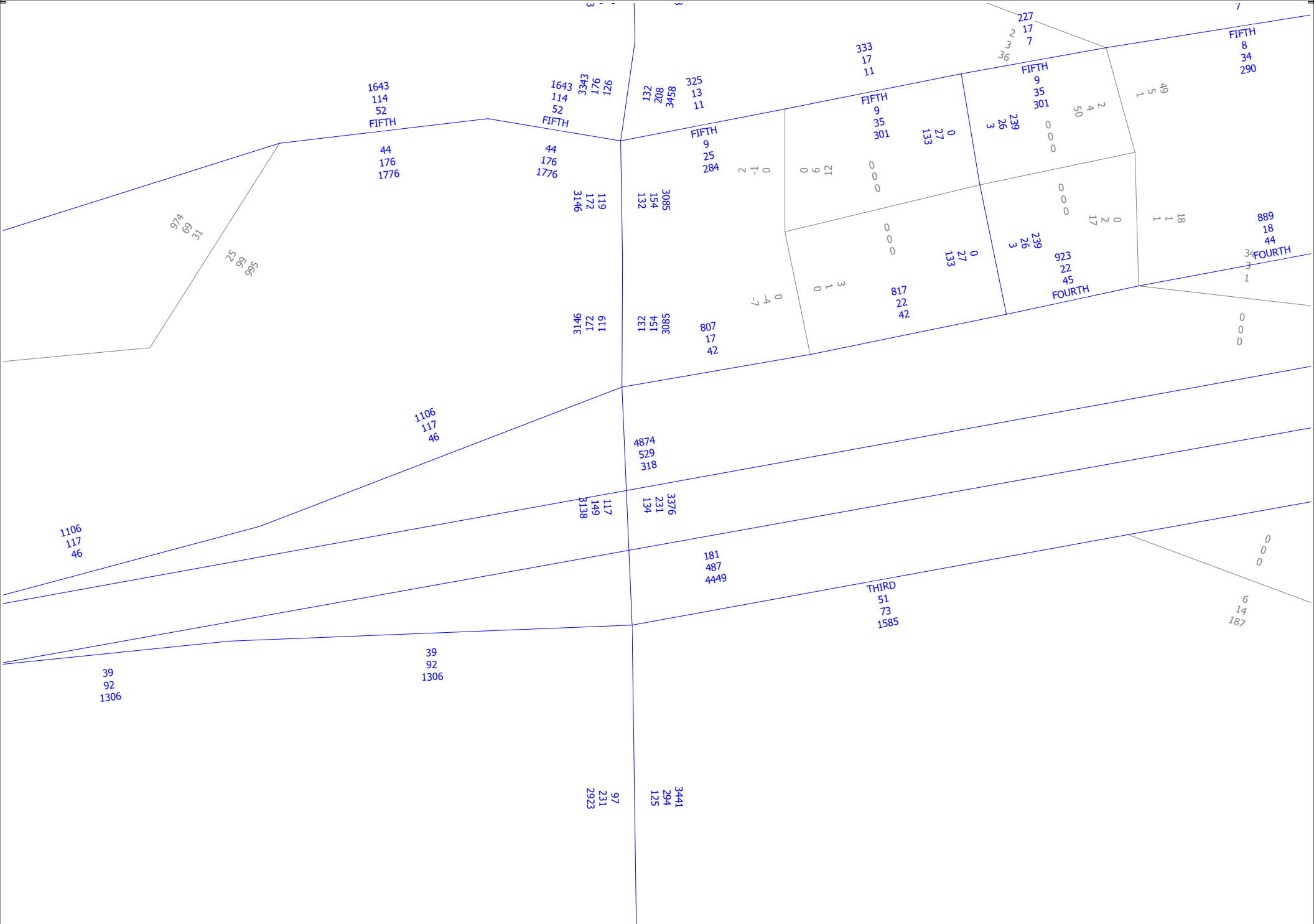

Lunaria TIA
 2042 Increment
 AM, PM and Daily Volumes

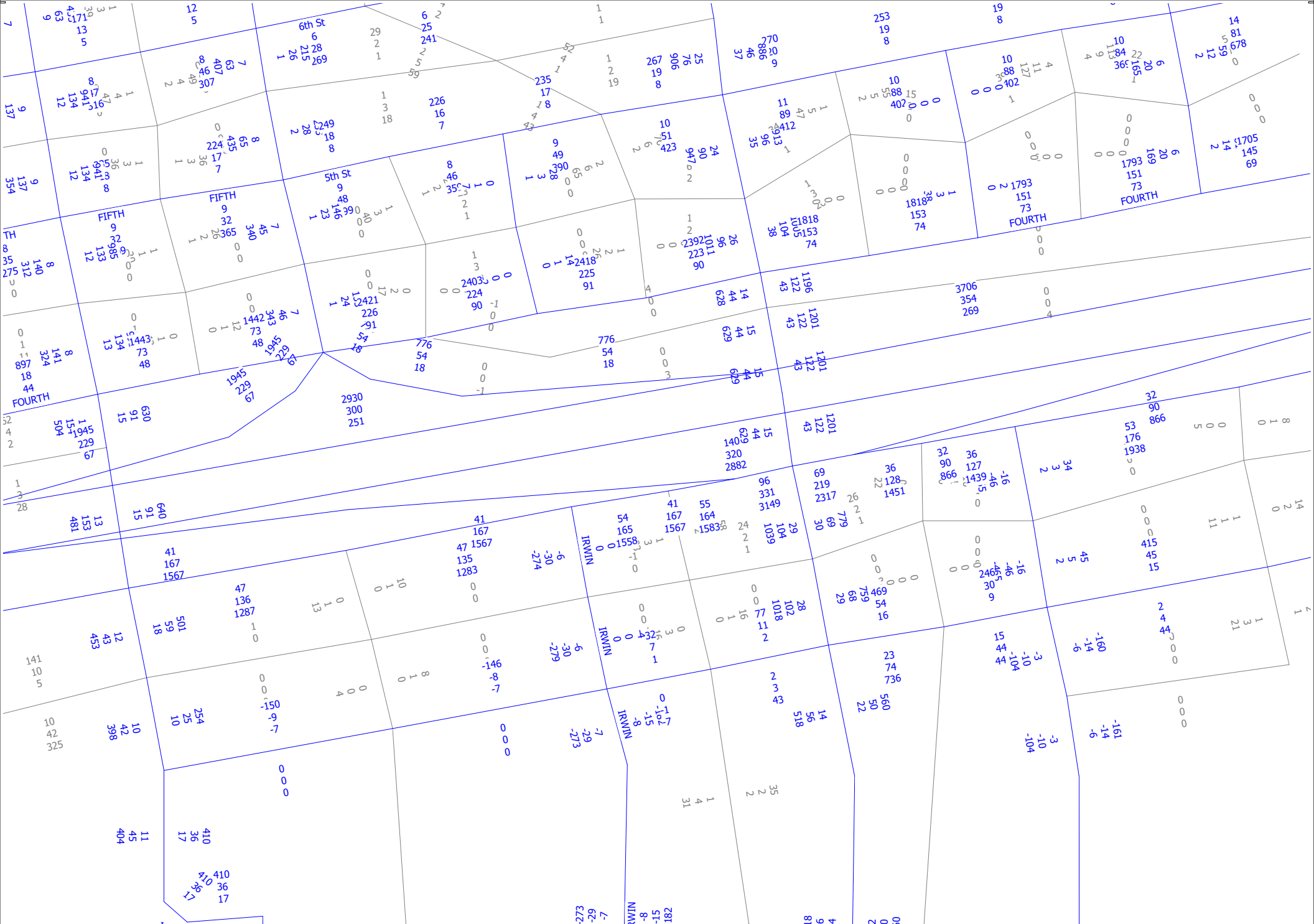

Lunaria TIA
 2042 Increment
 AM, PM and Daily Volumes

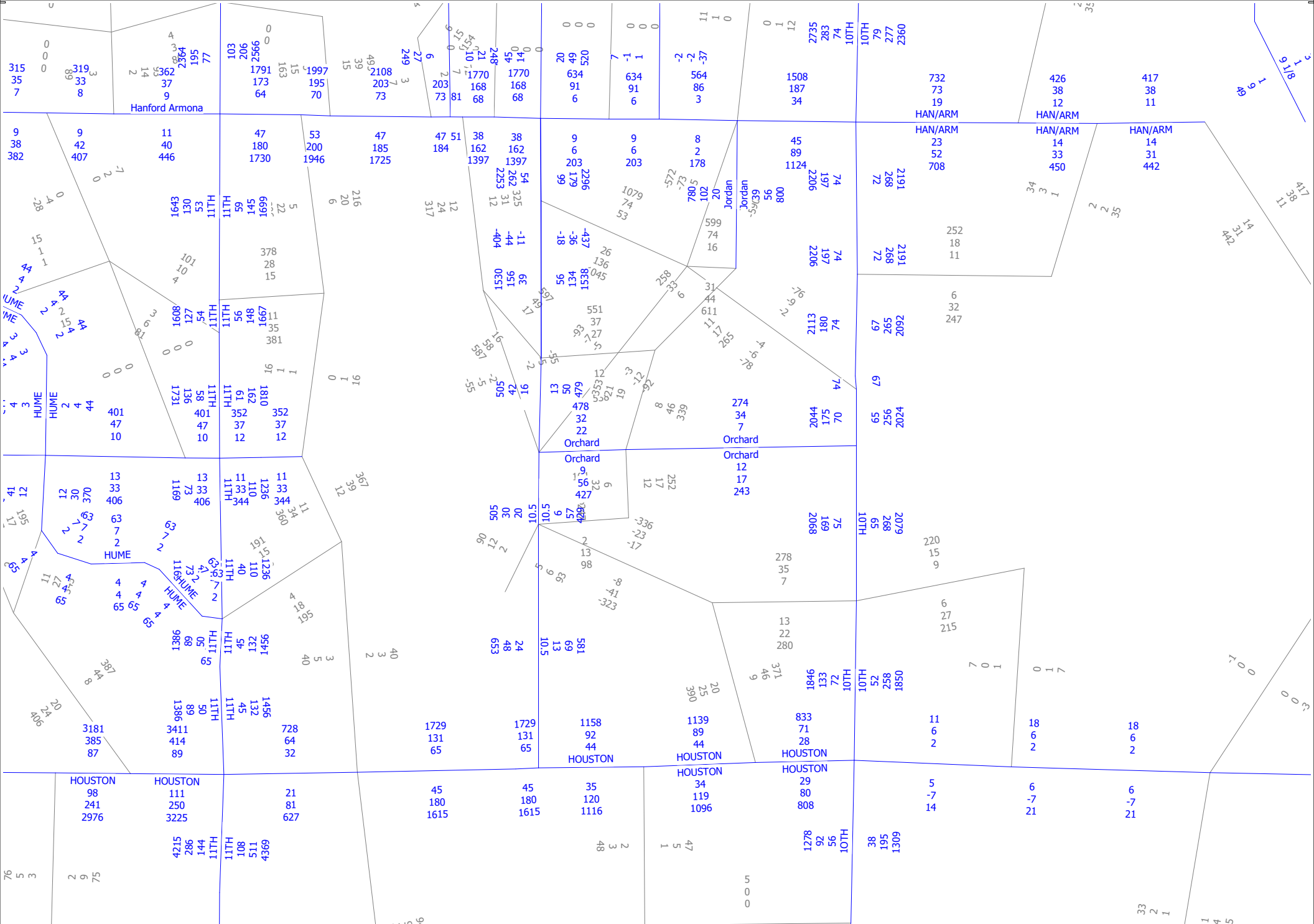

Lunaria TIA
 2042 Increment
 AM, PM and Daily Volumes



Appendix D: Methodology



www.JLBtraffic.com
info@JLBtraffic.com

516 W. Shaw Ave., Ste. 103
Fresno, CA 93704
(559) 570-8991

A p p | D

Levels of Service Methodology

The description and procedures for calculating capacity and level of service (LOS) are found in the Transportation Research Board, Highway Capacity Manual (HCM). The HCM 6th Edition represents the research on capacity and quality of service for transportation facilities.

Quality of service requires quantitative measures to characterize operational conditions within a traffic stream. Level of service is a quality measure describing operational conditions within a traffic stream, generally in terms of such service measures as speed and travel time, freedom to maneuver, traffic interruptions, comfort and convenience.

Six levels of service are defined for each type of facility that has analysis procedures available. Letters designate each level of service (LOS), from A to F, with LOS A representing the best operating conditions and LOS F the worst. Each LOS represents a range of operating conditions and the driver's perception of these conditions. Safety is not included in the measures that establish an LOS.

Intersection Levels of Service

One of the more important elements limiting and often interrupting the flow of traffic on a highway is the intersection. Flow on an interrupted facility is usually dominated by points of fixed operation such as traffic signals, stop signs and yield signs.

Signalized Intersections – Performance Measures

For signalized intersections, the performance measures include automobile volume-to-capacity ratio, automobile delay, queue storage length, ratio of pedestrian delay, pedestrian circulation area, pedestrian perception score, bicycle delay and bicycle perception score. LOS is also considered a performance measure. For the automobile mode, the average control delay per vehicle per approach is determined for the peak hour. A weighted average of control delay per vehicle is then determined for the intersection. An LOS designation is given to the weighted average control delay to better describe the level of operation. A description of LOS for signalized intersections is found in Table A-1.

Table A-1: Signalized Intersection Levels of Service Description (Automobile Mode)

<i>Level of Service</i>	<i>Description</i>	<i>Average Control Delay (Seconds per Vehicle)</i>
A	Operations with a control delay of 10 seconds/vehicle or less and a volume-to-capacity ratio no greater than 1.0. This level is typically assigned when the volume-to-capacity ratio is really low and either progression is exceptionally favorable or the cycle length is very short. If it's due to favorable progression, most vehicles arrive during the green indication and travel through the intersection without stopping.	≤10
B	Operations with control delay between 10.1 to 20.0 seconds/vehicle and a volume-to-capacity ratio no greater than 1.0. This level is typically assigned when the volume-to-capacity ratio is low and either progression is highly favorable or the cycle length is short. More vehicles stop than with LOS A.	>10.0 to 20.0
C	Operations with average control delays between 20.1 to 35.0 seconds/vehicle and a volume-to-capacity ratio no greater than 1.0. This level is typically assigned when the volume-to-capacity ratio no greater than 1.0, the progression is favorable or the cycle length is moderate. Individual cycle failures (i.e., one or more queued vehicles are not able to depart as a result of insufficient capacity during the cycle) may begin to appear at this level. The number of vehicles stopping is significant, although many vehicles still pass through the intersection without stopping.	>20 to 35
D	Operations with control delay between 35.1 to 55.0 seconds/vehicle and a volume-to-capacity ratio no greater than 1.0. This level is typically assigned when the volume-to-capacity ratio is high and either progression is ineffective or the cycle length is long. Many vehicles stop and individual cycle failures are noticeable.	>35 to 55
E	Operations with control delay between 55.1 to 80.0 seconds/vehicle and a volume-to-capacity ratio no greater than 1.0. This level is typically assigned when the volume-to-capacity ratio is high, progression is unfavorable and the cycle length is long. Individual cycle failures are frequent.	>55 to 80
F	Operations with unacceptable control delay exceeding 80.0 seconds/vehicle and a volume-to-capacity ratio greater than 1.0. This level is typically assigned when the volume-to-capacity ratio is very high, progression is very poor and the cycle length is long. Most cycles fail to clear the queue.	>80

Note: Source: Highway Capacity Manual 6th Edition

Unsignalized Intersections

The HCM 6th Edition procedures use control delay as a measure of effectiveness to determine level of service. Delay is a measure of driver discomfort, frustration, fuel consumption and increased travel time. The delay experienced by a motorist is made up of a number of factors that relate to control, traffic and incidents. Total delay is the difference between the travel time actually experienced and the reference travel time that would result during base conditions, i.e., in the absence of traffic control, geometric delay, any incidents and any other vehicles. Control delay is the increased time of travel for a vehicle approaching and passing through an unsignalized intersection, compared with a free-flow vehicle if it were not required to slow or stop at the intersection.



www.JLBtraffic.com
info@JLBtraffic.com

516 W. Shaw Ave., Ste. 103
Fresno, CA 93704
(559) 570-8991

All-Way Stop Controlled Intersections

All-way stop controlled intersections are a form of traffic controls in which all approaches to an intersection are required to stop. Similar to signalized intersections, at all-way stop controlled intersections the average control delay per vehicle per approach is determined for the peak hour. A weighted average of control delay per vehicle is then determined for the intersection as a whole. In other words, the delay measured for all-way stop controlled intersections is a measure of the average delay for all vehicles passing through the intersection during the peak hour. An LOS designation is given to the weighted average control delay to better describe the level of operation.

Two-Way Stop Controlled Intersections

Two-way stop controlled (TWSC) intersections in which stop signs are used to assign the right-of-way, are the most prevalent type of intersection in the United States. At TWSC intersections the stop-controlled approaches are referred to as the minor street approaches and can be either public streets or private driveways. The approaches that are not controlled by stop signs are referred to as the major street approaches.

The capacity of movements subject to delay are determined using the "critical gap" method of capacity analysis. Expected average control delay based on movement volume and movement capacity is calculated. An LOS for a TWSC intersection is determined by the computed or measured control delay for each minor movement. LOS is not defined for the intersection as a whole for three main reasons: (a) major-street through vehicles are assumed to experience zero delay; (b) the disproportionate number of major-street through vehicles at the typical TWSC intersection skews the weighted average of all movements, resulting in a very low overall average delay from all vehicles; and (c) the resulting low delay can mask important LOS deficiencies for minor movements. Table A-2 provides a description of LOS at unsignalized intersections.

Table A-2: Unsignalized Intersection Levels of Service Description (Automobile Mode)

<i>Control Delay (Seconds per Vehicle)</i>	<i>LOS by Volume-to-Capacity Ratio</i>	
	<i>v/c ≤ 1.0</i>	<i>v/c > 1.0</i>
≤10	A	F
>10 to 15	B	F
>15 to 25	C	F
>25 to 35	D	F
>35 to 50	E	F
>50	F	F

Note: Source: HCM 6th Edition, Exhibit 20-2.



www.JLBtraffic.com
info@JLBtraffic.com

516 W. Shaw Ave., Ste. 103
Fresno, CA 93704
(559) 570-8991

Roundabout Controlled Intersections

Roundabouts are intersections with a generally circular shape, characterized by yield on entry and circulation around a central island. Roundabouts have been used successfully throughout the world and are being used increasingly in the United States, especially since 1990. The procedure used to calculate LOS incorporates a combination of lane-based regression models and gap acceptance models for both single-lane and multi-lane roundabouts. As a result, the capacity models focus on one entry of a roundabout at a time. Table A-3 provides a description of LOS at roundabout intersections.

Table A-3: Roundabout Intersection Level of Service Description (Automobile Mode)

Control Delay (Seconds per Vehicle)	LOS by Volume-to-Capacity Ratio	
	$v/c \leq 1.0$	$v/c > 1.0$
≤10	A	F
>10 to 15	B	F
>15 to 25	C	F
>25 to 35	D	F
>35 to 50	E	F
>50	F	F

Note: Source: HCM 6th Edition, Exhibit 22-8.

Segment Levels of Service

Segments are portions of roads without any interruption of flow. These are typically studied as urban streets, basic freeways, multilane highways or two-lane highways. Each of these categories has further classification and the level of service analysis can differ between them.

Basic Freeway and Multilane Highway Segments

For segments of multilane highways and basic freeways outside the influence of merging, diverging and weaving maneuvers, LOS is defined by density. Density describes a motorist's proximity to other vehicles and is related to a motorist's freedom to maneuver within the traffic stream. Chapter 12 of the Highway Capacity Manual categorizes each LOS as follows:

LOS A describes free-flow operations. FFS prevails on the freeway or multilane highway, and vehicles are almost completely unimpeded in their ability to maneuver within the traffic stream. The effects of incidents or point breakdowns are easily absorbed.

LOS B represents reasonably free-flow operations, and FFS on the freeway or multilane highway is maintained. The ability to maneuver within the traffic stream is only slightly restricted, and the general level of physical and psychological comfort provided to drivers is still high. The effects of minor incidents are still easily absorbed.

LOS C provides for flow with speeds near the FFS of the freeway or multilane highway. Freedom to maneuver within the traffic stream is noticeably restricted, and lane changes require more care and vigilance on the part of the driver. Minor incidents may still be absorbed, but the local deterioration in service quality will be significant. Queues may be expected to form behind any significant blockages.

LOS D is the level at which speeds begin to decline with increasing flows, with density increasing more quickly. Freedom to maneuver within the traffic stream is seriously limited, and drivers experience reduced physical and psychological comfort levels. Even minor incidents can be expected to create queuing, because the traffic stream has little space to absorb disruptions.

LOS E describes operation at or near capacity. Operations on the freeway or multilane highway at this level are highly volatile because there are virtually no usable gaps within the traffic stream, leaving little room to maneuver within the traffic stream. Any disruption to the traffic stream, such as vehicles entering from a ramp or an access point or a vehicle changing lanes, can establish a disruption wave that propagates throughout the upstream traffic stream. Toward the upper boundary of LOS E, the traffic stream has no ability to dissipate even the most minor disruption, and any incident can be expected to produce a serious breakdown and substantial queuing. The physical and psychological comfort afforded to drivers is poor.

LOS F describes unstable flow. Such conditions exist within queues forming behind bottlenecks. Breakdowns occur for a number of reasons:

- Traffic incidents can temporarily reduce the capacity of a short segment so that the number of vehicles arriving at a point is greater than the number of vehicles that can move through it.
- Points of recurring congestion, such as merge or weaving segments and lane drops, experience very high demand in which the number of vehicles arriving is greater than the number of vehicles that can be discharged.
- In analyses using forecast volumes, the projected flow rate can exceed the estimated capacity of a given location.

Basic Freeway

Basic Freeway segments generally have four to eight lanes and posted speed limits between 50 and 75 mi/hr. The performance measures include capacity, free flow speed, demand and volume-to-capacity ratio, space mean speed, average density and LOS. The LOS is dependent on the number of lanes, base free-flow speed, lane width, right side lateral clearance, total ramp density, hourly demand volume, peak hour factor and total truck percentage. Table A-4 provides a description of LOS for Basic Freeway Segments.

Multilane Highway

Multilane Highway segments generally have four to six lanes and posted speed limits between 40 and 55 mi/hr. The performance measures include capacity, free flow speed, demand and volume-to-capacity ratio, space mean speed, average density and LOS. The LOS is dependent on the number of lanes, base free-flow speed, lane width, right side lateral clearance, left side lateral clearance, access point density, terrain type, median type, hourly demand volume, peak hour factor and total truck percentage. Table A-4 provides a description of LOS for Multilane Highway Segments.

Table A-4: Basic Freeway and Multilane Highway Segment Level of Service Description

<i>Level of Service</i>	<i>Density (Passenger Cars per Mile per Lane)</i>
A	≤11
B	>11 to 18
C	>18 to 26
D	>26 to 35
E	>35 to 45
F	>45 or Demand Exceeds Capacity

Note: Source: HCM 6th Edition, Exhibit 12-15.



www.JLBtraffic.com
info@JLBtraffic.com

516 W. Shaw Ave., Ste. 103
Fresno, CA 93704
(559) 570-8991

Two-Lane Highway Segments

Two-Lane Highways generally have one lane per direction and only allow passing maneuvers to take place in the opposing lane of traffic. If allowed, passing maneuvers are limited by the availability of gaps in the opposing traffic stream and by the availability of sufficient sight distance for a driver to discern the approach of an opposing vehicle safely. A principal measure of LOS is percent time spent following and follower density. This is the average percent of time that vehicles must travel in platoons behind slower vehicles due to the inability to pass. Chapter 15 of the Highway Capacity Manual categorizes each LOS as follows:

At **LOS A**, motorists experience high operating speeds on Class I highways and little difficulty in passing. Platoons of three or more vehicles are rare. On Class II highways, speed is controlled primarily by roadway conditions, but a small amount of platooning would be expected. On Class III highways, motorists can maintain operating speeds at or near the facility's FFS.

At **LOS B**, passing demand and passing capacity are balanced. On both Class I and Class II highways, the degree of platooning becomes noticeable. Some speed reductions are present on Class I highways. On Class III highways, maintenance of FFS operation becomes difficult, but the speed reduction is still relatively small.

At **LOS C**, most vehicles travel in platoons. Speeds are noticeably curtailed on all three classes of highways.

At **LOS D**, platooning increases significantly. Passing demand is high on both Class I and Class II facilities, but passing capacity approaches zero. A high percentage of vehicles travels in platoons, and PTSF is noticeable. On Class III highways, the fall-off from FFS is significant.

At **LOS E**, demand is approaching capacity. Passing on Class I and II highways is virtually impossible, and PTSF is more than 80%. Speeds are seriously curtailed. On Class III highways, speed is less than two-thirds of the FFS. The lower limit of LOSE represents capacity.

LOS F exists whenever demand flow in one or both directions exceeds the segment's capacity. Operating conditions are unstable and heavy congestion exists on all classes of two-lane highways.

Two-Lane Highway

The performance measures include average travel speed, segment travel time, percent followers, volume to capacity ratio, follower density and LOS. The LOS is dependent on Highway Class (I, II, or III), lane width, shoulder width, access point density, terrain type, free flow speed, passing lane length, demand flow rate, opposing demand flow rate peak hour factor and total truck percentage. Tables A-5 and A-6 provide a description of LOS for Two-Lane Highway Segments.

Table A-5: Two-Lane Highway Segment Level of Service Description

LOS	Class I Highways		Class II Highways	Class III Highways
	ATS (Mile per Hour)	PTSF (%)	PTSF (%)	PFFS (%)
A	>55	≤35	≤40	>91.7
B	>50 to 55	>35 to 50	>40 to 55	>83.3 to 91.7
C	>45 to 50	>50 to 65	>55 to 70	>75.0 to 83.3
D	>40 to 45	>65 to 80	>70 to 85	>66.7 to 75.0
E	≤40	>80	>85	≤66.7
F	Demand exceeds capacity			

Note: ATS = Average Travel Speed
 PTSF = Percent Time Spent Following
 PFFS = Percent of Free Flow Speed
 Source: HCM 6th Edition, Exhibit 15-3.

Table A-6: Two-Lane Highway Segment Level of Service Description

LOS	Follower Density (Followers per Mile per Lane)	
	High Speed Highways Posted Speed Limit ≥ 50 miles per hour	High Speed Highways Posted Speed Limit < 50 miles per hour
	A	≤2.0
B	>2.0 to 4.0	>2.5 to 5.0
C	>4.0 to 8.0	>5.0 to 10.0
D	>8.0 to 12.0	>10.0 to 15.0
E	>12.0	>15.0

Note: Source: NCHRP 'Improved Analysis of Two-Lane Highway Capacity and Operational Performance, Table 3-23.

Urban Streets (Automobile Mode)

The term “urban streets” refers to urban arterials and collectors, including those in downtown areas. Arterial streets are roads that primarily serve longer through trips. However, providing access to abutting commercial and residential land uses is also an important function of arterials. Collector streets provide both land access and traffic circulation within residential, commercial and industrial areas. Their access function is more important than that of arterials and unlike arterials their operation is not always dominated by traffic signals. Downtown streets are signalized facilities that often resemble arterials.

They not only move through traffic but also provide access to local businesses for passenger cars, transit buses and trucks. Pedestrian conflicts and lane obstructions created by stopping or standing taxicabs, buses, trucks and parking vehicles that cause turbulence in the traffic flow are typical of downtown streets.

Flow Characteristics

The speed of vehicles on urban streets is influenced by three main factors, street environment, interaction among vehicles and traffic control.

The street environment includes the geometric characteristics of the facility, the character of roadside activity and adjacent land uses. Thus, the environment reflects the number and width of lanes, type of median, driveway/access point density, spacing between signalized intersections, existence of parking, level of pedestrian and bicyclist activity and speed limit.

The interaction among vehicles is determined by traffic density, the proportion of trucks and buses and turning movements. This interaction affects the operation of vehicles at intersections and, to a lesser extent, between signals.

Traffic controls (including signals and signs) force a portion of all vehicles to slow or stop. The delays and speed changes caused by traffic control devices reduce vehicle speeds; however, such controls are needed to establish right-of-way.



www.JLBtraffic.com
info@JLBtraffic.com

516 W. Shaw Ave., Ste. 103
Fresno, CA 93704
(559) 570-8991

Urban Street Segments LOS

The average travel speed for through vehicles along an urban street is the determinant of the operating level of service (LOS). The travel speed along a segment, section or entire length of an urban street is dependent on the running speed between signalized intersections and the amount of control delay incurred at signalized intersections. Table A-7 provides a description of LOS for Urban Street Segments.

LOS A describes primarily free-flow operation. Vehicles are completely unimpeded in their ability to maneuver within the traffic stream. Control delay at signalized intersections is minimal. Travel speeds exceed 80 percent of the base free flow speed (FFS).

LOS B describes reasonably unimpeded operation. The ability to maneuver within the traffic stream is only slightly restricted and control delay at the boundary intersections is not significant. The travel speed is between 67 and 80 percent of the base FFS.

LOS C describes stable operations. The ability to maneuver and change lanes in midblock location may be more restricted than at LOS B. Longer queues at the boundary intersections may contribute to lower travel speeds. The travel speed is between 50 and 67 percent of the base FFS.

LOS D indicates a less stable condition in which small increases in flow may cause substantial increases in delay and decreases in travel speed. This operation may be due to adverse signal progression, high volumes or inappropriate signal timing at the boundary intersections. The travel speed is between 40 and 50 percent of the base FFS.

LOS E is characterized as an unstable operation and has significant delay. Such operations may be due to some combination of adverse progression, high volume and inappropriate signal timing at the boundary intersections. The travel speed is between 30 and 40 percent of the base FFS.

LOS F is characterized by street flow at extremely low speed. Congestion is likely occurring at the boundary intersections, as indicated by high delay and extensive queuing. The travel speed is 30 percent or less of the base FFS.

Table A-7: Urban Street Levels of Service (Automobile Mode)

LOS	Travel Speed Threshold by Base Free-Flow Speed (miles/hour)							Volume-to-Capacity Ratio
	55	50	45	40	35	30	25	
A	>44	>40	>36	>32	>28	>24	>20	≤ 1.0
B	>37	>34	>30	>27	>23	>20	>17	
C	>28	>25	>23	>20	>18	>15	>13	
D	>22	>20	>18	>16	>14	>12	>10	
E	>17	>15	>14	>12	>11	>9	>8	
F	≤17	≤15	≤14	≤12	≤11	≤9	≤8	
F	Any							> 1.0

Note: a = The Critical volume-to-capacity ratio is based on consideration of the through movement-to-capacity ratio at each boundary intersection in the subject direction of travel. The critical volume-to-capacity ratio is the largest ratio of those considered.
Source: Highway Capacity Manual 6th Edition, Exhibit 16-3.



www.JLBtraffic.com
info@JLBtraffic.com

516 W. Shaw Ave., Ste. 103
Fresno, CA 93704
(559) 570-8991

Appendix E: Existing Traffic Conditions



www.JLBtraffic.com
info@JLBtraffic.com

516 W. Shaw Ave., Ste. 103
Fresno, CA 93704
(559) 570-8991

App | E

HCM 6th Signalized Intersection Summary
 3: 10 1/2 Avenue & Hanford Armona Road

Existing AM Peak
 04/26/2022



Movement	EBL	EBT	EBR	WBL	WBT	WBR	NBL	NBT	NBR	SBL	SBT	SBR
Lane Configurations	↖	↗		↖	↗		↖	↗	↗	↖	↗	↖
Traffic Volume (veh/h)	55	226	17	12	202	22	39	31	11	11	12	34
Future Volume (veh/h)	55	226	17	12	202	22	39	31	11	11	12	34
Initial Q (Qb), veh	0	0	0	0	0	0	0	0	0	0	0	0
Ped-Bike Adj(A_pbT)	1.00		1.00	1.00		1.00	1.00		1.00	1.00		1.00
Parking Bus, Adj	1.00	1.00	1.00	1.00	1.00	1.00	1.00	1.00	1.00	1.00	1.00	1.00
Work Zone On Approach		No			No			No			No	
Adj Sat Flow, veh/h/ln	1826	1826	1826	1826	1826	1826	1826	1826	1826	1826	1826	1826
Adj Flow Rate, veh/h	76	314	24	17	281	31	54	43	15	15	17	47
Peak Hour Factor	0.72	0.72	0.72	0.72	0.72	0.72	0.72	0.72	0.72	0.72	0.72	0.72
Percent Heavy Veh, %	5	5	5	5	5	5	5	5	5	5	5	5
Cap, veh/h	128	523	40	38	420	46	101	259	220	34	189	160
Arrive On Green	0.07	0.31	0.31	0.02	0.26	0.26	0.06	0.14	0.14	0.02	0.10	0.10
Sat Flow, veh/h	1739	1675	128	1739	1615	178	1739	1826	1547	1739	1826	1547
Grp Volume(v), veh/h	76	0	338	17	0	312	54	43	15	15	17	47
Grp Sat Flow(s),veh/h/ln	1739	0	1803	1739	0	1793	1739	1826	1547	1739	1826	1547
Q Serve(g_s), s	1.5	0.0	5.7	0.3	0.0	5.6	1.1	0.7	0.3	0.3	0.3	1.0
Cycle Q Clear(g_c), s	1.5	0.0	5.7	0.3	0.0	5.6	1.1	0.7	0.3	0.3	0.3	1.0
Prop In Lane	1.00		0.07	1.00		0.10	1.00		1.00	1.00		1.00
Lane Grp Cap(c), veh/h	128	0	563	38	0	467	101	259	220	34	189	160
V/C Ratio(X)	0.59	0.00	0.60	0.45	0.00	0.67	0.54	0.17	0.07	0.45	0.09	0.29
Avail Cap(c_a), veh/h	376	0	1464	241	0	1317	280	1392	1179	241	1366	1158
HCM Platoon Ratio	1.00	1.00	1.00	1.00	1.00	1.00	1.00	1.00	1.00	1.00	1.00	1.00
Upstream Filter(I)	1.00	0.00	1.00	1.00	0.00	1.00	1.00	1.00	1.00	1.00	1.00	1.00
Uniform Delay (d), s/veh	16.2	0.0	10.5	17.4	0.0	11.9	16.5	13.6	13.4	17.5	14.6	15.0
Incr Delay (d2), s/veh	4.3	0.0	1.0	8.2	0.0	1.7	4.4	0.3	0.1	9.0	0.2	1.0
Initial Q Delay(d3),s/veh	0.0	0.0	0.0	0.0	0.0	0.0	0.0	0.0	0.0	0.0	0.0	0.0
%ile BackOfQ(50%),veh/ln	0.6	0.0	1.6	0.2	0.0	1.7	0.5	0.3	0.1	0.2	0.1	0.3
Unsig. Movement Delay, s/veh												
LnGrp Delay(d),s/veh	20.5	0.0	11.5	25.6	0.0	13.6	20.9	13.9	13.5	26.5	14.8	16.0
LnGrp LOS	C	A	B	C	A	B	C	B	B	C	B	B
Approach Vol, veh/h		414			329			112			79	
Approach Delay, s/veh		13.2			14.2			17.2			17.7	
Approach LOS		B			B			B			B	
Timer - Assigned Phs	1	2	3	4	5	6	7	8				
Phs Duration (G+Y+Rc), s	4.9	10.0	5.0	16.2	6.3	8.6	6.9	14.3				
Change Period (Y+Rc), s	* 4.2	4.9	* 4.2	4.9	* 4.2	* 4.9	* 4.2	4.9				
Max Green Setting (Gmax), s	* 5	27.5	* 5	29.3	* 5.8	* 27	* 7.8	26.5				
Max Q Clear Time (g_c+I1), s	2.3	2.7	2.3	7.7	3.1	3.0	3.5	7.6				
Green Ext Time (p_c), s	0.0	0.2	0.0	1.8	0.0	0.2	0.0	1.6				

Intersection Summary												
HCM 6th Ctrl Delay				14.4								
HCM 6th LOS				B								

Notes

* HCM 6th computational engine requires equal clearance times for the phases crossing the barrier.

Intersection

Int Delay, s/veh 1.6

Movement	EBT	EBR	WBL	WBT	NBL	NBR
Lane Configurations	↶		↷	↶	↷	
Traffic Vol, veh/h	200	21	14	178	34	21
Future Vol, veh/h	200	21	14	178	34	21
Conflicting Peds, #/hr	0	0	0	0	0	1
Sign Control	Free	Free	Free	Free	Stop	Stop
RT Channelized	-	None	-	None	-	None
Storage Length	-	-	75	-	0	-
Veh in Median Storage, #	0	-	-	0	0	-
Grade, %	0	-	-	0	0	-
Peak Hour Factor	74	74	74	74	74	74
Heavy Vehicles, %	6	6	6	6	6	6
Mvmt Flow	270	28	19	241	46	28

Major/Minor	Major1	Major2	Minor1		
Conflicting Flow All	0	0	298	0	563 285
Stage 1	-	-	-	-	284 -
Stage 2	-	-	-	-	279 -
Critical Hdwy	-	-	4.16	-	6.46 6.26
Critical Hdwy Stg 1	-	-	-	-	5.46 -
Critical Hdwy Stg 2	-	-	-	-	5.46 -
Follow-up Hdwy	-	-	2.254	-	3.554 3.354
Pot Cap-1 Maneuver	-	-	1241	-	481 745
Stage 1	-	-	-	-	755 -
Stage 2	-	-	-	-	759 -
Platoon blocked, %	-	-	-	-	-
Mov Cap-1 Maneuver	-	-	1241	-	474 744
Mov Cap-2 Maneuver	-	-	-	-	559 -
Stage 1	-	-	-	-	755 -
Stage 2	-	-	-	-	748 -

Approach	EB	WB	NB
HCM Control Delay, s	0	0.6	11.6
HCM LOS			B

Minor Lane/Major Mvmt	NBLn1	EBT	EBR	WBL	WBT
Capacity (veh/h)	618	-	-	1241	-
HCM Lane V/C Ratio	0.12	-	-	0.015	-
HCM Control Delay (s)	11.6	-	-	7.9	-
HCM Lane LOS	B	-	-	A	-
HCM 95th %tile Q(veh)	0.4	-	-	0	-

HCM 6th Signalized Intersection Summary
5: 10th Avenue & Hanford Armona Road

Existing AM Peak
04/26/2022



Movement	EBL	EBT	EBR	WBL	WBT	WBR	NBL	NBT	NBR	SBL	SBT	SBR
Lane Configurations												
Traffic Volume (veh/h)	166	4	50	3	4	12	54	167	1	6	154	144
Future Volume (veh/h)	166	4	50	3	4	12	54	167	1	6	154	144
Initial Q (Qb), veh	0	0	0	0	0	0	0	0	0	0	0	0
Ped-Bike Adj(A_pbT)	1.00		1.00	1.00		1.00	1.00		1.00	1.00		1.00
Parking Bus, Adj	1.00	1.00	1.00	1.00	1.00	1.00	1.00	1.00	1.00	1.00	1.00	1.00
Work Zone On Approach		No			No			No			No	
Adj Sat Flow, veh/h/ln	1796	1796	1796	1796	1796	1796	1796	1796	1796	1796	1796	1796
Adj Flow Rate, veh/h	205	5	62	4	5	15	67	206	1	7	190	178
Peak Hour Factor	0.81	0.81	0.81	0.81	0.81	0.81	0.81	0.81	0.81	0.81	0.81	0.81
Percent Heavy Veh, %	7	7	7	7	7	7	7	7	7	7	7	7
Cap, veh/h	256	404	342	9	32	96	114	457	388	16	355	301
Arrive On Green	0.15	0.22	0.22	0.01	0.08	0.08	0.07	0.25	0.25	0.01	0.20	0.20
Sat Flow, veh/h	1711	1796	1522	1711	396	1187	1711	1796	1522	1711	1796	1522
Grp Volume(v), veh/h	205	5	62	4	0	20	67	206	1	7	190	178
Grp Sat Flow(s),veh/h/ln	1711	1796	1522	1711	0	1583	1711	1796	1522	1711	1796	1522
Q Serve(g_s), s	4.4	0.1	1.3	0.1	0.0	0.5	1.5	3.7	0.0	0.2	3.6	4.1
Cycle Q Clear(g_c), s	4.4	0.1	1.3	0.1	0.0	0.5	1.5	3.7	0.0	0.2	3.6	4.1
Prop In Lane	1.00		1.00	1.00		0.75	1.00		1.00	1.00		1.00
Lane Grp Cap(c), veh/h	256	404	342	9	0	128	114	457	388	16	355	301
V/C Ratio(X)	0.80	0.01	0.18	0.43	0.00	0.16	0.59	0.45	0.00	0.44	0.54	0.59
Avail Cap(c_a), veh/h	303	1741	1476	223	0	1443	223	1348	1142	223	1367	1158
HCM Platoon Ratio	1.00	1.00	1.00	1.00	1.00	1.00	1.00	1.00	1.00	1.00	1.00	1.00
Upstream Filter(I)	1.00	1.00	1.00	1.00	0.00	1.00	1.00	1.00	1.00	1.00	1.00	1.00
Uniform Delay (d), s/veh	15.8	11.6	12.0	19.0	0.0	16.4	17.4	12.0	10.7	18.9	13.8	14.0
Incr Delay (d2), s/veh	12.3	0.0	0.3	28.4	0.0	0.6	4.8	0.7	0.0	17.6	1.3	1.9
Initial Q Delay(d3),s/veh	0.0	0.0	0.0	0.0	0.0	0.0	0.0	0.0	0.0	0.0	0.0	0.0
%ile BackOfQ(50%),veh/ln	2.2	0.0	0.3	0.1	0.0	0.1	0.6	1.1	0.0	0.1	1.2	1.2
Unsig. Movement Delay, s/veh												
LnGrp Delay(d),s/veh	28.1	11.6	12.3	47.4	0.0	17.0	22.2	12.7	10.7	36.5	15.1	15.8
LnGrp LOS	C	B	B	D	A	B	C	B	B	D	B	B
Approach Vol, veh/h		272			24			274			375	
Approach Delay, s/veh		24.2			22.0			15.0			15.8	
Approach LOS		C			C			B			B	
Timer - Assigned Phs	1	2	3	4	5	6	7	8				
Phs Duration (G+Y+Rc), s	4.6	15.5	4.4	13.9	6.8	13.3	9.9	8.4				
Change Period (Y+Rc), s	* 4.2	5.7	* 4.2	* 5.3	* 4.2	* 5.7	* 4.2	5.3				
Max Green Setting (Gmax), s	* 5	28.8	* 5	* 37	* 5	* 29	* 6.8	35.0				
Max Q Clear Time (g_c+I1), s	2.2	5.7	2.1	3.3	3.5	6.1	6.4	2.5				
Green Ext Time (p_c), s	0.0	0.9	0.0	0.2	0.0	1.5	0.0	0.1				

Intersection Summary

HCM 6th Ctrl Delay	18.2
HCM 6th LOS	B

Notes

* HCM 6th computational engine requires equal clearance times for the phases crossing the barrier.

HCM Signalized Intersection Capacity Analysis

7: 11th Avenue & Houston Avenue

Existing AM Peak

04/26/2022



Movement	EBL	EBT	EBR	WBL	WBT	WBR	NBL	NBT	NBR	SBL	SBT	SBR
Lane Configurations												
Traffic Volume (vph)	32	66	24	24	57	35	17	73	21	40	59	21
Future Volume (vph)	32	66	24	24	57	35	17	73	21	40	59	21
Ideal Flow (vphp)	1900	1900	1900	1900	1900	1900	1900	1900	1900	1900	1900	1900
Total Lost time (s)	4.2	6.0	6.0	4.2	5.7	5.7	4.2	5.7	5.7	4.2	5.3	5.3
Lane Util. Factor	1.00	1.00	1.00	1.00	1.00	1.00	1.00	0.95	1.00	1.00	1.00	1.00
Frt	1.00	1.00	0.85	1.00	1.00	0.85	1.00	1.00	0.85	1.00	1.00	0.85
Flt Protected	0.95	1.00	1.00	0.95	1.00	1.00	0.95	1.00	1.00	0.95	1.00	1.00
Satd. Flow (prot)	1597	1681	1429	1597	1681	1429	1597	3195	1429	1597	1681	1429
Flt Permitted	0.95	1.00	1.00	0.95	1.00	1.00	0.95	1.00	1.00	0.95	1.00	1.00
Satd. Flow (perm)	1597	1681	1429	1597	1681	1429	1597	3195	1429	1597	1681	1429
Peak-hour factor, PHF	0.96	0.96	0.96	0.96	0.96	0.96	0.96	0.96	0.96	0.96	0.96	0.96
Adj. Flow (vph)	33	69	25	25	59	36	18	76	22	42	61	22
RTOR Reduction (vph)	0	0	21	0	0	31	0	0	13	0	0	12
Lane Group Flow (vph)	33	69	4	25	59	5	18	76	9	42	61	10
Heavy Vehicles (%)	13%	13%	13%	13%	13%	13%	13%	13%	13%	13%	13%	13%
Turn Type	Prot	NA	Perm	Prot	NA	Perm	Prot	NA	Perm	Prot	NA	Perm
Protected Phases	7	4		3	8		5	2		1	6	
Permitted Phases			4			8			2			6
Actuated Green, G (s)	3.0	9.9	9.9	1.0	8.2	8.2	1.0	22.3	22.3	3.0	24.7	24.7
Effective Green, g (s)	3.0	9.9	9.9	1.0	8.2	8.2	1.0	22.3	22.3	3.0	24.7	24.7
Actuated g/C Ratio	0.05	0.18	0.18	0.02	0.15	0.15	0.02	0.40	0.40	0.05	0.44	0.44
Clearance Time (s)	4.2	6.0	6.0	4.2	5.7	5.7	4.2	5.7	5.7	4.2	5.3	5.3
Vehicle Extension (s)	3.0	3.0	3.0	3.0	3.0	3.0	3.0	3.0	3.0	3.0	3.0	3.0
Lane Grp Cap (vph)	85	295	251	28	244	208	28	1265	566	85	737	626
v/s Ratio Prot	c0.02	c0.04		0.02	0.04		0.01	0.02		c0.03	c0.04	
v/s Ratio Perm			0.00			0.00			0.01			0.01
v/c Ratio	0.39	0.23	0.02	0.89	0.24	0.03	0.64	0.06	0.02	0.49	0.08	0.02
Uniform Delay, d1	25.8	19.9	19.2	27.6	21.3	20.6	27.5	10.5	10.3	25.9	9.2	8.9
Progression Factor	1.00	1.00	1.00	1.00	1.00	1.00	1.00	1.00	1.00	1.00	1.00	1.00
Incremental Delay, d2	2.9	0.4	0.0	123.8	0.5	0.0	40.9	0.0	0.0	4.5	0.0	0.0
Delay (s)	28.7	20.3	19.2	151.4	21.8	20.7	68.4	10.5	10.3	30.4	9.3	8.9
Level of Service	C	C	B	F	C	C	E	B	B	C	A	A
Approach Delay (s)		22.3			48.5			19.5			16.3	
Approach LOS		C			D			B			B	

Intersection Summary

HCM 2000 Control Delay	26.5	HCM 2000 Level of Service	C
HCM 2000 Volume to Capacity ratio	0.19		
Actuated Cycle Length (s)	56.3	Sum of lost time (s)	20.1
Intersection Capacity Utilization	30.9%	ICU Level of Service	A
Analysis Period (min)	15		
c Critical Lane Group			

Intersection

Int Delay, s/veh 1

Movement	EBL	EBT	WBT	WBR	SBL	SBR
Lane Configurations		↕	↕		↕	
Traffic Vol, veh/h	9	94	80	22	8	7
Future Vol, veh/h	9	94	80	22	8	7
Conflicting Peds, #/hr	0	0	0	0	0	0
Sign Control	Free	Free	Free	Free	Stop	Stop
RT Channelized	-	None	-	None	-	None
Storage Length	-	-	-	-	0	-
Veh in Median Storage, #	-	0	0	-	0	-
Grade, %	-	0	0	-	0	-
Peak Hour Factor	89	89	89	89	89	89
Heavy Vehicles, %	19	19	19	19	19	19
Mvmt Flow	10	106	90	25	9	8

Major/Minor	Major1	Major2	Minor2
Conflicting Flow All	115	0	0 229 103
Stage 1	-	-	- 103 -
Stage 2	-	-	- 126 -
Critical Hdwy	4.29	-	- 6.59 6.39
Critical Hdwy Stg 1	-	-	- 5.59 -
Critical Hdwy Stg 2	-	-	- 5.59 -
Follow-up Hdwy	2.371	-	- 3.671 3.471
Pot Cap-1 Maneuver	1375	-	- 723 907
Stage 1	-	-	- 880 -
Stage 2	-	-	- 859 -
Platoon blocked, %		-	-
Mov Cap-1 Maneuver	1375	-	- 717 907
Mov Cap-2 Maneuver	-	-	- 717 -
Stage 1	-	-	- 873 -
Stage 2	-	-	- 859 -

Approach	EB	WB	SB
HCM Control Delay, s	0.7	0	9.6
HCM LOS			A

Minor Lane/Major Mvmt	EBL	EBT	WBT	WBR	SBLn1
Capacity (veh/h)	1375	-	-	-	795
HCM Lane V/C Ratio	0.007	-	-	-	0.021
HCM Control Delay (s)	7.6	0	-	-	9.6
HCM Lane LOS	A	A	-	-	A
HCM 95th %tile Q(veh)	0	-	-	-	0.1

Intersection	
Intersection Delay, s/veh	8.8
Intersection LOS	A

Movement	EBL	EBT	EBR	WBL	WBT	WBR	NBL	NBT	NBR	SBL	SBT	SBR
Lane Configurations		↕			↕			↕			↕	
Traffic Vol, veh/h	29	63	18	12	56	13	13	58	5	13	61	39
Future Vol, veh/h	29	63	18	12	56	13	13	58	5	13	61	39
Peak Hour Factor	0.91	0.91	0.91	0.91	0.91	0.91	0.91	0.91	0.91	0.91	0.91	0.91
Heavy Vehicles, %	26	26	26	26	26	26	26	26	26	26	26	26
Mvmt Flow	32	69	20	13	62	14	14	64	5	14	67	43
Number of Lanes	0	1	0	0	1	0	0	1	0	0	1	0

Approach	EB	WB	NB	SB
Opposing Approach	WB	EB	SB	NB
Opposing Lanes	1	1	1	1
Conflicting Approach Left	SB	NB	EB	WB
Conflicting Lanes Left	1	1	1	1
Conflicting Approach Right	NB	SB	WB	EB
Conflicting Lanes Right	1	1	1	1
HCM Control Delay	8.9	8.7	8.7	8.8
HCM LOS	A	A	A	A

Lane	NBLn1	EBLn1	WBLn1	SBLn1
Vol Left, %	17%	26%	15%	12%
Vol Thru, %	76%	57%	69%	54%
Vol Right, %	7%	16%	16%	35%
Sign Control	Stop	Stop	Stop	Stop
Traffic Vol by Lane	76	110	81	113
LT Vol	13	29	12	13
Through Vol	58	63	56	61
RT Vol	5	18	13	39
Lane Flow Rate	84	121	89	124
Geometry Grp	1	1	1	1
Degree of Util (X)	0.116	0.165	0.122	0.165
Departure Headway (Hd)	5.021	4.927	4.947	4.795
Convergence, Y/N	Yes	Yes	Yes	Yes
Cap	714	729	725	749
Service Time	3.049	2.955	2.976	2.821
HCM Lane V/C Ratio	0.118	0.166	0.123	0.166
HCM Control Delay	8.7	8.9	8.7	8.8
HCM Lane LOS	A	A	A	A
HCM 95th-tile Q	0.4	0.6	0.4	0.6

HCM 6th Signalized Intersection Summary
3: 10 1/2 Avenue & Hanford Armona Road

Existing PM Peak
04/25/2022



Movement	EBL	EBT	EBR	WBL	WBT	WBR	NBL	NBT	NBR	SBL	SBT	SBR
Lane Configurations	↖	↗		↖	↗		↖	↗	↖	↗	↖	↗
Traffic Volume (veh/h)	44	286	15	6	285	27	27	16	5	23	18	56
Future Volume (veh/h)	44	286	15	6	285	27	27	16	5	23	18	56
Initial Q (Qb), veh	0	0	0	0	0	0	0	0	0	0	0	0
Ped-Bike Adj(A_pbT)	1.00		1.00	1.00		1.00	1.00		1.00	1.00		1.00
Parking Bus, Adj	1.00	1.00	1.00	1.00	1.00	1.00	1.00	1.00	1.00	1.00	1.00	1.00
Work Zone On Approach		No			No			No			No	
Adj Sat Flow, veh/h/ln	1856	1856	1856	1856	1856	1856	1856	1856	1856	1856	1856	1856
Adj Flow Rate, veh/h	48	311	16	7	310	29	29	17	5	25	20	61
Peak Hour Factor	0.92	0.92	0.92	0.92	0.92	0.92	0.92	0.92	0.92	0.92	0.92	0.92
Percent Heavy Veh, %	3	3	3	3	3	3	3	3	3	3	3	3
Cap, veh/h	94	571	29	17	472	44	62	198	168	55	190	161
Arrive On Green	0.05	0.33	0.33	0.01	0.28	0.28	0.04	0.11	0.11	0.03	0.10	0.10
Sat Flow, veh/h	1767	1749	90	1767	1670	156	1767	1856	1572	1767	1856	1572
Grp Volume(v), veh/h	48	0	327	7	0	339	29	17	5	25	20	61
Grp Sat Flow(s),veh/h/ln	1767	0	1839	1767	0	1827	1767	1856	1572	1767	1856	1572
Q Serve(g_s), s	0.9	0.0	5.0	0.1	0.0	5.7	0.6	0.3	0.1	0.5	0.3	1.3
Cycle Q Clear(g_c), s	0.9	0.0	5.0	0.1	0.0	5.7	0.6	0.3	0.1	0.5	0.3	1.3
Prop In Lane	1.00		0.05	1.00		0.09	1.00		1.00	1.00		1.00
Lane Grp Cap(c), veh/h	94	0	600	17	0	516	62	198	168	55	190	161
V/C Ratio(X)	0.51	0.00	0.54	0.42	0.00	0.66	0.47	0.09	0.03	0.46	0.11	0.38
Avail Cap(c_a), veh/h	348	0	1549	256	0	1443	297	1455	1233	286	1461	1238
HCM Platoon Ratio	1.00	1.00	1.00	1.00	1.00	1.00	1.00	1.00	1.00	1.00	1.00	1.00
Upstream Filter(I)	1.00	0.00	1.00	1.00	0.00	1.00	1.00	1.00	1.00	1.00	1.00	1.00
Uniform Delay (d), s/veh	15.9	0.0	9.5	17.0	0.0	10.9	16.4	13.9	13.8	16.5	14.1	14.5
Incr Delay (d2), s/veh	4.2	0.0	0.8	16.0	0.0	1.4	5.4	0.2	0.1	5.9	0.2	1.5
Initial Q Delay(d3),s/veh	0.0	0.0	0.0	0.0	0.0	0.0	0.0	0.0	0.0	0.0	0.0	0.0
%ile BackOfQ(50%),veh/ln	0.4	0.0	1.4	0.1	0.0	1.7	0.3	0.1	0.0	0.2	0.1	0.4
Unsig. Movement Delay, s/veh												
LnGrp Delay(d),s/veh	20.1	0.0	10.3	33.1	0.0	12.4	21.7	14.1	13.9	22.3	14.3	16.0
LnGrp LOS	C	A	B	C	A	B	C	B	B	C	B	B
Approach Vol, veh/h		375			346			51			106	
Approach Delay, s/veh		11.6			12.8			18.4			17.2	
Approach LOS		B			B			B			B	
Timer - Assigned Phs	1	2	3	4	5	6	7	8				
Phs Duration (G+Y+Rc), s	5.3	8.6	4.5	16.2	5.4	8.4	6.0	14.7				
Change Period (Y+Rc), s	* 4.2	4.9	* 4.2	4.9	* 4.2	* 4.9	* 4.2	4.9				
Max Green Setting (Gmax), s	* 5.6	27.1	* 5	29.1	* 5.8	* 27	* 6.8	27.3				
Max Q Clear Time (g_c+I1), s	2.5	2.3	2.1	7.0	2.6	3.3	2.9	7.7				
Green Ext Time (p_c), s	0.0	0.0	0.0	1.8	0.0	0.2	0.0	1.8				

Intersection Summary

HCM 6th Ctrl Delay	13.1
HCM 6th LOS	B

Notes

* HCM 6th computational engine requires equal clearance times for the phases crossing the barrier.

Intersection

Int Delay, s/veh 1.4

Movement	EBT	EBR	WBL	WBT	NBL	NBR
Lane Configurations	↶		↷	↶	↷	
Traffic Vol, veh/h	250	36	27	273	39	16
Future Vol, veh/h	250	36	27	273	39	16
Conflicting Peds, #/hr	0	2	2	0	0	0
Sign Control	Free	Free	Free	Free	Stop	Stop
RT Channelized	-	None	-	None	-	None
Storage Length	-	-	75	-	0	-
Veh in Median Storage, #	0	-	-	0	0	-
Grade, %	0	-	-	0	0	-
Peak Hour Factor	90	90	90	90	90	90
Heavy Vehicles, %	3	3	3	3	3	3
Mvmt Flow	278	40	30	303	43	18

Major/Minor	Major1	Major2	Minor1		
Conflicting Flow All	0	0	320	0	663 300
Stage 1	-	-	-	-	300 -
Stage 2	-	-	-	-	363 -
Critical Hdwy	-	-	4.13	-	6.43 6.23
Critical Hdwy Stg 1	-	-	-	-	5.43 -
Critical Hdwy Stg 2	-	-	-	-	5.43 -
Follow-up Hdwy	-	-	2.227	-	3.527 3.327
Pot Cap-1 Maneuver	-	-	1234	-	425 737
Stage 1	-	-	-	-	749 -
Stage 2	-	-	-	-	702 -
Platoon blocked, %	-	-	-	-	-
Mov Cap-1 Maneuver	-	-	1232	-	414 736
Mov Cap-2 Maneuver	-	-	-	-	514 -
Stage 1	-	-	-	-	748 -
Stage 2	-	-	-	-	685 -

Approach	EB	WB	NB
HCM Control Delay, s	0	0.7	12.2
HCM LOS			B

Minor Lane/Major Mvmt	NBLn1	EBT	EBR	WBL	WBT
Capacity (veh/h)	563	-	-	1232	-
HCM Lane V/C Ratio	0.109	-	-	0.024	-
HCM Control Delay (s)	12.2	-	-	8	-
HCM Lane LOS	B	-	-	A	-
HCM 95th %tile Q(veh)	0.4	-	-	0.1	-

HCM 6th Signalized Intersection Summary
5: 10th Avenue & Hanford Armona Road

Existing PM Peak
04/25/2022



Movement	EBL	EBT	EBR	WBL	WBT	WBR	NBL	NBT	NBR	SBL	SBT	SBR
Lane Configurations												
Traffic Volume (veh/h)	149	15	96	4	8	8	112	203	5	16	154	176
Future Volume (veh/h)	149	15	96	4	8	8	112	203	5	16	154	176
Initial Q (Qb), veh	0	0	0	0	0	0	0	0	0	0	0	0
Ped-Bike Adj(A_pbT)	1.00		1.00	1.00		1.00	1.00		0.99	1.00		0.99
Parking Bus, Adj	1.00	1.00	1.00	1.00	1.00	1.00	1.00	1.00	1.00	1.00	1.00	1.00
Work Zone On Approach		No			No			No			No	
Adj Sat Flow, veh/h/ln	1856	1856	1856	1856	1856	1856	1856	1856	1856	1856	1856	1856
Adj Flow Rate, veh/h	157	16	101	4	8	8	118	214	5	17	162	185
Peak Hour Factor	0.95	0.95	0.95	0.95	0.95	0.95	0.95	0.95	0.95	0.95	0.95	0.95
Percent Heavy Veh, %	3	3	3	3	3	3	3	3	3	3	3	3
Cap, veh/h	201	412	348	10	97	97	160	510	430	38	382	322
Arrive On Green	0.11	0.22	0.22	0.01	0.11	0.11	0.09	0.27	0.27	0.02	0.21	0.21
Sat Flow, veh/h	1767	1856	1565	1767	849	849	1767	1856	1564	1767	1856	1561
Grp Volume(v), veh/h	157	16	101	4	0	16	118	214	5	17	162	185
Grp Sat Flow(s),veh/h/ln	1767	1856	1565	1767	0	1698	1767	1856	1564	1767	1856	1561
Q Serve(g_s), s	3.5	0.3	2.2	0.1	0.0	0.3	2.7	3.9	0.1	0.4	3.1	4.4
Cycle Q Clear(g_c), s	3.5	0.3	2.2	0.1	0.0	0.3	2.7	3.9	0.1	0.4	3.1	4.4
Prop In Lane	1.00		1.00	1.00		0.50	1.00		1.00	1.00		1.00
Lane Grp Cap(c), veh/h	201	412	348	10	0	194	160	510	430	38	382	322
V/C Ratio(X)	0.78	0.04	0.29	0.42	0.00	0.08	0.74	0.42	0.01	0.45	0.42	0.58
Avail Cap(c_a), veh/h	295	1693	1429	217	0	1458	251	1311	1105	217	1293	1088
HCM Platoon Ratio	1.00	1.00	1.00	1.00	1.00	1.00	1.00	1.00	1.00	1.00	1.00	1.00
Upstream Filter(I)	1.00	1.00	1.00	1.00	0.00	1.00	1.00	1.00	1.00	1.00	1.00	1.00
Uniform Delay (d), s/veh	17.6	12.4	13.2	20.2	0.0	16.1	18.1	12.1	10.7	19.7	14.1	14.6
Incr Delay (d2), s/veh	8.0	0.0	0.5	26.3	0.0	0.2	6.5	0.5	0.0	8.1	0.7	1.6
Initial Q Delay(d3),s/veh	0.0	0.0	0.0	0.0	0.0	0.0	0.0	0.0	0.0	0.0	0.0	0.0
%ile BackOfQ(50%),veh/ln	1.6	0.1	0.6	0.1	0.0	0.1	1.1	1.1	0.0	0.2	1.0	1.3
Unsig. Movement Delay, s/veh												
LnGrp Delay(d),s/veh	25.5	12.5	13.6	46.5	0.0	16.3	24.6	12.7	10.8	27.8	14.8	16.2
LnGrp LOS	C	B	B	D	A	B	C	B	B	C	B	B
Approach Vol, veh/h		274			20			337			364	
Approach Delay, s/veh		20.4			22.4			16.8			16.1	
Approach LOS		C			C			B			B	
Timer - Assigned Phs	1	2	3	4	5	6	7	8				
Phs Duration (G+Y+Rc), s	5.1	16.9	4.4	14.4	7.9	14.1	8.8	9.9				
Change Period (Y+Rc), s	* 4.2	5.7	* 4.2	* 5.3	* 4.2	* 5.7	* 4.2	5.3				
Max Green Setting (Gmax), s	* 5	28.8	* 5	* 37	* 5.8	* 28	* 6.8	35.0				
Max Q Clear Time (g_c+I1), s	2.4	5.9	2.1	4.2	4.7	6.4	5.5	2.3				
Green Ext Time (p_c), s	0.0	1.0	0.0	0.4	0.0	1.4	0.0	0.0				

Intersection Summary

HCM 6th Ctrl Delay	17.7
HCM 6th LOS	B

Notes

* HCM 6th computational engine requires equal clearance times for the phases crossing the barrier.

HCM Signalized Intersection Capacity Analysis

7: 11th Avenue & Houston Avenue

Existing PM Peak
04/25/2022

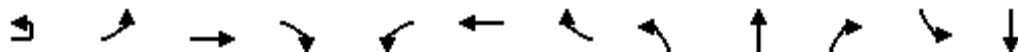

Movement	EBU	EBL	EBT	EBR	WBL	WBT	WBR	NBL	NBT	NBR	SBL	SBT
Lane Configurations		↔	↑	↗	↖	↑	↗	↖	↑↑	↗	↖	↑
Traffic Volume (vph)	1	21	93	18	18	96	74	33	159	24	48	78
Future Volume (vph)	1	21	93	18	18	96	74	33	159	24	48	78
Ideal Flow (vphp)	1900	1900	1900	1900	1900	1900	1900	1900	1900	1900	1900	1900
Total Lost time (s)		4.2	6.0	6.0	4.2	5.7	5.7	4.2	5.7	5.7	4.2	5.3
Lane Util. Factor		1.00	1.00	1.00	1.00	1.00	1.00	1.00	0.95	1.00	1.00	1.00
Frt		1.00	1.00	0.85	1.00	1.00	0.85	1.00	1.00	0.85	1.00	1.00
Flt Protected		0.95	1.00	1.00	0.95	1.00	1.00	0.95	1.00	1.00	0.95	1.00
Satd. Flow (prot)		1719	1810	1538	1719	1810	1538	1719	3438	1538	1719	1810
Flt Permitted		0.95	1.00	1.00	0.95	1.00	1.00	0.95	1.00	1.00	0.95	1.00
Satd. Flow (perm)		1719	1810	1538	1719	1810	1538	1719	3438	1538	1719	1810
Peak-hour factor, PHF	0.84	0.84	0.84	0.84	0.84	0.84	0.84	0.84	0.84	0.84	0.84	0.84
Adj. Flow (vph)	1	25	111	21	21	114	88	39	189	29	57	93
RTOR Reduction (vph)	0	0	0	17	0	0	71	0	0	19	0	0
Lane Group Flow (vph)	0	26	111	4	21	114	17	39	189	10	57	93
Heavy Vehicles (%)	5%	5%	5%	5%	5%	5%	5%	5%	5%	5%	5%	5%
Turn Type	Prot	Prot	NA	Perm	Prot	NA	Perm	Prot	NA	Perm	Prot	NA
Protected Phases	7	7	4		3	8		5	2		1	6
Permitted Phases				4			8			2		
Actuated Green, G (s)		0.9	10.2	10.2	0.9	10.5	10.5	3.1	18.8	18.8	5.4	21.5
Effective Green, g (s)		0.9	10.2	10.2	0.9	10.5	10.5	3.1	18.8	18.8	5.4	21.5
Actuated g/C Ratio		0.02	0.18	0.18	0.02	0.19	0.19	0.06	0.34	0.34	0.10	0.39
Clearance Time (s)		4.2	6.0	6.0	4.2	5.7	5.7	4.2	5.7	5.7	4.2	5.3
Vehicle Extension (s)		3.0	3.0	3.0	3.0	3.0	3.0	3.0	3.0	3.0	3.0	3.0
Lane Grp Cap (vph)		27	333	283	27	343	291	96	1166	521	167	702
v/s Ratio Prot		c0.02	0.06		0.01	c0.06		0.02	c0.05		c0.03	0.05
v/s Ratio Perm				0.00			0.01			0.01		
v/c Ratio		0.96	0.33	0.01	0.78	0.33	0.06	0.41	0.16	0.02	0.34	0.13
Uniform Delay, d1		27.2	19.6	18.5	27.2	19.4	18.4	25.3	12.8	12.2	23.3	10.9
Progression Factor		1.00	1.00	1.00	1.00	1.00	1.00	1.00	1.00	1.00	1.00	1.00
Incremental Delay, d2		156.3	0.6	0.0	81.9	0.6	0.1	2.8	0.1	0.0	1.2	0.1
Delay (s)		183.5	20.2	18.5	109.0	20.0	18.5	28.1	12.9	12.2	24.6	11.0
Level of Service		F	C	B	F	B	B	C	B	B	C	B
Approach Delay (s)			46.9			27.8			15.1			15.4
Approach LOS			D			C			B			B

Intersection Summary

HCM 2000 Control Delay	24.8	HCM 2000 Level of Service	C
HCM 2000 Volume to Capacity ratio	0.26		
Actuated Cycle Length (s)	55.4	Sum of lost time (s)	20.1
Intersection Capacity Utilization	30.6%	ICU Level of Service	A
Analysis Period (min)	15		
c Critical Lane Group			



Movement	SBR
Lane Configurations	7
Traffic Volume (vph)	20
Future Volume (vph)	20
Ideal Flow (vphpl)	1900
Total Lost time (s)	5.3
Lane Util. Factor	1.00
Frt	0.85
Flt Protected	1.00
Satd. Flow (prot)	1538
Flt Permitted	1.00
Satd. Flow (perm)	1538
Peak-hour factor, PHF	0.84
Adj. Flow (vph)	24
RTOR Reduction (vph)	15
Lane Group Flow (vph)	9
Heavy Vehicles (%)	5%
Turn Type	Perm
Protected Phases	
Permitted Phases	6
Actuated Green, G (s)	21.5
Effective Green, g (s)	21.5
Actuated g/C Ratio	0.39
Clearance Time (s)	5.3
Vehicle Extension (s)	3.0
Lane Grp Cap (vph)	596
v/s Ratio Prot	
v/s Ratio Perm	0.01
v/c Ratio	0.02
Uniform Delay, d1	10.4
Progression Factor	1.00
Incremental Delay, d2	0.0
Delay (s)	10.4
Level of Service	B
Approach Delay (s)	
Approach LOS	
Intersection Summary	

Intersection

Int Delay, s/veh 1.1

Movement	EBL	EBT	WBT	WBR	SBL	SBR
Lane Configurations		↕	↕		↕	
Traffic Vol, veh/h	8	107	134	21	17	10
Future Vol, veh/h	8	107	134	21	17	10
Conflicting Peds, #/hr	0	0	0	0	0	0
Sign Control	Free	Free	Free	Free	Stop	Stop
RT Channelized	-	None	-	None	-	None
Storage Length	-	-	-	-	0	-
Veh in Median Storage, #	-	0	0	-	0	-
Grade, %	-	0	0	-	0	-
Peak Hour Factor	93	93	93	93	93	93
Heavy Vehicles, %	3	3	3	3	3	3
Mvmt Flow	9	115	144	23	18	11

Major/Minor	Major1	Major2	Minor2
Conflicting Flow All	167	0	0 289 156
Stage 1	-	-	- 156 -
Stage 2	-	-	- 133 -
Critical Hdwy	4.13	-	- 6.43 6.23
Critical Hdwy Stg 1	-	-	- 5.43 -
Critical Hdwy Stg 2	-	-	- 5.43 -
Follow-up Hdwy	2.227	-	- 3.527 3.327
Pot Cap-1 Maneuver	1405	-	- 699 887
Stage 1	-	-	- 870 -
Stage 2	-	-	- 891 -
Platoon blocked, %		-	- -
Mov Cap-1 Maneuver	1405	-	- 694 887
Mov Cap-2 Maneuver	-	-	- 694 -
Stage 1	-	-	- 864 -
Stage 2	-	-	- 891 -

Approach	EB	WB	SB
HCM Control Delay, s	0.5	0	10
HCM LOS			B

Minor Lane/Major Mvmt	EBL	EBT	WBT	WBR	SBLn1
Capacity (veh/h)	1405	-	-	-	755
HCM Lane V/C Ratio	0.006	-	-	-	0.038
HCM Control Delay (s)	7.6	0	-	-	10
HCM Lane LOS	A	A	-	-	B
HCM 95th %tile Q(veh)	0	-	-	-	0.1

Intersection	
Intersection Delay, s/veh	8.8
Intersection LOS	A

Movement	EBL	EBT	EBR	WBL	WBT	WBR	NBL	NBT	NBR	SBL	SBT	SBR
Lane Configurations		↕			↕			↕			↕	
Traffic Vol, veh/h	29	72	15	8	85	48	23	101	8	41	70	35
Future Vol, veh/h	29	72	15	8	85	48	23	101	8	41	70	35
Peak Hour Factor	0.98	0.98	0.98	0.98	0.98	0.98	0.98	0.98	0.98	0.98	0.98	0.98
Heavy Vehicles, %	5	5	5	5	5	5	5	5	5	5	5	5
Mvmt Flow	30	73	15	8	87	49	23	103	8	42	71	36
Number of Lanes	0	1	0	0	1	0	0	1	0	0	1	0

Approach	EB	WB	NB	SB
Opposing Approach	WB	EB	SB	NB
Opposing Lanes	1	1	1	1
Conflicting Approach Left	SB	NB	EB	WB
Conflicting Lanes Left	1	1	1	1
Conflicting Approach Right	NB	SB	WB	EB
Conflicting Lanes Right	1	1	1	1
HCM Control Delay	8.8	8.7	8.9	8.9
HCM LOS	A	A	A	A

Lane	NBLn1	EBLn1	WBLn1	SBLn1
Vol Left, %	17%	25%	6%	28%
Vol Thru, %	77%	62%	60%	48%
Vol Right, %	6%	13%	34%	24%
Sign Control	Stop	Stop	Stop	Stop
Traffic Vol by Lane	132	116	141	146
LT Vol	23	29	8	41
Through Vol	101	72	85	70
RT Vol	8	15	48	35
Lane Flow Rate	135	118	144	149
Geometry Grp	1	1	1	1
Degree of Util (X)	0.179	0.158	0.184	0.194
Departure Headway (Hd)	4.787	4.808	4.616	4.686
Convergence, Y/N	Yes	Yes	Yes	Yes
Cap	748	743	774	764
Service Time	2.83	2.854	2.661	2.728
HCM Lane V/C Ratio	0.18	0.159	0.186	0.195
HCM Control Delay	8.9	8.8	8.7	8.9
HCM Lane LOS	A	A	A	A
HCM 95th-tile Q	0.6	0.6	0.7	0.7

Intersection: 1: Douty St & 3rd Street

Movement	EB	EB	EB	NB	NB	NB	SB
Directions Served	L	T	TR	T	T	R	LT
Maximum Queue (ft)	102	97	92	81	114	54	87
Average Queue (ft)	49	53	44	36	31	17	43
95th Queue (ft)	81	81	71	59	65	43	69
Link Distance (ft)	320	320	320	356	356		787
Upstream Blk Time (%)							
Queuing Penalty (veh)							
Storage Bay Dist (ft)						90	
Storage Blk Time (%)					0		
Queuing Penalty (veh)					0		

Intersection: 2: 10th Avenue & 4th Street/SR-198 WB Off Ramp

Movement	WB	NB	NB	NB	SB	SB	SB
Directions Served	LTR	L	T	T	T	T	R
Maximum Queue (ft)	133	52	114	113	185	206	90
Average Queue (ft)	43	27	52	47	97	36	39
95th Queue (ft)	84	52	101	102	161	121	64
Link Distance (ft)	775		759	759	758	758	
Upstream Blk Time (%)							
Queuing Penalty (veh)							
Storage Bay Dist (ft)		295					105
Storage Blk Time (%)						0	0
Queuing Penalty (veh)						0	0

Intersection: 3: 10 1/2 Avenue & Hanford Armona Road

Movement	EB	EB	WB	WB	NB	NB	NB	SB	SB	SB
Directions Served	L	TR	L	TR	L	T	R	L	T	R
Maximum Queue (ft)	50	142	25	101	53	53	31	31	91	53
Average Queue (ft)	26	48	6	38	28	11	7	8	12	22
95th Queue (ft)	48	105	22	82	55	38	26	28	47	49
Link Distance (ft)		1346		1547		396			386	
Upstream Blk Time (%)										
Queuing Penalty (veh)										
Storage Bay Dist (ft)	150		95		150		95	150		100
Storage Blk Time (%)		0		0					0	
Queuing Penalty (veh)		0		0					0	

Intersection: 4: Jordan Way & Hanford Armona Road

Movement	WB	NB
Directions Served	L	LR
Maximum Queue (ft)	47	79
Average Queue (ft)	7	35
95th Queue (ft)	28	61
Link Distance (ft)	1339	
Upstream Blk Time (%)		
Queuing Penalty (veh)		
Storage Bay Dist (ft)	75	
Storage Blk Time (%)		
Queuing Penalty (veh)		

Intersection: 5: 10th Avenue & Hanford Armona Road

Movement	EB	EB	EB	WB	WB	NB	NB	SB	SB	SB	
Directions Served	L	T	R	L	TR	L	T	L	T	R	
Maximum Queue (ft)	143	93	40	26	48	68	132	31	118	54	
Average Queue (ft)	70	4	13	4	12	27	37	6	49	31	
95th Queue (ft)	127	32	31	18	37	58	86	24	97	58	
Link Distance (ft)	936			372			448		399		
Upstream Blk Time (%)											
Queuing Penalty (veh)											
Storage Bay Dist (ft)	105		55		155		155		110		265
Storage Blk Time (%)	3	0		0				1	0		
Queuing Penalty (veh)	1	0		0				0	0		

Intersection: 6: 10 1/2 Avenue & Orchard Avenue

Movement
Directions Served
Maximum Queue (ft)
Average Queue (ft)
95th Queue (ft)
Link Distance (ft)
Upstream Blk Time (%)
Queuing Penalty (veh)
Storage Bay Dist (ft)
Storage Blk Time (%)
Queuing Penalty (veh)

Intersection: 7: 11th Avenue & Houston Avenue

Movement	EB	EB	EB	WB	WB	WB	NB	NB	NB	NB	SB	SB
Directions Served	UL	T	R	L	T	R	L	T	T	R	L	T
Maximum Queue (ft)	57	64	50	65	110	57	69	68	70	56	57	46
Average Queue (ft)	19	20	9	18	28	13	9	21	11	6	21	9
95th Queue (ft)	49	45	32	49	66	38	34	50	45	25	49	29
Link Distance (ft)		680			436			276	276			1524
Upstream Blk Time (%)												
Queuing Penalty (veh)												
Storage Bay Dist (ft)	165		150	175		175	175			100	250	
Storage Blk Time (%)												
Queuing Penalty (veh)												

Intersection: 7: 11th Avenue & Houston Avenue

Movement	SB
Directions Served	R
Maximum Queue (ft)	62
Average Queue (ft)	8
95th Queue (ft)	34
Link Distance (ft)	1524
Upstream Blk Time (%)	
Queuing Penalty (veh)	
Storage Bay Dist (ft)	
Storage Blk Time (%)	
Queuing Penalty (veh)	

Intersection: 8: Houston Avenue & 10 1/2 Avenue

Movement	SB
Directions Served	LR
Maximum Queue (ft)	51
Average Queue (ft)	12
95th Queue (ft)	36
Link Distance (ft)	2057
Upstream Blk Time (%)	
Queuing Penalty (veh)	
Storage Bay Dist (ft)	
Storage Blk Time (%)	
Queuing Penalty (veh)	

Intersection: 9: 10th Avenue & Houston Avenue

Movement	EB	WB	NB	SB
Directions Served	LTR	LTR	LTR	LTR
Maximum Queue (ft)	78	76	75	77
Average Queue (ft)	41	37	44	33
95th Queue (ft)	75	65	69	67
Link Distance (ft)	2557	1661	1092	4776
Upstream Blk Time (%)				
Queuing Penalty (veh)				
Storage Bay Dist (ft)				
Storage Blk Time (%)				
Queuing Penalty (veh)				

Intersection: 10: 3rd Street & SR-198 EB Off Ramp

Movement	EB	SE
Directions Served	T	L
Maximum Queue (ft)	30	53
Average Queue (ft)	1	26
95th Queue (ft)	10	52
Link Distance (ft)	361	209
Upstream Blk Time (%)		
Queuing Penalty (veh)		
Storage Bay Dist (ft)		
Storage Blk Time (%)		
Queuing Penalty (veh)		

Network Summary

Network wide Queuing Penalty: 3

Intersection: 1: Douty St & 3rd Street

Movement	EB	EB	EB	NB	NB	NB	SB	SB
Directions Served	L	T	TR	T	T	R	LT	T
Maximum Queue (ft)	97	96	112	72	79	31	154	56
Average Queue (ft)	53	60	62	37	34	13	69	8
95th Queue (ft)	86	89	97	59	72	37	118	35
Link Distance (ft)	320	320	320	356	356		787	787
Upstream Blk Time (%)								
Queuing Penalty (veh)								
Storage Bay Dist (ft)						90		
Storage Blk Time (%)					0			
Queuing Penalty (veh)					0			

Intersection: 2: 10th Avenue & 4th Street/SR-198 WB Off Ramp

Movement	WB	NB	NB	NB	SB	SB	SB
Directions Served	LTR	L	T	T	T	T	R
Maximum Queue (ft)	162	95	136	139	188	161	79
Average Queue (ft)	65	52	68	56	104	29	41
95th Queue (ft)	126	85	124	121	170	99	67
Link Distance (ft)	775		759	759	758	758	
Upstream Blk Time (%)							
Queuing Penalty (veh)							
Storage Bay Dist (ft)		295				105	
Storage Blk Time (%)							
Queuing Penalty (veh)							

Intersection: 3: 10 1/2 Avenue & Hanford Armona Road

Movement	EB	EB	WB	WB	NB	NB	NB	SB	SB	SB
Directions Served	L	TR	L	TR	L	T	R	L	T	R
Maximum Queue (ft)	69	109	45	213	55	52	31	74	52	53
Average Queue (ft)	26	38	6	57	19	8	6	17	10	29
95th Queue (ft)	56	85	25	133	49	32	25	53	36	57
Link Distance (ft)		1346		1547		396			386	
Upstream Blk Time (%)										
Queuing Penalty (veh)										
Storage Bay Dist (ft)	150		95		150		95	150		100
Storage Blk Time (%)				3						
Queuing Penalty (veh)				0						

Intersection: 4: Jordan Way & Hanford Armona Road

Movement	WB	NB
Directions Served	L	LR
Maximum Queue (ft)	46	68
Average Queue (ft)	4	29
95th Queue (ft)	23	55
Link Distance (ft)	1339	
Upstream Blk Time (%)		
Queuing Penalty (veh)		
Storage Bay Dist (ft)	75	
Storage Blk Time (%)		
Queuing Penalty (veh)		

Intersection: 5: 10th Avenue & Hanford Armona Road

Movement	EB	EB	EB	WB	WB	NB	NB	SB	SB	SB	
Directions Served	L	T	R	L	TR	L	T	L	T	R	
Maximum Queue (ft)	140	44	60	25	52	117	125	53	96	102	
Average Queue (ft)	68	4	19	4	11	54	49	13	45	48	
95th Queue (ft)	112	20	44	19	36	92	107	42	85	76	
Link Distance (ft)	936			372			448		399		
Upstream Blk Time (%)											
Queuing Penalty (veh)											
Storage Bay Dist (ft)	105		55		155		155		110		265
Storage Blk Time (%)	3	0		0		0		0		0	
Queuing Penalty (veh)	4	0		0		0		0		0	

Intersection: 6: 10 1/2 Avenue & Orchard Avenue

Movement
Directions Served
Maximum Queue (ft)
Average Queue (ft)
95th Queue (ft)
Link Distance (ft)
Upstream Blk Time (%)
Queuing Penalty (veh)
Storage Bay Dist (ft)
Storage Blk Time (%)
Queuing Penalty (veh)

Intersection: 7: 11th Avenue & Houston Avenue

Movement	EB	EB	EB	WB	WB	WB	NB	NB	NB	NB	SB	SB
Directions Served	UL	T	R	L	T	R	L	T	T	R	L	T
Maximum Queue (ft)	63	67	20	47	113	45	75	65	68	32	70	66
Average Queue (ft)	14	30	6	12	37	16	17	28	13	7	23	22
95th Queue (ft)	38	60	18	33	78	37	50	58	41	20	52	58
Link Distance (ft)		680			436			276	276			1524
Upstream Blk Time (%)												
Queuing Penalty (veh)												
Storage Bay Dist (ft)	165		150	175		175	175			100	250	
Storage Blk Time (%)												
Queuing Penalty (veh)												

Intersection: 7: 11th Avenue & Houston Avenue

Movement	SB
Directions Served	R
Maximum Queue (ft)	35
Average Queue (ft)	4
95th Queue (ft)	18
Link Distance (ft)	1524
Upstream Blk Time (%)	
Queuing Penalty (veh)	
Storage Bay Dist (ft)	
Storage Blk Time (%)	
Queuing Penalty (veh)	

Intersection: 8: Houston Avenue & 10 1/2 Avenue

Movement	SB
Directions Served	LR
Maximum Queue (ft)	51
Average Queue (ft)	18
95th Queue (ft)	41
Link Distance (ft)	2057
Upstream Blk Time (%)	
Queuing Penalty (veh)	
Storage Bay Dist (ft)	
Storage Blk Time (%)	
Queuing Penalty (veh)	

Intersection: 9: 10th Avenue & Houston Avenue

Movement	EB	WB	NB	SB
Directions Served	LTR	LTR	LTR	LTR
Maximum Queue (ft)	75	78	72	77
Average Queue (ft)	32	36	34	39
95th Queue (ft)	55	60	52	66
Link Distance (ft)	2557	1661	1092	4776
Upstream Blk Time (%)				
Queuing Penalty (veh)				
Storage Bay Dist (ft)				
Storage Blk Time (%)				
Queuing Penalty (veh)				

Intersection: 10: 3rd Street & SR-198 EB Off Ramp

Movement	SE
Directions Served	L
Maximum Queue (ft)	123
Average Queue (ft)	48
95th Queue (ft)	98
Link Distance (ft)	209
Upstream Blk Time (%)	
Queuing Penalty (veh)	
Storage Bay Dist (ft)	
Storage Blk Time (%)	
Queuing Penalty (veh)	

Network Summary

Network wide Queuing Penalty: 4

HCS7 Two-Lane Highway Report

Project Information

Analyst	C. Ayala-Magana	Date	7/20/2022
Agency	JLB Traffic Engineering, Inc.	Analysis Year	2022
Jurisdiction	City of Hanford	Time Period Analyzed	Existing AM Peak
Project Description	01 Hanford-Armona Road Between 11th Avenue and 10 1/2 Avenue	Unit	United States Customary

Segment 1

Vehicle Inputs

Segment Type	Passing Constrained	Length, ft	2583
Lane Width, ft	12	Shoulder Width, ft	6
Speed Limit, mi/h	40	Access Point Density, pts/mi	34.8

Demand and Capacity

Directional Demand Flow Rate, veh/h	414	Opposing Demand Flow Rate, veh/h	-
Peak Hour Factor	0.72	Total Trucks, %	4.03
Segment Capacity, veh/h	1700	Demand/Capacity (D/C)	0.24

Intermediate Results

Segment Vertical Class	1	Free-Flow Speed, mi/h	36.8
Speed Slope Coefficient	2.52195	Speed Power Coefficient	0.41674
PF Slope Coefficient	-1.44139	PF Power Coefficient	0.67822
In Passing Lane Effective Length?	No	Total Segment Density, veh/mi/ln	6.4
%Improved % Followers	0.0	% Improved Avg Speed	0.0

Subsegment Data

#	Segment Type	Length, ft	Radius, ft	Superelevation, %	Average Speed, mi/h
1	Tangent	2583	-	-	35.2

Vehicle Results

Average Speed, mi/h	35.2	Percent Followers, %	54.7
Segment Travel Time, minutes	0.83	Follower Density, followers/mi/ln	6.4
Vehicle LOS	C		

Facility Results

T	Follower Density, followers/mi/ln	LOS
1	6.4	C

HCS7 Two-Lane Highway Report

Project Information

Analyst	C. Ayala-Magana	Date	7/20/2022
Agency	JLB Traffic Engineering, Inc.	Analysis Year	2022
Jurisdiction	City of Hanford	Time Period Analyzed	Existing AM Peak
Project Description	02 Hanford-Armona Road Between 10 1/2 Avenue and Jordan Way	Unit	United States Customary

Segment 1

Vehicle Inputs

Segment Type	Passing Constrained	Length, ft	1556
Lane Width, ft	12	Shoulder Width, ft	6
Speed Limit, mi/h	40	Access Point Density, pts/mi	67.9

Demand and Capacity

Directional Demand Flow Rate, veh/h	335	Opposing Demand Flow Rate, veh/h	-
Peak Hour Factor	0.74	Total Trucks, %	3.39
Segment Capacity, veh/h	1700	Demand/Capacity (D/C)	0.20

Intermediate Results

Segment Vertical Class	1	Free-Flow Speed, mi/h	35.5
Speed Slope Coefficient	2.43653	Speed Power Coefficient	0.41674
PF Slope Coefficient	-1.48329	PF Power Coefficient	0.66113
In Passing Lane Effective Length?	No	Total Segment Density, veh/mi/ln	5.0
%Improved % Followers	0.0	% Improved Avg Speed	0.0

Subsegment Data

#	Segment Type	Length, ft	Radius, ft	Superelevation, %	Average Speed, mi/h
1	Tangent	1556	-	-	34.2

Vehicle Results

Average Speed, mi/h	34.2	Percent Followers, %	51.3
Segment Travel Time, minutes	0.52	Follower Density, followers/mi/ln	5.0
Vehicle LOS	C		

Facility Results

T	Follower Density, followers/mi/ln	LOS
1	5.0	C

HCS7 Two-Lane Highway Report

Project Information

Analyst	C. Ayala-Magana	Date	7/20/2022
Agency	JLB Traffic Engineering, Inc.	Analysis Year	2022
Jurisdiction	City of Hanford	Time Period Analyzed	Existing AM Peak
Project Description	03 Hanford-Armona Road Between Jordan Way and 10th Avenue	Unit	United States Customary

Segment 1

Vehicle Inputs

Segment Type	Passing Constrained	Length, ft	901
Lane Width, ft	12	Shoulder Width, ft	6
Speed Limit, mi/h	40	Access Point Density, pts/mi	23.4

Demand and Capacity

Directional Demand Flow Rate, veh/h	293	Opposing Demand Flow Rate, veh/h	-
Peak Hour Factor	0.75	Total Trucks, %	6.25
Segment Capacity, veh/h	1700	Demand/Capacity (D/C)	0.17

Intermediate Results

Segment Vertical Class	1	Free-Flow Speed, mi/h	39.5
Speed Slope Coefficient	2.65189	Speed Power Coefficient	0.41674
PF Slope Coefficient	-1.50451	PF Power Coefficient	0.67582
In Passing Lane Effective Length?	No	Total Segment Density, veh/mi/ln	3.7
%Improved % Followers	0.0	% Improved Avg Speed	0.0

Subsegment Data

#	Segment Type	Length, ft	Radius, ft	Superelevation, %	Average Speed, mi/h
1	Tangent	901	-	-	38.2

Vehicle Results

Average Speed, mi/h	38.2	Percent Followers, %	48.1
Segment Travel Time, minutes	0.27	Follower Density, followers/mi/ln	3.7
Vehicle LOS	B		

Facility Results

T	Follower Density, followers/mi/ln	LOS
1	3.7	B

HCS7 Two-Lane Highway Report

Project Information

Analyst	C. Ayala-Magana	Date	7/20/2022
Agency	JLB Traffic Engineering, Inc.	Analysis Year	2022
Jurisdiction	City of Hanford	Time Period Analyzed	Existing AM Peak
Project Description	04 10.5 Avenue Between Hanford Armona Road and Orchard Avenue	Unit	United States Customary

Segment 1

Vehicle Inputs

Segment Type	Passing Constrained	Length, ft	2735
Lane Width, ft	12	Shoulder Width, ft	2
Speed Limit, mi/h	40	Access Point Density, pts/mi	50.2

Demand and Capacity

Directional Demand Flow Rate, veh/h	92	Opposing Demand Flow Rate, veh/h	-
Peak Hour Factor	0.60	Total Trucks, %	9.87
Segment Capacity, veh/h	1700	Demand/Capacity (D/C)	0.05

Intermediate Results

Segment Vertical Class	1	Free-Flow Speed, mi/h	32.5
Speed Slope Coefficient	2.29128	Speed Power Coefficient	0.41674
PF Slope Coefficient	-1.42068	PF Power Coefficient	0.65951
In Passing Lane Effective Length?	No	Total Segment Density, veh/mi/ln	0.7
%Improved % Followers	0.0	% Improved Avg Speed	0.0

Subsegment Data

#	Segment Type	Length, ft	Radius, ft	Superelevation, %	Average Speed, mi/h
1	Tangent	2735	-	-	32.5

Vehicle Results

Average Speed, mi/h	32.5	Percent Followers, %	25.6
Segment Travel Time, minutes	0.96	Follower Density, followers/mi/ln	0.7
Vehicle LOS	A		

Facility Results

T	Follower Density, followers/mi/ln	LOS
1	0.7	A

HCS7 Two-Lane Highway Report

Project Information

Analyst	C. Ayala-Magana	Date	7/20/2022
Agency	JLB Traffic Engineering, Inc.	Analysis Year	2022
Jurisdiction	City of Hanford	Time Period Analyzed	Existing AM Peak
Project Description	05 10.5 Avenue Between Orchard Avenue and Houston Avenue	Unit	United States Customary

Segment 1

Vehicle Inputs

Segment Type	Passing Constrained	Length, ft	2594
Lane Width, ft	12	Shoulder Width, ft	2
Speed Limit, mi/h	40	Access Point Density, pts/mi	52.9

Demand and Capacity

Directional Demand Flow Rate, veh/h	95	Opposing Demand Flow Rate, veh/h	-
Peak Hour Factor	0.42	Total Trucks, %	13.33
Segment Capacity, veh/h	1700	Demand/Capacity (D/C)	0.06

Intermediate Results

Segment Vertical Class	1	Free-Flow Speed, mi/h	32.4
Speed Slope Coefficient	2.28310	Speed Power Coefficient	0.41674
PF Slope Coefficient	-1.42395	PF Power Coefficient	0.65839
In Passing Lane Effective Length?	No	Total Segment Density, veh/mi/ln	0.8
%Improved % Followers	0.0	% Improved Avg Speed	0.0

Subsegment Data

#	Segment Type	Length, ft	Radius, ft	Superelevation, %	Average Speed, mi/h
1	Tangent	2594	-	-	32.4

Vehicle Results

Average Speed, mi/h	32.4	Percent Followers, %	26.1
Segment Travel Time, minutes	0.91	Follower Density, followers/mi/ln	0.8
Vehicle LOS	A		

Facility Results

T	Follower Density, followers/mi/ln	LOS
1	0.8	A

HCS7 Two-Lane Highway Report

Project Information

Analyst	C. Ayala-Magana	Date	7/20/2022
Agency	JLB Traffic Engineering, Inc.	Analysis Year	2022
Jurisdiction	City of Hanford	Time Period Analyzed	Existing AM Peak
Project Description	06 Houston Avenue Between 11th Avenue and 10 1/2 Avenue	Unit	United States Customary

Segment 1

Vehicle Inputs

Segment Type	Passing Constrained	Length, ft	2567
Lane Width, ft	12	Shoulder Width, ft	2
Speed Limit, mi/h	50	Access Point Density, pts/mi	20.6

Demand and Capacity

Directional Demand Flow Rate, veh/h	211	Opposing Demand Flow Rate, veh/h	-
Peak Hour Factor	0.68	Total Trucks, %	21.40
Segment Capacity, veh/h	1700	Demand/Capacity (D/C)	0.12

Intermediate Results

Segment Vertical Class	1	Free-Flow Speed, mi/h	48.3
Speed Slope Coefficient	3.14891	Speed Power Coefficient	0.41674
PF Slope Coefficient	-1.42118	PF Power Coefficient	0.72418
In Passing Lane Effective Length?	No	Total Segment Density, veh/mi/ln	1.7
%Improved % Followers	0.0	% Improved Avg Speed	0.0

Subsegment Data

#	Segment Type	Length, ft	Radius, ft	Superelevation, %	Average Speed, mi/h
1	Tangent	2567	-	-	47.1

Vehicle Results

Average Speed, mi/h	47.1	Percent Followers, %	36.9
Segment Travel Time, minutes	0.62	Follower Density, followers/mi/ln	1.7
Vehicle LOS	A		

Facility Results

T	Follower Density, followers/mi/ln	LOS
1	1.7	A

HCS7 Two-Lane Highway Report

Project Information

Analyst	C. Ayala-Magana	Date	7/20/2022
Agency	JLB Traffic Engineering, Inc.	Analysis Year	2022
Jurisdiction	City of Hanford	Time Period Analyzed	Existing AM Peak
Project Description	07 Houston Avenue Between 10 1/2 Avenue and 10th Avenue	Unit	United States Customary

Segment 1

Vehicle Inputs

Segment Type	Passing Constrained	Length, ft	2570
Lane Width, ft	12	Shoulder Width, ft	2
Speed Limit, mi/h	55	Access Point Density, pts/mi	45.2

Demand and Capacity

Directional Demand Flow Rate, veh/h	188	Opposing Demand Flow Rate, veh/h	-
Peak Hour Factor	0.88	Total Trucks, %	17.65
Segment Capacity, veh/h	1700	Demand/Capacity (D/C)	0.11

Intermediate Results

Segment Vertical Class	1	Free-Flow Speed, mi/h	49.3
Speed Slope Coefficient	3.20179	Speed Power Coefficient	0.41674
PF Slope Coefficient	-1.41674	PF Power Coefficient	0.72668
In Passing Lane Effective Length?	No	Total Segment Density, veh/mi/ln	1.3
%Improved % Followers	0.0	% Improved Avg Speed	0.0

Subsegment Data

#	Segment Type	Length, ft	Radius, ft	Superelevation, %	Average Speed, mi/h
1	Tangent	2570	-	-	48.2

Vehicle Results

Average Speed, mi/h	48.2	Percent Followers, %	34.3
Segment Travel Time, minutes	0.61	Follower Density, followers/mi/ln	1.3
Vehicle LOS	A		

Facility Results

T	Follower Density, followers/mi/ln	LOS
1	1.3	A

HCS7 Two-Lane Highway Report

Project Information

Analyst	C. Ayala-Magana	Date	7/20/2022
Agency	JLB Traffic Engineering, Inc.	Analysis Year	2022
Jurisdiction	City of Hanford	Time Period Analyzed	Existing PM Peak
Project Description	01 Hanford-Armona Road Between 11th Avenue and 10 1/2 Avenue	Unit	United States Customary

Segment 1

Vehicle Inputs

Segment Type	Passing Constrained	Length, ft	2583
Lane Width, ft	12	Shoulder Width, ft	6
Speed Limit, mi/h	40	Access Point Density, pts/mi	34.8

Demand and Capacity

Directional Demand Flow Rate, veh/h	517	Opposing Demand Flow Rate, veh/h	-
Peak Hour Factor	0.83	Total Trucks, %	3.00
Segment Capacity, veh/h	1700	Demand/Capacity (D/C)	0.30

Intermediate Results

Segment Vertical Class	1	Free-Flow Speed, mi/h	36.8
Speed Slope Coefficient	2.52381	Speed Power Coefficient	0.41674
PF Slope Coefficient	-1.44159	PF Power Coefficient	0.67823
In Passing Lane Effective Length?	No	Total Segment Density, veh/mi/ln	8.9
%Improved % Followers	0.0	% Improved Avg Speed	0.0

Subsegment Data

#	Segment Type	Length, ft	Radius, ft	Superelevation, %	Average Speed, mi/h
1	Tangent	2583	-	-	35.0

Vehicle Results

Average Speed, mi/h	35.0	Percent Followers, %	60.2
Segment Travel Time, minutes	0.84	Follower Density, followers/mi/ln	8.9
Vehicle LOS	C		

Facility Results

T	Follower Density, followers/mi/ln	LOS
1	8.9	C

HCS7 Two-Lane Highway Report

Project Information

Analyst	C. Ayala-Magana	Date	7/20/2022
Agency	JLB Traffic Engineering, Inc.	Analysis Year	2022
Jurisdiction	City of Hanford	Time Period Analyzed	Existing PM Peak
Project Description	02 Hanford-Armona Road Between 10 1/2 Avenue and Jordan Way	Unit	United States Customary

Segment 1

Vehicle Inputs

Segment Type	Passing Constrained	Length, ft	1556
Lane Width, ft	12	Shoulder Width, ft	6
Speed Limit, mi/h	40	Access Point Density, pts/mi	67.9

Demand and Capacity

Directional Demand Flow Rate, veh/h	374	Opposing Demand Flow Rate, veh/h	-
Peak Hour Factor	0.85	Total Trucks, %	3.00
Segment Capacity, veh/h	1700	Demand/Capacity (D/C)	0.22

Intermediate Results

Segment Vertical Class	1	Free-Flow Speed, mi/h	35.5
Speed Slope Coefficient	2.43724	Speed Power Coefficient	0.41674
PF Slope Coefficient	-1.48339	PF Power Coefficient	0.66114
In Passing Lane Effective Length?	No	Total Segment Density, veh/mi/ln	5.9
%Improved % Followers	0.0	% Improved Avg Speed	0.0

Subsegment Data

#	Segment Type	Length, ft	Radius, ft	Superelevation, %	Average Speed, mi/h
1	Tangent	1556	-	-	34.1

Vehicle Results

Average Speed, mi/h	34.1	Percent Followers, %	53.9
Segment Travel Time, minutes	0.52	Follower Density, followers/mi/ln	5.9
Vehicle LOS	C		

Facility Results

T	Follower Density, followers/mi/ln	LOS
1	5.9	C

HCS7 Two-Lane Highway Report

Project Information

Analyst	C. Ayala-Magana	Date	7/20/2022
Agency	JLB Traffic Engineering, Inc.	Analysis Year	2022
Jurisdiction	City of Hanford	Time Period Analyzed	Existing PM Peak
Project Description	03 Hanford-Armona Road Between Jordan Way and 10th Avenue	Unit	United States Customary

Segment 1

Vehicle Inputs

Segment Type	Passing Constrained	Length, ft	901
Lane Width, ft	12	Shoulder Width, ft	6
Speed Limit, mi/h	40	Access Point Density, pts/mi	17.6

Demand and Capacity

Directional Demand Flow Rate, veh/h	305	Opposing Demand Flow Rate, veh/h	-
Peak Hour Factor	0.97	Total Trucks, %	3.00
Segment Capacity, veh/h	1700	Demand/Capacity (D/C)	0.18

Intermediate Results

Segment Vertical Class	1	Free-Flow Speed, mi/h	41.1
Speed Slope Coefficient	2.73635	Speed Power Coefficient	0.41674
PF Slope Coefficient	-1.50445	PF Power Coefficient	0.68170
In Passing Lane Effective Length?	No	Total Segment Density, veh/mi/ln	3.8
%Improved % Followers	0.0	% Improved Avg Speed	0.0

Subsegment Data

#	Segment Type	Length, ft	Radius, ft	Superelevation, %	Average Speed, mi/h
1	Tangent	901	-	-	39.7

Vehicle Results

Average Speed, mi/h	39.7	Percent Followers, %	48.8
Segment Travel Time, minutes	0.26	Follower Density, followers/mi/ln	3.8
Vehicle LOS	B		

Facility Results

T	Follower Density, followers/mi/ln	LOS
1	3.8	B

HCS7 Two-Lane Highway Report

Project Information

Analyst	C. Ayala-Magana	Date	7/20/2022
Agency	JLB Traffic Engineering, Inc.	Analysis Year	2022
Jurisdiction	City of Hanford	Time Period Analyzed	Existing PM Peak
Project Description	04 10.5 Avenue Between Hanford Armona Road and Orchard Avenue	Unit	United States Customary

Segment 1

Vehicle Inputs

Segment Type	Passing Constrained	Length, ft	2735
Lane Width, ft	12	Shoulder Width, ft	2
Speed Limit, mi/h	40	Access Point Density, pts/mi	50.2

Demand and Capacity

Directional Demand Flow Rate, veh/h	67	Opposing Demand Flow Rate, veh/h	-
Peak Hour Factor	0.75	Total Trucks, %	3.00
Segment Capacity, veh/h	1700	Demand/Capacity (D/C)	0.04

Intermediate Results

Segment Vertical Class	1	Free-Flow Speed, mi/h	32.7
Speed Slope Coefficient	2.30368	Speed Power Coefficient	0.41674
PF Slope Coefficient	-1.42275	PF Power Coefficient	0.65971
In Passing Lane Effective Length?	No	Total Segment Density, veh/mi/ln	0.4
%Improved % Followers	0.0	% Improved Avg Speed	0.0

Subsegment Data

#	Segment Type	Length, ft	Radius, ft	Superelevation, %	Average Speed, mi/h
1	Tangent	2735	-	-	32.7

Vehicle Results

Average Speed, mi/h	32.7	Percent Followers, %	21.2
Segment Travel Time, minutes	0.95	Follower Density, followers/mi/ln	0.4
Vehicle LOS	A		

Facility Results

T	Follower Density, followers/mi/ln	LOS
1	0.4	A

HCS7 Two-Lane Highway Report

Project Information

Analyst	C. Ayala-Magana	Date	7/20/2022
Agency	JLB Traffic Engineering, Inc.	Analysis Year	2022
Jurisdiction	City of Hanford	Time Period Analyzed	Existing PM Peak
Project Description	05 10.5 Avenue Between Orchard Avenue and Houston Avenue	Unit	United States Customary

Segment 1

Vehicle Inputs

Segment Type	Passing Constrained	Length, ft	2594
Lane Width, ft	12	Shoulder Width, ft	2
Speed Limit, mi/h	40	Access Point Density, pts/mi	52.9

Demand and Capacity

Directional Demand Flow Rate, veh/h	80	Opposing Demand Flow Rate, veh/h	-
Peak Hour Factor	0.56	Total Trucks, %	3.70
Segment Capacity, veh/h	1700	Demand/Capacity (D/C)	0.05

Intermediate Results

Segment Vertical Class	1	Free-Flow Speed, mi/h	32.7
Speed Slope Coefficient	2.30048	Speed Power Coefficient	0.41674
PF Slope Coefficient	-1.42689	PF Power Coefficient	0.65868
In Passing Lane Effective Length?	No	Total Segment Density, veh/mi/ln	0.6
%Improved % Followers	0.0	% Improved Avg Speed	0.0

Subsegment Data

#	Segment Type	Length, ft	Radius, ft	Superelevation, %	Average Speed, mi/h
1	Tangent	2594	-	-	32.7

Vehicle Results

Average Speed, mi/h	32.7	Percent Followers, %	23.7
Segment Travel Time, minutes	0.90	Follower Density, followers/mi/ln	0.6
Vehicle LOS	A		

Facility Results

T	Follower Density, followers/mi/ln	LOS
1	0.6	A

HCS7 Two-Lane Highway Report

Project Information

Analyst	C. Ayala-Magana	Date	7/20/2022
Agency	JLB Traffic Engineering, Inc.	Analysis Year	2022
Jurisdiction	City of Hanford	Time Period Analyzed	Existing PM Peak
Project Description	06 Houston Avenue Between 11th Avenue and 10 1/2 Avenue	Unit	United States Customary

Segment 1

Vehicle Inputs

Segment Type	Passing Constrained	Length, ft	2567
Lane Width, ft	12	Shoulder Width, ft	2
Speed Limit, mi/h	50	Access Point Density, pts/mi	20.6

Demand and Capacity

Directional Demand Flow Rate, veh/h	200	Opposing Demand Flow Rate, veh/h	-
Peak Hour Factor	0.89	Total Trucks, %	3.75
Segment Capacity, veh/h	1700	Demand/Capacity (D/C)	0.12

Intermediate Results

Segment Vertical Class	1	Free-Flow Speed, mi/h	48.9
Speed Slope Coefficient	3.18076	Speed Power Coefficient	0.41674
PF Slope Coefficient	-1.42061	PF Power Coefficient	0.72351
In Passing Lane Effective Length?	No	Total Segment Density, veh/mi/ln	1.5
%Improved % Followers	0.0	% Improved Avg Speed	0.0

Subsegment Data

#	Segment Type	Length, ft	Radius, ft	Superelevation, %	Average Speed, mi/h
1	Tangent	2567	-	-	47.7

Vehicle Results

Average Speed, mi/h	47.7	Percent Followers, %	35.8
Segment Travel Time, minutes	0.61	Follower Density, followers/mi/ln	1.5
Vehicle LOS	A		

Facility Results

T	Follower Density, followers/mi/ln	LOS
1	1.5	A

HCS7 Two-Lane Highway Report

Project Information

Analyst	C. Ayala-Magana	Date	7/20/2022
Agency	JLB Traffic Engineering, Inc.	Analysis Year	2022
Jurisdiction	City of Hanford	Time Period Analyzed	Existing PM Peak
Project Description	07 Houston Avenue Between 10 1/2 Avenue and 10th Avenue	Unit	United States Customary

Segment 1

Vehicle Inputs

Segment Type	Passing Constrained	Length, ft	2570
Lane Width, ft	12	Shoulder Width, ft	2
Speed Limit, mi/h	55	Access Point Density, pts/mi	45.2

Demand and Capacity

Directional Demand Flow Rate, veh/h	228	Opposing Demand Flow Rate, veh/h	-
Peak Hour Factor	0.90	Total Trucks, %	3.00
Segment Capacity, veh/h	1700	Demand/Capacity (D/C)	0.13

Intermediate Results

Segment Vertical Class	1	Free-Flow Speed, mi/h	49.8
Speed Slope Coefficient	3.22823	Speed Power Coefficient	0.41674
PF Slope Coefficient	-1.41606	PF Power Coefficient	0.72608
In Passing Lane Effective Length?	No	Total Segment Density, veh/mi/ln	1.8
%Improved % Followers	0.0	% Improved Avg Speed	0.0

Subsegment Data

#	Segment Type	Length, ft	Radius, ft	Superelevation, %	Average Speed, mi/h
1	Tangent	2570	-	-	48.4

Vehicle Results

Average Speed, mi/h	48.4	Percent Followers, %	38.4
Segment Travel Time, minutes	0.60	Follower Density, followers/mi/ln	1.8
Vehicle LOS	A		

Facility Results

T	Follower Density, followers/mi/ln	LOS
1	1.8	A

Appendix F: Existing plus Project Traffic Conditions



www.JLBtraffic.com
info@JLBtraffic.com

516 W. Shaw Ave., Ste. 103
Fresno, CA 93704
(559) 570-8991

App | F

HCM 6th Signalized Intersection Summary
 3: 10 1/2 Avenue & Hanford Armona Road

Existing Plus Project AM Peak
 04/26/2022



Movement	EBL	EBT	EBR	WBL	WBT	WBR	NBL	NBT	NBR	SBL	SBT	SBR
Lane Configurations												
Traffic Volume (veh/h)	55	232	47	18	218	27	124	62	24	12	21	34
Future Volume (veh/h)	55	232	47	18	218	27	124	62	24	12	21	34
Initial Q (Qb), veh	0	0	0	0	0	0	0	0	0	0	0	0
Ped-Bike Adj(A_pbT)	1.00		1.00	1.00		1.00	1.00		1.00	1.00		1.00
Parking Bus, Adj	1.00	1.00	1.00	1.00	1.00	1.00	1.00	1.00	1.00	1.00	1.00	1.00
Work Zone On Approach		No			No			No			No	
Adj Sat Flow, veh/h/ln	1826	1826	1826	1826	1826	1826	1826	1826	1826	1826	1826	1826
Adj Flow Rate, veh/h	76	322	65	25	303	38	172	86	33	17	29	47
Peak Hour Factor	0.72	0.72	0.72	0.72	0.72	0.72	0.72	0.72	0.72	0.72	0.72	0.72
Percent Heavy Veh, %	5	5	5	5	5	5	5	5	5	5	5	5
Cap, veh/h	121	450	91	52	423	53	219	389	329	37	198	168
Arrive On Green	0.07	0.31	0.31	0.03	0.27	0.27	0.13	0.21	0.21	0.02	0.11	0.11
Sat Flow, veh/h	1739	1474	298	1739	1590	199	1739	1826	1547	1739	1826	1547
Grp Volume(v), veh/h	76	0	387	25	0	341	172	86	33	17	29	47
Grp Sat Flow(s),veh/h/ln	1739	0	1772	1739	0	1790	1739	1826	1547	1739	1826	1547
Q Serve(g_s), s	1.8	0.0	8.2	0.6	0.0	7.3	4.1	1.6	0.7	0.4	0.6	1.2
Cycle Q Clear(g_c), s	1.8	0.0	8.2	0.6	0.0	7.3	4.1	1.6	0.7	0.4	0.6	1.2
Prop In Lane	1.00		0.17	1.00		0.11	1.00		1.00	1.00		1.00
Lane Grp Cap(c), veh/h	121	0	541	52	0	476	219	389	329	37	198	168
V/C Ratio(X)	0.63	0.00	0.71	0.48	0.00	0.72	0.79	0.22	0.10	0.46	0.15	0.28
Avail Cap(c_a), veh/h	206	0	1143	206	0	1155	321	1273	1079	206	1165	988
HCM Platoon Ratio	1.00	1.00	1.00	1.00	1.00	1.00	1.00	1.00	1.00	1.00	1.00	1.00
Upstream Filter(I)	1.00	0.00	1.00	1.00	0.00	1.00	1.00	1.00	1.00	1.00	1.00	1.00
Uniform Delay (d), s/veh	19.1	0.0	13.1	20.2	0.0	14.1	17.9	13.8	13.4	20.5	17.1	17.3
Incr Delay (d2), s/veh	5.2	0.0	1.8	6.6	0.0	2.0	7.7	0.3	0.1	8.5	0.3	0.9
Initial Q Delay(d3),s/veh	0.0	0.0	0.0	0.0	0.0	0.0	0.0	0.0	0.0	0.0	0.0	0.0
%ile BackOfQ(50%),veh/ln	0.8	0.0	2.6	0.3	0.0	2.5	1.8	0.6	0.2	0.2	0.2	0.4
Unsig. Movement Delay, s/veh												
LnGrp Delay(d),s/veh	24.3	0.0	14.8	26.8	0.0	16.1	25.6	14.0	13.5	28.9	17.4	18.2
LnGrp LOS	C	A	B	C	A	B	C	B	B	C	B	B
Approach Vol, veh/h		463			366			291			93	
Approach Delay, s/veh		16.4			16.9			20.8			19.9	
Approach LOS		B			B			C			B	
Timer - Assigned Phs	1	2	3	4	5	6	7	8				
Phs Duration (G+Y+Rc), s	5.1	13.9	5.5	17.8	9.5	9.5	7.2	16.1				
Change Period (Y+Rc), s	* 4.2	4.9	* 4.2	4.9	* 4.2	* 4.9	* 4.2	4.9				
Max Green Setting (Gmax), s	* 5	29.5	* 5	27.3	* 7.8	* 27	* 5	27.3				
Max Q Clear Time (g_c+I1), s	2.4	3.6	2.6	10.2	6.1	3.2	3.8	9.3				
Green Ext Time (p_c), s	0.0	0.5	0.0	2.0	0.1	0.2	0.0	1.8				

Intersection Summary

HCM 6th Ctrl Delay	17.9
HCM 6th LOS	B

Notes

* HCM 6th computational engine requires equal clearance times for the phases crossing the barrier.

Intersection

Int Delay, s/veh 2.6

Movement	EBT	EBR	WBL	WBT	NBL	NBR
Lane Configurations						
Traffic Vol, veh/h	212	28	24	184	55	44
Future Vol, veh/h	212	28	24	184	55	44
Conflicting Peds, #/hr	0	0	0	0	0	1
Sign Control	Free	Free	Free	Free	Stop	Stop
RT Channelized	-	None	-	None	-	None
Storage Length	-	-	75	-	0	-
Veh in Median Storage, #	0	-	-	0	0	-
Grade, %	0	-	-	0	0	-
Peak Hour Factor	74	74	74	74	74	74
Heavy Vehicles, %	6	6	6	6	6	6
Mvmt Flow	286	38	32	249	74	59

Major/Minor

	Major1	Major2	Minor1		
Conflicting Flow All	0	0	324	0	618
Stage 1	-	-	-	-	305
Stage 2	-	-	-	-	313
Critical Hdwy	-	-	4.16	-	6.46
Critical Hdwy Stg 1	-	-	-	-	5.46
Critical Hdwy Stg 2	-	-	-	-	5.46
Follow-up Hdwy	-	-	2.254	-	3.554
Pot Cap-1 Maneuver	-	-	1214	-	446
Stage 1	-	-	-	-	739
Stage 2	-	-	-	-	732
Platoon blocked, %	-	-	-	-	-
Mov Cap-1 Maneuver	-	-	1214	-	434
Mov Cap-2 Maneuver	-	-	-	-	529
Stage 1	-	-	-	-	739
Stage 2	-	-	-	-	713

Approach

	EB	WB	NB
HCM Control Delay, s	0	0.9	12.7
HCM LOS			B

Minor Lane/Major Mvmt

	NBLn1	EBT	EBR	WBL	WBT
Capacity (veh/h)	601	-	-	1214	-
HCM Lane V/C Ratio	0.223	-	-	0.027	-
HCM Control Delay (s)	12.7	-	-	8	-
HCM Lane LOS	B	-	-	A	-
HCM 95th %tile Q(veh)	0.8	-	-	0.1	-

HCM 6th Signalized Intersection Summary
5: 10th Avenue & Hanford Armona Road

Existing Plus Project AM Peak

04/26/2022



Movement	EBL	EBT	EBR	WBL	WBT	WBR	NBL	NBT	NBR	SBL	SBT	SBR
Lane Configurations												
Traffic Volume (veh/h)	197	5	53	3	6	12	55	167	1	6	154	157
Future Volume (veh/h)	197	5	53	3	6	12	55	167	1	6	154	157
Initial Q (Qb), veh	0	0	0	0	0	0	0	0	0	0	0	0
Ped-Bike Adj(A_pbT)	1.00		1.00	1.00		1.00	1.00		1.00	1.00		1.00
Parking Bus, Adj	1.00	1.00	1.00	1.00	1.00	1.00	1.00	1.00	1.00	1.00	1.00	1.00
Work Zone On Approach		No			No			No			No	
Adj Sat Flow, veh/h/ln	1796	1796	1796	1796	1796	1796	1796	1796	1796	1796	1796	1796
Adj Flow Rate, veh/h	243	6	65	4	7	15	68	206	1	7	190	194
Peak Hour Factor	0.81	0.81	0.81	0.81	0.81	0.81	0.81	0.81	0.81	0.81	0.81	0.81
Percent Heavy Veh, %	7	7	7	7	7	7	7	7	7	7	7	7
Cap, veh/h	288	440	373	9	42	90	113	468	397	16	367	311
Arrive On Green	0.17	0.24	0.24	0.01	0.08	0.08	0.07	0.26	0.26	0.01	0.20	0.20
Sat Flow, veh/h	1711	1796	1522	1711	509	1091	1711	1796	1522	1711	1796	1522
Grp Volume(v), veh/h	243	6	65	4	0	22	68	206	1	7	190	194
Grp Sat Flow(s),veh/h/ln	1711	1796	1522	1711	0	1600	1711	1796	1522	1711	1796	1522
Q Serve(g_s), s	5.6	0.1	1.4	0.1	0.0	0.5	1.6	3.9	0.0	0.2	3.8	4.7
Cycle Q Clear(g_c), s	5.6	0.1	1.4	0.1	0.0	0.5	1.6	3.9	0.0	0.2	3.8	4.7
Prop In Lane	1.00		1.00	1.00		0.68	1.00		1.00	1.00		1.00
Lane Grp Cap(c), veh/h	288	440	373	9	0	131	113	468	397	16	367	311
V/C Ratio(X)	0.84	0.01	0.17	0.43	0.00	0.17	0.60	0.44	0.00	0.44	0.52	0.62
Avail Cap(c_a), veh/h	288	1652	1400	211	0	1385	211	1279	1084	211	1297	1099
HCM Platoon Ratio	1.00	1.00	1.00	1.00	1.00	1.00	1.00	1.00	1.00	1.00	1.00	1.00
Upstream Filter(I)	1.00	1.00	1.00	1.00	0.00	1.00	1.00	1.00	1.00	1.00	1.00	1.00
Uniform Delay (d), s/veh	16.3	11.6	12.0	20.0	0.0	17.3	18.4	12.5	11.1	19.9	14.3	14.7
Incr Delay (d2), s/veh	20.0	0.0	0.2	28.5	0.0	0.6	5.1	0.7	0.0	17.7	1.1	2.1
Initial Q Delay(d3),s/veh	0.0	0.0	0.0	0.0	0.0	0.0	0.0	0.0	0.0	0.0	0.0	0.0
%ile BackOfQ(50%),veh/ln	3.3	0.0	0.4	0.1	0.0	0.2	0.6	1.1	0.0	0.1	1.3	1.4
Unsig. Movement Delay, s/veh												
LnGrp Delay(d),s/veh	36.3	11.6	12.3	48.5	0.0	17.9	23.4	13.1	11.1	37.6	15.5	16.7
LnGrp LOS	D	B	B	D	A	B	C	B	B	D	B	B
Approach Vol, veh/h		314			26			275			391	
Approach Delay, s/veh		30.9			22.6			15.7			16.5	
Approach LOS		C			C			B			B	
Timer - Assigned Phs	1	2	3	4	5	6	7	8				
Phs Duration (G+Y+Rc), s	4.6	16.2	4.4	15.2	6.9	14.0	11.0	8.6				
Change Period (Y+Rc), s	* 4.2	5.7	* 4.2	* 5.3	* 4.2	* 5.7	* 4.2	5.3				
Max Green Setting (Gmax), s	* 5	28.8	* 5	* 37	* 5	* 29	* 6.8	35.0				
Max Q Clear Time (g_c+I1), s	2.2	5.9	2.1	3.4	3.6	6.7	7.6	2.5				
Green Ext Time (p_c), s	0.0	0.9	0.0	0.2	0.0	1.6	0.0	0.1				

Intersection Summary

HCM 6th Ctrl Delay	20.9
HCM 6th LOS	C

Notes

* HCM 6th computational engine requires equal clearance times for the phases crossing the barrier.

Intersection

Int Delay, s/veh 4.9

Movement WBL WBR NBT NBR SBL SBT

Lane Configurations						
Traffic Vol, veh/h	37	64	60	12	22	35
Future Vol, veh/h	37	64	60	12	22	35
Conflicting Peds, #/hr	0	0	0	0	0	0
Sign Control	Stop	Stop	Free	Free	Free	Free
RT Channelized	-	None	-	None	-	None
Storage Length	0	-	-	-	-	-
Veh in Median Storage, #	0	-	0	-	-	0
Grade, %	0	-	0	-	-	0
Peak Hour Factor	88	88	88	88	88	88
Heavy Vehicles, %	5	5	5	5	5	5
Mvmt Flow	42	73	68	14	25	40

Major/Minor Minor1 Major1 Major2

Conflicting Flow All	165	75	0	0	82	0
Stage 1	75	-	-	-	-	-
Stage 2	90	-	-	-	-	-
Critical Hdwy	6.45	6.25	-	-	4.15	-
Critical Hdwy Stg 1	5.45	-	-	-	-	-
Critical Hdwy Stg 2	5.45	-	-	-	-	-
Follow-up Hdwy	3.545	3.345	-	-	2.245	-
Pot Cap-1 Maneuver	819	978	-	-	1497	-
Stage 1	940	-	-	-	-	-
Stage 2	926	-	-	-	-	-
Platoon blocked, %			-	-		
Mov Cap-1 Maneuver	805	978	-	-	1497	-
Mov Cap-2 Maneuver	805	-	-	-	-	-
Stage 1	940	-	-	-	-	-
Stage 2	910	-	-	-	-	-

Approach WB NB SB

HCM Control Delay, s	9.5	0	2.9
HCM LOS	A		

Minor Lane/Major Mvmt NBT NBRWBLn1 SBL SBT

Capacity (veh/h)	-	-	907	1497	-
HCM Lane V/C Ratio	-	-	0.127	0.017	-
HCM Control Delay (s)	-	-	9.5	7.4	0
HCM Lane LOS	-	-	A	A	A
HCM 95th %tile Q(veh)	-	-	0.4	0.1	-

HCM Signalized Intersection Capacity Analysis
7: 11th Avenue & Houston Avenue

Existing Plus Project AM Peak

04/26/2022



Movement	EBL	EBT	EBR	WBL	WBT	WBR	NBL	NBT	NBR	SBL	SBT	SBR
Lane Configurations	↔	↑	↗	↖	↑	↗	↖	↑↑	↗	↖	↑	↗
Traffic Volume (vph)	32	76	24	30	85	39	17	73	23	41	59	21
Future Volume (vph)	32	76	24	30	85	39	17	73	23	41	59	21
Ideal Flow (vphp)	1900	1900	1900	1900	1900	1900	1900	1900	1900	1900	1900	1900
Total Lost time (s)	4.2	6.0	6.0	4.2	5.7	5.7	4.2	5.7	5.7	4.2	5.3	5.3
Lane Util. Factor	1.00	1.00	1.00	1.00	1.00	1.00	1.00	0.95	1.00	1.00	1.00	1.00
Frt	1.00	1.00	0.85	1.00	1.00	0.85	1.00	1.00	0.85	1.00	1.00	0.85
Flt Protected	0.95	1.00	1.00	0.95	1.00	1.00	0.95	1.00	1.00	0.95	1.00	1.00
Satd. Flow (prot)	1597	1681	1429	1597	1681	1429	1597	3195	1429	1597	1681	1429
Flt Permitted	0.95	1.00	1.00	0.95	1.00	1.00	0.95	1.00	1.00	0.95	1.00	1.00
Satd. Flow (perm)	1597	1681	1429	1597	1681	1429	1597	3195	1429	1597	1681	1429
Peak-hour factor, PHF	0.96	0.96	0.96	0.96	0.96	0.96	0.96	0.96	0.96	0.96	0.96	0.96
Adj. Flow (vph)	33	79	25	31	89	41	18	76	24	43	61	22
RTOR Reduction (vph)	0	0	22	0	0	35	0	0	15	0	0	12
Lane Group Flow (vph)	33	79	3	31	89	6	18	76	9	43	61	10
Heavy Vehicles (%)	13%	13%	13%	13%	13%	13%	13%	13%	13%	13%	13%	13%
Turn Type	Prot	NA	Perm	Prot	NA	Perm	Prot	NA	Perm	Prot	NA	Perm
Protected Phases	7	4		3	8		5	2		1	6	
Permitted Phases			4			8			2			6
Actuated Green, G (s)	3.0	7.5	7.5	3.0	7.8	7.8	1.0	21.6	21.6	3.0	24.0	24.0
Effective Green, g (s)	3.0	7.5	7.5	3.0	7.8	7.8	1.0	21.6	21.6	3.0	24.0	24.0
Actuated g/C Ratio	0.05	0.14	0.14	0.05	0.14	0.14	0.02	0.39	0.39	0.05	0.43	0.43
Clearance Time (s)	4.2	6.0	6.0	4.2	5.7	5.7	4.2	5.7	5.7	4.2	5.3	5.3
Vehicle Extension (s)	3.0	3.0	3.0	3.0	3.0	3.0	3.0	3.0	3.0	3.0	3.0	3.0
Lane Grp Cap (vph)	86	228	194	86	237	201	28	1250	559	86	730	621
v/s Ratio Prot	c0.02	0.05		0.02	c0.05		0.01	0.02		c0.03	c0.04	
v/s Ratio Perm			0.00			0.00			0.01			0.01
v/c Ratio	0.38	0.35	0.02	0.36	0.38	0.03	0.64	0.06	0.02	0.50	0.08	0.02
Uniform Delay, d1	25.2	21.6	20.7	25.2	21.5	20.4	26.9	10.5	10.3	25.4	9.1	8.9
Progression Factor	1.00	1.00	1.00	1.00	1.00	1.00	1.00	1.00	1.00	1.00	1.00	1.00
Incremental Delay, d2	2.8	0.9	0.0	2.6	1.0	0.1	40.9	0.0	0.0	4.5	0.0	0.0
Delay (s)	28.0	22.5	20.7	27.7	22.5	20.5	67.9	10.5	10.3	29.9	9.2	8.9
Level of Service	C	C	C	C	C	C	E	B	B	C	A	A
Approach Delay (s)		23.5			23.0			19.2			16.2	
Approach LOS		C			C			B			B	

Intersection Summary

HCM 2000 Control Delay	20.7	HCM 2000 Level of Service	C
HCM 2000 Volume to Capacity ratio	0.21		
Actuated Cycle Length (s)	55.2	Sum of lost time (s)	20.1
Intersection Capacity Utilization	30.9%	ICU Level of Service	A
Analysis Period (min)	15		
c Critical Lane Group			

Intersection

Int Delay, s/veh 3

Movement	EBL	EBT	WBT	WBR	SBL	SBR
Lane Configurations		↶	↷		↶	↷
Traffic Vol, veh/h	22	94	80	26	26	45
Future Vol, veh/h	22	94	80	26	26	45
Conflicting Peds, #/hr	0	0	0	0	0	0
Sign Control	Free	Free	Free	Free	Stop	Stop
RT Channelized	-	None	-	None	-	None
Storage Length	-	-	-	-	0	-
Veh in Median Storage, #	-	0	0	-	0	-
Grade, %	-	0	0	-	0	-
Peak Hour Factor	89	89	89	89	89	89
Heavy Vehicles, %	19	19	19	19	19	19
Mvmt Flow	25	106	90	29	29	51

Major/Minor	Major1	Major2	Minor2
Conflicting Flow All	119	0	0
Stage 1	-	-	-
Stage 2	-	-	-
Critical Hdwy	4.29	-	-
Critical Hdwy Stg 1	-	-	-
Critical Hdwy Stg 2	-	-	-
Follow-up Hdwy	2.371	-	-
Pot Cap-1 Maneuver	1370	-	-
Stage 1	-	-	-
Stage 2	-	-	-
Platoon blocked, %	-	-	-
Mov Cap-1 Maneuver	1370	-	-
Mov Cap-2 Maneuver	-	-	-
Stage 1	-	-	-
Stage 2	-	-	-

Approach	EB	WB	SB
HCM Control Delay, s	1.5	0	10
HCM LOS			B

Minor Lane/Major Mvmt	EBL	EBT	WBT	WBR	SBLn1
Capacity (veh/h)	1370	-	-	-	807
HCM Lane V/C Ratio	0.018	-	-	-	0.099
HCM Control Delay (s)	7.7	0	-	-	10
HCM Lane LOS	A	A	-	-	B
HCM 95th %tile Q(veh)	0.1	-	-	-	0.3

Intersection	
Intersection Delay, s/veh	8.9
Intersection LOS	A

Movement	EBL	EBT	EBR	WBL	WBT	WBR	NBL	NBT	NBR	SBL	SBT	SBR
Lane Configurations		↕			↕			↕			↕	
Traffic Vol, veh/h	30	66	31	12	56	13	14	59	5	13	63	41
Future Vol, veh/h	30	66	31	12	56	13	14	59	5	13	63	41
Peak Hour Factor	0.91	0.91	0.91	0.91	0.91	0.91	0.91	0.91	0.91	0.91	0.91	0.91
Heavy Vehicles, %	26	26	26	26	26	26	26	26	26	26	26	26
Mvmt Flow	33	73	34	13	62	14	15	65	5	14	69	45
Number of Lanes	0	1	0	0	1	0	0	1	0	0	1	0

Approach	EB	WB	NB	SB
Opposing Approach	WB	EB	SB	NB
Opposing Lanes	1	1	1	1
Conflicting Approach Left	SB	NB	EB	WB
Conflicting Lanes Left	1	1	1	1
Conflicting Approach Right	NB	SB	WB	EB
Conflicting Lanes Right	1	1	1	1
HCM Control Delay	9.1	8.7	8.8	8.9
HCM LOS	A	A	A	A

Lane	NBLn1	EBLn1	WBLn1	SBLn1
Vol Left, %	18%	24%	15%	11%
Vol Thru, %	76%	52%	69%	54%
Vol Right, %	6%	24%	16%	35%
Sign Control	Stop	Stop	Stop	Stop
Traffic Vol by Lane	78	127	81	117
LT Vol	14	30	12	13
Through Vol	59	66	56	63
RT Vol	5	31	13	41
Lane Flow Rate	86	140	89	129
Geometry Grp	1	1	1	1
Degree of Util (X)	0.121	0.19	0.123	0.173
Departure Headway (Hd)	5.078	4.895	4.991	4.842
Convergence, Y/N	Yes	Yes	Yes	Yes
Cap	705	733	717	741
Service Time	3.111	2.927	3.026	2.873
HCM Lane V/C Ratio	0.122	0.191	0.124	0.174
HCM Control Delay	8.8	9.1	8.7	8.9
HCM Lane LOS	A	A	A	A
HCM 95th-tile Q	0.4	0.7	0.4	0.6

HCM 6th Signalized Intersection Summary
 3: 10 1/2 Avenue & Hanford Armona Road

Existing Plus Project PM Peak

04/26/2022

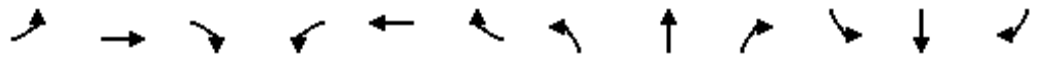

Movement	EBL	EBT	EBR	WBL	WBT	WBR	NBL	NBT	NBR	SBL	SBT	SBR
Lane Configurations												
Traffic Volume (veh/h)	44	303	111	24	297	29	89	36	14	27	43	56
Future Volume (veh/h)	44	303	111	24	297	29	89	36	14	27	43	56
Initial Q (Qb), veh	0	0	0	0	0	0	0	0	0	0	0	0
Ped-Bike Adj(A_pbT)	1.00		1.00	1.00		1.00	1.00		1.00	1.00		1.00
Parking Bus, Adj	1.00	1.00	1.00	1.00	1.00	1.00	1.00	1.00	1.00	1.00	1.00	1.00
Work Zone On Approach		No			No			No			No	
Adj Sat Flow, veh/h/ln	1856	1856	1856	1856	1856	1856	1856	1856	1856	1856	1856	1856
Adj Flow Rate, veh/h	48	329	121	26	323	32	97	39	15	29	47	61
Peak Hour Factor	0.92	0.92	0.92	0.92	0.92	0.92	0.92	0.92	0.92	0.92	0.92	0.92
Percent Heavy Veh, %	3	3	3	3	3	3	3	3	3	3	3	3
Cap, veh/h	91	439	162	55	531	53	144	287	243	61	199	169
Arrive On Green	0.05	0.34	0.34	0.03	0.32	0.32	0.08	0.15	0.15	0.03	0.11	0.11
Sat Flow, veh/h	1767	1293	475	1767	1661	165	1767	1856	1572	1767	1856	1572
Grp Volume(v), veh/h	48	0	450	26	0	355	97	39	15	29	47	61
Grp Sat Flow(s),veh/h/ln	1767	0	1768	1767	0	1825	1767	1856	1572	1767	1856	1572
Q Serve(g_s), s	1.1	0.0	9.3	0.6	0.0	6.8	2.2	0.8	0.3	0.7	1.0	1.5
Cycle Q Clear(g_c), s	1.1	0.0	9.3	0.6	0.0	6.8	2.2	0.8	0.3	0.7	1.0	1.5
Prop In Lane	1.00		0.27	1.00		0.09	1.00		1.00	1.00		1.00
Lane Grp Cap(c), veh/h	91	0	601	55	0	584	144	287	243	61	199	169
V/C Ratio(X)	0.53	0.00	0.75	0.47	0.00	0.61	0.68	0.14	0.06	0.48	0.24	0.36
Avail Cap(c_a), veh/h	214	0	1176	214	0	1214	325	1284	1088	244	1212	1027
HCM Platoon Ratio	1.00	1.00	1.00	1.00	1.00	1.00	1.00	1.00	1.00	1.00	1.00	1.00
Upstream Filter(I)	1.00	0.00	1.00	1.00	0.00	1.00	1.00	1.00	1.00	1.00	1.00	1.00
Uniform Delay (d), s/veh	19.1	0.0	12.1	19.7	0.0	11.9	18.5	15.1	14.9	19.6	16.9	17.1
Incr Delay (d2), s/veh	4.7	0.0	1.9	6.1	0.0	1.0	5.4	0.2	0.1	5.8	0.6	1.3
Initial Q Delay(d3),s/veh	0.0	0.0	0.0	0.0	0.0	0.0	0.0	0.0	0.0	0.0	0.0	0.0
%ile BackOfQ(50%),veh/ln	0.5	0.0	2.9	0.3	0.0	2.1	1.0	0.3	0.1	0.3	0.4	0.5
Unsig. Movement Delay, s/veh												
LnGrp Delay(d),s/veh	23.9	0.0	14.0	25.8	0.0	12.9	23.9	15.3	15.0	25.4	17.5	18.4
LnGrp LOS	C	A	B	C	A	B	C	B	B	C	B	B
Approach Vol, veh/h		498			381			151			137	
Approach Delay, s/veh		14.9			13.8			20.8			19.6	
Approach LOS		B			B			C			B	
Timer - Assigned Phs	1	2	3	4	5	6	7	8				
Phs Duration (G+Y+Rc), s	5.6	11.3	5.5	18.9	7.6	9.3	6.3	18.1				
Change Period (Y+Rc), s	* 4.2	4.9	* 4.2	4.9	* 4.2	* 4.9	* 4.2	4.9				
Max Green Setting (Gmax), s	* 5.7	28.6	* 5	27.5	* 7.6	* 27	* 5	27.5				
Max Q Clear Time (g_c+I1), s	2.7	2.8	2.6	11.3	4.2	3.5	3.1	8.8				
Green Ext Time (p_c), s	0.0	0.2	0.0	2.4	0.1	0.4	0.0	1.9				

Intersection Summary

HCM 6th Ctrl Delay	15.9
HCM 6th LOS	B

Notes

* HCM 6th computational engine requires equal clearance times for the phases crossing the barrier.

Intersection

Int Delay, s/veh 2.1

Movement	EBT	EBR	WBL	WBT	NBL	NBR
Lane Configurations						
Traffic Vol, veh/h	257	57	59	291	53	31
Future Vol, veh/h	257	57	59	291	53	31
Conflicting Peds, #/hr	0	2	2	0	0	0
Sign Control	Free	Free	Free	Free	Stop	Stop
RT Channelized	-	None	-	None	-	None
Storage Length	-	-	75	-	0	-
Veh in Median Storage, #	0	-	-	0	0	-
Grade, %	0	-	-	0	0	-
Peak Hour Factor	90	90	90	90	90	90
Heavy Vehicles, %	3	3	3	3	3	3
Mvmt Flow	286	63	66	323	59	34

Major/Minor	Major1	Major2	Minor1	Minor2	Minor3
Conflicting Flow All	0	0	351	0	775
Stage 1	-	-	-	-	320
Stage 2	-	-	-	-	455
Critical Hdwy	-	-	4.13	-	6.43
Critical Hdwy Stg 1	-	-	-	-	5.43
Critical Hdwy Stg 2	-	-	-	-	5.43
Follow-up Hdwy	-	-	2.227	-	3.527
Pot Cap-1 Maneuver	-	-	1202	-	365
Stage 1	-	-	-	-	734
Stage 2	-	-	-	-	637
Platoon blocked, %	-	-	-	-	-
Mov Cap-1 Maneuver	-	-	1200	-	344
Mov Cap-2 Maneuver	-	-	-	-	456
Stage 1	-	-	-	-	733
Stage 2	-	-	-	-	602

Approach	EB	WB	NB
HCM Control Delay, s	0	1.4	13.3
HCM LOS			B

Minor Lane/Major Mvmt	NBLn1	EBT	EBR	WBL	WBT
Capacity (veh/h)	527	-	-	1200	-
HCM Lane V/C Ratio	0.177	-	-	0.055	-
HCM Control Delay (s)	13.3	-	-	8.2	-
HCM Lane LOS	B	-	-	A	-
HCM 95th %tile Q(veh)	0.6	-	-	0.2	-

HCM 6th Signalized Intersection Summary
5: 10th Avenue & Hanford Armona Road

Existing Plus Project PM Peak
04/26/2022



Movement	EBL	EBT	EBR	WBL	WBT	WBR	NBL	NBT	NBR	SBL	SBT	SBR
Lane Configurations												
Traffic Volume (veh/h)	169	16	97	4	11	8	114	203	5	16	154	221
Future Volume (veh/h)	169	16	97	4	11	8	114	203	5	16	154	221
Initial Q (Qb), veh	0	0	0	0	0	0	0	0	0	0	0	0
Ped-Bike Adj(A_pbT)	1.00		1.00	1.00		0.99	1.00		0.99	1.00		0.99
Parking Bus, Adj	1.00	1.00	1.00	1.00	1.00	1.00	1.00	1.00	1.00	1.00	1.00	1.00
Work Zone On Approach		No			No			No			No	
Adj Sat Flow, veh/h/ln	1856	1856	1856	1856	1856	1856	1856	1856	1856	1856	1856	1856
Adj Flow Rate, veh/h	178	17	102	4	12	8	120	214	5	17	162	233
Peak Hour Factor	0.95	0.95	0.95	0.95	0.95	0.95	0.95	0.95	0.95	0.95	0.95	0.95
Percent Heavy Veh, %	3	3	3	3	3	3	3	3	3	3	3	3
Cap, veh/h	225	433	365	10	115	77	155	551	465	38	428	360
Arrive On Green	0.13	0.23	0.23	0.01	0.11	0.11	0.09	0.30	0.30	0.02	0.23	0.23
Sat Flow, veh/h	1767	1856	1566	1767	1036	691	1767	1856	1565	1767	1856	1562
Grp Volume(v), veh/h	178	17	102	4	0	20	120	214	5	17	162	233
Grp Sat Flow(s),veh/h/ln	1767	1856	1566	1767	0	1727	1767	1856	1565	1767	1856	1562
Q Serve(g_s), s	4.3	0.3	2.3	0.1	0.0	0.5	2.9	4.0	0.1	0.4	3.2	5.9
Cycle Q Clear(g_c), s	4.3	0.3	2.3	0.1	0.0	0.5	2.9	4.0	0.1	0.4	3.2	5.9
Prop In Lane	1.00		1.00	1.00		0.40	1.00		1.00	1.00		1.00
Lane Grp Cap(c), veh/h	225	433	365	10	0	192	155	551	465	38	428	360
V/C Ratio(X)	0.79	0.04	0.28	0.42	0.00	0.10	0.77	0.39	0.01	0.45	0.38	0.65
Avail Cap(c_a), veh/h	274	1576	1330	202	0	1380	202	1220	1029	202	1237	1041
HCM Platoon Ratio	1.00	1.00	1.00	1.00	1.00	1.00	1.00	1.00	1.00	1.00	1.00	1.00
Upstream Filter(I)	1.00	1.00	1.00	1.00	0.00	1.00	1.00	1.00	1.00	1.00	1.00	1.00
Uniform Delay (d), s/veh	18.5	13.0	13.8	21.7	0.0	17.5	19.6	12.2	10.9	21.2	14.2	15.2
Incr Delay (d2), s/veh	12.0	0.0	0.4	26.4	0.0	0.2	12.9	0.4	0.0	8.2	0.6	1.9
Initial Q Delay(d3),s/veh	0.0	0.0	0.0	0.0	0.0	0.0	0.0	0.0	0.0	0.0	0.0	0.0
%ile BackOfQ(50%),veh/ln	2.2	0.1	0.7	0.1	0.0	0.2	1.5	1.2	0.0	0.2	1.1	1.8
Unsig. Movement Delay, s/veh												
LnGrp Delay(d),s/veh	30.6	13.0	14.2	48.1	0.0	17.7	32.5	12.7	10.9	29.4	14.8	17.2
LnGrp LOS	C	B	B	D	A	B	C	B	B	C	B	B
Approach Vol, veh/h		297			24			339			412	
Approach Delay, s/veh		23.9			22.8			19.7			16.7	
Approach LOS		C			C			B			B	
Timer - Assigned Phs	1	2	3	4	5	6	7	8				
Phs Duration (G+Y+Rc), s	5.1	18.7	4.4	15.5	8.0	15.8	9.8	10.2				
Change Period (Y+Rc), s	* 4.2	5.7	* 4.2	* 5.3	* 4.2	* 5.7	* 4.2	5.3				
Max Green Setting (Gmax), s	* 5	28.8	* 5	* 37	* 5	* 29	* 6.8	35.0				
Max Q Clear Time (g_c+I1), s	2.4	6.0	2.1	4.3	4.9	7.9	6.3	2.5				
Green Ext Time (p_c), s	0.0	1.0	0.0	0.4	0.0	1.5	0.0	0.1				

Intersection Summary

HCM 6th Ctrl Delay	19.8
HCM 6th LOS	B

Notes

* HCM 6th computational engine requires equal clearance times for the phases crossing the barrier.

Intersection						
Int Delay, s/veh	4.1					
Movement	WBL	WBR	NBT	NBR	SBL	SBT
Lane Configurations						
Traffic Vol, veh/h	23	44	56	51	70	45
Future Vol, veh/h	23	44	56	51	70	45
Conflicting Peds, #/hr	0	0	0	0	0	0
Sign Control	Stop	Stop	Free	Free	Free	Free
RT Channelized	-	None	-	None	-	None
Storage Length	0	-	-	-	-	-
Veh in Median Storage, #	0	-	0	-	-	0
Grade, %	0	-	0	-	-	0
Peak Hour Factor	88	88	88	88	88	88
Heavy Vehicles, %	3	3	3	3	3	3
Mvmt Flow	26	50	64	58	80	51

Major/Minor	Minor1	Major1	Major2			
Conflicting Flow All	304	93	0	0	122	0
Stage 1	93	-	-	-	-	-
Stage 2	211	-	-	-	-	-
Critical Hdwy	6.43	6.23	-	-	4.13	-
Critical Hdwy Stg 1	5.43	-	-	-	-	-
Critical Hdwy Stg 2	5.43	-	-	-	-	-
Follow-up Hdwy	3.527	3.327	-	-	2.227	-
Pot Cap-1 Maneuver	686	961	-	-	1459	-
Stage 1	928	-	-	-	-	-
Stage 2	822	-	-	-	-	-
Platoon blocked, %			-	-		-
Mov Cap-1 Maneuver	648	961	-	-	1459	-
Mov Cap-2 Maneuver	648	-	-	-	-	-
Stage 1	928	-	-	-	-	-
Stage 2	776	-	-	-	-	-

Approach	WB	NB	SB
HCM Control Delay, s	9.8	0	4.6
HCM LOS	A		

Minor Lane/Major Mvmt	NBT	NBRWBLn1	SBL	SBT
Capacity (veh/h)	-	-	824	1459
HCM Lane V/C Ratio	-	-	0.092	0.055
HCM Control Delay (s)	-	-	9.8	7.6
HCM Lane LOS	-	-	A	A
HCM 95th %tile Q(veh)	-	-	0.3	0.2

HCM Signalized Intersection Capacity Analysis

7: 11th Avenue & Houston Avenue

Existing Plus Project PM Peak

04/26/2022

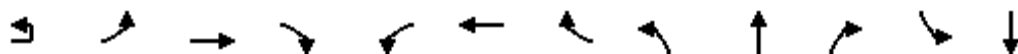

Movement	EBU	EBL	EBT	EBR	WBL	WBT	WBR	NBL	NBT	NBR	SBL	SBT
Lane Configurations												
Traffic Volume (vph)	1	21	129	18	24	112	76	33	159	38	50	78
Future Volume (vph)	1	21	129	18	24	112	76	33	159	38	50	78
Ideal Flow (vphp)	1900	1900	1900	1900	1900	1900	1900	1900	1900	1900	1900	1900
Total Lost time (s)		4.2	6.0	6.0	4.2	5.7	5.7	4.2	5.7	5.7	4.2	5.3
Lane Util. Factor		1.00	1.00	1.00	1.00	1.00	1.00	1.00	0.95	1.00	1.00	1.00
Frt		1.00	1.00	0.85	1.00	1.00	0.85	1.00	1.00	0.85	1.00	1.00
Flt Protected		0.95	1.00	1.00	0.95	1.00	1.00	0.95	1.00	1.00	0.95	1.00
Satd. Flow (prot)		1719	1810	1538	1719	1810	1538	1719	3438	1538	1719	1810
Flt Permitted		0.95	1.00	1.00	0.95	1.00	1.00	0.95	1.00	1.00	0.95	1.00
Satd. Flow (perm)		1719	1810	1538	1719	1810	1538	1719	3438	1538	1719	1810
Peak-hour factor, PHF	0.84	0.84	0.84	0.84	0.84	0.84	0.84	0.84	0.84	0.84	0.84	0.84
Adj. Flow (vph)	1	25	154	21	29	133	90	39	189	45	60	93
RTOR Reduction (vph)	0	0	0	17	0	0	69	0	0	30	0	0
Lane Group Flow (vph)	0	26	154	4	29	133	21	39	189	15	60	93
Heavy Vehicles (%)	5%	5%	5%	5%	5%	5%	5%	5%	5%	5%	5%	5%
Turn Type	Prot	Prot	NA	Perm	Prot	NA	Perm	Prot	NA	Perm	Prot	NA
Protected Phases	7	7	4		3	8		5	2		1	6
Permitted Phases				4			8			2		
Actuated Green, G (s)		1.0	11.8	11.8	2.7	13.8	13.8	2.7	19.1	19.1	5.1	21.9
Effective Green, g (s)		1.0	11.8	11.8	2.7	13.8	13.8	2.7	19.1	19.1	5.1	21.9
Actuated g/C Ratio		0.02	0.20	0.20	0.05	0.23	0.23	0.05	0.32	0.32	0.09	0.37
Clearance Time (s)		4.2	6.0	6.0	4.2	5.7	5.7	4.2	5.7	5.7	4.2	5.3
Vehicle Extension (s)		3.0	3.0	3.0	3.0	3.0	3.0	3.0	3.0	3.0	3.0	3.0
Lane Grp Cap (vph)		29	363	308	78	424	360	78	1116	499	149	674
v/s Ratio Prot		0.02	c0.09		c0.02	0.07		0.02	c0.05		c0.03	0.05
v/s Ratio Perm				0.00			0.01			0.01		
v/c Ratio		0.90	0.42	0.01	0.37	0.31	0.06	0.50	0.17	0.03	0.40	0.14
Uniform Delay, d1		28.8	20.5	18.8	27.2	18.6	17.5	27.4	14.2	13.5	25.4	12.2
Progression Factor		1.00	1.00	1.00	1.00	1.00	1.00	1.00	1.00	1.00	1.00	1.00
Incremental Delay, d2		122.2	0.8	0.0	3.0	0.4	0.1	5.0	0.1	0.0	1.8	0.1
Delay (s)		151.1	21.3	18.9	30.2	19.0	17.5	32.4	14.3	13.6	27.2	12.3
Level of Service		F	C	B	C	B	B	C	B	B	C	B
Approach Delay (s)			37.9			19.8			16.7			17.3
Approach LOS			D			B			B			B

Intersection Summary

HCM 2000 Control Delay	22.4	HCM 2000 Level of Service	C
HCM 2000 Volume to Capacity ratio	0.28		
Actuated Cycle Length (s)	58.8	Sum of lost time (s)	20.1
Intersection Capacity Utilization	40.2%	ICU Level of Service	A
Analysis Period (min)	15		
c Critical Lane Group			



Movement	SBR
Lane Configurations	7
Traffic Volume (vph)	20
Future Volume (vph)	20
Ideal Flow (vphpl)	1900
Total Lost time (s)	5.3
Lane Util. Factor	1.00
Frt	0.85
Flt Protected	1.00
Satd. Flow (prot)	1538
Flt Permitted	1.00
Satd. Flow (perm)	1538
Peak-hour factor, PHF	0.84
Adj. Flow (vph)	24
RTOR Reduction (vph)	15
Lane Group Flow (vph)	9
Heavy Vehicles (%)	5%
Turn Type	Perm
Protected Phases	
Permitted Phases	6
Actuated Green, G (s)	21.9
Effective Green, g (s)	21.9
Actuated g/C Ratio	0.37
Clearance Time (s)	5.3
Vehicle Extension (s)	3.0
Lane Grp Cap (vph)	572
v/s Ratio Prot	
v/s Ratio Perm	0.01
v/c Ratio	0.02
Uniform Delay, d1	11.6
Progression Factor	1.00
Incremental Delay, d2	0.0
Delay (s)	11.7
Level of Service	B
Approach Delay (s)	
Approach LOS	
Intersection Summary	

Intersection

Int Delay, s/veh 2.8

Movement EBL EBT WBT WBR SBL SBR

Lane Configurations		↶	↷		↶	↷
Traffic Vol, veh/h	60	107	134	39	28	34
Future Vol, veh/h	60	107	134	39	28	34
Conflicting Peds, #/hr	0	0	0	0	0	0
Sign Control	Free	Free	Free	Free	Stop	Stop
RT Channelized	-	None	-	None	-	None
Storage Length	-	-	-	-	0	-
Veh in Median Storage, #	-	0	0	-	0	-
Grade, %	-	0	0	-	0	-
Peak Hour Factor	93	93	93	93	93	93
Heavy Vehicles, %	3	3	3	3	3	3
Mvmt Flow	65	115	144	42	30	37

Major/Minor Major1 Major2 Minor2

Conflicting Flow All	186	0	-	0	410	165
Stage 1	-	-	-	-	165	-
Stage 2	-	-	-	-	245	-
Critical Hdwy	4.13	-	-	-	6.43	6.23
Critical Hdwy Stg 1	-	-	-	-	5.43	-
Critical Hdwy Stg 2	-	-	-	-	5.43	-
Follow-up Hdwy	2.227	-	-	-	3.527	3.327
Pot Cap-1 Maneuver	1382	-	-	-	596	877
Stage 1	-	-	-	-	862	-
Stage 2	-	-	-	-	793	-
Platoon blocked, %		-	-	-		
Mov Cap-1 Maneuver	1382	-	-	-	566	877
Mov Cap-2 Maneuver	-	-	-	-	566	-
Stage 1	-	-	-	-	819	-
Stage 2	-	-	-	-	793	-

Approach EB WB SB

HCM Control Delay, s	2.8	0	10.7
HCM LOS			B

Minor Lane/Major Mvmt EBL EBT WBT WBR SBLn1

Capacity (veh/h)	1382	-	-	-	703
HCM Lane V/C Ratio	0.047	-	-	-	0.095
HCM Control Delay (s)	7.7	0	-	-	10.7
HCM Lane LOS	A	A	-	-	B
HCM 95th %tile Q(veh)	0.1	-	-	-	0.3

Intersection	
Intersection Delay, s/veh	9
Intersection LOS	A

Movement	EBL	EBT	EBR	WBL	WBT	WBR	NBL	NBT	NBR	SBL	SBT	SBR
Lane Configurations		↕			↕			↕			↕	
Traffic Vol, veh/h	32	75	20	8	87	48	37	103	8	41	70	37
Future Vol, veh/h	32	75	20	8	87	48	37	103	8	41	70	37
Peak Hour Factor	0.98	0.98	0.98	0.98	0.98	0.98	0.98	0.98	0.98	0.98	0.98	0.98
Heavy Vehicles, %	5	5	5	5	5	5	5	5	5	5	5	5
Mvmt Flow	33	77	20	8	89	49	38	105	8	42	71	38
Number of Lanes	0	1	0	0	1	0	0	1	0	0	1	0

Approach	EB	WB	NB	SB
Opposing Approach	WB	EB	SB	NB
Opposing Lanes	1	1	1	1
Conflicting Approach Left	SB	NB	EB	WB
Conflicting Lanes Left	1	1	1	1
Conflicting Approach Right	NB	SB	WB	EB
Conflicting Lanes Right	1	1	1	1
HCM Control Delay	8.9	8.8	9.1	9
HCM LOS	A	A	A	A

Lane	NBLn1	EBLn1	WBLn1	SBLn1
Vol Left, %	25%	25%	6%	28%
Vol Thru, %	70%	59%	61%	47%
Vol Right, %	5%	16%	34%	25%
Sign Control	Stop	Stop	Stop	Stop
Traffic Vol by Lane	148	127	143	148
LT Vol	37	32	8	41
Through Vol	103	75	87	70
RT Vol	8	20	48	37
Lane Flow Rate	151	130	146	151
Geometry Grp	1	1	1	1
Degree of Util (X)	0.203	0.175	0.19	0.199
Departure Headway (Hd)	4.847	4.848	4.686	4.739
Convergence, Y/N	Yes	Yes	Yes	Yes
Cap	737	736	762	754
Service Time	2.9	2.9	2.737	2.791
HCM Lane V/C Ratio	0.205	0.177	0.192	0.2
HCM Control Delay	9.1	8.9	8.8	9
HCM Lane LOS	A	A	A	A
HCM 95th-tile Q	0.8	0.6	0.7	0.7

Intersection: 1: Douty St & 3rd Street

Movement	EB	EB	EB	NB	NB	NB	SB	SB
Directions Served	L	T	TR	T	T	R	LT	T
Maximum Queue (ft)	104	105	72	55	78	31	119	49
Average Queue (ft)	57	43	41	37	40	20	49	5
95th Queue (ft)	87	72	62	54	67	43	83	28
Link Distance (ft)	320	320	320	356	356		787	787
Upstream Blk Time (%)								
Queuing Penalty (veh)								
Storage Bay Dist (ft)						90		
Storage Blk Time (%)					0			
Queuing Penalty (veh)					0			

Intersection: 2: 10th Avenue & 4th Street/SR-198 WB Off Ramp

Movement	WB	NB	NB	NB	SB	SB	SB
Directions Served	LTR	L	T	T	T	T	R
Maximum Queue (ft)	151	52	115	162	179	174	75
Average Queue (ft)	48	23	64	68	88	24	35
95th Queue (ft)	103	53	110	142	151	101	59
Link Distance (ft)	775		759	759	758	758	
Upstream Blk Time (%)							
Queuing Penalty (veh)							
Storage Bay Dist (ft)		295					105
Storage Blk Time (%)							
Queuing Penalty (veh)							

Intersection: 3: 10 1/2 Avenue & Hanford Armona Road

Movement	EB	EB	WB	WB	NB	NB	NB	SB	SB	SB
Directions Served	L	TR	L	TR	L	T	R	L	T	R
Maximum Queue (ft)	107	106	47	154	141	116	50	31	31	53
Average Queue (ft)	34	62	7	55	61	33	12	10	14	18
95th Queue (ft)	77	106	27	113	109	79	37	33	38	45
Link Distance (ft)		1346		1547		396			386	
Upstream Blk Time (%)										
Queuing Penalty (veh)										
Storage Bay Dist (ft)	150		95		150		95	150		100
Storage Blk Time (%)				1	0	1				
Queuing Penalty (veh)				0	0	1				

Intersection: 4: Jordan Way & Hanford Armona Road

Movement	WB	NB
Directions Served	L	LR
Maximum Queue (ft)	30	75
Average Queue (ft)	5	42
95th Queue (ft)	22	71
Link Distance (ft)	1339	
Upstream Blk Time (%)		
Queuing Penalty (veh)		
Storage Bay Dist (ft)	75	
Storage Blk Time (%)		
Queuing Penalty (veh)		

Intersection: 5: 10th Avenue & Hanford Armona Road

Movement	EB	EB	EB	WB	WB	NB	NB	SB	SB	SB
Directions Served	L	T	R	L	TR	L	T	L	T	R
Maximum Queue (ft)	152	75	54	25	45	89	134	31	137	101
Average Queue (ft)	86	4	16	1	10	34	47	5	56	36
95th Queue (ft)	146	27	38	10	33	61	111	23	115	70
Link Distance (ft)	936			372			448			399
Upstream Blk Time (%)										
Queuing Penalty (veh)										
Storage Bay Dist (ft)	105		55	155		155		110		265
Storage Blk Time (%)	7	0	0				0		2	
Queuing Penalty (veh)	4	0	0				0		3	

Intersection: 6: 10 1/2 Avenue & Orchard Avenue

Movement	WB	SB
Directions Served	LR	LT
Maximum Queue (ft)	79	32
Average Queue (ft)	37	4
95th Queue (ft)	65	20
Link Distance (ft)	862	2833
Upstream Blk Time (%)		
Queuing Penalty (veh)		
Storage Bay Dist (ft)		
Storage Blk Time (%)		
Queuing Penalty (veh)		

Intersection: 7: 11th Avenue & Houston Avenue

Movement	EB	EB	EB	WB	WB	WB	NB	NB	NB	NB	SB	SB
Directions Served	UL	T	R	L	T	R	L	T	T	R	L	T
Maximum Queue (ft)	103	92	51	61	108	43	69	46	79	50	95	82
Average Queue (ft)	20	23	6	17	36	15	15	20	5	11	23	18
95th Queue (ft)	59	53	24	44	74	39	49	47	32	31	57	53
Link Distance (ft)	680			436			276		276		1524	
Upstream Blk Time (%)												
Queuing Penalty (veh)												
Storage Bay Dist (ft)	165		150		175		175		175		100 250	
Storage Blk Time (%)												
Queuing Penalty (veh)												

Intersection: 7: 11th Avenue & Houston Avenue

Movement	SB
Directions Served	R
Maximum Queue (ft)	69
Average Queue (ft)	14
95th Queue (ft)	47
Link Distance (ft)	1524
Upstream Blk Time (%)	
Queuing Penalty (veh)	
Storage Bay Dist (ft)	
Storage Blk Time (%)	
Queuing Penalty (veh)	

Intersection: 8: Houston Avenue & 10 1/2 Avenue

Movement	SB
Directions Served	LR
Maximum Queue (ft)	73
Average Queue (ft)	37
95th Queue (ft)	68
Link Distance (ft)	2057
Upstream Blk Time (%)	
Queuing Penalty (veh)	
Storage Bay Dist (ft)	
Storage Blk Time (%)	
Queuing Penalty (veh)	

Intersection: 9: 10th Avenue & Houston Avenue

Movement	EB	WB	NB	SB
Directions Served	LTR	LTR	LTR	LTR
Maximum Queue (ft)	100	79	74	87
Average Queue (ft)	50	41	35	41
95th Queue (ft)	83	80	66	77
Link Distance (ft)	2557	1661	1092	4776
Upstream Blk Time (%)				
Queuing Penalty (veh)				
Storage Bay Dist (ft)				
Storage Blk Time (%)				
Queuing Penalty (veh)				

Intersection: 10: 3rd Street & SR-198 EB Off Ramp

Movement	EB	SE
Directions Served	T	L
Maximum Queue (ft)	31	73
Average Queue (ft)	1	24
95th Queue (ft)	10	65
Link Distance (ft)	361	209
Upstream Blk Time (%)		
Queuing Penalty (veh)		
Storage Bay Dist (ft)		
Storage Blk Time (%)		
Queuing Penalty (veh)		

Network Summary

Network wide Queuing Penalty: 9

Intersection: 1: Douty St & 3rd Street

Movement	EB	EB	EB	NB	NB	NB	SB	SB
Directions Served	L	T	TR	T	T	R	LT	T
Maximum Queue (ft)	99	108	94	79	77	54	162	92
Average Queue (ft)	64	63	54	37	35	25	80	15
95th Queue (ft)	92	92	85	59	58	54	146	56
Link Distance (ft)	320	320	320	356	356		787	787
Upstream Blk Time (%)								
Queuing Penalty (veh)								
Storage Bay Dist (ft)						90		
Storage Blk Time (%)					0			
Queuing Penalty (veh)					0			

Intersection: 2: 10th Avenue & 4th Street/SR-198 WB Off Ramp

Movement	WB	NB	NB	NB	SB	SB	SB
Directions Served	LTR	L	T	T	T	T	R
Maximum Queue (ft)	142	121	120	138	243	180	101
Average Queue (ft)	68	51	60	55	125	55	36
95th Queue (ft)	115	87	110	121	210	159	68
Link Distance (ft)	775		759	759	758	758	
Upstream Blk Time (%)							
Queuing Penalty (veh)							
Storage Bay Dist (ft)		295					105
Storage Blk Time (%)						1	0
Queuing Penalty (veh)						2	0

Intersection: 3: 10 1/2 Avenue & Hanford Armona Road

Movement	EB	EB	WB	WB	NB	NB	NB	SB	SB	SB
Directions Served	L	TR	L	TR	L	T	R	L	T	R
Maximum Queue (ft)	88	298	47	167	135	74	31	53	75	72
Average Queue (ft)	23	102	17	76	51	25	10	17	23	26
95th Queue (ft)	61	198	41	138	99	61	33	47	53	57
Link Distance (ft)		1346		1547		396			386	
Upstream Blk Time (%)										
Queuing Penalty (veh)										
Storage Bay Dist (ft)	150		95		150		95	150		100
Storage Blk Time (%)		2		4	0					
Queuing Penalty (veh)		1		1	0					

Intersection: 4: Jordan Way & Hanford Armona Road

Movement	EB	WB	NB
Directions Served	TR	L	LR
Maximum Queue (ft)	22	72	75
Average Queue (ft)	1	15	37
95th Queue (ft)	10	46	68
Link Distance (ft)	1547		1339
Upstream Blk Time (%)			
Queuing Penalty (veh)			
Storage Bay Dist (ft)		75	
Storage Blk Time (%)		0	
Queuing Penalty (veh)		0	

Intersection: 5: 10th Avenue & Hanford Armona Road

Movement	EB	EB	EB	WB	WB	NB	NB	NB	SB	SB	SB
Directions Served	L	T	R	L	TR	L	T	R	L	T	R
Maximum Queue (ft)	202	23	147	24	48	153	157	20	52	159	80
Average Queue (ft)	83	5	27	1	16	65	62	1	22	54	51
95th Queue (ft)	156	21	71	8	39	116	130	7	49	111	78
Link Distance (ft)		936			372		448			399	
Upstream Blk Time (%)											
Queuing Penalty (veh)											
Storage Bay Dist (ft)	105		55	155		155		130	110		265
Storage Blk Time (%)	6		0			1	2			2	
Queuing Penalty (veh)	6		1			1	3			4	

Intersection: 6: 10 1/2 Avenue & Orchard Avenue

Movement	WB	SB
Directions Served	LR	LT
Maximum Queue (ft)	67	46
Average Queue (ft)	31	7
95th Queue (ft)	54	28
Link Distance (ft)	862	2833
Upstream Blk Time (%)		
Queuing Penalty (veh)		
Storage Bay Dist (ft)		
Storage Blk Time (%)		
Queuing Penalty (veh)		

Intersection: 7: 11th Avenue & Houston Avenue

Movement	EB	EB	EB	WB	WB	WB	NB	NB	NB	NB	SB	SB
Directions Served	UL	T	R	L	T	R	L	T	T	R	L	T
Maximum Queue (ft)	60	150	39	51	88	42	61	79	60	37	94	82
Average Queue (ft)	12	34	6	11	42	17	20	29	11	10	30	23
95th Queue (ft)	35	77	22	34	83	32	52	57	36	25	67	62
Link Distance (ft)		680			436			276	276			1524
Upstream Blk Time (%)												
Queuing Penalty (veh)												
Storage Bay Dist (ft)	165		150	175		175	175			100	250	
Storage Blk Time (%)		0										
Queuing Penalty (veh)		0										

Intersection: 7: 11th Avenue & Houston Avenue

Movement	SB
Directions Served	R
Maximum Queue (ft)	42
Average Queue (ft)	6
95th Queue (ft)	23
Link Distance (ft)	1524
Upstream Blk Time (%)	
Queuing Penalty (veh)	
Storage Bay Dist (ft)	
Storage Blk Time (%)	
Queuing Penalty (veh)	

Intersection: 8: Houston Avenue & 10 1/2 Avenue

Movement	EB	SB
Directions Served	LT	LR
Maximum Queue (ft)	43	52
Average Queue (ft)	9	25
95th Queue (ft)	31	44
Link Distance (ft)	2076	2057
Upstream Blk Time (%)		
Queuing Penalty (veh)		
Storage Bay Dist (ft)		
Storage Blk Time (%)		
Queuing Penalty (veh)		

Intersection: 9: 10th Avenue & Houston Avenue

Movement	EB	WB	NB	SB
Directions Served	LTR	LTR	LTR	LTR
Maximum Queue (ft)	78	103	75	68
Average Queue (ft)	33	41	35	35
95th Queue (ft)	57	72	58	57
Link Distance (ft)	2557	1661	1092	4776
Upstream Blk Time (%)				
Queuing Penalty (veh)				
Storage Bay Dist (ft)				
Storage Blk Time (%)				
Queuing Penalty (veh)				

Intersection: 10: 3rd Street & SR-198 EB Off Ramp

Movement	EB	SE
Directions Served	T	L
Maximum Queue (ft)	99	94
Average Queue (ft)	7	35
95th Queue (ft)	43	71
Link Distance (ft)	361	209
Upstream Blk Time (%)		
Queuing Penalty (veh)		
Storage Bay Dist (ft)		
Storage Blk Time (%)		
Queuing Penalty (veh)		

Network Summary

Network wide Queuing Penalty: 19

HCS7 Two-Lane Highway Report

Project Information

Analyst	C. Ayala-Magana	Date	7/20/2022
Agency	JLB Traffic Engineering, Inc.	Analysis Year	2022
Jurisdiction	City of Hanford	Time Period Analyzed	Existing Plus Project AM Peak
Project Description	01 Hanford-Armona Road Between 11th Avenue and 10 1/2 Avenue	Unit	United States Customary

Segment 1

Vehicle Inputs

Segment Type	Passing Constrained	Length, ft	2583
Lane Width, ft	12	Shoulder Width, ft	6
Speed Limit, mi/h	40	Access Point Density, pts/mi	34.8

Demand and Capacity

Directional Demand Flow Rate, veh/h	547	Opposing Demand Flow Rate, veh/h	-
Peak Hour Factor	0.72	Total Trucks, %	4.03
Segment Capacity, veh/h	1700	Demand/Capacity (D/C)	0.32

Intermediate Results

Segment Vertical Class	1	Free-Flow Speed, mi/h	36.8
Speed Slope Coefficient	2.52195	Speed Power Coefficient	0.41674
PF Slope Coefficient	-1.44139	PF Power Coefficient	0.67822
In Passing Lane Effective Length?	No	Total Segment Density, veh/mi/ln	9.6
%Improved % Followers	0.0	% Improved Avg Speed	0.0

Subsegment Data

#	Segment Type	Length, ft	Radius, ft	Superelevation, %	Average Speed, mi/h
1	Tangent	2583	-	-	35.0

Vehicle Results

Average Speed, mi/h	35.0	Percent Followers, %	61.6
Segment Travel Time, minutes	0.84	Follower Density, followers/mi/ln	9.6
Vehicle LOS	C		

Facility Results

T	Follower Density, followers/mi/ln	LOS
1	9.6	C

HCS7 Two-Lane Highway Report

Project Information

Analyst	C. Ayala-Magana	Date	7/20/2022
Agency	JLB Traffic Engineering, Inc.	Analysis Year	2022
Jurisdiction	City of Hanford	Time Period Analyzed	Existing Plus Project AM Peak
Project Description	02 Hanford-Armona Road Between 10 1/2 Avenue and Jordan Way	Unit	United States Customary

Segment 1

Vehicle Inputs

Segment Type	Passing Constrained	Length, ft	1556
Lane Width, ft	12	Shoulder Width, ft	6
Speed Limit, mi/h	40	Access Point Density, pts/mi	67.9

Demand and Capacity

Directional Demand Flow Rate, veh/h	362	Opposing Demand Flow Rate, veh/h	-
Peak Hour Factor	0.74	Total Trucks, %	3.39
Segment Capacity, veh/h	1700	Demand/Capacity (D/C)	0.21

Intermediate Results

Segment Vertical Class	1	Free-Flow Speed, mi/h	35.5
Speed Slope Coefficient	2.43653	Speed Power Coefficient	0.41674
PF Slope Coefficient	-1.48329	PF Power Coefficient	0.66113
In Passing Lane Effective Length?	No	Total Segment Density, veh/mi/ln	5.6
%Improved % Followers	0.0	% Improved Avg Speed	0.0

Subsegment Data

#	Segment Type	Length, ft	Radius, ft	Superelevation, %	Average Speed, mi/h
1	Tangent	1556	-	-	34.1

Vehicle Results

Average Speed, mi/h	34.1	Percent Followers, %	53.1
Segment Travel Time, minutes	0.52	Follower Density, followers/mi/ln	5.6
Vehicle LOS	C		

Facility Results

T	Follower Density, followers/mi/ln	LOS
1	5.6	C

HCS7 Two-Lane Highway Report

Project Information

Analyst	C. Ayala-Magana	Date	7/20/2022
Agency	JLB Traffic Engineering, Inc.	Analysis Year	2022
Jurisdiction	City of Hanford	Time Period Analyzed	Existing Plus Project AM Peak
Project Description	03 Hanford-Armona Road Between Jordan Way and 10th Avenue	Unit	United States Customary

Segment 1

Vehicle Inputs

Segment Type	Passing Constrained	Length, ft	901
Lane Width, ft	12	Shoulder Width, ft	6
Speed Limit, mi/h	40	Access Point Density, pts/mi	23.4

Demand and Capacity

Directional Demand Flow Rate, veh/h	340	Opposing Demand Flow Rate, veh/h	-
Peak Hour Factor	0.75	Total Trucks, %	6.25
Segment Capacity, veh/h	1700	Demand/Capacity (D/C)	0.20

Intermediate Results

Segment Vertical Class	1	Free-Flow Speed, mi/h	39.5
Speed Slope Coefficient	2.65189	Speed Power Coefficient	0.41674
PF Slope Coefficient	-1.50451	PF Power Coefficient	0.67582
In Passing Lane Effective Length?	No	Total Segment Density, veh/mi/ln	4.6
%Improved % Followers	0.0	% Improved Avg Speed	0.0

Subsegment Data

#	Segment Type	Length, ft	Radius, ft	Superelevation, %	Average Speed, mi/h
1	Tangent	901	-	-	38.1

Vehicle Results

Average Speed, mi/h	38.1	Percent Followers, %	51.6
Segment Travel Time, minutes	0.27	Follower Density, followers/mi/ln	4.6
Vehicle LOS	B		

Facility Results

T	Follower Density, followers/mi/ln	LOS
1	4.6	B

HCS7 Two-Lane Highway Report

Project Information

Analyst	C. Ayala-Magana	Date	7/20/2022
Agency	JLB Traffic Engineering, Inc.	Analysis Year	2022
Jurisdiction	City of Hanford	Time Period Analyzed	Existing Plus Project AM Peak
Project Description	04 10.5 Avenue Between Hanford Armona Road and Orchard Avenue	Unit	United States Customary

Segment 1

Vehicle Inputs

Segment Type	Passing Constrained	Length, ft	2735
Lane Width, ft	12	Shoulder Width, ft	2
Speed Limit, mi/h	40	Access Point Density, pts/mi	50.2

Demand and Capacity

Directional Demand Flow Rate, veh/h	307	Opposing Demand Flow Rate, veh/h	-
Peak Hour Factor	0.60	Total Trucks, %	9.87
Segment Capacity, veh/h	1700	Demand/Capacity (D/C)	0.18

Intermediate Results

Segment Vertical Class	1	Free-Flow Speed, mi/h	32.5
Speed Slope Coefficient	2.29128	Speed Power Coefficient	0.41674
PF Slope Coefficient	-1.42068	PF Power Coefficient	0.65951
In Passing Lane Effective Length?	No	Total Segment Density, veh/mi/ln	4.7
%Improved % Followers	0.0	% Improved Avg Speed	0.0

Subsegment Data

#	Segment Type	Length, ft	Radius, ft	Superelevation, %	Average Speed, mi/h
1	Tangent	2735	-	-	31.3

Vehicle Results

Average Speed, mi/h	31.3	Percent Followers, %	47.9
Segment Travel Time, minutes	0.99	Follower Density, followers/mi/ln	4.7
Vehicle LOS	B		

Facility Results

T	Follower Density, followers/mi/ln	LOS
1	4.7	B

HCS7 Two-Lane Highway Report

Project Information

Analyst	C. Ayala-Magana	Date	7/20/2022
Agency	JLB Traffic Engineering, Inc.	Analysis Year	2022
Jurisdiction	City of Hanford	Time Period Analyzed	Existing Plus Project AM Peak
Project Description	05 10.5 Avenue Between Orchard Avenue and Houston Avenue	Unit	United States Customary

Segment 1

Vehicle Inputs

Segment Type	Passing Constrained	Length, ft	2594
Lane Width, ft	12	Shoulder Width, ft	2
Speed Limit, mi/h	40	Access Point Density, pts/mi	52.9

Demand and Capacity

Directional Demand Flow Rate, veh/h	155	Opposing Demand Flow Rate, veh/h	-
Peak Hour Factor	0.42	Total Trucks, %	13.33
Segment Capacity, veh/h	1700	Demand/Capacity (D/C)	0.09

Intermediate Results

Segment Vertical Class	1	Free-Flow Speed, mi/h	32.4
Speed Slope Coefficient	2.28310	Speed Power Coefficient	0.41674
PF Slope Coefficient	-1.42395	PF Power Coefficient	0.65839
In Passing Lane Effective Length?	No	Total Segment Density, veh/mi/ln	1.7
%Improved % Followers	0.0	% Improved Avg Speed	0.0

Subsegment Data

#	Segment Type	Length, ft	Radius, ft	Superelevation, %	Average Speed, mi/h
1	Tangent	2594	-	-	31.7

Vehicle Results

Average Speed, mi/h	31.7	Percent Followers, %	34.1
Segment Travel Time, minutes	0.93	Follower Density, followers/mi/ln	1.7
Vehicle LOS	A		

Facility Results

T	Follower Density, followers/mi/ln	LOS
1	1.7	A

HCS7 Two-Lane Highway Report

Project Information

Analyst	C. Ayala-Magana	Date	7/20/2022
Agency	JLB Traffic Engineering, Inc.	Analysis Year	2022
Jurisdiction	City of Hanford	Time Period Analyzed	Existing Plus Project AM Peak
Project Description	06 Houston Avenue Between 11th Avenue and 10 1/2 Avenue	Unit	United States Customary

Segment 1

Vehicle Inputs

Segment Type	Passing Constrained	Length, ft	2567
Lane Width, ft	12	Shoulder Width, ft	2
Speed Limit, mi/h	50	Access Point Density, pts/mi	20.6

Demand and Capacity

Directional Demand Flow Rate, veh/h	260	Opposing Demand Flow Rate, veh/h	-
Peak Hour Factor	0.68	Total Trucks, %	21.40
Segment Capacity, veh/h	1700	Demand/Capacity (D/C)	0.15

Intermediate Results

Segment Vertical Class	1	Free-Flow Speed, mi/h	48.3
Speed Slope Coefficient	3.14891	Speed Power Coefficient	0.41674
PF Slope Coefficient	-1.42118	PF Power Coefficient	0.72418
In Passing Lane Effective Length?	No	Total Segment Density, veh/mi/ln	2.3
%Improved % Followers	0.0	% Improved Avg Speed	0.0

Subsegment Data

#	Segment Type	Length, ft	Radius, ft	Superelevation, %	Average Speed, mi/h
1	Tangent	2567	-	-	46.9

Vehicle Results

Average Speed, mi/h	46.9	Percent Followers, %	41.5
Segment Travel Time, minutes	0.62	Follower Density, followers/mi/ln	2.3
Vehicle LOS	A		

Facility Results

T	Follower Density, followers/mi/ln	LOS
1	2.3	A

HCS7 Two-Lane Highway Report

Project Information

Analyst	C. Ayala-Magana	Date	7/20/2022
Agency	JLB Traffic Engineering, Inc.	Analysis Year	2022
Jurisdiction	City of Hanford	Time Period Analyzed	Existing Plus Project AM Peak
Project Description	07 Houston Avenue Between 10 1/2 Avenue and 10th Avenue	Unit	United States Customary

Segment 1

Vehicle Inputs

Segment Type	Passing Constrained	Length, ft	2570
Lane Width, ft	12	Shoulder Width, ft	2
Speed Limit, mi/h	55	Access Point Density, pts/mi	45.2

Demand and Capacity

Directional Demand Flow Rate, veh/h	198	Opposing Demand Flow Rate, veh/h	-
Peak Hour Factor	0.88	Total Trucks, %	17.65
Segment Capacity, veh/h	1700	Demand/Capacity (D/C)	0.12

Intermediate Results

Segment Vertical Class	1	Free-Flow Speed, mi/h	49.3
Speed Slope Coefficient	3.20179	Speed Power Coefficient	0.41674
PF Slope Coefficient	-1.41674	PF Power Coefficient	0.72668
In Passing Lane Effective Length?	No	Total Segment Density, veh/mi/ln	1.5
%Improved % Followers	0.0	% Improved Avg Speed	0.0

Subsegment Data

#	Segment Type	Length, ft	Radius, ft	Superelevation, %	Average Speed, mi/h
1	Tangent	2570	-	-	48.1

Vehicle Results

Average Speed, mi/h	48.1	Percent Followers, %	35.4
Segment Travel Time, minutes	0.61	Follower Density, followers/mi/ln	1.5
Vehicle LOS	A		

Facility Results

T	Follower Density, followers/mi/ln	LOS
1	1.5	A

HCS7 Two-Lane Highway Report

Project Information

Analyst	C. Ayala-Magana	Date	7/20/2022
Agency	JLB Traffic Engineering, Inc.	Analysis Year	2022
Jurisdiction	City of Hanford	Time Period Analyzed	Existing Plus Project PM Peak
Project Description	01 Hanford-Armona Road Between 11th Avenue and 10 1/2 Avenue	Unit	United States Customary

Segment 1

Vehicle Inputs

Segment Type	Passing Constrained	Length, ft	2583
Lane Width, ft	12	Shoulder Width, ft	6
Speed Limit, mi/h	40	Access Point Density, pts/mi	34.8

Demand and Capacity

Directional Demand Flow Rate, veh/h	653	Opposing Demand Flow Rate, veh/h	-
Peak Hour Factor	0.83	Total Trucks, %	3.00
Segment Capacity, veh/h	1700	Demand/Capacity (D/C)	0.38

Intermediate Results

Segment Vertical Class	1	Free-Flow Speed, mi/h	36.8
Speed Slope Coefficient	2.52381	Speed Power Coefficient	0.41674
PF Slope Coefficient	-1.44159	PF Power Coefficient	0.67823
In Passing Lane Effective Length?	No	Total Segment Density, veh/mi/ln	12.4
%Improved % Followers	0.0	% Improved Avg Speed	0.0

Subsegment Data

#	Segment Type	Length, ft	Radius, ft	Superelevation, %	Average Speed, mi/h
1	Tangent	2583	-	-	34.8

Vehicle Results

Average Speed, mi/h	34.8	Percent Followers, %	66.0
Segment Travel Time, minutes	0.84	Follower Density, followers/mi/ln	12.4
Vehicle LOS	D		

Facility Results

T	Follower Density, followers/mi/ln	LOS
1	12.4	D

HCS7 Two-Lane Highway Report

Project Information

Analyst	C. Ayala-Magana	Date	7/20/2022
Agency	JLB Traffic Engineering, Inc.	Analysis Year	2022
Jurisdiction	City of Hanford	Time Period Analyzed	Existing Plus Project PM Peak
Project Description	02 Hanford-Armona Road Between 10 1/2 Avenue and Jordan Way	Unit	United States Customary

Segment 1

Vehicle Inputs

Segment Type	Passing Constrained	Length, ft	1556
Lane Width, ft	12	Shoulder Width, ft	6
Speed Limit, mi/h	40	Access Point Density, pts/mi	67.9

Demand and Capacity

Directional Demand Flow Rate, veh/h	412	Opposing Demand Flow Rate, veh/h	-
Peak Hour Factor	0.85	Total Trucks, %	3.00
Segment Capacity, veh/h	1700	Demand/Capacity (D/C)	0.24

Intermediate Results

Segment Vertical Class	1	Free-Flow Speed, mi/h	35.5
Speed Slope Coefficient	2.43724	Speed Power Coefficient	0.41674
PF Slope Coefficient	-1.48339	PF Power Coefficient	0.66114
In Passing Lane Effective Length?	No	Total Segment Density, veh/mi/ln	6.8
%Improved % Followers	0.0	% Improved Avg Speed	0.0

Subsegment Data

#	Segment Type	Length, ft	Radius, ft	Superelevation, %	Average Speed, mi/h
1	Tangent	1556	-	-	34.0

Vehicle Results

Average Speed, mi/h	34.0	Percent Followers, %	56.2
Segment Travel Time, minutes	0.52	Follower Density, followers/mi/ln	6.8
Vehicle LOS	C		

Facility Results

T	Follower Density, followers/mi/ln	LOS
1	6.8	C

HCS7 Two-Lane Highway Report

Project Information

Analyst	C. Ayala-Magana	Date	7/20/2022
Agency	JLB Traffic Engineering, Inc.	Analysis Year	2022
Jurisdiction	City of Hanford	Time Period Analyzed	Existing Plus Project PM Peak
Project Description	03 Hanford-Armona Road Between Jordan Way and 10th Avenue	Unit	United States Customary

Segment 1

Vehicle Inputs

Segment Type	Passing Constrained	Length, ft	901
Lane Width, ft	12	Shoulder Width, ft	6
Speed Limit, mi/h	40	Access Point Density, pts/mi	17.6

Demand and Capacity

Directional Demand Flow Rate, veh/h	357	Opposing Demand Flow Rate, veh/h	-
Peak Hour Factor	0.97	Total Trucks, %	3.00
Segment Capacity, veh/h	1700	Demand/Capacity (D/C)	0.21

Intermediate Results

Segment Vertical Class	1	Free-Flow Speed, mi/h	41.1
Speed Slope Coefficient	2.73635	Speed Power Coefficient	0.41674
PF Slope Coefficient	-1.50445	PF Power Coefficient	0.68170
In Passing Lane Effective Length?	No	Total Segment Density, veh/mi/ln	4.7
%Improved % Followers	0.0	% Improved Avg Speed	0.0

Subsegment Data

#	Segment Type	Length, ft	Radius, ft	Superelevation, %	Average Speed, mi/h
1	Tangent	901	-	-	39.5

Vehicle Results

Average Speed, mi/h	39.5	Percent Followers, %	52.5
Segment Travel Time, minutes	0.26	Follower Density, followers/mi/ln	4.7
Vehicle LOS	B		

Facility Results

T	Follower Density, followers/mi/ln	LOS
1	4.7	B

HCS7 Two-Lane Highway Report

Project Information

Analyst	C. Ayala-Magana	Date	7/20/2022
Agency	JLB Traffic Engineering, Inc.	Analysis Year	2022
Jurisdiction	City of Hanford	Time Period Analyzed	Existing Plus Project PM Peak
Project Description	04 10.5 Avenue Between Hanford Armona Road and Orchard Avenue	Unit	United States Customary

Segment 1

Vehicle Inputs

Segment Type	Passing Constrained	Length, ft	2735
Lane Width, ft	12	Shoulder Width, ft	2
Speed Limit, mi/h	40	Access Point Density, pts/mi	50.2

Demand and Capacity

Directional Demand Flow Rate, veh/h	251	Opposing Demand Flow Rate, veh/h	-
Peak Hour Factor	0.75	Total Trucks, %	3.00
Segment Capacity, veh/h	1700	Demand/Capacity (D/C)	0.15

Intermediate Results

Segment Vertical Class	1	Free-Flow Speed, mi/h	32.7
Speed Slope Coefficient	2.30368	Speed Power Coefficient	0.41674
PF Slope Coefficient	-1.42275	PF Power Coefficient	0.65971
In Passing Lane Effective Length?	No	Total Segment Density, veh/mi/ln	3.4
%Improved % Followers	0.0	% Improved Avg Speed	0.0

Subsegment Data

#	Segment Type	Length, ft	Radius, ft	Superelevation, %	Average Speed, mi/h
1	Tangent	2735	-	-	31.7

Vehicle Results

Average Speed, mi/h	31.7	Percent Followers, %	43.5
Segment Travel Time, minutes	0.98	Follower Density, followers/mi/ln	3.4
Vehicle LOS	B		

Facility Results

T	Follower Density, followers/mi/ln	LOS
1	3.4	B

HCS7 Two-Lane Highway Report

Project Information

Analyst	C. Ayala-Magana	Date	7/20/2022
Agency	JLB Traffic Engineering, Inc.	Analysis Year	2022
Jurisdiction	City of Hanford	Time Period Analyzed	Existing Plus Project PM Peak
Project Description	05 10.5 Avenue Between Orchard Avenue and Houston Avenue	Unit	United States Customary

Segment 1

Vehicle Inputs

Segment Type	Passing Constrained	Length, ft	2594
Lane Width, ft	12	Shoulder Width, ft	2
Speed Limit, mi/h	40	Access Point Density, pts/mi	52.9

Demand and Capacity

Directional Demand Flow Rate, veh/h	205	Opposing Demand Flow Rate, veh/h	-
Peak Hour Factor	0.56	Total Trucks, %	3.70
Segment Capacity, veh/h	1700	Demand/Capacity (D/C)	0.12

Intermediate Results

Segment Vertical Class	1	Free-Flow Speed, mi/h	32.7
Speed Slope Coefficient	2.30048	Speed Power Coefficient	0.41674
PF Slope Coefficient	-1.42689	PF Power Coefficient	0.65868
In Passing Lane Effective Length?	No	Total Segment Density, veh/mi/ln	2.6
%Improved % Followers	0.0	% Improved Avg Speed	0.0

Subsegment Data

#	Segment Type	Length, ft	Radius, ft	Superelevation, %	Average Speed, mi/h
1	Tangent	2594	-	-	31.8

Vehicle Results

Average Speed, mi/h	31.8	Percent Followers, %	39.5
Segment Travel Time, minutes	0.93	Follower Density, followers/mi/ln	2.6
Vehicle LOS	B		

Facility Results

T	Follower Density, followers/mi/ln	LOS
1	2.6	B

HCS7 Two-Lane Highway Report

Project Information

Analyst	C. Ayala-Magana	Date	7/20/2022
Agency	JLB Traffic Engineering, Inc.	Analysis Year	2022
Jurisdiction	City of Hanford	Time Period Analyzed	Existing Plus Project PM Peak
Project Description	06 Houston Avenue Between 11th Avenue and 10 1/2 Avenue	Unit	United States Customary

Segment 1

Vehicle Inputs

Segment Type	Passing Constrained	Length, ft	2567
Lane Width, ft	12	Shoulder Width, ft	2
Speed Limit, mi/h	50	Access Point Density, pts/mi	20.6

Demand and Capacity

Directional Demand Flow Rate, veh/h	251	Opposing Demand Flow Rate, veh/h	-
Peak Hour Factor	0.89	Total Trucks, %	3.75
Segment Capacity, veh/h	1700	Demand/Capacity (D/C)	0.15

Intermediate Results

Segment Vertical Class	1	Free-Flow Speed, mi/h	48.9
Speed Slope Coefficient	3.18076	Speed Power Coefficient	0.41674
PF Slope Coefficient	-1.42061	PF Power Coefficient	0.72351
In Passing Lane Effective Length?	No	Total Segment Density, veh/mi/ln	2.1
%Improved % Followers	0.0	% Improved Avg Speed	0.0

Subsegment Data

#	Segment Type	Length, ft	Radius, ft	Superelevation, %	Average Speed, mi/h
1	Tangent	2567	-	-	47.5

Vehicle Results

Average Speed, mi/h	47.5	Percent Followers, %	40.7
Segment Travel Time, minutes	0.61	Follower Density, followers/mi/ln	2.1
Vehicle LOS	A		

Facility Results

T	Follower Density, followers/mi/ln	LOS
1	2.1	A

HCS7 Two-Lane Highway Report

Project Information

Analyst	C. Ayala-Magana	Date	7/20/2022
Agency	JLB Traffic Engineering, Inc.	Analysis Year	2022
Jurisdiction	City of Hanford	Time Period Analyzed	Existing Plus Project PM Peak
Project Description	07 Houston Avenue Between 10 1/2 Avenue and 10th Avenue	Unit	United States Customary

Segment 1

Vehicle Inputs

Segment Type	Passing Constrained	Length, ft	2570
Lane Width, ft	12	Shoulder Width, ft	2
Speed Limit, mi/h	55	Access Point Density, pts/mi	45.2

Demand and Capacity

Directional Demand Flow Rate, veh/h	248	Opposing Demand Flow Rate, veh/h	-
Peak Hour Factor	0.90	Total Trucks, %	3.00
Segment Capacity, veh/h	1700	Demand/Capacity (D/C)	0.15

Intermediate Results

Segment Vertical Class	1	Free-Flow Speed, mi/h	49.8
Speed Slope Coefficient	3.22823	Speed Power Coefficient	0.41674
PF Slope Coefficient	-1.41606	PF Power Coefficient	0.72608
In Passing Lane Effective Length?	No	Total Segment Density, veh/mi/ln	2.1
%Improved % Followers	0.0	% Improved Avg Speed	0.0

Subsegment Data

#	Segment Type	Length, ft	Radius, ft	Superelevation, %	Average Speed, mi/h
1	Tangent	2570	-	-	48.3

Vehicle Results

Average Speed, mi/h	48.3	Percent Followers, %	40.2
Segment Travel Time, minutes	0.60	Follower Density, followers/mi/ln	2.1
Vehicle LOS	B		

Facility Results

T	Follower Density, followers/mi/ln	LOS
1	2.1	B

Appendix G: Near Term plus Project Traffic Conditions



www.JLBtraffic.com
info@JLBtraffic.com

516 W. Shaw Ave., Ste. 103
Fresno, CA 93704
(559) 570-8991

App | G

HCM 6th Signalized Intersection Summary
 3: 10 1/2 Avenue & Hanford Armona Road

Near Term Plus Project AM Peak

04/26/2022



Movement	EBL	EBT	EBR	WBL	WBT	WBR	NBL	NBT	NBR	SBL	SBT	SBR
Lane Configurations	↖	↗		↖	↗		↖	↑	↗	↖	↑	↗
Traffic Volume (veh/h)	58	235	47	18	220	27	124	74	24	12	22	36
Future Volume (veh/h)	58	235	47	18	220	27	124	74	24	12	22	36
Initial Q (Qb), veh	0	0	0	0	0	0	0	0	0	0	0	0
Ped-Bike Adj(A_pbT)	1.00		1.00	1.00		1.00	1.00		1.00	1.00		1.00
Parking Bus, Adj	1.00	1.00	1.00	1.00	1.00	1.00	1.00	1.00	1.00	1.00	1.00	1.00
Work Zone On Approach		No			No			No			No	
Adj Sat Flow, veh/h/ln	1826	1826	1826	1826	1826	1826	1826	1826	1826	1826	1826	1826
Adj Flow Rate, veh/h	81	326	65	25	306	38	172	103	33	17	31	50
Peak Hour Factor	0.72	0.72	0.72	0.72	0.72	0.72	0.72	0.72	0.72	0.72	0.72	0.72
Percent Heavy Veh, %	5	5	5	5	5	5	5	5	5	5	5	5
Cap, veh/h	126	457	91	52	425	53	219	391	331	37	200	170
Arrive On Green	0.07	0.31	0.31	0.03	0.27	0.27	0.13	0.21	0.21	0.02	0.11	0.11
Sat Flow, veh/h	1739	1478	295	1739	1592	198	1739	1826	1547	1739	1826	1547
Grp Volume(v), veh/h	81	0	391	25	0	344	172	103	33	17	31	50
Grp Sat Flow(s),veh/h/ln	1739	0	1772	1739	0	1790	1739	1826	1547	1739	1826	1547
Q Serve(g_s), s	1.9	0.0	8.4	0.6	0.0	7.5	4.1	2.0	0.7	0.4	0.7	1.3
Cycle Q Clear(g_c), s	1.9	0.0	8.4	0.6	0.0	7.5	4.1	2.0	0.7	0.4	0.7	1.3
Prop In Lane	1.00		0.17	1.00		0.11	1.00		1.00	1.00		1.00
Lane Grp Cap(c), veh/h	126	0	548	52	0	477	219	391	331	37	200	170
V/C Ratio(X)	0.64	0.00	0.71	0.48	0.00	0.72	0.79	0.26	0.10	0.46	0.15	0.29
Avail Cap(c_a), veh/h	203	0	1131	203	0	1143	317	1260	1067	203	1153	977
HCM Platoon Ratio	1.00	1.00	1.00	1.00	1.00	1.00	1.00	1.00	1.00	1.00	1.00	1.00
Upstream Filter(I)	1.00	0.00	1.00	1.00	0.00	1.00	1.00	1.00	1.00	1.00	1.00	1.00
Uniform Delay (d), s/veh	19.3	0.0	13.1	20.4	0.0	14.2	18.1	14.0	13.5	20.7	17.2	17.5
Incr Delay (d2), s/veh	5.4	0.0	1.7	6.6	0.0	2.1	7.9	0.4	0.1	8.5	0.4	1.0
Initial Q Delay(d3),s/veh	0.0	0.0	0.0	0.0	0.0	0.0	0.0	0.0	0.0	0.0	0.0	0.0
%ile BackOfQ(50%),veh/ln	0.8	0.0	2.7	0.3	0.0	2.6	1.8	0.7	0.2	0.2	0.3	0.4
Unsig. Movement Delay, s/veh												
LnGrp Delay(d),s/veh	24.7	0.0	14.8	27.1	0.0	16.3	26.1	14.4	13.6	29.2	17.6	18.5
LnGrp LOS	C	A	B	C	A	B	C	B	B	C	B	B
Approach Vol, veh/h		472			369			308			98	
Approach Delay, s/veh		16.5			17.0			20.8			20.1	
Approach LOS		B			B			C			C	
Timer - Assigned Phs	1	2	3	4	5	6	7	8				
Phs Duration (G+Y+Rc), s	5.1	14.1	5.5	18.1	9.6	9.6	7.3	16.3				
Change Period (Y+Rc), s	* 4.2	4.9	* 4.2	4.9	* 4.2	* 4.9	* 4.2	4.9				
Max Green Setting (Gmax), s	* 5	29.5	* 5	27.3	* 7.8	* 27	* 5	27.3				
Max Q Clear Time (g_c+I1), s	2.4	4.0	2.6	10.4	6.1	3.3	3.9	9.5				
Green Ext Time (p_c), s	0.0	0.6	0.0	2.0	0.1	0.2	0.0	1.8				

Intersection Summary

HCM 6th Ctrl Delay	18.0
HCM 6th LOS	B

Notes

* HCM 6th computational engine requires equal clearance times for the phases crossing the barrier.

Intersection

Int Delay, s/veh 2.6

Movement	EBT	EBR	WBL	WBT	NBL	NBR
Lane Configurations						
Traffic Vol, veh/h	215	28	24	186	55	44
Future Vol, veh/h	215	28	24	186	55	44
Conflicting Peds, #/hr	0	0	0	0	0	1
Sign Control	Free	Free	Free	Free	Stop	Stop
RT Channelized	-	None	-	None	-	None
Storage Length	-	-	75	-	0	-
Veh in Median Storage, #	0	-	-	0	0	-
Grade, %	0	-	-	0	0	-
Peak Hour Factor	74	74	74	74	74	74
Heavy Vehicles, %	6	6	6	6	6	6
Mvmt Flow	291	38	32	251	74	59

Major/Minor	Major1	Major2	Minor1	Minor2	Minor3
Conflicting Flow All	0	0	329	0	625
Stage 1	-	-	-	-	310
Stage 2	-	-	-	-	315
Critical Hdwy	-	-	4.16	-	6.46
Critical Hdwy Stg 1	-	-	-	-	5.46
Critical Hdwy Stg 2	-	-	-	-	5.46
Follow-up Hdwy	-	-	2.254	-	3.554
Pot Cap-1 Maneuver	-	-	1208	-	442
Stage 1	-	-	-	-	735
Stage 2	-	-	-	-	731
Platoon blocked, %	-	-	-	-	-
Mov Cap-1 Maneuver	-	-	1208	-	431
Mov Cap-2 Maneuver	-	-	-	-	527
Stage 1	-	-	-	-	735
Stage 2	-	-	-	-	712

Approach	EB	WB	NB
HCM Control Delay, s	0	0.9	12.7
HCM LOS			B

Minor Lane/Major Mvmt	NBLn1	EBT	EBR	WBL	WBT
Capacity (veh/h)	598	-	-	1208	-
HCM Lane V/C Ratio	0.224	-	-	0.027	-
HCM Control Delay (s)	12.7	-	-	8.1	-
HCM Lane LOS	B	-	-	A	-
HCM 95th %tile Q(veh)	0.9	-	-	0.1	-

HCM 6th Signalized Intersection Summary
5: 10th Avenue & Hanford Armona Road

Near Term Plus Project AM Peak

04/26/2022



Movement	EBL	EBT	EBR	WBL	WBT	WBR	NBL	NBT	NBR	SBL	SBT	SBR
Lane Configurations												
Traffic Volume (veh/h)	200	5	53	3	6	12	55	173	2	6	156	159
Future Volume (veh/h)	200	5	53	3	6	12	55	173	2	6	156	159
Initial Q (Qb), veh	0	0	0	0	0	0	0	0	0	0	0	0
Ped-Bike Adj(A_pbT)	1.00		1.00	1.00		1.00	1.00		1.00	1.00		1.00
Parking Bus, Adj	1.00	1.00	1.00	1.00	1.00	1.00	1.00	1.00	1.00	1.00	1.00	1.00
Work Zone On Approach		No			No			No			No	
Adj Sat Flow, veh/h/ln	1796	1796	1796	1796	1796	1796	1796	1796	1796	1796	1796	1796
Adj Flow Rate, veh/h	247	6	65	4	7	15	68	214	2	7	193	196
Peak Hour Factor	0.81	0.81	0.81	0.81	0.81	0.81	0.81	0.81	0.81	0.81	0.81	0.81
Percent Heavy Veh, %	7	7	7	7	7	7	7	7	7	7	7	7
Cap, veh/h	287	439	372	9	42	89	113	471	399	16	369	313
Arrive On Green	0.17	0.24	0.24	0.01	0.08	0.08	0.07	0.26	0.26	0.01	0.21	0.21
Sat Flow, veh/h	1711	1796	1522	1711	509	1091	1711	1796	1522	1711	1796	1522
Grp Volume(v), veh/h	247	6	65	4	0	22	68	214	2	7	193	196
Grp Sat Flow(s),veh/h/ln	1711	1796	1522	1711	0	1600	1711	1796	1522	1711	1796	1522
Q Serve(g_s), s	5.7	0.1	1.4	0.1	0.0	0.5	1.6	4.0	0.0	0.2	3.9	4.8
Cycle Q Clear(g_c), s	5.7	0.1	1.4	0.1	0.0	0.5	1.6	4.0	0.0	0.2	3.9	4.8
Prop In Lane	1.00		1.00	1.00		0.68	1.00		1.00	1.00		1.00
Lane Grp Cap(c), veh/h	287	439	372	9	0	131	113	471	399	16	369	313
V/C Ratio(X)	0.86	0.01	0.17	0.43	0.00	0.17	0.60	0.45	0.01	0.44	0.52	0.63
Avail Cap(c_a), veh/h	287	1649	1397	211	0	1382	211	1276	1082	211	1294	1097
HCM Platoon Ratio	1.00	1.00	1.00	1.00	1.00	1.00	1.00	1.00	1.00	1.00	1.00	1.00
Upstream Filter(I)	1.00	1.00	1.00	1.00	0.00	1.00	1.00	1.00	1.00	1.00	1.00	1.00
Uniform Delay (d), s/veh	16.4	11.6	12.1	20.1	0.0	17.3	18.4	12.5	11.0	20.0	14.3	14.7
Incr Delay (d2), s/veh	22.3	0.0	0.2	28.5	0.0	0.6	5.1	0.7	0.0	17.7	1.1	2.1
Initial Q Delay(d3),s/veh	0.0	0.0	0.0	0.0	0.0	0.0	0.0	0.0	0.0	0.0	0.0	0.0
%ile BackOfQ(50%),veh/ln	3.5	0.0	0.4	0.1	0.0	0.2	0.6	1.2	0.0	0.1	1.3	1.4
Unsig. Movement Delay, s/veh												
LnGrp Delay(d),s/veh	38.7	11.6	12.3	48.6	0.0	17.9	23.5	13.2	11.0	37.7	15.5	16.7
LnGrp LOS	D	B	B	D	A	B	C	B	B	D	B	B
Approach Vol, veh/h		318			26			284			396	
Approach Delay, s/veh		32.8			22.6			15.7			16.5	
Approach LOS		C			C			B			B	
Timer - Assigned Phs	1	2	3	4	5	6	7	8				
Phs Duration (G+Y+Rc), s	4.6	16.3	4.4	15.2	6.9	14.0	11.0	8.6				
Change Period (Y+Rc), s	* 4.2	5.7	* 4.2	* 5.3	* 4.2	* 5.7	* 4.2	5.3				
Max Green Setting (Gmax), s	* 5	28.8	* 5	* 37	* 5	* 29	* 6.8	35.0				
Max Q Clear Time (g_c+I1), s	2.2	6.0	2.1	3.4	3.6	6.8	7.7	2.5				
Green Ext Time (p_c), s	0.0	1.0	0.0	0.2	0.0	1.6	0.0	0.1				

Intersection Summary

HCM 6th Ctrl Delay	21.5
HCM 6th LOS	C

Notes

* HCM 6th computational engine requires equal clearance times for the phases crossing the barrier.

Intersection

Int Delay, s/veh 4.6

Movement WBL WBR NBT NBR SBL SBT

Lane Configurations						
Traffic Vol, veh/h	37	64	73	12	22	36
Future Vol, veh/h	37	64	73	12	22	36
Conflicting Peds, #/hr	0	0	0	0	0	0
Sign Control	Stop	Stop	Free	Free	Free	Free
RT Channelized	-	None	-	None	-	None
Storage Length	0	-	-	-	-	-
Veh in Median Storage, #	0	-	0	-	-	0
Grade, %	0	-	0	-	-	0
Peak Hour Factor	88	88	88	88	88	88
Heavy Vehicles, %	5	5	5	5	5	5
Mvmt Flow	42	73	83	14	25	41

Major/Minor Minor1 Major1 Major2

Conflicting Flow All	181	90	0	0	97	0
Stage 1	90	-	-	-	-	-
Stage 2	91	-	-	-	-	-
Critical Hdwy	6.45	6.25	-	-	4.15	-
Critical Hdwy Stg 1	5.45	-	-	-	-	-
Critical Hdwy Stg 2	5.45	-	-	-	-	-
Follow-up Hdwy	3.545	3.345	-	-	2.245	-
Pot Cap-1 Maneuver	802	960	-	-	1478	-
Stage 1	926	-	-	-	-	-
Stage 2	925	-	-	-	-	-
Platoon blocked, %			-	-	-	-
Mov Cap-1 Maneuver	788	960	-	-	1478	-
Mov Cap-2 Maneuver	788	-	-	-	-	-
Stage 1	926	-	-	-	-	-
Stage 2	909	-	-	-	-	-

Approach WB NB SB

HCM Control Delay, s	9.6	0	2.8
HCM LOS	A		

Minor Lane/Major Mvmt NBT NBRWBLn1 SBL SBT

Capacity (veh/h)	-	-	889	1478	-
HCM Lane V/C Ratio	-	-	0.129	0.017	-
HCM Control Delay (s)	-	-	9.6	7.5	0
HCM Lane LOS	-	-	A	A	A
HCM 95th %tile Q(veh)	-	-	0.4	0.1	-

HCM Signalized Intersection Capacity Analysis
7: 11th Avenue & Houston Avenue

Near Term Plus Project AM Peak

04/26/2022



Movement	EBL	EBT	EBR	WBL	WBT	WBR	NBL	NBT	NBR	SBL	SBT	SBR
Lane Configurations												
Traffic Volume (vph)	75	111	29	30	94	40	19	73	23	43	60	34
Future Volume (vph)	75	111	29	30	94	40	19	73	23	43	60	34
Ideal Flow (vphp)	1900	1900	1900	1900	1900	1900	1900	1900	1900	1900	1900	1900
Total Lost time (s)	4.2	6.0	6.0	4.2	5.7	5.7	4.2	5.7	5.7	4.2	5.3	5.3
Lane Util. Factor	1.00	1.00	1.00	1.00	1.00	1.00	1.00	0.95	1.00	1.00	1.00	1.00
Frt	1.00	1.00	0.85	1.00	1.00	0.85	1.00	1.00	0.85	1.00	1.00	0.85
Flt Protected	0.95	1.00	1.00	0.95	1.00	1.00	0.95	1.00	1.00	0.95	1.00	1.00
Satd. Flow (prot)	1597	1681	1429	1597	1681	1429	1597	3195	1429	1597	1681	1429
Flt Permitted	0.95	1.00	1.00	0.95	1.00	1.00	0.95	1.00	1.00	0.95	1.00	1.00
Satd. Flow (perm)	1597	1681	1429	1597	1681	1429	1597	3195	1429	1597	1681	1429
Peak-hour factor, PHF	0.96	0.96	0.96	0.96	0.96	0.96	0.96	0.96	0.96	0.96	0.96	0.96
Adj. Flow (vph)	78	116	30	31	98	42	20	76	24	45	62	35
RTOR Reduction (vph)	0	0	21	0	0	34	0	0	17	0	0	24
Lane Group Flow (vph)	78	116	9	31	98	8	20	76	7	45	63	11
Heavy Vehicles (%)	13%	13%	13%	13%	13%	13%	13%	13%	13%	13%	13%	13%
Turn Type	Prot	NA	Perm	Prot	NA	Perm	Prot	NA	Perm	Prot	NA	Perm
Protected Phases	7	4		3	8		5	2		1	6	
Permitted Phases			4			8			2			6
Actuated Green, G (s)	10.0	18.6	18.6	3.4	12.3	12.3	1.2	18.2	18.2	3.4	20.8	20.8
Effective Green, g (s)	10.0	18.6	18.6	3.4	12.3	12.3	1.2	18.2	18.2	3.4	20.8	20.8
Actuated g/C Ratio	0.16	0.29	0.29	0.05	0.19	0.19	0.02	0.29	0.29	0.05	0.33	0.33
Clearance Time (s)	4.2	6.0	6.0	4.2	5.7	5.7	4.2	5.7	5.7	4.2	5.3	5.3
Vehicle Extension (s)	3.0	3.0	3.0	3.0	3.0	3.0	3.0	3.0	3.0	3.0	3.0	3.0
Lane Grp Cap (vph)	250	490	417	85	324	275	30	912	408	85	548	466
v/s Ratio Prot	c0.05	0.07		0.02	c0.06		0.01	0.02		c0.03	c0.04	
v/s Ratio Perm			0.01			0.01			0.00			0.01
v/c Ratio	0.31	0.24	0.02	0.36	0.30	0.03	0.67	0.08	0.02	0.53	0.11	0.02
Uniform Delay, d1	23.8	17.2	16.1	29.1	22.0	20.9	31.1	16.6	16.3	29.4	15.0	14.6
Progression Factor	1.00	1.00	1.00	1.00	1.00	1.00	1.00	1.00	1.00	1.00	1.00	1.00
Incremental Delay, d2	0.7	0.3	0.0	2.6	0.5	0.0	44.1	0.0	0.0	5.8	0.1	0.0
Delay (s)	24.5	17.4	16.1	31.8	22.6	20.9	75.2	16.7	16.3	35.2	15.1	14.6
Level of Service	C	B	B	C	C	C	E	B	B	D	B	B
Approach Delay (s)		19.7			23.8			26.4			21.3	
Approach LOS		B			C			C			C	

Intersection Summary

HCM 2000 Control Delay	22.3	HCM 2000 Level of Service	C
HCM 2000 Volume to Capacity ratio	0.25		
Actuated Cycle Length (s)	63.7	Sum of lost time (s)	20.1
Intersection Capacity Utilization	33.3%	ICU Level of Service	A
Analysis Period (min)	15		
c Critical Lane Group			

Intersection

Int Delay, s/veh 3

Movement	EBL	EBT	WBT	WBR	SBL	SBR
Lane Configurations		↶	↷		↶	↷
Traffic Vol, veh/h	35	117	89	26	26	46
Future Vol, veh/h	35	117	89	26	26	46
Conflicting Peds, #/hr	0	0	0	0	0	0
Sign Control	Free	Free	Free	Free	Stop	Stop
RT Channelized	-	None	-	None	-	None
Storage Length	-	-	-	-	0	-
Veh in Median Storage, #	-	0	0	-	0	-
Grade, %	-	0	0	-	0	-
Peak Hour Factor	89	89	89	89	89	89
Heavy Vehicles, %	19	19	19	19	19	19
Mvmt Flow	39	131	100	29	29	52

Major/Minor	Major1	Major2	Minor2
Conflicting Flow All	129	0	0
Stage 1	-	-	-
Stage 2	-	-	-
Critical Hdwy	4.29	-	-
Critical Hdwy Stg 1	-	-	-
Critical Hdwy Stg 2	-	-	-
Follow-up Hdwy	2.371	-	-
Pot Cap-1 Maneuver	1358	-	-
Stage 1	-	-	-
Stage 2	-	-	-
Platoon blocked, %	-	-	-
Mov Cap-1 Maneuver	1358	-	-
Mov Cap-2 Maneuver	-	-	-
Stage 1	-	-	-
Stage 2	-	-	-

Approach	EB	WB	SB
HCM Control Delay, s	1.8	0	10.2
HCM LOS			B

Minor Lane/Major Mvmt	EBL	EBT	WBT	WBR	SBLn1
Capacity (veh/h)	1358	-	-	-	768
HCM Lane V/C Ratio	0.029	-	-	-	0.105
HCM Control Delay (s)	7.7	0	-	-	10.2
HCM Lane LOS	A	A	-	-	B
HCM 95th %tile Q(veh)	0.1	-	-	-	0.4

Intersection	
Intersection Delay, s/veh	9.1
Intersection LOS	A

Movement	EBL	EBT	EBR	WBL	WBT	WBR	NBL	NBT	NBR	SBL	SBT	SBR
Lane Configurations		↕			↕			↕			↕	
Traffic Vol, veh/h	37	79	34	12	61	13	15	59	5	13	63	43
Future Vol, veh/h	37	79	34	12	61	13	15	59	5	13	63	43
Peak Hour Factor	0.91	0.91	0.91	0.91	0.91	0.91	0.91	0.91	0.91	0.91	0.91	0.91
Heavy Vehicles, %	26	26	26	26	26	26	26	26	26	26	26	26
Mvmt Flow	41	87	37	13	67	14	16	65	5	14	69	47
Number of Lanes	0	1	0	0	1	0	0	1	0	0	1	0

Approach	EB	WB	NB	SB
Opposing Approach	WB	EB	SB	NB
Opposing Lanes	1	1	1	1
Conflicting Approach Left	SB	NB	EB	WB
Conflicting Lanes Left	1	1	1	1
Conflicting Approach Right	NB	SB	WB	EB
Conflicting Lanes Right	1	1	1	1
HCM Control Delay	9.4	8.9	9	9
HCM LOS	A	A	A	A

Lane	NBLn1	EBLn1	WBLn1	SBLn1
Vol Left, %	19%	25%	14%	11%
Vol Thru, %	75%	53%	71%	53%
Vol Right, %	6%	23%	15%	36%
Sign Control	Stop	Stop	Stop	Stop
Traffic Vol by Lane	79	150	86	119
LT Vol	15	37	12	13
Through Vol	59	79	61	63
RT Vol	5	34	13	43
Lane Flow Rate	87	165	95	131
Geometry Grp	1	1	1	1
Degree of Util (X)	0.125	0.226	0.132	0.179
Departure Headway (Hd)	5.167	4.929	5.042	4.919
Convergence, Y/N	Yes	Yes	Yes	Yes
Cap	693	727	710	728
Service Time	3.209	2.968	3.085	2.957
HCM Lane V/C Ratio	0.126	0.227	0.134	0.18
HCM Control Delay	9	9.4	8.9	9
HCM Lane LOS	A	A	A	A
HCM 95th-tile Q	0.4	0.9	0.5	0.6

HCM 6th Signalized Intersection Summary
3: 10 1/2 Avenue & Hanford Armona Road

Near Term Plus Project PM Peak
04/27/2022



Movement	EBL	EBT	EBR	WBL	WBT	WBR	NBL	NBT	NBR	SBL	SBT	SBR
Lane Configurations												
Traffic Volume (veh/h)	45	306	111	24	302	29	89	53	14	27	52	61
Future Volume (veh/h)	45	306	111	24	302	29	89	53	14	27	52	61
Initial Q (Qb), veh	0	0	0	0	0	0	0	0	0	0	0	0
Ped-Bike Adj(A_pbT)	1.00		1.00	1.00		1.00	1.00		1.00	1.00		1.00
Parking Bus, Adj	1.00	1.00	1.00	1.00	1.00	1.00	1.00	1.00	1.00	1.00	1.00	1.00
Work Zone On Approach		No			No			No			No	
Adj Sat Flow, veh/h/ln	1856	1856	1856	1856	1856	1856	1856	1856	1856	1856	1856	1856
Adj Flow Rate, veh/h	49	333	121	26	328	32	97	58	15	29	57	66
Peak Hour Factor	0.92	0.92	0.92	0.92	0.92	0.92	0.92	0.92	0.92	0.92	0.92	0.92
Percent Heavy Veh, %	3	3	3	3	3	3	3	3	3	3	3	3
Cap, veh/h	92	443	161	55	533	52	143	292	248	60	206	174
Arrive On Green	0.05	0.34	0.34	0.03	0.32	0.32	0.08	0.16	0.16	0.03	0.11	0.11
Sat Flow, veh/h	1767	1298	471	1767	1663	162	1767	1856	1572	1767	1856	1572
Grp Volume(v), veh/h	49	0	454	26	0	360	97	58	15	29	57	66
Grp Sat Flow(s),veh/h/ln	1767	0	1769	1767	0	1826	1767	1856	1572	1767	1856	1572
Q Serve(g_s), s	1.1	0.0	9.5	0.6	0.0	7.0	2.2	1.1	0.3	0.7	1.2	1.6
Cycle Q Clear(g_c), s	1.1	0.0	9.5	0.6	0.0	7.0	2.2	1.1	0.3	0.7	1.2	1.6
Prop In Lane	1.00		0.27	1.00		0.09	1.00		1.00	1.00		1.00
Lane Grp Cap(c), veh/h	92	0	603	55	0	585	143	292	248	60	206	174
V/C Ratio(X)	0.53	0.00	0.75	0.47	0.00	0.62	0.68	0.20	0.06	0.48	0.28	0.38
Avail Cap(c_a), veh/h	212	0	1165	212	0	1202	322	1271	1077	241	1200	1017
HCM Platoon Ratio	1.00	1.00	1.00	1.00	1.00	1.00	1.00	1.00	1.00	1.00	1.00	1.00
Upstream Filter(I)	1.00	0.00	1.00	1.00	0.00	1.00	1.00	1.00	1.00	1.00	1.00	1.00
Uniform Delay (d), s/veh	19.3	0.0	12.2	19.9	0.0	12.0	18.7	15.3	15.0	19.8	17.0	17.2
Incr Delay (d2), s/veh	4.8	0.0	1.9	6.1	0.0	1.1	5.5	0.3	0.1	5.8	0.7	1.4
Initial Q Delay(d3),s/veh	0.0	0.0	0.0	0.0	0.0	0.0	0.0	0.0	0.0	0.0	0.0	0.0
%ile BackOfQ(50%),veh/ln	0.5	0.0	2.9	0.3	0.0	2.2	1.0	0.4	0.1	0.3	0.5	0.5
Unsig. Movement Delay, s/veh												
LnGrp Delay(d),s/veh	24.1	0.0	14.1	26.0	0.0	13.1	24.2	15.6	15.1	25.6	17.7	18.6
LnGrp LOS	C	A	B	C	A	B	C	B	B	C	B	B
Approach Vol, veh/h		503			386			170			152	
Approach Delay, s/veh		15.1			13.9			20.5			19.6	
Approach LOS		B			B			C			B	
Timer - Assigned Phs	1	2	3	4	5	6	7	8				
Phs Duration (G+Y+Rc), s	5.6	11.5	5.5	19.1	7.6	9.5	6.4	18.3				
Change Period (Y+Rc), s	* 4.2	4.9	* 4.2	4.9	* 4.2	* 4.9	* 4.2	4.9				
Max Green Setting (Gmax), s	* 5.7	28.6	* 5	27.5	* 7.6	* 27	* 5	27.5				
Max Q Clear Time (g_c+I1), s	2.7	3.1	2.6	11.5	4.2	3.6	3.1	9.0				
Green Ext Time (p_c), s	0.0	0.3	0.0	2.4	0.1	0.4	0.0	1.9				

Intersection Summary

HCM 6th Ctrl Delay	16.0
HCM 6th LOS	B

Notes

* HCM 6th computational engine requires equal clearance times for the phases crossing the barrier.

Intersection

Int Delay, s/veh 2.2

Movement	EBT	EBR	WBL	WBT	NBL	NBR
Lane Configurations	↔		↔	↑	↔	
Traffic Vol, veh/h	258	57	59	296	53	31
Future Vol, veh/h	258	57	59	296	53	31
Conflicting Peds, #/hr	0	2	2	0	0	0
Sign Control	Free	Free	Free	Free	Stop	Stop
RT Channelized	-	None	-	None	-	None
Storage Length	-	-	75	-	0	-
Veh in Median Storage, #	0	-	-	0	0	-
Grade, %	0	-	-	0	0	-
Peak Hour Factor	90	90	90	90	90	90
Heavy Vehicles, %	3	3	3	3	3	3
Mvmt Flow	287	63	66	329	59	34

Major/Minor	Major1	Major2	Minor1		
Conflicting Flow All	0	0	352	0	782 321
Stage 1	-	-	-	-	321 -
Stage 2	-	-	-	-	461 -
Critical Hdwy	-	-	4.13	-	6.43 6.23
Critical Hdwy Stg 1	-	-	-	-	5.43 -
Critical Hdwy Stg 2	-	-	-	-	5.43 -
Follow-up Hdwy	-	-	2.227	-	3.527 3.327
Pot Cap-1 Maneuver	-	-	1201	-	361 718
Stage 1	-	-	-	-	733 -
Stage 2	-	-	-	-	633 -
Platoon blocked, %	-	-	-	-	-
Mov Cap-1 Maneuver	-	-	1199	-	340 717
Mov Cap-2 Maneuver	-	-	-	-	452 -
Stage 1	-	-	-	-	732 -
Stage 2	-	-	-	-	598 -

Approach	EB	WB	NB
HCM Control Delay, s	0	1.4	13.4
HCM LOS			B

Minor Lane/Major Mvmt	NBLn1	EBT	EBR	WBL	WBT
Capacity (veh/h)	523	-	-	1199	-
HCM Lane V/C Ratio	0.178	-	-	0.055	-
HCM Control Delay (s)	13.4	-	-	8.2	-
HCM Lane LOS	B	-	-	A	-
HCM 95th %tile Q(veh)	0.6	-	-	0.2	-

HCM 6th Signalized Intersection Summary
5: 10th Avenue & Hanford Armona Road

Near Term Plus Project PM Peak

04/27/2022



Movement	EBL	EBT	EBR	WBL	WBT	WBR	NBL	NBT	NBR	SBL	SBT	SBR
Lane Configurations												
Traffic Volume (veh/h)	170	16	97	5	11	8	114	210	7	16	169	226
Future Volume (veh/h)	170	16	97	5	11	8	114	210	7	16	169	226
Initial Q (Qb), veh	0	0	0	0	0	0	0	0	0	0	0	0
Ped-Bike Adj(A_pbT)	1.00		1.00	1.00		0.99	1.00		1.00	1.00		0.99
Parking Bus, Adj	1.00	1.00	1.00	1.00	1.00	1.00	1.00	1.00	1.00	1.00	1.00	1.00
Work Zone On Approach		No			No			No			No	
Adj Sat Flow, veh/h/ln	1856	1856	1856	1856	1856	1856	1856	1856	1856	1856	1856	1856
Adj Flow Rate, veh/h	179	17	102	5	12	8	120	221	7	17	178	238
Peak Hour Factor	0.95	0.95	0.95	0.95	0.95	0.95	0.95	0.95	0.95	0.95	0.95	0.95
Percent Heavy Veh, %	3	3	3	3	3	3	3	3	3	3	3	3
Cap, veh/h	226	431	364	12	115	77	154	558	470	38	436	367
Arrive On Green	0.13	0.23	0.23	0.01	0.11	0.11	0.09	0.30	0.30	0.02	0.23	0.23
Sat Flow, veh/h	1767	1856	1566	1767	1036	691	1767	1856	1565	1767	1856	1562
Grp Volume(v), veh/h	179	17	102	5	0	20	120	221	7	17	178	238
Grp Sat Flow(s),veh/h/ln	1767	1856	1566	1767	0	1727	1767	1856	1565	1767	1856	1562
Q Serve(g_s), s	4.3	0.3	2.4	0.1	0.0	0.5	2.9	4.2	0.1	0.4	3.6	6.1
Cycle Q Clear(g_c), s	4.3	0.3	2.4	0.1	0.0	0.5	2.9	4.2	0.1	0.4	3.6	6.1
Prop In Lane	1.00		1.00	1.00		0.40	1.00		1.00	1.00		1.00
Lane Grp Cap(c), veh/h	226	431	364	12	0	192	154	558	470	38	436	367
V/C Ratio(X)	0.79	0.04	0.28	0.42	0.00	0.10	0.78	0.40	0.01	0.45	0.41	0.65
Avail Cap(c_a), veh/h	272	1562	1318	200	0	1368	200	1209	1020	200	1226	1032
HCM Platoon Ratio	1.00	1.00	1.00	1.00	1.00	1.00	1.00	1.00	1.00	1.00	1.00	1.00
Upstream Filter(I)	1.00	1.00	1.00	1.00	0.00	1.00	1.00	1.00	1.00	1.00	1.00	1.00
Uniform Delay (d), s/veh	18.7	13.1	13.9	21.9	0.0	17.7	19.8	12.3	10.9	21.4	14.3	15.3
Incr Delay (d2), s/veh	12.4	0.0	0.4	21.8	0.0	0.2	13.5	0.5	0.0	8.2	0.6	1.9
Initial Q Delay(d3),s/veh	0.0	0.0	0.0	0.0	0.0	0.0	0.0	0.0	0.0	0.0	0.0	0.0
%ile BackOfQ(50%),veh/ln	2.2	0.1	0.7	0.1	0.0	0.2	1.5	1.3	0.0	0.2	1.2	1.8
Unsig. Movement Delay, s/veh												
LnGrp Delay(d),s/veh	31.1	13.2	14.3	43.7	0.0	17.9	33.3	12.7	10.9	29.6	14.9	17.2
LnGrp LOS	C	B	B	D	A	B	C	B	B	C	B	B
Approach Vol, veh/h		298			25			348			433	
Approach Delay, s/veh		24.3			23.1			19.8			16.8	
Approach LOS		C			C			B			B	
Timer - Assigned Phs	1	2	3	4	5	6	7	8				
Phs Duration (G+Y+Rc), s	5.1	19.0	4.5	15.6	8.1	16.1	9.9	10.2				
Change Period (Y+Rc), s	* 4.2	5.7	* 4.2	* 5.3	* 4.2	* 5.7	* 4.2	5.3				
Max Green Setting (Gmax), s	* 5	28.8	* 5	* 37	* 5	* 29	* 6.8	35.0				
Max Q Clear Time (g_c+I1), s	2.4	6.2	2.1	4.4	4.9	8.1	6.3	2.5				
Green Ext Time (p_c), s	0.0	1.0	0.0	0.4	0.0	1.6	0.0	0.1				

Intersection Summary

HCM 6th Ctrl Delay	19.9
HCM 6th LOS	B

Notes

* HCM 6th computational engine requires equal clearance times for the phases crossing the barrier.

Intersection

Int Delay, s/veh 3.8

Movement WBL WBR NBT NBR SBL SBT

Lane Configurations						
Traffic Vol, veh/h	23	44	73	51	70	54
Future Vol, veh/h	23	44	73	51	70	54
Conflicting Peds, #/hr	0	0	0	0	0	0
Sign Control	Stop	Stop	Free	Free	Free	Free
RT Channelized	-	None	-	None	-	None
Storage Length	0	-	-	-	-	-
Veh in Median Storage, #	0	-	0	-	-	0
Grade, %	0	-	0	-	-	0
Peak Hour Factor	88	88	88	88	88	88
Heavy Vehicles, %	3	3	3	3	3	3
Mvmt Flow	26	50	83	58	80	61

Major/Minor Minor1 Major1 Major2

Conflicting Flow All	333	112	0	0	141	0
Stage 1	112	-	-	-	-	-
Stage 2	221	-	-	-	-	-
Critical Hdwy	6.43	6.23	-	-	4.13	-
Critical Hdwy Stg 1	5.43	-	-	-	-	-
Critical Hdwy Stg 2	5.43	-	-	-	-	-
Follow-up Hdwy	3.527	3.327	-	-	2.227	-
Pot Cap-1 Maneuver	660	938	-	-	1436	-
Stage 1	910	-	-	-	-	-
Stage 2	813	-	-	-	-	-
Platoon blocked, %			-	-	-	-
Mov Cap-1 Maneuver	622	938	-	-	1436	-
Mov Cap-2 Maneuver	622	-	-	-	-	-
Stage 1	910	-	-	-	-	-
Stage 2	766	-	-	-	-	-

Approach WB NB SB

HCM Control Delay, s	10	0	4.3
HCM LOS	B		

Minor Lane/Major Mvmt NBT NBRWBLn1 SBL SBT

Capacity (veh/h)	-	-	799	1436	-
HCM Lane V/C Ratio	-	-	0.095	0.055	-
HCM Control Delay (s)	-	-	10	7.7	0
HCM Lane LOS	-	-	B	A	A
HCM 95th %tile Q(veh)	-	-	0.3	0.2	-

HCM Signalized Intersection Capacity Analysis
7: 11th Avenue & Houston Avenue

Near Term Plus Project PM Peak

04/27/2022

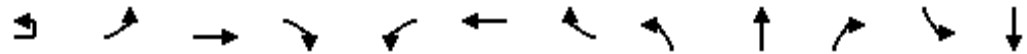

Movement	EBU	EBL	EBT	EBR	WBL	WBT	WBR	NBL	NBT	NBR	SBL	SBT
Lane Configurations		↔	↑	↗	↖	↑	↗	↖	↑↑	↗	↖	↑
Traffic Volume (vph)	1	36	172	21	24	190	80	39	159	38	53	78
Future Volume (vph)	1	36	172	21	24	190	80	39	159	38	53	78
Ideal Flow (vphp)	1900	1900	1900	1900	1900	1900	1900	1900	1900	1900	1900	1900
Total Lost time (s)		4.2	6.0	6.0	4.2	5.7	5.7	4.2	5.7	5.7	4.2	5.3
Lane Util. Factor		1.00	1.00	1.00	1.00	1.00	1.00	1.00	0.95	1.00	1.00	1.00
Frt		1.00	1.00	0.85	1.00	1.00	0.85	1.00	1.00	0.85	1.00	1.00
Flt Protected		0.95	1.00	1.00	0.95	1.00	1.00	0.95	1.00	1.00	0.95	1.00
Satd. Flow (prot)		1719	1810	1538	1719	1810	1538	1719	3438	1538	1719	1810
Flt Permitted		0.95	1.00	1.00	0.95	1.00	1.00	0.95	1.00	1.00	0.95	1.00
Satd. Flow (perm)		1719	1810	1538	1719	1810	1538	1719	3438	1538	1719	1810
Peak-hour factor, PHF	0.84	0.84	0.84	0.84	0.84	0.84	0.84	0.84	0.84	0.84	0.84	0.84
Adj. Flow (vph)	1	43	205	25	29	226	95	46	189	45	63	93
RTOR Reduction (vph)	0	0	0	17	0	0	68	0	0	35	0	0
Lane Group Flow (vph)	0	44	205	8	29	226	27	46	189	10	63	93
Heavy Vehicles (%)	5%	5%	5%	5%	5%	5%	5%	5%	5%	5%	5%	5%
Turn Type	Prot	Prot	NA	Perm	Prot	NA	Perm	Prot	NA	Perm	Prot	NA
Protected Phases	7	7	4		3	8		5	2		1	6
Permitted Phases				4			8			2		
Actuated Green, G (s)		4.7	18.2	18.2	2.8	16.6	16.6	4.7	12.9	12.9	4.7	13.3
Effective Green, g (s)		4.7	18.2	18.2	2.8	16.6	16.6	4.7	12.9	12.9	4.7	13.3
Actuated g/C Ratio		0.08	0.31	0.31	0.05	0.28	0.28	0.08	0.22	0.22	0.08	0.23
Clearance Time (s)		4.2	6.0	6.0	4.2	5.7	5.7	4.2	5.7	5.7	4.2	5.3
Vehicle Extension (s)		3.0	3.0	3.0	3.0	3.0	3.0	3.0	3.0	3.0	3.0	3.0
Lane Grp Cap (vph)		137	561	476	81	511	434	137	755	337	137	410
v/s Ratio Prot		c0.03	0.11		0.02	c0.12		0.03	c0.05		c0.04	0.05
v/s Ratio Perm				0.01			0.02			0.01		
v/c Ratio		0.32	0.37	0.02	0.36	0.44	0.06	0.34	0.25	0.03	0.46	0.23
Uniform Delay, d1		25.5	15.8	14.0	27.1	17.3	15.4	25.5	18.9	18.0	25.8	18.5
Progression Factor		1.00	1.00	1.00	1.00	1.00	1.00	1.00	1.00	1.00	1.00	1.00
Incremental Delay, d2		1.4	0.4	0.0	2.7	0.6	0.1	1.5	0.2	0.0	2.4	0.3
Delay (s)		26.9	16.2	14.1	29.8	17.9	15.4	27.0	19.1	18.0	28.2	18.8
Level of Service		C	B	B	C	B	B	C	B	B	C	B
Approach Delay (s)			17.7			18.2			20.2			21.4
Approach LOS			B			B			C			C

Intersection Summary		
HCM 2000 Control Delay	19.2	HCM 2000 Level of Service
HCM 2000 Volume to Capacity ratio	0.37	B
Actuated Cycle Length (s)	58.7	Sum of lost time (s)
Intersection Capacity Utilization	44.3%	20.1
Analysis Period (min)	15	ICU Level of Service
c Critical Lane Group		A



Movement	SBR
Lane Configurations	7
Traffic Volume (vph)	45
Future Volume (vph)	45
Ideal Flow (vphpl)	1900
Total Lost time (s)	5.3
Lane Util. Factor	1.00
Frt	0.85
Flt Protected	1.00
Satd. Flow (prot)	1538
Flt Permitted	1.00
Satd. Flow (perm)	1538
Peak-hour factor, PHF	0.84
Adj. Flow (vph)	54
RTOR Reduction (vph)	42
Lane Group Flow (vph)	12
Heavy Vehicles (%)	5%
Turn Type	Perm
Protected Phases	
Permitted Phases	6
Actuated Green, G (s)	13.3
Effective Green, g (s)	13.3
Actuated g/C Ratio	0.23
Clearance Time (s)	5.3
Vehicle Extension (s)	3.0
Lane Grp Cap (vph)	348
v/s Ratio Prot	
v/s Ratio Perm	0.01
v/c Ratio	0.04
Uniform Delay, d1	17.7
Progression Factor	1.00
Incremental Delay, d2	0.0
Delay (s)	17.7
Level of Service	B
Approach Delay (s)	
Approach LOS	
Intersection Summary	

Intersection

Int Delay, s/veh 2.7

Movement EBL EBT WBT WBR SBL SBR

Lane Configurations		↶	↷		↶	
Traffic Vol, veh/h	77	136	208	39	28	43
Future Vol, veh/h	77	136	208	39	28	43
Conflicting Peds, #/hr	0	0	0	0	0	0
Sign Control	Free	Free	Free	Free	Stop	Stop
RT Channelized	-	None	-	None	-	None
Storage Length	-	-	-	-	0	-
Veh in Median Storage, #	-	0	0	-	0	-
Grade, %	-	0	0	-	0	-
Peak Hour Factor	93	93	93	93	93	93
Heavy Vehicles, %	3	3	3	3	3	3
Mvmt Flow	83	146	224	42	30	46

Major/Minor Major1 Major2 Minor2

Conflicting Flow All	266	0	-	0	557	245
Stage 1	-	-	-	-	245	-
Stage 2	-	-	-	-	312	-
Critical Hdwy	4.13	-	-	-	6.43	6.23
Critical Hdwy Stg 1	-	-	-	-	5.43	-
Critical Hdwy Stg 2	-	-	-	-	5.43	-
Follow-up Hdwy	2.227	-	-	-	3.527	3.327
Pot Cap-1 Maneuver	1292	-	-	-	490	791
Stage 1	-	-	-	-	793	-
Stage 2	-	-	-	-	740	-
Platoon blocked, %		-	-	-		
Mov Cap-1 Maneuver	1292	-	-	-	456	791
Mov Cap-2 Maneuver	-	-	-	-	456	-
Stage 1	-	-	-	-	737	-
Stage 2	-	-	-	-	740	-

Approach EB WB SB

HCM Control Delay, s	2.9	0	11.7
HCM LOS			B

Minor Lane/Major Mvmt EBL EBT WBT WBR SBLn1

Capacity (veh/h)	1292	-	-	-	613
HCM Lane V/C Ratio	0.064	-	-	-	0.125
HCM Control Delay (s)	8	0	-	-	11.7
HCM Lane LOS	A	A	-	-	B
HCM 95th %tile Q(veh)	0.2	-	-	-	0.4

Intersection	
Intersection Delay, s/veh	9.6
Intersection LOS	A

Movement	EBL	EBT	EBR	WBL	WBT	WBR	NBL	NBT	NBR	SBL	SBT	SBR
Lane Configurations		↕			↕			↕			↕	
Traffic Vol, veh/h	41	91	25	8	137	48	44	103	8	41	70	52
Future Vol, veh/h	41	91	25	8	137	48	44	103	8	41	70	52
Peak Hour Factor	0.98	0.98	0.98	0.98	0.98	0.98	0.98	0.98	0.98	0.98	0.98	0.98
Heavy Vehicles, %	5	5	5	5	5	5	5	5	5	5	5	5
Mvmt Flow	42	93	26	8	140	49	45	105	8	42	71	53
Number of Lanes	0	1	0	0	1	0	0	1	0	0	1	0

Approach	EB	WB	NB	SB
Opposing Approach	WB	EB	SB	NB
Opposing Lanes	1	1	1	1
Conflicting Approach Left	SB	NB	EB	WB
Conflicting Lanes Left	1	1	1	1
Conflicting Approach Right	NB	SB	WB	EB
Conflicting Lanes Right	1	1	1	1
HCM Control Delay	9.5	9.7	9.7	9.5
HCM LOS	A	A	A	A

Lane	NBLn1	EBLn1	WBLn1	SBLn1
Vol Left, %	28%	26%	4%	25%
Vol Thru, %	66%	58%	71%	43%
Vol Right, %	5%	16%	25%	32%
Sign Control	Stop	Stop	Stop	Stop
Traffic Vol by Lane	155	157	193	163
LT Vol	44	41	8	41
Through Vol	103	91	137	70
RT Vol	8	25	48	52
Lane Flow Rate	158	160	197	166
Geometry Grp	1	1	1	1
Degree of Util (X)	0.224	0.222	0.266	0.228
Departure Headway (Hd)	5.099	4.999	4.858	4.927
Convergence, Y/N	Yes	Yes	Yes	Yes
Cap	697	711	733	722
Service Time	3.179	3.08	2.934	3.006
HCM Lane V/C Ratio	0.227	0.225	0.269	0.23
HCM Control Delay	9.7	9.5	9.7	9.5
HCM Lane LOS	A	A	A	A
HCM 95th-tile Q	0.9	0.8	1.1	0.9

Intersection: 1: Douty St & 3rd Street

Movement	EB	EB	EB	NB	NB	NB	SB	SB
Directions Served	L	T	TR	T	T	R	LT	T
Maximum Queue (ft)	142	75	79	54	74	54	87	30
Average Queue (ft)	63	48	40	38	35	28	48	1
95th Queue (ft)	103	68	68	54	62	55	75	10
Link Distance (ft)	320	320	320	356	356		787	787
Upstream Blk Time (%)								
Queuing Penalty (veh)								
Storage Bay Dist (ft)						90		
Storage Blk Time (%)					0			
Queuing Penalty (veh)					0			

Intersection: 2: 10th Avenue & 4th Street/SR-198 WB Off Ramp

Movement	WB	NB	NB	NB	SB	SB	SB
Directions Served	LTR	L	T	T	T	T	R
Maximum Queue (ft)	114	52	164	173	169	51	54
Average Queue (ft)	52	20	70	58	96	10	37
95th Queue (ft)	92	49	125	120	151	36	55
Link Distance (ft)	775		759	759	758	758	
Upstream Blk Time (%)							
Queuing Penalty (veh)							
Storage Bay Dist (ft)		295					105
Storage Blk Time (%)							
Queuing Penalty (veh)							

Intersection: 3: 10 1/2 Avenue & Hanford Armona Road

Movement	EB	EB	WB	WB	NB	NB	NB	SB	SB	SB
Directions Served	L	TR	L	TR	L	T	R	L	T	R
Maximum Queue (ft)	111	212	77	194	138	53	77	68	68	47
Average Queue (ft)	39	70	17	68	71	30	15	11	27	19
95th Queue (ft)	81	144	50	135	121	61	50	41	56	45
Link Distance (ft)		1346		1547		396			386	
Upstream Blk Time (%)										
Queuing Penalty (veh)										
Storage Bay Dist (ft)	150		95		150		95	150		100
Storage Blk Time (%)		1	0	2	0		0			
Queuing Penalty (veh)		1	0	0	0		0			

Intersection: 4: Jordan Way & Hanford Armona Road

Movement	WB	NB
Directions Served	L	LR
Maximum Queue (ft)	28	89
Average Queue (ft)	4	42
95th Queue (ft)	19	69
Link Distance (ft)	1339	
Upstream Blk Time (%)		
Queuing Penalty (veh)		
Storage Bay Dist (ft)	75	
Storage Blk Time (%)		
Queuing Penalty (veh)		

Intersection: 5: 10th Avenue & Hanford Armona Road

Movement	EB	EB	EB	WB	WB	NB	NB	NB	SB	SB	SB			
Directions Served	L	T	R	L	TR	L	T	R	L	T	R			
Maximum Queue (ft)	185	23	64	25	52	109	109	22	51	159	113			
Average Queue (ft)	93	3	14	2	13	35	45	1	6	59	49			
95th Queue (ft)	157	15	39	13	40	75	82	7	28	123	85			
Link Distance (ft)	936			372			448			399				
Upstream Blk Time (%)														
Queuing Penalty (veh)														
Storage Bay Dist (ft)	105		55		155		155		130		110		265	
Storage Blk Time (%)	8		0								1			
Queuing Penalty (veh)	5		0								2			

Intersection: 6: 10 1/2 Avenue & Orchard Avenue

Movement	WB	SB
Directions Served	LR	LT
Maximum Queue (ft)	78	27
Average Queue (ft)	33	3
95th Queue (ft)	53	16
Link Distance (ft)	862	2833
Upstream Blk Time (%)		
Queuing Penalty (veh)		
Storage Bay Dist (ft)		
Storage Blk Time (%)		
Queuing Penalty (veh)		

Intersection: 7: 11th Avenue & Houston Avenue

Movement	EB	EB	EB	WB	WB	WB	NB	NB	NB	NB	SB	SB
Directions Served	UL	T	R	L	T	R	L	T	T	R	L	T
Maximum Queue (ft)	153	69	60	68	77	69	69	44	64	17	84	108
Average Queue (ft)	47	31	11	26	40	14	15	17	5	6	21	12
95th Queue (ft)	103	66	37	55	70	38	45	38	25	17	51	49
Link Distance (ft)		680			436			276	276			1524
Upstream Blk Time (%)												
Queuing Penalty (veh)												
Storage Bay Dist (ft)	165		150	175		175	175			100	250	
Storage Blk Time (%)	0											
Queuing Penalty (veh)	0											

Intersection: 7: 11th Avenue & Houston Avenue

Movement	SB
Directions Served	R
Maximum Queue (ft)	62
Average Queue (ft)	9
95th Queue (ft)	29
Link Distance (ft)	1524
Upstream Blk Time (%)	
Queuing Penalty (veh)	
Storage Bay Dist (ft)	
Storage Blk Time (%)	
Queuing Penalty (veh)	

Intersection: 8: Houston Avenue & 10 1/2 Avenue

Movement	EB	SB
Directions Served	LT	LR
Maximum Queue (ft)	44	73
Average Queue (ft)	5	40
95th Queue (ft)	22	67
Link Distance (ft)	2076	2057
Upstream Blk Time (%)		
Queuing Penalty (veh)		
Storage Bay Dist (ft)		
Storage Blk Time (%)		
Queuing Penalty (veh)		

Intersection: 9: 10th Avenue & Houston Avenue

Movement	EB	WB	NB	SB
Directions Served	LTR	LTR	LTR	LTR
Maximum Queue (ft)	101	140	75	76
Average Queue (ft)	48	47	35	41
95th Queue (ft)	77	86	67	70
Link Distance (ft)	2557	1661	1092	4776
Upstream Blk Time (%)				
Queuing Penalty (veh)				
Storage Bay Dist (ft)				
Storage Blk Time (%)				
Queuing Penalty (veh)				

Intersection: 10: 3rd Street & SR-198 EB Off Ramp

Movement	EB	SE
Directions Served	T	L
Maximum Queue (ft)	31	141
Average Queue (ft)	4	28
95th Queue (ft)	20	77
Link Distance (ft)	361	209
Upstream Blk Time (%)		
Queuing Penalty (veh)		
Storage Bay Dist (ft)		
Storage Blk Time (%)		
Queuing Penalty (veh)		

Network Summary

Network wide Queuing Penalty: 9

Intersection: 1: Douty St & 3rd Street

Movement	EB	EB	EB	NB	NB	NB	SB	SB
Directions Served	L	T	TR	T	T	R	LT	T
Maximum Queue (ft)	122	100	78	56	77	55	158	54
Average Queue (ft)	59	62	58	40	37	26	79	9
95th Queue (ft)	95	92	82	57	70	53	133	34
Link Distance (ft)	320	320	320	356	356		787	787
Upstream Blk Time (%)								
Queuing Penalty (veh)								
Storage Bay Dist (ft)						90		
Storage Blk Time (%)					0			
Queuing Penalty (veh)					0			

Intersection: 2: 10th Avenue & 4th Street/SR-198 WB Off Ramp

Movement	WB	NB	NB	NB	SB	SB	SB
Directions Served	LTR	L	T	T	T	T	R
Maximum Queue (ft)	112	142	139	156	293	194	89
Average Queue (ft)	66	63	63	50	119	46	44
95th Queue (ft)	104	110	114	106	219	142	73
Link Distance (ft)	775		759	759	758	758	
Upstream Blk Time (%)							
Queuing Penalty (veh)							
Storage Bay Dist (ft)		295					105
Storage Blk Time (%)						1	0
Queuing Penalty (veh)						2	0

Intersection: 3: 10 1/2 Avenue & Hanford Armona Road

Movement	EB	EB	WB	WB	NB	NB	NB	SB	SB	SB
Directions Served	L	TR	L	TR	L	T	R	L	T	R
Maximum Queue (ft)	106	267	69	214	94	72	31	79	78	56
Average Queue (ft)	36	110	14	81	52	27	5	20	30	30
95th Queue (ft)	81	203	45	158	84	60	22	53	66	56
Link Distance (ft)		1346		1547		396			386	
Upstream Blk Time (%)										
Queuing Penalty (veh)										
Storage Bay Dist (ft)	150		95		150		95	150		100
Storage Blk Time (%)		4		6						
Queuing Penalty (veh)		2		1						

Intersection: 4: Jordan Way & Hanford Armona Road

Movement	WB	NB
Directions Served	L	LR
Maximum Queue (ft)	67	116
Average Queue (ft)	12	40
95th Queue (ft)	40	72
Link Distance (ft)	1339	
Upstream Blk Time (%)		
Queuing Penalty (veh)		
Storage Bay Dist (ft)	75	
Storage Blk Time (%)	0	
Queuing Penalty (veh)	0	

Intersection: 5: 10th Avenue & Hanford Armona Road

Movement	EB	EB	EB	WB	WB	NB	NB	NB	SB	SB	SB			
Directions Served	L	T	R	L	TR	L	T	R	L	T	R			
Maximum Queue (ft)	180	155	154	26	72	125	200	22	31	161	134			
Average Queue (ft)	84	16	29	5	13	57	66	1	14	60	53			
95th Queue (ft)	151	64	73	22	41	108	149	10	37	111	91			
Link Distance (ft)	936			372			448			399				
Upstream Blk Time (%)														
Queuing Penalty (veh)														
Storage Bay Dist (ft)	105		55		155		155		130		110		265	
Storage Blk Time (%)	5		0		0		2		1		1		1	
Queuing Penalty (veh)	5		0		0		3		2		2		2	

Intersection: 6: 10 1/2 Avenue & Orchard Avenue

Movement	WB	SB
Directions Served	LR	LT
Maximum Queue (ft)	55	53
Average Queue (ft)	30	11
95th Queue (ft)	51	38
Link Distance (ft)	862	2833
Upstream Blk Time (%)		
Queuing Penalty (veh)		
Storage Bay Dist (ft)		
Storage Blk Time (%)		
Queuing Penalty (veh)		

Intersection: 7: 11th Avenue & Houston Avenue

Movement	EB	EB	EB	WB	WB	WB	NB	NB	NB	NB	SB	SB
Directions Served	UL	T	R	L	T	R	L	T	T	R	L	T
Maximum Queue (ft)	71	86	32	48	109	91	71	65	63	42	81	81
Average Queue (ft)	23	39	7	11	54	18	29	32	19	9	26	25
95th Queue (ft)	49	78	20	34	90	47	60	56	46	25	56	56
Link Distance (ft)		680			436			276	276			1524
Upstream Blk Time (%)												
Queuing Penalty (veh)												
Storage Bay Dist (ft)	165		150	175		175	175			100	250	
Storage Blk Time (%)												
Queuing Penalty (veh)												

Intersection: 7: 11th Avenue & Houston Avenue

Movement	SB
Directions Served	R
Maximum Queue (ft)	33
Average Queue (ft)	11
95th Queue (ft)	24
Link Distance (ft)	1524
Upstream Blk Time (%)	
Queuing Penalty (veh)	
Storage Bay Dist (ft)	
Storage Blk Time (%)	
Queuing Penalty (veh)	

Intersection: 8: Houston Avenue & 10 1/2 Avenue

Movement	EB	SB
Directions Served	LT	LR
Maximum Queue (ft)	32	74
Average Queue (ft)	9	29
95th Queue (ft)	30	59
Link Distance (ft)	2076	2057
Upstream Blk Time (%)		
Queuing Penalty (veh)		
Storage Bay Dist (ft)		
Storage Blk Time (%)		
Queuing Penalty (veh)		

Intersection: 9: 10th Avenue & Houston Avenue

Movement	EB	WB	NB	SB
Directions Served	LTR	LTR	LTR	LTR
Maximum Queue (ft)	78	73	90	78
Average Queue (ft)	35	38	41	41
95th Queue (ft)	55	66	68	70
Link Distance (ft)	2557	1661	1092	4776
Upstream Blk Time (%)				
Queuing Penalty (veh)				
Storage Bay Dist (ft)				
Storage Blk Time (%)				
Queuing Penalty (veh)				

Intersection: 10: 3rd Street & SR-198 EB Off Ramp

Movement	EB	SE
Directions Served	T	L
Maximum Queue (ft)	30	117
Average Queue (ft)	2	45
95th Queue (ft)	14	96
Link Distance (ft)	361	209
Upstream Blk Time (%)		
Queuing Penalty (veh)		
Storage Bay Dist (ft)		
Storage Blk Time (%)		
Queuing Penalty (veh)		

Network Summary

Network wide Queuing Penalty: 15

HCS7 Two-Lane Highway Report

Project Information

Analyst	C. Ayala-Magana	Date	7/20/2022
Agency	JLB Traffic Engineering, Inc.	Analysis Year	2022
Jurisdiction	City of Hanford	Time Period Analyzed	Near Term Plus Project AM Peak
Project Description	01 Hanford-Armona Road Between 11th Avenue and 10 1/2 Avenue	Unit	United States Customary

Segment 1

Vehicle Inputs

Segment Type	Passing Constrained	Length, ft	2583
Lane Width, ft	12	Shoulder Width, ft	6
Speed Limit, mi/h	40	Access Point Density, pts/mi	34.8

Demand and Capacity

Directional Demand Flow Rate, veh/h	553	Opposing Demand Flow Rate, veh/h	-
Peak Hour Factor	0.72	Total Trucks, %	4.02
Segment Capacity, veh/h	1700	Demand/Capacity (D/C)	0.33

Intermediate Results

Segment Vertical Class	1	Free-Flow Speed, mi/h	36.8
Speed Slope Coefficient	2.52197	Speed Power Coefficient	0.41674
PF Slope Coefficient	-1.44139	PF Power Coefficient	0.67822
In Passing Lane Effective Length?	No	Total Segment Density, veh/mi/ln	9.8
%Improved % Followers	0.0	% Improved Avg Speed	0.0

Subsegment Data

#	Segment Type	Length, ft	Radius, ft	Superelevation, %	Average Speed, mi/h
1	Tangent	2583	-	-	35.0

Vehicle Results

Average Speed, mi/h	35.0	Percent Followers, %	61.9
Segment Travel Time, minutes	0.84	Follower Density, followers/mi/ln	9.8
Vehicle LOS	C		

Facility Results

T	Follower Density, followers/mi/ln	LOS
1	9.8	C

HCS7 Two-Lane Highway Report

Project Information

Analyst	C. Ayala-Magana	Date	7/20/2022
Agency	JLB Traffic Engineering, Inc.	Analysis Year	2022
Jurisdiction	City of Hanford	Time Period Analyzed	Near Term Plus Project AM Peak
Project Description	02 Hanford-Armona Road Between 10 1/2 Avenue and Jordan Way	Unit	United States Customary

Segment 1

Vehicle Inputs

Segment Type	Passing Constrained	Length, ft	1556
Lane Width, ft	12	Shoulder Width, ft	6
Speed Limit, mi/h	40	Access Point Density, pts/mi	67.9

Demand and Capacity

Directional Demand Flow Rate, veh/h	366	Opposing Demand Flow Rate, veh/h	-
Peak Hour Factor	0.74	Total Trucks, %	3.39
Segment Capacity, veh/h	1700	Demand/Capacity (D/C)	0.22

Intermediate Results

Segment Vertical Class	1	Free-Flow Speed, mi/h	35.5
Speed Slope Coefficient	2.43653	Speed Power Coefficient	0.41674
PF Slope Coefficient	-1.48329	PF Power Coefficient	0.66113
In Passing Lane Effective Length?	No	Total Segment Density, veh/mi/ln	5.7
%Improved % Followers	0.0	% Improved Avg Speed	0.0

Subsegment Data

#	Segment Type	Length, ft	Radius, ft	Superelevation, %	Average Speed, mi/h
1	Tangent	1556	-	-	34.1

Vehicle Results

Average Speed, mi/h	34.1	Percent Followers, %	53.4
Segment Travel Time, minutes	0.52	Follower Density, followers/mi/ln	5.7
Vehicle LOS	C		

Facility Results

T	Follower Density, followers/mi/ln	LOS
1	5.7	C

HCS7 Two-Lane Highway Report

Project Information

Analyst	C. Ayala-Magana	Date	7/20/2022
Agency	JLB Traffic Engineering, Inc.	Analysis Year	2022
Jurisdiction	City of Hanford	Time Period Analyzed	Near Term Plus Project AM Peak
Project Description	03 Hanford-Armona Road Between Jordan Way and 10th Avenue	Unit	United States Customary

Segment 1

Vehicle Inputs

Segment Type	Passing Constrained	Length, ft	901
Lane Width, ft	12	Shoulder Width, ft	6
Speed Limit, mi/h	40	Access Point Density, pts/mi	23.4

Demand and Capacity

Directional Demand Flow Rate, veh/h	344	Opposing Demand Flow Rate, veh/h	-
Peak Hour Factor	0.75	Total Trucks, %	6.25
Segment Capacity, veh/h	1700	Demand/Capacity (D/C)	0.20

Intermediate Results

Segment Vertical Class	1	Free-Flow Speed, mi/h	39.5
Speed Slope Coefficient	2.65189	Speed Power Coefficient	0.41674
PF Slope Coefficient	-1.50451	PF Power Coefficient	0.67582
In Passing Lane Effective Length?	No	Total Segment Density, veh/mi/ln	4.7
%Improved % Followers	0.0	% Improved Avg Speed	0.0

Subsegment Data

#	Segment Type	Length, ft	Radius, ft	Superelevation, %	Average Speed, mi/h
1	Tangent	901	-	-	38.1

Vehicle Results

Average Speed, mi/h	38.1	Percent Followers, %	51.9
Segment Travel Time, minutes	0.27	Follower Density, followers/mi/ln	4.7
Vehicle LOS	B		

Facility Results

T	Follower Density, followers/mi/ln	LOS
1	4.7	B

HCS7 Two-Lane Highway Report

Project Information

Analyst	C. Ayala-Magana	Date	7/20/2022
Agency	JLB Traffic Engineering, Inc.	Analysis Year	2022
Jurisdiction	City of Hanford	Time Period Analyzed	Near Term Plus Project AM Peak
Project Description	04 10.5 Avenue Between Hanford Armona Drive and Orchard Avenue	Unit	United States Customary

Segment 1

Vehicle Inputs

Segment Type	Passing Constrained	Length, ft	2735
Lane Width, ft	12	Shoulder Width, ft	2
Speed Limit, mi/h	40	Access Point Density, pts/mi	50.2

Demand and Capacity

Directional Demand Flow Rate, veh/h	327	Opposing Demand Flow Rate, veh/h	-
Peak Hour Factor	0.60	Total Trucks, %	9.87
Segment Capacity, veh/h	1700	Demand/Capacity (D/C)	0.19

Intermediate Results

Segment Vertical Class	1	Free-Flow Speed, mi/h	32.5
Speed Slope Coefficient	2.29128	Speed Power Coefficient	0.41674
PF Slope Coefficient	-1.42068	PF Power Coefficient	0.65951
In Passing Lane Effective Length?	No	Total Segment Density, veh/mi/ln	5.2
%Improved % Followers	0.0	% Improved Avg Speed	0.0

Subsegment Data

#	Segment Type	Length, ft	Radius, ft	Superelevation, %	Average Speed, mi/h
1	Tangent	2735	-	-	31.2

Vehicle Results

Average Speed, mi/h	31.2	Percent Followers, %	49.3
Segment Travel Time, minutes	0.99	Follower Density, followers/mi/ln	5.2
Vehicle LOS	C		

Facility Results

T	Follower Density, followers/mi/ln	LOS
1	5.2	C

HCS7 Two-Lane Highway Report

Project Information

Analyst	C. Ayala-Magana	Date	7/20/2022
Agency	JLB Traffic Engineering, Inc.	Analysis Year	2022
Jurisdiction	City of Hanford	Time Period Analyzed	Near Term Plus Project AM Peak
Project Description	05 10.5 Avenue Between Orchard Avenue and Houston Avenue	Unit	United States Customary

Segment 1

Vehicle Inputs

Segment Type	Passing Constrained	Length, ft	2594
Lane Width, ft	12	Shoulder Width, ft	2
Speed Limit, mi/h	40	Access Point Density, pts/mi	52.9

Demand and Capacity

Directional Demand Flow Rate, veh/h	167	Opposing Demand Flow Rate, veh/h	-
Peak Hour Factor	0.42	Total Trucks, %	13.33
Segment Capacity, veh/h	1700	Demand/Capacity (D/C)	0.10

Intermediate Results

Segment Vertical Class	1	Free-Flow Speed, mi/h	32.4
Speed Slope Coefficient	2.28310	Speed Power Coefficient	0.41674
PF Slope Coefficient	-1.42395	PF Power Coefficient	0.65839
In Passing Lane Effective Length?	No	Total Segment Density, veh/mi/ln	1.9
%Improved % Followers	0.0	% Improved Avg Speed	0.0

Subsegment Data

#	Segment Type	Length, ft	Radius, ft	Superelevation, %	Average Speed, mi/h
1	Tangent	2594	-	-	31.6

Vehicle Results

Average Speed, mi/h	31.6	Percent Followers, %	35.4
Segment Travel Time, minutes	0.93	Follower Density, followers/mi/ln	1.9
Vehicle LOS	A		

Facility Results

T	Follower Density, followers/mi/ln	LOS
1	1.9	A

HCS7 Two-Lane Highway Report

Project Information

Analyst	C. Ayala-Magana	Date	7/20/2022
Agency	JLB Traffic Engineering, Inc.	Analysis Year	2022
Jurisdiction	City of Hanford	Time Period Analyzed	Near Term Plus Project AM Peak
Project Description	06 Houston Avenue Between 11th Avenue and 10 1/2 Avenue	Unit	United States Customary

Segment 1

Vehicle Inputs

Segment Type	Passing Constrained	Length, ft	2567
Lane Width, ft	12	Shoulder Width, ft	2
Speed Limit, mi/h	50	Access Point Density, pts/mi	20.6

Demand and Capacity

Directional Demand Flow Rate, veh/h	284	Opposing Demand Flow Rate, veh/h	-
Peak Hour Factor	0.68	Total Trucks, %	21.40
Segment Capacity, veh/h	1700	Demand/Capacity (D/C)	0.17

Intermediate Results

Segment Vertical Class	1	Free-Flow Speed, mi/h	48.3
Speed Slope Coefficient	3.14891	Speed Power Coefficient	0.41674
PF Slope Coefficient	-1.42118	PF Power Coefficient	0.72418
In Passing Lane Effective Length?	No	Total Segment Density, veh/mi/ln	2.6
%Improved % Followers	0.0	% Improved Avg Speed	0.0

Subsegment Data

#	Segment Type	Length, ft	Radius, ft	Superelevation, %	Average Speed, mi/h
1	Tangent	2567	-	-	46.8

Vehicle Results

Average Speed, mi/h	46.8	Percent Followers, %	43.5
Segment Travel Time, minutes	0.62	Follower Density, followers/mi/ln	2.6
Vehicle LOS	B		

Facility Results

T	Follower Density, followers/mi/ln	LOS
1	2.6	B

HCS7 Two-Lane Highway Report

Project Information

Analyst	C. Ayala-Magana	Date	7/20/2022
Agency	JLB Traffic Engineering, Inc.	Analysis Year	2022
Jurisdiction	City of Hanford	Time Period Analyzed	Near Term Plus Project AM Peak
Project Description	07 Houston Avenue Between 10 1/2 Avenue and 10th Avenue	Unit	United States Customary

Segment 1

Vehicle Inputs

Segment Type	Passing Constrained	Length, ft	2570
Lane Width, ft	12	Shoulder Width, ft	2
Speed Limit, mi/h	55	Access Point Density, pts/mi	45.2

Demand and Capacity

Directional Demand Flow Rate, veh/h	224	Opposing Demand Flow Rate, veh/h	-
Peak Hour Factor	0.88	Total Trucks, %	17.65
Segment Capacity, veh/h	1700	Demand/Capacity (D/C)	0.13

Intermediate Results

Segment Vertical Class	1	Free-Flow Speed, mi/h	49.3
Speed Slope Coefficient	3.20179	Speed Power Coefficient	0.41674
PF Slope Coefficient	-1.41674	PF Power Coefficient	0.72668
In Passing Lane Effective Length?	No	Total Segment Density, veh/mi/ln	1.8
%Improved % Followers	0.0	% Improved Avg Speed	0.0

Subsegment Data

#	Segment Type	Length, ft	Radius, ft	Superelevation, %	Average Speed, mi/h
1	Tangent	2570	-	-	48.0

Vehicle Results

Average Speed, mi/h	48.0	Percent Followers, %	38.0
Segment Travel Time, minutes	0.61	Follower Density, followers/mi/ln	1.8
Vehicle LOS	A		

Facility Results

T	Follower Density, followers/mi/ln	LOS
1	1.8	A

HCS7 Two-Lane Highway Report

Project Information

Analyst	C. Ayala-Magana	Date	7/20/2022
Agency	JLB Traffic Engineering, Inc.	Analysis Year	2022
Jurisdiction	City of Hanford	Time Period Analyzed	Near Term Plus Project PM Peak
Project Description	01 Hanford-Armona Road Between 11th Avenue and 10 1/2 Avenue	Unit	United States Customary

Segment 1

Vehicle Inputs

Segment Type	Passing Constrained	Length, ft	2583
Lane Width, ft	12	Shoulder Width, ft	6
Speed Limit, mi/h	40	Access Point Density, pts/mi	34.8

Demand and Capacity

Directional Demand Flow Rate, veh/h	658	Opposing Demand Flow Rate, veh/h	-
Peak Hour Factor	0.83	Total Trucks, %	3.00
Segment Capacity, veh/h	1700	Demand/Capacity (D/C)	0.39

Intermediate Results

Segment Vertical Class	1	Free-Flow Speed, mi/h	36.8
Speed Slope Coefficient	2.52381	Speed Power Coefficient	0.41674
PF Slope Coefficient	-1.44159	PF Power Coefficient	0.67823
In Passing Lane Effective Length?	No	Total Segment Density, veh/mi/ln	12.5
%Improved % Followers	0.0	% Improved Avg Speed	0.0

Subsegment Data

#	Segment Type	Length, ft	Radius, ft	Superelevation, %	Average Speed, mi/h
1	Tangent	2583	-	-	34.8

Vehicle Results

Average Speed, mi/h	34.8	Percent Followers, %	66.2
Segment Travel Time, minutes	0.84	Follower Density, followers/mi/ln	12.5
Vehicle LOS	D		

Facility Results

T	Follower Density, followers/mi/ln	LOS
1	12.5	D

HCS7 Two-Lane Highway Report

Project Information

Analyst	C. Ayala-Magana	Date	7/20/2022
Agency	JLB Traffic Engineering, Inc.	Analysis Year	2022
Jurisdiction	City of Hanford	Time Period Analyzed	Near Term Plus Project PM Peak
Project Description	02 Hanford-Armona Road Between 10 1/2 Avenue and Jordan Way	Unit	United States Customary

Segment 1

Vehicle Inputs

Segment Type	Passing Constrained	Length, ft	1556
Lane Width, ft	12	Shoulder Width, ft	6
Speed Limit, mi/h	40	Access Point Density, pts/mi	67.9

Demand and Capacity

Directional Demand Flow Rate, veh/h	418	Opposing Demand Flow Rate, veh/h	-
Peak Hour Factor	0.85	Total Trucks, %	3.00
Segment Capacity, veh/h	1700	Demand/Capacity (D/C)	0.25

Intermediate Results

Segment Vertical Class	1	Free-Flow Speed, mi/h	35.5
Speed Slope Coefficient	2.43724	Speed Power Coefficient	0.41674
PF Slope Coefficient	-1.48339	PF Power Coefficient	0.66114
In Passing Lane Effective Length?	No	Total Segment Density, veh/mi/ln	6.9
%Improved % Followers	0.0	% Improved Avg Speed	0.0

Subsegment Data

#	Segment Type	Length, ft	Radius, ft	Superelevation, %	Average Speed, mi/h
1	Tangent	1556	-	-	34.0

Vehicle Results

Average Speed, mi/h	34.0	Percent Followers, %	56.5
Segment Travel Time, minutes	0.52	Follower Density, followers/mi/ln	6.9
Vehicle LOS	C		

Facility Results

T	Follower Density, followers/mi/ln	LOS
1	6.9	C

HCS7 Two-Lane Highway Report

Project Information

Analyst	C. Ayala-Magana	Date	7/20/2022
Agency	JLB Traffic Engineering, Inc.	Analysis Year	2022
Jurisdiction	City of Hanford	Time Period Analyzed	Near Term Plus Project PM Peak
Project Description	03 Hanford-Armona Road Between Jordan Way and 10th Avenue	Unit	United States Customary

Segment 1

Vehicle Inputs

Segment Type	Passing Constrained	Length, ft	901
Lane Width, ft	12	Shoulder Width, ft	6
Speed Limit, mi/h	40	Access Point Density, pts/mi	17.6

Demand and Capacity

Directional Demand Flow Rate, veh/h	362	Opposing Demand Flow Rate, veh/h	-
Peak Hour Factor	0.97	Total Trucks, %	3.00
Segment Capacity, veh/h	1700	Demand/Capacity (D/C)	0.21

Intermediate Results

Segment Vertical Class	1	Free-Flow Speed, mi/h	41.1
Speed Slope Coefficient	2.73635	Speed Power Coefficient	0.41674
PF Slope Coefficient	-1.50445	PF Power Coefficient	0.68170
In Passing Lane Effective Length?	No	Total Segment Density, veh/mi/ln	4.8
%Improved % Followers	0.0	% Improved Avg Speed	0.0

Subsegment Data

#	Segment Type	Length, ft	Radius, ft	Superelevation, %	Average Speed, mi/h
1	Tangent	901	-	-	39.5

Vehicle Results

Average Speed, mi/h	39.5	Percent Followers, %	52.9
Segment Travel Time, minutes	0.26	Follower Density, followers/mi/ln	4.8
Vehicle LOS	B		

Facility Results

T	Follower Density, followers/mi/ln	LOS
1	4.8	B

HCS7 Two-Lane Highway Report

Project Information

Analyst	C. Ayala-Magana	Date	7/20/2022
Agency	JLB Traffic Engineering, Inc.	Analysis Year	2022
Jurisdiction	City of Hanford	Time Period Analyzed	Near Term Plus Project PM Peak
Project Description	04 10.5 Avenue Between Hanford Armona Drive and Orchard Avenue	Unit	United States Customary

Segment 1

Vehicle Inputs

Segment Type	Passing Constrained	Length, ft	2735
Lane Width, ft	12	Shoulder Width, ft	2
Speed Limit, mi/h	40	Access Point Density, pts/mi	50.2

Demand and Capacity

Directional Demand Flow Rate, veh/h	263	Opposing Demand Flow Rate, veh/h	-
Peak Hour Factor	0.75	Total Trucks, %	3.00
Segment Capacity, veh/h	1700	Demand/Capacity (D/C)	0.15

Intermediate Results

Segment Vertical Class	1	Free-Flow Speed, mi/h	32.7
Speed Slope Coefficient	2.30368	Speed Power Coefficient	0.41674
PF Slope Coefficient	-1.42275	PF Power Coefficient	0.65971
In Passing Lane Effective Length?	No	Total Segment Density, veh/mi/ln	3.7
%Improved % Followers	0.0	% Improved Avg Speed	0.0

Subsegment Data

#	Segment Type	Length, ft	Radius, ft	Superelevation, %	Average Speed, mi/h
1	Tangent	2735	-	-	31.6

Vehicle Results

Average Speed, mi/h	31.6	Percent Followers, %	44.5
Segment Travel Time, minutes	0.98	Follower Density, followers/mi/ln	3.7
Vehicle LOS	B		

Facility Results

T	Follower Density, followers/mi/ln	LOS
1	3.7	B

HCS7 Two-Lane Highway Report

Project Information

Analyst	C. Ayala-Magana	Date	7/20/2022
Agency	JLB Traffic Engineering, Inc.	Analysis Year	2022
Jurisdiction	City of Hanford	Time Period Analyzed	Near Term Plus Project PM Peak
Project Description	05 10.5 Avenue Between Orchard Avenue and Houston Avenue	Unit	United States Customary

Segment 1

Vehicle Inputs

Segment Type	Passing Constrained	Length, ft	2594
Lane Width, ft	12	Shoulder Width, ft	2
Speed Limit, mi/h	40	Access Point Density, pts/mi	52.9

Demand and Capacity

Directional Demand Flow Rate, veh/h	236	Opposing Demand Flow Rate, veh/h	-
Peak Hour Factor	0.56	Total Trucks, %	3.70
Segment Capacity, veh/h	1700	Demand/Capacity (D/C)	0.14

Intermediate Results

Segment Vertical Class	1	Free-Flow Speed, mi/h	32.7
Speed Slope Coefficient	2.30048	Speed Power Coefficient	0.41674
PF Slope Coefficient	-1.42689	PF Power Coefficient	0.65868
In Passing Lane Effective Length?	No	Total Segment Density, veh/mi/ln	3.2
%Improved % Followers	0.0	% Improved Avg Speed	0.0

Subsegment Data

#	Segment Type	Length, ft	Radius, ft	Superelevation, %	Average Speed, mi/h
1	Tangent	2594	-	-	31.7

Vehicle Results

Average Speed, mi/h	31.7	Percent Followers, %	42.4
Segment Travel Time, minutes	0.93	Follower Density, followers/mi/ln	3.2
Vehicle LOS	B		

Facility Results

T	Follower Density, followers/mi/ln	LOS
1	3.2	B

HCS7 Two-Lane Highway Report

Project Information

Analyst	C. Ayala-Magana	Date	7/20/2022
Agency	JLB Traffic Engineering, Inc.	Analysis Year	2022
Jurisdiction	City of Hanford	Time Period Analyzed	Near Term Plus Project PM Peak
Project Description	06 Houston Avenue Between 11th Avenue and 10 1/2 Avenue	Unit	United States Customary

Segment 1

Vehicle Inputs

Segment Type	Passing Constrained	Length, ft	2567
Lane Width, ft	12	Shoulder Width, ft	2
Speed Limit, mi/h	50	Access Point Density, pts/mi	20.6

Demand and Capacity

Directional Demand Flow Rate, veh/h	302	Opposing Demand Flow Rate, veh/h	-
Peak Hour Factor	0.89	Total Trucks, %	3.75
Segment Capacity, veh/h	1700	Demand/Capacity (D/C)	0.18

Intermediate Results

Segment Vertical Class	1	Free-Flow Speed, mi/h	48.9
Speed Slope Coefficient	3.18076	Speed Power Coefficient	0.41674
PF Slope Coefficient	-1.42061	PF Power Coefficient	0.72351
In Passing Lane Effective Length?	No	Total Segment Density, veh/mi/ln	2.9
%Improved % Followers	0.0	% Improved Avg Speed	0.0

Subsegment Data

#	Segment Type	Length, ft	Radius, ft	Superelevation, %	Average Speed, mi/h
1	Tangent	2567	-	-	47.3

Vehicle Results

Average Speed, mi/h	47.3	Percent Followers, %	45.0
Segment Travel Time, minutes	0.62	Follower Density, followers/mi/ln	2.9
Vehicle LOS	B		

Facility Results

T	Follower Density, followers/mi/ln	LOS
1	2.9	B

HCS7 Two-Lane Highway Report

Project Information

Analyst	C. Ayala-Magana	Date	7/20/2022
Agency	JLB Traffic Engineering, Inc.	Analysis Year	2022
Jurisdiction	City of Hanford	Time Period Analyzed	Near Term Plus Project PM Peak
Project Description	07 Houston Avenue Between 10 1/2 Avenue and 10th Avenue	Unit	United States Customary

Segment 1

Vehicle Inputs

Segment Type	Passing Constrained	Length, ft	2570
Lane Width, ft	12	Shoulder Width, ft	2
Speed Limit, mi/h	55	Access Point Density, pts/mi	45.2

Demand and Capacity

Directional Demand Flow Rate, veh/h	328	Opposing Demand Flow Rate, veh/h	-
Peak Hour Factor	0.90	Total Trucks, %	3.00
Segment Capacity, veh/h	1700	Demand/Capacity (D/C)	0.19

Intermediate Results

Segment Vertical Class	1	Free-Flow Speed, mi/h	49.8
Speed Slope Coefficient	3.22823	Speed Power Coefficient	0.41674
PF Slope Coefficient	-1.41606	PF Power Coefficient	0.72608
In Passing Lane Effective Length?	No	Total Segment Density, veh/mi/ln	3.2
%Improved % Followers	0.0	% Improved Avg Speed	0.0

Subsegment Data

#	Segment Type	Length, ft	Radius, ft	Superelevation, %	Average Speed, mi/h
1	Tangent	2570	-	-	48.1

Vehicle Results

Average Speed, mi/h	48.1	Percent Followers, %	46.7
Segment Travel Time, minutes	0.61	Follower Density, followers/mi/ln	3.2
Vehicle LOS	B		

Facility Results

T	Follower Density, followers/mi/ln	LOS
1	3.2	B

Appendix H: Cumulative Year 2042 plus Project Traffic Conditions



www.JLBtraffic.com
info@JLBtraffic.com

516 W. Shaw Ave., Ste. 103
Fresno, CA 93704
(559) 570-8991

A p p | H

HCM 6th Signalized Intersection Summary
3: 10 1/2 Avenue & Hanford Armona Road

Cumulative Year 2042 Plus Project AM Peak

05/05/2022



Movement	EBL	EBT	EBR	WBL	WBT	WBR	NBL	NBT	NBR	SBL	SBT	SBR
Lane Configurations												
Traffic Volume (veh/h)	60	237	52	17	221	27	124	80	19	12	25	37
Future Volume (veh/h)	60	237	52	17	221	27	124	80	19	12	25	37
Initial Q (Qb), veh	0	0	0	0	0	0	0	0	0	0	0	0
Ped-Bike Adj(A_pbT)	1.00		1.00	1.00		1.00	1.00		1.00	1.00		1.00
Parking Bus, Adj	1.00	1.00	1.00	1.00	1.00	1.00	1.00	1.00	1.00	1.00	1.00	1.00
Work Zone On Approach		No			No			No			No	
Adj Sat Flow, veh/h/ln	1826	1826	1826	1826	1826	1826	1826	1826	1826	1826	1826	1826
Adj Flow Rate, veh/h	70	276	60	20	257	31	144	93	22	14	29	43
Peak Hour Factor	0.86	0.86	0.86	0.86	0.86	0.86	0.86	0.86	0.86	0.86	0.86	0.86
Percent Heavy Veh, %	5	5	5	5	5	5	5	5	5	5	5	5
Cap, veh/h	119	412	90	43	384	46	184	370	313	31	209	177
Arrive On Green	0.07	0.28	0.28	0.02	0.24	0.24	0.11	0.20	0.20	0.02	0.11	0.11
Sat Flow, veh/h	1739	1453	316	1739	1598	193	1739	1826	1547	1739	1826	1547
Grp Volume(v), veh/h	70	0	336	20	0	288	144	93	22	14	29	43
Grp Sat Flow(s),veh/h/ln	1739	0	1768	1739	0	1791	1739	1826	1547	1739	1826	1547
Q Serve(g_s), s	1.5	0.0	6.5	0.4	0.0	5.6	3.1	1.7	0.4	0.3	0.6	1.0
Cycle Q Clear(g_c), s	1.5	0.0	6.5	0.4	0.0	5.6	3.1	1.7	0.4	0.3	0.6	1.0
Prop In Lane	1.00		0.18	1.00		0.11	1.00		1.00	1.00		1.00
Lane Grp Cap(c), veh/h	119	0	501	43	0	430	184	370	313	31	209	177
V/C Ratio(X)	0.59	0.00	0.67	0.46	0.00	0.67	0.78	0.25	0.07	0.45	0.14	0.24
Avail Cap(c_a), veh/h	225	0	1236	225	0	1251	365	1408	1193	225	1276	1081
HCM Platoon Ratio	1.00	1.00	1.00	1.00	1.00	1.00	1.00	1.00	1.00	1.00	1.00	1.00
Upstream Filter(I)	1.00	0.00	1.00	1.00	0.00	1.00	1.00	1.00	1.00	1.00	1.00	1.00
Uniform Delay (d), s/veh	17.5	0.0	12.2	18.6	0.0	13.3	16.8	12.9	12.5	18.8	15.4	15.6
Incr Delay (d2), s/veh	4.6	0.0	1.6	7.4	0.0	1.8	7.0	0.4	0.1	9.6	0.3	0.7
Initial Q Delay(d3),s/veh	0.0	0.0	0.0	0.0	0.0	0.0	0.0	0.0	0.0	0.0	0.0	0.0
%ile BackOfQ(50%),veh/ln	0.6	0.0	2.0	0.2	0.0	1.9	1.3	0.5	0.1	0.2	0.2	0.3
Unsig. Movement Delay, s/veh												
LnGrp Delay(d),s/veh	22.0	0.0	13.8	26.0	0.0	15.1	23.8	13.3	12.6	28.4	15.7	16.3
LnGrp LOS	C	A	B	C	A	B	C	B	B	C	B	B
Approach Vol, veh/h		406			308			259				86
Approach Delay, s/veh		15.2			15.8			19.1				18.1
Approach LOS		B			B			B				B
Timer - Assigned Phs	1	2	3	4	5	6	7	8				
Phs Duration (G+Y+Rc), s	4.9	12.7	5.2	15.9	8.3	9.3	6.8	14.2				
Change Period (Y+Rc), s	* 4.2	4.9	* 4.2	4.9	* 4.2	* 4.9	* 4.2	4.9				
Max Green Setting (Gmax), s	* 5	29.8	* 5	27.0	* 8.1	* 27	* 5	27.0				
Max Q Clear Time (g_c+I1), s	2.3	3.7	2.4	8.5	5.1	3.0	3.5	7.6				
Green Ext Time (p_c), s	0.0	0.5	0.0	1.8	0.1	0.2	0.0	1.5				

Intersection Summary

HCM 6th Ctrl Delay	16.6
HCM 6th LOS	B

Notes

* HCM 6th computational engine requires equal clearance times for the phases crossing the barrier.

Intersection

Int Delay, s/veh 2.9

Movement	EBT	EBR	WBL	WBT	NBL	NBR
Lane Configurations	↶		↷	↶	↷	
Traffic Vol, veh/h	208	28	36	182	55	62
Future Vol, veh/h	208	28	36	182	55	62
Conflicting Peds, #/hr	0	0	0	0	0	1
Sign Control	Free	Free	Free	Free	Stop	Stop
RT Channelized	-	None	-	None	-	None
Storage Length	-	-	75	-	0	-
Veh in Median Storage, #	0	-	-	0	0	-
Grade, %	0	-	-	0	0	-
Peak Hour Factor	92	92	92	92	92	92
Heavy Vehicles, %	6	6	6	6	6	6
Mvmt Flow	226	30	39	198	60	67

Major/Minor	Major1	Major2	Minor1	Minor2	Minor3
Conflicting Flow All	0	0	256	0	517
Stage 1	-	-	-	-	241
Stage 2	-	-	-	-	276
Critical Hdwy	-	-	4.16	-	6.46
Critical Hdwy Stg 1	-	-	-	-	5.46
Critical Hdwy Stg 2	-	-	-	-	5.46
Follow-up Hdwy	-	-	2.254	-	3.554
Pot Cap-1 Maneuver	-	-	1286	-	511
Stage 1	-	-	-	-	790
Stage 2	-	-	-	-	761
Platoon blocked, %	-	-	-	-	-
Mov Cap-1 Maneuver	-	-	1286	-	496
Mov Cap-2 Maneuver	-	-	-	-	574
Stage 1	-	-	-	-	790
Stage 2	-	-	-	-	738

Approach	EB	WB	NB
HCM Control Delay, s	0	1.3	11.6
HCM LOS			B

Minor Lane/Major Mvmt	NBLn1	EBT	EBR	WBL	WBT
Capacity (veh/h)	670	-	-	1286	-
HCM Lane V/C Ratio	0.19	-	-	0.03	-
HCM Control Delay (s)	11.6	-	-	7.9	-
HCM Lane LOS	B	-	-	A	-
HCM 95th %tile Q(veh)	0.7	-	-	0.1	-

HCM 6th Signalized Intersection Summary
5: 10th Avenue & Hanford Armona Road

Cumulative Year 2042 Plus Project AM Peak

05/05/2022



Movement	EBL	EBT	EBR	WBL	WBT	WBR	NBL	NBT	NBR	SBL	SBT	SBR
Lane Configurations												
Traffic Volume (veh/h)	186	11	67	10	7	21	70	217	6	16	203	158
Future Volume (veh/h)	186	11	67	10	7	21	70	217	6	16	203	158
Initial Q (Qb), veh	0	0	0	0	0	0	0	0	0	0	0	0
Ped-Bike Adj(A_pbT)	1.00		1.00	1.00		1.00	1.00		1.00	1.00		1.00
Parking Bus, Adj	1.00	1.00	1.00	1.00	1.00	1.00	1.00	1.00	1.00	1.00	1.00	1.00
Work Zone On Approach		No			No			No			No	
Adj Sat Flow, veh/h/ln	1796	1796	1796	1796	1796	1796	1796	1796	1796	1796	1796	1796
Adj Flow Rate, veh/h	202	12	73	11	8	23	76	236	7	17	221	172
Peak Hour Factor	0.92	0.92	0.92	0.92	0.92	0.92	0.92	0.92	0.92	0.92	0.92	0.92
Percent Heavy Veh, %	7	7	7	7	7	7	7	7	7	7	7	7
Cap, veh/h	252	408	346	25	39	111	122	454	385	37	365	309
Arrive On Green	0.15	0.23	0.23	0.01	0.09	0.09	0.07	0.25	0.25	0.02	0.20	0.20
Sat Flow, veh/h	1711	1796	1522	1711	409	1176	1711	1796	1522	1711	1796	1522
Grp Volume(v), veh/h	202	12	73	11	0	31	76	236	7	17	221	172
Grp Sat Flow(s),veh/h/ln	1711	1796	1522	1711	0	1585	1711	1796	1522	1711	1796	1522
Q Serve(g_s), s	4.6	0.2	1.6	0.3	0.0	0.7	1.7	4.5	0.1	0.4	4.5	4.1
Cycle Q Clear(g_c), s	4.6	0.2	1.6	0.3	0.0	0.7	1.7	4.5	0.1	0.4	4.5	4.1
Prop In Lane	1.00		1.00	1.00		0.74	1.00		1.00	1.00		1.00
Lane Grp Cap(c), veh/h	252	408	346	25	0	150	122	454	385	37	365	309
V/C Ratio(X)	0.80	0.03	0.21	0.45	0.00	0.21	0.62	0.52	0.02	0.46	0.61	0.56
Avail Cap(c_a), veh/h	290	1668	1414	214	0	1384	214	1291	1094	214	1309	1110
HCM Platoon Ratio	1.00	1.00	1.00	1.00	1.00	1.00	1.00	1.00	1.00	1.00	1.00	1.00
Upstream Filter(I)	1.00	1.00	1.00	1.00	0.00	1.00	1.00	1.00	1.00	1.00	1.00	1.00
Uniform Delay (d), s/veh	16.5	12.0	12.6	19.6	0.0	16.8	18.1	12.9	11.2	19.4	14.5	14.3
Incr Delay (d2), s/veh	13.2	0.0	0.3	12.2	0.0	0.7	5.1	0.9	0.0	8.8	1.6	1.6
Initial Q Delay(d3),s/veh	0.0	0.0	0.0	0.0	0.0	0.0	0.0	0.0	0.0	0.0	0.0	0.0
%ile BackOfQ(50%),veh/ln	2.3	0.1	0.4	0.2	0.0	0.2	0.7	1.3	0.0	0.2	1.5	1.2
Unsig. Movement Delay, s/veh												
LnGrp Delay(d),s/veh	29.8	12.1	12.9	31.8	0.0	17.4	23.2	13.8	11.3	28.1	16.1	15.9
LnGrp LOS	C	B	B	C	A	B	C	B	B	C	B	B
Approach Vol, veh/h		287			42			319			410	
Approach Delay, s/veh		24.7			21.2			16.0			16.5	
Approach LOS		C			C			B			B	
Timer - Assigned Phs	1	2	3	4	5	6	7	8				
Phs Duration (G+Y+Rc), s	5.1	15.8	4.8	14.4	7.1	13.8	10.1	9.1				
Change Period (Y+Rc), s	* 4.2	5.7	* 4.2	* 5.3	* 4.2	* 5.7	* 4.2	5.3				
Max Green Setting (Gmax), s	* 5	28.8	* 5	* 37	* 5	* 29	* 6.8	35.0				
Max Q Clear Time (g_c+I1), s	2.4	6.5	2.3	3.6	3.7	6.5	6.6	2.7				
Green Ext Time (p_c), s	0.0	1.1	0.0	0.3	0.0	1.7	0.0	0.1				

Intersection Summary

HCM 6th Ctrl Delay	18.8
HCM 6th LOS	B

Notes

* HCM 6th computational engine requires equal clearance times for the phases crossing the barrier.

Intersection

Int Delay, s/veh 4

Movement	WBL	WBR	NBT	NBR	SBL	SBT
Lane Configurations						
Traffic Vol, veh/h	28	51	80	9	20	39
Future Vol, veh/h	28	51	80	9	20	39
Conflicting Peds, #/hr	0	0	0	0	0	0
Sign Control	Stop	Stop	Free	Free	Free	Free
RT Channelized	-	None	-	None	-	None
Storage Length	0	-	-	-	-	-
Veh in Median Storage, #	0	-	0	-	-	0
Grade, %	0	-	0	-	-	0
Peak Hour Factor	92	92	92	92	92	92
Heavy Vehicles, %	5	5	5	5	5	5
Mvmt Flow	30	55	87	10	22	42

Major/Minor	Minor1	Major1	Major2		
Conflicting Flow All	178	92	0	0	97
Stage 1	92	-	-	-	-
Stage 2	86	-	-	-	-
Critical Hdwy	6.45	6.25	-	-	4.15
Critical Hdwy Stg 1	5.45	-	-	-	-
Critical Hdwy Stg 2	5.45	-	-	-	-
Follow-up Hdwy	3.545	3.345	-	-	2.245
Pot Cap-1 Maneuver	805	957	-	-	1478
Stage 1	924	-	-	-	-
Stage 2	930	-	-	-	-
Platoon blocked, %			-	-	-
Mov Cap-1 Maneuver	793	957	-	-	1478
Mov Cap-2 Maneuver	793	-	-	-	-
Stage 1	924	-	-	-	-
Stage 2	916	-	-	-	-

Approach	WB	NB	SB
HCM Control Delay, s	9.5	0	2.5
HCM LOS	A		

Minor Lane/Major Mvmt	NBT	NBRWBLn1	SBL	SBT
Capacity (veh/h)	-	-	892	1478
HCM Lane V/C Ratio	-	-	0.096	0.015
HCM Control Delay (s)	-	-	9.5	7.5
HCM Lane LOS	-	-	A	A
HCM 95th %tile Q(veh)	-	-	0.3	0

HCM Signalized Intersection Capacity Analysis
7: 11th Avenue & Houston Avenue

Cumulative Year 2042 Plus Project AM Peak

05/05/2022



Movement	EBL	EBT	EBR	WBL	WBT	WBR	NBL	NBT	NBR	SBL	SBT	SBR
Lane Configurations	↔	↑	↗	↖	↑	↗	↖	↑↑	↗	↖	↑	↗
Traffic Volume (vph)	96	128	46	37	99	40	34	144	41	44	99	40
Future Volume (vph)	96	128	46	37	99	40	34	144	41	44	99	40
Ideal Flow (vphp)	1900	1900	1900	1900	1900	1900	1900	1900	1900	1900	1900	1900
Total Lost time (s)	4.2	6.0	6.0	4.2	5.7	5.7	4.2	5.7	5.7	4.2	5.3	5.3
Lane Util. Factor	1.00	1.00	1.00	1.00	1.00	1.00	1.00	0.95	1.00	1.00	1.00	1.00
Frt	1.00	1.00	0.85	1.00	1.00	0.85	1.00	1.00	0.85	1.00	1.00	0.85
Flt Protected	0.95	1.00	1.00	0.95	1.00	1.00	0.95	1.00	1.00	0.95	1.00	1.00
Satd. Flow (prot)	1597	1681	1429	1597	1681	1429	1597	3195	1429	1597	1681	1429
Flt Permitted	0.95	1.00	1.00	0.95	1.00	1.00	0.95	1.00	1.00	0.95	1.00	1.00
Satd. Flow (perm)	1597	1681	1429	1597	1681	1429	1597	3195	1429	1597	1681	1429
Peak-hour factor, PHF	0.96	0.96	0.96	0.96	0.96	0.96	0.96	0.96	0.96	0.96	0.96	0.96
Adj. Flow (vph)	100	133	48	39	103	42	35	150	43	46	103	42
RTOR Reduction (vph)	0	0	35	0	0	34	0	0	30	0	0	28
Lane Group Flow (vph)	100	133	13	39	103	8	35	150	13	46	103	14
Heavy Vehicles (%)	13%	13%	13%	13%	13%	13%	13%	13%	13%	13%	13%	13%
Turn Type	Prot	NA	Perm	Prot	NA	Perm	Prot	NA	Perm	Prot	NA	Perm
Protected Phases	7	4		3	8		5	2		1	6	
Permitted Phases			4			8			2			6
Actuated Green, G (s)	9.7	18.3	18.3	3.6	12.5	12.5	3.6	20.3	20.3	6.0	23.1	23.1
Effective Green, g (s)	9.7	18.3	18.3	3.6	12.5	12.5	3.6	20.3	20.3	6.0	23.1	23.1
Actuated g/C Ratio	0.14	0.27	0.27	0.05	0.18	0.18	0.05	0.30	0.30	0.09	0.34	0.34
Clearance Time (s)	4.2	6.0	6.0	4.2	5.7	5.7	4.2	5.7	5.7	4.2	5.3	5.3
Vehicle Extension (s)	3.0	3.0	3.0	3.0	3.0	3.0	3.0	3.0	3.0	3.0	3.0	3.0
Lane Grp Cap (vph)	226	450	382	84	307	261	84	949	424	140	568	483
v/s Ratio Prot	c0.06	c0.08		0.02	0.06		0.02	0.05		c0.03	c0.06	
v/s Ratio Perm			0.01			0.01			0.01			0.01
v/c Ratio	0.44	0.30	0.03	0.46	0.34	0.03	0.42	0.16	0.03	0.33	0.18	0.03
Uniform Delay, d1	26.8	19.9	18.5	31.4	24.3	22.9	31.3	17.7	17.0	29.3	15.9	15.1
Progression Factor	1.00	1.00	1.00	1.00	1.00	1.00	1.00	1.00	1.00	1.00	1.00	1.00
Incremental Delay, d2	1.4	0.4	0.0	4.0	0.6	0.0	3.3	0.1	0.0	1.4	0.2	0.0
Delay (s)	28.2	20.2	18.5	35.4	24.9	23.0	34.7	17.8	17.0	30.6	16.1	15.1
Level of Service	C	C	B	D	C	C	C	B	B	C	B	B
Approach Delay (s)		22.8			26.7			20.2			19.4	
Approach LOS		C			C			C			B	

Intersection Summary		
HCM 2000 Control Delay	22.2	HCM 2000 Level of Service
HCM 2000 Volume to Capacity ratio	0.30	C
Actuated Cycle Length (s)	68.3	Sum of lost time (s)
Intersection Capacity Utilization	40.2%	ICU Level of Service
Analysis Period (min)	15	A
c Critical Lane Group		

Intersection

Int Delay, s/veh 2.5

Movement EBL EBT WBT WBR SBL SBR

Lane Configurations		↶	↷		↶	
Traffic Vol, veh/h	42	129	122	23	14	47
Future Vol, veh/h	42	129	122	23	14	47
Conflicting Peds, #/hr	0	0	0	0	0	0
Sign Control	Free	Free	Free	Free	Stop	Stop
RT Channelized	-	None	-	None	-	None
Storage Length	-	-	-	-	0	-
Veh in Median Storage, #	-	0	0	-	0	-
Grade, %	-	0	0	-	0	-
Peak Hour Factor	92	92	92	92	92	92
Heavy Vehicles, %	19	19	19	19	19	19
Mvmt Flow	46	140	133	25	15	51

Major/Minor Major1 Major2 Minor2

Conflicting Flow All	158	0	-	0	378	146
Stage 1	-	-	-	-	146	-
Stage 2	-	-	-	-	232	-
Critical Hdwy	4.29	-	-	-	6.59	6.39
Critical Hdwy Stg 1	-	-	-	-	5.59	-
Critical Hdwy Stg 2	-	-	-	-	5.59	-
Follow-up Hdwy	2.371	-	-	-	3.671	3.471
Pot Cap-1 Maneuver	1324	-	-	-	592	858
Stage 1	-	-	-	-	841	-
Stage 2	-	-	-	-	768	-
Platoon blocked, %		-	-	-		
Mov Cap-1 Maneuver	1324	-	-	-	570	858
Mov Cap-2 Maneuver	-	-	-	-	570	-
Stage 1	-	-	-	-	809	-
Stage 2	-	-	-	-	768	-

Approach EB WB SB

HCM Control Delay, s	1.9	0	10.1
HCM LOS			B

Minor Lane/Major Mvmt EBL EBT WBT WBR SBLn1

Capacity (veh/h)	1324	-	-	-	769
HCM Lane V/C Ratio	0.034	-	-	-	0.086
HCM Control Delay (s)	7.8	0	-	-	10.1
HCM Lane LOS	A	A	-	-	B
HCM 95th %tile Q(veh)	0.1	-	-	-	0.3

Intersection	
Intersection Delay, s/veh	9.9
Intersection LOS	A

Movement	EBL	EBT	EBR	WBL	WBT	WBR	NBL	NBT	NBR	SBL	SBT	SBR
Lane Configurations		↕			↕			↕			↕	
Traffic Vol, veh/h	46	83	28	12	64	13	17	91	5	15	108	61
Future Vol, veh/h	46	83	28	12	64	13	17	91	5	15	108	61
Peak Hour Factor	0.92	0.92	0.92	0.92	0.92	0.92	0.92	0.92	0.92	0.92	0.92	0.92
Heavy Vehicles, %	26	26	26	26	26	26	26	26	26	26	26	26
Mvmt Flow	50	90	30	13	70	14	18	99	5	16	117	66
Number of Lanes	0	1	0	0	1	0	0	1	0	0	1	0

Approach	EB	WB	NB	SB
Opposing Approach	WB	EB	SB	NB
Opposing Lanes	1	1	1	1
Conflicting Approach Left	SB	NB	EB	WB
Conflicting Lanes Left	1	1	1	1
Conflicting Approach Right	NB	SB	WB	EB
Conflicting Lanes Right	1	1	1	1
HCM Control Delay	10.1	9.3	9.6	10.1
HCM LOS	B	A	A	B

Lane	NBLn1	EBLn1	WBLn1	SBLn1
Vol Left, %	15%	29%	13%	8%
Vol Thru, %	81%	53%	72%	59%
Vol Right, %	4%	18%	15%	33%
Sign Control	Stop	Stop	Stop	Stop
Traffic Vol by Lane	113	157	89	184
LT Vol	17	46	12	15
Through Vol	91	83	64	108
RT Vol	5	28	13	61
Lane Flow Rate	123	171	97	200
Geometry Grp	1	1	1	1
Degree of Util (X)	0.181	0.249	0.144	0.28
Departure Headway (Hd)	5.317	5.256	5.35	5.035
Convergence, Y/N	Yes	Yes	Yes	Yes
Cap	671	679	666	710
Service Time	3.386	3.322	3.423	3.095
HCM Lane V/C Ratio	0.183	0.252	0.146	0.282
HCM Control Delay	9.6	10.1	9.3	10.1
HCM Lane LOS	A	B	A	B
HCM 95th-tile Q	0.7	1	0.5	1.1

HCM 6th Signalized Intersection Summary
 3: 10 1/2 Avenue & Hanford Armona Road

Cumulative Year 2042 Project PM Peak

05/05/2022



Movement	EBL	EBT	EBR	WBL	WBT	WBR	NBL	NBT	NBR	SBL	SBT	SBR
Lane Configurations												
Traffic Volume (veh/h)	46	307	154	65	330	29	146	61	16	27	61	64
Future Volume (veh/h)	46	307	154	65	330	29	146	61	16	27	61	64
Initial Q (Qb), veh	0	0	0	0	0	0	0	0	0	0	0	0
Ped-Bike Adj(A_pbT)	1.00		1.00	1.00		1.00	1.00		1.00	1.00		1.00
Parking Bus, Adj	1.00	1.00	1.00	1.00	1.00	1.00	1.00	1.00	1.00	1.00	1.00	1.00
Work Zone On Approach		No			No			No			No	
Adj Sat Flow, veh/h/ln	1856	1856	1856	1856	1856	1856	1856	1856	1856	1856	1856	1856
Adj Flow Rate, veh/h	50	334	167	71	359	32	159	66	17	29	66	70
Peak Hour Factor	0.92	0.92	0.92	0.92	0.92	0.92	0.92	0.92	0.92	0.92	0.92	0.92
Percent Heavy Veh, %	3	3	3	3	3	3	3	3	3	3	3	3
Cap, veh/h	89	414	207	111	618	55	203	333	282	59	182	154
Arrive On Green	0.05	0.36	0.36	0.06	0.37	0.37	0.11	0.18	0.18	0.03	0.10	0.10
Sat Flow, veh/h	1767	1166	583	1767	1679	150	1767	1856	1572	1767	1856	1572
Grp Volume(v), veh/h	50	0	501	71	0	391	159	66	17	29	66	70
Grp Sat Flow(s),veh/h/ln	1767	0	1749	1767	0	1828	1767	1856	1572	1767	1856	1572
Q Serve(g_s), s	1.4	0.0	12.8	1.9	0.0	8.5	4.3	1.5	0.4	0.8	1.6	2.1
Cycle Q Clear(g_c), s	1.4	0.0	12.8	1.9	0.0	8.5	4.3	1.5	0.4	0.8	1.6	2.1
Prop In Lane	1.00		0.33	1.00		0.08	1.00		1.00	1.00		1.00
Lane Grp Cap(c), veh/h	89	0	621	111	0	673	203	333	282	59	182	154
V/C Ratio(X)	0.56	0.00	0.81	0.64	0.00	0.58	0.78	0.20	0.06	0.49	0.36	0.45
Avail Cap(c_a), veh/h	179	0	965	179	0	1008	283	1088	922	204	1016	861
HCM Platoon Ratio	1.00	1.00	1.00	1.00	1.00	1.00	1.00	1.00	1.00	1.00	1.00	1.00
Upstream Filter(I)	1.00	0.00	1.00	1.00	0.00	1.00	1.00	1.00	1.00	1.00	1.00	1.00
Uniform Delay (d), s/veh	22.9	0.0	14.4	22.5	0.0	12.5	21.2	17.2	16.8	23.4	20.8	21.0
Incr Delay (d2), s/veh	5.5	0.0	2.9	5.9	0.0	0.8	9.2	0.3	0.1	6.3	1.2	2.1
Initial Q Delay(d3),s/veh	0.0	0.0	0.0	0.0	0.0	0.0	0.0	0.0	0.0	0.0	0.0	0.0
%ile BackOfQ(50%),veh/ln	0.6	0.0	4.3	0.9	0.0	2.8	2.1	0.6	0.1	0.4	0.7	0.7
Unsig. Movement Delay, s/veh												
LnGrp Delay(d),s/veh	28.4	0.0	17.3	28.5	0.0	13.3	30.5	17.5	16.9	29.7	22.0	23.1
LnGrp LOS	C	A	B	C	A	B	C	B	B	C	C	C
Approach Vol, veh/h		551			462			242			165	
Approach Delay, s/veh		18.3			15.7			26.0			23.8	
Approach LOS		B			B			C			C	
Timer - Assigned Phs	1	2	3	4	5	6	7	8				
Phs Duration (G+Y+Rc), s	5.8	13.7	7.3	22.4	9.9	9.7	6.7	23.0				
Change Period (Y+Rc), s	* 4.2	4.9	* 4.2	4.9	* 4.2	* 4.9	* 4.2	4.9				
Max Green Setting (Gmax), s	* 5.7	28.9	* 5	27.2	* 7.9	* 27	* 5	27.2				
Max Q Clear Time (g_c+I1), s	2.8	3.5	3.9	14.8	6.3	4.1	3.4	10.5				
Green Ext Time (p_c), s	0.0	0.3	0.0	2.5	0.1	0.5	0.0	2.0				

Intersection Summary

HCM 6th Ctrl Delay	19.4
HCM 6th LOS	B

Notes

* HCM 6th computational engine requires equal clearance times for the phases crossing the barrier.

Intersection

Int Delay, s/veh 3.2

Movement EBT EBR WBL WBT NBL NBR

Lane Configurations	↶		↷	↶	↷	
Traffic Vol, veh/h	261	57	117	349	53	83
Future Vol, veh/h	261	57	117	349	53	83
Conflicting Peds, #/hr	0	2	2	0	0	0
Sign Control	Free	Free	Free	Free	Stop	Stop
RT Channelized	-	None	-	None	-	None
Storage Length	-	-	75	-	0	-
Veh in Median Storage, #	0	-	-	0	0	-
Grade, %	0	-	-	0	0	-
Peak Hour Factor	92	92	92	92	92	92
Heavy Vehicles, %	3	3	3	3	3	3
Mvmt Flow	284	62	127	379	58	90

Major/Minor Major1 Major2 Minor1

Conflicting Flow All	0	0	348	0	950	317
Stage 1	-	-	-	-	317	-
Stage 2	-	-	-	-	633	-
Critical Hdwy	-	-	4.13	-	6.43	6.23
Critical Hdwy Stg 1	-	-	-	-	5.43	-
Critical Hdwy Stg 2	-	-	-	-	5.43	-
Follow-up Hdwy	-	-	2.227	-	3.527	3.327
Pot Cap-1 Maneuver	-	-	1205	-	287	721
Stage 1	-	-	-	-	736	-
Stage 2	-	-	-	-	527	-
Platoon blocked, %	-	-	-	-	-	-
Mov Cap-1 Maneuver	-	-	1203	-	256	720
Mov Cap-2 Maneuver	-	-	-	-	369	-
Stage 1	-	-	-	-	735	-
Stage 2	-	-	-	-	471	-

Approach EB WB NB

HCM Control Delay, s	0	2.1	14.5
HCM LOS			B

Minor Lane/Major Mvmt NBLn1 EBT EBR WBL WBT

Capacity (veh/h)	525	-	-	1203	-
HCM Lane V/C Ratio	0.282	-	-	0.106	-
HCM Control Delay (s)	14.5	-	-	8.3	-
HCM Lane LOS	B	-	-	A	-
HCM 95th %tile Q(veh)	1.1	-	-	0.4	-

HCM 6th Signalized Intersection Summary
5: 10th Avenue & Hanford Armona Road

Cumulative Year 2042 Project PM Peak

05/05/2022



Movement	EBL	EBT	EBR	WBL	WBT	WBR	NBL	NBT	NBR	SBL	SBT	SBR
Lane Configurations												
Traffic Volume (veh/h)	197	25	127	21	28	42	176	397	15	48	302	277
Future Volume (veh/h)	197	25	127	21	28	42	176	397	15	48	302	277
Initial Q (Qb), veh	0	0	0	0	0	0	0	0	0	0	0	0
Ped-Bike Adj(A_pbT)	1.00		1.00	1.00		0.99	1.00		1.00	1.00		0.99
Parking Bus, Adj	1.00	1.00	1.00	1.00	1.00	1.00	1.00	1.00	1.00	1.00	1.00	1.00
Work Zone On Approach		No			No			No			No	
Adj Sat Flow, veh/h/ln	1856	1856	1856	1856	1856	1856	1856	1856	1856	1856	1856	1856
Adj Flow Rate, veh/h	207	26	134	22	29	44	185	418	16	51	318	292
Peak Hour Factor	0.95	0.95	0.95	0.95	0.95	0.95	0.95	0.95	0.95	0.95	0.95	0.95
Percent Heavy Veh, %	3	3	3	3	3	3	3	3	3	3	3	3
Cap, veh/h	259	420	354	46	70	106	233	641	541	87	488	411
Arrive On Green	0.15	0.23	0.23	0.03	0.11	0.11	0.13	0.35	0.35	0.05	0.26	0.26
Sat Flow, veh/h	1767	1856	1566	1767	663	1005	1767	1856	1566	1767	1856	1564
Grp Volume(v), veh/h	207	26	134	22	0	73	185	418	16	51	318	292
Grp Sat Flow(s),veh/h/ln	1767	1856	1566	1767	0	1668	1767	1856	1566	1767	1856	1564
Q Serve(g_s), s	6.2	0.6	4.0	0.7	0.0	2.3	5.6	10.5	0.4	1.6	8.4	9.3
Cycle Q Clear(g_c), s	6.2	0.6	4.0	0.7	0.0	2.3	5.6	10.5	0.4	1.6	8.4	9.3
Prop In Lane	1.00		1.00	1.00		0.60	1.00		1.00	1.00		1.00
Lane Grp Cap(c), veh/h	259	420	354	46	0	177	233	641	541	87	488	411
V/C Ratio(X)	0.80	0.06	0.38	0.48	0.00	0.41	0.79	0.65	0.03	0.59	0.65	0.71
Avail Cap(c_a), veh/h	379	1404	1184	180	0	1061	347	1130	954	170	958	807
HCM Platoon Ratio	1.00	1.00	1.00	1.00	1.00	1.00	1.00	1.00	1.00	1.00	1.00	1.00
Upstream Filter(I)	1.00	1.00	1.00	1.00	0.00	1.00	1.00	1.00	1.00	1.00	1.00	1.00
Uniform Delay (d), s/veh	22.7	16.7	18.0	26.4	0.0	23.0	23.1	15.2	11.9	25.6	18.0	18.4
Incr Delay (d2), s/veh	7.4	0.1	0.7	7.6	0.0	1.5	7.3	1.1	0.0	6.1	1.5	2.3
Initial Q Delay(d3),s/veh	0.0	0.0	0.0	0.0	0.0	0.0	0.0	0.0	0.0	0.0	0.0	0.0
%ile BackOfQ(50%),veh/ln	2.8	0.2	1.3	0.3	0.0	0.8	2.4	3.6	0.1	0.7	3.2	3.0
Unsig. Movement Delay, s/veh												
LnGrp Delay(d),s/veh	30.1	16.8	18.7	34.0	0.0	24.5	30.5	16.3	11.9	31.7	19.5	20.7
LnGrp LOS	C	B	B	C	A	C	C	B	B	C	B	C
Approach Vol, veh/h		367			95			619			661	
Approach Delay, s/veh		25.0			26.7			20.4			21.0	
Approach LOS		C			C			C			C	
Timer - Assigned Phs	1	2	3	4	5	6	7	8				
Phs Duration (G+Y+Rc), s	6.9	24.7	5.6	17.7	11.5	20.2	12.3	11.1				
Change Period (Y+Rc), s	* 4.2	5.7	* 4.2	* 5.3	* 4.2	* 5.7	* 4.2	5.3				
Max Green Setting (Gmax), s	* 5.3	33.5	* 5.6	* 42	* 11	* 28	* 12	35.0				
Max Q Clear Time (g_c+I1), s	3.6	12.5	2.7	6.0	7.6	11.3	8.2	4.3				
Green Ext Time (p_c), s	0.0	2.2	0.0	0.6	0.1	2.5	0.2	0.3				

Intersection Summary

HCM 6th Ctrl Delay	21.9
HCM 6th LOS	C

Notes

* HCM 6th computational engine requires equal clearance times for the phases crossing the barrier.

Intersection

Int Delay, s/veh 2.9

Movement WBL WBR NBT NBR SBL SBT

Lane Configurations						
Traffic Vol, veh/h	17	37	105	39	57	81
Future Vol, veh/h	17	37	105	39	57	81
Conflicting Peds, #/hr	0	0	0	0	0	0
Sign Control	Stop	Stop	Free	Free	Free	Free
RT Channelized	-	None	-	None	-	None
Storage Length	0	-	-	-	-	-
Veh in Median Storage, #	0	-	0	-	-	0
Grade, %	0	-	0	-	-	0
Peak Hour Factor	92	92	92	92	92	92
Heavy Vehicles, %	3	3	3	3	3	3
Mvmt Flow	18	40	114	42	62	88

Major/Minor Minor1 Major1 Major2

Conflicting Flow All	347	135	0	0	156	0
Stage 1	135	-	-	-	-	-
Stage 2	212	-	-	-	-	-
Critical Hdwy	6.43	6.23	-	-	4.13	-
Critical Hdwy Stg 1	5.43	-	-	-	-	-
Critical Hdwy Stg 2	5.43	-	-	-	-	-
Follow-up Hdwy	3.527	3.327	-	-	2.227	-
Pot Cap-1 Maneuver	648	911	-	-	1418	-
Stage 1	889	-	-	-	-	-
Stage 2	821	-	-	-	-	-
Platoon blocked, %			-	-	-	-
Mov Cap-1 Maneuver	618	911	-	-	1418	-
Mov Cap-2 Maneuver	618	-	-	-	-	-
Stage 1	889	-	-	-	-	-
Stage 2	783	-	-	-	-	-

Approach WB NB SB

HCM Control Delay, s 9.9 0 3.2
HCM LOS A

Minor Lane/Major Mvmt NBT NBRWBLn1 SBL SBT

Capacity (veh/h)	-	-	793	1418	-
HCM Lane V/C Ratio	-	-	0.074	0.044	-
HCM Control Delay (s)	-	-	9.9	7.7	0
HCM Lane LOS	-	-	A	A	A
HCM 95th %tile Q(veh)	-	-	0.2	0.1	-

HCM Signalized Intersection Capacity Analysis
7: 11th Avenue & Houston Avenue

Cumulative Year 2042 Project PM Peak
05/05/2022

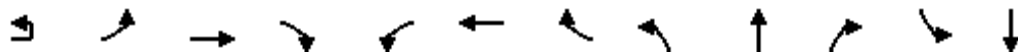

Movement	EBU	EBL	EBT	EBR	WBL	WBT	WBR	NBL	NBT	NBR	SBL	SBT
Lane Configurations												
Traffic Volume (vph)	1	61	269	52	35	229	82	114	529	83	55	155
Future Volume (vph)	1	61	269	52	35	229	82	114	529	83	55	155
Ideal Flow (vphp)	1900	1900	1900	1900	1900	1900	1900	1900	1900	1900	1900	1900
Total Lost time (s)		4.2	6.0	6.0	4.2	5.7	5.7	4.2	5.7	5.7	4.2	5.3
Lane Util. Factor		1.00	1.00	1.00	1.00	1.00	1.00	1.00	0.95	1.00	1.00	1.00
Frt		1.00	1.00	0.85	1.00	1.00	0.85	1.00	1.00	0.85	1.00	1.00
Flt Protected		0.95	1.00	1.00	0.95	1.00	1.00	0.95	1.00	1.00	0.95	1.00
Satd. Flow (prot)		1719	1810	1538	1719	1810	1538	1719	3438	1538	1719	1810
Flt Permitted		0.95	1.00	1.00	0.95	1.00	1.00	0.95	1.00	1.00	0.95	1.00
Satd. Flow (perm)		1719	1810	1538	1719	1810	1538	1719	3438	1538	1719	1810
Peak-hour factor, PHF	0.92	0.92	0.92	0.92	0.92	0.92	0.92	0.92	0.92	0.92	0.92	0.92
Adj. Flow (vph)	1	66	292	57	38	249	89	124	575	90	60	168
RTOR Reduction (vph)	0	0	0	40	0	0	65	0	0	63	0	0
Lane Group Flow (vph)	0	67	292	17	38	249	24	124	575	27	60	168
Heavy Vehicles (%)	5%	5%	5%	5%	5%	5%	5%	5%	5%	5%	5%	5%
Turn Type	Prot	Prot	NA	Perm	Prot	NA	Perm	Prot	NA	Perm	Prot	NA
Protected Phases	7	7	4		3	8		5	2		1	6
Permitted Phases				4			8			2		
Actuated Green, G (s)		7.3	22.4	22.4	4.9	20.3	20.3	8.0	21.9	21.9	4.9	19.2
Effective Green, g (s)		7.3	22.4	22.4	4.9	20.3	20.3	8.0	21.9	21.9	4.9	19.2
Actuated g/C Ratio		0.10	0.30	0.30	0.07	0.27	0.27	0.11	0.30	0.30	0.07	0.26
Clearance Time (s)		4.2	6.0	6.0	4.2	5.7	5.7	4.2	5.7	5.7	4.2	5.3
Vehicle Extension (s)		3.0	3.0	3.0	3.0	3.0	3.0	3.0	3.0	3.0	3.0	3.0
Lane Grp Cap (vph)		169	546	464	113	495	420	185	1014	453	113	468
v/s Ratio Prot		c0.04	c0.16		0.02	0.14		c0.07	c0.17		0.03	0.09
v/s Ratio Perm				0.01			0.02			0.02		
v/c Ratio		0.40	0.53	0.04	0.34	0.50	0.06	0.67	0.57	0.06	0.53	0.36
Uniform Delay, d1		31.4	21.6	18.3	33.1	22.7	19.9	31.8	22.1	18.8	33.5	22.5
Progression Factor		1.00	1.00	1.00	1.00	1.00	1.00	1.00	1.00	1.00	1.00	1.00
Incremental Delay, d2		1.5	1.0	0.0	1.8	0.8	0.1	9.2	0.7	0.1	4.7	0.5
Delay (s)		32.9	22.6	18.3	34.9	23.5	20.0	41.0	22.9	18.8	38.3	22.9
Level of Service		C	C	B	C	C	B	D	C	B	D	C
Approach Delay (s)			23.7			23.8			25.3			25.6
Approach LOS			C			C			C			C

Intersection Summary		
HCM 2000 Control Delay	24.7	HCM 2000 Level of Service C
HCM 2000 Volume to Capacity ratio	0.58	
Actuated Cycle Length (s)	74.2	Sum of lost time (s) 20.1
Intersection Capacity Utilization	62.2%	ICU Level of Service B
Analysis Period (min)	15	
c Critical Lane Group		



Movement	SBR
Lane Configurations	7
Traffic Volume (vph)	57
Future Volume (vph)	57
Ideal Flow (vphpl)	1900
Total Lost time (s)	5.3
Lane Util. Factor	1.00
Frt	0.85
Flt Protected	1.00
Satd. Flow (prot)	1538
Flt Permitted	1.00
Satd. Flow (perm)	1538
Peak-hour factor, PHF	0.92
Adj. Flow (vph)	62
RTOR Reduction (vph)	46
Lane Group Flow (vph)	16
Heavy Vehicles (%)	5%
Turn Type	Perm
Protected Phases	
Permitted Phases	6
Actuated Green, G (s)	19.2
Effective Green, g (s)	19.2
Actuated g/C Ratio	0.26
Clearance Time (s)	5.3
Vehicle Extension (s)	3.0
Lane Grp Cap (vph)	397
v/s Ratio Prot	
v/s Ratio Perm	0.01
v/c Ratio	0.04
Uniform Delay, d1	20.6
Progression Factor	1.00
Incremental Delay, d2	0.0
Delay (s)	20.6
Level of Service	C
Approach Delay (s)	
Approach LOS	
Intersection Summary	

Intersection

Int Delay, s/veh 2.4

Movement EBL EBT WBT WBR SBL SBR

Lane Configurations		↕	↕		↕	
Traffic Vol, veh/h	85	222	244	27	21	54
Future Vol, veh/h	85	222	244	27	21	54
Conflicting Peds, #/hr	0	0	0	0	0	0
Sign Control	Free	Free	Free	Free	Stop	Stop
RT Channelized	-	None	-	None	-	None
Storage Length	-	-	-	-	0	-
Veh in Median Storage, #	-	0	0	-	0	-
Grade, %	-	0	0	-	0	-
Peak Hour Factor	93	93	93	93	93	93
Heavy Vehicles, %	3	3	3	3	3	3
Mvmt Flow	91	239	262	29	23	58

Major/Minor Major1 Major2 Minor2

Conflicting Flow All	291	0	-	0	698	277
Stage 1	-	-	-	-	277	-
Stage 2	-	-	-	-	421	-
Critical Hdwy	4.13	-	-	-	6.43	6.23
Critical Hdwy Stg 1	-	-	-	-	5.43	-
Critical Hdwy Stg 2	-	-	-	-	5.43	-
Follow-up Hdwy	2.227	-	-	-	3.527	3.327
Pot Cap-1 Maneuver	1265	-	-	-	405	759
Stage 1	-	-	-	-	767	-
Stage 2	-	-	-	-	660	-
Platoon blocked, %		-	-	-		
Mov Cap-1 Maneuver	1265	-	-	-	371	759
Mov Cap-2 Maneuver	-	-	-	-	371	-
Stage 1	-	-	-	-	703	-
Stage 2	-	-	-	-	660	-

Approach EB WB SB

HCM Control Delay, s	2.2	0	12.1
HCM LOS			B

Minor Lane/Major Mvmt EBL EBT WBT WBR SBLn1

Capacity (veh/h)	1265	-	-	-	587
HCM Lane V/C Ratio	0.072	-	-	-	0.137
HCM Control Delay (s)	8.1	0	-	-	12.1
HCM Lane LOS	A	A	-	-	B
HCM 95th %tile Q(veh)	0.2	-	-	-	0.5

Intersection	
Intersection Delay, s/veh	14.8
Intersection LOS	B

Movement	EBL	EBT	EBR	WBL	WBT	WBR	NBL	NBT	NBR	SBL	SBT	SBR
Lane Configurations		↕			↕			↕			↕	
Traffic Vol, veh/h	102	96	25	8	161	51	38	282	8	43	151	89
Future Vol, veh/h	102	96	25	8	161	51	38	282	8	43	151	89
Peak Hour Factor	0.98	0.98	0.98	0.98	0.98	0.98	0.98	0.98	0.98	0.98	0.98	0.98
Heavy Vehicles, %	5	5	5	5	5	5	5	5	5	5	5	5
Mvmt Flow	104	98	26	8	164	52	39	288	8	44	154	91
Number of Lanes	0	1	0	0	1	0	0	1	0	0	1	0

Approach	EB	WB	NB	SB
Opposing Approach	WB	EB	SB	NB
Opposing Lanes	1	1	1	1
Conflicting Approach Left	SB	NB	EB	WB
Conflicting Lanes Left	1	1	1	1
Conflicting Approach Right	NB	SB	WB	EB
Conflicting Lanes Right	1	1	1	1
HCM Control Delay	13.8	13.4	16.6	14.5
HCM LOS	B	B	C	B

Lane	NBLn1	EBLn1	WBLn1	SBLn1
Vol Left, %	12%	46%	4%	15%
Vol Thru, %	86%	43%	73%	53%
Vol Right, %	2%	11%	23%	31%
Sign Control	Stop	Stop	Stop	Stop
Traffic Vol by Lane	328	223	220	283
LT Vol	38	102	8	43
Through Vol	282	96	161	151
RT Vol	8	25	51	89
Lane Flow Rate	335	228	224	289
Geometry Grp	1	1	1	1
Degree of Util (X)	0.562	0.406	0.392	0.48
Departure Headway (Hd)	6.049	6.426	6.287	5.986
Convergence, Y/N	Yes	Yes	Yes	Yes
Cap	596	560	572	601
Service Time	4.09	4.474	4.336	4.029
HCM Lane V/C Ratio	0.562	0.407	0.392	0.481
HCM Control Delay	16.6	13.8	13.4	14.5
HCM Lane LOS	C	B	B	B
HCM 95th-tile Q	3.5	2	1.9	2.6

Intersection: 1: Douty St & 3rd Street

Movement	EB	EB	EB	NB	NB	NB	SB
Directions Served	L	T	TR	T	T	R	LT
Maximum Queue (ft)	100	94	112	79	77	55	94
Average Queue (ft)	58	51	47	38	34	29	55
95th Queue (ft)	90	81	78	58	64	55	88
Link Distance (ft)	320	320	320	356	356		787
Upstream Blk Time (%)							
Queuing Penalty (veh)							
Storage Bay Dist (ft)						90	
Storage Blk Time (%)					0		
Queuing Penalty (veh)					0		

Intersection: 2: 10th Avenue & 4th Street/SR-198 WB Off Ramp

Movement	WB	NB	NB	NB	SB	SB	SB
Directions Served	LTR	L	T	T	T	T	R
Maximum Queue (ft)	230	93	180	175	235	188	93
Average Queue (ft)	74	40	77	78	121	49	49
95th Queue (ft)	156	76	136	144	195	144	82
Link Distance (ft)	775		759	759	758	758	
Upstream Blk Time (%)							
Queuing Penalty (veh)							
Storage Bay Dist (ft)		295					105
Storage Blk Time (%)						0	0
Queuing Penalty (veh)						0	0

Intersection: 3: 10 1/2 Avenue & Hanford Armona Road

Movement	EB	EB	WB	WB	NB	NB	NB	SB	SB	SB
Directions Served	L	TR	L	TR	L	T	R	L	T	R
Maximum Queue (ft)	89	169	58	212	137	75	65	31	89	52
Average Queue (ft)	36	71	18	66	65	35	18	9	18	12
95th Queue (ft)	73	128	49	139	112	66	47	32	61	37
Link Distance (ft)		1346		1547		396			386	
Upstream Blk Time (%)										
Queuing Penalty (veh)										
Storage Bay Dist (ft)	150		95		150		95	150		100
Storage Blk Time (%)		0		3	0				0	
Queuing Penalty (veh)		0		1	0				0	

Intersection: 4: Jordan Way & Hanford Armona Road

Movement	WB	NB
Directions Served	L	LR
Maximum Queue (ft)	31	74
Average Queue (ft)	5	43
95th Queue (ft)	22	65
Link Distance (ft)	1339	
Upstream Blk Time (%)		
Queuing Penalty (veh)		
Storage Bay Dist (ft)	75	
Storage Blk Time (%)		
Queuing Penalty (veh)		

Intersection: 5: 10th Avenue & Hanford Armona Road

Movement	EB	EB	EB	WB	WB	NB	NB	SB	SB	SB	
Directions Served	L	T	R	L	TR	L	T	L	T	R	
Maximum Queue (ft)	149	75	61	30	52	94	178	31	159	133	
Average Queue (ft)	86	5	21	4	19	37	59	8	65	46	
95th Queue (ft)	140	28	44	19	46	77	130	29	130	95	
Link Distance (ft)	936			372			448		399		
Upstream Blk Time (%)											
Queuing Penalty (veh)											
Storage Bay Dist (ft)	105		55		155		155		110		265
Storage Blk Time (%)	4	0	0				2	1			
Queuing Penalty (veh)	3	0	1				1	1			

Intersection: 6: 10 1/2 Avenue & Orchard Avenue

Movement	WB	SB
Directions Served	LR	LT
Maximum Queue (ft)	70	28
Average Queue (ft)	38	2
95th Queue (ft)	58	14
Link Distance (ft)	862	2833
Upstream Blk Time (%)		
Queuing Penalty (veh)		
Storage Bay Dist (ft)		
Storage Blk Time (%)		
Queuing Penalty (veh)		

Intersection: 7: 11th Avenue & Houston Avenue

Movement	EB	EB	EB	WB	WB	WB	NB	NB	NB	NB	SB	SB
Directions Served	UL	T	R	L	T	R	L	T	T	R	L	T
Maximum Queue (ft)	96	136	57	48	132	43	109	92	128	74	87	109
Average Queue (ft)	47	57	17	24	59	12	33	33	29	13	33	38
95th Queue (ft)	94	117	45	47	111	31	77	67	82	39	71	82
Link Distance (ft)		680			436			276	276			1524
Upstream Blk Time (%)												
Queuing Penalty (veh)												
Storage Bay Dist (ft)	165		150	175		175	175			100	250	
Storage Blk Time (%)		0							0			
Queuing Penalty (veh)		0							0			

Intersection: 7: 11th Avenue & Houston Avenue

Movement	SB
Directions Served	R
Maximum Queue (ft)	35
Average Queue (ft)	11
95th Queue (ft)	27
Link Distance (ft)	1524
Upstream Blk Time (%)	
Queuing Penalty (veh)	
Storage Bay Dist (ft)	
Storage Blk Time (%)	
Queuing Penalty (veh)	

Intersection: 8: Houston Avenue & 10 1/2 Avenue

Movement	EB	SB
Directions Served	LT	LR
Maximum Queue (ft)	62	70
Average Queue (ft)	9	35
95th Queue (ft)	36	62
Link Distance (ft)	2076	2057
Upstream Blk Time (%)		
Queuing Penalty (veh)		
Storage Bay Dist (ft)		
Storage Blk Time (%)		
Queuing Penalty (veh)		

Intersection: 9: 10th Avenue & Houston Avenue

Movement	EB	WB	NB	SB
Directions Served	LTR	LTR	LTR	LTR
Maximum Queue (ft)	117	79	74	124
Average Queue (ft)	59	40	44	59
95th Queue (ft)	93	62	70	100
Link Distance (ft)	2557	1661	1092	4776
Upstream Blk Time (%)				
Queuing Penalty (veh)				
Storage Bay Dist (ft)				
Storage Blk Time (%)				
Queuing Penalty (veh)				

Intersection: 10: 3rd Street & SR-198 EB Off Ramp

Movement	SE
Directions Served	L
Maximum Queue (ft)	75
Average Queue (ft)	34
95th Queue (ft)	66
Link Distance (ft)	209
Upstream Blk Time (%)	
Queuing Penalty (veh)	
Storage Bay Dist (ft)	
Storage Blk Time (%)	
Queuing Penalty (veh)	

Network Summary

Network wide Queuing Penalty: 9

Intersection: 1: Douty St & 3rd Street

Movement	EB	EB	EB	NB	NB	NB	SB	SB
Directions Served	L	T	TR	T	T	R	LT	T
Maximum Queue (ft)	146	209	181	74	77	78	243	56
Average Queue (ft)	75	91	89	39	40	26	104	20
95th Queue (ft)	123	153	139	60	64	54	177	53
Link Distance (ft)	320	320	320	356	356		787	787
Upstream Blk Time (%)								
Queuing Penalty (veh)								
Storage Bay Dist (ft)						90		
Storage Blk Time (%)					0	0		
Queuing Penalty (veh)					0	0		

Intersection: 2: 10th Avenue & 4th Street/SR-198 WB Off Ramp

Movement	WB	NB	NB	NB	SB	SB	SB
Directions Served	LTR	L	T	T	T	T	R
Maximum Queue (ft)	223	345	488	463	345	283	225
Average Queue (ft)	94	276	277	173	227	166	58
95th Queue (ft)	156	421	561	381	327	278	135
Link Distance (ft)	775		759	759	758	758	
Upstream Blk Time (%)							
Queuing Penalty (veh)							
Storage Bay Dist (ft)		295					105
Storage Blk Time (%)		51	0			3	
Queuing Penalty (veh)		256	0			6	

Intersection: 3: 10 1/2 Avenue & Hanford Armona Road

Movement	EB	EB	WB	WB	NB	NB	NB	SB	SB	SB
Directions Served	L	TR	L	TR	L	T	R	L	T	R
Maximum Queue (ft)	219	420	174	209	214	230	31	51	77	53
Average Queue (ft)	45	186	65	104	92	41	8	21	36	30
95th Queue (ft)	143	324	140	186	149	108	29	49	72	57
Link Distance (ft)		1346		1547		396			386	
Upstream Blk Time (%)										
Queuing Penalty (veh)										
Storage Bay Dist (ft)	150		95		150		95	150		100
Storage Blk Time (%)		14	2	9	2	0				
Queuing Penalty (veh)		6	8	6	2	0				

Intersection: 4: Jordan Way & Hanford Armona Road

Movement	WB	NB
Directions Served	L	LR
Maximum Queue (ft)	75	96
Average Queue (ft)	24	44
95th Queue (ft)	52	71
Link Distance (ft)	1339	
Upstream Blk Time (%)		
Queuing Penalty (veh)		
Storage Bay Dist (ft)	75	
Storage Blk Time (%)	0	
Queuing Penalty (veh)	0	

Intersection: 5: 10th Avenue & Hanford Armona Road

Movement	EB	EB	EB	WB	WB	NB	NB	NB	SB	SB	SB	
Directions Served	L	T	R	L	TR	L	T	R	L	T	R	
Maximum Queue (ft)	162	194	80	52	94	136	211	44	194	336	357	
Average Queue (ft)	93	21	28	17	44	86	111	4	42	133	86	
95th Queue (ft)	153	79	57	41	91	134	198	22	99	258	187	
Link Distance (ft)	936			372			448			399		
Upstream Blk Time (%)												
Queuing Penalty (veh)												
Storage Bay Dist (ft)	105		55	155		155		130	110		265	
Storage Blk Time (%)	8	0	1			0	5			11		
Queuing Penalty (veh)	13	0	2			0	10			35		

Intersection: 6: 10 1/2 Avenue & Orchard Avenue

Movement	WB	SB
Directions Served	LR	LT
Maximum Queue (ft)	66	52
Average Queue (ft)	29	6
95th Queue (ft)	58	28
Link Distance (ft)	862	2833
Upstream Blk Time (%)		
Queuing Penalty (veh)		
Storage Bay Dist (ft)		
Storage Blk Time (%)		
Queuing Penalty (veh)		

Intersection: 7: 11th Avenue & Houston Avenue

Movement	EB	EB	EB	WB	WB	WB	NB	NB	NB	NB	SB	SB
Directions Served	UL	T	R	L	T	R	L	T	T	R	L	T
Maximum Queue (ft)	112	219	44	69	187	43	104	152	171	62	69	216
Average Queue (ft)	37	90	16	19	77	20	50	89	83	21	33	78
95th Queue (ft)	76	162	36	50	165	38	83	149	143	43	70	172
Link Distance (ft)		680			436			276	276			1524
Upstream Blk Time (%)												
Queuing Penalty (veh)												
Storage Bay Dist (ft)	165		150	175		175	175			100	250	
Storage Blk Time (%)		2			1			5				
Queuing Penalty (veh)		2			1			4				

Intersection: 7: 11th Avenue & Houston Avenue

Movement	SB
Directions Served	R
Maximum Queue (ft)	33
Average Queue (ft)	12
95th Queue (ft)	25
Link Distance (ft)	1524
Upstream Blk Time (%)	
Queuing Penalty (veh)	
Storage Bay Dist (ft)	
Storage Blk Time (%)	
Queuing Penalty (veh)	

Intersection: 8: Houston Avenue & 10 1/2 Avenue

Movement	EB	SB
Directions Served	LT	LR
Maximum Queue (ft)	52	74
Average Queue (ft)	20	33
95th Queue (ft)	45	58
Link Distance (ft)	2076	2057
Upstream Blk Time (%)		
Queuing Penalty (veh)		
Storage Bay Dist (ft)		
Storage Blk Time (%)		
Queuing Penalty (veh)		

Intersection: 9: 10th Avenue & Houston Avenue

Movement	EB	WB	NB	SB
Directions Served	LTR	LTR	LTR	LTR
Maximum Queue (ft)	118	184	160	189
Average Queue (ft)	51	61	69	73
95th Queue (ft)	84	119	119	138
Link Distance (ft)	2557	1661	1092	4776
Upstream Blk Time (%)				
Queuing Penalty (veh)				
Storage Bay Dist (ft)				
Storage Blk Time (%)				
Queuing Penalty (veh)				

Intersection: 10: 3rd Street & SR-198 EB Off Ramp

Movement	EB	SE
Directions Served	T	L
Maximum Queue (ft)	75	243
Average Queue (ft)	9	95
95th Queue (ft)	40	204
Link Distance (ft)	361	209
Upstream Blk Time (%)		3
Queuing Penalty (veh)		0
Storage Bay Dist (ft)		
Storage Blk Time (%)		
Queuing Penalty (veh)		

Network Summary

Network wide Queuing Penalty: 351

HCS7 Two-Lane Highway Report

Project Information

Analyst	C. Ayala-Magana	Date	7/20/2022
Agency	JLB Traffic Engineering, Inc.	Analysis Year	2022
Jurisdiction	City of Hanford	Time Period Analyzed	Cumulative Year 2042 Plus Project AM Peak
Project Description	01 Hanford-Armona Road Between 11th Avenue and 10 1/2 Avenue	Unit	United States Customary

Segment 1

Vehicle Inputs

Segment Type	Passing Constrained	Length, ft	2583
Lane Width, ft	12	Shoulder Width, ft	6
Speed Limit, mi/h	40	Access Point Density, pts/mi	34.8

Demand and Capacity

Directional Demand Flow Rate, veh/h	556	Opposing Demand Flow Rate, veh/h	-
Peak Hour Factor	0.72	Total Trucks, %	4.02
Segment Capacity, veh/h	1700	Demand/Capacity (D/C)	0.33

Intermediate Results

Segment Vertical Class	1	Free-Flow Speed, mi/h	36.8
Speed Slope Coefficient	2.52197	Speed Power Coefficient	0.41674
PF Slope Coefficient	-1.44139	PF Power Coefficient	0.67822
In Passing Lane Effective Length?	No	Total Segment Density, veh/mi/ln	9.9
%Improved % Followers	0.0	% Improved Avg Speed	0.0

Subsegment Data

#	Segment Type	Length, ft	Radius, ft	Superelevation, %	Average Speed, mi/h
1	Tangent	2583	-	-	34.9

Vehicle Results

Average Speed, mi/h	34.9	Percent Followers, %	62.0
Segment Travel Time, minutes	0.84	Follower Density, followers/mi/ln	9.9
Vehicle LOS	C		

Facility Results

T	Follower Density, followers/mi/ln	LOS
1	9.9	C

HCS7 Two-Lane Highway Report

Project Information

Analyst	C. Ayala-Magana	Date	7/20/2022
Agency	JLB Traffic Engineering, Inc.	Analysis Year	2022
Jurisdiction	City of Hanford	Time Period Analyzed	Cumulative Year 2042 Plus Project AM Peak
Project Description	02 Hanford-Armona Road Between 10 1/2 Avenue and Jordan Way	Unit	United States Customary

Segment 1

Vehicle Inputs

Segment Type	Passing Constrained	Length, ft	1556
Lane Width, ft	12	Shoulder Width, ft	6
Speed Limit, mi/h	40	Access Point Density, pts/mi	67.9

Demand and Capacity

Directional Demand Flow Rate, veh/h	353	Opposing Demand Flow Rate, veh/h	-
Peak Hour Factor	0.74	Total Trucks, %	3.39
Segment Capacity, veh/h	1700	Demand/Capacity (D/C)	0.21

Intermediate Results

Segment Vertical Class	1	Free-Flow Speed, mi/h	35.5
Speed Slope Coefficient	2.43653	Speed Power Coefficient	0.41674
PF Slope Coefficient	-1.48329	PF Power Coefficient	0.66113
In Passing Lane Effective Length?	No	Total Segment Density, veh/mi/ln	5.4
%Improved % Followers	0.0	% Improved Avg Speed	0.0

Subsegment Data

#	Segment Type	Length, ft	Radius, ft	Superelevation, %	Average Speed, mi/h
1	Tangent	1556	-	-	34.1

Vehicle Results

Average Speed, mi/h	34.1	Percent Followers, %	52.5
Segment Travel Time, minutes	0.52	Follower Density, followers/mi/ln	5.4
Vehicle LOS	C		

Facility Results

T	Follower Density, followers/mi/ln	LOS
1	5.4	C

HCS7 Two-Lane Highway Report

Project Information

Analyst	C. Ayala-Magana	Date	7/20/2022
Agency	JLB Traffic Engineering, Inc.	Analysis Year	2022
Jurisdiction	City of Hanford	Time Period Analyzed	Cumulative Year 2042 Plus Project AM Peak
Project Description	03 Hanford-Armona Road Between Jordan Way and 10th Avenue	Unit	United States Customary

Segment 1

Vehicle Inputs

Segment Type	Passing Constrained	Length, ft	901
Lane Width, ft	12	Shoulder Width, ft	6
Speed Limit, mi/h	40	Access Point Density, pts/mi	23.4

Demand and Capacity

Directional Demand Flow Rate, veh/h	336	Opposing Demand Flow Rate, veh/h	-
Peak Hour Factor	0.75	Total Trucks, %	6.25
Segment Capacity, veh/h	1700	Demand/Capacity (D/C)	0.20

Intermediate Results

Segment Vertical Class	1	Free-Flow Speed, mi/h	39.5
Speed Slope Coefficient	2.65189	Speed Power Coefficient	0.41674
PF Slope Coefficient	-1.50451	PF Power Coefficient	0.67582
In Passing Lane Effective Length?	No	Total Segment Density, veh/mi/ln	4.5
%Improved % Followers	0.0	% Improved Avg Speed	0.0

Subsegment Data

#	Segment Type	Length, ft	Radius, ft	Superelevation, %	Average Speed, mi/h
1	Tangent	901	-	-	38.1

Vehicle Results

Average Speed, mi/h	38.1	Percent Followers, %	51.3
Segment Travel Time, minutes	0.27	Follower Density, followers/mi/ln	4.5
Vehicle LOS	B		

Facility Results

T	Follower Density, followers/mi/ln	LOS
1	4.5	B

HCS7 Two-Lane Highway Report

Project Information

Analyst	C. Ayala-Magana	Date	7/20/2022
Agency	JLB Traffic Engineering, Inc.	Analysis Year	2022
Jurisdiction	City of Hanford	Time Period Analyzed	Cumulative Year 2042 Plus Project AM Peak
Project Description	04 10.5 Avenue Between Hanford Armona Drive and Orchard Avenue	Unit	United States Customary

Segment 1

Vehicle Inputs

Segment Type	Passing Constrained	Length, ft	2735
Lane Width, ft	12	Shoulder Width, ft	2
Speed Limit, mi/h	40	Access Point Density, pts/mi	50.2

Demand and Capacity

Directional Demand Flow Rate, veh/h	317	Opposing Demand Flow Rate, veh/h	-
Peak Hour Factor	0.60	Total Trucks, %	9.87
Segment Capacity, veh/h	1700	Demand/Capacity (D/C)	0.19

Intermediate Results

Segment Vertical Class	1	Free-Flow Speed, mi/h	32.5
Speed Slope Coefficient	2.29128	Speed Power Coefficient	0.41674
PF Slope Coefficient	-1.42068	PF Power Coefficient	0.65951
In Passing Lane Effective Length?	No	Total Segment Density, veh/mi/ln	4.9
%Improved % Followers	0.0	% Improved Avg Speed	0.0

Subsegment Data

#	Segment Type	Length, ft	Radius, ft	Superelevation, %	Average Speed, mi/h
1	Tangent	2735	-	-	31.3

Vehicle Results

Average Speed, mi/h	31.3	Percent Followers, %	48.6
Segment Travel Time, minutes	0.99	Follower Density, followers/mi/ln	4.9
Vehicle LOS	B		

Facility Results

T	Follower Density, followers/mi/ln	LOS
1	4.9	B

HCS7 Two-Lane Highway Report

Project Information

Analyst	C. Ayala-Magana	Date	7/20/2022
Agency	JLB Traffic Engineering, Inc.	Analysis Year	2022
Jurisdiction	City of Hanford	Time Period Analyzed	Cumulative Year 2042 Plus Project AM Peak
Project Description	05 10.5 Avenue Between Orchard Avenue and Houston Avenue	Unit	United States Customary

Segment 1

Vehicle Inputs

Segment Type	Passing Constrained	Length, ft	2594
Lane Width, ft	12	Shoulder Width, ft	2
Speed Limit, mi/h	40	Access Point Density, pts/mi	52.9

Demand and Capacity

Directional Demand Flow Rate, veh/h	176	Opposing Demand Flow Rate, veh/h	-
Peak Hour Factor	0.42	Total Trucks, %	13.33
Segment Capacity, veh/h	1700	Demand/Capacity (D/C)	0.10

Intermediate Results

Segment Vertical Class	1	Free-Flow Speed, mi/h	32.4
Speed Slope Coefficient	2.28310	Speed Power Coefficient	0.41674
PF Slope Coefficient	-1.42395	PF Power Coefficient	0.65839
In Passing Lane Effective Length?	No	Total Segment Density, veh/mi/ln	2.0
%Improved % Followers	0.0	% Improved Avg Speed	0.0

Subsegment Data

#	Segment Type	Length, ft	Radius, ft	Superelevation, %	Average Speed, mi/h
1	Tangent	2594	-	-	31.6

Vehicle Results

Average Speed, mi/h	31.6	Percent Followers, %	36.5
Segment Travel Time, minutes	0.93	Follower Density, followers/mi/ln	2.0
Vehicle LOS	A		

Facility Results

T	Follower Density, followers/mi/ln	LOS
1	2.0	A

HCS7 Two-Lane Highway Report

Project Information

Analyst	C. Ayala-Magana	Date	7/20/2022
Agency	JLB Traffic Engineering, Inc.	Analysis Year	2022
Jurisdiction	City of Hanford	Time Period Analyzed	Cumulative Year 2042 Plus Project AM Peak
Project Description	06 Houston Avenue Between 11th Avenue and 10 1/2 Avenue	Unit	United States Customary

Segment 1

Vehicle Inputs

Segment Type	Passing Constrained	Length, ft	2567
Lane Width, ft	12	Shoulder Width, ft	2
Speed Limit, mi/h	50	Access Point Density, pts/mi	20.6

Demand and Capacity

Directional Demand Flow Rate, veh/h	329	Opposing Demand Flow Rate, veh/h	-
Peak Hour Factor	0.68	Total Trucks, %	21.40
Segment Capacity, veh/h	1700	Demand/Capacity (D/C)	0.19

Intermediate Results

Segment Vertical Class	1	Free-Flow Speed, mi/h	48.3
Speed Slope Coefficient	3.14891	Speed Power Coefficient	0.41674
PF Slope Coefficient	-1.42118	PF Power Coefficient	0.72418
In Passing Lane Effective Length?	No	Total Segment Density, veh/mi/ln	3.3
%Improved % Followers	0.0	% Improved Avg Speed	0.0

Subsegment Data

#	Segment Type	Length, ft	Radius, ft	Superelevation, %	Average Speed, mi/h
1	Tangent	2567	-	-	46.6

Vehicle Results

Average Speed, mi/h	46.6	Percent Followers, %	47.1
Segment Travel Time, minutes	0.63	Follower Density, followers/mi/ln	3.3
Vehicle LOS	B		

Facility Results

T	Follower Density, followers/mi/ln	LOS
1	3.3	B

HCS7 Two-Lane Highway Report

Project Information

Analyst	C. Ayala-Magana	Date	7/20/2022
Agency	JLB Traffic Engineering, Inc.	Analysis Year	2022
Jurisdiction	City of Hanford	Time Period Analyzed	Cumulative Year 2042 Plus Project AM Peak
Project Description	07 Houston Avenue Between 10 1/2 Avenue and 10th Avenue	Unit	United States Customary

Segment 1

Vehicle Inputs

Segment Type	Passing Constrained	Length, ft	2570
Lane Width, ft	12	Shoulder Width, ft	2
Speed Limit, mi/h	55	Access Point Density, pts/mi	45.2

Demand and Capacity

Directional Demand Flow Rate, veh/h	224	Opposing Demand Flow Rate, veh/h	-
Peak Hour Factor	0.88	Total Trucks, %	17.65
Segment Capacity, veh/h	1700	Demand/Capacity (D/C)	0.13

Intermediate Results

Segment Vertical Class	1	Free-Flow Speed, mi/h	49.3
Speed Slope Coefficient	3.20179	Speed Power Coefficient	0.41674
PF Slope Coefficient	-1.41674	PF Power Coefficient	0.72668
In Passing Lane Effective Length?	No	Total Segment Density, veh/mi/ln	1.8
%Improved % Followers	0.0	% Improved Avg Speed	0.0

Subsegment Data

#	Segment Type	Length, ft	Radius, ft	Superelevation, %	Average Speed, mi/h
1	Tangent	2570	-	-	48.0

Vehicle Results

Average Speed, mi/h	48.0	Percent Followers, %	38.0
Segment Travel Time, minutes	0.61	Follower Density, followers/mi/ln	1.8
Vehicle LOS	A		

Facility Results

T	Follower Density, followers/mi/ln	LOS
1	1.8	A

HCS7 Two-Lane Highway Report

Project Information

Analyst	C. Ayala-Magana	Date	7/20/2022
Agency	JLB Traffic Engineering, Inc.	Analysis Year	2022
Jurisdiction	City of Hanford	Time Period Analyzed	Cumulative Year 2042 Plus Project PM Peak
Project Description	01 Hanford-Armona Road Between 11th Avenue and 10 1/2 Avenue	Unit	United States Customary

Segment 1

Vehicle Inputs

Segment Type	Passing Constrained	Length, ft	2583
Lane Width, ft	12	Shoulder Width, ft	6
Speed Limit, mi/h	40	Access Point Density, pts/mi	34.8

Demand and Capacity

Directional Demand Flow Rate, veh/h	712	Opposing Demand Flow Rate, veh/h	-
Peak Hour Factor	0.83	Total Trucks, %	3.00
Segment Capacity, veh/h	1700	Demand/Capacity (D/C)	0.42

Intermediate Results

Segment Vertical Class	1	Free-Flow Speed, mi/h	36.8
Speed Slope Coefficient	2.52381	Speed Power Coefficient	0.41674
PF Slope Coefficient	-1.44159	PF Power Coefficient	0.67823
In Passing Lane Effective Length?	No	Total Segment Density, veh/mi/ln	14.0
%Improved % Followers	0.0	% Improved Avg Speed	0.0

Subsegment Data

#	Segment Type	Length, ft	Radius, ft	Superelevation, %	Average Speed, mi/h
1	Tangent	2583	-	-	34.7

Vehicle Results

Average Speed, mi/h	34.7	Percent Followers, %	68.2
Segment Travel Time, minutes	0.84	Follower Density, followers/mi/ln	14.0
Vehicle LOS	D		

Facility Results

T	Follower Density, followers/mi/ln	LOS
1	14.0	D

HCS7 Two-Lane Highway Report

Project Information

Analyst	C. Ayala-Magana	Date	7/20/2022
Agency	JLB Traffic Engineering, Inc.	Analysis Year	2022
Jurisdiction	City of Hanford	Time Period Analyzed	Cumulative Year 2042 Plus Project PM Peak
Project Description	02 Hanford-Armona Road Between 10 1/2 Avenue and Jordan Way	Unit	United States Customary

Segment 1

Vehicle Inputs

Segment Type	Passing Constrained	Length, ft	1556
Lane Width, ft	12	Shoulder Width, ft	6
Speed Limit, mi/h	40	Access Point Density, pts/mi	67.9

Demand and Capacity

Directional Demand Flow Rate, veh/h	464	Opposing Demand Flow Rate, veh/h	-
Peak Hour Factor	0.85	Total Trucks, %	3.00
Segment Capacity, veh/h	1700	Demand/Capacity (D/C)	0.27

Intermediate Results

Segment Vertical Class	1	Free-Flow Speed, mi/h	35.5
Speed Slope Coefficient	2.43724	Speed Power Coefficient	0.41674
PF Slope Coefficient	-1.48339	PF Power Coefficient	0.66114
In Passing Lane Effective Length?	No	Total Segment Density, veh/mi/ln	8.1
%Improved % Followers	0.0	% Improved Avg Speed	0.0

Subsegment Data

#	Segment Type	Length, ft	Radius, ft	Superelevation, %	Average Speed, mi/h
1	Tangent	1556	-	-	33.9

Vehicle Results

Average Speed, mi/h	33.9	Percent Followers, %	59.0
Segment Travel Time, minutes	0.52	Follower Density, followers/mi/ln	8.1
Vehicle LOS	C		

Facility Results

T	Follower Density, followers/mi/ln	LOS
1	8.1	C

HCS7 Two-Lane Highway Report

Project Information

Analyst	C. Ayala-Magana	Date	7/20/2022
Agency	JLB Traffic Engineering, Inc.	Analysis Year	2022
Jurisdiction	City of Hanford	Time Period Analyzed	Cumulative Year 2042 Plus Project PM Peak
Project Description	03 Hanford-Armona Road Between Jordan Way and 10th Avenue	Unit	United States Customary

Segment 1

Vehicle Inputs

Segment Type	Passing Constrained	Length, ft	901
Lane Width, ft	12	Shoulder Width, ft	6
Speed Limit, mi/h	40	Access Point Density, pts/mi	17.6

Demand and Capacity

Directional Demand Flow Rate, veh/h	469	Opposing Demand Flow Rate, veh/h	-
Peak Hour Factor	0.97	Total Trucks, %	3.00
Segment Capacity, veh/h	1700	Demand/Capacity (D/C)	0.28

Intermediate Results

Segment Vertical Class	1	Free-Flow Speed, mi/h	41.1
Speed Slope Coefficient	2.73635	Speed Power Coefficient	0.41674
PF Slope Coefficient	-1.50445	PF Power Coefficient	0.68170
In Passing Lane Effective Length?	No	Total Segment Density, veh/mi/ln	7.1
%Improved % Followers	0.0	% Improved Avg Speed	0.0

Subsegment Data

#	Segment Type	Length, ft	Radius, ft	Superelevation, %	Average Speed, mi/h
1	Tangent	901	-	-	39.3

Vehicle Results

Average Speed, mi/h	39.3	Percent Followers, %	59.3
Segment Travel Time, minutes	0.26	Follower Density, followers/mi/ln	7.1
Vehicle LOS	C		

Facility Results

T	Follower Density, followers/mi/ln	LOS
1	7.1	C

HCS7 Two-Lane Highway Report

Project Information

Analyst	C. Ayala-Magana	Date	7/20/2022
Agency	JLB Traffic Engineering, Inc.	Analysis Year	2022
Jurisdiction	City of Hanford	Time Period Analyzed	Cumulative Year 2042 Plus Project PM Peak
Project Description	04 10.5 Avenue Between Hanford Armona Drive and Orchard Avenue	Unit	United States Customary

Segment 1

Vehicle Inputs

Segment Type	Passing Constrained	Length, ft	2735
Lane Width, ft	12	Shoulder Width, ft	2
Speed Limit, mi/h	40	Access Point Density, pts/mi	50.2

Demand and Capacity

Directional Demand Flow Rate, veh/h	368	Opposing Demand Flow Rate, veh/h	-
Peak Hour Factor	0.75	Total Trucks, %	3.00
Segment Capacity, veh/h	1700	Demand/Capacity (D/C)	0.22

Intermediate Results

Segment Vertical Class	1	Free-Flow Speed, mi/h	32.7
Speed Slope Coefficient	2.30368	Speed Power Coefficient	0.41674
PF Slope Coefficient	-1.42275	PF Power Coefficient	0.65971
In Passing Lane Effective Length?	No	Total Segment Density, veh/mi/ln	6.1
%Improved % Followers	0.0	% Improved Avg Speed	0.0

Subsegment Data

#	Segment Type	Length, ft	Radius, ft	Superelevation, %	Average Speed, mi/h
1	Tangent	2735	-	-	31.4

Vehicle Results

Average Speed, mi/h	31.4	Percent Followers, %	52.1
Segment Travel Time, minutes	0.99	Follower Density, followers/mi/ln	6.1
Vehicle LOS	C		

Facility Results

T	Follower Density, followers/mi/ln	LOS
1	6.1	C

HCS7 Two-Lane Highway Report

Project Information

Analyst	C. Ayala-Magana	Date	7/20/2022
Agency	JLB Traffic Engineering, Inc.	Analysis Year	2022
Jurisdiction	City of Hanford	Time Period Analyzed	Cumulative Year 2042 Plus Project PM Peak
Project Description	05 10.5 Avenue Between Orchard Avenue and Houston Avenue	Unit	United States Customary

Segment 1

Vehicle Inputs

Segment Type	Passing Constrained	Length, ft	2594
Lane Width, ft	12	Shoulder Width, ft	2
Speed Limit, mi/h	40	Access Point Density, pts/mi	52.9

Demand and Capacity

Directional Demand Flow Rate, veh/h	229	Opposing Demand Flow Rate, veh/h	-
Peak Hour Factor	0.56	Total Trucks, %	3.70
Segment Capacity, veh/h	1700	Demand/Capacity (D/C)	0.13

Intermediate Results

Segment Vertical Class	1	Free-Flow Speed, mi/h	32.7
Speed Slope Coefficient	2.30048	Speed Power Coefficient	0.41674
PF Slope Coefficient	-1.42689	PF Power Coefficient	0.65868
In Passing Lane Effective Length?	No	Total Segment Density, veh/mi/ln	3.0
%Improved % Followers	0.0	% Improved Avg Speed	0.0

Subsegment Data

#	Segment Type	Length, ft	Radius, ft	Superelevation, %	Average Speed, mi/h
1	Tangent	2594	-	-	31.7

Vehicle Results

Average Speed, mi/h	31.7	Percent Followers, %	41.7
Segment Travel Time, minutes	0.93	Follower Density, followers/mi/ln	3.0
Vehicle LOS	B		

Facility Results

T	Follower Density, followers/mi/ln	LOS
1	3.0	B

HCS7 Two-Lane Highway Report

Project Information

Analyst	C. Ayala-Magana	Date	7/20/2022
Agency	JLB Traffic Engineering, Inc.	Analysis Year	2022
Jurisdiction	City of Hanford	Time Period Analyzed	Cumulative Year 2042 Plus Project PM Peak
Project Description	06 Houston Avenue Between 11th Avenue and 10 1/2 Avenue	Unit	United States Customary

Segment 1

Vehicle Inputs

Segment Type	Passing Constrained	Length, ft	2567
Lane Width, ft	12	Shoulder Width, ft	2
Speed Limit, mi/h	50	Access Point Density, pts/mi	20.6

Demand and Capacity

Directional Demand Flow Rate, veh/h	458	Opposing Demand Flow Rate, veh/h	-
Peak Hour Factor	0.89	Total Trucks, %	3.75
Segment Capacity, veh/h	1700	Demand/Capacity (D/C)	0.27

Intermediate Results

Segment Vertical Class	1	Free-Flow Speed, mi/h	48.9
Speed Slope Coefficient	3.18076	Speed Power Coefficient	0.41674
PF Slope Coefficient	-1.42061	PF Power Coefficient	0.72351
In Passing Lane Effective Length?	No	Total Segment Density, veh/mi/ln	5.4
%Improved % Followers	0.0	% Improved Avg Speed	0.0

Subsegment Data

#	Segment Type	Length, ft	Radius, ft	Superelevation, %	Average Speed, mi/h
1	Tangent	2567	-	-	46.9

Vehicle Results

Average Speed, mi/h	46.9	Percent Followers, %	55.4
Segment Travel Time, minutes	0.62	Follower Density, followers/mi/ln	5.4
Vehicle LOS	C		

Facility Results

T	Follower Density, followers/mi/ln	LOS
1	5.4	C

HCS7 Two-Lane Highway Report

Project Information

Analyst	C. Ayala-Magana	Date	7/20/2022
Agency	JLB Traffic Engineering, Inc.	Analysis Year	2022
Jurisdiction	City of Hanford	Time Period Analyzed	Cumulative Year 2042 Plus Project PM Peak
Project Description	07 Houston Avenue Between 10 1/2 Avenue and 10th Avenue	Unit	United States Customary

Segment 1

Vehicle Inputs

Segment Type	Passing Constrained	Length, ft	2570
Lane Width, ft	12	Shoulder Width, ft	2
Speed Limit, mi/h	55	Access Point Density, pts/mi	45.2

Demand and Capacity

Directional Demand Flow Rate, veh/h	354	Opposing Demand Flow Rate, veh/h	-
Peak Hour Factor	0.90	Total Trucks, %	3.00
Segment Capacity, veh/h	1700	Demand/Capacity (D/C)	0.21

Intermediate Results

Segment Vertical Class	1	Free-Flow Speed, mi/h	49.8
Speed Slope Coefficient	3.22823	Speed Power Coefficient	0.41674
PF Slope Coefficient	-1.41606	PF Power Coefficient	0.72608
In Passing Lane Effective Length?	No	Total Segment Density, veh/mi/ln	3.6
%Improved % Followers	0.0	% Improved Avg Speed	0.0

Subsegment Data

#	Segment Type	Length, ft	Radius, ft	Superelevation, %	Average Speed, mi/h
1	Tangent	2570	-	-	48.0

Vehicle Results

























Average Speed, mi/h	48.0	Percent Followers, %	48.7
Segment Travel Time, minutes	0.61	Follower Density, followers/mi/ln	3.6
Vehicle LOS	B		

Facility Results

T	Follower Density, followers/mi/ln	LOS
1	3.6	B

Cumulative Year 2042 Plus Project AM Peak W/ Additional Project Trips
 HCM Signalized Intersection Capacity Analysis
 7: 11th Avenue & Houston Avenue

08/04/2022

												
Movement	EBL	EBT	EBR	WBL	WBT	WBR	NBL	NBT	NBR	SBL	SBT	SBR
Lane Configurations												
Traffic Volume (vph)	96	131	46	38	104	41	34	144	41	44	99	40
Future Volume (vph)	96	131	46	38	104	41	34	144	41	44	99	40
Ideal Flow (vphp)	1900	1900	1900	1900	1900	1900	1900	1900	1900	1900	1900	1900
Total Lost time (s)	4.2	6.0	6.0	4.2	5.7	5.7	4.2	5.7	5.7	4.2	5.3	5.3
Lane Util. Factor	1.00	1.00	1.00	1.00	1.00	1.00	1.00	0.95	1.00	1.00	1.00	1.00
Frt	1.00	1.00	0.85	1.00	1.00	0.85	1.00	1.00	0.85	1.00	1.00	0.85
Flt Protected	0.95	1.00	1.00	0.95	1.00	1.00	0.95	1.00	1.00	0.95	1.00	1.00
Satd. Flow (prot)	1597	1681	1429	1597	1681	1429	1597	3195	1429	1597	1681	1429
Flt Permitted	0.95	1.00	1.00	0.95	1.00	1.00	0.95	1.00	1.00	0.95	1.00	1.00
Satd. Flow (perm)	1597	1681	1429	1597	1681	1429	1597	3195	1429	1597	1681	1429
Peak-hour factor, PHF	0.96	0.96	0.96	0.96	0.96	0.96	0.96	0.96	0.96	0.96	0.96	0.96
Adj. Flow (vph)	100	136	48	40	108	43	35	150	43	46	103	42
RTOR Reduction (vph)	0	0	35	0	0	35	0	0	30	0	0	28
Lane Group Flow (vph)	100	136	13	40	108	8	35	150	13	46	103	14
Heavy Vehicles (%)	13%	13%	13%	13%	13%	13%	13%	13%	13%	13%	13%	13%
Turn Type	Prot	NA	Perm	Prot	NA	Perm	Prot	NA	Perm	Prot	NA	Perm
Protected Phases	7	4		3	8		5	2		1	6	
Permitted Phases			4			8			2			6
Actuated Green, G (s)	9.7	18.4	18.4	3.6	12.6	12.6	3.6	20.3	20.3	6.0	23.1	23.1
Effective Green, g (s)	9.7	18.4	18.4	3.6	12.6	12.6	3.6	20.3	20.3	6.0	23.1	23.1
Actuated g/C Ratio	0.14	0.27	0.27	0.05	0.18	0.18	0.05	0.30	0.30	0.09	0.34	0.34
Clearance Time (s)	4.2	6.0	6.0	4.2	5.7	5.7	4.2	5.7	5.7	4.2	5.3	5.3
Vehicle Extension (s)	3.0	3.0	3.0	3.0	3.0	3.0	3.0	3.0	3.0	3.0	3.0	3.0
Lane Grp Cap (vph)	226	452	384	84	309	263	84	948	424	140	567	482
v/s Ratio Prot	c0.06	c0.08		0.03	0.06		0.02	0.05		c0.03	c0.06	
v/s Ratio Perm			0.01			0.01			0.01			0.01
v/c Ratio	0.44	0.30	0.03	0.48	0.35	0.03	0.42	0.16	0.03	0.33	0.18	0.03
Uniform Delay, d1	26.9	19.9	18.4	31.5	24.3	22.9	31.4	17.7	17.1	29.3	16.0	15.2
Progression Factor	1.00	1.00	1.00	1.00	1.00	1.00	1.00	1.00	1.00	1.00	1.00	1.00
Incremental Delay, d2	1.4	0.4	0.0	4.2	0.7	0.0	3.3	0.1	0.0	1.4	0.2	0.0
Delay (s)	28.3	20.3	18.5	35.7	25.0	22.9	34.7	17.8	17.1	30.7	16.1	15.2
Level of Service	C	C	B	D	C	C	C	B	B	C	B	B
Approach Delay (s)		22.8			26.8			20.3			19.4	
Approach LOS		C			C			C			B	
Intersection Summary												
HCM 2000 Control Delay			22.3									C
HCM 2000 Volume to Capacity ratio			0.30									
Actuated Cycle Length (s)			68.4						20.1			
Intersection Capacity Utilization			40.7%									A
Analysis Period (min)			15									
c Critical Lane Group												

Cumulative Year 2042 Plus Project PM Peak W/ Additional Project Trips
 HCM Signalized Intersection Capacity Analysis
 7: 11th Avenue & Houston Avenue

08/04/2022

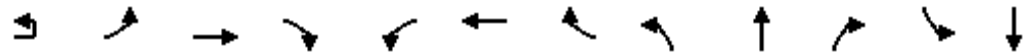

Movement	EBU	EBL	EBT	EBR	WBL	WBT	WBR	NBL	NBT	NBR	SBL	SBT
Lane Configurations		↔	↑	↗	↖	↑	↗	↖	↑↑	↗	↖	↑
Traffic Volume (vph)	1	61	275	52	36	232	82	114	529	85	56	155
Future Volume (vph)	1	61	275	52	36	232	82	114	529	85	56	155
Ideal Flow (vphpl)	1900	1900	1900	1900	1900	1900	1900	1900	1900	1900	1900	1900
Total Lost time (s)		4.2	6.0	6.0	4.2	5.7	5.7	4.2	5.7	5.7	4.2	5.3
Lane Util. Factor		1.00	1.00	1.00	1.00	1.00	1.00	1.00	0.95	1.00	1.00	1.00
Frt		1.00	1.00	0.85	1.00	1.00	0.85	1.00	1.00	0.85	1.00	1.00
Flt Protected		0.95	1.00	1.00	0.95	1.00	1.00	0.95	1.00	1.00	0.95	1.00
Satd. Flow (prot)		1719	1810	1538	1719	1810	1538	1719	3438	1538	1719	1810
Flt Permitted		0.95	1.00	1.00	0.95	1.00	1.00	0.95	1.00	1.00	0.95	1.00
Satd. Flow (perm)		1719	1810	1538	1719	1810	1538	1719	3438	1538	1719	1810
Peak-hour factor, PHF	0.92	0.92	0.92	0.92	0.92	0.92	0.92	0.92	0.92	0.92	0.92	0.92
Adj. Flow (vph)	1	66	299	57	39	252	89	124	575	92	61	168
RTOR Reduction (vph)	0	0	0	40	0	0	65	0	0	65	0	0
Lane Group Flow (vph)	0	67	299	17	39	252	24	124	575	27	61	168
Heavy Vehicles (%)	5%	5%	5%	5%	5%	5%	5%	5%	5%	5%	5%	5%
Turn Type	Prot	Prot	NA	Perm	Prot	NA	Perm	Prot	NA	Perm	Prot	NA
Protected Phases	7	7	4		3	8		5	2		1	6
Permitted Phases				4			8			2		
Actuated Green, G (s)		7.3	22.6	22.6	4.9	20.5	20.5	8.0	22.0	22.0	4.9	19.3
Effective Green, g (s)		7.3	22.6	22.6	4.9	20.5	20.5	8.0	22.0	22.0	4.9	19.3
Actuated g/C Ratio		0.10	0.30	0.30	0.07	0.28	0.28	0.11	0.30	0.30	0.07	0.26
Clearance Time (s)		4.2	6.0	6.0	4.2	5.7	5.7	4.2	5.7	5.7	4.2	5.3
Vehicle Extension (s)		3.0	3.0	3.0	3.0	3.0	3.0	3.0	3.0	3.0	3.0	3.0
Lane Grp Cap (vph)		168	549	466	113	498	423	184	1015	454	113	468
v/s Ratio Prot		c0.04	c0.17		0.02	0.14		c0.07	c0.17		0.04	0.09
v/s Ratio Perm				0.01			0.02			0.02		
v/c Ratio		0.40	0.54	0.04	0.35	0.51	0.06	0.67	0.57	0.06	0.54	0.36
Uniform Delay, d1		31.5	21.7	18.3	33.3	22.7	19.9	32.0	22.2	18.8	33.7	22.5
Progression Factor		1.00	1.00	1.00	1.00	1.00	1.00	1.00	1.00	1.00	1.00	1.00
Incremental Delay, d2		1.6	1.1	0.0	1.8	0.8	0.1	9.4	0.7	0.1	4.9	0.5
Delay (s)		33.1	22.8	18.3	35.1	23.5	19.9	41.3	22.9	18.9	38.6	23.0
Level of Service		C	C	B	D	C	B	D	C	B	D	C
Approach Delay (s)			23.8			23.9			25.4			25.8
Approach LOS			C			C			C			C

Intersection Summary		
HCM 2000 Control Delay	24.8	HCM 2000 Level of Service
HCM 2000 Volume to Capacity ratio	0.59	C
Actuated Cycle Length (s)	74.5	Sum of lost time (s)
Intersection Capacity Utilization	62.5%	20.1
Analysis Period (min)	15	ICU Level of Service
c Critical Lane Group		B

Cumulative Year 2042 Plus Project PM Peak W/ Additional Project Trips
 HCM Signalized Intersection Capacity Analysis
 7: 11th Avenue & Houston Avenue

08/04/2022

Movement	SBR
Lane Configurations	7
Traffic Volume (vph)	57
Future Volume (vph)	57
Ideal Flow (vphpl)	1900
Total Lost time (s)	5.3
Lane Util. Factor	1.00
Frt	0.85
Flt Protected	1.00
Satd. Flow (prot)	1538
Flt Permitted	1.00
Satd. Flow (perm)	1538
Peak-hour factor, PHF	0.92
Adj. Flow (vph)	62
RTOR Reduction (vph)	46
Lane Group Flow (vph)	16
Heavy Vehicles (%)	5%
Turn Type	Perm
Protected Phases	
Permitted Phases	6
Actuated Green, G (s)	19.3
Effective Green, g (s)	19.3
Actuated g/C Ratio	0.26
Clearance Time (s)	5.3
Vehicle Extension (s)	3.0
Lane Grp Cap (vph)	398
v/s Ratio Prot	
v/s Ratio Perm	0.01
v/c Ratio	0.04
Uniform Delay, d1	20.7
Progression Factor	1.00
Incremental Delay, d2	0.0
Delay (s)	20.7
Level of Service	C
Approach Delay (s)	
Approach LOS	
Intersection Summary	

Appendix I: Traffic Signal Warrants



www.JLBtraffic.com
info@JLBtraffic.com

516 W. Shaw Ave., Ste. 103
Fresno, CA 93704
(559) 570-8991

App | I

Warrant 3: Peak Hour (Urban)

Existing Traffic Conditions 4. Jordan Way / Hanford-Armona Road AM (PM) Peak Hour

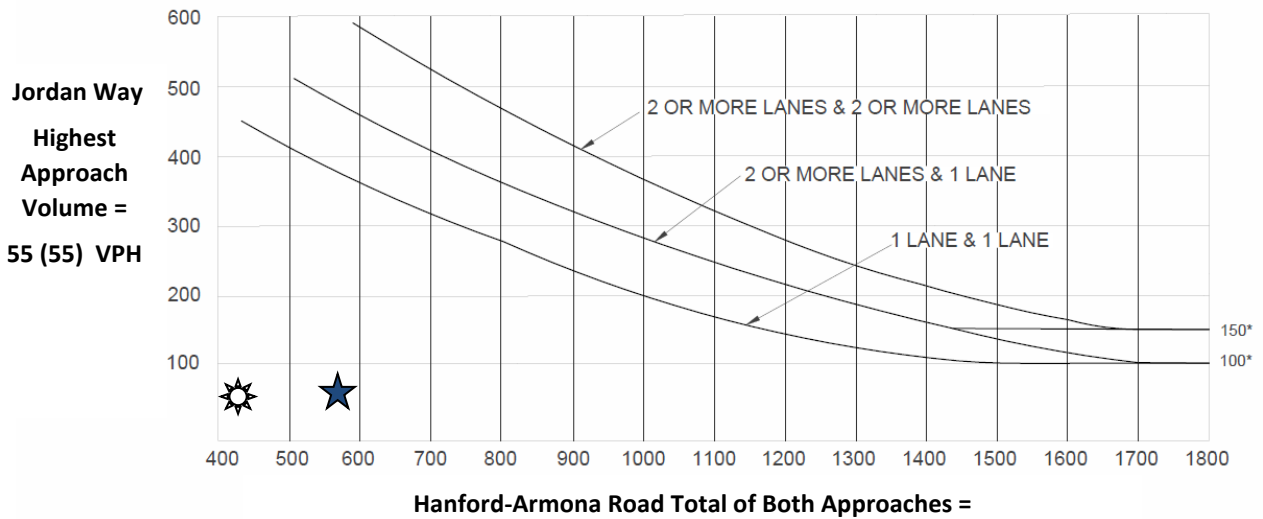

*Note: 150 vph applies as the lower threshold volume for a minor-street approach with two or more lanes and 100 vph applies as the lower threshold volume for a minor street approach with one lane.



AM Peak Hour – Signal Warrant is Not Met



PM Peak Hour – Signal Warrant is Not Met

Source: California Manual of Uniform Traffic Control Devices (CA MUTCD 2014 Edition)
Chapter 4C: Traffic Control Signal Needs Studies
Part 4: Highway Traffic Signals
November 7, 2014

Warrant 3: Peak Hour (Rural)

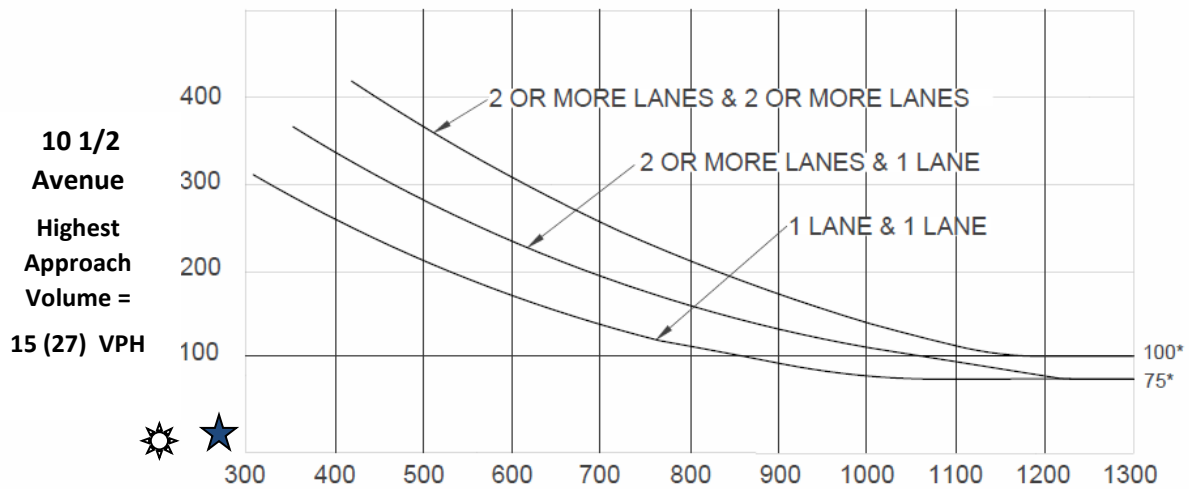

Existing Traffic Conditions
8. 10 1/2 Avenue / Houston Avenue
AM (PM) Peak Hour

(COMMUNITY LESS THAN 10,000 POPULATION OR ABOVE 40 MPH ON MAJOR STREET)



Houston Avenue Total of Both Approaches =
205 (270) VPH

*Note: 100 vph applies as the lower threshold volume for a minor-street approach with two or more lanes and 75 vph applies as the lower threshold volume for a minor street approach with one lane.

-  **AM Peak Hour – Signal Warrant is Not Met**
-  **PM Peak Hour – Signal Warrant is Not Met**

Source: California Manual of Uniform Traffic Control Devices (CA MUTCD 2014 Edition)
 Chapter 4C: Traffic Control Signal Needs Studies
 Part 4: Highway Traffic Signals
 November 7, 2014

Warrant 3: Peak Hour (Rural)

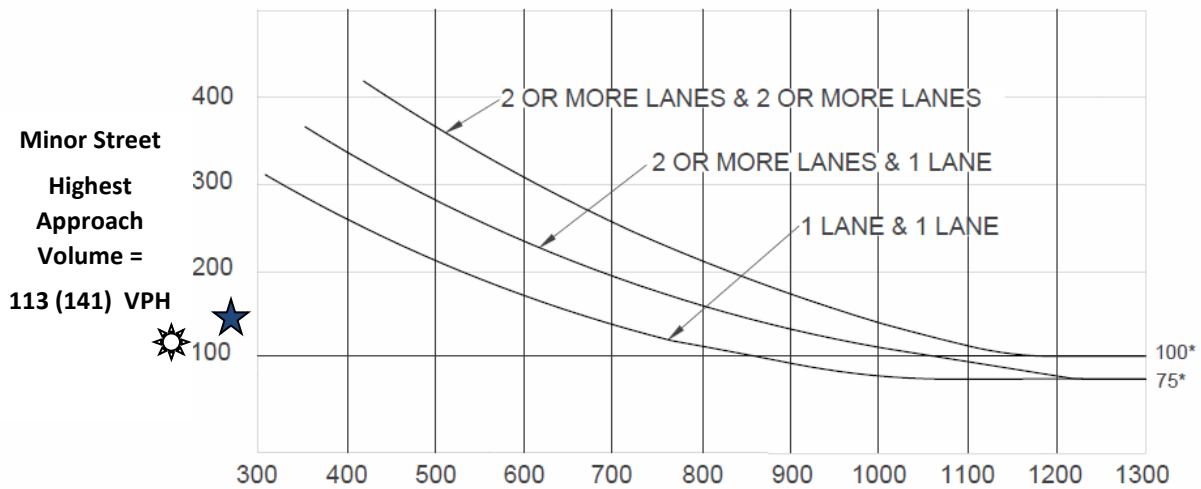

Existing Traffic Conditions
9. 10th Avenue / Houston Avenue
AM (PM) Peak Hour

(COMMUNITY LESS THAN 10,000 POPULATION OR ABOVE 40 MPH ON MAJOR STREET)



Major Street Total of Both Approaches =
191 (278) VPH

*Note: 100 vph applies as the lower threshold volume for a minor-street approach with two or more lanes and 75 vph applies as the lower threshold volume for a minor street approach with one lane.

-  AM Peak Hour – Signal Warrant is Not Met
-  PM Peak Hour – Signal Warrant is Not Met

Source: California Manual of Uniform Traffic Control Devices (CA MUTCD 2014 Edition)
Chapter 4C: Traffic Control Signal Needs Studies
Part 4: Highway Traffic Signals
November 7, 2014

Warrant 3: Peak Hour (Urban)

Existing plus Project Traffic Conditions 4. Jordan Way / Hanford-Armona Road AM (PM) Peak Hour

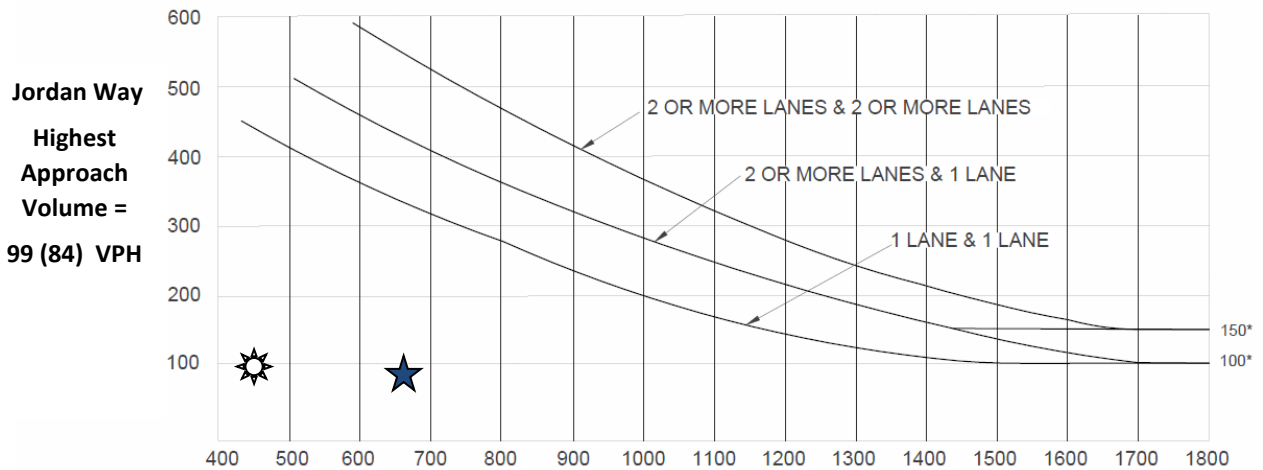

Hanford-Armona Road Total of Both Approaches =

448 (664) VPH

*Note: 150 vph applies as the lower threshold volume for a minor-street approach with two or more lanes and 100 vph applies as the lower threshold volume for a minor street approach with one lane.



AM Peak Hour – Signal Warrant is Not Met



PM Peak Hour – Signal Warrant is Not Met



Source: California Manual of Uniform Traffic Control Devices (CA MUTCD 2014 Edition)
Chapter 4C: Traffic Control Signal Needs Studies
Part 4: Highway Traffic Signals
November 7, 2014

Warrant 3: Peak Hour (Urban)

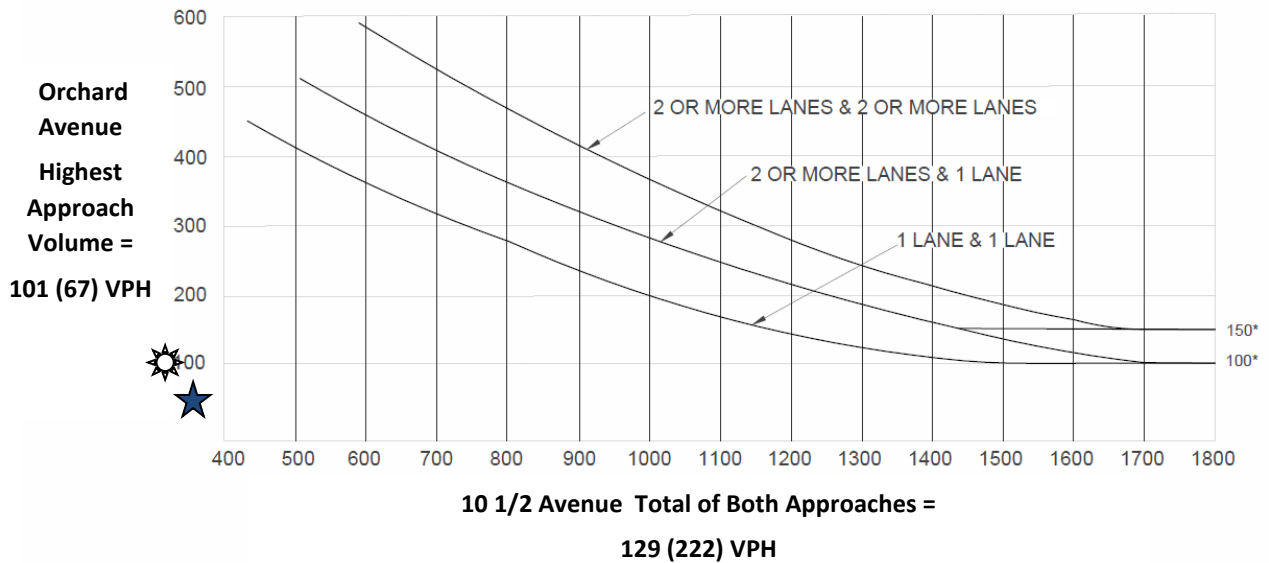
Existing plus Project Traffic Conditions
6. 10 1/2 Avenue / Orchard Avenue
AM (PM) Peak Hour



*Note: 150 vph applies as the lower threshold volume for a minor-street approach with two or more lanes and 100 vph applies as the lower threshold volume for a minor street approach with one lane.

-  **AM Peak Hour – Signal Warrant is Not Met**
-  **PM Peak Hour – Signal Warrant is Not Met**

Source: California Manual of Uniform Traffic Control Devices (CA MUTCD 2014 Edition)
 Chapter 4C: Traffic Control Signal Needs Studies
 Part 4: Highway Traffic Signals
 November 7, 2014

Warrant 3: Peak Hour (Rural)

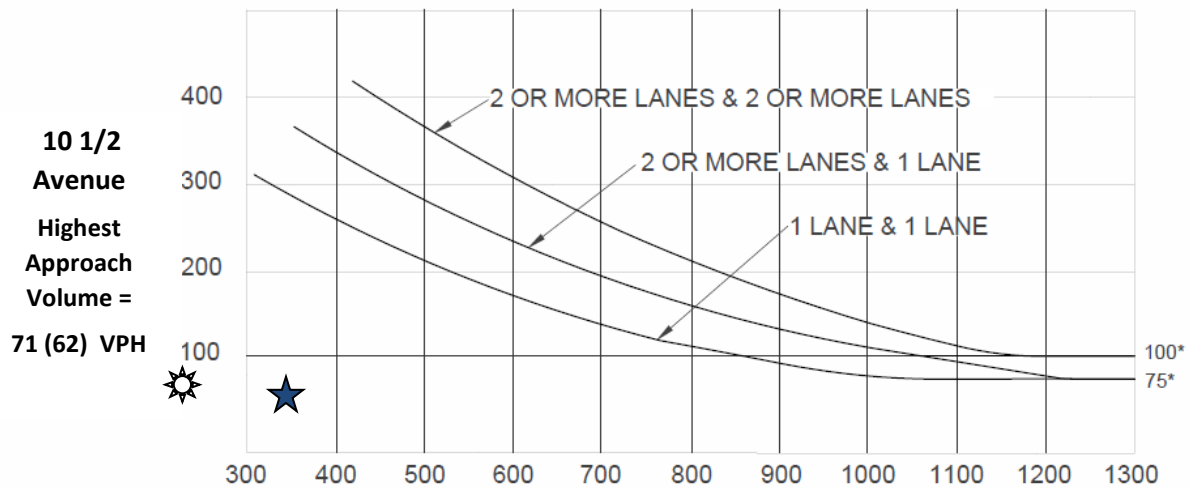

Existing plus Project Traffic Conditions
8. 10 1/2 Avenue / Houston Avenue
AM (PM) Peak Hour

(COMMUNITY LESS THAN 10,000 POPULATION OR ABOVE 40 MPH ON MAJOR STREET)



Houston Avenue Total of Both Approaches =
222 (340) VPH

*Note: 100 vph applies as the lower threshold volume for a minor-street approach with two or more lanes and 75 vph applies as the lower threshold volume for a minor street approach with one lane.

-  **AM Peak Hour – Signal Warrant is Not Met**
-  **PM Peak Hour – Signal Warrant is Not Met**

Source: California Manual of Uniform Traffic Control Devices (CA MUTCD 2014 Edition)
 Chapter 4C: Traffic Control Signal Needs Studies
 Part 4: Highway Traffic Signals
 November 7, 2014

Warrant 3: Peak Hour (Rural)

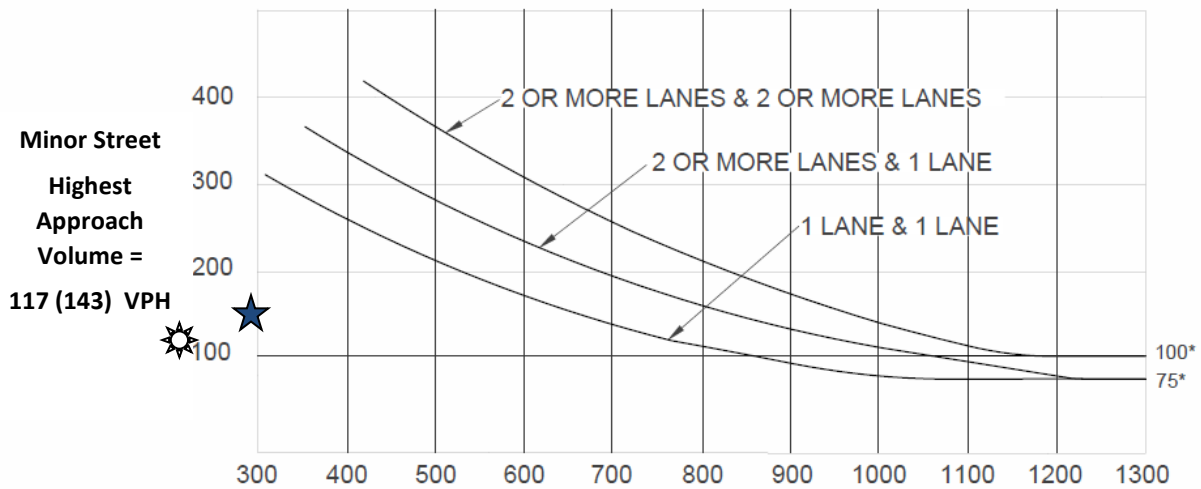

Existing plus Project Traffic Conditions
9. 10th Avenue / Houston Avenue
AM (PM) Peak Hour

(COMMUNITY LESS THAN 10,000 POPULATION OR ABOVE 40 MPH ON MAJOR STREET)



Major Street Total of Both Approaches =
208 (296) VPH

*Note: 100 vph applies as the lower threshold volume for a minor-street approach with two or more lanes and 75 vph applies as the lower threshold volume for a minor street approach with one lane.

-  AM Peak Hour – Signal Warrant is Not Met
-  PM Peak Hour – Signal Warrant is Not Met

Source: California Manual of Uniform Traffic Control Devices (CA MUTCD 2014 Edition)
Chapter 4C: Traffic Control Signal Needs Studies
Part 4: Highway Traffic Signals
November 7, 2014

Warrant 3: Peak Hour (Urban)

Near Term plus Project Traffic Conditions
4. Jordan Way / Hanford-Armona Road
AM (PM) Peak Hour

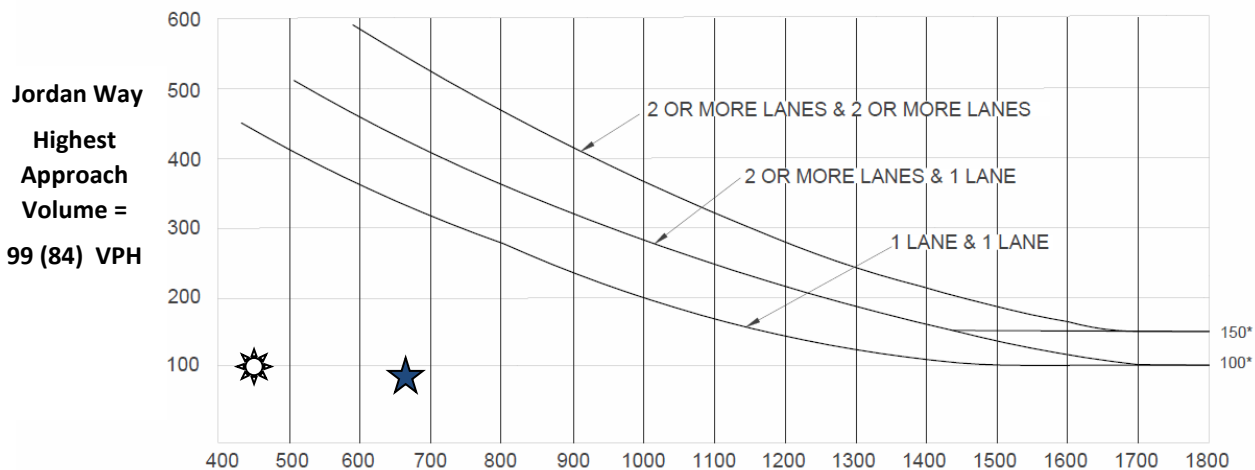

Hanford-Armona Road Total of Both Approaches =
453 (670) VPH

*Note: 150 vph applies as the lower threshold volume for a minor-street approach with two or more lanes and 100 vph applies as the lower threshold volume for a minor street approach with one lane.

- AM Peak Hour – Signal Warrant is Not Met**
- PM Peak Hour – Signal Warrant is Not Met**

Source: California Manual of Uniform Traffic Control Devices (CA MUTCD 2014 Edition)
 Chapter 4C: Traffic Control Signal Needs Studies
 Part 4: Highway Traffic Signals
 November 7, 2014



www.JLBtraffic.com
 info@JLBtraffic.com

516 W. Shaw Ave., Ste. 103
 Fresno, CA 93704
 (559) 570-8991

Warrant 3: Peak Hour (Urban)

Near Term plus Project Traffic Conditions

6. 10 1/2 Avenue / Orchard Avenue

AM (PM) Peak Hour

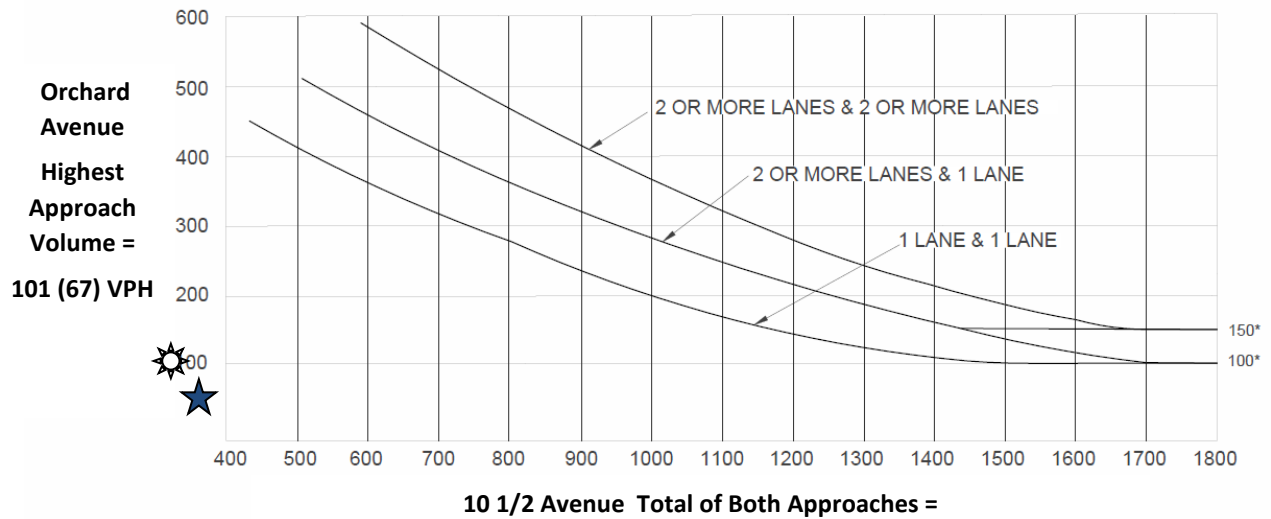

*Note: 150 vph applies as the lower threshold volume for a minor-street approach with two or more lanes and 100 vph applies as the lower threshold volume for a minor street approach with one lane.



AM Peak Hour – Signal Warrant is Not Met



PM Peak Hour – Signal Warrant is Not Met

Source: California Manual of Uniform Traffic Control Devices (CA MUTCD 2014 Edition)
Chapter 4C: Traffic Control Signal Needs Studies
Part 4: Highway Traffic Signals
November 7, 2014

Warrant 3: Peak Hour (Rural)

Near Term plus Project Traffic Conditions

8. 10 1/2 Avenue / Houston Avenue

AM (PM) Peak Hour

(COMMUNITY LESS THAN 10,000 POPULATION OR ABOVE 40 MPH ON MAJOR STREET)

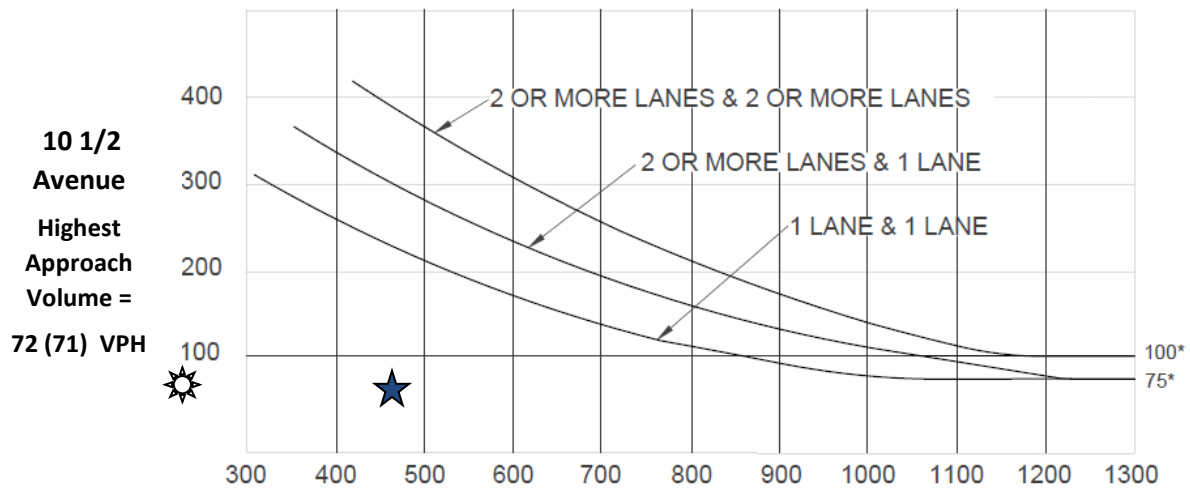

Houston Avenue Total of Both Approaches =

267 (460) VPH

*Note: 100 vph applies as the lower threshold volume for a minor-street approach with two or more lanes and 75 vph applies as the lower threshold volume for a minor street approach with one lane.



AM Peak Hour – Signal Warrant is Not Met



PM Peak Hour – Signal Warrant is Not Met

Source: California Manual of Uniform Traffic Control Devices (CA MUTCD 2014 Edition)
 Chapter 4C: Traffic Control Signal Needs Studies
 Part 4: Highway Traffic Signals
 November 7, 2014

Warrant 3: Peak Hour (Rural)

**Near Term plus Project Traffic Conditions
9. 10th Avenue / Houston Avenue
AM (PM) Peak Hour**

(COMMUNITY LESS THAN 10,000 POPULATION OR ABOVE 40 MPH ON MAJOR STREET)

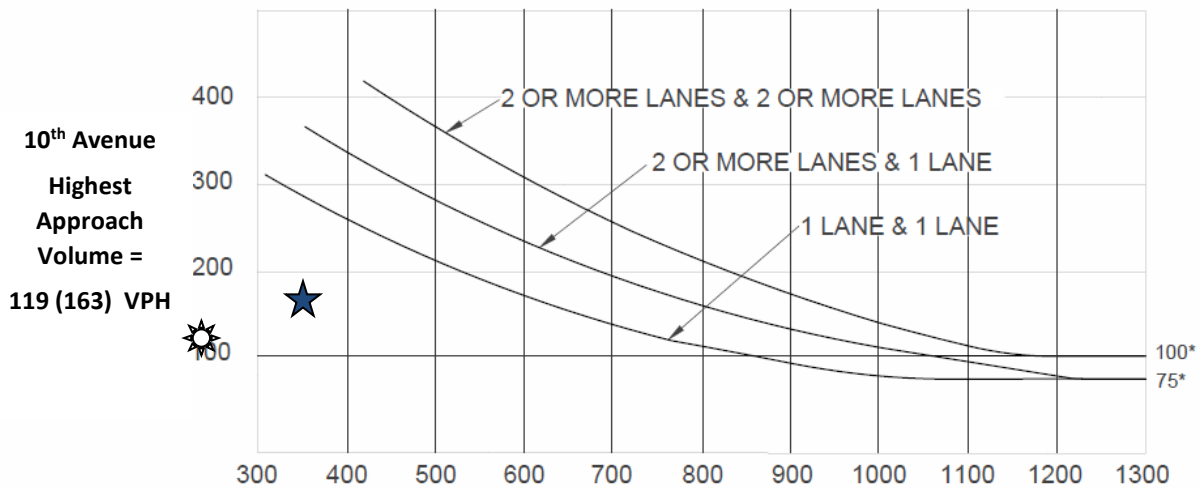

**Houston Avenue Total of Both Approaches =
236 (350) VPH**

*Note: 100 vph applies as the lower threshold volume for a minor-street approach with two or more lanes and 75 vph applies as the lower threshold volume for a minor street approach with one lane.

- AM Peak Hour – Signal Warrant is Not Met**
- PM Peak Hour – Signal Warrant is Not Met**

Source: California Manual of Uniform Traffic Control Devices (CA MUTCD 2014 Edition)
Chapter 4C: Traffic Control Signal Needs Studies
Part 4: Highway Traffic Signals
November 7, 2014

Warrant 3: Peak Hour (Urban)

Cumulative Year 2042 plus Project Traffic Conditions 4. Jordan Way / Hanford-Armona Road AM (PM) Peak Hour

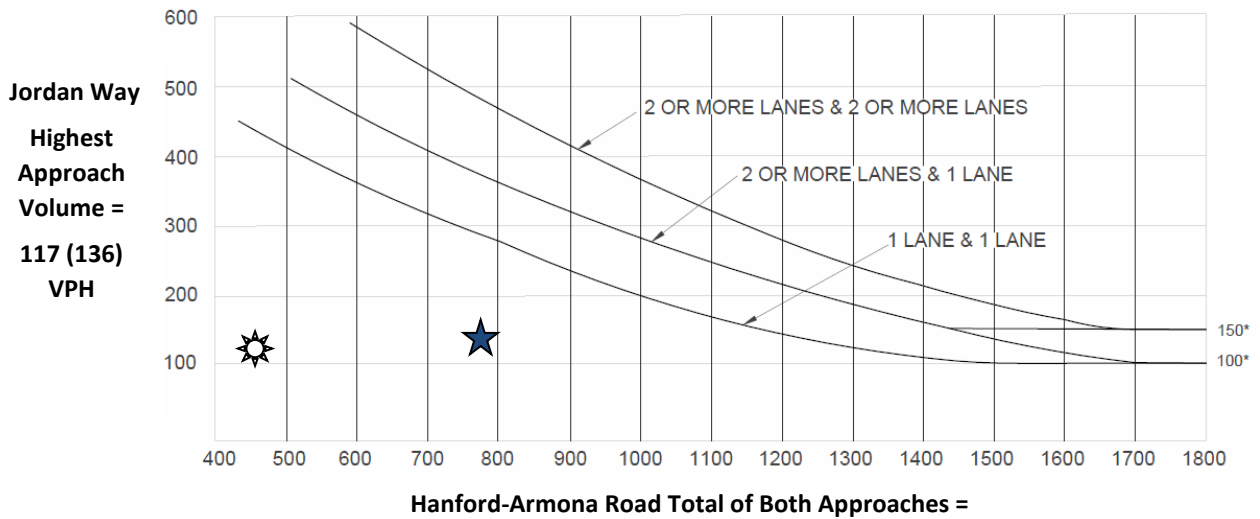

*Note: 150 vph applies as the lower threshold volume for a minor-street approach with two or more lanes and 100 vph applies as the lower threshold volume for a minor street approach with one lane.



AM Peak Hour – Signal Warrant is Not Met



PM Peak Hour – Signal Warrant is Not Met

Source: California Manual of Uniform Traffic Control Devices (CA MUTCD 2014 Edition)
Chapter 4C: Traffic Control Signal Needs Studies
Part 4: Highway Traffic Signals
November 7, 2014

Warrant 3: Peak Hour (Urban)

Cumulative Year 2042 plus Project Traffic Conditions
6. 10 1/2 Avenue / Orchard Avenue
AM (PM) Peak Hour

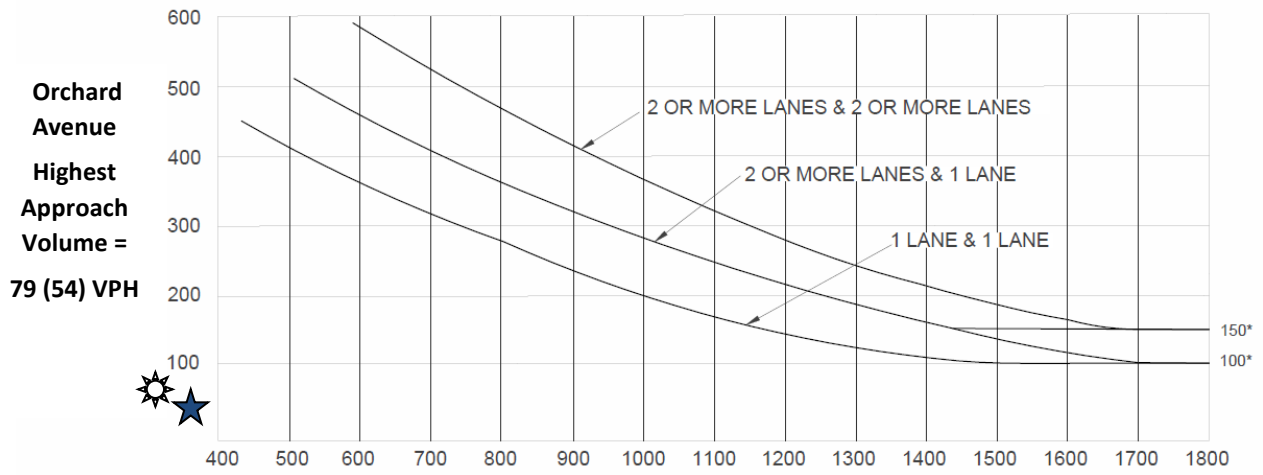

10 1/2 Avenue Total of Both Approaches =
148 (282) VPH

*Note: 150 vph applies as the lower threshold volume for a minor-street approach with two or more lanes and 100 vph applies as the lower threshold volume for a minor street approach with one lane.



AM Peak Hour – Signal Warrant is Not Met



PM Peak Hour – Signal Warrant is Not Met

Source: California Manual of Uniform Traffic Control Devices (CA MUTCD 2014 Edition)
 Chapter 4C: Traffic Control Signal Needs Studies
 Part 4: Highway Traffic Signals
 November 7, 2014



www.JLBtraffic.com
 info@JLBtraffic.com

516 W. Shaw Ave., Ste. 103
 Fresno, CA 93704
 (559) 570-8991

Warrant 3: Peak Hour (Rural)

Cumulative Year 2042 plus Project Traffic Conditions



8. 10 1/2 Avenue / Houston Avenue

AM (PM) Peak Hour

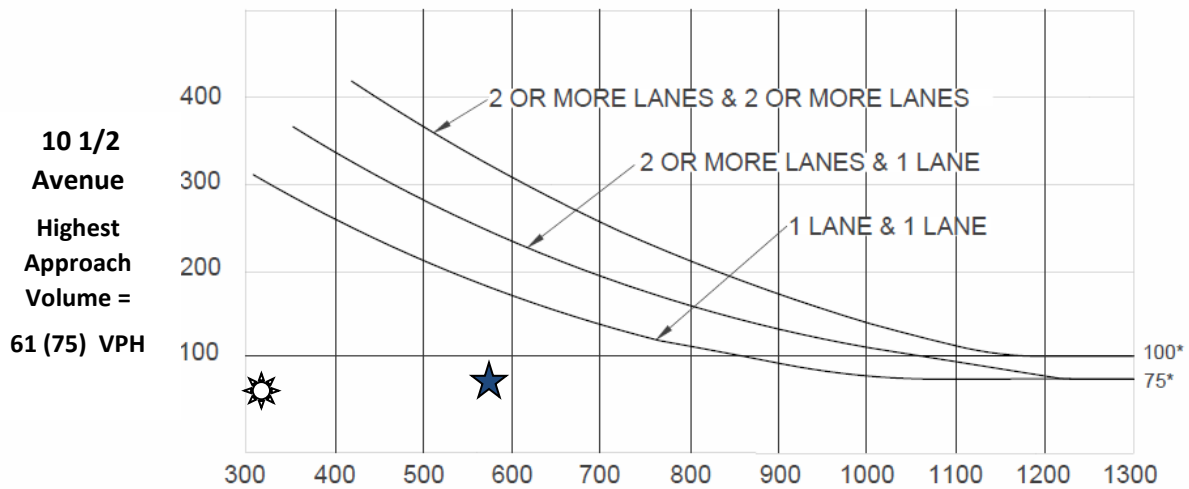
(COMMUNITY LESS THAN 10,000 POPULATION OR ABOVE 40 MPH ON MAJOR STREET)



*Note: 100 vph applies as the lower threshold volume for a minor-street approach with two or more lanes and 75 vph applies as the lower threshold volume for a minor street approach with one lane.

-  **AM Peak Hour – Signal Warrant is Not Met**
-  **PM Peak Hour – Signal Warrant is Not Met**

Source: California Manual of Uniform Traffic Control Devices (CA MUTCD 2014 Edition)
 Chapter 4C: Traffic Control Signal Needs Studies
 Part 4: Highway Traffic Signals
 November 7, 2014

Warrant 3: Peak Hour (Rural)

Cumulative Year 2042 plus Project Traffic Conditions
9. 10th Avenue / Houston Avenue
AM (PM) Peak Hour

(COMMUNITY LESS THAN 10,000 POPULATION OR ABOVE 40 MPH ON MAJOR STREET)

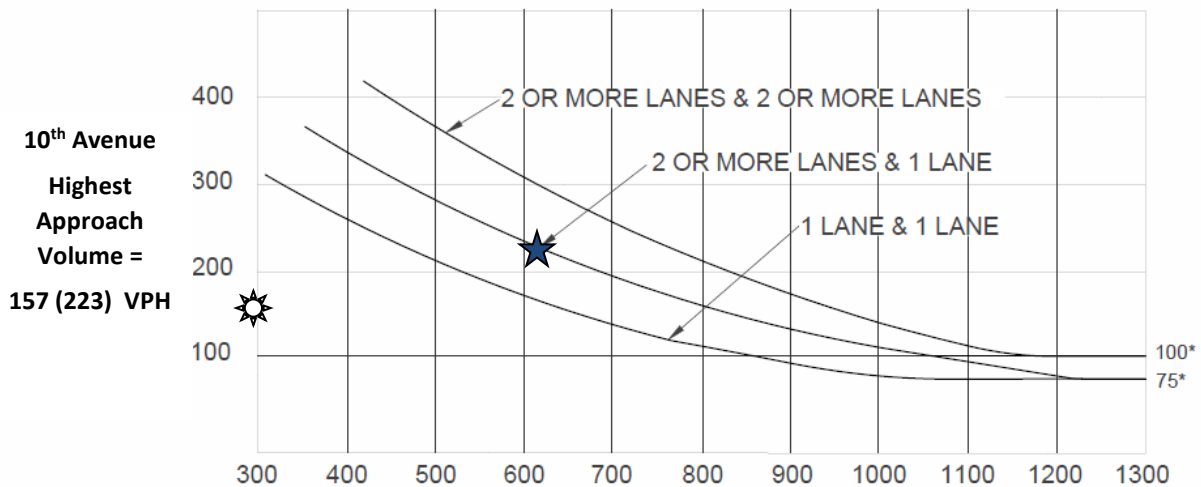

Houston Avenue Total of Both Approaches =
297 (611) VPH

*Note: 100 vph applies as the lower threshold volume for a minor-street approach with two or more lanes and 75 vph applies as the lower threshold volume for a minor street approach with one lane.



AM Peak Hour – Signal Warrant is Not Met



PM Peak Hour – Signal Warrant is Met

Source: California Manual of Uniform Traffic Control Devices (CA MUTCD 2014 Edition)
Chapter 4C: Traffic Control Signal Needs Studies
Part 4: Highway Traffic Signals
November 7, 2014

Vehicle Miles Traveled Analysis

Lunaria (Single-Family Detached Housing)

Located on the Southeast Quadrant of Hanford-
Armona Road and 10 ½ Avenue

In the City of Hanford, California

Prepared for:

Quad Knopf, Inc.
601 Pollasky Avenue, Suite 301
Clovis, CA 93612

August 24, 2022

Project No. 047-002



Traffic Engineering, Transportation Planning, & Parking Solutions

516 W. Shaw Ave., Ste. 103

Fresno, CA 93704

Phone: (559) 570-8991

www.JLBtraffic.com



Traffic Engineering, Transportation Planning, & Parking Solutions

Vehicle Miles Traveled Analysis

**For Lunaria located on the Southeast Quadrant of Hanford-Armona Road and
10 ½ Avenue**

In the City of Hanford, CA

August 24, 2022

This Vehicle Miles Traveled Analysis has been prepared under the direction of a licensed Traffic Engineer. The licensed Traffic Engineer attests to the technical information contained therein and has judged the qualifications of any technical specialists providing engineering data from which recommendations, conclusions and decisions are based.

Prepared by:

Jose Luis Benavides, P.E., T.E.

President



Traffic Engineering, Transportation Planning, & Parking Solutions

516 W. Shaw Ave., Ste. 103
Fresno, CA 93704
Phone: (559) 570-8991
www.JLBtraffic.com

Table of Contents

Project Description	1
VMT Analysis	1
Regulatory Setting.....	1
Baseline VMT	2
VMT Mitigation Measures	2
VMT Results and Conclusion.....	4
Study Participants	5
References	6

List of Tables

Table I: Residential VMT Results	4
---	----------

List of Appendices

Appendix A: VMT Output and Mitigation Measures

Project Description

This report describes a **Vehicle Miles Traveled (VMT)** Analysis prepared by **JLB Traffic Engineering, Inc. (JLB)** for the **Lunaria Development (Project)** located in the City of Hanford. Specifically, the Project proposes to develop 457 single family residential units and a 5.8-acre public park on the Southeast Quadrant of Hanford-Armona Road and 10 ½ Avenue. Based on information provided to JLB, the Project is consistent with the City's General Plan.

VMT Analysis

Regulatory Setting

Senate Bill (SB) 743 requires that relevant California Environmental Quality Act (CEQA) analysis of transportation impacts be conducted using a metric known as VMT instead of level of service (LOS). VMT measures how much actual auto travel (additional miles driven) a proposed project would create on California roads. If the project adds excessive car travel onto our roads, the project may cause a significant transportation impact.

The State CEQA Guidelines were amended to implement SB 743, by adding Section 15064.3. Among its provisions, Section 15064.3 confirms that, except with respect to transportation projects, a project's effect on automobile delay shall not constitute a significant environmental impact. Therefore, LOS measures of impacts on traffic facilities are no longer a relevant CEQA criteria for transportation impacts.

CEQA Guidelines Section 15064.3(b)(4) states that "[a] lead agency has discretion to choose the most appropriate methodology to evaluate a project's vehicle miles traveled, including whether to express the change in absolute terms, per capita, per household or in any other measure. A lead agency may use models to estimate a project's vehicle miles traveled, and may revise those estimates to reflect professional judgment based on substantial evidence. Any assumptions used to estimate vehicle miles traveled and any revision to model outputs should be documented and explained in the environmental document prepared for the project. The standard of adequacy in Section 15151 shall apply to the analysis described in this section."

As of the creation of this report, neither the City of Hanford nor Kings CAG have adopted guidelines or thresholds for VMT pursuant to Senate Bill 743. For this reason, this VMT analysis follows the guide of the December 2018 *Technical Advisory on Evaluating Transportation Impacts in CEQA* (TA) published by the Governor's Office of Planning and Research (OPR) and the August 2010 *Quantifying Greenhouse Gas Mitigation Measures* published by the California Air Pollution Control Officers Association (CAPCOA) to analyze the Project's VMT.

The TA contains screening standard and criteria that can be used to screen out qualified development projects that meet the adopted criteria from needing to prepare a detailed VMT Analysis. These criteria may be size, location, proximity to transit or trip making potential. In general development projects that meet one or more of the criteria can be screened out from a quantitative VMT analysis. In this case, the Project does not meet any of the screening criteria.



For projects that are not screened out, a quantitative analysis of VMT impacts must be prepared and compared against the adopted VMT thresholds of significance. According to the TA, residential developments that generate vehicle travel that is 15 percent or more below the existing residential VMT per capita, measured against the region, are considered to have a less-than-significant transportation impact. The threshold of significance was developed using the County of Kings as the applicable region, and the required reduction of VMT corresponds to Kings County's contribution to the statewide GHG emission reduction target. In order to reach the statewide GHG reduction target of 15%, Kings County must reduce its GHG emissions by 15%. The method of reducing GHG by 15% is to reduce VMT by 15% as well.

Baseline VMT

VMT is simply the product of a number of trips and those trips' lengths. The first step in a VMT analysis is to establish the baseline average VMT, which requires the definition of a region. The established region for the project is Kings County, which is modeled by the Kings County Association of Governments (KCAG). Based on the KCAG Model, the King's County average VMT per Capita is 9.56. Therefore, the target VMT for residential land uses is a maximum of $(9.56 \times (1.00 - 0.15) = 8.13)$ 8.13 VMT per capita. The Project's trip generation, number of residential units, and square footages of non-residential uses were provided to KCAG in order to conduct a Project-specific VMT analysis using the KCAG model for specific Project components. Based on KCAG VMT results, Project components containing residential land uses are projected to yield an average VMT per capita of 9.78. This exceeds the City's VMT threshold for residential uses of 8.13 VMT per capita. As a result, it is recommended that the Project implement VMT mitigation measures for the residential component to reduce VMT per Capita. Appendix A presents the Project VMT outputs from the KCAG model.

VMT Mitigation Measures

The VMT mitigation measures that were considered feasible for this Project include the following: increase density, increasing destination accessibility, locate project near bike path/bike lane, provide pedestrian network improvements and incorporate bike lane street design (on-site). It is estimated that given the design elements associated with the Project and the surrounding multi-modal network, the Project will benefit from reductions in VMT. The VMT measures analyzed were selected to be applicable to the Project and its surrounding areas. The VMT mitigation measures and reduction rates were determined based on the following:

- Land-Use/Location (Maximum Possible Reduction: 5.00%)
 - LUT-1: Increase Density
 - This measure is appropriate for residential, office, retail, mixed-use and industrial projects in urban or suburban context.
 - The Project proposes a gross density of 7.64 units per acre.
 - VMT Mitigation Method: $VMT\ Reduction\ (\%) = (7.64 - 7.6) / 7.6 * 0.07 = 0.03\%$ (CAPCOA 2010)
 - $VMT\ Reduction\ (\%) = \text{Number of Housing Units per acre} * B$ (not to exceed 30%), where
 - Number of Housing Units per acre = (total units / gross acres)
 - B = Elasticity of VMT with respect to density [use 0.07]

- LUT-4: Increase Destination Accessibility
 - This measure is appropriate for residential, office, retail, mixed-use and industrial projects in urban or suburban context.
 - The effectiveness of this measure will depend largely on the Project location and increasing potential for pedestrians to walk and bike to central locations (CAPCOA 2010).
 - It is recommended that Class II Bikeways get added along the Project frontages to 10 ½ Avenue and Orchard Avenue.
 - The Project is located 1.7 miles from downtown Hanford, 3.28 miles from the existing major shopping center on Lacey Boulevard at 12th Avenue and 4.0 miles from the proposed major shopping center on Lacey Boulevard at State Route 43. So, the Project's average distance to downtown/job center is 2.99 miles.
 - VMT Mitigation Method: $VMT\ Reduction\ (\%) = (12 - 2.99)/12 * 0.2 = 15.00\%$ (CAPCOA 2010)
 - $VMT\ Reduction\ (\%) = Center\ Distance * B$ (not to exceed 30%), where
 - Center Distance = $(12 - Distance\ to\ downtown/job\ center\ for\ Project) / 12$
 - B = Elasticity of VMT with respect to distance to downtown or major job center [use 0.2]
- LUT-8: Locate project near bike path/bike lane
 - This measure is appropriate for residential, office, retail, mixed-use and industrial projects in urban or suburban contexts.
 - It is recommended that Class II Bikeways get added along the Project frontages to 10 ½ Avenue and Orchard Avenue.
 - The effectiveness of this measure will depend largely on its implementation as a stand-alone strategy or in combination with multiple design elements that increase opportunities for multi-modal travel (CAPCOA 2010).
- Neighborhood/Site Design (Max. Possible Reduction: 5.00%)
 - SDT-1: Provide Pedestrian Network Improvements
 - This measure is appropriate for residential, office, retail, mixed-use and industrial projects in urban, suburban and rural context.
 - It is recommended that Class II Bikeways get added along the Project frontages to 10 ½ Avenue and Orchard Avenue.
 - The effectiveness of this measure requires providing a pedestrian access network that internally links all uses and connects to all existing or planned external streets and pedestrian facilities contiguous with the Project site (CAPCOA 2010).
 - SDT-5: Incorporate Bike Lane Street Design (on-site)
 - This measure is appropriate for residential, office, retail, mixed-use and industrial projects in urban or suburban context.
 - It is recommended that Class II Bikeways get added along the Project frontages to 10 ½ Avenue and Orchard Avenue.
 - The effectiveness of this measure will depend largely on its implementation as a stand-alone strategy or in combination with multiple design elements to strengthen street network characteristics and enhance multi-modal environments (CAPCOA 2010).

VMT Results and Conclusion

As can be seen in Table I below, VMT mitigation measures are projected to reduce the residential VMT per capita from 9.78 to 9.11. However, this reduced residential VMT per capita is short of meeting the City's default threshold of 8.13 VMT per capita. In conclusion, the Project with mitigations would result in significant but unavoidable VMT impacts by the residential components pursuant to the *Quantifying Greenhouse Gas Mitigation Measures* published by CAPCOA.

Table I: Residential VMT Results

<i>Project Components</i>	<i>Kings CAG plus Project VMT Results¹</i>	<i>Reduction in VMT from Mitigation²</i>	<i>VMT (With Mitigations)</i>	<i>City of Hanford VMT Threshold</i>	<i>Significant VMT Impact?</i>
Residential	9.78 / capita	-0.67 / capita	9.11 / capita	8.13 / capita	Yes

Note: 1 = VMT Results per Kings CAG model

2 = VMT Mitigation Measures from CAPCOA *Quantifying Greenhouse Gas Mitigation Measures*

- Per the Kings CAG model, the Project's VMT for the residential component was output to be 9.78 VMT per capita which exceeds the City of Hanford default threshold of 8.13 VMT per capita.
- The reduction of VMT per capita from recommended mitigations is 0.67 and reduces the residential VMT per Capita to 9.11.
- As a result, the residential components after applying reductions from feasible mitigations are projected to result in a significant but unavoidable VMT impact.

Study Participants

JLB Traffic Engineering, Inc. Personnel:

Jose Luis Benavides, PE, TE	Project Manager
Carlos Ayala-Magaña, EIT	Engineer I/II
Matthew Arndt, EIT	Engineer I/II
Jove Alcazar, EIT	Engineer I/II
Javier Rios	Engineer I/II
Dennis Wynn	Sr. Engineering Technician
Adrian Benavides	Engineering Aide
Christian Sanchez	Engineering Aide

Persons Consulted:

Ernie Escobedo	QK Inc.
Mary Beatie	City of Hanford
John Doyel	City of Hanford
Dominic Tyburski	County of Kings
Chuck Kinney	County of Kings
David Padilla	Caltrans
Christopher Xiong	Caltrans
Mike Aronson	Kittleson & Associates, Inc.
Miao Gao	Kittleson & Associates, Inc.

References

- California Air Pollution Control Officers Association. 2010. "Quantifying Greenhouse Gas Mitigation Measures: A Resource For Local Government To Assess Emission Reductions From Greenhouse Gas Mitigation Measures". Sacramento: State of California.
- California Department of Transportation. 2020. "California Highway Design Manual". Sacramento: State of California.
- California Department of Transportation. 2020. "California Manual On Uniform Traffic Control Devices, FHWA's MUTCD 2009 Edition, including Revisions 1 & 2 as amended for use in California ". Sacramento: 2014 ed. State of California, pp.1-1419.
- California Department of Transportation. 2002. "Guide For The Preparation Of Traffic Impact Studies". State of California, pp.1-19. 2014.
- City of Hanford. 2014. "General Plan Background Report." Hanford: City of Hanford.
- City of Hanford. 2017. "2035 General Plan Policy Document." Hanford: City of Hanford.
- City of Hanford. 2016. "Pedestrian and Bicycle Master Plan." Hanford: City of Hanford.
- County of Kings. 2010. "2035 Kings County General Plan". Kings: County of Kings, Circulation Element.
- County of Kings. 2011. "2011 Kings County Regional Bicycle Plan". Kings: County of Kings, pp.1-70.
- Governor's Office of Planning and Research. 2018. Technical Advisory On Evaluating Transportation Impacts In CEQA. Ebook. Sacramento: State of California, pp.1-34. Available at: <https://opr.ca.gov/docs/20190122-743_Technical_Advisory.pdf> [Accessed 20 January 2021].
- Institute of Transportation Engineers. 2017. "Trip Generation Manual". Washington: Institute of Transportation Engineers. Vol. 1-3.

Appendix A: VMT Output and Mitigation Measures



www.JLBtraffic.com
info@JLBtraffic.com

516 W. Shaw Ave., Ste. 103
Fresno, CA 93704
(559) 570-8991

App | A

Lunaria TAZs

Row Labels	VMT/Capita
686	9.66
687	10.16
Grand Total	9.78

Lunaria VMT Analysis

			Land Use:	Residential
			KCAG Average VMT Per Capita Output:	9.78
			<i>County of Kings Regonal VMT Threshold (Assumes 15% Reduction Target):</i>	8.13
			Target VMT Satisfied (Without Mitigations)?	FALSE
			% deviation from target threshold:	20.35%
Measure #	VMT Mitigation	Grouped with	VMT Reduction Rate (%)	
<i>Land Use/Location</i>				
LUT-1	Increase Density	N/A	0.03%	
LUT-2	Increase Location Efficiency	N/A	0.00%	
LUT-3	Increase Diversity of Urban and Suburban Developments (Mixed Use)	N/A	0.00%	
LUT-4	Increase Destination Accessibility	N/A	15.00%	
LUT-5	Increase Transit Accessibility	N/A	0.00%	
LUT-6	Integrate Affordable and Below Market Rate Housing	N/A	0.00%	
LUT-7	Orient Project Toward Non-Auto Corridor	LUT-3	N/A	
LUT-8	Locate Project near Bike Path/Bike Lane	LUT-4	N/A	
LUT-9	Improve Design of Development	N/A	0.00%	
			Land Use/Location Category VMT Reduction (%)	15.03%
			Max. Land Use/Location Category VMT Reduction (%)	5.00%
<i>Neighborhood/Site Enhancements</i>				
SDT-1	Provide Pedestrian Network Improvements	N/A	2.00%	
SDT-2	Provide Traffic Calming Measures	N/A	0.00%	
SDT-3	Implement a Neighborhood Electric Vehicle (NEV) Network	N/A	0.00%	
SDT-4	Urban Non-Motorized Zones	SDT-1	N/A	
SDT-5	Incorporate Bike Lane Street Design (on-site)	LUT-9	N/A	
SDT-6	Provide Bike Parking in Non-Residential Projects	LUT-9	N/A	
SDT-7	Provide Bike Parking with Multi-Unit Residential Projects	LUT-9	N/A	
SDT-8	Provide EV Parking	SDT-3	N/A	
SDT-9	Dedicate Land for Bike Trails	LUT-9	N/A	
			Neighborhood/Site Enhancements Category VMT Reduction (%)	2.00%
			Max. Neighborhood/Site Enhancements Category VMT Reduction (%)	5.00%
			Transportation Cross-Category VMT Reduction (%)	6.90%
			Max. Transportation Cross-Category VMT Reduction (%)	10.00%
			Total VMT Reduction:	-0.67
			Project VMT with Mitigation Reductions:	9.11
			<i>County of Kings VMT Threshold:</i>	8.13
			Target VMT Satisfied?	FALSE

Chart 6-2: Transportation Strategies Organization

Transportation Measures (Five Subcategories) Global Maximum Reduction (all VMT): urban = 75%; compact infill = 40%; suburban center or suburban with NEV = 20%; suburban = 15%		Global Cap for Road Pricing needs further study
Transportation Measures (Four Categories) Cross-Category Max Reduction (all VMT): urban = 70%; compact infill = 35%; suburban center or suburban with NEV = 15%; suburban = 10%		Max Reduction = 25% (all VMT)
Land Use / Location Max Reduction: urban = 65%; compact infill = 30%; suburban center = 10%; suburban = 5%	Neighborhood / Site Enhancement Max Reduction: without NEV = 5%; with NEV = 15%	Road Pricing Management Max Reduction = 25%
Density (30%)	Pedestrian Network (2%)	Vehicles
Design (21.3%)	Traffic Calming (1%)	Electrify Loading Docks
Location Efficiency (65%)	NEV Network (14.4) <NEV Parking>	Traffic Flow Improvements (45% CO2)
Diversity (30%)	Car Share Program (0.7%)	Utilize Alternative Fueled Vehicles
Destination Accessibility (20%)	Bicycle Network <Lanes> <Parking> <Land Dedication for Trails>	Utilize Electric or Hybrid Vehicles
Transit Accessibility (25%)	Urban Non-Motorized Zones	
BMR Housing (1.2%)		
Orientation Toward Non-Auto Corridor		
Proximity to Bike Path		
	Parking Policy / Pricing Max Reduction = 20%	Commuter Trip Reduction (assumes mixed use) Max Reduction = 25% (work VMT)
	Parking Supply Limits (12.5%)	CTR Program Required = 21% work VMT Voluntary = 6.2% work VMT
	Unbundled Parking Costs (13%)	Transit Fare Subsidy (20% work VMT)
	On-Street Market Pricing (5.5%)	Employee Parking Cash-out (7.7% work VMT)
	Residential Area Parking Permits	Workplace Parking Pricing (19.7% work VMT)
		Alternative Work Schedules & Telecommute (5.5% work VMT)
		CTR Marketing (5.5% work VMT)
		Employer-Sponsored Vanpool/Shuttle (13.4% work VMT)
		Ride Share Program (15% work VMT)
		Bike Share Program
		End of Trip Facilities
		Preferential Parking Permit
		School Pool (15.8% school VMT)
		School Bus (6.3% school VMT)
	Transit System Improvements Max Reduction = 10%	
	Network Expansion (8.2%)	
	Service Frequency / Speed (2.5%)	
	Bus Rapid Transit (3.2%)	
	Access Improvements	
	Station Bike Parking	
	Local Shuttles	
	Park & Ride Lots*	

Note: Strategies in bold text are primary strategies with reported VMT reductions; non-bolded strategies are support or grouped strategies.

Transportation

CEQA# MM D-1 & D-4
MP# LU-1.5 & LU-2.1.8

LUT-1

Land Use / Location

3.0 Transportation

3.1 Land Use/Location

3.1.1 Increase Density

Range of Effectiveness: 0.8 – 30.0% vehicle miles traveled (VMT) reduction and therefore a 0.8 – 30.0% reduction in GHG emissions.

Measure Description:

Designing the Project with increased densities, where allowed by the General Plan and/or Zoning Ordinance reduces GHG emissions associated with traffic in several ways. Density is usually measured in terms of persons, jobs, or dwellings per unit area. Increased densities affect the distance people travel and provide greater options for the mode of travel they choose. This strategy also provides a foundation for implementation of many other strategies which would benefit from increased densities. For example, transit ridership increases with density, which justifies enhanced transit service.

The reductions in GHG emissions are quantified based on reductions to VMT. The relationship between density and VMT is described by its elasticity. According to a recent study published by Brownstone, et al. in 2009, the elasticity between density and VMT is 0.12. Default densities are based on the typical suburban densities in North America which reflects the characteristics of the ITE Trip Generation Manual data used in the baseline estimates.

Measure Applicability:

- Urban and suburban context
 - Negligible impact in a rural context
- Appropriate for residential, retail, office, industrial, and mixed-use projects

Baseline Method:

See introduction to transportation section for a discussion of how to estimate trip rates and VMT. The CO₂ emissions are calculated from VMT as follows:

$$CO_2 = VMT \times EF_{\text{running}}$$

Where:

traveled

for running emissions

VMT = vehicle miles

EF_{running} = emission factor

Transportation

CEQA# MM D-1 & D-4
MP# LU-1.5 & LU-2.1.8

LUT-1

Land Use / Location

Inputs:

The following information needs to be provided by the Project Applicant:

- Number of housing units per acre or jobs per job acre

Mitigation Method:

$$\% \text{ VMT Reduction} = A * B \text{ [not to exceed 30\%]}$$

Where:

A = Percentage increase in housing units per acre or jobs per job acre³³ = (number of housing units per acre or jobs per job acre – number of housing units per acre or jobs per job acre for typical ITE development) / (number of housing units per acre or jobs per job acre for typical ITE development) For small and medium sites (less than ½ mile in radius) the calculation of housing and jobs per acre should be performed for the development site as a whole, so that the analysis does not erroneously attribute trip reduction benefits to measures that simply shift jobs and housing within the site with no overall increase in site density. For larger sites, the analysis should address the development as several ½-mile-radius sites, so that shifts from one area to another would increase the density of the receiving area but reduce the density of the donating area, resulting in trip generation rate decreases and increases, respectively, which cancel one another.

B = Elasticity of VMT with respect to density (from literature)

Detail:

- A: [not to exceed 500% increase]
 - If housing: (Number of housing units per acre – 7.6) / 7.6
(See Appendix C for detail)
 - If jobs: (Number of jobs per acre – 20) / 20
(See Appendix C for detail)
- B: 0.07 (Boarnet and Handy 2010)

Assumptions:

Data based upon the following references:

- Boarnet, Marlon and Handy, Susan. 2010. “DRAFT Policy Brief on the Impacts of Residential Density Based on a Review of the Empirical Literature.” <http://arb.ca.gov/cc/sb375/policies/policies.htm>; Table 1.

³³ This value should be checked first to see if it exceeds 500% in which case A = 500%.

Transportation

CEQA# MM D-1 & D-4
MP# LU-1.5 & LU-2.1.8

LUT-1

Land Use / Location

Emission Reduction Ranges and Variables:

Pollutant	Category Emissions Reductions ³⁴
CO ₂ e	1.5-30% of running
PM	1.5-30% of running
CO	1.5-30% of running
NOx	1.5-30% of running
SO ₂	1.5-30% of running
ROG	0.9-18% of total

Discussion:

The VMT reductions for this strategy are based on changes in density versus the typical suburban residential and employment densities in North America (referred to as “ITE densities”). These densities are used as a baseline to mirror those densities reflected in the ITE Trip Generation Manual, which is the baseline method for determining VMT.

There are two separate maxima noted in the fact sheet: a cap of 500% on the allowable percentage increase of housing units or jobs per acre (variable A) and a cap of 30% on % VMT reduction. The rationale for the 500% cap is that there are diminishing returns to any change in environment. For example, it is reasonably doubtful that increasing residential density by a factor of six instead of five would produce any additional change in travel behavior. The purpose for the 30% cap is to limit the influence of any single environmental factor (such as density). This emphasizes that community designs that implement multiple land use strategies (such as density, design, diversity, etc.) will show more of a reduction than relying on improvements from a single land use factor.

Example:

Sample calculations are provided below for housing:

$$\begin{aligned} \text{Low Range \% VMT Reduction (8.5 housing units per acre)} \\ = (8.5 - 7.6) / 7.6 * 0.07 = 0.8\% \end{aligned}$$

$$\text{High Range \% VMT Reduction (60 housing units per acre)}$$

$$= \frac{60 - 7.6}{7.6} = 6.9 \text{ or } 690\% \text{ Since greater than } 500\%, \text{ set to } 500\%$$

$$= 500\% \times 0.07 = 0.35 \text{ or } 35\% \text{ Since greater than } 30\%, \text{ set to } 30\%$$

³⁴ The percentage reduction reflects emission reductions from running emissions. The actual value will be less than this when starting and evaporative emissions are factored into the analysis. ROG emissions have been adjusted to reflect a ratio of 40% evaporative and 60% exhaust emissions based on a statewide EMFAC run of all vehicles.

Transportation

CEQA# MM D-1 & D-4
MP# LU-1.5 & LU-2.1.8

LUT-1

Land Use / Location

Sample calculations are provided below for jobs:

$$\begin{aligned} \text{Low Range \% VMT Reduction (25 jobs per acre)} \\ = (25 - 20) / 20 * 0.12 = 3\% \end{aligned}$$

$$\begin{aligned} \text{High Range \% VMT Reduction (100 jobs per acre)} \\ = \frac{100 - 20}{20} = 4 \text{ or } 400\% \\ = 400\% \times 0.12 = 0.48 \text{ or } 48\% \text{ Since greater than } 30\%, \text{ set to } 30\% \end{aligned}$$

Preferred Literature:

- -0.07 = elasticity of VMT with respect to density

Boarnet and Handy's detailed review of existing literature highlighted three individual studies that used the best available methods for analyzing data for individual households. These studies provided the following elasticities: -0.12 - Brownstone (2009), -0.07 - Bento (2005), and -0.08 - Fang (2008). To maintain a conservative estimate of the impacts of this strategy, the lower elasticity of -0.07 is used in the calculations.

Alternative Literature:

- -0.05 to -0.25 = elasticity of VMT with respect to density

The *TRB Special Report 298* literature suggests that doubling neighborhood density across a metropolitan area might lower household VMT by about 5 to 12 percent, and perhaps by as much as 25 percent, if coupled with higher employment concentrations, significant public transit improvements, mixed uses, and other supportive demand management measures.

Alternative Literature References:

TRB, 2009. *Driving and the Built Environment*, Transportation Research Board Special Report 298. <http://onlinepubs.trb.org/Onlinepubs/sr/sr298.pdf> . Accessed March 2010. (p. 4)

Other Literature Reviewed:

None

Transportation

CEQA# MM D-3
MP# LU-2.1.4

LUT-4

Land Use / Location

3.1.4 Increase Destination Accessibility

Range of Effectiveness: 6.7 – 20% vehicle miles traveled (VMT) reduction and therefore 6.7-20% reduction in GHG emissions.

Measure Description:

The project will be located in an area with high accessibility to destinations. Destination accessibility is measured in terms of the number of jobs or other attractions reachable within a given travel time, which tends to be highest at central locations and lowest at peripheral ones. The location of the project also increases the potential for pedestrians to walk and bike to these destinations and therefore reduces the VMT.

Measure Applicability:

- Urban and suburban context
- Negligible impact in a rural context
- Appropriate for residential, retail, office, industrial and mixed-use projects

Baseline Method:

See introduction to transportation section for a discussion of how to estimate trip rates and VMT. The CO₂ emissions are calculated from VMT as follows:

$$CO_2 = VMT \times EF_{\text{running}}$$

Where:

traveled

for running emissions

VMT = vehicle miles

EF_{running} = emission factor

Inputs:

The following information needs to be provided by the Project Applicant:

- Distance to downtown or major job center

Mitigation Method:

$$\% \text{ VMT Reduction} = \text{Center Distance} * B \text{ [not to exceed 30\%]}$$

Where

Transportation

CEQA# MM D-3
MP# LU-2.1.4

LUT-4

Land Use / Location

Center Distance = Percentage decrease in distance to downtown or major job center versus typical ITE suburban development = (distance to downtown/job center for typical ITE development – distance to downtown/job center for project) / (distance to downtown/job center for typical ITE development)

Center Distance = 12 - Distance to downtown/job center for project) / 12
See Appendix C for detail

B = Elasticity of VMT with respect to distance to downtown or major job center (0.20 from [1])

Assumptions:

Data based upon the following references:

[1] Ewing, R., and Cervero, R., "Travel and the Built Environment - A Meta-Analysis." Journal of the American Planning Association, <to be published> (2010). Table 4.

Emission Reduction Ranges and Variables:

Pollutant	Category Emissions Reductions ³⁸
CO ₂ e	6.7 – 20% of running
PM	6.7 – 20% of running
CO	6.7 – 20% of running
NOx	6.7 – 20% of running
SO ₂	6.7 – 20% of running
ROG	4 – 12% of total

Discussion:

The VMT reductions for this strategy are based on changes in distance to key destinations versus the standard suburban distance in North America. This distance is used as a baseline to mirror the distance to destinations reflected in the land uses for the ITE Trip Generation Manual, which is the baseline method for determining VMT.

The purpose for the 30% cap on % VMT reduction is to limit the influence of any single environmental factor (such as destination accessibility). This emphasizes that community designs that implement multiple land use strategies (such as density,

³⁸ The percentage reduction reflects emission reductions from running emissions. The actual value will be less than this when starting and evaporative emissions are factored into the analysis. ROG emissions have been adjusted to reflect a ratio of 40% evaporative and 60% exhaust emissions based on a statewide EMFAC run of all vehicles.

Transportation

CEQA# MM D-3
MP# LU-2.1.4

LUT-4

Land Use / Location

design, diversity, destination, etc.) will show more of a reduction than relying on improvements from a single land use factor.

Example:

Sample calculations are provided below:

- Low Range % VMT Reduction (8 miles to downtown/job center) =

$$\frac{12-8}{12} \times 0.20 = 6.7\%$$
- High Range % VMT Reduction (0.1 miles to downtown/job center) =

$$\frac{12-0.1}{12} \times 0.20 = 20.0\%$$

Preferred Literature:

- -0.20 = elasticity of VMT with respect to job accessibility by auto
- -0.20 = elasticity of VMT with respect to distance to downtown

The Ewing and Cervero report [1] finds that VMT is strongly related to measures of accessibility to destinations. The weighted average elasticity of VMT with respect to job accessibility by auto is -0.20 (looking at five total studies). The weighted average elasticity of VMT with respect to distance to downtown is -0.22 (looking at four total studies, of which one controls for self selection³⁹).

Alternative Literature:

- 10-30% reduction in vehicle trips

The VTPI literature [2] suggests a 10-30% reduction in vehicle trips for “smart growth” development practices that result in more compact, accessible, multi-modal communities where travel distances are shorter, people have more travel options, and it is possible to walk and bicycle more.

Alternative Literature References:

[2] Litman, T., 2009. “Win-Win Emission Reduction Strategies.” Victoria Transport Policy Institute (VTPI). Website: <http://www.vtppi.org/wwclimate.pdf>. Accessed March 2010. (p. 7, Table 3)

³⁹ Self selection occurs when residents or employees that favor travel by non-auto modes choose locations where this type of travel is possible. They are therefore more inclined to take advantage of the available options than a typical resident or employee might otherwise be.

Transportation

CEQA# MM D-3
MP# LU-2.1.4

LUT-4

Land Use / Location

Other Literature Reviewed:

None

Transportation

LUT-8

Land Use / Location

3.1.8 Locate Project near Bike Path/Bike Lane

Range of Effectiveness: Grouped strategy. [See LUT-4]

Measure Description:

A Project that is designed around an existing or planned bicycle facility encourages alternative mode use. The project will be located within 1/2 mile of an existing Class I path or Class II bike lane. The project design should include a comparable network that connects the project uses to the existing offsite facilities.

This measure is most effective when applied in combination of multiple design elements that encourage this use. Refer to Increase Destination Accessibility (LUT-4) strategy. The benefits of Proximity to Bike Path/Bike Lane are small as a standalone strategy. The strategy should be grouped with the Increase Destination Accessibility strategy to increase the opportunities for multi-modal travel.

Measure Applicability:

- Urban or suburban context; may be applicable in a rural master planned community
- Appropriate for residential, retail, office, industrial, and mixed-use projects

Alternative Literature:

Alternate:

- 0.625% reduction in vehicle miles traveled (VMT)

As a rule of thumb, the *Center for Clean Air Policy (CCAP) Guidebook* [1] attributes a 1% to 5% reduction associated with comprehensive bicycle programs. Based on the CCAP guidebook, the TIAX report allots 2.5% reduction for all bicycle-related measures and a 1/4 of that for this measure alone. (This information is based on a TIAX review for SMAQMD).

Alternative Literature References:

[1] Center for Clean Air Policy (CCAP). *Transportation Emission Guidebook*. http://www.ccap.org/safe/guidebook/guide_complete.html; TIAX Results of 2005 Literature Search Conducted by TIAX on behalf of SMAQMD.

Other Literature Reviewed:

None

Transportation

CEQA# MM-T-6 MP# LU-4	SDT-1	Neighborhood / Site Enhancement
--------------------------	--------------	--

3.2 Neighborhood/Site Enhancements

3.2.1 Provide Pedestrian Network Improvements

Range of Effectiveness: 0 - 2% vehicle miles traveled (VMT) reduction and therefore 0 - 2% reduction in GHG emissions.

Measure Description:

Providing a pedestrian access network to link areas of the Project site encourages people to walk instead of drive. This mode shift results in people driving less and thus a reduction in VMT. The project will provide a pedestrian access network that internally links all uses and connects to all existing or planned external streets and pedestrian facilities contiguous with the project site. The project will minimize barriers to pedestrian access and interconnectivity. Physical barriers such as walls, landscaping, and slopes that impede pedestrian circulation will be eliminated.

Measure Applicability:

- Urban, suburban, and rural context
- Appropriate for residential, retail, office, industrial and mixed-use projects
- Reduction benefit only occurs if the project has both pedestrian network improvements on site and connections to the larger off-site network.

Baseline Method:

See introduction to transportation section for a discussion of how to estimate trip rates and VMT. The CO₂ emissions are calculated from VMT as follows:

$$CO_2 = VMT \times EF_{\text{running}}$$

Where:

traveled	VMT = vehicle miles
for running emissions	EF _{running} = emission factor

Inputs:

The project applicant must provide information regarding pedestrian access and connectivity within the project and to/from off-site destinations.

Transportation

CEQA# MM-T-6
MP# LU-4

SDT-1

**Neighborhood / Site
Enhancement**

Mitigation Method:

Estimated VMT Reduction	Extent of Pedestrian Accommodations	Context
2%	Within Project Site and Connecting Off-Site	Urban/Suburban
1%	Within Project Site	Urban/Suburban
< 1%	Within Project Site and Connecting Off-Site	Rural

Assumptions:

Data based upon the following references:

- Center for Clean Air Policy (CCAP) Transportation Emission Guidebook. http://www.ccap.org/safe/guidebook/guide_complete.html (accessed March 2010)
- 1000 Friends of Oregon (1997) “Making the Connections: A Summary of the LUTRAQ Project” (p. 16): http://www.onethousandfriendsoforegon.org/resources/lut_vol7.html

Emission Reduction Ranges and Variables:

Pollutant	Category Emissions Reductions ⁴⁵
CO _{2e}	0 - 2% of running
PM	0 - 2% of running
CO	0 - 2% of running
NOx	0 - 2% of running
SO ₂	0 - 2% of running
ROG	0 – 1.2% of total

Discussion:

As detailed in the preferred literature section below, the lower range of 1 – 2% VMT reduction was pulled from the literature to provide a conservative estimate of reduction potential. The literature does not speak directly to a rural context, but an assumption was made that the benefits will likely be lower than a suburban/urban context.

Example:

N/A – calculations are not needed.

Preferred Literature:

⁴⁵ The percentage reduction reflects emission reductions from running emissions. The actual value will be less than this when starting and evaporative emissions are factored into the analysis. ROG emissions have been adjusted to reflect a ratio of 40% evaporative and 60% exhaust emissions based on a statewide EMFAC run of all vehicles.

Transportation

CEQA# MM-T-6
MP# LU-4

SDT-1

Neighborhood / Site Enhancement

- 1 - 2% reduction in VMT

The Center for Clean Air Policy (CCAP) attributes a 1% reduction in VMT from pedestrian-oriented design assuming this creates a 5% decrease in automobile mode share (e.g. auto split shifts from 95% to 90%). This mode split is based on the Portland Regional Land Use Transportation and Air Quality (LUTRAQ) project. The LUTRAQ analysis also provides the high end of 10% reduction in VMT. This 10% assumes the following features:

- | | |
|-------------------------|------------------------------|
| – communities | Compact, mixed-use |
| – network | Interconnected street |
| – shorter block lengths | Narrower roadways and |
| – | Sidewalks |
| – transit shelters | Accessibility to transit and |
| – and street trees | Traffic calming measures |
| – | Parks and public spaces |

Other strategies (development density, diversity, design, transit accessibility, traffic calming) are intended to account for the effects of many of the measures in the above list. Therefore, the assumed effectiveness of the Pedestrian Network measure should utilize the lower end of the 1 - 10% reduction range. If the pedestrian improvements are being combined with a significant number of the companion strategies, trip reductions for those strategies should be applied as well, based on the values given specifically for those strategies in other sections of this report. Based upon these findings, and drawing upon recommendations presented in the alternate literature below, the recommended VMT reduction attributable to pedestrian network improvements, above and beyond the benefits of other measures in the above bullet list, should be 1% for comprehensive pedestrian accommodations within the development plan or project itself, or 2% for comprehensive internal accommodations and external accommodations connecting to off-site destinations.

Alternative Literature:

Alternate:

- Walking is three times more common with enhanced pedestrian infrastructure
- 58% increase in non-auto mode share for work trips

Transportation

CEQA# MM-T-6
MP# LU-4

SDT-1

**Neighborhood / Site
Enhancement**

The Nelson\Nygaard [1] report for the City of Santa Monica Land Use and Circulation Element EIR summarized studies looking at pedestrian environments. These studies have found a direct connection between non-auto forms of travel and a high quality pedestrian environment. Walking is three times more common with communities that have pedestrian friendly streets compared to less pedestrian friendly communities. Non-auto mode share for work trips is 49% in a pedestrian friendly community, compared to 31% in an auto-oriented community. Non-auto mode share for non-work trips is 15%, compared to 4% in an auto-oriented community. However, these effects also depend upon other aspects of the pedestrian friendliness being present, which are accounted for separately in this report through land use strategy mitigation measures such as density and urban design.

Alternate:

- 0.5% - 2.0% reduction in VMT

The Sacramento Metropolitan Air Quality Management District (SMAQMD) Recommended Guidance for Land Use Emission Reductions [2] attributes 1% reduction for a project connecting to *existing* external streets and pedestrian facilities. A 0.5% reduction is attributed to connecting to *planned* external streets and pedestrian facilities (which must be included in a pedestrian master plan or equivalent). Minimizing pedestrian barriers attribute an additional 1% reduction in VMT. These recommendations are generally in line with the recommended discounts derived from the preferred literature above.

Preferred and Alternative Literature Notes:

[1] Nelson\Nygaard, 2010. City of Santa Monica Land Use and Circulation Element EIR Report, Appendix – Santa Monica Luce Trip Reduction Impacts Analysis (p.401). <http://www.shapethefuture2025.net/>

Nelson\Nygaard looked at the following studies: Anne Vernez Moudon, Paul Hess, Mary Catherine Snyder and Kiril Stanilov (2003), Effects of Site Design on Pedestrian Travel in Mixed Use, Medium-Density Environments, <http://www.wsdot.wa.gov/research/reports/fullreports/432.1.pdf>; Robert Cervero and Carolyn Radisch (1995), Travel Choices in Pedestrian Versus Automobile Oriented Neighborhoods, <http://www.uctc.net/papers/281.pdf>;

[2] Sacramento Metropolitan Air Quality Management District (SMAQMD) Recommended Guidance for Land Use Emission Reductions. (p. 11) <http://www.airquality.org/ceqa/GuidanceLUEmissionReductions.pdf>

Other Literature Reviewed:

None

3.2.5 Incorporate Bike Lane Street Design (on-site)

Range of Effectiveness: Grouped strategy. [See LUT-9]

Measure Description:

The project will incorporate bicycle lanes, routes, and shared-use paths into street systems, new subdivisions, and large developments. These on-street bike accommodations will be created to provide a continuous network of routes, facilitated with markings and signage. These improvements can help reduce peak-hour vehicle trips by making commuting by bike easier and more convenient for more people. In addition, improved bicycle facilities can increase access to and from transit hubs, thereby expanding the “catchment area” of the transit stop or station and increasing ridership. Bicycle access can also reduce parking pressure on heavily-used and/or heavily-subsidized feeder bus lines and auto-oriented park-and-ride facilities.

Refer to Improve Design of Development (LUT-9) strategy for overall effectiveness levels. The benefits of Bike Lane Street Design are small and should be grouped with the Improve Design of Development strategy to strengthen street network characteristics and enhance multi-modal environments.

Measure Applicability:

- Urban and suburban context
- Appropriate for residential, retail, office, industrial, and mixed-use projects

Alternative Literature:

Alternate:

- 1% increase in share of workers commuting by bicycle (for each additional mile of bike lanes per square mile)

Dill and Carr (2003) [1] showed that each additional mile of Type 2 bike lanes per square mile is associated with a 1% increase in the share of workers commuting by bicycle. Note that increasing by 1 mile is significant compared to the current average of 0.34 miles per square mile. Also, an increase in 1% in share of bicycle commuters would double the number of bicycle commuters in many areas with low existing bicycle mode share.

Alternate:

- 0.05 – 0.14% annual greenhouse gas (GHG) reduction
- 258 – 830% increase in bicycle community

Moving Cooler [2], based off of a national baseline, estimates 0.05% annual reduction in GHG emissions and 258% increase in bicycle commuting assuming 2 miles of bicycle

Transportation

MP# TR-4.1

SDT-5

**Neighborhood / Site
Enhancement**

lanes per square mile in areas with density > 2,000 persons per square mile. For 4 miles of bicycle lanes, estimates 0.09% GHG reductions and 449% increase in bicycle commuting. For 8 miles of bicycle lanes, estimates 0.14% GHG reductions and 830% increase in bicycle commuting. Companion strategies assumed include bicycle parking at commercial destinations, busses fitted with bicycle carriers, bike accessible rapid transit lines, education, bicycle stations, end-trip facilities, and signage.

Alternate:

- 0.075% increase in bicycle commuting with each mile of bikeway per 100,000 residents

A before-and-after study by Nelson and Allen (1997) [3] of bicycle facility implementation found that each mile of bikeway per 100,000 residents increases bicycle commuting 0.075%, all else being equal.

Alternative Literature References:

- [1] Dill, Jennifer and Theresa Carr (2003). "Bicycle Commuting and Facilities in Major U.S. Cities: If You Build Them, Commuters Will Use Them – Another Look." *TRB 2003 Annual Meeting CD-ROM*.
- [2] Cambridge Systematics. *Moving Cooler: An Analysis of Transportation Strategies for Reducing Greenhouse Gas Emissions*. Technical Appendices. Prepared for the Urban Land Institute.
http://www.movingcooler.info/Library/Documents/Moving%20Cooler_Appendix%20B_Effectiveness_102209.pdf
- [3] Nelson, Arthur and David Allen (1997). "If You Build Them, Commuters Will Use Them; Cross-Sectional Analysis of Commuters and Bicycle Facilities." *Transportation Research Record 1578*.

Other Literature Reviewed:

None