

TRANSPORTATION ASSESSMENT FOR A PROPOSED MIXED - USE PROJECT

Located at 8141 Van Nuys Boulevard
and 14550 Titus Street
in the City of Los Angeles



Prepared by:
Overland Traffic Consultants, Inc.
24325 Main Street, #202
Santa Clarita, California 91321
(661) 799 - 8423

May 2020

TRANSPORTATION ASSESSMENT
FOR A MIXED-USE PROJECT

Located at 8141 Van Nuys Boulevard and 14550 Titus Street
in the Mission Hills-Panorama City-North Hills Community Plan Area
of the City of Los Angeles

Prepared by:

Overland Traffic Consultants, Inc.
952 Manhattan Beach Bl., Suite 100
Manhattan Beach, California 90266
(661) 799 - 8423

May 2020



EXECUTIVE SUMMARY

Introduction

Overland Traffic Consultants prepared this Transportation Assessment (TA) of the potential transportation impacts for a proposed mixed-use project located at 8141 Van Nuys Boulevard and 14550 Titus Street in the Mission Hills-Panorama City-North Hills Community Plan Area (Community Plan) in the City of Los Angeles (City).

The purpose of this TA is to document transportation impacts associated with the project using the updated Los Angeles Department of Transportation's (LADOT) Transportation Assessment Guidelines (TAG). The TAG establishes procedures and methods for project review pursuant to the California Environmental Quality Act (CEQA) guidelines. LADOT determined that a Transportation Assessment is required for this project and set the study parameters in a Memorandum of Understanding (MOU) (see LADOT MOU Appendix A).

Project Description

The project site is located on the west side of Van Nuys Boulevard south of Titus Street and on the south side of Titus Street west of Van Nuys Boulevard in the City (Project Site), as shown in the following aerial photograph.

The Project Site is approximately 4.13 acres (179,975 square feet) and contains a surface parking lot and an existing adaptive reuse mixed-use building on the south west corner of Van Nuys Boulevard and Titus Street (Panorama Tower at 8155 Van Nuys Boulevard). The Panorama Tower will remain, but the surface parking lot will be removed for the construction of two new buildings and a small surface parking lot (Project).

The first new building at 8141 Van Nuys Boulevard ("Mixed-use Site"), fronts the west side of Van Nuys Boulevard and will be developed with a seven-story building occupied by 200 apartments and approximately 2,450 square feet of ground floor commercial.



The second building at 14550 Titus Street is west of the proposed Mixed-use Site and fronts the south side of Titus Street (“Accessory Parking/Warehouse Site”). A reconfigured surface parking lot with 26 parking spaces and a new 4-level above ground parking building will be constructed. The parking building will include 498 parking spaces and approximately 18,928 square foot private warehouse located on the roof level.

Project Parking and Access

Parking - The Project must provide at least 524 parking spaces for the mixed-use building, the warehouse use and the existing Panorama Tower mixed-use building. The Project will provide 524 parking spaces (465 residential parking spaces and 59 commercial parking spaces). The surface parking lot will provide 26 parking spaces with 498 parking spaces located in the proposed new 4-level parking building.

Bike Parking - The Project must provide at least 146 bike parking spaces, comprised of 17 short term spaces and 129 long term spaces. The Project will provide the required 17 short term and 129 long term bike parking spaces for a total of 146 bike parking spaces.

Access - Vehicle access to the Project’s parking is from two existing driveways on the south side of Titus Street. The Project has been designed to eliminate 2 existing driveways on Van Nuys Boulevard. The elimination of these driveways restore continuity to the sidewalk fronting the Project and remove vehicle/pedestrian sidewalk conflicts along the Project’s Van Nuys Boulevard frontage.

Transportation Assessment CEQA and Non – CEQA Review

On July 30, 2019, the City adopted vehicle miles traveled (VMT) as its criterion for determining transportation impacts under CEQA. These changes are mandated by requirements of the State of California Senate Bill 743 (SB 743) and the State’s CEQA Guidelines.

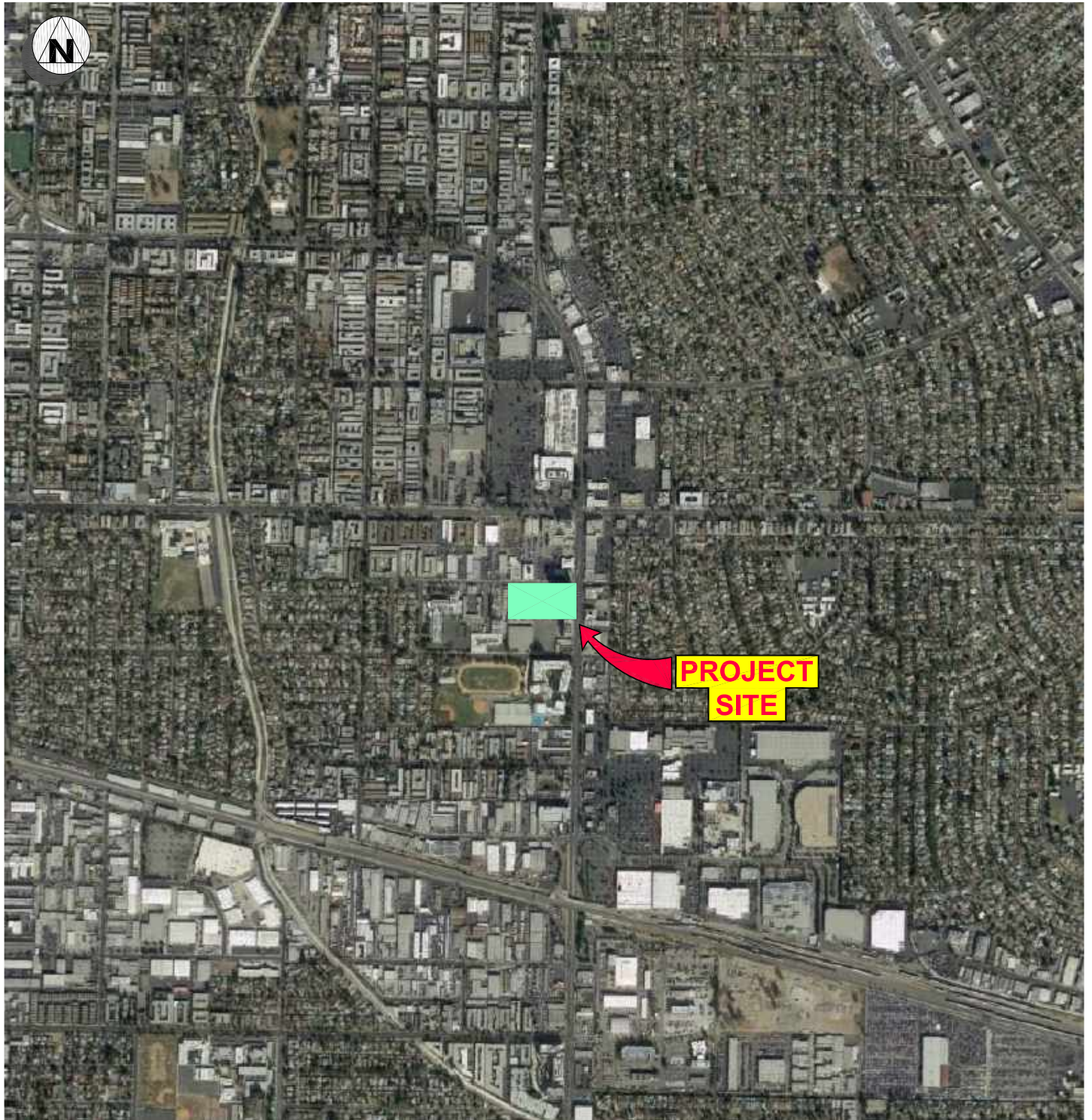

4/2020

PROJECT SETTING

 **Overland Traffic Consultants, Inc.**
24325 Main Street #202, Santa Clarita, CA 91321
(661) 799 - 8423, OTC@overlandtraffic.com



The new CEQA guidelines for evaluating transportation impacts no longer focus on measuring automobile delay and level of service (LOS). Instead, SB 743 directed lead agencies to revise transportation assessment guidelines to include a transportation performance metric that promotes: the reduction of greenhouse gas emissions, the development of multimodal networks, and access to diverse land uses. By state law, VMT must be adopted by the local agencies by July 2020.

The updated LADOT TAG is the City document providing guidance for conducting both CEQA and non-CEQA transportation analyses for land development projects. The TAG identifies three CEQA thresholds for identifying significant transportation impacts in accordance with SB 743 that are applicable to the Project.

- Threshold T-1: Conflicting with Plans, Programs, Ordinances, or Policies
- Threshold T-2.1: Causing Substantial Vehicle Miles Traveled (VMT)
- Threshold T-3: Substantially Increasing Hazards Due to a Geometric Design Feature or Incompatible Use

The City's adopted process also requires additional non-CEQA analysis and review for land development projects. The purpose of this review is to evaluate how projects affect vehicular access, circulation, and safety for all users of the transportation system.

Initial Screening

The first step in evaluating whether conditions exist that might indicate an environmental impact, a project is reviewed through a series of screening criteria to determine whether further CEQA analysis is required to address the threshold questions.

If the development project requires a discretionary action, and the answer is yes to any of the following threshold questions, further analysis will be required to assess whether the proposed Project would negatively affect the transportation system for all travel modes including pedestrian, bicycle, or transit facilities.

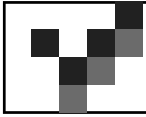

1. Does the Project involve a discretionary action that would be under review by the Department of Planning?

Yes, Project is requesting a Site Plan and Community Design Overlay review.

2. Would the Project generate a net increase of 250 or more daily vehicle trips?

Yes, using the LADOT VMT calculator (version 1.2) for screening purposes, the Project will generate an increase of 990 more daily vehicle trips without any Transportation Demand Management (TDM) strategies. TDM strategies are not considered in the screening criteria.

3. Is the Project proposing to, or required to, make any voluntary or required, modifications to the public right-of-way (i.e., street dedications, reconfigurations of curb lines, etc.)?

Yes, pursuant to the Mobility Element street standards, the portion of Van Nuys adjacent to the Project is designated a Boulevard II roadway which requires an 80-foot roadway on 110 feet of right-of-way (40-foot half roadway and 55-foot half right-of-way). Van Nuys Boulevard is currently developed 40-foot half roadway and 50-foot half right-of-way. Therefore, a 5-foot right-of-way dedication will be required but no street widening.

4. Is the Project on a lot that is $\frac{1}{2}$ acre or more in total gross area, or is the Project's frontage along a street classified as an Avenue or Boulevard (as designated in the Mobility Plan 2035) 250 linear feet or more, or is the Project's frontage encompassing an entire block along an Avenue or Boulevard (as designated in the Mobility Plan 2035)?

Yes, the Project Site is approximately 4.13 acres (179,975 square feet). The portion of Van Nuys Boulevard adjacent to the Project Site is designated a Boulevard II roadway. The Project's Van Nuys Boulevard frontage is approximately 300 feet in length.



5. Would the Project generate a net increase in daily VMT?

Yes, using the LADOT VMT calculator, the Project would generate 6,958 daily VMT. TDM strategies are not considered in the screening criteria. Appendix H contains the VMT reports.

6. Would the Project located within a one-half mile of a fixed-rail or fixed-guideway transit station replace an existing number of residential units with a smaller number of residential units?

No, the location of the Project is approximately a half mile north of the Van Nuys Metrolink fixed rail transit station. A future rail station is also planned at the intersection of Roscoe Boulevard and Van Nuys Boulevard as part of the East San Fernando Valley Transit Corridor Project. This future rail station will be located approximately one block north of the Project Site. Furthermore, the Project will not replace residential units with a smaller number of residential units, in fact, the Project will add 200 residential units.

7. Is the project proposing new driveways, or introducing new vehicle access to the property from the public right-of-way?

No, the project is proposing to remove 2 driveways on Van Nuys Boulevard and reuse the two existing driveways on Titus Street.

8. Does the land use project include the construction, 50 dwelling units or guest rooms or combination thereof or 50,000 square feet of non-residential space?

Yes, the Project includes the construction of a seven-story mixed-use building with 200 residential apartments, approximately 2,450 square feet of ground floor commercial retail and approximately 18,928 square feet of private warehouse storage use.



TAG also provides screening criteria for consistency in accordance with CEQA Section 15064.3 subdivision (b)(2) on VMT impacts from Transportation Projects. The screening criteria for Transportation Projects is determined from the following question below.

Criteria for Transportation Projects - Would the Transportation Project include the addition of through traffic lanes on existing or new highways, including general purpose lanes, high-occupancy vehicle (HOV) lanes, peak period lanes, auxiliary lanes, and lanes through grade-separated interchanges (except managed lanes, transit lanes, and auxiliary lanes of less than one mile in length designed to improve roadway safety)?

This analysis for Transportation Projects is not applicable to land development projects and the Project is not a transportation project because the Project is a land development project, therefore, the transportation project analysis is not part of the Project's CEQA review.

Based on the above Screening Criteria for land development projects, further analysis is required to assess whether the Project would negatively affect the transportation system. Screening criteria presented in the TAG document specific to each area of analysis is contained in Appendix B.

Based on the following review discussed in Chapters 2 and 3, no unmitigated significant CEQA impacts or significant circulation, access, and safety deficiencies (non-CEQA) were identified for the Project. The Project's VMT mitigation measures include TDM measures that reduce trips and VMT through TDM strategies selected in the VMT calculator.

TDM Program

Specifically, the Project's TDM program include unbundled parking mitigation and bike parking which is a regulatory measure and part of the Project's design features. These strategies as described by LADOT'S TAG are listed below:

- Unbundle Parking - This strategy unbundles the parking costs from the property costs, requiring those who wish to purchase parking spaces to do so at an additional cost from the property cost. The strategy assumes the parking cost is set by the VMT calculator to be a minimum of \$114 per month and paid by the vehicle owners/drivers. Unbundled parking and monthly fees would be part of the leasing and operation plans for the Project. The Project proposed to unbundle parking.
- Bike Parking - This strategy involves implementation of short and long-term bicycle parking to support safe and comfortable bicycle travel by providing parking facilities at destinations under existing LAMC regulations applicable to the Project (LAMC Section 12.21.A.16). The Project provides bicycle parking consistent with LAMC Section 12.21.A.16 - The Project will provide the required 17 short term and 129 long term bike parking spaces for a total of 146 bike parking spaces.

The effectiveness of each of the TDM strategies included in the VMT Calculator is based primarily on research documented in the 2010 California Air Pollution Control Officers Association (CAPCOA) publication, Quantifying Greenhouse Gas Mitigation Measures (CAPCOA, 2010).

Furthermore, potential conflicts with other proposed projects have been reviewed to assess cumulative impacts that may result from the proposed Project in combination with other development projects. No cumulative development project impacts have been identified that would preclude the City's ability to provide transportation mobility in the area.



TABLE OF CONTENTS

Chapter 1 - Project Description	1
Chapter 2 - CEQA Transportation Assessment	7
Conflicting with Plans, Programs, Ordinances, or Policies	7
Cumulative Consistency Check.....	10
Causing Substantial Vehicle Miles Traveled (VMT)	11
TDM Program.....	12
Cumulative VMT Consistency Check	13
Substantially Increasing Hazards Due to a Geometric Design Feature or Incompatible Use.....	14
Chapter 3 – Non-CEQA Transportation Assessment	15
Environmental Setting	15
Land Use	15
Transportation Facilities	16
Transit Information	18
Complete Streets Mobility Networks	20
Project Traffic Generation.....	23
Pedestrian, Bicycle and Transit Access Assessment	24
Removal or Degradation of Facilities	24
Project Intensification of Use.....	24
High Injury Network.....	25
Project Access, Safety and Circulation Evaluation	26
Operational Evaluation.....	26
Analysis of Existing and Future Traffic Conditions	27
Safety Evaluation	30
Passenger Loading Evaluation	30
Construction Overview.....	30
Interim Guidance for Freeway Safety Analysis	32



Appendices

- Appendix A – LADOT Memorandum of Understanding (MOU)
- Appendix B – Screening Criteria
- Appendix C – Plans, Programs, Ordinances and Policies
- Appendix D – Community Plan Land Use Map
- Appendix E – Street Standards, Circulation & High Injury Network Maps
- Appendix F – Transit Routes
- Appendix G – Mobility Network Maps
- Appendix H – VMT Report
- Appendix I – Related Project Information Traffic Volume Data
- Appendix J – Traffic Volume Data, Figures and Level of Service Worksheets
- Appendix K – Interim Guidance for Freeway Safety Analysis



LIST OF FIGURES

Figure 1 - Project Location..... 3

Figures 2a,b,c - Project Site Plans 4 - 6

The following figures are provided in Appendix J.

Figure 3 - Project Traffic Distribution Percentages

Figure 4 - Intersection Configuration and Project Assignment.....

Figure 5 - Peak Hour Traffic Volumes – Existing (2020) without and with Project..

Figure 6 - Related Project Information

Figure 7 - Peak Hour Traffic Volumes – Future (2024) without and with Project



LIST OF TABLES

Table 1 Consistency Check with Plans, Programs, Ordinances or Policies..... 8 - 9

Table 2 Project Trip Generation Rates 23

Table 3 Project Traffic Generation 23

Table 4 Level of Service Definitions..... 27

Table 5 Existing + Project Traffic Conditions 28

Table 6 Future Traffic Conditions - Without and With Project 29

Table 7 Project Driveway Traffic Conditions 29



CHAPTER 1

PROJECT DESCRIPTION

The project site is located on the west side of Van Nuys south of Titus Street and on the south side of Titus Street west of Van Nuys Boulevard in the City (Project Site), as shown in Figure 1.

The Project Site is approximately 4.13 acres (179,975 square feet) and contains a surface parking lot and an existing adaptive reuse mixed-use building on the south west corner of Van Nuys Boulevard and Titus Street (Panorama Tower at 8155 Van Nuys Boulevard). The Panorama Tower will remain, but the surface parking lot will be removed for the construction of two new buildings and a small surface parking lot (Project).

The first new building at 8141 Van Nuys Boulevard ("Mixed-use Site"), fronts the west side of Van Nuys Boulevard and will be developed with a seven-story building occupied by 200 apartments and approximately 2,450 square feet of ground floor commercial.

The second building at 14550 Titus Street is west of the proposed Mixed-use Site and fronts the south side of Titus Street ("Accessory Parking/Warehouse Site"). A reconfigured surface parking lot with 26 parking spaces and a new 4-level above ground parking building will be constructed. The parking building will include 498 parking spaces and approximately 18,928 square foot private warehouse located on the roof level.

Project Parking and Access

Parking - The Project must provide at least 524 parking spaces for the mixed-use building, the warehouse use and the existing Panorama Tower mixed-use building. The Project will provide 524 parking spaces (465 residential parking spaces and 59 commercial parking spaces). The surface parking lot will provide 26 parking spaces with 498 parking spaces located in the proposed new 4-level parking building.



Bike Parking - The Project must provide at least 146 bike parking spaces, comprised of 17 short term spaces and 129 long term spaces. The Project will provide the required 17 short term and 129 long term bike parking spaces for a total of 146 bike parking spaces.

Access - Vehicle access to the Project's parking is from two existing driveways on the south side of Titus Street. The Project has been designed to eliminate 2 existing driveways on Van Nuys Boulevard. The elimination of these driveways restore continuity to the sidewalk fronting the Project and remove vehicle/pedestrian sidewalk conflicts along the Project's Van Nuys Boulevard frontage.

Figure 2a illustrates the Project Site plan. And Figures 2b and 2c show the Project's access and parking.

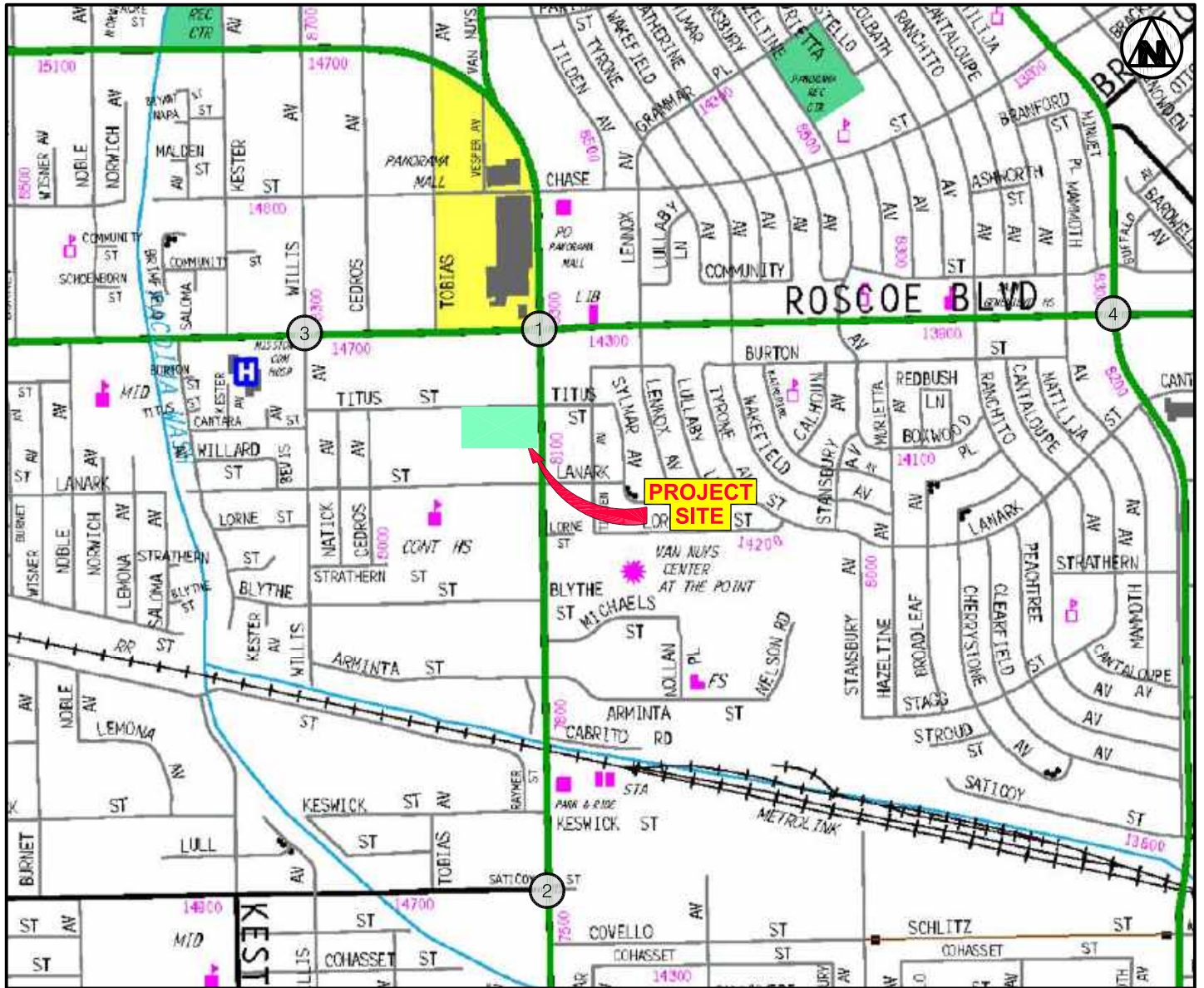
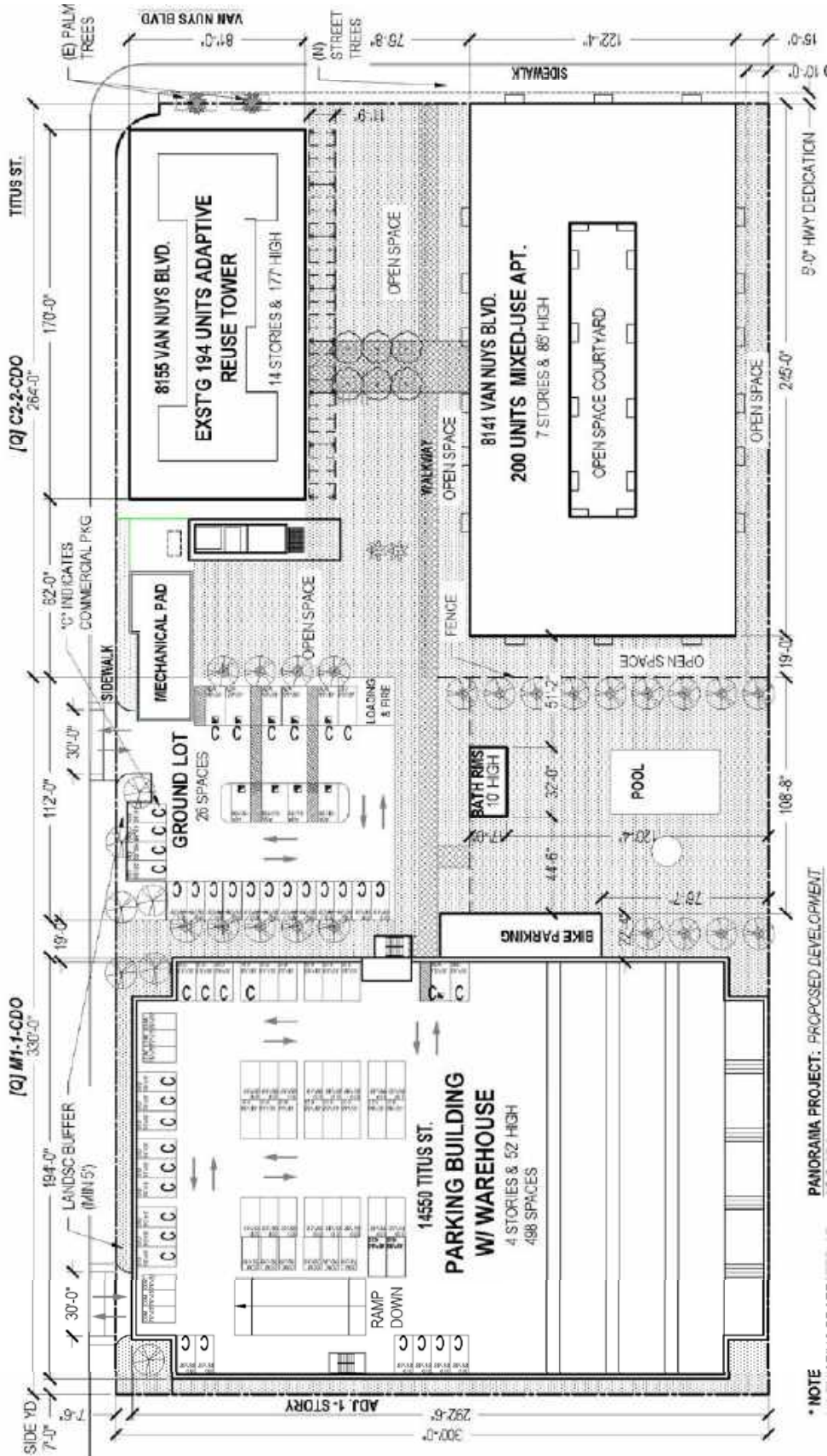

FIGURE 1

4/2020

**PROJECT LOCATION AND
STUDY INTERSECTIONS**

 **Overland Traffic Consultants, Inc.**
952 Manhattan Beach Bl, #100, Manhattan Beach, CA 90266
(310) 545 - 1235, OTC@overlandtraffic.com



* NOTE PANORAMA PROJECT: PROPOSED DEVELOPMENT.

FIGURE 2a

5/2020

PROJECT SITE PLAN

 **Overland Traffic Consultants, Inc.**
 952 Manhattan Beach Bl, #100, Manhattan Beach, CA 90266
 (310) 545 - 1235, OTC@overlandtraffic.com



SQUARE FOOTAGE OF CONSTRUCTION

BUILDING			
LEVEL	RESIDENTIAL AREA	NON-RESID AREA	TOTAL AREA
01	52,253	3,180	55,443
02	53,595	0	53,595
03	53,595	0	53,595
04	0	20,828	20,828
TOTAL	159,453	24,028	183,461

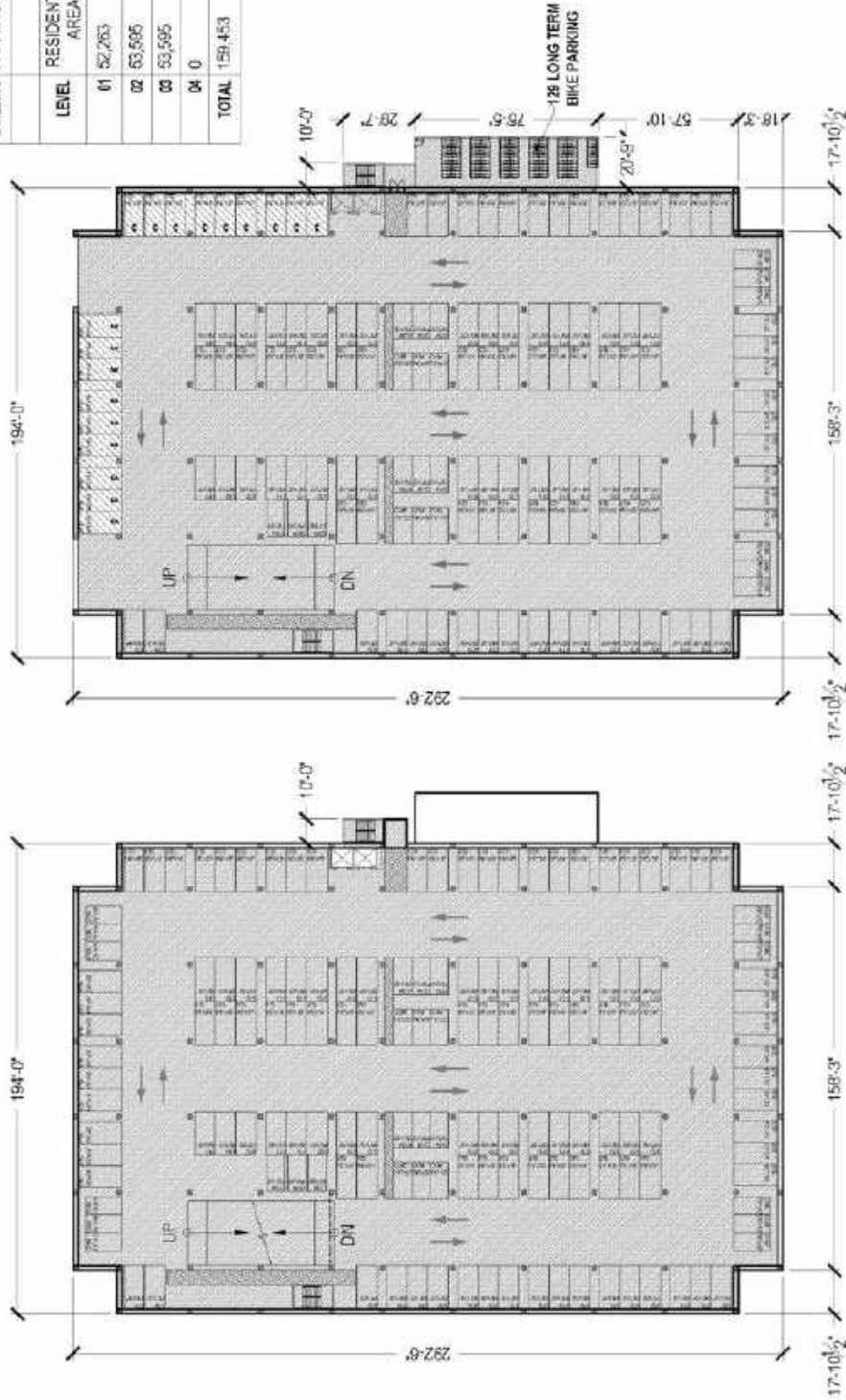

FIGURE 2b

**PROJECT SITE PLAN
PARKING LEVELS**



Overland Traffic Consultants, Inc.

952 Manhattan Beach Bl, #100, Manhattan Beach, CA 90266
(310) 545 - 1235, OTC@overlandtraffic.com

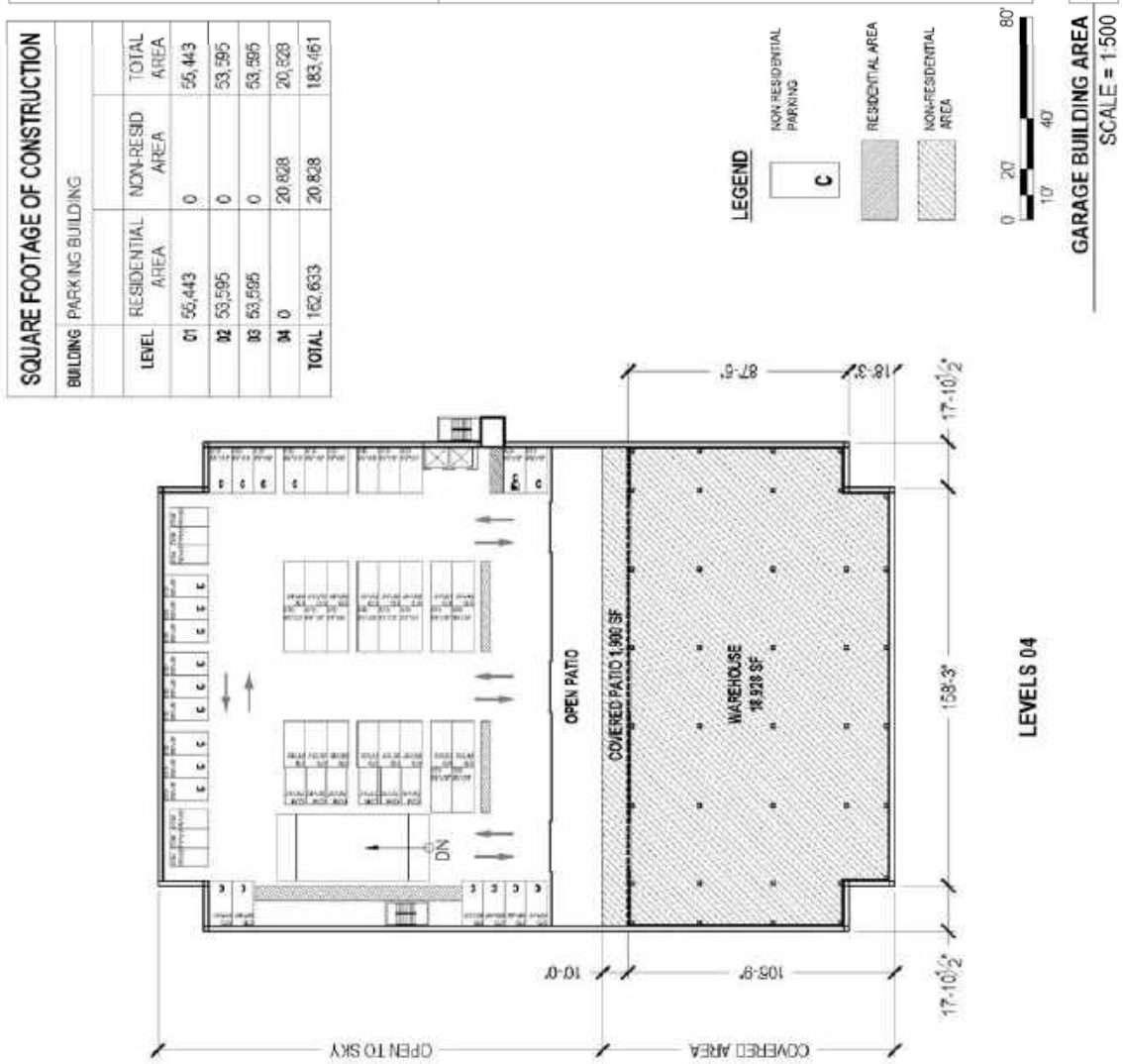

FIGURE 2c

5/2020

**PROJECT SITE PLAN
ROOF PARKING LEVEL**



Overland Traffic Consultants, Inc.

952 Manhattan Beach Bl, #100, Manhattan Beach, CA 90266
(310) 545 - 1235, OTC@overlandtraffic.com



CHAPTER 2

CEQA TRANSPORTATION ASSESSMENT

The scope for this study was reviewed and approved by LADOT in accordance with the City CEQA requirements as contained in the LADOT TAG, adopted in July 2019.

The TAG is the City document that establishes procedures and methods for conducting CEQA transportation analyses for land development projects. The TAG identifies three CEQA thresholds for identifying significant transportation impacts in accordance with SB 743 that are applicable to the Project.

- Threshold T-1: Conflicting with Plans, Programs, Ordinances, or Policies
- Threshold T-2.1: Causing Substantial Vehicle Miles Traveled (VMT)
- Threshold T-3: Substantially Increasing Hazards Due to a Geometric Design Feature or Incompatible Use

I. **Conflicts with Plans, Programs, Ordinances or Policies (Threshold T-1)**

To guide the City's Mobility Plan 2035 (Transportation Element of the General Plan), the City adopted programs, plans, ordinances, and policies that establish the transportation planning framework for all travel modes, including vehicular, transit, bicycle, and pedestrian facilities. Land development projects shall be evaluated for conformance with these City adopted transportation plans, programs, and policies.

Per the TAG guidelines, a project would not be shown to result in an impact merely based on whether a project would not implement a program, policy, or plan. Rather, it is the intention of this threshold test to ensure that proposed development does not conflict with nor preclude the City from implementing adopted programs, plans, and policies.

The TAG provides a list of key City plans, policies, programs, and ordinances for consistency review, see Table 1. Projects that generally conform with and do not conflict with the City's development policies and standards addressing the circulation system, will generally be considered consistent.

The TAG also provides a list of questions to guide the Project's consistency review. These questions and answers relative to the Project are provided in Appendix C.



Table 1
Consistency Check with Key City Plans, Programs, Ordinances or Policies

TAG Table 2.1-1: City Documents that Establish the Regulatory Framework				
	Plan or Policy	Consistent?	Notes	Preclude City Implementation?
1.	LA Mobility Plan 2035	Yes	The Project complies with the Mobility Plan 2035 street standard for Van Nuys Boulevard and Titus Street.	No
2.	Plan for Healthy LA	Yes	The Project would support Policy 5.7, Land Use Planning for Public Health and Greenhouse Gas (GHG) Emission Reduction, by reducing single-occupant vehicle trips by its proximity to high quality and high frequency transit service. The Project would include both electric charging stations and pre-wiring spaces for potential future electric vehicle charging (Ord. 186485). The Project would not conflict with other policies in the Plan for Healthy LA	No
3.	Land Use Element of the General Plan (35 Community Plans)	Yes	The Project is in the Mission Hills-Panorama City-North Hills Community Plan area. The Project would be in substantial conformance with the purposes, intent, and provisions of the General Plan and the Community Plan.	No
4.	Specific Plans	Yes	The Project substantially complies with the applicable regulations, findings, standards, and provisions of the Community Plan. No Specific Plans are adopted for Panorama City.	No
5.	LAMC Section 12.21A.16 (Bicycle Parking)	Yes	The Project complies with the ratio of short- and long-term bicycle parking pursuant to LAMC Section 12.21. A.16.	No
6.	LAMC Section 12.26J (TDM Ordinance)	Yes	LAMC Section 12.26J for Transportation Demand Management and Trip Reduction Measures applies only to the construction of new non-residential floor area greater than 25,000 s.f. The Project provides 2,450 s.f. of retail and an 18,928 square foot private warehouse, therefore the TDM ordinance does not apply.	No
7.	LAMC Section 12.37 (Waivers of Dedications and Improvement)	Yes	A 5-foot street dedications is required for Van Nuys Boulevard which the Project complies with as required to serve long-term mobility needs identified in the Mobility Plan 2035.	No
8.	Vision Zero Action Plan	Yes	No new driveways are proposed along Van Nuys Boulevard and two existing curb cuts along Van Nuys Boulevard will be removed. The Project would not preclude or conflict with the implementation of future Vision Zero projects in the public right-of-way.	No
9.	Vision Zero Corridor Plan	Yes	No Vision Zero Corridor projects are planned in the Van Nuys Boulevard corridor. The Project would not preclude or conflict with the implementation of future Vision Zero projects in the public right-of-way.	No



Table 1 (cont'd)
Consistency Check with Key City Plans, Programs, Ordinances or Policies

	Plan or Policy	Consistent?	Notes	Preclude City Implementation?
10.	Pedestrian Safety Action Plan (pending)	Pending		No
11.	Streetscape Plans	Yes	Project is located within the Panorama City Community Design Overlay District (CDO) area which provides design guidelines that enhance the visual identity and character of a neighborhood. The Panorama City Streetscape Plan Overlay provide a blueprint for streetscape improvements in the public right-of-way on key street segments. The Project will comply with and would not preclude or conflict with the implementation of Panorama City CDO and Panorama City Streetscape Plan.	No
12.	Citywide Design Guidelines for Residential, Commercial and Industrial Development	Yes	The Project complies with the Citywide Design Guidelines incorporating vehicle access locations that do not discourage and/or inhibit the pedestrian experience. Vehicular access is located on Titus Street, a local street. The Project would activate pedestrian activity and promote the safety of pedestrians with the location of ground level commercial uses.	No
13.	Walkability Checklist	Yes	Walk Score measures pedestrian friendliness by analyzing population and road metrics such as block length and intersection density. The Property receives a Walk Score of 85, categorized as "Very Walkable," where most errands can be accomplished by walking. The Project will create a continuous and straight sidewalk fronting the Project Site. The Project will provide adequate sidewalk width that accommodates pedestrian flow and activity and is consistent with Mobility Plan street designation. The closure of the existing driveways on Van Nuys Boulevard will allow additional street parking to be install for the nearby commercial uses.	No
14.	LADOT Transportation Technology Strategy - Urban Mobility in a Digital Age	Yes	The LADOT platform for mobility innovation focuses on the exchange of real-time conditions and service information for mobility data, transportation services, and digital infrastructure. The Project would not interfere or conflict with future technology strategies that add flexibility and reshape transportation decision making.	No
15.	Mobility Hubs Reader's Guide	Yes	The Project would not conflict with the Mobility Hubs goal to create an active center around any future rail station. The Project supports the first-last mile solutions to satisfy the needs of transit users by encouraging walking, providing retail services and bike parking. The Project will coordinate with LADOT on future Bike Hub programs in the area.	No
16.	LADOT Manual of Policies and Procedures (Design Standards)	Yes	The LADOT MPP, Section 321, Driveway Design, includes driveway design standards to minimize adverse effects on street traffic. The Project vehicular access complies with driveway location standards by locating access on the adjacent local street. No vehicular access is provided on Van Nuys Boulevard. The Project would not interfere with any of the applicable LADOT design standards.	No



As summarized above in Table 1, the Project is consistent with the relevant programs, plans or ordinances identified by the TAG for review. As discussed above and in more detail in Appendix C, the Project would not conflict with these key City planning documents, and potential impacts would be less than significant.

Cumulative Consistency Check

Pursuant to the TAG, each of the plans, programs, ordinances, and policies to assess potential conflicts with proposed projects should be reviewed to assess cumulative impacts that may result from the Project in combination with other nearby development projects.

A cumulative impact could occur if the Project, with other future development projects located on the same block were to cumulatively preclude the City's ability to serve transportation user needs as defined by the City's transportation policy framework.

No cumulative impact has been identified with this project that would preclude the City's implementation of any transportation related policies, programs, or standards.

Therefore, the Project does not have a significant transportation impact under CEQA Threshold T-1.



II. **Causing Substantial Vehicle Miles Traveled (Threshold T - 2.1)**

The intent of this threshold question is to assess whether a land development project causes a substantial VMT impact. CEQA Guidelines Section 15064.3(b) relates to use of VMT as the methodology for analyzing transportation impacts. Generally, projects within one-half mile of either an existing major transit stop or a stop along an existing high-quality transit corridor should be presumed to cause a less than significant transportation impact.

The Project is within the half-mile distance to the intersection of Van Nuys Boulevard and Roscoe Boulevard, a designated major transit stop. Furthermore, the Project is located within a High Quality Transit Area (HQTA), which is defined by the 2016–2040 RTP/SCS as generally walkable transit villages or corridors that are within 0.5 miles of a well-serviced transit stop or a transit corridor with 15-minute or less service frequency during peak commute hours.

To address this question for land development projects, LADOT's TAG identified significant VMT impact thresholds for each of seven Area Planning Commission (APC) sub-areas in the City. A project's VMT is compared against the City's APC threshold goals for household VMT per capita and work VMT per employee to evaluate the significance of the project's VMT.

A development project will have a potential impact if the development project would generate VMT exceeding 15% below the existing average VMT for the Area Planning Commission (APC) area in which the project is located per TAG Table 2.2-1.

Mixed-use projects are analyzed for each component separately for VMT impacts. Per the TAG, local serving retail uses produce shorter neighborhood trips that promote walking and bicycle trips that reduce VMT whereas regional retail projects generally produce longer vehicle trips and may increase VMT.



The Project is in the North Valley APC sub - area which limits daily household VMT per capita to a threshold value of 9.2 and a daily work VMT per employee threshold value of 15.0 (15% below the existing VMT for the North Valley APC).

Results of the Project's VMT calculation provides an estimate based on the Project's land uses, size and TDM program strategies and Project design features. The Project's household VMT was estimated to be 10.7 per capita for the 200 apartments prior to implementing TDM strategies which is above the North Valley APC threshold value. The commercial portion of the Project was estimated to generate 4.9 work VMT per employee which is below the North Valley APC threshold value.

The Project household VMT exceeds the North Valley APC threshold, therefore the Project does have a significant impact on household VMT per capita in the North Valley APC prior to implementing TDM mitigation. With the recommended TDM measures listed below, however, the Project will have a household VMT value of 9.2 per capita and will fully mitigate the VMT household impact. The Project's VMT analysis is provided in Appendix H.

TDM Program

The Project's VMT mitigation measures include TDM measures that reduce trips and VMT through TDM strategies selected in the VMT calculator. Specifically, the Project's TDM program include unbundled parking mitigation and bike parking which is a regulatory measure and part of the Project's design features. These strategies as described by LADOT'S TAG are listed below:

- Unbundle Parking - This strategy unbundles the parking costs from the property costs, requiring those who wish to purchase parking spaces to do so at an additional cost from the property cost. The strategy assumes the parking cost is set by the VMT calculator to be a minimum of \$114 per month and paid by the vehicle owners/drivers. Unbundled parking and monthly fees would be part of the leasing and operation plans for the Project. The Project proposed to unbundle parking.



- **Bike Parking** - This strategy involves implementation of short and long-term bicycle parking to support safe and comfortable bicycle travel by providing parking facilities at destinations under existing LAMC regulations applicable to the Project (LAMC Section 12.21.A.16). The Project provides bicycle parking consistent with LAMC Section 12.21.A.16 - The Project will provide the required 17 short term and 129 long term bike parking spaces for a total of 146 bike parking spaces.

The effectiveness of each of the TDM strategies included in the VMT Calculator is based primarily on research documented in the 2010 California Air Pollution Control Officers Association (CAPCOA) publication, Quantifying Greenhouse Gas Mitigation Measures (CAPCOA, 2010).

Cumulative VMT Consistency Check

Cumulative VMT impacts are evaluated through a consistency check with the Southern California Association of Governments' (SCAG) Regional Transportation Plan/Sustainable Communities Strategy (2016-2040 RTP/SCS) plan. The RTP/SCS is the regional plan that demonstrates compliance with air quality conformity requirements and greenhouse gas (GHG) reduction targets.

The Project represents an infill development that would concentrate new residential and commercial uses within an High Quality Transit Area (HQTA), which is defined by the 2016–2040 RTP/SCS as generally walkable transit villages or corridors that are within 0.5 miles of a well-served transit stop or a transit corridor with 15-minute or less service frequency during peak commute hours. The Project Site is in a walkable environment near the future East San Fernando rail station, several Metro local and Rapid bus routes and the LADOT Panorama City DASH route.

Per the City's TAG, projects that are consistent with the RTP/SCS plan in terms of development location and density are part of the regional solution for meeting air pollution and GHG goals. Projects that have less than a significant VMT impact are deemed to be consistent with the SCAG's 2016-2040 RTP/SCS and would have a less-than-significant cumulative impact on VMT.



As shown, the Project VMT impact would not exceed the City's VMT impact threshold and as such, the Project's contribution to the cumulative VMT impact is adequate to demonstrate there is no cumulative VMT impact.

III. Substantially Increasing Hazards Due to a Geometric Design Feature or Incompatible Use (Threshold T- 3.1)

Impacts regarding the potential increase of hazards due to a geometric design feature generally relate to the design of access points to and from the project site, and may include safety, operational, or capacity impacts. Impacts can be related to vehicle conflicts as well as to operational delays caused by vehicles slowing and/or queuing to access a project site.

Changes to the Project Site access will improve roadway and pedestrian conditions. No deficiencies are apparent in the site access plans which would be considered significant. This determination considers the following factors:

1. The Project Site will be served by two existing curb cuts currently on Titus Street, a local street. In addition, development of the Project Site will remove two existing driveways from Van Nuys Boulevard, thereby improving street movement for vehicles, pedestrians, and future bike lanes. The Project's access is consistent with LADOT driveway placement and location per LADOT Manual of Policies and Procedures, Section 321, Driveway Design.
2. No new driveways will be introduced on Van Nuys Boulevard, a Boulevard II street and designated as part of the High Injury Network System.

A review of the Project Site plans does not present any hazardous geometric design features.



CHAPTER 3

NON-CEQA TRANSPORTATION ASSESSMENT

In addition to conducting a CEQA review of development projects pursuant to SB743, LAMC Section 16.05 (Site Plan Review) authorizes a non-CEQA transportation analysis of development projects to identify deficiencies that may have an adverse effect of the environment. LADOT retains the ability to impose development conditions to improve operational safety and access around a project site and to better assess how proposed projects may affect the City's transportation system under the non-CEQA assessment.

Pursuant to the TAG, a delay-based analysis has been used to evaluate if the Project would contribute to potential circulation and access deficiencies that require specific operational improvements to the circulation system.

To assist in the non-CEQA evaluation, the following information provides the environmental conditions in which the Project is located.

ENVIRONMENTAL SETTING

Land Use

The project is in the Mission Hills-Panorama City-North Hills Community Plan area in the north central portion of the San Fernando Valley approximately 17 miles northwest of downtown Los Angeles. The Panorama Mall is the central commercial area for the community plan area and is identified as a regional center.

The Mission Hills – Panorama City – North Hills is Community Plan area contains 5,571 acres. Within the Community Plan area, single family residential uses represent 3,404 acres (61%) with 593 acres (11%) of multi-family, commercial uses represent 648 acres (12%), with 311 acres (6%) for industrial land use and the remaining acreage designated open space/public facilities.

Appendix D contains the current land use map for the Community Plan (last updated 1999).



Transportation Facilities

The streets within the study area are under the jurisdiction of the City of Los Angeles. The nearest regional facility serving the site is the San Diego Freeway (Interstate 405), which is under the jurisdiction of the California Department of Transportation (Caltrans).

The San Diego Freeway (Interstate 405) is located approximately 1.5 miles west of the Project Site. This north-south freeway provides four mixed-flow lanes and one high-occupancy lane (HOV) in each direction. Full access to the freeway is provided from Roscoe Boulevard. Average daily traffic volume on the 405 Freeway at Roscoe Boulevard is approximately 223,000 vehicles per day (ADT). Current non-directional peak hour traffic volume on the 405 Freeway is approximately 15,500 VPH.

The City of Los Angeles has adopted the Mobility Plan 2035 as an update to the City's General Plan Transportation Element to incorporate the complete streets principles for integrating multi-mode transportation networks. The Mobility Plan 2035 dictates the street standards and designations. Appendix E contains the Community Plan Circulation Plan, City of Los Angeles street standards, and High Injury Network map.

Pursuant to the City of Los Angeles Mobility Element, arterial roadways are designated Boulevards and Avenues. Boulevards represent the City's widest streets that typically provide regional access to major destinations; the roadway standard for a Boulevard II roadway is a right-of-way width of 110 feet and a roadway width of 80 feet. Avenues may vary in their land use context, with some streets passing through both residential and commercial areas; the roadway standard for an Avenue II roadway is a right-of-way width of 86 feet and a roadway width of 56 feet.

Non-arterial roadways connect arterial roadways to local residential neighborhoods or industrial areas. Non-arterial roadways are designated collector or local streets. The standard for a collector street is a right-of-way width of 66 feet and a roadway width of 40 feet; and the standard for a local street is a right-of-way width of 60 feet and a roadway width of 36 feet.

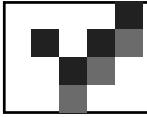

Major east-west streets serving the study area include: Parthenia Street, Roscoe Boulevard, Saticoy Street and Chase Street. Key north-south streets providing access to the project are Sepulveda Boulevard, Van Nuys Boulevard, and Woodman Avenue.

Van Nuys Boulevard is a designated north-south Boulevard II roadway. The roadway provides two lanes in each direction and median left turn lane with a third lane in each direction between 7-9 am and 4-7 pm weekdays. Van Nuys Boulevard carries approximately 40,000 vpd with 3,000 vph during the morning peak hour and 3,250 vph during the afternoon peak hour.

Roscoe Boulevard is a designated east-west Boulevard II roadway. The roadway provides three lanes in each direction between 7-9 am and 4-7 pm weekdays. Roscoe Boulevard carries approximately 45,000 vpd with 3,200 vph during the morning peak hour and 3,000 vph during the afternoon peak hour.

Saticoy Street is a designated east-west Avenue II roadway. The roadway provides two lanes in each direction, left turn lanes and on-street parking. Saticoy Street carries approximately 17,500 vpd with 1,300 vph during the morning peak hour and 1,650 vph during the afternoon peak hour

Woodman Avenue is a north-south designated Avenue I roadway. The roadway provides two lanes in each direction, left turn lanes, bike lanes and on - street parking. Woodman Avenue carries approximately 34,000 vpd with 2,300 vph during the morning peak hour and 3,000 vph during the afternoon peak hour.

Titus Street is an east-west local street with multi-family and commercial uses. The roadway provides on-street parking and one lane in each direction. Traffic volume is approximately 3,000 vehicles per day and peak hour traffic volume of approximately 200 – 300 vehicles per peak hour (estimated from LADOT 12/12/202 traffic count).

Figures 4 illustrates the study locations, type of intersection traffic control and lane configurations, traffic counts used for the Project impact analysis (non-CEQA analysis), see Appendix J.



Transit Information

Public transportation in the study area is provided by the Metropolitan Transportation Authority (Metro) and LADOT. Approximately 600 feet north at Roscoe Boulevard there are LADOT DASH Panorama City/Van Nuys, four Metro lines (Routes 152,167,169,233 and 353) plus 2 Metro Rapid lines (Routes 744 and 788) serving the Project Site.

Nearby transit lines are described below:

Metro Local Transit

Metro Local Line 152 - 353 provides service between the Fallbrook Center in Woodland Hills and the North Hollywood Red and Orange Line Station. The route travels along Roscoe Boulevard adjacent to the project site with a transit stop at the intersection of Roscoe Boulevard and Tobias Avenue. Route 353 provides extended service between North Hollywood and Sun Valley serving Cleveland High School and the West Hills Medical Center. The line runs from approximately 4:00 am to 12:15 am on weekdays with 10-20 minute headways during the peak hours and 24 minute headways off peak.

Metro Local Line 169 provides service between the Warner Transit Center and the Bob Hope Airport. The line runs along Van Nuys Boulevard from Saticoy Street to Chase Street in the study area. Major stops include Westfield Topanga, El Camino Real High School, Fallbrook Shopping Center, Northridge Hospital, Van Nuys Airport, Van Nuys Metrolink Station, and the Panorama Mall. The line runs from approximately 5:00 am to 8:45 pm with 60 minute headways.

Metro Local Line 233 provides service between the Van Nuys Orange Line Station and Hansen Dam Recreation Center. The line runs primarily along Van Nuys Boulevard from approximately 5:45 am to 11:15 pm with 12-15 minute headways during peak.

Metro Rapid Transit

Metro Rapid Line 744 provides service from the Hansen Dam Recreation Area along Van Nuys Boulevard, Ventura Boulevard, Reseda Boulevard to CSUN. The line runs from approximately 5:00 am to 9:00 pm on weekdays with 20-minute headways.



Metro Rapid Line 788 provides service between Arleta and Westwood communities. The line travels along Van Nuys Boulevard and the 405 Freeway to Wilshire Boulevard. The line runs from 5:00 am to 8:00 pm on weekdays with 20-minute headways during peak hours.

Local Circulator

LADOT DASH Panorama City/Van Nuys provides a loop route connecting the Van Nuys Civic Center, Van Nuys High School, Sepulveda Park Recreation Center, Panorama Mall and Amtrak/Van Nuys Metrolink Station. The DASH service runs from approximately 7:00 am to 6:40 pm on weekdays with 15-20 minute headways. On weekends, the service runs from 9:00 am to 6:00 pm with 20-minute headways.

Regional Rail

Metrolink regional commuter rail Van Nuys Station, at Van Nuys Boulevard and Keswick Street, 2,650 feet south of the Project Site. The station is served by eleven weekday round trips on the Metrolink Ventura County Line, five daily round trips of the Amtrak Pacific Surfliner, and one daily round trip of the Amtrak Coast Starlight. This rail line provides access to Los Angeles Union Station, which provides service for Metro Rail B Line (Red), D Line (Purple), and L Line (Gold).

East San Fernando Valley Transit Corridor Project – Metro is in the process of preparing a Final EIS/EIR to study the feasibility of a new mass transit project that would operate in the center or curb-lane of Van Nuys Boulevard from the Metro Orange Line station north to the Sylmar/San Fernando Metrolink station, approximately 9.2 miles. It is important to note that LA County Measure M has earmarked \$1.3 billion for this project scheduled for completion in 2028. The importance of this project is highlighted by several important facts identified by Metro for this corridor, which include:

1. Van Nuys Boulevard has the 2nd highest transit boardings in the San Fernando Valley, following the Metro Orange Line.
2. On an average weekday, there are nearly 50,000 boardings on Metro buses operating on Van Nuys Boulevard.



3. Approximately 50% of the Boulevard's boardings occur along 2.8 miles stretch between the Orange Line and Roscoe Boulevard.
4. Of the study area population, 35% is transit dependent.

Many transfer opportunities are available to/from the Project Site by these local and regional transit lines. Per the VMT calculator, the Project would have a residential population of approximately 451 persons and 11 employees. The projected level of transit ridership by the Project, approximately 178 daily transit trips will not adversely affect the current or future ridership capacity of the transit services in the area.

Complete Streets Mobility Networks (Vehicle, Bicycle, Transit, Neighborhood and Pedestrian Enhanced Districts)

The Mobility Plan Element establishes a layered network of street standards that are designed to emphasize mobility modes within the larger system. This approach maintains the primary function of the streets that exist but identifies streets for potential alternative transportation modes providing a range of options available when selecting the appropriate design elements. Street may be listed in several networks with the goal of selecting a variety of mobility enhancements.

Network layers have been created that prioritizes a certain mode within each layer with the goal of providing better connectivity. The network layers are: Vehicle-Enhanced Network, Transit-Enhanced Network, Bicycle-Enhanced Network and Neighborhood-Enhanced Network. Definitions of these networks per the Complete Street Design Guidelines are provide below.

Vehicle-Enhanced Network (VEN) - The VEN includes a select number of arterials that carry high volume of traffic for long distance travel on corridors with freeway access. Moderate enhancements typically include technology upgrades and peak-hour restrictions for parking and turning movements. Comprehensive enhancements can include improvements to access management, all-day lane conversions of parking, and all-day turning movement restrictions or permanent access control.

- No study area streets have been identified in the VEN.



Transit-Enhanced Network (TEN) - The TEN is comprised of streets that prioritize travel for transit riders.

- Van Nuys Boulevard is designated as a Comprehensive Transit Enhanced street which typically include transit vehicles operating in an all-day exclusive bus lane.
- Roscoe Boulevard is designated as a Moderate Plus Transit Enhanced street - An upgraded enhancement would include an exclusive bus lane during the peak travel period only.

Bicycle-Enhanced Network (BEN) – The BEN is comprised of a network of low – stressed protected bike lanes (Tier 1) and bike paths prioritize bicycle travel by providing specific bicycle facilities and improvements. The BEN also proposes bike facilities on arterial roadways with a striped separation. Tier 1 corresponds to protected bicycle lanes, and Tier 2 and Tier 3 bicycle lanes on arterial roads with a striped separation that are differentiated only by their potential implementation phasing - the difference between Tier 2 and Tier 3 implies probability that some lanes are not expected to be implemented by 2035.

The City of Los Angeles adopted a 2010 Bicycle Master Plan to encourage alternative modes of transportation throughout the City of Los Angeles. The Master Plan was developed to provide a network system that is safe and efficient to use in coordination with the vehicle and pedestrian traffic on the City street systems. The Master Plan has mapped out the existing, funded, and potential future Bicycle Paths, Bicycle Lanes, and Bicycle Routes. A brief definition of the bicycle facilities is provided below:

Bicycle Path – A bicycle path is facility that is separated from the vehicular traffic for the exclusive use of the cyclist (although sometimes combined with a pedestrian lane). The designated path can be completely separated from vehicular traffic or cross the vehicular traffic with right-of-way assigned through signals or stop signs.

- Pacoima Wash and the Metro link right-of-way alignment are identified as bike paths in the study area.

Bicycle Lane – A bicycle lane is typically provided on street with a designated lane striped on the street for the exclusive use of the cyclist. The bicycle lanes are occasionally curbside, outside the parking lane, or along a right turn lane at intersections.



- Van Nuys Boulevard is listed on the Bicycle Lane Network map as Tier 1 bicycle lane street.
- Roscoe Boulevard east of Van Nuys Boulevard is listed on the Bicycle Lane Network map as Tier 1 bicycle lane street.

Bicycle Route – A bicycle route is a designated route in a cycling system where the cyclist shares the lane with the vehicle. Cyclist would follow the route and share the right - of - way with the vehicle.

- No bike routes are identified in the study area.

Neighborhood Enhanced Network (NEN) - NEN is comprised of local streets intended to benefit from pedestrian and bicycle related safety enhancements for more localized travel of slower means of travel while preserving the connectivity of local streets to other enhanced networks. These enhancements encourage lower vehicle speeds providing added safety for pedestrians and bicyclists.

- Chase Street, Lanark Street, Cedros Avenue north of Chase Street, and Willis Avenue south of Chase Street in the study area have been identified in the NEN.

Pedestrian Enhanced District (PEDs)

In addition to these street networks, many arterial streets that could benefit from additional pedestrian features to provide better walking connections are identified as Pedestrian Enhanced Districts.

Several streets within the study area has been identified in the pedestrian enhanced district maps with the goal of providing a more attractive environment to promote walking for shorter trips. Adding pedestrian design features and street trees encourages people to take trips on foot instead of by car. This helps to reduce the volume of cars on the road and emissions, increase economic vitality, and make the City feel like a more vibrant place.

- Van Nuys Boulevard, Roscoe Boulevard and portions of Woodman Avenue have been identified in the PED map.

Mobility Plan Network Maps and the 2010 Bicycle Plan are included in Appendix G.



Project Traffic Generation

As part of the Non-CEQA assessment, an operational analysis of the peak hour traffic flow with the Project is required. This evaluation is based on peak hour traffic flow level of service (LOS) methodologies which determines vehicle delay using current traffic volume data, traffic signal and street characteristics together with the estimates of peak hour Project traffic.

Traffic - generating characteristics of land uses have been studied by the Institute of Transportation Engineers (ITE). The results of these traffic generation studies have been published in Trip Generation, 10th Edition Handbook. Traffic rates used in this analysis are presented in Table 2. Table 3 shows the Project’s peak hour trip estimate. Daily traffic estimates are provided by the LADOT VMT calculator.

Table 2
Traffic Generation Rates

ITE Code	Description	AM Peak Hour			PM Peak Hour		
		In	Out	Total	In	Out	Total
820	Retail (per 1,000 s.f.)	62%	38%	0.94	48%	52%	3.81
221	Apartments mid-rise (per unit)	26%	74%	0.36	61%	39%	0.44
150	Warehouse (per 1,000 s.f.)	77%	23%	0.17	27%	73%	0.19

Table 3
Estimated Project Traffic Generation

ITE Code	Description	Size	AM Peak Hour			PM Peak Hour		
			In	Out	Total	In	Out	Total
<u>Proposed Project</u>								
221	Apartments mid-rise (per unit)	200 units	19	53	72	53	35	88
	Transit/Walk	15%	(3)	(8)	(11)	(8)	(5)	(13)
820	Retail (per 1,000 s.f.)	2,450 sf	1	1	2	4	5	9
	Transit/Walk	15%	(0)	(0)	(0)	(0)	(1)	(1)
	Pass By	10%	(0)	(0)	(0)	(1)	(0)	(1)
150	Warehouse (per 1,000 s.f.)	18,928 sf	2	1	3	1	3	4
	Street Traffic		19	47	66	49	37	86
	Driveway Traffic		19	47	66	50	37	87

Appendix J contains the study intersection characteristics, traffic peak hour data, and Project traffic assignment for the existing and future traffic analysis.



PEDESTRIAN, BICYCLE AND TRANSIT ACCESS ASSESSMENT

Purpose - The pedestrian, bicycle and transit facilities assessments are intended to determine a project's potential effect on pedestrian, bicycle, and transit facilities in the vicinity of the Project. The deficiencies could be physical (through removal, modification, or degradation of facilities) or demand-based (by adding pedestrian or bicycle demand to inadequate facilities).

Removal or Degradation of Facilities

The Project will not remove, modify, or degrade any pedestrian, bicycle, and transit facilities in the vicinity of the Project Site. In fact, any damaged or off-grade sidewalk, curb and gutter along the property frontage will be repaired under Section 12.37 of the Los Angeles Municipal Code (LAMC).

Project Intensification of Use

Generally, projects that contribute to efficient land use patterns enabling higher levels of walking, cycling, and transit as well as lower average trip length are considered to have a less than significant impact on transportation. These projects include, for example, projects in transit priority areas, projects consisting of residential infill or those located in low VMT areas.

Governor's Office of Planning and Research (OPR) December 2018 Technical Advisory on Evaluating Transportation Impacts in CEQA, identifies projects and areas presumed to have a less than significant transportation impact to include:

- Residential, office, or retail projects within a Transit Priority Area, where a project is within a ½ mile of an existing or major transit stop or an existing stop along a high - quality transit corridor. A major transit stop is defined as a site containing an existing rail transit station, or the intersection of two or more major bus routes with a frequency of service interval of 15 minutes or less during the morning and afternoon peak commute periods (Pub. Resources Code, § 21064.3).



➤ A high-quality transit corridor is defined as a corridor with fixed route bus service with service intervals no longer than 15 minutes during peak commute hours (Pub. Resources 215 Code, § 21155).

The Project site is in a Transit Priority Area with multiple local and regional transit options and within ½ mile of a future fixed rail station at Roscoe Boulevard and Van Nuys Boulevard. The Project (8141 Van Nuys Boulevard) has a Walk Score of 85 out of 100.

The Project is located on Van Nuys Boulevard which is designated a Boulevard II roadway and is included in the Transit Enhanced Network, Bike Enhanced and Pedestrian Enhanced Networks. No bike facilities are currently located along this segment of Van Nuys Boulevard, but are identified as a potential future Tier 1 bike facility.

Pedestrian facilities will be improved along Van Nuys Boulevard with the replacement of broken sidewalks, the removal of the two existing Van Nuys Boulevard driveways and the provision of 5 feet of dedication for a wider sidewalk. Furthermore, an existing traffic signal with marked crosswalks at the intersection of Van Nuys Boulevard and Roscoe Boulevard provides a safe pedestrian crossing which was recently enhanced by the Vision Zero Roscoe Boulevard Safety Improvements Project, discussed below.

Per the VMT calculator, the Project would have a residential population of approximately 451 persons and 11 employees. This level of intensification would not require any additional pedestrian facilities to be constructed. No transit facilities will be impacted by the construction of this Project.

High Injury Network

Vision Zero Los Angeles identified a strategic plan to reduce traffic deaths to zero by focusing on engineering, enforcement, education, and evaluation. The priority identified in the report is safety with a goal to make the streets of the City of Los Angeles the safest in the nation. As part of an effort to achieve this goal, LADOT identified a High



Injury Network (HIN) of city streets. The HIN identifies streets with a high number of traffic-related severe injuries and deaths across all modes of travel with emphasis on those involving pedestrians and cyclists.

This segment of Van Nuys Boulevard is part of the High Injury Network, see Appendix E. As previously stated, the removal of the vehicular access from Van Nuys Boulevard will eliminate vehicle conflicts with pedestrians and bicyclists traveling on Van Nuys Boulevard.

A Vision Zero project (Roscoe Boulevard Safety Improvements Project) was completed in July 2019 on Roscoe Boulevard between the 405 Freeway and Woodman Avenue to reconstruct failed portions of street and sidewalk, and make critical safety improvements, such as improving signals and crossings to prevent deaths and severe injuries - high visibility crosswalks, left-turn arrows, speed feedback signs, leading pedestrian intervals were installed.

PROJECT ACCESS, SAFETY AND CIRCULATION EVALUATION

Purpose – Project access and circulation is evaluated for safety, operational, and capacity constraints using vehicle level of service to identify circulation and access deficiencies that may require specific operational improvements. CEQA analysis for other subject areas, such as air quality analysis, may also continue to rely on vehicle level of service analysis.

Operational Evaluation –

Criteria - Per the TAG, the Transportation Assessment should include a quantitative evaluation of the project's expected access and circulation operations. Project access is considered constrained if the project's traffic would contribute to unacceptable queuing on at project driveway(s) or would cause or substantially extend queuing at nearby signalized intersections.

Evaluation - The following traffic conditions evaluation has been prepared to identify any new circulation and access deficiencies that may require specific operational improvements. The circulation level of service evaluation has been prepared using the Highway Capacity Manual (HCM) methodology which calculates the amount of delay per

vehicle based upon the intersection traffic volumes, lane configurations, and signal timing.

Once the vehicle delay value has been calculated, operating characteristics are assigned a level of service grade (A through F) to estimate the level of congestion and stability of the traffic flow. The term "Level of Service" (LOS) is used by traffic engineers to describe the quality of traffic flow. Definitions of the LOS grades in terms of vehicle delay are shown in Table 4.

Table 4
Level of Service Definitions

<u>LOS</u>	<u>HCM (delay in seconds)</u>	<u>Operating Conditions</u>
A	Less than 10	No loaded cycles and few are even close. No approach phase is fully utilized with no delay.
B	>10 to 20	A stable flow of traffic.
C	>20 to 35	Stable operation continues. Loading is intermittent. Occasionally drivers may have to wait more on red signal and backups may develop behind turning vehicles.
D	>35-55	Approaching instability. Delays may be lengthy during short time periods within the peak hour. Vehicles may be required to wait through more than one signal cycle.
E	>55 to 80	At or near capacity with possible long queues for left-turning vehicles. Full utilization of every signal cycle is seldom attained.
F	> 80	Gridlock conditions with stoppages of long duration.

Analysis of Existing and Future Traffic Conditions

Baseline (2017 and 2016) traffic counts were obtained from traffic studies prepared for other recently approved land development projects (see related projects #21 and #22 in Appendix I). These counts were used because new traffic data cannot be collected during the COV-19 shutdown as directed by LADOT. Therefore, traffic generated by other projects identified in those traffic studies has been added to the base counts to reflect growth in area traffic since 2016/2017. Twenty-four other related projects were included for this growth forecast. Note that some of these projects may be currently operational. In addition, baseline traffic data was increased by 1 percent per



year area to study year 2024 to account for other unknown projects or projects outside the study area. This 1 percent growth rate was provided by LADOT staff. These adjustments provide a very conservative traffic flow estimate for the study area and may overstate actual levels of congestion. The locations of related projects and the peak hour trips generated are provided in Appendix I.

These adjusted existing (2020) and future (2024) traffic volumes have been used to evaluate traffic conditions after completion of the Project. The intersections analyzed include:

1. Van Nuys Boulevard and Roscoe Boulevard;
2. Van Nuys Boulevard and Saticoy Street;
3. Roscoe Boulevard and Willis Avenue; and
4. Roscoe Boulevard and Woodman Avenue.

Table 5 contains the results of the existing plus Project traffic conditions at the four study intersections.

Table 5
Existing + Project Traffic Conditions

<u>No.</u>	<u>Intersection</u>	<u>Peak Hour</u>	<u>Existing</u>		<u>Existing + Project</u>	
			<u>Delay</u>	<u>LOS</u>	<u>Delay</u>	<u>LOS</u>
1	Van Nuys Boulevard & Roscoe Boulevard	AM	89.9	F	90.8	F
		PM	85.0	F	86.9	F
2	Van Nuys Boulevard & Saticoy Street	AM	81.2	F	82.5	F
		PM	83.8	F	85.2	F
3	Roscoe Boulevard & Willis Avenue	AM	26.8	C	26.8	C
		PM	24.3	C	24.5	C
4	Roscoe Boulevard & Woodman Avenue	AM	59.6	E	60.0	E
		PM	53.8	D	54.2	D

Appendix J contains the study intersection characteristics, traffic peak hour data, existing and future traffic flow maps, and LOS worksheets.



Table 6 contains the results of the future cumulative plus Project traffic conditions at the four study intersections for the 2024 study year.

Table 6
Future Traffic Conditions – Without and With Project

No.	Intersection	Peak Hour	Future (2024) Without Project		Future (2024) With Project	
			Delay	LOS	Delay	LOS
1	Van Nuys Boulevard & Roscoe Boulevard	AM	122.5	F	123.5	F
		PM	122.2	F	124.2	F
2	Van Nuys Boulevard & Saticoy Street	AM	96.0	F	96.8	F
		PM	96.9	F	97.7	F
3	Roscoe Boulevard & Willis Avenue	AM	24.5	C	24.6	C
		PM	27.3	C	28.0	C
4	Roscoe Boulevard & Woodman Avenue	AM	75.8	E	75.8	E
		PM	68.7	E	69.2	E

Project Driveway Access Evaluation

Table 7 contains the results of the traffic conditions the Project driveways on Titus Street. As shown by the level of service at both driveways during both peak hours, access has been designed to accommodate the Project traffic without significant vehicle delays. Note that the Project driveway traffic volume includes the traffic generated by the existing Panorama Tower located on the SEC of Titus Street and Van Nuys Boulevard because the Panorama Tower will be parking in the parking garage and surface lot. See Appendix J for capacity calculations and driveway peak hour volume.

Table 7
Project Driveway Traffic Conditions

Intersection	Peak Hour	Driveway Conditions		
		Delay	LOS	Exit Vehicle Queue
Titus Street	AM	9.7	A	0.4
Project Garage Driveway	PM	10.5	B	0.4
Titus Street	AM	9.6	A	0.0
Project Surface Lot Driveway	PM	10.1	B	0.0



Based on the traffic conditions analysis, no Project access and circulation constraints have been identified. The results of this evaluation show that the Project will not create any non-CEQA traffic deficiencies on the existing streets or near-by intersections, pedestrian, bicycle, and transit facilities.

Safety Evaluation

Removing multiple existing driveways on Van Nuys Boulevard and providing local street access will improve access conditions and reduce the number of vehicle conflicts with pedestrians, bicycles and transit vehicles along Van Nuys Boulevard.

All emergency ingress/egress associated with the Project would be designed and constructed in conformance to all applicable City Building and Safety Department, LADOT, and LAFD standards and requirements for design and construction. This would also ensure pedestrian safety. There are adequate sidewalks and crosswalks serving the Project Site and at nearby signal-controlled intersection. The Project would not affect these facilities.

No access deficiencies are apparent in the site access plans which would be considered significant.

Passenger Loading Evaluation

All parking is located on-site in a parking garage. It is anticipated that all loading will occur from within the surface parking lot or parking garage.

Construction Overview

Project construction is evaluated to determine if activities substantially interfere with pedestrian, bicycle, transit, or vehicle mobility. Factors to be considered are the location of the Project Site, the functional classification of the adjacent street affected, temporary loss of bus stops or rerouting of transit lines, and the loss of vehicle, bicycle, or pedestrian access. LADOT's TAG considers three areas to be considered when evaluating construction activities of a project.



1. Temporary Transportation Constraints

As part of the Project's construction, the City will require a Construction Traffic Management Plan (Plan) to be implemented during the construction phase to minimize potential conflicts with vehicles, pedestrians, bicycle, and transit facilities associated with the Project's construction. The Plan should include a construction schedule, the location of any traffic lane or sidewalk closures, any traffic detours, haul routes, hours of operation, access plans to abutting properties, and contact information.

Construction workers are typically expected to arrive at the Project Site before 7:00 am and depart before or after the weekday peak hours of 4:00 to 6:00 pm. Deliveries of construction materials will be coordinated to non-peak travel periods, to the extent possible and occur from the parking lane along the Project's Van Nuys Boulevard frontage or the adjacent local street.

For off-site activities, Worksite Traffic Control Plans would be prepared for any temporary traffic lane or sidewalk closures in accordance with City guidelines. These worksite plans will require a formal review and approval by the City prior to the issuance of any construction permits. In addition, the City will require a Truck Haul Route plan including permitted hauling hours and a haul route to and from the landfill.

No detours around the construction site are expected; however, flagmen would be used to control traffic movement during the ingress and egress of construction trucks and heavy equipment.

During site preparation and the first phase of the building construction, while the parking garage is under construction, it is anticipated that construction employees would be parked in the existing parking lot.

Since Project construction would not substantially interfere with pedestrian, bicycle or vehicle mobility, the construction impacts would be less than significant.



2. Temporary Loss of Access

Vehicular access to the adjacent commercial properties will be maintained. Safe pedestrian circulation paths adjacent to or around the work areas will be provided by covered pedestrian walkways if necessary and will be maintained as required by City-approved Work Area Traffic Control Plans.

The nearby signalized intersection that provides protected pedestrian street crossings, Van Nuys Boulevard and Roscoe Boulevard will not be impacted by the Project construction.

Since Project construction would not result in loss of vehicular or pedestrian access, the construction impacts on loss of access would be less than significant.

3. Temporary Loss of Bus Stops or Rerouting of Bus Lines

No bus stops are located within the work zone adjacent to the Project Site that would need to be temporarily relocated. There will be no loss of pedestrian access to transit stops located at Van Nuys Boulevard and Roscoe Boulevard.

Since Project construction would not require relocation of bus stops or bus lines, the construction impacts on transit operations would be less than significant.

Interim Guidance for Freeway Safety Analysis

On May 1, 2020, LADOT issued an Interim Guidance for Freeway Safety Analysis memorandum. The purpose of this memorandum is to provide interim guidance on the preparation of freeway safety analysis for land use proposals that are required by LADOT to prepare Transportation Assessments.

Caltrans District 7 requested that environmental analyses for new land use development projects include freeway off-ramp safety considerations. Specifically, it was requested that the City evaluate a development project effects on vehicle queuing on freeway off-ramps



In response, LADOT has developed the following criteria for a project freeway safety analysis to be included in Transportation Assessments for land development projects.

The initial step is to identify the number of Project trips expected to be added to nearby freeway off-ramps serving the Project Site. If the Project adds 25 or more trips to any off ramp in either the morning or afternoon peak hour, then that ramp should be studied for potential queuing impacts. If the Project is not expected to generate more than 25 or more peak hour trips at any freeway off-ramps, then a freeway ramp analysis is not required.

As shown in Figure 4, the Project traffic west of Willis Avenue is estimated at 25% of the Project traffic and 20% east of Woodman Avenue. Applying these traffic assignment percentages, no freeway ramps would not exceed 25 project peak hour trips, in fact west of Willis Avenue the peak hour project trips are 12 trips or less, east of Woodman Avenue the peak hour project trips are 10 peak hour trips or less.

No further freeway safety analysis is necessary for the Project analysis using this guidance criteria.



APPENDIX A

LADOT MEMORANDUM OF UNDERSTANDING (MOU)



Transportation Assessment Memorandum of Understanding (MOU)

This MOU acknowledges that the Transportation Assessment for the following Project will be prepared in accordance with the latest version of LADOT's Transportation Assessment Guidelines:

I. PROJECT INFORMATION

Project Name: _____

Project Address: 8141 N Van Nuys Boulevard

Project Description: Construct a new mixed use building with 200 apartments and approximately 2,450 sf retail

LADOT Project Case Number: _____ Project Site Plan attached? (Required) Yes No

II. TRIP GENERATION

Geographic Distribution: N 20 % S 30 % E 25 % W 30 %

Illustration of Project trip distribution percentages at Study intersections attached? (Required) Yes No

Trip Generation Rate(s): ITE 10th Edition / Other ITE 10th Edition

Trip Generation Adjustment <i>(Exact amount of credit subject to approval by LADOT)</i>	Yes	No
Transit Usage	<input checked="" type="checkbox"/>	
Transportation Demand Management		<input checked="" type="checkbox"/>
Existing Active Land Use		<input checked="" type="checkbox"/>
Previous Land Use		<input checked="" type="checkbox"/>
Internal Trip		<input checked="" type="checkbox"/>
Pass-By Trip	<input checked="" type="checkbox"/>	

Trip generation table including a description of the proposed land uses, ITE rates, estimated morning and afternoon peak hour volumes (ins/outs/totals), proposed trip credits, etc. attached? (Required) Yes No

	IN	OUT	TOTAL	
AM Trips	<u>17</u>	<u>46</u>	<u>63</u>	Daily Trips <u>961</u> (From VMT Calculator)
PM Trips	<u>48</u>	<u>34</u>	<u>82</u>	

III. STUDY AREA AND ASSUMPTIONS

Project Buildout Year: 2024 Ambient Growth Rate: 1 % Per Yr.

Related Projects List, researched by the consultant and approved by LADOT, attached? (Required) Yes No

Map of Study Intersections/Segments attached? Yes No

STUDY INTERSECTIONS (May be subject to LADOT revision after access, safety and circulation analysis)

- 1 Van Nuys Boulevard and Roscoe Boulevard
- 2 Van Nuys Boulevard and Saticoy Street
- 3 Roscoe Boulevard and Willis Avenue
- 4 Roscoe Boulevard and Woodman Avenue
- 5 Project Dwy.

Is this Project located on a street within the High Injury Network? Yes No

IV. ACCESS ASSESSMENT

Is the project on a lot that is 0.5-acre or more in total gross area? Yes

Is the project's frontage 250 linear feet or more along an Avenue or Boulevard as classified by the City's General Plan? Yes No

Is the project's building frontage encompassing an entire block along an Avenue or Boulevard as classified by the City's General Plan? Yes No

★

V. CONTACT INFORMATION

	Name:	<u>DEVELOPER</u>
Consultant:	<u>Overland Traffic Consultants, Inc</u>	<u>Grand Pacific 7-28, LLC</u>
Address:	<u>24325 Main St. #202, Santa Clarita, CA 91321</u>	<u>724 S Spring Street, Suite 801</u> <u>Los Angeles Ca 90014 (213) 623-3800</u>
Phone Number:	<u>(310) 930 - 3303</u>	<u>hamid.behdad@ccd-g-la.com</u>
E-Mail:	<u>otc@overlandtraffic.com</u>	

Approved by:	x <u><i>Dany P. Christal</i></u>	<u>4-22-2020</u>	x <u><i>Danesh Shekhnaz</i></u>	<u>4/29/2020</u>
	Consultant's Representative	Date	LADOT Representative	*Date

*MOUs are generally valid for two years after signing. If after two years a transportation assessment has not been submitted to LADOT, the developer's representative shall check with the appropriate LADOT office to determine if the terms of this MOU are still valid or if a new MOU is needed.

★ Both CEQA & NON-CEQA analysis will be done as per LADOT Transportation Assessment Guidelines.



4/2024

PROJECT SETTING

 **Overland Traffic Consultants, Inc.**

24325 Main Street #202, Santa Clarita, CA 91321
(661) 799-8423, OTC@overlandtraffic.com

TRIP GENERATION RATES

ITE Code	Description	Daily Traffic	AM Peak Hour			PM Peak Hour		
			In	Out	Total	In	Out	Total
820	Retail (per 1,000 s.f.)	37.75	62%	38%	0.94	48%	52%	3.81
221	Apartments mid-rise (per unit)	5.44	26%	74%	0.36	61%	39%	0.44

PROJECT TRIPS

ITE Code	Description	Size	Daily Traffic	AM Peak Hour			PM Peak Hour		
				In	Out	Total	In	Out	Total
<u>Proposed Project</u>									
221	Apartments mid-rise (per unit)	200 units	1,088	19	53	72	53	35	88
	Transit/Walk	15% ✓	(163)	(3)	(8)	(11)	(8)	(5)	(13)
820	Retail (per 1,000 s.f.)	2,450 sf	92	1	1	2	4	5	9
	Transit/Walk	15% ✓	(14)	(0)	(0)	(0)	(0)	(1)	(1)
	Pass By	10% ✓	(8)	(0)	(0)	(0)	(1)	(0)	(1)
	Street Traffic		995	17	46	63	48	34	82
	Driveway Traffic		1,003	17	46	63	49	34	83

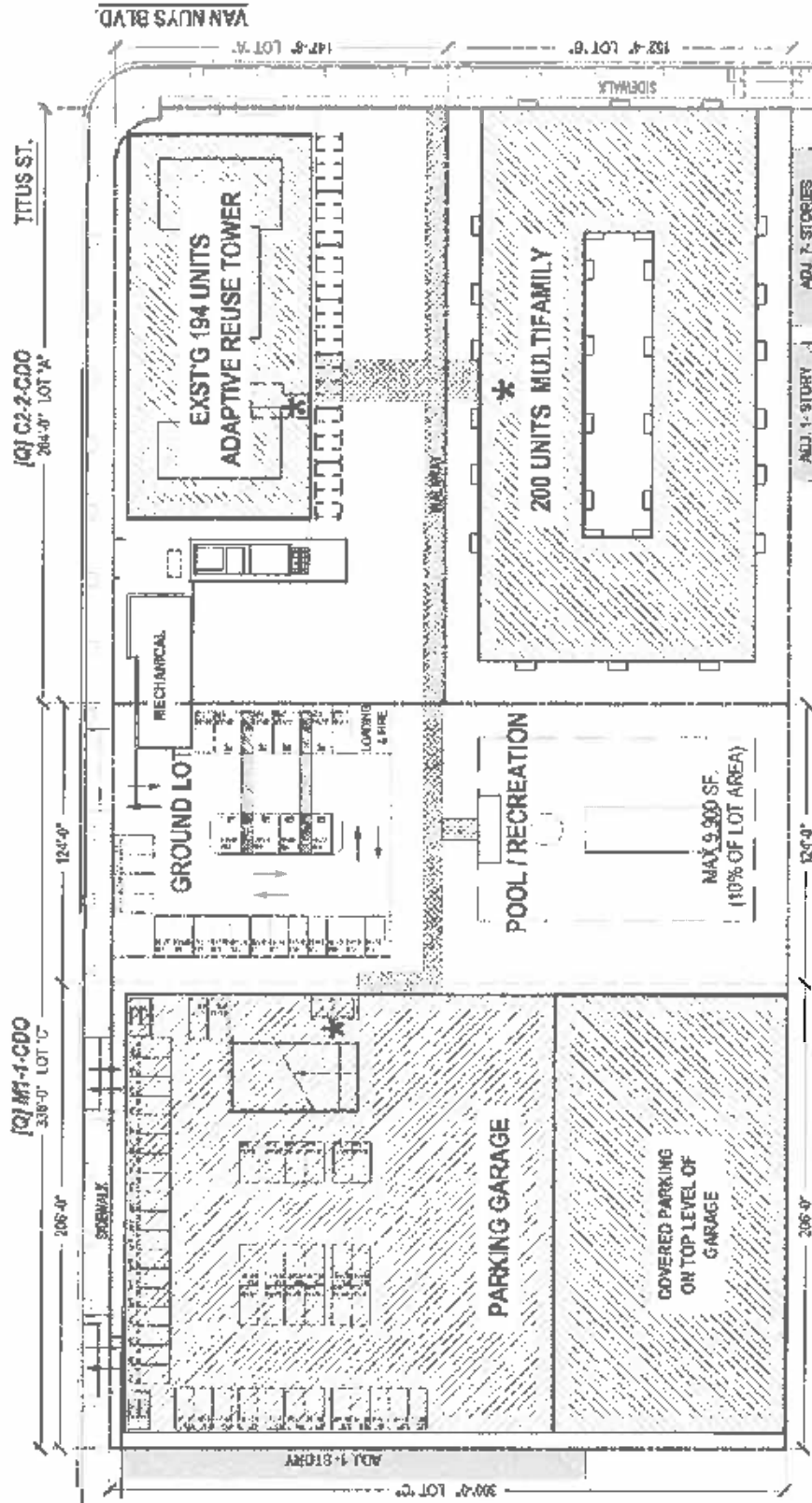

FIGURE 2a

4/2020

PROJECT SITE PLAN

 Overland Traffic Consultants, Inc.
 952 Manhattan Beach Bl, #100, Manhattan Beach, CA 90266
 (310) 545 - 1235, OTC@overlandtraffic.com

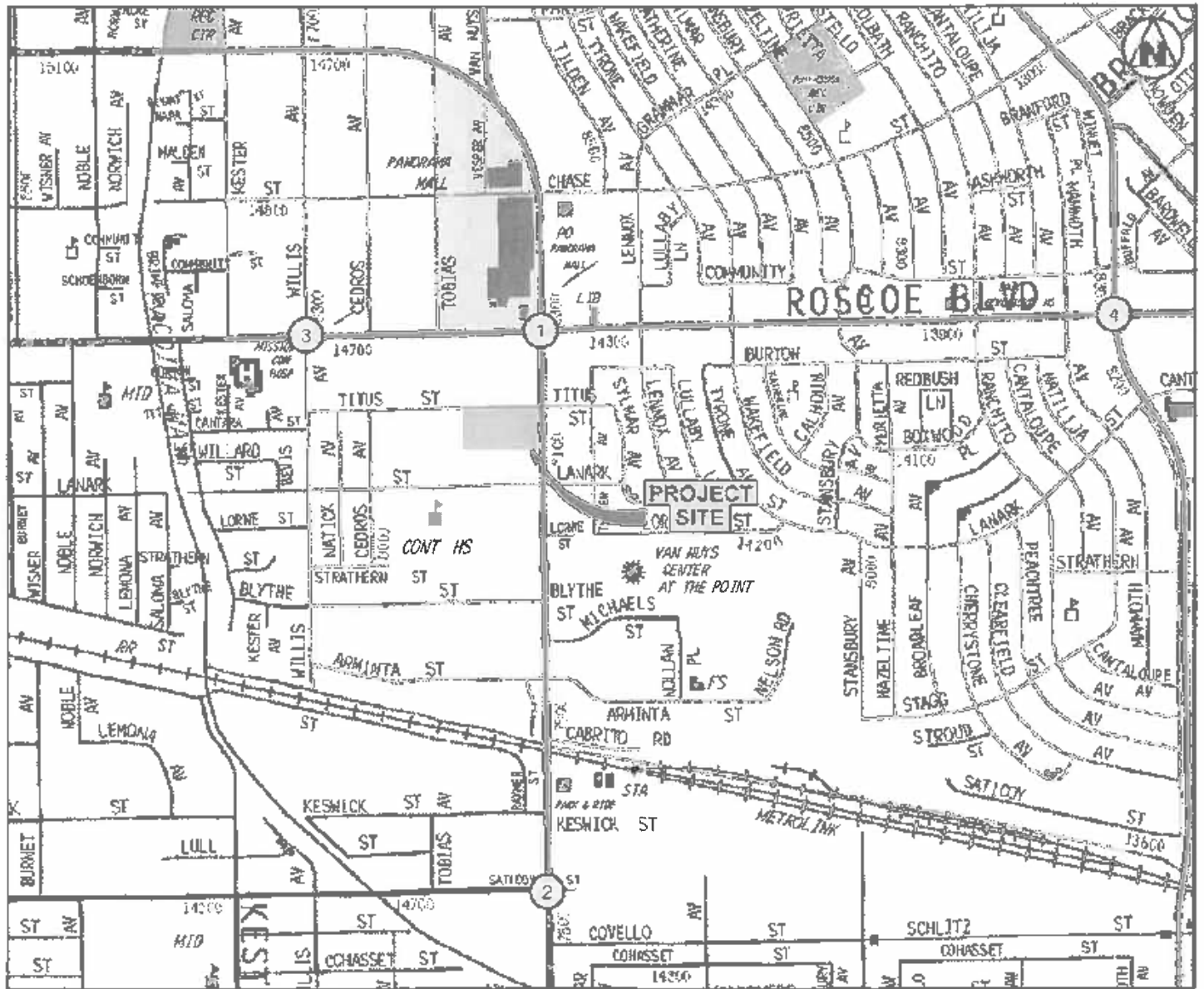
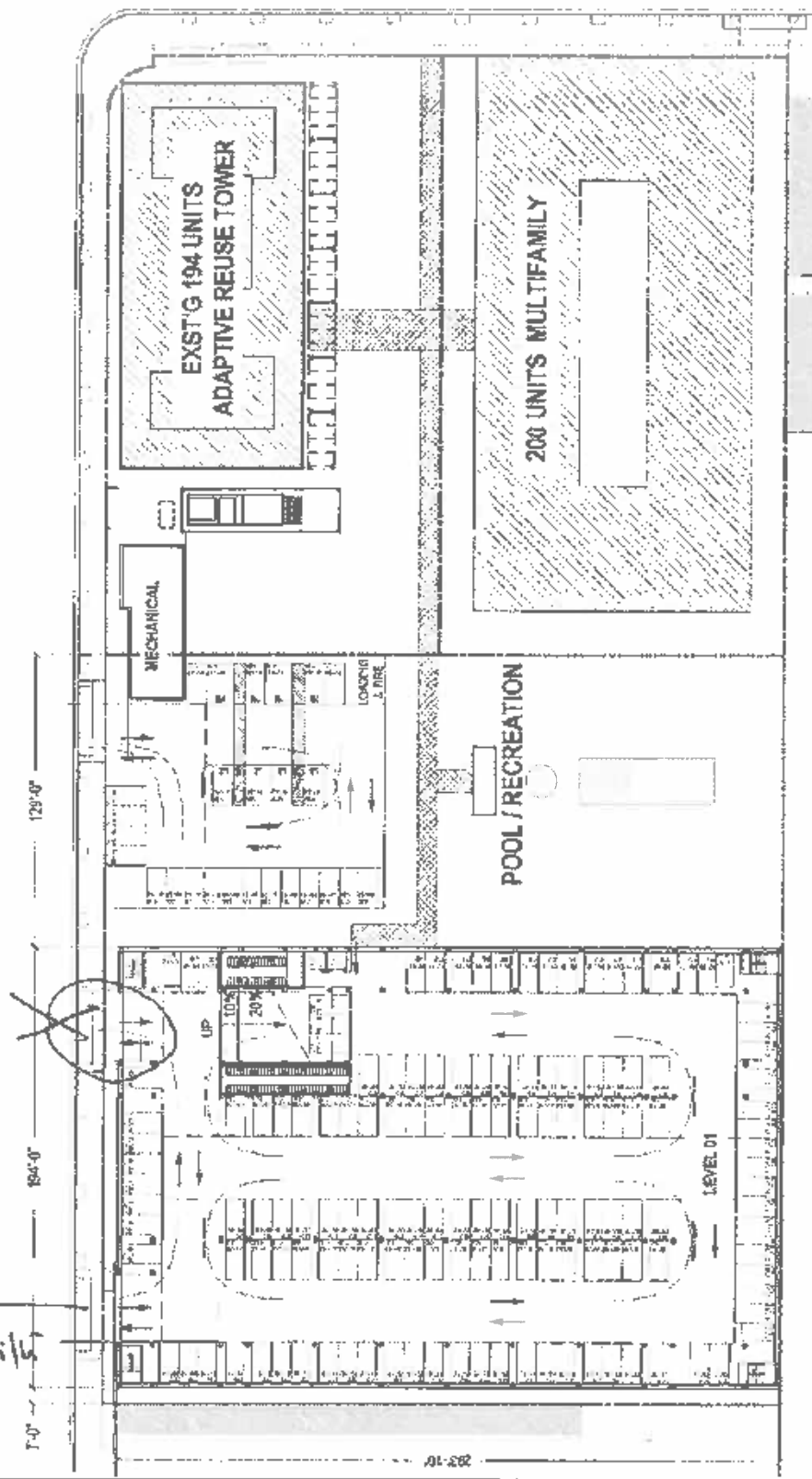

FIGURE 1

**PROJECT LOCATION AND
STUDY INTERSECTIONS**

 **Overland Traffic Consultants, Inc.**
 952 Manhattan Beach Bl, #100, Manhattan Beach, CA 90268
 (310) 545-1235, OTC@overlandtraffic.com



Pls Use one two-way driveway with internal circulation

FIGURE 2b

**PROJECT SITE PLAN
PARKING PLAN**

 **Overland Traffic Consultants, Inc.**
 952 Manhattan Beach Bl, #100, Manhattan Beach, CA 90266
 (310) 545 - 1235, OTC@overlandtraffic.com

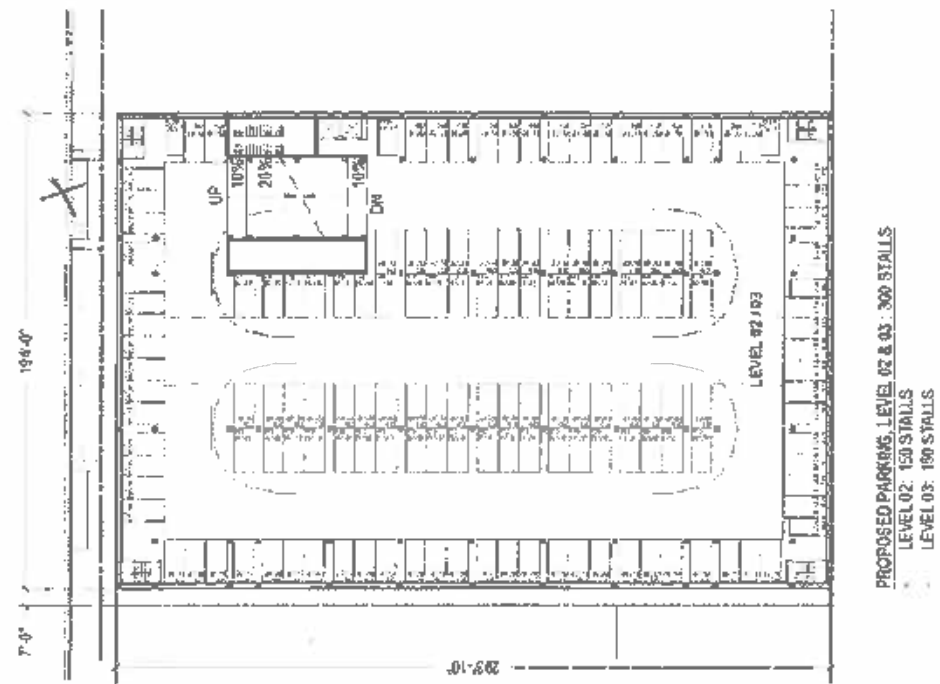
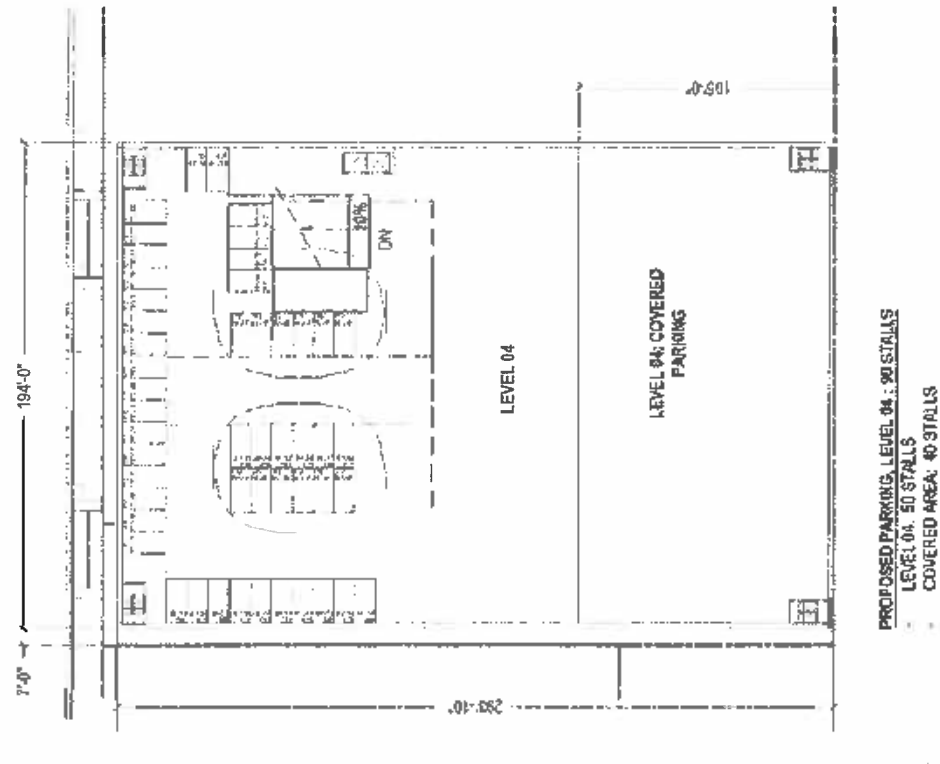

FIGURE 2c

4/2020

PROJECT SITE PLAN
GARAGE PARKING PLAN

 Overland Traffic Consultants, Inc.

952 Manhattan Beach Bl, #100, Manhattan Beach, CA 90266
(310) 545 - 1235, OTC@overlandtraffic.com

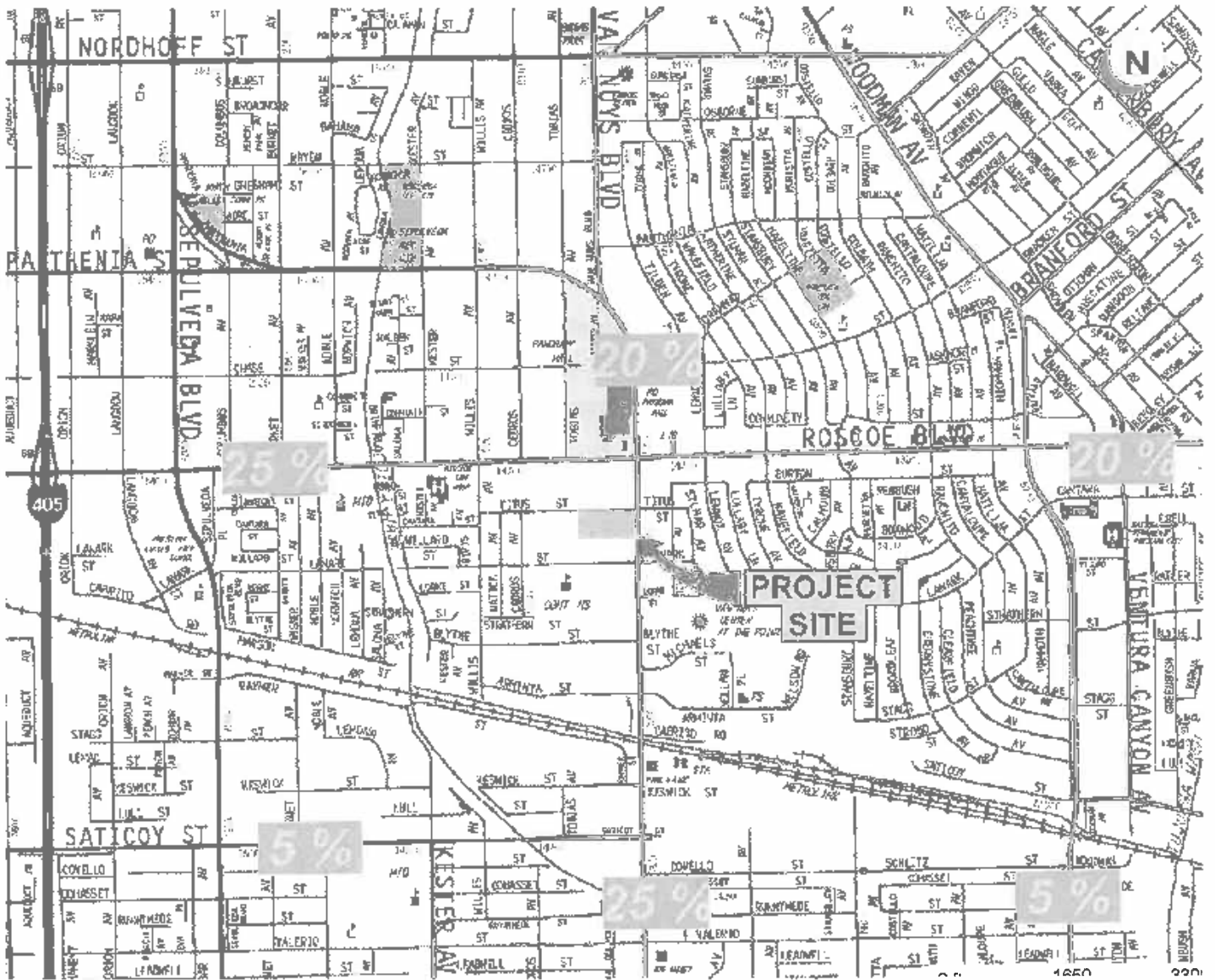

FIGURE 3

4/2020

PROJECT DISTRIBUTION PERCENTAGES

Overland Traffic Consultants, Inc.
 24325 Main Street #202, Santa Clarita, CA 91321
 (661) 799-8423, OTC@overlandtraffic.com

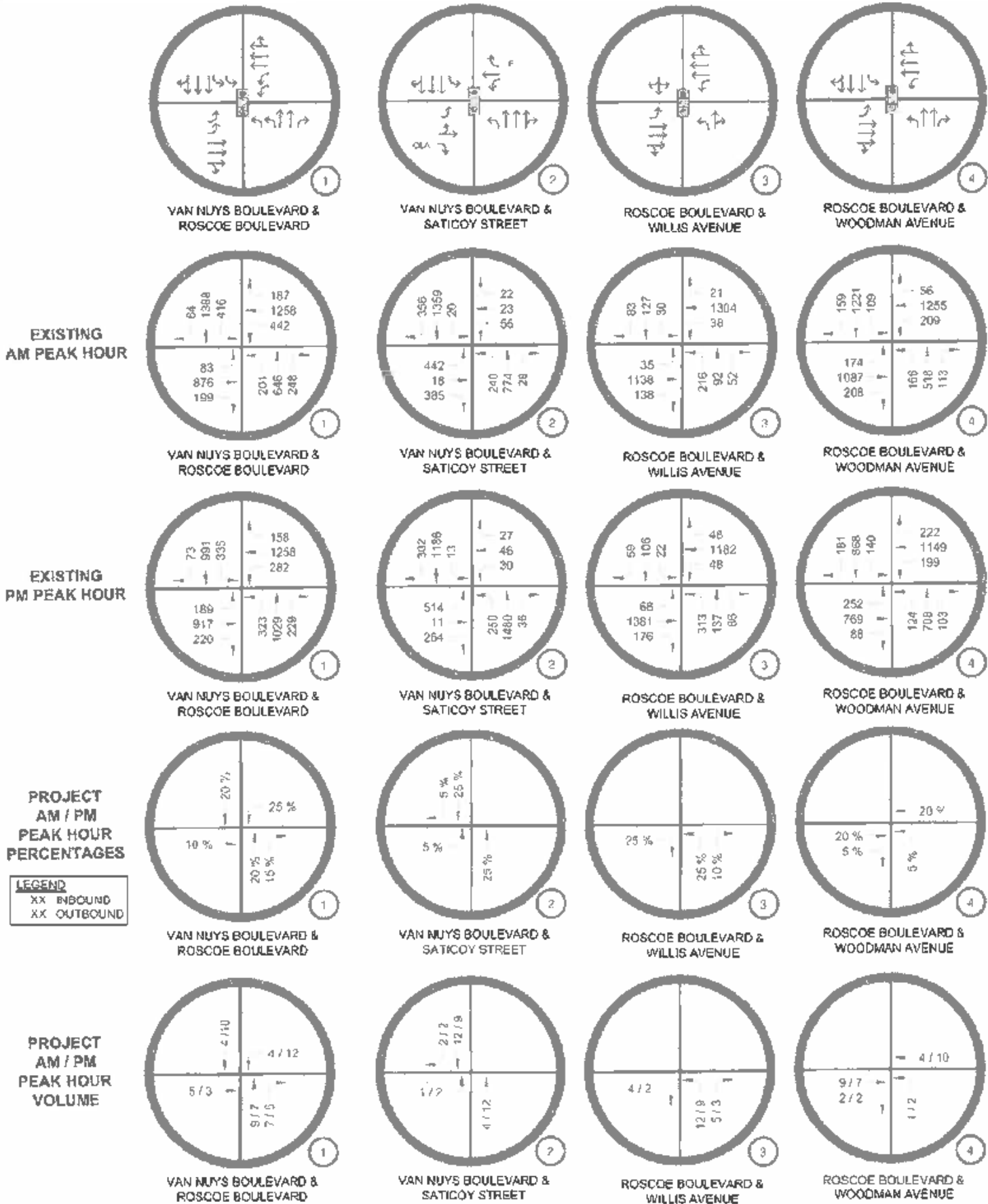

FIGURE 4

4/2020

INTERSECTION CHARACTERISTICS AND PROJECT ASSIGNMENT

Overland Traffic Consultants, Inc.
 24325 Main Street #202, Santa Clara, CA 91321
 (651) 799-8423, OTC@overlandtraffic.com

HIGH INJURY NETWORK



4/2020

HIGH INJURY NETWORK

Overland Traffic Consultants, Inc.
 952 Manhattan Beach Bl. #100, Manhattan Beach, CA 90266
 (310) 545 - 1235, OTC@overlandtraffic.com

CITY OF LOS ANGELES VMT CALCULATOR Version 1.2



Project Screening Criteria: Is this project required to conduct a vehicle miles traveled analysis?

Project Information

Project:

Scenario:

Address:



If the project is replacing an existing number of residential units with a smaller number of residential units, is the proposed project located within one-half mile of a fixed-rail or fixed-guideway transit station?

Yes No

Existing Land Use

Land Use Type: Value: Unit:

Land Use Type	Value	Unit
Housing Multi-Family		DU

Click here to add a single custom land use type (will be included in the above list)

Proposed Project Land Use

Land Use Type: Value: Unit:

Land Use Type	Value	Unit
Retail General Retail	2.45	ksf
Housing Multi-Family	200	DU
Retail General Retail	2.45	ksf

Click here to add a single custom land use type (will be included in the above list)

Project Screening Summary

Existing Land Use	Proposed Project
0 Daily Vehicle Trips	961 Daily Vehicle Trips
0 Daily VMT	6,750 Daily VMT

Tier 1 Screening Criteria

Project will have less residential units compared to existing residential units & is within one-half mile of a fixed-rail station.

Tier 2 Screening Criteria

The net increase in daily trips < 250 trips	961 Net Daily Trips
The net increase in daily VMT ≤ 0	6,750 Net Daily VMT
The proposed project consists of only retail land uses ≤ 50,000 square feet total.	2,450 ksf

The proposed project is required to perform VMT analysis.



CLATS

Case Logging and Tracking System

RELATED PROJECTS

Centroid info:
 Address:
 City/State:
 City/State:

Buffer Radius:

Record Count: 4 | Records Per Page:

ProjID Office Area CD Year Project Title Project Date Project Inactive In Related Project Do not show in Related Project

40148	SF	Valley	7	2012	Panorama Mall Expansion	03/13/2013	<input type="checkbox"/>	<input type="checkbox"/>	<input type="checkbox"/>	<input type="checkbox"/>	8401 VAN NUYS BL	03/13/2013	<input type="checkbox"/>	<input type="checkbox"/>	<input type="checkbox"/>	0.2
40938	SF	Valley	6	2013	Commercial space with retail, offices & parking facility	07/12/2013	<input type="checkbox"/>	<input type="checkbox"/>	<input type="checkbox"/>	<input type="checkbox"/>	2869 Van Nuys Bl	07/12/2013	<input type="checkbox"/>	<input type="checkbox"/>	<input type="checkbox"/>	0.4
46427	SF	Valley	6	2017	The KON of Panorama Apartments	10/05/2017	<input type="checkbox"/>	<input type="checkbox"/>	<input type="checkbox"/>	<input type="checkbox"/>	8155 VAN NUYS BLVD	10/05/2017	<input type="checkbox"/>	<input type="checkbox"/>	<input type="checkbox"/>	0.1
46427	SF	Valley	6	2017	The KON of Panorama	10/05/2017	<input type="checkbox"/>	<input type="checkbox"/>	<input type="checkbox"/>	<input type="checkbox"/>	14655 W ROSCOE BL	10/05/2017	<input type="checkbox"/>	<input type="checkbox"/>	<input type="checkbox"/>	0.3

Welcome durre2 | Log Out | Profile | Admin

Include NPL: Trip info:
 Include NPL: First Study Submittal Date:
 Include "inacting" projects:
 Include "Do not show in Related Project":
 Net Amt. Trips:
 Net PM Trips:
 Net Daily Trips:

Results generated from: 08/29/2020 12:00 PM

Land Use	Unit ID	Use	Net Amt. Trips	Net PM Trips	Net Daily Trips	Net Amt. Trips	Net PM Trips	Net Daily Trips	Net Amt. Trips	Net PM Trips	Net Daily Trips	Net Amt. Trips	Net PM Trips	Net Daily Trips
Res	48738	48738	26	159	2797	26	159	2797	26	159	2797	26	159	2797
Land Use	Unit ID	Use	Net Amt. Trips	Net PM Trips	Net Daily Trips	Net Amt. Trips	Net PM Trips	Net Daily Trips	Net Amt. Trips	Net PM Trips	Net Daily Trips	Net Amt. Trips	Net PM Trips	Net Daily Trips
Office Use	58	58	118	1089	35	118	1089	35	118	1089	35	118	1089	35
Land Use	Unit ID	Use	Net Amt. Trips	Net PM Trips	Net Daily Trips	Net Amt. Trips	Net PM Trips	Net Daily Trips	Net Amt. Trips	Net PM Trips	Net Daily Trips	Net Amt. Trips	Net PM Trips	Net Daily Trips
Apartment	180	180	112	1197	18	112	1197	18	112	1197	18	112	1197	18
Res	46427	46427	27	499	32	27	499	32	27	499	32	27	499	32
Office Use	111	111	111	804	18	111	804	18	111	804	18	111	804	18
Land Use	Unit ID	Use	Net Amt. Trips	Net PM Trips	Net Daily Trips	Net Amt. Trips	Net PM Trips	Net Daily Trips	Net Amt. Trips	Net PM Trips	Net Daily Trips	Net Amt. Trips	Net PM Trips	Net Daily Trips
Office Use	462	462	562	7996	185	562	7996	185	562	7996	185	562	7996	185
Office Use	462	462	562	7996	185	562	7996	185	562	7996	185	562	7996	185

APPENDIX B

SCREENING CRITERIA

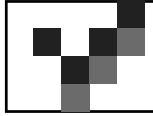

TAG SCREENING CRITERIA	
<p>If the development project requires a discretionary action, and the answer is yes to any of the following threshold questions, further analysis will be required for that question to assess whether the proposed Project would negatively affect the transportation system for all travel modes including pedestrian, bicycle, or transit facilities.</p>	
Screening Criteria	Determination
Threshold T-1 Conflicting with Plans, Programs, Ordinances, or Policies	
<p>Would the Project generate a net increase of 250 or more daily vehicle trips?</p>	<p>Yes, using the LADOT VMT calculator (version 1.2) for screening purposes, the Project will generate a net increase of 990 more daily vehicle trips without any Transportation Demand Management (TDM) strategies. TDM strategies are not considered in the screening criteria.</p>
<p>Is the Project proposing to, or required to, make any voluntary or required, modifications to the public right-of-way (i.e. street dedications, reconfigurations of curb lines, etc.)?</p>	<p>No, pursuant to the Mobility Element street standards, the portion of Van Nuys Boulevard south of Roscoe Boulevard is designated and Boulevard II roadway which requires an 80-foot roadway on 110 feet of right-of-way (40-foot half roadway and 55-foot half right-of-way). Van Nuys Boulevard is currently developed to a 40-foot half roadway and 50-foot half right-of-way.</p>
Threshold T-2.1 Causing Substantial Vehicle Miles Traveled – Would the project conflict or would it be inconsistent with California Environmental Quality Act (CEQA) Guidelines section 15064.3 subdivision (b)(1)?	
<p>Would the Project generate a net increase of 250 or more daily vehicle trips?</p>	<p>Yes, using the LADOT VMT calculator (version 1.2) for screening purposes, the Project will generate a net increase of 990 more daily vehicle trips without any Transportation Demand Management (TDM) strategies. TDM strategies are not considered in the screening criteria.</p>
<p>Would the project generate a net increase in daily VMT?</p>	<p>Yes, using the LADOT VMT calculator, the Project would generate 7002 daily VMT. TDM strategies are not considered in the screening criteria.</p>

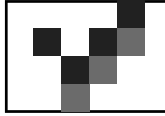

<p>Would the Project located within a one-half mile of a fixed-rail or fixed-guideway transit station replace an existing number of residential units with a smaller number of residential units?</p>	<p>No, the location of the Project is within a half mile of a future fixed rail transit station at Van Nuys Boulevard and Roscoe Boulevard. Furthermore, the Project will not replace residential units with a smaller number of residential units, the Project will remove existing commercial uses and add 124 residential units.</p>
<p align="center">Threshold T- 3.1: Substantially Increasing Hazards Due to a Geometric Design Feature or Incompatible Use</p>	
<p>Is the Project proposing new driveways, or introducing new vehicle access to the property from the public right-of-way?</p>	<p>No, the project is proposing to remove 2 driveways on Van Nuys Boulevard and reuse 2 driveways on Titus Street.</p>
<p>Is the Project proposing to, or required to make any voluntary or required, modifications to the public right-of-way (i.e., street dedications, reconfigurations of curb line, etc.)?</p>	<p>Yes, pursuant to the Mobility Element street standards, the portion of Van Nuys Boulevard south of Roscoe Boulevard is designated and Boulevard II roadway which requires an 80-foot roadway on 110 feet of right-of-way (40-foot half roadway and 55-foot half right-of-way). Van Nuys Boulevard is currently developed to a 40-foot half roadway and 50-foot half right-of-way.</p>
<p align="center">Pedestrian, Bicycle and Transit Access Assessment (Non-CEQA Transportation Analysis)</p>	
<p>Would the Project generate a net increase of 250 or more daily vehicle trips?</p>	<p>Yes, using the LADOT VMT calculator (version 1.2) for screening purposes, the Project will generate a net increase of 990 more daily vehicle trips without any Transportation Demand Management (TDM) strategies. TDM strategies are not considered in the screening criteria.</p>
<p>Does the land use project include the construction, 50 dwelling units or guest rooms or combination thereof or 50,000 square feet of non-residential space?</p>	<p>Yes, the Project includes demolition of the existing structures and the construction of a five-story mixed-use building with 200 residential apartments and approximately 2,450 square feet of commercial retail and 18,928 square feet of private warehouse floor area.</p>

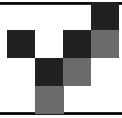

<p>Is the Project on a lot that is ½ acre or more in total gross area, or is the Project’s frontage along a street classified as an Avenue or Boulevard (as designated in the Mobility Plan 2035) 250 linear feet or more, or is the Project’s frontage encompassing an entire block along an Avenue or Boulevard (as designated in the Mobility Plan 2035)?</p>	<p>Yes, the Project Site is approximately 4.13 acres (179,975 square feet). The portion of Van Nuys Boulevard adjacent to the Project Site is designated a Boulevard II roadway. The Project’s Van Nuys Boulevard frontage is approximately 300 feet in length.</p>
<p>Project Access, Safety and Circulation Evaluation (Non-CEQA Transportation Analysis)</p>	
<p>Does the land use project involve a discretionary action that would be under review by the Department of Planning?</p>	<p>Yes, Project will require the approval of Site plan Review (SPR), is located within the Panorama City Community Design Overlay District (CDO) and within the State Enterprise Zone.</p>
<p>Would the Project generate a net increase of 250 or more daily vehicle trips?</p>	<p>Yes, using the LADOT VMT calculator (version 1.2) for screening purposes, the Project will generate a net increase of 990 more daily vehicle trips without any Transportation Demand Management (TDM) strategies. TDM strategies are not considered in the screening criteria.</p>



APPENDIX C

PLANS, PROGRAMS, ORDINANCES AND POLICY CONSISTENCY

Threshold Question T-1



TAG ATTACHMENT D - CITY PLAN, POLICIES AND GUIDELINES

The Transportation Element of the City’s General Plan, Mobility Plan 2035, established the “Complete Streets Design Guide” as the City’s document to guide the operations and design of streets and other public rights-of-way. It lays out a vision for designing safer, more vibrant streets that are accessible to people, no matter what their mode choice. As a living document, it is intended to be frequently updated as City departments identify and implement street standards and experiment with different configurations to promote complete streets. The guide is meant to be a toolkit that provides numerous examples of what is possible in the public right-of-way and provide guidance on context-sensitive design.

The Plan for A Healthy Los Angeles (March 2015) includes policies directing several City departments to develop plans that promote active transportation and safety.

The City of Los Angeles Community Plans, which make up the Land Use Element of the City’s General Plan, guide the physical development of neighborhoods by establishing the goals and policies for land use. The 35 Community Plans provide specific, neighborhood-level detail for land uses and the transportation network, relevant policies, and implementation strategies necessary to achieve General Plan and community-specific objectives.

The stated goal of Vision Zero is to eliminate traffic-related deaths in Los Angeles by 2025 through several strategies, including modifying the design of streets to increase the safety of vulnerable road users. Extensive crash data analysis is conducted on an ongoing basis to prioritize intersections and corridors for implementation of projects that will have the greatest effect on overall fatality reduction. The City designs and deploys Vision Zero Corridor Plans as part of the implementation of Vision Zero. If a project is proposed whose site lies on the High Injury Network (HIN), the applicant should consult with LADOT to inform the project’s site plan and to determine appropriate improvements, whether by funding their implementation in full or by making a contribution toward their implementation.



The Citywide Design Guidelines for Residential, Commercial and Industrial Development (November 1, 2016) includes sections relevant to development projects where improvements are proposed within the public realm. Specifically, Section 3 addresses sidewalks, crosswalks, and on-street parking and Section 4 addresses off-street parking, driveways and loading facilities. That section of the checklist(s) for specific types of development should be reviewed by LADOT and LADCP to assess the consistency of a proposed project with those plans.

The Walkability Checklist: Guidance for Entitlement Review (November 2008) provides a list of recommended strategies that projects should employ to improve the pedestrian environment in the public right-of-way and on private property. Specific topics covered in the Walkability Checklist include sidewalks, crosswalks, on-street parking, and off-street parking. Each of the implementation strategies on the Checklist should be considered in a proposed project, although not all will be appropriate in every proposed project. LADCP staff will use the Checklist in evaluating entitlement applications. In making a finding of conformance with the policies and objectives of the General Plan, LADCP staff weighs the project's walkability against the adopted objectives listed in the Appendix to this Checklist and additional objectives and policies contained in Community Plans.

The City's Transportation Demand Management (TDM) Ordinance (LA Municipal Code 12.26.J) requires certain projects to incorporate strategies that reduce drive-alone vehicle trips and improve access to destinations and services. The ordinance is revised and updated periodically and should be reviewed for application to specific projects as they are reviewed.

The City's LAMC Section 12.37 (Waivers of Dedication and Improvement) requires certain projects to dedicate and/or implement improvements within the public right-of-way to meet the street designation standards of the Mobility Plan 2035.



TAG Table 2.1-2 Questions to Determine Project Applicability to Plans, Policies and Programs

1.	Does the Project include additions or new construction along a street designated as a Boulevard I, II and/or Avenue I, II or III on property zoned for R3 or less restrictive zone?	LAMC Section 12.37 Highway and Collector Street Dedication and Improvement		Yes, the Project does include construction along Van Nuys Boulevard (Boulevard II street). The Project is split-zoned [Q] C2-2-CDO and [Q] M1-1-CDO Regional commercial. Source: Zimas
2.	Is Project Site along any network identified in the City's Mobility Plan?	MP 2.3 through 2.7		Yes, Van Nuys Boulevard is part of the PED, TEN & BEN Networks.
		MP 2.3 Pedestrian Infrastructure (Map F)		Van Nuys Boulevard is identified as a pedestrian segment street. The Project has been designed to improve the continuity of the pedestrian sidewalk by eliminate 2 existing driveways. Providing a safer walkable sidewalk on this portion of Van Nuys Boulevard.
		MP 2.4 Neighborhood Enhanced Network (Map C4)		Van Nuys Boulevard is not identified on the neighborhood network. Willis Avenue south of Chase Street is part of the Neighborhood Network. The Project is not proposing any changes along these streets that would prevent the City from installing additional features as part of the NEN, nor does the Project propose to modify any streets that would increase travel speeds on the neighborhood network.
		MP 2.5 Transit Network (Map B)		The Project is located adjacent to the Van Nuys rail line. The Project does not propose to remove or modify transit facilities in a manner that would negatively impact the reliability of existing transit service.
		MP 2.6 Bicycle Network (Map D2)		Van Nuys Boulevard is designated a Tier 1 bicycle lane street. Project development would not preclude development of the bike lanes envisioned in Mobility Plan 2035.
		MP 2.7 Vehicle Network (Map E)		Van Nuys Boulevard is not identified as a vehicle enhanced street. The Project would not conflict with the street designations and for any roadways identified in Mobility Plan 2035.
3.	Are dedications or improvements needed to serve long-term mobility needs identified in the Mobility Plan 2035?	MP - Street Classifications; MP- Street Designations & Standard Roadway Dimensions	MP - 2.17 Street Widening	Yes, Van Nuys Boulevard is constructed to the Boulevard II street standard. A 5-foot dedication but no roadway improvements are needed on Van Nuys Boulevard.
4.	Does the Project require placement of transit furniture in accordance with City's Coordinated Street Furniture and Bus Bench Program?			No
5.	Is Project Site in an identified Transit Oriented Community (TOC)?	MP - TEN; MP - PED; MP - BEN; TOC Guidelines		Yes, the Project Site qualifies for Tier 2 TOC incentives. The Project, however, is not seeking any Density Bonus or TOC incentives.
6.	Is Project Site on a roadway identified in City's High Injury Network?	Vision Zero	Mobility Plan 2035	Yes, Van Nuys Boulevard is identified as part of the HIN. However, no Vision Zero projects are currently listed for this segment of Van Nuys Boulevard. The Project would not prevent any future Vision zero project.
7..	Does Project propose repurposing existing curb space? (Bike corral, car-sharing, parklet, electric vehicle charging, loading zone, curb extension, etc.)	MP - 2.1 Adaptive Reuse of Streets; MP - 2.10 Loading Areas; MP - 3.5 Multi-Modal Features; MP - 3.8 Bicycle Parking; MP - 4.13 Parking & Land Use Management; MP - 5.4 Clean Fuels & Vehicles	MP - 2.3 Pedestrian Infrastructure; MP - 2.4 Neighborhood Enhanced Network; MP - 3.2 People with Disabilities; MP -4.1 New Technologies; MP 5.1 Substantial Transportation; MP - 5.5 Green Streets	No



9..	Does Project propose paving, narrowing, shifting, or removing an existing parkway?	MP - 5.5 Green Streets; Sustainability Plan		No
10..	Does Project propose modifying, removing or otherwise affect existing bicycle infrastructure? (ex: driveway proposed along street with bicycle facility)	MP- BEN; MP - 4.15 Public Hearing Process	Vision Zero	No, the Project does not propose new driveways on Van Nuys Boulevard, a future Tier 1 bike lane street.
11.	Is Project Site adjacent to an alley? If yes, will Project make use of, modify, or restrict alley access?	MP - 3.9 Increased Network Access; MP - ENG.9; MP - PL.1; MP - PL.13; MP - PS.3		No, the Project will use adjacent local street for vehicular access.
12.	Does Project create a cul-de-sac or is project site located adjacent to existing cul-de-sac? If yes, is cul-de-sac consistent with design goal in Mobility Plan 2035 (maintain through bicycle and pedestrian access)?	MP - 3.10 Cul-de-sacs		No, Not applicable
ACCESS: DRIVEWAYS AND LOADING				
13.	Does Project site introduce a new driveway or loading access along an arterial (Avenue or Boulevard)?	MO - PL.1; MP - PK.10, CDG 4.1.02	Vision Zero	No
14.	If yes to 13, Is a non-arterial frontage or alley access available to serve the driveway or loading access needs?	MP - PL.1; MPP 321	Vision Zero	Not applicable
15.	Does Project Site include a corner lot? (avoid driveways too close to intersections)	CDG 4.1.01		No
16.	Does Project propose driveway width more than City standard?	MPP Sec. 321	Vision Zero; Sustainability Plan, MP - PED, MP - BEN; CDG 4.1.04	No
17.	Does Project propose more driveways than permitted by the City maximum standard?	MPP - Sec No. 321 Driveway Design	Vision Zero; Healthy LA	No
18.	Are loading zones proposed as part of the Project?	MP - 2.1 Loading Areas; MP - PK.1; MP - PK.7; MP - PK.8; MPP 321		No, all loading & unloading will be provided on-site.
19.	Does Project include "drop-off" zones or areas? If yes, are such areas located to the side or rear of the buildings?	MP - 2.10 Loading Areas		No
20.	Does Project propose modifying, limiting/restricting, or removing public access to a public right-of-way (e.g. vacating public right-of-way?)	MP - 2.3 Pedestrian Infrastructure; MP - 3.9 Increased Network Access		No



APPENDIX D

COMMUNITY PLAN LAND USE MAPS

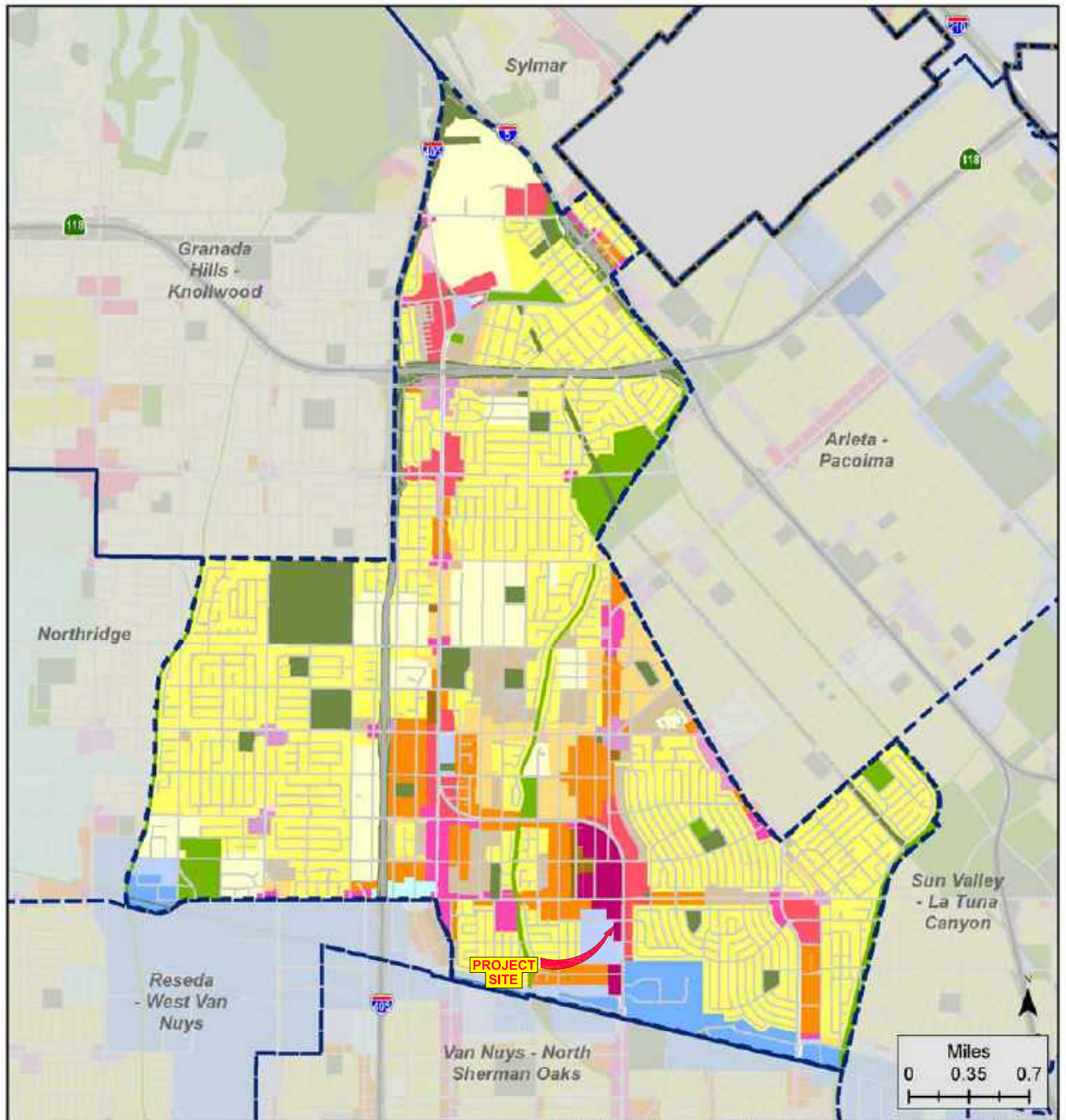

Copyright June 2019 City of Los Angeles. All Rights Reserved. Source: General Plan, IOP June 2019, Street, Freeway, TSM, Copyright 2014

General Plan Land Use

Mission Hills - Panorama City - North Hills Community Plan Area

City Boundary	Low I	Limited Commercial	Regional Commercial	Open Space
Community Plan Boundary	Low Medium I	General Commercial	Commercial Manufacturing	Public Facilities
Very Low	Low Medium II	Community Commercial	Light Manufacturing	Public Facilities - Freeways
Very Low I	Medium	Neighborhood Commercial	Limited Industrial	
Low	High Medium	Neighborhood Office Commercial	Limited Manufacturing	



5/2020

COMMUNITY PLAN LAND USE MAP

Overland Traffic Consultants, Inc.
 952 Manhattan Beach Bl, #100, Manhattan Beach, CA 90266
 (310) 545 - 1235, OTC@overlandtraffic.com



APPENDIX E

STREET STANDARDS, CIRCULATION AND HIGH INJURY NETWORK MAP

MISSION HILLS - PANORAMA CITY - NORTH HILLS CIRCULATION

Legend

- Boulevard II
- Boulevard II Divided
- Boulevard II Divided Scenic
- Avenue I
- Avenue I Scenic
- Avenue II
- Avenue II Divided
- - - - Avenue II Proposed
- Avenue II Scenic
- Avenue III
- Collector
- Local
- Private Street
- Community Plan Area Boundary

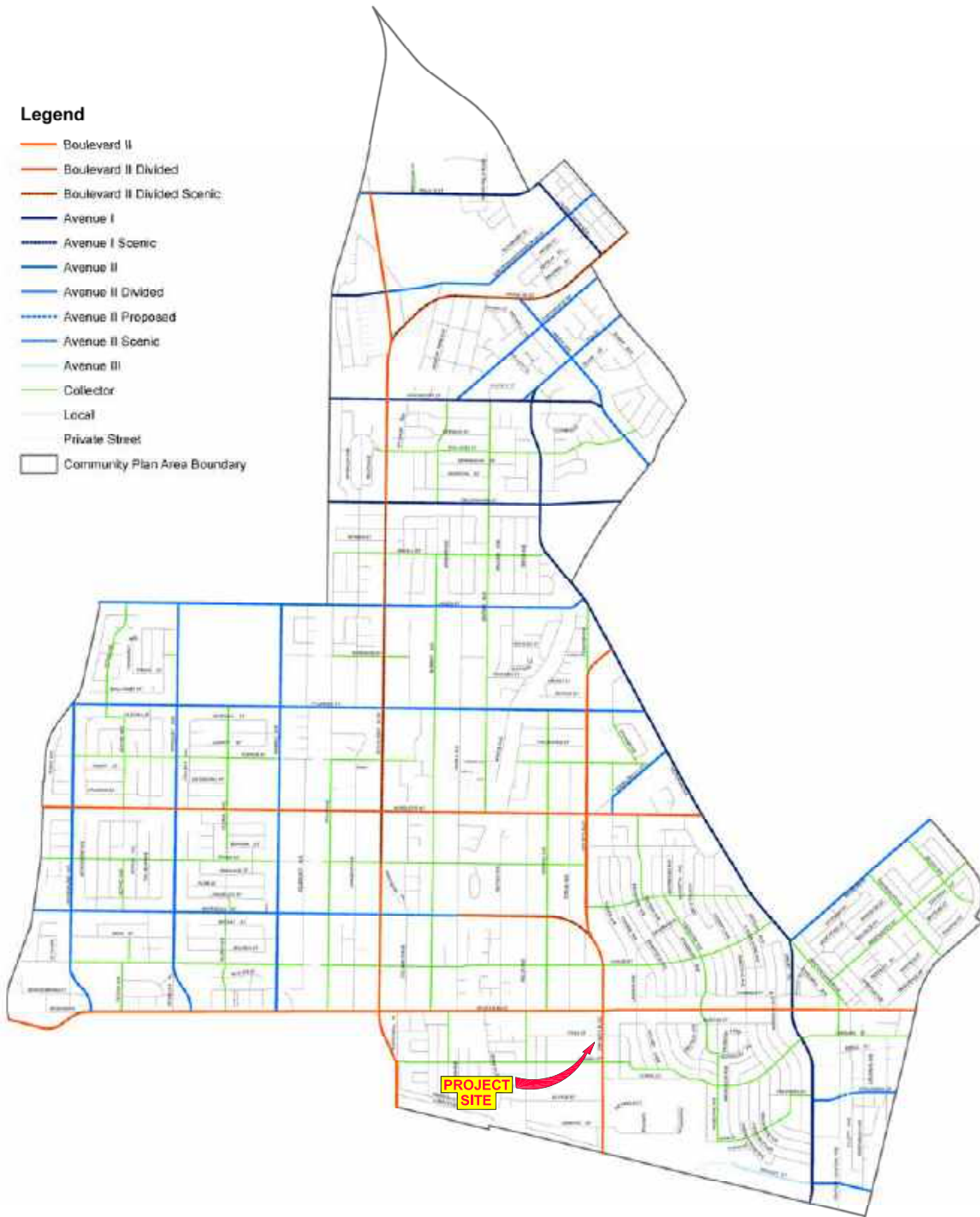

Date: 2/6/2017
DEPARTMENT OF CITY PLANNING
INFORMATION TECHNOLOGIES DIVISION

Disclaimer:
The City of Los Angeles is not responsible for errors or omissions in this report or the results obtained therefrom. The user of this report is responsible for the accuracy of the data and the interpretation of the results. The City of Los Angeles is not responsible for any special, indirect, incidental or consequential damages that result from the use of the information in this report. The user of this report is responsible for the accuracy of the data and the interpretation of the results.



5/2020

COMMUNITY PLAN CIRCULATION MAP



Overland Traffic Consultants, Inc.

952 Manhattan Beach Bl, #100, Manhattan Beach, CA 90266
(310) 545 - 1235, OTC@overlandtraffic.com

ARTERIAL STREETS

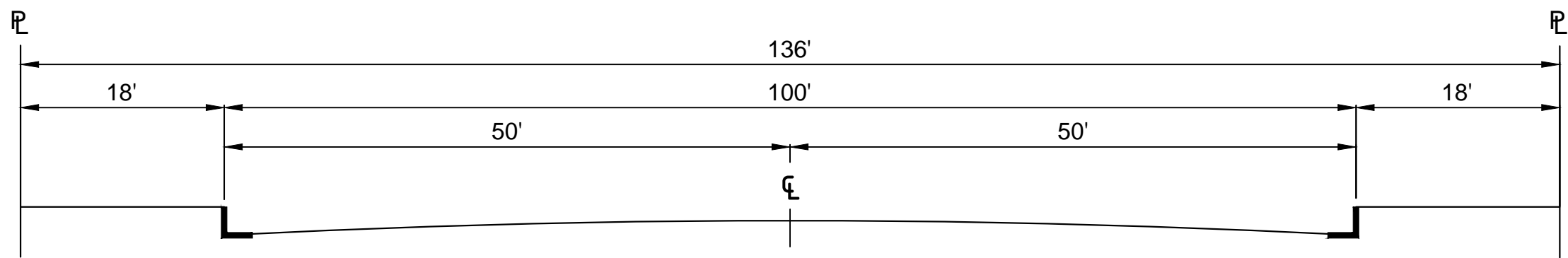

BOULEVARD I (MAJOR HIGHWAY CLASS I)

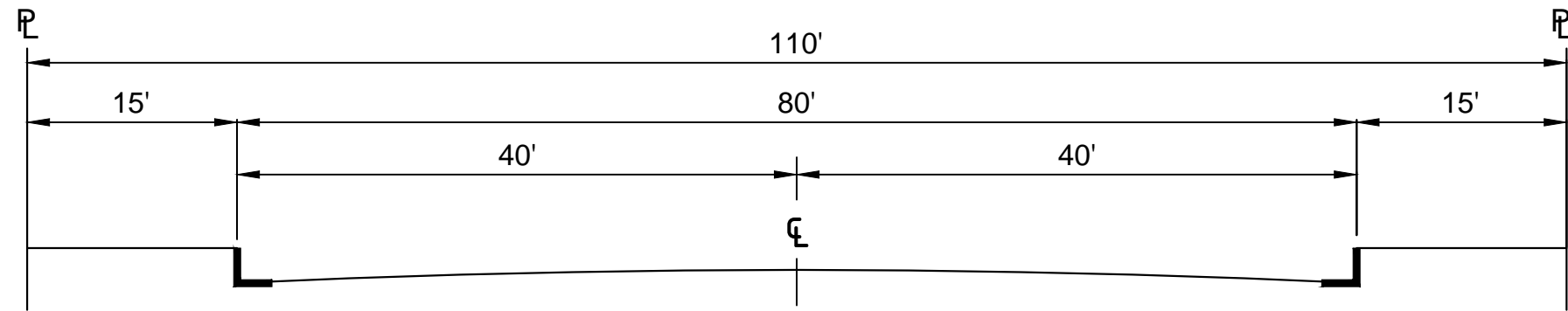

BOULEVARD II (MAJOR HIGHWAY CLASS II)

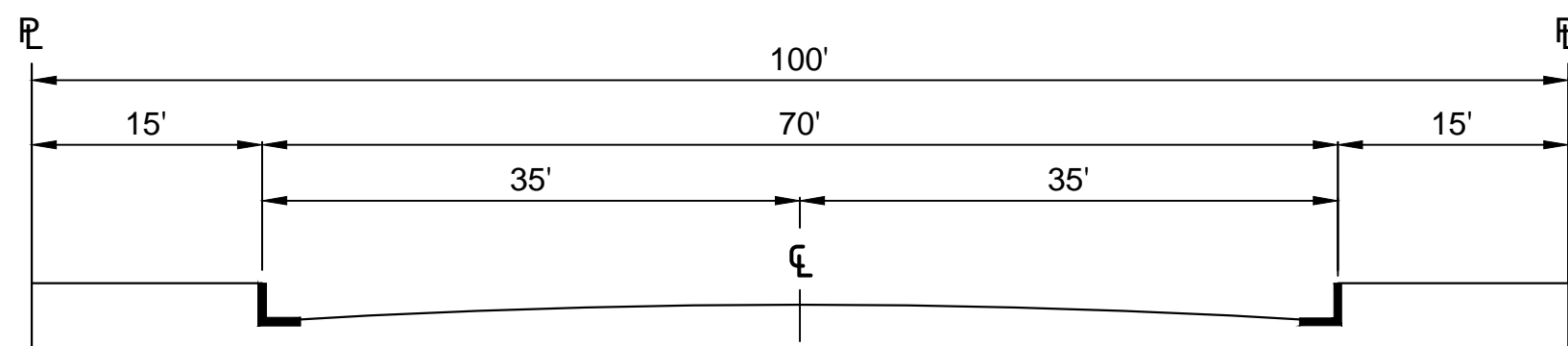

AVENUE I (SECONDARY HIGHWAY)

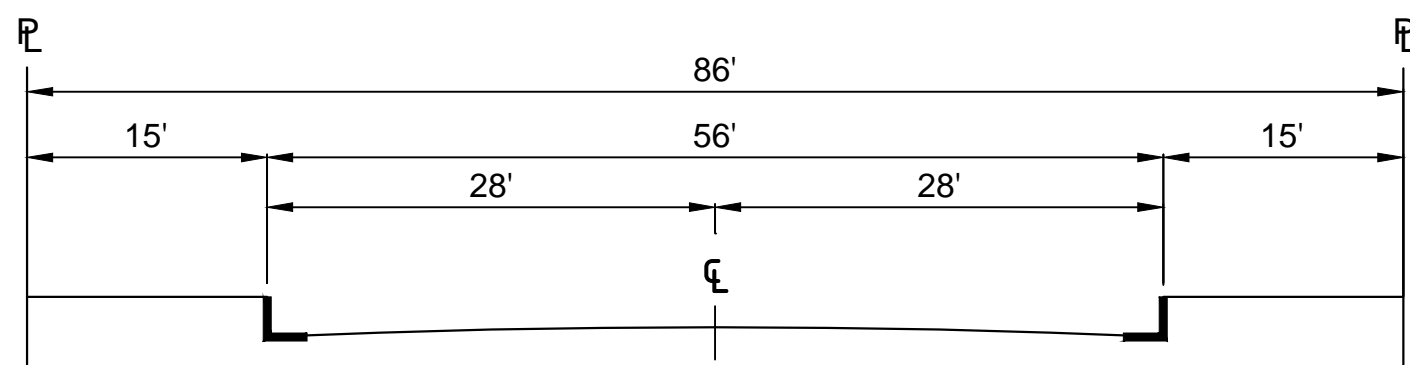

AVENUE II (SECONDARY HIGHWAY)

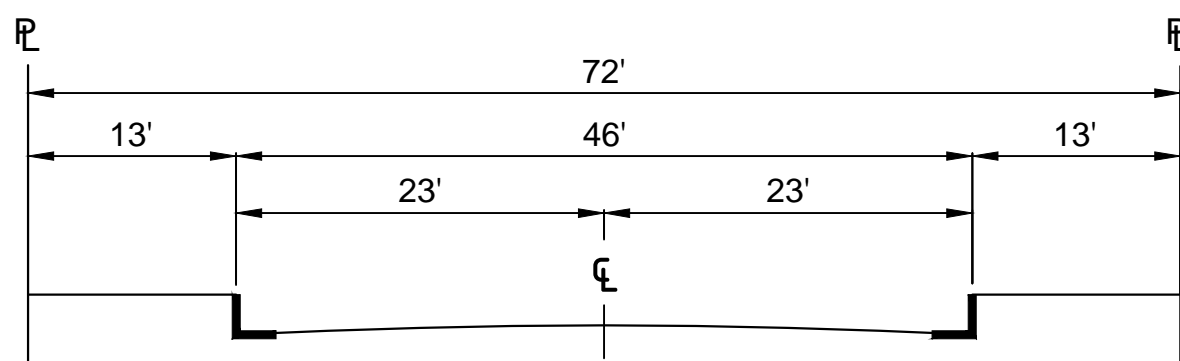

AVENUE III (SECONDARY HIGHWAY)

THIS STANDARD PLAN BECOMES EFFECTIVE CONCURRENT WITH THE ADOPTION OF THE MOBILITY PLAN 2035.

BUREAU OF ENGINEERING		DEPARTMENT OF PUBLIC WORKS		CITY OF LOS ANGELES		
--- DRAFT --- STANDARD STREET DIMENSIONS				STANDARD PLAN S-470-1		
PREPARED HAMID MADANI, P.E. BUREAU OF ENGINEERING	SUBMITTED SAMARA ALI-AHMAD, P.E. DATE ENGINEER OF DESIGN BUREAU OF ENGINEERING	APPROVED GARY LEE MOORE, P.E., ENV. SP. DATE CITY ENGINEER		SUPERSEDES D-22549 S-470-0	REFERENCES	
CHECKED RAFFI MASSABKI, P.E. BUREAU OF ENGINEERING	KENNETH REDD, P.E. DATE DEPUTY CITY ENGINEER	DEPARTMENT OF TRANSPORTATION DATE GENERAL MANAGER		VAULT INDEX NUMBER:		
				SHEET 1 OF 4 SHEETS		

NON-ARTERIAL STREETS

HILLSIDE STREETS

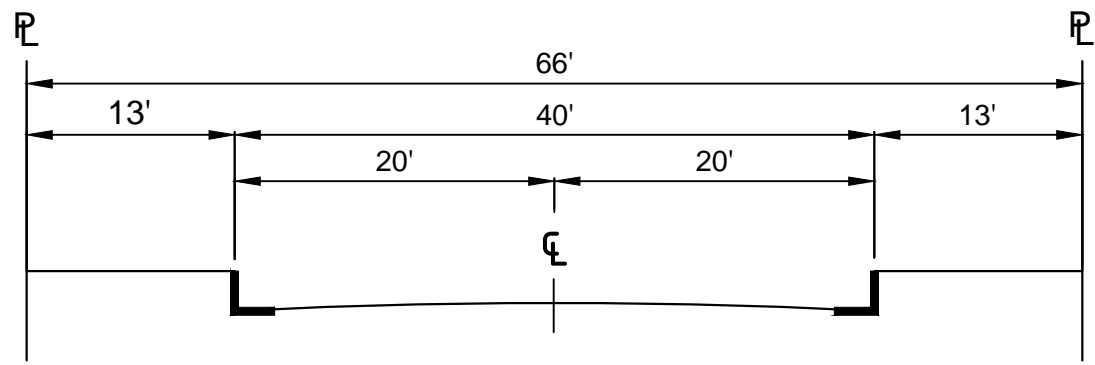

COLLECTOR STREET

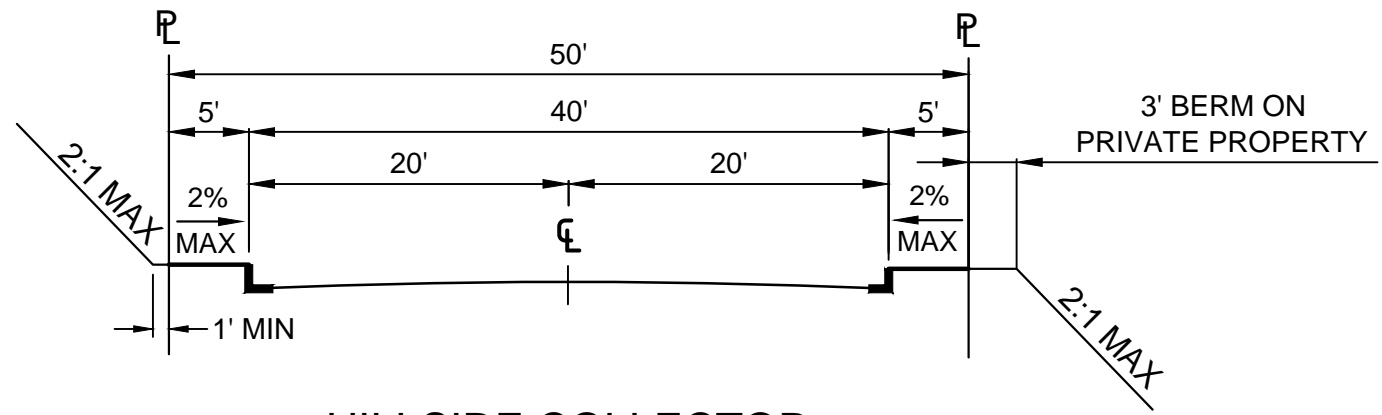

HILLSIDE COLLECTOR

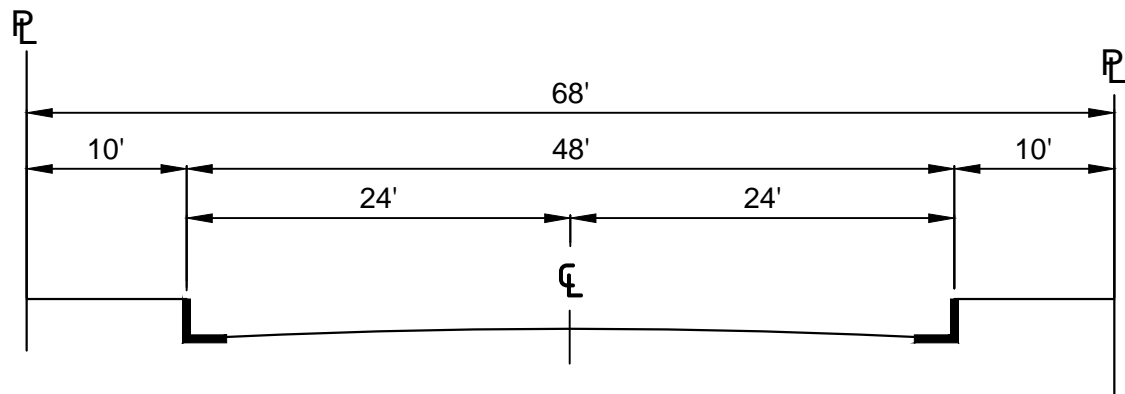

INDUSTRIAL COLLECTOR STREET

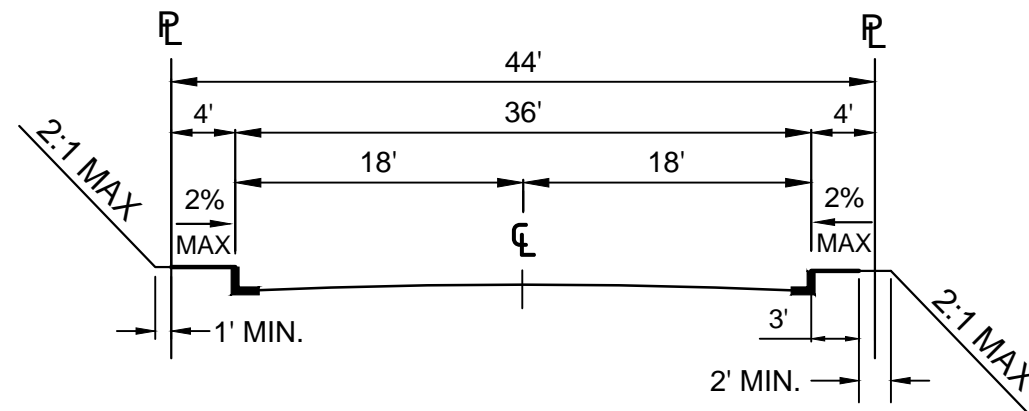

HILLSIDE LOCAL

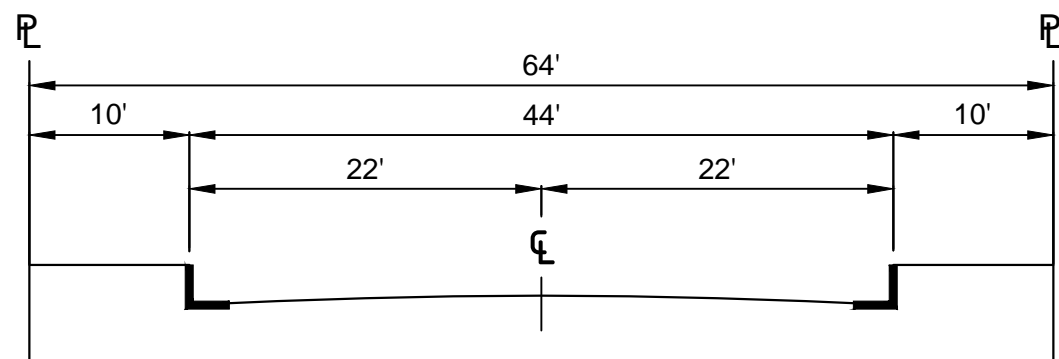

INDUSTRIAL LOCAL STREET

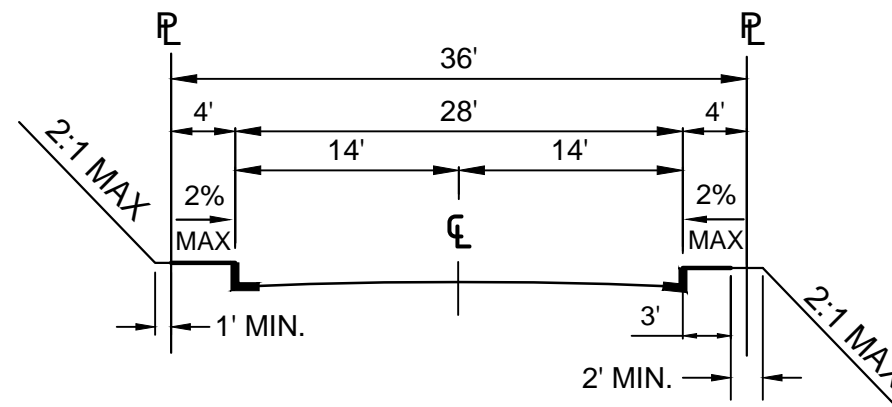

HILLSIDE LIMITED STANDARD

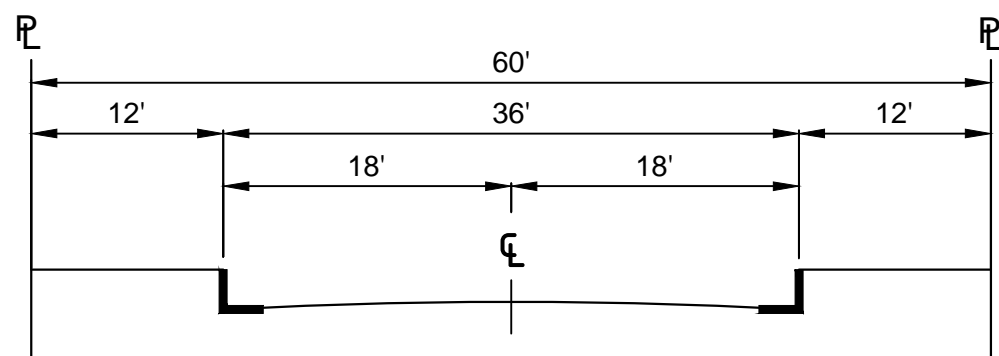

LOCAL STREET - STANDARD

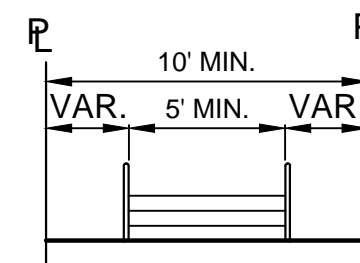

PUBLIC STAIRWAY

CONSTRUCTED IN ACCORDANCE WITH
BUREAU OF ENGINEERING STANDARD PLANS

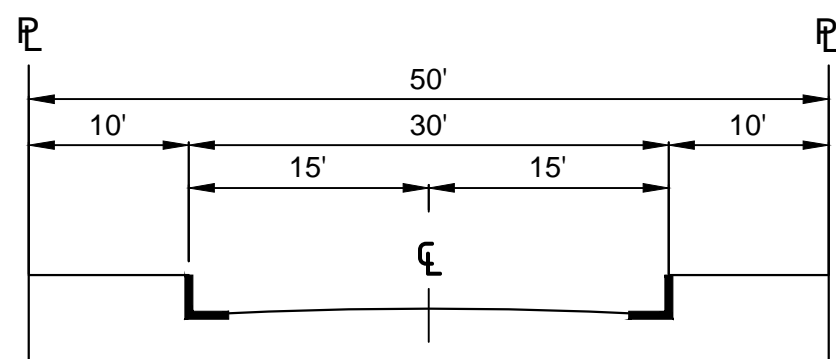

LOCAL STREET - LIMITED

OTHER PUBLIC RIGHTS-OF-WAY

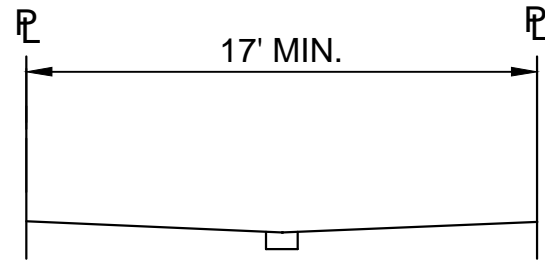

SHARED STREET

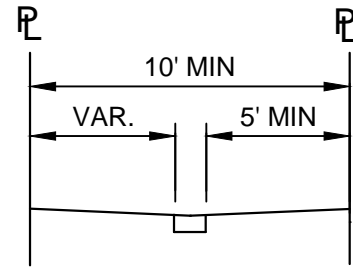

PEDESTRIAN WALKWAY

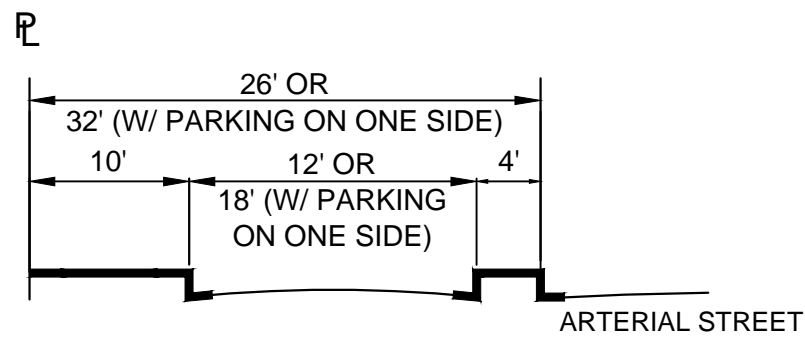

ONE-WAY SERVICE ROAD

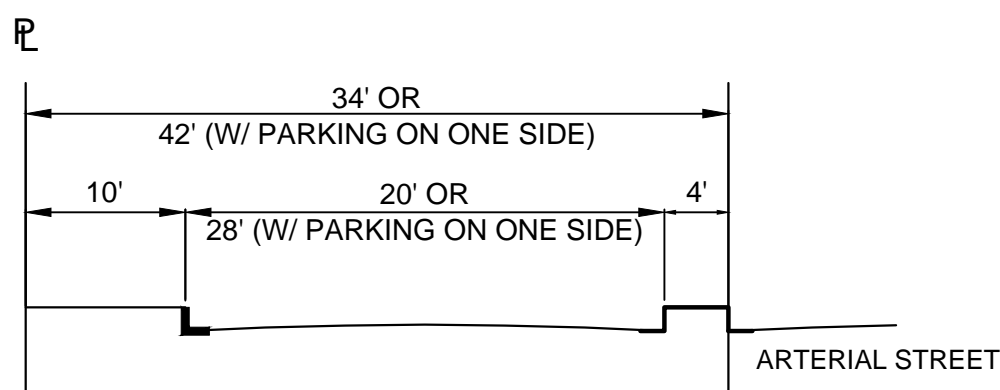

BI-DIRECTIONAL SERVICE ROAD

CUL-DE-SAC

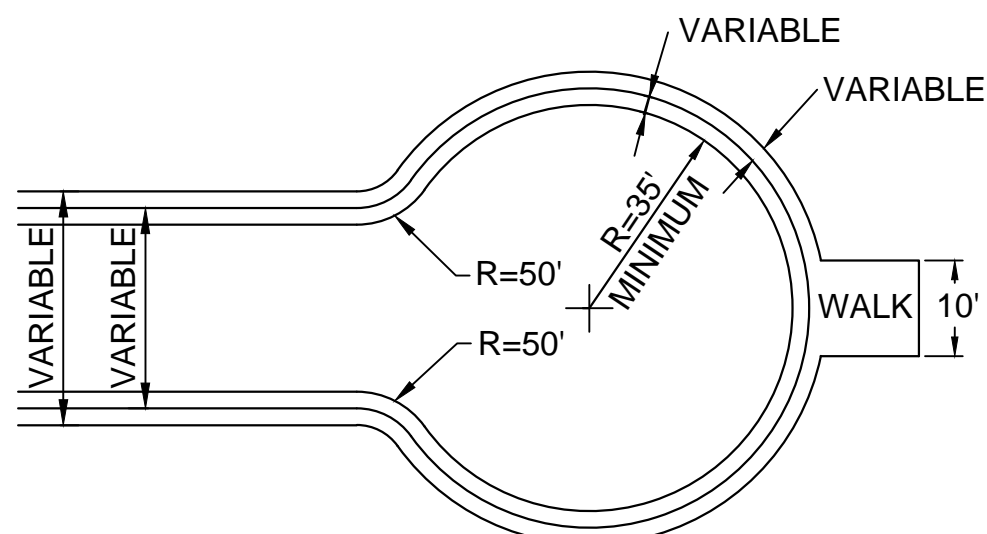

MAY BE UNSYMMETRICAL (PLAN VIEW)

NOTE: FOR FIRE TRUCK CLEARANCE, NO OBSTRUCTION TALLER THAN 6" SHALL BE PERMITTED WITHIN 3FT. OF THE CURB. ON-STREET PARKING SHALL BE PROHIBITED.

TRANSITIONAL EXTENSIONS

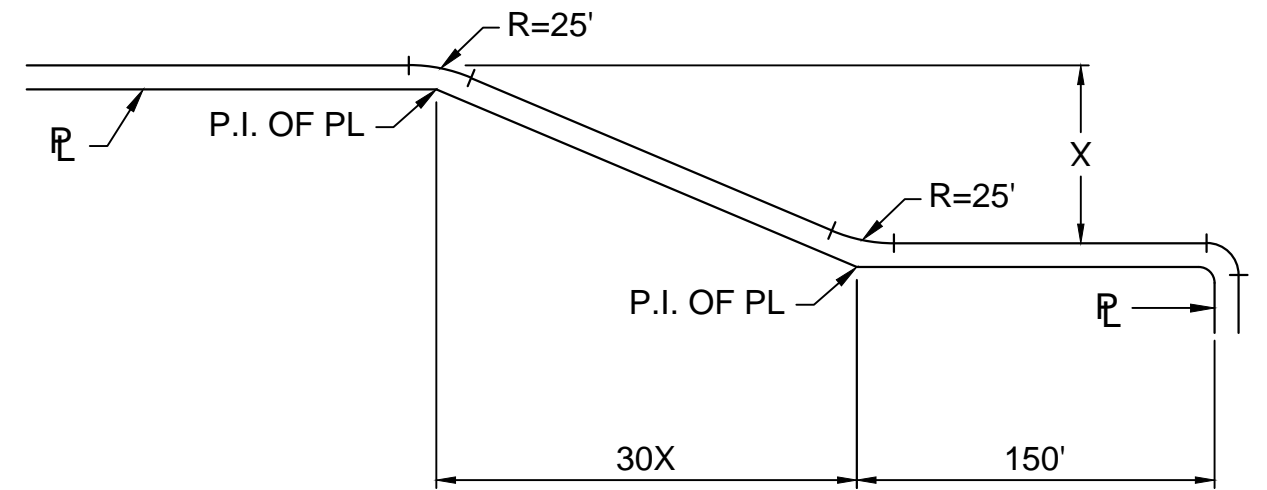

STANDARD FLARE SECTION (PLAN VIEW)

ALLEYS

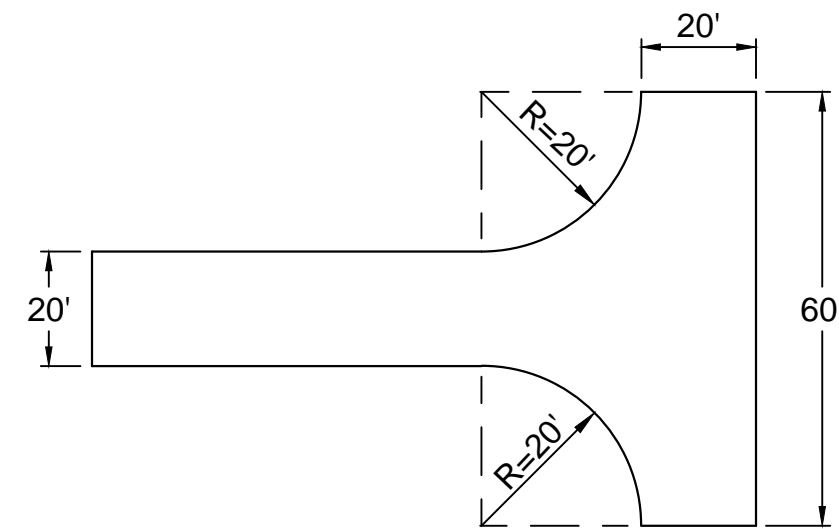

STANDARD TURNING AREA (PLAN VIEW)

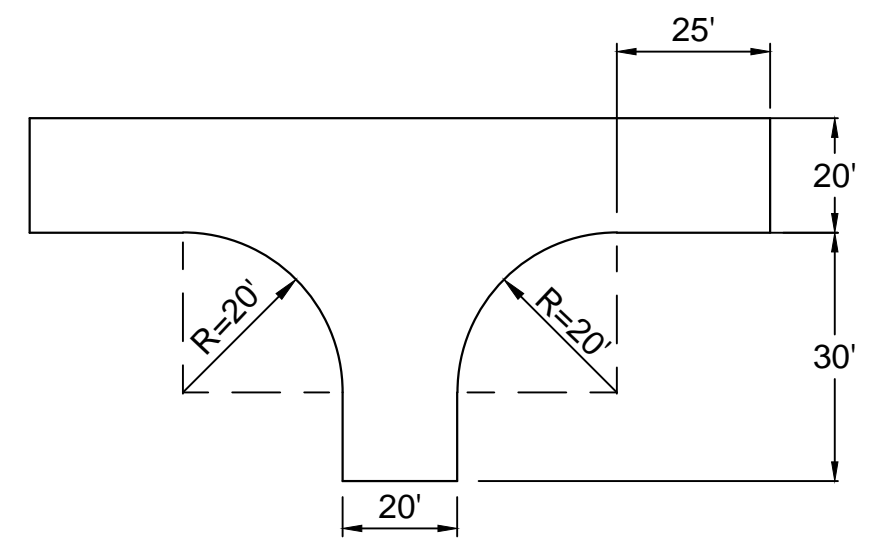

MINIMUM TURNING AREA (PLAN VIEW)

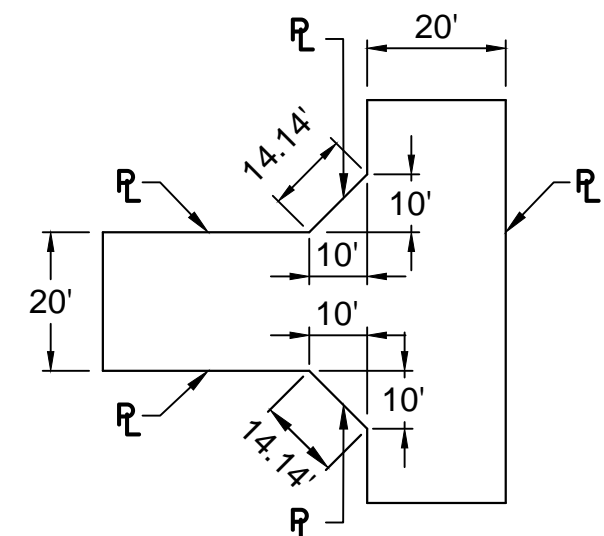

STANDARD CUT CORNERS FOR 90° INTERSECTION (PLAN VIEW)

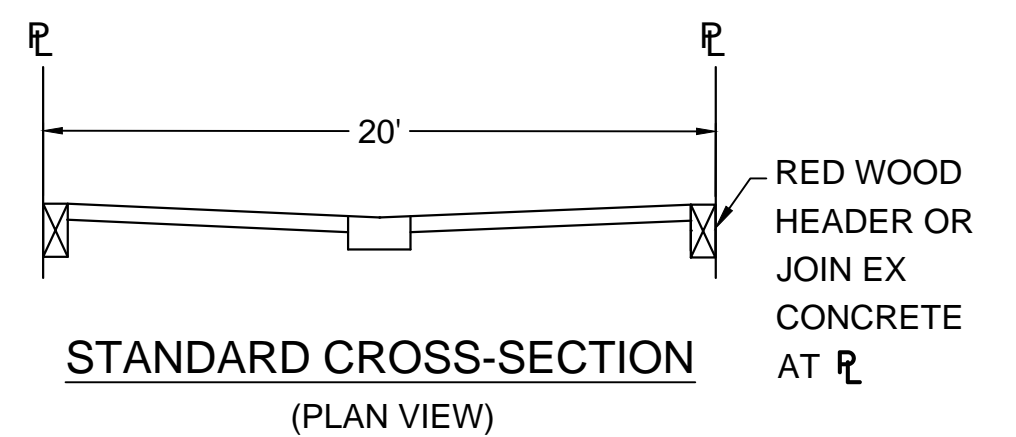

STANDARD CROSS-SECTION (PLAN VIEW)

HIGH INJURY NETWORK



5/2020

HIGH INJURY NETWORK MAP

 **Overland Traffic Consultants, Inc.**
952 Manhattan Beach Bl, #100, Manhattan Beach, CA 90266
(310) 545 - 1235, OTC@overlandtraffic.com



APPENDIX F

TRANSIT ROUTES

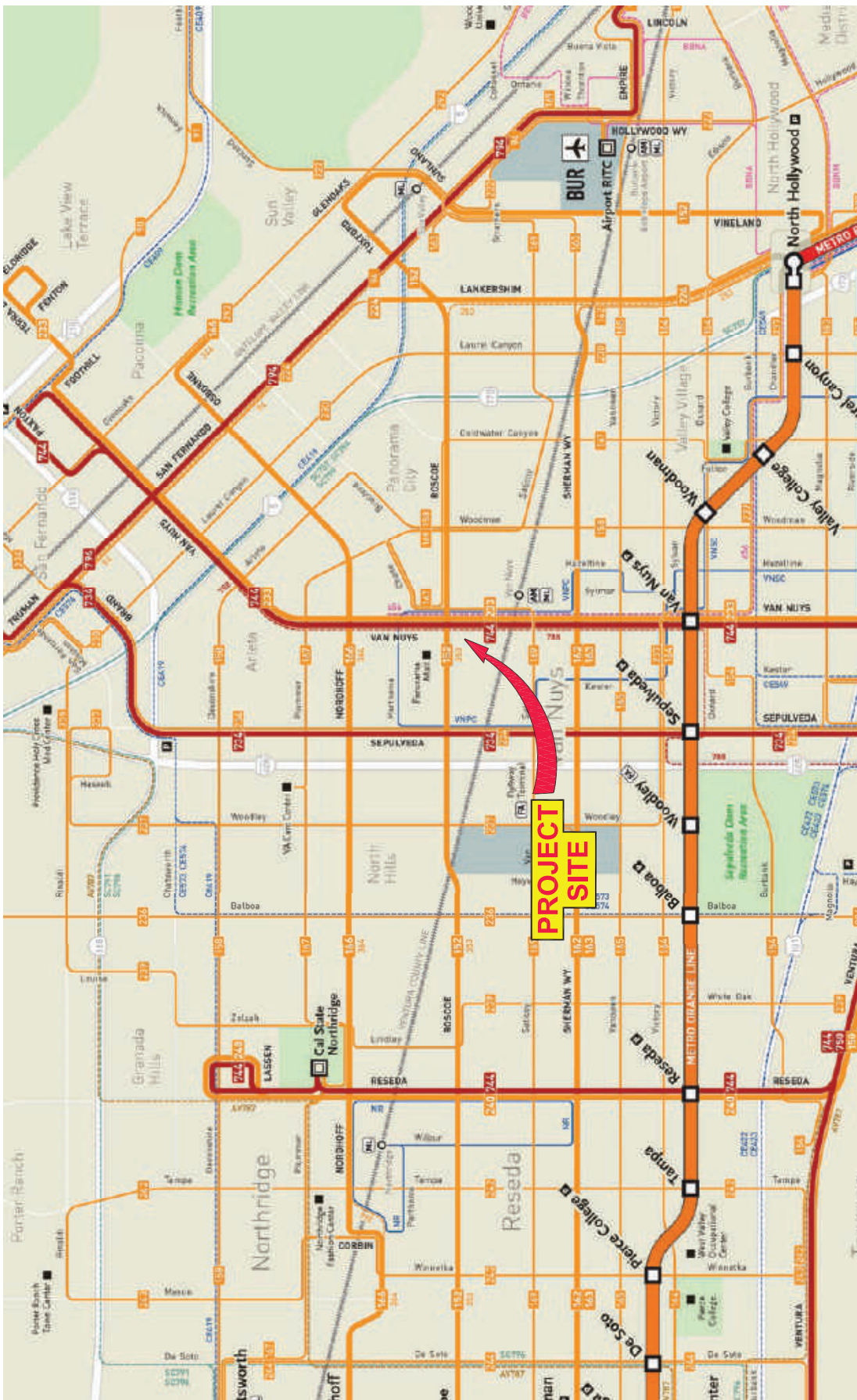

Line	Weekday	Saturday	Sunday
744	6:00 - 11:00	6:00 - 11:00	6:00 - 11:00
745	6:00 - 11:00	6:00 - 11:00	6:00 - 11:00
746	6:00 - 11:00	6:00 - 11:00	6:00 - 11:00
747	6:00 - 11:00	6:00 - 11:00	6:00 - 11:00
748	6:00 - 11:00	6:00 - 11:00	6:00 - 11:00
749	6:00 - 11:00	6:00 - 11:00	6:00 - 11:00
750	6:00 - 11:00	6:00 - 11:00	6:00 - 11:00
751	6:00 - 11:00	6:00 - 11:00	6:00 - 11:00
752	6:00 - 11:00	6:00 - 11:00	6:00 - 11:00
753	6:00 - 11:00	6:00 - 11:00	6:00 - 11:00
754	6:00 - 11:00	6:00 - 11:00	6:00 - 11:00
755	6:00 - 11:00	6:00 - 11:00	6:00 - 11:00
756	6:00 - 11:00	6:00 - 11:00	6:00 - 11:00
757	6:00 - 11:00	6:00 - 11:00	6:00 - 11:00
758	6:00 - 11:00	6:00 - 11:00	6:00 - 11:00
759	6:00 - 11:00	6:00 - 11:00	6:00 - 11:00
760	6:00 - 11:00	6:00 - 11:00	6:00 - 11:00
761	6:00 - 11:00	6:00 - 11:00	6:00 - 11:00
762	6:00 - 11:00	6:00 - 11:00	6:00 - 11:00
763	6:00 - 11:00	6:00 - 11:00	6:00 - 11:00
764	6:00 - 11:00	6:00 - 11:00	6:00 - 11:00
765	6:00 - 11:00	6:00 - 11:00	6:00 - 11:00
766	6:00 - 11:00	6:00 - 11:00	6:00 - 11:00
767	6:00 - 11:00	6:00 - 11:00	6:00 - 11:00
768	6:00 - 11:00	6:00 - 11:00	6:00 - 11:00
769	6:00 - 11:00	6:00 - 11:00	6:00 - 11:00
770	6:00 - 11:00	6:00 - 11:00	6:00 - 11:00
771	6:00 - 11:00	6:00 - 11:00	6:00 - 11:00
772	6:00 - 11:00	6:00 - 11:00	6:00 - 11:00
773	6:00 - 11:00	6:00 - 11:00	6:00 - 11:00
774	6:00 - 11:00	6:00 - 11:00	6:00 - 11:00
775	6:00 - 11:00	6:00 - 11:00	6:00 - 11:00
776	6:00 - 11:00	6:00 - 11:00	6:00 - 11:00
777	6:00 - 11:00	6:00 - 11:00	6:00 - 11:00
778	6:00 - 11:00	6:00 - 11:00	6:00 - 11:00
779	6:00 - 11:00	6:00 - 11:00	6:00 - 11:00
780	6:00 - 11:00	6:00 - 11:00	6:00 - 11:00
781	6:00 - 11:00	6:00 - 11:00	6:00 - 11:00
782	6:00 - 11:00	6:00 - 11:00	6:00 - 11:00
783	6:00 - 11:00	6:00 - 11:00	6:00 - 11:00
784	6:00 - 11:00	6:00 - 11:00	6:00 - 11:00
785	6:00 - 11:00	6:00 - 11:00	6:00 - 11:00
786	6:00 - 11:00	6:00 - 11:00	6:00 - 11:00
787	6:00 - 11:00	6:00 - 11:00	6:00 - 11:00
788	6:00 - 11:00	6:00 - 11:00	6:00 - 11:00
789	6:00 - 11:00	6:00 - 11:00	6:00 - 11:00
790	6:00 - 11:00	6:00 - 11:00	6:00 - 11:00
791	6:00 - 11:00	6:00 - 11:00	6:00 - 11:00
792	6:00 - 11:00	6:00 - 11:00	6:00 - 11:00
793	6:00 - 11:00	6:00 - 11:00	6:00 - 11:00
794	6:00 - 11:00	6:00 - 11:00	6:00 - 11:00
795	6:00 - 11:00	6:00 - 11:00	6:00 - 11:00
796	6:00 - 11:00	6:00 - 11:00	6:00 - 11:00
797	6:00 - 11:00	6:00 - 11:00	6:00 - 11:00
798	6:00 - 11:00	6:00 - 11:00	6:00 - 11:00
799	6:00 - 11:00	6:00 - 11:00	6:00 - 11:00
800	6:00 - 11:00	6:00 - 11:00	6:00 - 11:00

SAN FERNANDO VALLEY METRO TRANSIT SYSTEM MAP

Overland Traffic Consultants, Inc.
 952 Manhattan Beach Bl, #100, Manhattan Beach, CA 90266
 (310) 545 - 1235, OTC@overlandtraffic.com

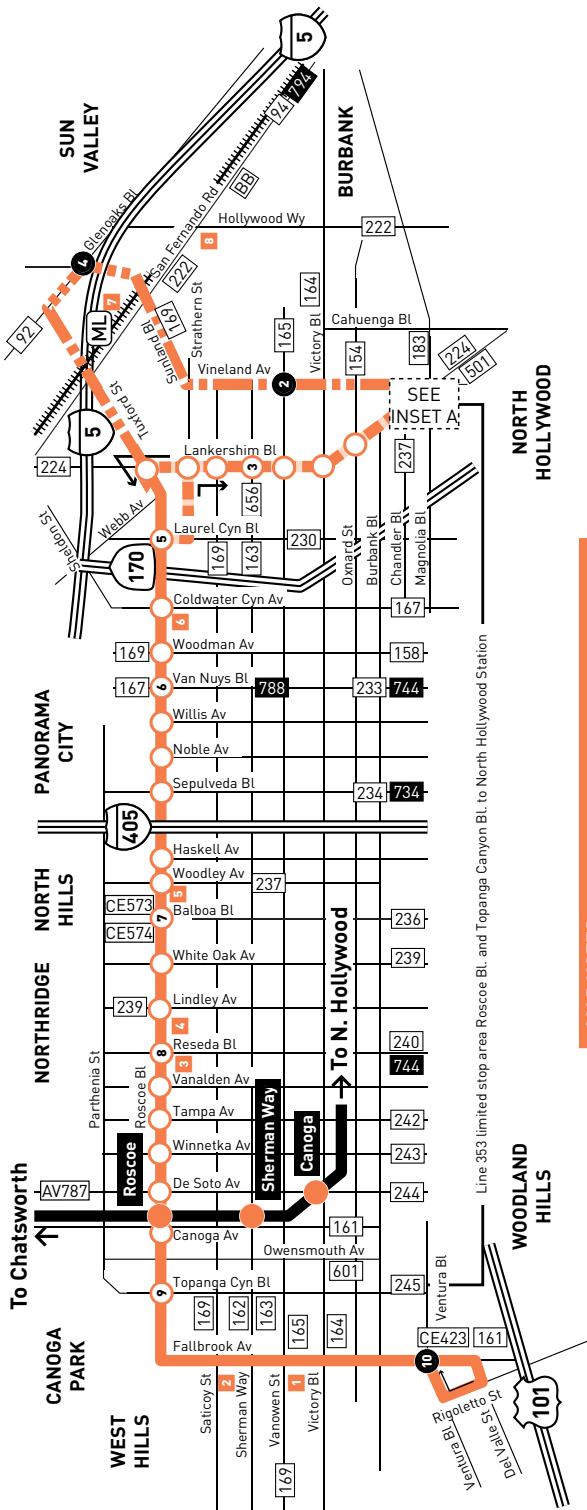

LEGEND

- Route of Lines 152, 353
- Route Line 152 only
- Route of Line 353 only
- Metro Red Line
- Local Stop Timepoint
- Limited Stop Timepoint
- Limited Stop
- Limited Stop - Single Direction Only
- Transit Center
- Metrolink Station
- Metro Orange Line Station
- Antelope Valley Transit Authority
- Burbank Bus
- LADOT Commuter Express
- Santa Clarita Transit

INSET MAP A

- North Hollywood Red Line Station
- Metro Orange Line
- Metro Orange Line Station
- Stop & Timepoint
- Limited Stop

MAP NOTES

- 1 Fallbrook Center**
- 2 West Hills Medical Center**
- 3 Cleveland High School**
- 4 Northridge Hospital**
- 5 Van Nuys Airport**
- 6 Kaiser-Permanente Hospital**
- 7 Sun Valley Metrolink Station**
Metro 94, 794; Metrolink Antelope Valley Line
- 8 Hollywood Burbank Airport**
- 9 North Hollywood Red & Orange Line Stations**
Metro 152, 154, 162, 183, 224, 237, 353, 501, 656 Owl, Metro Red Line, Metro Orange Line; BB Media District, BB Noho/Airport; CE549; SC757

INSET MAP A

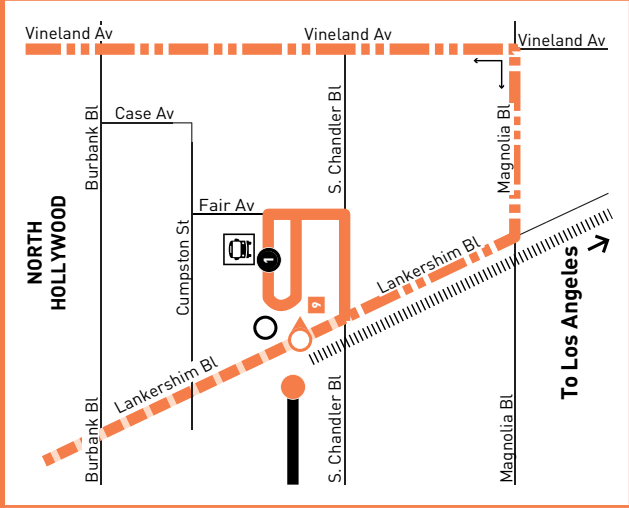

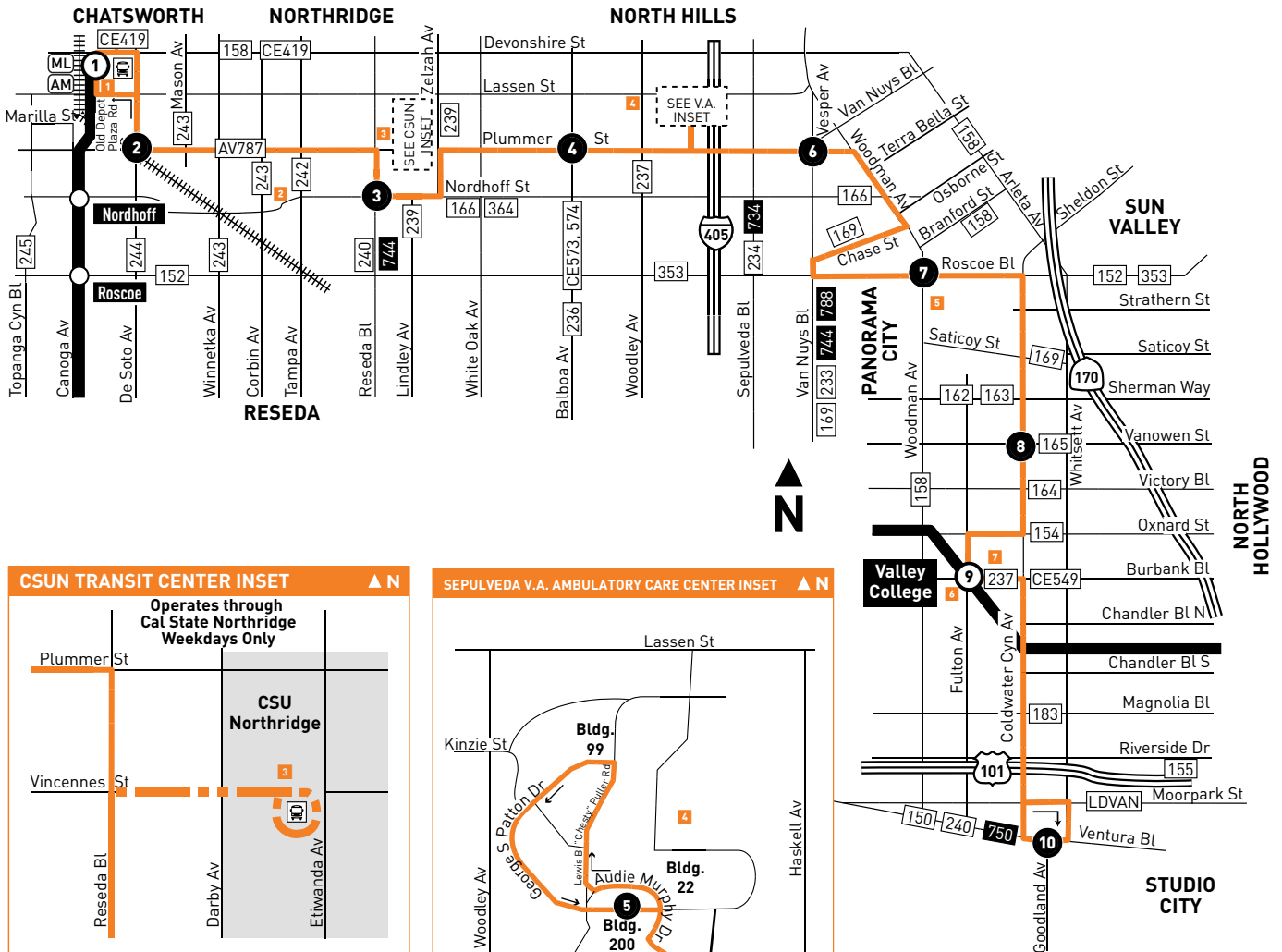

CSUN TRANSIT CENTER INSET ▲ N

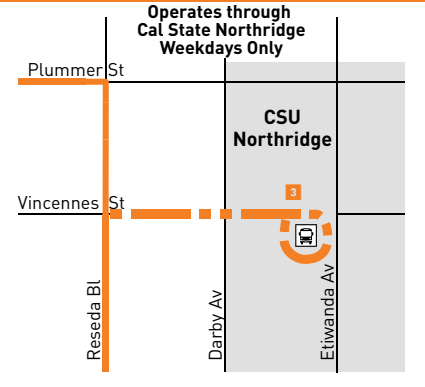

SEPULVEDA V.A. AMBULATORY CARE CENTER INSET ▲ N

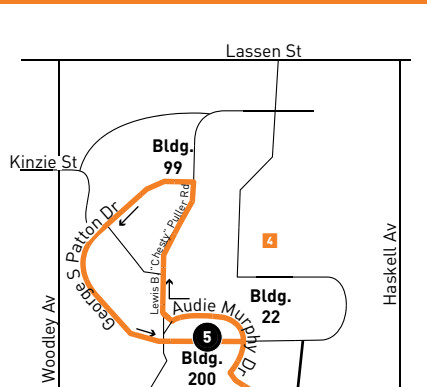

LEGEND

- Line 167 Route
- Extended Line 167 Route (Weekdays Only)
- # Timepoint
- Metro Orange Line
- Metrolink, Amtrak
- Orange Line Station
- # Orange Line Station & Timepoint
- Transit Center
- AM Amtrak Station
- ML Metrolink Station
- AV Antelope Valley Transit
- CE LADOT Commuter Express
- LDVAN LADOT Dash Van Nuys/Studio City
- SC Santa Clarita Transit
- SV Simi Valley Transit

MAP NOTES

- 1 Chatsworth Station**
Metro 158, 166, 167, 244, 245, 364, Metro Orange Line; CE419: SC791; SV-C; Ventura County Metrolink Line; Amtrak
- 2 Northridge Fashion Center**
- 3 California State University, Northridge Transit Center**
Metro 167, 744, AV787; CSUN Shuttle
- 4 Sepulveda V.A. Ambulatory Care Center**
- 5 Kaiser Hospital**
- 6 Valley College Station**
Metro 167, 237, Orange Line; CE549; DASH Van Nuys/Studio City
- 7 L.A. Valley College**

MAP NOTES

- 1 **Canoga Station**
Metro 161, 401, 750, Orange Line
- 2 **Warner Center Transit Hub**
Metro 245, 750, VCTC Conejo
Connection: Nearby transfers to CE422; LA County Beach Bus
- 3 **Westfield Topanga**
- 4 **Westfield Promenade**
- 5 **El Camino Real H.S.**
- 6 **Fallbrook Shopping Center**
- 7 **West Hills Medical Center**
Transfer to Metro 162, 163
- 8 **Northridge Hospital**
- 9 **Van Nuys Airport**
- 10 **Fulton College Preparatory School**
- 11 **Van Nuys Metrolink Station**
Metro 169, 233, 456 Owl, 744, 788;
Metrolink Ventura County Line; Amtrak
- 12 **Panorama Mall**
- 13 **Kaiser Foundation Hospital**
- 14 **Burbank Airport - North Station**
Metro 94, 169, 222, 794; BB Gold
Route: Metrolink Antelope Valley Line
- 15 **Hollywood Burbank Airport**
Transfer to Metro 94, 222, 794
- 16 **Regional Intermodal Transportation Center**
Metro 169, 222; BB Noho/Airport
- 17 **Burbank Airport - South Station**
Metro 165; Metrolink Ventura County Line; Amtrak





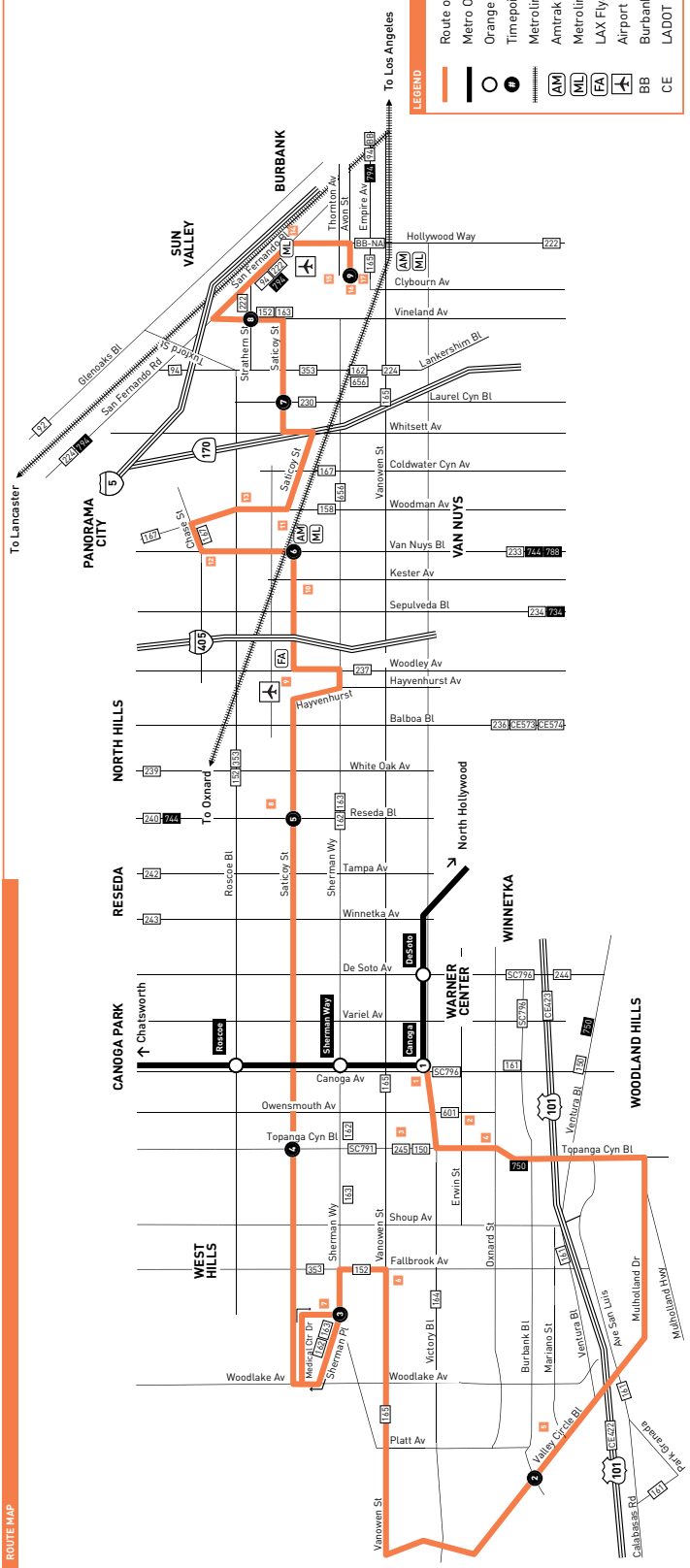

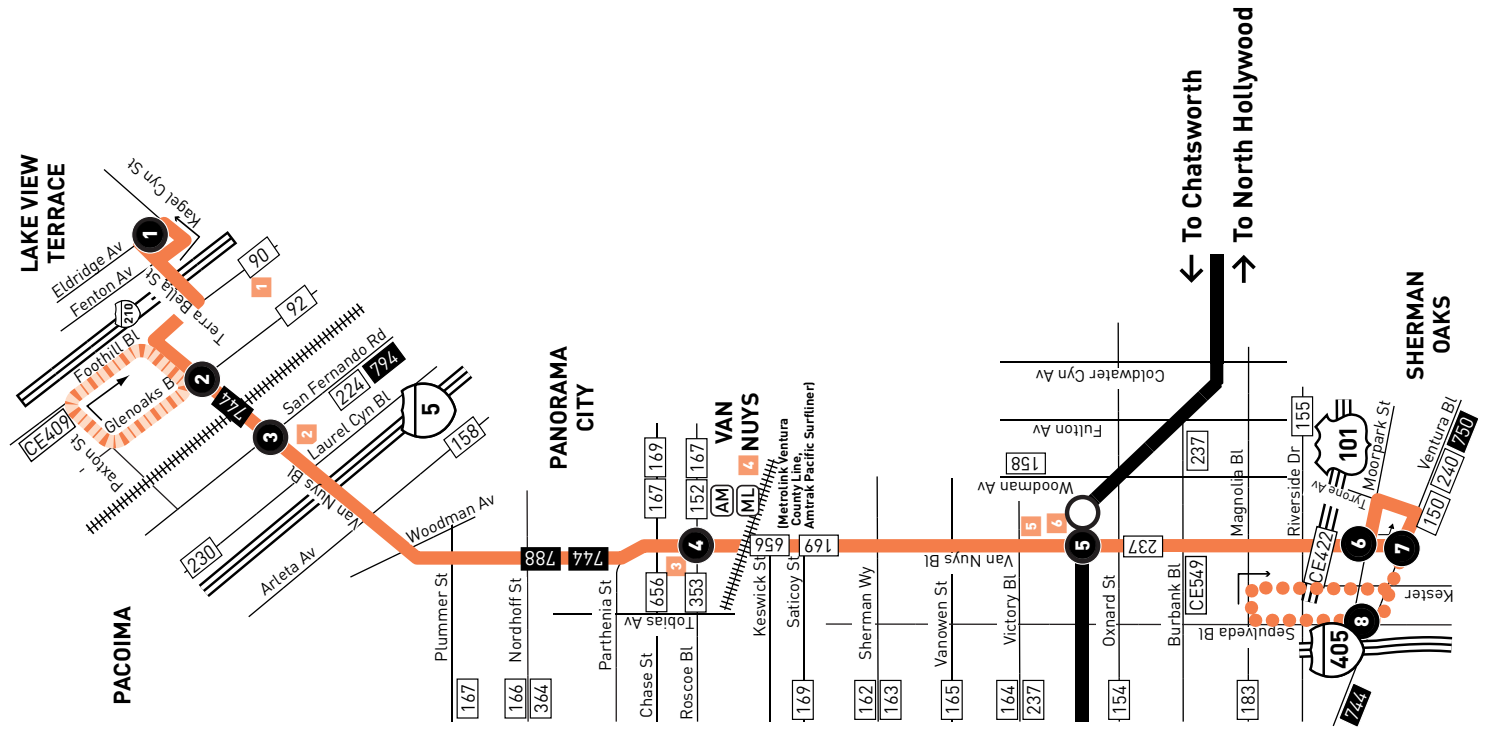



LEGEND

- Route of Line 169
- Metro Orange Line
- Orange Line Station
- Timepoint
- Metrolink, Amtrak
- Metrolink Station
- LAX Flyaway
- Airport
- Burbank Bus
- LA DOT Commuter Express





LEGEND

-  Route of Line 233
-  Early Morning & Late Night Service Extension
-  Van Nuys & Glenoaks Short Line Turnaround Loop
-  Metro Orange Line
-  Timepoint
-  Metro Orange Line Station
-  Amtrak Station
-  Metrolink Station
-  LADOT Commuter Express
-  LADOT DASH

MAP NOTES

- 1 Hansen Dam Recreation Area**
- 2 Pacoima Civic Center**
- 3 Panorama Mall**
- 4 Van Nuys Metrolink Station**
Metro 169, 233, 656 Owl, 744, 788;
Metrolink Ventura County Line; Amtrak
- 5 Van Nuys Civic Center**
- 6 Van Nuys Orange Line Station**
Metro 154, 233, 237, 744, 788; LDVAN

ROUTE MAP

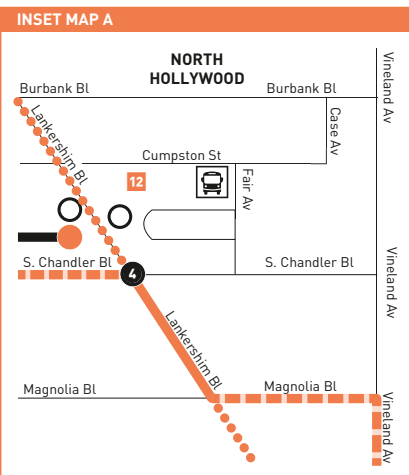
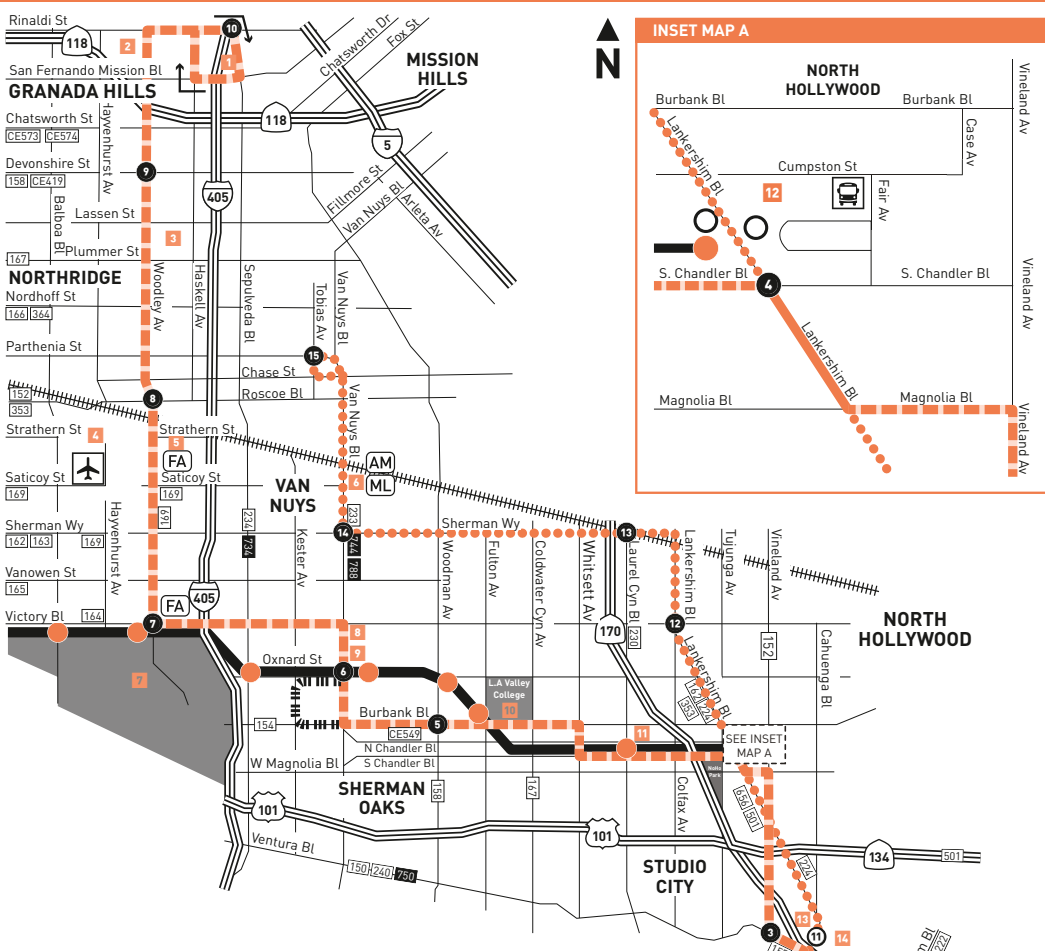

MAP NOTES

- 1 Facey Medical Center**
- 2 Kennedy High School**
- 3 Sepulveda V.A. Ambulatory Care Center**
- 4 Van Nuys Airport**
- 5 Van Nuys Fly Away Terminal (Bus Service to LAX)**
- 6 Van Nuys Metrolink Station**
Ventura County Line/Amtrak
- 7 Sepulveda Dam Recreation Area**
- 8 Van Nuys Civic Center**
- 9 Van Nuys Orange Line Station**
Metro 154, 233, 237, 744, 788; LDVAN
- 10 Valley College Station**
Metro 167, 237; CE549, LDVAN
- 11 Laurel Canyon Station**
Metro Lines 230, 237
- 12 North Hollywood Red & Orange Line Stations**
Metro 152, 154, 162, 183, 224, 237, 353, 501, 656 Owl, Orange Line; BB Media District, NoHo Empire; CE549; SC757
- 13 Universal City/Studio City Station**
Metro 150, 155, 224, 240, 656 Owl (Northbound Only), 750; Universal Studios Shuttle
- 14 Universal Studios**
- 15 Hollywood Bowl**
- 16 John Anson Ford Theater**
- 17 Hollywood/Highland Station**
Metro 212, 217, 237, 312, 656 Owl, 780, LD-Hollywood

LEGEND

- Route of Lines 237 and 656
- Route of Line 237 only
- Route of Line 656 Late Night Service Only
- Short Line Turn-Around
- Route of Orange Line
- Metrolink, Amtrak
- Metro Rail Station
- Metro Orange Line Station
- Local Stop Timepoint
- Amtrak Station
- Metrolink Station
- LAX Flyaway
- Transit Center
- BB Burbank Bus
- CE LADOT Commuter Express
- LD LADOT Dash
- LADVAN LADOT Dash Van Nuys
- SC Santa Clarita Transit

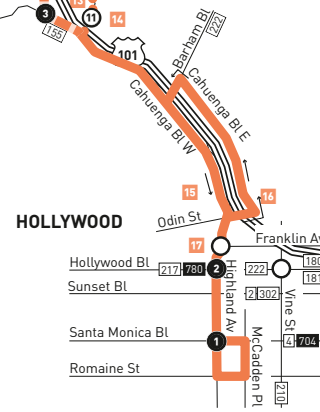

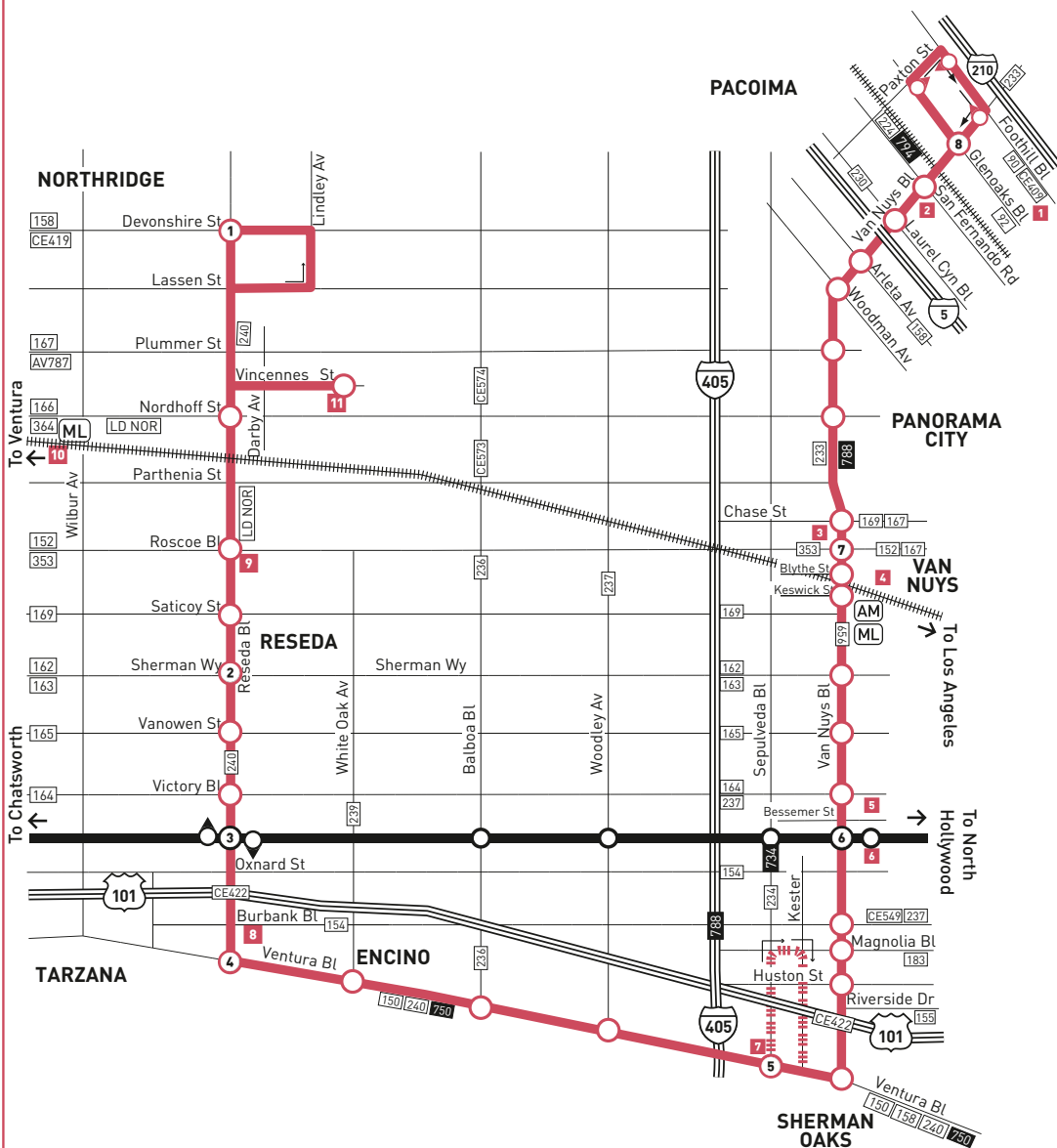

LEGEND

- Line 744 Route
- - - - - Weekend Turn-Around Loop
- Metro Orange Line Route
- Metrolink
- # Rapid Stop Timepoint
- Rapid Stop
- Rapid Stop - Single Direction Only
- # Metro Orange Line Station & Timepoint
- Metro Orange Line Station - Single Direction Only
- Metro Orange Line Station
- AM Amtrak Station
- ML Metrolink Station
- AV Antelope Valley Transit Authority
- CE LADOT Commuter Express
- LD LADOT DASH

MAP NOTES

- 1 Hansen Dam Recreation Area**
- 2 Pacoima Neighborhood City Hall**
- 3 Panorama Mall**
- 4 Van Nuys Metrolink Station**
Metro 169, 233, 656 Owl, 744, 788;
Metrolink Ventura County Line; Amtrak
- 5 Van Nuys Civic Center**
- 6 Van Nuys Orange Line Station**
Metro 154, 233, 237, 744, 788; LD Van Nuys/ Studio City
- 7 Sherman Oaks Galleria**
- 8 Providence Tarzana Medical Center**
- 9 Northridge Hospital Medical Center**
- 10 Northridge Metrolink Station**
Metrolink Ventura County Line; LD Northridge/Reseda
- 11 California State University, Northridge Transit Center**
Metro 167, 744; AV787; CSUN Shuttle



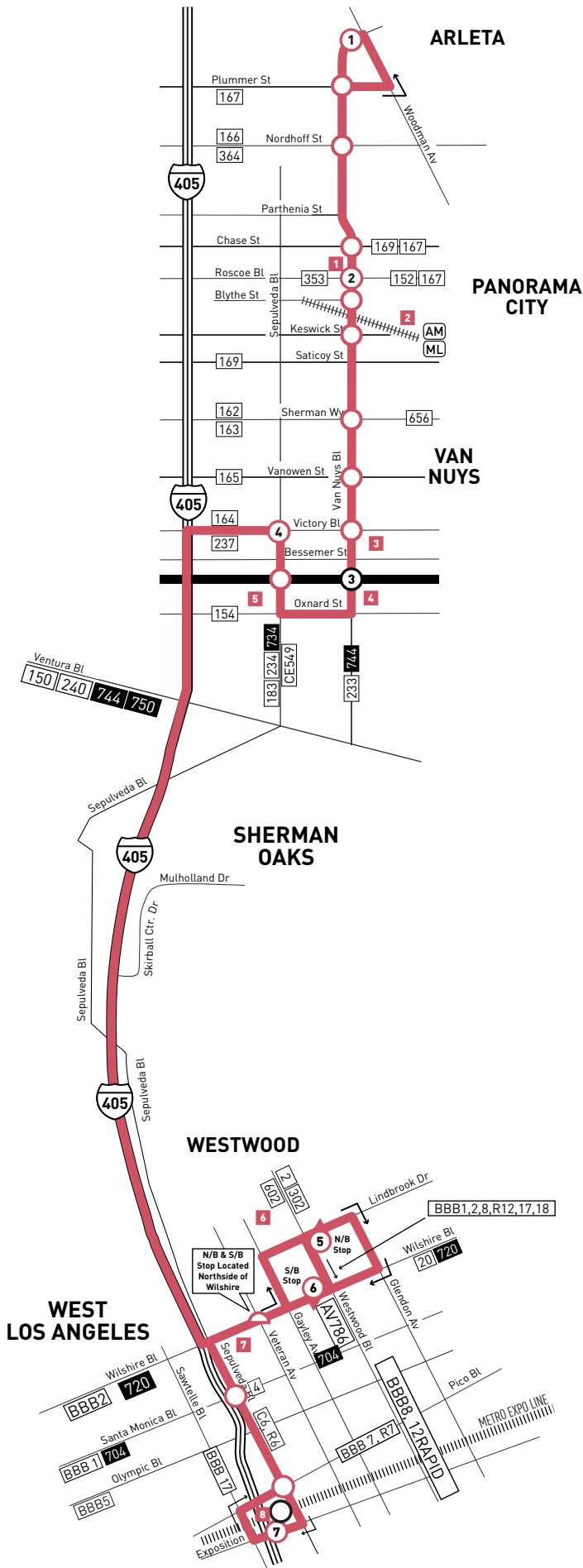

LEGEND

- Line 788 Valley-Westside
- Express Route
- Orange Line Route
- Metro Rail & Station
- Metrolink
- Express Line Timepoint
- Busway Station Timepoint
- Express Line Stop
- Single Direction Stop
- Single Direction Timepoint
- Amtrak Station
- Metrolink Station
- AV Antelope Valley Transit Authority
- C Culver City Bus
- CE LADOT Commuter Express
- LD LADOT DASH
- BBB Santa Monica's Big Blue Bus

MAP NOTES

- 1 Panorama Mall**
- 2 Van Nuys Metrolink Station**
Metro 169, 233, 656 Owl, 744, 788; Metrolink Ventura County Line; Amtrak
- 3 Van Nuys Civic Center**
- 4 Van Nuys Orange Line Station**
Metro 154, 233, 237, 744, 788; LDVAN
- 5 Sepulveda Orange Line Station**
Metro 234, 734, 788
- 6 UCLA**
- 7 Federal Building**
- 8 Sepulveda Expo Line Station**
Metro 234 (Late night, early mornings, weekends), 734, 788; BBB 7, Rapid 7; Culver City 6; R6

ROUTE MAP





APPENDIX G

MOBILITY NETWORK MAPS

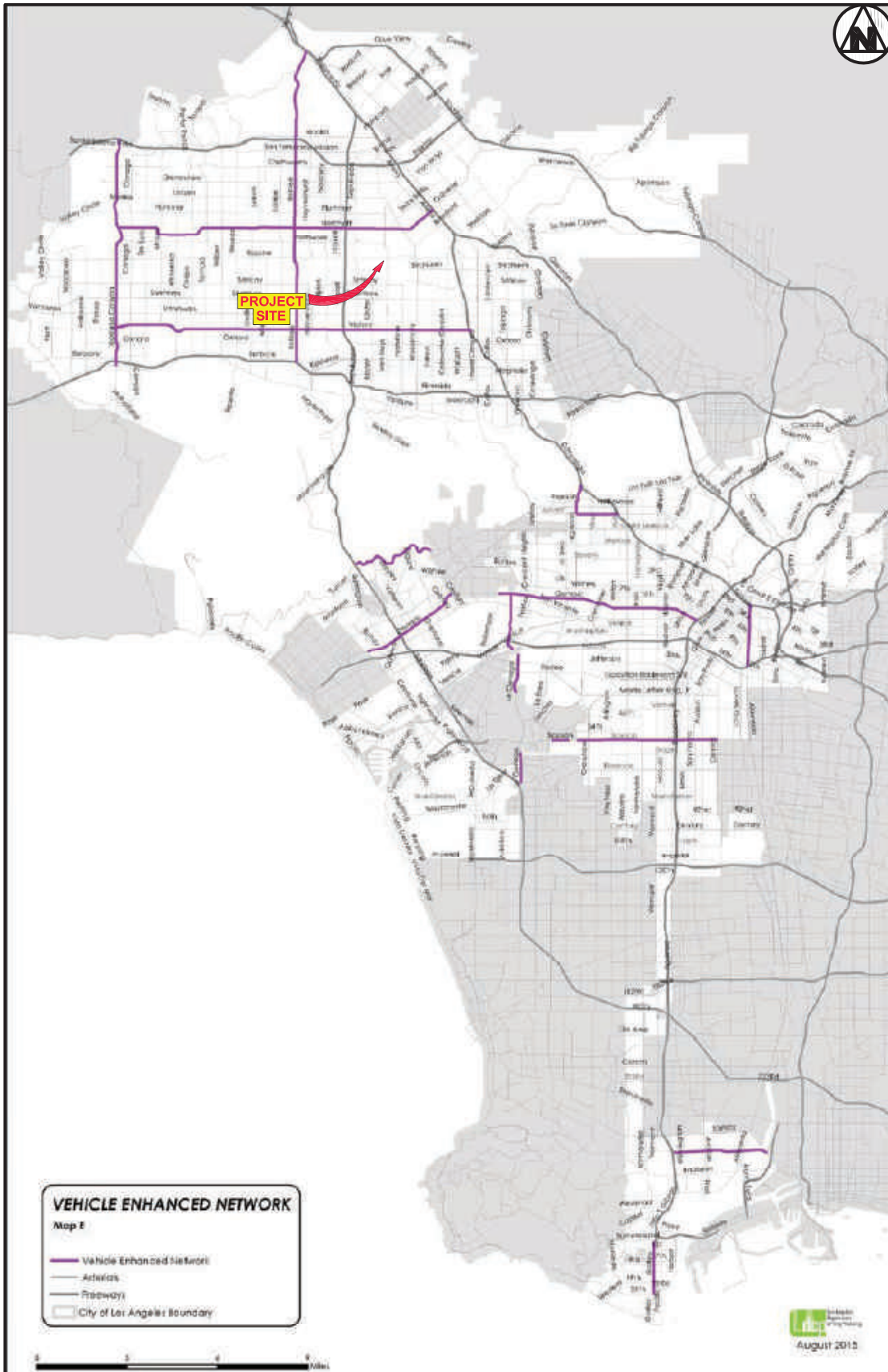

5/2020

VEHICLE ENHANCED NETWORK MAP



Overland Traffic Consultants, Inc.
952 Manhattan Beach Bl, #100, Manhattan Beach, CA 90266
(310) 545 - 1235, OTC@overlandtraffic.com

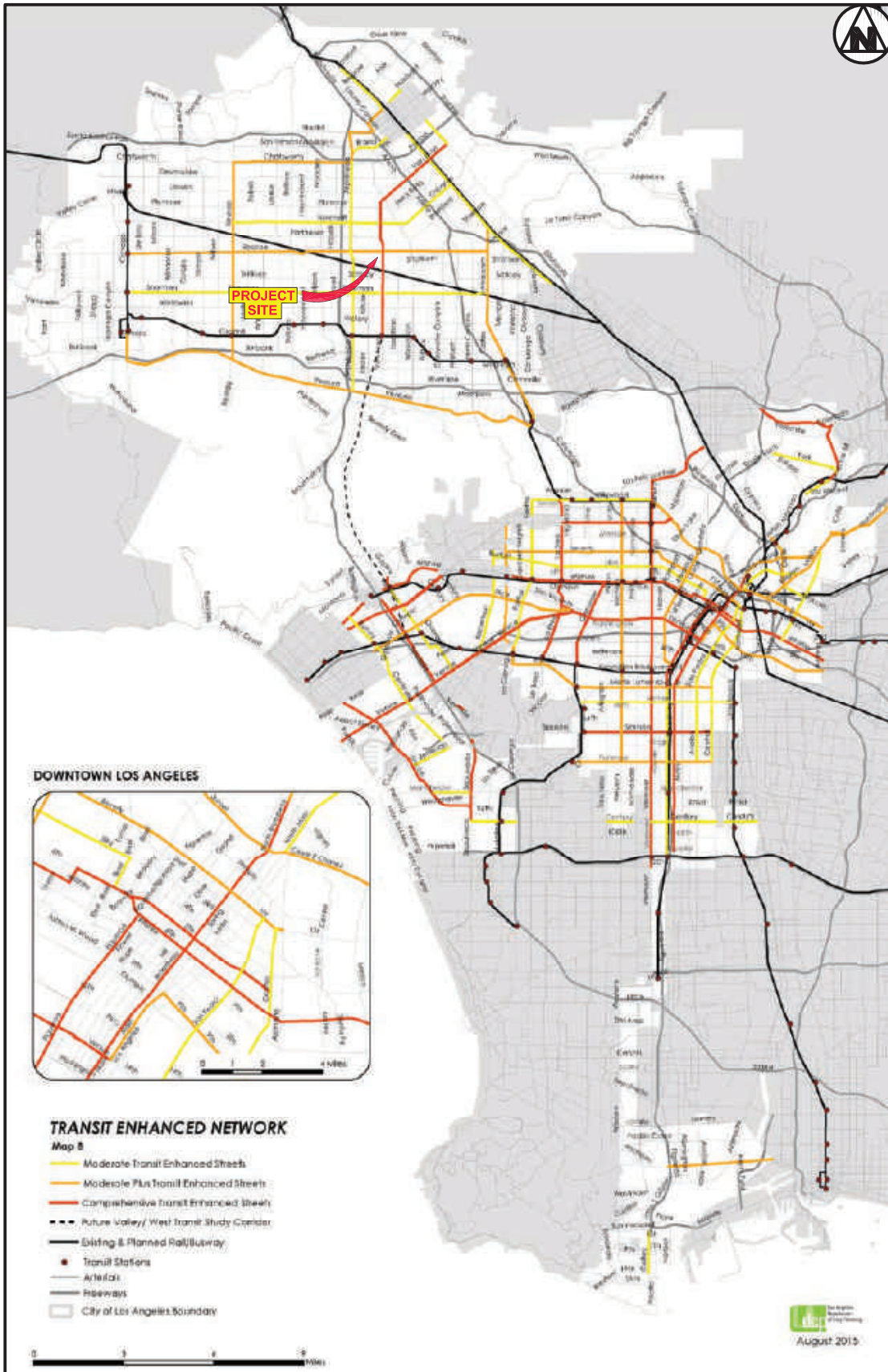

5/2020

TRANSIT ENHANCED NETWORK MAP

 **Overland Traffic Consultants, Inc.**
952 Manhattan Beach Bl, #100, Manhattan Beach, CA 90266
(310) 545 - 1235, OTC@overlandtraffic.com

Transit Enhanced Network (TEN)

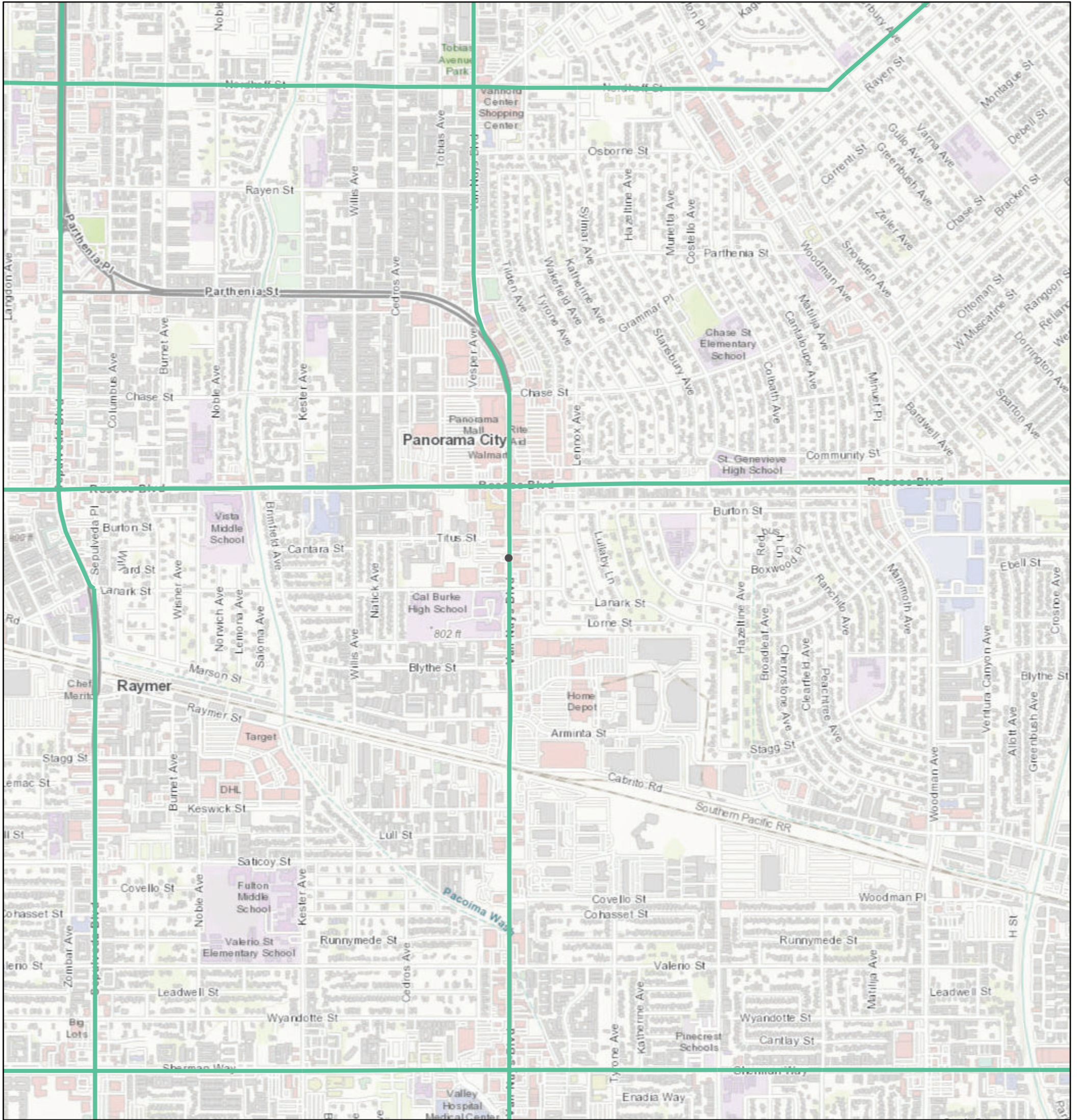

5/21/2020, 6:04:18 PM

— Transit Enhanced Network (TEN)

1:18,056

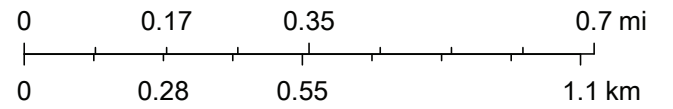

Sources: Esri, HERE, Garmin, Intermap, increment P Corp., GEBCO, USGS, FAO, NPS, NRCAN, GeoBase, IGN, Kadaster NL, Ordnance Survey, Esri Japan, METI, Esri China (Hong Kong), (c) OpenStreetMap contributors, and the GIS User Community

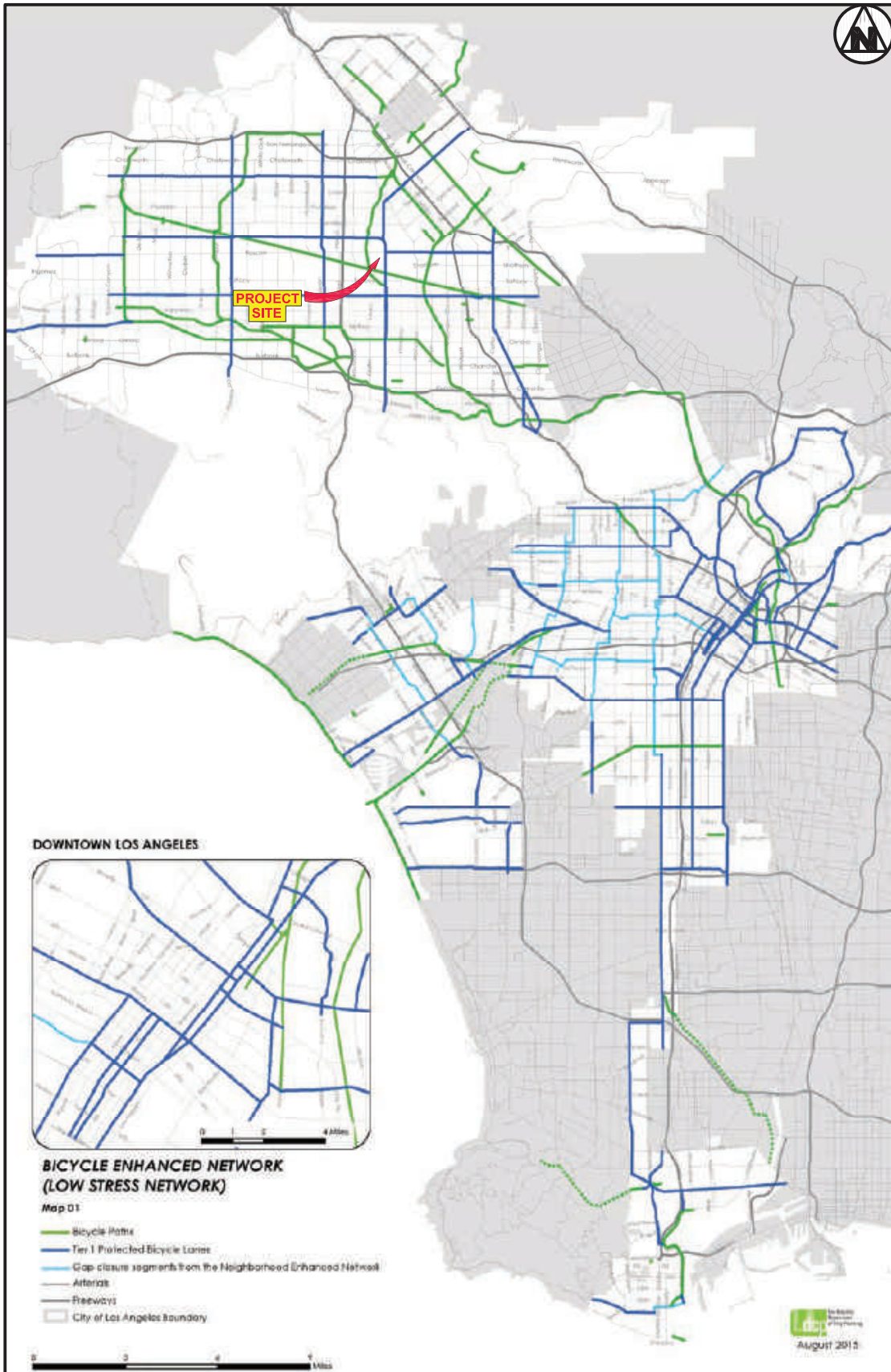

5/2020

BICYCLE ENHANCED NETWORK MAP (LOW STRESS NETWORK)



Overland Traffic Consultants, Inc.

952 Manhattan Beach Bl, #100, Manhattan Beach, CA 90266
(310) 545 - 1235, OTC@overlandtraffic.com

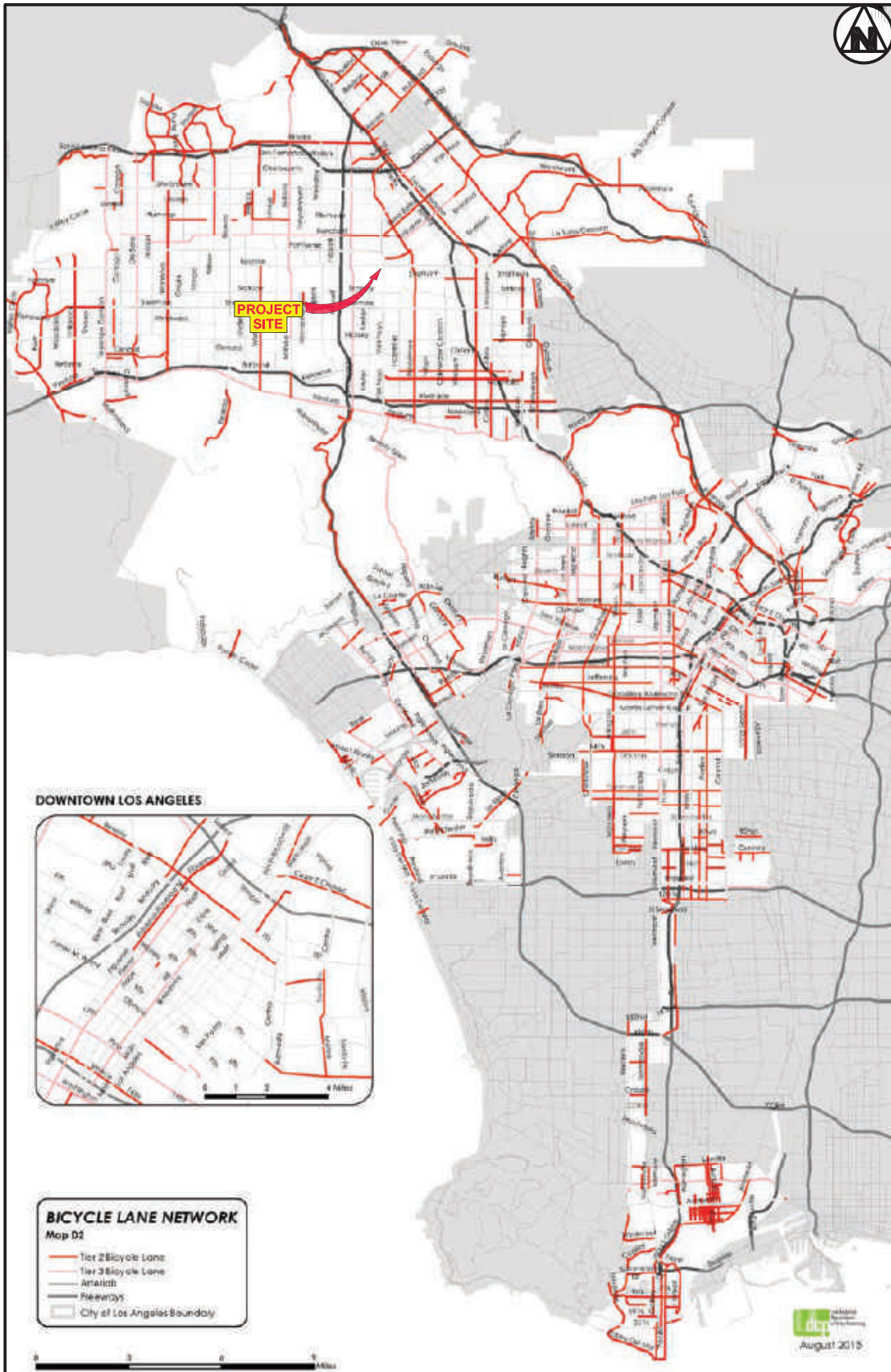

5/2020

BICYCLE LANE NETWORK MAP

 **Overland Traffic Consultants, Inc.**
 952 Manhattan Beach Bl, #100, Manhattan Beach, CA 90266
 (310) 545 - 1235, OTC@overlandtraffic.com

Bicycle Enhanced Network (BEN)

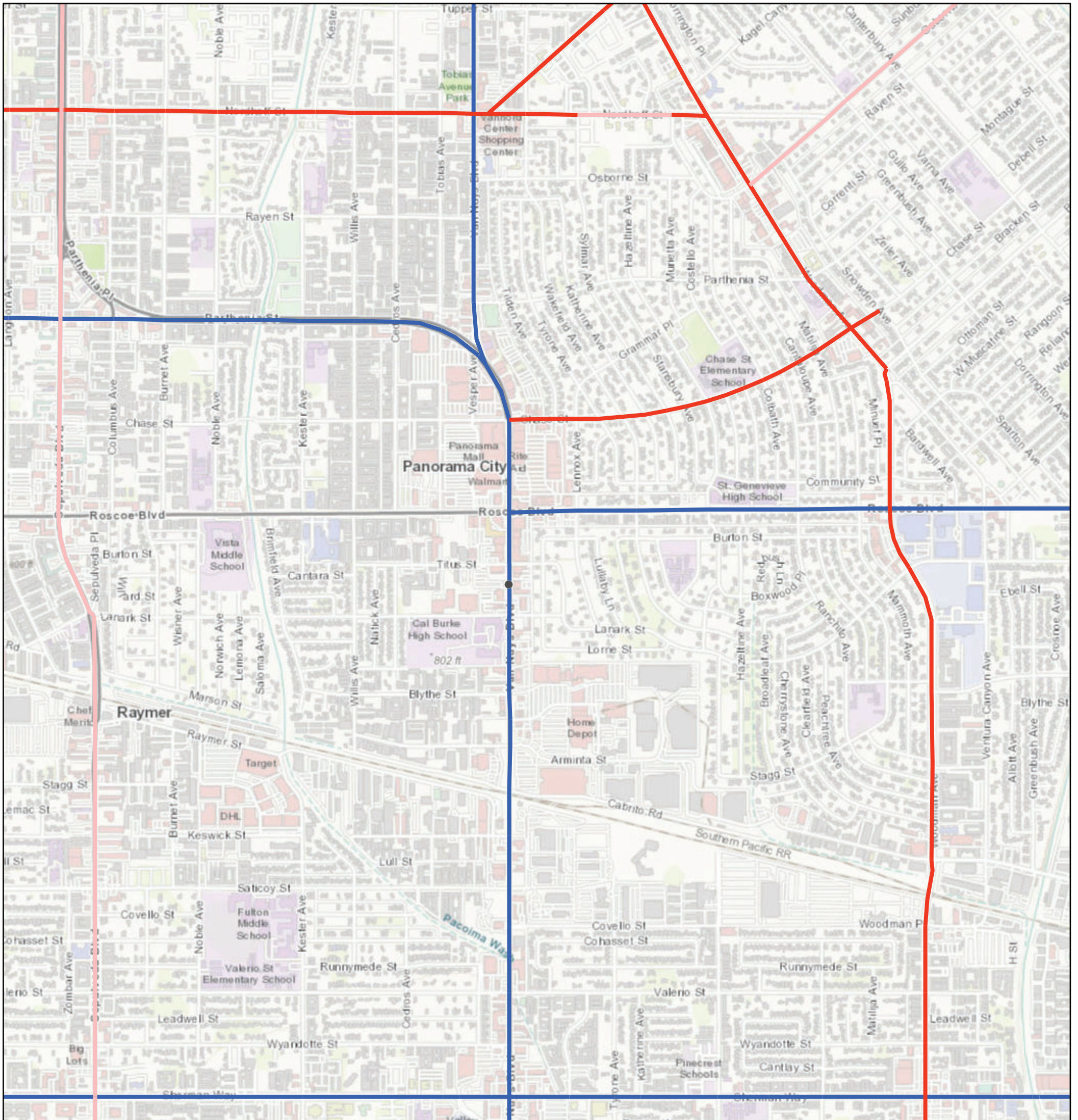

5/21/2020, 6:06:05 PM

Bicycle Network

- Tier 1 (BEN)
- Tier 2 (BLN)
- Tier 3 (BLN)

1:18,056

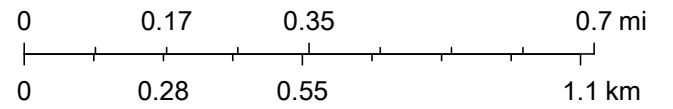

Sources: Esri, HERE, Garmin, Intermap, increment P Corp., GEBCO, USGS, FAO, NPS, NRCAN, GeoBase, IGN, Kadaster NL, Ordnance Survey, Esri Japan, METI, Esri China (Hong Kong), (c) OpenStreetMap contributors, and the GIS User Community

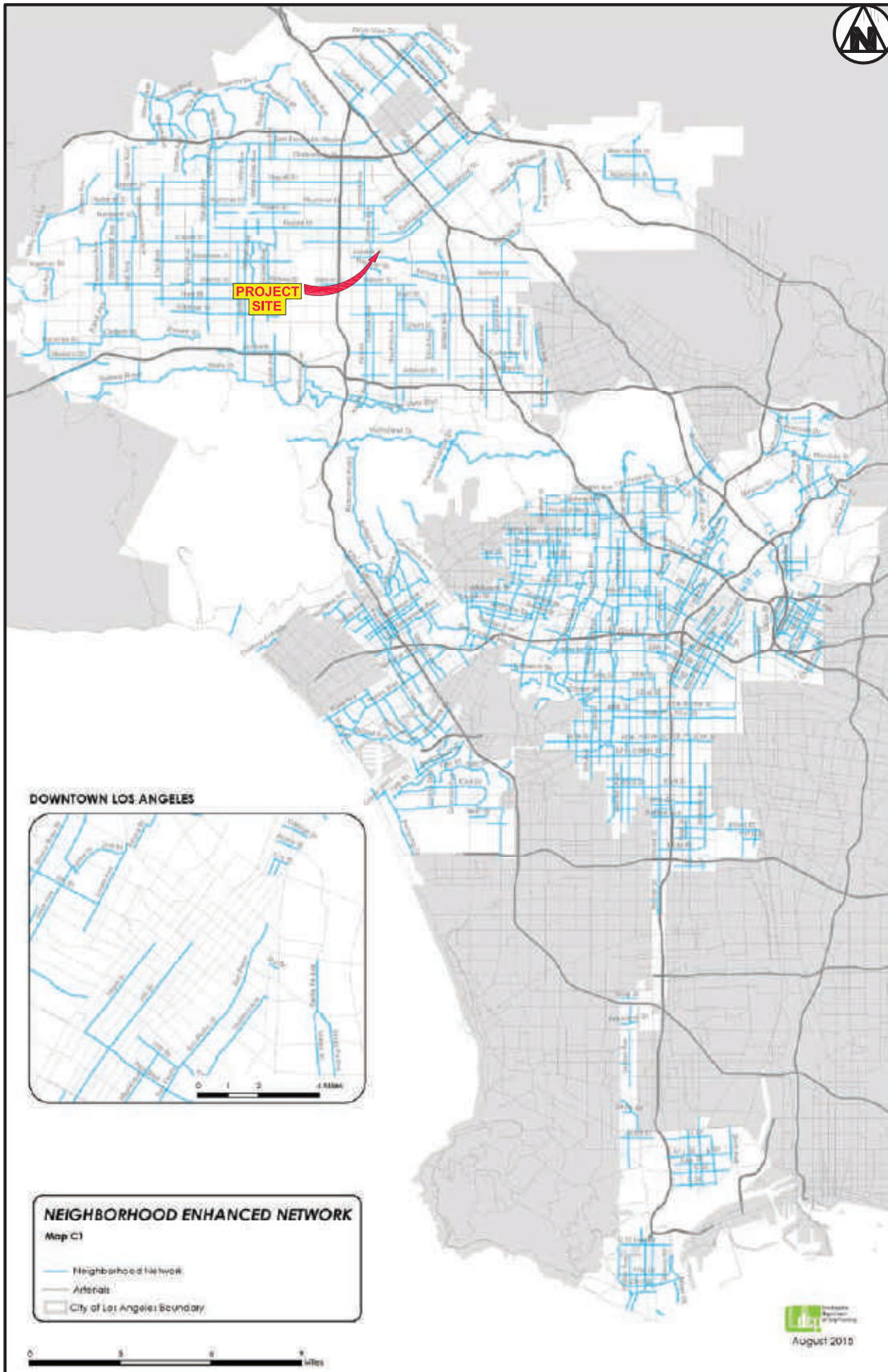

5/2020

NEIGHBORHOOD ENHANCED NETWORK MAP



Overland Traffic Consultants, Inc.

952 Manhattan Beach Bl, #100, Manhattan Beach, CA 90266
(310) 545 - 1235, OTC@overlandtraffic.com

Neighborhood Enhanced Network (NEN)



5/21/2020, 6:07:15 PM

Neighborhood Network (NEN)

— Tier 2 NEN

1:18,056

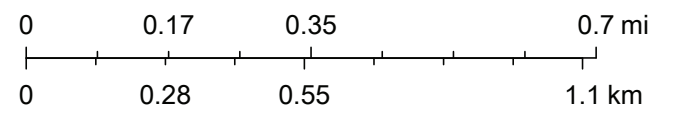

Sources: Esri, HERE, Garmin, Intermap, increment P Corp., GEBCO, USGS, FAO, NPS, NRCAN, GeoBase, IGN, Kadaster NL, Ordnance Survey, Esri Japan, METI, Esri China (Hong Kong), (c) OpenStreetMap contributors, and the GIS User Community

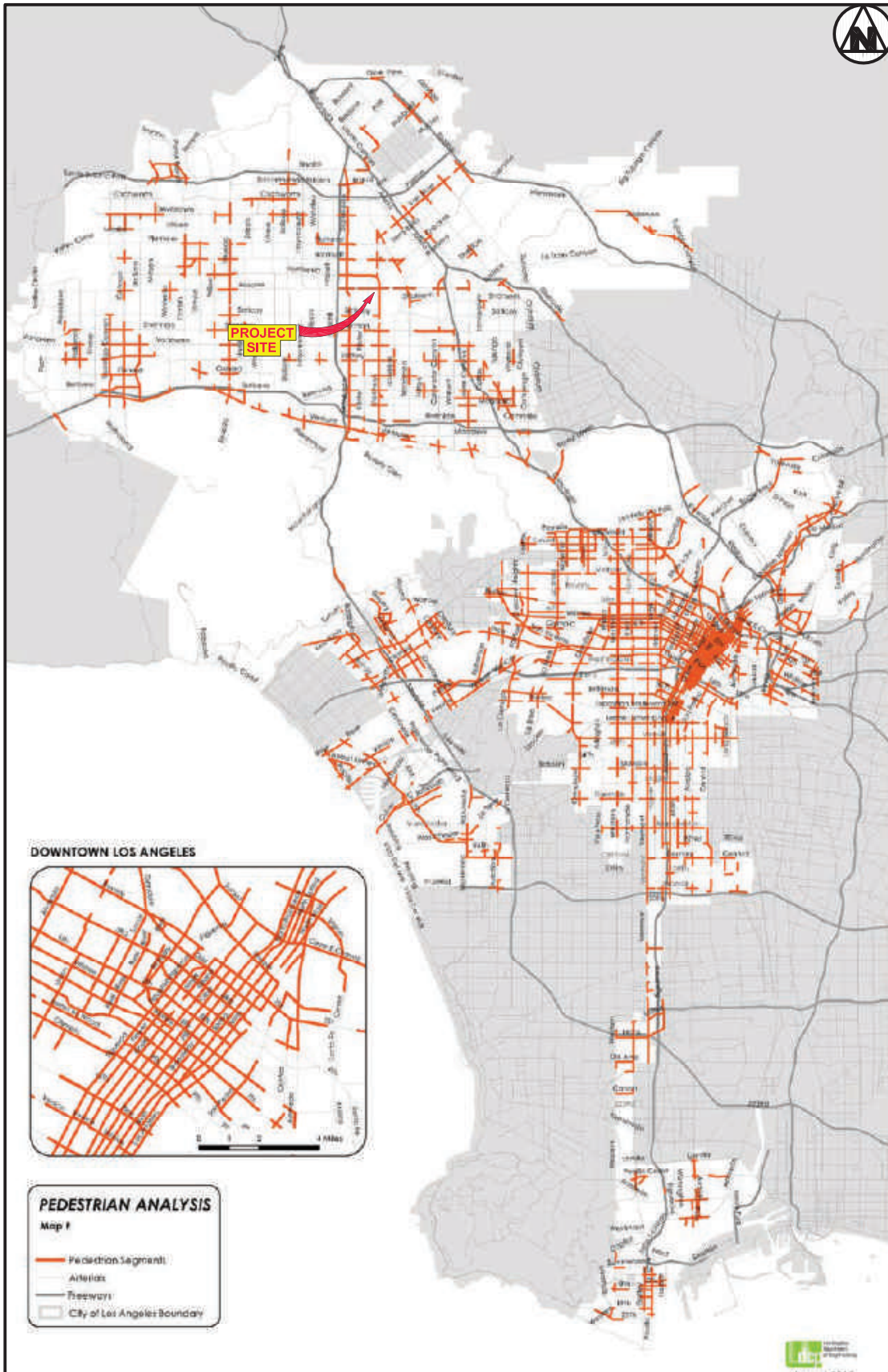

5/2020

PEDESTRIAN ENHANCED DISTRICT MAP



Overland Traffic Consultants, Inc.

952 Manhattan Beach Bl, #100, Manhattan Beach, CA 90266
(310) 545 - 1235, OTC@overlandtraffic.com

Pedestrian Enhanced Network (PEDs)

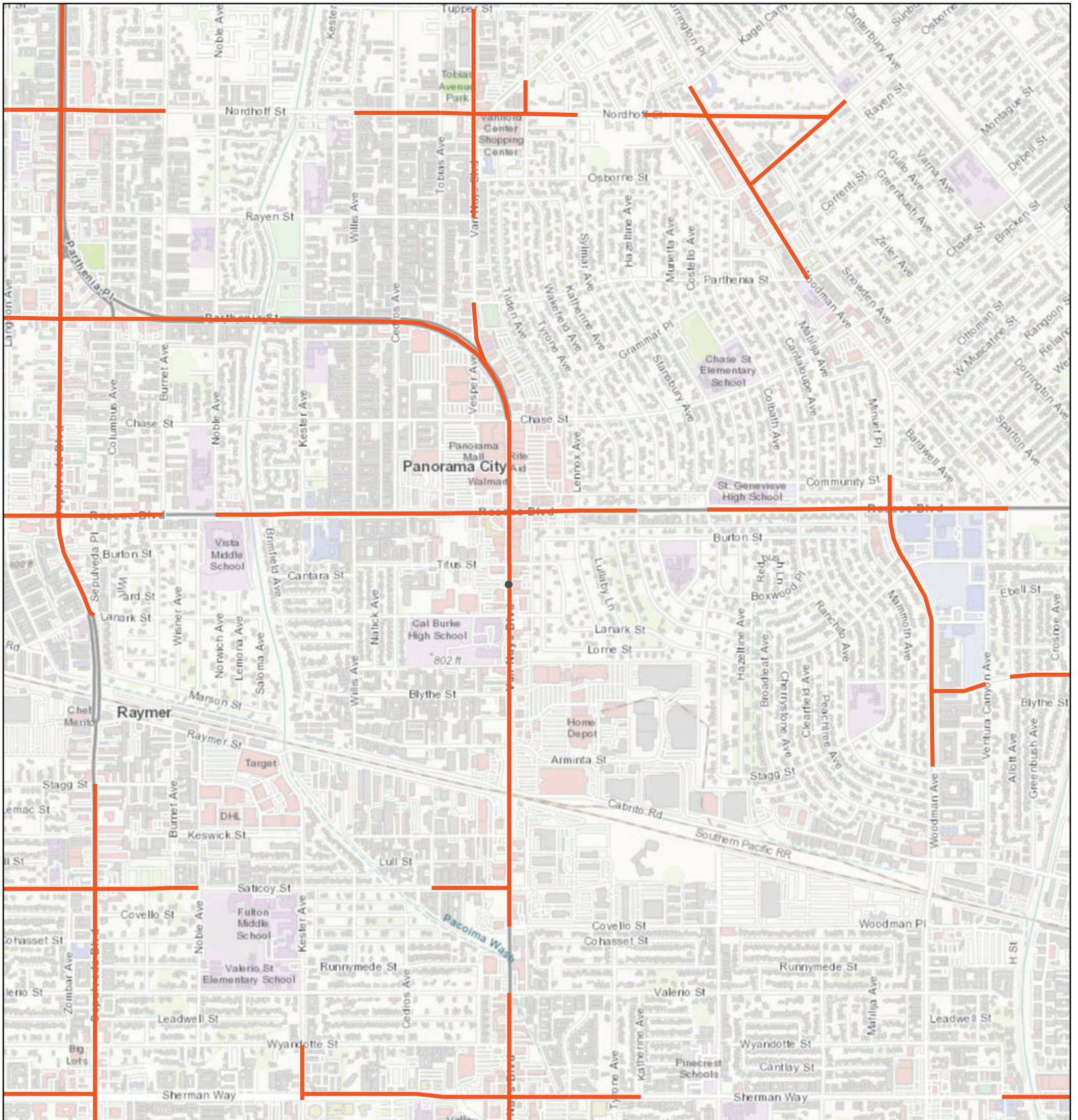

5/21/2020, 6:08:08 PM

1:18,056

— Pedestrian Enhanced Districts (PEDs)

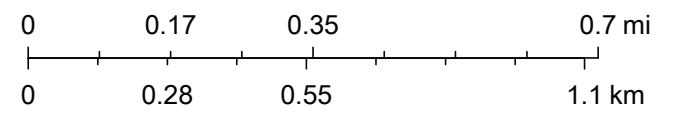

Sources: Esri, HERE, Garmin, Intermap, increment P Corp., GEBCO, USGS, FAO, NPS, NRCAN, GeoBase, IGN, Kadaster NL, Ordnance Survey, Esri Japan, METI, Esri China (Hong Kong), (c) OpenStreetMap contributors, and the GIS User Community

Percentage of Trips Under Three Miles

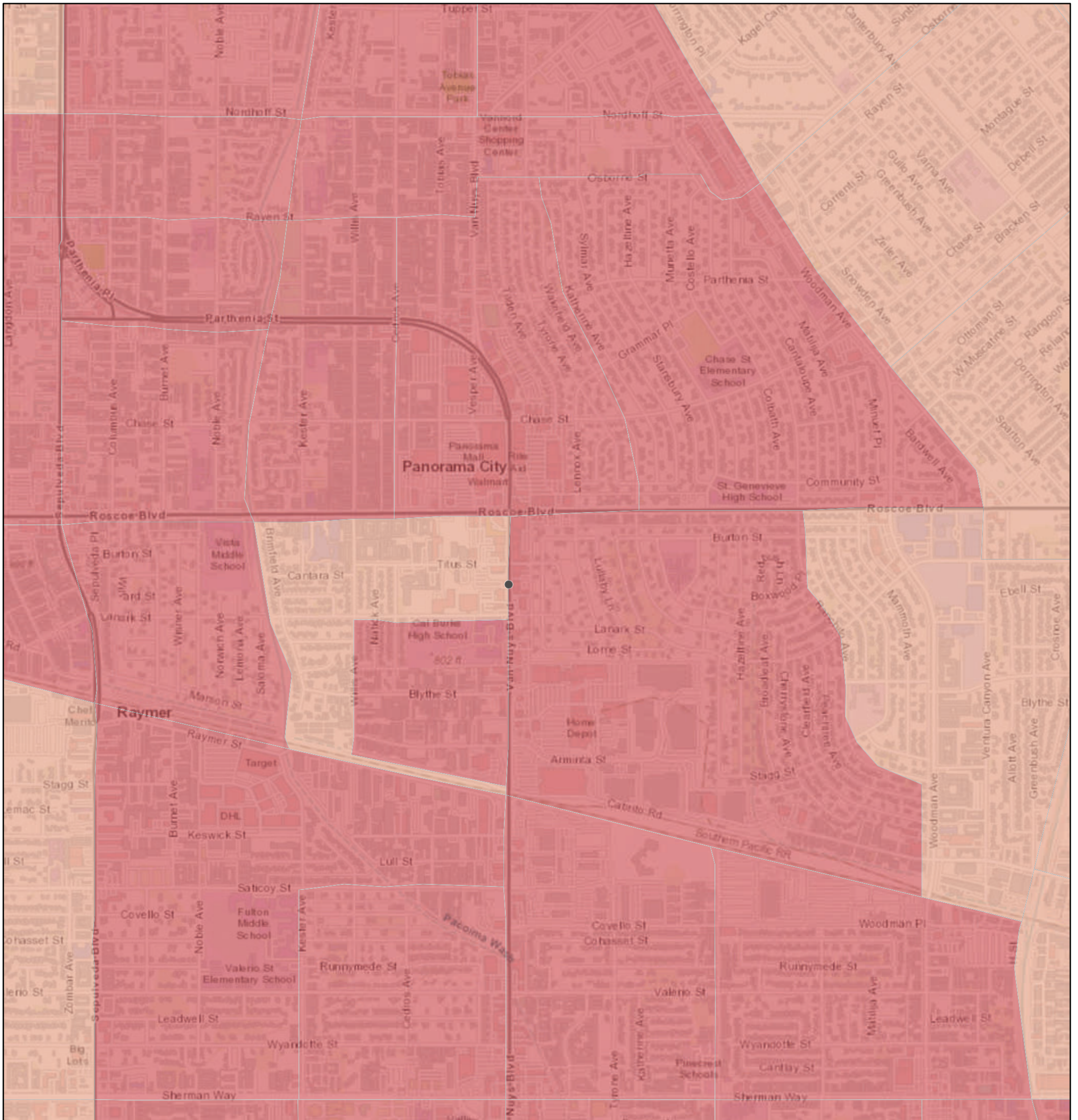

5/21/2020, 6:10:16 PM

Percentage of Trips Under Three Miles

- 35 - 50 %
- 50 - 70.4 %

1:18,056

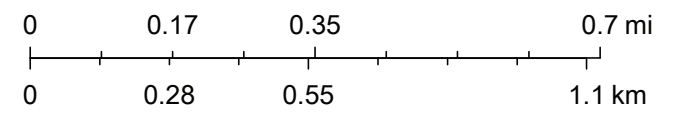

Sources: Esri, HERE, Garmin, Intermap, increment P Corp., GEBCO, USGS, FAO, NPS, NRCAN, GeoBase, IGN, Kadaster NL, Ordnance Survey, Esri Japan, METI, Esri China (Hong Kong), (c) OpenStreetMap contributors, and the GIS User Community

8141 Van Nuys Boulevard

Add scores to your site

Panorama City, Los Angeles, 91402

Commute to **Downtown San Fernando** 

 23 min  40 min  29 min  60+ min [View Routes](#)

 **Favorite**

 **Map**

 **Nearby Apartments**

Looking for a home for sale in Los Angeles? [🔗](#)

Walk Score

85

Very Walkable

Most errands can be accomplished on foot.

Transit Score

52

Good Transit

Many nearby public transportation options.

Bike Score

55

Bikeable

Some bike infrastructure.

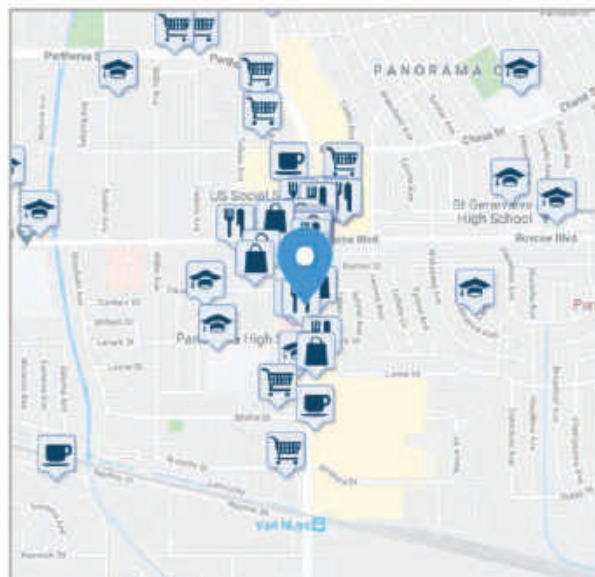

What's Nearby

Restaurants:

Emanuel #2 .04mi >

Coffee:

It's Boba Time .2mi >

Bars:

Rouge Gentlemen Club .6mi >

Groceries:

GNC .2mi >

Parks:

Blythe Street Park .4mi >

Schools:

Panorama High School .2mi >

Shopping:

La Furniture Center .04mi >

Entertainment:

Regency Van Nuys Plant 16 .3mi >

Errands:

D'right Cut Hair & Nail Studio .05mi >

Search Nearby:

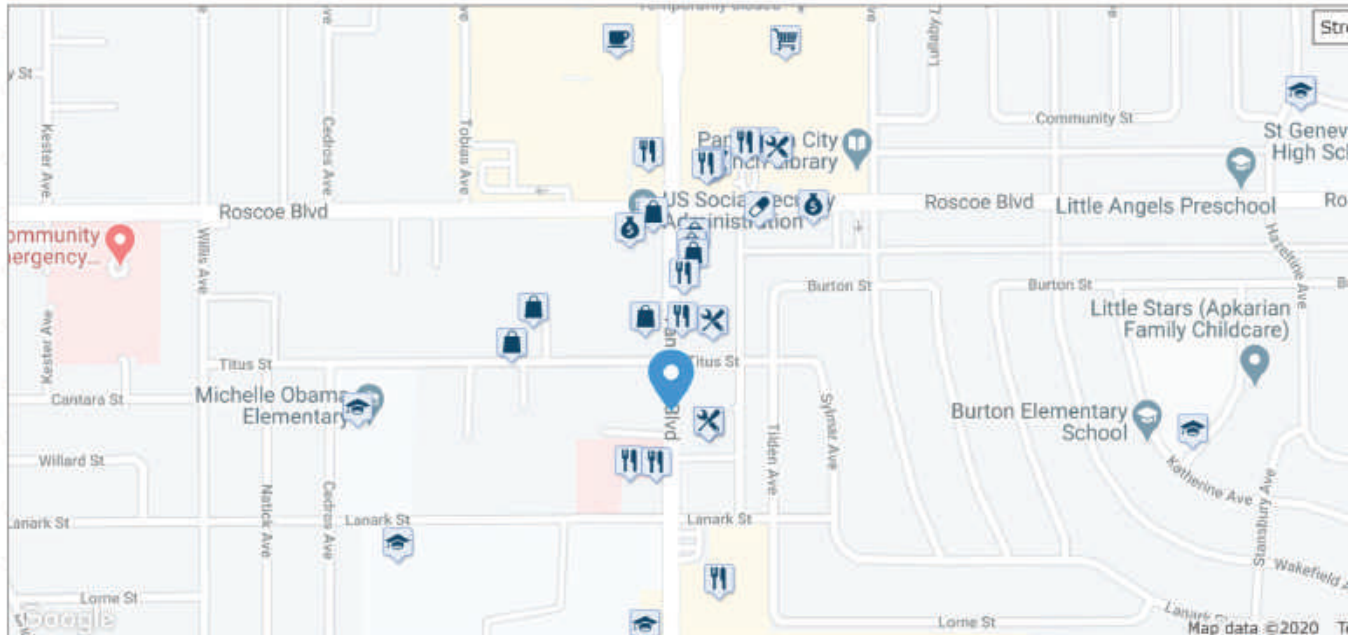

Walkability Index

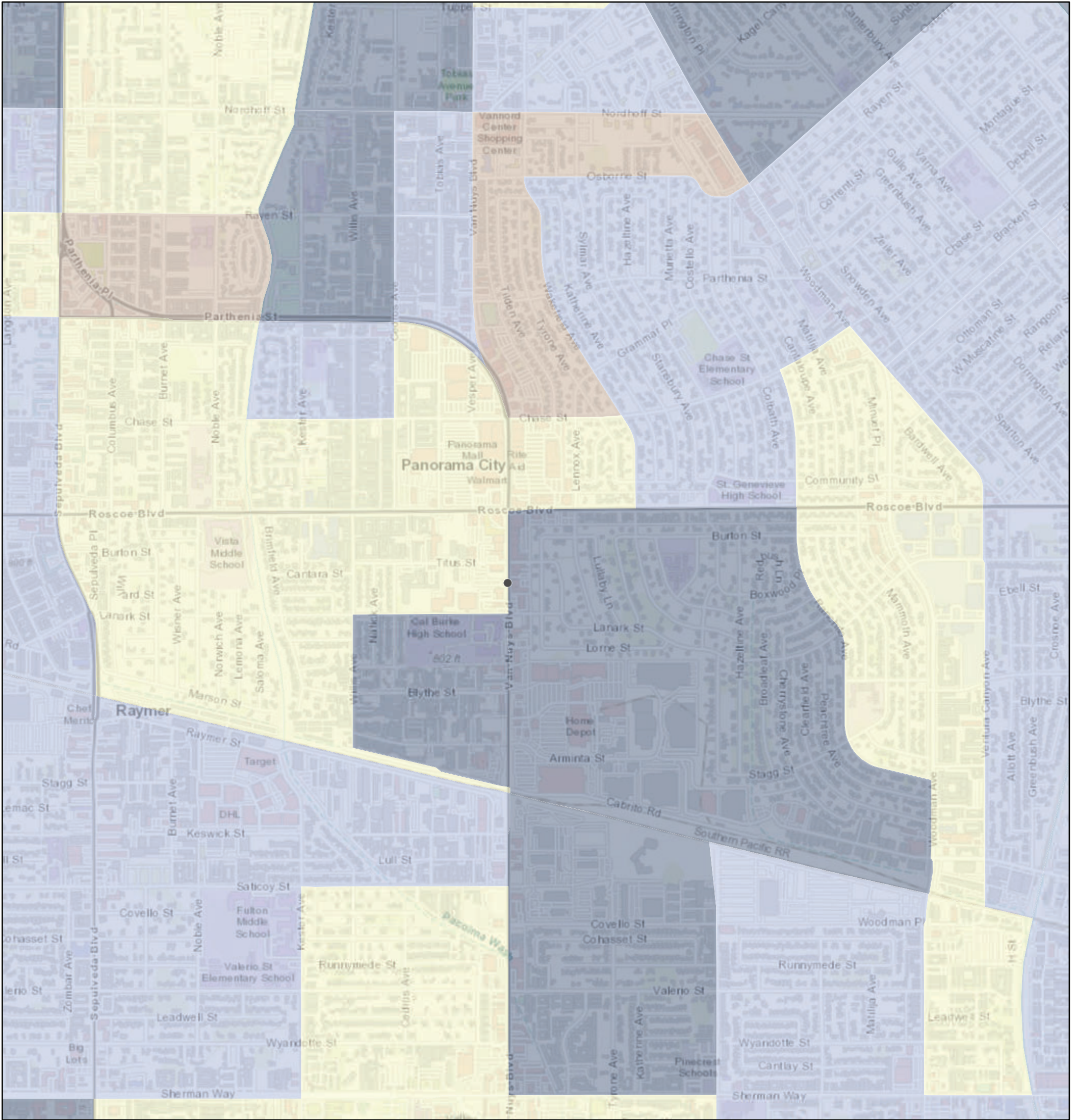

5/21/2020, 6:09:00 PM

Walkability Index

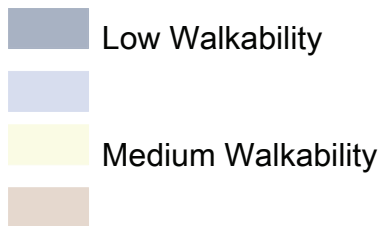

1:18,056

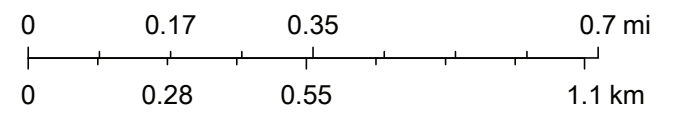

Sources: Esri, HERE, Garmin, Intermap, increment P Corp., GEBCO, USGS, FAO, NPS, NRCAN, GeoBase, IGN, Kadaster NL, Ordnance Survey, Esri Japan, METI, Esri China (Hong Kong), (c) OpenStreetMap contributors, and the GIS User Community



APPENDIX H

VMT REPORT

CITY OF LOS ANGELES VMT CALCULATOR Version 1.2



Project Screening Criteria: Is this project required to conduct a vehicle miles traveled analysis?

Project Information

Project:

Scenario: [www](#)

Address:

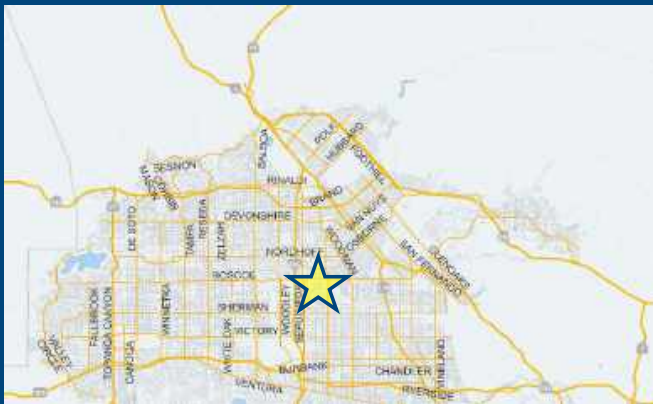

If the project is replacing an existing number of residential units with a smaller number of residential units, is the proposed project located within one-half mile of a fixed-rail or fixed-guideway transit station?

Yes No

Existing Land Use

Land Use Type	Value	Unit
Housing Multi-Family	<input type="text"/>	DU

Click here to add a single custom land use type (will be included in the above list)

Proposed Project Land Use

Land Use Type	Value	Unit
Industrial Warehousing/Self-Storage	18.928	ksf
Housing Multi-Family	200	DU
Retail General Retail	2.45	ksf
Industrial Warehousing/Self-Storage	18.928	ksf

Click here to add a single custom land use type (will be included in the above list)

Project Screening Summary

Existing Land Use	Proposed Project
0 Daily Vehicle Trips	990 Daily Vehicle Trips
0 Daily VMT	7,002 Daily VMT
Tier 1 Screening Criteria	
Project will have less residential units compared to existing residential units & is within one-half mile of a fixed-rail station. <input type="checkbox"/>	
Tier 2 Screening Criteria	
The net increase in daily trips < 250 trips	990 Net Daily Trips
The net increase in daily VMT ≤ 0	7,002 Net Daily VMT
The proposed project consists of only retail land uses ≤ 50,000 square feet total.	2.450 ksf
The proposed project is required to perform VMT analysis.	



CITY OF LOS ANGELES VMT CALCULATOR Version 1.2



Project Information

Project:

Scenario:

Address:

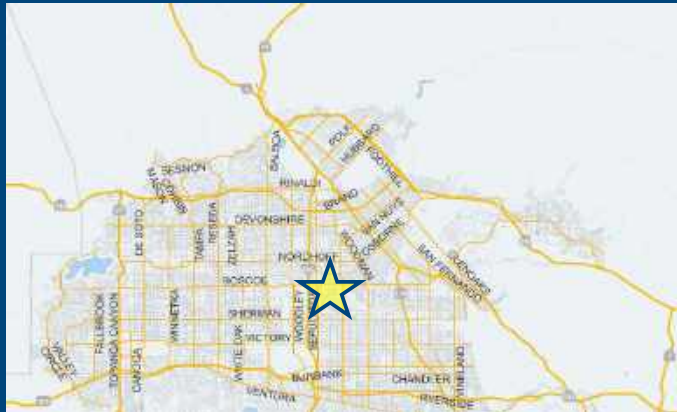

TDM Strategies

Select each section to show individual strategies
Use to denote if the TDM strategy is part of the proposed project or is a mitigation strategy

	Proposed Project	With Mitigation
Max Home Based TDM Achieved?	No	No
Max Work Based TDM Achieved?	No	No

- A** Parking
- B** Transit
- C** Education & Encouragement
- D** Commute Trip Reductions
- E** Shared Mobility
- F** Bicycle Infrastructure
 - Implement/Improve On-street Bicycle Facility Select Proposed Prj or Mitigation to include this strategy
 Proposed Prj Mitigation
 - Include Bike Parking Per LAMC Select Proposed Prj or Mitigation to include this strategy
 Proposed Prj Mitigation
 - Include Secure Bike Parking and Showers Select Proposed Prj or Mitigation to include this strategy
 Proposed Prj Mitigation
- G** Neighborhood Enhancement

Analysis Results

Proposed Project	With Mitigation
984 Daily Vehicle Trips	885 Daily Vehicle Trips
6,958 Daily VMT	6,298 Daily VMT
10.7 Household VMT per Capita	9.2 Household VMT per Capita
4.9 Work VMT per Employee	4.9 Work VMT per Employee

Proposed Project Land Use Type	Value	Unit
Housing Multi-Family	200	DU
Retail General Retail	2.45	ksf
Industrial Warehousing/Self-Storage	18.928	ksf

Significant VMT Impact?

Household: Yes	Household: No
Threshold = 9.2 15% Below APC	Threshold = 9.2 15% Below APC
Work: No Threshold = 15.0 15% Below APC	Work: No Threshold = 15.0 15% Below APC



CITY OF LOS ANGELES VMT CALCULATOR

Report 1: Project & Analysis Overview

Date: May 21, 2020

Project Name:

Project Scenario: With TDM and Project Design Features

Project Address: 8141 N VAN NUYS BLVD, 91402



Version 1.2

Project Information			
Land Use Type		Value	Units
Housing	<i>Single Family</i>	0	DU
	Multi Family	200	DU
	<i>Townhouse</i>	0	DU
	<i>Hotel</i>	0	Rooms
	<i>Motel</i>	0	Rooms
<i>Affordable Housing</i>	<i>Family</i>	0	DU
	<i>Senior</i>	0	DU
	<i>Special Needs</i>	0	DU
	<i>Permanent Supportive</i>	0	DU
Retail	General Retail	2.450	ksf
	<i>Furniture Store</i>	0.000	ksf
	<i>Pharmacy/Drugstore</i>	0.000	ksf
	<i>Supermarket</i>	0.000	ksf
	<i>Bank</i>	0.000	ksf
	<i>Health Club</i>	0.000	ksf
	<i>High-Turnover Sit-Down Restaurant</i>	0.000	ksf
	<i>Fast-Food Restaurant</i>	0.000	ksf
	<i>Quality Restaurant</i>	0.000	ksf
	<i>Auto Repair</i>	0.000	ksf
	<i>Home Improvement</i>	0.000	ksf
	<i>Free-Standing Discount</i>	0.000	ksf
	<i>Movie Theater</i>	0	Seats
	<i>Office</i>	<i>General Office</i>	0.000
<i>Medical Office</i>		0.000	ksf
Industrial	<i>Light Industrial</i>	0.000	ksf
	<i>Manufacturing</i>	0.000	ksf
	Warehousing/Self-Storage	18.928	ksf
<i>School</i>	<i>University</i>	0	Students
	<i>High School</i>	0	Students
	<i>Middle School</i>	0	Students
	<i>Elementary</i>	0	Students
	<i>Private School (K-12)</i>	0	Students

CITY OF LOS ANGELES VMT CALCULATOR

Report 1: Project & Analysis Overview

Date: May 21, 2020

Project Name:

Project Scenario: With TDM and Project Design Features

Project Address: 8141 N VAN NUYS BLVD, 91402



Version 1.2

<i>Other</i>	<i>0</i>	<i>Trips</i>
--------------	----------	--------------

CITY OF LOS ANGELES VMT CALCULATOR

Report 1: Project & Analysis Overview

Date: May 21, 2020

Project Name:

Project Scenario: With TDM and Project Design Features

Project Address: 8141 N VAN NUYS BLVD, 91402



Version 1.2

Analysis Results			
Total Employees: 11			
Total Population: 451			
Proposed Project		With Mitigation	
984	Daily Vehicle Trips	885	Daily Vehicle Trips
6,958	Daily VMT	6,298	Daily VMT
10.7	Household VMT per Capita	9.2	Household VMT per Capita
4.9	Work VMT per Employee	4.9	Work VMT per Employee
Significant VMT Impact?			
APC: North Valley			
Impact Threshold: 15% Below APC Average			
Household = 9.2			
Work = 15.0			
Proposed Project		With Mitigation	
VMT Threshold	Impact	VMT Threshold	Impact
Household > 9.2	Yes	Household > 9.2	No
Work > 15.0	No	Work > 15.0	No

CITY OF LOS ANGELES VMT CALCULATOR

Report 2: TDM Inputs

Date: May 21, 2020

Project Name:

Project Scenario: With TDM and Project Design Features

Project Address: 8141 N VAN NUYS BLVD, 91402



Version 1.2

TDM Strategy Inputs				
Strategy Type	Description	Proposed Project	Mitigations	
Parking	<i>Reduce parking supply</i>	<i>City code parking provision (spaces)</i>	0	
		<i>Actual parking provision (spaces)</i>	0	
	Unbundle parking	Monthly cost for parking (\$)	\$0	\$114
	<i>Parking cash-out</i>	<i>Employees eligible (%)</i>	0%	0%
	<i>Price workplace parking</i>	<i>Daily parking charge (\$)</i>	\$0.00	\$0.00
		<i>Employees subject to priced parking (%)</i>	0%	0%
	<i>Residential area parking permits</i>	<i>Cost of annual permit (\$)</i>	\$0	\$0
(cont. on following page)				

CITY OF LOS ANGELES VMT CALCULATOR

Report 2: TDM Inputs

Date: May 21, 2020

Project Name:

Project Scenario: With TDM and Project Design Features

Project Address: 8141 N VAN NUYS BLVD, 91402



Version 1.2

TDM Strategy Inputs, Cont.				
Strategy Type	Description	Proposed Project	Mitigations	
Transit	<i>Reduce transit headways</i>	<i>Reduction in headways (increase in frequency) (%)</i>	0%	
		<i>Existing transit mode share (as a percent of total daily trips) (%)</i>	0%	
		<i>Lines within project site improved (<50%, >=50%)</i>	0	
	<i>Implement neighborhood shuttle</i>	<i>Degree of implementation (low, medium, high)</i>	0	0
		<i>Employees and residents eligible (%)</i>	0%	0%
	<i>Transit subsidies</i>	<i>Employees and residents eligible (%)</i>	0%	0%
<i>Amount of transit subsidy per passenger (daily equivalent) (\$)</i>		\$0.00	\$0.00	
Education & Encouragement	<i>Voluntary travel behavior change program</i>	<i>Employees and residents participating (%)</i>	0%	
	<i>Promotions and marketing</i>	<i>Employees and residents participating (%)</i>	0%	
(cont. on following page)				

CITY OF LOS ANGELES VMT CALCULATOR

Report 2: TDM Inputs

Date: May 21, 2020

Project Name:

Project Scenario: With TDM and Project Design Features

Project Address: 8141 N VAN NUYS BLVD, 91402



Version 1.2

TDM Strategy Inputs, Cont.				
Strategy Type		Description	Proposed Project	Mitigations
Commuter Trip Reductions	<i>Required commute trip reduction program</i>	<i>Employees participating (%)</i>	0%	0%
	<i>Alternative Work Schedules and Telecommute Program</i>	<i>Employees participating (%)</i>	0%	0%
		<i>Type of program</i>	0	0
	<i>Employer sponsored vanpool or shuttle</i>	<i>Degree of implementation (low, medium, high)</i>	0	0
		<i>Employees eligible (%)</i>	0%	0%
		<i>Employer size (small, medium, large)</i>	0	0
<i>Ride-share program</i>	<i>Employees eligible (%)</i>	0%	0%	
Shared Mobility	<i>Car share</i>	<i>Car share project setting (Urban, Suburban, All Other)</i>	0	0
	<i>Bike share</i>	<i>Within 600 feet of existing bike share station - OR- implementing new bike share station (Yes/No)</i>	0	0
		<i>School carpool program</i>	<i>Level of implementation (Low, Medium, High)</i>	0
(cont. on following page)				

CITY OF LOS ANGELES VMT CALCULATOR

Report 2: TDM Inputs

Date: May 21, 2020

Project Name:

Project Scenario: With TDM and Project Design Features

Project Address: 8141 N VAN NUYS BLVD, 91402



Version 1.2

TDM Strategy Inputs, Cont.				
Strategy Type	Description	Proposed Project	Mitigations	
Bicycle Infrastructure	<i>Implement/Improve on-street bicycle facility</i>	<i>Provide bicycle facility along site (Yes/No)</i>	0	0
	Include Bike parking per LAMC	Meets City Bike Parking Code (Yes/No)	Yes	Yes
	<i>Include secure bike parking and showers</i>	<i>Includes indoor bike parking/lockers, showers, & repair station (Yes/No)</i>	0	0
Neighborhood Enhancement	<i>Traffic calming improvements</i>	<i>Streets with traffic calming improvements (%)</i>	0%	0%
		<i>Intersections with traffic calming improvements (%)</i>	0%	0%
	<i>Pedestrian network improvements</i>	<i>Included (within project and connecting off-site/within project only)</i>	0	0

CITY OF LOS ANGELES VMT CALCULATOR

Report 3: TDM Outputs

Date: May 21, 2020

Project Name:

Project Scenario: With TDM and Project Design Features

Project Address: 8141 N VAN NUYS BLVD, 91402



Version 1.2

TDM Adjustments by Trip Purpose & Strategy

Place type: Compact Infill

		Home Based Work Production		Home Based Work Attraction		Home Based Other Production		Home Based Other Attraction		Non-Home Based Other Production		Non-Home Based Other Attraction		Source
		Proposed	Mitigated	Proposed	Mitigated	Proposed	Mitigated	Proposed	Mitigated	Proposed	Mitigated	Proposed	Mitigated	
Parking	Reduce parking supply	0%	0%	0%	0%	0%	0%	0%	0%	0%	0%	0%	0%	TDM Strategy Appendix, Parking sections 1 - 5
	Unbundle parking	0%	14%	0%	0%	0%	14%	0%	0%	0%	0%	0%	0%	
	Parking cash-out	0%	0%	0%	0%	0%	0%	0%	0%	0%	0%	0%	0%	
	Price workplace parking	0%	0%	0%	0%	0%	0%	0%	0%	0%	0%	0%	0%	
	Residential area parking permits	0.00%	0.00%	0.00%	0.00%	0.00%	0.00%	0.00%	0.00%	0.00%	0.00%	0.00%	0.00%	
Transit	Reduce transit headways	0%	0%	0%	0%	0%	0%	0%	0%	0%	0%	0%	0%	TDM Strategy Appendix, Transit sections 1 - 3
	Implement neighborhood shuttle	0%	0%	0%	0%	0%	0%	0%	0%	0%	0%	0%	0%	
	Transit subsidies	0%	0%	0%	0%	0%	0%	0%	0%	0%	0%	0%	0%	
Education & Encouragement	Voluntary travel behavior change program	0%	0%	0%	0%	0%	0%	0%	0%	0%	0%	0%	0%	TDM Strategy Appendix, Education & Encouragement sections 1 - 2
	Promotions and marketing	0%	0%	0%	0%	0%	0%	0%	0%	0%	0%	0%	0%	
Commute Trip Reductions	Required commute trip reduction program	0%	0%	0%	0%	0%	0%	0%	0%	0%	0%	0%	0%	TDM Strategy Appendix, Commute Trip Reductions sections 1 - 4
	Alternative Work Schedules and Telecommute Program	0%	0%	0%	0%	0%	0%	0%	0%	0%	0%	0%	0%	
	Employer sponsored vanpool or shuttle	0%	0%	0%	0%	0%	0%	0%	0%	0%	0%	0%	0%	
	Ride-share program	0%	0%	0%	0%	0%	0%	0%	0%	0%	0%	0%	0%	
Shared Mobility	Car-share	0.0%	0.0%	0.0%	0.0%	0.0%	0.0%	0.0%	0.0%	0.0%	0.0%	0.0%	0.0%	TDM Strategy Appendix, Shared Mobility sections 1 - 3
	Bike share	0.00%	0.00%	0.00%	0.00%	0.00%	0.00%	0.00%	0.00%	0.00%	0.00%	0.00%	0.00%	
	School carpool program	0.0%	0.0%	0.0%	0.0%	0.0%	0.0%	0.0%	0.0%	0.0%	0.0%	0.0%	0.0%	

CITY OF LOS ANGELES VMT CALCULATOR

Report 3: TDM Outputs

Date: May 21, 2020

Project Name:

Project Scenario: With TDM and Project Design Features

Project Address: 8141 N VAN NUYS BLVD, 91402



Version 1.2

TDM Adjustments by Trip Purpose & Strategy, Cont.

Place type: Compact Infill

		Home Based Work Production		Home Based Work Attraction		Home Based Other Production		Home Based Other Attraction		Non-Home Based Other Production		Non-Home Based Other Attraction		Source
		Proposed	Mitigated	Proposed	Mitigated	Proposed	Mitigated	Proposed	Mitigated	Proposed	Mitigated	Proposed	Mitigated	
		Bicycle Infrastructure	Implement/ Improve on-street bicycle facility	0.0%	0.0%	0.0%	0.0%	0.0%	0.0%	0.0%	0.0%	0.0%	0.0%	
	Include Bike parking per LAMC	0.6%	0.6%	0.6%	0.6%	0.6%	0.6%	0.6%	0.6%	0.6%	0.6%	0.6%	0.6%	
	Include secure bike parking and showers	0.0%	0.0%	0.0%	0.0%	0.0%	0.0%	0.0%	0.0%	0.0%	0.0%	0.0%	0.0%	
Neighborhood Enhancement	Traffic calming improvements	0.0%	0.0%	0.0%	0.0%	0.0%	0.0%	0.0%	0.0%	0.0%	0.0%	0.0%	0.0%	TDM Strategy Appendix, Neighborhood Enhancement
	Pedestrian network improvements	0.0%	0.0%	0.0%	0.0%	0.0%	0.0%	0.0%	0.0%	0.0%	0.0%	0.0%	0.0%	

Final Combined & Maximum TDM Effect

	Home Based Work Production		Home Based Work Attraction		Home Based Other Production		Home Based Other Attraction		Non-Home Based Other Production		Non-Home Based Other Attraction	
	Proposed	Mitigated	Proposed	Mitigated	Proposed	Mitigated	Proposed	Mitigated	Proposed	Mitigated	Proposed	Mitigated
	COMBINED TOTAL	1%	14%	1%	1%	1%	14%	1%	1%	1%	1%	1%
MAX. TDM EFFECT	1%	14%	1%	1%	1%	14%	1%	1%	1%	1%	1%	1%

$$= \text{Minimum}(X\%, 1 - [(1-A) * (1-B)...])$$

where X%=

PLACE	urban	75%
TYPE	compact infill	40%
MAX:	suburban center	20%
	suburban	15%

Note: $(1 - [(1-A) * (1-B)...])$ reflects the dampened combined effectiveness of TDM Strategies (e.g., A, B,...). See the TDM Strategy Appendix (*Transportation Assessment Guidelines Attachment G*) for further discussion of dampening.

CITY OF LOS ANGELES VMT CALCULATOR

Report 4: MXD Methodology

Date: May 21, 2020

Project Name:

Project Scenario: With TDM and Project Design Features

Project Address: 8141 N VAN NUYS BLVD, 91402



Version 1.2

MXD Methodology - Project Without TDM

	Unadjusted Trips	MXD Adjustment	MXD Trips	Average Trip Length	Unadjusted VMT	MXD VMT
Home Based Work Production	271	-17.7%	223	8.5	2,304	1,896
Home Based Other Production	725	-30.8%	502	5.9	4,278	2,962
Non-Home Based Other Production	32	-9.4%	29	8.1	259	235
Home-Based Work Attraction	16	-75.0%	4	13.8	221	55
Home-Based Other Attraction	202	-32.2%	137	6.6	1,333	904
Non-Home Based Other Attraction	105	-9.5%	95	10.0	1,050	950

MXD Methodology with TDM Measures

	<i>Proposed Project</i>			<i>Project with Mitigation Measures</i>		
	TDM Adjustment	Project Trips	Project VMT	TDM Adjustment	Mitigated Trips	Mitigated VMT
Home Based Work Production	-0.6%	222	1,884	-14.2%	191	1,626
Home Based Other Production	-0.6%	499	2,943	-14.2%	431	2,541
Non-Home Based Other Production	-0.6%	29	234	-0.6%	29	234
Home-Based Work Attraction	-0.6%	4	55	-0.6%	4	55
Home-Based Other Attraction	-0.6%	136	898	-0.6%	136	898
Non-Home Based Other Attraction	-0.6%	94	944	-0.6%	94	944

MXD VMT Methodology Per Capita & Per Employee

Total Population: 451

Total Employees: 11

APC: North Valley

	<i>Proposed Project</i>	<i>Project with Mitigation Measures</i>
<i>Total Home Based Production VMT</i>	4,827	4,167
<i>Total Home Based Work Attraction VMT</i>	55	55
<i>Total Home Based VMT Per Capita</i>	10.7	9.2
<i>Total Work Based VMT Per Employee</i>	4.9	4.9



APPENDIX I

RELATED PROJECT INFORMATION

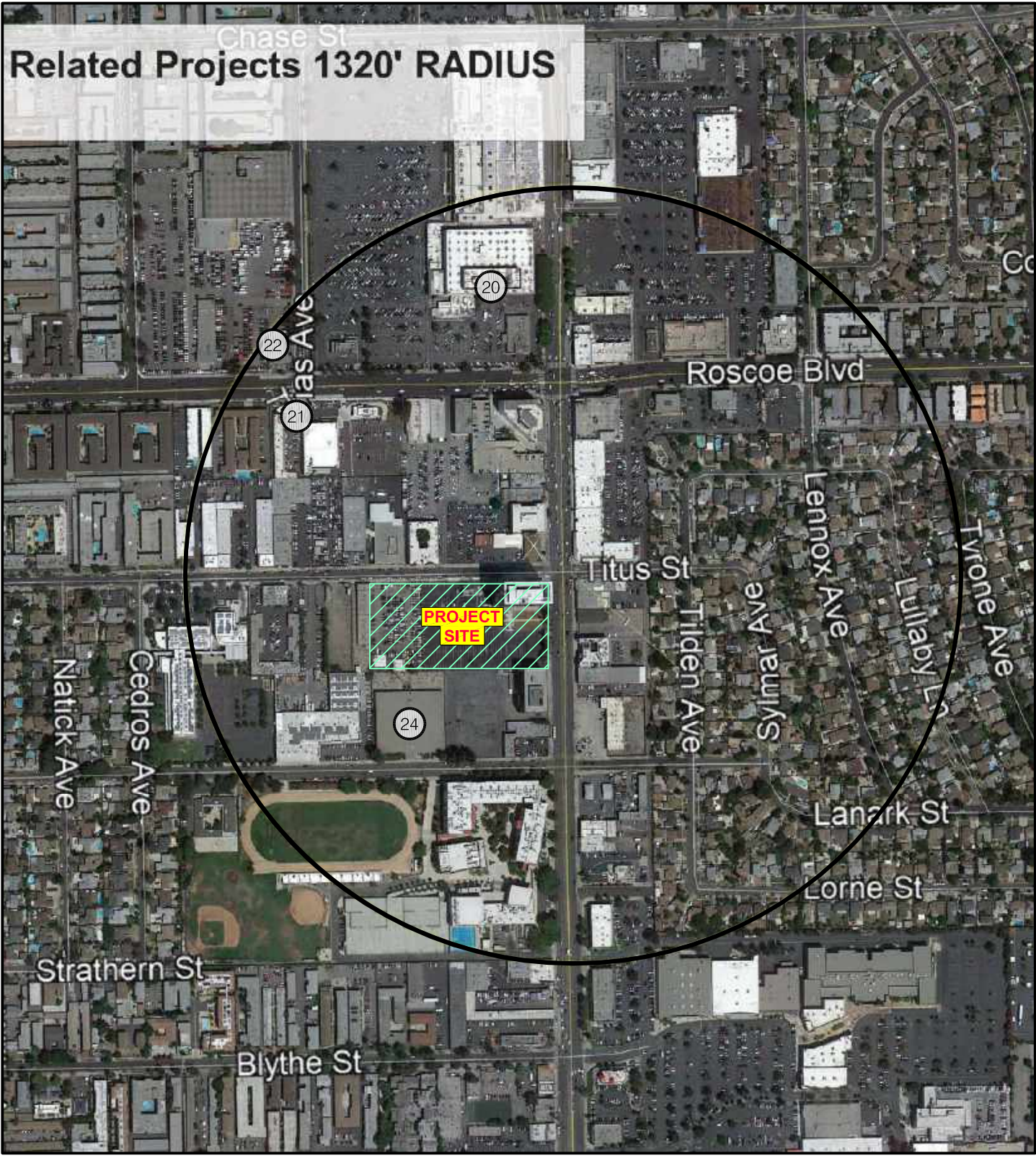

FIGURE 6a

5/2020

**RELATED PROJECT LOCATIONS
 1,320 FOOT RADIUS**

 **Overland Traffic Consultants, Inc.**
 24325 Main Street #202, Santa Clarita, CA 91321
 (661)799-8423, OTC@overlandtraffic.com

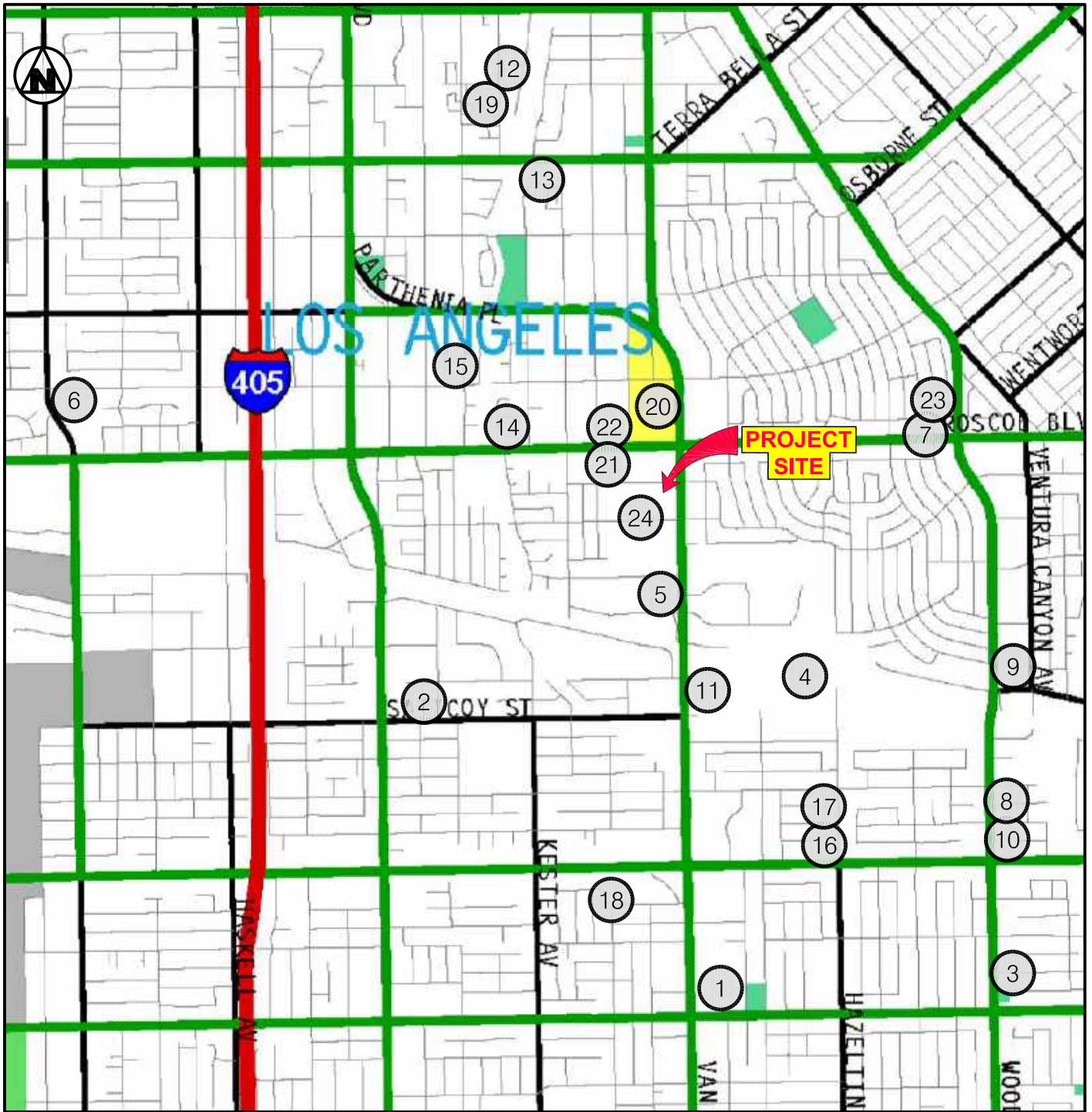

FIGURE 6

5/2020

**RELATED PROJECT LOCATIONS
FOR BASE COUNT ADJUSTMENT**

Overland Traffic Consultants, Inc.
 24325 Main Street #202, Santa Clarita, CA 91321
 (661)799-8423, OTC@overlandtraffic.com

RELATED PROJECT 8141 VAN NUYS BOULEVARD

	<u>Project</u>	<u>Size</u>	<u>Location</u>	<u>Daily</u>	<u>AM Peak Hour</u>			<u>PM Peak Hour</u>		
				<u>Traffic</u>	<u>In</u>	<u>Out</u>	<u>Total</u>	<u>In</u>	<u>Out</u>	<u>Total</u>
1	Apartments	100 units	6828 Van Nuys Boulevard	1,123	17	45	62	38	52	90
	Retail	13,000 sf								
2	Condominium	85 units	15141 Saticoy Street	402	17	38	55	31	36	67
3	Apartments	16 units	6844 Woodman Avenue	106	2	7	9	6	3	9
4	Industrial	283,920 sf	7600 Tyrone Street	2,009	233	32	265	34	246	280
5	Mixed-Use	46,200 sf	7869 Van Nuys Boulevard	1,089	35	23	58	60	58	118
6	Single Family	74 du	16110 Chase Street	695	14	41	55	46	27	73
7	Retail	4,230 sf	13755 Roscoe Boulevard	751	45	43	88	21	21	42
8	Apartments	86 units	7346 Woodman Avenue	572	9	35	44	35	19	54
9	Senior Apartments	288 units	7700 Woodman Avenue	630	3	30	33	19	14	33
10	Apartments	93 units	13641 Sherman Way	618	9	38	47	37	20	57
11	Apartments	124 units	7644 Van Nuys Boulevard	675	12	33	45	33	12	45
12	School	500 students	9356 Lemona Avenue	645	124	101	225	37	38	75
	Apartments	160 units								
13	Single Family	58 du	14834 Nordhoff Street	618	9	38	47	37	20	57
14	Apartments	22 units	14915 Roscoe Boulevard	146	2	9	11	9	5	14
15	Single Family	10 du	8621 Noble Avenue	95	2	6	8	6	4	10
16	Single Family	132 du	14110 Chapparel Lane	1,257	25	74	99	83	49	132
17	Single Family	29 du	7355 Hazeltine Avenue	276	5	16	21	18	11	29
18	Apartments	70 units	14645 Gault Street	466	7	29	36	28	15	43
19	Single Family	24 du	9231 Lemona Avenue	228	5	14	19	15	9	24
20	Panorama Mall	132,000 sf	8401 Van Nuys Boulevard	6,326	83	57	140	187	216	403
	Hotel	100 room								
	Theater	2,000 seats								
21	Supermarket	18,600 sf	14626 Roscoe Boulevard	1,357	38	29	67	59	56	115
	Restaurant	1,900 sf								
22	Apartments	623 du	14665 Roscoe Boulevard	4,484	89	252	341	256	166	422
	Health Club	18,000 sf								
	Shopping Center	42,000 sf								
23	Mixed-Use	100 du	8323 Woodman Avenue	1,108	18	32	50	54	47	101
		14,982 sf								
24	Mixed-Use	180 du	14545 Lanark Street	619	15	39	54	45	20	65
		300 sf								



APPENDIX J

**TRAFFIC VOLUME DATA, FIGURES
AND LEVEL OF SERVICE WORKSHEETS**



TRAFFIC VOLUME DATA

INTERSECTION TURNING MOVEMENT COUNT SUMMARY

CLIENT: OVERLAND TRAFFIC CONSULTANTS, INC.
 PROJECT: PANORAMA CITY
 DATE: WEDNESDAY, MAY 11, 2016
 PERIOD: 07:00 AM TO 10:00 AM
 INTERSECTION N/S VAN NUYS BOULEVARD
 E/W ROSCOE BOULEVARD
 FILE NUMBER: 7-AM

15 MINUTE TOTALS	1	2	3	4	5	6	7	8	9	10	11	12
	SBRT	SBTH	SBLT	WBRT	WBTH	WBLT	NBRT	NBTH	NBLT	EBRT	EBTH	EBLT
0700-0715	19	283	70	37	268	105	47	119	26	35	261	15
0715-0730	16	319	92	39	307	100	65	158	38	37	225	17
0730-0745	11	368	123	38	304	112	68	167	60	57	195	23
0745-0800	18	370	115	52	344	119	67	184	53	62	238	22
0800-0815	19	331	86	58	303	111	48	137	50	43	218	21
0815-0830	19	319	81	39	261	103	49	130	45	52	229	15
0830-0845	14	241	63	40	254	100	45	121	41	51	233	26
0845-0900	13	234	72	25	238	95	35	108	51	55	176	37
0900-0915	16	205	51	29	224	90	47	135	49	50	170	24
0915-0930	22	247	47	20	223	75	45	112	44	59	140	22
0930-0945	19	218	53	26	221	77	52	120	40	62	153	22
0945-1000	20	221	48	22	219	70	43	111	38	51	142	19

1 HOUR TOTALS	1	2	3	4	5	6	7	8	9	10	11	12	TOTALS
	SBRT	SBTH	SBLT	WBRT	WBTH	WBLT	NBRT	NBTH	NBLT	EBRT	EBTH	EBLT	
0700-0800	64	1340	400	166	1223	436	247	628	177	191	919	77	5868
0715-0815	64	1388	416	187	1258	442	248	646	201	199	876	83	6008
0730-0830	67	1388	405	187	1212	445	232	618	208	214	880	81	5937
0745-0845	70	1261	345	189	1162	433	209	572	189	208	918	84	5640
0800-0900	65	1125	302	162	1056	409	177	496	187	201	856	99	5135
0815-0915	62	999	267	133	977	388	176	494	186	208	808	102	4800
0830-0930	65	927	233	114	939	360	172	476	185	215	719	109	4514
0845-0945	70	904	223	100	906	337	179	475	184	226	639	105	4348
0900-1000	77	891	199	97	887	312	187	478	171	222	605	87	4213

A.M. PEAK HOUR
0715-0815

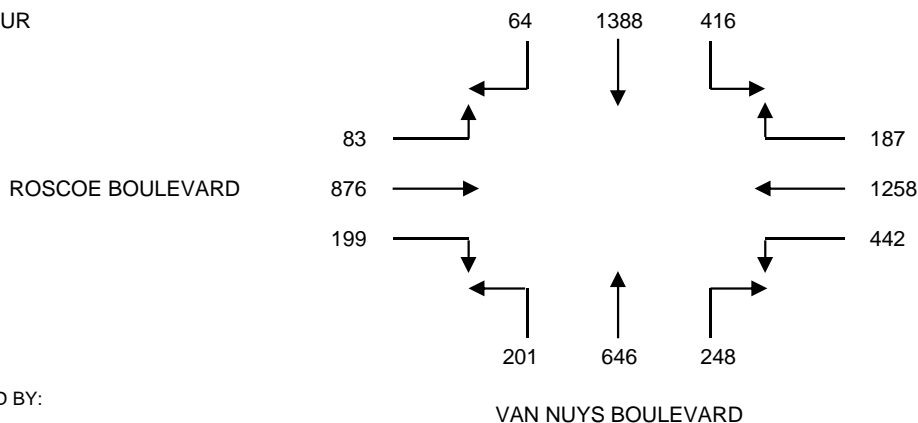

DATA PROVIDED BY:

THE TRAFFIC SOLUTION
 329 DIAMOND STREET
 ARCADIA, CALIFORNIA 91005
 PH: 626-446-7978
 FAX: 626-446-2877

INTERSECTION TURNING MOVEMENT COUNT SUMMARY

CLIENT: OVERLAND TRAFFIC CONSULTANTS, INC.
 PROJECT: PANORAMA CITY
 DATE: WEDNESDAY, MAY 11, 2016
 PERIOD: 03:00 PM TO 06:00 PM
 INTERSECTION N/S VAN NUYS BOULEVARD
 E/W ROSCOE BOULEVARD
 FILE NUMBER: 7-PM

15 MINUTE TOTALS	1	2	3	4	5	6	7	8	9	10	11	12
	SBRT	SBTH	SBLT	WBRT	WBTH	WBLT	NBRT	NBTH	NBLT	EBRT	EBTH	EBLT
0300-0315	18	245	72	48	342	99	86	240	97	73	233	54
0315-0330	15	224	61	36	222	98	70	237	78	53	180	41
0330-0345	23	267	60	46	327	106	80	244	97	71	216	56
0345-0400	21	229	60	39	260	74	54	231	84	51	192	45
0400-0415	14	259	89	38	315	71	68	252	76	54	227	40
0415-0430	19	223	92	34	326	80	61	259	79	54	232	53
0430-0445	16	253	87	42	285	64	43	244	79	49	202	34
0445-0500	15	260	80	41	358	63	51	251	84	68	247	46
0500-0515	23	255	76	41	289	75	74	275	81	49	236	56
0515-0530	18	221	95	36	286	52	55	244	85	33	194	45
0530-0545	17	231	80	43	290	76	67	251	80	45	221	53
0545-0600	18	234	89	42	267	67	60	262	77	50	226	55

1 HOUR TOTALS	1	2	3	4	5	6	7	8	9	10	11	12	TOTALS
	SBRT	SBTH	SBLT	WBRT	WBTH	WBLT	NBRT	NBTH	NBLT	EBRT	EBTH	EBLT	
0300-0400	77	965	253	169	1151	377	290	952	356	248	821	196	5855
0315-0415	73	979	270	159	1124	349	272	964	335	229	815	182	5751
0330-0430	77	978	301	157	1228	331	263	986	336	230	867	194	5948
0345-0445	70	964	328	153	1186	289	226	986	318	208	853	172	5753
0400-0500	64	995	348	155	1284	278	223	1006	318	225	908	173	5977
0415-0515	73	991	335	158	1258	282	229	1029	323	220	917	189	6004
0430-0530	72	989	338	160	1218	254	223	1014	329	199	879	181	5856
0445-0545	73	967	331	161	1223	266	247	1021	330	195	898	200	5912
0500-0600	76	941	340	162	1132	270	256	1032	323	177	877	209	5795

P.M. PEAK HOUR
0415-0515

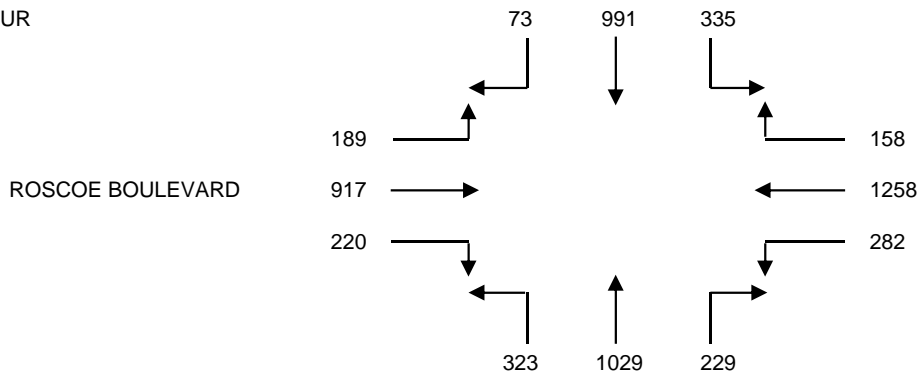

DATA PROVIDED BY:

THE TRAFFIC SOLUTION
 329 DIAMOND STREET
 ARCADIA, CALIFORNIA 91005
 PH: 626-446-7978
 FAX: 626-446-2877

VAN NUYS BOULEVARD

PEDESTRIAN - BICYCLE COUNT SUMMARY

CLIENT: OVERLAND TRAFFIC CONSULTANTS, INC.
 PROJECT: PANORAMA CITY
 DATE: WEDNESDAY, MAY 11, 2016
 PERIOD: 07:00 AM TO 10:00 AM
 INTERSECTION: VAN NUYS BOULEVARD
 ROSCOE BOULEVARD
 FILE: 7AMPED-BIKE

15-MINUTE PERIOD	PEDESTRIAN MOVEMENTS			
	NORTH LEG	EAST LEG	SOUTH LEG	WEST LEG
	A	B	C	D
0700-0715	31	14	18	36
0715-0730	11	13	15	20
0730-0745	23	28	38	47
0745-0800	21	20	15	29
0800-0815	20	20	21	18
0815-0830	11	20	15	18
0830-0845	20	19	18	36
0845-0900	20	18	31	36
0900-0915	38	19	11	39
0915-0930	17	26	21	39
0930-0945	28	24	27	33
0945-1000	20	19	23	28

15-MINUTE PERIOD	BICYCLIST MOVEMENTS			
	NORTH LEG	EAST LEG	SOUTH LEG	WEST LEG
	A	B	C	D
0700-0715	1	3	3	3
0715-0730	0	4	0	4
0730-0745	1	0	1	5
0745-0800	0	5	2	4
0800-0815	0	2	1	5
0815-0830	0	1	2	4
0830-0845	0	2	1	2
0845-0900	2	1	2	3
0900-0915	3	3	1	2
0915-0930	2	0	0	2
0930-0945	1	2	1	2
0945-1000	2	1	0	1

1-HOUR PERIOD	PEDESTRIAN MOVEMENTS				TOTALS
	NORTH LEG	EAST LEG	SOUTH LEG	WEST LEG	
	A	B	C	D	
0700-0800	86	75	86	132	379
0715-0815	75	81	89	114	359
0730-0830	75	88	89	112	364
0745-0845	72	79	69	101	321
0800-0900	71	77	85	108	341
0815-0915	89	76	75	129	369
0830-0930	95	82	81	150	408
0845-0945	103	87	90	147	427
0900-1000	103	88	82	139	412

1-HOUR PERIOD	BICYCLIST MOVEMENTS				TOTALS
	NORTH LEG	EAST LEG	SOUTH LEG	WEST LEG	
	A	B	C	D	
0700-0800	2	12	6	16	36
0715-0815	1	11	4	18	34
0730-0830	1	8	6	18	33
0745-0845	0	10	6	15	31
0800-0900	2	6	6	14	28
0815-0915	5	7	6	11	29
0830-0930	7	6	4	9	26
0845-0945	8	6	4	9	27
0900-1000	8	6	2	7	23

PEDESTRIAN - BICYCLE COUNT SUMMARY

CLIENT: OVERLAND TRAFFIC CONSULTANTS, INC.
 PROJECT: PANORAMA CITY
 DATE: WEDNESDAY, MAY 11, 2016
 PERIOD: 03:00 PM TO 06:00 PM
 INTERSECTION: VAN NUYS BOULEVARD
 ROSCOE BOULEVARD
 FILE: 7PMPED-BIKE

15-MINUTE PERIOD	PEDESTRIAN MOVEMENTS			
	NORTH LEG	EAST LEG	SOUTH LEG	WEST LEG
	A	B	C	D
0300-0315	38	36	51	92
0315-0330	32	46	29	78
0330-0345	42	44	36	85
0345-0400	36	37	18	36
0400-0415	39	33	25	65
0415-0430	49	48	17	58
0430-0445	33	43	20	55
0445-0500	38	57	25	66
0500-0515	37	37	17	49
0515-0530	73	41	15	30
0530-0545	56	45	22	52
0545-0600	55	40	20	60

15-MINUTE PERIOD	BICYCLIST MOVEMENTS			
	NORTH LEG	EAST LEG	SOUTH LEG	WEST LEG
	A	B	C	D
0300-0315	4	3	1	8
0315-0330	1	1	4	2
0330-0345	3	3	3	7
0345-0400	0	4	1	3
0400-0415	4	1	1	3
0415-0430	3	3	1	7
0430-0445	2	0	1	1
0445-0500	3	4	4	7
0500-0515	1	3	1	2
0515-0530	1	2	1	2
0530-0545	2	1	0	2
0545-0600	0	0	1	1

1-HOUR PERIOD	PEDESTRIAN MOVEMENTS				TOTALS
	NORTH LEG	EAST LEG	SOUTH LEG	WEST LEG	
	A	B	C	D	
0300-0400	148	163	134	291	736
0315-0415	149	160	108	264	681
0330-0430	166	162	96	244	668
0345-0445	157	161	80	214	612
0400-0500	159	181	87	244	671
0415-0515	157	185	79	228	649
0430-0530	181	178	77	200	636
0445-0545	204	180	79	197	660
0500-0600	221	163	74	191	649

1-HOUR PERIOD	BICYCLIST MOVEMENTS				TOTALS
	NORTH LEG	EAST LEG	SOUTH LEG	WEST LEG	
	A	B	C	D	
0300-0400	8	11	9	20	48
0315-0415	8	9	9	15	41
0330-0430	10	11	6	20	47
0345-0445	9	8	4	14	35
0400-0500	12	8	7	18	45
0415-0515	9	10	7	17	43
0430-0530	7	9	7	12	35
0445-0545	7	10	6	13	36
0500-0600	4	6	3	7	20

INTERSECTION TURNING MOVEMENT COUNT SUMMARY

CLIENT: OVERLAND TRAFFIC CONSULTANTS, INC.
 PROJECT: PANORAMA CITY
 DATE: WEDNESDAY, MAY 11, 2016
 PERIOD: 07:00 AM TO 10:00 AM
 INTERSECTION N/S VAN NUYS BOULEVARD
 E/W SATICOY STREET
 FILE NUMBER: 12-AM

15 MINUTE TOTALS	1	2	3	4	5	6	7	8	9	10	11	12
	SBRT	SBTH	SBLT	WBRT	WBTH	WBLT	NBRT	NBTH	NBLT	EBRT	EBTH	EBLT
0700-0715	99	307	8	8	9	11	15	123	40	63	12	77
0715-0730	93	384	9	7	6	10	10	174	51	74	8	94
0730-0745	85	333	5	5	8	19	7	188	73	109	5	140
0745-0800	88	324	3	7	6	14	5	189	49	100	5	112
0800-0815	90	318	3	3	3	12	6	223	67	102	0	96
0815-0830	85	359	7	4	2	6	5	191	51	80	7	89
0830-0845	73	269	5	3	5	4	10	194	33	63	2	56
0845-0900	68	231	10	2	2	2	7	159	40	54	2	50
0900-0915	50	234	12	5	4	3	11	176	33	57	3	51
0915-0930	66	261	5	4	6	7	7	208	34	67	2	69
0930-0945	52	257	6	4	4	5	6	181	33	63	4	57
0945-1000	49	240	7	3	5	3	8	169	29	59	4	55

1 HOUR TOTALS	1	2	3	4	5	6	7	8	9	10	11	12	TOTALS
	SBRT	SBTH	SBLT	WBRT	WBTH	WBLT	NBRT	NBTH	NBLT	EBRT	EBTH	EBLT	
0700-0800	365	1348	25	27	29	54	37	674	213	346	30	423	3571
0715-0815	356	1359	20	22	23	55	28	774	240	385	18	442	3722
0730-0830	348	1334	18	19	19	51	23	791	240	391	17	437	3688
0745-0845	336	1270	18	17	16	36	26	797	200	345	14	353	3428
0800-0900	316	1177	25	12	12	24	28	767	191	299	11	291	3153
0815-0915	276	1093	34	14	13	15	33	720	157	254	14	246	2869
0830-0930	257	995	32	14	17	16	35	737	140	241	9	226	2719
0845-0945	236	983	33	15	16	17	31	724	140	241	11	227	2674
0900-1000	217	992	30	16	19	18	32	734	129	246	13	232	2678

A.M. PEAK HOUR
0715-0815

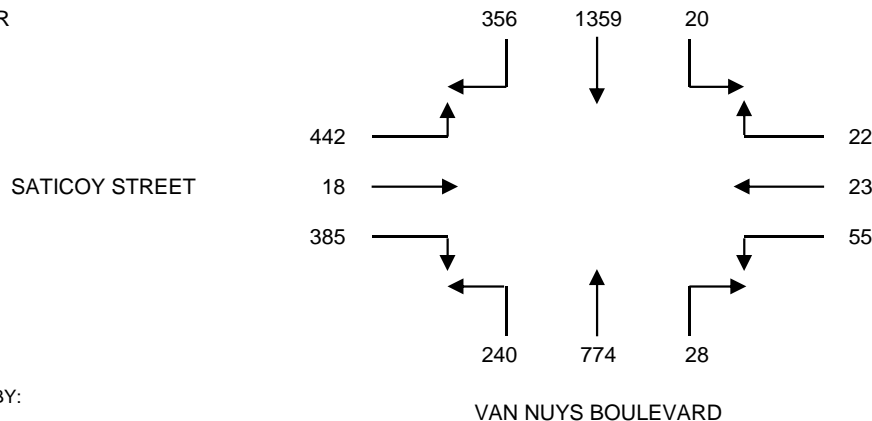

DATA PROVIDED BY:

THE TRAFFIC SOLUTION
 329 DIAMOND STREET
 ARCADIA, CALIFORNIA 91005
 PH: 626-446-7978
 FAX: 626-446-2877

VAN NUYS BOULEVARD

INTERSECTION TURNING MOVEMENT COUNT SUMMARY

CLIENT: OVERLAND TRAFFIC CONSULTANTS, INC.
 PROJECT: PANORAMA CITY
 DATE: WEDNESDAY, MAY 11, 2016
 PERIOD: 03:00 PM TO 06:00 PM
 INTERSECTION N/S VAN NUYS BOULEVARD
 E/W SATICOY STREET
 FILE NUMBER: 12-PM

15 MINUTE TOTALS	1	2	3	4	5	6	7	8	9	10	11	12
	SBRT	SBTH	SBLT	WBRT	WBTH	WBLT	NBRT	NBTH	NBLT	EBRT	EBTH	EBLT
0300-0315	78	273	2	15	13	6	17	317	54	53	8	104
0315-0330	61	242	5	7	8	9	10	286	40	62	10	115
0330-0345	86	294	3	10	17	11	6	378	69	76	5	121
0345-0400	81	264	2	10	26	12	5	306	52	62	2	153
0400-0415	77	308	5	11	19	7	10	378	51	61	2	139
0415-0430	82	281	4	5	12	9	11	356	79	77	4	119
0430-0445	71	270	2	7	10	9	7	366	60	68	3	131
0445-0500	72	327	2	4	5	5	8	380	60	58	2	125
0500-0515	63	223	6	5	6	7	4	251	47	55	1	106
0515-0530	75	254	5	6	7	8	5	275	53	62	2	123
0530-0545	69	287	4	5	5	6	3	300	50	57	1	120
0545-0600	67	271	3	4	3	7	5	288	47	65	0	116

1 HOUR TOTALS	1	2	3	4	5	6	7	8	9	10	11	12	TOTALS
	SBRT	SBTH	SBLT	WBRT	WBTH	WBLT	NBRT	NBTH	NBLT	EBRT	EBTH	EBLT	
0300-0400	306	1073	12	42	64	38	38	1287	215	253	25	493	3846
0315-0415	305	1108	15	38	70	39	31	1348	212	261	19	528	3974
0330-0430	326	1147	14	36	74	39	32	1418	251	276	13	532	4158
0345-0445	311	1123	13	33	67	37	33	1406	242	268	11	542	4086
0400-0500	302	1186	13	27	46	30	36	1480	250	264	11	514	4159
0415-0515	288	1101	14	21	33	30	30	1353	246	258	10	481	3865
0430-0530	281	1074	15	22	28	29	24	1272	220	243	8	485	3701
0445-0545	279	1091	17	20	23	26	20	1206	210	232	6	474	3604
0500-0600	274	1035	18	20	21	28	17	1114	197	239	4	465	3432

P.M. PEAK HOUR
0400-0500

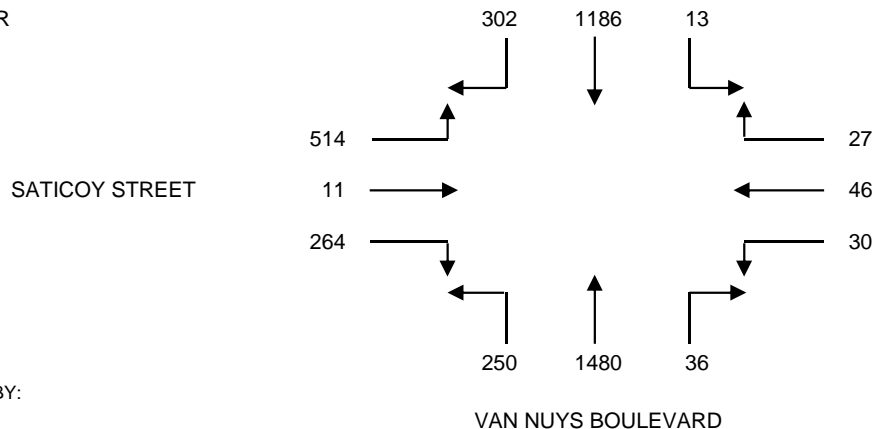

DATA PROVIDED BY:

THE TRAFFIC SOLUTION
 329 DIAMOND STREET
 ARCADIA, CALIFORNIA 91005
 PH: 626-446-7978
 FAX: 626-446-2877

PEDESTRIAN - BICYCLE COUNT SUMMARY

CLIENT: OVERLAND TRAFFIC CONSULTANTS, INC.
 PROJECT: PANORAMA CITY
 DATE: WEDNESDAY, MAY 11, 2016
 PERIOD: 07:00 AM TO 10:00 AM
 INTERSECTION: VAN NUYS BOULEVARD
 SATICOY STREET
 FILE: 12AMPED-BIKE

15-MINUTE PERIOD	PEDESTRIAN MOVEMENTS			
	NORTH LEG	EAST LEG	SOUTH LEG	WEST LEG
	A	B	C	D
0700-0715	0	4	3	11
0715-0730	0	9	9	15
0730-0745	0	5	4	18
0745-0800	0	2	2	10
0800-0815	0	6	4	8
0815-0830	0	10	8	10
0830-0845	0	3	5	9
0845-0900	0	2	3	7
0900-0915	0	4	3	18
0915-0930	0	3	9	16
0930-0945	0	4	5	15
0945-1000	0	3	5	16

15-MINUTE PERIOD	BICYCLIST MOVEMENTS			
	NORTH LEG	EAST LEG	SOUTH LEG	WEST LEG
	A	B	C	D
0700-0715	0	1	0	4
0715-0730	0	5	0	2
0730-0745	0	2	2	5
0745-0800	0	3	1	3
0800-0815	0	2	0	0
0815-0830	0	0	1	1
0830-0845	0	1	0	0
0845-0900	0	1	2	0
0900-0915	0	1	1	1
0915-0930	0	2	1	3
0930-0945	0	1	0	2
0945-1000	0	0	1	1

1-HOUR PERIOD	PEDESTRIAN MOVEMENTS				TOTALS
	NORTH LEG	EAST LEG	SOUTH LEG	WEST LEG	
	A	B	C	D	
0700-0800	0	20	18	54	92
0715-0815	0	22	19	51	92
0730-0830	0	23	18	46	87
0745-0845	0	21	19	37	77
0800-0900	0	21	20	34	75
0815-0915	0	19	19	44	82
0830-0930	0	12	20	50	82
0845-0945	0	13	20	56	89
0900-1000	0	14	22	65	101

1-HOUR PERIOD	BICYCLIST MOVEMENTS				TOTALS
	NORTH LEG	EAST LEG	SOUTH LEG	WEST LEG	
	A	B	C	D	
0700-0800	0	11	3	14	28
0715-0815	0	12	3	10	25
0730-0830	0	7	4	9	20
0745-0845	0	6	2	4	12
0800-0900	0	4	3	1	8
0815-0915	0	3	4	2	9
0830-0930	0	5	4	4	13
0845-0945	0	5	4	6	15
0900-1000	0	4	3	7	14

PEDESTRIAN - BICYCLE COUNT SUMMARY

CLIENT: OVERLAND TRAFFIC CONSULTANTS, INC.
 PROJECT: PANORAMA CITY
 DATE: WEDNESDAY, MAY 11, 2016
 PERIOD: 03:00 PM TO 06:00 PM
 INTERSECTION: VAN NUYS BOULEVARD
 SATICOY STREET
 FILE: 12PMPED-BIKE

15-MINUTE PERIOD	PEDESTRIAN MOVEMENTS			
	NORTH LEG	EAST LEG	SOUTH LEG	WEST LEG
	A	B	C	D
0300-0315	0	18	20	37
0315-0330	0	6	12	15
0330-0345	0	18	14	26
0345-0400	0	5	18	24
0400-0415	0	10	28	32
0415-0430	0	4	13	30
0430-0445	0	6	13	15
0445-0500	0	9	20	20
0500-0515	0	7	10	17
0515-0530	0	13	21	23
0530-0545	0	12	19	20
0545-0600	0	10	23	16

15-MINUTE PERIOD	BICYCLIST MOVEMENTS			
	NORTH LEG	EAST LEG	SOUTH LEG	WEST LEG
	A	B	C	D
0300-0315	0	2	1	3
0315-0330	0	1	1	4
0330-0345	0	1	3	4
0345-0400	0	0	2	2
0400-0415	0	1	3	7
0415-0430	0	0	1	2
0430-0445	0	1	3	6
0445-0500	0	0	2	1
0500-0515	0	0	1	7
0515-0530	0	1	2	3
0530-0545	0	2	2	4
0545-0600	0	0	1	2

1-HOUR PERIOD	PEDESTRIAN MOVEMENTS				TOTALS
	NORTH LEG	EAST LEG	SOUTH LEG	WEST LEG	
	A	B	C	D	
0300-0400	0	47	64	102	213
0315-0415	0	39	72	97	208
0330-0430	0	37	73	112	222
0345-0445	0	25	72	101	198
0400-0500	0	29	74	97	200
0415-0515	0	26	56	82	164
0430-0530	0	35	64	75	174
0445-0545	0	41	70	80	191
0500-0600	0	42	73	76	191

1-HOUR PERIOD	BICYCLIST MOVEMENTS				TOTALS
	NORTH LEG	EAST LEG	SOUTH LEG	WEST LEG	
	A	B	C	D	
0300-0400	0	4	7	13	24
0315-0415	0	3	9	17	29
0330-0430	0	2	9	15	26
0345-0445	0	2	9	17	28
0400-0500	0	2	9	16	27
0415-0515	0	1	7	16	24
0430-0530	0	2	8	17	27
0445-0545	0	3	7	15	25
0500-0600	0	3	6	16	25

Turning Movement Count Report AM

Location ID: 3
 North/South: Willis Avenue
 East/West: Roscoe Blvd

Date: 04/20/17
 City: Panorama City, CA

	Southbound			Westbound			Northbound			Eastbound			Totals:
	1	2	3	4	5	6	7	8	9	10	11	12	
Movements:	R	T	L	R	T	L	R	T	L	R	T	L	
07:00	18	23	10	5	277	8	17	13	57	25	265	7	725
07:15	21	31	4	3	304	5	15	9	65	45	257	2	761
07:30	31	33	8	2	336	12	7	22	64	38	284	6	843
07:45	21	36	10	7	334	9	11	29	49	44	310	11	871
08:00	16	30	8	5	305	4	18	28	61	31	271	13	790
08:15	15	28	4	7	329	13	16	13	42	25	273	5	770
08:30	12	20	7	6	282	7	14	7	39	48	283	12	737
08:45	17	16	1	3	303	5	15	9	32	27	295	12	735
09:00	11	12	8	9	233	6	13	8	43	25	241	8	617
09:15	8	16	5	4	226	6	7	7	34	31	262	4	610
09:30	12	8	2	7	239	6	11	14	34	29	276	6	644
09:45	4	10	4	7	215	5	10	8	31	24	285	6	609

Total Volume:	186	263	71	65	3383	86	154	167	551	392	3302	92	8712
Approach %	36%	51%	14%	2%	96%	2%	18%	19%	63%	10%	87%	2%	

Peak Hr Begin:	7:30												
PHV	83	127	30	21	1304	38	52	92	216	138	1138	35	3274
PHF	0.833			0.974			0.841			0.898			0.940

Turning Movement Count Report PM

Location ID: 3
 North/South: Willis Avenue
 East/West: Roscoe Blvd

Date: 04/20/17
 City: Panorama City, CA

	Southbound			Westbound			Northbound			Eastbound			Totals:
	1	2	3	4	5	6	7	8	9	10	11	12	
Movements:	R	T	L	R	T	L	R	T	L	R	T	L	
15:00	18	26	7	11	291	6	9	19	54	29	312	14	796
15:15	13	18	7	11	301	14	16	16	62	30	310	11	809
15:30	14	15	12	14	306	9	21	25	73	41	301	16	847
15:45	17	29	13	8	302	12	14	23	58	47	349	18	890
16:00	14	25	3	6	306	12	19	29	85	33	319	17	868
16:15	18	22	6	15	323	9	17	47	79	46	326	14	922
16:30	19	18	4	10	289	11	17	25	81	30	347	14	865
16:45	8	26	7	10	337	8	8	31	74	40	318	17	884
17:00	21	29	6	7	292	11	26	28	80	48	357	18	923
17:15	13	25	4	9	302	11	20	34	76	31	344	20	889
17:30	11	26	6	18	280	13	23	38	83	39	324	16	877
17:45	14	26	6	14	308	13	17	37	74	58	356	14	937

Total Volume:	180	285	81	133	3637	129	207	352	879	472	3963	189	10507
Approach %	33%	52%	15%	3%	93%	3%	14%	24%	61%	10%	86%	4%	

Peak Hr Begin:	17:00												
PHV	59	106	22	48	1182	48	86	137	313	176	1381	68	3626
PHF	0.835			0.954			0.931			0.949			0.967

Pedestrian/Bicycle Count Report

Leg:	North		East		South		West	
	Peds	Bicycle	Peds	Bicycle	Peds	Bicycle	Peds	Bicycle
07:00	13	0	11	0	10	1	14	1
07:15	24	3	75	0	30	2	34	3
07:30	27	0	160	2	47	1	111	0
07:45	16	1	105	0	37	0	72	2
08:00	11	0	26	0	13	0	17	0
08:15	3	0	7	1	8	0	10	0
08:30	9	0	11	1	4	0	4	1
08:45	7	0	6	0	2	0	3	1
09:00	6	2	10	1	6	2	5	0
09:15	10	2	1	0	5	1	6	0
09:30	2	0	4	0	5	1	3	0
09:45	4	0	3	0	5	0	6	0

Leg:	North		East		South		West	
	Peds	Bicycle	Peds	Bicycle	Peds	Bicycle	Peds	Bicycle
15:00	24	0	27	0	57	0	63	0
15:15	15	0	67	1	36	0	55	0
15:30	15	2	25	2	13	2	27	3
15:45	7	2	18	1	13	1	18	1
16:00	16	0	29	0	15	0	16	0
16:15	14	0	22	0	6	1	19	1
16:30	8	0	11	0	11	6	21	0
16:45	13	0	15	2	5	1	18	0
17:00	7	0	11	0	20	1	18	0
17:15	3	2	16	0	7	0	16	0
17:30	7	1	16	0	10	1	13	2
17:45	1	0	25	2	10	1	15	2

INTERSECTION TURNING MOVEMENT COUNT SUMMARY

CLIENT: OVERLAND TRAFFIC CONSULTANTS, INC.
 PROJECT: PANORAMA CITY
 DATE: WEDNESDAY, MAY 11, 2016
 PERIOD: 07:00 AM TO 10:00 AM
 INTERSECTION N/S WOODMAN AVENUE
 E/W ROSCOE BOULEVARD
 FILE NUMBER: 6-AM

15 MINUTE TOTALS	1	2	3	4	5	6	7	8	9	10	11	12
	SBRT	SBTH	SBLT	WBRT	WBTH	WBLT	NBRT	NBTH	NBLT	EBRT	EBTH	EBLT
0700-0715	37	267	27	11	274	32	26	92	32	48	258	37
0715-0730	38	302	29	11	350	43	32	116	38	58	295	36
0730-0745	39	318	36	19	333	44	22	131	54	59	284	47
0745-0800	35	294	20	16	305	63	35	133	35	48	265	51
0800-0815	47	307	24	10	267	59	24	138	39	43	243	40
0815-0830	38	271	33	16	269	53	31	131	39	41	229	28
0830-0845	46	225	31	13	272	44	26	102	25	51	262	31
0845-0900	45	253	31	19	231	47	20	105	20	31	206	22
0900-0915	33	210	26	13	191	33	23	126	35	44	199	23
0915-0930	43	239	31	11	165	51	34	97	34	30	200	31
0930-0945	40	213	32	14	187	46	33	101	37	35	215	28
0945-1000	37	230	28	13	173	42	35	103	30	38	211	26

1 HOUR TOTALS	1	2	3	4	5	6	7	8	9	10	11	12	TOTALS
	SBRT	SBTH	SBLT	WBRT	WBTH	WBLT	NBRT	NBTH	NBLT	EBRT	EBTH	EBLT	
0700-0800	149	1181	112	57	1262	182	115	472	159	213	1102	171	5175
0715-0815	159	1221	109	56	1255	209	113	518	166	208	1087	174	5275
0730-0830	159	1190	113	61	1174	219	112	533	167	191	1021	166	5106
0745-0845	166	1097	108	55	1113	219	116	504	138	183	999	150	4848
0800-0900	176	1056	119	58	1039	203	101	476	123	166	940	121	4578
0815-0915	162	959	121	61	963	177	100	464	119	167	896	104	4293
0830-0930	167	927	119	56	859	175	103	430	114	156	867	107	4080
0845-0945	161	915	120	57	774	177	110	429	126	140	820	104	3933
0900-1000	153	892	117	51	716	172	125	427	136	147	825	108	3869

A.M. PEAK HOUR
0715-0815

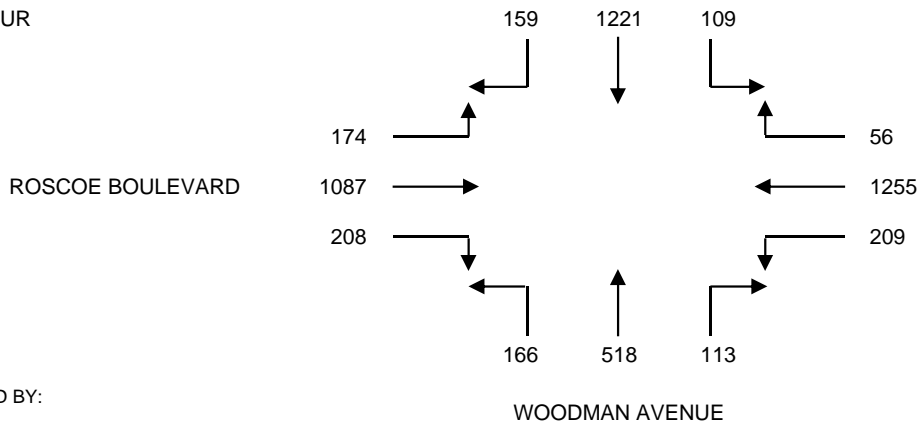

DATA PROVIDED BY:

THE TRAFFIC SOLUTION
 329 DIAMOND STREET
 ARCADIA, CALIFORNIA 91005
 PH: 626-446-7978
 FAX: 626-446-2877

INTERSECTION TURNING MOVEMENT COUNT SUMMARY

CLIENT: OVERLAND TRAFFIC CONSULTANTS, INC.
 PROJECT: PANORAMA CITY
 DATE: WEDNESDAY, MAY 11, 2016
 PERIOD: 03:00 PM TO 06:00 PM
 INTERSECTION N/S WOODMAN AVENUE
 E/W ROSCOE BOULEVARD
 FILE NUMBER: 6-PM

15 MINUTE TOTALS	1	2	3	4	5	6	7	8	9	10	11	12
	SBRT	SBTH	SBLT	WBRT	WBTH	WBLT	NBRT	NBTH	NBLT	EBRT	EBTH	EBLT
0300-0315	50	191	29	48	233	43	23	152	35	18	236	31
0315-0330	36	186	23	42	294	34	44	180	34	22	189	47
0330-0345	55	201	31	39	279	60	30	187	41	24	190	55
0345-0400	50	195	43	46	327	48	24	175	30	34	184	45
0400-0415	47	196	26	36	263	56	28	144	27	23	198	58
0415-0430	51	184	41	51	330	35	24	180	39	28	242	52
0430-0445	50	191	24	57	254	41	29	166	25	18	167	51
0445-0500	48	234	32	79	324	38	24	135	30	18	164	47
0500-0515	56	206	37	74	270	45	29	194	23	25	173	60
0515-0530	37	221	32	41	297	53	20	177	31	19	195	65
0530-0545	45	213	38	56	299	50	27	166	33	21	203	64
0545-0600	43	228	33	51	283	51	27	171	37	23	198	63

1 HOUR TOTALS	1	2	3	4	5	6	7	8	9	10	11	12	TOTALS
	SBRT	SBTH	SBLT	WBRT	WBTH	WBLT	NBRT	NBTH	NBLT	EBRT	EBTH	EBLT	
0300-0400	191	773	126	175	1133	185	121	694	140	98	799	178	4613
0315-0415	188	778	123	163	1163	198	126	686	132	103	761	205	4626
0330-0430	203	776	141	172	1199	199	106	686	137	109	814	210	4752
0345-0445	198	766	134	190	1174	180	105	665	121	103	791	206	4633
0400-0500	196	805	123	223	1171	170	105	625	121	87	771	208	4605
0415-0515	205	815	134	261	1178	159	106	675	117	89	746	210	4695
0430-0530	191	852	125	251	1145	177	102	672	109	80	699	223	4626
0445-0545	186	874	139	250	1190	186	100	672	117	83	735	236	4768
0500-0600	181	868	140	222	1149	199	103	708	124	88	769	252	4803

P.M. PEAK HOUR
0500-0600

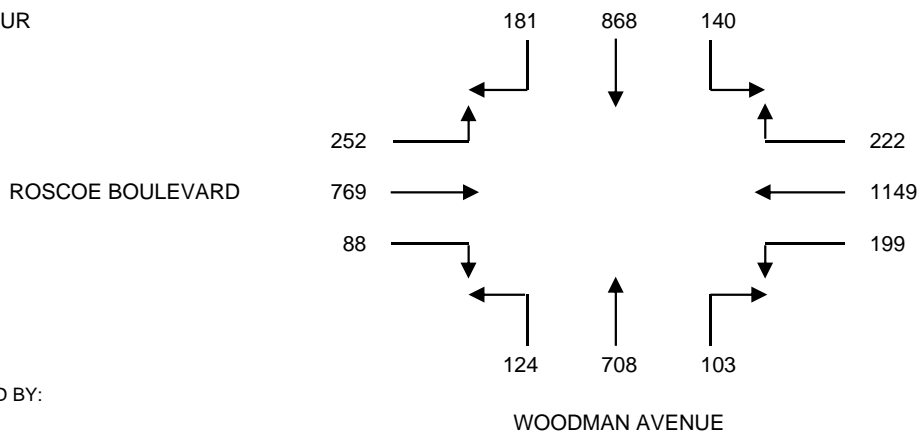

DATA PROVIDED BY:

THE TRAFFIC SOLUTION
 329 DIAMOND STREET
 ARCADIA, CALIFORNIA 91005
 PH: 626-446-7978
 FAX: 626-446-2877

PEDESTRIAN - BICYCLE COUNT SUMMARY

CLIENT: OVERLAND TRAFFIC CONSULTANTS, INC.
 PROJECT: PANORAMA CITY
 DATE: WEDNESDAY, MAY 11, 2016
 PERIOD: 07:00 AM TO 10:00 AM
 INTERSECTION: WOODMAN AVENUE
 ROSCOE BOULEVARD
 FILE: 6AMPED-BIKE

15-MINUTE PERIOD	PEDESTRIAN MOVEMENTS			
	NORTH LEG	EAST LEG	SOUTH LEG	WEST LEG
	A	B	C	D
0700-0715	5	7	8	9
0715-0730	2	4	4	5
0730-0745	9	7	5	8
0745-0800	6	3	5	6
0800-0815	5	2	9	7
0815-0830	0	3	8	3
0830-0845	3	4	7	3
0845-0900	5	6	9	6
0900-0915	2	0	7	5
0915-0930	1	2	10	7
0930-0945	4	3	8	5
0945-1000	2	1	6	5

15-MINUTE PERIOD	BICYCLIST MOVEMENTS			
	NORTH LEG	EAST LEG	SOUTH LEG	WEST LEG
	A	B	C	D
0700-0715	0	1	1	0
0715-0730	1	1	1	2
0730-0745	0	0	3	0
0745-0800	1	1	0	1
0800-0815	1	1	0	0
0815-0830	0	1	2	0
0830-0845	0	0	0	0
0845-0900	0	1	0	0
0900-0915	1	1	1	0
0915-0930	1	2	1	1
0930-0945	0	1	0	0
0945-1000	1	0	1	1

1-HOUR PERIOD	PEDESTRIAN MOVEMENTS				TOTALS
	NORTH LEG	EAST LEG	SOUTH LEG	WEST LEG	
	A	B	C	D	
0700-0800	22	21	22	28	93
0715-0815	22	16	23	26	87
0730-0830	20	15	27	24	86
0745-0845	14	12	29	19	74
0800-0900	13	15	33	19	80
0815-0915	10	13	31	17	71
0830-0930	11	12	33	21	77
0845-0945	12	11	34	23	80
0900-1000	9	6	31	22	68

1-HOUR PERIOD	BICYCLIST MOVEMENTS				TOTALS
	NORTH LEG	EAST LEG	SOUTH LEG	WEST LEG	
	A	B	C	D	
0700-0800	2	3	5	3	13
0715-0815	3	3	4	3	13
0730-0830	2	3	5	1	11
0745-0845	2	3	2	1	8
0800-0900	1	3	2	0	6
0815-0915	1	3	3	0	7
0830-0930	2	4	2	1	9
0845-0945	2	5	2	1	10
0900-1000	3	4	3	2	12

PEDESTRIAN - BICYCLE COUNT SUMMARY

CLIENT: OVERLAND TRAFFIC CONSULTANTS, INC.
 PROJECT: PANORAMA CITY
 DATE: WEDNESDAY, MAY 11, 2016
 PERIOD: 03:00 PM TO 06:00 PM
 INTERSECTION: WOODMAN AVENUE
 ROSCOE BOULEVARD
 FILE: 6PMPED-BIKE

15-MINUTE PERIOD	PEDESTRIAN MOVEMENTS			
	NORTH LEG	EAST LEG	SOUTH LEG	WEST LEG
	A	B	C	D
0300-0315	4	6	4	7
0315-0330	6	5	8	17
0330-0345	4	6	8	14
0345-0400	7	3	11	20
0400-0415	7	8	5	13
0415-0430	7	3	7	10
0430-0445	6	2	5	4
0445-0500	6	7	9	6
0500-0515	2	6	7	6
0515-0530	3	5	3	5
0530-0545	5	7	6	8
0545-0600	6	4	4	7

15-MINUTE PERIOD	BICYCLIST MOVEMENTS			
	NORTH LEG	EAST LEG	SOUTH LEG	WEST LEG
	A	B	C	D
0300-0315	1	0	0	2
0315-0330	0	0	1	1
0330-0345	0	1	0	2
0345-0400	2	0	1	1
0400-0415	0	0	0	0
0415-0430	2	2	1	0
0430-0445	1	3	1	1
0445-0500	5	1	0	0
0500-0515	1	0	1	0
0515-0530	1	1	0	2
0530-0545	2	1	0	1
0545-0600	0	0	0	1

1-HOUR PERIOD	PEDESTRIAN MOVEMENTS				TOTALS
	NORTH LEG	EAST LEG	SOUTH LEG	WEST LEG	
	A	B	C	D	
0300-0400	21	20	31	58	130
0315-0415	24	22	32	64	142
0330-0430	25	20	31	57	133
0345-0445	27	16	28	47	118
0400-0500	26	20	26	33	105
0415-0515	21	18	28	26	93
0430-0530	17	20	24	21	82
0445-0545	16	25	25	25	91
0500-0600	16	22	20	26	84

1-HOUR PERIOD	BICYCLIST MOVEMENTS				TOTALS
	NORTH LEG	EAST LEG	SOUTH LEG	WEST LEG	
	A	B	C	D	
0300-0400	3	1	2	6	12
0315-0415	2	1	2	4	9
0330-0430	4	3	2	3	12
0345-0445	5	5	3	2	15
0400-0500	8	6	2	1	17
0415-0515	9	6	3	1	19
0430-0530	8	5	2	3	18
0445-0545	9	3	1	3	16
0500-0600	4	2	1	4	11



24 HOURS TRAFFIC VOLUME

City of Los Angeles

Department of Transportation

Counter MANDO
 Date 12/10/2002
 Start Time 12 AM

Location TITUS ST E/O WILLIS AV Day of Week TUESDAY Prepared 1/7/2003
 Direction E/W ST DOT District EAST VALLEY Sensor Layout 31
 Description 7297079560 Weather SUNNY Sensor Spacing 160

Time	WEST BOUND					EAST BOUND					Total
	1ST	2ND	3RD	4TH	HOUR TOTAL	1ST	2ND	3RD	4TH	HOUR TOTAL	
12 AM	2	2	5	1	10	2	3	2	1	8	18
1 AM	0	0	0	1	1	0	1	0	3	4	5
2 AM	1	0	1	1	3	1	0	3	1	5	8
3 AM	0	0	0	0	0	0	0	2	1	3	3
4 AM	1	1	1	2	5	2	1	0	0	3	8
5 AM	0	2	5	8	15	0	1	3	12	16	31
6 AM	5	9	16	12	42	10	2	6	9	27	69
7 AM	17	10	17	13	57	16	23	14	20	73	130
8 AM	11	10	15	14	50	18	19	22	26	85	135
9 AM	23	18	14	13	68	28	15	20	24	87	155
10 AM	13	20	22	14	69	24	13	12	16	65	134
11 AM	12	23	24	16	75	14	16	18	14	62	137
12 NN	16	22	26	18	82	23	16	24	21	84	166
1 PM	21	22	24	20	87	20	18	17	13	68	155
2 PM	23	22	24	34	103	17	24	18	25	84	187
3 PM	42	20	28	32	122	21	16	18	15	70	192
4 PM	30	31	32	32	125	26	19	20	15	80	205
5 PM	46	25	36	27	134	26	24	26	20	96	230
6 PM	32	26	24	18	100	16	18	20	12	66	166
7 PM	18	16	2	6	42	12	13	18	14	57	99
8 PM	12	12	8	16	48	18	7	7	11	43	91
9 PM	7	16	10	2	35	5	8	9	11	33	68
10 PM	10	3	6	4	23	6	4	1	6	17	40
11 PM	5	8	2	1	16	1	6	2	1	10	26

FIRST 12-HOUR PEAK QUARTER COUNT
 LAST 12-HOUR PEAK QUARTER COUNT
 24 HOUR VEHICLES TOTAL
 TOTAL VEHICLES STANDARD DEVIATION (STD)

24	11 AM	3RD
46	5 PM	1ST
1312		
- 41.13		

28	9 AM	1ST
26	4 PM	1ST
1146		
2458		
- 32.12		
- 71.07		

PEAK HOURS VOLUME



TRAFFIC VOLUME FIGURES

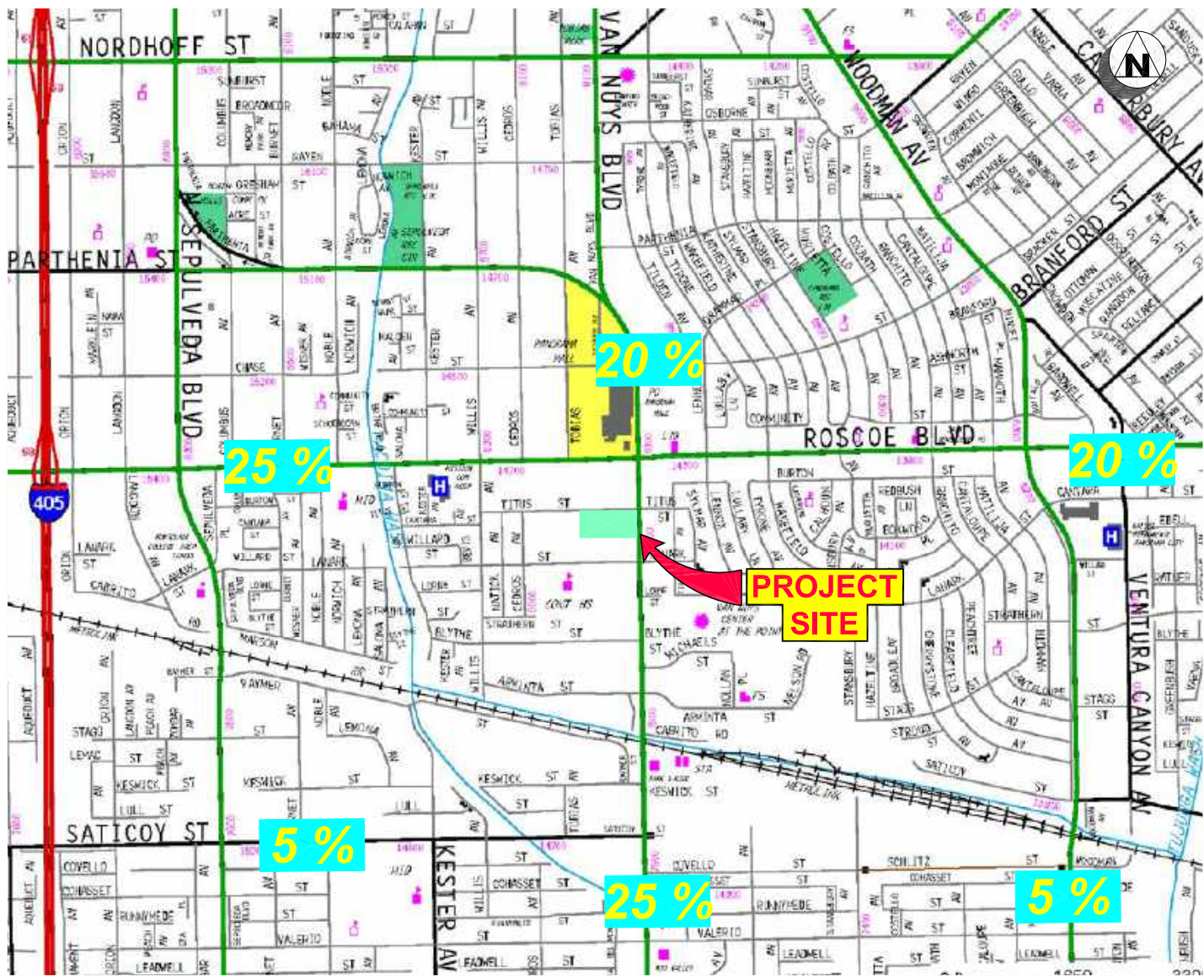

FIGURE 3

4/2020

PROJECT TRAFFIC DISTRIBUTION PERCENTAGES



Overland Traffic Consultants, Inc.

24325 Main Street #202, Santa Clarita, CA 91321
 (661) 799 - 8423, OTC@overlandtraffic.com

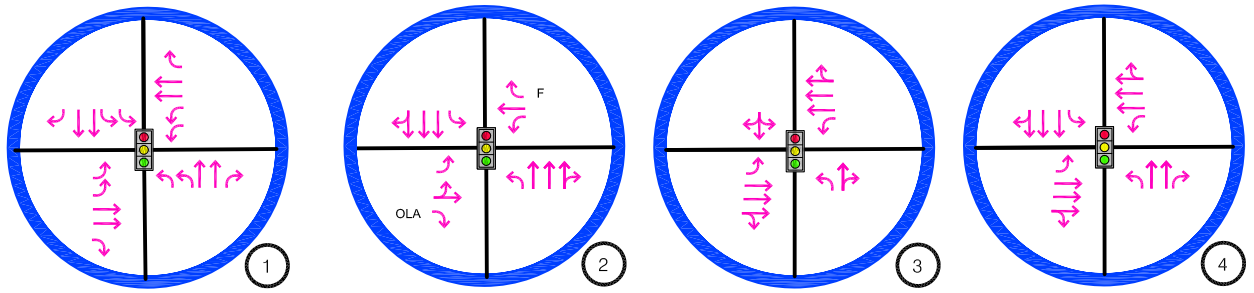

VAN NUYS BOULEVARD & ROSCOE BOULEVARD

VAN NUYS BOULEVARD & SATICOY STREET

ROSCOE BOULEVARD & WILLIS AVENUE

ROSCOE BOULEVARD & WOODMAN AVENUE

**PROJECT
AM / PM
PEAK HOUR
PERCENTAGES**

LEGEND
XX INBOUND
XX OUTBOUND

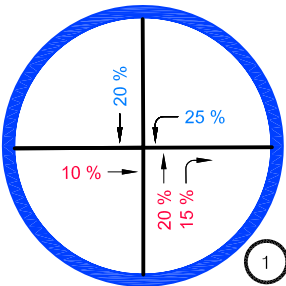

VAN NUYS BOULEVARD & ROSCOE BOULEVARD

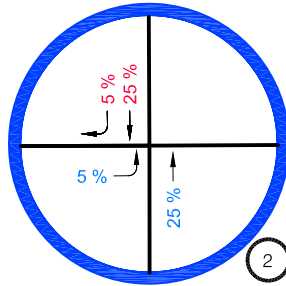

VAN NUYS BOULEVARD & SATICOY STREET

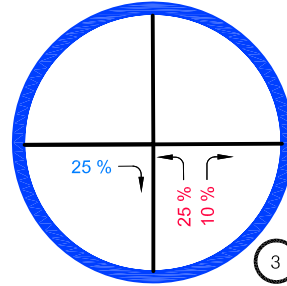

ROSCOE BOULEVARD & WILLIS AVENUE

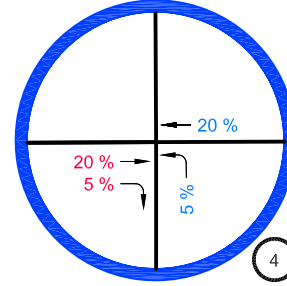

ROSCOE BOULEVARD & WOODMAN AVENUE

**PROJECT
AM / PM
PEAK HOUR
VOLUME**

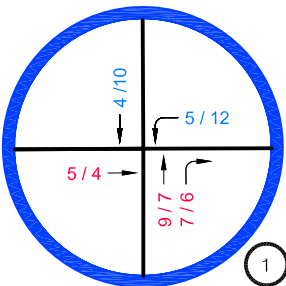

VAN NUYS BOULEVARD & ROSCOE BOULEVARD

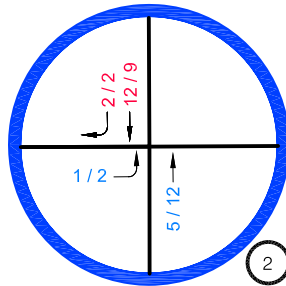

VAN NUYS BOULEVARD & SATICOY STREET

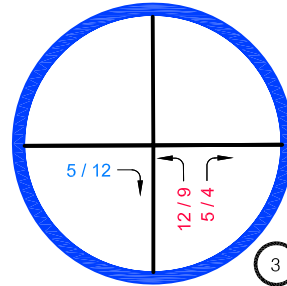

ROSCOE BOULEVARD & WILLIS AVENUE

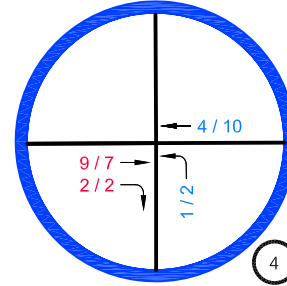

ROSCOE BOULEVARD & WOODMAN AVENUE

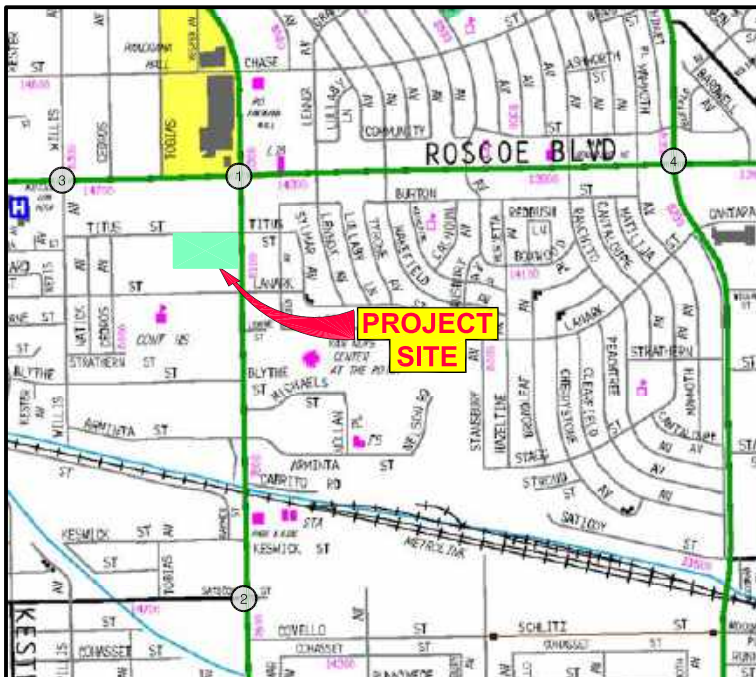

**DRIVEWAY PEAK HOUR TRAFFIC VOLUME
PROJECT AND EXISTING TOWER**

AM PEAK HOUR

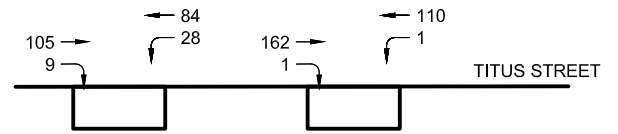

PM PEAK HOUR

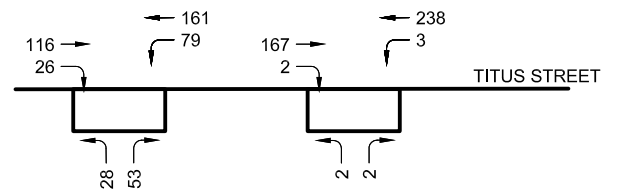

FIGURE 4

5/2020

**INTERSECTION CHARACTERISTICS
AND PROJECT ASSIGNMENT**



Overland Traffic Consultants, Inc.

24325 Main Street #202, Santa Clarita, CA 91321
(661) 799 - 8423, OTC@overlandtraffic.com

**PROJECT
AM / PM
PEAK HOUR
VOLUME**

LEGEND
XX INBOUND
XX OUTBOUND

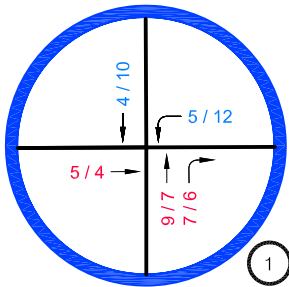

VAN NUYS BOULEVARD & ROSCOE BOULEVARD

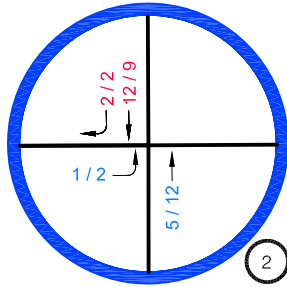

VAN NUYS BOULEVARD & SATICOY STREET

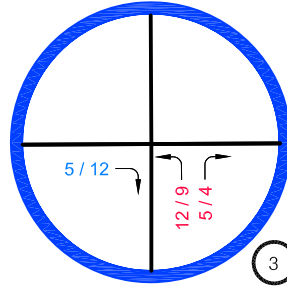

ROSCOE BOULEVARD & WILLIS AVENUE

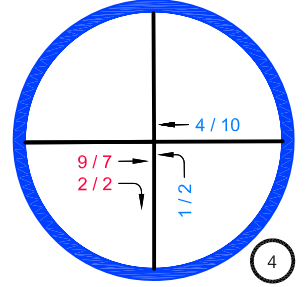

ROSCOE BOULEVARD & WOODMAN AVENUE

**EXISTING (2020)
AM PEAK HOUR**

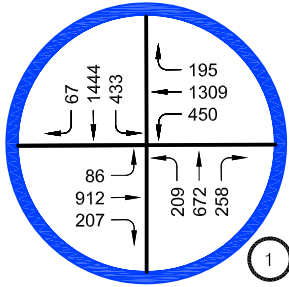

VAN NUYS BOULEVARD & ROSCOE BOULEVARD

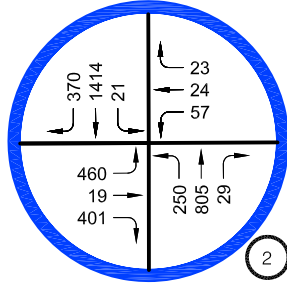

VAN NUYS BOULEVARD & SATICOY STREET

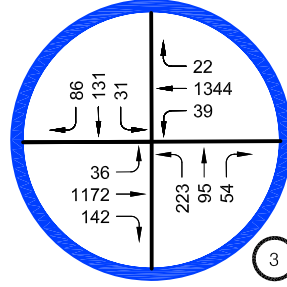

ROSCOE BOULEVARD & WILLIS AVENUE

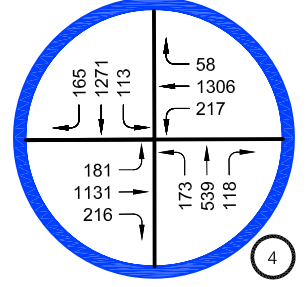

ROSCOE BOULEVARD & WOODMAN AVENUE

**EXISTING (2020)
PM PEAK HOUR**

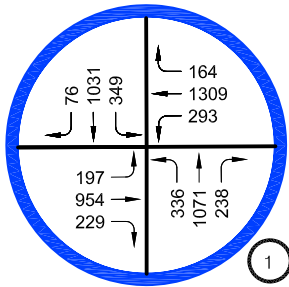

VAN NUYS BOULEVARD & ROSCOE BOULEVARD

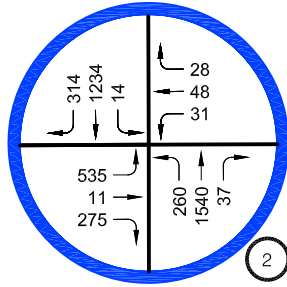

VAN NUYS BOULEVARD & SATICOY STREET

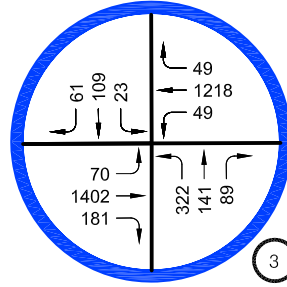

ROSCOE BOULEVARD & WILLIS AVENUE

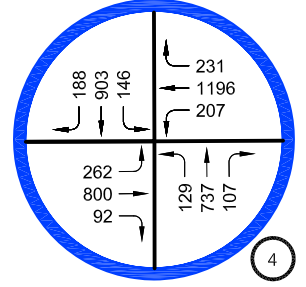

ROSCOE BOULEVARD & WOODMAN AVENUE

**EXISTING (2020)
WITH PROJECT
AM PEAK HOUR**

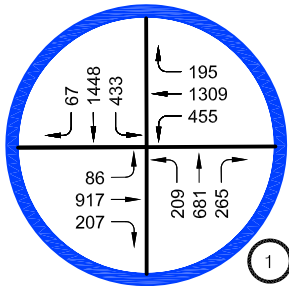

VAN NUYS BOULEVARD & ROSCOE BOULEVARD

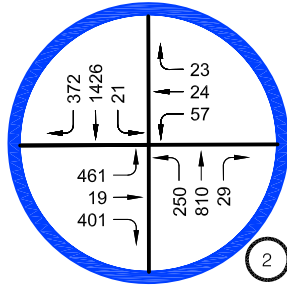

VAN NUYS BOULEVARD & SATICOY STREET

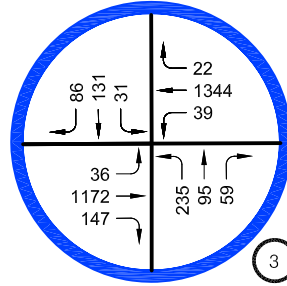

ROSCOE BOULEVARD & WILLIS AVENUE

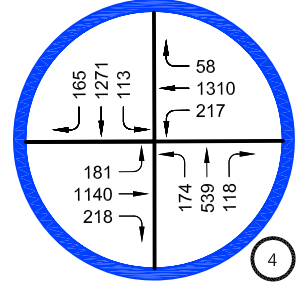

ROSCOE BOULEVARD & WOODMAN AVENUE

**EXISTING (2020)
WITH PROJECT
PM PEAK HOUR**

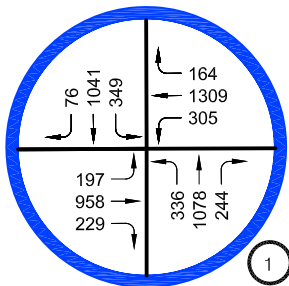

VAN NUYS BOULEVARD & ROSCOE BOULEVARD

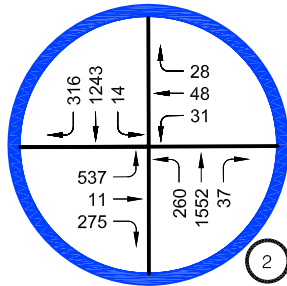

VAN NUYS BOULEVARD & SATICOY STREET

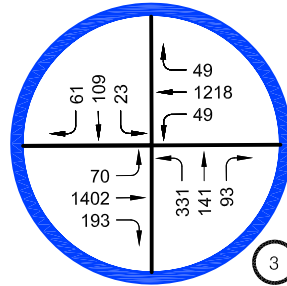

ROSCOE BOULEVARD & WILLIS AVENUE

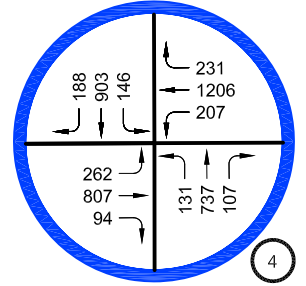

ROSCOE BOULEVARD & WOODMAN AVENUE

FIGURE 5

5/2020

**PEAK HOUR TRAFFIC VOLUMES
EXISTING (2020) WITHOUT AND WITH PROJECT**



Overland Traffic Consultants, Inc.

24325 Main Street #202, Santa Clarita, CA 91321
(661) 799 - 8423, OTC@overlandtraffic.com

RELATED PROJECT PEAK HOUR TRAFFIC

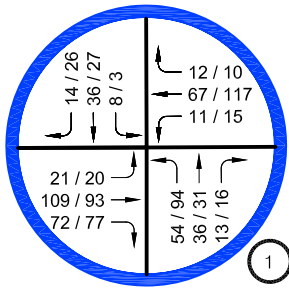

VAN NUYS BOULEVARD & ROSCOE BOULEVARD

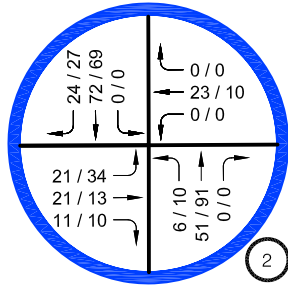

VAN NUYS BOULEVARD & SATICOY STREET

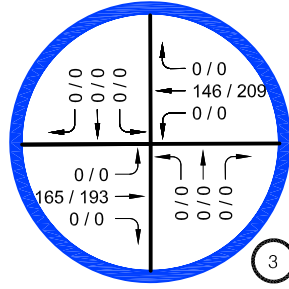

ROSCOE BOULEVARD & WILLIS AVENUE

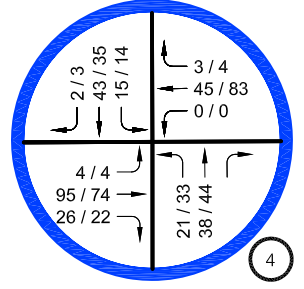

ROSCOE BOULEVARD & WOODMAN AVENUE

FUTURE (2024) WITHOUT PROJECT AM PEAK HOUR

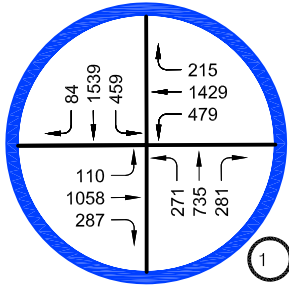

VAN NUYS BOULEVARD & ROSCOE BOULEVARD

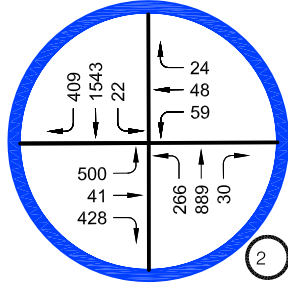

VAN NUYS BOULEVARD & SATICOY STREET

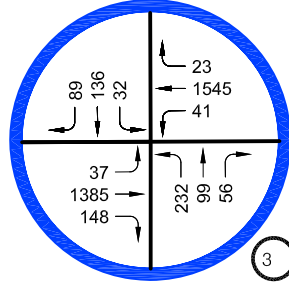

ROSCOE BOULEVARD & WILLIS AVENUE

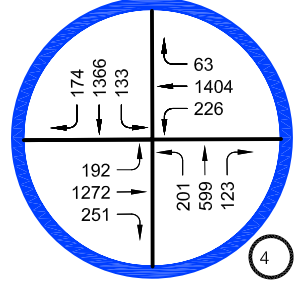

ROSCOE BOULEVARD & WOODMAN AVENUE

FUTURE (2024) WITHOUT PROJECT PM PEAK HOUR

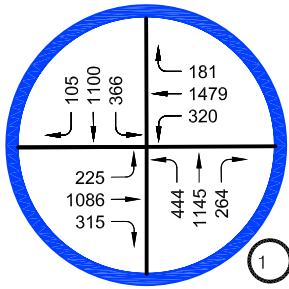

VAN NUYS BOULEVARD & ROSCOE BOULEVARD

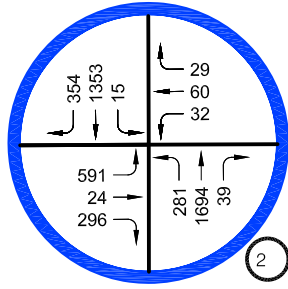

VAN NUYS BOULEVARD & SATICOY STREET

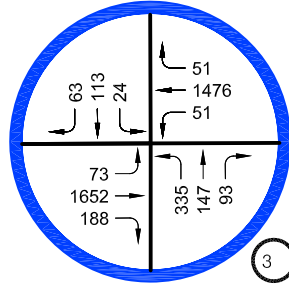

ROSCOE BOULEVARD & WILLIS AVENUE

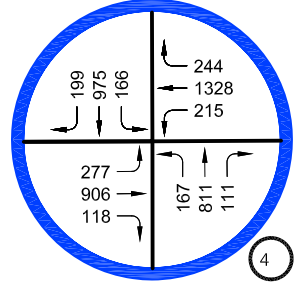

ROSCOE BOULEVARD & WOODMAN AVENUE

FUTURE (2024) WITH PROJECT AM PEAK HOUR

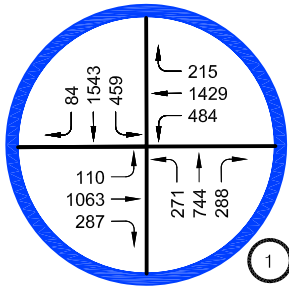

VAN NUYS BOULEVARD & ROSCOE BOULEVARD

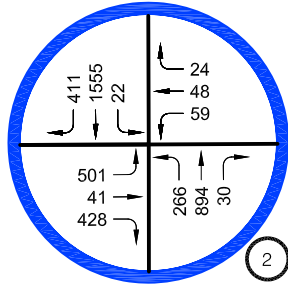

VAN NUYS BOULEVARD & SATICOY STREET

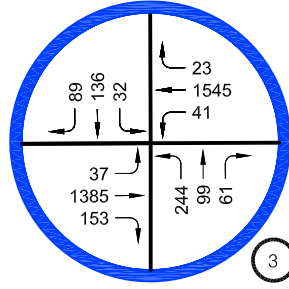

ROSCOE BOULEVARD & WILLIS AVENUE

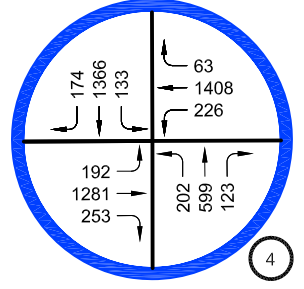

ROSCOE BOULEVARD & WOODMAN AVENUE

FUTURE (2024) WITH PROJECT PM PEAK HOUR

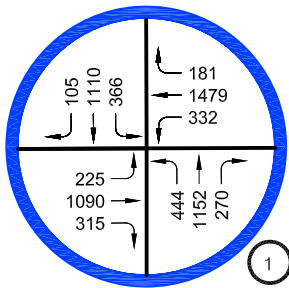

VAN NUYS BOULEVARD & ROSCOE BOULEVARD

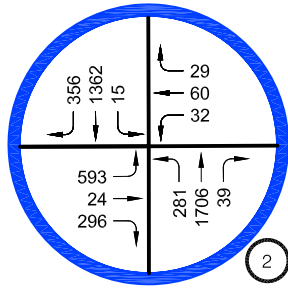

VAN NUYS BOULEVARD & SATICOY STREET

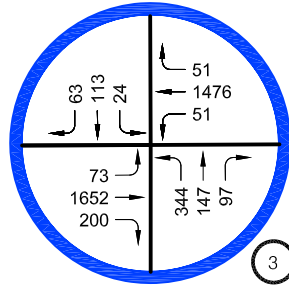

ROSCOE BOULEVARD & WILLIS AVENUE

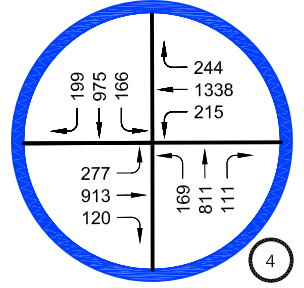

ROSCOE BOULEVARD & WOODMAN AVENUE

FIGURE 7

5/2020

**PEAK HOUR TRAFFIC VOLUMES
FUTURE (2024) WITHOUT AND WITH PROJECT**



Overland Traffic Consultants, Inc.

24325 Main Street #202, Santa Clarita, CA 91321
(661) 799 - 8423, OTC@overlandtraffic.com



LOS WORKSHEETS



EXISTING HCS WORKSHEETS



EXISTING AM PEAK HOUR

HCS7 Signalized Intersection Results Summary

General Information				Intersection Information	
Agency	otc			Duration, h	0.25
Analyst	jto	Analysis Date	May 12, 2020	Area Type	CBD
Jurisdiction	City of Los Angeles	Time Period	am peak	PHF	1.00
Urban Street	Roscoe Boulevard	Analysis Year	2020	Analysis Period	1 > 7:00
Intersection	Van Nuys Boulevard	File Name	1AM.xus		
Project Description	am peak hour wo project				

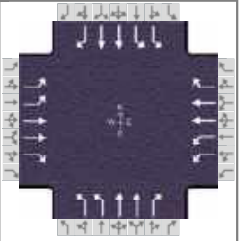

Demand Information	EB			WB			NB			SB		
	L	T	R	L	T	R	L	T	R	L	T	R
Approach Movement												
Demand (v), veh/h	86	912	207	450	1309	195	209	672	258	433	1444	67

Signal Information													
Cycle, s	120.0	Reference Phase	2										
Offset, s	0	Reference Point	End										
Uncoordinated	No	Simult. Gap E/W	On	Green	7.0	11.8	32.2	6.0	10.0	31.0			
Force Mode	Fixed	Simult. Gap N/S	On	Yellow	3.0	3.0	3.0	3.0	3.0	3.0			
				Red	0.0	0.0	2.0	0.0	0.0	2.0			

Timer Results	EBL	EBT	WBL	WBT	NBL	NBT	SBL	SBT
Assigned Phase	7	4	3	8	5	2	1	6
Case Number	2.0	3.0	2.0	3.0	2.0	3.0	2.0	3.0
Phase Duration, s	9.0	36.0	22.0	49.0	10.0	37.2	24.8	52.0
Change Period, (Y+R _c), s	3.0	5.0	3.0	5.0	3.0	5.0	3.0	5.0
Max Allow Headway (MAH), s	3.4	3.1	3.4	3.1	3.4	0.0	3.4	0.0
Queue Clearance Time (g _s), s	5.7	33.0	21.0	46.0	9.0		20.6	
Green Extension Time (g _e), s	0.0	0.0	0.0	0.0	0.0	0.0	1.2	0.0
Phase Call Probability	1.00	1.00	1.00	1.00	1.00		1.00	
Max Out Probability	1.00	1.00	1.00	1.00	1.00		0.00	

Movement Group Results	EB			WB			NB			SB		
	L	T	R	L	T	R	L	T	R	L	T	R
Assigned Movement	7	4	14	3	8	18	5	2	12	1	6	16
Adjusted Flow Rate (v), veh/h	86	912	157	450	1309	145	209	672	208	433	1444	42
Adjusted Saturation Flow Rate (s), veh/h/ln	1361	1628	1111	1361	1628	1141	1361	1628	1225	1361	1628	1286
Queue Service Time (g _s), s	3.7	31.0	14.7	19.0	44.0	11.1	7.0	22.8	18.0	18.6	47.0	2.5
Cycle Queue Clearance Time (g _c), s	3.7	31.0	14.7	19.0	44.0	11.1	7.0	22.8	18.0	18.6	47.0	2.5
Green Ratio (g/C)	0.05	0.26	0.26	0.16	0.37	0.37	0.06	0.27	0.27	0.18	0.39	0.39
Capacity (c), veh/h	136	841	287	431	1194	418	159	874	329	494	1275	504
Volume-to-Capacity Ratio (X)	0.632	1.084	0.547	1.044	1.096	0.347	1.316	0.769	0.632	0.877	1.132	0.083
Back of Queue (Q), ft/ln (50 th percentile)	32.5	470.9	101.3	242.3	659	75.2	158.7	244.7	153.5	159.2	758.8	19.7
Back of Queue (Q), veh/ln (50 th percentile)	1.3	18.8	4.1	9.7	26.4	3.0	6.3	9.8	6.1	6.4	30.4	0.8
Queue Storage Ratio (RQ) (50 th percentile)	0.08	0.00	0.25	0.56	0.00	0.19	0.29	0.00	0.38	0.28	0.00	0.05
Uniform Delay (d ₁), s/veh	55.9	44.5	38.4	50.5	38.0	27.6	56.5	40.4	38.7	47.8	36.5	23.0
Incremental Delay (d ₂), s/veh	1.8	56.4	1.3	55.3	56.6	0.2	179.7	6.4	8.9	2.1	69.9	0.3
Initial Queue Delay (d ₃), s/veh	0.0	0.0	0.0	0.0	0.0	0.0	0.0	0.0	0.0	0.0	0.0	0.0
Control Delay (d), s/veh	57.7	100.9	39.7	105.8	94.6	27.8	236.2	46.9	47.6	49.9	106.4	23.3
Level of Service (LOS)	E	F	D	F	F	C	F	D	D	D	F	C
Approach Delay, s/veh / LOS	89.4			F			92.1			F		
Intersection Delay, s/veh / LOS	89.9						F					

Multimodal Results	EB		WB		NB		SB	
Pedestrian LOS Score / LOS	2.66	C	2.61	C	2.66	C	2.65	C
Bicycle LOS Score / LOS	1.44	A	2.06	B	1.39	A	2.07	B

HCS7 Signalized Intersection Results Summary

General Information				Intersection Information	
Agency	otc			Duration, h	0.25
Analyst	jto	Analysis Date	May 12, 2020	Area Type	CBD
Jurisdiction	City of Los Angeles	Time Period	am peak	PHF	1.00
Urban Street	Saticoy Street	Analysis Year	2020	Analysis Period	1 > 7:00
Intersection	Van Nuys Boulevard	File Name	2AM.xus		
Project Description	am peak hour wo project				

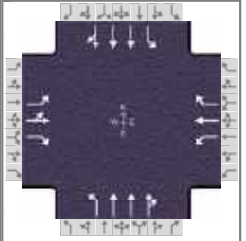

Demand Information	EB			WB			NB			SB		
Approach Movement	L	T	R	L	T	R	L	T	R	L	T	R
Demand (v), veh/h	460	19	401	57	24	23	250	805	29	21	1414	370

Signal Information														
Cycle, s	120.0	Reference Phase	2											
Offset, s	0	Reference Point	End											
Uncoordinated	No	Simult. Gap E/W	On	Green	6.0	7.0	43.0	9.7	33.3	0.0				
Force Mode	Fixed	Simult. Gap N/S	On	Yellow	3.0	3.0	3.0	3.0	3.0	0.0				
				Red	0.0	0.0	2.0	2.0	2.0	0.0				

Timer Results	EBL	EBT	WBL	WBT	NBL	NBT	SBL	SBT
Assigned Phase		4		8	5	2	1	6
Case Number		9.0		9.0	2.0	4.0	1.1	4.0
Phase Duration, s		38.3		14.7	19.0	58.0	9.0	48.0
Change Period, (Y+R _c), s		5.0		5.0	3.0	5.0	3.0	5.0
Max Allow Headway (MAH), s		3.5		3.5	3.4	0.0	3.4	0.0
Queue Clearance Time (g _s), s		35.3		6.7	18.1		3.1	
Green Extension Time (g _e), s		0.0		0.2	0.0	0.0	0.0	0.0
Phase Call Probability		1.00		0.97	1.00		1.00	
Max Out Probability		1.00		0.00	1.00		1.00	

Movement Group Results	EB			WB			NB			SB		
Approach Movement	L	T	R	L	T	R	L	T	R	L	T	R
Assigned Movement	7	4	14	3	8	18	5	2	12	1	6	16
Adjusted Flow Rate (v), veh/h	460	19	351	57	24	23	250	568	266	21	1276	508
Adjusted Saturation Flow Rate (s), veh/h/ln	1402	1710	1217	1402	1710	1031	1402	1710	1596	1402	1710	1351
Queue Service Time (g _s), s	33.3	1.0	28.6	4.7	1.6	2.5	16.1	13.3	13.4	1.1	42.9	42.9
Cycle Queue Clearance Time (g _c), s	33.3	1.0	28.6	4.7	1.6	2.5	16.1	13.3	13.4	1.1	42.9	42.9
Green Ratio (g/C)	0.28	0.28	0.41	0.08	0.08	0.08	0.13	0.44	0.44	0.41	0.36	0.36
Capacity (c), veh/h	389	474	507	113	138	83	188	1511	705	319	1223	483
Volume-to-Capacity Ratio (X)	1.183	0.040	0.693	0.504	0.174	0.276	1.331	0.376	0.377	0.066	1.043	1.052
Back of Queue (Q), ft/ln (50 th percentile)	567.6	10.6	230	41.9	17	16.6	375.3	135.6	131.2	8.9	595.5	529.6
Back of Queue (Q), veh/ln (50 th percentile)	22.7	0.4	9.2	1.7	0.7	0.7	15.0	5.4	5.2	0.4	23.8	21.2
Queue Storage Ratio (RQ) (50 th percentile)	0.95	0.00	0.38	0.70	0.00	0.28	2.35	0.00	0.00	0.06	0.00	0.00
Uniform Delay (d ₁), s/veh	43.4	31.7	29.2	52.9	51.4	51.9	52.0	22.4	22.4	21.5	38.5	38.5
Incremental Delay (d ₂), s/veh	105.6	0.2	7.6	1.3	0.2	0.7	180.6	0.7	1.5	0.0	37.6	55.2
Initial Queue Delay (d ₃), s/veh	0.0	0.0	0.0	0.0	0.0	0.0	0.0	0.0	0.0	0.0	0.0	0.0
Control Delay (d), s/veh	148.9	31.8	36.8	54.1	51.6	52.5	232.5	23.1	24.0	21.5	76.1	93.7
Level of Service (LOS)	F	C	D	D	D	D	F	C	C	C	F	F
Approach Delay, s/veh / LOS	98.8	F		53.2	D		71.6	E		80.4	F	
Intersection Delay, s/veh / LOS	81.2						F					

Multimodal Results	EB		WB		NB		SB	
Pedestrian LOS Score / LOS	2.59	C	2.62	C	2.11	B	2.19	B
Bicycle LOS Score / LOS	1.86	B	0.66	A	1.08	A	1.48	A

HCS7 Signalized Intersection Results Summary

General Information				Intersection Information	
Agency	otc			Duration, h	0.25
Analyst	jto	Analysis Date	May 12, 2020	Area Type	CBD
Jurisdiction	City of Los Angeles	Time Period	am peak	PHF	1.00
Urban Street	Roscoe Boulevard	Analysis Year	2020	Analysis Period	1 > 7:00
Intersection	Willis Avenue	File Name	3AM.xus		
Project Description	am peak hour wo project				

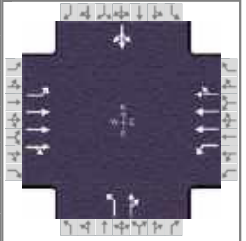

Demand Information	EB			WB			NB			SB		
	L	T	R	L	T	R	L	T	R	L	T	R
Approach Movement												
Demand (v), veh/h	36	1172	142	39	1344	22	223	95	54	31	131	86

Signal Information													
Cycle, s	120.0	Reference Phase	2										
Offset, s	0	Reference Point	End										
Uncoordinated	No	Simult. Gap E/W	On	Green	14.6	38.9	53.5	0.0	0.0	0.0			
Force Mode	Fixed	Simult. Gap N/S	On	Yellow	3.0	3.0	3.0	0.0	0.0	0.0			
				Red	0.0	2.0	2.0	0.0	0.0	0.0			

Timer Results	EBL	EBT	WBL	WBT	NBL	NBT	SBL	SBT
Assigned Phase		4		8	5	2		6
Case Number		6.0		6.0	1.0	4.0		8.3
Phase Duration, s		58.5		58.5	17.6	61.5		43.9
Change Period, (Y+R _c), s		5.0		5.0	3.0	5.0		5.0
Max Allow Headway (MAH), s		3.3		3.3	3.4	0.0		0.0
Queue Clearance Time (g _s), s		37.4		41.9	14.1			
Green Extension Time (g _e), s		12.1		12.0	0.5	0.0		0.0
Phase Call Probability		1.00		1.00	1.00			
Max Out Probability		0.04		0.05	0.00			

Movement Group Results	EB			WB			NB			SB		
	L	T	R	L	T	R	L	T	R	L	T	R
Assigned Movement	7	4	14	3	8	18	5	2	12	1	6	16
Adjusted Flow Rate (v), veh/h	36	1020	294	39	931	435	223	149			248	
Adjusted Saturation Flow Rate (s), veh/h/ln	353	1710	983	364	1710	1599	1402	1541			1441	
Queue Service Time (g _s), s	10.4	28.4	28.6	11.4	25.0	25.0	12.1	6.8			3.2	
Cycle Queue Clearance Time (g _c), s	35.4	28.4	28.6	39.9	25.0	25.0	12.1	6.8			16.2	
Green Ratio (g/C)	0.45	0.45	0.45	0.45	0.45	0.45	0.47	0.47			0.32	
Capacity (c), veh/h	143	1513	435	135	1513	707	435	731			506	
Volume-to-Capacity Ratio (X)	0.252	0.674	0.677	0.290	0.615	0.615	0.513	0.204			0.491	
Back of Queue (Q), ft/ln (50 th percentile)	22.8	282.6	164.7	26	248.3	233.1	98.2	62.6			155.3	
Back of Queue (Q), veh/ln (50 th percentile)	0.9	11.3	6.6	1.0	9.9	9.3	3.9	2.5			6.2	
Queue Storage Ratio (RQ) (50 th percentile)	0.30	0.00	0.00	0.52	0.00	0.00	1.64	0.00			0.00	
Uniform Delay (d ₁), s/veh	39.2	26.6	26.6	42.5	25.6	25.6	22.1	18.4			32.5	
Incremental Delay (d ₂), s/veh	0.3	0.2	0.7	0.4	0.2	0.3	0.3	0.6			3.4	
Initial Queue Delay (d ₃), s/veh	0.0	0.0	0.0	0.0	0.0	0.0	0.0	0.0			0.0	
Control Delay (d), s/veh	39.5	26.8	27.3	42.9	25.8	26.0	22.5	19.0			35.9	
Level of Service (LOS)	D	C	C	D	C	C	C	B			D	
Approach Delay, s/veh / LOS	27.2		C	26.3		C	21.1		C	35.9		D
Intersection Delay, s/veh / LOS	26.8						C					

Multimodal Results	EB		WB		NB		SB	
Pedestrian LOS Score / LOS	1.91	B	1.69	B	2.56	C	2.58	C
Bicycle LOS Score / LOS	1.23	A	1.26	A	1.10	A	0.90	A

HCS7 Signalized Intersection Results Summary

General Information				Intersection Information	
Agency	otc			Duration, h	0.25
Analyst	jto	Analysis Date	May 12, 2020	Area Type	CBD
Jurisdiction	City of Los Angeles	Time Period	am peak	PHF	1.00
Urban Street	Roscoe Boulevard	Analysis Year	2020	Analysis Period	1 > 7:00
Intersection	Woodman Avenue	File Name	4AM.xus		
Project Description	am peak hour wo project				

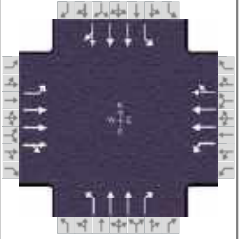

Demand Information	EB			WB			NB			SB		
	L	T	R	L	T	R	L	T	R	L	T	R
Approach Movement												
Demand (v), veh/h	181	1131	216	217	1306	58	173	539	118	113	1271	165

Signal Information													
Cycle, s	120.0	Reference Phase	2										
Offset, s	0	Reference Point	End										
Uncoordinated	No	Simult. Gap E/W	On	Green	11.3	0.4	36.6	17.0	0.5	38.2			
Force Mode	Fixed	Simult. Gap N/S	On	Yellow	3.0	0.0	3.0	3.0	0.0	3.0			
				Red	0.0	0.0	2.0	0.0	0.0	2.0			

Timer Results	EBL	EBT	WBL	WBT	NBL	NBT	SBL	SBT
Assigned Phase	7	4	3	8	5	2	1	6
Case Number	2.0	4.0	2.0	4.0	2.0	3.0	2.0	4.0
Phase Duration, s	20.5	43.7	20.0	43.2	14.3	41.6	14.7	42.0
Change Period, (Y+R _c), s	3.0	5.0	3.0	5.0	3.0	5.0	3.0	5.0
Max Allow Headway (MAH), s	3.4	3.1	3.4	3.1	3.4	0.0	3.4	0.0
Queue Clearance Time (g _s), s	17.2	34.6	19.0	32.6	13.3		11.5	
Green Extension Time (g _e), s	0.3	4.1	0.0	4.7	0.0	0.0	0.2	0.0
Phase Call Probability	1.00	1.00	1.00	1.00	1.00		1.00	
Max Out Probability	0.00	0.75	1.00	0.66	1.00		0.00	

Movement Group Results	EB			WB			NB			SB		
	L	T	R	L	T	R	L	T	R	L	T	R
Assigned Movement	7	4	14	3	8	18	5	2	12	1	6	16
Adjusted Flow Rate (v), veh/h	181	979	368	217	931	433	173	539	118	113	992	444
Adjusted Saturation Flow Rate (s), veh/h/ln	1402	1710	1286	1402	1710	1591	1402	1628	1332	1402	1710	1531
Queue Service Time (g _s), s	15.2	32.6	32.6	17.0	30.6	30.6	11.3	16.5	6.5	9.5	33.9	33.9
Cycle Queue Clearance Time (g _c), s	15.2	32.6	32.6	17.0	30.6	30.6	11.3	16.5	6.5	9.5	33.9	33.9
Green Ratio (g/C)	0.15	0.32	0.32	0.14	0.32	0.32	0.09	0.31	0.45	0.10	0.31	0.31
Capacity (c), veh/h	205	1103	415	199	1088	506	132	994	602	136	1054	472
Volume-to-Capacity Ratio (X)	0.885	0.888	0.888	1.093	0.856	0.856	1.310	0.542	0.196	0.829	0.941	0.941
Back of Queue (Q), ft/ln (50 th percentile)	138.8	364	302.9	272.7	335.8	332.6	266.8	169.2	52.5	87.5	409.5	407.1
Back of Queue (Q), veh/ln (50 th percentile)	5.6	14.6	12.1	10.9	13.4	13.3	10.7	6.8	2.1	3.5	16.4	16.3
Queue Storage Ratio (RQ) (50 th percentile)	0.69	0.00	0.00	1.16	0.00	0.00	1.40	0.00	0.13	0.46	0.00	0.00
Uniform Delay (d ₁), s/veh	50.3	38.6	38.6	51.5	38.3	38.3	54.3	34.7	20.1	53.2	40.4	40.4
Incremental Delay (d ₂), s/veh	4.9	7.8	17.9	90.8	5.8	11.6	183.2	2.1	0.7	4.8	16.7	29.0
Initial Queue Delay (d ₃), s/veh	0.0	0.0	0.0	0.0	0.0	0.0	0.0	0.0	0.0	0.0	0.0	0.0
Control Delay (d), s/veh	55.2	46.4	56.5	142.3	44.1	49.9	237.5	36.8	20.9	58.0	57.1	69.4
Level of Service (LOS)	E	D	E	F	D	D	F	D	C	E	E	E
Approach Delay, s/veh / LOS	49.9		D	59.2		E	76.4		E	60.7		E
Intersection Delay, s/veh / LOS	59.6						E					

Multimodal Results	EB		WB		NB		SB	
Pedestrian LOS Score / LOS	2.58	C	2.44	B	2.59	C	2.59	C
Bicycle LOS Score / LOS	1.33	A	1.36	A	1.17	A	1.34	A



EXISTING PM PEAK HOUR

HCS7 Signalized Intersection Results Summary

General Information				Intersection Information		
Agency	otc			Duration, h	0.25	
Analyst	jto	Analysis Date	May 12, 2020		Area Type	CBD
Jurisdiction	City of Los Angeles		Time Period	pm peak	PHF	1.00
Urban Street	Roscoe Boulevard		Analysis Year	2020	Analysis Period	1 > 7:00
Intersection	Van Nuys Boulevard		File Name	1PM.xus		
Project Description	pm peak hour wo project					

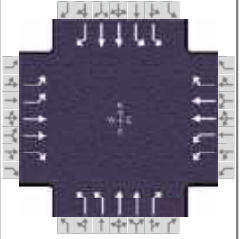

Demand Information	EB			WB			NB			SB		
Approach Movement	L	T	R	L	T	R	L	T	R	L	T	R
Demand (v), veh/h	197	954	229	293	1309	164	336	1071	238	349	1031	76

Signal Information				Signal Timing (s)														
Cycle, s	120.0	Reference Phase	2	Green	17.4	0.5	35.1	7.0	5.4	35.6	Yellow	3.0	0.0	3.0	3.0	3.0	3.0	
Offset, s	0	Reference Point	End	Red	0.0	0.0	2.0	0.0	0.0	2.0	Uncoordinated	No	Simult. Gap E/W	On	Force Mode	Fixed	Simult. Gap N/S	On

Timer Results	EBL	EBT	WBL	WBT	NBL	NBT	SBL	SBT
Assigned Phase	7	4	3	8	5	2	1	6
Case Number	2.0	3.0	2.0	3.0	2.0	3.0	2.0	3.0
Phase Duration, s	10.0	40.6	18.4	49.0	20.4	40.1	20.9	40.6
Change Period, (Y+R _c), s	3.0	5.0	3.0	5.0	3.0	5.0	3.0	5.0
Max Allow Headway (MAH), s	3.4	3.1	3.4	3.1	3.4	0.0	3.4	0.0
Queue Clearance Time (g _s), s	9.0	37.0	14.6	46.0	16.4		17.0	
Green Extension Time (g _e), s	0.0	0.0	0.8	0.0	1.0	0.0	0.9	0.0
Phase Call Probability	1.00	1.00	1.00	1.00	1.00		1.00	
Max Out Probability	1.00	1.00	0.00	1.00	0.00		0.00	

Movement Group Results	EB			WB			NB			SB		
Approach Movement	L	T	R	L	T	R	L	T	R	L	T	R
Assigned Movement	7	4	14	3	8	18	5	2	12	1	6	16
Adjusted Flow Rate (v), veh/h	197	954	179	293	1309	114	336	1071	188	349	1031	26
Adjusted Saturation Flow Rate (s), veh/h/ln	1361	1628	1035	1361	1628	989	1361	1628	1170	1361	1628	1191
Queue Service Time (g _s), s	7.0	35.0	17.7	12.6	44.0	9.9	14.4	35.1	16.3	15.0	35.6	1.9
Cycle Queue Clearance Time (g _c), s	7.0	35.0	17.7	12.6	44.0	9.9	14.4	35.1	16.3	15.0	35.6	1.9
Green Ratio (g/C)	0.06	0.30	0.30	0.13	0.37	0.37	0.15	0.29	0.29	0.15	0.30	0.30
Capacity (c), veh/h	159	965	307	350	1194	363	395	951	342	407	966	353
Volume-to-Capacity Ratio (X)	1.241	0.989	0.584	0.836	1.096	0.314	0.851	1.126	0.550	0.858	1.068	0.074
Back of Queue (Q), ft/ln (50 th percentile)	142.5	430.7	114.1	108.9	658.6	58.4	124.3	576.2	129.5	129.2	513.1	14.5
Back of Queue (Q), veh/ln (50 th percentile)	5.7	17.2	4.6	4.4	26.3	2.3	5.0	23.0	5.2	5.2	20.5	0.6
Queue Storage Ratio (RQ) (50 th percentile)	0.35	0.00	0.29	0.25	0.00	0.15	0.22	0.00	0.32	0.23	0.00	0.04
Uniform Delay (d ₁), s/veh	56.5	42.0	35.9	51.0	38.0	27.2	50.0	42.5	35.8	49.8	42.2	30.4
Incremental Delay (d ₂), s/veh	150.4	26.1	1.9	2.1	56.6	0.2	2.0	70.2	6.2	2.1	48.9	0.4
Initial Queue Delay (d ₃), s/veh	0.0	0.0	0.0	0.0	0.0	0.0	0.0	0.0	0.0	0.0	0.0	0.0
Control Delay (d), s/veh	206.9	68.1	37.8	53.1	94.6	27.4	52.0	112.7	42.1	51.9	91.1	30.8
Level of Service (LOS)	F	E	D	D	F	C	D	F	D	D	F	C
Approach Delay, s/veh / LOS	84.6	F		83.0	F		91.6	F		80.2	F	
Intersection Delay, s/veh / LOS	85.0						F					

Multimodal Results	EB		WB		NB		SB	
Pedestrian LOS Score / LOS	2.66	C	2.65	C	2.66	C	2.66	C
Bicycle LOS Score / LOS	1.58	B	1.90	B	1.80	B	1.65	B

HCS7 Signalized Intersection Results Summary

General Information				Intersection Information	
Agency	otc			Duration, h	0.25
Analyst	jto	Analysis Date	May 12, 2020	Area Type	CBD
Jurisdiction	City of Los Angeles	Time Period	pm peak	PHF	1.00
Urban Street	Saticoy Street	Analysis Year	2020	Analysis Period	1 > 7:00
Intersection	Van Nuys Boulevard	File Name	2PM.xus		
Project Description	pm peak hour wo project				

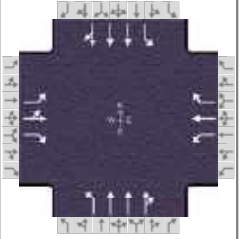

Demand Information	EB			WB			NB			SB		
	L	T	R	L	T	R	L	T	R	L	T	R
Approach Movement												
Demand (v), veh/h	535	11	275	31	48	28	260	1540	37	14	1234	314

Signal Information													
Cycle, s	120.0	Reference Phase	2										
Offset, s	0	Reference Point	End										
Uncoordinated	No	Simult. Gap E/W	On	Green	6.0	5.0	39.0	9.7	39.3	0.0			
Force Mode	Fixed	Simult. Gap N/S	On	Yellow	3.0	3.0	3.0	3.0	3.0	0.0			
				Red	0.0	0.0	2.0	2.0	2.0	0.0			

Timer Results	EBL	EBT	WBL	WBT	NBL	NBT	SBL	SBT
Assigned Phase		4		8	5	2	1	6
Case Number		9.0		9.0	2.0	4.0	1.1	4.0
Phase Duration, s		44.3		14.7	17.0	52.0	9.0	44.0
Change Period, (Y+R _c), s		5.0		5.0	3.0	5.0	3.0	5.0
Max Allow Headway (MAH), s		3.5		3.6	3.4	0.0	3.4	0.0
Queue Clearance Time (g _s), s		41.3		5.5	16.0		2.8	
Green Extension Time (g _e), s		0.0		0.1	0.0	0.0	0.0	0.0
Phase Call Probability		1.00		0.97	1.00		1.00	
Max Out Probability		1.00		0.11	1.00		1.00	

Movement Group Results	EB			WB			NB			SB		
	L	T	R	L	T	R	L	T	R	L	T	R
Assigned Movement	7	4	14	3	8	18	5	2	12	1	6	16
Adjusted Flow Rate (v), veh/h	535	11	200	31	48	28	260	1072	505	14	1136	412
Adjusted Saturation Flow Rate (s), veh/h/ln	1402	1710	1202	1402	1710	915	1402	1710	1609	1402	1710	1241
Queue Service Time (g _s), s	39.3	0.5	13.3	2.5	3.2	3.5	14.0	33.4	33.4	0.8	39.0	39.0
Cycle Queue Clearance Time (g _c), s	39.3	0.5	13.3	2.5	3.2	3.5	14.0	33.4	33.4	0.8	39.0	39.0
Green Ratio (g/C)	0.33	0.33	0.44	0.08	0.08	0.08	0.12	0.39	0.39	0.37	0.32	0.32
Capacity (c), veh/h	459	560	541	114	138	74	164	1339	630	159	1111	403
Volume-to-Capacity Ratio (X)	1.166	0.020	0.370	0.273	0.347	0.378	1.589	0.801	0.801	0.088	1.022	1.023
Back of Queue (Q), ft/ln (50 th percentile)	635.8	5.6	99.7	22.2	34.5	20.5	453.7	359.3	360.8	7.5	525.4	431.8
Back of Queue (Q), veh/ln (50 th percentile)	25.4	0.2	4.0	0.9	1.4	0.8	18.1	14.4	14.4	0.3	21.0	17.3
Queue Storage Ratio (RQ) (50 th percentile)	0.91	0.00	0.14	0.37	0.00	0.34	2.84	0.00	0.00	0.05	0.00	0.00
Uniform Delay (d ₁), s/veh	40.4	27.3	22.2	51.8	52.1	52.3	53.0	32.4	32.4	26.9	40.5	40.5
Incremental Delay (d ₂), s/veh	96.1	0.1	1.9	0.5	0.6	1.2	292.1	5.1	10.3	1.1	32.7	50.8
Initial Queue Delay (d ₃), s/veh	0.0	0.0	0.0	0.0	0.0	0.0	0.0	0.0	0.0	0.0	0.0	0.0
Control Delay (d), s/veh	136.5	27.4	24.2	52.3	52.7	53.5	345.1	37.5	42.7	28.0	73.2	91.3
Level of Service (LOS)	F	C	C	D	D	D	F	D	D	C	F	F
Approach Delay, s/veh / LOS	104.8	F		52.8	D		82.4	F		77.5	E	
Intersection Delay, s/veh / LOS	83.8						F					

Multimodal Results	EB		WB		NB		SB	
Pedestrian LOS Score / LOS	2.58	C	2.62	C	2.11	B	2.23	B
Bicycle LOS Score / LOS	1.72	B	0.66	A	1.50	A	1.35	A

HCS7 Signalized Intersection Results Summary

General Information				Intersection Information	
Agency	otc			Duration, h	0.25
Analyst	jto	Analysis Date	May 12, 2020	Area Type	CBD
Jurisdiction	City of Los Angeles	Time Period	pm peak	PHF	1.00
Urban Street	Roscoe Boulevard	Analysis Year	2020	Analysis Period	1 > 7:00
Intersection	Willis Avenue	File Name	3PM.xus		
Project Description	pm peak hour wo project				

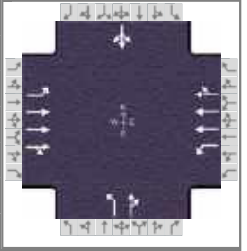

Demand Information	EB			WB			NB			SB		
	L	T	R	L	T	R	L	T	R	L	T	R
Approach Movement												
Demand (v), veh/h	70	1402	181	49	1218	49	322	141	89	23	109	61

Signal Information													
Cycle, s	120.0	Reference Phase	2										
Offset, s	0	Reference Point	End										
Uncoordinated	No	Simult. Gap E/W	On	Green	23.9	20.0	63.1	0.0	0.0	0.0			
Force Mode	Fixed	Simult. Gap N/S	On	Yellow	3.0	3.0	3.0	0.0	0.0	0.0			
				Red	0.0	2.0	2.0	0.0	0.0	0.0			

Timer Results	EBL	EBT	WBL	WBT	NBL	NBT	SBL	SBT
Assigned Phase		4		8	5	2		6
Case Number		6.0		6.0	1.0	4.0		8.3
Phase Duration, s		68.1		68.1	26.9	51.9		25.0
Change Period, (Y+R _c), s		5.0		5.0	3.0	5.0		5.0
Max Allow Headway (MAH), s		3.4		3.4	3.4	0.0		0.0
Queue Clearance Time (g _s), s		39.0		49.6	23.9			
Green Extension Time (g _e), s		14.6		14.0	0.6	0.0		0.0
Phase Call Probability		1.00		1.00	1.00			
Max Out Probability		0.08		0.14	0.01			

Movement Group Results	EB			WB			NB			SB		
	L	T	R	L	T	R	L	T	R	L	T	R
Assigned Movement	7	4	14	3	8	18	5	2	12	1	6	16
Adjusted Flow Rate (v), veh/h	70	1157	426	49	869	398	322	230			193	
Adjusted Saturation Flow Rate (s), veh/h/ln	391	1710	1256	292	1710	1563	1402	1534			1394	
Queue Service Time (g _s), s	16.9	29.4	29.5	17.6	19.6	19.6	21.9	12.8			7.4	
Cycle Queue Clearance Time (g _c), s	37.0	29.4	29.5	47.6	19.6	19.6	21.9	12.8			15.7	
Green Ratio (g/C)	0.53	0.53	0.53	0.53	0.53	0.53	0.39	0.39			0.17	
Capacity (c), veh/h	198	1781	654	139	1781	814	404	607			280	
Volume-to-Capacity Ratio (X)	0.353	0.650	0.651	0.352	0.488	0.489	0.797	0.379			0.689	
Back of Queue (Q), ft/ln (50 th percentile)	39.8	282.7	209	31.7	188.2	172.7	192.3	122.7			161.1	
Back of Queue (Q), veh/ln (50 th percentile)	1.6	11.3	8.4	1.3	7.5	6.9	7.7	4.9			6.4	
Queue Storage Ratio (RQ) (50 th percentile)	0.53	0.00	0.00	0.63	0.00	0.00	3.20	0.00			0.00	
Uniform Delay (d ₁), s/veh	30.5	20.8	20.8	38.3	18.5	18.5	30.6	25.8			47.0	
Incremental Delay (d ₂), s/veh	0.4	0.2	0.4	0.6	0.1	0.2	4.2	1.8			13.0	
Initial Queue Delay (d ₃), s/veh	0.0	0.0	0.0	0.0	0.0	0.0	0.0	0.0			0.0	
Control Delay (d), s/veh	30.9	21.0	21.2	38.9	18.6	18.6	34.8	27.6			60.0	
Level of Service (LOS)	C	C	C	D	B	B	C	C			E	
Approach Delay, s/veh / LOS	21.5	C		19.3	B		31.8	C		60.0	E	
Intersection Delay, s/veh / LOS	24.3						C					

Multimodal Results	EB		WB		NB		SB	
Pedestrian LOS Score / LOS	1.90	B	1.68	B	2.58	C	2.60	C
Bicycle LOS Score / LOS	1.40	A	1.21	A	1.40	A	0.81	A

HCS7 Signalized Intersection Results Summary

General Information				Intersection Information	
Agency	otc			Duration, h	0.25
Analyst	jto	Analysis Date	May 12, 2020	Area Type	CBD
Jurisdiction	City of Los Angeles	Time Period	pm peak	PHF	1.00
Urban Street	Roscoe Boulevard	Analysis Year	2020	Analysis Period	1 > 7:00
Intersection	Woodman Avenue	File Name	4PM.xus		
Project Description	pm peak hour wo project				

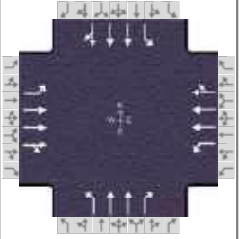

Demand Information	EB			WB			NB			SB		
	L	T	R	L	T	R	L	T	R	L	T	R
Approach Movement												
Demand (v), veh/h	262	800	92	207	1196	231	129	737	107	146	903	188

Signal Information													
Cycle, s	120.0	Reference Phase	2										
Offset, s	0	Reference Point	End										
Uncoordinated	No	Simult. Gap E/W	On	Green	13.1	1.5	29.8	18.0	1.8	39.8			
Force Mode	Fixed	Simult. Gap N/S	On	Yellow	3.0	0.0	3.0	3.0	0.0	3.0			
				Red	0.0	0.0	2.0	0.0	0.0	2.0			

Timer Results	EBL	EBT	WBL	WBT	NBL	NBT	SBL	SBT
Assigned Phase	7	4	3	8	5	2	1	6
Case Number	2.0	4.0	2.0	4.0	2.0	3.0	2.0	4.0
Phase Duration, s	21.0	44.8	22.8	46.6	16.1	34.8	17.5	36.3
Change Period, (Y+R _c), s	3.0	5.0	3.0	5.0	3.0	5.0	3.0	5.0
Max Allow Headway (MAH), s	3.4	3.1	3.4	3.1	3.4	0.0	3.4	0.0
Queue Clearance Time (g _s), s	20.0	20.8	19.4	34.5	12.8		14.3	
Green Extension Time (g _e), s	0.0	7.2	0.4	7.1	0.2	0.0	0.3	0.0
Phase Call Probability	1.00	1.00	1.00	1.00	1.00		1.00	
Max Out Probability	1.00	0.01	0.00	0.02	0.00		0.00	

Movement Group Results	EB			WB			NB			SB		
	L	T	R	L	T	R	L	T	R	L	T	R
Assigned Movement	7	4	14	3	8	18	5	2	12	1	6	16
Adjusted Flow Rate (v), veh/h	262	639	253	207	1003	424	129	737	107	146	765	326
Adjusted Saturation Flow Rate (s), veh/h/ln	1402	1710	1331	1402	1710	1444	1402	1628	1313	1402	1710	1445
Queue Service Time (g _s), s	18.0	18.4	18.8	17.4	32.5	32.5	10.8	26.4	6.2	12.3	25.6	25.9
Cycle Queue Clearance Time (g _c), s	18.0	18.4	18.8	17.4	32.5	32.5	10.8	26.4	6.2	12.3	25.6	25.9
Green Ratio (g/C)	0.15	0.33	0.33	0.17	0.35	0.35	0.11	0.25	0.41	0.12	0.26	0.26
Capacity (c), veh/h	210	1135	442	231	1187	501	153	809	554	170	891	377
Volume-to-Capacity Ratio (X)	1.246	0.563	0.572	0.895	0.845	0.845	0.844	0.911	0.193	0.860	0.858	0.866
Back of Queue (Q), ft/ln (50 th percentile)	366.3	188.9	150.7	157.8	333.8	285.5	99.6	306.8	50.8	112.4	297.8	285.8
Back of Queue (Q), veh/ln (50 th percentile)	14.7	7.6	6.0	6.3	13.4	11.4	4.0	12.3	2.0	4.5	11.9	11.4
Queue Storage Ratio (RQ) (50 th percentile)	1.83	0.00	0.00	0.67	0.00	0.00	0.52	0.00	0.13	0.59	0.00	0.00
Uniform Delay (d ₁), s/veh	51.0	32.9	33.1	49.1	36.2	36.2	52.5	43.8	22.5	51.7	42.3	42.4
Incremental Delay (d ₂), s/veh	144.1	0.2	0.4	4.8	0.7	1.6	4.8	16.2	0.8	4.8	10.5	22.5
Initial Queue Delay (d ₃), s/veh	0.0	0.0	0.0	0.0	0.0	0.0	0.0	0.0	0.0	0.0	0.0	0.0
Control Delay (d), s/veh	195.1	33.1	33.5	53.9	36.9	37.8	57.2	60.0	23.2	56.6	52.7	64.8
Level of Service (LOS)	F	C	C	D	D	D	E	E	C	E	D	E
Approach Delay, s/veh / LOS	70.0		E	39.3		D	55.6		E	56.4		E
Intersection Delay, s/veh / LOS	53.8						D					

Multimodal Results	EB		WB		NB		SB	
Pedestrian LOS Score / LOS	2.58	C	2.44	B	2.59	C	2.59	C
Bicycle LOS Score / LOS	1.12	A	1.39	A	1.29	A	1.17	A



EXISTING + PROJECT HCS WORKSHEETS



EXISTING + PROJECT AM PEAK HOUR

HCS7 Signalized Intersection Results Summary

General Information				Intersection Information	
Agency	otc			Duration, h	0.25
Analyst	jto	Analysis Date	May 12, 2020	Area Type	CBD
Jurisdiction	City of Los Angeles	Time Period	am peak plus project	PHF	1.00
Urban Street	Roscoe Boulevard	Analysis Year	2020	Analysis Period	1 > 7:00
Intersection	Van Nuys Boulevard	File Name	1AM PLUS.xus		
Project Description	am peak hour with project				

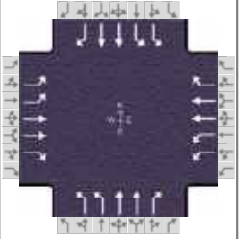

Demand Information	EB			WB			NB			SB		
Approach Movement	L	T	R	L	T	R	L	T	R	L	T	R
Demand (v), veh/h	86	917	207	455	1309	195	209	681	265	433	1448	67

Signal Information													
Cycle, s	120.0	Reference Phase	2										
Offset, s	0	Reference Point	End										
Uncoordinated	No	Simult. Gap E/W	On	Green	7.0	11.8	32.2	6.0	10.0	31.0			
Force Mode	Fixed	Simult. Gap N/S	On	Yellow	3.0	3.0	3.0	3.0	3.0	3.0			
				Red	0.0	0.0	2.0	0.0	0.0	2.0			

Timer Results	EBL	EBT	WBL	WBT	NBL	NBT	SBL	SBT
Assigned Phase	7	4	3	8	5	2	1	6
Case Number	2.0	3.0	2.0	3.0	2.0	3.0	2.0	3.0
Phase Duration, s	9.0	36.0	22.0	49.0	10.0	37.2	24.8	52.0
Change Period, (Y+R _c), s	3.0	5.0	3.0	5.0	3.0	5.0	3.0	5.0
Max Allow Headway (MAH), s	3.4	3.1	3.4	3.1	3.4	0.0	3.4	0.0
Queue Clearance Time (g _s), s	5.7	33.0	21.0	46.0	9.0		20.6	
Green Extension Time (g _e), s	0.0	0.0	0.0	0.0	0.0	0.0	1.2	0.0
Phase Call Probability	1.00	1.00	1.00	1.00	1.00		1.00	
Max Out Probability	1.00	1.00	1.00	1.00	1.00		0.00	

Movement Group Results	EB			WB			NB			SB		
Approach Movement	L	T	R	L	T	R	L	T	R	L	T	R
Assigned Movement	7	4	14	3	8	18	5	2	12	1	6	16
Adjusted Flow Rate (v), veh/h	86	917	157	455	1309	145	209	681	215	433	1448	42
Adjusted Saturation Flow Rate (s), veh/h/ln	1361	1628	1111	1361	1628	1141	1361	1628	1225	1361	1628	1286
Queue Service Time (g _s), s	3.7	31.0	14.7	19.0	44.0	11.1	7.0	23.2	18.7	18.6	47.0	2.5
Cycle Queue Clearance Time (g _c), s	3.7	31.0	14.7	19.0	44.0	11.1	7.0	23.2	18.7	18.6	47.0	2.5
Green Ratio (g/C)	0.05	0.26	0.26	0.16	0.37	0.37	0.06	0.27	0.27	0.18	0.39	0.39
Capacity (c), veh/h	136	841	287	431	1194	418	159	874	329	494	1275	504
Volume-to-Capacity Ratio (X)	0.632	1.090	0.547	1.056	1.096	0.347	1.316	0.779	0.654	0.877	1.136	0.083
Back of Queue (Q), ft/ln (50 th percentile)	32.5	477	101.3	247.5	659	75.2	158.7	249.5	160.9	159.2	764.3	19.7
Back of Queue (Q), veh/ln (50 th percentile)	1.3	19.1	4.1	9.9	26.4	3.0	6.3	10.0	6.4	6.4	30.6	0.8
Queue Storage Ratio (RQ) (50 th percentile)	0.08	0.00	0.25	0.57	0.00	0.19	0.29	0.00	0.40	0.28	0.00	0.05
Uniform Delay (d ₁), s/veh	55.9	44.5	38.4	50.5	38.0	27.6	56.5	40.6	38.9	47.8	36.5	23.0
Incremental Delay (d ₂), s/veh	1.8	58.5	1.3	58.8	56.6	0.2	179.7	6.8	9.7	2.1	71.1	0.3
Initial Queue Delay (d ₃), s/veh	0.0	0.0	0.0	0.0	0.0	0.0	0.0	0.0	0.0	0.0	0.0	0.0
Control Delay (d), s/veh	57.7	103.0	39.7	109.3	94.6	27.8	236.2	47.4	48.7	49.9	107.6	23.3
Level of Service (LOS)	E	F	D	F	F	C	F	D	D	D	F	C
Approach Delay, s/veh / LOS	91.1	F		93.0	F		83.3	F			92.8	F
Intersection Delay, s/veh / LOS	90.8						F					

Multimodal Results	EB		WB		NB		SB	
Pedestrian LOS Score / LOS	2.66	C	2.61	C	2.66	C	2.65	C
Bicycle LOS Score / LOS	1.44	A	2.06	B	1.40	A	2.07	B

HCS7 Signalized Intersection Results Summary

General Information				Intersection Information			
Agency	otc			Duration, h	0.25		
Analyst	jto		Analysis Date	May 12, 2020		Area Type	CBD
Jurisdiction	City of Los Angeles		Time Period	am peak		PHF	1.00
Urban Street	Saticoy Street		Analysis Year	2020		Analysis Period	1 > 7:00
Intersection	Van Nuys Boulevard		File Name	2AM PLUS.xus			
Project Description	am peak hour with project						

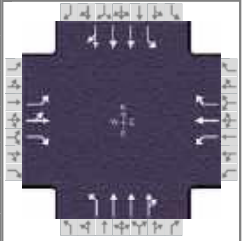

Demand Information	EB			WB			NB			SB		
	L	T	R	L	T	R	L	T	R	L	T	R
Approach Movement												
Demand (v), veh/h	461	19	401	57	24	23	250	810	29	21	1426	372

Signal Information													
Cycle, s	120.0	Reference Phase	2										
Offset, s	0	Reference Point	End										
Uncoordinated	No	Simult. Gap E/W	On	Green	6.0	7.0	43.0	9.7	33.3	0.0			
Force Mode	Fixed	Simult. Gap N/S	On	Yellow	3.0	3.0	3.0	3.0	3.0	0.0			
				Red	0.0	0.0	2.0	2.0	2.0	0.0			

Timer Results	EBL	EBT	WBL	WBT	NBL	NBT	SBL	SBT
Assigned Phase		4		8	5	2	1	6
Case Number		9.0		9.0	2.0	4.0	1.1	4.0
Phase Duration, s		38.3		14.7	19.0	58.0	9.0	48.0
Change Period, (Y+R _c), s		5.0		5.0	3.0	5.0	3.0	5.0
Max Allow Headway (MAH), s		3.5		3.5	3.4	0.0	3.4	0.0
Queue Clearance Time (g _s), s		35.3		6.7	18.1		3.1	
Green Extension Time (g _e), s		0.0		0.2	0.0	0.0	0.0	0.0
Phase Call Probability		1.00		0.97	1.00		1.00	
Max Out Probability		1.00		0.00	1.00		1.00	

Movement Group Results	EB			WB			NB			SB		
	L	T	R	L	T	R	L	T	R	L	T	R
Assigned Movement	7	4	14	3	8	18	5	2	12	1	6	16
Adjusted Flow Rate (v), veh/h	461	19	351	57	24	23	250	571	268	21	1285	513
Adjusted Saturation Flow Rate (s), veh/h/ln	1402	1710	1217	1402	1710	1031	1402	1710	1597	1402	1710	1352
Queue Service Time (g _s), s	33.3	1.0	28.6	4.7	1.6	2.5	16.1	13.4	13.5	1.1	42.9	42.9
Cycle Queue Clearance Time (g _c), s	33.3	1.0	28.6	4.7	1.6	2.5	16.1	13.4	13.5	1.1	42.9	42.9
Green Ratio (g/C)	0.28	0.28	0.41	0.08	0.08	0.08	0.13	0.44	0.44	0.41	0.36	0.36
Capacity (c), veh/h	389	474	507	113	138	83	188	1511	705	318	1223	484
Volume-to-Capacity Ratio (X)	1.185	0.040	0.693	0.504	0.174	0.276	1.331	0.378	0.380	0.066	1.050	1.060
Back of Queue (Q), ft/ln (50 th percentile)	570.3	10.6	230	41.9	17	16.6	375.3	136.5	132.2	8.9	606.1	538.9
Back of Queue (Q), veh/ln (50 th percentile)	22.8	0.4	9.2	1.7	0.7	0.7	15.0	5.5	5.3	0.4	24.2	21.6
Queue Storage Ratio (RQ) (50 th percentile)	0.95	0.00	0.38	0.70	0.00	0.28	2.35	0.00	0.00	0.06	0.00	0.00
Uniform Delay (d ₁), s/veh	43.4	31.7	29.2	52.9	51.4	51.9	52.0	22.4	22.5	21.5	38.5	38.5
Incremental Delay (d ₂), s/veh	106.5	0.2	7.6	1.3	0.2	0.7	180.6	0.7	1.6	0.0	40.1	57.8
Initial Queue Delay (d ₃), s/veh	0.0	0.0	0.0	0.0	0.0	0.0	0.0	0.0	0.0	0.0	0.0	0.0
Control Delay (d), s/veh	149.9	31.8	36.8	54.1	51.6	52.5	232.5	23.2	24.0	21.5	78.6	96.4
Level of Service (LOS)	F	C	D	D	D	D	F	C	C	C	F	F
Approach Delay, s/veh / LOS	99.4		F	53.2		D	71.4		E	83.0		F
Intersection Delay, s/veh / LOS	82.5						F					

Multimodal Results	EB		WB		NB		SB	
Pedestrian LOS Score / LOS	2.59	C	2.62	C	2.11	B	2.19	B
Bicycle LOS Score / LOS	1.86	B	0.66	A	1.09	A	1.49	A

HCS7 Signalized Intersection Results Summary

General Information				Intersection Information	
Agency	otc			Duration, h	0.25
Analyst	jto	Analysis Date	May 12, 2020	Area Type	CBD
Jurisdiction	City of Los Angeles	Time Period	am peak	PHF	1.00
Urban Street	Roscoe Boulevard	Analysis Year	2020	Analysis Period	1 > 7:00
Intersection	Willis Avenue	File Name	3AMplus.xus		
Project Description	am peak hour with project				

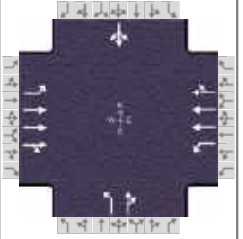

Demand Information	EB			WB			NB			SB		
	L	T	R	L	T	R	L	T	R	L	T	R
Approach Movement												
Demand (v), veh/h	36	1172	145	39	1344	22	235	95	59	31	131	86

Signal Information													
Cycle, s	120.0	Reference Phase	2										
Offset, s	0	Reference Point	End										
Uncoordinated	No	Simult. Gap E/W	On	Green	15.5	37.8	53.7	0.0	0.0	0.0			
Force Mode	Fixed	Simult. Gap N/S	On	Yellow	3.0	3.0	3.0	0.0	0.0	0.0			
				Red	0.0	2.0	2.0	0.0	0.0	0.0			

Timer Results	EBL	EBT	WBL	WBT	NBL	NBT	SBL	SBT
Assigned Phase		4		8	5	2		6
Case Number		6.0		6.0	1.0	4.0		8.3
Phase Duration, s		58.7		58.7	18.5	61.3		42.8
Change Period, (Y+R _c), s		5.0		5.0	3.0	5.0		5.0
Max Allow Headway (MAH), s		3.3		3.3	3.4	0.0		0.0
Queue Clearance Time (g _s), s		37.3		42.1	14.9			
Green Extension Time (g _e), s		12.2		12.1	0.5	0.0		0.0
Phase Call Probability		1.00		1.00	1.00			
Max Out Probability		0.04		0.05	0.00			

Movement Group Results	EB			WB			NB			SB		
	L	T	R	L	T	R	L	T	R	L	T	R
Approach Movement												
Assigned Movement	7	4	14	3	8	18	5	2	12	1	6	16
Adjusted Flow Rate (v), veh/h	36	1024	293	39	931	435	235	154			248	
Adjusted Saturation Flow Rate (s), veh/h/ln	353	1710	976	363	1710	1599	1402	1532			1439	
Queue Service Time (g _s), s	10.4	28.5	28.7	11.5	25.0	25.0	12.9	7.1			3.5	
Cycle Queue Clearance Time (g _c), s	35.3	28.5	28.7	40.1	25.0	25.0	12.9	7.1			16.4	
Green Ratio (g/C)	0.45	0.45	0.45	0.45	0.45	0.45	0.46	0.47			0.32	
Capacity (c), veh/h	143	1517	433	135	1517	709	434	725			493	
Volume-to-Capacity Ratio (X)	0.251	0.675	0.677	0.290	0.613	0.614	0.542	0.212			0.503	
Back of Queue (Q), ft/ln (50 th percentile)	22.7	282.9	163.8	25.9	247.4	232.2	105	65.3			158.2	
Back of Queue (Q), veh/ln (50 th percentile)	0.9	11.3	6.6	1.0	9.9	9.3	4.2	2.6			6.3	
Queue Storage Ratio (RQ) (50 th percentile)	0.30	0.00	0.00	0.52	0.00	0.00	1.75	0.00			0.00	
Uniform Delay (d ₁), s/veh	39.0	26.5	26.5	42.4	25.5	25.5	22.5	18.5			33.3	
Incremental Delay (d ₂), s/veh	0.3	0.2	0.7	0.4	0.2	0.3	0.4	0.7			3.6	
Initial Queue Delay (d ₃), s/veh	0.0	0.0	0.0	0.0	0.0	0.0	0.0	0.0			0.0	
Control Delay (d), s/veh	39.3	26.7	27.2	42.9	25.7	25.8	22.9	19.2			37.0	
Level of Service (LOS)	D	C	C	D	C	C	C	B			D	
Approach Delay, s/veh / LOS	27.2	C		26.2	C		21.4	C		37.0	D	
Intersection Delay, s/veh / LOS	26.8						C					

Multimodal Results	EB		WB		NB		SB	
Pedestrian LOS Score / LOS	1.91	B	1.69	B	2.56	C	2.59	C
Bicycle LOS Score / LOS	1.23	A	1.26	A	1.13	A	0.90	A

HCS7 Signalized Intersection Results Summary

General Information				Intersection Information	
Agency	otc			Duration, h	0.25
Analyst	jto	Analysis Date	May 12, 2020	Area Type	CBD
Jurisdiction	City of Los Angeles	Time Period	am peak	PHF	1.00
Urban Street	Roscoe Boulevard	Analysis Year	2020	Analysis Period	1 > 7:00
Intersection	Woodman Avenue	File Name	4AM plus.xus		
Project Description	am peak hour with project				

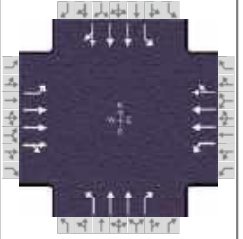

Demand Information	EB			WB			NB			SB		
	L	T	R	L	T	R	L	T	R	L	T	R
Approach Movement												
Demand (v), veh/h	181	1140	218	217	1310	58	174	539	118	113	1271	165

Signal Information													
Cycle, s	120.0	Reference Phase	2										
Offset, s	0	Reference Point	End										
Uncoordinated	No	Simult. Gap E/W	On	Green	11.1	0.5	36.5	17.0	0.5	38.4			
Force Mode	Fixed	Simult. Gap N/S	On	Yellow	3.0	0.0	3.0	3.0	0.0	3.0			
				Red	0.0	0.0	2.0	0.0	0.0	2.0			

Timer Results	EBL	EBT	WBL	WBT	NBL	NBT	SBL	SBT
Assigned Phase	7	4	3	8	5	2	1	6
Case Number	2.0	4.0	2.0	4.0	2.0	3.0	2.0	4.0
Phase Duration, s	20.5	43.9	20.0	43.4	14.1	41.5	14.7	42.0
Change Period, (Y+R _c), s	3.0	5.0	3.0	5.0	3.0	5.0	3.0	5.0
Max Allow Headway (MAH), s	3.4	3.1	3.4	3.1	3.4	0.0	3.4	0.0
Queue Clearance Time (g _s), s	17.2	34.9	19.0	32.7	13.1		11.5	
Green Extension Time (g _e), s	0.3	3.9	0.0	4.7	0.0	0.0	0.2	0.0
Phase Call Probability	1.00	1.00	1.00	1.00	1.00		1.00	
Max Out Probability	0.00	0.77	1.00	0.66	1.00		0.00	

Movement Group Results	EB			WB			NB			SB		
	L	T	R	L	T	R	L	T	R	L	T	R
Assigned Movement	7	4	14	3	8	18	5	2	12	1	6	16
Adjusted Flow Rate (v), veh/h	181	987	371	217	934	434	174	539	118	113	992	444
Adjusted Saturation Flow Rate (s), veh/h/ln	1402	1710	1286	1402	1710	1591	1402	1628	1331	1402	1710	1531
Queue Service Time (g _s), s	15.2	32.9	32.9	17.0	30.7	30.7	11.1	16.6	6.5	9.5	33.9	33.9
Cycle Queue Clearance Time (g _c), s	15.2	32.9	32.9	17.0	30.7	30.7	11.1	16.6	6.5	9.5	33.9	33.9
Green Ratio (g/C)	0.15	0.32	0.32	0.14	0.32	0.32	0.09	0.30	0.45	0.10	0.31	0.31
Capacity (c), veh/h	205	1108	417	199	1093	508	130	989	600	136	1054	472
Volume-to-Capacity Ratio (X)	0.885	0.891	0.891	1.093	0.854	0.854	1.338	0.545	0.197	0.829	0.941	0.941
Back of Queue (Q), ft/ln (50 th percentile)	138.8	368	307	272.7	336	332.8	273.1	169.7	52.7	87.5	409.5	407.1
Back of Queue (Q), veh/ln (50 th percentile)	5.6	14.7	12.3	10.9	13.4	13.3	10.9	6.8	2.1	3.5	16.4	16.3
Queue Storage Ratio (RQ) (50 th percentile)	0.69	0.00	0.00	1.16	0.00	0.00	1.44	0.00	0.13	0.46	0.00	0.00
Uniform Delay (d ₁), s/veh	50.3	38.6	38.6	51.5	38.2	38.2	54.4	34.8	20.2	53.2	40.4	40.4
Incremental Delay (d ₂), s/veh	4.9	8.1	18.4	90.8	5.8	11.5	194.8	2.2	0.7	4.8	16.7	29.0
Initial Queue Delay (d ₃), s/veh	0.0	0.0	0.0	0.0	0.0	0.0	0.0	0.0	0.0	0.0	0.0	0.0
Control Delay (d), s/veh	55.2	46.7	57.0	142.3	44.0	49.7	249.2	37.0	21.0	58.0	57.1	69.4
Level of Service (LOS)	E	D	E	F	D	D	F	D	C	E	E	E
Approach Delay, s/veh / LOS	50.2	D		59.0	E		79.2	E		60.7	E	
Intersection Delay, s/veh / LOS	60.0						E					

Multimodal Results	EB		WB		NB		SB	
Pedestrian LOS Score / LOS	2.58	C	2.44	B	2.59	C	2.59	C
Bicycle LOS Score / LOS	1.33	A	1.36	A	1.17	A	1.34	A



EXISTING + PROJECT PM PEAK HOUR

HCS7 Signalized Intersection Results Summary

General Information				Intersection Information	
Agency	otc			Duration, h	0.25
Analyst	jto	Analysis Date	May 12, 2020	Area Type	CBD
Jurisdiction	City of Los Angeles	Time Period	pm peak	PHF	1.00
Urban Street	Roscoe Boulevard	Analysis Year	2020	Analysis Period	1 > 7:00
Intersection	Van Nuys Boulevard	File Name	1PM PLUS.xus		
Project Description	pm peak hour with project				

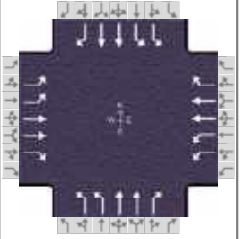

Demand Information	EB			WB			NB			SB		
	L	T	R	L	T	R	L	T	R	L	T	R
Approach Movement												
Demand (v), veh/h	197	958	229	305	1309	164	336	1078	244	349	1041	76

Signal Information													
Cycle, s	120.0	Reference Phase	2										
Offset, s	0	Reference Point	End										
Uncoordinated	No	Simult. Gap E/W	On	Green	17.4	0.5	35.1	7.0	6.0	35.0			
Force Mode	Fixed	Simult. Gap N/S	On	Yellow	3.0	0.0	3.0	3.0	3.0	3.0			
				Red	0.0	0.0	2.0	0.0	0.0	2.0			

Timer Results	EBL	EBT	WBL	WBT	NBL	NBT	SBL	SBT
Assigned Phase	7	4	3	8	5	2	1	6
Case Number	2.0	3.0	2.0	3.0	2.0	3.0	2.0	3.0
Phase Duration, s	10.0	40.0	19.0	49.0	20.4	40.1	20.9	40.6
Change Period, (Y+R _c), s	3.0	5.0	3.0	5.0	3.0	5.0	3.0	5.0
Max Allow Headway (MAH), s	3.4	3.1	3.4	3.1	3.4	0.0	3.4	0.0
Queue Clearance Time (g _s), s	9.0	37.0	15.1	46.0	16.4		17.0	
Green Extension Time (g _e), s	0.0	0.0	0.9	0.0	1.0	0.0	0.9	0.0
Phase Call Probability	1.00	1.00	1.00	1.00	1.00		1.00	
Max Out Probability	1.00	1.00	0.00	1.00	0.00		0.00	

Movement Group Results	EB			WB			NB			SB		
	L	T	R	L	T	R	L	T	R	L	T	R
Assigned Movement	7	4	14	3	8	18	5	2	12	1	6	16
Adjusted Flow Rate (v), veh/h	197	958	179	305	1309	114	336	1078	194	349	1041	26
Adjusted Saturation Flow Rate (s), veh/h/ln	1361	1628	1032	1361	1628	989	1361	1628	1170	1361	1628	1191
Queue Service Time (g _s), s	7.0	35.0	17.8	13.1	44.0	9.9	14.4	35.1	16.9	15.0	35.6	1.9
Cycle Queue Clearance Time (g _c), s	7.0	35.0	17.8	13.1	44.0	9.9	14.4	35.1	16.9	15.0	35.6	1.9
Green Ratio (g/C)	0.06	0.29	0.29	0.13	0.37	0.37	0.15	0.29	0.29	0.15	0.30	0.30
Capacity (c), veh/h	159	950	301	363	1194	363	395	951	342	407	966	353
Volume-to-Capacity Ratio (X)	1.241	1.009	0.595	0.841	1.096	0.314	0.851	1.133	0.568	0.858	1.078	0.074
Back of Queue (Q), ft/ln (50 th percentile)	142.5	446.6	115.5	113.4	658.6	58.4	124.3	585.6	134.9	129.2	525.1	14.5
Back of Queue (Q), veh/ln (50 th percentile)	5.7	17.9	4.6	4.5	26.3	2.3	5.0	23.4	5.4	5.2	21.0	0.6
Queue Storage Ratio (RQ) (50 th percentile)	0.35	0.00	0.29	0.26	0.00	0.15	0.22	0.00	0.34	0.23	0.00	0.04
Uniform Delay (d ₁), s/veh	56.5	42.5	36.4	50.8	38.0	27.2	50.0	42.5	36.0	49.8	42.2	30.4
Incremental Delay (d ₂), s/veh	150.4	31.3	2.2	2.0	56.6	0.2	2.0	73.1	6.7	2.1	52.4	0.4
Initial Queue Delay (d ₃), s/veh	0.0	0.0	0.0	0.0	0.0	0.0	0.0	0.0	0.0	0.0	0.0	0.0
Control Delay (d), s/veh	206.9	73.8	38.6	52.8	94.6	27.4	52.0	115.5	42.7	51.9	94.6	30.8
Level of Service (LOS)	F	F	D	D	F	C	D	F	D	D	F	C
Approach Delay, s/veh / LOS	88.7		F	82.8		F	93.5		F	82.9		F
Intersection Delay, s/veh / LOS	86.9						F					

Multimodal Results	EB		WB		NB		SB	
Pedestrian LOS Score / LOS	2.66	C	2.65	C	2.66	C	2.66	C
Bicycle LOS Score / LOS	1.59	B	1.91	B	1.81	B	1.66	B

HCS7 Signalized Intersection Results Summary

General Information				Intersection Information			
Agency	otc			Duration, h	0.25		
Analyst	jto		Analysis Date	May 12, 2020		Area Type	CBD
Jurisdiction	City of Los Angeles		Time Period	pm peak		PHF	1.00
Urban Street	Saticoy Street		Analysis Year	2020		Analysis Period	1 > 7:00
Intersection	Van Nuys Boulevard		File Name	2PM PLUS.xus			
Project Description	pm peak hour with project						

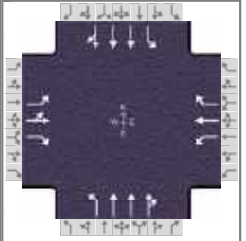

Demand Information	EB			WB			NB			SB		
	L	T	R	L	T	R	L	T	R	L	T	R
Approach Movement												
Demand (v), veh/h	537	11	275	31	48	28	260	1552	37	14	1243	316

Signal Information				Signal Phases																		
Cycle, s	120.0	Reference Phase	2																			
Offset, s	0	Reference Point	End																			
Uncoordinated	No	Simult. Gap E/W	On																			
Force Mode	Fixed	Simult. Gap N/S	On																			
		Green		6.0	4.0	40.0	9.7	39.3	0.0													
		Yellow		3.0	3.0	3.0	3.0	3.0	0.0													
		Red		0.0	0.0	2.0	2.0	2.0	0.0													

Timer Results	EBL	EBT	WBL	WBT	NBL	NBT	SBL	SBT
Assigned Phase		4		8	5	2	1	6
Case Number		9.0		9.0	2.0	4.0	1.1	4.0
Phase Duration, s		44.3		14.7	16.0	52.0	9.0	45.0
Change Period, (Y+R _c), s		5.0		5.0	3.0	5.0	3.0	5.0
Max Allow Headway (MAH), s		3.5		3.6	3.4	0.0	3.4	0.0
Queue Clearance Time (g _s), s		41.3		5.5	15.0		2.7	
Green Extension Time (g _e), s		0.0		0.1	0.0	0.0	0.0	0.0
Phase Call Probability		1.00		0.97	1.00		1.00	
Max Out Probability		1.00		0.11	1.00		1.00	

Movement Group Results	EB			WB			NB			SB		
	L	T	R	L	T	R	L	T	R	L	T	R
Approach Movement												
Assigned Movement	7	4	14	3	8	18	5	2	12	1	6	16
Adjusted Flow Rate (v), veh/h	537	11	200	31	48	28	260	1081	508	14	1143	416
Adjusted Saturation Flow Rate (s), veh/h/ln	1402	1710	1202	1402	1710	915	1402	1710	1609	1402	1710	1245
Queue Service Time (g _s), s	39.3	0.5	13.5	2.5	3.2	3.5	13.0	33.7	33.7	0.7	40.0	40.0
Cycle Queue Clearance Time (g _c), s	39.3	0.5	13.5	2.5	3.2	3.5	13.0	33.7	33.7	0.7	40.0	40.0
Green Ratio (g/C)	0.33	0.33	0.44	0.08	0.08	0.08	0.11	0.39	0.39	0.38	0.33	0.33
Capacity (c), veh/h	459	560	530	114	138	74	152	1339	630	158	1140	415
Volume-to-Capacity Ratio (X)	1.170	0.020	0.377	0.273	0.347	0.378	1.711	0.807	0.807	0.089	1.002	1.003
Back of Queue (Q), ft/ln (50 th percentile)	641.1	5.6	101.6	22.2	34.5	20.5	478.8	363.8	365.7	7.4	516.6	427.5
Back of Queue (Q), veh/ln (50 th percentile)	25.6	0.2	4.1	0.9	1.4	0.8	19.2	14.6	14.6	0.3	20.7	17.1
Queue Storage Ratio (RQ) (50 th percentile)	0.92	0.00	0.15	0.37	0.00	0.34	2.99	0.00	0.00	0.05	0.00	0.00
Uniform Delay (d ₁), s/veh	40.4	27.3	22.9	51.8	52.1	52.3	53.5	32.5	32.5	26.7	40.0	40.0
Incremental Delay (d ₂), s/veh	97.8	0.1	2.0	0.5	0.6	1.2	346.4	5.3	10.6	1.1	27.2	45.1
Initial Queue Delay (d ₃), s/veh	0.0	0.0	0.0	0.0	0.0	0.0	0.0	0.0	0.0	0.0	0.0	0.0
Control Delay (d), s/veh	138.2	27.4	25.0	52.3	52.7	53.5	399.9	37.8	43.1	27.8	67.2	85.1
Level of Service (LOS)	F	C	C	D	D	D	F	D	D	C	F	F
Approach Delay, s/veh / LOS	106.3		F	52.8		D	90.2		F	71.6		E
Intersection Delay, s/veh / LOS	85.2						F					

Multimodal Results	EB		WB		NB		SB	
Pedestrian LOS Score / LOS	2.58	C	2.62	C	2.11	B	2.23	B
Bicycle LOS Score / LOS	1.72	B	0.66	A	1.50	B	1.35	A

HCS7 Signalized Intersection Results Summary

General Information				Intersection Information	
Agency	otc			Duration, h	0.25
Analyst	jto	Analysis Date	May 12, 2020	Area Type	CBD
Jurisdiction	City of Los Angeles	Time Period	pm peak	PHF	1.00
Urban Street	Roscoe Boulevard	Analysis Year	2020	Analysis Period	1 > 7:00
Intersection	Willis Avenue	File Name	3PM plus.xus		
Project Description	pm peak hour with project				

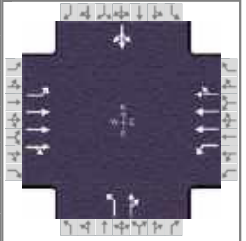

Demand Information	EB			WB			NB			SB		
	L	T	R	L	T	R	L	T	R	L	T	R
Approach Movement												
Demand (v), veh/h	70	1402	193	49	1218	49	331	141	93	23	109	61

Signal Information													
Cycle, s	120.0	Reference Phase	2										
Offset, s	0	Reference Point	End										
Uncoordinated	No	Simult. Gap E/W	On	Green	24.6	18.8	63.6	0.0	0.0	0.0			
Force Mode	Fixed	Simult. Gap N/S	On	Yellow	3.0	3.0	3.0	0.0	0.0	0.0			
				Red	0.0	2.0	2.0	0.0	0.0	0.0			

Timer Results	EBL	EBT	WBL	WBT	NBL	NBT	SBL	SBT
Assigned Phase		4		8	5	2		6
Case Number		6.0		6.0	1.0	4.0		8.3
Phase Duration, s		68.6		68.6	27.6	51.4		23.8
Change Period, (Y+R _c), s		5.0		5.0	3.0	5.0		5.0
Max Allow Headway (MAH), s		3.4		3.4	3.4	0.0		0.0
Queue Clearance Time (g _s), s		38.7		50.0	24.9			
Green Extension Time (g _e), s		14.8		14.1	0.6	0.0		0.0
Phase Call Probability		1.00		1.00	1.00			
Max Out Probability		0.08		0.15	0.02			

Movement Group Results	EB			WB			NB			SB		
	L	T	R	L	T	R	L	T	R	L	T	R
Assigned Movement	7	4	14	3	8	18	5	2	12	1	6	16
Adjusted Flow Rate (v), veh/h	70	1169	426	49	869	398	331	234			193	
Adjusted Saturation Flow Rate (s), veh/h/ln	391	1710	1244	289	1710	1563	1402	1529			1387	
Queue Service Time (g _s), s	16.8	29.6	29.6	17.8	19.4	19.4	22.9	13.2			8.2	
Cycle Queue Clearance Time (g _c), s	36.7	29.6	29.6	48.0	19.4	19.4	22.9	13.2			16.0	
Green Ratio (g/C)	0.53	0.53	0.53	0.53	0.53	0.53	0.39	0.39			0.16	
Capacity (c), veh/h	200	1797	654	139	1797	821	400	598			268	
Volume-to-Capacity Ratio (X)	0.349	0.651	0.652	0.353	0.484	0.484	0.828	0.391			0.720	
Back of Queue (Q), ft/ln (50 th percentile)	39.4	283.1	207.7	31.7	185.8	170.5	206.4	126.6			166	
Back of Queue (Q), veh/ln (50 th percentile)	1.6	11.3	8.3	1.3	7.4	6.8	8.3	5.1			6.6	
Queue Storage Ratio (RQ) (50 th percentile)	0.53	0.00	0.00	0.63	0.00	0.00	3.44	0.00			0.00	
Uniform Delay (d ₁), s/veh	30.0	20.5	20.6	38.1	18.1	18.1	31.3	26.2			47.9	
Incremental Delay (d ₂), s/veh	0.4	0.1	0.4	0.6	0.1	0.2	6.3	1.9			15.4	
Initial Queue Delay (d ₃), s/veh	0.0	0.0	0.0	0.0	0.0	0.0	0.0	0.0			0.0	
Control Delay (d), s/veh	30.4	20.7	21.0	38.7	18.2	18.3	37.6	28.2			63.3	
Level of Service (LOS)	C	C	C	D	B	B	D	C			E	
Approach Delay, s/veh / LOS	21.2	C		19.0	B		33.7	C		63.3	E	
Intersection Delay, s/veh / LOS	24.5						C					

Multimodal Results	EB		WB		NB		SB	
Pedestrian LOS Score / LOS	1.90	B	1.68	B	2.58	C	2.60	C
Bicycle LOS Score / LOS	1.40	A	1.21	A	1.42	A	0.81	A

HCS7 Signalized Intersection Results Summary

General Information				Intersection Information	
Agency	otc			Duration, h	0.25
Analyst	jto	Analysis Date	May 12, 2020	Area Type	CBD
Jurisdiction	City of Los Angeles	Time Period	pm peak	PHF	1.00
Urban Street	Roscoe Boulevard	Analysis Year	2020	Analysis Period	1 > 7:00
Intersection	Woodman Avenue	File Name	4PM plus.xus		
Project Description	pm peak hour with project				

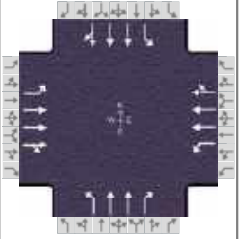

Demand Information	EB			WB			NB			SB		
	L	T	R	L	T	R	L	T	R	L	T	R
Approach Movement												
Demand (v), veh/h	262	807	94	207	1206	231	131	737	107	146	903	188

Signal Information				Signal Timing Diagram															
Cycle, s	120.0	Reference Phase	2																
Offset, s	0	Reference Point	End																
Uncoordinated	No	Simult. Gap E/W	On																
Force Mode	Fixed	Simult. Gap N/S	On																
		Green		13.3	1.3	29.5	18.0	1.8	40.1										
		Yellow		3.0	0.0	3.0	3.0	0.0	3.0										
		Red		0.0	0.0	2.0	0.0	0.0	2.0										

Timer Results	EBL	EBT	WBL	WBT	NBL	NBT	SBL	SBT
Assigned Phase	7	4	3	8	5	2	1	6
Case Number	2.0	4.0	2.0	4.0	2.0	3.0	2.0	4.0
Phase Duration, s	21.0	45.1	22.8	46.9	16.3	34.5	17.5	35.8
Change Period, (Y+R _c), s	3.0	5.0	3.0	5.0	3.0	5.0	3.0	5.0
Max Allow Headway (MAH), s	3.4	3.1	3.4	3.1	3.4	0.0	3.4	0.0
Queue Clearance Time (g _s), s	20.0	21.0	19.4	34.7	13.0		14.3	
Green Extension Time (g _e), s	0.0	7.3	0.4	7.2	0.3	0.0	0.3	0.0
Phase Call Probability	1.00	1.00	1.00	1.00	1.00		1.00	
Max Out Probability	1.00	0.01	0.00	0.02	0.00		0.00	

Movement Group Results	EB			WB			NB			SB		
	L	T	R	L	T	R	L	T	R	L	T	R
Assigned Movement	7	4	14	3	8	18	5	2	12	1	6	16
Adjusted Flow Rate (v), veh/h	262	646	255	207	1010	427	131	737	107	146	765	326
Adjusted Saturation Flow Rate (s), veh/h/ln	1402	1710	1329	1402	1710	1446	1402	1628	1312	1402	1710	1445
Queue Service Time (g _s), s	18.0	18.6	19.0	17.4	32.7	32.7	11.0	26.5	6.3	12.3	25.7	26.0
Cycle Queue Clearance Time (g _c), s	18.0	18.6	19.0	17.4	32.7	32.7	11.0	26.5	6.3	12.3	25.7	26.0
Green Ratio (g/C)	0.15	0.33	0.33	0.17	0.35	0.35	0.11	0.25	0.41	0.12	0.26	0.26
Capacity (c), veh/h	210	1143	444	231	1195	505	155	801	551	170	878	371
Volume-to-Capacity Ratio (X)	1.246	0.565	0.574	0.895	0.845	0.845	0.846	0.920	0.194	0.860	0.871	0.879
Back of Queue (Q), ft/ln (50 th percentile)	366.3	190.4	151.9	157.8	335.9	287.5	101	310.6	51	112.4	301.8	290.7
Back of Queue (Q), veh/ln (50 th percentile)	14.7	7.6	6.1	6.3	13.4	11.5	4.0	12.4	2.0	4.5	12.1	11.6
Queue Storage Ratio (RQ) (50 th percentile)	1.83	0.00	0.00	0.67	0.00	0.00	0.53	0.00	0.13	0.59	0.00	0.00
Uniform Delay (d ₁), s/veh	51.0	32.8	32.9	49.1	36.0	36.0	52.4	44.1	22.6	51.7	42.7	42.8
Incremental Delay (d ₂), s/veh	144.1	0.2	0.4	4.8	0.7	1.7	4.8	17.4	0.8	4.8	11.5	24.3
Initial Queue Delay (d ₃), s/veh	0.0	0.0	0.0	0.0	0.0	0.0	0.0	0.0	0.0	0.0	0.0	0.0
Control Delay (d), s/veh	195.1	32.9	33.3	53.9	36.8	37.8	57.2	61.4	23.4	56.6	54.2	67.1
Level of Service (LOS)	F	C	C	D	D	D	E	E	C	E	D	E
Approach Delay, s/veh / LOS	69.6		E	39.2		D	56.7		E	57.9		E
Intersection Delay, s/veh / LOS	54.2						D					

Multimodal Results	EB		WB		NB		SB	
Pedestrian LOS Score / LOS	2.58	C	2.44	B	2.59	C	2.59	C
Bicycle LOS Score / LOS	1.13	A	1.39	A	1.29	A	1.17	A



FUTURE HCS WORKSHEETS



WITHOUT PROJECT AM PEAK HOUR

HCS7 Signalized Intersection Results Summary

General Information				Intersection Information			
Agency	otc			Duration, h	0.25		
Analyst	jto	Analysis Date	May 12, 2020	Area Type	CBD		
Jurisdiction	City of Los Angeles	Time Period	am peak	PHF	1.00		
Urban Street	Roscoe Boulevard	Analysis Year	2024	Analysis Period	1> 7:00		
Intersection	Van Nuys Boulevard	File Name	1AM 2024.xus				
Project Description	am peak hour wo project						

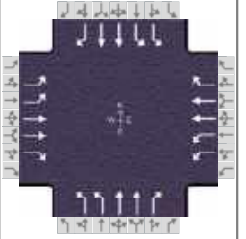

Demand Information	EB			WB			NB			SB		
	L	T	R	L	T	R	L	T	R	L	T	R
Approach Movement												
Demand (v), veh/h	110	1058	287	479	1429	215	271	735	281	459	1539	84

Signal Information													
Cycle, s	120.0	Reference Phase	2										
Offset, s	0	Reference Point	End										
Uncoordinated	No	Simult. Gap E/W	On	Green	8.0	11.2	28.8	6.0	9.0	35.0			
Force Mode	Fixed	Simult. Gap N/S	On	Yellow	3.0	3.0	3.0	3.0	3.0	3.0			
				Red	0.0	0.0	2.0	0.0	0.0	2.0			

Timer Results	EBL	EBT	WBL	WBT	NBL	NBT	SBL	SBT
Assigned Phase	7	4	3	8	5	2	1	6
Case Number	2.0	3.0	2.0	3.0	2.0	3.0	2.0	3.0
Phase Duration, s	9.0	40.0	21.0	52.0	11.0	33.8	25.2	48.0
Change Period, (Y+R _c), s	3.0	5.0	3.0	5.0	3.0	5.0	3.0	5.0
Max Allow Headway (MAH), s	3.4	3.1	3.4	3.1	3.4	0.0	3.4	0.0
Queue Clearance Time (g _s), s	6.8	37.0	20.0	49.0	10.0		21.8	
Green Extension Time (g _e), s	0.0	0.0	0.0	0.0	0.0	0.0	0.4	0.0
Phase Call Probability	1.00	1.00	1.00	1.00	1.00		1.00	
Max Out Probability	1.00	1.00	1.00	1.00	1.00		1.00	

Movement Group Results	EB			WB			NB			SB		
	L	T	R	L	T	R	L	T	R	L	T	R
Assigned Movement	7	4	14	3	8	18	5	2	12	1	6	16
Adjusted Flow Rate (v), veh/h	110	1058	212	479	1429	140	271	735	206	459	1539	34
Adjusted Saturation Flow Rate (s), veh/h/ln	1361	1628	1126	1361	1628	1152	1361	1628	1206	1361	1628	1277
Queue Service Time (g _s), s	4.8	35.0	19.7	18.0	47.0	10.1	8.0	26.6	18.8	19.8	43.0	2.1
Cycle Queue Clearance Time (g _c), s	4.8	35.0	19.7	18.0	47.0	10.1	8.0	26.6	18.8	19.8	43.0	2.1
Green Ratio (g/C)	0.05	0.29	0.29	0.15	0.39	0.39	0.07	0.24	0.24	0.18	0.36	0.36
Capacity (c), veh/h	136	950	328	408	1275	451	181	781	289	503	1167	458
Volume-to-Capacity Ratio (X)	0.808	1.114	0.646	1.173	1.121	0.310	1.493	0.941	0.712	0.912	1.319	0.074
Back of Queue (Q), ft/ln (50 th percentile)	53.8	560.2	141.6	294.6	738.1	68.8	224.8	319.5	165.8	197.6	1021.8	17
Back of Queue (Q), veh/ln (50 th percentile)	2.2	22.4	5.7	11.8	29.5	2.8	9.0	12.8	6.6	7.9	40.9	0.7
Queue Storage Ratio (RQ) (50 th percentile)	0.13	0.00	0.35	0.68	0.00	0.17	0.41	0.00	0.41	0.35	0.00	0.04
Uniform Delay (d ₁), s/veh	56.4	42.5	37.1	51.0	36.5	25.3	56.0	44.8	41.8	47.9	38.5	25.4
Incremental Delay (d ₂), s/veh	27.4	65.8	3.4	101.0	65.2	0.1	248.8	20.6	13.9	18.0	149.7	0.3
Initial Queue Delay (d ₃), s/veh	0.0	0.0	0.0	0.0	0.0	0.0	0.0	0.0	0.0	0.0	0.0	0.0
Control Delay (d), s/veh	83.8	108.3	40.5	152.0	101.7	25.4	304.8	65.3	55.7	66.0	188.2	25.7
Level of Service (LOS)	F	F	D	F	F	C	F	E	E	E	F	C
Approach Delay, s/veh / LOS	95.9	F		108.2	F		117.2	F		157.9	F	
Intersection Delay, s/veh / LOS	122.5						F					

Multimodal Results	EB		WB		NB		SB	
Pedestrian LOS Score / LOS	2.69	C	2.65	C	2.70	C	2.69	C
Bicycle LOS Score / LOS	1.63	B	2.18	B	1.49	A	2.16	B

HCS7 Signalized Intersection Results Summary

General Information				Intersection Information	
Agency	otc			Duration, h	0.25
Analyst	jto	Analysis Date	May 12, 2020	Area Type	CBD
Jurisdiction	City of Los Angeles	Time Period	am peak	PHF	1.00
Urban Street	Saticoy Street	Analysis Year	2024	Analysis Period	1> 7:00
Intersection	Van Nuys Boulevard	File Name	2AM2024wo.xus		
Project Description	am peak hour wo project				

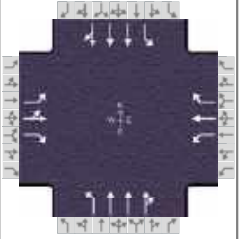

Demand Information	EB			WB			NB			SB		
Approach Movement	L	T	R	L	T	R	L	T	R	L	T	R
Demand (v), veh/h	500	41	428	59	48	24	266	889	30	22	1543	409

Signal Information													
Cycle, s	120.0	Reference Phase	2	EB		WB		NB		SB			
Offset, s	0	Reference Point	End	Green	6.0	6.0	48.0	9.9	29.1	0.0			
Uncoordinated	No	Simult. Gap E/W	On	Yellow	3.0	3.0	3.0	3.0	3.0	0.0			
Force Mode	Fixed	Simult. Gap N/S	On	Red	0.0	0.0	2.0	2.0	2.0	0.0			

Timer Results	EBL	EBT	WBL	WBT	NBL	NBT	SBL	SBT
Assigned Phase		4		8	5	2	1	6
Case Number		9.0		9.0	2.0	4.0	1.1	4.0
Phase Duration, s		34.1		14.9	18.0	62.0	9.0	53.0
Change Period, (Y+R _c), s		5.0		5.0	3.0	5.0	3.0	5.0
Max Allow Headway (MAH), s		3.5		3.4	3.4	0.0	3.4	0.0
Queue Clearance Time (g _s), s		31.1		6.8	17.0		2.9	
Green Extension Time (g _e), s		0.0		0.1	0.0	0.0	0.0	0.0
Phase Call Probability		1.00		0.99	1.00		1.00	
Max Out Probability		1.00		0.46	1.00		0.00	

Movement Group Results	EB			WB			NB			SB		
Approach Movement	L	T	R	L	T	R	L	T	R	L	T	R
Assigned Movement	7	4	14	3	8	18	5	2	12	1	6	16
Adjusted Flow Rate (v), veh/h	500	41	378	59	48	24	266	626	293	22	1390	562
Adjusted Saturation Flow Rate (s), veh/h/ln	1402	1710	1213	1402	1710	1031	1402	1710	1599	1402	1710	1355
Queue Service Time (g _s), s	29.1	2.2	29.1	4.8	3.2	2.6	15.0	14.1	14.2	0.9	48.0	48.0
Cycle Queue Clearance Time (g _c), s	29.1	2.2	29.1	4.8	3.2	2.6	15.0	14.1	14.2	0.9	48.0	48.0
Green Ratio (g/C)	0.24	0.24	0.37	0.08	0.08	0.08	0.13	0.47	0.47	0.53	0.40	0.40
Capacity (c), veh/h	340	415	452	115	141	85	175	1624	759	329	1368	542
Volume-to-Capacity Ratio (X)	1.470	0.099	0.836	0.512	0.341	0.283	1.518	0.385	0.386	0.067	1.016	1.037
Back of Queue (Q), ft/ln (50 th percentile)	784.4	24.6	298.5	43.4	34.5	17.3	446.8	141.8	137.2	7.2	617	563.9
Back of Queue (Q), veh/ln (50 th percentile)	31.4	1.0	11.9	1.7	1.4	0.7	17.9	5.7	5.5	0.3	24.7	22.6
Queue Storage Ratio (RQ) (50 th percentile)	1.31	0.00	0.50	0.72	0.00	0.29	2.79	0.00	0.00	0.05	0.00	0.00
Uniform Delay (d ₁), s/veh	45.4	35.3	34.8	52.8	52.0	51.7	52.5	20.2	20.3	14.6	36.0	36.0
Incremental Delay (d ₂), s/veh	226.8	0.5	16.6	1.3	0.5	0.7	259.9	0.7	1.5	0.0	28.5	48.4
Initial Queue Delay (d ₃), s/veh	0.0	0.0	0.0	0.0	0.0	0.0	0.0	0.0	0.0	0.0	0.0	0.0
Control Delay (d), s/veh	272.2	35.7	51.4	54.1	52.5	52.4	312.4	20.9	21.7	14.7	64.5	84.5
Level of Service (LOS)	F	D	D	D	D	D	F	C	C	B	F	F
Approach Delay, s/veh / LOS	170.9	F		53.2	D		86.6	F		69.6	E	
Intersection Delay, s/veh / LOS	96.0						F					

Multimodal Results	EB		WB		NB		SB	
Pedestrian LOS Score / LOS	2.59	C	2.62	C	2.10	B	2.18	B
Bicycle LOS Score / LOS	2.00	B	0.70	A	1.14	A	1.57	B

HCS7 Signalized Intersection Results Summary

General Information				Intersection Information	
Agency	otc			Duration, h	0.25
Analyst	jto	Analysis Date	May 12, 2020	Area Type	CBD
Jurisdiction	City of Los Angeles	Time Period	am peak	PHF	1.00
Urban Street	Roscoe Boulevard	Analysis Year	2024	Analysis Period	1> 7:00
Intersection	Willis Avenue	File Name	3AM2024.xus		
Project Description	am peak hour wo project				

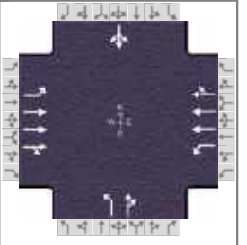

Demand Information	EB			WB			NB			SB		
	L	T	R	L	T	R	L	T	R	L	T	R
Approach Movement												
Demand (v), veh/h	37	1385	148	41	1545	23	232	99	56	32	136	89

Signal Information													
Cycle, s	120.0	Reference Phase	2										
Offset, s	0	Reference Point	End										
Uncoordinated	No	Simult. Gap E/W	On	Green	16.8	28.5	61.7	0.0	0.0	0.0			
Force Mode	Fixed	Simult. Gap N/S	On	Yellow	3.0	3.0	3.0	0.0	0.0	0.0			
				Red	0.0	2.0	2.0	0.0	0.0	0.0			

Timer Results	EBL	EBT	WBL	WBT	NBL	NBT	SBL	SBT
Assigned Phase		4		8	5	2		6
Case Number		6.0		6.0	1.0	4.0		8.3
Phase Duration, s		66.7		66.7	19.8	53.3		33.5
Change Period, (Y+R _c), s		5.0		5.0	3.0	5.0		5.0
Max Allow Headway (MAH), s		3.3		3.3	3.4	0.0		0.0
Queue Clearance Time (g _s), s		41.3		46.7	16.3			
Green Extension Time (g _e), s		15.9		15.5	0.5	0.0		0.0
Phase Call Probability		1.00		1.00	1.00			
Max Out Probability		0.12		0.15	0.00			

Movement Group Results	EB			WB			NB			SB		
	L	T	R	L	T	R	L	T	R	L	T	R
Assigned Movement	7	4	14	3	8	18	5	2	12	1	6	16
Adjusted Flow Rate (v), veh/h	37	1160	373	41	1066	502	232	155			257	
Adjusted Saturation Flow Rate (s), veh/h/ln	294	1710	1097	300	1710	1610	1402	1536			1411	
Queue Service Time (g _s), s	12.4	30.2	30.2	14.1	26.6	26.6	14.3	8.0			10.1	
Cycle Queue Clearance Time (g _c), s	39.3	30.2	30.2	44.7	26.6	26.6	14.3	8.0			20.0	
Green Ratio (g/C)	0.51	0.51	0.51	0.51	0.51	0.51	0.40	0.40			0.24	
Capacity (c), veh/h	144	1745	560	137	1745	821	338	624			375	
Volume-to-Capacity Ratio (X)	0.257	0.665	0.666	0.300	0.611	0.611	0.686	0.248			0.685	
Back of Queue (Q), ft/ln (50 th percentile)	22.3	291.1	188.3	26.2	256.6	242.4	119.6	76			198.5	
Back of Queue (Q), veh/ln (50 th percentile)	0.9	11.6	7.5	1.0	10.3	9.7	4.8	3.0			7.9	
Queue Storage Ratio (RQ) (50 th percentile)	0.30	0.00	0.00	0.52	0.00	0.00	1.99	0.00			0.00	
Uniform Delay (d ₁), s/veh	35.0	21.8	21.8	38.5	20.9	20.9	28.5	23.5			41.9	
Incremental Delay (d ₂), s/veh	0.3	0.2	0.5	0.5	0.1	0.3	0.9	0.9			9.7	
Initial Queue Delay (d ₃), s/veh	0.0	0.0	0.0	0.0	0.0	0.0	0.0	0.0			0.0	
Control Delay (d), s/veh	35.4	22.0	22.3	39.0	21.0	21.2	29.5	24.5			51.6	
Level of Service (LOS)	D	C	C	D	C	C	C	C			D	
Approach Delay, s/veh / LOS	22.4		C	21.6		C	27.5		C	51.6		D
Intersection Delay, s/veh / LOS	24.5						C					

Multimodal Results	EB		WB		NB		SB	
Pedestrian LOS Score / LOS	1.90	B	1.68	B	2.57	C	2.59	C
Bicycle LOS Score / LOS	1.35	A	1.37	A	1.13	A	0.91	A

HCS7 Signalized Intersection Results Summary

General Information				Intersection Information	
Agency	otc			Duration, h	0.25
Analyst	jto	Analysis Date	May 12, 2020	Area Type	CBD
Jurisdiction	City of Los Angeles	Time Period	am peak	PHF	1.00
Urban Street	Roscoe Boulevard	Analysis Year	2024	Analysis Period	1 > 7:00
Intersection	Woodman Avenue	File Name	4AM2024 wo.xus		
Project Description	am peak hour wo project				

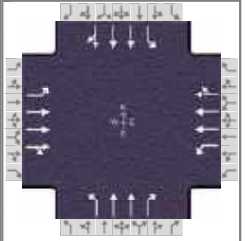

Demand Information	EB			WB			NB			SB		
	L	T	R	L	T	R	L	T	R	L	T	R
Approach Movement												
Demand (v), veh/h	192	1272	251	226	1404	63	201	599	123	133	1366	174

Signal Information													
Cycle, s	120.0	Reference Phase	2										
Offset, s	0	Reference Point	End										
Uncoordinated	No	Simult. Gap E/W	On	Green	11.0	2.4	33.6	17.0	1.5	38.5			
Force Mode	Fixed	Simult. Gap N/S	On	Yellow	3.0	0.0	3.0	3.0	0.0	3.0			
				Red	0.0	0.0	2.0	0.0	0.0	2.0			

Timer Results	EBL	EBT	WBL	WBT	NBL	NBT	SBL	SBT
Assigned Phase	7	4	3	8	5	2	1	6
Case Number	2.0	4.0	2.0	4.0	2.0	3.0	2.0	4.0
Phase Duration, s	21.5	45.0	20.0	43.5	14.0	38.6	16.4	41.0
Change Period, (Y+R _c), s	3.0	5.0	3.0	5.0	3.0	5.0	3.0	5.0
Max Allow Headway (MAH), s	3.4	3.1	3.4	3.1	3.4	0.0	3.4	0.0
Queue Clearance Time (g _s), s	18.1	40.3	19.0	35.7	13.0		13.2	
Green Extension Time (g _e), s	0.4	0.0	0.0	2.2	0.0	0.0	0.2	0.0
Phase Call Probability	1.00	1.00	1.00	1.00	1.00		1.00	
Max Out Probability	0.00	1.00	1.00	1.00	1.00		0.00	

Movement Group Results	EB			WB			NB			SB		
	L	T	R	L	T	R	L	T	R	L	T	R
Assigned Movement	7	4	14	3	8	18	5	2	12	1	6	16
Adjusted Flow Rate (v), veh/h	192	1108	415	226	1001	466	201	599	123	133	1063	477
Adjusted Saturation Flow Rate (s), veh/h/ln	1402	1710	1281	1402	1710	1590	1402	1628	1329	1402	1710	1533
Queue Service Time (g _s), s	16.1	38.3	38.3	17.0	33.7	33.7	11.0	19.5	7.1	11.2	36.0	36.0
Cycle Queue Clearance Time (g _c), s	16.1	38.3	38.3	17.0	33.7	33.7	11.0	19.5	7.1	11.2	36.0	36.0
Green Ratio (g/C)	0.15	0.33	0.33	0.14	0.32	0.32	0.09	0.28	0.42	0.11	0.30	0.30
Capacity (c), veh/h	216	1140	427	199	1097	510	128	913	568	156	1026	460
Volume-to-Capacity Ratio (X)	0.889	0.972	0.972	1.138	0.913	0.913	1.564	0.656	0.217	0.852	1.036	1.037
Back of Queue (Q), ft/ln (50 th percentile)	146.8	470.4	400	293.5	388.6	393.9	353.2	203.2	58.2	102.8	505.5	497.4
Back of Queue (Q), veh/ln (50 th percentile)	5.9	18.8	16.0	11.7	15.5	15.8	14.1	8.1	2.3	4.1	20.2	19.9
Queue Storage Ratio (RQ) (50 th percentile)	0.73	0.00	0.00	1.25	0.00	0.00	1.86	0.00	0.15	0.54	0.00	0.00
Uniform Delay (d ₁), s/veh	49.7	39.4	39.4	51.5	39.1	39.1	54.5	38.1	22.1	52.3	42.0	42.0
Incremental Delay (d ₂), s/veh	4.9	20.0	36.0	106.0	11.2	20.4	288.2	3.7	0.9	5.0	37.9	51.7
Initial Queue Delay (d ₃), s/veh	0.0	0.0	0.0	0.0	0.0	0.0	0.0	0.0	0.0	0.0	0.0	0.0
Control Delay (d), s/veh	54.6	59.5	75.4	157.5	50.3	59.5	342.7	41.8	23.0	57.3	79.9	93.7
Level of Service (LOS)	D	E	E	F	D	E	F	D	C	E	F	F
Approach Delay, s/veh / LOS	62.8		E	67.2		E	104.8		F	82.0		F
Intersection Delay, s/veh / LOS	75.8						E					

Multimodal Results	EB		WB		NB		SB	
Pedestrian LOS Score / LOS	2.58	C	2.44	B	2.59	C	2.59	C
Bicycle LOS Score / LOS	1.43	A	1.42	A	1.25	A	1.41	A



PM PEAK HOUR WITHOUT PROJECT

HCS7 Signalized Intersection Results Summary

General Information				Intersection Information	
Agency	otc			Duration, h	0.25
Analyst	jto	Analysis Date	May 12, 2020	Area Type	CBD
Jurisdiction	City of Los Angeles	Time Period	pm peak	PHF	1.00
Urban Street	Roscoe Boulevard	Analysis Year	2024	Analysis Period	1 > 7:00
Intersection	Van Nuys Boulevard	File Name	1PM 2024.xus		
Project Description	pm peak hour wo project				

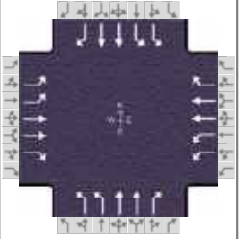

Demand Information	EB			WB			NB			SB		
	L	T	R	L	T	R	L	T	R	L	T	R
Approach Movement												
Demand (v), veh/h	225	1086	315	320	1479	181	444	1145	264	366	1100	105

Signal Information				Signal Phases									
Cycle, s	120.0	Reference Phase	2										
Offset, s	0	Reference Point	End	Green	16.0	2.4	34.6	7.0	3.0	38.0			
Uncoordinated	No	Simult. Gap E/W	On	Yellow	3.0	0.0	3.0	3.0	3.0	3.0			
Force Mode	Fixed	Simult. Gap N/S	On	Red	0.0	0.0	2.0	0.0	0.0	2.0			

Timer Results	EBL	EBT	WBL	WBT	NBL	NBT	SBL	SBT
Assigned Phase	7	4	3	8	5	2	1	6
Case Number	2.0	3.0	2.0	3.0	2.0	3.0	2.0	3.0
Phase Duration, s	10.0	43.0	16.0	49.0	19.0	39.6	21.4	42.0
Change Period, (Y+R _c), s	3.0	5.0	3.0	5.0	3.0	5.0	3.0	5.0
Max Allow Headway (MAH), s	3.4	3.1	3.4	3.1	3.4	0.0	3.4	0.0
Queue Clearance Time (g _s), s	9.0	40.0	15.0	46.0	18.0		17.8	
Green Extension Time (g _e), s	0.0	0.0	0.0	0.0	0.0	0.0	0.6	0.0
Phase Call Probability	1.00	1.00	1.00	1.00	1.00		1.00	
Max Out Probability	1.00	1.00	1.00	1.00	1.00		0.14	

Movement Group Results	EB			WB			NB			SB		
	L	T	R	L	T	R	L	T	R	L	T	R
Assigned Movement	7	4	14	3	8	18	5	2	12	1	6	16
Adjusted Flow Rate (v), veh/h	225	1086	240	320	1479	106	444	1145	189	366	1100	55
Adjusted Saturation Flow Rate (s), veh/h/ln	1361	1628	1135	1361	1628	1141	1361	1628	1236	1361	1628	1259
Queue Service Time (g _s), s	7.0	38.0	22.0	13.0	44.0	7.8	16.0	34.6	15.4	15.8	37.0	3.8
Cycle Queue Clearance Time (g _c), s	7.0	38.0	22.0	13.0	44.0	7.8	16.0	34.6	15.4	15.8	37.0	3.8
Green Ratio (g/C)	0.06	0.32	0.32	0.11	0.37	0.37	0.13	0.29	0.29	0.15	0.31	0.31
Capacity (c), veh/h	159	1031	360	295	1194	418	363	939	356	417	1004	388
Volume-to-Capacity Ratio (X)	1.417	1.053	0.668	1.085	1.239	0.253	1.223	1.219	0.530	0.877	1.096	0.142
Back of Queue (Q), ft/ln (50 th percentile)	181.1	525.4	159	188.8	900	52.9	289.5	693.2	128.6	147.8	564.9	30.7
Back of Queue (Q), veh/ln (50 th percentile)	7.2	21.0	6.4	7.6	36.0	2.1	11.6	27.7	5.1	5.9	22.6	1.2
Queue Storage Ratio (RQ) (50 th percentile)	0.44	0.00	0.40	0.43	0.00	0.13	0.52	0.00	0.32	0.26	0.00	0.08
Uniform Delay (d ₁), s/veh	56.5	41.0	35.5	53.5	38.0	26.5	52.0	42.7	35.9	49.7	41.5	30.0
Incremental Delay (d ₂), s/veh	220.5	43.2	3.8	77.0	114.8	0.1	122.8	108.4	5.6	10.3	58.3	0.8
Initial Queue Delay (d ₃), s/veh	0.0	0.0	0.0	0.0	0.0	0.0	0.0	0.0	0.0	0.0	0.0	0.0
Control Delay (d), s/veh	277.0	84.2	39.3	130.5	152.8	26.6	174.8	151.1	41.4	60.0	99.8	30.8
Level of Service (LOS)	F	F	D	F	F	C	F	F	D	E	F	C
Approach Delay, s/veh / LOS	105.2	F		142.1	F		145.3	F		87.7	F	
Intersection Delay, s/veh / LOS	122.2						F					

Multimodal Results	EB		WB		NB		SB	
Pedestrian LOS Score / LOS	2.69	C	2.65	C	2.69	C	2.69	C
Bicycle LOS Score / LOS	1.77	B	2.06	B	1.95	B	1.74	B

HCS7 Signalized Intersection Results Summary

General Information				Intersection Information	
Agency	otc			Duration, h	0.25
Analyst	jto	Analysis Date	May 12, 2020	Area Type	CBD
Jurisdiction	City of Los Angeles	Time Period	pm peak	PHF	1.00
Urban Street	Saticoy Street	Analysis Year	2024	Analysis Period	1 > 7:00
Intersection	Van Nuys Boulevard	File Name	2PM2024wo.xus		
Project Description	pm peak hour wo project				

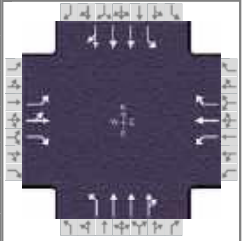

Demand Information	EB			WB			NB			SB		
	L	T	R	L	T	R	L	T	R	L	T	R
Approach Movement												
Demand (v), veh/h	591	24	296	32	60	29	281	1694	39	15	1353	354

Signal Information													
Cycle, s	120.0	Reference Phase	2										
Offset, s	0	Reference Point	End										
Uncoordinated	No	Simult. Gap E/W	On	Green	0.0	0.0	0.0	0.0	0.0	0.0			
Force Mode	Fixed	Simult. Gap N/S	On	Yellow	0.0	0.0	0.0	0.0	0.0	0.0			
				Red	0.0	0.0	0.0	0.0	0.0	0.0			

Timer Results	EBL	EBT	WBL	WBT	NBL	NBT	SBL	SBT
Assigned Phase		4		8	5	2	1	6
Case Number		9.0		9.0	2.0	4.0	1.1	4.0
Phase Duration, s		37.2		14.8	19.1	59.0	9.0	48.9
Change Period, (Y+R _c), s		5.0		5.0	3.0	5.0	3.0	5.0
Max Allow Headway (MAH), s		3.5		3.5	3.4	0.0	3.4	0.0
Queue Clearance Time (g _s), s		34.2		6.0	18.2		2.6	
Green Extension Time (g _e), s		0.0		0.3	0.0	0.0	0.0	0.0
Phase Call Probability		1.00		0.98	1.00		1.00	
Max Out Probability		1.00		0.00	1.00		0.00	

Movement Group Results	EB			WB			NB			SB		
	L	T	R	L	T	R	L	T	R	L	T	R
Assigned Movement	7	4	14	3	8	18	5	2	12	1	6	16
Adjusted Flow Rate (v), veh/h	591	24	246	32	60	29	281	1178	555	15	1247	460
Adjusted Saturation Flow Rate (s), veh/h/ln	1402	1710	1192	1402	1710	915	1402	1710	1610	1402	1710	1253
Queue Service Time (g _s), s	32.2	1.3	18.6	2.6	4.0	3.6	16.2	34.7	34.7	0.6	43.7	43.9
Cycle Queue Clearance Time (g _c), s	32.2	1.3	18.6	2.6	4.0	3.6	16.2	34.7	34.7	0.6	43.7	43.9
Green Ratio (g/C)	0.27	0.27	0.40	0.08	0.08	0.08	0.13	0.45	0.45	0.50	0.37	0.37
Capacity (c), veh/h	376	458	489	115	140	75	189	1540	725	171	1250	458
Volume-to-Capacity Ratio (X)	1.574	0.052	0.503	0.279	0.429	0.387	1.489	0.765	0.766	0.087	0.997	1.004
Back of Queue (Q), ft/ln (50 th percentile)	979.1	13.6	142.6	22.9	43.5	21.2	462.8	361.3	360.2	5.2	550.9	462.8
Back of Queue (Q), veh/ln (50 th percentile)	39.2	0.5	5.7	0.9	1.7	0.8	18.5	14.5	14.4	0.2	22.0	18.5
Queue Storage Ratio (RQ) (50 th percentile)	1.63	0.00	0.24	0.38	0.00	0.35	2.89	0.00	0.00	0.04	0.00	0.00
Uniform Delay (d ₁), s/veh	43.9	32.6	27.0	51.8	52.4	52.2	51.9	27.7	27.7	20.4	38.0	38.1
Incremental Delay (d ₂), s/veh	270.7	0.2	3.7	0.5	0.8	1.2	246.0	3.7	7.6	0.1	24.9	43.1
Initial Queue Delay (d ₃), s/veh	0.0	0.0	0.0	0.0	0.0	0.0	0.0	0.0	0.0	0.0	0.0	0.0
Control Delay (d), s/veh	314.6	32.8	30.6	52.2	53.2	53.4	298.0	31.3	35.2	20.5	62.9	81.2
Level of Service (LOS)	F	C	C	D	D	D	F	C	D	C	E	F
Approach Delay, s/veh / LOS	225.6		F	53.0		D	69.6		E	67.4		E
Intersection Delay, s/veh / LOS	96.9						F					

Multimodal Results	EB		WB		NB		SB	
Pedestrian LOS Score / LOS	2.59	C	2.62	C	2.10	B	2.19	B
Bicycle LOS Score / LOS	1.91	B	0.69	A	1.60	B	1.43	A

HCS7 Signalized Intersection Results Summary

General Information				Intersection Information	
Agency	otc			Duration, h	0.25
Analyst	jto	Analysis Date	May 12, 2020	Area Type	CBD
Jurisdiction	City of Los Angeles	Time Period	pm peak	PHF	1.00
Urban Street	Roscoe Boulevard	Analysis Year	2024	Analysis Period	1> 7:00
Intersection	Willis Avenue	File Name	3PM2024.xus		
Project Description	pm peak hour wo project				

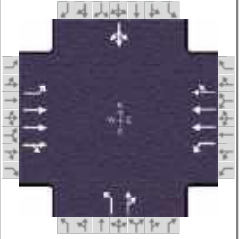

Demand Information	EB			WB			NB			SB		
	L	T	R	L	T	R	L	T	R	L	T	R
Approach Movement												
Demand (v), veh/h	73	1652	188	51	1476	51	335	147	93	24	113	63

Signal Information													
Cycle, s	120.0	Reference Phase	2										
Offset, s	0	Reference Point	End										
Uncoordinated	No	Simult. Gap E/W	On	Green	12.0	31.0	64.0	0.0	0.0	0.0			
Force Mode	Fixed	Simult. Gap N/S	On	Yellow	3.0	3.0	3.0	0.0	0.0	0.0			
				Red	0.0	2.0	2.0	0.0	0.0	0.0			

Timer Results	EBL	EBT	WBL	WBT	NBL	NBT	SBL	SBT
Assigned Phase		4		8	5	2		6
Case Number		6.0		6.0	1.0	4.0		8.3
Phase Duration, s		69.0		69.0	15.0	51.0		36.0
Change Period, (Y+R _c), s		5.0		5.0	3.0	5.0		5.0
Max Allow Headway (MAH), s		3.4		3.4	3.4	0.0		0.0
Queue Clearance Time (g _s), s		51.8		64.9	14.0			
Green Extension Time (g _e), s		9.2		0.0	0.0	0.0		0.0
Phase Call Probability		1.00		1.00	1.00			
Max Out Probability		0.77		1.00	1.00			

Movement Group Results	EB			WB			NB			SB		
	L	T	R	L	T	R	L	T	R	L	T	R
Assigned Movement	7	4	14	3	8	18	5	2	12	1	6	16
Adjusted Flow Rate (v), veh/h	73	1334	506	51	1045	482	335	240			200	
Adjusted Saturation Flow Rate (s), veh/h/ln	307	1710	1283	229	1710	1576	1402	1532			1441	
Queue Service Time (g _s), s	25.1	35.8	36.4	26.5	24.6	24.7	12.0	13.7			1.1	
Cycle Queue Clearance Time (g _c), s	49.8	35.8	36.4	62.9	24.6	24.7	12.0	13.7			13.7	
Green Ratio (g/C)	0.53	0.53	0.53	0.53	0.53	0.53	0.38	0.38			0.26	
Capacity (c), veh/h	161	1824	684	113	1824	841	359	587			406	
Volume-to-Capacity Ratio (X)	0.454	0.732	0.739	0.453	0.573	0.573	0.933	0.409			0.493	
Back of Queue (Q), ft/ln (50 th percentile)	47	348.6	277.2	37.8	235.9	219.4	212.2	132.6			136.5	
Back of Queue (Q), veh/ln (50 th percentile)	1.9	13.9	11.1	1.5	9.4	8.8	8.5	5.3			5.5	
Queue Storage Ratio (RQ) (50 th percentile)	0.63	0.00	0.00	0.76	0.00	0.00	3.54	0.00			0.00	
Uniform Delay (d ₁), s/veh	35.6	21.4	21.6	45.8	18.8	18.8	39.6	27.1			38.1	
Incremental Delay (d ₂), s/veh	0.7	1.3	3.7	1.1	0.3	0.6	30.4	2.1			4.2	
Initial Queue Delay (d ₃), s/veh	0.0	0.0	0.0	0.0	0.0	0.0	0.0	0.0			0.0	
Control Delay (d), s/veh	36.3	22.8	25.3	46.8	19.1	19.4	70.0	29.2			42.3	
Level of Service (LOS)	D	C	C	D	B	B	E	C			D	
Approach Delay, s/veh / LOS	24.0	C		20.1	C		53.0	D		42.3	D	
Intersection Delay, s/veh / LOS	27.3						C					

Multimodal Results	EB		WB		NB		SB	
Pedestrian LOS Score / LOS	1.90	B	1.68	B	2.58	C	2.59	C
Bicycle LOS Score / LOS	1.54	B	1.36	A	1.44	A	0.82	A

HCS7 Signalized Intersection Results Summary

General Information				Intersection Information	
Agency	otc			Duration, h	0.25
Analyst	jto	Analysis Date	May 12, 2020	Area Type	CBD
Jurisdiction	City of Los Angeles	Time Period	pm peak	PHF	1.00
Urban Street	Roscoe Boulevard	Analysis Year	2024	Analysis Period	1 > 7:00
Intersection	Woodman Avenue	File Name	4PM2024 wo.xus		
Project Description	pm peak hour wo project				

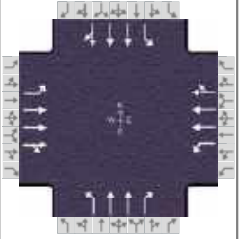

Demand Information	EB			WB			NB			SB		
	L	T	R	L	T	R	L	T	R	L	T	R
Approach Movement												
Demand (v), veh/h	277	906	118	215	1328	244	167	811	111	166	975	199

Signal Information													
Cycle, s	120.0	Reference Phase	2										
Offset, s	0	Reference Point	End										
Uncoordinated	No	Simult. Gap E/W	On	Green	16.2	0.1	31.6	16.0	1.5	35.5			
Force Mode	Fixed	Simult. Gap N/S	On	Yellow	3.0	0.0	3.0	3.0	3.0	3.0			
				Red	0.0	0.0	2.0	0.0	0.0	2.0			

Timer Results	EBL	EBT	WBL	WBT	NBL	NBT	SBL	SBT
Assigned Phase	7	4	3	8	5	2	1	6
Case Number	2.0	4.0	2.0	4.0	2.0	3.0	2.0	4.0
Phase Duration, s	19.0	40.5	23.5	45.0	19.4	36.8	19.2	36.6
Change Period, (Y+R _c), s	3.0	5.0	3.0	5.0	3.0	5.0	3.0	5.0
Max Allow Headway (MAH), s	3.4	3.1	3.4	3.1	3.4	0.0	3.4	0.0
Queue Clearance Time (g _s), s	18.0	25.6	20.0	40.1	16.0		15.9	
Green Extension Time (g _e), s	0.0	5.4	0.4	0.0	0.3	0.0	0.3	0.0
Phase Call Probability	1.00	1.00	1.00	1.00	1.00		1.00	
Max Out Probability	1.00	0.53	0.00	1.00	0.00		0.00	

Movement Group Results	EB			WB			NB			SB		
	L	T	R	L	T	R	L	T	R	L	T	R
Assigned Movement	7	4	14	3	8	18	5	2	12	1	6	16
Adjusted Flow Rate (v), veh/h	277	739	285	215	1103	469	167	811	111	166	823	351
Adjusted Saturation Flow Rate (s), veh/h/ln	1402	1710	1308	1402	1710	1452	1402	1628	1316	1402	1710	1449
Queue Service Time (g _s), s	16.0	23.3	23.6	18.0	38.1	38.1	14.0	29.3	6.2	13.9	28.0	28.2
Cycle Queue Clearance Time (g _c), s	16.0	23.3	23.6	18.0	38.1	38.1	14.0	29.3	6.2	13.9	28.0	28.2
Green Ratio (g/C)	0.13	0.30	0.30	0.17	0.33	0.33	0.14	0.26	0.44	0.14	0.26	0.26
Capacity (c), veh/h	187	1013	387	239	1140	484	191	862	584	189	902	382
Volume-to-Capacity Ratio (X)	1.482	0.729	0.737	0.899	0.968	0.969	0.874	0.941	0.190	0.876	0.913	0.918
Back of Queue (Q), ft/ln (50 th percentile)	454.7	247.8	202.9	164	464.9	440.3	128.2	346.5	50.5	127.6	337.8	325.8
Back of Queue (Q), veh/ln (50 th percentile)	18.2	9.9	8.1	6.6	18.6	17.6	5.1	13.9	2.0	5.1	13.5	13.0
Queue Storage Ratio (RQ) (50 th percentile)	2.27	0.00	0.00	0.70	0.00	0.00	0.67	0.00	0.13	0.67	0.00	0.00
Uniform Delay (d ₁), s/veh	52.0	37.9	38.0	48.8	39.4	39.4	50.8	43.2	20.9	50.9	42.8	42.9
Incremental Delay (d ₂), s/veh	243.4	2.4	6.4	4.9	19.2	32.6	4.8	19.2	0.7	5.0	15.1	29.4
Initial Queue Delay (d ₃), s/veh	0.0	0.0	0.0	0.0	0.0	0.0	0.0	0.0	0.0	0.0	0.0	0.0
Control Delay (d), s/veh	295.4	40.3	44.4	53.6	58.6	72.0	55.6	62.4	21.6	55.9	58.0	72.3
Level of Service (LOS)	F	D	D	D	E	E	E	E	C	E	E	E
Approach Delay, s/veh / LOS	95.5		F	61.5		E	57.2		E	61.5		E
Intersection Delay, s/veh / LOS	68.7						E					

Multimodal Results	EB		WB		NB		SB	
Pedestrian LOS Score / LOS	2.59	C	2.44	B	2.59	C	2.59	C
Bicycle LOS Score / LOS	1.20	A	1.47	A	1.39	A	1.22	A



FUTURE + PROJECT HCS WORKSHEETS



WITH PROJECT AM PEAK HOUR

HCS7 Signalized Intersection Results Summary

General Information				Intersection Information	
Agency	otc			Duration, h	0.25
Analyst	jto	Analysis Date	May 12, 2020	Area Type	CBD
Jurisdiction	City of Los Angeles	Time Period	am peak	PHF	1.00
Urban Street	Roscoe Boulevard	Analysis Year	2024	Analysis Period	1 > 7:00
Intersection	Van Nuys Boulevard	File Name	1AM 2024 plus.xus		
Project Description	am peak hour with project				

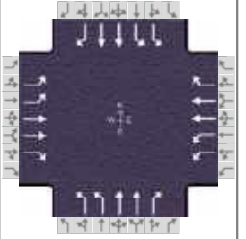

Demand Information	EB			WB			NB			SB		
	L	T	R	L	T	R	L	T	R	L	T	R
Approach Movement												
Demand (v), veh/h	110	1063	287	484	1429	215	271	744	288	459	1543	84

Signal Information												
Cycle, s	120.0	Reference Phase	2									
Offset, s	0	Reference Point	End									
Uncoordinated	No	Simult. Gap E/W	On	Green	8.0	11.6	28.4	6.0	9.0	35.0		
Force Mode	Fixed	Simult. Gap N/S	On	Yellow	3.0	3.0	3.0	3.0	3.0	3.0		
				Red	0.0	0.0	2.0	0.0	0.0	2.0		

Timer Results	EBL	EBT	WBL	WBT	NBL	NBT	SBL	SBT
Assigned Phase	7	4	3	8	5	2	1	6
Case Number	2.0	3.0	2.0	3.0	2.0	3.0	2.0	3.0
Phase Duration, s	9.0	40.0	21.0	52.0	11.0	33.4	25.6	48.0
Change Period, (Y+R _c), s	3.0	5.0	3.0	5.0	3.0	5.0	3.0	5.0
Max Allow Headway (MAH), s	3.4	3.1	3.4	3.1	3.4	0.0	3.4	0.0
Queue Clearance Time (g _s), s	6.8	37.0	20.0	49.0	10.0		21.8	
Green Extension Time (g _e), s	0.0	0.0	0.0	0.0	0.0	0.0	0.8	0.0
Phase Call Probability	1.00	1.00	1.00	1.00	1.00		1.00	
Max Out Probability	1.00	1.00	1.00	1.00	1.00		0.18	

Movement Group Results	EB			WB			NB			SB		
	L	T	R	L	T	R	L	T	R	L	T	R
Assigned Movement	7	4	14	3	8	18	5	2	12	1	6	16
Adjusted Flow Rate (v), veh/h	110	1063	212	484	1429	140	271	744	213	459	1543	34
Adjusted Saturation Flow Rate (s), veh/h/ln	1361	1628	1126	1361	1628	1152	1361	1628	1204	1361	1628	1277
Queue Service Time (g _s), s	4.8	35.0	19.7	18.0	47.0	10.1	8.0	27.1	19.7	19.8	43.0	2.1
Cycle Queue Clearance Time (g _c), s	4.8	35.0	19.7	18.0	47.0	10.1	8.0	27.1	19.7	19.8	43.0	2.1
Green Ratio (g/C)	0.05	0.29	0.29	0.15	0.39	0.39	0.07	0.24	0.24	0.19	0.36	0.36
Capacity (c), veh/h	136	950	328	408	1275	451	181	771	285	512	1167	458
Volume-to-Capacity Ratio (X)	0.808	1.119	0.646	1.185	1.121	0.310	1.493	0.964	0.747	0.897	1.323	0.074
Back of Queue (Q), ft/ln (50 th percentile)	53.8	566.8	141.6	301.2	738.1	68.8	224.8	335.6	176.6	186.6	1027.8	17
Back of Queue (Q), veh/ln (50 th percentile)	2.2	22.7	5.7	12.0	29.5	2.8	9.0	13.4	7.1	7.5	41.1	0.7
Queue Storage Ratio (RQ) (50 th percentile)	0.13	0.00	0.35	0.69	0.00	0.17	0.41	0.00	0.44	0.33	0.00	0.04
Uniform Delay (d ₁), s/veh	56.4	42.5	37.1	51.0	36.5	25.3	56.0	45.3	42.4	47.6	38.5	25.4
Incremental Delay (d ₂), s/veh	27.4	67.8	3.4	105.7	65.2	0.1	248.8	24.8	16.3	11.9	151.2	0.3
Initial Queue Delay (d ₃), s/veh	0.0	0.0	0.0	0.0	0.0	0.0	0.0	0.0	0.0	0.0	0.0	0.0
Control Delay (d), s/veh	83.8	110.3	40.5	156.7	101.7	25.4	304.8	70.1	58.7	59.5	189.7	25.7
Level of Service (LOS)	F	F	D	F	F	C	F	E	E	E	F	C
Approach Delay, s/veh / LOS	97.5	F		109.5	F		119.9	F		157.6	F	
Intersection Delay, s/veh / LOS	123.5						F					

Multimodal Results	EB		WB		NB		SB	
Pedestrian LOS Score / LOS	2.69	C	2.65	C	2.70	C	2.69	C
Bicycle LOS Score / LOS	1.63	B	2.18	B	1.50	B	2.17	B

HCS7 Signalized Intersection Results Summary

General Information				Intersection Information			
Agency	otc			Duration, h	0.25		
Analyst	jto		Analysis Date	May 12, 2020		Area Type	CBD
Jurisdiction	City of Los Angeles		Time Period	am peak		PHF	1.00
Urban Street	Saticoy Street		Analysis Year	2024		Analysis Period	1> 7:00
Intersection	Van Nuys Boulevard		File Name	2AM2024with.xus			
Project Description	am peak hour with project						

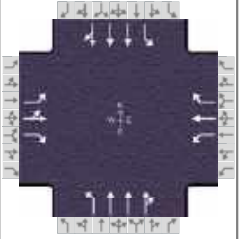

Demand Information	EB			WB			NB			SB		
	L	T	R	L	T	R	L	T	R	L	T	R
Approach Movement												
Demand (v), veh/h	501	41	428	59	48	24	266	894	30	22	1555	411

Signal Information				Signal Phases									
Cycle, s	120.0	Reference Phase	2										
Offset, s	0	Reference Point	End	Green	6.0	6.1	48.9	9.9	28.1	0.0			
Uncoordinated	No	Simult. Gap E/W	On	Yellow	3.0	3.0	3.0	3.0	3.0	0.0			
Force Mode	Fixed	Simult. Gap N/S	On	Red	0.0	0.0	2.0	2.0	2.0	0.0			

Timer Results	EBL	EBT	WBL	WBT	NBL	NBT	SBL	SBT
Assigned Phase		4		8	5	2	1	6
Case Number		9.0		9.0	2.0	4.0	1.1	4.0
Phase Duration, s		33.1		14.9	18.1	63.0	9.0	53.9
Change Period, (Y+R _c), s		5.0		5.0	3.0	5.0	3.0	5.0
Max Allow Headway (MAH), s		3.5		3.4	3.4	0.0	3.4	0.0
Queue Clearance Time (g _s), s		30.1		6.8	17.1		2.9	
Green Extension Time (g _e), s		0.0		0.3	0.0	0.0	0.0	0.0
Phase Call Probability		1.00		0.99	1.00		1.00	
Max Out Probability		1.00		0.00	1.00		0.04	

Movement Group Results	EB			WB			NB			SB		
	L	T	R	L	T	R	L	T	R	L	T	R
Assigned Movement	7	4	14	3	8	18	5	2	12	1	6	16
Adjusted Flow Rate (v), veh/h	501	41	378	59	48	24	266	629	295	22	1399	567
Adjusted Saturation Flow Rate (s), veh/h/ln	1402	1710	1211	1402	1710	1031	1402	1710	1599	1402	1710	1356
Queue Service Time (g _s), s	28.1	2.3	28.1	4.8	3.2	2.6	15.1	14.0	14.0	0.9	48.9	48.9
Cycle Queue Clearance Time (g _c), s	28.1	2.3	28.1	4.8	3.2	2.6	15.1	14.0	14.0	0.9	48.9	48.9
Green Ratio (g/C)	0.23	0.23	0.36	0.08	0.08	0.08	0.13	0.48	0.48	0.53	0.41	0.41
Capacity (c), veh/h	328	400	443	115	141	85	177	1654	773	333	1393	553
Volume-to-Capacity Ratio (X)	1.526	0.102	0.854	0.512	0.341	0.283	1.505	0.380	0.382	0.066	1.004	1.025
Back of Queue (Q), ft/ln (50 th percentile)	813.9	24.9	306.7	43.4	34.5	17.3	443.7	139.7	135.1	7	611.4	560.6
Back of Queue (Q), veh/ln (50 th percentile)	32.6	1.0	12.3	1.7	1.4	0.7	17.7	5.6	5.4	0.3	24.5	22.4
Queue Storage Ratio (RQ) (50 th percentile)	1.36	0.00	0.51	0.72	0.00	0.29	2.77	0.00	0.00	0.05	0.00	0.00
Uniform Delay (d ₁), s/veh	45.9	36.1	35.7	52.8	52.0	51.7	52.4	19.6	19.6	14.1	35.6	35.6
Incremental Delay (d ₂), s/veh	251.7	0.5	18.5	1.3	0.5	0.7	254.3	0.7	1.4	0.0	25.2	44.9
Initial Queue Delay (d ₃), s/veh	0.0	0.0	0.0	0.0	0.0	0.0	0.0	0.0	0.0	0.0	0.0	0.0
Control Delay (d), s/veh	297.7	36.6	54.2	54.1	52.5	52.4	306.7	20.3	21.1	14.1	60.7	80.5
Level of Service (LOS)	F	D	D	D	D	D	F	C	C	B	F	F
Approach Delay, s/veh / LOS	186.0		F	53.2		D	84.5		F	65.8		E
Intersection Delay, s/veh / LOS	96.8						F					

Multimodal Results	EB		WB		NB		SB	
Pedestrian LOS Score / LOS	2.59	C	2.62	C	2.10	B	2.18	B
Bicycle LOS Score / LOS	2.01	B	0.70	A	1.14	A	1.58	B

HCS7 Signalized Intersection Results Summary

General Information				Intersection Information	
Agency	otc			Duration, h	0.25
Analyst	jto	Analysis Date	May 12, 2020	Area Type	CBD
Jurisdiction	City of Los Angeles	Time Period	am peak	PHF	1.00
Urban Street	Roscoe Boulevard	Analysis Year	2024	Analysis Period	1> 7:00
Intersection	Willis Avenue	File Name	3AM2024 plus.xus		
Project Description	am peak hour with project				

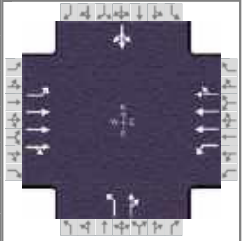

Demand Information	EB			WB			NB			SB		
	L	T	R	L	T	R	L	T	R	L	T	R
Approach Movement												
Demand (v), veh/h	37	1385	153	41	1545	23	244	99	61	32	136	89

Signal Information												
Cycle, s	120.0	Reference Phase	2									
Offset, s	0	Reference Point	End									
Uncoordinated	No	Simult. Gap E/W	On	Green	0.0	0.0	0.0	0.0	0.0	0.0		
Force Mode	Fixed	Simult. Gap N/S	On	Yellow	0.0	0.0	0.0	0.0	0.0	0.0		
				Red	0.0	0.0	0.0	0.0	0.0	0.0		

Timer Results	EBL	EBT	WBL	WBT	NBL	NBT	SBL	SBT
Assigned Phase		4		8	5	2		6
Case Number		6.0		6.0	1.0	4.0		8.3
Phase Duration, s		67.0		67.0	20.7	53.0		32.3
Change Period, (Y+R _c), s		5.0		5.0	3.0	5.0		5.0
Max Allow Headway (MAH), s		3.3		3.3	3.4	0.0		0.0
Queue Clearance Time (g _s), s		41.1		46.9	17.3			
Green Extension Time (g _e), s		16.1		15.6	0.5	0.0		0.0
Phase Call Probability		1.00		1.00	1.00			
Max Out Probability		0.12		0.16	0.00			

Movement Group Results	EB			WB			NB			SB		
	L	T	R	L	T	R	L	T	R	L	T	R
Approach Movement												
Assigned Movement	7	4	14	3	8	18	5	2	12	1	6	16
Adjusted Flow Rate (v), veh/h	37	1167	371	41	1066	502	244	160			257	
Adjusted Saturation Flow Rate (s), veh/h/ln	294	1710	1088	299	1710	1610	1402	1527			1405	
Queue Service Time (g _s), s	12.3	30.3	30.3	14.2	26.5	26.5	15.3	8.4			11.0	
Cycle Queue Clearance Time (g _c), s	39.1	30.3	30.3	44.9	26.5	26.5	15.3	8.4			20.4	
Green Ratio (g/C)	0.52	0.52	0.52	0.52	0.52	0.52	0.40	0.40			0.23	
Capacity (c), veh/h	145	1752	557	137	1752	825	336	617			360	
Volume-to-Capacity Ratio (X)	0.256	0.666	0.666	0.300	0.608	0.609	0.726	0.259			0.714	
Back of Queue (Q), ft/ln (50 th percentile)	22.2	292.2	187.4	26.2	255.5	241.4	128	79.1			204.6	
Back of Queue (Q), veh/ln (50 th percentile)	0.9	11.7	7.5	1.0	10.2	9.7	5.1	3.2			8.2	
Queue Storage Ratio (RQ) (50 th percentile)	0.30	0.00	0.00	0.52	0.00	0.00	2.13	0.00			0.00	
Uniform Delay (d ₁), s/veh	34.7	21.7	21.7	38.4	20.7	20.7	29.1	23.8			43.1	
Incremental Delay (d ₂), s/veh	0.3	0.2	0.5	0.5	0.1	0.3	1.1	1.0			11.5	
Initial Queue Delay (d ₃), s/veh	0.0	0.0	0.0	0.0	0.0	0.0	0.0	0.0			0.0	
Control Delay (d), s/veh	35.1	21.8	22.2	38.9	20.9	21.0	30.2	24.8			54.5	
Level of Service (LOS)	D	C	C	D	C	C	C	C			D	
Approach Delay, s/veh / LOS	22.2		C	21.4		C	28.1		C	54.5		D
Intersection Delay, s/veh / LOS	24.6						C					

Multimodal Results	EB		WB		NB		SB	
Pedestrian LOS Score / LOS	1.90	B	1.68	B	2.57	C	2.59	C
Bicycle LOS Score / LOS	1.35	A	1.37	A	1.15	A	0.91	A

HCS7 Signalized Intersection Results Summary

General Information				Intersection Information	
Agency	otc			Duration, h	0.25
Analyst	jto	Analysis Date	May 12, 2020	Area Type	CBD
Jurisdiction	City of Los Angeles	Time Period	am peak	PHF	1.00
Urban Street	Roscoe Boulevard	Analysis Year	2024	Analysis Period	1 > 7:00
Intersection	Woodman Avenue	File Name	4AM2024 plus.xus		
Project Description	am peak hour with project				

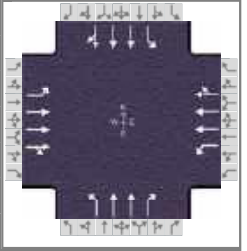

Demand Information	EB			WB			NB			SB		
	L	T	R	L	T	R	L	T	R	L	T	R
Approach Movement												
Demand (v), veh/h	192	1281	253	226	1408	63	202	599	123	133	1366	174

Signal Information													
Cycle, s	120.0	Reference Phase	2										
Offset, s	0	Reference Point	End										
Uncoordinated	No	Simult. Gap E/W	On	Green	11.1	2.3	34.7	15.0	1.0	39.9			
Force Mode	Fixed	Simult. Gap N/S	On	Yellow	3.0	0.0	3.0	3.0	0.0	3.0			
				Red	0.0	0.0	2.0	0.0	0.0	2.0			

Timer Results	EBL	EBT	WBL	WBT	NBL	NBT	SBL	SBT
Assigned Phase	7	4	3	8	5	2	1	6
Case Number	2.0	4.0	2.0	4.0	2.0	3.0	2.0	4.0
Phase Duration, s	19.0	45.9	18.0	44.9	14.1	39.7	16.4	42.0
Change Period, (Y+R _c), s	3.0	5.0	3.0	5.0	3.0	5.0	3.0	5.0
Max Allow Headway (MAH), s	3.4	3.1	3.4	3.1	3.4	0.0	3.4	0.0
Queue Clearance Time (g _s), s	18.0	40.3	17.0	35.3	13.1		13.2	
Green Extension Time (g _e), s	0.0	0.6	0.0	3.5	0.0	0.0	0.3	0.0
Phase Call Probability	1.00	1.00	1.00	1.00	1.00		1.00	
Max Out Probability	1.00	1.00	1.00	0.89	1.00		0.00	

Movement Group Results	EB			WB			NB			SB		
	L	T	R	L	T	R	L	T	R	L	T	R
Assigned Movement	7	4	14	3	8	18	5	2	12	1	6	16
Adjusted Flow Rate (v), veh/h	192	1116	418	226	1004	467	202	599	123	133	1063	477
Adjusted Saturation Flow Rate (s), veh/h/ln	1402	1710	1282	1402	1710	1591	1402	1628	1330	1402	1710	1534
Queue Service Time (g _s), s	16.0	38.3	38.3	15.0	33.3	33.3	11.1	19.2	7.2	11.2	37.0	37.0
Cycle Queue Clearance Time (g _c), s	16.0	38.3	38.3	15.0	33.3	33.3	11.1	19.2	7.2	11.2	37.0	37.0
Green Ratio (g/C)	0.13	0.34	0.34	0.12	0.33	0.33	0.09	0.29	0.41	0.11	0.31	0.31
Capacity (c), veh/h	187	1166	437	175	1137	529	130	941	557	157	1055	473
Volume-to-Capacity Ratio (X)	1.027	0.957	0.958	1.290	0.883	0.883	1.558	0.637	0.221	0.848	1.008	1.008
Back of Queue (Q), ft/ln (50 th percentile)	233.8	459.2	389.9	332.8	372.2	373.4	353.7	199.8	59.2	102.6	488.9	483.7
Back of Queue (Q), veh/ln (50 th percentile)	9.4	18.4	15.6	13.3	14.9	14.9	14.1	8.0	2.4	4.1	19.6	19.3
Queue Storage Ratio (RQ) (50 th percentile)	1.17	0.00	0.00	1.42	0.00	0.00	1.86	0.00	0.15	0.54	0.00	0.00
Uniform Delay (d ₁), s/veh	52.0	38.7	38.7	52.5	37.8	37.8	54.4	37.2	22.7	52.3	41.5	41.5
Incremental Delay (d ₂), s/veh	73.2	16.9	31.9	166.3	8.1	15.5	285.2	3.3	0.9	4.8	29.7	43.5
Initial Queue Delay (d ₃), s/veh	0.0	0.0	0.0	0.0	0.0	0.0	0.0	0.0	0.0	0.0	0.0	0.0
Control Delay (d), s/veh	125.2	55.6	70.6	218.8	45.9	53.3	339.6	40.5	23.6	57.1	71.2	85.0
Level of Service (LOS)	F	E	E	F	D	D	F	D	C	E	F	F
Approach Delay, s/veh / LOS	67.0	E		71.0	E		103.6	F		74.0	E	
Intersection Delay, s/veh / LOS	75.7						E					

Multimodal Results	EB		WB		NB		SB	
Pedestrian LOS Score / LOS	2.58	C	2.44	B	2.59	C	2.59	C
Bicycle LOS Score / LOS	1.44	A	1.42	A	1.25	A	1.41	A



WITH PROJECT PM PEAK HOUR

HCS7 Signalized Intersection Results Summary

General Information				Intersection Information	
Agency	otc			Duration, h	0.25
Analyst	jto	Analysis Date	May 12, 2020	Area Type	CBD
Jurisdiction	City of Los Angeles	Time Period	pm peak	PHF	1.00
Urban Street	Roscoe Boulevard	Analysis Year	2024	Analysis Period	1> 7:00
Intersection	Van Nuys Boulevard	File Name	1PM 2024 plus.xus		
Project Description	pm peak hour with project				

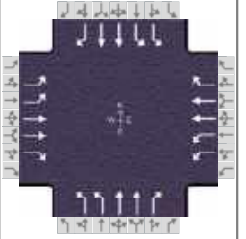

Demand Information	EB			WB			NB			SB		
	L	T	R	L	T	R	L	T	R	L	T	R
Approach Movement												
Demand (v), veh/h	225	1090	315	332	1479	181	444	1152	270	366	1110	105

Signal Information													
Cycle, s	120.0	Reference Phase	2										
Offset, s	0	Reference Point	End										
Uncoordinated	No	Simult. Gap E/W	On	Green	16.0	2.4	34.6	7.0	3.0	38.0			
Force Mode	Fixed	Simult. Gap N/S	On	Yellow	3.0	0.0	3.0	3.0	3.0	3.0			
				Red	0.0	0.0	2.0	0.0	0.0	2.0			

Timer Results	EBL	EBT	WBL	WBT	NBL	NBT	SBL	SBT
Assigned Phase	7	4	3	8	5	2	1	6
Case Number	2.0	3.0	2.0	3.0	2.0	3.0	2.0	3.0
Phase Duration, s	10.0	43.0	16.0	49.0	19.0	39.6	21.4	42.0
Change Period, (Y+R _c), s	3.0	5.0	3.0	5.0	3.0	5.0	3.0	5.0
Max Allow Headway (MAH), s	3.4	3.1	3.4	3.1	3.4	0.0	3.4	0.0
Queue Clearance Time (g _s), s	9.0	40.0	15.0	46.0	18.0		17.8	
Green Extension Time (g _e), s	0.0	0.0	0.0	0.0	0.0	0.0	0.6	0.0
Phase Call Probability	1.00	1.00	1.00	1.00	1.00		1.00	
Max Out Probability	1.00	1.00	1.00	1.00	1.00		0.14	

Movement Group Results	EB			WB			NB			SB		
	L	T	R	L	T	R	L	T	R	L	T	R
Approach Movement												
Assigned Movement	7	4	14	3	8	18	5	2	12	1	6	16
Adjusted Flow Rate (v), veh/h	225	1090	240	332	1479	106	444	1152	195	366	1110	55
Adjusted Saturation Flow Rate (s), veh/h/ln	1361	1628	1135	1361	1628	1141	1361	1628	1236	1361	1628	1259
Queue Service Time (g _s), s	7.0	38.0	22.0	13.0	44.0	7.8	16.0	34.6	16.0	15.8	37.0	3.8
Cycle Queue Clearance Time (g _c), s	7.0	38.0	22.0	13.0	44.0	7.8	16.0	34.6	16.0	15.8	37.0	3.8
Green Ratio (g/C)	0.06	0.32	0.32	0.11	0.37	0.37	0.13	0.29	0.29	0.15	0.31	0.31
Capacity (c), veh/h	159	1031	360	295	1194	418	363	939	356	417	1004	388
Volume-to-Capacity Ratio (X)	1.417	1.057	0.668	1.126	1.239	0.253	1.223	1.227	0.547	0.877	1.106	0.142
Back of Queue (Q), ft/ln (50 th percentile)	181.1	530	159	202.9	900	52.9	289.5	703.4	133.8	147.8	577.8	30.7
Back of Queue (Q), veh/ln (50 th percentile)	7.2	21.2	6.4	8.1	36.0	2.1	11.6	28.1	5.4	5.9	23.1	1.2
Queue Storage Ratio (RQ) (50 th percentile)	0.44	0.00	0.40	0.47	0.00	0.13	0.52	0.00	0.33	0.26	0.00	0.08
Uniform Delay (d ₁), s/veh	56.5	41.0	35.5	53.5	38.0	26.5	52.0	42.7	36.1	49.7	41.5	30.0
Incremental Delay (d ₂), s/veh	220.5	44.4	3.8	90.7	114.8	0.1	122.8	111.5	5.9	10.3	62.0	0.8
Initial Queue Delay (d ₃), s/veh	0.0	0.0	0.0	0.0	0.0	0.0	0.0	0.0	0.0	0.0	0.0	0.0
Control Delay (d), s/veh	277.0	85.4	39.3	144.2	152.8	26.6	174.8	154.2	42.0	60.0	103.5	30.8
Level of Service (LOS)	F	F	D	F	F	C	F	F	D	E	F	C
Approach Delay, s/veh / LOS	106.0		F	144.4		F	147.1		F	90.5		F
Intersection Delay, s/veh / LOS	124.2						F					

Multimodal Results	EB		WB		NB		SB	
Pedestrian LOS Score / LOS	2.69	C	2.65	C	2.69	C	2.69	C
Bicycle LOS Score / LOS	1.77	B	2.07	B	1.97	B	1.75	B

HCS7 Signalized Intersection Results Summary

General Information				Intersection Information			
Agency	otc			Duration, h	0.25		
Analyst	jto		Analysis Date	May 12, 2020		Area Type	CBD
Jurisdiction	City of Los Angeles		Time Period	pm peak		PHF	1.00
Urban Street	Saticoy Street		Analysis Year	2024		Analysis Period	1 > 7:00
Intersection	Van Nuys Boulevard		File Name	2PM2024with.xus			
Project Description	pm peak hour with project						

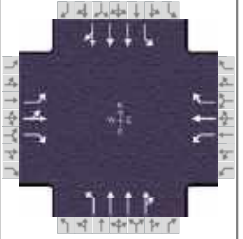

Demand Information	EB			WB			NB			SB		
	L	T	R	L	T	R	L	T	R	L	T	R
Approach Movement												
Demand (v), veh/h	593	24	296	32	60	29	281	1706	39	15	1362	356

Signal Information													
Cycle, s	120.0	Reference Phase	2										
Offset, s	0	Reference Point	End										
Uncoordinated	No	Simult. Gap E/W	On	Green	0.0	0.0	0.0	0.0	0.0	0.0			
Force Mode	Fixed	Simult. Gap N/S	On	Yellow	0.0	0.0	0.0	0.0	0.0	0.0			
				Red	0.0	0.0	0.0	0.0	0.0	0.0			



Timer Results	EBL	EBT	WBL	WBT	NBL	NBT	SBL	SBT
Assigned Phase		4		8	5	2	1	6
Case Number		9.0		9.0	2.0	4.0	1.1	4.0
Phase Duration, s		37.2		14.8	19.1	59.0	9.0	48.9
Change Period, (Y+R _c), s		5.0		5.0	3.0	5.0	3.0	5.0
Max Allow Headway (MAH), s		3.5		3.5	3.4	0.0	3.4	0.0
Queue Clearance Time (g _s), s		34.2		6.0	18.2		2.6	
Green Extension Time (g _e), s		0.0		0.3	0.0	0.0	0.0	0.0
Phase Call Probability		1.00		0.98	1.00		1.00	
Max Out Probability		1.00		0.00	1.00		1.00	

Movement Group Results	EB			WB			NB			SB		
	L	T	R	L	T	R	L	T	R	L	T	R
Assigned Movement	7	4	14	3	8	18	5	2	12	1	6	16
Adjusted Flow Rate (v), veh/h	593	24	246	32	60	29	281	1186	559	15	1255	463
Adjusted Saturation Flow Rate (s), veh/h/ln	1402	1710	1192	1402	1710	915	1402	1710	1610	1402	1710	1253
Queue Service Time (g _s), s	32.2	1.3	18.6	2.6	4.0	3.6	16.2	35.0	35.1	0.6	43.9	43.9
Cycle Queue Clearance Time (g _c), s	32.2	1.3	18.6	2.6	4.0	3.6	16.2	35.0	35.1	0.6	43.9	43.9
Green Ratio (g/C)	0.27	0.27	0.40	0.08	0.08	0.08	0.13	0.45	0.45	0.50	0.37	0.37
Capacity (c), veh/h	376	458	489	115	140	75	189	1540	725	170	1250	458
Volume-to-Capacity Ratio (X)	1.579	0.052	0.503	0.279	0.429	0.387	1.489	0.770	0.771	0.088	1.004	1.011
Back of Queue (Q), ft/ln (50 th percentile)	985.1	13.6	142.6	22.9	43.5	21.2	462.8	365.8	364.7	5.2	558.8	468.5
Back of Queue (Q), veh/ln (50 th percentile)	39.4	0.5	5.7	0.9	1.7	0.8	18.5	14.6	14.6	0.2	22.4	18.7
Queue Storage Ratio (RQ) (50 th percentile)	1.64	0.00	0.24	0.38	0.00	0.35	2.89	0.00	0.00	0.04	0.00	0.00
Uniform Delay (d ₁), s/veh	43.9	32.6	27.0	51.8	52.4	52.2	51.9	27.8	27.8	20.6	38.1	38.1
Incremental Delay (d ₂), s/veh	273.1	0.2	3.7	0.5	0.8	1.2	246.0	3.8	7.8	0.1	26.3	44.8
Initial Queue Delay (d ₃), s/veh	0.0	0.0	0.0	0.0	0.0	0.0	0.0	0.0	0.0	0.0	0.0	0.0
Control Delay (d), s/veh	317.0	32.8	30.6	52.2	53.2	53.4	298.0	31.6	35.5	20.6	64.4	82.9
Level of Service (LOS)	F	C	C	D	D	D	F	C	D	C	F	F
Approach Delay, s/veh / LOS	227.5		F	53.0		D	69.6		E	69.0		E
Intersection Delay, s/veh / LOS	97.7						F					

Multimodal Results	EB		WB		NB		SB	
Pedestrian LOS Score / LOS	2.59	C	2.62	C	2.10	B	2.19	B
Bicycle LOS Score / LOS	1.91	B	0.69	A	1.60	B	1.44	A

HCS7 Signalized Intersection Results Summary

General Information				Intersection Information	
Agency	otc			Duration, h	0.25
Analyst	jto	Analysis Date	May 12, 2020	Area Type	CBD
Jurisdiction	City of Los Angeles	Time Period	pm peak	PHF	1.00
Urban Street	Roscoe Boulevard	Analysis Year	2024	Analysis Period	1> 7:00
Intersection	Willis Avenue	File Name	3PM2024 plus.xus		
Project Description	pm peak hour with project				

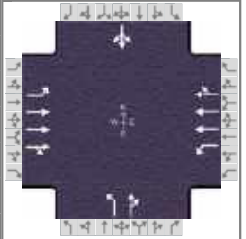

Demand Information	EB			WB			NB			SB		
	L	T	R	L	T	R	L	T	R	L	T	R
Approach Movement												
Demand (v), veh/h	73	1652	200	51	1476	51	344	147	97	24	113	63

Signal Information													
Cycle, s	120.0	Reference Phase	2										
Offset, s	0	Reference Point	End										
Uncoordinated	No	Simult. Gap E/W	On	Green	13.0	31.0	63.0	0.0	0.0	0.0			
Force Mode	Fixed	Simult. Gap N/S	On	Yellow	3.0	3.0	3.0	0.0	0.0	0.0			
				Red	0.0	2.0	2.0	0.0	0.0	0.0			

Timer Results	EBL	EBT	WBL	WBT	NBL	NBT	SBL	SBT
Assigned Phase		4		8	5	2		6
Case Number		6.0		6.0	1.0	4.0		8.3
Phase Duration, s		68.0		68.0	16.0	52.0		36.0
Change Period, (Y+R _c), s		5.0		5.0	3.0	5.0		5.0
Max Allow Headway (MAH), s		3.4		3.4	3.4	0.0		0.0
Queue Clearance Time (g _s), s		52.7		65.0	15.0			
Green Extension Time (g _e), s		8.0		0.0	0.0	0.0		0.0
Phase Call Probability		1.00		1.00	1.00			
Max Out Probability		0.81		1.00	1.00			

Movement Group Results	EB			WB			NB			SB		
	L	T	R	L	T	R	L	T	R	L	T	R
Assigned Movement	7	4	14	3	8	18	5	2	12	1	6	16
Adjusted Flow Rate (v), veh/h	73	1346	506	51	1045	482	344	244			200	
Adjusted Saturation Flow Rate (s), veh/h/ln	307	1710	1271	226	1710	1576	1402	1529			1440	
Queue Service Time (g _s), s	25.6	37.0	37.7	25.3	25.1	25.1	13.0	13.9			1.1	
Cycle Queue Clearance Time (g _c), s	50.7	37.0	37.7	63.0	25.1	25.1	13.0	13.9			13.7	
Green Ratio (g/C)	0.52	0.52	0.52	0.52	0.52	0.52	0.38	0.39			0.26	
Capacity (c), veh/h	157	1796	667	108	1796	827	371	599			406	
Volume-to-Capacity Ratio (X)	0.465	0.750	0.758	0.474	0.582	0.582	0.928	0.407			0.493	
Back of Queue (Q), ft/ln (50 th percentile)	48	362.9	287.7	39.1	241.2	224.4	207.3	133.1			136.5	
Back of Queue (Q), veh/ln (50 th percentile)	1.9	14.5	11.5	1.6	9.6	9.0	8.3	5.3			5.5	
Queue Storage Ratio (RQ) (50 th percentile)	0.64	0.00	0.00	0.78	0.00	0.00	3.45	0.00			0.00	
Uniform Delay (d ₁), s/veh	36.8	22.3	22.5	48.2	19.5	19.5	38.6	26.4			38.1	
Incremental Delay (d ₂), s/veh	0.8	1.6	4.5	1.2	0.3	0.7	28.7	2.1			4.2	
Initial Queue Delay (d ₃), s/veh	0.0	0.0	0.0	0.0	0.0	0.0	0.0	0.0			0.0	
Control Delay (d), s/veh	37.6	23.9	27.0	49.4	19.8	20.2	67.3	28.5			42.3	
Level of Service (LOS)	D	C	C	D	B	C	E	C			D	
Approach Delay, s/veh / LOS	25.2		C	20.9		C	51.2		D	42.3		D
Intersection Delay, s/veh / LOS	28.0						C					

Multimodal Results	EB		WB		NB		SB	
Pedestrian LOS Score / LOS	1.90	B	1.68	B	2.58	C	2.59	C
Bicycle LOS Score / LOS	1.55	B	1.36	A	1.46	A	0.82	A

HCS7 Signalized Intersection Results Summary

General Information				Intersection Information	
Agency	otc			Duration, h	0.25
Analyst	jto	Analysis Date	May 12, 2020	Area Type	CBD
Jurisdiction	City of Los Angeles	Time Period	pm peak	PHF	1.00
Urban Street	Roscoe Boulevard	Analysis Year	2024	Analysis Period	1 > 7:00
Intersection	Woodman Avenue	File Name	4PM2024 plus.xus		
Project Description	pm peak hour with project				

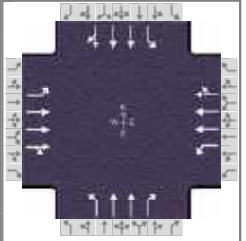

Demand Information	EB			WB			NB			SB		
	L	T	R	L	T	R	L	T	R	L	T	R
Approach Movement												
Demand (v), veh/h	277	913	120	215	1338	244	169	811	111	166	975	199

Signal Information													
Cycle, s	120.0	Reference Phase	2										
Offset, s	0	Reference Point	End										
Uncoordinated	No	Simult. Gap E/W	On	Green	16.2	0.3	31.5	16.0	1.5	35.5			
Force Mode	Fixed	Simult. Gap N/S	On	Yellow	3.0	0.0	3.0	3.0	3.0	3.0			
				Red	0.0	0.0	2.0	0.0	0.0	2.0			

Timer Results	EBL	EBT	WBL	WBT	NBL	NBT	SBL	SBT
Assigned Phase	7	4	3	8	5	2	1	6
Case Number	2.0	4.0	2.0	4.0	2.0	3.0	2.0	4.0
Phase Duration, s	19.0	40.5	23.5	45.0	19.5	36.8	19.2	36.5
Change Period, (Y+R _c), s	3.0	5.0	3.0	5.0	3.0	5.0	3.0	5.0
Max Allow Headway (MAH), s	3.4	3.1	3.4	3.1	3.4	0.0	3.4	0.0
Queue Clearance Time (g _s), s	18.0	25.9	20.0	40.5	16.2		15.9	
Green Extension Time (g _e), s	0.0	5.3	0.4	0.0	0.3	0.0	0.3	0.0
Phase Call Probability	1.00	1.00	1.00	1.00	1.00		1.00	
Max Out Probability	1.00	0.54	0.00	1.00	0.00		0.00	

Movement Group Results	EB			WB			NB			SB		
	L	T	R	L	T	R	L	T	R	L	T	R
Assigned Movement	7	4	14	3	8	18	5	2	12	1	6	16
Adjusted Flow Rate (v), veh/h	277	745	288	215	1110	472	169	811	111	166	823	351
Adjusted Saturation Flow Rate (s), veh/h/ln	1402	1710	1306	1402	1710	1453	1402	1628	1316	1402	1710	1449
Queue Service Time (g _s), s	16.0	23.5	23.9	18.0	38.4	38.5	14.2	29.3	6.2	13.9	28.1	28.3
Cycle Queue Clearance Time (g _c), s	16.0	23.5	23.9	18.0	38.4	38.5	14.2	29.3	6.2	13.9	28.1	28.3
Green Ratio (g/C)	0.13	0.30	0.30	0.17	0.33	0.33	0.14	0.26	0.44	0.14	0.26	0.26
Capacity (c), veh/h	187	1013	387	239	1140	484	192	862	584	189	898	381
Volume-to-Capacity Ratio (X)	1.482	0.736	0.744	0.899	0.974	0.975	0.878	0.941	0.190	0.876	0.916	0.921
Back of Queue (Q), ft/ln (50 th percentile)	454.7	251.3	205.6	164	473.2	448.6	129.9	346.5	50.5	127.6	339.5	327.4
Back of Queue (Q), veh/ln (50 th percentile)	18.2	10.1	8.2	6.6	18.9	17.9	5.2	13.9	2.0	5.1	13.6	13.1
Queue Storage Ratio (RQ) (50 th percentile)	2.27	0.00	0.00	0.70	0.00	0.00	0.68	0.00	0.13	0.67	0.00	0.00
Uniform Delay (d ₁), s/veh	52.0	38.0	38.1	48.8	39.5	39.5	50.8	43.2	20.9	50.9	43.0	43.0
Incremental Delay (d ₂), s/veh	243.4	2.5	6.7	4.9	20.4	34.1	5.0	19.2	0.7	5.0	15.5	30.0
Initial Queue Delay (d ₃), s/veh	0.0	0.0	0.0	0.0	0.0	0.0	0.0	0.0	0.0	0.0	0.0	0.0
Control Delay (d), s/veh	295.4	40.5	44.9	53.6	59.9	73.6	55.7	62.4	21.6	55.9	58.5	73.0
Level of Service (LOS)	F	D	D	D	E	E	E	E	C	E	E	E
Approach Delay, s/veh / LOS	95.4		F	62.7		E	57.2		E	62.0		E
Intersection Delay, s/veh / LOS	69.2						E					

Multimodal Results	EB		WB		NB		SB	
Pedestrian LOS Score / LOS	2.59	C	2.44	B	2.59	C	2.59	C
Bicycle LOS Score / LOS	1.21	A	1.48	A	1.39	A	1.22	A



DRIVEWAY CONDITIONS

HCS7 Two-Way Stop-Control Report

General Information				Site Information			
Analyst	jto			Intersection	Titus Street Driveway		
Agency/Co.	otc			Jurisdiction	Los Angeles		
Date Performed	5/20/2020			East/West Street	Project Garage Driveway		
Analysis Year	2020			North/South Street	Driveway		
Time Analyzed	am peak hour			Peak Hour Factor	1.00		
Intersection Orientation	East-West			Analysis Time Period (hrs)	0.25		
Project Description	Titus Street Garage Driveway						

Lanes

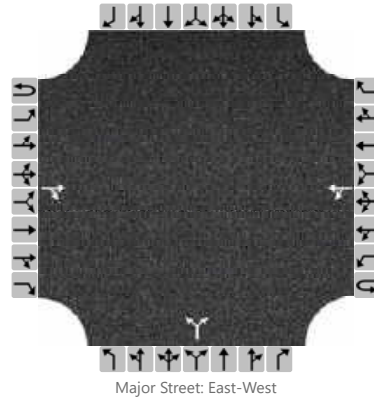

Vehicle Volumes and Adjustments

Approach	Eastbound				Westbound				Northbound				Southbound			
	U	L	T	R	U	L	T	R	U	L	T	R	U	L	T	R
Movement	1U	1	2	3	4U	4	5	6		7	8	9		10	11	12
Priority																
Number of Lanes	0	0	1	0	0	0	1	0		0	1	0		0	0	0
Configuration				TR		LT					LR					
Volume, V (veh/h)			105	9		28	84			32		58				
Percent Heavy Vehicles (%)						3				3		3				
Proportion Time Blocked																
Percent Grade (%)									0							
Right Turn Channelized	No				No				No				No			
Median Type/Storage	Undivided															

Critical and Follow-up Headways

Base Critical Headway (sec)						4.1					7.1		6.2			
Critical Headway (sec)						4.13					6.43		6.23			
Base Follow-Up Headway (sec)						2.2					3.5		3.3			
Follow-Up Headway (sec)						2.23					3.53		3.33			

Delay, Queue Length, and Level of Service

Flow Rate, v (veh/h)						28						90				
Capacity, c (veh/h)						1467						849				
v/c Ratio						0.02						0.11				
95% Queue Length, Q ₉₅ (veh)						0.1						0.4				
Control Delay (s/veh)						7.5						9.7				
Level of Service, LOS						A						A				
Approach Delay (s/veh)					2.0				9.7							
Approach LOS									A							

HCS7 Two-Way Stop-Control Report

General Information				Site Information			
Analyst	jto			Intersection	Titus Street Driveway		
Agency/Co.	otc			Jurisdiction	Los Angeles		
Date Performed	5/20/2020			East/West Street	Project Garage Driveway		
Analysis Year	2020			North/South Street	Driveway		
Time Analyzed	pm peak hour			Peak Hour Factor	1.00		
Intersection Orientation	East-West			Analysis Time Period (hrs)	0.25		
Project Description	Titus Street Garage Driveway						

Lanes

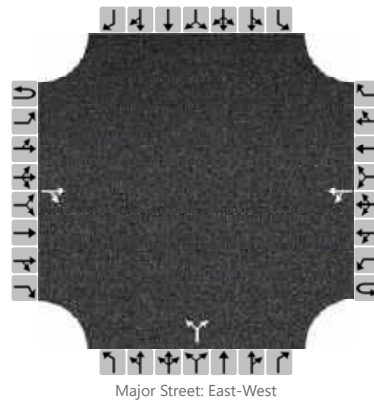

Vehicle Volumes and Adjustments

Approach	Eastbound				Westbound				Northbound				Southbound			
	U	L	T	R	U	L	T	R	U	L	T	R	U	L	T	R
Movement	1U	1	2	3	4U	4	5	6		7	8	9		10	11	12
Priority																
Number of Lanes	0	0	1	0	0	0	1	0		0	1	0		0	0	0
Configuration				TR		LT					LR					
Volume, V (veh/h)			116	26		79	161			28		53				
Percent Heavy Vehicles (%)						3				3		3				
Proportion Time Blocked																
Percent Grade (%)									0							
Right Turn Channelized	No				No				No				No			
Median Type/Storage	Undivided															

Critical and Follow-up Headways

Base Critical Headway (sec)						4.1					7.1		6.2			
Critical Headway (sec)						4.13					6.43		6.23			
Base Follow-Up Headway (sec)						2.2					3.5		3.3			
Follow-Up Headway (sec)						2.23					3.53		3.33			

Delay, Queue Length, and Level of Service

Flow Rate, v (veh/h)						79						81				
Capacity, c (veh/h)						1433						736				
v/c Ratio						0.06						0.11				
95% Queue Length, Q ₉₅ (veh)						0.2						0.4				
Control Delay (s/veh)						7.7						10.5				
Level of Service, LOS						A						B				
Approach Delay (s/veh)					2.8				10.5							
Approach LOS									B							

HCS7 Two-Way Stop-Control Report

General Information				Site Information			
Analyst	jto			Intersection	Titus Street Driveway		
Agency/Co.	otc			Jurisdiction	Los Angeles		
Date Performed	5/20/2020			East/West Street	Project Surface Driveway		
Analysis Year	2020			North/South Street	Driveway		
Time Analyzed	am peak hour			Peak Hour Factor	1.00		
Intersection Orientation	East-West			Analysis Time Period (hrs)	0.25		
Project Description	Titus Street Surface Lot Driveway						

Lanes

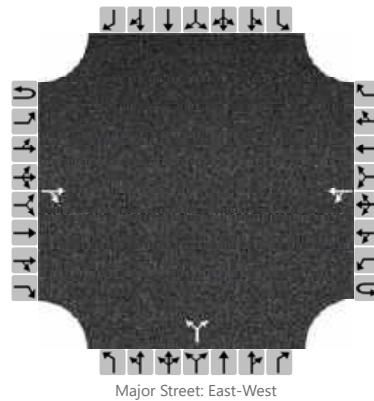

Vehicle Volumes and Adjustments

Approach	Eastbound				Westbound				Northbound				Southbound			
	U	L	T	R	U	L	T	R	U	L	T	R	U	L	T	R
Movement	1U	1	2	3	4U	4	5	6		7	8	9		10	11	12
Priority																
Number of Lanes	0	0	1	0	0	0	1	0		0	1	0		0	0	0
Configuration				TR		LT					LR					
Volume, V (veh/h)			162	1		1	110			2		2				
Percent Heavy Vehicles (%)						3				3		3				
Proportion Time Blocked																
Percent Grade (%)									0							
Right Turn Channelized	No				No				No				No			
Median Type/Storage	Undivided															

Critical and Follow-up Headways

Base Critical Headway (sec)						4.1					7.1		6.2			
Critical Headway (sec)						4.13					6.43		6.23			
Base Follow-Up Headway (sec)						2.2					3.5		3.3			
Follow-Up Headway (sec)						2.23					3.53		3.33			

Delay, Queue Length, and Level of Service

Flow Rate, v (veh/h)						1						4				
Capacity, c (veh/h)						1408						787				
v/c Ratio						0.00						0.01				
95% Queue Length, Q ₉₅ (veh)						0.0						0.0				
Control Delay (s/veh)						7.6						9.6				
Level of Service, LOS						A						A				
Approach Delay (s/veh)					0.1				9.6							
Approach LOS									A							

HCS7 Two-Way Stop-Control Report

General Information				Site Information			
Analyst	jto			Intersection	Titus Street Driveway		
Agency/Co.	otc			Jurisdiction	Los Angeles		
Date Performed	5/20/2020			East/West Street	Project Surface Driveway		
Analysis Year	2020			North/South Street	Driveway		
Time Analyzed	pm peak hour			Peak Hour Factor	1.00		
Intersection Orientation	East-West			Analysis Time Period (hrs)	0.25		
Project Description	Titus Street Surface Lot Driveway						

Lanes

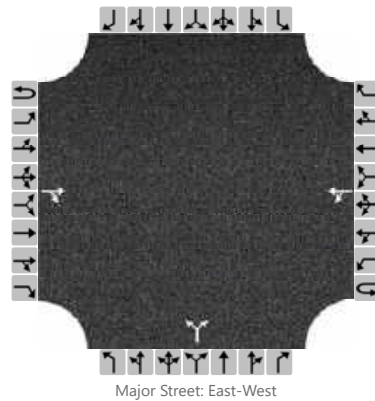

Vehicle Volumes and Adjustments

Approach	Eastbound				Westbound				Northbound				Southbound			
	U	L	T	R	U	L	T	R	U	L	T	R	U	L	T	R
Movement	1U	1	2	3	4U	4	5	6		7	8	9		10	11	12
Priority																
Number of Lanes	0	0	1	0	0	0	1	0		0	1	0		0	0	0
Configuration				TR		LT					LR					
Volume, V (veh/h)			167	2		3	238			2		2				
Percent Heavy Vehicles (%)						3				3		3				
Proportion Time Blocked																
Percent Grade (%)									0							
Right Turn Channelized	No				No				No				No			
Median Type/Storage	Undivided															

Critical and Follow-up Headways

Base Critical Headway (sec)						4.1					7.1		6.2			
Critical Headway (sec)						4.13					6.43		6.23			
Base Follow-Up Headway (sec)						2.2					3.5		3.3			
Follow-Up Headway (sec)						2.23					3.53		3.33			

Delay, Queue Length, and Level of Service

Flow Rate, v (veh/h)						3					4					
Capacity, c (veh/h)						1401					706					
v/c Ratio						0.00					0.01					
95% Queue Length, Q ₉₅ (veh)						0.0					0.0					
Control Delay (s/veh)						7.6					10.1					
Level of Service, LOS						A					B					
Approach Delay (s/veh)					0.1				10.1							
Approach LOS									B							



APPENDIX K

**LADOT INTERIM GUIDANCE FOR FREEWAY SAFETY ANALYSIS
(MAY 1, 2020)**

CITY OF LOS ANGELES

CALIFORNIA

SELETA J. REYNOLDS
GENERAL MANAGER



ERIC GARCETTI
MAYOR

DEPARTMENT OF TRANSPORTATION

100 South Main Street, 10th Floor
Los Angeles, California 90012
(213) 972-8470
FAX (213) 972-8410

May 1, 2020

Transportation Engineering and Planning Consultant Firms

Subject: LADOT Transportation Assessments - Interim Guidance for Freeway Safety Analysis

On July 30, 2019, the City of Los Angeles adopted vehicle miles traveled (VMT) as a criteria in determining transportation impacts under the State's California Environmental Quality Act (CEQA). This was required by Senate Bill (SB) 743 and the adoption of Section 15064.3 to the CEQA Guidelines. SB743 also provided that the change from delay, as described by level of service (LOS), to VMT analysis as the CEQA metric does not relieve a public agency of the requirement to analyze a project's potential significant impacts related to air quality, noise, safety, or any other impact associated with transportation. The purpose of this memorandum is to provide interim guidance on the preparation of freeway safety analysis for land use proposals that are required by LADOT to prepare a Transportation Assessment.

BACKGROUND

This freeway safety analysis interim guidance will help address the recent comment letters sent by Caltrans District 7 to the Department of City Planning on development project environmental documents. In these letters, Caltrans requested that environmental analyses for new land use development projects include freeway off-ramp safety considerations. Specifically, they requested that the City evaluate a development project's effects on vehicle queuing on freeway off-ramps. Such an evaluation would measure a project's potential to lengthen a forecasted off-ramp queue and create speed differentials between vehicles exiting the freeway off-ramps and vehicles operating on the freeway mainline.

In order to respond to these comment letters in absence of published guidelines by Caltrans that evaluate safety concerns on freeways, the City of Los Angeles Department of City Planning, in collaboration with LADOT and the Los Angeles City Attorney's Office, convened a Freeway Analysis Technical Working Group that included transportation engineering, planning, and environmental firms with a long history of preparing transportation analyses in Southern California. The goal of this Working Group was to establish interim guidance on how transportation assessments for land use proposals should review and analyze potential safety impacts on the freeway system. The Working Group, which met weekly throughout the month of April 2020, developed the steps described below to conduct a freeway safety analysis to determine if a project may potentially result in off-ramp queuing and differential travel speeds that could constitute a potential safety impact under CEQA.

The Working Group included staff from LADOT, the Department of City Planning, Los Angeles City Attorney's Office, and the following consultants:

- Cambridge Systematics, Inc.
- Gibson Transportation Consulting, Inc.
- Fehr & Peers
- Hirsch/Green Transportation Consulting, Inc.
- Iteris, Inc.
- Linscott, Law & Greenspan, Engineers
- The Mobility Group
- Overland Traffic Consultants
- Rincon Consultants, Inc.

It should be noted that new Caltrans Transportation Study Guidelines are expected to be released later this year to meet the State's deadline of July 1, 2020, which requires all California agencies to comply with SB743. Caltrans announced that their new guidelines will include a State Highway System safety analysis section. Therefore, the City's interim guidance is expected to be revisited once Caltrans releases the State guidelines to determine if changes are necessary.

FREEWAY SAFETY ANALYSIS STEPS

Effective immediately, land use development projects within the City of Los Angeles that are required to prepare a transportation assessment shall conduct a freeway safety analysis as follows:

1. Identify the number of Project trips expected to be added to nearby freeway off ramps serving the site. If the Project adds 25 or more trips to any off ramp in either the morning or afternoon peak hour, then that ramp should be studied for potential queueing impacts following the steps below. If the project is not expected to generate more than 25 or more peak hour trips at any freeway off-ramps, then a freeway ramp analysis is not required.
2. Using Synchro analysis software, or similar tools, prepare a queuing study for the "Future with Project" conditions for the proposed project build-out year. LADOT's Transportation Assessment Guidelines provide recommended steps to forecast future traffic volumes.
3. To evaluate the adequacy of the existing and future storage lengths, use the 95th percentile queue provided from the Synchro results worksheet, and use 100% of the storage length on each lane of the ramp from the stop line to the gore point. If an Auxiliary Lane exists, add 50% of the length of the auxiliary lane to the ramp storage area.
4. If the Project traffic is expected to cause or add to a queue extending onto the freeway mainline by less than two car lengths, the project would cause a less-than-significant safety impact. If the queue is already extending or projected to extend onto the freeway mainline, and the Project increases the overflow onto the mainline lanes by less than two car lengths, the project would cause a less-than-significant safety impact. If the Project adds two or more car

lengths to the ramp backup that extends to the freeway mainline, then the location must be tested for safety issues which include a test for speed differential between the off-ramp queue and the mainline of the freeway during the particular peak hour.

5. The speed differential would identify the operating speed of the freeway mainline lanes during the peak hour that corresponds to the peak hour during which the ramp is expected to experience project-related queue overflow. Caltrans Performance Measurement System (PeMS) data should be used to identify freeway operating speed(s) during the peak hour being analyzed. If reliable PeMS data are not available at the subject location, other sources of speed data including location-based services data from available sources could be used.
6. If the speed differential between the mainline lane speeds and the ramp traffic is below 30 mph, the project would be considered to cause a less-than-significant safety impact.
7. If the speed differential is 30 mph or more, then there is a potential safety issue. To offset this potential condition, the project should consider the following preferred corrective measures:
 - a. Transportation demand management program(s) to reduce the project's trip generation,
 - b. Investments to active transportation infrastructure, or transit system amenities (or expansion) to reduce the project's trip generation, and/or
 - c. Potential operational change(s) to the ramp terminal operations including, but not limited to, lane reassignment, traffic signalization, signal phasing or timing modifications, etc. This option requires coordination with Caltrans and LADOT to assess feasibility and for approval of the proposed measure(s).

A physical change to the ramp itself (addition of auxiliary lane, ramp widening, etc.) may be considered. However, this change would have to demonstrate substantial safety benefits, not be a VMT-inducing improvement, and not result in other environmental issues.

8. If the cost of the physical change to the ramp is substantial, then a fair-share contribution to the improvement may be required if necessary requirements are met, including, but not limited to, Caltrans defining the improvement cost, and opening a Project File/Project Account to accept a financial contribution for the improvement. If required, the Applicant would pay the Project's fair-share of the improvement cost, and the fair-share contribution would be deposited in the Project Account to be used for the identified improvement.

We understand that Caltrans' direction on evaluating transportation impacts under CEQA continues to evolve. Relevant State documents are being drafted for release later this year, including a VMT-focused Transportation Impact Study Guide that guides Caltrans comments on land use project EIRs of local agencies, and a Transportation Analysis Framework that addresses how Caltrans evaluates the CEQA impacts of capacity-increasing projects on the State Highway System (SHS). While we look to these guidance documents to inform our methodology of safety impacts on freeway facilities, we release this

interim guidance to inform practitioners on the technical approach, developed by the Working Group that can be applied to project-level Transportation Assessments immediately.

If you have any questions, please email me at tomas.carranza@lacity.org or call me at 213-435-4056.

Sincerely,

A handwritten signature in black ink, appearing to read 'T. Carranza', with a long, sweeping underline.

Tomas Carranza, PE

Principal Transportation Engineer

c: Kathryn Phelan / John Fox, City Attorney's Office
Lisa Webber / Arthi Varma / Luci Ibarra, DCP
Rubina Ghazarian / Eddie Guerrero / Jesus Serrano, LADOT

Attachment 1
Freeway Safety Analysis Working Group
Findings

The City of Los Angeles formed a Working Group made up of City staff and transportation engineering and planning consultants to develop a policy to respond to Caltrans' requests that off-ramp safety considerations be included in the environmental analyses for new development projects. While SB 743 calls for the inclusion of safety considerations, Caltrans District 7 verbal and written comments focus on the potential backup of off-ramps onto the mainline freeway lanes as their primary safety concern.

Since Caltrans has not established a methodology or thresholds based on substantial evidence, the Working Group was tasked with developing a freeway safety analysis based on research, local traffic conditions, and best practices. The Working Group met weekly during the month of April 2020 to share research into the number of project trips that should constitute a threshold for triggering an off-ramp investigation, the issue of speed differential and its relationship to freeway safety, the ability to collect reliable mainline freeway speed data, and a study process to identify freeway locations where queuing and speed differential is a concern that should be addressed.

RECOMMENDED POLICY DRAFT

The recommendations by the Working Group, which are summarized in the cover memorandum, were developed based on research, a review of best practices, and an analysis of local data. The first step was to determine when an off-ramp near a proposed project should be studied. The consultants participating in the Working Group researched their previous project transportation assessments to identify the level at which project-related traffic can cause traffic to back up onto the freeway. From these case studies, over 100 off-ramps were evaluated and it was determined that very few of these locations were expected to result in queues extending onto the freeway. So, this is not a common occurrence.

Project trips added to an off-ramp varied between one trip and over 100 trips per hour. Very rarely did an evaluated off-ramp result in a projected back-up onto the mainline.

Screening Threshold

The Working Group recommended a screening threshold of 25 or more project trips during a peak hour assigned to an off-ramp as the threshold for selecting that off-ramp for further study. The consultants on the Working Group cited inconsistencies in the direction given by Caltrans District 7 for different projects. In one case, a large land use proposal near the junction of two major downtown freeways was estimated to generate over 800 trips in each of the peak hours. Caltrans requested the analysis of up to 16 interchange ramps. During the project traffic assignment, the project was expected to generate 25 or more peak hour project trips at only four of the off-ramps. A screening threshold of 25 or more project trips was identified by the Working Group as a reasonable threshold to measure those ramps

where congestion already exists, while eliminating the locations where the addition of fewer project trips is not expected to cause a backup onto the freeway.

Speed Data Source

The Working Group discussed the premise that a queue extending onto the freeway mainlines is a safety concern when the speed on the freeway was high enough to potentially lead to a collision because freeway mainline traffic did not have enough time to stop safely. So the group discussed how to consistently determine the actual operating speed of the mainline of a particular freeway, in the appropriate direction, during the affected peak hour. Two data sources were discussed: Caltrans Performance Measurement System (PeMS) data and big data platforms that aggregate location based services data such as StreetLight Data, NPMRDS, or other available sources.

The group agreed that the needed speed data can be collected from PeMS - a source managed by Caltrans. PeMS data can be obtained in graphic and tabular formats which make it easy to identify the mainline speed at the correct spot on the freeway during the right hour in the appropriate direction. The group determined that for some of the freeways with relatively less traffic (e.g., SR 170), there were freeway segments where the data points were less robust. Freeway segments near Downtown Los Angeles, Hollywood, and the West side did not have this problem.

Speed Differential

The Working Group evaluated the amount of speed differential that could be used to define a safety issue. A freeway mainline operating at slow speeds during the peak hour did not present the safety concerns compared to a mainline operating at higher speeds.

Research revealed hundreds of studies related to speed differential analyses with not much agreement on their effects on safety. However, the research did yield information on the severity of collisions at varying speeds. The two most relevant studies suggested 30 mph as the critical speed differential level that would apply to freeway segments. The Caltrans Design Manual does not provide Decision Sight Distance readings for speeds less than 30 mph, implying that speeds less than 30 mph may not be an issue on freeway segments.

According to the [Texas Transportation Institute](#): “Drivers are usually aware that they are closing in on a slower vehicle; however, if there is a large speed differential (over 25 mph) they often have a very poor perception of just how quickly they are closing in until they get very close to the slower vehicle. Often that can be too late, especially when the faster vehicle is a heavy vehicle that needs more room to brake. The slower vehicles risk getting rear-ended; the faster ones risk being cut off by turning or lane-changing drivers who think they have an adequate gap in traffic but do not.”

Based on this literature research, the Working Group selected 30 mph as the speed differential included in this interim guidance. At less than 30 mph, the stopping sight distance related to driver’s perception and reaction times is much lower, thereby minimizing the potential for a collision.