

EXHIBIT D-1

Gilpin Geosciences, Inc
Earthquake & Engineering Geology

March 7, 2019
91650.01

Annalee Sanborn
PPI Engineering, Inc.
2800 Jefferson Street
Napa, California 94558

**SUBJECT: Engineering Geological Investigation
Hibbard Vineyard,
Henry Road
Napa, California**

Dear Ms. Sanborn:

We are pleased to present the results of our investigation of the Hibbard Ranch Vineyards located in the Carneros District as shown on Figure 1. The proposed vineyard development is located on Henry Road southwest of the incorporated City of Napa. The site consists of approximately 425 acres. Unimproved dirt roads and tracks access the site. Numerous structures are located on the west side of Henry Road that serve as storage and working facilities for the farming operation. The proposed development involves installation of 9 vineyard blocks across the upland areas of the ridges overlooking the Carneros Valley.

SCOPE OF SERVICES

The purpose of this investigation was to review the proposed vineyard development for impacts on surface erosion and slope stability. In order to accomplish this, we performed the following tasks:

- reviewed published and unpublished reports and maps of the site;
- reviewed aerial photographs;
- logged 18 test pit excavations on 14 & 15 May 2018;

- performed a geologic reconnaissance on 15 May 2018 and 30 January 2019; and
- prepared this report.

REGIONAL GEOLOGY

The site is located in the Coast Ranges geomorphic province, which is characterized by northwest-southeast trending valleys and ridges. These are controlled by folds and faults that resulted from the collision of the Farallon and North American plates and subsequent shearing along the San Andreas fault.

The site lies within the Carneros District that wraps around the southeastern end of the Mayacamas Mountains, locally dominated by Mt Veeder. Although the surface exposes much younger deposits, bedrock of the Great Valley Sequence underlies the Carneros District (Figure 2). The Great Valley Sequence is composed of sediments deposited in an elongate basin located between the Mesozoic (~100 million years ago) volcanic arc, now preserved in the Sierra Nevada, and the Coastal Mountains and subduction zone trench to the west. The strata underlying the Carneros is an approximately 3.5 km thick slab of sand-rich sediments that is tilted gently to the east. These sedimentary rocks are exposed in the Mayacamas Mountains on Mt Veeder, to the north of Carneros.

Tertiary Sonoma Volcanics cap most of the mountains north of the Carneros and are exposed between Highway 29 and Old Sonoma Road. The volcanic deposits are the result of major changes in the earth's plate movements. The San Andreas fault zone originated about 17 million years ago when the plate movement geometry changed from collision and subduction to oblique movements that culminated in the right lateral movement between the North American and Farallon Plates that characterizes the San Andreas today. This abrupt change triggered the northward migration of a plate boundary triple junction, now

located near Mendocino. The slow northward movement of this unique junction was characterized by effusive volcanics that can be traced by their decreasing northward age. The Sonoma Volcanics are the legacy of this northward migration in the Carneros District. The Sonoma Volcanics are composed of rhyolite and andesite lavas interfingering with ash flow tuffs. These volcanics cap the Great Valley Sequence sedimentary rocks and are mapped at the upper elevations of Mt Veeder north of Carneros, and on the western side of the Carneros Valley (Figure 2).

The bedrock in the site vicinity is distinctly divided by the Carneros fault that separates the two bedrock units in the vicinity (Figure 2). The Carneros fault traverses the southwest end of the site. The Carneros fault is an ancient fault that shows no activity during the last 2 million years (Fox, 1983). To the east of the generally northwest-southeast trending Carneros fault, Great Valley Sequence mudstones and siltstones are mapped (Graymer et al., 2007; Fox and others, 1973).

The Huichica Formation composed mostly of gravelly sediments is the most widespread mapped unit in Carneros. It is the result of stream deposition in the Miocene (~4 million years ago) from the Mayacamas Mountains rising to the north, similar to the more recent broad alluvial fan deposition evident in the Valley of the Moon and lower courses of the Napa River.

SEISMICITY

The site lies in a seismically very active area and has been subject to strong shaking caused by earthquakes on nearby faults. The major active faults in the region include the West Napa, Rodgers Creek, Concord-Green Valley, Hunting Creek, Maacama, and San Andreas faults.

The 2014 South Napa Earthquake (M 6.0) is believed to have occurred on the West Napa fault approximately 11 km south of the site and caused significant damage in Napa and surrounding communities.

The 2000 Napa Earthquake (M. 5.2) was centered in the hills between Napa and Yountville approximately 9.6 km northwest of the site. It produced moderate ground shaking and minor damage in the residential areas west of downtown Napa.

The Rodgers Creek fault that lies 16 kilometers west of the site in the Sonoma Valley has experienced the most recent significant activity that includes the 1969 Santa Rosa earthquakes. Two earthquakes occurred on 1 October 1969 near the junction of the northern end of the Rodgers Creek and the southern end of Healdsburg faults (Steinbrugge, and others, 1969). The two Santa Rosa Earthquake magnitudes were 5.6 and 5.7, respectively and were separated by 83 minutes.

The Concord-Green Valley, Hunting Creek, Maacama, and San Andreas faults lie 19, 23, 41 km and 47 km from the site, respectively and are capable of Magnitude 6.6 to 7.9 earthquakes.

The U.S. Geological Survey's 2014 Working Group (2013) on California Earthquake Probabilities has compiled the earthquake fault research for the San Francisco Bay area in order to estimate the probability of fault segment rupture. They have determined that the overall probability of moment magnitude 6.7 or greater earthquake occurring in the San Francisco Region during the next 30 years (starting from 2014) is 72 percent. The highest probabilities are assigned to the Hayward Fault (Rodgers Creek), Calaveras Fault, and the northern segment of the San Andreas Fault. These probabilities are 14.3, 7.4, and 6.4 percent, respectively.

SITE CONDITIONS

We evaluated site conditions based on aerial photograph interpretation, a geological reconnaissance and logging of 18 test pits (Figure 4A & 4B). We used available LIDAR mapping to analyze the site geology (Figure 3).

A drainage, tributary to the Carneros Creek divides the site roughly in half. The tributary flows southwest between two prominent northeast-southwest trending ridges. The tributary has eroded a relatively flat-bottomed valley with gently sloping benches between the channels and adjacent hillsides. The vineyard elevations on the site range from approximately 380 feet (MSL) on Block 9 to over 860 feet on Block 6 D near the northern corner of the property.

Hummocky topography between Blocks 4 and 5 (Figures 3 and 4A) that appears eroded on the LIDAR map (Figure 3) is underlain by old alluvial deposits. An area of the site south of Block 4 and west of Block 2 appears to have been quarried at some time in the past. Cut slopes and hummocky topography is typical of areas subject to past grading activities.

Site Geology

The site has been mapped by Graymer et al., (2007), Fox and others (1973), and Dwyer and others (1976). Fox and others (1973) mapped Great Valley Sequence sedimentary rocks composed of mudstones, siltstones and minor amounts of sandstones. Bedding in the Great Valley Sequence is oriented roughly northwest-southeast with dips to the north from 37 degrees to 80 degrees. We identified prominent northwest-southeast trending anticline/ syncline pair at the north end of the site that trends similar to the Carneros fault to the southwest.

The fold axes control the local bedding dips which vary from 25 to 45 degrees toward the northeast and southwest.

The Carneros fault trends northwest-southeast along the main creek valley and forms a fault contact with the San Ramon Sandstone, a bluish-gray to light brown sandstone, cropping out on the southwestern end of the ridges along Henry Road in the site vicinity. A thin area along Henry Road crops out a distinct white sandstone, siltstone and sandy shale unit of about the same age as the San Ramon. The San Ramon Sandstone unit is mapped with an approximately east-west strike and a 65 southerly dip.

Dwyer and others (1976) compiled a photo-interpretation landslide map of the Napa and Sonoma 7.5 minute U.S. Geological Survey topographic quadrangles. They show numerous active landslides on the site. A large landslide complex is mapped on the northwest-facing slope, extending between vineyard Blocks 6C and 4A (Figure 4A). Another landslide complex is mapped just north of vineyard Block 7D and it incorporates part of Block 7A. Smaller landslide zones are mapped to the northwest and southeast of the western end of vineyard Block 1B.

We mapped surficial deposits at the site as shown on Figures 4A & 4B. Landslides are mapped and characterized by activity, type, depth and certainty. The landslides include slump, debris and earthflow type deposits. Active landslides are mapped based on the sharpness of the surface features associated with the deposit. Well defined and sharp features such as open cracks in the head scarp area, bulging and ground cracked toe areas and bulging ground surface areas, "mole tracks", mark the lateral margins of the active slide. Whereas surface features associated with dormant or inactive landslides are marked by rounded to very subtle head scarp areas, a lack of fresh scarps and subdued toe areas. Lateral margins of dormant landslides do not have fresh scarps and "mole tracks" composed of loose soil.

We mapped only one significant dormant landslide at the western edge of the property between vineyard Blocks 4A and 6B. It appeared from our aerial photograph and site review that the main body of this dormant landslide, is subject to erosion along the margins, and experiences ongoing creep movement.

Many of the landslides we mapped on this site extend from the relatively steep side slopes of the valley down into the main drainage channels. This is observed along the both the minor secondary or tertiary tributaries that drain the uplands of the site as well as the drainage that flows along the centerline of the site. We noted landslides and localized soil creep encroaching on the prominent ridgeline proposed for vineyard Block 7 development.

The surficial geology of the site is characterized by widespread alluvial fan deposits that emanate from the highly eroded upland areas of the Mayacama Mountains and higher elevations of the site (Figures 4A & 4B). We found alluvial deposits in many of the test pits characterized by clayey gravel with sand and clayey sand with gravel that we identify as similar to Huichica Formation deposits mapped in the vicinity (Figures 4A & 4B). Where mapped and explored, they constitute relatively shallow alluvial deposits that are highlighted by distinct surface morphology and show localized evidence of soil creep.

We mapped fill in areas that were subject to grading in the past. One pile of old fill was placed on top of the dormant landslide just northeast of Block 4, and has probably contributed to the slope movement in the vicinity (Figures 4A).

Subsurface Conditions

We explored the site by excavating and logging 18 test pits at locations shown on Figure 4A & 4B. The test pits encountered fill, colluvium¹, sandstone, and shale. We have compiled the geologic data on the Site Plan and Geologic Map and present our interpretation of subsurface conditions on the Geologic Cross Sections shown on Figures 5A & 5B.

Colluvium was encountered in almost all of the test pits to depths of 6-inches to 3.5 feet below ground surface (BGS). Residual soil weathered from the underlying bedrock was common in the test pits and formed a layer between the colluvium and the bedrock surface up to 2.5 feet thick. We identified tuffaceous material interlayered in the residual soil in Block 1 at test pits TP-13, TP-14, and TP-16. Numerous test pits exposed alluvial deposits of the Huichica Formation characterized by clayey gravels and clayey sand with gravel. The decomposed gravel clasts are evidence of old deposits having been subject to long-term weathering.

We encountered fractured moderately to deeply weathered, interbedded siltstone and sandstone in the test pits. At Test Pit TP-2 in Block 6 we encountered a massive sandstone near the surface that was weak to moderately strong and moderately weathered. Test Pit 13 in Block 1 exposed fractured siltstone that was thinly bedded, weak to moderately strong, and little to moderately weathered.

CONCLUSIONS AND RECOMMENDATIONS

The proposed vineyard development is feasible from the standpoint of erosion control and slope stability. However, active and dormant landslide mapped on

¹ Colluvium – a deposit caused by the gravitational accumulation of soil, weathered rock, and organic matter on a hillslope.

the site lie adjacent to proposed vineyard areas and concentrated surface water flow should not be allowed to drain onto unstable areas of the slopes. Typically the vineyard blocks are located at the top of the gently rounded ridge lines, or along the toe of the slopes where the benches define the drainage channel limits. Both of these areas are prone to encroachment by slope creep and landslide movement.

Excessive watering of the vineyard blocks can lead to accelerated soil creep and landslide movement. Saturation of the toes of landslides, active or dormant, can trigger localized slope failures because of the nature of the underlying weak material. We recommend a setback, or staging area, along block boundaries that are adjacent to steep slopes or downslope of the toe of landslides. The setback should be a minimum of 50 feet in the blocks specified below. Proper maintenance of the surface water drainage facilities, periodic monitoring and immediate attention to eroded areas, will minimize the impact of the poor slope stability areas to the vineyard blocks.

We mapped older alluvium deposits (Huichica Formation) in several locations across the site that have been previously identified as landslide zones (Dwyer and others, 1976). Although Block 7 should be set back from the active landslide to the north and soil creep areas to the south, we do not believe Block 7A is underlain by landslide deposits as mapped by Dwyer and others, (1976). Rather, it is underlain by older alluvium as mapped in the vicinity (Figure 4B). The limits of Block 7D vineyard as shown on Geologic Cross Section J-J' (Figure 5B) should be set back 25 feet and 50 feet from the top of the southern ridgeline slope and the northern ridgeline slope with the landslide, respectively (Figure 4B, & 5B).

LIMITATIONS

Our services have been performed in accordance with generally accepted principles and practices of the geological profession. This warranty is in lieu of

all other warranties, either expressed or implied. In addition, the conclusions and recommendations presented in this report are professional opinions based on the indicated project criteria and data described in this report. They are intended only for the purpose, site location and project indicated.

We trust that this provides you with the information you need. If you have any questions, please call.

GILPIN GEOSCIENCES, INC.

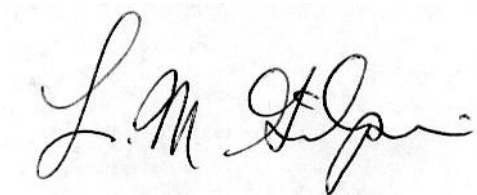

Lou M. Gilpin, Ph.D.
Engineering Geologist

Attachments:

References

Figures:

Figure 1 Site Location

Figure 2 Regional Geology

Figure 3 Site LIDAR Map

Figure 4A & 4B Site Plan and Geology Map

Figure 5 A & 5B Geologic Cross Sections A-A' – K-K'

Appendix:

Figures A1 – A18 Logs of Test Pits

Figure A19 Soil Classification

Figure A20 Physical Criteria for Rock Description

REFERENCES

Dwyer, M. J., Noguchi, N., and O'Rourke, J., 1976, Reconnaissance photo-interpretation map of landslides in 24 selected 7.5 minute quadrangles in Lake, Napa, Solano, and Sonoma Counties, California: U.S. Geological Survey Open File Report 76-74, St. Helena Quadrangle, scale 1:24,000.

Fox, K.F., Jr., 1983, Tectonic Setting of Late Miocene, Pliocene, and Pleistocene rocks in part of the Coast Ranges north of San Francisco, California: U.S. Geological Survey Professional Paper 1239, p. 33.

Fox, K.T., Sims, J.D., Bartow, J.A., and Helley, E.J., 1973, Preliminary Geologic map of Eastern Sonoma County and western Napa County, California: U.S. Geological Survey Miscellaneous Field Studies MF-483, scale 1:62500.

Graymer, R.W., Brabb, E.E., Jones, D.I., Barnes, J., Nicholson, R.S., and Stamski, R.E., 2007, Geologic map and Database of Eastern Sonoma and Western Napa Counties, California: U.S. Geological Survey Scientific Investigations Map 2956, scale 1:100,000.

Steinbrugge, K. V., Cloud, W. K., and Scott, N. H., 1970, The Santa Rosa, California, earthquakes of October 1, 1969: United States Department of Commerce, Environmental Science Services Administration, 99 p.

Aerial Photographs



<u>Date</u>	<u>Photo Number</u>	<u>Scale</u>	<u>Source</u>
11/2/00	CIR-6745-3-19,20,21	1:12,000	PAS
9/1/98	CIR 4900-3-7, 8, 9	1:12,000	PAS
10/8/91	AV 4070-19-20,21	1:12,000	PAS

FIGURES



0 1,000 2,000 4,000 Feet

Legend

-  Proposed Block Boundary
-  Proposed Clearing Limits
-  Property Boundary

USGS Napa and Sonoma Quadrangles

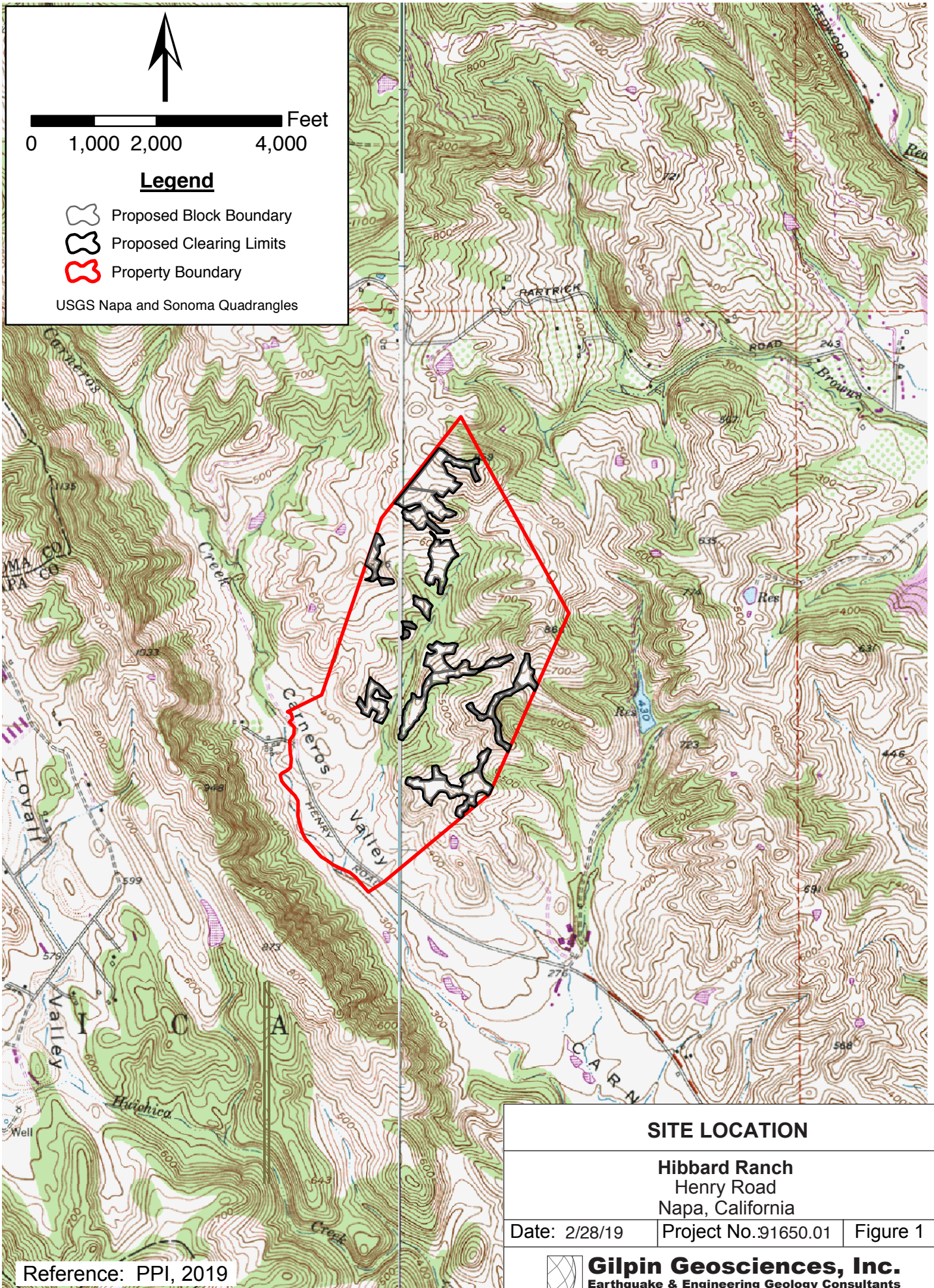

SITE LOCATION

Hibbard Ranch
Henry Road
Napa, California

Date: 2/28/19 Project No. 91650.01 Figure 1

Reference: PPI, 2019



Gilpin Geosciences, Inc.
Earthquake & Engineering Geology Consultants

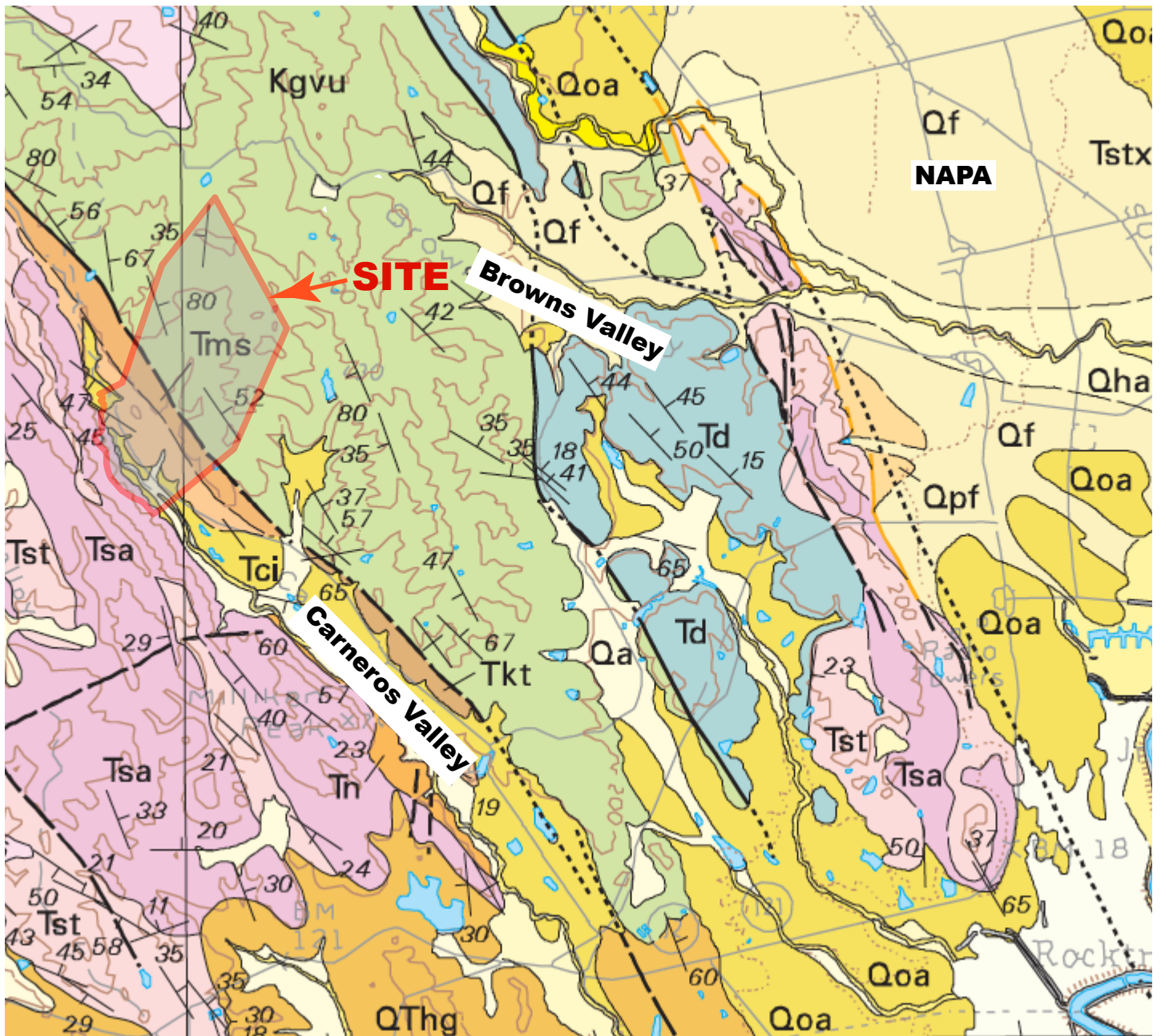

EXPLANATION

Geologic Units

- af - artificial fill
- Qa - alluvium
- Qf - alluvial fan
- Qoa - Alluvium (Pleistocene)
- QThg - Huichica & Glen Ellen Formations, undivided

Sonoma Volcanics

- Tsa - andesitic lava
- Tst - pumaceous ash flow tuff

- Tn - Neroly Sandstone
- Tci - Cierbo Sandstone
- Tms - Sandstone
- Tkt - Kirker Tuff

Great Valley Sequence

- Kgvu

Key

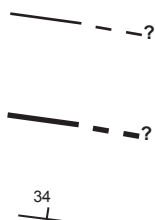

Geologic contact - dashed where covered, queried where uncertain

Fault - dashed where covered, queried where uncertain

Strike of bedding - with direction and magnitude of dip

0 1 mile

Scale

N



REGIONAL GEOLOGY

Hibbard Ranch
Henry Road
Napa, California

Date: 2/28/19

Project No. 91650.01

Figure 2



Gilpin Geosciences, Inc.
Earthquake & Engineering Geology Consultants

Reference: Graymer, et al., 2007; Fox et al., 1973.

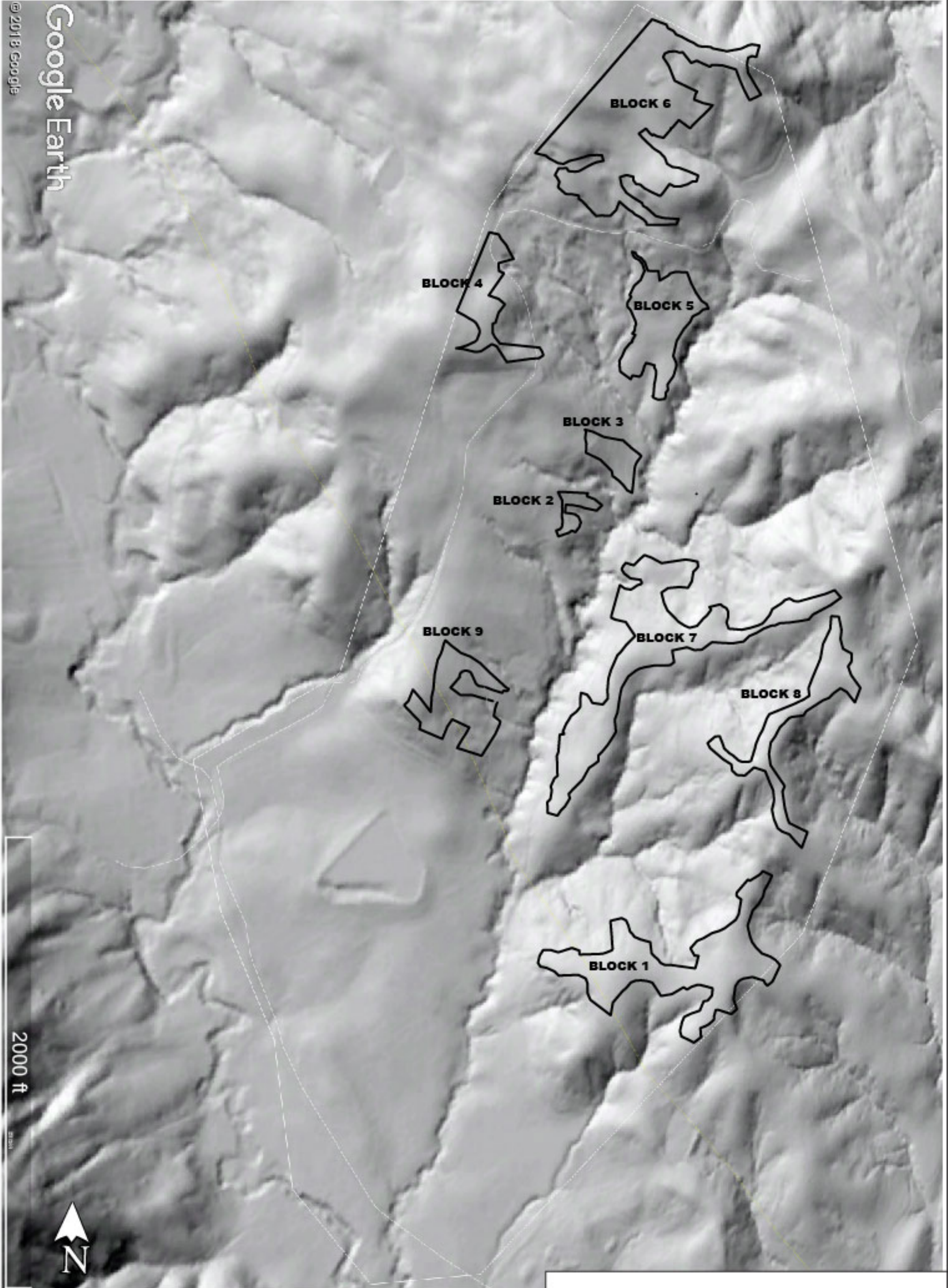

SITE LIDAR MAP

Hibbard Vineyards
Napa, California

JOB NUMBER
91650.01

DATE
2/28/19

FIGURE

3

 **Gilpin Geosciences, Inc.**
Earthquake & Engineering Geology Consultants

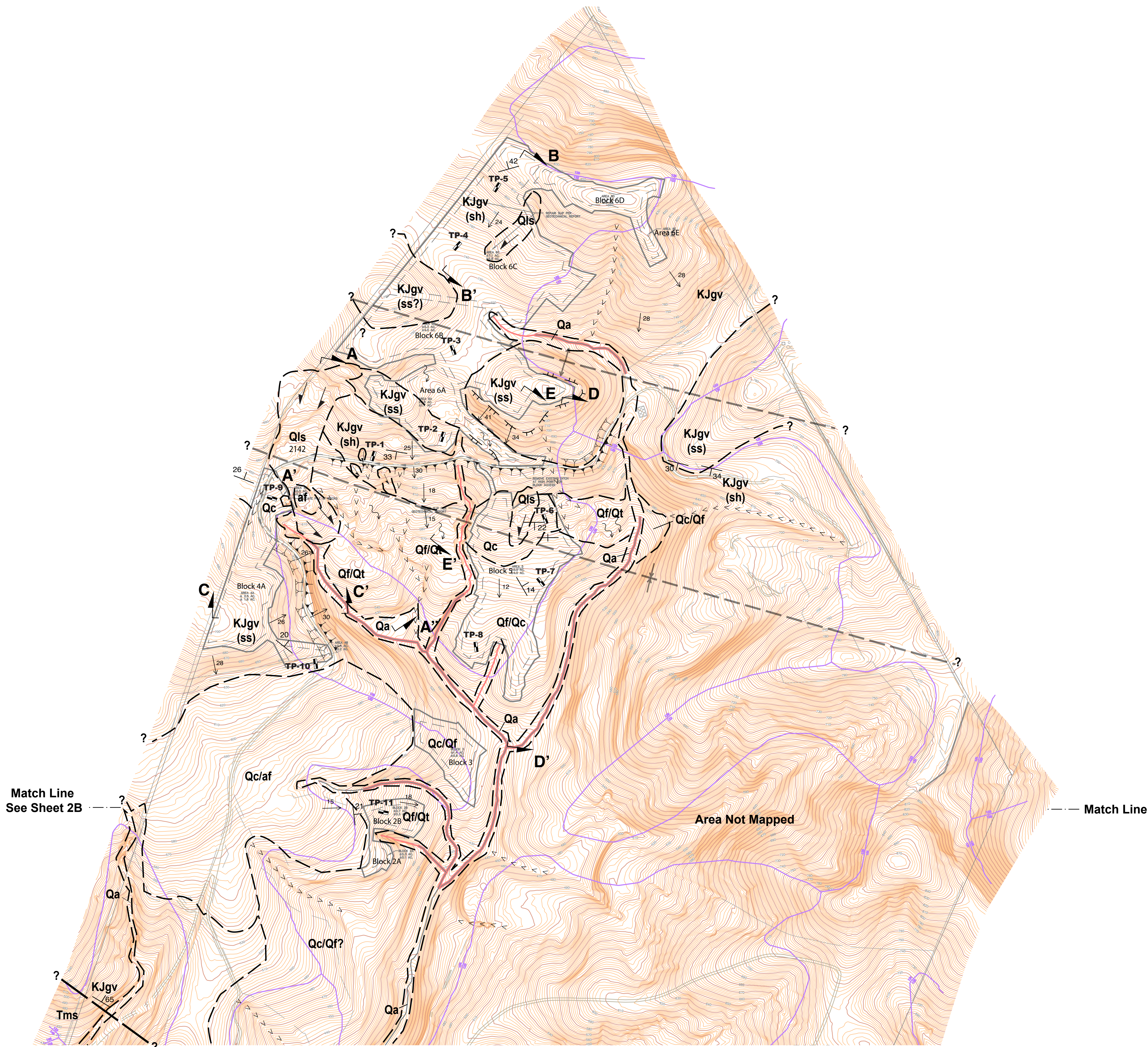

Key

- Geologic Contact
- Anticline queried where uncertain
- Syncline queried where uncertain
- Carmeros fault
- Slope inclination with angle in degrees
- Strike and dip of bedding
- Break in slope
- Soil Creep, disturbed or hummocky surface
- Erosion Gully with depth in feet
- Road cut, hatchures pointed down slope
- Road fill, hatchures pointed down slope
- Line of Cross Sections - See Figure 3 for Cross Sections
- Test Pit location - See Figure A1 through A9 for logs of Test Pits

Geologic Units

- af** Artificial Fill (locally combined with Qf and Qc to designate graded surface; Qf/af or Qc/af)
- Qa** Alluvium, includes alluvial terraces
- Qls** Landslide Deposit
- Qf/Qt** Alluvial Fan/ Terrace Deposits, undifferentiated
- Qc** Colluvium
- Tms** Marine Sandstone and Mudstone
- KJgv** Interbedded Sandstone (ss) and Shale (sh) (Great Valley Complex)

SLOPE STABILITY

- Landslide, scarp area hachured, arrow in direction of downslope movement, compressional toe with debris pushing over the original ground surface by a dash and semi-circle symbol, number associated with mapped deposit described below
- Landslide designation
 - Activity
 - 1 - active
 - 2 - dormant
 - 3 - ancient
 - Type
 - 1 - debris slide
 - 2 - earth flow
 - 3 - slump
 - 4 - rotation
 - 5 - translation
 - 6 - topple
 - Depth
 - 1 0 - 5 ft.
 - 2 5 - 10 ft.
 - 3 10 - 15 ft.
 - 4 15 - 20 ft.
 - 5 20+ ft.
 - Certainty
 - 1 - certain
 - 2 - probable
 - 3 - questionable

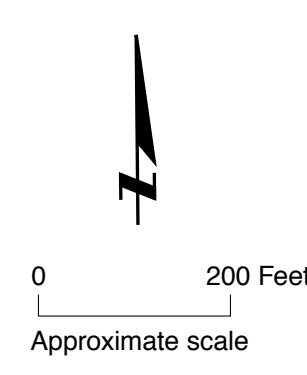

Notes: 1. Standard tape and compass mapping techniques, feature locations are approximate.
 2. See Figure 3 for geologic cross sections.
 3. Topographic Base by PPI Engineering, 5-3-2018.

SITE PLAN AND GEOLOGY MAP		
Hibbard Ranch Henry Road Napa, California		
Date 2/28/19	Project No. 91650.01	Figure 4A
Gilpin Geosciences, Inc. Earthquake & Engineering Geology Consultants		

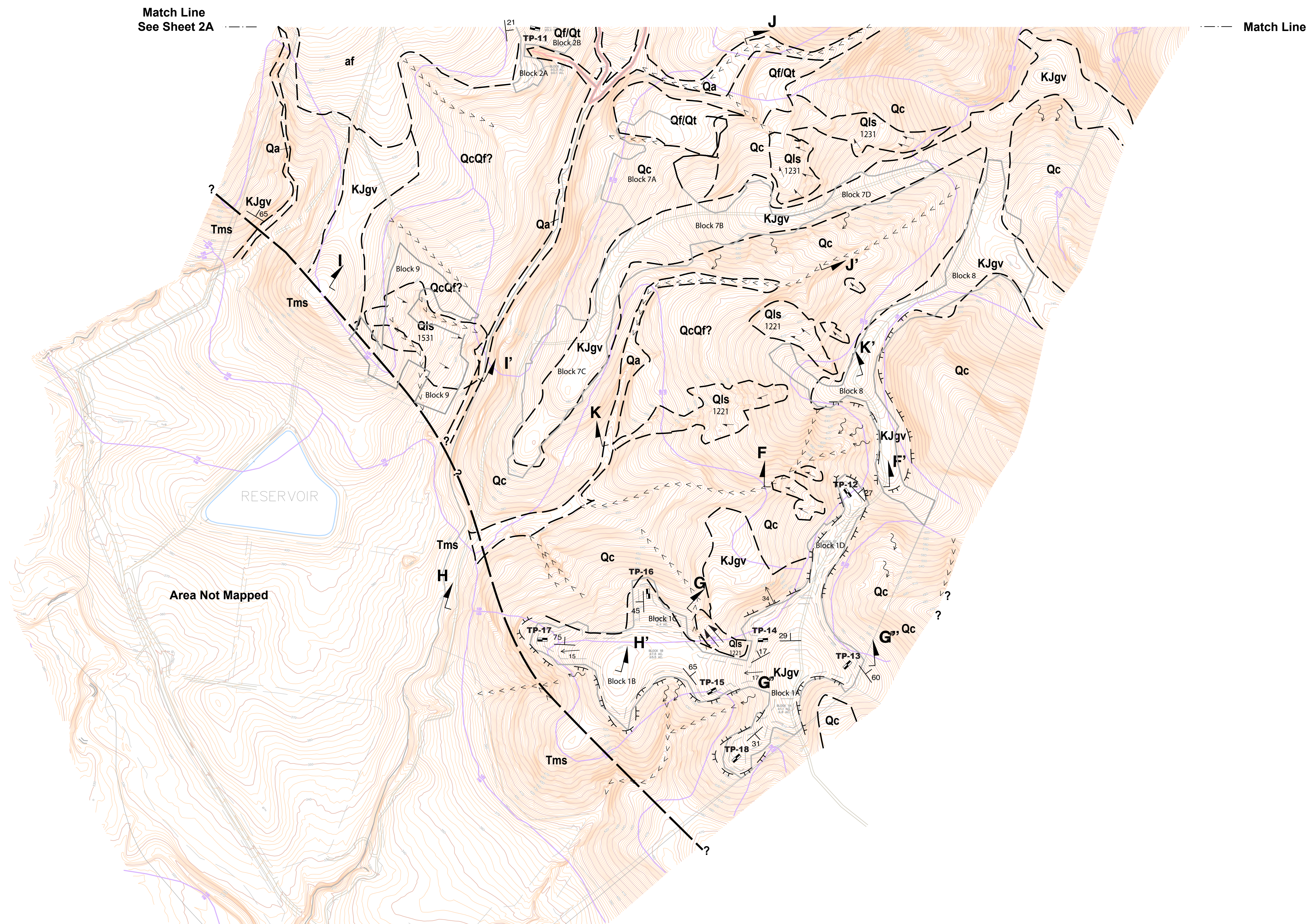

- Key**
- Geologic Contact
 - Anticline queried where uncertain
 - Syncline queried where uncertain
 - Cameros fault
 - Slope inclination with angle in degrees
 - Strike and dip of bedding
 - Break in slope
 - Soil Creep, disturbed or hummocky surface
 - Erosion Gully with depth in feet
 - Road cut, hatchures pointed down slope
 - Road fill, hatchures pointed down slope
 - Line of Cross Sections - See Figure 3 for Cross Sections
 - Test Pit location - See Figure A1 through A9 for logs of Test Pits

- Geologic Units**
- af** Artificial Fill (locally combined with Qf and Qc to designate graded surface; Qf/af or Qc/af)
 - Qa** Alluvium
 - Qf/Qt** Landslide Deposit
 - Qc** Alluvial Fan / Terrace Deposits, undifferentiated
 - Qls** Colluvium (Commonly 1-4 feet thick, creeping and unstable on slopes greater than 2:1 (horizontal to vertical))
 - Tms** Marine Sandstone, Mudstone and interlayered Tuff
 - KJgv** Interbedded Sandstone (ss) and Shale (sh) (Great Valley Complex)

- SLOPE STABILITY**
- Qls** Landslide designation
- Activity
 - 1 - active
 - 2 - dormant
 - 3 - ancient
 - Type
 - 1 - debris slide
 - 2 - earth flow
 - 3 - slump
 - 4 - rotation
 - 5 - translation
 - 6 - topple
 - Depth
 - 1 0 - 5 ft.
 - 2 5 - 10 ft.
 - 3 10 - 15 ft.
 - 4 15 - 20 ft.
 - 5 20+ ft.
 - Certainty
 - 1 - certain
 - 2 - probable
 - 3 - questionable

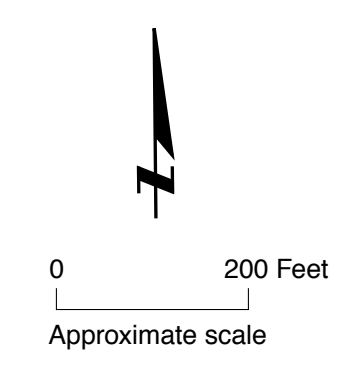

Notes: 1. Standard tape and compass mapping techniques, feature locations are approximate.
 2. See Figure 3 for geologic cross sections.
 3. Topographic Base by PPI Engineering, 5-3-2018.

SITE PLAN AND GEOLOGY MAP		
Hibbard Ranch Henry Road Napa, California		
Date 2/28/19	Project No. 91650.01	Figure 4B
Gilpin Geosciences, Inc. Earthquake & Engineering Geology Consultants		

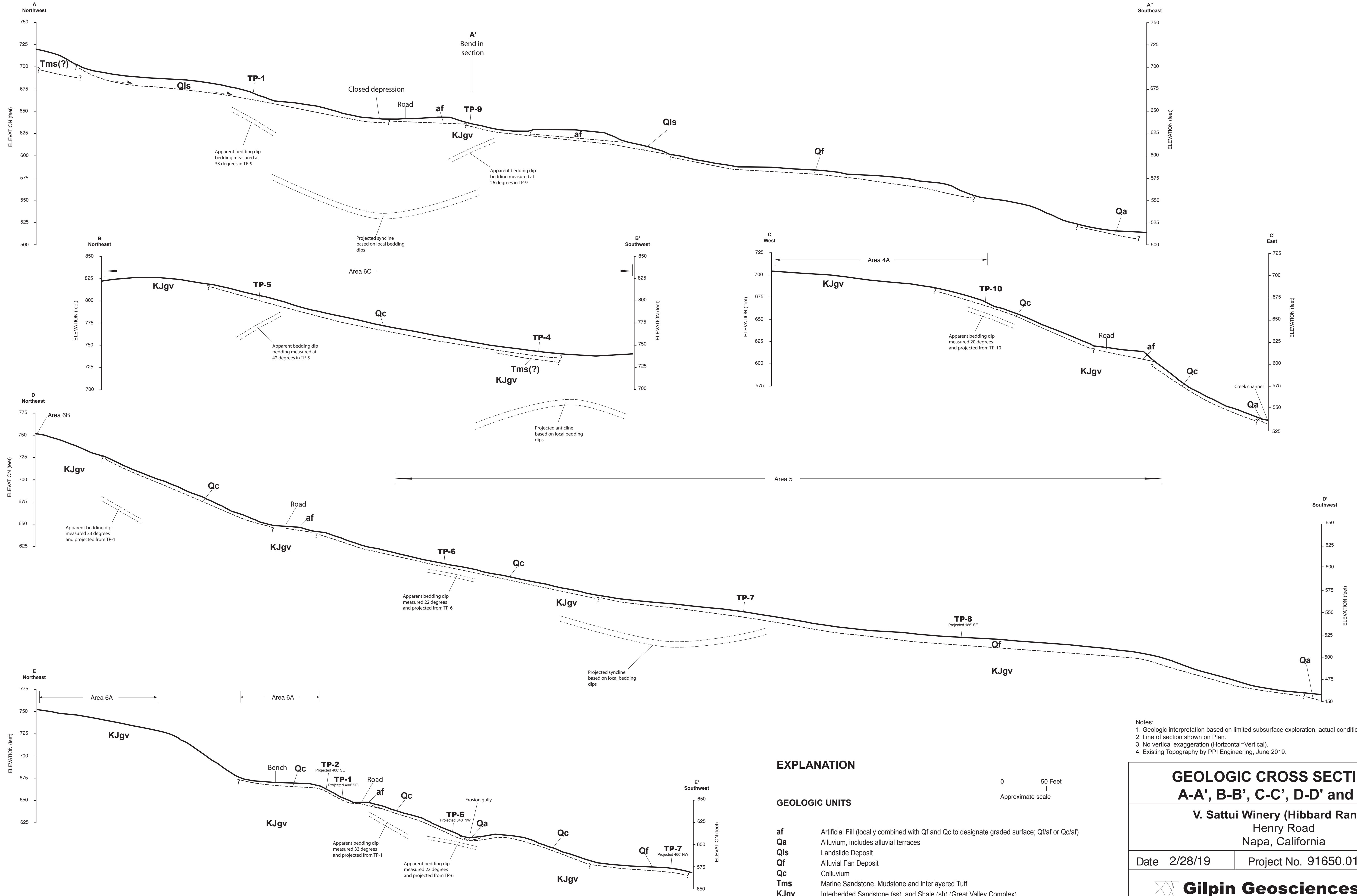

GEOLOGIC CROSS SECTIONS
A-A', B-B', C-C', D-D' and E-E'

V. Sattui Winery (Hibbard Ranch)
 Henry Road
 Napa, California

Date 2/28/19 Project No. 91650.01 Figure 5A

Gilpin Geosciences, Inc.
 Earthquake & Engineering Geology Consultants

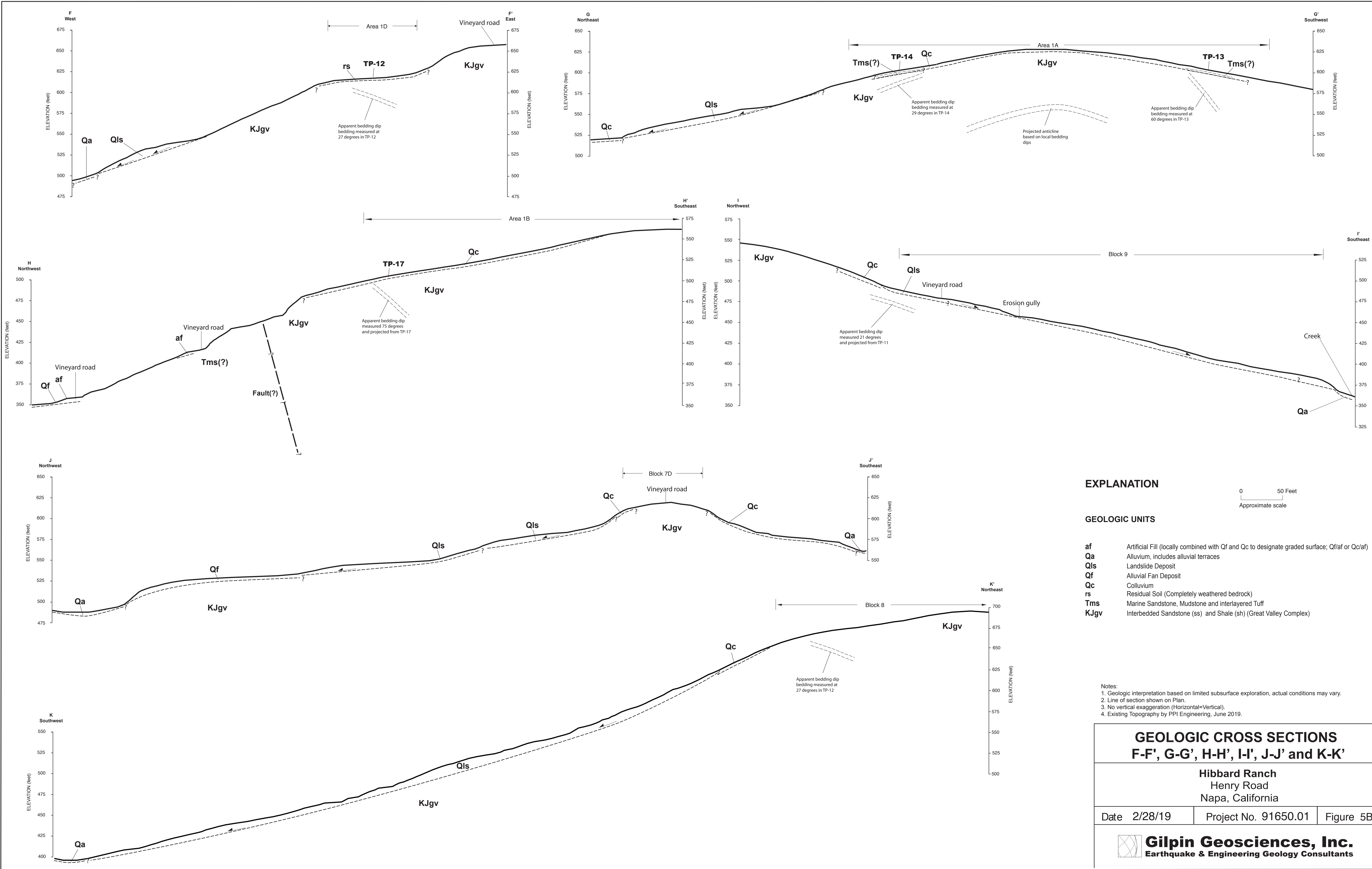

EXPLANATION

GEOLOGIC UNITS

- af** Artificial Fill (locally combined with Qf and Qc to designate graded surface; Qf/af or Qc/af)
- Qa** Alluvium, includes alluvial terraces
- Qls** Landslide Deposit
- Qf** Alluvial Fan Deposit
- Qc** Colluvium
- rs** Residual Soil (Completely weathered bedrock)
- Tms** Marine Sandstone, Mudstone and interlayered Tuff
- KJgv** Interbedded Sandstone (ss) and Shale (sh) (Great Valley Complex)

- Notes:
1. Geologic interpretation based on limited subsurface exploration, actual conditions may vary.
 2. Line of section shown on Plan.
 3. No vertical exaggeration (Horizontal=Vertical).
 4. Existing Topography by PPI Engineering, June 2019.

GEOLOGIC CROSS SECTIONS
F-F', G-G', H-H', I-I', J-J' and K-K'

Hibbard Ranch
 Henry Road
 Napa, California

Date 2/28/19	Project No. 91650.01	Figure 5B
--------------	----------------------	-----------

Gilpin Geosciences, Inc.
 Earthquake & Engineering Geology Consultants

APPENDIX A
Logs of Test Pits

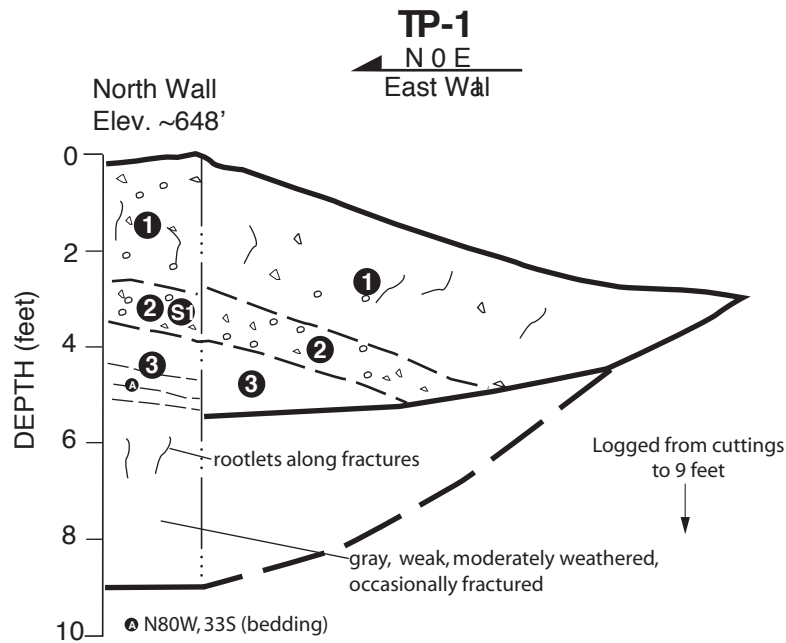

UNIT DESCRIPTIONS

- ① SANDY CLAY with GRAVEL (CL), yellowish brown to dark yellowish brown, slightly moist to moist, stiff, fine sub-angular gravel, rootlets (Colluvium).
- ② CLAYEY SAND to SILT with GRAVEL (SC-ML), yellow, light gray, brown, yellowish orange mottled, slightly moist, medium dense/stiff, decomposed fine gravel (Residual Soil)
- ③ SILTSTONE, grayish brown to olive and gray, reddish brown and yellowish orange oxidized, very thinly bedded, low hardness, friable to weak, deeply to moderately weathered, closely to occasionally fractured (Great Valley Complex).

Notes:

- 1. See figure 2 for test pit locations.
- 2. Ground surface profiles constructed using hand level and tape.
- 3. Horizontal = Vertical Scale.
- 4. Excavated by Case 580 Super M with 24-inch bucket

LOG OF TEST PIT 1		
Hibbard Ranch Henry Road Napa, California		
Date 6/6/18	Project No. 91650.01	Figure A-1
 Gilpin Geosciences, Inc. Earthquake & Engineering Geology Consultants		

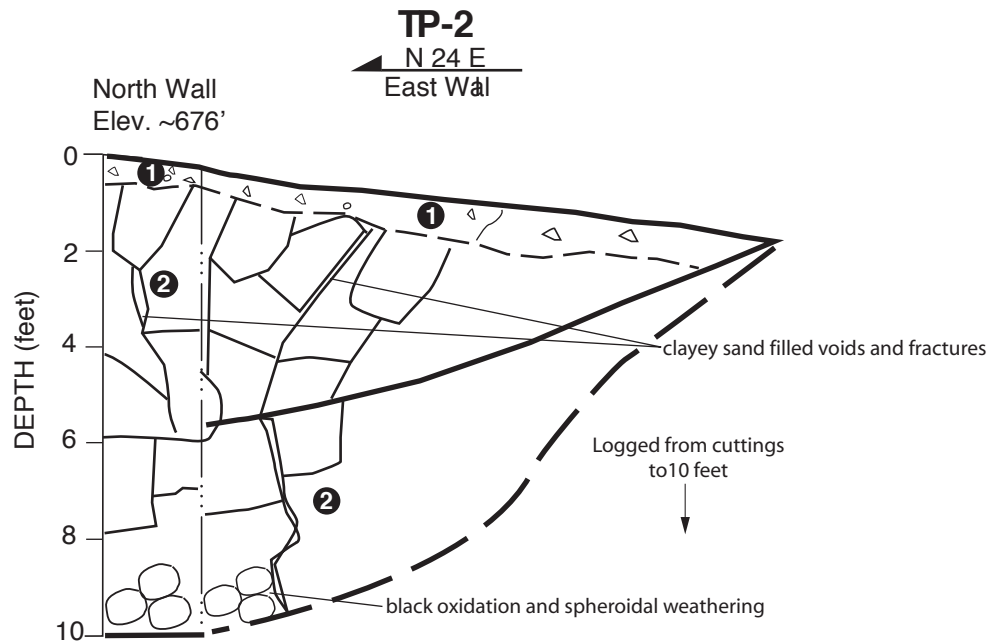

UNIT DESCRIPTIONS

- ① CLAYEY SAND with GRAVEL (SC), brown, slightly moist, loose to medium dense (Topsoil/Colluvium).
- ② SANDSTONE, yellow to yellowish brown, localized black oxidization at 8 to 10 feet, massive, low to moderate hardness, weak to moderately strong, moderately weathered, upper 6 feet is occasionally fractured with dilation and voids up to 6 inches, notable spheroidal weathering and black oxidation from 8 to 10 feet (Great Valley Complex/Landslide Block?).

Notes:

- 1. See figure 2 for test pit locations.
- 2. Ground surface profiles constructed using hand level and tape.
- 3. Horizontal = Vertical Scale.
- 4. Excavated by Case 580 Super M with 24-inch bucket

LOG OF TEST PIT 2		
Hibbard Ranch Henry Road Napa, California		
Date 6/6/18	Project No. 91650.01	Figure A-2
 Gilpin Geosciences, Inc. Earthquake & Engineering Geology Consultants		

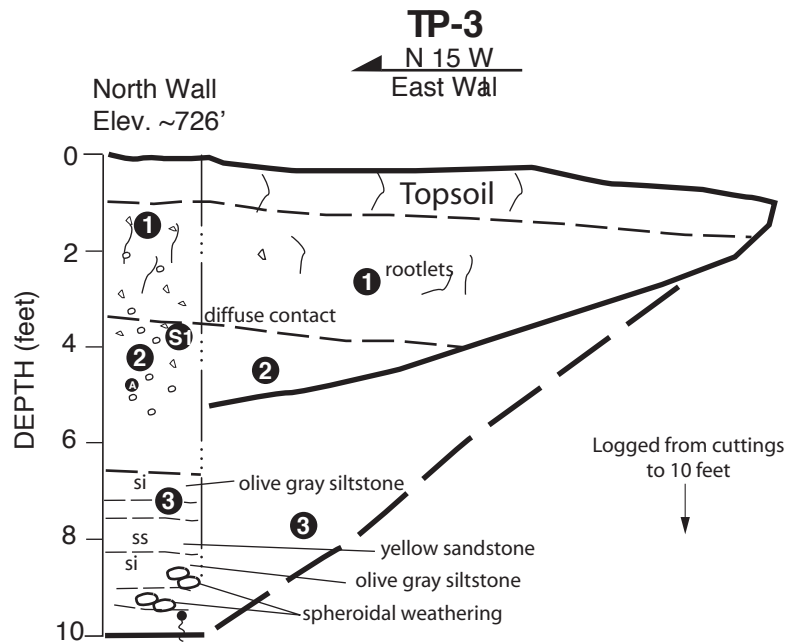

UNIT DESCRIPTIONS

- 1 CLAYEY SAND to SANDY CLAY with GRAVEL (SC-CL), yellowish brown and grayish brown mottled, fine sand to silt, slightly moist to moist, medium dense, trace resistant, fine sub-rounded to sub-angular gravel consisting of decomposed sandstone (Colluvium).
- 2 CLAYEY GRAVEL with SAND to SANDY CLAY with GRAVEL (GC-CL), brown, reddish brown, yellowish red and gray speckled mottling, moist, medium dense/very stiff, abundant decomposed fine gravel, KJf? clasts (Old Alluvium/Huichica Formation?).
- 3 Interbedded SILTSTONE/SANDSTONE, grayish brown to olive brown and gray, reddish brown and black and reddish brown oxidation, very thinly bedded, low hardness, weak, deeply to moderately weathered, closely to intensely fractured, spheroidal weathering, locally (Great Valley Complex).

Notes:

1. See figure 2 for test pit locations.
2. Ground surface profiles constructed using hand level and tape.
3. Horizontal = Vertical Scale.
4. Excavated by Case 580 Super M with 24-inch bucket

LOG OF TEST PIT 3

Hibbard Ranch
Henry Road
Napa, California

Date 6/6/18

Project No. 91650.01

Figure A-3



Gilpin Geosciences, Inc.
Earthquake & Engineering Geology Consultants

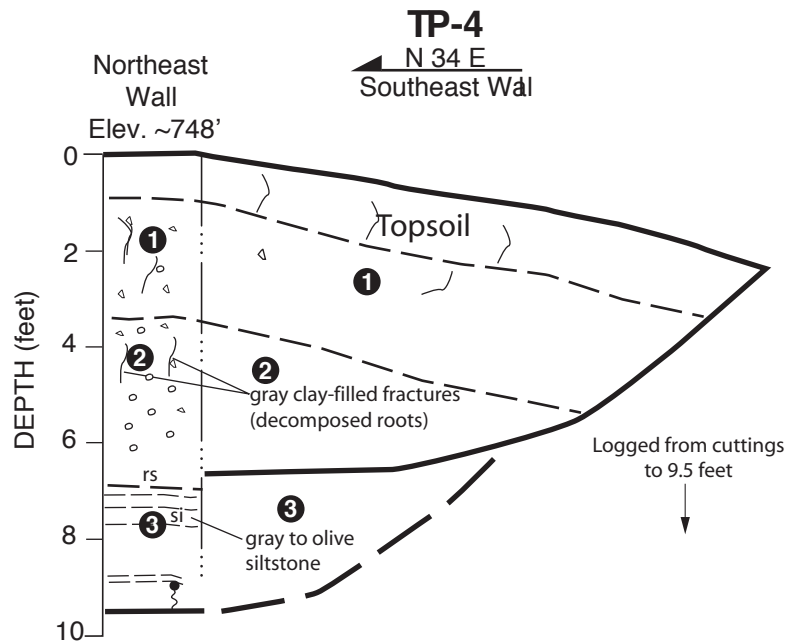

UNIT DESCRIPTIONS

- 1** CLAYEY SAND to SANDY CLAY with GRAVEL (SC-CL), yellowish brown and grayish brown mottled, fine sand to silt, slightly moist to moist, medium dense, trace resistant, fine sub-rounded to sub-angular gravel consisting of decomposed sandstone (Colluvium).
- 2** CLAYEY GRAVEL with SAND to SANDY CLAY with GRAVEL (GC-CL), dark brown, reddish brown, yellowish red and gray speckled mottling, moist, medium dense/very stiff, abundant decomposed fine gravel with KJf? clasts (Old Alluvium/ Huichica Formation?).
- 3** Interbedded SILTSTONE/SANDSTONE, grayish brown to olive brown and gray, reddish brown and black and reddish brown oxidation, very thinly bedded, low hardness, weak, deeply to moderately weathered, closely to intensely fractured, spheroidal weathering, locally (Great Valley Complex).

Notes:

- 1. See figure 2 for test pit locations.
- 2. Ground surface profiles constructed using hand level and tape.
- 3. Horizontal = Vertical Scale.
- 4. Excavated by Case 580 Super M with 24-inch bucket

LOG OF TEST PIT 4		
Hibbard Ranch Henry Road Napa, California		
Date 6/6/18	Project No. 91650.01	Figure A-4
 Gilpin Geosciences, Inc. Earthquake & Engineering Geology Consultants		

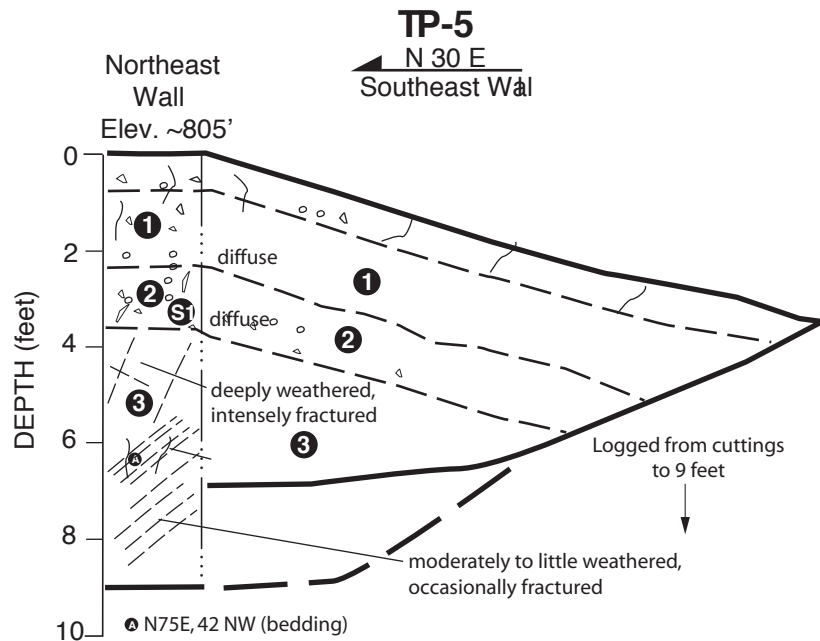

UNIT DESCRIPTIONS

- 1 CLAYEY SAND to SILT with GRAVEL (SC-SM), brown, slightly moist to dry, loose to medium dense, sub-rounded to sub-angular fine gravel, porous, rootlets (Colluvium).
- 2 CLAYEY GRAVEL with SAND (GC), light brown to light yellowish brown, slightly moist, medium dense, sub-angular fine gravel, consisting of decomposed siltstone and sandstone (Residual Soil)
- 3 Interbedded SILTSTONE and SANDSTONE, light brown to grayish brown and olive brown, yellow (sandstone), reddish brown and black oxidized, very-thinly bedded, low hardness, weak, deeply to moderately weathered, closely to intensely fractured, with clay filled fractures, localized spheroidal weathering (Great Valley Complex).

Notes:

1. See figure 2 for test pit locations.
2. Ground surface profiles constructed using hand level and tape.
3. Horizontal = Vertical Scale.
4. Excavated by Case 580 Super M with 24-inch bucket

LOG OF TEST PIT 5

Hibbard Ranch
Henry Road
Napa, California

Date 6/6/18

Project No. 91650.01

Figure A-5



Gilpin Geosciences, Inc.
Earthquake & Engineering Geology Consultants

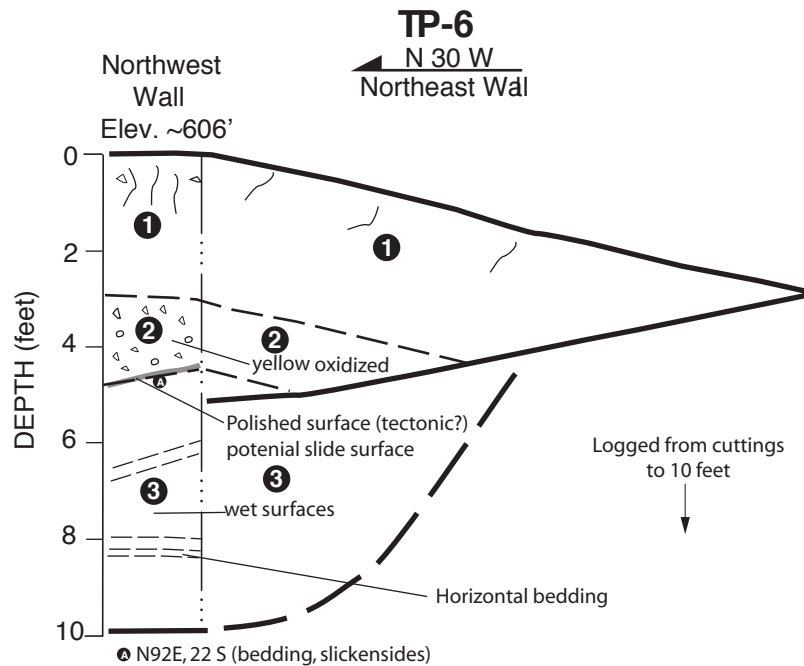

UNIT DESCRIPTIONS

- ① SANDY CLAY to CLAYEY SAND with GRAVEL (CL-SC), grayish brown to dark yellowish brown, dry to moist, medium stiff, fine sub-angular gravel, porous, rootlets (Colluvium).
- ② CLAYEY SAND to SILT with GRAVEL (SC-ML), yellow, light gray, brown, yellowish orange mottled, slightly moist, medium dense/stiff, decomposed fine gravel (Residual Soil)
- ③ SILTSTONE, yellowish brown to olive brown, reddish brown and yellowish orange oxidized, very thinly bedded, low hardness, friable to weak, deeply to moderately weathered, closely to occasionally fractured (Great Valley Complex).

Notes:

- 1. See figure 2 for test pit locations.
- 2. Ground surface profiles constructed using hand level and tape.
- 3. Horizontal = Vertical Scale.
- 4. Excavated by Case 580 Super M with 24-inch bucket

LOG OF TEST PIT 6		
Hibbard Ranch Henry Road Napa, California		
Date 6/6/18	Project No. 91650.01	Figure A-6
 Gilpin Geosciences, Inc. Earthquake & Engineering Geology Consultants		

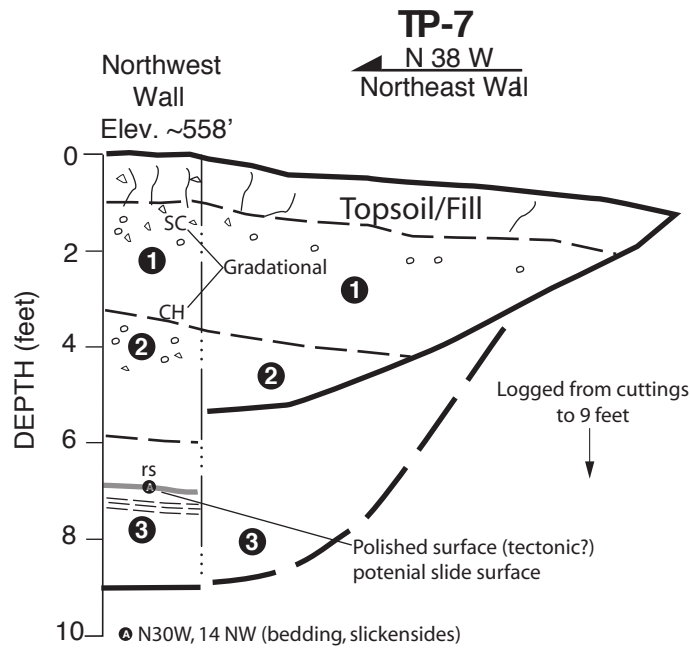

UNIT DESCRIPTIONS

- 1 CLAYEY SAND to SANDY CLAY(SC-CH), pale yellowish brown to light brown, slightly moist to moist, stiff, medium to high plasticity at 3 feet (Colluvium).
- 2 SANDY CLAY with GRAVEL to CLAYEY GRAVEL (CL-GC), reddish brown, with brown and yellow mottling, slightly moist, very stiff/medium dense to dense, fine gravel (Old Alluvium/ Huichica Formation?)
- 3 SILTSTONE, yellowish brown to olive brown, reddish brown and yellowish orange oxidized, very thinly bedded, low hardness, friable to weak, deeply to moderately weathered, closely to occasionally fractured (Great Valley Complex).

Notes:

- 1. See figure 2 for test pit locations.
- 2. Ground surface profiles constructed using hand level and tape.
- 3. Horizontal = Vertical Scale.
- 4. Excavated by Case 580 Super M with 24-inch bucket

LOG OF TEST PIT 7		
Hibbard Ranch Henry Road Napa, California		
Date 6/6/18	Project No. 91650.01	Figure A-7
Gilpin Geosciences, Inc. Earthquake & Engineering Geology Consultants		

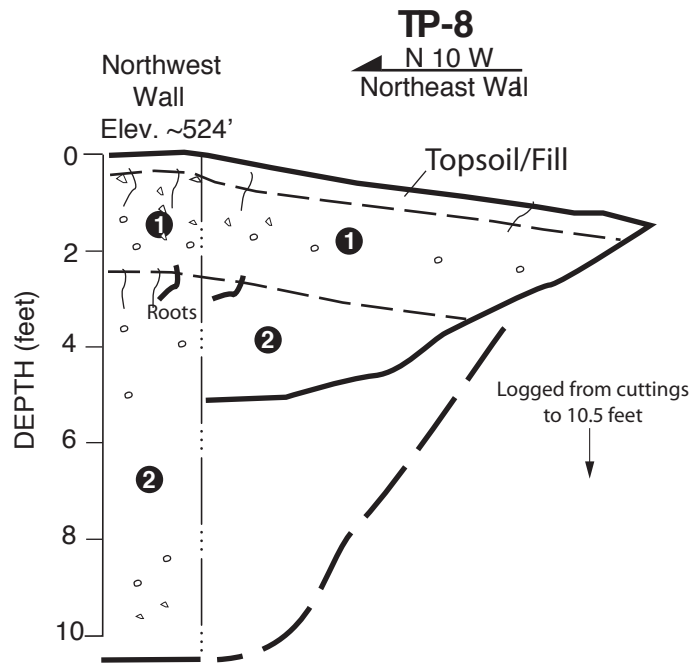

UNIT DESCRIPTIONS

- 1 CLAYEY to SAND SANDY CLAY(SC-CH), pale yellowish brown to light brown, slightly moist to moist, stiff, roots to 1/4" along basal contact (Colluvium).
- 2 SANDY CLAY with GRAVEL to CLAYEY GRAVEL (CL-GC), dark grayish brown to dark yellowish brown, gray mottling, moist, very stiff/medium dense, fine gravel, charcoal fragments (Old Alluvium/ Huichica Formation?)

Notes:

- 1. See figure 2 for test pit locations.
- 2. Ground surface profiles constructed using hand level and tape.
- 3. Horizontal = Vertical Scale.
- 4. Excavated by Case 580 Super M with 24-inch bucket

LOG OF TEST PIT 8		
Hibbard Ranch Henry Road Napa, California		
Date 6/6/18	Project No. 91650.01	Figure A-8
Gilpin Geosciences, Inc. Earthquake & Engineering Geology Consultants		

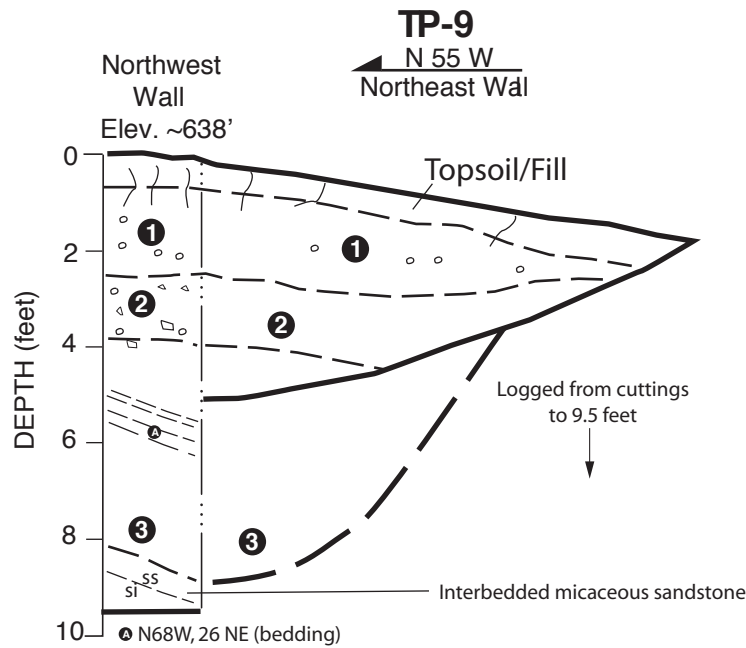

UNIT DESCRIPTIONS

- 1 CLAYEY SAND to SANDY CLAY(SC-CL), pale yellowish brown to light brown, slightly moist, mediu stiff(?), fine mudstone gravel (Colluvium).
- 2 CLAYEY GRAVEL with SAND (GC), light brown, with red and yellow oxidation, moist, medium dense to dense, fine olive brown mudstone gravel (Residual Soil)
- 3 Interbedded SILTSTONE/SANDSTONE, light brown to light olive brown, reddish brown hue and oxidation, very-thinly bedded, low hardness, weak, closely to intently fractured, moderately weathered to completely weathered pockets, locally. Micaceous SANDSTONE interbed at 8.5 feet, grayish brown, yellow, with yellowish orange oxidation, medium grained (Great Valley Complex).

Notes:

- 1. See figure 2 for test pit locations.
- 2. Ground surface profiles constructed using hand level and tape.
- 3. Horizontal = Vertical Scale.
- 4. Excavated by Case 580 Super M with 24-inch bucket

LOG OF TEST PIT 9		
Hibbard Ranch Henry Road Napa, California		
Date 6/6/18	Project No. 91650.01	Figure A-9
 Gilpin Geosciences, Inc. Earthquake & Engineering Geology Consultants		

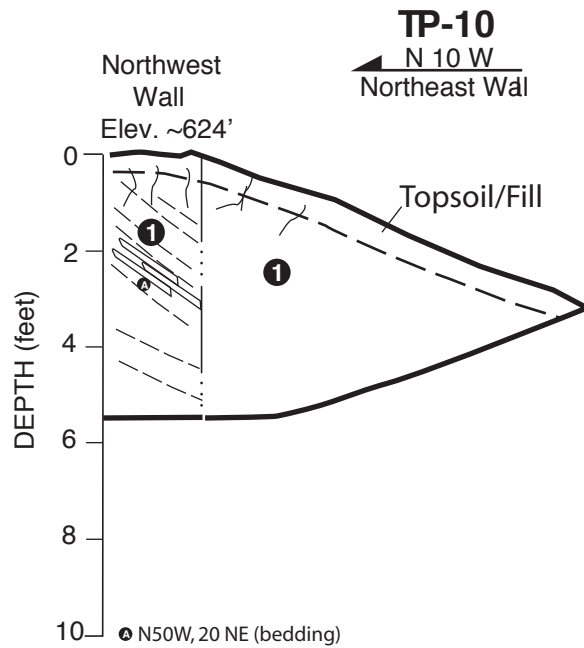

UNIT DESCRIPTIONS

- 1 Interbedded SILTSTONE/SANDSTONE, light brown to light olive brown, reddish brown hue and oxidation, very-thinly bedded, low hardness, weak, closely to intensely fractured, moderately weathered to completely weathered pockets, locally (Great Valley Complex).

Notes:

1. See figure 2 for test pit locations.
2. Ground surface profiles constructed using hand level and tape.
3. Horizontal = Vertical Scale.
4. Excavated by Case 580 Super M with 24-inch bucket

LOG OF TEST PIT 10

Hibbard Ranch
Henry Road
Napa, California

Date 6/6/18

Project No. 91650.01

Figure A-10



Gilpin Geosciences, Inc.
Earthquake & Engineering Geology Consultants

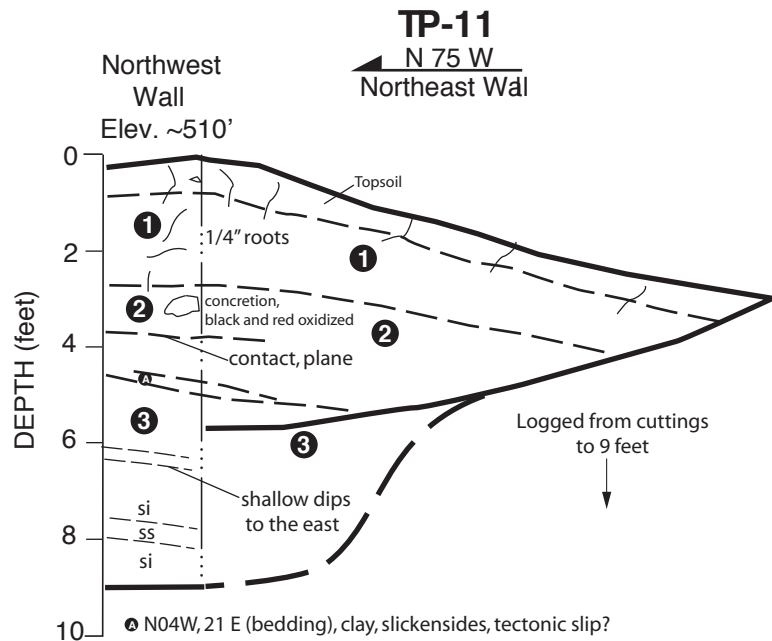

UNIT DESCRIPTIONS

- ① SANDY CLAY with GRAVEL (CL), dark yellowish brown and brown mottled, moist, stiff, fine gravel, roots to 1/4" (Colluvium).
- ② CLAYEY GRAVEL with SAND (GC), pale yellowish brown, light reddish brown, moist, medium dense, sub-angular fine gravel, consisting of decomposed siltstone and mudstone (Residual Soil)
- ③ Interbedded SILTSTONE and SANDSTONE, olive brown, light brown to grayish brown, yellow, light gray and yellowish orange (sandstone), reddish brown and black oxidized, very-thinly bedded, low hardness, friable to weak, deeply to moderately weathered, closely to intensely fractured, (Great Valley Complex).

Notes:

- 1. See figure 2 for test pit locations.
- 2. Ground surface profiles constructed using hand level and tape.
- 3. Horizontal = Vertical Scale.
- 4. Excavated by Case 580 Super M with 24-inch bucket

LOG OF TEST PIT 11		
Hibbard Ranch Henry Road Napa, California		
Date 6/6/18	Project No. 91650.01	Figure A-11
Gilpin Geosciences, Inc. Earthquake & Engineering Geology Consultants		

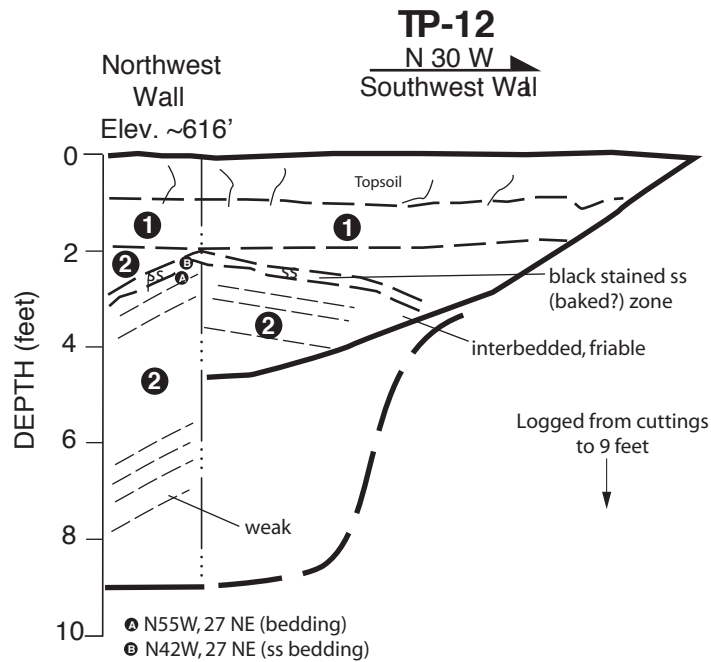

UNIT DESCRIPTIONS

- ① CLAYEY GRAVEL with SAND (GC), light brown, yellow, light reddish brown hue, slightly moist, medium dense, sub-angular fine gravel, consisting of decomposed siltstone and mudstone (Residual Soil)
- ② Interbedded MUDSTONE/SILTSTONE and SANDSTONE, olive brown, light brown to grayish brown, with gray interbedded sandstone with conspicuous black stained (baked?) zone at 2', very-thinly bedded, low hardness, friable to weak, deeply to moderately weathered, closely to intensely fractured (Great Valley Complex).

Notes:

1. See figure 2 for test pit locations.
2. Ground surface profiles constructed using hand level and tape.
3. Horizontal = Vertical Scale.
4. Excavated by Case 580 Super M with 24-inch bucket

LOG OF TEST PIT 12

Hibbard Ranch
Henry Road
Napa, California

Date 6/6/18

Project No. 91650.01

Figure A-12



Gilpin Geosciences, Inc.
Earthquake & Engineering Geology Consultants

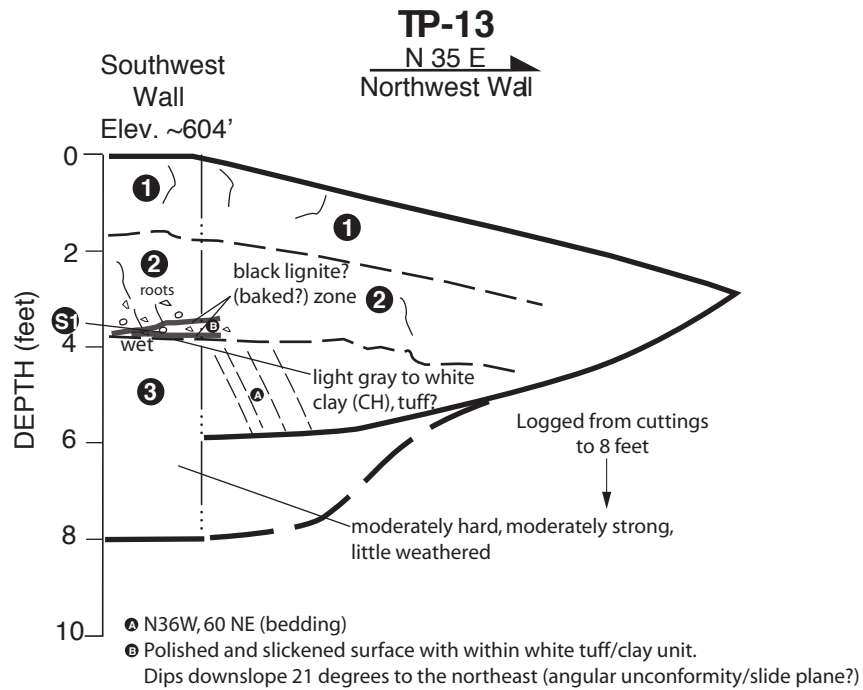

UNIT DESCRIPTIONS

- ① CLAYEY SAND (SC), light brown, slightly moist to dry, loose to medium dense, fine grained, porous locally (Colluvium)
- ② SANDY CLAY to CLAYEY GRAVEL with SAND (CL-GC), light gray, yellowish brown to yellowish orange oxidized, moist, stiff to very stiff/medium dense, white to gray clay (weathered tuff?) at 3.75', roots at basal contact, black (organic?) layers, potentially baked zone or lignite?, sub-angular fine gravel, consisting of decomposed siltstone and mudstone sample at 4' (Residual Soil/Tuff)
- ③ SILTSTONE, olive gray, with yellowish orange and black oxidation, thinly bedded, low to moderate hardness, weak to moderately strong, little to moderately weathered, closely to intensely fractured (Great Valley Complex).

Notes:

1. See figure 2 for test pit locations.
2. Ground surface profiles constructed using hand level and tape.
3. Horizontal = Vertical Scale.
4. Excavated by Case 580 Super M with 24-inch bucket

LOG OF TEST PIT 13

Hibbard Ranch
Henry Road
Napa, California

Date 6/6/18

Project No. 91650.01

Figure A-13



Gilpin Geosciences, Inc.
Earthquake & Engineering Geology Consultants

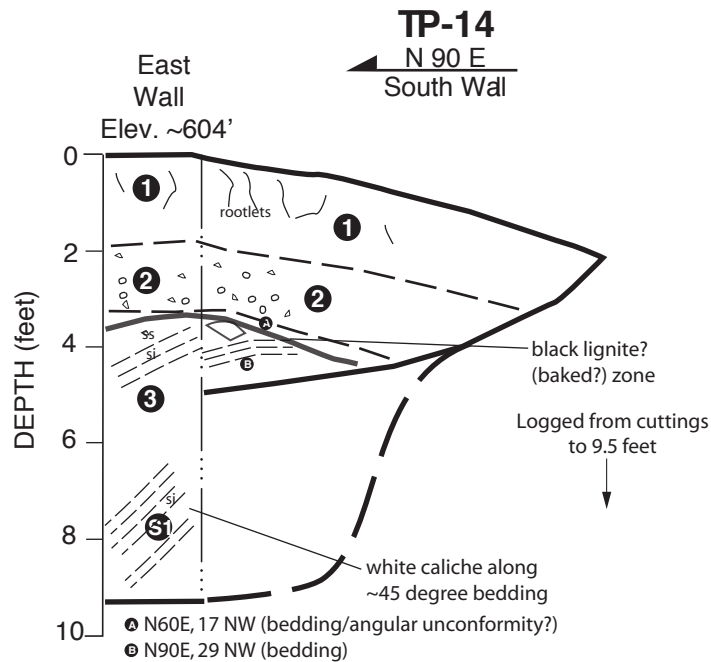

UNIT DESCRIPTIONS

- 1 CLAYEY SAND (SC), light brown, slightly moist to dry, loose to medium dense, fine grained, porous locally (Colluvium)
- 2 SANDY CLAY to CLAYEY GRAVEL with SAND (CL-GC), light gray, yellowish brown to yellowish orange oxidized, moist, stiff to very stiff/medium dense, white to gray clay (weathered tuff?) at 3.5', roots at basal contact, black (organic?) layers, potentially baked zone or lignite?, sub-angular fine gravel, (Residual Soil/Tuff)
- 3 Interbedded MUDSTONE/SILTSTONE and SANDSTONE, light brown, olive brown with yellowish brown interbedded sandstone with conspicuous black stained (lignitic?) zone at 3.75'-4', very-thinly bedded, low hardness, friable to weak, deeply weathered, closely to intensely fractured, white caliche(?), sample at 8' (Great Valley Complex).

Notes:

1. See figure 2 for test pit locations.
2. Ground surface profiles constructed using hand level and tape.
3. Horizontal = Vertical Scale.
4. Excavated by Case 580 Super M with 24-inch bucket

LOG OF TEST PIT 14

Hibbard Ranch
Henry Road
Napa, California

Date 6/6/18

Project No. 91650.01

Figure A-14



Gilpin Geosciences, Inc.
Earthquake & Engineering Geology Consultants

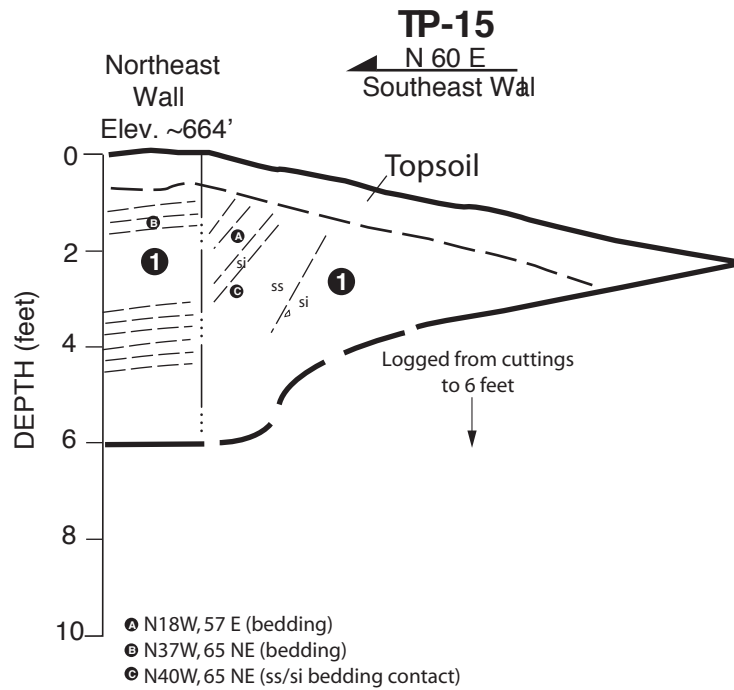

UNIT DESCRIPTIONS

- 1 Interbedded SILTSTONE and SANDSTONE, light grayish brown to olive with reddish oxidation, yellow interbedded micaceous sandstone, very-thinly to thinly bedded, low hardness, weak to moderately strong, moderately to little weathered, moderately to closely fractured (Great Valley Complex).

Notes:

1. See figure 2 for test pit locations.
2. Ground surface profiles constructed using hand level and tape.
3. Horizontal = Vertical Scale.
4. Excavated by Case 580 Super M with 24-inch bucket

LOG OF TEST PIT 15

Hibbard Ranch
Henry Road
Napa, California

Date 6/6/18

Project No. 91650.01

Figure A-15



Gilpin Geosciences, Inc.
Earthquake & Engineering Geology Consultants

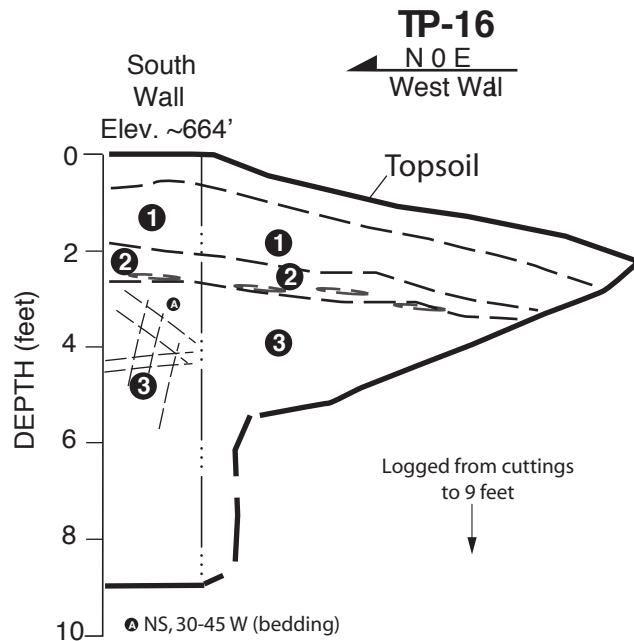

UNIT DESCRIPTIONS

- ① CLAYEY SAND (SC), light brown, slightly moist to dry, loose to medium dense, fine grained, porous locally (Colluvium)
- ② SANDY CLAY to CLAYEY GRAVEL with SAND (CL-GC), light gray, yellowish brown to yellowish orange oxidized, moist, stiff to very stiff/medium dense, white to gray clay (weathered tuff?) at 2-3', roots at basal contact, black (organic?) layers, potentially baked zone or lignite?, sub-angular fine gravel, consisting of decomposed siltstone and mudstone sample at 2.5' (Residual Soil/Tuff)
- ③ Interbedded MUDSTONE/SILTSTONE and SANDSTONE, light brown, olive brown with yellowish brown interbedded sandstone very-thinly bedded, low hardness, friable to weak, deeply weathered, closely to intensely fractured (Great Valley Complex).

Notes:

- 1. See figure 2 for test pit locations.
- 2. Ground surface profiles constructed using hand level and tape.
- 3. Horizontal = Vertical Scale.
- 4. Excavated by Case 580 Super M with 24-inch bucket

LOG OF TEST PIT 16

Hibbard Ranch
Henry Road
Napa, California

Date 6/6/18

Project No. 91650.01

Figure A-16



Gilpin Geosciences, Inc.
Earthquake & Engineering Geology Consultants

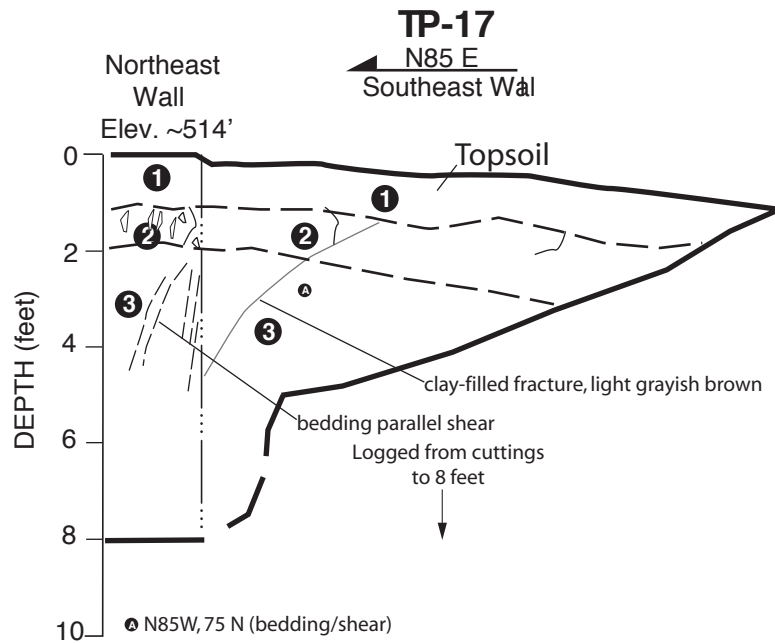

UNIT DESCRIPTIONS

- ① SANDY SILT with GRAVEL (ML-GP), light brown, dry, medium stiff, roots (Colluvium)
- ② CLAYEY GRAVEL (GC), brown, olive, slightly moist, medium dense (Residual Soil)
- ③ SILTSTONE, olive, with black and yellowish orange oxidation, very-thinly bedded, low hardness, friable to weak, deeply to moderately weathered, closely to intensely fractured (Great Valley Complex).

Notes:

1. See figure 2 for test pit locations.
2. Ground surface profiles constructed using hand level and tape.
3. Horizontal = Vertical Scale.
4. Excavated by Case 580 Super M with 24-inch bucket

LOG OF TEST PIT 17

Hibbard Ranch
Henry Road
Napa, California

Date 6/6/18

Project No. 91650.01

Figure A-17



Gilpin Geosciences, Inc.
Earthquake & Engineering Geology Consultants

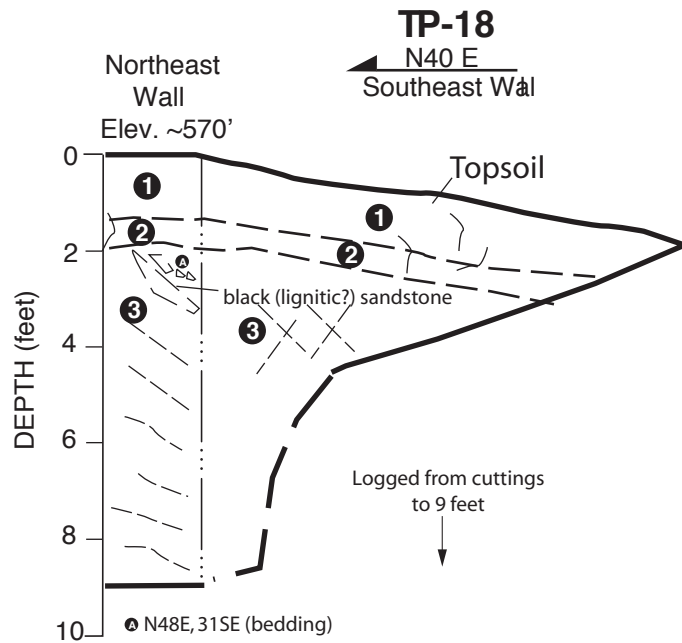

UNIT DESCRIPTIONS

- ① SANDY SILT with GRAVEL (ML-GP), light brown, dry, medium stiff, roots (Colluvium)
- ② CLAYEY GRAVEL (GC), brown, olive, slightly moist, medium dense (Residual Soil)
- ③ SILTSTONE, olive gray to gray, with black and yellowish brown sandstone, very-thinly bedded, low hardness, friable to weak, deeply to moderately weathered, closely to intensely fractured (Great Valley Complex).

Notes:

1. See figure 2 for test pit locations.
2. Ground surface profiles constructed using hand level and tape.
3. Horizontal = Vertical Scale.
4. Excavated by Case 580 Super M with 24-inch bucket

LOG OF TEST PIT 18

Hibbard Ranch
Henry Road
Napa, California

Date 6/6/18

Project No. 91650.01

Figure A-18



Gilpin Geosciences, Inc.
Earthquake & Engineering Geology Consultants

UNIFIED SOIL CLASSIFICATION SYSTEM

Major Divisions	Symbols	Typical Names
Coarse-Grained Soils (more than half of soil > no. 200 sieve size)	Gravels (More than half of coarse fraction > no. 4 sieve size)	GW Well-graded gravels or gravel-sand mixtures, little or no fines
		GP Poorly-graded gravels or gravel-sand mixtures, little or no fines
		GM Silty gravels, gravel-sand-silt mixtures
		GC Clayey gravels, gravel-sand-clay mixtures
	Sands (More than half of coarse fraction < no. 4 sieve size)	SW Well-graded sands or gravelly sands, little or no fines
		SP Poorly-graded sands or gravelly sands, little or no fines
		SM Silty sands, sand-silt mixtures
		SC Clayey sands, sand-clay mixtures
Fine-Grained Soils (more than half of soil < no. 200 sieve size)	Silts and Clays LL = <50	ML Inorganic silts and clayey silts of low plasticity, sandy silts, gravelly silts
		CL Inorganic clays of low to medium plasticity, gravelly clays, sandy clays, lean clays
		OL Organic silts and organic silt-clays of low plasticity
	Silts and Clays LL = >50	MH Inorganic silts of high plasticity
		CH Inorganic clays of high plasticity, fat clays
		OH Organic silts and clays of high plasticity
Highly Organic Soils	PT Peat and other highly organic soils	

GRAIN SIZE CHART		
Classification	Range of Grain Sizes	
	U.S. Standard Sieve Size	Grain Size in Millimeters
Boulders	Above 12"	Above 305
Cobbles	12" to 3"	305 to 76.2
Gravel coarse fine	3" to No. 4	76.2 to 4.76
	3" to 3/4" 3/4" to No. 4	76.2 to 19.1 19.1 to 4.76
Sand coarse medium fine	No. 4 to No. 200	4.76 to 0.074
	No. 4 to No. 10	4.76 to 2.00
	No. 10 to No. 40 No. 40 to No. 200	2.00 to 0.420 0.420 to 0.074
Silt and Clay	Below No. 200	Below 0.074

SAMPLE DESIGNATIONS/SYMBOLS

- Sample taken with spit-barrel sampler other than Standard Penetration Test sampler. Darkened are indicated sample obtained
- Classification sample taken with Standard Penetration Test sampler
- Undisturbed sample taken with thin-walled tube
- Disturbed sample
- Sampling attempted with no recovery
- Core sample
- Groundwater level at the time and date indicated

SAMPLER TYPE

- | | |
|--|---|
| <p>C Core barrel</p> <p>CA California split-barrel sampler with 2.5-inch outside diameter and 1.93-inch inside diameter</p> <p>D&M Dames & Moore piston sampler using 2.5-inch outside diameter, thin-walled tube</p> <p>O Osterberg piston sampler using 3.0-inch outside diameter, thin-walled Shelby tube</p> | <p>PT Pitcher tube sampler using 3.0-inch outside diameter, thin-walled Shelby tube</p> <p>S&H Sprague & Henwood split-barrel sampler with a 3.0-inch outside diameter and a 2.43-inch inside diameter</p> <p>SPT Standard Penetration Test (SPT) split-barrel sampler with a 2.0-inch outside diameter and a 1.5-inch inside diameter</p> <p>ST Shelby tube (3.0-inch outside diameter, thin-walled tube) advanced with hydraulic pressure</p> |
|--|---|

Hibbard Ranch

Henry Road
Napa, California

SOIL CLASSIFICATION CHART



Gilpin Geosciences, Inc.
Earthquake & Engineering Geology Consultants

Date 2/28/19

Project No. 91650.02

Figure A-19

I CONSOLIDATION OF SEDIMENTARY ROCKS: usually determined from unweathered samples.
Largely dependent on cementation.

U = unconsolidated
P = poorly consolidated
M = moderately consolidated
W = well consolidated

II BEDDING OF SEDIMENTARY ROCKS

Splitting Property	Thickness	Stratification
Massive	Greater than 4.0 ft.	very thick-bedded
Blocky	2.0 to 4.0 ft.	thick bedded
Slabby	0.2 to 2.0 ft.	thin bedded
Flaggy	0.05 to 0.2 ft.	very thin-bedded
Shaly or platy	0.01 to 0.05 ft.	laminated
Papery	less than 0.01	thinly laminated

III FRACTURING - graphic logs indicate f-fractures and mf-mechanical breaks caused by drilling.

Intensity	Size of Pieces in Feet
Very little fractured	Greater than 4.0
Occasionally fractured	1.0 to 4.0
Moderately fractured	0.5 to 1.0
Closely fractured	0.1 to 0.5
Intensely fractured	0.05 to 0.1
Crushed	Less than 0.05

IV HARDNESS

1. **Soft** - reserved for plastic material alone.
2. **Low hardness** - can be gouged deeply or carve easily with a knife blade.
3. **Moderately hard** - can be readily scratched by a knife blade; scratch leaves a heavy trace of dust and is readily visible after the powder has been blown away.
4. **Hard** - can be scratched with difficulty; scratch produced a little powder and is often faintly visible.
5. **Very hard** - cannot be scratched with knife blade; leaves a metallic streak.

V STRENGTH

1. **Plastic** or very low strength.
2. **Friable** - crumbles easily by rubbing with fingers.
3. **Weak** - an unfractured specimen of such material will crumble under light hammer blows.
4. **Moderately strong** - specimen will withstand a few hammer blows before breaking.
5. **Strong** - specimen will withstand a few heavy ringing hammer blows and will yield with difficulty only dust and small flying fragments.
6. **Very strong** - specimen will resist heavy ringing hammer blows and will yield with difficulty only dust and small flying fragments.

VI WEATHERING - The physical and chemical disintegration and decomposition of rocks and minerals by natural processes such as oxidation, reduction, hydration, solution, carbonation, and freezing and thawing.

Deep - moderate to complete mineral decomposition; extensive disintegration; deep and thorough discoloration; many fractures, all extensively coated or filled with oxides, carbonates and/or clay or silt.

Moderate - slight change or partial decomposition of minerals; little disintegration; cementation little to unaffected. Moderate to occasionally intense discoloration. Moderately coated fractures.

Little - no megascopic decomposition of minerals; little or no effect on normal cementation. Slight and intermittent, or localized discoloration. Few stains on fracture surfaces.

Fresh - unaffected by weathering agents. No disintegration or discoloration. Fractures usually less numerous than joints.

Hibbard Ranch
Henry Road
Napa, California

**PHYSICAL PROPERTIES CRITERIA
FOR ROCK DESCRIPTIONS**



Gilpin Geosciences, Inc.
Earthquake & Engineering Geology Consultants

Date 2/28/19

Project No. 91650.01

Figure A-20