

PRELIMINARY HYDROLOGY STUDY

FOR

PREPARED FOR:

Industrial Property Group, Inc
10515 20th Street Southeast
Lake Stevens, Washington 98258
(314) 713-9516

PREPARED BY:

Kier + Wright
163 Technology Drive, Suite 150
Irvine, CA 92618
(949) 508-0202

February 28, 2023

TABLE OF CONTENTS

Contents

Purpose	1
Project Description.....	1
Methodology.....	1
Project Site Drainage.....	2
Summary	2
Results.....	2

Appendix:

- Appendix 1: Existing Condition Hydrology Map
- Appendix 2: Proposed Condition Hydrology Map
- Appendix 3: Geotechnical Report
- Appendix 4: Hydrology Calculations

Purpose

This study will estimate the post-development peak flow rate for the 100-year storm event at the project site. A 100-year 24-hour Unit Hydrograph analysis is also included to satisfy WQMP volume runoff requirements.

Project Description

This hydrology study is for the Rancho Road Development Project in Adelanto, California. The site is in the vacant land southeast of Rancho Road and Adelanto Road in Adelanto, California. The site is mostly undeveloped, with solar field to the east, vacant land to the southeast, and commercial/industrial buildings to the west. The site is 37.54 acres.

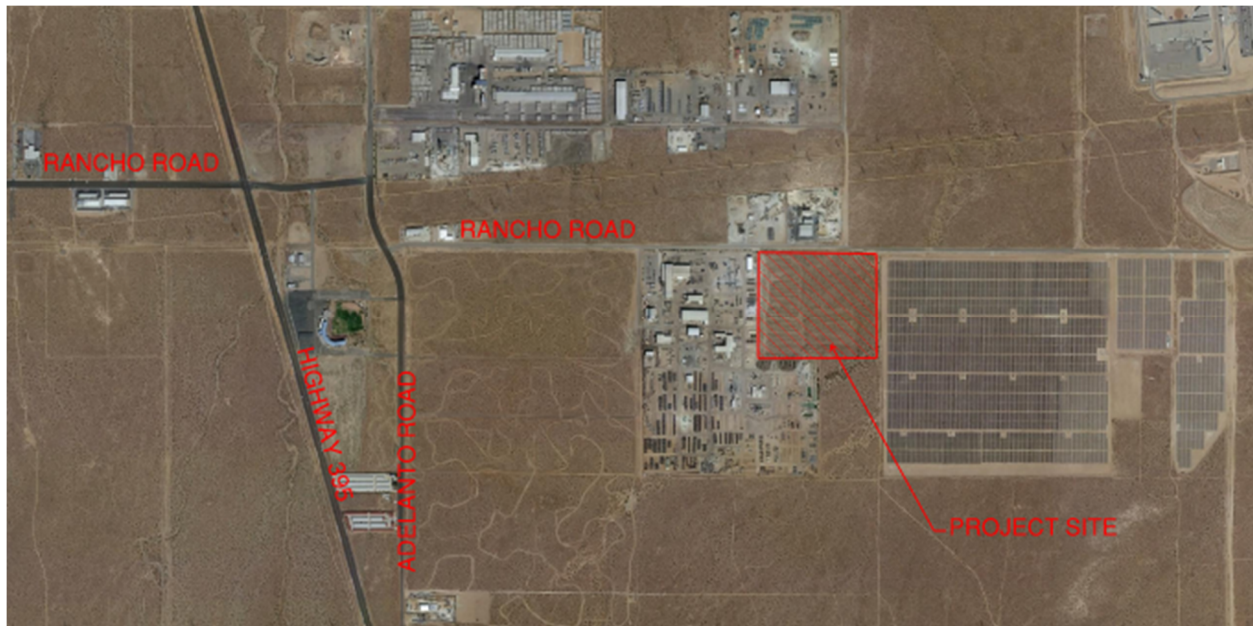

Location Map

Methodology

Calculations and design criteria contained within this report are consistent with the San Bernardino County Hydrology requirements. The hydrology and storage calculations are per rational method runoff equations and are in accordance with County design criteria as performed in the CivilDesign software.

Rainfall depths contained in this report used for CivilDesign software are based on San Bernardino County Hydrology Manual readings.

The hydrologic soil type for the entire site is "C. This value was taken from USDA Web Soil Survey. A "commercial" land use was used for the project site with AMC III for the proposed condition.

Project Site Drainage

Existing Site Drainage Conditions:

Currently, the existing site is undeveloped. The existing site generally slopes from southwest to northeast. There are no existing storm drains within the project site. The slopes within the project site range from flat to mild slopes, ranging from 2% to 10% in some areas. With the majority of the site being type C soils, the drainage percolates into the ground, and the remaining runoff flows to Rancho Road.

Proposed Site Drainage Conditions:

In the proposed condition, the site drainage is split into two areas. The northern half of the site drains to a basin on the northeast. The flow is transferred to the basin through a combination of storm drain pipe, and surface flow. The southern half of the site drains to a basin located in the southeast of the site. This basin receives the site drainage through a combination of storm drain pipe and surface flow as well.

Summary

The following table shows the pre and post development peak flow rate and volume for the project.

	Peak Flow Rate	Volume After 24 Hours
Pre-Development	69.57 cfs	6.393 ac-ft
Post-Development	101.31 cfs	8.897 ac-ft

Results

The required capture volume is 110,385 cubic feet (2.534 ac-ft) of storm water per the unit hydrograph calculations. The basin has been sized to store 6.45 acre feet of storm due to the increase of peak flow runoff from the post-development state compared to the pre-development state. Unit hydrograph calculations were prepared to establish the baseline Qs for the 100-year 24-hour storm for the project. In order to mitigate the extra runoff, the basin has been sized to prevent extra runoff from leaving the site during the storm event. The basins are located in areas that results in favorable infiltration rates based on the geotechnical report provided by LGC Geotechnical, Inc. found in Appendix 3. With a factor of safety of 3 applied to the observed infiltration rate, the native soils has a rate of 3.67" per hour. With the largest basin filled completely with a depth of 9', the basin should drain within 30 hours with this rate.

Appendix 1: Existing Condition Hydrology Map

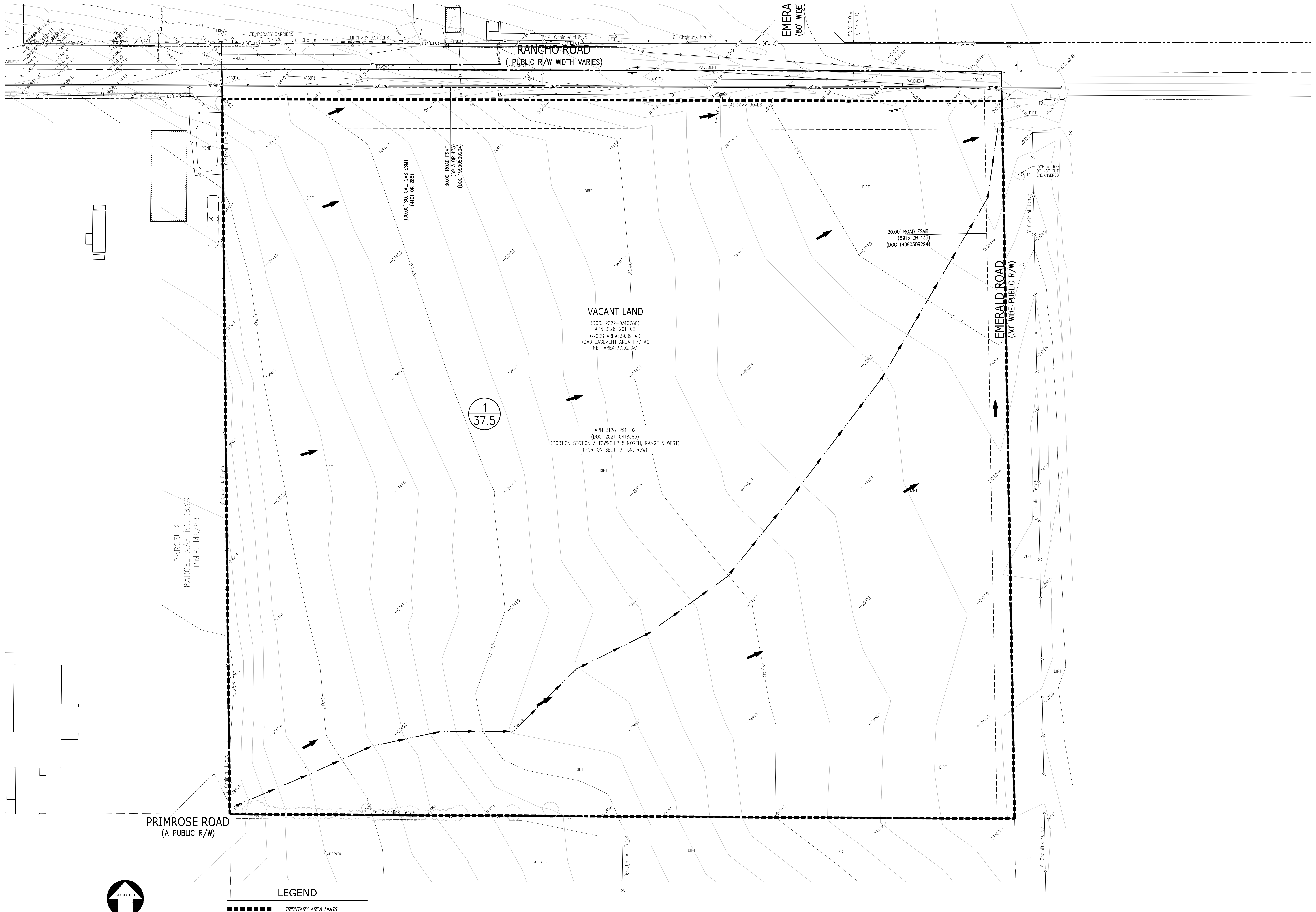

PARCEL 2
PARCEL MAP NO. 13199
P.M.B. 146/88

1
37.5

VACANT LAND
(DOC. 2022-0316780)
APN: 3128-291-02
GROSS AREA: 39.09 AC
ROAD EASEMENT AREA: 1.77 AC
NET AREA: 37.32 AC

APN 3128-291-02
(DOC. 2021-0418385)
(PORTION SECTION 3 TOWNSHIP 5 NORTH, RANGE 5 WEST)
(PORTION SECT. 3 TSN, RSW)

RANCHO ROAD
(PUBLIC R/W WIDTH VARIES)

EMERA
(50' WIDE)

EMERALD ROAD
(30' WIDE PUBLIC R/W)

PRIMROSE ROAD
(A PUBLIC R/W)

30.00' ROAD ESMT
(6913 OR 135)
(DOC 19990509294)

100.00' SO. CAL. GAS ESMT
(4101 OR 285)

30.00' ROAD ESMT
(6913 OR 135)
(DOC 19990509294)

BY		REVISION	
NO.	DATE	NO.	DATE
BY		REVISION	
NO.	DATE	NO.	DATE
 163 Technology Drive Irvine, CA 92618 Phone: (949) 594-0702 www.kierwright.com			
CALIFORNIA			
EXISTING HYDROLOGY MAP OF RANCHO ROAD DEVELOPMENT FOR INDUSTRIAL PROPERTY GROUP			
DATE	FEB. 2023	ADELANTO,	
SCALE	AS SHOWN		
DESIGNER	JM		
DRAWN BY	JM		
JOB NO.	A22326		
SHEET	EX.1		
OF	1	SHEETS	

Z:\2022\A22326\DWG\ENTITLEMENTS\Exhibits\Existing Hydrology.dwg 2-27-23 01:59:15 PM jmarshall

Appendix 2: Proposed Condition Hydrology Map

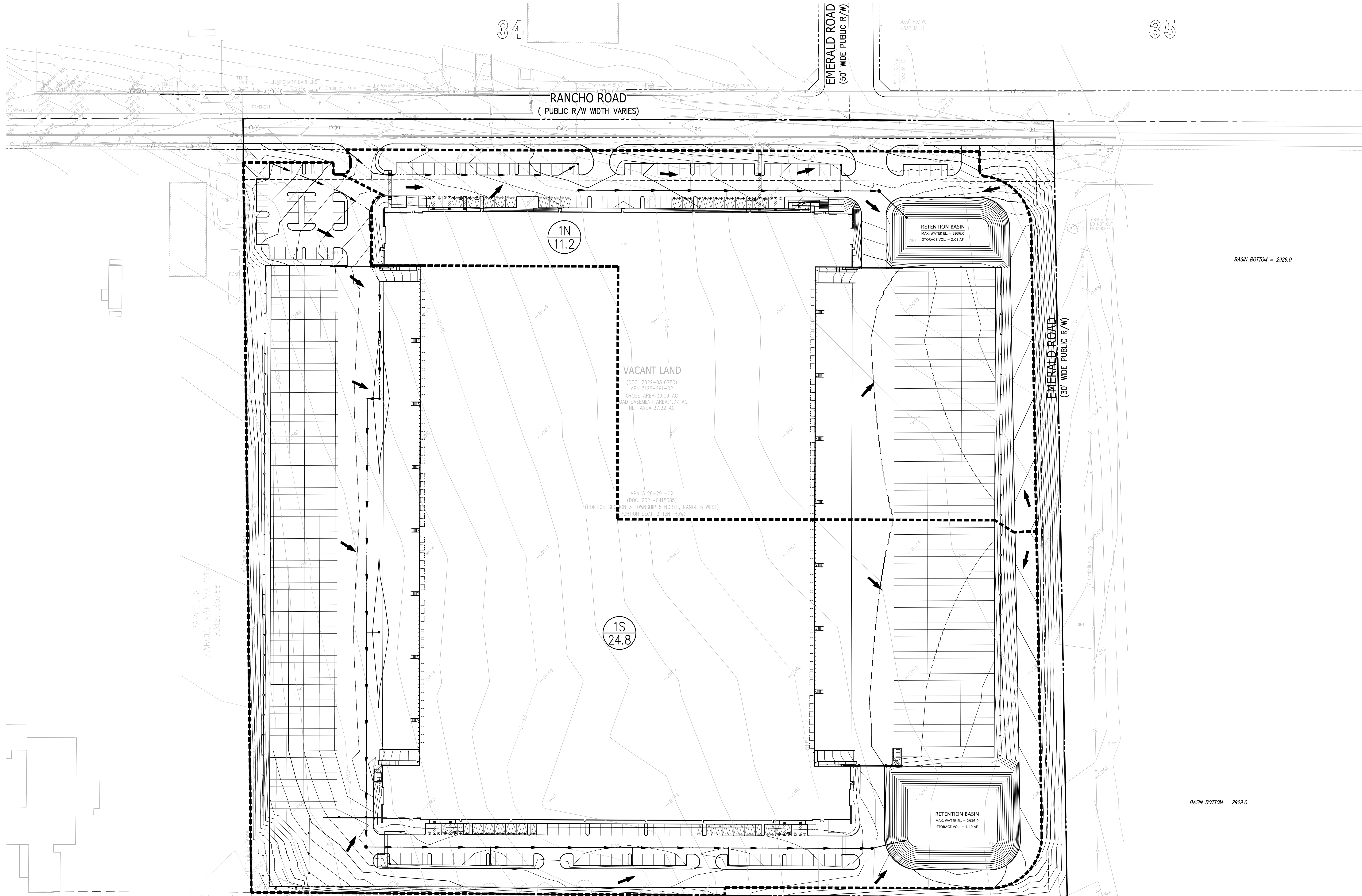

PRIMROSE ROAD
(A PUBLIC R/W)

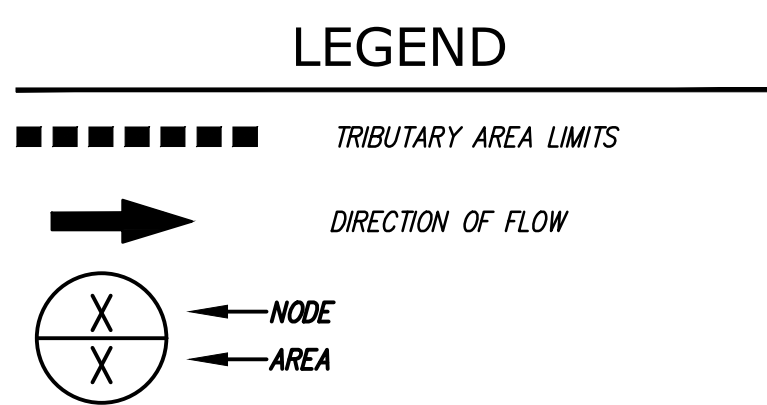
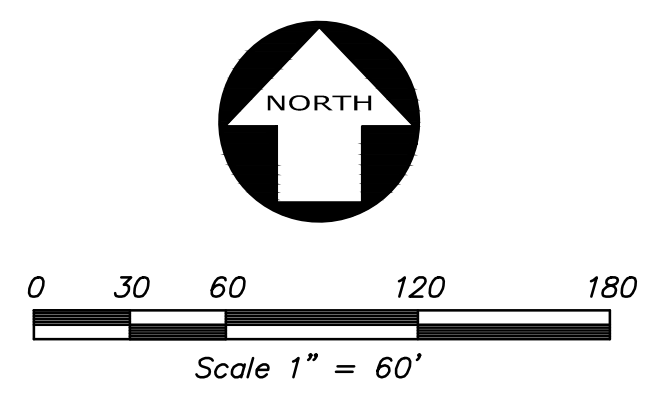

VACANT LAND
(DOC. 2022-0316780)
APN: 3128-291-02
GROSS AREA: 39.09 AC
DAD EASEMENT AREA: 1.77 AC
NET AREA: 37.32 AC

APN 3128-291-02
(DOC. 2021-0418385)
(PORTION SECTION 3, TOWNSHIP 5 NORTH, RANGE 5 WEST)
(PORTION SECT. 3, 15th, ROW)

RETENTION BASIN
MAX. WATER EL. = 2936.0
STORAGE VOL. = 2.05 AF

BASIN BOTTOM = 2926.0

RETENTION BASIN
MAX. WATER EL. = 2936.0
STORAGE VOL. = 4.40 AF

BASIN BOTTOM = 2929.0

BY		REVISION	
NO.	DATE	NO.	DESCRIPTION
1	06/08/2022	1	PLANNING SUBMITTAL
2		2	
3		3	
4		4	
5		5	
 163 Technology Drive Irvine, CA 92618 Phone: (949) 598-0702 www.kierwright.com			
PROPOSED HYDROLOGY MAP OF RANCHO ROAD DEVELOPMENT FOR INDUSTRIAL PROPERTY GROUP			
CALIFORNIA			
ADELANTO,			
DATE	08/31/2022		
SCALE	AS SHOWN		
DESIGNER	DGR		
DRAWN BY	VB		
JOB NO.	A22160		
SHEET	PR.1		
OF	1	SHEETS	

Z:\2022\A22160\INDUSTRIAL PROPERTY GROUP\A22160-PR.1.dwg, 8/31/2022, 10:42:07 AM, jwong

Appendix 3: Geotechnical Report



November 30, 2022

Project No. 22178-01

Mr. Craig Wilde
Industrial Property Group, Inc.
10515 20th Street Southeast
Lake Stevens, Washington 98258

Subject: Preliminary Geotechnical Evaluation, Proposed Adelanto 38 Industrial Development, Southwest Corner of Intersection of Rancho Road and Emerald Road, Adelanto, California

In accordance with your request, LGC Geotechnical, Inc. has performed a preliminary geotechnical evaluation for the proposed industrial development to be located southwest of the intersection of Rancho Road and Emerald Road, in the City of Adelanto, California. The purpose of our study was to evaluate the existing onsite geotechnical conditions and to provide preliminary geotechnical recommendations relative to the proposed development.

Should you have any questions regarding this report, please do not hesitate to contact our office. We appreciate this opportunity to be of service.

Respectfully,

LGC Geotechnical, Inc.

A handwritten signature in blue ink that reads "Brad Zellmer".

Brad Zellmer, GE 2618
Project Engineer



A handwritten signature in blue ink that reads "Kevin B. Colson".

Kevin B. Colson, CEG 2210
Vice President



KBC/BTZ/CPM/amm

Distribution: (5) Addressee (4 wet-signed copies and 1 electronic copy)

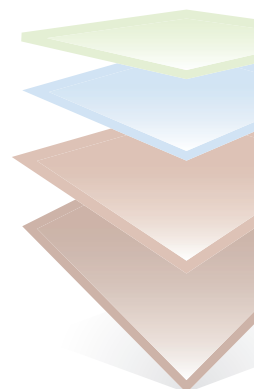

TABLE OF CONTENTS

<u>Section</u>	<u>Page</u>
1.0 INTRODUCTION.....	1
1.1 Project Description and Background.....	1
1.2 Subsurface Exploration.....	1
1.3 Field Percolation Testing.....	2
1.4 Laboratory Testing.....	3
2.0 GEOTECHNICAL CONDITIONS.....	4
2.1 Regional and Local Geology.....	4
2.2 Site-Specific Geology & Generalized Subsurface Conditions.....	4
2.2.1 Artificial Fill – Undocumented (Map Symbol – afu).....	4
2.2.2 Quaternary Alluvium (Map Symbol – Qa).....	5
2.3 Geologic Structure.....	5
2.4 Landslides.....	5
2.5 Groundwater.....	5
2.6 Faulting.....	6
2.6.1 Lurching and Shallow Ground Rupture.....	7
2.6.2 Liquefaction and Dynamic Settlement.....	7
2.6.3 Lateral Spreading.....	7
2.6.4 Tsunamis and Seiches.....	7
2.7 Seismic Design Parameters.....	8
2.8 Subsidence.....	9
2.9 Rippability.....	9
2.10 Oversized Material.....	9
2.11 Expansion Potential.....	9
3.0 FINDINGS AND CONCLUSIONS.....	10
4.0 RECOMMENDATIONS.....	11
4.1 Site Earthwork.....	11
4.1.1 Site Preparation.....	11
4.1.2 Removal Depths and Limits.....	12
4.1.3 Temporary Excavations.....	13
4.1.4 Removal Bottoms and Subgrade Preparation.....	13
4.1.5 Material for Fill.....	13
4.1.6 Fill Placement and Compaction.....	14
4.1.7 Trench and Retaining Wall Backfill and Compaction.....	15
4.1.8 Shrinkage and Subsidence.....	15
4.2 Preliminary Foundation Recommendations.....	16
4.2.1 Slab Design and Construction.....	16
4.2.2 Shallow Foundation Maintenance.....	17
4.3 Soil Bearing and Lateral Resistance.....	17
4.4 Lateral Earth Pressures for Retaining Walls.....	18
4.5 Preliminary Pavement Sections.....	20

TABLE OF CONTENTS cont'd

4.6	Soil Corrosivity	21
4.7	Nonstructural Concrete Flatwork	21
4.8	Surface Drainage and Landscaping.....	22
	4.8.1 General	22
	4.8.2 Precise Grading.....	23
	4.8.3 Landscaping	23
4.9	Subsurface Water Infiltration	24
4.10	Pre-Construction Documentation and Construction Monitoring.....	26
4.11	Geotechnical Plan Review.....	26
4.12	Geotechnical Observation and Testing During Construction	26
5.0	LIMITATIONS.....	28

LIST OF TABLES, ILLUSTRATIONS, & APPENDICES

Tables

Table 1 – Summary of Field Infiltration Testing (Page 3)
Table 2 – Seismic Design Parameters (Page 8)
Table 3 – Allowable Soil Bearing Pressures (Page 18)
Table 4 – Lateral Earth Pressures – Select Sandy Backfill (Page 19)
Table 5 – Paving Section Options (Page 20)
Table 6 – Nonstructural Concrete Flatwork for Very Low/Low Expansion Potential (Page 22)
Table 7 – Geotechnical Factors of Safety for Design Infiltration Rate (Page 25)

Figures

Figure 1 – Site Location Map (Rear of Text)
Figure 2 – Geotechnical Map (Rear of Text)
Figure 3 – Retaining Wall Backfill Detail (Rear of Text)

Appendices

Appendix A – References
Appendix B – Boring Logs & Infiltration Data
Appendix C – Laboratory Test Results
Appendix D – General Earthwork and Grading Specifications

1.0 INTRODUCTION

LGC Geotechnical has performed a geotechnical evaluation for the proposed industrial development to be located southwest of the intersection of Rancho Road and Emerald Road, in the City of Adelanto, San Bernardino County, California. (Figure 1). This report summarizes our findings, conclusions, and preliminary geotechnical recommendations relative to the proposed development.

1.1 Project Description and Background

The approximately 39-acre, generally square-shaped site is bound on the north by Rancho Road, on the east by Emerald Road, on the west by an existing industrial development (concrete pipe manufacturer), and on the south by the industrial development and vacant land. At the time evaluation, Rancho Road was a paved road, while Emerald Road was an unimproved dirt road. The site consists of vacant land with a few man-made dirt trails. A series of low, parallel earthen berms, estimated at 1 to 2 feet tall, had been constructed along the western and southern halves of the site, adjacent to the pipe manufacturing facility. Similar parallel berms were observed on the pipe manufacturing facility property where they were being used to store pipes, having the pipes span from one berm to the next, allowing a forklift or crane access beneath the pipes to lift them. At the time of our field work some large diameter concrete pipes were stacked in the northwestern corner of the site adjacent to the pipe manufacturing facility. Vegetation generally consisted of low scrub and weeds scattered across the site. The majority of the site is relatively flat with topographic relief on the order of approximately 20 feet. Drainage is toward the northeast generally via sheet flow. No structures were observed at the site.

We understand that the proposed site will include one approximately 638,720 square foot at-grade industrial building, container storage areas, and associated parking and driveways (HPA Architecture, 2022). Grading plans were not available. It is anticipated that relatively minor design cuts and fills are proposed for the building pad. Preliminary building (dead plus live) loads were not provided at the time of this report. The assumed maximum column and wall structural (dead plus live) loads are 125 kips and 10 kips per lineal foot, respectively.

The recommendations given in this report are based on assumptions as indicated above. LGC Geotechnical should be provided with any updated project information, plans and/or any structural loads when they become available, in order to either confirm or modify the recommendations provided herein.

1.2 Subsurface Exploration

In October of 2022, LGC Geotechnical performed a subsurface geotechnical evaluation of the site consisting of the excavation of eleven hollow-stem auger borings in order to evaluate onsite geotechnical conditions.

Eleven borings (HS-1 through HS-7 and I-1 through I-4) were excavated using a truck-mounted drill rig equipped with 6-inch and 8-inch-diameter hollow-stem augers to depths ranging from approximately 10 to 50 feet below existing grade. An LGC Geotechnical representative observed the drilling operations, logged the borings, and collected soil samples for laboratory testing.

Driven soil samples were collected by means of the Standard Penetration Test (SPT) and Modified California Drive (MCD) sampler. The SPT sampler (1.4-inch ID) and MCD sampler (2.4-inch ID, 3.0-inch OD) were driven using a 140-pound hammer falling 30 inches to advance the sampler a total depth of 18 inches or until refusal. The raw blow counts for each 6-inch increment of penetration were recorded on the boring logs. Bulk samples were also collected and logged for laboratory testing at select depths. In select borings, after removal of the augers the depth of the boring due to caving was measured and is noted on the boring logs. The borings were backfilled with cuttings. The approximate locations of our subsurface explorations are provided on our Geotechnical Map (Figure 2). The boring logs are provided in Appendix B.

At the completion of excavation of Infiltration Borings, I-1 through I-4, an infiltration well was constructed within each boring for testing as outlined in the “Field Percolation Testing” Section below. At the completion of infiltration testing, the installed pipe was removed, and the resulting void backfilled with native soils.

Please note that some settlement of the backfill may occur over time and the excavations should be topped off as needed.

1.3 Field Percolation Testing

Four field percolation tests (I-1 through I-4) were performed in the approximate locations indicated on our Geotechnical Map (Figure 2). Estimation of infiltration rates was accomplished in general accordance with the guidelines set forth by the County of San Bernardino (2013). A 3-inch diameter perforated PVC pipe was placed in the borehole, and the annulus was backfilled with gravel, including placement of approximately 2 inches of gravel at the bottom of the borehole. The infiltration wells were pre-soaked the day prior to testing. During the pre-test, if the water level drops more than 6 inches in 25 minutes for two consecutive readings, the test procedure for coarse-grained soils should be followed. If the water level does not meet that criterion, the procedure for fine-grained soils should be followed. The procedure for coarse-grained soils requires performing the test for one hour and taking one reading every 10 minutes from a fixed reference point. The procedure for fine-grained soils requires performing the test for six hours and taking one reading every 30 minutes from a fixed reference point. The pre-tests indicated the procedure for coarse-grained soils should be followed. The calculated (observed) infiltration is normalized relative to the three-dimensional flow that occurs within the field test to a one-dimensional flow out of the bottom of the boring only (i.e., “Porchet Method”). The observed infiltration rates are provided in Table 1 on the following page and do not include any factors of safety.

TABLE 1

Summary of Field Infiltration Testing

Infiltration Test Location	Infiltration Test Approximate Depth (ft)	Observed Infiltration Rate (inch/hr.) *
I-1	10	11.3
I-2	10	1.6
I-3	10	3.9
I-4	10	10.9

*Does not include a factor of safety

It should also be emphasized that infiltration test results are only representative of the location and depth where they are performed. Varying subsurface conditions may exist outside of the test locations which could alter the calculated infiltration rates indicated above. The percolation tests were performed using relatively clean water free of particulates, silt, etc. Field percolation test data is attached. Infiltration test data is presented in Appendix B. Refer to further discussion in Section 4.9.

1.4 Laboratory Testing

Representative bulk and driven samples were obtained for laboratory testing during our field evaluation. Laboratory testing included in-situ moisture content and dry density, gradation/fines content, consolidation, expansion index, laboratory compaction, R-Value, and corrosion characteristics (sulfate, chloride, pH and minimum resistivity).

- Dry density of the samples collected ranged from approximately 99 pounds per cubic foot (pcf) to 125 pcf, with an average of approximately 116 pcf. Field moisture contents ranged from less than 1 percent to 15 percent, with an average of approximately 3 percent.
- Two sieve analysis and five fines content tests indicated a fines content (passing No. 200 sieve) ranging from approximately 7 to 64 percent. Based on the Unified Soils Classification System (USCS), four of the tested samples are classified as “coarse-grained” and three of samples are classified as “fine-grained.”
- Two Expansion Index (EI) tests indicated EI values of 0 and 2, corresponding to “Very Low” expansion potential.
- A Consolidation test was performed. The deformation versus vertical stress plot is provided in Appendix C.
- A laboratory compaction curve resulted in a maximum dry density value of 132.5 pcf with an optimum moisture content value of 8.0 percent.
- An R-Value test was performed and indicated a result of 75.
- Corrosion testing indicated soluble sulfate contents less than approximately 0.01 percent, a chloride content of 41 parts per million (ppm), pH of 7.7, and a minimum resistivity of 3,080 ohm-centimeters.

A summary of the results is presented in Appendix C. The moisture and dry density test results are presented on the boring logs in Appendix B.

2.0 GEOTECHNICAL CONDITIONS

2.1 Regional and Local Geology

Regionally the site is located in the southwestern portion of the Mojave Desert Geomorphic Province of California. The following discussion regarding the geomorphic province is from the California Geological Survey Note 36 (CGS, 2002). The Mojave Desert is a broad interior region of isolated mountain ranges separated by expanses of desert plains. It has an interior enclosed drainage and many playas. There are two important fault trends that control topography: a prominent northwest-southeast trend and a secondary east-west trend, which is in apparent alignment with the Transverse Ranges Geomorphic Province on the southwestern side of the Mojave Desert. The Mojave Province is wedged in a sharp angle between the Garlock Fault which is the southern boundary of the Sierra Nevada Province, and the San Andreas Fault where it bends east from its northwest trend. The northern boundary of the Mojave is separated from the prominent Basin and Range Province by the eastern extension of the Garlock Fault. The site is located southeast of the Garlock Fault and north of the San Andreas Fault.

Locally, the site is located on a broad, nearly flat alluvial plain. The alluvium is derived from the nearby hills and mountains. The northward-flowing Mojave River is located approximately 3 miles northeast of the site and drainage in the vicinity of the site is generally via sheet flow towards the northeast. Old alluvial deposits are located in the upper reaches of incised drainages along the banks of the river. The alluvial plain is underlain at depth by granitic and metasedimentary rocks of the San Bernardino Mountain assemblage, and steep rugged hillsides that expose these rocks are located approximately 4 to 7 miles northeast and northwest of the site, respectively (Dibblee, 2008). A large playa (dry lakebed), known as El Mirage Dry Lake, is located adjacent to the hillsides northwest of the site.

2.2 Site-Specific Geology & Generalized Subsurface Conditions

Based on our review of regional geologic mapping in the vicinity of the site (Dibblee, 2008) and our site visit, the project area is underlain by Quaternary alluvial deposits. A brief description of the geologic units encountered is presented below.

It should be noted that our excavations are only representative of the location and time where/when they are performed, and varying subsurface conditions may exist outside of the performed location. In addition, subsurface conditions can change over time. The soil descriptions provided above should not be construed to mean that the subsurface profile is uniform, and that soil is homogeneous within the project area. For details on the stratigraphy at the exploration locations, refer to Appendix B.

2.2.1 Artificial Fill - Undocumented (Map Symbol - afu)

Undocumented fill was observed along the western and southern halves of the site which consisted of parallel earthen berms. The berms are estimated at approximately 1

to 2 feet tall, and they are interpreted to be loose and dry. Localized areas of undocumented fill may also present elsewhere on the site.

2.2.2 Quaternary Alluvium (Map Symbol - Qa)

Quaternary alluvial deposits were exposed at the surface and were encountered to the maximum depth explored, approximately 50 feet below the ground surface. The alluvium was found to consist mostly of sands and silty sand, with scattered gravel deposits with occasional silts and clay. The alluvium was found to be loose to very dense with increasing apparent density (based on blow counts) with depth. Moisture content of upper soils (approximate upper 5 feet) were generally well below optimum.

2.3 Geologic Structure

Geologic structure was not identified in the subject geotechnical evaluation. The alluvial materials encountered are generally massive, and bedding (if present) is assumed to be nearly horizontal.

2.4 Landslides

The topography of the site and surrounding area is generally flat. Our research and field observations do not indicate the presence of landslides on the site or in the immediate vicinity. Review of regional geologic maps of the area do not indicate the presence of known or suspected landslides in the vicinity of the site. Therefore, the possibility of landslides at the site is considered nil.

2.5 Groundwater

Groundwater was not encountered during our subsurface field evaluation to the maximum explored depth of approximately 50 feet below existing ground surface. Historic high groundwater is anticipated to be greater than 50 feet below existing grade. The California Department of Water Resources Water Data Library (CDWR, 2022) indicates several wells existed within approximately 1-mile of the site; however, the wells were not frequently monitored. Based on the data, it appears that groundwater between the 1950's and early 1960's was between approximately 100 to 200 feet deep, while in the mid 1990's it was over 300 feet deep.

Seasonal fluctuations of groundwater elevations should be expected over time. In general, groundwater levels fluctuate with the seasons and local zones of perched groundwater may be present within the near-surface deposits due to local seepage or during rainy seasons. Groundwater conditions below the site may be variable, depending on numerous factors including seasonal rainfall, local irrigation and groundwater pumping, among others.

2.6 Faulting

California is located on the boundary between the Pacific and North American Lithospheric Plates. The average motion along this boundary is on the order of 50-mm/yr. in a right-lateral sense. The majority of the motion is expressed at the surface along the northwest trending San Andreas Fault Zone with lesser amounts of motion accommodated by sub-parallel faults located predominantly west of the San Andreas including the San Jacinto, Elsinore, Newport-Inglewood, Rose Canyon, and Coronado Bank Faults. Within Southern California, a large bend in the San Andreas Fault north of the San Gabriel Mountains has resulted in a transfer of a portion of the right-lateral motion between the plates into left-lateral displacement and vertical uplift. Compression south and west of the bend has resulted in folding, left-lateral, reverse thrust faulting, and regional uplift creating the east-west trending Transverse Ranges and several east-west trending faults. Further south within the Los Angeles Basin, “blind thrust” faults are believed to have developed below the surface also as a result of this compression, which have resulted in earthquakes such as the 1994 Northridge event along faults with little to no surface expression.

Prompted by damaging earthquakes in Northern and Southern California, State legislation and policies concerning the classification and land-use criteria associated with faults have been developed. The Alquist-Priolo Earthquake Fault Zoning Act was implemented in 1972 to prevent the construction of urban developments across the trace of active faults. California Geologic Survey Special Publication 42 was created to provide guidance for following and implementing the law requirements. Special Publication 42 was most recently revised in 2018 (CGS, 2018). According to the State Geologist, a “Holocene-active” fault is defined as one which has had surface displacement within Holocene time (roughly the last 11,700 years). Regulatory Earthquake Fault Zones have been delineated to encompass traces of known, Holocene-active faults to address hazards associated with surface fault rupture within California. Where developments for human occupation are proposed within these zones, the state requires detailed fault evaluations be performed so that engineering-geologists can identify the locations of active faults and recommend setbacks from locations of possible surface fault rupture.

The subject site is not located within a State of California Fault Rupture Hazard Zone (CGS, 2018 and 2022). The nearest Holocene-active faults identified by CGS are the Helendale Fault, located approximately 13 miles northeast of the site, the Ord Mountains Fault, located approximately 14 miles to the southeast of the site, and the San Andreas Fault Zone located approximately 19 miles to the southwest of the site. The Helendale and San Andreas faults trend northwest-southeast, while the Ord Mountains fault trends north-south. These faults are oblique to the site and do not trend toward the site. Therefore, the possibility of damage due to ground rupture is considered low since no active faults are known to cross the site.

Secondary effects of seismic shaking resulting from large earthquakes on the major faults in the Southern California region, which may affect the site, include ground lurching and shallow ground rupture, soil liquefaction, dynamic settlement, seiches and tsunamis. These secondary effects of seismic shaking are a possibility throughout the Southern California region and are dependent on the distance between the site and causative fault, and the onsite geology. A discussion of these secondary effects is provided in the following sections.

2.6.1 Lurching and Shallow Ground Rupture

Soil lurching refers to the rolling motion on the ground surface by the passage of seismic surface waves. Effects of this nature are not likely to be significant where the thickness of soft sediments do not vary appreciably under structures. Ground rupture due to active faulting is not likely to occur onsite due to the absence of known active fault traces. Ground cracking due to shaking from distant seismic events is not considered a significant hazard, although it is a possibility at any site.

2.6.2 Liquefaction and Dynamic Settlement

Liquefaction is a seismic phenomenon in which loose, saturated, granular soils behave similarly to a fluid when subject to high-intensity ground shaking. Liquefaction occurs when three general conditions coexist: 1) shallow groundwater; 2) low density non-cohesive (granular) soils; and 3) high-intensity ground motion. Studies indicate that saturated, loose near-surface cohesionless soils exhibit the highest liquefaction potential, while dry, dense, cohesionless soils and cohesive soils exhibit low to negligible liquefaction potential. In general, cohesive soils are not considered susceptible to liquefaction, depending on their plasticity and moisture content. Effects of liquefaction on level ground include settlement, sand boils, and bearing capacity failures below structures. Dynamic settlement of dry loose sands can occur as the sand particles tend to settle and densify as a result of a seismic event.

Due to the depth of groundwater greater than 50 feet and the generally dense nature of underlying native soils, the potential for liquefaction and liquefaction-induced settlement is considered very low.

2.6.3 Lateral Spreading

Lateral spreading is a type of liquefaction-induced ground failure associated with the lateral displacement of surficial blocks of sediment resulting from liquefaction in a subsurface layer. Once liquefaction transforms the subsurface layer into a fluid mass, gravity plus the earthquake inertial forces may cause the mass to move down-slope towards a free face (such as a river channel or an embankment). Lateral spreading may cause large horizontal displacements and such movement typically damages pipelines, utilities, bridges, and structures.

Due to the very low potential for liquefaction, the potential for lateral spreading is also considered very low.

2.6.4 Tsunamis and Seiches

Based on the elevation of the site, with respect to sea level, the possibility of damage to the site during a large tsunami event is considered nil. There are no nearby large, enclosed bodies of water, therefore the possibility of damage due to a seiche is nil.

2.7 Seismic Design Parameters

The site seismic characteristics were evaluated per the guidelines set forth in Chapter 16, Section 1613 of the 2019/2022 California Building Code (CBC) and applicable portions of ASCE 7-16 which has been adopted by the CBC. Please note that the following seismic parameters are only applicable for code-based acceleration response spectra and are not applicable for where site-specific ground motion procedures are required by ASCE 7-16. Representative site coordinates of latitude 34.5541 degrees north and longitude -117.3851 degrees west were utilized in our analyses. The maximum considered earthquake (MCE) spectral response accelerations (S_{MS} and S_{M1}) and adjusted design spectral response acceleration parameters (S_{DS} and S_{D1}) for Site Class C are provided in Table 2 below. The structural designer should contact the geotechnical consultant if structural conditions (e.g., number of stories, seismically isolated structures, etc.) require site-specific ground motions.

TABLE 2
Seismic Design Parameters

Selected Parameters from 2019/2022 CBC, Section 1613 - Earthquake Loads	Seismic Design Values	Notes/Exceptions
Distance to applicable faults classifies the site as a "Near-Fault" site.		Section 11.4.1 of ASCE 7
Site Class	C	Chapter 20 of ASCE 7
S_s (Risk-Targeted Spectral Acceleration for Short Periods)	1.127g	From SEAOC, 2022
S_1 (Risk-Targeted Spectral Accelerations for 1-Second Periods)	0.439g	From SEAOC, 2022
F_a (per Table 1613.2.3(1))	1.2	For Simplified Design Procedure of Section 12.14 of ASCE 7, F_a shall be taken as 1.4 (Section 12.14.8.1)
F_v (per Table 1613.2.3(2))	1.5	-
S_{MS} for Site Class C [Note: $S_{MS} = F_a S_s$]	1.353g	-
S_{M1} for Site Class C [Note: $S_{M1} = F_v S_1$]	0.658g	-
S_{DS} for Site Class C [Note: $S_{DS} = (2/3) S_{MS}$]	0.902g	-
S_{D1} for Site Class C [Note: $S_{D1} = (2/3) S_{M1}$]	0.439g	-
C_{RS} (Mapped Risk Coefficient at 0.2 sec)	0.935	ASCE 7 Chapter 22
C_{R1} (Mapped Risk Coefficient at 1 sec)	0.920	ASCE 7 Chapter 22

A deaggregation of the PGA based on a 2,475-year average return period (MCE) indicates that an earthquake magnitude of 6.75 at a distance of approximately 14.34 km from the site would

contribute the most to this ground motion. A deaggregation of the PGA based on a 475-year average return period (Design Earthquake) indicates that an earthquake magnitude of 6.66 at a distance of approximately 19.25 km from the site would contribute the most to this ground motion (USGS, 2014).

Section 1803.5.12 of the 2019/2022 CBC (per Section 11.8.3 of ASCE 7) states that the maximum considered earthquake geometric mean (MCE_G) Peak Ground Acceleration (PGA) should be used for liquefaction potential. The PGA_M for the site is equal to 0.582g (SEAOC, 2022). The design PGA is equal to 0.388g (2/3 of PGA_M).

2.8 Subsidence

Subsidence is the settlement of the ground surface over large areas (typically on the order of square miles) typically due to the lowering of the groundwater table. Mitigation against such a large-scale groundwater drawdown cannot be performed on a site-specific level, but instead “requires regional cooperation among numerous agencies” and therefore is not a site-specific geotechnical consideration. The soils encountered in our field evaluation did not indicate the presence of soils susceptible to collapse or excessive settlement. Based on the local site geologic conditions, the potential for subsidence in the site development area is considered low.

2.9 Rippability

In general, excavation for foundations and underground improvements should be achievable with the appropriate earthwork equipment.

2.10 Oversized Material

Encountering significant quantities of oversized material (material larger than 8 inches in maximum dimension) is not anticipated during grading. Recommendations are provided for appropriate handling of oversized materials, if encountered, in Appendix D. If feasible, crushing oversized materials or exporting to an offsite location may be considered.

2.11 Expansion Potential

Based on the results of laboratory testing, site soils are anticipated to have a “Very Low” expansion potential. Final expansion potential of site soils should be determined at the completion of grading. Results of expansion testing at finish grades will be utilized to confirm final foundation design.

3.0 FINDINGS AND CONCLUSIONS

Based on the results of our geotechnical evaluation, it is our opinion that the proposed site development is feasible from a geotechnical standpoint, provided the following conclusions and recommendations are incorporated into the site design, grading, and construction.

The following is a summary of the primary geotechnical factors, which may affect future development of the site.

- In general, our subsurface evaluation primarily indicates that the site contains loose to very dense sands to silty sands with scattered gravel to the maximum explored depth of approximately 50 feet below existing grade. Moisture content of soils in the upper approximate 5 feet are generally well below optimum. Approximately 1 to 2 feet of undocumented fill is present on about half of the site. The undocumented fill and near-surface compressible native soils are not suitable for the planned improvements in their present condition (refer to Section 4.1).
- From a geotechnical perspective, onsite soils are anticipated to be suitable for use as general compacted fill, provided they are screened of construction debris and any oversized material (8 inches in greatest dimension). Significant moisture conditioning of site soils should be anticipated to achieve adequate compaction.
- Groundwater was not encountered to the maximum explored depth of approximately 50 feet below existing ground surface. Historic high groundwater is anticipated to be greater than 50 feet below existing ground surface (CDWR, 2022).
- The subject site is not located within an Alquist-Priolo Earthquake Fault Zone. No active faults are mapped on the site. No faults were identified on the site during our site evaluation. The proposed development will likely be subjected to strong seismic ground shaking during its design life from one of the regional faults.
- Due to a lack of groundwater in the upper 50 feet and the generally dense underlying native soils, the potential for liquefaction and liquefaction-induced settlement is considered very low.
- Based on laboratory testing, soils exposed at the proposed foundation level are anticipated to have a "Very Low" expansion potential (EI not exceeding 20). This shall be confirmed at the completion of site earthwork.
- Excavation for foundations and underground improvements should be achievable with the appropriate earthwork equipment.
- The four field infiltration tests indicated observed infiltration rates ranging from 1.6 inch/hour to 11.3 inch/hour. These values do not include any factor of safety. Refer to Section 4.9.
- The site contains soils with high fines content (i.e., silts and clay) that are not suitable for backfill of retaining walls. Therefore, select grading and stockpiling of native suitable sandy soils and/or import of select sandy soils meeting project recommendations will be required for retaining wall backfill.

4.0 RECOMMENDATIONS

The following recommendations are to be considered preliminary and should be confirmed upon completion of earthwork operations. In addition, they should be considered minimal from a geotechnical viewpoint, as there may be more restrictive requirements from the architect, structural engineer, building codes, governing agencies, or the City. It is the responsibility of the builder to ensure these recommendations are provided to the appropriate parties.

It should be noted that the following geotechnical recommendations are intended to provide sufficient information to develop the site in general accordance with the 2019/2022 California Building Code (CBC) requirements. With regard to the potential occurrence of potentially catastrophic geotechnical hazards such as fault rupture, earthquake-induced landslides, liquefaction, etc. the following geotechnical recommendations should provide adequate protection for the proposed development to the extent required to reduce seismic risk to an “acceptable level.” The “acceptable level” of risk is defined by the California Code of Regulations as “the level that provides reasonable protection of the public safety, though it does not necessarily ensure continued structural integrity and functionality of the project” [Section 3721(a)]. Therefore, repair and remedial work of the proposed improvement may be required after a significant seismic event. With regards to the potential for less significant geologic hazards to the proposed development, the recommendations contained herein are intended as a reasonable protection against the potential damaging effects of geotechnical phenomena such as expansive soils, fill settlement, groundwater seepage, etc. It should be understood, however, that although our recommendations are intended to maintain the structural integrity of the proposed development and structures given the site geotechnical conditions, they cannot preclude the potential for some cosmetic distress or nuisance issues to develop as a result of the site geotechnical conditions.

The geotechnical recommendations contained herein must be confirmed to be suitable or modified based on the actual exposed conditions.

4.1 Site Earthwork

We anticipate that earthwork at the site will consist of required earthwork removals, foundation construction and utility line construction and backfill. We recommend that earthwork onsite be performed in accordance with the following recommendations, the City of Adelanto, 2019/2022 CBC and the General Earthwork and Grading Specifications included in Appendix D. In case of conflict, the following recommendations shall supersede previous recommendations and those included as part of Appendix D.

4.1.1 Site Preparation

Prior to grading of areas to receive structural fill, engineered structures or improvements should be demolished and the area should be cleared of existing vegetation (shrubs, trees, grass, etc.), surface obstructions, existing debris and potentially compressible or otherwise unsuitable material. Debris should be removed and properly disposed of off-site. Holes resulting from the removal of buried obstructions, which extend below proposed removal bottoms, should be replaced with suitable compacted fill material. Any

abandoned utility lines should be completely removed and replaced with properly compacted fill.

If cesspools or septic systems are encountered, they should be removed in their entirety. The resulting excavation should be backfilled with properly compacted fill soils. As an alternative, cesspools can be backfilled with lean sand-cement slurry. Any encountered wells should be properly abandoned in accordance with regulatory requirements. At the conclusion of the clearing operations, a representative of LGC Geotechnical should observe and accept the site prior to further grading.

4.1.2 Removal Depths and Limits

In order to provide a relatively uniform bearing condition for the planned improvements, the undocumented fill and the upper loose/compressible native soils are to be removed and replaced as properly compacted fills. The undocumented fill, consisting of parallel earthen berms in the western and southern halves of the site, is estimated at approximately 1 to 2 feet thick. Undocumented fills must be removed, cleared of debris, and may then be utilized as fill material. For preliminary planning purposes, the depth of required native soil removals, after the undocumented fill has been removed may be estimated as indicated below.

Building Structure: Removals should extend a minimum depth of 5 feet below existing grade (not including overlying stockpiles), or 2 feet below the proposed footings, whichever is greater. In general, the envelope for removals should extend laterally a minimum horizontal distance equal to the fill thickness so that a 1:1 plane may be projected from the footing to the edge of the removal, with a minimum lateral extent of 5 feet beyond the edges of the proposed building footprint. The removals for loading dock areas, which act as retaining walls, should extend a minimum of 2 feet below the bottom of the proposed footings, which is likely deeper than 5 feet below existing grade, depending upon the design of the loading docks.

Retaining/Free-Standing Wall Structures: Removals should extend a minimum of 3 feet below existing grade (not including overlying stockpiles), or 1-foot below proposed footings, whichever is greater.

Pavement and Hardscape Areas: Removals should extend to a depth of at least 2 feet below the existing grade (not including overlying stockpiles),. In general, the envelope for removals should extend laterally a minimum lateral distance of 2 feet beyond the edges of the proposed improvements.

Local conditions may be encountered during excavation that could require additional over-excavation beyond the above-noted minimum in order to obtain an acceptable subgrade including localized areas of undocumented fill. The actual depths and lateral extents of grading will be determined by the geotechnical consultant, based on subsurface conditions encountered during grading. Removal areas should be accurately staked in the field by the Project Surveyor.

4.1.3 Temporary Excavations

Temporary excavations should be performed in accordance with project plans, specifications, and applicable Occupational Safety and Health Administration (OSHA) requirements. Excavations should be laid back or shored in accordance with OSHA requirements before personnel or equipment are allowed to enter. Based on our field investigation, the majority of site soils are anticipated to be OSHA Type "C" soils (refer to the attached boring logs). Sandy soils are present and should be considered susceptible to caving. Soil conditions should be regularly evaluated during construction to verify conditions are as anticipated. The contractor shall be responsible for providing the "competent person" required by OSHA standards to evaluate soil conditions. Close coordination with the geotechnical consultant should be maintained to facilitate construction while providing safe excavations. Excavation safety is the sole responsibility of the contractor.

Vehicular traffic, stockpiles, and equipment storage should be set back from the perimeter of excavations a minimum distance equivalent to a 1:1 projection from the bottom of the excavation or 5 feet, whichever is greater. Once an excavation has been initiated, it should be backfilled as soon as practical. Prolonged exposure of temporary excavations may result in some localized instability. Excavations should be planned so that they are not initiated without sufficient time to shore/fill them prior to weekends, holidays, or forecasted rain.

It should be noted that any excavation that extends below a 1:1 (horizontal to vertical) projection of an existing foundation will remove existing support of the structure foundation. If requested, temporary shoring parameters can be provided.

4.1.4 Removal Bottoms and Subgrade Preparation

In general, removal bottom areas and any areas to receive compacted fill should be scarified to a minimum depth of 6 inches, brought to a near-optimum moisture condition, and re-compacted per project recommendations.

Removal bottoms and areas to receive fill should be observed and accepted by the geotechnical consultant prior to subsequent fill placement.

4.1.5 Material for Fill

From a geotechnical perspective, the onsite soils are generally considered suitable for use as general compacted fill (i.e., non-retaining wall backfill), provided they are screened of organic materials, construction debris and any oversized material (8 inches in greatest dimension). Significant moisture conditioning of site soils should be anticipated as outlined in the section below.

From a geotechnical viewpoint, any required import soils should consist of clean, relatively granular soils of Very Low expansion potential (expansion index 20 or less based on ASTM D4829) and no particles larger than 3 inches in greatest dimension.

Source samples of planned importation should be provided to the geotechnical consultant for laboratory testing a minimum of 3 working days prior to any planned importation for required laboratory testing.

Any required retaining wall backfill should consist of sandy soils with a maximum of 35 percent fines (passing the No. 200 sieve) per American Society for Testing and Materials (ASTM) Test Method D1140 (or ASTM D6913/D422) and a Very Low expansion potential (EI of 20 or less per ASTM D4829). Soils should also be screened of organic materials, construction debris and any material greater than 3 inches in maximum dimension. The site contains soils that are not suitable for retaining wall backfill due to their fines content; therefore, select grading and stockpiling and/or import of select sandy soils will be required by the contractor to obtain suitable retaining wall backfill soil.

Aggregate base (crushed aggregate base or crushed miscellaneous base) should conform to the requirements of Section 200-2 of the Standard Specifications for Public Works Construction ("Greenbook") for untreated base materials (except processed miscellaneous base) or Caltrans Class 2 aggregate base.

4.1.6 Fill Placement and Compaction

Material to be placed as fill should be brought to near-optimum moisture content (generally at about 2 percent above optimum moisture content) and recompacted to at least 90 percent relative compaction (per ASTM D1557). Significant moisture conditioning of site soils should be anticipated in order to achieve the required degree of compaction. In general, soils will require additional moisture conditioning in order to achieve the required compaction are present. Soils may also be present that will require drying and/or mixing the very moist soils prior to reusing the materials in compacted fills. The optimum lift thickness to produce a uniformly compacted fill will depend on the type and size of compaction equipment used. In general, fill should be placed in uniform lifts not exceeding 8 inches in loose thickness. Each lift should be thoroughly compacted and accepted prior to subsequent lifts. Generally, placement and compaction of fill should be performed in accordance with local grading ordinances and with observation and testing by the geotechnical consultant. Oversized material as previously defined should be removed from site fills.

Fill placed on any slopes greater than 5:1 (horizontal to vertical) should be properly keyed and benched into firm and competent soils as it is placed in lifts. During backfill of excavations, the fill should be properly benched into firm and competent soils of temporary backcut slopes as it is placed in lifts.

Aggregate base material should be compacted to a minimum of 95 percent relative compaction at or slightly above-optimum moisture content per ASTM D1557. Subgrade below aggregate base should be compacted to a minimum of 90 percent relative compaction per ASTM D1557 at or slightly above-optimum moisture content.

If gap-graded ¾-inch rock is used for backfill (around storm drain storage chambers, retaining wall backfill, etc.) it will require compaction. Rock shall be placed in thin lifts (typically not exceeding 6 inches) and mechanically compacted with observation by the geotechnical consultant. Backfill rock shall meet the requirements of ASTM D2321. Gap-

graded rock is required to be wrapped in filter fabric to prevent the migration of fines into the rock backfill.

4.1.7 Trench and Retaining Wall Backfill and Compaction

Bedding material used within the pipe zone should conform to the requirements of the current Greenbook and the pipe manufacturer. Where applicable, sand having a sand equivalent (SE) of 20 or greater (per Caltrans Test Method [CTM] 217) may be used to bed and shade the pipes within the bedding zone. Sand backfill should be densified by jetting or flooding and then tamped to ensure adequate compaction. Bedding sand should be from a natural source, manufactured sand from recycled material is not suitable for jetting. The onsite soils may generally be considered suitable as trench backfill (zone defined as 12 inches above the pipe to subgrade), provided the soils are screened of rocks greater than 6 inches in maximum dimension, construction debris and organic material. Trench backfill should be compacted in uniform lifts (as outlined in Section 4.1.5 "Material for Fill") by mechanical means to at least 90 percent relative compaction (per ASTM D1557). If gap-graded rock is used for trench backfill, refer to Section 4.1.6.

In backfill areas where mechanical compaction of soil backfill is impractical due to space constraints, flowable fill such as sand-cement slurry may be substituted for compacted backfill. The slurry should contain about one sack of cement per cubic yard. When set, such a mix typically has the consistency of compacted soil. Sand cement slurry placed near the surface within landscape areas should be evaluated for potential impacts on planned improvements.

Any required retaining wall backfill should consist of predominately granular, sandy soils outlined in Section 4.1.5. The limits of select sandy backfill should extend at minimum $\frac{1}{2}$ the height of the retaining wall or the width of the heel (if applicable), whichever is greater (Refer to Figure 3). Retaining wall backfill soils should be compacted in relatively uniform thin lifts to a minimum of 90 percent relative compaction (per ASTM D1557). Jetting or flooding of retaining wall backfill materials should not be permitted. If gap-graded rock is used for retaining wall backfill, refer to Section 4.1.6.

A representative from LGC Geotechnical should observe, probe, and test the backfill to verify compliance with the project recommendations.

4.1.8 Shrinkage and Subsidence

Allowance in the earthwork volumes budget should be made for an estimated 5 to 15 percent reduction in volume of near-surface (upper approximate 5 feet) soils. It should be stressed that these values are only estimates and that an actual shrinkage factor would be extremely difficult to predetermine. Subsidence, due to earthwork operations, is expected to be on the order of 0.1-foot. These values are estimates only and exclude losses due to removal of any vegetation or debris. The above shrinkage estimate is intended as an aid for others in determining preliminary earthwork quantities. However, these estimates should be used with some caution since they are not absolute values. The effective shrinkage of onsite soils will depend primarily on the type of

compaction equipment and method of compaction used onsite by the contractor and accuracy of the topographic survey.

4.2 Preliminary Foundation Recommendations

The following foundation recommendations are preliminary and must be confirmed by LGC Geotechnical at the completion of project plans (i.e., foundation, grading, etc.) as well as completion of earthwork. Please note that foundation recommendations are based on estimated structural loads. Increase of structural loads may require revision of the provided foundation recommendations and parameters and/or revised remedial recommendations.

Based on preliminary laboratory testing, site soils are anticipated to be of Very Low expansion potential (EI of 20 or less per ASTM D4829). However, this must be verified based on as-graded conditions. Recommended soil bearing and estimated static settlement are provided in Section 4.3. Since site soils are anticipated to be of “Very Low” expansion potential special design considerations from a geotechnical perspective are not anticipated to be required.

4.2.1 Slab Design and Construction

From a geotechnical perspective, minimum slab thicknesses of 6 inches and 4 inches are recommended for new slabs in the warehouse areas and office areas, respectively. Slabs are to be supported on compacted fill soils properly prepared in accordance with the recommendations provided in this report. Actual slab reinforcement and thickness should be determined by the structural engineer based on the imposed loading. Additional slab-on-grade recommendations can be provided for alternative building types upon request.

The foundation designer may use a modulus of vertical subgrade reaction (k) of 150 pounds per cubic inch (pounds per square inch per inch of deflection). This value is for a 1-foot by 1-foot square loaded area and should be adjusted by the structural designer for the area of the proposed footing using the following formula:

$$k = 150 \times [(B+1)/2B]^2$$

k = modulus of vertical subgrade reaction, pounds per cubic inch (pci)

B = foundation width (feet)

It is recommended that subgrade soils below slabs be moisture conditioned in order to maintain the recommended moisture content up to the time of concrete placement. The recommended moisture content of the slab subgrade soils should be between optimum moisture content and approximately 2 percent above optimum moisture content to a minimum depth of 12 inches. The moisture content of the slab subgrade should be verified by the geotechnical consultant within 1 to 2 days prior to concrete placement. In addition, this moisture content should be maintained around the immediate perimeter of the slab during construction and up to occupancy of the building structures.

The following recommendations are for informational purposes only, as they are

unrelated to the geotechnical performance of the foundation. The following recommendations may be superseded by the foundation engineer and/or owner. Some post-construction moisture migration should be expected below the foundation. In general, interior floor slabs with moisture sensitive floor coverings should be underlain by a minimum 10 mil thick polyolefin material vapor retarder, which has a water vapor transmission rate (permeance) of less than 0.03 perms. The need for sand and/or the sand thickness (above and/or below the vapor retarder) should be specified by the structural engineer, architect or concrete contactor. The selection and thickness of sand is not a geotechnical engineering issue and is therefore outside our purview.

4.2.2 Shallow Foundation Maintenance

The geotechnical parameters provided herein assume that if the areas adjacent to the foundation are planted and irrigated, these areas will be designed with proper drainage and adequately maintained so that ponding, which causes significant moisture changes below the foundation, does not occur. Our recommendations do not account for excessive irrigation and/or incorrect landscape design. Plants should only be provided with sufficient irrigation for life and not overwatered to saturate subgrade soils. Sunken planters placed adjacent to the foundation, should either be designed with an efficient drainage system or liners to prevent moisture infiltration below the foundation. Some lifting of the perimeter foundation beam should be expected even with properly constructed planters.

In addition to the factors mentioned above, future owners/property management personnel should be made aware of the potential negative influences of trees and/or other large vegetation. Roots that extend near the vicinity of foundations can cause distress to foundations. Future owners (and the owner's landscape architect) should not plant trees/large shrubs closer to the foundations than a distance equal to half the mature height of the tree or 20 feet, whichever is more conservative unless specifically provided with root barriers to prevent root growth below the building foundation.

It is the owner's responsibility to perform periodic maintenance during hot and dry periods to ensure that adequate watering has been provided to keep soil from separating or pulling back from the foundation. Future owners and property management personnel should be informed and educated regarding the importance of maintaining a constant level of soil-moisture. The owners should be made aware of the potential negative consequences of both excessive watering, as well as allowing potentially expansive soils to become too dry. Expansive soils can undergo shrinkage during drying, and swelling during the rainy winter season, or when irrigation is resumed. This can result in distress to building structures and hardscape improvements. These recommendations should be provided to future owners and property management personnel.

4.3 Soil Bearing and Lateral Resistance

Provided our earthwork recommendations are implemented, the following minimum footing widths and embedments for isolated spread and continuous wall footings are recommended

for the corresponding allowable bearing pressures.

TABLE 3

Allowable Soil Bearing Pressures

Allowable Static Bearing Pressure (psf)	Minimum Footing Width (feet)	Minimum Footing Embedment* (feet)
3,000	4	2
2,500	3	2
2,000	2	1.5
1,500	1.5	1

*Refers to minimum depth to the bottom of the footing below lowest adjacent finish grade.

These allowable bearing pressures are applicable for level (ground slope equal to or flatter than 5 horizontal feet to 1-foot vertical) conditions only. Bearing values indicated above are for total dead loads and live loads. The above vertical bearing may be increased by one-third for short durations of loading which will include the effect of wind or seismic loading. The increase is based on a reduced factor of safety (seismic factor of safety equal to three-fourths of the static factor of safety) for short duration loading.

Soil settlement is a function of footing dimensions and applied soil bearing pressure. In utilizing the above-mentioned allowable bearing capacity and provided our earthwork recommendations are implemented, foundation settlement due to structural loads is anticipated to be on the order of 1-inch or less. Differential static settlement may be taken as half of the static settlement (i.e., ½-inch over a horizontal span of 40 feet). Additionally, differential settlement should be anticipated between nearby columns or walls where a large differential loading condition exists. Settlement estimates should be updated by LGC Geotechnical when the final foundation plans are available.

Resistance to lateral loads can be provided by friction acting at the base of foundations and by passive earth pressure. For concrete/soil frictional resistance, an allowable coefficient of friction of 0.30 may be assumed with dead-load forces. An allowable passive lateral earth pressure of 250 psf per foot of depth (or pcf) to a maximum of 2,500 psf may be used for lateral resistance. Allowable passive pressure may be increased to 340 pcf (maximum of 3,400 psf) for short duration seismic loading. This passive pressure is applicable for level (ground slope equal to or flatter than 5 horizontal feet to 1-foot vertical) conditions only. Frictional resistance and passive pressure may be used in combination without reduction. We recommend that the upper foot of passive resistance be neglected if finished grade will not be covered with concrete or asphalt concrete. The provided allowable passive pressures are based on a factor of safety of 1.5 and 1.1 for static and seismic loading conditions, respectively.

4.4 Lateral Earth Pressures for Retaining Walls

The following preliminary lateral earth pressures may be used for any site retaining walls 10 feet

or less. Lateral earth pressures are provided as equivalent fluid unit weights, in pound per square foot (psf) per foot of depth or pcf. These values do not contain an appreciable factor of safety, so the retaining wall designer should apply the applicable factors of safety and/or load factors during design.

The following lateral earth pressures are presented on Table 4 below for approved select granular soils with a maximum of 35 percent fines (passing the No. 200 sieve per ASTM D-421/422) and Very Low expansion potential (EI of 20 or less per ASTM D4829). The wall designer should clearly indicate on the retaining wall plans the required sandy soil backfill criteria.

TABLE 4

Lateral Earth Pressures – Select Sandy Backfill

Conditions	Equivalent Fluid Unit Weight (pcf)
	Level Backfill
	Approved Soils
Active	35
At-Rest	55

If the wall can yield enough to mobilize the full shear strength of the soil, it can be designed for “active” pressure. If the wall cannot yield under the applied load, the earth pressure will be higher. This would include 90-degree corners of retaining walls. Such walls should be designed for “at-rest.” The equivalent fluid pressure values assume free-draining conditions. Retaining wall structures should be provided with appropriate drainage and appropriately waterproofed (Figure 3). Please note that waterproofing and outlet systems are not the purview of the geotechnical consultant. If conditions other than those assumed above are anticipated, the equivalent fluid pressure values should be provided on an individual-case basis by the geotechnical consultant.

Surcharge loading effects from any adjacent structures should be evaluated by the basement/retaining wall designer. The amount of surcharge loading on a proposed retaining wall structure is primarily a function of the distance, magnitude and lateral extents of the surcharge loading and should be evaluated on a case-by-case basis. In addition to the recommended lateral earth pressure, basement/retaining walls adjacent to streets should be designed to resist vehicular traffic if applicable. Uniform surcharges may be estimated using the applicable coefficient of lateral earth pressure using a rectangular distribution. A factor of 0.5 and 0.3 may be used for at-rest and active conditions, respectively for a level backfill. The vertical traffic surcharge may be determined by the structural designer. The structural designer should contact the geotechnical consultant for any required geotechnical input in estimating any applicable surcharge loads.

If required, the retaining wall designer may use a seismic lateral earth pressure increment of 5

pcf for a level backfill condition. This increment should be applied in addition to the provided static lateral earth pressure using a triangular distribution with the resultant acting at H/3 in relation to the base of the retaining structure (where H is the retained height). For the restrained, at-rest condition, the seismic increment may be added to the applicable active lateral earth pressure (in lieu of the at-rest lateral earth pressure) when analyzing short duration seismic loading. Per Section 1803.5.12 of the 2019/2022 CBC, the seismic lateral earth pressure is applicable to structures assigned to Seismic Design Category D through F for retaining wall structures supporting more than 6 feet of backfill height. The provided seismic lateral earth pressure should not be used for retaining walls exceeding 10 feet in height. If a retaining wall greater than 10 feet in height is proposed or a retaining wall with a sloping backfill condition, the retaining wall designer should contact the geotechnical consultant for specific seismic lateral earth pressure increments based on the configuration of the planned retaining wall structures. Seismic lateral earth pressures are estimated using the procedure outlined by the Structural Engineers Association of California (Lew, et al, 2010).

Soil bearing and lateral resistance (friction coefficient and passive resistance) are provided in Section 4.3. Earthwork considerations (temporary backcuts, backfill, compaction, etc.) for retaining walls are provided in Section 4.1 (Site Earthwork) and the subsequent earthwork related sub-sections.

4.5 Preliminary Pavement Sections

The following provisional minimum asphalt concrete (AC) pavement sections are provided in Table 5 based on an assumed R-value of 50 for Traffic Indices (TI) up to 7.0. These recommendations should be confirmed with R-value testing of representative near-surface soils at the completion of earthwork. Final pavement sections should be confirmed by the project civil engineer based upon the final design Traffic Index. Determination of the TI is not the purview of the geotechnical consultant. If requested, LGC Geotechnical will provide sections for alternate TI values.

TABLE 5

Paving Section Options

Assumed Traffic Index	≤ 6.0	7.0
R -Value Subgrade	50	50
AC Thickness	4.0 inches	4.0 inches
Aggregate Base Thickness	4.0 inches	5.0 inches

The provided preliminary Portland Cement concrete pavement section is based on the guidelines of the American Concrete Institute (ACI 330R-08). For the final design section, we recommend a traffic study be performed as LGC Geotechnical does not perform traffic engineering. Traffic study should include the design vehicle (number of axles and load per axle) and estimated number of daily repetitions/trips. Based on an assumed Traffic Category C with an assumed Average Daily Truck Traffic (ADTT) of 50, we recommend a preliminary section of a minimum of 6 inches of concrete over 4 inches of compacted aggregate base over compacted subgrade. The

concrete should have a minimum compressive strength of 4,000 psi and a minimum flexural strength of 550 psi at the time the pavement is subjected to traffic. Steel reinforcement is not required (ACI, 2013). The 4-inch layer of aggregate base may be omitted if the upper 6-inches of subgrade underlying the concrete pavement is compacted to at least 95 percent (instead of 90 percent) relative compaction near optimum moisture content. This pavement section assumes that edge restraints like a curb and gutter will be provided. To reduce the potential (but not eliminate) for cracking, paving should provide control joints at regular intervals not exceeding 10 feet in each direction. Decreasing the spacing of these joints will further reduce, but not eliminate the potential for unsightly cracking. Preliminary pavement section is based on a 30-year design. Truck loading is defined one 16-kip axle and two 32-kip tandem axles (80 kips). Alternate section(s) may be provided based on anticipated specific traffic loadings and repetitions provided by others. LGC Geotechnical does not perform traffic engineering and determination of traffic loading is not the purview of the geotechnical consultant.

The thicknesses shown are for minimum thicknesses. Increasing the thickness of any or all of the above layers will reduce the likelihood of the pavement experiencing distress during its service life. The above recommendations are based on the assumption that proper maintenance and irrigation of the areas adjacent to the roadway will occur through the design life of the pavement. Failure to maintain a proper maintenance and/or irrigation program may jeopardize the integrity of the pavement.

Earthwork recommendations regarding aggregate base and subgrade are provided in the previous section "Site Earthwork" and the related sub-sections of this report.

4.6 Soil Corrosivity

Although not corrosion engineers (LGC Geotechnical is not a corrosion consultant), several governing agencies in Southern California require the geotechnical consultant to determine the corrosion potential of soils to buried concrete and metal facilities. We therefore present the results of our testing with regard to corrosion for the use of the client and other consultants, as they determine necessary.

Corrosion testing indicated soluble sulfate contents less than approximately 0.01 percent, a chloride content of 41 parts per million (ppm), pH of 7.7, and a minimum resistivity of 3,080 ohm-centimeters. Based on Caltrans Corrosion Guidelines (2021), soils are considered corrosive if the pH is 5.5 or less, or the chloride concentration is 500 ppm or greater, or the sulfate concentration is 1,500 ppm (0.15 percent) or greater.

Based on laboratory sulfate test results, the near surface soils are designated to a class "S0" per ACI 318, Table 19.3.1.1 with respect to sulfates.

4.7 Nonstructural Concrete Flatwork

Nonstructural concrete (such as flatwork, sidewalks, etc.) has a potential for cracking due to changes in soil volume related to soil-moisture fluctuations. To reduce the potential for excessive cracking and lifting, concrete should be designed in accordance with the minimum guidelines outlined in Table 6 on the following page. These guidelines will reduce the potential

for irregular cracking and promote cracking along construction joints but will not eliminate all cracking or lifting. Thickening the concrete and/or adding additional reinforcement will further reduce cosmetic distress.

TABLE 6

Nonstructural Concrete Flatwork for Very Low/Low Expansion Potential

	Flatwork	City Sidewalk Curb and Gutters
Minimum Thickness (in.)	4 (full)	City/Agency Standard
Presoaking	Wet down prior to placing	City/Agency Standard
Reinforcement	No. 3 at 24 inches on centers	City/Agency Standard
Crack Control Joints	Saw cut or deep open tool joint to a minimum of 1/3 the concrete thickness	City/Agency Standard
Maximum Joint Spacing	6 feet	City/Agency Standard
Aggregate Base Thickness (in.)	—	City/Agency Standard

To reduce the potential for nonstructural concrete flatwork to separate from entryways and doorways, the owner may elect to install dowels to tie these two elements together.

4.8 Surface Drainage and Landscaping

Landscape design should limit the potential for surface water to penetrate the soils adjacent to the proposed structures and improvements.

4.8.1 General

Surface drainage should be carefully taken into consideration during precise grading, building construction, future landscaping, and throughout the design life of the industrial structure. Positive drainage should be provided to direct surface water away from improvements and towards either the street or other suitable drainage devices. Ponding of water, adjacent to any structural improvement foundation, must be avoided. The performance of structural foundations is dependent upon maintaining adequate surface drainage away from them, thereby reducing excessive moisture fluctuations. From a geotechnical perspective, area drains, drainage swales, and finished grade soils should be aligned so as to transport surface water to a minimum distance of 5 feet away

from the proposed foundations. Roof gutters and downspout systems should be discharged directly to a pipe or to a paved surface with a positive gradient away from the building and should not outlet directly into unpaved landscape areas.

Decorative gravel tends to act as a reservoir trapping surface water; therefore, we do not recommend it be used adjacent to buildings unless the system is designed with a subsurface drainage system and is properly lined.

4.8.2 Precise Grading

From a geotechnical perspective, we recommend that compacted finished grade soils adjacent to the proposed industrial structures be sloped away from the proposed structures and towards an approved drainage device or unobstructed swale. Drainage swales, wherever feasible, should not be constructed within 5 feet of buildings. Where lot and building geometry necessitates that the drainage swales be routed closer than 5 feet to structural foundations, we recommend the use of area drains together with drainage swales. Drainage swales used in conjunction with area drains should be designed by the project civil engineer so that a properly constructed and maintained system will prevent ponding within 5 feet of the foundation. Code compliance of grades is not the purview of the geotechnical consultant. We do not recommend that area drains be connected to basement/retaining subdrains.

Planters with open bottoms adjacent to buildings should be avoided. Planters should not be designed adjacent to buildings unless provisions for drainage, such as catch basins, liners, and/or area drains, are made. Overwatering must be avoided.

4.8.3 Landscaping

Planters adjacent to a building or structure should be avoided wherever possible or be properly designed (e.g., lined with a membrane and properly outlet), to reduce the penetration of water into the adjacent footing subgrades and thereby reduce moisture related damage to the foundation. Planting areas at grade should be provided with appropriate positive drainage. Wherever possible, exposed soil areas should be above adjacent paved grades to facilitate drainage. Planters should not be depressed below adjacent paved grades unless provisions for drainage, such as multiple depressed area drains, are constructed. Adequate drainage gradients, devices, and curbing should be provided to prevent runoff from adjacent pavement or walks into the planting areas. Irrigation methods should promote uniformity of moisture in planters and beneath adjacent concrete flatwork. Overwatering and underwatering of landscape areas must be avoided. Irrigation levels should be kept to the absolute minimum level necessary to maintain healthy plant life.

Area drain inlets should be maintained and kept clear of debris in order to properly function. The building owner should also be made aware that excessive irrigation of neighboring properties can cause seepage and moisture conditions on adjacent lots.

The impact of heavy irrigation or inadequate runoff gradients can create perched water

conditions. This may result in seepage or shallow groundwater conditions where previously none existed. Maintaining adequate surface drainage and controlled irrigation will significantly reduce the potential for nuisance-type moisture problems. To reduce differential earth movements such as heaving and shrinkage due to the change in moisture content of foundation soils, which may cause distress to a structure and associated improvements, moisture content of the soils surrounding the structure should be kept as relatively constant as possible.

4.9 Subsurface Water Infiltration

Recent regulatory changes have occurred that mandate that storm water be infiltrated below grade rather than collected in a conventional storm drain system. It should be noted that collecting and concentrating surface water for the purpose of intentionally infiltrating it below grade, conflicts with the geotechnical engineering objective of directing surface water away from slopes, structures and other improvements. The geotechnical stability and integrity of a site is reliant upon appropriately handling surface water. In general, we do not recommend that surface water be intentionally infiltrated into the subsurface soils.

If it is determined that water must be infiltrated due to regulatory requirements, we recommend the absolute minimum amount of water be infiltrated and that the infiltration areas not be located near slopes or near settlement sensitive existing/proposed improvements. Contamination and environmental suitability of the site for infiltration is not the purview of the geotechnical consultant and should be evaluated by others. LGC Geotechnical only addressed the geotechnical issues associated with stormwater infiltration.

As with all systems that are designed to concentrate surface flow and direct the water into the subsurface soils, some minor settlement, nuisance type localized saturation and/or other water related issues should be expected. Due to variability in geologic and hydraulic conductivity characteristics, these effects may be experienced at the onsite location and/or potentially at other locations well beyond the physical limits of the subject site. Infiltrated water may enter underground utility pipe zones or flow along heterogeneous soil layers or geologic structure and migrate laterally impacting other improvements which may be located far away or at an elevation much different than the infiltration source.

Based on the results of our field infiltration testing the observed (no factor of safety) infiltration rates were 1.6 to 11.3 inches per hour (refer to Table 1). The design infiltration rate shall be determined by dividing the observed infiltration rate by a series of safety factors for site suitability and design considerations that are the purview of both the geotechnical consultant and designer of the infiltration system (County of San Bernardino, 2013). The recommended geotechnical factors of safety that are to be used to determine the design infiltration rate are provided in Table 7 on the following page.

TABLE 7

Geotechnical Factors of Safety for Design Infiltration Rate

A: Site Suitability Considerations (From Table VII.3)	
Consideration	Factor of Safety (F.S.)
Soil Assessment Methods	2
Texture Class	1
Site Soil Variability	2
Depth to Groundwater/Impervious Layer	1
Calculated Suitability Assessment Factor of Safety	1.5
B: Design Related Considerations (From Table VII.4)	
Consideration	Factor of Safety (F.S.)
Tributary Size Area	Per Infiltration Designer
Level of Pretreatment	Per Infiltration Designer
Redundancy of Treatment	Per Infiltration Designer
Compaction during Construction	2
Calculated Design Factor of Safety	Per Infiltration Designer
Combined F.S.= Suitability F.S x Design F.S.	TBD

Per the requirements of the San Bernardino County testing guidelines (2013), subsurface materials should have a design infiltration rate equal to or greater than 0.3 inches per hour. The factor of safety used to determine the design infiltration rate is determined by multiplying the calculated suitability assessment factor of safety of 1.5 by the design factor of safety which is to be determined by the infiltration system designer. The design infiltration rate is thereby equal to the Measured Infiltration Rate provided in Table 1 (inches per hour) divided by the product of 1.5 times the calculated design factor of safety. The combined factor of safety must be a minimum of 2.0 but need not exceed 9.0. Results of field infiltration testing are provided in Appendix B.

Please note that the infiltration values reported herein are for native materials only and are not for compacted fill. Water discharge from any infiltration systems should not occur within the zone of influence of foundation footings (column and load bearing wall locations). For preliminary purposes we recommend a minimum setback of 15 feet from the structural improvements. Infiltration shall not be permitted directly on or into compacted fill soils. The infiltration values provided are based on clean water and this requires the removal of trash, debris, soil particles, etc., and on-going maintenance. Over time, siltation, plugging and clogging of the system may reduce the infiltration rate and subsequently reduce the effectiveness of the infiltration system. Any designed infiltration system will require routine periodic maintenance. It should be noted that methods to prevent this shall be the sole responsibility of the infiltration designer and are not the purview of the geotechnical consultant. If adequate measures cannot be incorporated into the design and maintenance of the system, then the infiltration rates may need to be further reduced. These and other factors should be considered in selecting a design infiltration rate.

We recommend the design of any infiltration system include at least one redundancy or overflow system. It may be prudent to provide an overflow system connected directly to a storm drain system in order to prevent failure of the infiltration system, either as a result of lower than anticipated infiltration with time and/or very high flow volumes.

LGC Geotechnical should be provided with details for any planned required infiltration system early in the design process for geotechnical input.

4.10 Pre-Construction Documentation and Construction Monitoring

A program of documentation and monitoring should be devised and put into practice before the onset of any groundwork. LGC Geotechnical can perform these services at your request. This should include, but not necessarily be limited to, detailed documentation of the existing improvements, buildings, and utilities around the area of proposed excavation, with particular attention to any distress that is already present prior to the start of work. At the completion of construction, we recommend that the adjacent properties be re-documented to confirm their condition after potentially damaging activities are completed. In the event of future claims, any post-construction damage may be attributed to other causes.

4.11 Geotechnical Plan Review

Project plans (e.g., grading, foundation, etc.) and any other improvement plans, and final project drawings should be reviewed by this office prior to construction to verify that our geotechnical recommendations, provided herein, have been appropriately incorporated. Additional or modified geotechnical recommendations may be required based on the proposed design.

4.12 Geotechnical Observation and Testing During Construction

The recommendations provided in this report are based on limited subsurface observations and geotechnical analysis. The interpolated subsurface conditions should be checked in the field during construction by a representative of LGC Geotechnical. Geotechnical observation and testing is required per Section 1705 of the 2019/2022 California Building Code (CBC).

Geotechnical observation and/or testing should be performed by LGC Geotechnical at the following stages:

- During grading (removal bottoms, fill placement, etc.);
- During utility trench and any retaining wall backfill and compaction;
- During precise grading;
- Preparation of building pads and other concrete-flatwork subgrades, and prior to placement of aggregate base or concrete;
- After building and wall footing excavation and prior to placement of steel reinforcement and/or concrete;
- Preparation of pavement subgrade and placement of aggregate base; and

- When any unusual soil conditions are encountered during any construction operation subsequent to issuance of this report.

5.0 LIMITATIONS

Our services were performed using the degree of care and skill ordinarily exercised, under similar circumstances, by reputable engineers and geologists practicing in this or similar localities. No other warranty, expressed or implied, is made as to the conclusions and professional advice included in this report. The samples taken and submitted for laboratory testing, the observations made, and the in-situ field testing performed are believed representative of the entire project; however, soil and geologic conditions revealed by excavation may be different than our preliminary findings. If this occurs, the changed conditions must be evaluated by the project soils engineer and geologist and design(s) adjusted as required or alternate design(s) recommended.

This report is issued with the understanding that it is the responsibility of the owner, or of his/her representative, to ensure that the information and recommendations contained herein are brought to the attention of the architect and/or project engineer and incorporated into the plans, and the necessary steps are taken to see that the contractor and/or subcontractor properly implements the recommendations in the field. The contractor and/or subcontractor should notify the owner if they consider any of the recommendations presented herein to be unsafe.

The findings of this report are valid as of the present date. However, changes in the conditions of a property can and do occur with the passage of time, whether they be due to natural processes or the works of man on this or adjacent properties. Therefore, the findings, conclusions, and recommendations presented in this report can be relied upon only if LGC Geotechnical has the opportunity to observe the subsurface conditions during grading and construction of the project, in order to confirm that our preliminary findings are representative for the site.

In addition, changes in applicable or appropriate standards may occur, whether they result from legislation or the broadening of knowledge. Accordingly, the findings of this report may be invalidated wholly or partially by changes outside our control. Therefore, this report is subject to review and modification, and should not be relied upon after a period of 3 years.

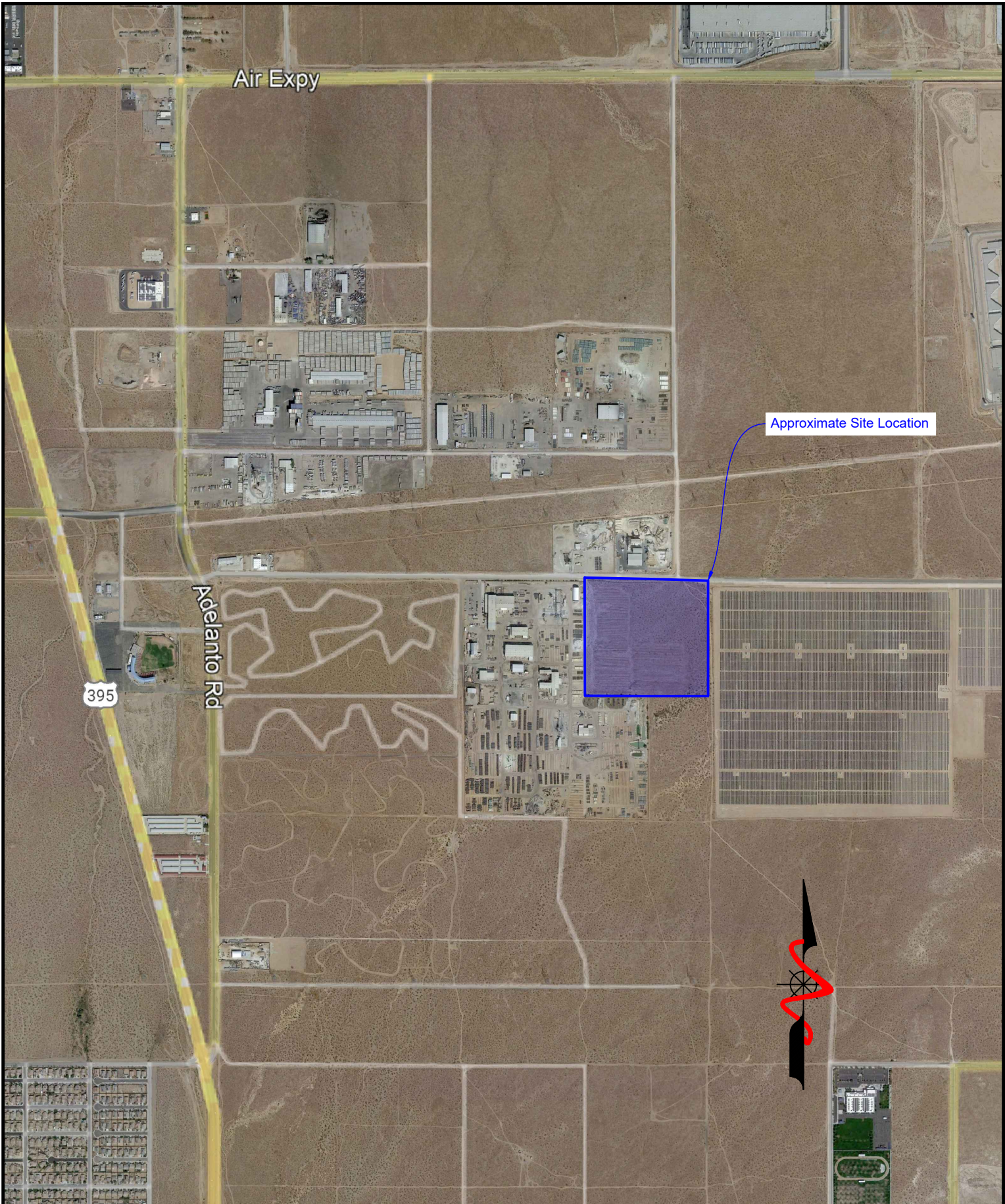
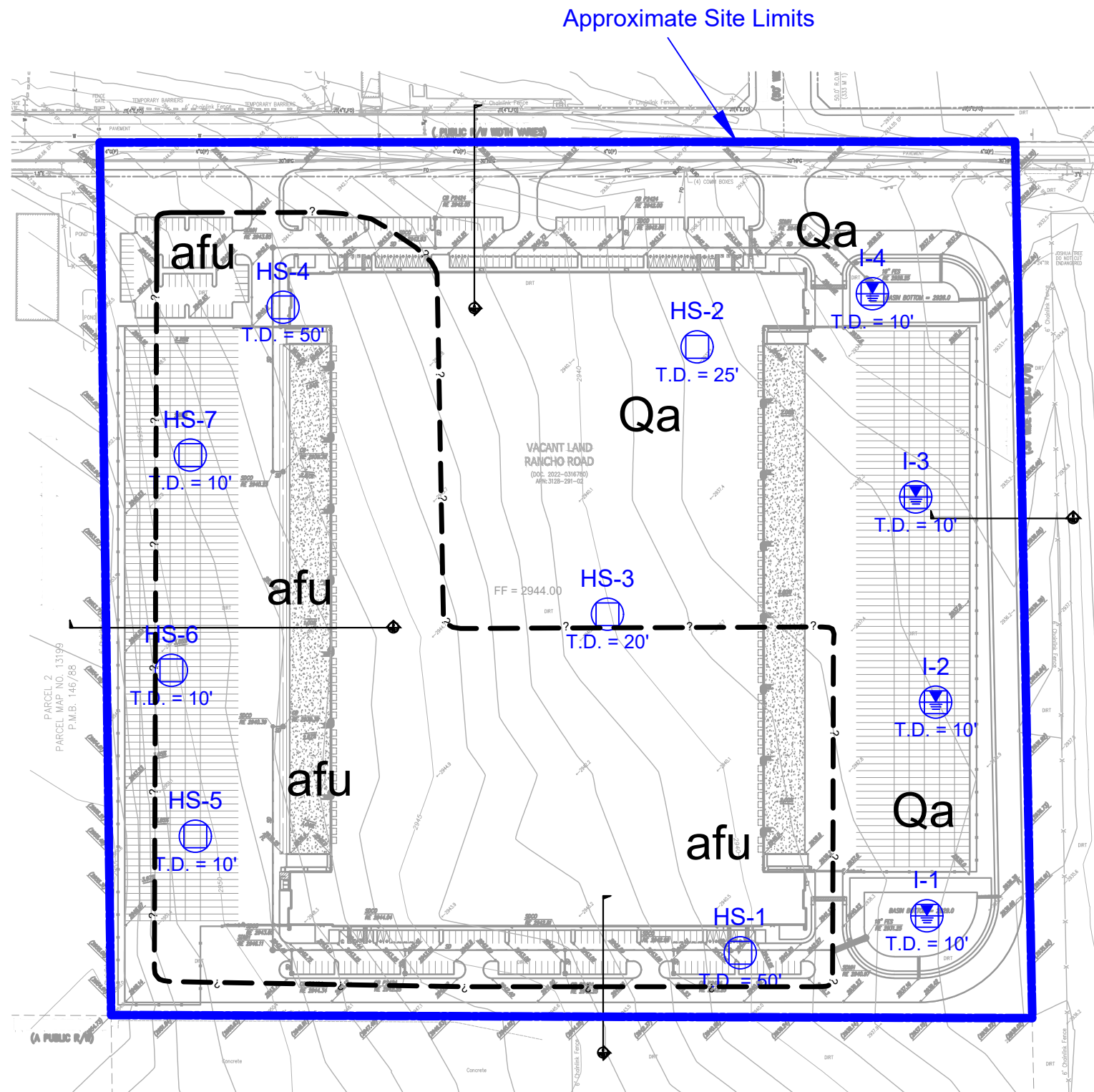

FIGURE 1
Site Location Map

PROJECT NAME	IPG - Adelanto Rancho 38
PROJECT NO.	22178-01
ENG. / GEOL.	KBC
SCALE	Not to Scale
DATE	November 2022



LEGEND

afu Undocumented Fill

Qa Quaternary Alluvium

Approximate Geologic Contact

Approximate Location of Hollow Stem Auger Boring with Total Depth in Feet

Approximate Location of Infiltration Boring with Total Depth in Feet

HS-7
T.D. = 10'

I-4
T.D. = 10'

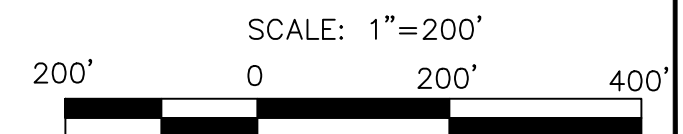
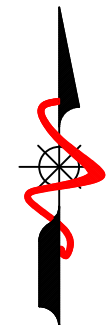

LGC Geotechnical, Inc.
 131 Calle Iglesia, Ste. 200
 San Clemente, CA 92672
 TEL (949) 369-6141 FAX (949) 369-6142

FIGURE 2
Geotechnical Map

PROJECT NAME	IPG - Adelanto Rancho 38
PROJECT NO.	22178-01
ENG. / GEOL.	KBC
SCALE	1" = 200'
DATE	November 2022

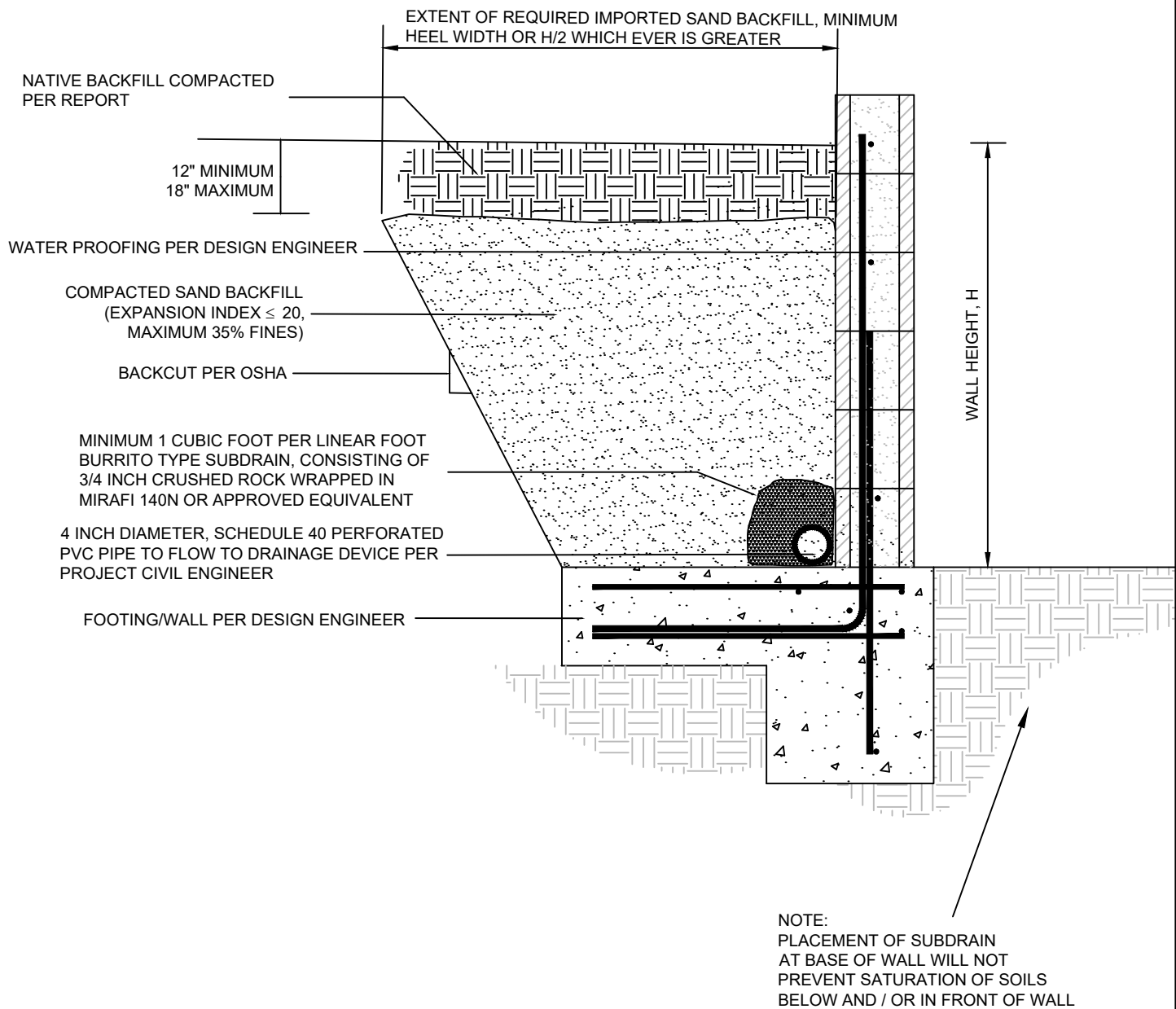

FIGURE 3
Retaining Wall
Backfill Detail

PROJECT NAME	IPG-Adelanto Rancho 38
PROJECT NO.	22178-01
ENG. / GEOL.	BTZ/KBC
SCALE	Not to Scale
DATE	November 2022

Appendix A
References

APPENDIX A

References

- American Concrete Institute, 2013, Guide for the Design and Construction of Concrete Parking Lots (ACI 330R-08), fifteenth printing, November 2013.
- _____, 2017, Guide for the Design and Construction of Concrete Site Paving for Industrial and Trucking Facilities (ACI 3302R-17), May 2017.
- _____, 2019, Building Code Requirements for Structural Concrete (ACI 318-19) and Commentary (ACI 318R-19), June 2019.
- American Society of Civil Engineers (ASCE), 2017, Minimum Design Loads for Buildings and Other Structures, ASCE/SEI 7-16, 2017.
- _____, 2018, Standard 7-16, Minimum Design Loads for Buildings and Associated Criteria for Buildings and Other Structures, Supplement 1, effective: December 12, 2018.
- American Society for Testing and Materials (ASTM), Volume 04.08 Soil and Rock (I):D420 – D5876.
- California Building Standards Commission, 2019, California Building Code (CBC), California Code of Regulations Title 24, Volumes 1 and 2, dated July 2019.
- _____, 2022, California Building Code (CBC), California Code of Regulations Title 24, Volumes 1 and 2, dated July 2022.
- California Department of Transportation (Caltrans), 2021, Corrosion Guidelines, Version 3.2, dated May 2021.
- California Department of Water Resources (CDWR), 2022, Water Data Library, retrieved October 27, 2022, from <https://wdl.water.ca.gov/waterdatalibrary/>
- California Geological Survey (CGS), (Previously California Division of Mines and Geology [CDMG]), 2002, California Geomorphic Provinces, CGS Note 36, dated 2002.
- _____, 2008, California Geological Survey Special Publication 117A: Guidelines for Evaluating and Mitigating Seismic Hazards in California.
- _____, 2018, Earthquake Fault Zones, Special Publication 42, Revised 2018.
- _____, 2022, Earthquake Zones of Required Investigation, web application, retrieved October 27, 2022, from <https://maps.conservation.ca.gov/cgs/EQZApp/>
- County of San Bernardino, 2013, Technical Guidance Document for Water Quality Management Plans, dated September 19, 2013.

Dibblee, Thomas W., Jr., 2008, Geologic Map of the Shadow Mountains and Victorville, 15 Minute Quadrangles, San Bernardino and Los Angeles Counties, California, Dibblee Geology Center Map #DF-387, scale: 1:62,500, dated 2008.

Geoculus, 2021, Topographic Survey Map, Vacant Lot (40 Acres), Adelanto, California, File No. T-1, scale 1"=80', map dated October 8, 2021.

HPA Architecture, 2022, Conceptual Site Plan, Mojave Rancho Road, Adelanto, California, Scheme 7, scale 1" =60', plan dated October 13, 2022.

Lew, et al, 2010, Seismic Earth Pressures on Deep Basements, Structural Engineers Association of California (SEAOC) Convention Proceedings.

Structural Engineers Association of California (SEAOC), 2022, Seismic Design Maps, Retrieved November 22, 2022, from <https://seismicmaps.org/>

United States Geological Survey (USGS), 2014, Unified Hazard Tool, Dynamic: Conterminous U.S. 2014 (update) (v4.2.0), Retrieved November 22, 2022, from: <https://earthquake.usgs.gov/hazards/interactive/>

Appendix B
Boring Logs & Field Infiltration Data

Geotechnical Boring Log Borehole HS-1

Date: 10/17/2022	Drilling Company: Choice Drilling
Project Name: Adelanto Rancho 38	Type of Rig: HD 75
Project Number: 22178-01	Drop: 30" Hole Diameter: 6"
Elevation of Top of Hole: ~2944' MSL	Drive Weight: 140 pounds
Hole Location: See Geotechnical Map	Page 1 of 2

Elevation (ft)	Depth (ft)	Graphic Log	Sample Number	Blow Count	Dry Density (pcf)	Moisture (%)	USCS Symbol	DESCRIPTION	Type of Test
	0							@ 0' - Silty SAND: yellowish brown, slightly moist	EI CR
2940		B-1	R-1	17 19 24	103.0	1.5	SM	@ 2.5' - Silty SAND: light brown, dry, dense, small pebbles in sample	
	5		SPT-1	4 4 4		1.9		@ 5' - Silty SAND: light brown, dry, medium dense, small amount of sample recovered, rock stuck in shoe	SA
2935			R-2	19 21 33		0.4	SP	@ 7.5' - SAND: light yellowish brown, dry, dense, sample was disturbed.	
	10		SPT-2	6 14 18		1.6		@ 10' - SAND with gravel: light grayish brown, dry, dense	
2930			R-3	24 28 50/5.5"	115.4	15.2	CL	@ 15' - CLAY: brown, moist, hard	CN
2925									
	20		SPT-3	7 8 10		12.2	ML	@ 20' - Sandy SILT: light yellowish brown, moist, very stiff	SA
2920			R-4	30 50/4"	105.4	6.2	SM	@ 25' - Silty SAND: brown, slightly moist, very dense	
2915									
	30								



THIS SUMMARY APPLIES ONLY AT THE LOCATION OF THIS BORING AND AT THE TIME OF DRILLING. SUBSURFACE CONDITIONS MAY DIFFER AT OTHER LOCATIONS AND MAY CHANGE AT THIS LOCATION WITH THE PASSAGE OF TIME. THE DATA PRESENTED IS A SIMPLIFICATION OF THE ACTUAL CONDITIONS ENCOUNTERED. THE DESCRIPTIONS PROVIDED ARE QUALITATIVE FIELD DESCRIPTIONS AND ARE NOT BASED ON QUANTITATIVE ENGINEERING ANALYSIS.

SAMPLE TYPES: B BULK SAMPLE R RING SAMPLE (CA Modified Sampler) G GRAB SAMPLE SPT STANDARD PENETRATION TEST SAMPLE GROUNDWATER TABLE	TEST TYPES: DS DIRECT SHEAR MD MAXIMUM DENSITY SA SIEVE ANALYSIS S&H SIEVE AND HYDROMETER EI EXPANSION INDEX CN CONSOLIDATION CR CORROSION AL ATTERBERG LIMITS CO COLLAPSE/SWELL RV R-VALUE #200 % PASSING # 200 SIEVE
--	--

Geotechnical Boring Log Borehole HS-1

Date: 10/17/2022	Drilling Company: Choice Drilling
Project Name: Adelanto Rancho 38	Type of Rig: HD 75
Project Number: 22178-01	Drop: 30" Hole Diameter: 6"
Elevation of Top of Hole: ~2944' MSL	Drive Weight: 140 pounds
Hole Location: See Geotechnical Map	Page 2 of 2

Elevation (ft)	Depth (ft)	Graphic Log	Sample Number	Blow Count	Dry Density (pcf)	Moisture (%)	USCS Symbol	DESCRIPTION	Type of Test
2910	30		SPT-4	6 6 13		9.0	SM	@ 30' - Silty SAND: light brown, moist, medium dense	
2905	35		R-5	50/6"	99.0	2.6		@ 35' - Silty SAND: light yellowish brown, dry, very dense, oxidation visible	
2900	40		SPT-5	24 24 31		0.9	SP-SM	@ 40' - SAND with Silt: light brown, dry, very dense	
2895	45		R-6	42 50/4"	115.4	9.7	ML	@ 45' - Sandy SILT: gyaish brown, moist, hard	
2890	50		SPT-6	17 25 30		2.5	SP	@ 50' - SAND: light brown, dry, very dense	
2885	55							Total Depth = 51.5' Groundwater Not Encountered Caving: Hole Measured Approximately 33' after Removal of the Augers Backfilled with Cuttings on 10/17/2022	
	60								



THIS SUMMARY APPLIES ONLY AT THE LOCATION OF THIS BORING AND AT THE TIME OF DRILLING. SUBSURFACE CONDITIONS MAY DIFFER AT OTHER LOCATIONS AND MAY CHANGE AT THIS LOCATION WITH THE PASSAGE OF TIME. THE DATA PRESENTED IS A SIMPLIFICATION OF THE ACTUAL CONDITIONS ENCOUNTERED. THE DESCRIPTIONS PROVIDED ARE QUALITATIVE FIELD DESCRIPTIONS AND ARE NOT BASED ON QUANTITATIVE ENGINEERING ANALYSIS.

<p>SAMPLE TYPES:</p> <p>B BULK SAMPLE R RING SAMPLE (CA Modified Sampler) G GRAB SAMPLE SPT STANDARD PENETRATION TEST SAMPLE</p> <p> GROUNDWATER TABLE</p>	<p>TEST TYPES:</p> <p>DS DIRECT SHEAR MD MAXIMUM DENSITY SA SIEVE ANALYSIS S&H SIEVE AND HYDROMETER EI EXPANSION INDEX CN CONSOLIDATION CR CORROSION AL ATTERBERG LIMITS CO COLLAPSE/SWELL RV R-VALUE #200 % PASSING # 200 SIEVE</p>
---	---

Geotechnical Boring Log Borehole HS-2

Date: 10/17/2022	Drilling Company: Choice Drilling
Project Name: Adelanto Rancho 38	Type of Rig: HD 75
Project Number: 22178-01	Drop: 30" Hole Diameter: 6"
Elevation of Top of Hole: ~2942' MSL	Drive Weight: 140 pounds
Hole Location: See Geotechnical Map	Page 1 of 1

Elevation (ft)	Depth (ft)	Graphic Log	Sample Number	Blow Count	Dry Density (pcf)	Moisture (%)	USCS Symbol	DESCRIPTION	Type of Test
2940	0							@ 0' - Coarse Sand: yellowish brown, dry, vegetation is dry	
			SPT-1	5 4 3		2.1	SM	@ 2.5' - Silty SAND: light brown, slightly moist, loose	
	5	B-1	R-1	9 11 11		2.5		@ 5' - Silty SAND: light yellowish brown, slightly moist, medium dense, sample disturbed	
2935			SPT-2	6 10 13		0.6	SP-SM	@ 7.5' - SAND with Silt: light yellowish brown, dry, medium dense, coarse	
	10		R-2	26 37 50/6"		0.4	SP	@ 10' - SAND with gravel: yellowish gray, dry, very dense, sample disturbed	
2930			SPT-3	11 14 17		3.3	SM	@ 15' - Silty SAND: light yellowish brown, slightly moist, dense	
2925			R-3	50/4"				@ 20' - No Recovery	
2920			SPT-4	9 10 20		4.9		@ 25' - Silty SAND: brown, slightly moist, dense	
2915								Total Depth = 25' Groundwater Not Encountered Backfilled with Cuttings on 10/17/2022	
	30								



THIS SUMMARY APPLIES ONLY AT THE LOCATION OF THIS BORING AND AT THE TIME OF DRILLING. SUBSURFACE CONDITIONS MAY DIFFER AT OTHER LOCATIONS AND MAY CHANGE AT THIS LOCATION WITH THE PASSAGE OF TIME. THE DATA PRESENTED IS A SIMPLIFICATION OF THE ACTUAL CONDITIONS ENCOUNTERED. THE DESCRIPTIONS PROVIDED ARE QUALITATIVE FIELD DESCRIPTIONS AND ARE NOT BASED ON QUANTITATIVE ENGINEERING ANALYSIS.

SAMPLE TYPES:
 B BULK SAMPLE
 R RING SAMPLE (CA Modified Sampler)
 G GRAB SAMPLE
 SPT STANDARD PENETRATION TEST SAMPLE

TEST TYPES:
 DS DIRECT SHEAR
 MD MAXIMUM DENSITY
 SA SIEVE ANALYSIS
 S&H SIEVE AND HYDROMETER
 EI EXPANSION INDEX
 CN CONSOLIDATION
 CR CORROSION
 AL ATTERBERG LIMITS
 CO COLLAPSE/SWELL
 RV R-VALUE
 #200 % PASSING # 200 SIEVE

GROUNDWATER TABLE

Geotechnical Boring Log Borehole HS-3

Date: 10/17/2022	Drilling Company: Choice Drilling
Project Name: Adelanto Rancho 38	Type of Rig: HD 75
Project Number: 22178-01	Drop: 30" Hole Diameter: 6"
Elevation of Top of Hole: ~2943' MSL	Drive Weight: 140 pounds
Hole Location: See Geotechnical Map	Page 1 of 1

Elevation (ft)	Depth (ft)	Graphic Log	Sample Number	Blow Count	Dry Density (pcf)	Moisture (%)	USCS Symbol	DESCRIPTION	Type of Test
	0						SM	@ 0' - Silty SAND: reddish brown, dry, some dry vegetation/shrubs	MD CR
2940			R-1	33 33 28	121.1	3.2	SP-SM	@ 2.5' - SAND with Silt: light brown, slightly moist, dense	
	5	B-1	SPT-1	6 5 5		1.1		@ 5' - SAND with Silt: light brown, dry, medium dense, crushed rock in sampler	#200
2935			R-2	29 50/6"	121.0	0.5	SP	@ 7.5' - SAND with Gravel: light yellowish brown, dry, very dense	
	10		SPT-2	9 8 9				@ 10' - No Recovery	
2930									
	15		R-3	40 50/5"	114.9	2.3	SM	@ 15' - Silty SAND: light brown, dry, very dense	
2925									
	20		SPT-3	9 15 20		7.0	ML	@ 20' - Sandy SILT: light brown, slightly moist, hard	#200
2920								Total Depth = 20' Groundwater Not Encountered Caving: Hole Measured Approximately 5' after Removal of the Augers Backfilled with Cuttings on 10/17/2022	
	25								
2915									
	30								





THIS SUMMARY APPLIES ONLY AT THE LOCATION OF THIS BORING AND AT THE TIME OF DRILLING. SUBSURFACE CONDITIONS MAY DIFFER AT OTHER LOCATIONS AND MAY CHANGE AT THIS LOCATION WITH THE PASSAGE OF TIME. THE DATA PRESENTED IS A SIMPLIFICATION OF THE ACTUAL CONDITIONS ENCOUNTERED. THE DESCRIPTIONS PROVIDED ARE QUALITATIVE FIELD DESCRIPTIONS AND ARE NOT BASED ON QUANTITATIVE ENGINEERING ANALYSIS.

SAMPLE TYPES:	TEST TYPES:
B BULK SAMPLE	DS DIRECT SHEAR
R RING SAMPLE (CA Modified Sampler)	MD MAXIMUM DENSITY
G GRAB SAMPLE	SA SIEVE ANALYSIS
SPT STANDARD PENETRATION TEST SAMPLE	S&H SIEVE AND HYDROMETER
	EI EXPANSION INDEX
	CN CONSOLIDATION
	CR CORROSION
	AL ATTERBERG LIMITS
GROUNDWATER TABLE	CO COLLAPSE/SWELL
	RV R-VALUE
	#200 % PASSING # 200 SIEVE

Geotechnical Boring Log Borehole HS-4

Date: 10/18/2022	Drilling Company: Choice Drilling
Project Name: Adelanto Rancho 38	Type of Rig: HD 75
Project Number: 22178-01	Drop: 30" Hole Diameter: 6"
Elevation of Top of Hole: ~2950' MSL	Drive Weight: 140 pounds
Hole Location: See Geotechnical Map	Page 1 of 2



Elevation (ft)	Depth (ft)	Graphic Log	Sample Number	Blow Count	Dry Density (pcf)	Moisture (%)	USCS Symbol	DESCRIPTION	Type of Test
	0							@ 0' - Silty SAND: yellowish brown, dry	SO ₄
			R-1	24 40 31	124.9	4.4	SM	@ 2.5' - Silty SAND: brown, slightly moist, very dense	
2945	5	B-1	SPT-1	6 5 6		1.2	SP-SM	@ 5' - SAND with Silt: light brown, dry, medium dense, coarse	#200
			R-2	15 41 50/5"	115.6	3.3	SM	@ 7.5' - Silty SAND: light yellowish brown, slightly moist, very dense, large gravel stuck in ring sample	
2940	10		SPT-2	7 9 9		1.3	SP-SM	@ 10' - SAND with SILT: light yellowish brown, dry, medium dense, coarse	#200
2935	15		R-3	21 33 50	120.7	1.7	SP	@ 15' - SAND with Gravel: pale yellowish brown, dry, very dense	
2930	20		SPT-3	13 21 24		1.7	SP-SM	@ 20' - SAND with Silt: yellowish brown, dry, dense	
2925	25		R-4	30 50/5"	110.7	1.1		@ 25' - SAND with Silt: pale brown, dry, very dense	
	30								

	<p style="font-size: small;">THIS SUMMARY APPLIES ONLY AT THE LOCATION OF THIS BORING AND AT THE TIME OF DRILLING. SUBSURFACE CONDITIONS MAY DIFFER AT OTHER LOCATIONS AND MAY CHANGE AT THIS LOCATION WITH THE PASSAGE OF TIME. THE DATA PRESENTED IS A SIMPLIFICATION OF THE ACTUAL CONDITIONS ENCOUNTERED. THE DESCRIPTIONS PROVIDED ARE QUALITATIVE FIELD DESCRIPTIONS AND ARE NOT BASED ON QUANTITATIVE ENGINEERING ANALYSIS.</p>	<p style="font-size: x-small;">SAMPLE TYPES:</p> <p>B BULK SAMPLE R RING SAMPLE (CA Modified Sampler) G GRAB SAMPLE SPT STANDARD PENETRATION TEST SAMPLE</p> <p style="text-align: center;"> GROUNDWATER TABLE</p>	<p style="font-size: x-small;">TEST TYPES:</p> <p>DS DIRECT SHEAR MD MAXIMUM DENSITY SA SIEVE ANALYSIS S&H SIEVE AND HYDROMETER EI EXPANSION INDEX CN CONSOLIDATION CR CORROSION AL ATTERBERG LIMITS SO₄ SULFATE RV R-VALUE #200 % PASSING # 200 SIEVE</p>
---	--	---	--

Geotechnical Boring Log Borehole HS-4

Date: 10/18/2022	Drilling Company: Choice Drilling
Project Name: Adelanto Rancho 38	Type of Rig: HD 75
Project Number: 22178-01	Drop: 30" Hole Diameter: 6"
Elevation of Top of Hole: ~2950' MSL	Drive Weight: 140 pounds
Hole Location: See Geotechnical Map	Page 2 of 2

Elevation (ft)	Depth (ft)	Graphic Log	Sample Number	Blow Count	Dry Density (pcf)	Moisture (%)	USCS Symbol	DESCRIPTION	Type of Test
	30		SPT-4	9 21 50		2.8	SM	@ 30' - Silty SAND: pale grayish brown, slightly moist, very dense	
2915	35		R-5	100/4"				@ 35' - No Recovery	
2910	40		SPT-5	35 22 18		7.4	ML	@ 40' - Sandy SILT: pale brown, slightly moist, hard	
2905	45		R-6	50/3"	123.5	7.5	SM	@ 45' - Silty SAND: brown, moist, very dense	
2900	50		SPT-6	15 18 13		10.4		@ 50' - Silty SAND: light brown, moist, dense	#200
2895	55							Total Depth = 51.5' Groundwater Not Encountered Caving: Hole Measured Approximately 45' after Removal of the Augers Backfilled with Cuttings on 10/18/2022	
	60								

	<p>THIS SUMMARY APPLIES ONLY AT THE LOCATION OF THIS BORING AND AT THE TIME OF DRILLING. SUBSURFACE CONDITIONS MAY DIFFER AT OTHER LOCATIONS AND MAY CHANGE AT THIS LOCATION WITH THE PASSAGE OF TIME. THE DATA PRESENTED IS A SIMPLIFICATION OF THE ACTUAL CONDITIONS ENCOUNTERED. THE DESCRIPTIONS PROVIDED ARE QUALITATIVE FIELD DESCRIPTIONS AND ARE NOT BASED ON QUANTITATIVE ENGINEERING ANALYSIS.</p>	<p>SAMPLE TYPES: B BULK SAMPLE R RING SAMPLE (CA Modified Sampler) G GRAB SAMPLE SPT STANDARD PENETRATION TEST SAMPLE</p> <p> GROUNDWATER TABLE</p>	<p>TEST TYPES: DS DIRECT SHEAR MD MAXIMUM DENSITY SA SIEVE ANALYSIS S&H SIEVE AND HYDROMETER EI EXPANSION INDEX CN CONSOLIDATION CR CORROSION AL ATTERBERG LIMITS CO COLLAPSE/SWELL RV R-VALUE #200 % PASSING # 200 SIEVE</p>
---	--	--	---

Geotechnical Boring Log Borehole HS-5

Date: 10/18/2022	Drilling Company: Choice Drilling
Project Name: Adelanto Rancho 38	Type of Rig: HD 75
Project Number: 22178-01	Drop: 30" Hole Diameter: 6"
Elevation of Top of Hole: ~2955' MSL	Drive Weight: 140 pounds
Hole Location: See Geotechnical Map	Page 1 of 1

Elevation (ft)	Depth (ft)	Graphic Log	Sample Number	Blow Count	Dry Density (pcf)	Moisture (%)	USCS Symbol	Logged By JMN Sampled By JMN Checked By KBC/BTZ DESCRIPTION	Type of Test
	0							@ 0' - Silty SAND: pale yellowish brown, dry, fine	
			SPT-1	3 9 10		3.9	SM	@ 2.5' - Silty SAND: light reddish brown, dry, medium dense	
2950	5	B-1	R-1	29 16 13		1.7	SP-SM	@ 5' - SAND with Silt: brown, dry, medium dense, sample disturbed	
			SPT-2	3 6 7				@ 7.5' -No Recovery	
2945	10		R-2	37 50/5"	122.6	1.0	SP	@ 10' - SAND with Gravel: light brown, dry, very dense	
								Total Depth = 10' Groundwater Not Encountered Caving: Hole Measured Approximately 3' after Removal of the Augers Backfilled with Cuttings on 10/18/2022	
2940	15								
2935	20								
2930	25								
	30								



THIS SUMMARY APPLIES ONLY AT THE LOCATION OF THIS BORING AND AT THE TIME OF DRILLING. SUBSURFACE CONDITIONS MAY DIFFER AT OTHER LOCATIONS AND MAY CHANGE AT THIS LOCATION WITH THE PASSAGE OF TIME. THE DATA PRESENTED IS A SIMPLIFICATION OF THE ACTUAL CONDITIONS ENCOUNTERED. THE DESCRIPTIONS PROVIDED ARE QUALITATIVE FIELD DESCRIPTIONS AND ARE NOT BASED ON QUANTITATIVE ENGINEERING ANALYSIS.

SAMPLE TYPES: B BULK SAMPLE R RING SAMPLE (CA Modified Sampler) G GRAB SAMPLE SPT STANDARD PENETRATION TEST SAMPLE GROUNDWATER TABLE	TEST TYPES: DS DIRECT SHEAR MD MAXIMUM DENSITY SA SIEVE ANALYSIS S&H SIEVE AND HYDROMETER EI EXPANSION INDEX CN CONSOLIDATION CR CORROSION AL ATTERBERG LIMITS CO COLLAPSE/SWELL RV R-VALUE #200 % PASSING # 200 SIEVE
--	--

Last Edited: 10/20/2022

Geotechnical Boring Log Borehole HS-6

Date: 10/18/2022	Drilling Company: Choice Drilling
Project Name: Adelanto Rancho 38	Type of Rig: HD 75
Project Number: 22178-01	Drop: 30" Hole Diameter: 6"
Elevation of Top of Hole: ~2953' MSL	Drive Weight: 140 pounds
Hole Location: See Geotechnical Map	Page 1 of 1

Elevation (ft)	Depth (ft)	Graphic Log	Sample Number	Blow Count	Dry Density (pcf)	Moisture (%)	USCS Symbol	DESCRIPTION	Type of Test
2950	0	B B-1	R-1	50/6"	118.6	2.4	SM	@ 0' - Silty SAND: pale yellowish brown, dry, scattered gravel shrubs	RV
	5		SPT-1	18 19 17		2.3		@ 2.5' - Silty SAND: light brown, slightly moist, very dense, some fine gravel	
2945			R-2	29 41 50	121.6	1.0	SP	@ 5' - Silty SAND: brown, slightly moist, dense, gravel	
	10		SPT-2	21 18 19		2.3	SM	@ 7.5' - SAND with Gravel: pale yellowish brown, dry, very dense, flecks of oxidation	
2940								@ 10' - Silty SAND with Gravel: light yellowish brown, slightly moist, dense, coarse	
	15							Total Depth = 10' Groundwater Not Encountered Caving: Hole Measured Approximately 3' after Removal of the Augers Backfilled with Cuttings on 10/18/2022	
2935	20								
2930	25								
2925	30								





THIS SUMMARY APPLIES ONLY AT THE LOCATION OF THIS BORING AND AT THE TIME OF DRILLING. SUBSURFACE CONDITIONS MAY DIFFER AT OTHER LOCATIONS AND MAY CHANGE AT THIS LOCATION WITH THE PASSAGE OF TIME. THE DATA PRESENTED IS A SIMPLIFICATION OF THE ACTUAL CONDITIONS ENCOUNTERED. THE DESCRIPTIONS PROVIDED ARE QUALITATIVE FIELD DESCRIPTIONS AND ARE NOT BASED ON QUANTITATIVE ENGINEERING ANALYSIS.

SAMPLE TYPES:	TEST TYPES:
B BULK SAMPLE	DS DIRECT SHEAR
R RING SAMPLE (CA Modified Sampler)	MD MAXIMUM DENSITY
G GRAB SAMPLE	SA SIEVE ANALYSIS
SPT STANDARD PENETRATION TEST SAMPLE	S&H SIEVE AND HYDROMETER
	EI EXPANSION INDEX
	CN CONSOLIDATION
	CR CORROSION
	AL ATTERBERG LIMITS
GROUNDWATER TABLE	CO COLLAPSE/SWELL
	RV R-VALUE
	#200 % PASSING # 200 SIEVE

Geotechnical Boring Log Borehole HS-7

Date: 10/18/2022	Drilling Company: Choice Drilling
Project Name: Adelanto Rancho 38	Type of Rig: HD 75
Project Number: 22178-01	Drop: 30" Hole Diameter: 6"
Elevation of Top of Hole: ~2952' MSL	Drive Weight: 140 pounds
Hole Location: See Geotechnical Map	Page 1 of 1

Elevation (ft)	Depth (ft)	Graphic Log	Sample Number	Blow Count	Dry Density (pcf)	Moisture (%)	USCS Symbol	DESCRIPTION	Type of Test
2950	0	B-1	SPT-1	10 15 13		2.3	SM	@ 0' - Silty SAND: very pale yellowish brown, dry, scattered gravel	
	5		R-1	30 20 18	116.2	1.2	SP	@ 2.5' - Silty SAND with Gravel: light brown, slightly moist, dense	
2945			SPT-2	10 8 8		1.8	SP-SM	@ 5' - SAND with Gravel: light reddish brown, dry, medium dense	
	10		R-2	37 34 35	122.7	1.1	SP	@ 7.5' - SAND with Silt: yellowish brown, dry, medium dense	
2940								Total Depth = 10' Groundwater Not Encountered Caving: Hole Measured Approximately 4' after Removal of the Augers Backfilled with Cuttings on 10/18/2022	
	15								
2935									
	20								
2930									
	25								
2925									
	30								

	<p>THIS SUMMARY APPLIES ONLY AT THE LOCATION OF THIS BORING AND AT THE TIME OF DRILLING. SUBSURFACE CONDITIONS MAY DIFFER AT OTHER LOCATIONS AND MAY CHANGE AT THIS LOCATION WITH THE PASSAGE OF TIME. THE DATA PRESENTED IS A SIMPLIFICATION OF THE ACTUAL CONDITIONS ENCOUNTERED. THE DESCRIPTIONS PROVIDED ARE QUALITATIVE FIELD DESCRIPTIONS AND ARE NOT BASED ON QUANTITATIVE ENGINEERING ANALYSIS.</p>	<p>SAMPLE TYPES: B BULK SAMPLE R RING SAMPLE (CA Modified Sampler) G GRAB SAMPLE SPT STANDARD PENETRATION TEST SAMPLE</p> <p> GROUNDWATER TABLE</p> <p>TEST TYPES: DS DIRECT SHEAR MD MAXIMUM DENSITY SA SIEVE ANALYSIS S&H SIEVE AND HYDROMETER EI EXPANSION INDEX CN CONSOLIDATION CR CORROSION AL ATTERBERG LIMITS CO COLLAPSE/SWELL RV R-VALUE #200 % PASSING # 200 SIEVE</p>
---	--	--

Last Edited: 10/21/2022

Geotechnical Boring Log Borehole I-1

Date: 10/17/2022	Drilling Company: Choice Drilling
Project Name: Adelanto Rancho 38	Type of Rig: HD 75
Project Number: 22178-01	Drop: 30" Hole Diameter: 8"
Elevation of Top of Hole: ~2942' MSL	Drive Weight: 140 pounds
Hole Location: See Geotechnical Map	Page 1 of 1

Elevation (ft)	Depth (ft)	Graphic Log	Sample Number	Blow Count	Dry Density (pcf)	Moisture (%)	USCS Symbol	DESCRIPTION	Type of Test
2940	0							@ 0' - SAND: pale yellowish brown, dry to slightly moist, some vegetation	
			SPT-1	11 13 9		3.9	SM	@ 2.5' - Silty SAND: light brown, slightly moist, medium dense	
	5		SPT-1	7 6 5		1.5		@ 5' - Silty SAND: light brown, dry, medium dense	
2935			SPT-3	3 6 10		1.5	SP	@ 7.5' - SAND: pale brown, dry, medium dense	
2930	10							Total Depth = 10' Groundwater Not Encountered 3" Perforated Pipe with Filter Sock Installed Surrounded by Gravel, and Presoaked on 10/16/2022 Pipe Removed and Boring Backfilled with Cuttings on 10/17/2022	
	15								
2925									
	20								
2920									
	25								
2915									
	30								



THIS SUMMARY APPLIES ONLY AT THE LOCATION OF THIS BORING AND AT THE TIME OF DRILLING. SUBSURFACE CONDITIONS MAY DIFFER AT OTHER LOCATIONS AND MAY CHANGE AT THIS LOCATION WITH THE PASSAGE OF TIME. THE DATA PRESENTED IS A SIMPLIFICATION OF THE ACTUAL CONDITIONS ENCOUNTERED. THE DESCRIPTIONS PROVIDED ARE QUALITATIVE FIELD DESCRIPTIONS AND ARE NOT BASED ON QUANTITATIVE ENGINEERING ANALYSIS.

SAMPLE TYPES:	TEST TYPES:
B BULK SAMPLE	DS DIRECT SHEAR
R RING SAMPLE (CA Modified Sampler)	MD MAXIMUM DENSITY
G GRAB SAMPLE	SA SIEVE ANALYSIS
SPT STANDARD PENETRATION TEST SAMPLE	S&H SIEVE AND HYDROMETER
	EI EXPANSION INDEX
	CN CONSOLIDATION
	CR CORROSION
	AL ATTERBERG LIMITS
GROUNDWATER TABLE	CO COLLAPSE/SWELL
	RV R-VALUE
	#200 % PASSING # 200 SIEVE

Geotechnical Boring Log Borehole I-2

Date: 10/17/2022	Drilling Company: Choice Drilling
Project Name: Adelanto Rancho 38	Type of Rig: HD 75
Project Number: 22178-01	Drop: 30" Hole Diameter: 8"
Elevation of Top of Hole: ~2940' MSL	Drive Weight: 140 pounds
Hole Location: See Geotechnical Map	Page 1 of 1

Elevation (ft)	Depth (ft)	Graphic Log	Sample Number	Blow Count	Dry Density (pcf)	Moisture (%)	USCS Symbol	DESCRIPTION	Type of Test
	0							@ 0' - SAND: pale yellowish brown, vegetation is dry	
			SPT-1	11 22 24		7.2	SM	@ 2.5' - Silty SAND with Caliche: reddish brown, moist, very dense	
2935	5		SPT-1	10 7 6		1.8		@ 5' - Silty SAND: light brown, dry, medium dense	
			SPT-3	5 9 13		1.3	SP	@ 7.5' - SAND: light brown, dry, medium dense	
2930	10								
								Total Depth = 10' Groundwater Not Encountered 3" Perforated Pipe with Filter Sock Installed Surrounded by Gravel, and Presoaked on 10/16/2022 Pipe Removed and Boring Backfilled with Cuttings on 10/17/2022	
2925	15								
2920	20								
2915	25								
	30								

Last Edited: 10/21/2022



THIS SUMMARY APPLIES ONLY AT THE LOCATION OF THIS BORING AND AT THE TIME OF DRILLING. SUBSURFACE CONDITIONS MAY DIFFER AT OTHER LOCATIONS AND MAY CHANGE AT THIS LOCATION WITH THE PASSAGE OF TIME. THE DATA PRESENTED IS A SIMPLIFICATION OF THE ACTUAL CONDITIONS ENCOUNTERED. THE DESCRIPTIONS PROVIDED ARE QUALITATIVE FIELD DESCRIPTIONS AND ARE NOT BASED ON QUANTITATIVE ENGINEERING ANALYSIS.

SAMPLE TYPES:
 B BULK SAMPLE
 R RING SAMPLE (CA Modified Sampler)
 G GRAB SAMPLE
 SPT STANDARD PENETRATION TEST SAMPLE

GROUNDWATER TABLE

TEST TYPES:
 DS DIRECT SHEAR
 MD MAXIMUM DENSITY
 SA SIEVE ANALYSIS
 S&H SIEVE AND HYDROMETER
 EI EXPANSION INDEX
 CN CONSOLIDATION
 CR CORROSION
 AL ATTERBERG LIMITS
 CO COLLAPSE/SWELL
 RV R-VALUE
 #200 % PASSING # 200 SIEVE

Geotechnical Boring Log Borehole I-3

Date: 10/17/2022	Drilling Company: Choice Drilling
Project Name: Adelanto Rancho 38	Type of Rig: HD 75
Project Number: 22178-01	Drop: 30" Hole Diameter: 8"
Elevation of Top of Hole: ~2941' MSL	Drive Weight: 140 pounds
Hole Location: See Geotechnical Map	Page 1 of 1

Elevation (ft)	Depth (ft)	Graphic Log	Sample Number	Blow Count	Dry Density (pcf)	Moisture (%)	USCS Symbol	DESCRIPTION	Type of Test
2940	0		SPT-1	10 13 12		4.3	SM/ML	@ 2.5' - SILT/SAND: brown, slightly moist, dense/hard	
2935	5		SPT-1	11 8 9		1.4	SP-SM	@ 5' - SAND with Silt: light brown, dry, medium dense	
			SPT-3	39 50/5"		0.9	SM	@ 7.5' - Silty SAND with Gravel: pale grayish brown, dry, very dense, rock fragments in sample	
2930	10							Total Depth = 10' Groundwater Not Encountered 3" Perforated Pipe with Filter Sock Installed Surrounded by Gravel, and Presoaked on 10/16/2022 Pipe Removed and Boring Backfilled with Cuttings on 10/17/2022	
2925	15								
2920	20								
2915	25								
	30								

Last Edited: 10/21/2022



THIS SUMMARY APPLIES ONLY AT THE LOCATION OF THIS BORING AND AT THE TIME OF DRILLING. SUBSURFACE CONDITIONS MAY DIFFER AT OTHER LOCATIONS AND MAY CHANGE AT THIS LOCATION WITH THE PASSAGE OF TIME. THE DATA PRESENTED IS A SIMPLIFICATION OF THE ACTUAL CONDITIONS ENCOUNTERED. THE DESCRIPTIONS PROVIDED ARE QUALITATIVE FIELD DESCRIPTIONS AND ARE NOT BASED ON QUANTITATIVE ENGINEERING ANALYSIS.

SAMPLE TYPES:
 B BULK SAMPLE
 R RING SAMPLE (CA Modified Sampler)
 G GRAB SAMPLE
 SPT STANDARD PENETRATION TEST SAMPLE

GROUNDWATER TABLE

TEST TYPES:
 DS DIRECT SHEAR
 MD MAXIMUM DENSITY
 SA SIEVE ANALYSIS
 S&H SIEVE AND HYDROMETER
 EI EXPANSION INDEX
 CN CONSOLIDATION
 CR CORROSION
 AL ATTERBERG LIMITS
 CO COLLAPSE/SWELL
 RV R-VALUE
 #200 % PASSING # 200 SIEVE

Geotechnical Boring Log Borehole I-4

Date: 10/17/2022	Drilling Company: Choice Drilling
Project Name: Adelanto Rancho 38	Type of Rig: HD 75
Project Number: 22178-01	Drop: 30" Hole Diameter: 8"
Elevation of Top of Hole: ~2943' MSL	Drive Weight: 140 pounds
Hole Location: See Geotechnical Map	Page 1 of 1

Elevation (ft)	Depth (ft)	Graphic Log	Sample Number	Blow Count	Dry Density (pcf)	Moisture (%)	USCS Symbol	DESCRIPTION	Type of Test
	0							@ 0'- SAND: pale yellowish brown, dry	
			SPT-1	7 9 9		4.7	SM/ML	@ 2.5'- Sandy SILT/Silty SAND: light brown, slightly moist, very stiff/medium dense	
2940	5		SPT-2	12 12 17		1.2	SP-SM	@ 5'- SAND with Silt: pale yellowish brown, dry, dense	
			SPT-3	5 3 15		1.7	SM	@ 7.5'- Silty SAND: pale brown, dry, medium dense, crushed rock powder	
2935	10							Total Depth = 10' Groundwater Not Encountered 3" Perforated Pipe with Filter Sock Installed Surrounded by Gravel, and Presoaked on 10/16/2022 Pipe Removed and Boring Backfilled with Cuttings on 10/17/2022	
2930	15								
2925	20								
2920	25								
	30								



THIS SUMMARY APPLIES ONLY AT THE LOCATION OF THIS BORING AND AT THE TIME OF DRILLING. SUBSURFACE CONDITIONS MAY DIFFER AT OTHER LOCATIONS AND MAY CHANGE AT THIS LOCATION WITH THE PASSAGE OF TIME. THE DATA PRESENTED IS A SIMPLIFICATION OF THE ACTUAL CONDITIONS ENCOUNTERED. THE DESCRIPTIONS PROVIDED ARE QUALITATIVE FIELD DESCRIPTIONS AND ARE NOT BASED ON QUANTITATIVE ENGINEERING ANALYSIS.

SAMPLE TYPES:	TEST TYPES:
B BULK SAMPLE	DS DIRECT SHEAR
R RING SAMPLE (CA Modified Sampler)	MD MAXIMUM DENSITY
G GRAB SAMPLE	SA SIEVE ANALYSIS
SPT STANDARD PENETRATION TEST SAMPLE	S&H SIEVE AND HYDROMETER
	EI EXPANSION INDEX
	CN CONSOLIDATION
	CR CORROSION
	AL ATTERBERG LIMITS
GROUNDWATER TABLE	CO COLLAPSE/SWELL
	RV R-VALUE
	#200 % PASSING # 200 SIEVE

Infiltration Test Data Sheet

LGC Geotechnical, Inc

131 Calle Iglesia Suite 200, San Clemente, CA 92672 tel. (949) 369-6141

Project Name: Adelanto - Rancho 38
Project Number: 22178-01
Date: 10/19/2022
Boring Number: I-1

Test hole dimensions (if circular)	
Boring Depth (feet)*:	<u>10</u>
Boring Diameter (inches):	<u>8</u>
Pipe Diameter (inches):	<u>3</u>

*measured at time of test

Test pit dimensions (if rectangular)	
Pit Depth (feet):	<u> </u>
Pit Length (feet):	<u> </u>
Pit Breadth (feet):	<u> </u>

Pre-Test (Sandy Soil Criteria)*

Trial No.	Start Time (24:HR)	Stop Time (24:HR)	Time Interval (min)	Initial Depth to Water (feet)	Final Depth to Water (feet)	Total Change in Water Level (feet)	Greater Than or Equal to 0.5 feet (yes/no)
1	8:28	8:53	25.0	7.13	9.00	1.87	Yes
2	8:54	9:19	25.0	7.13	9.00	1.87	Yes

*If two consecutive measurements show that six inches of water seeps away in less than 25 minutes, the test shall be run for an additional hour with measurements taken every 10 minutes. Otherwise, pre-soak (fill) overnight, and then obtain at least twelve measurements per hole over at least six hours (approximately 30 minute intervals) with a precision of at least 0.25 inches

Main Test Data

Trial No.	Start Time (24:HR)	Stop Time (24:HR)	Time Interval, Δt (min)	Initial Depth to Water, D_o (feet)	Final Depth to Water, D_f (feet)	Change in Water Level, ΔD (feet)	Observed Infiltration Rate(in/hr)
1	9:53	10:03	10.0	7.13	9.00	1.87	10.7
2	10:04	10:14	10.0	6.83	9.00	2.17	11.6
3	10:15	10:25	10.0	7.03	9.00	1.97	11.0
4	10:27	10:37	10.0	6.93	9.00	2.07	11.3
5	10:40	10:50	10.0	7.23	9.00	1.77	10.4
6	10:53	11:03	10.0	6.93	9.00	2.07	11.3

Observed Infiltration Rate (Does Not Include Any Factor of Safety) 11.3

Sketch:

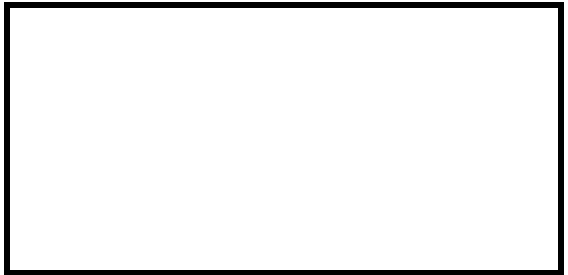

Infiltration Test Data Sheet

LGC Geotechnical, Inc

131 Calle Iglesia Suite 200, San Clemente, CA 92672 tel. (949) 369-6141

Project Name: Adelanto - Rancho 38
Project Number: 22178-01
Date: 10/19/2022
Boring Number: I-2

Test hole dimensions (if circular)	
Boring Depth (feet)*:	<u>10</u>
Boring Diameter (inches):	<u>8</u>
Pipe Diameter (inches):	<u>3</u>

*measured at time of test

Test pit dimensions (if rectangular)	
Pit Depth (feet):	<u> </u>
Pit Length (feet):	<u> </u>
Pit Breadth (feet):	<u> </u>

Pre-Test (Sandy Soil Criteria)*

Trial No.	Start Time (24:HR)	Stop Time (24:HR)	Time Interval (min)	Initial Depth to Water (feet)	Final Depth to Water (feet)	Total Change in Water Level (feet)	Greater Than or Equal to 0.5 feet (yes/no)
1	8:36	9:01	25.0	6.48	7.03	0.55	Yes
2	9:04	9:29	25.0	6.31	7.10	0.79	Yes

*If two consecutive measurements show that six inches of water seeps away in less than 25 minutes, the test shall be run for an additional hour with measurements taken every 10 minutes. Otherwise, pre-soak (fill) overnight, and then obtain at least twelve measurements per hole over at least six hours (approximately 30 minute intervals) with a precision of at least 0.25 inches

Main Test Data

Trial No.	Start Time (24:HR)	Stop Time (24:HR)	Time Interval, Δt (min)	Initial Depth to Water, D_o (feet)	Final Depth to Water, D_f (feet)	Change in Water Level, ΔD (feet)	Observed Infiltration Rate(in/hr)
1	9:57	10:07	10.0	5.88	6.70	0.82	2.5
2	10:09	10:19	10.0	6.05	6.75	0.70	2.2
3	10:21	10:31	10.0	6.14	6.69	0.55	1.8
4	10:34	10:44	10.0	6.06	6.70	0.64	2.0
5	10:46	10:56	10.0	6.14	6.74	0.60	1.9
6	10:57	11:08	11.0	6.18	6.74	0.56	1.6

Observed Infiltration Rate (Does Not Include Any Factor of Safety) 1.6

Sketch:

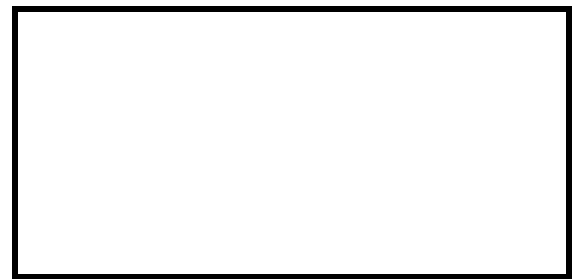

Infiltration Test Data Sheet

LGC Geotechnical, Inc

131 Calle Iglesia Suite 200, San Clemente, CA 92672 tel. (949) 369-6141

Project Name: Adelanto - Rancho 38
Project Number: 22178-01
Date: 10/19/2022
Boring Number: I-3

Test hole dimensions (if circular)

Boring Depth (feet)*: 10
 Boring Diameter (inches): 8
 Pipe Diameter (inches): 3

*measured at time of test

Test pit dimensions (if rectangular)

Pit Depth (feet): _____
 Pit Length (feet): _____
 Pit Breadth (feet): _____

Pre-Test (Sandy Soil Criteria)*

Trial No.	Start Time (24:HR)	Stop Time (24:HR)	Time Interval (min)	Initial Depth to Water (feet)	Final Depth to Water (feet)	Total Change in Water Level (feet)	Greater Than or Equal to 0.5 feet (yes/no)
1	8:43	9:08	25.0	6.53	7.76	1.23	Yes
2	9:10	9:35	25.0	6.50	7.82	1.32	Yes

*If two consecutive measurements show that six inches of water seeps away in less than 25 minutes, the test shall be run for an additional hour with measurements taken every 10 minutes. Otherwise, pre-soak (fill) overnight, and then obtain at least twelve measurements per hole over at least six hours (approximately 30 minute intervals) with a precision of at least 0.25 inches

Main Test Data

Trial No.	Start Time (24:HR)	Stop Time (24:HR)	Time Interval, Δt (min)	Initial Depth to Water, D_o (feet)	Final Depth to Water, D_f (feet)	Change in Water Level, ΔD (feet)	Observed Infiltration Rate(in/hr)
1	11:27	11:38	11.0	6.73	7.61	0.88	3.2
2	11:40	11:50	10.0	6.60	7.60	1.00	3.9
3	11:52	12:02	10.0	6.50	7.61	1.11	4.3
4	12:04	12:15	11.0	6.50	7.65	1.15	4.1
5	12:17	12:27	10.0	6.50	7.65	1.15	4.5
6	12:30	12:40	10.0	6.65	7.63	0.98	3.9

Observed Infiltration Rate (Does Not Include Any Factor of Safety) 3.9

Sketch:

Based on Guidelines from: San Bernardino County (2013)

Spreadsheet Revised on: 6/29/2018



Infiltration Test Data Sheet

LGC Geotechnical, Inc

131 Calle Iglesia Suite 200, San Clemente, CA 92672 tel. (949) 369-6141

Project Name: Adelanto - Rancho 38
Project Number: 22178-01
Date: 10/19/2022
Boring Number: I-4

Test hole dimensions (if circular)	
Boring Depth (feet)*:	<u>10</u>
Boring Diameter (inches):	<u>8</u>
Pipe Diameter (inches):	<u>3</u>

*measured at time of test

Test pit dimensions (if rectangular)	
Pit Depth (feet):	<u> </u>
Pit Length (feet):	<u> </u>
Pit Breadth (feet):	<u> </u>

Pre-Test (Sandy Soil Criteria)*

Trial No.	Start Time (24:HR)	Stop Time (24:HR)	Time Interval (min)	Initial Depth to Water (feet)	Final Depth to Water (feet)	Total Change in Water Level (feet)	Greater Than or Equal to 0.5 feet (yes/no)
1	8:50	9:15	25.0	7.37	9.30	1.93	Yes
2	9:16	9:41	25.0	7.37	9.30	1.93	Yes

*If two consecutive measurements show that six inches of water seeps away in less than 25 minutes, the test shall be run for an additional hour with measurements taken every 10 minutes. Otherwise, pre-soak (fill) overnight, and then obtain at least twelve measurements per hole over at least six hours (approximately 30 minute intervals) with a precision of at least 0.25 inches

Main Test Data

Trial No.	Start Time (24:HR)	Stop Time (24:HR)	Time Interval, Δt (min)	Initial Depth to Water, D_o (feet)	Final Depth to Water, D_f (feet)	Change in Water Level, ΔD (feet)	Observed Infiltration Rate(in/hr)
1	11:34	11:44	10.0	7.50	9.08	1.58	10.1
2	11:46	11:56	10.0	7.37	9.09	1.72	10.7
3	11:58	12:08	10.0	7.77	9.13	1.36	9.5
4	12:11	12:22	11.0	6.70	9.15	2.45	11.9
5	12:23	12:33	10.0	7.42	9.12	1.70	10.8
6	12:35	12:45	10.0	7.32	9.10	1.78	10.9

Observed Infiltration Rate (Does Not Include Any Factor of Safety) 10.9

Sketch:

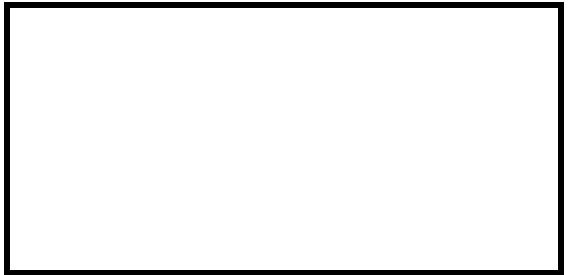

Appendix C
Laboratory Test Results

APPENDIX C

Laboratory Test Results

The laboratory testing program was directed towards providing quantitative data relating to the relevant engineering properties of the soils. Samples considered representative of site conditions were tested in general accordance with American Society for Testing and Materials (ASTM) procedure and/or California Test Methods (CTM), where applicable. The following summary is a brief outline of the test type and a table summarizing the test results.

Moisture and Density Determination Tests: Moisture content (ASTM D2216) and dry density determinations (ASTM D2937) were performed on driven samples obtained from the test borings. The results of these tests are presented in the boring logs. Where applicable, only moisture content was determined from undisturbed or disturbed samples.

Grain Size Distribution/Fines Content: Representative samples were dried, weighed, and soaked in water until individual soil particles were separated (per ASTM D421) and then washed on a No. 200 sieve (ASTM D1140). Where applicable, the portion retained on the No. 200 sieve was dried and then sieved on a U.S. Standard brass sieve set in accordance with ASTM D6913 (sieve).

Sample Location	Description	% Passing # 200 Sieve
HS-1 @ 5 ft	Silty Sand	15
HS-1 @ 20 ft	Sandy Silt	60
HS-3 @ 5 ft	Sand with Silt	9
HS-3 @ 20 ft	Sandy Silt	64
HS-4 @ 5 ft	Sand with Silt	8
HS-4 @ 10 ft	Sand with Silt	7
HS-4 @ 50 ft	Silty Sand	41

Expansion Index: The expansion potential of selected representative samples was evaluated by the Expansion Index Test per ASTM D4829. The results are presented in the table below.

Sample Location	Expansion Index	Expansion Potential*
HS-1 @ 0-5 ft	0	Very Low
HS-3 @ 0-5 ft	2	Very Low

* Per ASTM D4829

APPENDIX C (Cont'd)

Laboratory Test Results

Consolidation: A consolidation test was performed per ASTM D2435. Samples (2.4 inches in diameter and 1 inch in height) were placed in a consolidometer and increasing loads were applied. The samples were allowed to consolidate under “double drainage” and total deformation for each loading step was recorded. The percent consolidation for each load step was recorded as the ratio of the amount of vertical compression to the original sample height. The consolidation pressure curve is provided in this Appendix.

Laboratory Compaction: The maximum dry density and optimum moisture content of typical materials were determined in accordance with ASTM D1557. The results are presented in the table below.

Sample Location	Sample Description	Maximum Dry Density (pcf)	Optimum Moisture Content (%)
HS-3 @ 0-5 ft	Reddish Brown Silty Sand	132.5	8.0

R-value Test: R-value test was performed in general accordance with California Test Method 301. The plot is attached.

Sample No.	R-Value
HS-6 @ 0-5 ft	75

Soluble Sulfates: The soluble sulfate contents of selected samples were determined by standard geochemical methods (CTM 417). The test results are presented in the table below.

Sample Location	Sulfate Content (ppm)	Sulfate Content (%)
HS-1 @ 0-5 ft	55	< 0.01
HS-4 @ 0-5 ft	60	< 0.01

APPENDIX C (Cont'd)

Laboratory Test Results

Chloride Content: Chloride content was tested per CTM 422. The results are presented below.

Sample Location	Chloride Content (ppm)
HS-1 @ 0-5 ft	41

Minimum Resistivity and pH Tests: Minimum resistivity and pH tests were performed in general accordance with CTM 643 and standard geochemical methods. The results are presented in the table below.

Sample Location	pH	Minimum Resistivity (ohms-cm)
HS-3 @ 0-5 ft	7.7	3,080

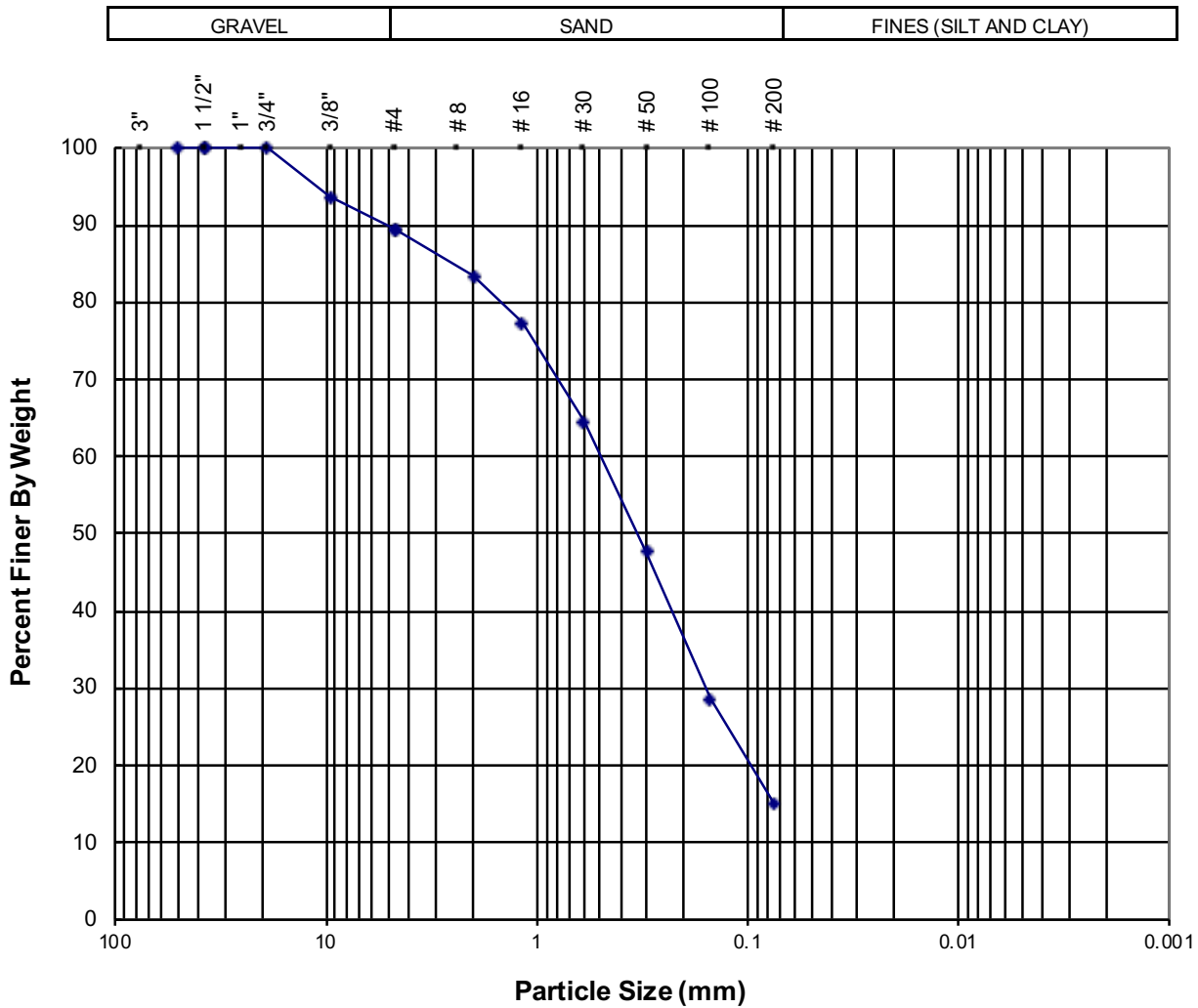

Location:	Sample No.:	Depth (ft.)	Soil Type	Gravel (%)	Sand (%)	Fines (%)
HS-1	SPT-1	5'	SM	10	75	15

Sample Description: Light brown silty SAND



PARTICLE SIZE ANALYSIS
(ASTM D 422)

Project Number: 22178-01

Date: Oct-22

Adelanto Rancho 38

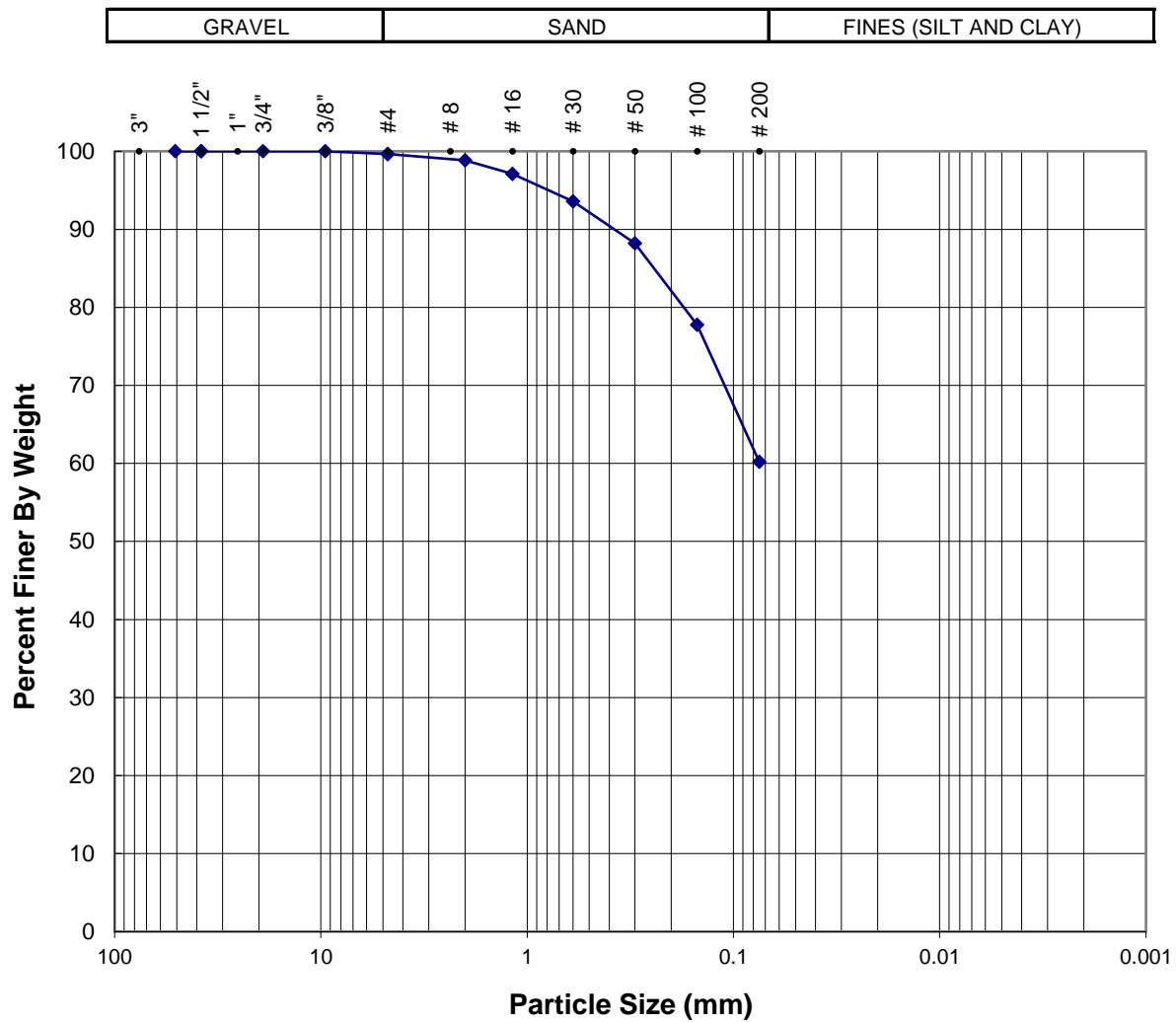

Location:	Sample No.:	Depth (ft.)	Soil Type	Gravel (%)	Sand (%)	Fines (%)
HS-1	SPT-3	20'	ML	0	40	60

Sample Description: Light yellowish brown sandy SILT



PARTICLE SIZE ANALYSIS
(ASTM D 422)

Project Number: 22178-01
Date: Oct-22

Adelanto Rancho 38

Location	Sample No.	Depth (ft)	Molding Moisture Content (%)	Initial Dry Density (pcf)	Final Moisture Content (%)	Expansion Index	Expansion Classification ¹
HS-1	B-1	0-5'	8.7	114.5	13.9	0	Very Low
HS-3	B-1	0-5'	7.6	119.5	14.2	2	Very Low



EXPANSION INDEX
(ASTM D 4829)

Project Number: 22178-01
Date: Oct-22

Adelanto Ranch 38

Time Readings

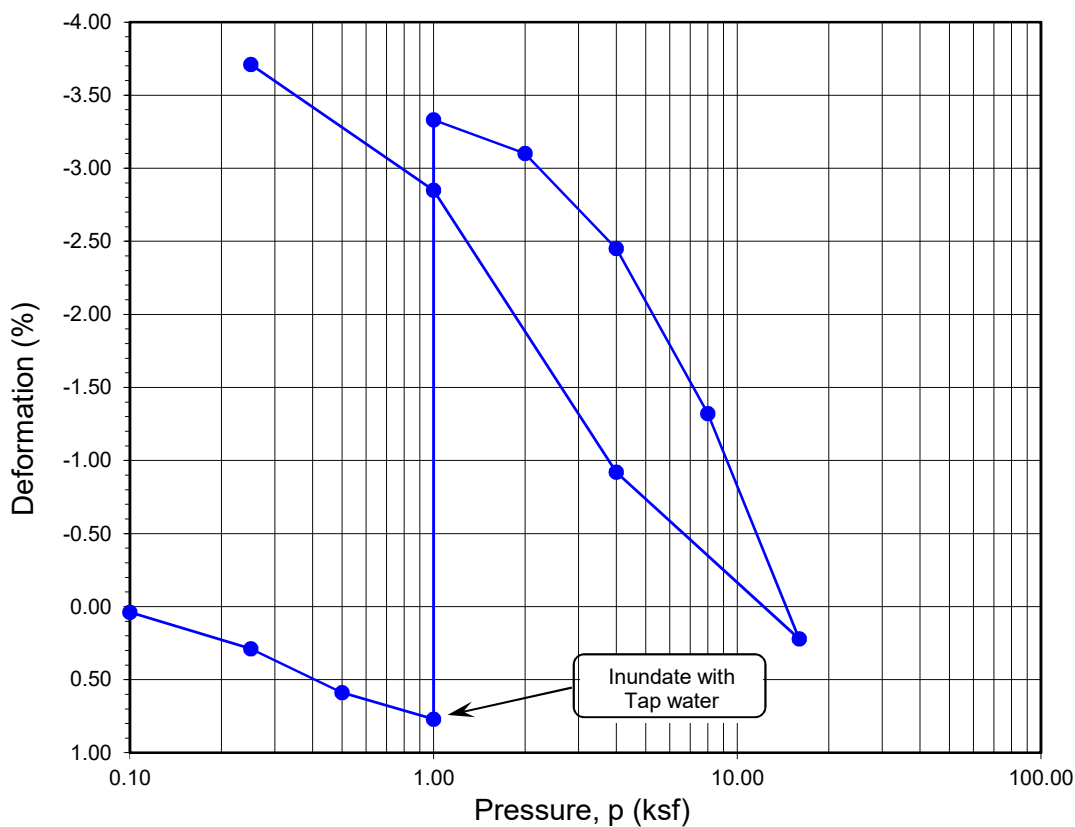
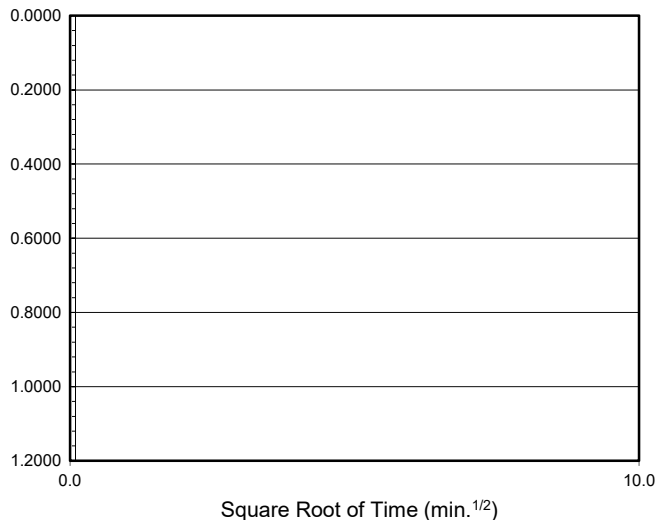
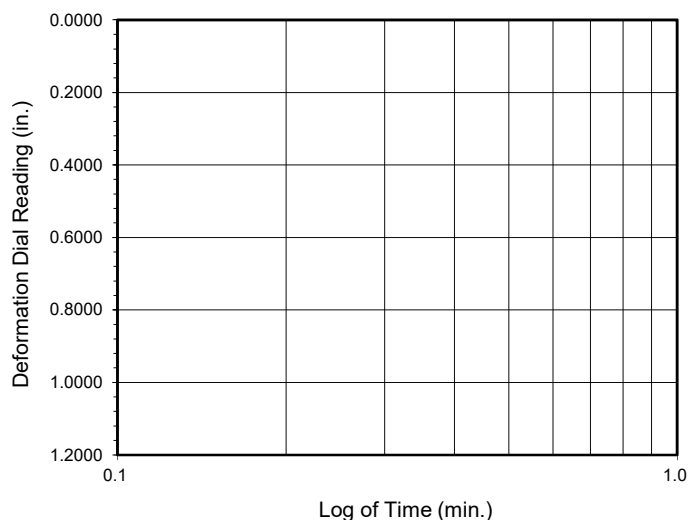

Boring No.	Sample No.	Depth (ft.)	Moisture Content (%)		Dry Density (pcf)		Void Ratio		Degree of Saturation (%)	
			Initial	Final	Initial	Final	Initial	Final	Initial	Final
HS-1	R-3	15	15.2	18.4	115.4	112.6	0.461	0.515	89	100

Soil Identification: Brown lean clay (CL)

**ONE-DIMENSIONAL CONSOLIDATION
PROPERTIES of SOILS
ASTM D 2435**

Project No.: 22178-01

Adelanto Rancho 38

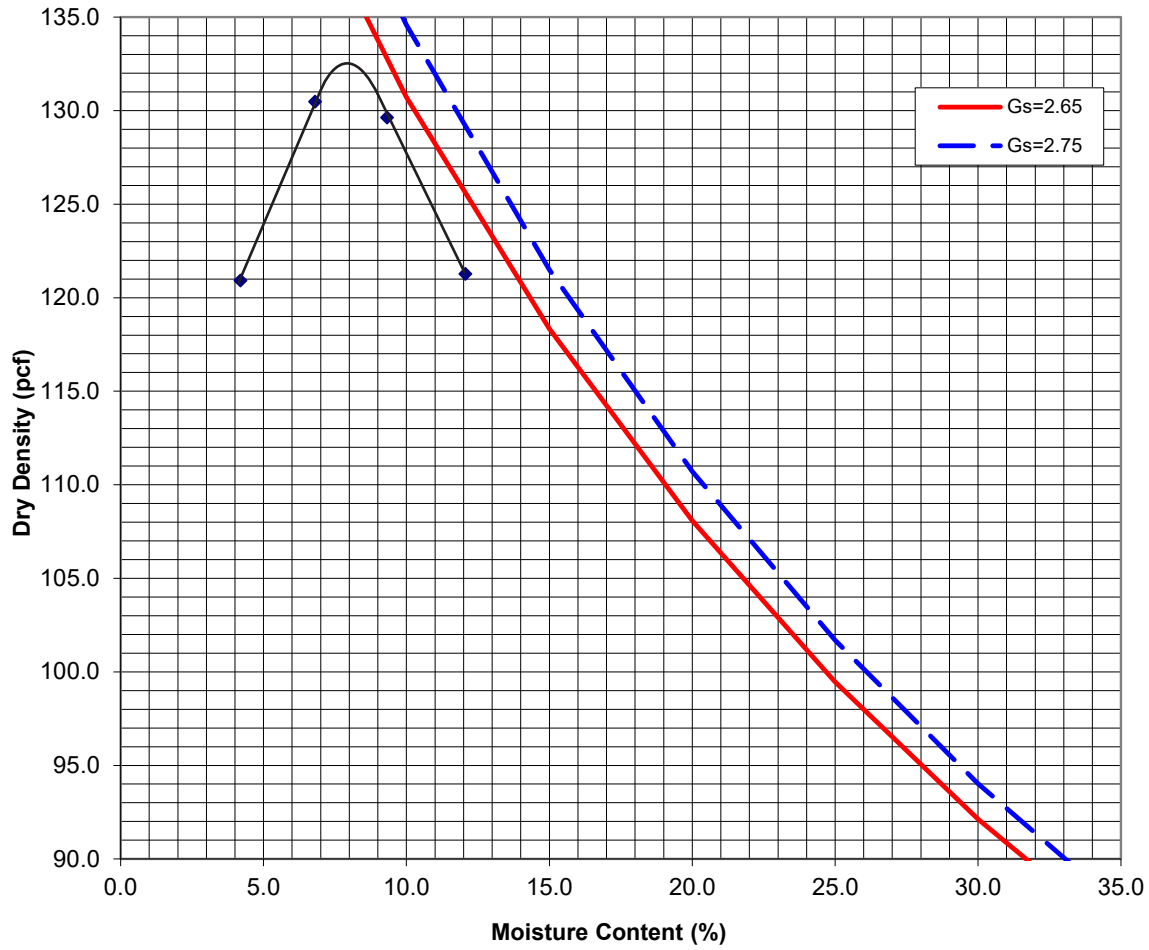

Location:	Sample No.:	Depth (ft)	Sample Description	Maximum Dry Density (pcf)	Optimum Moisture Content (%)
HS-3	B-1	0-5'	Reddish brown silty SAND (SM)	132.5	8.0



LABORATORY COMPACTION
(ASTM D 1557)

Project Number: 22178-01
Date: Nov-22

Adelanto Rnacho 38

R-VALUE TEST RESULTS

DOT CA Test 301

PROJECT NAME:	Adelanto Rancho 38	PROJECT NUMBER:	22178-01
BORING NUMBER:	HS-6	DEPTH (FT.):	0-5
SAMPLE NUMBER:	B-1	TECHNICIAN:	ACS/OHF
SAMPLE DESCRIPTION:	Yellowish brown silty sand (SM)	DATE COMPLETED:	11/10/2022

TEST SPECIMEN	a	b	c
MOISTURE AT COMPACTION %	9.0	9.6	10.0
HEIGHT OF SAMPLE, Inches	2.47	2.44	2.57
DRY DENSITY, pcf	126.2	125.5	124.8
COMPACTOR PRESSURE, psi	350	325	300
EXUDATION PRESSURE, psi	477	236	125
EXPANSION, Inches x 10exp-4	6	3	0
STABILITY Ph 2,000 lbs (160 psi)	19	21	26
TURNS DISPLACEMENT	4.50	5.45	4.65
R-VALUE UNCORRECTED	80	75	73
R-VALUE CORRECTED	80	74	74

DESIGN CALCULATION DATA	a	b	c
GRAVEL EQUIVALENT FACTOR	1.0	1.0	1.0
TRAFFIC INDEX	5.0	5.0	5.0
STABILOMETER THICKNESS, ft.	0.32	0.42	0.42
EXPANSION PRESSURE THICKNESS, ft.	0.20	0.10	0.00

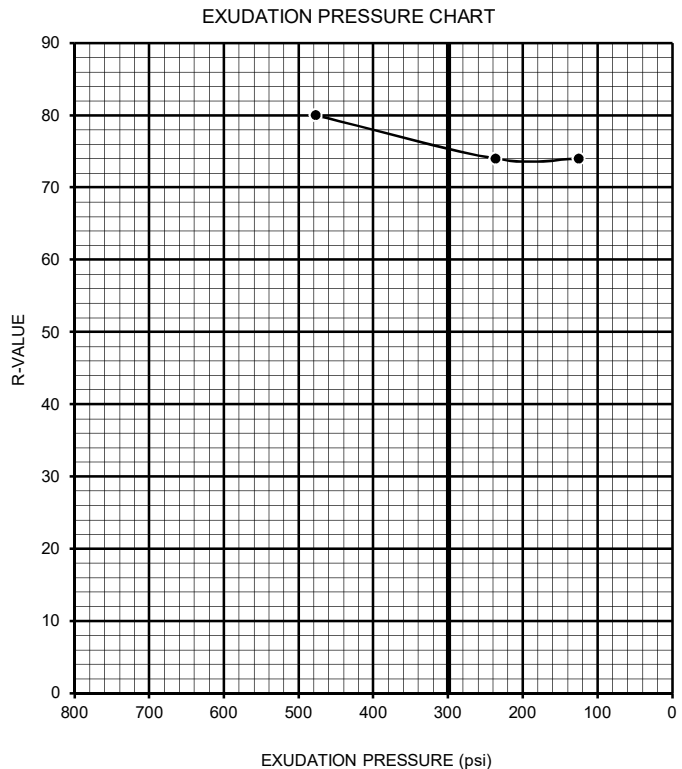
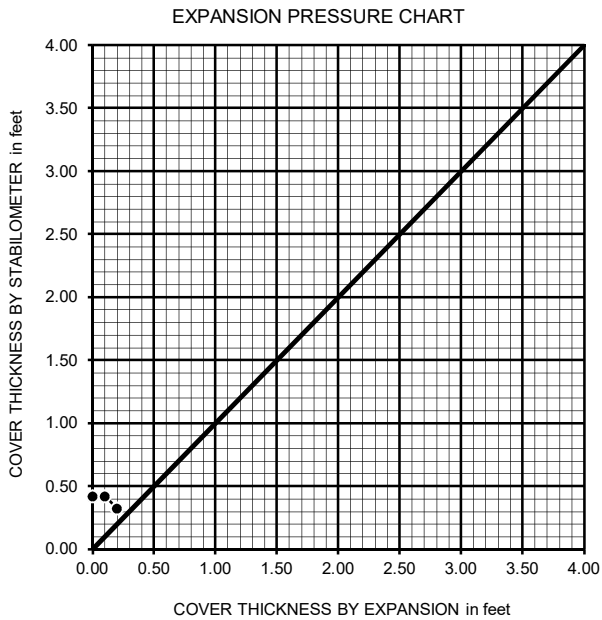

R-VALUE BY EXPANSION:	84
R-VALUE BY EXUDATION:	75
EQUILIBRIUM R-VALUE:	75

**TESTS for SULFATE CONTENT
CHLORIDE CONTENT and pH of SOILS**

Project Name: Adelanto Rancho 38 Tested By : GEB/JD Date: 10/25/22
 Project No. : 22178-01 Checked By: J. Ward Date: 11/21/22

Boring No.	HS-1			
Sample No.	B-1			
Sample Depth (ft)	0-5			
Soil Identification:	Strong brown SM			
Wet Weight of Soil + Container (g)	191.04			
Dry Weight of Soil + Container (g)	186.99			
Weight of Container (g)	58.37			
Moisture Content (%)	3.15			
Weight of Soaked Soil (g)	100.61			

SULFATE CONTENT, DOT California Test 417, Part II

Beaker No.	8			
Crucible No.	8			
Furnace Temperature (°C)	860			
Time In / Time Out	12:20/13:05			
Duration of Combustion (min)	45			
Wt. of Crucible + Residue (g)	20.4016			
Wt. of Crucible (g)	20.4003			
Wt. of Residue (g) (A)	0.0013			
PPM of Sulfate (A) x 41150	53.49			
PPM of Sulfate, Dry Weight Basis	55			

CHLORIDE CONTENT, DOT California Test 422

ml of Extract For Titration (B)	15			
ml of AgNO ₃ Soln. Used in Titration (C)	0.4			
PPM of Chloride (C -0.2) * 100 * 30 / B	40			
PPM of Chloride, Dry Wt. Basis	41			

pH TEST, DOT California Test 643

pH Value	7.71			
Temperature °C	20.6			

SOIL RESISTIVITY TEST

DOT CA TEST 643

Project Name: Adelanto Rancho 38
 Project No. : 22178-01
 Boring No.: HS-1
 Sample No. : B-1

Tested By : G. Berdy Date: 10/26/22
 Checked By: J. Ward Date: 11/21/22
 Depth (ft.) : 0-5

Soil Identification:* Strong brown SM

*California Test 643 requires soil specimens to consist only of portions of samples passing through the No. 8 US Standard Sieve before resistivity testing. Therefore, this test method may not be representative for coarser materials.

Specimen No.	Water Added (ml) (Wa)	Adjusted Moisture Content (MC)	Resistance Reading (ohm)	Soil Resistivity (ohm-cm)
1	20	18.94	3600	3600
2	30	26.84	3100	3100
3	40	34.74	3200	3200
4				
5				

Moisture Content (%) (Mci)	3.15
Wet Wt. of Soil + Cont. (g)	191.04
Dry Wt. of Soil + Cont. (g)	186.99
Wt. of Container (g)	58.37
Container No.	
Initial Soil Wt. (g) (Wt)	130.60
Box Constant	1.000
$MC = (((1 + Mci / 100) \times (Wa / Wt + 1)) - 1) \times 100$	

Min. Resistivity (ohm-cm)	Moisture Content (%)	Sulfate Content (ppm)	Chloride Content (ppm)	Soil pH	
				pH	Temp. (°C)
DOT CA Test 643		DOT CA Test 417 Part II		DOT CA Test 643	
3080	28.4	55	41	7.71	20.6

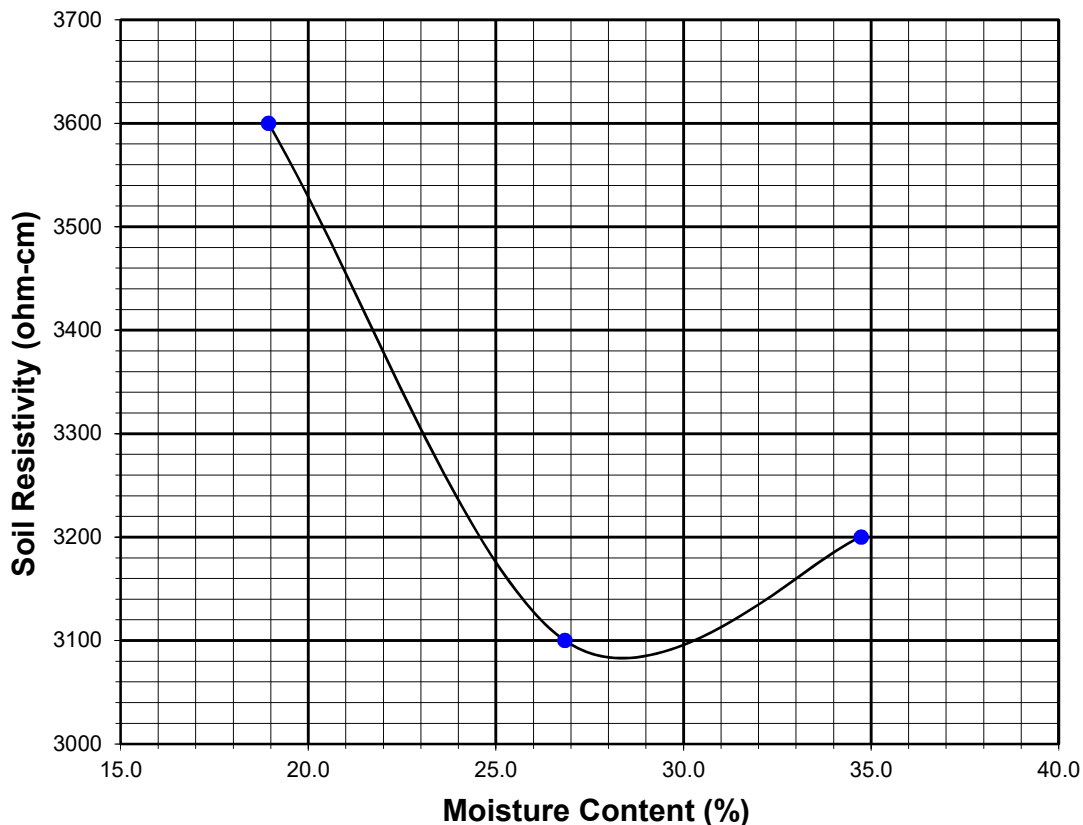

**TESTS for SULFATE CONTENT
CHLORIDE CONTENT and pH of SOILS**

Project Name: Adelanto Rancho 38 Tested By : GEB/JD Date: 10/25/22
 Project No. : 22178-01 Checked By: J. Ward Date: 11/21/22

Boring No.	HS-4			
Sample No.	B-1			
Sample Depth (ft)	0-5			
Soil Identification:	Strong brown CL			
Wet Weight of Soil + Container (g)	197.69			
Dry Weight of Soil + Container (g)	192.75			
Weight of Container (g)	56.35			
Moisture Content (%)	3.62			
Weight of Soaked Soil (g)	100.14			

SULFATE CONTENT, DOT California Test 417, Part II

Beaker No.	10			
Crucible No.	11			
Furnace Temperature (°C)	860			
Time In / Time Out	12:20/13:05			
Duration of Combustion (min)	45			
Wt. of Crucible + Residue (g)	18.0353			
Wt. of Crucible (g)	18.0339			
Wt. of Residue (g) (A)	0.0014			
PPM of Sulfate (A) x 41150	57.61			
PPM of Sulfate, Dry Weight Basis	60			

CHLORIDE CONTENT, DOT California Test 422

ml of Extract For Titration (B)				
ml of AgNO ₃ Soln. Used in Titration (C)				
PPM of Chloride (C -0.2) * 100 * 30 / B				
PPM of Chloride, Dry Wt. Basis	N/A			

pH TEST, DOT California Test 643

pH Value	N/A			
Temperature °C				

Appendix D
General Earthwork and Grading Specifications

General Earthwork and Grading Specifications for Rough Grading

1.0 General

1.1 Intent

These General Earthwork and Grading Specifications are for the grading and earthwork shown on the approved grading plan(s) and/or indicated in the geotechnical report(s). These Specifications are a part of the recommendations contained in the geotechnical report(s). In case of conflict, the specific recommendations in the geotechnical report shall supersede these more general Specifications. Observations of the earthwork by the project Geotechnical Consultant during the course of grading may result in new or revised recommendations that could supersede these specifications or the recommendations in the geotechnical report(s).

1.2 The Geotechnical Consultant of Record

Prior to commencement of work, the owner shall employ a qualified Geotechnical Consultant of Record (Geotechnical Consultant). The Geotechnical Consultant shall be responsible for reviewing the approved geotechnical report(s) and accepting the adequacy of the preliminary geotechnical findings, conclusions, and recommendations prior to the commencement of the grading.

Prior to commencement of grading, the Geotechnical Consultant shall review the "work plan" prepared by the Earthwork Contractor (Contractor) and schedule sufficient personnel to perform the appropriate level of observation, mapping, and compaction testing.

During the grading and earthwork operations, the Geotechnical Consultant shall observe, map, and document the subsurface exposures to verify the geotechnical design assumptions. If the observed conditions are found to be significantly different than the interpreted assumptions during the design phase, the Geotechnical Consultant shall inform the owner, recommend appropriate changes in design to accommodate the observed conditions, and notify the review agency where required.

The Geotechnical Consultant shall observe the moisture-conditioning and processing of the subgrade and fill materials and perform relative compaction testing of fill to confirm that the attained level of compaction is being accomplished as specified. The Geotechnical Consultant shall provide the test results to the owner and the Contractor on a routine and frequent basis.

1.3 The Earthwork Contractor

The Earthwork Contractor (Contractor) shall be qualified, experienced, and knowledgeable in earthwork logistics, preparation and processing of ground to receive fill, moisture-conditioning and processing of fill, and compacting fill. The Contractor shall review and accept the plans, geotechnical report(s), and these Specifications prior to commencement of grading. The Contractor shall be solely responsible for performing the grading in accordance with the project plans and specifications. The Contractor shall prepare and submit to the owner and the Geotechnical Consultant a work plan that indicates the sequence of earthwork grading, the number of "equipment" of work and the estimated quantities of daily earthwork

contemplated for the site prior to commencement of grading. The Contractor shall inform the owner and the Geotechnical Consultant of changes in work schedules and updates to the work plan at least 24 hours in advance of such changes so that appropriate personnel will be available for observation and testing. The Contractor shall not assume that the Geotechnical Consultant is aware of all grading operations.

The Contractor shall have the sole responsibility to provide adequate equipment and methods to accomplish the earthwork in accordance with the applicable grading codes and agency ordinances, these Specifications, and the recommendations in the approved geotechnical report(s) and grading plan(s). If, in the opinion of the Geotechnical Consultant, unsatisfactory conditions, such as unsuitable soil, improper moisture condition, inadequate compaction, insufficient buttress key size, adverse weather, etc., are resulting in a quality of work less than required in these specifications, the Geotechnical Consultant shall reject the work and may recommend to the owner that construction be stopped until the conditions are rectified. It is the contractor's sole responsibility to provide proper fill compaction.

2.0 Preparation of Areas to be Filled

2.1 Clearing and Grubbing

Vegetation, such as brush, grass, roots, and other deleterious material shall be sufficiently removed and properly disposed of in a method acceptable to the owner, governing agencies, and the Geotechnical Consultant.

The Geotechnical Consultant shall evaluate the extent of these removals depending on specific site conditions. Earth fill material shall not contain more than 1 percent of organic materials (by volume). Nesting of the organic materials shall not be allowed.

If potentially hazardous materials are encountered, the Contractor shall stop work in the affected area, and a hazardous material specialist shall be informed immediately for proper evaluation and handling of these materials prior to continuing to work in that area.

As presently defined by the State of California, most refined petroleum products (gasoline, diesel fuel, motor oil, grease, coolant, etc.) have chemical constituents that are considered to be hazardous waste. As such, the indiscriminate dumping or spillage of these fluids onto the ground may constitute a misdemeanor, punishable by fines and/or imprisonment, and shall not be allowed. The contractor is responsible for all hazardous waste relating to his work. The Geotechnical Consultant does not have expertise in this area. If hazardous waste is a concern, then the Client should acquire the services of a qualified environmental assessor.

2.2 Processing

Existing ground that has been declared satisfactory for support of fill by the Geotechnical Consultant shall be scarified to a minimum depth of 6 inches. Existing ground that is not satisfactory shall be over-excavated as specified in the following section. Scarification shall continue until soils are broken down and free of oversize material and the working surface is reasonably uniform, flat, and free of uneven features that would inhibit uniform compaction.

2.3 Over-excavation

In addition to removals and over-excavations recommended in the approved geotechnical report(s) and the grading plan, soft, loose, dry, saturated, spongy, organic-rich, highly fractured or otherwise unsuitable ground shall be over-excavated to competent ground as evaluated by the Geotechnical Consultant during grading.

2.4 Benching

Where fills are to be placed on ground with slopes steeper than 5:1 (horizontal to vertical units), the ground shall be stepped or benched. Please see the Standard Details for a graphic illustration. The lowest bench or key shall be a minimum of 15 feet wide and at least 2 feet deep, into competent material as evaluated by the Geotechnical Consultant. Other benches shall be excavated a minimum height of 4 feet into competent material or as otherwise recommended by the Geotechnical Consultant. Fill placed on ground sloping flatter than 5:1 shall also be benched or otherwise over-excavated to provide a flat subgrade for the fill.

2.5 Evaluation/Acceptance of Fill Areas

All areas to receive fill, including removal and processed areas, key bottoms, and benches, shall be observed, mapped, elevations recorded, and/or tested prior to being accepted by the Geotechnical Consultant as suitable to receive fill. The Contractor shall obtain a written acceptance from the Geotechnical Consultant prior to fill placement. A licensed surveyor shall provide the survey control for determining elevations of processed areas, keys, and benches.

3.0 Fill Material

3.1 General

Material to be used as fill shall be essentially free of organic matter and other deleterious substances evaluated and accepted by the Geotechnical Consultant prior to placement. Soils of poor quality, such as those with unacceptable gradation, high expansion potential, or low strength shall be placed in areas acceptable to the Geotechnical Consultant or mixed with other soils to achieve satisfactory fill material.

3.2 Oversize

Oversize material defined as rock, or other irreducible material with a maximum dimension greater than 8 inches, shall not be buried or placed in fill unless location, materials, and placement methods are specifically accepted by the Geotechnical Consultant. Placement operations shall be such that nesting of oversized material does not occur and such that oversize material is completely surrounded by compacted or densified fill. Oversize material shall not be placed within 10 vertical feet of finish grade or within 2 feet of future utilities or underground construction.

3.3 Import

If importing of fill material is required for grading, proposed import material shall meet the requirements of the geotechnical consultant. The potential import source shall be given to the Geotechnical Consultant at least 48 hours (2 working days) before importing begins so that its suitability can be determined and appropriate tests performed.

4.0 Fill Placement and Compaction

4.1 Fill Layers

Approved fill material shall be placed in areas prepared to receive fill (per Section 3.0) in near-horizontal layers not exceeding 8 inches in loose thickness. The Geotechnical Consultant may accept thicker layers if testing indicates the grading procedures can adequately compact the thicker layers. Each layer shall be spread evenly and mixed thoroughly to attain relative uniformity of material and moisture throughout.

4.2 Fill Moisture Conditioning

Fill soils shall be watered, dried back, blended, and/or mixed, as necessary to attain a relatively uniform moisture content at or slightly over optimum. Maximum density and optimum soil moisture content tests shall be performed in accordance with the American Society of Testing and Materials (ASTM Test Method D1557).

4.3 Compaction of Fill

After each layer has been moisture-conditioned, mixed, and evenly spread, it shall be uniformly compacted to not less than 90 percent of maximum dry density (ASTM Test Method D1557). Compaction equipment shall be adequately sized and be either specifically designed for soil compaction or of proven reliability to efficiently achieve the specified level of compaction with uniformity.

4.4 Compaction of Fill Slopes

In addition to normal compaction procedures specified above, compaction of slopes shall be accomplished by backrolling of slopes with sheepfoot rollers at increments of 3 to 4 feet in fill elevation, or by other methods producing satisfactory results acceptable to the Geotechnical Consultant. Upon completion of grading, relative compaction of the fill, out to the slope face, shall be at least 90 percent of maximum density per ASTM Test Method D1557.

4.5 Compaction Testing

Field tests for moisture content and relative compaction of the fill soils shall be performed by the Geotechnical Consultant. Location and frequency of tests shall be at the Consultant's discretion based on field conditions encountered. Compaction test locations will not necessarily be selected on a random basis. Test locations shall be selected to verify adequacy of compaction levels in areas that are judged to be prone to inadequate compaction (such as close to slope faces and at the fill/bedrock benches).

4.6 Frequency of Compaction Testing

Tests shall be taken at intervals not exceeding 2 feet in vertical rise and/or 1,000 cubic yards of compacted fill soils embankment. In addition, as a guideline, at least one test shall be taken on slope faces for each 5,000 square feet of slope face and/or each 10 feet of vertical height of slope. The Contractor shall assure that fill construction is such that the testing schedule can be accomplished by the Geotechnical Consultant. The Contractor shall stop or slow down the earthwork construction if these minimum standards are not met.

4.7 Compaction Test Locations

The Geotechnical Consultant shall document the approximate elevation and horizontal coordinates of each test location. The Contractor shall coordinate with the project surveyor to assure that sufficient grade stakes are established so that the Geotechnical Consultant can determine the test locations with sufficient accuracy. At a minimum, two grade stakes within a horizontal distance of 100 feet and vertically less than 5 feet apart from potential test locations shall be provided.

5.0 Subdrain Installation

Subdrain systems shall be installed in accordance with the approved geotechnical report(s), the grading plan, and the Standard Details. The Geotechnical Consultant may recommend additional subdrains and/or changes in subdrain extent, location, grade, or material depending on conditions encountered during grading. All subdrains shall be surveyed by a land surveyor/civil engineer for line and grade after installation and prior to burial. Sufficient time should be allowed by the Contractor for these surveys.

6.0 Excavation

Excavations, as well as over-excavation for remedial purposes, shall be evaluated by the Geotechnical Consultant during grading. Remedial removal depths shown on geotechnical plans are estimates only. The actual extent of removal shall be determined by the Geotechnical Consultant based on the field evaluation of exposed conditions during grading. Where fill-over-cut slopes are to be graded, the cut portion of the slope shall be made, evaluated, and accepted by the Geotechnical Consultant prior to placement of materials for construction of the fill portion of the slope, unless otherwise recommended by the Geotechnical Consultant.

7.0 Trench Backfills

7.1 The Contractor shall follow all OSHA and Cal/OSHA requirements for safety of trench excavations.

7.2 All bedding and backfill of utility trenches shall be done in accordance with the applicable provisions of Standard Specifications of Public Works Construction. Bedding material shall have a Sand Equivalent greater than 30 (SE>30). The bedding shall be placed to 1 foot over

the top of the conduit and densified by jetting. Backfill shall be placed and densified to a minimum of 90 percent of maximum from 1 foot above the top of the conduit to the surface.

- 7.3 The jetting of the bedding around the conduits shall be observed by the Geotechnical Consultant.
- 7.4 The Geotechnical Consultant shall test the trench backfill for relative compaction. At least one test should be made for every 300 feet of trench and 2 feet of fill.
- 7.5 Lift thickness of trench backfill shall not exceed those allowed in the Standard Specifications of Public Works Construction unless the Contractor can demonstrate to the Geotechnical Consultant that the fill lift can be compacted to the minimum relative compaction by his alternative equipment and method.

Fill Slope

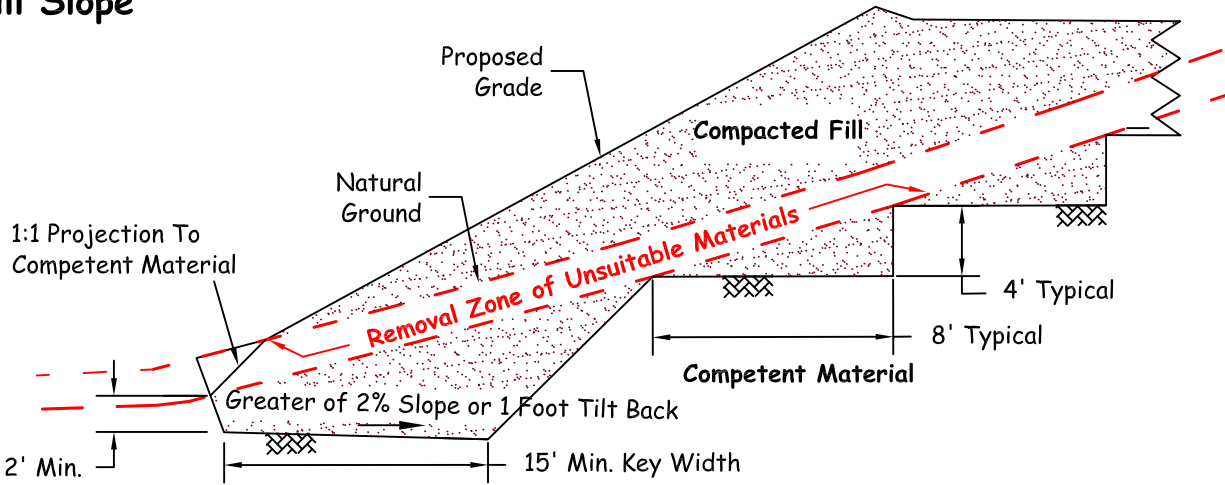

Fill-Over-Cut Slope

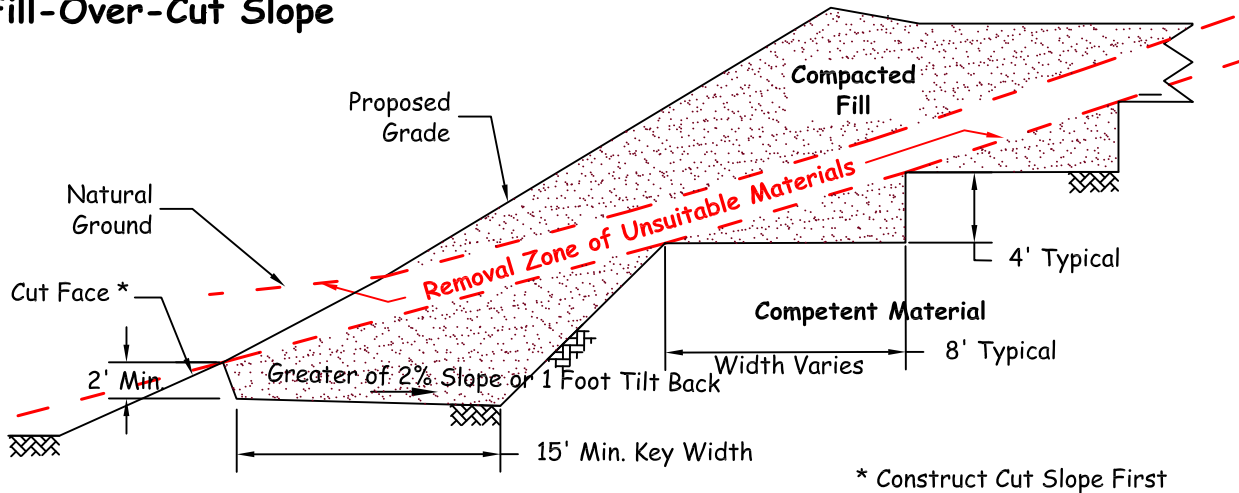

* Construct Cut Slope First

Cut-Over-Fill Slope

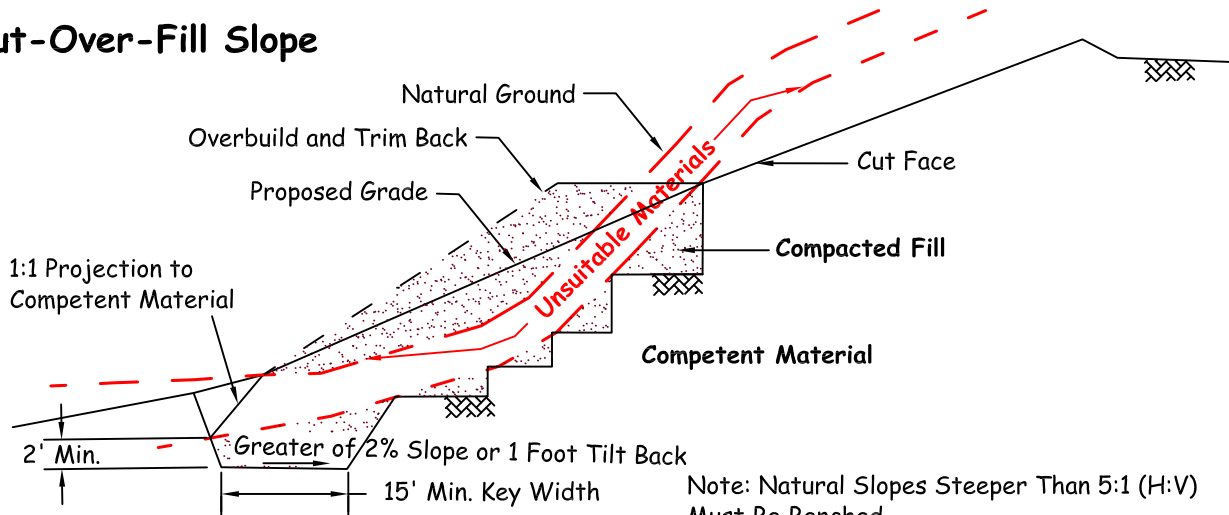

Note: Natural Slopes Steeper Than 5:1 (H:V) Must Be Benched.



KEYING AND BENCHING

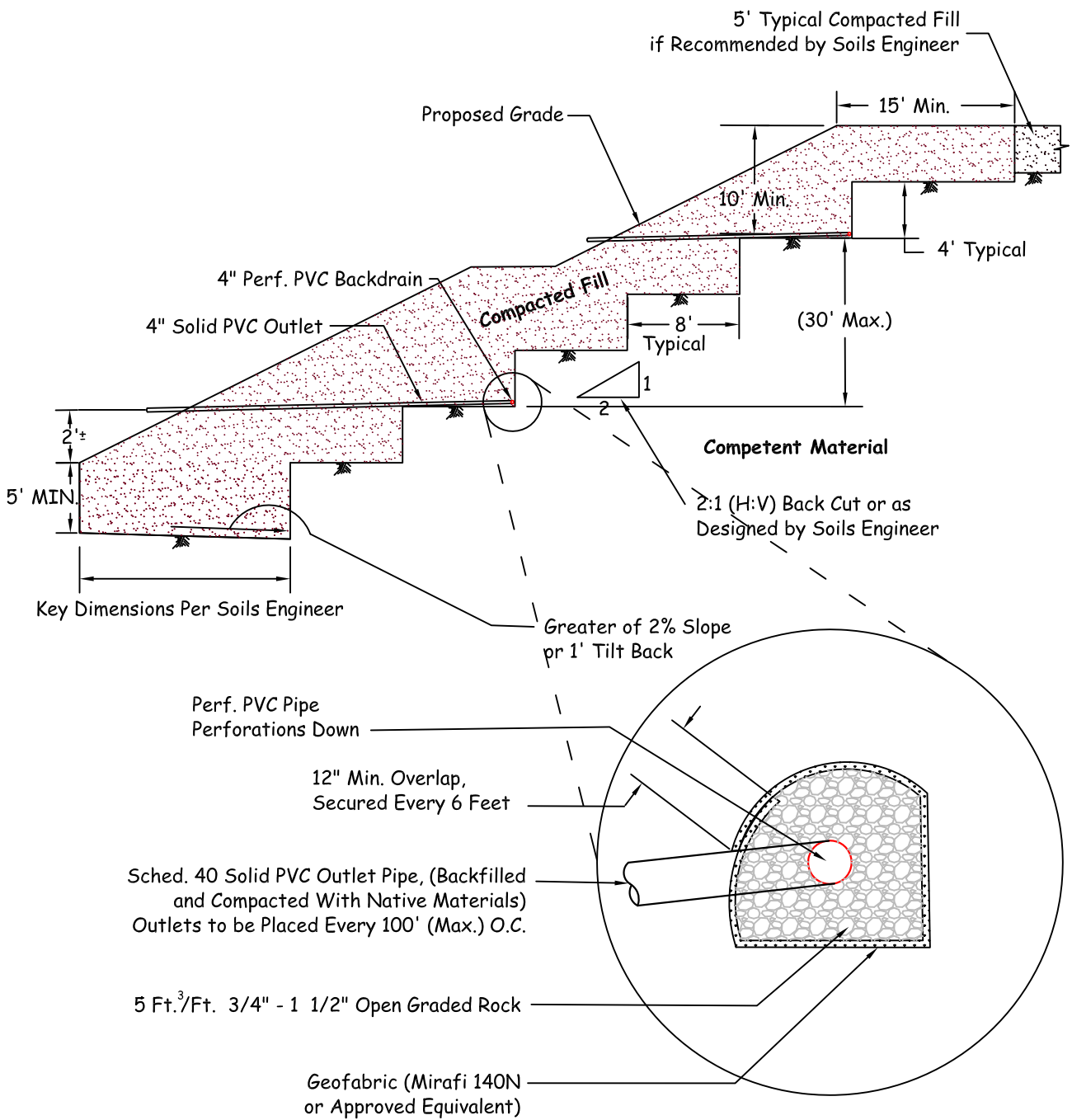

TYPICAL BUTTRESS DETAIL

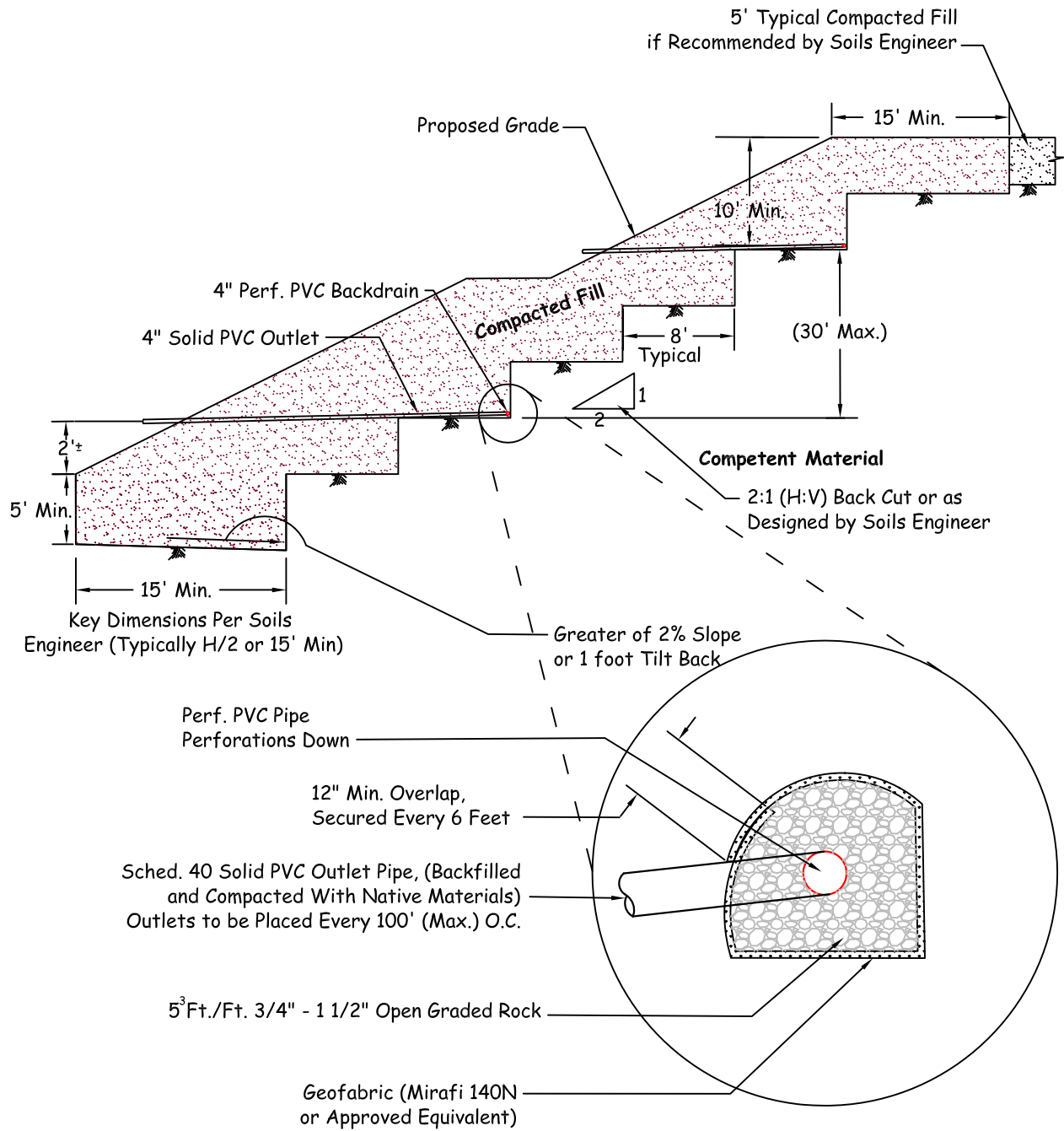

TYPICAL STABILIZATION FILL DETAIL

SUBDRAIN OUTLET MARKER -6" & 8" PIPE

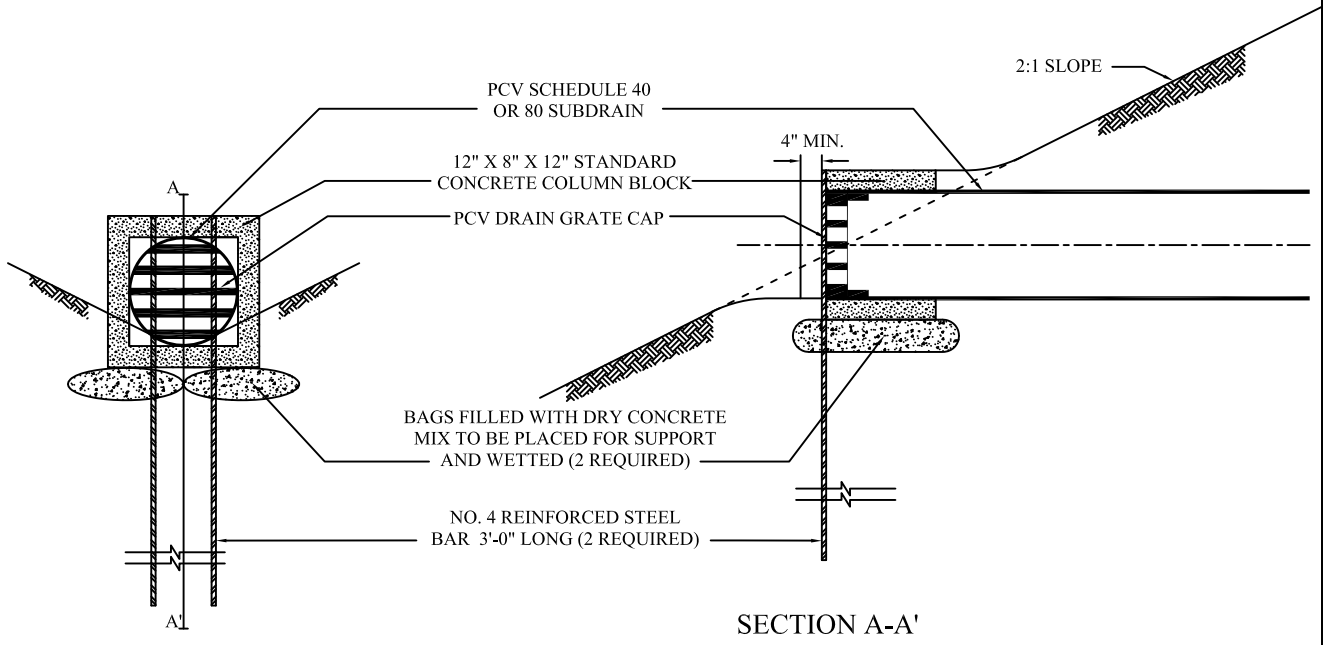

SUBDRAIN OUTLET MARKER -4" PIPE

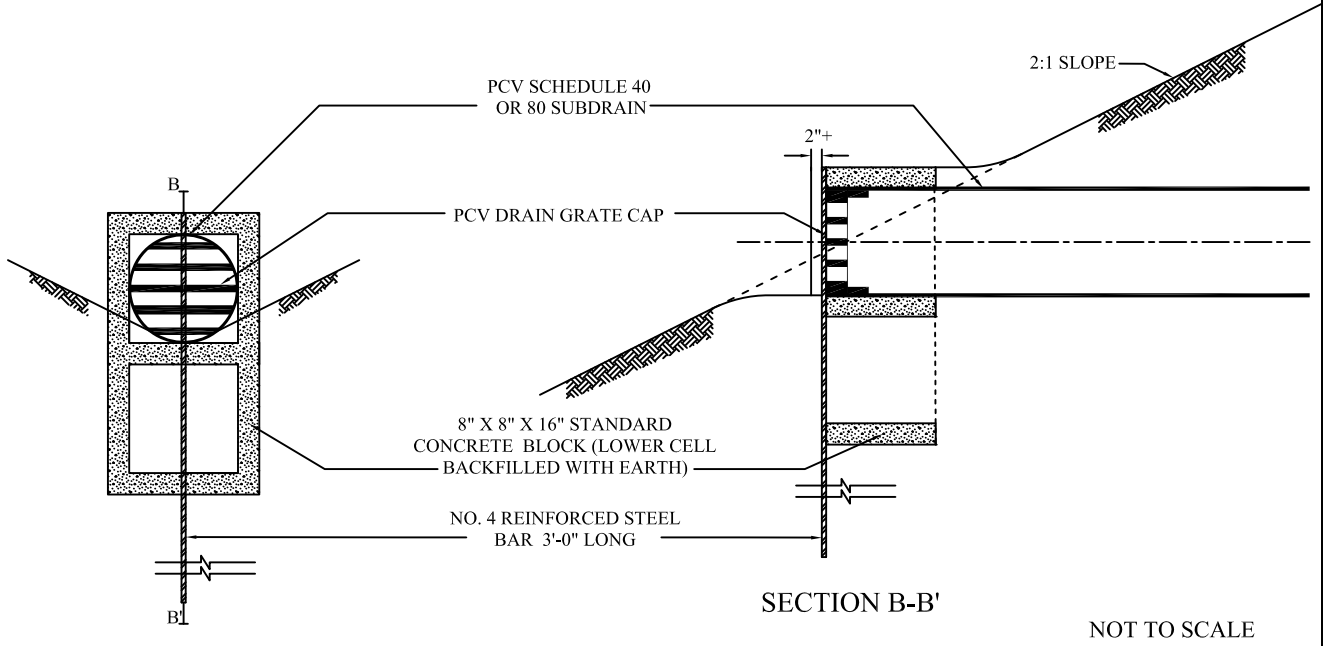

**SUBDRAIN OUTLET
MARKER DETAIL**

Cut Lot (Exposing Unsuitable Soils at Design Grade)

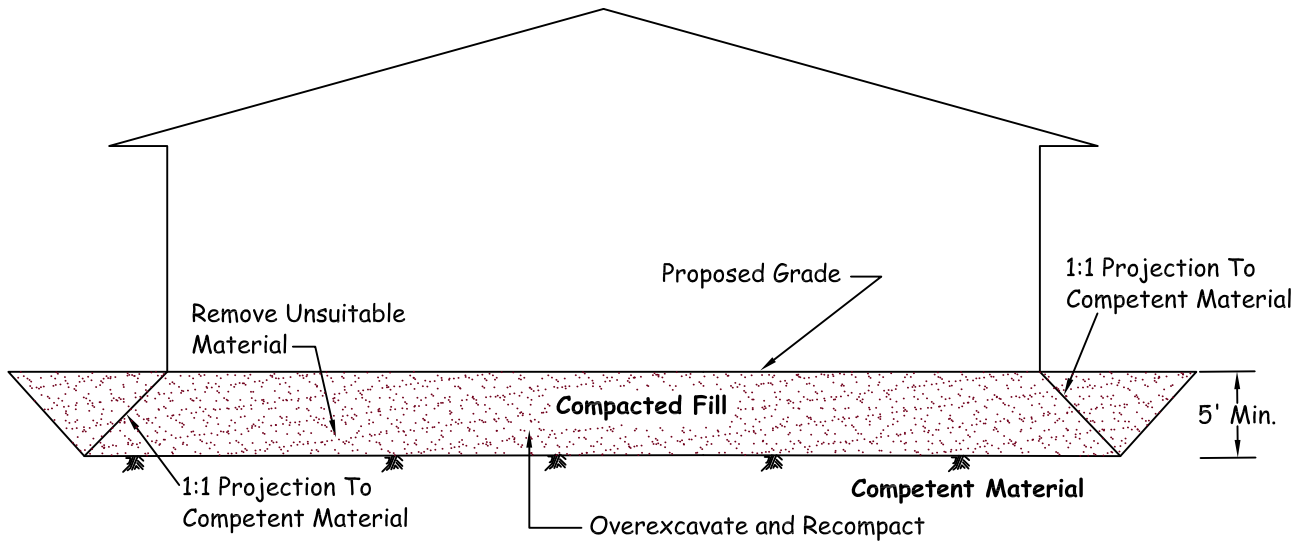

Note 1: Removal Bottom Should be Graded With Minimum 2% Fall Towards Street or Other Suitable Area (as Determined by Soils Engineer) to Avoid Ponding Below Building

Note 2: Where Design Cut Lots are Excavated Entirely Into Competent Material, Overexcavation May Still be Required for Hard-Rock Conditions or for Materials With Variable Expansion Characteristics.

Cut/Fill Transition Lot

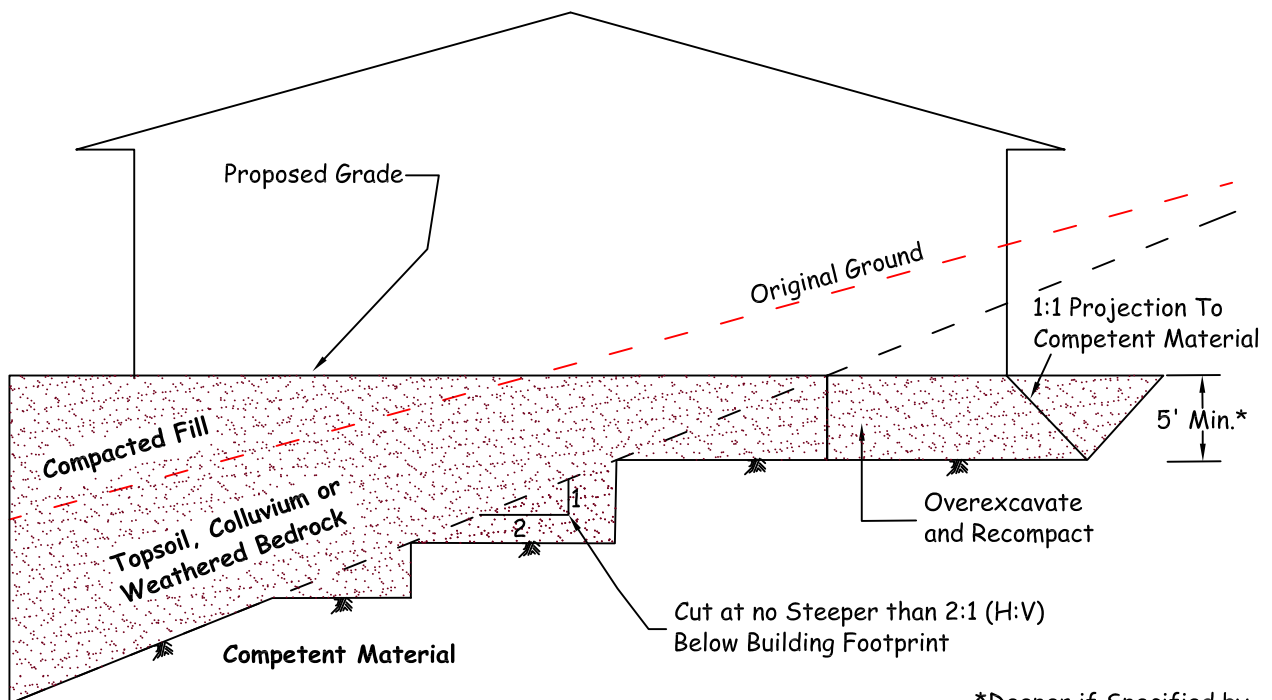

*Deeper if Specified by Soils Engineer



CUT AND TRANSITION LOT OVEREXCAVATION DETAIL

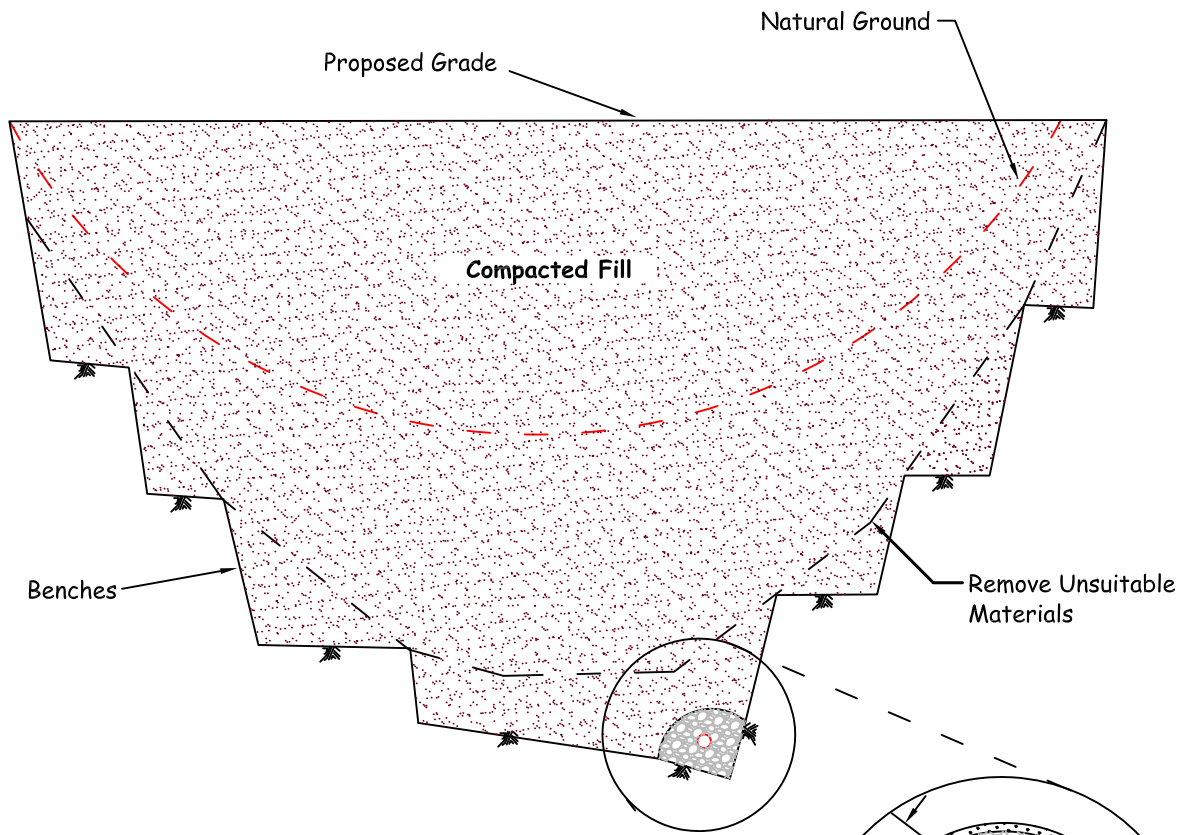

Notes:

- 1) Continuous Runs in Excess of 500' Shall Use 8" Diameter Pipe.
- 2) Final 20' of Pipe at Outlet Shall be Solid and Backfilled with Fine-grained Material.

12" Min. Overlap,
Secured Every 6 Feet

6" Collector Pipe
(Sched. 40, Perf. PVC)

9 Ft.³/Ft.
3/4" - 1 1/2" Crushed Rock

Geofabric (Mirafi 140N
or Approved Equivalent)

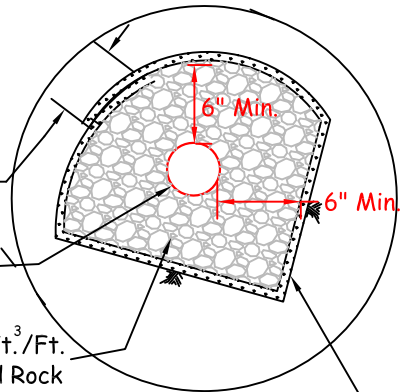

Proposed Outlet Detail

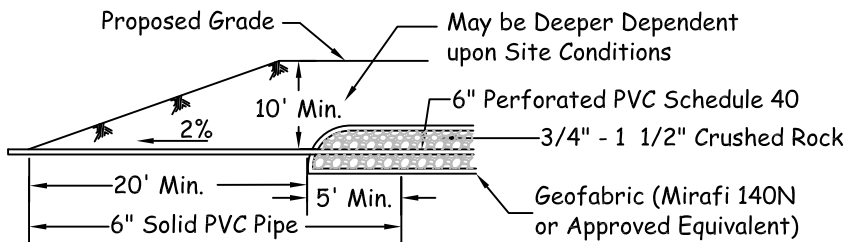

CANYON SUBDRAINS

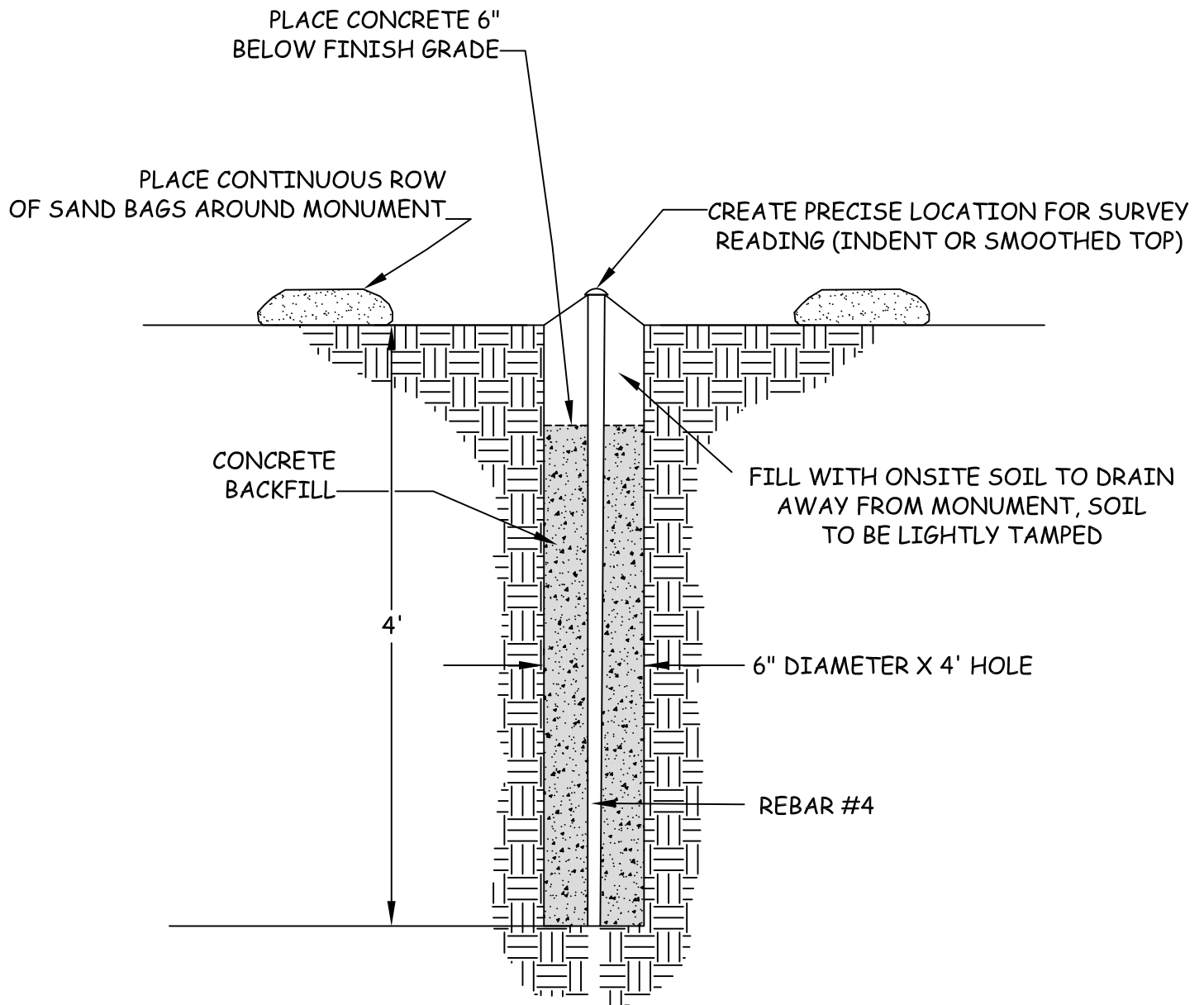

NO CONSTRUCTION EQUIPMENT WITHIN 25 FEET OF ANY INSTALLED SETTLEMENT MONUMENTS



TYPICAL SURFACE SETTLEMENT MONUMENT

TOP VIEW

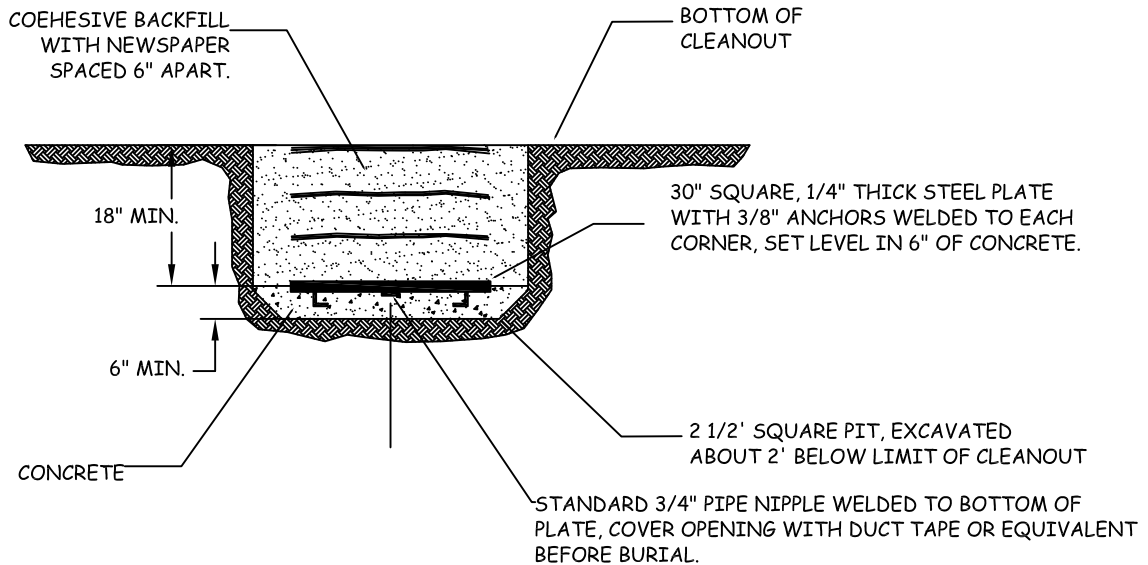
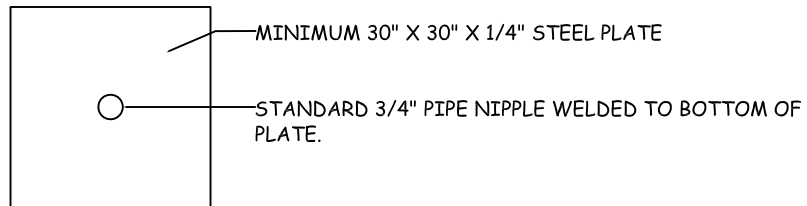

1. SURVEY FOR HORIZONTAL AND VERTICAL LOCATION TO NEAREST .01 INCH PRIOR TO BACKFILL USING KNOW LOCATIONS THAT WILL REMAIN INTACT DURING THE DURATION OF THE MONITORING PROGRAM. KNOW POINTS EXPLICITLY NOT ALLOWED ARE THOSE LOCATED ON FILL OR THAT WILL BE DESTROYED DURING GRADING.
2. IN THE EVENT OF DAMAGE TO SETTLEMENT PLATE DURING GRADING, CONTRACTOR SHALL IMMEDIATELY NOTIFY THE GEOTECHNICAL ENGINEER AND SHALL BE RESPONSIBLE FOR RESTORING THE SETTLEMENT PLATES TO WORKING ORDER.
3. DRILL TO RECOVER AND ATTACH RISER PIPE.



TYPICAL SETTLEMENT PLATE AND RISER

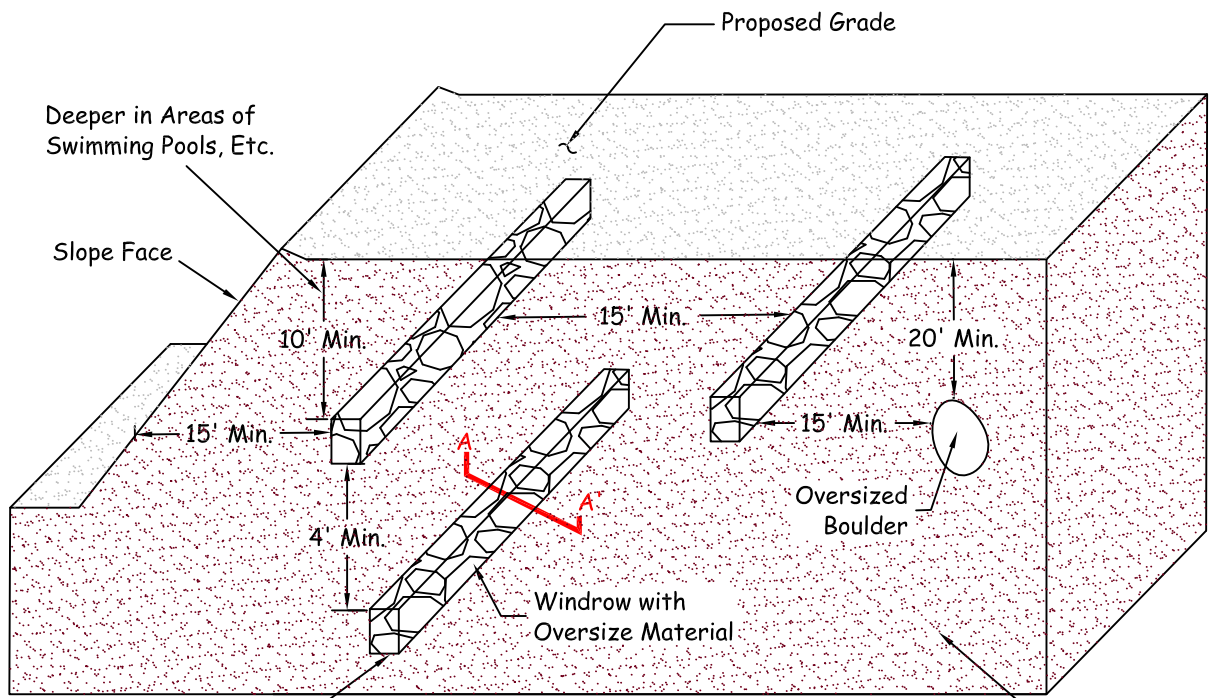

Windrow Parallel to Slope Face

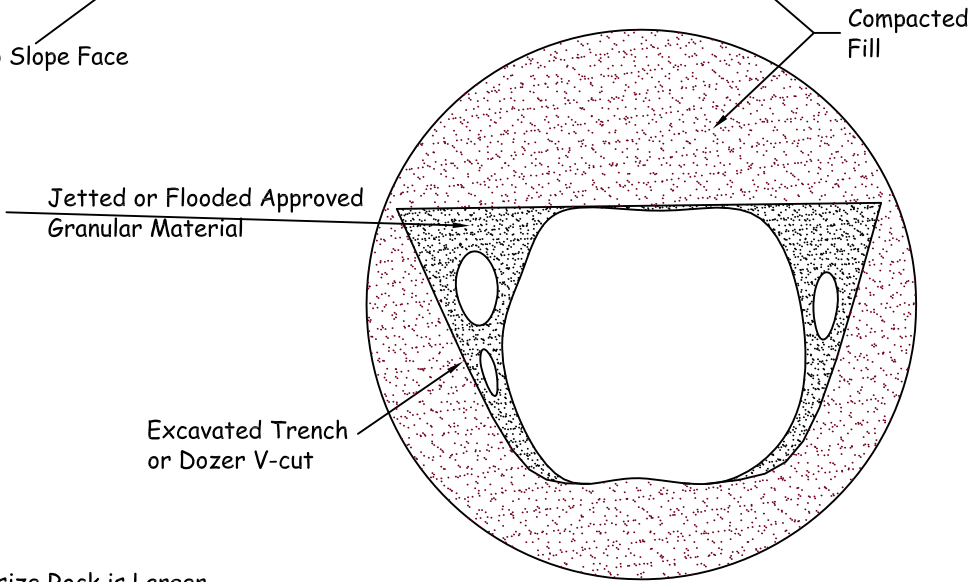

Section A-A'

Note: Oversize Rock is Larger than 8" in Maximum Dimension.



OVERSIZE ROCK DISPOSAL DETAIL

Appendix 4: Hydrology Calculations

San Bernardino County Rational Hydrology Program

(Hydrology Manual Date - August 1986)

CIVILCADD/CIVILDESIGN Engineering Software, (c) 1989-2019 Version

9.1

Rational Hydrology Study

Date: 02/08/23

A22326 PRE-DEVELOPMENT Q100 RATIONAL

Program License Serial Number 6509

***** Hydrology Study Control Information *****

Rational hydrology study storm event year is 100.0
10 Year storm 1 hour rainfall = 0.750(In.)
100 Year storm 1 hour rainfall = 1.150(In.)
Computed rainfall intensity:
Storm year = 100.00 1 hour rainfall = 1.150 (In.)
Slope used for rainfall intensity curve b = 0.7000
Soil antecedent moisture condition (AMC) = 3

++++
Process from Point/Station 100.000 to Point/Station 101.000
**** INITIAL AREA EVALUATION ****

UNDEVELOPED (poor cover) subarea
Decimal fraction soil group A = 0.000
Decimal fraction soil group B = 0.000
Decimal fraction soil group C = 1.000
Decimal fraction soil group D = 0.000
SCS curve number for soil(AMC 2) = 86.00
Adjusted SCS curve number for AMC 3 = 97.20
Pervious ratio(Ap) = 1.0000 Max loss rate(Fm)= 0.055(In/Hr)
Initial subarea data:
Initial area flow distance = 950.000(Ft.)
Top (of initial area) elevation = 2954.800(Ft.)

Bottom (of initial area) elevation = 2940.290(Ft.)
 Difference in elevation = 14.510(Ft.)
 Slope = 0.01527 s(%)= 1.53
 $TC = k(0.525)*[(length^3)/(elevation\ change)]^{0.2}$
 Initial area time of concentration = 18.813 min.
 Rainfall intensity = 2.590(In/Hr) for a 100.0 year storm
 Effective runoff coefficient used for area (Q=KCIA) is C = 0.881
 Subarea runoff = 12.199(CFS)
 Total initial stream area = 5.348(Ac.)
 Pervious area fraction = 1.000
 Initial area Fm value = 0.055(In/Hr)

++++++
 Process from Point/Station 101.000 to Point/Station 102.000
 **** IRREGULAR CHANNEL FLOW TRAVEL TIME ****

Estimated mean flow rate at midpoint of channel = 0.000(CFS)
 Depth of flow = 5.609(Ft.), Average velocity = 3.753(Ft/s)
 !!Warning: Water is above left or right bank elevations
 ***** Irregular Channel Data *****

 Information entered for subchannel number 1 :
 Point number 'X' coordinate 'Y' coordinate
 1 0.00 0.00
 2 530.00 732.00
 Manning's 'N' friction factor = 0.050

 Sub-Channel flow = 42.737(CFS)
 ' ' flow top width = 4.061(Ft.)
 ' ' velocity= 3.753(Ft/s)
 ' ' area = 11.388(Sq.Ft)
 ' ' Froude number = 0.395

Upstream point elevation = 2940.290(Ft.)
 Downstream point elevation = 2931.790(Ft.)
 Flow length = 1035.000(Ft.)
 Travel time = 4.60 min.
 Time of concentration = 23.41 min.
 Depth of flow = 5.609(Ft.)
 Average velocity = 3.753(Ft/s)
 Total irregular channel flow = 42.737(CFS)
 Irregular channel normal depth above invert elev. = 5.609(Ft.)
 Average velocity of channel(s) = 3.753(Ft/s)
 !!Warning: Water is above left or right bank elevations
 Adding area flow to channel
 UNDEVELOPED (poor cover) subarea
 Decimal fraction soil group A = 0.000
 Decimal fraction soil group B = 0.000
 Decimal fraction soil group C = 1.000
 Decimal fraction soil group D = 0.000
 SCS curve number for soil(AMC 2) = 86.00
 Adjusted SCS curve number for AMC 3 = 97.20

Pervious ratio(Ap) = 1.0000 Max loss rate(Fm)= 0.055(In/Hr)
 Rainfall intensity = 2.222(In/Hr) for a 100.0 year storm
 Effective runoff coefficient used for area,(total area with modified
 rational method)(Q=KCIA) is C = 0.878
 Subarea runoff = 61.016(CFS) for 32.192(Ac.)
 Total runoff = 73.215(CFS)
 Effective area this stream = 37.54(Ac.)
 Total Study Area (Main Stream No. 1) = 37.54(Ac.)
 Area averaged Fm value = 0.055(In/Hr)
 Depth of flow = 6.863(Ft.), Average velocity = 4.293(Ft/s)
 !!Warning: Water is above left or right bank elevations

++++++
 Process from Point/Station 101.000 to Point/Station 102.000
 **** CONFLUENCE OF MAIN STREAMS ****

The following data inside Main Stream is listed:

In Main Stream number: 1
 Stream flow area = 37.540(Ac.)
 Runoff from this stream = 73.215(CFS)
 Time of concentration = 23.41 min.
 Rainfall intensity = 2.222(In/Hr)
 Area averaged loss rate (Fm) = 0.0554(In/Hr)
 Area averaged Pervious ratio (Ap) = 1.0000
 Summary of stream data:

Stream No.	Flow rate (CFS)	Area (Ac.)	TC (min)	Fm (In/Hr)	Rainfall Intensity (In/Hr)
1	73.21	37.540	23.41	0.055	2.222
$Q_{max}(1) = 1.000 * 1.000 * 73.215) + = 73.215$					

Total of 1 main streams to confluence:

Flow rates before confluence point:
74.215

Maximum flow rates at confluence using above data:
73.215

Area of streams before confluence:
37.540

Effective area values after confluence:
37.540

Results of confluence:

Total flow rate = 73.215(CFS)
 Time of concentration = 23.410 min.
 Effective stream area after confluence = 37.540(Ac.)
 Study area average Pervious fraction(Ap) = 1.000
 Study area average soil loss rate(Fm) = 0.055(In/Hr)
 Study area total = 37.54(Ac.)

End of computations, Total Study Area = 37.54 (Ac.)

The following figures may

be used for a unit hydrograph study of the same area.

Note: These figures do not consider reduced effective area effects caused by confluences in the rational equation.

Area averaged pervious area fraction(A_p) = 1.000

Area averaged SCS curve number = 86.0

U n i t H y d r o g r a p h A n a l y s i s

Copyright (c) CIVILCADD/CIVILDESIGN, 1989 - 2018, Version 9.0

Study date 02/08/23

+++++

San Bernardino County Synthetic Unit Hydrology Method
Manual date - August 1986

Program License Serial Number 6509

Storm Event Year = 100

Antecedent Moisture Condition = 3

English (in-lb) Input Units Used

English Rainfall Data (Inches) Input Values Used

English Units used in output format

Area averaged rainfall intensity isohyetal data:

Sub-Area (Ac.)	Duration (hours)	Isohyetal (In)
Rainfall data for year 100		
37.54	1	1.15

Rainfall data for year 100		
37.54	6	1.80

Rainfall data for year 100		
37.54	24	3.00

+++++

***** Area-averaged max loss rate, Fm *****

SCS curve SCS curve Area Area Fp(Fig C6) Ap Fm

(In/Hr)	No.(AMCII)	NO.(AMC 3)	(Ac.)	Fraction	(In/Hr)	(dec.)
	71.0	87.8	37.54	1.000	0.233	1.000 0.233

Area-averaged adjusted loss rate Fm (In/Hr) = 0.233

***** Area-Averaged low loss rate fraction, Yb *****

Area	Area	SCS CN	SCS CN	S	Pervious
(Ac.)	Fract	(AMC2)	(AMC3)		Yield Fr
37.54	1.000	71.0	87.8	1.39	0.601

Area-averaged catchment yield fraction, Y = 0.601

Area-averaged low loss fraction, Yb = 0.399

User entry of time of concentration = 0.390 (hours)

+++++

Watershed area = 37.54(Ac.)

Catchment Lag time = 0.312 hours

Unit interval = 5.000 minutes

Unit interval percentage of lag time = 26.7094

Hydrograph baseflow = 0.00(CFS)

Average maximum watershed loss rate(Fm) = 0.233(In/Hr)

Average low loss rate fraction (Yb) = 0.399 (decimal)

DESERT S-Graph Selected

Computed peak 5-minute rainfall = 0.546(In)

Computed peak 30-minute rainfall = 0.934(In)

Specified peak 1-hour rainfall = 1.150(In)

Computed peak 3-hour rainfall = 1.514(In)

Specified peak 6-hour rainfall = 1.800(In)

Specified peak 24-hour rainfall = 3.000(In)

Rainfall depth area reduction factors:

Using a total area of 37.54(Ac.) (Ref: fig. E-4)

5-minute factor = 0.998 Adjusted rainfall = 0.545(In)

30-minute factor = 0.998 Adjusted rainfall = 0.932(In)

1-hour factor = 0.998 Adjusted rainfall = 1.148(In)

3-hour factor = 1.000 Adjusted rainfall = 1.513(In)

6-hour factor = 1.000 Adjusted rainfall = 1.800(In)

24-hour factor = 1.000 Adjusted rainfall = 3.000(In)

U n i t H y d r o g r a p h

+++++

Interval	'S' Graph	Unit Hydrograph
Number	Mean values	((CFS))

(K = 454.00 (CFS))

1	1.482	6.728
2	7.420	26.958
3	23.386	72.487

4	45.504	100.416
5	59.274	62.513
6	67.621	37.895
7	73.654	27.391
8	78.228	20.764
9	81.762	16.044
10	84.638	13.060
11	87.117	11.255
12	89.115	9.071
13	90.695	7.173
14	92.107	6.408
15	93.340	5.602
16	94.376	4.701
17	95.282	4.112
18	96.053	3.502
19	96.739	3.115
20	97.275	2.434
21	97.738	2.102
22	98.043	1.383
23	98.317	1.247
24	98.632	1.429
25	98.953	1.455
26	99.273	1.455
27	99.545	1.236
28	99.716	0.773
29	99.883	0.758
30	100.000	0.533

Peak Unit Number	Adjusted mass rainfall (In)	Unit rainfall (In)
1	0.5447	0.5447
2	0.6706	0.1259
3	0.7574	0.0867
4	0.8257	0.0683
5	0.8828	0.0572
6	0.9324	0.0496
7	0.9766	0.0441
8	1.0165	0.0399
9	1.0531	0.0366
10	1.0869	0.0338
11	1.1184	0.0315
12	1.1480	0.0296
13	1.1713	0.0233
14	1.1933	0.0220
15	1.2142	0.0209
16	1.2341	0.0199
17	1.2531	0.0190
18	1.2712	0.0181
19	1.2886	0.0174
20	1.3053	0.0167
21	1.3214	0.0161
22	1.3370	0.0155
23	1.3520	0.0150

24	1.3666	0.0145
25	1.3807	0.0141
26	1.3943	0.0137
27	1.4076	0.0133
28	1.4206	0.0129
29	1.4332	0.0126
30	1.4454	0.0123
31	1.4574	0.0120
32	1.4691	0.0117
33	1.4805	0.0114
34	1.4916	0.0112
35	1.5025	0.0109
36	1.5132	0.0107
37	1.5236	0.0104
38	1.5338	0.0102
39	1.5438	0.0100
40	1.5536	0.0098
41	1.5633	0.0096
42	1.5727	0.0095
43	1.5820	0.0093
44	1.5911	0.0091
45	1.6001	0.0090
46	1.6089	0.0088
47	1.6176	0.0087
48	1.6262	0.0085
49	1.6346	0.0084
50	1.6429	0.0083
51	1.6510	0.0082
52	1.6591	0.0080
53	1.6670	0.0079
54	1.6748	0.0078
55	1.6825	0.0077
56	1.6901	0.0076
57	1.6976	0.0075
58	1.7050	0.0074
59	1.7123	0.0073
60	1.7195	0.0072
61	1.7267	0.0071
62	1.7337	0.0070
63	1.7407	0.0070
64	1.7475	0.0069
65	1.7543	0.0068
66	1.7610	0.0067
67	1.7677	0.0066
68	1.7742	0.0066
69	1.7807	0.0065
70	1.7871	0.0064
71	1.7935	0.0064
72	1.7998	0.0063
73	1.8090	0.0092
74	1.8181	0.0091
75	1.8271	0.0090
76	1.8360	0.0089

77	1.8449	0.0089
78	1.8537	0.0088
79	1.8624	0.0087
80	1.8710	0.0087
81	1.8796	0.0086
82	1.8882	0.0085
83	1.8966	0.0085
84	1.9050	0.0084
85	1.9133	0.0083
86	1.9216	0.0083
87	1.9298	0.0082
88	1.9379	0.0081
89	1.9460	0.0081
90	1.9541	0.0080
91	1.9620	0.0080
92	1.9699	0.0079
93	1.9778	0.0079
94	1.9856	0.0078
95	1.9934	0.0078
96	2.0011	0.0077
97	2.0087	0.0077
98	2.0163	0.0076
99	2.0239	0.0076
100	2.0314	0.0075
101	2.0389	0.0075
102	2.0463	0.0074
103	2.0537	0.0074
104	2.0610	0.0073
105	2.0683	0.0073
106	2.0755	0.0072
107	2.0827	0.0072
108	2.0899	0.0072
109	2.0970	0.0071
110	2.1040	0.0071
111	2.1111	0.0070
112	2.1181	0.0070
113	2.1250	0.0069
114	2.1319	0.0069
115	2.1388	0.0069
116	2.1456	0.0068
117	2.1524	0.0068
118	2.1592	0.0068
119	2.1659	0.0067
120	2.1726	0.0067
121	2.1793	0.0067
122	2.1859	0.0066
123	2.1925	0.0066
124	2.1990	0.0066
125	2.2055	0.0065
126	2.2120	0.0065
127	2.2185	0.0065
128	2.2249	0.0064
129	2.2313	0.0064

130	2.2376	0.0064
131	2.2440	0.0063
132	2.2503	0.0063
133	2.2565	0.0063
134	2.2628	0.0062
135	2.2690	0.0062
136	2.2752	0.0062
137	2.2813	0.0062
138	2.2874	0.0061
139	2.2935	0.0061
140	2.2996	0.0061
141	2.3056	0.0060
142	2.3117	0.0060
143	2.3176	0.0060
144	2.3236	0.0060
145	2.3295	0.0059
146	2.3354	0.0059
147	2.3413	0.0059
148	2.3472	0.0059
149	2.3530	0.0058
150	2.3588	0.0058
151	2.3646	0.0058
152	2.3704	0.0058
153	2.3761	0.0057
154	2.3818	0.0057
155	2.3875	0.0057
156	2.3932	0.0057
157	2.3988	0.0056
158	2.4044	0.0056
159	2.4100	0.0056
160	2.4156	0.0056
161	2.4211	0.0056
162	2.4267	0.0055
163	2.4322	0.0055
164	2.4377	0.0055
165	2.4431	0.0055
166	2.4486	0.0054
167	2.4540	0.0054
168	2.4594	0.0054
169	2.4648	0.0054
170	2.4702	0.0054
171	2.4755	0.0053
172	2.4808	0.0053
173	2.4861	0.0053
174	2.4914	0.0053
175	2.4967	0.0053
176	2.5020	0.0052
177	2.5072	0.0052
178	2.5124	0.0052
179	2.5176	0.0052
180	2.5228	0.0052
181	2.5279	0.0052
182	2.5331	0.0051

183	2.5382	0.0051
184	2.5433	0.0051
185	2.5484	0.0051
186	2.5534	0.0051
187	2.5585	0.0051
188	2.5635	0.0050
189	2.5685	0.0050
190	2.5735	0.0050
191	2.5785	0.0050
192	2.5835	0.0050
193	2.5884	0.0050
194	2.5934	0.0049
195	2.5983	0.0049
196	2.6032	0.0049
197	2.6081	0.0049
198	2.6129	0.0049
199	2.6178	0.0049
200	2.6226	0.0048
201	2.6275	0.0048
202	2.6323	0.0048
203	2.6371	0.0048
204	2.6419	0.0048
205	2.6466	0.0048
206	2.6514	0.0048
207	2.6561	0.0047
208	2.6608	0.0047
209	2.6655	0.0047
210	2.6702	0.0047
211	2.6749	0.0047
212	2.6796	0.0047
213	2.6842	0.0047
214	2.6889	0.0046
215	2.6935	0.0046
216	2.6981	0.0046
217	2.7027	0.0046
218	2.7073	0.0046
219	2.7118	0.0046
220	2.7164	0.0046
221	2.7209	0.0045
222	2.7255	0.0045
223	2.7300	0.0045
224	2.7345	0.0045
225	2.7390	0.0045
226	2.7435	0.0045
227	2.7479	0.0045
228	2.7524	0.0045
229	2.7568	0.0044
230	2.7613	0.0044
231	2.7657	0.0044
232	2.7701	0.0044
233	2.7745	0.0044
234	2.7789	0.0044
235	2.7832	0.0044

236	2.7876	0.0044
237	2.7919	0.0043
238	2.7963	0.0043
239	2.8006	0.0043
240	2.8049	0.0043
241	2.8092	0.0043
242	2.8135	0.0043
243	2.8178	0.0043
244	2.8221	0.0043
245	2.8263	0.0043
246	2.8306	0.0042
247	2.8348	0.0042
248	2.8390	0.0042
249	2.8432	0.0042
250	2.8474	0.0042
251	2.8516	0.0042
252	2.8558	0.0042
253	2.8600	0.0042
254	2.8641	0.0042
255	2.8683	0.0042
256	2.8724	0.0041
257	2.8766	0.0041
258	2.8807	0.0041
259	2.8848	0.0041
260	2.8889	0.0041
261	2.8930	0.0041
262	2.8971	0.0041
263	2.9011	0.0041
264	2.9052	0.0041
265	2.9092	0.0041
266	2.9133	0.0040
267	2.9173	0.0040
268	2.9213	0.0040
269	2.9253	0.0040
270	2.9294	0.0040
271	2.9333	0.0040
272	2.9373	0.0040
273	2.9413	0.0040
274	2.9453	0.0040
275	2.9492	0.0040
276	2.9532	0.0039
277	2.9571	0.0039
278	2.9610	0.0039
279	2.9650	0.0039
280	2.9689	0.0039
281	2.9728	0.0039
282	2.9767	0.0039
283	2.9806	0.0039
284	2.9844	0.0039
285	2.9883	0.0039
286	2.9922	0.0039
287	2.9960	0.0039
288	2.9999	0.0038

Unit Period (number)	Unit Rainfall (In)	Unit Soil-Loss (In)	Effective Rainfall (In)
1	0.0038	0.0015	0.0023
2	0.0039	0.0015	0.0023
3	0.0039	0.0015	0.0023
4	0.0039	0.0015	0.0023
5	0.0039	0.0016	0.0023
6	0.0039	0.0016	0.0023
7	0.0039	0.0016	0.0024
8	0.0039	0.0016	0.0024
9	0.0039	0.0016	0.0024
10	0.0040	0.0016	0.0024
11	0.0040	0.0016	0.0024
12	0.0040	0.0016	0.0024
13	0.0040	0.0016	0.0024
14	0.0040	0.0016	0.0024
15	0.0040	0.0016	0.0024
16	0.0040	0.0016	0.0024
17	0.0041	0.0016	0.0024
18	0.0041	0.0016	0.0024
19	0.0041	0.0016	0.0025
20	0.0041	0.0016	0.0025
21	0.0041	0.0016	0.0025
22	0.0041	0.0016	0.0025
23	0.0042	0.0017	0.0025
24	0.0042	0.0017	0.0025
25	0.0042	0.0017	0.0025
26	0.0042	0.0017	0.0025
27	0.0042	0.0017	0.0025
28	0.0042	0.0017	0.0025
29	0.0042	0.0017	0.0026
30	0.0043	0.0017	0.0026
31	0.0043	0.0017	0.0026
32	0.0043	0.0017	0.0026
33	0.0043	0.0017	0.0026
34	0.0043	0.0017	0.0026
35	0.0043	0.0017	0.0026
36	0.0044	0.0017	0.0026
37	0.0044	0.0017	0.0026
38	0.0044	0.0018	0.0026
39	0.0044	0.0018	0.0027
40	0.0044	0.0018	0.0027
41	0.0045	0.0018	0.0027
42	0.0045	0.0018	0.0027
43	0.0045	0.0018	0.0027
44	0.0045	0.0018	0.0027
45	0.0045	0.0018	0.0027
46	0.0045	0.0018	0.0027
47	0.0046	0.0018	0.0027
48	0.0046	0.0018	0.0028

49	0.0046	0.0018	0.0028
50	0.0046	0.0018	0.0028
51	0.0047	0.0019	0.0028
52	0.0047	0.0019	0.0028
53	0.0047	0.0019	0.0028
54	0.0047	0.0019	0.0028
55	0.0047	0.0019	0.0028
56	0.0048	0.0019	0.0029
57	0.0048	0.0019	0.0029
58	0.0048	0.0019	0.0029
59	0.0048	0.0019	0.0029
60	0.0048	0.0019	0.0029
61	0.0049	0.0019	0.0029
62	0.0049	0.0020	0.0029
63	0.0049	0.0020	0.0030
64	0.0049	0.0020	0.0030
65	0.0050	0.0020	0.0030
66	0.0050	0.0020	0.0030
67	0.0050	0.0020	0.0030
68	0.0050	0.0020	0.0030
69	0.0051	0.0020	0.0030
70	0.0051	0.0020	0.0031
71	0.0051	0.0020	0.0031
72	0.0051	0.0021	0.0031
73	0.0052	0.0021	0.0031
74	0.0052	0.0021	0.0031
75	0.0052	0.0021	0.0031
76	0.0052	0.0021	0.0032
77	0.0053	0.0021	0.0032
78	0.0053	0.0021	0.0032
79	0.0053	0.0021	0.0032
80	0.0054	0.0021	0.0032
81	0.0054	0.0022	0.0032
82	0.0054	0.0022	0.0033
83	0.0055	0.0022	0.0033
84	0.0055	0.0022	0.0033
85	0.0055	0.0022	0.0033
86	0.0056	0.0022	0.0033
87	0.0056	0.0022	0.0034
88	0.0056	0.0022	0.0034
89	0.0057	0.0023	0.0034
90	0.0057	0.0023	0.0034
91	0.0057	0.0023	0.0034
92	0.0058	0.0023	0.0035
93	0.0058	0.0023	0.0035
94	0.0058	0.0023	0.0035
95	0.0059	0.0023	0.0035
96	0.0059	0.0024	0.0035
97	0.0060	0.0024	0.0036
98	0.0060	0.0024	0.0036
99	0.0060	0.0024	0.0036
100	0.0061	0.0024	0.0036
101	0.0061	0.0024	0.0037

102	0.0062	0.0025	0.0037
103	0.0062	0.0025	0.0037
104	0.0062	0.0025	0.0037
105	0.0063	0.0025	0.0038
106	0.0063	0.0025	0.0038
107	0.0064	0.0026	0.0038
108	0.0064	0.0026	0.0039
109	0.0065	0.0026	0.0039
110	0.0065	0.0026	0.0039
111	0.0066	0.0026	0.0040
112	0.0066	0.0026	0.0040
113	0.0067	0.0027	0.0040
114	0.0067	0.0027	0.0040
115	0.0068	0.0027	0.0041
116	0.0068	0.0027	0.0041
117	0.0069	0.0028	0.0042
118	0.0069	0.0028	0.0042
119	0.0070	0.0028	0.0042
120	0.0071	0.0028	0.0042
121	0.0072	0.0029	0.0043
122	0.0072	0.0029	0.0043
123	0.0073	0.0029	0.0044
124	0.0073	0.0029	0.0044
125	0.0074	0.0030	0.0045
126	0.0075	0.0030	0.0045
127	0.0076	0.0030	0.0045
128	0.0076	0.0030	0.0046
129	0.0077	0.0031	0.0046
130	0.0078	0.0031	0.0047
131	0.0079	0.0031	0.0047
132	0.0079	0.0032	0.0048
133	0.0080	0.0032	0.0048
134	0.0081	0.0032	0.0049
135	0.0082	0.0033	0.0049
136	0.0083	0.0033	0.0050
137	0.0084	0.0033	0.0050
138	0.0085	0.0034	0.0051
139	0.0086	0.0034	0.0052
140	0.0087	0.0035	0.0052
141	0.0088	0.0035	0.0053
142	0.0089	0.0035	0.0053
143	0.0090	0.0036	0.0054
144	0.0091	0.0036	0.0055
145	0.0063	0.0025	0.0038
146	0.0064	0.0025	0.0038
147	0.0065	0.0026	0.0039
148	0.0066	0.0026	0.0039
149	0.0067	0.0027	0.0040
150	0.0068	0.0027	0.0041
151	0.0070	0.0028	0.0042
152	0.0070	0.0028	0.0042
153	0.0072	0.0029	0.0043
154	0.0073	0.0029	0.0044

155	0.0075	0.0030	0.0045
156	0.0076	0.0030	0.0046
157	0.0078	0.0031	0.0047
158	0.0079	0.0032	0.0048
159	0.0082	0.0033	0.0049
160	0.0083	0.0033	0.0050
161	0.0085	0.0034	0.0051
162	0.0087	0.0035	0.0052
163	0.0090	0.0036	0.0054
164	0.0091	0.0036	0.0055
165	0.0095	0.0038	0.0057
166	0.0096	0.0038	0.0058
167	0.0100	0.0040	0.0060
168	0.0102	0.0041	0.0061
169	0.0107	0.0043	0.0064
170	0.0109	0.0044	0.0066
171	0.0114	0.0046	0.0069
172	0.0117	0.0047	0.0070
173	0.0123	0.0049	0.0074
174	0.0126	0.0050	0.0076
175	0.0133	0.0053	0.0080
176	0.0137	0.0055	0.0082
177	0.0145	0.0058	0.0087
178	0.0150	0.0060	0.0090
179	0.0161	0.0064	0.0097
180	0.0167	0.0067	0.0100
181	0.0181	0.0072	0.0109
182	0.0190	0.0076	0.0114
183	0.0209	0.0083	0.0125
184	0.0220	0.0088	0.0132
185	0.0296	0.0118	0.0178
186	0.0315	0.0126	0.0189
187	0.0366	0.0146	0.0220
188	0.0399	0.0159	0.0240
189	0.0496	0.0194	0.0302
190	0.0572	0.0194	0.0378
191	0.0867	0.0194	0.0674
192	0.1259	0.0194	0.1065
193	0.5447	0.0194	0.5253
194	0.0683	0.0194	0.0489
195	0.0441	0.0176	0.0265
196	0.0338	0.0135	0.0203
197	0.0233	0.0093	0.0140
198	0.0199	0.0079	0.0119
199	0.0174	0.0069	0.0105
200	0.0155	0.0062	0.0093
201	0.0141	0.0056	0.0085
202	0.0129	0.0052	0.0078
203	0.0120	0.0048	0.0072
204	0.0112	0.0045	0.0067
205	0.0104	0.0042	0.0063
206	0.0098	0.0039	0.0059
207	0.0093	0.0037	0.0056

208	0.0088	0.0035	0.0053
209	0.0084	0.0034	0.0051
210	0.0080	0.0032	0.0048
211	0.0077	0.0031	0.0046
212	0.0074	0.0030	0.0044
213	0.0071	0.0028	0.0043
214	0.0069	0.0027	0.0041
215	0.0066	0.0027	0.0040
216	0.0064	0.0026	0.0039
217	0.0092	0.0037	0.0055
218	0.0089	0.0036	0.0054
219	0.0087	0.0035	0.0052
220	0.0085	0.0034	0.0051
221	0.0083	0.0033	0.0050
222	0.0081	0.0033	0.0049
223	0.0080	0.0032	0.0048
224	0.0078	0.0031	0.0047
225	0.0077	0.0031	0.0046
226	0.0075	0.0030	0.0045
227	0.0074	0.0029	0.0044
228	0.0072	0.0029	0.0043
229	0.0071	0.0028	0.0043
230	0.0070	0.0028	0.0042
231	0.0069	0.0027	0.0041
232	0.0068	0.0027	0.0041
233	0.0067	0.0027	0.0040
234	0.0066	0.0026	0.0039
235	0.0065	0.0026	0.0039
236	0.0064	0.0025	0.0038
237	0.0063	0.0025	0.0038
238	0.0062	0.0025	0.0037
239	0.0061	0.0024	0.0037
240	0.0060	0.0024	0.0036
241	0.0059	0.0024	0.0036
242	0.0059	0.0023	0.0035
243	0.0058	0.0023	0.0035
244	0.0057	0.0023	0.0034
245	0.0056	0.0023	0.0034
246	0.0056	0.0022	0.0033
247	0.0055	0.0022	0.0033
248	0.0054	0.0022	0.0033
249	0.0054	0.0022	0.0032
250	0.0053	0.0021	0.0032
251	0.0053	0.0021	0.0032
252	0.0052	0.0021	0.0031
253	0.0052	0.0021	0.0031
254	0.0051	0.0020	0.0031
255	0.0051	0.0020	0.0030
256	0.0050	0.0020	0.0030
257	0.0050	0.0020	0.0030
258	0.0049	0.0020	0.0029
259	0.0049	0.0019	0.0029
260	0.0048	0.0019	0.0029

261	0.0048	0.0019	0.0029
262	0.0047	0.0019	0.0028
263	0.0047	0.0019	0.0028
264	0.0046	0.0019	0.0028
265	0.0046	0.0018	0.0028
266	0.0046	0.0018	0.0027
267	0.0045	0.0018	0.0027
268	0.0045	0.0018	0.0027
269	0.0044	0.0018	0.0027
270	0.0044	0.0018	0.0026
271	0.0044	0.0017	0.0026
272	0.0043	0.0017	0.0026
273	0.0043	0.0017	0.0026
274	0.0043	0.0017	0.0026
275	0.0042	0.0017	0.0025
276	0.0042	0.0017	0.0025
277	0.0042	0.0017	0.0025
278	0.0041	0.0017	0.0025
279	0.0041	0.0016	0.0025
280	0.0041	0.0016	0.0025
281	0.0041	0.0016	0.0024
282	0.0040	0.0016	0.0024
283	0.0040	0.0016	0.0024
284	0.0040	0.0016	0.0024
285	0.0039	0.0016	0.0024
286	0.0039	0.0016	0.0024
287	0.0039	0.0016	0.0023
288	0.0039	0.0015	0.0023

Total soil rain loss = 0.94(In)
Total effective rainfall = 2.06(In)
Peak flow rate in flood hydrograph = 69.57(CFS)

++++
24 - H O U R S T O R M
R u n o f f H y d r o g r a p h

Hydrograph in 5 Minute intervals ((CFS))

Time(h+m)	Volume	Ac.Ft	Q(CFS)	0	17.5	35.0	52.5	70.0
0+ 5	0.0001	0.02	Q					
0+10	0.0006	0.08	Q					
0+15	0.0023	0.25	Q					
0+20	0.0056	0.48	Q					
0+25	0.0099	0.62	Q					
0+30	0.0148	0.71	Q					
0+35	0.0202	0.78	Q					
0+40	0.0259	0.83	Q					
0+45	0.0319	0.87	Q					
0+50	0.0381	0.90	Q					

0+55	0.0445	0.93	Q
1+ 0	0.0511	0.96	Q
1+ 5	0.0578	0.98	Q
1+10	0.0646	0.99	Q
1+15	0.0716	1.01	Q
1+20	0.0787	1.02	Q
1+25	0.0858	1.04	Q
1+30	0.0930	1.05	Q
1+35	0.1003	1.06	Q
1+40	0.1077	1.07	Q
1+45	0.1151	1.08	Q
1+50	0.1226	1.08	Q
1+55	0.1301	1.09	Q
2+ 0	0.1377	1.10	Q
2+ 5	0.1453	1.11	Q
2+10	0.1529	1.11	Q
2+15	0.1607	1.12	Q
2+20	0.1684	1.13	QV
2+25	0.1762	1.13	QV
2+30	0.1841	1.14	QV
2+35	0.1919	1.14	QV
2+40	0.1998	1.15	QV
2+45	0.2077	1.15	QV
2+50	0.2157	1.16	QV
2+55	0.2237	1.16	QV
3+ 0	0.2317	1.16	QV
3+ 5	0.2398	1.17	QV
3+10	0.2478	1.17	QV
3+15	0.2559	1.18	QV
3+20	0.2641	1.18	QV
3+25	0.2723	1.19	QV
3+30	0.2805	1.19	QV
3+35	0.2887	1.20	QV
3+40	0.2970	1.20	QV
3+45	0.3053	1.21	QV
3+50	0.3137	1.21	QV
3+55	0.3220	1.22	Q V
4+ 0	0.3305	1.22	Q V
4+ 5	0.3389	1.23	Q V
4+10	0.3474	1.23	Q V
4+15	0.3559	1.24	Q V
4+20	0.3645	1.24	Q V
4+25	0.3731	1.25	Q V
4+30	0.3817	1.25	Q V
4+35	0.3904	1.26	Q V
4+40	0.3991	1.27	Q V
4+45	0.4079	1.27	Q V
4+50	0.4167	1.28	Q V
4+55	0.4255	1.28	Q V
5+ 0	0.4344	1.29	Q V
5+ 5	0.4433	1.29	Q V
5+10	0.4522	1.30	Q V
5+15	0.4612	1.31	Q V

5+20	0.4703	1.31	Q	V
5+25	0.4793	1.32	Q	V
5+30	0.4885	1.32	Q	V
5+35	0.4976	1.33	Q	V
5+40	0.5069	1.34	Q	V
5+45	0.5161	1.34	Q	V
5+50	0.5254	1.35	Q	V
5+55	0.5348	1.36	Q	V
6+ 0	0.5442	1.36	Q	V
6+ 5	0.5536	1.37	Q	V
6+10	0.5631	1.38	Q	V
6+15	0.5726	1.39	Q	V
6+20	0.5822	1.39	Q	V
6+25	0.5919	1.40	Q	V
6+30	0.6016	1.41	Q	V
6+35	0.6113	1.41	Q	V
6+40	0.6211	1.42	Q	V
6+45	0.6309	1.43	Q	V
6+50	0.6408	1.44	Q	V
6+55	0.6508	1.45	Q	V
7+ 0	0.6608	1.45	Q	V
7+ 5	0.6709	1.46	Q	V
7+10	0.6810	1.47	Q	V
7+15	0.6912	1.48	Q	V
7+20	0.7014	1.49	Q	V
7+25	0.7117	1.49	Q	V
7+30	0.7220	1.50	Q	V
7+35	0.7325	1.51	Q	V
7+40	0.7429	1.52	Q	V
7+45	0.7535	1.53	Q	V
7+50	0.7641	1.54	Q	V
7+55	0.7748	1.55	Q	V
8+ 0	0.7855	1.56	Q	V
8+ 5	0.7963	1.57	Q	V
8+10	0.8072	1.58	Q	V
8+15	0.8181	1.59	Q	V
8+20	0.8291	1.60	Q	V
8+25	0.8402	1.61	Q	V
8+30	0.8514	1.62	Q	V
8+35	0.8626	1.63	Q	V
8+40	0.8739	1.64	Q	V
8+45	0.8853	1.65	Q	V
8+50	0.8967	1.66	Q	V
8+55	0.9083	1.68	Q	V
9+ 0	0.9199	1.69	Q	V
9+ 5	0.9316	1.70	Q	V
9+10	0.9434	1.71	Q	V
9+15	0.9552	1.72	Q	V
9+20	0.9672	1.74	Q	V
9+25	0.9792	1.75	Q	V
9+30	0.9914	1.76	Q	V
9+35	1.0036	1.78	Q	V
9+40	1.0159	1.79	Q	V

9+45	1.0284	1.80	Q	V
9+50	1.0409	1.82	Q	V
9+55	1.0535	1.83	Q	V
10+ 0	1.0662	1.85	Q	V
10+ 5	1.0790	1.86	Q	V
10+10	1.0920	1.88	Q	V
10+15	1.1050	1.89	Q	V
10+20	1.1181	1.91	Q	V
10+25	1.1314	1.93	Q	V
10+30	1.1448	1.94	Q	V
10+35	1.1583	1.96	Q	V
10+40	1.1719	1.98	Q	V
10+45	1.1856	2.00	Q	V
10+50	1.1995	2.01	Q	V
10+55	1.2135	2.03	Q	V
11+ 0	1.2276	2.05	Q	V
11+ 5	1.2419	2.07	Q	V
11+10	1.2563	2.09	Q	V
11+15	1.2709	2.11	Q	V
11+20	1.2856	2.14	Q	V
11+25	1.3005	2.16	Q	V
11+30	1.3155	2.18	Q	V
11+35	1.3306	2.20	Q	V
11+40	1.3460	2.23	Q	V
11+45	1.3615	2.25	Q	V
11+50	1.3772	2.28	Q	V
11+55	1.3930	2.30	Q	V
12+ 0	1.4091	2.33	Q	V
12+ 5	1.4252	2.35	Q	V
12+10	1.4413	2.33	Q	V
12+15	1.4566	2.23	Q	V
12+20	1.4709	2.08	Q	V
12+25	1.4846	1.99	Q	V
12+30	1.4981	1.96	Q	V
12+35	1.5115	1.94	Q	V
12+40	1.5247	1.93	Q	V
12+45	1.5380	1.93	Q	V
12+50	1.5514	1.94	Q	V
12+55	1.5648	1.95	Q	V
13+ 0	1.5784	1.97	Q	V
13+ 5	1.5921	1.99	Q	V
13+10	1.6060	2.02	Q	V
13+15	1.6201	2.05	Q	V
13+20	1.6345	2.08	Q	V
13+25	1.6490	2.11	Q	V
13+30	1.6638	2.15	Q	V
13+35	1.6789	2.19	Q	V
13+40	1.6943	2.24	Q	V
13+45	1.7100	2.28	Q	V
13+50	1.7261	2.33	Q	V
13+55	1.7426	2.39	Q	V
14+ 0	1.7594	2.45	Q	V
14+ 5	1.7767	2.51	Q	V

14+10	1.7944	2.58	Q	V					
14+15	1.8127	2.65	Q	V					
14+20	1.8315	2.73	Q	V					
14+25	1.8508	2.81	Q	V					
14+30	1.8708	2.90	Q	V					
14+35	1.8915	3.00	Q	V					
14+40	1.9129	3.11	Q	V					
14+45	1.9351	3.22	Q	V					
14+50	1.9581	3.35	Q	V					
14+55	1.9822	3.49	Q	V					
15+ 0	2.0072	3.64	Q	V					
15+ 5	2.0335	3.81	Q	V					
15+10	2.0610	4.00	Q	V					
15+15	2.0900	4.21	Q	V					
15+20	2.1208	4.46	Q	V					
15+25	2.1535	4.76	Q	V					
15+30	2.1892	5.17	Q	V					
15+35	2.2290	5.78	Q	V					
15+40	2.2742	6.56	Q	V					
15+45	2.3251	7.39	Q	V					
15+50	2.3829	8.39	Q	V					
15+55	2.4509	9.88	Q	V					
16+ 0	2.5372	12.54	Q	V					
16+ 5	2.6750	20.01		Q	V				
16+10	2.9150	34.84			VQ	V			
16+15	3.3188	58.64				V		Q	
16+20	3.7980	69.57				V			Q
16+25	4.1338	48.76				V	Q		
16+30	4.3677	33.96				Q			
16+35	4.5494	26.38				Q			
16+40	4.6954	21.20			Q				
16+45	4.8156	17.45			Q				
16+50	4.9180	14.88			Q				
16+55	5.0078	13.04			Q				
17+ 0	5.0849	11.20			Q				
17+ 5	5.1514	9.65			Q				
17+10	5.2115	8.72			Q				
17+15	5.2655	7.85			Q				
17+20	5.3137	7.00			Q				
17+25	5.3573	6.34			Q				
17+30	5.3967	5.71			Q				
17+35	5.4326	5.21			Q				
17+40	5.4644	4.61			Q				
17+45	5.4933	4.20			Q				
17+50	5.5185	3.67			Q				
17+55	5.5423	3.45	Q						
18+ 0	5.5657	3.40	Q						
18+ 5	5.5884	3.30	Q						
18+10	5.6105	3.20	Q						
18+15	5.6316	3.07	Q						
18+20	5.6516	2.90	Q						
18+25	5.6712	2.85	Q						
18+30	5.6897	2.67	Q						

18+35	5.7060	2.37	Q	V
18+40	5.7219	2.31	Q	V
18+45	5.7375	2.27	Q	V
18+50	5.7529	2.23	Q	V
18+55	5.7680	2.19	Q	V
19+ 0	5.7828	2.15	Q	V
19+ 5	5.7974	2.12	Q	V
19+10	5.8117	2.08	Q	V
19+15	5.8258	2.05	Q	V
19+20	5.8397	2.01	Q	V
19+25	5.8533	1.98	Q	V
19+30	5.8668	1.95	Q	V
19+35	5.8800	1.92	Q	V
19+40	5.8930	1.89	Q	V
19+45	5.9058	1.86	Q	V
19+50	5.9185	1.83	Q	V
19+55	5.9309	1.81	Q	V
20+ 0	5.9432	1.78	Q	V
20+ 5	5.9553	1.76	Q	V
20+10	5.9672	1.73	Q	V
20+15	5.9789	1.71	Q	V
20+20	5.9905	1.69	Q	V
20+25	6.0020	1.66	Q	V
20+30	6.0133	1.64	Q	V
20+35	6.0245	1.62	Q	V
20+40	6.0355	1.60	Q	V
20+45	6.0463	1.58	Q	V
20+50	6.0571	1.56	Q	V
20+55	6.0677	1.54	Q	V
21+ 0	6.0781	1.52	Q	V
21+ 5	6.0885	1.50	Q	V
21+10	6.0987	1.48	Q	V
21+15	6.1088	1.47	Q	V
21+20	6.1188	1.45	Q	V
21+25	6.1287	1.44	Q	V
21+30	6.1385	1.42	Q	V
21+35	6.1481	1.41	Q	V
21+40	6.1577	1.39	Q	V
21+45	6.1672	1.38	Q	V
21+50	6.1766	1.36	Q	V
21+55	6.1859	1.35	Q	V
22+ 0	6.1951	1.34	Q	V
22+ 5	6.2042	1.32	Q	V
22+10	6.2132	1.31	Q	V
22+15	6.2221	1.30	Q	V
22+20	6.2310	1.29	Q	V
22+25	6.2398	1.27	Q	V
22+30	6.2485	1.26	Q	V
22+35	6.2571	1.25	Q	V
22+40	6.2657	1.24	Q	V
22+45	6.2741	1.23	Q	V
22+50	6.2825	1.22	Q	V
22+55	6.2909	1.21	Q	V

23+ 0	6.2991	1.20	Q				V
23+ 5	6.3073	1.19	Q				V
23+10	6.3155	1.18	Q				V
23+15	6.3235	1.17	Q				V
23+20	6.3315	1.16	Q				V
23+25	6.3395	1.15	Q				V
23+30	6.3474	1.14	Q				V
23+35	6.3552	1.14	Q				V
23+40	6.3629	1.13	Q				V
23+45	6.3707	1.12	Q				V
23+50	6.3783	1.11	Q				V
23+55	6.3859	1.10	Q				V
24+ 0	6.3934	1.10	Q				V

San Bernardino County Rational Hydrology Program

(Hydrology Manual Date - August 1986)

CIVILCADD/CIVILDESIGN Engineering Software, (c) 1989-2019 Version

9.1

Rational Hydrology Study

Date: 02/28/23

Program License Serial Number 6509

***** Hydrology Study Control Information *****

Rational hydrology study storm event year is 100.0

10 Year storm 1 hour rainfall = 0.750(In.)

100 Year storm 1 hour rainfall = 1.150(In.)

Computed rainfall intensity:

Storm year = 100.00 1 hour rainfall = 1.150 (In.)

Slope used for rainfall intensity curve b = 0.7000

Soil antecedent moisture condition (AMC) = 3

++++
Process from Point/Station 100.000 to Point/Station 101.000
**** INITIAL AREA EVALUATION ****

COMMERCIAL subarea type

Decimal fraction soil group A = 0.000

Decimal fraction soil group B = 0.000

Decimal fraction soil group C = 1.000

Decimal fraction soil group D = 0.000

SCS curve number for soil(AMC 2) = 69.00

Adjusted SCS curve number for AMC 3 = 86.20

Pervious ratio(Ap) = 0.1000 Max loss rate(Fm)= 0.026(In/Hr)

Initial subarea data:

Initial area flow distance = 404.000(Ft.)

Top (of initial area) elevation = 2943.720(Ft.)

Bottom (of initial area) elevation = 2939.190(Ft.)

Difference in elevation = 4.530(Ft.)

Slope = 0.01121 s(%)= 1.12

TC = k(0.304)*[(length^3)/(elevation change)]^0.2

Initial area time of concentration = 8.232 min.

Rainfall intensity = 4.619(In/Hr) for a 100.0 year storm

Effective runoff coefficient used for area (Q=KCIA) is C = 0.895

Subarea runoff = 2.013(CFS)

Total initial stream area = 0.487(Ac.)

Pervious area fraction = 0.100
 Initial area Fm value = 0.026(In/Hr)

++++
 Process from Point/Station 101.000 to Point/Station 102.000
 **** PIPEFLOW TRAVEL TIME (User specified size) ****

Upstream point/station elevation = 2934.520(Ft.)
 Downstream point/station elevation = 2928.500(Ft.)
 Pipe length = 602.00(Ft.) Manning's N = 0.013
 No. of pipes = 1 Required pipe flow = 2.013(CFS)
 Given pipe size = 24.00(In.)
 Calculated individual pipe flow = 2.013(CFS)
 Normal flow depth in pipe = 4.84(In.)
 Flow top width inside pipe = 19.26(In.)
 Critical Depth = 5.91(In.)
 Pipe flow velocity = 4.45(Ft/s)
 Travel time through pipe = 2.25 min.
 Time of concentration (TC) = 10.49 min.

++++
 Process from Point/Station 101.000 to Point/Station 102.000
 **** CONFLUENCE OF MAIN STREAMS ****

The following data inside Main Stream is listed:

In Main Stream number: 1
 Stream flow area = 0.487(Ac.)
 Runoff from this stream = 2.013(CFS)
 Time of concentration = 10.49 min.
 Rainfall intensity = 3.899(In/Hr)
 Area averaged loss rate (Fm) = 0.0262(In/Hr)
 Area averaged Pervious ratio (Ap) = 0.1000
 Summary of stream data:

Stream No.	Flow rate (CFS)	Area (Ac.)	TC (min)	Fm (In/Hr)	Rainfall Intensity (In/Hr)
1	2.01	0.487	10.49	0.026	3.899
Qmax(1) =					
	1.000 *	1.000 *		2.013) + =	2.013

Total of 1 main streams to confluence:

Flow rates before confluence point:

3.013

Maximum flow rates at confluence using above data:

2.013

Area of streams before confluence:

0.487

Effective area values after confluence:

0.487

Results of confluence:

Total flow rate = 2.013(CFS)

Time of concentration = 10.486 min.

Effective stream area after confluence = 0.487(Ac.)

Study area average Pervious fraction(A_p) = 0.100

Study area average soil loss rate(F_m) = 0.026(In/Hr)

Study area total = 0.49(Ac.)

End of computations, Total Study Area = 0.49 (Ac.)

The following figures may

be used for a unit hydrograph study of the same area.

Note: These figures do not consider reduced effective area effects caused by confluences in the rational equation.

Area averaged pervious area fraction(A_p) = 0.100

Area averaged SCS curve number = 69.0

San Bernardino County Rational Hydrology Program

(Hydrology Manual Date - August 1986)

CIVILCADD/CIVILDESIGN Engineering Software, (c) 1989-2019 Version

9.1

Rational Hydrology Study

Date: 02/28/23

Program License Serial Number 6509

***** Hydrology Study Control Information *****

Rational hydrology study storm event year is 100.0

10 Year storm 1 hour rainfall = 0.750(In.)

100 Year storm 1 hour rainfall = 1.150(In.)

Computed rainfall intensity:

Storm year = 100.00 1 hour rainfall = 1.150 (In.)

Slope used for rainfall intensity curve b = 0.7000

Soil antecedent moisture condition (AMC) = 3

++++
Process from Point/Station 100.000 to Point/Station 101.000
**** INITIAL AREA EVALUATION ****

COMMERCIAL subarea type

Decimal fraction soil group A = 0.000

Decimal fraction soil group B = 0.000

Decimal fraction soil group C = 1.000

Decimal fraction soil group D = 0.000

SCS curve number for soil(AMC 2) = 69.00

Adjusted SCS curve number for AMC 3 = 86.20

Pervious ratio(Ap) = 0.1000 Max loss rate(Fm)= 0.026(In/Hr)

Initial subarea data:

Initial area flow distance = 500.000(Ft.)

Top (of initial area) elevation = 2947.130(Ft.)

Bottom (of initial area) elevation = 2939.630(Ft.)

Difference in elevation = 7.500(Ft.)

Slope = 0.01500 s(%)= 1.50

TC = k(0.304)*[(length^3)/(elevation change)]^0.2

Initial area time of concentration = 8.458 min.

Rainfall intensity = 4.532(In/Hr) for a 100.0 year storm

Effective runoff coefficient used for area (Q=KCIA) is C = 0.895

Subarea runoff = 26.552(CFS)

Total initial stream area = 6.547(Ac.)

Pervious area fraction = 0.100
 Initial area Fm value = 0.026(In/Hr)

++++
 Process from Point/Station 101.000 to Point/Station 102.000
 **** PIPEFLOW TRAVEL TIME (User specified size) ****

Upstream point/station elevation = 2937.720(Ft.)
 Downstream point/station elevation = 2929.500(Ft.)
 Pipe length = 1643.00(Ft.) Manning's N = 0.013
 No. of pipes = 1 Required pipe flow = 26.552(CFS)
 Given pipe size = 24.00(In.)
 NOTE: Normal flow is pressure flow in user selected pipe size.
 The approximate hydraulic grade line above the pipe invert is
 16.071(Ft.) at the headworks or inlet of the pipe(s)
 Pipe friction loss = 22.627(Ft.)
 Minor friction loss = 1.664(Ft.) K-factor = 1.50
 Pipe flow velocity = 8.45(Ft/s)
 Travel time through pipe = 3.24 min.
 Time of concentration (TC) = 11.70 min.

++++
 Process from Point/Station 101.000 to Point/Station 102.000
 **** CONFLUENCE OF MAIN STREAMS ****

The following data inside Main Stream is listed:

In Main Stream number: 1
 Stream flow area = 6.547(Ac.)
 Runoff from this stream = 26.552(CFS)
 Time of concentration = 11.70 min.
 Rainfall intensity = 3.612(In/Hr)
 Area averaged loss rate (Fm) = 0.0262(In/Hr)
 Area averaged Pervious ratio (Ap) = 0.1000
 Summary of stream data:

Stream No.	Flow rate (CFS)	Area (Ac.)	TC (min)	Fm (In/Hr)	Rainfall Intensity (In/Hr)
------------	-----------------	------------	----------	------------	----------------------------

1	26.55	6.547	11.70	0.026	3.612
Qmax(1) =					
	1.000 *	1.000 *	26.552) + =	26.552	

Total of 1 main streams to confluence:

Flow rates before confluence point:
 27.552

Maximum flow rates at confluence using above data:
 26.552

Area of streams before confluence:
 6.547

Effective area values after confluence:

6.547

Results of confluence:

Total flow rate = 26.552(CFS)

Time of concentration = 11.697 min.

Effective stream area after confluence = 6.547(Ac.)

Study area average Pervious fraction(A_p) = 0.100

Study area average soil loss rate(F_m) = 0.026(In/Hr)

Study area total = 6.55(Ac.)

End of computations, Total Study Area = 6.55 (Ac.)

The following figures may

be used for a unit hydrograph study of the same area.

Note: These figures do not consider reduced effective area effects caused by confluences in the rational equation.

Area averaged pervious area fraction(A_p) = 0.100

Area averaged SCS curve number = 69.0

U n i t H y d r o g r a p h A n a l y s i s

Copyright (c) CIVILCADD/CIVILDESIGN, 1989 - 2018, Version 9.0

Study date 02/28/23

+++++

San Bernardino County Synthetic Unit Hydrology Method
Manual date - August 1986

Program License Serial Number 6509

Storm Event Year = 100

Antecedent Moisture Condition = 3

English (in-lb) Input Units Used

English Rainfall Data (Inches) Input Values Used

English Units used in output format

Area averaged rainfall intensity isohyetal data:

Sub-Area (Ac.)	Duration (hours)	Isohyetal (In)
Rainfall data for year 100		
11.22	1	1.15

Rainfall data for year 100		
11.22	6	1.80

Rainfall data for year 100		
11.22	24	3.00

+++++

***** Area-averaged max loss rate, Fm *****

SCS curve SCS curve Area Area Fp(Fig C6) Ap Fm

(In/Hr)	No.(AMCII)	NO.(AMC 3)	(Ac.)	Fraction	(In/Hr)	(dec.)	
	98.0	99.6	11.22	1.000	0.008	0.112	0.001

Area-averaged adjusted loss rate Fm (In/Hr) = 0.001

***** Area-Averaged low loss rate fraction, Yb *****

Area (Ac.)	Area Fract	SCS CN (AMC2)	SCS CN (AMC3)	S	Pervious Yield Fr
1.26	0.112	98.0	99.6	0.04	0.984
9.96	0.888	98.0	98.0	0.20	0.923

Area-averaged catchment yield fraction, Y = 0.930

Area-averaged low loss fraction, Yb = 0.070

User entry of time of concentration = 0.175 (hours)

+++++

Watershed area = 11.22(Ac.)

Catchment Lag time = 0.140 hours

Unit interval = 5.000 minutes

Unit interval percentage of lag time = 59.5238

Hydrograph baseflow = 0.00(CFS)

Average maximum watershed loss rate(Fm) = 0.001(In/Hr)

Average low loss rate fraction (Yb) = 0.070 (decimal)

DESERT S-Graph Selected

Computed peak 5-minute rainfall = 0.546(In)

Computed peak 30-minute rainfall = 0.934(In)

Specified peak 1-hour rainfall = 1.150(In)

Computed peak 3-hour rainfall = 1.514(In)

Specified peak 6-hour rainfall = 1.800(In)

Specified peak 24-hour rainfall = 3.000(In)

Rainfall depth area reduction factors:

Using a total area of 11.22(Ac.) (Ref: fig. E-4)

5-minute factor = 0.999 Adjusted rainfall = 0.545(In)

30-minute factor = 0.999 Adjusted rainfall = 0.934(In)

1-hour factor = 0.999 Adjusted rainfall = 1.149(In)

3-hour factor = 1.000 Adjusted rainfall = 1.513(In)

6-hour factor = 1.000 Adjusted rainfall = 1.800(In)

24-hour factor = 1.000 Adjusted rainfall = 3.000(In)

Unit Hydrograph

+++++

Interval Number	'S' Graph Mean values	Unit Hydrograph ((CFS))
-----------------	-----------------------	-------------------------

(K = 135.69 (CFS))

1	5.496	7.458
2	40.999	48.174

3	67.773	36.331
4	79.221	15.534
5	85.931	9.105
6	90.304	5.933
7	93.290	4.052
8	95.432	2.907
9	96.969	2.085
10	97.941	1.319
11	98.600	0.895
12	99.304	0.955
13	99.775	0.639
14	100.000	0.305

Peak Unit Number	Adjusted mass rainfall (In)	Unit rainfall (In)
1	0.5454	0.5454
2	0.6715	0.1261
3	0.7583	0.0869
4	0.8267	0.0684
5	0.8839	0.0572
6	0.9336	0.0497
7	0.9778	0.0442
8	1.0178	0.0400
9	1.0544	0.0366
10	1.0882	0.0339
11	1.1198	0.0316
12	1.1494	0.0296
13	1.1727	0.0233
14	1.1946	0.0220
15	1.2155	0.0208
16	1.2353	0.0198
17	1.2542	0.0189
18	1.2723	0.0181
19	1.2896	0.0173
20	1.3063	0.0167
21	1.3223	0.0161
22	1.3378	0.0155
23	1.3528	0.0150
24	1.3673	0.0145
25	1.3814	0.0141
26	1.3950	0.0136
27	1.4082	0.0132
28	1.4211	0.0129
29	1.4337	0.0125
30	1.4459	0.0122
31	1.4578	0.0119
32	1.4695	0.0116
33	1.4808	0.0114
34	1.4920	0.0111
35	1.5028	0.0109
36	1.5135	0.0106
37	1.5239	0.0104
38	1.5341	0.0102

39	1.5441	0.0100
40	1.5539	0.0098
41	1.5635	0.0096
42	1.5729	0.0095
43	1.5822	0.0093
44	1.5914	0.0091
45	1.6003	0.0090
46	1.6091	0.0088
47	1.6178	0.0087
48	1.6264	0.0085
49	1.6348	0.0084
50	1.6431	0.0083
51	1.6512	0.0082
52	1.6593	0.0080
53	1.6672	0.0079
54	1.6750	0.0078
55	1.6827	0.0077
56	1.6903	0.0076
57	1.6978	0.0075
58	1.7052	0.0074
59	1.7125	0.0073
60	1.7197	0.0072
61	1.7268	0.0071
62	1.7339	0.0070
63	1.7408	0.0070
64	1.7477	0.0069
65	1.7545	0.0068
66	1.7612	0.0067
67	1.7678	0.0066
68	1.7744	0.0066
69	1.7809	0.0065
70	1.7873	0.0064
71	1.7937	0.0064
72	1.7999	0.0063
73	1.8091	0.0092
74	1.8182	0.0091
75	1.8272	0.0090
76	1.8362	0.0089
77	1.8450	0.0089
78	1.8538	0.0088
79	1.8625	0.0087
80	1.8712	0.0087
81	1.8798	0.0086
82	1.8883	0.0085
83	1.8968	0.0085
84	1.9051	0.0084
85	1.9135	0.0083
86	1.9217	0.0083
87	1.9299	0.0082
88	1.9381	0.0081
89	1.9462	0.0081
90	1.9542	0.0080
91	1.9622	0.0080

92	1.9701	0.0079
93	1.9780	0.0079
94	1.9858	0.0078
95	1.9935	0.0078
96	2.0012	0.0077
97	2.0089	0.0077
98	2.0165	0.0076
99	2.0241	0.0076
100	2.0316	0.0075
101	2.0390	0.0075
102	2.0464	0.0074
103	2.0538	0.0074
104	2.0611	0.0073
105	2.0684	0.0073
106	2.0757	0.0072
107	2.0828	0.0072
108	2.0900	0.0072
109	2.0971	0.0071
110	2.1042	0.0071
111	2.1112	0.0070
112	2.1182	0.0070
113	2.1251	0.0069
114	2.1321	0.0069
115	2.1389	0.0069
116	2.1458	0.0068
117	2.1526	0.0068
118	2.1593	0.0068
119	2.1661	0.0067
120	2.1727	0.0067
121	2.1794	0.0067
122	2.1860	0.0066
123	2.1926	0.0066
124	2.1992	0.0066
125	2.2057	0.0065
126	2.2122	0.0065
127	2.2186	0.0065
128	2.2250	0.0064
129	2.2314	0.0064
130	2.2378	0.0064
131	2.2441	0.0063
132	2.2504	0.0063
133	2.2567	0.0063
134	2.2629	0.0062
135	2.2691	0.0062
136	2.2753	0.0062
137	2.2815	0.0062
138	2.2876	0.0061
139	2.2937	0.0061
140	2.2997	0.0061
141	2.3058	0.0060
142	2.3118	0.0060
143	2.3178	0.0060
144	2.3237	0.0060

145	2.3297	0.0059
146	2.3356	0.0059
147	2.3415	0.0059
148	2.3473	0.0059
149	2.3531	0.0058
150	2.3590	0.0058
151	2.3647	0.0058
152	2.3705	0.0058
153	2.3762	0.0057
154	2.3819	0.0057
155	2.3876	0.0057
156	2.3933	0.0057
157	2.3989	0.0056
158	2.4046	0.0056
159	2.4102	0.0056
160	2.4157	0.0056
161	2.4213	0.0056
162	2.4268	0.0055
163	2.4323	0.0055
164	2.4378	0.0055
165	2.4433	0.0055
166	2.4487	0.0054
167	2.4541	0.0054
168	2.4596	0.0054
169	2.4649	0.0054
170	2.4703	0.0054
171	2.4756	0.0053
172	2.4810	0.0053
173	2.4863	0.0053
174	2.4916	0.0053
175	2.4968	0.0053
176	2.5021	0.0052
177	2.5073	0.0052
178	2.5125	0.0052
179	2.5177	0.0052
180	2.5229	0.0052
181	2.5280	0.0052
182	2.5332	0.0051
183	2.5383	0.0051
184	2.5434	0.0051
185	2.5485	0.0051
186	2.5536	0.0051
187	2.5586	0.0051
188	2.5636	0.0050
189	2.5687	0.0050
190	2.5737	0.0050
191	2.5786	0.0050
192	2.5836	0.0050
193	2.5886	0.0050
194	2.5935	0.0049
195	2.5984	0.0049
196	2.6033	0.0049
197	2.6082	0.0049

198	2.6131	0.0049
199	2.6179	0.0049
200	2.6228	0.0048
201	2.6276	0.0048
202	2.6324	0.0048
203	2.6372	0.0048
204	2.6420	0.0048
205	2.6467	0.0048
206	2.6515	0.0048
207	2.6562	0.0047
208	2.6609	0.0047
209	2.6657	0.0047
210	2.6703	0.0047
211	2.6750	0.0047
212	2.6797	0.0047
213	2.6843	0.0047
214	2.6890	0.0046
215	2.6936	0.0046
216	2.6982	0.0046
217	2.7028	0.0046
218	2.7074	0.0046
219	2.7120	0.0046
220	2.7165	0.0046
221	2.7211	0.0045
222	2.7256	0.0045
223	2.7301	0.0045
224	2.7346	0.0045
225	2.7391	0.0045
226	2.7436	0.0045
227	2.7481	0.0045
228	2.7525	0.0045
229	2.7569	0.0044
230	2.7614	0.0044
231	2.7658	0.0044
232	2.7702	0.0044
233	2.7746	0.0044
234	2.7790	0.0044
235	2.7833	0.0044
236	2.7877	0.0044
237	2.7921	0.0043
238	2.7964	0.0043
239	2.8007	0.0043
240	2.8050	0.0043
241	2.8093	0.0043
242	2.8136	0.0043
243	2.8179	0.0043
244	2.8222	0.0043
245	2.8264	0.0043
246	2.8307	0.0042
247	2.8349	0.0042
248	2.8391	0.0042
249	2.8433	0.0042
250	2.8475	0.0042

251	2.8517	0.0042
252	2.8559	0.0042
253	2.8601	0.0042
254	2.8642	0.0042
255	2.8684	0.0042
256	2.8725	0.0041
257	2.8767	0.0041
258	2.8808	0.0041
259	2.8849	0.0041
260	2.8890	0.0041
261	2.8931	0.0041
262	2.8972	0.0041
263	2.9012	0.0041
264	2.9053	0.0041
265	2.9093	0.0041
266	2.9134	0.0040
267	2.9174	0.0040
268	2.9214	0.0040
269	2.9255	0.0040
270	2.9295	0.0040
271	2.9334	0.0040
272	2.9374	0.0040
273	2.9414	0.0040
274	2.9454	0.0040
275	2.9493	0.0040
276	2.9533	0.0039
277	2.9572	0.0039
278	2.9611	0.0039
279	2.9651	0.0039
280	2.9690	0.0039
281	2.9729	0.0039
282	2.9768	0.0039
283	2.9807	0.0039
284	2.9845	0.0039
285	2.9884	0.0039
286	2.9923	0.0039
287	2.9961	0.0039
288	3.0000	0.0038

Unit Period (number)	Unit Rainfall (In)	Unit Soil-Loss (In)	Effective Rainfall (In)
1	0.0038	0.0001	0.0038
2	0.0039	0.0001	0.0038
3	0.0039	0.0001	0.0038
4	0.0039	0.0001	0.0038
5	0.0039	0.0001	0.0038
6	0.0039	0.0001	0.0038
7	0.0039	0.0001	0.0038
8	0.0039	0.0001	0.0039
9	0.0039	0.0001	0.0039
10	0.0040	0.0001	0.0039

11	0.0040	0.0001	0.0039
12	0.0040	0.0001	0.0039
13	0.0040	0.0001	0.0039
14	0.0040	0.0001	0.0039
15	0.0040	0.0001	0.0040
16	0.0040	0.0001	0.0040
17	0.0041	0.0001	0.0040
18	0.0041	0.0001	0.0040
19	0.0041	0.0001	0.0040
20	0.0041	0.0001	0.0040
21	0.0041	0.0001	0.0040
22	0.0041	0.0001	0.0041
23	0.0042	0.0001	0.0041
24	0.0042	0.0001	0.0041
25	0.0042	0.0001	0.0041
26	0.0042	0.0001	0.0041
27	0.0042	0.0001	0.0041
28	0.0042	0.0001	0.0041
29	0.0042	0.0001	0.0042
30	0.0043	0.0001	0.0042
31	0.0043	0.0001	0.0042
32	0.0043	0.0001	0.0042
33	0.0043	0.0001	0.0042
34	0.0043	0.0001	0.0042
35	0.0043	0.0001	0.0043
36	0.0044	0.0001	0.0043
37	0.0044	0.0001	0.0043
38	0.0044	0.0001	0.0043
39	0.0044	0.0001	0.0043
40	0.0044	0.0001	0.0044
41	0.0045	0.0001	0.0044
42	0.0045	0.0001	0.0044
43	0.0045	0.0001	0.0044
44	0.0045	0.0001	0.0044
45	0.0045	0.0001	0.0045
46	0.0045	0.0001	0.0045
47	0.0046	0.0001	0.0045
48	0.0046	0.0001	0.0045
49	0.0046	0.0001	0.0045
50	0.0046	0.0001	0.0045
51	0.0047	0.0001	0.0046
52	0.0047	0.0001	0.0046
53	0.0047	0.0001	0.0046
54	0.0047	0.0001	0.0046
55	0.0047	0.0001	0.0047
56	0.0048	0.0001	0.0047
57	0.0048	0.0001	0.0047
58	0.0048	0.0001	0.0047
59	0.0048	0.0001	0.0048
60	0.0048	0.0001	0.0048
61	0.0049	0.0001	0.0048
62	0.0049	0.0001	0.0048
63	0.0049	0.0001	0.0048

64	0.0049	0.0001	0.0049
65	0.0050	0.0001	0.0049
66	0.0050	0.0001	0.0049
67	0.0050	0.0001	0.0049
68	0.0050	0.0001	0.0050
69	0.0051	0.0001	0.0050
70	0.0051	0.0001	0.0050
71	0.0051	0.0001	0.0050
72	0.0051	0.0001	0.0051
73	0.0052	0.0001	0.0051
74	0.0052	0.0001	0.0051
75	0.0052	0.0001	0.0052
76	0.0052	0.0001	0.0052
77	0.0053	0.0001	0.0052
78	0.0053	0.0001	0.0052
79	0.0053	0.0001	0.0053
80	0.0054	0.0001	0.0053
81	0.0054	0.0001	0.0053
82	0.0054	0.0001	0.0054
83	0.0055	0.0001	0.0054
84	0.0055	0.0001	0.0054
85	0.0055	0.0001	0.0055
86	0.0056	0.0001	0.0055
87	0.0056	0.0001	0.0055
88	0.0056	0.0001	0.0055
89	0.0057	0.0001	0.0056
90	0.0057	0.0001	0.0056
91	0.0057	0.0001	0.0057
92	0.0058	0.0001	0.0057
93	0.0058	0.0001	0.0057
94	0.0058	0.0001	0.0058
95	0.0059	0.0001	0.0058
96	0.0059	0.0001	0.0058
97	0.0060	0.0001	0.0059
98	0.0060	0.0001	0.0059
99	0.0060	0.0001	0.0060
100	0.0061	0.0001	0.0060
101	0.0061	0.0001	0.0060
102	0.0062	0.0001	0.0061
103	0.0062	0.0001	0.0061
104	0.0062	0.0001	0.0062
105	0.0063	0.0001	0.0062
106	0.0063	0.0001	0.0063
107	0.0064	0.0001	0.0063
108	0.0064	0.0001	0.0063
109	0.0065	0.0001	0.0064
110	0.0065	0.0001	0.0064
111	0.0066	0.0001	0.0065
112	0.0066	0.0001	0.0065
113	0.0067	0.0001	0.0066
114	0.0067	0.0001	0.0067
115	0.0068	0.0001	0.0067
116	0.0068	0.0001	0.0068

117	0.0069	0.0001	0.0068
118	0.0069	0.0001	0.0069
119	0.0070	0.0001	0.0070
120	0.0071	0.0001	0.0070
121	0.0072	0.0001	0.0071
122	0.0072	0.0001	0.0071
123	0.0073	0.0001	0.0072
124	0.0073	0.0001	0.0073
125	0.0074	0.0001	0.0073
126	0.0075	0.0001	0.0074
127	0.0076	0.0001	0.0075
128	0.0076	0.0001	0.0075
129	0.0077	0.0001	0.0076
130	0.0078	0.0001	0.0077
131	0.0079	0.0001	0.0078
132	0.0079	0.0001	0.0078
133	0.0080	0.0001	0.0080
134	0.0081	0.0001	0.0080
135	0.0082	0.0001	0.0081
136	0.0083	0.0001	0.0082
137	0.0084	0.0001	0.0083
138	0.0085	0.0001	0.0084
139	0.0086	0.0001	0.0085
140	0.0087	0.0001	0.0086
141	0.0088	0.0001	0.0087
142	0.0089	0.0001	0.0088
143	0.0090	0.0001	0.0089
144	0.0091	0.0001	0.0090
145	0.0063	0.0001	0.0062
146	0.0064	0.0001	0.0063
147	0.0065	0.0001	0.0064
148	0.0066	0.0001	0.0065
149	0.0067	0.0001	0.0066
150	0.0068	0.0001	0.0067
151	0.0070	0.0001	0.0069
152	0.0070	0.0001	0.0070
153	0.0072	0.0001	0.0071
154	0.0073	0.0001	0.0072
155	0.0075	0.0001	0.0074
156	0.0076	0.0001	0.0075
157	0.0078	0.0001	0.0077
158	0.0079	0.0001	0.0078
159	0.0082	0.0001	0.0081
160	0.0083	0.0001	0.0082
161	0.0085	0.0001	0.0085
162	0.0087	0.0001	0.0086
163	0.0090	0.0001	0.0089
164	0.0091	0.0001	0.0090
165	0.0095	0.0001	0.0094
166	0.0096	0.0001	0.0096
167	0.0100	0.0001	0.0099
168	0.0102	0.0001	0.0101
169	0.0106	0.0001	0.0106

170	0.0109	0.0001	0.0108
171	0.0114	0.0001	0.0113
172	0.0116	0.0001	0.0116
173	0.0122	0.0001	0.0122
174	0.0125	0.0001	0.0125
175	0.0132	0.0001	0.0132
176	0.0136	0.0001	0.0136
177	0.0145	0.0001	0.0144
178	0.0150	0.0001	0.0149
179	0.0161	0.0001	0.0160
180	0.0167	0.0001	0.0166
181	0.0181	0.0001	0.0180
182	0.0189	0.0001	0.0188
183	0.0208	0.0001	0.0207
184	0.0220	0.0001	0.0219
185	0.0296	0.0001	0.0295
186	0.0316	0.0001	0.0315
187	0.0366	0.0001	0.0365
188	0.0400	0.0001	0.0399
189	0.0497	0.0001	0.0496
190	0.0572	0.0001	0.0572
191	0.0869	0.0001	0.0868
192	0.1261	0.0001	0.1260
193	0.5454	0.0001	0.5453
194	0.0684	0.0001	0.0683
195	0.0442	0.0001	0.0441
196	0.0339	0.0001	0.0338
197	0.0233	0.0001	0.0232
198	0.0198	0.0001	0.0197
199	0.0173	0.0001	0.0173
200	0.0155	0.0001	0.0154
201	0.0141	0.0001	0.0140
202	0.0129	0.0001	0.0128
203	0.0119	0.0001	0.0118
204	0.0111	0.0001	0.0110
205	0.0104	0.0001	0.0103
206	0.0098	0.0001	0.0097
207	0.0093	0.0001	0.0092
208	0.0088	0.0001	0.0087
209	0.0084	0.0001	0.0083
210	0.0080	0.0001	0.0080
211	0.0077	0.0001	0.0076
212	0.0074	0.0001	0.0073
213	0.0071	0.0001	0.0070
214	0.0069	0.0001	0.0068
215	0.0066	0.0001	0.0066
216	0.0064	0.0001	0.0063
217	0.0092	0.0001	0.0091
218	0.0089	0.0001	0.0089
219	0.0087	0.0001	0.0086
220	0.0085	0.0001	0.0084
221	0.0083	0.0001	0.0083
222	0.0081	0.0001	0.0081

223	0.0080	0.0001	0.0079
224	0.0078	0.0001	0.0077
225	0.0077	0.0001	0.0076
226	0.0075	0.0001	0.0074
227	0.0074	0.0001	0.0073
228	0.0072	0.0001	0.0072
229	0.0071	0.0001	0.0070
230	0.0070	0.0001	0.0069
231	0.0069	0.0001	0.0068
232	0.0068	0.0001	0.0067
233	0.0067	0.0001	0.0066
234	0.0066	0.0001	0.0065
235	0.0065	0.0001	0.0064
236	0.0064	0.0001	0.0063
237	0.0063	0.0001	0.0062
238	0.0062	0.0001	0.0061
239	0.0061	0.0001	0.0060
240	0.0060	0.0001	0.0059
241	0.0059	0.0001	0.0059
242	0.0059	0.0001	0.0058
243	0.0058	0.0001	0.0057
244	0.0057	0.0001	0.0056
245	0.0056	0.0001	0.0056
246	0.0056	0.0001	0.0055
247	0.0055	0.0001	0.0054
248	0.0054	0.0001	0.0054
249	0.0054	0.0001	0.0053
250	0.0053	0.0001	0.0053
251	0.0053	0.0001	0.0052
252	0.0052	0.0001	0.0051
253	0.0052	0.0001	0.0051
254	0.0051	0.0001	0.0050
255	0.0051	0.0001	0.0050
256	0.0050	0.0001	0.0049
257	0.0050	0.0001	0.0049
258	0.0049	0.0001	0.0048
259	0.0049	0.0001	0.0048
260	0.0048	0.0001	0.0047
261	0.0048	0.0001	0.0047
262	0.0047	0.0001	0.0046
263	0.0047	0.0001	0.0046
264	0.0046	0.0001	0.0046
265	0.0046	0.0001	0.0045
266	0.0046	0.0001	0.0045
267	0.0045	0.0001	0.0044
268	0.0045	0.0001	0.0044
269	0.0044	0.0001	0.0044
270	0.0044	0.0001	0.0043
271	0.0044	0.0001	0.0043
272	0.0043	0.0001	0.0043
273	0.0043	0.0001	0.0042
274	0.0043	0.0001	0.0042
275	0.0042	0.0001	0.0042

276	0.0042	0.0001	0.0041
277	0.0042	0.0001	0.0041
278	0.0041	0.0001	0.0041
279	0.0041	0.0001	0.0040
280	0.0041	0.0001	0.0040
281	0.0041	0.0001	0.0040
282	0.0040	0.0001	0.0039
283	0.0040	0.0001	0.0039
284	0.0040	0.0001	0.0039
285	0.0039	0.0001	0.0039
286	0.0039	0.0001	0.0038
287	0.0039	0.0001	0.0038
288	0.0039	0.0001	0.0038

Total soil rain loss = 0.02(In)
Total effective rainfall = 2.98(In)
Peak flow rate in flood hydrograph = 33.95(CFS)

+++++
24 - H O U R S T O R M
R u n o f f H y d r o g r a p h

Hydrograph in 5 Minute intervals ((CFS))

Time(h+m)	Volume Ac.Ft	Q(CFS)	0	10.0	20.0	30.0	40.0
0+ 5	0.0002	0.03	Q				
0+10	0.0016	0.21	Q				
0+15	0.0040	0.35	Q				
0+20	0.0068	0.41	Q				
0+25	0.0099	0.44	Q				
0+30	0.0131	0.47	Q				
0+35	0.0164	0.48	Q				
0+40	0.0198	0.50	Q				
0+45	0.0233	0.51	Q				
0+50	0.0268	0.51	Q				
0+55	0.0304	0.52	Q				
1+ 0	0.0340	0.52	Q				
1+ 5	0.0376	0.53	Q				
1+10	0.0413	0.53	Q				
1+15	0.0449	0.53	Q				
1+20	0.0486	0.53	Q				
1+25	0.0523	0.54	Q				
1+30	0.0560	0.54	Q				
1+35	0.0597	0.54	Q				
1+40	0.0635	0.54	Q				
1+45	0.0672	0.54	Q				
1+50	0.0710	0.55	QV				
1+55	0.0747	0.55	QV				
2+ 0	0.0785	0.55	QV				
2+ 5	0.0823	0.55	QV				

2+10	0.0861	0.55	QV
2+15	0.0900	0.56	QV
2+20	0.0938	0.56	QV
2+25	0.0977	0.56	QV
2+30	0.1015	0.56	QV
2+35	0.1054	0.56	QV
2+40	0.1093	0.57	QV
2+45	0.1132	0.57	QV
2+50	0.1172	0.57	QV
2+55	0.1211	0.57	QV
3+ 0	0.1251	0.58	QV
3+ 5	0.1291	0.58	QV
3+10	0.1331	0.58	QV
3+15	0.1371	0.58	QV
3+20	0.1411	0.59	Q V
3+25	0.1452	0.59	Q V
3+30	0.1492	0.59	Q V
3+35	0.1533	0.59	Q V
3+40	0.1574	0.60	Q V
3+45	0.1615	0.60	Q V
3+50	0.1657	0.60	Q V
3+55	0.1698	0.60	Q V
4+ 0	0.1740	0.61	Q V
4+ 5	0.1782	0.61	Q V
4+10	0.1824	0.61	Q V
4+15	0.1866	0.61	Q V
4+20	0.1909	0.62	Q V
4+25	0.1951	0.62	Q V
4+30	0.1994	0.62	Q V
4+35	0.2037	0.62	Q V
4+40	0.2080	0.63	Q V
4+45	0.2124	0.63	Q V
4+50	0.2167	0.63	Q V
4+55	0.2211	0.64	Q V
5+ 0	0.2255	0.64	Q V
5+ 5	0.2300	0.64	Q V
5+10	0.2344	0.65	Q V
5+15	0.2389	0.65	Q V
5+20	0.2434	0.65	Q V
5+25	0.2479	0.66	Q V
5+30	0.2524	0.66	Q V
5+35	0.2570	0.66	Q V
5+40	0.2616	0.67	Q V
5+45	0.2662	0.67	Q V
5+50	0.2708	0.67	Q V
5+55	0.2754	0.68	Q V
6+ 0	0.2801	0.68	Q V
6+ 5	0.2848	0.68	Q V
6+10	0.2895	0.69	Q V
6+15	0.2943	0.69	Q V
6+20	0.2991	0.69	Q V
6+25	0.3039	0.70	Q V
6+30	0.3087	0.70	Q V

6+35	0.3135	0.70	Q	V
6+40	0.3184	0.71	Q	V
6+45	0.3233	0.71	Q	V
6+50	0.3283	0.72	Q	V
6+55	0.3332	0.72	Q	V
7+ 0	0.3382	0.72	Q	V
7+ 5	0.3432	0.73	Q	V
7+10	0.3483	0.73	Q	V
7+15	0.3534	0.74	Q	V
7+20	0.3585	0.74	Q	V
7+25	0.3636	0.75	Q	V
7+30	0.3688	0.75	Q	V
7+35	0.3740	0.76	Q	V
7+40	0.3792	0.76	Q	V
7+45	0.3845	0.77	Q	V
7+50	0.3898	0.77	Q	V
7+55	0.3951	0.77	Q	V
8+ 0	0.4005	0.78	Q	V
8+ 5	0.4059	0.78	Q	V
8+10	0.4114	0.79	Q	V
8+15	0.4168	0.80	Q	V
8+20	0.4224	0.80	Q	V
8+25	0.4279	0.81	Q	V
8+30	0.4335	0.81	Q	V
8+35	0.4391	0.82	Q	V
8+40	0.4448	0.82	Q	V
8+45	0.4505	0.83	Q	V
8+50	0.4562	0.83	Q	V
8+55	0.4620	0.84	Q	V
9+ 0	0.4679	0.85	Q	V
9+ 5	0.4737	0.85	Q	V
9+10	0.4797	0.86	Q	V
9+15	0.4856	0.87	Q	V
9+20	0.4916	0.87	Q	V
9+25	0.4977	0.88	Q	V
9+30	0.5038	0.89	Q	V
9+35	0.5099	0.89	Q	V
9+40	0.5161	0.90	Q	V
9+45	0.5224	0.91	Q	V
9+50	0.5287	0.92	Q	V
9+55	0.5351	0.92	Q	V
10+ 0	0.5415	0.93	Q	V
10+ 5	0.5479	0.94	Q	V
10+10	0.5545	0.95	Q	V
10+15	0.5610	0.96	Q	V
10+20	0.5677	0.96	Q	V
10+25	0.5744	0.97	Q	V
10+30	0.5811	0.98	Q	V
10+35	0.5879	0.99	Q	V
10+40	0.5948	1.00	Q	V
10+45	0.6018	1.01	Q	V
10+50	0.6088	1.02	Q	V
10+55	0.6159	1.03	Q	V

11+ 0	0.6231	1.04	Q	V			
11+ 5	0.6303	1.05	Q	V			
11+10	0.6376	1.06	Q	V			
11+15	0.6450	1.07	Q	V			
11+20	0.6525	1.08	Q	V			
11+25	0.6600	1.10	Q	V			
11+30	0.6676	1.11	Q	V			
11+35	0.6754	1.12	Q	V			
11+40	0.6832	1.13	Q	V			
11+45	0.6911	1.15	Q	V			
11+50	0.6991	1.16	Q	V			
11+55	0.7071	1.17	Q	V			
12+ 0	0.7153	1.19	Q	V			
12+ 5	0.7235	1.18	Q	V			
12+10	0.7307	1.05	Q	V			
12+15	0.7374	0.96	Q	V			
12+20	0.7438	0.93	Q	V			
12+25	0.7501	0.92	Q	V			
12+30	0.7564	0.92	Q	V			
12+35	0.7627	0.92	Q	V			
12+40	0.7691	0.93	Q	V			
12+45	0.7755	0.94	Q	V			
12+50	0.7821	0.95	Q	V			
12+55	0.7887	0.96	Q	V			
13+ 0	0.7955	0.98	Q	V			
13+ 5	0.8023	1.00	Q	V			
13+10	0.8093	1.02	Q	V			
13+15	0.8165	1.04	Q	V			
13+20	0.8238	1.06	Q	V			
13+25	0.8312	1.08	Q	V			
13+30	0.8389	1.11	Q	V			
13+35	0.8467	1.13	Q	V			
13+40	0.8547	1.16	Q	V			
13+45	0.8629	1.19	Q	V			
13+50	0.8713	1.22	Q	V			
13+55	0.8799	1.25	Q	V			
14+ 0	0.8888	1.29	Q	V			
14+ 5	0.8980	1.33	Q	V			
14+10	0.9074	1.37	Q	V			
14+15	0.9171	1.41	Q	V			
14+20	0.9271	1.46	Q	V			
14+25	0.9375	1.51	Q	V			
14+30	0.9483	1.56	Q	V			
14+35	0.9594	1.62	Q	V			
14+40	0.9710	1.68	Q	V			
14+45	0.9831	1.75	Q	V			
14+50	0.9957	1.83	Q	V			
14+55	1.0089	1.91	Q	V			
15+ 0	1.0227	2.02	Q	V			
15+ 5	1.0373	2.12	Q	V			
15+10	1.0528	2.25	Q	V			
15+15	1.0692	2.38	Q	V			
15+20	1.0868	2.55	Q	V			

15+25	1.1059	2.77	Q	V			
15+30	1.1283	3.25	Q	V			
15+35	1.1539	3.72	Q	V			
15+40	1.1829	4.21	Q	V			
15+45	1.2156	4.75	Q	V			
15+50	1.2538	5.55	Q	V			
15+55	1.2996	6.64	Q	V			
16+ 0	1.3607	8.88	Q	V			
16+ 5	1.4658	15.25		Q	V		
16+10	1.6996	33.95			V		Q
16+15	1.8856	27.02				Q	
16+20	1.9929	15.57		Q		V	
16+25	2.0682	10.94				V	
16+30	2.1239	8.08				V	
16+35	2.1666	6.20	Q			V	
16+40	2.2008	4.97	Q			V	
16+45	2.2287	4.05	Q			V	
16+50	2.2514	3.29	Q			V	
16+55	2.2705	2.78	Q			V	
17+ 0	2.2881	2.54	Q			V	
17+ 5	2.3030	2.17	Q			V	
17+10	2.3155	1.82	Q			V	
17+15	2.3261	1.53	Q			V	
17+20	2.3359	1.42	Q			V	
17+25	2.3450	1.32	Q			V	
17+30	2.3535	1.25	Q			V	
17+35	2.3617	1.18	Q			V	
17+40	2.3694	1.12	Q			V	
17+45	2.3768	1.07	Q			V	
17+50	2.3839	1.03	Q			V	
17+55	2.3907	0.99	Q			V	
18+ 0	2.3972	0.95	Q			V	
18+ 5	2.4036	0.94	Q			V	
18+10	2.4108	1.05	Q			V	
18+15	2.4186	1.12	Q			V	
18+20	2.4264	1.14	Q			V	
18+25	2.4342	1.13	Q			V	
18+30	2.4419	1.12	Q			V	
18+35	2.4496	1.11	Q			V	
18+40	2.4571	1.09	Q			V	
18+45	2.4645	1.07	Q			V	
18+50	2.4717	1.06	Q			V	
18+55	2.4789	1.04	Q			V	
19+ 0	2.4859	1.02	Q			V	
19+ 5	2.4928	1.00	Q			V	
19+10	2.4996	0.98	Q			V	
19+15	2.5062	0.97	Q			V	
19+20	2.5127	0.95	Q			V	
19+25	2.5192	0.93	Q			V	
19+30	2.5255	0.92	Q			V	
19+35	2.5317	0.90	Q			V	
19+40	2.5378	0.89	Q			V	
19+45	2.5438	0.87	Q			V	

19+50	2.5497	0.86	Q	V
19+55	2.5556	0.85	Q	V
20+ 0	2.5613	0.84	Q	V
20+ 5	2.5670	0.82	Q	V
20+10	2.5726	0.81	Q	V
20+15	2.5781	0.80	Q	V
20+20	2.5835	0.79	Q	V
20+25	2.5889	0.78	Q	V
20+30	2.5942	0.77	Q	V
20+35	2.5995	0.76	Q	V
20+40	2.6046	0.75	Q	V
20+45	2.6098	0.74	Q	V
20+50	2.6148	0.73	Q	V
20+55	2.6198	0.73	Q	V
21+ 0	2.6247	0.72	Q	V
21+ 5	2.6296	0.71	Q	V
21+10	2.6345	0.70	Q	V
21+15	2.6392	0.69	Q	V
21+20	2.6440	0.69	Q	V
21+25	2.6486	0.68	Q	V
21+30	2.6533	0.67	Q	V
21+35	2.6578	0.67	Q	V
21+40	2.6624	0.66	Q	V
21+45	2.6669	0.65	Q	V
21+50	2.6713	0.65	Q	V
21+55	2.6757	0.64	Q	V
22+ 0	2.6801	0.63	Q	V
22+ 5	2.6844	0.63	Q	V
22+10	2.6887	0.62	Q	V
22+15	2.6930	0.62	Q	V
22+20	2.6972	0.61	Q	V
22+25	2.7013	0.61	Q	V
22+30	2.7055	0.60	Q	V
22+35	2.7096	0.60	Q	V
22+40	2.7136	0.59	Q	V
22+45	2.7177	0.59	Q	V
22+50	2.7217	0.58	Q	V
22+55	2.7256	0.58	Q	V
23+ 0	2.7296	0.57	Q	V
23+ 5	2.7335	0.57	Q	V
23+10	2.7373	0.56	Q	V
23+15	2.7412	0.56	Q	V
23+20	2.7450	0.55	Q	V
23+25	2.7488	0.55	Q	V
23+30	2.7526	0.55	Q	V
23+35	2.7563	0.54	Q	V
23+40	2.7600	0.54	Q	V
23+45	2.7637	0.53	Q	V
23+50	2.7673	0.53	Q	V
23+55	2.7709	0.53	Q	V
24+ 0	2.7745	0.52	Q	V

U n i t H y d r o g r a p h A n a l y s i s

Copyright (c) CIVILCADD/CIVILDESIGN, 1989 - 2018, Version 9.0

Study date 02/28/23

+++++

San Bernardino County Synthetic Unit Hydrology Method
Manual date - August 1986

Program License Serial Number 6509

Storm Event Year = 100

Antecedent Moisture Condition = 3

English (in-lb) Input Units Used

English Rainfall Data (Inches) Input Values Used

English Units used in output format

Area averaged rainfall intensity isohyetal data:

Sub-Area (Ac.)	Duration (hours)	Isohyetal (In)
Rainfall data for year 100		
24.79	1	1.15

Rainfall data for year 100		
24.79	6	1.80

Rainfall data for year 100		
24.79	24	3.00

+++++

***** Area-averaged max loss rate, Fm *****

SCS curve SCS curve Area Area Fp(Fig C6) Ap Fm

(In/Hr)	No.(AMCII)	NO.(AMC 3)	(Ac.)	Fraction	(In/Hr)	(dec.)
	98.0	99.6	24.79	1.000	0.008	0.124
						0.001

Area-averaged adjusted loss rate Fm (In/Hr) = 0.001

***** Area-Averaged low loss rate fraction, Yb *****

Area (Ac.)	Area Fract	SCS CN (AMC2)	SCS CN (AMC3)	S	Pervious Yield Fr
3.07	0.124	98.0	99.6	0.04	0.984
21.71	0.876	98.0	98.0	0.20	0.923

Area-averaged catchment yield fraction, Y = 0.930

Area-averaged low loss fraction, Yb = 0.070

User entry of time of concentration = 0.195 (hours)

+++++

Watershed area = 24.79(Ac.)

Catchment Lag time = 0.156 hours

Unit interval = 5.000 minutes

Unit interval percentage of lag time = 53.5314

Hydrograph baseflow = 0.00(CFS)

Average maximum watershed loss rate(Fm) = 0.001(In/Hr)

Average low loss rate fraction (Yb) = 0.070 (decimal)

DESERT S-Graph Selected

Computed peak 5-minute rainfall = 0.546(In)

Computed peak 30-minute rainfall = 0.934(In)

Specified peak 1-hour rainfall = 1.150(In)

Computed peak 3-hour rainfall = 1.514(In)

Specified peak 6-hour rainfall = 1.800(In)

Specified peak 24-hour rainfall = 3.000(In)

Rainfall depth area reduction factors:

Using a total area of 24.79(Ac.) (Ref: fig. E-4)

5-minute factor = 0.999 Adjusted rainfall = 0.545(In)

30-minute factor = 0.999 Adjusted rainfall = 0.933(In)

1-hour factor = 0.999 Adjusted rainfall = 1.149(In)

3-hour factor = 1.000 Adjusted rainfall = 1.513(In)

6-hour factor = 1.000 Adjusted rainfall = 1.800(In)

24-hour factor = 1.000 Adjusted rainfall = 3.000(In)

Unit Hydrograph

+++++

Interval Number	'S' Graph Mean values	Unit Hydrograph ((CFS))
-----------------	-----------------------	-------------------------

(K = 299.78 (CFS))

1	4.468	13.395
2	34.572	90.243

3	63.536	86.830
4	76.007	37.386
5	83.255	21.726
6	88.162	14.710
7	91.439	9.825
8	93.891	7.349
9	95.695	5.409
10	97.029	3.999
11	97.905	2.625
12	98.490	1.754
13	99.130	1.919
14	99.641	1.532
15	100.000	1.077

Peak Unit Number	Adjusted mass rainfall (In)	Unit rainfall (In)
1	0.5451	0.5451
2	0.6710	0.1260
3	0.7578	0.0868
4	0.8261	0.0683
5	0.8833	0.0572
6	0.9330	0.0497
7	0.9772	0.0442
8	1.0171	0.0399
9	1.0537	0.0366
10	1.0875	0.0338
11	1.1191	0.0315
12	1.1487	0.0296
13	1.1720	0.0233
14	1.1940	0.0220
15	1.2148	0.0209
16	1.2347	0.0198
17	1.2536	0.0189
18	1.2717	0.0181
19	1.2891	0.0174
20	1.3058	0.0167
21	1.3219	0.0161
22	1.3374	0.0155
23	1.3524	0.0150
24	1.3669	0.0145
25	1.3810	0.0141
26	1.3947	0.0137
27	1.4079	0.0133
28	1.4208	0.0129
29	1.4334	0.0126
30	1.4457	0.0122
31	1.4576	0.0119
32	1.4693	0.0117
33	1.4807	0.0114
34	1.4918	0.0111
35	1.5027	0.0109
36	1.5133	0.0107
37	1.5237	0.0104

38	1.5339	0.0102
39	1.5439	0.0100
40	1.5538	0.0098
41	1.5634	0.0096
42	1.5728	0.0095
43	1.5821	0.0093
44	1.5912	0.0091
45	1.6002	0.0090
46	1.6090	0.0088
47	1.6177	0.0087
48	1.6263	0.0085
49	1.6347	0.0084
50	1.6430	0.0083
51	1.6511	0.0082
52	1.6592	0.0080
53	1.6671	0.0079
54	1.6749	0.0078
55	1.6826	0.0077
56	1.6902	0.0076
57	1.6977	0.0075
58	1.7051	0.0074
59	1.7124	0.0073
60	1.7196	0.0072
61	1.7267	0.0071
62	1.7338	0.0070
63	1.7407	0.0070
64	1.7476	0.0069
65	1.7544	0.0068
66	1.7611	0.0067
67	1.7677	0.0066
68	1.7743	0.0066
69	1.7808	0.0065
70	1.7872	0.0064
71	1.7936	0.0064
72	1.7999	0.0063
73	1.8090	0.0092
74	1.8181	0.0091
75	1.8271	0.0090
76	1.8361	0.0089
77	1.8449	0.0089
78	1.8537	0.0088
79	1.8625	0.0087
80	1.8711	0.0087
81	1.8797	0.0086
82	1.8882	0.0085
83	1.8967	0.0085
84	1.9051	0.0084
85	1.9134	0.0083
86	1.9217	0.0083
87	1.9299	0.0082
88	1.9380	0.0081
89	1.9461	0.0081
90	1.9541	0.0080

91	1.9621	0.0080
92	1.9700	0.0079
93	1.9779	0.0079
94	1.9857	0.0078
95	1.9934	0.0078
96	2.0012	0.0077
97	2.0088	0.0077
98	2.0164	0.0076
99	2.0240	0.0076
100	2.0315	0.0075
101	2.0390	0.0075
102	2.0464	0.0074
103	2.0537	0.0074
104	2.0611	0.0073
105	2.0683	0.0073
106	2.0756	0.0072
107	2.0828	0.0072
108	2.0899	0.0072
109	2.0970	0.0071
110	2.1041	0.0071
111	2.1111	0.0070
112	2.1181	0.0070
113	2.1251	0.0069
114	2.1320	0.0069
115	2.1389	0.0069
116	2.1457	0.0068
117	2.1525	0.0068
118	2.1593	0.0068
119	2.1660	0.0067
120	2.1727	0.0067
121	2.1793	0.0067
122	2.1859	0.0066
123	2.1925	0.0066
124	2.1991	0.0066
125	2.2056	0.0065
126	2.2121	0.0065
127	2.2185	0.0065
128	2.2250	0.0064
129	2.2314	0.0064
130	2.2377	0.0064
131	2.2440	0.0063
132	2.2503	0.0063
133	2.2566	0.0063
134	2.2628	0.0062
135	2.2691	0.0062
136	2.2752	0.0062
137	2.2814	0.0062
138	2.2875	0.0061
139	2.2936	0.0061
140	2.2997	0.0061
141	2.3057	0.0060
142	2.3117	0.0060
143	2.3177	0.0060

144	2.3237	0.0060
145	2.3296	0.0059
146	2.3355	0.0059
147	2.3414	0.0059
148	2.3472	0.0059
149	2.3531	0.0058
150	2.3589	0.0058
151	2.3647	0.0058
152	2.3704	0.0058
153	2.3762	0.0057
154	2.3819	0.0057
155	2.3876	0.0057
156	2.3932	0.0057
157	2.3989	0.0056
158	2.4045	0.0056
159	2.4101	0.0056
160	2.4157	0.0056
161	2.4212	0.0056
162	2.4267	0.0055
163	2.4323	0.0055
164	2.4377	0.0055
165	2.4432	0.0055
166	2.4487	0.0054
167	2.4541	0.0054
168	2.4595	0.0054
169	2.4649	0.0054
170	2.4702	0.0054
171	2.4756	0.0053
172	2.4809	0.0053
173	2.4862	0.0053
174	2.4915	0.0053
175	2.4968	0.0053
176	2.5020	0.0052
177	2.5072	0.0052
178	2.5125	0.0052
179	2.5176	0.0052
180	2.5228	0.0052
181	2.5280	0.0052
182	2.5331	0.0051
183	2.5382	0.0051
184	2.5433	0.0051
185	2.5484	0.0051
186	2.5535	0.0051
187	2.5585	0.0051
188	2.5636	0.0050
189	2.5686	0.0050
190	2.5736	0.0050
191	2.5786	0.0050
192	2.5835	0.0050
193	2.5885	0.0050
194	2.5934	0.0049
195	2.5983	0.0049
196	2.6032	0.0049

197	2.6081	0.0049
198	2.6130	0.0049
199	2.6179	0.0049
200	2.6227	0.0048
201	2.6275	0.0048
202	2.6323	0.0048
203	2.6371	0.0048
204	2.6419	0.0048
205	2.6467	0.0048
206	2.6514	0.0048
207	2.6562	0.0047
208	2.6609	0.0047
209	2.6656	0.0047
210	2.6703	0.0047
211	2.6750	0.0047
212	2.6796	0.0047
213	2.6843	0.0047
214	2.6889	0.0046
215	2.6935	0.0046
216	2.6981	0.0046
217	2.7027	0.0046
218	2.7073	0.0046
219	2.7119	0.0046
220	2.7165	0.0046
221	2.7210	0.0045
222	2.7255	0.0045
223	2.7300	0.0045
224	2.7346	0.0045
225	2.7390	0.0045
226	2.7435	0.0045
227	2.7480	0.0045
228	2.7524	0.0045
229	2.7569	0.0044
230	2.7613	0.0044
231	2.7657	0.0044
232	2.7701	0.0044
233	2.7745	0.0044
234	2.7789	0.0044
235	2.7833	0.0044
236	2.7877	0.0044
237	2.7920	0.0043
238	2.7963	0.0043
239	2.8007	0.0043
240	2.8050	0.0043
241	2.8093	0.0043
242	2.8136	0.0043
243	2.8178	0.0043
244	2.8221	0.0043
245	2.8264	0.0043
246	2.8306	0.0042
247	2.8348	0.0042
248	2.8391	0.0042
249	2.8433	0.0042

250	2.8475	0.0042
251	2.8517	0.0042
252	2.8559	0.0042
253	2.8600	0.0042
254	2.8642	0.0042
255	2.8683	0.0042
256	2.8725	0.0041
257	2.8766	0.0041
258	2.8807	0.0041
259	2.8848	0.0041
260	2.8889	0.0041
261	2.8930	0.0041
262	2.8971	0.0041
263	2.9012	0.0041
264	2.9052	0.0041
265	2.9093	0.0041
266	2.9133	0.0040
267	2.9174	0.0040
268	2.9214	0.0040
269	2.9254	0.0040
270	2.9294	0.0040
271	2.9334	0.0040
272	2.9374	0.0040
273	2.9414	0.0040
274	2.9453	0.0040
275	2.9493	0.0040
276	2.9532	0.0039
277	2.9572	0.0039
278	2.9611	0.0039
279	2.9650	0.0039
280	2.9689	0.0039
281	2.9728	0.0039
282	2.9767	0.0039
283	2.9806	0.0039
284	2.9845	0.0039
285	2.9884	0.0039
286	2.9922	0.0039
287	2.9961	0.0039
288	2.9999	0.0038

Unit Period (number)	Unit Rainfall (In)	Unit Soil-Loss (In)	Effective Rainfall (In)
1	0.0038	0.0001	0.0038
2	0.0039	0.0001	0.0038
3	0.0039	0.0001	0.0038
4	0.0039	0.0001	0.0038
5	0.0039	0.0001	0.0038
6	0.0039	0.0001	0.0038
7	0.0039	0.0001	0.0038
8	0.0039	0.0001	0.0038
9	0.0039	0.0001	0.0039

10	0.0040	0.0001	0.0039
11	0.0040	0.0001	0.0039
12	0.0040	0.0001	0.0039
13	0.0040	0.0001	0.0039
14	0.0040	0.0001	0.0039
15	0.0040	0.0001	0.0039
16	0.0040	0.0001	0.0040
17	0.0041	0.0001	0.0040
18	0.0041	0.0001	0.0040
19	0.0041	0.0001	0.0040
20	0.0041	0.0001	0.0040
21	0.0041	0.0001	0.0040
22	0.0041	0.0001	0.0040
23	0.0042	0.0001	0.0041
24	0.0042	0.0001	0.0041
25	0.0042	0.0001	0.0041
26	0.0042	0.0001	0.0041
27	0.0042	0.0001	0.0041
28	0.0042	0.0001	0.0041
29	0.0042	0.0001	0.0042
30	0.0043	0.0001	0.0042
31	0.0043	0.0001	0.0042
32	0.0043	0.0001	0.0042
33	0.0043	0.0001	0.0042
34	0.0043	0.0001	0.0042
35	0.0043	0.0001	0.0043
36	0.0044	0.0001	0.0043
37	0.0044	0.0001	0.0043
38	0.0044	0.0001	0.0043
39	0.0044	0.0001	0.0043
40	0.0044	0.0001	0.0043
41	0.0045	0.0001	0.0044
42	0.0045	0.0001	0.0044
43	0.0045	0.0001	0.0044
44	0.0045	0.0001	0.0044
45	0.0045	0.0001	0.0044
46	0.0045	0.0001	0.0045
47	0.0046	0.0001	0.0045
48	0.0046	0.0001	0.0045
49	0.0046	0.0001	0.0045
50	0.0046	0.0001	0.0045
51	0.0047	0.0001	0.0046
52	0.0047	0.0001	0.0046
53	0.0047	0.0001	0.0046
54	0.0047	0.0001	0.0046
55	0.0047	0.0001	0.0047
56	0.0048	0.0001	0.0047
57	0.0048	0.0001	0.0047
58	0.0048	0.0001	0.0047
59	0.0048	0.0001	0.0047
60	0.0048	0.0001	0.0048
61	0.0049	0.0001	0.0048
62	0.0049	0.0001	0.0048

63	0.0049	0.0001	0.0048
64	0.0049	0.0001	0.0049
65	0.0050	0.0001	0.0049
66	0.0050	0.0001	0.0049
67	0.0050	0.0001	0.0049
68	0.0050	0.0001	0.0050
69	0.0051	0.0001	0.0050
70	0.0051	0.0001	0.0050
71	0.0051	0.0001	0.0050
72	0.0051	0.0001	0.0051
73	0.0052	0.0001	0.0051
74	0.0052	0.0001	0.0051
75	0.0052	0.0001	0.0051
76	0.0052	0.0001	0.0052
77	0.0053	0.0001	0.0052
78	0.0053	0.0001	0.0052
79	0.0053	0.0001	0.0053
80	0.0054	0.0001	0.0053
81	0.0054	0.0001	0.0053
82	0.0054	0.0001	0.0053
83	0.0055	0.0001	0.0054
84	0.0055	0.0001	0.0054
85	0.0055	0.0001	0.0054
86	0.0056	0.0001	0.0055
87	0.0056	0.0001	0.0055
88	0.0056	0.0001	0.0055
89	0.0057	0.0001	0.0056
90	0.0057	0.0001	0.0056
91	0.0057	0.0001	0.0057
92	0.0058	0.0001	0.0057
93	0.0058	0.0001	0.0057
94	0.0058	0.0001	0.0057
95	0.0059	0.0001	0.0058
96	0.0059	0.0001	0.0058
97	0.0060	0.0001	0.0059
98	0.0060	0.0001	0.0059
99	0.0060	0.0001	0.0060
100	0.0061	0.0001	0.0060
101	0.0061	0.0001	0.0060
102	0.0062	0.0001	0.0061
103	0.0062	0.0001	0.0061
104	0.0062	0.0001	0.0062
105	0.0063	0.0001	0.0062
106	0.0063	0.0001	0.0062
107	0.0064	0.0001	0.0063
108	0.0064	0.0001	0.0063
109	0.0065	0.0001	0.0064
110	0.0065	0.0001	0.0064
111	0.0066	0.0001	0.0065
112	0.0066	0.0001	0.0065
113	0.0067	0.0001	0.0066
114	0.0067	0.0001	0.0066
115	0.0068	0.0001	0.0067

116	0.0068	0.0001	0.0068
117	0.0069	0.0001	0.0068
118	0.0069	0.0001	0.0069
119	0.0070	0.0001	0.0069
120	0.0071	0.0001	0.0070
121	0.0072	0.0001	0.0071
122	0.0072	0.0001	0.0071
123	0.0073	0.0001	0.0072
124	0.0073	0.0001	0.0072
125	0.0074	0.0001	0.0073
126	0.0075	0.0001	0.0074
127	0.0076	0.0001	0.0075
128	0.0076	0.0001	0.0075
129	0.0077	0.0001	0.0076
130	0.0078	0.0001	0.0077
131	0.0079	0.0001	0.0078
132	0.0079	0.0001	0.0078
133	0.0080	0.0001	0.0079
134	0.0081	0.0001	0.0080
135	0.0082	0.0001	0.0081
136	0.0083	0.0001	0.0082
137	0.0084	0.0001	0.0083
138	0.0085	0.0001	0.0084
139	0.0086	0.0001	0.0085
140	0.0087	0.0001	0.0086
141	0.0088	0.0001	0.0087
142	0.0089	0.0001	0.0088
143	0.0090	0.0001	0.0089
144	0.0091	0.0001	0.0090
145	0.0063	0.0001	0.0062
146	0.0064	0.0001	0.0063
147	0.0065	0.0001	0.0064
148	0.0066	0.0001	0.0065
149	0.0067	0.0001	0.0066
150	0.0068	0.0001	0.0067
151	0.0070	0.0001	0.0069
152	0.0070	0.0001	0.0070
153	0.0072	0.0001	0.0071
154	0.0073	0.0001	0.0072
155	0.0075	0.0001	0.0074
156	0.0076	0.0001	0.0075
157	0.0078	0.0001	0.0077
158	0.0079	0.0001	0.0078
159	0.0082	0.0001	0.0081
160	0.0083	0.0001	0.0082
161	0.0085	0.0001	0.0085
162	0.0087	0.0001	0.0086
163	0.0090	0.0001	0.0089
164	0.0091	0.0001	0.0090
165	0.0095	0.0001	0.0094
166	0.0096	0.0001	0.0095
167	0.0100	0.0001	0.0099
168	0.0102	0.0001	0.0101

169	0.0107	0.0001	0.0106
170	0.0109	0.0001	0.0108
171	0.0114	0.0001	0.0113
172	0.0117	0.0001	0.0116
173	0.0122	0.0001	0.0122
174	0.0126	0.0001	0.0125
175	0.0133	0.0001	0.0132
176	0.0137	0.0001	0.0136
177	0.0145	0.0001	0.0144
178	0.0150	0.0001	0.0149
179	0.0161	0.0001	0.0160
180	0.0167	0.0001	0.0166
181	0.0181	0.0001	0.0180
182	0.0189	0.0001	0.0188
183	0.0209	0.0001	0.0208
184	0.0220	0.0001	0.0219
185	0.0296	0.0001	0.0295
186	0.0315	0.0001	0.0315
187	0.0366	0.0001	0.0365
188	0.0399	0.0001	0.0399
189	0.0497	0.0001	0.0496
190	0.0572	0.0001	0.0571
191	0.0868	0.0001	0.0867
192	0.1260	0.0001	0.1259
193	0.5451	0.0001	0.5450
194	0.0683	0.0001	0.0682
195	0.0442	0.0001	0.0441
196	0.0338	0.0001	0.0338
197	0.0233	0.0001	0.0232
198	0.0198	0.0001	0.0198
199	0.0174	0.0001	0.0173
200	0.0155	0.0001	0.0154
201	0.0141	0.0001	0.0140
202	0.0129	0.0001	0.0128
203	0.0119	0.0001	0.0119
204	0.0111	0.0001	0.0111
205	0.0104	0.0001	0.0103
206	0.0098	0.0001	0.0097
207	0.0093	0.0001	0.0092
208	0.0088	0.0001	0.0087
209	0.0084	0.0001	0.0083
210	0.0080	0.0001	0.0080
211	0.0077	0.0001	0.0076
212	0.0074	0.0001	0.0073
213	0.0071	0.0001	0.0070
214	0.0069	0.0001	0.0068
215	0.0066	0.0001	0.0066
216	0.0064	0.0001	0.0063
217	0.0092	0.0001	0.0091
218	0.0089	0.0001	0.0089
219	0.0087	0.0001	0.0086
220	0.0085	0.0001	0.0084
221	0.0083	0.0001	0.0082

222	0.0081	0.0001	0.0081
223	0.0080	0.0001	0.0079
224	0.0078	0.0001	0.0077
225	0.0077	0.0001	0.0076
226	0.0075	0.0001	0.0074
227	0.0074	0.0001	0.0073
228	0.0072	0.0001	0.0072
229	0.0071	0.0001	0.0070
230	0.0070	0.0001	0.0069
231	0.0069	0.0001	0.0068
232	0.0068	0.0001	0.0067
233	0.0067	0.0001	0.0066
234	0.0066	0.0001	0.0065
235	0.0065	0.0001	0.0064
236	0.0064	0.0001	0.0063
237	0.0063	0.0001	0.0062
238	0.0062	0.0001	0.0061
239	0.0061	0.0001	0.0060
240	0.0060	0.0001	0.0059
241	0.0059	0.0001	0.0059
242	0.0059	0.0001	0.0058
243	0.0058	0.0001	0.0057
244	0.0057	0.0001	0.0056
245	0.0056	0.0001	0.0056
246	0.0056	0.0001	0.0055
247	0.0055	0.0001	0.0054
248	0.0054	0.0001	0.0054
249	0.0054	0.0001	0.0053
250	0.0053	0.0001	0.0052
251	0.0053	0.0001	0.0052
252	0.0052	0.0001	0.0051
253	0.0052	0.0001	0.0051
254	0.0051	0.0001	0.0050
255	0.0051	0.0001	0.0050
256	0.0050	0.0001	0.0049
257	0.0050	0.0001	0.0049
258	0.0049	0.0001	0.0048
259	0.0049	0.0001	0.0048
260	0.0048	0.0001	0.0047
261	0.0048	0.0001	0.0047
262	0.0047	0.0001	0.0046
263	0.0047	0.0001	0.0046
264	0.0046	0.0001	0.0046
265	0.0046	0.0001	0.0045
266	0.0046	0.0001	0.0045
267	0.0045	0.0001	0.0044
268	0.0045	0.0001	0.0044
269	0.0044	0.0001	0.0044
270	0.0044	0.0001	0.0043
271	0.0044	0.0001	0.0043
272	0.0043	0.0001	0.0043
273	0.0043	0.0001	0.0042
274	0.0043	0.0001	0.0042

275	0.0042	0.0001	0.0042
276	0.0042	0.0001	0.0041
277	0.0042	0.0001	0.0041
278	0.0041	0.0001	0.0041
279	0.0041	0.0001	0.0040
280	0.0041	0.0001	0.0040
281	0.0041	0.0001	0.0040
282	0.0040	0.0001	0.0039
283	0.0040	0.0001	0.0039
284	0.0040	0.0001	0.0039
285	0.0039	0.0001	0.0039
286	0.0039	0.0001	0.0038
287	0.0039	0.0001	0.0038
288	0.0039	0.0001	0.0038

Total soil rain loss = 0.02(In)
Total effective rainfall = 2.98(In)
Peak flow rate in flood hydrograph = 67.36(CFS)

++++
24 - H O U R S T O R M
R u n o f f H y d r o g r a p h

Hydrograph in 5 Minute intervals ((CFS))

Time(h+m)	Volume Ac.Ft	Q(CFS)	0	17.5	35.0	52.5	70.0
0+ 5	0.0003	0.05	Q				
0+10	0.0030	0.39	Q				
0+15	0.0080	0.72	Q				
0+20	0.0139	0.86	Q				
0+25	0.0204	0.94	Q				
0+30	0.0273	1.00	Q				
0+35	0.0345	1.04	Q				
0+40	0.0419	1.07	Q				
0+45	0.0495	1.10	Q				
0+50	0.0572	1.12	Q				
0+55	0.0650	1.13	Q				
1+ 0	0.0728	1.14	Q				
1+ 5	0.0808	1.15	Q				
1+10	0.0888	1.16	Q				
1+15	0.0969	1.17	Q				
1+20	0.1050	1.18	Q				
1+25	0.1131	1.18	Q				
1+30	0.1212	1.18	Q				
1+35	0.1294	1.19	Q				
1+40	0.1376	1.19	Q				
1+45	0.1459	1.20	Q				
1+50	0.1542	1.20	QV				
1+55	0.1625	1.21	QV				
2+ 0	0.1708	1.21	QV				

2+ 5	0.1792	1.22	QV
2+10	0.1876	1.22	QV
2+15	0.1960	1.22	QV
2+20	0.2045	1.23	QV
2+25	0.2130	1.23	QV
2+30	0.2215	1.24	QV
2+35	0.2301	1.24	QV
2+40	0.2387	1.25	QV
2+45	0.2473	1.25	QV
2+50	0.2560	1.26	QV
2+55	0.2647	1.26	QV
3+ 0	0.2734	1.27	QV
3+ 5	0.2822	1.27	QV
3+10	0.2910	1.28	QV
3+15	0.2998	1.28	QV
3+20	0.3087	1.29	Q V
3+25	0.3176	1.29	Q V
3+30	0.3266	1.30	Q V
3+35	0.3356	1.31	Q V
3+40	0.3446	1.31	Q V
3+45	0.3537	1.32	Q V
3+50	0.3628	1.32	Q V
3+55	0.3719	1.33	Q V
4+ 0	0.3811	1.33	Q V
4+ 5	0.3903	1.34	Q V
4+10	0.3996	1.35	Q V
4+15	0.4089	1.35	Q V
4+20	0.4183	1.36	Q V
4+25	0.4277	1.36	Q V
4+30	0.4371	1.37	Q V
4+35	0.4466	1.38	Q V
4+40	0.4561	1.38	Q V
4+45	0.4657	1.39	Q V
4+50	0.4753	1.40	Q V
4+55	0.4849	1.40	Q V
5+ 0	0.4946	1.41	Q V
5+ 5	0.5044	1.42	Q V
5+10	0.5142	1.42	Q V
5+15	0.5240	1.43	Q V
5+20	0.5339	1.44	Q V
5+25	0.5439	1.44	Q V
5+30	0.5539	1.45	Q V
5+35	0.5639	1.46	Q V
5+40	0.5740	1.47	Q V
5+45	0.5841	1.47	Q V
5+50	0.5943	1.48	Q V
5+55	0.6046	1.49	Q V
6+ 0	0.6149	1.50	Q V
6+ 5	0.6252	1.50	Q V
6+10	0.6356	1.51	Q V
6+15	0.6461	1.52	Q V
6+20	0.6566	1.53	Q V
6+25	0.6672	1.54	Q V

6+30	0.6778	1.54	Q	V
6+35	0.6885	1.55	Q	V
6+40	0.6992	1.56	Q	V
6+45	0.7101	1.57	Q	V
6+50	0.7209	1.58	Q	V
6+55	0.7319	1.59	Q	V
7+ 0	0.7429	1.60	Q	V
7+ 5	0.7539	1.61	Q	V
7+10	0.7650	1.62	Q	V
7+15	0.7762	1.62	Q	V
7+20	0.7875	1.63	Q	V
7+25	0.7988	1.64	Q	V
7+30	0.8102	1.65	Q	V
7+35	0.8217	1.66	Q	V
7+40	0.8332	1.67	Q	V
7+45	0.8448	1.69	Q	V
7+50	0.8565	1.70	Q	V
7+55	0.8682	1.71	Q	V
8+ 0	0.8801	1.72	Q	V
8+ 5	0.8920	1.73	Q	V
8+10	0.9040	1.74	Q	V
8+15	0.9160	1.75	Q	V
8+20	0.9282	1.76	Q	V
8+25	0.9404	1.78	Q	V
8+30	0.9527	1.79	Q	V
8+35	0.9651	1.80	Q	V
8+40	0.9776	1.81	Q	V
8+45	0.9901	1.82	Q	V
8+50	1.0028	1.84	Q	V
8+55	1.0155	1.85	Q	V
9+ 0	1.0284	1.86	Q	V
9+ 5	1.0413	1.88	Q	V
9+10	1.0544	1.89	Q	V
9+15	1.0675	1.91	Q	V
9+20	1.0807	1.92	Q	V
9+25	1.0941	1.94	Q	V
9+30	1.1075	1.95	Q	V
9+35	1.1210	1.97	Q	V
9+40	1.1347	1.98	Q	V
9+45	1.1485	2.00	Q	V
9+50	1.1623	2.02	Q	V
9+55	1.1763	2.03	Q	V
10+ 0	1.1905	2.05	Q	V
10+ 5	1.2047	2.07	Q	V
10+10	1.2190	2.08	Q	V
10+15	1.2335	2.10	Q	V
10+20	1.2481	2.12	Q	V
10+25	1.2629	2.14	Q	V
10+30	1.2778	2.16	Q	V
10+35	1.2928	2.18	Q	V
10+40	1.3080	2.20	Q	V
10+45	1.3233	2.22	Q	V
10+50	1.3387	2.24	Q	V

10+55	1.3543	2.27	Q	V			
11+ 0	1.3701	2.29	Q	V			
11+ 5	1.3860	2.31	Q	V			
11+10	1.4021	2.34	Q	V			
11+15	1.4184	2.36	Q	V			
11+20	1.4348	2.39	Q	V			
11+25	1.4514	2.41	Q	V			
11+30	1.4682	2.44	Q	V			
11+35	1.4852	2.47	Q	V			
11+40	1.5024	2.49	Q	V			
11+45	1.5197	2.52	Q	V			
11+50	1.5373	2.55	Q	V			
11+55	1.5551	2.58	Q	V			
12+ 0	1.5731	2.62	Q	V			
12+ 5	1.5911	2.61	Q	V			
12+10	1.6075	2.38	Q	V			
12+15	1.6223	2.15	Q	V			
12+20	1.6366	2.07	Q	V			
12+25	1.6506	2.04	Q	V			
12+30	1.6646	2.03	Q	V			
12+35	1.6786	2.03	Q	V			
12+40	1.6927	2.05	Q	V			
12+45	1.7069	2.07	Q	V			
12+50	1.7213	2.09	Q	V			
12+55	1.7360	2.12	Q	V			
13+ 0	1.7508	2.16	Q	V			
13+ 5	1.7660	2.20	Q	V			
13+10	1.7814	2.24	Q	V			
13+15	1.7970	2.28	Q	V			
13+20	1.8131	2.33	Q	V			
13+25	1.8295	2.38	Q	V			
13+30	1.8462	2.43	Q	V			
13+35	1.8633	2.49	Q	V			
13+40	1.8809	2.55	Q	V			
13+45	1.8989	2.61	Q	V			
13+50	1.9174	2.68	Q	V			
13+55	1.9363	2.75	Q	V			
14+ 0	1.9558	2.83	Q	V			
14+ 5	1.9758	2.91	Q	V			
14+10	1.9964	3.00	Q	V			
14+15	2.0177	3.09	Q	V			
14+20	2.0398	3.20	Q	V			
14+25	2.0625	3.30	Q	V			
14+30	2.0861	3.42	Q	V			
14+35	2.1105	3.55	Q	V			
14+40	2.1359	3.69	Q	V			
14+45	2.1624	3.84	Q	V			
14+50	2.1900	4.01	Q	V			
14+55	2.2188	4.19	Q	V			
15+ 0	2.2492	4.40	Q	V			
15+ 5	2.2810	4.63	Q	V			
15+10	2.3148	4.90	Q	V			
15+15	2.3506	5.20	Q	V			

15+20	2.3889	5.56	Q		V			
15+25	2.4304	6.03	Q		V			
15+30	2.4784	6.97	Q		V			
15+35	2.5335	8.00	Q		V			
15+40	2.5958	9.04	Q		V			
15+45	2.6661	10.21	Q		V			
15+50	2.7478	11.86	Q		V			
15+55	2.8453	14.15	Q		V			
16+ 0	2.9734	18.61		Q	V			
16+ 5	3.1869	30.99			Q	V		
16+10	3.6508	67.36				V		Q
16+15	4.0833	62.81				V		Q
16+20	4.3330	36.25			Q		V	
16+25	4.5079	25.39			Q		V	
16+30	4.6395	19.12		Q			V	
16+35	4.7400	14.58		Q			V	
16+40	4.8215	11.84		Q			V	
16+45	4.8885	9.73		Q			V	
16+50	4.9444	8.11		Q			V	
16+55	4.9907	6.72	Q				V	
17+ 0	5.0302	5.74	Q				V	
17+ 5	5.0668	5.32	Q				V	
17+10	5.0992	4.70	Q				V	
17+15	5.1272	4.08	Q				V	
17+20	5.1498	3.27	Q				V	
17+25	5.1706	3.02	Q				V	
17+30	5.1900	2.83	Q				V	
17+35	5.2084	2.66	Q				V	
17+40	5.2258	2.53	Q				V	
17+45	5.2424	2.41	Q				V	
17+50	5.2582	2.30	Q				V	
17+55	5.2734	2.21	Q				V	
18+ 0	5.2880	2.12	Q				V	
18+ 5	5.3024	2.08	Q				V	
18+10	5.3180	2.28	Q				V	
18+15	5.3350	2.46	Q				V	
18+20	5.3522	2.50	Q				V	
18+25	5.3694	2.50	Q				V	
18+30	5.3865	2.48	Q				V	
18+35	5.4034	2.45	Q				V	
18+40	5.4200	2.41	Q				V	
18+45	5.4363	2.38	Q				V	
18+50	5.4524	2.34	Q				V	
18+55	5.4682	2.30	Q				V	
19+ 0	5.4838	2.25	Q				V	
19+ 5	5.4990	2.22	Q				V	
19+10	5.5140	2.18	Q				V	
19+15	5.5288	2.14	Q				V	
19+20	5.5433	2.10	Q				V	
19+25	5.5575	2.07	Q				V	
19+30	5.5715	2.03	Q				V	
19+35	5.5853	2.00	Q				V	
19+40	5.5988	1.97	Q				V	

19+45	5.6122	1.94	Q	V
19+50	5.6253	1.91	Q	V
19+55	5.6382	1.88	Q	V
20+ 0	5.6510	1.85	Q	V
20+ 5	5.6636	1.82	Q	V
20+10	5.6759	1.80	Q	V
20+15	5.6882	1.77	Q	V
20+20	5.7002	1.75	Q	V
20+25	5.7121	1.73	Q	V
20+30	5.7239	1.71	Q	V
20+35	5.7355	1.68	Q	V
20+40	5.7469	1.66	Q	V
20+45	5.7583	1.64	Q	V
20+50	5.7695	1.62	Q	V
20+55	5.7805	1.61	Q	V
21+ 0	5.7914	1.59	Q	V
21+ 5	5.8022	1.57	Q	V
21+10	5.8129	1.55	Q	V
21+15	5.8235	1.53	Q	V
21+20	5.8340	1.52	Q	V
21+25	5.8443	1.50	Q	V
21+30	5.8546	1.49	Q	V
21+35	5.8647	1.47	Q	V
21+40	5.8747	1.46	Q	V
21+45	5.8847	1.44	Q	V
21+50	5.8945	1.43	Q	V
21+55	5.9042	1.42	Q	V
22+ 0	5.9139	1.40	Q	V
22+ 5	5.9235	1.39	Q	V
22+10	5.9329	1.38	Q	V
22+15	5.9423	1.36	Q	V
22+20	5.9516	1.35	Q	V
22+25	5.9609	1.34	Q	V
22+30	5.9700	1.33	Q	V
22+35	5.9791	1.32	Q	V
22+40	5.9881	1.31	Q	V
22+45	5.9970	1.29	Q	V
22+50	6.0058	1.28	Q	V
22+55	6.0146	1.27	Q	V
23+ 0	6.0233	1.26	Q	V
23+ 5	6.0319	1.25	Q	V
23+10	6.0405	1.24	Q	V
23+15	6.0490	1.23	Q	V
23+20	6.0574	1.22	Q	V
23+25	6.0658	1.21	Q	V
23+30	6.0741	1.21	Q	V
23+35	6.0823	1.20	Q	V
23+40	6.0905	1.19	Q	V
23+45	6.0986	1.18	Q	V
23+50	6.1067	1.17	Q	V
23+55	6.1147	1.16	Q	V
24+ 0	6.1226	1.15	Q	V

FLOOD HYDROGRAPH ROUTING PROGRAM
Copyright (c) CIVILCADD/CIVILDESIGN, 1989 - 2018
Study date: 02/28/23

Program License Serial Number 6509

***** HYDROGRAPH INFORMATION *****

From study/file name: A22326POSTQ100UHNORTH.rte

*****HYDROGRAPH

DATA*****

Number of intervals = 301
Time interval = 5.0 (Min.)
Maximum/Peak flow rate = 33.949 (CFS)
Total volume = 2.783 (Ac.Ft)
Status of hydrographs being held in storage
Stream 1 Stream 2 Stream 3 Stream 4 Stream 5
Peak (CFS) 0.000 0.000 0.000 0.000 0.000
Vol (Ac.Ft) 0.000 0.000 0.000 0.000 0.000

++++
Process from Point/Station 100.000 to Point/Station 101.000
**** RETARDING BASIN ROUTING ****

Program computation of outflow v. depth

CALCULATED OUTFLOW DATA AT DEPTH = 1.00(Ft.))
Total outflow at this depth = 0.00(CFS)

CALCULATED OUTFLOW DATA AT DEPTH = 2.00(Ft.))
Total outflow at this depth = 0.00(CFS)

CALCULATED OUTFLOW DATA AT DEPTH = 3.00(Ft.))
Total outflow at this depth = 0.00(CFS)

CALCULATED OUTFLOW DATA AT DEPTH = 4.00(Ft.))
Total outflow at this depth = 0.00(CFS)

CALCULATED OUTFLOW DATA AT DEPTH = 5.00(Ft.))
Total outflow at this depth = 0.00(CFS)

CALCULATED OUTFLOW DATA AT DEPTH = 6.00(Ft.))
Total outflow at this depth = 0.00(CFS)

CALCULATED OUTFLOW DATA AT DEPTH = 7.00(Ft.))
Total outflow at this depth = 0.00(CFS)

CALCULATED OUTFLOW DATA AT DEPTH = 8.00(Ft.))

Weir capacity using equation $Q = CLH^{Exp}$ (Using Feet as units)
Weir Length = 20.00(Ft.) C value = 3.00 Exp = 1.50
Weir flow: Depth = H = 0.50(Ft.) Flow = 21.21 (CFS)

Total outflow at this depth = 21.21(CFS)

Total number of inflow hydrograph intervals = 301
Hydrograph time unit = 5.000 (Min.)
Initial depth in storage basin = 0.00(Ft.)

Initial basin depth = 0.00 (Ft.)
Initial basin storage = 0.00 (Ac.Ft)
Initial basin outflow = 0.00 (CFS)

Depth vs. Storage and Depth vs. Discharge data:

Basin Depth (Ft.)	Storage (Ac.Ft)	Outflow (CFS)	(S-0*dt/2) (Ac.Ft)	(S+0*dt/2) (Ac.Ft)
0.000	0.000	0.000	0.000	0.000
1.000	0.155	0.000	0.155	0.155
2.000	0.336	0.000	0.336	0.336
3.000	0.545	0.000	0.545	0.545
4.000	0.782	0.000	0.782	0.782
5.000	1.051	0.000	1.051	1.051
6.000	1.351	0.000	1.351	1.351
7.000	1.684	0.000	1.684	1.684
8.000	2.053	21.213	1.980	2.126

Hydrograph Detention Basin Routing

Graph values: 'I'= unit inflow; 'O'=outflow at time shown

Time (Hours)	Inflow (CFS)	Outflow (CFS)	Storage (Ac.Ft)	.0	8.5	16.97	25.46	33.95	Depth (Ft.)
0.083	0.03	0.00	0.000	0					0.00
0.167	0.21	0.00	0.001	0					0.01
0.250	0.35	0.00	0.003	0					0.02
0.333	0.41	0.00	0.005	0					0.04
0.417	0.44	0.00	0.008	0					0.05
0.500	0.47	0.00	0.011	0					0.07
0.583	0.48	0.00	0.015	0					0.10
0.667	0.50	0.00	0.018	0					0.12
0.750	0.51	0.00	0.022	0					0.14
0.833	0.51	0.00	0.025	0					0.16
0.917	0.52	0.00	0.029	0					0.18
1.000	0.52	0.00	0.032	0					0.21
1.083	0.53	0.00	0.036	0					0.23
1.167	0.53	0.00	0.039	0					0.25
1.250	0.53	0.00	0.043	0					0.28
1.333	0.53	0.00	0.047	0					0.30
1.417	0.54	0.00	0.050	0					0.33
1.500	0.54	0.00	0.054	0					0.35
1.583	0.54	0.00	0.058	0					0.37
1.667	0.54	0.00	0.062	0					0.40
1.750	0.54	0.00	0.065	0					0.42
1.833	0.55	0.00	0.069	0					0.45
1.917	0.55	0.00	0.073	0					0.47
2.000	0.55	0.00	0.077	0					0.49
2.083	0.55	0.00	0.080	0					0.52
2.167	0.55	0.00	0.084	0					0.54
2.250	0.56	0.00	0.088	0					0.57
2.333	0.56	0.00	0.092	0					0.59
2.417	0.56	0.00	0.096	0					0.62
2.500	0.56	0.00	0.100	0					0.64
2.583	0.56	0.00	0.103	0					0.67
2.667	0.57	0.00	0.107	0					0.69
2.750	0.57	0.00	0.111	0					0.72
2.833	0.57	0.00	0.115	0					0.74
2.917	0.57	0.00	0.119	0					0.77
3.000	0.58	0.00	0.123	0					0.79
3.083	0.58	0.00	0.127	0					0.82
3.167	0.58	0.00	0.131	0					0.85
3.250	0.58	0.00	0.135	0					0.87
3.333	0.59	0.00	0.139	0					0.90
3.417	0.59	0.00	0.143	0					0.92
3.500	0.59	0.00	0.147	0					0.95
3.583	0.59	0.00	0.151	0					0.98
3.667	0.60	0.00	0.155	0					1.00
3.750	0.60	0.00	0.159	0					1.02
3.833	0.60	0.00	0.164	0					1.05
3.917	0.60	0.00	0.168	0					1.07
4.000	0.61	0.00	0.172	0					1.09

4.083	0.61	0.00	0.176	0					1.12
4.167	0.61	0.00	0.180	0					1.14
4.250	0.61	0.00	0.185	0					1.16
4.333	0.62	0.00	0.189	0					1.19
4.417	0.62	0.00	0.193	0					1.21
4.500	0.62	0.00	0.197	0					1.23
4.583	0.62	0.00	0.202	0					1.26
4.667	0.63	0.00	0.206	0					1.28
4.750	0.63	0.00	0.210	0					1.31
4.833	0.63	0.00	0.215	0					1.33
4.917	0.64	0.00	0.219	0					1.35
5.000	0.64	0.00	0.223	0					1.38
5.083	0.64	0.00	0.228	0					1.40
5.167	0.65	0.00	0.232	0					1.43
5.250	0.65	0.00	0.237	0					1.45
5.333	0.65	0.00	0.241	0					1.48
5.417	0.66	0.00	0.246	0					1.50
5.500	0.66	0.00	0.250	0					1.53
5.583	0.66	0.00	0.255	0					1.55
5.667	0.67	0.00	0.259	0					1.58
5.750	0.67	0.00	0.264	0					1.60
5.833	0.67	0.00	0.268	0					1.63
5.917	0.68	0.00	0.273	0					1.65
6.000	0.68	0.00	0.278	0					1.68
6.083	0.68	0.00	0.282	0					1.70
6.167	0.69	0.00	0.287	0					1.73
6.250	0.69	0.00	0.292	0					1.76
6.333	0.69	0.00	0.297	0					1.78
6.417	0.70	0.00	0.301	0					1.81
6.500	0.70	0.00	0.306	0					1.84
6.583	0.70	0.00	0.311	0					1.86
6.667	0.71	0.00	0.316	0					1.89
6.750	0.71	0.00	0.321	0					1.92
6.833	0.72	0.00	0.326	0					1.94
6.917	0.72	0.00	0.331	0					1.97
7.000	0.72	0.00	0.336	0					2.00
7.083	0.73	0.00	0.341	0					2.02
7.167	0.73	0.00	0.346	0					2.05
7.250	0.74	0.00	0.351	0					2.07
7.333	0.74	0.00	0.356	0					2.10
7.417	0.75	0.00	0.361	0					2.12
7.500	0.75	0.00	0.366	0					2.14
7.583	0.76	0.00	0.371	0					2.17
7.667	0.76	0.00	0.377	0					2.19
7.750	0.77	0.00	0.382	0					2.22
7.833	0.77	0.00	0.387	0					2.24
7.917	0.77	0.00	0.392	0					2.27
8.000	0.78	0.00	0.398	0					2.30
8.083	0.78	0.00	0.403	0					2.32
8.167	0.79	0.00	0.409	0					2.35
8.250	0.80	0.00	0.414	0					2.37
8.333	0.80	0.00	0.420	0					2.40
8.417	0.81	0.00	0.425	0					2.43

8.500	0.81	0.00	0.431	0					2.45
8.583	0.82	0.00	0.436	0					2.48
8.667	0.82	0.00	0.442	0					2.51
8.750	0.83	0.00	0.448	0					2.53
8.833	0.83	0.00	0.453	0					2.56
8.917	0.84	0.00	0.459	0					2.59
9.000	0.85	0.00	0.465	0					2.62
9.083	0.85	0.00	0.471	0					2.64
9.167	0.86	0.00	0.477	0					2.67
9.250	0.87	0.00	0.483	0					2.70
9.333	0.87	0.00	0.489	0					2.73
9.417	0.88	0.00	0.495	0					2.76
9.500	0.89	0.00	0.501	0					2.79
9.583	0.89	0.00	0.507	0					2.82
9.667	0.90	0.00	0.513	0					2.85
9.750	0.91	0.00	0.519	0					2.88
9.833	0.92	0.00	0.526	0					2.91
9.917	0.92	0.00	0.532	0					2.94
10.000	0.93	0.00	0.538	0					2.97
10.083	0.94	0.00	0.545	0					3.00
10.167	0.95	0.00	0.551	0					3.03
10.250	0.96	0.00	0.558	0					3.05
10.333	0.96	0.00	0.564	0					3.08
10.417	0.97	0.00	0.571	0					3.11
10.500	0.98	0.00	0.578	0					3.14
10.583	0.99	0.00	0.585	0					3.17
10.667	1.00	0.00	0.591	0					3.20
10.750	1.01	0.00	0.598	0					3.22
10.833	1.02	0.00	0.605	0					3.25
10.917	1.03	0.00	0.612	0					3.28
11.000	1.04	0.00	0.619	0					3.31
11.083	1.05	0.00	0.627	0					3.34
11.167	1.06	0.00	0.634	OI					3.38
11.250	1.07	0.00	0.641	OI					3.41
11.333	1.08	0.00	0.649	OI					3.44
11.417	1.10	0.00	0.656	OI					3.47
11.500	1.11	0.00	0.664	OI					3.50
11.583	1.12	0.00	0.672	OI					3.53
11.667	1.13	0.00	0.679	OI					3.57
11.750	1.15	0.00	0.687	OI					3.60
11.833	1.16	0.00	0.695	OI					3.63
11.917	1.17	0.00	0.703	OI					3.67
12.000	1.19	0.00	0.711	OI					3.70
12.083	1.18	0.00	0.719	OI					3.74
12.167	1.05	0.00	0.727	0					3.77
12.250	0.96	0.00	0.734	0					3.80
12.333	0.93	0.00	0.741	0					3.83
12.417	0.92	0.00	0.747	0					3.85
12.500	0.92	0.00	0.753	0					3.88
12.583	0.92	0.00	0.760	0					3.91
12.667	0.93	0.00	0.766	0					3.93
12.750	0.94	0.00	0.772	0					3.96
12.833	0.95	0.00	0.779	0					3.99

12.917	0.96	0.00	0.785	0					4.01
13.000	0.98	0.00	0.792	0					4.04
13.083	1.00	0.00	0.799	0					4.06
13.167	1.02	0.00	0.806	0					4.09
13.250	1.04	0.00	0.813	0					4.11
13.333	1.06	0.00	0.820	0					4.14
13.417	1.08	0.00	0.828	OI					4.17
13.500	1.11	0.00	0.835	OI					4.20
13.583	1.13	0.00	0.843	OI					4.23
13.667	1.16	0.00	0.851	OI					4.26
13.750	1.19	0.00	0.859	OI					4.29
13.833	1.22	0.00	0.867	OI					4.32
13.917	1.25	0.00	0.876	OI					4.35
14.000	1.29	0.00	0.884	OI					4.38
14.083	1.33	0.00	0.893	OI					4.41
14.167	1.37	0.00	0.903	OI					4.45
14.250	1.41	0.00	0.912	OI					4.48
14.333	1.46	0.00	0.922	OI					4.52
14.417	1.51	0.00	0.932	OI					4.56
14.500	1.56	0.00	0.943	OI					4.60
14.583	1.62	0.00	0.954	OI					4.64
14.667	1.68	0.00	0.965	OI					4.68
14.750	1.75	0.00	0.977	OI					4.73
14.833	1.83	0.00	0.989	OI					4.77
14.917	1.91	0.00	1.002	OI					4.82
15.000	2.02	0.00	1.016	OI					4.87
15.083	2.12	0.00	1.030	OI					4.92
15.167	2.25	0.00	1.045	O I					4.98
15.250	2.38	0.00	1.061	O I					5.03
15.333	2.55	0.00	1.078	O I					5.09
15.417	2.77	0.00	1.096	O I					5.15
15.500	3.25	0.00	1.117	O I					5.22
15.583	3.72	0.00	1.141	O I					5.30
15.667	4.21	0.00	1.168	O I					5.39
15.750	4.75	0.00	1.199	O I					5.49
15.833	5.55	0.00	1.235	O I					5.61
15.917	6.64	0.00	1.277	O I					5.75
16.000	8.88	0.00	1.330	O I					5.93
16.083	15.25	0.00	1.413	O I		I			6.19
16.167	33.95	0.00	1.583	O				I	6.70
16.250	27.02	5.21	1.775	O			I		7.25
16.333	15.57	10.53	1.867	O		I			7.50
16.417	10.94	11.43	1.883	O					7.54
16.500	8.08	10.80	1.872	O I					7.51
16.583	6.20	9.59	1.851	O I					7.45
16.667	4.97	8.26	1.828	O I					7.39
16.750	4.05	7.02	1.806	O I					7.33
16.833	3.29	5.91	1.787	O I					7.28
16.917	2.78	4.96	1.770	O I					7.23
17.000	2.54	4.20	1.757	O I					7.20
17.083	2.17	3.59	1.746	O I					7.17
17.167	1.82	3.06	1.737	O I					7.14
17.250	1.53	2.61	1.729	O I					7.12

17.333	1.42	2.23	1.723	IO					7.11
17.417	1.32	1.95	1.718	0					7.09
17.500	1.25	1.73	1.714	0					7.08
17.583	1.18	1.56	1.711	0					7.07
17.667	1.12	1.42	1.709	0					7.07
17.750	1.07	1.32	1.707	0					7.06
17.833	1.03	1.23	1.705	IO					7.06
17.917	0.99	1.15	1.704	IO					7.05
18.000	0.95	1.09	1.703	IO					7.05
18.083	0.94	1.04	1.702	0					7.05
18.167	1.05	1.03	1.702	0					7.05
18.250	1.12	1.04	1.702	OI					7.05
18.333	1.14	1.07	1.703	0					7.05
18.417	1.13	1.09	1.703	0					7.05
18.500	1.12	1.10	1.703	0					7.05
18.583	1.11	1.11	1.703	0					7.05
18.667	1.09	1.11	1.703	0					7.05
18.750	1.07	1.10	1.703	0					7.05
18.833	1.06	1.09	1.703	IO					7.05
18.917	1.04	1.07	1.703	IO					7.05
19.000	1.02	1.06	1.702	0					7.05
19.083	1.00	1.04	1.702	0					7.05
19.167	0.98	1.03	1.702	0					7.05
19.250	0.97	1.01	1.702	0					7.05
19.333	0.95	0.99	1.701	0					7.05
19.417	0.93	0.97	1.701	0					7.05
19.500	0.92	0.96	1.701	0					7.05
19.583	0.90	0.94	1.700	0					7.04
19.667	0.89	0.93	1.700	0					7.04
19.750	0.87	0.91	1.700	0					7.04
19.833	0.86	0.90	1.700	0					7.04
19.917	0.85	0.88	1.699	0					7.04
20.000	0.84	0.87	1.699	0					7.04
20.083	0.82	0.86	1.699	0					7.04
20.167	0.81	0.84	1.699	0					7.04
20.250	0.80	0.83	1.698	0					7.04
20.333	0.79	0.82	1.698	0					7.04
20.417	0.78	0.81	1.698	0					7.04
20.500	0.77	0.80	1.698	0					7.04
20.583	0.76	0.79	1.698	0					7.04
20.667	0.75	0.78	1.698	0					7.04
20.750	0.74	0.77	1.697	0					7.04
20.833	0.73	0.76	1.697	0					7.04
20.917	0.73	0.75	1.697	0					7.04
21.000	0.72	0.74	1.697	0					7.03
21.083	0.71	0.73	1.697	0					7.03
21.167	0.70	0.72	1.697	0					7.03
21.250	0.69	0.71	1.696	0					7.03
21.333	0.69	0.71	1.696	0					7.03
21.417	0.68	0.70	1.696	0					7.03
21.500	0.67	0.69	1.696	0					7.03
21.583	0.67	0.68	1.696	0					7.03
21.667	0.66	0.68	1.696	0					7.03

21.750	0.65	0.67	1.696	0					7.03
21.833	0.65	0.66	1.696	0					7.03
21.917	0.64	0.66	1.695	0					7.03
22.000	0.63	0.65	1.695	0					7.03
22.083	0.63	0.64	1.695	0					7.03
22.167	0.62	0.64	1.695	0					7.03
22.250	0.62	0.63	1.695	0					7.03
22.333	0.61	0.63	1.695	0					7.03
22.417	0.61	0.62	1.695	0					7.03
22.500	0.60	0.61	1.695	0					7.03
22.583	0.60	0.61	1.695	0					7.03
22.667	0.59	0.60	1.695	0					7.03
22.750	0.59	0.60	1.694	0					7.03
22.833	0.58	0.59	1.694	0					7.03
22.917	0.58	0.59	1.694	0					7.03
23.000	0.57	0.58	1.694	0					7.03
23.083	0.57	0.58	1.694	0					7.03
23.167	0.56	0.57	1.694	0					7.03
23.250	0.56	0.57	1.694	0					7.03
23.333	0.55	0.57	1.694	0					7.03
23.417	0.55	0.56	1.694	0					7.03
23.500	0.55	0.56	1.694	0					7.03
23.583	0.54	0.55	1.694	0					7.03
23.667	0.54	0.55	1.694	0					7.03
23.750	0.53	0.54	1.693	0					7.03
23.833	0.53	0.54	1.693	0					7.03
23.917	0.53	0.54	1.693	0					7.03
24.000	0.52	0.53	1.693	0					7.03
24.083	0.49	0.52	1.693	0					7.02
24.167	0.31	0.48	1.692	0					7.02
24.250	0.17	0.40	1.691	0					7.02
24.333	0.11	0.31	1.689	0					7.01
24.417	0.07	0.24	1.688	0					7.01
24.500	0.05	0.18	1.687	0					7.01
24.583	0.03	0.14	1.686	0					7.01
24.667	0.02	0.10	1.686	0					7.00
24.750	0.02	0.07	1.685	0					7.00
24.833	0.01	0.05	1.685	0					7.00
24.917	0.01	0.04	1.685	0					7.00
25.000	0.00	0.03	1.684	0					7.00
25.083	0.00	0.02	1.684	0					7.00
25.167	0.00	0.01	1.684	0					7.00
25.250	0.00	0.01	1.684	0					7.00
25.333	0.00	0.01	1.684	0					7.00
25.417	0.00	0.00	1.684	0					7.00
25.500	0.00	0.00	1.684	0					7.00
25.583	0.00	0.00	1.684	0					7.00
25.667	0.00	0.00	1.684	0					7.00
25.750	0.00	0.00	1.684	0					7.00

Remaining water in basin = 1.68 (Ac.Ft)

*****HYDROGRAPH

DATA*****

Number of intervals = 309

Time interval = 5.0 (Min.)

Maximum/Peak flow rate = 11.430 (CFS)

Total volume = 1.099 (Ac.Ft)

Status of hydrographs being held in storage

	Stream 1	Stream 2	Stream 3	Stream 4	Stream 5
Peak (CFS)	0.000	0.000	0.000	0.000	0.000
Vol (Ac.Ft)	0.000	0.000	0.000	0.000	0.000

FLOOD HYDROGRAPH ROUTING PROGRAM
Copyright (c) CIVILCADD/CIVILDESIGN, 1989 - 2018
Study date: 02/28/23

Program License Serial Number 6509

***** HYDROGRAPH INFORMATION *****

From study/file name: A22326POSTQ100UHSOUTH.rte

*****HYDROGRAPH

DATA*****

Number of intervals = 302
Time interval = 5.0 (Min.)
Maximum/Peak flow rate = 67.362 (CFS)
Total volume = 6.145 (Ac.Ft)
Status of hydrographs being held in storage
Stream 1 Stream 2 Stream 3 Stream 4 Stream 5
Peak (CFS) 0.000 0.000 0.000 0.000 0.000
Vol (Ac.Ft) 0.000 0.000 0.000 0.000 0.000

++++
Process from Point/Station 100.000 to Point/Station 101.000
**** RETARDING BASIN ROUTING ****

Program computation of outflow v. depth

CALCULATED OUTFLOW DATA AT DEPTH = 1.00(Ft.)
Total outflow at this depth = 0.00(CFS)

CALCULATED OUTFLOW DATA AT DEPTH = 2.00(Ft.)
Total outflow at this depth = 0.00(CFS)

CALCULATED OUTFLOW DATA AT DEPTH = 3.00(Ft.)
Total outflow at this depth = 0.00(CFS)

CALCULATED OUTFLOW DATA AT DEPTH = 4.00(Ft.))
Total outflow at this depth = 0.00(CFS)

CALCULATED OUTFLOW DATA AT DEPTH = 5.00(Ft.))
Total outflow at this depth = 0.00(CFS)

CALCULATED OUTFLOW DATA AT DEPTH = 6.00(Ft.))
Total outflow at this depth = 0.00(CFS)

CALCULATED OUTFLOW DATA AT DEPTH = 7.00(Ft.))
Total outflow at this depth = 0.00(CFS)

CALCULATED OUTFLOW DATA AT DEPTH = 8.00(Ft.))
Total outflow at this depth = 0.00(CFS)

CALCULATED OUTFLOW DATA AT DEPTH = 9.00(Ft.))

Weir capacity using equation $Q = CLH^{Exp}$ (Using Feet as units)
Weir Length = 20.00(Ft.) C value = 3.00 Exp = 1.50
Weir flow: Depth = H = 0.50(Ft.) Flow = 21.21 (CFS)

Total outflow at this depth = 21.21(CFS)

Total number of inflow hydrograph intervals = 302
Hydrograph time unit = 5.000 (Min.)
Initial depth in storage basin = 0.00(Ft.)

Initial basin depth = 0.00 (Ft.)
Initial basin storage = 0.00 (Ac.Ft)
Initial basin outflow = 0.00 (CFS)

Depth vs. Storage and Depth vs. Discharge data:

Basin Depth (Ft.)	Storage (Ac.Ft)	Outflow (CFS)	(S-0*dt/2) (Ac.Ft)	(S+0*dt/2) (Ac.Ft)
0.000	0.000	0.000	0.000	0.000
1.000	0.339	0.000	0.339	0.339
2.000	0.712	0.000	0.712	0.712
3.000	1.120	0.000	1.120	1.120
4.000	1.566	0.000	1.566	1.566
5.000	2.050	0.000	2.050	2.050
6.000	2.574	0.000	2.574	2.574
7.000	3.139	0.000	3.139	3.139

8.000	3.747	0.000	3.747	3.747
9.000	4.400	21.213	4.327	4.473

Hydrograph Detention Basin Routing

Graph values: 'I'= unit inflow; 'O'=outflow at time shown

Time (Hours)	Inflow (CFS)	Outflow (CFS)	Storage (Ac.Ft)	.0	16.8	33.68	50.52	67.36	Depth (Ft.)
0.083	0.05	0.00	0.000	0					0.00
0.167	0.39	0.00	0.002	0					0.00
0.250	0.72	0.00	0.006	0					0.02
0.333	0.86	0.00	0.011	0					0.03
0.417	0.94	0.00	0.017	0					0.05
0.500	1.00	0.00	0.024	0					0.07
0.583	1.04	0.00	0.031	0					0.09
0.667	1.07	0.00	0.038	0					0.11
0.750	1.10	0.00	0.046	0					0.13
0.833	1.12	0.00	0.053	0					0.16
0.917	1.13	0.00	0.061	0					0.18
1.000	1.14	0.00	0.069	0					0.20
1.083	1.15	0.00	0.077	0					0.23
1.167	1.16	0.00	0.085	0					0.25
1.250	1.17	0.00	0.093	0					0.27
1.333	1.18	0.00	0.101	0					0.30
1.417	1.18	0.00	0.109	0					0.32
1.500	1.18	0.00	0.117	0					0.35
1.583	1.19	0.00	0.125	0					0.37
1.667	1.19	0.00	0.134	0					0.39
1.750	1.20	0.00	0.142	0					0.42
1.833	1.20	0.00	0.150	0					0.44
1.917	1.21	0.00	0.158	0					0.47
2.000	1.21	0.00	0.167	0					0.49
2.083	1.22	0.00	0.175	0					0.52
2.167	1.22	0.00	0.183	0					0.54
2.250	1.22	0.00	0.192	0					0.57
2.333	1.23	0.00	0.200	0					0.59
2.417	1.23	0.00	0.209	0					0.62
2.500	1.24	0.00	0.217	0					0.64
2.583	1.24	0.00	0.226	0					0.67
2.667	1.25	0.00	0.234	0					0.69
2.750	1.25	0.00	0.243	0					0.72
2.833	1.26	0.00	0.252	0					0.74
2.917	1.26	0.00	0.260	0					0.77
3.000	1.27	0.00	0.269	0					0.79
3.083	1.27	0.00	0.278	0					0.82
3.167	1.28	0.00	0.287	0					0.85
3.250	1.28	0.00	0.295	0					0.87
3.333	1.29	0.00	0.304	0					0.90
3.417	1.29	0.00	0.313	0					0.92
3.500	1.30	0.00	0.322	0					0.95
3.583	1.31	0.00	0.331	0					0.98

3.667	1.31	0.00	0.340	0					1.00
3.750	1.32	0.00	0.349	0					1.03
3.833	1.32	0.00	0.358	0					1.05
3.917	1.33	0.00	0.367	0					1.08
4.000	1.33	0.00	0.377	0					1.10
4.083	1.34	0.00	0.386	0					1.13
4.167	1.35	0.00	0.395	0					1.15
4.250	1.35	0.00	0.404	0					1.17
4.333	1.36	0.00	0.414	0					1.20
4.417	1.36	0.00	0.423	0					1.23
4.500	1.37	0.00	0.432	0					1.25
4.583	1.38	0.00	0.442	0					1.28
4.667	1.38	0.00	0.451	0					1.30
4.750	1.39	0.00	0.461	0					1.33
4.833	1.40	0.00	0.470	0					1.35
4.917	1.40	0.00	0.480	0					1.38
5.000	1.41	0.00	0.490	0					1.40
5.083	1.42	0.00	0.500	0					1.43
5.167	1.42	0.00	0.509	0					1.46
5.250	1.43	0.00	0.519	0					1.48
5.333	1.44	0.00	0.529	0					1.51
5.417	1.44	0.00	0.539	0					1.54
5.500	1.45	0.00	0.549	0					1.56
5.583	1.46	0.00	0.559	0					1.59
5.667	1.47	0.00	0.569	0					1.62
5.750	1.47	0.00	0.579	0					1.64
5.833	1.48	0.00	0.589	0					1.67
5.917	1.49	0.00	0.599	0					1.70
6.000	1.50	0.00	0.610	0					1.73
6.083	1.50	0.00	0.620	0					1.75
6.167	1.51	0.00	0.630	0					1.78
6.250	1.52	0.00	0.641	0					1.81
6.333	1.53	0.00	0.651	0					1.84
6.417	1.54	0.00	0.662	0					1.87
6.500	1.54	0.00	0.672	0					1.89
6.583	1.55	0.00	0.683	0					1.92
6.667	1.56	0.00	0.694	0					1.95
6.750	1.57	0.00	0.705	0					1.98
6.833	1.58	0.00	0.715	0					2.01
6.917	1.59	0.00	0.726	0					2.04
7.000	1.60	0.00	0.737	0					2.06
7.083	1.61	0.00	0.748	0					2.09
7.167	1.62	0.00	0.759	0					2.12
7.250	1.62	0.00	0.771	0					2.14
7.333	1.63	0.00	0.782	0					2.17
7.417	1.64	0.00	0.793	0					2.20
7.500	1.65	0.00	0.805	0					2.23
7.583	1.66	0.00	0.816	0					2.25
7.667	1.67	0.00	0.827	0					2.28
7.750	1.69	0.00	0.839	0					2.31
7.833	1.70	0.00	0.851	0					2.34
7.917	1.71	0.00	0.862	0					2.37
8.000	1.72	0.00	0.874	0					2.40

8.083	1.73	0.00	0.886	0					2.43
8.167	1.74	0.00	0.898	0					2.46
8.250	1.75	0.00	0.910	0					2.49
8.333	1.76	0.00	0.922	0					2.51
8.417	1.78	0.00	0.934	0					2.54
8.500	1.79	0.00	0.947	0					2.57
8.583	1.80	0.00	0.959	0					2.61
8.667	1.81	0.00	0.971	0					2.64
8.750	1.82	0.00	0.984	0					2.67
8.833	1.84	0.00	0.996	0					2.70
8.917	1.85	0.00	1.009	0					2.73
9.000	1.86	0.00	1.022	0					2.76
9.083	1.88	0.00	1.035	0					2.79
9.167	1.89	0.00	1.048	0					2.82
9.250	1.91	0.00	1.061	0					2.86
9.333	1.92	0.00	1.074	0					2.89
9.417	1.94	0.00	1.087	0					2.92
9.500	1.95	0.00	1.101	0					2.95
9.583	1.97	0.00	1.114	0					2.99
9.667	1.98	0.00	1.128	0					3.02
9.750	2.00	0.00	1.142	0					3.05
9.833	2.02	0.00	1.155	0					3.08
9.917	2.03	0.00	1.169	0					3.11
10.000	2.05	0.00	1.183	0					3.14
10.083	2.07	0.00	1.198	0					3.17
10.167	2.08	0.00	1.212	0					3.21
10.250	2.10	0.00	1.226	0					3.24
10.333	2.12	0.00	1.241	OI					3.27
10.417	2.14	0.00	1.256	OI					3.30
10.500	2.16	0.00	1.270	OI					3.34
10.583	2.18	0.00	1.285	OI					3.37
10.667	2.20	0.00	1.300	OI					3.40
10.750	2.22	0.00	1.316	OI					3.44
10.833	2.24	0.00	1.331	OI					3.47
10.917	2.27	0.00	1.347	OI					3.51
11.000	2.29	0.00	1.362	OI					3.54
11.083	2.31	0.00	1.378	OI					3.58
11.167	2.34	0.00	1.394	OI					3.61
11.250	2.36	0.00	1.410	OI					3.65
11.333	2.39	0.00	1.427	OI					3.69
11.417	2.41	0.00	1.443	OI					3.72
11.500	2.44	0.00	1.460	OI					3.76
11.583	2.47	0.00	1.477	OI					3.80
11.667	2.49	0.00	1.494	OI					3.84
11.750	2.52	0.00	1.511	OI					3.88
11.833	2.55	0.00	1.529	OI					3.92
11.917	2.58	0.00	1.546	OI					3.96
12.000	2.62	0.00	1.564	OI					4.00
12.083	2.61	0.00	1.582	OI					4.03
12.167	2.38	0.00	1.599	OI					4.07
12.250	2.15	0.00	1.615	OI					4.10
12.333	2.07	0.00	1.629	0					4.13
12.417	2.04	0.00	1.644	0					4.16

12.500	2.03	0.00	1.658	0					4.19
12.583	2.03	0.00	1.672	0					4.22
12.667	2.05	0.00	1.686	0					4.25
12.750	2.07	0.00	1.700	0					4.28
12.833	2.09	0.00	1.714	0					4.31
12.917	2.12	0.00	1.729	OI					4.34
13.000	2.16	0.00	1.743	OI					4.37
13.083	2.20	0.00	1.758	OI					4.40
13.167	2.24	0.00	1.774	OI					4.43
13.250	2.28	0.00	1.789	OI					4.46
13.333	2.33	0.00	1.805	OI					4.49
13.417	2.38	0.00	1.821	OI					4.53
13.500	2.43	0.00	1.838	OI					4.56
13.583	2.49	0.00	1.855	OI					4.60
13.667	2.55	0.00	1.872	OI					4.63
13.750	2.61	0.00	1.890	OI					4.67
13.833	2.68	0.00	1.908	OI					4.71
13.917	2.75	0.00	1.927	OI					4.75
14.000	2.83	0.00	1.946	OI					4.79
14.083	2.91	0.00	1.966	OI					4.83
14.167	3.00	0.00	1.986	OI					4.87
14.250	3.09	0.00	2.007	OI					4.91
14.333	3.20	0.00	2.029	OI					4.96
14.417	3.30	0.00	2.051	OI					5.00
14.500	3.42	0.00	2.074	OI					5.05
14.583	3.55	0.00	2.098	OI					5.09
14.667	3.69	0.00	2.123	OI					5.14
14.750	3.84	0.00	2.149	OI					5.19
14.833	4.01	0.00	2.176	OI					5.24
14.917	4.19	0.00	2.204	OI					5.29
15.000	4.40	0.00	2.234	0 I					5.35
15.083	4.63	0.00	2.265	0 I					5.41
15.167	4.90	0.00	2.298	0 I					5.47
15.250	5.20	0.00	2.333	0 I					5.54
15.333	5.56	0.00	2.370	0 I					5.61
15.417	6.03	0.00	2.410	0 I					5.69
15.500	6.97	0.00	2.454	0 I					5.77
15.583	8.00	0.00	2.506	0 I					5.87
15.667	9.04	0.00	2.565	0 I					5.98
15.750	10.21	0.00	2.631	0 I					6.10
15.833	11.86	0.00	2.707	0 I					6.24
15.917	14.15	0.00	2.797	0 I					6.39
16.000	18.61	0.00	2.909	0 I					6.59
16.083	30.99	0.00	3.080	0		I			6.90
16.167	67.36	0.00	3.419	0				I	7.46
16.250	62.81	3.51	3.855	0				I	8.17
16.333	36.25	12.77	4.140	0		I			8.60
16.417	25.39	16.40	4.252	0		I			8.77
16.500	19.12	17.58	4.288	0		OI			8.83
16.583	14.58	17.43	4.284	0		I			8.82
16.667	11.84	16.58	4.257	0		I			8.78
16.750	9.73	15.42	4.222	0		I			8.73
16.833	8.11	14.11	4.181	0		I			8.67

16.917	6.72	12.76	4.140	I 0				8.60
17.000	5.74	11.45	4.099	I 0				8.54
17.083	5.32	10.26	4.063	I 0				8.48
17.167	4.70	9.20	4.030	I 0				8.43
17.250	4.08	8.23	4.000	I 0				8.39
17.333	3.27	7.31	3.972	I 0				8.34
17.417	3.02	6.48	3.946	I 0				8.31
17.500	2.83	5.76	3.924	IO				8.27
17.583	2.66	5.15	3.906	IO				8.24
17.667	2.53	4.64	3.890	IO				8.22
17.750	2.41	4.20	3.876	0				8.20
17.833	2.30	3.83	3.865	0				8.18
17.917	2.21	3.51	3.855	0				8.17
18.000	2.12	3.24	3.847	0				8.15
18.083	2.08	3.01	3.840	IO				8.14
18.167	2.28	2.84	3.835	0				8.13
18.250	2.46	2.75	3.832	0				8.13
18.333	2.50	2.69	3.830	0				8.13
18.417	2.50	2.66	3.829	0				8.13
18.500	2.48	2.62	3.828	0				8.12
18.583	2.45	2.59	3.827	0				8.12
18.667	2.41	2.56	3.826	0				8.12
18.750	2.38	2.53	3.825	0				8.12
18.833	2.34	2.49	3.824	0				8.12
18.917	2.30	2.46	3.823	0				8.12
19.000	2.25	2.42	3.821	0				8.11
19.083	2.22	2.38	3.820	0				8.11
19.167	2.18	2.35	3.819	0				8.11
19.250	2.14	2.31	3.818	0				8.11
19.333	2.10	2.27	3.817	IO				8.11
19.417	2.07	2.23	3.816	IO				8.11
19.500	2.03	2.20	3.815	IO				8.10
19.583	2.00	2.16	3.813	IO				8.10
19.667	1.97	2.12	3.812	IO				8.10
19.750	1.94	2.09	3.811	0				8.10
19.833	1.91	2.06	3.810	0				8.10
19.917	1.88	2.02	3.809	0				8.10
20.000	1.85	1.99	3.808	0				8.09
20.083	1.82	1.96	3.807	0				8.09
20.167	1.80	1.93	3.806	0				8.09
20.250	1.77	1.90	3.806	0				8.09
20.333	1.75	1.87	3.805	0				8.09
20.417	1.73	1.85	3.804	0				8.09
20.500	1.71	1.82	3.803	0				8.09
20.583	1.68	1.80	3.802	0				8.08
20.667	1.66	1.77	3.802	0				8.08
20.750	1.64	1.75	3.801	0				8.08
20.833	1.62	1.72	3.800	0				8.08
20.917	1.61	1.70	3.799	0				8.08
21.000	1.59	1.68	3.799	0				8.08
21.083	1.57	1.66	3.798	0				8.08
21.167	1.55	1.64	3.797	0				8.08
21.250	1.53	1.62	3.797	0				8.08

21.333	1.52	1.60	3.796	0					8.08
21.417	1.50	1.58	3.796	0					8.07
21.500	1.49	1.57	3.795	0					8.07
21.583	1.47	1.55	3.795	0					8.07
21.667	1.46	1.53	3.794	0					8.07
21.750	1.44	1.52	3.794	0					8.07
21.833	1.43	1.50	3.793	0					8.07
21.917	1.42	1.48	3.793	0					8.07
22.000	1.40	1.47	3.792	0					8.07
22.083	1.39	1.45	3.792	0					8.07
22.167	1.38	1.44	3.791	0					8.07
22.250	1.36	1.43	3.791	0					8.07
22.333	1.35	1.41	3.790	0					8.07
22.417	1.34	1.40	3.790	0					8.07
22.500	1.33	1.39	3.790	0					8.07
22.583	1.32	1.37	3.789	0					8.06
22.667	1.31	1.36	3.789	0					8.06
22.750	1.29	1.35	3.788	0					8.06
22.833	1.28	1.34	3.788	0					8.06
22.917	1.27	1.32	3.788	0					8.06
23.000	1.26	1.31	3.787	0					8.06
23.083	1.25	1.30	3.787	0					8.06
23.167	1.24	1.29	3.787	0					8.06
23.250	1.23	1.28	3.786	0					8.06
23.333	1.22	1.27	3.786	0					8.06
23.417	1.21	1.26	3.786	0					8.06
23.500	1.21	1.25	3.785	0					8.06
23.583	1.20	1.24	3.785	0					8.06
23.667	1.19	1.23	3.785	0					8.06
23.750	1.18	1.22	3.785	0					8.06
23.833	1.17	1.21	3.784	0					8.06
23.917	1.16	1.20	3.784	0					8.06
24.000	1.15	1.19	3.784	0					8.06
24.083	1.10	1.18	3.783	0					8.06
24.167	0.75	1.13	3.782	0					8.05
24.250	0.42	1.02	3.778	0					8.05
24.333	0.28	0.88	3.774	0					8.04
24.417	0.19	0.75	3.770	0					8.04
24.500	0.14	0.63	3.767	0					8.03
24.583	0.10	0.53	3.763	0					8.03
24.667	0.07	0.44	3.761	0					8.02
24.750	0.05	0.36	3.758	0					8.02
24.833	0.03	0.30	3.756	0					8.01
24.917	0.02	0.24	3.755	0					8.01
25.000	0.02	0.20	3.753	0					8.01
25.083	0.01	0.16	3.752	0					8.01
25.167	0.00	0.13	3.751	0					8.01
25.250	0.00	0.11	3.750	0					8.00
25.333	0.00	0.08	3.750	0					8.00
25.417	0.00	0.07	3.749	0					8.00
25.500	0.00	0.05	3.749	0					8.00
25.583	0.00	0.04	3.748	0					8.00
25.667	0.00	0.03	3.748	0					8.00

25.750	0.00	0.03	3.748	0					8.00
25.833	0.00	0.02	3.748	0					8.00
25.917	0.00	0.02	3.748	0					8.00
26.000	0.00	0.01	3.747	0					8.00
26.083	0.00	0.01	3.747	0					8.00
26.167	0.00	0.01	3.747	0					8.00
26.250	0.00	0.01	3.747	0					8.00
26.333	0.00	0.01	3.747	0					8.00
26.417	0.00	0.00	3.747	0					8.00
26.500	0.00	0.00	3.747	0					8.00
26.583	0.00	0.00	3.747	0					8.00
26.667	0.00	0.00	3.747	0					8.00
26.750	0.00	0.00	3.747	0					8.00
26.833	0.00	0.00	3.747	0					8.00
26.917	0.00	0.00	3.747	0					8.00
27.000	0.00	0.00	3.747	0					8.00

Remaining water in basin = 3.75 (Ac.Ft)

*****HYDROGRAPH

DATA*****

Number of intervals = 324
Time interval = 5.0 (Min.)
Maximum/Peak flow rate = 17.579 (CFS)
Total volume = 2.398 (Ac.Ft)
Status of hydrographs being held in storage

	Stream 1	Stream 2	Stream 3	Stream 4	Stream 5
Peak (CFS)	0.000	0.000	0.000	0.000	0.000
Vol (Ac.Ft)	0.000	0.000	0.000	0.000	0.000

++++
Process from Point/Station 100.000 to Point/Station 101.000
**** PRINT CURRENT HYDROGRAPH ****

++++
P R I N T O F S T O R M
R u n o f f H y d r o g r a p h

Hydrograph in 5 Minute intervals (CFS)

Time(h+m)	Volume(Ac.Ft)	Q(CFS)	0	4.4	8.8	13.2	17.6
0+ 5	0.0000	0.00	Q				
0+10	0.0000	0.00	Q				
0+15	0.0000	0.00	Q				

0+20	0.0000	0.00	Q
0+25	0.0000	0.00	Q
0+30	0.0000	0.00	Q
0+35	0.0000	0.00	Q
0+40	0.0000	0.00	Q
0+45	0.0000	0.00	Q
0+50	0.0000	0.00	Q
0+55	0.0000	0.00	Q
1+ 0	0.0000	0.00	Q
1+ 5	0.0000	0.00	Q
1+10	0.0000	0.00	Q
1+15	0.0000	0.00	Q
1+20	0.0000	0.00	Q
1+25	0.0000	0.00	Q
1+30	0.0000	0.00	Q
1+35	0.0000	0.00	Q
1+40	0.0000	0.00	Q
1+45	0.0000	0.00	Q
1+50	0.0000	0.00	Q
1+55	0.0000	0.00	Q
2+ 0	0.0000	0.00	Q
2+ 5	0.0000	0.00	Q
2+10	0.0000	0.00	Q
2+15	0.0000	0.00	Q
2+20	0.0000	0.00	Q
2+25	0.0000	0.00	Q
2+30	0.0000	0.00	Q
2+35	0.0000	0.00	Q
2+40	0.0000	0.00	Q
2+45	0.0000	0.00	Q
2+50	0.0000	0.00	Q
2+55	0.0000	0.00	Q
3+ 0	0.0000	0.00	Q
3+ 5	0.0000	0.00	Q
3+10	0.0000	0.00	Q
3+15	0.0000	0.00	Q
3+20	0.0000	0.00	Q
3+25	0.0000	0.00	Q
3+30	0.0000	0.00	Q
3+35	0.0000	0.00	Q
3+40	0.0000	0.00	Q
3+45	0.0000	0.00	Q
3+50	0.0000	0.00	Q
3+55	0.0000	0.00	Q
4+ 0	0.0000	0.00	Q
4+ 5	0.0000	0.00	Q
4+10	0.0000	0.00	Q
4+15	0.0000	0.00	Q
4+20	0.0000	0.00	Q
4+25	0.0000	0.00	Q
4+30	0.0000	0.00	Q
4+35	0.0000	0.00	Q
4+40	0.0000	0.00	Q

4+45	0.0000	0.00	Q
4+50	0.0000	0.00	Q
4+55	0.0000	0.00	Q
5+ 0	0.0000	0.00	Q
5+ 5	0.0000	0.00	Q
5+10	0.0000	0.00	Q
5+15	0.0000	0.00	Q
5+20	0.0000	0.00	Q
5+25	0.0000	0.00	Q
5+30	0.0000	0.00	Q
5+35	0.0000	0.00	Q
5+40	0.0000	0.00	Q
5+45	0.0000	0.00	Q
5+50	0.0000	0.00	Q
5+55	0.0000	0.00	Q
6+ 0	0.0000	0.00	Q
6+ 5	0.0000	0.00	Q
6+10	0.0000	0.00	Q
6+15	0.0000	0.00	Q
6+20	0.0000	0.00	Q
6+25	0.0000	0.00	Q
6+30	0.0000	0.00	Q
6+35	0.0000	0.00	Q
6+40	0.0000	0.00	Q
6+45	0.0000	0.00	Q
6+50	0.0000	0.00	Q
6+55	0.0000	0.00	Q
7+ 0	0.0000	0.00	Q
7+ 5	0.0000	0.00	Q
7+10	0.0000	0.00	Q
7+15	0.0000	0.00	Q
7+20	0.0000	0.00	Q
7+25	0.0000	0.00	Q
7+30	0.0000	0.00	Q
7+35	0.0000	0.00	Q
7+40	0.0000	0.00	Q
7+45	0.0000	0.00	Q
7+50	0.0000	0.00	Q
7+55	0.0000	0.00	Q
8+ 0	0.0000	0.00	Q
8+ 5	0.0000	0.00	Q
8+10	0.0000	0.00	Q
8+15	0.0000	0.00	Q
8+20	0.0000	0.00	Q
8+25	0.0000	0.00	Q
8+30	0.0000	0.00	Q
8+35	0.0000	0.00	Q
8+40	0.0000	0.00	Q
8+45	0.0000	0.00	Q
8+50	0.0000	0.00	Q
8+55	0.0000	0.00	Q
9+ 0	0.0000	0.00	Q
9+ 5	0.0000	0.00	Q

9+10	0.0000	0.00	Q
9+15	0.0000	0.00	Q
9+20	0.0000	0.00	Q
9+25	0.0000	0.00	Q
9+30	0.0000	0.00	Q
9+35	0.0000	0.00	Q
9+40	0.0000	0.00	Q
9+45	0.0000	0.00	Q
9+50	0.0000	0.00	Q
9+55	0.0000	0.00	Q
10+ 0	0.0000	0.00	Q
10+ 5	0.0000	0.00	Q
10+10	0.0000	0.00	Q
10+15	0.0000	0.00	Q
10+20	0.0000	0.00	Q
10+25	0.0000	0.00	Q
10+30	0.0000	0.00	Q
10+35	0.0000	0.00	Q
10+40	0.0000	0.00	Q
10+45	0.0000	0.00	Q
10+50	0.0000	0.00	Q
10+55	0.0000	0.00	Q
11+ 0	0.0000	0.00	Q
11+ 5	0.0000	0.00	Q
11+10	0.0000	0.00	Q
11+15	0.0000	0.00	Q
11+20	0.0000	0.00	Q
11+25	0.0000	0.00	Q
11+30	0.0000	0.00	Q
11+35	0.0000	0.00	Q
11+40	0.0000	0.00	Q
11+45	0.0000	0.00	Q
11+50	0.0000	0.00	Q
11+55	0.0000	0.00	Q
12+ 0	0.0000	0.00	Q
12+ 5	0.0000	0.00	Q
12+10	0.0000	0.00	Q
12+15	0.0000	0.00	Q
12+20	0.0000	0.00	Q
12+25	0.0000	0.00	Q
12+30	0.0000	0.00	Q
12+35	0.0000	0.00	Q
12+40	0.0000	0.00	Q
12+45	0.0000	0.00	Q
12+50	0.0000	0.00	Q
12+55	0.0000	0.00	Q
13+ 0	0.0000	0.00	Q
13+ 5	0.0000	0.00	Q
13+10	0.0000	0.00	Q
13+15	0.0000	0.00	Q
13+20	0.0000	0.00	Q
13+25	0.0000	0.00	Q
13+30	0.0000	0.00	Q

13+35	0.0000	0.00	Q				
13+40	0.0000	0.00	Q				
13+45	0.0000	0.00	Q				
13+50	0.0000	0.00	Q				
13+55	0.0000	0.00	Q				
14+ 0	0.0000	0.00	Q				
14+ 5	0.0000	0.00	Q				
14+10	0.0000	0.00	Q				
14+15	0.0000	0.00	Q				
14+20	0.0000	0.00	Q				
14+25	0.0000	0.00	Q				
14+30	0.0000	0.00	Q				
14+35	0.0000	0.00	Q				
14+40	0.0000	0.00	Q				
14+45	0.0000	0.00	Q				
14+50	0.0000	0.00	Q				
14+55	0.0000	0.00	Q				
15+ 0	0.0000	0.00	Q				
15+ 5	0.0000	0.00	Q				
15+10	0.0000	0.00	Q				
15+15	0.0000	0.00	Q				
15+20	0.0000	0.00	Q				
15+25	0.0000	0.00	Q				
15+30	0.0000	0.00	Q				
15+35	0.0000	0.00	Q				
15+40	0.0000	0.00	Q				
15+45	0.0000	0.00	Q				
15+50	0.0000	0.00	Q				
15+55	0.0000	0.00	Q				
16+ 0	0.0000	0.00	Q				
16+ 5	0.0000	0.00	Q				
16+10	0.0000	0.00	Q				
16+15	0.0242	3.51	V	Q			
16+20	0.1121	12.77	V			Q	
16+25	0.2251	16.40	V				Q
16+30	0.3461	17.58	V				Q
16+35	0.4662	17.43	V				Q
16+40	0.5804	16.58	V				Q
16+45	0.6866	15.42	V			Q	
16+50	0.7837	14.11	V			Q	
16+55	0.8716	12.76	V			Q	
17+ 0	0.9505	11.45	V			Q	
17+ 5	1.0211	10.26	V			Q	
17+10	1.0845	9.20	V			Q	
17+15	1.1411	8.23	V			Q	
17+20	1.1915	7.31	V			Q	
17+25	1.2361	6.48	V			Q	
17+30	1.2758	5.76	V			Q	
17+35	1.3113	5.15	V			Q	
17+40	1.3433	4.64	V			Q	
17+45	1.3722	4.20	V			Q	
17+50	1.3986	3.83	V			Q	
17+55	1.4228	3.51	V			Q	

18+ 0	1.4451	3.24	Q	V
18+ 5	1.4659	3.01	Q	V
18+10	1.4854	2.84	Q	V
18+15	1.5044	2.75	Q	V
18+20	1.5229	2.69	Q	V
18+25	1.5412	2.66	Q	V
18+30	1.5593	2.62	Q	V
18+35	1.5771	2.59	Q	V
18+40	1.5947	2.56	Q	V
18+45	1.6121	2.53	Q	V
18+50	1.6293	2.49	Q	V
18+55	1.6462	2.46	Q	V
19+ 0	1.6629	2.42	Q	V
19+ 5	1.6793	2.38	Q	V
19+10	1.6954	2.35	Q	V
19+15	1.7113	2.31	Q	V
19+20	1.7269	2.27	Q	V
19+25	1.7423	2.23	Q	V
19+30	1.7575	2.20	Q	V
19+35	1.7723	2.16	Q	V
19+40	1.7870	2.12	Q	V
19+45	1.8014	2.09	Q	V
19+50	1.8155	2.06	Q	V
19+55	1.8295	2.02	Q	V
20+ 0	1.8432	1.99	Q	V
20+ 5	1.8567	1.96	Q	V
20+10	1.8700	1.93	Q	V
20+15	1.8831	1.90	Q	V
20+20	1.8960	1.87	Q	V
20+25	1.9087	1.85	Q	V
20+30	1.9212	1.82	Q	V
20+35	1.9336	1.80	Q	V
20+40	1.9458	1.77	Q	V
20+45	1.9578	1.75	Q	V
20+50	1.9697	1.72	Q	V
20+55	1.9814	1.70	Q	V
21+ 0	1.9930	1.68	Q	V
21+ 5	2.0044	1.66	Q	V
21+10	2.0157	1.64	Q	V
21+15	2.0269	1.62	Q	V
21+20	2.0379	1.60	Q	V
21+25	2.0488	1.58	Q	V
21+30	2.0596	1.57	Q	V
21+35	2.0703	1.55	Q	V
21+40	2.0808	1.53	Q	V
21+45	2.0913	1.52	Q	V
21+50	2.1016	1.50	Q	V
21+55	2.1118	1.48	Q	V
22+ 0	2.1219	1.47	Q	V
22+ 5	2.1319	1.45	Q	V
22+10	2.1419	1.44	Q	V
22+15	2.1517	1.43	Q	V
22+20	2.1614	1.41	Q	V

22+25	2.1710	1.40	Q	V
22+30	2.1806	1.39	Q	V
22+35	2.1900	1.37	Q	V
22+40	2.1994	1.36	Q	V
22+45	2.2087	1.35	Q	V
22+50	2.2179	1.34	Q	V
22+55	2.2270	1.32	Q	V
23+ 0	2.2360	1.31	Q	V
23+ 5	2.2450	1.30	Q	V
23+10	2.2539	1.29	Q	V
23+15	2.2627	1.28	Q	V
23+20	2.2715	1.27	Q	V
23+25	2.2801	1.26	Q	V
23+30	2.2887	1.25	Q	V
23+35	2.2973	1.24	Q	V
23+40	2.3058	1.23	Q	V
23+45	2.3142	1.22	Q	V
23+50	2.3225	1.21	Q	V
23+55	2.3308	1.20	Q	V
24+ 0	2.3390	1.19	Q	V
24+ 5	2.3472	1.18	Q	V
24+10	2.3549	1.13	Q	V
24+15	2.3619	1.02	Q	V
24+20	2.3680	0.88	Q	V
24+25	2.3732	0.75	Q	V
24+30	2.3776	0.63	Q	V
24+35	2.3812	0.53	Q	V
24+40	2.3843	0.44	Q	V
24+45	2.3868	0.36	Q	V
24+50	2.3889	0.30	Q	V
24+55	2.3905	0.24	Q	V
25+ 0	2.3919	0.20	Q	V
25+ 5	2.3930	0.16	Q	V
25+10	2.3939	0.13	Q	V
25+15	2.3947	0.11	Q	V
25+20	2.3952	0.08	Q	V
25+25	2.3957	0.07	Q	V
25+30	2.3961	0.05	Q	V
25+35	2.3964	0.04	Q	V
25+40	2.3966	0.03	Q	V
25+45	2.3968	0.03	Q	V
25+50	2.3969	0.02	Q	V
25+55	2.3971	0.02	Q	V
26+ 0	2.3971	0.01	Q	V
26+ 5	2.3972	0.01	Q	V
26+10	2.3973	0.01	Q	V
26+15	2.3973	0.01	Q	V
26+20	2.3974	0.01	Q	V
26+25	2.3974	0.00	Q	V
26+30	2.3974	0.00	Q	V
26+35	2.3975	0.00	Q	V
26+40	2.3975	0.00	Q	V
26+45	2.3975	0.00	Q	V

26+50	2.3975	0.00	Q				V
26+55	2.3975	0.00	Q				V
27+ 0	2.3975	0.00	Q				V

*****HYDROGRAPH

DATA*****

Number of intervals = 324
Time interval = 5.0 (Min.)
Maximum/Peak flow rate = 17.579 (CFS)
Total volume = 2.398 (Ac.Ft)
Status of hydrographs being held in storage

	Stream 1	Stream 2	Stream 3	Stream 4	Stream 5
Peak (CFS)	0.000	0.000	0.000	0.000	0.000
Vol (Ac.Ft)	0.000	0.000	0.000	0.000	0.000
