

BCI IV HARVILL INDUSTRIAL CENTER (PPT220001)

TRAFFIC ANALYSIS

PREPARED BY: Charlene So | cso@urbanxroads.com
Aric Evatt | aevatt@urbanxroads.com



TABLE OF CONTENTS

Table of Contents	ii
Appendices.....	iv
List of Exhibits.....	v
List of Tables	vi
List of Abbreviated Terms	vii
1 Introduction.....	1
1.1 Summary of Findings	1
1.2 Project Overview	3
1.3 Analysis Scenarios.....	3
1.4 Study Area	5
1.5 Deficiencies	7
1.6 Recommendations.....	9
1.7 Truck Access.....	13
1.8 Queuing Analysis	13
2 Methodologies	17
2.1 Level of Service.....	17
2.2 Intersection Capacity Analysis.....	17
2.3 Traffic Signal Warrant Analysis Methodology	19
2.4 Queuing Analysis	20
2.5 Minimum Acceptable Levels of Service (LOS).....	21
2.6 Deficiency Criteria.....	22
2.7 Project Fair Share Calculation Methodology	22
3 Area Conditions	23
3.1 Existing Circulation Network	23
3.2 County of Riverside General Plan Circulation Element.....	23
3.3 City of Perris General Plan Circulation Element.....	27
3.4 Bicycle & Pedestrian Facilities.....	27
3.5 Transit Service.....	27
3.6 Truck Routes.....	27
3.7 Existing (2022) Traffic Counts.....	35
3.8 Intersection Operations Analysis.....	37
3.9 Traffic Signal Warrants Analysis.....	37
3.10 Queuing Analysis	37
4 Projected Future Traffic.....	39
4.1 Project Trip Generation	39

4.2	Project Trip Distribution	44
4.3	Modal Split	44
4.4	Project Trip Assignment.....	44
4.5	Background Traffic.....	48
4.6	Cumulative Development Traffic.....	48
4.7	Near-Term Traffic Conditions.....	52
5	EAP (2024) Traffic Conditions.....	53
5.1	Roadway Improvements	53
5.2	EAP (2024) Traffic Volume Forecasts.....	53
5.3	Intersection Operations Analysis.....	53
5.4	Traffic Signal Warrants Analysis.....	55
5.5	Queuing Analysis	55
5.5	Project Deficiencies and Recommended Improvements.....	56
6	EAPC (2024) Traffic Conditions	57
6.1	Roadway Improvements	57
6.2	EAPC (2024) Traffic Volume Forecasts.....	57
6.3	Intersection Operations Analysis.....	57
6.4	Traffic Signal Warrants Analysis.....	59
6.5	Queuing Analysis	60
6.6	Near-Term Deficiencies and Recommended Improvements.....	61
7	Local and Regional Funding Mechanisms	63
7.1	Riverside County Transportation Uniform Mitigation Fee (TUMF).....	63
7.2	Riverside County Development Impact Fee (DIF) Program.....	63
7.3	Measure A.....	63
7.4	Fair Share Contribution.....	64
8	References.....	65

APPENDICES

Appendix 1.1: Approved Traffic Study Scoping Agreement

Appendix 1.2: Site Adjacent Queues

Appendix 3.1: Traffic Counts – February 2022

Appendix 3.2: Existing (2022) Conditions Intersection Operations Analysis Worksheets

Appendix 3.3: Existing (2022) Conditions Traffic Signal Warrant Analysis Worksheets

Appendix 3.4: Existing (2022) Conditions Freeway Off-Ramp Queuing Analysis Worksheets

Appendix 5.1: EAP (2024) Conditions Intersection Operations Analysis Worksheets

Appendix 5.2: EAP (2024) Conditions Traffic Signal Warrant Analysis Worksheets

Appendix 5.3: EAP (2024) Conditions Freeway Off-Ramp Queuing Analysis Worksheets

Appendix 6.1: EAPC (2024) Conditions Intersection Operations Analysis Worksheets

Appendix 6.2: EAPC (2024) Conditions Traffic Signal Warrant Analysis Worksheets

Appendix 6.3: EAPC (2024) Conditions Freeway Off-Ramp Queuing Analysis Worksheets

Appendix 6.4: EAPC (2024) Conditions Intersection Operations Analysis Worksheets With Improvements

Appendix 6.5: EAPC (2024) Conditions Freeway Off-Ramp Queuing Analysis Worksheets With Improvements

LIST OF EXHIBITS

Exhibit 1-1: Location Map.....	2
Exhibit 1-2: Preliminary Site Plan	4
Exhibit 1-3: Study Area.....	6
Exhibit 1-4: Site Access Recommendations	10
Exhibit 1-5: Concept Striping Plan.....	11
Exhibit 1-6: Driveway 1 Truck Access.....	14
Exhibit 1-7: Driveway 3 Truck Access.....	15
Exhibit 3-1: Existing Number of Through Lanes and Intersection Controls	24
Exhibit 3-2: County of Riverside General Plan Circulation Element.....	25
Exhibit 3-3: County of Riverside General Plan Roadway Cross-Sections	26
Exhibit 3-4: City of Perris General Plan Circulation Element	28
Exhibit 3-5: City of Perris General Plan Roadway Cross-Sections.....	29
Exhibit 3-6: County of Riverside General Plan Bike Network	30
Exhibit 3-7: City of Perris Bike Plan	31
Exhibit 3-8: Existing Pedestrian Facilities	32
Exhibit 3-9: Existing Transit Routes.....	33
Exhibit 3-10: City of Perris Truck Routes	34
Exhibit 3-11: Existing (2022) Traffic Volumes.....	36
Exhibit 4-1: Project (Truck) Trip Distribution.....	45
Exhibit 4-2: Project (Passenger Car) Trip Distribution	46
Exhibit 4-3: Project Only Traffic volumes	47
Exhibit 4-4: Cumulative Development Location Map	49
Exhibit 4-5: Cumulative Only Traffic Volumes	50
Exhibit 5-1: EAP (2024) Traffic Volumes.....	54
Exhibit 6-1: EAPC (2024) Traffic Volumes	58

LIST OF TABLES

Table 1-1: Intersection Analysis Locations	7
Table 1-2: Summary of LOS.....	7
Table 1-3: Summary of Improvements by Analysis Scenario	12
Table 1-4: PEAK HOUR QUEUING ANALYSIS FOR Site adjacent intersections.....	13
Table 2-1: Signalized Intersection LOS Thresholds.....	18
Table 2-2: Unsignalized Intersection LOS Thresholds	19
Table 2-3: Traffic Signal Warrant Analysis Locations	20
Table 3-1: Intersection Analysis for Existing (2022) Conditions	37
Table 3-2: Peak Hour Queuing Summary for Existing (2022) Conditions	38
Table 4-1: Trip Generation Rates.....	40
Table 4-2: Project Trip Generation Summary (Actual Vehicles).....	41
Table 4-3: Project Trip Generation Summary (PCE).....	41
Table 4-4: Trip Generation Rates.....	42
Table 4-5: Trip Generation Summary for Warehousing Use (Actual Vehicles).....	43
Table 4-6: Trip Generation Summary for Warehousing Use (PCE)	43
Table 4-7: Cumulative Development land use Summary.....	51
Table 5-1: Intersection Analysis for EAP (2024) Conditions	55
Table 5-2: Peak Hour Queuing Summary for EAP (2024) Conditions	56
Table 6-1: Intersection Analysis for EAPC (2024) Conditions.....	59
Table 6-2: Peak Hour Queuing Summary for EAPC (2024) Conditions.....	60
Table 6-3: Intersection Analysis for EAPC (2024) Conditions With Improvements.....	61
Table 6-4: Peak Hour Queuing Summary for EAPC (2024) Conditions With improvements.....	62
Table 7-1: Project Fair Share Calculations.....	64

LIST OF ABBREVIATED TERMS

(1)	Reference
ADT	Average Daily Traffic
CAMUTCD	California Manual on Uniform Traffic Control Devices
Caltrans	California Department of Transportation
CEQA	California Environmental Quality Act
CMP	Congestion Management Program
DIF	Development Impact Fee
EAP	Existing Plus Ambient Growth Plus Project
EAPC	Existing Plus Ambient Growth Plus Project Plus Cumulative
HCM	Highway Capacity Manual
ITE	Institute of Transportation Engineers
LOS	Level of Service
OPR	Office of Planning and Research
PHF	Peak Hour Factor
Project	BCI IV Harvill Industrial Center
RCTC	Riverside County Transportation Commission
RTA	Riverside Transit Authority
SCAG	Southern California Association of Governments
sf	Square Feet
SHS	State Highway System
TA	Traffic Analysis
TUMF	Transportation Uniform Mitigation Fee
WRCOG	Western Riverside Council of Governments
v/c	Volume to Capacity
VMT	Vehicle Miles Traveled
vphgpl	Vehicles per Hour Green per Lane

This page intentionally left blank

1 INTRODUCTION

This report presents the results of the Traffic Analysis (TA) for BCI IV Harvill Industrial Center development ("Project"), which is located on the northeast corner of Harvill Avenue and Cajalco Road in the County of Riverside, as shown on Exhibit 1-1. The purpose of this TA is to evaluate the potential circulation system deficiencies that may result from the development of the proposed Project, and where necessary recommend improvements to achieve acceptable operations consistent with the County's General Plan level of service goals and policies. This TA has been prepared in accordance with the County of Riverside's Transportation Analysis Guidelines for Level of Service and Vehicle Miles Traveled (December 2020) and through consultation with County of Riverside staff during the scoping process. (1) The Project traffic study scoping agreement is provided in Appendix 1.1 of this TA, which has been reviewed and approved by the County of Riverside.

1.1 SUMMARY OF FINDINGS

The Project is to construct the following improvements as design features in conjunction with development of the site:

- Harvill Avenue is currently built to its ultimate cross-section as a Major Highway (118-foot right-of-way) along the Project's frontage between the northerly Project boundary to Cajalco Road consistent with the County's standards. However, the Project should modify the existing curb-and-gutter improvements to accommodate a 100-foot minimum northbound right turn pocket at Driveway 1 on Harvill Avenue.
- Similarly, Cajalco Road currently has approximately 40-feet of pavement along the Project's frontage from Harvill Avenue to the easterly Project boundary. There are curb-and-gutter and sidewalk improvements in place on the north side only. Cajalco Road will be improved to include a cul-de-sac at the eastern terminus.
- Project to install stop controls for all egress traffic from each Project driveway. Driveway 1 on Harvill Avenue will be restricted to right-in/right-out access only and will only serve trucks. All other driveways will allow full turning movements.

Additional details and intersection lane geometrics are provided in Section 1.6 *Recommendations* of this report. The proposed Project is not anticipated to require the construction of any off-site improvements but would need to contribute to improvement needs identified at off-site intersections for future near-term cumulative traffic conditions. As such, the Project Applicant's responsibility for the Project's contributions towards deficient off-site intersections is fulfilled through payment into pre-existing fee programs (if applicable) and/or fair share contributions that would be assigned to the future construction of the identified recommended improvements. The Project Applicant would be required to pay requisite fees consistent with the County's requirements (see Section 7 *Local and Regional Funding Mechanisms*).

EXHIBIT 1-1: LOCATION MAP

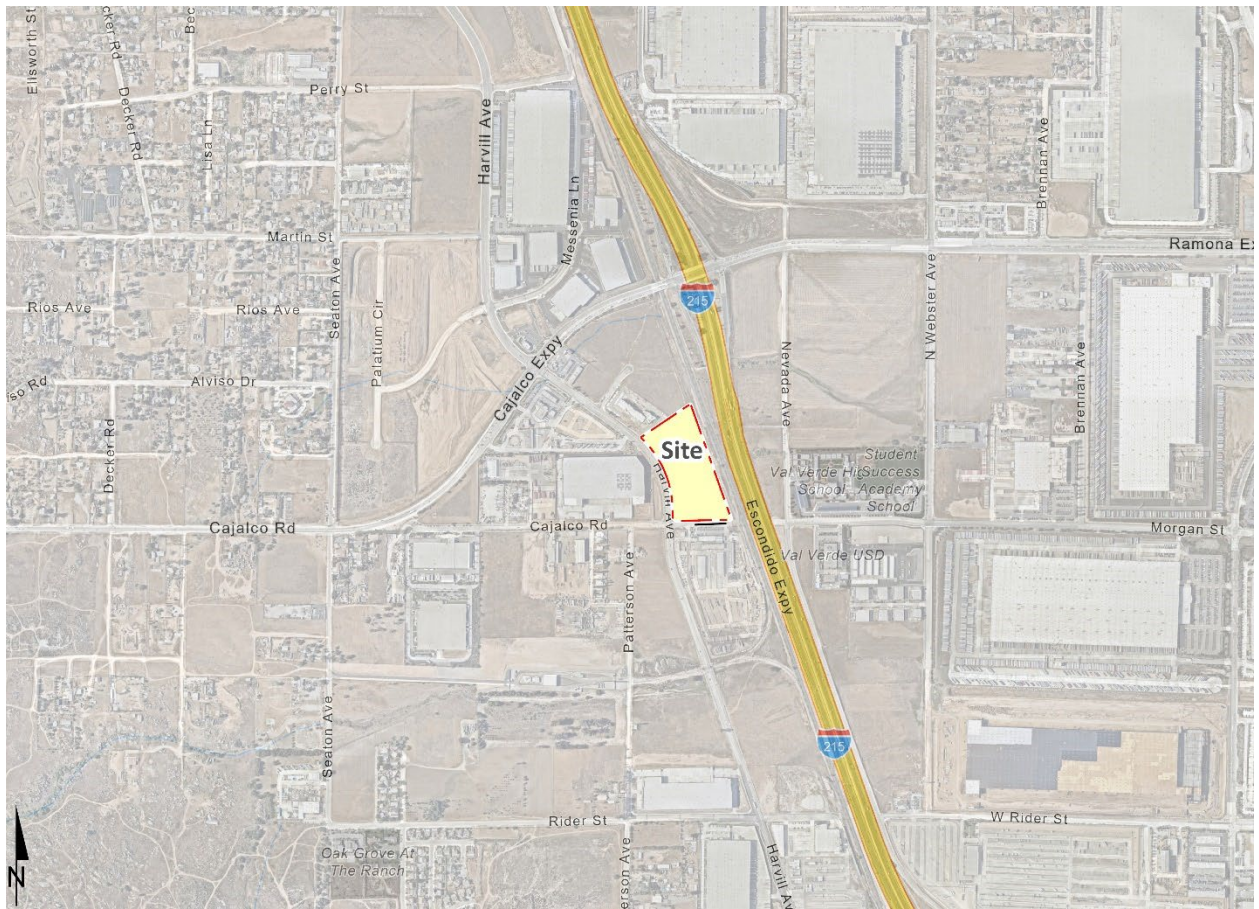

1.2 PROJECT OVERVIEW

A preliminary site plan for the proposed Project is shown on Exhibit 1-2. The Project is proposed to consist of the development of a 99,770 square foot warehouse building with a 118-stall truck parking lot. Although the latest plan reflects 118-stall truck parking lot, the analysis conducted for the purposes of this TA conservatively assumes a 133-stall truck parking lot. For the purposes of the TA, the warehouse building has been evaluated assuming general light industrial use in an effort to conduct a conservative analysis. As indicated on Exhibit 1-2, vehicular access will be provided to Harvill Avenue via a single driveway for trucks only and on Cajalco Road via two driveways (both will have full access with no turn restrictions) where trucks will be served by the easterly driveway only and both driveways on Cajalco Road would accommodate passenger car access. Regional access to the Project site is available from the I-215 Freeway via Placentia Avenue or Ramona Expressway interchanges. In order to develop the traffic characteristics of the proposed project, trip-generation statistics published in the Institute of Transportation Engineers (ITE) Trip Generation Manual for the proposed general light industrial land use and empirical data was used to calculate trip generation for the truck parking lot. (2) The Project is anticipated to generate a net total of 594 two-way trips per day with 76 AM peak hour trips and 66 PM peak hour trips (actual vehicles). However, if the proposed building were to be occupied by a warehouse user, the Project would generate 278 two-way trips per day with 21 AM peak hour trips and 19 PM peak hour trips, which is much lower than the trips evaluated as part of this TA. The assumptions and methods used to estimate the Project's trip generation characteristics are discussed in greater detail in Section 4.1 *Project Trip Generation* of this report.

1.3 ANALYSIS SCENARIOS

For the purposes of this traffic study, potential deficiencies to traffic and circulation have been assessed for each of the following conditions:

- Existing (2022) Conditions
- Existing plus Ambient Growth plus Project (EAP) (2024) Conditions
- Existing plus Ambient Growth plus Project plus Cumulative (EAPC) (2024) Conditions

1.3.1 EXISTING (2022) CONDITIONS

Information for Existing (2022) conditions is disclosed to represent the baseline traffic conditions as they existed at the time this report was prepared. For a detailed discussion on the existing traffic counts, see Section 3.7 *Existing Traffic Counts*.

EXHIBIT 1-2: PRELIMINARY SITE PLAN



1.3.2 EAP (2024) CONDITIONS

The EAP (2024) conditions analysis determines the potential circulation system deficiencies based on a comparison of the EAP traffic conditions to Existing conditions. The roadway network is similar to Existing conditions except for new connections to be constructed by the Project. To account for background traffic growth, an ambient growth factor from Existing (2022) conditions of 4.04% (2 percent per year, compounded over 2 years) is included for EAP (2024) traffic conditions. The assumed ambient growth factor is based on the requirements per the County of Riverside traffic study guidelines. Consistent with Riverside County traffic study guidelines, the EAP analysis is intended to identify “Opening Year” deficiencies associated with the development of the proposed Project based on the expected background growth within the study area.

1.3.3 EAPC (2024) CONDITIONS

The EAPC (2024) traffic conditions analysis determines the potential near-term cumulative circulation system deficiencies. The roadway network is similar to Existing conditions except for new connections to be constructed by the Project. To account for background traffic growth, an ambient growth factor from Existing (2022) conditions of 4.04% (2 percent per year, compounded over 2 years) is included for EAPC (2024) traffic. Conservatively, this TA estimates the area ambient traffic growth and then adds traffic generated by other known or probable related projects. These related projects are at least in part already accounted for in the assumed ambient growth rates; and some of these related projects may not be implemented and operational within the 2024 Opening Year time frame assumed for the Project. The resulting traffic growth utilized in the TA (ambient growth factor plus traffic generated by related projects) would therefore tend to overstate rather than understate background cumulative traffic deficiencies under 2024 conditions.

1.4 STUDY AREA

To ensure that this TA satisfies the County of Riverside’s traffic study requirements, Urban Crossroads, Inc. prepared a Project traffic study scoping package for review by County of Riverside staff prior to the preparation of this report. This agreement provides an outline of the Project study area, trip generation, trip distribution, and analysis methodology. The agreement approved by the City is included in Appendix 1.1 of this TA.

The 9 study area intersections shown on Exhibit 1-3 and listed in Table 1-1 were selected for evaluation in this TA based on consultation with County of Riverside staff. At a minimum, the study area includes intersections where the Project is anticipated to contribute 50 or more peak hour trips per the County’s Guidelines. (1) The “50 peak hour trip” criterion represents a minimum number of trips at which a typical intersection would have the potential to be affected by a given development proposal. The 50 peak hour trip criterion is a traffic engineering rule of thumb that is accepted and used throughout the County for the purposes of estimating a potential area of influence (i.e., study area).

EXHIBIT 1-3: STUDY AREA

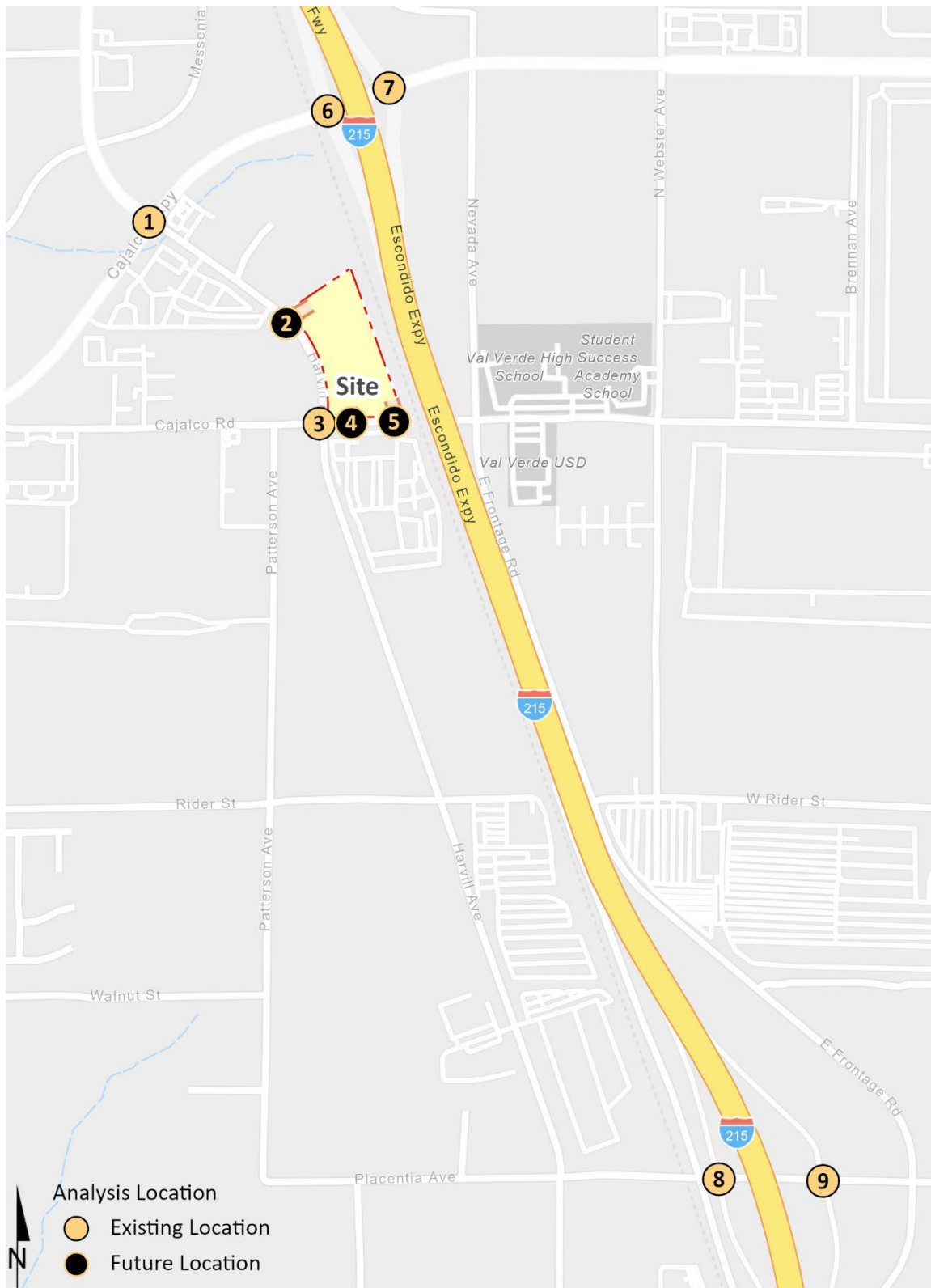

The intent of a Congestion Management Program (CMP) is to more directly link land use, transportation, and air quality, thereby prompting reasonable growth management programs that will effectively utilize new transportation funds, alleviate traffic congestion and related deficiencies, and improve air quality. The County of Riverside CMP became effective with the passage of Proposition 111 in 1990 and most recently updated in 2019 as part of the Riverside County Long Range Transportation Study. The Riverside County Transportation Commission (RCTC) adopted the 2019 CMP for the County of Riverside in December 2019. (3) There are no study area intersections identified as a Riverside County CMP intersection.

TABLE 1-1: INTERSECTION ANALYSIS LOCATIONS

#	Intersection	Jurisdiction	CMP?
1	Harvill Av. & Cajalco Exwy.	County of Riverside	No
2	Harvill Av. & Driveway 1	County of Riverside	No
3	Harvill Av. & Old Cajalco Rd.	County of Riverside	No
4	Driveway 2 & Old Cajalco Rd.	County of Riverside	No
5	Driveway 3 & Old Cajalco Rd.	County of Riverside	No
6	I-215 SB Ramps & Ramona Exwy.	County, Perris, Caltrans	No
7	I-215 NB Ramps & Ramona Exwy.	County, Perris, Caltrans	No
8	I-215 SB Ramps & Placentia Av.	County, Perris, Caltrans	No
9	I-215 NB Ramps & Placentia Av.	Perris, Caltrans	No

1.5 DEFICIENCIES

This section provides a summary of deficiencies by analysis scenario. Section 2 *Methodologies* provides information on the methodologies used in the analysis and Section 5 *EAP (2024) Traffic Conditions* and Section 6 *EAPC (2024) Traffic Conditions* include the detailed analysis. A summary of LOS results for all analysis scenarios is presented on Table 1-2.

TABLE 1-2: SUMMARY OF LOS

#	Intersection	Existing		EAP		EAPC	
		AM	PM	AM	PM	AM	PM
1	Harvill Av. & Cajalco Exwy.	●	●	●	●	●	●
2	Harvill Av. & Driveway 1	N/A	N/A	●	●	●	●
3	Harvill Av. & Old Cajalco Rd.	●	●	●	●	●	●
4	Driveway 2 & Old Cajalco Rd.	N/A	N/A	●	●	●	●
5	Driveway 3 & Old Cajalco Rd.	N/A	N/A	●	●	●	●
6	I-215 SB Ramps & Ramona Exwy.	●	●	●	●	●	●
7	I-215 NB Ramps & Ramona Exwy.	●	●	●	●	●	●
8	I-215 SB Ramps & Placentia Av.	N/A	N/A	●	●	●	●
9	I-215 NB Ramps & Placentia Av.	N/A	N/A	●	●	●	●

● = A - D ● = E ● = F

1.5.1 EXISTING (2022) CONDITIONS

Intersections

The study area intersections are currently operating at an acceptable LOS during the peak hours.

Queues

There are no movements that are currently experiencing queuing issues during the weekday AM or weekday PM peak 95th percentile traffic flows.

1.5.2 EAP (2024) CONDITIONS

Intersections

The study area intersections are anticipated to continue to operate at an acceptable LOS with the addition of Project traffic under EAP (2024) traffic conditions.

Queues

Consistent with Existing traffic conditions, there are no movements that are anticipated to experience queuing issues during the weekday AM or weekday PM peak 95th percentile traffic flows with the addition of Project traffic for EAP (2024) traffic conditions.

1.5.3 EAPC (2024) CONDITIONS

Intersections

The following study area intersections are anticipated to operate at an unacceptable LOS under EAPC (2024) traffic conditions:

- Harvill Av. & Cajalco Exwy. (#1) – LOS E AM peak hour; LOS F PM peak hour
- I-215 SB Ramps & Ramona Exwy. (#6) – LOS F AM and PM peak hours
- I-215 NB Ramps & Ramona Exwy. (#7) – LOS F AM and PM peak hours

Queues

The following turning movements are anticipated to experience queuing issues during the weekday AM or weekday PM peak 95th percentile traffic flows for EAPC (2024) traffic conditions:

- I-215 SB Ramps & Ramona Exwy. (#6): Southbound Left (AM and PM peak hours, Southbound Left-Through (AM and PM peak hours), and Southbound Right (AM peak hour only)

1.6 RECOMMENDATIONS

1.6.1 SITE ADJACENT AND SITE ACCESS RECOMMENDATIONS

The following recommendations are based on the minimum improvements needed to accommodate site access and maintain acceptable peak hour operations for the proposed Project. The site adjacent recommendations are shown on Exhibit 1-4. The site adjacent queuing analysis worksheets are provided in Appendix 1.2. No site adjacent queues are anticipated with the proposed improvements. A concept striping plan has been provided on Exhibit 1-5.

Recommendation 1 – Harvill Av. & Driveway 1 (#1) – The following improvements are necessary to accommodate site access:

- Project to install a stop control on the westbound approach (egress Project traffic) to implement a cross-street stop-controlled intersection. Driveway will be restricted to right-in/right-out access for trucks only.
- Project should construct and accommodate a minimum 100-foot northbound right turn lane on Harvill Avenue at Driveway 1.

Recommendation 2 – Driveway 2 & Cajalco Road (#4) – The following improvement is necessary to accommodate site access:

- Project to install a stop control on the southbound approach (egress Project traffic) to implement a cross-street stop-controlled intersection.

Recommendation 3 – Driveway 3 & Cajalco Road (#5) – The following improvement is necessary to accommodate site access:

- Project to install a stop control on the southbound approach (egress Project traffic) to implement a cross-street stop-controlled intersection.

Recommendation 4 – Harvill Avenue is a north-south oriented roadway located on the Project's western boundary. Harvill Avenue is currently constructed to its ultimate cross-section as a Major Arterial (118-foot right-of-way) consistent with the County's standards; however, the Project should construct the driveways necessary to accommodate site access, including the minimum 100-foot northbound right turn lane at Driveway 1.

Recommendation 5 – Cajalco Road is an east-west oriented roadway located on the Project's southern boundary. Cajalco Road is currently constructed with 40-feet of pavement and also includes sidewalk and curb-and-gutter improvements along the north side of the roadway (along the Project's frontage). The Project will improve Cajalco Road to include a cul-de-sac at the eastern terminus consistent with the County's standards.

EXHIBIT 1-4: SITE ACCESS RECOMMENDATIONS

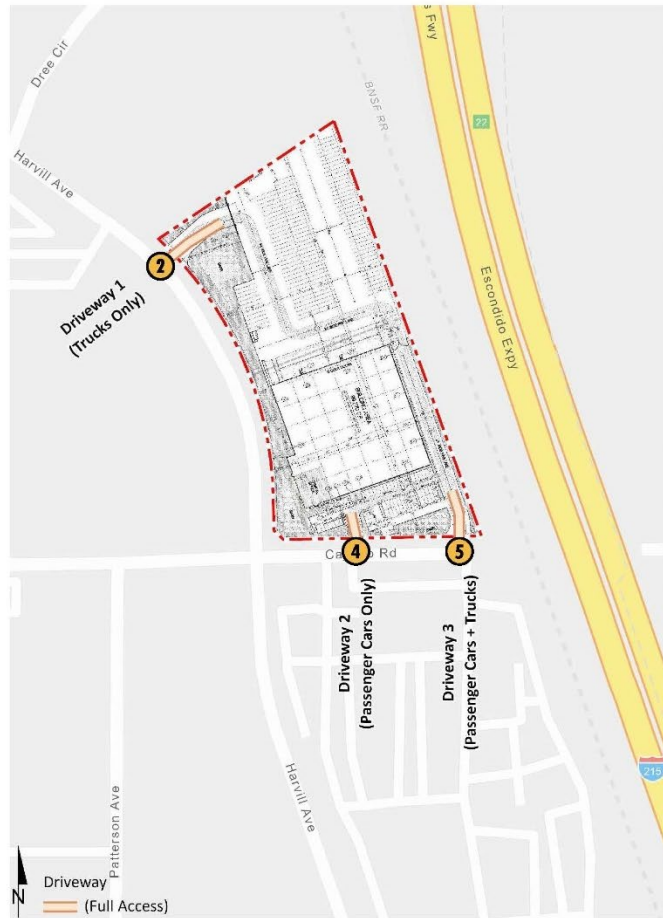

2	Harvill Av. & Dwy. 1	4	Dwy. 2 & Old Cajalco Rd.	5	Dwy. 3 & Old Cajalco Rd.

- = Stop Sign
- = Stop Sign Improvement
- = Existing Lane
- = Lane Improvement
- = Recommended Turn Pocket Length

EXHIBIT 1-5: CONCEPT STRIPING PLAN

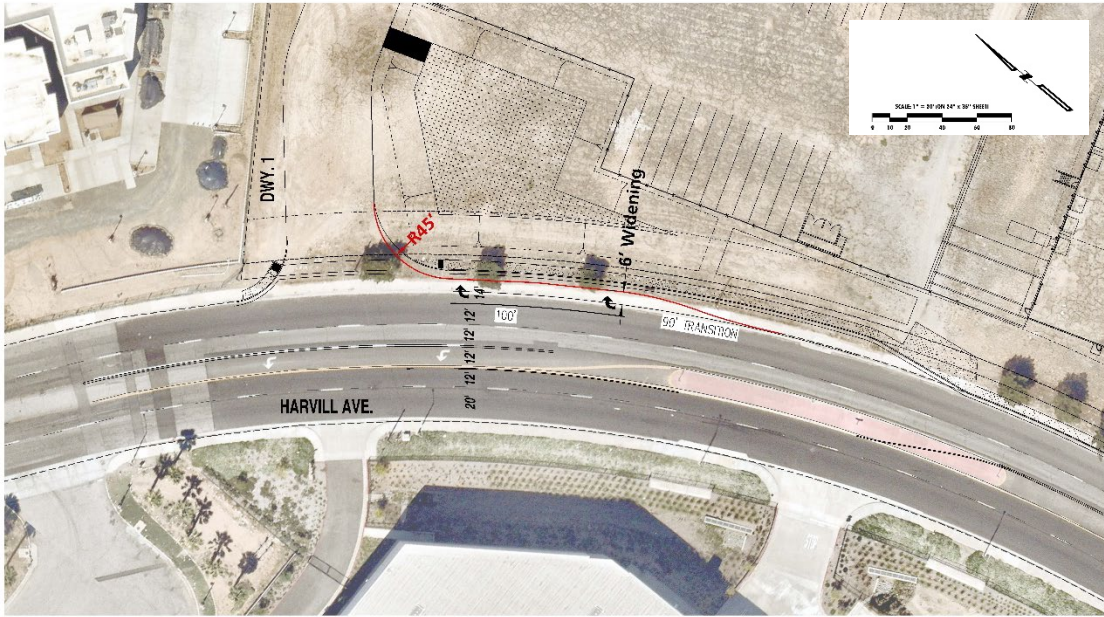

On-site traffic signing and striping should be implemented agreeable with the provisions of the California Manual on Uniform Traffic Control Devices (CA MUTCD) and in conjunction with detailed construction plans for the Project site.

Sight distance at each project access point should be reviewed with respect to standard Caltrans and County of Riverside sight distance standards at the time of preparation of final grading, landscape, and street improvement plans.

1.6.2 OFF-SITE RECOMMENDATIONS

The recommended improvements needed to address the deficiencies identified under Existing (2022), EAP (2024), and EAPC (2024) traffic conditions are shown in Table 1-3. Improvements that appear under EAP (2024) that are not also identified for Existing (2022) traffic conditions would be the Project's responsibility to implement/construct in order to maintain acceptable LOS. For those remaining improvements listed in Table 1-3 and not constructed as part of the Project, the Project Applicant's responsibility for the Project's contributions towards deficient intersections is fulfilled through payment of fair share or payment of fees (if applicable) that would be assigned to construction of the identified recommended improvements. The Project Applicant would be required to pay fair share fees and participate in pre-existing fee programs consistent with the County's requirements (see Section 7 *Local and Regional Funding Mechanisms*).

TABLE 1-3: SUMMARY OF IMPROVEMENTS BY ANALYSIS SCENARIO

#	Intersection Location	Jurisdiction	Analysis Scenario		Improvements in DIF, TUMF, etc. ¹	Project Responsibility ²	Project Fair Share ³
			EAP	EAPC			
1	Harvill Av. & Cajalco Exwy.	County	- None	- Add 3rd EB through lane	No	Fair Share	1.8%
				- Add 3rd WB through lane	No	Fair Share	
6	I-215 SB Ramps & Ramona Exwy.	Caltrans, Perris, County	- None	- Add 2nd WB left turn lane	Yes (TUMF)	Fees	0.4%
				- Add 3rd EB through lane	Yes (TUMF)	Fees	
				- Add 3rd WB through lane	Yes (TUMF)	Fees	
				- Add 2nd SB left turn lane	No	Fair Share	
				- Add EB right turn lane	No	Fair Share	
7	I-215 NB Ramps & Ramona Exwy.	Caltrans, Perris, County	- None	- Add 2nd EB left turn lane	Yes (TUMF)	Fees	0.2%
				- Add 3rd EB through lane	Yes (TUMF)	Fees	
				- Add 3rd WB through lane	Yes (TUMF)	Fees	
				- Add WB free-right turn lane	No	Fair Share	

¹ Improvements included in TUMF Nexus or County DIF programs have been identified as such.

² Program improvements constructed by Project may be eligible for fee credit. In lieu fee payment is at discretion of County.

Represents the fair share percentage for the Project during the most impacted peak hour. Identifies the Project's responsibility to construct an off-site improvement, contribute fair share, or fee payment towards the improvements shown. If identified as a Project construct obligation/in a fee program, then no fair share percentage has been identified.

³ Total project fair share is applicable to the improvements which are not already included in the County DIF/TUMF for those intersections wholly or partially within the County.

1.7 TRUCK ACCESS

Due to the typical wide turning radius of large trucks, a truck turning template has been overlaid on the site plan at each applicable Project driveway anticipated to be utilized by heavy trucks in order to determine appropriate curb radii and to verify that trucks will have sufficient space to execute turning maneuvers (see Exhibit 1-6 and Exhibit 1-7). A WB-67 truck (53-foot trailer) has been utilized for the purposes of this analysis. As shown on Exhibit 1-6 and Exhibit 1-7, the Driveway 1 and Driveway 3 are anticipated to accommodate the ingress and egress of heavy trucks as currently designed.

1.8 QUEUING ANALYSIS

The traffic modeling and signal timing optimization software package SimTraffic has been utilized to assess the queues. SimTraffic is designed to model networks of signalized and unsignalized intersections, with the primary purpose of checking and fine-tuning signal operations. SimTraffic uses the input parameters from Synchro to generate random simulations. These random simulations generated by SimTraffic have been utilized to determine the 95th percentile queue lengths observed for each applicable turn lane. A SimTraffic simulation has been recorded up to 5 times, during the weekday AM and weekday PM peak hours, and has been seeded for 15-minute periods with 60-minute recording intervals. The results of the queuing analysis are shown in Table 1-4 and the worksheets for the weekday AM and PM peak hours are provided in Appendix 1.2 of this report for EAPC (2024) traffic conditions.

TABLE 1-4: PEAK HOUR QUEUING ANALYSIS FOR SITE ADJACENT INTERSECTIONS

Intersection	Movement	Available Stacking Distance (Feet) ³	95th Percentile Queue (Feet)		Acceptable? ¹	
			AM Peak	PM Peak	AM	PM
Harvill Av. & Driveway 1	NBR	100	15	15	Yes	Yes
Old Cajalco Rd. & Driveway 2	SBL/R	50	17	33	Yes	Yes
Old Cajalco Rd. & Driveway 3	SBL/R	50	25	38	Yes	Yes

¹ Stacking Distance is acceptable if the required stacking distance is less than or equal to the stacking distance provided. An additional 15 feet of stacking which is assumed to be provided in the transition for turn pockets is reflected in the stacking distance shown on this table, where applicable.

² 95th percentile volume exceeds capacity, queue may be longer. Queue shown is maximum after two cycles.

³ Although 95th percentile queue is anticipated to exceed the available storage for the turn lane, the adjacent through lane has sufficient storage to accommodate any spillover without spilling back and affecting the I-215 Freeway mainline.

EXHIBIT 1-6: DRIVEWAY 1 TRUCK ACCESS

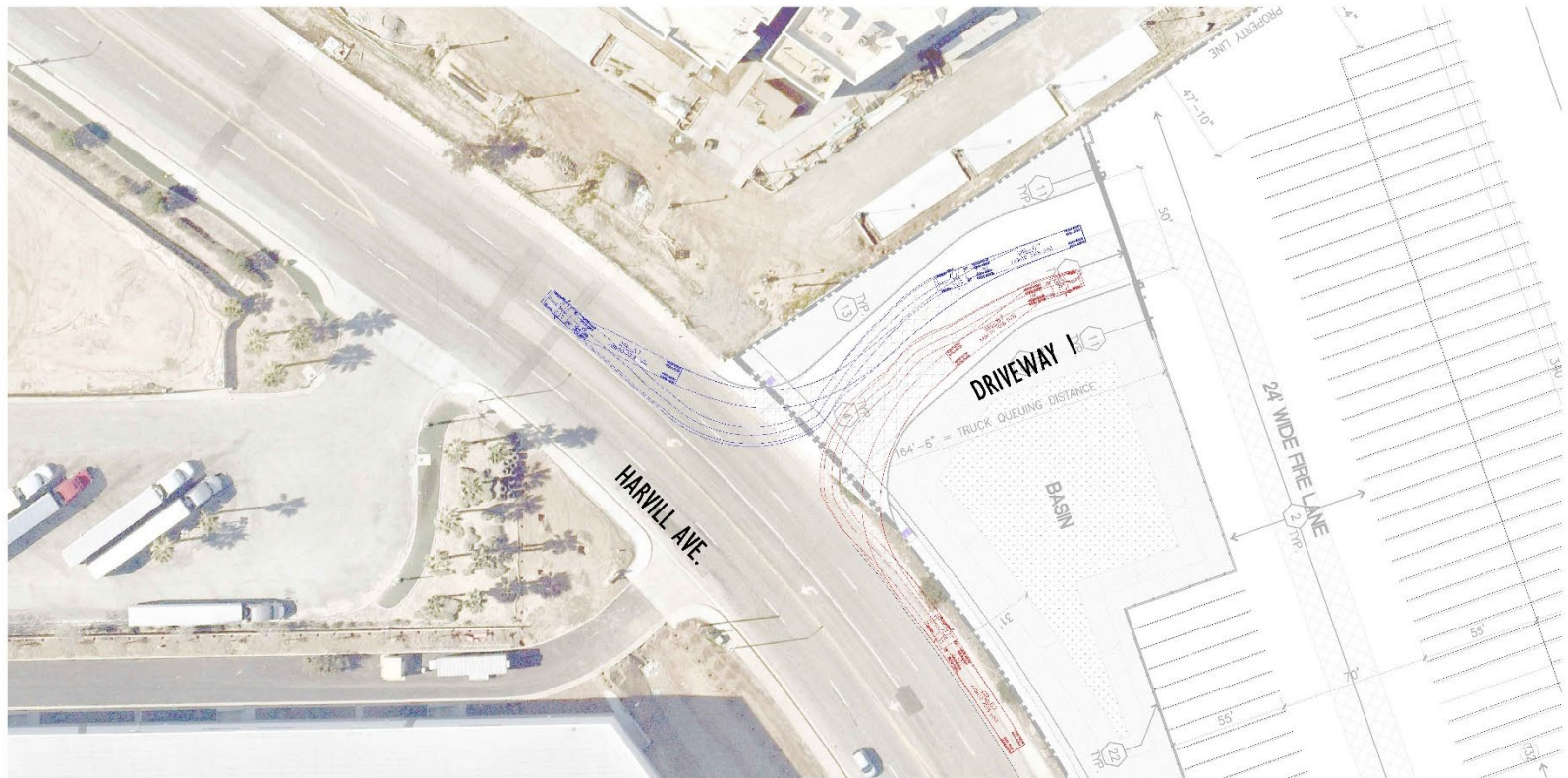

SCALE: 1" = 50' (ON 11" x 17" SHEET)

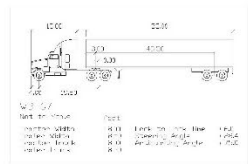

Symbol	Description
[Symbol]	TRUCK
[Symbol]	TRUCK
[Symbol]	TRUCK
[Symbol]	TRUCK

EXHIBIT A: HARVILL AVENUE AT DRIVEWAY 1 TRUCK TURNING TEMPLATES

EXHIBIT 1-7: DRIVEWAY 3 TRUCK ACCESS

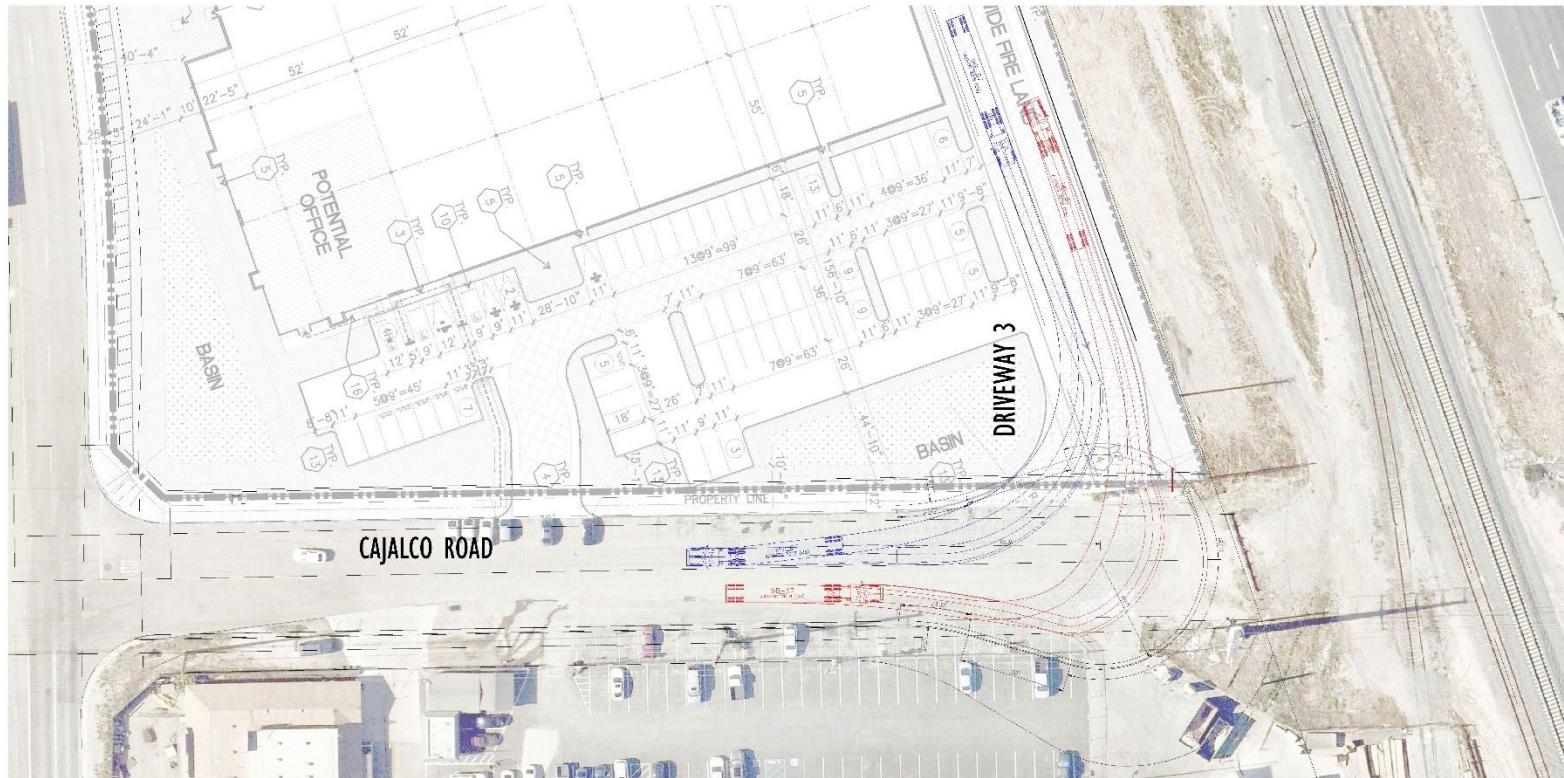

1/4" = 10' (ON 11" x 17" SHEET)
 1/8" = 5' (ON 11" x 17" SHEET)

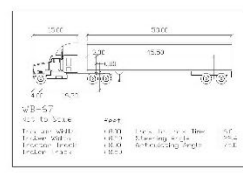
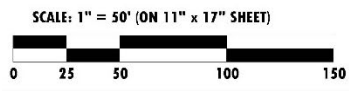

EXHIBIT A: DRIVEWAY 3 AT CAJALCO ROAD TRUCK TURNING TEMPLATES

This page intentionally left blank

2 METHODOLOGIES

This section of the report presents the methodologies used to perform the traffic analyses summarized in this report. The methodologies described are consistent with County of Riverside's Traffic Study Guidelines.

2.1 LEVEL OF SERVICE

Traffic operations of roadway facilities are described using the term "Level of Service" (LOS). LOS is a qualitative description of traffic flow based on several factors, such as speed, travel time, delay, and freedom to maneuver. Six levels are typically defined ranging from LOS A, representing completely free-flow conditions, to LOS F, representing breakdown in flow resulting in stop-and-go conditions. LOS E represents operations at or near capacity, an unstable level where vehicles are operating with the minimum spacing for maintaining uniform flow.

2.2 INTERSECTION CAPACITY ANALYSIS

The definitions of LOS for interrupted traffic flow (flow restrained by the existence of traffic signals and other traffic control devices) differ slightly depending on the type of traffic control. The LOS is typically dependent on the quality of traffic flow at the intersections along a roadway. The 6th Edition Highway Capacity Manual (HCM) methodology expresses the LOS at an intersection in terms of delay time for the various intersection approaches. (4) The HCM uses different procedures depending on the type of intersection control.

2.2.1 SIGNALIZED INTERSECTIONS

The County of Riverside, City of Perris, and California Department of Transportation (Caltrans) require signalized intersection operations analysis based on the methodology described in the HCM. (4) Intersection LOS operations are based on an intersection's average control delay. Control delay includes initial deceleration delay, queue move-up time, stopped delay, and final acceleration delay. For signalized intersections LOS is related to the average control delay per vehicle and is correlated to a LOS designation as described on Table 2-1.

The traffic modeling and signal timing optimization software package Synchro (Version 11) has been utilized to analyze signalized intersections. Synchro is a macroscopic traffic software program that is based on the signalized intersection capacity analysis as specified in the HCM. Macroscopic level models represent traffic in terms of aggregate measures for each movement at the study intersections. Equations are used to determine measures of effectiveness such as delay and queue length. The level of service and capacity analysis performed by Synchro takes into consideration optimization and coordination of signalized intersections within a network.

TABLE 2-1: SIGNALIZED INTERSECTION LOS THRESHOLDS

Description	Average Control Delay (Seconds), V/C ≤ 1.0	Level of Service, V/C ≤ 1.0 ¹
Operations with very low delay occurring with favorable progression and/or short cycle length.	0 to 10.00	A
Operations with low delay occurring with good progression and/or short cycle lengths.	10.01 to 20.00	B
Operations with average delays resulting from fair progression and/or longer cycle lengths. Individual cycle failures begin to appear.	20.01 to 35.00	C
Operations with longer delays due to a combination of unfavorable progression, long cycle lengths, or high V/C ratios. Many vehicles stop and individual cycle failures are noticeable.	35.01 to 55.00	D
Operations with high delay values indicating poor progression, long cycle lengths, and high V/C ratios. Individual cycle failures are frequent occurrences. This is considered to be the limit of acceptable delay.	55.01 to 80.00	E
Operation with delays unacceptable to most drivers occurring due to over saturation, poor progression, or very long cycle lengths.	80.01 and up	F

Source: HCM, 6th Edition

¹ If V/C is greater than 1.0 then LOS is F per HCM.

A saturation flow rate of 1900 has been utilized for all study area intersections located within the County of Riverside and City of Perris. The peak hour traffic volumes have been adjusted using a peak hour factor (PHF) to reflect peak 15-minute volumes. Customary practice for LOS analysis is to use a peak 15-minute rate of flow. However, flow rates are typically expressed in vehicles per hour. The PHF is the relationship between the peak 15-minute flow rate and the full hourly volume (e.g., PHF = [Hourly Volume] / [4 x Peak 15-minute Flow Rate]). The use of a 15-minute PHF produces a more detailed analysis as compared to analyzing vehicles per hour. Existing PHFs have been used for all analysis scenarios. Per the HCM, PHF values over 0.95 often are indicative of high traffic volumes with capacity constraints on peak hour flows while lower PHF values are indicative of greater variability of flow during the peak hour. (4)

2.2.2 UNSIGNALIZED INTERSECTIONS

The County of Riverside and City of Perris require the operations of unsignalized intersections be evaluated using the methodology described in the HCM. (4) The LOS rating is based on the weighted average control delay expressed in seconds per vehicle (see Table 2-2). At two-way or side-street stop-controlled intersections, LOS is calculated for each controlled movement and for the left turn movement from the major street, as well as for the intersection as a whole. For approaches composed of a single lane, the delay is computed as the average of all movements in that lane. Delay for the intersection is reported for the worst individual movement at a two-way stop-controlled intersection. For all-way stop controlled intersections, LOS is computed for the intersection as a whole (average delay).

TABLE 2-2: UNSIGNALIZED INTERSECTION LOS THRESHOLDS

Description	Average Control Delay (Seconds), V/C ≤ 1.0	Level of Service, V/C ≤ 1.0 ¹
Little or no delays.	0 to 10.00	A
Short traffic delays.	10.01 to 15.00	B
Average traffic delays.	15.01 to 25.00	C
Long traffic delays.	25.01 to 35.00	D
Very long traffic delays.	35.01 to 50.00	E
Extreme traffic delays with intersection capacity exceeded.	> 50.00	F

Source: HCM, 6th Edition

¹ If V/C is greater than 1.0 then LOS is F per HCM.

2.3 TRAFFIC SIGNAL WARRANT ANALYSIS METHODOLOGY

The term “signal warrants” refers to the list of established criteria used by Caltrans and other public agencies to quantitatively justify or determine the potential need for installation of a traffic signal at an otherwise unsignalized intersection. This TA uses the signal warrant criteria presented in the latest edition of the Caltrans California Manual on Uniform Traffic Control Devices (CA MUTCD). (5)

The signal warrant criteria for Existing study area intersections are based upon several factors, including volume of vehicular and pedestrian traffic, frequency of accidents, and location of school areas. The CA MUTCD indicates that the installation of a traffic signal should be considered if one or more of the signal warrants are met. (5) Specifically, this TA utilizes the Peak Hour Volume-based Warrant 3 as the appropriate representative traffic signal warrant analysis for existing traffic conditions and for all future analysis scenarios for existing unsignalized intersections. Warrant 3 is appropriate to use for this TA because it provides specialized warrant criteria for intersections with rural characteristics. For the purposes of this study, the speed limit was the basis for determining whether Urban or Rural warrants were used for a given intersection. Rural warrants have been used as posted speed limits on the major roadways with unsignalized intersections are over 40 miles per hour while urban warrants have been used where speeds are 40 miles per hour or below.

Future intersections that do not currently exist have been assessed regarding the potential need for new traffic signals based on future average daily traffic (ADT) volumes, using the Caltrans planning level ADT-based signal warrant analysis worksheets. Similarly, the speed limit has been used as the basis for determining the use of Urban and Rural warrants. Traffic signal warrant analyses were performed for the following study area intersection shown on Table 2-3:

TABLE 2-3: TRAFFIC SIGNAL WARRANT ANALYSIS LOCATIONS

#	Intersection
1	Harvill Av. & Cajalco Exwy.
3	Harvill Av. & Old Cajalco Rd.
4	Driveway 2 & Old Cajalco Rd.
5	Driveway 3 & Old Cajalco Rd.

The Existing conditions traffic signal warrant analysis is presented in the subsequent section, Section 3 *Area Conditions* of this report. The traffic signal warrant analyses for future conditions are presented in Section 5 *EAP (2024) Traffic Conditions* and Section 6 *EAPC (2024) Traffic Conditions* of this report. It is important to note that a signal warrant defines the minimum condition under which the installation of a traffic signal might be warranted. Meeting this threshold condition does not require that a traffic control signal be installed at a particular location, but rather, that other traffic factors and conditions be evaluated in order to determine whether the signal is truly justified. It should also be noted that signal warrants do not necessarily correlate with LOS. An intersection may satisfy a signal warrant condition and operate at or above acceptable LOS or operate below acceptable LOS and not meet a signal warrant.

2.4 QUEUING ANALYSIS

Consistent with Caltrans requirements, the 95th percentile queuing of vehicles has been assessed at the off-ramps to determine potential queuing deficiencies at the freeway ramp intersections at the I-215 Freeway at the existing Ramona Expressway and future Placentia Avenue interchanges. Specifically, the off-ramp queuing analysis is utilized to identify any potential queuing and “spill back” onto the I-215 Freeway mainline from the off-ramps. The 95th percentile queue has also been utilized to assess the queues at Ramona Expressway and Placentia Avenue to identify any potential queuing.

The traffic progression analysis tool and HCM intersection analysis program, Synchro, has been used to assess the potential deficiencies/needs of the intersections with traffic added from the proposed Project. Storage (turn-pocket) length recommendations at the ramps have been based upon the 95th percentile queue resulting from the Synchro progression analysis. The footnote from the Synchro output sheets indicates if the 95th percentile cycle exceeds capacity. Traffic is simulated for two complete cycles of the 95th percentile traffic in Synchro in order to account for the effects of spillover between cycles. In practice, the 95th percentile queue shown will rarely be exceeded and the queues shown with the footnote are acceptable for the design of storage bays. The 95th percentile queue is derived from the average queue plus 1.65 standard deviations.

2.5 MINIMUM ACCEPTABLE LEVELS OF SERVICE (LOS)

Minimum Acceptable LOS and associated definitions of intersection deficiencies has been obtained from each of the applicable surrounding jurisdictions.

2.5.1 COUNTY OF RIVERSIDE

The definition of an intersection deficiency has been obtained from the County of Riverside General Plan. Riverside County General Plan Policy C 2.1 states that the County will maintain the following County-wide target LOS:

The following minimum target levels of service have been designated for the review of development proposals in the unincorporated areas of Riverside County with respect to transportation impacts on roadways designated in the Riverside County Circulation Plan which are currently County maintained, or are intended to be accepted into the County maintained roadway system:

- *LOS C shall apply to all development proposals in any area of the Riverside County not located within the boundaries of an Area Plan, as well as those areas located within the following Area Plans: REMAP, Eastern Coachella Valley, Desert Center, Palo Verde Valley, and those non-Community Development areas of the Elsinore, Lake Mathews/Woodcrest, Mead Valley and Temescal Canyon Area Plans.*
- *LOS D shall apply to all development proposals located within any of the following Area Plans: Eastvale, Jurupa, Highgrove, Reche Canyon/Badlands, Lakeview/Nuevo, Sun City/Menifee Valley, Harvest Valley/Winchester, Southwest Area, The Pass, San Jacinto Valley, Western Coachella Valley and those Community Development Areas of the Elsinore, Lake Mathews/Woodcrest, Mead Valley and Temescal Canyon Area Plans.*
- *LOS E may be allowed by the Board of Supervisors within designated areas where transit-oriented development and walkable communities are proposed.*

The applicable minimum LOS utilized for the purposes of this analysis is LOS D per the County-wide target LOS for projects located within the Mead Valley Area Plan.

2.5.2 CITY OF PERRIS

Required LOS for roadway segments and intersections within the City of Perris is LOS D. An exception to the local road standard is LOS E, at intersections of any Arterials and Expressways with SR-74, the Ramona-Cajalco Expressway or at I-215 Freeway ramps. For the purposes of this traffic impact analysis, LOS D has also been considered the acceptable threshold for all intersections within the study area.

2.5.3 CALTRANS

Senate Bill 743 (SB 743), approved in 2013, endeavors to change the way transportation impacts will be determined according to the California Environmental Quality Act (CEQA). The Office of Planning and Research (OPR) has recommended the use of vehicle miles traveled (VMT) as the replacement for automobile delay-based LOS. Caltrans acknowledges automobile delay will no longer be considered a CEQA impact for development projects and will use VMT as the metric for determining impacts on the State Highway System (SHS). However, LOS D has been utilized as the target LOS for Caltrans facilities, consistent with the County of Riverside.

2.6 DEFICIENCY CRITERIA

This section outlines the methodology used in this analysis related to identifying circulation system deficiencies. The following deficiency criteria has been utilized for the County of Riverside. To determine whether the addition of project-related traffic at a study intersection would result in a deficiency, the following will be utilized:

- A deficiency occurs at study area intersections if the pre-Project condition is at or better than LOS D (i.e., acceptable LOS), and the addition of project trips causes the peak hour LOS of the study area intersection to operate at unacceptable LOS (i.e., LOS E or F). Per the County of Riverside traffic study guidelines, for intersections currently operating at unacceptable LOS (LOS E or F), a deficiency will occur if the Project contributes peak hour trips to pre-project traffic conditions.

2.7 PROJECT FAIR SHARE CALCULATION METHODOLOGY

Improvements found to be included in the TUMF and/or DIF will be identified as such. For improvements that do not appear to be in either of the pre-existing fee programs, a fair share contribution based on the Project's proportional share may be imposed in order to address the Project's share of deficiencies in lieu of construction. It should be noted that fair share calculations are for informational purposes only and the County Traffic Engineer will determine the appropriate improvements to be implemented by a project (to be identified in the conditions of approval). The Project's fair share contribution is determined based on the following equations, which are the ratio of Project traffic to net new traffic (where net new traffic is the future traffic less existing traffic):

$$\text{Project Fair Share \%} = \text{Project (EAPC) Traffic} / (\text{EAPC Total Traffic} - \text{Existing Traffic})$$

3 AREA CONDITIONS

This section provides a summary of the existing circulation network, the County of Riverside General Plan Circulation Network, and a review of existing peak hour intersection operations, traffic signal warrant, and off-ramp queuing analyses.

3.1 EXISTING CIRCULATION NETWORK

Pursuant to the scoping agreement with County of Riverside staff (Appendix 1.1), the study area includes a total of 9 existing and future intersections as shown previously on Exhibit 1-3, where the Project is anticipated to contribute 50 or more peak hour trips or were added at the County's request during the scoping process. Exhibit 3-1 illustrates the study area intersections located near the proposed Project and identifies the number of through traffic lanes for existing roadways and intersection traffic controls.

3.2 COUNTY OF RIVERSIDE GENERAL PLAN CIRCULATION ELEMENT

As noted previously, the Project site is located within the County of Riverside. The roadway classifications and planned (ultimate) roadway cross-sections of the major roadways within the study area, as identified on County of Riverside General Plan Circulation Element, are described subsequently. Exhibit 3-2 shows the County of Riverside General Plan Circulation Element and Exhibit 3-3 illustrates the County of Riverside General Plan roadway cross-sections.

Expressways are six to eight-lane divided roadways (typically divided by a raised median) with a 220-foot right-of-way and a 134-foot curb-to-curb measurement. These roadways serve regional through-traffic. The following study area roadway within the County of Riverside is classified as an Expressway:

- Ramona Expressway/Cajalco Expressway

Arterials are four-lane divided roadways (typically divided by a raised median or painted two-way turn-lane) with a 128-foot right-of-way and an 86-foot curb-to-curb measurement. These roadways serve both regional through-traffic and inter-city traffic and typically direct traffic onto and off-of the freeways. The following study area roadway within the County of Riverside is classified as an Arterial:

- Placentia Avenue, east of Harvill Avenue

Major Highways are four-lane roadways and may include a painted median. These roadways typically have a 118-foot right-of-way and a 76-foot curb-to-curb measurement. These roadways typically direct traffic through major development areas. The following study area roadway within the County of Riverside is classified as a Major Highway:

- Harvill Avenue

EXHIBIT 3-1: EXISTING NUMBER OF THROUGH LANES AND INTERSECTION CONTROLS

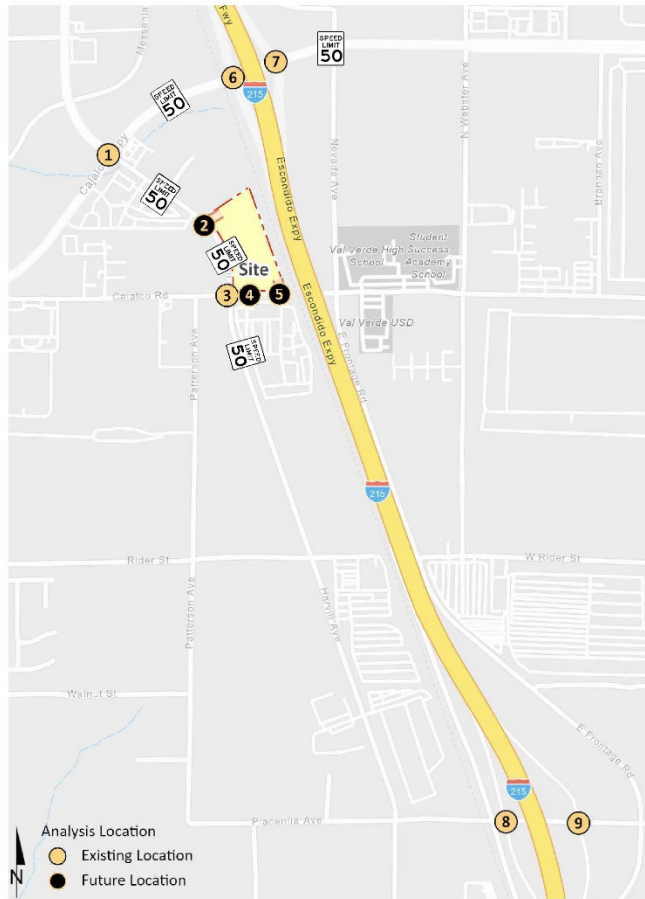

1	2	3	4	5
Harvill Av. & Cajalco Expy.	Harvill Av. & Dwy. 1	Harvill Av. & Old Cajalco Rd.	Dwy. 2 & Old Cajalco Rd.	Dwy. 3 & Old Cajalco Rd.
	Future Intersection		Future Intersection	Future Intersection
I-215 SB Ramps & Cajalco Expy.	I-215 NB Ramps & Cajalco Expy.	I-215 SB Ramps & Placentia Av.	I-215 NB Ramps & Placentia Av.	
		Future Intersection	Future Intersection	

= Traffic Signal
 = Stop Sign
4 = Number of Lanes
D = Divided
U = Undivided
DEF = Defacto Right Turn
 = Speed Limit (MPH)

EXHIBIT 3-2: COUNTY OF RIVERSIDE GENERAL PLAN CIRCULATION ELEMENT

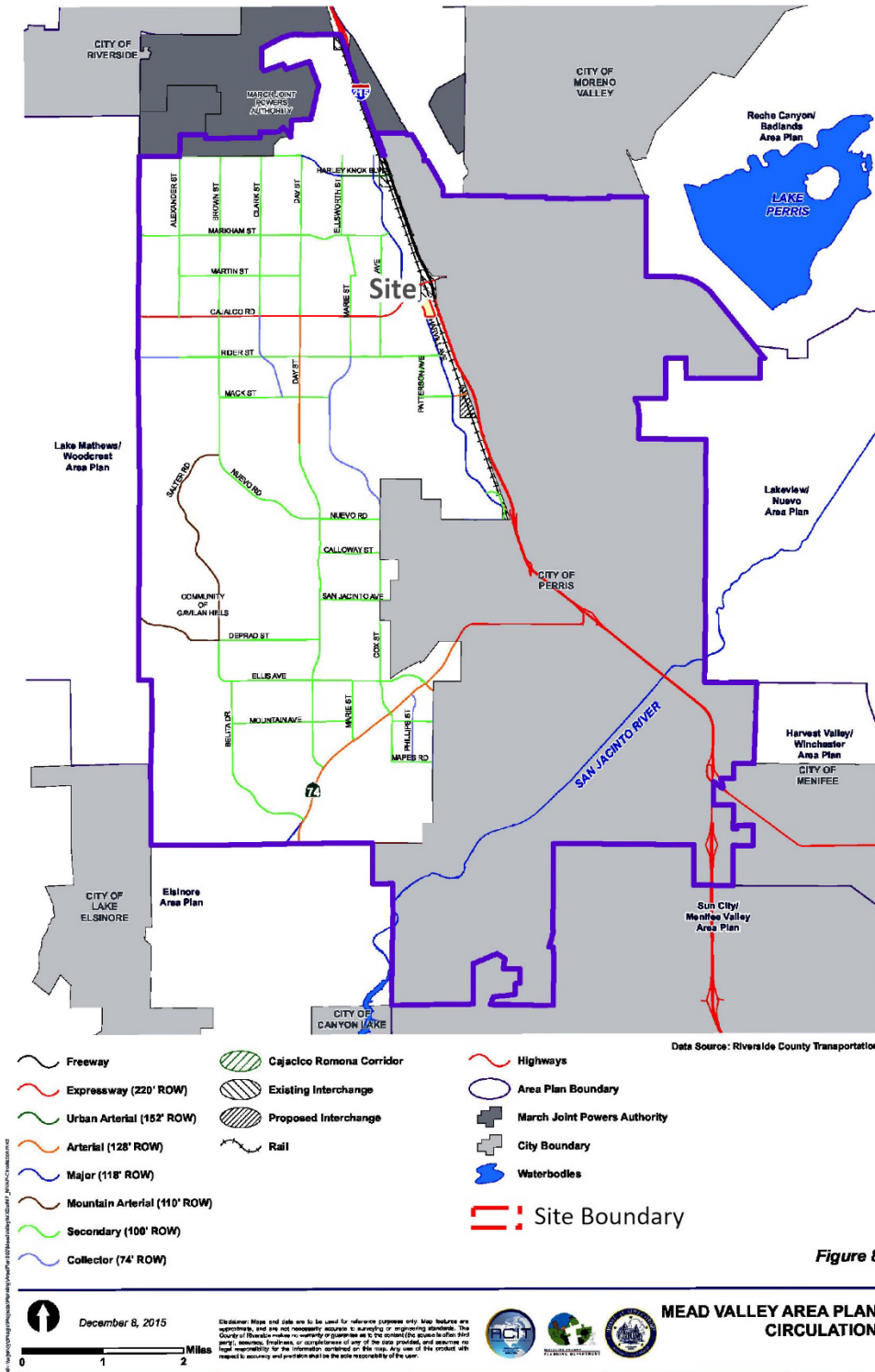
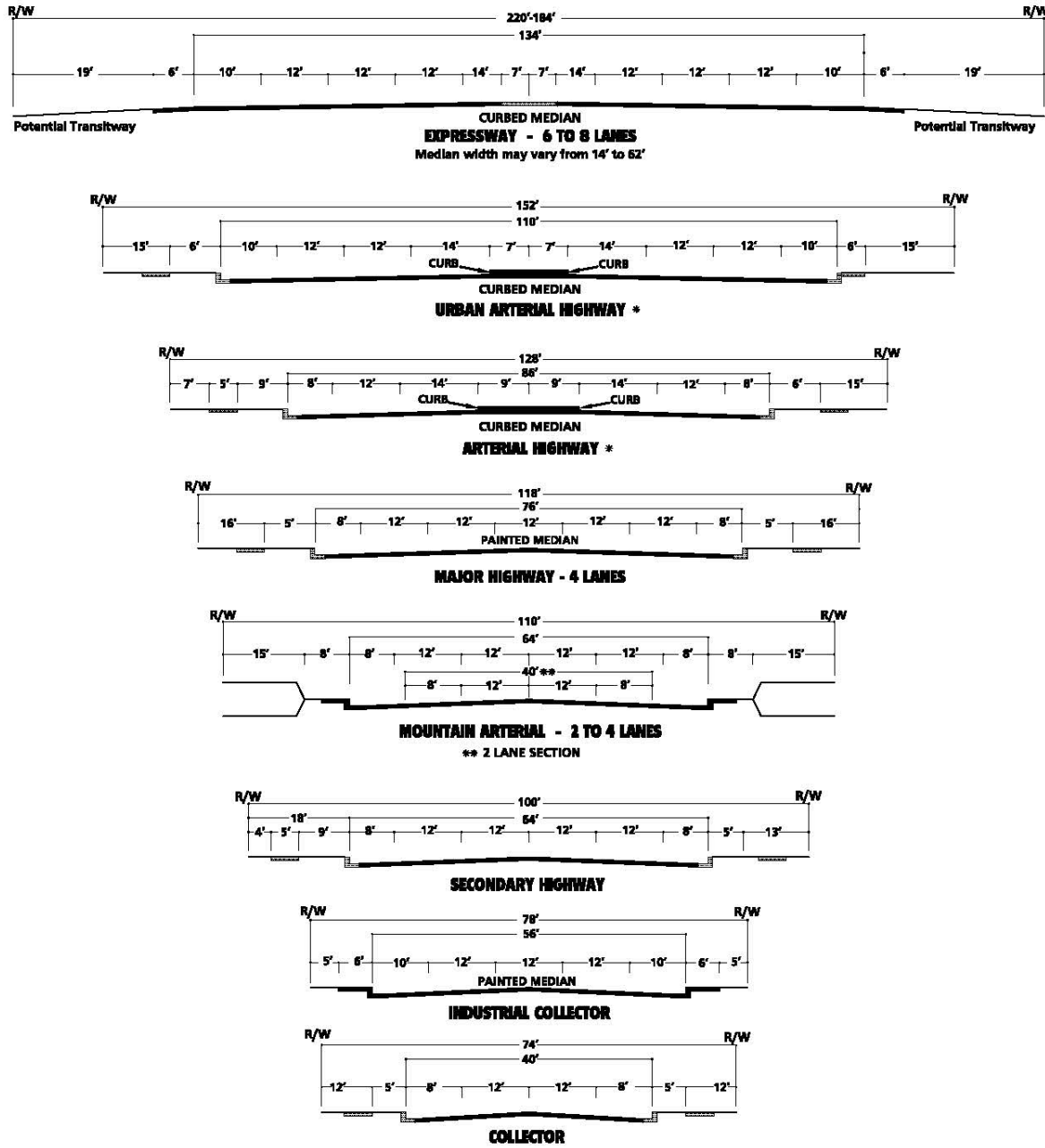

Figure 8

EXHIBIT 3-3: COUNTY OF RIVERSIDE GENERAL PLAN ROADWAY CROSS-SECTIONS



* IMPROVEMENTS MAY BE RECONFIGURED TO ACCOMMODATE EXCLUSIVE TRANSIT LANES OR ALTERNATIVE LANE ARRANGEMENTS. ADDITIONAL RIGHT OF WAY MAY BE REQUIRED AT INTERSECTIONS TO ACCOMMODATE ULTIMATE IMPROVEMENTS FOR STATE HIGHWAYS. SHALL CONFORM TO CALTRANS DESIGN STANDARDS.

NOT TO SCALE

SOURCE: COUNTY OF RIVERSIDE
 July 7, 2020

Secondary Highways are four-lane roadways. These roadways typically have a 100-foot right-of-way and a 64-foot curb-to-curb measurement. The following study area roadway within the County of Riverside is classified as a Secondary Highway:

- Placentia Avenue, west of Harvill Avenue

3.3 CITY OF PERRIS GENERAL PLAN CIRCULATION ELEMENT

Exhibits 3-4 and 3-5 show the City of Perris General Plan Circulation Element and roadway cross-sections, respectively.

3.4 BICYCLE & PEDESTRIAN FACILITIES

The County of Riverside and City of Perris bike networks are shown on Exhibit 3-6 and Exhibit 3-7, respectively. As shown on Exhibit 3-6, there is a planned Regional Trail (Urban/Suburban) trail proposed along Placentia Avenue and a Class II (on-street, striped) bike lane along Ramona Expressway/Cajalco Expressway. Exhibit 3-8 illustrates the existing crosswalks throughout the study area. As shown on Exhibit 3-8, there are pedestrian facilities in place in the vicinity of the Project site on either side of Harvill Avenue and along Cajalco Road on the south side of the Project.

3.5 TRANSIT SERVICE

The study area is currently served by Riverside Transit Agency (RTA) with bus service along the I-215 Freeway and Cajalco Expressway/Ramona Expressway. RTA Route 27 runs along the I-215 Freeway and stops at Perris High School (on Nuevo Road) and runs between the Perris Station Transit Center and the Galleria at Tyler in the City of Riverside. RTA Route 41 runs along Cajalco Expressway and has existing bus stops to the west and east of Harvill Avenue, which is located approximately ¼ mile from the Project. There are currently no transit routes or stops along the Harvill Avenue corridor near the proposed Project. The transit services are illustrated on Exhibit 3-9. As shown, the closest existing transit route that could potentially serve the site is along Cajalco Expressway. Transit service is reviewed and updated by RTA periodically to address ridership, budget, and community demand needs. Changes in land use can affect these periodic adjustments which may lead to either enhanced or reduced service where appropriate.

3.6 TRUCK ROUTES

The County of Riverside's General Plan does not provide designated truck routes, and the City of Perris' truck routes are shown on Exhibit 3-10. Trucks are prohibited on certain County roadways through the Municipal Code through weight restrictions. Truck routes for the proposed Project have been determined based on discussions with County staff and takes into consideration the approved truck routes within the adjacent City of Perris. These truck routes serve both the proposed Project and future cumulative development projects throughout the study area. Sensitive land uses have also been taken into consideration as part of determining the best routes for future trucks.

EXHIBIT 3-4: CITY OF PERRIS GENERAL PLAN CIRCULATION ELEMENT

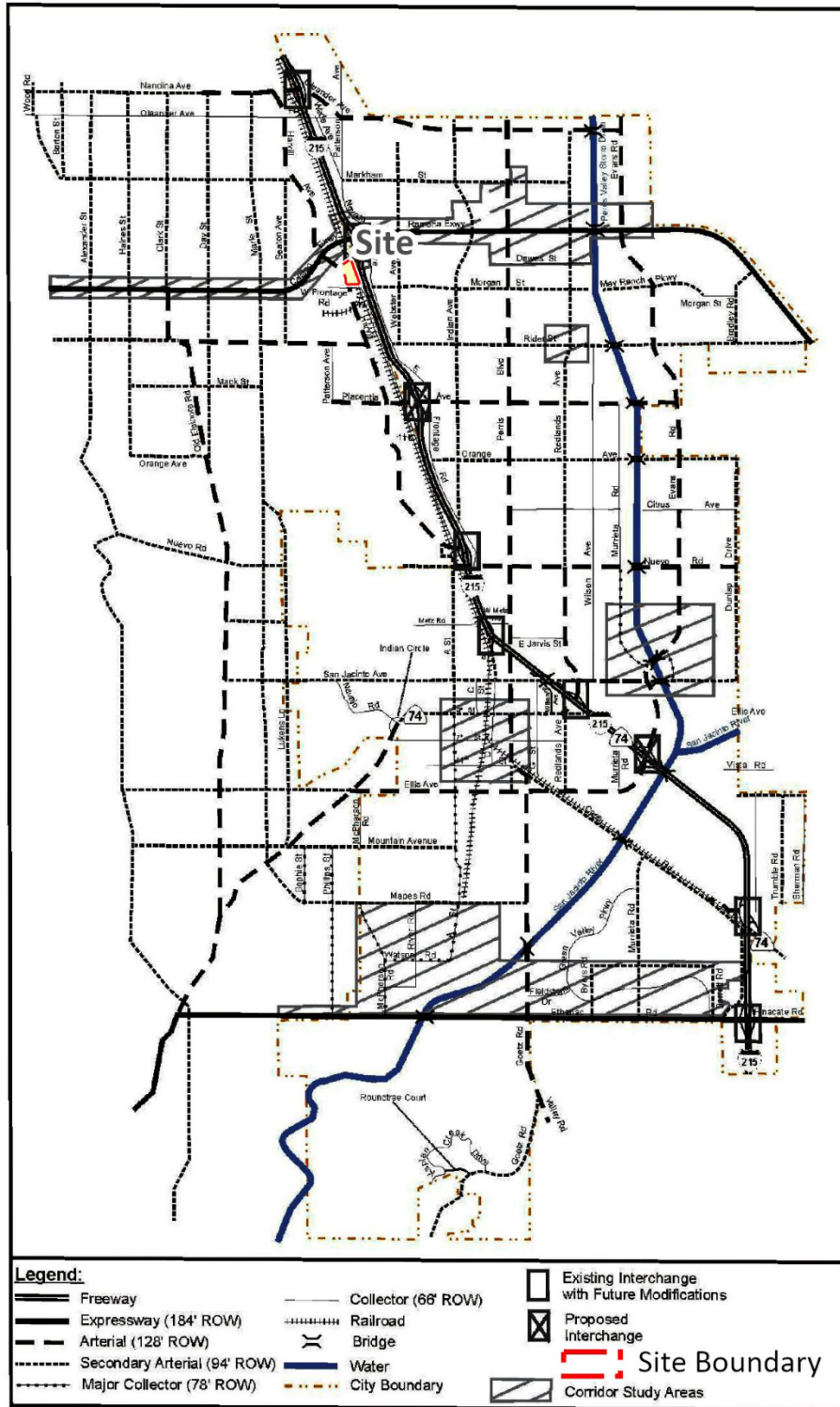
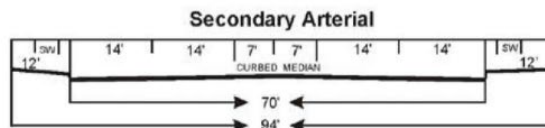
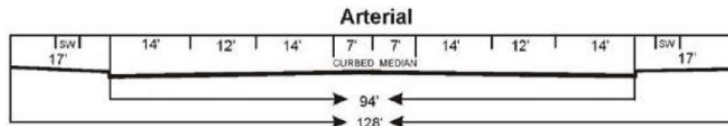
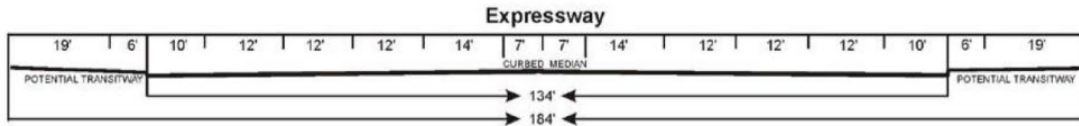
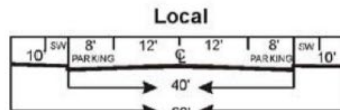
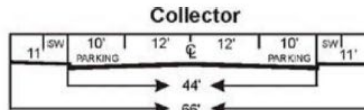
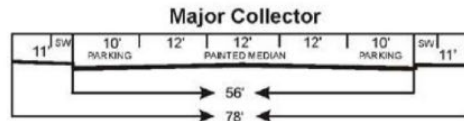
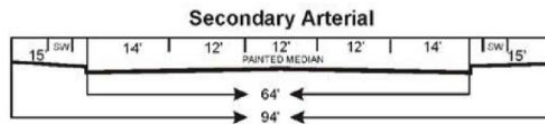

EXHIBIT 3-5: CITY OF PERRIS GENERAL PLAN ROADWAY CROSS-SECTIONS



or



Specific details for each cross-section follow in Figures 4.1 A - 4.1 F

Legend

- SW Sidewalk or Trail (at least 4 feet)
- PARKING Parking or Bike Lane
- PAINTED MEDIAN Center Median and/or Continuous Left Turning Lane
- CURBED MEDIAN Landscaped Center Median

Source: City of Perris
General Plan
1-11-2022

EXHIBIT 3-6: COUNTY OF RIVERSIDE GENERAL PLAN BIKE NETWORK

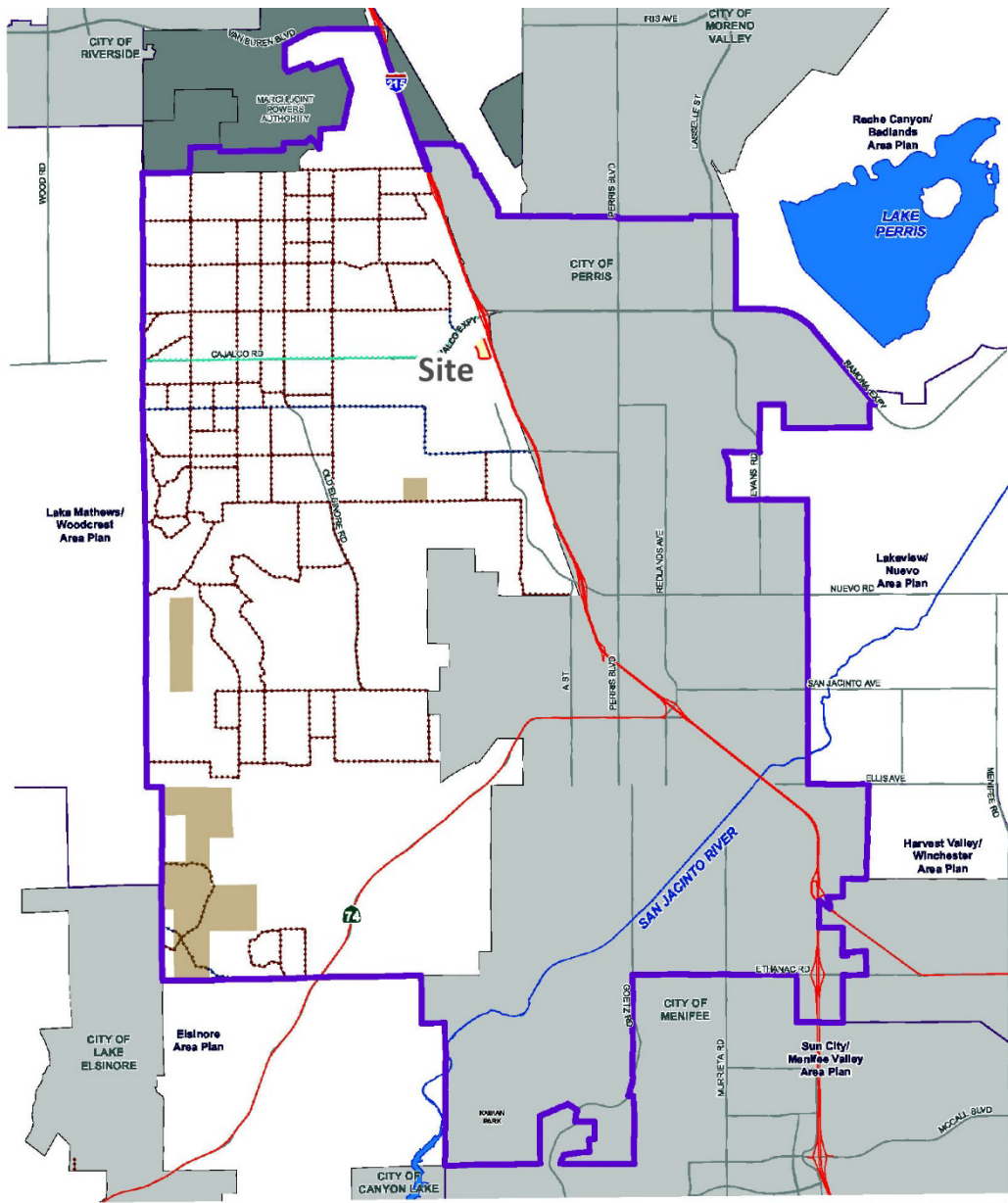

Data Source: Riverside County Parks

- Regional Trail: Urban/Suburban
- Community Trail
- Class II Bike Path
- Non-County Trail (Public and Quasi-Public Lands)
- Site Boundary
- Highways
- Area Plan Boundary
- March Joint Powers Authority
- City Boundary
- Waterbodies
- Bureau of Land Management (BLM) Lands

Note: Trails shown in surrounding jurisdictions for informational purposes only.
 Data are from Riverside County Parks and Recreation Department, Riverside County Planning Department, and various local planning departments.
 Note: Trails and library maps are a graphic representation of the general location and distribution of existing and proposed trails and libraries in the unincorporated area of the County and do not constitute any binding agreement or representation of any kind. The County does not warrant the accuracy of the information shown on this map.
 Note: Trails for regional, national, state, and international systems located within the County are generally indicated. These trails and systems are not shown in the unincorporated area of the County and are not shown for representation with existing or future trails and libraries within the County. The County does not warrant the accuracy of the information shown on this map.

Figure 9

EXHIBIT 3-7: CITY OF PERRIS BIKE PLAN

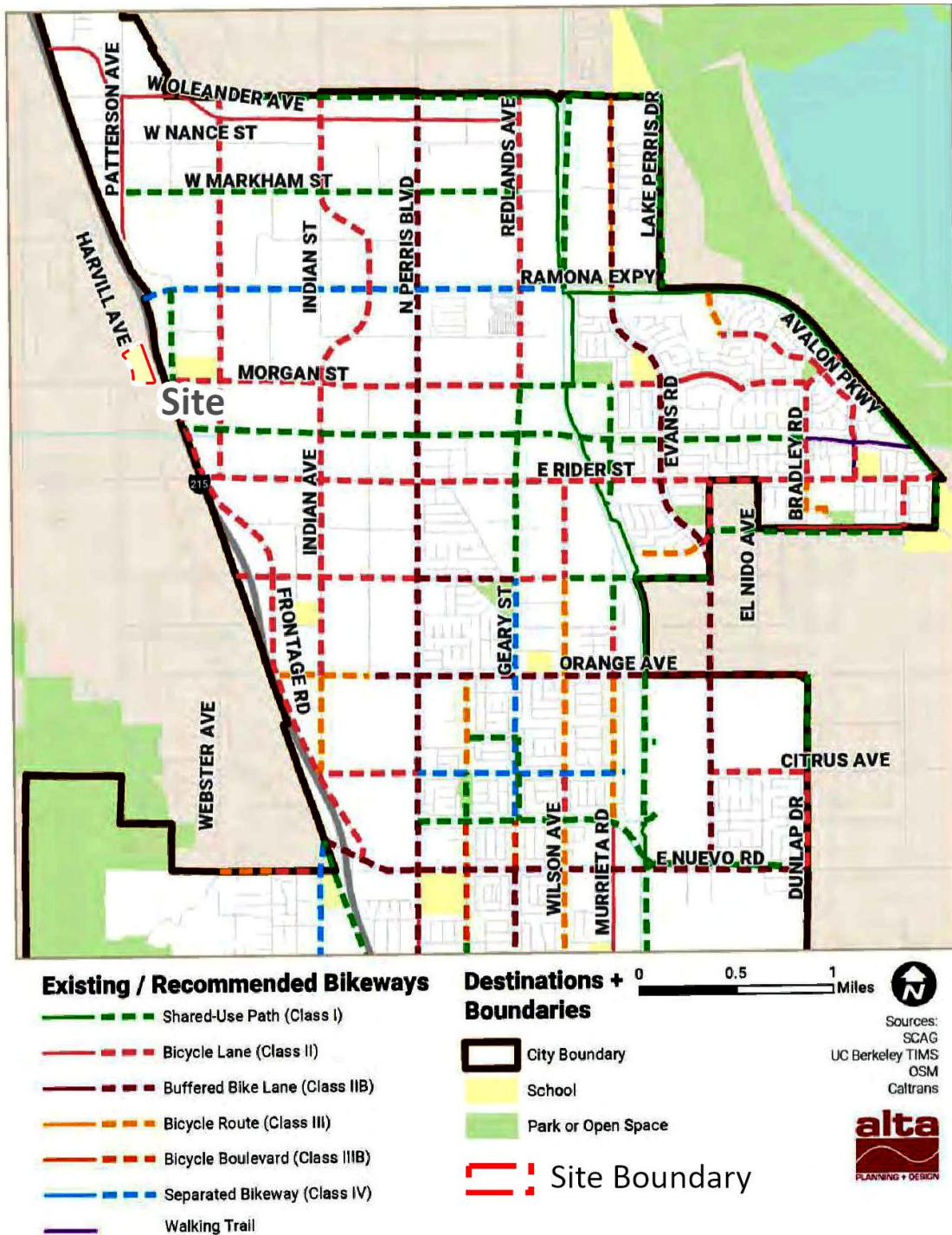

EXHIBIT 3-8: EXISTING PEDESTRIAN FACILITIES

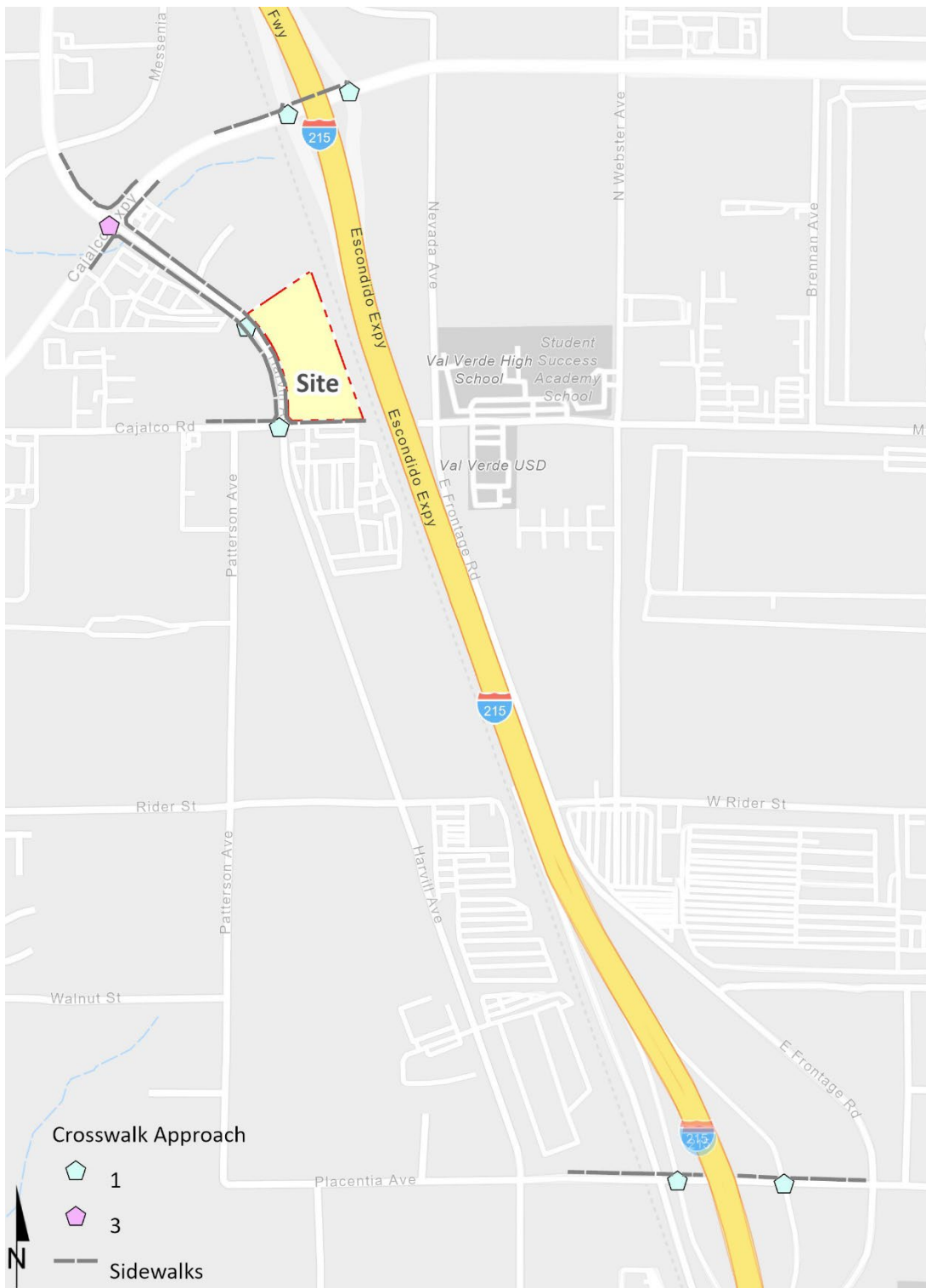
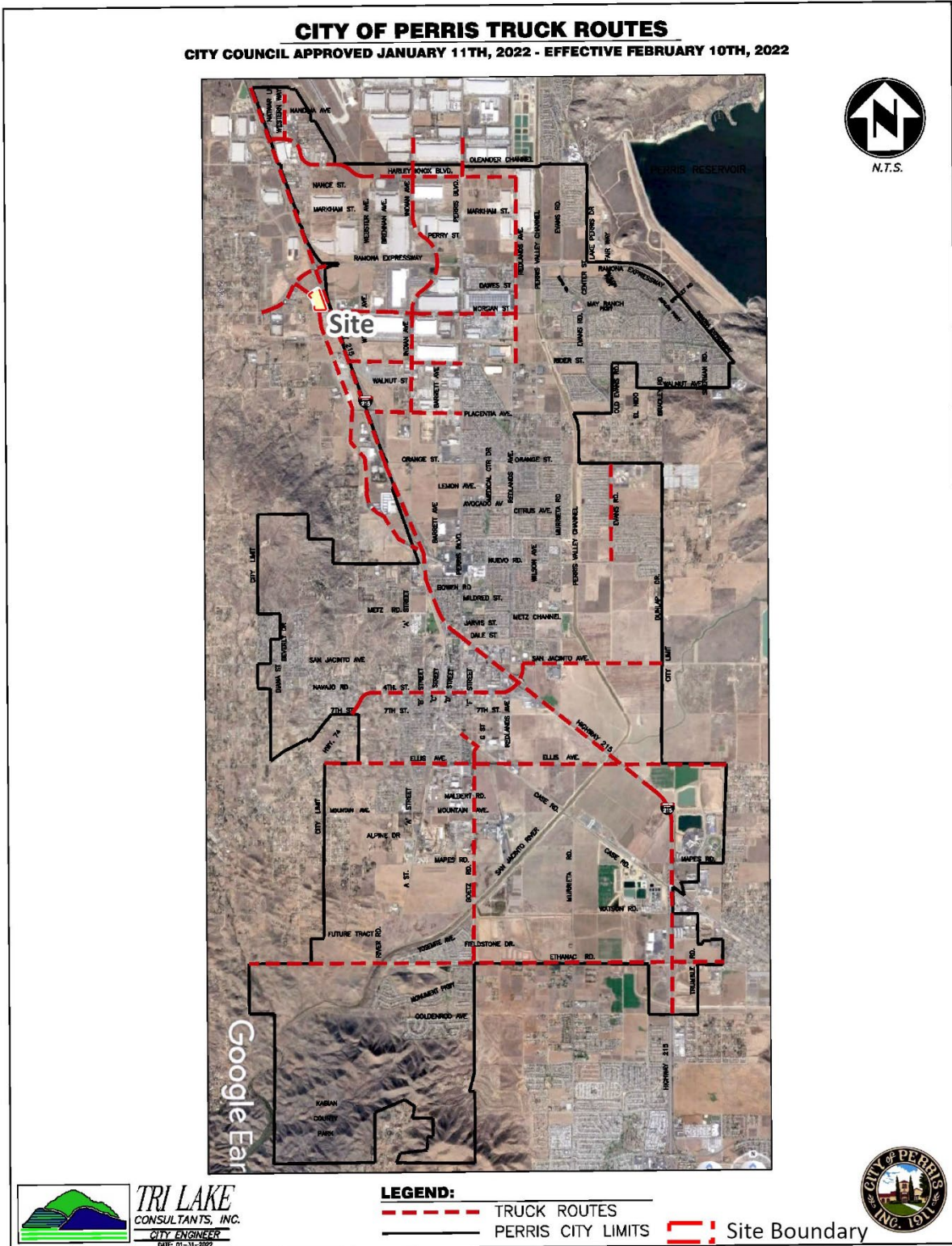

EXHIBIT 3-9: EXISTING TRANSIT ROUTES



EXHIBIT 3-10: CITY OF PERRIS TRUCK ROUTES



3.7 EXISTING (2022) TRAFFIC COUNTS

The intersection LOS analysis is based on the traffic volumes observed during the peak hour conditions using traffic count data collected in February 2022 when local schools were in session and operating on normal bell schedules. The following peak hours were selected for analysis:

- Weekday AM Peak Hour (peak hour between 7:00 AM and 9:00 AM)
- Weekday PM Peak Hour (peak hour between 4:00 PM and 6:00 PM)

There were no observations made in the field that would indicate atypical traffic conditions on the count dates, such as construction activity or detour routes and near-by schools were in session and operating on normal schedules. The raw manual peak hour turning movement traffic count data sheets are included in Appendix 3.1.

Existing weekday ADT volumes on arterial highways throughout the study area are shown on Exhibit 3-11. Existing ADT volumes were based upon factored intersection peak hour counts collected by Urban Crossroads, Inc. using the following formula for each intersection leg:

$$\text{Weekday PM Peak Hour (Approach Volume + Exit Volume)} \times 16.28 = \text{Leg Volume}$$

A comparison of the PM peak hour and daily traffic volumes of various roadway segments within the study area indicated that the peak-to-daily relationship is approximately 6.14 percent. As such, the above equation utilizing a factor of 16.28 estimates the ADT volumes on the study area roadway segments assuming a peak-to-daily relationship of approximately 6.14 percent (i.e., $1/0.0614 = 16.28$) and was assumed to sufficiently estimate ADT volumes for planning-level analyses. This factor is consistent with that used for other traffic studies within the study area. Existing weekday AM and weekday PM peak hour intersection volumes are shown on Exhibit 3-11.

Volumes reported on the exhibits are expressed in actual vehicles. However, consistent with the County's guidelines, the peak hour intersection operations analysis utilizes passenger car equivalent (PCE) volumes. PCEs allow the typical "real-world" mix of vehicle types to be represented as a single, standardized unit, such as the passenger car, to be used for the purposes of capacity and level of service analyses. The PCE factors are consistent with the recommended PCE factors in the County's Guidelines. PCE volumes can be found in Appendix 3.1.

EXHIBIT 3-11: EXISTING (2022) TRAFFIC VOLUMES

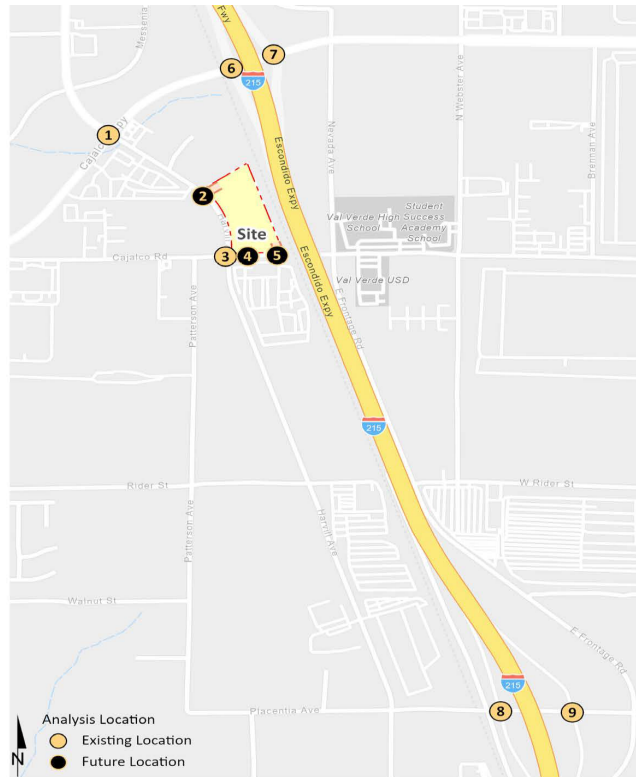

1	Harvill Av. & Cajalco Exwy.	2	Harvill Av. & Driveway 1	3	Harvill Av. & Old Cajalco Rd.	4	Driveway 2 & Old Cajalco Rd.	5	Driveway 3 & Old Cajalco Rd.
10,850	30,800	13,600	13,600	13,600	550	450	450	450	450
19(32) 102(200) 174(218)	94(175) 628(597) 135(101)	245(442)	719(393)	36(22) 201(416) 8(4)	2(16) 3(5)	5(21)	15(6)	15(6)	5(21)
37(22) 626(686) 48(200)	285(159) 328(140) 65(116)			20(54) 3(13)	5(4) 697(323) 7(2)				
27,600	14,900		13,600	1,500	12,400	450	450	450	450
6	I-215 SB Ramps & Ramona Exwy.	7	I-215 NB Ramps & Ramona Exwy.	8	I-215 SB Ramps & Placentia Av.	9	I-215 NB Ramps & Placentia Av.		
14,650	44,700	11,150	54,300						
144(135) 1(4) 619(760)	943(821) 281(346)	100(100) 1169(1480)	599(583) 910(848)						
650(820) 307(323)		314(319) 3(3) 552(425)							
34,150	10,950	44,700	12,150						

##(##) AM(PM) Peak Hour Intersection Volumes

Average Daily Trips

3.8 INTERSECTION OPERATIONS ANALYSIS

Existing peak hour traffic operations have been evaluated for the study area intersections based on the analysis methodologies presented in Section 2.2 *Intersection Capacity Analysis* of this report. The intersection operations analysis results are summarized on Table 3-1, which indicates that all existing study area intersections are currently operating at acceptable LOS during the peak hours. The intersection operations analysis worksheets are included in Appendix 3.2 of this TA.

TABLE 3-1: INTERSECTION ANALYSIS FOR EXISTING (2022) CONDITIONS

# Intersection	Traffic Control ²	Delay ¹ (secs.)		Level of Service	
		AM	PM	AM	PM
1 Harvill Av. & Cajalco Exwy.	CSS	38.4	37.8	D	D
2 Harvill Av. & Driveway 1		Future Intersection			
3 Harvill Av. & Old Cajalco Rd.	CSS	15.9	14.1	C	B
4 Driveway 2 & Old Cajalco Rd.		Future Intersection			
5 Driveway 3 & Old Cajalco Rd.		Future Intersection			
6 I-215 SB Ramps & Ramona Exwy.	TS	36.7	44.0	D	D
7 I-215 NB Ramps & Ramona Exwy.	TS	25.5	18.4	C	B
8 I-215 SB Ramps & Placentia Av.		Future Intersection			
9 I-215 NB Ramps & Placentia Av.		Future Intersection			

¹ Per the Highway Capacity Manual (6th Edition), overall average intersection delay and level of service are shown for intersections with a traffic signal or all way stop control. For intersections with cross street stop control, the delay and level of service for the worst individual movement (or movements sharing a single lane) are shown. HCM delay reported in seconds.

² TS = Traffic Signal; CSS = Cross-street Stop

3.9 TRAFFIC SIGNAL WARRANTS ANALYSIS

Traffic signal warrants for Existing traffic conditions are based on existing peak hour intersection turning volumes. There are no unsignalized study area intersections that currently warrant a traffic signal for Existing traffic conditions. Existing conditions traffic signal warrant analysis worksheets are provided in Appendix 3.3.

3.10 QUEUING ANALYSIS

A queuing analysis was performed for the off-ramps at the I-215 Freeway at Ramona Expressway interchange. Queuing analysis findings are presented in Table 3-2. It is important to note that off-ramp lengths are consistent with the measured distance between the intersection and the freeway mainline. As shown in Table 3-2, there are no movements that are currently experiencing queuing issues during the weekday AM or weekday PM peak 95th percentile traffic flows. Worksheets for Existing (2022) traffic conditions off-ramp queuing analysis are provided in Appendix 3.4.

TABLE 3-2: PEAK HOUR QUEUING SUMMARY FOR EXISTING (2022) CONDITIONS

Intersection	Movement	Available Stacking Distance (Feet)	95th Percentile Queue (Feet)		Acceptable? ¹	
			AM Peak Hour	PM Peak Hour	AM	PM
I-215 SB Ramps & Ramona Exwy.	SBL	530	445 ²	468 ²	Yes	Yes
	SBT	1,100	448 ²	481 ²	Yes	Yes
	SBR	530	138	78	Yes	Yes
I-215 NB Ramps & Ramona Exwy.	NBL	520	184	176	Yes	Yes
	NBT	1,120	187	181	Yes	Yes
	NBR	520	685 ^{2,3}	457 ²	Yes	Yes
I-215 SB Ramps & Placentia Av.	Future Intersection		Future Intersection			
	Future Intersection		Future Intersection			
I-215 NB Ramps & Placentia Av.	Future Intersection		Future Intersection			
	Future Intersection		Future Intersection			

¹ Stacking Distance is acceptable if the required stacking distance is less than or equal to the stacking distance provided. An additional 15 feet of stacking which is assumed to be provided in the transition for turn pockets is reflected in the stacking distance shown on this table, where applicable.

² 95th percentile volume exceeds capacity, queue may be longer. Queue shown is maximum after two cycles.

³ Although 95th percentile queue is anticipated to exceed the available storage for the turn lane, the adjacent through lane has sufficient storage to accommodate any spillover without spilling back and affecting the I-215 Freeway mainline.

4 PROJECTED FUTURE TRAFFIC

This section presents the traffic volumes estimated to be generated by the Project, as well as the Project's trip assignment onto the study area roadway network. The Project consists of the development of a 99,770 square foot warehouse within a single building with a 133-stall truck parking lot. For the purposes of this TA, the building has been evaluated assuming general light industrial use. Access to the Project site will be accommodated via Harvill Avenue and Cajalco Road. Regional access to the Project site is available from the I-215 Freeway via the existing Ramona Expressway and future Placentia Avenue interchanges.

4.1 PROJECT TRIP GENERATION

4.1.1 PROPOSED PROJECT TRIP GENERATION

Trip generation represents the amount of traffic which is both attracted to and produced by a development. Determining traffic generation for a specific project is therefore based upon forecasting the amount of traffic that is expected to be both attracted to and produced by the specific land uses being proposed for a given development. In order to develop the traffic characteristics of the proposed project, trip-generation statistics published in the ITE Trip Generation Manual (11th Edition, 2021) was used to calculate the trip generation. (2) The following trip generation rates and vehicle mix were utilized for calculating the trip generation for the proposed Project:

- ITE land use code 110 (General Light Industrial) has been used to derive site specific trip generation estimates for up to 99,770 square feet of the proposed Project. A light industrial facility is a free-standing facility devoted to a single use that has an emphasis on activities other than manufacturing. Typically, there is minimum office space. The vehicle mix has also been obtained from the ITE's latest Trip Generation Manual. The truck percentages were further broken down by axle type per the following SCAQMD recommended truck mix: 2-Axle = 16.7%; 3-Axle = 20.7%; 4+-Axle = 62.6%. The General Light Industrial land use category is more conservative and would cover a 100% warehouse use alternative.

The ITE Trip Generation Manual does not currently have any trip generation rates for a truck parking lot, as such, trip generation estimates for the proposed project have been developed using data collected at other facilities with operations similar to those proposed. Table A-1 in Attachment A of Appendix 1.1 summarizes the count data collected at 2 existing facilities located at 5087 Patterson Avenue in the City of Perris and 14769 San Bernardino Avenue in the City of Fontana. The actual driveway counts have been attached to this assessment for each of these facilities in Appendix 1.1. In other words, this traffic analysis will conservatively assume the truck lot will be an independent lot that does not specifically serve the adjacent warehouse use.

Table A-2 in Appendix 1.1 shows the trip generation rates for each existing facility which have been developed by dividing the data collected at the sites by their respective total acreage as shown on Table A-1. The average trip rate has been calculated by averaging the 2 comparable sites. A passenger-car equivalent (PCE) of 1.5, 2.0, and 3.0 have been applied to 2-axle, 3-axle, and 4+-axle vehicles, consistent with the County's traffic study guidelines. PCE rates were calculated by taking the actual vehicle trip generation rates and applying the PCE factors shown in Table A-2. PCE factors were applied to the trip generation rates for heavy trucks (large 2-axles, 3-axles, 4+-axles). PCEs allow the

typical “real-world” mix of vehicle types to be represented as a single, standardized unit, such as the passenger car, to be used for the purposes of capacity and level of service analyses. The trip generation rates used for the Project are summarized on Table 4-1.

The PCE factors are consistent with the recommended PCE factors In the County’s Guidelines. Trip generation rates are summarized on Table 4-1 for actual vehicles and PCE.

TABLE 4-1: TRIP GENERATION RATES

Land Use ¹	Units ²	ITE LU Code	AM Peak Hour			PM Peak Hour			Daily
			In	Out	Total	In	Out	Total	
Actual Vehicle Trip Generation Rates									
General Light Industrial ³	TSF	110	0.651	0.089	0.740	0.091	0.559	0.650	4.870
Passenger Cars			0.645	0.085	0.730	0.086	0.554	0.640	4.620
2-Axle Trucks			0.001	0.001	0.002	0.001	0.001	0.002	0.042
3-Axle Trucks			0.001	0.001	0.002	0.001	0.001	0.002	0.052
4+-Axle Trucks			0.004	0.002	0.006	0.003	0.003	0.006	0.157
Truck Trailer Yard ⁴	Spaces	--	0.016	0.024	0.040	0.016	0.013	0.028	0.781
Passenger Cars			0.010	0.006	0.016	0.003	0.003	0.006	0.179
2-Axle Trucks			0.000	0.016	0.016	0.009	0.000	0.009	0.113
3-Axle Trucks			0.003	0.002	0.005	0.003	0.000	0.003	0.209
4+-Axle Trucks			0.003	0.000	0.003	0.000	0.009	0.009	0.281
Passenger Car Equivalent (PCE) Trip Generation									
General Light Industrial ³	TSF	110	0.651	0.089	0.740	0.091	0.559	0.650	4.870
Passenger Cars			0.645	0.085	0.730	0.086	0.554	0.640	4.620
2-Axle Trucks (PCE = 1.5)			0.002	0.001	0.003	0.002	0.001	0.003	0.063
3-Axle Trucks (PCE = 2.0)			0.003	0.003	0.005	0.003	0.003	0.005	0.129
4+-Axle Trucks (PCE = 3.0)			0.012	0.007	0.019	0.009	0.010	0.019	0.470
Truck Trailer Yard ⁴	Spaces	--	0.016	0.024	0.040	0.016	0.013	0.028	0.781
Passenger Cars			0.010	0.006	0.016	0.003	0.003	0.006	0.179
2-Axle Trucks (PCE = 1.5)			0.000	0.023	0.023	0.014	0.000	0.014	0.169
3-Axle Trucks (PCE = 2.0)			0.006	0.004	0.010	0.006	0.000	0.006	0.418
4+-Axle Trucks (PCE = 3.0)			0.009	0.000	0.009	0.000	0.028	0.028	0.844

¹ Trip Generation & Vehicle Mix Source: Institute of Transportation Engineers (ITE), Trip Generation Manual, Eleventh Edition (2021).

² TSF = thousand square feet

³ Truck Mix: South Coast Air Quality Management District’s (SCAQMD) recommended truck mix, by axle type.

Normalized % - Without Cold Storage: 16.7% 2-Axle trucks, 20.7% 3-Axle trucks, 62.6% 4-Axle trucks.

⁴ See Table A-2 of Appendix 1.1 for Trip Generation Rates based on empirical data.

Per the County’s Guidelines, any operations analysis is to utilize the PCE trip generation. The trip generation summary illustrating daily and peak hour trip generation estimates for the Project in actual vehicles are shown on Table 4-2. The proposed Project is anticipated to generate 594 two-way trip-ends per day with 76 AM peak hour trips and 66 PM peak hour trips (see Table 4-2). PCE based trip generation for the Project is summarized on Table 4-3.

TABLE 4-2: PROJECT TRIP GENERATION SUMMARY (ACTUAL VEHICLES)

Land Use	Quantity Units ¹	AM Peak Hour			PM Peak Hour			Daily
		In	Out	Total	In	Out	Total	
Actual Vehicles:								
General Light Industrial	99.770 TSF							
Passenger Cars:		64	8	72	9	55	64	462
2-axle Trucks:		0	0	0	0	0	0	4
3-axle Trucks:		0	0	0	0	0	0	6
4+-axle Trucks:		0	0	0	0	0	0	16
Total Truck Trips (Actual Vehicles):		0	0	0	0	0	0	26
Total Trips (Actual Vehicles)²		64	8	72	9	55	64	488
Truck Trailer Yard								
	133 Spaces							
Passenger Cars:		1	1	2	0	0	0	24
2-axle Trucks:		0	2	2	1	0	1	16
3-axle Trucks:		0	0	0	0	0	0	28
4+-axle Trucks:		0	0	0	0	1	1	38
Total Truck Trips (Actual Vehicles):		0	2	2	1	1	2	82
Total Trips (Actual Vehicles)²		1	3	4	1	1	2	106
Project Total (Actual Vehicles)		65	11	76	10	56	66	594

¹ TSF = thousand square feet

² Total Trips = Passenger Cars + Truck Trips.

TABLE 4-3: PROJECT TRIP GENERATION SUMMARY (PCE)

Land Use	Quantity Units ¹	AM Peak Hour			PM Peak Hour			Daily
		In	Out	Total	In	Out	Total	
Passenger Car Equivalent (PCE):								
General Light Industrial	99.770 TSF							
Passenger Cars:		64	8	72	9	55	64	462
2-axle Trucks:		0	0	0	0	0	0	6
3-axle Trucks:		0	0	0	0	0	0	14
4+-axle Trucks:		1	1	2	1	1	2	48
Total Truck Trips (PCE):		1	1	2	1	1	2	68
Total Trips (PCE)²		65	9	74	10	56	66	530
Truck Trailer Yard								
	133 Spaces							
Passenger Cars:		1	1	2	0	0	0	24
2-axle Trucks:		0	3	3	2	0	2	22
3-axle Trucks:		1	1	2	1	0	1	56
4+-axle Trucks:		1	0	1	0	4	4	112
Total Truck Trips (PCE):		2	4	6	3	4	7	190
Total Trips (PCE)²		3	5	8	3	4	7	214
Project Total (PCE)		68	14	82	13	60	73	744

¹ TSF = thousand square feet

² Total Trips = Passenger Cars + Truck Trips.

4.1.2 ALTERNATIVE PROJECT TRIP GENERATION

Similar to the proposed Project, trip-generation statistics published in the ITE Trip Generation Manual (11th Edition, 2021) was used to calculate the trip generation. (2) The following trip generation rates and vehicle mix were utilized for calculating the trip generation for the proposed Project if occupied by a warehouse user:

- ITE land use code 150 (Warehousing) has been used to derive site specific trip generation estimates for up to 99,770 square feet of the proposed Project. A warehouse is primarily devoted to the storage of materials but may also include office and maintenance areas. The vehicle mix has also been obtained from the ITE's latest Trip Generation Manual. The truck percentages were further broken down by axle type per the following SCAQMD recommended truck mix: 2-Axle = 16.7%; 3-Axle = 20.7%; 4+-Axle = 62.6%.

Trip generation rates are summarized on Table 4-4 for actual vehicles and PCE.

TABLE 4-4: TRIP GENERATION RATES

Land Use ¹	Units ²	ITE LU Code	AM Peak Hour			PM Peak Hour			Daily
			In	Out	Total	In	Out	Total	
Actual Vehicle Trip Generation Rates									
Warehousing ³	TSF	150	0.131	0.039	0.170	0.050	0.130	0.180	1.710
Passenger Cars			0.120	0.030	0.150	0.034	0.116	0.150	1.110
2-Axle Trucks			0.002	0.001	0.003	0.003	0.002	0.005	0.100
3-Axle Trucks			0.002	0.002	0.004	0.003	0.003	0.006	0.124
4+-Axle Trucks			0.007	0.006	0.013	0.010	0.009	0.019	0.376
Passenger Car Equivalent (PCE) Trip Generation									
Warehousing ³	TSF	150	0.131	0.039	0.170	0.050	0.130	0.180	1.710
Passenger Cars			0.120	0.030	0.150	0.034	0.116	0.150	1.110
2-Axle Trucks (PCE = 1.5)			0.003	0.002	0.005	0.005	0.003	0.008	0.150
3-Axle Trucks (PCE = 2.0)			0.005	0.005	0.010	0.008	0.008	0.016	0.311
4+-Axle Trucks (PCE = 3.0)			0.021	0.017	0.038	0.030	0.026	0.056	1.127

¹ Trip Generation & Vehicle Mix Source: Institute of Transportation Engineers (ITE), Trip Generation Manual, Eleventh Edition (2021).

² TSF = thousand square feet

³ Truck Mix: South Coast Air Quality Management District's (SCAQMD) recommended truck mix, by axle type.

Normalized % - Without Cold Storage: 16.7% 2-Axle trucks, 20.7% 3-Axle trucks, 62.6% 4-Axle trucks.

The trip generation summary illustrating daily and peak hour trip generation estimates for a warehouse use are shown on Table 4-5 (in actual vehicles). The proposed Project is anticipated to generate 278 two-way trip-ends per day with 21 AM peak hour trips and 19 PM peak hour trips (see Table 4-5). PCE based trip generation for the Project is summarized on Table 4-6. The trip generation for the truck parking lot is consistent with that shown on Table 4-2 and Table 4-3.

TABLE 4-5: TRIP GENERATION SUMMARY FOR WAREHOUSING USE (ACTUAL VEHICLES)

Land Use	Quantity Units ¹	AM Peak Hour			PM Peak Hour			Daily
		In	Out	Total	In	Out	Total	
Actual Vehicles:								
Warehousing	99.770 TSF							
Passenger Cars:		12	3	15	3	12	15	112
2-axle Trucks:		0	0	0	0	0	0	10
3-axle Trucks:		0	0	0	0	0	0	12
4+-axle Trucks:		1	1	2	1	1	2	38
Total Truck Trips (Actual Vehicles):		1	1	2	1	1	2	60
Total Trips (Actual Vehicles) ²		13	4	17	4	13	17	172
Truck Trailer Yard								
	133 Spaces							
Passenger Cars:		1	1	2	0	0	0	24
2-axle Trucks:		0	2	2	1	0	1	16
3-axle Trucks:		0	0	0	0	0	0	28
4+-axle Trucks:		0	0	0	0	1	1	38
Total Truck Trips (Actual Vehicles):		0	2	2	1	1	2	82
Total Trips (Actual Vehicles) ²		1	3	4	1	1	2	106
Project Total (Actual Vehicles)		14	7	21	5	14	19	278

¹ TSF = thousand square feet

² Total Trips = Passenger Cars + Truck Trips.

TABLE 4-6: TRIP GENERATION SUMMARY FOR WAREHOUSING USE (PCE)

Land Use	Quantity Units ¹	AM Peak Hour			PM Peak Hour			Daily
		In	Out	Total	In	Out	Total	
Passenger Car Equivalent (PCE):								
Warehousing	99.770 TSF							
Passenger Cars:		12	3	15	3	12	15	112
2-axle Trucks:		0	0	0	0	0	0	16
3-axle Trucks:		0	1	1	1	1	2	32
4+-axle Trucks:		2	2	4	3	3	6	112
Total Truck Trips (PCE):		2	3	5	4	4	8	160
Total Trips (PCE) ²		14	6	20	7	16	23	272
Truck Trailer Yard								
	133 Spaces							
Passenger Cars:		1	1	2	0	0	0	24
2-axle Trucks:		0	3	3	2	0	2	22
3-axle Trucks:		1	1	2	1	0	1	56
4+-axle Trucks:		1	0	1	0	4	4	112
Total Truck Trips (PCE):		2	4	6	3	4	7	190
Total Trips (PCE) ²		3	5	8	3	4	7	214
Project Total (PCE)		17	11	28	10	20	30	486

¹ TSF = thousand square feet

² Total Trips = Passenger Cars + Truck Trips.

4.2 PROJECT TRIP DISTRIBUTION

The Project trip distribution represents the directional orientation of traffic to and from the Project site. Trip distribution is the process of identifying the probable destinations, directions or traffic routes that will be utilized by Project traffic. The potential interaction between the planned land uses and surrounding regional access routes are considered, to identify the route where the Project traffic would distribute. In addition, truck routes for neighboring agencies have been taken into consideration in the development of the trip distribution patterns for heavy trucks. Exhibits 4-1 and 4-2 show the Project truck and passenger car trip distribution patterns, respectively. Note that the Project Truck distribution shows two alternatives that have been evaluated in this TA.

4.3 MODAL SPLIT

The potential for Project trips (non-truck) to be reduced by the use of public transit, walking or bicycling have not been included as part of the Project's estimated trip generation. Essentially, the Project's traffic projections are "conservative" in that these alternative travel modes would reduce the forecasted traffic volumes.

4.4 PROJECT TRIP ASSIGNMENT

The assignment of traffic from the Project area to the adjoining roadway system is based upon the Project trip generation, trip distribution, and the arterial highway and local street system improvements that would be in place by the time of initial occupancy of the Project. Based on the identified Project traffic generation and trip distribution patterns, the Project only ADT and peak hour intersection turning movement volumes are shown on Exhibit 4-3.

EXHIBIT 4-1: PROJECT (TRUCK) TRIP DISTRIBUTION

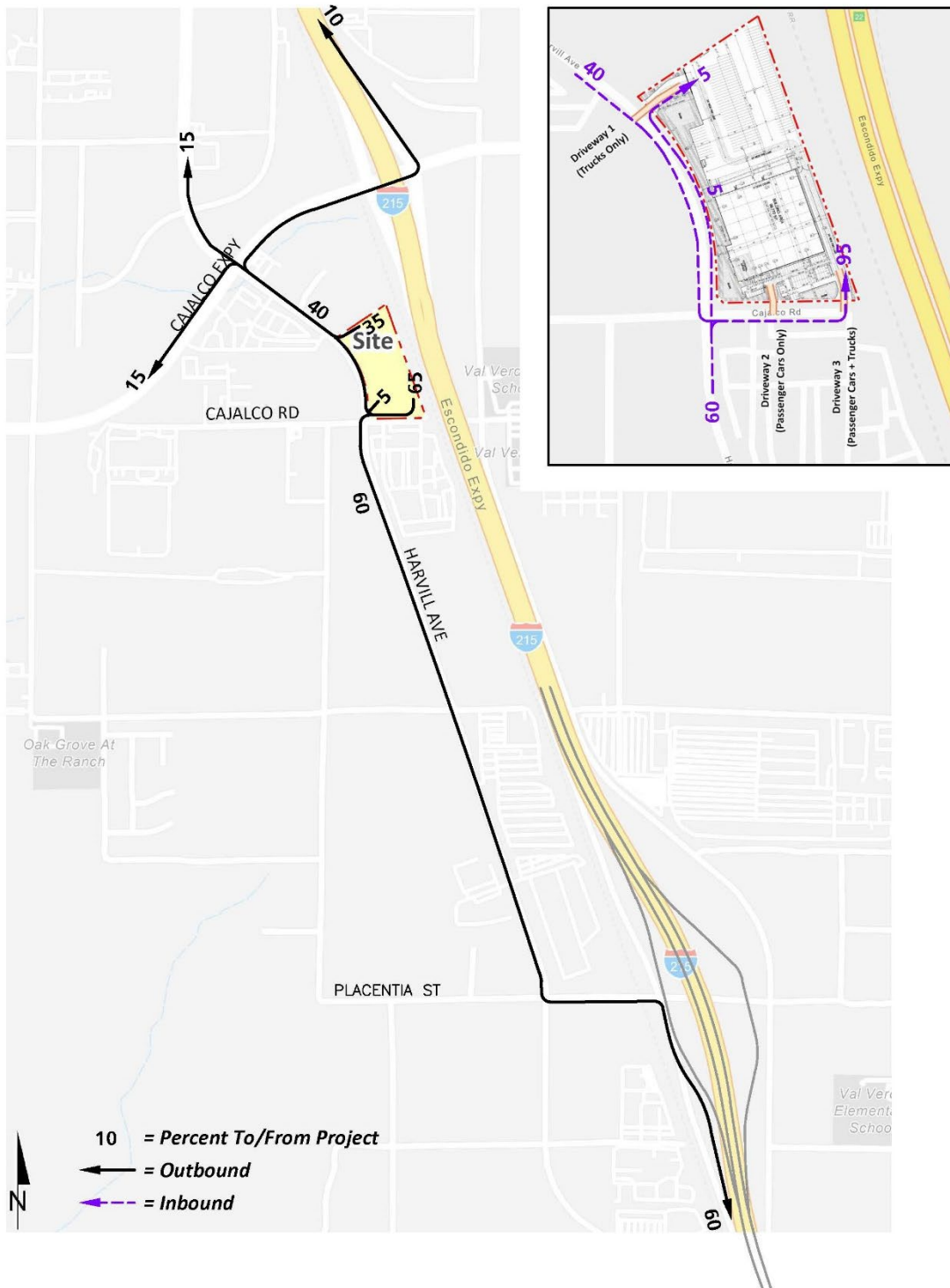

EXHIBIT 4-2: PROJECT (PASSENGER CAR) TRIP DISTRIBUTION

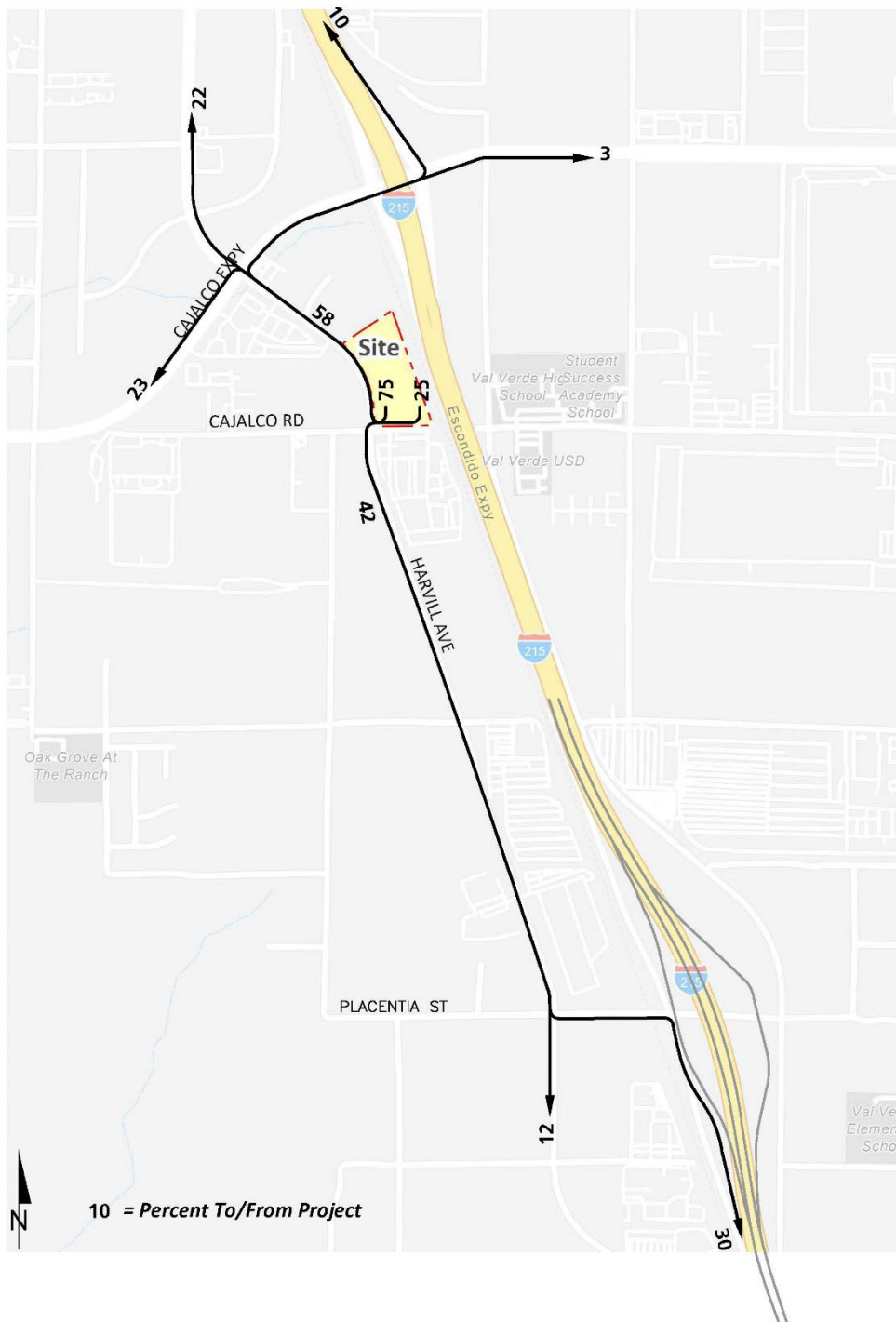
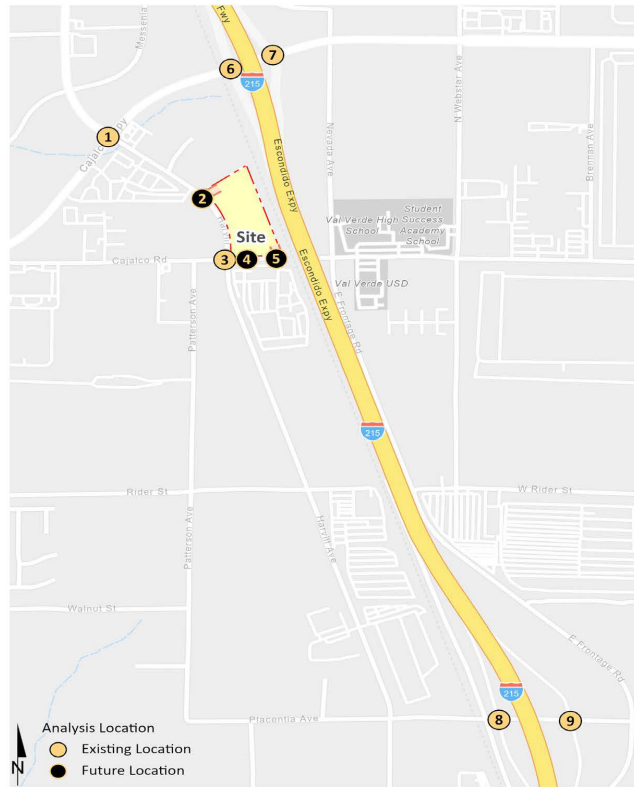

EXHIBIT 4-3: PROJECT ONLY TRAFFIC VOLUMES



1	Harvill Av. & Cajalco Exwy.	2	Harvill Av. & Driveway 1	3	Harvill Av. & Old Cajalco Rd.	4	Driveway 2 & Old Cajalco Rd.	5	Driveway 3 & Old Cajalco Rd.
100	Nominal	350		300	550	350	200	200	
150	← 14(2) 15(2) ↓ 2(13) → 2(12) → 1(7) ↘	↑ 1(0) 5(32) ↑	← 38(6) 5(32) ↑	← 38(6) 5(32) ↑ 5(24) ↑ 27(4) ↘	← 7(41) 49(7) ↘ 16(3) →	← 4(14)	← 4(14) 16(3) →		
	350	300	250	550	200	200			
6	I-215 SB Ramps & Ramona Exwy.	7	I-215 NB Ramps & Ramona Exwy.	8	I-215 SB Ramps & Placentia Av.	9	I-215 NB Ramps & Placentia Av.		
Nominal	Nominal	Nominal	Nominal	100					
← 7(1) 1(7) →	← 2(0)	← 2(0) 1(6) ↘ 0(2) →	← 20(3) 4(17) ↘		20(3) ↑				
Nominal	Nominal	Nominal	200	100	100	100			

##(##) AM(PM) Peak Hour Intersection Volumes
 ## Average Daily Trips

4.5 BACKGROUND TRAFFIC

Future year traffic forecasts have been based upon background (ambient) growth at 2% per year, compounded annually, for 2024 conditions. The total ambient growth is 4.04% for 2024 traffic conditions (compounded growth of 2 percent per year over 2 years or $1.02^{2\text{years}}$). The ambient growth factor is intended to approximate regional traffic growth. This ambient growth rate is added to existing traffic volumes to account for area-wide growth not reflected by cumulative development projects. Ambient growth has been added to daily and peak hour traffic volumes on surrounding roadways, in addition to traffic generated by the development of future projects that have been approved but not yet built and/or for which development applications have been filed and are under consideration by governing agencies.

The currently adopted Southern California Association of Governments (SCAG) 2020 Regional Transportation Plan/Sustainable Communities Strategy (RTP/SCS) (May 2020) growth forecasts for the County of Riverside identifies projected growth in population of 370,500 in 2016 to 525,600 in 2045, or a 41.9 percent increase over the 29-year period. (6) The change in population equates to roughly a 1.21 percent growth rate, compounded annually. Similarly, growth over the same 29-year period in households is projected to increase by 59.2 percent, or 1.62 percent annual growth rate. Finally, growth in employment over the same 29-year period is projected to increase by 83.4 percent, or a 2.11 percent annual growth rate. This results in an average of 1.65 percent annual growth rate. As such, the 2.0 percent per year ambient growth rate utilized in this TA would appear to conservatively estimate annual traffic growth and overstate as opposed to understate future traffic forecasts.

4.6 CUMULATIVE DEVELOPMENT TRAFFIC

A cumulative project list was developed for the purposes of this analysis through consultation with planning and engineering staff from the County of Riverside and City of Perris. The cumulative project list includes known and foreseeable projects that are anticipated to contribute traffic to the study area intersections.

Where applicable, cumulative projects anticipated to contribute measurable traffic (i.e., 50 or more peak hour trips) to study area intersections have been manually added to the study area network to generate EAPC forecasts. In other words, this list of cumulative development projects has been reviewed to determine which projects would likely contribute measurable traffic through the study area intersections (e.g., those cumulative projects in close proximity to the proposed Project). For the purposes of this analysis, the cumulative projects that were determined to affect one or more of the study area intersections are shown on Exhibit 4-4, listed in Table 4-7, and have been considered for inclusion. Any additional traffic generated by other projects not on the cumulative projects list is likely accounted for through background ambient growth factors that have been applied to the peak hour volumes at study area intersections as discussed in Section 4.5 *Background Traffic*. Cumulative development projects shown in Exhibit 4-4 and listed in Table 4-7. Cumulative Only ADT and peak hour intersection turning movement volumes are shown on Exhibit 4-5.

EXHIBIT 4-4: CUMULATIVE DEVELOPMENT LOCATION MAP

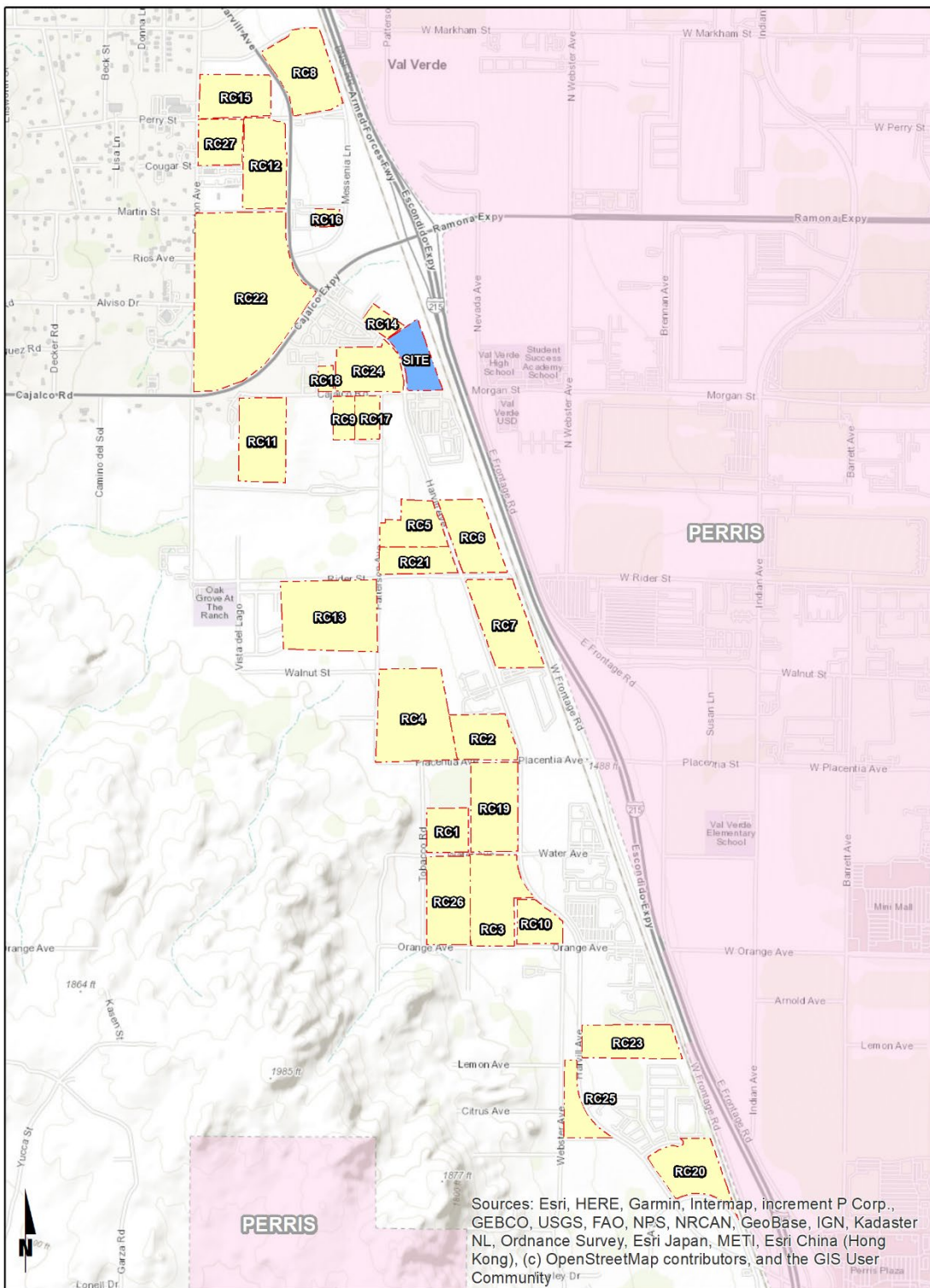
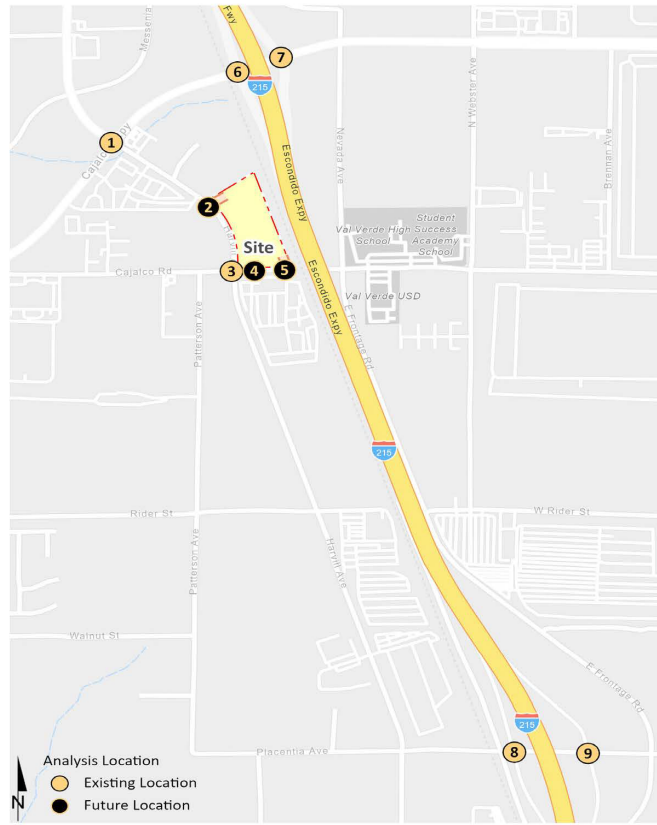

EXHIBIT 4-5: CUMULATIVE ONLY TRAFFIC VOLUMES



1	Harvill Av. & Cajalco Exwy.	2	Harvill Av. & Driveway 3	3	Harvill Av. & Old Cajalco Rd.	4	Driveway 2 & Old Cajalco Rd.	5	Driveway 3 & Old Cajalco Rd.
14,400		40,200	9,500	9,500	9,500				
52(125) 73(67) 206(611)			651(355)	14(7) 637(348)					
129(94) 120(471) 134(64)			251(657)	4(14) 7(20)					
48(141) 52(87) 151(429)				21(9) 247(643)					
25,950		13,100	9,500	1,500	9,200				
6	I-215 SB Ramps & Ramona Exwy.	7	I-215 NB Ramps & Ramona Exwy.	8	I-215 SB Ramps & Placentia Av.	9	I-215 NB Ramps & Placentia Av.		
39,250		24,450	48,750	4,150	8,450	4,450	10,400		
581(258) 889(1144)			836(1065) 556(618)	163(86) 157(196)			131(226) 79(255)		
314(942) 165(567)		184(565) 1020(1520)	533(273) 218(158)	100(219) 66(143)		94(208) 164(207)	114(76) 201(133)		
40,200		9,000	7,450	6,350	3,900	8,450	3,800		

##(##) AM(PM) Peak Hour Intersection Volumes
 ## Average Daily Trips

TABLE 4-7: CUMULATIVE DEVELOPMENT LAND USE SUMMARY

No.	Project Name	Address/Location	Land Use ¹	Quantity Units ²
RC1	Thrifty Oil Warehouse	NEC of Tobacco Rd. & Water Av.	Warehousing	194.479 TSF
RC2	Placentia Truck Drop Lot	NWC of Harvill Av. & Placentia Av.	Truck Trailer Storage	8.06 AC
RC3	Harvill & Water Logistics	SWC of Harvill Av. & Water St.	High-Cube Fulfillment Center Warehouse	304.376 TSF
			High-Cube Cold Storage Warehouse	130.447 TSF
RC4	Barker Logistics	NWC of Patterson Av. & Placentia Av.	High-Cube Fulfillment Center Warehouse	699.630 TSF
RC5	Dedeaux Harvill Truck Terminal	North of Rider St., west of Harvill Av.	Truck Terminal	55.700 TSF
RC6	Harvill & Rider Warehouse	NEC of Harvill Av. & Rider St.	General Light Industrial	50.249 TSF
			High-Cube Transload Short-Term Warehouse	284.746 TSF
RC7	WPC Perris	SEC of Harvill Av. & Rider St.	High-Cube Fulfillment Center Warehouse	384.448 TSF
			High-Cube Cold Storage Warehouse	96.112 TSF
RC8	Majestic Freeway Busines Center (Building 11)	NEC of Harvill Av. & Perry St.	High-Cube Fulfillment Center Warehouse	391.045 TSF
RC9	PPT190029	South of Old Cajalco St., west of Patterson Av.	Warehousing	36.000 TSF
RC10	PPT210021	NWC of Harvill Av. & Orange Av.	Trailer Maintenance Facility/Storage	16.200 TSF
RC11	PPT210133	SEC of Seaton Av. & Cajalco Exwy.	Warehousing	365.046 TSF
RC12	Majestic Freeway Busines Center (Building 13)	SWC of Harvill Av. & Perry St.	High-Cube Fulfillment Center Warehouse	322.997 TSF
RC13	Rider & Patterson Business Center	SWC of Patterson Av. & Rider St.	High-Cube Fulfillment Center Warehouse	591.203 TSF
			Single Family Detached Residential	2 DU
RC14	CUP03599	North of Cajalco Rd., east of Harvill Av.	Hotel	103 RM
RC15	Majestic Freeway Busines Center (Buildings 14A,14B)	SWC of Harvill Av. & Commerce Center Dr.	Warehousing	354.583 TSF
RC16	PP16763	NEC of Harvill Av. & Messenia Ln.	Warehousing	19.500 TSF
RC17	PP16823	South of Old Cajalco St., west of Harvill Av.	Manufacturing	22.000 TSF
RC18	PP16932	North of Old Cajalco St., east of Cajalco Exwy.	Manufacturing	12.000 TSF
RC19	PP21207	SWC of Harvill Av. & Placentia Av.	Warehousing	311.412 TSF
RC20	PP23170	NEC of Harvill Av. & A St.	Warehousing	286.829 TSF
RC21	PP23342	NWC of Harvill Av. & Rider St.	Warehousing	180.551 TSF
RC22	Majestic Freeway Busines Center (Buildings 1,3,4)	NWC of Harvill Av. & Cajalco Exwy.	High-Cube Fulfillment Center Warehouse	1,195.740 TSF
RC23	PPT190005	NEC of Harvill Av. & Lemon St.	Warehousing	333.553 TSF
RC24	PPT190006	NWC of Harvill Av. & Cajalco Rd.	Warehousing	289.556 TSF
RC25	PPT190028	NWC of Harvill Av. & Citrus Av.	Warehousing	197.856 TSF
RC26	TR27997	NEC of Patterson Av. & Orange Av.	Multifamily Housing	120 DU
RC27	Seaton Commerce Center	SEC of Seaton Av. & Perry St.	High-Cube Fulfillment Center Warehouse	210.800 TSF

¹ TSF = Thousand Square Feet; DU = Dwelling Units; RM = Rooms; TPY = Tons per Year

4.7 NEAR-TERM TRAFFIC CONDITIONS

The “buildup” approach combines existing traffic counts with a background ambient growth factor to forecast EAP (2024) and EAPC (2024) traffic conditions. An ambient growth factor accounts for background (area-wide) traffic increases that occur over time up to the year 2024 from the year 2022. Traffic volumes generated by the Project are then added to assess the near-term traffic conditions. The 2024 roadway network is similar to the Existing conditions roadway network, with the exception of future driveways proposed to be developed by the Project. The near-term traffic analysis includes the following traffic conditions, with the various traffic components:

- Existing Plus Ambient Growth Plus Project (2024)
 - Existing 2022 counts
 - Ambient growth traffic (4.04%)
 - Project traffic
- Existing Plus Ambient Growth Plus Project Plus Cumulative (2024)
 - Existing 2022 counts
 - Ambient growth traffic (4.04%)
 - Cumulative Development traffic
 - Project traffic

5 EAP (2024) TRAFFIC CONDITIONS

This section discusses the traffic forecasts for EAP (2024) conditions and the resulting intersection operations, traffic signal warrant, and queuing analyses.

5.1 ROADWAY IMPROVEMENTS

The lane configurations and traffic controls assumed to be in place for EAP (2024) conditions are consistent with those shown previously on Exhibit 3-1, with the exception of the following:

- Project driveways and those facilities assumed to be constructed by the Project to provide site access are also assumed to be in place for EAP conditions only (e.g., intersection and roadway improvements at the Project's frontage and driveways).
- The I-215 Freeway at Placentia Avenue interchange which is anticipated to be completed and open in Summer of 2022 has been assumed to be completed with improvements in place for EAP (2024) traffic conditions.

5.2 EAP (2024) TRAFFIC VOLUME FORECASTS

This scenario includes Existing (2022) traffic volumes plus an ambient growth factor of 4.04% and the addition of Project traffic. The weekday ADT volumes and peak hour volumes which can be expected for EAP (2024) traffic conditions are shown on Exhibit 5-1.

5.3 INTERSECTION OPERATIONS ANALYSIS

EAP (2024) peak hour traffic operations have been evaluated for the study area intersections based on the analysis methodologies presented in Section 2 *Methodologies* of this TA. The intersection analysis results are summarized on Table 5-1 for EAP traffic conditions, which indicate that all of the study area intersections are anticipated to continue to operate at an acceptable LOS under EAP traffic conditions. The intersection operations analysis worksheets for EAP traffic conditions are included in Appendix 5.1 of this TA.

EXHIBIT 5-1: EAP (2024) TRAFFIC VOLUMES

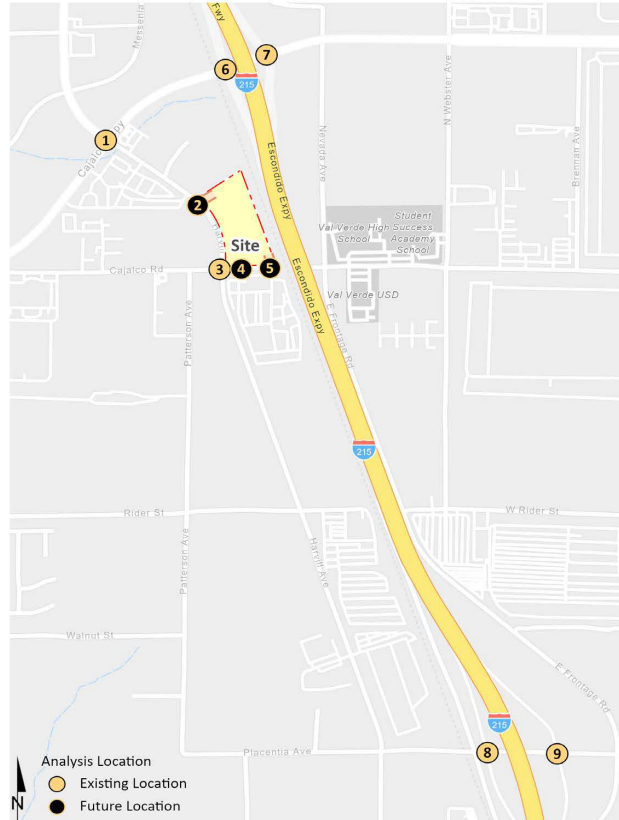

1 Harvill Av. & Cajalco Exwpy.	2 Harvill Av. & Driveway 1	3 Harvill Av. & Old Cajalco Rd.	4 Driveway 2 & Old Cajalco Rd.	5 Driveway 3 & Old Cajalco Rd.																																																						
<table border="1"> <tr><td>11,450</td><td>32,150</td></tr> <tr><td>20(33)</td><td>98(182)</td></tr> <tr><td>120(210)</td><td>653(621)</td></tr> <tr><td>181(227)</td><td>148(106)</td></tr> <tr><td>38(23)</td><td>299(178)</td></tr> <tr><td>651(714)</td><td>343(158)</td></tr> <tr><td>65(210)</td><td>69(128)</td></tr> <tr><td>28,850</td><td>15,850</td></tr> </table>	11,450	32,150	20(33)	98(182)	120(210)	653(621)	181(227)	148(106)	38(23)	299(178)	651(714)	343(158)	65(210)	69(128)	28,850	15,850	<table border="1"> <tr><td>14,450</td><td>1(0)</td></tr> <tr><td>293(466)</td><td>753(441)</td></tr> <tr><td></td><td>14,450</td></tr> </table>	14,450	1(0)	293(466)	753(441)		14,450	<table border="1"> <tr><td>14,450</td><td>1,150</td></tr> <tr><td>37(23)</td><td>7(49)</td></tr> <tr><td>209(433)</td><td>8(29)</td></tr> <tr><td>46(10)</td><td>5(4)</td></tr> <tr><td>21(56)</td><td>725(336)</td></tr> <tr><td>3(14)</td><td>34(6)</td></tr> <tr><td>1,550</td><td>13,200</td></tr> </table>	14,450	1,150	37(23)	7(49)	209(433)	8(29)	46(10)	5(4)	21(56)	725(336)	3(14)	34(6)	1,550	13,200	<table border="1"> <tr><td>350</td><td>650</td></tr> <tr><td>7(41)</td><td>9(36)</td></tr> <tr><td>49(7)</td><td></td></tr> <tr><td>32(9)</td><td></td></tr> <tr><td>1,050</td><td>650</td></tr> </table>	350	650	7(41)	9(36)	49(7)		32(9)		1,050	650	<table border="1"> <tr><td>200</td><td>4(14)</td></tr> <tr><td>16(3)</td><td>16(6)</td></tr> <tr><td>5(22)</td><td></td></tr> <tr><td>650</td><td>450</td></tr> </table>	200	4(14)	16(3)	16(6)	5(22)		650	450
11,450	32,150																																																									
20(33)	98(182)																																																									
120(210)	653(621)																																																									
181(227)	148(106)																																																									
38(23)	299(178)																																																									
651(714)	343(158)																																																									
65(210)	69(128)																																																									
28,850	15,850																																																									
14,450	1(0)																																																									
293(466)	753(441)																																																									
	14,450																																																									
14,450	1,150																																																									
37(23)	7(49)																																																									
209(433)	8(29)																																																									
46(10)	5(4)																																																									
21(56)	725(336)																																																									
3(14)	34(6)																																																									
1,550	13,200																																																									
350	650																																																									
7(41)	9(36)																																																									
49(7)																																																										
32(9)																																																										
1,050	650																																																									
200	4(14)																																																									
16(3)	16(6)																																																									
5(22)																																																										
650	450																																																									
6 I-215 SB Ramps & Ramona Exwpy.	7 I-215 NB Ramps & Ramona Exwpy.	8 I-215 SB Ramps & Placentia Av.	9 I-215 NB Ramps & Placentia Av.																																																							
<table border="1"> <tr><td>11,450</td><td>31,500</td></tr> <tr><td>119(106)</td><td>790(655)</td></tr> <tr><td>1(4)</td><td>236(298)</td></tr> <tr><td>574(703)</td><td></td></tr> <tr><td>439(571)</td><td></td></tr> <tr><td>240(252)</td><td></td></tr> <tr><td>23,300</td><td>8,550</td></tr> </table>	11,450	31,500	119(106)	790(655)	1(4)	236(298)	574(703)		439(571)		240(252)		23,300	8,550	<table border="1"> <tr><td>8,750</td><td>43,600</td></tr> <tr><td>79(84)</td><td>467(455)</td></tr> <tr><td>934(1190)</td><td>781(704)</td></tr> <tr><td>79(84)</td><td></td></tr> <tr><td>245(249)</td><td>3(3)</td></tr> <tr><td>431(332)</td><td></td></tr> <tr><td>36,150</td><td>9,500</td></tr> </table>	8,750	43,600	79(84)	467(455)	934(1190)	781(704)	79(84)		245(249)	3(3)	431(332)		36,150	9,500	<table border="1"> <tr><td>6,100</td><td>27,350</td></tr> <tr><td>57(55)</td><td>415(515)</td></tr> <tr><td>0(1)</td><td>128(231)</td></tr> <tr><td>215(319)</td><td></td></tr> <tr><td>434(612)</td><td></td></tr> <tr><td>109(150)</td><td></td></tr> <tr><td>21,550</td><td>6,050</td></tr> </table>	6,100	27,350	57(55)	415(515)	0(1)	128(231)	215(319)		434(612)		109(150)		21,550	6,050	<table border="1"> <tr><td>5,050</td><td>31,450</td></tr> <tr><td>56(61)</td><td>266(250)</td></tr> <tr><td>592(870)</td><td>378(601)</td></tr> <tr><td>165(146)</td><td></td></tr> <tr><td>238(212)</td><td></td></tr> <tr><td>27,350</td><td>5,900</td></tr> </table>	5,050	31,450	56(61)	266(250)	592(870)	378(601)	165(146)		238(212)		27,350	5,900	
11,450	31,500																																																									
119(106)	790(655)																																																									
1(4)	236(298)																																																									
574(703)																																																										
439(571)																																																										
240(252)																																																										
23,300	8,550																																																									
8,750	43,600																																																									
79(84)	467(455)																																																									
934(1190)	781(704)																																																									
79(84)																																																										
245(249)	3(3)																																																									
431(332)																																																										
36,150	9,500																																																									
6,100	27,350																																																									
57(55)	415(515)																																																									
0(1)	128(231)																																																									
215(319)																																																										
434(612)																																																										
109(150)																																																										
21,550	6,050																																																									
5,050	31,450																																																									
56(61)	266(250)																																																									
592(870)	378(601)																																																									
165(146)																																																										
238(212)																																																										
27,350	5,900																																																									

###(###) AM(PM) Peak Hour Intersection Volumes

Average Daily Trips

TABLE 5-1: INTERSECTION ANALYSIS FOR EAP (2024) CONDITIONS

# Intersection	Traffic Control ²	Existing (2022)				EAP (2024)			
		Delay ¹ (secs.)		Level of Service		Delay ¹ (secs.)		Level of Service	
		AM	PM	AM	PM	AM	PM	AM	PM
1 Harvill Av. & Cajalco Exwy.	CSS	38.4	37.8	D	D	39.5	38.7	D	D
2 Harvill Av. & Driveway 1	CSS	Future Intersection				11.4	9.9	B	A
3 Harvill Av. & Old Cajalco Rd.	CSS	15.9	14.1	C	B	16.6	14.8	C	B
4 Driveway 2 & Old Cajalco Rd.	CSS	Future Intersection				8.4	8.6	A	A
5 Driveway 3 & Old Cajalco Rd.	CSS	Future Intersection				6.9	6.8	A	A
6 I-215 SB Ramps & Ramona Exwy.	TS	36.7	44.0	D	D	33.3	35.0	C	D
7 I-215 NB Ramps & Ramona Exwy.	TS	25.5	18.4	C	B	18.5	15.2	B	B
8 I-215 SB Ramps & Placentia Av.	TS	Future Intersection				11.4	13.2	B	B
9 I-215 NB Ramps & Placentia Av.	TS	Future Intersection				15.6	13.0	B	B

¹ Per the Highway Capacity Manual (6th Edition), overall average intersection delay and level of service are shown for intersections with a traffic signal or all way stop control. For intersections with cross street stop control, the delay and level of service for the worst individual movement (or movements sharing a single lane) are shown. HCM delay reported in seconds.

² TS = Traffic Signal; CSS = Cross-street Stop

5.4 TRAFFIC SIGNAL WARRANTS ANALYSIS

The traffic signal warrant analysis for EAP (2024) traffic conditions are based on the peak hour volumes or planning level ADT volume-based traffic signal warrants. No study area intersections are anticipated to meet either peak hour volume or ADT volume-based warrants with the addition of Project traffic (see Appendix 5.2).

5.5 QUEUING ANALYSIS

Queuing analysis findings for EAP (2024) are presented on Table 5-2. As shown on Table 5-2, there are no movements that are anticipated to experience queuing issues during the weekday AM or weekday PM peak 95th percentile traffic flows with the addition of Project traffic. Worksheets for EAP (2024) traffic conditions queuing analysis are provided in Appendix 5.3.

TABLE 5-2: PEAK HOUR QUEUING SUMMARY FOR EAP (2024) CONDITIONS

Intersection	Movement	Available Stacking Distance (Feet)	Existing (2022)				EAP (2024)			
			95th Percentile Queue (Feet)		Acceptable? ¹		95th Percentile Queue (Feet)		Acceptable? ¹	
			AM Peak	PM Peak	AM	PM	AM Peak	PM Peak	AM	PM
I-215 SB Ramps & Ramona Exwy.	SBL	530	445 ²	468 ²	Yes	Yes	455 ²	397 ²	Yes	Yes
	SBT	1,100	448 ²	481 ²	Yes	Yes	458 ²	426 ²	Yes	Yes
	SBR	530	138	78	Yes	Yes	75	46	Yes	Yes
I-215 NB Ramps & Ramona Exwy.	NBL	520	184	176	Yes	Yes	148	143	Yes	Yes
	NBT	1,120	187	181	Yes	Yes	146	140	Yes	Yes
	NBR	520	685 ^{2,3}	457 ²	Yes	Yes	463 ²	293	Yes	Yes
I-215 SB Ramps & Placentia Av.	SBL	1,530	Future Intersection				96	122	Yes	Yes
	SBT	1,530					96	122	Yes	Yes
	SBR	350					12	9	Yes	Yes
I-215 NB Ramps & Placentia Av.	NBL	575	Future Intersection				75	66	Yes	Yes
	NBT	1,600					75	66	Yes	Yes
	NBR	1,600					88	96	Yes	Yes

¹ Stacking Distance is acceptable if the required stacking distance is less than or equal to the stacking distance provided. An additional 15 feet of stacking which is assumed to be provided in the transition for turn pockets is reflected in the stacking distance shown on this table, where applicable.

² 95th percentile volume exceeds capacity, queue may be longer. Queue shown is maximum after two cycles.

³ Although 95th percentile queue is anticipated to exceed the available storage for the turn lane, the adjacent through lane has sufficient storage to accommodate any spillover without spilling back and affecting the I-215 Freeway mainline.

5.5 PROJECT DEFICIENCIES AND RECOMMENDED IMPROVEMENTS

The study area intersections are anticipated to operate at an acceptable LOS with the addition of Project traffic. As such, no additional improvements aside from those that are needed to facilitate site access have been recommended. As shown previously in Table 5-2, there are no movements that are anticipated to experience queuing issues during the weekday AM or weekday PM peak 95th percentile traffic flows for EAP (2024) traffic conditions. As such, no improvements have been identified for the off-ramps.

6 EAPC (2024) TRAFFIC CONDITIONS

This section discusses the traffic forecasts for EAPC (2024) conditions and the resulting intersection operations, traffic signal warrant, and queuing analyses.

6.1 ROADWAY IMPROVEMENTS

The lane configurations and traffic controls assumed to be in place for EAPC (2024) conditions are consistent with those shown previously on Exhibit 3-1, with the exception of the following:

- Project driveways and those facilities assumed to be constructed by the Project to provide site access are also assumed to be in place for EAPC (2024) conditions only (e.g., intersection and roadway improvements at the Project's frontage and driveways).
- Driveways and those facilities assumed to be constructed by cumulative developments to provide site access are also assumed to be in place for EAPC (2024) conditions only (e.g., intersection and roadway improvements along the cumulative development's frontages).
- The I-215 Freeway at Placentia Avenue interchange which is anticipated to be completed and open in Summer of 2022 has been assumed to be completed with improvements in place for EAPC (2024) traffic conditions.

6.2 EAPC (2024) TRAFFIC VOLUME FORECASTS

This scenario includes Existing (2022) traffic volumes plus an ambient growth factor of 4.04%, traffic from pending and approved cumulative development projects, and the addition of Project traffic. The weekday ADT volumes and peak hour volumes which can be expected for EAPC (2024) traffic conditions are shown on Exhibit 6-1.

6.3 INTERSECTION OPERATIONS ANALYSIS

LOS calculations were conducted for the study intersections to evaluate their operations under EAPC (2024) conditions with roadway and intersection geometrics consistent with Section 6.1 *Roadway Improvements*. As shown on Table 6-1, the study area intersections are anticipated to operate at an acceptable LOS under EAPC (2024) traffic conditions with the exception of the following intersections:

- Harvill Av. & Cajalco Exwy. (#1) – LOS E AM peak hour; LOS F PM peak hour
- I-215 SB Ramps & Ramona Exwy. (#6) – LOS F AM and PM peak hours
- I-215 NB Ramps & Ramona Exwy. (#7) – LOS F AM and PM peak hours

The intersection operations analysis worksheets for EAPC (2024) traffic conditions are included in Appendix 6.1 of this TA.

EXHIBIT 6-1: EAPC (2024) TRAFFIC VOLUMES

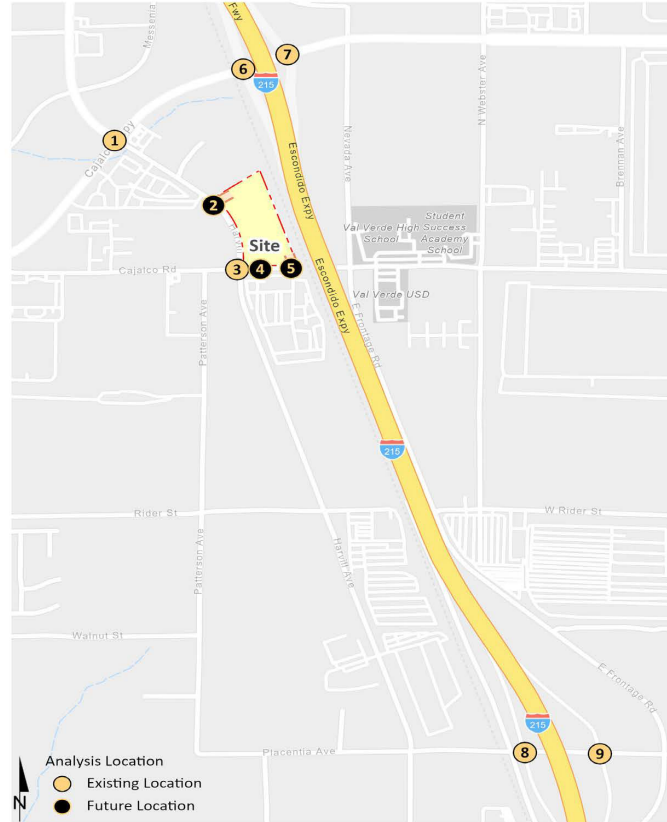

<p>1 Harvill Av. & Cajalco Exwy.</p> <table border="1"> <tr> <td>25,850</td> <td>72,350</td> </tr> <tr> <td>72(158)</td> <td>↑ 677(435)</td> </tr> <tr> <td>193(277)</td> <td>↑ 1065(874)</td> </tr> <tr> <td>387(838)</td> <td>↑ 584(304)</td> </tr> <tr> <td>167(117)</td> <td>↑ 346(320)</td> </tr> <tr> <td>771(1185)</td> <td>↑ 396(244)</td> </tr> <tr> <td>199(274)</td> <td>↑ 219(557)</td> </tr> <tr> <td>54,800</td> <td>28,950</td> </tr> </table>	25,850	72,350	72(158)	↑ 677(435)	193(277)	↑ 1065(874)	387(838)	↑ 584(304)	167(117)	↑ 346(320)	771(1185)	↑ 396(244)	199(274)	↑ 219(557)	54,800	28,950	<p>2 Harvill Av. & Driveway 1</p> <table border="1"> <tr> <td>23,950</td> <td>1(0)</td> </tr> <tr> <td>944(821)</td> <td>1004(1098)</td> </tr> <tr> <td>23,950</td> <td>23,950</td> </tr> </table>	23,950	1(0)	944(821)	1004(1098)	23,950	23,950	<p>3 Harvill Av. & Old Cajalco Rd.</p> <table border="1"> <tr> <td>23,950</td> <td>1,150</td> </tr> <tr> <td>51(30)</td> <td>↑ 7(49)</td> </tr> <tr> <td>846(781)</td> <td>8(29)</td> </tr> <tr> <td>46(10)</td> <td>↑ 26(13)</td> </tr> <tr> <td>25(70)</td> <td>↑ 972(979)</td> </tr> <tr> <td>10(34)</td> <td>↑ 34(6)</td> </tr> <tr> <td>3,050</td> <td>22,400</td> </tr> </table>	23,950	1,150	51(30)	↑ 7(49)	846(781)	8(29)	46(10)	↑ 26(13)	25(70)	↑ 972(979)	10(34)	↑ 34(6)	3,050	22,400	<p>4 Driveway 2 & Old Cajalco Rd.</p> <table border="1"> <tr> <td>350</td> <td>650</td> </tr> <tr> <td>7(41)</td> <td>← 9(36)</td> </tr> <tr> <td>49(7)</td> <td>32(9)</td> </tr> <tr> <td>1,050</td> <td>650</td> </tr> </table>	350	650	7(41)	← 9(36)	49(7)	32(9)	1,050	650	<p>5 Driveway 3 & Old Cajalco Rd.</p> <table border="1"> <tr> <td>200</td> <td>4(14)</td> </tr> <tr> <td>16(3)</td> <td>5(22)</td> </tr> <tr> <td>16(6)</td> <td>450</td> </tr> <tr> <td>650</td> <td>450</td> </tr> </table>	200	4(14)	16(3)	5(22)	16(6)	450	650	450
25,850	72,350																																																							
72(158)	↑ 677(435)																																																							
193(277)	↑ 1065(874)																																																							
387(838)	↑ 584(304)																																																							
167(117)	↑ 346(320)																																																							
771(1185)	↑ 396(244)																																																							
199(274)	↑ 219(557)																																																							
54,800	28,950																																																							
23,950	1(0)																																																							
944(821)	1004(1098)																																																							
23,950	23,950																																																							
23,950	1,150																																																							
51(30)	↑ 7(49)																																																							
846(781)	8(29)																																																							
46(10)	↑ 26(13)																																																							
25(70)	↑ 972(979)																																																							
10(34)	↑ 34(6)																																																							
3,050	22,400																																																							
350	650																																																							
7(41)	← 9(36)																																																							
49(7)	32(9)																																																							
1,050	650																																																							
200	4(14)																																																							
16(3)	5(22)																																																							
16(6)	450																																																							
650	450																																																							
<p>6 I-215 SB Ramps & Ramona Exwy.</p> <table border="1"> <tr> <td>15,900</td> <td>41,900</td> </tr> <tr> <td>700(365)</td> <td>↑ 1645(1125)</td> </tr> <tr> <td>1(4)</td> <td>↑ 470(722)</td> </tr> <tr> <td>1498(1848)</td> <td></td> </tr> <tr> <td>719(1513)</td> <td></td> </tr> <tr> <td>405(819)</td> <td></td> </tr> <tr> <td>31,750</td> <td>12,350</td> </tr> </table>	15,900	41,900	700(365)	↑ 1645(1125)	1(4)	↑ 470(722)	1498(1848)		719(1513)		405(819)		31,750	12,350	<p>7 I-215 NB Ramps & Ramona Exwy.</p> <table border="1"> <tr> <td>33,200</td> <td>92,350</td> </tr> <tr> <td>263(649)</td> <td>↑ 1303(1520)</td> </tr> <tr> <td>1954(2711)</td> <td>↑ 1338(1324)</td> </tr> <tr> <td>778(523)</td> <td>3(3)</td> </tr> <tr> <td>649(490)</td> <td>649(490)</td> </tr> <tr> <td>16,950</td> <td>16,950</td> </tr> </table>	33,200	92,350	263(649)	↑ 1303(1520)	1954(2711)	↑ 1338(1324)	778(523)	3(3)	649(490)	649(490)	16,950	16,950	<p>8 I-215 SB Ramps & Placentia Av.</p> <table border="1"> <tr> <td>10,250</td> <td>35,800</td> </tr> <tr> <td>220(141)</td> <td>↑ 539(598)</td> </tr> <tr> <td>0(1)</td> <td>↑ 197(478)</td> </tr> <tr> <td>372(515)</td> <td></td> </tr> <tr> <td>534(831)</td> <td></td> </tr> <tr> <td>175(293)</td> <td></td> </tr> <tr> <td>27,900</td> <td>9,900</td> </tr> </table>	10,250	35,800	220(141)	↑ 539(598)	0(1)	↑ 197(478)	372(515)		534(831)		175(293)		27,900	9,900	<p>9 I-215 NB Ramps & Placentia Av.</p> <table border="1"> <tr> <td>9,500</td> <td>41,850</td> </tr> <tr> <td>150(269)</td> <td>↑ 397(476)</td> </tr> <tr> <td>756(1077)</td> <td>↑ 457(856)</td> </tr> <tr> <td>279(222)</td> <td>439(345)</td> </tr> <tr> <td>35,800</td> <td>9,700</td> </tr> </table>	9,500	41,850	150(269)	↑ 397(476)	756(1077)	↑ 457(856)	279(222)	439(345)	35,800	9,700			
15,900	41,900																																																							
700(365)	↑ 1645(1125)																																																							
1(4)	↑ 470(722)																																																							
1498(1848)																																																								
719(1513)																																																								
405(819)																																																								
31,750	12,350																																																							
33,200	92,350																																																							
263(649)	↑ 1303(1520)																																																							
1954(2711)	↑ 1338(1324)																																																							
778(523)	3(3)																																																							
649(490)	649(490)																																																							
16,950	16,950																																																							
10,250	35,800																																																							
220(141)	↑ 539(598)																																																							
0(1)	↑ 197(478)																																																							
372(515)																																																								
534(831)																																																								
175(293)																																																								
27,900	9,900																																																							
9,500	41,850																																																							
150(269)	↑ 397(476)																																																							
756(1077)	↑ 457(856)																																																							
279(222)	439(345)																																																							
35,800	9,700																																																							

##(##) AM(PM) Peak Hour Intersection Volumes
 ## Average Daily Trips

TABLE 6-1: INTERSECTION ANALYSIS FOR EAPC (2024) CONDITIONS

# Intersection	Traffic Control ²	EAPC (2024)			
		Delay ¹ (secs.)		Level of Service	
		AM	PM	AM	PM
1 Harvill Av. & Cajalco Exwy.	CSS	72.3	121.2	E	F
2 Harvill Av. & Driveway 1	CSS	12.9	12.9	B	B
3 Harvill Av. & Old Cajalco Rd.	CSS	31.8	34.6	D	D
4 Driveway 2 & Old Cajalco Rd.	CSS	8.6	8.6	A	A
5 Driveway 3 & Old Cajalco Rd.	CSS	7.3	7.3	A	A
6 I-215 SB Ramps & Ramona Exwy.	TS	180.2	<200.0	F	F
7 I-215 NB Ramps & Ramona Exwy.	TS	<200.0	<200.0	F	F
8 I-215 SB Ramps & Placentia Av.	TS	13.8	26.4	B	C
9 I-215 NB Ramps & Placentia Av.	TS	16.3	14.4	B	B

¹ Per the Highway Capacity Manual (6th Edition), overall average intersection delay and level of service are shown for intersections with a traffic signal or all way stop control. For intersections with cross street stop control, the delay and level of service for the worst individual movement (or movements sharing a single lane) are shown. HCM delay reported in seconds.

² TS = Traffic Signal; CSS = Cross-street Stop

6.4 TRAFFIC SIGNAL WARRANTS ANALYSIS

The traffic signal warrant analysis for EAPC (2024) traffic conditions are based on the peak hour volumes or planning level ADT volume-based traffic signal warrants. The intersection of Harvill Avenue at Cajalco Road is anticipated to meet a peak hour volume-based warrant for EAPC (2024) traffic conditions (see Appendix 6.2).

6.5 QUEUING ANALYSIS

Queuing analysis findings for EAPC (2024) are presented on Table 6-2. As shown on Table 6-2, there are no movements that are anticipated to experience queuing issues during the weekday AM or weekday PM peak 95th percentile traffic flows with the addition of Project traffic, with the exception of the following movements:

- I-215 SB Ramps & Ramona Exwy. (#6): Southbound Left (AM and PM peak hours, Southbound Left-Through (AM and PM peak hours), and Southbound Right (AM peak hour only)

Worksheets for EAPC (2024) traffic conditions queuing analysis are provided in Appendix 6.3.

TABLE 6-2: PEAK HOUR QUEUING SUMMARY FOR EAPC (2024) CONDITIONS

Intersection	Movement	Available Stacking Distance	95th Percentile Queue (Feet)		Acceptable? ¹	
			AM Peak	PM Peak	AM	PM
I-215 SB Ramps & Ramona Exwy.	SBL	530	1,302 ²	1,412 ²	No	No
	SBT	1,100	1,304 ²	1,426 ²	No	No
	SBR	530	934 ²	335	No	Yes
I-215 NB Ramps & Ramona Exwy.	NBL	520	418	271	Yes	Yes
	NBT	1,120	425 ²	275	Yes	Yes
	NBR	520	993 ^{2,3}	616 ^{2,3}	Yes	Yes
I-215 SB Ramps & Placentia Av.	SBL	1,530	150 ²	258 ²	Yes	Yes
	SBT	1,530	150 ²	260 ²	Yes	Yes
	SBR	350	62	30	Yes	Yes
I-215 NB Ramps & Placentia Av.	NBL	575	107	89	Yes	Yes
	NBT	1,600	107	89	Yes	Yes
	NBR	1,600	419 ²	267 ²	Yes	Yes

¹ Stacking Distance is acceptable if the required stacking distance is less than or equal to the stacking distance provided. An additional 15 feet of stacking which is assumed to be provided in the transition for turn pockets is reflected in the stacking distance shown on this table, where applicable.

² 95th percentile volume exceeds capacity, queue may be longer. Queue shown is maximum after two cycles.

³ Although 95th percentile queue is anticipated to exceed the available storage for the turn lane, the adjacent through lane has sufficient storage to accommodate any spillover without spilling back and affecting the I-215 Freeway mainline.

6.6 NEAR-TERM DEFICIENCIES AND RECOMMENDED IMPROVEMENTS

This section provides a summary of Project deficiencies and recommended improvements. Based on the County of Riverside deficiency criteria discussed in Section 2.6 *Deficiency Criteria*, roadway intersections were found to be deficient. Improvements necessary to improve project-related traffic deficiencies are shown in Table 6-2. Table 6-2 indicates the physical improvements needed to address LOS deficiencies at each of the study area intersections under EAPC (2024) traffic conditions. The improvements have been identified to improve the EAPC (2024) deficiencies back to acceptable levels.

Although the intersection of Harvill Avenue at Old Cajalco Road is anticipated to meet peak hour volume-based traffic signal warrants under EAPC traffic conditions, the intersection is anticipated to operate at an acceptable LOS under peak hour conditions. As such, no improvements have been recommended. However, since the intersection of Harvill Avenue at Old Cajalco Road warrants a traffic signal, fair share calculations are provided subsequently for a future traffic signal, should the County require one to be installed. Intersection analysis worksheets for EAPC (2024) traffic conditions, with improvements, are provided in Appendix 6.4.

TABLE 6-3: INTERSECTION ANALYSIS FOR EAPC (2024) CONDITIONS WITH IMPROVEMENTS

# Intersection	Traffic Control ³	Intersection Approach Lanes ¹												Delay ² (secs.)		Level of Service		
		Northbound			Southbound			Eastbound			Westbound			AM	PM	AM	PM	
		L	T	R	L	T	R	L	T	R	L	T	R					
1 Harvill Av. & Cajalco Exwy.																		
- Without Improvements	TS	2	2	0	2	2	0	1	2	1	2	2	1>	72.3	121.2	E	F	
- With Improvements	TS	2	2	0	2	2	0	1	3	1	2	3	1	52.4	47.6	D	D	
6 I-215 SB Ramps & Ramona Exwy.																		
- Without Improvements	TS	0	0	0	1	1	1	0	2	0	1	2	0	180.2	<200.0	F	F	
- With Improvements	TS	0	0	0	2	1	1	0	3	1	2	3	0	35.9	53.4	D	D	
7 I-215 NB Ramps & Ramona Exwy.																		
- Without Improvements	TS	1	1	1	0	0	0	1	2	0	0	2	1	<200.0	<200.0	F	F	
- With Improvements	TS	1	1	1	0	0	0	2	3	0	0	3	1>>	42.9	29.4	D	C	

BOLD = LOS does not meet the applicable jurisdictional requirements (i.e., unacceptable LOS).

¹ When a right turn is designated, the lane can either be striped or unstriped. To function as a right turn lane there must be sufficient width for right turning vehicles to travel outside the through lanes.

L = Left; T = Through; R = Right; > = Right-Turn Overlap Phasing; >> = Free Right Turn Lane; **1** = Improvement

² Per the Highway Capacity Manual 6th Edition, overall average intersection delay and level of service are shown for intersections with a traffic signal or all-way stop control. For intersections with cross street stop control, the delay and level of service for the worst individual movement (or movements sharing a single lane) are shown.

³ TS = Traffic Signal

With the proposed intersection improvements at the I-215 Southbound Ramps and Ramona Expressway, the peak hour queues are also anticipated to improve (see Table 6-4).

TABLE 6-4: PEAK HOUR QUEUING SUMMARY FOR EAPC (2024) CONDITIONS WITH IMPROVEMENTS

Intersection	Movement	Available Stacking Distance	95th Percentile Queue (Feet)		Acceptable? ¹	
			AM Peak	PM Peak	AM	PM
I-215 SB Ramps & Ramona Exwy.	SBL	530	350	689 ^{2,3}	Yes	Yes
	SBT	1,100	343	783 ²	Yes	Yes
	SBR	530	480	332	Yes	Yes

¹ Stacking Distance is acceptable if the required stacking distance is less than or equal to the stacking distance provided. An additional 15 feet of stacking which is assumed to be provided in the transition for turn pockets is reflected in the stacking distance shown on this table, where applicable.

² 95th percentile volume exceeds capacity, queue may be longer. Queue shown is maximum after two cycles.

³ Although 95th percentile queue is anticipated to exceed the available storage for the turn lane, the adjacent through lane has sufficient storage to accommodate any spillover without spilling back and affecting the I-215 Freeway mainline.

7 LOCAL AND REGIONAL FUNDING MECHANISMS

Transportation improvements within the County of Riverside are funded through a combination of improvements constructed by the Project, development impact fee programs. Fee programs applicable to the Project are described below.

7.1 RIVERSIDE COUNTY TRANSPORTATION UNIFORM MITIGATION FEE (TUMF)

The TUMF program is administered by the WRCOG based upon a regional Nexus Study most recently updated in 2016 to address major changes in right of way acquisition and improvement cost factors. (7) This regional program was put into place to ensure that development pays its fair share, and that funding is in place for construction of facilities needed to maintain the requisite level of service and critical to mobility in the region. TUMF is a truly regional mitigation fee program and is imposed and implemented in every jurisdiction in Western Riverside County.

7.2 RIVERSIDE COUNTY DEVELOPMENT IMPACT FEE (DIF) PROGRAM

The Project is located within the County's Mead Valley Area Plan and therefore will be subject to County of Riverside DIF in an effort by the County to address development throughout its unincorporated area. The DIF program consists of two separate transportation components: the Roads, Bridges and Major Improvements component and the Traffic Signals component. Eligible facilities for funding by the County DIF program are identified on the County's Public Needs List, which currently extends through the year 2020. (8) A comprehensive review of the DIF program is now planned in order to update the nexus study. This will result in development of a revised "needs list" extending the program time horizon from 2010 to 2030.

The cost of signaling DIF network intersections is identified under the Traffic Signals component of the DIF program. County staff generally defines DIF eligible intersections as those consisting of two intersecting general plan roadways. If the intersection meets this requirement, it is potentially eligible for up to \$235,000 of credit, which is subject to negotiations with the County.

7.3 MEASURE A

Measure A, Riverside County's half-cent sales tax for transportation, was adopted by voters in 1988 and extended in 2002. It will continue to fund transportation improvements through 2038. Measure A funds a wide variety of transportation projects and services throughout the County. Riverside County Transportation Commission (RCTC) is responsible for administering the program. Measure A dollars are spent in accordance with a voter-approved expenditure plan that was adopted as part of the 1988 election.

7.4 FAIR SHARE CONTRIBUTION

Project improvements may include a combination of fee payments to established programs, construction of specific improvements, payment of a fair share contribution toward future improvements or a combination of these approaches. Improvements constructed by development may be eligible for a fee credit or reimbursement through the program where appropriate. When off-site improvements are identified with a minor share of responsibility assigned to proposed development, the approving jurisdiction may elect to collect a fair share contribution or require the development to construct improvements. Detailed fair share calculations, for each peak hour, have been provided in Table 7-1 for the applicable deficient study area intersections. These fees are collected with the proceeds solely used as part of a funding mechanism aimed at ensuring that regional highways and arterial expansions keep pace with the projected population increases.

Although the intersection of Harvill Avenue at Old Cajalco Road is anticipated to operate at an acceptable LOS under EAPC traffic conditions (see Table 6-1), fair share calculations have been provided as the intersection meets peak hour volume-based warrants for a traffic signal under EAPC traffic conditions.

TABLE 7-1: PROJECT FAIR SHARE CALCULATIONS

#	Intersection	Existing	Project Only	EAPC	Net New Traffic	Project % of New Traffic	
1	Harvill Av. & Cajalco Exwy.	AM:	2,761	47	5,330	2,569	1.8%
		PM:	2,811	42	5,712	2,901	1.4%
3	Harvill Av. & Old Cajalco Rd. ¹	AM:	1,107	80	2,177	1,070	7.5%
		PM:	944	71	2,010	1,066	6.7%
6	I-215 SB Ramps & Ramona Exwy.	AM:	3,599	11	6,135	2,536	0.4%
		PM:	3,586	9	6,850	3,264	0.3%
7	I-215 NB Ramps & Ramona Exwy.	AM:	4,379	3	7,195	2,816	0.1%
		PM:	4,164	8	7,870	3,706	0.2%

BOLD = Denotes highest fair share percentage.

¹ Although the intersection operates at an acceptable LOS under EAPC traffic conditions, fair share calculations have been provided as the intersection meets peak hour warrants for a traffic signal under EAPC traffic conditions.

8 REFERENCES

1. **County of Riverside Transportation Department.** *Transportation Analysis Guidelines for Level of Service and Vehicle Miles Traveled.* County of Riverside : s.n., December 2020.
2. **Institute of Transportation Engineers.** *Trip Generation Manual.* 11th Edition. 2021.
3. **VRPA Technologies, Inc. for Riverside County Transportation Commission.** *Riverside County Long Range Transportation Study.* County of Riverside : VRPA Technologies, Inc., December 2019.
4. **Transportation Research Board.** *Highway Capacity Manual (HCM).* 6th Edition. s.l. : National Academy of Sciences, 2016.
5. **California Department of Transportation.** California Manual on Uniform Traffic Control Devices (CA MUTCD). [book auth.] California Department of Transportation. *California Manual on Uniform Traffic Control Devices (CA MUTCD).* 2014, Updated March 30, 2021 (Revision 6).
6. **Southern California Association of Governments (SCAG).** *2020 Regional Transportation Plan / Sustainable Communities Strategy.* Adopted September 2020.
7. **Western Riverside Council of Governments.** *TUMF Nexus Study, 2016 Program Update.* July 2017.
8. **Willdan Financial Services.** *County of Riverside Development Impact Fee Study Update.* County of Riverside : s.n., 2013.

This page intentionally left blank

APPENDIX 1.1: APPROVED TRAFFIC STUDY SCOPING AGREEMENT

This Page Intentionally Left Blank

EXHIBIT B

SCOPING AGREEMENT FOR TRAFFIC IMPACT STUDY

This letter acknowledges the Riverside County Transportation Department requirements for traffic impact analysis of the following project. The analysis must follow the Riverside County Transportation Department Traffic Study Guidelines dated December 2020.

Case No. PPT220001, PAR210157

Related Cases- _____

SP No. _____

EIR No. _____

GPA No. _____

CZ No. _____

Project Name: Harvill Logistics

Project Address: Northeast corner of Harvill Avenue and Cajalco Road

Project Description: 95,580 square foot warehouse plus 118 trailer parking stalls

	<u>Consultant</u>		<u>Developer</u>
Name:	<u>Urban Crossroads Inc. - Charlene So</u>		<u>BCI IV Harvill Industrial Center LP - Peter Schafer</u>
Address:	<u>1133 Camelback St. #8329</u>		<u>4675 MacArthur Court, Suite 625</u>
	<u>Newport Beach, CA 92658</u>		<u>Newport Beach, CA 92660</u>
Telephone:	<u>(949) 861-0177</u>		<u>949-892-4904</u>
Email:	<u>cs@urbanxroads.com</u>		<u>pschafer@aresmgmt.com</u>

A. Trip Generation Source: ITE Trip Generation Manual (11th Edition, 2021) + Empirical Data (Truck Lot)

Current GP Land Use	<u>LI</u>	Proposed Land Use	<u>LI</u>
Current Zoning	<u>M-SC</u>	Proposed Zoning	<u>M-SC</u>

	Current Trip Generation			Proposed Trip Generation			
	<u>In</u>	<u>Out</u>	<u>Total</u>	<u>In</u>	<u>Out</u>	<u>Total</u>	
AM Trips				<u>65</u>	<u>11</u>	<u>76</u>	(Actual)
PM Trips				<u>10</u>	<u>56</u>	<u>66</u>	(Actual)

Internal Trip Allowance	<input type="checkbox"/> Yes	<input checked="" type="checkbox"/> No	(<u>0</u> % Trip Discount)
Pass-By Trip Allowance	<input type="checkbox"/> Yes	<input checked="" type="checkbox"/> No	(<u>0</u> % Trip Discount)

A passby trip discount of 25% is allowed for appropriate land uses. The passby trips at adjacent study area intersections and project driveways shall be indicated on a report figure.

B. Trip Geographic Distribution:

N varies % S varies % E varies % W varies %

C. Background Traffic

Project Build-out Year: 2024 Annual Ambient Growth Rate: 2 %

Phase Year(s) N/A

Other area Projects to be analyzed: To be provided by the County

Model/Forecast Methodology: _____



D. Study Intersections: (NOTE: Subject to revision after other projects, trip generation and distribution are determined, or comments form other agencies). (See Exhibit 2)

- | | |
|----------------------------------|-----------|
| 1. Harvill Av. & Cajalco Expwy. | 11. _____ |
| 2. Harvill Av. & Driveway 1 | 12. _____ |
| 3. Harvill Av. & Cajalco Rd. | 13. _____ |
| 4. Driveway 2 & Cajalco Rd. | 14. _____ |
| 5. Driveway 3 & Cajalco Rd. | 15. _____ |
| 6. I-215 SB Ramps & Ramona Exwy. | 16. _____ |
| 7. I-215 NB Ramps & Ramona Exwy. | 17. _____ |
| 8. _____ | 18. _____ |
| 9. _____ | 19. _____ |
| 10. _____ | 20. _____ |

E. Study Roadway Segments: (NOTE: Subject to revision after other projects, trip generation and distribution are determined, or comments form other agencies).

1. _____ 2. _____

F. Other Jurisdictional Impacts

Is this project within a City's Sphere of influence or one mile radius of City boundaries? Yes No

If so, name of City jurisdiction: Caltrans - I-215 Freeway

G. Site Plan (please attach reduced copy)

H. Specific issues to be addressed in the Study (in addition to the standard analysis described in the Guideline) (To be filled out by Transportation Department)

(NOTE: If the traffic study states that "a traffic signal is warranted" (or "a traffic signal appears to be warranted", or similar statement) at an existing unsignalized intersection under existing conditions, 8-hour approach traffic volume information must be submitted in addition to the peak hourly turning movement counts for that intersection.

I. Existing Conditions

Traffic count data must be new or recent. Provide traffic count dates if using other than new counts.

Date of counts: Counts conducted in January, February, May 2022

NOTE Traffic Study Submittal Form and appropriate fee must be submitted with, or prior to submittal of this form. Transportation Department staff will not process the Scoping Agreement prior to receipt of the fee.

Recommended by:

Charlene S

1/18/2022

Consultant's Representative

Date

Approved Scoping Agreement:

Riverside County Transportation
Department

Date

Scoping Agreement Revised on

6/3/2022



June 3, 2022

Mr. Kevin Tsang
County of Riverside, Transportation Department
4080 Lemon Street, 8th Floor
Riverside, CA 92501

SUBJECT: HARVILL LOGISTICS (PAR 210157) TRAFFIC ANALYSIS SCOPING AGREEMENT

Dear Mr. Kevin Tsang:

The firm of Urban Crossroads, Inc. is pleased to submit this scoping letter regarding the traffic analysis for Harvill Logistics development (**Project**), which is located on the northeast corner of Harvill Avenue and Cajalco Road in the County of Riverside. This letter describes the proposed Project trip generation, trip distribution, and analysis methodology, which have been used to establish the draft proposed Project study area and analysis locations.

PROJECT DESCRIPTION

The Project is anticipated to have an Opening Year of 2024. The Project consists of the development of 99,770 square feet of general light industrial use and a truck parking lot with 133-stalls. A preliminary land use plan for the proposed Project is shown on Exhibit 1. Access to the Project site will be accommodated via Harvill Avenue (Driveway 1) and Cajalco Road (Driveways 2 and 3).

EXHIBIT 1: PRELIMINARY SITE PLAN



TRIP GENERATION

Trip generation represents the amount of traffic that is attracted and produced by a development and is based upon the specific land uses planned for a given project. In order to develop the traffic characteristics of the proposed project, trip-generation statistics published in the Institute of Transportation Engineers (ITE) Trip Generation Manual (11th Edition, 2021) and empirical data were used to estimate the trip generation. The following trip generation rate and vehicle mix were utilized for calculating the trip generation for the proposed Project:

- ITE land use code 110 (General Light Industrial) has been used to derive site specific trip generation estimates for up to 99,770 square feet of the proposed Project. A light industrial facility is a free-standing facility devoted to a single use that has an emphasis on activities other than manufacturing. Typically, there is minimum office space. The vehicle mix has also been obtained from the ITE's latest Trip Generation Manual. The truck percentages were further broken down by axle type per the following SCAQMD recommended truck mix: 2-Axle = 16.7%; 3-Axle = 20.7%; 4+-Axle = 62.6%.

The ITE Trip Generation Manual does not currently have any trip generation rates for a truck lot, as such, trip generation estimates for the proposed project have been developed using data collected at other facilities with operations similar to those proposed. Table A-1 in Attachment A summarizes the count data collected at 2 existing facilities located at 5087 Patterson Avenue in the City of Perris and 14769 San Bernardino Avenue in the City of Fontana. The actual driveway counts have been attached to this assessment for each of these facilities in Attachment A. In other words, this traffic analysis will conservatively assume the truck lot will be an independent lot that does not specifically serve the adjacent warehouse use.

Table A-2 in Attachment A shows the trip generation rates for each existing facility which have been developed by dividing the data collected at the sites by their respective total acreage as shown on Table A-1. The average trip rate has been calculated by averaging the 2 comparable sites. A passenger-car equivalent (PCE) of 1.5, 2.0, and 3.0 have been applied to 2-axle, 3-axle, and 4+-axle vehicles, consistent with the County's traffic study guidelines. PCE rates were calculated by taking the actual vehicle trip generation rates and applying the PCE factors shown in Table A-2. PCE factors were applied to the trip generation rates for heavy trucks (large 2-axes, 3-axes, 4+-axes). PCEs allow the typical "real-world" mix of vehicle types to be represented as a single, standardized unit, such as the passenger car, to be used for the purposes of capacity and level of service analyses. The trip generation rates used for the Project are summarized on Table 1.

TABLE 1: TRIP GENERATION RATES

Land Use ¹	Units ²	ITE LU Code	AM Peak Hour			PM Peak Hour			Daily
			In	Out	Total	In	Out	Total	
Actual Vehicle Trip Generation Rates									
General Light Industrial ³	TSF	110	0.651	0.089	0.740	0.091	0.559	0.650	4.870
Passenger Cars			0.645	0.085	0.730	0.086	0.554	0.640	4.620
2-Axle Trucks			0.001	0.001	0.002	0.001	0.001	0.002	0.042
3-Axle Trucks			0.001	0.001	0.002	0.001	0.001	0.002	0.052
4+Axle Trucks			0.004	0.002	0.006	0.003	0.003	0.006	0.157
Truck Trailer Yard ⁴	Spaces	--	0.016	0.024	0.040	0.016	0.013	0.028	0.781
Passenger Cars			0.010	0.006	0.016	0.003	0.003	0.006	0.179
2-Axle Trucks			0.000	0.016	0.016	0.009	0.000	0.009	0.113
3-Axle Trucks			0.003	0.002	0.005	0.003	0.000	0.003	0.209
4+Axle Trucks			0.003	0.000	0.003	0.000	0.009	0.009	0.281
Passenger Car Equivalent (PCE) Trip Generation Rates⁵									
General Light Industrial ³	TSF	110	0.651	0.089	0.740	0.091	0.559	0.650	4.870
Passenger Cars			0.645	0.085	0.730	0.086	0.554	0.640	4.620
2-Axle Trucks (PCE = 1.5)			0.002	0.001	0.003	0.002	0.001	0.003	0.063
3-Axle Trucks (PCE = 2.0)			0.003	0.003	0.005	0.003	0.003	0.005	0.129
4+Axle Trucks (PCE = 3.0)			0.012	0.007	0.019	0.009	0.010	0.019	0.470
Truck Trailer Yard ⁴	Spaces	--	0.016	0.024	0.040	0.016	0.013	0.028	0.781
Passenger Cars			0.010	0.006	0.016	0.003	0.003	0.006	0.179
2-Axle Trucks (PCE = 1.5)			0.000	0.023	0.023	0.014	0.000	0.014	0.169
3-Axle Trucks (PCE = 2.0)			0.006	0.004	0.010	0.006	0.000	0.006	0.418
4+Axle Trucks (PCE = 3.0)			0.009	0.000	0.009	0.000	0.028	0.028	0.844

¹ Trip Generation & Vehicle Mix Source: Institute of Transportation Engineers (ITE), Trip Generation Manual, Eleventh Edition (2021).

² TSF = thousand square feet

³ Truck Mix: South Coast Air Quality Management District's (SCAQMD) recommended truck mix, by axle type. Normalized % - Without Cold Storage: 16.7% 2-Axle trucks, 20.7% 3-Axle trucks, 62.6% 4-Axle trucks.

⁴ See Table A-2 for Trip Generation Rates based on empirical data.

⁵ PCE factors: 2-axle = 1.5; 3-axle = 2.0; 4+axle = 3.0.

The Project trip generation summary is shown on Table 2. The proposed Project is anticipated to generate a total of 594 two-way trips per day with 76 AM peak hour trips and 66 PM peak hour trips (actual vehicles). Per the County's Guidelines, any operations analysis is to utilize the PCE trip generation. As shown on Table 3, the Project is anticipated to generate a total of 744 two-way PCE trips per day with 82 AM PCE peak hour trips and 73 PM PCE peak hour trips.

TABLE 2: PROJECT TRIP GENERATION SUMMARY (ACTUAL VEHICLES)

Land Use	Quantity Units ¹	AM Peak Hour			PM Peak Hour			Daily
		In	Out	Total	In	Out	Total	
Actual Vehicles:								
General Light Industrial	99.770 TSF							
Passenger Cars:		64	8	72	9	55	64	462
2-axle Trucks:		0	0	0	0	0	0	4
3-axle Trucks:		0	0	0	0	0	0	6
4+-axle Trucks:		0	0	0	0	0	0	16
Total Truck Trips (Actual Vehicles):		0	0	0	0	0	0	26
Total Trips (Actual Vehicles)²		64	8	72	9	55	64	488
Truck Trailer Yard	133 Spaces							
Passenger Cars:		1	1	2	0	0	0	24
2-axle Trucks:		0	2	2	1	0	1	16
3-axle Trucks:		0	0	0	0	0	0	28
4+-axle Trucks:		0	0	0	0	1	1	38
Total Truck Trips (Actual Vehicles):		0	2	2	1	1	2	82
Total Trips (Actual Vehicles)²		1	3	4	1	1	2	106
Project Total (Actual Vehicles)		65	11	76	10	56	66	594

¹ TSF = thousand square feet

² Total Trips = Passenger Cars + Truck Trips.

TABLE 3: PROJECT TRIP GENERATION SUMMARY (PCE)

Land Use	Quantity Units ¹	AM Peak Hour			PM Peak Hour			Daily
		In	Out	Total	In	Out	Total	
Passenger Car Equivalent (PCE):								
General Light Industrial	99.770 TSF							
Passenger Cars:		64	8	72	9	55	64	462
2-axle Trucks:		0	0	0	0	0	0	6
3-axle Trucks:		0	0	0	0	0	0	14
4+-axle Trucks:		1	1	2	1	1	2	48
Total Truck Trips (PCE):		1	1	2	1	1	2	68
Total Trips (PCE)²		65	9	74	10	56	66	530
Truck Trailer Yard	133 Spaces							
Passenger Cars:		1	1	2	0	0	0	24
2-axle Trucks:		0	3	3	2	0	2	22
3-axle Trucks:		1	1	2	1	0	1	56
4+-axle Trucks:		1	0	1	0	4	4	112
Total Truck Trips (PCE):		2	4	6	3	4	7	190
Total Trips (PCE)²		3	5	8	3	4	7	214
Project Total (PCE)		68	14	82	13	60	73	744

¹ TSF = thousand square feet

² Total Trips = Passenger Cars + Truck Trips.

EXHIBIT 3: PROJECT (PASSENGER CAR) TRIP DISTRIBUTION



ANALYSIS SCENARIOS

Consistent with the County’s Guidelines, intersection analysis will be provided for the following analysis scenarios:

- Existing (2022) Conditions
- Existing plus Ambient Growth plus Project (EAP) (2024) Conditions
- Existing plus Ambient Growth plus Project plus Cumulative (EAPC) (2024) Conditions

All study area intersections will be evaluated using the Highway Capacity Manual (HCM) 6th Edition analysis methodology. The study area that is proposed to be evaluated is shown on Exhibit 4.

EXHIBIT 4: STUDY AREA

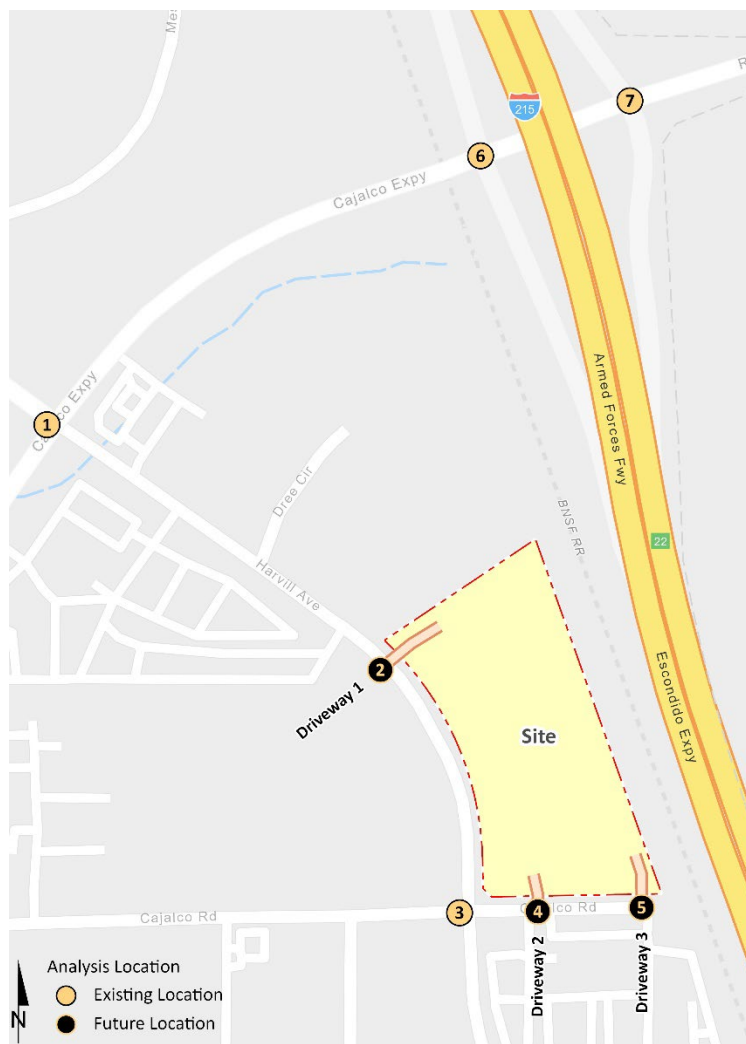

Mr. Kevin Tsang
County of Riverside, Transportation Department
June 3, 2022
Page 9 of 9

CUMULATIVE PROJECTS

It is requested that the County of Riverside provide current cumulative projects within the study area for inclusion in the Focused Traffic Analysis.

TRAFFIC COUNTS

Traffic counts (classified by vehicle type) were conducted during a typical Tuesday, Wednesday, or Thursday when local schools are in session and operating on a typical bell schedule in January, February, and May 2022. No adjustments are proposed to the new traffic counts for the baseline traffic condition (other than those adjustments to ensure flow of traffic between two closely spaced intersections).

CONCLUSION

Urban Crossroads, Inc. is pleased to submit this letter documenting the Project trip generation and trip distribution for the Harvill Logistics development. The County's Guidelines indicates that any use that can demonstrate a project would generate fewer than 100 vehicle trips during the peak hours would be exempt from traffic operations analysis. However, operations analysis is proposed for the Project driveways and off-site intersections identified in this scoping document to address any potential deficiencies at nearby intersections.

If you have any questions, please contact me directly at (949) 861-0177.

Respectfully submitted,

URBAN CROSSROADS, INC.



Charlene So, PE
Principal

**ATTACHMENT A:
DRIVEWAY COUNTS – EMPIRICAL DATA**

Table A-1

Empirical Data for Existing Facilities

Source	Quantity Units	AM Peak Hour			PM Peak Hour			Daily
		In	Out	Total	In	Out	Total	
5087 Patterson Avenue, Perris, CA	160 Spaces							
Passenger Cars		0	2	2	1	1	2	38
2-axle		0	5	5	3	0	3	36
3-axle		1	0	1	1	0	1	38
4+-axle		1	0	1	0	3	3	58
Truck Trips (Actual Vehicles)		2	5	7	4	3	7	132
5087 Patterson Av. Total Trips (Actual Vehicles)		2	7	9	5	4	9	170
14769 San Bernardino Avenue, Fontana	100 Spaces							
Passenger Cars:		2	0	2	0	0	0	12
2-axle Trucks:		0	0	0	0	0	0	0
3-axle Trucks:		0	0	0	0	0	0	18
4+-axle Trucks:		0	0	0	0	0	0	20
Total Trucks (Actual Vehicles)		0	0	0	0	0	0	38
14769 San Bernardino Av. Total Trips (Actual Vehicles)		2	0	2	0	0	0	50

** Data presented based on driveway counts conducted on January 23, 2019 (Site 1), March 30, 2021 (Site 2), and March 17, 2020 (Site 3).

Table A-2

Calculated Trip Generation Rates

Land Use	Units	Weekday AM Peak Hour			Weekday PM Peak Hour			Weekday Daily
		In	Out	Total	In	Out	Total	
Actual Vehicles:¹								
Site 1:								
Passenger Cars:		0.000	0.013	0.013	0.006	0.006	0.013	0.238
2-axle Trucks:		0.000	0.031	0.031	0.019	0.000	0.019	0.225
3-axle Trucks:		0.006	0.000	0.006	0.006	0.000	0.006	0.238
4+-axle Trucks:		0.006	0.000	0.006	0.000	0.019	0.019	0.363
Site 2:								
Passenger Cars:		0.020	0.000	0.020	0.000	0.000	0.000	0.120
2-axle Trucks:		0.000	0.000	0.000	0.000	0.000	0.000	0.000
3-axle Trucks:		0.000	0.004	0.004	0.000	0.000	0.000	0.180
4+-axle Trucks:		0.000	0.000	0.000	0.000	0.000	0.000	0.200
Average Truck Storage Yard								
Passenger Cars:	Spaces	0.010	0.006	0.016	0.003	0.003	0.006	0.179
2-axle Trucks:		0.000	0.016	0.016	0.009	0.000	0.009	0.113
3-axle Trucks:		0.003	0.002	0.005	0.003	0.000	0.003	0.209
4+-axle Trucks:		0.003	0.000	0.003	0.000	0.009	0.009	0.281
Passenger Car Equivalent (PCE):²								
Average Truck Storage Yard								
Passenger Cars:	Spaces	0.010	0.006	0.016	0.003	0.003	0.006	0.179
2-axle Trucks (PCE = 1.5):		0.000	0.023	0.023	0.014	0.000	0.014	0.169
3-axle Trucks (PCE = 2.0):		0.006	0.004	0.010	0.006	0.000	0.006	0.418
4+-axle Trucks (PCE = 3.0):		0.009	0.000	0.009	0.000	0.028	0.028	0.844

¹ The trip generation rates were calculated by taking the AM, PM and daily trips identified in Table 1 and divided by the total trailer parking spaces



City: Fontana
 Location: 14769 San Bernardino Avenue
 Date: Tuesday 3/17/2020
 Count Type: Driveway Classification

	Entering				
	Pass Veh	Large 2 Axle	3 Axle	4+ Axle	Total
0:00	0	0	0	0	0
0:15	0	0	0	0	0
0:30	0	0	0	0	0
0:45	0	0	0	0	0
1:00	0	0	0	4	4
1:15	0	0	0	2	2
1:30	0	0	0	2	2
1:45	1	0	0	2	3
2:00	0	0	0	2	2
2:15	0	0	0	2	2
2:30	0	0	0	1	1
2:45	0	0	0	2	2
3:00	0	0	0	1	1
3:15	0	0	0	0	0
3:30	0	0	0	1	1
3:45	0	0	0	0	0
4:00	0	0	0	0	0
4:15	0	0	0	0	0
4:30	0	0	0	0	0
4:45	0	0	0	0	0
5:00	0	0	0	0	0
5:15	0	0	0	0	0
5:30	0	0	0	0	0
5:45	0	0	0	0	0
6:00	0	0	0	0	0
6:15	0	0	0	0	0
6:30	0	0	0	0	0
6:45	0	0	0	0	0
7:00	0	0	0	0	0
7:15	0	0	0	0	0
7:30	0	0	0	0	0
7:45	0	0	0	0	0
8:00	0	0	0	0	0
8:15	0	0	0	0	0
8:30	0	0	0	0	0
8:45	2	0	0	2	2
9:00	0	0	0	0	0
9:15	1	0	0	0	1
9:30	0	0	0	0	0
9:45	0	0	0	0	0
10:00	1	0	0	0	1
10:15	0	0	0	0	0
10:30	0	0	0	0	0
10:45	0	0	0	0	0
11:00	1	0	0	0	1
11:15	0	0	0	0	0
11:30	0	0	0	0	0
11:45	0	0	0	0	0
12:00	0	0	0	0	0
12:15	0	0	0	0	0
12:30	0	0	0	0	0
12:45	0	0	0	0	0
13:00	0	0	0	0	0
13:15	0	0	0	0	0
13:30	0	0	0	0	0
13:45	0	0	0	0	0
14:00	0	0	0	0	0
14:15	0	0	0	0	0
14:30	0	0	0	0	0
14:45	0	0	0	0	0
15:00	0	0	0	0	0
15:15	0	0	0	0	0
15:30	0	0	0	0	0
15:45	0	0	0	0	0
16:00	0	0	0	0	0
16:15	0	0	0	0	0
16:30	0	0	0	0	0
16:45	0	0	0	0	0
17:00	0	0	0	0	0
17:15	0	0	0	0	0
17:30	0	0	0	0	0
17:45	0	0	0	0	0
18:00	0	0	0	0	0
18:15	0	0	0	0	0
18:30	0	0	0	0	0
18:45	0	0	0	0	0
19:00	0	0	0	0	0
19:15	0	0	0	0	0
19:30	0	0	0	0	0
19:45	0	0	0	0	0
20:00	0	0	0	0	0
20:15	0	0	0	0	0
20:30	0	0	0	0	0
20:45	0	0	0	0	0
21:00	0	0	0	0	0
21:15	0	0	0	0	0
21:30	0	0	0	0	0
21:45	0	0	0	0	0
22:00	0	0	0	0	0
22:15	0	0	0	0	0
22:30	0	0	0	0	0
22:45	0	0	0	0	0
23:00	0	0	0	0	0
23:15	0	0	0	0	0
23:30	0	0	0	0	0
23:45	0	0	0	0	0
TOTAL	6	0	0	19	25

	Exiting				
	Pass Veh	Large 2 Axle	3 Axle	4+ Axle	Total
0:00	0	0	0	0	0
0:15	0	0	0	0	0
0:30	0	0	0	0	0
0:45	0	0	0	0	0
1:00	0	0	2	0	2
1:15	0	0	4	0	4
1:30	0	0	2	0	2
1:45	0	0	1	0	1
2:00	0	0	2	0	2
2:15	0	0	2	0	2
2:30	0	0	2	0	2
2:45	0	0	2	0	2
3:00	0	0	1	0	1
3:15	0	0	0	0	0
3:30	0	0	0	0	0
3:45	0	0	0	0	0
4:00	0	0	0	0	0
4:15	0	0	0	0	0
4:30	0	0	0	0	0
4:45	0	0	0	0	0
5:00	0	0	0	0	0
5:15	0	0	0	0	0
5:30	0	0	0	0	0
5:45	0	0	0	0	0
6:00	0	0	0	0	0
6:15	0	0	0	0	0
6:30	0	0	0	0	0
6:45	0	0	0	0	0
7:00	0	0	0	0	0
7:15	0	0	0	0	0
7:30	0	0	0	0	0
7:45	0	0	0	0	0
8:00	0	0	0	0	0
8:15	0	0	0	0	0
8:30	0	0	0	0	0
8:45	0	0	0	0	0
9:00	0	0	0	0	0
9:15	2	0	0	0	2
9:30	1	0	0	0	1
9:45	0	0	0	0	0
10:00	1	0	0	0	1
10:15	0	0	0	0	0
10:30	0	0	0	0	0
10:45	0	0	0	0	0
11:00	0	0	0	0	0
11:15	0	0	0	0	0
11:30	1	0	0	0	1
11:45	0	0	0	0	0
12:00	0	0	0	0	0
12:15	0	0	0	0	0
12:30	0	0	0	0	0
12:45	0	0	0	0	0
13:00	0	0	0	0	0
13:15	0	0	0	0	0
13:30	0	0	0	0	0
13:45	0	0	0	0	0
14:00	0	0	0	0	0
14:15	0	0	0	0	0
14:30	0	0	0	0	0
14:45	0	0	0	0	0
15:00	0	0	0	0	0
15:15	0	0	0	0	0
15:30	0	0	0	0	0
15:45	0	0	0	0	0
16:00	0	0	0	0	0
16:15	0	0	0	0	0
16:30	0	0	0	0	0
16:45	0	0	0	0	0
17:00	0	0	0	0	0
17:15	0	0	0	0	0
17:30	0	0	0	0	0
17:45	0	0	0	0	0
18:00	0	0	0	0	0
18:15	0	0	0	0	0
18:30	0	0	0	0	0
18:45	0	0	0	0	0
19:00	0	0	0	0	0
19:15	0	0	0	0	0
19:30	0	0	0	0	0
19:45	0	0	0	0	0
20:00	0	0	0	0	0
20:15	0	0	0	0	0
20:30	0	0	0	0	0
20:45	0	0	0	0	0
21:00	0	0	0	0	0
21:15	0	0	0	0	0
21:30	0	0	0	0	0
21:45	0	0	0	0	0
22:00	0	0	0	0	0
22:15	0	0	0	0	0
22:30	0	0	0	0	0
22:45	0	0	0	0	0
23:00	0	0	0	0	0
23:15	0	0	0	0	0
23:30	0	0	0	0	0
23:45	0	0	0	0	0
TOTAL	5	0	18	0	23



City: Perris
 Location: 5087 Patterson Avenue
 Date: 1/23/2019
 Count Type: Classification

		Entering					
		Pass Veh	Large 2 Axle	3 Axle	4 Axle	5+ Axle	Total
0:00	0	0	0	0	0	0	0
0:15	0	0	0	0	0	0	0
0:30	0	0	0	0	0	0	0
0:45	1	0	0	0	0	0	1
1:00	1	0	0	0	0	0	1
1:15	0	0	0	0	0	0	0
1:30	0	0	0	0	0	0	0
1:45	0	0	1	0	0	0	1
2:00	0	0	0	0	0	0	0
2:15	0	0	0	0	0	0	0
2:30	0	0	0	0	0	0	0
2:45	0	0	0	0	0	0	0
3:00	0	0	0	0	0	0	0
3:15	0	0	0	0	0	0	0
3:30	0	0	0	0	0	0	0
3:45	0	0	0	0	0	0	0
4:00	0	0	0	0	0	0	0
4:15	0	0	0	0	0	0	0
4:30	0	0	0	0	0	0	0
4:45	0	0	0	0	0	0	0
5:00	0	0	0	0	0	0	0
5:15	0	0	0	0	0	0	0
5:30	0	0	0	0	0	0	0
5:45	0	0	0	0	0	0	0
6:00	1	0	0	0	0	0	1
6:15	0	0	0	0	1	1	1
6:30	0	0	0	0	1	1	1
6:45	2	0	0	0	3	5	5
7:00	0	0	0	0	0	0	0
7:15	0	0	1	0	0	1	1
7:30	0	0	0	0	1	1	1
7:45	0	0	0	0	0	0	0
8:00	2	0	0	0	0	2	2
8:15	0	0	0	0	0	0	0
8:30	0	0	0	0	0	0	0
8:45	0	1	0	0	0	1	1
9:00	1	0	0	1	1	3	3
9:15	0	0	0	0	0	0	0
9:30	0	0	0	0	0	0	0
9:45	1	0	0	0	0	1	1
10:00	0	0	0	0	0	0	0
10:15	0	0	0	0	0	0	0
10:30	0	0	0	0	0	0	0
10:45	0	0	0	0	0	0	0
11:00	0	0	0	0	1	1	1
11:15	0	0	1	0	1	2	2
11:30	0	1	1	0	1	3	3
11:45	0	0	0	0	0	0	0
12:00	0	1	0	0	0	1	1
12:15	0	1	0	0	2	3	3
12:30	0	2	0	0	0	2	2
12:45	0	0	0	0	1	1	1
13:00	0	0	1	0	1	2	2
13:15	0	0	0	0	0	0	0
13:30	1	0	0	2	1	4	4
13:45	0	0	0	0	0	0	0

		Exiting					
		Pass Veh	Large 2 Axle	3 Axle	4 Axle	5+ Axle	Total
0:00	0	0	0	0	0	0	0
0:15	0	0	0	0	0	0	0
0:30	0	0	0	0	0	0	0
0:45	0	0	0	0	0	0	0
1:00	0	0	0	0	0	0	0
1:15	0	0	0	0	0	0	0
1:30	0	0	0	0	0	0	0
1:45	0	0	0	0	0	0	0
2:00	0	0	1	0	0	1	1
2:15	0	0	0	0	0	0	0
2:30	0	0	0	0	0	0	0
2:45	0	0	0	0	0	0	0
3:00	1	0	0	0	0	1	1
3:15	1	0	0	0	0	1	1
3:30	0	0	0	0	0	0	0
3:45	0	0	0	0	0	0	0
4:00	0	0	0	0	0	0	0
4:15	0	0	0	0	0	0	0
4:30	0	0	0	0	0	0	0
4:45	0	0	0	0	0	0	0
5:00	0	0	0	0	0	0	0
5:15	0	0	0	0	0	0	0
5:30	0	0	0	0	0	0	0
5:45	0	0	0	0	0	0	0
6:00	0	0	0	0	0	0	0
6:15	0	0	0	0	0	0	0
6:30	1	0	1	0	0	2	2
6:45	0	0	0	0	0	0	0
7:00	1	0	3	0	0	4	4
7:15	1	0	1	0	0	2	2
7:30	0	0	1	0	0	1	1
7:45	0	0	0	0	0	0	0
8:00	0	1	0	0	0	1	1
8:15	1	0	0	0	0	1	1
8:30	0	0	0	0	0	0	0
8:45	0	1	0	0	0	1	1
9:00	0	0	0	0	0	0	0
9:15	1	0	0	0	0	1	1
9:30	0	1	0	0	0	1	1
9:45	0	0	1	0	0	1	1
10:00	1	0	0	0	0	1	1
10:15	0	0	0	0	0	0	0
10:30	0	0	0	0	0	0	0
10:45	0	0	0	0	0	0	0
11:00	0	0	0	0	0	0	0
11:15	0	0	1	0	0	1	1
11:30	0	0	2	0	0	2	2
11:45	0	0	0	1	1	2	2
12:00	0	0	1	0	0	1	1
12:15	0	0	0	2	0	2	2
12:30	0	0	2	0	0	2	2
12:45	0	0	0	0	0	0	0
13:00	1	0	2	2	0	5	5
13:15	0	0	1	0	0	1	1
13:30	1	0	1	0	0	2	2
13:45	0	2	0	0	0	2	2



City: Perris
 Location: 5087 Patterson Avenue
 Date: 1/23/2019
 Count Type: Classification

	Entering					
	Pass Veh	Large 2 Axle	3 Axle	4 Axle	5+ Axle	Total
14:00	1	0	0	0	2	3
14:15	0	0	0	0	0	0
14:30	0	0	0	0	0	0
14:45	0	0	0	0	0	0
15:00	1	0	0	0	0	1
15:15	0	0	0	0	0	0
15:30	0	0	0	0	0	0
15:45	0	0	0	0	2	2
16:00	0	0	0	1	0	1
16:15	0	0	0	0	0	0
16:30	1	0	0	0	0	1
16:45	0	0	0	0	0	0
17:00	0	1	0	0	0	1
17:15	1	1	0	0	0	2
17:30	0	0	0	0	0	0
17:45	0	1	1	0	0	2
18:00	1	0	0	0	0	1
18:15	0	0	0	0	2	2
18:30	0	0	0	0	3	3
18:45	0	1	0	0	0	1
19:00	0	1	0	0	0	1
19:15	0	0	0	0	0	0
19:30	1	0	0	1	0	2
19:45	2	0	0	0	1	3
20:00	0	0	0	0	0	0
20:15	0	1	0	0	0	1
20:30	0	2	1	0	0	3
20:45	1	1	0	0	0	2
21:00	0	0	1	0	0	1
21:15	0	0	0	0	0	0
21:30	0	0	0	0	0	0
21:45	0	2	0	0	1	3
22:00	0	2	1	0	0	3
22:15	0	0	0	1	0	1
22:30	0	0	0	0	0	0
22:45	0	1	0	0	0	1
23:00	0	2	0	1	1	4
23:15	0	0	0	0	0	0
23:30	0	0	0	0	0	0
23:45	0	0	0	0	0	0
TOTAL	19	22	9	7	27	84

	Exiting					
	Pass Veh	Large 2 Axle	3 Axle	4 Axle	5+ Axle	Total
14:00	0	0	1	0	0	1
14:15	0	0	0	0	0	0
14:30	0	0	1	0	0	1
14:45	0	0	0	0	0	0
15:00	0	0	0	0	0	0
15:15	1	0	0	0	0	1
15:30	0	0	0	0	0	0
15:45	0	0	1	0	0	1
16:00	0	0	1	0	0	1
16:15	0	1	0	0	0	1
16:30	1	0	0	0	0	1
16:45	0	0	0	0	0	0
17:00	0	0	0	1	0	1
17:15	1	0	0	1	0	2
17:30	0	0	0	0	0	0
17:45	0	0	0	1	0	1
18:00	0	0	0	0	1	1
18:15	0	0	0	0	0	0
18:30	2	2	0	0	0	4
18:45	0	1	2	0	0	3
19:00	0	0	0	0	1	1
19:15	0	0	0	1	0	1
19:30	0	0	0	0	0	0
19:45	0	1	0	0	0	1
20:00	1	0	1	0	0	2
20:15	0	0	0	1	0	1
20:30	0	1	0	1	0	2
20:45	0	0	0	1	1	2
21:00	2	0	0	0	0	2
21:15	0	0	0	0	0	0
21:30	0	0	1	0	0	1
21:45	0	0	0	0	1	1
22:00	0	0	1	2	0	3
22:15	0	0	1	0	1	2
22:30	0	1	0	0	0	1
22:45	0	0	0	1	0	1
23:00	0	1	0	0	0	1
23:15	0	0	1	1	1	3
23:30	0	0	0	0	0	0
23:45	1	0	0	0	0	1
TOTAL	19	13	29	16	7	84

**ATTACHMENT B:
EXISTING TRAFFIC COUNTS – TRIP DISTRIBUTION VERIFICATION**

AM Peak Hour - Passenger Car Distribution

1: Harvill Av. & Cajalco Exwy.

	<u>NBL</u>	<u>NBT</u>	<u>NBR</u>	<u>SBL</u>	<u>SBT</u>	<u>SBR</u>	<u>EBL</u>	<u>EBT</u>	<u>EBR</u>	<u>WBL</u>	<u>WBT</u>	<u>WBR</u>	<u>TOTAL</u>
2022 Counts	285	328	65	174	102	19	37	626	48	135	628	94	2541
Dist	17%	19%	4%										

3: Harvill Av. & Old Cajalco Rd.

	<u>NBL</u>	<u>NBT</u>	<u>NBR</u>	<u>SBL</u>	<u>SBT</u>	<u>SBR</u>	<u>EBL</u>	<u>EBT</u>	<u>EBR</u>	<u>WBL</u>	<u>WBT</u>	<u>WBR</u>	<u>TOTAL</u>
2022 Counts	5	697	7	8	201	36	20	0	3	3	0	2	982
Dist										60%		40%	

6: I-215 SB Ramps & Ramona Exwy.

	<u>NBL</u>	<u>NBT</u>	<u>NBR</u>	<u>SBL</u>	<u>SBT</u>	<u>SBR</u>	<u>EBL</u>	<u>EBT</u>	<u>EBR</u>	<u>WBL</u>	<u>WBT</u>	<u>WBR</u>	<u>TOTAL</u>
2022 Counts	0	0	0	619	1	144	0	650	307	281	943	0	2945
Dist													

7: I-215 NB Ramps & Ramona Exwy.

	<u>NBL</u>	<u>NBT</u>	<u>NBR</u>	<u>SBL</u>	<u>SBT</u>	<u>SBR</u>	<u>EBL</u>	<u>EBT</u>	<u>EBR</u>	<u>WBL</u>	<u>WBT</u>	<u>WBR</u>	<u>TOTAL</u>
2022 Counts	314	3	552	0	0	0	100	1,169	0	0	910	599	3647
Dist							3%	1%					

PM Peak Hour - Passenger Car Distribution

1: Harvill Av. & Cajalco Exwy.

	<u>NBL</u>	<u>NBT</u>	<u>NBR</u>	<u>SBL</u>	<u>SBT</u>	<u>SBR</u>	<u>EBL</u>	<u>EBT</u>	<u>EBR</u>	<u>WBL</u>	<u>WBT</u>	<u>WBR</u>	<u>TOTAL</u>
2022 Counts	159	140	116	218	200	32	22	686	200	101	597	175	2646
Dist	29%	26%	21%										
AM/PM Avg:	23%	22%	13%										

3: Harvill Av. & Old Cajalco Rd.

	<u>NBL</u>	<u>NBT</u>	<u>NBR</u>	<u>SBL</u>	<u>SBT</u>	<u>SBR</u>	<u>EBL</u>	<u>EBT</u>	<u>EBR</u>	<u>WBL</u>	<u>WBT</u>	<u>WBR</u>	<u>TOTAL</u>
2022 Counts	4	323	2	4	416	22	54	0	13	5	0	16	859
Dist										24%		76%	
AM/PM Avg:										42%		58%	

6: I-215 SB Ramps & Ramona Exwy.

	<u>NBL</u>	<u>NBT</u>	<u>NBR</u>	<u>SBL</u>	<u>SBT</u>	<u>SBR</u>	<u>EBL</u>	<u>EBT</u>	<u>EBR</u>	<u>WBL</u>	<u>WBT</u>	<u>WBR</u>	<u>TOTAL</u>
2022 Counts	0	0	0	760	4	135	0	820	323	346	821	0	3209
Dist													
AM/PM Avg:													

7: I-215 NB Ramps & Ramona Exwy.

	<u>NBL</u>	<u>NBT</u>	<u>NBR</u>	<u>SBL</u>	<u>SBT</u>	<u>SBR</u>	<u>EBL</u>	<u>EBT</u>	<u>EBR</u>	<u>WBL</u>	<u>WBT</u>	<u>WBR</u>	<u>TOTAL</u>
2022 Counts	319	3	425	0	0	0	100	1,480	0	0	848	583	3758
Dist							16%	5%					
AM/PM Avg:							10%	3%					

AM Peak Hour - Truck Distribution

1: Harvill Av. & Cajalco Exwy.

	<u>NBL</u>	<u>NBT</u>	<u>NBR</u>	<u>SBL</u>	<u>SBT</u>	<u>SBR</u>	<u>EBL</u>	<u>EBT</u>	<u>EBR</u>	<u>WBL</u>	<u>WBT</u>	<u>WBR</u>	<u>TOTAL</u>
2022 Counts	14	6	10	14	9	6	8	43	1	25	48	7	191
Dist	15%	7%	11%										

3: Harvill Av. & Old Cajalco Rd.

	<u>NBL</u>	<u>NBT</u>	<u>NBR</u>	<u>SBL</u>	<u>SBT</u>	<u>SBR</u>	<u>EBL</u>	<u>EBT</u>	<u>EBR</u>	<u>WBL</u>	<u>WBT</u>	<u>WBR</u>	<u>TOTAL</u>
2022 Counts	1	44	0	1	24	6	9	0	1	2	0	1	89
Dist										67%		33%	

6: I-215 SB Ramps & Ramona Exwy.

	<u>NBL</u>	<u>NBT</u>	<u>NBR</u>	<u>SBL</u>	<u>SBT</u>	<u>SBR</u>	<u>EBL</u>	<u>EBT</u>	<u>EBR</u>	<u>WBL</u>	<u>WBT</u>	<u>WBR</u>	<u>TOTAL</u>
2022 Counts	0	0	0	165	1	46	0	107	59	52	170	0	600
Dist													

7: I-215 NB Ramps & Ramona Exwy.

	<u>NBL</u>	<u>NBT</u>	<u>NBR</u>	<u>SBL</u>	<u>SBT</u>	<u>SBR</u>	<u>EBL</u>	<u>EBT</u>	<u>EBR</u>	<u>WBL</u>	<u>WBT</u>	<u>WBR</u>	<u>TOTAL</u>
2022 Counts	73	1	49	0	0	0	47	225	0	0	149	114	658
Dist							6%	5%					

PM Peak Hour - Truck Distributon

1: Harvill Av. & Cajalco Exwy.

	<u>NBL</u>	<u>NBT</u>	<u>NBR</u>	<u>SBL</u>	<u>SBT</u>	<u>SBR</u>	<u>EBL</u>	<u>EBT</u>	<u>EBR</u>	<u>WBL</u>	<u>WBT</u>	<u>WBR</u>	<u>TOTAL</u>
2022 Counts	4	4	6	4	7	3	1	31	8	19	32	15	134
Dist	11%	11%	17%										
AM/PM Avg:	14%	15%	10%										

3: Harvill Av. & Old Cajalco Rd.

	<u>NBL</u>	<u>NBT</u>	<u>NBR</u>	<u>SBL</u>	<u>SBT</u>	<u>SBR</u>	<u>EBL</u>	<u>EBT</u>	<u>EBR</u>	<u>WBL</u>	<u>WBT</u>	<u>WBR</u>	<u>TOTAL</u>
2022 Counts	1	21	2	1	27	5	7	0	0	0	0	0	64
Dist													
AM/PM Avg:										60%		40%	

6: I-215 SB Ramps & Ramona Exwy.

	<u>NBL</u>	<u>NBT</u>	<u>NBR</u>	<u>SBL</u>	<u>SBT</u>	<u>SBR</u>	<u>EBL</u>	<u>EBT</u>	<u>EBR</u>	<u>WBL</u>	<u>WBT</u>	<u>WBR</u>	<u>TOTAL</u>
2022 Counts	0	0	0	78	4	35	0	105	27	19	95	0	363
Dist													
AM/PM Avg:													

7: I-215 NB Ramps & Ramona Exwy.

	<u>NBL</u>	<u>NBT</u>	<u>NBR</u>	<u>SBL</u>	<u>SBT</u>	<u>SBR</u>	<u>EBL</u>	<u>EBT</u>	<u>EBR</u>	<u>WBL</u>	<u>WBT</u>	<u>WBR</u>	<u>TOTAL</u>
2022 Counts	52	2	45	0	0	0	18	165	0	0	62	61	405
Dist							12%	5%					
AM/PM Avg:							8%	3%					

APPENDIX 1.2: SITE ADJACENT QUEUES

This Page Intentionally Left Blank

Intersection: 2: Harvill Av. & Driveway 1

Movement	WB
Directions Served	R
Maximum Queue (ft)	27
Average Queue (ft)	2
95th Queue (ft)	15
Link Distance (ft)	158
Upstream Blk Time (%)	
Queuing Penalty (veh)	
Storage Bay Dist (ft)	
Storage Blk Time (%)	
Queuing Penalty (veh)	

Intersection: 4: Old Cajalco Rd. & Driveway 2

Movement	EB	SB
Directions Served	LT	LR
Maximum Queue (ft)	22	31
Average Queue (ft)	1	7
95th Queue (ft)	13	29
Link Distance (ft)	158	185
Upstream Blk Time (%)		
Queuing Penalty (veh)		
Storage Bay Dist (ft)		
Storage Blk Time (%)		
Queuing Penalty (veh)		

Intersection: 5: Old Cajalco Rd. & Driveway 3

Movement	EB	NB	SB
Directions Served	LR	LT	TR
Maximum Queue (ft)	32	30	32
Average Queue (ft)	18	9	6
95th Queue (ft)	39	32	26
Link Distance (ft)	204	139	163
Upstream Blk Time (%)			
Queuing Penalty (veh)			
Storage Bay Dist (ft)			
Storage Blk Time (%)			
Queuing Penalty (veh)			

Network Summary

Network wide Queuing Penalty: 0

Intersection: 2: Harvill Av. & Driveway 1

Movement	WB
Directions Served	R
Maximum Queue (ft)	27
Average Queue (ft)	2
95th Queue (ft)	15
Link Distance (ft)	158
Upstream Blk Time (%)	
Queuing Penalty (veh)	
Storage Bay Dist (ft)	
Storage Blk Time (%)	
Queuing Penalty (veh)	

Intersection: 4: Old Cajalco Rd. & Driveway 2

Movement	EB	SB
Directions Served	LT	LR
Maximum Queue (ft)	12	41
Average Queue (ft)	1	22
95th Queue (ft)	8	45
Link Distance (ft)	158	185
Upstream Blk Time (%)		
Queuing Penalty (veh)		
Storage Bay Dist (ft)		
Storage Blk Time (%)		
Queuing Penalty (veh)		

Intersection: 5: Old Cajalco Rd. & Driveway 3

Movement	EB	NB	SB
Directions Served	LR	LT	TR
Maximum Queue (ft)	27	36	36
Average Queue (ft)	13	18	14
95th Queue (ft)	34	43	40
Link Distance (ft)	204	139	163
Upstream Blk Time (%)			
Queuing Penalty (veh)			
Storage Bay Dist (ft)			
Storage Blk Time (%)			
Queuing Penalty (veh)			

Network Summary

Network wide Queuing Penalty: 0

APPENDIX 3.1: TRAFFIC COUNTS – FEBRUARY 2022

This Page Intentionally Left Blank

**Volume Development
AM Peak Hour**

1: Harvill Av. & Cajalco Exwy.

	PHF: 0.930		7:00		Count Date: 2/8/2022								
	<u>NBL</u>	<u>NBT</u>	<u>NBR</u>	<u>SBL</u>	<u>SBT</u>	<u>SBR</u>	<u>EBL</u>	<u>EBT</u>	<u>EBR</u>	<u>WBL</u>	<u>WBT</u>	<u>WBR</u>	<u>TOTAL</u>
2022 PCE:	297	337	75	189	116	27	47	680	50	167	677	102	2,761
Project PCE:	3	3	2	0	15	0	0	0	15	9	0	0	47
Cumulative PCE	50	54	151	206	77	54	134	120	138	436	412	579	2,411
EAP 2024 PCE:	312	353	80	197	135	28	48	707	67	182	704	106	2,919
EAPC 2024 PCE:	362	408	231	403	212	82	182	827	205	618	1,116	685	5,330

2: Harvill Av. & Driveway 1

	PHF: 0.920		Count Date:										
	<u>NBL</u>	<u>NBT</u>	<u>NBR</u>	<u>SBL</u>	<u>SBT</u>	<u>SBR</u>	<u>EBL</u>	<u>EBT</u>	<u>EBR</u>	<u>WBL</u>	<u>WBT</u>	<u>WBR</u>	<u>TOTAL</u>
2022 PCE:	0	788	0	0	293	0	0	0	0	0	0	0	1,081
Project PCE:	0	5	0	0	39	0	0	0	0	0	0	2	46
Cumulative PCE	0	255	0	0	659	0	0	0	0	0	0	0	914
EAP 2024 PCE:	0	825	0	0	344	0	0	0	0	0	0	2	1,171
EAPC 2024 PCE:	0	1,080	0	0	1,003	0	0	0	0	0	0	2	2,085

3: Harvill Av. & Old Cajalco Rd.

	PHF: 0.966		7:00		Count Date: 5/10/2022								
	<u>NBL</u>	<u>NBT</u>	<u>NBR</u>	<u>SBL</u>	<u>SBT</u>	<u>SBR</u>	<u>EBL</u>	<u>EBT</u>	<u>EBR</u>	<u>WBL</u>	<u>WBT</u>	<u>WBR</u>	<u>TOTAL</u>
2022 PCE:	7	750	7	9	238	47	35	0	5	7	0	3	1,107
Project PCE:	0	0	29	39	0	0	0	0	0	7	0	5	80
Cumulative PCE	23	249	0	0	644	15	6	0	8	0	0	0	945
EAP 2024 PCE:	7	780	36	48	247	48	36	0	5	14	0	8	1,232
EAPC 2024 PCE:	30	1,029	36	48	891	63	42	0	13	14	0	8	2,177

4: Driveway 2 & Old Cajalco Rd.

	PHF: 0.920		Count Date:										
	<u>NBL</u>	<u>NBT</u>	<u>NBR</u>	<u>SBL</u>	<u>SBT</u>	<u>SBR</u>	<u>EBL</u>	<u>EBT</u>	<u>EBR</u>	<u>WBL</u>	<u>WBT</u>	<u>WBR</u>	<u>TOTAL</u>
2022 PCE:	0	0	0	0	0	0	0	16	0	0	10	0	26
Project PCE:	0	0	0	0	0	7	49	19	0	0	6	0	81
Cumulative PCE	0	0	0	0	0	0	0	0	0	0	0	0	0
EAP 2024 PCE:	0	0	0	0	0	7	49	36	0	0	16	0	108
EAPC 2024 PCE:	0	0	0	0	0	7	49	36	0	0	16	0	108

5: Driveway 3 & Old Cajalco Rd.

	PHF: 0.920		Count Date: 1/0/1900										
	<u>NBL</u>	<u>NBT</u>	<u>NBR</u>	<u>SBL</u>	<u>SBT</u>	<u>SBR</u>	<u>EBL</u>	<u>EBT</u>	<u>EBR</u>	<u>WBL</u>	<u>WBT</u>	<u>WBR</u>	<u>TOTAL</u>
2022 PCE:	10	0	0	0	0	0	0	0	16	0	0	0	26
Project PCE:	0	0	0	0	0	6	19	0	0	0	0	0	25
Cumulative PCE	0	0	0	0	0	0	0	0	0	0	0	0	0
EAP 2024 PCE:	10	0	0	0	0	6	19	0	17	0	0	0	52
EAPC 2024 PCE:	10	0	0	0	0	6	19	0	17	0	0	0	52

6: I-215 SB Ramps & Ramona Exwy.

	PHF: 0.982		7:15		Count Date: 1/25/2022								
	<u>NBL</u>	<u>NBT</u>	<u>NBR</u>	<u>SBL</u>	<u>SBT</u>	<u>SBR</u>	<u>EBL</u>	<u>EBT</u>	<u>EBR</u>	<u>WBL</u>	<u>WBT</u>	<u>WBR</u>	<u>TOTAL</u>
2022 PCE:	0	0	0	817	2	210	0	759	364	328	1,121	0	3,599
Project PCE:	0	0	0	0	0	7	0	2	0	0	2	0	11
Cumulative PCE	0	0	0	1,043	0	581	0	319	165	267	856	0	3,230
EAP 2024 PCE:	0	0	0	830	2	171	0	408	284	275	936	0	2,905
EAPC 2024 PCE:	0	0	0	1,834	2	752	0	766	449	542	1,792	0	6,135

**Volume Development
AM Peak Hour**

7: I-215 NB Ramps & Ramona Exwy.

	PHF: 0.967		7:15		Count Date: 1/25/2022								
	<u>NBL</u>	<u>NBT</u>	<u>NBR</u>	<u>SBL</u>	<u>SBT</u>	<u>SBR</u>	<u>EBL</u>	<u>EBT</u>	<u>EBR</u>	<u>WBL</u>	<u>WBT</u>	<u>WBR</u>	<u>TOTAL</u>
2022 PCE:	398	4	612	0	0	0	159	1,417	0	0	1,051	740	4,379
Project PCE:	0	0	0	0	0	0	1	0	0	0	2	0	3
Cumulative PCE	533	0	321	0	0	0	184	1,177	0	0	590	882	3,687
EAP 2024 PCE:	310	4	478	0	0	0	125	1,114	0	0	900	577	3,508
EAPC 2024 PCE:	843	4	799	0	0	0	309	2,291	0	0	1,490	1,459	7,195

8: I-215 SB Ramps & Placentia Av.

	PHF: 0.920		Count Date:										
	<u>NBL</u>	<u>NBT</u>	<u>NBR</u>	<u>SBL</u>	<u>SBT</u>	<u>SBR</u>	<u>EBL</u>	<u>EBT</u>	<u>EBR</u>	<u>WBL</u>	<u>WBT</u>	<u>WBR</u>	<u>TOTAL</u>
2022 PCE:	0	0	0	258	0	72	0	512	116	138	439	0	1,536
Project PCE:	0	0	0	0	0	0	0	0	6	0	21	0	27
Cumulative PCE	0	0	0	157	0	180	0	119	72	101	135	0	764
EAP 2024 PCE:	0	0	0	269	0	75	0	533	127	144	477	0	1,625
EAPC 2024 PCE:	0	0	0	426	0	255	0	652	199	245	612	0	2,389

9: I-215 NB Ramps & Placentia Av.

	PHF: 0.920		Count Date: 1/0/1900										
	<u>NBL</u>	<u>NBT</u>	<u>NBR</u>	<u>SBL</u>	<u>SBT</u>	<u>SBR</u>	<u>EBL</u>	<u>EBT</u>	<u>EBR</u>	<u>WBL</u>	<u>WBT</u>	<u>WBR</u>	<u>TOTAL</u>
2022 PCE:	171	0	250	0	0	0	76	694	0	0	406	297	1,894
Project PCE:	21	0	0	0	0	0	0	0	0	0	0	0	21
Cumulative PCE	124	0	304	0	0	0	107	169	0	0	112	131	947
EAP 2024 PCE:	199	0	260	0	0	0	79	722	0	0	422	309	1,992
EAPC 2024 PCE:	323	0	564	0	0	0	186	891	0	0	534	440	2,939

**Volume Development
PM Peak Hour**

1: Harvill Av. & Cajalco Exwy.

	PHF: 0.934		4:00		Count Date: 2/8/2022								
	<u>NBL</u>	<u>NBT</u>	<u>NBR</u>	<u>SBL</u>	<u>SBT</u>	<u>SBR</u>	<u>EBL</u>	<u>EBT</u>	<u>EBR</u>	<u>WBL</u>	<u>WBT</u>	<u>WBR</u>	<u>TOTAL</u>
2022 PCE:	165	144	125	222	211	35	24	723	207	132	637	187	2,811
Project PCE:	13	13	8	0	3	0	0	0	3	2	0	0	42
Cumulative PCE	110	56	429	611	71	130	96	471	68	197	253	253	2,745
EAP 2024 PCE:	184	163	138	231	223	36	25	752	218	139	663	195	2,967
EAPC 2024 PCE:	294	218	567	842	293	166	121	1,223	286	337	916	448	5,712

2: Harvill Av. & Driveway 1

	PHF: 0.920				Count Date:								
	<u>NBL</u>	<u>NBT</u>	<u>NBR</u>	<u>SBL</u>	<u>SBT</u>	<u>SBR</u>	<u>EBL</u>	<u>EBT</u>	<u>EBR</u>	<u>WBL</u>	<u>WBT</u>	<u>WBR</u>	<u>TOTAL</u>
2022 PCE:	0	431	0	0	483	0	0	0	0	0	0	0	914
Project PCE:	0	32	0	0	7	0	0	0	0	0	0	2	41
Cumulative PCE	0	595	0	0	362	0	0	0	0	0	0	0	957
EAP 2024 PCE:	0	480	0	0	510	0	0	0	0	0	0	2	991
EAPC 2024 PCE:	0	1,075	0	0	872	0	0	0	0	0	0	2	1,948

3: Harvill Av. & Old Cajalco Rd.

	PHF: 0.946		4:00		Count Date: 5/10/2022								
	<u>NBL</u>	<u>NBT</u>	<u>NBR</u>	<u>SBL</u>	<u>SBT</u>	<u>SBR</u>	<u>EBL</u>	<u>EBT</u>	<u>EBR</u>	<u>WBL</u>	<u>WBT</u>	<u>WBR</u>	<u>TOTAL</u>
2022 PCE:	6	352	6	6	447	31	63	0	13	5	0	16	944
Project PCE:	0	0	6	7	0	0	0	0	0	26	0	32	71
Cumulative PCE	0	595	0	0	362	0	0	0	0	0	0	0	957
EAP 2024 PCE:	6	366	12	13	465	32	65	0	14	31	0	49	1,053
EAPC 2024 PCE:	6	961	12	13	827	32	65	0	14	31	0	49	2,010

4: Driveway 2 & Old Cajalco Rd.

	PHF: 0.920				Count Date:								
	<u>NBL</u>	<u>NBT</u>	<u>NBR</u>	<u>SBL</u>	<u>SBT</u>	<u>SBR</u>	<u>EBL</u>	<u>EBT</u>	<u>EBR</u>	<u>WBL</u>	<u>WBT</u>	<u>WBR</u>	<u>TOTAL</u>
2022 PCE:	0	0	0	0	0	0	0	12	0	0	21	0	33
Project PCE:	0	0	0	0	0	41	7	6	0	0	17	0	71
Cumulative PCE	0	0	0	0	0	0	0	0	0	0	0	0	0
EAP 2024 PCE:	0	0	0	0	0	41	7	18	0	0	39	0	105
EAPC 2024 PCE:	0	0	0	0	0	41	7	18	0	0	39	0	105

5: Driveway 3 & Old Cajalco Rd.

	PHF: 0.920				Count Date:								
	<u>NBL</u>	<u>NBT</u>	<u>NBR</u>	<u>SBL</u>	<u>SBT</u>	<u>SBR</u>	<u>EBL</u>	<u>EBT</u>	<u>EBR</u>	<u>WBL</u>	<u>WBT</u>	<u>WBR</u>	<u>TOTAL</u>
2022 PCE:	21	0	0	0	0	0	0	0	12	0	0	0	33
Project PCE:	0	0	0	0	0	17	6	0	0	0	0	0	23
Cumulative PCE	0	0	0	0	0	0	0	0	0	0	0	0	0
EAP 2024 PCE:	22	0	0	0	0	17	6	0	12	0	0	0	57
EAPC 2024 PCE:	22	0	0	0	0	17	6	0	12	0	0	0	57

6: I-215 SB Ramps & Ramona Exwy.

	PHF: 0.990		5:00		Count Date: 1/25/2022								
	<u>NBL</u>	<u>NBT</u>	<u>NBR</u>	<u>SBL</u>	<u>SBT</u>	<u>SBR</u>	<u>EBL</u>	<u>EBT</u>	<u>EBR</u>	<u>WBL</u>	<u>WBT</u>	<u>WBR</u>	<u>TOTAL</u>
2022 PCE:	0	0	0	853	8	184	0	911	348	369	915	0	3,586
Project PCE:	0	0	0	0	0	1	0	8	0	0	0	0	9
Cumulative PCE	0	0	0	1,197	0	258	0	944	567	514	479	0	3,960
EAP 2024 PCE:	0	0	0	789	8	145	0	630	271	317	732	0	2,890
EAPC 2024 PCE:	0	0	0	1,989	8	403	0	1,571	838	839	1,203	0	6,850

Volume Development
PM Peak Hour

7: I-215 NB Ramps & Ramona Exwy.

	PHF: 0.940				5:00				Count Date: 1/25/2022				TOTAL
	<u>NBL</u>	<u>NBT</u>	<u>NBR</u>	<u>SBL</u>	<u>SBT</u>	<u>SBR</u>	<u>EBL</u>	<u>EBT</u>	<u>EBR</u>	<u>WBL</u>	<u>WBT</u>	<u>WBR</u>	
2022 PCE:	371	4	461	0	0	0	121	1,643	0	0	913	652	4,164
Project PCE:	0	0	0	0	0	0	6	2	0	0	0	0	8
Cumulative PCE	274	0	194	0	0	0	565	1,576	0	0	719	1,203	4,531
EAP 2024 PCE:	289	4	359	0	0	0	100	1,318	0	0	759	509	3,339
EAPC 2024 PCE:	563	4	553	0	0	0	666	2,894	0	0	1,478	1,712	7,870

8: I-215 SB Ramps & Placentia Av.

	PHF: 0.920				Count Date:								TOTAL
	<u>NBL</u>	<u>NBT</u>	<u>NBR</u>	<u>SBL</u>	<u>SBT</u>	<u>SBR</u>	<u>EBL</u>	<u>EBT</u>	<u>EBR</u>	<u>WBL</u>	<u>WBT</u>	<u>WBR</u>	
2022 PCE:	0	0	0	334	1	66	0	640	138	233	527	0	1,938
Project PCE:	0	0	0	0	0	0	0	0	20	0	5	0	25
Cumulative PCE	0	0	0	196	0	39	0	125	112	341	87	0	900
EAP 2024 PCE:	0	0	0	348	1	68	0	666	163	242	553	0	2,042
EAPC 2024 PCE:	0	0	0	544	1	107	0	791	275	583	640	0	2,942

9: I-215 NB Ramps & Placentia Av.

	PHF: 0.920				Count Date:								TOTAL
	<u>NBL</u>	<u>NBT</u>	<u>NBR</u>	<u>SBL</u>	<u>SBT</u>	<u>SBR</u>	<u>EBL</u>	<u>EBT</u>	<u>EBR</u>	<u>WBL</u>	<u>WBT</u>	<u>WBR</u>	
2022 PCE:	158	0	217	0	0	0	67	909	0	0	602	262	2,215
Project PCE:	5	0	0	0	0	0	0	0	0	0	0	0	5
Cumulative PCE	79	0	169	0	0	0	122	199	0	0	350	226	1,145
EAP 2024 PCE:	169	0	226	0	0	0	69	946	0	0	626	273	2,309
EAPC 2024 PCE:	248	0	395	0	0	0	191	1,145	0	0	976	499	3,454

County of Riverside
 N/S: Harvill Avenue
 E/W: Cajalco Expressway
 Weather: Clear

File Name : 18_CRV_Har_Caj AM
 Site Code : 05122112
 Start Date : 2/8/2022
 Page No : 1

Groups Printed- Passenger Vehicles - Large 2 Axle Vehicles - 3 Axle Vehicles - 4+ Axle Trucks

Start Time	Harvill Avenue Southbound					Cajalco Expressway Westbound					Harvill Avenue Northbound					Cajalco Expressway Eastbound					Exclu. Total	Inclu. Total	Int. Total
	Left	Thru	Right	RTOR	App. Total	Left	Thru	Right	RTOR	App. Total	Left	Thru	Right	RTOR	App. Total	Left	Thru	Right	RTOR	App. Total			
07:00 AM	52	24	5	1	81	34	177	13	12	224	79	80	10	14	169	9	130	7	6	146	33	620	653
07:15 AM	41	23	6	0	70	28	154	16	13	198	91	68	18	15	177	6	149	11	10	166	38	611	649
07:30 AM	35	23	6	1	64	43	167	34	23	244	61	94	13	10	168	9	180	18	16	207	50	683	733
07:45 AM	46	32	2	0	80	30	130	31	15	191	54	86	24	11	164	13	167	12	15	192	41	627	668
Total	174	102	19	2	295	135	628	94	63	857	285	328	65	50	678	37	626	48	47	711	162	2541	2703
08:00 AM	42	30	2	0	74	31	154	28	11	213	54	61	17	15	132	8	133	19	5	160	31	579	610
08:15 AM	56	31	3	4	90	25	132	18	24	175	31	32	5	16	68	9	130	13	11	152	55	485	540
08:30 AM	40	27	0	0	67	29	124	17	10	170	29	29	2	20	60	5	134	14	12	153	42	450	492
08:45 AM	31	17	7	3	55	29	175	21	7	225	27	21	2	13	50	5	131	20	7	156	30	486	516
Total	169	105	12	7	286	114	585	84	52	783	141	143	26	64	310	27	528	66	35	621	158	2000	2158
Grand Total	343	207	31	9	581	249	1213	178	115	1640	426	471	91	114	988	64	1154	114	82	1332	320	4541	4861
Apprch %	59	35.6	5.3			15.2	74	10.9			43.1	47.7	9.2			4.8	86.6	8.6					
Total %	7.6	4.6	0.7		12.8	5.5	26.7	3.9		36.1	9.4	10.4	2		21.8	1.4	25.4	2.5		29.3	6.6	93.4	
Passenger Vehicles	314	187	19		525	191	1118	161		1579	407	460	75		1036	51	1064	107		1301	0	0	4441
% Passenger Vehicles	91.5	90.3	61.3	55.6	89	76.7	92.2	90.4	94.8	90	95.5	97.7	82.4	82.5	94	79.7	92.2	93.9	96.3	92	0	0	91.4
Large 2 Axle Vehicles	17	10	5		33	23	47	12		85	13	3	6		30	3	41	0		46	0	0	194
% Large 2 Axle Vehicles	5	4.8	16.1	11.1	5.6	9.2	3.9	6.7	2.6	4.8	3.1	0.6	6.6	7	2.7	4.7	3.6	0	2.4	3.3	0	0	4
3 Axle Vehicles	3	1	0		5	5	9	1		17	2	3	1		8	3	10	1		14	0	0	44
% 3 Axle Vehicles	0.9	0.5	0	11.1	0.8	2	0.7	0.6	1.7	1	0.5	0.6	1.1	1.8	0.7	4.7	0.9	0.9	0	1	0	0	0.9
4+ Axle Trucks	9	9	7		27	30	39	4		74	4	5	9		28	7	39	6		53	0	0	182
% 4+ Axle Trucks	2.6	4.3	22.6	22.2	4.6	12	3.2	2.2	0.9	4.2	0.9	1.1	9.9	8.8	2.5	10.9	3.4	5.3	1.2	3.7	0	0	3.7

Start Time	Harvill Avenue Southbound				Cajalco Expressway Westbound				Harvill Avenue Northbound				Cajalco Expressway Eastbound				Int. Total
	Left	Thru	Right	App. Total	Left	Thru	Right	App. Total	Left	Thru	Right	App. Total	Left	Thru	Right	App. Total	
Peak Hour Analysis From 07:00 AM to 08:45 AM - Peak 1 of 1																	
Peak Hour for Entire Intersection Begins at 07:00 AM																	
07:00 AM	52	24	5	81	34	177	13	224	79	80	10	169	9	130	7	146	620
07:15 AM	41	23	6	70	28	154	16	198	91	68	18	177	6	149	11	166	611
07:30 AM	35	23	6	64	43	167	34	244	61	94	13	168	9	180	18	207	683
07:45 AM	46	32	2	80	30	130	31	191	54	86	24	164	13	167	12	192	627
Total Volume	174	102	19	295	135	628	94	857	285	328	65	678	37	626	48	711	2541
% App. Total	59	34.6	6.4		15.8	73.3	11		42	48.4	9.6		5.2	88	6.8		
PHF	.837	.797	.792	.910	.785	.887	.691	.878	.783	.872	.677	.958	.712	.869	.667	.859	.930

County of Riverside
 N/S: Harvill Avenue
 E/W: Cajalco Expressway
 Weather: Clear

File Name : 18_CRV_Har_Caj AM
 Site Code : 05122112
 Start Date : 2/8/2022
 Page No : 2

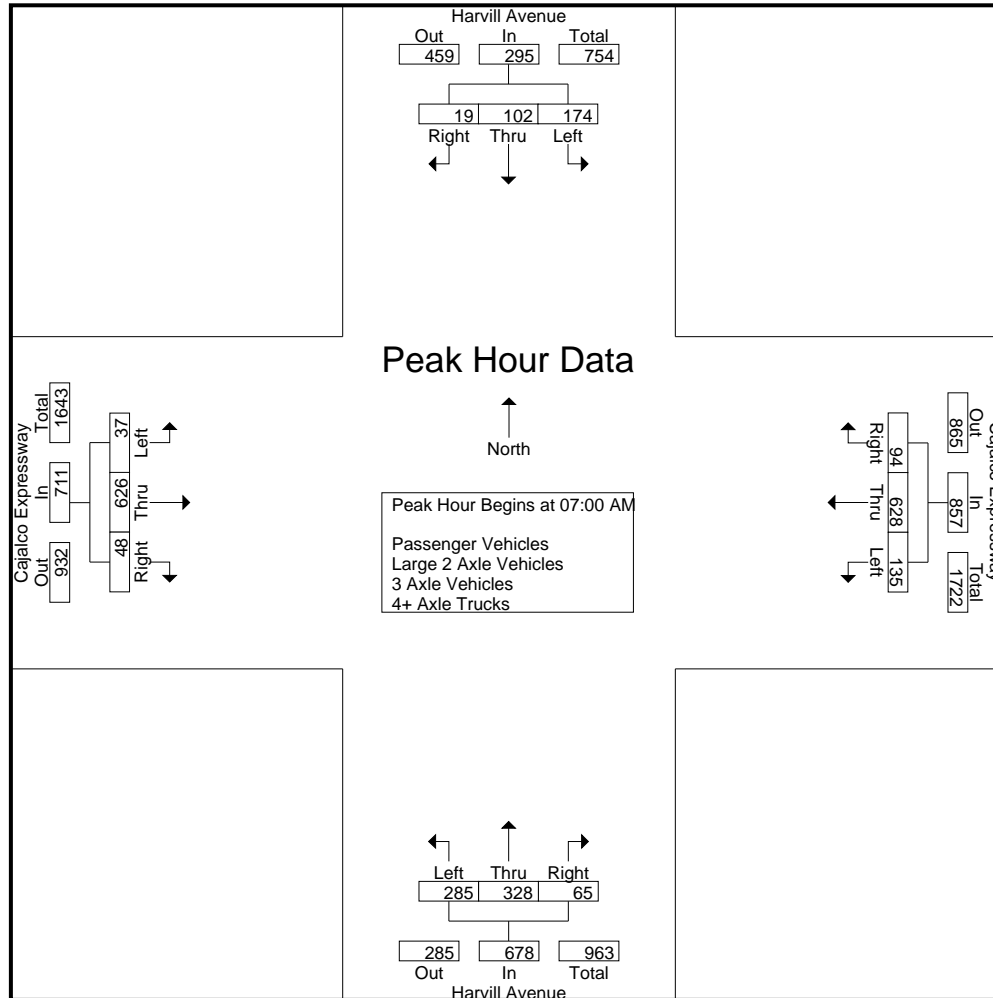

County of Riverside
 N/S: Harvill Avenue
 E/W: Cajalco Expressway
 Weather: Clear

File Name : 18_CRV_Har_Caj AM
 Site Code : 05122112
 Start Date : 2/8/2022
 Page No : 3

Start Time	Harvill Avenue Southbound				Cajalco Expressway Westbound				Harvill Avenue Northbound				Cajalco Expressway Eastbound				Int. Total
	Left	Thru	Right	App. Total	Left	Thru	Right	App. Total	Left	Thru	Right	App. Total	Left	Thru	Right	App. Total	
Peak Hour Analysis From 07:00 AM to 08:45 AM - Peak 1 of 1																	
Peak Hour for Each Approach Begins at:																	
	07:45 AM				07:00 AM				07:00 AM				07:15 AM				
+0 mins.	46	32	2	80	34	177	13	224	79	80	10	169	6	149	11	166	
+15 mins.	42	30	2	74	28	154	16	198	91	68	18	177	9	180	18	207	
+30 mins.	56	31	3	90	43	167	34	244	61	94	13	168	13	167	12	192	
+45 mins.	40	27	0	67	30	130	31	191	54	86	24	164	8	133	19	160	
Total Volume	184	120	7	311	135	628	94	857	285	328	65	678	36	629	60	725	
% App. Total	59.2	38.6	2.3		15.8	73.3	11		42	48.4	9.6		5	86.8	8.3		
PHF	.821	.938	.583	.864	.785	.887	.691	.878	.783	.872	.677	.958	.692	.874	.789	.876	

County of Riverside
 N/S: Harvill Avenue
 E/W: Cajalco Expressway
 Weather: Clear

File Name : 18_CRV_Har_Caj AM
 Site Code : 05122112
 Start Date : 2/8/2022
 Page No : 1

Groups Printed- Large 2 Axle Vehicles

Start Time	Harvill Avenue Southbound					Cajalco Expressway Westbound					Harvill Avenue Northbound					Cajalco Expressway Eastbound					Exclu. Total	Inclu. Total	Int. Total
	Left	Thru	Right	RTOR	App. Total	Left	Thru	Right	RTOR	App. Total	Left	Thru	Right	RTOR	App. Total	Left	Thru	Right	RTOR	App. Total			
07:00 AM	3	0	1	0	4	4	6	2	1	12	5	1	3	2	9	0	2	0	0	2	3	27	30
07:15 AM	2	0	0	0	2	3	5	1	0	9	4	0	1	0	5	0	5	0	1	5	1	21	22
07:30 AM	0	2	1	1	3	1	10	1	0	12	0	0	1	0	1	1	7	0	0	8	1	24	25
07:45 AM	3	1	1	0	5	3	8	0	0	11	1	0	1	1	2	2	5	0	0	7	1	25	26
Total	8	3	3	1	14	11	29	4	1	44	10	1	6	3	17	3	19	0	1	22	6	97	103
08:00 AM	4	2	0	0	6	1	5	3	0	9	0	1	0	1	1	0	6	0	0	6	1	22	23
08:15 AM	0	3	0	0	3	3	3	2	1	8	1	1	0	1	2	0	8	0	0	8	2	21	23
08:30 AM	4	2	0	0	6	3	5	0	0	8	1	0	0	1	1	0	3	0	1	3	2	18	20
08:45 AM	1	0	2	0	3	5	5	3	1	13	1	0	0	2	1	0	5	0	0	5	3	22	25
Total	9	7	2	0	18	12	18	8	2	38	3	2	0	5	5	0	22	0	1	22	8	83	91
Grand Total	17	10	5	1	32	23	47	12	3	82	13	3	6	8	22	3	41	0	2	44	14	180	194
Apprch %	53.1	31.2	15.6			28	57.3	14.6			59.1	13.6	27.3			6.8	93.2	0					
Total %	9.4	5.6	2.8		17.8	12.8	26.1	6.7		45.6	7.2	1.7	3.3		12.2	1.7	22.8	0		24.4	7.2	92.8	

Start Time	Harvill Avenue Southbound				Cajalco Expressway Westbound				Harvill Avenue Northbound				Cajalco Expressway Eastbound				Int. Total
	Left	Thru	Right	App. Total	Left	Thru	Right	App. Total	Left	Thru	Right	App. Total	Left	Thru	Right	App. Total	
Peak Hour Analysis From 07:00 AM to 07:45 AM - Peak 1 of 1																	
Peak Hour for Entire Intersection Begins at 07:00 AM																	
07:00 AM	3	0	1	4	4	6	2	12	5	1	3	9	0	2	0	2	27
07:15 AM	2	0	0	2	3	5	1	9	4	0	1	5	0	5	0	5	21
07:30 AM	0	2	1	3	1	10	1	12	0	0	1	1	1	7	0	8	24
07:45 AM	3	1	1	5	3	8	0	11	1	0	1	2	2	5	0	7	25
Total Volume	8	3	3	14	11	29	4	44	10	1	6	17	3	19	0	22	97
% App. Total	57.1	21.4	21.4		25	65.9	9.1		58.8	5.9	35.3		13.6	86.4	0		
PHF	.667	.375	.750	.700	.688	.725	.500	.917	.500	.250	.500	.472	.375	.679	.000	.688	.898

County of Riverside
 N/S: Harvill Avenue
 E/W: Cajalco Expressway
 Weather: Clear

File Name : 18_CRV_Har_Caj AM
 Site Code : 05122112
 Start Date : 2/8/2022
 Page No : 2

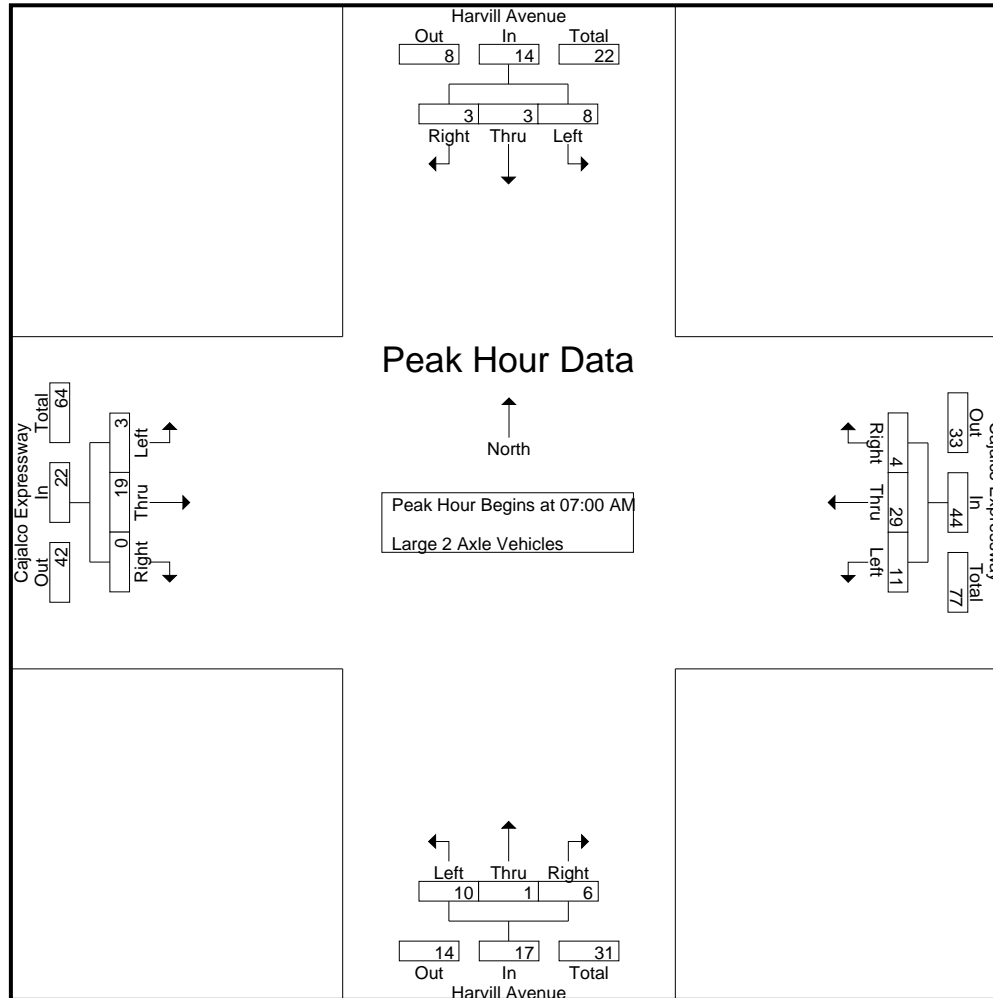

County of Riverside
 N/S: Harvill Avenue
 E/W: Cajalco Expressway
 Weather: Clear

File Name : 18_CRV_Har_Caj AM
 Site Code : 05122112
 Start Date : 2/8/2022
 Page No : 3

Start Time	Harvill Avenue Southbound				Cajalco Expressway Westbound				Harvill Avenue Northbound				Cajalco Expressway Eastbound				Int. Total
	Left	Thru	Right	App. Total	Left	Thru	Right	App. Total	Left	Thru	Right	App. Total	Left	Thru	Right	App. Total	
Peak Hour Analysis From 07:00 AM to 07:45 AM - Peak 1 of 1																	
Peak Hour for Each Approach Begins at:																	
	07:00 AM				07:00 AM				07:00 AM				07:00 AM				
+0 mins.	3	0	1	4	4	6	2	12	5	1	3	9	0	2	0	2	
+15 mins.	2	0	0	2	3	5	1	9	4	0	1	5	0	5	0	5	
+30 mins.	0	2	1	3	1	10	1	12	0	0	1	1	1	7	0	8	
+45 mins.	3	1	1	5	3	8	0	11	1	0	1	2	2	5	0	7	
Total Volume	8	3	3	14	11	29	4	44	10	1	6	17	3	19	0	22	
% App. Total	57.1	21.4	21.4		25	65.9	9.1		58.8	5.9	35.3		13.6	86.4	0		
PHF	.667	.375	.750	.700	.688	.725	.500	.917	.500	.250	.500	.472	.375	.679	.000	.688	

County of Riverside
 N/S: Harvill Avenue
 E/W: Cajalco Expressway
 Weather: Clear

File Name : 18_CRV_Har_Caj AM
 Site Code : 05122112
 Start Date : 2/8/2022
 Page No : 1

Groups Printed- 3 Axle Vehicles

Start Time	Harvill Avenue Southbound					Cajalco Expressway Westbound					Harvill Avenue Northbound					Cajalco Expressway Eastbound					Exclu. Total	Inclu. Total	Int. Total		
	Left	Thru	Right	RTOR	App. Total	Left	Thru	Right	RTOR	App. Total	Left	Thru	Right	RTOR	App. Total	Left	Thru	Right	RTOR	App. Total					
07:00 AM	0	0	0	0	0	0	0	0	1	0	0	0	0	1	0	0	0	0	0	0	0	2	0	0	2
07:15 AM	1	0	0	0	1	1	2	0	0	3	0	1	0	0	1	1	0	0	0	1	0	0	0	0	6
07:30 AM	0	0	0	0	0	1	1	0	0	2	0	0	1	1	1	1	2	0	0	3	1	0	0	0	7
07:45 AM	0	0	0	0	0	0	1	0	0	1	1	1	0	0	2	0	2	0	0	2	0	0	0	0	5
Total	1	0	0	0	1	2	4	0	1	6	1	2	1	2	4	2	4	0	0	6	3	17	0	0	20
08:00 AM	1	1	0	0	2	0	2	0	0	2	0	1	0	0	1	0	2	0	0	2	0	0	0	0	7
08:15 AM	0	0	0	0	0	1	1	0	0	2	0	0	0	0	0	0	1	0	0	1	0	0	0	0	3
08:30 AM	1	0	0	0	1	0	2	0	1	2	0	0	0	0	0	1	1	0	0	2	1	0	0	0	6
08:45 AM	0	0	0	1	0	2	0	1	0	3	1	0	0	0	1	0	2	1	0	3	1	0	0	0	8
Total	2	1	0	1	3	3	5	1	1	9	1	1	0	0	2	1	6	1	0	8	2	22	0	0	24
Grand Total	3	1	0	1	4	5	9	1	2	15	2	3	1	2	6	3	10	1	0	14	5	39	0	0	44
Apprch %	75	25	0			33.3	60	6.7			33.3	50	16.7			21.4	71.4	7.1							
Total %	7.7	2.6	0		10.3	12.8	23.1	2.6		38.5	5.1	7.7	2.6		15.4	7.7	25.6	2.6		35.9	11.4	88.6			

Start Time	Harvill Avenue Southbound				Cajalco Expressway Westbound				Harvill Avenue Northbound				Cajalco Expressway Eastbound				Int. Total
	Left	Thru	Right	App. Total	Left	Thru	Right	App. Total	Left	Thru	Right	App. Total	Left	Thru	Right	App. Total	
Peak Hour Analysis From 07:00 AM to 07:45 AM - Peak 1 of 1																	
Peak Hour for Entire Intersection Begins at 07:00 AM																	
07:00 AM	0	0	0	0	0	0	0	0	0	0	0	0	0	0	0	0	
07:15 AM	1	0	0	1	1	2	0	3	0	1	0	1	1	0	0	1	
07:30 AM	0	0	0	0	1	1	0	2	0	0	1	1	1	2	0	3	
07:45 AM	0	0	0	0	0	1	0	1	1	1	0	2	0	2	0	2	
Total Volume	1	0	0	1	2	4	0	6	1	2	1	4	2	4	0	6	
% App. Total	100	0	0		33.3	66.7	0		25	50	25		33.3	66.7	0		
PHF	.250	.000	.000	.250	.500	.500	.000	.500	.250	.500	.250	.500	.500	.500	.000	.500	

County of Riverside
 N/S: Harvill Avenue
 E/W: Cajalco Expressway
 Weather: Clear

File Name : 18_CRV_Har_Caj AM
 Site Code : 05122112
 Start Date : 2/8/2022
 Page No : 2

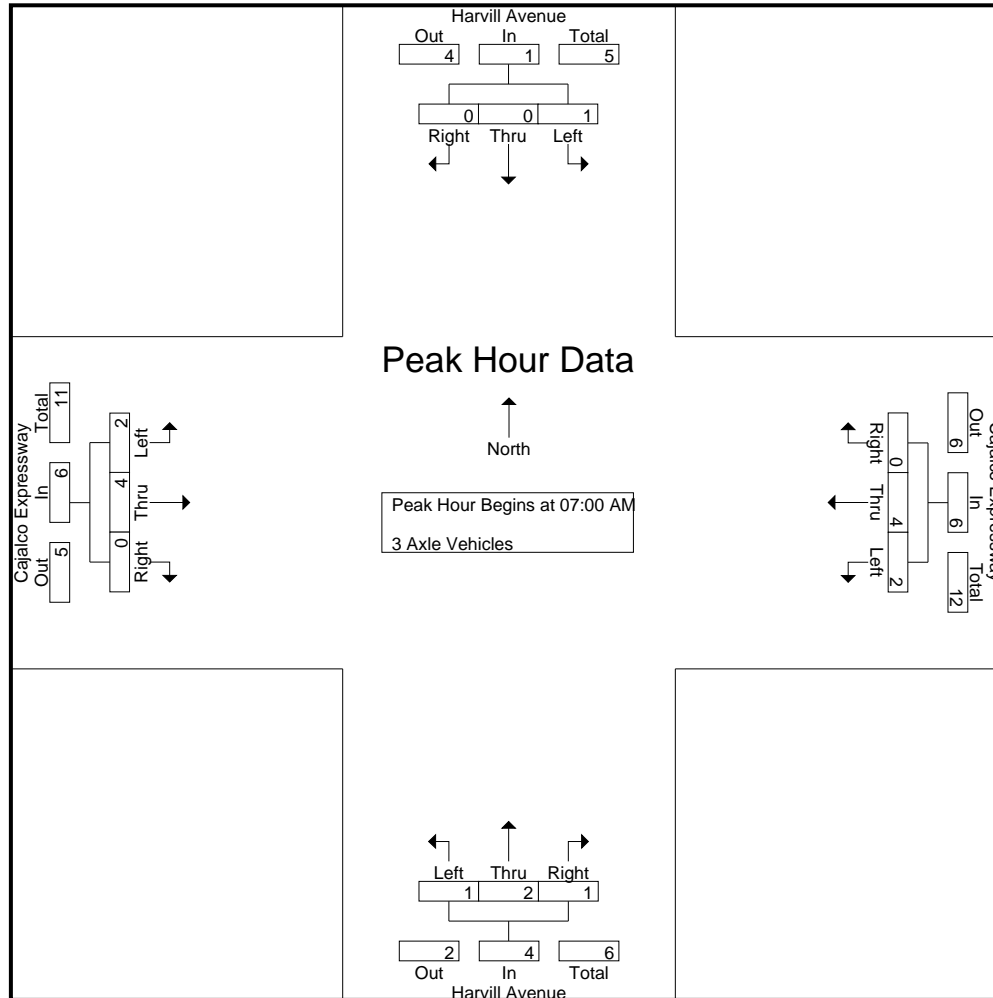

County of Riverside
 N/S: Harvill Avenue
 E/W: Cajalco Expressway
 Weather: Clear

File Name : 18_CRV_Har_Caj AM
 Site Code : 05122112
 Start Date : 2/8/2022
 Page No : 3

Start Time	Harvill Avenue Southbound				Cajalco Expressway Westbound				Harvill Avenue Northbound				Cajalco Expressway Eastbound				Int. Total
	Left	Thru	Right	App. Total	Left	Thru	Right	App. Total	Left	Thru	Right	App. Total	Left	Thru	Right	App. Total	
Peak Hour Analysis From 07:00 AM to 07:45 AM - Peak 1 of 1																	
Peak Hour for Each Approach Begins at:																	
	07:00 AM				07:00 AM				07:00 AM				07:00 AM				
+0 mins.	0	0	0	0	0	0	0	0	0	0	0	0	0	0	0	0	
+15 mins.	1	0	0	1	1	2	0	3	0	1	0	1	1	0	0	1	
+30 mins.	0	0	0	0	1	1	0	2	0	0	1	1	1	2	0	3	
+45 mins.	0	0	0	0	0	1	0	1	1	1	0	2	0	2	0	2	
Total Volume	1	0	0	1	2	4	0	6	1	2	1	4	2	4	0	6	
% App. Total	100	0	0		33.3	66.7	0		25	50	25		33.3	66.7	0		
PHF	.250	.000	.000	.250	.500	.500	.000	.500	.250	.500	.250	.500	.500	.500	.000	.500	

County of Riverside
 N/S: Harvill Avenue
 E/W: Cajalco Expressway
 Weather: Clear

File Name : 18_CRV_Har_Caj AM
 Site Code : 05122112
 Start Date : 2/8/2022
 Page No : 1

Groups Printed- 4+ Axle Trucks

Start Time	Harvill Avenue Southbound					Cajalco Expressway Westbound					Harvill Avenue Northbound					Cajalco Expressway Eastbound					Exclu. Total	Inclu. Total	Int. Total
	Left	Thru	Right	RTOR	App. Total	Left	Thru	Right	RTOR	App. Total	Left	Thru	Right	RTOR	App. Total	Left	Thru	Right	RTOR	App. Total			
07:00 AM	2	2	2	0	6	4	5	1	0	10	1	0	1	1	2	1	7	0	0	8	1	26	27
07:15 AM	2	2	0	0	4	3	1	0	0	4	1	2	1	1	4	0	4	0	0	4	1	16	17
07:30 AM	1	0	1	0	2	3	4	1	0	8	0	1	0	1	1	0	4	0	0	4	1	15	16
07:45 AM	0	2	0	0	2	2	5	1	0	8	1	0	1	2	2	2	5	1	1	8	3	20	23
Total	5	6	3	0	14	12	15	3	0	30	3	3	3	5	9	3	20	1	1	24	6	77	83
08:00 AM	1	1	1	0	3	4	7	1	0	12	0	1	3	0	4	0	5	3	0	8	0	27	27
08:15 AM	2	0	2	1	4	4	3	0	1	7	0	0	1	1	1	3	5	1	0	9	3	21	24
08:30 AM	1	0	0	0	1	5	5	0	0	10	0	0	2	1	2	1	6	0	0	7	1	20	21
08:45 AM	0	2	1	1	3	5	9	0	0	14	1	1	0	3	2	0	3	1	0	4	4	23	27
Total	4	3	4	2	11	18	24	1	1	43	1	2	6	5	9	4	19	5	0	28	8	91	99
Grand Total	9	9	7	2	25	30	39	4	1	73	4	5	9	10	18	7	39	6	1	52	14	168	182
Apprch %	36	36	28			41.1	53.4	5.5			22.2	27.8	50			13.5	75	11.5					
Total %	5.4	5.4	4.2		14.9	17.9	23.2	2.4		43.5	2.4	3	5.4		10.7	4.2	23.2	3.6		31	7.7	92.3	

Start Time	Harvill Avenue Southbound				Cajalco Expressway Westbound				Harvill Avenue Northbound				Cajalco Expressway Eastbound				Int. Total
	Left	Thru	Right	App. Total	Left	Thru	Right	App. Total	Left	Thru	Right	App. Total	Left	Thru	Right	App. Total	
Peak Hour Analysis From 07:00 AM to 07:45 AM - Peak 1 of 1																	
Peak Hour for Entire Intersection Begins at 07:00 AM																	
07:00 AM	2	2	2	6	4	5	1	10	1	0	1	2	1	7	0	8	26
07:15 AM	2	2	0	4	3	1	0	4	1	2	1	4	0	4	0	4	16
07:30 AM	1	0	1	2	3	4	1	8	0	1	0	1	0	4	0	4	15
07:45 AM	0	2	0	2	2	5	1	8	1	0	1	2	2	5	1	8	20
Total Volume	5	6	3	14	12	15	3	30	3	3	3	9	3	20	1	24	77
% App. Total	35.7	42.9	21.4		40	50	10		33.3	33.3	33.3		12.5	83.3	4.2		
PHF	.625	.750	.375	.583	.750	.750	.750	.750	.750	.375	.750	.563	.375	.714	.250	.750	.740

County of Riverside
 N/S: Harvill Avenue
 E/W: Cajalco Expressway
 Weather: Clear

File Name : 18_CRV_Har_Caj AM
 Site Code : 05122112
 Start Date : 2/8/2022
 Page No : 2

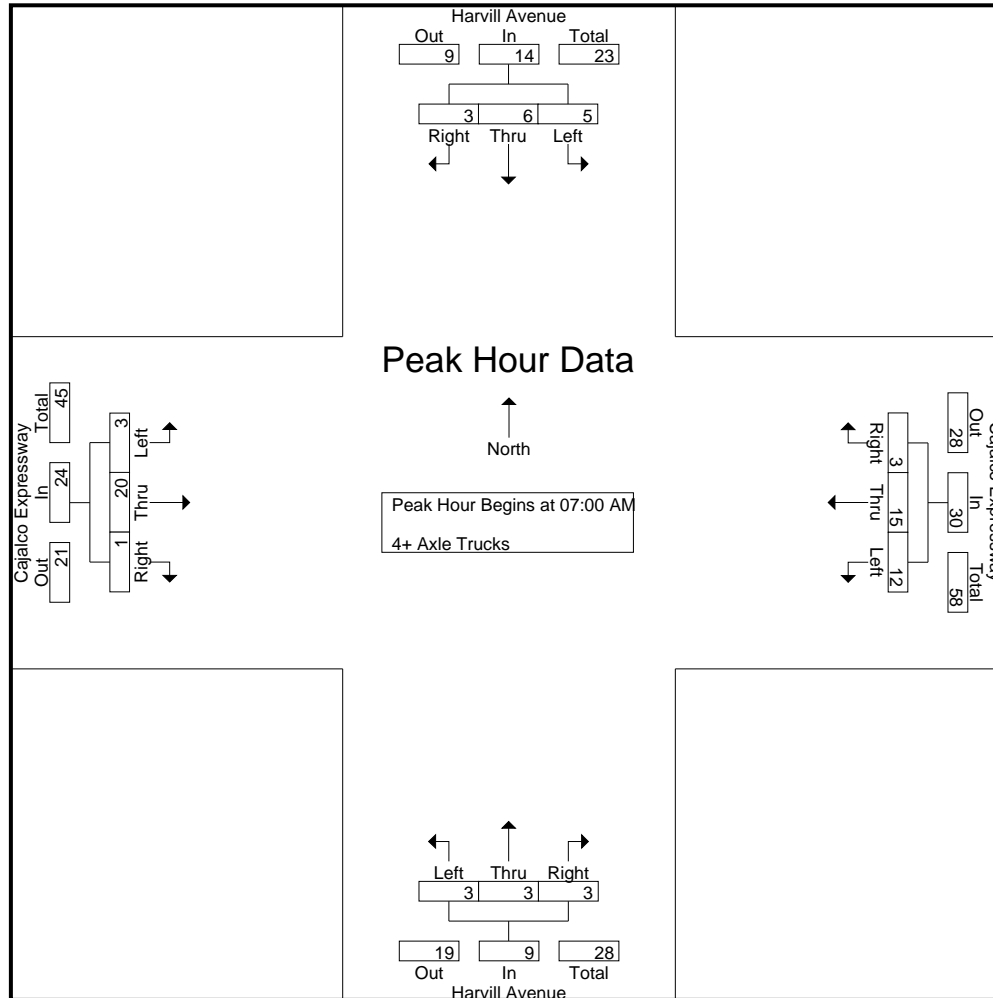

County of Riverside
 N/S: Harvill Avenue
 E/W: Cajalco Expressway
 Weather: Clear

File Name : 18_CRV_Har_Caj AM
 Site Code : 05122112
 Start Date : 2/8/2022
 Page No : 3

Start Time	Harvill Avenue Southbound				Cajalco Expressway Westbound				Harvill Avenue Northbound				Cajalco Expressway Eastbound				Int. Total
	Left	Thru	Right	App. Total	Left	Thru	Right	App. Total	Left	Thru	Right	App. Total	Left	Thru	Right	App. Total	
Peak Hour Analysis From 07:00 AM to 07:45 AM - Peak 1 of 1																	
Peak Hour for Each Approach Begins at:																	
	07:00 AM				07:00 AM				07:00 AM				07:00 AM				
+0 mins.	2	2	2	6	4	5	1	10	1	0	1	2	1	7	0	8	
+15 mins.	2	2	0	4	3	1	0	4	1	2	1	4	0	4	0	4	
+30 mins.	1	0	1	2	3	4	1	8	0	1	0	1	0	4	0	4	
+45 mins.	0	2	0	2	2	5	1	8	1	0	1	2	2	5	1	8	
Total Volume	5	6	3	14	12	15	3	30	3	3	3	9	3	20	1	24	
% App. Total	35.7	42.9	21.4		40	50	10		33.3	33.3	33.3		12.5	83.3	4.2		
PHF	.625	.750	.375	.583	.750	.750	.750	.750	.750	.375	.750	.563	.375	.714	.250	.750	

County of Riverside
 N/S: Harvill Avenue
 E/W: Cajalco Expressway
 Weather: Clear

File Name : 18_CRV_Har_Caj PM
 Site Code : 05122112
 Start Date : 2/8/2022
 Page No : 1

Groups Printed- Passenger Vehicles - Large 2 Axle Vehicles - 3 Axle Vehicles - 4+ Axle Trucks

Start Time	Harvill Avenue Southbound					Cajalco Expressway Westbound					Harvill Avenue Northbound					Cajalco Expressway Eastbound					Exclu. Total	Inclu. Total	Int. Total
	Left	Thru	Right	RTOR	App. Total	Left	Thru	Right	RTOR	App. Total	Left	Thru	Right	RTOR	App. Total	Left	Thru	Right	RTOR	App. Total			
04:00 PM	42	48	14	7	104	31	173	64	31	268	50	40	30	11	120	5	147	64	29	216	78	708	786
04:15 PM	46	46	5	2	97	23	139	33	7	195	33	33	25	15	91	11	158	44	29	213	53	596	649
04:30 PM	77	51	8	0	136	25	151	42	22	218	38	39	25	11	102	4	196	52	26	252	59	708	767
04:45 PM	53	55	5	1	113	22	134	35	14	191	38	28	36	26	102	2	185	40	21	227	62	633	695
Total	218	200	32	10	450	101	597	174	74	872	159	140	116	63	415	22	686	200	105	908	252	2645	2897
05:00 PM	60	42	6	2	108	21	150	45	19	216	39	22	26	14	87	7	189	30	20	226	55	637	692
05:15 PM	68	44	7	2	119	22	174	47	20	243	33	27	24	16	84	7	166	41	20	214	58	660	718
05:30 PM	43	49	4	0	96	20	166	40	17	226	41	29	19	14	89	4	229	33	12	266	43	677	720
05:45 PM	63	35	6	1	104	27	157	35	16	219	46	21	26	17	93	2	209	32	8	243	42	659	701
Total	234	170	23	5	427	90	647	167	72	904	159	99	95	61	353	20	793	136	60	949	198	2633	2831
Grand Total	452	370	55	15	877	191	1244	341	146	1776	318	239	211	124	768	42	1479	336	165	1857	450	5278	5728
Apprch %	51.5	42.2	6.3			10.8	70	19.2			41.4	31.1	27.5			2.3	79.6	18.1					
Total %	8.6	7	1		16.6	3.6	23.6	6.5		33.6	6	4.5	4		14.6	0.8	28	6.4		35.2	7.9	92.1	
Passenger Vehicles	443	354	50		861	148	1190	322		1799	311	230	201		859	37	1426	320		1942	0	0	5461
% Passenger Vehicles	98	95.7	90.9	93.3	96.5	77.5	95.7	94.4	95.2	93.6	97.8	96.2	95.3	94.4	96.3	88.1	96.4	95.2	96.4	96	0	0	95.3
Large 2 Axle Vehicles	4	5	2		11	7	19	15		47	2	2	2		8	0	26	9		40	0	0	106
% Large 2 Axle Vehicles	0.9	1.4	3.6	0	1.2	3.7	1.5	4.4	4.1	2.4	0.6	0.8	0.9	1.6	0.9	0	1.8	2.7	3	2	0	0	1.9
3 Axle Vehicles	2	2	0		4	5	9	0		14	2	5	2		11	1	5	1		7	0	0	36
% 3 Axle Vehicles	0.4	0.5	0	0	0.4	2.6	0.7	0	0	0.7	0.6	2.1	0.9	1.6	1.2	2.4	0.3	0.3	0	0.3	0	0	0.6
4+ Axle Trucks	3	9	3		16	31	26	4		62	3	2	6		14	4	22	6		33	0	0	125
% 4+ Axle Trucks	0.7	2.4	5.5	6.7	1.8	16.2	2.1	1.2	0.7	3.2	0.9	0.8	2.8	2.4	1.6	9.5	1.5	1.8	0.6	1.6	0	0	2.2

Start Time	Harvill Avenue Southbound				Cajalco Expressway Westbound				Harvill Avenue Northbound				Cajalco Expressway Eastbound				Int. Total
	Left	Thru	Right	App. Total	Left	Thru	Right	App. Total	Left	Thru	Right	App. Total	Left	Thru	Right	App. Total	
Peak Hour Analysis From 04:00 PM to 05:45 PM - Peak 1 of 1																	
Peak Hour for Entire Intersection Begins at 04:00 PM																	
04:00 PM	42	48	14	104	31	173	64	268	50	40	30	120	5	147	64	216	708
04:15 PM	46	46	5	97	23	139	33	195	33	33	25	91	11	158	44	213	596
04:30 PM	77	51	8	136	25	151	42	218	38	39	25	102	4	196	52	252	708
04:45 PM	53	55	5	113	22	134	35	191	38	28	36	102	2	185	40	227	633
Total Volume	218	200	32	450	101	597	174	872	159	140	116	415	22	686	200	908	2645
% App. Total	48.4	44.4	7.1		11.6	68.5	20		38.3	33.7	28		2.4	75.6	22		
PHF	.708	.909	.571	.827	.815	.863	.680	.813	.795	.875	.806	.865	.500	.875	.781	.901	.934

County of Riverside
 N/S: Harvill Avenue
 E/W: Cajalco Expressway
 Weather: Clear

File Name : 18_CRV_Har_Caj PM
 Site Code : 05122112
 Start Date : 2/8/2022
 Page No : 2

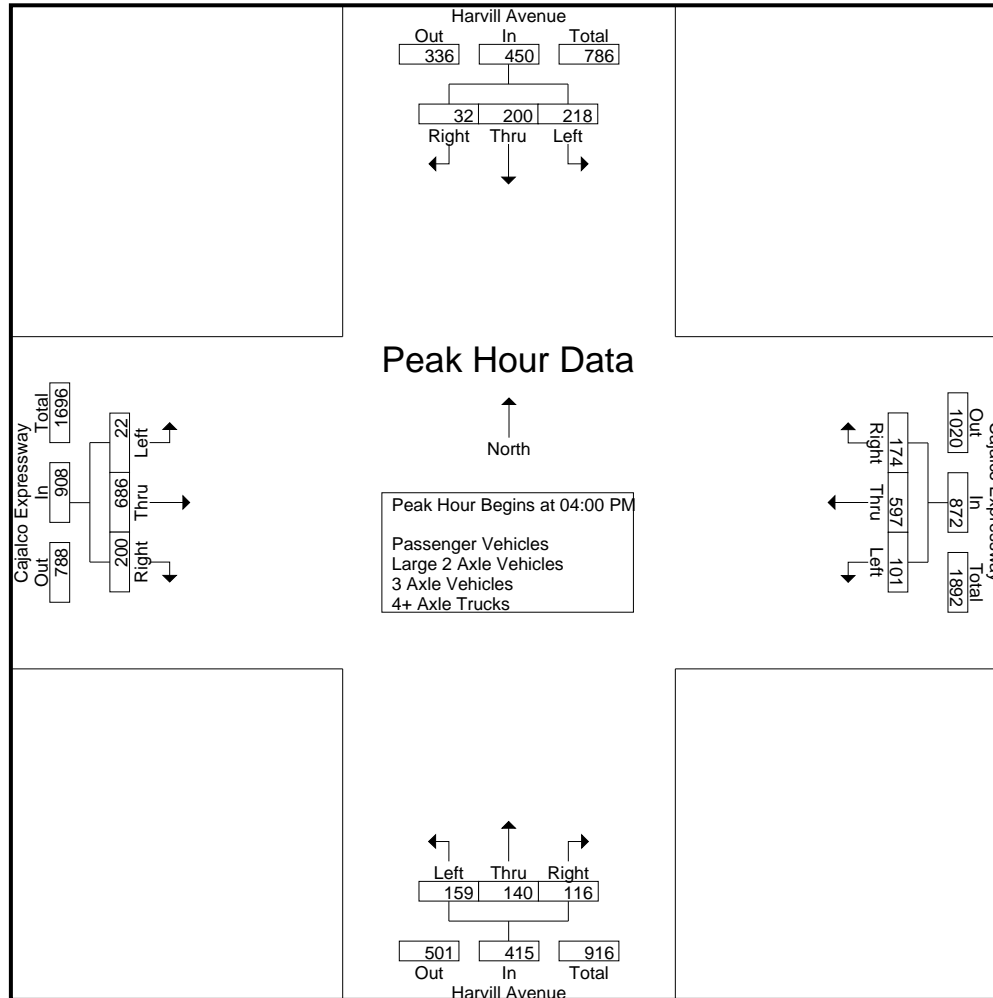

County of Riverside
 N/S: Harvill Avenue
 E/W: Cajalco Expressway
 Weather: Clear

File Name : 18_CRV_Har_Caj PM
 Site Code : 05122112
 Start Date : 2/8/2022
 Page No : 3

Start Time	Harvill Avenue Southbound				Cajalco Expressway Westbound				Harvill Avenue Northbound				Cajalco Expressway Eastbound				Int. Total
	Left	Thru	Right	App. Total	Left	Thru	Right	App. Total	Left	Thru	Right	App. Total	Left	Thru	Right	App. Total	
Peak Hour Analysis From 04:00 PM to 05:45 PM - Peak 1 of 1																	
Peak Hour for Each Approach Begins at:																	
	04:30 PM				05:00 PM				04:00 PM				05:00 PM				
+0 mins.	77	51	8	136	21	150	45	216	50	40	30	120	7	189	30	226	
+15 mins.	53	55	5	113	22	174	47	243	33	33	25	91	7	166	41	214	
+30 mins.	60	42	6	108	20	166	40	226	38	39	25	102	4	229	33	266	
+45 mins.	68	44	7	119	27	157	35	219	38	28	36	102	2	209	32	243	
Total Volume	258	192	26	476	90	647	167	904	159	140	116	415	20	793	136	949	
% App. Total	54.2	40.3	5.5		10	71.6	18.5		38.3	33.7	28		2.1	83.6	14.3		
PHF	.838	.873	.813	.875	.833	.930	.888	.930	.795	.875	.806	.865	.714	.866	.829	.892	

County of Riverside
 N/S: Harvill Avenue
 E/W: Cajalco Expressway
 Weather: Clear

File Name : 18_CRV_Har_Caj PM
 Site Code : 05122112
 Start Date : 2/8/2022
 Page No : 1

Groups Printed- Large 2 Axle Vehicles

Start Time	Harvill Avenue Southbound					Cajalco Expressway Westbound					Harvill Avenue Northbound					Cajalco Expressway Eastbound					Exclu. Total	Inclu. Total	Int. Total
	Left	Thru	Right	RTOR	App. Total	Left	Thru	Right	RTOR	App. Total	Left	Thru	Right	RTOR	App. Total	Left	Thru	Right	RTOR	App. Total			
04:00 PM	1	0	1	0	2	1	7	3	2	11	0	0	1	1	1	0	5	3	1	8	4	22	26
04:15 PM	0	0	0	0	0	1	3	2	0	6	1	0	0	0	1	0	2	1	1	3	1	10	11
04:30 PM	1	1	0	0	2	0	3	4	2	7	0	0	0	0	0	0	3	1	0	4	2	13	15
04:45 PM	0	1	1	0	2	0	1	3	0	4	0	0	0	0	0	0	4	1	1	5	1	11	12
Total	2	2	2	0	6	2	14	12	4	28	1	0	1	1	2	0	14	6	3	20	8	56	64
05:00 PM	1	0	0	0	1	2	2	0	0	4	0	1	0	0	1	0	1	1	1	2	1	8	9
05:15 PM	1	0	0	0	1	2	0	3	2	5	0	1	1	1	2	0	1	0	0	1	3	9	12
05:30 PM	0	2	0	0	2	1	3	0	0	4	0	0	0	0	0	0	7	2	1	9	1	15	16
05:45 PM	0	1	0	0	1	0	0	0	0	0	1	0	0	0	1	0	3	0	0	3	0	5	5
Total	2	3	0	0	5	5	5	3	2	13	1	2	1	1	4	0	12	3	2	15	5	37	42
Grand Total	4	5	2	0	11	7	19	15	6	41	2	2	2	2	6	0	26	9	5	35	13	93	106
Apprch %	36.4	45.5	18.2			17.1	46.3	36.6			33.3	33.3	33.3			0	74.3	25.7					
Total %	4.3	5.4	2.2		11.8	7.5	20.4	16.1		44.1	2.2	2.2	2.2		6.5	0	28	9.7		37.6	12.3	87.7	

Start Time	Harvill Avenue Southbound				Cajalco Expressway Westbound				Harvill Avenue Northbound				Cajalco Expressway Eastbound				Int. Total
	Left	Thru	Right	App. Total	Left	Thru	Right	App. Total	Left	Thru	Right	App. Total	Left	Thru	Right	App. Total	
Peak Hour Analysis From 04:00 PM to 04:45 PM - Peak 1 of 1																	
Peak Hour for Entire Intersection Begins at 04:00 PM																	
04:00 PM	1	0	1	2	1	7	3	11	0	0	1	1	0	5	3	8	22
04:15 PM	0	0	0	0	1	3	2	6	1	0	0	1	0	2	1	3	10
04:30 PM	1	1	0	2	0	3	4	7	0	0	0	0	0	3	1	4	13
04:45 PM	0	1	1	2	0	1	3	4	0	0	0	0	0	4	1	5	11
Total Volume	2	2	2	6	2	14	12	28	1	0	1	2	0	14	6	20	56
% App. Total	33.3	33.3	33.3		7.1	50	42.9		50	0	50		0	70	30		
PHF	.500	.500	.500	.750	.500	.500	.750	.636	.250	.000	.250	.500	.000	.700	.500	.625	.636

County of Riverside
 N/S: Harvill Avenue
 E/W: Cajalco Expressway
 Weather: Clear

File Name : 18_CRV_Har_Caj PM
 Site Code : 05122112
 Start Date : 2/8/2022
 Page No : 2

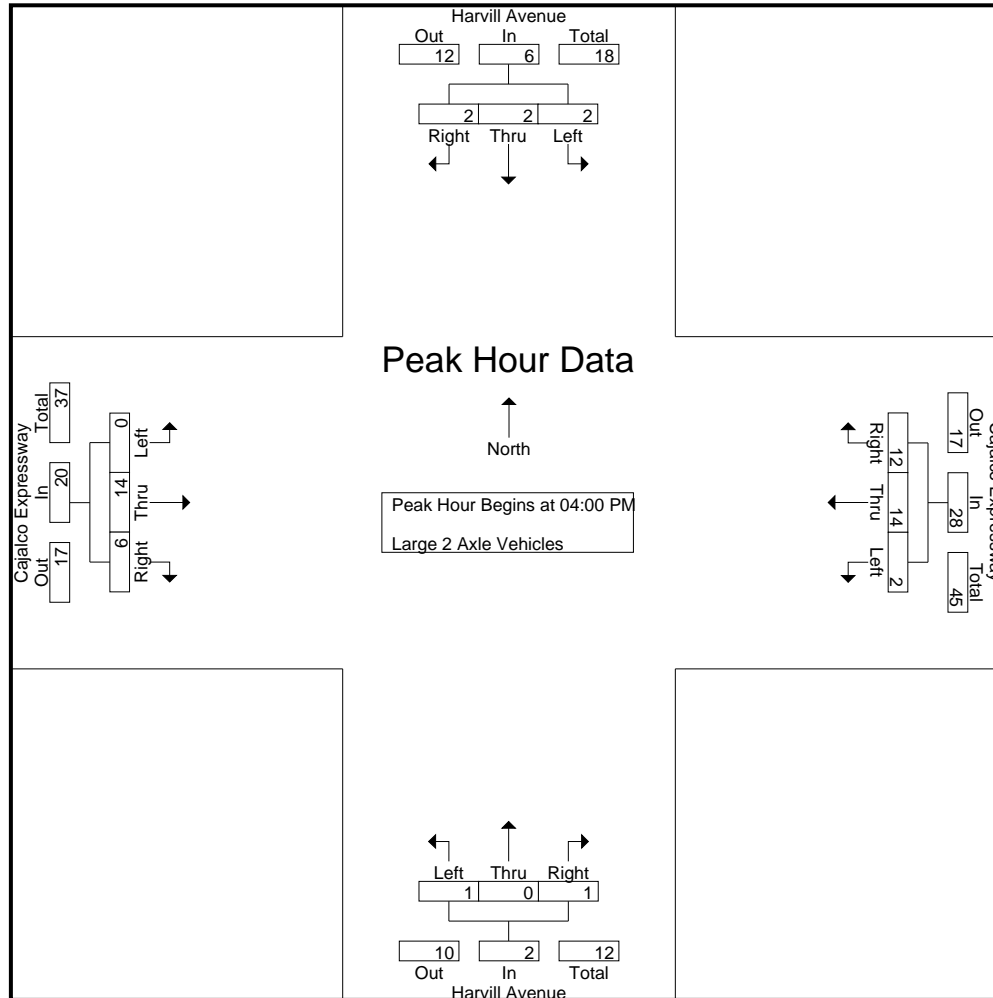

County of Riverside
 N/S: Harvill Avenue
 E/W: Cajalco Expressway
 Weather: Clear

File Name : 18_CRV_Har_Caj PM
 Site Code : 05122112
 Start Date : 2/8/2022
 Page No : 3

Start Time	Harvill Avenue Southbound				Cajalco Expressway Westbound				Harvill Avenue Northbound				Cajalco Expressway Eastbound				Int. Total
	Left	Thru	Right	App. Total	Left	Thru	Right	App. Total	Left	Thru	Right	App. Total	Left	Thru	Right	App. Total	
Peak Hour Analysis From 04:00 PM to 04:45 PM - Peak 1 of 1																	
Peak Hour for Each Approach Begins at:																	
	04:00 PM				04:00 PM				04:00 PM				04:00 PM				
+0 mins.	1	0	1	2	1	7	3	11	0	0	1	1	0	5	3	8	
+15 mins.	0	0	0	0	1	3	2	6	1	0	0	1	0	2	1	3	
+30 mins.	1	1	0	2	0	3	4	7	0	0	0	0	0	3	1	4	
+45 mins.	0	1	1	2	0	1	3	4	0	0	0	0	0	4	1	5	
Total Volume	2	2	2	6	2	14	12	28	1	0	1	2	0	14	6	20	
% App. Total	33.3	33.3	33.3		7.1	50	42.9		50	0	50		0	70	30		
PHF	.500	.500	.500	.750	.500	.500	.750	.636	.250	.000	.250	.500	.000	.700	.500	.625	

County of Riverside
 N/S: Harvill Avenue
 E/W: Cajalco Expressway
 Weather: Clear

File Name : 18_CRV_Har_Caj PM
 Site Code : 05122112
 Start Date : 2/8/2022
 Page No : 1

Groups Printed- 3 Axle Vehicles

Start Time	Harvill Avenue Southbound					Cajalco Expressway Westbound					Harvill Avenue Northbound					Cajalco Expressway Eastbound					Exclu. Total	Inclu. Total	Int. Total
	Left	Thru	Right	RTOR	App. Total	Left	Thru	Right	RTOR	App. Total	Left	Thru	Right	RTOR	App. Total	Left	Thru	Right	RTOR	App. Total			
04:00 PM	1	0	0	0	1	0	2	0	0	2	0	3	1	1	4	0	2	0	0	2	1	9	10
04:15 PM	0	0	0	0	0	2	1	0	0	3	0	1	1	1	2	0	1	0	0	1	1	6	7
04:30 PM	0	0	0	0	0	1	0	0	0	1	0	0	0	0	0	0	1	0	0	1	0	2	2
04:45 PM	0	0	0	0	0	1	0	0	0	1	1	0	0	0	1	0	0	0	0	0	0	2	2
Total	1	0	0	0	1	4	3	0	0	7	1	4	2	2	7	0	4	0	0	4	2	19	21
05:00 PM	1	0	0	0	1	0	2	0	0	2	0	0	0	0	0	0	0	0	0	0	0	3	3
05:15 PM	0	2	0	0	2	0	2	0	0	2	0	1	0	0	1	0	0	1	0	1	0	6	6
05:30 PM	0	0	0	0	0	0	1	0	0	1	0	0	0	0	0	0	0	0	0	0	0	1	1
05:45 PM	0	0	0	0	0	1	1	0	0	2	1	0	0	0	1	1	1	0	0	2	0	5	5
Total	1	2	0	0	3	1	6	0	0	7	1	1	0	0	2	1	1	1	0	3	0	15	15
Grand Total	2	2	0	0	4	5	9	0	0	14	2	5	2	2	9	1	5	1	0	7	2	34	36
Aprpch %	50	50	0			35.7	64.3	0			22.2	55.6	22.2			14.3	71.4	14.3					
Total %	5.9	5.9	0		11.8	14.7	26.5	0		41.2	5.9	14.7	5.9		26.5	2.9	14.7	2.9		20.6	5.6	94.4	

Start Time	Harvill Avenue Southbound				Cajalco Expressway Westbound				Harvill Avenue Northbound				Cajalco Expressway Eastbound				Int. Total
	Left	Thru	Right	App. Total	Left	Thru	Right	App. Total	Left	Thru	Right	App. Total	Left	Thru	Right	App. Total	
Peak Hour Analysis From 04:00 PM to 04:45 PM - Peak 1 of 1																	
Peak Hour for Entire Intersection Begins at 04:00 PM																	
04:00 PM	1	0	0	1	0	2	0	2	0	3	1	4	0	2	0	2	9
04:15 PM	0	0	0	0	2	1	0	3	0	1	1	2	0	1	0	1	6
04:30 PM	0	0	0	0	1	0	0	1	0	0	0	0	0	1	0	1	2
04:45 PM	0	0	0	0	1	0	0	1	1	0	0	1	0	0	0	0	2
Total Volume	1	0	0	1	4	3	0	7	1	4	2	7	0	4	0	4	19
% App. Total	100	0	0		57.1	42.9	0		14.3	57.1	28.6		0	100	0		
PHF	.250	.000	.000	.250	.500	.375	.000	.583	.250	.333	.500	.438	.000	.500	.000	.500	.528

County of Riverside
 N/S: Harvill Avenue
 E/W: Cajalco Expressway
 Weather: Clear

File Name : 18_CRV_Har_Caj PM
 Site Code : 05122112
 Start Date : 2/8/2022
 Page No : 2

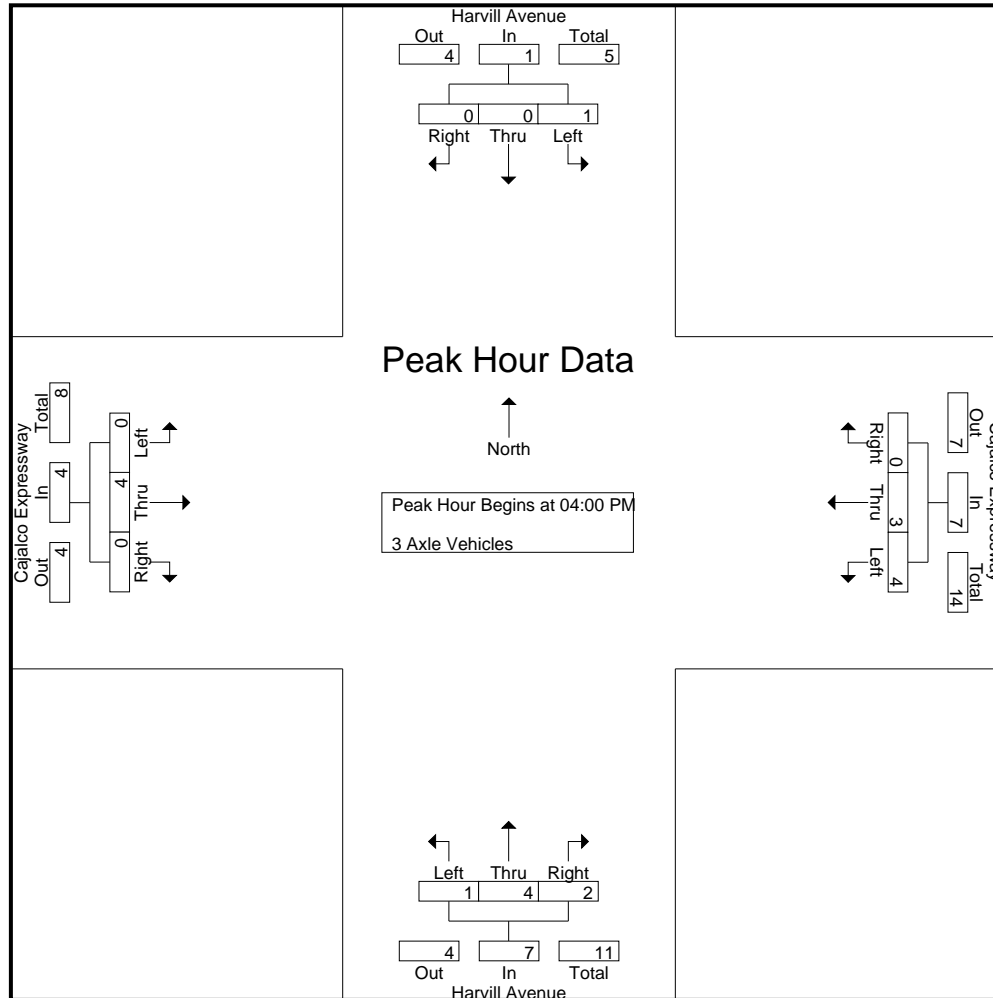

County of Riverside
 N/S: Harvill Avenue
 E/W: Cajalco Expressway
 Weather: Clear

File Name : 18_CRV_Har_Caj PM
 Site Code : 05122112
 Start Date : 2/8/2022
 Page No : 3

Start Time	Harvill Avenue Southbound				Cajalco Expressway Westbound				Harvill Avenue Northbound				Cajalco Expressway Eastbound				Int. Total
	Left	Thru	Right	App. Total	Left	Thru	Right	App. Total	Left	Thru	Right	App. Total	Left	Thru	Right	App. Total	
Peak Hour Analysis From 04:00 PM to 04:45 PM - Peak 1 of 1																	
Peak Hour for Each Approach Begins at:																	
	04:00 PM				04:00 PM				04:00 PM				04:00 PM				
+0 mins.	1	0	0	1	0	2	0	2	0	3	1	4	0	2	0	2	
+15 mins.	0	0	0	0	2	1	0	3	0	1	1	2	0	1	0	1	
+30 mins.	0	0	0	0	1	0	0	1	0	0	0	0	0	1	0	1	
+45 mins.	0	0	0	0	1	0	0	1	1	0	0	1	0	0	0	0	
Total Volume	1	0	0	1	4	3	0	7	1	4	2	7	0	4	0	4	
% App. Total	100	0	0		57.1	42.9	0		14.3	57.1	28.6		0	100	0		
PHF	.250	.000	.000	.250	.500	.375	.000	.583	.250	.333	.500	.438	.000	.500	.000	.500	

County of Riverside
 N/S: Harvill Avenue
 E/W: Cajalco Expressway
 Weather: Clear

File Name : 18_CRV_Har_Caj PM
 Site Code : 05122112
 Start Date : 2/8/2022
 Page No : 1

Groups Printed- 4+ Axle Trucks

Start Time	Harvill Avenue Southbound					Cajalco Expressway Westbound					Harvill Avenue Northbound					Cajalco Expressway Eastbound					Exclu. Total	Inclu. Total	Int. Total
	Left	Thru	Right	RTOR	App. Total	Left	Thru	Right	RTOR	App. Total	Left	Thru	Right	RTOR	App. Total	Left	Thru	Right	RTOR	App. Total			
04:00 PM	0	2	1	1	3	8	5	1	1	14	1	0	1	1	2	1	4	1	0	6	3	25	28
04:15 PM	0	0	0	0	0	2	4	0	0	6	0	0	1	0	1	0	6	0	0	6	0	13	13
04:30 PM	1	1	0	0	2	2	3	1	0	6	1	0	0	0	1	0	2	0	0	2	0	11	11
04:45 PM	0	2	0	0	2	1	3	1	0	5	0	0	1	0	1	0	1	1	0	2	0	10	10
Total	1	5	1	1	7	13	15	3	1	31	2	0	3	1	5	1	13	2	0	16	3	59	62
05:00 PM	1	1	1	0	3	3	4	1	0	8	0	1	1	0	2	0	1	1	1	2	1	15	16
05:15 PM	0	2	0	0	2	5	2	0	0	7	0	1	0	0	1	3	3	0	0	6	0	16	16
05:30 PM	0	0	0	0	0	6	3	0	0	9	0	0	1	1	1	0	2	1	0	3	1	13	14
05:45 PM	1	1	1	0	3	4	2	0	0	6	1	0	1	1	2	0	3	2	0	5	1	16	17
Total	2	4	2	0	8	18	11	1	0	30	1	2	3	2	6	3	9	4	1	16	3	60	63
Grand Total	3	9	3	1	15	31	26	4	1	61	3	2	6	3	11	4	22	6	1	32	6	119	125
Apprch %	20	60	20			50.8	42.6	6.6			27.3	18.2	54.5			12.5	68.8	18.8					
Total %	2.5	7.6	2.5		12.6	26.1	21.8	3.4		51.3	2.5	1.7	5		9.2	3.4	18.5	5		26.9	4.8	95.2	

Start Time	Harvill Avenue Southbound				Cajalco Expressway Westbound				Harvill Avenue Northbound				Cajalco Expressway Eastbound				Int. Total
	Left	Thru	Right	App. Total	Left	Thru	Right	App. Total	Left	Thru	Right	App. Total	Left	Thru	Right	App. Total	
Peak Hour Analysis From 04:00 PM to 04:45 PM - Peak 1 of 1																	
Peak Hour for Entire Intersection Begins at 04:00 PM																	
04:00 PM	0	2	1	3	8	5	1	14	1	0	1	2	1	4	1	6	25
04:15 PM	0	0	0	0	2	4	0	6	0	0	1	1	0	6	0	6	13
04:30 PM	1	1	0	2	2	3	1	6	1	0	0	1	0	2	0	2	11
04:45 PM	0	2	0	2	1	3	1	5	0	0	1	1	0	1	1	2	10
Total Volume	1	5	1	7	13	15	3	31	2	0	3	5	1	13	2	16	59
% App. Total	14.3	71.4	14.3		41.9	48.4	9.7		40	0	60		6.2	81.2	12.5		
PHF	.250	.625	.250	.583	.406	.750	.750	.554	.500	.000	.750	.625	.250	.542	.500	.667	.590

County of Riverside
 N/S: Harvill Avenue
 E/W: Cajalco Expressway
 Weather: Clear

File Name : 18_CRV_Har_Caj PM
 Site Code : 05122112
 Start Date : 2/8/2022
 Page No : 2

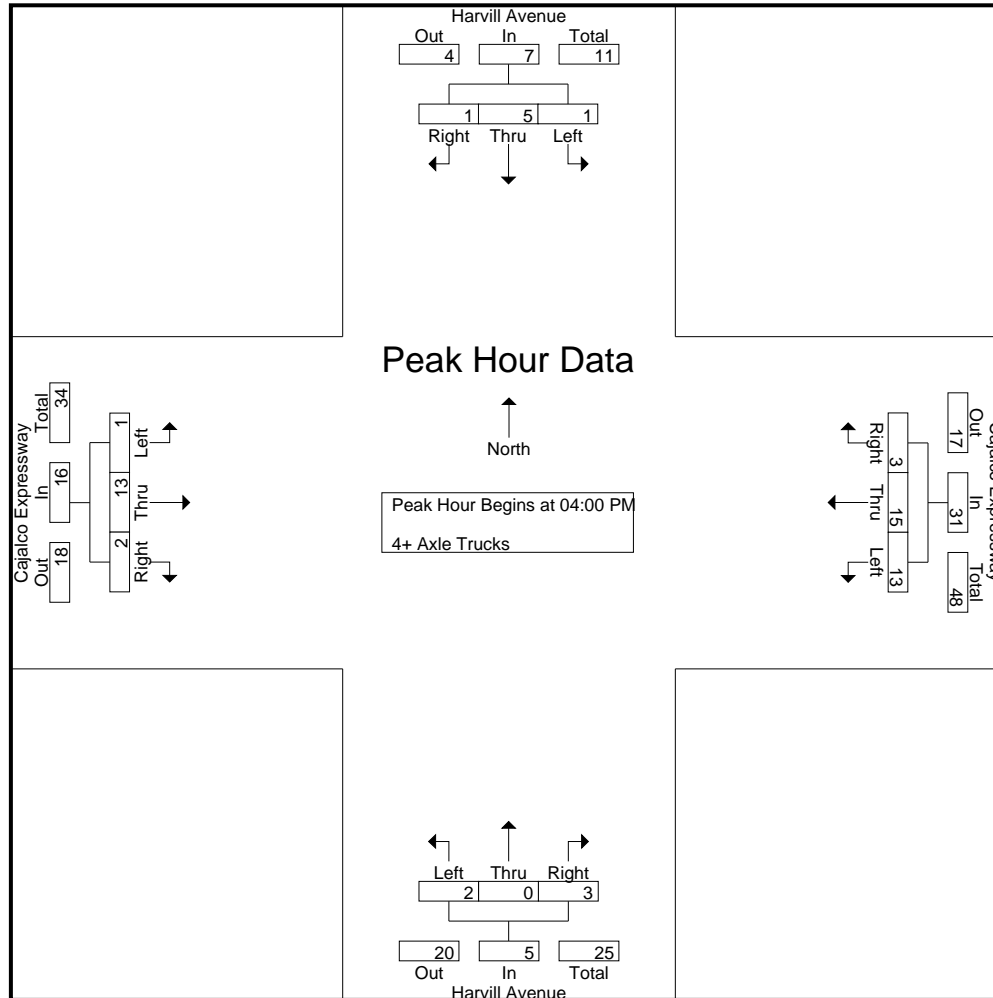

County of Riverside
 N/S: Harvill Avenue
 E/W: Cajalco Expressway
 Weather: Clear

File Name : 18_CRV_Har_Caj PM
 Site Code : 05122112
 Start Date : 2/8/2022
 Page No : 3

Start Time	Harvill Avenue Southbound				Cajalco Expressway Westbound				Harvill Avenue Northbound				Cajalco Expressway Eastbound				Int. Total
	Left	Thru	Right	App. Total	Left	Thru	Right	App. Total	Left	Thru	Right	App. Total	Left	Thru	Right	App. Total	
Peak Hour Analysis From 04:00 PM to 04:45 PM - Peak 1 of 1																	
Peak Hour for Each Approach Begins at:																	
	04:00 PM				04:00 PM				04:00 PM				04:00 PM				
+0 mins.	0	2	1	3	8	5	1	14	1	0	1	2	1	4	1	6	
+15 mins.	0	0	0	0	2	4	0	6	0	0	1	1	0	6	0	6	
+30 mins.	1	1	0	2	2	3	1	6	1	0	0	1	0	2	0	2	
+45 mins.	0	2	0	2	1	3	1	5	0	0	1	1	0	1	1	2	
Total Volume	1	5	1	7	13	15	3	31	2	0	3	5	1	13	2	16	
% App. Total	14.3	71.4	14.3		41.9	48.4	9.7		40	0	60		6.2	81.2	12.5		
PHF	.250	.625	.250	.583	.406	.750	.750	.554	.500	.000	.750	.625	.250	.542	.500	.667	

Location: County of Riverside
 N/S: Harvill Avenue
 E/W: Cajalco Expressway



Date: 2/8/2022
 Day: Tuesday

PEDESTRIANS

	North Leg Harvill Avenue	East Leg Cajalco Expressway	South Leg Harvill Avenue	West Leg Cajalco Expressway	
	Pedestrians	Pedestrians	Pedestrians	Pedestrians	
7:00 AM	0	0	0	0	0
7:15 AM	0	0	0	0	0
7:30 AM	0	0	0	0	0
7:45 AM	0	0	0	0	0
8:00 AM	0	0	0	0	0
8:15 AM	0	0	0	0	0
8:30 AM	0	0	0	0	0
8:45 AM	0	0	0	0	0
TOTAL VOLUMES:	0	0	0	0	0

	North Leg Harvill Avenue	East Leg Cajalco Expressway	South Leg Harvill Avenue	West Leg Cajalco Expressway	
	Pedestrians	Pedestrians	Pedestrians	Pedestrians	
4:00 PM	0	0	0	0	0
4:15 PM	0	0	0	0	0
4:30 PM	0	0	0	0	0
4:45 PM	0	0	0	0	0
5:00 PM	0	0	0	0	0
5:15 PM	0	0	0	0	0
5:30 PM	0	0	0	0	0
5:45 PM	0	0	0	0	0
TOTAL VOLUMES:	0	0	0	0	0

Location: County of Riverside
 N/S: Harvill Avenue
 E/W: Cajalco Expressway



Date: 2/8/2022
 Day: Tuesday

BICYCLES

	Southbound Harvill Avenue			Westbound Cajalco Expressway			Northbound Harvill Avenue			Eastbound Cajalco Expressway			
	Left	Thru	Right	Left	Thru	Right	Left	Thru	Right	Left	Thru	Right	
7:00 AM	0	0	0	0	0	0	0	0	0	0	0	0	0
7:15 AM	0	0	0	0	0	0	0	0	0	0	0	0	1
7:30 AM	0	0	0	0	0	0	0	0	0	0	0	0	0
7:45 AM	0	0	0	0	0	0	0	0	0	0	0	0	0
8:00 AM	0	0	0	0	0	0	0	0	0	0	0	0	0
8:15 AM	0	0	0	0	0	0	0	0	0	0	0	0	0
8:30 AM	0	0	0	0	0	0	0	0	0	0	0	0	0
8:45 AM	0	0	0	0	0	0	0	0	0	0	0	0	0
TOTAL VOLUMES:	0	0	0	0	0	0	0	0	0	0	0	0	1

	Southbound Harvill Avenue			Westbound Cajalco Expressway			Northbound Harvill Avenue			Eastbound Cajalco Expressway			
	Left	Thru	Right	Left	Thru	Right	Left	Thru	Right	Left	Thru	Right	
4:00 PM	0	0	0	0	0	0	0	0	0	0	0	0	0
4:15 PM	0	0	0	0	0	0	0	0	0	0	0	0	0
4:30 PM	0	0	0	0	0	0	0	0	0	0	0	0	0
4:45 PM	0	0	0	0	0	0	0	0	0	0	0	0	0
5:00 PM	0	0	0	0	0	0	0	0	0	0	1	0	1
5:15 PM	0	0	0	0	0	0	0	0	0	0	0	0	0
5:30 PM	0	0	0	0	0	0	0	0	0	0	0	0	0
5:45 PM	0	0	0	0	0	0	0	1	0	0	0	0	1
TOTAL VOLUMES:	0	0	0	0	0	0	0	1	0	0	1	0	2

AimTD LLC
TURNING MOVEMENT COUNTS

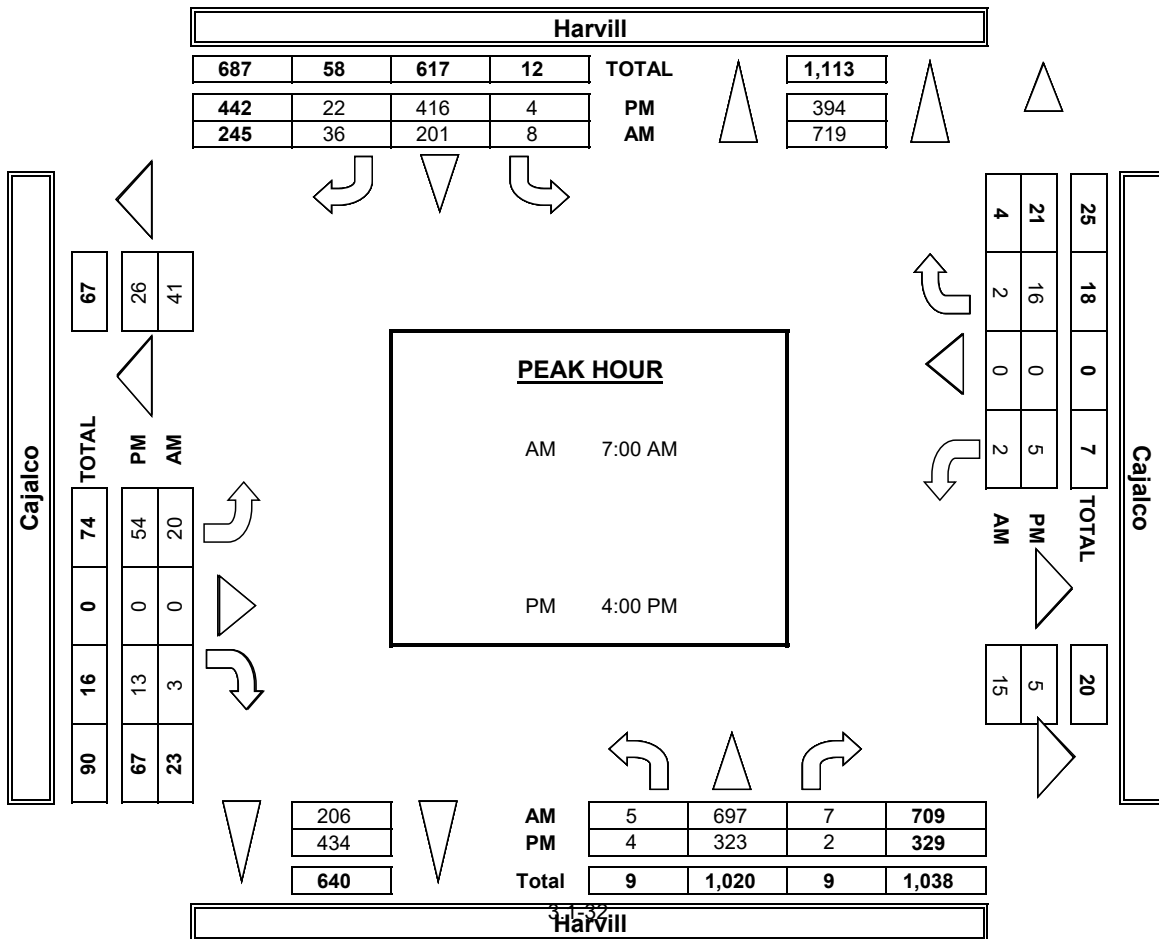
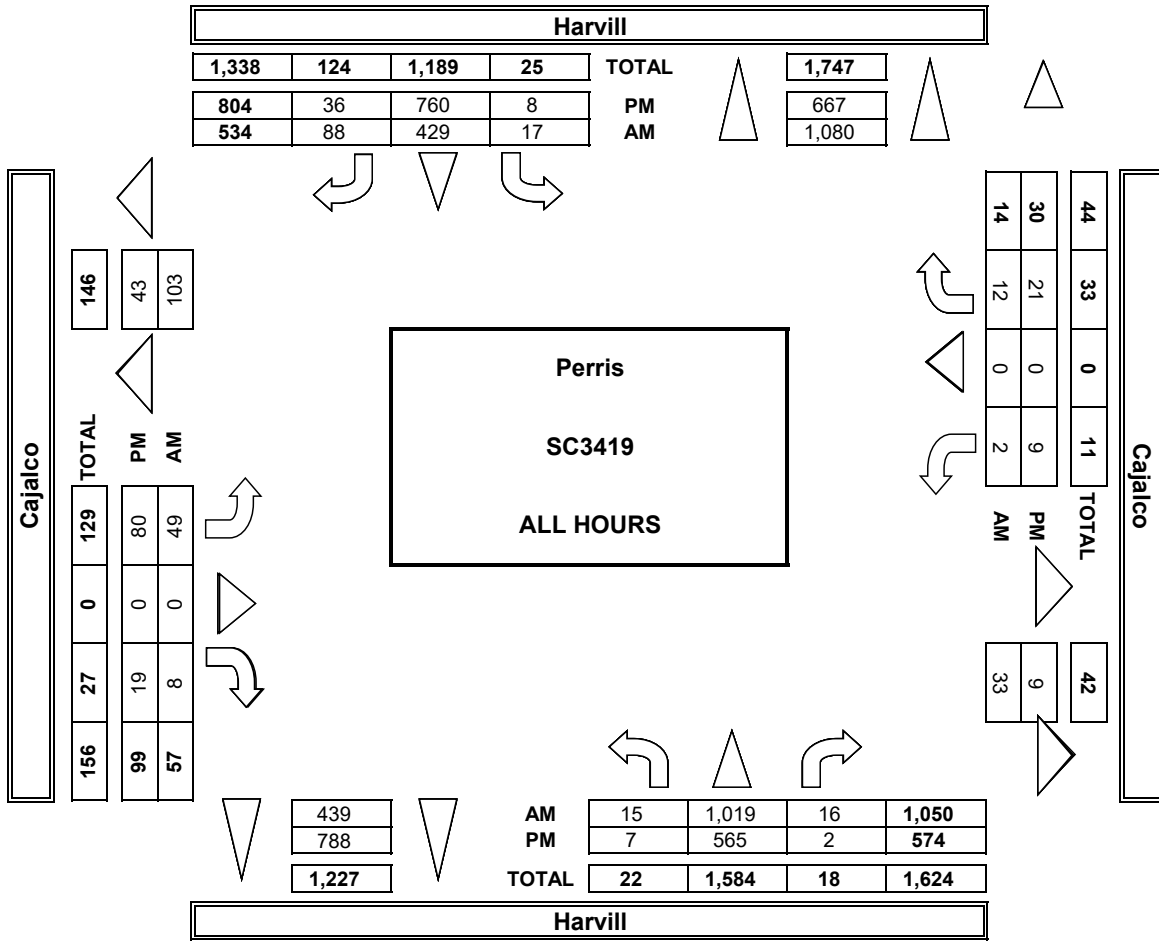

AimTD LLC
TURNING MOVEMENT COUNTS

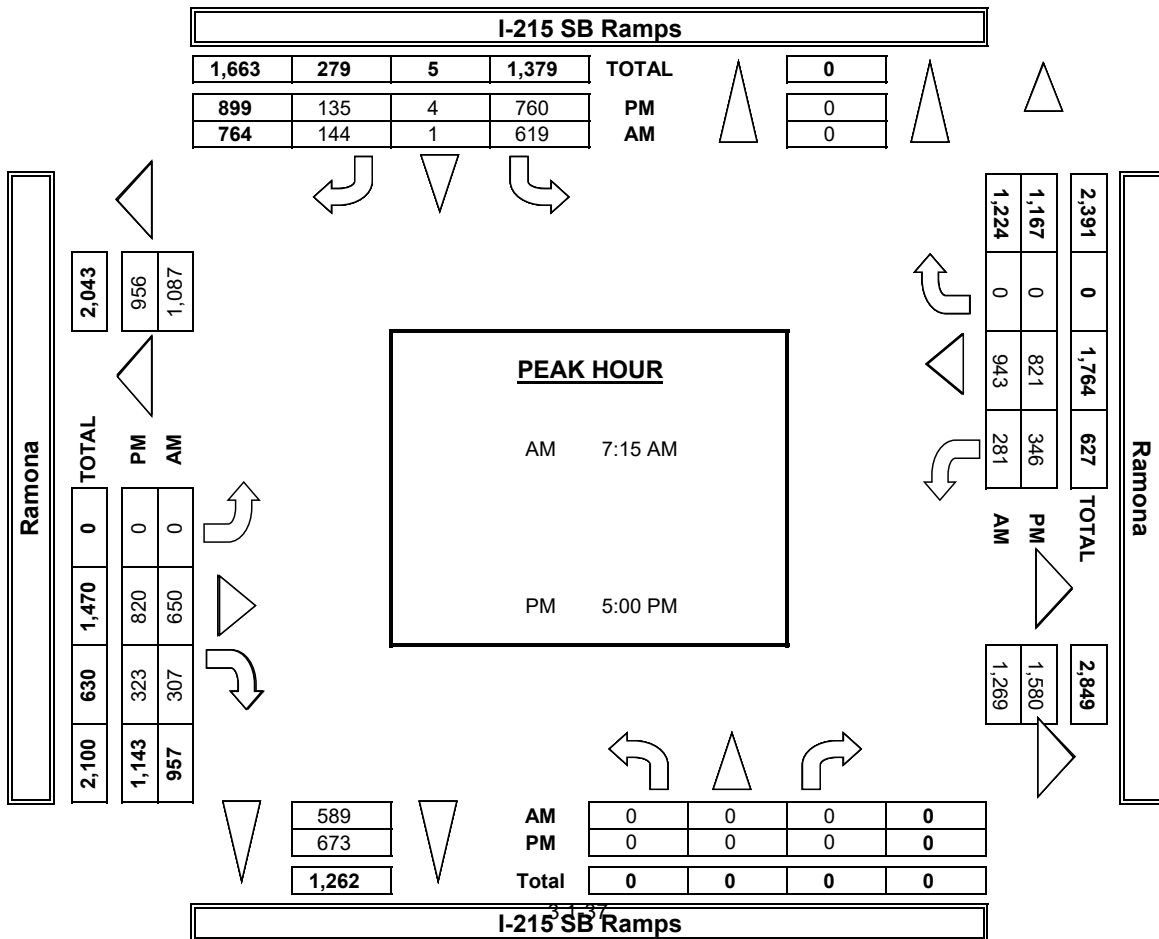
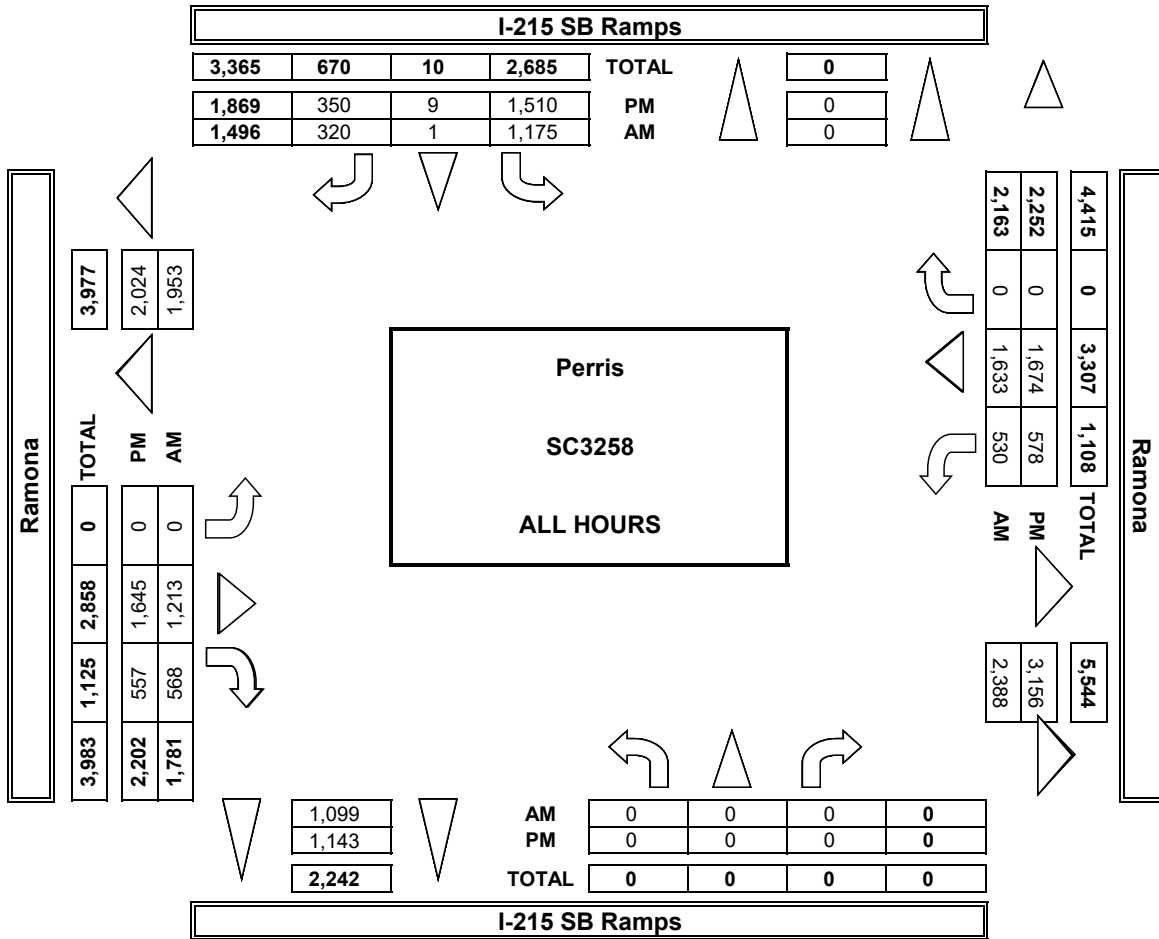

AimTD LLC
TURNING MOVEMENT COUNTS

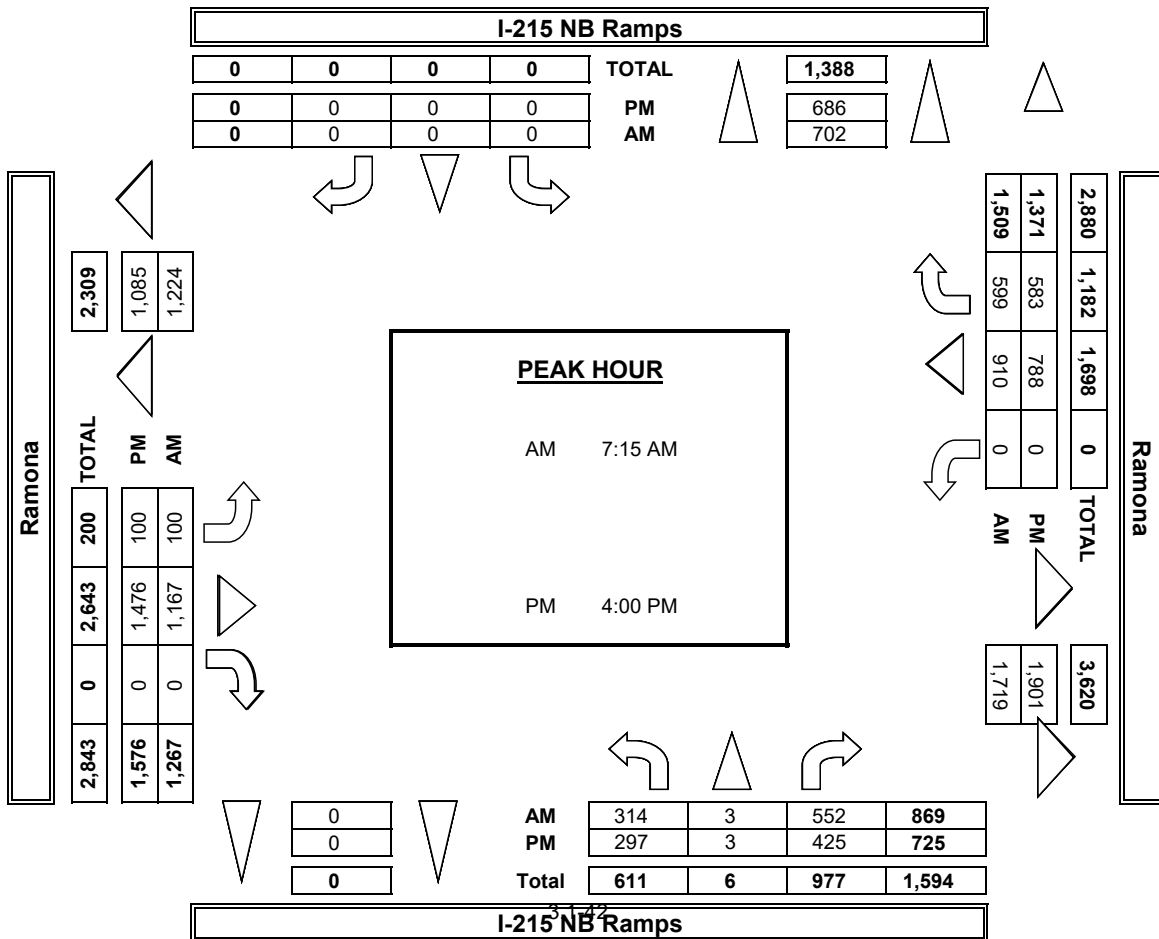
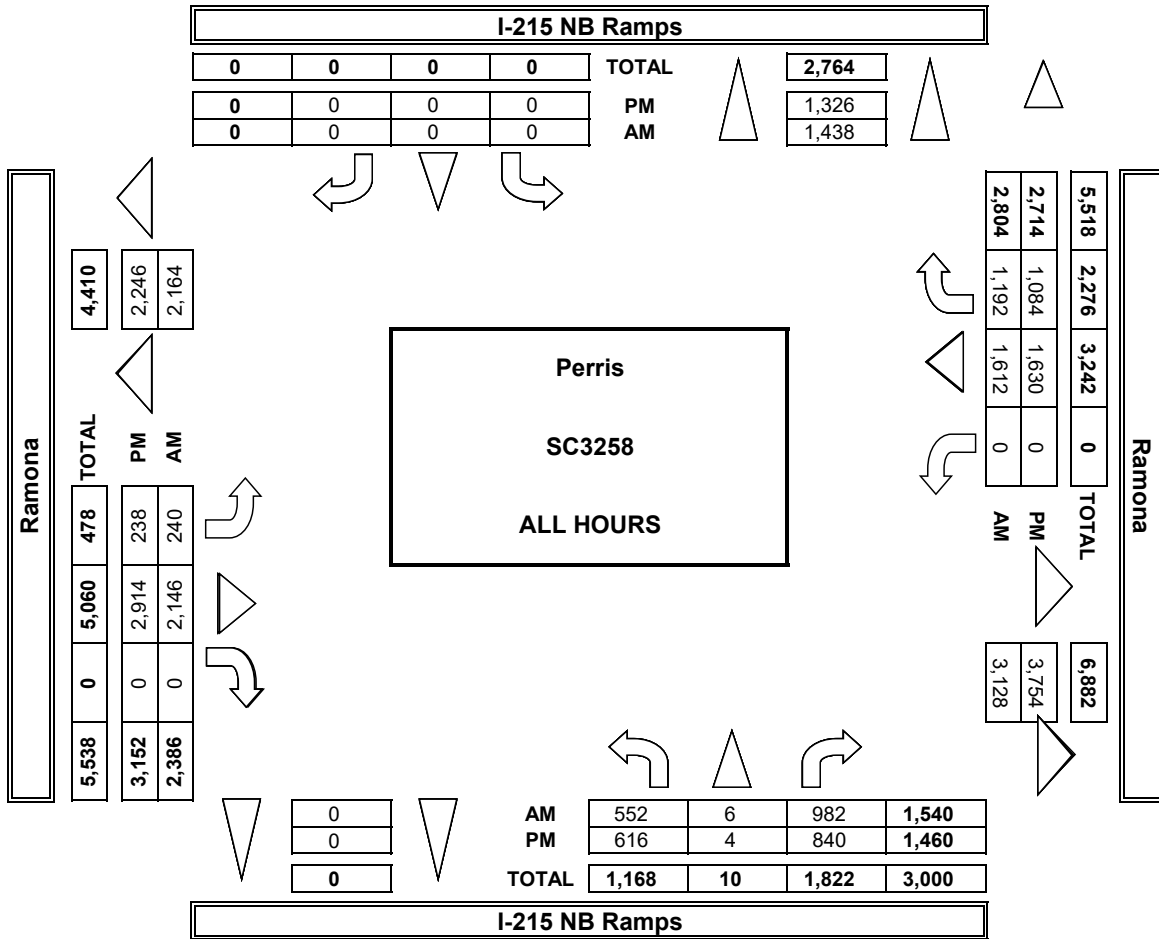

24-HOUR ROADWAY SEGMENT COUNTS (WITH FHWA CLASSIFICATION)

PREPARED BY: AimTD LLC. tel: 714 253 7888 cs@aimtd.com

DATE: Tuesday, May 10, 2022
JOB #: SC3419

CITY: Perris
LOCATION: CLASS2 Cajalco east of Harvill

AM TIME	NORTHBOUND													TOTAL	PM Time	NORTHBOUND													TOTAL
	1	2	3	4	5	6	7	8	9	10	11	12	13			1	2	3	4	5	6	7	8	9	10	11	12	13	
0:00	0	5	0	0	0	0	0	0	0	0	0	0	0	5	12:00	1	74	6	0	0	2	0	0	5	0	0	0	88	
0:15	0	5	0	0	0	0	0	0	0	0	0	0	0	5	12:15	0	54	3	0	2	2	0	0	3	0	2	0	66	
0:30	0	17	0	0	0	0	0	0	1	0	0	0	0	18	12:30	0	54	5	1	2	2	0	0	6	0	2	0	72	
0:45	0	5	0	0	0	0	0	0	0	0	0	0	0	5	12:45	1	51	5	0	8	5	0	0	4	0	0	74		
1:00	1	6	0	0	0	0	0	0	2	0	0	0	0	9	13:00	0	43	4	0	2	4	0	0	4	0	1	0	58	
1:15	0	4	0	0	0	0	0	0	2	0	0	0	0	6	13:15	0	55	1	1	1	3	0	0	6	0	0	0	67	
1:30	0	4	0	0	0	0	0	0	1	0	0	0	0	5	13:30	0	105	7	0	0	2	0	0	3	0	1	0	118	
1:45	0	5	0	0	0	0	0	0	2	0	0	0	0	7	13:45	1	89	5	0	5	0	0	0	5	0	1	0	106	
2:00	0	3	0	0	0	1	0	0	3	0	0	0	0	7	14:00	0	85	4	0	2	1	0	0	2	0	0	0	94	
2:15	0	2	0	0	0	0	0	0	1	0	0	0	0	3	14:15	0	85	4	0	1	2	0	1	3	0	3	0	99	
2:30	0	4	0	0	0	0	0	0	0	0	0	0	0	4	14:30	1	162	9	0	1	1	0	0	4	0	0	0	178	
2:45	0	3	0	0	0	0	0	0	1	0	0	0	0	4	14:45	0	105	3	0	4	1	1	0	2	0	0	0	116	
3:00	0	6	0	0	0	1	0	0	2	0	0	0	0	9	15:00	0	99	3	0	1	0	0	0	1	0	1	0	105	
3:15	1	8	1	0	0	0	0	0	0	0	0	0	0	10	15:15	0	113	7	0	2	3	0	0	1	0	0	0	126	
3:30	0	14	0	0	0	1	0	0	1	0	0	0	0	16	15:30	0	120	10	0	2	0	0	0	2	0	0	0	134	
3:45	0	12	0	0	0	0	0	0	1	0	0	0	0	13	15:45	0	101	5	1	3	0	1	0	3	0	0	0	114	
4:00	0	18	0	0	1	0	0	0	2	0	0	0	0	21	16:00	0	96	8	0	0	2	1	0	2	0	2	0	111	
4:15	0	28	0	0	0	0	0	0	0	0	0	0	0	28	16:15	0	84	6	0	0	3	0	0	3	0	0	0	96	
4:30	0	21	0	0	2	1	0	0	6	0	0	0	0	30	16:30	0	92	8	2	1	1	0	0	0	0	0	0	104	
4:45	0	23	1	0	2	0	0	0	1	0	0	0	0	27	16:45	0	76	4	0	1	0	1	0	1	0	0	0	83	
5:00	0	27	0	0	1	0	0	0	4	0	0	0	0	32	17:00	1	63	5	0	0	1	0	0	3	0	0	0	73	
5:15	1	42	2	0	1	1	0	0	3	0	0	0	0	50	17:15	1	69	4	0	0	0	0	0	0	0	0	0	74	
5:30	1	53	3	0	3	1	0	0	5	0	0	0	0	66	17:30	0	69	2	0	1	1	0	0	1	0	0	0	74	
5:45	0	46	3	1	2	1	0	0	5	0	0	0	0	58	17:45	0	49	3	0	0	0	0	0	0	0	0	0	52	
6:00	0	50	6	3	5	0	0	0	1	0	0	0	0	65	18:00	0	56	4	0	0	0	0	0	2	0	0	0	62	
6:15	0	70	6	2	1	2	0	0	0	0	1	0	0	82	18:15	0	62	1	0	0	2	0	0	0	0	0	0	65	
6:30	0	117	9	1	3	1	0	0	3	0	0	0	0	134	18:30	0	58	1	0	0	0	0	0	2	0	0	0	61	
6:45	0	172	12	2	4	1	0	0	2	0	1	0	0	194	18:45	1	48	2	0	0	1	0	0	1	0	0	0	53	
7:00	0	164	4	0	5	1	1	0	4	0	1	0	0	180	19:00	0	40	2	0	0	1	0	0	3	0	0	0	46	
7:15	0	170	7	0	7	0	1	0	3	0	0	0	0	188	19:15	0	40	3	0	0	3	0	0	1	0	1	0	48	
7:30	0	161	12	0	6	1	0	0	3	0	0	1	0	184	19:30	0	37	0	0	0	0	0	0	1	0	0	0	38	
7:45	0	141	8	0	4	1	0	0	5	0	3	0	0	162	19:45	2	30	0	0	0	0	0	1	2	0	0	0	35	
8:00	0	123	5	0	2	1	0	0	5	0	0	0	0	136	20:00	0	31	0	0	0	0	0	1	0	0	0	0	32	
8:15	0	86	2	0	5	2	0	0	5	0	1	0	0	101	20:15	1	48	0	0	0	0	1	0	1	0	0	0	51	
8:30	0	57	5	0	2	0	0	0	2	0	1	0	0	67	20:30	0	29	1	0	0	0	0	0	1	0	0	0	31	
8:45	0	50	3	0	1	0	0	0	6	0	1	1	0	62	20:45	0	39	0	0	0	0	0	0	0	0	0	0	39	
9:00	0	60	8	0	1	0	0	0	5	0	0	0	0	74	21:00	0	36	1	0	0	0	0	0	1	0	0	0	38	
9:15	0	38	1	0	6	2	0	0	1	0	1	0	0	49	21:15	0	23	0	0	0	0	0	0	0	0	0	0	23	
9:30	0	36	9	0	1	3	0	0	2	0	0	0	0	51	21:30	0	15	0	0	0	0	0	0	1	0	0	0	16	
9:45	0	49	6	0	5	0	1	0	4	0	0	0	0	65	21:45	0	27	1	0	0	0	0	0	0	0	0	0	28	
10:00	1	55	4	0	2	1	0	0	4	0	0	0	0	67	22:00	0	24	1	0	0	0	0	0	0	0	0	0	25	
10:15	0	45	1	0	2	1	0	0	6	0	0	0	0	55	22:15	0	14	0	0	0	3	0	0	0	0	0	0	17	
10:30	0	52	5	0	1	1	0	0	12	0	0	0	0	71	22:30	0	18	0	0	0	0	0	0	1	0	0	0	19	
10:45	0	41	1	0	1	2	0	0	5	0	1	0	0	51	22:45	0	13	0	0	0	0	0	0	0	0	0	0	13	
11:00	1	65	7	0	2	2	0	0	7	0	0	0	0	84	23:00	0	14	0	0	0	0	0	0	0	0	0	0	14	
11:15	0	50	4	0	2	1	0	0	4	0	1	0	0	62	23:15	0	13	0	0	0	0	0	0	0	0	0	0	13	
11:30	0	50	5	0	2	3	0	0	4	0	0	0	0	64	23:30	0	11	0	0	0	0	0	0	0	0	0	0	11	
11:45	0	45	6	1	6	1	0	0	2	0	0	0	0	61	23:45	0	5	0	0	0	0	0	0	0	0	0	0	5	
TOTAL	6	2,308	146	10	88	34	3	0	138	0	13	1	0	2,747	TOTAL	10	2,724	138	5	39	46	5	3	81	0	14	0	0	3,065

AM PEAK HOUR 6:45 AM
AM PEAK VOLUME 746

PM PEAK HOUR 2:30 PM
PM PEAK VOLUME 525

CLASS 1	Class 1 — Motorcycles	CLASS 8	3 to 4 Axles, Single Trailer
CLASS 2	Passenger Cars	CLASS 9	5 Axles, Single Trailer
CLASS 3	2 Axles, 4-Tire Single Units	CLASS 10	6 or More Axles, Single Trailer
CLASS 4	Buses	CLASS 11	5 or Less Axles, Multi-Trailers
CLASS 5	2 Axles, 6-Tire Single Units	CLASS 12	6 Axles, Multi-Trailers
CLASS 6	3 Axles, Single Unit	CLASS 13	7 or More Axles, Multi-Trailers
CLASS 7	4 or More Axles, Single Unit		

TOTAL: AM+PM	16	5,032	284	15	127	80	8	3	219	0	27	1	0	5,812
% OF TOTAL	0.3%	86.6%	4.9%	0.3%	2.2%	1.4%	0.1%	0.1%	3.8%	0.0%	0.5%	0.0%	0.0%	100.0%

Class	1	2	3	4	5	6	7	8	9	10	11	12	13
--------------	----------	----------	----------	----------	----------	----------	----------	----------	----------	-----------	-----------	-----------	-----------

TOTAL: ALL	29	9,355	525	30	247	151	17	7	457	1	49	1	0	10,869
% OF TOTAL	0.5%	161.0%	9.0%	0.5%	4.2%	2.6%	0.3%	0.1%	7.9%	0.0%	0.8%	0.0%	0.0%	100.0%

24-HOUR ROADWAY SEGMENT COUNTS (WITH FHWA CLASSIFICATION)

PREPARED BY: AimTD LLC. tel: 714 253 7888 cs@aimtd.com

DATE: Tuesday, May 10, 2022
JOB #: SC3419

CITY: Perris
LOCATION: CLASS2 Cajalco east of Harvill

AM TIME	SOUTHBOUND													TOTAL	PM Time	SOUTHBOUND													TOTAL
	1	2	3	4	5	6	7	8	9	10	11	12	13			1	2	3	4	5	6	7	8	9	10	11	12	13	
0:00	0	7	0	0	0	0	0	0	0	0	0	0	0	7	12:00	0	56	4	0	2	3	0	0	6	0	0	0	71	
0:15	0	3	0	0	0	0	0	0	0	0	0	0	0	3	12:15	0	58	9	0	0	1	0	0	11	0	0	0	79	
0:30	0	9	0	0	0	1	0	0	0	0	0	0	0	10	12:30	0	58	5	0	2	2	0	0	8	0	0	0	75	
0:45	0	7	0	0	0	0	0	0	0	0	0	0	0	7	12:45	1	70	4	0	1	1	0	0	9	0	0	0	86	
1:00	1	4	0	0	0	0	0	0	0	0	0	0	0	5	13:00	2	53	3	0	1	0	0	0	3	0	2	0	64	
1:15	0	3	0	0	0	0	0	0	0	0	0	0	0	3	13:15	0	46	2	0	3	0	0	0	3	0	0	0	54	
1:30	0	4	0	0	0	0	0	0	0	0	0	0	0	4	13:30	1	58	2	0	1	2	1	0	4	0	0	0	69	
1:45	0	10	0	0	0	0	1	0	0	0	0	0	0	11	13:45	0	59	4	0	2	1	0	0	4	0	1	0	71	
2:00	0	10	0	0	0	0	0	0	1	0	0	0	0	11	14:00	0	88	10	0	3	1	0	0	6	0	1	0	109	
2:15	0	5	0	0	0	0	0	0	0	0	0	0	0	5	14:15	1	93	5	1	2	3	0	0	5	0	1	0	111	
2:30	0	3	0	0	0	0	0	0	0	0	0	0	0	3	14:30	0	118	8	0	6	2	0	0	3	0	0	0	137	
2:45	0	2	0	0	0	1	0	0	0	0	0	0	0	3	14:45	0	134	6	0	6	2	1	0	4	0	2	0	155	
3:00	0	2	0	0	0	0	0	0	0	0	0	0	0	2	15:00	0	120	7	1	4	2	1	0	3	0	1	0	139	
3:15	0	9	0	0	0	1	0	0	1	0	0	0	0	11	15:15	0	102	12	0	4	1	1	1	2	0	3	0	126	
3:30	0	8	1	0	1	0	0	0	0	0	0	0	0	10	15:30	0	94	3	1	2	1	0	0	2	0	0	0	103	
3:45	0	6	0	0	0	0	0	0	1	0	0	0	0	7	15:45	0	92	8	2	3	0	0	1	9	0	0	0	115	
4:00	0	10	1	0	0	1	0	0	0	0	0	0	0	12	16:00	0	73	7	1	1	1	0	0	4	0	0	0	87	
4:15	0	16	0	0	0	0	0	0	2	0	0	0	0	18	16:15	0	109	8	0	1	2	0	0	2	0	0	0	122	
4:30	0	27	0	0	0	0	0	0	0	0	0	0	0	27	16:30	0	98	6	1	2	0	0	0	4	0	0	0	111	
4:45	0	49	1	0	1	1	0	0	0	0	0	0	0	52	16:45	0	103	13	1	1	0	1	0	3	0	0	0	122	
5:00	0	34	0	0	0	0	0	0	0	0	0	0	0	34	17:00	0	93	3	1	3	0	0	0	1	0	0	0	101	
5:15	0	34	0	0	0	3	0	0	0	0	0	0	0	37	17:15	0	86	4	1	0	1	0	0	1	0	0	0	93	
5:30	0	45	0	0	2	0	0	0	0	0	0	0	0	47	17:30	0	85	4	1	0	0	0	0	2	0	1	0	93	
5:45	0	99	3	0	2	1	0	0	1	0	0	0	0	106	17:45	0	67	3	0	1	1	0	0	3	0	0	0	75	
6:00	0	44	1	0	0	0	0	0	0	0	0	0	0	45	18:00	0	78	6	0	1	0	0	0	3	0	0	0	88	
6:15	0	32	1	0	2	1	0	0	0	0	1	0	0	37	18:15	0	63	1	0	0	1	0	1	4	0	0	0	70	
6:30	0	40	3	0	1	0	1	0	4	0	2	0	0	51	18:30	0	64	3	0	0	0	0	0	4	0	0	0	71	
6:45	0	48	2	0	0	0	1	0	6	0	2	0	0	59	18:45	0	68	2	0	0	2	0	0	6	0	0	0	78	
7:00	0	36	3	0	1	0	0	0	6	0	0	0	0	46	19:00	0	69	1	0	1	0	0	0	3	0	0	0	74	
7:15	0	46	3	0	1	1	0	0	1	1	0	0	0	53	19:15	1	33	1	0	0	1	0	0	4	0	0	0	40	
7:30	1	55	4	0	2	3	1	0	4	0	0	0	0	70	19:30	0	31	0	0	1	0	0	0	5	0	0	0	37	
7:45	0	65	3	0	4	0	0	0	2	0	0	0	0	74	19:45	0	36	0	0	1	0	0	0	2	0	0	0	39	
8:00	0	82	4	0	3	0	0	0	4	0	0	0	0	93	20:00	3	36	1	0	0	0	0	0	0	0	0	0	40	
8:15	0	56	1	0	4	1	0	0	0	0	2	0	0	64	20:15	0	30	0	0	0	0	0	0	0	0	0	0	30	
8:30	1	66	5	1	4	1	0	0	4	0	0	0	0	82	20:30	0	28	0	0	0	1	0	0	3	0	0	0	32	
8:45	0	42	3	2	2	0	0	0	2	0	1	0	0	52	20:45	0	33	0	0	1	0	0	0	0	0	0	0	34	
9:00	0	37	2	1	1	0	0	0	2	0	0	0	0	43	21:00	0	23	0	0	0	0	0	0	2	0	0	0	25	
9:15	1	41	6	0	4	3	0	0	5	0	0	0	0	60	21:15	0	29	1	0	0	1	0	0	0	0	0	0	31	
9:30	0	35	6	0	0	2	0	0	8	0	0	0	0	51	21:30	0	22	0	0	0	0	0	0	0	0	0	0	22	
9:45	0	47	4	0	1	2	0	0	5	0	0	0	0	59	21:45	0	18	0	0	0	0	0	0	0	0	0	0	18	
10:00	0	48	5	0	3	2	0	0	5	0	1	0	0	64	22:00	0	21	0	0	0	1	0	0	0	0	0	0	22	
10:15	0	38	2	0	2	3	0	0	8	0	0	0	0	53	22:15	0	16	0	0	0	0	0	0	1	0	0	0	17	
10:30	0	46	2	0	2	0	0	1	6	0	0	0	0	57	22:30	0	20	0	0	0	0	0	0	1	0	0	0	21	
10:45	0	44	6	0	2	2	0	0	6	0	0	0	0	60	22:45	0	12	0	0	1	0	0	0	0	0	0	0	13	
11:00	0	46	5	0	0	1	0	0	4	0	0	0	0	56	23:00	0	10	0	0	0	0	0	0	1	0	0	0	11	
11:15	0	43	3	0	9	1	0	0	2	0	0	0	0	58	23:15	0	14	0	0	1	1	0	0	1	0	0	0	17	
11:30	0	50	4	0	5	2	0	0	3	0	0	0	0	64	23:30	0	15	0	0	1	1	0	0	0	0	0	0	17	
11:45	0	44	1	0	2	1	0	0	3	0	1	0	0	52	23:45	0	4	0	0	0	0	0	0	0	0	0	0	4	
TOTAL	4	1,537	85	4	61	35	4	1	96	1	10	0	0	1,838	TOTAL	9	2,786	156	11	59	36	5	3	142	0	12	0	0	3,219
AM PEAK HOUR														7:45 AM	PM PEAK HOUR														2:30 PM
AM PEAK VOLUME														313	PM PEAK VOLUME														557

CLASS 1	Class 1 — Motorcycles	CLASS 8	3 to 4 Axles, Single Trailer
CLASS 2	Passenger Cars	CLASS 9	5 Axles, Single Trailer
CLASS 3	2 Axles, 4-Tire Single Units	CLASS 10	6 or More Axles, Single Trailer
CLASS 4	Buses	CLASS 11	5 or Less Axles, Multi-Trailers
CLASS 5	2 Axles, 6-Tire Single Units	CLASS 12	6 Axles, Multi-Trailers
CLASS 6	3 Axles, Single Unit	CLASS 13	7 or More Axles, Multi-Trailers
CLASS 7	4 or More Axles, Single Unit		

TOTAL: AM+PM	13	4,323	241	15	120	71	9	4	238	1	22	0	0	5,057
% OF TOTAL	0.3%	85.5%	4.8%	0.3%	2.4%	1.4%	0.2%	0.1%	4.7%	0.0%	0.4%	0.0%	0.0%	100.0%

Class	1	2	3	4	5	6	7	8	9	10	11	12	13
--------------	----------	----------	----------	----------	----------	----------	----------	----------	----------	-----------	-----------	-----------	-----------

24-HOUR ROADWAY SEGMENT COUNTS (WITH FHWA CLASSIFICATION)

PREPARED BY: AimTD LLC. tel: 714 253 7888 cs@aimtd.com

DATE: Tuesday, May 10, 2022
JOB #: SC3419

CITY: Perris
LOCATION: TMC1 Harvill and Cajalco

AM TIME	EASTBOUND													TOTAL	PM Time	EASTBOUND													TOTAL
	1	2	3	4	5	6	7	8	9	10	11	12	13			1	2	3	4	5	6	7	8	9	10	11	12	13	
0:00	0	0	0	0	0	0	0	0	0	0	0	0	0	0	12:00	0	1	0	0	0	0	0	0	2	0	0	0	0	3
0:15	0	0	0	0	0	0	0	0	0	0	0	0	0	0	12:15	0	0	0	0	0	0	0	0	0	0	0	0	0	0
0:30	0	2	0	0	0	0	0	0	0	0	0	0	0	0	12:30	0	3	0	0	0	0	0	0	0	0	0	0	0	3
0:45	0	0	0	0	0	0	0	0	0	0	0	0	0	0	12:45	0	2	0	0	0	0	0	0	0	0	0	0	0	2
1:00	0	0	0	0	0	0	0	0	0	0	0	0	0	0	13:00	0	3	0	0	1	0	0	0	1	0	0	0	0	5
1:15	0	0	0	0	0	0	0	0	0	0	0	0	0	0	13:15	0	2	0	0	0	0	0	0	0	0	0	0	0	2
1:30	0	0	0	0	0	0	0	0	0	0	0	0	0	0	13:30	0	3	0	0	0	1	0	0	0	0	0	0	0	4
1:45	0	0	0	0	0	0	0	0	0	0	0	0	0	0	13:45	0	2	0	0	0	0	0	0	0	0	0	0	0	2
2:00	0	0	0	0	0	0	0	0	0	0	0	0	0	0	14:00	1	2	0	0	0	0	0	0	0	0	0	0	0	3
2:15	0	1	0	0	0	0	0	0	0	0	0	0	0	0	14:15	0	4	0	0	1	0	0	0	0	0	0	0	0	5
2:30	0	0	0	0	0	0	0	0	0	0	0	0	0	0	14:30	0	11	0	0	0	0	0	0	0	0	0	0	0	11
2:45	0	0	0	0	0	0	0	0	0	0	0	0	0	0	14:45	0	21	1	0	0	0	0	0	0	0	0	0	0	22
3:00	0	1	0	0	0	0	0	0	0	0	0	0	0	0	15:00	0	1	0	0	0	0	0	1	0	0	0	0	0	2
3:15	0	3	0	0	0	0	0	0	0	0	0	0	0	0	15:15	0	0	0	0	0	0	0	0	0	0	0	0	0	0
3:30	0	8	0	0	0	0	0	0	0	0	0	0	0	0	15:30	0	0	0	0	0	0	0	0	0	0	0	0	0	0
3:45	0	9	0	0	0	0	0	0	0	0	0	0	0	0	15:45	0	1	0	0	0	0	0	0	0	0	0	0	0	1
4:00	0	8	0	0	0	0	0	0	0	0	0	0	0	0	16:00	0	0	0	0	0	0	0	0	0	0	0	0	0	0
4:15	0	7	0	0	0	0	0	0	0	0	0	0	0	0	16:15	0	0	0	0	0	0	0	2	0	0	0	0	0	2
4:30	0	24	2	0	0	0	0	0	0	0	0	0	0	0	16:30	0	1	0	0	0	0	0	1	0	0	0	0	0	2
4:45	0	24	1	0	0	0	0	0	0	0	0	0	0	0	16:45	0	1	0	0	0	0	0	0	0	0	0	0	0	1
5:00	0	5	0	0	0	0	0	0	0	0	0	0	0	0	17:00	0	1	0	0	0	0	0	0	0	0	0	0	0	1
5:15	0	3	0	0	0	2	0	0	0	0	0	0	0	0	17:15	0	0	0	0	0	0	0	0	0	0	0	0	0	0
5:30	0	1	0	0	1	0	0	0	0	0	0	0	0	0	17:30	0	0	0	0	0	0	0	0	0	0	0	0	0	0
5:45	0	1	1	0	0	0	0	0	0	0	0	0	0	0	17:45	0	1	0	0	0	0	0	2	0	0	0	0	0	3
6:00	0	1	0	0	0	0	0	0	0	0	0	0	0	0	18:00	0	0	0	0	0	0	0	2	0	0	0	0	0	2
6:15	0	4	0	0	0	0	0	0	0	0	0	0	0	0	18:15	0	0	0	0	0	0	0	0	0	0	0	0	0	0
6:30	0	4	0	0	0	0	0	0	0	0	0	0	0	0	18:30	0	0	0	0	0	0	0	0	0	0	0	0	0	0
6:45	0	5	0	0	0	0	0	0	0	0	0	0	0	0	18:45	0	1	0	0	0	0	0	0	0	0	0	0	0	1
7:00	0	2	0	0	0	0	0	0	0	0	0	0	0	0	19:00	0	0	0	0	0	0	0	0	0	0	0	0	0	0
7:15	0	1	0	0	0	0	0	0	0	1	0	0	0	0	19:15	1	1	0	0	0	0	0	0	0	0	0	0	0	2
7:30	0	3	0	0	0	1	0	0	0	0	0	0	0	0	19:30	0	0	0	0	0	0	0	0	0	0	0	0	0	0
7:45	0	6	1	0	0	0	0	0	0	0	0	0	0	0	19:45	0	0	0	0	0	0	0	0	0	0	0	0	0	0
8:00	0	4	0	0	0	0	0	0	0	1	0	0	0	0	20:00	0	1	0	0	0	0	0	0	0	0	0	0	0	1
8:15	0	3	0	0	0	0	0	0	0	0	0	0	0	0	20:15	0	0	0	0	0	0	0	0	0	0	0	0	0	0
8:30	0	3	2	0	2	0	0	0	0	0	0	0	0	0	20:30	0	1	0	0	0	0	0	0	0	0	0	0	0	1
8:45	0	3	0	0	0	0	0	0	0	0	0	0	0	0	20:45	0	0	0	0	0	0	0	0	0	0	0	0	0	0
9:00	0	5	0	0	0	0	0	0	0	0	0	0	0	0	21:00	0	1	0	0	0	0	0	0	0	0	0	0	0	1
9:15	0	2	0	0	0	1	0	0	0	1	0	0	0	0	21:15	0	0	0	0	0	0	0	0	0	0	0	0	0	0
9:30	0	0	0	0	1	0	0	0	0	1	0	0	0	0	21:30	0	0	0	0	0	0	0	0	0	0	0	0	0	0
9:45	0	1	0	0	0	0	0	0	0	0	0	0	0	0	21:45	0	0	0	0	0	1	0	0	0	0	0	0	0	1
10:00	0	3	0	0	0	0	0	0	0	0	0	0	0	0	22:00	0	0	0	0	0	0	0	0	0	0	0	0	0	0
10:15	0	1	0	0	0	0	0	0	0	1	0	0	0	0	22:15	0	0	0	0	0	0	0	0	0	0	0	0	0	0
10:30	0	3	1	0	0	0	0	0	0	0	0	0	0	0	22:30	0	0	0	0	0	0	0	0	0	0	0	0	0	0
10:45	0	1	0	0	0	0	0	0	0	1	0	0	0	0	22:45	0	0	0	0	0	0	0	0	0	0	0	0	0	0
11:00	0	1	0	0	0	0	0	0	0	1	0	0	0	0	23:00	0	0	0	0	0	0	0	0	0	0	0	0	0	0
11:15	0	1	0	0	0	0	0	0	0	0	0	0	0	0	23:15	0	0	0	0	0	0	0	0	0	0	0	0	0	0
11:30	0	1	1	0	0	0	0	0	0	0	0	0	0	0	23:30	0	0	0	0	0	0	0	0	0	0	0	0	0	0
11:45	0	3	0	0	1	0	0	0	1	0	0	0	0	0	23:45	0	0	0	0	0	0	0	0	0	0	0	0	0	0
TOTAL	0	158	9	0	5	4	0	0	8	0	0	0	0	184	TOTAL	2	65	1	0	2	2	0	0	11	0	0	0	0	83

AM PEAK HOUR 4:00 AM
AM PEAK VOLUME 66

PM PEAK HOUR 2:00 PM
PM PEAK VOLUME 41

CLASS 1	Class 1 — Motorcycles	CLASS 8	3 to 4 Axles, Single Trailer
CLASS 2	Passenger Cars	CLASS 9	5 Axles, Single Trailer
CLASS 3	2 Axles, 4-Tire Single Units	CLASS 10	6 or More Axles, Single Trailer
CLASS 4	Buses	CLASS 11	5 or Less Axles, Multi-Trailers
CLASS 5	2 Axles, 6-Tire Single Units	CLASS 12	6 Axles, Multi-Trailers
CLASS 6	3 Axles, Single Unit	CLASS 13	7 or More Axles, Multi-Trailers
CLASS 7	4 or More Axles, Single Unit		

TOTAL: AM+PM	2	223	10	0	7	6	0	0	19	0	0	0	0	267
% OF TOTAL	0.7%	83.5%	3.7%	0.0%	2.6%	2.2%	0.0%	0.0%	7.1%	0.0%	0.0%	0.0%	0.0%	100.0%

Class	1	2	3	4	5	6	7	8	9	10	11	12	13	
TOTAL: ALL	3	445	24	0	11	13	0	0	39	0	0	0	0	535
% OF TOTAL	1.1%	166.7%	9.0%	0.0%	4.1%	4.9%	0.0%	0.0%	14.6%	0.0%	0.0%	0.0%	0.0%	100.0%

This Page Intentionally Left Blank

**APPENDIX 3.2: EXISTING (2022) CONDITIONS INTERSECTION
OPERATIONS ANALYSIS WORKSHEETS**

This Page Intentionally Left Blank

Timings
1: Harvill Av. & Cajalco Exwy./Ramona Exwy.

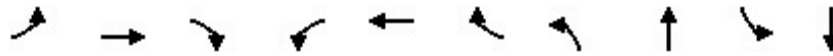

Lane Group	EBL	EBT	EBR	WBL	WBT	WBR	NBL	NBT	SBL	SBT
Lane Configurations	↙	↑↑	↗	↙↗	↑↑	↗	↙↗	↑↑	↙↗	↑↑
Traffic Volume (vph)	47	680	50	167	677	102	297	337	189	116
Future Volume (vph)	47	680	50	167	677	102	297	337	189	116
Turn Type	Prot	NA	Perm	Prot	NA	pm+ov	Prot	NA	Prot	NA
Protected Phases	5	2		1	6	7	3	8	7	4
Permitted Phases			2			6				
Detector Phase	5	2	2	1	6	7	3	8	7	4
Switch Phase										
Minimum Initial (s)	5.0	10.0	10.0	5.0	10.0	5.0	5.0	10.0	5.0	10.0
Minimum Split (s)	9.6	36.2	36.2	9.6	32.5	9.6	9.6	16.2	9.6	41.2
Total Split (s)	10.2	38.8	38.8	16.7	45.3	15.6	23.3	48.9	15.6	41.2
Total Split (%)	8.5%	32.3%	32.3%	13.9%	37.8%	13.0%	19.4%	40.8%	13.0%	34.3%
Yellow Time (s)	3.6	5.2	5.2	3.6	3.5	3.6	3.6	5.2	3.6	5.2
All-Red Time (s)	1.0	1.0	1.0	1.0	1.0	1.0	1.0	1.0	1.0	1.0
Lost Time Adjust (s)	0.0	0.0	0.0	0.0	0.0	0.0	0.0	0.0	0.0	0.0
Total Lost Time (s)	4.6	6.2	6.2	4.6	4.5	4.6	4.6	6.2	4.6	6.2
Lead/Lag	Lead	Lag	Lag	Lead	Lag	Lead	Lead	Lag	Lead	Lag
Lead-Lag Optimize?	Yes	Yes	Yes	Yes	Yes	Yes	Yes	Yes	Yes	Yes
Recall Mode	None	None	None	None	None	None	None	Max	None	Max
Act Effct Green (s)	5.5	27.8	27.8	9.9	36.1	50.6	14.5	42.9	9.9	38.4
Actuated g/C Ratio	0.05	0.25	0.25	0.09	0.32	0.45	0.13	0.38	0.09	0.34
v/c Ratio	0.58	0.82	0.10	0.58	0.63	0.14	0.71	0.33	0.66	0.13
Control Delay	80.7	48.2	0.4	58.3	35.5	3.6	56.6	25.0	61.5	24.0
Queue Delay	0.0	0.0	0.0	0.0	0.0	0.0	0.0	0.0	0.0	0.0
Total Delay	80.7	48.2	0.4	58.3	35.5	3.6	56.6	25.0	61.5	24.0
LOS	F	D	A	E	D	A	E	C	E	C
Approach Delay		47.1			36.1			38.2		45.3
Approach LOS		D			D			D		D

Intersection Summary

Cycle Length: 120
 Actuated Cycle Length: 112.3
 Natural Cycle: 100
 Control Type: Actuated-Uncoordinated
 Maximum v/c Ratio: 0.82
 Intersection Signal Delay: 40.8
 Intersection LOS: D
 Intersection Capacity Utilization 58.7%
 ICU Level of Service B
 Analysis Period (min) 15

Splits and Phases: 1: Harvill Av. & Cajalco Exwy./Ramona Exwy.

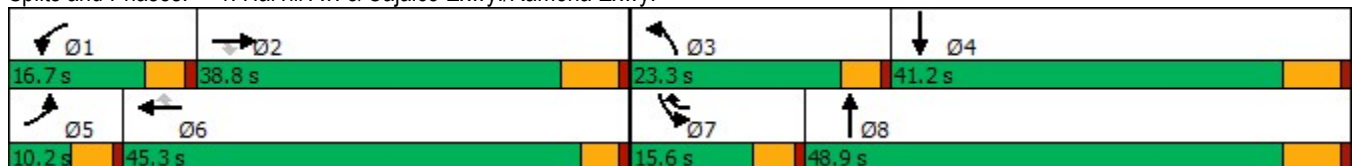

HCM 6th Signalized Intersection Summary
 1: Harvill Av. & Cajalco Exwy./Ramona Exwy.

Harvill Logistics (JN 14231)

06/16/2022

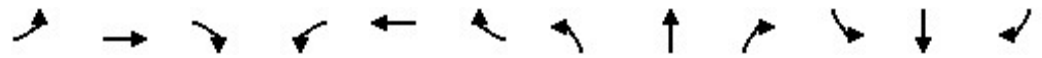

Movement	EBL	EBT	EBR	WBL	WBT	WBR	NBL	NBT	NBR	SBL	SBT	SBR
Lane Configurations	↘	↑↑	↗	↘↗	↑↑	↗	↘↗	↑↑		↘↗	↑↑	
Traffic Volume (veh/h)	47	680	50	167	677	102	297	337	75	189	116	27
Future Volume (veh/h)	47	680	50	167	677	102	297	337	75	189	116	27
Initial Q (Qb), veh	0	0	0	0	0	0	0	0	0	0	0	0
Ped-Bike Adj(A_pbT)	1.00		1.00	1.00		1.00	1.00		0.99	1.00		1.00
Parking Bus, Adj	1.00	1.00	1.00	1.00	1.00	1.00	1.00	1.00	1.00	1.00	1.00	1.00
Work Zone On Approach		No			No			No			No	
Adj Sat Flow, veh/h/ln	1900	1900	1900	1900	1900	1900	1900	1900	1900	1900	1900	1900
Adj Flow Rate, veh/h	51	731	3	180	728	42	319	362	27	203	125	27
Peak Hour Factor	0.93	0.93	0.93	0.93	0.93	0.93	0.93	0.93	0.93	0.93	0.93	0.93
Percent Heavy Veh, %	0	0	0	0	0	0	0	0	0	0	0	0
Cap, veh/h	67	874	390	246	993	566	390	1382	103	268	1102	232
Arrive On Green	0.04	0.24	0.24	0.07	0.28	0.28	0.11	0.41	0.41	0.08	0.37	0.37
Sat Flow, veh/h	1810	3610	1610	3510	3610	1610	3510	3403	253	3510	2968	625
Grp Volume(v), veh/h	51	731	3	180	728	42	319	191	198	203	75	77
Grp Sat Flow(s),veh/h/ln	1810	1805	1610	1755	1805	1610	1755	1805	1851	1755	1805	1788
Q Serve(g_s), s	2.9	20.2	0.1	5.3	19.3	1.8	9.3	7.4	7.5	6.0	2.9	3.0
Cycle Q Clear(g_c), s	2.9	20.2	0.1	5.3	19.3	1.8	9.3	7.4	7.5	6.0	2.9	3.0
Prop In Lane	1.00		1.00	1.00		1.00	1.00		0.14	1.00		0.35
Lane Grp Cap(c), veh/h	67	874	390	246	993	566	390	733	752	268	670	664
V/C Ratio(X)	0.77	0.84	0.01	0.73	0.73	0.07	0.82	0.26	0.26	0.76	0.11	0.12
Avail Cap(c_a), veh/h	96	1119	499	404	1401	748	624	733	752	367	670	664
HCM Platoon Ratio	1.00	1.00	1.00	1.00	1.00	1.00	1.00	1.00	1.00	1.00	1.00	1.00
Upstream Filter(I)	1.00	1.00	1.00	1.00	1.00	1.00	1.00	1.00	1.00	1.00	1.00	1.00
Uniform Delay (d), s/veh	50.2	37.9	30.3	47.9	34.6	22.7	45.7	20.7	20.8	47.6	21.7	21.7
Incr Delay (d2), s/veh	10.7	4.5	0.0	1.6	1.2	0.1	2.0	0.9	0.9	3.6	0.3	0.4
Initial Q Delay(d3),s/veh	0.0	0.0	0.0	0.0	0.0	0.0	0.0	0.0	0.0	0.0	0.0	0.0
%ile BackOfQ(50%),veh/ln	1.5	9.0	0.1	2.3	8.1	0.7	4.0	3.1	3.2	2.6	1.2	1.2
Unsig. Movement Delay, s/veh												
LnGrp Delay(d),s/veh	60.9	42.4	30.3	49.5	35.8	22.7	47.7	21.6	21.6	51.2	22.0	22.1
LnGrp LOS	E	D	C	D	D	C	D	C	C	D	C	C
Approach Vol, veh/h		785			950			708			355	
Approach Delay, s/veh		43.6			37.8			33.4			38.7	
Approach LOS		D			D			C			D	
Timer - Assigned Phs	1	2	3	4	5	6	7	8				
Phs Duration (G+Y+Rc), s	12.0	31.6	16.3	45.2	8.5	35.1	12.6	48.9				
Change Period (Y+Rc), s	4.6	6.2	4.6	6.2	4.6	* 6.2	4.6	6.2				
Max Green Setting (Gmax), s	12.1	32.6	18.7	35.0	5.6	* 41	11.0	42.7				
Max Q Clear Time (g_c+I1), s	7.3	22.2	11.3	5.0	4.9	21.3	8.0	9.5				
Green Ext Time (p_c), s	0.1	3.2	0.4	0.7	0.0	4.4	0.1	2.0				

Intersection Summary

HCM 6th Ctrl Delay	38.4
HCM 6th LOS	D

Notes

* HCM 6th computational engine requires equal clearance times for the phases crossing the barrier.

Intersection												
Int Delay, s/veh	0.8											
Movement	EBL	EBT	EBR	WBL	WBT	WBR	NBL	NBT	NBR	SBL	SBT	SBR
Lane Configurations		↕			↕	↕	↕	↕		↕	↕	
Traffic Vol, veh/h	35	0	5	7	0	3	7	750	7	9	238	47
Future Vol, veh/h	35	0	5	7	0	3	7	750	7	9	238	47
Conflicting Peds, #/hr	0	0	0	0	0	0	0	0	0	0	0	0
Sign Control	Stop	Stop	Stop	Stop	Stop	Stop	Free	Free	Free	Free	Free	Free
RT Channelized	-	-	None	-	-	None	-	-	None	-	-	None
Storage Length	-	-	-	-	-	0	160	-	-	110	-	-
Veh in Median Storage, #	-	2	-	-	2	-	-	0	-	-	0	-
Grade, %	-	0	-	-	0	-	-	0	-	-	0	-
Peak Hour Factor	86	86	86	86	86	86	86	86	86	86	86	86
Heavy Vehicles, %	0	0	0	0	0	0	0	0	0	0	0	0
Mvmt Flow	41	0	6	8	0	3	8	872	8	10	277	55

Major/Minor	Minor2		Minor1		Major1			Major2				
Conflicting Flow All	777	1221	166	1051	1244	440	332	0	0	880	0	0
Stage 1	325	325	-	892	892	-	-	-	-	-	-	-
Stage 2	452	896	-	159	352	-	-	-	-	-	-	-
Critical Hdwy	6.5	6.5	6.9	6.5	6.5	6.9	4.1	-	-	4.1	-	-
Critical Hdwy Stg 1	6.5	5.5	-	6.5	5.5	-	-	-	-	-	-	-
Critical Hdwy Stg 2	6.5	5.5	-	6.5	5.5	-	-	-	-	-	-	-
Follow-up Hdwy	3.5	4	3.3	3.5	4	3.3	2.2	-	-	2.2	-	-
Pot Cap-1 Maneuver	360	181	856	246	176	570	1239	-	-	777	-	-
Stage 1	667	653	-	307	363	-	-	-	-	-	-	-
Stage 2	562	362	-	833	635	-	-	-	-	-	-	-
Platoon blocked, %								-	-	-	-	-
Mov Cap-1 Maneuver	352	178	856	241	173	570	1239	-	-	777	-	-
Mov Cap-2 Maneuver	482	317	-	289	323	-	-	-	-	-	-	-
Stage 1	663	645	-	305	361	-	-	-	-	-	-	-
Stage 2	555	360	-	817	627	-	-	-	-	-	-	-

Approach	EB		WB		NB			SB		
HCM Control Delay, s	12.8		15.9		0.1			0.3		
HCM LOS	B		C							

Minor Lane/Major Mvmt	NBL	NBT	NBR	EBLn1	WBLn1	WBLn2	SBL	SBT	SBR
Capacity (veh/h)	1239	-	-	510	289	570	777	-	-
HCM Lane V/C Ratio	0.007	-	-	0.091	0.028	0.006	0.013	-	-
HCM Control Delay (s)	7.9	-	-	12.8	17.8	11.4	9.7	-	-
HCM Lane LOS	A	-	-	B	C	B	A	-	-
HCM 95th %tile Q(veh)	0	-	-	0.3	0.1	0	0	-	-

Timings
6: I-215 SB Ramps & Ramona Exwy.



Lane Group	EBT	WBL	WBT	SBL	SBT	SBR
Lane Configurations	↑↑	↖	↑↑	↖	↖	↖
Traffic Volume (vph)	759	328	1121	817	2	210
Future Volume (vph)	759	328	1121	817	2	210
Turn Type	NA	Prot	NA	Split	NA	Perm
Protected Phases	2	1	6	4	4	
Permitted Phases						4
Detector Phase	2	1	6	4	4	4
Switch Phase						
Minimum Initial (s)	5.0	5.0	5.0	5.0	5.0	5.0
Minimum Split (s)	11.0	9.5	31.0	10.5	10.5	10.5
Total Split (s)	44.0	27.0	71.0	39.0	39.0	39.0
Total Split (%)	40.0%	24.5%	64.5%	35.5%	35.5%	35.5%
Yellow Time (s)	5.0	3.5	5.0	4.5	4.5	4.5
All-Red Time (s)	1.0	1.0	1.0	1.0	1.0	1.0
Lost Time Adjust (s)	0.0	0.0	0.0	0.0	0.0	0.0
Total Lost Time (s)	6.0	4.5	6.0	5.5	5.5	5.5
Lead/Lag	Lag	Lead				
Lead-Lag Optimize?	Yes	Yes				
Recall Mode	C-Max	None	C-Max	Max	Max	Max
Act Effct Green (s)	38.5	22.0	65.0	33.5	33.5	33.5
Actuated g/C Ratio	0.35	0.20	0.59	0.30	0.30	0.30
v/c Ratio	0.92	0.93	0.54	0.80	0.80	0.39
Control Delay	44.6	48.7	4.4	48.2	48.3	20.4
Queue Delay	0.6	0.0	0.7	61.7	61.7	0.0
Total Delay	45.2	48.7	5.1	109.9	110.0	20.4
LOS	D	D	A	F	F	C
Approach Delay	45.2		15.0		91.7	
Approach LOS	D		B		F	

Intersection Summary

Cycle Length: 110
 Actuated Cycle Length: 110
 Offset: 34 (31%), Referenced to phase 2:EBT and 6:WBT, Start of Yellow
 Natural Cycle: 90
 Control Type: Actuated-Coordinated
 Maximum v/c Ratio: 0.93
 Intersection Signal Delay: 46.3
 Intersection LOS: D
 Intersection Capacity Utilization 148.5%
 ICU Level of Service H
 Analysis Period (min) 15

Splits and Phases: 6: I-215 SB Ramps & Ramona Exwy.

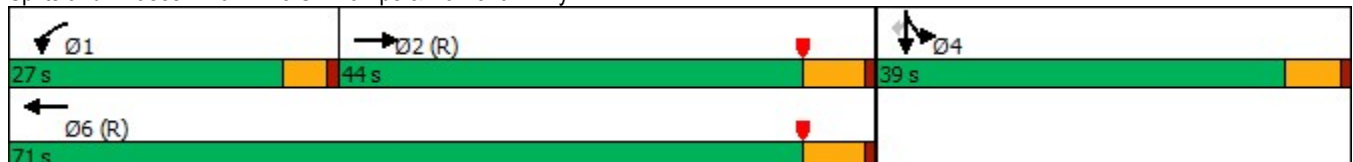

HCM 6th Signalized Intersection Summary
6: I-215 SB Ramps & Ramona Exwy.

Harvill Logistics (JN 14231)

06/16/2022



Movement	EBL	EBT	EBR	WBL	WBT	WBR	NBL	NBT	NBR	SBL	SBT	SBR
Lane Configurations		↑↑		↖	↑↑					↖	↑↑	↖
Traffic Volume (veh/h)	0	759	364	328	1121	0	0	0	0	817	2	210
Future Volume (veh/h)	0	759	364	328	1121	0	0	0	0	817	2	210
Initial Q (Qb), veh	0	0	0	0	0	0				0	0	0
Ped-Bike Adj(A_pbT)	1.00		0.99	1.00		1.00				1.00		1.00
Parking Bus, Adj	1.00	1.00	1.00	1.00	1.00	1.00				1.00	1.00	1.00
Work Zone On Approach		No			No						No	
Adj Sat Flow, veh/h/ln	0	1900	1900	1900	1900	0				1900	1900	1900
Adj Flow Rate, veh/h	0	774	242	335	1144	0				835	0	151
Peak Hour Factor	0.98	0.98	0.98	0.98	0.98	0.98				0.98	0.98	0.98
Percent Heavy Veh, %	0	0	0	0	0	0				0	0	0
Cap, veh/h	0	940	294	365	2133	0				1102	0	490
Arrive On Green	0.00	0.35	0.35	0.12	0.35	0.00				0.30	0.00	0.30
Sat Flow, veh/h	0	2792	843	1810	3705	0				3619	0	1610
Grp Volume(v), veh/h	0	518	498	335	1144	0				835	0	151
Grp Sat Flow(s),veh/h/ln	0	1805	1735	1810	1805	0				1810	0	1610
Q Serve(g_s), s	0.0	28.8	28.9	20.1	27.8	0.0				22.9	0.0	7.9
Cycle Q Clear(g_c), s	0.0	28.8	28.9	20.1	27.8	0.0				22.9	0.0	7.9
Prop In Lane	0.00		0.49	1.00		0.00				1.00		1.00
Lane Grp Cap(c), veh/h	0	629	605	365	2133	0				1102	0	490
V/C Ratio(X)	0.00	0.82	0.82	0.92	0.54	0.00				0.76	0.00	0.31
Avail Cap(c_a), veh/h	0	629	605	370	2133	0				1102	0	490
HCM Platoon Ratio	1.00	1.00	1.00	0.60	0.60	1.00				1.00	1.00	1.00
Upstream Filter(I)	0.00	0.53	0.53	0.64	0.64	0.00				1.00	0.00	1.00
Uniform Delay (d), s/veh	0.0	32.8	32.8	47.4	23.5	0.0				34.6	0.0	29.4
Incr Delay (d2), s/veh	0.0	6.5	6.8	19.7	0.6	0.0				4.9	0.0	1.6
Initial Q Delay(d3),s/veh	0.0	0.0	0.0	0.0	0.0	0.0				0.0	0.0	0.0
%ile BackOfQ(50%),veh/ln	0.0	12.9	12.4	11.3	12.5	0.0				10.4	0.0	3.2
Unsig. Movement Delay, s/veh												
LnGrp Delay(d),s/veh	0.0	39.3	39.6	67.1	24.1	0.0				39.5	0.0	31.0
LnGrp LOS	A	D	D	E	C	A				D	A	C
Approach Vol, veh/h		1016			1479						986	
Approach Delay, s/veh		39.4			33.8						38.2	
Approach LOS		D			C						D	
Timer - Assigned Phs	1	2		4		6						
Phs Duration (G+Y+Rc), s	26.7	44.3		39.0		71.0						
Change Period (Y+Rc), s	4.5	6.0		5.5		6.0						
Max Green Setting (Gmax), s	22.5	38.0		33.5		65.0						
Max Q Clear Time (g_c+I1), s	22.1	30.9		24.9		29.8						
Green Ext Time (p_c), s	0.0	2.4		2.6		5.3						

Intersection Summary

HCM 6th Ctrl Delay	36.7
HCM 6th LOS	D

Notes

User approved volume balancing among the lanes for turning movement.

Timings
7: I-215 NB Ramps & Ramona Exwy.

Lane Group	EBL	EBT	WBT	WBR	NBL	NBT	NBR
Lane Configurations							
Traffic Volume (vph)	159	1417	1051	740	398	4	612
Future Volume (vph)	159	1417	1051	740	398	4	612
Turn Type	Prot	NA	NA	Perm	Split	NA	Perm
Protected Phases	5	2	6		8	8	
Permitted Phases				6			8
Detector Phase	5	2	6	6	8	8	8
Switch Phase							
Minimum Initial (s)	5.0	5.0	5.0	5.0	5.0	5.0	5.0
Minimum Split (s)	9.5	11.0	26.0	26.0	10.5	10.5	10.5
Total Split (s)	23.0	68.0	45.0	45.0	42.0	42.0	42.0
Total Split (%)	20.9%	61.8%	40.9%	40.9%	38.2%	38.2%	38.2%
Yellow Time (s)	3.5	5.0	5.0	5.0	4.5	4.5	4.5
All-Red Time (s)	1.0	1.0	1.0	1.0	1.0	1.0	1.0
Lost Time Adjust (s)	0.0	0.0	0.0	0.0	0.0	0.0	0.0
Total Lost Time (s)	4.5	6.0	6.0	6.0	5.5	5.5	5.5
Lead/Lag	Lead		Lag	Lag			
Lead-Lag Optimize?	Yes		Yes	Yes			
Recall Mode	None	C-Max	C-Max	C-Max	None	None	None
Act Effct Green (s)	14.7	62.0	42.8	42.8	36.5	36.5	36.5
Actuated g/C Ratio	0.13	0.56	0.39	0.39	0.33	0.33	0.33
v/c Ratio	0.68	0.72	0.77	0.76	0.36	0.37	1.08
Control Delay	42.4	28.0	34.7	12.0	30.2	30.3	92.3
Queue Delay	0.0	49.5	0.0	0.0	0.0	0.0	0.0
Total Delay	42.4	77.5	34.7	12.0	30.2	30.3	92.3
LOS	D	E	C	B	C	C	F
Approach Delay		73.9	25.3			67.7	
Approach LOS		E	C			E	

Intersection Summary





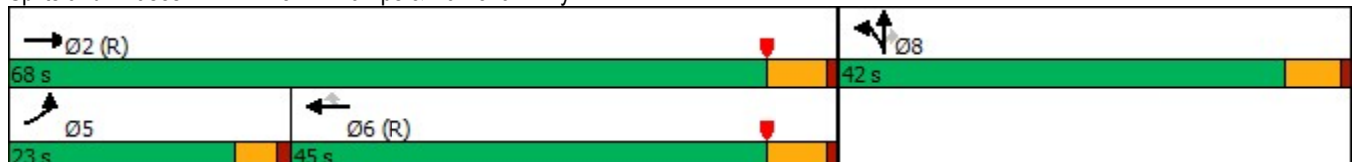















Cycle Length: 110
 Actuated Cycle Length: 110
 Offset: 0 (0%), Referenced to phase 2:EBT and 6:WBT, Start of Yellow, Master Intersection
 Natural Cycle: 75
 Control Type: Actuated-Coordinated
 Maximum v/c Ratio: 1.08
 Intersection Signal Delay: 52.6
 Intersection LOS: D
 Intersection Capacity Utilization 148.5%
 ICU Level of Service H
 Analysis Period (min) 15

Splits and Phases: 7: I-215 NB Ramps & Ramona Exwy.



HCM 6th Signalized Intersection Summary
 7: I-215 NB Ramps & Ramona Exwy.

Harvill Logistics (JN 14231)
 06/16/2022

												
Movement	EBL	EBT	EBR	WBL	WBT	WBR	NBL	NBT	NBR	SBL	SBT	SBR
Lane Configurations		 			 							
Traffic Volume (veh/h)	159	1417	0	0	1051	740	398	4	612	0	0	0
Future Volume (veh/h)	159	1417	0	0	1051	740	398	4	612	0	0	0
Initial Q (Qb), veh	0	0	0	0	0	0	0	0	0			
Ped-Bike Adj(A_pbT)	1.00		1.00	1.00		1.00	1.00		1.00			
Parking Bus, Adj	1.00	1.00	1.00	1.00	1.00	1.00	1.00	1.00	1.00			
Work Zone On Approach		No			No			No				
Adj Sat Flow, veh/h/ln	1900	1900	0	0	1900	1900	1900	1900	1900			
Adj Flow Rate, veh/h	164	1461	0	0	1084	615	413	0	479			
Peak Hour Factor	0.97	0.97	0.97	0.97	0.97	0.97	0.97	0.97	0.97			
Percent Heavy Veh, %	0	0	0	0	0	0	0	0	0			
Cap, veh/h	193	2089	0	0	1557	695	1146	0	510			
Arrive On Green	0.21	1.00	0.00	0.00	0.43	0.43	0.32	0.00	0.32			
Sat Flow, veh/h	1810	3705	0	0	3705	1610	3619	0	1610			
Grp Volume(v), veh/h	164	1461	0	0	1084	615	413	0	479			
Grp Sat Flow(s),veh/h/ln	1810	1805	0	0	1805	1610	1810	0	1610			
Q Serve(g_s), s	9.6	0.0	0.0	0.0	26.8	38.7	9.7	0.0	31.8			
Cycle Q Clear(g_c), s	9.6	0.0	0.0	0.0	26.8	38.7	9.7	0.0	31.8			
Prop In Lane	1.00		0.00	0.00		1.00	1.00		1.00			
Lane Grp Cap(c), veh/h	193	2089	0	0	1557	695	1146	0	510			
V/C Ratio(X)	0.85	0.70	0.00	0.00	0.70	0.89	0.36	0.00	0.94			
Avail Cap(c_a), veh/h	304	2089	0	0	1557	695	1201	0	534			
HCM Platoon Ratio	2.00	2.00	1.00	1.00	1.00	1.00	1.00	1.00	1.00			
Upstream Filter(I)	0.34	0.34	0.00	0.00	1.00	1.00	1.00	0.00	1.00			
Uniform Delay (d), s/veh	42.4	0.0	0.0	0.0	25.4	28.8	29.0	0.0	36.6			
Incr Delay (d2), s/veh	4.7	0.7	0.0	0.0	2.6	15.4	0.2	0.0	24.3			
Initial Q Delay(d3),s/veh	0.0	0.0	0.0	0.0	0.0	0.0	0.0	0.0	0.0			
%ile BackOfQ(50%),veh/ln	3.9	0.2	0.0	0.0	11.1	16.5	4.1	0.0	15.3			
Unsig. Movement Delay, s/veh												
LnGrp Delay(d),s/veh	47.1	0.7	0.0	0.0	28.0	44.2	29.2	0.0	60.8			
LnGrp LOS	D	A	A	A	C	D	C	A	E			
Approach Vol, veh/h		1625			1699			892				
Approach Delay, s/veh		5.4			33.9			46.2				
Approach LOS		A			C			D				
Timer - Assigned Phs		2			5	6		8				
Phs Duration (G+Y+Rc), s		69.7			16.2	53.5		40.3				
Change Period (Y+Rc), s		6.0			4.5	6.0		5.5				
Max Green Setting (Gmax), s		62.0			18.5	39.0		36.5				
Max Q Clear Time (g_c+I1), s		2.0			11.6	40.7		33.8				
Green Ext Time (p_c), s		8.0			0.2	0.0		1.0				
Intersection Summary												
HCM 6th Ctrl Delay				25.5								
HCM 6th LOS				C								
Notes												
User approved volume balancing among the lanes for turning movement.												

Timings
1: Harvill Av. & Cajalco Exwy./Ramona Exwy.

Harvill Logistics (JN 14231)

06/16/2022

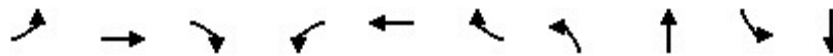

Lane Group	EBL	EBT	EBR	WBL	WBT	WBR	NBL	NBT	SBL	SBT
Lane Configurations	↙	↑↑	↗	↙↗	↑↑	↗	↙↗	↑↑	↙↗	↑↑
Traffic Volume (vph)	24	723	207	132	637	187	165	144	222	211
Future Volume (vph)	24	723	207	132	637	187	165	144	222	211
Turn Type	Prot	NA	Perm	Prot	NA	pm+ov	Prot	NA	Prot	NA
Protected Phases	5	2		1	6	7	3	8	7	4
Permitted Phases			2			6				
Detector Phase	5	2	2	1	6	7	3	8	7	4
Switch Phase										
Minimum Initial (s)	5.0	10.0	10.0	5.0	10.0	5.0	5.0	10.0	5.0	10.0
Minimum Split (s)	9.6	36.2	36.2	9.6	32.5	9.6	9.6	16.2	9.6	41.2
Total Split (s)	10.2	38.8	38.8	16.7	45.3	15.6	23.3	48.9	15.6	41.2
Total Split (%)	8.5%	32.3%	32.3%	13.9%	37.8%	13.0%	19.4%	40.8%	13.0%	34.3%
Yellow Time (s)	3.6	5.2	5.2	3.6	3.5	3.6	3.6	5.2	3.6	5.2
All-Red Time (s)	1.0	1.0	1.0	1.0	1.0	1.0	1.0	1.0	1.0	1.0
Lost Time Adjust (s)	0.0	0.0	0.0	0.0	0.0	0.0	0.0	0.0	0.0	0.0
Total Lost Time (s)	4.6	6.2	6.2	4.6	4.5	4.6	4.6	6.2	4.6	6.2
Lead/Lag	Lead	Lag	Lag	Lead	Lag	Lead	Lead	Lag	Lead	Lag
Lead-Lag Optimize?	Yes	Yes	Yes	Yes	Yes	Yes	Yes	Yes	Yes	Yes
Recall Mode	None	None	None	None	None	None	None	Max	None	Max
Act Effct Green (s)	5.4	29.4	29.4	9.0	38.9	53.8	10.1	42.9	10.4	43.2
Actuated g/C Ratio	0.05	0.26	0.26	0.08	0.34	0.47	0.09	0.38	0.09	0.38
v/c Ratio	0.31	0.83	0.38	0.51	0.55	0.23	0.57	0.21	0.74	0.20
Control Delay	64.0	48.5	6.4	57.6	32.9	3.2	57.5	13.8	65.8	24.0
Queue Delay	0.0	0.0	0.0	0.0	0.0	0.0	0.0	0.0	0.0	0.0
Total Delay	64.0	48.5	6.4	57.6	32.9	3.2	57.5	13.8	65.8	24.0
LOS	E	D	A	E	C	A	E	B	E	C
Approach Delay		39.7			30.5			30.4		43.8
Approach LOS		D			C			C		D

Intersection Summary

Cycle Length: 120
 Actuated Cycle Length: 113.4
 Natural Cycle: 100
 Control Type: Actuated-Uncoordinated
 Maximum v/c Ratio: 0.83
 Intersection Signal Delay: 35.8
 Intersection LOS: D
 Intersection Capacity Utilization 56.8%
 ICU Level of Service B
 Analysis Period (min) 15

Splits and Phases: 1: Harvill Av. & Cajalco Exwy./Ramona Exwy.

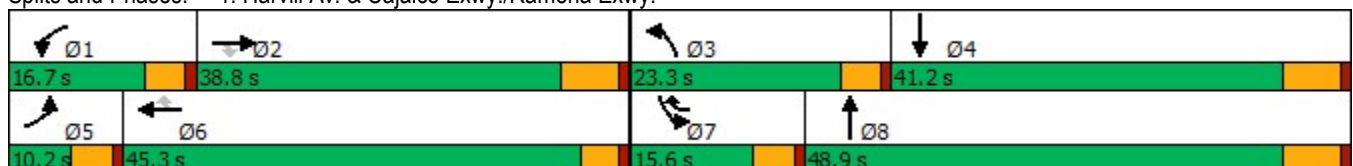

HCM 6th Signalized Intersection Summary
 1: Harvill Av. & Cajalco Exwy./Ramona Exwy.

Harvill Logistics (JN 14231)

06/16/2022

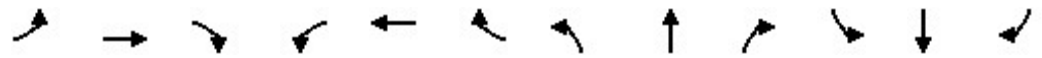

Movement	EBL	EBT	EBR	WBL	WBT	WBR	NBL	NBT	NBR	SBL	SBT	SBR
Lane Configurations	↘	↗	↘	↘↗	↗	↘	↘↗	↗		↘↗	↗	
Traffic Volume (veh/h)	24	723	207	132	637	187	165	144	125	222	211	35
Future Volume (veh/h)	24	723	207	132	637	187	165	144	125	222	211	35
Initial Q (Qb), veh	0	0	0	0	0	0	0	0	0	0	0	0
Ped-Bike Adj(A_pbT)	1.00		1.00	1.00		1.00	1.00		0.99	1.00		1.00
Parking Bus, Adj	1.00	1.00	1.00	1.00	1.00	1.00	1.00	1.00	1.00	1.00	1.00	1.00
Work Zone On Approach		No			No			No			No	
Adj Sat Flow, veh/h/ln	1900	1900	1900	1900	1900	1900	1900	1900	1900	1900	1900	1900
Adj Flow Rate, veh/h	26	777	110	142	685	121	177	155	66	239	227	27
Peak Hour Factor	0.93	0.93	0.93	0.93	0.93	0.93	0.93	0.93	0.93	0.93	0.93	0.93
Percent Heavy Veh, %	0	0	0	0	0	0	0	0	0	0	0	0
Cap, veh/h	46	918	409	205	1038	602	245	995	405	302	1352	159
Arrive On Green	0.03	0.25	0.25	0.06	0.29	0.29	0.07	0.40	0.40	0.09	0.42	0.42
Sat Flow, veh/h	1810	3610	1610	3510	3610	1610	3510	2493	1014	3510	3253	383
Grp Volume(v), veh/h	26	777	110	142	685	121	177	110	111	239	125	129
Grp Sat Flow(s),veh/h/ln	1810	1805	1610	1755	1805	1610	1755	1805	1702	1755	1805	1831
Q Serve(g_s), s	1.5	21.9	5.8	4.2	17.8	5.4	5.3	4.2	4.5	7.1	4.6	4.7
Cycle Q Clear(g_c), s	1.5	21.9	5.8	4.2	17.8	5.4	5.3	4.2	4.5	7.1	4.6	4.7
Prop In Lane	1.00		1.00	1.00		1.00	1.00		0.60	1.00		0.21
Lane Grp Cap(c), veh/h	46	918	409	205	1038	602	245	721	680	302	750	761
V/C Ratio(X)	0.57	0.85	0.27	0.69	0.66	0.20	0.72	0.15	0.16	0.79	0.17	0.17
Avail Cap(c_a), veh/h	95	1100	491	397	1377	753	614	721	680	361	750	761
HCM Platoon Ratio	1.00	1.00	1.00	1.00	1.00	1.00	1.00	1.00	1.00	1.00	1.00	1.00
Upstream Filter(I)	1.00	1.00	1.00	1.00	1.00	1.00	1.00	1.00	1.00	1.00	1.00	1.00
Uniform Delay (d), s/veh	51.6	37.9	31.9	49.4	33.5	22.7	48.7	20.6	20.7	47.9	19.6	19.6
Incr Delay (d2), s/veh	4.1	5.4	0.3	1.6	0.7	0.2	1.5	0.5	0.5	7.8	0.5	0.5
Initial Q Delay(d3),s/veh	0.0	0.0	0.0	0.0	0.0	0.0	0.0	0.0	0.0	0.0	0.0	0.0
%ile BackOfQ(50%),veh/ln	0.7	9.8	2.2	1.8	7.4	2.0	2.3	1.7	1.8	3.3	1.9	2.0
Unsig. Movement Delay, s/veh												
LnGrp Delay(d),s/veh	55.7	43.3	32.3	51.0	34.2	22.8	50.3	21.0	21.2	55.8	20.1	20.1
LnGrp LOS	E	D	C	D	C	C	D	C	C	E	C	C
Approach Vol, veh/h		913			948			398			493	
Approach Delay, s/veh		42.3			35.3			34.1			37.4	
Approach LOS		D			D			C			D	
Timer - Assigned Phs	1	2	3	4	5	6	7	8				
Phs Duration (G+Y+Rc), s	10.9	33.4	12.1	50.7	7.3	37.0	13.8	48.9				
Change Period (Y+Rc), s	4.6	6.2	4.6	6.2	4.6	* 6.2	4.6	6.2				
Max Green Setting (Gmax), s	12.1	32.6	18.7	35.0	5.6	* 41	11.0	42.7				
Max Q Clear Time (g_c+I1), s	6.2	23.9	7.3	6.7	3.5	19.8	9.1	6.5				
Green Ext Time (p_c), s	0.1	3.3	0.2	1.2	0.0	4.5	0.1	1.1				

Intersection Summary

HCM 6th Ctrl Delay	37.8
HCM 6th LOS	D

Notes

* HCM 6th computational engine requires equal clearance times for the phases crossing the barrier.

Intersection												
Int Delay, s/veh	1.5											
Movement	EBL	EBT	EBR	WBL	WBT	WBR	NBL	NBT	NBR	SBL	SBT	SBR
Lane Configurations		↕			↕	↕	↕	↕		↕	↕	
Traffic Vol, veh/h	63	0	13	5	0	16	6	352	6	6	447	31
Future Vol, veh/h	63	0	13	5	0	16	6	352	6	6	447	31
Conflicting Peds, #/hr	0	0	0	0	0	0	0	0	0	0	0	0
Sign Control	Stop	Stop	Stop	Stop	Stop	Stop	Free	Free	Free	Free	Free	Free
RT Channelized	-	-	None	-	-	None	-	-	None	-	-	None
Storage Length	-	-	-	-	-	0	160	-	-	110	-	-
Veh in Median Storage, #	-	2	-	-	2	-	-	0	-	-	0	-
Grade, %	-	0	-	-	0	-	-	0	-	-	0	-
Peak Hour Factor	86	86	86	86	86	86	86	86	86	86	86	86
Heavy Vehicles, %	0	0	0	0	0	0	0	0	0	0	0	0
Mvmt Flow	73	0	15	6	0	19	7	409	7	7	520	36

Major/Minor	Minor2		Minor1			Major1		Major2				
Conflicting Flow All	771	982	278	701	997	208	556	0	0	416	0	0
Stage 1	552	552	-	427	427	-	-	-	-	-	-	-
Stage 2	219	430	-	274	570	-	-	-	-	-	-	-
Critical Hdwy	6.5	6.5	6.9	6.5	6.5	6.9	4.1	-	-	4.1	-	-
Critical Hdwy Stg 1	6.5	5.5	-	6.5	5.5	-	-	-	-	-	-	-
Critical Hdwy Stg 2	6.5	5.5	-	6.5	5.5	-	-	-	-	-	-	-
Follow-up Hdwy	3.5	4	3.3	3.5	4	3.3	2.2	-	-	2.2	-	-
Pot Cap-1 Maneuver	363	251	725	400	246	804	1025	-	-	1154	-	-
Stage 1	491	518	-	581	589	-	-	-	-	-	-	-
Stage 2	769	587	-	714	509	-	-	-	-	-	-	-
Platoon blocked, %								-	-	-	-	-
Mov Cap-1 Maneuver	351	248	725	388	243	804	1025	-	-	1154	-	-
Mov Cap-2 Maneuver	452	421	-	513	415	-	-	-	-	-	-	-
Stage 1	488	515	-	577	585	-	-	-	-	-	-	-
Stage 2	746	583	-	695	506	-	-	-	-	-	-	-

Approach	EB		WB			NB		SB		
HCM Control Delay, s	14.1		10.2			0.1		0.1		
HCM LOS	B		B							

Minor Lane/Major Mvmt	NBL	NBT	NBR	EBLn1	WBLn1	WBLn2	SBL	SBT	SBR
Capacity (veh/h)	1025	-	-	483	513	804	1154	-	-
HCM Lane V/C Ratio	0.007	-	-	0.183	0.011	0.023	0.006	-	-
HCM Control Delay (s)	8.5	-	-	14.1	12.1	9.6	8.1	-	-
HCM Lane LOS	A	-	-	B	B	A	A	-	-
HCM 95th %tile Q(veh)	0	-	-	0.7	0	0.1	0	-	-

Timings
6: I-215 SB Ramps & Ramona Exwy.



Lane Group	EBT	WBL	WBT	SBL	SBT	SBR
Lane Configurations	↑↑	↖	↑↑	↖	↖	↖
Traffic Volume (vph)	911	369	915	853	8	184
Future Volume (vph)	911	369	915	853	8	184
Turn Type	NA	Prot	NA	Split	NA	Perm
Protected Phases	2	1	6	4	4	
Permitted Phases						4
Detector Phase	2	1	6	4	4	4
Switch Phase						
Minimum Initial (s)	5.0	5.0	5.0	5.0	5.0	5.0
Minimum Split (s)	11.0	9.5	31.0	10.5	10.5	10.5
Total Split (s)	44.0	27.0	71.0	39.0	39.0	39.0
Total Split (%)	40.0%	24.5%	64.5%	35.5%	35.5%	35.5%
Yellow Time (s)	5.0	3.5	5.0	4.5	4.5	4.5
All-Red Time (s)	1.0	1.0	1.0	1.0	1.0	1.0
Lost Time Adjust (s)	0.0	0.0	0.0	0.0	0.0	0.0
Total Lost Time (s)	6.0	4.5	6.0	5.5	5.5	5.5
Lead/Lag	Lag	Lead				
Lead-Lag Optimize?	Yes	Yes				
Recall Mode	C-Max	None	C-Max	Max	Max	Max
Act Effct Green (s)	38.0	22.5	65.0	33.5	33.5	33.5
Actuated g/C Ratio	0.35	0.20	0.59	0.30	0.30	0.30
v/c Ratio	1.04	1.01	0.43	0.83	0.84	0.32
Control Delay	70.1	69.7	5.2	50.4	51.6	10.3
Queue Delay	13.2	0.0	0.4	72.5	72.1	0.0
Total Delay	83.3	69.7	5.6	122.9	123.7	10.3
LOS	F	E	A	F	F	B
Approach Delay	83.3		24.0		103.4	
Approach LOS	F		C		F	

Intersection Summary

Cycle Length: 110
 Actuated Cycle Length: 110
 Offset: 34 (31%), Referenced to phase 2:EBT and 6:WBT, Start of Yellow
 Natural Cycle: 90
 Control Type: Actuated-Coordinated
 Maximum v/c Ratio: 1.04
 Intersection Signal Delay: 67.9
 Intersection LOS: E
 Intersection Capacity Utilization 138.6%
 ICU Level of Service H
 Analysis Period (min) 15

Splits and Phases: 6: I-215 SB Ramps & Ramona Exwy.

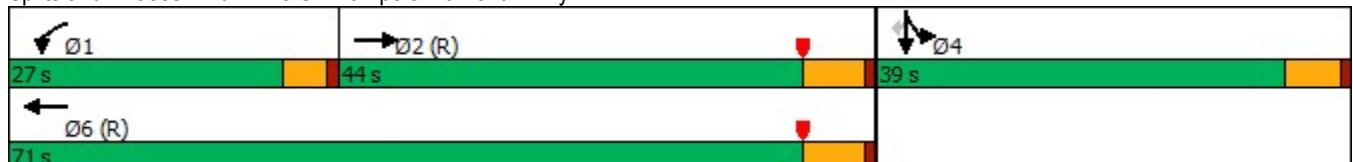

HCM 6th Signalized Intersection Summary
6: I-215 SB Ramps & Ramona Exwy.

Harvill Logistics (JN 14231)

06/16/2022

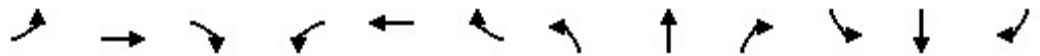

Movement	EBL	EBT	EBR	WBL	WBT	WBR	NBL	NBT	NBR	SBL	SBT	SBR
Lane Configurations		↑↑		↖	↑↑					↖	↑	↗
Traffic Volume (veh/h)	0	911	348	369	915	0	0	0	0	853	8	184
Future Volume (veh/h)	0	911	348	369	915	0	0	0	0	853	8	184
Initial Q (Qb), veh	0	0	0	0	0	0				0	0	0
Ped-Bike Adj(A_pbT)	1.00		0.99	1.00		1.00				1.00		1.00
Parking Bus, Adj	1.00	1.00	1.00	1.00	1.00	1.00				1.00	1.00	1.00
Work Zone On Approach		No			No						No	
Adj Sat Flow, veh/h/ln	0	1900	1900	1900	1900	0				1900	1900	1900
Adj Flow Rate, veh/h	0	920	244	373	924	0				868	0	127
Peak Hour Factor	0.99	0.99	0.99	0.99	0.99	0.99				0.99	0.99	0.99
Percent Heavy Veh, %	0	0	0	0	0	0				0	0	0
Cap, veh/h	0	972	257	370	2133	0				1102	0	490
Arrive On Green	0.00	0.35	0.35	0.12	0.35	0.00				0.30	0.00	0.30
Sat Flow, veh/h	0	2910	745	1810	3705	0				3619	0	1610
Grp Volume(v), veh/h	0	589	575	373	924	0				868	0	127
Grp Sat Flow(s),veh/h/ln	0	1805	1755	1810	1805	0				1810	0	1610
Q Serve(g_s), s	0.0	34.9	35.1	22.5	21.5	0.0				24.1	0.0	6.6
Cycle Q Clear(g_c), s	0.0	34.9	35.1	22.5	21.5	0.0				24.1	0.0	6.6
Prop In Lane	0.00		0.42	1.00		0.00				1.00		1.00
Lane Grp Cap(c), veh/h	0	624	606	370	2133	0				1102	0	490
V/C Ratio(X)	0.00	0.95	0.95	1.01	0.43	0.00				0.79	0.00	0.26
Avail Cap(c_a), veh/h	0	624	606	370	2133	0				1102	0	490
HCM Platoon Ratio	1.00	1.00	1.00	0.60	0.60	1.00				1.00	1.00	1.00
Upstream Filter(I)	0.00	0.48	0.48	0.79	0.79	0.00				1.00	0.00	1.00
Uniform Delay (d), s/veh	0.0	35.0	35.0	48.2	21.5	0.0				35.0	0.0	28.9
Incr Delay (d2), s/veh	0.0	14.9	15.6	43.5	0.5	0.0				5.7	0.0	1.3
Initial Q Delay(d3),s/veh	0.0	0.0	0.0	0.0	0.0	0.0				0.0	0.0	0.0
%ile BackOfQ(50%),veh/ln	0.0	16.8	16.5	14.8	9.7	0.0				11.0	0.0	2.6
Unsig. Movement Delay, s/veh												
LnGrp Delay(d),s/veh	0.0	49.9	50.6	91.8	22.0	0.0				40.7	0.0	30.2
LnGrp LOS	A	D	D	F	C	A				D	A	C
Approach Vol, veh/h		1164			1297						995	
Approach Delay, s/veh		50.3			42.0						39.4	
Approach LOS		D			D						D	
Timer - Assigned Phs	1	2		4		6						
Phs Duration (G+Y+Rc), s	27.0	44.0		39.0		71.0						
Change Period (Y+Rc), s	4.5	6.0		5.5		6.0						
Max Green Setting (Gmax), s	22.5	38.0		33.5		65.0						
Max Q Clear Time (g_c+I1), s	24.5	37.1		26.1		23.5						
Green Ext Time (p_c), s	0.0	0.5		2.4		4.0						

Intersection Summary

HCM 6th Ctrl Delay	44.0
HCM 6th LOS	D

Notes

User approved volume balancing among the lanes for turning movement.

Timings
7: I-215 NB Ramps & Ramona Exwy.

Lane Group	EBL	EBT	WBT	WBR	NBL	NBT	NBR
Lane Configurations							
Traffic Volume (vph)	121	1643	913	652	371	4	461
Future Volume (vph)	121	1643	913	652	371	4	461
Turn Type	Prot	NA	NA	Perm	Split	NA	Perm
Protected Phases	5	2	6		8	8	
Permitted Phases				6			8
Detector Phase	5	2	6	6	8	8	8
Switch Phase							
Minimum Initial (s)	5.0	5.0	5.0	5.0	5.0	5.0	5.0
Minimum Split (s)	9.5	11.0	26.0	26.0	10.5	10.5	10.5
Total Split (s)	23.0	68.0	45.0	45.0	42.0	42.0	42.0
Total Split (%)	20.9%	61.8%	40.9%	40.9%	38.2%	38.2%	38.2%
Yellow Time (s)	3.5	5.0	5.0	5.0	4.5	4.5	4.5
All-Red Time (s)	1.0	1.0	1.0	1.0	1.0	1.0	1.0
Lost Time Adjust (s)	0.0	0.0	0.0	0.0	0.0	0.0	0.0
Total Lost Time (s)	4.5	6.0	6.0	6.0	5.5	5.5	5.5
Lead/Lag	Lead		Lag	Lag			
Lead-Lag Optimize?	Yes		Yes	Yes			
Recall Mode	None	C-Max	C-Max	C-Max	None	None	None
Act Effct Green (s)	13.1	65.2	47.6	47.6	33.3	33.3	33.3
Actuated g/C Ratio	0.12	0.59	0.43	0.43	0.30	0.30	0.30
v/c Ratio	0.60	0.82	0.62	0.66	0.38	0.39	0.91
Control Delay	39.1	30.9	28.0	7.2	31.7	31.9	52.7
Queue Delay	0.0	48.6	0.0	0.0	0.0	0.0	0.0
Total Delay	39.1	79.4	28.0	7.2	31.7	31.9	52.7
LOS	D	E	C	A	C	C	D
Approach Delay		76.7	19.3			43.3	
Approach LOS		E	B			D	

Intersection Summary

Cycle Length: 110
 Actuated Cycle Length: 110
 Offset: 0 (0%), Referenced to phase 2:EBT and 6:WBT, Start of Yellow, Master Intersection
 Natural Cycle: 60
 Control Type: Actuated-Coordinated
 Maximum v/c Ratio: 0.91
 Intersection Signal Delay: 48.4
 Intersection LOS: D
 Intersection Capacity Utilization 138.6%
 ICU Level of Service H
 Analysis Period (min) 15

Splits and Phases: 7: I-215 NB Ramps & Ramona Exwy.

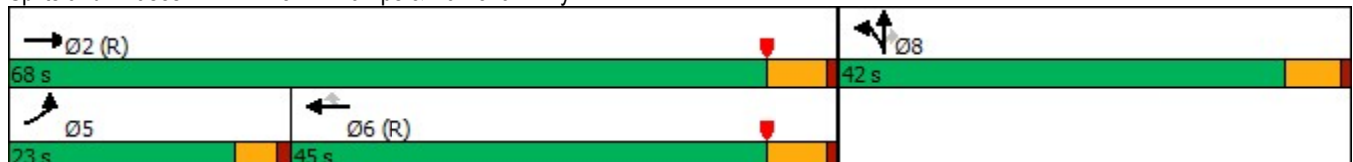

HCM 6th Signalized Intersection Summary
 7: I-215 NB Ramps & Ramona Exwy.

Harvill Logistics (JN 14231)

06/16/2022

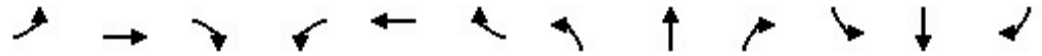

Movement	EBL	EBT	EBR	WBL	WBT	WBR	NBL	NBT	NBR	SBL	SBT	SBR
Lane Configurations	↘	↑↑			↑↑	↗	↘	↗	↗			
Traffic Volume (veh/h)	121	1643	0	0	913	652	371	4	461	0	0	0
Future Volume (veh/h)	121	1643	0	0	913	652	371	4	461	0	0	0
Initial Q (Qb), veh	0	0	0	0	0	0	0	0	0			
Ped-Bike Adj(A_pbT)	1.00		1.00	1.00		1.00	1.00		1.00			
Parking Bus, Adj	1.00	1.00	1.00	1.00	1.00	1.00	1.00	1.00	1.00			
Work Zone On Approach		No			No			No				
Adj Sat Flow, veh/h/ln	1900	1900	0	0	1900	1900	1900	1900	1900			
Adj Flow Rate, veh/h	129	1748	0	0	971	544	398	0	409			
Peak Hour Factor	0.94	0.94	0.94	0.94	0.94	0.94	0.94	0.94	0.94			
Percent Heavy Veh, %	0	0	0	0	0	0	0	0	0			
Cap, veh/h	157	2220	0	0	1759	785	1015	0	452			
Arrive On Green	0.17	1.00	0.00	0.00	0.49	0.49	0.28	0.00	0.28			
Sat Flow, veh/h	1810	3705	0	0	3705	1610	3619	0	1610			
Grp Volume(v), veh/h	129	1748	0	0	971	544	398	0	409			
Grp Sat Flow(s),veh/h/ln	1810	1805	0	0	1805	1610	1810	0	1610			
Q Serve(g_s), s	7.6	0.0	0.0	0.0	20.8	28.8	9.8	0.0	27.0			
Cycle Q Clear(g_c), s	7.6	0.0	0.0	0.0	20.8	28.8	9.8	0.0	27.0			
Prop In Lane	1.00		0.00	0.00		1.00	1.00		1.00			
Lane Grp Cap(c), veh/h	157	2220	0	0	1759	785	1015	0	452			
V/C Ratio(X)	0.82	0.79	0.00	0.00	0.55	0.69	0.39	0.00	0.91			
Avail Cap(c_a), veh/h	304	2220	0	0	1759	785	1201	0	534			
HCM Platoon Ratio	2.00	2.00	1.00	1.00	1.00	1.00	1.00	1.00	1.00			
Upstream Filter(l)	0.13	0.13	0.00	0.00	1.00	1.00	1.00	0.00	1.00			
Uniform Delay (d), s/veh	44.6	0.0	0.0	0.0	19.8	21.8	32.0	0.0	38.2			
Incr Delay (d2), s/veh	1.5	0.4	0.0	0.0	1.3	5.0	0.2	0.0	17.2			
Initial Q Delay(d3),s/veh	0.0	0.0	0.0	0.0	0.0	0.0	0.0	0.0	0.0			
%ile BackOfQ(50%),veh/ln	3.1	0.1	0.0	0.0	8.2	10.8	4.2	0.0	12.3			
Unsig. Movement Delay, s/veh												
LnGrp Delay(d),s/veh	46.1	0.4	0.0	0.0	21.0	26.8	32.2	0.0	55.4			
LnGrp LOS	D	A	A	A	C	C	C	A	E			
Approach Vol, veh/h		1877			1515			807				
Approach Delay, s/veh		3.5			23.1			44.0				
Approach LOS		A			C			D				
Timer - Assigned Phs		2			5	6		8				
Phs Duration (G+Y+Rc), s		73.7			14.0	59.6		36.3				
Change Period (Y+Rc), s		6.0			4.5	6.0		5.5				
Max Green Setting (Gmax), s		62.0			18.5	39.0		36.5				
Max Q Clear Time (g_c+I1), s		2.0			9.6	30.8		29.0				
Green Ext Time (p_c), s		11.2			0.2	3.4		1.9				

Intersection Summary

HCM 6th Ctrl Delay	18.4
HCM 6th LOS	B

Notes

User approved volume balancing among the lanes for turning movement.

**APPENDIX 3.3: EXISTING (2022) CONDITIONS TRAFFIC SIGNAL
WARRANT ANALYSIS WORKSHEETS**

This Page Intentionally Left Blank

Figure 4C-4. Warrant 3, Peak Hour (70% Factor)

(COMMUNITY LESS THAN 10,000 POPULATION OR ABOVE 64 km/h OR ABOVE 40 mph ON MAJOR STREET)

Traffic Conditions = **Existing (2022) Conditions - Weekday PM Peak Hour**

Major Street Name = **Harvill Avenue**

Total of Both Approaches (VPH) = **847**
 Number of Approach Lanes Major Street = **2**

Minor Street Name = **Old Cajalco Road**

High Volume Approach (VPH) = **76**
 Number of Approach Lanes Minor Street = **1**

SIGNAL WARRANT NOT SATISFIED

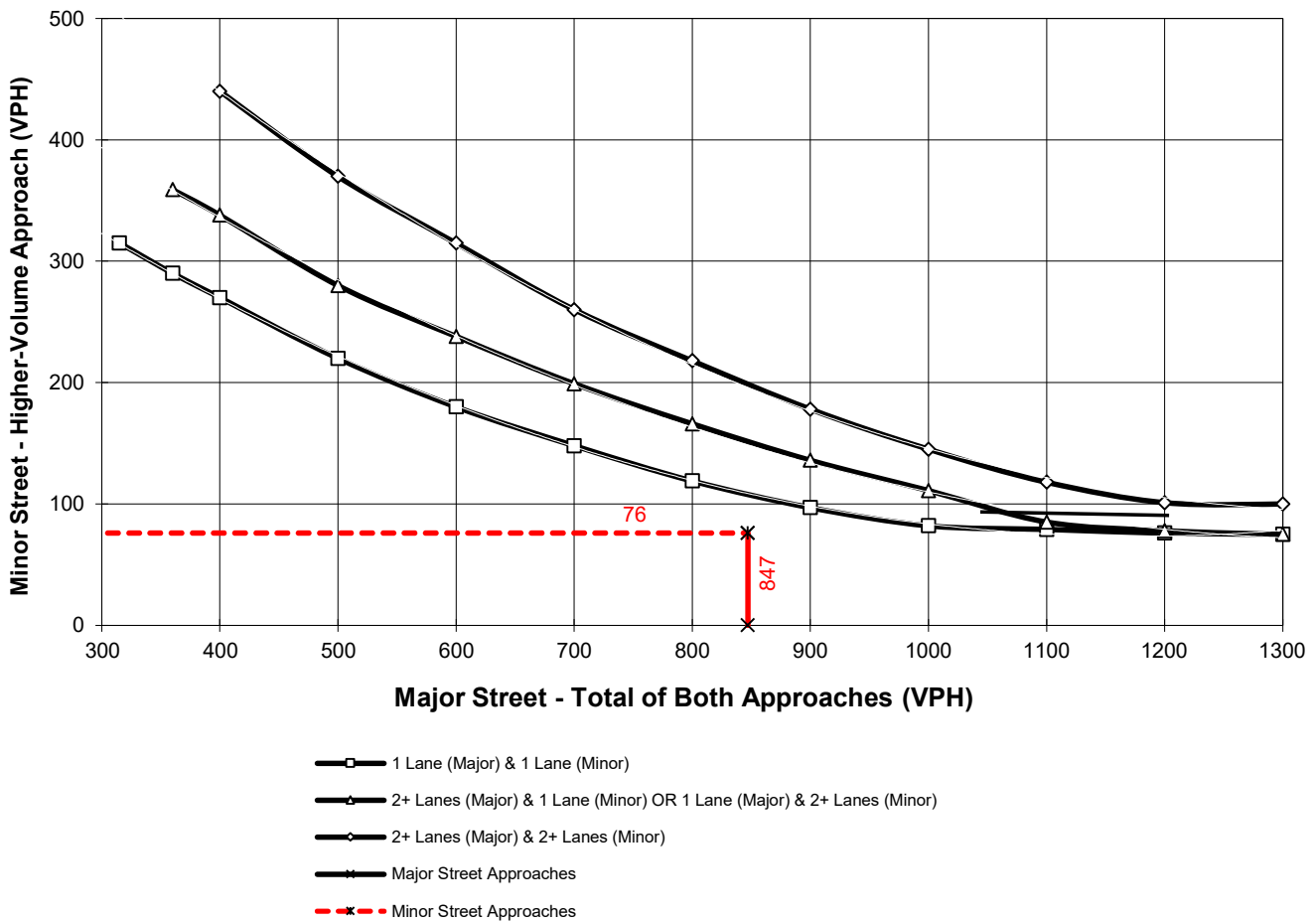

*Note: 100 vph applies as the lower threshold for a minor-street approach with two or more lanes and 75 vph applies as the lower threshold for a minor-street approach with one lane



This Page Intentionally Left Blank

**APPENDIX 3.4: EXISTING (2022) CONDITIONS FREEWAY OFF-RAMP
QUEUING ANALYSIS WORKSHEETS**

This Page Intentionally Left Blank

Queues
6: I-215 SB Ramps & Ramona Exwy.



Lane Group	EBT	WBL	WBT	SBL	SBT	SBR
Lane Group Flow (vph)	1145	335	1144	417	419	214
v/c Ratio	0.92	0.93	0.54	0.80	0.80	0.39
Control Delay	44.6	48.7	4.4	48.2	48.3	20.4
Queue Delay	0.6	0.0	0.7	61.7	61.7	0.0
Total Delay	45.2	48.7	5.1	109.9	110.0	20.4
Queue Length 50th (ft)	383	93	54	284	285	70
Queue Length 95th (ft)	#523	m#346	24	#445	#448	138
Internal Link Dist (ft)	1408		344		1111	
Turn Bay Length (ft)		100		510		510
Base Capacity (vph)	1248	369	2133	522	523	549
Starvation Cap Reductn	0	0	579	0	0	0
Spillback Cap Reductn	14	0	0	325	326	0
Storage Cap Reductn	0	0	0	0	0	0
Reduced v/c Ratio	0.93	0.91	0.74	2.12	2.13	0.39

Intersection Summary

95th percentile volume exceeds capacity, queue may be longer.

Queue shown is maximum after two cycles.

m Volume for 95th percentile queue is metered by upstream signal.

Queues

7: I-215 NB Ramps & Ramona Exwy.



Lane Group	EBL	EBT	WBT	WBR	NBL	NBT	NBR
Lane Group Flow (vph)	164	1461	1084	763	205	209	631
v/c Ratio	0.68	0.72	0.77	0.76	0.36	0.37	1.08
Control Delay	42.4	28.0	34.7	12.0	30.2	30.3	92.3
Queue Delay	0.0	49.5	0.0	0.0	0.0	0.0	0.0
Total Delay	42.4	77.5	34.7	12.0	30.2	30.3	92.3
Queue Length 50th (ft)	120	576	349	76	114	117	~462
Queue Length 95th (ft)	m127	m634	457	268	184	187	#685
Internal Link Dist (ft)		344	532			1162	
Turn Bay Length (ft)	105			200			500
Base Capacity (vph)	303	2034	1403	1000	569	570	585
Starvation Cap Reductn	0	1006	0	0	0	0	0
Spillback Cap Reductn	0	0	0	0	0	0	0
Storage Cap Reductn	0	0	0	0	0	0	0
Reduced v/c Ratio	0.54	1.42	0.77	0.76	0.36	0.37	1.08

Intersection Summary

- ~ Volume exceeds capacity, queue is theoretically infinite.
Queue shown is maximum after two cycles.
- # 95th percentile volume exceeds capacity, queue may be longer.
Queue shown is maximum after two cycles.
- m Volume for 95th percentile queue is metered by upstream signal.

Queues
6: I-215 SB Ramps & Ramona Exwy.

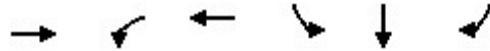

Lane Group	EBT	WBL	WBT	SBL	SBT	SBR
Lane Group Flow (vph)	1272	373	924	431	439	186
v/c Ratio	1.04	1.01	0.43	0.83	0.84	0.32
Control Delay	70.1	69.7	5.2	50.4	51.6	10.3
Queue Delay	13.2	0.0	0.4	72.5	72.1	0.0
Total Delay	83.3	69.7	5.6	122.9	123.7	10.3
Queue Length 50th (ft)	~496	~242	74	296	304	24
Queue Length 95th (ft)	#634	#441	22	#468	#481	78
Internal Link Dist (ft)	1408		344		1111	
Turn Bay Length (ft)		100		510		510
Base Capacity (vph)	1227	369	2133	522	523	588
Starvation Cap Reductn	0	0	659	0	0	0
Spillback Cap Reductn	40	0	0	414	415	0
Storage Cap Reductn	0	0	0	0	0	0
Reduced v/c Ratio	1.07	1.01	0.63	3.99	4.06	0.32

Intersection Summary

~ Volume exceeds capacity, queue is theoretically infinite.
Queue shown is maximum after two cycles.

95th percentile volume exceeds capacity, queue may be longer.
Queue shown is maximum after two cycles.

Queues

7: I-215 NB Ramps & Ramona Exwy.



Lane Group	EBL	EBT	WBT	WBR	NBL	NBT	NBR
Lane Group Flow (vph)	129	1748	971	694	197	202	490
v/c Ratio	0.60	0.82	0.62	0.66	0.38	0.39	0.91
Control Delay	39.1	30.9	28.0	7.2	31.7	31.9	52.7
Queue Delay	0.0	48.6	0.0	0.0	0.0	0.0	0.0
Total Delay	39.1	79.4	28.0	7.2	31.7	31.9	52.7
Queue Length 50th (ft)	88	664	289	32	109	112	276
Queue Length 95th (ft)	m83	m660	392	161	176	181	#457
Internal Link Dist (ft)		344	532			1162	
Turn Bay Length (ft)	105			200			500
Base Capacity (vph)	303	2139	1562	1050	569	570	585
Starvation Cap Reductn	0	992	0	0	0	0	0
Spillback Cap Reductn	0	0	0	0	0	0	0
Storage Cap Reductn	0	0	0	0	0	0	0
Reduced v/c Ratio	0.43	1.52	0.62	0.66	0.35	0.35	0.84

Intersection Summary

95th percentile volume exceeds capacity, queue may be longer.

Queue shown is maximum after two cycles.

m Volume for 95th percentile queue is metered by upstream signal.

APPENDIX 5.1: EAP (2024) CONDITIONS INTERSECTION OPERATIONS ANALYSIS WORKSHEETS

This Page Intentionally Left Blank

Timings
1: Harvill Av. & Cajalco Exwy./Ramona Exwy.

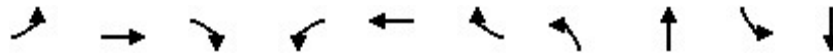

Lane Group	EBL	EBT	EBR	WBL	WBT	WBR	NBL	NBT	SBL	SBT
Lane Configurations	↙	↕↕	↘	↙↘	↕↕	↘	↙↘	↕↕	↙↘	↕↕
Traffic Volume (vph)	48	707	67	182	704	106	312	353	197	135
Future Volume (vph)	48	707	67	182	704	106	312	353	197	135
Turn Type	Prot	NA	Perm	Prot	NA	pm+ov	Prot	NA	Prot	NA
Protected Phases	5	2		1	6	7	3	8	7	4
Permitted Phases			2			6				
Detector Phase	5	2	2	1	6	7	3	8	7	4
Switch Phase										
Minimum Initial (s)	5.0	10.0	10.0	5.0	10.0	5.0	5.0	10.0	5.0	10.0
Minimum Split (s)	9.6	36.2	36.2	9.6	32.5	9.6	9.6	16.2	9.6	41.2
Total Split (s)	10.2	38.8	38.8	16.7	45.3	15.6	23.3	48.9	15.6	41.2
Total Split (%)	8.5%	32.3%	32.3%	13.9%	37.8%	13.0%	19.4%	40.8%	13.0%	34.3%
Yellow Time (s)	3.6	5.2	5.2	3.6	3.5	3.6	3.6	5.2	3.6	5.2
All-Red Time (s)	1.0	1.0	1.0	1.0	1.0	1.0	1.0	1.0	1.0	1.0
Lost Time Adjust (s)	0.0	0.0	0.0	0.0	0.0	0.0	0.0	0.0	0.0	0.0
Total Lost Time (s)	4.6	6.2	6.2	4.6	4.5	4.6	4.6	6.2	4.6	6.2
Lead/Lag	Lead	Lag	Lag	Lead	Lag	Lead	Lead	Lag	Lead	Lag
Lead-Lag Optimize?	Yes	Yes	Yes	Yes	Yes	Yes	Yes	Yes	Yes	Yes
Recall Mode	None	None	None	None	None	None	None	Max	None	Max
Act Effct Green (s)	5.5	28.8	28.8	10.3	37.4	51.9	14.9	42.9	10.0	38.0
Actuated g/C Ratio	0.05	0.25	0.25	0.09	0.33	0.46	0.13	0.38	0.09	0.33
v/c Ratio	0.60	0.83	0.13	0.62	0.64	0.14	0.73	0.35	0.69	0.15
Control Delay	82.9	49.2	0.5	59.6	35.6	3.7	57.7	25.8	63.4	25.7
Queue Delay	0.0	0.0	0.0	0.0	0.0	0.0	0.0	0.0	0.0	0.0
Total Delay	82.9	49.2	0.5	59.6	35.6	3.7	57.7	25.8	63.4	25.7
LOS	F	D	A	E	D	A	E	C	E	C
Approach Delay		47.2			36.6			39.1		46.3
Approach LOS		D			D			D		D

Intersection Summary

Cycle Length: 120
 Actuated Cycle Length: 113.6
 Natural Cycle: 100
 Control Type: Actuated-Uncoordinated
 Maximum v/c Ratio: 0.83
 Intersection Signal Delay: 41.4
 Intersection LOS: D
 Intersection Capacity Utilization 60.7%
 ICU Level of Service B
 Analysis Period (min) 15

Splits and Phases: 1: Harvill Av. & Cajalco Exwy./Ramona Exwy.

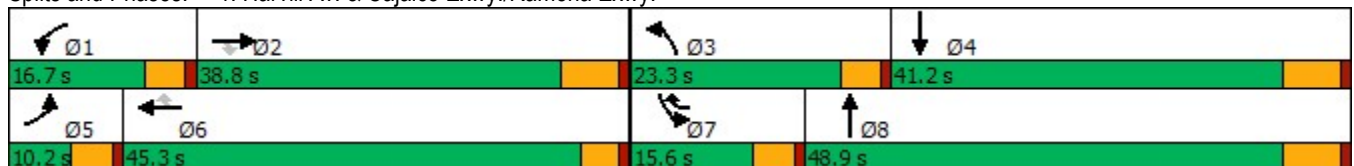

HCM 6th Signalized Intersection Summary
 1: Harvill Av. & Cajalco Exwy./Ramona Exwy.

Harvill Logistics (JN 14231)

06/16/2022

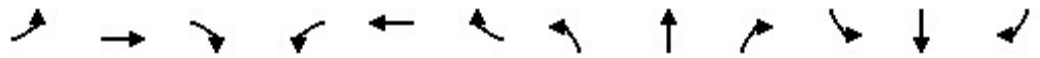

Movement	EBL	EBT	EBR	WBL	WBT	WBR	NBL	NBT	NBR	SBL	SBT	SBR
Lane Configurations	↘	↑↑	↗	↘↗	↑↑	↗	↘↗	↑↑		↘↗	↑↑	
Traffic Volume (veh/h)	48	707	67	182	704	106	312	353	80	197	135	28
Future Volume (veh/h)	48	707	67	182	704	106	312	353	80	197	135	28
Initial Q (Qb), veh	0	0	0	0	0	0	0	0	0	0	0	0
Ped-Bike Adj(A_pbT)	1.00		1.00	1.00		1.00	1.00		0.99	1.00		1.00
Parking Bus, Adj	1.00	1.00	1.00	1.00	1.00	1.00	1.00	1.00	1.00	1.00	1.00	1.00
Work Zone On Approach		No			No			No			No	
Adj Sat Flow, veh/h/ln	1900	1900	1900	1900	1900	1900	1900	1900	1900	1900	1900	1900
Adj Flow Rate, veh/h	52	760	21	196	757	46	335	380	32	212	145	28
Peak Hour Factor	0.93	0.93	0.93	0.93	0.93	0.93	0.93	0.93	0.93	0.93	0.93	0.93
Percent Heavy Veh, %	0	0	0	0	0	0	0	0	0	0	0	0
Cap, veh/h	67	896	400	261	1030	586	405	1339	112	276	1094	207
Arrive On Green	0.04	0.25	0.25	0.07	0.29	0.29	0.12	0.40	0.40	0.08	0.36	0.36
Sat Flow, veh/h	1810	3610	1610	3510	3610	1610	3510	3368	282	3510	3030	572
Grp Volume(v), veh/h	52	760	21	196	757	46	335	203	209	212	85	88
Grp Sat Flow(s),veh/h/ln	1810	1805	1610	1755	1805	1610	1755	1805	1845	1755	1805	1797
Q Serve(g_s), s	3.1	21.5	1.1	5.9	20.4	2.0	10.0	8.2	8.3	6.4	3.4	3.5
Cycle Q Clear(g_c), s	3.1	21.5	1.1	5.9	20.4	2.0	10.0	8.2	8.3	6.4	3.4	3.5
Prop In Lane	1.00		1.00	1.00		1.00	1.00		0.15	1.00		0.32
Lane Grp Cap(c), veh/h	67	896	400	261	1030	586	405	718	734	276	652	649
V/C Ratio(X)	0.77	0.85	0.05	0.75	0.73	0.08	0.83	0.28	0.29	0.77	0.13	0.14
Avail Cap(c_a), veh/h	94	1096	489	396	1372	738	611	718	734	360	652	649
HCM Platoon Ratio	1.00	1.00	1.00	1.00	1.00	1.00	1.00	1.00	1.00	1.00	1.00	1.00
Upstream Filter(I)	1.00	1.00	1.00	1.00	1.00	1.00	1.00	1.00	1.00	1.00	1.00	1.00
Uniform Delay (d), s/veh	51.2	38.4	30.7	48.7	34.7	22.4	46.5	21.9	22.0	48.5	23.0	23.0
Incr Delay (d2), s/veh	14.0	5.4	0.1	1.6	1.4	0.1	3.4	1.0	1.0	5.1	0.4	0.4
Initial Q Delay(d3),s/veh	0.0	0.0	0.0	0.0	0.0	0.0	0.0	0.0	0.0	0.0	0.0	0.0
%ile BackOfQ(50%),veh/ln	1.6	9.6	0.4	2.5	8.6	0.7	4.4	3.4	3.5	2.9	1.4	1.5
Unsig. Movement Delay, s/veh												
LnGrp Delay(d),s/veh	65.3	43.8	30.8	50.4	36.1	22.4	49.9	22.9	22.9	53.6	23.4	23.5
LnGrp LOS	E	D	C	D	D	C	D	C	C	D	C	C
Approach Vol, veh/h		833			999			747			385	
Approach Delay, s/veh		44.8			38.3			35.0			40.0	
Approach LOS		D			D			D			D	
Timer - Assigned Phs	1	2	3	4	5	6	7	8				
Phs Duration (G+Y+Rc), s	12.6	32.8	17.0	45.0	8.6	36.8	13.0	48.9				
Change Period (Y+Rc), s	4.6	6.2	4.6	6.2	4.6	* 6.2	4.6	6.2				
Max Green Setting (Gmax), s	12.1	32.6	18.7	35.0	5.6	* 41	11.0	42.7				
Max Q Clear Time (g_c+I1), s	7.9	23.5	12.0	5.5	5.1	22.4	8.4	10.3				
Green Ext Time (p_c), s	0.1	3.1	0.4	0.8	0.0	4.5	0.1	2.2				

Intersection Summary

HCM 6th Ctrl Delay	39.5
HCM 6th LOS	D

Notes

* HCM 6th computational engine requires equal clearance times for the phases crossing the barrier.

Intersection						
Int Delay, s/veh	0					
Movement	WBL	WBR	NBT	NBR	SBL	SBT
Lane Configurations		↗	↕	↗		↕
Traffic Vol, veh/h	0	2	825	0	0	344
Future Vol, veh/h	0	2	825	0	0	344
Conflicting Peds, #/hr	0	0	0	0	0	0
Sign Control	Stop	Stop	Free	Free	Free	Free
RT Channelized	-	None	-	None	-	None
Storage Length	-	0	-	100	-	-
Veh in Median Storage, #	2	-	0	-	-	0
Grade, %	0	-	0	-	-	0
Peak Hour Factor	92	92	92	92	92	92
Heavy Vehicles, %	0	0	0	0	0	0
Mvmt Flow	0	2	897	0	0	374

Major/Minor	Minor1	Major1	Major2		
Conflicting Flow All	-	449	0	0	-
Stage 1	-	-	-	-	-
Stage 2	-	-	-	-	-
Critical Hdwy	-	6.9	-	-	-
Critical Hdwy Stg 1	-	-	-	-	-
Critical Hdwy Stg 2	-	-	-	-	-
Follow-up Hdwy	-	3.3	-	-	-
Pot Cap-1 Maneuver	0	563	-	-	0
Stage 1	0	-	-	-	0
Stage 2	0	-	-	-	0
Platoon blocked, %			-	-	-
Mov Cap-1 Maneuver	-	563	-	-	-
Mov Cap-2 Maneuver	-	-	-	-	-
Stage 1	-	-	-	-	-
Stage 2	-	-	-	-	-

Approach	WB	NB	SB
HCM Control Delay, s	11.4	0	0
HCM LOS	B		

Minor Lane/Major Mvmt	NBT	NBRWBLn1	SBT
Capacity (veh/h)	-	-	563
HCM Lane V/C Ratio	-	-	0.004
HCM Control Delay (s)	-	-	11.4
HCM Lane LOS	-	-	B
HCM 95th %tile Q(veh)	-	-	0

Intersection												
Int Delay, s/veh	1.2											
Movement	EBL	EBT	EBR	WBL	WBT	WBR	NBL	NBT	NBR	SBL	SBT	SBR
Lane Configurations		↔			↔	↔	↔	↔		↔	↔	
Traffic Vol, veh/h	36	0	5	14	0	8	7	780	36	48	247	48
Future Vol, veh/h	36	0	5	14	0	8	7	780	36	48	247	48
Conflicting Peds, #/hr	0	0	0	0	0	0	0	0	0	0	0	0
Sign Control	Stop	Stop	Stop	Stop	Stop	Stop	Free	Free	Free	Free	Free	Free
RT Channelized	-	-	None	-	-	None	-	-	None	-	-	None
Storage Length	-	-	-	-	-	0	160	-	-	110	-	-
Veh in Median Storage, #	-	2	-	-	2	-	-	0	-	-	0	-
Grade, %	-	0	-	-	0	-	-	0	-	-	0	-
Peak Hour Factor	86	86	86	86	86	86	86	86	86	86	86	86
Heavy Vehicles, %	0	0	0	0	0	0	0	0	0	0	0	0
Mvmt Flow	42	0	6	16	0	9	8	907	42	56	287	56

Major/Minor	Minor2		Minor1		Major1		Major2					
Conflicting Flow All	897	1392	172	1200	1399	475	343	0	0	949	0	0
Stage 1	427	427	-	944	944	-	-	-	-	-	-	-
Stage 2	470	965	-	256	455	-	-	-	-	-	-	-
Critical Hdwy	6.5	6.5	6.9	6.5	6.5	6.9	4.1	-	-	4.1	-	-
Critical Hdwy Stg 1	6.5	5.5	-	6.5	5.5	-	-	-	-	-	-	-
Critical Hdwy Stg 2	6.5	5.5	-	6.5	5.5	-	-	-	-	-	-	-
Follow-up Hdwy	3.5	4	3.3	3.5	4	3.3	2.2	-	-	2.2	-	-
Pot Cap-1 Maneuver	305	143	848	200	142	541	1227	-	-	732	-	-
Stage 1	581	589	-	286	344	-	-	-	-	-	-	-
Stage 2	548	336	-	732	572	-	-	-	-	-	-	-
Platoon blocked, %								-	-	-	-	-
Mov Cap-1 Maneuver	281	131	848	186	130	541	1227	-	-	732	-	-
Mov Cap-2 Maneuver	415	252	-	266	292	-	-	-	-	-	-	-
Stage 1	577	544	-	284	342	-	-	-	-	-	-	-
Stage 2	535	334	-	671	528	-	-	-	-	-	-	-

Approach	EB		WB		NB		SB	
HCM Control Delay, s	14.1		16.6		0.1		1.4	
HCM LOS	B		C					

Minor Lane/Major Mvmt	NBL	NBT	NBR	EBLn1	WBLn1	WBLn2	SBL	SBT	SBR
Capacity (veh/h)	1227	-	-	443	266	541	732	-	-
HCM Lane V/C Ratio	0.007	-	-	0.108	0.061	0.017	0.076	-	-
HCM Control Delay (s)	8	-	-	14.1	19.4	11.8	10.3	-	-
HCM Lane LOS	A	-	-	B	C	B	B	-	-
HCM 95th %tile Q(veh)	0	-	-	0.4	0.2	0.1	0.2	-	-

Intersection						
Int Delay, s/veh	3.9					
Movement	EBL	EBT	WBT	WBR	SBL	SBR
Lane Configurations		↶	↷		↶	
Traffic Vol, veh/h	49	36	16	0	0	7
Future Vol, veh/h	49	36	16	0	0	7
Conflicting Peds, #/hr	0	0	0	0	0	0
Sign Control	Free	Free	Free	Free	Stop	Stop
RT Channelized	-	None	-	None	-	None
Storage Length	-	-	-	-	0	-
Veh in Median Storage, #	-	0	0	-	0	-
Grade, %	-	0	0	-	0	-
Peak Hour Factor	92	92	92	92	92	92
Heavy Vehicles, %	0	0	0	0	0	0
Mvmt Flow	53	39	17	0	0	8

Major/Minor	Major1	Major2	Minor2		
Conflicting Flow All	17	0	-	0	162
Stage 1	-	-	-	-	17
Stage 2	-	-	-	-	145
Critical Hdwy	4.1	-	-	-	6.4
Critical Hdwy Stg 1	-	-	-	-	5.4
Critical Hdwy Stg 2	-	-	-	-	5.4
Follow-up Hdwy	2.2	-	-	-	3.5
Pot Cap-1 Maneuver	1613	-	-	-	834
Stage 1	-	-	-	-	1011
Stage 2	-	-	-	-	887
Platoon blocked, %		-	-	-	
Mov Cap-1 Maneuver	1613	-	-	-	806
Mov Cap-2 Maneuver	-	-	-	-	806
Stage 1	-	-	-	-	977
Stage 2	-	-	-	-	887

Approach	EB	WB	SB
HCM Control Delay, s	4.2	0	8.4
HCM LOS			A

Minor Lane/Major Mvmt	EBL	EBT	WBT	WBR	SBLn1
Capacity (veh/h)	1613	-	-	-	1068
HCM Lane V/C Ratio	0.033	-	-	-	0.007
HCM Control Delay (s)	7.3	0	-	-	8.4
HCM Lane LOS	A	A	-	-	A
HCM 95th %tile Q(veh)	0.1	-	-	-	0

Intersection	
Intersection Delay, s/veh	6.9
Intersection LOS	A

Movement	EBL	EBR	NBL	NBT	SBT	SBR
Lane Configurations	W			↑	↑	
Traffic Vol, veh/h	19	17	10	0	0	6
Future Vol, veh/h	19	17	10	0	0	6
Peak Hour Factor	0.92	0.92	0.92	0.92	0.92	0.92
Heavy Vehicles, %	0	0	0	0	0	0
Mvmt Flow	21	18	11	0	0	7
Number of Lanes	1	0	0	1	1	0

Approach	EB	NB	SB
Opposing Approach		SB	NB
Opposing Lanes	0	1	1
Conflicting Approach Left	SB	EB	
Conflicting Lanes Left	1	1	0
Conflicting Approach Right	NB		EB
Conflicting Lanes Right	1	0	1
HCM Control Delay	6.9	7.2	6.4
HCM LOS	A	A	A

Lane	NBLn1	EBLn1	SBLn1
Vol Left, %	100%	53%	0%
Vol Thru, %	0%	0%	0%
Vol Right, %	0%	47%	100%
Sign Control	Stop	Stop	Stop
Traffic Vol by Lane	10	36	6
LT Vol	10	19	0
Through Vol	0	0	0
RT Vol	0	17	6
Lane Flow Rate	11	39	7
Geometry Grp	1	1	1
Degree of Util (X)	0.013	0.041	0.006
Departure Headway (Hd)	4.174	3.753	3.377
Convergence, Y/N	Yes	Yes	Yes
Cap	860	958	1062
Service Time	2.186	1.759	1.391
HCM Lane V/C Ratio	0.013	0.041	0.007
HCM Control Delay	7.2	6.9	6.4
HCM Lane LOS	A	A	A
HCM 95th-tile Q	0	0.1	0

Timings
6: I-215 SB Ramps & Ramona Exwy.



Lane Group	EBT	WBL	WBT	SBL	SBT	SBR
Lane Configurations	↑↑	↵	↑↑	↵	↵	↵
Traffic Volume (vph)	408	275	936	830	2	171
Future Volume (vph)	408	275	936	830	2	171
Turn Type	NA	Prot	NA	Split	NA	Perm
Protected Phases	2	1	6	4	4	
Permitted Phases						4
Detector Phase	2	1	6	4	4	4
Switch Phase						
Minimum Initial (s)	5.0	5.0	5.0	5.0	5.0	5.0
Minimum Split (s)	11.0	9.5	31.0	10.5	10.5	10.5
Total Split (s)	44.0	27.0	71.0	39.0	39.0	39.0
Total Split (%)	40.0%	24.5%	64.5%	35.5%	35.5%	35.5%
Yellow Time (s)	5.0	3.5	5.0	4.5	4.5	4.5
All-Red Time (s)	1.0	1.0	1.0	1.0	1.0	1.0
Lost Time Adjust (s)	0.0	0.0	0.0	0.0	0.0	0.0
Total Lost Time (s)	6.0	4.5	6.0	5.5	5.5	5.5
Lead/Lag	Lag	Lead				
Lead-Lag Optimize?	Yes	Yes				
Recall Mode	C-Max	None	C-Max	Max	Max	Max
Act Effct Green (s)	40.0	20.5	65.0	33.5	33.5	33.5
Actuated g/C Ratio	0.36	0.19	0.59	0.30	0.30	0.30
v/c Ratio	0.53	0.84	0.45	0.81	0.81	0.30
Control Delay	22.3	39.6	5.7	49.1	49.4	10.4
Queue Delay	0.0	0.0	0.5	53.3	53.2	0.0
Total Delay	22.3	39.6	6.2	102.4	102.6	10.4
LOS	C	D	A	F	F	B
Approach Delay	22.3		13.8		86.9	
Approach LOS	C		B		F	

Intersection Summary

Cycle Length: 110
 Actuated Cycle Length: 110
 Offset: 34 (31%), Referenced to phase 2:EBT and 6:WBT, Start of Yellow
 Natural Cycle: 60
 Control Type: Actuated-Coordinated
 Maximum v/c Ratio: 0.84
 Intersection Signal Delay: 41.0
 Intersection LOS: D
 Intersection Capacity Utilization 118.3%
 ICU Level of Service H
 Analysis Period (min) 15

Splits and Phases: 6: I-215 SB Ramps & Ramona Exwy.



HCM 6th Signalized Intersection Summary
6: I-215 SB Ramps & Ramona Exwy.

Harvill Logistics (JN 14231)

06/16/2022

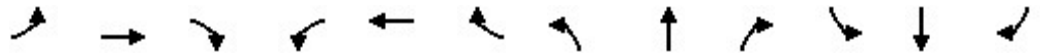

Movement	EBL	EBT	EBR	WBL	WBT	WBR	NBL	NBT	NBR	SBL	SBT	SBR
Lane Configurations		↑↑		↖	↑↑					↖	↖	↖
Traffic Volume (veh/h)	0	408	284	275	936	0	0	0	0	830	2	171
Future Volume (veh/h)	0	408	284	275	936	0	0	0	0	830	2	171
Initial Q (Qb), veh	0	0	0	0	0	0				0	0	0
Ped-Bike Adj(A_pbT)	1.00		0.99	1.00		1.00				1.00		1.00
Parking Bus, Adj	1.00	1.00	1.00	1.00	1.00	1.00				1.00	1.00	1.00
Work Zone On Approach		No			No						No	
Adj Sat Flow, veh/h/ln	0	1900	1900	1900	1900	0				1900	1900	1900
Adj Flow Rate, veh/h	0	416	161	281	955	0				848	0	111
Peak Hour Factor	0.98	0.98	0.98	0.98	0.98	0.98				0.98	0.98	0.98
Percent Heavy Veh, %	0	0	0	0	0	0				0	0	0
Cap, veh/h	0	956	366	315	2133	0				1102	0	490
Arrive On Green	0.00	0.38	0.38	0.10	0.35	0.00				0.30	0.00	0.30
Sat Flow, veh/h	0	2638	973	1810	3705	0				3619	0	1610
Grp Volume(v), veh/h	0	294	283	281	955	0				848	0	111
Grp Sat Flow(s),veh/h/ln	0	1805	1710	1810	1805	0				1810	0	1610
Q Serve(g_s), s	0.0	13.3	13.6	16.9	22.3	0.0				23.4	0.0	5.7
Cycle Q Clear(g_c), s	0.0	13.3	13.6	16.9	22.3	0.0				23.4	0.0	5.7
Prop In Lane	0.00		0.57	1.00		0.00				1.00		1.00
Lane Grp Cap(c), veh/h	0	679	643	315	2133	0				1102	0	490
V/C Ratio(X)	0.00	0.43	0.44	0.89	0.45	0.00				0.77	0.00	0.23
Avail Cap(c_a), veh/h	0	679	643	370	2133	0				1102	0	490
HCM Platoon Ratio	1.00	1.00	1.00	0.60	0.60	1.00				1.00	1.00	1.00
Upstream Filter(I)	0.00	0.50	0.50	0.81	0.81	0.00				1.00	0.00	1.00
Uniform Delay (d), s/veh	0.0	25.6	25.7	48.2	21.7	0.0				34.7	0.0	28.6
Incr Delay (d2), s/veh	0.0	1.0	1.1	17.5	0.6	0.0				5.2	0.0	1.1
Initial Q Delay(d3),s/veh	0.0	0.0	0.0	0.0	0.0	0.0				0.0	0.0	0.0
%ile BackOfQ(50%),veh/ln	0.0	5.6	5.4	9.3	10.1	0.0				10.6	0.0	2.3
Unsig. Movement Delay, s/veh												
LnGrp Delay(d),s/veh	0.0	26.6	26.8	65.8	22.3	0.0				39.9	0.0	29.6
LnGrp LOS	A	C	C	E	C	A				D	A	C
Approach Vol, veh/h		577			1236						959	
Approach Delay, s/veh		26.7			32.2						38.7	
Approach LOS		C			C						D	
Timer - Assigned Phs	1	2		4		6						
Phs Duration (G+Y+Rc), s	23.6	47.4		39.0		71.0						
Change Period (Y+Rc), s	4.5	6.0		5.5		6.0						
Max Green Setting (Gmax), s	22.5	38.0		33.5		65.0						
Max Q Clear Time (g_c+I1), s	18.9	15.6		25.4		24.3						
Green Ext Time (p_c), s	0.3	1.9		2.4		4.2						

Intersection Summary

HCM 6th Ctrl Delay	33.3
HCM 6th LOS	C

Notes

User approved volume balancing among the lanes for turning movement.

Timings
7: I-215 NB Ramps & Ramona Exwy.



Lane Group	EBL	EBT	WBT	WBR	NBL	NBT	NBR
Lane Configurations	↶	↷	↶	↷	↶	↷	↷
Traffic Volume (vph)	125	1114	900	577	310	4	478
Future Volume (vph)	125	1114	900	577	310	4	478
Turn Type	Prot	NA	NA	Perm	Split	NA	Perm
Protected Phases	5	2	6		8	8	
Permitted Phases				6			8
Detector Phase	5	2	6	6	8	8	8
Switch Phase							
Minimum Initial (s)	5.0	5.0	5.0	5.0	5.0	5.0	5.0
Minimum Split (s)	9.5	11.0	26.0	26.0	10.5	10.5	10.5
Total Split (s)	23.0	68.0	45.0	45.0	42.0	42.0	42.0
Total Split (%)	20.9%	61.8%	40.9%	40.9%	38.2%	38.2%	38.2%
Yellow Time (s)	3.5	5.0	5.0	5.0	4.5	4.5	4.5
All-Red Time (s)	1.0	1.0	1.0	1.0	1.0	1.0	1.0
Lost Time Adjust (s)	0.0	0.0	0.0	0.0	0.0	0.0	0.0
Total Lost Time (s)	4.5	6.0	6.0	6.0	5.5	5.5	5.5
Lead/Lag	Lead		Lag	Lag			
Lead-Lag Optimize?	Yes		Yes	Yes			
Recall Mode	None	C-Max	C-Max	C-Max	None	None	None
Act Effct Green (s)	13.1	65.1	47.5	47.5	33.4	33.4	33.4
Actuated g/C Ratio	0.12	0.59	0.43	0.43	0.30	0.30	0.30
v/c Ratio	0.60	0.54	0.59	0.59	0.31	0.31	0.91
Control Delay	50.7	13.6	27.4	5.7	30.4	30.3	53.3
Queue Delay	0.0	15.8	0.0	0.0	0.0	0.0	0.0
Total Delay	50.7	29.4	27.4	5.7	30.4	30.3	53.3
LOS	D	C	C	A	C	C	D
Approach Delay		31.5	18.9			44.2	
Approach LOS		C	B			D	

Intersection Summary

Cycle Length: 110
 Actuated Cycle Length: 110
 Offset: 0 (0%), Referenced to phase 2:EBT and 6:WBT, Start of Yellow, Master Intersection
 Natural Cycle: 60
 Control Type: Actuated-Coordinated
 Maximum v/c Ratio: 0.91
 Intersection Signal Delay: 29.1
 Intersection Capacity Utilization 118.3%
 Analysis Period (min) 15
 Intersection LOS: C
 ICU Level of Service H

Splits and Phases: 7: I-215 NB Ramps & Ramona Exwy.

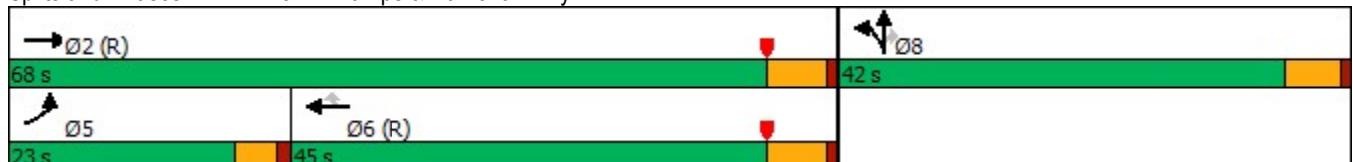

HCM 6th Signalized Intersection Summary
 7: I-215 NB Ramps & Ramona Exwy.

Harvill Logistics (JN 14231)

06/16/2022

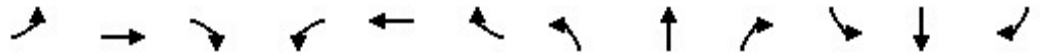

Movement	EBL	EBT	EBR	WBL	WBT	WBR	NBL	NBT	NBR	SBL	SBT	SBR
Lane Configurations	↘	↑↑			↑↑	↗	↘	↗	↗			
Traffic Volume (veh/h)	125	1114	0	0	900	577	310	4	478	0	0	0
Future Volume (veh/h)	125	1114	0	0	900	577	310	4	478	0	0	0
Initial Q (Qb), veh	0	0	0	0	0	0	0	0	0			
Ped-Bike Adj(A_pbT)	1.00		1.00	1.00		1.00	1.00		1.00			
Parking Bus, Adj	1.00	1.00	1.00	1.00	1.00	1.00	1.00	1.00	1.00			
Work Zone On Approach		No			No			No				
Adj Sat Flow, veh/h/ln	1900	1900	0	0	1900	1900	1900	1900	1900			
Adj Flow Rate, veh/h	129	1148	0	0	928	447	323	0	341			
Peak Hour Factor	0.97	0.97	0.97	0.97	0.97	0.97	0.97	0.97	0.97			
Percent Heavy Veh, %	0	0	0	0	0	0	0	0	0			
Cap, veh/h	157	2367	0	0	1906	850	868	0	386			
Arrive On Green	0.17	1.00	0.00	0.00	0.53	0.53	0.24	0.00	0.24			
Sat Flow, veh/h	1810	3705	0	0	3705	1610	3619	0	1610			
Grp Volume(v), veh/h	129	1148	0	0	928	447	323	0	341			
Grp Sat Flow(s),veh/h/ln	1810	1805	0	0	1805	1610	1810	0	1610			
Q Serve(g_s), s	7.6	0.0	0.0	0.0	18.0	20.0	8.2	0.0	22.5			
Cycle Q Clear(g_c), s	7.6	0.0	0.0	0.0	18.0	20.0	8.2	0.0	22.5			
Prop In Lane	1.00		0.00	0.00		1.00	1.00		1.00			
Lane Grp Cap(c), veh/h	157	2367	0	0	1906	850	868	0	386			
V/C Ratio(X)	0.82	0.48	0.00	0.00	0.49	0.53	0.37	0.00	0.88			
Avail Cap(c_a), veh/h	304	2367	0	0	1906	850	1201	0	534			
HCM Platoon Ratio	2.00	2.00	1.00	1.00	1.00	1.00	1.00	1.00	1.00			
Upstream Filter(I)	0.73	0.73	0.00	0.00	1.00	1.00	1.00	0.00	1.00			
Uniform Delay (d), s/veh	44.6	0.0	0.0	0.0	16.5	17.0	34.9	0.0	40.3			
Incr Delay (d2), s/veh	7.6	0.5	0.0	0.0	0.9	2.3	0.3	0.0	12.4			
Initial Q Delay(d3),s/veh	0.0	0.0	0.0	0.0	0.0	0.0	0.0	0.0	0.0			
%ile BackOfQ(50%),veh/ln	3.3	0.2	0.0	0.0	6.9	7.1	3.5	0.0	9.8			
Unsig. Movement Delay, s/veh												
LnGrp Delay(d),s/veh	52.2	0.5	0.0	0.0	17.4	19.3	35.2	0.0	52.7			
LnGrp LOS	D	A	A	A	B	B	D	A	D			
Approach Vol, veh/h		1277			1375			664				
Approach Delay, s/veh		5.7			18.0			44.2				
Approach LOS		A			B			D				
Timer - Assigned Phs		2			5	6		8				
Phs Duration (G+Y+Rc), s		78.1			14.0	64.1		31.9				
Change Period (Y+Rc), s		6.0			4.5	6.0		5.5				
Max Green Setting (Gmax), s		62.0			18.5	39.0		36.5				
Max Q Clear Time (g_c+I1), s		2.0			9.6	22.0		24.5				
Green Ext Time (p_c), s		5.4			0.2	4.4		1.9				

Intersection Summary

HCM 6th Ctrl Delay	18.5
HCM 6th LOS	B

Notes

User approved volume balancing among the lanes for turning movement.

Timings
8: I-215 SB Ramps & Placentia Av.

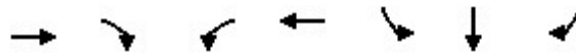

Lane Group	EBT	EBR	WBL	WBT	SBL	SBT	SBR
Lane Configurations	↑↑	↑	↑↑	↑↑	↑	↑	↑
Traffic Volume (vph)	533	127	144	477	269	0	75
Future Volume (vph)	533	127	144	477	269	0	75
Turn Type	NA	Perm	Prot	NA	Split	NA	Perm
Protected Phases	2		1	6	4	4	
Permitted Phases		2					4
Detector Phase	2	2	1	6	4	4	4
Switch Phase							
Minimum Initial (s)	10.0	10.0	5.0	10.0	10.0	10.0	10.0
Minimum Split (s)	27.8	27.8	9.6	27.8	15.8	15.8	15.8
Total Split (s)	29.8	29.8	11.6	41.4	18.6	18.6	18.6
Total Split (%)	49.7%	49.7%	19.3%	69.0%	31.0%	31.0%	31.0%
Yellow Time (s)	4.8	4.8	3.6	4.8	4.8	4.8	4.8
All-Red Time (s)	1.0	1.0	1.0	1.0	1.0	1.0	1.0
Lost Time Adjust (s)	0.0	0.0	0.0	0.0	0.0	0.0	0.0
Total Lost Time (s)	5.8	5.8	4.6	5.8	5.8	5.8	5.8
Lead/Lag	Lag	Lag	Lead				
Lead-Lag Optimize?	Yes	Yes	Yes				
Recall Mode	None	None	None	C-Max	Max	Max	Max
Act Effct Green (s)	26.5	26.5	6.4	35.6	12.8	12.8	12.8
Actuated g/C Ratio	0.44	0.44	0.11	0.59	0.21	0.21	0.21
v/c Ratio	0.36	0.17	0.42	0.24	0.40	0.40	0.18
Control Delay	12.9	3.2	26.6	4.9	24.2	24.2	2.6
Queue Delay	0.0	0.0	0.0	0.0	0.0	0.0	0.0
Total Delay	12.9	3.2	26.6	4.9	24.2	24.2	2.6
LOS	B	A	C	A	C	C	A
Approach Delay	11.0			10.0		19.4	
Approach LOS	B			A		B	

Intersection Summary

Cycle Length: 60
 Actuated Cycle Length: 60
 Offset: 0 (0%), Referenced to phase 6:WBT, Start of Yellow, Master Intersection
 Natural Cycle: 55
 Control Type: Actuated-Coordinated
 Maximum v/c Ratio: 0.42
 Intersection Signal Delay: 12.4
 Intersection Capacity Utilization 45.7%
 Analysis Period (min) 15
 Intersection LOS: B
 ICU Level of Service A

Splits and Phases: 8: I-215 SB Ramps & Placentia Av.



HCM 6th Signalized Intersection Summary
 8: I-215 SB Ramps & Placentia Av.

Harvill Logistics (JN 14231)

06/16/2022



Movement	EBL	EBT	EBR	WBL	WBT	WBR	NBL	NBT	NBR	SBL	SBT	SBR
Lane Configurations		↑↑	↗	↘↗	↑↑					↘	↗	↗
Traffic Volume (veh/h)	0	533	127	144	477	0	0	0	0	269	0	75
Future Volume (veh/h)	0	533	127	144	477	0	0	0	0	269	0	75
Initial Q (Qb), veh	0	0	0	0	0	0				0	0	0
Ped-Bike Adj(A_pbT)	1.00		1.00	1.00		1.00				1.00		1.00
Parking Bus, Adj	1.00	1.00	1.00	1.00	1.00	1.00				1.00	1.00	1.00
Work Zone On Approach		No			No						No	
Adj Sat Flow, veh/h/ln	0	1900	1900	1900	1900	0				1900	1900	1900
Adj Flow Rate, veh/h	0	579	138	157	518	0				292	0	82
Peak Hour Factor	0.92	0.92	0.92	0.92	0.92	0.92				0.92	0.92	0.92
Percent Heavy Veh, %	0	0	0	0	0	0				0	0	0
Cap, veh/h	0	1586	708	271	2142	0				772	0	344
Arrive On Green	0.00	0.44	0.44	0.15	1.00	0.00				0.21	0.00	0.21
Sat Flow, veh/h	0	3705	1610	3510	3705	0				3619	0	1610
Grp Volume(v), veh/h	0	579	138	157	518	0				292	0	82
Grp Sat Flow(s),veh/h/ln	0	1805	1610	1755	1805	0				1810	0	1610
Q Serve(g_s), s	0.0	6.4	3.2	2.5	0.0	0.0				4.1	0.0	2.5
Cycle Q Clear(g_c), s	0.0	6.4	3.2	2.5	0.0	0.0				4.1	0.0	2.5
Prop In Lane	0.00		1.00	1.00		0.00				1.00		1.00
Lane Grp Cap(c), veh/h	0	1586	708	271	2142	0				772	0	344
V/C Ratio(X)	0.00	0.36	0.20	0.58	0.24	0.00				0.38	0.00	0.24
Avail Cap(c_a), veh/h	0	1586	708	410	2142	0				772	0	344
HCM Platoon Ratio	1.00	1.00	1.00	2.00	2.00	1.00				1.00	1.00	1.00
Upstream Filter(I)	0.00	1.00	1.00	0.97	0.97	0.00				1.00	0.00	1.00
Uniform Delay (d), s/veh	0.0	11.2	10.3	24.5	0.0	0.0				20.2	0.0	19.6
Incr Delay (d2), s/veh	0.0	0.1	0.1	0.7	0.3	0.0				1.4	0.0	1.6
Initial Q Delay(d3),s/veh	0.0	0.0	0.0	0.0	0.0	0.0				0.0	0.0	0.0
%ile BackOfQ(50%),veh/ln	0.0	2.0	0.9	0.9	0.1	0.0				1.7	0.0	1.0
Unsig. Movement Delay, s/veh												
LnGrp Delay(d),s/veh	0.0	11.4	10.4	25.2	0.3	0.0				21.6	0.0	21.2
LnGrp LOS	A	B	B	C	A	A				C	A	C
Approach Vol, veh/h		717			675						374	
Approach Delay, s/veh		11.2			6.1						21.5	
Approach LOS		B			A						C	
Timer - Assigned Phs	1	2		4		6						
Phs Duration (G+Y+Rc), s	9.2	32.2		18.6		41.4						
Change Period (Y+Rc), s	4.6	5.8		5.8		5.8						
Max Green Setting (Gmax), s	7.0	24.0		12.8		35.6						
Max Q Clear Time (g_c+I1), s	4.5	8.4		6.1		2.0						
Green Ext Time (p_c), s	0.1	3.5		0.7		3.4						

Intersection Summary

HCM 6th Ctrl Delay	11.4
HCM 6th LOS	B

Notes

User approved volume balancing among the lanes for turning movement.

Timings
9: I-215 NB Ramps & Placentia Av.



Lane Group	EBL	EBT	WBT	WBR	NBL	NBT	NBR
Lane Configurations	↗↗	↗↗	↗↗	↗	↗	↗	↗
Traffic Volume (vph)	79	722	422	309	199	0	260
Future Volume (vph)	79	722	422	309	199	0	260
Turn Type	Prot	NA	NA	Perm	Split	NA	Perm
Protected Phases	5	2	6		8	8	
Permitted Phases				6			8
Detector Phase	5	2	6	6	8	8	8
Switch Phase							
Minimum Initial (s)	5.0	10.0	10.0	10.0	10.0	10.0	10.0
Minimum Split (s)	9.6	27.8	27.8	27.8	15.8	15.8	15.8
Total Split (s)	11.6	42.2	30.6	30.6	17.8	17.8	17.8
Total Split (%)	19.3%	70.3%	51.0%	51.0%	29.7%	29.7%	29.7%
Yellow Time (s)	3.6	4.8	4.8	4.8	4.8	4.8	4.8
All-Red Time (s)	1.0	1.0	1.0	1.0	1.0	1.0	1.0
Lost Time Adjust (s)	0.0	0.0	0.0	0.0	0.0	0.0	0.0
Total Lost Time (s)	4.6	5.8	5.8	5.8	5.8	5.8	5.8
Lead/Lag	Lead		Lag	Lag			
Lead-Lag Optimize?	Yes		Yes	Yes			
Recall Mode	None	C-Max	C-Max	C-Max	None	None	None
Act Effct Green (s)	5.9	37.6	29.0	29.0	10.8	10.8	10.8
Actuated g/C Ratio	0.10	0.63	0.48	0.48	0.18	0.18	0.18
v/c Ratio	0.25	0.35	0.26	0.35	0.35	0.35	0.62
Control Delay	21.4	4.5	10.8	2.8	24.8	24.8	14.1
Queue Delay	0.0	0.0	0.0	0.0	0.0	0.0	0.0
Total Delay	21.4	4.5	10.8	2.8	24.8	24.8	14.1
LOS	C	A	B	A	C	C	B
Approach Delay		6.2	7.4			18.8	
Approach LOS		A	A			B	

Intersection Summary

Cycle Length: 60
 Actuated Cycle Length: 60
 Offset: 0 (0%), Referenced to phase 2:EBT and 6:WBT, Start of Yellow
 Natural Cycle: 55
 Control Type: Actuated-Coordinated
 Maximum v/c Ratio: 0.62
 Intersection Signal Delay: 9.5
 Intersection Capacity Utilization 45.7%
 Analysis Period (min) 15

Intersection LOS: A
 ICU Level of Service A

Splits and Phases: 9: I-215 NB Ramps & Placentia Av.



HCM 6th Signalized Intersection Summary
 9: I-215 NB Ramps & Placentia Av.

Harvill Logistics (JN 14231)

06/16/2022

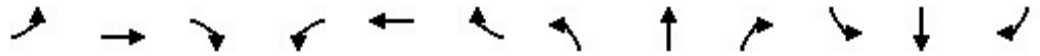

Movement	EBL	EBT	EBR	WBL	WBT	WBR	NBL	NBT	NBR	SBL	SBT	SBR
Lane Configurations	↖↗	↖↖			↖↖	↖↗	↖↗	↖↖	↖↗			
Traffic Volume (veh/h)	79	722	0	0	422	309	199	0	260	0	0	0
Future Volume (veh/h)	79	722	0	0	422	309	199	0	260	0	0	0
Initial Q (Qb), veh	0	0	0	0	0	0	0	0	0			
Ped-Bike Adj(A_pbT)	1.00		1.00	1.00		1.00	1.00		1.00			
Parking Bus, Adj	1.00	1.00	1.00	1.00	1.00	1.00	1.00	1.00	1.00			
Work Zone On Approach		No			No			No				
Adj Sat Flow, veh/h/ln	1900	1900	0	0	1900	1900	1900	1900	1900			
Adj Flow Rate, veh/h	86	785	0	0	459	336	216	0	283			
Peak Hour Factor	0.92	0.92	0.92	0.92	0.92	0.92	0.92	0.92	0.92			
Percent Heavy Veh, %	0	0	0	0	0	0	0	0	0			
Cap, veh/h	223	2190	0	0	1684	751	724	0	322			
Arrive On Green	0.06	0.61	0.00	0.00	0.47	0.47	0.20	0.00	0.20			
Sat Flow, veh/h	3510	3705	0	0	3705	1610	3619	0	1610			
Grp Volume(v), veh/h	86	785	0	0	459	336	216	0	283			
Grp Sat Flow(s),veh/h/ln	1755	1805	0	0	1805	1610	1810	0	1610			
Q Serve(g_s), s	1.4	6.6	0.0	0.0	4.7	8.4	3.0	0.0	10.2			
Cycle Q Clear(g_c), s	1.4	6.6	0.0	0.0	4.7	8.4	3.0	0.0	10.2			
Prop In Lane	1.00		0.00	0.00		1.00	1.00		1.00			
Lane Grp Cap(c), veh/h	223	2190	0	0	1684	751	724	0	322			
V/C Ratio(X)	0.39	0.36	0.00	0.00	0.27	0.45	0.30	0.00	0.88			
Avail Cap(c_a), veh/h	410	2190	0	0	1684	751	724	0	322			
HCM Platoon Ratio	1.00	1.00	1.00	1.00	1.00	1.00	1.00	1.00	1.00			
Upstream Filter(l)	0.94	0.94	0.00	0.00	1.00	1.00	1.00	0.00	1.00			
Uniform Delay (d), s/veh	27.0	5.9	0.0	0.0	9.8	10.8	20.4	0.0	23.3			
Incr Delay (d2), s/veh	0.4	0.4	0.0	0.0	0.4	1.9	0.2	0.0	23.1			
Initial Q Delay(d3),s/veh	0.0	0.0	0.0	0.0	0.0	0.0	0.0	0.0	0.0			
%ile BackOfQ(50%),veh/ln	0.5	1.6	0.0	0.0	1.5	2.7	1.1	0.0	5.4			
Unsig. Movement Delay, s/veh												
LnGrp Delay(d),s/veh	27.4	6.4	0.0	0.0	10.2	12.7	20.6	0.0	46.4			
LnGrp LOS	C	A	A	A	B	B	C	A	D			
Approach Vol, veh/h		871			795			499				
Approach Delay, s/veh		8.4			11.3			35.2				
Approach LOS		A			B			D				
Timer - Assigned Phs		2			5	6		8				
Phs Duration (G+Y+Rc), s		42.2			8.4	33.8		17.8				
Change Period (Y+Rc), s		5.8			4.6	5.8		5.8				
Max Green Setting (Gmax), s		36.4			7.0	24.8		12.0				
Max Q Clear Time (g_c+I1), s		8.6			3.4	10.4		12.2				
Green Ext Time (p_c), s		5.4			0.0	3.4		0.0				

Intersection Summary

HCM 6th Ctrl Delay	15.6
HCM 6th LOS	B

Notes

User approved volume balancing among the lanes for turning movement.

Timings
1: Harvill Av. & Cajalco Exwy./Ramona Exwy.

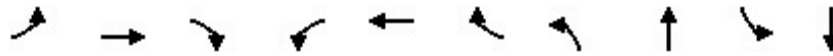

Lane Group	EBL	EBT	EBR	WBL	WBT	WBR	NBL	NBT	SBL	SBT
Lane Configurations	↙	↑↑	↗	↙↗	↑↑	↗	↙↗	↑↔	↙↗	↑↔
Traffic Volume (vph)	25	752	218	139	663	195	184	163	231	223
Future Volume (vph)	25	752	218	139	663	195	184	163	231	223
Turn Type	Prot	NA	Perm	Prot	NA	pm+ov	Prot	NA	Prot	NA
Protected Phases	5	2		1	6	7	3	8	7	4
Permitted Phases			2			6				
Detector Phase	5	2	2	1	6	7	3	8	7	4
Switch Phase										
Minimum Initial (s)	5.0	10.0	10.0	5.0	10.0	5.0	5.0	10.0	5.0	10.0
Minimum Split (s)	9.6	36.2	36.2	9.6	32.5	9.6	9.6	16.2	9.6	41.2
Total Split (s)	10.2	38.8	38.8	16.7	45.3	15.6	23.3	48.9	15.6	41.2
Total Split (%)	8.5%	32.3%	32.3%	13.9%	37.8%	13.0%	19.4%	40.8%	13.0%	34.3%
Yellow Time (s)	3.6	5.2	5.2	3.6	3.5	3.6	3.6	5.2	3.6	5.2
All-Red Time (s)	1.0	1.0	1.0	1.0	1.0	1.0	1.0	1.0	1.0	1.0
Lost Time Adjust (s)	0.0	0.0	0.0	0.0	0.0	0.0	0.0	0.0	0.0	0.0
Total Lost Time (s)	4.6	6.2	6.2	4.6	4.5	4.6	4.6	6.2	4.6	6.2
Lead/Lag	Lead	Lag	Lag	Lead	Lag	Lead	Lead	Lag	Lead	Lag
Lead-Lag Optimize?	Yes	Yes	Yes	Yes	Yes	Yes	Yes	Yes	Yes	Yes
Recall Mode	None	None	None	None	None	None	None	Max	None	Max
Act Effct Green (s)	5.4	30.0	30.0	9.2	39.7	54.7	10.9	42.8	10.5	42.5
Actuated g/C Ratio	0.05	0.26	0.26	0.08	0.35	0.48	0.10	0.37	0.09	0.37
v/c Ratio	0.32	0.85	0.39	0.53	0.57	0.24	0.60	0.24	0.77	0.21
Control Delay	64.8	50.1	6.3	58.1	33.1	3.1	57.8	14.2	67.9	25.0
Queue Delay	0.0	0.0	0.0	0.0	0.0	0.0	0.0	0.0	0.0	0.0
Total Delay	64.8	50.1	6.3	58.1	33.1	3.1	57.8	14.2	67.9	25.0
LOS	E	D	A	E	C	A	E	B	E	C
Approach Delay		40.9			30.7			30.7		45.2
Approach LOS		D			C			C		D

Intersection Summary

Cycle Length: 120
 Actuated Cycle Length: 114.3
 Natural Cycle: 100
 Control Type: Actuated-Uncoordinated
 Maximum v/c Ratio: 0.85
 Intersection Signal Delay: 36.5
 Intersection LOS: D
 Intersection Capacity Utilization 58.5%
 ICU Level of Service B
 Analysis Period (min) 15

Splits and Phases: 1: Harvill Av. & Cajalco Exwy./Ramona Exwy.

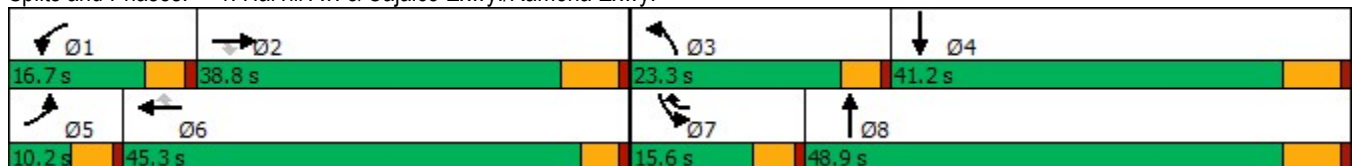

HCM 6th Signalized Intersection Summary
 1: Harvill Av. & Cajalco Exwy./Ramona Exwy.

Harvill Logistics (JN 14231)

06/16/2022

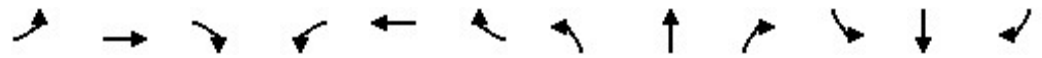

Movement	EBL	EBT	EBR	WBL	WBT	WBR	NBL	NBT	NBR	SBL	SBT	SBR
Lane Configurations	↖	↗	↘	↖	↗	↘	↖	↗	↘	↖	↗	↘
Traffic Volume (veh/h)	25	752	218	139	663	195	184	163	138	231	223	36
Future Volume (veh/h)	25	752	218	139	663	195	184	163	138	231	223	36
Initial Q (Qb), veh	0	0	0	0	0	0	0	0	0	0	0	0
Ped-Bike Adj(A_pbT)	1.00		1.00	1.00		1.00	1.00		0.99	1.00		1.00
Parking Bus, Adj	1.00	1.00	1.00	1.00	1.00	1.00	1.00	1.00	1.00	1.00	1.00	1.00
Work Zone On Approach		No			No			No			No	
Adj Sat Flow, veh/h/ln	1900	1900	1900	1900	1900	1900	1900	1900	1900	1900	1900	1900
Adj Flow Rate, veh/h	27	809	121	149	713	130	198	175	80	248	240	28
Peak Hour Factor	0.93	0.93	0.93	0.93	0.93	0.93	0.93	0.93	0.93	0.93	0.93	0.93
Percent Heavy Veh, %	0	0	0	0	0	0	0	0	0	0	0	0
Cap, veh/h	46	940	419	212	1065	617	265	955	417	310	1321	153
Arrive On Green	0.03	0.26	0.26	0.06	0.30	0.30	0.08	0.39	0.39	0.09	0.41	0.41
Sat Flow, veh/h	1810	3610	1610	3510	3610	1610	3510	2434	1064	3510	3261	376
Grp Volume(v), veh/h	27	809	121	149	713	130	198	128	127	248	132	136
Grp Sat Flow(s),veh/h/ln	1810	1805	1610	1755	1805	1610	1755	1805	1693	1755	1805	1832
Q Serve(g_s), s	1.6	23.2	6.5	4.5	18.9	5.9	6.0	5.0	5.4	7.5	5.1	5.2
Cycle Q Clear(g_c), s	1.6	23.2	6.5	4.5	18.9	5.9	6.0	5.0	5.4	7.5	5.1	5.2
Prop In Lane	1.00		1.00	1.00		1.00	1.00		0.63	1.00		0.21
Lane Grp Cap(c), veh/h	46	940	419	212	1065	617	265	708	664	310	731	742
V/C Ratio(X)	0.58	0.86	0.29	0.70	0.67	0.21	0.75	0.18	0.19	0.80	0.18	0.18
Avail Cap(c_a), veh/h	93	1082	482	390	1354	746	603	708	664	355	731	742
HCM Platoon Ratio	1.00	1.00	1.00	1.00	1.00	1.00	1.00	1.00	1.00	1.00	1.00	1.00
Upstream Filter(I)	1.00	1.00	1.00	1.00	1.00	1.00	1.00	1.00	1.00	1.00	1.00	1.00
Uniform Delay (d), s/veh	52.4	38.3	32.2	50.2	33.7	22.5	49.3	21.6	21.7	48.7	20.8	20.8
Incr Delay (d2), s/veh	4.2	6.5	0.4	1.6	0.9	0.2	1.6	0.6	0.6	9.4	0.5	0.5
Initial Q Delay(d3),s/veh	0.0	0.0	0.0	0.0	0.0	0.0	0.0	0.0	0.0	0.0	0.0	0.0
%ile BackOfQ(50%),veh/ln	0.8	10.5	2.5	2.0	7.9	2.1	2.6	2.1	2.1	3.6	2.1	2.2
Unsig. Movement Delay, s/veh												
LnGrp Delay(d),s/veh	56.7	44.8	32.5	51.8	34.6	22.7	50.8	22.2	22.4	58.0	21.3	21.3
LnGrp LOS	E	D	C	D	C	C	D	C	C	E	C	C
Approach Vol, veh/h		957			992			453			516	
Approach Delay, s/veh		43.6			35.6			34.8			39.0	
Approach LOS		D			D			C			D	
Timer - Assigned Phs	1	2	3	4	5	6	7	8				
Phs Duration (G+Y+Rc), s	11.2	34.5	12.8	50.3	7.4	38.3	14.2	48.9				
Change Period (Y+Rc), s	4.6	6.2	4.6	6.2	4.6	* 6.2	4.6	6.2				
Max Green Setting (Gmax), s	12.1	32.6	18.7	35.0	5.6	* 41	11.0	42.7				
Max Q Clear Time (g_c+I1), s	6.5	25.2	8.0	7.2	3.6	20.9	9.5	7.4				
Green Ext Time (p_c), s	0.1	3.1	0.2	1.3	0.0	4.6	0.1	1.3				

Intersection Summary

HCM 6th Ctrl Delay	38.7
HCM 6th LOS	D

Notes

* HCM 6th computational engine requires equal clearance times for the phases crossing the barrier.

Intersection						
Int Delay, s/veh	0					
Movement	WBL	WBR	NBT	NBR	SBL	SBT
Lane Configurations		↗	↕	↗		↕
Traffic Vol, veh/h	0	2	480	0	0	510
Future Vol, veh/h	0	2	480	0	0	510
Conflicting Peds, #/hr	0	0	0	0	0	0
Sign Control	Stop	Stop	Free	Free	Free	Free
RT Channelized	-	None	-	None	-	None
Storage Length	-	0	-	100	-	-
Veh in Median Storage, #	2	-	0	-	-	0
Grade, %	0	-	0	-	-	0
Peak Hour Factor	92	92	92	92	92	92
Heavy Vehicles, %	0	0	0	0	0	0
Mvmt Flow	0	2	522	0	0	554

Major/Minor	Minor1	Major1	Major2		
Conflicting Flow All	-	261	0	0	-
Stage 1	-	-	-	-	-
Stage 2	-	-	-	-	-
Critical Hdwy	-	6.9	-	-	-
Critical Hdwy Stg 1	-	-	-	-	-
Critical Hdwy Stg 2	-	-	-	-	-
Follow-up Hdwy	-	3.3	-	-	-
Pot Cap-1 Maneuver	0	744	-	-	0
Stage 1	0	-	-	-	0
Stage 2	0	-	-	-	0
Platoon blocked, %			-	-	-
Mov Cap-1 Maneuver	-	744	-	-	-
Mov Cap-2 Maneuver	-	-	-	-	-
Stage 1	-	-	-	-	-
Stage 2	-	-	-	-	-

Approach	WB	NB	SB
HCM Control Delay, s	9.9	0	0
HCM LOS	A		

Minor Lane/Major Mvmt	NBT	NBRWBLn1	SBT
Capacity (veh/h)	-	- 744	-
HCM Lane V/C Ratio	-	- 0.003	-
HCM Control Delay (s)	-	- 9.9	-
HCM Lane LOS	-	- A	-
HCM 95th %tile Q(veh)	-	- 0	-

Intersection												
Int Delay, s/veh	2.1											
Movement	EBL	EBT	EBR	WBL	WBT	WBR	NBL	NBT	NBR	SBL	SBT	SBR
Lane Configurations		↕			↕	↕	↕	↕		↕	↕	
Traffic Vol, veh/h	65	0	14	31	0	49	6	366	12	13	465	32
Future Vol, veh/h	65	0	14	31	0	49	6	366	12	13	465	32
Conflicting Peds, #/hr	0	0	0	0	0	0	0	0	0	0	0	0
Sign Control	Stop	Stop	Stop	Stop	Stop	Stop	Free	Free	Free	Free	Free	Free
RT Channelized	-	-	None	-	-	None	-	-	None	-	-	None
Storage Length	-	-	-	-	-	0	160	-	-	110	-	-
Veh in Median Storage, #	-	2	-	-	2	-	-	0	-	-	0	-
Grade, %	-	0	-	-	0	-	-	0	-	-	0	-
Peak Hour Factor	86	86	86	86	86	86	86	86	86	86	86	86
Heavy Vehicles, %	0	0	0	0	0	0	0	0	0	0	0	0
Mvmt Flow	76	0	16	36	0	57	7	426	14	15	541	37

Major/Minor	Minor2		Minor1		Major1		Major2					
Conflicting Flow All	817	1044	289	748	1055	220	578	0	0	440	0	0
Stage 1	590	590	-	447	447	-	-	-	-	-	-	-
Stage 2	227	454	-	301	608	-	-	-	-	-	-	-
Critical Hdwy	6.5	6.5	6.9	6.5	6.5	6.9	4.1	-	-	4.1	-	-
Critical Hdwy Stg 1	6.5	5.5	-	6.5	5.5	-	-	-	-	-	-	-
Critical Hdwy Stg 2	6.5	5.5	-	6.5	5.5	-	-	-	-	-	-	-
Follow-up Hdwy	3.5	4	3.3	3.5	4	3.3	2.2	-	-	2.2	-	-
Pot Cap-1 Maneuver	341	231	714	375	227	790	1006	-	-	1131	-	-
Stage 1	466	498	-	566	577	-	-	-	-	-	-	-
Stage 2	761	573	-	689	489	-	-	-	-	-	-	-
Platoon blocked, %								-	-	-	-	-
Mov Cap-1 Maneuver	312	226	714	361	222	790	1006	-	-	1131	-	-
Mov Cap-2 Maneuver	425	400	-	492	396	-	-	-	-	-	-	-
Stage 1	463	492	-	562	573	-	-	-	-	-	-	-
Stage 2	701	569	-	664	483	-	-	-	-	-	-	-

Approach	EB		WB		NB		SB	
HCM Control Delay, s	14.8		11.1		0.1		0.2	
HCM LOS	B		B					

Minor Lane/Major Mvmt	NBL	NBT	NBR	EBLn1	WBLn1	WBLn2	SBL	SBT	SBR
Capacity (veh/h)	1006	-	-	458	492	790	1131	-	-
HCM Lane V/C Ratio	0.007	-	-	0.201	0.073	0.072	0.013	-	-
HCM Control Delay (s)	8.6	-	-	14.8	12.9	9.9	8.2	-	-
HCM Lane LOS	A	-	-	B	B	A	A	-	-
HCM 95th %tile Q(veh)	0	-	-	0.7	0.2	0.2	0	-	-



Intersection						
Int Delay, s/veh	3.8					
Movement	EBL	EBT	WBT	WBR	SBL	SBR
Lane Configurations		↶	↷		↶	
Traffic Vol, veh/h	7	18	39	0	0	41
Future Vol, veh/h	7	18	39	0	0	41
Conflicting Peds, #/hr	0	0	0	0	0	0
Sign Control	Free	Free	Free	Free	Stop	Stop
RT Channelized	-	None	-	None	-	None
Storage Length	-	-	-	-	0	-
Veh in Median Storage, #	-	0	0	-	0	-
Grade, %	-	0	0	-	0	-
Peak Hour Factor	92	92	92	92	92	92
Heavy Vehicles, %	0	0	0	0	0	0
Mvmt Flow	8	20	42	0	0	45

Major/Minor	Major1	Major2	Minor2		
Conflicting Flow All	42	0	-	0	78 42
Stage 1	-	-	-	-	42 -
Stage 2	-	-	-	-	36 -
Critical Hdwy	4.1	-	-	-	6.4 6.2
Critical Hdwy Stg 1	-	-	-	-	5.4 -
Critical Hdwy Stg 2	-	-	-	-	5.4 -
Follow-up Hdwy	2.2	-	-	-	3.5 3.3
Pot Cap-1 Maneuver	1580	-	-	-	930 1034
Stage 1	-	-	-	-	986 -
Stage 2	-	-	-	-	992 -
Platoon blocked, %		-	-	-	
Mov Cap-1 Maneuver	1580	-	-	-	925 1034
Mov Cap-2 Maneuver	-	-	-	-	925 -
Stage 1	-	-	-	-	981 -
Stage 2	-	-	-	-	992 -

Approach	EB	WB	SB
HCM Control Delay, s	2	0	8.6
HCM LOS			A

Minor Lane/Major Mvmt	EBL	EBT	WBT	WBR	SBLn1
Capacity (veh/h)	1580	-	-	-	1034
HCM Lane V/C Ratio	0.005	-	-	-	0.043
HCM Control Delay (s)	7.3	0	-	-	8.6
HCM Lane LOS	A	A	-	-	A
HCM 95th %tile Q(veh)	0	-	-	-	0.1

Intersection	
Intersection Delay, s/veh	6.8
Intersection LOS	A

Movement	EBL	EBR	NBL	NBT	SBT	SBR
Lane Configurations						
Traffic Vol, veh/h	6	12	22	0	0	17
Future Vol, veh/h	6	12	22	0	0	17
Peak Hour Factor	0.92	0.92	0.92	0.92	0.92	0.92
Heavy Vehicles, %	0	0	0	0	0	0
Mvmt Flow	7	13	24	0	0	18
Number of Lanes	1	0	0	1	1	0

Approach	EB	NB	SB
Opposing Approach		SB	NB
Opposing Lanes	0	1	1
Conflicting Approach Left	SB	EB	
Conflicting Lanes Left	1	1	0
Conflicting Approach Right	NB		EB
Conflicting Lanes Right	1	0	1
HCM Control Delay	6.7	7.3	6.4
HCM LOS	A	A	A

Lane	NBLn1	EBLn1	SBLn1
Vol Left, %	100%	33%	0%
Vol Thru, %	0%	0%	0%
Vol Right, %	0%	67%	100%
Sign Control	Stop	Stop	Stop
Traffic Vol by Lane	22	18	17
LT Vol	22	6	0
Through Vol	0	0	0
RT Vol	0	12	17
Lane Flow Rate	24	20	18
Geometry Grp	1	1	1
Degree of Util (X)	0.028	0.02	0.017
Departure Headway (Hd)	4.147	3.639	3.351
Convergence, Y/N	Yes	Yes	Yes
Cap	867	985	1071
Service Time	2.154	1.654	1.363
HCM Lane V/C Ratio	0.028	0.02	0.017
HCM Control Delay	7.3	6.7	6.4
HCM Lane LOS	A	A	A
HCM 95th-tile Q	0.1	0.1	0.1

Timings
6: I-215 SB Ramps & Ramona Exwy.

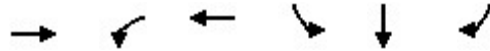

Lane Group	EBT	WBL	WBT	SBL	SBT	SBR
Lane Configurations	↑↑	↵	↑↑	↵	↵	↵
Traffic Volume (vph)	630	317	732	789	8	145
Future Volume (vph)	630	317	732	789	8	145
Turn Type	NA	Prot	NA	Split	NA	Perm
Protected Phases	2	1	6	4	4	
Permitted Phases						4
Detector Phase	2	1	6	4	4	4
Switch Phase						
Minimum Initial (s)	5.0	5.0	5.0	5.0	5.0	5.0
Minimum Split (s)	11.0	9.5	31.0	10.5	10.5	10.5
Total Split (s)	44.0	27.0	71.0	39.0	39.0	39.0
Total Split (%)	40.0%	24.5%	64.5%	35.5%	35.5%	35.5%
Yellow Time (s)	5.0	3.5	5.0	4.5	4.5	4.5
All-Red Time (s)	1.0	1.0	1.0	1.0	1.0	1.0
Lost Time Adjust (s)	0.0	0.0	0.0	0.0	0.0	0.0
Total Lost Time (s)	6.0	4.5	6.0	5.5	5.5	5.5
Lead/Lag	Lag	Lead				
Lead-Lag Optimize?	Yes	Yes				
Recall Mode	C-Max	None	C-Max	Max	Max	Max
Act Effct Green (s)	38.8	21.7	65.0	33.5	33.5	33.5
Actuated g/C Ratio	0.35	0.20	0.59	0.30	0.30	0.30
v/c Ratio	0.73	0.90	0.35	0.76	0.78	0.25
Control Delay	32.8	50.3	6.7	45.6	46.7	5.8
Queue Delay	0.0	0.0	0.3	55.8	55.5	0.0
Total Delay	32.8	50.3	7.0	101.4	102.1	5.8
LOS	C	D	A	F	F	A
Approach Delay	32.8		20.1		87.0	
Approach LOS	C		C		F	

Intersection Summary

Cycle Length: 110
 Actuated Cycle Length: 110
 Offset: 34 (31%), Referenced to phase 2:EBT and 6:WBT, Start of Yellow
 Natural Cycle: 70
 Control Type: Actuated-Coordinated
 Maximum v/c Ratio: 0.90
 Intersection Signal Delay: 45.9
 Intersection LOS: D
 Intersection Capacity Utilization 111.4%
 ICU Level of Service H
 Analysis Period (min) 15

Splits and Phases: 6: I-215 SB Ramps & Ramona Exwy.

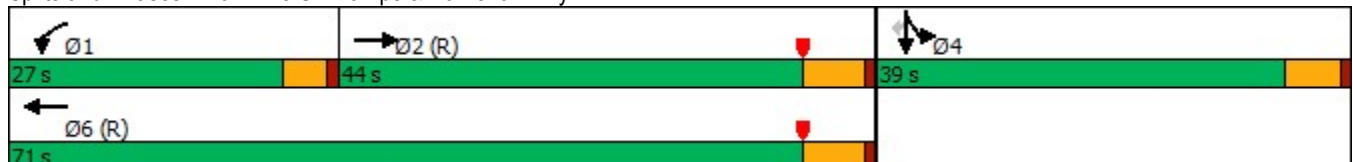

HCM 6th Signalized Intersection Summary
6: I-215 SB Ramps & Ramona Exwy.

Harvill Logistics (JN 14231)

06/16/2022

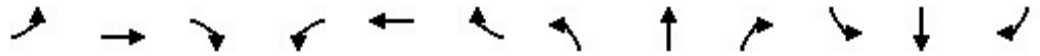

Movement	EBL	EBT	EBR	WBL	WBT	WBR	NBL	NBT	NBR	SBL	SBT	SBR
Lane Configurations		↑↑		↖	↑↑					↖	↖	↖
Traffic Volume (veh/h)	0	630	271	317	732	0	0	0	0	789	8	145
Future Volume (veh/h)	0	630	271	317	732	0	0	0	0	789	8	145
Initial Q (Qb), veh	0	0	0	0	0	0				0	0	0
Ped-Bike Adj(A_pbT)	1.00		0.99	1.00		1.00				1.00		1.00
Parking Bus, Adj	1.00	1.00	1.00	1.00	1.00	1.00				1.00	1.00	1.00
Work Zone On Approach		No			No						No	
Adj Sat Flow, veh/h/ln	0	1900	1900	1900	1900	0				1900	1900	1900
Adj Flow Rate, veh/h	0	636	166	320	739	0				803	0	87
Peak Hour Factor	0.99	0.99	0.99	0.99	0.99	0.99				0.99	0.99	0.99
Percent Heavy Veh, %	0	0	0	0	0	0				0	0	0
Cap, veh/h	0	1005	262	351	2133	0				1102	0	490
Arrive On Green	0.00	0.36	0.36	0.12	0.35	0.00				0.30	0.00	0.30
Sat Flow, veh/h	0	2920	736	1810	3705	0				3619	0	1610
Grp Volume(v), veh/h	0	406	396	320	739	0				803	0	87
Grp Sat Flow(s),veh/h/ln	0	1805	1756	1810	1805	0				1810	0	1610
Q Serve(g_s), s	0.0	20.6	20.6	19.2	16.6	0.0				21.8	0.0	4.4
Cycle Q Clear(g_c), s	0.0	20.6	20.6	19.2	16.6	0.0				21.8	0.0	4.4
Prop In Lane	0.00		0.42	1.00		0.00				1.00		1.00
Lane Grp Cap(c), veh/h	0	642	625	351	2133	0				1102	0	490
V/C Ratio(X)	0.00	0.63	0.63	0.91	0.35	0.00				0.73	0.00	0.18
Avail Cap(c_a), veh/h	0	642	625	370	2133	0				1102	0	490
HCM Platoon Ratio	1.00	1.00	1.00	0.60	0.60	1.00				1.00	1.00	1.00
Upstream Filter(I)	0.00	0.44	0.44	0.90	0.90	0.00				1.00	0.00	1.00
Uniform Delay (d), s/veh	0.0	29.4	29.5	47.6	19.9	0.0				34.2	0.0	28.1
Incr Delay (d2), s/veh	0.0	2.1	2.2	23.4	0.4	0.0				4.2	0.0	0.8
Initial Q Delay(d3),s/veh	0.0	0.0	0.0	0.0	0.0	0.0				0.0	0.0	0.0
%ile BackOfQ(50%),veh/ln	0.0	8.7	8.5	11.1	7.5	0.0				9.8	0.0	1.7
Unsig. Movement Delay, s/veh												
LnGrp Delay(d),s/veh	0.0	31.5	31.6	71.1	20.3	0.0				38.4	0.0	28.9
LnGrp LOS	A	C	C	E	C	A				D	A	C
Approach Vol, veh/h		802			1059						890	
Approach Delay, s/veh		31.6			35.6						37.5	
Approach LOS		C			D						D	
Timer - Assigned Phs	1	2		4		6						
Phs Duration (G+Y+Rc), s	25.9	45.1		39.0		71.0						
Change Period (Y+Rc), s	4.5	6.0		5.5		6.0						
Max Green Setting (Gmax), s	22.5	38.0		33.5		65.0						
Max Q Clear Time (g_c+I1), s	21.2	22.6		23.8		18.6						
Green Ext Time (p_c), s	0.1	2.5		2.5		3.0						

Intersection Summary

HCM 6th Ctrl Delay	35.0
HCM 6th LOS	D

Notes

User approved volume balancing among the lanes for turning movement.

Timings
7: I-215 NB Ramps & Ramona Exwy.

Lane Group	EBL	EBT	WBT	WBR	NBL	NBT	NBR
Lane Configurations							
Traffic Volume (vph)	100	1318	759	509	289	4	359
Future Volume (vph)	100	1318	759	509	289	4	359
Turn Type	Prot	NA	NA	Perm	Split	NA	Perm
Protected Phases	5	2	6		8	8	
Permitted Phases				6			8
Detector Phase	5	2	6	6	8	8	8
Switch Phase							
Minimum Initial (s)	5.0	5.0	5.0	5.0	5.0	5.0	5.0
Minimum Split (s)	9.5	11.0	26.0	26.0	10.5	10.5	10.5
Total Split (s)	23.0	68.0	45.0	45.0	42.0	42.0	42.0
Total Split (%)	20.9%	61.8%	40.9%	40.9%	38.2%	38.2%	38.2%
Yellow Time (s)	3.5	5.0	5.0	5.0	4.5	4.5	4.5
All-Red Time (s)	1.0	1.0	1.0	1.0	1.0	1.0	1.0
Lost Time Adjust (s)	0.0	0.0	0.0	0.0	0.0	0.0	0.0
Total Lost Time (s)	4.5	6.0	6.0	6.0	5.5	5.5	5.5
Lead/Lag	Lead		Lag	Lag			
Lead-Lag Optimize?	Yes		Yes	Yes			
Recall Mode	None	C-Max	C-Max	C-Max	None	None	None
Act Effct Green (s)	11.8	70.7	54.5	54.5	27.8	27.8	27.8
Actuated g/C Ratio	0.11	0.64	0.50	0.50	0.25	0.25	0.25
v/c Ratio	0.55	0.60	0.45	0.50	0.36	0.35	0.83
Control Delay	41.4	18.9	21.1	3.8	34.5	34.4	45.5
Queue Delay	0.0	36.6	0.0	0.0	0.0	0.0	0.0
Total Delay	41.4	55.5	21.1	3.8	34.5	34.4	45.5
LOS	D	E	C	A	C	C	D
Approach Delay		54.5	14.2			40.6	
Approach LOS		D	B			D	

Intersection Summary

Cycle Length: 110
 Actuated Cycle Length: 110
 Offset: 0 (0%), Referenced to phase 2:EBT and 6:WBT, Start of Yellow, Master Intersection
 Natural Cycle: 55
 Control Type: Actuated-Coordinated
 Maximum v/c Ratio: 0.83
 Intersection Signal Delay: 36.5
 Intersection LOS: D
 Intersection Capacity Utilization 111.4%
 ICU Level of Service H
 Analysis Period (min) 15

Splits and Phases: 7: I-215 NB Ramps & Ramona Exwy.

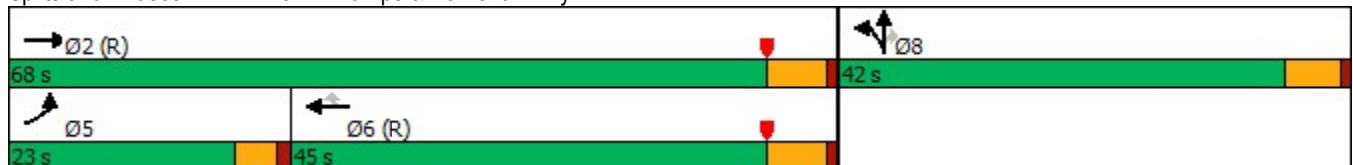

HCM 6th Signalized Intersection Summary
 7: I-215 NB Ramps & Ramona Exwy.

Harvill Logistics (JN 14231)

06/16/2022

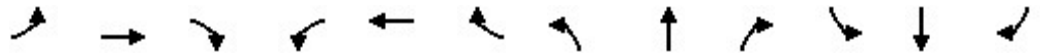

Movement	EBL	EBT	EBR	WBL	WBT	WBR	NBL	NBT	NBR	SBL	SBT	SBR
Lane Configurations	↘	↑↑			↑↑	↗	↘	↗	↗			
Traffic Volume (veh/h)	100	1318	0	0	759	509	289	4	359	0	0	0
Future Volume (veh/h)	100	1318	0	0	759	509	289	4	359	0	0	0
Initial Q (Qb), veh	0	0	0	0	0	0	0	0	0			
Ped-Bike Adj(A_pbT)	1.00		1.00	1.00		1.00	1.00		1.00			
Parking Bus, Adj	1.00	1.00	1.00	1.00	1.00	1.00	1.00	1.00	1.00			
Work Zone On Approach		No			No			No				
Adj Sat Flow, veh/h/ln	1900	1900	0	0	1900	1900	1900	1900	1900			
Adj Flow Rate, veh/h	106	1402	0	0	807	391	310	0	301			
Peak Hour Factor	0.94	0.94	0.94	0.94	0.94	0.94	0.94	0.94	0.94			
Percent Heavy Veh, %	0	0	0	0	0	0	0	0	0			
Cap, veh/h	132	2455	0	0	2043	911	780	0	347			
Arrive On Green	0.15	1.00	0.00	0.00	0.57	0.57	0.22	0.00	0.22			
Sat Flow, veh/h	1810	3705	0	0	3705	1610	3619	0	1610			
Grp Volume(v), veh/h	106	1402	0	0	807	391	310	0	301			
Grp Sat Flow(s),veh/h/ln	1810	1805	0	0	1805	1610	1810	0	1610			
Q Serve(g_s), s	6.2	0.0	0.0	0.0	13.7	15.3	8.1	0.0	19.8			
Cycle Q Clear(g_c), s	6.2	0.0	0.0	0.0	13.7	15.3	8.1	0.0	19.8			
Prop In Lane	1.00		0.00	0.00		1.00	1.00		1.00			
Lane Grp Cap(c), veh/h	132	2455	0	0	2043	911	780	0	347			
V/C Ratio(X)	0.80	0.57	0.00	0.00	0.39	0.43	0.40	0.00	0.87			
Avail Cap(c_a), veh/h	304	2455	0	0	2043	911	1201	0	534			
HCM Platoon Ratio	2.00	2.00	1.00	1.00	1.00	1.00	1.00	1.00	1.00			
Upstream Filter(I)	0.60	0.60	0.00	0.00	1.00	1.00	1.00	0.00	1.00			
Uniform Delay (d), s/veh	46.2	0.0	0.0	0.0	13.3	13.7	37.0	0.0	41.6			
Incr Delay (d2), s/veh	6.6	0.6	0.0	0.0	0.6	1.5	0.3	0.0	9.3			
Initial Q Delay(d3),s/veh	0.0	0.0	0.0	0.0	0.0	0.0	0.0	0.0	0.0			
%ile BackOfQ(50%),veh/ln	2.8	0.2	0.0	0.0	5.1	5.3	3.5	0.0	8.5			
Unsig. Movement Delay, s/veh												
LnGrp Delay(d),s/veh	52.8	0.6	0.0	0.0	13.9	15.2	37.4	0.0	50.9			
LnGrp LOS	D	A	A	A	B	B	D	A	D			
Approach Vol, veh/h		1508			1198			611				
Approach Delay, s/veh		4.3			14.3			44.0				
Approach LOS		A			B			D				
Timer - Assigned Phs		2			5	6		8				
Phs Duration (G+Y+Rc), s		80.8			12.6	68.3		29.2				
Change Period (Y+Rc), s		6.0			4.5	6.0		5.5				
Max Green Setting (Gmax), s		62.0			18.5	39.0		36.5				
Max Q Clear Time (g_c+I1), s		2.0			8.2	17.3		21.8				
Green Ext Time (p_c), s		7.5			0.1	3.9		1.9				

Intersection Summary

HCM 6th Ctrl Delay	15.2
HCM 6th LOS	B

Notes

User approved volume balancing among the lanes for turning movement.

Timings
8: I-215 SB Ramps & Placentia Av.

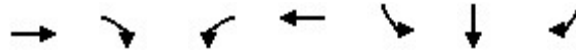

Lane Group	EBT	EBR	WBL	WBT	SBL	SBT	SBR
Lane Configurations	↑↑	↑	↑↑	↑↑	↑	↑	↑
Traffic Volume (vph)	666	163	242	553	348	1	68
Future Volume (vph)	666	163	242	553	348	1	68
Turn Type	NA	Perm	Prot	NA	Split	NA	Perm
Protected Phases	2		1	6	4	4	
Permitted Phases		2					4
Detector Phase	2	2	1	6	4	4	4
Switch Phase							
Minimum Initial (s)	10.0	10.0	5.0	10.0	10.0	10.0	10.0
Minimum Split (s)	27.8	27.8	9.6	27.8	15.8	15.8	15.8
Total Split (s)	29.8	29.8	11.6	41.4	18.6	18.6	18.6
Total Split (%)	49.7%	49.7%	19.3%	69.0%	31.0%	31.0%	31.0%
Yellow Time (s)	4.8	4.8	3.6	4.8	4.8	4.8	4.8
All-Red Time (s)	1.0	1.0	1.0	1.0	1.0	1.0	1.0
Lost Time Adjust (s)	0.0	0.0	0.0	0.0	0.0	0.0	0.0
Total Lost Time (s)	5.8	5.8	4.6	5.8	5.8	5.8	5.8
Lead/Lag	Lag	Lag	Lead				
Lead-Lag Optimize?	Yes	Yes	Yes				
Recall Mode	None	None	None	C-Max	Max	Max	Max
Act Effct Green (s)	24.2	24.2	6.8	35.6	12.8	12.8	12.8
Actuated g/C Ratio	0.40	0.40	0.11	0.59	0.21	0.21	0.21
v/c Ratio	0.50	0.23	0.66	0.28	0.52	0.52	0.16
Control Delay	14.9	3.2	36.1	5.0	26.7	26.7	2.0
Queue Delay	0.0	0.0	0.0	0.0	0.0	0.0	0.0
Total Delay	14.9	3.2	36.1	5.0	26.7	26.7	2.0
LOS	B	A	D	A	C	C	A
Approach Delay	12.6			14.4		22.7	
Approach LOS	B			B		C	

Intersection Summary

Cycle Length: 60
 Actuated Cycle Length: 60
 Offset: 0 (0%), Referenced to phase 6:WBT, Start of Yellow, Master Intersection
 Natural Cycle: 55
 Control Type: Actuated-Coordinated
 Maximum v/c Ratio: 0.66
 Intersection Signal Delay: 15.4
 Intersection LOS: B
 Intersection Capacity Utilization 49.8%
 ICU Level of Service A
 Analysis Period (min) 15

Splits and Phases: 8: I-215 SB Ramps & Placentia Av.

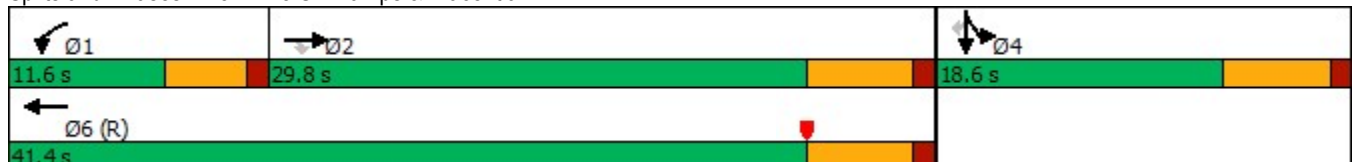

HCM 6th Signalized Intersection Summary
 8: I-215 SB Ramps & Placentia Av.

Harvill Logistics (JN 14231)

06/16/2022

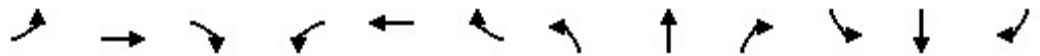

Movement	EBL	EBT	EBR	WBL	WBT	WBR	NBL	NBT	NBR	SBL	SBT	SBR
Lane Configurations		↑↑	↗	↘↗	↑↑					↘	↗	↗
Traffic Volume (veh/h)	0	666	163	242	553	0	0	0	0	348	1	68
Future Volume (veh/h)	0	666	163	242	553	0	0	0	0	348	1	68
Initial Q (Qb), veh	0	0	0	0	0	0				0	0	0
Ped-Bike Adj(A_pbT)	1.00		1.00	1.00		1.00				1.00		1.00
Parking Bus, Adj	1.00	1.00	1.00	1.00	1.00	1.00				1.00	1.00	1.00
Work Zone On Approach		No			No						No	
Adj Sat Flow, veh/h/ln	0	1900	1900	1900	1900	0				1900	1900	1900
Adj Flow Rate, veh/h	0	724	177	263	601	0				379	0	74
Peak Hour Factor	0.92	0.92	0.92	0.92	0.92	0.92				0.92	0.92	0.92
Percent Heavy Veh, %	0	0	0	0	0	0				0	0	0
Cap, veh/h	0	1494	666	361	2142	0				772	0	344
Arrive On Green	0.00	0.41	0.41	0.21	1.00	0.00				0.21	0.00	0.21
Sat Flow, veh/h	0	3705	1610	3510	3705	0				3619	0	1610
Grp Volume(v), veh/h	0	724	177	263	601	0				379	0	74
Grp Sat Flow(s),veh/h/ln	0	1805	1610	1755	1805	0				1810	0	1610
Q Serve(g_s), s	0.0	8.8	4.3	4.2	0.0	0.0				5.5	0.0	2.3
Cycle Q Clear(g_c), s	0.0	8.8	4.3	4.2	0.0	0.0				5.5	0.0	2.3
Prop In Lane	0.00		1.00	1.00		0.00				1.00		1.00
Lane Grp Cap(c), veh/h	0	1494	666	361	2142	0				772	0	344
V/C Ratio(X)	0.00	0.48	0.27	0.73	0.28	0.00				0.49	0.00	0.22
Avail Cap(c_a), veh/h	0	1494	666	410	2142	0				772	0	344
HCM Platoon Ratio	1.00	1.00	1.00	2.00	2.00	1.00				1.00	1.00	1.00
Upstream Filter(I)	0.00	1.00	1.00	0.94	0.94	0.00				1.00	0.00	1.00
Uniform Delay (d), s/veh	0.0	12.9	11.6	23.1	0.0	0.0				20.7	0.0	19.5
Incr Delay (d2), s/veh	0.0	0.2	0.2	4.2	0.3	0.0				2.2	0.0	1.4
Initial Q Delay(d3),s/veh	0.0	0.0	0.0	0.0	0.0	0.0				0.0	0.0	0.0
%ile BackOfQ(50%),veh/ln	0.0	2.9	1.3	1.6	0.1	0.0				2.3	0.0	0.9
Unsig. Movement Delay, s/veh												
LnGrp Delay(d),s/veh	0.0	13.1	11.8	27.2	0.3	0.0				23.0	0.0	20.9
LnGrp LOS	A	B	B	C	A	A				C	A	C
Approach Vol, veh/h		901			864						453	
Approach Delay, s/veh		12.9			8.5						22.6	
Approach LOS		B			A						C	
Timer - Assigned Phs	1	2		4		6						
Phs Duration (G+Y+Rc), s	10.8	30.6		18.6		41.4						
Change Period (Y+Rc), s	4.6	5.8		5.8		5.8						
Max Green Setting (Gmax), s	7.0	24.0		12.8		35.6						
Max Q Clear Time (g_c+I1), s	6.2	10.8		7.5		2.0						
Green Ext Time (p_c), s	0.0	4.2		0.8		4.0						

Intersection Summary

HCM 6th Ctrl Delay	13.2
HCM 6th LOS	B

Notes

User approved volume balancing among the lanes for turning movement.

Timings
9: I-215 NB Ramps & Placentia Av.



Lane Group	EBL	EBT	WBT	WBR	NBL	NBT	NBR
Lane Configurations	↶↶	↶↶	↶↶	↷	↶	↶	↷
Traffic Volume (vph)	69	946	626	273	169	0	226
Future Volume (vph)	69	946	626	273	169	0	226
Turn Type	Prot	NA	NA	Perm	Split	NA	Perm
Protected Phases	5	2	6		8	8	
Permitted Phases				6			8
Detector Phase	5	2	6	6	8	8	8
Switch Phase							
Minimum Initial (s)	5.0	10.0	10.0	10.0	10.0	10.0	10.0
Minimum Split (s)	9.6	27.8	27.8	27.8	15.8	15.8	15.8
Total Split (s)	11.6	42.2	30.6	30.6	17.8	17.8	17.8
Total Split (%)	19.3%	70.3%	51.0%	51.0%	29.7%	29.7%	29.7%
Yellow Time (s)	3.6	4.8	4.8	4.8	4.8	4.8	4.8
All-Red Time (s)	1.0	1.0	1.0	1.0	1.0	1.0	1.0
Lost Time Adjust (s)	0.0	0.0	0.0	0.0	0.0	0.0	0.0
Total Lost Time (s)	4.6	5.8	5.8	5.8	5.8	5.8	5.8
Lead/Lag	Lead		Lag	Lag			
Lead-Lag Optimize?	Yes		Yes	Yes			
Recall Mode	None	C-Max	C-Max	C-Max	None	None	None
Act Effct Green (s)	5.8	37.6	31.0	31.0	10.8	10.8	10.8
Actuated g/C Ratio	0.10	0.63	0.52	0.52	0.18	0.18	0.18
v/c Ratio	0.22	0.45	0.36	0.30	0.30	0.30	0.61
Control Delay	20.2	5.6	10.7	2.7	23.9	23.9	17.9
Queue Delay	0.0	0.0	0.0	0.0	0.0	0.0	0.0
Total Delay	20.2	5.6	10.7	2.7	23.9	23.9	17.9
LOS	C	A	B	A	C	C	B
Approach Delay		6.6	8.3			20.4	
Approach LOS		A	A			C	

Intersection Summary

Cycle Length: 60
 Actuated Cycle Length: 60
 Offset: 0 (0%), Referenced to phase 2:EBT and 6:WBT, Start of Yellow
 Natural Cycle: 55
 Control Type: Actuated-Coordinated
 Maximum v/c Ratio: 0.61
 Intersection Signal Delay: 9.6
 Intersection Capacity Utilization 49.8%
 Analysis Period (min) 15

Intersection LOS: A
 ICU Level of Service A

Splits and Phases: 9: I-215 NB Ramps & Placentia Av.

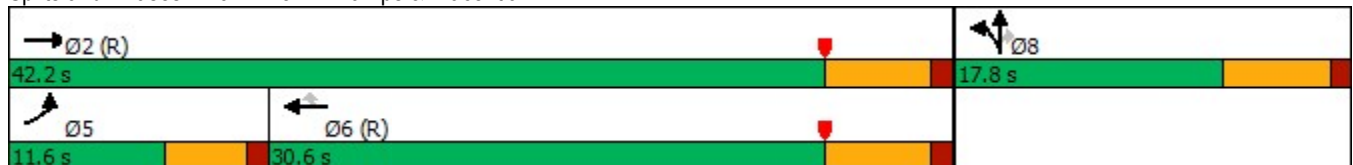

HCM 6th Signalized Intersection Summary
 9: I-215 NB Ramps & Placentia Av.

Harvill Logistics (JN 14231)

06/16/2022

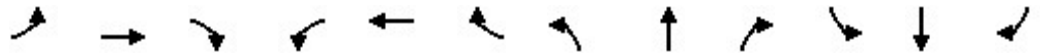

Movement	EBL	EBT	EBR	WBL	WBT	WBR	NBL	NBT	NBR	SBL	SBT	SBR
Lane Configurations	↖↗	↖↖			↖↖	↖↗	↖↗	↖↖	↖↗			
Traffic Volume (veh/h)	69	946	0	0	626	273	169	0	226	0	0	0
Future Volume (veh/h)	69	946	0	0	626	273	169	0	226	0	0	0
Initial Q (Qb), veh	0	0	0	0	0	0	0	0	0			
Ped-Bike Adj(A_pbT)	1.00		1.00	1.00		1.00	1.00		1.00			
Parking Bus, Adj	1.00	1.00	1.00	1.00	1.00	1.00	1.00	1.00	1.00			
Work Zone On Approach		No			No			No				
Adj Sat Flow, veh/h/ln	1900	1900	0	0	1900	1900	1900	1900	1900			
Adj Flow Rate, veh/h	75	1028	0	0	680	297	184	0	246			
Peak Hour Factor	0.92	0.92	0.92	0.92	0.92	0.92	0.92	0.92	0.92			
Percent Heavy Veh, %	0	0	0	0	0	0	0	0	0			
Cap, veh/h	209	2249	0	0	1757	784	665	0	296			
Arrive On Green	0.06	0.62	0.00	0.00	0.49	0.49	0.18	0.00	0.18			
Sat Flow, veh/h	3510	3705	0	0	3705	1610	3619	0	1610			
Grp Volume(v), veh/h	75	1028	0	0	680	297	184	0	246			
Grp Sat Flow(s),veh/h/ln	1755	1805	0	0	1805	1610	1810	0	1610			
Q Serve(g_s), s	1.2	9.0	0.0	0.0	7.1	7.0	2.6	0.0	8.8			
Cycle Q Clear(g_c), s	1.2	9.0	0.0	0.0	7.1	7.0	2.6	0.0	8.8			
Prop In Lane	1.00		0.00	0.00		1.00	1.00		1.00			
Lane Grp Cap(c), veh/h	209	2249	0	0	1757	784	665	0	296			
V/C Ratio(X)	0.36	0.46	0.00	0.00	0.39	0.38	0.28	0.00	0.83			
Avail Cap(c_a), veh/h	410	2249	0	0	1757	784	724	0	322			
HCM Platoon Ratio	1.00	1.00	1.00	1.00	1.00	1.00	1.00	1.00	1.00			
Upstream Filter(l)	0.86	0.86	0.00	0.00	1.00	1.00	1.00	0.00	1.00			
Uniform Delay (d), s/veh	27.1	6.0	0.0	0.0	9.7	9.7	21.1	0.0	23.6			
Incr Delay (d2), s/veh	0.3	0.6	0.0	0.0	0.6	1.4	0.2	0.0	15.7			
Initial Q Delay(d3),s/veh	0.0	0.0	0.0	0.0	0.0	0.0	0.0	0.0	0.0			
%ile BackOfQ(50%),veh/ln	0.5	2.2	0.0	0.0	2.2	2.1	1.0	0.0	4.2			
Unsig. Movement Delay, s/veh												
LnGrp Delay(d),s/veh	27.5	6.5	0.0	0.0	10.4	11.1	21.3	0.0	39.2			
LnGrp LOS	C	A	A	A	B	B	C	A	D			
Approach Vol, veh/h		1103			977			430				
Approach Delay, s/veh		8.0			10.6			31.6				
Approach LOS		A			B			C				
Timer - Assigned Phs		2			5	6		8				
Phs Duration (G+Y+Rc), s		43.2			8.2	35.0		16.8				
Change Period (Y+Rc), s		5.8			4.6	5.8		5.8				
Max Green Setting (Gmax), s		36.4			7.0	24.8		12.0				
Max Q Clear Time (g_c+I1), s		11.0			3.2	9.1		10.8				
Green Ext Time (p_c), s		7.3			0.0	4.7		0.2				

Intersection Summary

HCM 6th Ctrl Delay	13.0
HCM 6th LOS	B

Notes

User approved volume balancing among the lanes for turning movement.

APPENDIX 5.2: EAP (2024) CONDITIONS TRAFFIC SIGNAL WARRANT ANALYSIS WORKSHEETS

This Page Intentionally Left Blank

Figure 4C-4. Warrant 3, Peak Hour (70% Factor)

(COMMUNITY LESS THAN 10,000 POPULATION OR ABOVE 64 km/h OR ABOVE 40 mph ON MAJOR STREET)

Traffic Conditions = **EAP (2024) Conditions - Weekday PM Peak Hour**

Major Street Name = **Harvill Avenue**

Total of Both Approaches (VPH) = **894**
 Number of Approach Lanes Major Street = **2**

Minor Street Name = **Old Cajalco Road**

High Volume Approach (VPH) = **80**
 Number of Approach Lanes Minor Street = **1**

SIGNAL WARRANT NOT SATISFIED

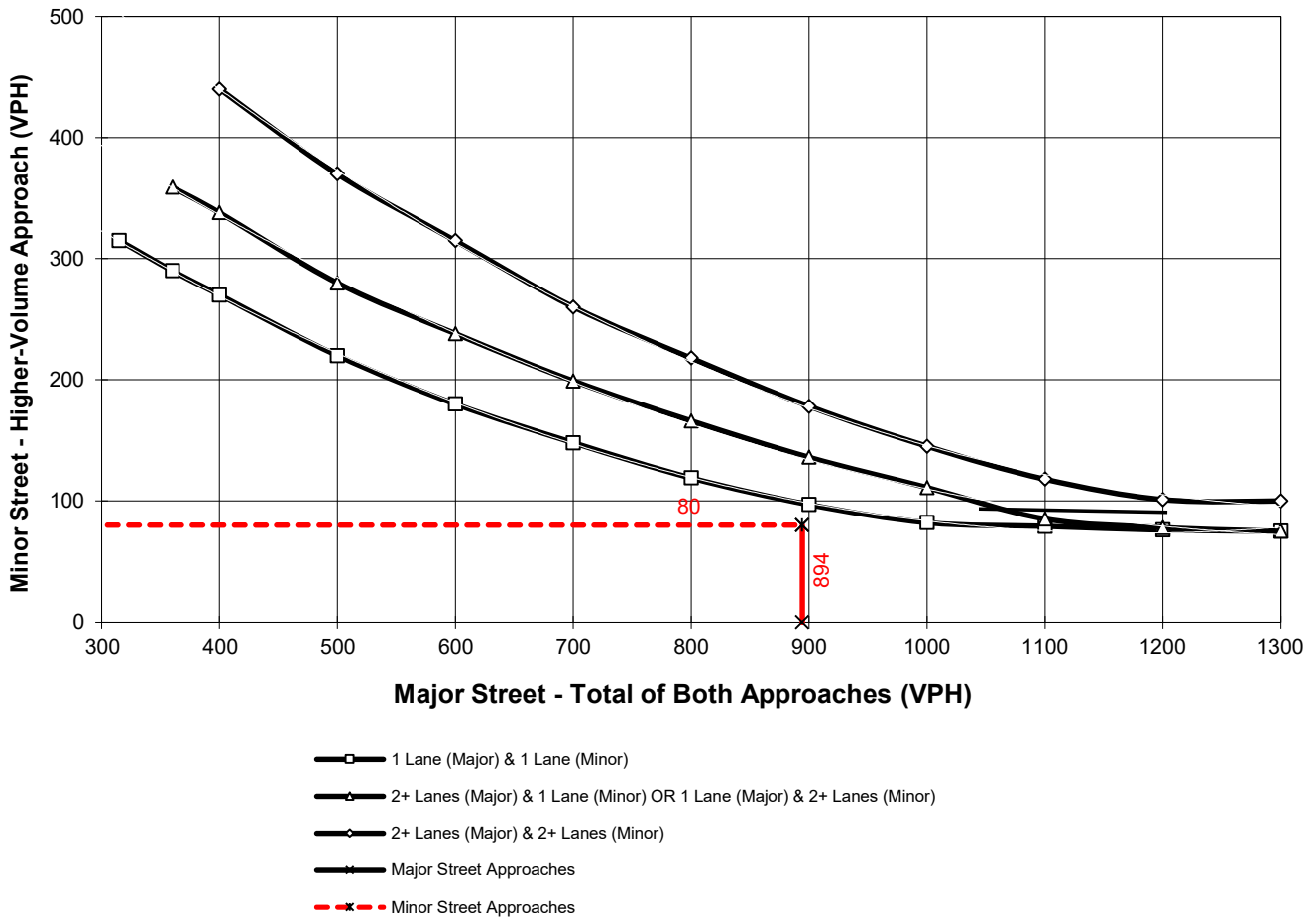

*Note: 100 vph applies as the lower threshold for a minor-street approach with two or more lanes and 75 vph applies as the lower threshold for a minor-street approach with one lane



Figure 4C-103 (CA). Traffic Signal Warrants Worksheet (Average Traffic Estimate Form)

<u>DIST</u>	<u>CO</u>	<u>RTE</u>	<u>PM</u>	<u>CALC</u>	<u>TRAFFIC CONDITIONS</u>	<u>EAP (2024)</u>
Jurisdiction: <u>County of Riverside</u>				<u>JB</u>		<u>DATE 06/08/22</u>
Major Street: <u>Old Cajalco Road</u>				<u>JB</u>		<u>DATE 06/08/22</u>
Minor Street: <u>Driveway 2</u>					Critical Approach Speed (Major) <u>25 mph</u>	
					Critical Approach Speed (Minor) <u>25 mph</u>	
Major Street Approach Lanes =		<u>1</u>	lane	Minor Street Approach Lanes =		<u>1</u> lane
Major Street Future ADT =		<u>847</u>	vpd	Minor Street Future ADT =		<u>182</u> vpd
Speed limit or critical speed on major street traffic > 64 km/h (40 mph);						<input type="checkbox"/>
						or
In built up area of isolated community of < 10,000 population						<input type="checkbox"/>

URBAN (U)

(Based on Estimated Average Daily Traffic - See Note)

<u>URBAN</u>	<u>RURAL</u>	Minimum Requirements			
XX		EADT			
CONDITION A - Minimum Vehicular Volume		Vehicles Per Day on Major Street		Vehicles Per Day on Higher-Volume Minor Street Approach	
<u>Satisfied</u>	<u>Not Satisfied</u>	(Total of Both Approaches)		(One Direction Only)	
	XX	<u>Urban</u>	<u>Rural</u>	<u>Urban</u>	<u>Rural</u>
Number of lanes for moving traffic on each approach					
<u>Major Street</u>	<u>Minor Street</u>				
<u>1 847</u>	<u>1 182</u>	8,000	5,600	2,400	1,680
<u>2 +</u>	<u>1</u>	9,600	6,720	2,400	1,680
<u>2 +</u>	<u>2 +</u>	9,600	6,720	3,200	2,240
<u>1</u>	<u>2 +</u>	8,000	5,600	3,200	2,240
CONDITION B - Interruption of Continuous Traffic		Vehicles Per Day on Major Street		Vehicles Per Day on Higher-Volume Minor Street Approach	
<u>Satisfied</u>	<u>Not Satisfied</u>	(Total of Both Approaches)		(One Direction Only)	
	XX	<u>Urban</u>	<u>Rural</u>	<u>Urban</u>	<u>Rural</u>
Number of lanes for moving traffic on each approach					
<u>Major Street</u>	<u>Minor Street</u>				
<u>1 847</u>	<u>1 182</u>	12,000	8,400	1,200	850
<u>2 +</u>	<u>1</u>	14,400	10,080	1,200	850
<u>2 +</u>	<u>2 +</u>	14,400	10,080	1,600	1,120
<u>1</u>	<u>2 +</u>	12,000	8,400	1,600	1,120
Combination of CONDITIONS A + B		2 CONDITIONS		2 CONDITIONS	
<u>Satisfied</u>	<u>Not Satisfied</u>	80%		80%	
No one condition satisfied, but following conditions fulfilled 80% of more	XX				
	A				
	8%				
	B				
	7%				

Note: To be used only for NEW INTERSECTIONS or other locations where it is not reasonable to count actual traffic volumes.

The satisfaction of a traffic signal warrant or warrants shall not in itself require the installation of a traffic control signal.



Figure 4C-103 (CA). Traffic Signal Warrants Worksheet (Average Traffic Estimate Form)

<u>DIST</u>	<u>CO</u>	<u>RTE</u>	<u>PM</u>	<u>CALC</u>	<u>TRAFFIC CONDITIONS</u>	<u>EAP (2024)</u>
Jurisdiction: <u>County of Riverside</u>				<u>JB</u>		<u>DATE 06/08/22</u>
Major Street: <u>Old Cajalco Road</u>				<u>JB</u>		<u>DATE 06/08/22</u>
Minor Street: <u>Driveway 3</u>					Critical Approach Speed (Major) <u>25 mph</u>	
					Critical Approach Speed (Minor) <u>25 mph</u>	
Major Street Approach Lanes =		<u>1</u>	lane	Minor Street Approach Lanes =		<u>1</u> lane
Major Street Future ADT =		<u>333</u>	vpd	Minor Street Future ADT =		<u>333</u> vpd
Speed limit or critical speed on major street traffic > 64 km/h (40 mph);						<input type="checkbox"/>
						or
In built up area of isolated community of < 10,000 population						<input type="checkbox"/>

URBAN (U)

(Based on Estimated Average Daily Traffic - See Note)

<u>URBAN</u>	<u>RURAL</u>	Minimum Requirements EADT			
XX		Vehicles Per Day on Major Street (Total of Both Approaches)		Vehicles Per Day on Higher-Volume Minor Street Approach (One Direction Only)	
CONDITION A - Minimum Vehicular Volume	Not Satisfied				
<u>Satisfied</u>	XX				
Number of lanes for moving traffic on each approach		<u>Urban</u>	<u>Rural</u>	<u>Urban</u>	<u>Rural</u>
<u>Major Street</u>	<u>Minor Street</u>				
1 333	1 333	8,000	5,600	2,400	1,680
2 +	1	9,600	6,720	2,400	1,680
2 +	2 +	9,600	6,720	3,200	2,240
1	2 +	8,000	5,600	3,200	2,240
CONDITION B - Interruption of Continuous Traffic		Vehicles Per Day on Major Street (Total of Both Approaches)		Vehicles Per Day on Higher-Volume Minor Street Approach (One Direction Only)	
<u>Satisfied</u>	XX				
Number of lanes for moving traffic on each approach		<u>Urban</u>	<u>Rural</u>	<u>Urban</u>	<u>Rural</u>
<u>Major Street</u>	<u>Minor Street</u>				
1 333	1 333	12,000	8,400	1,200	850
2 +	1	14,400	10,080	1,200	850
2 +	2 +	14,400	10,080	1,600	1,120
1	2 +	12,000	8,400	1,600	1,120
Combination of CONDITIONS A + B		2 CONDITIONS 80%		2 CONDITIONS 80%	
<u>Satisfied</u>	XX				
No one condition satisfied, but following conditions fulfilled 80% of more					
	<u>A</u>				
	4%				
	<u>B</u>				
	3%				

Note: To be used only for NEW INTERSECTIONS or other locations where it is not reasonable to count actual traffic volumes.

The satisfaction of a traffic signal warrant or warrants shall not in itself require the installation of a traffic control signal.



This Page Intentionally Left Blank

**APPENDIX 5.3: EAP (2024) CONDITIONS FREEWAY OFF-RAMP
QUEUING ANALYSIS WORKSHEETS**

This Page Intentionally Left Blank

Queues

6: I-215 SB Ramps & Ramona Exwy.

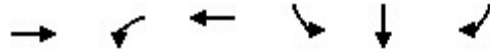

Lane Group	EBT	WBL	WBT	SBL	SBT	SBR
Lane Group Flow (vph)	706	281	955	423	426	174
v/c Ratio	0.53	0.84	0.45	0.81	0.81	0.30
Control Delay	22.3	39.6	5.7	49.1	49.4	10.4
Queue Delay	0.0	0.0	0.5	53.3	53.2	0.0
Total Delay	22.3	39.6	6.2	102.4	102.6	10.4
Queue Length 50th (ft)	157	102	103	289	291	23
Queue Length 95th (ft)	216	#222	19	#455	#458	75
Internal Link Dist (ft)	1408		344		1111	
Turn Bay Length (ft)		100		510		510
Base Capacity (vph)	1335	369	2133	522	523	581
Starvation Cap Reductn	0	0	679	0	0	0
Spillback Cap Reductn	15	0	0	152	152	0
Storage Cap Reductn	0	0	0	0	0	0
Reduced v/c Ratio	0.53	0.76	0.66	1.14	1.15	0.30

Intersection Summary

95th percentile volume exceeds capacity, queue may be longer.
 Queue shown is maximum after two cycles.

Queues

7: I-215 NB Ramps & Ramona Exwy.



Lane Group	EBL	EBT	WBT	WBR	NBL	NBT	NBR
Lane Group Flow (vph)	129	1148	928	595	163	161	493
v/c Ratio	0.60	0.54	0.59	0.59	0.31	0.31	0.91
Control Delay	50.7	13.6	27.4	5.7	30.4	30.3	53.3
Queue Delay	0.0	15.8	0.0	0.0	0.0	0.0	0.0
Total Delay	50.7	29.4	27.4	5.7	30.4	30.3	53.3
Queue Length 50th (ft)	93	433	272	17	89	87	278
Queue Length 95th (ft)	149	514	370	113	148	146	#463
Internal Link Dist (ft)		344	532			1162	
Turn Bay Length (ft)	105			200			500
Base Capacity (vph)	303	2137	1560	1013	569	571	585
Starvation Cap Reductn	0	996	0	0	0	0	0
Spillback Cap Reductn	0	0	0	0	0	0	0
Storage Cap Reductn	0	0	0	0	0	0	0
Reduced v/c Ratio	0.43	1.01	0.59	0.59	0.29	0.28	0.84

Intersection Summary

95th percentile volume exceeds capacity, queue may be longer.
 Queue shown is maximum after two cycles.

Queues
8: I-215 SB Ramps & Placentia Av.

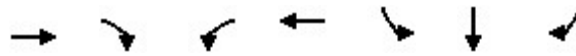

Lane Group	EBT	EBR	WBL	WBT	SBL	SBT	SBR
Lane Group Flow (vph)	579	138	157	518	146	146	82
v/c Ratio	0.36	0.17	0.42	0.24	0.40	0.40	0.18
Control Delay	12.9	3.2	26.6	4.9	24.2	24.2	2.6
Queue Delay	0.0	0.0	0.0	0.0	0.0	0.0	0.0
Total Delay	12.9	3.2	26.6	4.9	24.2	24.2	2.6
Queue Length 50th (ft)	75	0	28	49	48	48	0
Queue Length 95th (ft)	112	27	52	45	96	96	12
Internal Link Dist (ft)	968			769		2180	
Turn Bay Length (ft)		230	250				330
Base Capacity (vph)	1593	789	408	2141	365	365	450
Starvation Cap Reductn	0	0	0	0	0	0	0
Spillback Cap Reductn	0	0	0	0	0	0	0
Storage Cap Reductn	0	0	0	0	0	0	0
Reduced v/c Ratio	0.36	0.17	0.38	0.24	0.40	0.40	0.18
Intersection Summary							

Queues

9: I-215 NB Ramps & Placentia Av.



Lane Group	EBL	EBT	WBT	WBR	NBL	NBT	NBR
Lane Group Flow (vph)	86	785	459	336	108	108	283
v/c Ratio	0.25	0.35	0.26	0.35	0.35	0.35	0.62
Control Delay	21.4	4.5	10.8	2.8	24.8	24.8	14.1
Queue Delay	0.0	0.0	0.0	0.0	0.0	0.0	0.0
Total Delay	21.4	4.5	10.8	2.8	24.8	24.8	14.1
Queue Length 50th (ft)	12	24	50	0	36	36	26
Queue Length 95th (ft)	28	61	86	40	75	75	88
Internal Link Dist (ft)		769	517			1284	
Turn Bay Length (ft)	260			365	575		
Base Capacity (vph)	408	2262	1744	954	343	343	483
Starvation Cap Reductn	0	0	0	0	0	0	0
Spillback Cap Reductn	0	0	0	0	0	0	0
Storage Cap Reductn	0	0	0	0	0	0	0
Reduced v/c Ratio	0.21	0.35	0.26	0.35	0.31	0.31	0.59

Intersection Summary

Queues
6: I-215 SB Ramps & Ramona Exwy.



Lane Group	EBT	WBL	WBT	SBL	SBT	SBR
Lane Group Flow (vph)	910	320	739	398	407	146
v/c Ratio	0.73	0.90	0.35	0.76	0.78	0.25
Control Delay	32.8	50.3	6.7	45.6	46.7	5.8
Queue Delay	0.0	0.0	0.3	55.8	55.5	0.0
Total Delay	32.8	50.3	7.0	101.4	102.1	5.8
Queue Length 50th (ft)	274	219	134	267	274	0
Queue Length 95th (ft)	352	#343	17	#397	#426	46
Internal Link Dist (ft)	1408		344		1111	
Turn Bay Length (ft)		100		510		510
Base Capacity (vph)	1254	369	2133	522	523	593
Starvation Cap Reductn	0	0	703	0	0	0
Spillback Cap Reductn	7	0	0	198	199	0
Storage Cap Reductn	0	0	0	0	0	0
Reduced v/c Ratio	0.73	0.87	0.52	1.23	1.26	0.25

Intersection Summary

95th percentile volume exceeds capacity, queue may be longer.
Queue shown is maximum after two cycles.

Queues

7: I-215 NB Ramps & Ramona Exwy.



Lane Group	EBL	EBT	WBT	WBR	NBL	NBT	NBR
Lane Group Flow (vph)	106	1402	807	541	157	154	382
v/c Ratio	0.55	0.60	0.45	0.50	0.36	0.35	0.83
Control Delay	41.4	18.9	21.1	3.8	34.5	34.4	45.5
Queue Delay	0.0	36.6	0.0	0.0	0.0	0.0	0.0
Total Delay	41.4	55.5	21.1	3.8	34.5	34.4	45.5
Queue Length 50th (ft)	71	505	190	0	95	93	209
Queue Length 95th (ft)	m90	572	303	70	143	140	293
Internal Link Dist (ft)		344	532			1162	
Turn Bay Length (ft)	105			200			500
Base Capacity (vph)	303	2320	1787	1072	569	571	585
Starvation Cap Reductn	0	1010	0	0	0	0	0
Spillback Cap Reductn	0	0	0	0	0	0	0
Storage Cap Reductn	0	0	0	0	0	0	0
Reduced v/c Ratio	0.35	1.07	0.45	0.50	0.28	0.27	0.65

Intersection Summary

m Volume for 95th percentile queue is metered by upstream signal.

Queues

8: I-215 SB Ramps & Placentia Av.

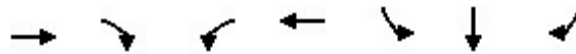

Lane Group	EBT	EBR	WBL	WBT	SBL	SBT	SBR
Lane Group Flow (vph)	724	177	263	601	189	190	74
v/c Ratio	0.50	0.23	0.66	0.28	0.52	0.52	0.16
Control Delay	14.9	3.2	36.1	5.0	26.7	26.7	2.0
Queue Delay	0.0	0.0	0.0	0.0	0.0	0.0	0.0
Total Delay	14.9	3.2	36.1	5.0	26.7	26.7	2.0
Queue Length 50th (ft)	99	0	55	47	64	64	0
Queue Length 95th (ft)	143	31	#93	57	122	122	9
Internal Link Dist (ft)	968			769		2180	
Turn Bay Length (ft)		230	250				330
Base Capacity (vph)	1454	756	408	2141	365	366	450
Starvation Cap Reductn	0	0	0	0	0	0	0
Spillback Cap Reductn	0	0	0	0	0	0	0
Storage Cap Reductn	0	0	0	0	0	0	0
Reduced v/c Ratio	0.50	0.23	0.64	0.28	0.52	0.52	0.16

Intersection Summary

95th percentile volume exceeds capacity, queue may be longer.
 Queue shown is maximum after two cycles.

Queues

9: I-215 NB Ramps & Placentia Av.



Lane Group	EBL	EBT	WBT	WBR	NBL	NBT	NBR
Lane Group Flow (vph)	75	1028	680	297	92	92	246
v/c Ratio	0.22	0.45	0.36	0.30	0.30	0.30	0.61
Control Delay	20.2	5.6	10.7	2.7	23.9	23.9	17.9
Queue Delay	0.0	0.0	0.0	0.0	0.0	0.0	0.0
Total Delay	20.2	5.6	10.7	2.7	23.9	23.9	17.9
Queue Length 50th (ft)	10	32	79	0	31	31	36
Queue Length 95th (ft)	m21	146	130	38	66	66	96
Internal Link Dist (ft)		769	517			1284	
Turn Bay Length (ft)	260			365	575		
Base Capacity (vph)	408	2262	1867	978	343	343	431
Starvation Cap Reductn	0	0	0	0	0	0	0
Spillback Cap Reductn	0	0	0	0	0	0	0
Storage Cap Reductn	0	0	0	0	0	0	0
Reduced v/c Ratio	0.18	0.45	0.36	0.30	0.27	0.27	0.57

Intersection Summary

m Volume for 95th percentile queue is metered by upstream signal.

APPENDIX 6.1: EAPC (2024) CONDITIONS INTERSECTION OPERATIONS ANALYSIS WORKSHEETS

This Page Intentionally Left Blank

Timings
1: Harvill Av. & Cajalco Exwy./Ramona Exwy.

Harvill Logistics (JN 14231)

06/17/2022

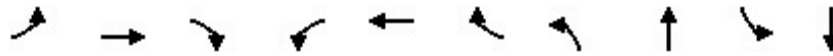

Lane Group	EBL	EBT	EBR	WBL	WBT	WBR	NBL	NBT	SBL	SBT
Lane Configurations	↙	↕	↘	↙↘	↕	↘	↙↘	↕	↙↘	↕
Traffic Volume (vph)	182	827	205	618	1116	685	362	408	403	212
Future Volume (vph)	182	827	205	618	1116	685	362	408	403	212
Turn Type	Prot	NA	Perm	Prot	NA	pm+ov	Prot	NA	Prot	NA
Protected Phases	5	2		1	6	7	3	8	7	4
Permitted Phases			2			6				
Detector Phase	5	2	2	1	6	7	3	8	7	4
Switch Phase										
Minimum Initial (s)	5.0	10.0	10.0	5.0	10.0	5.0	5.0	10.0	5.0	10.0
Minimum Split (s)	9.6	36.2	36.2	9.6	32.5	9.6	9.6	16.2	9.6	41.2
Total Split (s)	17.3	36.8	36.8	25.0	44.5	25.4	17.0	32.8	25.4	41.2
Total Split (%)	14.4%	30.7%	30.7%	20.8%	37.1%	21.2%	14.2%	27.3%	21.2%	34.3%
Yellow Time (s)	3.6	5.2	5.2	3.6	3.5	3.6	3.6	5.2	3.6	5.2
All-Red Time (s)	1.0	1.0	1.0	1.0	1.0	1.0	1.0	1.0	1.0	1.0
Lost Time Adjust (s)	0.0	0.0	0.0	0.0	0.0	0.0	0.0	0.0	0.0	0.0
Total Lost Time (s)	4.6	6.2	6.2	4.6	4.5	4.6	4.6	6.2	4.6	6.2
Lead/Lag	Lead	Lag	Lag	Lead	Lag	Lead	Lead	Lag	Lead	Lag
Lead-Lag Optimize?	Yes	Yes	Yes	Yes	Yes	Yes	Yes	Yes	Yes	Yes
Recall Mode	None	None	None	None	None	None	None	Max	None	Max
Act Effct Green (s)	12.7	30.6	30.6	20.4	40.0	63.1	12.4	28.8	18.6	35.0
Actuated g/C Ratio	0.11	0.26	0.26	0.17	0.33	0.53	0.10	0.24	0.16	0.29
v/c Ratio	1.03	0.97	0.39	1.12	1.00	0.83	1.08	0.78	0.80	0.30
Control Delay	124.9	67.0	7.9	119.2	65.6	30.4	120.1	44.9	60.5	28.7
Queue Delay	0.0	0.0	0.0	0.0	0.0	0.0	0.0	0.0	0.0	0.0
Total Delay	124.9	67.0	7.9	119.2	65.6	30.4	120.1	44.9	60.5	28.7
LOS	F	E	A	F	E	C	F	D	E	C
Approach Delay		65.8			69.3			72.0		47.1
Approach LOS		E			E			E		D

Intersection Summary

Cycle Length: 120
 Actuated Cycle Length: 120
 Natural Cycle: 130
 Control Type: Actuated-Uncoordinated
 Maximum v/c Ratio: 1.12
 Intersection Signal Delay: 66.1
 Intersection LOS: E
 Intersection Capacity Utilization 88.7%
 ICU Level of Service E
 Analysis Period (min) 15

Splits and Phases: 1: Harvill Av. & Cajalco Exwy./Ramona Exwy.

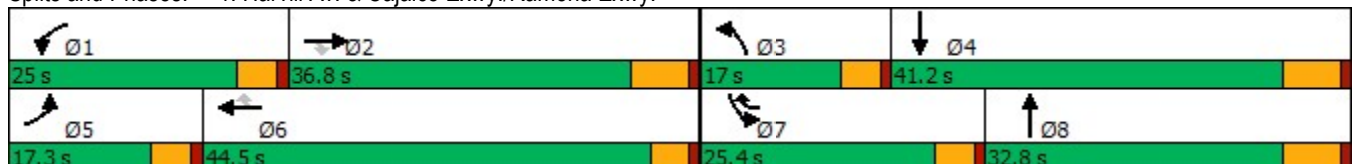

HCM 6th Signalized Intersection Summary
 1: Harvill Av. & Cajalco Exwy./Ramona Exwy.

Harvill Logistics (JN 14231)

06/17/2022

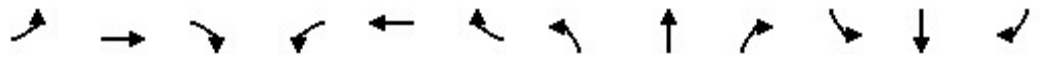

Movement	EBL	EBT	EBR	WBL	WBT	WBR	NBL	NBT	NBR	SBL	SBT	SBR
Lane Configurations	↘	↑↑	↗	↘↗	↑↑	↗	↘↗	↑↑		↘↗	↑↑	
Traffic Volume (veh/h)	182	827	205	618	1116	685	362	408	231	403	212	82
Future Volume (veh/h)	182	827	205	618	1116	685	362	408	231	403	212	82
Initial Q (Qb), veh	0	0	0	0	0	0	0	0	0	0	0	0
Ped-Bike Adj(A_pbT)	1.00		1.00	1.00		1.00	1.00		0.99	1.00		1.00
Parking Bus, Adj	1.00	1.00	1.00	1.00	1.00	1.00	1.00	1.00	1.00	1.00	1.00	1.00
Work Zone On Approach		No			No			No			No	
Adj Sat Flow, veh/h/ln	1900	1900	1900	1900	1900	1900	1900	1900	1900	1900	1900	1900
Adj Flow Rate, veh/h	196	889	169	665	1200	669	389	439	194	433	228	86
Peak Hour Factor	0.93	0.93	0.93	0.93	0.93	0.93	0.93	0.93	0.93	0.93	0.93	0.93
Percent Heavy Veh, %	0	0	0	0	0	0	0	0	0	0	0	0
Cap, veh/h	189	958	427	588	1187	755	358	606	265	493	744	273
Arrive On Green	0.10	0.27	0.27	0.17	0.33	0.33	0.10	0.25	0.25	0.14	0.29	0.29
Sat Flow, veh/h	1810	3610	1610	3510	3610	1610	3510	2433	1064	3510	2587	948
Grp Volume(v), veh/h	196	889	169	665	1200	669	389	325	308	433	157	157
Grp Sat Flow(s),veh/h/ln	1810	1805	1610	1755	1805	1610	1755	1805	1692	1755	1805	1729
Q Serve(g_s), s	12.7	29.2	10.5	20.4	40.0	40.0	12.4	20.0	20.4	14.7	8.3	8.7
Cycle Q Clear(g_c), s	12.7	29.2	10.5	20.4	40.0	40.0	12.4	20.0	20.4	14.7	8.3	8.7
Prop In Lane	1.00		1.00	1.00		1.00	1.00		0.63	1.00		0.55
Lane Grp Cap(c), veh/h	189	958	427	588	1187	755	358	450	422	493	519	497
V/C Ratio(X)	1.04	0.93	0.40	1.13	1.01	0.89	1.09	0.72	0.73	0.88	0.30	0.32
Avail Cap(c_a), veh/h	189	958	427	588	1187	755	358	450	422	600	519	497
HCM Platoon Ratio	1.00	1.00	1.00	1.00	1.00	1.00	1.00	1.00	1.00	1.00	1.00	1.00
Upstream Filter(I)	1.00	1.00	1.00	1.00	1.00	1.00	1.00	1.00	1.00	1.00	1.00	1.00
Uniform Delay (d), s/veh	54.5	43.6	36.7	50.6	40.8	29.3	54.7	41.8	42.0	51.3	33.8	34.0
Incr Delay (d2), s/veh	75.8	14.7	0.6	78.4	29.0	12.3	73.1	9.6	10.7	10.8	1.5	1.7
Initial Q Delay(d3),s/veh	0.0	0.0	0.0	0.0	0.0	0.0	0.0	0.0	0.0	0.0	0.0	0.0
%ile BackOfQ(50%),veh/ln	9.6	14.4	4.0	15.0	21.5	18.8	8.9	9.8	9.4	7.0	3.7	3.7
Unsig. Movement Delay, s/veh												
LnGrp Delay(d),s/veh	130.3	58.3	37.3	129.0	69.8	41.6	127.7	51.5	52.7	62.1	35.3	35.6
LnGrp LOS	F	E	D	F	F	D	F	D	D	E	D	D
Approach Vol, veh/h		1254			2534			1022			747	
Approach Delay, s/veh		66.7			77.9			80.9			50.9	
Approach LOS		E			E			F			D	
Timer - Assigned Phs	1	2	3	4	5	6	7	8				
Phs Duration (G+Y+Rc), s	25.0	38.5	17.0	41.2	17.3	46.2	21.7	36.5				
Change Period (Y+Rc), s	4.6	6.2	4.6	6.2	4.6	* 6.2	4.6	6.2				
Max Green Setting (Gmax), s	20.4	30.6	12.4	35.0	12.7	* 40	20.8	26.6				
Max Q Clear Time (g_c+I1), s	22.4	31.2	14.4	10.7	14.7	42.0	16.7	22.4				
Green Ext Time (p_c), s	0.0	0.0	0.0	1.6	0.0	0.0	0.4	1.4				

Intersection Summary

HCM 6th Ctrl Delay	72.3
HCM 6th LOS	E

Notes

* HCM 6th computational engine requires equal clearance times for the phases crossing the barrier.

Intersection						
Int Delay, s/veh	0					
Movement	WBL	WBR	NBT	NBR	SBL	SBT
Lane Configurations		↗	↕	↗		↕
Traffic Vol, veh/h	0	2	1075	0	0	872
Future Vol, veh/h	0	2	1075	0	0	872
Conflicting Peds, #/hr	0	0	0	0	0	0
Sign Control	Stop	Stop	Free	Free	Free	Free
RT Channelized	-	None	-	None	-	None
Storage Length	-	0	-	100	-	-
Veh in Median Storage, #	2	-	0	-	-	0
Grade, %	0	-	0	-	-	0
Peak Hour Factor	92	92	92	92	92	92
Heavy Vehicles, %	0	0	0	0	0	0
Mvmt Flow	0	2	1168	0	0	948

Major/Minor	Minor1	Major1	Major2		
Conflicting Flow All	-	584	0	0	-
Stage 1	-	-	-	-	-
Stage 2	-	-	-	-	-
Critical Hdwy	-	6.9	-	-	-
Critical Hdwy Stg 1	-	-	-	-	-
Critical Hdwy Stg 2	-	-	-	-	-
Follow-up Hdwy	-	3.3	-	-	-
Pot Cap-1 Maneuver	0	460	-	-	0
Stage 1	0	-	-	-	0
Stage 2	0	-	-	-	0
Platoon blocked, %			-	-	-
Mov Cap-1 Maneuver	-	460	-	-	-
Mov Cap-2 Maneuver	-	-	-	-	-
Stage 1	-	-	-	-	-
Stage 2	-	-	-	-	-

Approach	WB	NB	SB
HCM Control Delay, s	12.9	0	0
HCM LOS	B		

Minor Lane/Major Mvmt	NBT	NBRWBLn1	SBT
Capacity (veh/h)	-	-	460
HCM Lane V/C Ratio	-	-	0.005
HCM Control Delay (s)	-	-	12.9
HCM Lane LOS	-	-	B
HCM 95th %tile Q(veh)	-	-	0

Intersection												
Int Delay, s/veh	1.5											
Movement	EBL	EBT	EBR	WBL	WBT	WBR	NBL	NBT	NBR	SBL	SBT	SBR
Lane Configurations		↕			↕	↕	↕	↕		↕	↕	
Traffic Vol, veh/h	42	0	13	14	0	8	30	1029	36	48	891	63
Future Vol, veh/h	42	0	13	14	0	8	30	1029	36	48	891	63
Conflicting Peds, #/hr	0	0	0	0	0	0	0	0	0	0	0	0
Sign Control	Stop	Stop	Stop	Stop	Stop	Stop	Free	Free	Free	Free	Free	Free
RT Channelized	-	-	None	-	-	None	-	-	None	-	-	None
Storage Length	-	-	-	-	-	0	160	-	-	110	-	-
Veh in Median Storage, #	-	2	-	-	2	-	-	0	-	-	0	-
Grade, %	-	0	-	-	0	-	-	0	-	-	0	-
Peak Hour Factor	86	86	86	86	86	86	86	86	86	86	86	86
Heavy Vehicles, %	0	0	0	0	0	0	0	0	0	0	0	0
Mvmt Flow	49	0	15	16	0	9	35	1197	42	56	1036	73

Major/Minor	Minor2		Minor1		Major1		Major2					
Conflicting Flow All	1854	2494	555	1918	2509	620	1109	0	0	1239	0	0
Stage 1	1185	1185	-	1288	1288	-	-	-	-	-	-	-
Stage 2	669	1309	-	630	1221	-	-	-	-	-	-	-
Critical Hdwy	6.5	6.5	6.9	6.5	6.5	6.9	4.1	-	-	4.1	-	-
Critical Hdwy Stg 1	6.5	5.5	-	6.5	5.5	-	-	-	-	-	-	-
Critical Hdwy Stg 2	6.5	5.5	-	6.5	5.5	-	-	-	-	-	-	-
Follow-up Hdwy	3.5	4	3.3	3.5	4	3.3	2.2	-	-	2.2	-	-
Pot Cap-1 Maneuver	78	29	480	71	29	436	637	-	-	569	-	-
Stage 1	204	265	-	176	237	-	-	-	-	-	-	-
Stage 2	418	231	-	441	255	-	-	-	-	-	-	-
Platoon blocked, %								-	-	-	-	-
Mov Cap-1 Maneuver	68	25	480	61	25	436	637	-	-	569	-	-
Mov Cap-2 Maneuver	167	128	-	149	140	-	-	-	-	-	-	-
Stage 1	193	239	-	166	224	-	-	-	-	-	-	-
Stage 2	387	218	-	385	230	-	-	-	-	-	-	-

Approach	EB		WB		NB		SB	
HCM Control Delay, s	31.8		25.3		0.3		0.6	
HCM LOS	D		D					

Minor Lane/Major Mvmt	NBL	NBT	NBR	EBLn1	WBLn1	WBLn2	SBL	SBT	SBR
Capacity (veh/h)	637	-	-	197	149	436	569	-	-
HCM Lane V/C Ratio	0.055	-	-	0.325	0.109	0.021	0.098	-	-
HCM Control Delay (s)	11	-	-	31.8	32.1	13.4	12	-	-
HCM Lane LOS	B	-	-	D	D	B	B	-	-
HCM 95th %tile Q(veh)	0.2	-	-	1.3	0.4	0.1	0.3	-	-



Intersection						
Int Delay, s/veh	3.8					
Movement	EBL	EBT	WBT	WBR	SBL	SBR
Lane Configurations		↶	↷		↶	
Traffic Vol, veh/h	7	18	39	0	0	41
Future Vol, veh/h	7	18	39	0	0	41
Conflicting Peds, #/hr	0	0	0	0	0	0
Sign Control	Free	Free	Free	Free	Stop	Stop
RT Channelized	-	None	-	None	-	None
Storage Length	-	-	-	-	0	-
Veh in Median Storage, #	-	0	0	-	0	-
Grade, %	-	0	0	-	0	-
Peak Hour Factor	92	92	92	92	92	92
Heavy Vehicles, %	0	0	0	0	0	0
Mvmt Flow	8	20	42	0	0	45

Major/Minor	Major1	Major2	Minor2		
Conflicting Flow All	42	0	-	0	78 42
Stage 1	-	-	-	-	42 -
Stage 2	-	-	-	-	36 -
Critical Hdwy	4.1	-	-	-	6.4 6.2
Critical Hdwy Stg 1	-	-	-	-	5.4 -
Critical Hdwy Stg 2	-	-	-	-	5.4 -
Follow-up Hdwy	2.2	-	-	-	3.5 3.3
Pot Cap-1 Maneuver	1580	-	-	-	930 1034
Stage 1	-	-	-	-	986 -
Stage 2	-	-	-	-	992 -
Platoon blocked, %		-	-	-	
Mov Cap-1 Maneuver	1580	-	-	-	925 1034
Mov Cap-2 Maneuver	-	-	-	-	925 -
Stage 1	-	-	-	-	981 -
Stage 2	-	-	-	-	992 -

Approach	EB	WB	SB
HCM Control Delay, s	2	0	8.6
HCM LOS			A

Minor Lane/Major Mvmt	EBL	EBT	WBT	WBR	SBLn1
Capacity (veh/h)	1580	-	-	-	1034
HCM Lane V/C Ratio	0.005	-	-	-	0.043
HCM Control Delay (s)	7.3	0	-	-	8.6
HCM Lane LOS	A	A	-	-	A
HCM 95th %tile Q(veh)	0	-	-	-	0.1

Intersection	
Intersection Delay, s/veh	6.8
Intersection LOS	A

Movement	EBL	EBR	NBL	NBT	SBT	SBR
Lane Configurations						
Traffic Vol, veh/h	6	12	22	0	0	17
Future Vol, veh/h	6	12	22	0	0	17
Peak Hour Factor	0.92	0.92	0.92	0.92	0.92	0.92
Heavy Vehicles, %	0	0	0	0	0	0
Mvmt Flow	7	13	24	0	0	18
Number of Lanes	1	0	0	1	1	0

Approach	EB	NB	SB
Opposing Approach		SB	NB
Opposing Lanes	0	1	1
Conflicting Approach Left	SB	EB	
Conflicting Lanes Left	1	1	0
Conflicting Approach Right	NB		EB
Conflicting Lanes Right	1	0	1
HCM Control Delay	6.7	7.3	6.4
HCM LOS	A	A	A

Lane	NBLn1	EBLn1	SBLn1
Vol Left, %	100%	33%	0%
Vol Thru, %	0%	0%	0%
Vol Right, %	0%	67%	100%
Sign Control	Stop	Stop	Stop
Traffic Vol by Lane	22	18	17
LT Vol	22	6	0
Through Vol	0	0	0
RT Vol	0	12	17
Lane Flow Rate	24	20	18
Geometry Grp	1	1	1
Degree of Util (X)	0.028	0.02	0.017
Departure Headway (Hd)	4.147	3.639	3.351
Convergence, Y/N	Yes	Yes	Yes
Cap	867	985	1071
Service Time	2.154	1.654	1.363
HCM Lane V/C Ratio	0.028	0.02	0.017
HCM Control Delay	7.3	6.7	6.4
HCM Lane LOS	A	A	A
HCM 95th-tile Q	0.1	0.1	0.1

Timings
6: I-215 SB Ramps & Ramona Exwy.

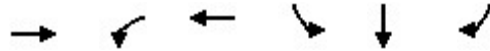

Lane Group	EBT	WBL	WBT	SBL	SBT	SBR
Lane Configurations	↑↑	↵	↑↑	↵	↵	↵
Traffic Volume (vph)	766	542	1792	1834	2	752
Future Volume (vph)	766	542	1792	1834	2	752
Turn Type	NA	Prot	NA	Split	NA	Perm
Protected Phases	2	1	6	4	4	
Permitted Phases						4
Detector Phase	2	1	6	4	4	4
Switch Phase						
Minimum Initial (s)	5.0	5.0	5.0	5.0	5.0	5.0
Minimum Split (s)	11.0	9.5	31.0	10.5	10.5	10.5
Total Split (s)	44.0	27.0	71.0	39.0	39.0	39.0
Total Split (%)	40.0%	24.5%	64.5%	35.5%	35.5%	35.5%
Yellow Time (s)	5.0	3.5	5.0	4.5	4.5	4.5
All-Red Time (s)	1.0	1.0	1.0	1.0	1.0	1.0
Lost Time Adjust (s)	0.0	0.0	0.0	0.0	0.0	0.0
Total Lost Time (s)	6.0	4.5	6.0	5.5	5.5	5.5
Lead/Lag	Lag	Lead				
Lead-Lag Optimize?	Yes	Yes				
Recall Mode	C-Max	None	C-Max	Max	Max	Max
Act Effct Green (s)	38.0	22.5	65.0	33.5	33.5	33.5
Actuated g/C Ratio	0.35	0.20	0.59	0.30	0.30	0.30
v/c Ratio	0.99	1.50	0.86	1.79	1.79	1.41
Control Delay	56.8	254.1	9.2	390.4	391.4	225.3
Queue Delay	4.4	0.0	29.8	12.3	12.2	0.0
Total Delay	61.2	254.1	39.0	402.6	403.6	225.3
LOS	E	F	D	F	F	F
Approach Delay	61.2		88.9		351.4	
Approach LOS	E		F		F	

Intersection Summary

Cycle Length: 110
 Actuated Cycle Length: 110
 Offset: 34 (31%), Referenced to phase 2:EBT and 6:WBT, Start of Yellow
 Natural Cycle: 150
 Control Type: Actuated-Coordinated
 Maximum v/c Ratio: 1.79
 Intersection Signal Delay: 194.1
 Intersection LOS: F
 Intersection Capacity Utilization 235.7%
 ICU Level of Service H
 Analysis Period (min) 15

Splits and Phases: 6: I-215 SB Ramps & Ramona Exwy.

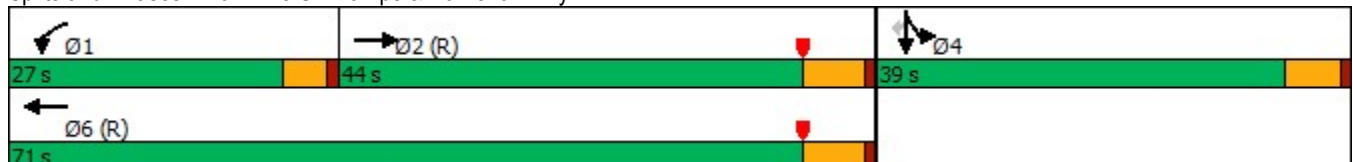

HCM 6th Signalized Intersection Summary
6: I-215 SB Ramps & Ramona Exwy.

Harvill Logistics (JN 14231)

06/16/2022

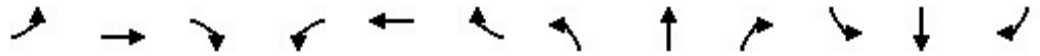

Movement	EBL	EBT	EBR	WBL	WBT	WBR	NBL	NBT	NBR	SBL	SBT	SBR
Lane Configurations		↑↑		↖	↑↑					↘	↖	↗
Traffic Volume (veh/h)	0	766	449	542	1792	0	0	0	0	1834	2	752
Future Volume (veh/h)	0	766	449	542	1792	0	0	0	0	1834	2	752
Initial Q (Qb), veh	0	0	0	0	0	0				0	0	0
Ped-Bike Adj(A_pbT)	1.00		0.99	1.00		1.00				1.00		1.00
Parking Bus, Adj	1.00	1.00	1.00	1.00	1.00	1.00				1.00	1.00	1.00
Work Zone On Approach		No			No						No	
Adj Sat Flow, veh/h/ln	0	1900	1900	1900	1900	0				1900	1900	1900
Adj Flow Rate, veh/h	0	782	329	553	1829	0				1872	0	704
Peak Hour Factor	0.98	0.98	0.98	0.98	0.98	0.98				0.98	0.98	0.98
Percent Heavy Veh, %	0	0	0	0	0	0				0	0	0
Cap, veh/h	0	852	358	370	2133	0				1102	0	490
Arrive On Green	0.00	0.35	0.35	0.12	0.35	0.00				0.30	0.00	0.30
Sat Flow, veh/h	0	2562	1036	1810	3705	0				3619	0	1610
Grp Volume(v), veh/h	0	572	539	553	1829	0				1872	0	704
Grp Sat Flow(s),veh/h/ln	0	1805	1698	1810	1805	0				1810	0	1610
Q Serve(g_s), s	0.0	33.4	33.5	22.5	51.7	0.0				33.5	0.0	33.5
Cycle Q Clear(g_c), s	0.0	33.4	33.5	22.5	51.7	0.0				33.5	0.0	33.5
Prop In Lane	0.00		0.61	1.00		0.00				1.00		1.00
Lane Grp Cap(c), veh/h	0	624	587	370	2133	0				1102	0	490
V/C Ratio(X)	0.00	0.92	0.92	1.49	0.86	0.00				1.70	0.00	1.44
Avail Cap(c_a), veh/h	0	624	587	370	2133	0				1102	0	490
HCM Platoon Ratio	1.00	1.00	1.00	0.60	0.60	1.00				1.00	1.00	1.00
Upstream Filter(l)	0.00	0.20	0.20	0.09	0.09	0.00				1.00	0.00	1.00
Uniform Delay (d), s/veh	0.0	34.5	34.5	48.2	31.2	0.0				38.3	0.0	38.3
Incr Delay (d2), s/veh	0.0	5.6	6.0	223.6	0.5	0.0				318.2	0.0	207.5
Initial Q Delay(d3),s/veh	0.0	0.0	0.0	0.0	0.0	0.0				0.0	0.0	0.0
%ile BackOfQ(50%),veh/ln	0.0	14.5	13.8	33.3	23.0	0.0				62.7	0.0	40.7
Unsig. Movement Delay, s/veh												
LnGrp Delay(d),s/veh	0.0	40.1	40.5	271.9	31.7	0.0				356.5	0.0	245.7
LnGrp LOS	A	D	D	F	C	A				F	A	F
Approach Vol, veh/h		1111			2382						2576	
Approach Delay, s/veh		40.3			87.4						326.2	
Approach LOS		D			F						F	
Timer - Assigned Phs	1	2		4		6						
Phs Duration (G+Y+Rc), s	27.0	44.0		39.0		71.0						
Change Period (Y+Rc), s	4.5	6.0		5.5		6.0						
Max Green Setting (Gmax), s	22.5	38.0		33.5		65.0						
Max Q Clear Time (g_c+I1), s	24.5	35.5		35.5		53.7						
Green Ext Time (p_c), s	0.0	1.2		0.0		6.6						

Intersection Summary

HCM 6th Ctrl Delay	180.2
HCM 6th LOS	F

Notes

User approved volume balancing among the lanes for turning movement.

Timings
7: I-215 NB Ramps & Ramona Exwy.



Lane Group	EBL	EBT	WBT	WBR	NBL	NBT	NBR
Lane Configurations	↶	↷	↶	↷	↶	↷	↷
Traffic Volume (vph)	309	2291	1490	1459	843	4	799
Future Volume (vph)	309	2291	1490	1459	843	4	799
Turn Type	Prot	NA	NA	Perm	Split	NA	Perm
Protected Phases	5	2	6		8	8	
Permitted Phases				6			8
Detector Phase	5	2	6	6	8	8	8
Switch Phase							
Minimum Initial (s)	5.0	5.0	5.0	5.0	5.0	5.0	5.0
Minimum Split (s)	9.5	11.0	26.0	26.0	10.5	10.5	10.5
Total Split (s)	23.0	68.0	45.0	45.0	42.0	42.0	42.0
Total Split (%)	20.9%	61.8%	40.9%	40.9%	38.2%	38.2%	38.2%
Yellow Time (s)	3.5	5.0	5.0	5.0	4.5	4.5	4.5
All-Red Time (s)	1.0	1.0	1.0	1.0	1.0	1.0	1.0
Lost Time Adjust (s)	0.0	0.0	0.0	0.0	0.0	0.0	0.0
Total Lost Time (s)	4.5	6.0	6.0	6.0	5.5	5.5	5.5
Lead/Lag	Lead		Lag	Lag			
Lead-Lag Optimize?	Yes		Yes	Yes			
Recall Mode	None	C-Max	C-Max	C-Max	None	None	None
Act Effct Green (s)	18.5	62.0	39.0	39.0	36.5	36.5	36.5
Actuated g/C Ratio	0.17	0.56	0.35	0.35	0.33	0.33	0.33
v/c Ratio	1.05	1.16	1.20	1.43	0.76	0.77	1.41
Control Delay	85.2	98.3	131.1	217.2	43.1	43.5	222.4
Queue Delay	0.0	2.4	0.6	0.0	0.0	0.0	0.0
Total Delay	85.2	100.7	131.7	217.2	43.1	43.5	222.4
LOS	F	F	F	F	D	D	F
Approach Delay		98.8	174.0			130.3	
Approach LOS		F	F			F	

Intersection Summary

Cycle Length: 110
 Actuated Cycle Length: 110
 Offset: 0 (0%), Referenced to phase 2:EBT and 6:WBT, Start of Yellow, Master Intersection
 Natural Cycle: 130
 Control Type: Actuated-Coordinated
 Maximum v/c Ratio: 1.43
 Intersection Signal Delay: 136.8
 Intersection Capacity Utilization 235.7%
 Analysis Period (min) 15
 Intersection LOS: F
 ICU Level of Service H

Splits and Phases: 7: I-215 NB Ramps & Ramona Exwy.

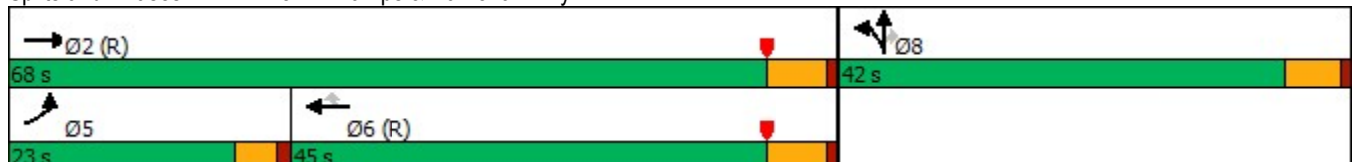

HCM 6th Signalized Intersection Summary
 7: I-215 NB Ramps & Ramona Exwy.

Harvill Logistics (JN 14231)

06/16/2022

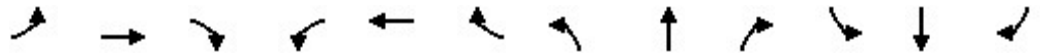

Movement	EBL	EBT	EBR	WBL	WBT	WBR	NBL	NBT	NBR	SBL	SBT	SBR
Lane Configurations	↘	↑↑			↑↑	↗	↘	↗	↗			
Traffic Volume (veh/h)	309	2291	0	0	1490	1459	843	4	799	0	0	0
Future Volume (veh/h)	309	2291	0	0	1490	1459	843	4	799	0	0	0
Initial Q (Qb), veh	0	0	0	0	0	0	0	0	0			
Ped-Bike Adj(A_pbT)	1.00		1.00	1.00		1.00	1.00		1.00			
Parking Bus, Adj	1.00	1.00	1.00	1.00	1.00	1.00	1.00	1.00	1.00			
Work Zone On Approach		No			No			No				
Adj Sat Flow, veh/h/ln	1900	1900	0	0	1900	1900	1900	1900	1900			
Adj Flow Rate, veh/h	319	2362	0	0	1536	1356	872	0	672			
Peak Hour Factor	0.97	0.97	0.97	0.97	0.97	0.97	0.97	0.97	0.97			
Percent Heavy Veh, %	0	0	0	0	0	0	0	0	0			
Cap, veh/h	304	2035	0	0	1280	571	1201	0	534			
Arrive On Green	0.22	0.75	0.00	0.00	0.35	0.35	0.33	0.00	0.33			
Sat Flow, veh/h	1810	3705	0	0	3705	1610	3619	0	1610			
Grp Volume(v), veh/h	319	2362	0	0	1536	1356	872	0	672			
Grp Sat Flow(s),veh/h/ln	1810	1805	0	0	1805	1610	1810	0	1610			
Q Serve(g_s), s	18.5	62.0	0.0	0.0	39.0	39.0	23.3	0.0	36.5			
Cycle Q Clear(g_c), s	18.5	62.0	0.0	0.0	39.0	39.0	23.3	0.0	36.5			
Prop In Lane	1.00		0.00	0.00		1.00	1.00		1.00			
Lane Grp Cap(c), veh/h	304	2035	0	0	1280	571	1201	0	534			
V/C Ratio(X)	1.05	1.16	0.00	0.00	1.20	2.38	0.73	0.00	1.26			
Avail Cap(c_a), veh/h	304	2035	0	0	1280	571	1201	0	534			
HCM Platoon Ratio	1.33	1.33	1.00	1.00	1.00	1.00	1.00	1.00	1.00			
Upstream Filter(l)	0.09	0.09	0.00	0.00	1.00	1.00	1.00	0.00	1.00			
Uniform Delay (d), s/veh	42.7	13.8	0.0	0.0	35.5	35.5	32.4	0.0	36.8			
Incr Delay (d2), s/veh	30.0	72.9	0.0	0.0	97.8	624.3	2.2	0.0	130.6			
Initial Q Delay(d3),s/veh	0.0	0.0	0.0	0.0	0.0	0.0	0.0	0.0	0.0			
%ile BackOfQ(50%),veh/ln	9.9	31.3	0.0	0.0	33.2	113.1	10.0	0.0	32.8			
Unsig. Movement Delay, s/veh												
LnGrp Delay(d),s/veh	72.7	86.7	0.0	0.0	133.3	659.8	34.6	0.0	167.3			
LnGrp LOS	F	F	A	A	F	F	C	A	F			
Approach Vol, veh/h		2681			2892			1544				
Approach Delay, s/veh		85.1			380.2			92.4				
Approach LOS		F			F			F				
Timer - Assigned Phs		2			5	6		8				
Phs Duration (G+Y+Rc), s		68.0			23.0	45.0		42.0				
Change Period (Y+Rc), s		6.0			4.5	6.0		5.5				
Max Green Setting (Gmax), s		62.0			18.5	39.0		36.5				
Max Q Clear Time (g_c+I1), s		64.0			20.5	41.0		38.5				
Green Ext Time (p_c), s		0.0			0.0	0.0		0.0				

Intersection Summary

HCM 6th Ctrl Delay	206.6
HCM 6th LOS	F

Notes

User approved volume balancing among the lanes for turning movement.

Timings
8: I-215 SB Ramps & Placentia Av.

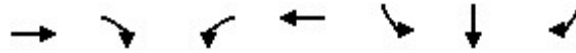

Lane Group	EBT	EBR	WBL	WBT	SBL	SBT	SBR
Lane Configurations	↑↑	↑	↑↑	↑↑	↑	↑	↑
Traffic Volume (vph)	652	199	245	612	426	0	255
Future Volume (vph)	652	199	245	612	426	0	255
Turn Type	NA	Perm	Prot	NA	Split	NA	Perm
Protected Phases	2		1	6	4	4	
Permitted Phases		2					4
Detector Phase	2	2	1	6	4	4	4
Switch Phase							
Minimum Initial (s)	10.0	10.0	5.0	10.0	10.0	10.0	10.0
Minimum Split (s)	27.8	27.8	9.6	27.8	15.8	15.8	15.8
Total Split (s)	29.0	29.0	12.0	41.0	19.0	19.0	19.0
Total Split (%)	48.3%	48.3%	20.0%	68.3%	31.7%	31.7%	31.7%
Yellow Time (s)	4.8	4.8	3.6	4.8	4.8	4.8	4.8
All-Red Time (s)	1.0	1.0	1.0	1.0	1.0	1.0	1.0
Lost Time Adjust (s)	0.0	0.0	0.0	0.0	0.0	0.0	0.0
Total Lost Time (s)	5.8	5.8	4.6	5.8	5.8	5.8	5.8
Lead/Lag	Lag	Lag	Lead				
Lead-Lag Optimize?	Yes	Yes	Yes				
Recall Mode	None	None	None	C-Max	Max	Max	Max
Act Effct Green (s)	23.4	23.4	7.2	35.2	13.2	13.2	13.2
Actuated g/C Ratio	0.39	0.39	0.12	0.59	0.22	0.22	0.22
v/c Ratio	0.50	0.28	0.64	0.31	0.61	0.62	0.50
Control Delay	15.5	3.3	28.5	5.1	29.2	29.3	8.0
Queue Delay	0.0	0.0	0.0	0.0	0.0	0.0	0.0
Total Delay	15.5	3.3	28.5	5.1	29.2	29.3	8.0
LOS	B	A	C	A	C	C	A
Approach Delay	12.6			11.8		21.3	
Approach LOS	B			B		C	

Intersection Summary

Cycle Length: 60
 Actuated Cycle Length: 60
 Offset: 0 (0%), Referenced to phase 6:WBT, Start of Yellow, Master Intersection
 Natural Cycle: 60
 Control Type: Actuated-Coordinated
 Maximum v/c Ratio: 0.64
 Intersection Signal Delay: 14.8
 Intersection Capacity Utilization 69.2%
 Analysis Period (min) 15
 Intersection LOS: B
 ICU Level of Service C

Splits and Phases: 8: I-215 SB Ramps & Placentia Av.

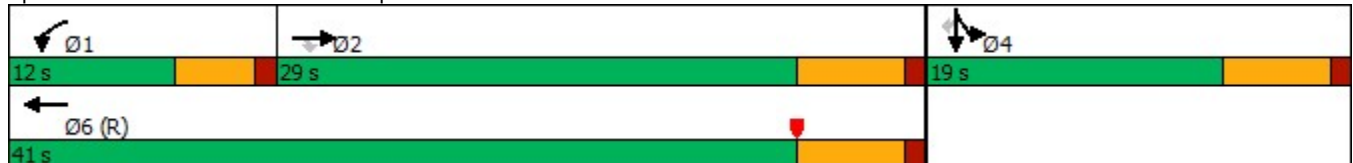

HCM 6th Signalized Intersection Summary
 8: I-215 SB Ramps & Placentia Av.

Harvill Logistics (JN 14231)

06/16/2022



Movement	EBL	EBT	EBR	WBL	WBT	WBR	NBL	NBT	NBR	SBL	SBT	SBR
Lane Configurations		↑↑	↗	↘↗	↑↑					↘	↗	↗
Traffic Volume (veh/h)	0	652	199	245	612	0	0	0	0	426	0	255
Future Volume (veh/h)	0	652	199	245	612	0	0	0	0	426	0	255
Initial Q (Qb), veh	0	0	0	0	0	0				0	0	0
Ped-Bike Adj(A_pbT)	1.00		1.00	1.00		1.00				1.00		1.00
Parking Bus, Adj	1.00	1.00	1.00	1.00	1.00	1.00				1.00	1.00	1.00
Work Zone On Approach		No			No						No	
Adj Sat Flow, veh/h/ln	0	1900	1900	1900	1900	0				1900	1900	1900
Adj Flow Rate, veh/h	0	709	113	266	665	0				463	0	141
Peak Hour Factor	0.92	0.92	0.92	0.92	0.92	0.92				0.92	0.92	0.92
Percent Heavy Veh, %	0	0	0	0	0	0				0	0	0
Cap, veh/h	0	1466	654	365	2118	0				796	0	354
Arrive On Green	0.00	0.41	0.41	0.21	1.00	0.00				0.22	0.00	0.22
Sat Flow, veh/h	0	3705	1610	3510	3705	0				3619	0	1610
Grp Volume(v), veh/h	0	709	113	266	665	0				463	0	141
Grp Sat Flow(s),veh/h/ln	0	1805	1610	1755	1805	0				1810	0	1610
Q Serve(g_s), s	0.0	8.7	2.7	4.2	0.0	0.0				6.9	0.0	4.5
Cycle Q Clear(g_c), s	0.0	8.7	2.7	4.2	0.0	0.0				6.9	0.0	4.5
Prop In Lane	0.00		1.00	1.00		0.00				1.00		1.00
Lane Grp Cap(c), veh/h	0	1466	654	365	2118	0				796	0	354
V/C Ratio(X)	0.00	0.48	0.17	0.73	0.31	0.00				0.58	0.00	0.40
Avail Cap(c_a), veh/h	0	1466	654	433	2118	0				796	0	354
HCM Platoon Ratio	1.00	1.00	1.00	2.00	2.00	1.00				1.00	1.00	1.00
Upstream Filter(l)	0.00	1.00	1.00	0.92	0.92	0.00				1.00	0.00	1.00
Uniform Delay (d), s/veh	0.0	13.2	11.4	23.0	0.0	0.0				20.9	0.0	20.0
Incr Delay (d2), s/veh	0.0	0.2	0.1	3.5	0.4	0.0				3.1	0.0	3.3
Initial Q Delay(d3),s/veh	0.0	0.0	0.0	0.0	0.0	0.0				0.0	0.0	0.0
%ile BackOfQ(50%),veh/ln	0.0	2.8	0.8	1.6	0.1	0.0				2.8	0.0	1.8
Unsig. Movement Delay, s/veh												
LnGrp Delay(d),s/veh	0.0	13.4	11.5	26.4	0.4	0.0				24.0	0.0	23.3
LnGrp LOS	A	B	B	C	A	A				C	A	C
Approach Vol, veh/h		822			931						604	
Approach Delay, s/veh		13.2			7.8						23.9	
Approach LOS		B			A						C	
Timer - Assigned Phs	1	2		4		6						
Phs Duration (G+Y+Rc), s	10.8	30.2		19.0		41.0						
Change Period (Y+Rc), s	4.6	5.8		5.8		5.8						
Max Green Setting (Gmax), s	7.4	23.2		13.2		35.2						
Max Q Clear Time (g_c+I1), s	6.2	10.7		8.9		2.0						
Green Ext Time (p_c), s	0.1	3.8		1.0		4.5						

Intersection Summary

HCM 6th Ctrl Delay	13.8
HCM 6th LOS	B

Notes

User approved volume balancing among the lanes for turning movement.

Timings
9: I-215 NB Ramps & Placentia Av.



Lane Group	EBL	EBT	WBT	WBR	NBL	NBT	NBR
Lane Configurations	↶↶	↶↶	↶↶	↷	↶	↶	↷
Traffic Volume (vph)	186	891	534	440	323	0	564
Future Volume (vph)	186	891	534	440	323	0	564
Turn Type	Prot	NA	NA	Perm	Split	NA	Perm
Protected Phases	5	2	6		8	8	
Permitted Phases				6			8
Detector Phase	5	2	6	6	8	8	8
Switch Phase							
Minimum Initial (s)	5.0	10.0	10.0	10.0	10.0	10.0	10.0
Minimum Split (s)	9.6	27.8	27.8	27.8	15.8	15.8	15.8
Total Split (s)	9.6	39.0	29.4	29.4	21.0	21.0	21.0
Total Split (%)	16.0%	65.0%	49.0%	49.0%	35.0%	35.0%	35.0%
Yellow Time (s)	3.6	4.8	4.8	4.8	4.8	4.8	4.8
All-Red Time (s)	1.0	1.0	1.0	1.0	1.0	1.0	1.0
Lost Time Adjust (s)	0.0	0.0	0.0	0.0	0.0	0.0	0.0
Total Lost Time (s)	4.6	5.8	5.8	5.8	5.8	5.8	5.8
Lead/Lag	Lead		Lag	Lag			
Lead-Lag Optimize?	Yes		Yes	Yes			
Recall Mode	None	C-Max	C-Max	C-Max	None	None	None
Act Effct Green (s)	5.0	33.2	23.6	23.6	15.2	15.2	15.2
Actuated g/C Ratio	0.08	0.55	0.39	0.39	0.25	0.25	0.25
v/c Ratio	0.69	0.48	0.41	0.52	0.40	0.41	1.20
Control Delay	34.1	8.0	14.3	3.7	22.0	22.1	130.5
Queue Delay	0.0	0.0	0.0	0.0	0.0	0.0	0.0
Total Delay	34.1	8.0	14.3	3.7	22.0	22.1	130.5
LOS	C	A	B	A	C	C	F
Approach Delay		12.5	9.5			91.0	
Approach LOS		B	A			F	

Intersection Summary

Cycle Length: 60
 Actuated Cycle Length: 60
 Offset: 0 (0%), Referenced to phase 2:EBT and 6:WBT, Start of Yellow
 Natural Cycle: 75
 Control Type: Actuated-Coordinated
 Maximum v/c Ratio: 1.20
 Intersection Signal Delay: 35.2
 Intersection Capacity Utilization 69.2%
 Analysis Period (min) 15

Intersection LOS: D
 ICU Level of Service C

Splits and Phases: 9: I-215 NB Ramps & Placentia Av.

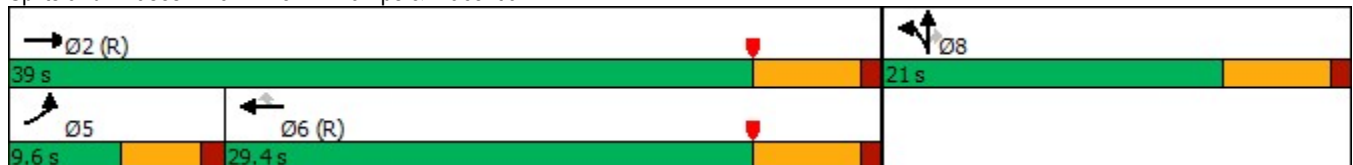

HCM 6th Signalized Intersection Summary
 9: I-215 NB Ramps & Placentia Av.

Harvill Logistics (JN 14231)
 06/16/2022

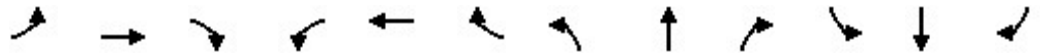

Movement	EBL	EBT	EBR	WBL	WBT	WBR	NBL	NBT	NBR	SBL	SBT	SBR
Lane Configurations	↗↘	↑↑			↑↑	↗	↗	↖	↖			
Traffic Volume (veh/h)	186	891	0	0	534	440	323	0	564	0	0	0
Future Volume (veh/h)	186	891	0	0	534	440	323	0	564	0	0	0
Initial Q (Qb), veh	0	0	0	0	0	0	0	0	0			
Ped-Bike Adj(A_pbT)	1.00		1.00	1.00		1.00	1.00		1.00			
Parking Bus, Adj	1.00	1.00	1.00	1.00	1.00	1.00	1.00	1.00	1.00			
Work Zone On Approach		No			No			No				
Adj Sat Flow, veh/h/ln	1900	1900	0	0	1900	1900	1900	1900	1900			
Adj Flow Rate, veh/h	202	968	0	0	580	261	351	0	314			
Peak Hour Factor	0.92	0.92	0.92	0.92	0.92	0.92	0.92	0.92	0.92			
Percent Heavy Veh, %	0	0	0	0	0	0	0	0	0			
Cap, veh/h	293	2084	0	0	1506	672	830	0	369			
Arrive On Green	0.08	0.58	0.00	0.00	0.42	0.42	0.23	0.00	0.23			
Sat Flow, veh/h	3510	3705	0	0	3705	1610	3619	0	1610			
Grp Volume(v), veh/h	202	968	0	0	580	261	351	0	314			
Grp Sat Flow(s),veh/h/ln	1755	1805	0	0	1805	1610	1810	0	1610			
Q Serve(g_s), s	3.4	9.3	0.0	0.0	6.7	6.8	5.0	0.0	11.2			
Cycle Q Clear(g_c), s	3.4	9.3	0.0	0.0	6.7	6.8	5.0	0.0	11.2			
Prop In Lane	1.00		0.00	0.00		1.00	1.00		1.00			
Lane Grp Cap(c), veh/h	293	2084	0	0	1506	672	830	0	369			
V/C Ratio(X)	0.69	0.46	0.00	0.00	0.39	0.39	0.42	0.00	0.85			
Avail Cap(c_a), veh/h	293	2084	0	0	1506	672	917	0	408			
HCM Platoon Ratio	1.00	1.00	1.00	1.00	1.00	1.00	1.00	1.00	1.00			
Upstream Filter(I)	0.83	0.83	0.00	0.00	1.00	1.00	1.00	0.00	1.00			
Uniform Delay (d), s/veh	26.7	7.3	0.0	0.0	12.1	12.2	19.7	0.0	22.1			
Incr Delay (d2), s/veh	4.7	0.6	0.0	0.0	0.7	1.7	0.3	0.0	14.5			
Initial Q Delay(d3),s/veh	0.0	0.0	0.0	0.0	0.0	0.0	0.0	0.0	0.0			
%ile BackOfQ(50%),veh/ln	1.4	2.5	0.0	0.0	2.3	2.2	1.8	0.0	5.1			
Unsig. Movement Delay, s/veh												
LnGrp Delay(d),s/veh	31.5	7.9	0.0	0.0	12.9	13.9	20.1	0.0	36.7			
LnGrp LOS	C	A	A	A	B	B	C	A	D			
Approach Vol, veh/h		1170			841			665				
Approach Delay, s/veh		12.0			13.2			27.9				
Approach LOS		B			B			C				
Timer - Assigned Phs		2			5	6		8				
Phs Duration (G+Y+Rc), s		40.4			9.6	30.8		19.6				
Change Period (Y+Rc), s		5.8			4.6	5.8		5.8				
Max Green Setting (Gmax), s		33.2			5.0	23.6		15.2				
Max Q Clear Time (g_c+I1), s		11.3			5.4	8.8		13.2				
Green Ext Time (p_c), s		6.5			0.0	3.9		0.6				

Intersection Summary

HCM 6th Ctrl Delay	16.3
HCM 6th LOS	B

Notes

User approved volume balancing among the lanes for turning movement.

Timings
1: Harvill Av. & Cajalco Exwy./Ramona Exwy.

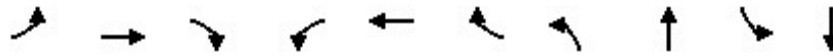

Lane Group	EBL	EBT	EBR	WBL	WBT	WBR	NBL	NBT	SBL	SBT
Lane Configurations	↘	↑↑	↗	↘↗	↑↑	↗	↘↗	↑↑	↘↗	↑↑
Traffic Volume (vph)	121	1223	286	337	916	448	294	218	842	293
Future Volume (vph)	121	1223	286	337	916	448	294	218	842	293
Turn Type	Prot	NA	Perm	Prot	NA	pm+ov	Prot	NA	Prot	NA
Protected Phases	5	2		1	6	7	3	8	7	4
Permitted Phases			2			6				
Detector Phase	5	2	2	1	6	7	3	8	7	4
Switch Phase										
Minimum Initial (s)	5.0	10.0	10.0	5.0	10.0	5.0	5.0	10.0	5.0	10.0
Minimum Split (s)	9.6	36.2	36.2	9.6	32.5	9.6	9.6	16.2	9.6	41.2
Total Split (s)	16.0	47.0	47.0	16.0	47.0	29.0	14.0	28.0	29.0	43.0
Total Split (%)	13.3%	39.2%	39.2%	13.3%	39.2%	24.2%	11.7%	23.3%	24.2%	35.8%
Yellow Time (s)	3.6	5.2	5.2	3.6	3.5	3.6	3.6	5.2	3.6	5.2
All-Red Time (s)	1.0	1.0	1.0	1.0	1.0	1.0	1.0	1.0	1.0	1.0
Lost Time Adjust (s)	0.0	0.0	0.0	0.0	0.0	0.0	0.0	0.0	0.0	0.0
Total Lost Time (s)	4.6	6.2	6.2	4.6	4.5	4.6	4.6	6.2	4.6	6.2
Lead/Lag	Lead	Lag	Lag	Lead	Lag	Lead	Lead	Lag	Lead	Lag
Lead-Lag Optimize?	Yes	Yes	Yes	Yes	Yes	Yes	Yes	Yes	Yes	Yes
Recall Mode	None	None	None	None	None	None	None	Max	None	Max
Act Effct Green (s)	10.8	40.8	40.8	11.4	43.1	72.0	9.4	21.8	24.4	36.8
Actuated g/C Ratio	0.09	0.34	0.34	0.10	0.36	0.60	0.08	0.18	0.20	0.31
v/c Ratio	0.80	1.07	0.44	1.09	0.76	0.46	1.15	1.41dr	1.27	0.44
Control Delay	86.8	85.5	10.9	126.1	38.7	9.0	150.8	124.5	172.5	28.0
Queue Delay	0.0	0.0	0.0	0.0	0.0	0.0	0.0	0.0	0.0	0.0
Total Delay	86.8	85.5	10.9	126.1	38.7	9.0	150.8	124.5	172.5	28.0
LOS	F	F	B	F	D	A	F	F	F	C
Approach Delay		72.5			48.2			131.7		121.5
Approach LOS		E			D			F		F

Intersection Summary

Cycle Length: 120
 Actuated Cycle Length: 120
 Natural Cycle: 140
 Control Type: Actuated-Uncoordinated
 Maximum v/c Ratio: 1.27
 Intersection Signal Delay: 87.6
 Intersection LOS: F
 Intersection Capacity Utilization 109.8%
 ICU Level of Service H
 Analysis Period (min) 15
 dr Defacto Right Lane. Recode with 1 though lane as a right lane.

Splits and Phases: 1: Harvill Av. & Cajalco Exwy./Ramona Exwy.

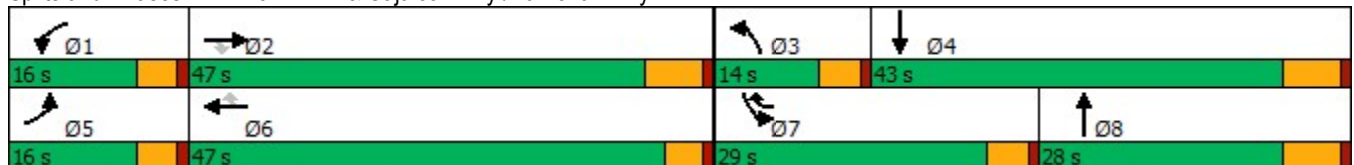

HCM 6th Signalized Intersection Summary
 1: Harvill Av. & Cajalco Exwy./Ramona Exwy.

Harvill Logistics (JN 14231)

06/17/2022

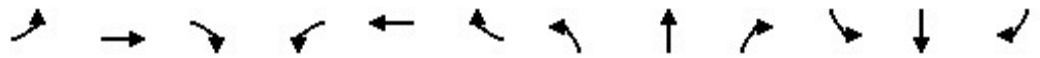

Movement	EBL	EBT	EBR	WBL	WBT	WBR	NBL	NBT	NBR	SBL	SBT	SBR
Lane Configurations	↖	↗	↘	↖	↗	↘	↖	↗	↘	↖	↗	↘
Traffic Volume (veh/h)	121	1223	286	337	916	448	294	218	567	842	293	166
Future Volume (veh/h)	121	1223	286	337	916	448	294	218	567	842	293	166
Initial Q (Qb), veh	0	0	0	0	0	0	0	0	0	0	0	0
Ped-Bike Adj(A_pbT)	1.00		1.00	1.00		1.00	1.00		0.99	1.00		1.00
Parking Bus, Adj	1.00	1.00	1.00	1.00	1.00	1.00	1.00	1.00	1.00	1.00	1.00	1.00
Work Zone On Approach		No			No			No			No	
Adj Sat Flow, veh/h/ln	1900	1900	1900	1900	1900	1900	1900	1900	1900	1900	1900	1900
Adj Flow Rate, veh/h	130	1315	195	362	985	402	316	234	542	905	315	167
Peak Hour Factor	0.93	0.93	0.93	0.93	0.93	0.93	0.93	0.93	0.93	0.93	0.93	0.93
Percent Heavy Veh, %	0	0	0	0	0	0	0	0	0	0	0	0
Cap, veh/h	156	1227	547	333	1259	889	275	328	289	714	705	365
Arrive On Green	0.09	0.34	0.34	0.09	0.35	0.35	0.08	0.18	0.18	0.20	0.31	0.31
Sat Flow, veh/h	1810	3610	1610	3510	3610	1610	3510	1805	1589	3510	2299	1191
Grp Volume(v), veh/h	130	1315	195	362	985	402	316	234	542	905	246	236
Grp Sat Flow(s),veh/h/ln	1810	1805	1610	1755	1805	1610	1755	1805	1589	1755	1805	1686
Q Serve(g_s), s	8.5	40.8	10.9	11.4	29.3	17.9	9.4	14.6	21.8	24.4	13.1	13.6
Cycle Q Clear(g_c), s	8.5	40.8	10.9	11.4	29.3	17.9	9.4	14.6	21.8	24.4	13.1	13.6
Prop In Lane	1.00		1.00	1.00		1.00	1.00		1.00	1.00		0.71
Lane Grp Cap(c), veh/h	156	1227	547	333	1259	889	275	328	289	714	554	517
V/C Ratio(X)	0.83	1.07	0.36	1.09	0.78	0.45	1.15	0.71	1.88	1.27	0.44	0.46
Avail Cap(c_a), veh/h	172	1227	547	333	1279	898	275	328	289	714	554	517
HCM Platoon Ratio	1.00	1.00	1.00	1.00	1.00	1.00	1.00	1.00	1.00	1.00	1.00	1.00
Upstream Filter(I)	1.00	1.00	1.00	1.00	1.00	1.00	1.00	1.00	1.00	1.00	1.00	1.00
Uniform Delay (d), s/veh	54.0	39.6	29.7	54.3	35.0	16.1	55.3	46.2	49.1	47.8	33.4	33.5
Incr Delay (d2), s/veh	23.9	47.1	0.4	74.1	3.2	0.4	100.7	12.5	407.9	131.5	2.6	2.9
Initial Q Delay(d3),s/veh	0.0	0.0	0.0	0.0	0.0	0.0	0.0	0.0	0.0	0.0	0.0	0.0
%ile BackOfQ(50%),veh/ln	4.8	25.0	4.1	8.3	12.7	6.1	7.9	7.4	41.0	23.2	5.9	5.7
Unsig. Movement Delay, s/veh												
LnGrp Delay(d),s/veh	77.9	86.7	30.1	128.4	38.2	16.4	156.0	58.6	457.0	179.3	36.0	36.4
LnGrp LOS	E	F	C	F	D	B	F	E	F	F	D	D
Approach Vol, veh/h		1640			1749			1092			1387	
Approach Delay, s/veh		79.3			51.9			284.5			129.6	
Approach LOS		E			D			F			F	
Timer - Assigned Phs	1	2	3	4	5	6	7	8				
Phs Duration (G+Y+Rc), s	16.0	47.0	14.0	43.0	15.0	48.0	29.0	28.0				
Change Period (Y+Rc), s	4.6	6.2	4.6	6.2	4.6	* 6.2	4.6	6.2				
Max Green Setting (Gmax), s	11.4	40.8	9.4	36.8	11.4	* 43	24.4	21.8				
Max Q Clear Time (g_c+I1), s	13.4	42.8	11.4	15.6	10.5	31.3	26.4	23.8				
Green Ext Time (p_c), s	0.0	0.0	0.0	2.5	0.0	5.7	0.0	0.0				

Intersection Summary

HCM 6th Ctrl Delay	121.2
HCM 6th LOS	F

Notes

* HCM 6th computational engine requires equal clearance times for the phases crossing the barrier.

Intersection						
Int Delay, s/veh	0					
Movement	WBL	WBR	NBT	NBR	SBL	SBT
Lane Configurations		↗	↕	↗		↕
Traffic Vol, veh/h	0	2	1075	0	0	872
Future Vol, veh/h	0	2	1075	0	0	872
Conflicting Peds, #/hr	0	0	0	0	0	0
Sign Control	Stop	Stop	Free	Free	Free	Free
RT Channelized	-	None	-	None	-	None
Storage Length	-	0	-	100	-	-
Veh in Median Storage, #	2	-	0	-	-	0
Grade, %	0	-	0	-	-	0
Peak Hour Factor	92	92	92	92	92	92
Heavy Vehicles, %	0	0	0	0	0	0
Mvmt Flow	0	2	1168	0	0	948

Major/Minor	Minor1	Major1	Major2		
Conflicting Flow All	-	584	0	0	-
Stage 1	-	-	-	-	-
Stage 2	-	-	-	-	-
Critical Hdwy	-	6.9	-	-	-
Critical Hdwy Stg 1	-	-	-	-	-
Critical Hdwy Stg 2	-	-	-	-	-
Follow-up Hdwy	-	3.3	-	-	-
Pot Cap-1 Maneuver	0	460	-	-	0
Stage 1	0	-	-	-	0
Stage 2	0	-	-	-	0
Platoon blocked, %			-	-	-
Mov Cap-1 Maneuver	-	460	-	-	-
Mov Cap-2 Maneuver	-	-	-	-	-
Stage 1	-	-	-	-	-
Stage 2	-	-	-	-	-

Approach	WB	NB	SB
HCM Control Delay, s	12.9	0	0
HCM LOS	B		

Minor Lane/Major Mvmt	NBT	NBRWBLn1	SBT
Capacity (veh/h)	-	-	460
HCM Lane V/C Ratio	-	-	0.005
HCM Control Delay (s)	-	-	12.9
HCM Lane LOS	-	-	B
HCM 95th %tile Q(veh)	-	-	0

Intersection												
Int Delay, s/veh	2.3											
Movement	EBL	EBT	EBR	WBL	WBT	WBR	NBL	NBT	NBR	SBL	SBT	SBR
Lane Configurations		↕			↕	↕	↕	↕		↕	↕	
Traffic Vol, veh/h	65	0	14	31	0	49	6	961	12	13	827	32
Future Vol, veh/h	65	0	14	31	0	49	6	961	12	13	827	32
Conflicting Peds, #/hr	0	0	0	0	0	0	0	0	0	0	0	0
Sign Control	Stop	Stop	Stop	Stop	Stop	Stop	Free	Free	Free	Free	Free	Free
RT Channelized	-	-	None	-	-	None	-	-	None	-	-	None
Storage Length	-	-	-	-	-	0	160	-	-	110	-	-
Veh in Median Storage, #	-	1	-	-	1	-	-	0	-	-	0	-
Grade, %	-	0	-	-	0	-	-	0	-	-	0	-
Peak Hour Factor	86	86	86	86	86	86	86	86	86	86	86	86
Heavy Vehicles, %	0	0	0	0	0	0	0	0	0	0	0	0
Mvmt Flow	76	0	16	36	0	57	7	1117	14	15	962	37

Major/Minor	Minor2		Minor1		Major1			Major2				
Conflicting Flow All	1584	2156	500	1649	2167	566	999	0	0	1131	0	0
Stage 1	1011	1011	-	1138	1138	-	-	-	-	-	-	-
Stage 2	573	1145	-	511	1029	-	-	-	-	-	-	-
Critical Hdwy	6.4	6.5	6.9	6.5	6.5	6.9	4.1	-	-	4.1	-	-
Critical Hdwy Stg 1	6.5	5.5	-	6.5	5.5	-	-	-	-	-	-	-
Critical Hdwy Stg 2	6.5	5.5	-	6.5	5.5	-	-	-	-	-	-	-
Follow-up Hdwy	3.5	4	3.3	3.5	4	3.3	2.2	-	-	2.2	-	-
Pot Cap-1 Maneuver	121	48	522	105	48	473	701	-	-	625	-	-
Stage 1	260	320	-	218	279	-	-	-	-	-	-	-
Stage 2	477	277	-	519	314	-	-	-	-	-	-	-
Platoon blocked, %								-	-	-	-	-
Mov Cap-1 Maneuver	104	46	522	99	46	473	701	-	-	625	-	-
Mov Cap-2 Maneuver	187	150	-	172	152	-	-	-	-	-	-	-
Stage 1	257	312	-	216	276	-	-	-	-	-	-	-
Stage 2	415	274	-	491	306	-	-	-	-	-	-	-

Approach	EB		WB		NB			SB		
HCM Control Delay, s	34.6		20.6		0.1			0.2		
HCM LOS	D		C							

Minor Lane/Major Mvmt	NBL	NBT	NBR	EBLn1	WBLn1	WBLn2	SBL	SBT	SBR
Capacity (veh/h)	701	-	-	211	172	473	625	-	-
HCM Lane V/C Ratio	0.01	-	-	0.435	0.21	0.12	0.024	-	-
HCM Control Delay (s)	10.2	-	-	34.6	31.4	13.7	10.9	-	-
HCM Lane LOS	B	-	-	D	D	B	B	-	-
HCM 95th %tile Q(veh)	0	-	-	2	0.8	0.4	0.1	-	-



Intersection						
Int Delay, s/veh	3.8					
Movement	EBL	EBT	WBT	WBR	SBL	SBR
Lane Configurations		↶	↷		↶	
Traffic Vol, veh/h	7	18	39	0	0	41
Future Vol, veh/h	7	18	39	0	0	41
Conflicting Peds, #/hr	0	0	0	0	0	0
Sign Control	Free	Free	Free	Free	Stop	Stop
RT Channelized	-	None	-	None	-	None
Storage Length	-	-	-	-	0	-
Veh in Median Storage, #	-	0	0	-	0	-
Grade, %	-	0	0	-	0	-
Peak Hour Factor	92	92	92	92	92	92
Heavy Vehicles, %	0	0	0	0	0	0
Mvmt Flow	8	20	42	0	0	45

Major/Minor	Major1	Major2	Minor2		
Conflicting Flow All	42	0	-	0	78 42
Stage 1	-	-	-	-	42 -
Stage 2	-	-	-	-	36 -
Critical Hdwy	4.1	-	-	-	6.4 6.2
Critical Hdwy Stg 1	-	-	-	-	5.4 -
Critical Hdwy Stg 2	-	-	-	-	5.4 -
Follow-up Hdwy	2.2	-	-	-	3.5 3.3
Pot Cap-1 Maneuver	1580	-	-	-	930 1034
Stage 1	-	-	-	-	986 -
Stage 2	-	-	-	-	992 -
Platoon blocked, %		-	-	-	
Mov Cap-1 Maneuver	1580	-	-	-	925 1034
Mov Cap-2 Maneuver	-	-	-	-	925 -
Stage 1	-	-	-	-	981 -
Stage 2	-	-	-	-	992 -

Approach	EB	WB	SB
HCM Control Delay, s	2	0	8.6
HCM LOS			A

Minor Lane/Major Mvmt	EBL	EBT	WBT	WBR	SBLn1
Capacity (veh/h)	1580	-	-	-	1034
HCM Lane V/C Ratio	0.005	-	-	-	0.043
HCM Control Delay (s)	7.3	0	-	-	8.6
HCM Lane LOS	A	A	-	-	A
HCM 95th %tile Q(veh)	0	-	-	-	0.1

Intersection	
Intersection Delay, s/veh	6.8
Intersection LOS	A

Movement	EBL	EBR	NBL	NBT	SBT	SBR
Lane Configurations						
Traffic Vol, veh/h	6	12	22	0	0	17
Future Vol, veh/h	6	12	22	0	0	17
Peak Hour Factor	0.92	0.92	0.92	0.92	0.92	0.92
Heavy Vehicles, %	0	0	0	0	0	0
Mvmt Flow	7	13	24	0	0	18
Number of Lanes	1	0	0	1	1	0

Approach	EB	NB	SB
Opposing Approach		SB	NB
Opposing Lanes	0	1	1
Conflicting Approach Left	SB	EB	
Conflicting Lanes Left	1	1	0
Conflicting Approach Right	NB		EB
Conflicting Lanes Right	1	0	1
HCM Control Delay	6.7	7.3	6.4
HCM LOS	A	A	A

Lane	NBLn1	EBLn1	SBLn1
Vol Left, %	100%	33%	0%
Vol Thru, %	0%	0%	0%
Vol Right, %	0%	67%	100%
Sign Control	Stop	Stop	Stop
Traffic Vol by Lane	22	18	17
LT Vol	22	6	0
Through Vol	0	0	0
RT Vol	0	12	17
Lane Flow Rate	24	20	18
Geometry Grp	1	1	1
Degree of Util (X)	0.028	0.02	0.017
Departure Headway (Hd)	4.147	3.639	3.351
Convergence, Y/N	Yes	Yes	Yes
Cap	867	985	1071
Service Time	2.154	1.654	1.363
HCM Lane V/C Ratio	0.028	0.02	0.017
HCM Control Delay	7.3	6.7	6.4
HCM Lane LOS	A	A	A
HCM 95th-tile Q	0.1	0.1	0.1

Timings
6: I-215 SB Ramps & Ramona Exwy.



Lane Group	EBT	WBL	WBT	SBL	SBT	SBR
Lane Configurations	↑↑	↖	↑↑	↖	↖	↖
Traffic Volume (vph)	1571	839	1203	1989	8	403
Future Volume (vph)	1571	839	1203	1989	8	403
Turn Type	NA	Prot	NA	Split	NA	Perm
Protected Phases	2	1	6	4	4	
Permitted Phases						4
Detector Phase	2	1	6	4	4	4
Switch Phase						
Minimum Initial (s)	5.0	5.0	5.0	5.0	5.0	5.0
Minimum Split (s)	11.0	9.5	31.0	10.5	10.5	10.5
Total Split (s)	44.0	27.0	71.0	39.0	39.0	39.0
Total Split (%)	40.0%	24.5%	64.5%	35.5%	35.5%	35.5%
Yellow Time (s)	5.0	3.5	5.0	4.5	4.5	4.5
All-Red Time (s)	1.0	1.0	1.0	1.0	1.0	1.0
Lost Time Adjust (s)	0.0	0.0	0.0	0.0	0.0	0.0
Total Lost Time (s)	6.0	4.5	6.0	5.5	5.5	5.5
Lead/Lag	Lag	Lead				
Lead-Lag Optimize?	Yes	Yes				
Recall Mode	C-Max	None	C-Max	Max	Max	Max
Act Effct Green (s)	38.0	22.5	65.0	33.5	33.5	33.5
Actuated g/C Ratio	0.35	0.20	0.59	0.30	0.30	0.30
v/c Ratio	1.96	2.30	0.57	1.92	1.94	0.75
Control Delay	459.5	605.0	3.5	447.9	453.8	37.9
Queue Delay	0.6	0.0	0.7	28.8	28.8	0.0
Total Delay	460.1	605.0	4.2	476.7	482.6	37.9
LOS	F	F	A	F	F	D
Approach Delay	460.1		250.9		405.5	
Approach LOS	F		F		F	

Intersection Summary

Cycle Length: 110
 Actuated Cycle Length: 110
 Offset: 34 (31%), Referenced to phase 2:EBT and 6:WBT, Start of Yellow
 Natural Cycle: 150
 Control Type: Actuated-Coordinated
 Maximum v/c Ratio: 2.30
 Intersection Signal Delay: 378.6
 Intersection LOS: F
 Intersection Capacity Utilization 275.3%
 ICU Level of Service H
 Analysis Period (min) 15

Splits and Phases: 6: I-215 SB Ramps & Ramona Exwy.

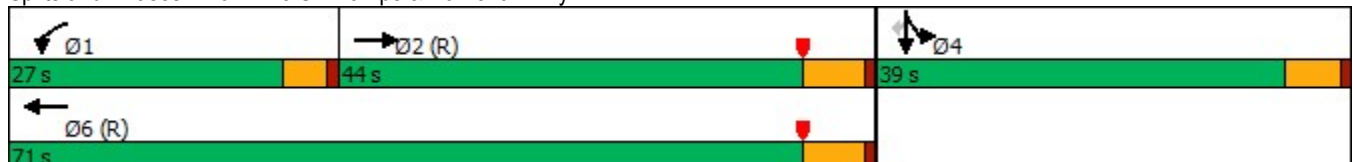

HCM 6th Signalized Intersection Summary
6: I-215 SB Ramps & Ramona Exwy.

Harvill Logistics (JN 14231)

06/16/2022

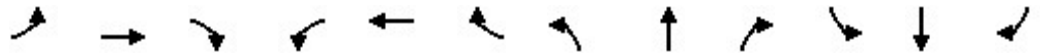

Movement	EBL	EBT	EBR	WBL	WBT	WBR	NBL	NBT	NBR	SBL	SBT	SBR
Lane Configurations		↑↑		↖	↑↑					↖	↑↑	↖
Traffic Volume (veh/h)	0	1571	838	839	1203	0	0	0	0	1989	8	403
Future Volume (veh/h)	0	1571	838	839	1203	0	0	0	0	1989	8	403
Initial Q (Qb), veh	0	0	0	0	0	0				0	0	0
Ped-Bike Adj(A_pbT)	1.00		0.99	1.00		1.00				1.00		1.00
Parking Bus, Adj	1.00	1.00	1.00	1.00	1.00	1.00				1.00	1.00	1.00
Work Zone On Approach		No			No						No	
Adj Sat Flow, veh/h/ln	0	1900	1900	1900	1900	0				1900	1900	1900
Adj Flow Rate, veh/h	0	1587	738	847	1215	0				2015	0	348
Peak Hour Factor	0.99	0.99	0.99	0.99	0.99	0.99				0.99	0.99	0.99
Percent Heavy Veh, %	0	0	0	0	0	0				0	0	0
Cap, veh/h	0	847	362	370	2133	0				1102	0	490
Arrive On Green	0.00	0.35	0.35	0.12	0.35	0.00				0.30	0.00	0.30
Sat Flow, veh/h	0	2546	1049	1810	3705	0				3619	0	1610
Grp Volume(v), veh/h	0	1133	1192	847	1215	0				2015	0	348
Grp Sat Flow(s),veh/h/ln	0	1805	1695	1810	1805	0				1810	0	1610
Q Serve(g_s), s	0.0	38.0	38.0	22.5	29.9	0.0				33.5	0.0	21.1
Cycle Q Clear(g_c), s	0.0	38.0	38.0	22.5	29.9	0.0				33.5	0.0	21.1
Prop In Lane	0.00		0.62	1.00		0.00				1.00		1.00
Lane Grp Cap(c), veh/h	0	624	586	370	2133	0				1102	0	490
V/C Ratio(X)	0.00	1.82	2.04	2.29	0.57	0.00				1.83	0.00	0.71
Avail Cap(c_a), veh/h	0	624	586	370	2133	0				1102	0	490
HCM Platoon Ratio	1.00	1.00	1.00	0.60	0.60	1.00				1.00	1.00	1.00
Upstream Filter(I)	0.00	0.09	0.09	0.09	0.09	0.00				1.00	0.00	1.00
Uniform Delay (d), s/veh	0.0	36.0	36.0	48.2	24.2	0.0				38.3	0.0	33.9
Incr Delay (d2), s/veh	0.0	368.0	466.7	580.5	0.1	0.0				376.3	0.0	8.4
Initial Q Delay(d3),s/veh	0.0	0.0	0.0	0.0	0.0	0.0				0.0	0.0	0.0
%ile BackOfQ(50%),veh/ln	0.0	79.2	90.4	70.0	13.3	0.0				71.6	0.0	9.0
Unsig. Movement Delay, s/veh												
LnGrp Delay(d),s/veh	0.0	404.0	502.7	628.8	24.3	0.0				414.5	0.0	42.4
LnGrp LOS	A	F	F	F	C	A				F	A	D
Approach Vol, veh/h		2325			2062						2363	
Approach Delay, s/veh		454.6			272.6						359.7	
Approach LOS		F			F						F	
Timer - Assigned Phs	1	2		4		6						
Phs Duration (G+Y+Rc), s	27.0	44.0		39.0		71.0						
Change Period (Y+Rc), s	4.5	6.0		5.5		6.0						
Max Green Setting (Gmax), s	22.5	38.0		33.5		65.0						
Max Q Clear Time (g_c+I1), s	24.5	40.0		35.5		31.9						
Green Ext Time (p_c), s	0.0	0.0		0.0		5.8						















Intersection Summary

HCM 6th Ctrl Delay	365.8
HCM 6th LOS	F

Notes

User approved volume balancing among the lanes for turning movement.

Timings
7: I-215 NB Ramps & Ramona Exwy.

							
Lane Group	EBL	EBT	WBT	WBR	NBL	NBT	NBR
Lane Configurations							
Traffic Volume (vph)	666	2894	1478	1712	563	4	553
Future Volume (vph)	666	2894	1478	1712	563	4	553
Turn Type	Prot	NA	NA	Perm	Split	NA	Perm
Protected Phases	5	2	6		8	8	
Permitted Phases				6			8
Detector Phase	5	2	6	6	8	8	8
Switch Phase							
Minimum Initial (s)	5.0	5.0	5.0	5.0	5.0	5.0	5.0
Minimum Split (s)	9.5	11.0	26.0	26.0	10.5	10.5	10.5
Total Split (s)	23.0	68.0	45.0	45.0	42.0	42.0	42.0
Total Split (%)	20.9%	61.8%	40.9%	40.9%	38.2%	38.2%	38.2%
Yellow Time (s)	3.5	5.0	5.0	5.0	4.5	4.5	4.5
All-Red Time (s)	1.0	1.0	1.0	1.0	1.0	1.0	1.0
Lost Time Adjust (s)	0.0	0.0	0.0	0.0	0.0	0.0	0.0
Total Lost Time (s)	4.5	6.0	6.0	6.0	5.5	5.5	5.5
Lead/Lag	Lead		Lag	Lag			
Lead-Lag Optimize?	Yes		Yes	Yes			
Recall Mode	None	C-Max	C-Max	C-Max	None	None	None
Act Effct Green (s)	18.5	62.0	39.0	39.0	36.5	36.5	36.5
Actuated g/C Ratio	0.17	0.56	0.35	0.35	0.33	0.33	0.33
v/c Ratio	2.34	1.51	1.23	1.76	0.53	0.53	1.01
Control Delay	625.1	257.0	142.7	365.5	33.8	34.0	71.5
Queue Delay	0.0	2.3	0.0	0.0	0.0	0.0	0.0
Total Delay	625.1	259.3	142.7	365.5	33.8	34.0	71.5
LOS	F	F	F	F	C	C	E
Approach Delay		327.7	262.3			52.5	
Approach LOS		F	F			D	

Intersection Summary

Cycle Length: 110
 Actuated Cycle Length: 110
 Offset: 0 (0%), Referenced to phase 2:EBT and 6:WBT, Start of Yellow, Master Intersection
 Natural Cycle: 150
 Control Type: Actuated-Coordinated
 Maximum v/c Ratio: 2.34
 Intersection Signal Delay: 262.1
 Intersection LOS: F
 Intersection Capacity Utilization 275.3%
 ICU Level of Service H
 Analysis Period (min) 15

Splits and Phases: 7: I-215 NB Ramps & Ramona Exwy.

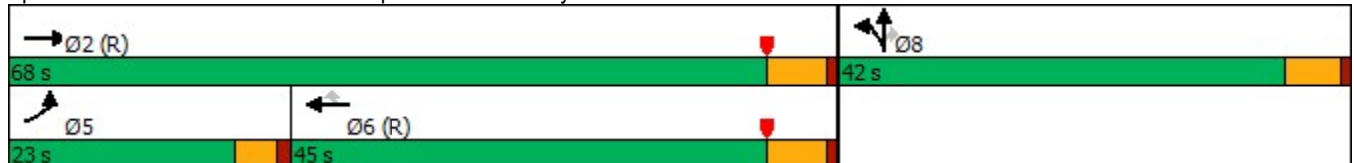

HCM 6th Signalized Intersection Summary
7: I-215 NB Ramps & Ramona Exwy.

Harvill Logistics (JN 14231)

06/16/2022

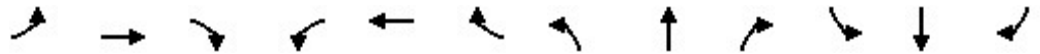

Movement	EBL	EBT	EBR	WBL	WBT	WBR	NBL	NBT	NBR	SBL	SBT	SBR
Lane Configurations	↘	↑↑			↑↑	↗	↘	↗	↗			
Traffic Volume (veh/h)	666	2894	0	0	1478	1712	563	4	553	0	0	0
Future Volume (veh/h)	666	2894	0	0	1478	1712	563	4	553	0	0	0
Initial Q (Qb), veh	0	0	0	0	0	0	0	0	0			
Ped-Bike Adj(A_pbT)	1.00		1.00	1.00		1.00	1.00		1.00			
Parking Bus, Adj	1.00	1.00	1.00	1.00	1.00	1.00	1.00	1.00	1.00			
Work Zone On Approach		No			No			No				
Adj Sat Flow, veh/h/ln	1900	1900	0	0	1900	1900	1900	1900	1900			
Adj Flow Rate, veh/h	709	3079	0	0	1572	1671	602	0	507			
Peak Hour Factor	0.94	0.94	0.94	0.94	0.94	0.94	0.94	0.94	0.94			
Percent Heavy Veh, %	0	0	0	0	0	0	0	0	0			
Cap, veh/h	304	2044	0	0	1289	575	1192	0	530			
Arrive On Green	0.17	0.57	0.00	0.00	0.36	0.36	0.33	0.00	0.33			
Sat Flow, veh/h	1810	3705	0	0	3705	1610	3619	0	1610			
Grp Volume(v), veh/h	709	3079	0	0	1572	1671	602	0	507			
Grp Sat Flow(s),veh/h/ln	1810	1805	0	0	1805	1610	1810	0	1610			
Q Serve(g_s), s	18.5	62.3	0.0	0.0	39.3	39.3	14.7	0.0	33.9			
Cycle Q Clear(g_c), s	18.5	62.3	0.0	0.0	39.3	39.3	14.7	0.0	33.9			
Prop In Lane	1.00		0.00	0.00		1.00	1.00		1.00			
Lane Grp Cap(c), veh/h	304	2044	0	0	1289	575	1192	0	530			
V/C Ratio(X)	2.33	1.51	0.00	0.00	1.22	2.91	0.51	0.00	0.96			
Avail Cap(c_a), veh/h	304	2044	0	0	1289	575	1201	0	534			
HCM Platoon Ratio	1.00	1.00	1.00	1.00	1.00	1.00	1.00	1.00	1.00			
Upstream Filter(I)	0.09	0.09	0.00	0.00	1.00	1.00	1.00	0.00	1.00			
Uniform Delay (d), s/veh	45.8	23.9	0.0	0.0	35.4	35.4	29.7	0.0	36.1			
Incr Delay (d2), s/veh	599.3	228.1	0.0	0.0	106.0	862.5	0.3	0.0	28.1			
Initial Q Delay(d3),s/veh	0.0	0.0	0.0	0.0	0.0	0.0	0.0	0.0	0.0			
%ile BackOfQ(50%),veh/ln	58.6	87.1	0.0	0.0	34.9	151.9	6.2	0.0	16.7			
Unsig. Movement Delay, s/veh												
LnGrp Delay(d),s/veh	645.1	252.0	0.0	0.0	141.3	897.9	30.0	0.0	64.2			
LnGrp LOS	F	F	A	A	F	F	C	A	E			
Approach Vol, veh/h		3788			3243			1109				
Approach Delay, s/veh		325.6			531.2			45.7				
Approach LOS		F			F			D				
Timer - Assigned Phs		2			5	6		8				
Phs Duration (G+Y+Rc), s		68.3			23.0	45.3		41.7				
Change Period (Y+Rc), s		6.0			4.5	6.0		5.5				
Max Green Setting (Gmax), s		62.0			18.5	39.0		36.5				
Max Q Clear Time (g_c+I1), s		64.3			20.5	41.3		35.9				
Green Ext Time (p_c), s		0.0			0.0	0.0		0.3				

Intersection Summary

HCM 6th Ctrl Delay	369.3
HCM 6th LOS	F

Notes

User approved volume balancing among the lanes for turning movement.

Timings
8: I-215 SB Ramps & Placentia Av.

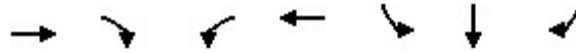

Lane Group	EBT	EBR	WBL	WBT	SBL	SBT	SBR
Lane Configurations	↑↑	↑	↑↑	↑↑	↑	↑	↑
Traffic Volume (vph)	791	275	583	640	544	1	107
Future Volume (vph)	791	275	583	640	544	1	107
Turn Type	NA	Perm	Prot	NA	Split	NA	Perm
Protected Phases	2		1	6	4	4	
Permitted Phases		2					4
Detector Phase	2	2	1	6	4	4	4
Switch Phase							
Minimum Initial (s)	10.0	10.0	5.0	10.0	10.0	10.0	10.0
Minimum Split (s)	27.8	27.8	9.6	27.8	15.8	15.8	15.8
Total Split (s)	28.5	28.5	15.4	43.9	16.1	16.1	16.1
Total Split (%)	47.5%	47.5%	25.7%	73.2%	26.8%	26.8%	26.8%
Yellow Time (s)	4.8	4.8	3.6	4.8	4.8	4.8	4.8
All-Red Time (s)	1.0	1.0	1.0	1.0	1.0	1.0	1.0
Lost Time Adjust (s)	0.0	0.0	0.0	0.0	0.0	0.0	0.0
Total Lost Time (s)	5.8	5.8	4.6	5.8	5.8	5.8	5.8
Lead/Lag	Lag	Lag	Lead				
Lead-Lag Optimize?	Yes	Yes	Yes				
Recall Mode	None	None	None	C-Max	Max	Max	Max
Act Effct Green (s)	22.7	22.7	10.8	38.1	10.3	10.3	10.3
Actuated g/C Ratio	0.38	0.38	0.18	0.64	0.17	0.17	0.17
v/c Ratio	0.63	0.38	1.01	0.30	1.00	1.01	0.30
Control Delay	17.8	3.5	60.4	7.2	83.5	84.2	6.2
Queue Delay	0.0	0.0	0.0	0.0	0.0	0.0	0.0
Total Delay	17.8	3.5	60.4	7.2	83.5	84.2	6.2
LOS	B	A	E	A	F	F	A
Approach Delay	14.1			32.6		71.1	
Approach LOS	B			C		E	

Intersection Summary

Cycle Length: 60
 Actuated Cycle Length: 60
 Offset: 0 (0%), Referenced to phase 6:WBT, Start of Yellow, Master Intersection
 Natural Cycle: 65
 Control Type: Actuated-Coordinated
 Maximum v/c Ratio: 1.01
 Intersection Signal Delay: 34.4
 Intersection Capacity Utilization 67.1%
 Analysis Period (min) 15
 Intersection LOS: C
 ICU Level of Service C

Splits and Phases: 8: I-215 SB Ramps & Placentia Av.

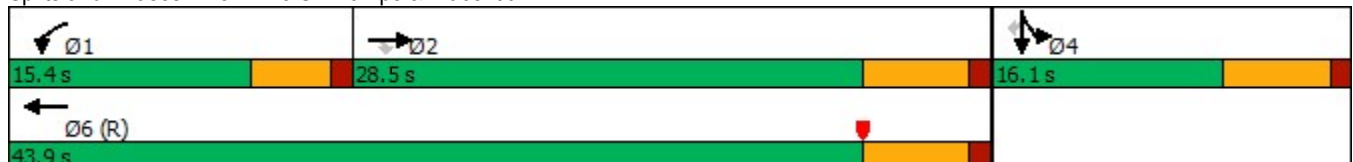

HCM 6th Signalized Intersection Summary
 8: I-215 SB Ramps & Placentia Av.

Harvill Logistics (JN 14231)

06/16/2022



Movement	EBL	EBT	EBR	WBL	WBT	WBR	NBL	NBT	NBR	SBL	SBT	SBR
Lane Configurations		↑↑	↗	↘↗	↑↑					↘	↗	↗
Traffic Volume (veh/h)	0	791	275	583	640	0	0	0	0	544	1	107
Future Volume (veh/h)	0	791	275	583	640	0	0	0	0	544	1	107
Initial Q (Qb), veh	0	0	0	0	0	0				0	0	0
Ped-Bike Adj(A_pbT)	1.00		1.00	1.00		1.00				1.00		1.00
Parking Bus, Adj	1.00	1.00	1.00	1.00	1.00	1.00				1.00	1.00	1.00
Work Zone On Approach		No			No						No	
Adj Sat Flow, veh/h/ln	0	1900	1900	1900	1900	0				1900	1900	1900
Adj Flow Rate, veh/h	0	860	136	634	696	0				592	0	34
Peak Hour Factor	0.92	0.92	0.92	0.92	0.92	0.92				0.92	0.92	0.92
Percent Heavy Veh, %	0	0	0	0	0	0				0	0	0
Cap, veh/h	0	1366	609	632	2292	0				621	0	276
Arrive On Green	0.00	0.38	0.38	0.36	1.00	0.00				0.17	0.00	0.17
Sat Flow, veh/h	0	3705	1610	3510	3705	0				3619	0	1610
Grp Volume(v), veh/h	0	860	136	634	696	0				592	0	34
Grp Sat Flow(s),veh/h/ln	0	1805	1610	1755	1805	0				1810	0	1610
Q Serve(g_s), s	0.0	11.7	3.4	10.8	0.0	0.0				9.7	0.0	1.1
Cycle Q Clear(g_c), s	0.0	11.7	3.4	10.8	0.0	0.0				9.7	0.0	1.1
Prop In Lane	0.00		1.00	1.00		0.00				1.00		1.00
Lane Grp Cap(c), veh/h	0	1366	609	632	2292	0				621	0	276
V/C Ratio(X)	0.00	0.63	0.22	1.00	0.30	0.00				0.95	0.00	0.12
Avail Cap(c_a), veh/h	0	1366	609	632	2292	0				621	0	276
HCM Platoon Ratio	1.00	1.00	1.00	2.00	2.00	1.00				1.00	1.00	1.00
Upstream Filter(I)	0.00	1.00	1.00	0.67	0.67	0.00				1.00	0.00	1.00
Uniform Delay (d), s/veh	0.0	15.2	12.7	19.2	0.0	0.0				24.6	0.0	21.0
Incr Delay (d2), s/veh	0.0	0.9	0.2	30.1	0.2	0.0				26.2	0.0	0.9
Initial Q Delay(d3),s/veh	0.0	0.0	0.0	0.0	0.0	0.0				0.0	0.0	0.0
%ile BackOfQ(50%),veh/ln	0.0	4.0	1.0	5.5	0.1	0.0				5.9	0.0	0.4
Unsig. Movement Delay, s/veh												
LnGrp Delay(d),s/veh	0.0	16.2	12.8	49.3	0.2	0.0				50.8	0.0	21.9
LnGrp LOS	A	B	B	F	A	A				D	A	C
Approach Vol, veh/h		996			1330						626	
Approach Delay, s/veh		15.7			23.6						49.2	
Approach LOS		B			C						D	
Timer - Assigned Phs	1	2		4		6						
Phs Duration (G+Y+Rc), s	15.4	28.5		16.1		43.9						
Change Period (Y+Rc), s	4.6	5.8		5.8		5.8						
Max Green Setting (Gmax), s	10.8	22.7		10.3		38.1						
Max Q Clear Time (g_c+I1), s	12.8	13.7		11.7		2.0						
Green Ext Time (p_c), s	0.0	3.9		0.0		4.8						

Intersection Summary

HCM 6th Ctrl Delay	26.4
HCM 6th LOS	C

Notes

User approved volume balancing among the lanes for turning movement.

Timings
9: I-215 NB Ramps & Placentia Av.



Lane Group	EBL	EBT	WBT	WBR	NBL	NBT	NBR
Lane Configurations	↗↗	↑↑	↑↑	↖	↖	↖	↖
Traffic Volume (vph)	191	1145	976	499	248	0	395
Future Volume (vph)	191	1145	976	499	248	0	395
Turn Type	Prot	NA	NA	Perm	Split	NA	Perm
Protected Phases	5	2	6		8	8	
Permitted Phases				6			8
Detector Phase	5	2	6	6	8	8	8
Switch Phase							
Minimum Initial (s)	5.0	10.0	10.0	10.0	10.0	10.0	10.0
Minimum Split (s)	9.6	27.8	27.8	27.8	15.8	15.8	15.8
Total Split (s)	11.2	41.0	29.8	29.8	19.0	19.0	19.0
Total Split (%)	18.7%	68.3%	49.7%	49.7%	31.7%	31.7%	31.7%
Yellow Time (s)	3.6	4.8	4.8	4.8	4.8	4.8	4.8
All-Red Time (s)	1.0	1.0	1.0	1.0	1.0	1.0	1.0
Lost Time Adjust (s)	0.0	0.0	0.0	0.0	0.0	0.0	0.0
Total Lost Time (s)	4.6	5.8	5.8	5.8	5.8	5.8	5.8
Lead/Lag	Lead		Lag	Lag			
Lead-Lag Optimize?	Yes		Yes	Yes			
Recall Mode	None	C-Max	C-Max	C-Max	None	None	None
Act Effct Green (s)	6.4	35.3	24.3	24.3	13.1	13.1	13.1
Actuated g/C Ratio	0.11	0.59	0.40	0.40	0.22	0.22	0.22
v/c Ratio	0.56	0.59	0.73	0.56	0.36	0.36	0.94
Control Delay	21.8	9.5	18.7	3.9	23.1	23.1	48.3
Queue Delay	0.0	0.0	0.0	0.0	0.0	0.0	0.0
Total Delay	21.8	9.5	18.7	3.9	23.1	23.1	48.3
LOS	C	A	B	A	C	C	D
Approach Delay		11.3	13.7			38.6	
Approach LOS		B	B			D	

Intersection Summary

Cycle Length: 60
 Actuated Cycle Length: 60
 Offset: 0 (0%), Referenced to phase 2:EBT and 6:WBT, Start of Yellow
 Natural Cycle: 60
 Control Type: Actuated-Coordinated
 Maximum v/c Ratio: 0.94
 Intersection Signal Delay: 17.4
 Intersection LOS: B
 Intersection Capacity Utilization 67.1%
 ICU Level of Service C
 Analysis Period (min) 15

Splits and Phases: 9: I-215 NB Ramps & Placentia Av.



HCM 6th Signalized Intersection Summary
 9: I-215 NB Ramps & Placentia Av.

Harvill Logistics (JN 14231)

06/16/2022

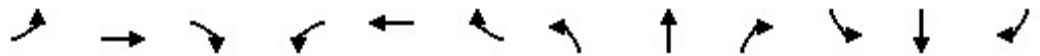

Movement	EBL	EBT	EBR	WBL	WBT	WBR	NBL	NBT	NBR	SBL	SBT	SBR
Lane Configurations	↖↗	↕			↕	↖	↖	↕	↖			
Traffic Volume (veh/h)	191	1145	0	0	976	499	248	0	395	0	0	0
Future Volume (veh/h)	191	1145	0	0	976	499	248	0	395	0	0	0
Initial Q (Qb), veh	0	0	0	0	0	0	0	0	0			
Ped-Bike Adj(A_pbT)	1.00		1.00	1.00		1.00	1.00		1.00			
Parking Bus, Adj	1.00	1.00	1.00	1.00	1.00	1.00	1.00	1.00	1.00			
Work Zone On Approach		No			No			No				
Adj Sat Flow, veh/h/ln	1900	1900	0	0	1900	1900	1900	1900	1900			
Adj Flow Rate, veh/h	208	1245	0	0	1061	297	270	0	239			
Peak Hour Factor	0.92	0.92	0.92	0.92	0.92	0.92	0.92	0.92	0.92			
Percent Heavy Veh, %	0	0	0	0	0	0	0	0	0			
Cap, veh/h	311	2247	0	0	1650	736	667	0	297			
Arrive On Green	0.09	0.62	0.00	0.00	0.46	0.46	0.18	0.00	0.18			
Sat Flow, veh/h	3510	3705	0	0	3705	1610	3619	0	1610			
Grp Volume(v), veh/h	208	1245	0	0	1061	297	270	0	239			
Grp Sat Flow(s),veh/h/ln	1755	1805	0	0	1805	1610	1810	0	1610			
Q Serve(g_s), s	3.4	11.9	0.0	0.0	13.6	7.4	3.9	0.0	8.5			
Cycle Q Clear(g_c), s	3.4	11.9	0.0	0.0	13.6	7.4	3.9	0.0	8.5			
Prop In Lane	1.00		0.00	0.00		1.00	1.00		1.00			
Lane Grp Cap(c), veh/h	311	2247	0	0	1650	736	667	0	297			
V/C Ratio(X)	0.67	0.55	0.00	0.00	0.64	0.40	0.40	0.00	0.81			
Avail Cap(c_a), veh/h	386	2247	0	0	1650	736	796	0	354			
HCM Platoon Ratio	1.00	1.00	1.00	1.00	1.00	1.00	1.00	1.00	1.00			
Upstream Filter(l)	0.62	0.62	0.00	0.00	1.00	1.00	1.00	0.00	1.00			
Uniform Delay (d), s/veh	26.5	6.5	0.0	0.0	12.5	10.8	21.6	0.0	23.4			
Incr Delay (d2), s/veh	1.1	0.6	0.0	0.0	1.9	1.6	0.4	0.0	11.0			
Initial Q Delay(d3),s/veh	0.0	0.0	0.0	0.0	0.0	0.0	0.0	0.0	0.0			
%ile BackOfQ(50%),veh/ln	1.3	2.8	0.0	0.0	4.6	2.3	1.5	0.0	3.7			
Unsig. Movement Delay, s/veh												
LnGrp Delay(d),s/veh	27.6	7.1	0.0	0.0	14.5	12.5	22.0	0.0	34.4			
LnGrp LOS	C	A	A	A	B	B	C	A	C			
Approach Vol, veh/h		1453			1358			509				
Approach Delay, s/veh		10.1			14.0			27.8				
Approach LOS		B			B			C				
Timer - Assigned Phs		2			5	6		8				
Phs Duration (G+Y+Rc), s		43.1			9.9	33.2		16.9				
Change Period (Y+Rc), s		5.8			4.6	5.8		5.8				
Max Green Setting (Gmax), s		35.2			6.6	24.0		13.2				
Max Q Clear Time (g_c+I1), s		13.9			5.4	15.6		10.5				
Green Ext Time (p_c), s		8.7			0.0	4.8		0.5				

Intersection Summary

HCM 6th Ctrl Delay	14.4
HCM 6th LOS	B

Notes

User approved volume balancing among the lanes for turning movement.

APPENDIX 6.2: EAPC (2024) CONDITIONS TRAFFIC SIGNAL WARRANT ANALYSIS WORKSHEETS

This Page Intentionally Left Blank

Figure 4C-4. Warrant 3, Peak Hour (70% Factor)

(COMMUNITY LESS THAN 10,000 POPULATION OR ABOVE 64 km/h OR ABOVE 40 mph ON MAJOR STREET)

Traffic Conditions = **EAPC (2024) Conditions - Weekday PM Peak Hour**

Major Street Name = **Harvill Avenue**

Total of Both Approaches (VPH) = **1851**
 Number of Approach Lanes Major Street = **2**

Minor Street Name = **Old Cajalco Road**

High Volume Approach (VPH) = **80**
 Number of Approach Lanes Minor Street = **1**

WARRANTED FOR A SIGNAL

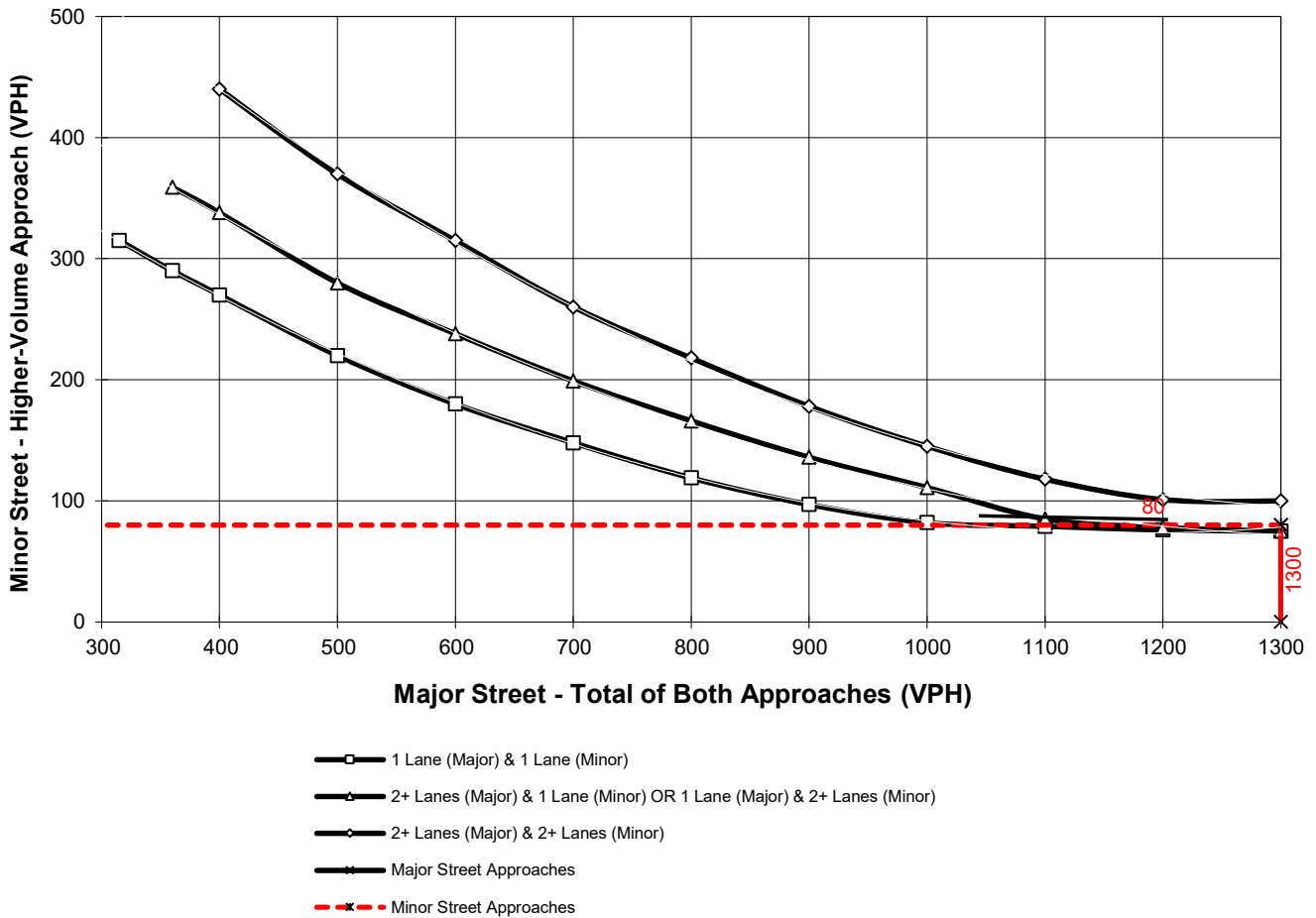

*Note: 100 vph applies as the lower threshold for a minor-street approach with two or more lanes and 75 vph applies as the lower threshold for a minor-street approach with one lane



Figure 4C-103 (CA). Traffic Signal Warrants Worksheet (Average Traffic Estimate Form)

<u>DIST</u>	<u>CO</u>	<u>RTE</u>	<u>PM</u>	TRAFFIC CONDITIONS	EAPC (2024)
Jurisdiction: <u>County of Riverside</u>				CALC <u>JB</u>	DATE <u>06/08/22</u>
Major Street: <u>Old Cajalco Road</u>				CHK <u>JB</u>	DATE <u>06/08/22</u>
Minor Street: <u>Driveway 2</u>				Critical Approach Speed (Major) <u>25</u> mph	
				Critical Approach Speed (Minor) <u>25</u> mph	
Major Street Approach Lanes = <u>1</u>	lane	Minor Street Approach Lanes = <u>1</u>	lane		
Major Street Future ADT = <u>847</u>	vpd	Minor Street Future ADT = <u>182</u>	vpd		
Speed limit or critical speed on major street traffic > 64 km/h (40 mph);				<input type="checkbox"/>	
				or	URBAN (U)
In built up area of isolated community of < 10,000 population				<input type="checkbox"/>	

(Based on Estimated Average Daily Traffic - See Note)

<u>URBAN</u>	<u>RURAL</u>	Minimum Requirements			
XX		EADT			
CONDITION A - Minimum Vehicular Volume		Vehicles Per Day on Major Street		Vehicles Per Day on Higher-Volume Minor Street Approach	
<u>Satisfied</u>	<u>Not Satisfied</u>	(Total of Both Approaches)		(One Direction Only)	
	XX	<u>Urban</u>	<u>Rural</u>	<u>Urban</u>	<u>Rural</u>
Number of lanes for moving traffic on each approach					
<u>Major Street</u>	<u>Minor Street</u>				
1 847	1 182	8,000	5,600	2,400	1,680
2 +	1	9,600	6,720	2,400	1,680
2 +	2 +	9,600	6,720	3,200	2,240
1	2 +	8,000	5,600	3,200	2,240
CONDITION B - Interruption of Continuous Traffic		Vehicles Per Day on Major Street		Vehicles Per Day on Higher-Volume Minor Street Approach	
<u>Satisfied</u>	<u>Not Satisfied</u>	(Total of Both Approaches)		(One Direction Only)	
	XX	<u>Urban</u>	<u>Rural</u>	<u>Urban</u>	<u>Rural</u>
Number of lanes for moving traffic on each approach					
<u>Major Street</u>	<u>Minor Street</u>				
1 847	1 182	12,000	8,400	1,200	850
2 +	1	14,400	10,080	1,200	850
2 +	2 +	14,400	10,080	1,600	1,120
1	2 +	12,000	8,400	1,600	1,120
Combination of CONDITIONS A + B		2 CONDITIONS		2 CONDITIONS	
<u>Satisfied</u>	<u>Not Satisfied</u>	80%		80%	
No one condition satisfied, but following conditions fulfilled 80% of more	XX				
	A				
	8%				
	B				
	7%				

Note: To be used only for NEW INTERSECTIONS or other locations where it is not reasonable to count actual traffic volumes.

The satisfaction of a traffic signal warrant or warrants shall not in itself require the installation of a traffic control signal.



Figure 4C-103 (CA). Traffic Signal Warrants Worksheet (Average Traffic Estimate Form)

<u>DIST</u>	<u>CO</u>	<u>RTE</u>	<u>PM</u>	TRAFFIC CONDITIONS	EAPC (2024)
Jurisdiction: <u>County of Riverside</u>				CALC <u>JB</u>	DATE <u>06/08/22</u>
Major Street: <u>Old Cajalco Road</u>				CHK <u>JB</u>	DATE <u>06/08/22</u>
Minor Street: <u>Driveway 3</u>				Critical Approach Speed (Major) <u>25</u> mph	
				Critical Approach Speed (Minor) <u>25</u> mph	
Major Street Approach Lanes = <u>1</u>	lane	Minor Street Approach Lanes = <u>1</u>	lane		
Major Street Future ADT = <u>333</u>	vpd	Minor Street Future ADT = <u>333</u>	vpd		
Speed limit or critical speed on major street traffic > 64 km/h (40 mph);					<input type="checkbox"/>
					or
In built up area of isolated community of < 10,000 population					<input type="checkbox"/>

URBAN (U)

(Based on Estimated Average Daily Traffic - See Note)

<u>URBAN</u>	<u>RURAL</u>	Minimum Requirements EADT			
XX					
CONDITION A - Minimum Vehicular Volume					
<u>Satisfied</u>	<u>Not Satisfied</u>				
	XX				
Number of lanes for moving traffic on each approach		Vehicles Per Day on Major Street (Total of Both Approaches)		Vehicles Per Day on Higher-Volume Minor Street Approach (One Direction Only)	
<u>Major Street</u>	<u>Minor Street</u>	<u>Urban</u>	<u>Rural</u>	<u>Urban</u>	<u>Rural</u>
1 333	1 333	8,000	5,600	2,400	1,680
2 +	1	9,600	6,720	2,400	1,680
2 +	2 +	9,600	6,720	3,200	2,240
1	2 +	8,000	5,600	3,200	2,240
CONDITION B - Interruption of Continuous Traffic					
<u>Satisfied</u>	<u>Not Satisfied</u>				
	XX				
Number of lanes for moving traffic on each approach		Vehicles Per Day on Major Street (Total of Both Approaches)		Vehicles Per Day on Higher-Volume Minor Street Approach (One Direction Only)	
<u>Major Street</u>	<u>Minor Street</u>	<u>Urban</u>	<u>Rural</u>	<u>Urban</u>	<u>Rural</u>
1 333	1 333	12,000	8,400	1,200	850
2 +	1	14,400	10,080	1,200	850
2 +	2 +	14,400	10,080	1,600	1,120
1	2 +	12,000	8,400	1,600	1,120
Combination of CONDITIONS A + B					
<u>Satisfied</u>	<u>Not Satisfied</u>				
	XX				
No one condition satisfied, but following conditions fulfilled 80% of more		2 CONDITIONS 80%		2 CONDITIONS 80%	
	<u>A</u>				
	4%				
	<u>B</u>				
	3%				

Note: To be used only for NEW INTERSECTIONS or other locations where it is not reasonable to count actual traffic volumes.

The satisfaction of a traffic signal warrant or warrants shall not in itself require the installation of a traffic control signal.



This Page Intentionally Left Blank

**APPENDIX 6.3: EAPC (2024) CONDITIONS FREEWAY OFF-RAMP
QUEUING ANALYSIS WORKSHEETS**

This Page Intentionally Left Blank

Queues

6: I-215 SB Ramps & Ramona Exwy.

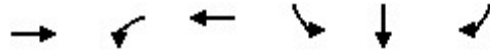

Lane Group	EBT	WBL	WBT	SBL	SBT	SBR
Lane Group Flow (vph)	1240	553	1829	935	938	767
v/c Ratio	0.99	1.50	0.86	1.79	1.79	1.41
Control Delay	56.8	254.1	9.2	390.4	391.4	225.3
Queue Delay	4.4	0.0	29.8	12.3	12.2	0.0
Total Delay	61.2	254.1	39.0	402.6	403.6	225.3
Queue Length 50th (ft)	423	~518	138	~1045	~1048	~696
Queue Length 95th (ft)	#583	m#382	m344	#1302	#1304	#934
Internal Link Dist (ft)	1408		344		1111	
Turn Bay Length (ft)		100		510		510
Base Capacity (vph)	1249	369	2133	522	523	543
Starvation Cap Reductn	0	0	406	0	0	0
Spillback Cap Reductn	22	0	0	337	337	0
Storage Cap Reductn	0	0	0	0	0	0
Reduced v/c Ratio	1.01	1.50	1.06	5.05	5.04	1.41

Intersection Summary

- ~ Volume exceeds capacity, queue is theoretically infinite.
Queue shown is maximum after two cycles.
- # 95th percentile volume exceeds capacity, queue may be longer.
Queue shown is maximum after two cycles.
- m Volume for 95th percentile queue is metered by upstream signal.

Queues

7: I-215 NB Ramps & Ramona Exwy.



Lane Group	EBL	EBT	WBT	WBR	NBL	NBT	NBR
Lane Group Flow (vph)	319	2362	1536	1504	434	439	824
v/c Ratio	1.05	1.16	1.20	1.43	0.76	0.77	1.41
Control Delay	85.2	98.3	131.1	217.2	43.1	43.5	222.4
Queue Delay	0.0	2.4	0.6	0.0	0.0	0.0	0.0
Total Delay	85.2	100.7	131.7	217.2	43.1	43.5	222.4
Queue Length 50th (ft)	~236	~1068	~694	~1087	287	290	~751
Queue Length 95th (ft)	m228	m608	#833	#1355	418	#425	#993
Internal Link Dist (ft)		344	532			1162	
Turn Bay Length (ft)	105			200			500
Base Capacity (vph)	303	2034	1279	1051	569	570	585
Starvation Cap Reductn	0	1001	0	0	0	0	0
Spillback Cap Reductn	0	0	160	0	0	0	0
Storage Cap Reductn	0	0	0	0	0	0	0
Reduced v/c Ratio	1.05	2.29	1.37	1.43	0.76	0.77	1.41

Intersection Summary

- ~ Volume exceeds capacity, queue is theoretically infinite.
Queue shown is maximum after two cycles.
- # 95th percentile volume exceeds capacity, queue may be longer.
Queue shown is maximum after two cycles.
- m Volume for 95th percentile queue is metered by upstream signal.

Queues

8: I-215 SB Ramps & Placentia Av.

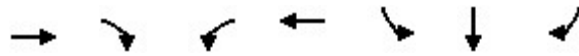

Lane Group	EBT	EBR	WBL	WBT	SBL	SBT	SBR
Lane Group Flow (vph)	709	216	266	665	231	232	277
v/c Ratio	0.50	0.28	0.64	0.31	0.61	0.62	0.50
Control Delay	15.5	3.3	28.5	5.1	29.2	29.3	8.0
Queue Delay	0.0	0.0	0.0	0.0	0.0	0.0	0.0
Total Delay	15.5	3.3	28.5	5.1	29.2	29.3	8.0
Queue Length 50th (ft)	99	0	51	65	80	80	8
Queue Length 95th (ft)	143	35	78	57	#150	#150	62
Internal Link Dist (ft)	968			769		2180	
Turn Bay Length (ft)		230	250				330
Base Capacity (vph)	1410	762	431	2117	377	377	549
Starvation Cap Reductn	0	0	0	0	0	0	0
Spillback Cap Reductn	0	0	0	0	0	0	0
Storage Cap Reductn	0	0	0	0	0	0	0
Reduced v/c Ratio	0.50	0.28	0.62	0.31	0.61	0.62	0.50

Intersection Summary

95th percentile volume exceeds capacity, queue may be longer.
 Queue shown is maximum after two cycles.

Queues
9: I-215 NB Ramps & Placentia Av.



Lane Group	EBL	EBT	WBT	WBR	NBL	NBT	NBR
Lane Group Flow (vph)	202	968	580	478	175	176	613
v/c Ratio	0.69	0.48	0.41	0.52	0.40	0.41	1.20
Control Delay	34.1	8.0	14.3	3.7	22.0	22.1	130.5
Queue Delay	0.0	0.0	0.0	0.0	0.0	0.0	0.0
Total Delay	34.1	8.0	14.3	3.7	22.0	22.1	130.5
Queue Length 50th (ft)	37	107	76	0	54	55	~240
Queue Length 95th (ft)	m#74	165	113	49	107	107	#419
Internal Link Dist (ft)		769	517			1284	
Turn Bay Length (ft)	260			365	575		
Base Capacity (vph)	291	1997	1419	925	434	434	509
Starvation Cap Reductn	0	0	0	0	0	0	0
Spillback Cap Reductn	0	0	0	0	0	0	0
Storage Cap Reductn	0	0	0	0	0	0	0
Reduced v/c Ratio	0.69	0.48	0.41	0.52	0.40	0.41	1.20

Intersection Summary

- ~ Volume exceeds capacity, queue is theoretically infinite.
Queue shown is maximum after two cycles.
- # 95th percentile volume exceeds capacity, queue may be longer.
Queue shown is maximum after two cycles.
- m Volume for 95th percentile queue is metered by upstream signal.

Queues
6: I-215 SB Ramps & Ramona Exwy.

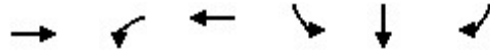

Lane Group	EBT	WBL	WBT	SBL	SBT	SBR
Lane Group Flow (vph)	2433	847	1215	1004	1013	407
v/c Ratio	1.96	2.30	0.57	1.92	1.94	0.75
Control Delay	459.5	605.0	3.5	447.9	453.8	37.9
Queue Delay	0.6	0.0	0.7	28.8	28.8	0.0
Total Delay	460.1	605.0	4.2	476.7	482.6	37.9
Queue Length 50th (ft)	~1396	~944	28	~1151	~1164	214
Queue Length 95th (ft)	#1534	m#714	m40	#1412	#1426	335
Internal Link Dist (ft)	1408		344		1111	
Turn Bay Length (ft)		100		510		510
Base Capacity (vph)	1240	369	2133	522	523	543
Starvation Cap Reductn	0	0	529	0	0	0
Spillback Cap Reductn	158	0	0	438	439	0
Storage Cap Reductn	0	0	0	0	0	0
Reduced v/c Ratio	2.25	2.30	0.76	11.95	12.06	0.75

Intersection Summary

~ Volume exceeds capacity, queue is theoretically infinite.

Queue shown is maximum after two cycles.

95th percentile volume exceeds capacity, queue may be longer.

Queue shown is maximum after two cycles.

m Volume for 95th percentile queue is metered by upstream signal.

Queues
7: I-215 NB Ramps & Ramona Exwy.



Lane Group	EBL	EBT	WBT	WBR	NBL	NBT	NBR
Lane Group Flow (vph)	709	3079	1572	1821	299	304	588
v/c Ratio	2.34	1.51	1.23	1.76	0.53	0.53	1.01
Control Delay	625.1	257.0	142.7	365.5	33.8	34.0	71.5
Queue Delay	0.0	2.3	0.0	0.0	0.0	0.0	0.0
Total Delay	625.1	259.3	142.7	365.5	33.8	34.0	71.5
Queue Length 50th (ft)	~742	~1568	~722	~1591	178	182	~377
Queue Length 95th (ft)	m#291	m610	#861	#1861	271	275	#616
Internal Link Dist (ft)		344	532			1162	
Turn Bay Length (ft)	105			200			500
Base Capacity (vph)	303	2034	1279	1033	569	570	585
Starvation Cap Reductn	0	975	0	0	0	0	0
Spillback Cap Reductn	0	0	0	0	0	0	0
Storage Cap Reductn	0	0	0	0	0	0	0
Reduced v/c Ratio	2.34	2.91	1.23	1.76	0.53	0.53	1.01

Intersection Summary

- ~ Volume exceeds capacity, queue is theoretically infinite.
Queue shown is maximum after two cycles.
- # 95th percentile volume exceeds capacity, queue may be longer.
Queue shown is maximum after two cycles.
- m Volume for 95th percentile queue is metered by upstream signal.

Queues
8: I-215 SB Ramps & Placentia Av.

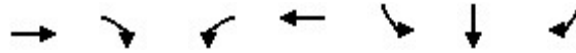

Lane Group	EBT	EBR	WBL	WBT	SBL	SBT	SBR
Lane Group Flow (vph)	860	299	634	696	295	297	116
v/c Ratio	0.63	0.38	1.01	0.30	1.00	1.01	0.30
Control Delay	17.8	3.5	60.4	7.2	83.5	84.2	6.2
Queue Delay	0.0	0.0	0.0	0.0	0.0	0.0	0.0
Total Delay	17.8	3.5	60.4	7.2	83.5	84.2	6.2
Queue Length 50th (ft)	129	0	~135	53	~114	~115	0
Queue Length 95th (ft)	183	41	#232	110	#258	#260	30
Internal Link Dist (ft)	968			769		2180	
Turn Bay Length (ft)		230	250				330
Base Capacity (vph)	1365	796	630	2292	294	295	389
Starvation Cap Reductn	0	0	0	0	0	0	0
Spillback Cap Reductn	0	0	0	0	0	0	0
Storage Cap Reductn	0	0	0	0	0	0	0
Reduced v/c Ratio	0.63	0.38	1.01	0.30	1.00	1.01	0.30

Intersection Summary

~ Volume exceeds capacity, queue is theoretically infinite.
Queue shown is maximum after two cycles.

95th percentile volume exceeds capacity, queue may be longer.
Queue shown is maximum after two cycles.

Queues

9: I-215 NB Ramps & Placentia Av.



Lane Group	EBL	EBT	WBT	WBR	NBL	NBT	NBR
Lane Group Flow (vph)	208	1245	1061	542	135	135	429
v/c Ratio	0.56	0.59	0.73	0.56	0.36	0.36	0.94
Control Delay	21.8	9.5	18.7	3.9	23.1	23.1	48.3
Queue Delay	0.0	0.0	0.0	0.0	0.0	0.0	0.0
Total Delay	21.8	9.5	18.7	3.9	23.1	23.1	48.3
Queue Length 50th (ft)	30	161	164	0	43	43	106
Queue Length 95th (ft)	m44	m215	231	51	89	89	#267
Internal Link Dist (ft)		769	517			1284	
Turn Bay Length (ft)	260			365	575		
Base Capacity (vph)	385	2122	1462	976	377	377	460
Starvation Cap Reductn	0	0	0	0	0	0	0
Spillback Cap Reductn	0	0	0	0	0	0	0
Storage Cap Reductn	0	0	0	0	0	0	0
Reduced v/c Ratio	0.54	0.59	0.73	0.56	0.36	0.36	0.93

Intersection Summary

95th percentile volume exceeds capacity, queue may be longer.

Queue shown is maximum after two cycles.

m Volume for 95th percentile queue is metered by upstream signal.

APPENDIX 6.4: EAPC (2024) CONDITIONS INTERSECTION OPERATIONS ANALYSIS WORKSHEETS WITH IMPROVEMENTS

This Page Intentionally Left Blank

Timings
1: Harvill Av. & Cajalco Exwy./Ramona Exwy.

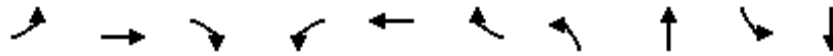

Lane Group	EBL	EBT	EBR	WBL	WBT	WBR	NBL	NBT	SBL	SBT
Lane Configurations	↙	↑↑↑	↘	↙↘	↑↑↑	↘	↙↘	↑↘	↙↘	↑↘
Traffic Volume (vph)	182	827	205	618	1116	685	362	408	403	212
Future Volume (vph)	182	827	205	618	1116	685	362	408	403	212
Turn Type	Prot	NA	Perm	Prot	NA	pm+ov	Prot	NA	Prot	NA
Protected Phases	5	2		1	6	7	3	8	7	4
Permitted Phases			2			6				
Detector Phase	5	2	2	1	6	7	3	8	7	4
Switch Phase										
Minimum Initial (s)	5.0	10.0	10.0	5.0	10.0	5.0	5.0	10.0	5.0	10.0
Minimum Split (s)	9.6	36.2	36.2	9.6	32.5	9.6	9.6	16.2	9.6	41.2
Total Split (s)	18.0	36.8	36.8	25.0	43.8	27.3	17.0	30.9	27.3	41.2
Total Split (%)	15.0%	30.7%	30.7%	20.8%	36.5%	22.8%	14.2%	25.8%	22.8%	34.3%
Yellow Time (s)	3.6	5.2	5.2	3.6	3.5	3.6	3.6	5.2	3.6	5.2
All-Red Time (s)	1.0	1.0	1.0	1.0	1.0	1.0	1.0	1.0	1.0	1.0
Lost Time Adjust (s)	0.0	0.0	0.0	0.0	0.0	0.0	0.0	0.0	0.0	0.0
Total Lost Time (s)	4.6	6.2	6.2	4.6	4.5	4.6	4.6	6.2	4.6	6.2
Lead/Lag	Lead	Lag	Lag	Lead	Lag	Lead	Lead	Lag	Lead	Lag
Lead-Lag Optimize?	Yes	Yes	Yes	Yes	Yes	Yes	Yes	Yes	Yes	Yes
Recall Mode	None	None	None	None	None	None	None	Max	None	Max
Act Effct Green (s)	13.4	25.9	25.9	20.4	34.6	57.6	12.4	28.9	18.6	35.1
Actuated g/C Ratio	0.12	0.22	0.22	0.18	0.30	0.50	0.11	0.25	0.16	0.30
v/c Ratio	0.94	0.70	0.41	1.04	0.70	0.87	1.00	0.71	0.75	0.28
Control Delay	99.3	44.2	7.1	93.4	38.2	34.6	98.4	39.6	54.6	26.5
Queue Delay	0.0	0.0	0.0	0.0	0.0	0.0	0.0	0.0	0.0	0.0
Total Delay	99.3	44.2	7.1	93.4	38.2	34.6	98.4	39.6	54.6	26.5
LOS	F	D	A	F	D	C	F	D	D	C
Approach Delay		46.2			51.3			60.8		42.7
Approach LOS		D			D			E		D

Intersection Summary

Cycle Length: 120
 Actuated Cycle Length: 115.4
 Natural Cycle: 120
 Control Type: Actuated-Uncoordinated
 Maximum v/c Ratio: 1.04
 Intersection Signal Delay: 50.8
 Intersection LOS: D
 Intersection Capacity Utilization 84.0%
 ICU Level of Service E
 Analysis Period (min) 15



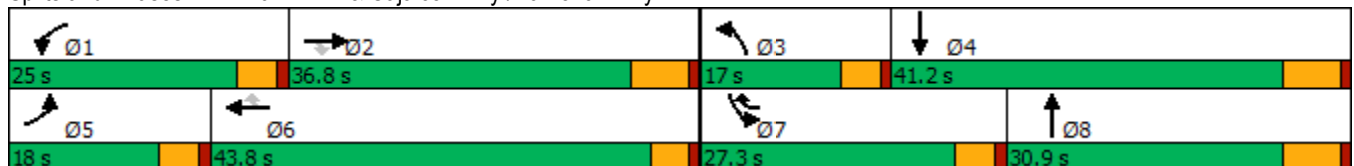































Splits and Phases: 1: Harvill Av. & Cajalco Exwy./Ramona Exwy.



HCM 6th Signalized Intersection Summary
 1: Harvill Av. & Cajalco Exwy./Ramona Exwy.

Harvill Logistics (JN 14231)

07/26/2022

												
Movement	EBL	EBT	EBR	WBL	WBT	WBR	NBL	NBT	NBR	SBL	SBT	SBR
Lane Configurations		  		  	  		 	 		 	 	
Traffic Volume (veh/h)	182	827	205	618	1116	685	362	408	231	403	212	82
Future Volume (veh/h)	182	827	205	618	1116	685	362	408	231	403	212	82
Initial Q (Qb), veh	0	0	0	0	0	0	0	0	0	0	0	0
Ped-Bike Adj(A_pbT)	1.00		1.00	1.00		1.00	1.00		0.99	1.00		1.00
Parking Bus, Adj	1.00	1.00	1.00	1.00	1.00	1.00	1.00	1.00	1.00	1.00	1.00	1.00
Work Zone On Approach		No			No			No			No	
Adj Sat Flow, veh/h/ln	1900	1900	1900	1900	1900	1900	1900	1900	1900	1900	1900	1900
Adj Flow Rate, veh/h	196	889	112	665	1200	371	389	439	124	433	228	45
Peak Hour Factor	0.93	0.93	0.93	0.93	0.93	0.93	0.93	0.93	0.93	0.93	0.93	0.93
Percent Heavy Veh, %	0	0	0	0	0	0	0	0	0	0	0	0
Cap, veh/h	212	1240	350	646	1589	673	393	785	220	503	947	184
Arrive On Green	0.12	0.22	0.22	0.18	0.28	0.28	0.11	0.28	0.28	0.14	0.31	0.31
Sat Flow, veh/h	1810	5700	1610	3619	5700	1610	3619	2848	797	3619	3093	599
Grp Volume(v), veh/h	196	889	112	665	1200	371	389	291	272	433	138	135
Grp Sat Flow(s),veh/h/ln	1810	1900	1610	1810	1900	1610	1810	1900	1744	1810	1900	1792
Q Serve(g_s), s	12.3	16.5	6.7	20.4	22.0	19.9	12.3	15.0	15.3	13.4	6.2	6.4
Cycle Q Clear(g_c), s	12.3	16.5	6.7	20.4	22.0	19.9	12.3	15.0	15.3	13.4	6.2	6.4
Prop In Lane	1.00		1.00	1.00		1.00	1.00		0.46	1.00		0.33
Lane Grp Cap(c), veh/h	212	1240	350	646	1589	673	393	524	481	503	582	549
V/C Ratio(X)	0.92	0.72	0.32	1.03	0.76	0.55	0.99	0.56	0.56	0.86	0.24	0.25
Avail Cap(c_a), veh/h	212	1527	431	646	1961	778	393	524	481	719	582	549
HCM Platoon Ratio	1.00	1.00	1.00	1.00	1.00	1.00	1.00	1.00	1.00	1.00	1.00	1.00
Upstream Filter(I)	1.00	1.00	1.00	1.00	1.00	1.00	1.00	1.00	1.00	1.00	1.00	1.00
Uniform Delay (d), s/veh	49.9	41.4	37.6	46.9	37.6	25.2	50.9	35.4	35.5	48.1	29.6	29.7
Incr Delay (d2), s/veh	40.5	1.3	0.5	43.1	1.4	0.7	42.7	4.2	4.7	5.4	1.0	1.1
Initial Q Delay(d3),s/veh	0.0	0.0	0.0	0.0	0.0	0.0	0.0	0.0	0.0	0.0	0.0	0.0
%ile BackOfQ(50%),veh/ln	7.7	7.5	2.6	12.6	9.9	7.2	7.7	7.2	6.8	6.2	2.9	2.8
Unsig. Movement Delay, s/veh												
LnGrp Delay(d),s/veh	90.4	42.7	38.1	90.0	39.0	25.9	93.5	39.6	40.2	53.5	30.6	30.8
LnGrp LOS	F	D	D	F	D	C	F	D	D	D	C	C
Approach Vol, veh/h		1197			2236			952			706	
Approach Delay, s/veh		50.1			52.0			61.8			44.7	
Approach LOS		D			D			E			D	
Timer - Assigned Phs	1	2	3	4	5	6	7	8				
Phs Duration (G+Y+Rc), s	25.0	31.1	17.0	41.2	18.0	38.1	20.5	37.7				
Change Period (Y+Rc), s	4.6	6.2	4.6	6.2	4.6	* 6.2	4.6	6.2				
Max Green Setting (Gmax), s	20.4	30.6	12.4	35.0	13.4	* 39	22.7	24.7				
Max Q Clear Time (g_c+I1), s	22.4	18.5	14.3	8.4	14.3	24.0	15.4	17.3				
Green Ext Time (p_c), s	0.0	4.6	0.0	1.3	0.0	7.9	0.5	1.8				
Intersection Summary												
HCM 6th Ctrl Delay			52.4									
HCM 6th LOS			D									
Notes												
* HCM 6th computational engine requires equal clearance times for the phases crossing the barrier.												

Timings
6: I-215 SB Ramps & Ramona Exwy.

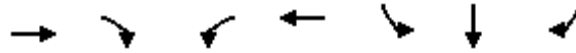

Lane Group	EBT	EBR	WBL	WBT	SBL	SBT	SBR
Lane Configurations	↑↑↑	↑	↔	↑↑↑	↔	↑	↑
Traffic Volume (vph)	766	449	542	1792	1834	2	752
Future Volume (vph)	766	449	542	1792	1834	2	752
Turn Type	NA	Perm	Prot	NA	Split	NA	Perm
Protected Phases	2		1	6	4	4	
Permitted Phases		2					4
Detector Phase	2	2	1	6	4	4	4
Switch Phase							
Minimum Initial (s)	5.0	5.0	5.0	5.0	5.0	5.0	5.0
Minimum Split (s)	11.0	11.0	9.5	31.0	10.5	10.5	10.5
Total Split (s)	26.7	26.7	26.3	53.0	67.0	67.0	67.0
Total Split (%)	22.3%	22.3%	21.9%	44.2%	55.8%	55.8%	55.8%
Yellow Time (s)	5.0	5.0	3.5	5.0	4.5	4.5	4.5
All-Red Time (s)	1.0	1.0	1.0	1.0	1.0	1.0	1.0
Lost Time Adjust (s)	0.0	0.0	0.0	0.0	0.0	0.0	0.0
Total Lost Time (s)	6.0	6.0	4.5	6.0	5.5	5.5	5.5
Lead/Lag	Lag	Lag	Lead				
Lead-Lag Optimize?	Yes	Yes	Yes				
Recall Mode	C-Max	C-Max	None	C-Max	Max	Max	Max
Act Effct Green (s)	21.4	21.4	21.1	47.0	61.5	61.5	61.5
Actuated g/C Ratio	0.18	0.18	0.18	0.39	0.51	0.51	0.51
v/c Ratio	0.77	0.69	0.87	0.82	0.68	0.67	0.89
Control Delay	53.1	10.2	45.6	36.8	24.2	26.1	38.3
Queue Delay	0.0	0.0	0.0	18.9	51.3	56.3	0.0
Total Delay	53.1	10.2	45.6	55.7	75.5	82.3	38.3
LOS	D	B	D	E	E	F	D
Approach Delay	37.2			53.4		66.3	
Approach LOS	D			D		E	

Intersection Summary

Cycle Length: 120
 Actuated Cycle Length: 120
 Offset: 0 (0%), Referenced to phase 2:EBT and 6:WBT, Start of Yellow
 Natural Cycle: 70
 Control Type: Actuated-Coordinated
 Maximum v/c Ratio: 0.89
 Intersection Signal Delay: 55.6
 Intersection LOS: E
 Intersection Capacity Utilization 162.1%
 ICU Level of Service H
 Analysis Period (min) 15

Splits and Phases: 6: I-215 SB Ramps & Ramona Exwy.

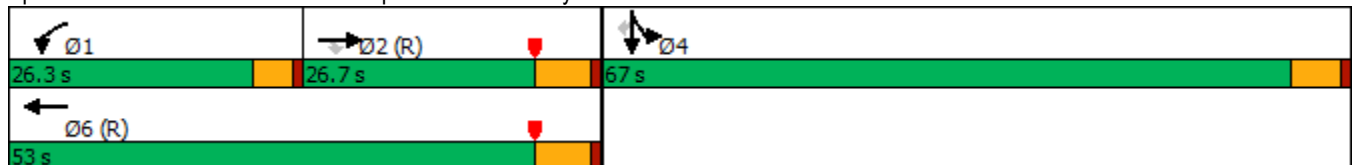

HCM 6th Signalized Intersection Summary
6: I-215 SB Ramps & Ramona Exwy.

Harvill Logistics (JN 14231)

07/26/2022



Movement	EBL	EBT	EBR	WBL	WBT	WBR	NBL	NBT	NBR	SBL	SBT	SBR
Lane Configurations		↑↑↑	↗	↘↗	↑↑↑					↘↗	↖	↗
Traffic Volume (veh/h)	0	766	449	542	1792	0	0	0	0	1834	2	752
Future Volume (veh/h)	0	766	449	542	1792	0	0	0	0	1834	2	752
Initial Q (Qb), veh	0	0	0	0	0	0				0	0	0
Ped-Bike Adj(A_pbT)	1.00		0.99	1.00		1.00				1.00		1.00
Parking Bus, Adj	1.00	1.00	1.00	1.00	1.00	1.00				1.00	1.00	1.00
Work Zone On Approach		No			No						No	
Adj Sat Flow, veh/h/ln	0	1900	1900	1900	1900	0				1900	1900	1900
Adj Flow Rate, veh/h	0	782	234	553	1829	0				1872	0	384
Peak Hour Factor	0.98	0.98	0.98	0.98	0.98	0.98				0.98	0.98	0.98
Percent Heavy Veh, %	0	0	0	0	0	0				0	0	0
Cap, veh/h	0	1050	293	615	2232	0				2782	0	825
Arrive On Green	0.00	0.18	0.18	0.17	0.39	0.00				0.51	0.00	0.51
Sat Flow, veh/h	0	5700	1589	3619	5700	0				5429	0	1610
Grp Volume(v), veh/h	0	782	234	553	1829	0				1872	0	384
Grp Sat Flow(s),veh/h/ln	0	1900	1589	1810	1900	0				1810	0	1610
Q Serve(g_s), s	0.0	15.6	16.9	18.0	34.5	0.0				30.8	0.0	18.3
Cycle Q Clear(g_c), s	0.0	15.6	16.9	18.0	34.5	0.0				30.8	0.0	18.3
Prop In Lane	0.00		1.00	1.00		0.00				1.00		1.00
Lane Grp Cap(c), veh/h	0	1050	293	615	2233	0				2782	0	825
V/C Ratio(X)	0.00	0.74	0.80	0.90	0.82	0.00				0.67	0.00	0.47
Avail Cap(c_a), veh/h	0	1050	293	657	2233	0				2782	0	825
HCM Platoon Ratio	1.00	1.00	1.00	1.00	1.00	1.00				1.00	1.00	1.00
Upstream Filter(I)	0.00	0.63	0.63	0.69	0.69	0.00				1.00	0.00	1.00
Uniform Delay (d), s/veh	0.0	46.3	46.8	48.8	32.7	0.0				21.8	0.0	18.7
Incr Delay (d2), s/veh	0.0	3.1	13.4	10.9	2.4	0.0				1.3	0.0	1.9
Initial Q Delay(d3),s/veh	0.0	0.0	0.0	0.0	0.0	0.0				0.0	0.0	0.0
%ile BackOfQ(50%),veh/ln	0.0	7.4	7.5	8.7	15.3	0.0				12.4	0.0	6.8
Unsig. Movement Delay, s/veh												
LnGrp Delay(d),s/veh	0.0	49.3	60.3	59.7	35.1	0.0				23.1	0.0	20.6
LnGrp LOS	A	D	E	E	D	A				C	A	C
Approach Vol, veh/h		1016			2382						2256	
Approach Delay, s/veh		51.9			40.8						22.7	
Approach LOS		D			D						C	
Timer - Assigned Phs	1	2		4		6						
Phs Duration (G+Y+Rc), s	24.9	28.1		67.0		53.0						
Change Period (Y+Rc), s	4.5	6.0		5.5		6.0						
Max Green Setting (Gmax), s	21.8	20.7		61.5		47.0						
Max Q Clear Time (g_c+I1), s	20.0	18.9		32.8		36.5						
Green Ext Time (p_c), s	0.4	0.8		12.0		6.0						

Intersection Summary

HCM 6th Ctrl Delay	35.6
HCM 6th LOS	D

Notes

User approved volume balancing among the lanes for turning movement.

Timings
7: I-215 NB Ramps & Ramona Exwy.



Lane Group	EBL	EBT	WBT	WBR	NBL	NBT	NBR
Lane Configurations	↶↷	↑↑↑	↑↑↑	↷	↶	↶	↷
Traffic Volume (vph)	309	2291	1490	1459	843	4	799
Future Volume (vph)	309	2291	1490	1459	843	4	799
Turn Type	Prot	NA	NA	Free	Split	NA	Perm
Protected Phases	5	2	6		8	8	
Permitted Phases				Free			8
Detector Phase	5	2	6		8	8	8
Switch Phase							
Minimum Initial (s)	5.0	5.0	5.0		5.0	5.0	5.0
Minimum Split (s)	9.5	11.0	26.0		10.5	10.5	10.5
Total Split (s)	13.0	74.0	61.0		46.0	46.0	46.0
Total Split (%)	10.8%	61.7%	50.8%		38.3%	38.3%	38.3%
Yellow Time (s)	3.5	5.0	5.0		4.5	4.5	4.5
All-Red Time (s)	1.0	1.0	1.0		1.0	1.0	1.0
Lost Time Adjust (s)	0.0	0.0	0.0		0.0	0.0	0.0
Total Lost Time (s)	4.5	6.0	6.0		5.5	5.5	5.5
Lead/Lag	Lead		Lag				
Lead-Lag Optimize?	Yes		Yes				
Recall Mode	None	C-Max	C-Max		None	None	None
Act Effct Green (s)	8.5	68.0	55.0	120.0	40.5	40.5	40.5
Actuated g/C Ratio	0.07	0.57	0.46	1.00	0.34	0.34	0.34
v/c Ratio	1.29	0.80	0.65	0.93	0.75	0.76	1.40
Control Delay	196.7	35.0	26.6	12.4	44.8	45.1	218.9
Queue Delay	0.0	47.7	9.3	0.0	0.0	0.0	0.0
Total Delay	196.7	82.7	35.9	12.4	44.8	45.1	218.9
LOS	F	F	D	B	D	D	F
Approach Delay		96.3	24.3			129.4	
Approach LOS		F	C			F	

Intersection Summary





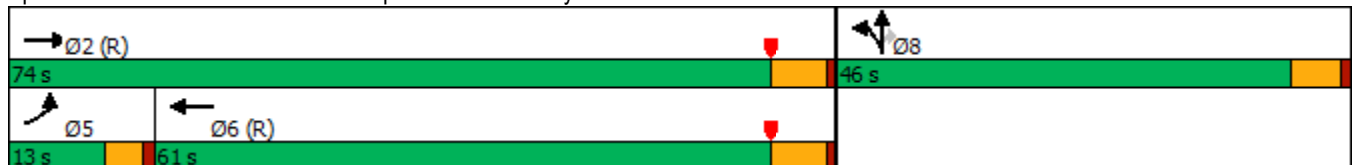



















Cycle Length: 120
 Actuated Cycle Length: 120
 Offset: 0 (0%), Referenced to phase 2:EBT and 6:WBT, Start of Yellow, Master Intersection
 Natural Cycle: 65
 Control Type: Actuated-Coordinated
 Maximum v/c Ratio: 1.40
 Intersection Signal Delay: 74.3
 Intersection LOS: E
 Intersection Capacity Utilization 162.1%
 ICU Level of Service H
 Analysis Period (min) 15

Splits and Phases: 7: I-215 NB Ramps & Ramona Exwy.



HCM 6th Signalized Intersection Summary
 7: I-215 NB Ramps & Ramona Exwy.

Harvill Logistics (JN 14231)
 07/26/2022

												
Movement	EBL	EBT	EBR	WBL	WBT	WBR	NBL	NBT	NBR	SBL	SBT	SBR
Lane Configurations	 	  			  							
Traffic Volume (veh/h)	309	2291	0	0	1490	1459	843	4	799	0	0	0
Future Volume (veh/h)	309	2291	0	0	1490	1459	843	4	799	0	0	0
Initial Q (Qb), veh	0	0	0	0	0	0	0	0	0			
Ped-Bike Adj(A_pbT)	1.00		1.00	1.00		1.00	1.00		1.00			
Parking Bus, Adj	1.00	1.00	1.00	1.00	1.00	1.00	1.00	1.00	1.00			
Work Zone On Approach		No			No			No				
Adj Sat Flow, veh/h/ln	1900	1900	0	0	1900	1900	1900	1900	1900			
Adj Flow Rate, veh/h	319	2362	0	0	1536	0	872	0	672			
Peak Hour Factor	0.97	0.97	0.97	0.97	0.97	0.97	0.97	0.97	0.97			
Percent Heavy Veh, %	0	0	0	0	0	0	0	0	0			
Cap, veh/h	249	2939	0	0	2377		1221	0	543			
Arrive On Green	0.14	1.00	0.00	0.00	0.46	0.00	0.34	0.00	0.34			
Sat Flow, veh/h	3510	5358	0	0	5358	1610	3619	0	1610			
Grp Volume(v), veh/h	319	2362	0	0	1536	0	872	0	672			
Grp Sat Flow(s),veh/h/ln	1755	1729	0	0	1729	1610	1810	0	1610			
Q Serve(g_s), s	8.5	0.0	0.0	0.0	27.3	0.0	25.2	0.0	40.5			
Cycle Q Clear(g_c), s	8.5	0.0	0.0	0.0	27.3	0.0	25.2	0.0	40.5			
Prop In Lane	1.00		0.00	0.00		1.00	1.00		1.00			
Lane Grp Cap(c), veh/h	249	2939	0	0	2377		1221	0	543			
V/C Ratio(X)	1.28	0.80	0.00	0.00	0.65		0.71	0.00	1.24			
Avail Cap(c_a), veh/h	249	2939	0	0	2377		1221	0	543			
HCM Platoon Ratio	2.00	2.00	1.00	1.00	1.00	1.00	1.00	1.00	1.00			
Upstream Filter(I)	0.63	0.63	0.00	0.00	1.00	0.00	1.00	0.00	1.00			
Uniform Delay (d), s/veh	51.5	0.0	0.0	0.0	25.0	0.0	34.7	0.0	39.8			
Incr Delay (d2), s/veh	145.4	1.6	0.0	0.0	1.4	0.0	2.0	0.0	121.6			
Initial Q Delay(d3),s/veh	0.0	0.0	0.0	0.0	0.0	0.0	0.0	0.0	0.0			
%ile BackOfQ(50%),veh/ln	8.4	0.4	0.0	0.0	10.7	0.0	11.0	0.0	33.5			
Unsig. Movement Delay, s/veh												
LnGrp Delay(d),s/veh	196.9	1.6	0.0	0.0	26.4	0.0	36.7	0.0	161.4			
LnGrp LOS	F	A	A	A	C		D	A	F			
Approach Vol, veh/h		2681			1536			1544				
Approach Delay, s/veh		24.8			26.4			91.0				
Approach LOS		C			C			F				
Timer - Assigned Phs		2			5	6		8				
Phs Duration (G+Y+Rc), s		74.0			13.0	61.0		46.0				
Change Period (Y+Rc), s		6.0			4.5	6.0		5.5				
Max Green Setting (Gmax), s		68.0			8.5	55.0		40.5				
Max Q Clear Time (g_c+I1), s		2.0			10.5	29.3		42.5				
Green Ext Time (p_c), s		19.6			0.0	7.5		0.0				

Intersection Summary

HCM 6th Ctrl Delay	42.9
HCM 6th LOS	D

Notes

User approved volume balancing among the lanes for turning movement.
 Unsignalized Delay for [WBR] is excluded from calculations of the approach delay and intersection delay.

Timings
1: Harvill Av. & Cajalco Exwy./Ramona Exwy.

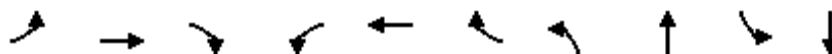

Lane Group	EBL	EBT	EBR	WBL	WBT	WBR	NBL	NBT	SBL	SBT
Lane Configurations	↘	↑↑↑	↗	↘↗	↑↑↑	↗	↘↗	↑↗	↘↗	↑↗
Traffic Volume (vph)	121	1223	286	337	916	448	294	218	842	293
Future Volume (vph)	121	1223	286	337	916	448	294	218	842	293
Turn Type	Prot	NA	Perm	Prot	NA	pm+ov	Prot	NA	Prot	NA
Protected Phases	5	2		1	6	7	3	8	7	4
Permitted Phases			2			6				
Detector Phase	5	2	2	1	6	7	3	8	7	4
Switch Phase										
Minimum Initial (s)	5.0	10.0	10.0	5.0	10.0	5.0	5.0	10.0	5.0	10.0
Minimum Split (s)	9.6	36.2	36.2	9.6	32.5	9.6	9.6	16.2	9.6	41.2
Total Split (s)	14.3	37.6	37.6	17.2	40.5	34.6	21.2	30.6	34.6	44.0
Total Split (%)	11.9%	31.3%	31.3%	14.3%	33.8%	28.8%	17.7%	25.5%	28.8%	36.7%
Yellow Time (s)	3.6	5.2	5.2	3.6	3.5	3.6	3.6	5.2	3.6	5.2
All-Red Time (s)	1.0	1.0	1.0	1.0	1.0	1.0	1.0	1.0	1.0	1.0
Lost Time Adjust (s)	0.0	0.0	0.0	0.0	0.0	0.0	0.0	0.0	0.0	0.0
Total Lost Time (s)	4.6	6.2	6.2	4.6	4.5	4.6	4.6	6.2	4.6	6.2
Lead/Lag	Lead	Lag	Lag	Lead	Lag	Lead	Lead	Lag	Lead	Lag
Lead-Lag Optimize?	Yes	Yes	Yes	Yes	Yes	Yes	Yes	Yes	Yes	Yes
Recall Mode	None	None	None	None	None	None	None	Max	None	Max
Act Effct Green (s)	9.7	31.4	31.4	12.6	36.0	70.5	14.3	24.4	30.0	40.1
Actuated g/C Ratio	0.08	0.26	0.26	0.10	0.30	0.59	0.12	0.20	0.25	0.33
v/c Ratio	0.90	0.88	0.47	0.96	0.58	0.47	0.73	1.34dr	1.00	0.39
Control Delay	106.4	50.6	6.5	89.9	37.2	8.9	61.3	80.4	75.9	24.6
Queue Delay	0.0	0.0	0.0	0.0	0.0	0.0	0.0	0.0	0.0	0.0
Total Delay	106.4	50.6	6.5	89.9	37.2	8.9	61.3	80.4	75.9	24.6
LOS	F	D	A	F	D	A	E	F	E	C
Approach Delay		47.0			40.2			75.2		57.8
Approach LOS		D			D			E		E

Intersection Summary

Cycle Length: 120
 Actuated Cycle Length: 120
 Natural Cycle: 120
 Control Type: Actuated-Uncoordinated
 Maximum v/c Ratio: 1.04
 Intersection Signal Delay: 52.7
 Intersection LOS: D
 Intersection Capacity Utilization 99.6%
 ICU Level of Service F
 Analysis Period (min) 15
 dr Defacto Right Lane. Recode with 1 though lane as a right lane.

Splits and Phases: 1: Harvill Av. & Cajalco Exwy./Ramona Exwy.

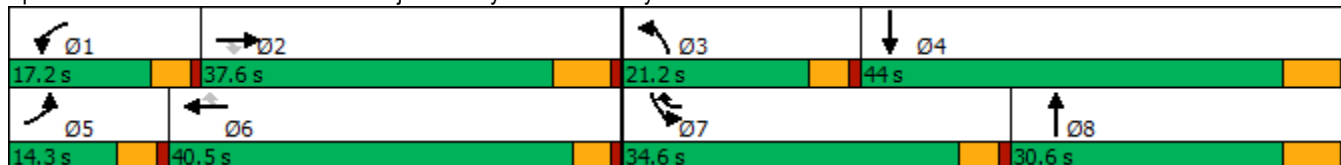

HCM 6th Signalized Intersection Summary
 1: Harvill Av. & Cajalco Exwy./Ramona Exwy.

Harvill Logistics (JN 14231)

07/26/2022

Movement	EBL	EBT	EBR	WBL	WBT	WBR	NBL	NBT	NBR	SBL	SBT	SBR
Lane Configurations												
Traffic Volume (veh/h)	121	1223	286	337	916	448	294	218	567	842	293	166
Future Volume (veh/h)	121	1223	286	337	916	448	294	218	567	842	293	166
Initial Q (Qb), veh	0	0	0	0	0	0	0	0	0	0	0	0
Ped-Bike Adj(A_pbT)	1.00		1.00	1.00		1.00	1.00		0.99	1.00		1.00
Parking Bus, Adj	1.00	1.00	1.00	1.00	1.00	1.00	1.00	1.00	1.00	1.00	1.00	1.00
Work Zone On Approach		No			No			No			No	
Adj Sat Flow, veh/h/ln	1900	1900	1900	1900	1900	1900	1900	1900	1900	1900	1900	1900
Adj Flow Rate, veh/h	130	1315	157	362	985	245	316	234	309	905	315	90
Peak Hour Factor	0.93	0.93	0.93	0.93	0.93	0.93	0.93	0.93	0.93	0.93	0.93	0.93
Percent Heavy Veh, %	0	0	0	0	0	0	0	0	0	0	0	0
Cap, veh/h	148	1456	411	383	1595	856	376	390	326	912	1009	283
Arrive On Green	0.12	0.38	0.38	0.16	0.42	0.42	0.16	0.31	0.31	0.38	0.53	0.53
Sat Flow, veh/h	1810	5700	1610	3619	5700	1610	3619	1900	1589	3619	2854	801
Grp Volume(v), veh/h	130	1315	157	362	985	245	316	234	309	905	208	197
Grp Sat Flow(s),veh/h/ln	1810	1900	1610	1810	1900	1610	1810	1900	1589	1810	1900	1756
Q Serve(g_s), s	8.4	25.9	8.4	11.8	16.1	8.8	10.1	12.4	22.6	29.6	7.3	7.6
Cycle Q Clear(g_c), s	8.4	25.9	8.4	11.8	16.1	8.8	10.1	12.4	22.6	29.6	7.3	7.6
Prop In Lane	1.00		1.00	1.00		1.00	1.00		1.00	1.00		0.46
Lane Grp Cap(c), veh/h	148	1456	411	383	1595	856	376	390	326	912	671	620
V/C Ratio(X)	0.88	0.90	0.38	0.94	0.62	0.29	0.84	0.60	0.95	0.99	0.31	0.32
Avail Cap(c_a), veh/h	148	1504	425	383	1724	893	505	390	326	912	671	620
HCM Platoon Ratio	1.50	1.50	1.50	1.50	1.50	1.50	1.50	1.50	1.50	1.50	1.50	1.50
Upstream Filter(I)	1.00	1.00	1.00	1.00	1.00	1.00	1.00	1.00	1.00	1.00	1.00	1.00
Uniform Delay (d), s/veh	51.7	35.3	29.9	49.7	29.5	12.2	49.3	37.1	40.6	36.9	19.8	19.9
Incr Delay (d2), s/veh	40.4	7.8	0.6	31.7	0.6	0.2	7.2	6.7	38.3	27.7	1.2	1.3
Initial Q Delay(d3),s/veh	0.0	0.0	0.0	0.0	0.0	0.0	0.0	0.0	0.0	0.0	0.0	0.0
%ile BackOfQ(50%),veh/ln	5.2	10.9	3.0	6.5	6.2	2.7	4.6	5.9	11.0	14.3	3.1	3.0
Unsig. Movement Delay, s/veh												
LnGrp Delay(d),s/veh	92.0	43.2	30.5	81.4	30.1	12.4	56.5	43.8	78.9	64.6	21.0	21.2
LnGrp LOS	F	D	C	F	C	B	E	D	E	E	C	C
Approach Vol, veh/h		1602			1592			859			1310	
Approach Delay, s/veh		45.9			39.1			61.1			51.1	
Approach LOS		D			D			E			D	
Timer - Assigned Phs	1	2	3	4	5	6	7	8				
Phs Duration (G+Y+Rc), s	17.2	36.6	16.9	48.3	14.3	39.5	34.6	30.6				
Change Period (Y+Rc), s	4.6	6.2	4.6	6.2	4.6	* 6.2	4.6	6.2				
Max Green Setting (Gmax), s	12.6	31.4	16.6	37.8	9.7	* 36	30.0	24.4				
Max Q Clear Time (g_c+I1), s	13.8	27.9	12.1	9.6	10.4	18.1	31.6	24.6				
Green Ext Time (p_c), s	0.0	2.5	0.3	2.1	0.0	6.7	0.0	0.0				

Intersection Summary

HCM 6th Ctrl Delay	47.6
HCM 6th LOS	D

Notes

* HCM 6th computational engine requires equal clearance times for the phases crossing the barrier.

Timings
6: I-215 SB Ramps & Ramona Exwy.

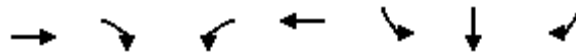

Lane Group	EBT	EBR	WBL	WBT	SBL	SBT	SBR
Lane Configurations	↑↑↑	↑	↔	↑↑↑	↔	↑	↑
Traffic Volume (vph)	1571	838	839	1203	1989	8	403
Future Volume (vph)	1571	838	839	1203	1989	8	403
Turn Type	NA	Perm	Prot	NA	Split	NA	Perm
Protected Phases	2		1	6	4	4	
Permitted Phases		2					4
Detector Phase	2	2	1	6	4	4	4
Switch Phase							
Minimum Initial (s)	5.0	5.0	5.0	5.0	5.0	5.0	5.0
Minimum Split (s)	11.0	11.0	9.5	31.0	10.5	10.5	10.5
Total Split (s)	38.8	38.8	32.2	71.0	49.0	49.0	49.0
Total Split (%)	32.3%	32.3%	26.8%	59.2%	40.8%	40.8%	40.8%
Yellow Time (s)	5.0	5.0	3.5	5.0	4.5	4.5	4.5
All-Red Time (s)	1.0	1.0	1.0	1.0	1.0	1.0	1.0
Lost Time Adjust (s)	0.0	0.0	0.0	0.0	0.0	0.0	0.0
Total Lost Time (s)	6.0	6.0	4.5	6.0	5.5	5.5	5.5
Lead/Lag	Lag	Lag	Lead				
Lead-Lag Optimize?	Yes	Yes	Yes				
Recall Mode	C-Max	C-Max	None	C-Max	Max	Max	Max
Act Effct Green (s)	32.8	32.8	27.7	65.0	43.5	43.5	43.5
Actuated g/C Ratio	0.27	0.27	0.23	0.54	0.36	0.36	0.36
v/c Ratio	1.02	0.93	1.02	0.39	1.03	1.02	0.65
Control Delay	70.8	27.7	105.0	20.1	70.5	79.3	31.9
Queue Delay	0.0	0.0	25.2	0.5	31.2	34.0	0.0
Total Delay	70.8	27.7	130.1	20.6	101.7	113.3	31.9
LOS	E	C	F	C	F	F	C
Approach Delay	55.8			65.6		93.2	
Approach LOS	E			E		F	

Intersection Summary

Cycle Length: 120
 Actuated Cycle Length: 120
 Offset: 0 (0%), Referenced to phase 2:EBT and 6:WBT, Start of Yellow
 Natural Cycle: 120
 Control Type: Actuated-Coordinated
 Maximum v/c Ratio: 1.03
 Intersection Signal Delay: 71.8
 Intersection LOS: E
 Intersection Capacity Utilization 161.1%
 ICU Level of Service H
 Analysis Period (min) 15

Splits and Phases: 6: I-215 SB Ramps & Ramona Exwy.

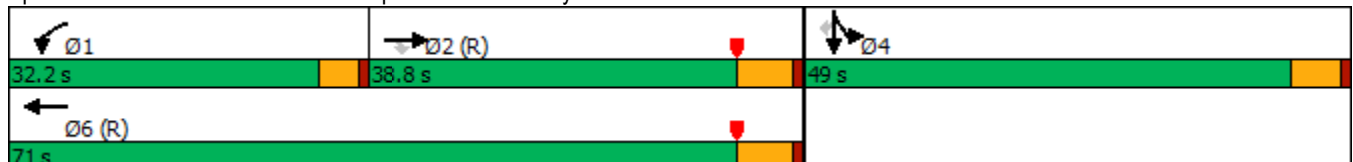

HCM 6th Signalized Intersection Summary
6: I-215 SB Ramps & Ramona Exwy.

Harvill Logistics (JN 14231)

07/26/2022



Movement	EBL	EBT	EBR	WBL	WBT	WBR	NBL	NBT	NBR	SBL	SBT	SBR
Lane Configurations		↑↑↑	↗	↘↗	↑↑↑					↘↗	↖	↗
Traffic Volume (veh/h)	0	1571	838	839	1203	0	0	0	0	1989	8	403
Future Volume (veh/h)	0	1571	838	839	1203	0	0	0	0	1989	8	403
Initial Q (Qb), veh	0	0	0	0	0	0				0	0	0
Ped-Bike Adj(A_pbT)	1.00		0.99	1.00		1.00				1.00		1.00
Parking Bus, Adj	1.00	1.00	1.00	1.00	1.00	1.00				1.00	1.00	1.00
Work Zone On Approach		No			No						No	
Adj Sat Flow, veh/h/ln	0	1900	1900	1900	1900	0				1900	1900	1900
Adj Flow Rate, veh/h	0	1587	424	847	1215	0				2015	0	204
Peak Hour Factor	0.92	0.99	0.99	0.99	0.99	0.99				0.99	0.99	0.99
Percent Heavy Veh, %	0	0	0	0	0	0				0	0	0
Cap, veh/h	0	1558	434	835	3088	0				1968	0	584
Arrive On Green	0.00	0.27	0.27	0.23	0.54	0.00				0.36	0.00	0.36
Sat Flow, veh/h	0	5700	1590	3619	5700	0				5429	0	1610
Grp Volume(v), veh/h	0	1587	424	847	1215	0				2015	0	204
Grp Sat Flow(s),veh/h/ln	0	1900	1590	1810	1900	0				1810	0	1610
Q Serve(g_s), s	0.0	32.8	31.7	27.7	14.9	0.0				43.5	0.0	11.1
Cycle Q Clear(g_c), s	0.0	32.8	31.7	27.7	14.9	0.0				43.5	0.0	11.1
Prop In Lane	0.00		1.00	1.00		0.00				1.00		1.00
Lane Grp Cap(c), veh/h	0	1558	434	835	3088	0				1968	0	584
V/C Ratio(X)	0.00	1.02	0.98	1.01	0.39	0.00				1.02	0.00	0.35
Avail Cap(c_a), veh/h	0	1558	434	835	3088	0				1968	0	584
HCM Platoon Ratio	1.00	1.00	1.00	1.00	1.00	1.00				1.00	1.00	1.00
Upstream Filter(I)	0.00	0.25	0.25	0.41	0.41	0.00				1.00	0.00	1.00
Uniform Delay (d), s/veh	0.0	43.6	43.2	46.2	16.0	0.0				38.3	0.0	27.9
Incr Delay (d2), s/veh	0.0	16.4	16.6	23.4	0.2	0.0				26.6	0.0	1.6
Initial Q Delay(d3),s/veh	0.0	0.0	0.0	0.0	0.0	0.0				0.0	0.0	0.0
%ile BackOfQ(50%),veh/ln	0.0	17.0	13.8	14.6	6.0	0.0				23.1	0.0	4.4
Unsig. Movement Delay, s/veh												
LnGrp Delay(d),s/veh	0.0	60.0	59.8	69.6	16.2	0.0				64.9	0.0	29.6
LnGrp LOS	A	F	E	F	B	A				F	A	C
Approach Vol, veh/h		2011			2062						2219	
Approach Delay, s/veh		60.0			38.1						61.6	
Approach LOS		E			D						E	
Timer - Assigned Phs	1	2		4		6						
Phs Duration (G+Y+Rc), s	32.2	38.8		49.0		71.0						
Change Period (Y+Rc), s	4.5	6.0		5.5		6.0						
Max Green Setting (Gmax), s	27.7	32.8		43.5		65.0						
Max Q Clear Time (g_c+I1), s	29.7	34.8		45.5		16.9						
Green Ext Time (p_c), s	0.0	0.0		0.0		5.8						

Intersection Summary

HCM 6th Ctrl Delay	53.4
HCM 6th LOS	D

Notes

User approved volume balancing among the lanes for turning movement.

Timings
7: I-215 NB Ramps & Ramona Exwy.



Lane Group	EBL	EBT	WBT	WBR	NBL	NBT	NBR
Lane Configurations	↶↶	↑↑↑	↶↶↶	↷	↶	↷	↷
Traffic Volume (vph)	666	2894	1478	1712	563	4	553
Future Volume (vph)	666	2894	1478	1712	563	4	553
Turn Type	Prot	NA	NA	Free	Split	NA	Perm
Protected Phases	5	2	6		8	8	
Permitted Phases				Free			8
Detector Phase	5	2	6		8	8	8
Switch Phase							
Minimum Initial (s)	5.0	5.0	5.0		5.0	5.0	5.0
Minimum Split (s)	9.5	11.0	26.0		10.5	10.5	10.5
Total Split (s)	30.0	76.0	46.0		44.0	44.0	44.0
Total Split (%)	25.0%	63.3%	38.3%		36.7%	36.7%	36.7%
Yellow Time (s)	3.5	5.0	5.0		4.5	4.5	4.5
All-Red Time (s)	1.0	1.0	1.0		1.0	1.0	1.0
Lost Time Adjust (s)	0.0	0.0	0.0		0.0	0.0	0.0
Total Lost Time (s)	4.5	6.0	6.0		5.5	5.5	5.5
Lead/Lag	Lead		Lag				
Lead-Lag Optimize?	Yes		Yes				
Recall Mode	None	C-Max	C-Max		None	None	None
Act Effct Green (s)	25.5	70.0	40.0	120.0	38.5	38.5	38.5
Actuated g/C Ratio	0.21	0.58	0.33	1.00	0.32	0.32	0.32
v/c Ratio	0.95	1.02	0.91	1.13	0.54	0.55	1.04
Control Delay	84.6	46.4	47.2	72.5	38.0	38.2	85.1
Queue Delay	0.0	34.0	23.0	0.0	0.0	0.0	0.0
Total Delay	84.6	80.4	70.2	72.5	38.0	38.2	85.1
LOS	F	F	E	E	D	D	F
Approach Delay		81.2	71.4			61.3	
Approach LOS		F	E			E	

Intersection Summary

























Cycle Length: 120
 Actuated Cycle Length: 120
 Offset: 0 (0%), Referenced to phase 2:EBT and 6:WBT, Start of Yellow, Master Intersection
 Natural Cycle: 65
 Control Type: Actuated-Coordinated
 Maximum v/c Ratio: 1.13
 Intersection Signal Delay: 74.4
 Intersection LOS: E
 Intersection Capacity Utilization 161.1%
 ICU Level of Service H
 Analysis Period (min) 15

Splits and Phases: 7: I-215 NB Ramps & Ramona Exwy.



HCM 6th Signalized Intersection Summary
 7: I-215 NB Ramps & Ramona Exwy.

Harvill Logistics (JN 14231)
 07/26/2022

												
Movement	EBL	EBT	EBR	WBL	WBT	WBR	NBL	NBT	NBR	SBL	SBT	SBR
Lane Configurations	 	  			  							
Traffic Volume (veh/h)	666	2894	0	0	1478	1712	563	4	553	0	0	0
Future Volume (veh/h)	666	2894	0	0	1478	1712	563	4	553	0	0	0
Initial Q (Qb), veh	0	0	0	0	0	0	0	0	0			
Ped-Bike Adj(A_pbT)	1.00		1.00	1.00		1.00	1.00		1.00			
Parking Bus, Adj	1.00	1.00	1.00	1.00	1.00	1.00	1.00	1.00	1.00			
Work Zone On Approach		No			No			No				
Adj Sat Flow, veh/h/ln	1900	1900	0	0	1900	1900	1900	1900	1900			
Adj Flow Rate, veh/h	709	3079	0	0	1572	0	602	0	507			
Peak Hour Factor	0.94	0.94	0.94	0.94	0.94	0.94	0.94	0.94	0.94			
Percent Heavy Veh, %	0	0	0	0	0	0	0	0	0			
Cap, veh/h	744	3026	0	0	1731		1161	0	517			
Arrive On Green	0.42	1.00	0.00	0.00	0.33	0.00	0.32	0.00	0.32			
Sat Flow, veh/h	3510	5358	0	0	5358	1610	3619	0	1610			
Grp Volume(v), veh/h	709	3079	0	0	1572	0	602	0	507			
Grp Sat Flow(s),veh/h/ln	1755	1729	0	0	1729	1610	1810	0	1610			
Q Serve(g_s), s	23.4	0.0	0.0	0.0	34.8	0.0	16.3	0.0	37.5			
Cycle Q Clear(g_c), s	23.4	0.0	0.0	0.0	34.8	0.0	16.3	0.0	37.5			
Prop In Lane	1.00		0.00	0.00		1.00	1.00		1.00			
Lane Grp Cap(c), veh/h	744	3026	0	0	1731		1161	0	517			
V/C Ratio(X)	0.95	1.02	0.00	0.00	0.91		0.52	0.00	0.98			
Avail Cap(c_a), veh/h	746	3026	0	0	1731		1161	0	517			
HCM Platoon Ratio	2.00	2.00	1.00	1.00	1.00	1.00	1.00	1.00	1.00			
Upstream Filter(I)	0.09	0.09	0.00	0.00	1.00	0.00	1.00	0.00	1.00			
Uniform Delay (d), s/veh	34.0	0.0	0.0	0.0	38.2	0.0	33.2	0.0	40.4			
Incr Delay (d2), s/veh	3.5	10.3	0.0	0.0	8.5	0.0	0.4	0.0	34.7			
Initial Q Delay(d3),s/veh	0.0	0.0	0.0	0.0	0.0	0.0	0.0	0.0	0.0			
%ile BackOfQ(50%),veh/ln	7.3	2.9	0.0	0.0	15.2	0.0	7.0	0.0	19.1			
Unsig. Movement Delay, s/veh												
LnGrp Delay(d),s/veh	37.4	10.3	0.0	0.0	46.7	0.0	33.6	0.0	75.1			
LnGrp LOS	D	F	A	A	D		C	A	E			
Approach Vol, veh/h		3788			1572			1109				
Approach Delay, s/veh		15.4			46.7			52.6				
Approach LOS		B			D			D				
Timer - Assigned Phs		2			5	6		8				
Phs Duration (G+Y+Rc), s		76.0			29.9	46.1		44.0				
Change Period (Y+Rc), s		6.0			4.5	6.0		5.5				
Max Green Setting (Gmax), s		70.0			25.5	40.0		38.5				
Max Q Clear Time (g_c+I1), s		2.0			25.4	36.8		39.5				
Green Ext Time (p_c), s		37.6			0.0	2.1		0.0				

Intersection Summary

HCM 6th Ctrl Delay	29.4
HCM 6th LOS	C

Notes

User approved volume balancing among the lanes for turning movement.
 Unsignalized Delay for [WBR] is excluded from calculations of the approach delay and intersection delay.

**APPENDIX 6.5: EAPC (2024) CONDITIONS FREEWAY OFF-RAMP
QUEUING ANALYSIS WORKSHEETS WITH IMPROVEMENTS**

This Page Intentionally Left Blank

Queues
6: I-215 SB Ramps & Ramona Exwy.

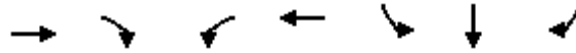

Lane Group	EBT	EBR	WBL	WBT	SBL	SBT	SBR
Lane Group Flow (vph)	782	458	553	1829	1254	619	767
v/c Ratio	0.77	0.69	0.87	0.82	0.68	0.67	0.89
Control Delay	53.1	10.2	45.6	36.8	24.2	26.1	38.3
Queue Delay	0.0	0.0	0.0	18.9	51.3	56.3	0.0
Total Delay	53.1	10.2	45.6	55.7	75.5	82.3	38.3
Queue Length 50th (ft)	195	0	103	470	350	343	480
Queue Length 95th (ft)	240	102	#237	522	425	477	#755
Internal Link Dist (ft)	1408			344		1111	
Turn Bay Length (ft)			100		510		510
Base Capacity (vph)	1014	659	655	2232	1850	928	860
Starvation Cap Reductn	0	0	0	454	0	0	0
Spillback Cap Reductn	0	0	0	0	1105	553	0
Storage Cap Reductn	0	0	0	0	0	0	0
Reduced v/c Ratio	0.77	0.69	0.84	1.03	1.68	1.65	0.89

Intersection Summary

95th percentile volume exceeds capacity, queue may be longer.
Queue shown is maximum after two cycles.

Queues
6: I-215 SB Ramps & Ramona Exwy.

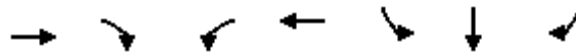

Lane Group	EBT	EBR	WBL	WBT	SBL	SBT	SBR
Lane Group Flow (vph)	1587	846	847	1215	1346	671	407
v/c Ratio	1.02	0.93	1.02	0.39	1.03	1.02	0.65
Control Delay	70.8	27.7	105.0	20.1	70.5	79.3	31.9
Queue Delay	0.0	0.0	25.2	0.5	31.2	34.0	0.0
Total Delay	70.8	27.7	130.1	20.6	101.7	113.3	31.9
Queue Length 50th (ft)	~434	177	~357	164	~557	~553	218
Queue Length 95th (ft)	#522	#483	m#425	m201	#689	#783	332
Internal Link Dist (ft)	1408			344		1111	
Turn Bay Length (ft)			100		510		510
Base Capacity (vph)	1558	908	833	3087	1308	656	628
Starvation Cap Reductn	0	0	54	1287	0	0	0
Spillback Cap Reductn	0	0	0	0	678	339	0
Storage Cap Reductn	0	0	0	0	0	0	0
Reduced v/c Ratio	1.02	0.93	1.09	0.68	2.14	2.12	0.65

Intersection Summary

~ Volume exceeds capacity, queue is theoretically infinite.

Queue shown is maximum after two cycles.

95th percentile volume exceeds capacity, queue may be longer.

Queue shown is maximum after two cycles.

m Volume for 95th percentile queue is metered by upstream signal.