

**PRELIMINARY  
GEOTECHNICAL INVESTIGATION**

**NIRVANA INDUSTRIAL BUILDINGS  
AND SELF STORAGE COMPLEX  
821 MAIN STREET  
CHULA VISTA, CALIFORNIA**

**PREPARED FOR**

**VWP-OP NIRVANA OWNER, LLC  
PHOENIX, ARIZONA**

**SEPTEMBER 14, 2021  
PROJECT NO. G2755-42-01**

Project No. G2755-42-01  
September 14, 2021

VWP-OP Nirvana Owner, LLC  
2390 East Camelback Road, Suite 305  
Phoenix, Arizona 85016

Attention: Mr. Steven Schwarz

Subject: PRELIMINARY GEOTECHNICAL INVESTIGATION  
NIRVANA INDUSTRIAL BUILDINGS  
AND SELF STORAGE COMPLEX  
821 MAIN STREET  
CHULA VISTA, CALIFORNIA

Dear Mr. Schwarz:

In accordance with your request, we have prepared this preliminary geotechnical investigation report for the proposed industrial buildings at the subject site. The site is underlain by Tertiary-age Otay Formation mantled by Very Old Paralic Deposits, alluvium, topsoil, and slope wash. Minor amounts of undocumented fill are also present on the property.

This report is based on review of available published geotechnical reports and literature, a previous subsurface geotechnical exploration by others, a site reconnaissance, observations made during our field investigation performed between July 29, 2021 and August 8, 2021, and laboratory testing. Based on the results of this study, we opine that the subject site is suitable for construction of the proposed industrial buildings. The accompanying report includes the results of our study and conclusions and recommendations regarding geotechnical aspects of site development.

Should you have questions regarding this investigation, or if we may be of further service, please contact the undersigned at your convenience.

Very truly yours,

GEOCON INCORPORATED

  
Rodney C. Mikesell  
GE 2533



  
Rupert Adams  
CEG 2561

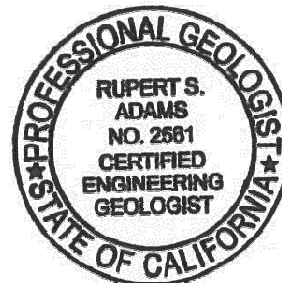

RCM:RSA:arm

(e-mail) Addressee

## TABLE OF CONTENTS

1.	PURPOSE AND SCOPE .....	1
2.	SITE AND PROJECT DESCRIPTION .....	2
3.	SOIL AND GEOLOGIC CONDITIONS .....	2
3.1	Undocumented Fill (Qudf) .....	3
3.2	Slope Wash (Unmapped).....	3
3.3	Topsoil (Unmapped).....	3
3.4	Alluvium (Qal) .....	3
3.5	Terrace Deposits (Qt) .....	4
3.6	Otay Formation (To).....	4
4.	GEOLOGIC STRUCTURE .....	4
5.	GROUNDWATER .....	5
6.	GEOLOGIC HAZARDS .....	5
6.1	Faulting and Seismicity .....	5
6.2	Ground Rupture .....	7
6.3	Storm Surge, Tsunamis, and Seiches.....	7
6.4	Flooding.....	8
6.5	Liquefaction.....	8
6.6	Landslides.....	8
6.7	Expansive Soil .....	8
7.	CONCLUSIONS AND RECOMMENDATIONS.....	9
7.1	General.....	9
7.2	Soil and Excavation Characteristics .....	10
7.3	Slope Stability.....	12
7.4	Slope Grading .....	14
7.5	Grading Recommendations .....	15
7.6	Earthwork Grading Factors.....	20
7.7	Subdrains .....	20
7.8	Settlement Monitoring .....	22
7.9	Seismic Design Criteria .....	23
7.10	Shallow Foundations .....	25
7.11	Conventional Retaining Wall Recommendations.....	29
7.12	Lateral Loading.....	32
7.13	Mechanically Stabilized Earth (MSE) Retaining Walls .....	33
7.14	Soil Nail Walls.....	35
7.15	Preliminary Pavement Recommendations.....	37
7.16	Exterior Concrete Flatwork .....	39
7.17	Slope Maintenance.....	41
7.18	Storm Water Management.....	41
7.19	Site Drainage and Moisture Protection.....	42
7.20	Grading and Foundation Plan Review .....	42
7.21	Testing and Observation Services During Construction.....	42

## **TABLE OF CONTENTS (Concluded)**

### **MAPS AND ILLUSTRATIONS**

- Figure 1, Geologic Map
- Figure 2, Geologic Cross Sections A-A' through G-G'
- Figure 3, Typical Buttress/Stability Fill Detail

### **APPENDIX A**

#### **FIELD INVESTIGATION**

- Figure A-1 to A-5, Logs of Large Diameter Borings
- Figures A-6 to A-13, Logs of Exploratory Test Pits

### **APPENDIX B**

#### **LABORATORY TESTING**

- Summary of Laboratory Maximum Dry Density and Optimum Moisture Content Test Results
- Summary of Laboratory Expansion Index Test Results
- Summary of Laboratory Water-Soluble Sulfate Test Results
- Summary of Laboratory Chloride Ion Content Test Results
- Summary of Laboratory pH and Resistivity Test Results
- Summary of Laboratory Atterberg Test Results

### **APPENDIX C**

#### **EXPLORATORY BORINGS AND TRENCHES PERFORMED BY OTHERS**

### **APPENDIX D**

#### **SLOPE STABILITY ANALYSIS**

### **APPENDIX E**

#### **RECOMMENDED GRADING SPECIFICATIONS**

### **LIST OF REFERENCES**

# PRELIMINARY GEOTECHNICAL INVESTIGATION

## 1. PURPOSE AND SCOPE

This report contains the results of our preliminary geotechnical investigation for proposed industrial buildings and self-storage facility located at 821 Main Street, in Chula Vista, California (see Vicinity Map).



Vicinity Map

The purpose of our investigation was to evaluate subsurface soil and geologic conditions at the site and provide conclusions and recommendations pertaining to geotechnical aspects of developing the property as proposed.

The scope of our study included performing a site reconnaissance and geologic mapping, reviewing readily available published geologic literature pertinent to the property, reviewing available geotechnical reports on this property and in the site vicinity (see List of References), and excavating and logging eight backhoe test pits and five large diameter borings. Appendix A presents a discussion of our field investigation. We performed laboratory tests on soil samples obtained from the exploratory test pits to evaluate pertinent physical properties for engineering analyses. The results of laboratory testing are presented in Appendix B. Exploratory borings and trenches performed by others is provided in Appendix C.

Site geologic conditions are depicted on Figure 1 (Geologic Map). A CAD file of the preliminary grading study prepared by Pasco Laret Suiter & Associates was utilized as a base map to plot geologic contacts and exploratory excavation locations.

The conclusions and recommendations presented herein are based on our analysis of the data obtained during the investigation, and our experience with similar soil and geologic conditions on this and adjacent properties.

## **2. SITE AND PROJECT DESCRIPTION**

The subject site encompasses approximately 13 acres of undeveloped land bounded on the north by automobile salvage yards, on the west by commercial buildings, on the south by Main Street and the Otay Riverbed, and on the east by the Otay Ranch Village 3 development. The property consists of natural, south-facing sloping terrain with elevations ranging from approximately 135 feet above mean sea level (MSL) to 220 feet MSL, with ephemeral drainages at the west and east ends of the property and one in the central area of the site. A storm drain pipe outlets near the toe of a fill slope at the upstream end of the central drainage. Storm water runoff then travels through the central drainage to a storm drain inlet near the southern property line. Trash, tires and debris are present in the drainage areas.

Proposed site development includes constructing four industrial buildings totaling approximately 290,500 square-feet, with associated improvements including utilities, paving, storm water management devices, and landscape improvements. One of the four proposed industrial buildings will be a self-storage facility. Proposed cuts and fills are estimated to be up to 50 feet, with proposed new slopes up to approximately 10 feet in height. Retaining walls are planned on north, south, and west sides of the site. The walls will have heights up to approximately 40 feet. A soil nail wall is planned along the majority of the northern property margin where cuts will be made to reach pad grade. In the central portion of the site the soil nail wall will transition into a mechanically stabilized earth (MSE) wall where fill is planned to reach pad grades. Along the south and west sides of the property MSE walls are planned to create proposed pad grades. New 72-inch-diameter and 60-inch-diameter storm drains will be installed on the property to convey storm water runoff from the properties to the north to a storm drain system below Main Street. Paved parking lots and driveways are planned along the perimeter of the site. Site access will be from Nirvana Street at the northwest corner of the property.

The locations and descriptions of the site and proposed development are based on our site reconnaissance and recent field investigations, and our understanding of site development as shown on the preliminary grading study prepared by Pasco Laret Suiter & Associates. If project details vary significantly from those described, Geocon Incorporated should be contacted to review the changes and provide additional analyses and/or revisions to this report, if warranted.

## **3. SOIL AND GEOLOGIC CONDITIONS**

Based on the results of the field investigation, the site is underlain by Tertiary Otay Formation capped with Terrace Deposits, alluvium, topsoil, slope wash, and undocumented fill. A description of the soil

and geologic conditions is provided below. Mapped geologic conditions are depicted on the *Geologic Map* (Figure 1), and on the *Geologic Cross Sections* (Figure 2). Exploratory boring and test pit logs are presented in Appendix A.

### **3.1 Undocumented Fill (Qudf)**

A prism of undocumented fill is mapped within the north-central portion of the site at the upstream end of the drainage. Some end-dumped piles of undocumented fill generally consisting of silty to clayey sand with cobbles is present on the property. Trash piles consisting of construction debris, auto parts and tires are also present at the site.

Undocumented fill and trash are unsuitable for support of structural fill and improvements. Undocumented fill should be removed and replaced as compacted fill. Trash should be hauled offsite prior to grading and not mixed with the fills.

### **3.2 Slope Wash (Unmapped)**

Steep, south-facing slopes are mantled with up to two feet of Holocene-age slope wash soils consisting of loose, dry, silty sand and sandy silt with cobble. The slope wash soils obscure the contact between the Terrance Deposits and the underlying Otay Formation, and the surface outcrop of bentonitic claystone beds within the Otay Formation.

The slope wash is compressible and possesses a “very low” to “high” expansion potential (expansion index of 130 or less). Slope wash should be removed during grading. Due to the limited thickness and extent of these deposits, slope wash is not shown on the Geologic Map (Figure 1).

### **3.3 Topsoil (Unmapped)**

Holocene-age topsoil is present as a relatively thin veneer locally overlying surficial and formational materials. The topsoil has a thickness of up to two feet and can be characterized as soft to stiff and loose to medium dense, dry to damp, dark brown, sandy clay to clayey sand with gravel and cobble. The topsoil is typically compressible and possesses a “very low” to “high” expansion potential (expansion index of 130 or less). Removal of the topsoil will be necessary within the limits of grading in areas supporting proposed fill or improvements. Due the limited thickness and extent of these deposits, topsoil is not shown on the Geologic Map (Figure 1).

### **3.4 Alluvium (Qal)**

Alluvium is present in the shallow, north-south trending drainages (Figure 1). The thickness of the alluvium is unknown, but previous studies indicate that it is at least five feet deep below existing grade. The alluvium generally consists of loose to medium dense to dense, silty to clayey sand with



gravel and cobble. Removal of the alluvium will be necessary within the limits of grading in areas supporting proposed fill or improvements.

### **3.5 Terrace Deposits (Qt)**

Pleistocene-age Terrace Deposits, also referred to as Old Alluvial Deposits, cap most of the site. Terrace Deposit thickness ranges between approximately 4 to 30 feet. The Terrace Deposits are generally dense to very dense, reddish brown, silty to clayey sand with gravel and cobble. The lower portions of the unit contain higher volume of larger cobbles and boulder-sized material up to about three feet in diameter. The Terrace Deposits are suitable for the support of proposed fill and structural loads; however, select grading and/or onsite screening operations will be required to properly place the cobble- and boulder-sized material in deeper fill areas, and generate soils suitable for mechanically stabilized earth (MSE) wall construction.

### **3.6 Otay Formation (To)**

The Tertiary-age (upper Oligocene) Otay Formation is exposed in the lower portion of the slope adjacent to Main Street and underlies the Terrace Deposits across the site. The Otay Formation consists of dense, silty, fine- to coarse-grained sandstone, clayey and sandy siltstone, and silty claystone with continuous and discontinuous interbeds of highly expansive bentonitic claystone. The coarse-grained portions of the Otay Formation typically possess a “very low” to “low” expansion potential (expansion index of 50 or less) and adequate shear strength. The fine-grained siltstone and claystone portions of the formation can exhibit a “medium” to “very high” expansion potential (expansion index greater than 50). The Otay Formation is suitable for the support of compacted fill and structural loads. Bentonitic claystone located within 5 feet of finish pad grade or within 2 feet of the bottom of structural footings will need to be undercut during grading and placed in deeper fill areas.

We identified two bentonitic claystone beds in large diameter borings, between 2 and 10 feet in thickness, extending under the site at elevations ranging between 145-155 feet MSL and 175-185 feet MSL. The bentonitic claystone beds consist of highly expansive clays, which typically exhibit low shear strength. Remolded clay seams referred to as bedding plane shears can develop on or within bentonitic claystone beds which can form landslide failure surfaces.

## **4. GEOLOGIC STRUCTURE**

Bedding attitudes observed within formational materials during logging of large diameter borings for this study, and during investigation and grading of the adjacent Otay Ranch Village 3 site to the east, are approximately horizontal to slightly dipping toward the southwest. The regional dip of sedimentary units in the eastern Chula Vista area is generally 1 to 5 degrees toward the southwest. The granular portions of the formational units are typically massive with bedding not discernible. Bentonitic



claystones and/or bedding plane shears create a possibility for slope instability and will require stabilization during grading. It is our opinion that the site geologic structure does not present a significant geologic hazard to the proposed development of the site provided the geotechnical recommendations in this report are incorporated into design and construction.

## 5. GROUNDWATER

We encountered seepage during the field investigation in several of our borings at depths ranging from 65 to 87 feet below existing grade (elevation 112 to 153 feet NGVD29) as shown in Table 5. The seepage depths recorded in borings LB-1 and LB-2 are considered most representative of conditions across the site. Seepage is likely a perched condition. The most likely location to encounter seepage is within the drainage areas and within backcuts for the lower retaining walls and/or stability buttresses. Although, we do not expect groundwater will significantly impact grading and construction of the planned improvements, management of seepage may be necessary if it is encountered during grading. It is not uncommon for groundwater or seepage conditions to develop where none previously existed. Groundwater and seepage is dependent on seasonal precipitation, irrigation, land use, among other factors, and varies as a result. Proper surface drainage will be important to future performance of the project.

**TABLE 5  
ESTIMATED SEEPAGE ELEVATION**

Boring No.	Date Recorded	Approximate Depth of Groundwater Below Existing Grade (feet)	Approximate Elevation of Groundwater (feet, NVGD29)
LB-1	7/29/2021	68	116
LB-2	7/30/2021	87	112
LB-3	7/30/2021	72*	122*
LB-5	08/03/2021	65**	153**

\* Seepage conditions

\*\* Inferred from boring spoils

## 6. GEOLOGIC HAZARDS

### 6.1 Faulting and Seismicity

A review of the referenced geologic materials and our knowledge of the general area indicate that the site is not underlain by active faults. A fault strand related to the potentially active La Nacion Fault is mapped on regional fault maps transecting the west property boundary. A study performed by AGS (2014) did not encounter the fault in a fault trench excavation.

The La Nacion Fault is considered to be potentially active. However, it is our opinion that the potential for fault rupture on the site is considered to be low based on review of geologic literature for the area

and our experience. Additional studies should be performed to evaluate if the fault is present on the property.

An active fault is defined by the California Geological Survey (CGS) as a fault showing evidence for activity within the last 11,700 years. The site is not located within a State of California Earthquake Fault Zone.

The USGS has developed a program to evaluate the approximate location of faulting in the area of properties. The following figure shows the location of the existing faulting in the San Diego County and Southern California region. The fault traces are shown as solid, dashed and dotted that represent well-constrained, moderately constrained and inferred, respectively. The fault line colors represent faults with ages less than 150 years (red), 15,000 years (orange), 130,000 years (green), 750,000 years (blue) and 1.6 million years (black).

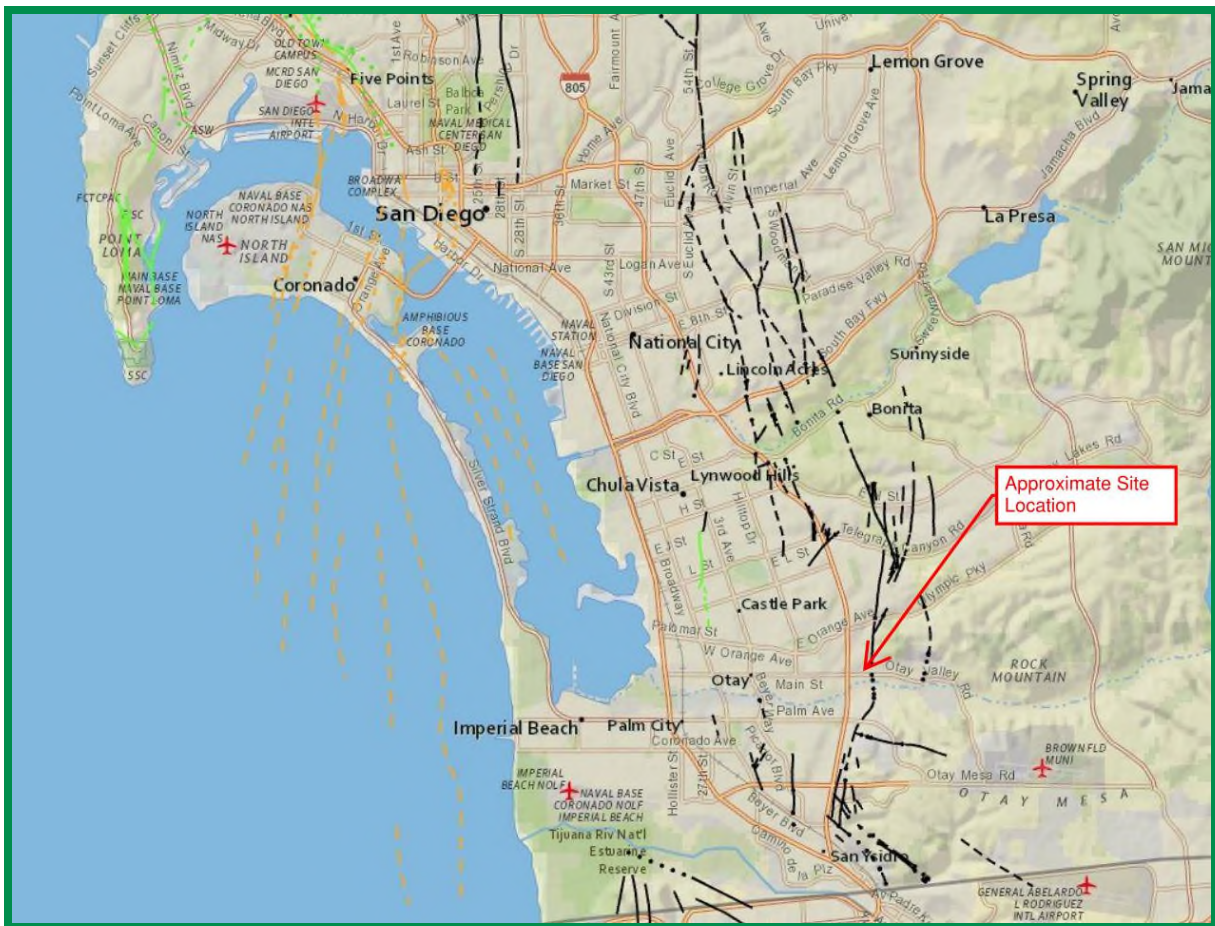

Faults in the San Diego Area

The San Diego County and Southern California region is seismically active. The following figure presents the occurrence of earthquakes with a magnitude greater than 2.5 from the period of 1900 through 2015 according to the Bay Area Earthquake Alliance website.

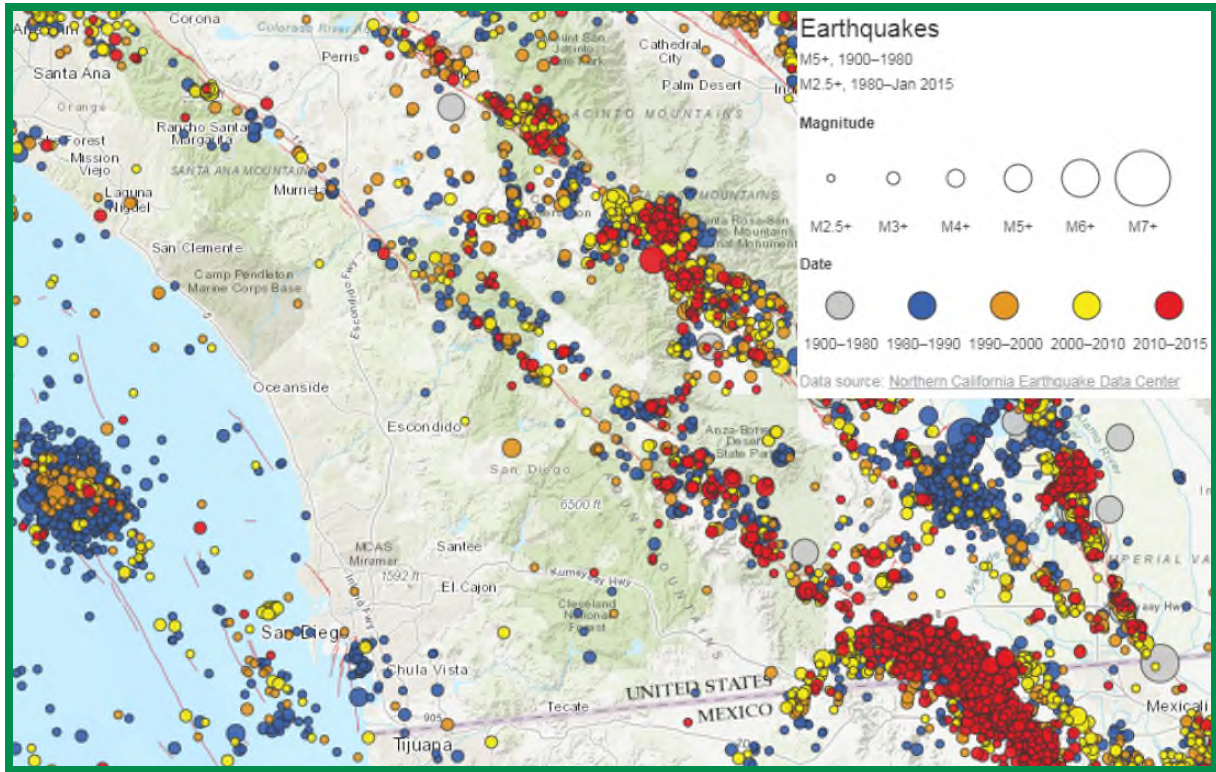

**Earthquakes in Southern California**

Considerations important in seismic design include the frequency and duration of motion and the soil conditions underlying the site. Seismic design of structures should be evaluated in accordance with the California Building Code (CBC) guidelines currently adopted by the local agency.

### 6.2 Ground Rupture

The risk associated with ground rupture hazard is low due to the absence of active faults at the subject site.

### 6.3 Storm Surge, Tsunamis, and Seiches

The site is located approximately seven miles from the Pacific Ocean and is at an elevation of about 138 feet or greater above Mean Sea Level (MSL). Therefore, the potential of storm surges and tsunamis affecting the site is considered low.

The site is not located in the vicinity of or downstream from such bodies of water. Therefore, the risk of seiches affecting the site is negligible.

#### **6.4 Flooding**

According to maps produced by the Federal Emergency Management Agency (FEMA), the site is zoned as “Zone X – Minimal Flood Hazard.” Based on our review of FEMA flood maps, the risk of site flooding is low.

#### **6.5 Liquefaction**

Due to the lack of a permanent, near-surface groundwater table and the dense nature of the underlying geologic units on the property, the potential for liquefaction is low.

#### **6.6 Landslides**

We did not observe evidence of previous or incipient slope instability at the site during our study. Published geologic mapping indicates landslides are not present on or immediately adjacent to the site. Therefore, the risk of landsliding at the site is low.

#### **6.7 Expansive Soil**

The fine-grained clay beds within the Otay Formation may possess a “high” to “very high” expansion potential (expansion index of 91 to greater than 130). We expect topsoil, Terrace Deposits, and sandy portions of the Otay Formation will likely possess a “medium” to “high” expansive potential (Expansion Index of 51 to 130).



## 7. CONCLUSIONS AND RECOMMENDATIONS

### 7.1 General

- 7.1.1 No soil or geologic conditions were observed that would preclude the development of the property as presently proposed provided that the recommendations of this report are followed.
- 7.1.2 The site is underlain by compressible surficial deposits consisting of undocumented fill, topsoil, slope wash, and alluvium, overlying Quaternary-age Terrace Deposits and Tertiary-age Otay Formation. We estimate the undocumented fill at the north end of the central drainage to be between ten to twenty feet thick. Topsoil and slope wash range from approximately one to four feet thick. The alluvium extends to depths greater than five feet and may be thicker in unexplored areas of the site. Minor amounts of trash and construction debris are present at the site that will require offsite disposal.
- 7.1.3 Undocumented fill, topsoil, slope wash, and alluvium are unsuitable in their present condition to support fill or settlement-sensitive structures and will require removal and recompaction.
- 7.1.4 Two bentonitic claystone beds within the Otay Formation identified as laterally continuous across the site require slope buttressing, stability fills, and consideration in wall design to provide stable slope conditions.
- 7.1.5 A concealed segment of the potentially active La Nacion Fault is mapped at a regional scale, crossing the western side of the property. We did not evaluate the presence or absence of this fault on the property during our investigation, but fault trenching performed by others did not identify the fault. Additional trenching will be necessary to determine if the fault crosses the property.
- 7.1.6 Based on the current grading plan, an east-west trending cut to fill- transition will be present at finish grade. The cut side of the transition will need to be undercut in building pads to reduce differential settlement across the transition.
- 7.1.7 Excavation to reach pad grades will also expose an expansive claystone bed at or near finish pad grade. The claystone bed will need to be undercut during grading where it is present within 5 feet of finish pad grade or 2 feet below the bottom of footings. Grading should be planned to bury the expansive clay in deeper fill areas, outside of wall backfill zones, and at least 15 feet from the face of slopes.

- 7.1.8 Gravel and cobble greater than six inches in diameter is present in portions of the Terrace Deposits. Selective grading and potentially screening will be necessary if the cobble Terrace Deposits will be utilized as MSE wall backfill.
- 7.1.9 We encountered seepage in exploratory borings; however, we don't expect groundwater will be a constraint to project development. Seepage within surficial soils and formational materials may be encountered during grading operations, especially during the rainy seasons.
- 7.1.10 Except for possible strong seismic shaking and slope instability, no significant geologic hazards were observed or are known to exist on the site that would adversely affect the site. No special seismic design considerations, other than those recommended herein, are required. Slope stabilization requirements are discussed in the grading section of this report.
- 7.1.11 Proper drainage should be maintained in order to preserve the engineering properties of the fill in both the building pads and slope areas. Recommendations for site drainage are provided herein.
- 7.1.12 We did not perform infiltration testing as part of this study as preliminary design plans were not available. Due to the proposed MSE walls and deep fills required in the south (down-gradient) portion of the site needed to create a level building pad, infiltration of storm water is not recommended on this site.
- 7.1.13 Provided the recommendations of this report are followed, it is our opinion that the proposed development will not destabilize or result in settlement of adjacent properties or the City right-of-way.
- 7.1.14 Subsurface conditions observed may be extrapolated to reflect general soil/geologic conditions; however, some variations in subsurface conditions between boring and test pit locations should be anticipated.

## **7.2 Soil and Excavation Characteristics**

- 7.2.1 The recommendations included herein are provided for stable excavations. It is the responsibility of the contractor and their competent person to ensure all excavations, temporary slopes and trenches are properly constructed and maintained in accordance with applicable OSHA guidelines in order to maintain safety and the stability of the excavations and adjacent improvements. These excavations should not be allowed to become saturated or to dry out. Surcharge loads should not be permitted to a distance equal to the height of the

excavation from the top of the excavation. The top of the excavation should be a minimum of 15 feet from the edge of existing improvements. Excavations steeper than those recommended or closer than 15 feet from an existing surface improvement should be shored in accordance with applicable OSHA codes and regulations.

7.2.2 The stability of the excavations is dependent on the design and construction of the shoring system and site conditions. Therefore, Geocon Incorporated cannot be responsible for site safety and the stability of the proposed excavations.

7.2.3 Excavation of undocumented fill and surficial deposits should be possible with moderate to heavy effort using conventional heavy-duty equipment. We expect excavation of the Terrace Deposits and the Otay Formation will require moderate to very heavy effort. Weakly to moderately cemented gravel and/or cobble and zones may be encountered requiring very heavy effort to excavate.

7.2.4 The soil encountered in the field investigation is considered to be both “non-expansive” (expansion index [EI] of 20 and less) and “expansive” (EI greater than 20) as defined by 2019 California Building Code (CBC) Section 1803.5.3. Table 7.2.1 presents soil classifications based on the expansion index. We expect the majority of the soils that will be encountered in remedial grading and cut areas will have a “low” to “medium” expansion potential. Portions of the topsoil and the clay beds possess a “high” to “very high” expansion potential (EI greater than 90).

**TABLE 7.2.1  
EXPANSION CLASSIFICATION BASED ON EXPANSION INDEX**

Expansion Index (EI)	ASTM D 4829 Expansion Classification	2019 CBC Expansion Classification
0 – 20	Very Low	Non-Expansive
21 – 50	Low	Expansive
51 – 90	Medium	
91 – 130	High	
Greater Than 130	Very High	

7.2.5 We performed laboratory tests on samples of the site materials to evaluate the percentage of water-soluble sulfate content. Appendix B presents results of the laboratory water-soluble sulfate content tests. The test results indicate the on-site materials at the locations tested possess “S0” sulfate exposure to concrete structures as defined by 2019 CBC Section 1904 and ACI 318-14 Chapter 19. Table 7.2.2 presents a summary of concrete requirements set



forth by 2019 CBC Section 1904 and ACI 318. The presence of water-soluble sulfates is not a visually discernible characteristic; therefore, other soil samples from the site could yield different concentrations. Additionally, over time landscaping activities (i.e., addition of fertilizers and other soil nutrients) may affect the concentration.

**TABLE 7.2.2  
REQUIREMENTS FOR CONCRETE EXPOSED TO  
SULFATE-CONTAINING SOLUTIONS**

Exposure Class	Water-Soluble Sulfate (SO <sub>4</sub> ) Percent by Weight	Cement Type (ASTM C 150)	Maximum Water to Cement Ratio by Weight <sup>1</sup>	Minimum Compressive Strength (psi)
S0	SO <sub>4</sub> <0.10	No Type Restriction	n/a	2,500
S1	0.10≤SO <sub>4</sub> <0.20	II	0.50	4,000
S2	0.20≤SO <sub>4</sub> ≤2.00	V	0.45	4,500
S3	SO <sub>4</sub> >2.00	V+Pozzolan or Slag	0.45	4,500

7.2.6 We tested samples for potential of hydrogen (pH) and resistivity and chloride to aid in evaluating the corrosion potential. Appendix B presents the laboratory test results.

7.2.7 Geocon Incorporated does not practice in the field of corrosion engineering. Therefore, further evaluation by a corrosion engineer may be needed if improvements susceptible to corrosion are planned.

### 7.3 Slope Stability

7.3.1 Slope stability analyses were performed to evaluate impacts the bentonitic claybeds have on the proposed project. A discussion of the slope stability analysis and the results of our analyses are discussed below and presented in Appendix D.

7.3.2 Based on our analysis, remedial grading to remove the claystone bed will be required within the existing hillside slope along the south and east sides of the property. Along the south side of the property, the backcut to enable placement of reinforcing grid for the MSE wall may sufficiently remove the claystone bed such that additional remedial removal is not required. Confirmation of this will be needed once wall design is complete and grid lengths are known. Where the wall backcut does not extend far enough into the hillside slope, additional clay bed removal will be required. The minimum removal length measured from the face of the wall is provided on the stability figures in Appendix D and cross sections on Figure 2. The front extent of the clay bed removal is shown on Figure 1.

- 7.3.3 On the east side of the site where the planned MSE wall terminates, a buttress will need to be constructed at the toe of the hillside slope below the planned MSE wall. The width of the required buttress measured from the toe of the slope is approximately 50 feet as shown on the Cross Section G-G (Figure 2) and on the stability figure in Appendix D. The estimated front extent of the clay bed removal is shown on Figure 1.
- 7.3.4 The recommended buttress/clay bed removal encompasses the area from the front key removal shown on Figure 1 and dipping into the slope at a minimum of 5 percent to the back of the recommended key width and then up at a 1:1 plane to where it intersects the existing ground surface as shown on the geologic cross sections (Figure 2). A typical buttress detail is shown on Figure 3.
- 7.3.5 Internal drainage of the buttress key should be constructed in accordance with Figure 3. The location of the heel drains and outlet points should be shown on the grading plans. All keyway and drainage features should be as-built in the field by the project civil engineer/surveyor.
- 7.3.6 A stability fill will also be needed along the top of the eastern slope where the clay bed is exposed on the slope face. The stability fill should have a minimum width of 15 feet measured from the slope face. The stability fill should include a back drain that outlets to the slope face. Subdrain cut off and head walls as shown in Section 7.7 of this report should be constructed. An outlet should be provided every approximately 100 feet of the stability fill.
- 7.3.7 The clay bed is expected to be present near the bottom of the wall cut along the north side of the property. The wall design will need to pin the clay bed to prevent slope instability. Geocon Incorporated can provide additional stability analysis and coordination with the wall designer, as needed.
- 7.3.8 Additional slope stability analysis should be performed to check buttress widths and limits once the MSE walls have been designed and grid type, location, and vertical spacing is known. Modifications to the buttress widths may be needed. Additional stability analysis should be performed on for the vertical slope supported by the soil nail wall once nail spacing and method to pin the claystone bed is known.
- 7.3.9 General slope stability analyses were performed for proposed cut and fill slopes up to 10 feet high (2:1 gradient). The stability analyses were performed using simplified Janbu analysis. The analyses indicate planned slopes above retaining walls will have a calculated factors of safety in excess of 1.5 under static conditions for both deep-seated failure and shallow sloughing conditions. Table 7.3.1 presents the slope stability analysis. Slope

stability analysis for MSE walls should be performed once the wall design is complete and grid locations and lengths are known.

**TABLE 7.3.1  
SLOPE STABILITY EVALUATION**

Parameter	Value
Slope Height, H	10 Feet
Slope Inclination, I (Horizontal to Vertical)	2:1
Total Soil Unit Weight, $\gamma$	130 pcf
Friction Angle, $\phi$	28 Degrees
Cohesion, C	250 psf
Slope Factor $\lambda_{C\phi} = (\gamma H \tan \phi) / C$	2.8
NCf (From Chart)	14
Factor of Safety = $(N_C C) / (\gamma H)$	2.7

7.3.10 Table 7.3.2 presents the surficial slope stability analysis for the proposed sloping conditions.

**TABLE 7.3.2  
SURFICIAL SLOPE STABILITY EVALUATION**

Parameter	Value
Slope Height, H	$\infty$
Vertical Depth of Saturation, Z	3 Feet
Slope Inclination, I (Horizontal to Vertical)	2:1 (26.6 Degrees)
Total Soil Unit Weight, $\gamma$	130 pcf
Water Unit Weight, $\gamma_w$	62.4 pcf
Friction Angle, $\phi$	28 Degrees
Cohesion, C	250 psf
Factor of Safety = $(C + (\gamma + \gamma_w) Z \cos^2 I \tan \phi) / (\gamma Z \sin I \cos I)$	2.2

7.3.11 All cut slope excavations should be observed during grading by an engineering geologist to verify that soil and geologic conditions do not differ significantly from those anticipated.

## 7.4 Slope Grading

7.4.1 Construction of fill slopes should begin with excavation of a fill slope keyway in accordance with the Fill Slope Keyway detail shown in the *Recommended Grading Specifications* in Appendix E.

- 7.4.2 The outer 15 feet (or a distance equal to the height of the slope, whichever is less) of fill slopes should be composed of properly compacted granular “soil” fill to reduce the potential for surficial sloughing. In general, soils with an Expansion Index of less than 50 should be acceptable as “granular” fill. Soils of questionable strength to satisfy surficial stability should be tested in the laboratory for acceptable drained shear strength.
- 7.4.3 Fill slopes should be overbuilt at least three feet horizontally, and cut back to the design finish grade. As an alternative, fill slopes may be compacted by back-rolling at vertical intervals not to exceed four feet and then track-walking with a D-8 dozer, or equivalent, upon completion such that the fill soils are uniformly compacted to at least 90 percent relative compaction to the face of the finished slope.
- 7.4.4 All slopes should be landscaped with drought-tolerant vegetation, having variable root depths and requiring minimal landscape irrigation. In addition, all slopes should be drained and properly maintained to reduce erosion.
- 7.4.5 Grading budgets should be established that include selective grading to provide suitable soil for the wall backfill, stability buttresses, as well as the outer 15 feet (or a distance equal to the height of the slope, whichever is less) of fill slopes with properly compacted granular “soil” fill to reduce the potential for slope creep and surficial sloughing. In general, soil with an  $EI \leq 50$  should be used within the outer slope zone. Minimum soil strength parameters for the stability buttresses is provided in the grading section.

## **7.5 Grading Recommendations**

- 7.5.1 Grading should be performed in accordance with the recommendations provided in this report, the Recommended Grading Specifications contained in Appendix E and the City of Chula Vista’s Grading Ordinance. Where the recommendations of this section conflict with those of Appendix E, the recommendations of this section take precedence. Geocon Incorporated should observe the grading operations on a full-time basis and provide testing during the fill placement.
- 7.5.2 Prior to commencing grading, a preconstruction meeting should be held at the site with the City inspector, developer, grading and underground contractors, civil engineer, and geotechnical engineer in attendance. Special soil handling and/or the grading plans can be discussed at that time.
- 7.5.3 Site preparation should begin with the removal of deleterious material, trash and debris, and vegetation. The depth of vegetation removal should be such that material exposed in cut areas

or soil to be used as fill is relatively free of organic matter. Material generated during stripping and/or site demolition should be exported from the site. Asphalt and concrete (if encountered) should not be mixed with the fill soil unless approved by the Geotechnical Engineer.

- 7.5.4 Abandoned foundations and buried utilities (if encountered) should be removed and the resulting depressions and/or trenches backfilled with properly compacted material as part of the remedial grading.
- 7.5.5 We recommend undocumented fill, topsoil, slope wash, and alluvium be removed to expose competent Terrace Deposits or Otay Formation and replaced as compacted fill throughout the site. Trash and debris may be encountered in the undocumented fill. Trash and debris, if encountered, should be removed from the fill and exported.
- 7.5.6 The actual depth of remedial removals should be determined in the field during grading by a representative of Geocon Incorporated prior to placement and compaction of fill.
- 7.5.7. Removals at the toes of slopes and in front of retaining walls should extend horizontally beyond the edge of the slope toe or wall a distance equal to the depth of removal. A typical detail of remedial grading beyond slope toes is presented below.

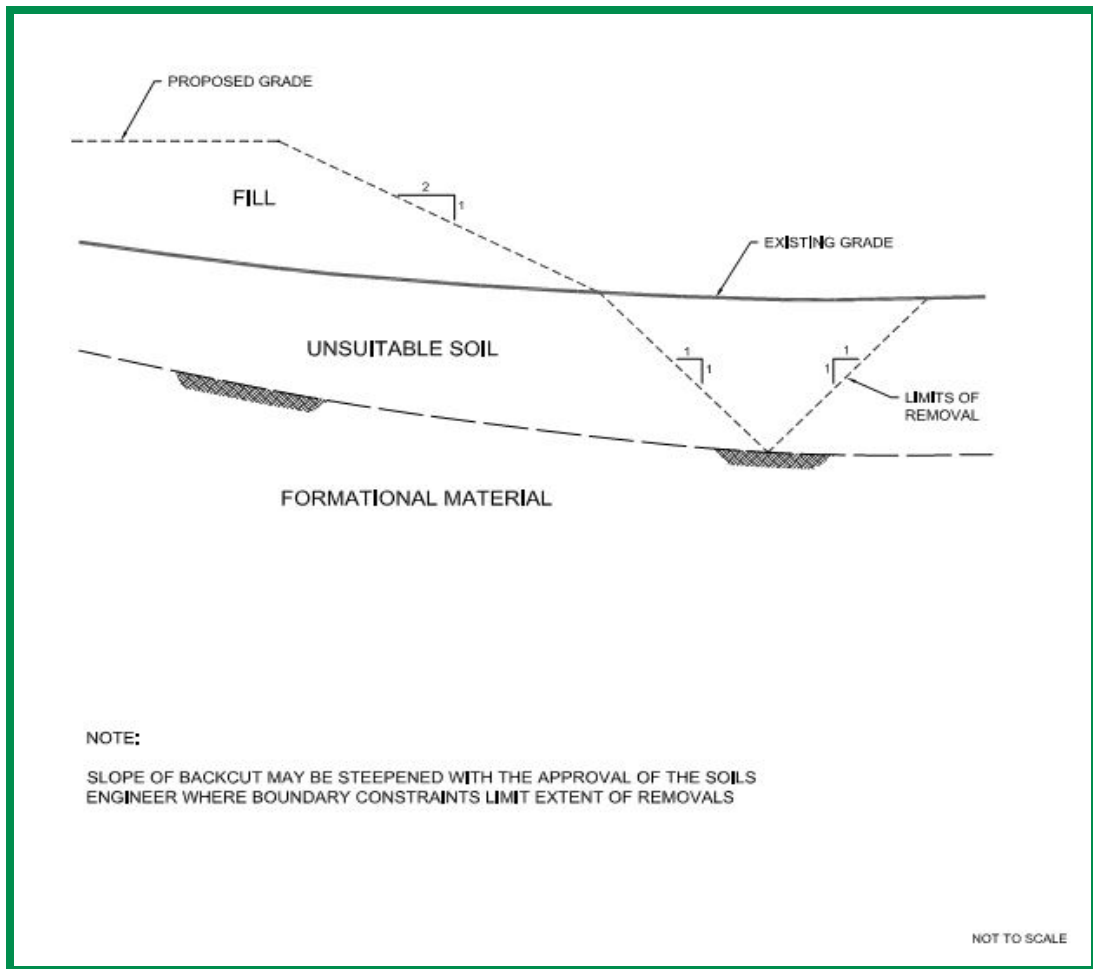

**Typical Limit of Remedial Grading**

- 7.5.8 Off-site grading within the adjacent property to the north will be required to remove the undocumented fill in the central drainage. Off-site grading will also be required to construct the stability buttress/fills on the eastern hillside slope.
- 7.5.9 Removal of the clay beds for slope stability purposes should be performed to the limits shown on Figures 1 and 2. Buttress and stability fills should be constructed as discussed in Section 7.3 of this report, Appendix D, and Figure 3. All fill placed within the buttress/stability fill area should meet the minimum strength requirement shown on the following table.

**TABLE 7.5.1  
RECOMMENDED SOIL STRENGTH PARAMETERS FOR BUTTRESS/STABILITY FILLS**

Friction Angle (degrees)	Cohesion (psf)
28	250

- 7.5.10 Grading will result in fill to formation transitions across the building pads. To reduce the potential for differential settlement, the cut portion of the transition should be over-excavated (undercut) at least 5 feet below proposed finish grade or at least two foot below the lowest foundation element, whichever is deeper, and replaced with properly compacted “very low” to “low” expansive fill soils. Overexcavations should extend to a horizontal distance of at least 5 feet beyond the edge of the building pad and cut at a gradient of one percent toward the deepest fill area to provide drainage for moisture migration along the contact between the native soil and compacted fill.
- 7.5.11 We expect the bentonitic clay bed will be encountered near finish subgrade across the site. The clay bed should be undercut to a depth of at least 5 feet below finish subgrade or at least 2 feet below the lowest foundation element, whichever is deeper, and replaced with properly compacted “very low” to “low” expansive fill soils. The clay bed undercut should be performed within both the building pads and below all structural improvements (pavement, concrete flatwork, retaining walls, etc.).
- 7.5.12 Expansive soils should be placed in deeper fill areas, outside of the foundation, reinforced and retained zones of MSE walls, and at least five feet below pad grade or two feet below the deepest foundation element, whichever is deeper.
- 7.5.13 A summary of grading recommendations is shown on the table below.



**TABLE 7.5.2  
SUMMARY OF REMEDIAL REMOVALS AND GRADING RECOMMENDATIONS**

Area	Removal Requirements
All Structural Improvement Areas	Remove all undocumented fill, topsoil, slope wash, and alluvium. Overexcavate clay bed to a depth of 5 feet below finish subgrade or 2 feet below building footing (whichever is deeper)
Building Pads with Cut to Fill Transition	Undercut building pad 5 feet below pad grade or 2 feet below bottom of building footings (whichever is deeper)
Fill Areas	Expansive Soil Buried at Least 5 Feet Below Pad Grade or at Least 2 Feet Below Bottom of Footings
Remedial Grading Limits	<ul style="list-style-type: none"> <li>• 5 Feet Outside of Building Pads;</li> <li>• 2 Feet Outside of Improvement Areas;</li> <li>• Beyond toe of slopes and retaining walls a distance equal to the depth of the remedial excavation, where possible</li> </ul>
Exposed Bottoms of Remedial Grading	Scarify Upper 12 Inches

7.5.14 Prior to fill soil being placed, the existing ground surface should be scarified, moisture conditioned as necessary, and compacted to a depth of at least 12 inches. Deeper removals may be required if saturated or loose fill soil is encountered. A representative of Geocon should be on-site during removals to evaluate the limits of the remedial grading.

7.5.15 The site should then be brought to final subgrade elevations with fill compacted in layers. In general, soil native to the site is suitable for use as fill if relatively free from vegetation, debris and other deleterious material. Layers of fill should be no thicker than will allow for adequate bonding and compaction. Fill, including backfill and scarified ground surfaces, should be compacted to a dry density of at least 90 percent of the laboratory maximum dry density near to slightly above optimum moisture content in accordance with ASTM Test Procedure D 1557. Fill materials placed below optimum moisture content may require additional moisture conditioning prior to placing additional fill.

7.5.16 Imported fill (if necessary) should consist of the characteristics presented in Table 7.5.3. Geocon Incorporated should be notified of the import soil source and should perform laboratory testing of import soil prior to its arrival at the site to determine its suitability as fill material.

**TABLE 7.5.3  
SUMMARY OF IMPORT FILL RECOMMENDATIONS**

Soil Characteristic	Values
Expansion Potential	“Very Low” to “Low” (Expansion Index of 50 or less)
Particle Size	Maximum Dimension Less Than 3 Inches
	Generally Free of Debris

## 7.6 Earthwork Grading Factors

7.6.1 Estimates of shrink-swell factors are based on comparing laboratory compaction tests with the density of the material in its natural state and experience with similar soil types. Variations in natural soil density and compacted fill render shrinkage value estimates very approximate. As an example, the contractor can compact fill to a density of 90 percent or higher of the laboratory maximum dry density. Thus, the contractor has at least a 10 percent range of control over the fill volume. Based on the work performed to date and considering the discussion herein, the earthwork factors in the following table may be used as a basis for estimating how much the on-site soils may shrink or swell when removed from their natural state and placed as compacted fill.

**TABLE 7.6  
SHRINKAGE AND BULK FACTORS**

Soil Unit	Shrink/Bulk Factor
Undocumented Fill (Dumped; Qudf)	10-15% Shrink
Undocumented Fill (Previously Compacted; Qudf)	0-3% Shrink
Topsoil and slope wash (unmapped)	5-10% Shrink
Alluvium (Qal)	4-10% Shrink
Terrace Deposits (Qt)	0-5% Bulk
Otay Formation (To)	3-5% Bulk

## 7.7 Subdrains

7.7.1 Subdrains should be installed in the canyon drainages that will be infilled. Typical subdrain installation details are presented below.

7.7.2 Canyon subdrains should be constructed from 6-inch Schedule 40 PVC pipe or equivalent. The approximate locations of proposed subdrains are shown on Figure 1. The recommended subdrain locations are based on anticipated site conditions prior to grading and are subject to change depending on the conditions encountered in the field.. Appropriate subdrain outlets should be evaluated prior to finalizing the grading plan.

7.7.3 The final 20-foot segment of a subdrain should consist of non-perforated drainpipe. At the non-perforated/perforated interface, a seepage cutoff wall should be constructed on the downslope side of the junction in accordance with the figure below. The subdrains should be tied into the storm drain system that outlets to Main Street.

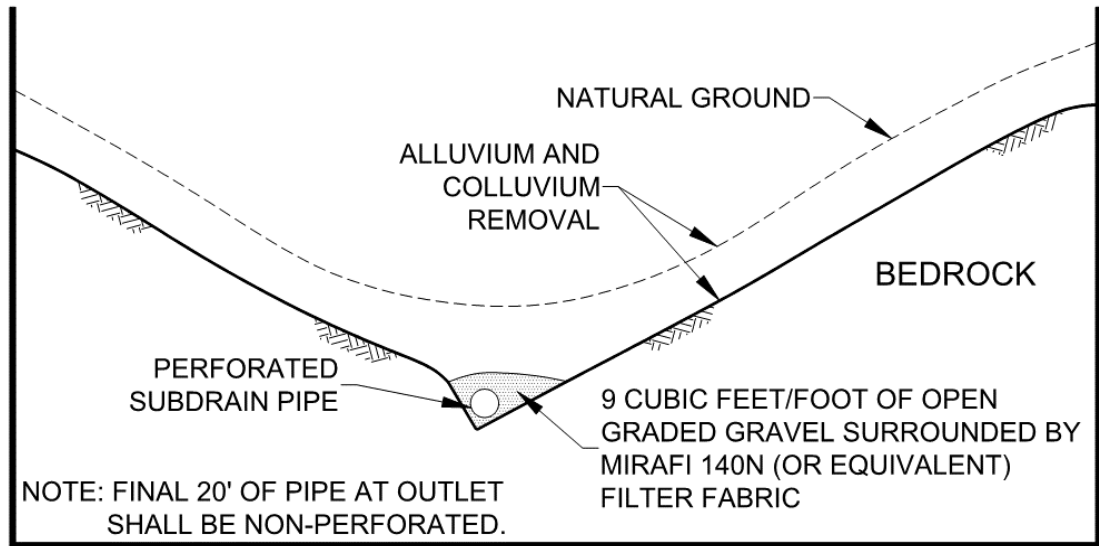

**Typical Canyon Subdrain Detail**

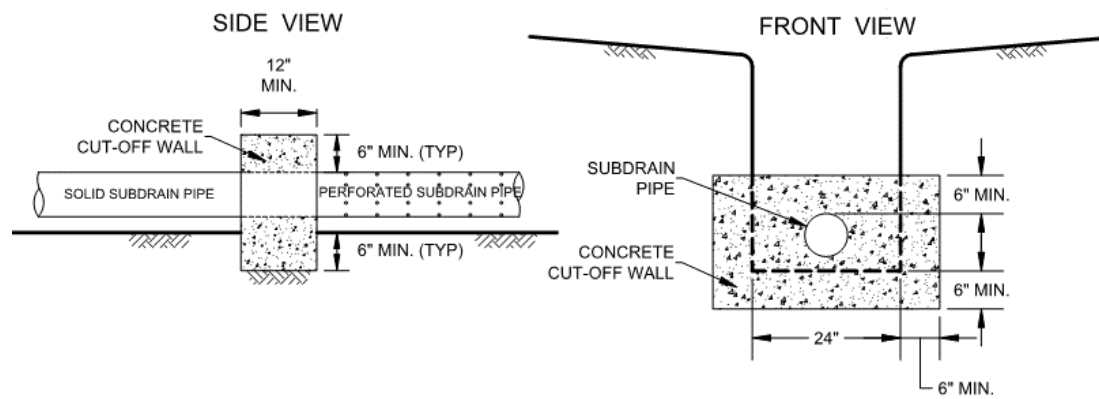

**Typical Cutoff Wall Detail**

7.7.4 Subdrains that discharge into a natural drainage course or open space area should be provided with a permanent headwall structure as shown herein.

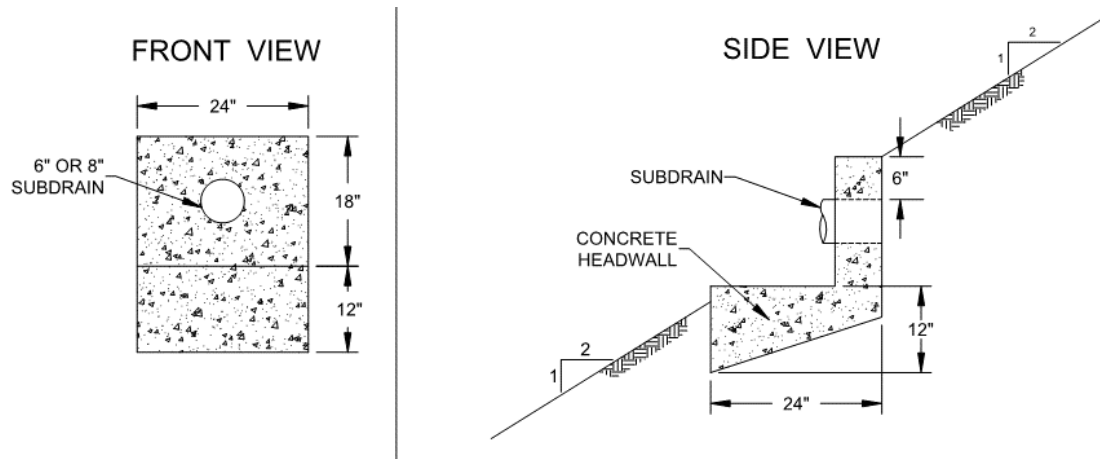

**Typical Headwall Detail**

7.7.5 The final grading plans should show the location of the proposed subdrains. Upon completion of remedial excavations and subdrain installation, the project civil engineer should survey the drain locations and prepare an “as-built” map depicting the existing conditions. The final outlet and connection locations should be determined during grading. The grading contractor should consider videoing the subdrains shortly after burial to check proper installation and to check that the pipe has not been crushed. The contractor is responsible for the performance of the drains.

## **7.8 Settlement Monitoring**

7.8.1 At the completion of grading, the south side of the site will be underlain by up to 45 feet of compacted fill behind MSE walls. Post-grading settlement (hydro-compression) of properly compacted new fill with a maximum thickness of 45 feet could be up to about 2.5 inches. We expect the settlement could occur over 20+ years depending on the influx of rain and irrigation water into the fill mass. This settlement will likely be linear from the time the fill is placed to the end of the settlement period. We do not expect the settlement will impact proposed utilities with proposed gradients of 1 percent or greater. The building foundation design should be designed to account for potential hydro-compression settlement. It has been our experience that developments/improvements, such as proposed, can be constructed with the planned fill depths and proposed settlements.

7.8.2 We expect settlement in the fill as a result of self-weight compression could take up to 3 to 9 months. If building foundations will be constructed shortly after completion of the fill mass, building foundations will need to be designed to accommodate differential settlement as a result of self-weight compression. If the planned structures cannot tolerate the expected movement, a construction waiting period should be implemented until settlement monitoring indicates self-weight compression has essentially ceased.

7.8.3 Due to the height of the MSE walls, we expect some settlement/lateral wall movement will occur. This could result in cracking in flatwork and pavement placed within the reinforced and retained zones of the wall.

7.8.4 At the south end of the property where fills are the greatest, we recommend settlement monuments be installed subsequent to the MSE wall construction. A typical settlement monument is shown below.

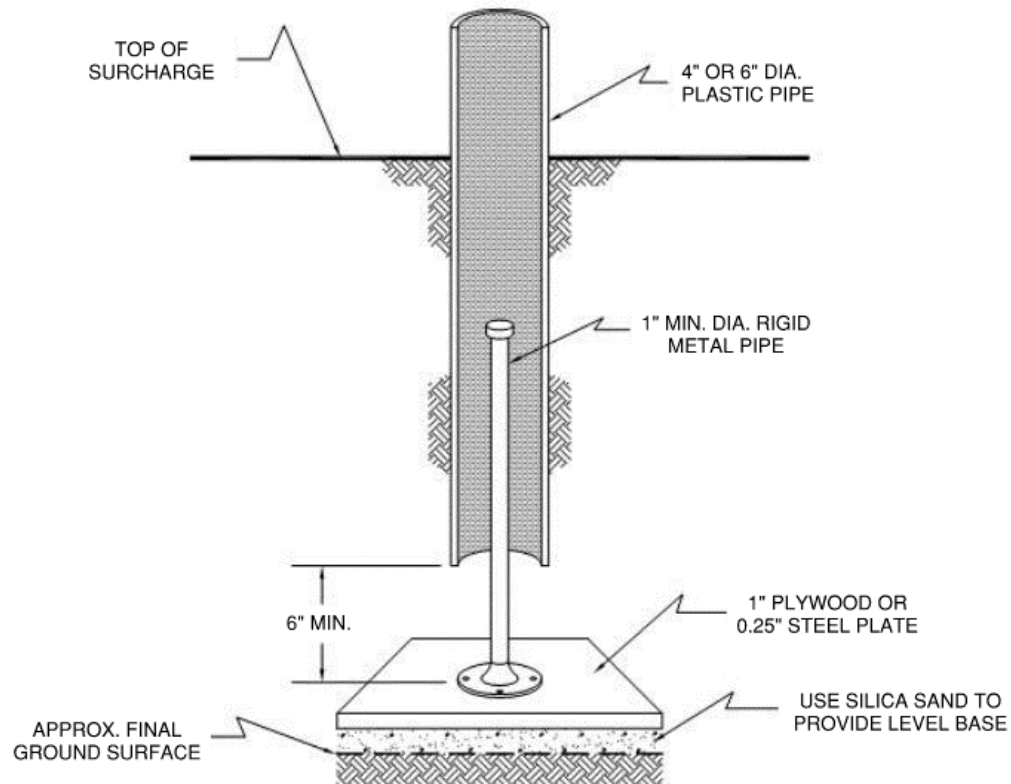

**Settlement Plate Detail**

7.8.5 Surveying of the surface monument should be performed by the project civil engineer every two weeks for at least four months with the results provided to Geocon for review. Settlement due to primary consolidation will be considered to have ceased when survey readings show a relatively level plateau of settlement data over 4 consecutive readings.

## 7.9 Seismic Design Criteria

7.9.1 Table 7.9.1 summarizes site-specific design criteria obtained from the 2019 California Building Code (CBC; Based on the 2018 International Building Code [IBC] and ASCE 7-16), Chapter 16 Structural Design, Section 1613 Earthquake Loads. We used the computer

program *Seismic Design Maps*, provided by the Structural Engineers Association (SEA) to calculate the seismic design parameters. The short spectral response uses a period of 0.2 second. We evaluated the Site Class based on the discussion in Section 1613.2.2 of the 2019 CBC and Table 20.3-1 of ASCE 7-16. The values presented herein are for the risk-targeted maximum considered earthquake ( $MCE_R$ ) for Site Classes C and D. The southern portion of the building will be underlain by compacted fill in excess of 40 feet. A Site Class D is appropriate for areas underlain by more than 20 feet of fill. The northern portion of the building pads will be underlain by shallow compacted fills. Site Class C is appropriate for this condition.

**TABLE 7.9.1  
2019 CBC SEISMIC DESIGN PARAMETERS**

Parameter	Value		2019 CBC Reference
	C	D	
Site Class	C	D	Section 1613.2.2
$MCE_R$ Ground Motion Spectral Response Acceleration – Class B (short), $S_S$	0.835g	0.835g	Figure 1613.2.1(1)
$MCE_R$ Ground Motion Spectral Response Acceleration – Class B (1 sec), $S_1$	0.297g	0.297g	Figure 1613.2.1(2)
Site Coefficient, $F_A$	1.2	1.166	Table 1613.2.3(1)
Site Coefficient, $F_V$	1.5	2.007*	Table 1613.2.3(2)
Site Class Modified $MCE_R$ Spectral Response Acceleration (short), $S_{MS}$	1.002g	0.973g	Section 1613.2.3 (Eqn 16-36)
Site Class Modified $MCE_R$ Spectral Response Acceleration – (1 sec), $S_{M1}$	0.445g	0.595g*	Section 1613.2.3 (Eqn 16-37)
5% Damped Design Spectral Response Acceleration (short), $S_{DS}$	0.668g	0.649g	Section 1613.2.4 (Eqn 16-38)
5% Damped Design Spectral Response Acceleration (1 sec), $S_{D1}$	0.297g	0.397g*	Section 1613.2.4 (Eqn 16-39)

\*Using the code-based values presented in this table, in lieu of a performing a ground motion hazard analysis, requires the exceptions outlined in ASCE 7-16 Section 11.4.8 be followed by the project structural engineer. Per Section 11.4.8 of ASCE/SEI 7-16, a ground motion hazard analysis should be performed for projects for Site Class “E” sites with  $S_S$  greater than or equal to 1.0g and for Site Class “D” and “E” sites with  $S_1$  greater than 0.2g. Section 11.4.8 also provides exceptions which indicates that the ground motion hazard analysis may be waived provided the exceptions are followed.

7.9.2 Table 7.9.2 presents the mapped maximum considered geometric mean ( $MCE_G$ ) seismic design parameters for projects located in Seismic Design Categories of D through F in accordance with ASCE 7-16.

**TABLE 7.9.2  
ASCE 7-16 PEAK GROUND ACCELERATION**

Parameter	Value		ASCE 7-16 Reference
Site Class	C	D	Section 1613.2.2 (2019 CBC)
Mapped $MCE_G$ Peak Ground Acceleration, $PGA$	0.365g	0.365g	Figure 22-7
Site Coefficient, $F_{PGA}$	1.2	1.235	Table 11.8-1
Site Class Modified $MCE_G$ Peak Ground Acceleration, $PGA_M$	0.438g	0.451g	Section 11.8.3 (Eqn 11.8-1)

7.9.3 Conformance to the criteria in Tables 7.9.1 and 7.9.2 for seismic design does not constitute any kind of guarantee or assurance that significant structural damage or ground failure will not occur if a large earthquake occurs. The primary goal of seismic design is to protect life, not to avoid all damage, since such design may be economically prohibitive.

7.9.4 The project structural engineer and architect should evaluate the appropriate Risk Category and Seismic Design Category for the planned structures. The values presented herein assume a Risk Category of II and resulting in a Seismic Design Category D. Table 7.9.3 presents a summary of the risk categories.

**TABLE 7.9.3  
ASCE 7-16 RISK CATEGORIES**

Risk Category	Building Use	Examples
I	Low risk to Human Life at Failure	Barn, Storage Shelter
II	Nominal Risk to Human Life at Failure (Buildings Not Designated as I, III or IV)	Residential, Commercial and Industrial Buildings
III	Substantial Risk to Human Life at Failure	Theaters, Lecture Halls, Dining Halls, Schools, Prisons, Small Healthcare Facilities, Infrastructure Plants, Storage for Explosives/Toxins
IV	Essential Facilities	Hazardous Material Facilities, Hospitals, Fire and Rescue, Emergency Shelters, Police Stations, Power Stations, Aviation Control Facilities, National Defense, Water Storage

## 7.10 Shallow Foundations

7.10.1 The proposed structure can be supported on a shallow foundation system bearing in compacted fill provided the grading and buttress recommendations provide in this report are followed. Foundations for the structure should consist of continuous strip footings and/or



isolated spread footings. Table 7.10.1 provides a summary of the foundation design recommendations.

**TABLE 7.10.1  
SUMMARY OF FOUNDATION RECOMMENDATIONS**

Parameter	Value
Minimum Continuous Foundation Width	12 inches
Minimum Isolated Foundation Width	24 inches
Minimum Foundation Depth	24 Inches Below Lowest Adjacent Grade
Minimum Steel Reinforcement	4 No. 5 Bars, 2 at the Top and 2 at the Bottom
Allowable Bearing Capacity	2,500 psf
Bearing Capacity Increase	500 psf per Foot of Depth
	300 psf per Foot of Width
Maximum Allowable Bearing Capacity	4,000 psf
Estimated Total Settlement	1 Inch
Estimated Static Differential Settlement	½ Inch in 40 Feet
Footing Size Used for Settlement	8-Foot Square
Design Expansion Index	50 or less

7.10.2 Additional settlement as a result of self-weight compression and hydro-compression could occur over the life of the structures. We estimate approximately 0.4 percent of the total fill thickness underlying the building pad. Self-weight compression is expected to occur over 3 to 9 months. Hydro-compression is expected to occur over a 20 year or more duration. The estimated fill thickness and total settlement as a result of self-weight compression and hydro-compression is shown on Table 7.10.2 and is in addition to the static settlement indicated on Table 7.10.1. The largest settlement over the shortest distance occurs in Buildings 2 and 3 that overlie the central drainage area. Foundations should be designed to accommodate total and differential settlement from both static loading and self-weight compression/hydro-compression.

**TABLE 7.10.2  
ESTIMATED FILL THICKNESS AND TOTAL AND DIFFERENTIAL FILL SETTLEMENT  
AS A RESULT OF SELF-WEIGHT AND HYDRO-COMPRESSION**

<b>Location</b>	<b>Estimated Compacted Fill Thickness in Building Pads (after grading) (feet)</b>	<b>Estimated Total Settlement (Self-Weight and Hydro-Compression) (inches)</b>	<b>Estimated Differential Settlement (Self-Weight and Hydro-Compression) (inches)</b>
Building 1 (Southwest Corner)	30	1.5	1.25 inches over a span of 130 feet (angular distortion of 1/1250)
Building 1 (Northeast Half)	5	0.25	0.25 over a span of 140 feet (angular distortion of 1/6700)
Building 2 (Northeast Portion)	45	2.2	2 inches over a span of 60 feet (angular distortion of 1/360)
Building 2 (Southeast Portion)	50	2.4	2.2 inches over a span of 160 feet (angular distortion of 1/900)
Building 2 (Western Half)	5	0.25	0.25 over a span of 120 feet (angular distortion of 1/5800)
Building 3 (Southwest Corner)	40	1.9	1.7 inches over a span of 60 feet (angular distortion of 1/425)
Building 3 (Northeast)	5	0.25	0.25 over a span of 110 feet (angular distortion of 1/5300)
Building 4	5	0.25	NA

7.10.3 The foundations should be embedded in accordance with the recommendations herein and the Wall/Column Footing Dimension Detail. The embedment depths should be measured from the lowest adjacent pad grade for both interior and exterior footings. Footings should be deepened such that the bottom outside edge of the footing is at least 7 feet horizontally from the face of the slope (unless designed with a post-tensioned foundation system as discussed herein).

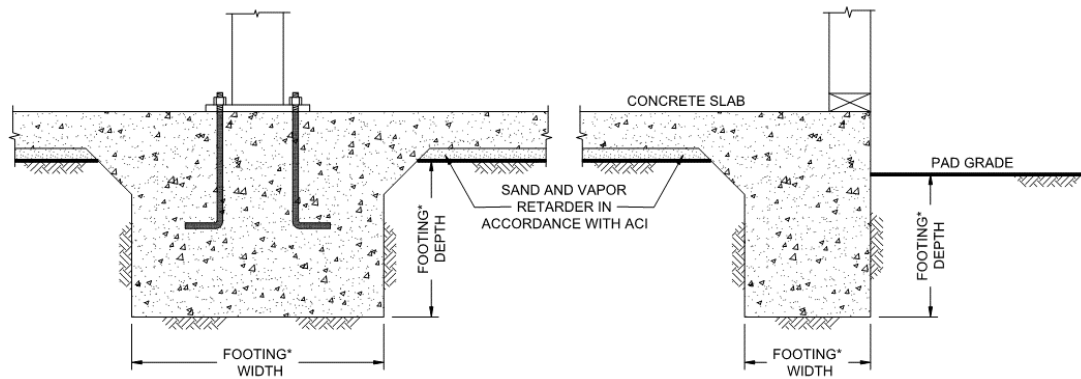

**Wall/Column Footing Dimension Detail**

7.10.4 The bearing capacity values presented herein are for dead plus live loads and may be increased by one-third when considering transient loads due to wind or seismic forces.

7.10.5 Where buildings or other improvements are planned near the top of a slope steeper than 3:1 (horizontal:vertical), special foundations and/or design considerations are recommended due to the tendency for lateral soil movement to occur.

- For fill slopes less than 20 feet high or cut slopes regardless of height, footings should be deepened such that the bottom outside edge of the footing is at least 7 feet horizontally from the face of the slope.
- When located next to a descending 3:1 (horizontal:vertical) fill slope or steeper, the foundations should be extended to a depth where the minimum horizontal distance is equal to  $H/3$  (where  $H$  equals the vertical distance from the top of the fill slope to the base of the fill soil) with a minimum of 7 feet but need not exceed 40 feet. The horizontal distance is measured from the outer, deepest edge of the footing to the face of the slope. A post-tensioned slab and foundation system or mat foundation system can be used to reduce the potential for distress in the structures associated with strain softening and lateral fill extension. Specific design parameters or recommendations for either of these alternatives can be provided once the building location and fill slope geometry have been determined.
- Although other improvements, which are relatively rigid or brittle, such as concrete flatwork or masonry walls, may experience some distress if located near the top of a slope, it is generally not economical to mitigate this potential. It may be possible, however, to incorporate design measures that would permit some lateral soil movement without causing extensive distress. Geocon Incorporated should be consulted for specific recommendations.

7.10.6 We should observe the foundation excavations prior to the placement of reinforcing steel and concrete to check that the exposed soil conditions are similar to those expected and that they have been extended to the appropriate bearing strata. Foundation modifications may be required if unexpected soil conditions are encountered.

7.10.7 Geocon Incorporated should be consulted to provide additional design parameters as required by the structural engineer.

## 7.11 Conventional Retaining Wall Recommendations

7.11.1 Retaining walls should be designed using the values presented in Table 7.11.1. Soil with an expansion index (EI) of greater than 50 should not be used as backfill soil behind retaining walls.

**TABLE 6.11.1  
RETAINING WALL DESIGN RECOMMENDATIONS**

Parameter	Value
Active Soil Pressure, A (Fluid Density, Level Backfill)	35 pcf
Active Soil Pressure, A (Fluid Density, 2:1 Sloping Backfill)	50 pcf
Seismic Pressure, S	18H psf
At-Rest/Restrained Walls Additional Uniform Pressure (0 to 8 Feet High)	7H psf
At-Rest/Restrained Walls Additional Uniform Pressure (8+ Feet High)	13H psf
Expected Expansion Index for the Subject Property	$EI \leq 50$

H equals the height of the retaining portion of the wall

7.11.2 The project retaining walls should be designed as shown in the Retaining Wall Loading Diagram.

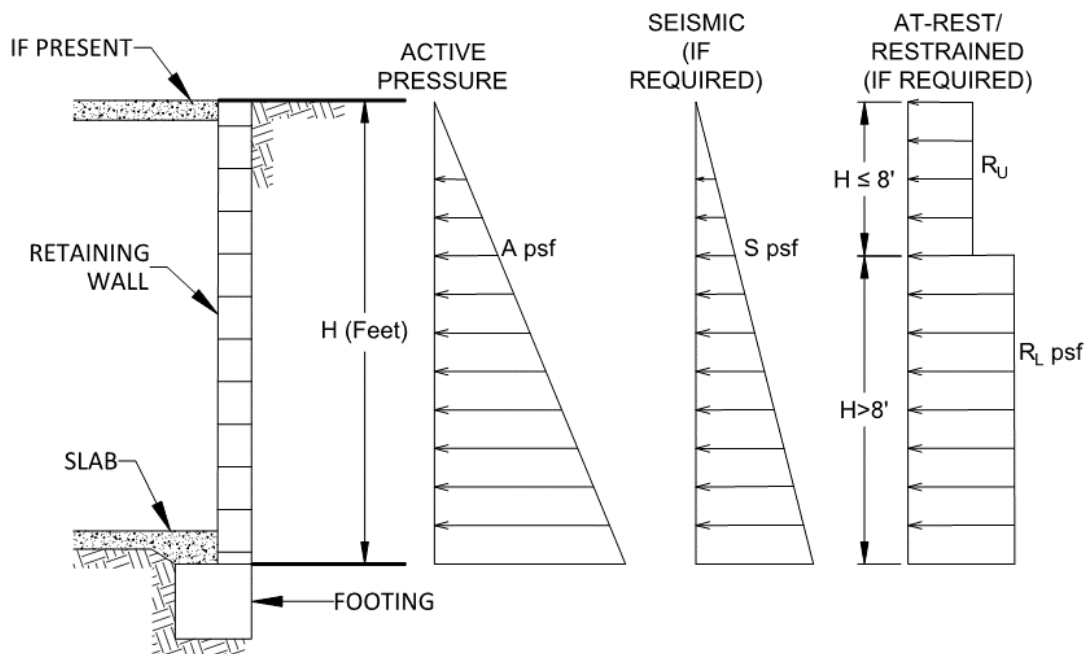

**Retaining Wall Loading Diagram**

- 7.11.3 Unrestrained walls are those that are allowed to rotate more than  $0.001H$  (where  $H$  equals the height of the retaining portion of the wall) at the top of the wall. Where walls are restrained from movement at the top (at-rest condition), an additional uniform pressure should be applied to the wall. For retaining walls subject to vehicular loads within a horizontal distance equal to two-thirds the wall height, a surcharge equivalent to 2 feet of fill soil should be added.
- 7.11.4 The structural engineer should determine the Seismic Design Category for the project in accordance with Section 1613.2.5 of the 2019 CBC or Section 11.6 of ASCE 7-16. For structures assigned to Seismic Design Category of D, E, or F, retaining walls that support more than 6 feet of backfill should be designed with seismic lateral pressure in accordance with Section 1803.5.12 of the 2019 CBC. The seismic load is dependent on the retained height where  $H$  is the height of the wall, in feet, and the calculated loads result in pounds per square foot (psf) exerted at the base of the wall and zero at the top of the wall.
- 7.11.5 Retaining walls should be designed to ensure stability against overturning sliding, and excessive foundation pressure. Where a keyway is extended below the wall base with the intent to engage passive pressure and enhance sliding stability, it is not necessary to consider active pressure on the keyway.
- 7.11.6 Drainage openings through the base of the wall (weep holes) should not be used where the seepage could be a nuisance or otherwise adversely affect the property adjacent to the base of the wall. The recommendations herein assume a properly compacted granular (EI of 50 or less) free-draining backfill material with no hydrostatic forces or imposed surcharge load. The retaining wall should be properly drained as shown in the Typical Retaining Wall Drainage Detail. If conditions different than those described are expected, or if specific drainage details are desired, Geocon Incorporated should be contacted for additional recommendations.

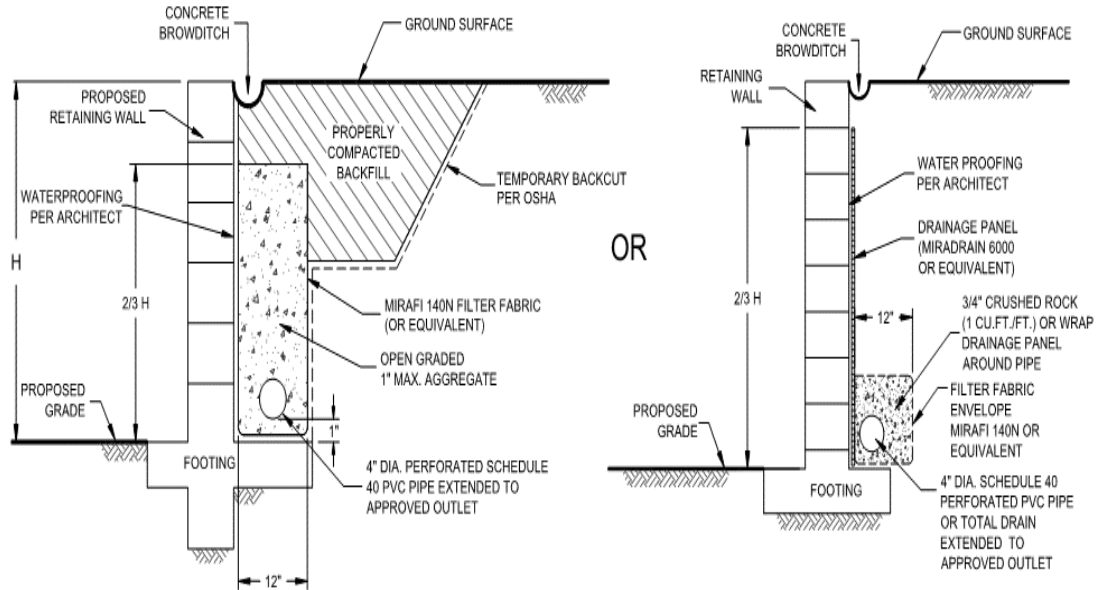

**Typical Retaining Wall Drainage Detail**

7.11.7 The retaining walls may be designed using either the active and restrained (at-rest) loading condition or the active and seismic loading condition as suggested by the structural engineer. Typically, it appears the design of the restrained condition for retaining wall loading may be adequate for the seismic design of the retaining walls. However, the active earth pressure combined with the seismic design load should be reviewed and also considered in the design of the retaining walls.

7.11.8 In general, wall foundations should be designed in accordance with Table 7.11.2. The proximity of the foundation to the top of a slope steeper than 3:1 could impact the allowable soil bearing pressure. Therefore, retaining wall foundations should be deepened such that the bottom outside edge of the footing is at least 7 feet horizontally from the face of the slope.

**TABLE 7.11.2  
SUMMARY OF RETAINING WALL FOUNDATION RECOMMENDATIONS**

Parameter	Value
Minimum Retaining Wall Foundation Width	12 inches
Minimum Retaining Wall Foundation Depth	12 Inches
Minimum Steel Reinforcement	Per Structural Engineer
Bearing Capacity	2,500 psf
Bearing Capacity Increase	500 psf per additional foot of footing depth
	300 psf per additional foot of footing width
Maximum Bearing Capacity	4,000 psf
Estimated Total Settlement	1 Inch
Estimated Differential Settlement	½ Inch in 40 Feet

- 7.11.9 The recommendations presented herein are generally applicable to the design of rigid concrete or masonry retaining walls. Additional recommendations for MSE walls and soil nail walls are provided in Sections 7.13 and 7.14.
- 7.11.10 Unrestrained walls will move laterally when backfilled and loading is applied. The amount of lateral deflection is dependent on the wall height, the type of soil used for backfill, and loads acting on the wall. The retaining walls and improvements above the retaining walls should be designed to incorporate an appropriate amount of lateral deflection as determined by the structural engineer.
- 7.11.11 Soil contemplated for use as retaining wall backfill, including import materials, should be identified in the field prior to backfill. At that time, Geocon Incorporated should obtain samples for laboratory testing to evaluate its suitability. Modified lateral earth pressures may be necessary if the backfill soil does not meet the required expansion index or shear strength. City or regional standard wall designs, if used, are based on a specific active lateral earth pressure and/or soil friction angle. In this regard, on-site soil to be used as backfill may or may not meet the values for standard wall designs. Geocon Incorporated should be consulted to assess the suitability of the on-site soil for use as wall backfill if standard wall designs will be used.

## 7.12 Lateral Loading

- 7.12.1 Table 7.12 should be used to help design the proposed structures and improvements to resist lateral loads for the design of footings or shear keys. The allowable passive pressure assumes a horizontal surface extending at least 5 feet, or three times the surface generating the passive pressure, whichever is greater. The upper 12 inches of material in areas not protected by floor slabs or pavement should not be included in design for passive resistance. Where walls are planned adjacent to and/or on descending slopes, a passive pressure of 150 pcf should be used in design.

**TABLE 7.12  
SUMMARY OF LATERAL LOAD DESIGN RECOMMENDATIONS**

Parameter	Value
Passive Pressure Fluid Density	350 pcf
Passive Pressure Fluid Density Adjacent to and/or on Descending Slopes	150 pcf
Coefficient of Friction (Concrete and Soil)	0.35
Coefficient of Friction (Along Vapor Barrier)	0.2 to 0.25*

\*Per manufacturer's recommendations.



7.12.2 The passive and frictional resistant loads can be combined for design purposes. The lateral passive pressures may be increased by one-third when considering transient loads due to wind or seismic forces.

### 7.13 Mechanically Stabilized Earth (MSE) Retaining Walls

7.13.1 Mechanized stabilized earth (MSE) retaining walls are planned for the project. MSE retaining walls are alternative walls that consist of modular block facing units with geogrid reinforced earth behind the block. The reinforcement grid attaches to the block units and is typically placed at specified vertical intervals and embedment lengths. The grid length and spacing will be determined by the wall designer.

7.13.2 The geotechnical parameters listed in Table 7.13.1 can be used for preliminary design of the MSE walls. Once actual soil to be used as backfill has been determined and stockpiled, laboratory testing should be performed to check that the soil meets the parameters used in the design of the MSE walls. Screening of onsite soil intended for MSE wall backfill may be necessary to meet maximum particle size requirements for soil used in the reinforced zone.

**TABLE 7.13.1  
GEOTECHNICAL PARAMETERS FOR MSE WALLS**

Parameter	Reinforced Zone	Retained Zone	Foundation Zone
Angle of Internal Friction	28 degrees	28 degrees	28 degrees
Cohesion	100 psf	100 psf	100 psf
Wet Unit Density	130 pcf	130 pcf	130 pcf

7.13.3 The soil parameters presented in Table 7.13.1 are based on our experience and direct shear-strength tests performed during the geotechnical investigation and represent some of the on-site materials. Geocon has no way of knowing which materials will actually be used as backfill behind the wall during construction. It is up to the wall designers to use their judgment in selection of the design parameters. As such, once backfill materials have been selected and/or stockpiled, sufficient shear tests should be conducted on samples of the proposed backfill materials to check that they conform to actual design values. Results should be provided to the designer to re-evaluate stability of the walls. Dependent upon test results, the designer may require modifications to the original wall design (e.g., longer reinforcement embedment lengths and/or steel reinforcement).

7.13.4 Wall foundations should be designed in accordance with Table 7.13.2 The walls should be deepened such that the bottom outside edge of the footing is at least 7 feet horizontally from

the face of the slope. The bearing zone on the MSE wall can be taken across the width of the reinforced zone.

**TABLE 7.13.2  
SUMMARY OF MSE RETAINING WALL FOUNDATION RECOMMENDATIONS**

Parameter	Value
Minimum Retaining Wall Foundation Width	12 inches
Minimum Retaining Wall Foundation Depth	12 Inches
Bearing Capacity	2,000 psf
Bearing Capacity Increase	500 psf per Foot of Depth
	300 psf per Foot of Width
Maximum Bearing Capacity	4,000 psf
Estimated Total Settlement	1 Inch
Estimated Differential Settlement	½ Inch in 40 Feet

- 7.13.5 Backfill materials within the reinforced zone should be compacted to a dry density of at least 90 percent of the laboratory maximum dry density near to slightly above optimum moisture content in accordance with ASTM D 1557. This is applicable to the entire embedment width of the reinforcement. Typically, wall designers specify no heavy compaction equipment within 3 feet of the face of the wall. However, smaller equipment (e.g., walk-behind, self-driven compactors or hand whackers) can be used to compact the materials without causing deformation of the wall. If the designer specifies no compactive effort for this zone, the materials are essentially not properly compacted and the reinforcement grid within the uncompacted zone should not be relied upon for reinforcement, and overall embedment lengths will have to be increased to account for the difference.
- 7.13.6 The wall should be provided with a drainage system sufficient to prevent excessive seepage through the wall and the base of the wall, thus preventing hydrostatic pressures behind the wall.
- 7.13.7 Geosynthetic reinforcement must elongate to develop full tensile resistance. This elongation generally results in movement at the top of the wall. The amount of movement is dependent on the height of the wall (e.g., higher walls rotate more) and the type of reinforcing grid used. In addition, over time the reinforcement grid has been known to exhibit creep (sometimes as much as 5 percent) and can undergo additional movement. Given this condition, the owner should be aware that structures and pavement placed within the

reinforced and retained zones of the wall will likely undergo movement for the wall heights proposed on this project.

- 7.13.8 The MSE wall contractor should provide the estimated deformation of wall and adjacent ground in associated with wall construction. The calculated horizontal and vertical deformations should be determined by the wall designer. Where buildings are located adjacent to the walls, the estimated movements should be provided to the project structural engineer to evaluate if the building foundation can tolerate the expected movements. With respect to improvements adjacent to the wall, cracking and/or movement should be expected.
- 7.13.9 The MSE wall designer/contractor should review this report, including the slope stability requirements, and incorporate our recommendations as presented herein. We should be provided the plans for the MSE walls to check if they are in conformance with our recommendations prior to issuance of a permit and construction.

## **7.14 Soil Nail Walls**

- 7.14.1 We understand soil nail walls are planned for the northern property line wall. Soil nail walls consist of installing closely spaced steel bars (nails) into a slope or excavation in a top-down construction sequence. Following installation of a horizontal row of nails, drains, waterproofing and wall reinforcing steel are placed and shotcrete applied to create a final wall. The wall should be designed by an engineer familiar with the design of soil nail walls.
- 7.14.2 In general, ground conditions are moderately suited to soil nail wall construction techniques. However, localized gravel, cobble and oversized material could be encountered that may be difficult to drill. Additionally, relatively clean sands may be encountered that may result in some raveling of the unsupported excavation. Casing or specialized drilling techniques should be planned where raveling exists (e.g. casing).
- 7.14.3 Testing of the soil nails should be performed in accordance with the guidelines of the Federal Highway Administration or similar guidelines. At least two verification tests should be performed to confirm design assumptions for each soil/rock type encountered. Verification tests nails should be sacrificial and should not be used to support the proposed wall. The bond length should be adjusted to allow for pullout testing of the verification nails to evaluate the ultimate bond stress. A minimum of 5 percent of the production nails should also be proof tested and a minimum of 4 sacrificial nails should be tested at the discretion of Geocon Incorporated. Consideration should be given to testing sacrificial nails with an

adjusted bond length rather than testing production nails. Geocon Incorporated should observe the nail installation and perform the nail testing.

7.14.4 The soil strength parameters listed in Table 7.14 can be used in design of the soil nails. The bond stress is dependent on drilling method, diameter, and construction method. Therefore, the designer should evaluate the bond stress based on soil conditions and the construction method.

**TABLE 7.14  
SOIL STRENGTH PARAMETERS FOR SOIL NAIL WALLS**

Description	Cohesion (psf)	Friction Angle (degrees)	Estimated Ultimate Bond Stress (psi)*
Compacted Fill	100	28	10
Very Old Paralic Deposits	200	33	20
Otay Formation	200	33	20

\*Assuming gravity fed, open hole drilling techniques.

7.14.5 A wall drain system should be incorporated into the design of the soil nail wall as shown herein. Corrosion protection should be provided for the nails.

7.14.6 A bentonitic clay bed is expected to be present near the bottom of the wall cut along the north side of the property. The wall design will need to pin the clay bed to prevent slope instability. Geocon Incorporated can provide additional stability analysis and coordination with the wall designer, as needed.

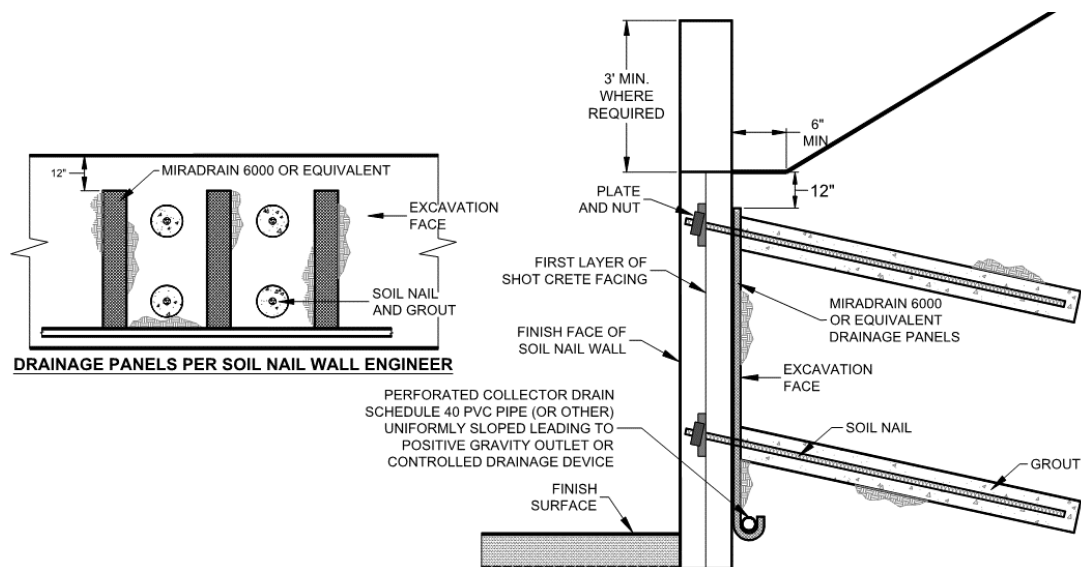

**Soil Nail Wall Drainage Detail**

## 7.15 Preliminary Pavement Recommendations

7.15.1 Preliminary pavement recommendations for the driveways and parking areas are provided below. The final pavement sections should be based on the R-Value of the subgrade soil encountered at final subgrade elevation. For preliminary design, we used a laboratory R-Value of 15. We calculated the preliminary flexible pavement sections for asphalt concrete using varying traffic indices (TIs) in general conformance with the *Caltrans Method of Flexible Pavement Design* (Highway Design Manual, Section 608.4). The project civil engineer or traffic engineer should determine the appropriate Traffic Index (TI) or traffic loading expected on the project for the various pavement areas that will be constructed. Recommended preliminary asphalt concrete pavement sections are provided on Table 7.15.1.

**TABLE 7.15.1  
PRELIMINARY ASPHALT CONCRETE PAVEMENT SECTIONS**

Traffic Index	Asphalt Concrete (inches)	Class 2 Base (inches)
4.5	3	6
5	3	8
5.5	3	10
6	3.5	10.5
6.5	3.5	12.5
7	4	13
7.5	4.5	15
8	5	15

7.15.2 Asphalt concrete should conform to Section 203-6 of the *Standard Specifications for Public Works Construction* (Green Book). Class 2 aggregate base materials should conform to Section 26-1.02B of the *Standard Specifications of the State of California, Department of Transportation* (Caltrans).

7.15.3 Prior to placing base material, the subgrade should be scarified, moisture conditioned and recompacted to a minimum of 95 percent relative compaction. The depth of compaction should be at least 12 inches. The base material should be compacted to at least 95 percent relative compaction. Asphalt concrete should be compacted to a density of at least 95 percent of the laboratory Hveem density in accordance with ASTM D 2726.

7.15.4 A rigid Portland Cement concrete (PCC) pavement section can also be used. We calculated the rigid pavement section in general conformance with the procedure recommended by the American Concrete Institute report ACI 330R-08 Guide for Design and Construction of Concrete Parking Lots using the parameters presented in Table 7.15.2.

**TABLE 7.15.2  
PRELIMINARY RIGID PAVEMENT DESIGN PARAMETERS**

Design Parameter	Design Value
Modulus of subgrade reaction, k	100 pci
Modulus of rupture for concrete, $M_R$	500 psi
Concrete Compressive Strength	3,000 psi
Traffic Category, TC	A and C
Average daily truck traffic, ADTT	10 and 300

7.15.5 Based on the criteria presented herein, the PCC pavement sections should have a minimum thickness as presented in Table 7.15.3.

**TABLE 7.15.3  
RIGID VEHICULAR PAVEMENT RECOMMENDATIONS**

Location	Portland Cement Concrete (inches)
Automobile Parking Stalls (TC=A, ADTT=10)	5.5
Driveways (TC=C, ADTT=100)	7.5

7.15.6 The PCC vehicular pavement should be placed over subgrade soil that is compacted to a dry density of at least 95 percent of the laboratory maximum dry density near to slightly above optimum moisture content.

7.15.7 The rigid pavement should also be designed and constructed incorporating the parameters presented in Table 7.15.4.

**TABLE 7.15.4  
ADDITIONAL RIGID PAVEMENT RECOMMENDATIONS**

Subject	Value
Thickened Edge	1.2 Times Slab Thickness
	Minimum Increase of 2 Inches
	4 Feet Wide
Crack Control Joint Spacing	30 Times Slab Thickness
	Max. Spacing of 12 feet for 5.5-Inch-Thick
	Max. Spacing of 15 Feet for Slabs 6 Inches and Thicker
Crack Control Joint Depth	Per ACI 330R-08
	1 Inch Using Early-Entry Saws on Slabs Less Than 9 Inches Thick
Crack Control Joint Width	¼-Inch for Sealed Joints
	⅜-Inch is Common for Sealed Joints
	1/10- to 1/8-Inch is Common for Unsealed Joints

- 7.15.8 Concrete reinforcing steel will not be necessary within the concrete for geotechnical purposes with the possible exception of dowels at construction joints as discussed herein.
- 7.15.9 To control the location and spread of concrete shrinkage cracks, crack-control joints (weakened plane joints) should be included in the design of the concrete pavement slab. Crack-control joints should be sealed with an appropriate sealant to prevent the migration of water through the control joint to the subgrade materials. The depth of the crack-control joints should be determined by the referenced ACI report.
- 7.15.10 To provide load transfer between adjacent pavement slab sections, a butt-type construction joint should be constructed. The butt-type joint should be thickened by at least 20 percent at the edge and taper back at least 4 feet from the face of the slab. As an alternative to the butt-type construction joint, dowelling can be used between construction joints for pavements of 7 inches or thicker. As discussed in the referenced ACI guide, dowels should consist of smooth, 1-inch-diameter reinforcing steel 14 inches long embedded a minimum of 6 inches into the slab on either side of the construction joint. Dowels should be located at the midpoint of the slab, spaced at 12 inches on center and lubricated to allow joint movement while still transferring loads. In addition, tie bars should be installed as recommended in Section 3.8.3 of the referenced ACI guide. The structural engineer should provide other alternative recommendations for load transfer.
- 7.15.11 Concrete curb/gutter should be placed on soil subgrade compacted to a dry density of at least 90 percent of the laboratory maximum dry density near to slightly above optimum moisture content. Cross-gutters that receives vehicular should be placed on subgrade soil compacted to a dry density of at least 95 percent of the laboratory maximum dry density near to slightly above optimum moisture content. Base materials should not be placed below the curb/gutter, or cross-gutters so water is not able to migrate from the adjacent parkways to the pavement sections. Where flatwork is located directly adjacent to the curb/gutter, the concrete flatwork should be structurally connected to the curbs to help reduce the potential for offsets between the curbs and the flatwork.

## **7.16 Exterior Concrete Flatwork**

- 7.16.1 Exterior concrete flatwork not subject to vehicular traffic should be constructed in accordance with the recommendations presented in Table 7.16. The recommended steel reinforcement would help reduce the potential for cracking.



**TABLE 7.16  
MINIMUM CONCRETE FLATWORK RECOMMENDATIONS**

Expansion Index, EI	Minimum Steel Reinforcement* Options	Minimum Thickness
EI ≤ 90	6x6-W2.9/W2.9 (6x6-6/6) welded wire mesh	4 Inches
	No. 3 Bars 18 inches on center, Both Directions	
EI ≤ 130	4x4-W4.0/W4.0 (4x4-4/4) welded wire mesh	
	No. 4 Bars 12 inches on center, Both Directions	

\*In excess of 8 feet square.

- 7.16.2 Even with the incorporation of the recommendations of this report, the exterior concrete flatwork has a potential to experience some uplift due to expansive soil beneath grade. The steel reinforcement should overlap continuously in flatwork to reduce the potential for vertical offsets within flatwork. Additionally, flatwork should be structurally connected to the curbs, where possible, to reduce the potential for offsets between the curbs and the flatwork.
- 7.16.3 Concrete flatwork should be provided with crack control joints to reduce and/or control shrinkage cracking. Crack control spacing should be determined by the project structural engineer based upon the slab thickness and intended usage. Criteria of the American Concrete Institute (ACI) should be taken into consideration when establishing crack control spacing. Subgrade soil for exterior slabs not subjected to vehicle loads should be compacted in accordance with criteria presented in the grading section prior to concrete placement. Subgrade soil should be properly compacted, and the moisture content of subgrade soil should be verified prior to placing concrete. Base materials will not be required below concrete improvements.
- 7.16.4 Where exterior flatwork abuts the structure at entrant or exit points, the exterior slab should be dowelled into the structure's foundation stemwall. This recommendation is intended to reduce the potential for differential elevations that could result from differential settlement or minor heave of the flatwork. Dowelling details should be designed by the project structural engineer.
- 7.16.5 The recommendations presented herein are intended to reduce the potential for cracking of exterior slabs as a result of differential movement. However, even with the incorporation of the recommendations presented herein, slabs-on-grade will still crack. The occurrence of concrete shrinkage cracks is independent of the soil supporting characteristics. Their occurrence may be reduced and/or controlled by limiting the slump of the concrete, the use of crack control joints and proper concrete placement and curing. Crack control joints

should be spaced at intervals no greater than 12 feet. Literature provided by the Portland Concrete Association (PCA) and American Concrete Institute (ACI) present recommendations for proper concrete mix, construction, and curing practices, and should be incorporated into project construction.

## **7.17 Slope Maintenance**

- 7.17.1 Slopes that are steeper than 3:1 (horizontal:vertical) may, under conditions which are both difficult to prevent and predict, be susceptible to near surface (surficial) slope instability. The instability is typically limited to the outer three feet of a portion of the slope and usually does not directly impact the improvements on the pad areas above or below the slope. The occurrence of surficial instability is more prevalent on fill slopes and is generally preceded by a period of heavy rainfall, excessive irrigation, or the migration of subsurface seepage. The disturbance and/or loosening of the surficial soils, as might result from root growth, soil expansion, or excavation for irrigation lines and slope planting, may also be a significant contributing factor to surficial instability. It is, therefore, recommended that, to the maximum extent practical: (a) disturbed/loosened surficial soils be either removed or properly recompacted, (b) irrigation systems be periodically inspected and maintained to eliminate leaks and excessive irrigation, and (c) surface drains on and adjacent to slopes be periodically maintained to preclude ponding or erosion. Although the incorporation of the above recommendations should reduce the potential for surficial slope instability, it will not eliminate the possibility, and, therefore, it may be necessary to rebuild or repair a portion of the project's slopes in the future.

## **7.18 Storm Water Management**

- 7.18.1 If storm water management devices are not properly designed and constructed, there is a risk for distress to improvements and property located hydrologically down gradient or adjacent to these devices. Factors such as the amount of water being detained, its residence time, and soil permeability have an important effect on seepage transmission and the potential adverse impacts that may occur if the storm water management features are not properly designed and constructed. We have not performed a hydrogeological study at the site. If infiltration of storm water runoff into the subsurface occurs, downstream improvements may be subjected to seeps, springs, slope instability, raised groundwater, movement of foundations and slabs, or other undesirable impacts as a result of water infiltration.
- 7.18.2 We did not perform an infiltration study on the property. However, based on predicted site conditions at the completion of grading, full and partial infiltration is considered infeasible due to the presence of deep fills surrounded by MSE walls at the down-gradient end of the

site. Basins or other storm water devices should utilize a liner to prevent infiltration from causing adverse settlement and heave, and migrating to utilities, and foundations.

## **7.19 Site Drainage and Moisture Protection**

- 7.19.1 Adequate site drainage is critical to reduce the potential for differential soil movement, erosion and subsurface seepage. Under no circumstances should water be allowed to pond adjacent to footings. The site should be graded and maintained such that surface drainage is directed away from structures in accordance with 2019 CBC 1803.3 or other applicable standards. In addition, surface drainage should be directed away from the top of slopes into swales or other controlled drainage devices. Roof and pavement drainage should be directed into conduits that carry runoff away from the proposed structure.
- 7.19.2 In the case of basement walls or building walls retaining landscaping areas, a water-proofing system should be used on the wall and joints, and a Miradrain drainage panel (or similar) should be placed over the waterproofing. The project architect or civil engineer should provide detailed specifications on the plans for all waterproofing and drainage.
- 7.19.3 Underground utilities should be leak free. Utility and irrigation lines should be checked periodically for leaks, and detected leaks should be repaired promptly. Detrimental soil movement could occur if water is allowed to infiltrate the soil for prolonged periods of time.
- 7.19.4 Landscaping planters adjacent to paved areas are not recommended due to the potential for surface or irrigation water to infiltrate the pavement's subgrade and base course. We recommend that subdrains to collect excess irrigation water and transmit it to drainage structures, or impervious above-grade planter boxes be used. In addition, where landscaping is planned adjacent to the pavement, we recommend construction of a cutoff wall along the edge of the pavement that extends at least 6 inches below the bottom of the base material.

## **7.20 Grading and Foundation Plan Review**

- 7.20.1 Geocon Incorporated should review the grading plans and foundation plans for the project prior to final design submittal to evaluate whether additional analyses and/or recommendations are required.

## **7.21 Testing and Observation Services During Construction**

- 7.21.1 Geocon Incorporated should provide geotechnical testing and observation services during the grading operations, foundation construction, utility installation, retaining wall backfill

and pavement installation. Table 7.21 presents the typical geotechnical observations we would expect for the proposed improvements.

**TABLE 7.21  
EXPECTED GEOTECHNICAL TESTING AND OBSERVATION SERVICES**

Construction Phase	Observations	Expected Time Frame
Ground Modification	Ground Modification Installation	Full Time
	Confirmation Testing	Part Time to Full Time
Grading	Base of Removal	Part Time During Removals
	Geologic Logging	Part Time to Full Time
	Fill Placement and Soil Compaction	Full Time
MSE Walls	Fill Placement and Soil Compaction	Full Time
Tieback Anchors	Tieback Drilling and Installation	Full Time
	Tieback Testing	Full Time
Soil Nail Walls	Soil Nail Drilling and Installation	Full Time
	Soil Nail Testing	Full Time
Foundations	Drilling Operations for Piles	Full Time
	Foundation Excavation Observations	Part Time
Utility Backfill	Fill Placement and Soil Compaction	Part Time to Full Time
Retaining Wall Backfill	Fill Placement and Soil Compaction	Part Time to Full Time
Subgrade for Sidewalks, Curb/Gutter and Pavement	Soil Compaction	Part Time
Pavement Construction	Base Placement and Compaction	Part Time
	Asphalt Concrete Placement and Compaction	Full Time

## LIMITATIONS AND UNIFORMITY OF CONDITIONS

1. The firm that performed the geotechnical investigation for the project should be retained to provide testing and observation services during construction to provide continuity of geotechnical interpretation and to check that the recommendations presented for geotechnical aspects of site development are incorporated during site grading, construction of improvements, and excavation of foundations. If another geotechnical firm is selected to perform the testing and observation services during construction operations, that firm should prepare a letter indicating their intent to assume the responsibilities of project geotechnical engineer of record. A copy of the letter should be provided to the regulatory agency for their records. In addition, that firm should provide revised recommendations concerning the geotechnical aspects of the proposed development, or a written acknowledgement of their concurrence with the recommendations presented in our report. They should also perform additional analyses deemed necessary to assume the role of Geotechnical Engineer of Record.
2. The recommendations of this report pertain only to the site investigated and are based upon the assumption that the soil conditions do not deviate from those disclosed in the investigation. If any variations or undesirable conditions are encountered during construction, or if the proposed construction will differ from that anticipated herein, Geocon Incorporated should be notified so that supplemental recommendations can be given. The evaluation or identification of the potential presence of hazardous or corrosive materials was not part of the scope of services provided by Geocon Incorporated.
3. This report is issued with the understanding that it is the responsibility of the owner or his representative to ensure that the information and recommendations contained herein are brought to the attention of the architect and engineer for the project and incorporated into the plans, and the necessary steps are taken to see that the contractor and subcontractors carry out such recommendations in the field.
4. The findings of this report are valid as of the present date. However, changes in the conditions of a property can occur with the passage of time, whether they be due to natural processes or the works of man on this or adjacent properties. In addition, changes in applicable or appropriate standards may occur, whether they result from legislation or the broadening of knowledge. Accordingly, the findings of this report may be invalidated wholly or partially by changes outside our control. Therefore, this report is subject to review and should not be relied upon after a period of three years.



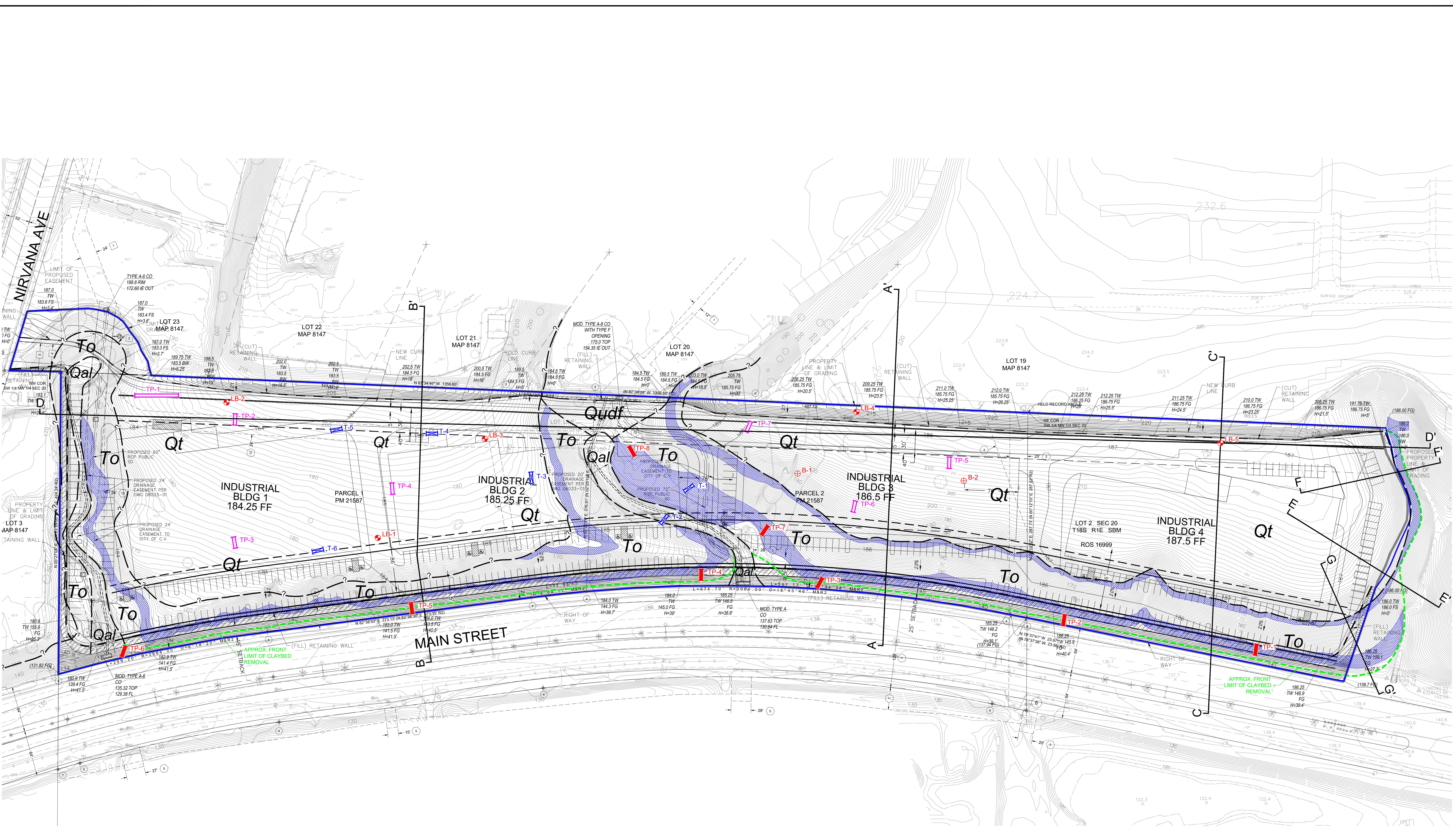

- GEOCON LEGEND**
- Qudf** ..... UNDOCUMENTED FILL
  - Qal** ..... ALLUVIUM
  - Qt** ..... TERRACE DEPOSITS
  - To** ..... OTAY FORMATION
  - ..... APPROX. LOCATION OF GEOLOGIC CONTACT
  - LB-4** ..... APPROX. LOCATION OF EXPLORATORY LARGE DIAMETER BORING (Current)
  - B-2** ..... APPROX. LOCATION OF EXPLORATORY BORING
  - TP-3** ..... APPROX. LOCATION OF EXPLORATORY TEST PIT (Current)
  - TP-7** ..... APPROX. LOCATION OF EXPLORATORY TEST PIT (AET, 2008)
  - TP-6** ..... APPROX. LOCATION OF EXPLORATORY TEST PIT (AGS, 2014)
  - TP-4** ..... APPROX. LOCATION OF EXPLORATORY TEST PIT (AET, 2008)
  - G** ..... APPROX. LOCATION OF GEOLOGIC CROSS SECTION
  - ..... APPROX. LOCATION OF PROPOSED SUBDRAIN
  - ..... APPROX. SURFACE EXPOSURE OF BENTONITIC CLAYSTONE

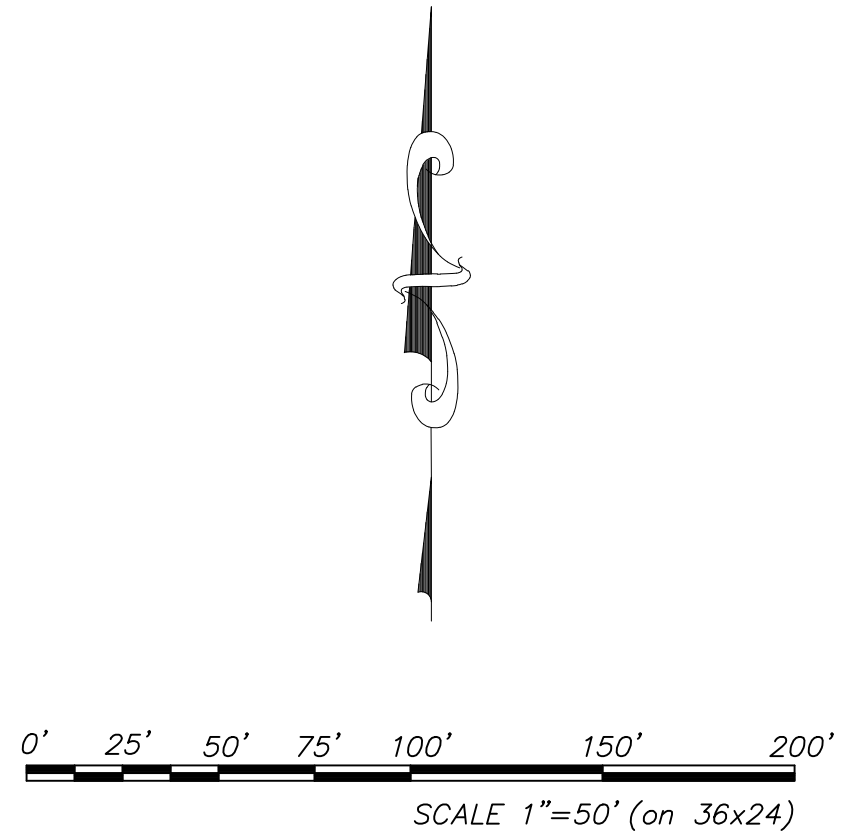

**GEOLOGIC MAP**  
 NIRVANA INDUSTRIAL BUILDINGS AND SELF STORAGE COMPLEX  
 821 MAIN STREET  
 CHULA VISTA, CALIFORNIA

<b>GEOCON</b> INCORPORATED GEOTECHNICAL ■ ENVIRONMENTAL ■ MATERIALS 6960 PLANDERS DRIVE ■ SAN DIEGO, CALIFORNIA 92121-2974 PHONE: 619.598.0900 ■ FAX: 619.598.0297	SCALE 1" = 50' DATE 09 - 14 - 2021
	PROJECT NO. G2755 - 42 - 01 SHEET 1 OF 1
	FIGURE 1



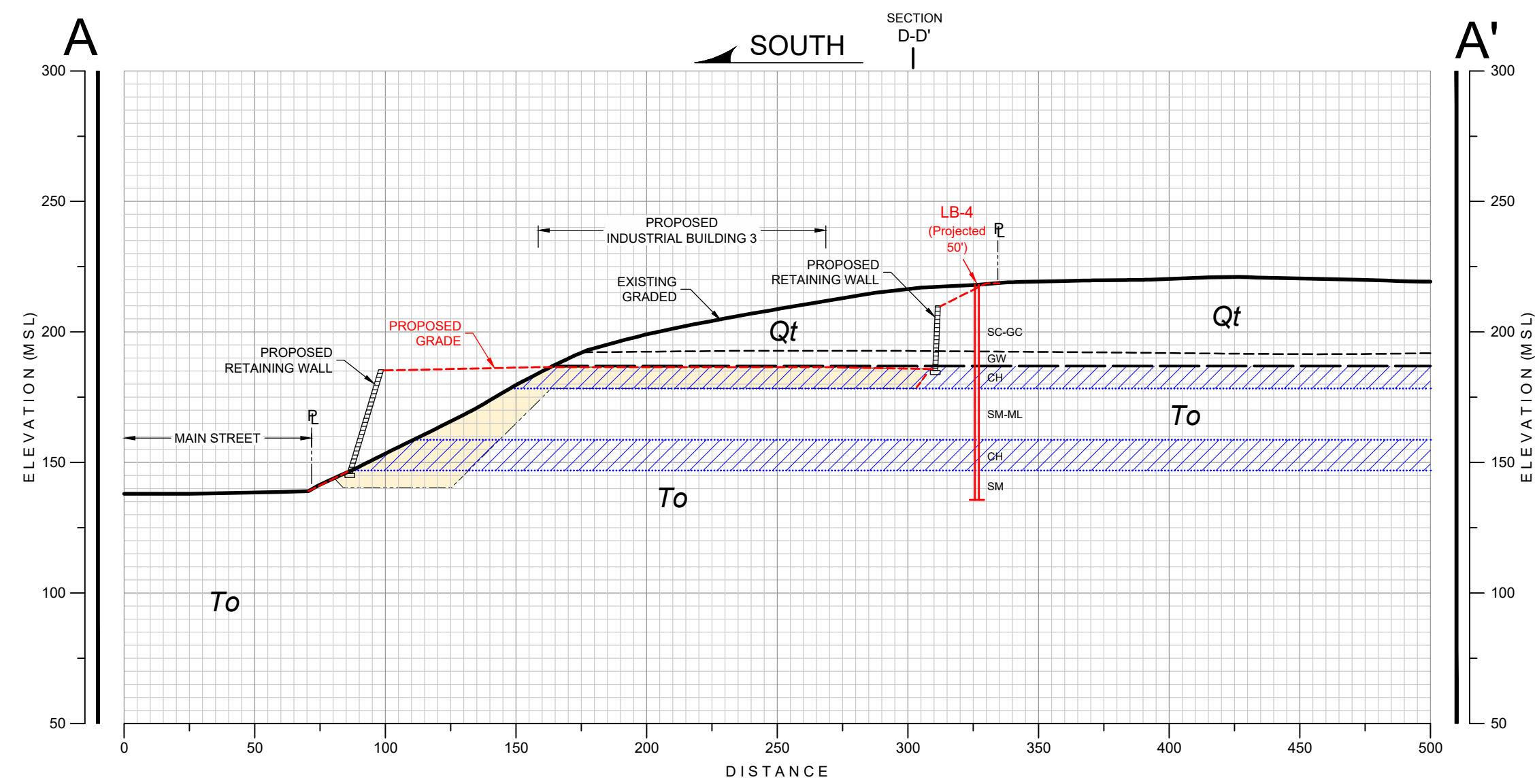

**GEOLOGIC CROSS-SECTION A-A'**  
SCALE: 1" = 50' (Vert. = Horiz.)

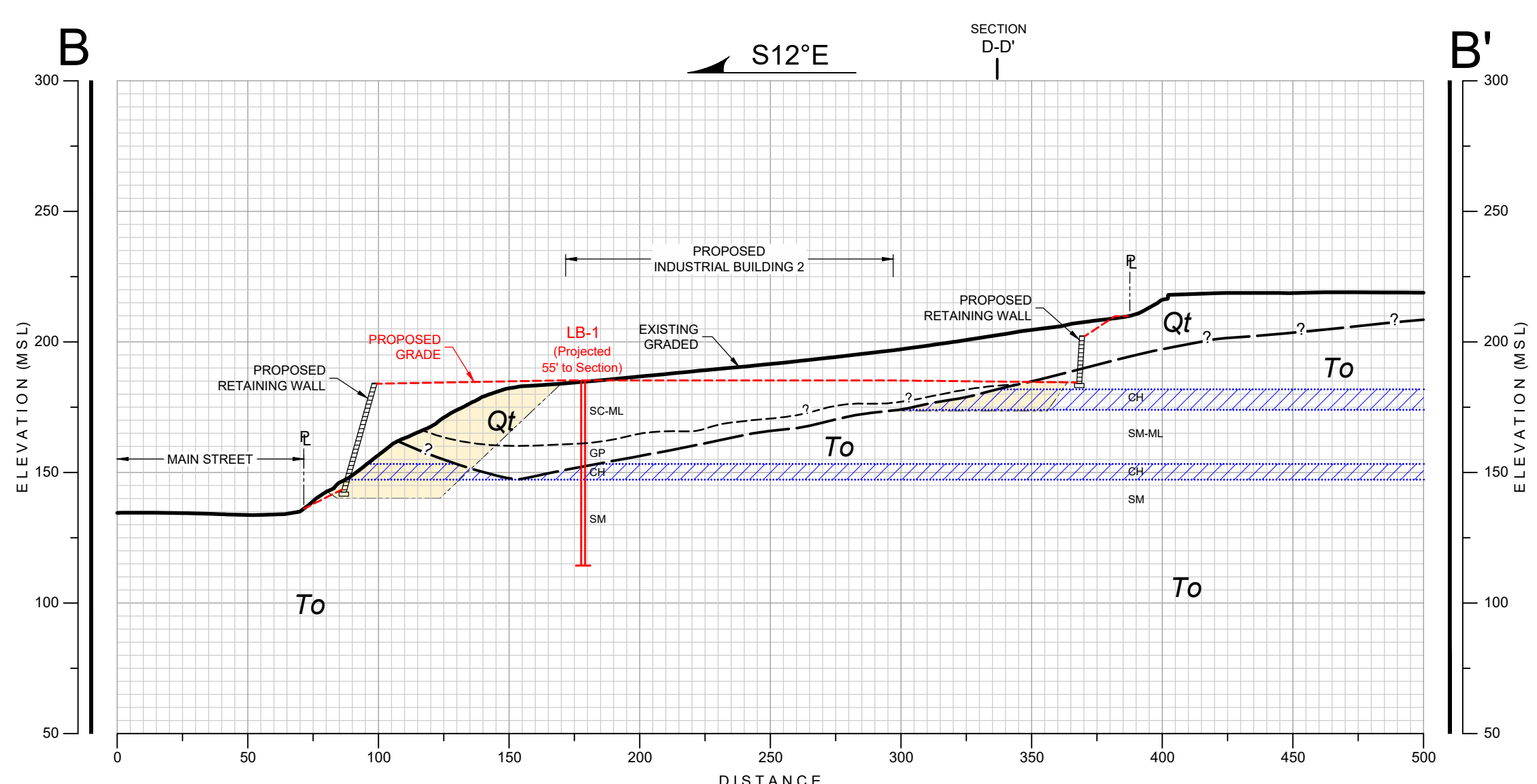

**GEOLOGIC CROSS-SECTION B-B'**  
SCALE: 1" = 50' (Vert. = Horiz.)

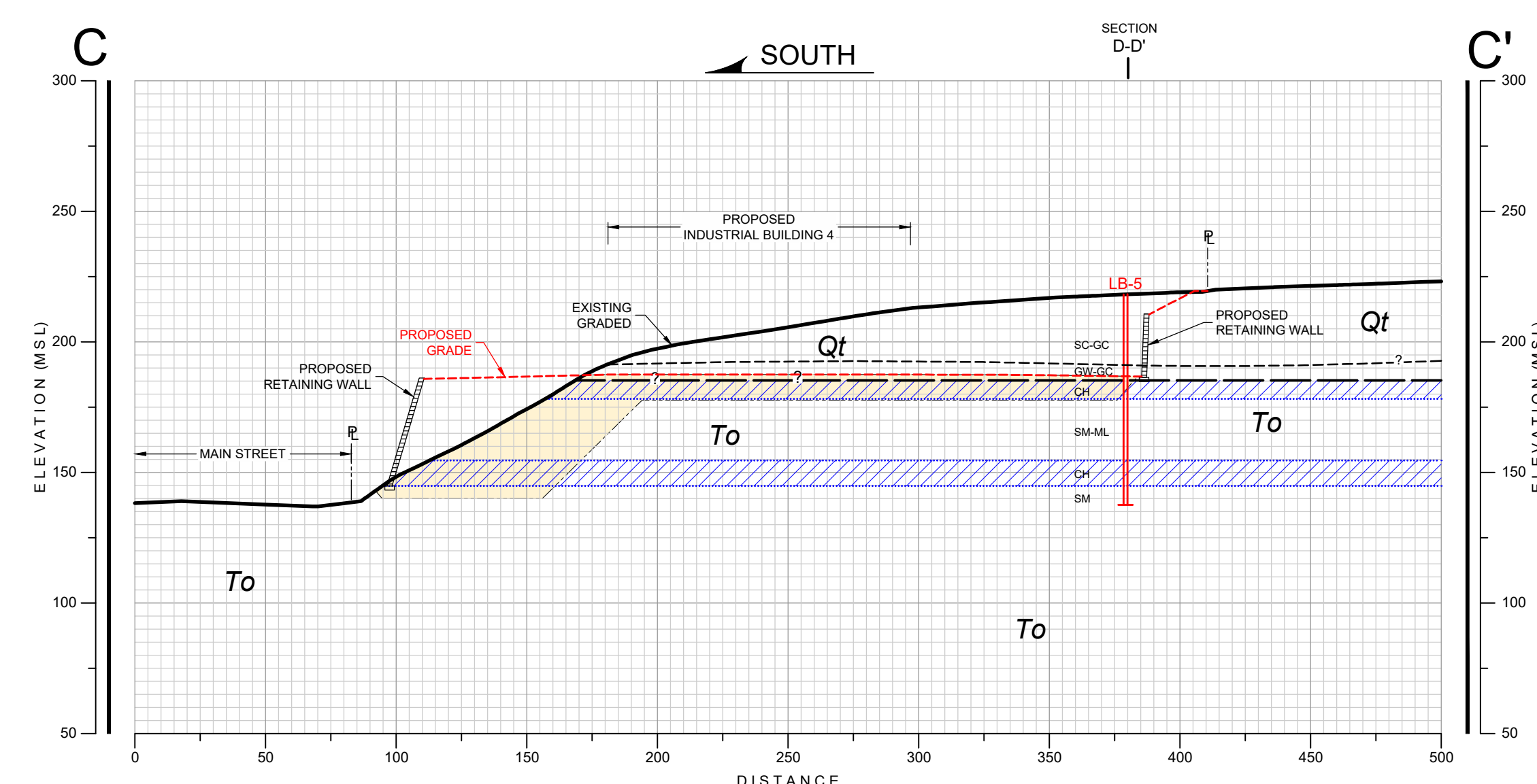

**GEOLOGIC CROSS-SECTION C-C'**  
SCALE: 1" = 50' (Vert. = Horiz.)

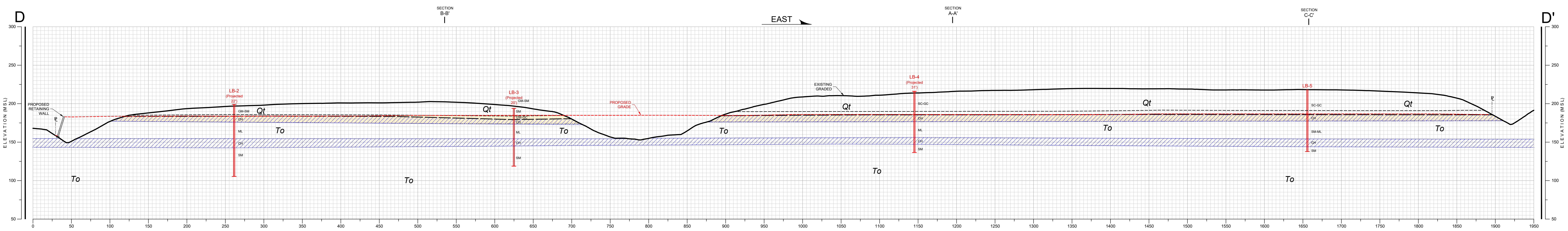

**GEOLOGIC CROSS-SECTION D-D'**  
SCALE: 1" = 50' (Vert. = Horiz.)

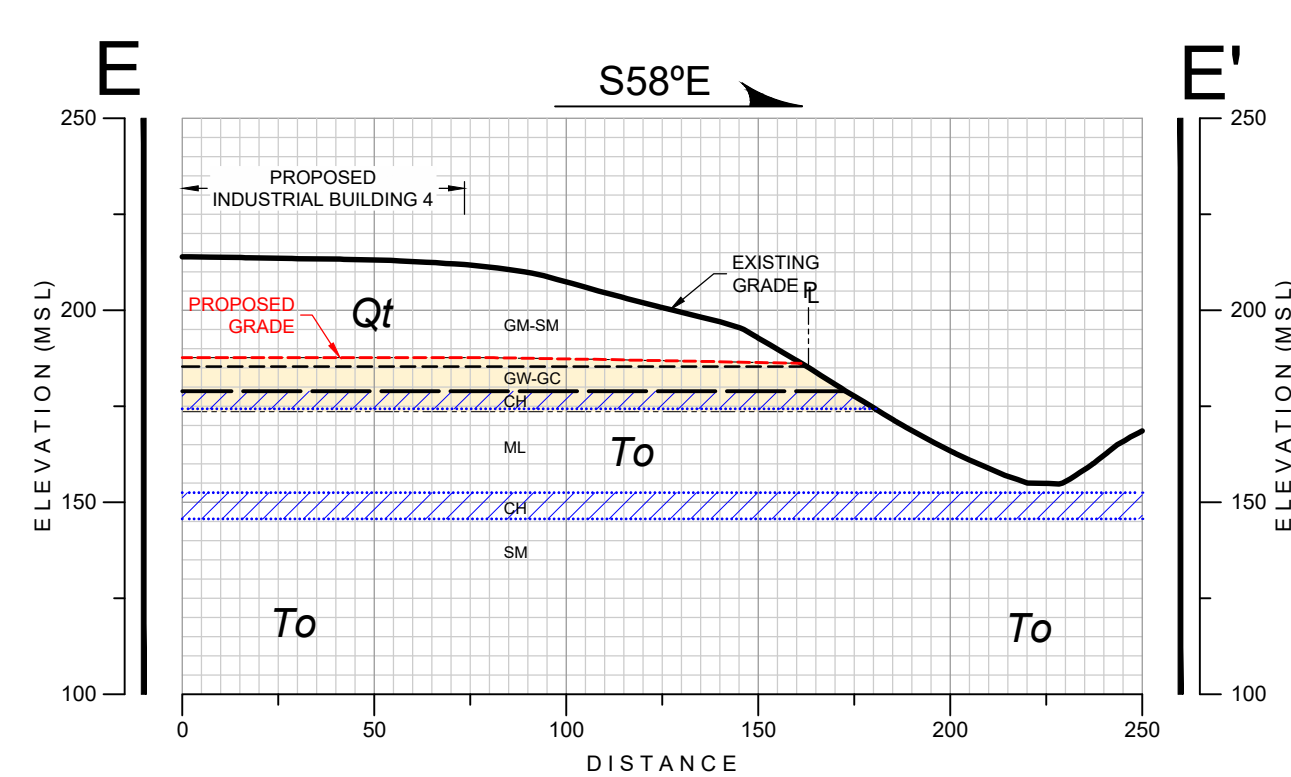

**GEOLOGIC CROSS-SECTION E-E'**  
SCALE: 1" = 50' (Vert. = Horiz.)

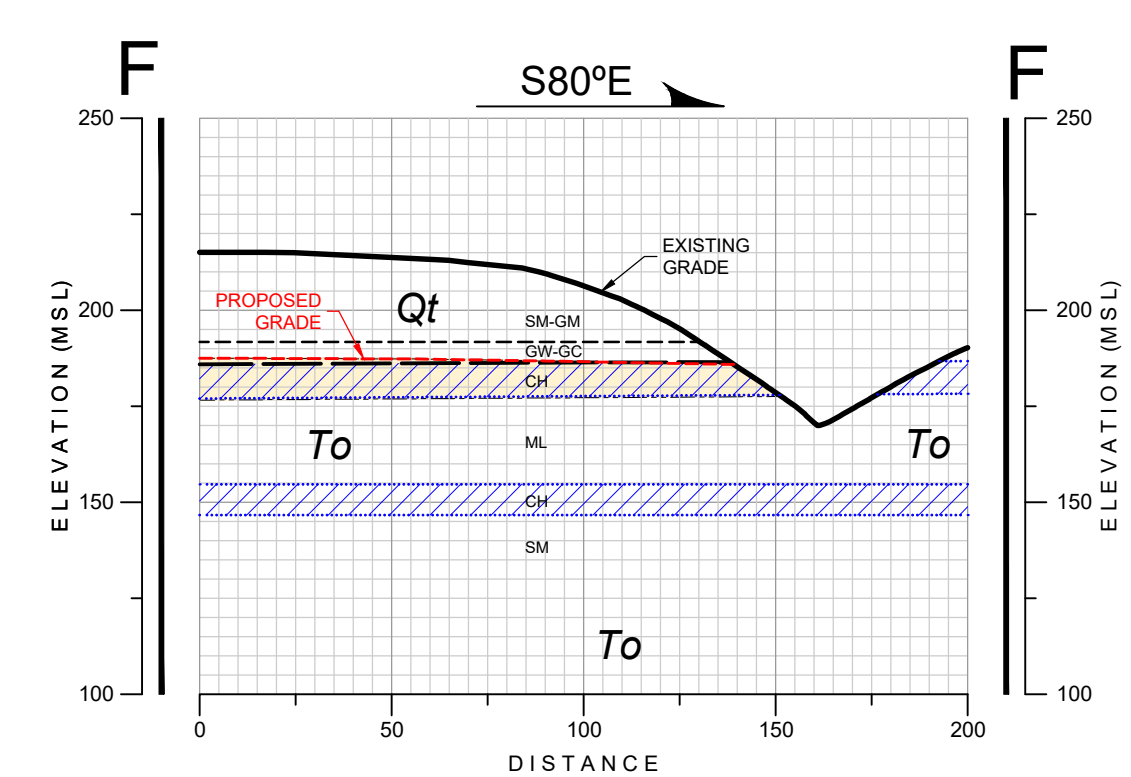

**GEOLOGIC CROSS-SECTION F-F'**  
SCALE: 1" = 50' (Vert. = Horiz.)

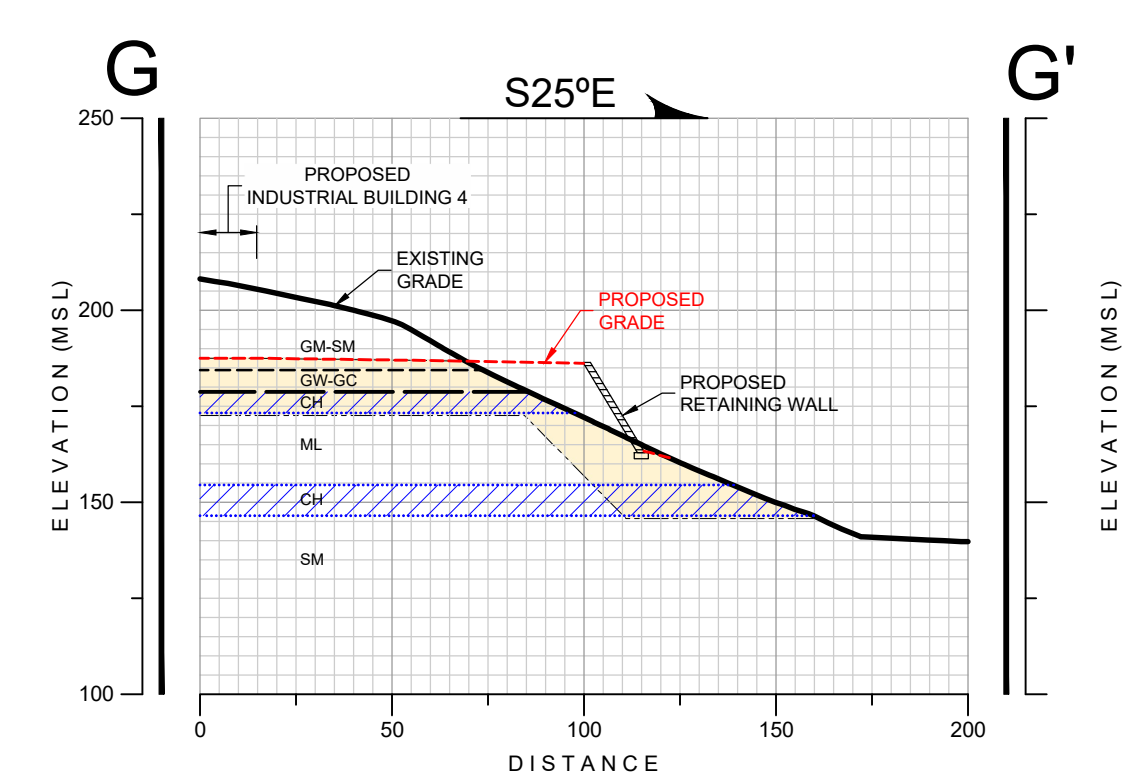

**GEOLOGIC CROSS-SECTION G-G'**  
SCALE: 1" = 50' (Vert. = Horiz.)

- GEOCON LEGEND**
- Qt ..... TERRACE DEPOSITS
  - To ..... OTAY FORMATION
  - ..... APPROX. LOCATION OF GEOLOGIC CONTACT (Queried Where Uncertain)
  - LB ..... APPROX. LOCATION OF EXPLORATORY LARGE DIAMETER BORING
  - ..... ESTIMATED CLAYSTONE AND BEDROCK REMEDIAL REMOVAL

**GEOLOGIC MAP**  
NIRVANA INDUSTRIAL BUILDINGS AND SELF STORAGE COMPLEX  
821 MAIN STREET  
CHULA VISTA, CALIFORNIA

<b>GEOCON</b> INCORPORATED	SCALE 1" = 50'	DATE 09 - 14 - 2021
GEOTECHNICAL • ENVIRONMENTAL • MATERIALS	PROJECT NO. G2755 - 42 - 01	FIGURE 2
6960 PLANKERS DRIVE • SAN DIEGO, CALIFORNIA 92121-2974 PHONE: 619.584.9900 • FAX: 619.584.9957	SHEET 1 OF 1	



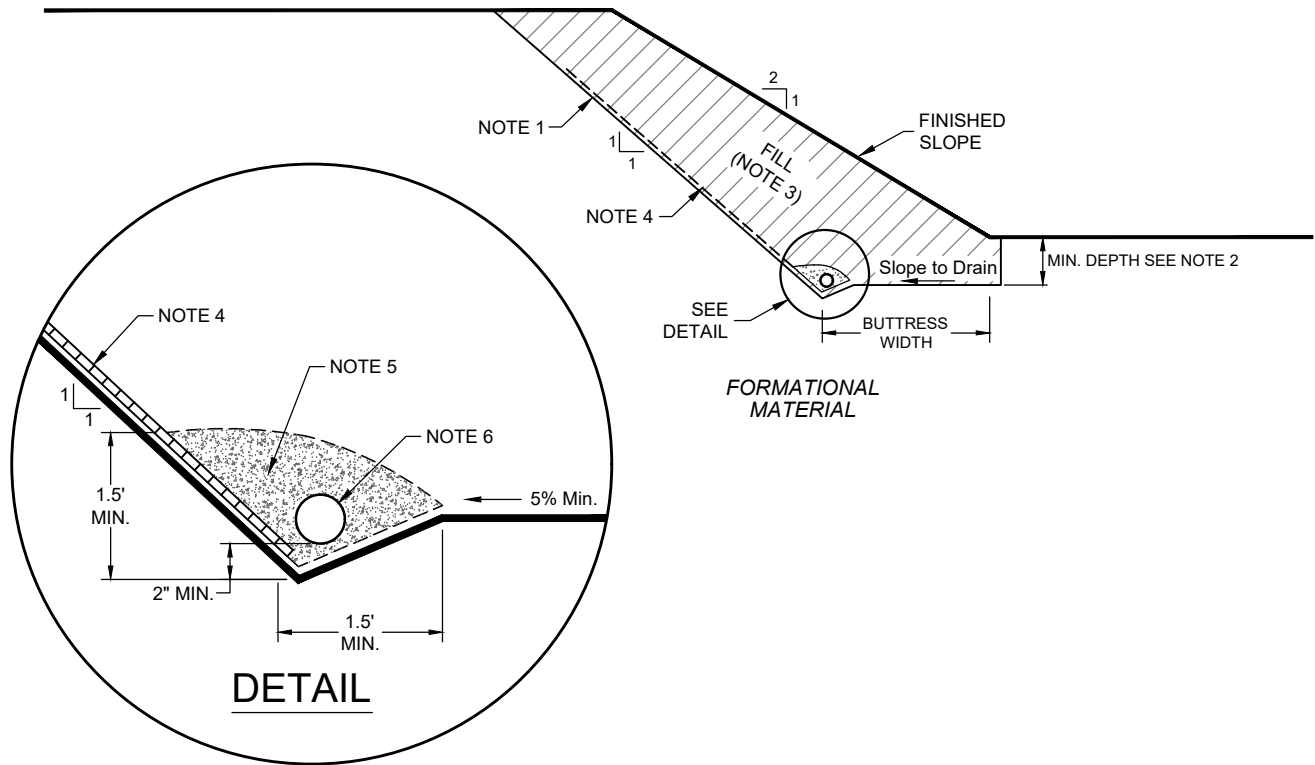

**NOTES:**

- 1....EXCAVATE BACKCUT AT 1:1 INCLINATION (UNLESS OTHERWISE NOTED).
- 2....BASE OF BUTTRESS FILL TO BE 3 FEET INTO FORMATIONAL MATERIAL OR 5 FEET BELOW BEDDING PLANE SHEAR OR LANDSLIDE SLIP SURFACE SLOPING A MINIMUM 5% INTO SLOPE.
- 3....BUTTRESS/STABILITY FILL TO BE COMPOSED OF PROPERLY COMPACTED GRANULAR SOIL.
- 4....CHIMNEY DRAINS TO BE APPROVED PREFABRICATED CHIMNEY DRAIN PANELS (MIRADRAIN G200N OR EQUIVALENT) SPACED APPROXIMATELY 20 FEET CENTER TO CENTER AND 4 FEET WIDE. CLOSER SPACING MAY BE REQUIRED IF SEEPAGE IS ENCOUNTERED.
- 5....FILTER MATERIAL TO BE 3/4-INCH, OPEN-GRADED CRUSHED ROCK ENCLOSED IN APPROVED FILTER FABRIC (MIRAFI 140NC).
- 6....COLLECTOR PIPE TO BE 4-INCH MINIMUM DIAMETER, PERFORATED, THICK-WALLED PVC SCHEDULE 40 OR EQUIVALENT, AND SLOPED TO DRAIN AT 1 PERCENT MINIMUM TO APPROVED OUTLET.

**TYPICAL BUTTRESS/STABILITY FILL DETAIL**

**GEOCON**  
INCORPORATED



GEOTECHNICAL ■ ENVIRONMENTAL ■ MATERIALS  
6960 FLANDERS DRIVE - SAN DIEGO, CALIFORNIA 92121 - 2974  
PHONE 858 558-6900 - FAX 858 558-6159

NIRVANA INDUSTRIAL BUILDINGS AND  
SELF STORAGE COMPLEX  
821 MAIN STREET  
CHULA VISTA, CALIFORNIA

RM / AML

DSK/GTYPD

DATE 09 - 14 - 2021

PROJECT NO. G2755 - 42 - 01

FIG. 3

APPENDIX

A

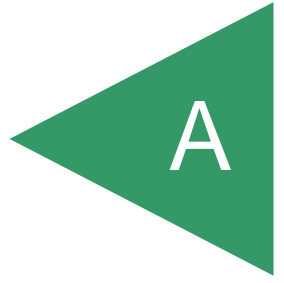

## APPENDIX A

### FIELD INVESTIGATION







We performed our field investigation between July 29 and August 8, 2021. Our investigation consisted of a site reconnaissance, logging of eight exploratory test pits and five large diameter borings. The exploratory test pits were excavated to depths between 2- and 11-feet using a rubber-tire Caterpillar 430F backhoe. Exploratory borings were drilled to depths between 70- and 90-feet using a truck-mounted bucket auger drill rig. The approximate locations of the exploratory test pits borings tests are shown on Figure 1.

The soil conditions encountered in the trenches were visually examined, classified, and logged in general conformance with the American Society for Testing and Materials (ASTM) Practice for Description and Identification of Soils (Visual-Manual Procedure D 2488). Exploratory boring logs are presented in Figures A-1 through A-5, and test pit logs are presented on Figures A-6 through A-13. The logs depict the various soil types encountered and indicate the depths at which samples were obtained.

DEPTH IN FEET	SAMPLE NO.	LITHOLOGY	GROUNDWATER	SOIL CLASS (USCS)	<b>BORING LB 1</b>		PENETRATION RESISTANCE (BLOWS/FT.)	DRY DENSITY (P.C.F.)	MOISTURE CONTENT (%)
					ELEV. (MSL.) <u>184'</u>	DATE COMPLETED <u>07-29-2021</u>			
					EQUIPMENT _____ BY: <u>R. ADAMS</u>				
MATERIAL DESCRIPTION									
0				CL	<b>TERRACE DEPOSITS (Qt)</b> Stiff, dry to damp, brown, Sandy CLAY; abundant caliche; few roots				
2									
4				SC	Medium dense, damp, grayish brown, Clayey SAND; few subrounded gravel; little caliche		4		
6	LB1-1								
8				SC	Medium dense to dense, damp, grayish brown, Clayey, medium to coarse SAND; interbedded with coarse sandy gravel beds; trace subrounded cobble up to 6-inch diameter; some cross-bedding				
10	LB1-2						6/8"		
12				ML	Stiff, damp, grayish brown to olive brown, Clayey SILT; massive; trace fine gravel				
14									
16									
18					-At 18 feet: few 4"-6" thick sandy gravel interbeds; horizontal				
20	LB1-3						3		
22									
24				GP	Medium dense to dense, damp, yellowish brown to orangish brown, coarse Sandy GRAVEL; gravel and cobble up to 12-inch diameter, subrounded to subangular: Hole belled out to 60"				
26									
28									

**Figure A-1,**  
**Log of Boring LB 1, Page 1 of 3**

G2755-42-01.GPJ

SAMPLE SYMBOLS	 ... SAMPLING UNSUCCESSFUL	 ... STANDARD PENETRATION TEST	 ... DRIVE SAMPLE (UNDISTURBED)
	 ... DISTURBED OR BAG SAMPLE	 ... CHUNK SAMPLE	 ... WATER TABLE OR  ... SEEPAGE

NOTE: THE LOG OF SUBSURFACE CONDITIONS SHOWN HEREON APPLIES ONLY AT THE SPECIFIC BORING OR TRENCH LOCATION AND AT THE DATE INDICATED. IT IS NOT WARRANTED TO BE REPRESENTATIVE OF SUBSURFACE CONDITIONS AT OTHER LOCATIONS AND TIMES.

DEPTH IN FEET	SAMPLE NO.	LITHOLOGY	GROUNDWATER	SOIL CLASS (USCS)	<b>BORING LB 1</b>		PENETRATION RESISTANCE (BLOWS/FT.)	DRY DENSITY (P.C.F.)	MOISTURE CONTENT (%)
					ELEV. (MSL.) <u>184'</u>	DATE COMPLETED <u>07-29-2021</u>			
					EQUIPMENT _____	BY: <u>R. ADAMS</u>			
MATERIAL DESCRIPTION									
30	LB1-4			ML	<b>OTAY FORMATION (To)</b> Hard, dry to damp, yellowish gray, SILTSTONE; massive		10/10"		
32	LB1-5			CH		Stiff to hard, damp to moist, dark reddish brown, bentonitic CLAYSTONE; moderately; fissured but not remolded			
34									
36				SM	Dense to very dense, damp, yellowish brown to grayish brown (mottled), Silty, fine- to medium-grained SANDSTONE; massive				
38									
40	LB1-6						10/8"		
42									
44									
46				SM	At 45 feet: becomes yellowish brown to reddish brown Very dense, damp, grayish white, Silty, fine to medium SANDSTONE; trace clay, massive				
48									
50	LB1-7						10/10"		
52									
54									
56	LB1-8								
58					At 58 feet: becomes moist to wet				

**Figure A-1,**  
**Log of Boring LB 1, Page 2 of 3**

G2755-42-01.GPJ

SAMPLE SYMBOLS		... SAMPLING UNSUCCESSFUL		... STANDARD PENETRATION TEST		... DRIVE SAMPLE (UNDISTURBED)
		... DISTURBED OR BAG SAMPLE		... CHUNK SAMPLE		... WATER TABLE OR  ... SEEPAGE

NOTE: THE LOG OF SUBSURFACE CONDITIONS SHOWN HEREON APPLIES ONLY AT THE SPECIFIC BORING OR TRENCH LOCATION AND AT THE DATE INDICATED. IT IS NOT WARRANTED TO BE REPRESENTATIVE OF SUBSURFACE CONDITIONS AT OTHER LOCATIONS AND TIMES.





DEPTH IN FEET	SAMPLE NO.	LITHOLOGY	GROUNDWATER	SOIL CLASS (USCS)	<b>BORING LB 1</b> ELEV. (MSL.) <u>184'</u> DATE COMPLETED <u>07-29-2021</u> EQUIPMENT _____ BY: <u>R. ADAMS</u>	PENETRATION RESISTANCE (BLOWS/FT.)	DRY DENSITY (P.C.F.)	MOISTURE CONTENT (%)
60	LB1-9			SM	<p>MATERIAL DESCRIPTION</p> <p>At 63 feet: seepage</p> <p>At 68 feet; standing water</p>	12		
62								
64								
66								
68								
70					<p>BORING TERMINATED AT 70 FEET</p> <p>Groundwater encountered at 68</p> <p>Backfilled on 07-29-2021</p>			

**Figure A-1,**  
**Log of Boring LB 1, Page 3 of 3**

G2755-42-01.GPJ

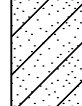
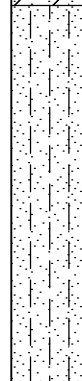





SAMPLE SYMBOLS	... SAMPLING UNSUCCESSFUL	... STANDARD PENETRATION TEST	... DRIVE SAMPLE (UNDISTURBED)
	... DISTURBED OR BAG SAMPLE	... CHUNK SAMPLE	... WATER TABLE OR  ... SEEPAGE

NOTE: THE LOG OF SUBSURFACE CONDITIONS SHOWN HEREON APPLIES ONLY AT THE SPECIFIC BORING OR TRENCH LOCATION AND AT THE DATE INDICATED. IT IS NOT WARRANTED TO BE REPRESENTATIVE OF SUBSURFACE CONDITIONS AT OTHER LOCATIONS AND TIMES.

DEPTH IN FEET	SAMPLE NO.	LITHOLOGY	GROUNDWATER	SOIL CLASS (USCS)	<b>BORING LB 2</b>		PENETRATION RESISTANCE (BLOWS/FT.)	DRY DENSITY (P.C.F.)	MOISTURE CONTENT (%)
					ELEV. (MSL.) <u>199'</u>	DATE COMPLETED <u>07-30-2021</u>			
					EQUIPMENT _____ BY: <u>R. ADAMS</u>				
MATERIAL DESCRIPTION									
0				CL	<b>TOPSOIL</b> Stiff, dry to damp, brown, Sandy CLAY; subrounded cobble up to 6-inch diameter				
2				SM	<b>TERRACE DEPOSITS (Qt)</b> Medium dense, damp, grayish brown, Silty SAND; trace clay, trace gravel  At 6 feet: subrounded cobble layer				
4									
6									
8									
10									
12				GP	Dense, damp, orangish brown, coarse Sandy GRAVEL; subrounded gravel and cobble up to 10-inch diameter				
14				CH	<b>OTAY FORMATION (To)</b> Hard to very hard, damp, dark reddish brown to pinkish brown, bentonitic CLAYSTONE; weakly to moderately fissured with many polished and striated surfaces, occasional discontinuous anastomosing clay films that are remolded plastic and remolded up to 1/2-inch thick  At 17 feet: 1/32-inch moderately remolded plastic clay seam; horizontal to undulatory with polished parting surfaces only				
16									
18									
20				SM	Very dense, damp, reddish brown to grayish brown, Silty, medium coarse SANDSTONE; trace clay, massive				
22									
24									
26									
28									
				SW	Very dense, dry to damp, light brown, very coarse grained SANDSTONE;				

**Figure A-2,**  
**Log of Boring LB 2, Page 1 of 4**

G2755-42-01.GPJ







SAMPLE SYMBOLS		... SAMPLING UNSUCCESSFUL		... STANDARD PENETRATION TEST		... DRIVE SAMPLE (UNDISTURBED)
		... DISTURBED OR BAG SAMPLE		... CHUNK SAMPLE		... WATER TABLE OR  ... SEEPAGE

NOTE: THE LOG OF SUBSURFACE CONDITIONS SHOWN HEREON APPLIES ONLY AT THE SPECIFIC BORING OR TRENCH LOCATION AND AT THE DATE INDICATED. IT IS NOT WARRANTED TO BE REPRESENTATIVE OF SUBSURFACE CONDITIONS AT OTHER LOCATIONS AND TIMES.

DEPTH IN FEET	SAMPLE NO.	LITHOLOGY	GROUNDWATER	SOIL CLASS (USCS)	<b>BORING LB 2</b>		PENETRATION RESISTANCE (BLOWS/FT.)	DRY DENSITY (P.C.F.)	MOISTURE CONTENT (%)
					ELEV. (MSL.) <u>199'</u>	DATE COMPLETED <u>07-30-2021</u>			
					EQUIPMENT _____ BY: <u>R. ADAMS</u>				
					MATERIAL DESCRIPTION				
30				ML-SM	bedding horizontal Very hard, damp, grayish white to pinkish brown, fine grained Sandy SILTSTONE; massive, gunbarrel				
32									
34									
36	LB2-1						10/8"		
38				SM	Very dense, damp, yellowish brown, Silty, very fine grained SANDSTONE; massive gunbarrel				
40									
42									
44				CH	Hard, damp, dark reddish brown, bentonitic CLAYSTONE; weakly fissured, no obvious clay films				
46	LB2-2			SM	Very dense, damp, grayish brown, Silty, fine SANDSTONE; massive		10/10"		
48	LB2-3			CH	Hard, damp, dark reddish brown to pinkish brown, bentonitic CLAYSTONE; massive, weakly to moderately fissured with polished and striated parting surfaces, occasional pockets of highly fissured claystone and weakly remolded clay				
50									
52									
54				SM	Very dense, damp, grayish brown, Silty, fine to coarse SANDSTONE; massive				
56									
58									

**Figure A-2,**  
**Log of Boring LB 2, Page 2 of 4**

G2755-42-01.GPJ

SAMPLE SYMBOLS	 ... SAMPLING UNSUCCESSFUL	 ... STANDARD PENETRATION TEST	 ... DRIVE SAMPLE (UNDISTURBED)
	 ... DISTURBED OR BAG SAMPLE	 ... CHUNK SAMPLE	 ... WATER TABLE OR  ... SEEPAGE

NOTE: THE LOG OF SUBSURFACE CONDITIONS SHOWN HEREON APPLIES ONLY AT THE SPECIFIC BORING OR TRENCH LOCATION AND AT THE DATE INDICATED. IT IS NOT WARRANTED TO BE REPRESENTATIVE OF SUBSURFACE CONDITIONS AT OTHER LOCATIONS AND TIMES.



DEPTH IN FEET	SAMPLE NO.	LITHOLOGY	GROUNDWATER	SOIL CLASS (USCS)	<b>BORING LB 2</b>		PENETRATION RESISTANCE (BLOWS/FT.)	DRY DENSITY (P.C.F.)	MOISTURE CONTENT (%)	
					ELEV. (MSL.) <u>199'</u>	DATE COMPLETED <u>07-30-2021</u>				
					EQUIPMENT _____ BY: <u>R. ADAMS</u>					
MATERIAL DESCRIPTION										
60	LB2-4			SM			12/8"			
62					At 62 feet: becomes moist					
64										
66										
68										
70	LB2-5					At 69 feet: 4" thick subrounded gravel layer, bedding horizontal At 70 feet: becomes moist to wet		15/10"		
72										
74										
76										
78						At 78 feet: moderate of heavy seepage				
80										
82										
84										
86										
88					At 87 feet: standing water					

**Figure A-2,**  
**Log of Boring LB 2, Page 3 of 4**

G2755-42-01.GPJ

SAMPLE SYMBOLS	... SAMPLING UNSUCCESSFUL	... STANDARD PENETRATION TEST	... DRIVE SAMPLE (UNDISTURBED)
	... DISTURBED OR BAG SAMPLE	... CHUNK SAMPLE	... WATER TABLE OR  ... SEEPAGE

NOTE: THE LOG OF SUBSURFACE CONDITIONS SHOWN HEREON APPLIES ONLY AT THE SPECIFIC BORING OR TRENCH LOCATION AND AT THE DATE INDICATED. IT IS NOT WARRANTED TO BE REPRESENTATIVE OF SUBSURFACE CONDITIONS AT OTHER LOCATIONS AND TIMES.











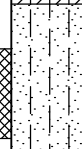



DEPTH IN FEET	SAMPLE NO.	LITHOLOGY	GROUNDWATER	SOIL CLASS (USCS)	<b>BORING LB 2</b>  ELEV. (MSL.) <u>199'</u> DATE COMPLETED <u>07-30-2021</u>  EQUIPMENT _____ BY: <u>R. ADAMS</u>	PENETRATION RESISTANCE (BLOWS/FT.)	DRY DENSITY (P.C.F.)	MOISTURE CONTENT (%)
					MATERIAL DESCRIPTION			
					BORING TERMINATED AT 90 FEET Groundwater encountered at 87 Backfilled on 07-30-2021			

**Figure A-2,  
Log of Boring LB 2, Page 4 of 4**

G2755-42-01.GPJ







SAMPLE SYMBOLS	<input type="checkbox"/> ... SAMPLING UNSUCCESSFUL <input checked="" type="checkbox"/> ... DISTURBED OR BAG SAMPLE	<input type="checkbox"/> ... STANDARD PENETRATION TEST <input checked="" type="checkbox"/> ... CHUNK SAMPLE	<input checked="" type="checkbox"/> ... DRIVE SAMPLE (UNDISTURBED) <input checked="" type="checkbox"/> ... WATER TABLE OR <input checked="" type="checkbox"/> ... SEEPAGE
----------------	---	--	--

NOTE: THE LOG OF SUBSURFACE CONDITIONS SHOWN HEREON APPLIES ONLY AT THE SPECIFIC BORING OR TRENCH LOCATION AND AT THE DATE INDICATED. IT IS NOT WARRANTED TO BE REPRESENTATIVE OF SUBSURFACE CONDITIONS AT OTHER LOCATIONS AND TIMES.

DEPTH IN FEET	SAMPLE NO.	LITHOLOGY	GROUNDWATER	SOIL CLASS (USCS)	<b>BORING LB 3</b>		PENETRATION RESISTANCE (BLOWS/FT.)	DRY DENSITY (P.C.F.)	MOISTURE CONTENT (%)
					ELEV. (MSL.) <u>194'</u>	DATE COMPLETED <u>07-30-2021</u>			
					EQUIPMENT _____ BY: <u>R. ADAMS</u>				
MATERIAL DESCRIPTION									
0	LB3-1			CL	<b>TOPSOIL</b> Stiff, damp, reddish brown, Sandy CLAY; some gravel, few roots				
2				SM	<b>TERRACE DEPOSITS (Qt)</b> Dense, dry to damp, orangish brown, Silty, medium to coarse SAND; some subrounded gravel and cobble up to 12-inch diameter				
4									
6				CH	<b>OTAY FORMATION (To)</b> Hard, dry, reddish brown, CLAYSTONE; numerous sub horizontal to undulatory remolded moderately fissured soft plastic 1/8" thick clay films				
8									
10				ML	Hard, dry to damp, grayish brown to pinkish brown, very fine grained Sandy SILTSTONE; massive; few subvertical clay filled fractures				
12									
14									
16				CH	Hard, damp, pinkish brown to reddish brown, bentonitic CLAYSTONE; moderately to well fissured with numerous polished parting surfaces				
18						At 18 feet: transitions to fine grained sandy claystone			
20									
22			ML	Hard, dry to damp, pale whitish brow to pinkish brown, fine grained Sandy SILTSTONE; minor caliche along top contact; massive, few of reddish brown sandy claystone interbeds					
24									
26									
28									

**Figure A-3,**  
**Log of Boring LB 3, Page 1 of 3**

G2755-42-01.GPJ







<b>SAMPLE SYMBOLS</b>	 ... SAMPLING UNSUCCESSFUL	 ... STANDARD PENETRATION TEST	 ... DRIVE SAMPLE (UNDISTURBED)
	 ... DISTURBED OR BAG SAMPLE	 ... CHUNK SAMPLE	 ... WATER TABLE OR  ... SEEPAGE

NOTE: THE LOG OF SUBSURFACE CONDITIONS SHOWN HEREON APPLIES ONLY AT THE SPECIFIC BORING OR TRENCH LOCATION AND AT THE DATE INDICATED. IT IS NOT WARRANTED TO BE REPRESENTATIVE OF SUBSURFACE CONDITIONS AT OTHER LOCATIONS AND TIMES.

DEPTH IN FEET	SAMPLE NO.	LITHOLOGY	GROUNDWATER	SOIL CLASS (USCS)	<b>BORING LB 3</b>		PENETRATION RESISTANCE (BLOWS/FT.)	DRY DENSITY (P.C.F.)	MOISTURE CONTENT (%)
					ELEV. (MSL.) <u>194'</u>	DATE COMPLETED <u>07-30-2021</u>			
					EQUIPMENT _____ BY: <u>R. ADAMS</u>				
MATERIAL DESCRIPTION									
30				ML	<p>At 35-38 feet: Few high-angle clay filled fractures</p>				
32									
34									
36									
38					<p>At 42 feet: thin band of caliche cementation</p> <p>At 47 feet: becomes moderately fissured</p>				
40				CH					
42									
44									
46					<p>Hard, damp, pinkish brown to grayish white, very fine grained Sandy SILTSTONE; massive</p>				
48				ML					
50									
52				SM					
54					<p>Very dense, damp, grayish white to pinkish white, Silty, fine to coarse SANDSTONE; massive</p>				
56									
58									
58									

**Figure A-3,**  
**Log of Boring LB 3, Page 2 of 3**

G2755-42-01.GPJ

SAMPLE SYMBOLS	 ... SAMPLING UNSUCCESSFUL	 ... STANDARD PENETRATION TEST	 ... DRIVE SAMPLE (UNDISTURBED)
	 ... DISTURBED OR BAG SAMPLE	 ... CHUNK SAMPLE	 ... WATER TABLE OR  ... SEEPAGE

NOTE: THE LOG OF SUBSURFACE CONDITIONS SHOWN HEREON APPLIES ONLY AT THE SPECIFIC BORING OR TRENCH LOCATION AND AT THE DATE INDICATED. IT IS NOT WARRANTED TO BE REPRESENTATIVE OF SUBSURFACE CONDITIONS AT OTHER LOCATIONS AND TIMES.

DEPTH IN FEET	SAMPLE NO.	LITHOLOGY	GROUNDWATER	SOIL CLASS (USCS)	<b>BORING LB 3</b> ELEV. (MSL.) <u>194'</u> DATE COMPLETED <u>07-30-2021</u> EQUIPMENT _____ BY: <u>R. ADAMS</u>	PENETRATION RESISTANCE (BLOWS/FT.)	DRY DENSITY (P.C.F.)	MOISTURE CONTENT (%)
60				SM	<p style="text-align: center;">MATERIAL DESCRIPTION</p> <p>At 65 feet: becomes damp to moist</p> <p>At 71 feet: 6-inch subrounded cobble bed; N70E/3°S</p> <p>At 72 feet: light seepage</p>			
62								
64								
66								
68								
70								
72			▽					
74								
					<p><b>BORING TERMINATED AT 75 FEET</b></p> <p>Groundwater not encountered</p> <p>Backfilled on 07-30-2021</p>			

**Figure A-3,**  
**Log of Boring LB 3, Page 3 of 3**

G2755-42-01.GPJ







<b>SAMPLE SYMBOLS</b>	... SAMPLING UNSUCCESSFUL	... STANDARD PENETRATION TEST	... DRIVE SAMPLE (UNDISTURBED)
	... DISTURBED OR BAG SAMPLE	... CHUNK SAMPLE	... WATER TABLE OR  ... SEEPAGE

NOTE: THE LOG OF SUBSURFACE CONDITIONS SHOWN HEREON APPLIES ONLY AT THE SPECIFIC BORING OR TRENCH LOCATION AND AT THE DATE INDICATED. IT IS NOT WARRANTED TO BE REPRESENTATIVE OF SUBSURFACE CONDITIONS AT OTHER LOCATIONS AND TIMES.

DEPTH IN FEET	SAMPLE NO.	LITHOLOGY	GROUNDWATER	SOIL CLASS (USCS)	<b>BORING LB 4</b>		PENETRATION RESISTANCE (BLOWS/FT.)	DRY DENSITY (P.C.F.)	MOISTURE CONTENT (%)
					ELEV. (MSL.) <u>216'</u>	DATE COMPLETED <u>08-02-2021</u>			
					EQUIPMENT _____ BY: <u>R. ADAMS</u>				
MATERIAL DESCRIPTION									
0				SC	<b>TERRACE DEPOSITS (Qt)</b> Dense, dry to moist, orangish brown, Clayey, medium to coarse SAND with gravel and cobble, subrounded gravel and cobble up to 18-inch diameter				
2									
4									
6									
8									
10	LB4-1								
12									
14									
16									
18									
20					Loose to medium dense, damp, orangish brown, Sandy GRAVEL; low cohesions present in cave zone, caving to 72-inch diameter, cobble and boulders up to 36 inches				
22									
24									
26				GW					
28									

**Figure A-4,**  
**Log of Boring LB 4, Page 1 of 3**

G2755-42-01.GPJ





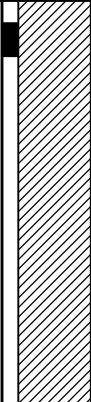
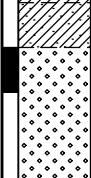
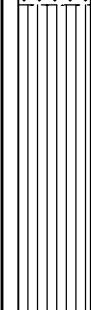

SAMPLE SYMBOLS	 ... SAMPLING UNSUCCESSFUL	 ... STANDARD PENETRATION TEST	 ... DRIVE SAMPLE (UNDISTURBED)
	 ... DISTURBED OR BAG SAMPLE	 ... CHUNK SAMPLE	 ... WATER TABLE OR  ... SEEPAGE

NOTE: THE LOG OF SUBSURFACE CONDITIONS SHOWN HEREON APPLIES ONLY AT THE SPECIFIC BORING OR TRENCH LOCATION AND AT THE DATE INDICATED. IT IS NOT WARRANTED TO BE REPRESENTATIVE OF SUBSURFACE CONDITIONS AT OTHER LOCATIONS AND TIMES.

DEPTH IN FEET	SAMPLE NO.	LITHOLOGY	GROUNDWATER	SOIL CLASS (USCS)	<b>BORING LB 4</b>		PENETRATION RESISTANCE (BLOWS/FT.)	DRY DENSITY (P.C.F.)	MOISTURE CONTENT (%)
					ELEV. (MSL.) <u>216'</u>	DATE COMPLETED <u>08-02-2021</u>			
					EQUIPMENT _____ BY: <u>R. ADAMS</u>				
MATERIAL DESCRIPTION									
30	LB4-2			CH	<b>OTAY FORMATION (To)</b> Firm to stiff, damp, dark reddish brown, bentonitic CLAYSTONE; weakly to moderately fissured with some polished and slanted parting surfaces, little to no remolding or soft plastic zones, massive		8/8"		
32									
34									
36									
38									
40	LB4-3			CL SW	Hard, damp, dark reddish brown, Sandy CLAYSTONE Very dense, damp, reddish brown, very coarse SANDSTONE (gritstone bed); cemented, few rounded gravel		10		
42									
44				ML	Stiff to hard, damp to moist, pale reddish brown to olive brown, SILTSTONE, Clayey SILTSTONE and Sandy SILTSTONE (interbedded); massive				
46									
48									
50	LB4-4						12		
52									
54									
56									
58									

**Figure A-4,**  
**Log of Boring LB 4, Page 2 of 3**

G2755-42-01.GPJ

SAMPLE SYMBOLS		... SAMPLING UNSUCCESSFUL		... STANDARD PENETRATION TEST		... DRIVE SAMPLE (UNDISTURBED)
		... DISTURBED OR BAG SAMPLE		... CHUNK SAMPLE		... WATER TABLE OR  ... SEEPAGE

NOTE: THE LOG OF SUBSURFACE CONDITIONS SHOWN HEREON APPLIES ONLY AT THE SPECIFIC BORING OR TRENCH LOCATION AND AT THE DATE INDICATED. IT IS NOT WARRANTED TO BE REPRESENTATIVE OF SUBSURFACE CONDITIONS AT OTHER LOCATIONS AND TIMES.

DEPTH IN FEET	SAMPLE NO.	LITHOLOGY	GROUNDWATER	SOIL CLASS (USCS)	<b>BORING LB 4</b>		PENETRATION RESISTANCE (BLOWS/FT.)	DRY DENSITY (P.C.F.)	MOISTURE CONTENT (%)
					ELEV. (MSL.) <u>216'</u>	DATE COMPLETED <u>08-02-2021</u>			
					EQUIPMENT _____	BY: <u>R. ADAMS</u>			
MATERIAL DESCRIPTION									
60	LB4-5						15		
62				CH	Very stiff to hard, damp, dark reddish brown, bentonitic CLAYSTONE; weakly to moderately fissured, blocky texture, no remolding				
64									
66									
68									
70	LB4-6			ML	Stiff to hard, damp, reddish brown, Clayey SILTSTONE; massive		15		
72				SM	Dense to very dense, damp, reddish brown to pinkish white, Silty, fine to coarse SANDSTONE; trace clay, massive				
74									
76									
78									
80	LB4-7						20/6"		
					BORING TERMINATED AT 81 FEET Groundwater not encountered Backfilled on 08-02-2021				

**Figure A-4,**  
**Log of Boring LB 4, Page 3 of 3**

G2755-42-01.GPJ

<b>SAMPLE SYMBOLS</b>	... SAMPLING UNSUCCESSFUL	... STANDARD PENETRATION TEST	... DRIVE SAMPLE (UNDISTURBED)
	... DISTURBED OR BAG SAMPLE	... CHUNK SAMPLE	... WATER TABLE OR  ... SEEPAGE







NOTE: THE LOG OF SUBSURFACE CONDITIONS SHOWN HEREON APPLIES ONLY AT THE SPECIFIC BORING OR TRENCH LOCATION AND AT THE DATE INDICATED. IT IS NOT WARRANTED TO BE REPRESENTATIVE OF SUBSURFACE CONDITIONS AT OTHER LOCATIONS AND TIMES.



DEPTH IN FEET	SAMPLE NO.	LITHOLOGY	GROUNDWATER	SOIL CLASS (USCS)	<b>BORING LB 5</b>		PENETRATION RESISTANCE (BLOWS/FT.)	DRY DENSITY (P.C.F.)	MOISTURE CONTENT (%)
					ELEV. (MSL.) <u>218'</u>	DATE COMPLETED <u>08-03-2021</u>			
					EQUIPMENT _____ BY: <u>R. ADAMS</u>				
MATERIAL DESCRIPTION									
0				CL	<b>TOPSOIL</b> Stiff, dry, dark brown, Sandy CLAY; trace gravel				
2				GW	<b>TERRACE DEPOSITS (Qt)</b> Medium dense to dense, damp, brown to orangish brown, Silty, medium coarse SAND; trace clay, some subrounded gravel and cobble up to 8-inch diameter				
4									
6									
8									
10									
12									
14									
16									
18									
20									
22									
24									
26									
28					At 26-32 feet: hole belled out to 60-inch diameter with abundant loose cobble and overhanging areas. Hole logged from cuttings below 32 feet				

**Figure A-5,**  
**Log of Boring LB 5, Page 1 of 3**

G2755-42-01.GPJ







SAMPLE SYMBOLS	 ... SAMPLING UNSUCCESSFUL	 ... STANDARD PENETRATION TEST	 ... DRIVE SAMPLE (UNDISTURBED)
	 ... DISTURBED OR BAG SAMPLE	 ... CHUNK SAMPLE	 ... WATER TABLE OR  ... SEEPAGE

NOTE: THE LOG OF SUBSURFACE CONDITIONS SHOWN HEREON APPLIES ONLY AT THE SPECIFIC BORING OR TRENCH LOCATION AND AT THE DATE INDICATED. IT IS NOT WARRANTED TO BE REPRESENTATIVE OF SUBSURFACE CONDITIONS AT OTHER LOCATIONS AND TIMES.





DEPTH IN FEET	SAMPLE NO.	LITHOLOGY	GROUNDWATER	SOIL CLASS (USCS)	<b>BORING LB 5</b>		PENETRATION RESISTANCE (BLOWS/FT.)	DRY DENSITY (P.C.F.)	MOISTURE CONTENT (%)
					ELEV. (MSL.) <b>218'</b>	DATE COMPLETED <b>08-03-2021</b>			
					EQUIPMENT _____	BY: <b>R. ADAMS</b>			
MATERIAL DESCRIPTION									
30				GW					
32				ML	<b>OTAY FORMATION (To)</b> Hard, damp, grayish brown, Clayey SILTSTONE				
34				CH	Hard, damp, reddish brown, bentonitic CLAYSTONE; blocky, weakly fissured				
36	LB5-1								
38									
40	LB5-2			ML/CL	Hard, damp, brown to olive brown, interbedded SILTSTONE, Clayey SILTSTONE, and Silty CLAYSTONE				
42									
44									
46									
48									
50	LB5-3		▽		At 50 feet: light to moderate seepage				
52									
54									
56									
58									

**Figure A-5,**  
**Log of Boring LB 5, Page 2 of 3**

G2755-42-01.GPJ

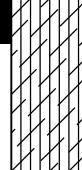





SAMPLE SYMBOLS	 ... SAMPLING UNSUCCESSFUL	 ... STANDARD PENETRATION TEST	 ... DRIVE SAMPLE (UNDISTURBED)
	 ... DISTURBED OR BAG SAMPLE	 ... CHUNK SAMPLE	 ... WATER TABLE OR  ... SEEPAGE

NOTE: THE LOG OF SUBSURFACE CONDITIONS SHOWN HEREON APPLIES ONLY AT THE SPECIFIC BORING OR TRENCH LOCATION AND AT THE DATE INDICATED. IT IS NOT WARRANTED TO BE REPRESENTATIVE OF SUBSURFACE CONDITIONS AT OTHER LOCATIONS AND TIMES.

DEPTH IN FEET	SAMPLE NO.	LITHOLOGY	GROUNDWATER	SOIL CLASS (USCS)	<b>BORING LB 5</b>		PENETRATION RESISTANCE (BLOWS/FT.)	DRY DENSITY (P.C.F.)	MOISTURE CONTENT (%)
					ELEV. (MSL.) <u>218'</u>	DATE COMPLETED <u>08-03-2021</u>			
					EQUIPMENT _____	BY: <u>R. ADAMS</u>			
MATERIAL DESCRIPTION									
60	LB5-4			ML/CL					
62									
64				CH	Hard, damp, reddish brown, bentonitic CLAYSTONE; massive, blocky and weakly fissured				
66	LB5-5		▼						
68									
70	LB5-6								
72									
74				SM	Dense, damp, pale yellowish brown, Silty, fine to coarse SANDSTONE; massive				
76									
78									
80					BORING TERMINATED AT 80 FEET Groundwater encountered at 65 Backfilled on 08-04-2021				

**Figure A-5,**  
**Log of Boring LB 5, Page 3 of 3**

G2755-42-01.GPJ

<b>SAMPLE SYMBOLS</b>	 ... SAMPLING UNSUCCESSFUL	 ... STANDARD PENETRATION TEST	 ... DRIVE SAMPLE (UNDISTURBED)
	 ... DISTURBED OR BAG SAMPLE	 ... CHUNK SAMPLE	 ... WATER TABLE OR  ... SEEPAGE

NOTE: THE LOG OF SUBSURFACE CONDITIONS SHOWN HEREON APPLIES ONLY AT THE SPECIFIC BORING OR TRENCH LOCATION AND AT THE DATE INDICATED. IT IS NOT WARRANTED TO BE REPRESENTATIVE OF SUBSURFACE CONDITIONS AT OTHER LOCATIONS AND TIMES.

DEPTH IN FEET	SAMPLE NO.	LITHOLOGY	GROUNDWATER	SOIL CLASS (USCS)	TEST PIT TP 1		PENETRATION RESISTANCE (BLOWS/FT.)	DRY DENSITY (P.C.F.)	MOISTURE CONTENT (%)
					ELEV. (MSL.) <u>+/-150'</u>	DATE COMPLETED <u>08-05-2021</u>			
					EQUIPMENT <u>CAT 430L BACKHOE</u>		BY: <u>R. ADAMS</u>		
MATERIAL DESCRIPTION									
0				SC	<b>SLOPEWASH</b> Loose, dry, brown, Clayey, fine to coarse SAND with subrounded gravel and cobble				
2				CL	<b>OTAY FORMATION (T<sub>o</sub>)</b> Hard, dry, reddish brown, bentonitic CLAYSTONE; dessicated and fractured with blocky texture, some caliche; Bedding: <2° dip/sub-horizontal				
4									
6									
					TRENCH TERMINATED AT 7 FEET Groundwater not encountered Backfilled on 08-05-2021				

**Figure A-6,**  
**Log of Test Pit TP 1, Page 1 of 1**

G2755-42-01.GPJ





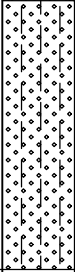

SAMPLE SYMBOLS	... SAMPLING UNSUCCESSFUL	... STANDARD PENETRATION TEST	... DRIVE SAMPLE (UNDISTURBED)
	... DISTURBED OR BAG SAMPLE	... CHUNK SAMPLE	... WATER TABLE OR  ... SEEPAGE

NOTE: THE LOG OF SUBSURFACE CONDITIONS SHOWN HEREON APPLIES ONLY AT THE SPECIFIC BORING OR TRENCH LOCATION AND AT THE DATE INDICATED. IT IS NOT WARRANTED TO BE REPRESENTATIVE OF SUBSURFACE CONDITIONS AT OTHER LOCATIONS AND TIMES.

DEPTH IN FEET	SAMPLE NO.	LITHOLOGY	GROUNDWATER	SOIL CLASS (USCS)	TEST PIT TP 2		PENETRATION RESISTANCE (BLOWS/FT.)	DRY DENSITY (P.C.F.)	MOISTURE CONTENT (%)
					ELEV. (MSL.) <u>+/-145'</u>	DATE COMPLETED <u>08-05-2021</u>			
					EQUIPMENT <u>CAT 430L BACKHOE</u>		BY: <u>R. ADAMS</u>		
MATERIAL DESCRIPTION									
0				SC	<b>SLOPEWASH</b> Loose, dry, light brown, Clayey, fine to coarse SAND with gravel				
2				SM	<b>OTAY FORMATION (To)</b> Dense, dry to damp, pinkish brown, Silty, fine to coarse SANDSTONE; massive				
4									
					TRENCH TERMINATED AT 5 FEET Groundwater not encountered Backfilled on 08-05-2021				

**Figure A-7,**  
**Log of Test Pit TP 2, Page 1 of 1**

G2755-42-01.GPJ

SAMPLE SYMBOLS		... SAMPLING UNSUCCESSFUL		... STANDARD PENETRATION TEST		... DRIVE SAMPLE (UNDISTURBED)
		... DISTURBED OR BAG SAMPLE		... CHUNK SAMPLE		... WATER TABLE OR  ... SEEPAGE

NOTE: THE LOG OF SUBSURFACE CONDITIONS SHOWN HEREON APPLIES ONLY AT THE SPECIFIC BORING OR TRENCH LOCATION AND AT THE DATE INDICATED. IT IS NOT WARRANTED TO BE REPRESENTATIVE OF SUBSURFACE CONDITIONS AT OTHER LOCATIONS AND TIMES.



DEPTH IN FEET	SAMPLE NO.	LITHOLOGY	GROUNDWATER	SOIL CLASS (USCS)	<b>TEST PIT TP 3</b>			PENETRATION RESISTANCE (BLOWS/FT.)	DRY DENSITY (P.C.F.)	MOISTURE CONTENT (%)
					ELEV. (MSL.) <u>+/-145'</u>	DATE COMPLETED <u>08-05-2021</u>	EQUIPMENT <u>CAT 430L BACKHOE</u> BY: <u>R. ADAMS</u>			
MATERIAL DESCRIPTION										
0				SC	<b>SLOPEWASH</b> Loose, dry, brown, Clayey, fine to coarse SAND with subrounded gravel and cobble					
2				CL	<b>OTAY FORMATION (To)</b> Hard, dry, dark reddish brown, bentonitic CLAYSTONE; dessicated and fractured with blocky texture, abundant caliche					
4				SM	Dense, dry to damp, pinkish brown, Silty, fine to coarse SANDSTONE; massive					
TRENCH TERMINATED AT 5 FEET Groundwater not encountered Backfilled on 08-05-2021										

**Figure A-8,**  
**Log of Test Pit TP 3, Page 1 of 1**

G2755-42-01.GPJ





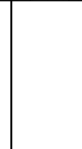

SAMPLE SYMBOLS		... SAMPLING UNSUCCESSFUL		... STANDARD PENETRATION TEST		... DRIVE SAMPLE (UNDISTURBED)
		... DISTURBED OR BAG SAMPLE		... CHUNK SAMPLE		... WATER TABLE OR ... SEEPAGE

NOTE: THE LOG OF SUBSURFACE CONDITIONS SHOWN HEREON APPLIES ONLY AT THE SPECIFIC BORING OR TRENCH LOCATION AND AT THE DATE INDICATED. IT IS NOT WARRANTED TO BE REPRESENTATIVE OF SUBSURFACE CONDITIONS AT OTHER LOCATIONS AND TIMES.

DEPTH IN FEET	SAMPLE NO.	LITHOLOGY	GROUNDWATER	SOIL CLASS (USCS)	TEST PIT TP 4		PENETRATION RESISTANCE (BLOWS/FT.)	DRY DENSITY (P.C.F.)	MOISTURE CONTENT (%)
					ELEV. (MSL.) <u>+/-145'</u>	DATE COMPLETED <u>08-05-2021</u>			
					EQUIPMENT <u>CAT 430L BACKHOE</u>		BY: <u>R. ADAMS</u>		
MATERIAL DESCRIPTION									
0				SC	<b>SLOPEWASH</b>				
				CL	Loose, dry, brown, Clayey, fine to coarse SAND with subrounded gravel and cobble				
2					<b>OTAY FORMATION (To)</b>				
					Hard, dry, dark reddish brown, bentonitic CLAYSTONE				
4					-----				
				SM	Dense, dry, pale yellowish brown, Silty, medium grained SANDSTONE				
6					TRENCH TERMINATED AT 6 FEET Groundwater not encountered Backfilled on 08-05-2021				

**Figure A-9,**  
**Log of Test Pit TP 4, Page 1 of 1**

G2755-42-01.GPJ

SAMPLE SYMBOLS	 ... SAMPLING UNSUCCESSFUL	 ... STANDARD PENETRATION TEST	 ... DRIVE SAMPLE (UNDISTURBED)
	 ... DISTURBED OR BAG SAMPLE	 ... CHUNK SAMPLE	 ... WATER TABLE OR  ... SEEPAGE

NOTE: THE LOG OF SUBSURFACE CONDITIONS SHOWN HEREON APPLIES ONLY AT THE SPECIFIC BORING OR TRENCH LOCATION AND AT THE DATE INDICATED. IT IS NOT WARRANTED TO BE REPRESENTATIVE OF SUBSURFACE CONDITIONS AT OTHER LOCATIONS AND TIMES.

DEPTH IN FEET	SAMPLE NO.	LITHOLOGY	GROUNDWATER	SOIL CLASS (USCS)	<b>TEST PIT TP 5</b> ELEV. (MSL.) <u>+/-145'</u> DATE COMPLETED <u>08-05-2021</u> EQUIPMENT <u>CAT 430L BACKHOE</u> BY: <u>R. ADAMS</u>	PENETRATION RESISTANCE (BLOWS/FT.)	DRY DENSITY (P.C.F.)	MOISTURE CONTENT (%)
MATERIAL DESCRIPTION								
0      2      4      6				SM	<b>OTAY FORMATION (To)</b> Dense, dry, pale whitish brown, Silty, fine to coarse SANDSTONE; fractured, some caliche			
TRENCH TERMINATED AT 7 FEET Groundwater not encountered Backfilled on 08-05-2021								

**Figure A-10,**  
**Log of Test Pit TP 5, Page 1 of 1**

G2755-42-01.GPJ

SAMPLE SYMBOLS ... SAMPLING UNSUCCESSFUL ... DISTURBED OR BAG SAMPLE	... STANDARD PENETRATION TEST ... CHUNK SAMPLE	... DRIVE SAMPLE (UNDISTURBED) ... WATER TABLE OR  ... SEEPAGE
--	---	---







NOTE: THE LOG OF SUBSURFACE CONDITIONS SHOWN HEREON APPLIES ONLY AT THE SPECIFIC BORING OR TRENCH LOCATION AND AT THE DATE INDICATED. IT IS NOT WARRANTED TO BE REPRESENTATIVE OF SUBSURFACE CONDITIONS AT OTHER LOCATIONS AND TIMES.



DEPTH IN FEET	SAMPLE NO.	LITHOLOGY	GROUNDWATER	SOIL CLASS (USCS)	TEST PIT TP 6		PENETRATION RESISTANCE (BLOWS/FT.)	DRY DENSITY (P.C.F.)	MOISTURE CONTENT (%)
					ELEV. (MSL.) <u>+/-140'</u>	DATE COMPLETED <u>08-05-2021</u>			
					EQUIPMENT <u>CAT 430L BACKHOE</u> BY: <u>R. ADAMS</u>				
MATERIAL DESCRIPTION									
0				SM	<b>OTAY FORMATION (To)</b> Dense, dry to damp, pale whitish yellow to pinkish white, Silty, fine to coarse SANDSTONE; fractured, trace caliche				
2									
4									
6					TRENCH TERMINATED AT 6 FEET Groundwater not encountered Backfilled on 08-05-2021				

**Figure A-11,**  
**Log of Test Pit TP 6, Page 1 of 1**

G2755-42-01.GPJ

SAMPLE SYMBOLS	 ... SAMPLING UNSUCCESSFUL	 ... STANDARD PENETRATION TEST	 ... DRIVE SAMPLE (UNDISTURBED)
	 ... DISTURBED OR BAG SAMPLE	 ... CHUNK SAMPLE	 ... WATER TABLE OR  ... SEEPAGE

NOTE: THE LOG OF SUBSURFACE CONDITIONS SHOWN HEREON APPLIES ONLY AT THE SPECIFIC BORING OR TRENCH LOCATION AND AT THE DATE INDICATED. IT IS NOT WARRANTED TO BE REPRESENTATIVE OF SUBSURFACE CONDITIONS AT OTHER LOCATIONS AND TIMES.

DEPTH IN FEET	SAMPLE NO.	LITHOLOGY	GROUNDWATER	SOIL CLASS (USCS)	TEST PIT TP 7		PENETRATION RESISTANCE (BLOWS/FT.)	DRY DENSITY (P.C.F.)	MOISTURE CONTENT (%)
					ELEV. (MSL.) <u>+/-150'</u>	DATE COMPLETED <u>08-05-2021</u>			
					EQUIPMENT <u>CAT 430L BACKHOE</u>		BY: <u>R. ADAMS</u>		
MATERIAL DESCRIPTION									
0				SC	<b>SLOPEWASH</b> Loose, dry, brown, Clayey, fine to coarse SAND with subrounded gravel and cobble				
2				CL	<b>OTAY FORMATION (To)</b> Hard, dry to damp, dark reddish brown, bentonitic CLAYSTONE; friable, weathered				
4									
6									
8									
10				SM	Dense, dry to damp, pale yellowish brown, Silty, fine to coarse SANDSTONE; massive				
					TRENCH TERMINATED AT 11 FEET Groundwater not encountered Backfilled on 08-05-2021				

**Figure A-12,**  
**Log of Test Pit TP 7, Page 1 of 1**

G2755-42-01.GPJ







SAMPLE SYMBOLS		... SAMPLING UNSUCCESSFUL		... STANDARD PENETRATION TEST		... DRIVE SAMPLE (UNDISTURBED)
		... DISTURBED OR BAG SAMPLE		... CHUNK SAMPLE		... WATER TABLE OR ... SEEPAGE

NOTE: THE LOG OF SUBSURFACE CONDITIONS SHOWN HEREON APPLIES ONLY AT THE SPECIFIC BORING OR TRENCH LOCATION AND AT THE DATE INDICATED. IT IS NOT WARRANTED TO BE REPRESENTATIVE OF SUBSURFACE CONDITIONS AT OTHER LOCATIONS AND TIMES.

DEPTH IN FEET	SAMPLE NO.	LITHOLOGY	GROUNDWATER	SOIL CLASS (USCS)	TEST PIT TP 8		PENETRATION RESISTANCE (BLOWS/FT.)	DRY DENSITY (P.C.F.)	MOISTURE CONTENT (%)
					ELEV. (MSL.) <u>+/-145'</u>	DATE COMPLETED <u>08-05-2021</u>			
					EQUIPMENT <u>CAT 430L BACKHOE</u>		BY: <u>R. ADAMS</u>		
MATERIAL DESCRIPTION									
0				CL	<b>OTAY FORMATION (To)</b> Hard, dry, dark reddish brown, bentonitic CLAYSTONE; friable, some caliche				
2									
4									
6					TRENCH TERMINATED AT 6 FEET Groundwater not encountered Backfilled on 08-05-2021				

**Figure A-13,**  
**Log of Test Pit TP 8, Page 1 of 1**

G2755-42-01.GPJ

SAMPLE SYMBOLS	 ... SAMPLING UNSUCCESSFUL	 ... STANDARD PENETRATION TEST	 ... DRIVE SAMPLE (UNDISTURBED)
	 ... DISTURBED OR BAG SAMPLE	 ... CHUNK SAMPLE	 ... WATER TABLE OR  ... SEEPAGE

NOTE: THE LOG OF SUBSURFACE CONDITIONS SHOWN HEREON APPLIES ONLY AT THE SPECIFIC BORING OR TRENCH LOCATION AND AT THE DATE INDICATED. IT IS NOT WARRANTED TO BE REPRESENTATIVE OF SUBSURFACE CONDITIONS AT OTHER LOCATIONS AND TIMES.

APPENDIX

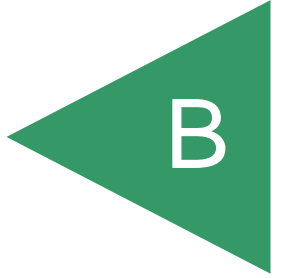

## APPENDIX B

### LABORATORY TESTING

Laboratory tests were performed in accordance with generally accepted test methods of the American Society for Testing and Materials (ASTM) or other suggested procedures. Selected samples were tested for in-situ dry density and moisture content, maximum dry density and optimum moisture content, expansion potential, gradation, Atterberg limits, soluble sulfate content, chloride content, pH and resistivity, and shear strength. The results of these tests are summarized on the following tables and figures.

#### SUMMARY OF LABORATORY MAXIMUM DRY DENSITY AND OPTIMUM MOISTURE CONTENT TEST RESULTS ASTM D 1557-02

Sample No.	Description	Maximum Dry Density (pcf)	Optimum Moisture Content (% dry wt.)
LB3-1	Brown clayey fine to coarse SAND; some gravel (SC)	127.2	10.4
LB4-1	Brown fine to coarse sandy GRAVEL; little silt (GW)	135.8	7.0

#### SUMMARY OF LABORATORY EXPANSION INDEX TEST RESULTS ASTM D 4829-03

Sample No.	Moisture Content		Dry Density (pcf)	Expansion Index
	Before Test (%)	After Test (%)		
LB2-3	14.8	33.6	91.8	55
LB4-1	7.7	14.1	117.8	1

#### SUMMARY OF LABORATORY WATER-SOLUBLE SULFATE TEST RESULTS CALIFORNIA TEST NO. 417

Sample No.	Water-Soluble Sulfate (%)	Sulfate Exposure
LB4-1	0.028	S0

**SUMMARY OF LABORATORY WATER-SOLUBLE CHLORIDE ION CONTENT TEST RESULTS  
AASHTO TEST NO. T 291**

Sample No.	Chloride Ion Content ppm (%)
LB4-1	937 (0.094)

**SUMMARY OF LABORATORY POTENTIAL OF HYDROGEN (PH) AND  
RESISTIVITY TEST RESULTS  
CALIFORNIA TEST METHOD 643**

Sample No.	Geologic Unit	pH	Minimum Resistivity (ohm-centimeters)
LB4-1	Qt	7.56	460

**SUMMARY OF LABORATORY ATTERBERG LIMITS TEST RESULTS  
ASTM D 4318**

Sample No.	Liquid Limit (%)	Plastic Limit (%)	Plasticity Index
LB2-3	57	26	31
LB3-1	50	18	32
LB4-1	30	19	11
LB5-1	56	24	32

SAMPLE NO.: **LBI-3** GEOLOGIC UNIT: **Qt**  
 SAMPLE DEPTH (FT): **20'** NATURAL/REMOLDED: **N**

INITIAL CONDITIONS				
NORMAL STRESS TEST LOAD	1 K	2 K	4 K	AVERAGE
ACTUAL NORMAL STRESS (PSF):	1000	2000	4000	--
WATER CONTENT (%):	11.6	10.5	9.1	10.4
DRY DENSITY (PCF):	114.6	107.2	109.0	110.3

AFTER TEST CONDITIONS				
NORMAL STRESS TEST LOAD	1 K	2 K	4 K	AVERAGE
WATER CONTENT (%):	16.8	19.5	17.7	18.0
PEAK SHEAR STRESS (PSF):	1466	1765	3111	--
ULT.-E.O.T. SHEAR STRESS (PSF):	1030	1759	3111	--

RESULTS		
<b>PEAK</b>	COHESION, C (PSF)	790
	FRICTION ANGLE (DEGREES)	30
<b>ULTIMATE</b>	COHESION, C (PSF)	350
	FRICTION ANGLE (DEGREES)	35

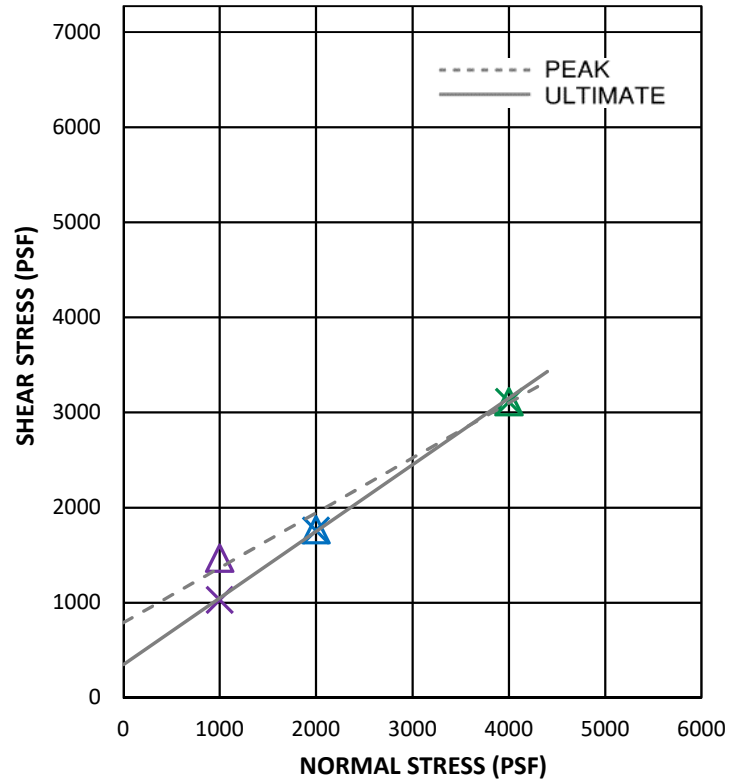
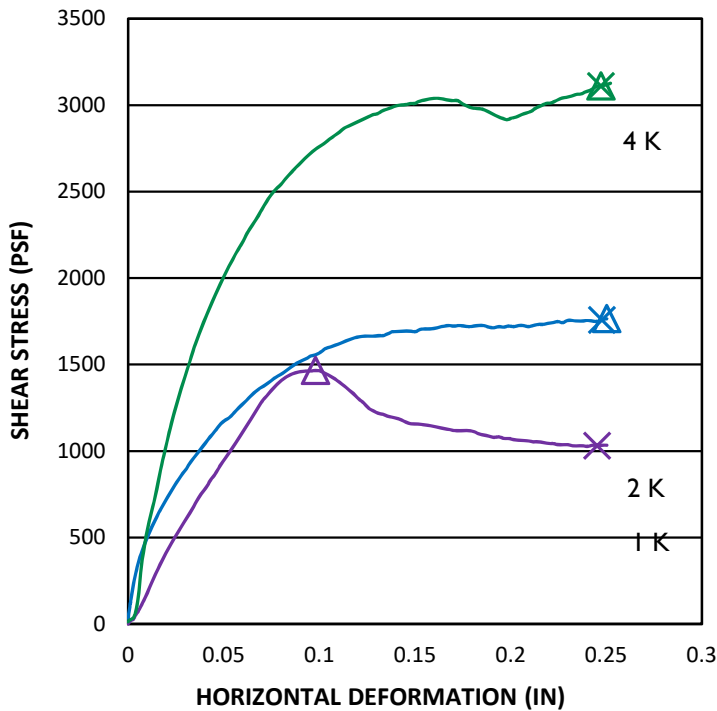

— 1 K      — 2 K      — 4 K  
 ▲ 1 K PEAK    ▲ 2 K PEAK    ▲ 4 K PEAK  
 × 1 K ULTIMATE    × 2 K ULTIMATE    × 4 K ULTIMATE

**DIRECT SHEAR - ASTM D 3080**

**GEOCON**  
INCORPORATED



GEOTECHNICAL CONSULTANTS  
 6960 FLANDERS DRIVE - SAN DIEGO, CALIFORNIA 92121-2974  
 PHONE 858 558-6900 - FAX 858 558-6159

**NIRVANA**

**PROJECT NO.: G2755-42-01**

SAMPLE NO.: LB3-1 GEOLOGIC UNIT: Qt  
 SAMPLE DEPTH (FT): 3' NATURAL/REMOVED: R

INITIAL CONDITIONS				
NORMAL STRESS TEST LOAD	1 K	2 K	4 K	AVERAGE
ACTUAL NORMAL STRESS (PSF):	890	2030	4300	--
WATER CONTENT (%):	10.8	11.2	10.5	10.8
DRY DENSITY (PCF):	114.1	114.1	114.6	114.3

AFTER TEST CONDITIONS				
NORMAL STRESS TEST LOAD	1 K	2 K	4 K	AVERAGE
WATER CONTENT (%):	20.3	20.9	21.3	20.8
PEAK SHEAR STRESS (PSF):	867	1320	2140	--
ULT.-E.O.T. SHEAR STRESS (PSF):	858	1320	2131	--

RESULTS		
PEAK	COHESION, C (PSF)	550
	FRICTION ANGLE (DEGREES)	20
ULTIMATE	COHESION, C (PSF)	540
	FRICTION ANGLE (DEGREES)	20

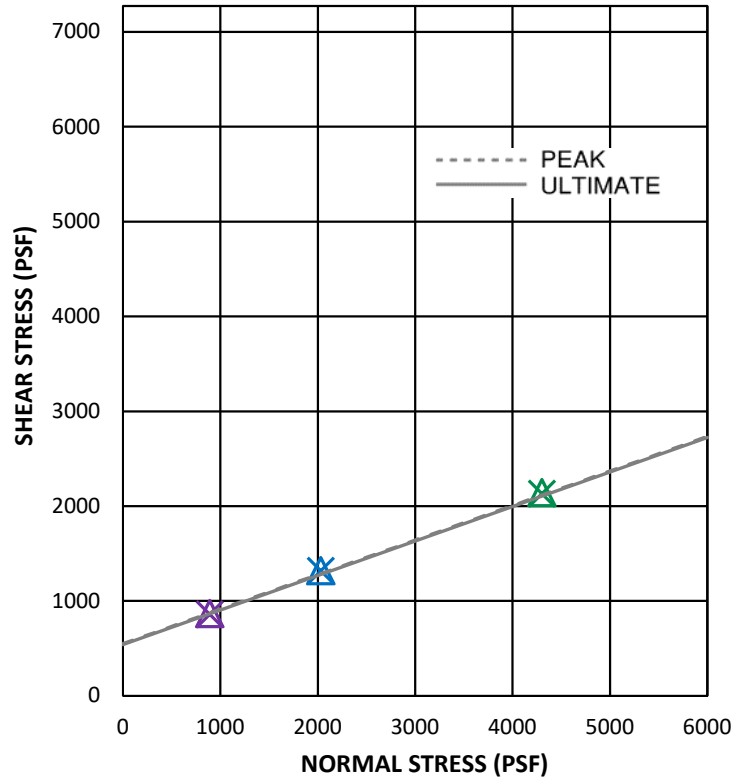
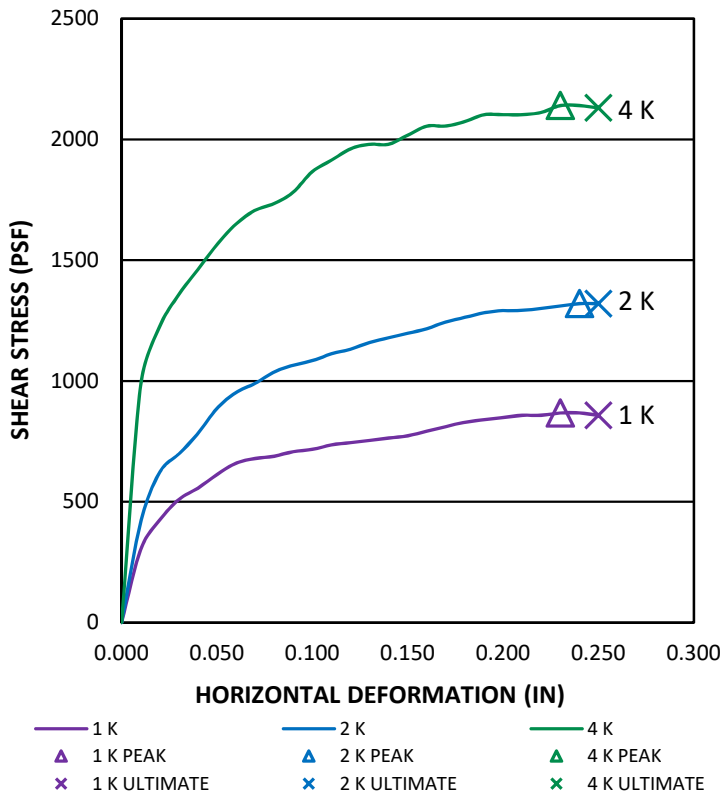

**DIRECT SHEAR - ASTM D 3080**

**GEOCON**  
 INCORPORATED



GEOTECHNICAL CONSULTANTS  
 6960 FLANDERS DRIVE - SAN DIEGO, CALIFORNIA 92121-2974  
 PHONE 858 558-6900 - FAX 858 558-6159

**NIRVANA**

**PROJECT NO.: G2755-42-01**



SAMPLE NO.: LB4-1 GEOLOGIC UNIT: Qt  
 SAMPLE DEPTH (FT): 9' NATURAL/REMOVED: R

INITIAL CONDITIONS				
NORMAL STRESS TEST LOAD	1 K	2 K	4 K	AVERAGE
ACTUAL NORMAL STRESS (PSF):	890	2030	4300	--
WATER CONTENT (%):	6.2	6.5	6.2	6.3
DRY DENSITY (PCF):	122.9	123.4	123.5	123.3

AFTER TEST CONDITIONS				
NORMAL STRESS TEST LOAD	1 K	2 K	4 K	AVERAGE
WATER CONTENT (%):	11.5	12.1	12.6	12.1
PEAK SHEAR STRESS (PSF):	1112	2036	3394	--
ULT.-E.O.T. SHEAR STRESS (PSF):	1009	1763	3111	--

RESULTS		
<b>PEAK</b>	COHESION, C (PSF)	590
	FRICTION ANGLE (DEGREES)	33
<b>ULTIMATE</b>	COHESION, C (PSF)	480
	FRICTION ANGLE (DEGREES)	32

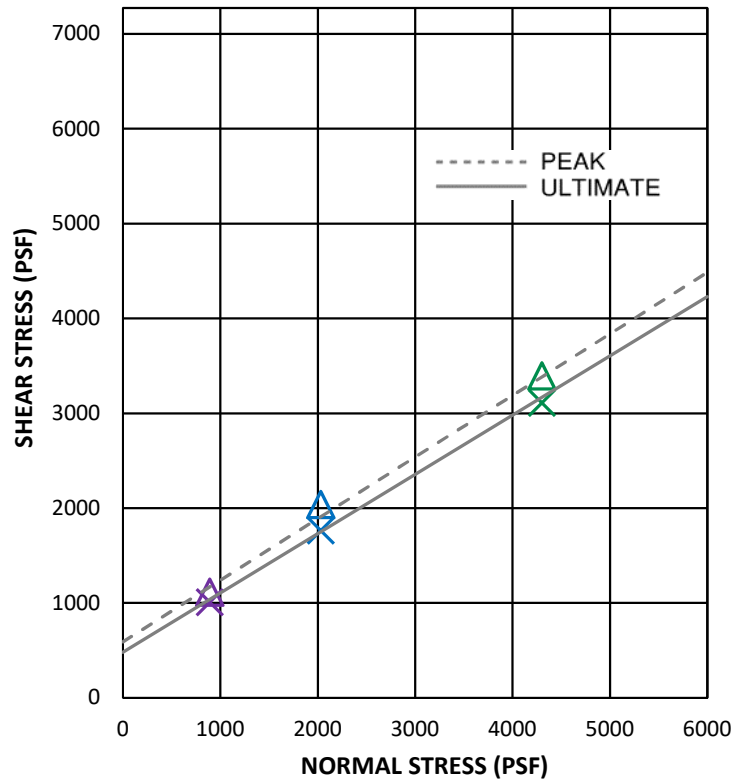
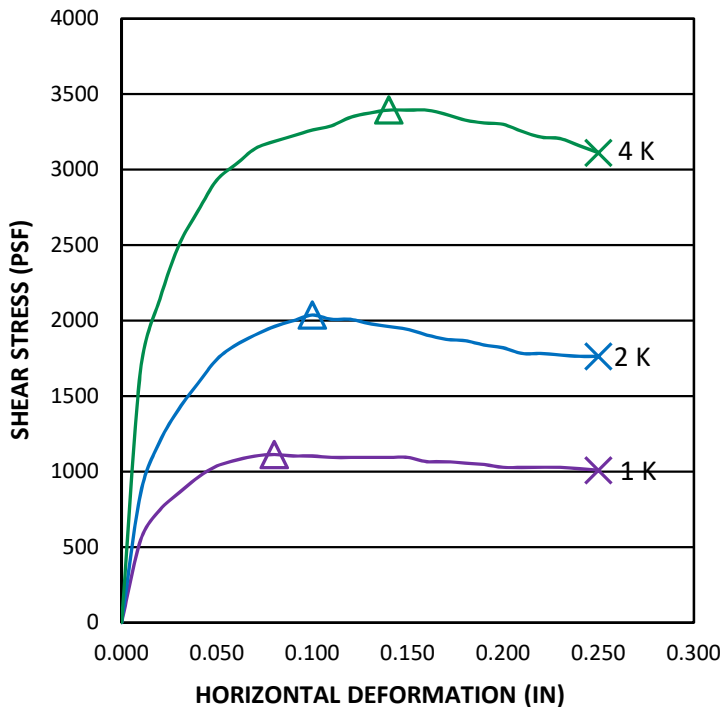

**DIRECT SHEAR - ASTM D 3080**

**GEOCON**  
INCORPORATED



GEOTECHNICAL CONSULTANTS  
 6960 FLANDERS DRIVE - SAN DIEGO, CALIFORNIA 92121-2974  
 PHONE 858 558-6900 - FAX 858 558-6159

**NIRVANA**

**PROJECT NO.: G2755-42-01**

SAMPLE NO.: **LB4-2** GEOLOGIC UNIT: **To**  
 SAMPLE DEPTH (FT): **30.5'** NATURAL/REMOLDED: **N**

INITIAL CONDITIONS				
NORMAL STRESS TEST LOAD	4 K	1 K	2 K	AVERAGE
ACTUAL NORMAL STRESS (PSF):	4000	1000	2000	--
WATER CONTENT (%):	21.0	20.0	21.0	20.7
DRY DENSITY (PCF):	109.8	108.4	104.7	107.7

AFTER TEST CONDITIONS				
NORMAL STRESS TEST LOAD	4 K	1 K	2 K	AVERAGE
WATER CONTENT (%):	24.5	23.5	25.1	24.4
PEAK SHEAR STRESS (PSF):	3592	1498	1937	--
ULT.-E.O.T. SHEAR STRESS (PSF):	2292	764	1573	--

RESULTS		
<b>PEAK</b>	COHESION, C (PSF)	670
	FRICTION ANGLE (DEGREES)	36
<b>ULTIMATE</b>	COHESION, C (PSF)	200
	FRICTION ANGLE (DEGREES)	30

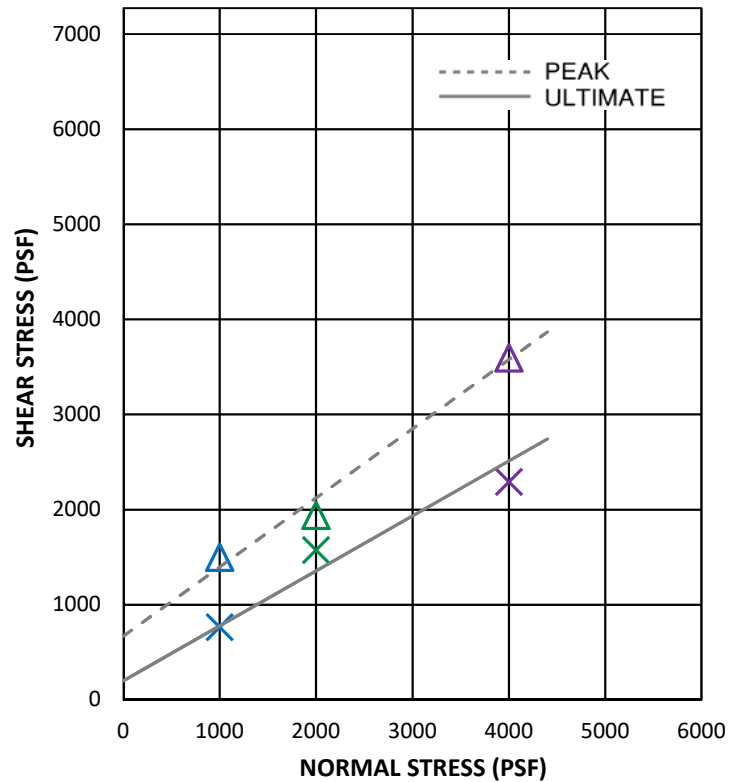
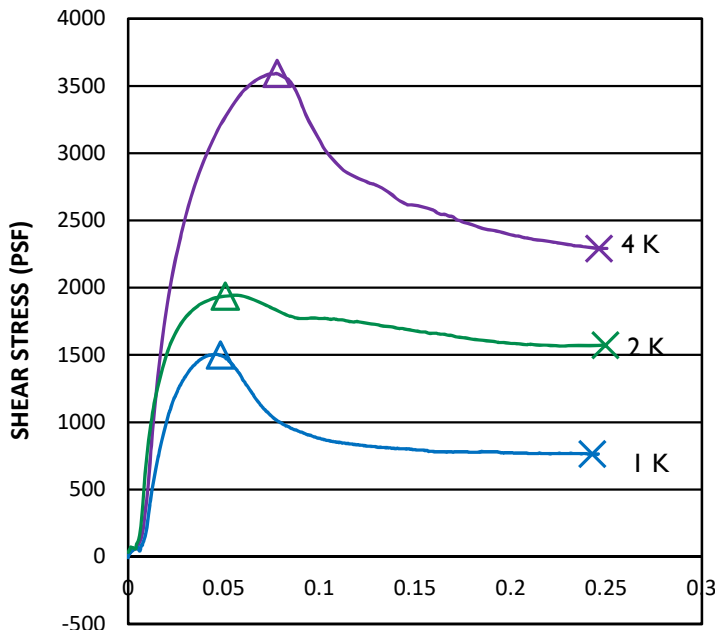

**HORIZONTAL DEFORMATION (IN)**

— 4 K      — 1 K      — 2 K  
 ▲ 4 K PEAK    ▲ 1 K PEAK    ▲ 2 K PEAK  
 × 4 K ULTIMATE    × 1 K ULTIMATE    × 2 K ULTIMATE

**DIRECT SHEAR - ASTM D 3080**

**GEOCON**  
INCORPORATED



GEOTECHNICAL CONSULTANTS  
 6960 FLANDERS DRIVE - SAN DIEGO, CALIFORNIA 92121-2974  
 PHONE 858 558-6900 - FAX 858 558-6159

**NIRVANA**

**PROJECT NO.: G2755-42-01**

SAMPLE NO.: **LB5-3** GEOLOGIC UNIT: **To**  
 SAMPLE DEPTH (FT): **50'** NATURAL/REMOVED: **N**

INITIAL CONDITIONS				
NORMAL STRESS TEST LOAD	1 K	2 K	4 K	AVERAGE
ACTUAL NORMAL STRESS (PSF):	1000	2000	4000	--
WATER CONTENT (%):	14.0	13.8	13.5	13.8
DRY DENSITY (PCF):	119.4	121.1	120.4	120.3

AFTER TEST CONDITIONS				
NORMAL STRESS TEST LOAD	1 K	2 K	4 K	AVERAGE
WATER CONTENT (%):	19.8	19.6	19.3	19.6
PEAK SHEAR STRESS (PSF):	1284	1895	3400	--
ULT.-E.O.T. SHEAR STRESS (PSF):	1024	1615	3068	--

RESULTS		
<b>PEAK</b>	COHESION, C (PSF)	530
	FRICTION ANGLE (DEGREES)	35
<b>ULTIMATE</b>	COHESION, C (PSF)	300
	FRICTION ANGLE (DEGREES)	34

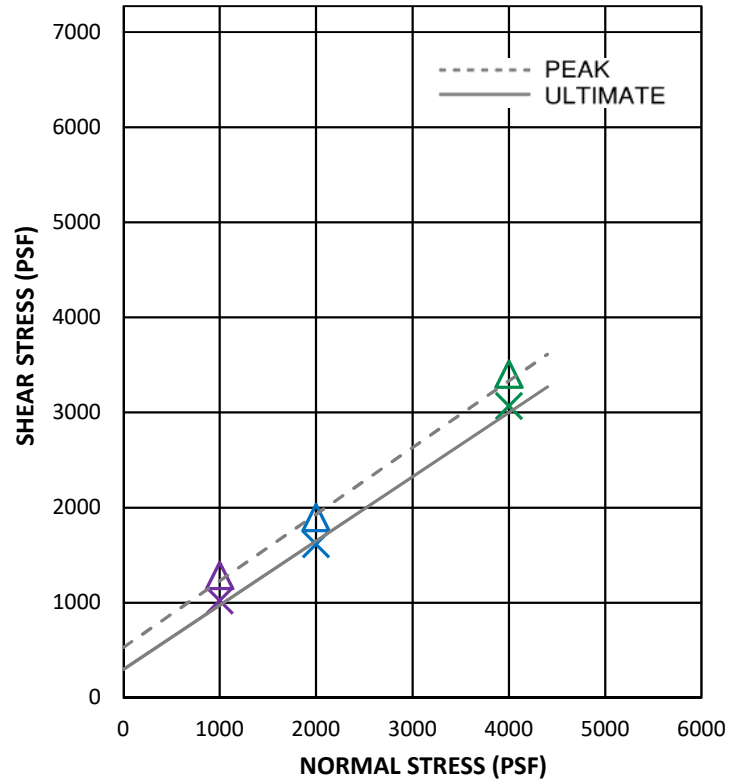
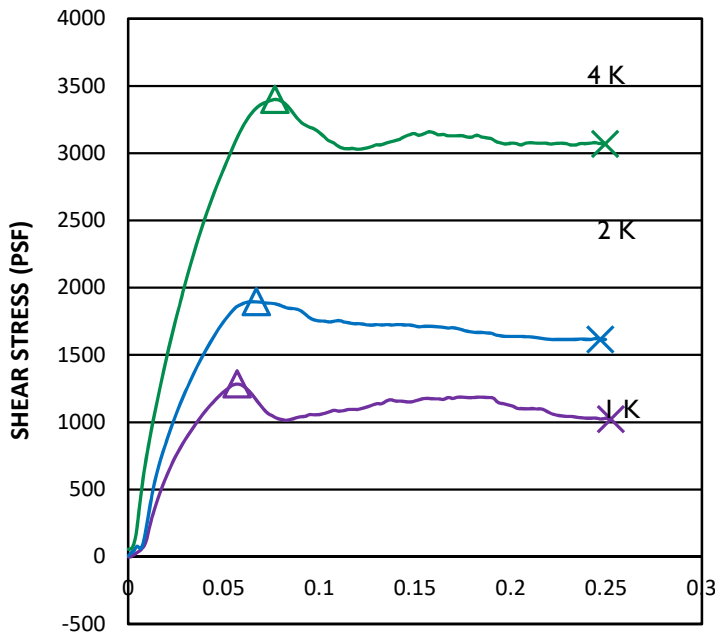

**HORIZONTAL DEFORMATION (IN)**

— 1 K                      — 2 K                      — 4 K  
 ▲ 1 K PEAK              ▲ 2 K PEAK              ▲ 4 K PEAK  
 × 1 K ULTIMATE        × 2 K ULTIMATE        × 4 K ULTIMATE

**DIRECT SHEAR - ASTM D 3080**

**GEOCON**  
INCORPORATED



GEOTECHNICAL CONSULTANTS  
 6960 FLANDERS DRIVE - SAN DIEGO, CALIFORNIA 92121-2974  
 PHONE 858 558-6900 - FAX 858 558-6159

**NIRVANA**

**PROJECT NO.: G2755-42-01**

SAMPLE NO.: **LB5-5** GEOLOGIC UNIT: **To**  
 SAMPLE DEPTH (FT): **65'** NATURAL/REMOLDED: **N**

INITIAL CONDITIONS				
NORMAL STRESS TEST LOAD	1 K	2 K	4 K	AVERAGE
ACTUAL NORMAL STRESS (PSF):	1000	2000	4000	--
WATER CONTENT (%):	17.3	18.0	17.5	17.6
DRY DENSITY (PCF):	112.1	113.3	112.4	112.6

AFTER TEST CONDITIONS				
NORMAL STRESS TEST LOAD	1 K	2 K	4 K	AVERAGE
WATER CONTENT (%):	23.0	23.5	23.1	23.2
PEAK SHEAR STRESS (PSF):	744	1905	2857	--
ULT.-E.O.T. SHEAR STRESS (PSF):	741	1329	2766	--

RESULTS		
<b>PEAK</b>	COHESION, C (PSF)	270
	FRICTION ANGLE (DEGREES)	34
<b>ULTIMATE</b>	COHESION, C (PSF)	22
	FRICTION ANGLE (DEGREES)	34

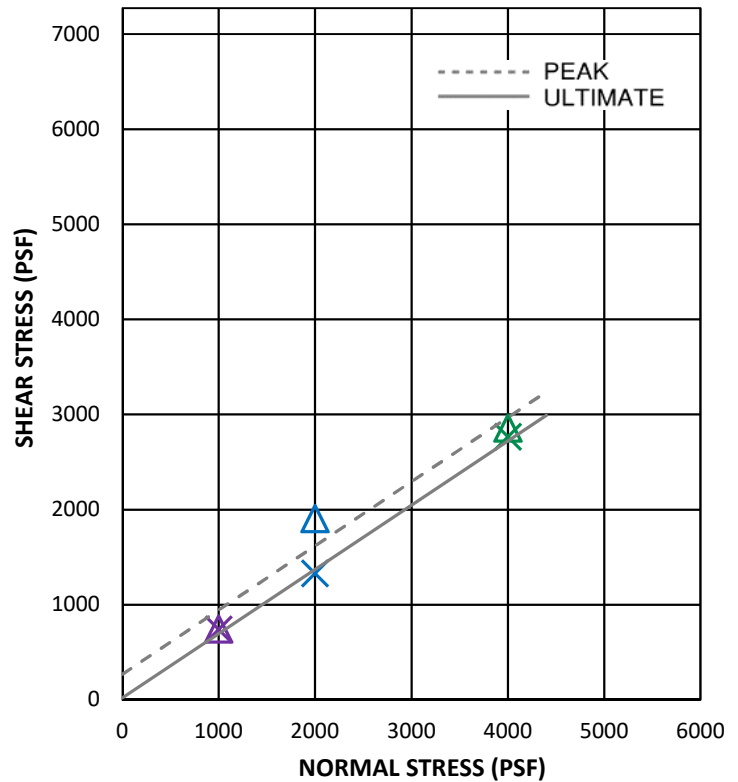
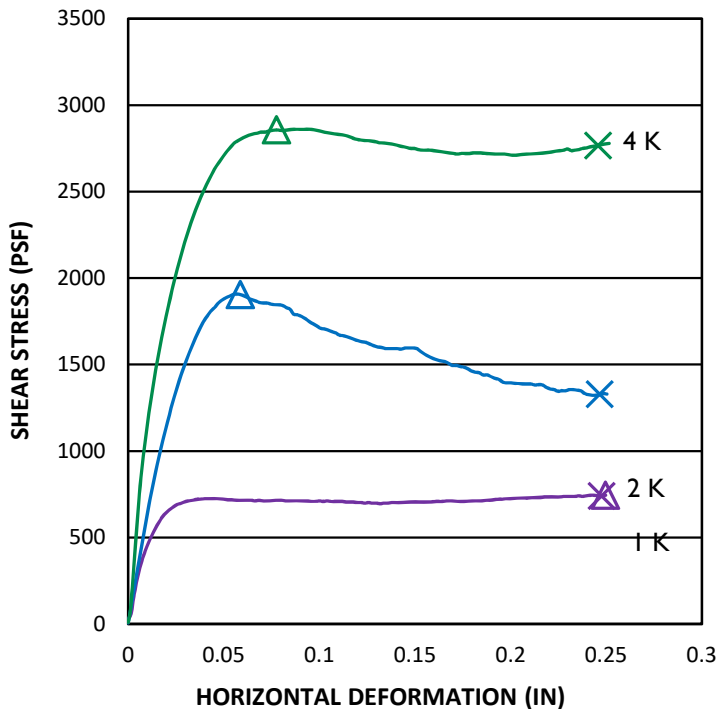

**DIRECT SHEAR - ASTM D 3080**

**GEOCON**  
 INCORPORATED



GEOTECHNICAL CONSULTANTS  
 6960 FLANDERS DRIVE - SAN DIEGO, CALIFORNIA 92121-2974  
 PHONE 858 558-6900 - FAX 858 558-6159

**NIRVANA**

**PROJECT NO.: G2755-42-01**

SAMPLE NO.: **LB2-3**  
 SAMPLE DEPTH (FT.): **46'**

GEOLOGIC UNIT: **To**

GRAVEL		SAND			SILT OR CLAY
COARSE	FINE	COARSE	MEDIUM	FINE	

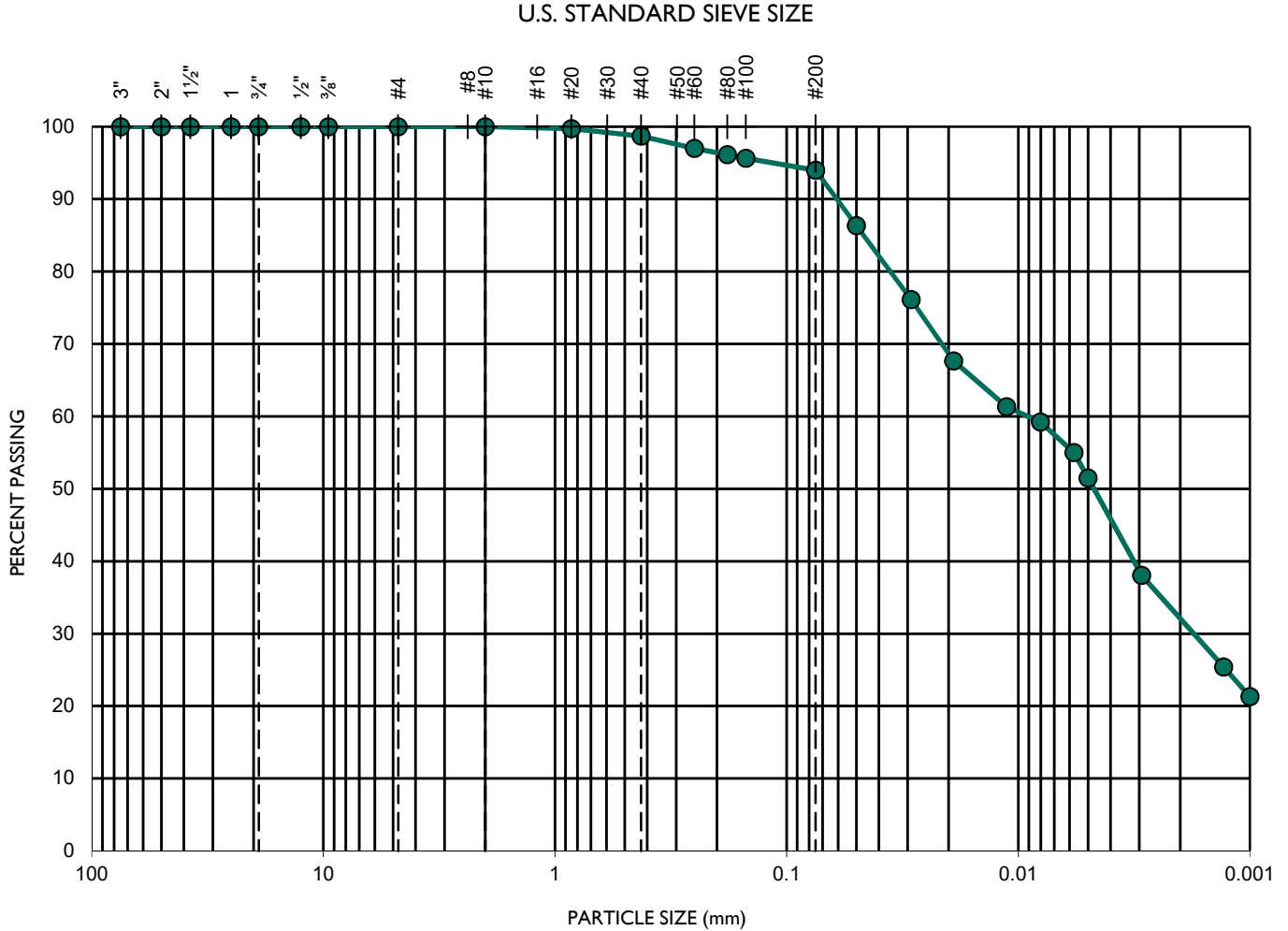

TEST DATA					
D <sub>10</sub> (mm)	D <sub>30</sub> (mm)	D <sub>60</sub> (mm)	C <sub>c</sub>	C <sub>u</sub>	SOIL DESCRIPTION
0.00017	0.00189	0.00921	2.3	53.7	CLAY

**GEOCON**  
INCORPORATED



GEOTECHNICAL CONSULTANTS  
 6960 FLANDERS DRIVE - SAN DIEGO, CALIFORNIA 92121 - 2974  
 PHONE 858 558-6900 - FAX 858 558-6159

**SIEVE ANALYSES - ASTM D 135 & D 422**

**NIRVANA**

**PROJECT NO.: G2755-42-01**

SAMPLE NO.: **LB3-I**  
 SAMPLE DEPTH (FT.): **3**

GEOLOGIC UNIT: **Qt**

<b>GRAVEL</b>		<b>SAND</b>			<b>SILT OR CLAY</b>
COARSE	FINE	COARSE	MEDIUM	FINE	

U.S. STANDARD SIEVE SIZE

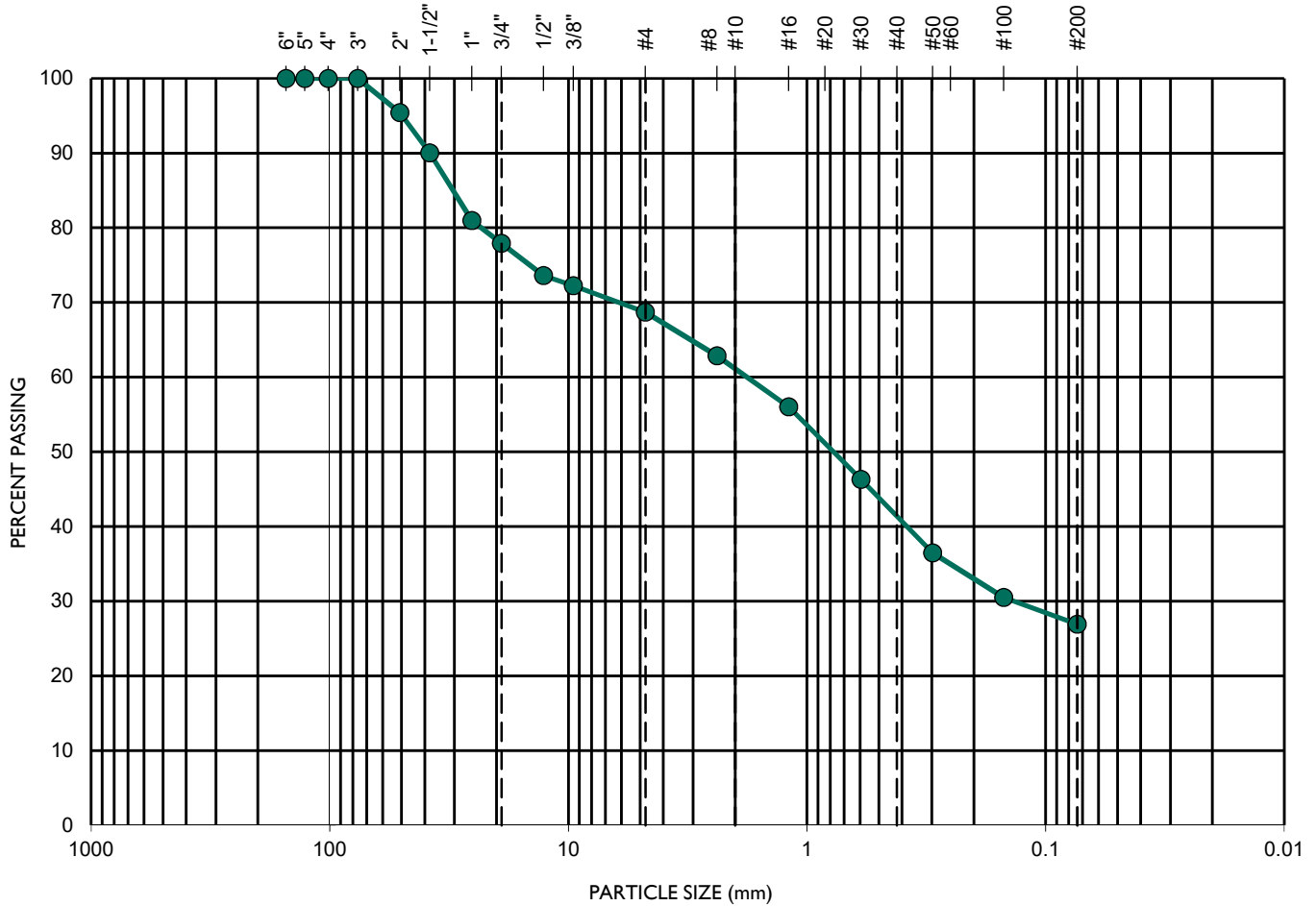

TEST DATA					SOIL DESCRIPTION
D <sub>10</sub> (mm)	D <sub>30</sub> (mm)	D <sub>60</sub> (mm)	C <sub>c</sub>	C <sub>u</sub>	
0.027	0.139	1.882	0.4	68.6	SC - Clayey SAND with gravel

**GEOCON**  
INCORPORATED



GEOTECHNICAL CONSULTANTS  
 6960 FLANDERS DRIVE - SAN DIEGO, CALIFORNIA 92121 - 2974  
 PHONE 858 558-6900 - FAX 858 558-6159

**SIEVE ANALYSES - ASTM D 135**

**NIRVANA**

**PROJECT NO.: G2755-42-01**

SAMPLE NO.: **LB4-I**  
 SAMPLE DEPTH (FT.): **9'**

GEOLOGIC UNIT: **Qt**

<b>GRAVEL</b>		<b>SAND</b>			<b>SILT OR CLAY</b>
COARSE	FINE	COARSE	MEDIUM	FINE	

U.S. STANDARD SIEVE SIZE

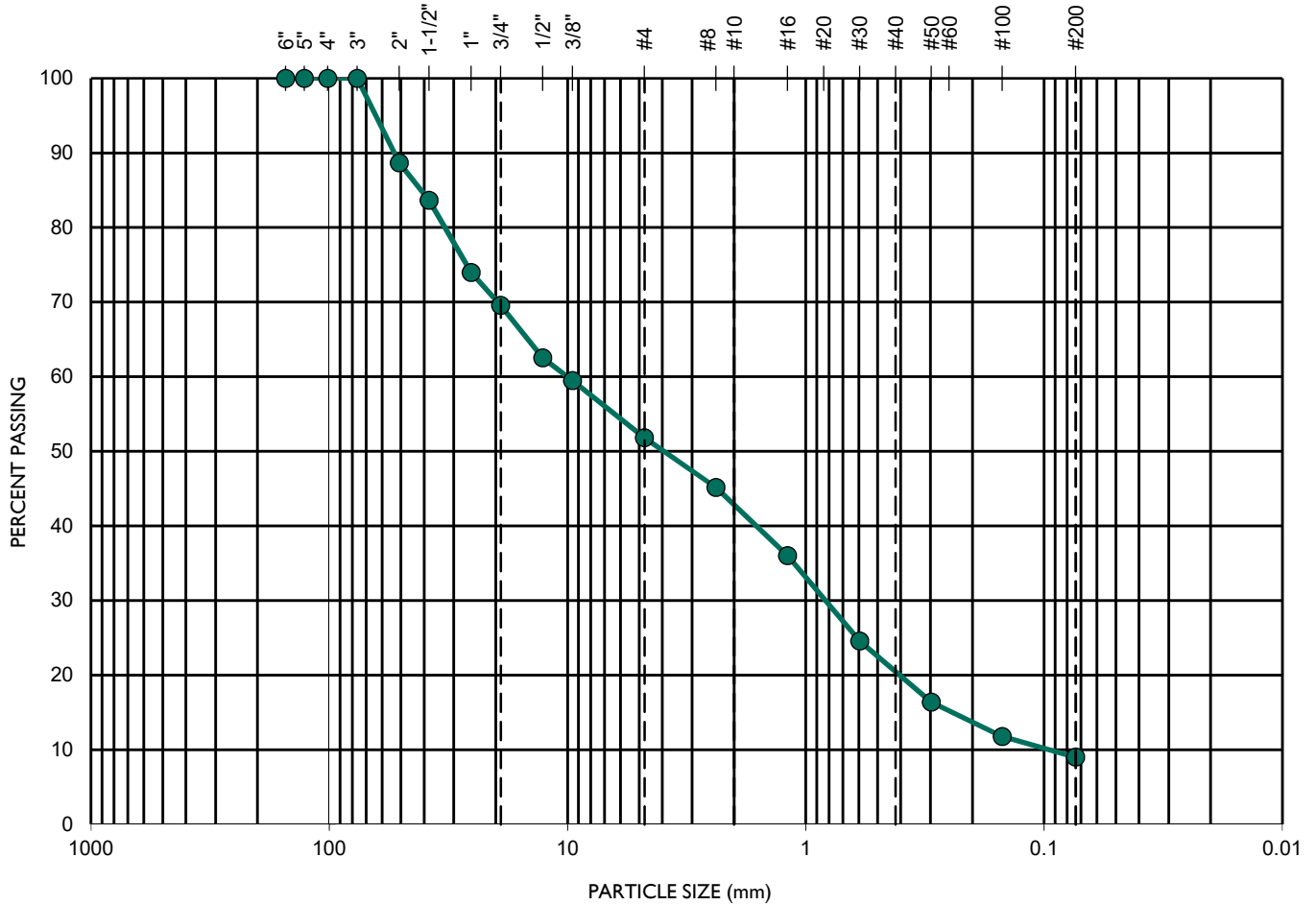

<b>TEST DATA</b>					
<b>D<sub>10</sub> (mm)</b>	<b>D<sub>30</sub> (mm)</b>	<b>D<sub>60</sub> (mm)</b>	<b>C<sub>c</sub></b>	<b>C<sub>u</sub></b>	<b>SOIL DESCRIPTION</b>
0.101	0.878	10.066	0.8	99.6	GP-GC - Poorly graded GRAVEL with clay and sand

**GEOCON**  
INCORPORATED



GEOTECHNICAL CONSULTANTS  
 6960 FLANDERS DRIVE - SAN DIEGO, CALIFORNIA 92121 - 2974  
 PHONE 858 558-6900 - FAX 858 558-6159

**SIEVE ANALYSES - ASTM D 135**

**NIRVANA**

**PROJECT NO.: G2755-42-01**



SAMPLE NO.: **LB5-1**  
 SAMPLE DEPTH (FT.): **35'**

GEOLOGIC UNIT: **To**

GRAVEL		SAND			SILT OR CLAY
COARSE	FINE	COARSE	MEDIUM	FINE	

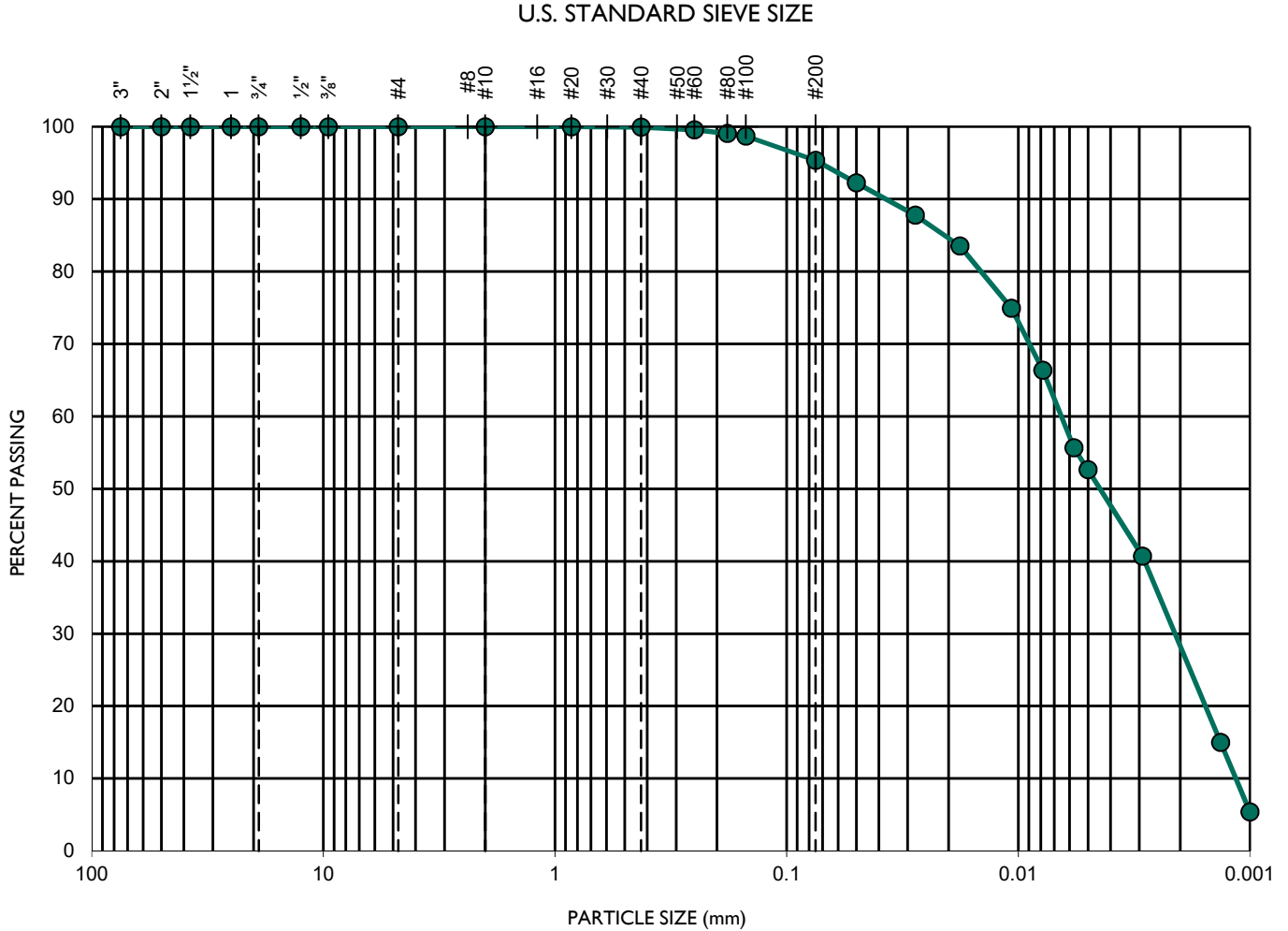

TEST DATA					
D <sub>10</sub> (mm)	D <sub>30</sub> (mm)	D <sub>60</sub> (mm)	C <sub>c</sub>	C <sub>u</sub>	SOIL DESCRIPTION
0.00116	0.00226	0.00658	0.7	5.7	CLAY

**GEOCON**  
INCORPORATED



GEOTECHNICAL CONSULTANTS  
 6960 FLANDERS DRIVE - SAN DIEGO, CALIFORNIA 92121 - 2974  
 PHONE 858 558-6900 - FAX 858 558-6159

**SIEVE ANALYSES - ASTM D 135 & D 422**

**NIRVANA**

**PROJECT NO.: G2755-42-01**

APPENDIX

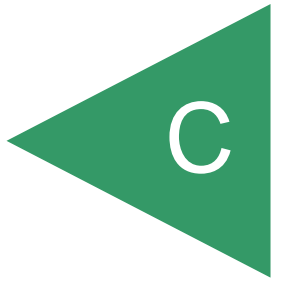

**APPENDIX C**

**EXPLORATORY BORINGS, TRENCHES AND LABORATORY  
PERFORMED BY OTHERS**

**FOR**

**NIRVANA INDUSTRIAL BUILDINGS AND SELF STORAGE  
COMPLEX  
821 MAIN STREET  
CHULA VISTA, CALIFORNIA**

**PROJECT NO. G2755-42-01**

Project Chula Vista Energy Park  
Date Excavated 8/12/2014  
Logged by PWM  
Equipment Cat 330C Trackhoe

**LOG OF TEST PITS**

Test Pit No.	Depth (ft.)	USCS	Description
TP-1	0.0 – 3.0	SC	<p><b><u>Topsoil:</u></b>  CLAYEY SAND, fine to coarse grained, grayish brown, dry, loose; some gravel and cobbles up to 10 in. diameter; white carbonate development from 2 to 3 ft. bgs.</p>
	3.0 – 11.0	CL	<p><b><u>Older Alluvium (Ooal):</u></b>  SILTY CLAY, grayish brown to gray, slightly moist, very stiff.  @4.5 ft. abundant cobbles and small boulders; hard.  @ 7.5 ft. CLAYEY SAND, fine to medium grained, pale brown to olive gray, slightly moist, moderately hard; highly weathered; carbonate development.  @8.5 ft. becomes pale yellowish brown, slightly moist, moderately hard to hard; with occasional gravel to small cobble.  @10.0 ft. becomes hard; tight digging.</p> <p>TOTAL DEPTH 11.0 FT.  NO WATER, NO CAVING</p>

Test Pit No.	Depth (ft.)	USCS	Description
TP-2	0.0 – 1.5	SC	<b><u>Topsoil:</u></b> CLAYEY SAND with silt, fine to medium grained, grayish brown, dry, loose.
	1.5 – 14.0	CL	<b><u>Older Alluvium (Ooal):</u></b> SILTY to SANDY CLAY, brown to reddish brown, slightly moist, stiff; porous; occasional subrounded to subangular cobbles; white carbonate development; root hairs.
	6.0 – 16.0	SC	@ 6.0 ft. CLAYEY SAND, fine grained, pale yellowish brown, slightly moist, loose to moderately dense; highly weathered; carbonate development; iron oxide development; occasional subrounded to subangular cobbles.  @ 7.0 ft. SILTY to CLAYEY SAND, fine grained, pale yellowish brown, slightly moist, moderately dense; weakly cemented, hand friable, abundant iron oxide staining, occasional small cobbles to 6 in. diameter.  @ 11.0 ft. becomes fine to coarse grained, grayish brown, dense, slightly moist; occasional brown claystone clasts, weakly cemented.  @ 13.0 ft. abundant cobbles to 10 in. diameter.
		CL	@ 14.0 ft. SANDY CLAY, fine grained, olive brown, grayish brown, and brown, hard; manganese and iron oxide development; occasional thin interbedded sandstone lenses.  TOTAL DEPTH 16.0 FT. NO WATER, NO CAVING

Test Pit No.	Depth (ft.)	USCS	Description
TP-3	0.0 – 1.0	SC	<b><u>Topsoil:</u></b> CLAYEY SAND with silt, fine to medium grained, grayish brown, dry, loose.
	1.0 – 12.0	CL	<b><u>Older Alluvium (Qoal):</u></b> SILTY CLAY, dark brown, slightly moist, firm; abundant white carbonate development, root hairs, porous.
		SP	@ 3.0 ft. SAND, fine grained, brown, slightly moist, medium dense; abundant carbonate development, root hairs.
		CL	@ 7.0 ft. SANDY CLAY, fine to coarse grained, brown, slightly moist, stiff; carbonate development.  @9.0 ft. Cobble lense with sandy clay matrix, dense; cobbles up to 8 inch diameter.
		SC	@10.0 ft. CLAYEY SAND, fine to medium grained, brown to reddish brown, moist, medium dense; occasional cobbles.
			TOTAL DEPTH 12.0 FT. NO WATER, NO CAVING
-----			
TP-4	0.0 – 1.5	SC	<b><u>Topsoil:</u></b> CLAYEY SAND with silt, fine to medium grained, grayish brown, dry, loose; slight white carbonate development; occasional cobbles to 6 in. diameter.
	1.5 – 13.0	CL	<b><u>Older Alluvium (Qoal):</u></b> SANDY CLAY, fine grained, reddish brown, stiff, slightly moist.
		SC	@ 6.5 ft. CLAYEY SAND, fine to coarse grained, reddish brown, slightly moist, medium dense to dense; manganese and iron oxide development, occasional gravel and cobbles to 8 in. diameter
		SP	@10.0 ft. POORLY GRADED SAND, fine to medium grained, light gray, slightly moist, medium dense.
		SC	@11.5 ft. CLAYEY SAND, fine to coarse grained, reddish brown, slightly moist, medium dense to dense; occasional gravel and cobbles.
			TOTAL DEPTH 13.0 FT. NO WATER, NO CAVING

Test Pit No.	Depth (ft.)	USCS	Description
TP-5	0.0 – 1.0	SM	<b><u>Topsoil:</u></b> SILTY SAND, fine to medium grained, brown, dry, loose; abundant subrounded gravel; occasional cobbles.
	1.0 – 20.0	SC	<b><u>Older Alluvium (Qoal):</u></b> CLAYEY SAND, fine to coarse grained, red, slightly moist, medium dense to dense; abundant subrounded gravel.  @3.0 ft. abundant subangular to subrounded cobble and occasional boulder.
		SW	@8.5 ft. WELL GRADED SAND, fine to coarse grained, reddish brown, slightly moist, dense; abundant subangular to subrounded cobbles to 6 in. diameter; about 60% sand, 40% cobble.  @18.0 ft. becomes sandier; about 75 sand, 25% cobble.  TOTAL DEPTH 20.0 FT. NO WATER, NO CAVING
-----			
TP-6	0.0 – 1.0	SC	<b><u>Topsoil:</u></b> CLAYEY SAND with silt, fine to medium grained, brown, dry, loose; abundant subrounded gravel; occasional cobbles to 6 in. diameter.
	1.0 – 9.0	CL	<b><u>Older Alluvium (Qoal):</u></b> SANDY CLAY, fine to coarse grained with subangular gravel and occasional small cobble, dark brown, slightly moist, firm; root hairs.
		SC	@ 2.5 ft. CLAYEY SAND, fine to coarse grained, red to reddish brown, slightly moist, medium dense; abundant carbonate and iron oxide development; occasional subangular to subrounded cobble to 8 in. diameter.  @5 ft. becomes dense.  TOTAL DEPTH 9.0 FT. NO WATER, NO CAVING



Test Pit No.	Depth (ft.)	USCS	Description
TP-7	0.0 – 0.5	SC	<b><u>Topsoil:</u></b> CLAYEY SAND with silt, fine to medium grained, brown, dry, loose; occasional gravel to small cobble.
	0.5 – 12.0	CL	<b><u>Older Alluvium (Qoal):</u></b> SANDY CLAY, fine to coarse grained, dark brown, slightly moist, firm; occasional gravel to small cobble.
		SC	CLAYEY SAND, fine to coarse grained, red to reddish brown, slightly moist, medium dense; moderate carbonate development to 7.0 ft. bgs., abundant gravel and cobbles to 8 in. diameter; about 30% cobble.  @10 ft. becomes dense; tighter digging.  TOTAL DEPTH 12.0 FT. NO WATER, NO CAVING

# TRENCH LOG SHEET

**TRENCH NO. 1**  
**ELEV. 151' msl**

FT.	DESCRIPTION		SOIL TYPE
0	Brown, dry, loose to slightly dense		SILTY FINE SAND (SM)
1	Fractured rocks to 6" dia. (alluvium)	6*	
2		8*	
3	①	12*	
4		10*	
5	Reddish brown, moist, dense (Terrace deposits)	31*	SILTSTONE (SM)
6	②	38*	
7		41*	
8		48*	
9	Very dense	55*	

Bottom of Trench (No Refusal)

### LEGEND

- - Indicates representative sample
- \* - Indicates blowcount/10 cm/Triggs penetrometer

Granular		Cohesive	
0	Very loose	0	Very soft
5	Loose	2	Soft
11	Medium dense	5	Medium stiff
31	Dense	9	Stiff
51	Very dense	16	Very stiff
		31	Hard

Project No. 08-1331A5

Figure No. 3

# TRENCH LOG SHEET

**TRENCH NO. 2**  
Elev. 152' msl

FT.	DESCRIPTION	SOIL TYPE
0	Brown, dry, loose to slightly dense (alluvium) 20% to 30% cobbles 6" to 8" dia.	SILTY FINE SAND (SM)
1		
2		
3		
4		
5	①	9*
6	Reddish brown, moist, medium dense Some cobbles to 4" dia. (Terrace deposits)	SILTY FINE SANDS (SM)
7		
8		
8		

Bottom of Trench (No Refusal)

# TRENCH LOG SHEET

**TRENCH NO. 3**

**Elev. 183' msl**

FT.		DESCRIPTION		SOIL TYPE
0		Brown, dry, loose (residual/topsoils)		SILTY SANDS (SM)
1	5*			
2	3	Dark brown, damp, medium dense (Terrace deposits) 20% cobbles 2" to 4" dia. <span style="font-size: 1.2em;">①</span>	25*	CLAYEY SANDS (SC)
4	5		30*	
6	7	Light brown, moist, medium dense 5% cobbles	21*	SILTY SANDS (SM)
8	9		28*	
10	11	Dense <span style="font-size: 1.2em;">②</span>	35*	
12				

Bottom of Trench (No refusal)

Project No. 08-1331A5

Figure No. 5

# TRENCH LOG SHEET

**TRENCH NO. 4**  
Elev. 200' msl

FT.	DESCRIPTION	SOIL TYPE
0	Brown, dry, loose (residual/topsoil)	SILTY SANDS (SM)
1	60% cobbles to 12" dia.	
2	Brown, damp, medium dense 50% cobbles to 12" dia.	SILTY SANDS (SM)
3	① (Terrace deposits)	
4	29*	
5		
6	30% cobbles to 3" dia. style="text-align: right;">28*	
7		
8	② Dense style="text-align: right;">35*	
9		
10		

Bottom of Trench (No Refusal)

# TRENCH LOG SHEET

**TRENCH NO. 5**

**Elev. 200' msl**

FT.		DESCRIPTION	SOIL TYPE	
0		Light brown, dry, loose (residual/topsoils)	SILTY SANDS (SM)	
1				
2		Dark brown, dry, dense (Terrace deposits)  30% cobbles to 4" dia.	CLAYEY SAND (SC)	
3	①			
4				52*
5		Tan, moist, dense	SILTY SANDS (SM)	
6	②			51*
7				
8				

Bottom of Trench (No Refusal)

# TRENCH LOG SHEET

**TRENCH NO. 6**

**Elev. 180' msl**

	FT.		DESCRIPTION		SOIL TYPE
0			Light brown, dry, loose (residual/topsoils)		SILTY SANDS (SM)
1	①				
2			Dark brown, damp, medium dense		CLAYEY SANDS (SC)
3			(Terrace deposits)		
4		②	30% cobbles to 3" dia.		
5				25*	
6					
7			Dense	33*	

Bottom of Trench (No refusal)

# BORING LOG SHEET

**BORING NO. 1**

**Elev. 198' msl**

FT.		DESCRIPTION		SOIL TYPE
0		Grayish brown, dry, loose (residual/topsoils) 40% cobbles to 6" dia		SILTY SANDS (SM)
1				
2	①		8*	
3				
4		Brown, moist, medium dense 50% cobbles to 8" dia. (Terrace deposits)	28*	SILTY SANDS (SM)
5	②			
6				
7		Dense	33*	

Bottom of Boring (No refusal)



# BORING LOG SHEET

**BORING NO. 2**

**Elev. 201' msl**

FT.		DESCRIPTION	SOIL TYPE
0		Grayish brown, dry, loose (residual/topsoils)	SILTY SANDS (SM)
1	40%	cobbles to 6" dia	
2			
3		Brown, damp, medium dense 50% cobbles to 8" dia. (Terrace deposits)	SILTY SANDS (SM)
4			
5		Dense	
6			
7			

35\*

Bottom of Boring (No refusal)

**CUT SLOPE LOG SHEET**  
**WEST SIDE OF PROPERTY**

FT.	DESCRIPTION	SOIL TYPE
0 5	Gray, dry, loose 40% cobbles to 6" dia (residual/topsoils)	SILTY SANDS (SM)
10 15 20 25 30 35 40	Brown, damp, medium dense 50% cobbles to 8" dia. (Terrace deposits)	SILTY SANDS
	Light brown, damp, medium dense 30% cobbles to 5" dia.	
	Brown/gray, damp, medium dense 40% cobbles to 4" dia.	
	Brown, damp, medium dense 30% cobbles to 6" dia.	

Bottom of Cut Slope @ 42'

**APPENDIX C**  
**LABORATORY DATA**

## Expansion Index (ASTM D4829)

G Force Lab No.	10124	Sample No:	T-1
Date Sampled:	08/12/14	By:	PWM
Date Submitted:	08/15/14	By:	PJ
Sample Location:	T-1		
Sample Depth:	3-4'		
Sample Description:	Tan Silty Clay (CL)		

Initial Water Content, %	11.6%
Dry Density, pcf	105.8
Saturation, %	52.9%
Initial Dial Reading, in.	0.0000
Final Dial Reading, in.	0.1477
Final Water Content, %	26.3%
<b>Expansion Index</b>	<b>151</b>
<b>Potential Expansion</b>	<b>Very High</b>

Reviewed by: \_\_\_\_\_



Joseph Bouknight, P.E., C81517



## Expansion Index (ASTM D4829)

G Force Lab No.	10127	Sample No:	T-6
Date Sampled:	08/12/14	By:	PWM
Date Submitted:	08/15/14	By:	PJ
Sample Location:	T-6		
Sample Depth:	0.5- 1.5		
Sample Description:	Brown Sandy Clay (CL)		

Initial Water Content, %	12.4%
Dry Density, pcf	101.7
Saturation, %	50.8%
Initial Dial Reading, in.	0.0000
Final Dial Reading, in.	0.1864
Final Water Content, %	32.4%
<b>Expansion Index</b>	<b>188</b>
<b>Potential Expansion</b>	<b>Very High</b>

Reviewed by:   
Joseph Bouknight, P.E., C81517



AGS Inc. Project No: 1404-05

## DIRECT SHEAR TEST REPORT

G-FORCE LAB NO.:	10125
SAMPLE LOCATION:	T-2 15 - 16'
SOIL TYPE:	Tan Sandy Clay (CL)
SAMPLE TYPE:	Remolded @ 114.8 @ 14.5 M.C. (90%RC)

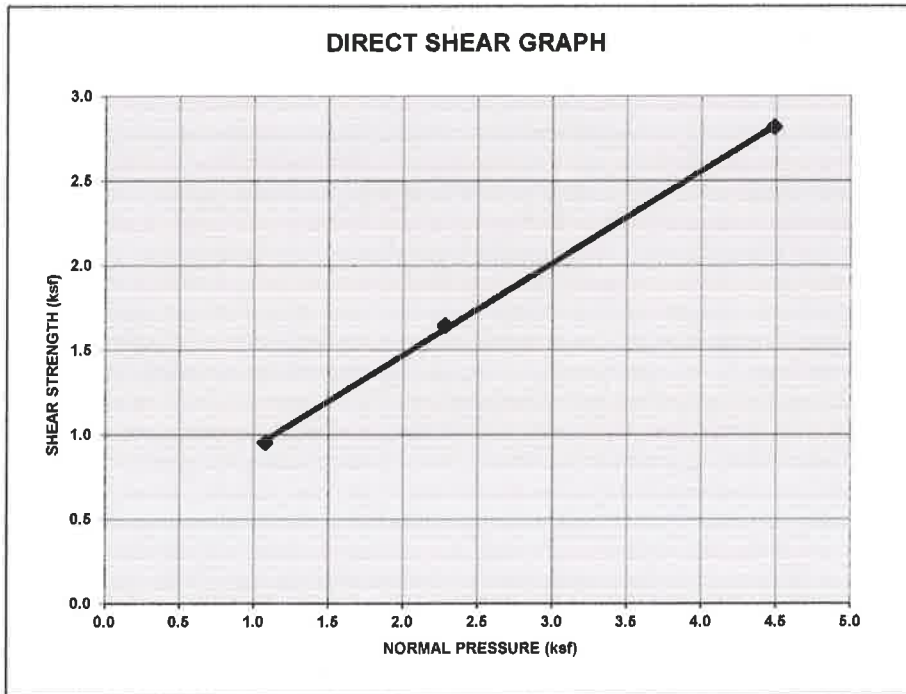

**CALCULATED DATA**

<b>INITIAL</b>	WET DENSITY	pcf	119.5	118.9	120.6
	DRY DENSITY	pcf	104.4	103.8	105.3
	MOISTURE	%	14.5	14.5	14.5
<b>FINAL, at failure</b>	MOISTURE	%	25.9	25.0	26.5

NORMAL PRESSURE, ksf	1.08	2.28	4.49
SHEAR STRENGTH, ksf	0.95	1.65	2.82
FRICITION ANGLE, degrees	<b>28.6</b>		
COHESION, ksf	<b>0.38</b>		

Reviewed by: \_\_\_\_\_

*Joseph Bouknight*  
Joseph Bouknight, P.E., C81517



## DIRECT SHEAR TEST REPORT

G-FORCE LAB NO.:	10126
SAMPLE LOCATION:	T-4 @ 7 - 9'
SOIL TYPE:	Brown Sandy Clay W Gravel (SC)
SAMPLE TYPE:	Remolded @ 128.5 @ 9.0 M.C. (90%RC)

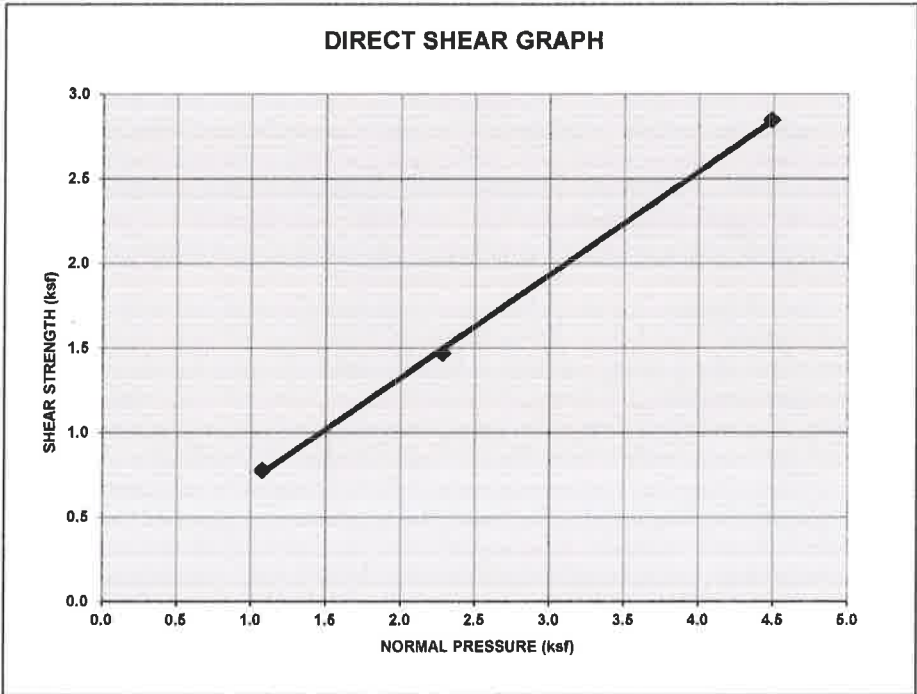

**CALCULATED DATA**

<b>INITIAL</b>					
	WET DENSITY	pcf	125.9	128.7	124.2
	DRY DENSITY	pcf	115.5	118.1	113.9
	MOISTURE	%	9.0	9.0	9.0
<b>FINAL, at failure</b>					
	MOISTURE	%	18.0	17.1	16.3

NORMAL PRESSURE, ksf	1.08	2.28	4.49
SHEAR STRENGTH, ksf	0.78	1.47	2.85
<b>FRICTION ANGLE, degrees</b>	<b>31.4</b>		
<b>COHESION, ksf</b>	<b>0.11</b>		

Reviewed by: \_\_\_\_\_

*Joe Bouknight*  
Joseph Bouknight, P.E. C81517



## LABORATORY COMPACTION CURVE

G Force Lab No.: **10125**  
 Sample Location: **T-2**  
 Soil Description: **Light Tan Sandy Clay (CL)**  
 Source of Soil: **On Site**

Depth, ft.: **15-16'**  
 Sampled By: **PJ**  
 Date Sampled: **8/12/2014**

Test Designation: **ASTM\_D1557**      Method **A**  
 % +3/4"      % +3/8"      % +#4  
 Oversize Correction Applied? **No**  
 Method of Sample Preparation: **Dry**  
 Type of Hammer Used: **Manual**

**M/D Curve No. T-2**

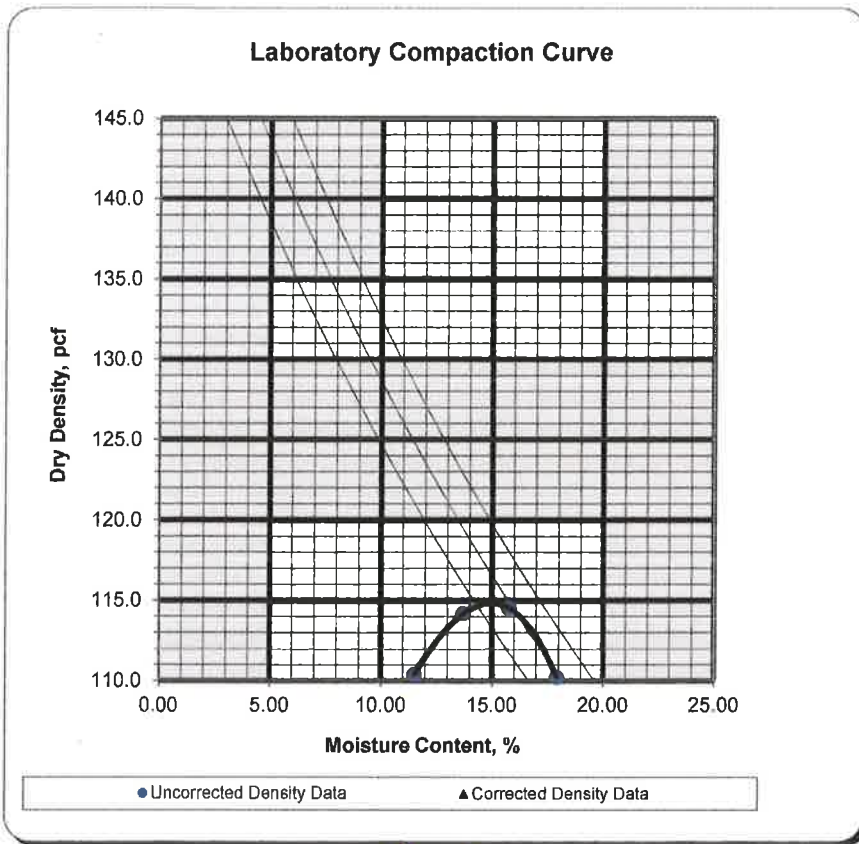

**Test Results**

Maximum Density, pcf	<b>114.8</b>
Optimum Moisture, %	<b>14.9</b>

**Oversize Corrected Results**

Maximum Density, pcf	<b>N/A</b>
Optimum Moisture, %	<b>N/A</b>

Reviewed by: *Joseph Bouknight*  
 Joseph Bouknight, P.E., C81517





## LABORATORY COMPACTION CURVE

G Force Lab No.: **10126**  
 Sample Location: **T-4**  
 Soil Description: **Brown Sandy Clay W/ Gravel (SC)**  
 Source of Soil: **On Site**

Depth, ft.: **7-9'**  
 Sampled By: **PJ**  
 Date Sampled: **8/12/2014**

Test Designation: **ASTM\_D1557**      **ASTM D4718, & ASTM C127**      Method      **B**  
 % +3/4"      **12.7**      % +3/8"      **19.7**      % +#4      **27.4**  
 Oversize Correction Applied?      **Yes**  
 Method of Sample Preparation:      **Dry**  
 Type of Hammer Used:      **Manual**

**M/D Curve No. T-4**

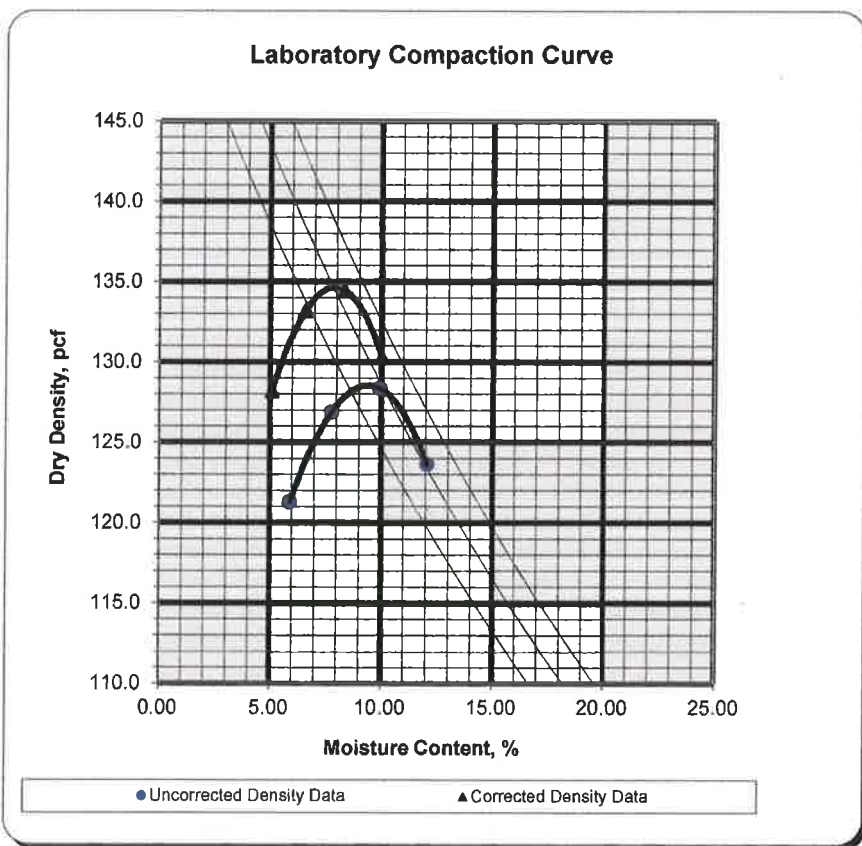

**Test Results**

Maximum Density, pcf	<b>128.5</b>
Optimum Moisture, %	<b>9.3</b>

**Oversize Corrected Results**

Maximum Density, pcf	<b>134.6</b>
Optimum Moisture, %	<b>7.8</b>

Reviewed by:           *Joe Bouknight*            
 Joseph Bouknight, P.E., C81517



## Soil Corrosivity

(ASTM D4972, CTM 417, CTM 422)

Lab Number	Boring No.	Depth	Sulfate %	Chloride %	PH	Resistivity (OHM-cm)
10127	T-6	.5-1.5	0.001	0.025	7.13	412

Lab Number	Boring No.	Depth	Sulfate %	Chloride %	PH	Resistivity (OHM-cm)
10124	T-1	3-4'	0.292	0.198	6.86	169

Sulfate and Chloride content test were performed by So. Cal. Soils & Testing Inc.

Date Sampled: 8/12/2014  
Sampled By: PWM/FE  
Date Submitted: 8/15/2014  
Submitted By: PJD

Reviewed by:



Joseph Bouknight, P.E., C81517

APPENDIX

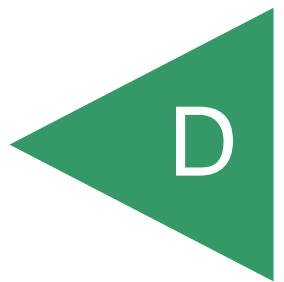

**APPENDIX D**

**SLOPE STABILITY EVALUATION**

**FOR**

**NIRVANA INDUSTRIAL BUILDINGS AND SELF STORAGE  
COMPLEX**

**821 MAIN STREET  
CHULA VISTA, CALIFORNIA**

**PROJECT NO. G2755-42-01**

## APPENDIX D

### SLOPE STABILITY EVALUATION

#### General

Slope stability analyses were performed on Cross-Sections A-A', B-B' C-C', E-E', F-F', and G-G' shown on Figures 1 and 2. The slope stability analyzes utilized the information on the preliminary grading study plans provided by PLSA with respect to proposed site conditions. Slope stability was evaluated for the MSE walls constructed along the south property margin and the natural hillside descending slope along the eastern property margin. Stability analysis for the soil nail wall along the northern property margin should be performed once preliminary wall design is performed and coordination with the wall designer occurs. Slope geometry, geologic structure, and calculated factors of safety for each cross section analyzed are presented on the figures in this Appendix. Additional analysis will be needed once preliminary wall designs are complete.

The computer program, *Slope/W* from GeoSlope 2018, distributed by Geo-Slope International, was utilized to perform slope stability analyses. This program uses conventional slope stability equations and a two-dimensional limit-equilibrium method to calculate the factor of safety against deep-seated failure. For our analyses, Spencer's Method with block failure mode within the claystone beds was used. Spencer's Method satisfies both moment and force equilibrium. Circular failure method was also utilized at some of the cross section locations.

The computer program searches for the most critical failure surface based on geometry and soil strength parameters. The computer program searches for the critical failure surface based on parameters inputted, including the location of the "left" and "right" sliding blocks and the failure plane entrance and exit locations. The critical failure surface for each analysis is shown on computer generated output directly above the failure surface (which is shown as the hatched area on the figure).

#### Shear Strength Parameters

Shear strength parameters used in the analyses are based on laboratory direct shear testing performed for our investigation, investigations and grading for the adjacent Otay Ranch Village 3 project, and our experience with similar soil conditions. Table D-1 summarizes the shear strength tests performed by Geocon Incorporated during this geotechnical investigation.

Table D-2 summarize residual and fully softened values for the bentonitic claystone bed. The residual and fully softened shear strength values were determined following the procedure presented in Stark, Choi, McCone (2005) and GeoInstitute (2016).

Shear strength values used in our analyses are shown on Table D-3. The shear strength values are also shown on stability output figures.

**TABLE D-1  
SUMMARY OF DIRECT SHEAR STRENGTH TEST RESULTS**

Soil/Geologic Unit	Sample No.	Angle of Shear Resistance (degrees)	Unit Cohesion (psf)
Terrace Deposits	LB1-3	30 (peak) 35 (ultimate)	790 (peak) 350 (ultimate)
	LB3-1*	20 (peak) 20 (ultimate)	550 (peak) 540 (ultimate)
	LB4-1*	33 (peak) (32 ultimate)	590 (peak) 480 (ultimate)
Otay Formation	LB4-2 (Claystone Bed)	36 (peak) 30 (ultimate)	670 (peak) 200 (ultimate)
	LB5-3 (Siltstone)	35 (peak) 34 (ultimate)	530 (peak) 300 (ultimate)
	LB5-5 (Claystone Bed)	34 (peak) 34 (ultimate)	270 (peak) 22 (ultimate)

\*Sample remolded to approximately 90 percent of maximum dry density near optimum moisture content.

**TABLE D-2  
RESIDUAL AND FULLY SOFTENED SHEAR STRENGTH VALUES FOR CLAYSTONE BED  
BASED ON STARK, CHOI, MCCONE (2005)**

Sample No.	Liquid Limit	Percent Clay	Residual Values		Fully Softened Values	
			Angle of Internal Friction (degrees)	Cohesion (psf)	Angle of Internal Friction (degrees)	Cohesion (psf)
LB2-3	57	32	14	50	24	60
LB5-1	56	29	15	55	25	60

**TABLE D-3  
SHEAR STRENGTH USED IN SLOPE STABILITY ANALYSES**

Soil Type	Angle of Internal Friction (degrees)	Cohesion (psf)
Qcf (Compacted Fill)	28	250
Qt (Terrace Deposits)	35	350
To (Otay Formation)	34	300
To (Claystone Bed)	18	50

With respect to the claystone bed shear strength, we utilized a value that corresponds to a mid-range value between residual and fully softened values determined using the Stark, Choi, McCone (2005) and GeoInstitute (2016) procedures. In our opinion this value is conservative as no shearing or remolding was observed in the claystone bed.

### **Slope Stability — Bentonitic Claystone Beds**

Stability analysis were performed to evaluate the impacts the observed bentonitic claystone beds have on slope stability. The following two conditions were analyzed: 1) MSE Wall along the south side of the property with the backcut for the reinforcing grid equal to the height of the retaining wall; and 2) the bentonitic claystone exposed near the toe of the natural hillside slope on the east side of the property. We have also assumed that perched groundwater is present on the lower claystone bed.

For condition number one, we have assumed the backcut for the MSE retaining wall along the south side of the property will remove the claystone bed to a horizontal distance (measured from the back of the wall) equal to the height of the retaining wall. If the claystone bed is removed to this horizontal limit, the proposed retaining wall and backfill will create a stabilizing buttress that provides a factor of safety greater than 1.5. Cross Sections A-A', B-B', and C-C' show the slope stability analysis after construction of the proposed MSE wall. The wall backcut has been assumed to extend up from the excavation bottom at a 1:1 plane to the proposed finish grade surface. If the final wall design has shorter wall grids and/or backcut dimensions, additional analysis should be performed to evaluate if the proposed condition will have a factor of safety greater than 1.5 after construction of the wall.

As shown on Figure 2 and the stability figures in this Appendix, the buttress should start in front of the wall and down to a depth of at least 5 feet below the claystone bed and sloped back into the slope as shown on Figure 3. Buttress drains as shown on Figure 3 should be installed and outlet to the storm drain system or in front of the retaining wall.

For condition number two, Cross Sections E-E', F-F', and G-G' have been drawn through the eastern facing hillside slope. At Cross Section G-G', the proposed MSE retaining wall is located approximately mid-height of the slope. As such, the wall backcut will not extend deep enough to intercept the lower claystone bed. Based on our analysis, a buttress will be needed to provide a factor of safety of at least 1.5. The buttress should start near the toe of the hillside slope and extend back into the slope a distance of at least 50 feet measured from the toe of the slope. The buttress backcut should extend up at a 1:1 plane to proposed pad grade. The approximate buttress/clay bed front removal limit is shown on Figure 2.

The upper clay near the top of the slope will require a stability fill. The clay bed should be removed to a horizontal distance of at least 15 feet back into the slope as shown on Cross Sections E-E' and F-F'.

The stability fill should include a back drain that outlets to the slope face. Subdrain cut off and head walls as shown in Section 7.7 of this report should be constructed. An outlet should be provided every approximately 100 feet of the stability fill.

Stability analysis for the soil nail wall along the northern property margin can be performed once preliminary wall design is performed and coordination with the wall designer occurs.

Our analyses assumes select material derived from excavations in the Terrace Deposits or sandstone portions of the Otay Formation will be used for the buttress fill. Minimum shear strength parameters to produce a factor of safety in excess of 1.5 are 28 degree friction angle and 250 psf cohesion.

### Summary of Stability Analyses

Table D-4 summarizes the stability analyses performed for this study. The calculated factor-of-safety for proposed slopes and recommended stabilization method is included on the table. Analyses for the soil nail wall will need to be performed once preliminary design of the wall is complete.

**TABLE D-4  
SUMMARY OF STABILITY ANALYSES  
AND RECOMMENDED STABILIZATION METHOD**

Cross Section	Location	Proposed Graded Factor-of-Safety	Stabilization Method
A-A', B-B', and C-C'	Southern Slope with MSE Wall Construction	1.7 to 2.1	Claystone bed removed during wall backcut excavation
E-E' and F-F'	Eastern Slope	1.5 to 2.0	15 foot-wide stability fill
G-G'	Southeast Slope Area	1.5 to 1.6	50 foot wide buttress at toe of slope



NIRVANA  
 Project No. G2755-42-01  
 File Name: A-A (Proposed) Fully Softened with Groundwater.gsz  
 Date: 09/14/2021

Color	Name	Unit Weight (pcf)	Cohesion' (psf)	Phi' (°)	Piezometric Line
Red	Claystone Bed (CL/CH)	130	50	18	1
Yellow	Qcf	130	250	28	1
Orange	Qt	130	325	33	1
Grey	To	130	325	33	1

CROSS SECTION A-A'

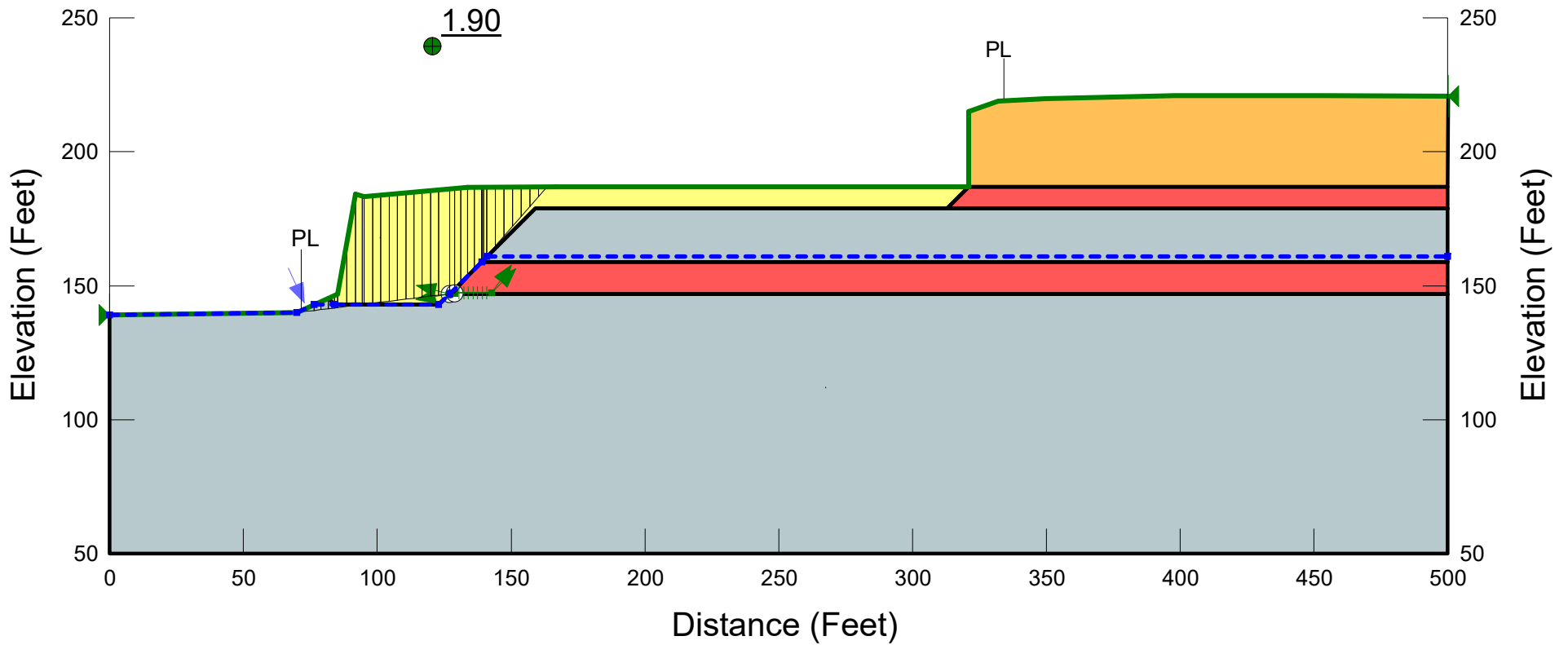

NIRVANA  
 Project No. G2755-42-01  
 File Name: B-B (Proposed) Fully Softened with Groundwater.gsz  
 Date: 09/14/2021

Color	Name	Unit Weight (pcf)	Cohesion' (psf)	Phi' (°)	Piezometric Line
Red	Claystone Bed (CL/CH)	130	50	18	1
Yellow	Qcf	130	250	28	1
Orange	Qt	130	325	33	1
Grey	To	130	325	33	1

CROSS SECTION B-B'

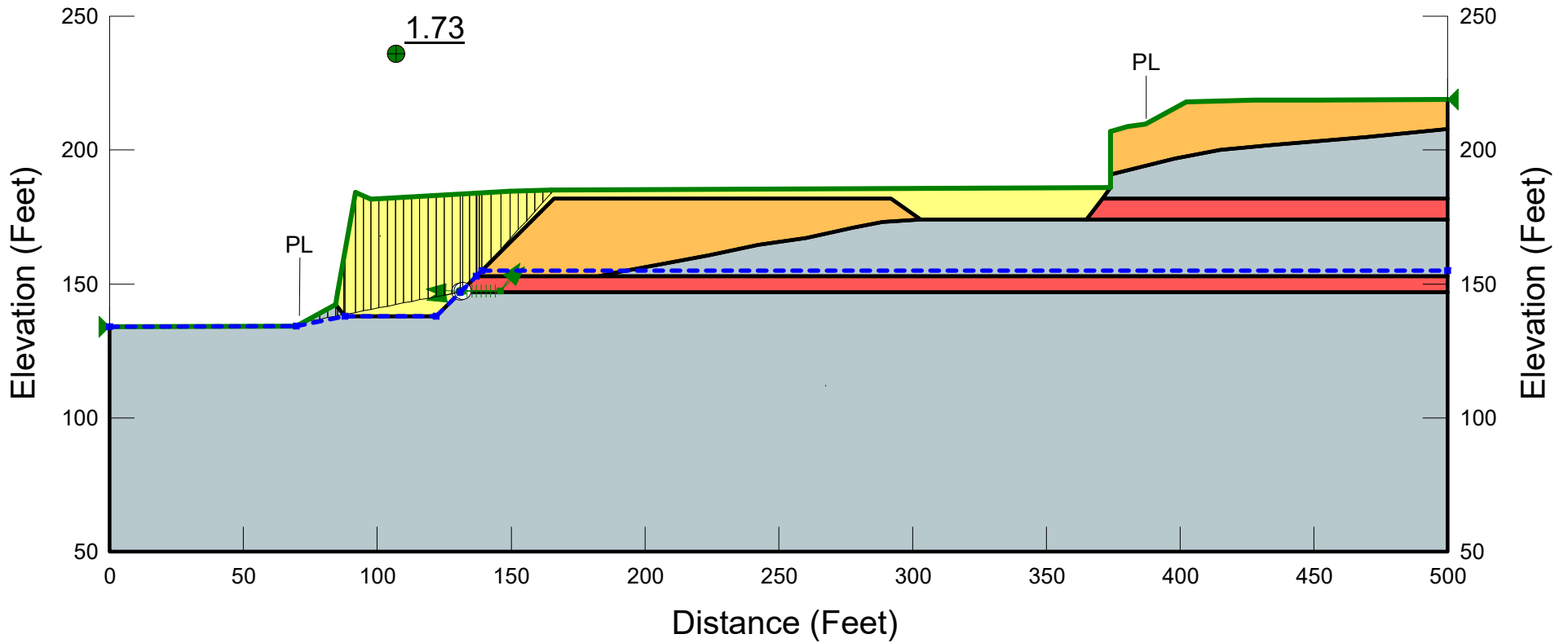

NIRVANA  
 Project No. G2755-42-01  
 File Name: C-C (Proposed) Fully Softened with Groundwater.gsz  
 Date: 09/14/2021

CROSS SECTION C-C'

Color	Name	Unit Weight (pcf)	Cohesion' (psf)	Phi' (°)	Piezometric Line
Red	Claystone Bed (CL/CH)	130	50	18	1
Yellow	Qcf	130	250	28	1
Orange	Qt	130	325	33	1
Blue-Gray	To	130	325	33	1

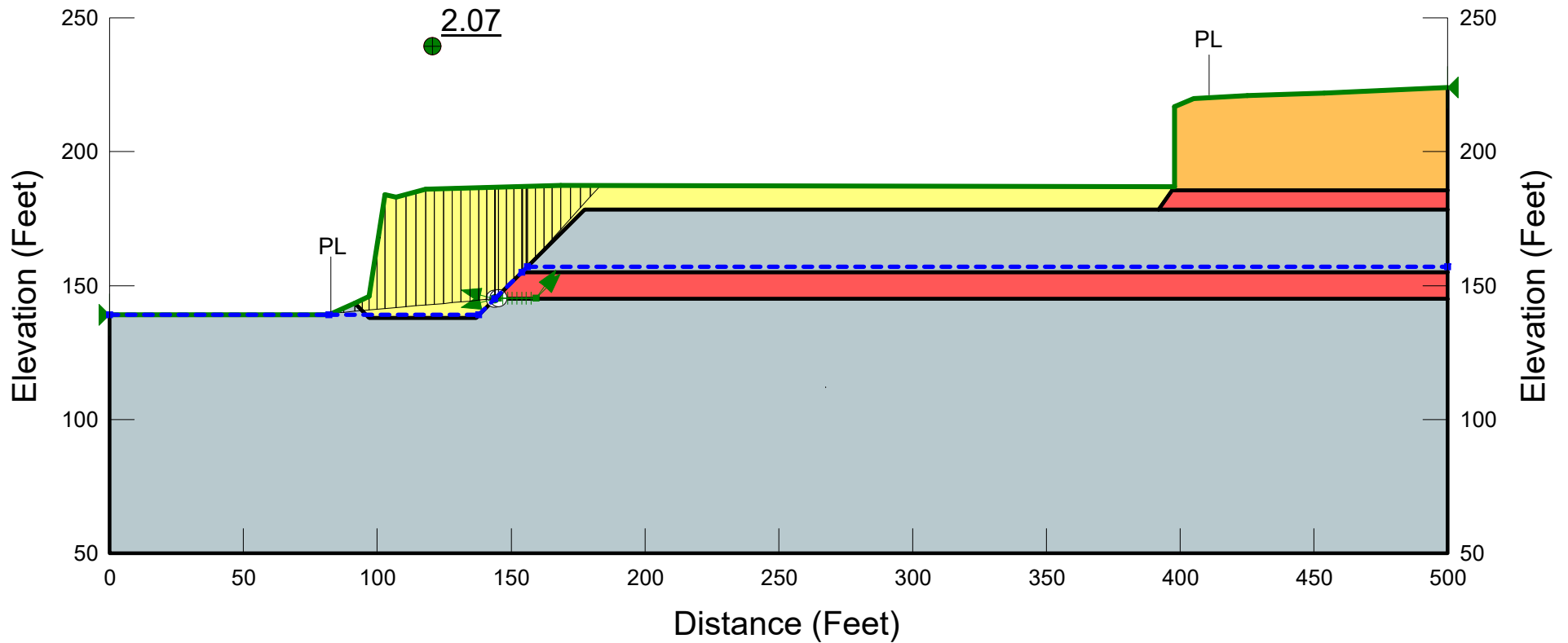

NIRVANA  
 Project No. G2755-42-01  
 File Name: E-E (Proposed) Circular - Fully Softened (Groundwater).gsz  
 Date: 09/14/2021

CROSS SECTION E-E'

Color	Name	Unit Weight (pcf)	Cohesion' (psf)	Phi' (°)	Piezometric Line
Red	Claystone Bed (CL/CH)	130	50	18	1
Orange	Qt	130	350	35	1
Blue-Gray	To	130	300	34	1

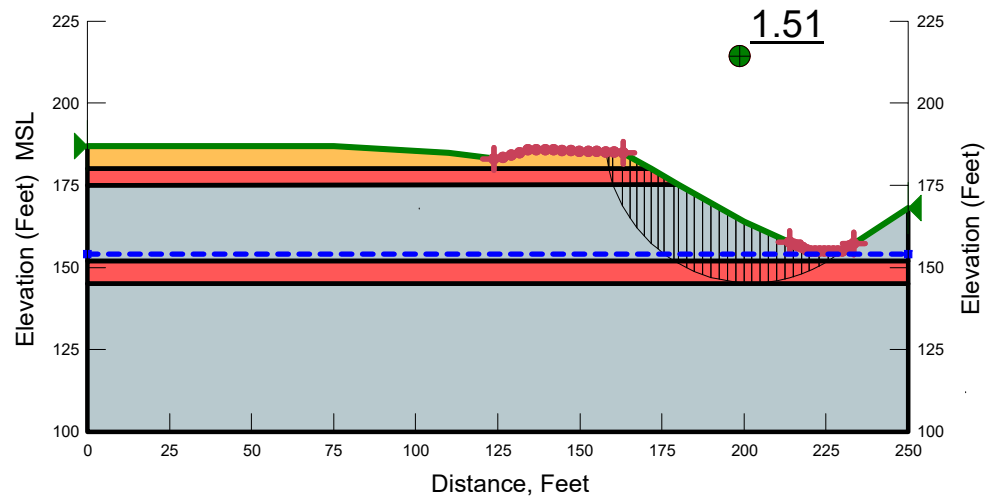

NIRVANA  
 Project No. G2755-42-01  
 File Name: E-E (Proposed) Fully Softened - Upper Clay Removed with Groundwater.gsz  
 Date: 09/14/2021

Color	Name	Unit Weight (pcf)	Cohesion' (psf)	Phi' (°)	Piezometric Line
Red	Claystone Bed (CL/CH)	130	50	18	1
Yellow	Qcf	130	250	28	1
Orange	Qt	130	350	35	1
Light Blue	To	130	300	34	1
Light Blue	To (2)				1

CROSS SECTION E-E'

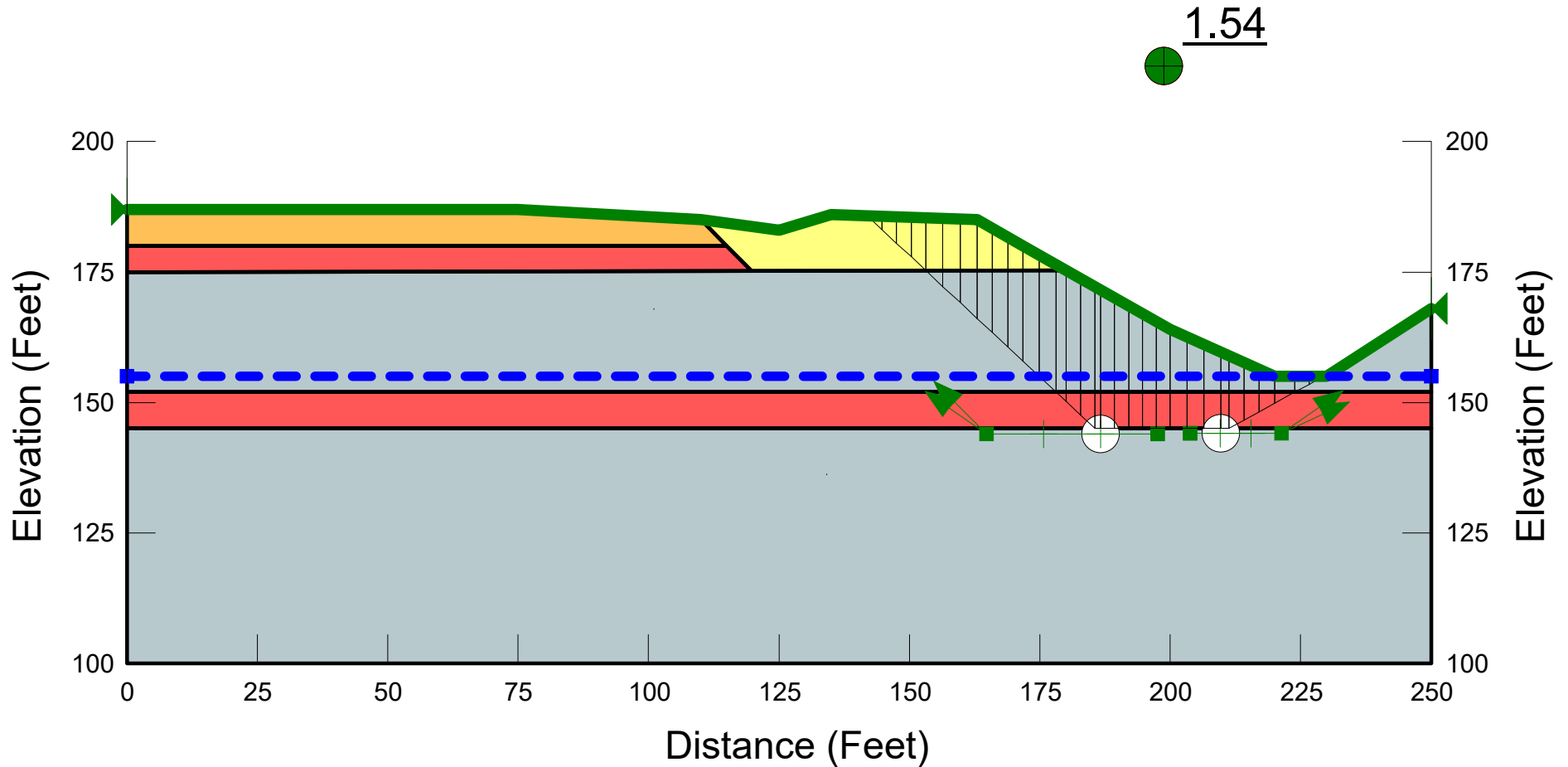

NIRVANA  
 Project No. G2755-42-01  
 File Name: E-E (Upper Clay Bed) Fully Softened - Circular.gsz  
 Date: 09/13/2021

Color	Name	Unit Weight (pcf)	Cohesion' (psf)	Phi' (°)	Piezometric Line
Red	Claystone Bed (CL/CH)	130	50	18	1
Yellow	Qcf	130	250	28	1
Orange	Qt	130	350	35	1
Light Blue	To	130	300	34	1
Light Blue	To (2)				1

CROSS SECTION E-E'

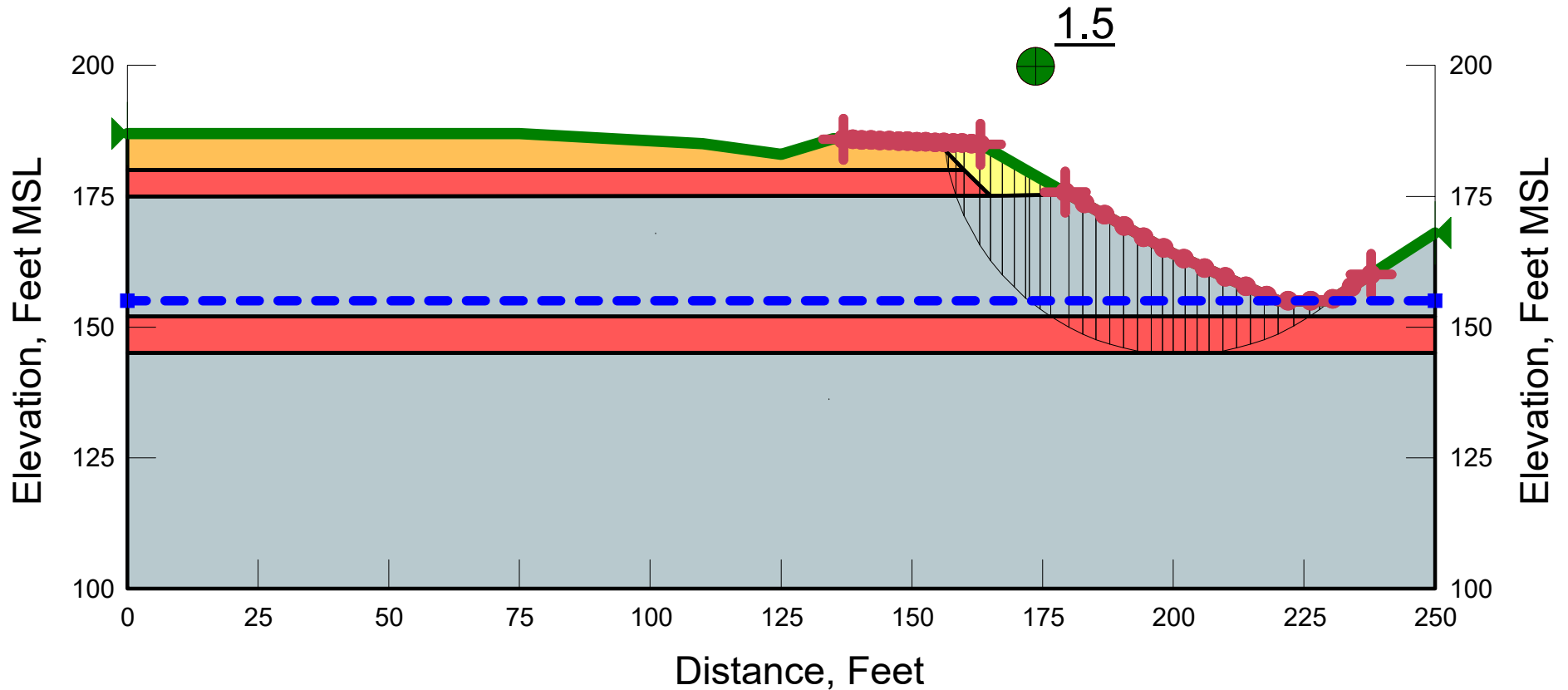

NIRVANA

Project No. G2755-42-01

File Name: E-E (Proposed) Fully Softened with Ground Water-Upper Clay Removed.gsz

Date: 09/14/2021

Color	Name	Unit Weight (pcf)	Cohesion' (psf)	Phi' (°)	Piezometric Line
Red	Claystone Bed (CL/CH)	130	50	18	1
Yellow	Qcf	130	250	28	1
Orange	Qt	130	350	35	1
Grey	To	130	300	34	1

### CROSS SECTION E-E'

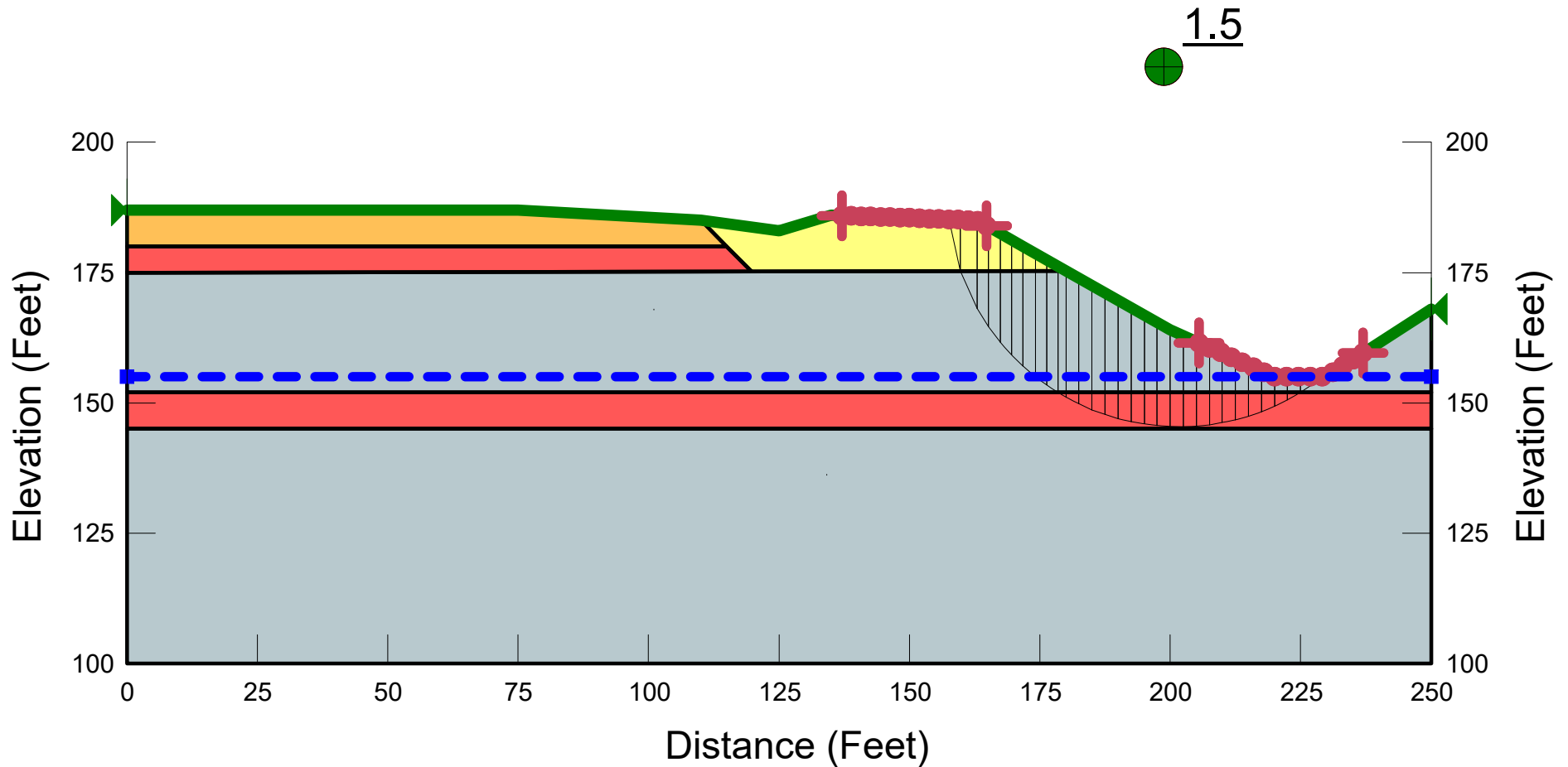

NIRVANA

Project No. G2755-42-01

File Name: F-F (Proposed) Fully Softened - Stability Fill, Circular.gsz

Date: 09/14/2021

### CROSS SECTION F-F'

Color	Name	Unit Weight (pcf)	Cohesion' (psf)	Phi' (°)
Red	Claystone Bed (CL/CH)	130	50	18
Yellow	Qcf	130	250	28
Orange	Qt	130	350	35
Grey	To	130	300	34

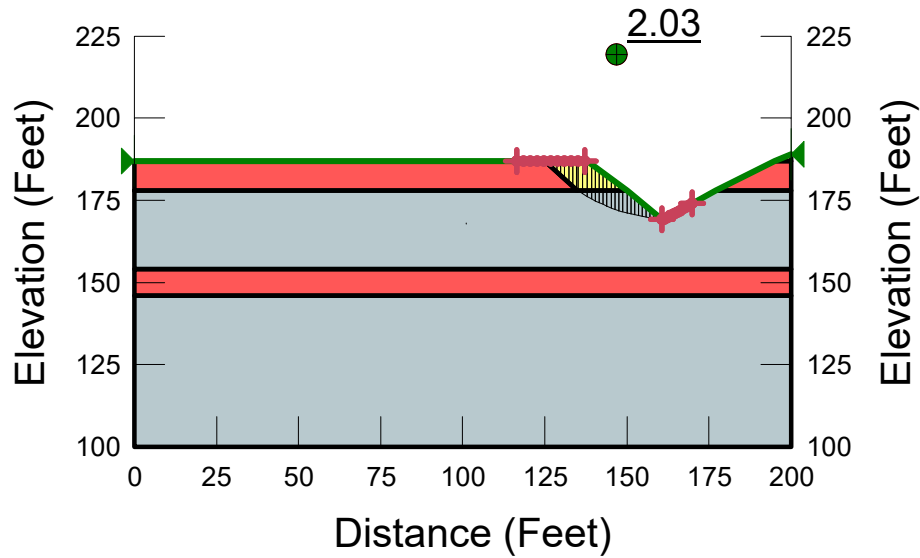



NIRVANA  
 Project No. G2755-42-01  
 File Name: G-G (Proposed) Buttress ( Fully Softened with Groundwater).gsz  
 Date: 09/14/2021

Color	Name	Unit Weight (pcf)	Cohesion' (psf)	Phi' (°)	Piezometric Line
Red	Claystone Bed (CL/CH)	130	50	18	1
Yellow	Qcf	130	250	28	1
Orange	Qt	130	350	35	1 </td
Light Blue	To	130	300	34	1
Light Blue	To (2)				1

CROSS SECTION G-G'

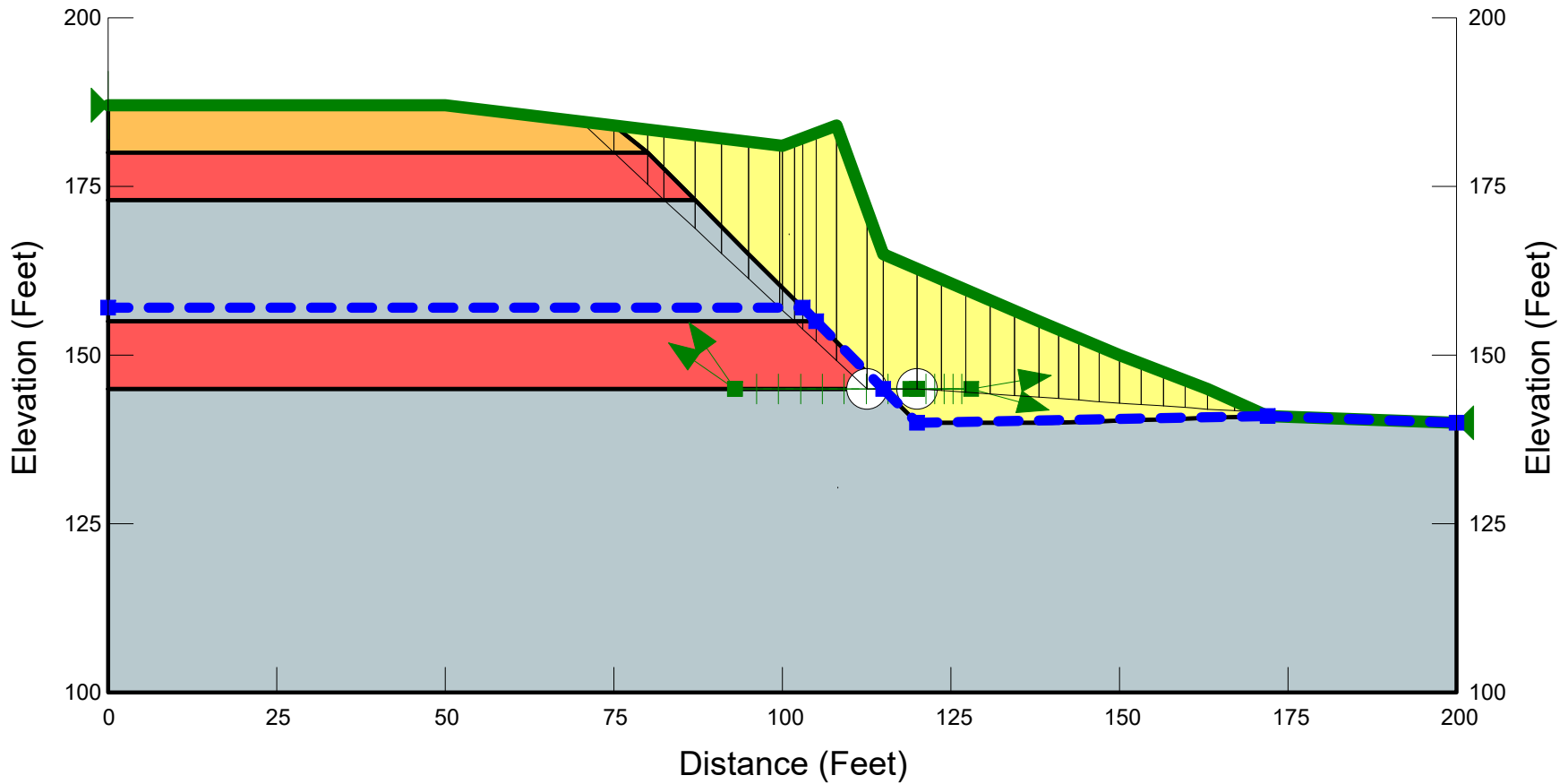
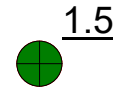

NIRVANA

Project No. G2755-42-01

File Name: G-G (Proposed) Buttress - Circular (Fully Softened with Groundwater).gsz

Date: 09/14/2021

Color	Name	Unit Weight (pcf)	Cohesion' (psf)	Phi' (°)	Piezometric Line
Red	Claystone Bed (CL/CH)	130	50	18	1
Yellow	Qcf	130	250	28	1
Orange	Qt	130	350	35	1
Blue-Gray	To	130	300	34	1

### CROSS SECTION G-G'

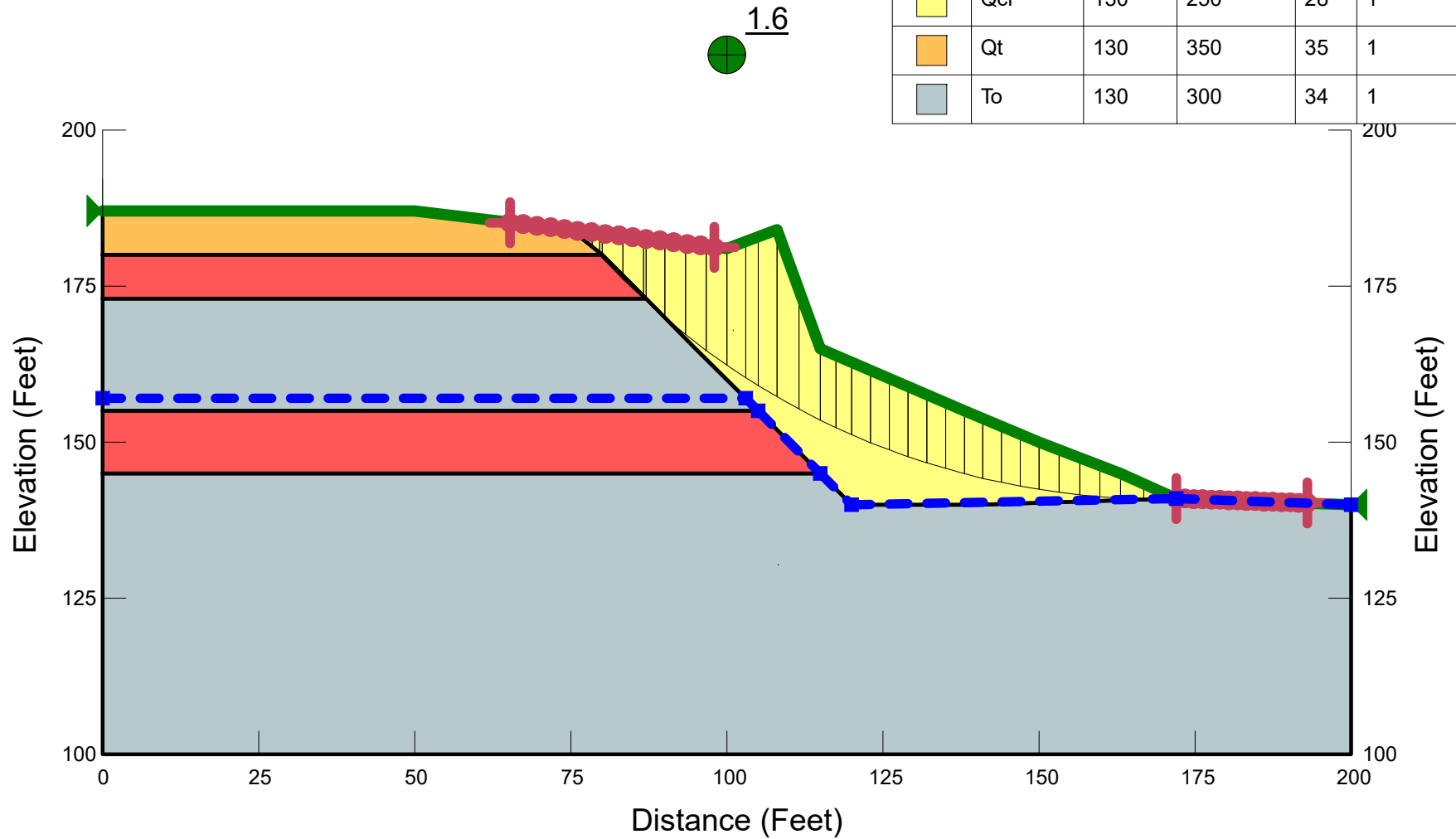

APPENDIX

A solid green triangle pointing to the left, containing the letter 'E' in white.

E

**APPENDIX E**

**RECOMMENDED GRADING SPECIFICATIONS**

**FOR**

**NIRVANA INDUSTRIAL BUILDINGS AND SELF STORAGE COMPLEX  
821 MAIN STREET  
CHULA VISTA, CALIFORNIA**

**PROJECT NO. G2755-42-01**

## RECOMMENDED GRADING SPECIFICATIONS

### 1. GENERAL

- 1.1 These Recommended Grading Specifications shall be used in conjunction with the Geotechnical Report for the project prepared by Geocon. The recommendations contained in the text of the Geotechnical Report are a part of the earthwork and grading specifications and shall supersede the provisions contained hereinafter in the case of conflict.
- 1.2 Prior to the commencement of grading, a geotechnical consultant (Consultant) shall be employed for the purpose of observing earthwork procedures and testing the fills for substantial conformance with the recommendations of the Geotechnical Report and these specifications. The Consultant should provide adequate testing and observation services so that they may assess whether, in their opinion, the work was performed in substantial conformance with these specifications. It shall be the responsibility of the Contractor to assist the Consultant and keep them apprised of work schedules and changes so that personnel may be scheduled accordingly.
- 1.3 It shall be the sole responsibility of the Contractor to provide adequate equipment and methods to accomplish the work in accordance with applicable grading codes or agency ordinances, these specifications and the approved grading plans. If, in the opinion of the Consultant, unsatisfactory conditions such as questionable soil materials, poor moisture condition, inadequate compaction, and/or adverse weather result in a quality of work not in conformance with these specifications, the Consultant will be empowered to reject the work and recommend to the Owner that grading be stopped until the unacceptable conditions are corrected.

### 2. DEFINITIONS

- 2.1 **Owner** shall refer to the owner of the property or the entity on whose behalf the grading work is being performed and who has contracted with the Contractor to have grading performed.
- 2.2 **Contractor** shall refer to the Contractor performing the site grading work.
- 2.3 **Civil Engineer** or **Engineer of Work** shall refer to the California licensed Civil Engineer or consulting firm responsible for preparation of the grading plans, surveying and verifying as-graded topography.
- 2.4 **Consultant** shall refer to the soil engineering and engineering geology consulting firm retained to provide geotechnical services for the project.

- 2.5 **Soil Engineer** shall refer to a California licensed Civil Engineer retained by the Owner, who is experienced in the practice of geotechnical engineering. The Soil Engineer shall be responsible for having qualified representatives on-site to observe and test the Contractor's work for conformance with these specifications.
- 2.6 **Engineering Geologist** shall refer to a California licensed Engineering Geologist retained by the Owner to provide geologic observations and recommendations during the site grading.
- 2.7 **Geotechnical Report** shall refer to a soil report (including all addenda) which may include a geologic reconnaissance or geologic investigation that was prepared specifically for the development of the project for which these Recommended Grading Specifications are intended to apply.

### 3. MATERIALS

- 3.1 Materials for compacted fill shall consist of any soil excavated from the cut areas or imported to the site that, in the opinion of the Consultant, is suitable for use in construction of fills. In general, fill materials can be classified as *soil* fills, *soil-rock* fills or *rock* fills, as defined below.
- 3.1.1 **Soil fills** are defined as fills containing no rocks or hard lumps greater than 12 inches in maximum dimension and containing at least 40 percent by weight of material smaller than  $\frac{3}{4}$  inch in size.
- 3.1.2 **Soil-rock fills** are defined as fills containing no rocks or hard lumps larger than 4 feet in maximum dimension and containing a sufficient matrix of soil fill to allow for proper compaction of soil fill around the rock fragments or hard lumps as specified in Paragraph 6.2. **Oversize rock** is defined as material greater than 12 inches.
- 3.1.3 **Rock fills** are defined as fills containing no rocks or hard lumps larger than 3 feet in maximum dimension and containing little or no fines. Fines are defined as material smaller than  $\frac{3}{4}$  inch in maximum dimension. The quantity of fines shall be less than approximately 20 percent of the rock fill quantity.
- 3.2 Material of a perishable, spongy, or otherwise unsuitable nature as determined by the Consultant shall not be used in fills.
- 3.3 Materials used for fill, either imported or on-site, shall not contain hazardous materials as defined by the California Code of Regulations, Title 22, Division 4, Chapter 30, Articles 9

and 10; 40CFR; and any other applicable local, state or federal laws. The Consultant shall not be responsible for the identification or analysis of the potential presence of hazardous materials. However, if observations, odors or soil discoloration cause Consultant to suspect the presence of hazardous materials, the Consultant may request from the Owner the termination of grading operations within the affected area. Prior to resuming grading operations, the Owner shall provide a written report to the Consultant indicating that the suspected materials are not hazardous as defined by applicable laws and regulations.

- 3.4 The outer 15 feet of *soil-rock* fill slopes, measured horizontally, should be composed of properly compacted *soil* fill materials approved by the Consultant. *Rock* fill may extend to the slope face, provided that the slope is not steeper than 2:1 (horizontal:vertical) and a soil layer no thicker than 12 inches is track-walked onto the face for landscaping purposes. This procedure may be utilized provided it is acceptable to the governing agency, Owner and Consultant.
- 3.5 Samples of soil materials to be used for fill should be tested in the laboratory by the Consultant to determine the maximum density, optimum moisture content, and, where appropriate, shear strength, expansion, and gradation characteristics of the soil.
- 3.6 During grading, soil or groundwater conditions other than those identified in the Geotechnical Report may be encountered by the Contractor. The Consultant shall be notified immediately to evaluate the significance of the unanticipated condition.

#### **4. CLEARING AND PREPARING AREAS TO BE FILLED**

- 4.1 Areas to be excavated and filled shall be cleared and grubbed. Clearing shall consist of complete removal above the ground surface of trees, stumps, brush, vegetation, man-made structures, and similar debris. Grubbing shall consist of removal of stumps, roots, buried logs and other unsuitable material and shall be performed in areas to be graded. Roots and other projections exceeding 1½ inches in diameter shall be removed to a depth of 3 feet below the surface of the ground. Borrow areas shall be grubbed to the extent necessary to provide suitable fill materials.
- 4.2 Asphalt pavement material removed during clearing operations should be properly disposed at an approved off-site facility or in an acceptable area of the project evaluated by Geocon and the property owner. Concrete fragments that are free of reinforcing steel may be placed in fills, provided they are placed in accordance with Section 6.2 or 6.3 of this document.

- 4.3 After clearing and grubbing of organic matter and other unsuitable material, loose or porous soils shall be removed to the depth recommended in the Geotechnical Report. The depth of removal and compaction should be observed and approved by a representative of the Consultant. The exposed surface shall then be plowed or scarified to a minimum depth of 6 inches and until the surface is free from uneven features that would tend to prevent uniform compaction by the equipment to be used.
- 4.4 Where the slope ratio of the original ground is steeper than 5:1 (horizontal:vertical), or where recommended by the Consultant, the original ground should be benched in accordance with the following illustration.

#### TYPICAL BENCHING DETAIL

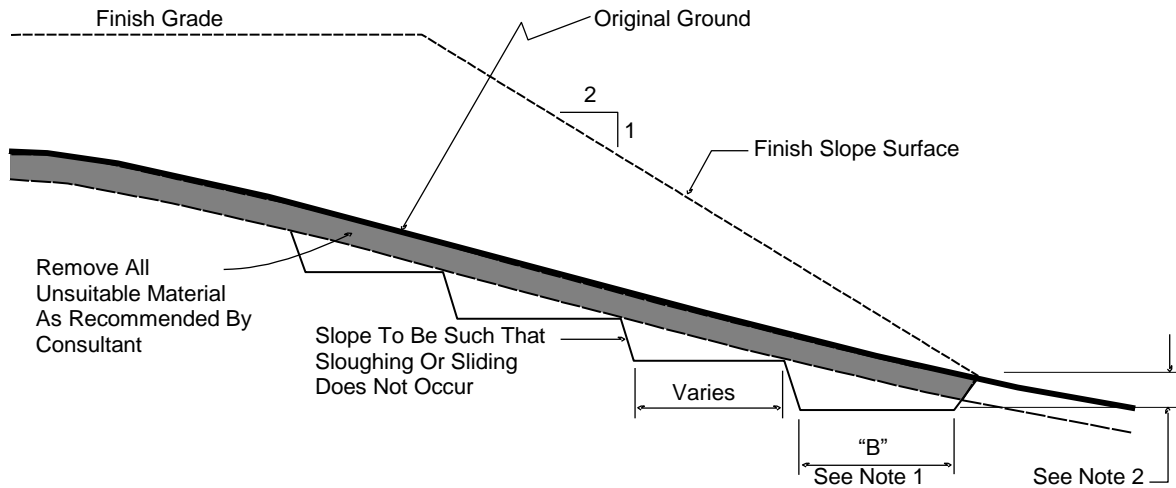

No Scale

- DETAIL NOTES: (1) Key width "B" should be a minimum of 10 feet, or sufficiently wide to permit complete coverage with the compaction equipment used. The base of the key should be graded horizontal, or inclined slightly into the natural slope.
- (2) The outside of the key should be below the topsoil or unsuitable surficial material and at least 2 feet into dense formational material. Where hard rock is exposed in the bottom of the key, the depth and configuration of the key may be modified as approved by the Consultant.

- 4.5 After areas to receive fill have been cleared and scarified, the surface should be moisture conditioned to achieve the proper moisture content, and compacted as recommended in Section 6 of these specifications.



## 5. COMPACTION EQUIPMENT

- 5.1 Compaction of *soil* or *soil-rock* fill shall be accomplished by sheepsfoot or segmented-steel wheeled rollers, vibratory rollers, multiple-wheel pneumatic-tired rollers, or other types of acceptable compaction equipment. Equipment shall be of such a design that it will be capable of compacting the *soil* or *soil-rock* fill to the specified relative compaction at the specified moisture content.
- 5.2 Compaction of *rock* fills shall be performed in accordance with Section 6.3.

## 6. PLACING, SPREADING AND COMPACTION OF FILL MATERIAL

- 6.1 *Soil* fill, as defined in Paragraph 3.1.1, shall be placed by the Contractor in accordance with the following recommendations:
- 6.1.1 *Soil* fill shall be placed by the Contractor in layers that, when compacted, should generally not exceed 8 inches. Each layer shall be spread evenly and shall be thoroughly mixed during spreading to obtain uniformity of material and moisture in each layer. The entire fill shall be constructed as a unit in nearly level lifts. Rock materials greater than 12 inches in maximum dimension shall be placed in accordance with Section 6.2 or 6.3 of these specifications.
- 6.1.2 In general, the *soil* fill shall be compacted at a moisture content at or above the optimum moisture content as determined by ASTM D 1557.
- 6.1.3 When the moisture content of *soil* fill is below that specified by the Consultant, water shall be added by the Contractor until the moisture content is in the range specified.
- 6.1.4 When the moisture content of the *soil* fill is above the range specified by the Consultant or too wet to achieve proper compaction, the *soil* fill shall be aerated by the Contractor by blading/mixing, or other satisfactory methods until the moisture content is within the range specified.
- 6.1.5 After each layer has been placed, mixed, and spread evenly, it shall be thoroughly compacted by the Contractor to a relative compaction of at least 90 percent. Relative compaction is defined as the ratio (expressed in percent) of the in-place dry density of the compacted fill to the maximum laboratory dry density as determined in accordance with ASTM D 1557. Compaction shall be continuous over the entire area, and compaction equipment shall make sufficient passes so that the specified minimum relative compaction has been achieved throughout the entire fill.

- 6.1.6 Where practical, soils having an Expansion Index greater than 50 should be placed at least 3 feet below finish pad grade and should be compacted at a moisture content generally 2 to 4 percent greater than the optimum moisture content for the material.
  - 6.1.7 Properly compacted *soil* fill shall extend to the design surface of fill slopes. To achieve proper compaction, it is recommended that fill slopes be over-built by at least 3 feet and then cut to the design grade. This procedure is considered preferable to track-walking of slopes, as described in the following paragraph.
  - 6.1.8 As an alternative to over-building of slopes, slope faces may be back-rolled with a heavy-duty loaded sheepsfoot or vibratory roller at maximum 4-foot fill height intervals. Upon completion, slopes should then be track-walked with a D-8 dozer or similar equipment, such that a dozer track covers all slope surfaces at least twice.
- 6.2 *Soil-rock* fill, as defined in Paragraph 3.1.2, shall be placed by the Contractor in accordance with the following recommendations:
- 6.2.1 Rocks larger than 12 inches but less than 4 feet in maximum dimension may be incorporated into the compacted *soil* fill, but shall be limited to the area measured 15 feet minimum horizontally from the slope face and 5 feet below finish grade or 3 feet below the deepest utility, whichever is deeper.
  - 6.2.2 Rocks or rock fragments up to 4 feet in maximum dimension may either be individually placed or placed in windrows. Under certain conditions, rocks or rock fragments up to 10 feet in maximum dimension may be placed using similar methods. The acceptability of placing rock materials greater than 4 feet in maximum dimension shall be evaluated during grading as specific cases arise and shall be approved by the Consultant prior to placement.
  - 6.2.3 For individual placement, sufficient space shall be provided between rocks to allow for passage of compaction equipment.
  - 6.2.4 For windrow placement, the rocks should be placed in trenches excavated in properly compacted *soil* fill. Trenches should be approximately 5 feet wide and 4 feet deep in maximum dimension. The voids around and beneath rocks should be filled with approved granular soil having a Sand Equivalent of 30 or greater and should be compacted by flooding. Windrows may also be placed utilizing an "open-face" method in lieu of the trench procedure, however, this method should first be approved by the Consultant.

- 6.2.5 Windrows should generally be parallel to each other and may be placed either parallel to or perpendicular to the face of the slope depending on the site geometry. The minimum horizontal spacing for windrows shall be 12 feet center-to-center with a 5-foot stagger or offset from lower courses to next overlying course. The minimum vertical spacing between windrow courses shall be 2 feet from the top of a lower windrow to the bottom of the next higher windrow.
- 6.2.6 Rock placement, fill placement and flooding of approved granular soil in the windrows should be continuously observed by the Consultant.
- 6.3 *Rock* fills, as defined in Section 3.1.3, shall be placed by the Contractor in accordance with the following recommendations:
- 6.3.1 The base of the *rock* fill shall be placed on a sloping surface (minimum slope of 2 percent). The surface shall slope toward suitable subdrainage outlet facilities. The *rock* fills shall be provided with subdrains during construction so that a hydrostatic pressure buildup does not develop. The subdrains shall be permanently connected to controlled drainage facilities to control post-construction infiltration of water.
- 6.3.2 *Rock* fills shall be placed in lifts not exceeding 3 feet. Placement shall be by rock trucks traversing previously placed lifts and dumping at the edge of the currently placed lift. Spreading of the *rock* fill shall be by dozer to facilitate *seating* of the rock. The *rock* fill shall be watered heavily during placement. Watering shall consist of water trucks traversing in front of the current rock lift face and spraying water continuously during rock placement. Compaction equipment with compactive energy comparable to or greater than that of a 20-ton steel vibratory roller or other compaction equipment providing suitable energy to achieve the required compaction or deflection as recommended in Paragraph 6.3.3 shall be utilized. The number of passes to be made should be determined as described in Paragraph 6.3.3. Once a *rock* fill lift has been covered with *soil* fill, no additional *rock* fill lifts will be permitted over the *soil* fill.
- 6.3.3 Plate bearing tests, in accordance with ASTM D 1196, may be performed in both the compacted *soil* fill and in the *rock* fill to aid in determining the required minimum number of passes of the compaction equipment. If performed, a minimum of three plate bearing tests should be performed in the properly compacted *soil* fill (minimum relative compaction of 90 percent). Plate bearing tests shall then be performed on areas of *rock* fill having two passes, four passes and six passes of the compaction equipment, respectively. The number of passes required for the *rock* fill shall be determined by comparing the results of the plate bearing tests for the *soil* fill and the *rock* fill and by evaluating the deflection

variation with number of passes. The required number of passes of the compaction equipment will be performed as necessary until the plate bearing deflections are equal to or less than that determined for the properly compacted *soil* fill. In no case will the required number of passes be less than two.

- 6.3.4 A representative of the Consultant should be present during *rock* fill operations to observe that the minimum number of “passes” have been obtained, that water is being properly applied and that specified procedures are being followed. The actual number of plate bearing tests will be determined by the Consultant during grading.
- 6.3.5 Test pits shall be excavated by the Contractor so that the Consultant can state that, in their opinion, sufficient water is present and that voids between large rocks are properly filled with smaller rock material. In-place density testing will not be required in the *rock* fills.
- 6.3.6 To reduce the potential for “piping” of fines into the *rock* fill from overlying *soil* fill material, a 2-foot layer of graded filter material shall be placed above the uppermost lift of *rock* fill. The need to place graded filter material below the *rock* should be determined by the Consultant prior to commencing grading. The gradation of the graded filter material will be determined at the time the *rock* fill is being excavated. Materials typical of the *rock* fill should be submitted to the Consultant in a timely manner, to allow design of the graded filter prior to the commencement of *rock* fill placement.
- 6.3.7 *Rock* fill placement should be continuously observed during placement by the Consultant.

## 7. SUBDRAINS

- 7.1 The geologic units on the site may have permeability characteristics and/or fracture systems that could be susceptible under certain conditions to seepage. The use of canyon subdrains may be necessary to mitigate the potential for adverse impacts associated with seepage conditions. Canyon subdrains with lengths in excess of 500 feet or extensions of existing offsite subdrains should use 8-inch-diameter pipes. Canyon subdrains less than 500 feet in length should use 6-inch-diameter pipes.

## TYPICAL CANYON DRAIN DETAIL

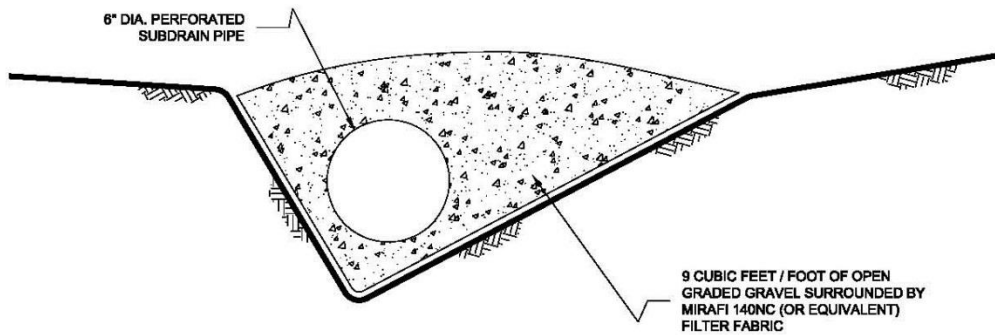
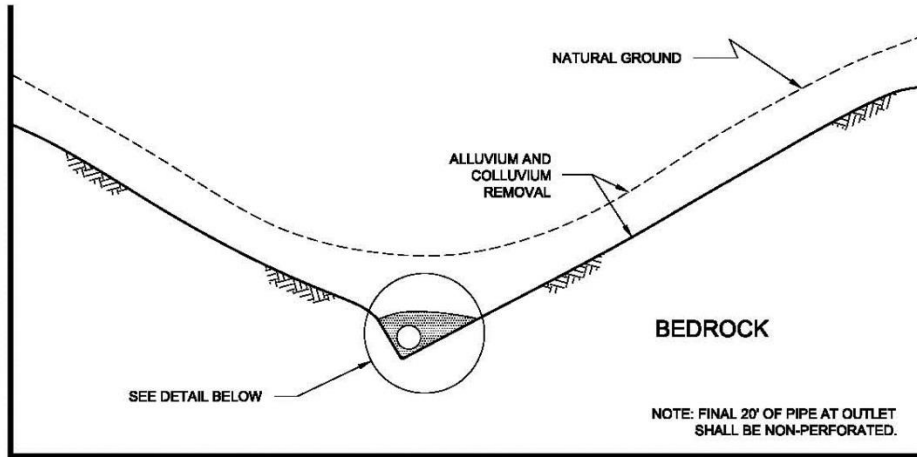

### NOTES:

- 1.....8-INCH DIAMETER, SCHEDULE 80 PVC PERFORATED PIPE FOR FILLS IN EXCESS OF 100-FEET IN DEPTH OR A PIPE LENGTH OF LONGER THAN 500 FEET.
- 2.....6-INCH DIAMETER, SCHEDULE 40 PVC PERFORATED PIPE FOR FILLS LESS THAN 100-FEET IN DEPTH OR A PIPE LENGTH SHORTER THAN 500 FEET.

NO SCALE

7.2 Slope drains within stability fill keyways should use 4-inch-diameter (or larger) pipes.

## TYPICAL STABILITY FILL DETAIL

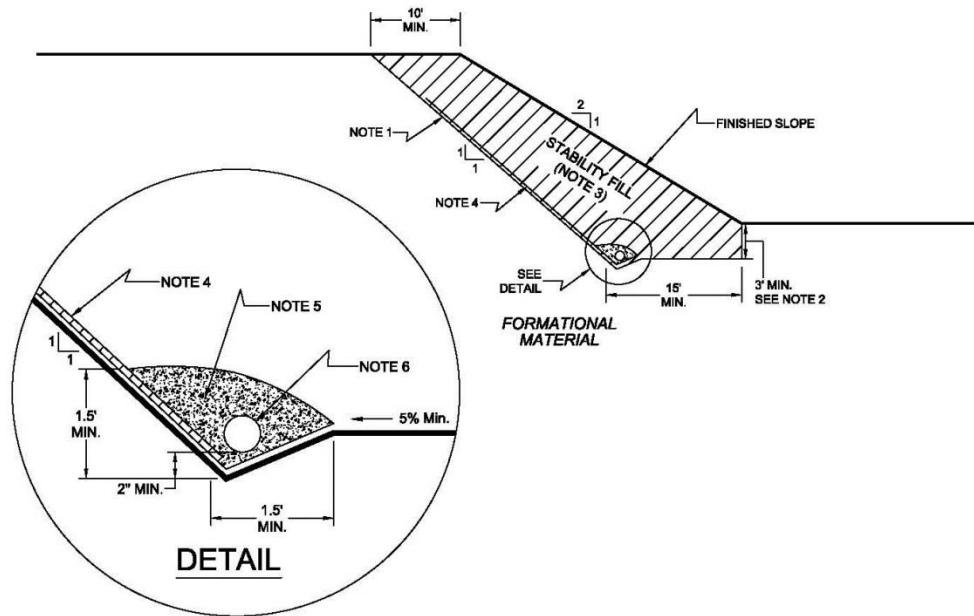

### NOTES:

- 1.....EXCAVATE BACKCUT AT 1:1 INCLINATION (UNLESS OTHERWISE NOTED).
- 2.....BASE OF STABILITY FILL TO BE 3 FEET INTO FORMATIONAL MATERIAL, SLOPING A MINIMUM 5% INTO SLOPE.
- 3.....STABILITY FILL TO BE COMPOSED OF PROPERLY COMPACTED GRANULAR SOIL.
- 4.....CHIMNEY DRAINS TO BE APPROVED PREFABRICATED CHIMNEY DRAIN PANELS (MIRADRAIN G200N OR EQUIVALENT) SPACED APPROXIMATELY 20 FEET CENTER TO CENTER AND 4 FEET WIDE. CLOSER SPACING MAY BE REQUIRED IF SEEPAGE IS ENCOUNTERED.
- 5.....FILTER MATERIAL TO BE 3/4-INCH, OPEN-GRADED CRUSHED ROCK ENCLOSED IN APPROVED FILTER FABRIC (MIRAFI 140NC).
- 6.....COLLECTOR PIPE TO BE 4-INCH MINIMUM DIAMETER, PERFORATED, THICK-WALLED PVC SCHEDULE 40 OR EQUIVALENT, AND SLOPED TO DRAIN AT 1 PERCENT MINIMUM TO APPROVED OUTLET.

NO SCALE

- 7.3 The actual subdrain locations will be evaluated in the field during the remedial grading operations. Additional drains may be necessary depending on the conditions observed and the requirements of the local regulatory agencies. Appropriate subdrain outlets should be evaluated prior to finalizing 40-scale grading plans.
- 7.4 *Rock fill or soil-rock fill* areas may require subdrains along their down-slope perimeters to mitigate the potential for buildup of water from construction or landscape irrigation. The subdrains should be at least 6-inch-diameter pipes encapsulated in gravel and filter fabric. *Rock fill* drains should be constructed using the same requirements as canyon subdrains.

7.5 Prior to outletting, the final 20-foot segment of a subdrain that will not be extended during future development should consist of non-perforated drainpipe. At the non-perforated/perforated interface, a seepage cutoff wall should be constructed on the downslope side of the pipe.

### TYPICAL CUT OFF WALL DETAIL

FRONT VIEW

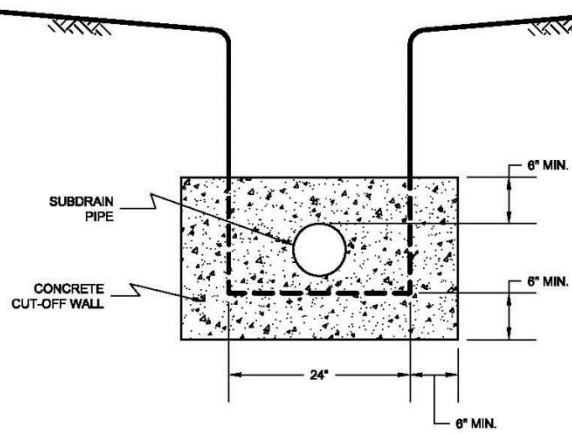

NO SCALE

SIDE VIEW

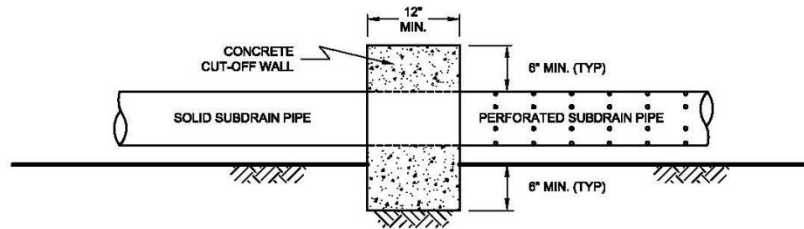

NO SCALE

7.6 Subdrains that discharge into a natural drainage course or open space area should be provided with a permanent headwall structure.

## TYPICAL HEADWALL DETAIL

### FRONT VIEW

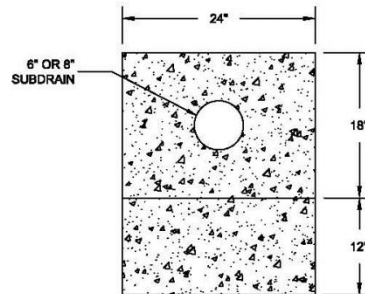

NO SCALE

### SIDE VIEW

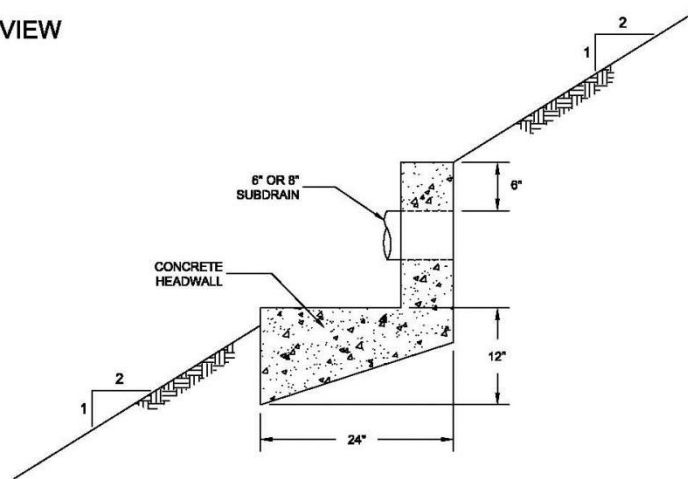

NOTE: HEADWALL SHOULD OUTLET AT TOE OF FILL SLOPE  
OR INTO CONTROLLED SURFACE DRAINAGE

NO SCALE

- 7.7 The final grading plans should show the location of the proposed subdrains. After completion of remedial excavations and subdrain installation, the project civil engineer should survey the drain locations and prepare an “as-built” map showing the drain locations. The final outlet and connection locations should be determined during grading operations. Subdrains that will be extended on adjacent projects after grading can be placed on formational material and a vertical riser should be placed at the end of the subdrain. The grading contractor should consider videoing the subdrains shortly after burial to check proper installation and functionality. The contractor is responsible for the performance of the drains.



## 8. OBSERVATION AND TESTING

- 8.1 The Consultant shall be the Owner's representative to observe and perform tests during clearing, grubbing, filling, and compaction operations. In general, no more than 2 feet in vertical elevation of *soil* or *soil-rock* fill should be placed without at least one field density test being performed within that interval. In addition, a minimum of one field density test should be performed for every 2,000 cubic yards of *soil* or *soil-rock* fill placed and compacted.
- 8.2 The Consultant should perform a sufficient distribution of field density tests of the compacted *soil* or *soil-rock* fill to provide a basis for expressing an opinion whether the fill material is compacted as specified. Density tests shall be performed in the compacted materials below any disturbed surface. When these tests indicate that the density of any layer of fill or portion thereof is below that specified, the particular layer or areas represented by the test shall be reworked until the specified density has been achieved.
- 8.3 During placement of *rock* fill, the Consultant should observe that the minimum number of passes have been obtained per the criteria discussed in Section 6.3.3. The Consultant should request the excavation of observation pits and may perform plate bearing tests on the placed *rock* fills. The observation pits will be excavated to provide a basis for expressing an opinion as to whether the *rock* fill is properly seated and sufficient moisture has been applied to the material. When observations indicate that a layer of *rock* fill or any portion thereof is below that specified, the affected layer or area shall be reworked until the *rock* fill has been adequately seated and sufficient moisture applied.
- 8.4 A settlement monitoring program designed by the Consultant may be conducted in areas of *rock* fill placement. The specific design of the monitoring program shall be as recommended in the Conclusions and Recommendations section of the project Geotechnical Report or in the final report of testing and observation services performed during grading.
- 8.5 We should observe the placement of subdrains, to check that the drainage devices have been placed and constructed in substantial conformance with project specifications.
- 8.6 Testing procedures shall conform to the following Standards as appropriate:

### 8.6.1 Soil and Soil-Rock Fills:

- 8.6.1.1 Field Density Test, ASTM D 1556, *Density of Soil In-Place By the Sand-Cone Method.*

- 8.6.1.2 Field Density Test, Nuclear Method, ASTM D 6938, *Density of Soil and Soil-Aggregate In-Place by Nuclear Methods (Shallow Depth)*.
- 8.6.1.3 Laboratory Compaction Test, ASTM D 1557, *Moisture-Density Relations of Soils and Soil-Aggregate Mixtures Using 10-Pound Hammer and 18-Inch Drop*.
- 8.6.1.4 Expansion Index Test, ASTM D 4829, *Expansion Index Test*.

## **9. PROTECTION OF WORK**

- 9.1 During construction, the Contractor shall properly grade all excavated surfaces to provide positive drainage and prevent ponding of water. Drainage of surface water shall be controlled to avoid damage to adjoining properties or to finished work on the site. The Contractor shall take remedial measures to prevent erosion of freshly graded areas until such time as permanent drainage and erosion control features have been installed. Areas subjected to erosion or sedimentation shall be properly prepared in accordance with the Specifications prior to placing additional fill or structures.
- 9.2 After completion of grading as observed and tested by the Consultant, no further excavation or filling shall be conducted except in conjunction with the services of the Consultant.

## **10. CERTIFICATIONS AND FINAL REPORTS**

- 10.1 Upon completion of the work, Contractor shall furnish Owner a certification by the Civil Engineer stating that the lots and/or building pads are graded to within 0.1 foot vertically of elevations shown on the grading plan and that all tops and toes of slopes are within 0.5 foot horizontally of the positions shown on the grading plans. After installation of a section of subdrain, the project Civil Engineer should survey its location and prepare an *as-built* plan of the subdrain location. The project Civil Engineer should verify the proper outlet for the subdrains and the Contractor should ensure that the drain system is free of obstructions.
- 10.2 The Owner is responsible for furnishing a final as-graded soil and geologic report satisfactory to the appropriate governing or accepting agencies. The as-graded report should be prepared and signed by a California licensed Civil Engineer experienced in geotechnical engineering and by a California Certified Engineering Geologist, indicating that the geotechnical aspects of the grading were performed in substantial conformance with the Specifications or approved changes to the Specifications.

## LIST OF REFERENCES

1. Advanced Geotechnical Solutions, Inc. (AGS), *Update Geotechnical Report and Grading Plan Review, Energy Park, Chula Vista, California*, dated September 29, 2014 (Report No. 1404-05-B-2);
2. FEMA (2012), *Flood Map Service Center*, FEMA website, <https://msc.fema.gov/portal/home>, flood map numbers 06073C2156G and 06073C2157G, effective May 16, 2012, accessed August 29, 2021;
3. Geocon Incorporated, *Final Report of Testing and Observation Services Performed During Site Grading, Otay Ranch Village 3, Chula Vista, California*, dated November 25, 2020 (Project No. 06930-52-06);
4. Stark, Choi, McCone (2005), *Journal of Geotechnical and Geoenvironmental Engineering, Drained Shear Strength Parameters for Analysis of Landslides*.
5. Geo Institute (2016), *Development and Use of Fully Softened Shear Strength in Slope Stability Analyses*, *Geo Institute*, dated February 12, 2016.
6. Kennedy, M. P. and S. S Tan, *Geologic Map of the San Diego 30'x60' Quadrangle*, California, California Geologic Survey, 2008.
7. Magellan Architecture, *Chula Vista Self Storage, Chula Vista, CA, Scheme B*, dated May 12, 2021;
8. Pasco Laret Suiter & Associates, *Preliminary Grading Study, Nirvana Self Storage, 821 Main Street, Chula Vista, CA*, dated July 23, 2021.
9. SEAOC (2019), *OSHPD Seismic Design Maps: Structural Engineers Association of California* website, <http://seismicmaps.org/>, accessed August 29, 2021;
10. USGS (2019), *Quaternary Fault and Fold Database of the United States: U.S. Geological Survey* website, <https://www.usgs.gov/natural-hazards/earthquake-hazards/faults>, accessed August 29, 2021;
11. Unpublished reports and maps on file with Geocon Incorporated.