

# TRANSPORTATION IMPACT STUDY

## Oyster Cove Petaluma, CA

PREPARED FOR:  
OYSTER COVE, LLC



MAY 2022 | FINAL

Prepared By:

**Kimley»Horn**



**WARNING!**

The electronic data files ("Files") furnished by Kimley-Horn and Associates, Inc. to the intended receiver of the Files ("Receiving Party") are provided only for the convenience of Receiving Party and only for its sole use.

In the case of any defects in the Files or any discrepancies between the electronic Files and the hardcopy of the Files prepared by Kimley-Horn, the hardcopy shall govern. Only printed copies of documents conveyed by Kimley-Horn may be relied upon. Any use of the information obtained or derived from these electronic files will be at the Receiving Party's sole risk. Because data stored in electronic media format can deteriorate or be modified inadvertently or otherwise without authorization of the data's creator, the Receiving Party agrees that it has 60 days to perform acceptance tests, after which it shall be deemed to have accepted the data transferred. Receiving Party accepts the Files on an "as is" basis with all faults. There are no express warranties made by Kimley-Horn with respect to the Files, and any implied warranties are excluded.



# CONTENTS

Contents .....	iii
Tables.....	iv
Figures.....	iv
Executive Summary .....	i
Project Trip Estimates .....	i
Project Impact and Deficiencies .....	i
1. Introduction .....	1
Vehicle Miles Traveled Methodology .....	1
Intersection Level of Service Methodology.....	3
2. Vehicle Miles Traveled Analysis .....	6
3. Existing Conditions.....	7
Existing Roadway Network.....	7
Existing Transit Facilities.....	8
Existing Pedestrian Facilities.....	9
Existing Bicycle Facilities .....	10
Existing Lane Configuration and Traffic Control .....	13
Existing Peak-Hour Turning Movement Volumes.....	13
Existing Intersection Level of Service .....	13
Field Observations .....	14
4. Existing Plus Project Conditions.....	17
Proposed Site Use .....	17
Trip Generation.....	17
Project Trip Distribution and Assignment .....	20
Existing Plus Project Intersection Level of Service.....	20
5. Pipeline Traffic Conditions.....	27
Pipeline Traffic Volumes.....	27
Pipeline Intersections Level of Service .....	27
Pipeline Plus Project Intersection Level of Service.....	30
6. Cumulative Traffic Conditions.....	33
Cumulative Transportation Improvements .....	33
Cumulative Traffic Volume .....	33
Cumulative Intersections Level of Service .....	33
Cumulative Plus Project Intersection Level of Service.....	36
7. Vehicle Queuing, Site Access and Circulation.....	39
Rail Queuing Evaluation.....	39
Site Access and Circulation.....	40
8. Collision Evaluation .....	43
9. Summary of Deficiencies and Recommended Improvements.....	44



**TABLES**

Table 1 - Intersection Level of Service Definitions .....4  
 Table 2 - Existing Intersection Level of Service Summary .....13  
 Table 3 - Project Trip Generation .....18  
 Table 4 - Existing Plus Project Intersection Level of Service Summary .....26  
 Table 5 - Pipeline Intersection Level of Service Summary .....27  
 Table 6 - Pipeline Plus Project Intersection Level of Service Summary .....32  
 Table 7 - Cumulative Intersection Level of Service Summary .....34  
 Table 8 - Cumulative Plus Project Intersection Level of Service Summary .....38  
 Table 9 – SimTraffic Queuing Evaluation – Northbound D Street and Washington Street .....39  
 Table 10 – Driveway Queuing Evaluation .....40  
 Table 11 – Collision Analysis .....43

**FIGURES**

Figure 1 - Project Location and Study Intersections .....2  
 Figure 2 - Existing Transit Facilities .....11  
 Figure 3 - Existing Bicycle Facilities .....12  
 Figure 4 - Existing Condition Lane Geometry and Traffic Control .....15  
 Figure 5 - Existing Condition Peak Hour Turning Movement Volumes .....16  
 Figure 6 – Site Plan .....19  
 Figure 7 - Existing Trip Distribution .....21  
 Figure 8 – Project Trip Distribution .....22  
 Figure 9 – Existing Trip Assignment Peak Hour Turning Movement Volumes .....23  
 Figure 10 – Proposed Trip Assignment Peak Hour Turning Movement Volumes .....24  
 Figure 11 - Existing Plus Project Conditions Peak Hour Turning Movement Volumes .....25  
 Figure 12 – Pending and Approved Project Locations .....28  
 Figure 13 - Pipeline Conditions Peak Hour Turning Movement Volumes .....29  
 Figure 14 - Pipeline Plus Project Peak Hour Turning Movement Volumes .....31  
 Figure 15 - Cumulative Conditions Peak Hour Turning Movement Volume .....35  
 Figure 16 - Cumulative Plus Project Conditions Peak Hour Turning Movement Volumes .....37  
 Figure 17 – Petaluma Fire Truck Turning Exhibit .....42



## EXECUTIVE SUMMARY

The Oyster Cove Project (“Project”) located at 100 and 310 D Street in Petaluma, CA proposes to construct 122 three-story townhomes, 10 live/work units, 1,500 square feet of commercial use, 1,500 square feet of public plaza, and 6,000 square feet institutional/boat storage. The project is bordered by D Street to the west, McNear Canal to the east, Lakeville Street to the north, and Petaluma River to the south. The project is located just north of Downtown Petaluma and is less than a 1,000-foot walking distance from the Downtown Petaluma Sonoma Marin Area Rail Transit (SMART) station. The 6.1-acre site currently contains three one-story buildings on the southern end that are used for industrial and agricultural use. The two buildings on the southeast portion will be demolished and the building on the southwest portion will be renovated and reused for the commercial, public plaza, and institutional/boat storage space. A traffic signal and a southbound left-turn lane will be constructed at the intersection of D Street and Copeland Street with the project. The project will coordinate with the City to determine its fair share cost of these improvements.

This TIS was prepared to determine potential vehicle miles traveled (VMT) impacts and intersection level of service (LOS) deficiencies of the proposed project on the adjacent roadway network. Site access, on-site circulation, and collision evaluations were also reviewed to determine the effects of the proposed project to the site.

## PROJECT TRIP ESTIMATES

Trips generated by the project were determined using the Institute of Transportation Engineer’s (ITE) *Trip Generation Manual, 11<sup>th</sup> Edition*. Trips generated by the townhomes were based on an average rate for ITE Land Use 220 (Multifamily Housing – Low-Rise, Close to Transit), due to the proximity of the residential project to the Downtown Petaluma SMART station. The live/work units are not expected to generate AM and PM peak hour trips as they are designed for residents who work from home and therefore will not commute during the peak periods. Daily trips for the live/work units were determined based on an average rate for ITE Land Use 220 (Multifamily Housing – Low-Rise, Close to Transit) excluding the AM and PM peak hour trips these units would have generated if they were typical townhomes with residents commuting during the AM and PM peak periods. Trips generated by the commercial use were based on an average rate for ITE Land Use 822 (Strip Retail Plaza – less than 40 KSF). Trips generated by the public plaza and institutional storage are assumed to be captured within the trips generated by the residential and retail uses. A four percent internal capture in the PM peak hour was applied to account for the interaction among the uses within the site. No internal capture reduction rates are provided for the AM peak hour. In addition, a 4 percent pass-by reduction in the PM peak hour was applied to account for the trips that will already be on the road and likely pass-by the commercial use of the project. An existing trip credit was taken for the three existing industrial buildings based on the existing counts collected at the intersection of D Street and Copeland Street.

The proposed project is anticipated to generate a net new +481 daily trips, +45 trips in the AM peak hour (11 trips in and 34 trips out) and a net new +63 trips in the PM peak hour (38 trips in and 25 trips out).

## PROJECT IMPACT AND DEFICIENCIES

The following summarizes the transportation impacts and project deficiencies related to the proposed project and the study area. Transportation impacts are based on vehicle miles traveled and not intersection level of service. Intersection level of service deficiencies under project conditions were also identified and summarized.

---

## VEHICLE MILES TRAVELED (VMT)

Based on the City's *Senate Bill 743 Vehicle Miles Traveled Implementation Guidelines*, VMT screening criteria may be applied to certain projects that qualify to be exempt from further VMT analysis. Due to the location of the project and its proximity to the Downtown Petaluma SMART station, the "Proximity to a Major Transit Stop" screening criteria was applied which is summarized as follows:

- A project would be screened from the VMT analysis if it is located within a ½ mile of an existing or planned high-quality transit corridor or major transit station. These include the existing Downtown Petaluma SMART station, the planned Petaluma North SMART station (also known as the Corona Station), and at stops for bus routes with 15-minute or less headways in the City of Petaluma.
- This screening criteria should not be applied to projects that meet the following requirements:
  - Has a Floor Area Ratio (FAR) of less than 0.75
  - Includes more parking than required by the City of Petaluma
  - Is inconsistent with Plan Bay Area
  - Replaces affordable residential units with a smaller number of moderate- or high-income residential units (although a small market-rate project could qualify for small project screening)

Since the project is located less than ½ mile from the Downtown Petaluma SMART station and the exemptions do not apply to the project, the project results in a less than significant VMT impact.

---

## INTERSECTION LEVEL OF SERVICE AND QUEUING DEFICIENCIES

No intersection LOS and queuing deficiencies result from the proposed project.

# 1. INTRODUCTION

This report presents the results of the transportation impact study (TIS) for the proposed Oyster Cove Project (“Project”) located at 100 and 310 D Street in Petaluma, CA. The project is bordered by D Street to the west, McNear Canal to the east, Lakeville Street to the north, and Petaluma River to the south. The project is located just north of Downtown Petaluma and is less than a 1,000-foot walking distance from the Petaluma Downtown Sonoma Marin Area Rail Transit (SMART) station. The project proposes to construct 122 three-story townhomes, 10 live/work units, 1,500 square feet of commercial use, 1,500 square feet of public plaza, and 6,000 square feet institutional/boat storage. The 6.1-acre site currently contains three one-story buildings on the southern end that are used for industrial and agricultural use. The two buildings on the southeast portion will be demolished and the building on the southwest portion will be renovated and reused for the commercial, public plaza, and institutional/boat storage space.

**Figure 1** illustrates the location of the project site in relation to the adjacent roadway network. The site would be accessed by the east leg of Copeland Street at the side-street stop-controlled intersection of D Street and Copeland Street. With the project, a traffic signal and a southbound left-turn lane would be constructed at this intersection.

This TIS was prepared to determine potential vehicle miles traveled (VMT) impacts and intersection level of service (LOS) deficiencies of the proposed project on the adjacent roadway network. This study includes a VMT analysis and an intersection LOS analysis during the weekday AM and PM peak hour traffic conditions for six (6) study intersections. Site access, on-site circulation, and collision evaluations were also reviewed to determine the effects of the proposed project to the site. The following discusses the methodology, analysis, and results of the traffic analysis.

## VEHICLE MILES TRAVELED METHODOLOGY

The project’s vehicle miles traveled (VMT) was analyzed to determine if the new development would result in a significant transportation impact under the California Environmental Quality Act (CEQA). VMT was analyzed based on standards and methodology set forth in the City’s *Senate Bill 743 Vehicle Miles Traveled Implementation Guidelines*<sup>1</sup>. The City’s VMT guidelines provide VMT initial screening criteria, significance thresholds, analysis methodologies, and mitigation measures for development projects under CEQA.

Based on the City’s VMT guidelines, projects may be exempt from further VMT analysis if certain screening criteria are met. For projects located within ½-mile of an existing high quality transit corridor or major transit station, it may be exempt from further VMT analysis. As mentioned previously, the project is located within 1,000 feet of the Petaluma SMART station and therefore the project may be exempt from the VMT analysis. If the project does not meet the VMT screening criteria, then the City’s VMT threshold was reviewed to determine whether the project results in a significant VMT impact. For residential projects, the VMT threshold is established at 82.3 percent of the citywide average. Therefore, if the VMT of the proposed residential component of the project exceeds 82.3 percent of the citywide average, a significant impact would occur. For the retail component of the project, a VMT impact would occur if the project results in a net increase in total VMT. Further evaluation of the VMT is described in the following sections.

---

<sup>1</sup> *City of Petaluma Senate Bill 743 Vehicle Miles Traveled Implementation Guidelines, Final*, Fehr & Peers, July 2021

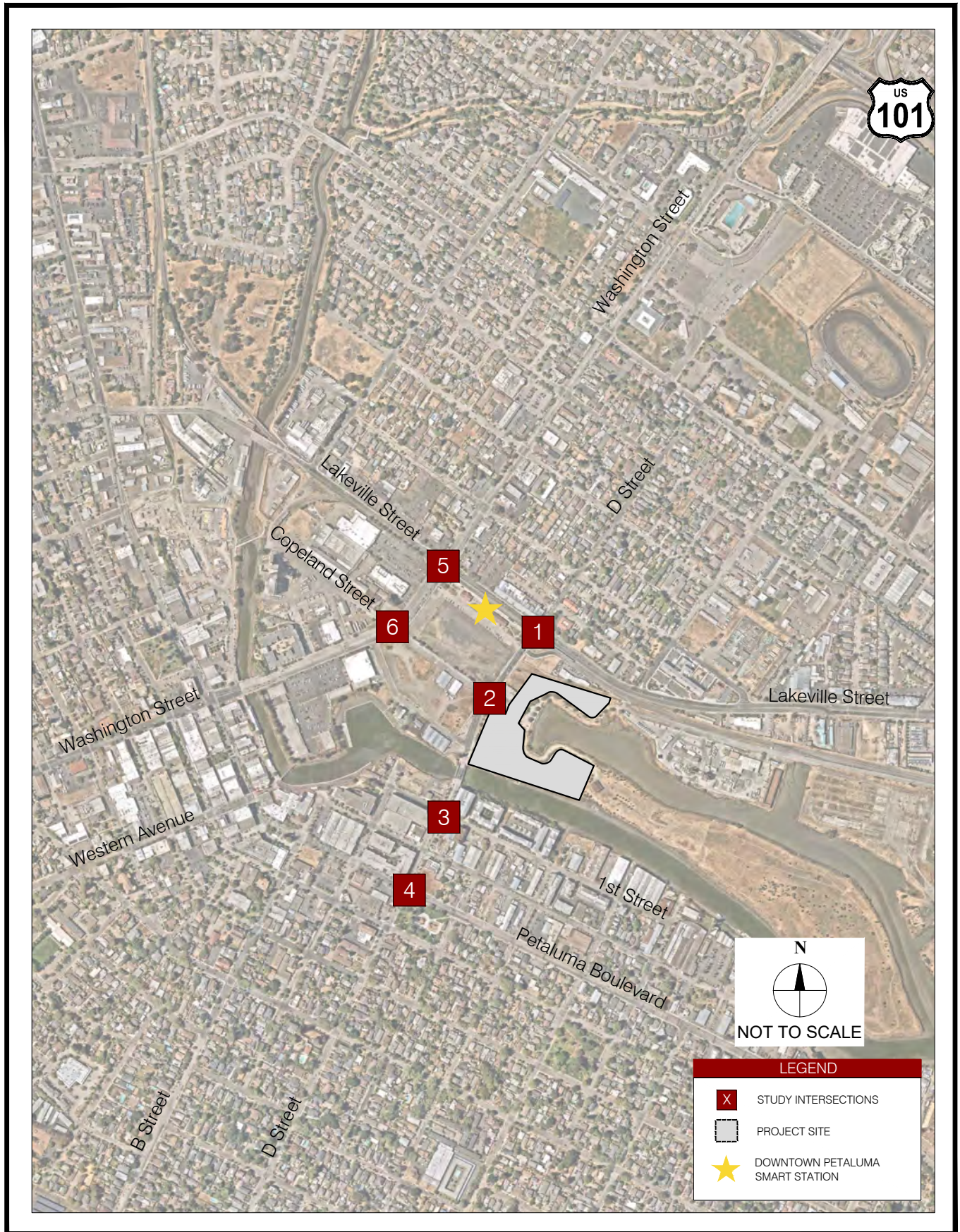



## INTERSECTION LEVEL OF SERVICE METHODOLOGY

### STUDY AREA

The proposed project would generate new vehicular trips that would increase traffic volumes for certain movements on the nearby street network. To assess changes in traffic conditions associated with the proposed project, the following intersections listed below were evaluated and are shown in **Figure 1**. The study intersections were selected based on the estimated vehicle trips generated by the project, the distribution of the trips to the roadway network, and with concurrence with the City Engineer.

- #1 – D Street/Lakeville Street – Signal
- #2 – D Street/Copeland Street – Side-Street Stop-Controlled (SSSC)\*
- #3 – D Street/1st Street – Signal
- #4 – D Street/Petaluma Boulevard – Signal
- #5 – Washington Street/Lakeville Street – Signal
- #6 – Washington Street/Copeland Street – Signal

\*Intersection is proposed to be signalized with the project.

### TRAFFIC CONDITIONS

This TIS evaluates the following traffic scenarios:

- Existing Conditions – Based on Existing (2022) traffic volumes with adjustments made to account for the impact of COVID-19 based on historical traffic volumes. This scenario assumes existing roadway geometry and traffic control.
- Existing Plus Project Conditions – Based on traffic generated by the project added to existing traffic volumes. Existing roadway geometry and traffic control are assumed for this scenario.
- Pipeline Conditions – Based on traffic volumes and traffic added by pipeline development projects assumed to be constructed and occupied during the project's opening day. This scenario assumes existing roadway, geometry, and traffic control.
- Pipeline Plus Project Conditions – Based on the Pipeline traffic conditions and traffic generated by the project. This scenario assumes existing roadway, geometry, and traffic control.
- Cumulative (2040) Conditions – Based on future year traffic forecasts from the Sonoma County (County) travel demand model. Future roadway geometry and traffic control were based on City roadway improvements identified in the Capital Improvement Program (CIP).
- Cumulative (2040) Plus Project Conditions – Based on the Cumulative conditions and traffic generated by the Project. This scenario includes roadway improvements anticipated to be in place at the same time the Project is to be completed.

### LEVEL OF SERVICE STANDARDS

Analysis of the study intersections were based on the concept of Level of Service (LOS) and is a qualitative measure used to describe operational conditions. LOS ranges from A (best), which represents minimal delay, to F (worst), which represents heavy delay and a facility that is operating at or near its functional capacity. Levels of service for this study were determined using methods defined in the *Highway Capacity Manual, 6<sup>th</sup> Edition* (HCM) and Synchro analysis software.

The HCM includes procedures for analyzing side street stop controlled (SSSC), all-way stop controlled (AWSC), and signalized intersections. The SSSC procedure defines LOS as a function of average control

delay for the worst minor street movement or major street left-turn. For this analysis, the delays for the worst approach and the overall intersection are reported. Conversely, the AWSC and signalized intersection procedures define LOS as a function of average control delay for the intersection as a whole. **Table 2** relates the operational characteristics associated with each LOS category for signalized and unsignalized intersections.

**Table 1 - Intersection Level of Service Definitions**

Level of Service	Description	Signalized (Avg. control delay per vehicle sec/veh.)	Unsignalized (Avg. control delay per vehicle sec/veh.)
A	Free flow with no delays. Users are virtually unaffected by others in the traffic stream	≤ 10	≤ 10
B	Stable traffic. Traffic flows smoothly with few delays.	> 10 – 20	> 10 – 15
C	Stable flow but the operation of individual users becomes affected by other vehicles. Modest delays.	> 20 – 35	> 15 – 25
D	Approaching unstable flow. Operation of individual users becomes significantly affected by other vehicles. Delays may be more than one cycle during peak hours.	> 35 – 55	> 25 – 35
E	Unstable flow with operating conditions at or near the capacity level. Long delays and vehicle queuing.	> 55 – 80	> 35 – 50
F	Forced or breakdown flow that causes reduced capacity. Stop and go traffic conditions. Excessive long delays and vehicle queuing.	> 80	> 50

Sources: Transportation Research Board, Highway Capacity Manual 6<sup>th</sup> Edition, National Research Council, 2016.

As outlined in the *Petaluma General Plan 2025 Draft Environmental Impact Report (DEIR)*<sup>2</sup>, Policy 5-P-1 sets the City’s LOS standard to LOS D. A project deficiency would occur at an intersection if one of the following conditions are met:

- Signalized Intersections
  - If the intersection operates at an acceptable LOS D or better without the project and degrades to an unacceptable LOS E or F with the addition of project traffic.
  - If the intersection operates at an unacceptable LOS E without the project and degrades to an unacceptable LOS F with the project.
  - If the intersection operates at an unacceptable LOS F without the project and the project generates additional vehicle trips to the intersection.
- Unsignalized Intersections
  - If the intersection operates at an acceptable LOS D or better without the project and degrades to an unacceptable LOS E or F with the addition of project traffic.

<sup>2</sup> *Petaluma General Plan 2025, Draft Environmental Impact Report, Dyett & Bhatia, December 2006*

- If the intersection operates at an unacceptable LOS E without the project and degrades to an unacceptable LOS F with the project and the intersection satisfies the Caltrans peak-hour volume signal warrant criteria.
- If the intersection operates at an unacceptable LOS F without the project and the average delay increases by five or more seconds with the project and the intersection satisfies the Caltrans peak-hour volume signal warrant criteria.

---

## QUEUING

The effects of vehicle queuing were analyzed and the 95th percentile queue for movements associated with the project site. The 95th percentile queue length represents a condition where 95 percent of the time during the peak hour, traffic queues will be less than or equal to the queue length determined by the analysis. This is referred to as the “95th percentile queue.” Average queuing is generally less.

Queues that exceed the turn pocket length can create potentially hazardous conditions by blocking or disrupting through traffic in adjacent travel lanes. The City of Petaluma does not have standards for queuing and for the purpose of this analysis, queuing deficiencies would be considered as operational issues. Thus, operational deficiencies were considered to occur under conditions where project traffic causes the queue to extend beyond the turn pocket by 25 feet or more (i.e. the length of one vehicle) into internal drive aisles or adjacent through lanes. Where the vehicle queue already exceeds that turn pocket length under pre-project conditions, a queuing deficiency would occur if project traffic lengthens the queue by 25 feet or more.

---

## REPORT ORGANIZATION

The remainder of the report is divided into the following chapters:

- Chapter 2: Vehicle Miles Traveled – describes the potential VMT impacts related to the proposed project.
- Chapter 3: Existing Conditions – describes existing conditions on the roadway network, transit system, pedestrian facilities, and bicycle facilities.
- Chapter 4: Existing Plus Project Conditions – describes the proposed project, trip generation, and estimated impact on the transportation system under Existing Plus Project Conditions.
- Chapter 5: Pipeline Conditions – describes the traffic conditions under Pipeline Conditions with and without the proposed project.
- Chapter 6: Cumulative Conditions – describes the traffic conditions under Cumulative Conditions with and without the proposed project.
- Chapter 7: Vehicle Queuing and Site Access and Circulation - describes vehicle queuing analysis at the project driveway, as well as site access for the project. This chapter also describes pedestrian and bicycle access to the project site.
- Chapter 8: Collision Evaluation – describes the collision analysis as the study intersections including the primary collision factors, collision types, and collision rates.
- Chapter 9: Summary of Impacts and Recommended Mitigation – summarizes potential impacts of the proposed project and mitigations, if necessary.

## 2. VEHICLE MILES TRAVELED ANALYSIS

A Vehicle Miles Traveled (VMT) analysis was completed for the proposed mixed-use development project. The project is proposing to construct 122 townhomes, 10 live/work units, 1,500 square feet of commercial use, 1,500 square feet of public plaza, and 6,000 square feet institutional/boat storage. The City's VMT screening criteria guidelines were reviewed to determine whether the project would be exempt from a VMT analysis. Due to the close proximity to the Petaluma SMART station, the City's screening criteria for "Proximity to a Major Transit Stop" was reviewed and is summarized as follows:

- A project would be screened from the VMT analysis if it is located within a ½ mile of an existing or planned high-quality transit corridor or major transit station. These include the existing Downtown Petaluma SMART station, the planned Petaluma North SMART station (also known as the Corona Station), and at stops for bus routes with 15-minute or less headways in the City of Petaluma.
- This screening criteria should not be applied to projects that meet the following requirements:
  - Has a Floor Area Ratio (FAR) of less than 0.75
  - Includes more parking than required by the City of Petaluma
  - Is inconsistent with Plan Bay Area
  - Replaces affordable residential units with a smaller number of moderate- or high-income residential units (although a small market-rate project could qualify for small project screening)

Since the project is located less than ½ mile from the Downtown Petaluma SMART station, the project may be exempt from further VMT analysis. The project is also not expected to meet the requirements that would exempt it from the screening criteria as described below:

- FAR of less than 0.75 – based on the site plan provided by CBG Civil Engineers, dated February 9, 2022, it is estimated that the project would have an FAR of approximately 1.13. Therefore, this criterion is not met.
- Includes more parking than required by the City of Petaluma – based on the City of Petaluma's parking requirements, single household and attached townhomes are required to provide one covered space plus two additional covered or uncovered spaces. For general retail, one space for each 300 square feet of gross floor area is required. Therefore, the project is required to provide 396 residential parking spaces and 10 retail parking spaces, excluding the requirements for the institutional/boat storage. Since the project is proposing to provide 281 parking spaces, including shared and dedicated parking spaces, and is less than required by the City, this criterion is not met. The proposed 281-parking spaces does not include the existing 17-space City lot.
- Inconsistency with Plan Bay Area – Plan Bay Area 2050 is a long-range strategic plan for Bay Area. Based on the project description and site plan, there are no known project inconsistencies with the strategic plan.
- Replaces affordable residential units – the project is not replacing existing affordable residential units. Therefore, this criterion is not met.

Since the above screening exemptions are not met and the project meets the screening criteria due to its close proximity to the Petaluma SMART station, the project results in a less than significant VMT impact.

### 3. EXISTING CONDITIONS

This chapter describes the existing conditions of the roadway network, transit service, pedestrian facilities, and bicycle facilities within the vicinity of the project site. The chapter also presents existing turning movement volumes and intersection levels of service.

#### EXISTING ROADWAY NETWORK

This section provides a description of the specific roadways included in this study.

**1<sup>st</sup> Street** is a two-lane east-west roadway within the study area. It begins just west of C street and ends at H street, running adjacent to and south of the Petaluma River. The roadway provides access to light industrial and residential land uses. There is no posted speed limit on 1<sup>st</sup> Street.

**Copeland Street** is a two-lane east-west roadway within the study area. It begins just east of D street and transitions to Madison Street west of Washington Street. Copeland Street between D Street and Washington Street is classified as a collector in the Petaluma General Plan. The east leg of Copeland Street at the intersection of Copeland Street and D Street provides access to the Project site. Based on field observations, many vehicles traveling to and from Washington Street and D Street use Copeland Street to by-pass the intersection of Lakeville Street and D Street. There is no posted speed limit on Copeland Street.

**D Street** – is a two-lane north-south roadway within the study area and is classified as an arterial south of Lakeville Street and a collector north of Lakeville Street. D Street provides a connection north and south of the Petaluma River. D Street provides access to mainly residential uses and to Downtown Petaluma. The posted speed limit on D Street is 25 mph near the Project site.

**Lakeville Street** – is a two- to four-lane roadway within the study area and is classified as an arterial. Lakeville Street transitions from a four-lane to two-lane roadway at D Street. The roadway provides access to the US-101 interchange to the east of the Project site and provides access to commercial and residential uses. The Downtown Petaluma SMART station is located on the south side of Lakeville Street between D Street and Washington Street. The posted speed limit on Lakeville Street is 30 mph near the Project site.

**Petaluma Boulevard** – is a two- to four-lane east-west roadway within the study area and is classified as an arterial. Petaluma Boulevard is two lanes with a two-way left-turn lane (TWLTL) west of D Street and is four lanes east of D Street. The roadway provides access to residential and commercial uses as well as to Downtown Petaluma. The posted speed limit on Petaluma Boulevard is 30 mph near the Project site.

**Washington Street** – is a four-lane north-south roadway and is classified as an arterial. Washington Street provides access to residential and commercial uses as well as to Downtown Petaluma. The roadway also provides access to the US-101 interchange north of Lakeville Street. The posted speed limit on Washington Street is 25 mph south of Lakeville Street and 30 mph north of Lakeville Street.

## EXISTING TRANSIT FACILITIES

Petaluma Transit, Sonoma-Marin Area Transit (SMART), Sonoma County Transit, and Golden Gate Transit provide transit services within the City of Petaluma and other nearby cities in Sonoma County and Marin County. Existing transit services within the study area are shown in **Figure 2** and described in this section. Many routes operate within the study area but do not run near the Project site; therefore, only routes that service the nearby area of the proposed Project are described below. It should be noted that the schedules described below may be operating on reduced schedules due to COVID-19 and are subject to change.

### PETALUMA TRANSIT

Petaluma Transit is a local bus service that provides transit services within the City of Petaluma. Multiple local routes provide service near the Project site and are described below.

**Route 10** provides service between the Downtown Petaluma SMART station and the Park and Ride near the intersection of Gossage Avenue and Petaluma Boulevard. In the vicinity of the project site, Route 10 runs on D Street, Lakeville Street, Copeland Street, Washington Avenue, and Petaluma Boulevard. On weekdays, Route 10 operates between 7:32 AM and 6:29 PM on 30-minute to 60-minute headways. Route 10 does not operate on Saturdays and Sundays. Near the project site, the nearest bus stop is located at the Copeland Street Transit Mall and at D Street near Hopper Street, both approximately a 500-foot walking distance from the project site.

**Route 11** provides service between the Downtown Petaluma SMART station and the Washington Square Shopping Center. In the vicinity of the project site, Route 11 runs on D Street, Lakeville Street, Copeland Street, Washington Avenue, and Petaluma Boulevard. On weekdays, Route 11 operates between 6:30 AM and 8:23 PM on 15-minute to 30-minute headways. On Saturdays and Sundays, Route 11 operations between 7:30 AM and 8:23 PM on 30-minute headways. Near the project site, the nearest bus stop is located at the Copeland Street Transit Mall and at D Street near Hopper Street, both approximately a 500-foot walking distance from the project site.

**Route 24** provides service between the Downtown Petaluma SMART station and the Kaiser Permanente Hospital on Pine View Way. In the vicinity of the project site, Route 24 runs on D Street, Lakeville Street, Copeland Street, and Washington Avenue. On weekdays, Route 24 operates between 6:15 AM and 7:09 PM on 15-minute to 60-minute headways. Route 24 does not operate on Saturdays and Sundays. Near the project site, the nearest bus stop is located at the Copeland Street Transit Mall and at D Street near Hopper Street, both approximately a 500-foot walking distance from the project site.

### SONOMA COUNTY TRANSIT

Sonoma County Transit is an intercity bus service that provides transit services within Sonoma County. Multiple routes service near the Project site and are described below.

**Route 40** provides service between the Downtown Petaluma SMART station and the Sonoma Plaza. In the vicinity of the project site, Route 40 runs on D Street, Lakeville Street, Copeland Street, and Washington Avenue. On weekdays, Route 40 operates between 6:10 AM and 9:55 PM on approximately 2-hour to 4-hour headways. Route 40 does not operate on Saturdays and Sundays. Near the project site, the nearest bus stop is located near the intersection of Copeland Street and Washington Street.

**Routes 44 and 48** provides service between the Downtown Petaluma SMART station and the Coddington Shopping Center in Santa Rosa. Route 44 runs along Washington Street, McDowell Boulevard, and

Petaluma Hill Road while Route 48 runs along Petaluma Boulevard and Old Redwood Highway. In the vicinity of the project site, Routes 44 and 48 run on D Street, Lakeville Street, Copeland Street, and Washington Avenue. On weekdays, Route 44 operates between 6:20 AM and 10:27 PM while and Route 48 operates between 6:15 AM and 10:47 PM. Near the project site, the nearest bus stop is located near the intersection of Copeland Street and Washington Street.

---

### SONOMA-MARIN AREA RAIL TRANSIT (SMART)

Sonoma-Marin Area Rail Transit (SMART) is a passenger rail transit service that operates between the Sonoma County Airport and the City of Larkspur. On weekdays, SMART provides service at the Downtown Petaluma SMART station in the AM peak between 5:39 AM and 11:36 AM and in the PM peak between 1:22 PM and 9:11 PM in approximately 30-minute to 60-minute headways. On Saturdays, SMART provides service at the Downtown Petaluma SMART station between 8:12 AM and 8:03 PM in approximately 2-hour headways. The Downtown Petaluma SMART station is located on the south side of Lakeville Street between D Street and Washington Street, approximately 1,000 feet from the project site.

---

### GOLDEN GATE TRANSIT

Golden Gate Transit is a bus service that operates between neighboring counties including the counties of Marin and Sonoma, as well as cities of San Francisco, Larkspur, Sausalito, and San Rafael. Multiple routes service near the Project site and are described below.

**Route 101** is a regional bus route that provides service between the cities of Santa Rosa and San Francisco. In the vicinity of the project site, Route 101 runs on D Street, Lakeville Street, Copeland Street, Washington Avenue, and Petaluma Boulevard. On weekdays and weekends, Route 101 operates between 3:52 AM and 1:28 AM in approximately 60-minute headways. Near the project site, the nearest bus stop is located at the Copeland Street Transit Mall, an approximately 500-foot walking distance from the project site.

**Route 172** is a commute bus route that provides service between the cities of Santa Rosa and San Francisco. In the vicinity of the project site, Route 172 runs on Washington Avenue, and Petaluma Boulevard. On weekdays, Route 172 operates in the southbound direction between 4:11 AM and 9:28 AM and in the northbound direction between 2:06 PM and 7:38 PM. Route 172 does not operate on weekends. Near the project site, the nearest bus stop is located at the intersection of Lakeville Street and Washington Street.

---

### EXISTING PEDESTRIAN FACILITIES

Sidewalks and crosswalks are mostly provided throughout the study area in Petaluma to allow pedestrians access to nearby transit stops, residential uses, and commercial uses. There are existing sidewalks present along both sides of D Street adjacent to the project site. There are also existing sidewalks on the north side of Copeland Street, a pedestrian path on the south side of Copeland Street, and sidewalks on both sides of Washington Street. These pedestrian facilities allow pedestrians to access the nearby transit stops at the Copeland Street Transit Mall and the Downtown Petaluma SMART station as well as access to Downtown Petaluma located southwest of the project site. On Copeland Street, there is currently an approximately 100-foot length sidewalk on the east side, adjacent to the existing building.

## EXISTING BICYCLE FACILITIES

**Figure 3** shows existing bicycle facilities within the study area.

The following is a list of the Class I bicycle paths near the study area:

- Along McNear Channel adjacent to the project site
- Lynch Creek Trail
- Along McNear Channel extending near the US-101 freeway (future)
- Along Petaluma River running parallel to Petaluma Boulevard (future)
- Hopper Street between D Street and east of the study area (future)
- Adjacent to the railroad tracks north of Lakeville Street

The following is a list of the Class II bicycle lanes near the study area:

- D Street between 6<sup>th</sup> Street and south of Pinnacle Drive
- B Street between 4<sup>th</sup> Street and El Rose Drive
- Western Avenue from Howard Street to Chileno Valley Road
- Lakeville Street between D Street and the US-101 interchange
- Kenilworth Drive between Washington Street and Lindberg Lane
- Johnson Street between Washington Street and Kenilworth Drive
- Petaluma Boulevard between D Street and Rovina Lane (future)
- D Street between Petaluma Boulevard and 6<sup>th</sup> Street (future)
- D Street between 1<sup>st</sup> Street and Lakeville Street (future)
- Payran Street between Jefferson Street and Caulfield Lane (future)
- Western Avenue between the Petaluma River and Howard Street (future)
- Copeland Street between Washington Street and Petaluma Boulevard (future)

The following is a list of the Class III bicycle routes near the study area:

- Lakeville Street between D Street and Petaluma Boulevard
- G Street between Petaluma Boulevard and Sunnyslope Avenue
- I Street between Petaluma Boulevard and Sunnyslope Road
- 6<sup>th</sup>/Howard Street between Mountain View Avenue and West Street
- 8<sup>th</sup> Street between I Street and B Street
- Petaluma Boulevard between E Street and Lakeville Street
- 10<sup>th</sup> Street/Fair Street between Western Avenue and D Street
- D Street between 1<sup>st</sup> Street and Payran Street
- 2<sup>nd</sup> Street between D Street and H Street (future)
- D Street between Petaluma Boulevard and Weller Street (future)
- Madison Street between Lakeville Street and Ellis Street (future)
- 1<sup>st</sup> Street between D Street and Petaluma River (future)
- Washington Street between Kenilworth Drive and 6<sup>th</sup> Street (future)
- Copeland Street between D Street and Washington Street (future)
- Payran Street between Washington Street and Lynch Creek Trail (future)
- B Street between 4<sup>th</sup> Street and 2<sup>nd</sup> Street (future)

In addition, a Class IV cycle track is proposed to be constructed on D Street between Weller Street and Lakeville Street.





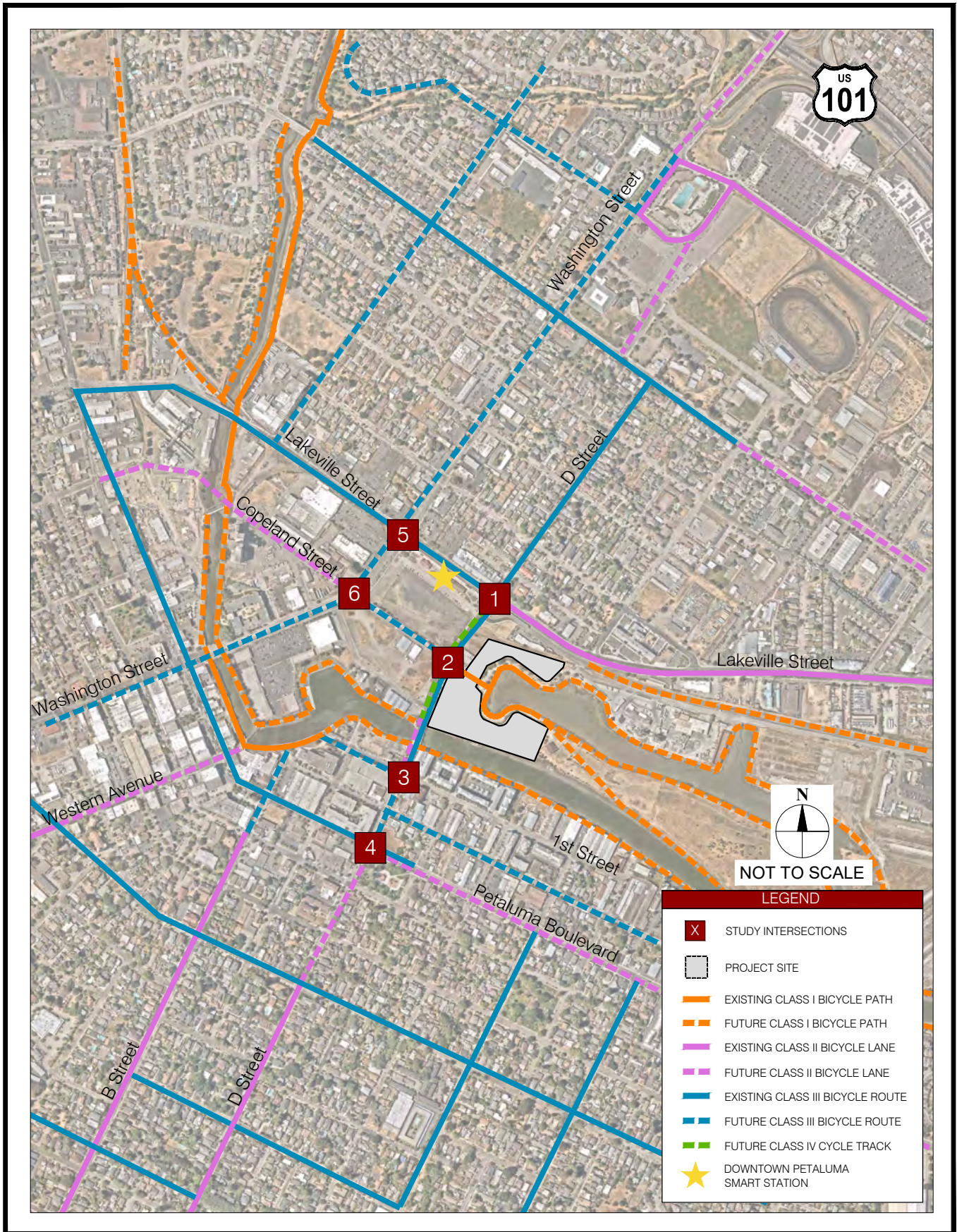

## EXISTING LANE CONFIGURATION AND TRAFFIC CONTROL

Existing intersection lane configuration and traffic controls are illustrated in **Figure 4**.

## EXISTING PEAK-HOUR TURNING MOVEMENT VOLUMES

Weekday intersection turning movement volumes were collected in January 2022 during the AM (7:00 – 9:00 AM) and PM (4:00 – 6:00 PM) peak periods on a weekday when local schools were in session. Volumes were compared to historical counts to determine whether the volumes were affected by the COVID-19 pandemic. Historical volumes from the Baywood Village Project Traffic Study collected in 2018 were shown to be greater than the collected January 2022 volumes. Therefore, historical 2018 volumes were used as existing volumes where available. For study intersections where historical 2018 volumes were not available, an adjustment factor was determined based the historical 2018 volumes of an adjacent intersection and applied to the January 2022 volumes at the study intersection to determine existing volumes.

Adjusted existing peak hour turning movement volumes are shown in **Figure 5**. Intersection volume data sheets and calculations are provided in the **Appendix**.

## EXISTING INTERSECTION LEVEL OF SERVICE

Traffic operations were evaluated at the study intersections under Existing traffic conditions. Results of the analysis are presented in **Table 2** and locations operating unacceptably are bolded. **Table 2** lists the LOS criteria, municipal jurisdiction, intersection control, and LOS/delay for each intersection. All study intersections function within acceptable LOS standards under this analysis scenario, except for the following intersection:

- #2 – D Street / Copeland Street (PM Peak Hour)

Synchro analysis sheets are provided in the **Appendix**.

Table 2 - Existing Intersection Level of Service Summary

#	Intersection	LOS Criteria	Jurisdiction	Control	Existing			
					AM Peak		PM Peak	
					LOS	Delay <sup>1</sup> (sec)	LOS	Delay <sup>1</sup> (sec)
1	D Street/Lakeville Street	D	City	Signal	D	37.0	D	38.7
2	D Street/Copeland Street	D	City	SSSC	A	3.7	A	6.9
	<i>Worst Approach</i>				C	19.4	<b>F</b>	<b>89.5</b>
3	D Street/1st Street	D	City	Signal	B	18.7	C	21.0
4	D Street/Petaluma Boulevard	D	City	Signal	C	34.1	D	40.2
5	Washington Street/Lakeville Street	D	City	Signal	D	38.6	D	46.5
6	Washington Street/Copeland Street	D	City	Signal	C	30.7	B	17.0

Note: Intersections that are operating below acceptable levels are shown in **BOLD**.

<sup>1</sup>The average control delay is reported for signalized intersections. The delay for the worst movement is reported for SSSC intersections.

## FIELD OBSERVATIONS

Field observations were conducted on Tuesday, January 11, 2022 to confirm existing roadway geometry and traffic operations. Many vehicles traveling in the northbound direction along D Street were observed to make a northbound left-turn at D Street/Copeland Street and then a westbound right-turn at Washington Street/Copeland Street rather than making a northbound through at D Street/Copeland Street and then a northbound left-turn at Washington Street/Copeland Street. It is assumed that these vehicles are traveling to north Washington Street and west Lakeville Street and want to avoid the intersection of Lakeville Street and D Street. A higher volume of trucks was observed to be traveling along Lakeville Street in the AM peak period than in the PM peak period. Heavy vehicle counts were collected in both the AM and PM peak periods and are accounted for in the Synchro analysis.

At the intersection of D Street/Copeland Street, minor street vehicles were observed to have a delay of approximately 30 seconds during the AM peak hour and 45 seconds during the PM peak. The observed northbound queue at D Street/Lakeville Street was approximately 275 feet, which did not extend into the intersection of D Street/Copeland Street.

At the intersection of Washington Street/Copeland Street, the observed northbound queue was approximately 300 feet. In the PM peak, the northbound queue from Washington Street/Lakeville Street occasionally extended into Washington Street/Copeland Street, causing congestion for the westbound right-turning vehicles from Copeland Street. Although the northbound queues along Washington Street were observed to have long queues, the signal timing coordination allowed the intersections to operate acceptably.

It should be noted that field observations were conducted during the COVID-19 pandemic and reflects unadjusted existing volumes. As mentioned in the Existing Peak-Hour Turning Movement Volumes, unadjusted counts were compared to the Baywood Village Project Traffic Study traffic volumes collected in 2018 and were shown to be less than the historical counts. Therefore, field observations may not represent pre-COVID operational conditions and may show less congestion than typical pre-COVID conditions.

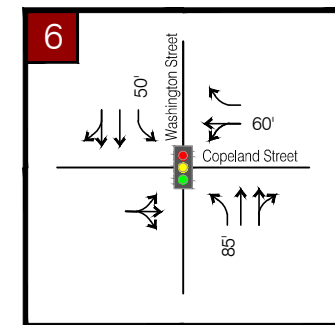
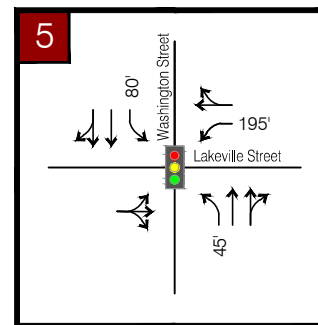
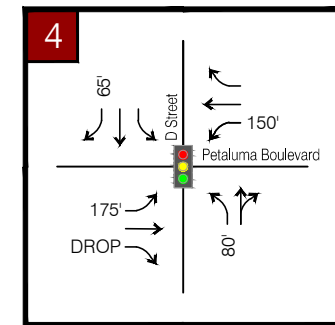
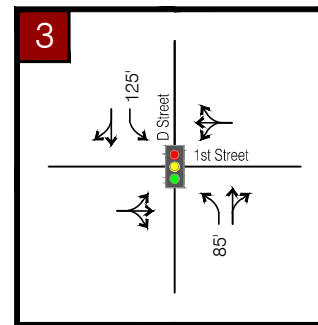
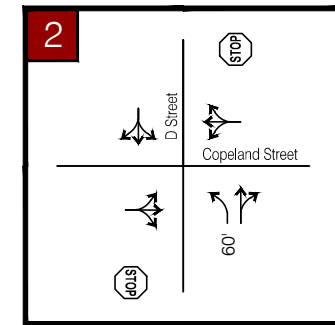
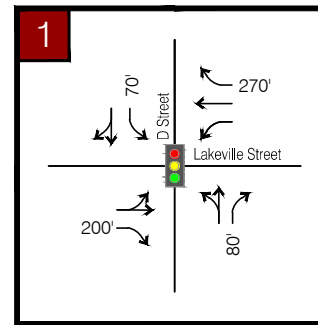

FIGURE 4  
EXISTING CONDITION  
LANE GEOMETRY AND TRAFFIC CONTROL  
PETALUMA OYSTER POINT

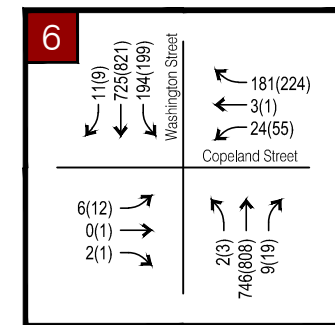
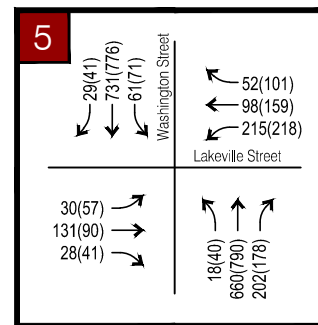
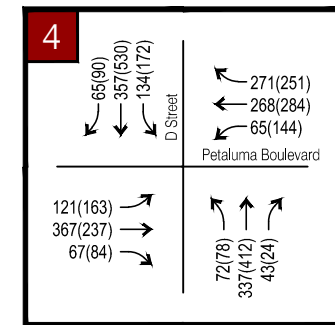
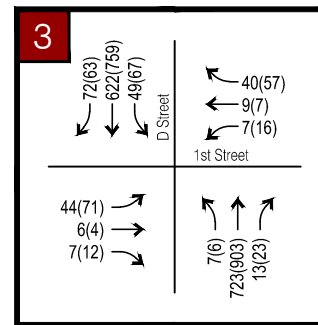
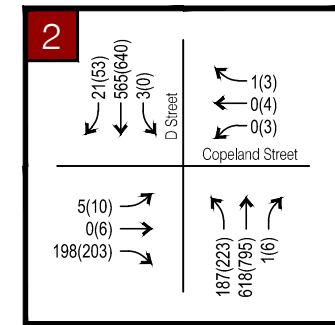
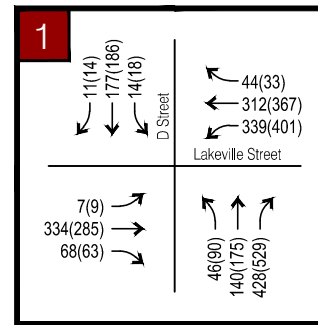

FIGURE 5  
EXISTING CONDITION  
PEAK HOUR TURNING MOVEMENT VOLUMES  
PETALUMA OYSTER POINT

## 4. EXISTING PLUS PROJECT CONDITIONS

This chapter presents a description of the proposed site use, trip generation, trip distribution, and trip assignment, as well as potential deficiencies of the proposed project on the transportation system.

### PROPOSED SITE USE

The proposed project will redevelop the existing three industrial and agricultural buildings located at 100 and 310 D Street in Petaluma, CA and construct 122 three-story townhomes, 10 live/work units, 1,500 square feet of commercial use, 1,500 square feet of public plaza, and 6,000 square feet institutional/boat storage. Access to the project site would be provided by the east leg of Copeland Street at the intersection of D Street and Copeland Street. A signal and a southbound left-turn will be constructed at this intersection with the proposed project. The project will work with the City to determine its fair share cost towards these improvements. **Figure 6** illustrates the site plan for the proposed project, as provided by CBG Civil Engineers.

### TRIP GENERATION

Trip generation for projects is typically calculated based on information contained in the Institute of Transportation Engineer's (ITE) publication, *Trip Generation Manual, 11th Edition*. The manual is a standard reference used by jurisdictions throughout the country for the estimation of trip generation potential of proposed projects. A trip is defined in the *Trip Generation Manual* as a single or one-directional vehicle movement with either the origin or destination at the project site. In other words, a trip can be either "to" or "from" the site and therefore, a single visitor to a site is counted as two trips.

For purposes of determining the worst-case impacts of traffic on the surrounding street network, the trips generated by a proposed project are estimated for the AM peak hour (between 7:00 AM and 9:00 AM), and for the PM peak hour (between 4:00 PM and 6:00 PM) on a typical weekday. Trips generated by the townhomes were based on an average rate for ITE Land Use 220 (Multifamily Housing – Low-Rise, Close to Transit), due to the proximity of the residential project to the Downtown Petaluma SMART station. The live/work units are not expected to generate AM and PM peak hour trips as they are designed for residents who work from home and therefore will not commute during the peak periods. Daily trips for the live/work units were determined based on an average rate for ITE Land Use 220 (Multifamily Housing – Low-Rise, Close to Transit) excluding the AM and PM peak hour trips these units would have generated if they were typical townhomes with residents commuting during the AM and PM peak periods. Trips generated by the commercial were based on an average rate for ITE Land Use 822 (Strip Retail Plaza – less than 40 KSF). Trips generated by the public plaza and institutional storage are assumed to be captured within the trips generated by the residential and retail uses.

### INTERNAL CAPTURE REDUCTION

With a multi-use development, there is potential for interaction among uses within the site. These types of trips are considered internal to the site and are "captured" within the site. The standard engineering reference for determining internal capture reductions for the proposed land uses is the ITE *Trip Generation Handbook, 3rd Edition*<sup>3</sup>. Following ITE methodology, no internal capture rates are provided for the AM peak and during the PM peak, it was determined that the internal capture was 4 percent. ITE methodology does

---

<sup>3</sup>*Trip Generation Handbook, 3rd Edition*, Institute of Transportation Engineers, 2017

not include internal capture calculation for daily trips, therefore an average percentage of the AM and PM peak was used.

## PASS-BY REDUCTION

Pass-by trip reductions are typically considered to account for trips that will already be on the road and will likely stop as they pass by the site. Data published in ITE's *Trip Generation Manual, 11th Edition* indicates that ITE Land Use 822 (Strip Retail Plaza – less than 40 KSF) has an average PM peak hour pass-by rate of 40 percent and no pass-by reductions during the AM peak hour are provided. ITE methodology does not include pass-by reductions for daily trips, therefore an average percentage of the AM and PM peak was used.

An existing trip credit was taken for the three existing industrial buildings based on the existing counts collected at the intersection of D Street and Copeland Street.

**Table 3** presents the trip generation for the existing and proposed project. The project will generate a net new +481 daily trips, +45 trips in the AM peak hour and a net new +63 trips in the PM peak hour.

Table 3 - Project Trip Generation

Land Use	ITE Code	Size	Unit	Daily	AM Peak Hour			PM Peak Hour		
					Total	In	Out	Total	In	Out
Existing Trip Generation										
Existing Industrial Buildings <sup>1</sup>	N/A	17	KSF	150	5	4	1	15	8	7
Trip Generation										
Multifamily Housing (Low-Rise, Close to Rail Transit) <sup>2</sup>	220	122	DU	576	46	13	33	74	44	30
Live/Work Residential Units <sup>3</sup>	N/A	10	DU	37	0	0	0	0	0	0
Strip Retail Plaza (<40k) <sup>2</sup>	822	1.5	KSF	82	4	2	2	10	5	5
Public Plaza <sup>4</sup>	N/A	1.5	KSF	0	0	0	0	0	0	0
Institutional/Boat Storage <sup>4</sup>	N/A	6	KSF	0	0	0	0	0	0	0
Internal Capture (Daily 2%, AM 0%, PM 4%) <sup>5</sup>				-59	0	0	0	-4	-2	-2
Pass-By (Daily 20%, AM 0%, PM 40%) <sup>6</sup>				-5	0	0	0	-2	-1	-1
Total Proposed Trip Generation				631	50	15	35	78	46	32
Net New Proposed Trip Generation				481	45	11	34	63	38	25

KSF = 1,000 square feet; DU = Dwelling Units

<sup>1</sup> Existing trip generation based on count data.

<sup>2</sup> Average rate from ITE Trip Generation Manual, 11th Edition used to develop trip generation.

<sup>3</sup> ITE Trip Generation Manual, 11th Edition does not provide a land use for live/work from home residential units. Therefore, it is assumed that these units will generate zero AM and PM peak hour trips. Daily trips were based on the daily rates for ITE Land Use Code 220, excluding the AM and PM peak hour trips that would be generated if these units were townhomes.

<sup>4</sup> These uses are assumed to be for resident use and will be captured within the trips generated by the townhomes.

<sup>5</sup> Internal capture derived from ITE Trip Generation Handbook, 3rd Edition. Daily rates are not provided and therefore were developed based on an average of the AM and PM peak hour reduction rates.

<sup>6</sup> Pass-by derived from ITE Trip Generation, 11th Edition. AM rates are not provided and therefore is assumed to be zero. Daily rates are not provided and therefore were developed based on an average of the AM and PM peak hour reduction rates.



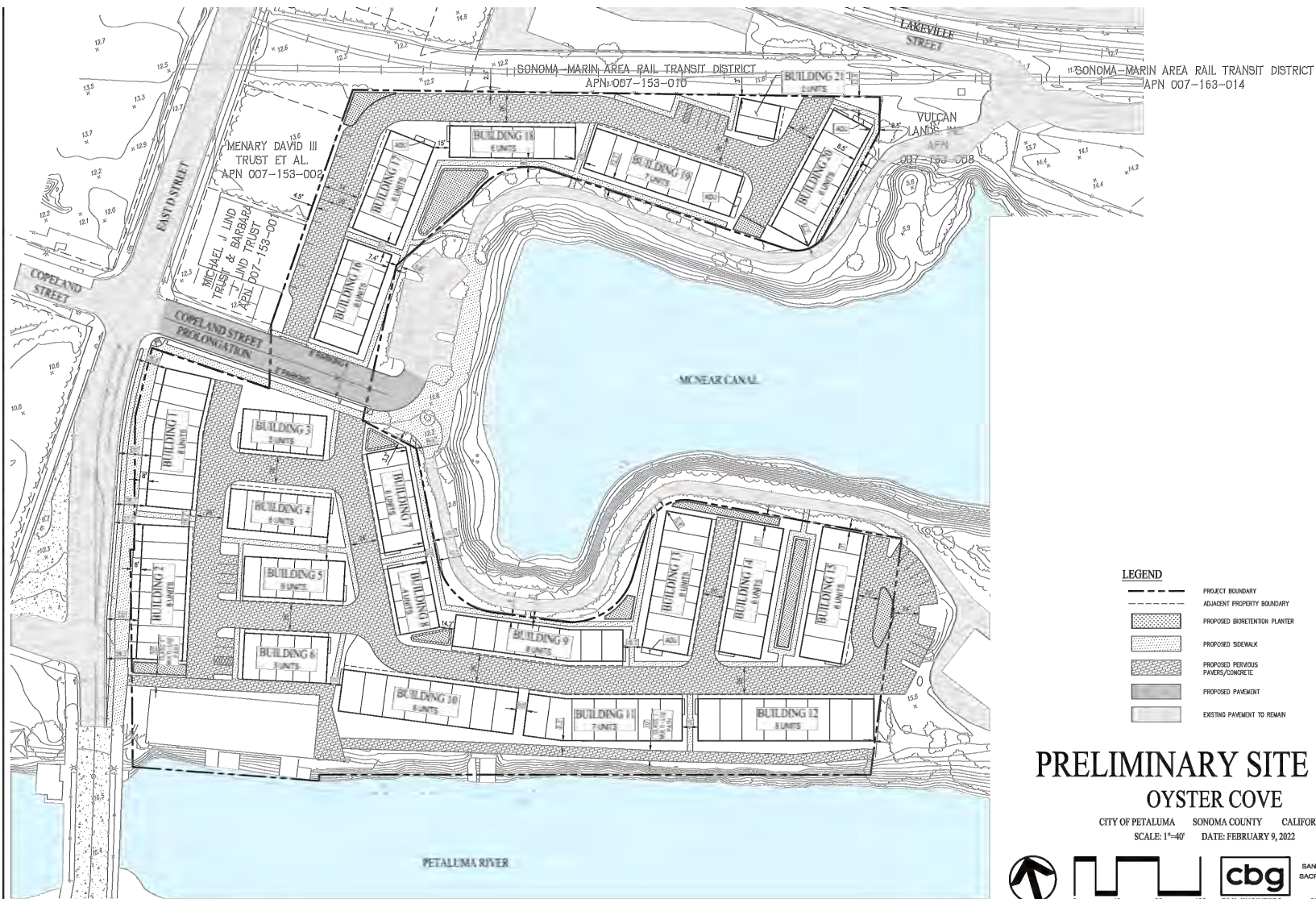

- LEGEND**
- PROJECT BOUNDARY
  - ADJACENT PROPERTY BOUNDARY
  - PROPOSED BIORETENTION PLANTER
  - PROPOSED SIDEWALK
  - PROPOSED PAVEMENT (PAVERS/CONCRETE)
  - PROPOSED PAVEMENT
  - EXISTING PAVEMENT TO REMAIN

## PRELIMINARY SITE PLAN

### OYSTER COVE

CITY OF PETALUMA SONOMA COUNTY CALIFORNIA  
 SCALE: 1"=40' DATE: FEBRUARY 9, 2022

SAN RAMON • (925) 899-0323  
 SACRAMENTO • (916) 376-1877  
 WWW.CBANDCO.COM  
 CIVIL ENGINEERS • SURVEYORS • PLANNERS

Source: CBG Civil Engineers

NOT TO SCALE

FIGURE 6  
 SITE PLAN

## PROJECT TRIP DISTRIBUTION AND ASSIGNMENT

A separate trip distribution was determined for the existing and proposed project uses. Trip distribution for the existing uses was based on existing traffic count information and the general orientation of population sources to the site. Trip distribution for the proposed project was based on existing traffic count information, the *Petaluma Station Transportation Impact Study*, and the general orientation of population sources to the site. **Figure 7** and **Figure 8** presents the traffic distribution assumed for the existing land use and proposed project, respectively.

Based on the assumed existing and proposed project trip distributions, the existing to be removed and new vehicle trips generated by the project were assigned to the street network. **Figure 9** and **Figure 10** present the trip assignment for existing land uses and proposed project, respectively.

## EXISTING PLUS PROJECT INTERSECTION LEVEL OF SERVICE

Existing Plus Project traffic conditions were evaluated at the study intersections and are shown in **Figure 11**. Results are presented in **Table 4** and intersections operating unacceptably are bolded. As shown in the table, all study intersections operate an at acceptable LOS under Existing Plus Project conditions. It should be noted that the delays at Intersections #2 and #3 improve under plus project conditions due to the traffic signal coordination with the proposed signal at Intersection #2.

Synchro analysis sheets and peak hour signal warrant sheets are provided in the **Appendix**.

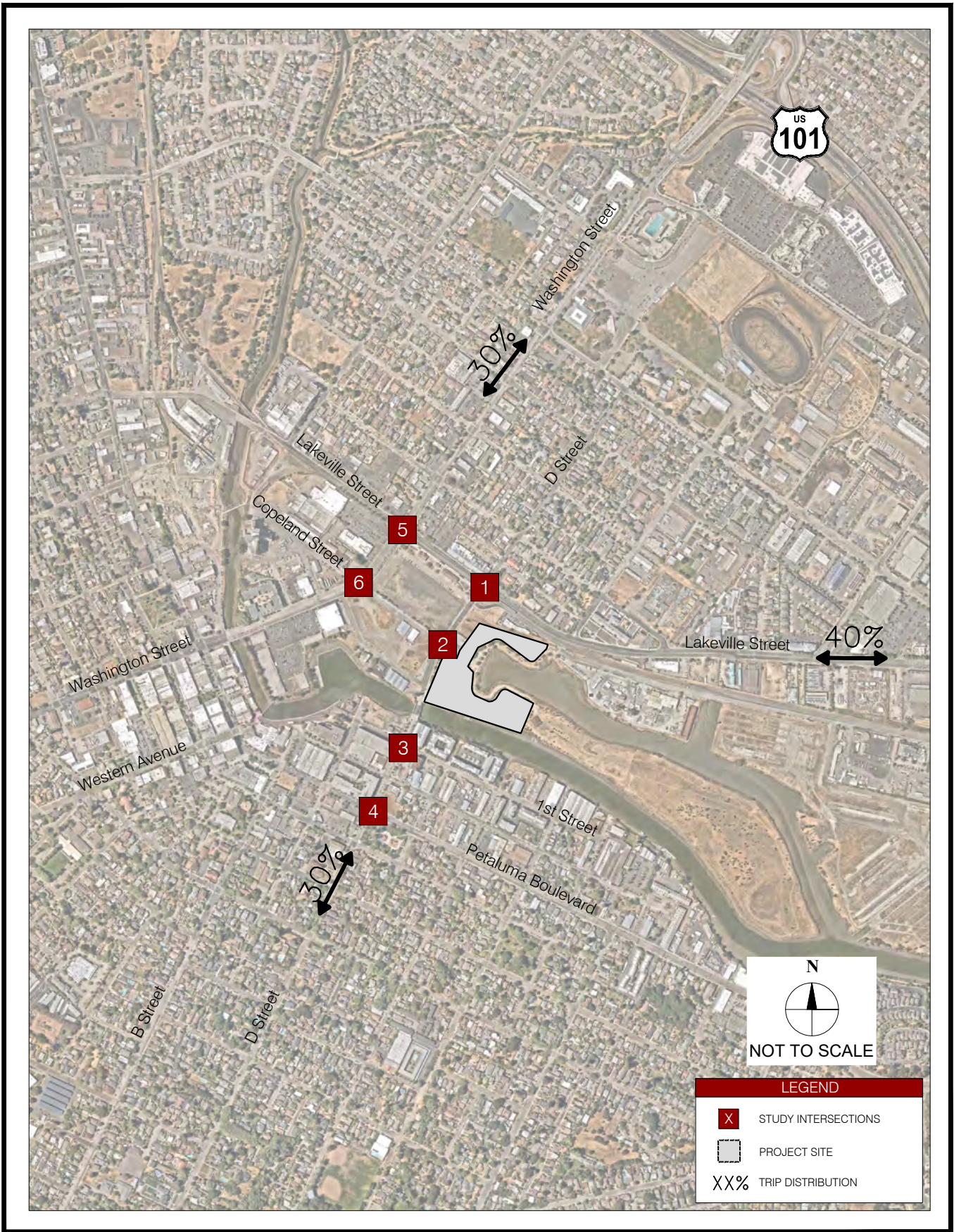

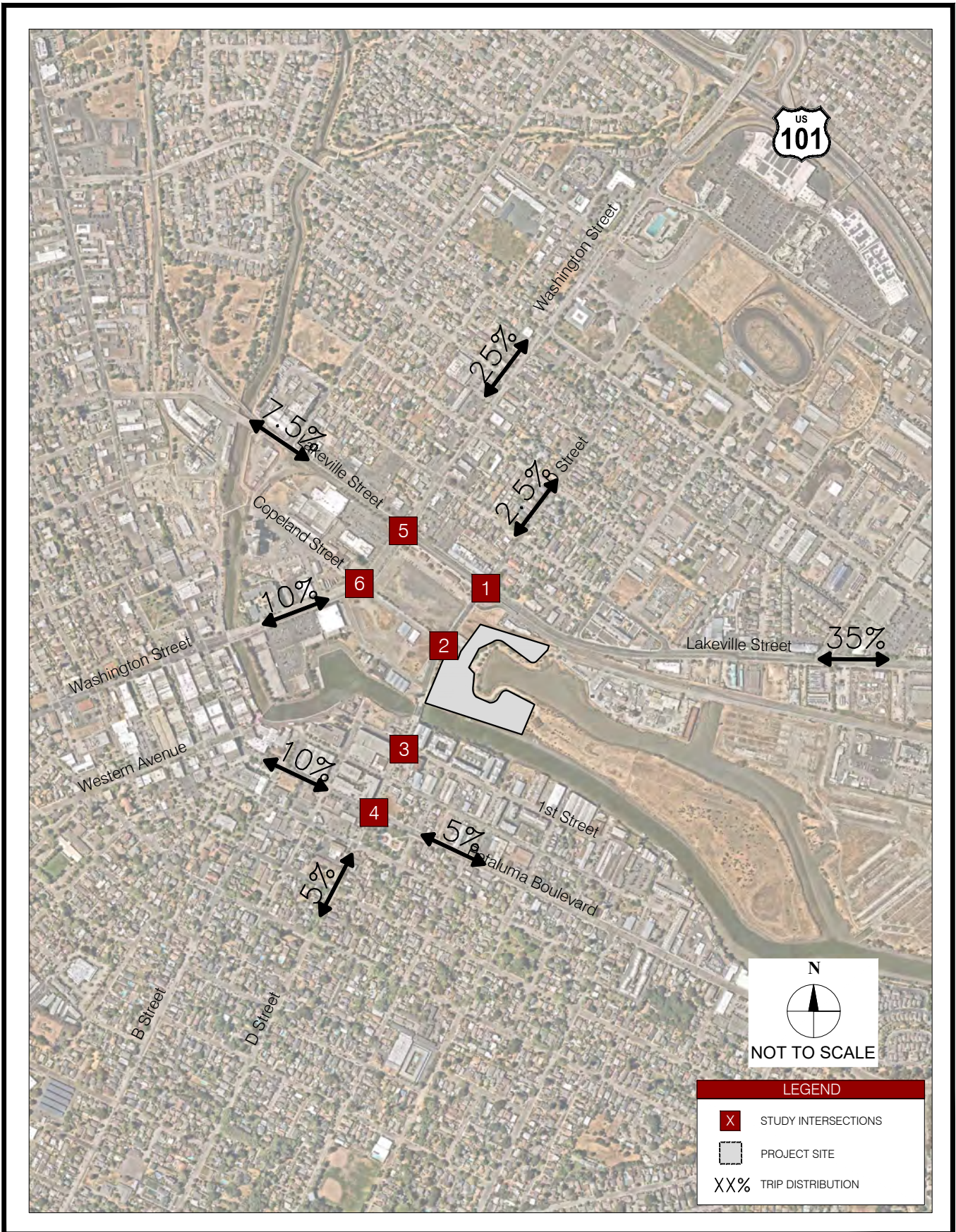

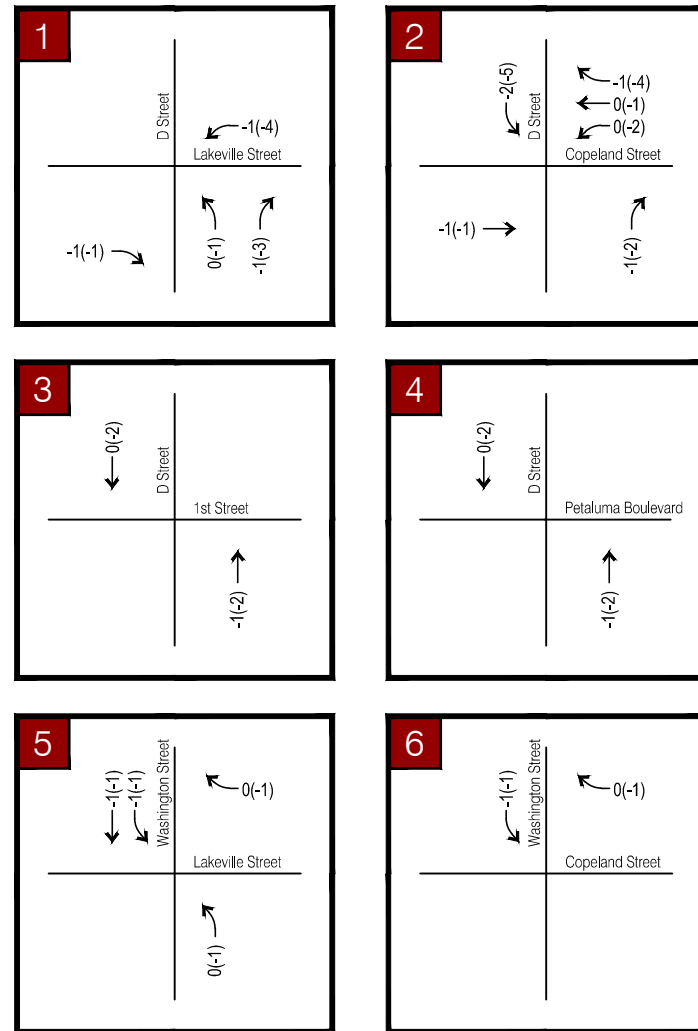

FIGURE 9  
EXISTING TRIP ASSIGNMENT  
PEAK HOUR TURNING MOVEMENT VOLUMES

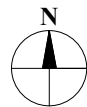
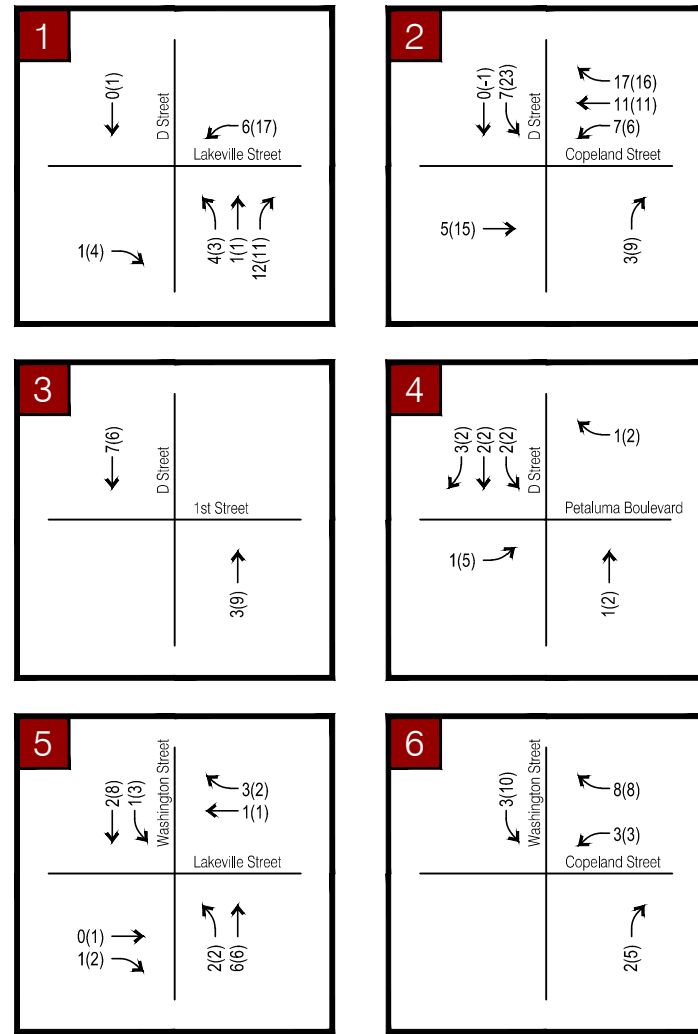

FIGURE 10  
PROPOSED TRIP ASSIGNMENT  
PEAK HOUR TURNING MOVEMENT VOLUMES

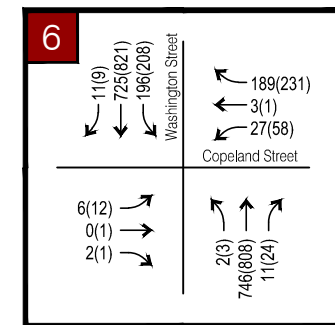
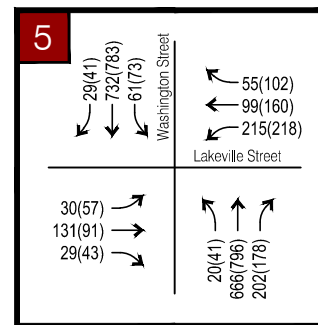
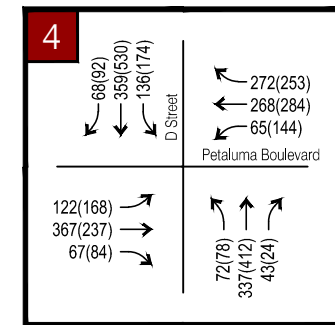
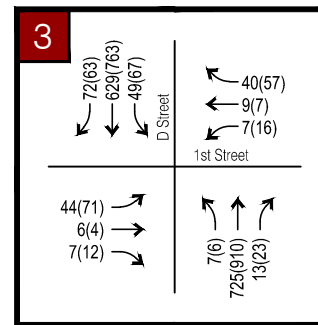
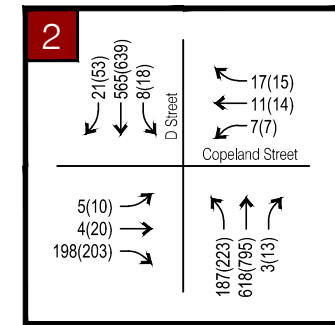
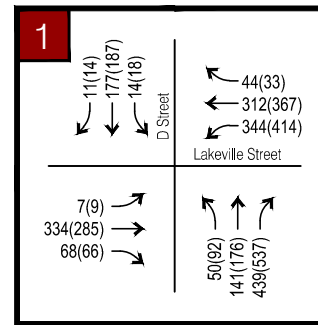

FIGURE 11  
EXISTING PLUS PROJECT CONDITIONS  
PEAK HOUR TURNING MOVEMENT VOLUMES

Table 4 - Existing Plus Project Intersection Level of Service Summary

#	Intersection	LOS Criteria	Jurisdiction	Control	Existing				Existing+Project					
					AM Peak		PM Peak		AM Peak			PM Peak		
					LOS	Delay <sup>1</sup> (sec)	LOS	Delay <sup>1</sup> (sec)	LOS	Delay <sup>1</sup> (sec)	Var	LOS	Delay <sup>1</sup> (sec)	Var
1	D Street/Lakeville Street	D	City	Signal	D	37.0	D	38.7	D	37.5	0.5	D	39.8	1.1
2	D Street/Copeland Street	D	City	SSSC/ Signal <sup>2</sup>	A	3.7	A	6.9	B	19.3	-0.1	C	23.4	-66.1
	C				19.4	<b>F</b>	<b>89.5</b>							
3	D Street/1st Street	D	City	Signal	B	18.7	C	21.0	B	14.0	-4.7	B	17.1	-3.9
4	D Street/Petaluma Boulevard	D	City	Signal	C	34.1	D	40.2	D	40.2	6.1	D	42.8	2.6
5	Washington Street/Lakeville Street	D	City	Signal	D	38.6	D	46.5	D	38.7	0.1	D	47.0	0.5
6	Washington Street/Copeland Street	D	City	Signal	C	30.7	B	17.0	C	30.8	0.1	B	17.6	0.6

Note: Intersections that are operating below acceptable levels are shown in **BOLD**.

<sup>1</sup>The average control delay is reported for signalized intersections. The delay for the worst movement is reported for SSSC intersections.

<sup>2</sup>Intersection control is a SSSC under Existing Conditions and is a signal under plus project conditions.



## 5. PIPELINE TRAFFIC CONDITIONS

This chapter will discuss the traffic conditions under the Pipeline and Pipeline Plus Project scenarios.

### PIPELINE TRAFFIC VOLUMES

At the time of the analysis a list of pending and approved development projects was derived from the City of Petaluma Planning Department's website. These projects are located within the vicinity of the project site and are expected to be constructed and occupied at the time the proposed project is constructed. **Figure 12** shows the location of the pending and approved development projects. To achieve Pipeline traffic conditions, traffic volumes from the pending and approved projects were added to the existing traffic volumes.

### PIPELINE INTERSECTIONS LEVEL OF SERVICE

Pipeline scenario volumes were evaluated at the study intersections and are presented in **Figure 13**. There are no new roadway and geometry improvements assumed at the study intersections under Pipeline Conditions. Therefore, Existing lane geometry was assumed in Pipeline Conditions as shown in **Figure 4**. Results are presented in **Table 5** and locations operating unacceptably are bolded. All study intersections function within acceptable LOS standards under this analysis scenario, except for the following intersections:

- #2 – D Street / Copeland Street (AM and PM Peak Hours)

Synchro analysis sheets are provided in the **Appendix**.

Table 5 - Pipeline Intersection Level of Service Summary

#	Intersection	LOS Criteria	Jurisdiction	Control	Pipeline			
					AM Peak		PM Peak	
					LOS	Delay <sup>1</sup> (sec)	LOS	Delay <sup>1</sup> (sec)
1	D Street/Lakeville Street	D	City	Signal	D	39.9	D	41.4
2	D Street/Copeland Street	D	City	SSSC	C	22.9	<b>E</b>	<b>48.1</b>
	<b>F</b>				<b>&gt;150.0</b>	<b>F</b>	<b>&gt;150.0</b>	
3	D Street/1st Street	D	City	Signal	C	22.9	C	26.8
4	D Street/Petaluma Boulevard	D	City	Signal	D	40.3	D	44.8
5	Washington Street/Lakeville Street	D	City	Signal	D	43.8	D	53.9
6	Washington Street/Copeland Street	D	City	Signal	C	32.9	C	20.0

Note: Intersections that are operating below acceptable levels are shown in **BOLD**.

Side-street stop-controlled (SSSC) intersections operating with a delay of greater than 150 seconds on the worst approach is shown with ">150.0".

<sup>1</sup>The average control delay is reported for signalized intersections. The delay for the worst movement is reported for SSSC intersections.

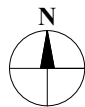
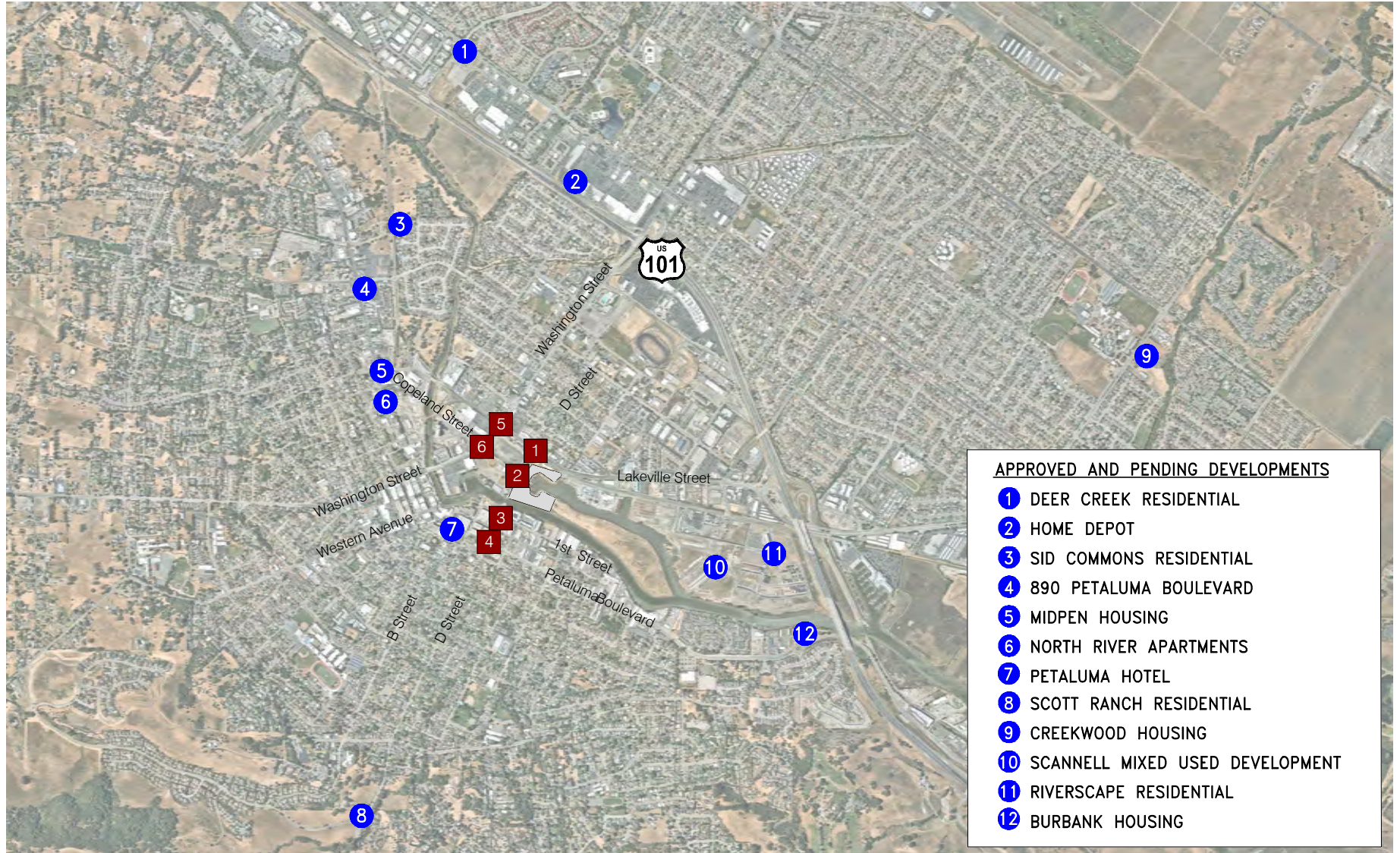

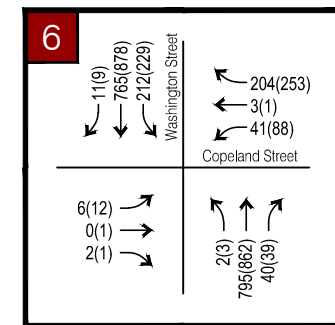
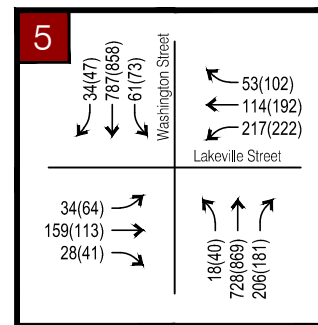
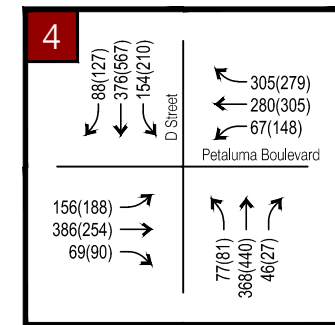
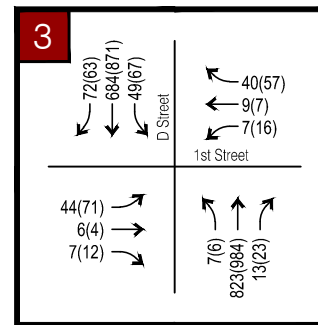
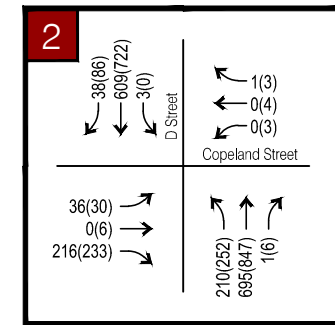
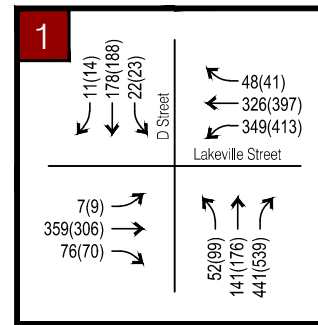

**LEGEND**

**X** STUDY INTERSECTIONS

**[Dashed Outline]** PROJECT SITE

XX(YY) AM(PM) PEAK HOUR VOLUME

FIGURE 13  
PIPELINE CONDITIONS  
PEAK HOUR TURNING MOVEMENT VOLUMES  
PETALUMA OYSTER POINT

## PIPELINE PLUS PROJECT INTERSECTION LEVEL OF SERVICE

Pipeline Plus Project traffic conditions were evaluated at the study intersections and are shown in **Figure 14**. Results are presented in **Table 6** and intersections operating unacceptably are bolded. As shown in the table, all study intersections operate at acceptable LOS under Pipeline Plus Project conditions. Similar to Existing Plus Project Conditions, Intersections #2 and #3 improve under Pipeline Plus Project conditions with the proposed traffic signal at Intersection #2 and the traffic signal coordination of the two intersections.

It should be noted that average delay at Intersection #6 (Washington Street/Copeland Street) improved by 0.1 seconds with the proposed project. This minimal improvement is due to the Synchro model adjusting the vehicle arrivals due to the effects of the upstream signal and improves the intersection delay.

Synchro analysis sheets and peak hour signal warrant sheets are provided in the **Appendix**.

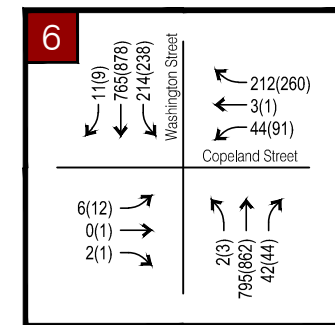
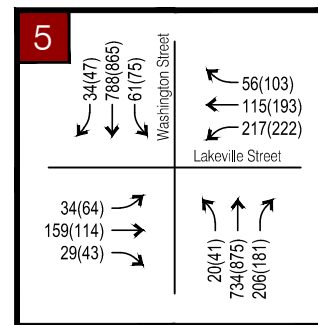
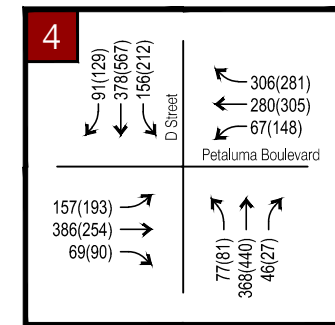
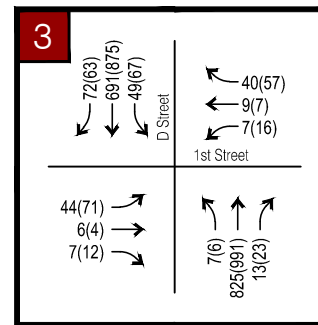
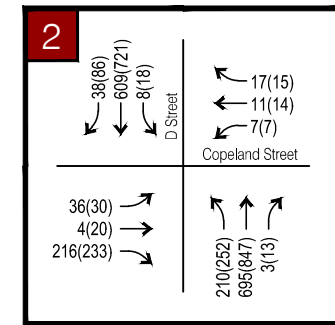
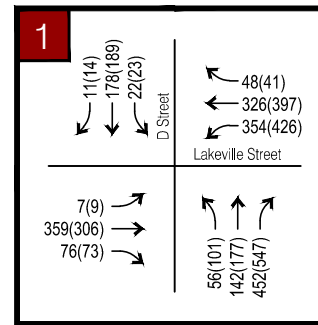

FIGURE 14  
PIPELINE PLUS PROJECT CONDITIONS  
PEAK HOUR TURNING MOVEMENT VOLUMES

Table 6 - Pipeline Plus Project Intersection Level of Service Summary

#	Intersection	LOS Criteria	Jurisdiction	Control	Pipeline				Pipeline+Project					
					AM Peak		PM Peak		AM Peak			PM Peak		
					LOS	Delay <sup>1</sup> (sec)	LOS	Delay <sup>1</sup> (sec)	LOS	Delay <sup>1</sup> (sec)	Var	LOS	Delay <sup>1</sup> (sec)	Var
1	D Street/Lakeville Street	D	City	Signal	D	39.9	D	41.4	D	40.5	0.6	D	42.7	1.3
2	D Street/Copeland Street	D	City	SSSC/ Signal <sup>2</sup>	C	22.9	<b>E</b>	<b>48.1</b>	C	22.7	-132.6	C	34.4	>-150.0
	<b>F</b>				<b>&gt;150.0</b>	<b>F</b>	<b>&gt;150.0</b>							
3	D Street/1st Street	D	City	Signal	C	22.9	C	26.8	B	16.4	-6.5	C	24.3	-2.5
4	D Street/Petaluma Boulevard	D	City	Signal	D	40.3	D	44.8	D	43.5	3.2	D	49.7	4.9
5	Washington Street/Lakeville Street	D	City	Signal	D	43.8	D	53.9	D	54.6	10.8	D	54.6	0.7
6	Washington Street/Copeland Street	D	City	Signal	C	32.9	C	20.0	C	32.8	-0.1	C	20.8	0.8

Note: Intersections that are operating below acceptable levels are shown in **BOLD**.

Side-street stop-controlled (SSSC) intersections operating with a delay of greater than 150 seconds on the worst approach is shown with ">150.0". Decrease in delays of greater than 150 seconds are shown with ">-150.0".

<sup>1</sup>The average control delay is reported for signalized intersections. The delay for the worst movement is reported for SSSC intersections.

<sup>2</sup>Intersection control is a SSSC under Pipeline Conditions and is a signal under plus project conditions.

## 6. CUMULATIVE TRAFFIC CONDITIONS

This chapter will discuss the traffic conditions under the Cumulative and Cumulative Plus Project conditions.

### CUMULATIVE TRANSPORTATION IMPROVEMENTS

Similar to Pipeline Conditions, no new roadway and geometry improvements are assumed at the study intersections. Therefore, Existing lane geometry was assumed in Cumulative conditions as shown in **Figure 4**. However, the following future roadway improvements were identified in the City of Petaluma's *Proposed Operating & Capital Improvement Budget*<sup>4</sup> and are located within the study area, outside of the study intersections. Although these improvements did not modify the lane geometry at the study intersections, they did affect the future volumes in and around the study area.

- Rainier Cross-Town Connector – Rainier Avenue would be extended from McDowell Boulevard to Petaluma Boulevard, consisting of two lanes in each direction. In addition, a new US-101 interchange at Rainer Avenue is planned.
- Petaluma Boulevard Road Diet Extension – Petaluma Boulevard between E Street and Crystal Lane would be reduced from two lanes in each direction to one lane in each direction with one TWLTL and Class II bicycle lanes.
- Caulfield Bridge and Extension – Caulfield Lane would be extended from Pico Street to Petaluma boulevard, crossing over the Petaluma River.

### CUMULATIVE TRAFFIC VOLUME

Model volumes from the Sonoma County Travel Demand Forecast model were used to develop Cumulative (2040) traffic volumes. AM and PM peak hour roadway link volumes along the study area were obtained from the future year (2040) and base year (2015) models to determine an annual incremental growth in traffic volumes at the study intersection. Cumulative (2040) turning movement volumes were calculated by adding the growth increment to the existing traffic counts to calculate the final adjusted roadway link forecast volume. Final adjusted forecast volumes were then converted to Cumulative (2040) intersection turning movement volumes using a traffic modeling standard process commonly referred to as the Furness method. The Furness method uses an iterative process to derive future turning movement volumes based on future year roadway link volumes and an initial estimate of turning percentages (obtained from the existing intersection turning movement counts).

Due to the roadway improvements identified above, more specifically the Caulfield Bridge and Extension and the Rainier Cross-Town Connector which run parallel to D Street, certain movements are expected show a decrease in volume from Pipeline Conditions to Cumulative Conditions as these improvements relieve traffic on the existing roadways.

### CUMULATIVE INTERSECTIONS LEVEL OF SERVICE

Cumulative volumes were evaluated at the study intersections and are presented in **Figure 15**. Results are presented in **Table 7** and locations operating unacceptably are bolded. All study intersections function within acceptable LOS standards under this analysis scenario, except for the following intersections:

---

<sup>4</sup> *Proposed Operating & Capital Improvement Budget, Fiscal Year 2020-2021, City of Petaluma, May 2020.*

- #1 – D Street/Lakeville Street (AM and PM Peak Hours)
- #2 – D Street/Copeland Street (AM and PM Peak Hours)
- #5 – Washington Street/Lakeville Street (AM and PM Peak Hours)

Synchro analysis sheets are provided in the **Appendix**.

Table 7 - Cumulative Intersection Level of Service Summary

#	Intersection	LOS Criteria	Jurisdiction	Control	Cumulative			
					AM Peak		PM Peak	
					LOS	Delay <sup>1</sup> (sec)	LOS	Delay <sup>1</sup> (sec)
1	D Street/Lakeville Street	D	City	Signal	<b>E</b>	<b>59.1</b>	<b>E</b>	<b>55.1</b>
2	D Street/Copeland Street	D	City	SSSC	C	23.2	F	<b>70.8</b>
	<i>Worst Approach</i>				<b>F</b>	<b>&gt;150.0</b>	<b>F</b>	<b>&gt;150.0</b>
3	D Street/1st Street	D	City	Signal	B	17.7	C	27.1
4	D Street/Petaluma Boulevard	D	City	Signal	D	44.0	D	46.7
5	Washington Street/Lakeville Street	D	City	Signal	<b>E</b>	<b>66.5</b>	<b>E</b>	<b>77.2</b>
6	Washington Street/Copeland Street	D	City	Signal	D	35.6	C	25.0

Note: Intersections that are operating below acceptable levels are shown in **BOLD**.

Side-street stop-controlled (SSSC) intersections operating with a delay of greater than 150 seconds on the worst approach is shown with ">150.0".

<sup>1</sup>The average control delay is reported for signalized intersections. The delay for the worst movement is reported for SSSC intersections.



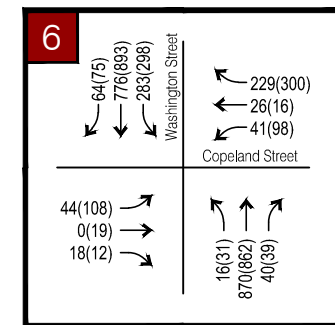
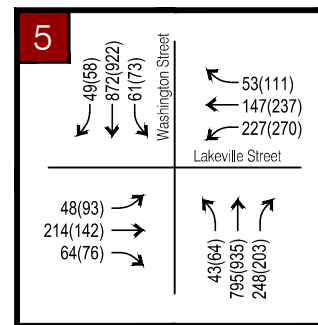
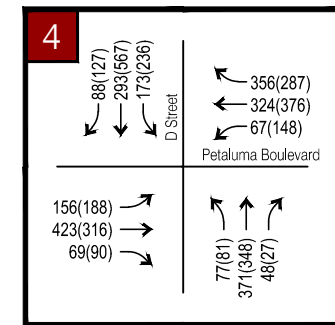
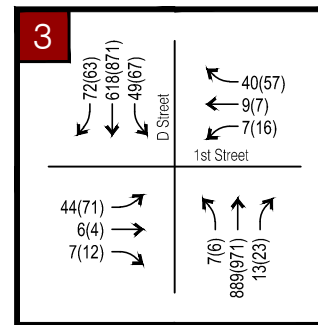
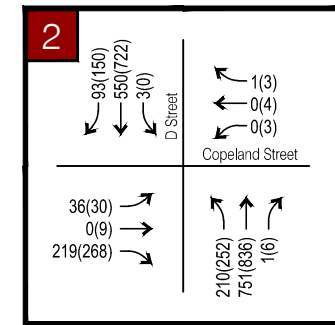
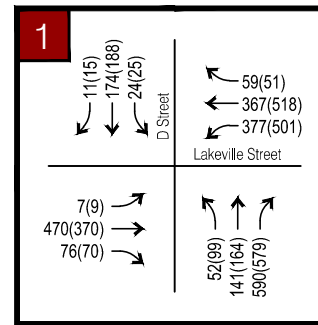

FIGURE 15  
CUMULATIVE CONDITIONS  
PEAK HOUR TURNING MOVEMENT VOLUMES

## CUMULATIVE PLUS PROJECT INTERSECTION LEVEL OF SERVICE

Cumulative Plus Project traffic conditions were evaluated at the study intersections and are shown in **Figure 16**. Results are presented in **Table 8** and intersections operating unacceptably are bolded. The following intersections would operate at an unacceptable level of service in the Cumulative Plus Project Conditions:

- #1 – D Street/Lakeville Street (AM and PM Peak Hours)
  - Intersection operating at an unacceptable LOS E without the project and continues to operate at an unacceptable LOS E with the project – Not a Deficiency
- #5 – Washington Street/Lakeville Street (AM and PM Peak Hours)
  - Intersection operating at an unacceptable LOS E without the project and continues to operate at an unacceptable LOS E with the project – Not a Deficiency

It should be noted that the average delay at Intersection #4 (D Street/Petaluma Boulevard) improved by 5.2 seconds with the proposed project in the PM peak hour. This is due coordination with the traffic signals at Intersections #2 and #3. In addition, the average delay at Intersection #6 (Washington Street/Copeland Street) improved by 0.01 seconds in the AM peak hour. This minimal improvement is due to the Synchro model adjusting the vehicle arrivals due to the effects of the upstream signal and therefore decreases the volume to capacity ratio and improves the intersection delay.

Synchro analysis sheets are provided in the **Appendix**.

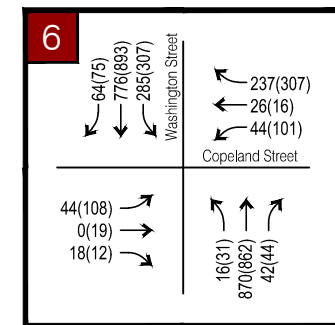
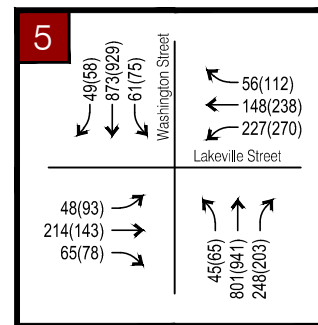
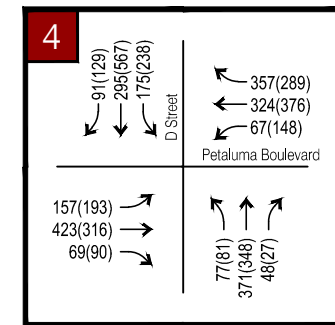
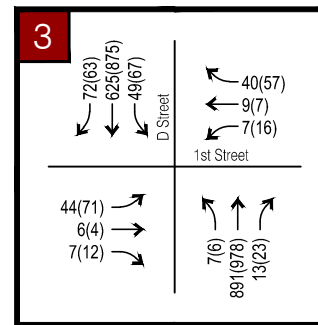
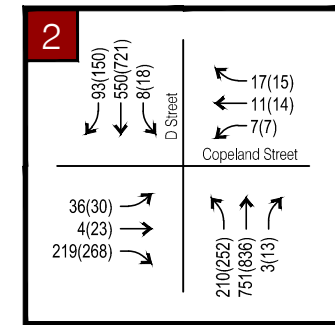
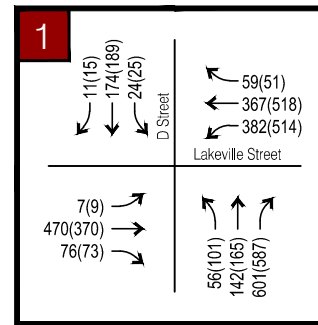

FIGURE 16  
CUMULATIVE PLUS PROJECT CONDITIONS  
PEAK HOUR TURNING MOVEMENT VOLUMES

Table 8 - Cumulative Plus Project Intersection Level of Service Summary

#	Intersection	LOS Criteria	Jurisdiction	Control	Cumulative				Cumulative+Project					
					AM Peak		PM Peak		AM Peak			PM Peak		
					LOS	Delay <sup>1</sup> (sec)	LOS	Delay <sup>1</sup> (sec)	LOS	Delay <sup>1</sup> (sec)	Var	LOS	Delay <sup>1</sup> (sec)	Var
1	D Street/Lakeville Street	D	City	Signal	<b>E</b>	<b>59.1</b>	<b>E</b>	<b>55.1</b>	<b>E</b>	<b>60.5</b>	<b>1.4</b>	<b>E</b>	<b>57.2</b>	<b>2.1</b>
2	D Street/Copeland Street	D	City	SSSC/ Signal <sup>2</sup>	C	23.2	F	<b>70.8</b>	C	22.1	>-150.0	D	45.9	>-150.0
	F				<b>&gt;150.0</b>	F	<b>&gt;150.0</b>							
3	D Street/1st Street	D	City	Signal	B	17.7	C	27.1	B	11.1	-6.6	C	23.6	-3.5
4	D Street/Petaluma Boulevard	D	City	Signal	D	44.0	D	46.7	D	44.1	0.1	D	41.5	-5.2
5	Washington Street/Lakeville Street	D	City	Signal	<b>E</b>	<b>66.5</b>	<b>E</b>	<b>77.2</b>	<b>E</b>	<b>67.1</b>	<b>0.6</b>	<b>E</b>	<b>79.3</b>	<b>2.1</b>
6	Washington Street/Copeland Street	D	City	Signal	D	35.6	C	25.0	D	35.5	-0.1	C	26.1	1.1

Note: Intersections that are operating below acceptable levels are shown in **BOLD**.

Side-street stop-controlled (SSSC) intersections operating with a delay of greater than 150 seconds on the worst approach is shown with ">150.0". Decrease in delays of greater than 150 seconds are shown with ">-150.0".

<sup>1</sup>The average control delay is reported for signalized intersections. The delay for the worst movement is reported for SSSC intersections.

<sup>2</sup>Intersection control is a SSSC under Cumulative Conditions and is a signal under plus project conditions.

## 7. VEHICLE QUEUING, SITE ACCESS AND CIRCULATION

This chapter presents the results from the vehicle queuing analysis and discussion of site access and circulation for the proposed project site.

### RAIL QUEUING EVALUATION

Due to the SMART rail located adjacent to Intersection #1 (Lakeville Street/D Street) and Intersection #5 (Lakeville Street/Washington Street), a supplemental traffic evaluation was conducted to determine the affects of when the rail crosses these intersections (which are anticipated to only be a few times each peak hour). Due to the limitations in analyzing the effects of upstream and downstream intersections within Synchro software, SimTraffic simulation was used to model the effects of when a SMART train crosses D Street and vehicles) and at Intersection #5 (Lakeville Street/Washington Street), there is an increase of 320 feet (or 13 vehicles).

Table 9 – SimTraffic Queuing Evaluation – Northbound D Street and Washington Street

#	Intersection	Scenario	Peak Period	Turning Movement	Storage Length (ft)	Queue Length (feet)	Difference (feet)
<b>Without Petaluma SMART Rail</b>							
1	Lakeville Street / D Street	Existing	AM	NB	400	177	-
			PM			<b>1,806</b>	-
5	Lakeville Street / Washington Street	Existing	AM	NB	400	333	-
			PM			<b>620</b>	-
<b>With Petaluma SMART Rail</b>							
1	Lakeville Street / D Street	Existing	AM	NB	400	339	162
			PM			<b>2,867</b>	1,061
5	Lakeville Street / Washington Street	Existing	AM	NB	400	389	56
			PM			<b>940</b>	320

Queues that exceed the available storage length are shown in **bold** and highlighted.

This rail queuing evaluation is for information purposes only as the train stops at the Downtown Petaluma SMART station three times during each peak hour and does not represent the average peak hour operations.

An Existing Plus Project SimTraffic scenario was reviewed to determine the additional queues the project would generate in the northbound direction with and without a train crossing. However, due to the variation in SimTraffic results from the model runs, the Existing Plus Project results show a wide range in variation (both increasing and decreasing) of the change in queues lengths. Therefore, Existing Plus Project conditions are not reported but due to the minimal increase in traffic generated by the project, the project is not expected to increase the queues extensively.

In addition, Pipeline and Cumulative SimTraffic models were ran to determine the northbound queuing with and without a train crossing. However, the model runs resulted in gridlock traffic conditions and was due to a vehicle waiting to make a left-turn or right-turn at an intersection with queues extending from an adjacent intersection. In turn, the remaining vehicles behind this vehicle extends into adjacent intersections and creates gridlock. It is assumed that if this were to occur in a real-life situation, these vehicles would attempt to find alternative routes to avoid any gridlock conditions.

## SITE ACCESS AND CIRCULATION

### VEHICULAR SITE ACCESS

As shown in **Figure 6**, the proposed development will be accessible through the east leg of Copeland Street at the intersection of Copeland Street and D Street. The eastbound and westbound approaches on Copeland Street are currently stop-controlled while the northbound and southbound approaches on D Street are uncontrolled. The intersection will be signalized with the proposed project. In addition, a southbound left-turn lane will be constructed on the north leg and a Class IV cycle track will be constructed on the south leg adjacent to the project frontage. The following describes the lane configuration at each approach of the intersection:

- Northbound Approach
  - 10-foot northbound left turn lane with a storage of 100 feet
  - 11-foot shared northbound through/right turn lane
  - 5-foot Class IV cycle track adjacent to the project site
  - 11-foot southbound receiving lane
- Southbound Approach
  - 12-foot southbound left turn lane with a storage of 100 feet
  - 12-foot shared southbound through/right turn lane
  - 12-foot northbound receiving lane
- Westbound Approach
  - 16-foot westbound shared left/through/right turn lane
  - 16-foot eastbound receiving lane
- Eastbound Approach
  - 23-foot eastbound shared left/through/right turn lane
  - 20-foot westbound receiving lane

A vehicle queuing evaluation was conducted for this intersection in the westbound approach to determine whether queues will extend into the project site and if sufficient driveway throat depth is provided within the site to accommodate the potential queues without hindering on-site operations. **Table 10** presents the results of the queuing evaluation. As shown in the table, all westbound through queues would be contained within the available approach distance of 125 feet, the distance from the intersection to the internal drive aisle within the project site.

Synchro queuing outputs are provided in the **Appendix**.

Table 10 – Driveway Queuing Evaluation

#	Intersection	Scenario	Peak Period	Turning Movement	Storage Length (ft)	Queue Length (feet)		Difference
						Without Project	With Project	
2	Copeland Street / D Street	Existing	AM	WB	125	0	40	40
			PM			18	42	24
		Pipeline	AM			0	40	40
			PM			30	42	12
		Cumulative	AM			0	40	40
			PM			38	42	4

---

## EMERGENCY VEHICLE ACCESS AND CIRCULATION

The project site was evaluated to determine whether sufficient emergency vehicle access and circulation were provided. An emergency vehicle truck turning movement exhibit is shown in **Figure 17**, as provided by CBG Civil Engineers, and shows the on-site turning movements for a Petaluma Fire Department (PFD) ladder truck. As shown in the figure, sufficient width is provided for emergency vehicles to circulate the project site without conflicting with parking spaces, buildings, etc. Hammerhead turnarounds are provided on the northeast and southeast corners of the site for the fire truck to make a three-point turn and exit the site.

The project site is not proposing any design features that would result in potential hazards for passenger car and emergency vehicle access.

---

## BICYCLE AND PEDESTRIAN ACCESS

There is currently an existing Class I bicycle path on the east leg of the intersection of Copeland Street and D Street that extends into the perimeter of the McNear Channel. There is also an existing Class III bicycle route along D Street, just west of the project site, between 1<sup>st</sup> Street and Payran Street which allows bicyclists access to nearby transit stops and the Downtown Petaluma SMART station. A future Class IV cycle track is proposed along D Street between Lakeville Street and Weller Street which would provide bicyclist its own protected bike facility. The project would construct the Class IV cycle track adjacent to its project frontage on the southeast side of the intersection of D Street and Copeland Street. Future Class III bicycle routes are proposed along Copeland Street between Washington Street and D Street and along D Street between 1<sup>st</sup> Street and Petaluma Boulevard which would increase bicyclist accessibility to more nearby uses such as transit stops along Copeland Street and commercial uses in Downtown Petaluma.

As identified in the Existing Pedestrian Facilities section, sidewalks exist on both sides of D Street and Copeland Street adjacent to the project site. With the proposed project, sidewalks will be constructed on both sides of Copeland Street, east of D Street, to provide pedestrians direct access from the project site to the existing sidewalks. This would allow pedestrian access to the commercial and transit uses nearby.

Within the project site, pedestrians can access the buildings using the proposed sidewalks within the site and the existing trail along the perimeter of McNear Canal. Pedestrian access is mainly provided along the rear end of the project buildings and is limited on the drive aisles as to reduce vehicular and pedestrian conflicts. The project site is not proposing any design features that would result in potential hazards for pedestrian access.

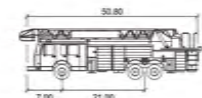
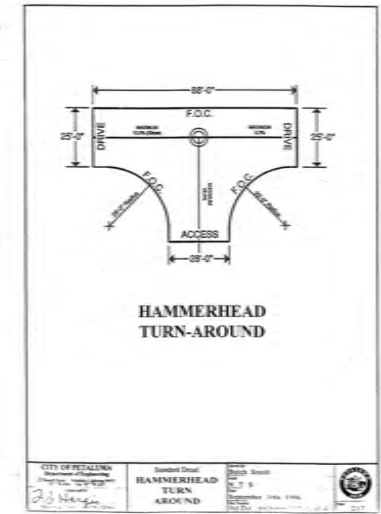

**PFD LADDER TRUCK**

Width	: 8.00
Track	: 7.67
Lock to Lock Time	: 5.0
Steering Angle	: 25.4

**FIRE ACCESS PLAN  
OYSTER COVE**

CITY OF PETALUMA SONOMA COUNTY CALIFORNIA  
SCALE: 1"=40' DATE: SEPTEMBER 17, 2020

**cbg** CIVIL ENGINEERS • SURVEYORS • PLANNERS

SAN RAMON • (925) 886-0222  
SACRAMENTO • (916) 375-1877  
WWW.CBGEO.COM

Source: CBG Civil Engineers



## 8. COLLISION EVALUATION

This chapter summarizes the collision evaluation at each study intersection. Collision information was obtained from the California Highway Patrol's Statewide Integrated Traffic Records System (SWITRS). Historical collisions were derived for the past five years between January 2017 to February 2022. The collision rate per million vehicle miles was calculated at each intersection based on the total collisions within the five-year period and the average daily traffic (ADT). ADT data was not collected and therefore a standard practice of applying a 10 percent factor to the PM peak hour volumes was applied. Results of the collision analysis are summarized in **Table 11**. To provide a general comparison of the intersection collision rates to expected collision rates for similar types of intersections, the calculated collision rates were compared to the statewide average rates listed in the most recent 2018 Collision Data on California State Highways (road miles, travel, collisions, collision rates) as listed in **Table 11**.

Table 11 – Collision Analysis

#	Intersection	Total Collisions (5 years)	ADT (vehicles per day)	Calculated Collision Rate Per Million Vehicle Miles	Statewide Collision Rate Per Million Vehicle Miles
1	D Street/Lakeville Street	28	21,700	<b>0.707</b>	0.24
2	D Street/Copeland Street	10	19,460	<b>0.282</b>	0.14
3	D Street/1st Street	7	19,880	0.193	0.24
4	D Street/Petaluma Boulevard	16	24,690	<b>0.355</b>	0.24
5	Washington Street/Lakeville Street	22	25,620	<b>0.471</b>	0.24
6	Washington Street/Copeland Street	9	21,530	0.229	0.24

Collisions rates higher than the statewide collision rates are shown in **bold** and highlighted.

As shown in the table, four of the six study intersections result in a higher calculated collision rate than the statewide collision rate. The City is currently working on a Local Road Safety plan (LRSP) which identifies safety issues within the City of Petaluma and prioritizes improvements to increase pedestrian and bicyclist safety. The City is working with the public to identify areas of concern and therefore a more detail collision evaluation will be analyzed in the City's LRSP.

## 9. SUMMARY OF DEFICIENCIES AND RECOMMENDED IMPROVEMENTS

Based on the results of the traffic analysis and evaluation of the proposed site plan, the project does not generate any intersection LOS or queuing deficiencies.

## APPENDIX

A – TURNING MOVEMENT COUNTS AND EXISTING VOLUME CALCULATIONS

B – EXISTING TRAFFIC CONDITIONS

C – EXISTING PLUS PROJECT TRAFFIC CONDITIONS

D – PIPELINE TRAFFIC CONDITIONS

E – PIPELINE PLUS PROJECT TRAFFIC CONDITIONS

F – CUMULATIVE TRAFFIC CONDITIONS

G – CUMULATIVE PLUS PROJECT TRAFFIC CONDITIONS

H – PEAK HOUR SIGNAL WARRANTS

# A – Turning Movement Counts and Existing Volume Calculations



# D St & Lakeville St

## Peak Hour Turning Movement Count

ID: 22-080023-001  
City: Petaluma

Day: Thursday  
Date: 1/13/2022

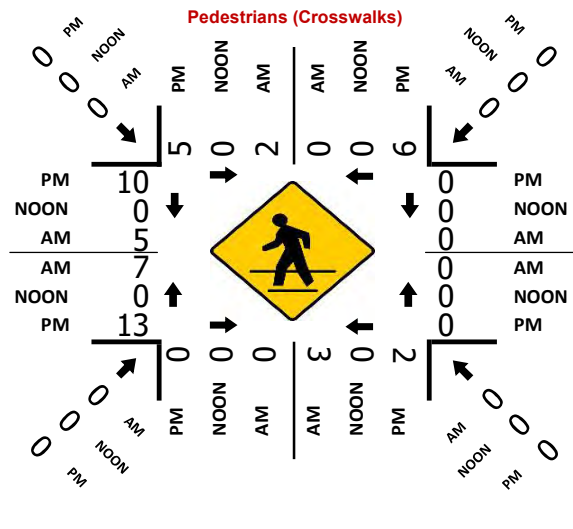
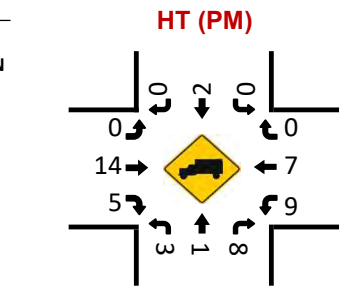
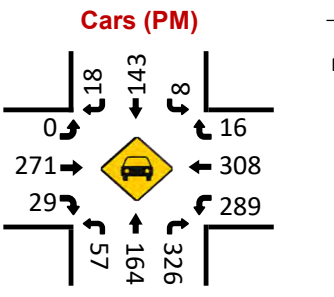
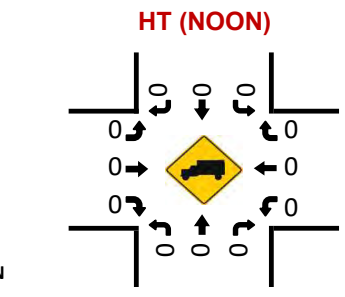
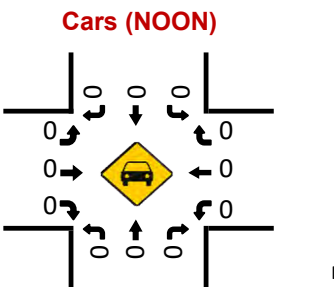
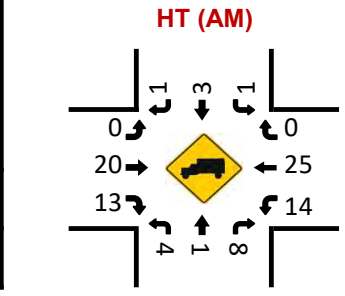
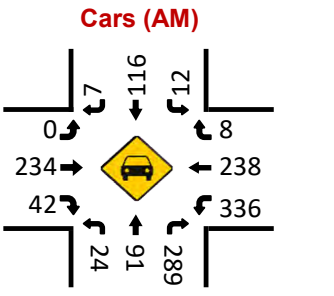
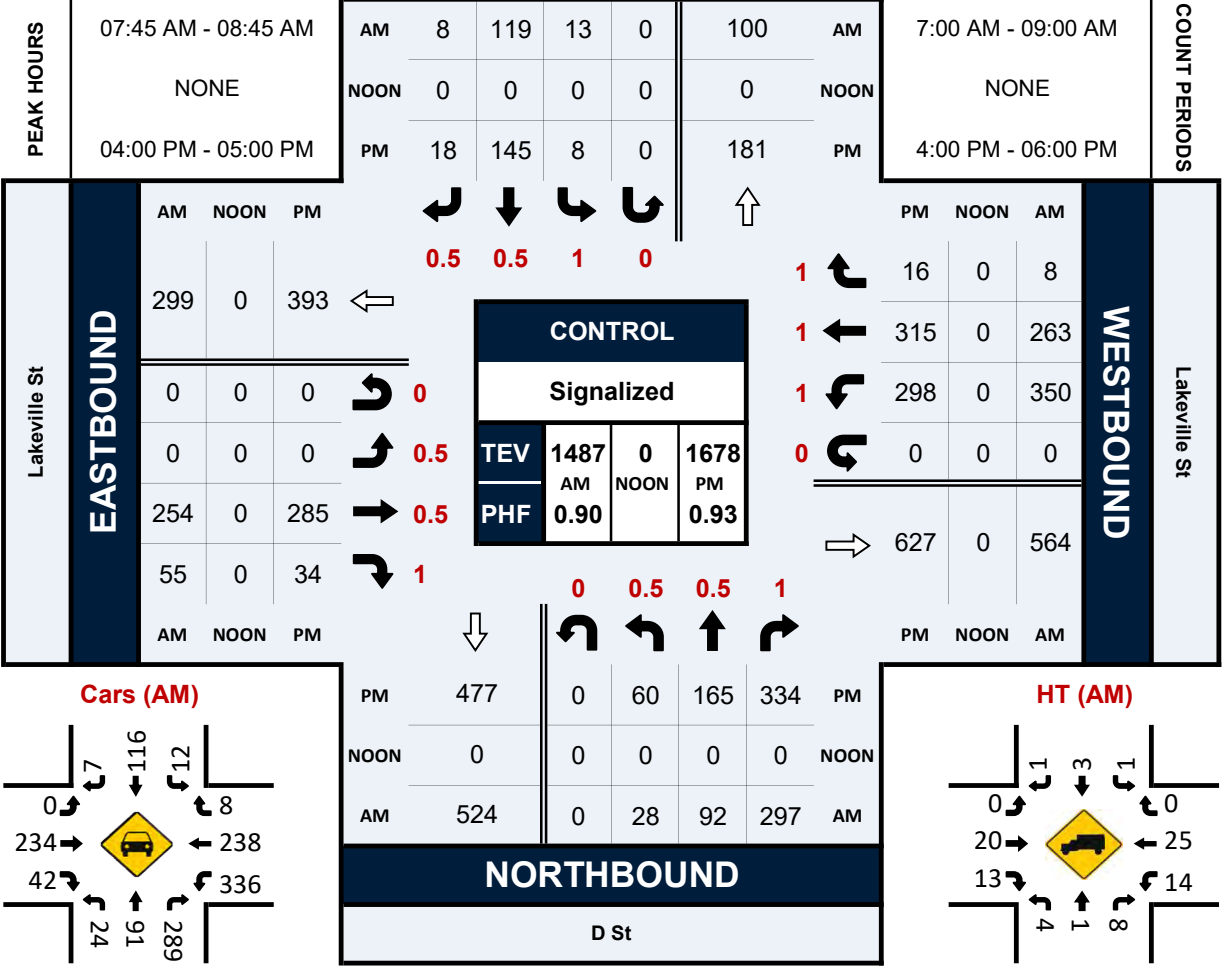

# D St & Copeland St

## Peak Hour Turning Movement Count

ID: 22-080023-002

City: Petaluma

Day: Thursday

Date: 1/13/2022

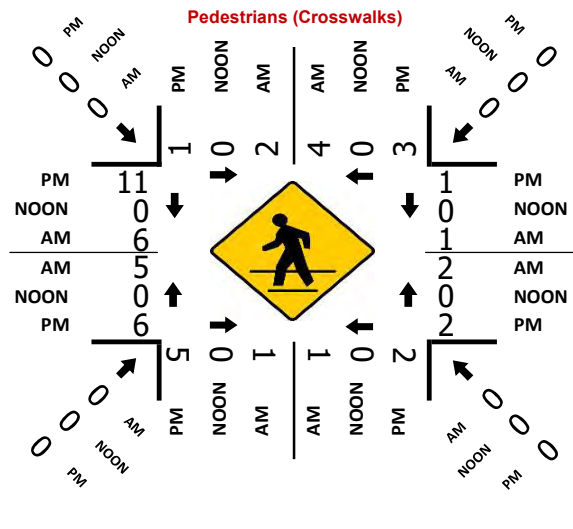
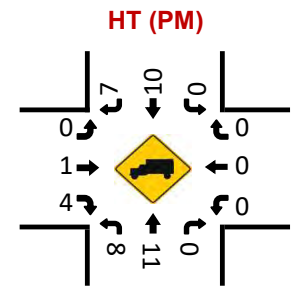
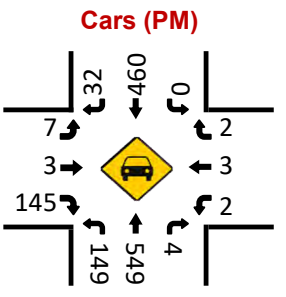
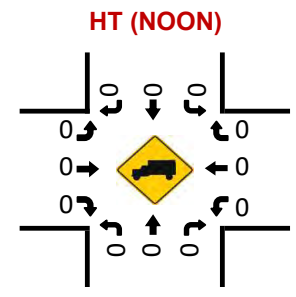
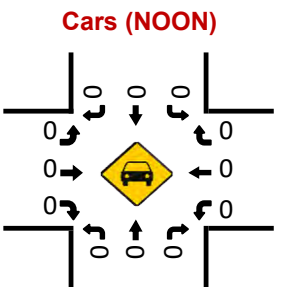
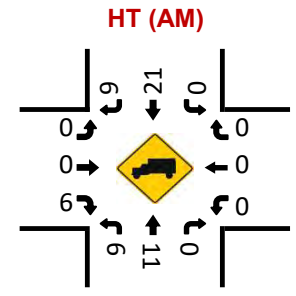
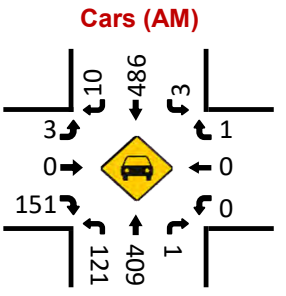
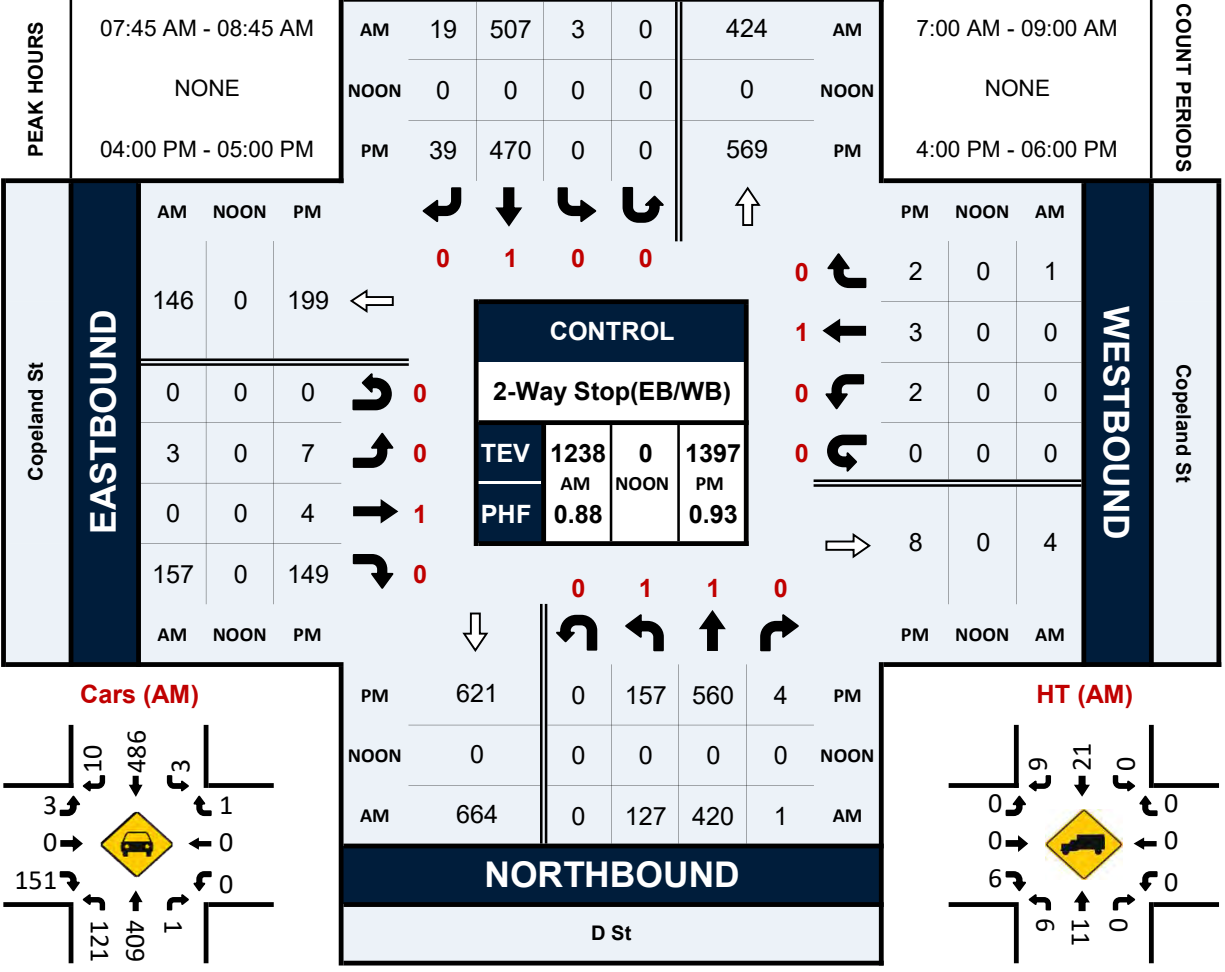

# D St & 1st St

## Peak Hour Turning Movement Count

ID: 22-080023-003

City: Petaluma

Day: Thursday

Date: 1/13/2022

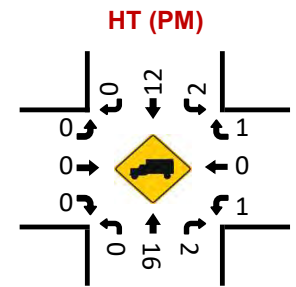
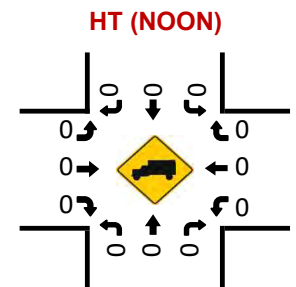
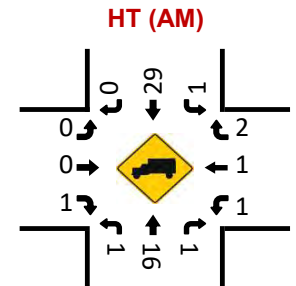
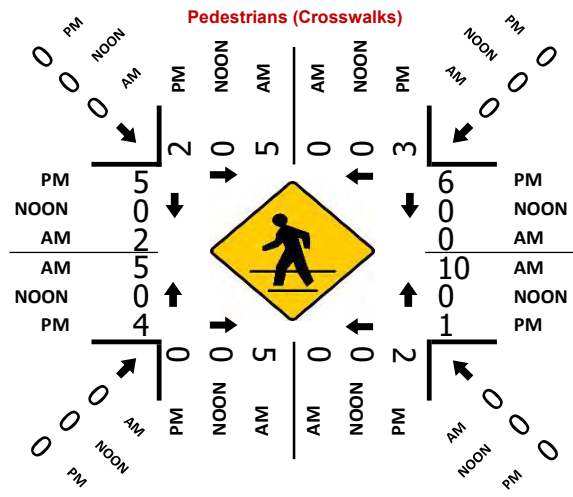
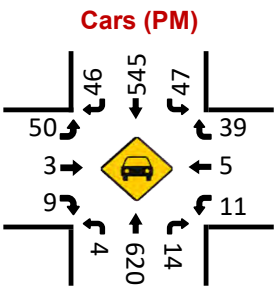
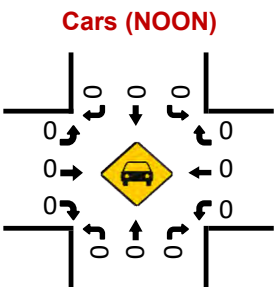
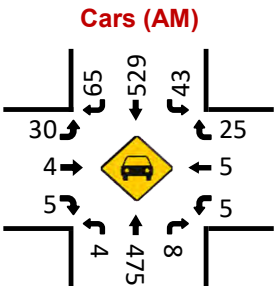
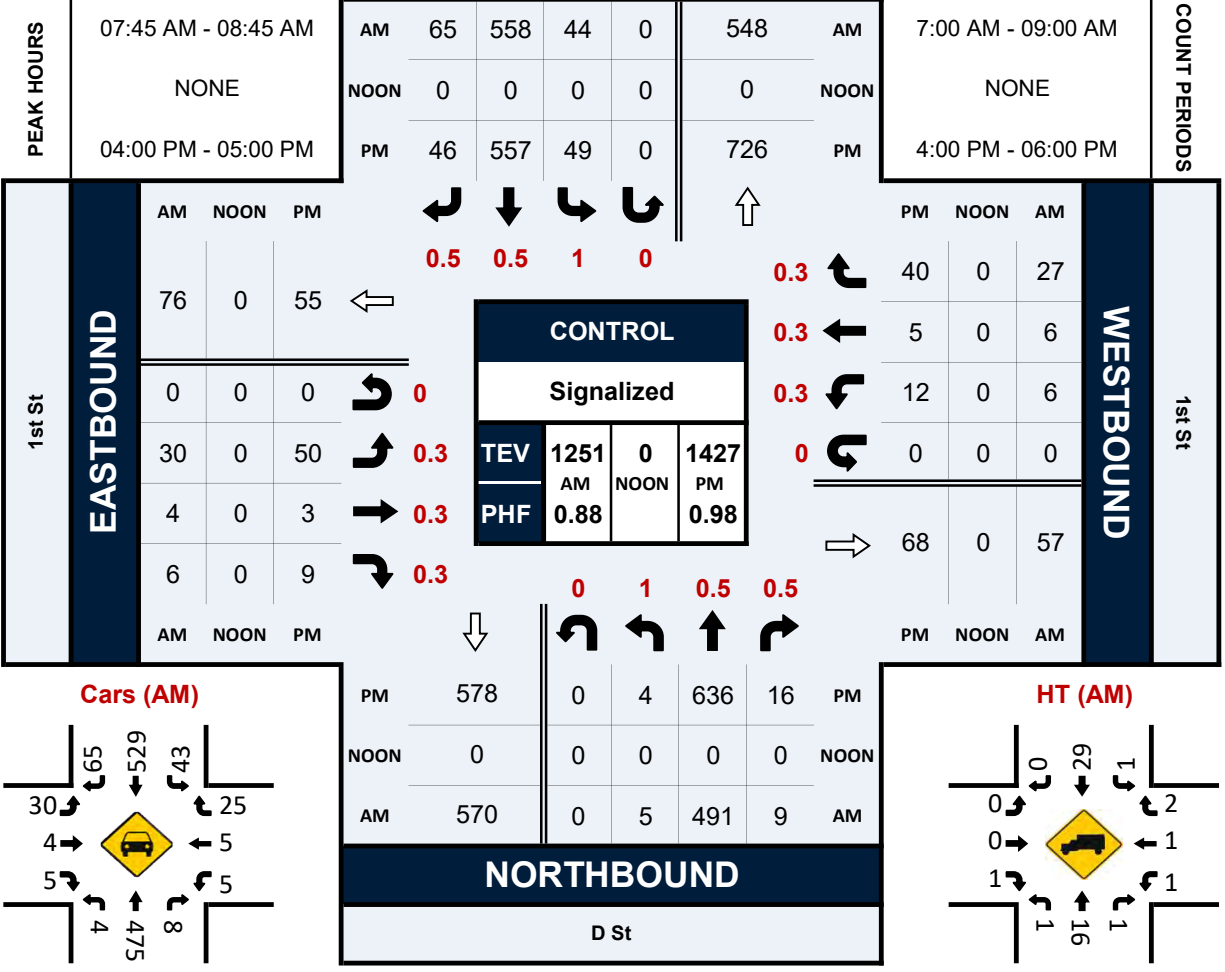

# D St & Petaluma Blvd

## Peak Hour Turning Movement Count

ID: 22-080023-004  
City: Petaluma

Day: Thursday  
Date: 1/13/2022

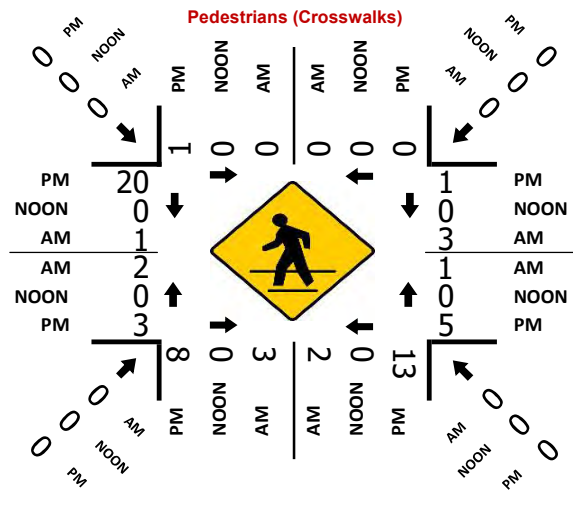
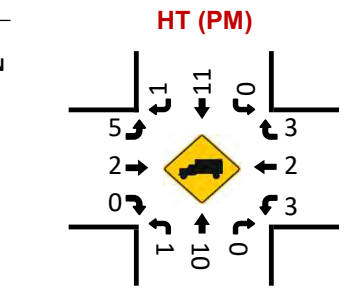
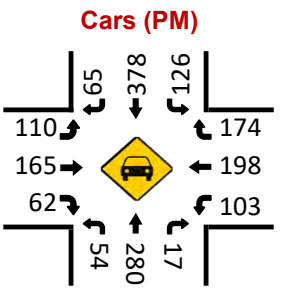
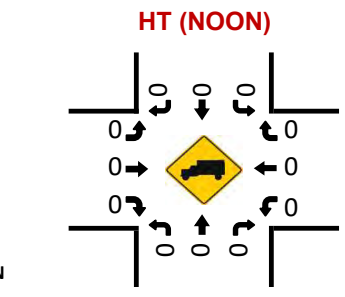
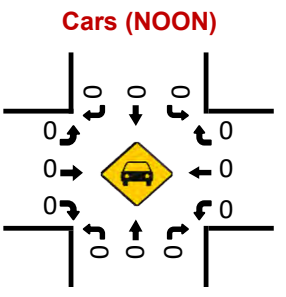
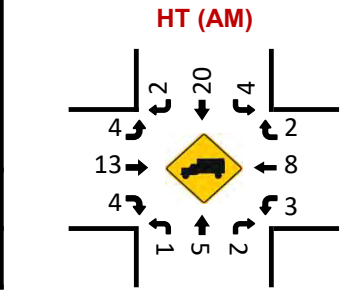
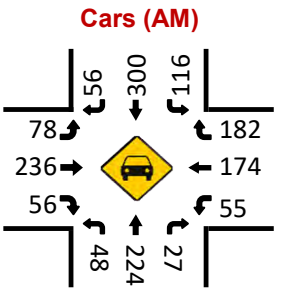
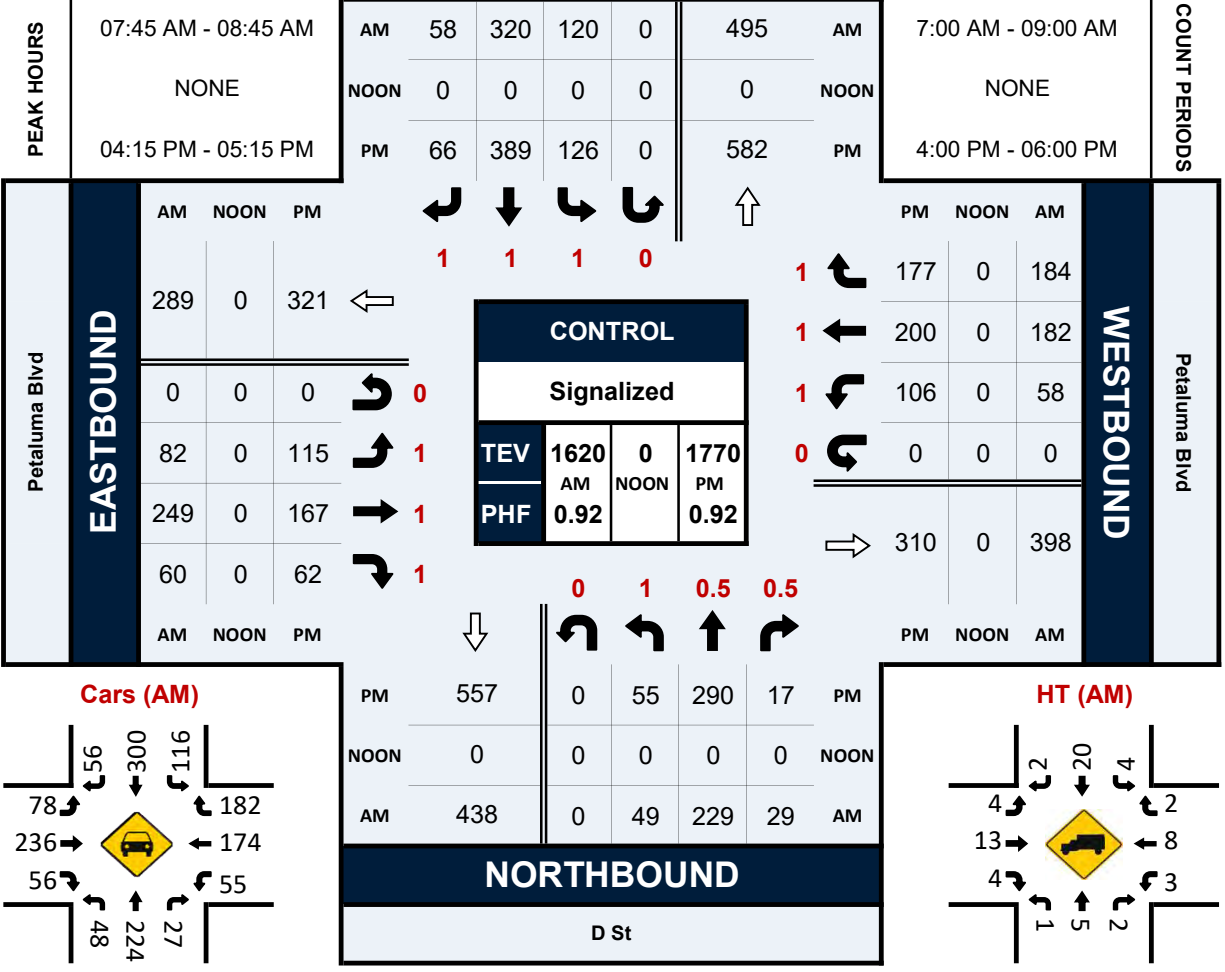



# Washington St & Lakeville St

## Peak Hour Turning Movement Count

ID: 22-080023-005  
City: Petaluma

Day: Thursday  
Date: 1/13/2022

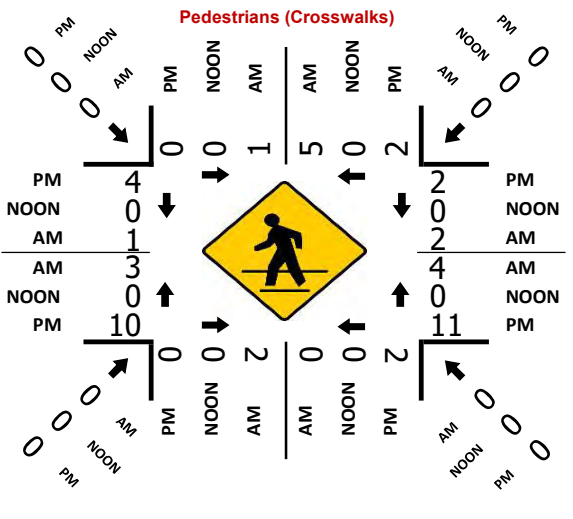
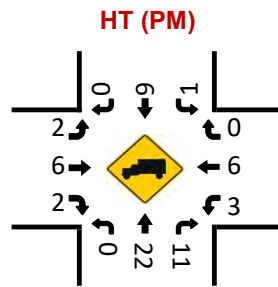
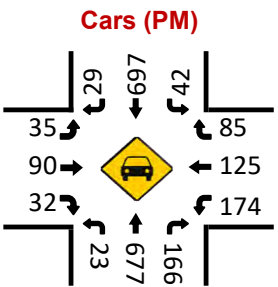
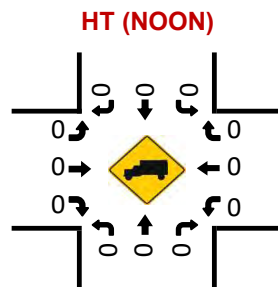
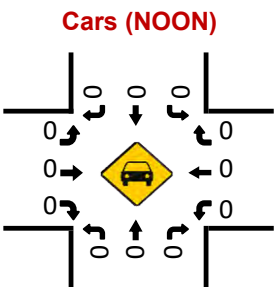
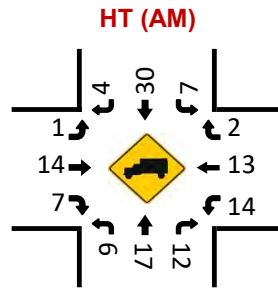
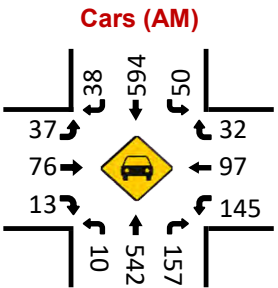
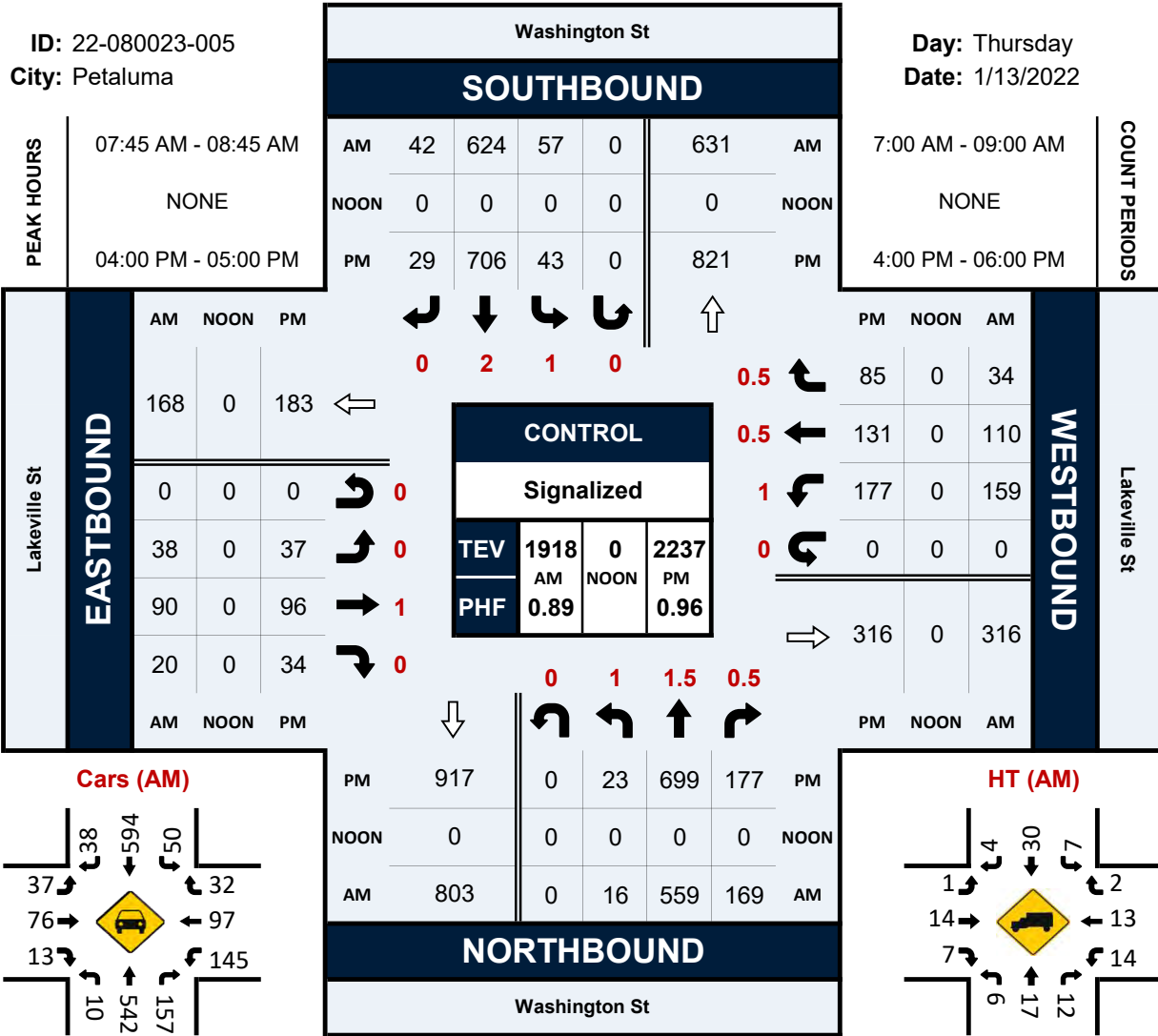

# Washington St & Copeland St

## Peak Hour Turning Movement Count

ID: 22-080023-006

City: Petaluma

Day: Thursday

Date: 1/13/2022

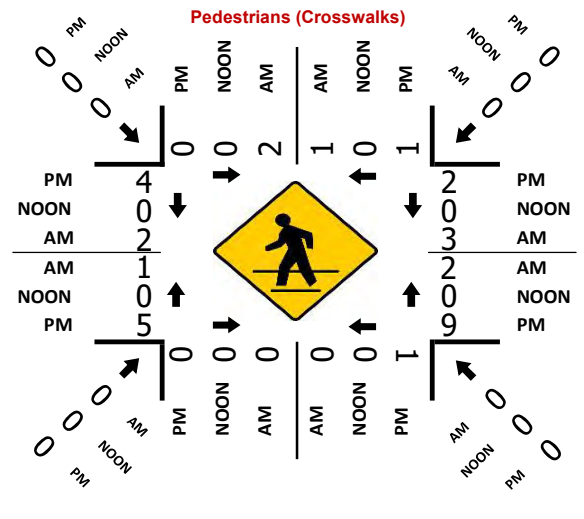
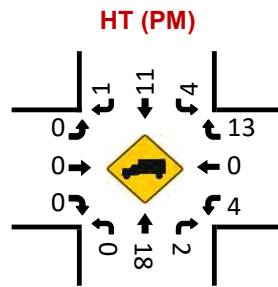
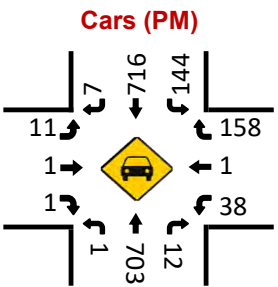
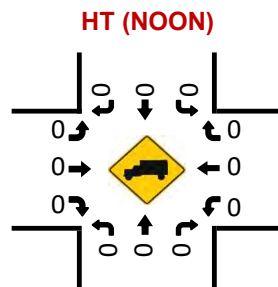
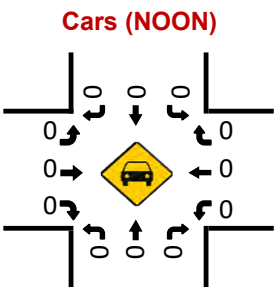
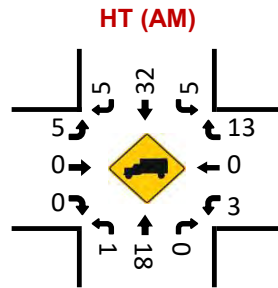
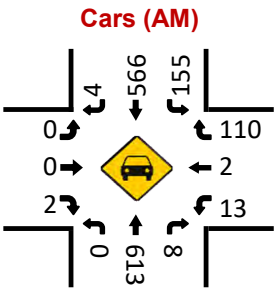
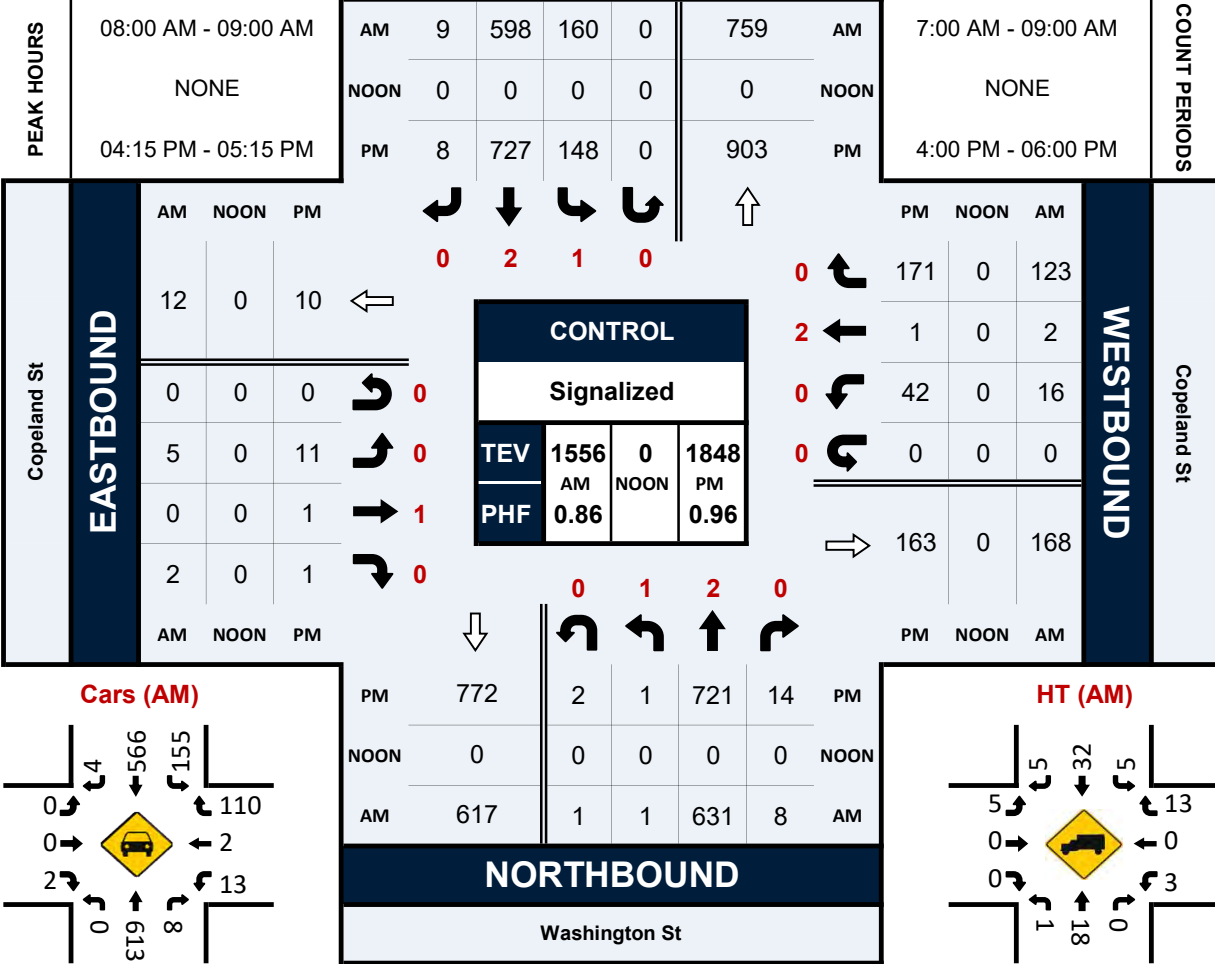

AM Peak

#	Intersection	NBL	NBT	NBR	SBL	SBT	SBR	EBL	EBT	EBR	WBL	WBT	WBR	Total	Year		Source
1	D Street/Lakeville Street	28	92	297	13	119	8	0	254	55	350	263	8	1487	2022		NDS Counts
		46	140	428	14	177	11	7	334	68	339	312	44	1920	2018	-6.19%	Baywood Village
		46	140	428	14	177	11	7	334	68	339	312	44	1920	2022		Use 2018 Volumes
2	D Street/Copeland Street	127	420	1	3	507	19	3	0	157	0	0	1	1238	2022		NDS Counts
		187	618	1	3	565	21	4	0	175	0	0	1	1575	2022		Calculated 2022
3	D Street/1st Street	5	491	9	44	558	65	30	4	6	6	6	27	1251	2022		NDS Counts
		7	723	13	49	622	72	44	6	7	7	9	40	1599	2022		Calculated 2022
4	D Street/Petaluma Boulevard	49	229	29	120	320	58	82	249	60	58	182	184	1620	2022		NDS Counts
		72	337	43	134	357	65	121	367	67	65	268	271	2167	2022		Calculated 2022
5	Washington Street/Lakeville Street	16	559	169	57	624	42	38	90	20	159	110	34	1918	2022		NDS Counts
		18	660	202	61	731	29	30	131	28	215	98	52	2255	2018	-3.97%	Baywood Village
		18	660	202	61	731	29	30	131	28	215	98	52	2255			Use 2018 Volumes
6	Washington Street/Copeland Street	2	631	8	160	598	9	5	0	2	16	2	123	1556	2022		NDS Counts
		2	746	9	194	725	11	6	0	2	19	2	145	1861	2022		Calculated 2022

PM Peak























#	Intersection	NBL	NBT	NBR	SBL	SBT	SBR	EBL	EBT	EBR	WBL	WBT	WBR	Total	Year		Source
1	D Street/Lakeville Street	60	165	334	8	145	18	0	285	34	298	315	16	1678	2022		NDS Counts
		90	175	529	18	186	14	9	285	63	401	367	33	2170	2018	-6.23%	Baywood Village
		90	175	529	18	186	14	9	285	63	401	367	33	2170	2022		Use 2018 Volumes
2	D Street/Copeland Street	157	560	4	0	470	39	7	4	149	2	3	2	1397	2022		NDS Counts
		223	795	6	0	640	53	10	6	203	3	4	3	1946	2022		Calculated 2022
3	D Street/1st Street	4	636	16	49	557	46	50	3	9	12	5	40	1427	2022		NDS Counts
		6	903	23	67	759	63	71	4	12	16	7	57	1988	2022		Calculated 2022
4	D Street/Petaluma Boulevard	55	290	17	126	389	66	115	167	62	106	200	177	1770	2022		NDS Counts
		78	412	24	172	530	90	163	237	84	144	284	251	2469	2022		Calculated 2022
5	Washington Street/Lakeville Street	23	699	177	43	706	29	37	96	34	177	131	85	2237	2022		NDS Counts
		40	790	178	71	776	41	57	90	41	218	159	101	2562	2018	-3.33%	Baywood Village
		40	790	178	71	776	41	57	90	41	218	159	101	2562	2022		Adjusted 2022
6	Washington Street/Copeland Street	3	721	14	148	727	8	11	1	1	42	1	171	1848	2022		NDS Counts
		3	808	16	167	821	9	12	1	1	47	1	192	2078	2022		Adjusted 2022

## B - Existing Traffic Conditions



HCM 6th Signalized Intersection Summary  
 1: D St & Lakeville St

Existing  
 Timing Plan: AM Peak

												
Movement	EBL	EBT	EBR	WBL	WBT	WBR	NBL	NBT	NBR	SBL	SBT	SBR
Lane Configurations												
Traffic Volume (veh/h)	7	334	68	339	312	44	46	140	428	14	177	11
Future Volume (veh/h)	7	334	68	339	312	44	46	140	428	14	177	11
Initial Q (Qb), veh	0	0	0	0	0	0	0	0	0	0	0	0
Ped-Bike Adj(A_pbT)	1.00		0.99	1.00		1.00	1.00		0.97	1.00		0.94
Parking Bus, Adj	1.00	1.00	1.00	1.00	1.00	1.00	1.00	1.00	1.00	1.00	1.00	1.00
Work Zone On Approach		No			No			No			No	
Adj Sat Flow, veh/h/ln	1900	1781	1544	1841	1752	1900	1693	1885	1856	1781	1856	1707
Adj Flow Rate, veh/h	8	371	76	377	347	49	51	156	476	16	197	12
Peak Hour Factor	0.90	0.90	0.90	0.90	0.90	0.90	0.90	0.90	0.90	0.90	0.90	0.90
Percent Heavy Veh, %	0	8	24	4	10	0	14	1	3	8	3	13
Cap, veh/h	35	417	309	405	882	809	101	308	698	256	260	16
Arrive On Green	0.24	0.24	0.24	0.23	0.50	0.50	0.22	0.22	0.22	0.15	0.15	0.15
Sat Flow, veh/h	13	1757	1300	1753	1752	1605	459	1403	1527	1697	1723	105
Grp Volume(v), veh/h	379	0	76	377	347	49	207	0	476	16	0	209
Grp Sat Flow(s),veh/h/ln	1770	0	1300	1753	1752	1605	1862	0	1527	1697	0	1828
Q Serve(g_s), s	6.2	0.0	5.4	24.0	14.0	1.8	11.1	0.0	25.0	0.9	0.0	12.5
Cycle Q Clear(g_c), s	23.6	0.0	5.4	24.0	14.0	1.8	11.1	0.0	25.0	0.9	0.0	12.5
Prop In Lane	0.02		1.00	1.00		1.00	0.25		1.00	1.00		0.06
Lane Grp Cap(c), veh/h	453	0	309	405	882	809	408	0	698	256	0	276
V/C Ratio(X)	0.84	0.00	0.25	0.93	0.39	0.06	0.51	0.00	0.68	0.06	0.00	0.76
Avail Cap(c_a), veh/h	650	0	456	692	922	845	408	0	698	417	0	449
HCM Platoon Ratio	1.00	1.00	1.00	1.00	1.00	1.00	1.00	1.00	1.00	1.00	1.00	1.00
Upstream Filter(l)	1.00	0.00	1.00	1.00	1.00	1.00	1.00	0.00	1.00	1.00	0.00	1.00
Uniform Delay (d), s/veh	42.1	0.0	35.2	43.0	17.5	14.5	39.1	0.0	25.0	41.5	0.0	46.4
Incr Delay (d2), s/veh	4.5	0.0	0.2	7.8	0.1	0.0	1.4	0.0	3.0	0.1	0.0	3.2
Initial Q Delay(d3),s/veh	0.0	0.0	0.0	0.0	0.0	0.0	0.0	0.0	0.0	0.0	0.0	0.0
%ile BackOfQ(50%),veh/ln	10.8	0.0	1.7	11.2	5.6	0.7	5.3	0.0	10.6	0.4	0.0	6.0
Unsig. Movement Delay, s/veh												
LnGrp Delay(d),s/veh	46.6	0.0	35.4	50.7	17.6	14.5	40.5	0.0	28.1	41.6	0.0	49.6
LnGrp LOS	D	A	D	D	B	B	D	A	C	D	A	D
Approach Vol, veh/h		455			773			683			225	
Approach Delay, s/veh		44.7			33.6			31.9			49.0	
Approach LOS		D			C			C			D	
Timer - Assigned Phs		2	3	4		6		8				
Phs Duration (G+Y+Rc), s		30.3	30.4	31.9		21.5		62.3				
Change Period (Y+Rc), s		* 5.3	4.0	* 4.8		4.3		* 4.8				
Max Green Setting (Gmax), s		* 25	45.0	* 40		28.0		* 60				
Max Q Clear Time (g_c+I1), s		27.0	26.0	25.6		14.5		16.0				
Green Ext Time (p_c), s		0.0	0.3	1.5		0.8		1.5				
<b>Intersection Summary</b>												
HCM 6th Ctrl Delay				37.0								
HCM 6th LOS				D								
<b>Notes</b>												
* HCM 6th computational engine requires equal clearance times for the phases crossing the barrier.												

Intersection												
Int Delay, s/veh	3.7											
Movement	EBL	EBT	EBR	WBL	WBT	WBR	NBL	NBT	NBR	SBL	SBT	SBR
Lane Configurations		↕			↕		↕	↕			↕	
Traffic Vol, veh/h	5	0	198	0	0	1	187	618	1	3	565	21
Future Vol, veh/h	5	0	198	0	0	1	187	618	1	3	565	21
Conflicting Peds, #/hr	6	0	2	2	0	6	11	0	3	3	0	11
Sign Control	Stop	Stop	Stop	Stop	Stop	Stop	Free	Free	Free	Free	Free	Free
RT Channelized	-	-	None	-	-	None	-	-	None	-	-	None
Storage Length	-	-	-	-	-	-	60	-	-	-	-	-
Veh in Median Storage, #	-	0	-	-	0	-	-	0	-	-	0	-
Grade, %	-	0	-	-	0	-	-	0	-	-	0	-
Peak Hour Factor	88	88	88	88	88	88	88	88	88	88	88	88
Heavy Vehicles, %	0	0	4	0	0	0	5	3	0	0	4	47
Mvmt Flow	6	0	225	0	0	1	213	702	1	3	642	24

Major/Minor	Minor2		Minor1		Major1			Major2				
Conflicting Flow All	1806	1803	667	1907	1815	712	677	0	0	706	0	0
Stage 1	671	671	-	1132	1132	-	-	-	-	-	-	-
Stage 2	1135	1132	-	775	683	-	-	-	-	-	-	-
Critical Hdwy	6.1	5.5	5.2	6.1	5.5	5.2	4.15	-	-	4.1	-	-
Critical Hdwy Stg 1	6.1	5.5	-	6.1	5.5	-	-	-	-	-	-	-
Critical Hdwy Stg 2	6.1	5.5	-	6.1	5.5	-	-	-	-	-	-	-
Follow-up Hdwy	3.5	4	3.336	3.5	4	3.3	2.245	-	-	2.2	-	-
Pot Cap-1 Maneuver	102	133	552	89	131	531	901	-	-	902	-	-
Stage 1	449	458	-	249	281	-	-	-	-	-	-	-
Stage 2	248	281	-	394	452	-	-	-	-	-	-	-
Platoon blocked, %								-	-	-	-	-
Mov Cap-1 Maneuver	81	99	545	42	98	526	892	-	-	899	-	-
Mov Cap-2 Maneuver	81	99	-	42	98	-	-	-	-	-	-	-
Stage 1	338	451	-	189	213	-	-	-	-	-	-	-
Stage 2	187	213	-	230	445	-	-	-	-	-	-	-



















Approach	EB		WB		NB		SB	
HCM Control Delay, s	19.4		11.9		2.4		0	
HCM LOS	C		B					

Minor Lane/Major Mvmt	NBL	NBT	NBR	EBLn1	WBLn1	SBL	SBT	SBR
Capacity (veh/h)	892	-	-	478	526	899	-	-
HCM Lane V/C Ratio	0.238	-	-	0.483	0.002	0.004	-	-
HCM Control Delay (s)	10.3	-	-	19.4	11.9	9	0	-
HCM Lane LOS	B	-	-	C	B	A	A	-
HCM 95th %tile Q(veh)	0.9	-	-	2.6	0	0	-	-

# HCM 6th Signalized Intersection Summary

## 3: D St & 1st St

Existing  
Timing Plan: AM Peak

												
Movement	EBL	EBT	EBR	WBL	WBT	WBR	NBL	NBT	NBR	SBL	SBT	SBR
Lane Configurations												
Traffic Volume (veh/h)	44	6	7	7	9	40	7	723	13	49	622	72
Future Volume (veh/h)	44	6	7	7	9	40	7	723	13	49	622	72
Initial Q (Qb), veh	0	0	0	0	0	0	0	0	0	0	0	0
Ped-Bike Adj(A_pbT)	0.98		0.99	0.99		0.98	1.00		0.97	1.00		0.97
Parking Bus, Adj	1.00	1.00	1.00	1.00	1.00	1.00	1.00	1.00	1.00	1.00	1.00	1.00
Work Zone On Approach		No			No			No			No	
Adj Sat Flow, veh/h/ln	1900	1900	1648	1648	1648	1796	1604	1856	1737	1870	1826	1900
Adj Flow Rate, veh/h	50	7	8	8	10	45	8	822	15	56	707	82
Peak Hour Factor	0.88	0.88	0.88	0.88	0.88	0.88	0.88	0.88	0.88	0.88	0.88	0.88
Percent Heavy Veh, %	0	0	17	17	17	7	20	3	11	2	5	0
Cap, veh/h	185	27	20	54	32	102	362	1237	23	119	807	94
Arrive On Green	0.10	0.10	0.10	0.10	0.10	0.10	0.47	1.00	1.00	0.07	0.50	0.50
Sat Flow, veh/h	1120	263	194	85	317	1005	1527	1815	33	1781	1600	186
Grp Volume(v), veh/h	65	0	0	63	0	0	8	0	837	56	0	789
Grp Sat Flow(s),veh/h/ln	1577	0	0	1407	0	0	1527	0	1848	1781	0	1785
Q Serve(g_s), s	0.0	0.0	0.0	0.0	0.0	0.0	0.3	0.0	0.0	2.7	0.0	35.3
Cycle Q Clear(g_c), s	3.0	0.0	0.0	3.7	0.0	0.0	0.3	0.0	0.0	2.7	0.0	35.3
Prop In Lane	0.77		0.12	0.13		0.71	1.00		0.02	1.00		0.10
Lane Grp Cap(c), veh/h	231	0	0	188	0	0	362	0	1259	119	0	901
V/C Ratio(X)	0.28	0.00	0.00	0.33	0.00	0.00	0.02	0.00	0.66	0.47	0.00	0.88
Avail Cap(c_a), veh/h	440	0	0	387	0	0	362	0	1259	178	0	901
HCM Platoon Ratio	1.00	1.00	1.00	1.00	1.00	1.00	2.00	2.00	2.00	1.00	1.00	1.00
Upstream Filter(I)	1.00	0.00	0.00	1.00	0.00	0.00	0.76	0.00	0.76	1.00	0.00	1.00
Uniform Delay (d), s/veh	37.7	0.0	0.0	38.0	0.0	0.0	18.1	0.0	0.0	40.4	0.0	19.8
Incr Delay (d2), s/veh	0.5	0.0	0.0	0.8	0.0	0.0	0.0	0.0	2.1	1.1	0.0	11.7
Initial Q Delay(d3),s/veh	0.0	0.0	0.0	0.0	0.0	0.0	0.0	0.0	0.0	0.0	0.0	0.0
%ile BackOfQ(50%),veh/ln	1.4	0.0	0.0	1.3	0.0	0.0	0.1	0.0	0.7	1.2	0.0	16.7
Unsig. Movement Delay, s/veh												
LnGrp Delay(d),s/veh	38.1	0.0	0.0	38.8	0.0	0.0	18.1	0.0	2.1	41.5	0.0	31.5
LnGrp LOS	D	A	A	D	A	A	B	A	A	D	A	C
Approach Vol, veh/h		65			63			845			845	
Approach Delay, s/veh		38.1			38.8			2.3			32.1	
Approach LOS		D			D			A			C	
Timer - Assigned Phs	1	2		4	5	6		8				
Phs Duration (G+Y+Rc), s	10.0	65.9		14.0	26.0	50.0		14.0				
Change Period (Y+Rc), s	4.0	4.6		* 4.9	4.6	* 4.6		* 4.9				
Max Green Setting (Gmax), s	9.0	45.4		* 22	9.0	* 45		* 22				
Max Q Clear Time (g_c+I1), s	4.7	2.0		5.0	2.3	37.3		5.7				
Green Ext Time (p_c), s	0.0	12.6		0.2	0.0	4.5		0.2				

### Intersection Summary

HCM 6th Ctrl Delay	18.7
HCM 6th LOS	B

### Notes

\* HCM 6th computational engine requires equal clearance times for the phases crossing the barrier.

# HCM 6th Signalized Intersection Summary

## 4: D St & Petaluma Blvd

Existing  
Timing Plan: AM Peak



Movement	EBL	EBT	EBR	WBL	WBT	WBR	NBL	NBT	NBR	SBL	SBT	SBR
Lane Configurations												
Traffic Volume (veh/h)	121	367	67	65	268	271	72	337	43	134	357	65
Future Volume (veh/h)	121	367	67	65	268	271	72	337	43	134	357	65
Initial Q (Qb), veh	0	0	0	0	0	0	0	0	0	0	0	0
Ped-Bike Adj(A_pbT)	1.00		0.99	1.00		0.99	1.00		0.97	1.00		0.99
Parking Bus, Adj	1.00	1.00	1.00	1.00	1.00	1.00	1.00	1.00	1.00	1.00	1.00	1.00
Work Zone On Approach		No			No			No			No	
Adj Sat Flow, veh/h/ln	1826	1826	1796	1826	1841	1885	1870	1870	1796	1856	1811	1856
Adj Flow Rate, veh/h	132	399	73	71	291	295	78	366	47	146	388	71
Peak Hour Factor	0.92	0.92	0.92	0.92	0.92	0.92	0.92	0.92	0.92	0.92	0.92	0.92
Percent Heavy Veh, %	5	5	7	5	4	1	2	2	7	3	6	3
Cap, veh/h	155	469	387	128	431	370	136	491	63	289	722	624
Arrive On Green	0.09	0.26	0.26	0.07	0.23	0.23	0.08	0.30	0.30	0.33	0.80	0.80
Sat Flow, veh/h	1739	1826	1507	1739	1841	1581	1781	1618	208	1767	1811	1565
Grp Volume(v), veh/h	132	399	73	71	291	295	78	0	413	146	388	71
Grp Sat Flow(s),veh/h/ln	1739	1826	1507	1739	1841	1581	1781	0	1826	1767	1811	1565
Q Serve(g_s), s	6.7	18.7	3.4	3.5	12.9	15.8	3.8	0.0	18.3	6.0	6.8	0.6
Cycle Q Clear(g_c), s	6.7	18.7	3.4	3.5	12.9	15.8	3.8	0.0	18.3	6.0	6.8	0.6
Prop In Lane	1.00		1.00	1.00		1.00	1.00		0.11	1.00		1.00
Lane Grp Cap(c), veh/h	155	469	387	128	431	370	136	0	554	289	722	624
V/C Ratio(X)	0.85	0.85	0.19	0.55	0.68	0.80	0.57	0.00	0.75	0.50	0.54	0.11
Avail Cap(c_a), veh/h	155	530	437	155	538	462	158	0	554	289	722	624
HCM Platoon Ratio	1.00	1.00	1.00	1.00	1.00	1.00	1.00	1.00	1.00	2.00	2.00	2.00
Upstream Filter(I)	1.00	1.00	1.00	1.00	1.00	1.00	1.00	0.00	1.00	0.80	0.80	0.80
Uniform Delay (d), s/veh	40.4	31.8	26.1	40.2	31.4	32.5	40.2	0.0	28.2	27.3	6.2	2.6
Incr Delay (d2), s/veh	33.1	12.2	0.3	1.4	3.1	8.7	1.4	0.0	8.8	0.5	2.3	0.3
Initial Q Delay(d3),s/veh	0.0	0.0	0.0	0.0	0.0	0.0	0.0	0.0	0.0	0.0	0.0	0.0
%ile BackOfQ(50%),veh/ln	4.3	9.6	1.2	1.6	6.0	6.8	1.7	0.0	9.2	2.3	2.2	0.3
Unsig. Movement Delay, s/veh												
LnGrp Delay(d),s/veh	73.5	44.0	26.4	41.6	34.5	41.2	41.6	0.0	37.1	27.8	8.5	2.9
LnGrp LOS	E	D	C	D	C	D	D	A	D	C	A	A
Approach Vol, veh/h		604			657			491			605	
Approach Delay, s/veh		48.3			38.2			37.8			12.5	
Approach LOS		D			D			D			B	
Timer - Assigned Phs	1	2	3	4	5	6	7	8				
Phs Duration (G+Y+Rc), s	9.3	32.0	10.6	28.0	10.9	40.5	12.9	25.8				
Change Period (Y+Rc), s	4.6	* 4.7	4.0	* 4.9	4.0	4.6	* 4.9	* 4.7				
Max Green Setting (Gmax), s	15	* 27	8.0	* 26	8.0	30.4	* 8	* 26				
Max Q Clear Time (g_c+1/3), s	19.0	20.3	5.5	20.7	5.8	8.8	8.7	17.8				
Green Ext Time (p_c), s	0.1	1.3	0.0	1.7	0.0	2.2	0.0	2.6				

### Intersection Summary

HCM 6th Ctrl Delay	34.1
HCM 6th LOS	C

### Notes

User approved pedestrian interval to be less than phase max green.  
\* HCM 6th computational engine requires equal clearance times for the phases crossing the barrier.



# HCM 6th Signalized Intersection Summary

## 5: Washington St & Lakeville St

Existing  
Timing Plan: AM Peak



Movement	EBL	EBT	EBR	WBL	WBT	WBR	NBL	NBT	NBR	SBL	SBT	SBR
Lane Configurations		↕		↗	↘		↗	↕		↗	↕	
Traffic Volume (veh/h)	30	131	28	215	98	52	18	660	202	61	731	29
Future Volume (veh/h)	30	131	28	215	98	52	18	660	202	61	731	29
Initial Q (Qb), veh	0	0	0	0	0	0	0	0	0	0	0	0
Ped-Bike Adj(A_pbT)	1.00		0.99	1.00		0.99	1.00		0.97	1.00		0.97
Parking Bus, Adj	1.00	1.00	1.00	1.00	1.00	1.00	1.00	1.00	1.00	1.00	1.00	1.00
Work Zone On Approach		No		No		No		No		No		No
Adj Sat Flow, veh/h/ln	1856	1663	1381	1767	1722	1811	1337	1856	1796	1722	1826	1752
Adj Flow Rate, veh/h	34	147	31	242	110	58	20	742	227	69	821	33
Peak Hour Factor	0.89	0.89	0.89	0.89	0.89	0.89	0.89	0.89	0.89	0.89	0.89	0.89
Percent Heavy Veh, %	3	16	35	9	12	6	38	3	7	12	5	10
Cap, veh/h	40	172	36	284	179	94	300	1170	358	131	961	39
Arrive On Green	0.16	0.16	0.16	0.17	0.17	0.17	0.47	0.89	0.89	0.08	0.28	0.28
Sat Flow, veh/h	257	1113	235	1682	1057	557	1273	2639	807	1640	3394	136
Grp Volume(v), veh/h	212	0	0	242	0	168	20	496	473	69	420	434
Grp Sat Flow(s),veh/h/ln	1605	0	0	1682	0	1615	1273	1763	1683	1640	1735	1796
Q Serve(g_s), s	16.1	0.0	0.0	17.5	0.0	12.1	1.1	9.1	9.1	5.1	28.6	28.6
Cycle Q Clear(g_c), s	16.1	0.0	0.0	17.5	0.0	12.1	1.1	9.1	9.1	5.1	28.6	28.6
Prop In Lane	0.16		0.15	1.00		0.35	1.00		0.48	1.00		0.08
Lane Grp Cap(c), veh/h	249	0	0	284	0	273	300	781	746	131	491	509
V/C Ratio(X)	0.85	0.00	0.00	0.85	0.00	0.62	0.07	0.63	0.63	0.53	0.85	0.85
Avail Cap(c_a), veh/h	372	0	0	400	0	384	300	781	746	131	491	509
HCM Platoon Ratio	1.00	1.00	1.00	1.00	1.00	1.00	2.00	2.00	2.00	1.00	1.00	1.00
Upstream Filter(l)	1.00	0.00	0.00	0.94	0.00	0.94	0.89	0.89	0.89	1.00	1.00	1.00
Uniform Delay (d), s/veh	51.4	0.0	0.0	50.4	0.0	48.2	25.6	4.5	4.5	55.2	42.4	42.4
Incr Delay (d2), s/veh	7.8	0.0	0.0	8.3	0.0	0.8	0.0	3.5	3.6	1.9	17.0	16.6
Initial Q Delay(d3),s/veh	0.0	0.0	0.0	0.0	0.0	0.0	0.0	0.0	0.0	0.0	0.0	0.0
%ile BackOfQ(50%),veh/ln	7.0	0.0	0.0	8.0	0.0	4.9	0.3	2.5	2.5	2.2	14.5	14.9
Unsig. Movement Delay, s/veh												
LnGrp Delay(d),s/veh	59.2	0.0	0.0	58.8	0.0	49.0	25.6	7.9	8.1	57.1	59.4	58.9
LnGrp LOS	E	A	A	E	A	D	C	A	A	E	E	E
Approach Vol, veh/h		212		410		989		923				
Approach Delay, s/veh		59.2		54.8		8.4		59.0				
Approach LOS		E		D		A		E				
Timer - Assigned Phs	1	2		4	5	6		8				
Phs Duration (G+Y+Rc), s	4.0	60.2		26.4	34.2	40.0		24.4				
Change Period (Y+Rc), s	4.0	* 4.8		* 5.3	4.8	* 4.6		5.0				
Max Green Setting (Gmax), s	10.0	* 37		* 30	12.0	* 35		29.0				
Max Q Clear Time (g_c+11), s	11.1			19.5	3.1	30.6		18.1				
Green Ext Time (p_c), s	0.0	5.0		0.8	0.0	1.7		0.6				

### Intersection Summary

HCM 6th Ctrl Delay	38.6
HCM 6th LOS	D

### Notes

User approved pedestrian interval to be less than phase max green.  
\* HCM 6th computational engine requires equal clearance times for the phases crossing the barrier.

# HCM 6th Signalized Intersection Summary

## 6: Washington St & Copeland St

Existing  
Timing Plan: AM Peak



Movement	EBL	EBT	EBR	WBL	WBT	WBR	NBL	NBT	NBR	SBL	SBT	SBR
Lane Configurations		↕			↕	↕	↕	↕		↕	↕	
Traffic Volume (veh/h)	6	0	2	24	3	181	2	746	9	194	725	11
Future Volume (veh/h)	6	0	2	24	3	181	2	746	9	194	725	11
Initial Q (Qb), veh	0	0	0	0	0	0	0	0	0	0	0	0
Ped-Bike Adj(A_pbT)	1.00		0.99	0.99		0.98	1.00		0.97	1.00		0.97
Parking Bus, Adj	1.00	1.00	1.00	1.00	1.00	1.00	1.00	1.00	1.00	1.00	1.00	1.00
Work Zone On Approach		No			No			No			No	
Adj Sat Flow, veh/h/ln	418	1900	1900	1618	1900	1737	418	1856	1900	1856	1826	1070
Adj Flow Rate, veh/h	7	0	2	28	3	210	2	867	10	226	843	13
Peak Hour Factor	0.86	0.86	0.86	0.86	0.86	0.86	0.86	0.86	0.86	0.86	0.86	0.86
Percent Heavy Veh, %	100	0	0	19	0	11	100	3	0	3	5	56
Cap, veh/h	204	6	46	283	28	247	59	1353	16	587	1969	30
Arrive On Green	0.17	0.00	0.17	0.17	0.17	0.17	0.15	0.38	0.38	0.33	0.56	0.56
Sat Flow, veh/h	895	38	266	1333	162	1445	398	3568	41	1767	3495	54
Grp Volume(v), veh/h	9	0	0	31	0	210	2	428	449	226	418	438
Grp Sat Flow(s),veh/h/ln	199	0	0	1495	0	1445	398	1763	1847	1767	1735	1815
Q Serve(g_s), s	0.0	0.0	0.0	0.0	0.0	17.6	0.5	24.9	24.9	12.2	17.4	17.4
Cycle Q Clear(g_c), s	1.8	0.0	0.0	1.8	0.0	17.6	0.5	24.9	24.9	12.2	17.4	17.4
Prop In Lane	0.78		0.22	0.90		1.00	1.00		0.02	1.00		0.03
Lane Grp Cap(c), veh/h	256	0	0	310	0	247	59	668	700	587	977	1022
V/C Ratio(X)	0.04	0.00	0.00	0.10	0.00	0.85	0.03	0.64	0.64	0.38	0.43	0.43
Avail Cap(c_a), veh/h	384	0	0	446	0	380	59	668	700	587	977	1022
HCM Platoon Ratio	1.00	1.00	1.00	1.00	1.00	1.00	1.00	1.00	1.00	1.00	1.00	1.00
Upstream Filter(l)	1.00	0.00	0.00	1.00	0.00	1.00	1.00	1.00	1.00	0.78	0.78	0.78
Uniform Delay (d), s/veh	43.2	0.0	0.0	43.7	0.0	50.3	45.6	31.8	31.8	32.0	15.7	15.7
Incr Delay (d2), s/veh	0.0	0.0	0.0	0.1	0.0	9.0	0.1	4.7	4.5	0.1	1.1	1.0
Initial Q Delay(d3),s/veh	0.0	0.0	0.0	0.0	0.0	0.0	0.0	0.0	0.0	0.0	0.0	0.0
%ile BackOfQ(50%),veh/ln	0.2	0.0	0.0	0.8	0.0	7.0	0.1	11.6	12.1	5.3	7.2	7.5
Unsig. Movement Delay, s/veh												
LnGrp Delay(d),s/veh	43.2	0.0	0.0	43.8	0.0	59.3	45.7	36.5	36.3	32.1	16.8	16.7
LnGrp LOS	D	A	A	D	A	E	D	D	D	C	B	B
Approach Vol, veh/h		9			241			879			1082	
Approach Delay, s/veh		43.2			57.3			36.4			20.0	
Approach LOS		D			E			D			B	
Timer - Assigned Phs	1	2		4	5	6		8				
Phs Duration (G+Y+Rc), s	46.5	52.0		26.5	23.5	75.0		26.5				
Change Period (Y+Rc), s	5.0	4.6		5.1	5.0	* 4.6		* 5.1				
Max Green Setting (Gmax), s	29.0	47.4		32.9	7.0	* 70		* 34				
Max Q Clear Time (g_c+1), s	14.2	26.9		19.6	2.5	19.4		3.8				
Green Ext Time (p_c), s	0.3	8.2		0.6	0.0	10.7		0.0				

### Intersection Summary























HCM 6th Ctrl Delay	30.7
HCM 6th LOS	C

### Notes

\* HCM 6th computational engine requires equal clearance times for the phases crossing the barrier.

HCM 6th Signalized Intersection Summary  
 1: D St & Lakeville St

Existing  
 Timing Plan: PM Peak

												
Movement	EBL	EBT	EBR	WBL	WBT	WBR	NBL	NBT	NBR	SBL	SBT	SBR
Lane Configurations												
Traffic Volume (veh/h)	9	285	63	401	367	33	90	175	529	18	186	14
Future Volume (veh/h)	9	285	63	401	367	33	90	175	529	18	186	14
Initial Q (Qb), veh	0	0	0	0	0	0	0	0	0	0	0	0
Ped-Bike Adj(A_pbT)	0.98		0.97	1.00		0.97	1.00		0.95	1.00		0.90
Parking Bus, Adj	1.00	1.00	1.00	1.00	1.00	1.00	1.00	1.00	1.00	1.00	1.00	1.00
Work Zone On Approach		No			No			No			No	
Adj Sat Flow, veh/h/ln	1900	1826	1678	1856	1870	1900	1826	1885	1870	1900	1885	1900
Adj Flow Rate, veh/h	10	306	68	431	395	35	97	188	569	19	200	15
Peak Hour Factor	0.93	0.93	0.93	0.93	0.93	0.93	0.93	0.93	0.93	0.93	0.93	0.93
Percent Heavy Veh, %	0	5	15	3	2	0	5	1	2	0	1	0
Cap, veh/h	37	353	274	459	922	767	138	267	741	296	281	21
Arrive On Green	0.20	0.20	0.20	0.26	0.49	0.49	0.22	0.22	0.22	0.16	0.16	0.16
Sat Flow, veh/h	23	1780	1382	1767	1870	1557	631	1223	1511	1810	1717	129
Grp Volume(v), veh/h	316	0	68	431	395	35	285	0	569	19	0	215
Grp Sat Flow(s),veh/h/ln	1803	0	1382	1767	1870	1557	1854	0	1511	1810	0	1846
Q Serve(g_s), s	6.0	0.0	4.8	27.4	15.6	1.3	16.3	0.0	25.0	1.0	0.0	12.6
Cycle Q Clear(g_c), s	19.5	0.0	4.8	27.4	15.6	1.3	16.3	0.0	25.0	1.0	0.0	12.6
Prop In Lane	0.03		1.00	1.00		1.00	0.34		1.00	1.00		0.07
Lane Grp Cap(c), veh/h	390	0	274	459	922	767	404	0	741	296	0	302
V/C Ratio(X)	0.81	0.00	0.25	0.94	0.43	0.05	0.71	0.00	0.77	0.06	0.00	0.71
Avail Cap(c_a), veh/h	657	0	482	694	979	815	404	0	741	442	0	451
HCM Platoon Ratio	1.00	1.00	1.00	1.00	1.00	1.00	1.00	1.00	1.00	1.00	1.00	1.00
Upstream Filter(I)	1.00	0.00	1.00	1.00	1.00	1.00	1.00	0.00	1.00	1.00	0.00	1.00
Uniform Delay (d), s/veh	44.6	0.0	38.8	41.6	18.7	15.1	41.4	0.0	25.0	40.5	0.0	45.4
Incr Delay (d2), s/veh	1.6	0.0	0.2	12.7	0.1	0.0	6.0	0.0	5.2	0.1	0.0	2.3
Initial Q Delay(d3),s/veh	0.0	0.0	0.0	0.0	0.0	0.0	0.0	0.0	0.0	0.0	0.0	0.0
%ile BackOfQ(50%),veh/ln	8.8	0.0	1.6	13.4	6.7	0.5	8.2	0.0	13.6	0.5	0.0	6.0
Unsig. Movement Delay, s/veh												
LnGrp Delay(d),s/veh	46.1	0.0	38.9	54.3	18.8	15.1	47.5	0.0	30.3	40.6	0.0	47.7
LnGrp LOS	D	A	D	D	B	B	D	A	C	D	A	D
Approach Vol, veh/h		384			861			854				234
Approach Delay, s/veh		44.9			36.4			36.0				47.1
Approach LOS		D			D			D				D
Timer - Assigned Phs		2	3	4		6		8				
Phs Duration (G+Y+Rc), s		30.3	33.8	27.5		23.1		61.3				
Change Period (Y+Rc), s		* 5.3	4.0	* 4.8		4.3		* 4.8				
Max Green Setting (Gmax), s		* 25	45.0	* 40		28.0		* 60				
Max Q Clear Time (g_c+I1), s		27.0	29.4	21.5		14.6		17.6				
Green Ext Time (p_c), s		0.0	0.4	1.3		0.9		1.7				
<b>Intersection Summary</b>												
HCM 6th Ctrl Delay			38.7									
HCM 6th LOS			D									
<b>Notes</b>												
* HCM 6th computational engine requires equal clearance times for the phases crossing the barrier.												

Intersection												
Int Delay, s/veh	6.9											
Movement	EBL	EBT	EBR	WBL	WBT	WBR	NBL	NBT	NBR	SBL	SBT	SBR
Lane Configurations		↕			↕		↕	↕			↕	
Traffic Vol, veh/h	10	6	203	3	4	3	223	795	6	0	640	53
Future Vol, veh/h	10	6	203	3	4	3	223	795	6	0	640	53
Conflicting Peds, #/hr	4	0	7	7	0	4	17	0	3	3	0	17
Sign Control	Stop	Stop	Stop	Stop	Stop	Stop	Free	Free	Free	Free	Free	Free
RT Channelized	-	-	None	-	-	None	-	-	None	-	-	None
Storage Length	-	-	-	-	-	-	60	-	-	-	-	-
Veh in Median Storage, #	-	0	-	-	0	-	-	0	-	-	0	-
Grade, %	-	0	-	-	0	-	-	0	-	-	0	-
Peak Hour Factor	93	93	93	93	93	93	93	93	93	93	93	93
Heavy Vehicles, %	0	25	3	0	0	0	5	2	0	0	2	18
Mvmt Flow	11	6	218	3	4	3	240	855	6	0	688	57

Major/Minor	Minor2		Minor1		Major1			Major2				
Conflicting Flow All	2080	2078	741	2177	2103	865	762	0	0	864	0	0
Stage 1	734	734	-	1341	1341	-	-	-	-	-	-	-
Stage 2	1346	1344	-	836	762	-	-	-	-	-	-	-
Critical Hdwy	6.1	5.8	5.2	6.1	5.5	5.2	4.15	-	-	4.1	-	-
Critical Hdwy Stg 1	6.1	5.75	-	6.1	5.5	-	-	-	-	-	-	-
Critical Hdwy Stg 2	6.1	5.75	-	6.1	5.5	-	-	-	-	-	-	-
Follow-up Hdwy	3.5	4.225	3.327	3.5	4	3.3	2.245	-	-	2.2	-	-
Pot Cap-1 Maneuver	71	80	512	62	94	453	837	-	-	787	-	-
Stage 1	415	394	-	190	223	-	-	-	-	-	-	-
Stage 2	189	198	-	364	416	-	-	-	-	-	-	-
Platoon blocked, %								-	-	-	-	-
Mov Cap-1 Maneuver	51	56	500	25	65	450	823	-	-	785	-	-
Mov Cap-2 Maneuver	51	56	-	25	65	-	-	-	-	-	-	-
Stage 1	289	388	-	134	157	-	-	-	-	-	-	-
Stage 2	129	140	-	200	409	-	-	-	-	-	-	-

Approach	EB	WB	NB	SB
HCM Control Delay, s	46	89.5	2.4	0
HCM LOS	E	F		

Minor Lane/Major Mvmt	NBL	NBT	NBR	EBLn1WBLn1	SBL	SBT	SBR
Capacity (veh/h)	823	-	-	309	53	785	-
HCM Lane V/C Ratio	0.291	-	-	0.762	0.203	-	-
HCM Control Delay (s)	11.2	-	-	46	89.5	0	-
HCM Lane LOS	B	-	-	E	F	A	-
HCM 95th %tile Q(veh)	1.2	-	-	5.9	0.7	0	-

HCM 6th Signalized Intersection Summary  
3: D St & 1st St

Existing  
Timing Plan: PM Peak

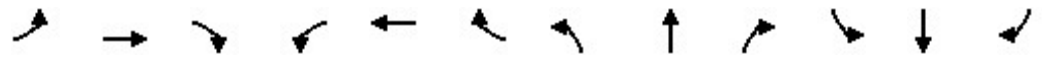

Movement	EBL	EBT	EBR	WBL	WBT	WBR	NBL	NBT	NBR	SBL	SBT	SBR
Lane Configurations		↕			↕		↗	↘		↗	↘	
Traffic Volume (veh/h)	71	4	12	16	7	57	6	903	23	67	759	63
Future Volume (veh/h)	71	4	12	16	7	57	6	903	23	67	759	63
Initial Q (Qb), veh	0	0	0	0	0	0	0	0	0	0	0	0
Ped-Bike Adj(A_pbT)	0.98		0.98	0.99		0.97	1.00		0.97	1.00		0.97
Parking Bus, Adj	1.00	1.00	1.00	1.00	1.00	1.00	1.00	1.00	1.00	1.00	1.00	1.00
Work Zone On Approach		No			No			No			No	
Adj Sat Flow, veh/h/ln	1900	1900	1900	1781	1900	1856	1900	1856	1707	1841	1870	1900
Adj Flow Rate, veh/h	72	4	12	16	7	58	6	921	23	68	774	64
Peak Hour Factor	0.98	0.98	0.98	0.98	0.98	0.98	0.98	0.98	0.98	0.98	0.98	0.98
Percent Heavy Veh, %	0	0	0	8	0	3	0	3	13	4	2	0
Cap, veh/h	154	11	18	54	24	110	455	1335	33	102	923	76
Arrive On Green	0.09	0.09	0.09	0.09	0.09	0.09	0.50	1.00	1.00	0.06	0.54	0.54
Sat Flow, veh/h	1104	124	194	208	268	1200	1810	1801	45	1753	1699	140
Grp Volume(v), veh/h	88	0	0	81	0	0	6	0	944	68	0	838
Grp Sat Flow(s),veh/h/ln	1422	0	0	1676	0	0	1810	0	1846	1753	0	1839
Q Serve(g_s), s	1.7	0.0	0.0	0.0	0.0	0.0	0.2	0.0	0.0	4.7	0.0	47.4
Cycle Q Clear(g_c), s	7.3	0.0	0.0	5.6	0.0	0.0	0.2	0.0	0.0	4.7	0.0	47.4
Prop In Lane	0.82		0.14	0.20		0.72	1.00		0.02	1.00		0.08
Lane Grp Cap(c), veh/h	183	0	0	188	0	0	455	0	1369	102	0	1000
V/C Ratio(X)	0.48	0.00	0.00	0.43	0.00	0.00	0.01	0.00	0.69	0.67	0.00	0.84
Avail Cap(c_a), veh/h	429	0	0	461	0	0	455	0	1369	127	0	1000
HCM Platoon Ratio	1.00	1.00	1.00	1.00	1.00	1.00	2.00	2.00	2.00	1.00	1.00	1.00
Upstream Filter(l)	1.00	0.00	0.00	1.00	0.00	0.00	0.72	0.00	0.72	1.00	0.00	1.00
Uniform Delay (d), s/veh	54.4	0.0	0.0	53.8	0.0	0.0	23.1	0.0	0.0	57.2	0.0	23.7
Incr Delay (d2), s/veh	1.5	0.0	0.0	1.2	0.0	0.0	0.0	0.0	2.1	4.9	0.0	8.4
Initial Q Delay(d3),s/veh	0.0	0.0	0.0	0.0	0.0	0.0	0.0	0.0	0.0	0.0	0.0	0.0
%ile BackOfQ(50%),veh/ln	2.8	0.0	0.0	2.5	0.0	0.0	0.1	0.0	0.8	2.2	0.0	22.4
Unsig. Movement Delay, s/veh												
LnGrp Delay(d),s/veh	55.9	0.0	0.0	55.0	0.0	0.0	23.1	0.0	2.1	62.1	0.0	32.1
LnGrp LOS	E	A	A	D	A	A	C	A	A	E	A	C
Approach Vol, veh/h		88			81			950				906
Approach Delay, s/veh		55.9			55.0			2.2				34.3
Approach LOS		E			D			A				C
Timer - Assigned Phs	1	2		4	5	6		8				
Phs Duration (G+Y+Rc), s	11.2	96.6		16.2	35.8	72.0		16.2				
Change Period (Y+Rc), s	4.0	4.6		* 4.9	4.6	* 4.6		* 4.9				
Max Green Setting (Gmax), s	9.0	68.4		* 33	10.0	* 67		* 33				
Max Q Clear Time (g_c+I1), s	6.7	2.0		9.3	2.2	49.4		7.6				
Green Ext Time (p_c), s	0.0	17.5		0.4	0.0	8.5		0.4				

Intersection Summary

HCM 6th Ctrl Delay	21.0
HCM 6th LOS	C

Notes

\* HCM 6th computational engine requires equal clearance times for the phases crossing the barrier.

# HCM 6th Signalized Intersection Summary

## 4: D St & Petaluma Blvd

Existing  
Timing Plan: PM Peak



Movement	EBL	EBT	EBR	WBL	WBT	WBR	NBL	NBT	NBR	SBL	SBT	SBR
Lane Configurations												
Traffic Volume (veh/h)	163	237	84	144	284	251	78	412	24	172	530	90
Future Volume (veh/h)	163	237	84	144	284	251	78	412	24	172	530	90
Initial Q (Qb), veh	0	0	0	0	0	0	0	0	0	0	0	0
Ped-Bike Adj(A_pbT)	1.00		0.93	1.00		0.93	1.00		0.95	1.00		0.95
Parking Bus, Adj	1.00	1.00	1.00	1.00	1.00	1.00	1.00	1.00	1.00	1.00	1.00	1.00
Work Zone On Approach		No			No			No			No	
Adj Sat Flow, veh/h/ln	1841	1885	1900	1856	1885	1870	1870	1856	1900	1900	1856	1870
Adj Flow Rate, veh/h	177	258	91	157	309	273	85	448	26	187	576	98
Peak Hour Factor	0.92	0.92	0.92	0.92	0.92	0.92	0.92	0.92	0.92	0.92	0.92	0.92
Percent Heavy Veh, %	4	1	0	3	1	2	2	3	0	0	3	2
Cap, veh/h	203	412	328	183	379	295	109	725	42	212	881	718
Arrive On Green	0.12	0.22	0.22	0.10	0.20	0.20	0.06	0.42	0.42	0.23	0.95	0.95
Sat Flow, veh/h	1753	1885	1500	1767	1885	1467	1781	1731	100	1810	1856	1513
Grp Volume(v), veh/h	177	258	91	157	309	273	85	0	474	187	576	98
Grp Sat Flow(s),veh/h/ln	1753	1885	1500	1767	1885	1467	1781	0	1832	1810	1856	1513
Q Serve(g_s), s	12.3	15.4	6.3	10.8	19.4	17.4	5.8	0.0	25.2	12.4	5.1	0.3
Cycle Q Clear(g_c), s	12.3	15.4	6.3	10.8	19.4	17.4	5.8	0.0	25.2	12.4	5.1	0.3
Prop In Lane	1.00		1.00	1.00		1.00	1.00		0.05	1.00		1.00
Lane Grp Cap(c), veh/h	203	412	328	183	379	295	109	0	767	212	881	718
V/C Ratio(X)	0.87	0.63	0.28	0.86	0.82	0.93	0.78	0.00	0.62	0.88	0.65	0.14
Avail Cap(c_a), veh/h	254	442	352	242	430	335	187	0	767	321	881	718
HCM Platoon Ratio	1.00	1.00	1.00	1.00	1.00	1.00	1.00	1.00	1.00	2.00	2.00	2.00
Upstream Filter(l)	1.00	1.00	1.00	1.00	1.00	1.00	1.00	0.00	1.00	0.80	0.80	0.80
Uniform Delay (d), s/veh	53.9	43.9	40.3	54.7	47.4	28.5	57.4	0.0	28.3	46.7	1.8	0.7
Incr Delay (d2), s/veh	19.7	3.0	0.6	16.5	11.3	30.1	4.5	0.0	3.7	10.0	3.0	0.3
Initial Q Delay(d3),s/veh	0.0	0.0	0.0	0.0	0.0	0.0	0.0	0.0	0.0	0.0	0.0	0.0
%ile BackOfQ(50%),veh/lr	6.5	7.5	2.4	5.7	10.3	8.6	2.8	0.0	11.9	5.5	1.6	0.2
Unsig. Movement Delay, s/veh												
LnGrp Delay(d),s/veh	73.6	46.9	40.9	71.2	58.7	58.7	61.9	0.0	32.0	56.7	4.8	1.0
LnGrp LOS	E	D	D	E	E	E	E	A	C	E	A	A
Approach Vol, veh/h		526			739			559			861	
Approach Delay, s/veh		54.9			61.3			36.5			15.6	
Approach LOS		D			E			D			B	
Timer - Assigned Phs	1	2	3	4	5	6	7	8				
Phs Duration (G+Y+Rc), s	18.5	56.6	16.9	32.0	11.6	63.6	19.3	29.6				
Change Period (Y+Rc), s	4.0	* 4.7	4.0	* 4.9	4.0	* 4.7	* 4.9	* 4.7				
Max Green Setting (Gmax), s	27.0	* 38	17.0	* 29	13.0	* 47	* 18	* 28				
Max Q Clear Time (g_c+1), s	14.4	27.2	12.8	17.4	7.8	7.1	14.3	21.4				
Green Ext Time (p_c), s	0.2	2.0	0.1	1.9	0.0	4.0	0.1	2.3				

### Intersection Summary

HCM 6th Ctrl Delay	40.2
HCM 6th LOS	D

### Notes

User approved pedestrian interval to be less than phase max green.  
\* HCM 6th computational engine requires equal clearance times for the phases crossing the barrier.

# HCM 6th Signalized Intersection Summary

## 5: Washington St & Lakeville St

Existing  
Timing Plan: PM Peak



Movement	EBL	EBT	EBR	WBL	WBT	WBR	NBL	NBT	NBR	SBL	SBT	SBR
Lane Configurations		↕		↗	↘		↗	↕		↗	↕	↘
Traffic Volume (veh/h)	57	90	41	218	159	101	40	790	178	71	776	41
Future Volume (veh/h)	57	90	41	218	159	101	40	790	178	71	776	41
Initial Q (Qb), veh	0	0	0	0	0	0	0	0	0	0	0	0
Ped-Bike Adj(A_pbT)	1.00		0.98	1.00		0.98	1.00		0.96	1.00		0.95
Parking Bus, Adj	1.00	1.00	1.00	1.00	1.00	1.00	1.00	1.00	1.00	1.00	1.00	1.00
Work Zone On Approach		No			No			No			No	
Adj Sat Flow, veh/h/ln	1826	1811	1811	1870	1826	1900	1900	1856	1811	1870	1885	1900
Adj Flow Rate, veh/h	59	94	43	227	166	105	42	823	185	74	808	43
Peak Hour Factor	0.96	0.96	0.96	0.96	0.96	0.96	0.96	0.96	0.96	0.96	0.96	0.96
Percent Heavy Veh, %	5	6	6	2	5	0	0	3	6	2	1	0
Cap, veh/h	69	111	51	325	189	120	446	1272	286	144	957	51
Arrive On Green	0.13	0.13	0.13	0.18	0.18	0.18	0.25	0.45	0.45	0.08	0.28	0.28
Sat Flow, veh/h	515	820	375	1781	1038	656	1810	2838	638	1781	3449	183
Grp Volume(v), veh/h	196	0	0	227	0	271	42	511	497	74	420	431
Grp Sat Flow(s),veh/h/ln	1710	0	0	1781	0	1694	1810	1763	1713	1781	1791	1841
Q Serve(g_s), s	13.9	0.0	0.0	14.8	0.0	19.3	2.2	27.9	28.0	4.9	27.4	27.4
Cycle Q Clear(g_c), s	13.9	0.0	0.0	14.8	0.0	19.3	2.2	27.9	28.0	4.9	27.4	27.4
Prop In Lane	0.30		0.22	1.00		0.39	1.00		0.37	1.00		0.10
Lane Grp Cap(c), veh/h	231	0	0	325	0	309	446	790	768	144	497	511
V/C Ratio(X)	0.85	0.00	0.00	0.70	0.00	0.88	0.09	0.65	0.65	0.52	0.84	0.84
Avail Cap(c_a), veh/h	372	0	0	441	0	419	446	790	768	144	497	511
HCM Platoon Ratio	1.00	1.00	1.00	1.00	1.00	1.00	1.00	1.00	1.00	1.00	1.00	1.00
Upstream Filter(l)	1.00	0.00	0.00	0.92	0.00	0.92	0.78	0.78	0.78	1.00	1.00	1.00
Uniform Delay (d), s/veh	52.4	0.0	0.0	47.5	0.0	49.4	36.0	26.6	26.6	54.7	42.3	42.3
Incr Delay (d2), s/veh	5.3	0.0	0.0	1.3	0.0	11.2	0.0	3.2	3.3	1.4	16.0	15.7
Initial Q Delay(d3),s/veh	0.0	0.0	0.0	0.0	0.0	0.0	0.0	0.0	0.0	0.0	0.0	0.0
%ile BackOfQ(50%),veh/ln	6.3	0.0	0.0	6.7	0.0	9.1	1.0	12.5	12.1	2.3	14.3	14.6
Unsig. Movement Delay, s/veh												
LnGrp Delay(d),s/veh	57.7	0.0	0.0	48.8	0.0	60.6	36.1	29.8	29.9	56.1	58.3	57.9
LnGrp LOS	E	A	A	D	A	E	D	C	C	E	E	E
Approach Vol, veh/h		196			498			1050			925	
Approach Delay, s/veh		57.7			55.2			30.1			57.9	
Approach LOS		E			E			C			E	
Timer - Assigned Phs	1	2		4	5	6		8				
Phs Duration (G+Y+Rc), s	4.0	60.4		27.9	35.4	39.0		21.7				
Change Period (Y+Rc), s	4.0	* 4.8		* 5.3	4.8	* 4.6		5.0				
Max Green Setting (Gmax), s	10.0	* 37		* 31	13.0	* 34		27.0				
Max Q Clear Time (g_c+10), s	10.0	30.0		21.3	4.2	29.4		15.9				
Green Ext Time (p_c), s	0.0	2.9		1.1	0.0	1.7		0.5				

### Intersection Summary

HCM 6th Ctrl Delay	46.5
HCM 6th LOS	D

### Notes

User approved pedestrian interval to be less than phase max green.  
\* HCM 6th computational engine requires equal clearance times for the phases crossing the barrier.

# HCM 6th Signalized Intersection Summary

## 6: Washington St & Copeland St

Existing  
Timing Plan: PM Peak



Movement	EBL	EBT	EBR	WBL	WBT	WBR	NBL	NBT	NBR	SBL	SBT	SBR
Lane Configurations		↕			↕	↕	↕	↕		↕	↕	
Traffic Volume (veh/h)	12	1	1	55	1	224	3	808	19	199	821	9
Future Volume (veh/h)	12	1	1	55	1	224	3	808	19	199	821	9
Initial Q (Qb), veh	0	0	0	0	0	0	0	0	0	0	0	0
Ped-Bike Adj(A_pbT)	1.00		1.00	1.00		1.00	1.00		0.96	1.00		0.97
Parking Bus, Adj	1.00	1.00	1.00	1.00	1.00	1.00	1.00	1.00	1.00	1.00	1.00	1.00
Work Zone On Approach		No			No			No			No	
Adj Sat Flow, veh/h/ln	1900	1900	1900	1752	1900	1781	1900	1870	1693	1856	1870	1707
Adj Flow Rate, veh/h	12	1	1	57	1	233	3	842	20	207	855	9
Peak Hour Factor	0.96	0.96	0.96	0.96	0.96	0.96	0.96	0.96	0.96	0.96	0.96	0.96
Percent Heavy Veh, %	0	0	0	10	0	8	0	2	14	3	2	13
Cap, veh/h	296	25	16	415	6	301	255	1419	34	260	1465	15
Arrive On Green	0.20	0.20	0.20	0.20	0.20	0.20	0.14	0.40	0.40	0.15	0.41	0.41
Sat Flow, veh/h	908	126	80	1460	31	1507	1810	3544	84	1767	3601	38
Grp Volume(v), veh/h	14	0	0	58	0	233	3	422	440	207	422	442
Grp Sat Flow(s),veh/h/ln	1113	0	0	1492	0	1507	1810	1777	1852	1767	1777	1862
Q Serve(g_s), s	0.0	0.0	0.0	0.0	0.0	8.5	0.1	10.9	10.9	6.6	10.7	10.7
Cycle Q Clear(g_c), s	1.6	0.0	0.0	1.5	0.0	8.5	0.1	10.9	10.9	6.6	10.7	10.7
Prop In Lane	0.86		0.07	0.98		1.00	1.00		0.05	1.00		0.02
Lane Grp Cap(c), veh/h	337	0	0	421	0	301	255	712	741	260	723	757
V/C Ratio(X)	0.04	0.00	0.00	0.14	0.00	0.77	0.01	0.59	0.59	0.80	0.58	0.58
Avail Cap(c_a), veh/h	830	0	0	997	0	904	622	1539	1604	911	2150	2253
HCM Platoon Ratio	1.00	1.00	1.00	1.00	1.00	1.00	1.00	1.00	1.00	1.00	1.00	1.00
Upstream Filter(I)	1.00	0.00	0.00	1.00	0.00	1.00	1.00	1.00	1.00	1.00	1.00	1.00
Uniform Delay (d), s/veh	18.8	0.0	0.0	19.2	0.0	22.0	21.5	13.7	13.7	24.0	13.4	13.4
Incr Delay (d2), s/veh	0.0	0.0	0.0	0.1	0.0	3.2	0.0	1.1	1.1	2.1	1.1	1.0
Initial Q Delay(d3),s/veh	0.0	0.0	0.0	0.0	0.0	0.0	0.0	0.0	0.0	0.0	0.0	0.0
%ile BackOfQ(50%),veh/ln	0.1	0.0	0.0	0.6	0.0	3.1	0.0	4.1	4.3	2.8	4.0	4.2
Unsig. Movement Delay, s/veh												
LnGrp Delay(d),s/veh	18.9	0.0	0.0	19.4	0.0	25.2	21.5	14.8	14.8	26.1	14.5	14.4
LnGrp LOS	B	A	A	B	A	C	C	B	B	C	B	B
Approach Vol, veh/h		14			291			865			1071	
Approach Delay, s/veh		18.9			24.0			14.8			16.7	
Approach LOS		B			C			B			B	
Timer - Assigned Phs	1	2		4	5	6		8				
Phs Duration (G+Y+Rc), s	3.6	27.9		16.7	13.2	28.3		16.7				
Change Period (Y+Rc), s	5.0	4.6		5.1	5.0	* 4.6		* 5.1				
Max Green Setting (Gmax), s	30.0	50.4		34.9	20.0	* 70		* 35				
Max Q Clear Time (g_c+1), s	10.6	12.9		10.5	2.1	12.7		3.6				
Green Ext Time (p_c), s	0.3	10.1		0.9	0.0	10.9		0.0				

### Intersection Summary

HCM 6th Ctrl Delay	17.0
HCM 6th LOS	B

### Notes

\* HCM 6th computational engine requires equal clearance times for the phases crossing the barrier.

























## C – Existing Plus Project Traffic Conditions



HCM 6th Signalized Intersection Summary  
1: D St & Lakeville St

Existing+Project  
Timing Plan: AM Peak

												
Movement	EBL	EBT	EBR	WBL	WBT	WBR	NBL	NBT	NBR	SBL	SBT	SBR
Lane Configurations												
Traffic Volume (veh/h)	7	334	68	344	312	44	50	141	439	14	177	11
Future Volume (veh/h)	7	334	68	344	312	44	50	141	439	14	177	11
Initial Q (Qb), veh	0	0	0	0	0	0	0	0	0	0	0	0
Ped-Bike Adj(A_pbT)	1.00		0.99	1.00		1.00	1.00		0.97	1.00		0.94
Parking Bus, Adj	1.00	1.00	1.00	1.00	1.00	1.00	1.00	1.00	1.00	1.00	1.00	1.00
Work Zone On Approach		No			No			No			No	
Adj Sat Flow, veh/h/ln	1900	1781	1544	1841	1752	1900	1693	1885	1856	1781	1856	1707
Adj Flow Rate, veh/h	8	371	76	382	347	49	56	157	488	16	197	12
Peak Hour Factor	0.90	0.90	0.90	0.90	0.90	0.90	0.90	0.90	0.90	0.90	0.90	0.90
Percent Heavy Veh, %	0	8	24	4	10	0	14	1	3	8	3	13
Cap, veh/h	35	417	309	410	887	812	107	299	700	255	259	16
Arrive On Green	0.24	0.24	0.24	0.23	0.51	0.51	0.22	0.22	0.22	0.15	0.15	0.15
Sat Flow, veh/h	13	1757	1300	1753	1752	1605	489	1372	1527	1697	1723	105
Grp Volume(v), veh/h	379	0	76	382	347	49	213	0	488	16	0	209
Grp Sat Flow(s),veh/h/ln	1770	0	1300	1753	1752	1605	1861	0	1527	1697	0	1828
Q Serve(g_s), s	6.2	0.0	5.4	24.5	14.0	1.8	11.6	0.0	25.0	0.9	0.0	12.6
Cycle Q Clear(g_c), s	23.8	0.0	5.4	24.5	14.0	1.8	11.6	0.0	25.0	0.9	0.0	12.6
Prop In Lane	0.02		1.00	1.00		1.00	0.26		1.00	1.00		0.06
Lane Grp Cap(c), veh/h	452	0	309	410	887	812	405	0	700	255	0	275
V/C Ratio(X)	0.84	0.00	0.25	0.93	0.39	0.06	0.53	0.00	0.70	0.06	0.00	0.76
Avail Cap(c_a), veh/h	647	0	453	688	916	839	405	0	700	414	0	446
HCM Platoon Ratio	1.00	1.00	1.00	1.00	1.00	1.00	1.00	1.00	1.00	1.00	1.00	1.00
Upstream Filter(I)	1.00	0.00	1.00	1.00	1.00	1.00	1.00	0.00	1.00	1.00	0.00	1.00
Uniform Delay (d), s/veh	42.4	0.0	35.4	43.1	17.5	14.4	39.6	0.0	25.3	41.8	0.0	46.7
Incr Delay (d2), s/veh	4.6	0.0	0.2	8.6	0.1	0.0	1.7	0.0	3.3	0.1	0.0	3.2
Initial Q Delay(d3),s/veh	0.0	0.0	0.0	0.0	0.0	0.0	0.0	0.0	0.0	0.0	0.0	0.0
%ile BackOfQ(50%),veh/ln	10.9	0.0	1.7	11.5	5.6	0.7	5.5	0.0	11.1	0.4	0.0	6.0
Unsig. Movement Delay, s/veh												
LnGrp Delay(d),s/veh	47.0	0.0	35.6	51.7	17.6	14.4	41.3	0.0	28.7	41.9	0.0	50.0
LnGrp LOS	D	A	D	D	B	B	D	A	C	D	A	D
Approach Vol, veh/h		455			778			701			225	
Approach Delay, s/veh		45.1			34.1			32.5			49.4	
Approach LOS		D			C			C			D	
Timer - Assigned Phs		2	3	4		6		8				
Phs Duration (G+Y+Rc), s		30.3	30.8	32.0		21.6		62.9				
Change Period (Y+Rc), s		* 5.3	4.0	* 4.8		4.3		* 4.8				
Max Green Setting (Gmax), s		* 25	45.0	* 40		28.0		* 60				
Max Q Clear Time (g_c+I1), s		27.0	26.5	25.8		14.6		16.0				
Green Ext Time (p_c), s		0.0	0.3	1.5		0.8		1.5				
<b>Intersection Summary</b>												
HCM 6th Ctrl Delay				37.5								
HCM 6th LOS				D								
<b>Notes</b>												
* HCM 6th computational engine requires equal clearance times for the phases crossing the barrier.												

HCM 6th Signalized Intersection Summary  
2: D St & Copeland St

Existing+Project  
Timing Plan: AM Peak

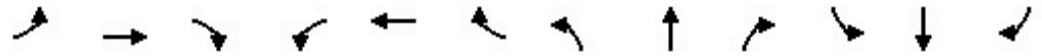

Movement	EBL	EBT	EBR	WBL	WBT	WBR	NBL	NBT	NBR	SBL	SBT	SBR
Lane Configurations		↕			↕		↗	↘		↗	↘	
Traffic Volume (veh/h)	5	4	198	7	11	17	187	618	3	8	565	21
Future Volume (veh/h)	5	4	198	7	11	17	187	618	3	8	565	21
Initial Q (Qb), veh	0	0	0	0	0	0	0	0	0	0	0	0
Ped-Bike Adj(A_pbT)	0.98		0.96	0.99		0.98	1.00		0.97	1.00		0.97
Parking Bus, Adj	1.00	1.00	1.00	1.00	1.00	1.00	1.00	1.00	1.00	1.00	1.00	1.00
Work Zone On Approach		No			No			No			No	
Adj Sat Flow, veh/h/ln	1900	1900	1841	1900	1900	1900	1826	1856	1900	1900	1841	1203
Adj Flow Rate, veh/h	6	5	225	8	12	19	212	702	3	9	642	24
Peak Hour Factor	0.88	0.88	0.88	0.88	0.88	0.88	0.88	0.88	0.88	0.88	0.88	0.88
Percent Heavy Veh, %	0	0	4	0	0	0	5	3	0	0	4	47
Cap, veh/h	39	10	255	76	108	134	336	1247	5	32	870	33
Arrive On Green	0.17	0.17	0.17	0.17	0.17	0.17	0.39	1.00	1.00	0.02	0.49	0.49
Sat Flow, veh/h	14	58	1484	191	631	781	1739	1846	8	1810	1760	66
Grp Volume(v), veh/h	236	0	0	39	0	0	212	0	705	9	0	666
Grp Sat Flow(s),veh/h/ln	1556	0	0	1603	0	0	1739	0	1854	1810	0	1826
Q Serve(g_s), s	3.8	0.0	0.0	0.0	0.0	0.0	9.9	0.0	0.0	0.5	0.0	29.0
Cycle Q Clear(g_c), s	14.8	0.0	0.0	1.9	0.0	0.0	9.9	0.0	0.0	0.5	0.0	29.0
Prop In Lane	0.03		0.95	0.21		0.49	1.00		0.00	1.00		0.04
Lane Grp Cap(c), veh/h	304	0	0	319	0	0	336	0	1252	32	0	902
V/C Ratio(X)	0.78	0.00	0.00	0.12	0.00	0.00	0.63	0.00	0.56	0.28	0.00	0.74
Avail Cap(c_a), veh/h	323	0	0	333	0	0	336	0	1252	154	0	902
HCM Platoon Ratio	1.00	1.00	1.00	1.00	1.00	1.00	2.00	2.00	2.00	1.00	1.00	1.00
Upstream Filter(l)	0.62	0.00	0.00	1.00	0.00	0.00	0.74	0.00	0.74	0.60	0.00	0.60
Uniform Delay (d), s/veh	40.4	0.0	0.0	35.1	0.0	0.0	27.8	0.0	0.0	48.5	0.0	20.2
Incr Delay (d2), s/veh	6.9	0.0	0.0	0.2	0.0	0.0	2.8	0.0	1.4	2.8	0.0	3.3
Initial Q Delay(d3),s/veh	0.0	0.0	0.0	0.0	0.0	0.0	0.0	0.0	0.0	0.0	0.0	0.0
%ile BackOfQ(50%),veh/ln	6.2	0.0	0.0	0.8	0.0	0.0	3.8	0.0	0.5	0.2	0.0	12.8
Unsig. Movement Delay, s/veh												
LnGrp Delay(d),s/veh	47.3	0.0	0.0	35.3	0.0	0.0	30.6	0.0	1.4	51.3	0.0	23.4
LnGrp LOS	D	A	A	D	A	A	C	A	A	D	A	C
Approach Vol, veh/h		236			39			917				675
Approach Delay, s/veh		47.3			35.3			8.1				23.8
Approach LOS		D			D			A				C
Timer - Assigned Phs	1	2		4	5	6		8				
Phs Duration (G+Y+Rc), s	5.8	72.2		22.1	23.9	54.0		22.1				
Change Period (Y+Rc), s	4.0	4.6		* 4.9	4.6	* 4.6		* 4.9				
Max Green Setting (Gmax), s	8.5	59.9		* 18	19.0	* 49		* 18				
Max Q Clear Time (g_c+I1), s	2.5	2.0		16.8	11.9	31.0		3.9				
Green Ext Time (p_c), s	0.0	6.5		0.2	0.3	4.7		0.1				

Intersection Summary



















HCM 6th Ctrl Delay	19.3
HCM 6th LOS	B

Notes

\* HCM 6th computational engine requires equal clearance times for the phases crossing the barrier.

























HCM 6th Signalized Intersection Summary  
3: D St & 1st St

Existing+Project  
Timing Plan: AM Peak

												
Movement	EBL	EBT	EBR	WBL	WBT	WBR	NBL	NBT	NBR	SBL	SBT	SBR
Lane Configurations												
Traffic Volume (veh/h)	44	6	7	7	9	40	7	725	13	49	629	72
Future Volume (veh/h)	44	6	7	7	9	40	7	725	13	49	629	72
Initial Q (Qb), veh	0	0	0	0	0	0	0	0	0	0	0	0
Ped-Bike Adj(A_pbT)	0.98		0.98	0.99		0.97	1.00		0.97	1.00		0.97
Parking Bus, Adj	1.00	1.00	1.00	1.00	1.00	1.00	1.00	1.00	1.00	1.00	1.00	1.00
Work Zone On Approach		No			No			No			No	
Adj Sat Flow, veh/h/ln	1900	1900	1648	1648	1648	1796	1604	1856	1737	1870	1826	1900
Adj Flow Rate, veh/h	50	7	8	8	10	45	8	824	15	56	715	82
Peak Hour Factor	0.88	0.88	0.88	0.88	0.88	0.88	0.88	0.88	0.88	0.88	0.88	0.88
Percent Heavy Veh, %	0	0	17	17	17	7	20	3	11	2	5	0
Cap, veh/h	170	25	18	49	30	94	21	1060	19	323	1214	139
Arrive On Green	0.09	0.09	0.09	0.09	0.09	0.09	0.01	0.58	0.58	0.36	1.00	1.00
Sat Flow, veh/h	1132	262	196	87	314	1003	1527	1815	33	1781	1603	184
Grp Volume(v), veh/h	65	0	0	63	0	0	8	0	839	56	0	797
Grp Sat Flow(s),veh/h/ln	1590	0	0	1404	0	0	1527	0	1848	1781	0	1787
Q Serve(g_s), s	0.0	0.0	0.0	0.0	0.0	0.0	0.5	0.0	34.6	2.1	0.0	0.0
Cycle Q Clear(g_c), s	3.4	0.0	0.0	4.2	0.0	0.0	0.5	0.0	34.6	2.1	0.0	0.0
Prop In Lane	0.77		0.12	0.13		0.71	1.00		0.02	1.00		0.10
Lane Grp Cap(c), veh/h	213	0	0	172	0	0	21	0	1079	323	0	1353
V/C Ratio(X)	0.31	0.00	0.00	0.37	0.00	0.00	0.38	0.00	0.78	0.17	0.00	0.59
Avail Cap(c_a), veh/h	369	0	0	320	0	0	107	0	1079	323	0	1353
HCM Platoon Ratio	1.00	1.00	1.00	1.00	1.00	1.00	1.00	1.00	1.00	2.00	2.00	2.00
Upstream Filter(l)	1.00	0.00	0.00	1.00	0.00	0.00	0.79	0.00	0.79	0.71	0.00	0.71
Uniform Delay (d), s/veh	42.6	0.0	0.0	42.9	0.0	0.0	48.9	0.0	15.8	26.8	0.0	0.0
Incr Delay (d2), s/veh	0.6	0.0	0.0	1.0	0.0	0.0	3.2	0.0	4.4	0.1	0.0	1.3
Initial Q Delay(d3),s/veh	0.0	0.0	0.0	0.0	0.0	0.0	0.0	0.0	0.0	0.0	0.0	0.0
%ile BackOfQ(50%),veh/ln	1.6	0.0	0.0	1.5	0.0	0.0	0.2	0.0	15.0	0.9	0.0	0.5
Unsig. Movement Delay, s/veh												
LnGrp Delay(d),s/veh	43.2	0.0	0.0	43.9	0.0	0.0	52.1	0.0	20.2	26.9	0.0	1.3
LnGrp LOS	D	A	A	D	A	A	D	A	C	C	A	A
Approach Vol, veh/h		65			63			847			853	
Approach Delay, s/veh		43.2			43.9			20.5			3.0	
Approach LOS		D			D			C			A	
Timer - Assigned Phs	1	2		4	5	6		8				
Phs Duration (G+Y+Rc), s	22.7	63.0		14.3	5.4	80.3		14.3				
Change Period (Y+Rc), s	4.6	* 4.6		* 4.9	4.0	4.6		* 4.9				
Max Green Setting (Gmax), s	8.0	* 58		* 20	7.0	59.4		* 20				
Max Q Clear Time (g_c+I1), s	4.1	36.6		5.4	2.5	2.0		6.2				
Green Ext Time (p_c), s	0.0	9.5		0.2	0.0	12.4		0.2				
<b>Intersection Summary</b>												
HCM 6th Ctrl Delay				14.0								
HCM 6th LOS				B								
<b>Notes</b>												
* HCM 6th computational engine requires equal clearance times for the phases crossing the barrier.												

HCM 6th Signalized Intersection Summary  
 4: D St & Petaluma Blvd

Existing+Project  
 Timing Plan: AM Peak

												
Movement	EBL	EBT	EBR	WBL	WBT	WBR	NBL	NBT	NBR	SBL	SBT	SBR
Lane Configurations												
Traffic Volume (veh/h)	122	367	67	65	268	272	72	337	43	136	359	68
Future Volume (veh/h)	122	367	67	65	268	272	72	337	43	136	359	68
Initial Q (Qb), veh	0	0	0	0	0	0	0	0	0	0	0	0
Ped-Bike Adj(A_pbT)	1.00		0.99	1.00		0.99	1.00		0.97	1.00		1.00
Parking Bus, Adj	1.00	1.00	1.00	1.00	1.00	1.00	1.00	1.00	1.00	1.00	1.00	1.00
Work Zone On Approach		No			No			No			No	
Adj Sat Flow, veh/h/ln	1826	1826	1796	1826	1841	1885	1870	1870	1796	1856	1811	1856
Adj Flow Rate, veh/h	133	399	73	71	291	296	78	366	47	148	390	74
Peak Hour Factor	0.92	0.92	0.92	0.92	0.92	0.92	0.92	0.92	0.92	0.92	0.92	0.92
Percent Heavy Veh, %	5	5	7	5	4	1	2	2	7	3	6	3
Cap, veh/h	162	468	386	120	415	356	126	555	71	265	777	671
Arrive On Green	0.09	0.26	0.26	0.07	0.23	0.23	0.07	0.34	0.34	0.10	0.29	0.29
Sat Flow, veh/h	1739	1826	1507	1739	1841	1580	1781	1618	208	1767	1811	1565
Grp Volume(v), veh/h	133	399	73	71	291	296	78	0	413	148	390	74
Grp Sat Flow(s),veh/h/ln	1739	1826	1507	1739	1841	1580	1781	0	1826	1767	1811	1565
Q Serve(g_s), s	7.5	20.8	3.8	4.0	14.5	17.9	4.3	0.0	19.2	8.0	17.9	2.3
Cycle Q Clear(g_c), s	7.5	20.8	3.8	4.0	14.5	17.9	4.3	0.0	19.2	8.0	17.9	2.3
Prop In Lane	1.00		1.00	1.00		1.00	1.00		0.11	1.00		1.00
Lane Grp Cap(c), veh/h	162	468	386	120	415	356	126	0	626	265	777	671
V/C Ratio(X)	0.82	0.85	0.19	0.59	0.70	0.83	0.62	0.00	0.66	0.56	0.50	0.11
Avail Cap(c_a), veh/h	191	531	439	139	484	416	143	0	626	265	777	671
HCM Platoon Ratio	1.00	1.00	1.00	1.00	1.00	1.00	1.00	1.00	1.00	0.67	0.67	0.67
Upstream Filter(I)	1.00	1.00	1.00	1.00	1.00	1.00	1.00	0.00	1.00	0.81	0.81	0.81
Uniform Delay (d), s/veh	44.5	35.4	29.1	45.2	35.7	36.9	45.1	0.0	27.9	41.8	26.7	9.7
Incr Delay (d2), s/veh	18.4	12.3	0.3	2.1	4.4	12.9	3.8	0.0	5.4	1.3	1.9	0.3
Initial Q Delay(d3),s/veh	0.0	0.0	0.0	0.0	0.0	0.0	0.0	0.0	0.0	0.0	0.0	0.0
%ile BackOfQ(50%),veh/ln	4.0	10.7	1.4	1.8	7.0	8.1	2.0	0.0	9.2	3.7	8.6	1.3
Unsig. Movement Delay, s/veh												
LnGrp Delay(d),s/veh	63.0	47.7	29.4	47.3	40.1	49.8	48.9	0.0	33.3	43.1	28.6	10.0
LnGrp LOS	E	D	C	D	D	D	D	A	C	D	C	A
Approach Vol, veh/h		605			658			491			612	
Approach Delay, s/veh		48.8			45.2			35.8			29.9	
Approach LOS		D			D			D			C	
Timer - Assigned Phs	1	2	3	4	5	6	7	8				
Phs Duration (G+Y+Rc), s	19.6	39.0	10.9	30.5	11.1	47.5	14.2	27.2				
Change Period (Y+Rc), s	* 4.6	* 4.7	4.0	* 4.9	4.0	4.6	* 4.9	* 4.7				
Max Green Setting (Gmax), s	* 11	* 34	8.0	* 29	8.0	37.4	* 11	* 26				
Max Q Clear Time (g_c+I1), s	10.0	21.2	6.0	22.8	6.3	19.9	9.5	19.9				
Green Ext Time (p_c), s	0.0	1.9	0.0	1.9	0.0	2.1	0.0	2.1				

Intersection Summary												
HCM 6th Ctrl Delay											40.2	
HCM 6th LOS											D	

Notes  
 User approved pedestrian interval to be less than phase max green.  
 \* HCM 6th computational engine requires equal clearance times for the phases crossing the barrier.

# HCM 6th Signalized Intersection Summary

## 5: Washington St & Lakeville St

Existing+Project  
Timing Plan: AM Peak



Movement	EBL	EBT	EBR	WBL	WBT	WBR	NBL	NBT	NBR	SBL	SBT	SBR
Lane Configurations		↔		↔	↔		↔	↕		↔	↕	
Traffic Volume (veh/h)	30	131	29	215	99	55	20	666	202	61	732	29
Future Volume (veh/h)	30	131	29	215	99	55	20	666	202	61	732	29
Initial Q (Qb), veh	0	0	0	0	0	0	0	0	0	0	0	0
Ped-Bike Adj(A_pbT)	1.00		0.99	1.00		0.99	1.00		0.97	1.00		0.97
Parking Bus, Adj	1.00	1.00	1.00	1.00	1.00	1.00	1.00	1.00	1.00	1.00	1.00	1.00
Work Zone On Approach		No			No			No			No	
Adj Sat Flow, veh/h/ln	1856	1663	1381	1767	1722	1811	1337	1856	1796	1722	1826	1752
Adj Flow Rate, veh/h	34	147	33	242	111	62	22	748	227	69	822	33
Peak Hour Factor	0.89	0.89	0.89	0.89	0.89	0.89	0.89	0.89	0.89	0.89	0.89	0.89
Percent Heavy Veh, %	3	16	35	9	12	6	38	3	7	12	5	10
Cap, veh/h	40	172	39	284	175	98	298	1169	355	131	961	39
Arrive On Green	0.16	0.16	0.16	0.17	0.17	0.17	0.47	0.88	0.88	0.08	0.28	0.28
Sat Flow, veh/h	255	1101	247	1682	1034	577	1273	2645	803	1640	3394	136
Grp Volume(v), veh/h	214	0	0	242	0	173	22	499	476	69	420	435
Grp Sat Flow(s),veh/h/ln	1602	0	0	1682	0	1611	1273	1763	1684	1640	1735	1796
Q Serve(g_s), s	16.3	0.0	0.0	17.5	0.0	12.5	1.2	9.5	9.5	5.1	28.6	28.6
Cycle Q Clear(g_c), s	16.3	0.0	0.0	17.5	0.0	12.5	1.2	9.5	9.5	5.1	28.6	28.6
Prop In Lane	0.16		0.15	1.00		0.36	1.00		0.48	1.00		0.08
Lane Grp Cap(c), veh/h	250	0	0	284	0	272	298	779	744	131	491	509
V/C Ratio(X)	0.85	0.00	0.00	0.85	0.00	0.64	0.07	0.64	0.64	0.53	0.86	0.86
Avail Cap(c_a), veh/h	372	0	0	400	0	383	298	779	744	131	491	509
HCM Platoon Ratio	1.00	1.00	1.00	1.00	1.00	1.00	2.00	2.00	2.00	1.00	1.00	1.00
Upstream Filter(l)	1.00	0.00	0.00	0.94	0.00	0.94	0.89	0.89	0.89	1.00	1.00	1.00
Uniform Delay (d), s/veh	51.3	0.0	0.0	50.4	0.0	48.4	25.8	4.6	4.6	55.2	42.4	42.4
Incr Delay (d2), s/veh	8.2	0.0	0.0	8.3	0.0	0.9	0.0	3.6	3.7	1.9	17.1	16.7
Initial Q Delay(d3),s/veh	0.0	0.0	0.0	0.0	0.0	0.0	0.0	0.0	0.0	0.0	0.0	0.0
%ile BackOfQ(50%),veh/ln	7.1	0.0	0.0	8.0	0.0	5.1	0.4	2.6	2.5	2.2	14.5	15.0
Unsig. Movement Delay, s/veh												
LnGrp Delay(d),s/veh	59.6	0.0	0.0	58.7	0.0	49.2	25.8	8.2	8.3	57.1	59.5	59.0
LnGrp LOS	E	A	A	E	A	D	C	A	A	E	E	E
Approach Vol, veh/h		214			415			997			924	
Approach Delay, s/veh		59.6			54.8			8.6			59.1	
Approach LOS		E			D			A			E	
Timer - Assigned Phs	1	2		4	5	6		8				
Phs Duration (G+Y+Rc), s	14.0	60.0		26.4	34.0	40.0		24.5				
Change Period (Y+Rc), s	4.0	* 4.8		* 5.3	4.8	* 4.6		5.0				
Max Green Setting (Gmax), s	10.0	* 37		* 30	12.0	* 35		29.0				
Max Q Clear Time (g_c+I1), s	7.1	11.5		19.5	3.2	30.6		18.3				
Green Ext Time (p_c), s	0.0	5.0		0.8	0.0	1.7		0.6				

### Intersection Summary

HCM 6th Ctrl Delay	38.7
HCM 6th LOS	D





















### Notes

User approved pedestrian interval to be less than phase max green.

\* HCM 6th computational engine requires equal clearance times for the phases crossing the barrier.

HCM 6th Signalized Intersection Summary  
6: Washington St & Copeland St

Existing+Project  
Timing Plan: AM Peak

												
Movement	EBL	EBT	EBR	WBL	WBT	WBR	NBL	NBT	NBR	SBL	SBT	SBR
Lane Configurations												
Traffic Volume (veh/h)	6	0	2	27	3	189	2	746	11	196	725	11
Future Volume (veh/h)	6	0	2	27	3	189	2	746	11	196	725	11
Initial Q (Qb), veh	0	0	0	0	0	0	0	0	0	0	0	0
Ped-Bike Adj(A_pbT)	1.00		0.99	1.00		0.98	1.00		0.97	1.00		0.97
Parking Bus, Adj	1.00	1.00	1.00	1.00	1.00	1.00	1.00	1.00	1.00	1.00	1.00	1.00
Work Zone On Approach		No			No			No			No	
Adj Sat Flow, veh/h/ln	418	1900	1900	1618	1900	1737	418	1856	1900	1856	1826	1070
Adj Flow Rate, veh/h	7	0	2	31	3	220	2	867	13	228	843	13
Peak Hour Factor	0.86	0.86	0.86	0.86	0.86	0.86	0.86	0.86	0.86	0.86	0.86	0.86
Percent Heavy Veh, %	100	0	0	19	0	11	100	3	0	3	5	56
Cap, veh/h	208	6	47	294	26	256	57	1348	20	576	1969	30
Arrive On Green	0.18	0.00	0.18	0.18	0.18	0.18	0.14	0.38	0.38	0.33	0.56	0.56
Sat Flow, veh/h	884	37	263	1347	147	1445	398	3554	53	1767	3495	54
Grp Volume(v), veh/h	9	0	0	34	0	220	2	430	450	228	418	438
Grp Sat Flow(s),veh/h/ln	1183	0	0	1494	0	1445	398	1763	1844	1767	1735	1815
Q Serve(g_s), s	0.0	0.0	0.0	0.0	0.0	18.5	0.5	25.0	25.0	12.5	17.4	17.4
Cycle Q Clear(g_c), s	2.0	0.0	0.0	2.0	0.0	18.5	0.5	25.0	25.0	12.5	17.4	17.4
Prop In Lane	0.78		0.22	0.91		1.00	1.00		0.03	1.00		0.03
Lane Grp Cap(c), veh/h	261	0	0	320	0	256	57	668	699	576	977	1022
V/C Ratio(X)	0.03	0.00	0.00	0.11	0.00	0.86	0.04	0.64	0.64	0.40	0.43	0.43
Avail Cap(c_a), veh/h	380	0	0	446	0	380	57	668	699	576	977	1022
HCM Platoon Ratio	1.00	1.00	1.00	1.00	1.00	1.00	1.00	1.00	1.00	1.00	1.00	1.00
Upstream Filter(l)	1.00	0.00	0.00	0.78	0.00	0.78	1.00	1.00	1.00	0.76	0.76	0.76
Uniform Delay (d), s/veh	42.5	0.0	0.0	43.1	0.0	49.9	46.2	31.9	31.9	32.6	15.7	15.7
Incr Delay (d2), s/veh	0.0	0.0	0.0	0.1	0.0	8.6	0.1	4.7	4.5	0.1	1.0	1.0
Initial Q Delay(d3),s/veh	0.0	0.0	0.0	0.0	0.0	0.0	0.0	0.0	0.0	0.0	0.0	0.0
%ile BackOfQ(50%),veh/ln	0.2	0.0	0.0	0.9	0.0	7.3	0.1	11.6	12.1	5.4	7.2	7.5
Unsig. Movement Delay, s/veh												
LnGrp Delay(d),s/veh	42.6	0.0	0.0	43.2	0.0	58.5	46.3	36.6	36.4	32.7	16.8	16.7
LnGrp LOS	D	A	A	D	A	E	D	D	D	C	B	B
Approach Vol, veh/h		9			254			882			1084	
Approach Delay, s/veh		42.6			56.4			36.5			20.1	
Approach LOS		D			E			D			C	
Timer - Assigned Phs	1	2		4	5	6		8				
Phs Duration (G+Y+Rc), s	45.7	52.0		27.3	22.7	75.0		27.3				
Change Period (Y+Rc), s	5.0	4.6		5.1	5.0	* 4.6		* 5.1				
Max Green Setting (Gmax), s	29.0	47.4		32.9	7.0	* 70		* 34				
Max Q Clear Time (g_c+I1), s	14.5	27.0		20.5	2.5	19.4		4.0				
Green Ext Time (p_c), s	0.3	8.2		0.6	0.0	10.7		0.0				
<b>Intersection Summary</b>												
HCM 6th Ctrl Delay				30.8								
HCM 6th LOS				C								
<b>Notes</b>												
* HCM 6th computational engine requires equal clearance times for the phases crossing the barrier.												

Queues  
2: D St & Copeland St

Existing+Project  
Timing Plan: AM Peak

























Lane Group	EBT	WBT	NBL	NBT	SBL	SBT
Lane Group Flow (vph)	236	40	213	705	9	666
v/c Ratio	0.65	0.27	0.65	0.49	0.06	0.65
Control Delay	15.2	29.2	33.8	3.1	43.8	19.2
Queue Delay	0.0	0.0	0.0	0.0	0.0	2.6
Total Delay	15.2	29.2	33.8	3.1	43.8	21.8
Queue Length 50th (ft)	7	13	109	27	5	253
Queue Length 95th (ft)	66	40	187	109	21	456
Internal Link Dist (ft)	666	244		693		446
Turn Bay Length (ft)			60		60	
Base Capacity (vph)	467	245	326	1433	153	1024
Starvation Cap Reductn	0	0	0	0	0	236
Spillback Cap Reductn	0	0	0	0	0	0
Storage Cap Reductn	0	0	0	0	0	0
Reduced v/c Ratio	0.51	0.16	0.65	0.49	0.06	0.85
<b>Intersection Summary</b>						



HCM 6th Signalized Intersection Summary  
1: D St & Lakeville St

Existing+Project  
Timing Plan: PM Peak

												
Movement	EBL	EBT	EBR	WBL	WBT	WBR	NBL	NBT	NBR	SBL	SBT	SBR
Lane Configurations												
Traffic Volume (veh/h)	9	285	66	414	367	33	92	176	537	18	187	14
Future Volume (veh/h)	9	285	66	414	367	33	92	176	537	18	187	14
Initial Q (Qb), veh	0	0	0	0	0	0	0	0	0	0	0	0
Ped-Bike Adj(A_pbT)	0.98		0.97	1.00		0.97	1.00		0.95	1.00		0.90
Parking Bus, Adj	1.00	1.00	1.00	1.00	1.00	1.00	1.00	1.00	1.00	1.00	1.00	1.00
Work Zone On Approach		No			No			No			No	
Adj Sat Flow, veh/h/ln	1900	1826	1678	1856	1870	1900	1826	1885	1870	1900	1885	1900
Adj Flow Rate, veh/h	10	306	71	445	395	35	99	189	577	19	201	15
Peak Hour Factor	0.93	0.93	0.93	0.93	0.93	0.93	0.93	0.93	0.93	0.93	0.93	0.93
Percent Heavy Veh, %	0	5	15	3	2	0	5	1	2	0	1	0
Cap, veh/h	36	352	274	472	934	777	137	261	747	295	280	21
Arrive On Green	0.20	0.20	0.20	0.27	0.50	0.50	0.21	0.21	0.21	0.16	0.16	0.16
Sat Flow, veh/h	23	1780	1382	1767	1870	1557	637	1216	1510	1810	1718	128
Grp Volume(v), veh/h	316	0	71	445	395	35	288	0	577	19	0	216
Grp Sat Flow(s),veh/h/ln	1803	0	1382	1767	1870	1557	1853	0	1510	1810	0	1846
Q Serve(g_s), s	6.2	0.0	5.1	28.8	15.6	1.3	16.9	0.0	25.0	1.0	0.0	12.9
Cycle Q Clear(g_c), s	19.8	0.0	5.1	28.8	15.6	1.3	16.9	0.0	25.0	1.0	0.0	12.9
Prop In Lane	0.03		1.00	1.00		1.00	0.34		1.00	1.00		0.07
Lane Grp Cap(c), veh/h	389	0	274	472	934	777	397	0	747	295	0	301
V/C Ratio(X)	0.81	0.00	0.26	0.94	0.42	0.05	0.73	0.00	0.77	0.06	0.00	0.72
Avail Cap(c_a), veh/h	645	0	474	682	962	801	397	0	747	434	0	443
HCM Platoon Ratio	1.00	1.00	1.00	1.00	1.00	1.00	1.00	1.00	1.00	1.00	1.00	1.00
Upstream Filter(l)	1.00	0.00	1.00	1.00	1.00	1.00	1.00	0.00	1.00	1.00	0.00	1.00
Uniform Delay (d), s/veh	45.4	0.0	39.6	41.9	18.5	15.0	42.6	0.0	25.3	41.3	0.0	46.3
Incr Delay (d2), s/veh	1.6	0.0	0.2	14.5	0.1	0.0	7.0	0.0	5.3	0.1	0.0	2.4
Initial Q Delay(d3),s/veh	0.0	0.0	0.0	0.0	0.0	0.0	0.0	0.0	0.0	0.0	0.0	0.0
%ile BackOfQ(50%),veh/ln	9.0	0.0	1.7	14.3	6.7	0.5	8.5	0.0	14.0	0.5	0.0	6.2
Unsig. Movement Delay, s/veh												
LnGrp Delay(d),s/veh	47.0	0.0	39.7	56.4	18.7	15.0	49.6	0.0	30.7	41.4	0.0	48.7
LnGrp LOS	D	A	D	E	B	B	D	A	C	D	A	D
Approach Vol, veh/h		387			875			865				235
Approach Delay, s/veh		45.7			37.7			37.0				48.1
Approach LOS		D			D			D				D
Timer - Assigned Phs		2	3	4		6		8				
Phs Duration (G+Y+Rc), s		30.3	35.2	27.9		23.3		63.0				
Change Period (Y+Rc), s		* 5.3	4.0	* 4.8		4.3		* 4.8				
Max Green Setting (Gmax), s		* 25	45.0	* 40		28.0		* 60				
Max Q Clear Time (g_c+I1), s		27.0	30.8	21.8		14.9		17.6				
Green Ext Time (p_c), s		0.0	0.4	1.3		0.9		1.7				
<b>Intersection Summary</b>												
HCM 6th Ctrl Delay				39.8								
HCM 6th LOS				D								
<b>Notes</b>												
* HCM 6th computational engine requires equal clearance times for the phases crossing the barrier.												

HCM 6th Signalized Intersection Summary  
 2: D St & Copeland St

Existing+Project  
 Timing Plan: PM Peak

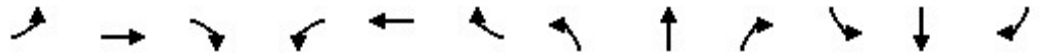

Movement	EBL	EBT	EBR	WBL	WBT	WBR	NBL	NBT	NBR	SBL	SBT	SBR
Lane Configurations		↕			↕		↗	↘		↗	↘	
Traffic Volume (veh/h)	10	20	203	7	14	15	223	795	13	18	639	53
Future Volume (veh/h)	10	20	203	7	14	15	223	795	13	18	639	53
Initial Q (Qb), veh	0	0	0	0	0	0	0	0	0	0	0	0
Ped-Bike Adj(A_pbT)	0.98		0.96	1.00		0.98	1.00		0.96	1.00		0.96
Parking Bus, Adj	1.00	1.00	1.00	1.00	1.00	1.00	1.00	1.00	1.00	1.00	1.00	1.00
Work Zone On Approach		No			No			No			No	
Adj Sat Flow, veh/h/ln	1900	1530	1856	1900	1900	1900	1826	1870	1900	1900	1870	1633
Adj Flow Rate, veh/h	11	22	218	8	15	16	240	855	14	19	687	57
Peak Hour Factor	0.93	0.93	0.93	0.93	0.93	0.93	0.93	0.93	0.93	0.93	0.93	0.93
Percent Heavy Veh, %	0	25	3	0	0	0	5	2	0	0	2	18
Cap, veh/h	42	26	202	75	130	112	316	1188	19	59	836	69
Arrive On Green	0.18	0.18	0.18	0.18	0.18	0.18	0.36	1.00	1.00	0.03	0.49	0.49
Sat Flow, veh/h	24	142	1101	172	706	611	1739	1834	30	1810	1697	141
Grp Volume(v), veh/h	251	0	0	39	0	0	240	0	869	19	0	744
Grp Sat Flow(s),veh/h/ln	1267	0	0	1490	0	0	1739	0	1864	1810	0	1837
Q Serve(g_s), s	8.2	0.0	0.0	0.0	0.0	0.0	12.1	0.0	0.0	1.0	0.0	34.5
Cycle Q Clear(g_c), s	18.4	0.0	0.0	1.9	0.0	0.0	12.1	0.0	0.0	1.0	0.0	34.5
Prop In Lane	0.04		0.87	0.21		0.41	1.00		0.02	1.00		0.08
Lane Grp Cap(c), veh/h	271	0	0	318	0	0	316	0	1208	59	0	906
V/C Ratio(X)	0.93	0.00	0.00	0.12	0.00	0.00	0.76	0.00	0.72	0.32	0.00	0.82
Avail Cap(c_a), veh/h	271	0	0	318	0	0	332	0	1208	156	0	906
HCM Platoon Ratio	1.00	1.00	1.00	1.00	1.00	1.00	2.00	2.00	2.00	1.00	1.00	1.00
Upstream Filter(I)	0.80	0.00	0.00	1.00	0.00	0.00	0.63	0.00	0.63	0.54	0.00	0.54
Uniform Delay (d), s/veh	41.4	0.0	0.0	34.1	0.0	0.0	29.9	0.0	0.0	47.3	0.0	21.6
Incr Delay (d2), s/veh	30.9	0.0	0.0	0.2	0.0	0.0	6.0	0.0	2.4	1.7	0.0	4.7
Initial Q Delay(d3),s/veh	0.0	0.0	0.0	0.0	0.0	0.0	0.0	0.0	0.0	0.0	0.0	0.0
%ile BackOfQ(50%),veh/ln	8.6	0.0	0.0	0.8	0.0	0.0	4.7	0.0	0.8	0.5	0.0	15.4
Unsig. Movement Delay, s/veh												
LnGrp Delay(d),s/veh	72.3	0.0	0.0	34.2	0.0	0.0	35.9	0.0	2.4	48.9	0.0	26.3
LnGrp LOS	E	A	A	C	A	A	D	A	A	D	A	C
Approach Vol, veh/h		251			39			1109				763
Approach Delay, s/veh		72.3			34.2			9.6				26.8
Approach LOS		E			C			A				C
Timer - Assigned Phs	1	2		4	5	6		8				
Phs Duration (G+Y+Rc), s	7.3	69.4		23.3	22.8	53.9		23.3				
Change Period (Y+Rc), s	4.0	4.6		* 4.9	4.6	* 4.6		* 4.9				
Max Green Setting (Gmax), s	8.6	59.8		* 18	19.1	* 49		* 18				
Max Q Clear Time (g_c+I1), s	3.0	2.0		20.4	14.1	36.5		3.9				
Green Ext Time (p_c), s	0.0	9.4		0.0	0.3	4.6		0.1				

Intersection Summary

HCM 6th Ctrl Delay	23.4
HCM 6th LOS	C

Notes

\* HCM 6th computational engine requires equal clearance times for the phases crossing the barrier.

HCM 6th Signalized Intersection Summary  
3: D St & 1st St

Existing+Project  
Timing Plan: PM Peak

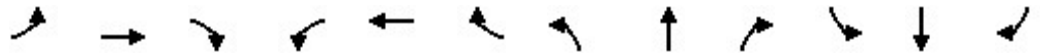

Movement	EBL	EBT	EBR	WBL	WBT	WBR	NBL	NBT	NBR	SBL	SBT	SBR
Lane Configurations		↔			↔		↗	↘		↗	↘	
Traffic Volume (veh/h)	71	4	12	16	7	57	6	910	23	67	763	63
Future Volume (veh/h)	71	4	12	16	7	57	6	910	23	67	763	63
Initial Q (Qb), veh	0	0	0	0	0	0	0	0	0	0	0	0
Ped-Bike Adj(A_pbT)	0.98		0.98	0.99		0.97	1.00		0.97	1.00		0.97
Parking Bus, Adj	1.00	1.00	1.00	1.00	1.00	1.00	1.00	1.00	1.00	1.00	1.00	1.00
Work Zone On Approach		No			No			No			No	
Adj Sat Flow, veh/h/ln	1900	1900	1900	1781	1900	1856	1900	1856	1707	1841	1870	1900
Adj Flow Rate, veh/h	72	4	12	16	7	58	6	929	23	68	779	64
Peak Hour Factor	0.98	0.98	0.98	0.98	0.98	0.98	0.98	0.98	0.98	0.98	0.98	0.98
Percent Heavy Veh, %	0	0	0	8	0	3	0	3	13	4	2	0
Cap, veh/h	179	13	20	62	25	112	19	1052	26	315	1291	106
Arrive On Green	0.10	0.10	0.10	0.10	0.10	0.10	0.01	0.58	0.58	0.36	1.00	1.00
Sat Flow, veh/h	1190	141	210	197	267	1171	1810	1801	45	1753	1700	140
Grp Volume(v), veh/h	88	0	0	81	0	0	6	0	952	68	0	843
Grp Sat Flow(s),veh/h/ln	1541	0	0	1636	0	0	1810	0	1846	1753	0	1840
Q Serve(g_s), s	0.4	0.0	0.0	0.0	0.0	0.0	0.3	0.0	44.3	2.7	0.0	0.0
Cycle Q Clear(g_c), s	5.0	0.0	0.0	4.5	0.0	0.0	0.3	0.0	44.3	2.7	0.0	0.0
Prop In Lane	0.82		0.14	0.20		0.72	1.00		0.02	1.00		0.08
Lane Grp Cap(c), veh/h	212	0	0	199	0	0	19	0	1078	315	0	1397
V/C Ratio(X)	0.41	0.00	0.00	0.41	0.00	0.00	0.31	0.00	0.88	0.22	0.00	0.60
Avail Cap(c_a), veh/h	362	0	0	363	0	0	127	0	1078	315	0	1397
HCM Platoon Ratio	1.00	1.00	1.00	1.00	1.00	1.00	1.00	1.00	1.00	2.00	2.00	2.00
Upstream Filter(l)	1.00	0.00	0.00	1.00	0.00	0.00	0.68	0.00	0.68	0.62	0.00	0.62
Uniform Delay (d), s/veh	43.1	0.0	0.0	43.0	0.0	0.0	49.1	0.0	17.9	27.1	0.0	0.0
Incr Delay (d2), s/veh	1.0	0.0	0.0	1.0	0.0	0.0	2.2	0.0	7.5	0.1	0.0	1.2
Initial Q Delay(d3),s/veh	0.0	0.0	0.0	0.0	0.0	0.0	0.0	0.0	0.0	0.0	0.0	0.0
%ile BackOfQ(50%),veh/ln	2.1	0.0	0.0	2.0	0.0	0.0	0.2	0.0	19.7	1.1	0.0	0.5
Unsig. Movement Delay, s/veh												
LnGrp Delay(d),s/veh	44.1	0.0	0.0	44.0	0.0	0.0	51.3	0.0	25.4	27.2	0.0	1.2
LnGrp LOS	D	A	A	D	A	A	D	A	C	C	A	A
Approach Vol, veh/h		88			81			958				911
Approach Delay, s/veh		44.1			44.0			25.5				3.1
Approach LOS		D			D			C				A
Timer - Assigned Phs	1	2		4	5	6		8				
Phs Duration (G+Y+Rc), s	22.6	63.0		14.4	5.1	80.5		14.4				
Change Period (Y+Rc), s	4.6	* 4.6		* 4.9	4.0	4.6		* 4.9				
Max Green Setting (Gmax), s	8.0	* 58		* 20	7.0	59.4		* 20				
Max Q Clear Time (g_c+I1), s	4.7	46.3		7.0	2.3	2.0		6.5				
Green Ext Time (p_c), s	0.0	7.5		0.3	0.0	13.6		0.2				

Intersection Summary

























HCM 6th Ctrl Delay	17.1
HCM 6th LOS	B

Notes

\* HCM 6th computational engine requires equal clearance times for the phases crossing the barrier.

HCM 6th Signalized Intersection Summary  
4: D St & Petaluma Blvd

Existing+Project  
Timing Plan: PM Peak

												
Movement	EBL	EBT	EBR	WBL	WBT	WBR	NBL	NBT	NBR	SBL	SBT	SBR
Lane Configurations												
Traffic Volume (veh/h)	168	237	84	144	284	253	78	412	24	174	530	92
Future Volume (veh/h)	168	237	84	144	284	253	78	412	24	174	530	92
Initial Q (Qb), veh	0	0	0	0	0	0	0	0	0	0	0	0
Ped-Bike Adj(A_pbT)	1.00		0.94	1.00		0.93	1.00		0.94	1.00		0.95
Parking Bus, Adj	1.00	1.00	1.00	1.00	1.00	1.00	1.00	1.00	1.00	1.00	1.00	1.00
Work Zone On Approach		No			No			No			No	
Adj Sat Flow, veh/h/ln	1841	1885	1900	1856	1885	1870	1870	1856	1900	1900	1856	1870
Adj Flow Rate, veh/h	183	258	91	157	309	275	85	448	26	189	576	100
Peak Hour Factor	0.92	0.92	0.92	0.92	0.92	0.92	0.92	0.92	0.92	0.92	0.92	0.92
Percent Heavy Veh, %	4	1	0	3	1	2	2	3	0	0	3	2
Cap, veh/h	210	485	389	187	445	349	129	564	33	233	723	586
Arrive On Green	0.12	0.26	0.26	0.11	0.24	0.24	0.07	0.33	0.33	0.13	0.39	0.39
Sat Flow, veh/h	1753	1885	1511	1767	1885	1479	1781	1730	100	1810	1856	1505
Grp Volume(v), veh/h	183	258	91	157	309	275	85	0	474	189	576	100
Grp Sat Flow(s),veh/h/ln	1753	1885	1511	1767	1885	1479	1781	0	1830	1810	1856	1505
Q Serve(g_s), s	10.3	11.8	4.8	8.7	15.0	17.4	4.6	0.0	23.6	10.2	27.5	2.8
Cycle Q Clear(g_c), s	10.3	11.8	4.8	8.7	15.0	17.4	4.6	0.0	23.6	10.2	27.5	2.8
Prop In Lane	1.00		1.00	1.00		1.00	1.00		0.05	1.00		1.00
Lane Grp Cap(c), veh/h	210	485	389	187	445	349	129	0	597	233	723	586
V/C Ratio(X)	0.87	0.53	0.23	0.84	0.69	0.79	0.66	0.00	0.79	0.81	0.80	0.17
Avail Cap(c_a), veh/h	210	505	405	194	490	385	143	0	597	233	723	586
HCM Platoon Ratio	1.00	1.00	1.00	1.00	1.00	1.00	1.00	1.00	1.00	1.00	1.00	1.00
Upstream Filter(I)	1.00	1.00	1.00	1.00	1.00	1.00	1.00	0.00	1.00	0.80	0.80	0.80
Uniform Delay (d), s/veh	43.2	32.0	29.4	43.9	34.9	35.8	45.2	0.0	30.7	42.4	27.0	8.4
Incr Delay (d2), s/veh	29.1	1.4	0.4	24.3	4.4	10.4	6.6	0.0	10.5	14.6	7.2	0.5
Initial Q Delay(d3),s/veh	0.0	0.0	0.0	0.0	0.0	0.0	0.0	0.0	0.0	0.0	0.0	0.0
%ile BackOfQ(50%),veh/ln	6.1	5.5	1.8	5.0	7.3	7.2	2.3	0.0	12.0	5.5	13.4	1.5
Unsig. Movement Delay, s/veh												
LnGrp Delay(d),s/veh	72.3	33.3	29.8	68.2	39.3	46.3	51.8	0.0	41.1	56.9	34.3	8.9
LnGrp LOS	E	C	C	E	D	D	D	A	D	E	C	A
Approach Vol, veh/h		532			741			559			865	
Approach Delay, s/veh		46.1			48.0			42.7			36.3	
Approach LOS		D			D			D			D	
Timer - Assigned Phs	1	2	3	4	5	6	7	8				
Phs Duration (G+Y+Rc), s	17.5	37.3	14.6	30.6	11.2	43.6	16.9	28.3				
Change Period (Y+Rc), s	* 4.6	* 4.7	4.0	* 4.9	4.0	4.6	* 4.9	* 4.7				
Max Green Setting (Gmax), s	* 12	* 33	11.0	* 27	8.0	36.7	* 12	* 26				
Max Q Clear Time (g_c+I1), s	12.2	25.6	10.7	13.8	6.6	29.5	12.3	19.4				
Green Ext Time (p_c), s	0.0	1.5	0.0	2.1	0.0	2.2	0.0	2.2				

Intersection Summary

HCM 6th Ctrl Delay	42.8
HCM 6th LOS	D

Notes

User approved pedestrian interval to be less than phase max green.  
\* HCM 6th computational engine requires equal clearance times for the phases crossing the barrier.

# HCM 6th Signalized Intersection Summary

## 5: Washington St & Lakeville St

Existing+Project  
Timing Plan: PM Peak



Movement	EBL	EBT	EBR	WBL	WBT	WBR	NBL	NBT	NBR	SBL	SBT	SBR
Lane Configurations		↕		↕	↕		↕	↕↔		↕	↕↔	
Traffic Volume (veh/h)	57	91	43	218	160	102	41	796	178	73	783	41
Future Volume (veh/h)	57	91	43	218	160	102	41	796	178	73	783	41
Initial Q (Qb), veh	0	0	0	0	0	0	0	0	0	0	0	0
Ped-Bike Adj(A_pbT)	1.00		0.98	1.00		0.98	1.00		0.96	1.00		0.95
Parking Bus, Adj	1.00	1.00	1.00	1.00	1.00	1.00	1.00	1.00	1.00	1.00	1.00	1.00
Work Zone On Approach		No			No			No			No	
Adj Sat Flow, veh/h/ln	1826	1811	1811	1870	1826	1900	1900	1856	1811	1870	1885	1900
Adj Flow Rate, veh/h	59	95	45	227	167	106	43	829	185	76	816	43
Peak Hour Factor	0.96	0.96	0.96	0.96	0.96	0.96	0.96	0.96	0.96	0.96	0.96	0.96
Percent Heavy Veh, %	5	6	6	2	5	0	0	3	6	2	1	0
Cap, veh/h	69	111	53	327	190	121	441	1265	282	144	957	50
Arrive On Green	0.14	0.14	0.14	0.18	0.18	0.18	0.24	0.45	0.45	0.08	0.28	0.28
Sat Flow, veh/h	506	815	386	1781	1036	658	1810	2842	634	1781	3451	182
Grp Volume(v), veh/h	199	0	0	227	0	273	43	514	500	76	423	436
Grp Sat Flow(s),veh/h/ln	1708	0	0	1781	0	1694	1810	1763	1713	1781	1791	1841
Q Serve(g_s), s	14.1	0.0	0.0	14.8	0.0	19.5	2.3	28.3	28.3	5.1	27.7	27.8
Cycle Q Clear(g_c), s	14.1	0.0	0.0	14.8	0.0	19.5	2.3	28.3	28.3	5.1	27.7	27.8
Prop In Lane	0.30		0.23	1.00		0.39	1.00		0.37	1.00		0.10
Lane Grp Cap(c), veh/h	233	0	0	327	0	311	441	785	763	144	497	511
V/C Ratio(X)	0.85	0.00	0.00	0.70	0.00	0.88	0.10	0.66	0.66	0.53	0.85	0.85
Avail Cap(c_a), veh/h	372	0	0	441	0	419	441	785	763	144	497	511
HCM Platoon Ratio	1.00	1.00	1.00	1.00	1.00	1.00	1.00	1.00	1.00	1.00	1.00	1.00
Upstream Filter(l)	1.00	0.00	0.00	0.92	0.00	0.92	0.78	0.78	0.78	1.00	1.00	1.00
Uniform Delay (d), s/veh	52.3	0.0	0.0	47.4	0.0	49.3	36.3	26.9	26.9	54.7	42.4	42.4
Incr Delay (d2), s/veh	5.9	0.0	0.0	1.2	0.0	11.5	0.0	3.3	3.4	1.9	16.7	16.3
Initial Q Delay(d3),s/veh	0.0	0.0	0.0	0.0	0.0	0.0	0.0	0.0	0.0	0.0	0.0	0.0
%ile BackOfQ(50%),veh/ln	6.4	0.0	0.0	6.7	0.0	9.2	1.0	12.7	12.3	2.4	14.5	14.9
Unsig. Movement Delay, s/veh												
LnGrp Delay(d),s/veh	58.2	0.0	0.0	48.6	0.0	60.8	36.4	30.3	30.4	56.6	59.1	58.7
LnGrp LOS	E	A	A	D	A	E	D	C	C	E	E	E
Approach Vol, veh/h		199			500			1057			935	
Approach Delay, s/veh		58.2			55.3			30.6			58.7	
Approach LOS		E			E			C			E	
Timer - Assigned Phs	1	2		4	5	6		8				
Phs Duration (G+Y+Rc), s	14.0	60.0		28.0	35.0	39.0		21.9				
Change Period (Y+Rc), s	4.0	* 4.8		* 5.3	4.8	* 4.6		5.0				
Max Green Setting (Gmax), s	10.0	* 37		* 31	13.0	* 34		27.0				
Max Q Clear Time (g_c+I1), s	7.1	30.3		21.5	4.3	29.8		16.1				
Green Ext Time (p_c), s	0.0	2.8		1.1	0.0	1.7		0.5				

### Intersection Summary

HCM 6th Ctrl Delay	47.0
HCM 6th LOS	D





















### Notes

User approved pedestrian interval to be less than phase max green.

\* HCM 6th computational engine requires equal clearance times for the phases crossing the barrier.

HCM 6th Signalized Intersection Summary  
6: Washington St & Copeland St

Existing+Project  
Timing Plan: PM Peak

												
Movement	EBL	EBT	EBR	WBL	WBT	WBR	NBL	NBT	NBR	SBL	SBT	SBR
Lane Configurations												
Traffic Volume (veh/h)	12	1	1	58	1	231	3	808	24	208	821	9
Future Volume (veh/h)	12	1	1	58	1	231	3	808	24	208	821	9
Initial Q (Qb), veh	0	0	0	0	0	0	0	0	0	0	0	0
Ped-Bike Adj(A_pbT)	1.00		1.00	1.00		1.00	1.00		0.96	1.00		0.97
Parking Bus, Adj	1.00	1.00	1.00	1.00	1.00	1.00	1.00	1.00	1.00	1.00	1.00	1.00
Work Zone On Approach		No			No			No			No	
Adj Sat Flow, veh/h/ln	1900	1900	1900	1752	1900	1781	1900	1870	1693	1856	1870	1707
Adj Flow Rate, veh/h	12	1	1	60	1	241	3	842	25	217	855	9
Peak Hour Factor	0.96	0.96	0.96	0.96	0.96	0.96	0.96	0.96	0.96	0.96	0.96	0.96
Percent Heavy Veh, %	0	0	0	10	0	8	0	2	14	3	2	13
Cap, veh/h	296	25	16	419	6	308	267	1397	41	270	1448	15
Arrive On Green	0.20	0.20	0.20	0.20	0.20	0.20	0.15	0.40	0.40	0.15	0.40	0.40
Sat Flow, veh/h	899	122	79	1463	30	1507	1810	3519	104	1767	3601	38
Grp Volume(v), veh/h	14	0	0	61	0	241	3	425	442	217	422	442
Grp Sat Flow(s),veh/h/ln	1100	0	0	1493	0	1507	1810	1777	1847	1767	1777	1862
Q Serve(g_s), s	0.1	0.0	0.0	0.0	0.0	9.1	0.1	11.3	11.3	7.1	11.1	11.1
Cycle Q Clear(g_c), s	1.7	0.0	0.0	1.7	0.0	9.1	0.1	11.3	11.3	7.1	11.1	11.1
Prop In Lane	0.86		0.07	0.98		1.00	1.00		0.06	1.00		0.02
Lane Grp Cap(c), veh/h	337	0	0	425	0	308	267	705	733	270	714	749
V/C Ratio(X)	0.04	0.00	0.00	0.14	0.00	0.78	0.01	0.60	0.60	0.80	0.59	0.59
Avail Cap(c_a), veh/h	801	0	0	971	0	880	605	1497	1556	886	2091	2192
HCM Platoon Ratio	1.00	1.00	1.00	1.00	1.00	1.00	1.00	1.00	1.00	1.00	1.00	1.00
Upstream Filter(I)	1.00	0.00	0.00	1.00	0.00	1.00	1.00	1.00	1.00	1.00	1.00	1.00
Uniform Delay (d), s/veh	19.2	0.0	0.0	19.6	0.0	22.5	21.8	14.3	14.3	24.5	14.0	14.0
Incr Delay (d2), s/veh	0.0	0.0	0.0	0.1	0.0	3.2	0.0	1.2	1.1	2.1	1.1	1.1
Initial Q Delay(d3),s/veh	0.0	0.0	0.0	0.0	0.0	0.0	0.0	0.0	0.0	0.0	0.0	0.0
%ile BackOfQ(50%),veh/ln	0.2	0.0	0.0	0.7	0.0	3.3	0.0	4.3	4.5	3.0	4.2	4.4
Unsig. Movement Delay, s/veh												
LnGrp Delay(d),s/veh	19.2	0.0	0.0	19.7	0.0	25.8	21.8	15.5	15.4	26.6	15.1	15.1
LnGrp LOS	B	A	A	B	A	C	C	B	B	C	B	B
Approach Vol, veh/h		14			302			870			1081	
Approach Delay, s/veh		19.2			24.6			15.5			17.4	
Approach LOS		B			C			B			B	
Timer - Assigned Phs	1	2		4	5	6		8				
Phs Duration (G+Y+Rc), s	14.1	28.3		17.3	13.8	28.7		17.3				
Change Period (Y+Rc), s	5.0	4.6		5.1	5.0	* 4.6		* 5.1				
Max Green Setting (Gmax), s	30.0	50.4		34.9	20.0	* 70		* 35				
Max Q Clear Time (g_c+I1), s	9.1	13.3		11.1	2.1	13.1		3.7				
Green Ext Time (p_c), s	0.3	10.1		0.9	0.0	10.9		0.0				
<b>Intersection Summary</b>												
HCM 6th Ctrl Delay				17.6								
HCM 6th LOS				B								
<b>Notes</b>												
* HCM 6th computational engine requires equal clearance times for the phases crossing the barrier.												

Queues  
2: D St & Copeland St

Existing+Project  
Timing Plan: PM Peak



Lane Group	EBT	WBT	NBL	NBT	SBL	SBT
Lane Group Flow (vph)	251	39	240	869	19	744
v/c Ratio	0.70	0.26	0.73	0.62	0.13	0.72
Control Delay	19.2	30.5	38.2	4.8	44.9	22.0
Queue Delay	0.0	0.0	0.0	0.2	0.0	5.6
Total Delay	19.2	30.5	38.2	4.9	44.9	27.6
Queue Length 50th (ft)	20	14	126	28	11	301
Queue Length 95th (ft)	90	42	m#219	140	34	#586
Internal Link Dist (ft)	666	244		693		446
Turn Bay Length (ft)			60		60	
Base Capacity (vph)	457	248	328	1393	155	1030
Starvation Cap Reductn	0	0	0	89	0	227
Spillback Cap Reductn	0	0	0	0	0	0
Storage Cap Reductn	0	0	0	0	0	0
Reduced v/c Ratio	0.55	0.16	0.73	0.67	0.12	0.93

Intersection Summary

# 95th percentile volume exceeds capacity, queue may be longer.

Queue shown is maximum after two cycles.

m Volume for 95th percentile queue is metered by upstream signal.























# D - Pipeline Traffic Conditions





HCM 6th Signalized Intersection Summary  
1: D St & Lakeville St

Pipeline  
Timing Plan: AM Peak

												
Movement	EBL	EBT	EBR	WBL	WBT	WBR	NBL	NBT	NBR	SBL	SBT	SBR
Lane Configurations												
Traffic Volume (veh/h)	7	359	76	349	326	48	52	141	441	22	178	11
Future Volume (veh/h)	7	359	76	349	326	48	52	141	441	22	178	11
Initial Q (Qb), veh	0	0	0	0	0	0	0	0	0	0	0	0
Ped-Bike Adj(A_pbT)	1.00		0.99	1.00		1.00	1.00		0.97	1.00		0.94
Parking Bus, Adj	1.00	1.00	1.00	1.00	1.00	1.00	1.00	1.00	1.00	1.00	1.00	1.00
Work Zone On Approach		No			No			No			No	
Adj Sat Flow, veh/h/ln	1900	1781	1544	1841	1752	1900	1693	1885	1856	1781	1856	1707
Adj Flow Rate, veh/h	8	399	84	388	362	53	58	157	490	24	198	12
Peak Hour Factor	0.90	0.90	0.90	0.90	0.90	0.90	0.90	0.90	0.90	0.90	0.90	0.90
Percent Heavy Veh, %	0	8	24	4	10	0	14	1	3	8	3	13
Cap, veh/h	34	443	328	415	914	838	105	284	690	253	257	16
Arrive On Green	0.25	0.25	0.25	0.24	0.52	0.52	0.21	0.21	0.21	0.15	0.15	0.15
Sat Flow, veh/h	12	1758	1301	1753	1752	1606	502	1358	1525	1697	1724	104
Grp Volume(v), veh/h	407	0	84	388	362	53	215	0	490	24	0	210
Grp Sat Flow(s),veh/h/ln	1770	0	1301	1753	1752	1606	1860	0	1525	1697	0	1828
Q Serve(g_s), s	7.3	0.0	6.2	26.0	14.9	2.0	12.4	0.0	25.0	1.5	0.0	13.2
Cycle Q Clear(g_c), s	26.7	0.0	6.2	26.0	14.9	2.0	12.4	0.0	25.0	1.5	0.0	13.2
Prop In Lane	0.02		1.00	1.00		1.00	0.27		1.00	1.00		0.06
Lane Grp Cap(c), veh/h	476	0	328	415	914	838	388	0	690	253	0	273
V/C Ratio(X)	0.85	0.00	0.26	0.94	0.40	0.06	0.55	0.00	0.71	0.09	0.00	0.77
Avail Cap(c_a), veh/h	620	0	435	659	914	838	388	0	690	397	0	428
HCM Platoon Ratio	1.00	1.00	1.00	1.00	1.00	1.00	1.00	1.00	1.00	1.00	1.00	1.00
Upstream Filter(I)	1.00	0.00	1.00	1.00	1.00	1.00	1.00	0.00	1.00	1.00	0.00	1.00
Uniform Delay (d), s/veh	43.5	0.0	35.8	44.8	17.3	14.2	42.4	0.0	27.1	43.9	0.0	49.0
Incr Delay (d2), s/veh	7.3	0.0	0.2	11.1	0.1	0.0	2.2	0.0	3.7	0.1	0.0	3.4
Initial Q Delay(d3),s/veh	0.0	0.0	0.0	0.0	0.0	0.0	0.0	0.0	0.0	0.0	0.0	0.0
%ile BackOfQ(50%),veh/ln	12.6	0.0	2.0	12.5	6.0	0.7	6.0	0.0	11.9	0.6	0.0	6.3
Unsig. Movement Delay, s/veh												
LnGrp Delay(d),s/veh	50.8	0.0	36.0	56.0	17.4	14.2	44.5	0.0	30.8	44.1	0.0	52.4
LnGrp LOS	D	A	D	E	B	B	D	A	C	D	A	D
Approach Vol, veh/h		491			803			705			234	
Approach Delay, s/veh		48.3			35.8			35.0			51.5	
Approach LOS		D			D			D			D	
Timer - Assigned Phs		2	3	4		6		8				
Phs Duration (G+Y+Rc), s		30.3	32.3	34.9		22.2		67.3				
Change Period (Y+Rc), s		* 5.3	4.0	* 4.8		4.3		* 4.8				
Max Green Setting (Gmax), s		* 25	45.0	* 40		28.0		* 60				
Max Q Clear Time (g_c+I1), s		27.0	28.0	28.7		15.2		16.9				
Green Ext Time (p_c), s		0.0	0.3	1.4		0.8		1.6				
<b>Intersection Summary</b>												
HCM 6th Ctrl Delay				39.9								
HCM 6th LOS				D								
<b>Notes</b>												
* HCM 6th computational engine requires equal clearance times for the phases crossing the barrier.												

Intersection												
Int Delay, s/veh	22.9											
Movement	EBL	EBT	EBR	WBL	WBT	WBR	NBL	NBT	NBR	SBL	SBT	SBR
Lane Configurations		↕			↕		↕	↕			↕	
Traffic Vol, veh/h	36	0	216	0	0	1	210	695	1	3	609	38
Future Vol, veh/h	36	0	216	0	0	1	210	695	1	3	609	38
Conflicting Peds, #/hr	6	0	2	2	0	6	11	0	3	3	0	11
Sign Control	Stop	Stop	Stop	Stop	Stop	Stop	Free	Free	Free	Free	Free	Free
RT Channelized	-	-	None	-	-	None	-	-	None	-	-	None
Storage Length	-	-	-	-	-	-	60	-	-	-	-	-
Veh in Median Storage, #	-	0	-	-	0	-	-	0	-	-	0	-
Grade, %	-	0	-	-	0	-	-	0	-	-	0	-
Peak Hour Factor	88	88	88	88	88	88	88	88	88	88	88	88
Heavy Vehicles, %	0	0	4	0	0	0	5	3	0	0	4	47
Mvmt Flow	41	0	245	0	0	1	239	790	1	3	692	43

Major/Minor	Minor2		Minor1		Major1		Major2					
Conflicting Flow All	2006	2003	727	2116	2024	800	746	0	0	794	0	0
Stage 1	731	731	-	1272	1272	-	-	-	-	-	-	-
Stage 2	1275	1272	-	844	752	-	-	-	-	-	-	-
Critical Hdwy	6.1	5.5	5.2	6.1	5.5	5.2	4.15	-	-	4.1	-	-
Critical Hdwy Stg 1	6.1	5.5	-	6.1	5.5	-	-	-	-	-	-	-
Critical Hdwy Stg 2	6.1	5.5	-	6.1	5.5	-	-	-	-	-	-	-
Follow-up Hdwy	3.5	4	3.336	3.5	4	3.3	2.245	-	-	2.2	-	-
Pot Cap-1 Maneuver	78	105	519	67	103	485	849	-	-	836	-	-
Stage 1	416	430	-	208	241	-	-	-	-	-	-	-
Stage 2	207	241	-	361	421	-	-	-	-	-	-	-
Platoon blocked, %								-	-	-	-	-
Mov Cap-1 Maneuver	59	74	513	27	72	481	840	-	-	834	-	-
Mov Cap-2 Maneuver	59	74	-	27	72	-	-	-	-	-	-	-
Stage 1	295	423	-	148	172	-	-	-	-	-	-	-
Stage 2	147	172	-	187	414	-	-	-	-	-	-	-

Approach	EB		WB		NB		SB	
HCM Control Delay, s	155.3		12.5		2.5		0	
HCM LOS	F		B					

Minor Lane/Major Mvmt	NBL	NBT	NBR	EBLn1	WBLn1	SBL	SBT	SBR
Capacity (veh/h)	840	-	-	244	481	834	-	-
HCM Lane V/C Ratio	0.284	-	-	1.174	0.002	0.004	-	-
HCM Control Delay (s)	11	-	-	155.3	12.5	9.3	0	-
HCM Lane LOS	B	-	-	F	B	A	A	-
HCM 95th %tile Q(veh)	1.2	-	-	13.3	0	0	-	-

HCM 6th Signalized Intersection Summary  
3: D St & 1st St

Pipeline  
Timing Plan: AM Peak

Movement	EBL	EBT	EBR	WBL	WBT	WBR	NBL	NBT	NBR	SBL	SBT	SBR
Lane Configurations												
Traffic Volume (veh/h)	44	6	7	7	9	40	7	823	13	49	684	72
Future Volume (veh/h)	44	6	7	7	9	40	7	823	13	49	684	72
Initial Q (Qb), veh	0	0	0	0	0	0	0	0	0	0	0	0
Ped-Bike Adj(A_pbT)	0.98		0.99	0.99		0.98	1.00		0.97	1.00		0.97
Parking Bus, Adj	1.00	1.00	1.00	1.00	1.00	1.00	1.00	1.00	1.00	1.00	1.00	1.00
Work Zone On Approach		No			No			No			No	
Adj Sat Flow, veh/h/ln	1900	1900	1648	1648	1648	1796	1604	1856	1737	1870	1826	1900
Adj Flow Rate, veh/h	50	7	8	8	10	45	8	935	15	56	777	82
Peak Hour Factor	0.88	0.88	0.88	0.88	0.88	0.88	0.88	0.88	0.88	0.88	0.88	0.88
Percent Heavy Veh, %	0	0	17	17	17	7	20	3	11	2	5	0
Cap, veh/h	185	27	20	54	32	102	362	1240	20	119	816	86
Arrive On Green	0.10	0.10	0.10	0.10	0.10	0.10	0.47	1.00	1.00	0.07	0.50	0.50
Sat Flow, veh/h	1120	263	194	85	317	1005	1527	1820	29	1781	1618	171
Grp Volume(v), veh/h	65	0	0	63	0	0	8	0	950	56	0	859
Grp Sat Flow(s),veh/h/ln	1577	0	0	1407	0	0	1527	0	1849	1781	0	1789
Q Serve(g_s), s	0.0	0.0	0.0	0.0	0.0	0.0	0.3	0.0	0.0	2.7	0.0	41.2
Cycle Q Clear(g_c), s	3.0	0.0	0.0	3.7	0.0	0.0	0.3	0.0	0.0	2.7	0.0	41.2
Prop In Lane	0.77		0.12	0.13		0.71	1.00		0.02	1.00		0.10
Lane Grp Cap(c), veh/h	231	0	0	188	0	0	362	0	1260	119	0	902
V/C Ratio(X)	0.28	0.00	0.00	0.33	0.00	0.00	0.02	0.00	0.75	0.47	0.00	0.95
Avail Cap(c_a), veh/h	440	0	0	387	0	0	362	0	1260	178	0	902
HCM Platoon Ratio	1.00	1.00	1.00	1.00	1.00	1.00	2.00	2.00	2.00	1.00	1.00	1.00
Upstream Filter(I)	1.00	0.00	0.00	1.00	0.00	0.00	0.66	0.00	0.66	1.00	0.00	1.00
Uniform Delay (d), s/veh	37.7	0.0	0.0	38.0	0.0	0.0	18.1	0.0	0.0	40.4	0.0	21.3
Incr Delay (d2), s/veh	0.5	0.0	0.0	0.8	0.0	0.0	0.0	0.0	2.8	1.1	0.0	20.4
Initial Q Delay(d3),s/veh	0.0	0.0	0.0	0.0	0.0	0.0	0.0	0.0	0.0	0.0	0.0	0.0
%ile BackOfQ(50%),veh/ln	1.4	0.0	0.0	1.3	0.0	0.0	0.1	0.0	1.0	1.2	0.0	21.2
Unsig. Movement Delay, s/veh												
LnGrp Delay(d),s/veh	38.1	0.0	0.0	38.8	0.0	0.0	18.1	0.0	2.8	41.5	0.0	41.6
LnGrp LOS	D	A	A	D	A	A	B	A	A	D	A	D
Approach Vol, veh/h		65			63			958				915
Approach Delay, s/veh		38.1			38.8			2.9				41.6
Approach LOS		D			D			A				D
Timer - Assigned Phs	1	2		4	5	6		8				
Phs Duration (G+Y+Rc), s	10.0	65.9		14.0	26.0	50.0		14.0				
Change Period (Y+Rc), s	4.0	4.6		* 4.9	4.6	* 4.6		* 4.9				
Max Green Setting (Gmax), s	9.0	45.4		* 22	9.0	* 45		* 22				
Max Q Clear Time (g_c+I1), s	4.7	2.0		5.0	2.3	43.2		5.7				
Green Ext Time (p_c), s	0.0	15.8		0.2	0.0	1.5		0.2				
<b>Intersection Summary</b>												
HCM 6th Ctrl Delay				22.9								
HCM 6th LOS				C								
<b>Notes</b>												
* HCM 6th computational engine requires equal clearance times for the phases crossing the barrier.												

# HCM 6th Signalized Intersection Summary

## 4: D St & Petaluma Blvd

Pipeline  
Timing Plan: AM Peak



Movement	EBL	EBT	EBR	WBL	WBT	WBR	NBL	NBT	NBR	SBL	SBT	SBR
Lane Configurations												
Traffic Volume (veh/h)	156	386	69	67	280	305	77	368	46	154	376	88
Future Volume (veh/h)	156	386	69	67	280	305	77	368	46	154	376	88
Initial Q (Qb), veh	0	0	0	0	0	0	0	0	0	0	0	0
Ped-Bike Adj(A_pbT)	1.00		0.99	1.00		0.99	1.00		0.97	1.00		0.99
Parking Bus, Adj	1.00	1.00	1.00	1.00	1.00	1.00	1.00	1.00	1.00	1.00	1.00	1.00
Work Zone On Approach		No		No		No		No		No		No
Adj Sat Flow, veh/h/ln	1826	1826	1796	1826	1841	1885	1870	1870	1796	1856	1811	1856
Adj Flow Rate, veh/h	170	420	75	73	304	332	84	400	50	167	409	96
Peak Hour Factor	0.92	0.92	0.92	0.92	0.92	0.92	0.92	0.92	0.92	0.92	0.92	0.92
Percent Heavy Veh, %	5	5	7	5	4	1	2	2	7	3	6	3
Cap, veh/h	155	500	413	130	463	398	139	493	62	258	687	593
Arrive On Green	0.09	0.27	0.27	0.07	0.25	0.25	0.08	0.30	0.30	0.29	0.76	0.76
Sat Flow, veh/h	1739	1826	1508	1739	1841	1582	1781	1624	203	1767	1811	1564
Grp Volume(v), veh/h	170	420	75	73	304	332	84	0	450	167	409	96
Grp Sat Flow(s),veh/h/ln	1739	1826	1508	1739	1841	1582	1781	0	1827	1767	1811	1564
Q Serve(g_s), s	8.0	19.5	3.4	3.6	13.3	17.9	4.1	0.0	20.5	7.4	9.0	1.0
Cycle Q Clear(g_c), s	8.0	19.5	3.4	3.6	13.3	17.9	4.1	0.0	20.5	7.4	9.0	1.0
Prop In Lane	1.00		1.00	1.00		1.00	1.00		0.11	1.00		1.00
Lane Grp Cap(c), veh/h	155	500	413	130	463	398	139	0	554	258	687	593
V/C Ratio(X)	1.10	0.84	0.18	0.56	0.66	0.83	0.60	0.00	0.81	0.65	0.60	0.16
Avail Cap(c_a), veh/h	155	530	437	155	538	462	158	0	554	258	687	593
HCM Platoon Ratio	1.00	1.00	1.00	1.00	1.00	1.00	1.00	1.00	1.00	2.00	2.00	2.00
Upstream Filter(l)	1.00	1.00	1.00	1.00	1.00	1.00	1.00	0.00	1.00	0.75	0.75	0.75
Uniform Delay (d), s/veh	41.0	30.8	25.0	40.2	30.2	31.9	40.1	0.0	29.0	29.8	7.8	3.3
Incr Delay (d2), s/veh	101.6	11.6	0.3	1.4	2.9	12.0	2.7	0.0	12.3	3.3	2.8	0.4
Initial Q Delay(d3),s/veh	0.0	0.0	0.0	0.0	0.0	0.0	0.0	0.0	0.0	0.0	0.0	0.0
%ile BackOfQ(50%),veh/ln	7.7	9.9	1.2	1.6	6.1	8.0	1.9	0.0	10.7	3.0	2.8	0.5
Unsig. Movement Delay, s/veh												
LnGrp Delay(d),s/veh	142.6	42.5	25.3	41.7	33.1	43.9	42.8	0.0	41.2	33.1	10.7	3.7
LnGrp LOS	F	D	C	D	C	D	D	A	D	C	B	A
Approach Vol, veh/h		665			709			534			672	
Approach Delay, s/veh		66.1			39.0			41.5			15.3	
Approach LOS		E			D			D			B	
Timer - Assigned Phs	1	2	3	4	5	6	7	8				
Phs Duration (G+Y+Rc), s	7.8	32.0	10.7	29.5	11.0	38.7	12.9	27.3				
Change Period (Y+Rc), s	4.6	* 4.7	4.0	* 4.9	4.0	4.6	* 4.9	* 4.7				
Max Green Setting (Gmax), s	15	* 27	8.0	* 26	8.0	30.4	* 8	* 26				
Max Q Clear Time (g_c+1), s	19.4	22.5	5.6	21.5	6.1	11.0	10.0	19.9				
Green Ext Time (p_c), s	0.0	1.1	0.0	1.5	0.0	2.4	0.0	2.3				

### Intersection Summary

HCM 6th Ctrl Delay	40.3
HCM 6th LOS	D

### Notes

- User approved pedestrian interval to be less than phase max green.
- \* HCM 6th computational engine requires equal clearance times for the phases crossing the barrier.

# HCM 6th Signalized Intersection Summary

## 5: Washington St & Lakeville St

Pipeline  
Timing Plan: AM Peak



Movement	EBL	EBT	EBR	WBL	WBT	WBR	NBL	NBT	NBR	SBL	SBT	SBR
Lane Configurations		↕		↙	↘		↙	↘		↙	↘	
Traffic Volume (veh/h)	34	159	28	217	114	53	18	728	206	61	787	34
Future Volume (veh/h)	34	159	28	217	114	53	18	728	206	61	787	34
Initial Q (Qb), veh	0	0	0	0	0	0	0	0	0	0	0	0
Ped-Bike Adj(A_pbT)	1.00		0.99	1.00		0.99	1.00		0.97	1.00		0.97
Parking Bus, Adj	1.00	1.00	1.00	1.00	1.00	1.00	1.00	1.00	1.00	1.00	1.00	1.00
Work Zone On Approach		No		No		No		No		No		No
Adj Sat Flow, veh/h/ln	1856	1663	1381	1767	1722	1811	1337	1856	1796	1722	1826	1752
Adj Flow Rate, veh/h	38	179	31	244	128	60	20	818	231	69	884	38
Peak Hour Factor	0.89	0.89	0.89	0.89	0.89	0.89	0.89	0.89	0.89	0.89	0.89	0.89
Percent Heavy Veh, %	3	16	35	9	12	6	38	3	7	12	5	10
Cap, veh/h	43	203	35	287	188	88	273	1138	321	131	958	41
Arrive On Green	0.17	0.17	0.17	0.17	0.17	0.17	0.43	0.84	0.84	0.08	0.28	0.28
Sat Flow, veh/h	247	1163	201	1682	1105	518	1273	2695	761	1640	3383	145
Grp Volume(v), veh/h	248	0	0	244	0	188	20	535	514	69	453	469
Grp Sat Flow(s),veh/h/ln	1612	0	0	1682	0	1622	1273	1763	1693	1640	1735	1794
Q Serve(g_s), s	18.8	0.0	0.0	17.6	0.0	13.6	1.2	15.0	15.0	5.1	31.7	31.7
Cycle Q Clear(g_c), s	18.8	0.0	0.0	17.6	0.0	13.6	1.2	15.0	15.0	5.1	31.7	31.7
Prop In Lane	0.15		0.12	1.00		0.32	1.00		0.45	1.00		0.08
Lane Grp Cap(c), veh/h	281	0	0	287	0	276	273	745	715	131	491	508
V/C Ratio(X)	0.88	0.00	0.00	0.85	0.00	0.68	0.07	0.72	0.72	0.53	0.92	0.92
Avail Cap(c_a), veh/h	374	0	0	400	0	385	273	745	715	131	491	508
HCM Platoon Ratio	1.00	1.00	1.00	1.00	1.00	1.00	2.00	2.00	2.00	1.00	1.00	1.00
Upstream Filter(l)	1.00	0.00	0.00	0.94	0.00	0.94	0.85	0.85	0.85	1.00	1.00	1.00
Uniform Delay (d), s/veh	50.3	0.0	0.0	50.3	0.0	48.7	28.4	6.8	6.8	55.2	43.5	43.5
Incr Delay (d2), s/veh	14.3	0.0	0.0	8.5	0.0	1.0	0.0	5.0	5.3	1.9	25.3	24.7
Initial Q Delay(d3),s/veh	0.0	0.0	0.0	0.0	0.0	0.0	0.0	0.0	0.0	0.0	0.0	0.0
%ile BackOfQ(50%),veh/lr	8.7	0.0	0.0	8.1	0.0	5.6	0.4	3.8	3.7	2.2	17.0	17.4
Unsig. Movement Delay, s/veh												
LnGrp Delay(d),s/veh	64.6	0.0	0.0	58.8	0.0	49.7	28.4	11.8	12.0	57.1	68.8	68.2
LnGrp LOS	E	A	A	E	A	D	C	B	B	E	E	E
Approach Vol, veh/h		248		432		1069		991				
Approach Delay, s/veh		64.6		54.9		12.2		67.7				
Approach LOS		E		D		B		E				
Timer - Assigned Phs	1	2		4	5	6		8				
Phs Duration (G+Y+Rc), s	4.0	57.6		26.6	31.6	40.0		26.8				
Change Period (Y+Rc), s	4.0	* 4.8		* 5.3	4.8	* 4.6		5.0				
Max Green Setting (Gmax), s	10.0	* 37		* 30	12.0	* 35		29.0				
Max Q Clear Time (g_c+1), s	17.0			19.6	3.2	33.7		20.8				
Green Ext Time (p_c), s	0.0	5.1		0.8	0.0	0.8		0.6				

### Intersection Summary

HCM 6th Ctrl Delay	43.8
HCM 6th LOS	D

### Notes

- User approved pedestrian interval to be less than phase max green.
- \* HCM 6th computational engine requires equal clearance times for the phases crossing the barrier.

# HCM 6th Signalized Intersection Summary

## 6: Washington St & Copeland St

Pipeline  
Timing Plan: AM Peak



Movement	EBL	EBT	EBR	WBL	WBT	WBR	NBL	NBT	NBR	SBL	SBT	SBR
Lane Configurations		↕			↕	↕	↕	↕		↕	↕	
Traffic Volume (veh/h)	6	0	2	41	3	204	2	795	40	212	765	11
Future Volume (veh/h)	6	0	2	41	3	204	2	795	40	212	765	11
Initial Q (Qb), veh	0	0	0	0	0	0	0	0	0	0	0	0
Ped-Bike Adj(A_pbT)	1.00		1.00	1.00		0.98	1.00		0.97	1.00		0.97
Parking Bus, Adj	1.00	1.00	1.00	1.00	1.00	1.00	1.00	1.00	1.00	1.00	1.00	1.00
Work Zone On Approach		No			No			No			No	
Adj Sat Flow, veh/h/ln	418	1900	1900	1618	1900	1737	418	1856	1900	1856	1826	1070
Adj Flow Rate, veh/h	7	0	2	48	3	237	2	924	47	247	890	13
Peak Hour Factor	0.86	0.86	0.86	0.86	0.86	0.86	0.86	0.86	0.86	0.86	0.86	0.86
Percent Heavy Veh, %	100	0	0	19	0	11	100	3	0	3	5	56
Cap, veh/h	209	6	47	319	18	272	52	1292	66	557	1970	29
Arrive On Green	0.19	0.00	0.19	0.19	0.19	0.19	0.13	0.38	0.38	0.32	0.56	0.56
Sat Flow, veh/h	838	35	249	1400	98	1446	398	3408	173	1767	3499	51
Grp Volume(v), veh/h	9	0	0	51	0	237	2	478	493	247	441	462
Grp Sat Flow(s),veh/h/ln	121	0	0	1497	0	1446	398	1763	1818	1767	1735	1815
Q Serve(g_s), s	0.0	0.0	0.0	0.0	0.0	19.9	0.5	28.9	28.9	13.9	18.6	18.6
Cycle Q Clear(g_c), s	3.0	0.0	0.0	2.9	0.0	19.9	0.5	28.9	28.9	13.9	18.6	18.6
Prop In Lane	0.78		0.22	0.94		1.00	1.00		0.10	1.00		0.03
Lane Grp Cap(c), veh/h	262	0	0	338	0	272	52	668	690	557	977	1022
V/C Ratio(X)	0.03	0.00	0.00	0.15	0.00	0.87	0.04	0.72	0.72	0.44	0.45	0.45
Avail Cap(c_a), veh/h	366	0	0	447	0	381	52	668	690	557	977	1022
HCM Platoon Ratio	1.00	1.00	1.00	1.00	1.00	1.00	1.00	1.00	1.00	1.00	1.00	1.00
Upstream Filter(l)	1.00	0.00	0.00	1.00	0.00	1.00	1.00	1.00	1.00	0.73	0.73	0.73
Uniform Delay (d), s/veh	41.4	0.0	0.0	42.4	0.0	49.3	47.4	33.0	33.0	34.1	16.0	16.0
Incr Delay (d2), s/veh	0.0	0.0	0.0	0.2	0.0	13.4	0.1	6.4	6.2	0.2	1.1	1.1
Initial Q Delay(d3),s/veh	0.0	0.0	0.0	0.0	0.0	0.0	0.0	0.0	0.0	0.0	0.0	0.0
%ile BackOfQ(50%),veh/ln	0.2	0.0	0.0	1.4	0.0	8.2	0.1	13.6	14.0	6.1	7.7	8.0
Unsig. Movement Delay, s/veh												
LnGrp Delay(d),s/veh	41.5	0.0	0.0	42.5	0.0	62.7	47.5	39.5	39.3	34.2	17.1	17.0
LnGrp LOS	D	A	A	D	A	E	D	D	D	C	B	B
Approach Vol, veh/h		9			288			973			1150	
Approach Delay, s/veh		41.5			59.1			39.4			20.8	
Approach LOS		D			E			D			C	
Timer - Assigned Phs	1	2		4	5	6		8				
Phs Duration (G+Y+Rc), s	44.4	52.0		28.6	21.4	75.0		28.6				
Change Period (Y+Rc), s	5.0	4.6		5.1	5.0	* 4.6		* 5.1				
Max Green Setting (Gmax), s	29.0	47.4		32.9	7.0	* 70		* 34				
Max Q Clear Time (g_c+1/3g), s	11.9	30.9		21.9	2.5	20.6		5.0				
Green Ext Time (p_c), s	0.3	8.1		0.7	0.0	11.5		0.0				

### Intersection Summary

HCM 6th Ctrl Delay	32.9
HCM 6th LOS	C

### Notes























\* HCM 6th computational engine requires equal clearance times for the phases crossing the barrier.

# HCM 6th Signalized Intersection Summary

## 1: D St & Lakeville St

Pipeline

Timing Plan: PM Peak

												
Movement	EBL	EBT	EBR	WBL	WBT	WBR	NBL	NBT	NBR	SBL	SBT	SBR
Lane Configurations												
Traffic Volume (veh/h)	9	306	70	413	397	41	99	176	539	23	188	14
Future Volume (veh/h)	9	306	70	413	397	41	99	176	539	23	188	14
Initial Q (Qb), veh	0	0	0	0	0	0	0	0	0	0	0	0
Ped-Bike Adj(A_pbT)	0.99		0.97	1.00		0.97	1.00		0.95	1.00		0.90
Parking Bus, Adj	1.00	1.00	1.00	1.00	1.00	1.00	1.00	1.00	1.00	1.00	1.00	1.00
Work Zone On Approach		No			No			No			No	
Adj Sat Flow, veh/h/ln	1900	1826	1678	1856	1870	1900	1826	1885	1870	1900	1885	1900
Adj Flow Rate, veh/h	10	329	75	444	427	44	106	189	580	25	202	15
Peak Hour Factor	0.93	0.93	0.93	0.93	0.93	0.93	0.93	0.93	0.93	0.93	0.93	0.93
Percent Heavy Veh, %	0	5	15	3	2	0	5	1	2	0	1	0
Cap, veh/h	35	374	291	470	953	794	139	247	736	293	278	21
Arrive On Green	0.21	0.21	0.21	0.27	0.51	0.51	0.21	0.21	0.21	0.16	0.16	0.16
Sat Flow, veh/h	21	1782	1385	1767	1870	1557	665	1186	1508	1810	1718	128
Grp Volume(v), veh/h	339	0	75	444	427	44	295	0	580	25	0	217
Grp Sat Flow(s),veh/h/ln	1803	0	1385	1767	1870	1557	1852	0	1508	1810	0	1846
Q Serve(g_s), s	7.0	0.0	5.4	29.5	17.4	1.7	18.0	0.0	25.0	1.4	0.0	13.4
Cycle Q Clear(g_c), s	21.8	0.0	5.4	29.5	17.4	1.7	18.0	0.0	25.0	1.4	0.0	13.4
Prop In Lane	0.03		1.00	1.00		1.00	0.36		1.00	1.00		0.07
Lane Grp Cap(c), veh/h	410	0	291	470	953	794	386	0	736	293	0	299
V/C Ratio(X)	0.83	0.00	0.26	0.94	0.45	0.06	0.76	0.00	0.79	0.09	0.00	0.73
Avail Cap(c_a), veh/h	629	0	462	663	953	794	386	0	736	423	0	431
HCM Platoon Ratio	1.00	1.00	1.00	1.00	1.00	1.00	1.00	1.00	1.00	1.00	1.00	1.00
Upstream Filter(I)	1.00	0.00	1.00	1.00	1.00	1.00	1.00	0.00	1.00	1.00	0.00	1.00
Uniform Delay (d), s/veh	46.0	0.0	39.5	43.1	18.7	14.8	44.7	0.0	26.8	42.7	0.0	47.7
Incr Delay (d2), s/veh	3.1	0.0	0.2	15.7	0.1	0.0	9.3	0.0	6.0	0.1	0.0	2.6
Initial Q Delay(d3),s/veh	0.0	0.0	0.0	0.0	0.0	0.0	0.0	0.0	0.0	0.0	0.0	0.0
%ile BackOfQ(50%),veh/ln	10.1	0.0	1.9	14.8	7.5	0.6	9.3	0.0	14.9	0.6	0.0	6.4
Unsig. Movement Delay, s/veh												
LnGrp Delay(d),s/veh	49.0	0.0	39.7	58.8	18.8	14.8	54.0	0.0	32.8	42.8	0.0	50.3
LnGrp LOS	D	A	D	E	B	B	D	A	C	D	A	D
Approach Vol, veh/h		414			915			875				242
Approach Delay, s/veh		47.3			38.0			40.0				49.5
Approach LOS		D			D			D				D
Timer - Assigned Phs		2	3	4		6		8				
Phs Duration (G+Y+Rc), s		30.3	35.9	30.0		23.7		65.9				
Change Period (Y+Rc), s		* 5.3	4.0	* 4.8		4.3		* 4.8				
Max Green Setting (Gmax), s		* 25	45.0	* 40		28.0		* 60				
Max Q Clear Time (g_c+I1), s		27.0	31.5	23.8		15.4		19.4				
Green Ext Time (p_c), s		0.0	0.4	1.3		0.9		1.9				
<b>Intersection Summary</b>												
HCM 6th Ctrl Delay			41.4									
HCM 6th LOS			D									
<b>Notes</b>												
* HCM 6th computational engine requires equal clearance times for the phases crossing the barrier.												

Intersection												
Int Delay, s/veh	48.1											
Movement	EBL	EBT	EBR	WBL	WBT	WBR	NBL	NBT	NBR	SBL	SBT	SBR
Lane Configurations		↕			↕		↕	↕			↕	
Traffic Vol, veh/h	30	6	233	3	4	3	252	847	6	0	722	86
Future Vol, veh/h	30	6	233	3	4	3	252	847	6	0	722	86
Conflicting Peds, #/hr	4	0	7	7	0	4	17	0	3	3	0	17
Sign Control	Stop	Stop	Stop	Stop	Stop	Stop	Free	Free	Free	Free	Free	Free
RT Channelized	-	-	None	-	-	None	-	-	None	-	-	None
Storage Length	-	-	-	-	-	-	60	-	-	-	-	-
Veh in Median Storage, #	-	0	-	-	0	-	-	0	-	-	0	-
Grade, %	-	0	-	-	0	-	-	0	-	-	0	-
Peak Hour Factor	93	93	93	93	93	93	93	93	93	93	93	93
Heavy Vehicles, %	0	25	3	0	0	0	5	2	0	0	2	18
Mvmt Flow	32	6	251	3	4	3	271	911	6	0	776	92

Major/Minor	Minor2		Minor1		Major1		Major2					
Conflicting Flow All	2303	2301	846	2417	2344	921	885	0	0	920	0	0
Stage 1	839	839	-	1459	1459	-	-	-	-	-	-	-
Stage 2	1464	1462	-	958	885	-	-	-	-	-	-	-
Critical Hdwy	6.1	5.8	5.2	6.1	5.5	5.2	4.15	-	-	4.1	-	-
Critical Hdwy Stg 1	6.1	5.75	-	6.1	5.5	-	-	-	-	-	-	-
Critical Hdwy Stg 2	6.1	5.75	-	6.1	5.5	-	-	-	-	-	-	-
Follow-up Hdwy	3.5	4.225	3.327	3.5	4	3.3	2.245	-	-	2.2	-	-
Pot Cap-1 Maneuver	52	61	460	44	70	427	752	-	-	750	-	-
Stage 1	363	351	-	162	196	-	-	-	-	-	-	-
Stage 2	161	173	-	312	366	-	-	-	-	-	-	-
Platoon blocked, %								-	-	-	-	-
Mov Cap-1 Maneuver	34	38	450	12	44	424	740	-	-	748	-	-
Mov Cap-2 Maneuver	34	38	-	12	44	-	-	-	-	-	-	-
Stage 1	227	345	-	102	124	-	-	-	-	-	-	-
Stage 2	97	109	-	135	360	-	-	-	-	-	-	-

Approach	EB		WB		NB		SB	
HCM Control Delay, s	373.2		189.4		2.9		0	
HCM LOS	F		F					

Minor Lane/Major Mvmt	NBL	NBT	NBR	EBLn1	WBLn1	SBL	SBT	SBR
Capacity (veh/h)	740	-	-	173	29	748	-	-
HCM Lane V/C Ratio	0.366	-	-	1.672	0.371	-	-	-
HCM Control Delay (s)	12.6	-	-	373.2	189.4	0	-	-
HCM Lane LOS	B	-	-	F	F	A	-	-
HCM 95th %tile Q(veh)	1.7	-	-	20	1.2	0	-	-

Notes  
 ~: Volume exceeds capacity    \$: Delay exceeds 300s    +: Computation Not Defined    \*: All major volume in platoon



HCM 6th Signalized Intersection Summary  
3: D St & 1st St

Pipeline  
Timing Plan: PM Peak

Movement	EBL	EBT	EBR	WBL	WBT	WBR	NBL	NBT	NBR	SBL	SBT	SBR
Lane Configurations												
Traffic Volume (veh/h)	71	4	12	16	7	57	6	984	23	67	871	63
Future Volume (veh/h)	71	4	12	16	7	57	6	984	23	67	871	63
Initial Q (Qb), veh	0	0	0	0	0	0	0	0	0	0	0	0
Ped-Bike Adj(A_pbT)	0.98		0.98	0.99		0.97	1.00		0.97	1.00		0.97
Parking Bus, Adj	1.00	1.00	1.00	1.00	1.00	1.00	1.00	1.00	1.00	1.00	1.00	1.00
Work Zone On Approach		No			No			No			No	
Adj Sat Flow, veh/h/ln	1900	1900	1900	1781	1900	1856	1900	1856	1707	1841	1870	1900
Adj Flow Rate, veh/h	72	4	12	16	7	58	6	1004	23	68	889	64
Peak Hour Factor	0.98	0.98	0.98	0.98	0.98	0.98	0.98	0.98	0.98	0.98	0.98	0.98
Percent Heavy Veh, %	0	0	0	8	0	3	0	3	13	4	2	0
Cap, veh/h	154	11	18	54	24	110	455	1339	31	102	934	67
Arrive On Green	0.09	0.09	0.09	0.09	0.09	0.09	0.50	1.00	1.00	0.06	0.54	0.54
Sat Flow, veh/h	1104	124	194	208	268	1200	1810	1805	41	1753	1719	124
Grp Volume(v), veh/h	88	0	0	81	0	0	6	0	1027	68	0	953
Grp Sat Flow(s),veh/h/ln	1422	0	0	1676	0	0	1810	0	1847	1753	0	1843
Q Serve(g_s), s	1.7	0.0	0.0	0.0	0.0	0.0	0.2	0.0	0.0	4.7	0.0	60.6
Cycle Q Clear(g_c), s	7.3	0.0	0.0	5.6	0.0	0.0	0.2	0.0	0.0	4.7	0.0	60.6
Prop In Lane	0.82		0.14	0.20		0.72	1.00		0.02	1.00		0.07
Lane Grp Cap(c), veh/h	183	0	0	188	0	0	455	0	1369	102	0	1002
V/C Ratio(X)	0.48	0.00	0.00	0.43	0.00	0.00	0.01	0.00	0.75	0.67	0.00	0.95
Avail Cap(c_a), veh/h	429	0	0	461	0	0	455	0	1369	127	0	1002
HCM Platoon Ratio	1.00	1.00	1.00	1.00	1.00	1.00	2.00	2.00	2.00	1.00	1.00	1.00
Upstream Filter(l)	1.00	0.00	0.00	1.00	0.00	0.00	0.62	0.00	0.62	1.00	0.00	1.00
Uniform Delay (d), s/veh	54.4	0.0	0.0	53.8	0.0	0.0	23.1	0.0	0.0	57.2	0.0	26.7
Incr Delay (d2), s/veh	1.5	0.0	0.0	1.2	0.0	0.0	0.0	0.0	2.4	4.9	0.0	18.9
Initial Q Delay(d3),s/veh	0.0	0.0	0.0	0.0	0.0	0.0	0.0	0.0	0.0	0.0	0.0	0.0
%ile BackOfQ(50%),veh/ln	2.8	0.0	0.0	2.5	0.0	0.0	0.1	0.0	0.9	2.2	0.0	31.0
Unsig. Movement Delay, s/veh												
LnGrp Delay(d),s/veh	55.9	0.0	0.0	55.0	0.0	0.0	23.1	0.0	2.4	62.1	0.0	45.6
LnGrp LOS	E	A	A	D	A	A	C	A	A	E	A	D
Approach Vol, veh/h		88			81			1033			1021	
Approach Delay, s/veh		55.9			55.0			2.5			46.7	
Approach LOS		E			D			A			D	
Timer - Assigned Phs	1	2		4	5	6		8				
Phs Duration (G+Y+Rc), s	11.2	96.6		16.2	35.8	72.0		16.2				
Change Period (Y+Rc), s	4.0	4.6		* 4.9	4.6	* 4.6		* 4.9				
Max Green Setting (Gmax), s	9.0	68.4		* 33	10.0	* 67		* 33				
Max Q Clear Time (g_c+I1), s	6.7	2.0		9.3	2.2	62.6		7.6				
Green Ext Time (p_c), s	0.0	21.1		0.4	0.0	3.4		0.4				

Intersection Summary

HCM 6th Ctrl Delay	26.8
HCM 6th LOS	C

Notes

\* HCM 6th computational engine requires equal clearance times for the phases crossing the barrier.

# HCM 6th Signalized Intersection Summary

## 4: D St & Petaluma Blvd

Pipeline  
Timing Plan: PM Peak



Movement	EBL	EBT	EBR	WBL	WBT	WBR	NBL	NBT	NBR	SBL	SBT	SBR
Lane Configurations												
Traffic Volume (veh/h)	188	254	90	148	305	279	81	440	27	210	567	127
Future Volume (veh/h)	188	254	90	148	305	279	81	440	27	210	567	127
Initial Q (Qb), veh	0	0	0	0	0	0	0	0	0	0	0	0
Ped-Bike Adj(A_pbT)	1.00		0.94	1.00		0.93	1.00		0.95	1.00		0.95
Parking Bus, Adj	1.00	1.00	1.00	1.00	1.00	1.00	1.00	1.00	1.00	1.00	1.00	1.00
Work Zone On Approach		No			No			No			No	
Adj Sat Flow, veh/h/ln	1841	1885	1900	1856	1885	1870	1870	1856	1900	1900	1856	1870
Adj Flow Rate, veh/h	204	276	98	161	332	303	88	478	29	228	616	138
Peak Hour Factor	0.92	0.92	0.92	0.92	0.92	0.92	0.92	0.92	0.92	0.92	0.92	0.92
Percent Heavy Veh, %	4	1	0	3	1	2	2	3	0	0	3	2
Cap, veh/h	230	446	356	187	389	303	110	649	39	251	841	685
Arrive On Green	0.13	0.24	0.24	0.11	0.21	0.21	0.06	0.38	0.38	0.28	0.91	0.91
Sat Flow, veh/h	1753	1885	1506	1767	1885	1469	1781	1725	105	1810	1856	1511
Grp Volume(v), veh/h	204	276	98	161	332	303	88	0	507	228	616	138
Grp Sat Flow(s),veh/h/ln	1753	1885	1506	1767	1885	1469	1781	0	1830	1810	1856	1511
Q Serve(g_s), s	14.2	16.2	6.6	11.1	21.0	18.8	6.0	0.0	29.6	15.1	11.4	0.8
Cycle Q Clear(g_c), s	14.2	16.2	6.6	11.1	21.0	18.8	6.0	0.0	29.6	15.1	11.4	0.8
Prop In Lane	1.00		1.00	1.00		1.00	1.00		0.06	1.00		1.00
Lane Grp Cap(c), veh/h	230	446	356	187	389	303	110	0	689	251	841	685
V/C Ratio(X)	0.89	0.62	0.27	0.86	0.85	1.00	0.80	0.00	0.74	0.91	0.73	0.20
Avail Cap(c_a), veh/h	254	446	356	242	430	335	187	0	689	321	841	685
HCM Platoon Ratio	1.00	1.00	1.00	1.00	1.00	1.00	1.00	1.00	1.00	2.00	2.00	2.00
Upstream Filter(I)	1.00	1.00	1.00	1.00	1.00	1.00	1.00	0.00	1.00	0.71	0.71	0.71
Uniform Delay (d), s/veh	53.0	42.3	38.6	54.5	47.4	26.7	57.4	0.0	33.3	44.0	3.7	1.2
Incr Delay (d2), s/veh	26.2	3.0	0.6	17.7	15.1	48.4	4.9	0.0	6.9	16.5	4.0	0.5
Initial Q Delay(d3),s/veh	0.0	0.0	0.0	0.0	0.0	0.0	0.0	0.0	0.0	0.0	0.0	0.0
%ile BackOfQ(50%),veh/ln	7.9	7.9	2.5	5.9	11.5	10.6	2.9	0.0	14.5	7.1	2.7	0.5
Unsig. Movement Delay, s/veh												
LnGrp Delay(d),s/veh	79.1	45.3	39.2	72.2	62.5	75.1	62.2	0.0	40.2	60.5	7.7	1.7
LnGrp LOS	E	D	D	E	E	F	E	A	D	E	A	A
Approach Vol, veh/h		578			796			595			982	
Approach Delay, s/veh		56.2			69.3			43.5			19.1	
Approach LOS		E			E			D			B	
Timer - Assigned Phs	1	2	3	4	5	6	7	8				
Phs Duration (G+Y+Rc), s	31.2	51.4	17.1	34.3	11.7	60.9	21.1	30.3				
Change Period (Y+Rc), s	4.0	* 4.7	4.0	* 4.9	4.0	* 4.7	* 4.9	* 4.7				
Max Green Setting (Gmax), s	27.0	* 38	17.0	* 29	13.0	* 47	* 18	* 28				
Max Q Clear Time (g_c+11), s	11.7	31.6	13.1	18.2	8.0	13.4	16.2	23.0				
Green Ext Time (p_c), s	0.2	1.6	0.1	2.0	0.0	4.4	0.1	2.0				

### Intersection Summary

HCM 6th Ctrl Delay	44.8
HCM 6th LOS	D

### Notes

- User approved pedestrian interval to be less than phase max green.
- \* HCM 6th computational engine requires equal clearance times for the phases crossing the barrier.

# HCM 6th Signalized Intersection Summary

## 5: Washington St & Lakeville St

Pipeline  
Timing Plan: PM Peak



Movement	EBL	EBT	EBR	WBL	WBT	WBR	NBL	NBT	NBR	SBL	SBT	SBR
Lane Configurations		↕		↗	↘		↖	↗		↖	↘	
Traffic Volume (veh/h)	64	113	41	222	192	102	40	869	181	73	858	47
Future Volume (veh/h)	64	113	41	222	192	102	40	869	181	73	858	47
Initial Q (Qb), veh	0	0	0	0	0	0	0	0	0	0	0	0
Ped-Bike Adj(A_pbT)	1.00		0.98	1.00		0.98	1.00		0.96	1.00		0.95
Parking Bus, Adj	1.00	1.00	1.00	1.00	1.00	1.00	1.00	1.00	1.00	1.00	1.00	1.00
Work Zone On Approach		No		No		No		No		No		No
Adj Sat Flow, veh/h/ln	1826	1811	1811	1870	1826	1900	1900	1856	1811	1870	1885	1900
Adj Flow Rate, veh/h	67	118	43	231	200	106	42	905	189	76	894	49
Peak Hour Factor	0.96	0.96	0.96	0.96	0.96	0.96	0.96	0.96	0.96	0.96	0.96	0.96
Percent Heavy Veh, %	5	6	6	2	5	0	0	3	6	2	1	0
Cap, veh/h	77	135	49	357	223	118	383	1190	248	144	955	52
Arrive On Green	0.15	0.15	0.15	0.20	0.20	0.20	0.21	0.41	0.41	0.08	0.28	0.28
Sat Flow, veh/h	506	891	325	1781	1116	591	1810	2881	601	1781	3442	189
Grp Volume(v), veh/h	228	0	0	231	0	306	42	553	541	76	465	478
Grp Sat Flow(s),veh/h/ln	1721	0	0	1781	0	1707	1810	1763	1720	1781	1791	1840
Q Serve(g_s), s	16.1	0.0	0.0	14.8	0.0	21.7	2.3	33.3	33.4	5.1	31.4	31.4
Cycle Q Clear(g_c), s	16.1	0.0	0.0	14.8	0.0	21.7	2.3	33.3	33.4	5.1	31.4	31.4
Prop In Lane	0.29		0.19	1.00		0.35	1.00		0.35	1.00		0.10
Lane Grp Cap(c), veh/h	262	0	0	357	0	342	383	728	710	144	497	510
V/C Ratio(X)	0.87	0.00	0.00	0.65	0.00	0.90	0.11	0.76	0.76	0.53	0.94	0.94
Avail Cap(c_a), veh/h	375	0	0	441	0	423	383	728	710	144	497	510
HCM Platoon Ratio	1.00	1.00	1.00	1.00	1.00	1.00	1.00	1.00	1.00	1.00	1.00	1.00
Upstream Filter(I)	1.00	0.00	0.00	0.91	0.00	0.91	0.74	0.74	0.74	1.00	1.00	1.00
Uniform Delay (d), s/veh	51.4	0.0	0.0	45.6	0.0	48.3	39.5	31.1	31.1	54.7	43.7	43.7
Incr Delay (d2), s/veh	10.9	0.0	0.0	1.0	0.0	15.3	0.0	5.5	5.7	1.9	27.3	26.8
Initial Q Delay(d3),s/veh	0.0	0.0	0.0	0.0	0.0	0.0	0.0	0.0	0.0	0.0	0.0	0.0
%ile BackOfQ(50%),veh/ln	7.7	0.0	0.0	6.6	0.0	10.6	1.1	15.3	14.9	2.4	17.6	18.0
Unsig. Movement Delay, s/veh												
LnGrp Delay(d),s/veh	62.3	0.0	0.0	46.6	0.0	63.6	39.5	36.6	36.8	56.6	71.0	70.5
LnGrp LOS	E	A	A	D	A	E	D	D	D	E	E	E
Approach Vol, veh/h		228		537		1136		1019				
Approach Delay, s/veh		62.3		56.3		36.8		69.7				
Approach LOS		E		E		D		E				
Timer - Assigned Phs	1	2		4	5	6		8				
Phs Duration (G+Y+Rc), s	4.0	56.0		30.1	31.0	39.0		23.9				
Change Period (Y+Rc), s	4.0	* 4.8		* 5.3	4.8	* 4.6		5.0				
Max Green Setting (Gmax), s	10.0	* 37		* 31	13.0	* 34		27.0				
Max Q Clear Time (g_c+11), s	10.0	35.4		23.7	4.3	33.4		18.1				
Green Ext Time (p_c), s	0.0	1.0		1.0	0.0	0.5		0.6				

### Intersection Summary

HCM 6th Ctrl Delay	53.9
HCM 6th LOS	D

### Notes

User approved pedestrian interval to be less than phase max green.  
\* HCM 6th computational engine requires equal clearance times for the phases crossing the barrier.

# HCM 6th Signalized Intersection Summary

## 6: Washington St & Copeland St

Pipeline  
Timing Plan: PM Peak



Movement	EBL	EBT	EBR	WBL	WBT	WBR	NBL	NBT	NBR	SBL	SBT	SBR
Lane Configurations		↕			↕	↕	↕	↕		↕	↕	
Traffic Volume (veh/h)	12	1	1	88	1	253	3	862	39	229	878	9
Future Volume (veh/h)	12	1	1	88	1	253	3	862	39	229	878	9
Initial Q (Qb), veh	0	0	0	0	0	0	0	0	0	0	0	0
Ped-Bike Adj(A_pbT)	1.00		1.00	1.00		1.00	1.00		0.96	1.00		0.97
Parking Bus, Adj	1.00	1.00	1.00	1.00	1.00	1.00	1.00	1.00	1.00	1.00	1.00	1.00
Work Zone On Approach		No			No			No			No	
Adj Sat Flow, veh/h/ln	1900	1900	1900	1752	1900	1781	1900	1870	1693	1856	1870	1707
Adj Flow Rate, veh/h	12	1	1	92	1	264	3	898	41	239	915	9
Peak Hour Factor	0.96	0.96	0.96	0.96	0.96	0.96	0.96	0.96	0.96	0.96	0.96	0.96
Percent Heavy Veh, %	0	0	0	10	0	8	0	2	14	3	2	13
Cap, veh/h	277	23	15	430	4	327	286	1391	64	289	1471	14
Arrive On Green	0.22	0.22	0.22	0.22	0.22	0.22	0.16	0.40	0.40	0.16	0.41	0.41
Sat Flow, veh/h	821	108	71	1496	19	1508	1810	3454	158	1767	3604	35
Grp Volume(v), veh/h	14	0	0	93	0	264	3	462	477	239	451	473
Grp Sat Flow(s),veh/h/ln1000	0	0	0	1515	0	1508	1810	1777	1835	1767	1777	1863
Q Serve(g_s), s	0.1	0.0	0.0	0.0	0.0	11.3	0.1	14.2	14.2	8.9	13.6	13.6
Cycle Q Clear(g_c), s	3.0	0.0	0.0	2.9	0.0	11.3	0.1	14.2	14.2	8.9	13.6	13.6
Prop In Lane	0.86		0.07	0.99		1.00	1.00		0.09	1.00		0.02
Lane Grp Cap(c), veh/h	316	0	0	434	0	327	286	715	739	289	725	760
V/C Ratio(X)	0.04	0.00	0.00	0.21	0.00	0.81	0.01	0.65	0.65	0.83	0.62	0.62
Avail Cap(c_a), veh/h	675	0	0	864	0	777	534	1322	1366	783	1847	1936
HCM Platoon Ratio	1.00	1.00	1.00	1.00	1.00	1.00	1.00	1.00	1.00	1.00	1.00	1.00
Upstream Filter(l)	1.00	0.00	0.00	1.00	0.00	1.00	1.00	1.00	1.00	1.00	1.00	1.00
Uniform Delay (d), s/veh	21.3	0.0	0.0	21.9	0.0	25.2	24.1	16.3	16.3	27.4	15.9	15.9
Incr Delay (d2), s/veh	0.0	0.0	0.0	0.2	0.0	3.6	0.0	1.4	1.4	2.3	1.2	1.2
Initial Q Delay(d3),s/veh	0.0	0.0	0.0	0.0	0.0	0.0	0.0	0.0	0.0	0.0	0.0	0.0
%ile BackOfQ(50%),veh/ln	0.2	0.0	0.0	1.2	0.0	4.2	0.0	5.6	5.8	3.8	5.4	5.6
Unsig. Movement Delay, s/veh												
LnGrp Delay(d),s/veh	21.3	0.0	0.0	22.1	0.0	28.7	24.1	17.7	17.7	29.7	17.1	17.1
LnGrp LOS	C	A	A	C	A	C	C	B	B	C	B	B
Approach Vol, veh/h		14			357			942			1163	
Approach Delay, s/veh		21.3			27.0			17.7			19.7	
Approach LOS		C			C			B			B	
Timer - Assigned Phs	1	2		4	5	6		8				
Phs Duration (G+Y+Rc), s	6.1	31.9		19.8	15.7	32.2		19.8				
Change Period (Y+Rc), s	5.0	4.6		5.1	5.0	* 4.6		* 5.1				
Max Green Setting (Gmax), s	30.0	50.4		34.9	20.0	* 70		* 35				
Max Q Clear Time (g_c+110), s	110.0	16.2		13.3	2.1	15.6		5.0				
Green Ext Time (p_c), s	0.3	11.1		1.1	0.0	12.0		0.0				

### Intersection Summary

HCM 6th Ctrl Delay	20.0
HCM 6th LOS	C

### Notes























\* HCM 6th computational engine requires equal clearance times for the phases crossing the barrier.

# E - Pipeline Plus Project Traffic Conditions



HCM 6th Signalized Intersection Summary  
1: D St & Lakeville St

Pipeline+Project  
Timing Plan: AM Peak

												
Movement	EBL	EBT	EBR	WBL	WBT	WBR	NBL	NBT	NBR	SBL	SBT	SBR
Lane Configurations												
Traffic Volume (veh/h)	7	359	76	354	326	48	56	142	452	22	178	11
Future Volume (veh/h)	7	359	76	354	326	48	56	142	452	22	178	11
Initial Q (Qb), veh	0	0	0	0	0	0	0	0	0	0	0	0
Ped-Bike Adj(A_pbT)	1.00		0.99	1.00		1.00	1.00		0.97	1.00		0.94
Parking Bus, Adj	1.00	1.00	1.00	1.00	1.00	1.00	1.00	1.00	1.00	1.00	1.00	1.00
Work Zone On Approach		No			No			No			No	
Adj Sat Flow, veh/h/ln	1900	1781	1544	1841	1752	1900	1693	1885	1856	1781	1856	1707
Adj Flow Rate, veh/h	8	399	84	393	362	53	62	158	502	24	198	12
Peak Hour Factor	0.90	0.90	0.90	0.90	0.90	0.90	0.90	0.90	0.90	0.90	0.90	0.90
Percent Heavy Veh, %	0	8	24	4	10	0	14	1	3	8	3	13
Cap, veh/h	34	442	327	419	918	841	109	277	693	253	257	16
Arrive On Green	0.25	0.25	0.25	0.24	0.52	0.52	0.21	0.21	0.21	0.15	0.15	0.15
Sat Flow, veh/h	12	1758	1301	1753	1752	1606	524	1335	1525	1697	1724	104
Grp Volume(v), veh/h	407	0	84	393	362	53	220	0	502	24	0	210
Grp Sat Flow(s),veh/h/ln	1770	0	1301	1753	1752	1606	1859	0	1525	1697	0	1828
Q Serve(g_s), s	7.4	0.0	6.2	26.5	14.9	2.0	12.8	0.0	25.0	1.5	0.0	13.3
Cycle Q Clear(g_c), s	26.9	0.0	6.2	26.5	14.9	2.0	12.8	0.0	25.0	1.5	0.0	13.3
Prop In Lane	0.02		1.00	1.00		1.00	0.28		1.00	1.00		0.06
Lane Grp Cap(c), veh/h	476	0	327	419	918	841	386	0	693	253	0	272
V/C Ratio(X)	0.86	0.00	0.26	0.94	0.39	0.06	0.57	0.00	0.72	0.09	0.00	0.77
Avail Cap(c_a), veh/h	616	0	432	655	918	841	386	0	693	394	0	425
HCM Platoon Ratio	1.00	1.00	1.00	1.00	1.00	1.00	1.00	1.00	1.00	1.00	1.00	1.00
Upstream Filter(I)	1.00	0.00	1.00	1.00	1.00	1.00	1.00	0.00	1.00	1.00	0.00	1.00
Uniform Delay (d), s/veh	43.8	0.0	36.1	44.9	17.2	14.1	42.9	0.0	27.5	44.3	0.0	49.3
Incr Delay (d2), s/veh	7.5	0.0	0.2	11.9	0.1	0.0	2.5	0.0	4.1	0.1	0.0	3.4
Initial Q Delay(d3),s/veh	0.0	0.0	0.0	0.0	0.0	0.0	0.0	0.0	0.0	0.0	0.0	0.0
%ile BackOfQ(50%),veh/ln	12.7	0.0	2.0	12.8	6.0	0.7	6.2	0.0	12.5	0.6	0.0	6.4
Unsig. Movement Delay, s/veh												
LnGrp Delay(d),s/veh	51.3	0.0	36.2	56.9	17.3	14.1	45.4	0.0	31.6	44.4	0.0	52.7
LnGrp LOS	D	A	D	E	B	B	D	A	C	D	A	D
Approach Vol, veh/h		491			808			722				234
Approach Delay, s/veh		48.7			36.3			35.8				51.9
Approach LOS		D			D			D				D
Timer - Assigned Phs		2	3	4		6		8				
Phs Duration (G+Y+Rc), s		30.3	32.8	35.1		22.3		67.9				
Change Period (Y+Rc), s		* 5.3	4.0	* 4.8		4.3		* 4.8				
Max Green Setting (Gmax), s		* 25	45.0	* 40		28.0		* 60				
Max Q Clear Time (g_c+I1), s		27.0	28.5	28.9		15.3		16.9				
Green Ext Time (p_c), s		0.0	0.3	1.4		0.8		1.6				
<b>Intersection Summary</b>												
HCM 6th Ctrl Delay			40.5									
HCM 6th LOS			D									
<b>Notes</b>												
* HCM 6th computational engine requires equal clearance times for the phases crossing the barrier.												

HCM 6th Signalized Intersection Summary  
2: D St & Copeland St

Pipeline+Project  
Timing Plan: AM Peak

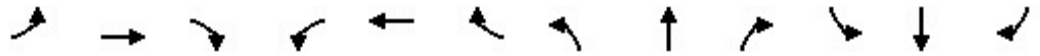

Movement	EBL	EBT	EBR	WBL	WBT	WBR	NBL	NBT	NBR	SBL	SBT	SBR
Lane Configurations		↕			↕		↗	↘		↗	↘	
Traffic Volume (veh/h)	36	4	216	7	11	17	210	695	3	8	609	38
Future Volume (veh/h)	36	4	216	7	11	17	210	695	3	8	609	38
Initial Q (Qb), veh	0	0	0	0	0	0	0	0	0	0	0	0
Ped-Bike Adj(A_pbT)	0.99		0.96	1.00		0.98	1.00		0.97	1.00		0.97
Parking Bus, Adj	1.00	1.00	1.00	1.00	1.00	1.00	1.00	1.00	1.00	1.00	1.00	1.00
Work Zone On Approach		No			No			No			No	
Adj Sat Flow, veh/h/ln	1900	1900	1841	1900	1900	1900	1826	1856	1900	1900	1841	1203
Adj Flow Rate, veh/h	41	5	245	8	12	19	239	790	3	9	692	43
Peak Hour Factor	0.88	0.88	0.88	0.88	0.88	0.88	0.88	0.88	0.88	0.88	0.88	0.88
Percent Heavy Veh, %	0	0	4	0	0	0	5	3	0	0	4	47
Cap, veh/h	69	17	240	77	110	136	308	1225	5	32	852	53
Arrive On Green	0.18	0.18	0.18	0.18	0.18	0.18	0.35	1.00	1.00	0.02	0.50	0.50
Sat Flow, veh/h	154	91	1302	181	600	742	1739	1847	7	1810	1711	106
Grp Volume(v), veh/h	291	0	0	39	0	0	239	0	793	9	0	735
Grp Sat Flow(s),veh/h/ln	1547	0	0	1522	0	0	1739	0	1854	1810	0	1817
Q Serve(g_s), s	13.2	0.0	0.0	0.0	0.0	0.0	12.2	0.0	0.0	0.5	0.0	34.1
Cycle Q Clear(g_c), s	18.4	0.0	0.0	1.9	0.0	0.0	12.2	0.0	0.0	0.5	0.0	34.1
Prop In Lane	0.14		0.84	0.21		0.49	1.00		0.00	1.00		0.06
Lane Grp Cap(c), veh/h	326	0	0	324	0	0	308	0	1230	32	0	905
V/C Ratio(X)	0.89	0.00	0.00	0.12	0.00	0.00	0.78	0.00	0.64	0.28	0.00	0.81
Avail Cap(c_a), veh/h	326	0	0	324	0	0	323	0	1230	154	0	905
HCM Platoon Ratio	1.00	1.00	1.00	1.00	1.00	1.00	2.00	2.00	2.00	1.00	1.00	1.00
Upstream Filter(l)	0.56	0.00	0.00	1.00	0.00	0.00	0.64	0.00	0.64	0.58	0.00	0.58
Uniform Delay (d), s/veh	40.9	0.0	0.0	34.1	0.0	0.0	30.5	0.0	0.0	48.5	0.0	21.2
Incr Delay (d2), s/veh	16.2	0.0	0.0	0.2	0.0	0.0	7.2	0.0	1.7	2.7	0.0	4.7
Initial Q Delay(d3),s/veh	0.0	0.0	0.0	0.0	0.0	0.0	0.0	0.0	0.0	0.0	0.0	0.0
%ile BackOfQ(50%),veh/ln	8.6	0.0	0.0	0.8	0.0	0.0	4.9	0.0	0.6	0.2	0.0	15.1
Unsig. Movement Delay, s/veh												
LnGrp Delay(d),s/veh	57.1	0.0	0.0	34.2	0.0	0.0	37.7	0.0	1.7	51.2	0.0	25.9
LnGrp LOS	E	A	A	C	A	A	D	A	A	D	A	C
Approach Vol, veh/h		291			39			1032				744
Approach Delay, s/veh		57.1			34.2			10.0				26.2
Approach LOS		E			C			B				C
Timer - Assigned Phs	1	2		4	5	6		8				
Phs Duration (G+Y+Rc), s	5.8	70.9		23.3	22.3	54.4		23.3				
Change Period (Y+Rc), s	4.0	4.6		* 4.9	4.6	* 4.6		* 4.9				
Max Green Setting (Gmax), s	8.5	59.9		* 18	18.6	* 50		* 18				
Max Q Clear Time (g_c+I1), s	2.5	2.0		20.4	14.2	36.1		3.9				
Green Ext Time (p_c), s	0.0	7.9		0.0	0.3	4.7		0.1				

Intersection Summary

HCM 6th Ctrl Delay	22.7
HCM 6th LOS	C

Notes

\* HCM 6th computational engine requires equal clearance times for the phases crossing the barrier.

HCM 6th Signalized Intersection Summary  
3: D St & 1st St

Pipeline+Project  
Timing Plan: AM Peak



Movement	EBL	EBT	EBR	WBL	WBT	WBR	NBL	NBT	NBR	SBL	SBT	SBR
Lane Configurations		↔			↔		↗	↘		↗	↘	
Traffic Volume (veh/h)	44	6	7	7	9	40	7	825	13	49	691	72
Future Volume (veh/h)	44	6	7	7	9	40	7	825	13	49	691	72
Initial Q (Qb), veh	0	0	0	0	0	0	0	0	0	0	0	0
Ped-Bike Adj(A_pbT)	0.98		0.98	0.99		0.97	1.00		0.97	1.00		0.97
Parking Bus, Adj	1.00	1.00	1.00	1.00	1.00	1.00	1.00	1.00	1.00	1.00	1.00	1.00
Work Zone On Approach		No			No			No			No	
Adj Sat Flow, veh/h/ln	1900	1900	1648	1648	1648	1796	1604	1856	1737	1870	1826	1900
Adj Flow Rate, veh/h	50	7	8	8	10	45	8	938	15	56	785	82
Peak Hour Factor	0.88	0.88	0.88	0.88	0.88	0.88	0.88	0.88	0.88	0.88	0.88	0.88
Percent Heavy Veh, %	0	0	17	17	17	7	20	3	11	2	5	0
Cap, veh/h	170	25	18	49	30	94	21	1063	17	323	1227	128
Arrive On Green	0.09	0.09	0.09	0.09	0.09	0.09	0.01	0.58	0.58	0.36	1.00	1.00
Sat Flow, veh/h	1132	262	196	87	314	1003	1527	1820	29	1781	1621	169
Grp Volume(v), veh/h	65	0	0	63	0	0	8	0	953	56	0	867
Grp Sat Flow(s),veh/h/ln	1590	0	0	1404	0	0	1527	0	1849	1781	0	1790
Q Serve(g_s), s	0.0	0.0	0.0	0.0	0.0	0.0	0.5	0.0	44.2	2.1	0.0	0.0
Cycle Q Clear(g_c), s	3.4	0.0	0.0	4.2	0.0	0.0	0.5	0.0	44.2	2.1	0.0	0.0
Prop In Lane	0.77		0.12	0.13		0.71	1.00		0.02	1.00		0.09
Lane Grp Cap(c), veh/h	213	0	0	172	0	0	21	0	1080	323	0	1355
V/C Ratio(X)	0.31	0.00	0.00	0.37	0.00	0.00	0.38	0.00	0.88	0.17	0.00	0.64
Avail Cap(c_a), veh/h	369	0	0	320	0	0	107	0	1080	323	0	1355
HCM Platoon Ratio	1.00	1.00	1.00	1.00	1.00	1.00	1.00	1.00	1.00	2.00	2.00	2.00
Upstream Filter(l)	1.00	0.00	0.00	1.00	0.00	0.00	0.69	0.00	0.69	0.60	0.00	0.60
Uniform Delay (d), s/veh	42.6	0.0	0.0	42.9	0.0	0.0	48.9	0.0	17.9	26.8	0.0	0.0
Incr Delay (d2), s/veh	0.6	0.0	0.0	1.0	0.0	0.0	2.8	0.0	7.6	0.1	0.0	1.4
Initial Q Delay(d3),s/veh	0.0	0.0	0.0	0.0	0.0	0.0	0.0	0.0	0.0	0.0	0.0	0.0
%ile BackOfQ(50%),veh/ln	1.6	0.0	0.0	1.5	0.0	0.0	0.2	0.0	19.7	0.9	0.0	0.5
Unsig. Movement Delay, s/veh												
LnGrp Delay(d),s/veh	43.2	0.0	0.0	43.9	0.0	0.0	51.7	0.0	25.4	26.8	0.0	1.4
LnGrp LOS	D	A	A	D	A	A	D	A	C	C	A	A
Approach Vol, veh/h		65			63			961			923	
Approach Delay, s/veh		43.2			43.9			25.6			2.9	
Approach LOS		D			D			C			A	
Timer - Assigned Phs	1	2		4	5	6		8				
Phs Duration (G+Y+Rc), s	22.7	63.0		14.3	5.4	80.3		14.3				
Change Period (Y+Rc), s	4.6	* 4.6		* 4.9	4.0	4.6		* 4.9				
Max Green Setting (Gmax), s	8.0	* 58		* 20	7.0	59.4		* 20				
Max Q Clear Time (g_c+I1), s	4.1	46.2		5.4	2.5	2.0		6.2				
Green Ext Time (p_c), s	0.0	7.5		0.2	0.0	14.5		0.2				

Intersection Summary

HCM 6th Ctrl Delay	16.4
HCM 6th LOS	B

Notes

\* HCM 6th computational engine requires equal clearance times for the phases crossing the barrier.



HCM 6th Signalized Intersection Summary  
4: D St & Petaluma Blvd

Pipeline+Project  
Timing Plan: AM Peak

Movement	EBL	EBT	EBR	WBL	WBT	WBR	NBL	NBT	NBR	SBL	SBT	SBR
Lane Configurations												
Traffic Volume (veh/h)	157	386	69	67	280	306	77	368	46	156	378	91
Future Volume (veh/h)	157	386	69	67	280	306	77	368	46	156	378	91
Initial Q (Qb), veh	0	0	0	0	0	0	0	0	0	0	0	0
Ped-Bike Adj(A_pbT)	1.00		0.99	1.00		0.99	1.00		0.97	1.00		0.99
Parking Bus, Adj	1.00	1.00	1.00	1.00	1.00	1.00	1.00	1.00	1.00	1.00	1.00	1.00
Work Zone On Approach		No			No			No			No	
Adj Sat Flow, veh/h/ln	1826	1826	1796	1826	1841	1885	1870	1870	1796	1856	1811	1856
Adj Flow Rate, veh/h	171	420	75	73	304	333	84	400	50	170	411	99
Peak Hour Factor	0.92	0.92	0.92	0.92	0.92	0.92	0.92	0.92	0.92	0.92	0.92	0.92
Percent Heavy Veh, %	5	5	7	5	4	1	2	2	7	3	6	3
Cap, veh/h	201	537	444	121	443	380	129	497	62	263	705	609
Arrive On Green	0.12	0.29	0.29	0.07	0.24	0.24	0.07	0.31	0.31	0.05	0.13	0.13
Sat Flow, veh/h	1739	1826	1509	1739	1841	1581	1781	1624	203	1767	1811	1564
Grp Volume(v), veh/h	171	420	75	73	304	333	84	0	450	170	411	99
Grp Sat Flow(s),veh/h/ln	1739	1826	1509	1739	1841	1581	1781	0	1827	1767	1811	1564
Q Serve(g_s), s	9.6	21.1	3.7	4.1	15.0	20.3	4.6	0.0	22.7	9.4	21.4	3.7
Cycle Q Clear(g_c), s	9.6	21.1	3.7	4.1	15.0	20.3	4.6	0.0	22.7	9.4	21.4	3.7
Prop In Lane	1.00		1.00	1.00		1.00	1.00		0.11	1.00		1.00
Lane Grp Cap(c), veh/h	201	537	444	121	443	380	129	0	559	263	705	609
V/C Ratio(X)	0.85	0.78	0.17	0.60	0.69	0.88	0.65	0.00	0.80	0.65	0.58	0.16
Avail Cap(c_a), veh/h	226	562	465	139	479	411	143	0	559	263	705	609
HCM Platoon Ratio	1.00	1.00	1.00	1.00	1.00	1.00	1.00	1.00	1.00	0.33	0.33	0.33
Upstream Filter(l)	1.00	1.00	1.00	1.00	1.00	1.00	1.00	0.00	1.00	0.77	0.77	0.77
Uniform Delay (d), s/veh	43.4	32.4	26.2	45.2	34.5	36.5	45.2	0.0	32.0	45.0	35.9	12.5
Incr Delay (d2), s/veh	21.2	7.3	0.3	2.8	4.3	18.5	6.2	0.0	11.7	3.3	2.7	0.4
Initial Q Delay(d3),s/veh	0.0	0.0	0.0	0.0	0.0	0.0	0.0	0.0	0.0	0.0	0.0	0.0
%ile BackOfQ(50%),veh/ln	5.3	10.2	1.4	1.8	7.2	9.6	2.3	0.0	11.7	4.7	10.9	2.2
Unsig. Movement Delay, s/veh												
LnGrp Delay(d),s/veh	64.6	39.7	26.5	48.0	38.8	55.0	51.4	0.0	43.7	48.3	38.6	12.9
LnGrp LOS	E	D	C	D	D	D	D	A	D	D	D	B
Approach Vol, veh/h		666			710			534			680	
Approach Delay, s/veh		44.6			47.3			44.9			37.3	
Approach LOS		D			D			D			D	
Timer - Assigned Phs	1	2	3	4	5	6	7	8				
Phs Duration (G+Y+Rc), s	19.5	35.3	10.9	34.3	11.2	43.5	16.5	28.8				
Change Period (Y+Rc), s	* 4.6	* 4.7	4.0	* 4.9	4.0	4.6	* 4.9	* 4.7				
Max Green Setting (Gmax), s	* 13	* 31	8.0	* 31	8.0	35.7	* 13	* 26				
Max Q Clear Time (g_c+I1), s	11.4	24.7	6.1	23.1	6.6	23.4	11.6	22.3				
Green Ext Time (p_c), s	0.0	1.3	0.0	2.3	0.0	2.0	0.0	1.5				

Intersection Summary

HCM 6th Ctrl Delay	43.5
HCM 6th LOS	D

Notes

User approved pedestrian interval to be less than phase max green.  
\* HCM 6th computational engine requires equal clearance times for the phases crossing the barrier.

# HCM 6th Signalized Intersection Summary

## 5: Washington St & Lakeville St

Pipeline+Project  
Timing Plan: AM Peak



Movement	EBL	EBT	EBR	WBL	WBT	WBR	NBL	NBT	NBR	SBL	SBT	SBR
Lane Configurations		↕		↕	↕		↕	↕		↕	↕	
Traffic Volume (veh/h)	34	159	29	217	115	56	20	734	206	61	788	34
Future Volume (veh/h)	34	159	29	217	115	56	20	734	206	61	788	34
Initial Q (Qb), veh	0	0	0	0	0	0	0	0	0	0	0	0
Ped-Bike Adj(A_pbT)	1.00		0.99	1.00		0.99	1.00		0.97	1.00		0.97
Parking Bus, Adj	1.00	1.00	1.00	1.00	1.00	1.00	1.00	1.00	1.00	1.00	1.00	1.00
Work Zone On Approach		No			No			No			No	
Adj Sat Flow, veh/h/ln	1856	1663	1381	1767	1722	1811	1337	1856	1796	1722	1826	1752
Adj Flow Rate, veh/h	38	179	33	244	129	63	22	825	231	69	885	38
Peak Hour Factor	0.89	0.89	0.89	0.89	0.89	0.89	0.89	0.89	0.89	0.89	0.89	0.89
Percent Heavy Veh, %	3	16	35	9	12	6	38	3	7	12	5	10
Cap, veh/h	43	203	37	287	185	91	271	1137	318	131	958	41
Arrive On Green	0.18	0.18	0.18	0.17	0.17	0.17	0.43	0.84	0.84	0.08	0.28	0.28
Sat Flow, veh/h	245	1153	212	1682	1088	531	1273	2701	756	1640	3383	145
Grp Volume(v), veh/h	250	0	0	244	0	192	22	538	518	69	454	469
Grp Sat Flow(s),veh/h/ln	1610	0	0	1682	0	1620	1273	1763	1694	1640	1735	1794
Q Serve(g_s), s	18.9	0.0	0.0	17.6	0.0	13.9	1.3	15.5	15.5	5.1	31.7	31.7
Cycle Q Clear(g_c), s	18.9	0.0	0.0	17.6	0.0	13.9	1.3	15.5	15.5	5.1	31.7	31.7
Prop In Lane	0.15		0.13	1.00		0.33	1.00		0.45	1.00		0.08
Lane Grp Cap(c), veh/h	283	0	0	287	0	276	271	742	713	131	491	508
V/C Ratio(X)	0.88	0.00	0.00	0.85	0.00	0.70	0.08	0.73	0.73	0.53	0.92	0.92
Avail Cap(c_a), veh/h	373	0	0	400	0	385	271	742	713	131	491	508
HCM Platoon Ratio	1.00	1.00	1.00	1.00	1.00	1.00	2.00	2.00	2.00	1.00	1.00	1.00
Upstream Filter(l)	1.00	0.00	0.00	0.94	0.00	0.94	0.85	0.85	0.85	1.00	1.00	1.00
Uniform Delay (d), s/veh	50.3	0.0	0.0	50.3	0.0	48.8	28.6	6.9	6.9	55.2	43.5	43.5
Incr Delay (d2), s/veh	14.7	0.0	0.0	8.5	0.0	1.1	0.0	5.2	5.4	1.9	25.5	24.9
Initial Q Delay(d3),s/veh	0.0	0.0	0.0	0.0	0.0	0.0	0.0	0.0	0.0	0.0	0.0	0.0
%ile BackOfQ(50%),veh/ln	8.8	0.0	0.0	8.1	0.0	5.7	0.4	3.9	3.8	2.2	17.0	17.5
Unsig. Movement Delay, s/veh												
LnGrp Delay(d),s/veh	65.0	0.0	0.0	58.8	0.0	49.9	28.6	12.2	12.4	57.1	68.9	68.4
LnGrp LOS	E	A	A	E	A	D	C	B	B	E	E	E
Approach Vol, veh/h		250			436			1078			992	
Approach Delay, s/veh		65.0			54.9			12.6			67.8	
Approach LOS		E			D			B			E	
Timer - Assigned Phs	1	2		4	5	6		8				
Phs Duration (G+Y+Rc), s	14.0	57.4		26.6	31.4	40.0		27.0				
Change Period (Y+Rc), s	4.0	* 4.8		* 5.3	4.8	* 4.6		5.0				
Max Green Setting (Gmax), s	10.0	* 37		* 30	12.0	* 35		29.0				
Max Q Clear Time (g_c+I1), s	7.1	17.5		19.6	3.3	33.7		20.9				
Green Ext Time (p_c), s	0.0	5.2		0.8	0.0	0.8		0.6				

### Intersection Summary

HCM 6th Ctrl Delay	43.9
HCM 6th LOS	D

### Notes

User approved pedestrian interval to be less than phase max green.

\* HCM 6th computational engine requires equal clearance times for the phases crossing the barrier.

HCM 6th Signalized Intersection Summary  
6: Washington St & Copeland St

Pipeline+Project  
Timing Plan: AM Peak



Movement	EBL	EBT	EBR	WBL	WBT	WBR	NBL	NBT	NBR	SBL	SBT	SBR
Lane Configurations		↔			↔	↔	↔	↕		↔	↕	
Traffic Volume (veh/h)	6	0	2	44	3	212	2	795	42	214	765	11
Future Volume (veh/h)	6	0	2	44	3	212	2	795	42	214	765	11
Initial Q (Qb), veh	0	0	0	0	0	0	0	0	0	0	0	0
Ped-Bike Adj(A_pbT)	1.00		1.00	1.00		0.98	1.00		0.97	1.00		0.97
Parking Bus, Adj	1.00	1.00	1.00	1.00	1.00	1.00	1.00	1.00	1.00	1.00	1.00	1.00
Work Zone On Approach		No			No			No			No	
Adj Sat Flow, veh/h/ln	418	1900	1900	1618	1900	1737	418	1856	1900	1856	1826	1070
Adj Flow Rate, veh/h	7	0	2	51	3	247	2	924	49	249	890	13
Peak Hour Factor	0.86	0.86	0.86	0.86	0.86	0.86	0.86	0.86	0.86	0.86	0.86	0.86
Percent Heavy Veh, %	100	0	0	19	0	11	100	3	0	3	5	56
Cap, veh/h	212	6	48	329	18	281	50	1289	68	546	1970	29
Arrive On Green	0.19	0.00	0.19	0.19	0.19	0.19	0.12	0.38	0.38	0.31	0.56	0.56
Sat Flow, veh/h	829	33	246	1405	92	1446	398	3399	180	1767	3499	51
Grp Volume(v), veh/h	9	0	0	54	0	247	2	479	494	249	441	462
Grp Sat Flow(s),veh/h/ln	1109	0	0	1497	0	1446	398	1763	1817	1767	1735	1815
Q Serve(g_s), s	0.0	0.0	0.0	0.0	0.0	20.7	0.6	29.0	29.0	14.2	18.6	18.6
Cycle Q Clear(g_c), s	3.1	0.0	0.0	3.1	0.0	20.7	0.6	29.0	29.0	14.2	18.6	18.6
Prop In Lane	0.78		0.22	0.94		1.00	1.00		0.10	1.00		0.03
Lane Grp Cap(c), veh/h	267	0	0	347	0	281	50	668	689	546	977	1022
V/C Ratio(X)	0.03	0.00	0.00	0.16	0.00	0.88	0.04	0.72	0.72	0.46	0.45	0.45
Avail Cap(c_a), veh/h	363	0	0	447	0	381	50	668	689	546	977	1022
HCM Platoon Ratio	1.00	1.00	1.00	1.00	1.00	1.00	1.00	1.00	1.00	1.00	1.00	1.00
Upstream Filter(I)	1.00	0.00	0.00	0.68	0.00	0.68	1.00	1.00	1.00	0.70	0.70	0.70
Uniform Delay (d), s/veh	40.8	0.0	0.0	41.8	0.0	48.9	48.1	33.1	33.1	34.7	16.0	16.0
Incr Delay (d2), s/veh	0.0	0.0	0.0	0.1	0.0	10.9	0.1	6.5	6.3	0.2	1.1	1.0
Initial Q Delay(d3),s/veh	0.0	0.0	0.0	0.0	0.0	0.0	0.0	0.0	0.0	0.0	0.0	0.0
%ile BackOfQ(50%),veh/ln	0.2	0.0	0.0	1.4	0.0	8.4	0.1	13.6	14.0	6.2	7.7	8.0
Unsig. Movement Delay, s/veh												
LnGrp Delay(d),s/veh	40.8	0.0	0.0	41.9	0.0	59.8	48.2	39.6	39.4	34.9	17.1	17.0
LnGrp LOS	D	A	A	D	A	E	D	D	D	C	B	B
Approach Vol, veh/h		9			301			975			1152	
Approach Delay, s/veh		40.8			56.6			39.5			20.9	
Approach LOS		D			E			D			C	
Timer - Assigned Phs	1	2		4	5	6		8				
Phs Duration (G+Y+Rc), s	43.6	52.0		29.4	20.6	75.0		29.4				
Change Period (Y+Rc), s	5.0	4.6		5.1	5.0	* 4.6		* 5.1				
Max Green Setting (Gmax), s	29.0	47.4		32.9	7.0	* 70		* 34				
Max Q Clear Time (g_c+I1), s	16.2	31.0		22.7	2.6	20.6		5.1				
Green Ext Time (p_c), s	0.3	8.1		0.7	0.0	11.5		0.0				

Intersection Summary

HCM 6th Ctrl Delay	32.8
HCM 6th LOS	C

Notes

\* HCM 6th computational engine requires equal clearance times for the phases crossing the barrier.

Queues  
2: D St & Copeland St



Lane Group	EBT	WBT	NBL	NBT	SBL	SBT
Lane Group Flow (vph)	291	40	239	793	9	735
v/c Ratio	0.76	0.23	0.75	0.56	0.06	0.74
Control Delay	23.2	27.0	38.1	2.7	43.8	23.0
Queue Delay	0.0	0.0	0.0	0.1	0.0	5.6
Total Delay	23.2	27.0	38.1	2.9	43.8	28.6
Queue Length 50th (ft)	34	13	126	14	5	309
Queue Length 95th (ft)	108	40	m#234	80	21	#546
Internal Link Dist (ft)	666	244		693		446
Turn Bay Length (ft)			60		60	
Base Capacity (vph)	466	261	319	1413	153	997
Starvation Cap Reductn	0	0	0	92	0	204
Spillback Cap Reductn	1	0	0	0	0	9
Storage Cap Reductn	0	0	0	0	0	0
Reduced v/c Ratio	0.63	0.15	0.75	0.60	0.06	0.93

Intersection Summary























# 95th percentile volume exceeds capacity, queue may be longer.

Queue shown is maximum after two cycles.

m Volume for 95th percentile queue is metered by upstream signal.

HCM 6th Signalized Intersection Summary  
1: D St & Lakeville St

Pipeline+Project  
Timing Plan: PM Peak

												
Movement	EBL	EBT	EBR	WBL	WBT	WBR	NBL	NBT	NBR	SBL	SBT	SBR
Lane Configurations												
Traffic Volume (veh/h)	9	306	73	426	397	41	101	177	547	23	189	14
Future Volume (veh/h)	9	306	73	426	397	41	101	177	547	23	189	14
Initial Q (Qb), veh	0	0	0	0	0	0	0	0	0	0	0	0
Ped-Bike Adj(A_pbT)	0.99		0.97	1.00		0.97	1.00		0.95	1.00		0.90
Parking Bus, Adj	1.00	1.00	1.00	1.00	1.00	1.00	1.00	1.00	1.00	1.00	1.00	1.00
Work Zone On Approach		No			No			No			No	
Adj Sat Flow, veh/h/ln	1900	1826	1678	1856	1870	1900	1826	1885	1870	1900	1885	1900
Adj Flow Rate, veh/h	10	329	78	458	427	44	109	190	588	25	203	15
Peak Hour Factor	0.93	0.93	0.93	0.93	0.93	0.93	0.93	0.93	0.93	0.93	0.93	0.93
Percent Heavy Veh, %	0	5	15	3	2	0	5	1	2	0	1	0
Cap, veh/h	35	374	290	483	965	804	138	241	742	291	277	20
Arrive On Green	0.21	0.21	0.21	0.27	0.52	0.52	0.20	0.20	0.20	0.16	0.16	0.16
Sat Flow, veh/h	22	1782	1384	1767	1870	1558	675	1176	1507	1810	1719	127
Grp Volume(v), veh/h	339	0	78	458	427	44	299	0	588	25	0	218
Grp Sat Flow(s),veh/h/ln	1803	0	1384	1767	1870	1558	1851	0	1507	1810	0	1846
Q Serve(g_s), s	7.2	0.0	5.8	31.0	17.5	1.7	18.7	0.0	25.0	1.4	0.0	13.7
Cycle Q Clear(g_c), s	22.3	0.0	5.8	31.0	17.5	1.7	18.7	0.0	25.0	1.4	0.0	13.7
Prop In Lane	0.03		1.00	1.00		1.00	0.36		1.00	1.00		0.07
Lane Grp Cap(c), veh/h	409	0	290	483	965	804	379	0	742	291	0	297
V/C Ratio(X)	0.83	0.00	0.27	0.95	0.44	0.05	0.79	0.00	0.79	0.09	0.00	0.73
Avail Cap(c_a), veh/h	618	0	454	652	965	804	379	0	742	415	0	424
HCM Platoon Ratio	1.00	1.00	1.00	1.00	1.00	1.00	1.00	1.00	1.00	1.00	1.00	1.00
Upstream Filter(I)	1.00	0.00	1.00	1.00	1.00	1.00	1.00	0.00	1.00	1.00	0.00	1.00
Uniform Delay (d), s/veh	46.8	0.0	40.4	43.5	18.5	14.7	46.0	0.0	27.1	43.5	0.0	48.7
Incr Delay (d2), s/veh	3.5	0.0	0.2	17.5	0.1	0.0	11.2	0.0	6.2	0.1	0.0	3.0
Initial Q Delay(d3),s/veh	0.0	0.0	0.0	0.0	0.0	0.0	0.0	0.0	0.0	0.0	0.0	0.0
%ile BackOfQ(50%),veh/ln	10.4	0.0	2.0	15.8	7.5	0.6	9.8	0.0	15.4	0.7	0.0	6.6
Unsig. Movement Delay, s/veh												
LnGrp Delay(d),s/veh	50.3	0.0	40.6	60.9	18.6	14.7	57.2	0.0	33.3	43.6	0.0	51.7
LnGrp LOS	D	A	D	E	B	B	E	A	C	D	A	D
Approach Vol, veh/h		417			929			887			243	
Approach Delay, s/veh		48.5			39.3			41.3			50.9	
Approach LOS		D			D			D			D	
Timer - Assigned Phs		2	3	4		6		8				
Phs Duration (G+Y+Rc), s		30.3	37.4	30.4		24.0		67.8				
Change Period (Y+Rc), s		* 5.3	4.0	* 4.8		4.3		* 4.8				
Max Green Setting (Gmax), s		* 25	45.0	* 40		28.0		* 60				
Max Q Clear Time (g_c+I1), s		27.0	33.0	24.3		15.7		19.5				
Green Ext Time (p_c), s		0.0	0.4	1.3		0.9		1.9				
<b>Intersection Summary</b>												
HCM 6th Ctrl Delay			42.7									
HCM 6th LOS			D									
<b>Notes</b>												
* HCM 6th computational engine requires equal clearance times for the phases crossing the barrier.												

HCM 6th Signalized Intersection Summary  
2: D St & Copeland St

Pipeline+Project  
Timing Plan: PM Peak

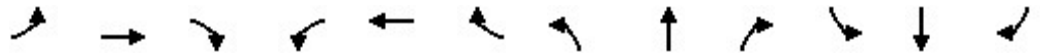

Movement	EBL	EBT	EBR	WBL	WBT	WBR	NBL	NBT	NBR	SBL	SBT	SBR
Lane Configurations		↕			↕		↗	↘		↗	↘	
Traffic Volume (veh/h)	30	20	233	7	14	15	252	847	13	18	721	86
Future Volume (veh/h)	30	20	233	7	14	15	252	847	13	18	721	86
Initial Q (Qb), veh	0	0	0	0	0	0	0	0	0	0	0	0
Ped-Bike Adj(A_pbT)	0.98		0.96	1.00		0.98	1.00		0.96	1.00		0.96
Parking Bus, Adj	1.00	1.00	1.00	1.00	1.00	1.00	1.00	1.00	1.00	1.00	1.00	1.00
Work Zone On Approach		No			No			No			No	
Adj Sat Flow, veh/h/ln	1900	1530	1856	1900	1900	1900	1826	1870	1900	1900	1870	1633
Adj Flow Rate, veh/h	32	22	251	8	15	16	271	911	14	19	775	92
Peak Hour Factor	0.93	0.93	0.93	0.93	0.93	0.93	0.93	0.93	0.93	0.93	0.93	0.93
Percent Heavy Veh, %	0	25	3	0	0	0	5	2	0	0	2	18
Cap, veh/h	56	25	191	76	132	114	316	1220	19	59	832	99
Arrive On Green	0.18	0.18	0.18	0.18	0.18	0.18	0.36	1.00	1.00	0.03	0.51	0.51
Sat Flow, veh/h	86	137	1036	178	716	622	1739	1836	28	1810	1632	194
Grp Volume(v), veh/h	305	0	0	39	0	0	271	0	925	19	0	867
Grp Sat Flow(s),veh/h/ln	1259	0	0	1515	0	0	1739	0	1864	1810	0	1825
Q Serve(g_s), s	12.1	0.0	0.0	0.0	0.0	0.0	14.4	0.0	0.0	1.0	0.0	44.3
Cycle Q Clear(g_c), s	18.4	0.0	0.0	1.9	0.0	0.0	14.4	0.0	0.0	1.0	0.0	44.3
Prop In Lane	0.10		0.82	0.21		0.41	1.00		0.02	1.00		0.11
Lane Grp Cap(c), veh/h	271	0	0	322	0	0	316	0	1239	59	0	931
V/C Ratio(X)	1.12	0.00	0.00	0.12	0.00	0.00	0.86	0.00	0.75	0.32	0.00	0.93
Avail Cap(c_a), veh/h	271	0	0	322	0	0	316	0	1239	154	0	931
HCM Platoon Ratio	1.00	1.00	1.00	1.00	1.00	1.00	2.00	2.00	2.00	1.00	1.00	1.00
Upstream Filter(l)	0.74	0.00	0.00	1.00	0.00	0.00	0.54	0.00	0.54	0.52	0.00	0.52
Uniform Delay (d), s/veh	42.1	0.0	0.0	34.1	0.0	0.0	30.6	0.0	0.0	47.3	0.0	22.9
Incr Delay (d2), s/veh	85.0	0.0	0.0	0.2	0.0	0.0	12.2	0.0	2.3	1.6	0.0	10.2
Initial Q Delay(d3),s/veh	0.0	0.0	0.0	0.0	0.0	0.0	0.0	0.0	0.0	0.0	0.0	0.0
%ile BackOfQ(50%),veh/ln	13.2	0.0	0.0	0.8	0.0	0.0	5.9	0.0	0.8	0.5	0.0	20.7
Unsig. Movement Delay, s/veh												
LnGrp Delay(d),s/veh	127.1	0.0	0.0	34.2	0.0	0.0	42.8	0.0	2.3	48.9	0.0	33.1
LnGrp LOS	F	A	A	C	A	A	D	A	A	D	A	C
Approach Vol, veh/h		305			39			1196				886
Approach Delay, s/veh		127.1			34.2			11.5				33.4
Approach LOS		F			C			B				C
Timer - Assigned Phs	1	2		4	5	6		8				
Phs Duration (G+Y+Rc), s	7.3	71.1		23.3	22.8	55.6		23.3				
Change Period (Y+Rc), s	4.0	4.6		* 4.9	4.6	* 4.6		* 4.9				
Max Green Setting (Gmax), s	8.5	59.9		* 18	17.4	* 51		* 18				
Max Q Clear Time (g_c+I1), s	3.0	2.0		20.4	16.4	46.3		3.9				
Green Ext Time (p_c), s	0.0	10.6		0.0	0.1	2.6		0.1				

Intersection Summary



















HCM 6th Ctrl Delay	34.4
HCM 6th LOS	C

Notes

\* HCM 6th computational engine requires equal clearance times for the phases crossing the barrier.

HCM 6th Signalized Intersection Summary  
3: D St & 1st St

Pipeline+Project  
Timing Plan: PM Peak

												
Movement	EBL	EBT	EBR	WBL	WBT	WBR	NBL	NBT	NBR	SBL	SBT	SBR
Lane Configurations												
Traffic Volume (veh/h)	71	4	12	16	7	57	6	991	23	67	875	63
Future Volume (veh/h)	71	4	12	16	7	57	6	991	23	67	875	63
Initial Q (Qb), veh	0	0	0	0	0	0	0	0	0	0	0	0
Ped-Bike Adj(A_pbT)	0.98		0.98	0.99		0.97	1.00		0.97	1.00		0.97
Parking Bus, Adj	1.00	1.00	1.00	1.00	1.00	1.00	1.00	1.00	1.00	1.00	1.00	1.00
Work Zone On Approach		No			No			No			No	
Adj Sat Flow, veh/h/ln	1900	1900	1900	1781	1900	1856	1900	1856	1707	1841	1870	1900
Adj Flow Rate, veh/h	72	4	12	16	7	58	6	1011	23	68	893	64
Peak Hour Factor	0.98	0.98	0.98	0.98	0.98	0.98	0.98	0.98	0.98	0.98	0.98	0.98
Percent Heavy Veh, %	0	0	0	8	0	3	0	3	13	4	2	0
Cap, veh/h	179	13	20	62	25	112	19	1054	24	315	1306	94
Arrive On Green	0.10	0.10	0.10	0.10	0.10	0.10	0.01	0.39	0.39	0.36	1.00	1.00
Sat Flow, veh/h	1190	141	210	197	267	1171	1810	1806	41	1753	1720	123
Grp Volume(v), veh/h	88	0	0	81	0	0	6	0	1034	68	0	957
Grp Sat Flow(s),veh/h/ln	1541	0	0	1636	0	0	1810	0	1847	1753	0	1844
Q Serve(g_s), s	0.4	0.0	0.0	0.0	0.0	0.0	0.3	0.0	54.6	2.7	0.0	0.0
Cycle Q Clear(g_c), s	5.0	0.0	0.0	4.5	0.0	0.0	0.3	0.0	54.6	2.7	0.0	0.0
Prop In Lane	0.82		0.14	0.20		0.72	1.00		0.02	1.00		0.07
Lane Grp Cap(c), veh/h	212	0	0	199	0	0	19	0	1078	315	0	1399
V/C Ratio(X)	0.41	0.00	0.00	0.41	0.00	0.00	0.31	0.00	0.96	0.22	0.00	0.68
Avail Cap(c_a), veh/h	362	0	0	363	0	0	127	0	1078	315	0	1399
HCM Platoon Ratio	1.00	1.00	1.00	1.00	1.00	1.00	0.67	0.67	0.67	2.00	2.00	2.00
Upstream Filter(l)	1.00	0.00	0.00	1.00	0.00	0.00	0.57	0.00	0.57	0.40	0.00	0.40
Uniform Delay (d), s/veh	43.1	0.0	0.0	43.0	0.0	0.0	49.3	0.0	29.3	27.1	0.0	0.0
Incr Delay (d2), s/veh	1.0	0.0	0.0	1.0	0.0	0.0	1.9	0.0	13.0	0.1	0.0	1.1
Initial Q Delay(d3),s/veh	0.0	0.0	0.0	0.0	0.0	0.0	0.0	0.0	0.0	0.0	0.0	0.0
%ile BackOfQ(50%),veh/ln	2.1	0.0	0.0	2.0	0.0	0.0	0.2	0.0	28.9	1.1	0.0	0.4
Unsig. Movement Delay, s/veh												
LnGrp Delay(d),s/veh	44.1	0.0	0.0	44.0	0.0	0.0	51.1	0.0	42.3	27.2	0.0	1.1
LnGrp LOS	D	A	A	D	A	A	D	A	D	C	A	A
Approach Vol, veh/h		88			81			1040			1025	
Approach Delay, s/veh		44.1			44.0			42.3			2.8	
Approach LOS		D			D			D			A	
Timer - Assigned Phs	1	2		4	5	6		8				
Phs Duration (G+Y+Rc), s	22.6	63.0		14.4	5.1	80.5		14.4				
Change Period (Y+Rc), s	4.6	* 4.6		* 4.9	4.0	4.6		* 4.9				
Max Green Setting (Gmax), s	8.0	* 58		* 20	7.0	59.4		* 20				
Max Q Clear Time (g_c+I1), s	4.7	56.6		7.0	2.3	2.0		6.5				
Green Ext Time (p_c), s	0.0	1.5		0.3	0.0	17.5		0.2				
<b>Intersection Summary</b>												
HCM 6th Ctrl Delay				24.3								
HCM 6th LOS				C								
<b>Notes</b>												
* HCM 6th computational engine requires equal clearance times for the phases crossing the barrier.												

HCM 6th Signalized Intersection Summary  
4: D St & Petaluma Blvd

Pipeline+Project  
Timing Plan: PM Peak

Movement	EBL	EBT	EBR	WBL	WBT	WBR	NBL	NBT	NBR	SBL	SBT	SBR
Lane Configurations												
Traffic Volume (veh/h)	193	254	90	148	305	281	81	440	27	212	567	129
Future Volume (veh/h)	193	254	90	148	305	281	81	440	27	212	567	129
Initial Q (Qb), veh	0	0	0	0	0	0	0	0	0	0	0	0
Ped-Bike Adj(A_pbT)	1.00		0.94	1.00		0.94	1.00		0.94	1.00		0.95
Parking Bus, Adj	1.00	1.00	1.00	1.00	1.00	1.00	1.00	1.00	1.00	1.00	1.00	1.00
Work Zone On Approach		No			No			No			No	
Adj Sat Flow, veh/h/ln	1841	1885	1900	1856	1885	1870	1870	1856	1900	1900	1856	1870
Adj Flow Rate, veh/h	210	276	98	161	332	305	88	478	29	230	616	140
Peak Hour Factor	0.92	0.92	0.92	0.92	0.92	0.92	0.92	0.92	0.92	0.92	0.92	0.92
Percent Heavy Veh, %	4	1	0	3	1	2	2	3	0	0	3	2
Cap, veh/h	228	516	415	191	462	364	130	528	32	249	701	568
Arrive On Green	0.13	0.27	0.27	0.11	0.25	0.25	0.07	0.31	0.31	0.09	0.25	0.25
Sat Flow, veh/h	1753	1885	1515	1767	1885	1482	1781	1724	105	1810	1856	1503
Grp Volume(v), veh/h	210	276	98	161	332	305	88	0	507	230	616	140
Grp Sat Flow(s),veh/h/ln	1753	1885	1515	1767	1885	1482	1781	0	1829	1810	1856	1503
Q Serve(g_s), s	11.8	12.5	5.0	8.9	16.1	19.6	4.8	0.0	26.6	12.6	31.9	4.8
Cycle Q Clear(g_c), s	11.8	12.5	5.0	8.9	16.1	19.6	4.8	0.0	26.6	12.6	31.9	4.8
Prop In Lane	1.00		1.00	1.00		1.00	1.00		0.06	1.00		1.00
Lane Grp Cap(c), veh/h	228	516	415	191	462	364	130	0	560	249	701	568
V/C Ratio(X)	0.92	0.53	0.24	0.84	0.72	0.84	0.68	0.00	0.91	0.92	0.88	0.25
Avail Cap(c_a), veh/h	228	516	415	212	490	385	143	0	560	249	701	568
HCM Platoon Ratio	1.00	1.00	1.00	1.00	1.00	1.00	1.00	1.00	1.00	0.67	0.67	0.67
Upstream Filter(I)	1.00	1.00	1.00	1.00	1.00	1.00	1.00	0.00	1.00	0.71	0.71	0.71
Uniform Delay (d), s/veh	43.0	30.9	28.2	43.7	34.6	35.9	45.2	0.0	33.3	44.9	35.2	11.0
Incr Delay (d2), s/veh	38.1	1.4	0.4	21.3	5.3	15.2	8.1	0.0	20.8	28.9	11.0	0.7
Initial Q Delay(d3),s/veh	0.0	0.0	0.0	0.0	0.0	0.0	0.0	0.0	0.0	0.0	0.0	0.0
%ile BackOfQ(50%),veh/ln	7.5	5.8	1.9	5.0	8.0	8.5	2.4	0.0	14.9	7.9	17.2	2.7
Unsig. Movement Delay, s/veh												
LnGrp Delay(d),s/veh	81.1	32.3	28.6	65.0	39.8	51.0	53.3	0.0	54.1	73.7	46.2	11.8
LnGrp LOS	F	C	C	E	D	D	D	A	D	E	D	B
Approach Vol, veh/h		584			798			595			986	
Approach Delay, s/veh		49.2			49.2			54.0			47.7	
Approach LOS		D			D			D			D	
Timer - Assigned Phs	1	2	3	4	5	6	7	8				
Phs Duration (G+Y+Rc), s	18.4	35.3	14.8	32.3	11.3	42.4	17.9	29.2				
Change Period (Y+Rc), s	* 4.6	* 4.7	4.0	* 4.9	4.0	4.6	* 4.9	* 4.7				
Max Green Setting (Gmax), s	* 13	* 31	12.0	* 27	8.0	35.7	* 13	* 26				
Max Q Clear Time (g_c+I1), s	14.6	28.6	10.9	14.5	6.8	33.9	13.8	21.6				
Green Ext Time (p_c), s	0.0	0.6	0.0	2.2	0.0	0.8	0.0	1.8				

Intersection Summary

HCM 6th Ctrl Delay	49.7
HCM 6th LOS	D

Notes

User approved pedestrian interval to be less than phase max green.  
\* HCM 6th computational engine requires equal clearance times for the phases crossing the barrier.



# HCM 6th Signalized Intersection Summary

## 5: Washington St & Lakeville St

Pipeline+Project  
Timing Plan: PM Peak



Movement	EBL	EBT	EBR	WBL	WBT	WBR	NBL	NBT	NBR	SBL	SBT	SBR
Lane Configurations		↕		↖	↗		↖	↗		↖	↗	
Traffic Volume (veh/h)	64	114	43	222	193	103	41	875	181	75	865	47
Future Volume (veh/h)	64	114	43	222	193	103	41	875	181	75	865	47
Initial Q (Qb), veh	0	0	0	0	0	0	0	0	0	0	0	0
Ped-Bike Adj(A_pbT)	1.00		0.98	1.00		0.98	1.00		0.96	1.00		0.95
Parking Bus, Adj	1.00	1.00	1.00	1.00	1.00	1.00	1.00	1.00	1.00	1.00	1.00	1.00
Work Zone On Approach		No		No		No		No		No		No
Adj Sat Flow, veh/h/ln	1826	1811	1811	1870	1826	1900	1900	1856	1811	1870	1885	1900
Adj Flow Rate, veh/h	67	119	45	231	201	107	43	911	189	78	901	49
Peak Hour Factor	0.96	0.96	0.96	0.96	0.96	0.96	0.96	0.96	0.96	0.96	0.96	0.96
Percent Heavy Veh, %	5	6	6	2	5	0	0	3	6	2	1	0
Cap, veh/h	77	136	52	358	224	119	377	1183	245	144	955	52
Arrive On Green	0.15	0.15	0.15	0.20	0.20	0.20	0.21	0.41	0.41	0.08	0.28	0.28
Sat Flow, veh/h	499	886	335	1781	1114	593	1810	2885	598	1781	3444	187
Grp Volume(v), veh/h	231	0	0	231	0	308	43	556	544	78	469	481
Grp Sat Flow(s),veh/h/ln	1719	0	0	1781	0	1707	1810	1763	1720	1781	1791	1840
Q Serve(g_s), s	16.3	0.0	0.0	14.8	0.0	21.8	2.4	33.7	33.8	5.2	31.7	31.7
Cycle Q Clear(g_c), s	16.3	0.0	0.0	14.8	0.0	21.8	2.4	33.7	33.8	5.2	31.7	31.7
Prop In Lane	0.29		0.19	1.00		0.35	1.00		0.35	1.00		0.10
Lane Grp Cap(c), veh/h	265	0	0	358	0	344	377	723	706	144	497	510
V/C Ratio(X)	0.87	0.00	0.00	0.64	0.00	0.90	0.11	0.77	0.77	0.54	0.94	0.94
Avail Cap(c_a), veh/h	374	0	0	441	0	423	377	723	706	144	497	510
HCM Platoon Ratio	1.00	1.00	1.00	1.00	1.00	1.00	1.00	1.00	1.00	1.00	1.00	1.00
Upstream Filter(I)	1.00	0.00	0.00	0.91	0.00	0.91	0.74	0.74	0.74	1.00	1.00	1.00
Uniform Delay (d), s/veh	51.3	0.0	0.0	45.5	0.0	48.3	39.8	31.5	31.5	54.8	43.8	43.8
Incr Delay (d2), s/veh	11.5	0.0	0.0	1.0	0.0	15.5	0.0	5.8	6.0	2.3	28.4	27.9
Initial Q Delay(d3),s/veh	0.0	0.0	0.0	0.0	0.0	0.0	0.0	0.0	0.0	0.0	0.0	0.0
%ile BackOfQ(50%),veh/ln	7.9	0.0	0.0	6.6	0.0	10.7	1.1	15.5	15.2	2.4	17.9	18.3
Unsig. Movement Delay, s/veh												
LnGrp Delay(d),s/veh	62.8	0.0	0.0	46.5	0.0	63.8	39.8	37.3	37.5	57.1	72.3	71.8
LnGrp LOS	E	A	A	D	A	E	D	D	D	E	E	E
Approach Vol, veh/h		231			539			1143			1028	
Approach Delay, s/veh		62.8			56.4			37.5			70.9	
Approach LOS		E			E			D			E	
Timer - Assigned Phs	1	2		4	5	6		8				
Phs Duration (G+Y+Rc), s	14.0	55.7		30.3	30.7	39.0		24.1				
Change Period (Y+Rc), s	4.0	* 4.8		* 5.3	4.8	* 4.6		5.0				
Max Green Setting (Gmax), s	10.0	* 37		* 31	13.0	* 34		27.0				
Max Q Clear Time (g_c+I1), s	7.2	35.8		23.8	4.4	33.7		18.3				
Green Ext Time (p_c), s	0.0	0.8		1.0	0.0	0.3		0.6				

### Intersection Summary

HCM 6th Ctrl Delay	54.6
HCM 6th LOS	D

### Notes

User approved pedestrian interval to be less than phase max green.

\* HCM 6th computational engine requires equal clearance times for the phases crossing the barrier.

HCM 6th Signalized Intersection Summary  
6: Washington St & Copeland St

Pipeline+Project  
Timing Plan: PM Peak

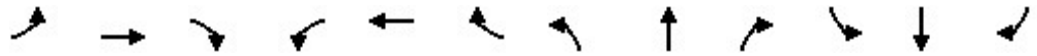

Movement	EBL	EBT	EBR	WBL	WBT	WBR	NBL	NBT	NBR	SBL	SBT	SBR
Lane Configurations		↕			↕	↗	↖	↕	↕	↖	↗	
Traffic Volume (veh/h)	12	1	1	91	1	260	3	862	44	238	878	9
Future Volume (veh/h)	12	1	1	91	1	260	3	862	44	238	878	9
Initial Q (Qb), veh	0	0	0	0	0	0	0	0	0	0	0	0
Ped-Bike Adj(A_pbT)	1.00		1.00	1.00		1.00	1.00		0.96	1.00		0.97
Parking Bus, Adj	1.00	1.00	1.00	1.00	1.00	1.00	1.00	1.00	1.00	1.00	1.00	1.00
Work Zone On Approach		No			No			No			No	
Adj Sat Flow, veh/h/ln	1900	1900	1900	1752	1900	1781	1900	1870	1693	1856	1870	1707
Adj Flow Rate, veh/h	12	1	1	95	1	271	3	898	46	248	915	9
Peak Hour Factor	0.96	0.96	0.96	0.96	0.96	0.96	0.96	0.96	0.96	0.96	0.96	0.96
Percent Heavy Veh, %	0	0	0	10	0	8	0	2	14	3	2	13
Cap, veh/h	275	23	16	433	4	332	298	1374	70	297	1455	14
Arrive On Green	0.22	0.22	0.22	0.22	0.22	0.22	0.16	0.40	0.40	0.17	0.40	0.40
Sat Flow, veh/h	814	106	71	1498	18	1508	1810	3432	176	1767	3604	35
Grp Volume(v), veh/h	14	0	0	96	0	271	3	465	479	248	451	473
Grp Sat Flow(s),veh/h/ln	990	0	0	1516	0	1508	1810	1777	1831	1767	1777	1862
Q Serve(g_s), s	0.2	0.0	0.0	0.0	0.0	11.9	0.1	14.8	14.8	9.5	14.1	14.1
Cycle Q Clear(g_c), s	3.2	0.0	0.0	3.0	0.0	11.9	0.1	14.8	14.8	9.5	14.1	14.1
Prop In Lane	0.86		0.07	0.99		1.00	1.00		0.10	1.00		0.02
Lane Grp Cap(c), veh/h	314	0	0	437	0	332	298	711	733	297	718	752
V/C Ratio(X)	0.04	0.00	0.00	0.22	0.00	0.82	0.01	0.65	0.65	0.84	0.63	0.63
Avail Cap(c_a), veh/h	650	0	0	841	0	756	520	1286	1325	761	1796	1883
HCM Platoon Ratio	1.00	1.00	1.00	1.00	1.00	1.00	1.00	1.00	1.00	1.00	1.00	1.00
Upstream Filter(I)	1.00	0.00	0.00	1.00	0.00	1.00	1.00	1.00	1.00	1.00	1.00	1.00
Uniform Delay (d), s/veh	21.8	0.0	0.0	22.3	0.0	25.8	24.3	17.0	17.0	28.0	16.6	16.6
Incr Delay (d2), s/veh	0.0	0.0	0.0	0.2	0.0	3.7	0.0	1.5	1.4	2.4	1.3	1.2
Initial Q Delay(d3),s/veh	0.0	0.0	0.0	0.0	0.0	0.0	0.0	0.0	0.0	0.0	0.0	0.0
%ile BackOfQ(50%),veh/ln	0.2	0.0	0.0	1.3	0.0	4.4	0.0	5.9	6.1	4.1	5.6	5.9
Unsig. Movement Delay, s/veh												
LnGrp Delay(d),s/veh	21.8	0.0	0.0	22.5	0.0	29.5	24.3	18.4	18.4	30.4	17.9	17.8
LnGrp LOS	C	A	A	C	A	C	C	B	B	C	B	B
Approach Vol, veh/h		14			367			947			1172	
Approach Delay, s/veh		21.8			27.6			18.4			20.5	
Approach LOS		C			C			B			C	
Timer - Assigned Phs	1	2		4	5	6		8				
Phs Duration (G+Y+Rc), s	16.7	32.5		20.5	16.5	32.7		20.5				
Change Period (Y+Rc), s	5.0	4.6		5.1	5.0	* 4.6		* 5.1				
Max Green Setting (Gmax), s	30.0	50.4		34.9	20.0	* 70		* 35				
Max Q Clear Time (g_c+I1), s	11.5	16.8		13.9	2.1	16.1		5.2				
Green Ext Time (p_c), s	0.3	11.1		1.1	0.0	12.0		0.0				

Intersection Summary

HCM 6th Ctrl Delay	20.8
HCM 6th LOS	C

Notes

\* HCM 6th computational engine requires equal clearance times for the phases crossing the barrier.

Queues  
2: D St & Copeland St



Lane Group	EBT	WBT	NBL	NBT	SBL	SBT
Lane Group Flow (vph)	305	39	271	925	19	867
v/c Ratio	0.82	0.21	0.91	0.68	0.13	0.86
Control Delay	31.7	27.4	59.6	8.1	44.9	30.0
Queue Delay	0.1	0.0	0.0	0.3	0.0	24.6
Total Delay	31.8	27.4	59.6	8.3	44.9	54.5
Queue Length 50th (ft)	60	13	157	96	11	433
Queue Length 95th (ft)	153	42	m#271	188	34	#779
Internal Link Dist (ft)	666	244		693		446
Turn Bay Length (ft)			60		60	
Base Capacity (vph)	443	259	299	1354	153	1012
Starvation Cap Reductn	0	0	0	79	0	176
Spillback Cap Reductn	3	0	0	0	0	29
Storage Cap Reductn	0	0	0	0	0	0
Reduced v/c Ratio	0.69	0.15	0.91	0.73	0.12	1.04

Intersection Summary

# 95th percentile volume exceeds capacity, queue may be longer.

Queue shown is maximum after two cycles.























m Volume for 95th percentile queue is metered by upstream signal.

## F – Cumulative Traffic Conditions



HCM 6th Signalized Intersection Summary  
 1: D St & Lakeville St

Cumulative  
 Timing Plan: AM Peak

												
Movement	EBL	EBT	EBR	WBL	WBT	WBR	NBL	NBT	NBR	SBL	SBT	SBR
Lane Configurations												
Traffic Volume (veh/h)	7	470	76	377	367	59	52	141	590	24	174	11
Future Volume (veh/h)	7	470	76	377	367	59	52	141	590	24	174	11
Initial Q (Qb), veh	0	0	0	0	0	0	0	0	0	0	0	0
Ped-Bike Adj(A_pbT)	1.00		0.99	1.00		1.00	1.00		0.97	1.00		0.93
Parking Bus, Adj	1.00	1.00	1.00	1.00	1.00	1.00	1.00	1.00	1.00	1.00	1.00	1.00
Work Zone On Approach		No			No			No			No	
Adj Sat Flow, veh/h/ln	1900	1781	1544	1841	1752	1900	1693	1885	1856	1781	1856	1707
Adj Flow Rate, veh/h	8	522	84	419	408	66	58	157	656	27	193	12
Peak Hour Factor	0.90	0.90	0.90	0.90	0.90	0.90	0.90	0.90	0.90	0.90	0.90	0.90
Percent Heavy Veh, %	0	8	24	4	10	0	14	1	3	8	3	13
Cap, veh/h	29	513	379	442	1002	919	91	247	673	240	243	15
Arrive On Green	0.29	0.29	0.29	0.25	0.57	0.57	0.18	0.18	0.18	0.14	0.14	0.14
Sat Flow, veh/h	10	1762	1302	1753	1752	1606	502	1358	1521	1697	1720	107
Grp Volume(v), veh/h	530	0	84	419	408	66	215	0	656	27	0	205
Grp Sat Flow(s),veh/h/ln	1771	0	1302	1753	1752	1606	1860	0	1521	1697	0	1827
Q Serve(g_s), s	14.6	0.0	6.7	32.3	17.9	2.5	14.7	0.0	25.0	1.9	0.0	14.9
Cycle Q Clear(g_c), s	40.0	0.0	6.7	32.3	17.9	2.5	14.7	0.0	25.0	1.9	0.0	14.9
Prop In Lane	0.02		1.00	1.00		1.00	0.27		1.00	1.00		0.06
Lane Grp Cap(c), veh/h	542	0	379	442	1002	919	338	0	673	240	0	258
V/C Ratio(X)	0.98	0.00	0.22	0.95	0.41	0.07	0.64	0.00	0.97	0.11	0.00	0.79
Avail Cap(c_a), veh/h	542	0	379	574	1002	919	338	0	673	346	0	372
HCM Platoon Ratio	1.00	1.00	1.00	1.00	1.00	1.00	1.00	1.00	1.00	1.00	1.00	1.00
Upstream Filter(I)	1.00	0.00	1.00	1.00	1.00	1.00	1.00	0.00	1.00	1.00	0.00	1.00
Uniform Delay (d), s/veh	49.2	0.0	36.9	50.5	16.4	13.1	52.0	0.0	38.4	51.5	0.0	57.1
Incr Delay (d2), s/veh	32.7	0.0	0.1	20.2	0.1	0.0	4.5	0.0	28.5	0.2	0.0	6.2
Initial Q Delay(d3),s/veh	0.0	0.0	0.0	0.0	0.0	0.0	0.0	0.0	0.0	0.0	0.0	0.0
%ile BackOfQ(50%),veh/ln	23.2	0.0	2.2	16.6	7.2	0.9	7.4	0.0	26.6	0.8	0.0	7.4
Unsig. Movement Delay, s/veh												
LnGrp Delay(d),s/veh	81.8	0.0	37.0	70.8	16.5	13.1	56.5	0.0	66.9	51.6	0.0	63.3
LnGrp LOS	F	A	D	E	B	B	E	A	E	D	A	E
Approach Vol, veh/h		614			893			871			232	
Approach Delay, s/veh		75.7			41.7			64.3			61.9	
Approach LOS		E			D			E			E	
Timer - Assigned Phs		2	3	4		6		8				
Phs Duration (G+Y+Rc), s		30.3	38.6	44.8		23.7		83.4				
Change Period (Y+Rc), s		* 5.3	4.0	* 4.8		4.3		* 4.8				
Max Green Setting (Gmax), s		* 25	45.0	* 40		28.0		* 60				
Max Q Clear Time (g_c+I1), s		27.0	34.3	42.0		16.9		19.9				
Green Ext Time (p_c), s		0.0	0.3	0.0		0.8		1.8				

Intersection Summary

HCM 6th Ctrl Delay	59.1
HCM 6th LOS	E

Notes

\* HCM 6th computational engine requires equal clearance times for the phases crossing the barrier.

Intersection												
Int Delay, s/veh	23.2											
Movement	EBL	EBT	EBR	WBL	WBT	WBR	NBL	NBT	NBR	SBL	SBT	SBR
Lane Configurations		↕			↕		↕	↕			↕	
Traffic Vol, veh/h	36	0	219	0	0	1	210	751	1	3	550	93
Future Vol, veh/h	36	0	219	0	0	1	210	751	1	3	550	93
Conflicting Peds, #/hr	6	0	2	2	0	6	11	0	3	3	0	11
Sign Control	Stop	Stop	Stop	Stop	Stop	Stop	Free	Free	Free	Free	Free	Free
RT Channelized	-	-	None	-	-	None	-	-	None	-	-	None
Storage Length	-	-	-	-	-	-	60	-	-	-	-	-
Veh in Median Storage, #	-	0	-	-	0	-	-	0	-	-	0	-
Grade, %	-	0	-	-	0	-	-	0	-	-	0	-
Peak Hour Factor	88	88	88	88	88	88	88	88	88	88	88	88
Heavy Vehicles, %	0	0	4	0	0	0	5	3	0	0	4	47
Mvmt Flow	41	0	249	0	0	1	239	853	1	3	625	106

Major/Minor	Minor2		Minor1		Major1			Major2				
Conflicting Flow All	2033	2030	691	2146	2083	863	742	0	0	857	0	0
Stage 1	695	695	-	1335	1335	-	-	-	-	-	-	-
Stage 2	1338	1335	-	811	748	-	-	-	-	-	-	-
Critical Hdwy	6.1	5.5	5.2	6.1	5.5	5.2	4.15	-	-	4.1	-	-
Critical Hdwy Stg 1	6.1	5.5	-	6.1	5.5	-	-	-	-	-	-	-
Critical Hdwy Stg 2	6.1	5.5	-	6.1	5.5	-	-	-	-	-	-	-
Follow-up Hdwy	3.5	4	3.336	3.5	4	3.3	2.245	-	-	2.2	-	-
Pot Cap-1 Maneuver	75	102	539	65	96	454	852	-	-	792	-	-
Stage 1	436	447	-	191	225	-	-	-	-	-	-	-
Stage 2	190	225	-	376	423	-	-	-	-	-	-	-
Platoon blocked, %								-	-	-	-	-
Mov Cap-1 Maneuver	57	72	532	27	67	450	843	-	-	790	-	-
Mov Cap-2 Maneuver	57	72	-	27	67	-	-	-	-	-	-	-
Stage 1	309	439	-	136	161	-	-	-	-	-	-	-
Stage 2	135	161	-	198	416	-	-	-	-	-	-	-



















Approach	EB	WB	NB	SB
HCM Control Delay, s	160.3	13	2.4	0
HCM LOS	F	B		

Minor Lane/Major Mvmt	NBL	NBT	NBR	EBLn1WBLn1	SBL	SBT	SBR
Capacity (veh/h)	843	-	-	244	450	790	-
HCM Lane V/C Ratio	0.283	-	-	1.188	0.003	0.004	-
HCM Control Delay (s)	10.9	-	-	160.3	13	9.6	0
HCM Lane LOS	B	-	-	F	B	A	A
HCM 95th %tile Q(veh)	1.2	-	-	13.7	0	0	-

# HCM 6th Signalized Intersection Summary

## 3: D St & 1st St

Cumulative  
Timing Plan: AM Peak

												
Movement	EBL	EBT	EBR	WBL	WBT	WBR	NBL	NBT	NBR	SBL	SBT	SBR
Lane Configurations												
Traffic Volume (veh/h)	44	6	7	7	9	40	7	889	13	49	618	72
Future Volume (veh/h)	44	6	7	7	9	40	7	889	13	49	618	72
Initial Q (Qb), veh	0	0	0	0	0	0	0	0	0	0	0	0
Ped-Bike Adj(A_pbT)	0.98		0.99	0.99		0.98	1.00		0.97	1.00		0.97
Parking Bus, Adj	1.00	1.00	1.00	1.00	1.00	1.00	1.00	1.00	1.00	1.00	1.00	1.00
Work Zone On Approach		No			No			No			No	
Adj Sat Flow, veh/h/ln	1900	1900	1648	1648	1648	1796	1604	1856	1737	1870	1826	1900
Adj Flow Rate, veh/h	50	7	8	8	10	45	8	1010	15	56	702	82
Peak Hour Factor	0.88	0.88	0.88	0.88	0.88	0.88	0.88	0.88	0.88	0.88	0.88	0.88
Percent Heavy Veh, %	0	0	17	17	17	7	20	3	11	2	5	0
Cap, veh/h	185	27	20	54	32	102	362	1242	18	119	806	94
Arrive On Green	0.10	0.10	0.10	0.10	0.10	0.10	0.47	1.00	1.00	0.07	0.50	0.50
Sat Flow, veh/h	1120	263	194	85	317	1005	1527	1823	27	1781	1598	187
Grp Volume(v), veh/h	65	0	0	63	0	0	8	0	1025	56	0	784
Grp Sat Flow(s),veh/h/ln	1577	0	0	1407	0	0	1527	0	1850	1781	0	1785
Q Serve(g_s), s	0.0	0.0	0.0	0.0	0.0	0.0	0.3	0.0	0.0	2.7	0.0	34.9
Cycle Q Clear(g_c), s	3.0	0.0	0.0	3.7	0.0	0.0	0.3	0.0	0.0	2.7	0.0	34.9
Prop In Lane	0.77		0.12	0.13		0.71	1.00		0.01	1.00		0.10
Lane Grp Cap(c), veh/h	231	0	0	188	0	0	362	0	1260	119	0	901
V/C Ratio(X)	0.28	0.00	0.00	0.33	0.00	0.00	0.02	0.00	0.81	0.47	0.00	0.87
Avail Cap(c_a), veh/h	440	0	0	387	0	0	362	0	1260	178	0	901
HCM Platoon Ratio	1.00	1.00	1.00	1.00	1.00	1.00	2.00	2.00	2.00	1.00	1.00	1.00
Upstream Filter(I)	1.00	0.00	0.00	1.00	0.00	0.00	0.63	0.00	0.63	1.00	0.00	1.00
Uniform Delay (d), s/veh	37.7	0.0	0.0	38.0	0.0	0.0	18.1	0.0	0.0	40.4	0.0	19.7
Incr Delay (d2), s/veh	0.5	0.0	0.0	0.8	0.0	0.0	0.0	0.0	3.8	1.1	0.0	11.3
Initial Q Delay(d3),s/veh	0.0	0.0	0.0	0.0	0.0	0.0	0.0	0.0	0.0	0.0	0.0	0.0
%ile BackOfQ(50%),veh/ln	1.4	0.0	0.0	1.3	0.0	0.0	0.1	0.0	1.3	1.2	0.0	16.4
Unsig. Movement Delay, s/veh												
LnGrp Delay(d),s/veh	38.1	0.0	0.0	38.8	0.0	0.0	18.1	0.0	3.8	41.5	0.0	31.0
LnGrp LOS	D	A	A	D	A	A	B	A	A	D	A	C
Approach Vol, veh/h		65			63			1033				840
Approach Delay, s/veh		38.1			38.8			3.9				31.7
Approach LOS		D			D			A				C
Timer - Assigned Phs	1	2		4	5	6		8				
Phs Duration (G+Y+Rc), s	10.0	65.9		14.0	26.0	50.0		14.0				
Change Period (Y+Rc), s	4.0	4.6		* 4.9	4.6	* 4.6		* 4.9				
Max Green Setting (Gmax), s	9.0	45.4		* 22	9.0	* 45		* 22				
Max Q Clear Time (g_c+I1), s	4.7	2.0		5.0	2.3	36.9		5.7				
Green Ext Time (p_c), s	0.0	18.3		0.2	0.0	4.7		0.2				
<b>Intersection Summary</b>												
HCM 6th Ctrl Delay				17.7								
HCM 6th LOS				B								
<b>Notes</b>												
* HCM 6th computational engine requires equal clearance times for the phases crossing the barrier.												

# HCM 6th Signalized Intersection Summary

## 4: D St & Petaluma Blvd

Cumulative  
Timing Plan: AM Peak



Movement	EBL	EBT	EBR	WBL	WBT	WBR	NBL	NBT	NBR	SBL	SBT	SBR
Lane Configurations												
Traffic Volume (veh/h)	156	423	69	67	324	356	77	371	48	173	293	88
Future Volume (veh/h)	156	423	69	67	324	356	77	371	48	173	293	88
Initial Q (Qb), veh	0	0	0	0	0	0	0	0	0	0	0	0
Ped-Bike Adj(A_pbT)	1.00		0.99	1.00		0.99	1.00		0.97	1.00		0.99
Parking Bus, Adj	1.00	1.00	1.00	1.00	1.00	1.00	1.00	1.00	1.00	1.00	1.00	1.00
Work Zone On Approach		No		No		No		No		No		No
Adj Sat Flow, veh/h/ln	1826	1826	1796	1826	1841	1885	1870	1870	1796	1856	1811	1856
Adj Flow Rate, veh/h	170	460	75	73	352	387	84	403	52	188	318	96
Peak Hour Factor	0.92	0.92	0.92	0.92	0.92	0.92	0.92	0.92	0.92	0.92	0.92	0.92
Percent Heavy Veh, %	5	5	7	5	4	1	2	2	7	3	6	3
Cap, veh/h	155	543	449	130	507	436	139	491	63	216	644	556
Arrive On Green	0.09	0.30	0.30	0.07	0.28	0.28	0.08	0.30	0.30	0.24	0.71	0.71
Sat Flow, veh/h	1739	1826	1509	1739	1841	1583	1781	1617	209	1767	1811	1564
Grp Volume(v), veh/h	170	460	75	73	352	387	84	0	455	188	318	96
Grp Sat Flow(s),veh/h/ln	1739	1826	1509	1739	1841	1583	1781	0	1826	1767	1811	1564
Q Serve(g_s), s	8.0	21.3	3.3	3.6	15.4	21.1	4.1	0.0	20.8	9.2	7.0	1.3
Cycle Q Clear(g_c), s	8.0	21.3	3.3	3.6	15.4	21.1	4.1	0.0	20.8	9.2	7.0	1.3
Prop In Lane	1.00		1.00	1.00		1.00	1.00		0.11	1.00		1.00
Lane Grp Cap(c), veh/h	155	543	449	130	507	436	139	0	554	216	644	556
V/C Ratio(X)	1.10	0.85	0.17	0.56	0.69	0.89	0.60	0.00	0.82	0.87	0.49	0.17
Avail Cap(c_a), veh/h	155	543	449	155	538	463	158	0	554	216	644	556
HCM Platoon Ratio	1.00	1.00	1.00	1.00	1.00	1.00	1.00	1.00	1.00	2.00	2.00	2.00
Upstream Filter(l)	1.00	1.00	1.00	1.00	1.00	1.00	1.00	0.00	1.00	0.81	0.81	0.81
Uniform Delay (d), s/veh	41.0	29.7	23.4	40.2	29.2	31.3	40.1	0.0	29.1	33.3	9.4	4.2
Incr Delay (d2), s/veh	101.6	12.3	0.2	1.4	4.1	18.5	2.7	0.0	12.9	24.1	2.2	0.5
Initial Q Delay(d3),s/veh	0.0	0.0	0.0	0.0	0.0	0.0	0.0	0.0	0.0	0.0	0.0	0.0
%ile BackOfQ(50%),veh/ln	7.7	10.9	1.2	1.6	7.2	10.0	1.9	0.0	10.9	4.9	2.5	0.7
Unsig. Movement Delay, s/veh												
LnGrp Delay(d),s/veh	142.6	41.9	23.6	41.7	33.3	49.8	42.8	0.0	42.0	57.4	11.6	4.8
LnGrp LOS	F	D	C	D	C	D	D	A	D	E	B	A
Approach Vol, veh/h		705			812			539			602	
Approach Delay, s/veh		64.3			41.9			42.1			24.8	
Approach LOS		E			D			D			C	
Timer - Assigned Phs	1	2	3	4	5	6	7	8				
Phs Duration (G+Y+Rc), s	5.6	32.0	10.7	31.7	11.0	36.6	12.9	29.5				
Change Period (Y+Rc), s	4.6	* 4.7	4.0	* 4.9	4.0	4.6	* 4.9	* 4.7				
Max Green Setting (Gmax), s	15	* 27	8.0	* 26	8.0	30.4	* 8	* 26				
Max Q Clear Time (g_c+fl), s	22.8	22.8	5.6	23.3	6.1	9.0	10.0	23.1				
Green Ext Time (p_c), s	0.0	1.0	0.0	1.1	0.0	1.9	0.0	1.5				

### Intersection Summary

HCM 6th Ctrl Delay	44.0
HCM 6th LOS	D

### Notes

User approved pedestrian interval to be less than phase max green.  
\* HCM 6th computational engine requires equal clearance times for the phases crossing the barrier.



# HCM 6th Signalized Intersection Summary

## 5: Washington St & Lakeville St

Cumulative  
Timing Plan: AM Peak



Movement	EBL	EBT	EBR	WBL	WBT	WBR	NBL	NBT	NBR	SBL	SBT	SBR
Lane Configurations		↕		↗	↖		↗	↖		↗	↖	
Traffic Volume (veh/h)	48	214	64	227	147	53	43	795	248	61	872	49
Future Volume (veh/h)	48	214	64	227	147	53	43	795	248	61	872	49
Initial Q (Qb), veh	0	0	0	0	0	0	0	0	0	0	0	0
Ped-Bike Adj(A_pbT)	1.00		0.99	1.00		0.99	1.00		0.97	1.00		0.97
Parking Bus, Adj	1.00	1.00	1.00	1.00	1.00	1.00	1.00	1.00	1.00	1.00	1.00	1.00
Work Zone On Approach		No		No		No		No		No		No
Adj Sat Flow, veh/h/ln	1856	1663	1381	1767	1722	1811	1337	1856	1796	1722	1826	1752
Adj Flow Rate, veh/h	54	240	72	255	165	60	48	893	279	69	980	55
Peak Hour Factor	0.89	0.89	0.89	0.89	0.89	0.89	0.89	0.89	0.89	0.89	0.89	0.89
Percent Heavy Veh, %	3	16	35	9	12	6	38	3	7	12	5	10
Cap, veh/h	54	242	73	297	212	77	192	941	293	131	944	53
Arrive On Green	0.23	0.23	0.23	0.18	0.18	0.18	0.30	0.72	0.72	0.08	0.28	0.28
Sat Flow, veh/h	235	1044	313	1682	1201	437	1273	2624	818	1640	3332	187
Grp Volume(v), veh/h	366	0	0	255	0	225	48	599	573	69	510	525
Grp Sat Flow(s),veh/h/ln	1592	0	0	1682	0	1638	1273	1763	1679	1640	1735	1785
Q Serve(g_s), s	28.7	0.0	0.0	18.4	0.0	16.4	3.6	37.5	38.0	5.1	35.4	35.4
Cycle Q Clear(g_c), s	28.7	0.0	0.0	18.4	0.0	16.4	3.6	37.5	38.0	5.1	35.4	35.4
Prop In Lane	0.15		0.20	1.00		0.27	1.00		0.49	1.00		0.10
Lane Grp Cap(c), veh/h	369	0	0	297	0	290	192	632	602	131	491	505
V/C Ratio(X)	0.99	0.00	0.00	0.86	0.00	0.78	0.25	0.95	0.95	0.53	1.04	1.04
Avail Cap(c_a), veh/h	369	0	0	400	0	389	192	632	602	131	491	505
HCM Platoon Ratio	1.00	1.00	1.00	1.00	1.00	1.00	2.00	2.00	2.00	1.00	1.00	1.00
Upstream Filter(l)	1.00	0.00	0.00	0.92	0.00	0.92	0.79	0.79	0.79	1.00	1.00	1.00
Uniform Delay (d), s/veh	47.9	0.0	0.0	49.9	0.0	49.1	38.4	16.7	16.7	55.2	44.8	44.8
Incr Delay (d2), s/veh	44.3	0.0	0.0	9.7	0.0	4.3	0.2	21.4	22.8	1.9	50.9	50.4
Initial Q Delay(d3),s/veh	0.0	0.0	0.0	0.0	0.0	0.0	0.0	0.0	0.0	0.0	0.0	0.0
%ile BackOfQ(50%),veh/ft	5.8	0.0	0.0	8.5	0.0	7.1	1.1	12.1	11.9	2.2	22.0	22.6
Unsig. Movement Delay, s/veh												
LnGrp Delay(d),s/veh	92.1	0.0	0.0	59.6	0.0	53.4	38.6	38.1	39.5	57.1	95.7	95.2
LnGrp LOS	F	A	A	E	A	D	D	D	D	E	F	F
Approach Vol, veh/h		366		480		1220		1104				
Approach Delay, s/veh		92.1		56.7		38.8		93.0				
Approach LOS		F		E		D		F				
Timer - Assigned Phs	1	2		4	5	6		8				
Phs Duration (G+Y+Rc), s	4.0	49.6		27.4	23.6	40.0		34.0				
Change Period (Y+Rc), s	4.0	* 4.8		* 5.3	4.8	* 4.6		5.0				
Max Green Setting (Gmax), s	40.0	* 37		* 30	12.0	* 35		29.0				
Max Q Clear Time (g_c+11), s	40.0			20.4	5.6	37.4		30.7				
Green Ext Time (p_c), s	0.0	0.0		0.9	0.0	0.0		0.0				

### Intersection Summary

HCM 6th Ctrl Delay	66.5
HCM 6th LOS	E

### Notes

User approved pedestrian interval to be less than phase max green.  
 \* HCM 6th computational engine requires equal clearance times for the phases crossing the barrier.

HCM 6th Signalized Intersection Summary  
6: Washington St & Copeland St

Cumulative  
Timing Plan: AM Peak



Movement	EBL	EBT	EBR	WBL	WBT	WBR	NBL	NBT	NBR	SBL	SBT	SBR
Lane Configurations		↕			↕	↕	↕	↕		↕	↕	
Traffic Volume (veh/h)	44	0	18	41	26	229	16	870	40	283	776	64
Future Volume (veh/h)	44	0	18	41	26	229	16	870	40	283	776	64
Initial Q (Qb), veh	0	0	0	0	0	0	0	0	0	0	0	0
Ped-Bike Adj(A_pbT)	1.00		1.00	1.00		0.98	1.00		0.97	1.00		0.97
Parking Bus, Adj	1.00	1.00	1.00	1.00	1.00	1.00	1.00	1.00	1.00	1.00	1.00	1.00
Work Zone On Approach		No			No			No			No	
Adj Sat Flow, veh/h/ln	418	1900	1900	1618	1900	1737	418	1856	1900	1856	1826	1070
Adj Flow Rate, veh/h	51	0	21	48	30	266	19	1012	47	329	902	74
Peak Hour Factor	0.86	0.86	0.86	0.86	0.86	0.86	0.86	0.86	0.86	0.86	0.86	0.86
Percent Heavy Veh, %	100	0	0	19	0	11	100	3	0	3	5	56
Cap, veh/h	192	8	62	235	137	298	45	1299	60	525	1824	150
Arrive On Green	0.21	0.00	0.21	0.21	0.21	0.21	0.11	0.38	0.38	0.30	0.56	0.56
Sat Flow, veh/h	693	41	302	915	664	1446	398	3425	159	1767	3239	266
Grp Volume(v), veh/h	72	0	0	78	0	266	19	521	538	329	483	493
Grp Sat Flow(s),veh/h/ln1035	0	0	1580	0	1446	398	1763	1821	1767	1735	1770	
Q Serve(g_s), s	5.3	0.0	0.0	0.0	0.0	22.4	5.6	32.5	32.5	20.1	21.1	21.1
Cycle Q Clear(g_c), s	10.2	0.0	0.0	4.9	0.0	22.4	5.6	32.5	32.5	20.1	21.1	21.1
Prop In Lane	0.71		0.29	0.62		1.00	1.00		0.09	1.00		0.15
Lane Grp Cap(c), veh/h	263	0	0	372	0	298	45	668	691	525	977	997
V/C Ratio(X)	0.27	0.00	0.00	0.21	0.00	0.89	0.42	0.78	0.78	0.63	0.49	0.49
Avail Cap(c_a), veh/h	343	0	0	461	0	381	45	668	691	525	977	997
HCM Platoon Ratio	1.00	1.00	1.00	1.00	1.00	1.00	1.00	1.00	1.00	1.00	1.00	1.00
Upstream Filter(l)	1.00	0.00	0.00	1.00	0.00	1.00	1.00	1.00	1.00	0.28	0.28	0.28
Uniform Delay (d), s/veh	44.4	0.0	0.0	41.2	0.0	48.2	51.7	34.2	34.2	38.0	16.5	16.5
Incr Delay (d2), s/veh	0.4	0.0	0.0	0.2	0.0	17.9	2.3	8.7	8.5	0.5	0.5	0.5
Initial Q Delay(d3),s/veh	0.0	0.0	0.0	0.0	0.0	0.0	0.0	0.0	0.0	0.0	0.0	0.0
%ile BackOfQ(50%),veh/ln2.0	0.0	0.0	0.0	2.1	0.0	9.6	0.6	15.6	16.1	8.9	8.5	8.7
Unsig. Movement Delay, s/veh												
LnGrp Delay(d),s/veh	44.8	0.0	0.0	41.4	0.0	66.1	54.0	42.9	42.7	38.5	17.0	17.0
LnGrp LOS	D	A	A	D	A	E	D	D	D	D	B	B
Approach Vol, veh/h		72			344			1078			1305	
Approach Delay, s/veh		44.8			60.5			43.0			22.4	
Approach LOS		D			E			D			C	
Timer - Assigned Phs	1	2		4	5	6		8				
Phs Duration (G+Y+Rc), s	42.1	52.0		30.9	19.1	75.0		30.9				
Change Period (Y+Rc), s	5.0	4.6		5.1	5.0	* 4.6		* 5.1				
Max Green Setting (Gmax), s	29.0	47.4		32.9	7.0	* 70		* 34				
Max Q Clear Time (g_c+Q), s	22.1	34.5		24.4	7.6	23.1		12.2				
Green Ext Time (p_c), s	0.3	7.5		0.7	0.0	12.9		0.3				

Intersection Summary























HCM 6th Ctrl Delay	35.6
HCM 6th LOS	D

Notes

\* HCM 6th computational engine requires equal clearance times for the phases crossing the barrier.

HCM 6th Signalized Intersection Summary  
 1: D St & Lakeville St

Cumulative  
 Timing Plan: PM Peak

												
Movement	EBL	EBT	EBR	WBL	WBT	WBR	NBL	NBT	NBR	SBL	SBT	SBR
Lane Configurations												
Traffic Volume (veh/h)	9	370	70	501	518	51	99	164	579	25	188	15
Future Volume (veh/h)	9	370	70	501	518	51	99	164	579	25	188	15
Initial Q (Qb), veh	0	0	0	0	0	0	0	0	0	0	0	0
Ped-Bike Adj(A_pbT)	0.99		0.98	1.00		0.97	1.00		0.94	1.00		0.90
Parking Bus, Adj	1.00	1.00	1.00	1.00	1.00	1.00	1.00	1.00	1.00	1.00	1.00	1.00
Work Zone On Approach		No			No			No			No	
Adj Sat Flow, veh/h/ln	1900	1826	1678	1856	1870	1900	1826	1885	1870	1900	1885	1900
Adj Flow Rate, veh/h	10	398	75	539	557	55	106	176	623	27	202	16
Peak Hour Factor	0.93	0.93	0.93	0.93	0.93	0.93	0.93	0.93	0.93	0.93	0.93	0.93
Percent Heavy Veh, %	0	5	15	3	2	0	5	1	2	0	1	0
Cap, veh/h	30	431	336	547	1083	903	120	199	748	272	256	20
Arrive On Green	0.24	0.24	0.24	0.31	0.58	0.58	0.17	0.17	0.17	0.15	0.15	0.15
Sat Flow, veh/h	18	1783	1389	1767	1870	1560	696	1155	1496	1810	1707	135
Grp Volume(v), veh/h	408	0	75	539	557	55	282	0	623	27	0	218
Grp Sat Flow(s),veh/h/ln	1801	0	1389	1767	1870	1560	1850	0	1496	1810	0	1842
Q Serve(g_s), s	12.0	0.0	6.3	44.1	26.0	2.2	21.7	0.0	25.0	1.9	0.0	16.6
Cycle Q Clear(g_c), s	32.2	0.0	6.3	44.1	26.0	2.2	21.7	0.0	25.0	1.9	0.0	16.6
Prop In Lane	0.02		1.00	1.00		1.00	0.38		1.00	1.00		0.07
Lane Grp Cap(c), veh/h	461	0	336	547	1083	903	318	0	748	272	0	277
V/C Ratio(X)	0.88	0.00	0.22	0.99	0.51	0.06	0.89	0.00	0.83	0.10	0.00	0.79
Avail Cap(c_a), veh/h	520	0	382	547	1083	903	318	0	748	348	0	355
HCM Platoon Ratio	1.00	1.00	1.00	1.00	1.00	1.00	1.00	1.00	1.00	1.00	1.00	1.00
Upstream Filter(l)	1.00	0.00	1.00	1.00	1.00	1.00	1.00	0.00	1.00	1.00	0.00	1.00
Uniform Delay (d), s/veh	53.9	0.0	44.2	49.9	18.4	13.4	58.8	0.0	33.2	53.3	0.0	59.6
Incr Delay (d2), s/veh	14.2	0.0	0.1	34.6	0.2	0.0	25.0	0.0	8.3	0.1	0.0	7.9
Initial Q Delay(d3),s/veh	0.0	0.0	0.0	0.0	0.0	0.0	0.0	0.0	0.0	0.0	0.0	0.0
%ile BackOfQ(50%),veh/ln	16.4	0.0	2.2	24.7	11.3	0.8	12.5	0.0	20.7	0.9	0.0	8.4
Unsig. Movement Delay, s/veh												
LnGrp Delay(d),s/veh	68.1	0.0	44.3	84.5	18.6	13.4	83.9	0.0	41.5	53.4	0.0	67.4
LnGrp LOS	E	A	D	F	B	B	F	A	D	D	A	E
Approach Vol, veh/h		483			1151			905				245
Approach Delay, s/veh		64.4			49.2			54.7				65.9
Approach LOS		E			D			D				E
Timer - Assigned Phs		2	3	4		6		8				
Phs Duration (G+Y+Rc), s		30.3	49.0	40.0		26.1		89.0				
Change Period (Y+Rc), s		* 5.3	4.0	* 4.8		4.3		* 4.8				
Max Green Setting (Gmax), s		* 25	45.0	* 40		28.0		* 60				
Max Q Clear Time (g_c+I1), s		27.0	46.1	34.2		18.6		28.0				
Green Ext Time (p_c), s		0.0	0.0	1.0		0.7		2.6				
<b>Intersection Summary</b>												
HCM 6th Ctrl Delay			55.1									
HCM 6th LOS			E									
<b>Notes</b>												
* HCM 6th computational engine requires equal clearance times for the phases crossing the barrier.												

HCM 6th TWSC  
2: D St & Copeland St

Cumulative  
Timing Plan: PM Peak

Intersection												
Int Delay, s/veh	70.8											
Movement	EBL	EBT	EBR	WBL	WBT	WBR	NBL	NBT	NBR	SBL	SBT	SBR
Lane Configurations		↕			↕		↕	↕			↕	
Traffic Vol, veh/h	30	9	268	3	4	3	252	836	6	0	722	150
Future Vol, veh/h	30	9	268	3	4	3	252	836	6	0	722	150
Conflicting Peds, #/hr	4	0	7	7	0	4	17	0	3	3	0	17
Sign Control	Stop	Stop	Stop	Stop	Stop	Stop	Free	Free	Free	Free	Free	Free
RT Channelized	-	-	None	-	-	None	-	-	None	-	-	None
Storage Length	-	-	-	-	-	-	60	-	-	-	-	-
Veh in Median Storage, #	-	0	-	-	0	-	-	0	-	-	0	-
Grade, %	-	0	-	-	0	-	-	0	-	-	0	-
Peak Hour Factor	93	93	93	93	93	93	93	93	93	93	93	93
Heavy Vehicles, %	0	25	3	0	0	0	5	2	0	0	2	18
Mvmt Flow	32	10	288	3	4	3	271	899	6	0	776	161

Major/Minor	Minor2		Minor1		Major1			Major2				
Conflicting Flow All	2326	2324	881	2460	2401	909	954	0	0	908	0	0
Stage 1	874	874	-	1447	1447	-	-	-	-	-	-	-
Stage 2	1452	1450	-	1013	954	-	-	-	-	-	-	-
Critical Hdwy	6.1	5.8	5.2	6.1	5.5	5.2	4.15	-	-	4.1	-	-
Critical Hdwy Stg 1	6.1	5.75	-	6.1	5.5	-	-	-	-	-	-	-
Critical Hdwy Stg 2	6.1	5.75	-	6.1	5.5	-	-	-	-	-	-	-
Follow-up Hdwy	3.5	4.225	3.327	3.5	4	3.3	2.245	-	-	2.2	-	-
Pot Cap-1 Maneuver	50	59	443	42	66	433	708	-	-	758	-	-
Stage 1	347	337	-	165	198	-	-	-	-	-	-	-
Stage 2	164	175	-	291	340	-	-	-	-	-	-	-
Platoon blocked, %								-	-	-	-	-
Mov Cap-1 Maneuver	~ 31	35	433	8	40	430	697	-	-	756	-	-
Mov Cap-2 Maneuver	~ 31	35	-	8	40	-	-	-	-	-	-	-
Stage 1	209	332	-	100	121	-	-	-	-	-	-	-
Stage 2	96	107	-	94	335	-	-	-	-	-	-	-



















Approach	EB	WB	NB	SB
HCM Control Delay, s	506.1	293.7	3.1	0
HCM LOS	F	F		

Minor Lane/Major Mvmt	NBL	NBT	NBR	EBLn1	WBLn1	SBL	SBT	SBR
Capacity (veh/h)	697	-	-	167	21	756	-	-
HCM Lane V/C Ratio	0.389	-	-	1.977	0.512	-	-	-
HCM Control Delay (s)	13.4	-	-	506.1	293.7	0	-	-
HCM Lane LOS	B	-	-	F	F	A	-	-
HCM 95th %tile Q(veh)	1.8	-	-	25.3	1.5	0	-	-

Notes  
 ~: Volume exceeds capacity    \$: Delay exceeds 300s    +: Computation Not Defined    \*: All major volume in platoon

HCM 6th Signalized Intersection Summary  
 3: D St & 1st St

Cumulative  
 Timing Plan: PM Peak

												
Movement	EBL	EBT	EBR	WBL	WBT	WBR	NBL	NBT	NBR	SBL	SBT	SBR
Lane Configurations												
Traffic Volume (veh/h)	71	4	12	16	7	57	6	971	23	67	871	63
Future Volume (veh/h)	71	4	12	16	7	57	6	971	23	67	871	63
Initial Q (Qb), veh	0	0	0	0	0	0	0	0	0	0	0	0
Ped-Bike Adj(A_pbT)	0.98		0.98	0.99		0.97	1.00		0.97	1.00		0.97
Parking Bus, Adj	1.00	1.00	1.00	1.00	1.00	1.00	1.00	1.00	1.00	1.00	1.00	1.00
Work Zone On Approach		No			No			No			No	
Adj Sat Flow, veh/h/ln	1900	1900	1900	1781	1900	1856	1900	1856	1707	1841	1870	1900
Adj Flow Rate, veh/h	72	4	12	16	7	58	6	991	23	68	889	64
Peak Hour Factor	0.98	0.98	0.98	0.98	0.98	0.98	0.98	0.98	0.98	0.98	0.98	0.98
Percent Heavy Veh, %	0	0	0	8	0	3	0	3	13	4	2	0
Cap, veh/h	154	11	18	54	24	110	455	1338	31	102	934	67
Arrive On Green	0.09	0.09	0.09	0.09	0.09	0.09	0.50	1.00	1.00	0.06	0.54	0.54
Sat Flow, veh/h	1104	124	194	208	268	1200	1810	1805	42	1753	1719	124
Grp Volume(v), veh/h	88	0	0	81	0	0	6	0	1014	68	0	953
Grp Sat Flow(s),veh/h/ln	1422	0	0	1676	0	0	1810	0	1847	1753	0	1843
Q Serve(g_s), s	1.7	0.0	0.0	0.0	0.0	0.0	0.2	0.0	0.0	4.7	0.0	60.6
Cycle Q Clear(g_c), s	7.3	0.0	0.0	5.6	0.0	0.0	0.2	0.0	0.0	4.7	0.0	60.6
Prop In Lane	0.82		0.14	0.20		0.72	1.00		0.02	1.00		0.07
Lane Grp Cap(c), veh/h	183	0	0	188	0	0	455	0	1369	102	0	1002
V/C Ratio(X)	0.48	0.00	0.00	0.43	0.00	0.00	0.01	0.00	0.74	0.67	0.00	0.95
Avail Cap(c_a), veh/h	429	0	0	461	0	0	455	0	1369	127	0	1002
HCM Platoon Ratio	1.00	1.00	1.00	1.00	1.00	1.00	2.00	2.00	2.00	1.00	1.00	1.00
Upstream Filter(l)	1.00	0.00	0.00	1.00	0.00	0.00	0.70	0.00	0.70	1.00	0.00	1.00
Uniform Delay (d), s/veh	54.4	0.0	0.0	53.8	0.0	0.0	23.1	0.0	0.0	57.2	0.0	26.7
Incr Delay (d2), s/veh	1.5	0.0	0.0	1.2	0.0	0.0	0.0	0.0	2.6	4.9	0.0	18.9
Initial Q Delay(d3),s/veh	0.0	0.0	0.0	0.0	0.0	0.0	0.0	0.0	0.0	0.0	0.0	0.0
%ile BackOfQ(50%),veh/ln	2.8	0.0	0.0	2.5	0.0	0.0	0.1	0.0	1.0	2.2	0.0	31.0
Unsig. Movement Delay, s/veh												
LnGrp Delay(d),s/veh	55.9	0.0	0.0	55.0	0.0	0.0	23.1	0.0	2.6	62.1	0.0	45.6
LnGrp LOS	E	A	A	D	A	A	C	A	A	E	A	D
Approach Vol, veh/h		88			81			1020			1021	
Approach Delay, s/veh		55.9			55.0			2.7			46.7	
Approach LOS		E			D			A			D	
Timer - Assigned Phs	1	2		4	5	6		8				
Phs Duration (G+Y+Rc), s	11.2	96.6		16.2	35.8	72.0		16.2				
Change Period (Y+Rc), s	4.0	4.6		* 4.9	4.6	* 4.6		* 4.9				
Max Green Setting (Gmax), s	9.0	68.4		* 33	10.0	* 67		* 33				
Max Q Clear Time (g_c+I1), s	6.7	2.0		9.3	2.2	62.6		7.6				
Green Ext Time (p_c), s	0.0	20.5		0.4	0.0	3.4		0.4				
<b>Intersection Summary</b>												
HCM 6th Ctrl Delay				27.1								
HCM 6th LOS				C								
<b>Notes</b>												
* HCM 6th computational engine requires equal clearance times for the phases crossing the barrier.												

HCM 6th Signalized Intersection Summary  
4: D St & Petaluma Blvd

Cumulative  
Timing Plan: PM Peak



Movement	EBL	EBT	EBR	WBL	WBT	WBR	NBL	NBT	NBR	SBL	SBT	SBR
Lane Configurations												
Traffic Volume (veh/h)	188	316	90	148	376	287	81	348	27	236	567	127
Future Volume (veh/h)	188	316	90	148	376	287	81	348	27	236	567	127
Initial Q (Qb), veh	0	0	0	0	0	0	0	0	0	0	0	0
Ped-Bike Adj(A_pbT)	1.00		0.94	1.00		0.93	1.00		0.95	1.00		0.95
Parking Bus, Adj	1.00	1.00	1.00	1.00	1.00	1.00	1.00	1.00	1.00	1.00	1.00	1.00
Work Zone On Approach		No		No		No		No		No		No
Adj Sat Flow, veh/h/ln	1841	1885	1900	1856	1885	1870	1870	1856	1900	1900	1856	1870
Adj Flow Rate, veh/h	204	343	98	161	409	312	88	378	29	257	616	138
Peak Hour Factor	0.92	0.92	0.92	0.92	0.92	0.92	0.92	0.92	0.92	0.92	0.92	0.92
Percent Heavy Veh, %	4	1	0	3	1	2	2	3	0	0	3	2
Cap, veh/h	230	488	391	187	430	337	110	574	44	279	800	651
Arrive On Green	0.13	0.26	0.26	0.11	0.23	0.23	0.06	0.34	0.34	0.31	0.86	0.86
Sat Flow, veh/h	1753	1885	1512	1767	1885	1477	1781	1693	130	1810	1856	1509
Grp Volume(v), veh/h	204	343	98	161	409	312	88	0	407	257	616	138
Grp Sat Flow(s),veh/h/ln	1753	1885	1512	1767	1885	1477	1781	0	1823	1810	1856	1509
Q Serve(g_s), s	14.2	20.4	6.4	11.1	26.5	18.2	6.0	0.0	23.6	17.0	16.8	1.2
Cycle Q Clear(g_c), s	14.2	20.4	6.4	11.1	26.5	18.2	6.0	0.0	23.6	17.0	16.8	1.2
Prop In Lane	1.00		1.00	1.00		1.00	1.00		0.07	1.00		1.00
Lane Grp Cap(c), veh/h	230	488	391	187	430	337	110	0	618	279	800	651
V/C Ratio(X)	0.89	0.70	0.25	0.86	0.95	0.93	0.80	0.00	0.66	0.92	0.77	0.21
Avail Cap(c_a), veh/h	254	488	391	242	430	337	187	0	618	321	800	651
HCM Platoon Ratio	1.00	1.00	1.00	1.00	1.00	1.00	1.00	1.00	1.00	2.00	2.00	2.00
Upstream Filter(l)	1.00	1.00	1.00	1.00	1.00	1.00	1.00	0.00	1.00	0.71	0.71	0.71
Uniform Delay (d), s/veh	53.0	41.6	36.4	54.5	47.2	23.5	57.4	0.0	34.9	42.1	6.0	2.0
Incr Delay (d2), s/veh	26.2	5.0	0.5	17.7	31.2	31.0	4.9	0.0	5.4	21.1	5.1	0.5
Initial Q Delay(d3),s/veh	0.0	0.0	0.0	0.0	0.0	0.0	0.0	0.0	0.0	0.0	0.0	0.0
%ile BackOfQ(50%),veh/ln	7.9	10.2	2.4	5.9	16.1	9.2	2.9	0.0	11.5	8.3	3.9	0.7
Unsig. Movement Delay, s/veh												
LnGrp Delay(d),s/veh	79.1	46.6	36.9	72.2	78.4	54.5	62.2	0.0	40.3	63.2	11.1	2.5
LnGrp LOS	E	D	D	E	E	D	E	A	D	E	B	A
Approach Vol, veh/h		645			882			495			1011	
Approach Delay, s/veh		55.4			68.8			44.2			23.2	
Approach LOS		E			E			D			C	
Timer - Assigned Phs	1	2	3	4	5	6	7	8				
Phs Duration (G+Y+Rc), s	33.1	46.7	17.1	37.0	11.7	58.2	21.1	33.0				
Change Period (Y+Rc), s	4.0	* 4.7	4.0	* 4.9	4.0	* 4.7	* 4.9	* 4.7				
Max Green Setting (Gmax), s	27.0	* 38	17.0	* 29	13.0	* 47	* 18	* 28				
Max Q Clear Time (g_c+119), s	119.0	25.6	13.1	22.4	8.0	18.8	16.2	28.5				
Green Ext Time (p_c), s	0.1	1.8	0.1	1.8	0.0	4.3	0.1	0.0				

Intersection Summary

HCM 6th Ctrl Delay	46.7
HCM 6th LOS	D

Notes

User approved pedestrian interval to be less than phase max green.  
\* HCM 6th computational engine requires equal clearance times for the phases crossing the barrier.

HCM 6th Signalized Intersection Summary  
5: Washington St & Lakeville St

Cumulative  
Timing Plan: PM Peak



Movement	EBL	EBT	EBR	WBL	WBT	WBR	NBL	NBT	NBR	SBL	SBT	SBR
Lane Configurations		↕		↗	↘		↗	↕		↗	↕	
Traffic Volume (veh/h)	93	142	76	270	237	111	64	935	203	73	922	58
Future Volume (veh/h)	93	142	76	270	237	111	64	935	203	73	922	58
Initial Q (Qb), veh	0	0	0	0	0	0	0	0	0	0	0	0
Ped-Bike Adj(A_pbT)	1.00		0.98	1.00		0.98	1.00		0.96	1.00		0.95
Parking Bus, Adj	1.00	1.00	1.00	1.00	1.00	1.00	1.00	1.00	1.00	1.00	1.00	1.00
Work Zone On Approach		No		No		No		No		No		No
Adj Sat Flow, veh/h/ln	1826	1811	1811	1870	1826	1900	1900	1856	1811	1870	1885	1900
Adj Flow Rate, veh/h	97	148	79	281	247	116	67	974	211	76	960	60
Peak Hour Factor	0.96	0.96	0.96	0.96	0.96	0.96	0.96	0.96	0.96	0.96	0.96	0.96
Percent Heavy Veh, %	5	6	6	2	5	0	0	3	6	2	1	0
Cap, veh/h	105	160	85	408	267	125	235	947	205	144	946	59
Arrive On Green	0.21	0.21	0.21	0.23	0.23	0.23	0.13	0.33	0.33	0.08	0.28	0.28
Sat Flow, veh/h	510	778	415	1781	1168	548	1810	2858	618	1781	3412	213
Grp Volume(v), veh/h	324	0	0	281	0	363	67	600	585	76	504	516
Grp Sat Flow(s),veh/h/ln	1703	0	0	1781	0	1716	1810	1763	1713	1781	1791	1834
Q Serve(g_s), s	23.2	0.0	0.0	17.9	0.0	25.7	4.1	41.1	41.1	5.1	34.4	34.4
Cycle Q Clear(g_c), s	23.2	0.0	0.0	17.9	0.0	25.7	4.1	41.1	41.1	5.1	34.4	34.4
Prop In Lane	0.30		0.24	1.00		0.32	1.00		0.36	1.00		0.12
Lane Grp Cap(c), veh/h	349	0	0	408	0	393	235	584	568	144	497	509
V/C Ratio(X)	0.93	0.00	0.00	0.69	0.00	0.92	0.29	1.03	1.03	0.53	1.01	1.01
Avail Cap(c_a), veh/h	371	0	0	441	0	425	235	584	568	144	497	509
HCM Platoon Ratio	1.00	1.00	1.00	1.00	1.00	1.00	1.00	1.00	1.00	1.00	1.00	1.00
Upstream Filter(I)	1.00	0.00	0.00	0.85	0.00	0.85	0.71	0.71	0.71	1.00	1.00	1.00
Uniform Delay (d), s/veh	48.4	0.0	0.0	43.8	0.0	46.8	48.8	41.5	41.5	54.7	44.8	44.8
Incr Delay (d2), s/veh	27.5	0.0	0.0	2.7	0.0	21.4	0.2	38.5	40.0	1.9	44.0	43.5
Initial Q Delay(d3),s/veh	0.0	0.0	0.0	0.0	0.0	0.0	0.0	0.0	0.0	0.0	0.0	0.0
%ile BackOfQ(50%),veh/ft	2.5	0.0	0.0	8.2	0.0	13.2	1.9	24.0	23.6	2.4	21.2	21.6
Unsig. Movement Delay, s/veh												
LnGrp Delay(d),s/veh	75.8	0.0	0.0	46.5	0.0	68.2	48.9	79.9	81.5	56.6	88.8	88.3
LnGrp LOS	E	A	A	D	A	E	D	F	F	E	F	F
Approach Vol, veh/h		324		644		1252		1096				
Approach Delay, s/veh		75.8		58.7		79.0		86.4				
Approach LOS		E		E		E		F				
Timer - Assigned Phs	1	2		4	5	6		8				
Phs Duration (G+Y+Rc), s	4.0	45.9		33.7	20.9	39.0		30.4				
Change Period (Y+Rc), s	4.0	* 4.8		* 5.3	4.8	* 4.6		5.0				
Max Green Setting (Gmax), s	4.0	* 37		* 31	13.0	* 34		27.0				
Max Q Clear Time (g_c+11), s	43.1			27.7	6.1	36.4		25.2				
Green Ext Time (p_c), s	0.0	0.0		0.7	0.0	0.0		0.3				

Intersection Summary

HCM 6th Ctrl Delay	77.2
HCM 6th LOS	E

Notes

User approved pedestrian interval to be less than phase max green.  
\* HCM 6th computational engine requires equal clearance times for the phases crossing the barrier.

# HCM 6th Signalized Intersection Summary

## 6: Washington St & Copeland St

Cumulative  
Timing Plan: PM Peak



Movement	EBL	EBT	EBR	WBL	WBT	WBR	NBL	NBT	NBR	SBL	SBT	SBR
Lane Configurations		↕			↕	↕	↕	↕		↕	↕	
Traffic Volume (veh/h)	108	19	12	98	16	300	31	862	39	298	893	75
Future Volume (veh/h)	108	19	12	98	16	300	31	862	39	298	893	75
Initial Q (Qb), veh	0	0	0	0	0	0	0	0	0	0	0	0
Ped-Bike Adj(A_pbT)	1.00		1.00	1.00		1.00	1.00		0.96	1.00		0.97
Parking Bus, Adj	1.00	1.00	1.00	1.00	1.00	1.00	1.00	1.00	1.00	1.00	1.00	1.00
Work Zone On Approach		No			No			No			No	
Adj Sat Flow, veh/h/ln	1900	1900	1900	1752	1900	1781	1900	1870	1693	1856	1870	1707
Adj Flow Rate, veh/h	112	20	12	102	17	312	32	898	41	310	930	78
Peak Hour Factor	0.96	0.96	0.96	0.96	0.96	0.96	0.96	0.96	0.96	0.96	0.96	0.96
Percent Heavy Veh, %	0	0	0	10	0	8	0	2	14	3	2	13
Cap, veh/h	243	41	19	390	59	365	281	1298	59	353	1391	117
Arrive On Green	0.24	0.24	0.24	0.24	0.24	0.24	0.16	0.38	0.38	0.20	0.42	0.42
Sat Flow, veh/h	675	171	77	1269	244	1508	1810	3454	158	1767	3308	277
Grp Volume(v), veh/h	144	0	0	119	0	312	32	462	477	310	499	509
Grp Sat Flow(s),veh/h/ln	922	0	0	1512	0	1508	1810	1777	1835	1767	1777	1809
Q Serve(g_s), s	8.3	0.0	0.0	0.0	0.0	16.0	1.2	17.7	17.7	13.8	18.3	18.3
Cycle Q Clear(g_c), s	13.3	0.0	0.0	5.1	0.0	16.0	1.2	17.7	17.7	13.8	18.3	18.3
Prop In Lane	0.78		0.08	0.86		1.00	1.00		0.09	1.00		0.15
Lane Grp Cap(c), veh/h	303	0	0	449	0	365	281	668	690	353	747	761
V/C Ratio(X)	0.48	0.00	0.00	0.26	0.00	0.85	0.11	0.69	0.69	0.88	0.67	0.67
Avail Cap(c_a), veh/h	528	0	0	725	0	651	448	1108	1145	656	1548	1576
HCM Platoon Ratio	1.00	1.00	1.00	1.00	1.00	1.00	1.00	1.00	1.00	1.00	1.00	1.00
Upstream Filter(l)	1.00	0.00	0.00	1.00	0.00	1.00	1.00	1.00	1.00	1.00	1.00	1.00
Uniform Delay (d), s/veh	29.8	0.0	0.0	25.1	0.0	29.2	29.3	21.3	21.3	31.4	18.9	18.9
Incr Delay (d2), s/veh	0.9	0.0	0.0	0.2	0.0	4.3	0.1	1.8	1.8	2.8	1.5	1.5
Initial Q Delay(d3),s/veh	0.0	0.0	0.0	0.0	0.0	0.0	0.0	0.0	0.0	0.0	0.0	0.0
%ile BackOfQ(50%),veh/ln	2.6	0.0	0.0	1.9	0.0	6.1	0.5	7.4	7.7	6.0	7.5	7.6
Unsig. Movement Delay, s/veh												
LnGrp Delay(d),s/veh	30.6	0.0	0.0	25.3	0.0	33.6	29.4	23.1	23.1	34.1	20.4	20.3
LnGrp LOS	C	A	A	C	A	C	C	C	C	C	C	C
Approach Vol, veh/h		144			431			971			1318	
Approach Delay, s/veh		30.6			31.3			23.3			23.6	
Approach LOS		C			C			C			C	
Timer - Assigned Phs	1	2		4	5	6		8				
Phs Duration (G+Y+Rc), s	31.2	35.0		24.7	17.5	38.6		24.7				
Change Period (Y+Rc), s	5.0	4.6		5.1	5.0	* 4.6		* 5.1				
Max Green Setting (Gmax), s	30.0	50.4		34.9	20.0	* 70		* 35				
Max Q Clear Time (g_c+115), s	115.8	19.7		18.0	3.2	20.3		15.3				
Green Ext Time (p_c), s	0.4	10.6		1.3	0.0	13.7		0.8				

### Intersection Summary

HCM 6th Ctrl Delay	25.0
HCM 6th LOS	C

### Notes

\* HCM 6th computational engine requires equal clearance times for the phases crossing the barrier.























# G - Cumulative Plus Project Traffic Conditions





















HCM 6th Signalized Intersection Summary  
1: D St & Lakeville St

Cumulative+Project  
Timing Plan: AM Peak

												
Movement	EBL	EBT	EBR	WBL	WBT	WBR	NBL	NBT	NBR	SBL	SBT	SBR
Lane Configurations												
Traffic Volume (veh/h)	7	470	76	382	367	59	56	142	601	24	174	11
Future Volume (veh/h)	7	470	76	382	367	59	56	142	601	24	174	11
Initial Q (Qb), veh	0	0	0	0	0	0	0	0	0	0	0	0
Ped-Bike Adj(A_pbT)	1.00		0.99	1.00		1.00	1.00		0.97	1.00		0.93
Parking Bus, Adj	1.00	1.00	1.00	1.00	1.00	1.00	1.00	1.00	1.00	1.00	1.00	1.00
Work Zone On Approach		No			No			No			No	
Adj Sat Flow, veh/h/ln	1900	1781	1544	1841	1752	1900	1693	1885	1856	1781	1856	1707
Adj Flow Rate, veh/h	8	522	84	424	408	66	62	158	668	27	193	12
Peak Hour Factor	0.90	0.90	0.90	0.90	0.90	0.90	0.90	0.90	0.90	0.90	0.90	0.90
Percent Heavy Veh, %	0	8	24	4	10	0	14	1	3	8	3	13
Cap, veh/h	29	511	377	446	1005	921	95	242	676	239	243	15
Arrive On Green	0.29	0.29	0.29	0.25	0.57	0.57	0.18	0.18	0.18	0.14	0.14	0.14
Sat Flow, veh/h	10	1762	1302	1753	1752	1606	524	1335	1521	1697	1720	107
Grp Volume(v), veh/h	530	0	84	424	408	66	220	0	668	27	0	205
Grp Sat Flow(s),veh/h/ln	1771	0	1302	1753	1752	1606	1859	0	1521	1697	0	1827
Q Serve(g_s), s	14.6	0.0	6.8	32.8	17.9	2.5	15.2	0.0	25.0	1.9	0.0	15.0
Cycle Q Clear(g_c), s	40.0	0.0	6.8	32.8	17.9	2.5	15.2	0.0	25.0	1.9	0.0	15.0
Prop In Lane	0.02		1.00	1.00		1.00	0.28		1.00	1.00		0.06
Lane Grp Cap(c), veh/h	540	0	377	446	1005	921	337	0	676	239	0	258
V/C Ratio(X)	0.98	0.00	0.22	0.95	0.41	0.07	0.65	0.00	0.99	0.11	0.00	0.80
Avail Cap(c_a), veh/h	540	0	377	572	1005	921	337	0	676	344	0	371
HCM Platoon Ratio	1.00	1.00	1.00	1.00	1.00	1.00	1.00	1.00	1.00	1.00	1.00	1.00
Upstream Filter(l)	1.00	0.00	1.00	1.00	1.00	1.00	1.00	0.00	1.00	1.00	0.00	1.00
Uniform Delay (d), s/veh	49.6	0.0	37.2	50.6	16.4	13.1	52.5	0.0	38.8	51.7	0.0	57.3
Incr Delay (d2), s/veh	33.8	0.0	0.1	20.8	0.1	0.0	5.1	0.0	31.6	0.2	0.0	6.3
Initial Q Delay(d3),s/veh	0.0	0.0	0.0	0.0	0.0	0.0	0.0	0.0	0.0	0.0	0.0	0.0
%ile BackOfQ(50%),veh/ln	23.5	0.0	2.2	17.0	7.2	0.9	7.6	0.0	27.9	0.8	0.0	7.4
Unsig. Movement Delay, s/veh												
LnGrp Delay(d),s/veh	83.4	0.0	37.3	71.4	16.5	13.1	57.5	0.0	70.4	51.9	0.0	63.7
LnGrp LOS	F	A	D	E	B	B	E	A	E	D	A	E
Approach Vol, veh/h		614			898			888			232	
Approach Delay, s/veh		77.1			42.1			67.2			62.3	
Approach LOS		E			D			E			E	
Timer - Assigned Phs		2	3	4		6		8				
Phs Duration (G+Y+Rc), s		30.3	39.1	44.8		23.8		83.9				
Change Period (Y+Rc), s		* 5.3	4.0	* 4.8		4.3		* 4.8				
Max Green Setting (Gmax), s		* 25	45.0	* 40		28.0		* 60				
Max Q Clear Time (g_c+I1), s		27.0	34.8	42.0		17.0		19.9				
Green Ext Time (p_c), s		0.0	0.3	0.0		0.7		1.8				
<b>Intersection Summary</b>												
HCM 6th Ctrl Delay			60.5									
HCM 6th LOS			E									
<b>Notes</b>												
* HCM 6th computational engine requires equal clearance times for the phases crossing the barrier.												

HCM 6th Signalized Intersection Summary  
2: D St & Copeland St

Cumulative+Project  
Timing Plan: AM Peak

												
Movement	EBL	EBT	EBR	WBL	WBT	WBR	NBL	NBT	NBR	SBL	SBT	SBR
Lane Configurations												
Traffic Volume (veh/h)	36	4	219	7	11	17	210	751	3	8	550	93
Future Volume (veh/h)	36	4	219	7	11	17	210	751	3	8	550	93
Initial Q (Qb), veh	0	0	0	0	0	0	0	0	0	0	0	0
Ped-Bike Adj(A_pbT)	0.99		0.96	1.00		0.98	1.00		0.97	1.00		0.97
Parking Bus, Adj	1.00	1.00	1.00	1.00	1.00	1.00	1.00	1.00	1.00	1.00	1.00	1.00
Work Zone On Approach		No			No			No			No	
Adj Sat Flow, veh/h/ln	1900	1900	1841	1900	1900	1900	1826	1856	1900	1900	1841	1203
Adj Flow Rate, veh/h	41	5	249	8	12	19	239	853	3	9	625	106
Peak Hour Factor	0.88	0.88	0.88	0.88	0.88	0.88	0.88	0.88	0.88	0.88	0.88	0.88
Percent Heavy Veh, %	0	0	4	0	0	0	5	3	0	0	4	47
Cap, veh/h	69	16	240	77	110	136	308	1226	4	32	759	129
Arrive On Green	0.18	0.18	0.18	0.18	0.18	0.18	0.35	1.00	1.00	0.02	0.50	0.50
Sat Flow, veh/h	152	89	1306	181	600	741	1739	1848	6	1810	1525	259
Grp Volume(v), veh/h	295	0	0	39	0	0	239	0	856	9	0	731
Grp Sat Flow(s),veh/h/ln	1547	0	0	1522	0	0	1739	0	1854	1810	0	1784
Q Serve(g_s), s	13.2	0.0	0.0	0.0	0.0	0.0	12.2	0.0	0.0	0.5	0.0	34.9
Cycle Q Clear(g_c), s	18.4	0.0	0.0	1.9	0.0	0.0	12.2	0.0	0.0	0.5	0.0	34.9
Prop In Lane	0.14		0.84	0.21		0.49	1.00		0.00	1.00		0.15
Lane Grp Cap(c), veh/h	326	0	0	323	0	0	308	0	1230	32	0	888
V/C Ratio(X)	0.91	0.00	0.00	0.12	0.00	0.00	0.78	0.00	0.70	0.28	0.00	0.82
Avail Cap(c_a), veh/h	326	0	0	323	0	0	323	0	1230	154	0	888
HCM Platoon Ratio	1.00	1.00	1.00	1.00	1.00	1.00	2.00	2.00	2.00	1.00	1.00	1.00
Upstream Filter(l)	0.49	0.00	0.00	1.00	0.00	0.00	0.56	0.00	0.56	0.52	0.00	0.52
Uniform Delay (d), s/veh	41.0	0.0	0.0	34.1	0.0	0.0	30.5	0.0	0.0	48.5	0.0	21.3
Incr Delay (d2), s/veh	16.1	0.0	0.0	0.2	0.0	0.0	6.3	0.0	1.9	2.5	0.0	4.6
Initial Q Delay(d3),s/veh	0.0	0.0	0.0	0.0	0.0	0.0	0.0	0.0	0.0	0.0	0.0	0.0
%ile BackOfQ(50%),veh/ln	8.7	0.0	0.0	0.8	0.0	0.0	4.8	0.0	0.6	0.2	0.0	15.1
Unsig. Movement Delay, s/veh												
LnGrp Delay(d),s/veh	57.2	0.0	0.0	34.2	0.0	0.0	36.9	0.0	1.9	50.9	0.0	26.0
LnGrp LOS	E	A	A	C	A	A	D	A	A	D	A	C
Approach Vol, veh/h		295			39			1095				740
Approach Delay, s/veh		57.2			34.2			9.5				26.3
Approach LOS		E			C			A				C
Timer - Assigned Phs	1	2		4	5	6		8				
Phs Duration (G+Y+Rc), s	5.8	70.9		23.3	22.3	54.4		23.3				
Change Period (Y+Rc), s	4.0	4.6		* 4.9	4.6	* 4.6		* 4.9				
Max Green Setting (Gmax), s	8.5	59.9		* 18	18.6	* 50		* 18				
Max Q Clear Time (g_c+I1), s	2.5	2.0		20.4	14.2	36.9		3.9				
Green Ext Time (p_c), s	0.0	9.1		0.0	0.3	4.6		0.1				

Intersection Summary



















HCM 6th Ctrl Delay	22.1
HCM 6th LOS	C

Notes

\* HCM 6th computational engine requires equal clearance times for the phases crossing the barrier.























HCM 6th Signalized Intersection Summary  
3: D St & 1st St

Cumulative+Project  
Timing Plan: AM Peak

												
Movement	EBL	EBT	EBR	WBL	WBT	WBR	NBL	NBT	NBR	SBL	SBT	SBR
Lane Configurations												
Traffic Volume (veh/h)	44	6	7	7	9	40	7	891	13	49	625	72
Future Volume (veh/h)	44	6	7	7	9	40	7	891	13	49	625	72
Initial Q (Qb), veh	0	0	0	0	0	0	0	0	0	0	0	0
Ped-Bike Adj(A_pbT)	0.98		0.98	0.99		0.97	1.00		0.97	1.00		0.97
Parking Bus, Adj	1.00	1.00	1.00	1.00	1.00	1.00	1.00	1.00	1.00	1.00	1.00	1.00
Work Zone On Approach		No			No			No			No	
Adj Sat Flow, veh/h/ln	1900	1900	1648	1648	1648	1796	1604	1856	1737	1870	1826	1900
Adj Flow Rate, veh/h	50	7	8	8	10	45	8	1012	15	56	710	82
Peak Hour Factor	0.88	0.88	0.88	0.88	0.88	0.88	0.88	0.88	0.88	0.88	0.88	0.88
Percent Heavy Veh, %	0	0	17	17	17	7	20	3	11	2	5	0
Cap, veh/h	170	25	18	49	30	94	21	1291	19	112	1213	140
Arrive On Green	0.09	0.09	0.09	0.09	0.09	0.09	0.01	0.71	0.71	0.13	1.00	1.00
Sat Flow, veh/h	1132	262	196	87	314	1003	1527	1823	27	1781	1601	185
Grp Volume(v), veh/h	65	0	0	63	0	0	8	0	1027	56	0	792
Grp Sat Flow(s),veh/h/ln	1590	0	0	1404	0	0	1527	0	1850	1781	0	1786
Q Serve(g_s), s	0.0	0.0	0.0	0.0	0.0	0.0	0.5	0.0	36.4	2.9	0.0	0.0
Cycle Q Clear(g_c), s	3.4	0.0	0.0	4.2	0.0	0.0	0.5	0.0	36.4	2.9	0.0	0.0
Prop In Lane	0.77		0.12	0.13		0.71	1.00		0.01	1.00		0.10
Lane Grp Cap(c), veh/h	213	0	0	172	0	0	21	0	1310	112	0	1353
V/C Ratio(X)	0.31	0.00	0.00	0.37	0.00	0.00	0.38	0.00	0.78	0.50	0.00	0.59
Avail Cap(c_a), veh/h	369	0	0	320	0	0	107	0	1310	143	0	1353
HCM Platoon Ratio	1.00	1.00	1.00	1.00	1.00	1.00	1.00	1.00	1.00	2.00	2.00	2.00
Upstream Filter(I)	1.00	0.00	0.00	1.00	0.00	0.00	0.66	0.00	0.66	0.55	0.00	0.55
Uniform Delay (d), s/veh	42.6	0.0	0.0	42.9	0.0	0.0	48.9	0.0	9.6	42.2	0.0	0.0
Incr Delay (d2), s/veh	0.6	0.0	0.0	1.0	0.0	0.0	2.7	0.0	3.2	0.7	0.0	1.0
Initial Q Delay(d3),s/veh	0.0	0.0	0.0	0.0	0.0	0.0	0.0	0.0	0.0	0.0	0.0	0.0
%ile BackOfQ(50%),veh/ln	1.6	0.0	0.0	1.5	0.0	0.0	0.2	0.0	13.7	1.3	0.0	0.4
Unsig. Movement Delay, s/veh												
LnGrp Delay(d),s/veh	43.2	0.0	0.0	43.9	0.0	0.0	51.5	0.0	12.8	42.9	0.0	1.0
LnGrp LOS	D	A	A	D	A	A	D	A	B	D	A	A
Approach Vol, veh/h		65			63			1035			848	
Approach Delay, s/veh		43.2			43.9			13.1			3.8	
Approach LOS		D			D			B			A	
Timer - Assigned Phs	1	2		4	5	6		8				
Phs Duration (G+Y+Rc), s	10.3	75.4		14.3	5.4	80.3		14.3				
Change Period (Y+Rc), s	4.0	4.6		* 4.9	4.0	4.6		* 4.9				
Max Green Setting (Gmax), s	8.0	58.4		* 20	7.0	59.4		* 20				
Max Q Clear Time (g_c+I1), s	4.9	38.4		5.4	2.5	2.0		6.2				
Green Ext Time (p_c), s	0.0	11.8		0.2	0.0	12.3		0.2				
<b>Intersection Summary</b>												
HCM 6th Ctrl Delay				11.1								
HCM 6th LOS				B								
<b>Notes</b>												
* HCM 6th computational engine requires equal clearance times for the phases crossing the barrier.												

HCM 6th Signalized Intersection Summary  
4: D St & Petaluma Blvd

Cumulative+Project  
Timing Plan: AM Peak

												
Movement	EBL	EBT	EBR	WBL	WBT	WBR	NBL	NBT	NBR	SBL	SBT	SBR
Lane Configurations												
Traffic Volume (veh/h)	157	423	69	67	324	357	77	371	48	175	295	91
Future Volume (veh/h)	157	423	69	67	324	357	77	371	48	175	295	91
Initial Q (Qb), veh	0	0	0	0	0	0	0	0	0	0	0	0
Ped-Bike Adj(A_pbT)	1.00		0.99	1.00		0.99	1.00		0.97	1.00		1.00
Parking Bus, Adj	1.00	1.00	1.00	1.00	1.00	1.00	1.00	1.00	1.00	1.00	1.00	1.00
Work Zone On Approach		No			No			No			No	
Adj Sat Flow, veh/h/ln	1826	1826	1796	1826	1841	1885	1870	1870	1796	1856	1811	1856
Adj Flow Rate, veh/h	171	460	75	73	352	388	84	403	52	190	321	99
Peak Hour Factor	0.92	0.92	0.92	0.92	0.92	0.92	0.92	0.92	0.92	0.92	0.92	0.92
Percent Heavy Veh, %	5	5	7	5	4	1	2	2	7	3	6	3
Cap, veh/h	201	578	478	121	485	417	129	500	64	333	782	676
Arrive On Green	0.12	0.32	0.32	0.07	0.26	0.26	0.07	0.31	0.31	0.06	0.14	0.14
Sat Flow, veh/h	1739	1826	1510	1739	1841	1582	1781	1617	209	1767	1811	1565
Grp Volume(v), veh/h	171	460	75	73	352	388	84	0	455	190	321	99
Grp Sat Flow(s),veh/h/ln	1739	1826	1510	1739	1841	1582	1781	0	1826	1767	1811	1565
Q Serve(g_s), s	9.6	23.0	3.6	4.1	17.4	23.9	4.6	0.0	22.9	10.5	16.1	4.1
Cycle Q Clear(g_c), s	9.6	23.0	3.6	4.1	17.4	23.9	4.6	0.0	22.9	10.5	16.1	4.1
Prop In Lane	1.00		1.00	1.00		1.00	1.00		0.11	1.00		1.00
Lane Grp Cap(c), veh/h	201	578	478	121	485	417	129	0	564	333	782	676
V/C Ratio(X)	0.85	0.80	0.16	0.60	0.73	0.93	0.65	0.00	0.81	0.57	0.41	0.15
Avail Cap(c_a), veh/h	209	578	478	139	491	423	178	0	564	333	782	676
HCM Platoon Ratio	1.00	1.00	1.00	1.00	1.00	1.00	1.00	1.00	1.00	0.33	0.33	0.33
Upstream Filter(I)	1.00	1.00	1.00	1.00	1.00	1.00	1.00	0.00	1.00	0.82	0.82	0.82
Uniform Delay (d), s/veh	43.4	31.2	24.6	45.2	33.5	35.9	45.2	0.0	31.8	43.0	31.3	14.8
Incr Delay (d2), s/veh	24.9	8.0	0.2	2.8	5.7	27.5	2.1	0.0	11.7	1.2	1.3	0.4
Initial Q Delay(d3),s/veh	0.0	0.0	0.0	0.0	0.0	0.0	0.0	0.0	0.0	0.0	0.0	0.0
%ile BackOfQ(50%),veh/ln	5.5	11.2	1.3	1.8	8.4	12.2	2.1	0.0	11.9	5.1	8.1	2.1
Unsig. Movement Delay, s/veh												
LnGrp Delay(d),s/veh	68.3	39.3	24.8	48.0	39.3	63.4	47.2	0.0	43.5	44.2	32.6	15.2
LnGrp LOS	E	D	C	D	D	E	D	A	D	D	C	B
Approach Vol, veh/h		706			813			539			610	
Approach Delay, s/veh		44.8			51.6			44.1			33.4	
Approach LOS		D			D			D			C	
Timer - Assigned Phs	1	2	3	4	5	6	7	8				
Phs Duration (G+Y+Rc), s	23.5	35.6	10.9	36.5	11.2	47.9	16.5	31.0				
Change Period (Y+Rc), s	* 4.6	* 4.7	4.0	* 4.9	4.0	4.6	* 4.9	* 4.7				
Max Green Setting (Gmax), s	* 13	* 31	8.0	* 31	10.0	34.0	* 12	* 27				
Max Q Clear Time (g_c+I1), s	12.5	24.9	6.1	25.0	6.6	18.1	11.6	25.9				
Green Ext Time (p_c), s	0.0	1.3	0.0	2.0	0.0	1.7	0.0	0.4				

Intersection Summary

HCM 6th Ctrl Delay	44.1
HCM 6th LOS	D

Notes

User approved pedestrian interval to be less than phase max green.  
\* HCM 6th computational engine requires equal clearance times for the phases crossing the barrier.

HCM 6th Signalized Intersection Summary  
5: Washington St & Lakeville St

Cumulative+Project  
Timing Plan: AM Peak

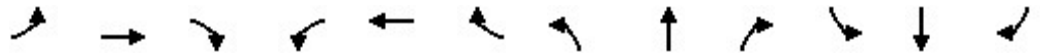

Movement	EBL	EBT	EBR	WBL	WBT	WBR	NBL	NBT	NBR	SBL	SBT	SBR
Lane Configurations		↔		↔	↔		↔	↔		↔	↔	
Traffic Volume (veh/h)	48	214	65	227	148	56	45	801	248	61	873	49
Future Volume (veh/h)	48	214	65	227	148	56	45	801	248	61	873	49
Initial Q (Qb), veh	0	0	0	0	0	0	0	0	0	0	0	0
Ped-Bike Adj(A_pbT)	1.00		0.99	1.00		0.99	1.00		0.97	1.00		0.97
Parking Bus, Adj	1.00	1.00	1.00	1.00	1.00	1.00	1.00	1.00	1.00	1.00	1.00	1.00
Work Zone On Approach		No		No		No		No		No		No
Adj Sat Flow, veh/h/ln	1856	1663	1381	1767	1722	1811	1337	1856	1796	1722	1826	1752
Adj Flow Rate, veh/h	54	240	73	255	166	63	51	900	279	69	981	55
Peak Hour Factor	0.89	0.89	0.89	0.89	0.89	0.89	0.89	0.89	0.89	0.89	0.89	0.89
Percent Heavy Veh, %	3	16	35	9	12	6	38	3	7	12	5	10
Cap, veh/h	54	241	73	298	210	80	191	943	291	131	944	53
Arrive On Green	0.23	0.23	0.23	0.18	0.18	0.18	0.30	0.72	0.72	0.08	0.28	0.28
Sat Flow, veh/h	234	1041	317	1682	1186	450	1273	2630	813	1640	3333	187
Grp Volume(v), veh/h	367	0	0	255	0	229	51	602	577	69	511	525
Grp Sat Flow(s),veh/h/ln	1591	0	0	1682	0	1636	1273	1763	1680	1640	1735	1785
Q Serve(g_s), s	28.8	0.0	0.0	18.4	0.0	16.8	3.8	38.2	38.7	5.1	35.4	35.4
Cycle Q Clear(g_c), s	28.8	0.0	0.0	18.4	0.0	16.8	3.8	38.2	38.7	5.1	35.4	35.4
Prop In Lane	0.15		0.20	1.00		0.28	1.00		0.48	1.00		0.10
Lane Grp Cap(c), veh/h	369	0	0	298	0	289	191	632	602	131	491	505
V/C Ratio(X)	0.99	0.00	0.00	0.86	0.00	0.79	0.27	0.95	0.96	0.53	1.04	1.04
Avail Cap(c_a), veh/h	369	0	0	400	0	389	191	632	602	131	491	505
HCM Platoon Ratio	1.00	1.00	1.00	1.00	1.00	1.00	2.00	2.00	2.00	1.00	1.00	1.00
Upstream Filter(l)	1.00	0.00	0.00	0.92	0.00	0.92	0.79	0.79	0.79	1.00	1.00	1.00
Uniform Delay (d), s/veh	47.9	0.0	0.0	49.9	0.0	49.2	38.5	16.8	16.8	55.2	44.8	44.8
Incr Delay (d2), s/veh	45.1	0.0	0.0	9.7	0.0	5.0	0.2	22.3	23.8	1.9	51.2	50.7
Initial Q Delay(d3),s/veh	0.0	0.0	0.0	0.0	0.0	0.0	0.0	0.0	0.0	0.0	0.0	0.0
%ile BackOfQ(50%),veh/ln	16.0	0.0	0.0	8.5	0.0	7.2	1.2	12.5	12.2	2.2	22.1	22.6
Unsig. Movement Delay, s/veh												
LnGrp Delay(d),s/veh	93.1	0.0	0.0	59.6	0.0	54.3	38.7	39.1	40.6	57.1	96.0	95.5
LnGrp LOS	F	A	A	E	A	D	D	D	D	E	F	F
Approach Vol, veh/h		367			484			1230			1105	
Approach Delay, s/veh		93.1			57.1			39.8			93.3	
Approach LOS		F			E			D			F	
Timer - Assigned Phs	1	2		4	5	6		8				
Phs Duration (G+Y+Rc), s	14.0	49.6		27.4	23.6	40.0		34.0				
Change Period (Y+Rc), s	4.0	* 4.8		* 5.3	4.8	* 4.6		5.0				
Max Green Setting (Gmax), s	10.0	* 37		* 30	12.0	* 35		29.0				
Max Q Clear Time (g_c+I1), s	7.1	40.7		20.4	5.8	37.4		30.8				
Green Ext Time (p_c), s	0.0	0.0		0.9	0.0	0.0		0.0				

Intersection Summary





















HCM 6th Ctrl Delay	67.1
HCM 6th LOS	E

Notes

User approved pedestrian interval to be less than phase max green.  
\* HCM 6th computational engine requires equal clearance times for the phases crossing the barrier.

HCM 6th Signalized Intersection Summary  
6: Washington St & Copeland St

Cumulative+Project  
Timing Plan: AM Peak

												
Movement	EBL	EBT	EBR	WBL	WBT	WBR	NBL	NBT	NBR	SBL	SBT	SBR
Lane Configurations												
Traffic Volume (veh/h)	44	0	18	44	26	237	16	870	42	285	776	64
Future Volume (veh/h)	44	0	18	44	26	237	16	870	42	285	776	64
Initial Q (Qb), veh	0	0	0	0	0	0	0	0	0	0	0	0
Ped-Bike Adj(A_pbT)	1.00		1.00	1.00		0.98	1.00		0.97	1.00		0.97
Parking Bus, Adj	1.00	1.00	1.00	1.00	1.00	1.00	1.00	1.00	1.00	1.00	1.00	1.00
Work Zone On Approach		No			No			No			No	
Adj Sat Flow, veh/h/ln	418	1900	1900	1618	1900	1737	418	1856	1900	1856	1826	1070
Adj Flow Rate, veh/h	51	0	21	51	30	276	19	1012	49	331	902	74
Peak Hour Factor	0.86	0.86	0.86	0.86	0.86	0.86	0.86	0.86	0.86	0.86	0.86	0.86
Percent Heavy Veh, %	100	0	0	19	0	11	100	3	0	3	5	56
Cap, veh/h	195	8	63	246	135	307	43	1296	63	514	1824	150
Arrive On Green	0.21	0.00	0.21	0.21	0.21	0.21	0.11	0.38	0.38	0.29	0.56	0.56
Sat Flow, veh/h	685	40	299	936	635	1447	398	3417	165	1767	3239	266
Grp Volume(v), veh/h	72	0	0	81	0	276	19	522	539	331	483	493
Grp Sat Flow(s),veh/h/ln	1024	0	0	1571	0	1447	398	1763	1820	1767	1735	1770
Q Serve(g_s), s	5.3	0.0	0.0	0.0	0.0	23.2	5.6	32.6	32.7	20.4	21.1	21.1
Cycle Q Clear(g_c), s	10.4	0.0	0.0	5.1	0.0	23.2	5.6	32.6	32.7	20.4	21.1	21.1
Prop In Lane	0.71		0.29	0.63		1.00	1.00		0.09	1.00		0.15
Lane Grp Cap(c), veh/h	267	0	0	381	0	307	43	668	690	514	977	997
V/C Ratio(X)	0.27	0.00	0.00	0.21	0.00	0.90	0.45	0.78	0.78	0.64	0.49	0.49
Avail Cap(c_a), veh/h	339	0	0	460	0	381	43	668	690	514	977	997
HCM Platoon Ratio	1.00	1.00	1.00	1.00	1.00	1.00	1.00	1.00	1.00	1.00	1.00	1.00
Upstream Filter(l)	1.00	0.00	0.00	0.68	0.00	0.68	1.00	1.00	1.00	0.27	0.27	0.27
Uniform Delay (d), s/veh	43.9	0.0	0.0	40.7	0.0	47.9	52.4	34.2	34.2	38.7	16.5	16.5
Incr Delay (d2), s/veh	0.4	0.0	0.0	0.1	0.0	14.4	2.7	8.8	8.6	0.6	0.5	0.5
Initial Q Delay(d3),s/veh	0.0	0.0	0.0	0.0	0.0	0.0	0.0	0.0	0.0	0.0	0.0	0.0
%ile BackOfQ(50%),veh/ln	2.0	0.0	0.0	2.1	0.0	9.6	0.6	15.6	16.1	9.0	8.5	8.7
Unsig. Movement Delay, s/veh												
LnGrp Delay(d),s/veh	44.3	0.0	0.0	40.9	0.0	62.3	55.1	43.0	42.8	39.3	17.0	17.0
LnGrp LOS	D	A	A	D	A	E	E	D	D	D	B	B
Approach Vol, veh/h		72			357			1080			1307	
Approach Delay, s/veh		44.3			57.4			43.1			22.6	
Approach LOS		D			E			D			C	
Timer - Assigned Phs	1	2		4	5	6		8				
Phs Duration (G+Y+Rc), s	41.3	52.0		31.7	18.3	75.0		31.7				
Change Period (Y+Rc), s	5.0	4.6		5.1	5.0	* 4.6		* 5.1				
Max Green Setting (Gmax), s	29.0	47.4		32.9	7.0	* 70		* 34				
Max Q Clear Time (g_c+I1), s	22.4	34.7		25.2	7.6	23.1		12.4				
Green Ext Time (p_c), s	0.3	7.4		0.7	0.0	12.9		0.3				

Intersection Summary

HCM 6th Ctrl Delay	35.5
HCM 6th LOS	D

Notes

\* HCM 6th computational engine requires equal clearance times for the phases crossing the barrier.

Queues  
2: D St & Copeland St



Lane Group	EBT	WBT	NBL	NBT	SBL	SBT
Lane Group Flow (vph)	295	40	239	856	9	731
v/c Ratio	0.76	0.23	0.75	0.61	0.06	0.77
Control Delay	23.1	27.0	37.4	3.3	43.8	24.6
Queue Delay	0.0	0.0	0.0	0.2	0.0	6.1
Total Delay	23.1	27.0	37.4	3.4	43.8	30.7
Queue Length 50th (ft)	34	13	128	50	5	314
Queue Length 95th (ft)	109	40	m190	71	21	#608
Internal Link Dist (ft)	666	244		693		446
Turn Bay Length (ft)			60		60	
Base Capacity (vph)	470	260	319	1413	153	950
Starvation Cap Reductn	0	0	0	89	0	169
Spillback Cap Reductn	0	0	0	0	0	0
Storage Cap Reductn	0	0	0	0	0	0
Reduced v/c Ratio	0.63	0.15	0.75	0.65	0.06	0.94























Intersection Summary

- # 95th percentile volume exceeds capacity, queue may be longer.  
Queue shown is maximum after two cycles.
- m Volume for 95th percentile queue is metered by upstream signal.



HCM 6th Signalized Intersection Summary  
1: D St & Lakeville St

Cumulative+Project  
Timing Plan: PM Peak

												
Movement	EBL	EBT	EBR	WBL	WBT	WBR	NBL	NBT	NBR	SBL	SBT	SBR
Lane Configurations												
Traffic Volume (veh/h)	9	370	73	514	518	51	101	165	587	25	189	15
Future Volume (veh/h)	9	370	73	514	518	51	101	165	587	25	189	15
Initial Q (Qb), veh	0	0	0	0	0	0	0	0	0	0	0	0
Ped-Bike Adj(A_pbT)	0.99		0.98	1.00		0.97	1.00		0.94	1.00		0.90
Parking Bus, Adj	1.00	1.00	1.00	1.00	1.00	1.00	1.00	1.00	1.00	1.00	1.00	1.00
Work Zone On Approach		No			No			No			No	
Adj Sat Flow, veh/h/ln	1900	1826	1678	1856	1870	1900	1826	1885	1870	1900	1885	1900
Adj Flow Rate, veh/h	10	398	78	553	557	55	109	177	631	27	203	16
Peak Hour Factor	0.93	0.93	0.93	0.93	0.93	0.93	0.93	0.93	0.93	0.93	0.93	0.93
Percent Heavy Veh, %	0	5	15	3	2	0	5	1	2	0	1	0
Cap, veh/h	30	431	336	547	1082	903	121	197	747	272	257	20
Arrive On Green	0.24	0.24	0.24	0.31	0.58	0.58	0.17	0.17	0.17	0.15	0.15	0.15
Sat Flow, veh/h	18	1783	1389	1767	1870	1560	705	1145	1496	1810	1708	135
Grp Volume(v), veh/h	408	0	78	553	557	55	286	0	631	27	0	219
Grp Sat Flow(s),veh/h/ln	1801	0	1389	1767	1870	1560	1850	0	1496	1810	0	1843
Q Serve(g_s), s	12.0	0.0	6.6	45.0	26.0	2.2	22.0	0.0	25.0	1.9	0.0	16.7
Cycle Q Clear(g_c), s	32.2	0.0	6.6	45.0	26.0	2.2	22.0	0.0	25.0	1.9	0.0	16.7
Prop In Lane	0.02		1.00	1.00		1.00	0.38		1.00	1.00		0.07
Lane Grp Cap(c), veh/h	461	0	336	547	1082	903	318	0	747	272	0	277
V/C Ratio(X)	0.88	0.00	0.23	1.01	0.51	0.06	0.90	0.00	0.84	0.10	0.00	0.79
Avail Cap(c_a), veh/h	519	0	382	547	1082	903	318	0	747	348	0	355
HCM Platoon Ratio	1.00	1.00	1.00	1.00	1.00	1.00	1.00	1.00	1.00	1.00	1.00	1.00
Upstream Filter(l)	1.00	0.00	1.00	1.00	1.00	1.00	1.00	0.00	1.00	1.00	0.00	1.00
Uniform Delay (d), s/veh	53.9	0.0	44.3	50.3	18.4	13.4	59.0	0.0	33.5	53.3	0.0	59.6
Incr Delay (d2), s/veh	14.2	0.0	0.1	41.5	0.2	0.0	27.3	0.0	9.1	0.1	0.0	8.0
Initial Q Delay(d3),s/veh	0.0	0.0	0.0	0.0	0.0	0.0	0.0	0.0	0.0	0.0	0.0	0.0
%ile BackOfQ(50%),veh/ln	16.4	0.0	2.3	26.1	11.3	0.8	12.8	0.0	21.2	0.9	0.0	8.5
Unsig. Movement Delay, s/veh												
LnGrp Delay(d),s/veh	68.1	0.0	44.4	91.7	18.6	13.4	86.3	0.0	42.6	53.4	0.0	67.6
LnGrp LOS	E	A	D	F	B	B	F	A	D	D	A	E
Approach Vol, veh/h		486			1165			917				246
Approach Delay, s/veh		64.3			53.1			56.2				66.1
Approach LOS		E			D			E				E
Timer - Assigned Phs		2	3	4		6		8				
Phs Duration (G+Y+Rc), s		30.3	49.0	40.0		26.2		89.0				
Change Period (Y+Rc), s		* 5.3	4.0	* 4.8		4.3		* 4.8				
Max Green Setting (Gmax), s		* 25	45.0	* 40		28.0		* 60				
Max Q Clear Time (g_c+I1), s		27.0	47.0	34.2		18.7		28.0				
Green Ext Time (p_c), s		0.0	0.0	1.0		0.7		2.6				
<b>Intersection Summary</b>												
HCM 6th Ctrl Delay				57.2								
HCM 6th LOS				E								
<b>Notes</b>												
* HCM 6th computational engine requires equal clearance times for the phases crossing the barrier.												



















HCM 6th Signalized Intersection Summary  
2: D St & Copeland St

Cumulative+Project  
Timing Plan: PM Peak

Movement	EBL	EBT	EBR	WBL	WBT	WBR	NBL	NBT	NBR	SBL	SBT	SBR
Lane Configurations												
Traffic Volume (veh/h)	30	23	268	7	14	15	252	836	13	18	721	150
Future Volume (veh/h)	30	23	268	7	14	15	252	836	13	18	721	150
Initial Q (Qb), veh	0	0	0	0	0	0	0	0	0	0	0	0
Ped-Bike Adj(A_pbT)	0.98		0.96	1.00		0.98	1.00		0.96	1.00		0.96
Parking Bus, Adj	1.00	1.00	1.00	1.00	1.00	1.00	1.00	1.00	1.00	1.00	1.00	1.00
Work Zone On Approach		No			No			No			No	
Adj Sat Flow, veh/h/ln	1900	1530	1856	1900	1900	1900	1826	1870	1900	1900	1870	1633
Adj Flow Rate, veh/h	32	25	288	8	15	16	271	899	14	19	775	161
Peak Hour Factor	0.93	0.93	0.93	0.93	0.93	0.93	0.93	0.93	0.93	0.93	0.93	0.93
Percent Heavy Veh, %	0	25	3	0	0	0	5	2	0	0	2	18
Cap, veh/h	53	24	193	76	131	114	347	1267	20	59	771	160
Arrive On Green	0.18	0.18	0.18	0.18	0.18	0.18	0.40	1.00	1.00	0.03	0.52	0.52
Sat Flow, veh/h	76	132	1051	177	714	620	1739	1835	29	1810	1489	309
Grp Volume(v), veh/h	345	0	0	39	0	0	271	0	913	19	0	936
Grp Sat Flow(s),veh/h/ln	1259	0	0	1510	0	0	1739	0	1864	1810	0	1799
Q Serve(g_s), s	12.1	0.0	0.0	0.0	0.0	0.0	13.6	0.0	0.0	1.0	0.0	51.8
Cycle Q Clear(g_c), s	18.4	0.0	0.0	1.9	0.0	0.0	13.6	0.0	0.0	1.0	0.0	51.8
Prop In Lane	0.09		0.83	0.21		0.41	1.00		0.02	1.00		0.17
Lane Grp Cap(c), veh/h	271	0	0	321	0	0	347	0	1287	59	0	932
V/C Ratio(X)	1.27	0.00	0.00	0.12	0.00	0.00	0.78	0.00	0.71	0.32	0.00	1.00
Avail Cap(c_a), veh/h	271	0	0	321	0	0	347	0	1287	154	0	932
HCM Platoon Ratio	1.00	1.00	1.00	1.00	1.00	1.00	2.00	2.00	2.00	1.00	1.00	1.00
Upstream Filter(l)	0.64	0.00	0.00	1.00	0.00	0.00	0.55	0.00	0.55	0.33	0.00	0.33
Uniform Delay (d), s/veh	42.1	0.0	0.0	34.1	0.0	0.0	28.2	0.0	0.0	47.3	0.0	24.1
Incr Delay (d2), s/veh	140.3	0.0	0.0	0.2	0.0	0.0	6.3	0.0	1.9	1.0	0.0	18.1
Initial Q Delay(d3),s/veh	0.0	0.0	0.0	0.0	0.0	0.0	0.0	0.0	0.0	0.0	0.0	0.0
%ile BackOfQ(50%),veh/ln	17.4	0.0	0.0	0.8	0.0	0.0	5.1	0.0	0.7	0.5	0.0	25.4
Unsig. Movement Delay, s/veh												
LnGrp Delay(d),s/veh	182.4	0.0	0.0	34.2	0.0	0.0	34.5	0.0	1.9	48.3	0.0	42.2
LnGrp LOS	F	A	A	C	A	A	C	A	A	D	A	F
Approach Vol, veh/h		345			39			1184				955
Approach Delay, s/veh		182.4			34.2			9.3				42.3
Approach LOS		F			C			A				D
Timer - Assigned Phs	1	2		4	5	6		8				
Phs Duration (G+Y+Rc), s	7.3	73.6		23.3	24.5	56.4		23.3				
Change Period (Y+Rc), s	4.0	4.6		* 4.9	4.6	* 4.6		* 4.9				
Max Green Setting (Gmax), s	8.5	59.9		* 18	16.6	* 52		* 18				
Max Q Clear Time (g_c+I1), s	3.0	2.0		20.4	15.6	53.8		3.9				
Green Ext Time (p_c), s	0.0	10.3		0.0	0.1	0.0		0.1				
<b>Intersection Summary</b>												
HCM 6th Ctrl Delay				45.9								
HCM 6th LOS				D								
<b>Notes</b>												
* HCM 6th computational engine requires equal clearance times for the phases crossing the barrier.												

HCM 6th Signalized Intersection Summary  
3: D St & 1st St

Cumulative+Project  
Timing Plan: PM Peak

												
Movement	EBL	EBT	EBR	WBL	WBT	WBR	NBL	NBT	NBR	SBL	SBT	SBR
Lane Configurations												
Traffic Volume (veh/h)	71	4	12	16	7	57	6	978	23	67	875	63
Future Volume (veh/h)	71	4	12	16	7	57	6	978	23	67	875	63
Initial Q (Qb), veh	0	0	0	0	0	0	0	0	0	0	0	0
Ped-Bike Adj(A_pbT)	0.98		0.98	0.99		0.97	1.00		0.97	1.00		0.97
Parking Bus, Adj	1.00	1.00	1.00	1.00	1.00	1.00	1.00	1.00	1.00	1.00	1.00	1.00
Work Zone On Approach		No			No			No			No	
Adj Sat Flow, veh/h/ln	1900	1900	1900	1781	1900	1856	1900	1856	1707	1841	1870	1900
Adj Flow Rate, veh/h	72	4	12	16	7	58	6	998	23	68	893	64
Peak Hour Factor	0.98	0.98	0.98	0.98	0.98	0.98	0.98	0.98	0.98	0.98	0.98	0.98
Percent Heavy Veh, %	0	0	0	8	0	3	0	3	13	4	2	0
Cap, veh/h	179	13	20	62	25	112	19	1054	24	315	1306	94
Arrive On Green	0.10	0.10	0.10	0.10	0.10	0.10	0.01	0.39	0.39	0.36	1.00	1.00
Sat Flow, veh/h	1190	141	210	197	267	1171	1810	1805	42	1753	1720	123
Grp Volume(v), veh/h	88	0	0	81	0	0	6	0	1021	68	0	957
Grp Sat Flow(s),veh/h/ln	1541	0	0	1636	0	0	1810	0	1846	1753	0	1844
Q Serve(g_s), s	0.4	0.0	0.0	0.0	0.0	0.0	0.3	0.0	53.5	2.7	0.0	0.0
Cycle Q Clear(g_c), s	5.0	0.0	0.0	4.5	0.0	0.0	0.3	0.0	53.5	2.7	0.0	0.0
Prop In Lane	0.82		0.14	0.20		0.72	1.00		0.02	1.00		0.07
Lane Grp Cap(c), veh/h	212	0	0	199	0	0	19	0	1078	315	0	1399
V/C Ratio(X)	0.41	0.00	0.00	0.41	0.00	0.00	0.31	0.00	0.95	0.22	0.00	0.68
Avail Cap(c_a), veh/h	362	0	0	363	0	0	127	0	1078	315	0	1399
HCM Platoon Ratio	1.00	1.00	1.00	1.00	1.00	1.00	0.67	0.67	0.67	2.00	2.00	2.00
Upstream Filter(l)	1.00	0.00	0.00	1.00	0.00	0.00	0.64	0.00	0.64	0.20	0.00	0.20
Uniform Delay (d), s/veh	43.1	0.0	0.0	43.0	0.0	0.0	49.3	0.0	28.9	27.1	0.0	0.0
Incr Delay (d2), s/veh	1.0	0.0	0.0	1.0	0.0	0.0	2.1	0.0	12.5	0.0	0.0	0.6
Initial Q Delay(d3),s/veh	0.0	0.0	0.0	0.0	0.0	0.0	0.0	0.0	0.0	0.0	0.0	0.0
%ile BackOfQ(50%),veh/ln	2.1	0.0	0.0	2.0	0.0	0.0	0.2	0.0	28.3	1.1	0.0	0.2
Unsig. Movement Delay, s/veh												
LnGrp Delay(d),s/veh	44.1	0.0	0.0	44.0	0.0	0.0	51.4	0.0	41.4	27.2	0.0	0.6
LnGrp LOS	D	A	A	D	A	A	D	A	D	C	A	A
Approach Vol, veh/h		88			81			1027			1025	
Approach Delay, s/veh		44.1			44.0			41.5			2.3	
Approach LOS		D			D			D			A	
Timer - Assigned Phs	1	2		4	5	6		8				
Phs Duration (G+Y+Rc), s	22.6	63.0		14.4	5.1	80.5		14.4				
Change Period (Y+Rc), s	4.6	* 4.6		* 4.9	4.0	4.6		* 4.9				
Max Green Setting (Gmax), s	8.0	* 58		* 20	7.0	59.4		* 20				
Max Q Clear Time (g_c+I1), s	4.7	55.5		7.0	2.3	2.0		6.5				
Green Ext Time (p_c), s	0.0	2.3		0.3	0.0	17.5		0.2				
<b>Intersection Summary</b>												
HCM 6th Ctrl Delay				23.6								
HCM 6th LOS				C								
<b>Notes</b>												
* HCM 6th computational engine requires equal clearance times for the phases crossing the barrier.												

HCM 6th Signalized Intersection Summary  
4: D St & Petaluma Blvd

Cumulative+Project  
Timing Plan: PM Peak

Movement	EBL	EBT	EBR	WBL	WBT	WBR	NBL	NBT	NBR	SBL	SBT	SBR
Lane Configurations												
Traffic Volume (veh/h)	193	316	90	148	376	289	81	348	27	238	567	129
Future Volume (veh/h)	193	316	90	148	376	289	81	348	27	238	567	129
Initial Q (Qb), veh	0	0	0	0	0	0	0	0	0	0	0	0
Ped-Bike Adj(A_pbT)	1.00		0.94	1.00		0.94	1.00		0.94	1.00		0.95
Parking Bus, Adj	1.00	1.00	1.00	1.00	1.00	1.00	1.00	1.00	1.00	1.00	1.00	1.00
Work Zone On Approach		No			No			No			No	
Adj Sat Flow, veh/h/ln	1841	1885	1900	1856	1885	1870	1870	1856	1900	1900	1856	1870
Adj Flow Rate, veh/h	210	343	98	161	409	314	88	378	29	259	616	140
Peak Hour Factor	0.92	0.92	0.92	0.92	0.92	0.92	0.92	0.92	0.92	0.92	0.92	0.92
Percent Heavy Veh, %	4	1	0	3	1	2	2	3	0	0	3	2
Cap, veh/h	228	527	424	191	473	372	130	484	37	463	883	720
Arrive On Green	0.13	0.28	0.28	0.11	0.25	0.25	0.07	0.29	0.29	0.26	0.48	0.48
Sat Flow, veh/h	1753	1885	1517	1767	1885	1484	1781	1692	130	1810	1856	1513
Grp Volume(v), veh/h	210	343	98	161	409	314	88	0	407	259	616	140
Grp Sat Flow(s),veh/h/ln	1753	1885	1517	1767	1885	1484	1781	0	1822	1810	1856	1513
Q Serve(g_s), s	11.8	16.0	5.0	8.9	20.8	20.1	4.8	0.0	20.5	12.4	26.0	4.2
Cycle Q Clear(g_c), s	11.8	16.0	5.0	8.9	20.8	20.1	4.8	0.0	20.5	12.4	26.0	4.2
Prop In Lane	1.00		1.00	1.00		1.00	1.00		0.07	1.00		1.00
Lane Grp Cap(c), veh/h	228	527	424	191	473	372	130	0	521	463	883	720
V/C Ratio(X)	0.92	0.65	0.23	0.84	0.87	0.84	0.68	0.00	0.78	0.56	0.70	0.19
Avail Cap(c_a), veh/h	228	527	424	212	490	386	143	0	521	463	883	720
HCM Platoon Ratio	1.00	1.00	1.00	1.00	1.00	1.00	1.00	1.00	1.00	1.00	1.00	1.00
Upstream Filter(I)	1.00	1.00	1.00	1.00	1.00	1.00	1.00	0.00	1.00	0.71	0.71	0.71
Uniform Delay (d), s/veh	43.0	31.7	27.8	43.7	35.8	35.6	45.2	0.0	32.8	32.3	20.6	9.3
Incr Delay (d2), s/veh	38.1	3.2	0.4	21.3	15.1	15.9	8.1	0.0	11.1	0.7	3.3	0.4
Initial Q Delay(d3),s/veh	0.0	0.0	0.0	0.0	0.0	0.0	0.0	0.0	0.0	0.0	0.0	0.0
%ile BackOfQ(50%),veh/ln	7.5	7.7	1.8	5.0	11.3	8.8	2.4	0.0	10.6	5.5	11.8	1.8
Unsig. Movement Delay, s/veh												
LnGrp Delay(d),s/veh	81.1	35.0	28.2	65.0	51.0	51.5	53.3	0.0	43.9	33.0	23.8	9.7
LnGrp LOS	F	C	C	E	D	D	D	A	D	C	C	A
Approach Vol, veh/h		651			884			495			1015	
Approach Delay, s/veh		48.8			53.7			45.6			24.2	
Approach LOS		D			D			D			C	
Timer - Assigned Phs	1	2	3	4	5	6	7	8				
Phs Duration (G+Y+Rc), s	30.2	33.3	14.8	32.8	11.3	52.2	17.9	29.8				
Change Period (Y+Rc), s	* 4.6	* 4.7	4.0	* 4.9	4.0	4.6	* 4.9	* 4.7				
Max Green Setting (Gmax), s	* 15	* 29	12.0	* 27	8.0	35.7	* 13	* 26				
Max Q Clear Time (g_c+I1), s	14.4	22.5	10.9	18.0	6.8	28.0	13.8	22.8				
Green Ext Time (p_c), s	0.0	1.1	0.0	2.2	0.0	2.5	0.0	1.6				

Intersection Summary

HCM 6th Ctrl Delay	41.5
HCM 6th LOS	D

Notes

User approved pedestrian interval to be less than phase max green.  
\* HCM 6th computational engine requires equal clearance times for the phases crossing the barrier.

HCM 6th Signalized Intersection Summary  
5: Washington St & Lakeville St

Cumulative+Project  
Timing Plan: PM Peak

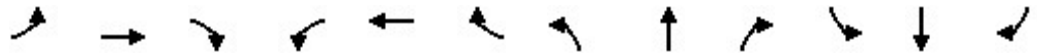

Movement	EBL	EBT	EBR	WBL	WBT	WBR	NBL	NBT	NBR	SBL	SBT	SBR
Lane Configurations		↕		↖	↗		↖	↗		↖	↗	
Traffic Volume (veh/h)	93	143	78	270	238	112	65	941	203	75	929	58
Future Volume (veh/h)	93	143	78	270	238	112	65	941	203	75	929	58
Initial Q (Qb), veh	0	0	0	0	0	0	0	0	0	0	0	0
Ped-Bike Adj(A_pbT)	1.00		0.98	1.00		0.98	1.00		0.96	1.00		0.95
Parking Bus, Adj	1.00	1.00	1.00	1.00	1.00	1.00	1.00	1.00	1.00	1.00	1.00	1.00
Work Zone On Approach		No		No		No		No		No		No
Adj Sat Flow, veh/h/ln	1826	1811	1811	1870	1826	1900	1900	1856	1811	1870	1885	1900
Adj Flow Rate, veh/h	97	149	81	281	248	117	68	980	211	78	968	60
Peak Hour Factor	0.96	0.96	0.96	0.96	0.96	0.96	0.96	0.96	0.96	0.96	0.96	0.96
Percent Heavy Veh, %	5	6	6	2	5	0	0	3	6	2	1	0
Cap, veh/h	104	160	87	409	268	126	230	941	202	144	947	59
Arrive On Green	0.21	0.21	0.21	0.23	0.23	0.23	0.13	0.33	0.33	0.08	0.28	0.28
Sat Flow, veh/h	505	775	422	1781	1166	550	1810	2861	615	1781	3414	212
Grp Volume(v), veh/h	327	0	0	281	0	365	68	603	588	78	508	520
Grp Sat Flow(s),veh/h/ln	1702	0	0	1781	0	1716	1810	1763	1713	1781	1791	1834
Q Serve(g_s), s	23.4	0.0	0.0	17.9	0.0	25.8	4.2	40.8	40.8	5.2	34.4	34.4
Cycle Q Clear(g_c), s	23.4	0.0	0.0	17.9	0.0	25.8	4.2	40.8	40.8	5.2	34.4	34.4
Prop In Lane	0.30		0.25	1.00		0.32	1.00		0.36	1.00		0.12
Lane Grp Cap(c), veh/h	352	0	0	409	0	394	230	580	563	144	497	509
V/C Ratio(X)	0.93	0.00	0.00	0.69	0.00	0.93	0.30	1.04	1.04	0.54	1.02	1.02
Avail Cap(c_a), veh/h	371	0	0	441	0	425	230	580	563	144	497	509
HCM Platoon Ratio	1.00	1.00	1.00	1.00	1.00	1.00	1.00	1.00	1.00	1.00	1.00	1.00
Upstream Filter(I)	1.00	0.00	0.00	0.85	0.00	0.85	0.70	0.70	0.70	1.00	1.00	1.00
Uniform Delay (d), s/veh	48.3	0.0	0.0	43.7	0.0	46.7	49.1	41.6	41.6	54.8	44.8	44.8
Incr Delay (d2), s/veh	28.0	0.0	0.0	2.7	0.0	21.7	0.2	42.2	43.9	2.3	46.1	45.6
Initial Q Delay(d3),s/veh	0.0	0.0	0.0	0.0	0.0	0.0	0.0	0.0	0.0	0.0	0.0	0.0
%ile BackOfQ(50%),veh/ln	12.6	0.0	0.0	8.2	0.0	13.3	1.9	24.5	24.0	2.4	21.5	21.9
Unsig. Movement Delay, s/veh												
LnGrp Delay(d),s/veh	76.3	0.0	0.0	46.3	0.0	68.4	49.3	83.8	85.5	57.1	90.9	90.4
LnGrp LOS	E	A	A	D	A	E	D	F	F	E	F	F
Approach Vol, veh/h		327			646			1259			1106	
Approach Delay, s/veh		76.3			58.8			82.7			88.3	
Approach LOS		E			E			F			F	
Timer - Assigned Phs	1	2		4	5	6		8				
Phs Duration (G+Y+Rc), s	14.0	45.6		33.8	20.6	39.0		30.6				
Change Period (Y+Rc), s	4.0	* 4.8		* 5.3	4.8	* 4.6		5.0				
Max Green Setting (Gmax), s	10.0	* 37		* 31	13.0	* 34		27.0				
Max Q Clear Time (g_c+I1), s	7.2	42.8		27.8	6.2	36.4		25.4				
Green Ext Time (p_c), s	0.0	0.0		0.7	0.0	0.0		0.2				

Intersection Summary



















HCM 6th Ctrl Delay	79.3
HCM 6th LOS	E

Notes

User approved pedestrian interval to be less than phase max green.  
\* HCM 6th computational engine requires equal clearance times for the phases crossing the barrier.

HCM 6th Signalized Intersection Summary  
6: Washington St & Copeland St

Cumulative+Project  
Timing Plan: PM Peak

												
Movement	EBL	EBT	EBR	WBL	WBT	WBR	NBL	NBT	NBR	SBL	SBT	SBR
Lane Configurations												
Traffic Volume (veh/h)	108	19	12	101	16	307	31	862	44	307	893	75
Future Volume (veh/h)	108	19	12	101	16	307	31	862	44	307	893	75
Initial Q (Qb), veh	0	0	0	0	0	0	0	0	0	0	0	0
Ped-Bike Adj(A_pbT)	1.00		1.00	1.00		1.00	1.00		0.96	1.00		0.97
Parking Bus, Adj	1.00	1.00	1.00	1.00	1.00	1.00	1.00	1.00	1.00	1.00	1.00	1.00
Work Zone On Approach		No			No			No			No	
Adj Sat Flow, veh/h/ln	1900	1900	1900	1752	1900	1781	1900	1870	1693	1856	1870	1707
Adj Flow Rate, veh/h	112	20	12	105	17	320	32	898	46	320	930	78
Peak Hour Factor	0.96	0.96	0.96	0.96	0.96	0.96	0.96	0.96	0.96	0.96	0.96	0.96
Percent Heavy Veh, %	0	0	0	10	0	8	0	2	14	3	2	13
Cap, veh/h	241	41	19	394	58	371	294	1280	66	362	1374	115
Arrive On Green	0.25	0.25	0.25	0.25	0.25	0.25	0.16	0.37	0.37	0.20	0.42	0.42
Sat Flow, veh/h	669	167	76	1274	236	1508	1810	3432	176	1767	3308	277
Grp Volume(v), veh/h	144	0	0	122	0	320	32	465	479	320	499	509
Grp Sat Flow(s),veh/h/ln	912	0	0	1510	0	1508	1810	1777	1831	1767	1777	1809
Q Serve(g_s), s	8.6	0.0	0.0	0.0	0.0	17.0	1.3	18.6	18.6	14.7	19.1	19.1
Cycle Q Clear(g_c), s	14.0	0.0	0.0	5.4	0.0	17.0	1.3	18.6	18.6	14.7	19.1	19.1
Prop In Lane	0.78		0.08	0.86		1.00	1.00		0.10	1.00		0.15
Lane Grp Cap(c), veh/h	301	0	0	452	0	371	294	663	683	362	738	751
V/C Ratio(X)	0.48	0.00	0.00	0.27	0.00	0.86	0.11	0.70	0.70	0.88	0.68	0.68
Avail Cap(c_a), veh/h	503	0	0	701	0	630	433	1072	1104	634	1497	1524
HCM Platoon Ratio	1.00	1.00	1.00	1.00	1.00	1.00	1.00	1.00	1.00	1.00	1.00	1.00
Upstream Filter(l)	1.00	0.00	0.00	1.00	0.00	1.00	1.00	1.00	1.00	1.00	1.00	1.00
Uniform Delay (d), s/veh	30.6	0.0	0.0	25.7	0.0	30.1	29.8	22.2	22.2	32.3	19.9	19.9
Incr Delay (d2), s/veh	0.9	0.0	0.0	0.2	0.0	4.9	0.1	1.9	1.9	3.2	1.6	1.5
Initial Q Delay(d3),s/veh	0.0	0.0	0.0	0.0	0.0	0.0	0.0	0.0	0.0	0.0	0.0	0.0
%ile BackOfQ(50%),veh/ln	2.7	0.0	0.0	2.0	0.0	6.5	0.6	7.8	8.1	6.5	7.9	8.0
Unsig. Movement Delay, s/veh												
LnGrp Delay(d),s/veh	31.5	0.0	0.0	26.0	0.0	35.0	29.9	24.2	24.1	35.4	21.4	21.4
LnGrp LOS	C	A	A	C	A	D	C	C	C	D	C	C
Approach Vol, veh/h		144			442			976			1328	
Approach Delay, s/veh		31.5			32.5			24.3			24.8	
Approach LOS		C			C			C			C	
Timer - Assigned Phs	1	2		4	5	6		8				
Phs Duration (G+Y+Rc), s	22.1	35.8		25.7	18.6	39.3		25.7				
Change Period (Y+Rc), s	5.0	4.6		5.1	5.0	* 4.6		* 5.1				
Max Green Setting (Gmax), s	30.0	50.4		34.9	20.0	* 70		* 35				
Max Q Clear Time (g_c+I1), s	16.7	20.6		19.0	3.3	21.1		16.0				
Green Ext Time (p_c), s	0.4	10.6		1.3	0.0	13.6		0.8				

Intersection Summary

HCM 6th Ctrl Delay	26.1
HCM 6th LOS	C

Notes

\* HCM 6th computational engine requires equal clearance times for the phases crossing the barrier.

Queues  
2: D St & Copeland St

Cumulative+Project  
Timing Plan: PM Peak



Lane Group	EBT	WBT	NBL	NBT	SBL	SBT
Lane Group Flow (vph)	345	39	271	913	19	936
v/c Ratio	0.85	0.19	0.95	0.68	0.13	0.95
Control Delay	34.7	26.5	66.8	6.6	44.9	41.9
Queue Delay	0.1	0.0	0.0	0.2	0.0	43.3
Total Delay	34.8	26.5	66.8	6.8	44.9	85.2
Queue Length 50th (ft)	75	13	161	64	11	536
Queue Length 95th (ft)	#202	42	m#286	141	34	#878
Internal Link Dist (ft)	666	244		693		446
Turn Bay Length (ft)			60		60	
Base Capacity (vph)	459	259	285	1333	153	984
Starvation Cap Reductn	0	0	0	73	0	139
Spillback Cap Reductn	4	0	0	0	0	31
Storage Cap Reductn	0	0	0	0	0	0
Reduced v/c Ratio	0.76	0.15	0.95	0.72	0.12	1.11

Intersection Summary

# 95th percentile volume exceeds capacity, queue may be longer.

Queue shown is maximum after two cycles.

m Volume for 95th percentile queue is metered by upstream signal.

# H – Peak Hour Signal Warrants





**TRAFFIC SIGNAL VOLUME WARRANT ANALYSIS (2014 MUTCD) - CONDITION B**

MAJOR STREET: D Street NB SB # OF APPROACH LANES:

MINOR STREET: Copeland St EB WB # OF APPROACH LANES:

CITY, STATE: Petaluma, CA

COMMENTS: Existing Plus Project Conditions

ISOLATED COMMUNITY WITH POPULATION LESS THAN 10,000 (Y OR N):   
 85TH PERCENTILE SPEED GREATER THAN 40 MPH ON MAJOR STREET (Y OR N):

	MAJOR ST TWO-WAY TRAFFIC	MINOR ST TRAFFIC HEAVY LEG	Ped Count CROSSING MAJOR ST	WARRANT 1 - Condition A, Part 1			WARRANT 1 - Condition B, Part 1			WARRANT 1 - Condition A, Part 2			WARRANT 1 - Condition B, Part 2			WARRANT 2 Four-Hour	WARRANT 3 Peak Hour
				MAIN LINE	SIDE STREET	BOTH MET	MAIN LINE	SIDE STREET	BOTH MET	MAIN LINE	SIDE STREET	BOTH MET	MAIN LINE	SIDE STREET	BOTH MET		
<b>THRESHOLD VALUES</b>				<b>500</b>	<b>150</b>		<b>750</b>	<b>75</b>		<b>400</b>	<b>120</b>		<b>600</b>	<b>60</b>		<b>60</b>	<b>75</b>
06:00 AM TO 07:00 AM																	
07:00 AM TO 08:00 AM																	
08:00 AM TO 09:00 AM	1,402	207		Y	Y	Y	Y	Y	Y	Y	Y	Y	Y	Y	Y	Y	Y
09:00 AM TO 10:00 AM																	
10:00 AM TO 11:00 AM																	
11:00 AM TO 12:00 PM																	
12:00 PM TO 01:00 PM																	
01:00 PM TO 02:00 PM																	
02:00 PM TO 03:00 PM																	
03:00 PM TO 04:00 PM																	
04:00 PM TO 05:00 PM																	
05:00 PM TO 06:00 PM	1,741	233		Y	Y	Y	Y	Y	Y	Y	Y	Y	Y	Y	Y	Y	Y
06:00 PM TO 07:00 PM																	
07:00 PM TO 08:00 PM																	
08:00 PM TO 09:00 PM																	
09:00 PM TO 10:00 PM																	
	3,143	440		2	2	2	2	2	2	2	2	2	2	2	2	2	2
				8 HOURS NEEDED NOT SATISFIED			8 HOURS NEEDED NOT SATISFIED			8 HOURS NEEDED for both Condition A & B NOT SATISFIED						4 HRS NEEDED NOT SATISFIED	1 HR NEEDED SATISFIED

**TRAFFIC SIGNAL VOLUME WARRANT ANALYSIS (2014 MUTCD) - CONDITION B**

MAJOR STREET: D Street NB SB # OF APPROACH LANES:

MINOR STREET: Copeland St EB WB # OF APPROACH LANES:

CITY, STATE: Petaluma, CA

COMMENTS: Pipeline Plus Project Conditions

ISOLATED COMMUNITY WITH POPULATION LESS THAN 10,000 (Y OR N):   
 85TH PERCENTILE SPEED GREATER THAN 40 MPH ON MAJOR STREET (Y OR N):

	MAJOR ST TWO-WAY TRAFFIC	MINOR ST TRAFFIC HEAVY LEG	Ped Count CROSSING MAJOR ST	WARRANT 1 - Condition A, Part 1			WARRANT 1 - Condition B, Part 1			WARRANT 1 - Condition A, Part 2			WARRANT 1 - Condition B, Part 2			WARRANT 2 Four-Hour	WARRANT 3 Peak Hour
				MAIN LINE	SIDE STREET	BOTH MET	MAIN LINE	SIDE STREET	BOTH MET	MAIN LINE	SIDE STREET	BOTH MET	MAIN LINE	SIDE STREET	BOTH MET		
<b>THRESHOLD VALUES</b>				<b>500</b>	<b>150</b>		<b>750</b>	<b>75</b>		<b>400</b>	<b>120</b>		<b>600</b>	<b>60</b>		<b>60</b>	<b>75</b>
06:00 AM TO 07:00 AM																	
07:00 AM TO 08:00 AM																	
08:00 AM TO 09:00 AM	1,563	256		Y	Y	Y	Y	Y	Y	Y	Y	Y	Y	Y	Y	Y	Y
09:00 AM TO 10:00 AM																	
10:00 AM TO 11:00 AM																	
11:00 AM TO 12:00 PM																	
12:00 PM TO 01:00 PM																	
01:00 PM TO 02:00 PM																	
02:00 PM TO 03:00 PM																	
03:00 PM TO 04:00 PM																	
04:00 PM TO 05:00 PM																	
05:00 PM TO 06:00 PM	1,937	283		Y	Y	Y	Y	Y	Y	Y	Y	Y	Y	Y	Y	Y	Y
06:00 PM TO 07:00 PM																	
07:00 PM TO 08:00 PM																	
08:00 PM TO 09:00 PM																	
09:00 PM TO 10:00 PM																	
	3,500	539		2	2	2	2	2	2	2	2	2	2	2	2	2	2
				8 HOURS NEEDED NOT SATISFIED			8 HOURS NEEDED NOT SATISFIED			8 HOURS NEEDED for both Condition A & B NOT SATISFIED						4 HRS NEEDED NOT SATISFIED	1 HR NEEDED SATISFIED

**TRAFFIC SIGNAL VOLUME WARRANT ANALYSIS (2014 MUTCD) - CONDITION B**

MAJOR STREET: D Street NB SB # OF APPROACH LANES:

MINOR STREET: Copeland St EB WB # OF APPROACH LANES:

CITY, STATE: Petaluma, CA

COMMENTS: Cumulative Plus Project Conditions

ISOLATED COMMUNITY WITH POPULATION LESS THAN 10,000 (Y OR N):   
 85TH PERCENTILE SPEED GREATER THAN 40 MPH ON MAJOR STREET (Y OR N):

	MAJOR ST TWO-WAY TRAFFIC	MINOR ST TRAFFIC HEAVY LEG	Ped Count CROSSING MAJOR ST	WARRANT 1 - Condition A, Part 1			WARRANT 1 - Condition B, Part 1			WARRANT 1 - Condition A, Part 2			WARRANT 1 - Condition B, Part 2			WARRANT 2 Four-Hour	WARRANT 3 Peak Hour
				MAIN LINE	SIDE STREET	BOTH MET	MAIN LINE	SIDE STREET	BOTH MET	MAIN LINE	SIDE STREET	BOTH MET	MAIN LINE	SIDE STREET	BOTH MET		
<b>THRESHOLD VALUES</b>				<b>500</b>	<b>150</b>		<b>750</b>	<b>75</b>		<b>400</b>	<b>120</b>		<b>600</b>	<b>60</b>		<b>60</b>	<b>75</b>
06:00 AM TO 07:00 AM																	
07:00 AM TO 08:00 AM																	
08:00 AM TO 09:00 AM	1,615	259		Y	Y	Y	Y	Y	Y	Y	Y	Y	Y	Y	Y	Y	Y
09:00 AM TO 10:00 AM																	
10:00 AM TO 11:00 AM																	
11:00 AM TO 12:00 PM																	
12:00 PM TO 01:00 PM																	
01:00 PM TO 02:00 PM																	
02:00 PM TO 03:00 PM																	
03:00 PM TO 04:00 PM																	
04:00 PM TO 05:00 PM																	
05:00 PM TO 06:00 PM	1,990	321		Y	Y	Y	Y	Y	Y	Y	Y	Y	Y	Y	Y	Y	Y
06:00 PM TO 07:00 PM																	
07:00 PM TO 08:00 PM																	
08:00 PM TO 09:00 PM																	
09:00 PM TO 10:00 PM																	
	3,605	580		2	2	2	2	2	2	2	2	2	2	2	2	2	2
				8 HOURS NEEDED NOT SATISFIED			8 HOURS NEEDED NOT SATISFIED			8 HOURS NEEDED for both Condition A & B NOT SATISFIED						4 HRS NEEDED NOT SATISFIED	1 HR NEEDED SATISFIED