

# **Appendix F**

---

## Geotechnical Investigation

**PRELIMINARY GEOTECHNICAL  
INVESTIGATION**

---

**PROPOSED INDUSTRIAL  
DISTRIBUTION CENTER  
LAWRENCE DRIVE & CORPORATE  
CENTER DRIVE  
THOUSAND OAKS, CALIFORNIA  
APN: 667 0172 015, 667 0172 025, 667  
0172 035**



**GEOCON**  
WEST, INC.

GEOTECHNICAL  
ENVIRONMENTAL  
MATERIALS

PREPARED FOR

**CRUZAN INDUSTRIAL PROJECTS**

**PROJECT NO. W1251-06-01**

**DECEMBER 8, 2020**



Project No. W1251-06-01  
December 8, 2020

Mr. Thomas Wood  
Cruzan Properties – Investments, LLC  
505 N. Brand Blvd., Suite 210  
Glendale, CA 91203

Subject: PRELIMINARY GEOTECHNICAL INVESTIGATION  
PROPOSED INDUSTRIAL DISTRIBUTION CENTER  
LAWRENCE DRIVE & CORPORATE CENTER DRIVE  
THOUSAND OAKS, CALIFORNIA  
APN: 667 0172 015, 667 0172 025, 667 0172 035

Dear Mr. Wood

In accordance with your authorization of our proposal dated October 23, 2020, we have performed a geotechnical investigation for proposed industrial distribution center located at the southeast corner of the intersection of Lawrence Drive and Corporate Center Drive in the City of Thousand Oaks, California. The accompanying report presents the findings of our study and our conclusions and recommendations pertaining to the geotechnical aspects of proposed design and construction. Based on the results of our investigation, it is our opinion that the site can be developed as proposed, provided the recommendations of this report are followed and implemented during design and construction.

If you have any questions regarding this report, or if we may be of further service, please contact the undersigned.

Very truly yours,

**GEOCON WEST, INC.**

Joshua Kulas  
Staff Engineer

(EMAIL) Addressee



Harry Derkalousdian  
PE 79694



Gerald A. Kasman  
CEG 2251

## TABLE OF CONTENTS

1.	PURPOSE AND SCOPE .....	1
2.	SITE AND PROJECT DESCRIPTION .....	1
3.	GEOLOGIC SETTING .....	2
4.	SOIL AND GEOLOGIC CONDITIONS .....	2
4.1	Artificial Fill .....	2
4.2	Older alluvium .....	3
5.	GROUDWATER .....	3
6.	GEOLOGIC HAZARDS .....	3
6.1	Surface Fault Rupture .....	3
6.2	Seismicity .....	4
6.3	Seismic Design Criteria .....	5
6.4	Liquefaction Potential .....	7
6.5	Slope Stability .....	7
6.6	Earthquake-Induced Flooding .....	7
6.7	Tsunamis, Seiches, and Flooding .....	8
6.8	Oil Fields & Methane Potential .....	8
6.9	Subsidence .....	8
7.	CONCLUSIONS AND RECOMMENDATIONS .....	9
7.1	General .....	9
7.2	Soil and Excavation Characteristics .....	11
7.3	Minimum Resistivity, pH, and Water-Soluble Sulfate .....	12
7.4	Grading .....	12
7.5	Shrinkage .....	15
7.6	Conventional Foundation Design .....	15
7.7	Foundation Settlement .....	17
7.8	Miscellaneous Foundations .....	17
7.9	Lateral Design .....	17
7.10	Concrete Slab-on-Grade .....	18
7.11	Preliminary Pavement Recommendations .....	19
7.12	Retaining Wall Design .....	21
7.13	Retaining Wall Drainage .....	23
7.14	Elevator Pit Design .....	24
7.15	Elevator Piston .....	24
7.16	Temporary Excavations .....	24
7.17	Surface Drainage .....	25
7.18	Plan Review .....	26

LIMITATIONS AND UNIFORMITY OF CONDITIONS

LIST OF REFERENCES

## **TABLE OF CONTENTS (Continued)**

### **MAPS, TABLES, AND ILLUSTRATIONS**

- Figure 1, Vicinity Map
- Figure 2, Site Plan
- Figure 3, Regional Fault Map
- Figure 4, Regional Seismicity Map
- Figures 5 and 6, Retaining Wall Drain Detail

### **APPENDIX A**

#### **FIELD INVESTIGATION**

- Figures A1 through A8, Boring Logs

### **APPENDIX B**

#### **LABORATORY TESTING**

- Figures B1 through B5, Direct Shear Test Results
- Figures B6 through B19, Consolidation Test Results
- Figure B20 and B21, Expansion Index Test Results
- Figure B22 and B23, Modified Compaction Test Results
- Figure B24, Corrosivity Test Results

# GEOTECHNICAL INVESTIGATION

## 1. PURPOSE AND SCOPE

This report presents the results of a preliminary geotechnical investigation for the proposed industrial distribution center located at the southeast corner of the intersection of Lawrence Drive and Corporate Center Drive in the City of Thousand Oaks, California (see Vicinity Map, Figure 1). The purpose of the investigation was to evaluate subsurface soil and geologic conditions underlying the site and, based on conditions encountered, to provide conclusions and preliminary recommendations pertaining to the geotechnical aspects of proposed design and construction.

The scope of this investigation included a site reconnaissance, field exploration, laboratory testing, engineering analysis, and the preparation of this report. The site was explored on October 21, 2020 by excavating eight 8-inch-diameter borings using a truck-mounted hollow-stem auger drilling machine. The hollow-stem auger borings were excavated to a maximum depth of 25½ feet below the existing ground surface. The approximate locations of the exploratory borings are depicted on the Site Plan (see Figure 2). A detailed discussion of the field investigation, including boring logs, is presented in Appendix A.

Laboratory tests were performed on selected soil samples obtained during the investigation to determine pertinent physical and chemical soil properties. Appendix B presents a summary of the laboratory test results.

The recommendations presented herein are based on analysis of the data obtained during the investigation and our experience with similar soil and geologic conditions. References reviewed to prepare this report are provided in the *List of References* section.

If project details vary significantly from those described herein, Geocon should be contacted to determine the necessity for review and possible revision of this report.

## 2. SITE AND PROJECT DESCRIPTION

The subject site is located at the southeast corner of the intersection of Lawrence Drive and Corporate Center Drive in the City of Thousand Oaks, California. The approximately 6.5-acre site is currently occupied by an asphalt paved parking lot with miscellaneous landscaping and paving improvements. The site is bounded by Lawrence Drive to the west, by Corporate Center Drive to the north, by a two-story industrial building to the south, and by a three-story industrial building to the east. The site is relatively level and surface water drainage at the site appears to be by sheet flow to the city streets. Vegetation on site consists of trees and shrubs that are confined to planter areas.

Based on the information provided by the Client, it is our understanding the proposed project is preliminary and the location of proposed structures and site improvements have not been determined at this time. It is assumed that proposed structures will be up to four stories high and will be constructed at or near present site grade. Plans for the proposed industrial distribution center are not available at this time. The limits of the existing improvements and adjacent structures are depicted on the Site Plan (see Figure 2).

Based on the preliminary nature of the design at this time, wall and column loads were not available. It is anticipated that column loads for the proposed structure will be up to 450 kips, and wall loads will be up to 4.5 kips per linear foot.

Once the design phase and foundation loading configuration proceeds to a more finalized plan, the recommendations within this report should be reviewed and revised, if necessary. Any changes in the design, location or elevation of any structure, as outlined in this report, should be reviewed by this office. Geocon should be contacted to determine the necessity for review and possible revision of this report.

### **3. GEOLOGIC SETTING**

The site is located in the Conejo Valley, located between the Santa Monica Mountains to the south and the Conejo Hills to the north. The Conejo Valley is an alluvial-filled valley that has been uplifted as a result of regional tectonics.

Regionally, the site is within the southern portion of the Transverse Ranges geomorphic province. The Santa Monica Mountains, formed during regional uplift, trend east-west along the southern margin of the San Fernando Valley and extend to the Oxnard Plain on the west. The Transverse Ranges geomorphic province is characterized by east-west trending geologic structures such as the Simi-Santa Rosa faults, located approximately 7.2 miles south and 2.7 miles north of the site.

### **4. SOIL AND GEOLOGIC CONDITIONS**

Based on published geologic maps of the area, the site is underlain by artificial fill and Pleistocene age alluvial fan deposits consisting of sand, and silt, clay and gravel (CGS, 2010; Dibblee, 1990).

#### **4.1 Artificial Fill**

Artificial fill was encountered in our explorations to a maximum depth of 8 feet below existing ground surface. The artificial fill generally consists of brown to grayish brown sand with silt and silty sand which can be characterized as dry and loose to medium dense. The fill is likely the result of past grading or construction activities at the site. Deeper fill may exist between excavations and in other portions of the site that were not directly explored.

## **4.2 Older alluvium**

The artificial fill is underlain by Pleistocene-age alluvial deposits that were observed to generally consist of grayish brown, brown and yellowish-brown interbedded poorly- to well-graded sand and silty sand with minor interbeds of silt and clay. The older alluvial soils are characterized as dry to slightly moist and medium dense to very dense or stiff to hard.

## **5. GROUNDWATER**

Groundwater was not encountered in any of our subsurface explorations to a maximum depth of 25½ feet below the existing ground surface. Groundwater is not expected to impact the proposed at-grade improvements to the site.

Recent requirements for stormwater infiltration could result in shallower seepage conditions in the immediate site vicinity. Proper surface drainage of irrigation and precipitation will be critical for future performance of the project. Recommendations for drainage are provided in the Surface Drainage section of this report (see Section 7.17).

## **6. GEOLOGIC HAZARDS**

### **6.1 Surface Fault Rupture**

The numerous faults in Southern California include Holocene-active, pre-Holocene, and inactive faults. The criteria for these major groups are based on criteria developed by the California Geological Survey (CGS, formerly known as CDMG) for the Alquist-Priolo Earthquake Fault Zone Program (CGS, 2018). By definition, a Holocene-active fault is one that has had surface displacement within Holocene time (about the last 11,700 years). A pre-Holocene fault has demonstrated surface displacement during Quaternary time (approximately the last 1.6 million years) but has had no known Holocene movement. Faults that have not moved in the last 1.6 million years are considered inactive.

The site is not within a state-designated Alquist-Priolo Earthquake Fault Zone (CDMG, 1999 2020a; 2020b) for surface fault rupture hazards. No Holocene-active or pre-Holocene faults with the potential for surface fault rupture are known to pass directly beneath the site. Therefore, the potential for surface rupture due to faulting occurring beneath the site during the design life of the proposed development is considered low. However, the site is located in the seismically active Southern California region, and could be subjected to moderate to strong ground shaking in the event of an earthquake on one of the many active Southern California faults. The faults in the vicinity of the site are shown in Figure 3, Regional Fault Map.



The closest surface trace of an active fault to the site is the Simi-Santa Rosa Fault Zone located approximately 2.7 miles to the north (CDMG, 1999; USGS, 2006). Other nearby active faults are the Wright Road Fault, Oak Ridge Fault, the San Cayatano Fault, and the Faults of Orcutt and Timber Canyons located approximately 10 miles west, 11 miles north, 14 miles north, and 14.5 miles north of the site, respectively (USGS, 2006; Ziony and Jones, 1989). The active San Andreas Fault Zone is located approximately 40 miles northeast of the site (Ziony and Jones, 1989).

Several buried thrust faults, commonly referred to as blind thrusts, underlie the Southern California area at depth. These faults are not exposed at the ground surface and are typically identified at depths greater than 3.0 kilometers. The October 1, 1987  $M_w$  5.9 Whittier Narrows earthquake and the January 17, 1994  $M_w$  6.7 Northridge earthquake were a result of movement on the Puente Hills Blind Thrust and the Northridge Thrust, respectively. These thrust faults and others in the Los Angeles area are not exposed at the surface and do not present a potential surface fault rupture hazard at the site; however, these deep thrust faults are considered active features capable of generating future earthquakes that could result in moderate to significant ground shaking at the site.

## 6.2 Seismicity

As with all of Southern California, the site has experienced historic earthquakes from various regional faults. The seismicity of the region surrounding the site was formulated based on research of an electronic database of earthquake data. The epicenters of recorded earthquakes with magnitudes equal to or greater than 5.0 in the site vicinity are depicted on Figure 4, Regional Seismicity Map. A partial list of moderate to major magnitude earthquakes that have occurred in the Southern California area within the last 100 years is included in the following table.

### LIST OF HISTORIC EARTHQUAKES

Earthquake (Oldest to Youngest)	Date of Earthquake	Magnitude	Distance to Epicenter (Miles)	Direction to Epicenter
Near Redlands	July 23, 1923	6.3	60	ENE
Long Beach	March 10, 1933	6.4	20	ESE
Tehachapi	July 21, 1952	7.5	94	NW
San Fernando	February 9, 1971	6.6	44	NNW
Whittier Narrows	October 1, 1987	5.9	22	NE
Sierra Madre	June 28, 1991	5.8	36	NNE
Landers	June 28, 1992	7.3	108	ENE
Big Bear	June 28, 1992	6.4	87	ENE
Northridge	January 17, 1994	6.7	34	NW
Hector Mine	October 16, 1999	7.1	127	ENE
Ridgecrest	July 5, 2019	7.1	142	NNE

The site could be subjected to strong ground shaking in the event of an earthquake. However, this hazard is common in Southern California and the effects of ground shaking can be mitigated if the proposed structures are designed and constructed in conformance with current building codes and engineering practices.

### 6.3 Seismic Design Criteria

The following table summarizes site-specific design criteria obtained from the 2019 California Building Code (CBC; Based on the 2018 International Building Code [IBC] and ASCE 7-16), Chapter 16 Structural Design, Section 1613 Earthquake Loads. The data was calculated using the online application *Seismic Design Maps*, provided by OSHPD. The short spectral response uses a period of 0.2 second. We evaluated the Site Class based on the discussion in Section 1613.2.2 of the 2019 CBC and Table 20.3-1 of ASCE 7-16. The values presented on the following page are for the risk-targeted maximum considered earthquake ( $MCE_R$ ).

**2019 CBC SEISMIC DESIGN PARAMETERS**

Parameter	Value	2019 CBC Reference
Site Class	D	Section 1613.2.2
$MCE_R$ Ground Motion Spectral Response Acceleration – Class B (short), $S_S$	1.491g	Figure 1613.2.1(1)
$MCE_R$ Ground Motion Spectral Response Acceleration – Class B (1 sec), $S_1$	0.542g	Figure 1613.2.1(2)
Site Coefficient, $F_A$	1.2	Table 1613.2.3(1)
Site Coefficient, $F_V$	1.7*	Table 1613.2.3(2)
Site Class Modified $MCE_R$ Spectral Response Acceleration (short), $S_{MS}$	1.491g	Section 1613.2.3 (Eqn 16-36)
Site Class Modified $MCE_R$ Spectral Response Acceleration – (1 sec), $S_{M1}$	0.953*	Section 1613.2.3 (Eqn 16-37)
5% Damped Design Spectral Response Acceleration (short), $S_{DS}$	0.994g	Section 1613.2.4 (Eqn 16-38)
5% Damped Design Spectral Response Acceleration (1 sec), $S_{D1}$	0.635*	Section 1613.2.4 (Eqn 16-39)
<p><b>Note:</b>            *Per Section 11.4.8 of ASCE/SEI 7-16, a ground motion hazard analysis shall be performed for projects for Site Class “E” sites with <math>S_S</math> greater than or equal to 1.0g and for Site Class “D” and “E” sites with <math>S_1</math> greater than 0.2g. Section 11.4.8 also provides exceptions which indicates that the ground motion hazard analysis may be waived provided the exceptions are followed. Using the code based values presented in the table above, in lieu of a performing a ground motion hazard analysis, requires the exceptions outlined in ASCE 7-16 Section 11.4.8 be followed.</p>		

The table below presents the mapped maximum considered geometric mean ( $MCE_G$ ) seismic design parameters for projects located in Seismic Design Categories of D through F in accordance with ASCE 7-16.

### ASCE 7-16 PEAK GROUND ACCELERATION

Parameter	Value	ASCE 7-16 Reference
Mapped $MCE_G$ Peak Ground Acceleration, $PGA$	0.601g	Figure 22-7
Site Coefficient, $F_{PGA}$	1.1	Table 11.8-1
Site Class Modified $MCE_G$ Peak Ground Acceleration, $PGA_M$	0.661g	Section 11.8.3 (Eqn 11.8-1)

The Maximum Considered Earthquake Ground Motion (MCE) is the level of ground motion that has a 2 percent chance of exceedance in 50 years, with a statistical return period of 2,475 years. According to the 2019 California Building Code and ASCE 7-16, the MCE is to be utilized for the evaluation of liquefaction, lateral spreading, seismic settlements, and it is our understanding that the intent of the Building code is to maintain “Life Safety” during a MCE event. The Design Earthquake Ground Motion (DE) is the level of ground motion that has a 10 percent chance of exceedance in 50 years, with a statistical return period of 475 years.

Deaggregation of the MCE peak ground acceleration was performed using the USGS online Unified Hazard Tool, 2014 Conterminous U.S. Dynamic edition (v4.2.0). The result of the deaggregation analysis indicates that the predominant earthquake contributing to the MCE peak ground acceleration is characterized as a 6.75 magnitude event occurring at a hypocentral distance of 12.65 kilometers from the site.

Deaggregation was also performed for the Design Earthquake (DE) peak ground acceleration, and the result of the analysis indicates that the predominant earthquake contributing to the DE peak ground acceleration is characterized as a 6.69 magnitude occurring at a hypocentral distance of 17.9 kilometers from the site.

Conformance to the criteria in the above tables for seismic design does not constitute any kind of guarantee or assurance that significant structural damage or ground failure will not occur if a large earthquake occurs. The primary goal of seismic design is to protect life, not to avoid all damage, since such design may be economically prohibitive.

## **6.4 Liquefaction Potential**

Liquefaction is a phenomenon in which loose, saturated, relatively cohesionless soil deposits lose shear strength during strong ground motions. Primary factors controlling liquefaction include intensity and duration of ground motion, gradation characteristics of the subsurface soils, in-situ stress conditions, and the depth to groundwater. Liquefaction is typified by a loss of shear strength in the liquefied layers due to rapid increases in pore water pressure generated by earthquake accelerations.

The current standard of practice, as outlined in the “Recommended Procedures for Implementation of DMG Special Publication 117, Guidelines for Analyzing and Mitigating Liquefaction in California” and “Special Publication 117A, Guidelines for Evaluating and Mitigating Seismic Hazards in California” requires liquefaction analysis to a depth of 50 feet below the lowest portion of the proposed structure. Liquefaction typically occurs in areas where the soils below the water table are composed of poorly consolidated, fine to medium-grained, primarily sandy soil. In addition to the requisite soil conditions, the ground acceleration and duration of the earthquake must also be of a sufficient level to induce liquefaction.

The State of California Seismic Hazard Zone Map for the Newbury Park Quadrangle (CDMG, 1998) indicates that the site is not located in an area designated as having a potential for liquefaction. In addition, a review of the City of Thousand Oaks General Plan (City of Thousand Oaks, 2014) indicates that the site is not located within an area identified as having a potential for liquefaction. Based on these considerations, the potential for liquefaction and associated ground deformations beneath the site is considered very low.

## **6.5 Slope Stability**

The topography at the site is relatively level and the topography in the immediate site vicinity slopes gently to the south. The site is not located within a City of Thousand Oaks Landslide Hazard Area (City of Thousand Oaks, 2014). Additionally, the site is not within an area identified as having a potential for seismic slope instability (CDMG, 1998). There are no known landslides near the site, nor is the site in the path of any known or potential landslides. Therefore, the potential for slope stability hazards to adversely affect the proposed development is considered low.

## **6.6 Earthquake-Induced Flooding**

Earthquake-induced flooding is inundation caused by failure of dams or other water-retaining structures due to earthquakes. The City of Thousand Oaks Safety Element (City of Thousand Oaks, 2014) indicates that the site is not located within an inundation area. Therefore, the potential for inundation at the site as a result of an earthquake-induced dam failure is considered low.

## **6.7 Tsunamis, Seiches, and Flooding**

The site is not located within a coastal area. Therefore, tsunamis are not considered a significant hazard at the site.

Seiches are large waves generated in enclosed bodies of water in response to ground shaking. No major water-retaining structures are located immediately up-gradient from the project site. Therefore, flooding resulting from a seismic-induced seiche is considered unlikely.

The site is within an area of minimal flooding (Zone X) as defined by the Federal Emergency Management Agency (FEMA, 2020; City of Thousand Oaks, 2014). Therefore, flooding is not anticipated to adversely impact the site.

## **6.8 Oil Fields & Methane Potential**

Based on a review of the California Geologic Energy Management Division (CalGEM) Well Finder Website, the site is not located within an oil field and active oil or gas wells are not documented in the immediate site vicinity (CalGEM, 2020). However, due to the voluntary nature of record reporting by the oil well drilling companies, wells may be improperly located or not shown on the location map and undocumented wells could be encountered during construction. Any wells encountered during construction will need to be properly abandoned in accordance with the current requirements of the CalGEM.

Since the site is not located within the boundaries of a known oil field, the potential for the presence of methane or other volatile gases at the site is considered low. However, should it be determined that a methane study is required for the proposed development it is recommended that a qualified methane consultant be retained to perform the study and provide mitigation measures as necessary.

## **6.9 Subsidence**

Subsidence occurs when a large portion of land is displaced vertically, usually due to the withdrawal of groundwater, oil, or natural gas. Soils that are particularly subject to subsidence include those with high silt or clay content. The site is not located within an area of known ground subsidence. No large-scale extraction of groundwater, gas, oil, or geothermal energy is occurring or planned at the site or in the general site vicinity. There appears to be little or no potential for ground subsidence due to withdrawal of fluids or gases at the site.

## 7. CONCLUSIONS AND RECOMMENDATIONS

### 7.1 General

- 7.1.1 It is our opinion that neither soil nor geologic conditions were encountered during the investigation that would preclude the construction of the proposed development provided the recommendations presented herein are followed and implemented during design and construction.
- 7.1.2 Between one and eight feet of existing artificial fill was encountered during the site investigation. The existing fill encountered is believed to be the result of past grading and construction activities at the site. Deeper fill may exist in other areas of the site that were not directly explored. Future demolition of existing improvements which occupy the site will likely disturb the upper few feet of soil. It is our opinion that the existing fill, in its present condition, is not suitable for direct support of proposed foundations or slabs. The existing fill and site soils are suitable for re-use as engineered fill provided the recommendations in the *Grading* section of this report are followed (see Section 7.4).
- 7.1.3 The results of our laboratory testing indicate that the existing upper alluvial soils are subject to excessive hydro-consolidation upon saturation. Hydro-consolidation is the tendency of a soil structure to collapse upon saturation, resulting in the overall settlement of the effected soils and any overlying soils, foundations, or improvements supported therein. The grading and foundation recommendations presented herein are intended to minimize the potential for settlement as a result of hydroconsolidation.
- 7.1.4 Based on these considerations, it is recommended that the upper 5 feet of existing earth materials within the building footprint areas be excavated and properly compacted for foundation and slab support. Deeper excavations, such as in the area where the existing artificial fill was encountered at a depth of 8 feet below ground surface, should be conducted as necessary to remove all existing artificial fill or soft alluvial soils at the direction of the Geotechnical Engineer (a representative of Geocon). Proposed building foundations should be underlain by a minimum of 3 feet of newly placed engineered fill. The excavation should extend laterally a minimum distance of 3 feet beyond the building footprint area, including building appurtenances, or for a distance equal to the depth of fill below the foundation, whichever is greater. The limits of existing fill and/or soft alluvial soil removal will be verified by the Geocon representative during site grading activities.
- 7.1.5 Additional grading should be conducted as necessary to maintain the required 3 feet of newly placed engineered fill below foundations. The grading contractor should verify all bottom of footing elevations prior to commencement of grading activities to ensure that grading is conducted deep enough to provide the required 3 feet of engineering fill below foundations.

- 7.1.6 Subsequent to the recommended grading, the proposed structures may be supported on a conventional spread foundation system deriving support in newly placed engineered fill. Recommendations for the design of a *Conventional Foundation System* are provided in Section 7.6.
- 7.1.7 All excavations must be observed and approved in writing by the Geotechnical Engineer (a representative of Geocon). Prior to placing any fill, the excavation bottom must be proof-rolled in the presence of the Geotechnical Engineer (a representative of Geocon) and approved in writing.
- 7.1.8 At the time of this investigation the upper site soils were above the optimum moisture content. The moisture content of the soil is likely to change between wet and dry seasons. If the soils are over optimum at the time of construction it is likely that spreading and drying will be required in order to obtain a moisture content suitable for placement and compaction
- 7.1.9 Where new foundations are constructed immediately adjacent to existing foundations, the new foundation should be deepened to match or exceed the depth of the existing foundation to prevent a surcharge on the existing foundation. Where a proposed foundation will be deeper than an existing adjacent foundation, the proposed foundation must be designed to resist the surcharge imposed by the existing foundation. The surcharge area may be defined by a 1:1 projection down and away from the bottom of an existing foundation.
- 7.1.10 Stable excavations for the recommended grading can be achieved with sloping measures where sufficient space is available. However, if excavations in close proximity to an existing adjacent structure and/or property line are required, special excavation measures may be necessary in order to maintain lateral support of existing improvements. Excavation recommendations are provided in the *Temporary Excavations* section of this report (Section 7.16).
- 7.1.11 Foundations for small outlying structures, such as block walls up to 6 feet in height, planter walls or trash enclosures, which will not be tied to the proposed structure, may be supported on conventional foundations deriving support on a minimum of 12 inches of newly placed engineered fill which extends laterally at least 12 inches beyond the foundation area. Where excavation and compaction cannot be performed or is undesirable, foundations may derive support directly in the undisturbed alluvial soils at or below 30 inches below the existing ground surface. If the soils exposed in the excavation bottom are soft or loose, compaction of the soils will be required prior to placing steel or concrete. Compaction of the foundation excavation bottom is typically accomplished with a compaction wheel or mechanical whacker and must be observed and approved by a Geocon representative.

- 7.1.12 Where new paving is to be placed, it is recommended that all existing fill and soft alluvial soils be excavated and properly compacted for paving support. The client should be aware that excavation and compaction of all existing fill and soft alluvial soils in the area of new paving is not required; however, paving constructed over existing uncertified fill or unsuitable alluvial soil may experience increased settlement and/or cracking, and may therefore have a shorter design life and increased maintenance costs. As a minimum, the upper 12 inches of subgrade soil should be scarified and properly compacted for paving support. Paving recommendations are provided in Section 7.11 of this report.
- 7.1.13 Once the design and foundation loading configuration for the proposed structures proceeds to a more finalized plan, the recommendations within this report should be reviewed and revised, if necessary. Based on the final foundation loading configurations, the potential for settlement should be reevaluated by this office.
- 7.1.14 Any changes in the design, location or elevation, as outlined in this report, should be reviewed by this office. Geocon should be contacted to determine the necessity for review and possible revision of this report.

## **7.2 Soil and Excavation Characteristics**

- 7.2.1 The in-situ soils can be excavated with moderate effort using conventional excavation equipment. Some caving should be anticipated in unshored excavations, especially where granular soils are encountered.
- 7.2.2 It is the responsibility of the contractor to ensure that all excavations and trenches are properly shored and maintained in accordance with applicable OSHA rules and regulations to maintain safety and maintain the stability of existing adjacent improvements.
- 7.2.3 All onsite excavations must be conducted in such a manner that potential surcharges from existing structures, construction equipment, and vehicle loads are resisted. The surcharge area may be defined by a 1:1 projection down and away from the bottom of an existing foundation or vehicle load. Penetrations below this 1:1 projection will require special excavation measures such as sloping or shoring. Excavation recommendations are provided in the *Temporary Excavations* section of this report (see Section 7.16).
- 7.2.4 The upper 5 feet of existing site soils encountered during this investigation are considered to have a “medium” expansive potential (EI’s = 59 and 83) and are classified as “expansive” based on the 2019 California Building Code (CBC) Section 1803.5.3. Recommendations presented herein assume that the proposed foundations and slabs will derive support in these materials.



### **7.3 Minimum Resistivity, pH, and Water-Soluble Sulfate**

- 7.3.1 Potential of Hydrogen (pH) and resistivity testing as well as chloride content testing were performed on representative samples of soil to generally evaluate the corrosion potential to surface utilities. The tests were performed in accordance with California Test Method Nos. 643 and 422 and indicate that the soils are considered “corrosive” to “severely corrosive” with respect to corrosion of buried ferrous metals on site. Due to the corrosive potential of the soils, it is recommended that PVC, ABS or other approved plastic piping be utilized in lieu of cast-iron when in direct contact with the site soils. The results are presented in Appendix B (Figure B24) and should be considered for design of underground structures.
- 7.3.2 Laboratory tests were performed on representative samples of the site materials to measure the percentage of water-soluble sulfate content. Results from the laboratory water-soluble sulfate tests are presented in Appendix B (Figure B24) and indicate that the on-site materials possess a sulfate exposure class of “S0” to concrete structures as defined by 2019 CBC Section 1904 and ACI 318-14 Table 19.3.1.1.
- 7.3.3 Geocon West, Inc. does not practice in the field of corrosion engineering and mitigation. If corrosion sensitive improvements are planned, it is recommended that a corrosion engineer be retained to evaluate corrosion test results and incorporate the necessary precautions to avoid premature corrosion of buried metal pipes and concrete structures in direct contact with the soils.

### **7.4 Grading**

- 7.4.1 Grading is anticipated to include preparation of building pad, excavation of site soils for proposed foundations and slabs, utility trenches, and placement of backfill for utility trenches.
- 7.4.2 A preconstruction conference should be held at the site prior to the beginning of grading operations with the owner, contractor, civil engineer, geotechnical engineer, and, if applicable, building official in attendance. Special soil handling requirements can be discussed at that time.
- 7.4.3 Some caving should be anticipated in unshored excavations, especially where granular soils are encountered, and the contractor should be aware that formwork may be required to prevent caving of shallow spread foundation excavations.
- 7.4.4 Earthwork should be observed, and compacted fill tested by representatives of Geocon West, Inc. The existing fill and alluvial soil encountered during exploration is suitable for re-use as engineered fill, provided any encountered oversized material (greater than 6 inches) and any encountered deleterious debris are removed.

- 7.4.5 At the time of this investigation the upper site soils were above the optimum moisture content. The moisture content of the soil is likely to change between wet and dry seasons. If the soils are over optimum at the time of construction it is likely that spreading and drying will be required in order to obtain a moisture content suitable for placement and compaction
- 7.4.6 Grading should commence with the removal of all existing vegetation and existing improvements from the area to be graded. Deleterious debris such as wood and root structures should be exported from the site and should not be mixed with the fill soils. Asphalt and concrete should not be mixed with the fill soils unless approved by the Geotechnical Engineer. All existing underground improvements planned for removal should be completely excavated and the resulting depressions properly backfilled in accordance with the procedures described herein. Once a clean excavation bottom has been established it must be observed and approved in writing by the Geotechnical Engineer (a representative of Geocon West, Inc.).
- 7.4.7 As a minimum, it is recommended that the upper 5 feet of existing earth materials within the proposed building footprint areas be excavated and properly compacted for foundation and slab support. Deeper excavations should be conducted as necessary, such as in the area where the existing artificial fill was encountered at a depth of 8 feet below ground surface, to remove all existing artificial fill or soft alluvial soils at the direction of the Geotechnical Engineer (a representative of Geocon). Proposed building foundations should be underlain by a minimum of 3 feet of newly placed engineered fill. The excavation should extend laterally a minimum distance of 3 feet beyond the building footprint area, including building appurtenances, or for a distance equal to the depth of fill below the foundation, whichever is greater. The limits of existing fill and/or soft alluvial soil removal will be verified by the Geocon representative during site grading activities.
- 7.4.8 Additional grading should be conducted as necessary to maintain the required 3 feet of newly placed engineered fill below foundations. The grading contractor should verify all bottom of footing elevations prior to commencement of grading activities to ensure that grading is conducted deep enough to provide the required 3 feet of engineering fill below foundations.
- 7.4.9 All excavations must be observed and approved in writing by the Geotechnical Engineer (a representative of Geocon). Prior to placing any fill, the excavation bottom must be proof-rolled in the presence of the Geotechnical Engineer (a representative of Geocon) and approved in writing.

- 7.4.10 It is anticipated that stable excavations for the recommended grading can be achieved with sloping measures. However, if excavations in close proximity to an existing adjacent structure and/or property line are required, special excavation measures may be required in order to maintain support of the existing improvements. Excavation recommendations are provided in the *Temporary Excavations* section of this report (Section 7.16).
- 7.4.11 All fill and backfill soils should be placed in horizontal loose layers approximately 6 to 8 inches thick, moisture conditioned to approximately two percent above optimum moisture content, and properly compacted to at least 90 percent relative compaction, as determined by ASTM Test Method D 1557 (latest edition).
- 7.4.12 Due to the expansive potential of the soils it is recommended that the subgrade be maintained at two percent above optimum moisture content prior to and at the time of concrete placement.
- 7.4.13 Foundations for small outlying structures, such as block walls up to 6 feet in height, planter walls or trash enclosures, which will not be tied to the proposed structure, may be supported on conventional foundations deriving support on a minimum of 12 inches of newly placed engineered fill which extends laterally at least 12 inches beyond the foundation area. Where excavation and compaction cannot be performed or is undesirable, foundations may derive support directly in the undisturbed alluvial soils at or below a depth of 30 inches below the existing ground surface. If the soils exposed in the excavation bottom are soft or loose, compaction of the soils will be required prior to placing steel or concrete. Compaction of the foundation excavation bottom is typically accomplished with a compaction wheel or mechanical whacker and must be observed and approved by a Geocon representative.
- 7.4.14 Where new paving is to be placed, it is recommended that all existing fill and soft alluvial soils be excavated and properly compacted for paving support. The client should be aware that excavation and compaction of all existing fill and soft alluvial soils in the area of new paving is not required; however, paving constructed over existing uncertified fill or unsuitable alluvial soil may experience increased settlement and/or cracking, and may therefore have a shorter design life and increased maintenance costs. As a minimum, the upper 12 inches of subgrade soil should be scarified and properly compacted to a minimum of 95 percent of the laboratory maximum dry density in accordance with ASTM D 1557 (latest edition). *Preliminary Pavement Recommendations* section of this report (see Section 7.11).
- 7.4.15 All imported fill shall be observed, tested, and approved by Geocon West, Inc. prior to bringing soil to the site. Rocks larger than 6 inches in diameter shall not be used in the fill. If necessary, import soils used as structural fill should have an expansion index less than 50 and soil corrosivity properties that are equally or less detrimental to that of the existing onsite soils (see Figure B24). Imported soil placed in building pad areas must be placed uniformly across the pad at the direction of the Geotechnical Engineer (a representative of Geocon).

- 7.4.16 Utility trenches should be properly backfilled in accordance with the requirements of the Green Book (latest edition). The pipe should be bedded with clean sands (Sand Equivalent greater than 30) to a depth of at least 1 foot over the pipe, and the bedding material must be inspected and approved in writing by the Geotechnical Engineer (a representative of Geocon). The use of gravel is not acceptable unless used in conjunction with filter fabric to prevent the gravel from having direct contact with soil. The remainder of the trench backfill may be derived from onsite soil or approved import soil, compacted as necessary, until the required compaction is obtained. The use of minimum 2-sack slurry as backfill is also acceptable. Prior to placing any bedding materials or pipes, the excavation bottom must be observed and approved in writing by the Geotechnical Engineer (a representative of Geocon).
- 7.4.17 All trench and foundation excavation bottoms must be observed and approved in writing by the Geotechnical Engineer (a representative of Geocon), prior to placing bedding materials, fill, steel, gravel, or concrete.

## **7.5 Shrinkage**

- 7.5.1 Shrinkage results when a volume of material removed at one density is compacted to a higher density. A shrinkage factor between 3 and 9 percent should be anticipated when excavating and compacting the upper five feet of existing earth materials on the site to an average relative compaction of 90 percent.
- 7.5.2 If import soils will be utilized in the building pad, the soils must be placed uniformly and at equal thickness at the direction of the Geotechnical Engineer (a representative of Geocon West, Inc.).

## **7.6 Conventional Foundation Design**

- 7.6.1 Subsequent to the recommended grading, a conventional foundation system may be utilized for support of the proposed structure provided foundations derive support in newly placed engineered fill. As a minimum, foundations for the proposed structures should be underlain by at least three feet of newly placed engineered fill.
- 7.6.2 Continuous footings may be designed for an allowable bearing capacity of 2,300 pounds per square foot (psf), and should be a minimum of 12 inches in width, 30 inches in depth below the lowest adjacent grade, and 18 inches into the recommended bearing material.
- 7.6.3 Isolated spread foundations may be designed for an allowable bearing capacity of 2,700 psf, and should be a minimum of 24 inches in width, 30 inches in depth below the lowest adjacent grade, and 18 inches into the recommended bearing material.

- 7.6.4 The allowable soil bearing pressure may be increased by 50 psf and 300 psf for each additional foot of foundation width and depth, respectively, up to a maximum allowable soil bearing pressure of 4,500 psf.
- 7.6.5 The allowable bearing pressures may be increased by one-third for transient loads due to wind or seismic forces.
- 7.6.6 If depth increases are utilized for the exterior wall footings, this office should be provided a copy of the final construction plans so that the excavation recommendations presented herein could be properly reviewed and revised if necessary.
- 7.6.7 Continuous footings should be reinforced with four No. 4 steel reinforcing bars, two placed near the top of the footing and two near the bottom. Reinforcement for spread footings should be designed by the project structural engineer.
- 7.6.8 The above foundation dimensions and minimum reinforcement recommendations are based on soil conditions and building code requirements only, and are not intended to be used in lieu of those required for structural purposes.
- 7.6.9 Due to the expansive potential of the subgrade soils, the moisture content in the slab and foundation subgrade should be maintained at 2 percent above optimum moisture content prior to and at the time of concrete placement
- 7.6.10 If depth increases are utilized for the exterior wall footings, this office should be provided a copy of the final construction plans so that the excavation recommendations presented herein could be properly reviewed and revised if necessary.
- 7.6.11 Foundation excavations should be observed and approved in writing by the Geotechnical Engineer (a representative of Geocon West, Inc.), prior to the placement of reinforcing steel and concrete to verify that the excavations and exposed soil conditions are consistent with those anticipated. If unanticipated soil conditions are encountered, foundation modifications may be required.
- 7.6.12 This office should be provided a copy of the final construction plans so that the excavation recommendations presented herein could be properly reviewed and revised if necessary.

## **7.7 Foundation Settlement**

- 7.7.1 The maximum expected static settlement for an on-grade structure supported on a conventional foundation system in the recommended bearing materials and designed with a maximum bearing pressure of 4,500 psf is estimated to be less than 1½ inches and occur below the heaviest loaded structural element. Settlement of the foundation system is expected to occur on initial application of loading. Differential settlement is not expected to exceed ¾ inch over a distance of 20 feet.
- 7.7.2 Once the design and foundation loading configurations for the proposed structure proceed to a more finalized plan, the estimated settlements presented in this report should be reviewed and revised, if necessary. If the final foundation loading configurations are greater than the assumed loading conditions, the potential for settlement should be reevaluated by this office.

## **7.8 Miscellaneous Foundations**

- 7.8.1 Foundations for small outlying structures, such as block walls up to 6 feet in height, planter walls or trash enclosures, which will not be tied to the proposed structure, may be supported on conventional foundations deriving support on a minimum of 12 inches of newly placed engineered fill which extends laterally at least 12 inches beyond the foundation area. Where excavation and compaction cannot be performed or is undesirable, foundations may derive support directly in the competent undisturbed alluvial soils at or below a depth of 30 inches below the existing ground surface.
- 7.8.2 If the soils exposed in the excavation bottom are soft, compaction of the soft soils will be required prior to placing steel or concrete. Compaction of the foundation excavation bottom is typically accomplished with a compaction wheel or mechanical whacker and must be observed and approved by a Geocon representative. Miscellaneous foundations may be designed for a bearing value of 1,500 psf, and should be a minimum of 12 inches in width, 30 inches in depth below the lowest adjacent grade and 18 inches into the recommended bearing material. The allowable bearing pressure may be increased by up to one-third for transient loads due to wind or seismic forces.
- 7.8.3 Foundation excavations should be observed and approved in writing by the Geotechnical Engineer (a representative of Geocon West, Inc.), prior to the placement of reinforcing steel and concrete to verify that the excavations and exposed soil conditions are consistent with those anticipated.

## **7.9 Lateral Design**

- 7.9.1 Resistance to lateral loading may be provided by friction acting at the base of foundations, slabs and by passive earth pressure. An allowable coefficient of friction of 0.28 may be used with the dead load forces in the undisturbed alluvial soils or engineered fill.

- 7.9.2 Passive earth pressure for the sides of foundations and slabs poured against the alluvial soils or properly compacted engineered fill may be computed as an equivalent fluid having a density of 180 pcf with a maximum earth pressure of 1,800 pcf. When combining passive and friction for lateral resistance, the passive component should be reduced by one-third.

## **7.10 Concrete Slab-on-Grade**

- 7.10.1 Concrete slab-on-grade subject to vehicle loading should be designed in accordance with the recommendations in the *Preliminary Pavement Recommendations* section of this report (Section 7.11).

- 7.10.2 Subsequent to the recommended grading, concrete slab-on-grade for structure, not subject to vehicle loading, should be a minimum of 4 inches thick and minimum slab reinforcement should consist of No. 4 steel reinforcing bars placed 16 inches on center in both horizontal directions. Steel reinforcing should be positioned vertically near the slab midpoint.

- 7.10.3 Slab-on-grade at the ground surface that may receive moisture-sensitive floor coverings or may be used to store moisture-sensitive materials should be underlain by a vapor retarder placed directly beneath the slab. The vapor retarder and acceptable permeance should be specified by the project architect or developer based on the type of floor covering that will be installed. The vapor retarder design should be consistent with the guidelines presented in Section 9.3 of the American Concrete Institute's (ACI) Guide for Concrete Slabs that Receive Moisture-Sensitive Flooring Materials (ACI 302.2R-06) and should be installed in general conformance with ASTM E 1643 (latest edition) and the manufacturer's recommendations. A minimum thickness of 15 mils extruded polyolefin plastic is recommended; vapor retarders which contain recycled content or woven materials are not recommended. The vapor retarder should have a permeance of less than 0.01 perms demonstrated by testing before and after mandatory conditioning is recommended. The vapor retarder should be installed in direct contact with the concrete slab with proper perimeter seal. If the California Green Building Code requirements apply to this project, the vapor retarder should be underlain by 4 inches of clean aggregate. It is important that the vapor retarder be puncture resistant since it will be in direct contact with angular gravel. As an alternative to the clean aggregate suggested in the Green Building Code, it is our opinion that the concrete slab-on-grade may be underlain by a vapor retarder over 4 inches of clean sand (sand equivalent greater than 30), since the sand will serve a capillary break and will minimize the potential for punctures and damage to the vapor barrier.

- 7.10.4 For seismic design purposes, a coefficient of friction of 0.28 may be utilized between concrete slabs and subgrade soils without a moisture barrier, and 0.15 for slabs underlain by a moisture barrier.

- 7.10.5 Exterior slabs for walkways or flatwork, not subject to traffic loads, should be at least 4 inches thick and reinforced with No. 3 steel reinforcing bars placed 18 inches on center in both horizontal directions, positioned near the slab midpoint. Prior to construction of slabs, the upper 12 inches of subgrade should be moistened to approximately two percent above optimum moisture content and properly compacted to at least 95 percent relative compaction, as determined by ASTM Test Method D 1557 (latest edition). Crack control joints should be spaced at intervals not greater than 8 feet and should be constructed using saw-cuts or other methods as soon as practical following concrete placement. Crack control joints should extend a minimum depth of one-fourth the slab thickness. The project structural engineer should design construction joints as necessary.
- 7.10.6 The recommendations of this report are intended to reduce the potential for cracking of slabs due to settlement. However, even with the incorporation of the recommendations presented herein, foundations, stucco walls, and slabs-on-grade may exhibit some cracking due to minor soil movement and/or concrete shrinkage. The occurrence of concrete shrinkage cracks is independent of the supporting soil characteristics. Their occurrence may be reduced and/or controlled by limiting the slump of the concrete, proper concrete placement and curing, and by the placement of crack control joints at periodic intervals, in particular, where re-entrant slab corners occur.

## **7.11 Preliminary Pavement Recommendations**

- 7.11.1 Where new paving is to be placed, it is recommended that all existing fill and soft or unsuitable alluvial materials be excavated and properly recompacted for paving support. The client should be aware that excavation and compaction of all existing artificial fill and soft alluvium in the area of new paving is not required; however, paving constructed over existing unsuitable material may experience increased settlement and/or cracking, and may therefore have a shorter design life and increased maintenance costs. As a minimum, the upper 12 inches of paving subgrade should be scarified, moisture conditioned to approximately two percent above optimum moisture content, and properly compacted to at least 95 percent relative compaction, as determined by ASTM Test Method D 1557 (latest edition).
- 7.11.2 The following pavement sections are based on an assumed R-Value of 20. Once site grading activities are complete an R-Value should be obtained by laboratory testing to confirm the properties of the soils serving as paving subgrade, prior to placing pavement.



7.11.3 The Traffic Indices listed below are estimates. Geocon does not practice in the field of traffic engineering. The actual Traffic Index for each area should be determined by the project civil engineer. If pavement sections for Traffic Indices other than those listed below are required, Geocon should be contacted to provide additional recommendations. Pavement thicknesses were determined following procedures outlined in the *California Highway Design Manual* (Caltrans). It is anticipated that the majority of traffic will consist of automobile and large truck traffic.

**PRELIMINARY PAVEMENT DESIGN SECTIONS**

Location	Estimated Traffic Index (TI)	Asphalt Concrete (inches)	Class 2 Aggregate Base (inches)
Automobile Parking And Driveways	4.0	4.0	4.0
Trash Truck & Fire Lanes	7.0	4.0	12.0

7.11.4 Asphalt concrete should conform to Section 203-6 of the “*Standard Specifications for Public Works Construction*” (Green Book). Class 2 aggregate base materials should conform to Section 26-1.02A of the “*Standard Specifications of the State of California, Department of Transportation*” (Caltrans). The use of Crushed Miscellaneous Base in lieu of Class 2 aggregate base is acceptable. Crushed Miscellaneous Base should conform to Section 200-2.4 of the “*Standard Specifications for Public Works Construction*” (Green Book).

7.11.5 Unless specifically designed and evaluated by the project structural engineer, where exterior concrete paving will be utilized for support of vehicles, it is recommended that the concrete be a minimum of 6 inches of concrete reinforced with No. 3 steel reinforcing bars placed 18 inches on center in both horizontal directions. Concrete paving supporting vehicular traffic should be underlain by a minimum of 4 inches of aggregate base and a properly compacted subgrade. The subgrade and base material should be compacted to 95 percent relative compaction as determined by ASTM Test Method D 1557 (latest edition).

7.11.6 The performance of pavements is highly dependent upon providing positive surface drainage away from the edge of pavements. Ponding of water on or adjacent to the pavement will likely result in saturation of the subgrade materials and subsequent cracking, subsidence and pavement distress. If planters are planned adjacent to paving, it is recommended that the perimeter curb be extended at least 12 inches below the bottom of the aggregate base to minimize the introduction of water beneath the paving.

## 7.12 Retaining Wall Design

- 7.12.1 The recommendations presented below are generally applicable to the design of rigid concrete or masonry retaining walls having a maximum height of 5 feet. In the event that walls significantly higher than 5 feet are planned, Geocon should be contacted for additional recommendations.
- 7.12.2 Retaining wall foundations may be designed in accordance with the recommendations provided in the *Conventional Foundation Design* section of this report (see Section 7.6).
- 7.12.3 Retaining walls with a level backfill surface that are not restrained at the top should be designed utilizing a triangular distribution of pressure (active pressure). Restrained walls are those that are not allowed to rotate more than  $0.001H$  (where  $H$  equals the height of the retaining portion of the wall in feet) at the top of the wall. Where walls are restrained from movement at the top, walls may be designed utilizing a triangular distribution of pressure (at-rest pressure). The table below presents recommended pressures to be used in retaining wall design, assuming that proper drainage will be maintained.

**RETAINING WALL WITH LEVEL BACKFILL SURFACE**

<b>HEIGHT OF RETAINING WALL (Feet)</b>	<b>ACTIVE PRESSURE EQUIVALENT FLUID PRESSURE (Pounds Per Cubic Foot)</b>	<b>AT-REST PRESSURE EQUIVALENT FLUID PRESSURE (Pounds Per Cubic Foot)</b>
Up to 5	30	66

- 7.12.4 The wall pressures provided above assume that the proposed retaining walls will support relatively undisturbed alluvial soils or engineered fill derived from onsite soil. If import soil is used to backfill proposed walls, revised earth pressures may be required to account for the geotechnical properties of the soil placed as engineered fill. This should be evaluated once the use of import soil is established. All imported fill shall be observed, tested, and approved by Geocon West, Inc. prior to bringing soil to the site.
- 7.12.5 The wall pressures provided above assume that the retaining wall will be properly drained preventing the buildup of hydrostatic pressure. If retaining wall drainage is not implemented, the equivalent fluid pressure to be used in design of undrained walls is 90 pcf. This value includes hydrostatic pressures plus buoyant lateral earth pressures.
- 7.12.6 Additional active pressure should be added for a surcharge condition due to sloping ground, vehicular traffic or adjacent structures and should be designed for each condition as the project progresses.

7.12.7 It is recommended that line-load surcharges from adjacent wall footings, use horizontal pressures generated from NAV-FAC DM 7.2. The governing equations are:

$$\text{For } x/H \leq 0.4$$

$$\sigma_H(z) = \frac{0.20 \times \left(\frac{z}{H}\right)}{\left[0.16 + \left(\frac{z}{H}\right)^2\right]^2} \times \frac{Q_L}{H}$$

and

$$\text{For } x/H > 0.4$$

$$\sigma_H(z) = \frac{1.28 \times \left(\frac{x}{H}\right)^2 \times \left(\frac{z}{H}\right)}{\left[\left(\frac{x}{H}\right)^2 + \left(\frac{z}{H}\right)^2\right]^2} \times \frac{Q_L}{H}$$

where  $x$  is the distance from the face of the excavation or wall to the vertical line-load,  $H$  is the distance from the bottom of the footing to the bottom of excavation or wall,  $z$  is the depth at which the horizontal pressure is desired,  $Q_L$  is the vertical line-load and  $\sigma_H(z)$  is the horizontal pressure at depth  $z$ .

7.12.8 It is recommended that vertical point-loads, from construction equipment outriggers or adjacent building columns use horizontal pressures generated from NAV-FAC DM 7.2. The governing equations are:

$$\text{For } x/H \leq 0.4$$

$$\sigma_H(z) = \frac{0.28 \times \left(\frac{z}{H}\right)^2}{\left[0.16 + \left(\frac{z}{H}\right)^2\right]^3} \times \frac{Q_P}{H^2}$$

and

$$\text{For } x/H > 0.4$$

$$\sigma_H(z) = \frac{1.77 \times \left(\frac{x}{H}\right)^2 \times \left(\frac{z}{H}\right)^2}{\left[\left(\frac{x}{H}\right)^2 + \left(\frac{z}{H}\right)^2\right]^3} \times \frac{Q_P}{H^2}$$

then

$$\sigma'_H(z) = \sigma_H(z) \cos^2(1.1\theta)$$

where  $x$  is the distance from the face of the excavation/wall to the vertical point-load,  $H$  is distance from the outrigger/bottom of column footing to the bottom of excavation,  $z$  is the depth at which the horizontal pressure is desired,  $Q_P$  is the vertical point-load,  $\sigma_H(z)$  is the horizontal pressure at depth  $z$ ,  $\theta$  is the angle between a line perpendicular to the excavation/wall and a line from the point-load to location on the excavation/wall where the surcharge is being evaluated, and  $\sigma_H(z)$  is the horizontal pressure at depth  $z$ .

- 7.12.9 In addition to the recommended earth pressure, the upper 10 feet of the retaining wall adjacent to the street or driveway areas should be designed to resist a uniform lateral pressure of 100 psf, acting as a result of an assumed 300 psf surcharge behind the shoring due to normal street traffic. If the traffic is kept back at least 10 feet from the wall, the traffic surcharge may be neglected.
- 7.12.10 Seismic lateral forces will be required for any retaining walls in excess of 6 feet. Recommendations for seismic lateral forces will be provided under separate cover, if necessary.

### **7.13 Retaining Wall Drainage**

- 7.13.1 Retaining walls should be provided with a drainage system extended at least two-thirds the height of the wall. At the base of the drain system, a subdrain covered with a minimum of 12 inches of gravel should be installed, and a compacted fill blanket or other seal placed at the surface (see Figure 5). The clean bottom and subdrain pipe, behind a retaining wall, should be observed by the Geotechnical Engineer (a representative of Geocon), prior to placement of gravel or compacting backfill.
- 7.13.2 As an alternative, a plastic drainage composite such as Miradrain or equivalent may be installed in continuous, 4-foot wide columns along the entire back face of the wall, at 8 feet on center. The top of these drainage composite columns should terminate approximately 18 inches below the ground surface, where either hardscape or a minimum of 18 inches of relatively cohesive material should be placed as a cap (see Figure 6). These vertical columns of drainage material would then be connected at the bottom of the wall to a 4-inch subdrain pipe.
- 7.13.3 Subdrainage pipes at the base of the retaining wall drainage system should outlet to an acceptable location via controlled drainage structures. Drainage should not be allowed to flow uncontrolled over descending slopes.
- 7.13.4 Moisture affecting below grade walls is one of the most common post-construction complaints. Poorly applied or omitted waterproofing can lead to efflorescence or standing water. Particular care should be taken in the design and installation of waterproofing to avoid moisture problems, or actual water seepage into the structure through any normal shrinkage cracks which may develop in the concrete walls, floor slab, foundations and/or construction joints. The design and inspection of the waterproofing is not the responsibility of the geotechnical engineer. A waterproofing consultant should be retained in order to recommend a product or method, which would provide protection to subterranean walls, floor slabs and foundations.

## **7.14 Elevator Pit Design**

- 7.14.1 The elevator pit slab and retaining wall should be designed by the project structural engineer. Elevator pits may be designed in accordance with the recommendations in the *Conventional Foundation Design and Retaining Wall Design* sections of this report (see Section 7.6 and Section 7.12).
- 7.14.2 Additional active pressure should be added for a surcharge condition due to sloping ground, vehicular traffic, or adjacent foundations and should be designed for each condition as the project progresses.
- 7.14.3 If retaining wall drainage is to be provided, the drainage system should be designed in accordance with the *Retaining Wall Drainage* section of this report (see Section 7.13).
- 7.14.4 It is suggested that the exterior walls and slab be waterproofed to prevent excessive moisture inside of the elevator pit. Waterproofing design and installation is not the responsibility of the geotechnical engineer.

## **7.15 Elevator Piston**

- 7.15.1 If a plunger-type elevator piston is installed for this project, a deep drilled excavation will be required. It is important to verify that the drilled excavation is not situated immediately adjacent to a foundation or the drilled excavation could compromise the existing foundation support, especially if the drilling is performed subsequent to the foundation construction. Additionally, some of the site soils have little to no cohesion and are prone to excessive caving.
- 7.15.2 Casing may be required if caving is expected in the drilled excavation. The contractor should be prepared to use casing and should have it readily available at the commencement of drilling activities. Continuous observation of the drilling and installation of the elevator piston by the Geotechnical Engineer (a representative of Geocon West, Inc.) is required.
- 7.15.3 The annular space between the piston casing and drilled excavation wall should be filled with a minimum of 1½-sack slurry pumped from the bottom up. As an alternative, pea gravel may be utilized. The use of soil to backfill the annular space is not acceptable.

## **7.16 Temporary Excavations**

- 7.16.1 Excavations up to 8 feet in height may be required during grading operations and foundation excavations. The excavations are expected to expose artificial fill and alluvial soils. Vertical excavations up to 5 feet may be attempted where not surcharged by adjacent traffic, construction equipment, or structures. Sloping measures will likely be required to provide a stable excavation.

- 7.16.2 Vertical excavations greater than 5 feet or where surcharged by existing structures will require sloping or shoring measures in order to provide a stable excavation. Where sufficient space is available, temporary unsurcharged embankments could be sloped back at a uniform 1:1 slope gradient or flatter up to maximum height of 12 feet. A uniform slope does not have a vertical portion.
- 7.16.3 If excavations in close proximity to an existing adjacent structure and/or property line are required, special excavation measures such as shoring may be necessary in order to maintain lateral support of existing improvements. Recommendations for special temporary excavation measures can be provided under separate cover, if necessary.
- 7.16.4 Where sloped embankments are utilized, the top of the slope should be barricaded to prevent vehicles and storage loads at the top of the slope within a horizontal distance equal to the height of the slope. If the temporary construction embankments are to be maintained during the rainy season, berms are suggested along the tops of the slopes where necessary to prevent runoff water from entering the excavation and eroding the slope faces. Geocon personnel should inspect the soils exposed in the cut slopes during excavation so that modifications of the slopes can be made if variations in the soil conditions occur. All excavations should be stabilized within 30 days of initial excavation.

## **7.17 Surface Drainage**

- 7.17.1 Proper surface drainage is critical to the future performance of the project. Uncontrolled infiltration of irrigation excess and storm runoff into the soils can adversely affect the performance of the planned improvements. Saturation of a soil can cause it to lose internal shear strength and increase its compressibility, resulting in a change in the original designed engineering properties. Proper drainage should be maintained at all times.
- 7.17.2 All site drainage should be collected and controlled in non-erosive drainage devices. Drainage should not be allowed to pond anywhere on the site, and especially not against any foundation or retaining wall. The site should be graded and maintained such that surface drainage is directed away from structures in accordance with 2019 CBC 1804.4 or other applicable standards. In addition, drainage should not be allowed to flow uncontrolled over any descending slope. Discharge from downspouts, roof drains and scuppers are not recommended onto unprotected soils within 5 feet of the building perimeter. Planters which are located adjacent to foundations should be sealed to prevent moisture intrusion into the soils providing foundation support. Landscape irrigation is not recommended within 5 feet of the building perimeter footings except when enclosed in protected planters.

7.17.3 Positive site drainage should be provided away from structures, pavement, and the tops of slopes to swales or other controlled drainage structures.

7.17.4 Landscaping planters immediately adjacent to paved areas are not recommended due to the potential for surface or irrigation water to infiltrate the pavement's subgrade and base course. Either a subdrain, which collects excess irrigation water and transmits it to drainage structures, or impervious above-grade planter boxes should be used. In addition, where landscaping is planned adjacent to the pavement, it is recommended that consideration be given to providing a cutoff wall along the edge of the pavement that extends at least 12 inches below the base material.

## **7.18 Plan Review**

7.18.1 Grading, foundation, and shoring plans (if applicable) should be reviewed by the Geotechnical Engineer (a representative of Geocon West, Inc.), prior to finalization to verify that the plans have been prepared in substantial conformance with the recommendations of this report and to provide additional analyses or recommendations.

## LIMITATIONS AND UNIFORMITY OF CONDITIONS

1. The recommendations of this report pertain only to the site investigated and are based upon the assumption that the soil conditions do not deviate from those disclosed in the investigation. If any variations or undesirable conditions are encountered during construction, or if the proposed construction will differ from that anticipated herein, Geocon West, Inc. should be notified so that supplemental recommendations can be given. The evaluation or identification of the potential presence of hazardous or corrosive materials was not part of the scope of services provided by Geocon West, Inc.
2. This report is issued with the understanding that it is the responsibility of the owner, or of his representative, to ensure that the information and recommendations contained herein are brought to the attention of the architect and engineer for the project and incorporated into the plans, and the necessary steps are taken to see that the contractor and subcontractors carry out such recommendations in the field.
3. The findings of this report are valid as of the date of this report. However, changes in the conditions of a property can occur with the passage of time, whether they are due to natural processes or the works of man on this or adjacent properties. In addition, changes in applicable or appropriate standards may occur, whether they result from legislation or the broadening of knowledge. Accordingly, the findings of this report may be invalidated wholly or partially by changes outside our control. Therefore, this report is subject to review and should not be relied upon after a period of three years.
4. The firm that performed the geotechnical investigation for the project should be retained to provide testing and observation services during construction to provide continuity of geotechnical interpretation and to check that the recommendations presented for geotechnical aspects of site development are incorporated during site grading, construction of improvements, and excavation of foundations. If another geotechnical firm is selected to perform the testing and observation services during construction operations, that firm should prepare a letter indicating their intent to assume the responsibilities of project geotechnical engineer of record. A copy of the letter should be provided to the regulatory agency for their records. In addition, that firm should provide revised recommendations concerning the geotechnical aspects of the proposed development, or a written acknowledgement of their concurrence with the recommendations presented in our report. They should also perform additional analyses deemed necessary to assume the role of Geotechnical Engineer of Record.



## LIST OF REFERENCES

- California Division of Mines and Geology, 2002, *Seismic Hazard Zone Report for the Newbury Park 7.5 Minute Quadrangle, Ventura, California*, Seismic Hazard Zone Report 055.
- California Division of Mines and Geology, 1999; *State of California Seismic Hazard Zones, Newbury Park Quadrangle*, Official Map, Released: May 1, 1999.
- California Geologic Energy Management Division, 2020, CalGEM Resources Well Finder, <http://maps.conservation.ca.gov/doggr/index.html#close>.
- California Geological Survey, 2020a, CGS Information Warehouse, Regulatory Map Portal, <http://maps.conservation.ca.gov/cgs/informationwarehouse/index.html?map=regulatorymaps>.
- California Geological Survey, 2020b, Earthquake Zones of Required Investigation, <https://maps.conservation.ca.gov/cgs/EQZApp/app/>.
- California Geological Survey, 2018, *Earthquake Fault Zones, A Guide for Government Agencies, Property Owners/Developers, and Geoscience Practitioners for Assessing Fault Rupture Hazards in California*, Special Publication 42, Revised 2018.
- California Geological Survey, 2002, *Earthquake Zones of Required Investigation, Newbury Park Quadrangle, Ventura County, California*, dated February 7, 2002.
- California Geological Survey, 2010, *Geologic Compilation of Quaternary Surficial Deposits in Southern California, Los Angeles 30' X 60' Quadrangle*, A Project for the Department of Water Resources by the California Geological Survey, Compiled from existing sources by Trinda L. Bedrossian, CEG and Peter D. Roffers, CGS Special Report 217, Plate 9, Scale 1:100,000.
- Dibblee, T. W. Jr., 1990, *Geologic Map of the Camarillo and Newbury Park Quadrangles, Los Angeles County, California*, Dibblee Foundation Map # DF-28.
- FEMA, 2020, Online Flood Hazard Maps, <http://www.esri.com/hazards/index.html>.
- Jennings, C. W. and Bryant, W. A., 2010, *Fault Activity Map of California*, California Geological Survey Geologic Data Map No. 6.
- Thousand Oaks, City of, 2014, *Safety Element, Thousand Oaks General Plan*, City of Thousand Oaks, Published March 2014.
- U.S.G.S Topographic Maps, 7.5-Minute Series, Newbury Park, CA Quadrangle, Released 1981
- U.S. Geological Survey and California Geological Survey, 2006, *Quaternary Fault and Fold Database for the United States*, accessed September 25, 2020 from USGS web site: <http://earthquake.usgs.gov/hazards/qfaults/>.
- Ziony, J. I., and Jones, L. M., 1989, *Map Showing Late Quaternary Faults and 1978–1984 Seismicity of the Los Angeles Region, California*, U.S. Geological Survey Miscellaneous Field Studies Map MF-1964.



REFERENCE: U.S.G.S. TOPOGRAPHIC MAPS, 7.5 MINUTE SERIES, NEWBURY PARK, CA QUADRANGLE

**GEOCON**  
WEST, INC.



ENVIRONMENTAL GEOTECHNICAL MATERIALS  
3303 N. SAN FERNANDO BLVD. - SUITE 100 - BURBANK, CA 91504  
PHONE (818) 841-8388 - FAX (818) 841-1704

DRAFTED BY: MDS

CHECKED BY: GAK

## VICINITY MAP

Lawrence Drive &  
Corporate Center Drive  
Thousand Oaks, CA



DEC. 2020

PROJECT NO. W1251-06-01

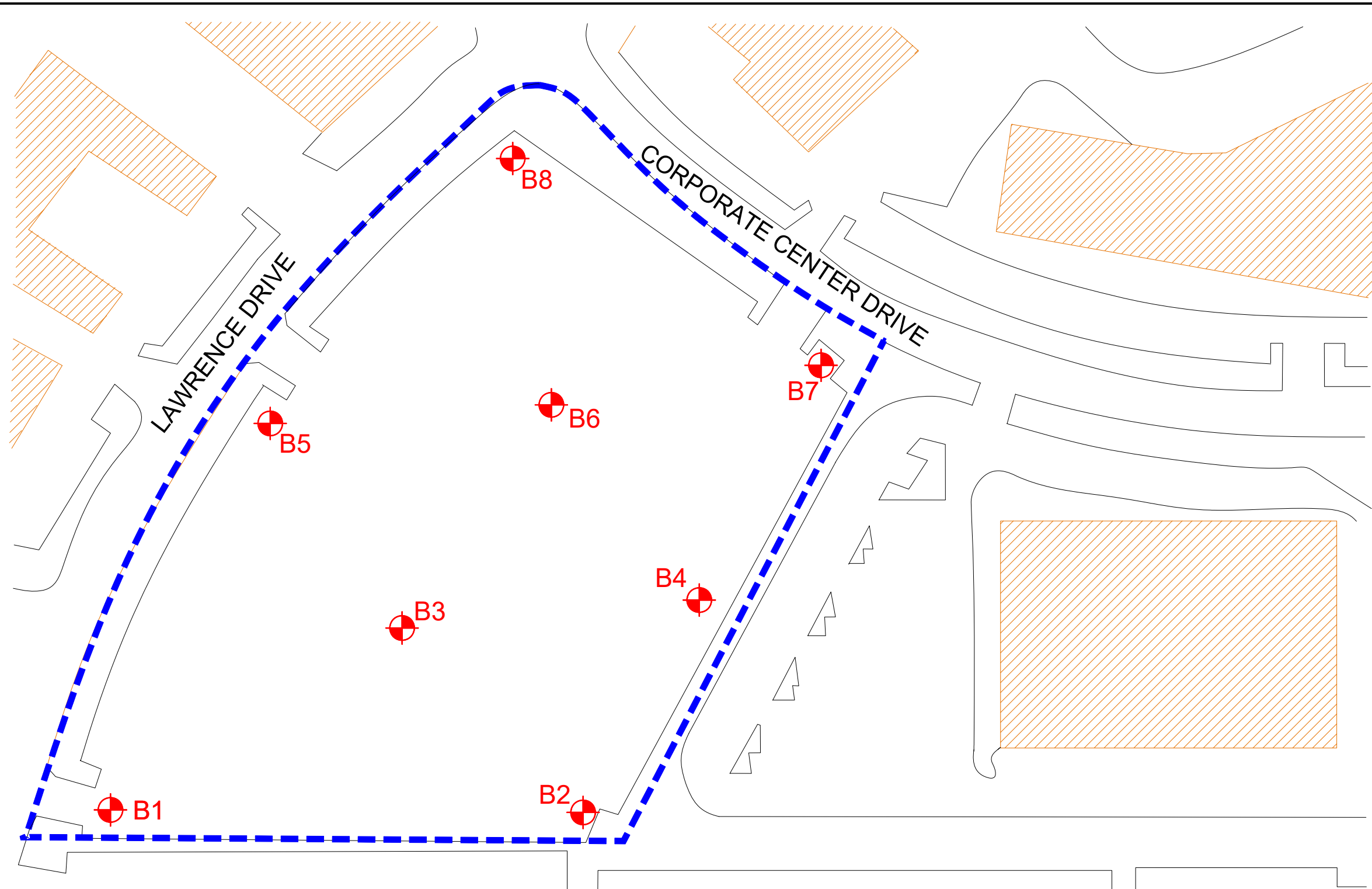
FIG. 1



**Legend**

-  Boring Locations
-  Limit of Proposed Improvements
-  Existing Off-Site Structures



**GEOCON**  
WEST, INC.

ENVIRONMENTAL GEOTECHNICAL MATERIALS  
3303 N. SAN FERNANDO BLVD. - SUITE 100 - BURBANK, CA 91504  
PHONE (818) 841-8388 - FAX (818) 841-1704

DRAFTED BY: JJK      CHECKED BY: HHD

**SITE PLAN**  
Lawrence Drive &  
Corporate Center Drive  
Thousand Oaks, CA

DEC. 2020      PROJECT NO: W1251-06-01      FIG. 2

Reference: Jennings, C.W. and Bryant, W. A., 2010, Fault Activity Map of California, California Geological Survey Geologic Data Map No. 6.

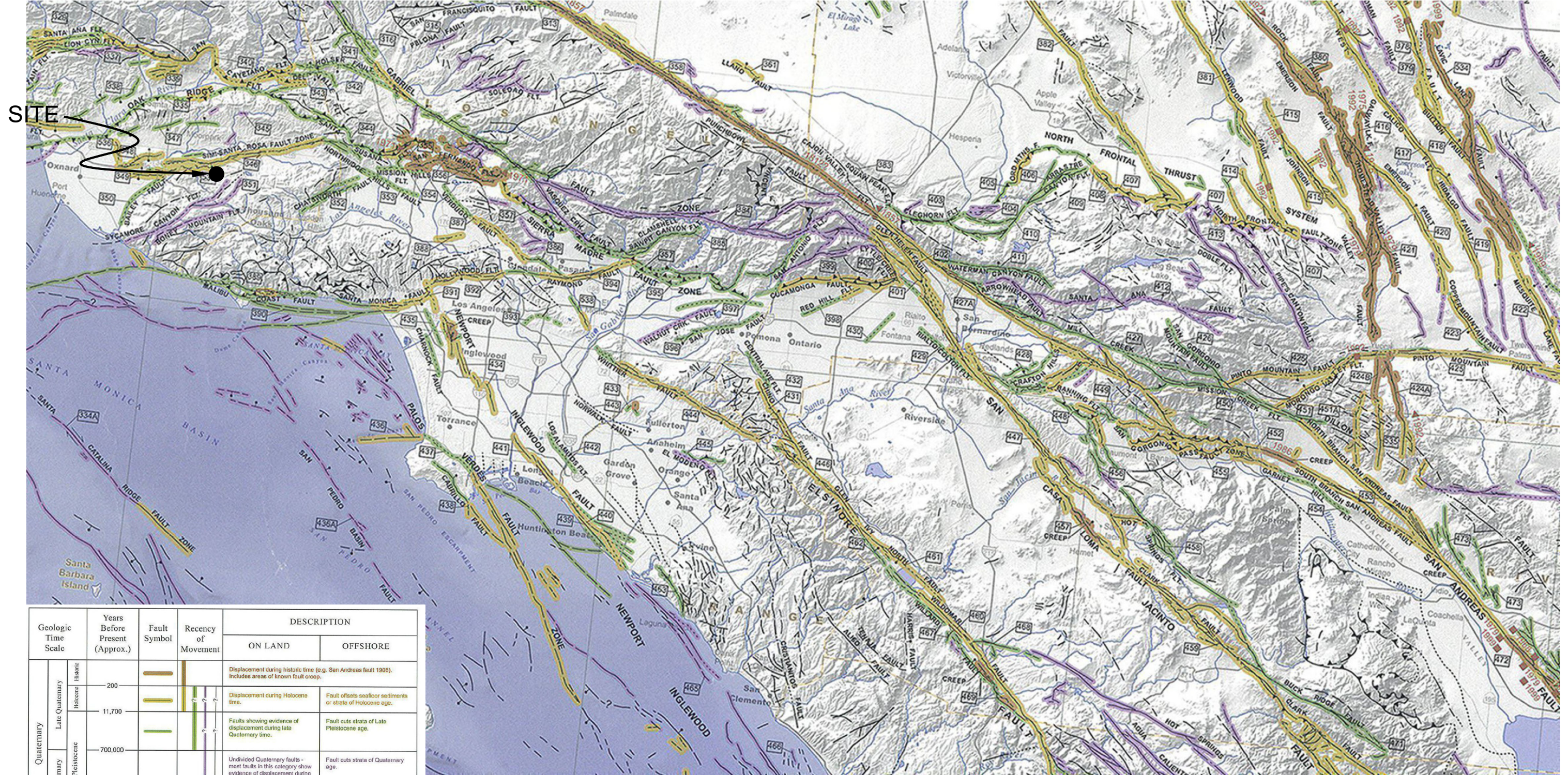

Geologic Time Scale	Years Before Present (Approx.)	Fault Symbol	Recency of Movement	DESCRIPTION	
				ON LAND	OFFSHORE
Quaternary	Holocene / Holocene			Displacement during historic time (e.g. San Andreas fault 1906). Includes areas of known fault creep.	
	Late Quaternary			Displacement during Holocene time.	Fault offsets seafloor sediments or strata of Holocene age.
Quaternary	Pleistocene			Faults showing evidence of displacement during late Quaternary time.	Fault cuts strata of Late Pleistocene age.
	Early Quaternary			Undiscovered Quaternary faults - most faults in this category show evidence of displacement during the last 1,600,000 years; possible exceptions are faults which displace rocks of undifferentiated Plio-Pleistocene age.	Fault cuts strata of Quaternary age.
Pre-Quaternary	1,600,000' - 4.5 billion (Age of Earth)			Faults without recognized Quaternary displacement or showing evidence of no displacement during Quaternary time. Not necessarily inactive.	Fault cuts strata of Pliocene or older age.

\* Quaternary now recognized as extending to 2.6 Ma (Walker and Geissman, 2009). Quaternary faults in this map were established using the previous 1.6 Ma criterion.

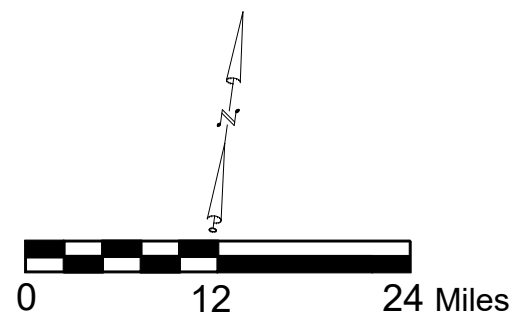

**GEOCON WEST, INC.**

ENVIRONMENTAL GEOTECHNICAL MATERIALS  
 3303 N. SAN FERNANDO BLVD. - SUITE 100 - BURBANK, CA 91504  
 PHONE (818) 841-8388 - FAX (818) 841-1704

DRAFTED BY: MDS      CHECKED BY: GAK

**REGIONAL FAULT MAP**

Lawrence Drive &  
 Corporate Center Drive  
 Thousand Oaks, CA

DEC.2020      PROJECT NO. W1251-06-01      FIG. 3

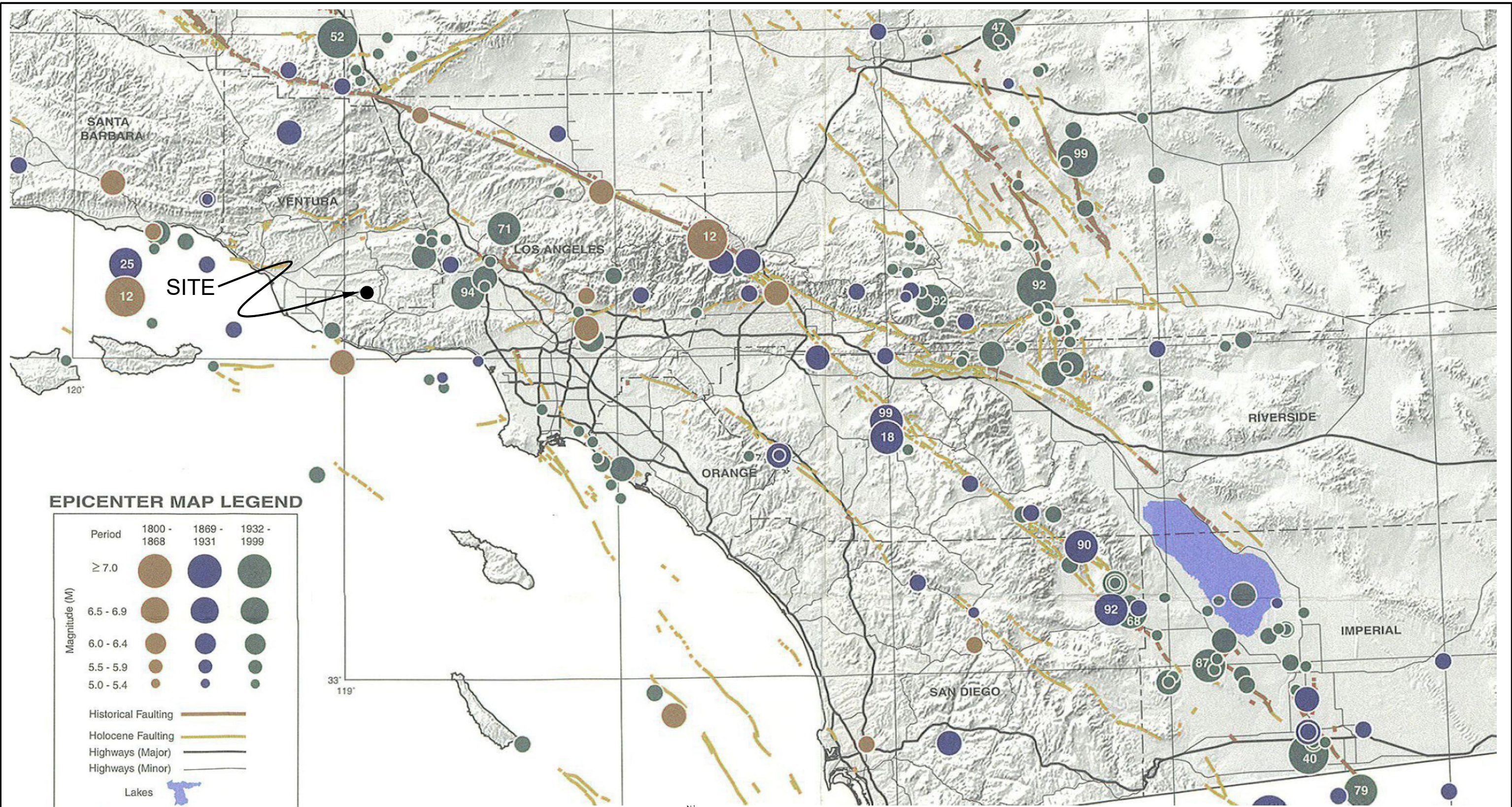

**EPICENTER MAP LEGEND**

Period	1800 - 1868	1869 - 1931	1932 - 1999
Magnitude (M)			
≥ 7.0			
6.5 - 6.9			
6.0 - 6.4			
5.5 - 5.9			
5.0 - 5.4			
Historical Faulting			
Holocene Faulting			
Highways (Major)			
Highways (Minor)			
Lakes			
	Last two digits of M ≥ 6.5 earthquake year		

Reference: Topozada, T., Branum, D., Petersen, M., Hallstrom, C., Cramer, C., and Reichle, M., 2000, Epicenters and Areas Damaged by M≥5 California Earthquakes, 1800 - 1999, California Geological Survey, Map Sheet 49.

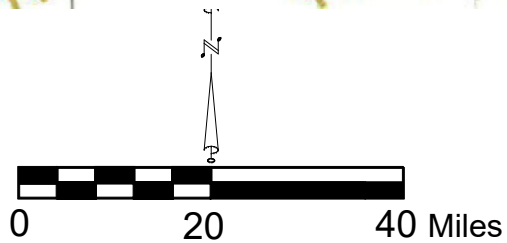

**GEOCON**  
WEST, INC.

ENVIRONMENTAL GEOTECHNICAL MATERIALS  
3303 N. SAN FERNANDO BLVD. - SUITE 100 - BURBANK, CA 91504  
PHONE (818) 841-8388 - FAX (818) 841-1704

DRAFTED BY: MDS      CHECKED BY: GAK

**REGIONAL SEISMICITY MAP**

Lawrence Drive &  
Corporate Center Drive  
Thousand Oaks, CA

DEC.2020      PROJECT NO. W1251-06-01      FIG.4

RETAINING WALL DRAIN DETAIL

Lawrence Drive &  
Corporate Center Drive  
Thousand Oaks, CA

DEC. 2020 PROJECT NO. W1251-06-01 FIG. 5

DRAFTED BY: JJK CHECKED BY: HHD

ENVIRONMENTAL GEOTECHNICAL MATERIALS  
3303 N. SAN FERNANDO BLVD. - SUITE 100 - BURBANK, CA 91504  
PHONE (818) 841-8388 - FAX (818) 841-1704

WEST, INC.  
GEOCON



NO SCALE

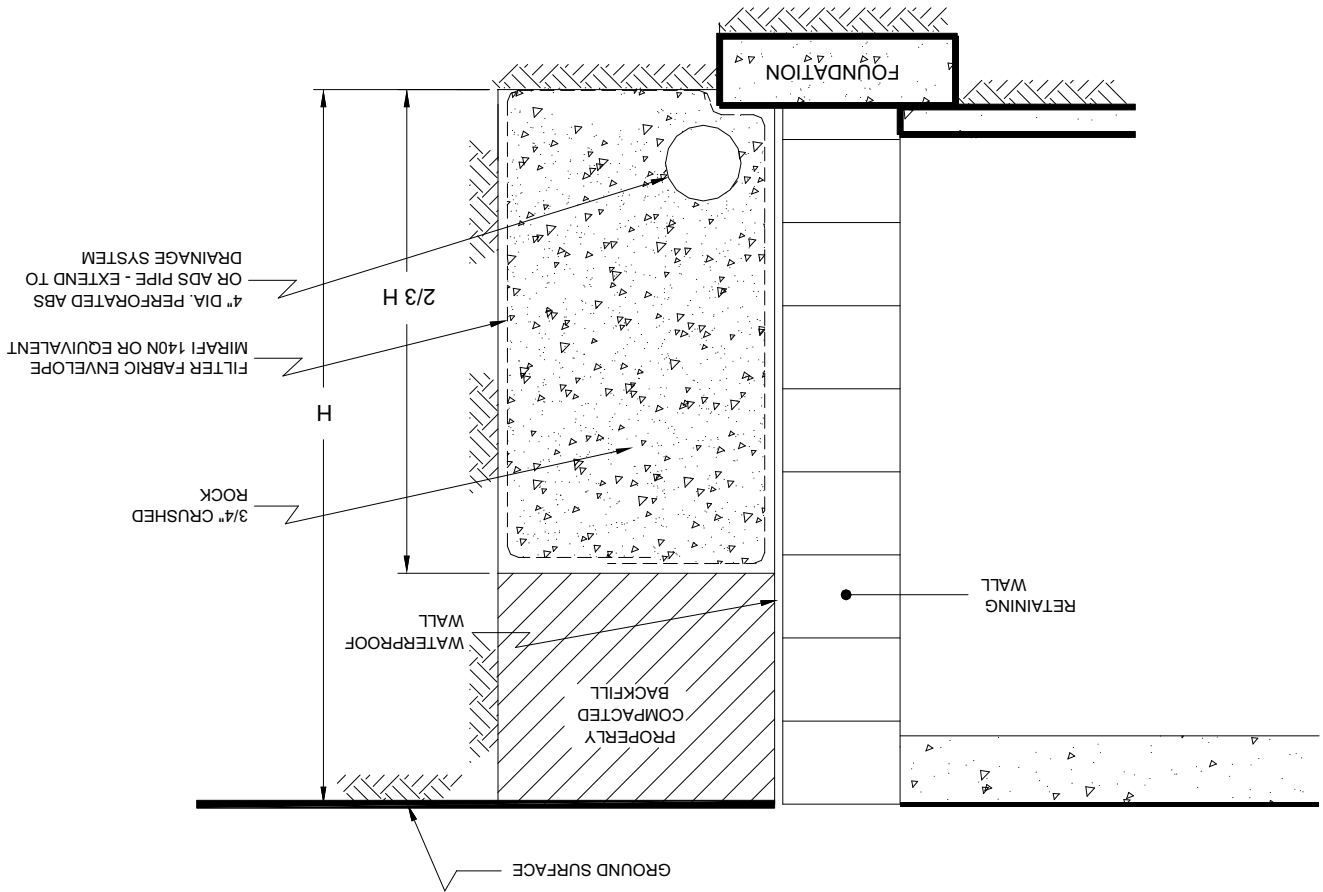

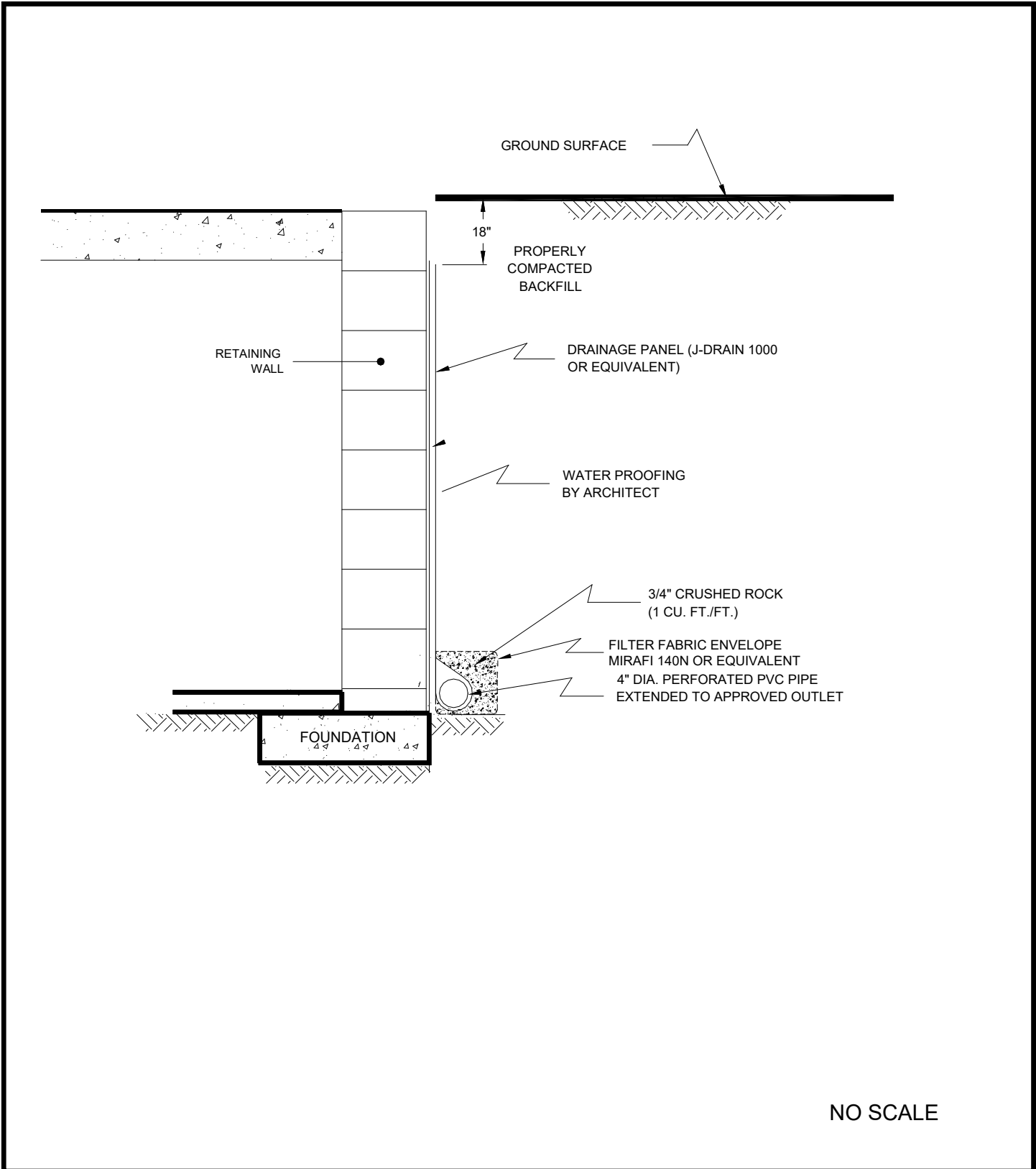

NO SCALE

**GEOCON**  
WEST, INC.

ENVIRONMENTAL GEOTECHNICAL MATERIALS  
3303 N. SAN FERNANDO BLVD. - SUITE 100 - BURBANK, CA 91504  
PHONE (818) 841-8388 - FAX (818) 841-1704

DRAFTED BY: JJK      CHECKED BY: HHD

**RETAINING WALL DRAIN DETAIL**

Lawrence Drive &  
Corporate Center Drive  
Thousand Oaks, CA

DEC. 2020      PROJECT NO. W1251-06-01      FIG. 6

APPENDIX

A

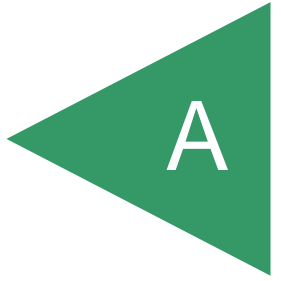



## APPENDIX A

### FIELD INVESTIGATION

The site was explored on October 21, 2020 by excavating eight 8-inch-diameter borings using a truck-mounted hollow-stem auger drilling machine. The hollow-stem auger borings were excavated to a maximum depth of 25½ feet below the existing ground surface. Representative and relatively undisturbed samples were obtained by driving a 3-inch, O. D., California Modified Sampler into the “undisturbed” soil mass with blows from a 140-pound auto-hammer falling 30 inches. The California Modified Sampler was equipped with 1-inch by 2<sup>3</sup>/<sub>8</sub>-inch diameter brass sampler rings to facilitate soil removal and testing. Bulk samples were also obtained.

The soil conditions encountered in the borings were visually examined, classified and logged in general accordance with the Unified Soil Classification System (USCS). The logs of the borings are presented on Figures A1 through A8. The logs depict the soil and geologic conditions encountered and the depth at which samples were obtained. The logs also include our interpretation of the conditions between sampling intervals. Therefore, the logs contain both observed and interpreted data. We determined the lines designating the interface between soil materials on the logs using visual observations, penetration rates, excavation characteristics and other factors. The transition between materials may be abrupt or gradual. Where applicable, the logs were revised based on subsequent laboratory testing. The approximate locations of the borings are shown on Figure 2.

DEPTH IN FEET	SAMPLE NO.	LITHOLOGY	GROUNDWATER	SOIL CLASS (USCS)	<b>BORING 1</b>			PENETRATION RESISTANCE (BLOWS/FT*)	DRY DENSITY (P.C.F.)	MOISTURE CONTENT (%)
					ELEV. (MSL.)	--	DATE COMPLETED			
					ELEV. (MSL.) -- DATE COMPLETED <b>10/21/2020</b>					
					EQUIPMENT <b>HOLLOW STEM AUGER</b> BY: <b>CB</b>					
					MATERIAL DESCRIPTION					
0	B1@1'				<b>AC: 4" BASE: 7"</b> <b>ARTIFICIAL FILL</b> Silty Sand, medium dense, slightly moist, light grayish brown, fine- to medium-grained, gravel, some clay.			50 (6")	99.1	11.4
2				SM	<b>OLDER ALLUVIUM</b> Silty Sand, poorly graded, very dense, dry, yellowish brown, fine- to medium-grained, pinhole porosity.					
4										
6	B1@5'			SW	Sand, well-graded, dense, slightly moist, yellowish brown with oxidation mottles, pinhole porosity, gravel, some silt			84	117.2	11.0
8	B1@6.5'				- moist, reddish brown			50 (6")	113.2	11.3
10	B1@10'			SM	Silty Sand, dense, dry, yellowish brown, fine-grained, pinhold porosity.			59	103.9	16.4
12										
14	B1@14.5'			SP-SM	Sand with Silt, poorly graded, very dense, moist, yellowish brown with oxidation mottles, fine- to medium-grained, some coarse-grained.			50 (6")	109.7	13.9
16										
18				SW	Sand, well-graded, medium dense, moist, reddish brown, trace fine gravel.					
20	B1@20'			SM	Silty Sand with Clay, medium dense, moist, gray with oxidation mottles, fine-grained, pinhole porosity.			44	109.5	15.0
22										
24	B1@24.5'			SP-SM	Sand with Silt, very dense, moist, gray with oxidation mottles, fine- to medium-grained, fine gravel, some coarse-grained, no porosity.			50 (6")	110.3	18.2
					Total depth of boring: 25 feet Fill to 1 foot. No groundwater encountered. Backfilled and patched. *Penetration resistance for 140-pound hammer falling 30 inches by auto-hammer.					

**Figure A1,**  
**Log of Boring 1, Page 1 of 1**

W1251-06-01 BORING LOGS.GPJ

SAMPLE SYMBOLS		... SAMPLING UNSUCCESSFUL		... STANDARD PENETRATION TEST		... DRIVE SAMPLE (UNDISTURBED)
		... DISTURBED OR BAG SAMPLE		... CHUNK SAMPLE		... WATER TABLE OR SEEPAGE

NOTE: THE LOG OF SUBSURFACE CONDITIONS SHOWN HEREON APPLIES ONLY AT THE SPECIFIC BORING OR TRENCH LOCATION AND AT THE DATE INDICATED. IT IS NOT WARRANTED TO BE REPRESENTATIVE OF SUBSURFACE CONDITIONS AT OTHER LOCATIONS AND TIMES.

DEPTH IN FEET	SAMPLE NO.	LITHOLOGY	GROUNDWATER	SOIL CLASS (USCS)	<b>BORING 2</b>			PENETRATION RESISTANCE (BLOWS/FT*)	DRY DENSITY (P.C.F.)	MOISTURE CONTENT (%)
					ELEV. (MSL.)	--	DATE COMPLETED			
					ELEV. (MSL.)	--	DATE COMPLETED	10/21/2020		
					EQUIPMENT	HOLLOW STEM AUGER		BY:	CB	
MATERIAL DESCRIPTION										
0	BULK 0-5'				<b>AC: 4" BASE: 7" ARTIFICIAL FILL</b> Silty Sand, poorly graded, medium dense, slightly moist, light gray with brown mottles, fine- to medium-grained, gravel, some clay.					
2	B2@2'							35	101.3	15.1
4	B2@5'							40	108.1	14.4
6	B2@7'				Clay with Sand, stiff, slightly moist, dark brown, fine- to coarse-grained, trace silt.			43	106.8	11.4
8	B2@9.5'			SW	<b>OLDER ALLUVIUM</b> Sand with Gravel, well-graded, very dense, slightly moist, yellowish brown, some silt.			50 (4")	98.0	8.2
12	B2@14.5'			SW-SM	Sand with Silt, well-graded, very dense, slightly moist, brown with oxidation mottles, fine gravel.			50 (6")	106.4	11.1
18	B2@20'			SP	Sand, poorly graded, medium dense, slightly moist, reddish brown, fine- to medium-grained, trace gravel.					
22	B2@25'			CL	Silty Clay, stiff, moist, gray with oxidation mottles.			43	111.9	14.9
24	B2@25'			SM	Silty Sand with Clay, medium dense, moist, fine-grained, gray with oxidation mottles.			53	106.4	22.0
					Total depth of boring: 25.5 feet Fill to 8 foot. No groundwater encountered. Backfilled and patched. *Penetration resistance for 140-pound hammer falling 30 inches by auto-hammer.					

**Figure A2,**  
**Log of Boring 2, Page 1 of 1**

W1251-06-01 BORING LOGS.GPJ

SAMPLE SYMBOLS		
	... SAMPLING UNSUCCESSFUL	
	... DISTURBED OR BAG SAMPLE	
	... CHUNK SAMPLE	

NOTE: THE LOG OF SUBSURFACE CONDITIONS SHOWN HEREON APPLIES ONLY AT THE SPECIFIC BORING OR TRENCH LOCATION AND AT THE DATE INDICATED. IT IS NOT WARRANTED TO BE REPRESENTATIVE OF SUBSURFACE CONDITIONS AT OTHER LOCATIONS AND TIMES.

DEPTH IN FEET	SAMPLE NO.	LITHOLOGY	GROUNDWATER	SOIL CLASS (USCS)	<b>BORING 3</b>			PENETRATION RESISTANCE (BLOWS/FT*)	DRY DENSITY (P.C.F.)	MOISTURE CONTENT (%)
					ELEV. (MSL.) --	DATE COMPLETED	10/21/2020			
					EQUIPMENT <u>HOLLOW STEM AUGER</u> BY: <u>CB</u>					
MATERIAL DESCRIPTION										
0					<b>AC: 4" BASE: 7"</b> <b>ARTIFICIAL FILL</b>					
2	B3@2'				Sand with Silt, poorly graded, medium dense, moist, dark brown, fine- to medium-grained, some clay, trace coarse-grained, and fine gravel.			25	103.6	20.2
4				SM	<b>OLDER ALLUVIUM</b> Silty Sand, poorly graded, medium dense, moist, yellowish brown, fine- to medium-grained, pinhole porosity.			52	108.8	19.7
6	B3@5'				Sand, well-graded, very dense, dry, yellowish brown with oxidation mottles.			50 (6")	108.1	6.9
8	B3@7'			SW	Sand, poorly graded, medium dense, moist, reddish brown, fine- to medium-grained.			45	100.1	20.2
10	B3@10'			SP	- increased gravel, very dense			50 (5")	110.1	12.6
12					Sand, well-graded, dense, moist, yellowish brown, some silt and gravel, trace clay, pinhole porosity.			66	121.6	17.5
14	B3@14.5'			SW	- very dense, increase in gravel content, no clay			50 (6")	112.2	8.7
16					Total depth of boring: 25 feet Fill to 3 feet. No groundwater encountered. Backfilled and patched.					
18					*Penetration resistance for 140-pound hammer falling 30 inches by auto-hammer.					
20	B3@20'									
22										
24	B3@24.5'									

**Figure A3,**  
**Log of Boring 3, Page 1 of 1**

W1251-06-01 BORING LOGS.GPJ

SAMPLE SYMBOLS		... SAMPLING UNSUCCESSFUL		... STANDARD PENETRATION TEST		... DRIVE SAMPLE (UNDISTURBED)
		... DISTURBED OR BAG SAMPLE		... CHUNK SAMPLE		... WATER TABLE OR SEEPAGE

NOTE: THE LOG OF SUBSURFACE CONDITIONS SHOWN HEREON APPLIES ONLY AT THE SPECIFIC BORING OR TRENCH LOCATION AND AT THE DATE INDICATED. IT IS NOT WARRANTED TO BE REPRESENTATIVE OF SUBSURFACE CONDITIONS AT OTHER LOCATIONS AND TIMES.

DEPTH IN FEET	SAMPLE NO.	LITHOLOGY	GROUNDWATER	SOIL CLASS (USCS)	<b>BORING 4</b>			PENETRATION RESISTANCE (BLOWS/FT*)	DRY DENSITY (P.C.F.)	MOISTURE CONTENT (%)
					ELEV. (MSL.)	DATE COMPLETED				
					ELEV. (MSL.) --	DATE COMPLETED <b>10/21/2020</b>				
					EQUIPMENT <b>HOLLOW STEM AUGER</b> BY: <b>CB</b>					
					MATERIAL DESCRIPTION					
0	BULK 0-5'				<b>AC: 4" BASE: 7" ARTIFICIAL FILL</b> Silty Sand, poorly graded, medium dense, moist, grayish brown, clay, gravel.					
2	B4@2'							43	109.9	15.2
4					Clay with Silt, hard, moist, dark brown, some fine- to medium-grained sand.					
6	B4@5'							58	111.4	19.0
6	B4@6'							50 (5")	91.6	14.7
8				SM	OLDER ALLUVIUM Silty Sand, poorly graded, very dense, moist, yellowish brown, fine- to medium-grained, pinhole porosity, some coarse-grained.					
10	B4@9.5'							50 (5")	105.5	8.3
12					Sand, well-graded, very dense, slightly moist, yellowish brown with oxidation mottles, fine- to medium-grained, some coarse-grained and silt.					
14				SW						
16	B4@15'				- dense, slightly moist, reddish brown			77	119.9	11.0
18					Silty Sand with Clay, poorly graded, dense, moist, yellowish brown with oxidation mottles, fine-grained, pinhole porosity.					
20	B4@20'							73	105.4	22.1
22					Silt with Clay, stiff, moist, gray with oxidation mottles, pinhole porosity, some fine-grained sand.					
24				ML						
24	B4@25'							36	97.2	26.4
					Total depth of boring: 25.5 feet Fill to 5.5 feet. No groundwater encountered. Backfilled and patched.					
					*Penetration resistance for 140-pound hammer falling 30 inches by auto-hammer.					

**Figure A4,**  
**Log of Boring 4, Page 1 of 1**

W1251-06-01 BORING LOGS.GPJ







SAMPLE SYMBOLS		... SAMPLING UNSUCCESSFUL		... STANDARD PENETRATION TEST		... DRIVE SAMPLE (UNDISTURBED)
		... DISTURBED OR BAG SAMPLE		... CHUNK SAMPLE		... WATER TABLE OR SEEPAGE

NOTE: THE LOG OF SUBSURFACE CONDITIONS SHOWN HEREON APPLIES ONLY AT THE SPECIFIC BORING OR TRENCH LOCATION AND AT THE DATE INDICATED. IT IS NOT WARRANTED TO BE REPRESENTATIVE OF SUBSURFACE CONDITIONS AT OTHER LOCATIONS AND TIMES.

DEPTH IN FEET	SAMPLE NO.	LITHOLOGY	GROUNDWATER	SOIL CLASS (USCS)	<b>BORING 5</b>		PENETRATION RESISTANCE (BLOWS/FT*)	DRY DENSITY (P.C.F.)	MOISTURE CONTENT (%)
					ELEV. (MSL.) --	DATE COMPLETED <u>10/21/2020</u>			
					EQUIPMENT <u>HOLLOW STEM AUGER</u> BY: <u>CB</u>				
MATERIAL DESCRIPTION									
0									
2	B5@1.5'					AC: 3" BASE: 8" ARTIFICIAL FILL Sand with Silt, well-graded, medium dense, moist, brown, some clay and fine gravel.	50 (6")	109.5	20.4
4						OLDER ALLUVIUM Silty Sand, poorly graded, very dense, moist, yellowish brown with oxidation mottles, fine-grained, trace clay.			
6	B5@5'						50 (6")	106.8	22.8
8	B5@7'			SM			50 (5")	110.2	19.6
10	B5@10'					- dense	63	106.5	21.5
14						Silty Sand with Clay, poorly graded, dense, moist, yellowish brown with oxidation mottles, fine-grained, pinhole porosity, trace medium-grained.			
16	B5@15'			SM			54	105.8	22.3
20	B5@20'					Sand, well-graded, very dense, moist, yellowish brown with oxidation mottles, pinhole porosity, some silt.	50 (6")	115.3	15.2
24	B5@24.5'			SW			50 (4")	113.1	9.6
					Total depth of boring: 25 feet Fill to 1.5 feet. No groundwater encountered. Backfilled and patched.  *Penetration resistance for 140-pound hammer falling 30 inches by auto-hammer.				

**Figure A5,**  
**Log of Boring 5, Page 1 of 1**

W1251-06-01 BORING LOGS.GPJ

SAMPLE SYMBOLS	 ... SAMPLING UNSUCCESSFUL	 ... STANDARD PENETRATION TEST	 ... DRIVE SAMPLE (UNDISTURBED)
	 ... DISTURBED OR BAG SAMPLE	 ... CHUNK SAMPLE	 ... WATER TABLE OR SEEPAGE

NOTE: THE LOG OF SUBSURFACE CONDITIONS SHOWN HEREON APPLIES ONLY AT THE SPECIFIC BORING OR TRENCH LOCATION AND AT THE DATE INDICATED. IT IS NOT WARRANTED TO BE REPRESENTATIVE OF SUBSURFACE CONDITIONS AT OTHER LOCATIONS AND TIMES.

DEPTH IN FEET	SAMPLE NO.	LITHOLOGY	GROUNDWATER	SOIL CLASS (USCS)	<b>BORING 6</b>			PENETRATION RESISTANCE (BLOWS/FT*)	DRY DENSITY (P.C.F.)	MOISTURE CONTENT (%)
					ELEV. (MSL.)	--	DATE COMPLETED <u>10/21/2020</u>			
					EQUIPMENT <u>HOLLOW STEM AUGER</u> BY: <u>CB</u>					
MATERIAL DESCRIPTION										
0	BULK 0-5'				<b>AC: 3" BASE: 7" ARTIFICIAL FILL</b> Sand with Silt, poorly graded, medium dense, slightly moist, brown, clay, some fine gravel.					
2	B6@2'							30	113.7	11.4
4				SM	<b>OLDER ALLUVIUM</b> Silty Sand, poorly graded, dense, slightly moist, yellowish brown, pinhole porosity.					
6	B6@5'			SW	Sand, well-graded, dense, slightly moist, yellowish brown with oxidation mottles with gravel, some silt.			75	111.5	10.3
8	B6@7'			SM	Silty Sand with Clay, poorly graded, very dense, dry, yellowish brown, fine-grained, pinhole porosity.			50 (6")	108.2	22.6
10	B6@10'				Sand, poorly graded, very dense, slightly moist, yellowish brown, fine-grained, pinhole porosity, trace silt and oxidation mottles.			87	106.9	6.5
12										
14										
16	B6@15'			SP	- fine- to medium-grained			76	108.0	18.8
18					- some gravel to 1", trace clay					
20	B6@20'							50 (5")	113.7	17.5
22										
24	B6@24.5'				- grades coarser			50 (6")	106.9	10.5
					Total depth of boring: 25 feet Fill to 2.5 feet. No groundwater encountered. Backfilled and patched.					
					*Penetration resistance for 140-pound hammer falling 30 inches by auto-hammer.					

**Figure A6,  
Log of Boring 6, Page 1 of 1**

W1251-06-01 BORING LOGS.GPJ

SAMPLE SYMBOLS		... SAMPLING UNSUCCESSFUL		... STANDARD PENETRATION TEST		... DRIVE SAMPLE (UNDISTURBED)
		... DISTURBED OR BAG SAMPLE		... CHUNK SAMPLE		... WATER TABLE OR SEEPAGE

NOTE: THE LOG OF SUBSURFACE CONDITIONS SHOWN HEREON APPLIES ONLY AT THE SPECIFIC BORING OR TRENCH LOCATION AND AT THE DATE INDICATED. IT IS NOT WARRANTED TO BE REPRESENTATIVE OF SUBSURFACE CONDITIONS AT OTHER LOCATIONS AND TIMES.

DEPTH IN FEET	SAMPLE NO.	LITHOLOGY	GROUNDWATER	SOIL CLASS (USCS)	<b>BORING 7</b>		PENETRATION RESISTANCE (BLOWS/FT*)	DRY DENSITY (P.C.F.)	MOISTURE CONTENT (%)
					ELEV. (MSL.) --	DATE COMPLETED <u>10/21/2020</u>			
					EQUIPMENT <u>HOLLOW STEM AUGER</u> BY: <u>CB</u>				
MATERIAL DESCRIPTION									
0									
2	B7@2'					AC: 4" BASE: 4" ARTIFICIAL FILL			
						Sand with Silt, medium dense, moist, brown, fine- to medium-grained, clay, some coarse grained and gravel (to 1").	60	103.6	19.6
4				ML		OLDER ALLUVIUM			
						Silt with Clay, hard, moist, yellowish brown, pinhole porosity, some fine-grained sand.			
4.5	B7@4.5'			SP-SM		Sand with Silt, very dense, moist, yellowish brown, fine-grained, pinhole porosity.	50 (4")	102.4	12.0
6				SW		Sand, well-graded, dense, slightly moist, yellowish brown, trace silt and fine gravel.			
7	B7@7'						68	105.9	8.6
10	B7@10'			SP		Sand, poorly graded, very dense, moist, reddish brown, fine- to medium-grained, trace silt.	50 (4")	113.2	11.2
12									
14				ML		Silt, hard, moist, yellowish brown with oxidation mottles, some sand, trace fine gravel.			
15	B7@15'						62	110.2	21.2
18									
19.5	B7@19.5'			SW		Sand, well-graded, very dense, moist, yellowish brown with oxidation mottles, some silt, trace fine gravel.	50 (3")	114.1	12.8
24	B7@24.5'					- increased gravel	50 (5")	105.4	8.9
					Total depth of boring: 25 feet Fill to 2.5 feet. No groundwater encountered. Backfilled and patched. *Penetration resistance for 140-pound hammer falling 30 inches by auto-hammer.				

Figure A7, Log of Boring 7, Page 1 of 1

W1251-06-01 BORING LOGS.GPJ

SAMPLE SYMBOLS		... SAMPLING UNSUCCESSFUL		... STANDARD PENETRATION TEST		... DRIVE SAMPLE (UNDISTURBED)
		... DISTURBED OR BAG SAMPLE		... CHUNK SAMPLE		... WATER TABLE OR SEEPAGE

NOTE: THE LOG OF SUBSURFACE CONDITIONS SHOWN HEREON APPLIES ONLY AT THE SPECIFIC BORING OR TRENCH LOCATION AND AT THE DATE INDICATED. IT IS NOT WARRANTED TO BE REPRESENTATIVE OF SUBSURFACE CONDITIONS AT OTHER LOCATIONS AND TIMES.



DEPTH IN FEET	SAMPLE NO.	LITHOLOGY	GROUNDWATER	SOIL CLASS (USCS)	<b>BORING 8</b>			PENETRATION RESISTANCE (BLOWS/FT*)	DRY DENSITY (P.C.F.)	MOISTURE CONTENT (%)
					ELEV. (MSL.)	DATE COMPLETED				
					ELEV. (MSL.) --	DATE COMPLETED <b>10/21/2020</b>				
					EQUIPMENT <b>HOLLOW STEM AUGER</b> BY: <b>CB</b>					
					MATERIAL DESCRIPTION					
0	BULK 0-5'				<b>AC: 4" BASE: 8" ARTIFICIAL FILL</b> Sand with Silt, loose, dry, brown, fine- to medium-grained, clay, some gravel, trace coarse-grained.					
2	B8@2'							18	114.1	13.4
4	B8@5'			CL	<b>OLDER ALLUVIUM</b> Clay with Silt, hard, moist, dark grayish brown, fine-grained, some sand.					
6	B8@7'							50 (5")	89.0	16.5
8	B8@10'			SP-SM	Sand with Silt, poorly graded, very dense, dry, brown, fine- to medium-grained, some coarse-grained and silt.  - dense, yellowish brown, fine- to medium-grained			63	113.1	19.2
10	B8@15'							44	100.6	20.1
12	B8@20'			ML	Silt with Sand, stiff, moist, yellowish brown, fine-grained, trace clay and oxidation mottles.					
14	B8@25'							40	95.3	31.8
16	B8@20'			SP-SM	Sand with Silt, dense, moist, yellowish brown with oxidation mottles, fine-grained.			69	107.2	21.2
18	B8@25'									
20	B8@25'			SW	Sand, well-graded, very dense, moist, yellowish brown, some silt, trace fine gravel.					
22	B8@25'							50 (4")	113.3	20.2
24	B8@25'				Total depth of boring: 25.5 feet Fill to 3 feet. No groundwater encountered. Backfilled and patched. *Penetration resistance for 140-pound hammer falling 30 inches by auto-hammer.					

**Figure A8,**  
**Log of Boring 8, Page 1 of 1**

W1251-06-01 BORING LOGS.GPJ

SAMPLE SYMBOLS		... SAMPLING UNSUCCESSFUL		... STANDARD PENETRATION TEST		... DRIVE SAMPLE (UNDISTURBED)
		... DISTURBED OR BAG SAMPLE		... CHUNK SAMPLE		... WATER TABLE OR SEEPAGE

NOTE: THE LOG OF SUBSURFACE CONDITIONS SHOWN HEREON APPLIES ONLY AT THE SPECIFIC BORING OR TRENCH LOCATION AND AT THE DATE INDICATED. IT IS NOT WARRANTED TO BE REPRESENTATIVE OF SUBSURFACE CONDITIONS AT OTHER LOCATIONS AND TIMES.

APPENDIX

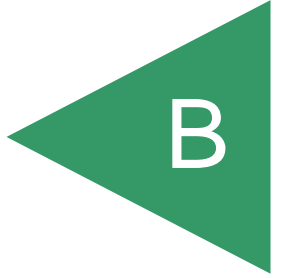

## **APPENDIX B**

### **LABORATORY TESTING**

Laboratory tests were performed in accordance with “American Society for Testing and Materials (ASTM)”, or other suggested procedures. Selected samples were tested for direct shear strength, expansion and consolidation characteristics, maximum dry density, corrosivity, in-place dry density and moisture content. The results of the laboratory tests are summarized in Figures B1 through B24. The in-place dry density and moisture content of the samples tested are presented on the boring logs, Appendix A.

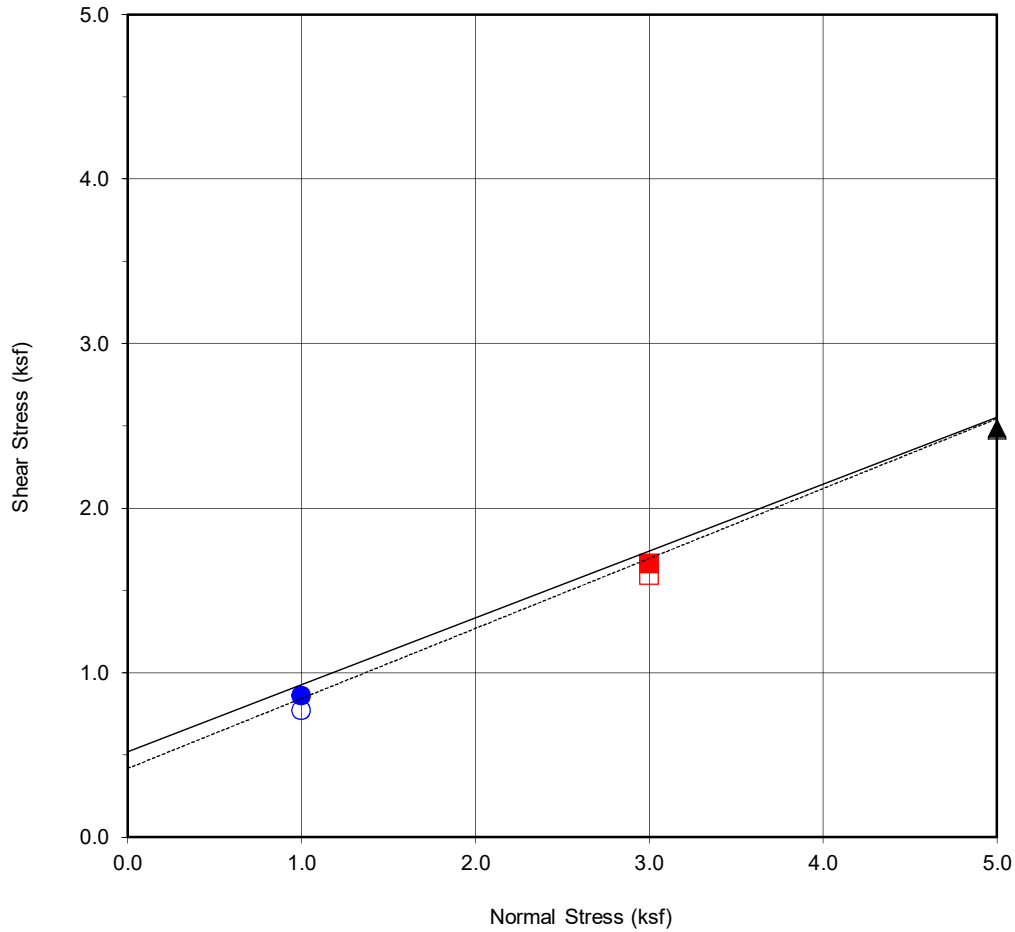

<b>Boring No.</b>	<b>B2&amp;B4</b>
<b>Sample No.</b>	<b>B2&amp;B4@0-5</b>
<b>Depth (ft)</b>	<b>0-5</b>
<u>Sample Type:</u>	Ring

<u>Soil Identification:</u>		
Grayish Brown Silty Sand with Clay (SM)		
<b>Strength Parameters</b>		
	C (psf)	$\phi$ ( $^{\circ}$ )
Peak	519	22.1
Ultimate	417	23.0

Normal Stress (kip/ft <sup>2</sup> )	1	3	5
Peak Shear Stress (kip/ft <sup>2</sup> )	● 0.86	■ 1.66	▲ 2.48
Shear Stress @ End of Test (ksf)	○ 0.77	□ 1.59	△ 2.47
Deformation Rate (in./min.)	0.05	0.05	0.05
Initial Sample Height (in.)	1.0	1.0	1.0
Ring Inside Diameter (in.)	2.375	2.375	2.375
Initial Moisture Content (%)	12.1	12.1	12.1
Initial Dry Density (pcf)	105.0	105.0	105.0
Initial Degree of Saturation (%)	54.1	53.9	54.1
Soil Height Before Shearing (in.)	1.2	1.2	1.2
Final Moisture Content (%)	23.9	22.1	21.3



**DIRECT SHEAR TEST RESULTS**  
Consolidated Drained ASTM D-3080

Checked by: JMH

Project No.: W1251-06-01  
Lawrence Drive &  
Corporate Center Drive  
Thousand Oaks, CA

DEC. 2020 Figure B1

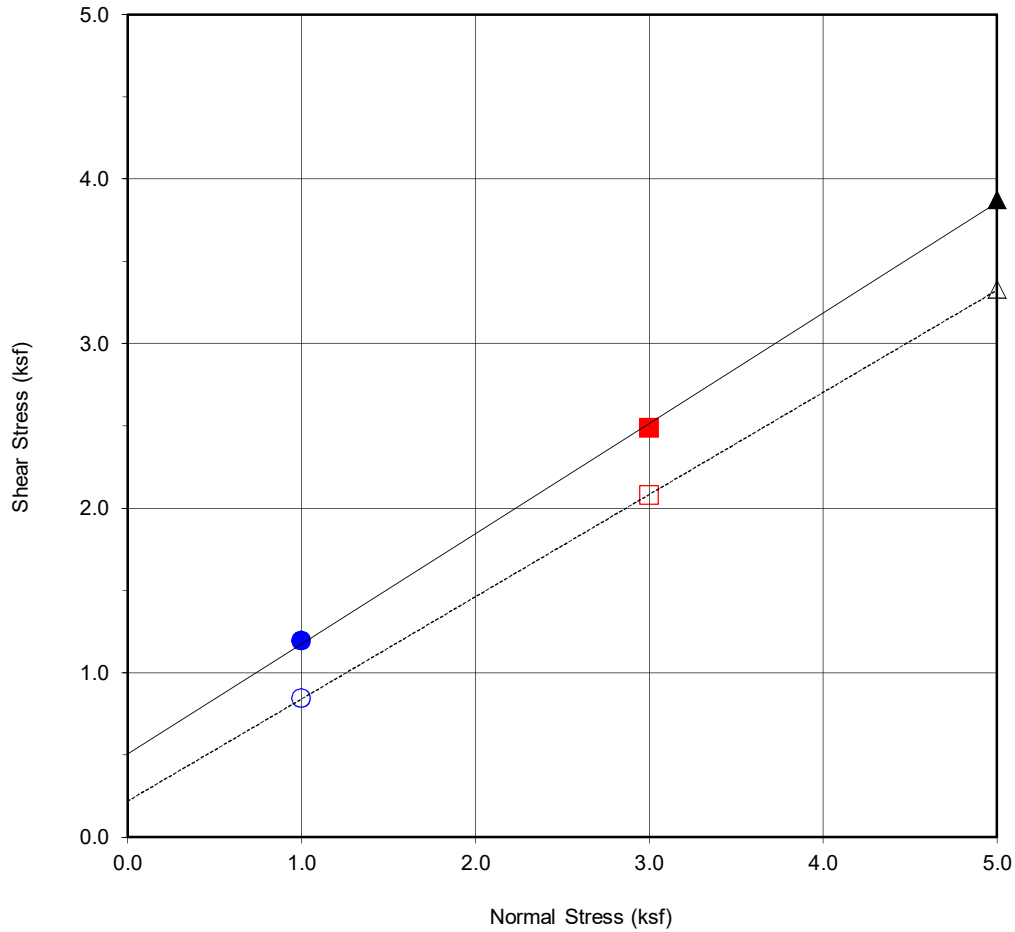

<b>Boring No.</b>	<b>B3</b>
<b>Sample No.</b>	<b>B3@5</b>
<b>Depth (ft)</b>	<b>5</b>
<u>Sample Type:</u>	Ring

<u>Soil Identification:</u>		
Yellowish Brown Silty Sand (SM)		
<b>Strength Parameters</b>		
	C (psf)	$\phi$ ( $^{\circ}$ )
Peak	505	33.8
Ultimate	219	31.8

Normal Stress (kip/ft <sup>2</sup> )	1	3	5
Peak Shear Stress (kip/ft <sup>2</sup> )	● 1.19	■ 2.48	▲ 3.87
Shear Stress @ End of Test (ksf)	○ 0.84	□ 2.07	△ 3.33
Deformation Rate (in./min.)	0.05	0.05	0.05
Initial Sample Height (in.)	1.0	1.0	1.0
Ring Inside Diameter (in.)	2.375	2.375	2.375
Initial Moisture Content (%)	21.7	22.2	23.1
Initial Dry Density (pcf)	104.6	104.3	101.5
Initial Degree of Saturation (%)	95.9	97.5	94.5
Soil Height Before Shearing (in.)	1.2	1.2	1.2
Final Moisture Content (%)	23.2	22.8	22.7



**DIRECT SHEAR TEST RESULTS**  
Consolidated Drained ASTM D-3080

Checked by: JMH

Project No.: W1251-06-01

Lawrence Drive &  
Corporate Center Drive  
Thousand Oaks, CA

DEC. 2020

Figure B2

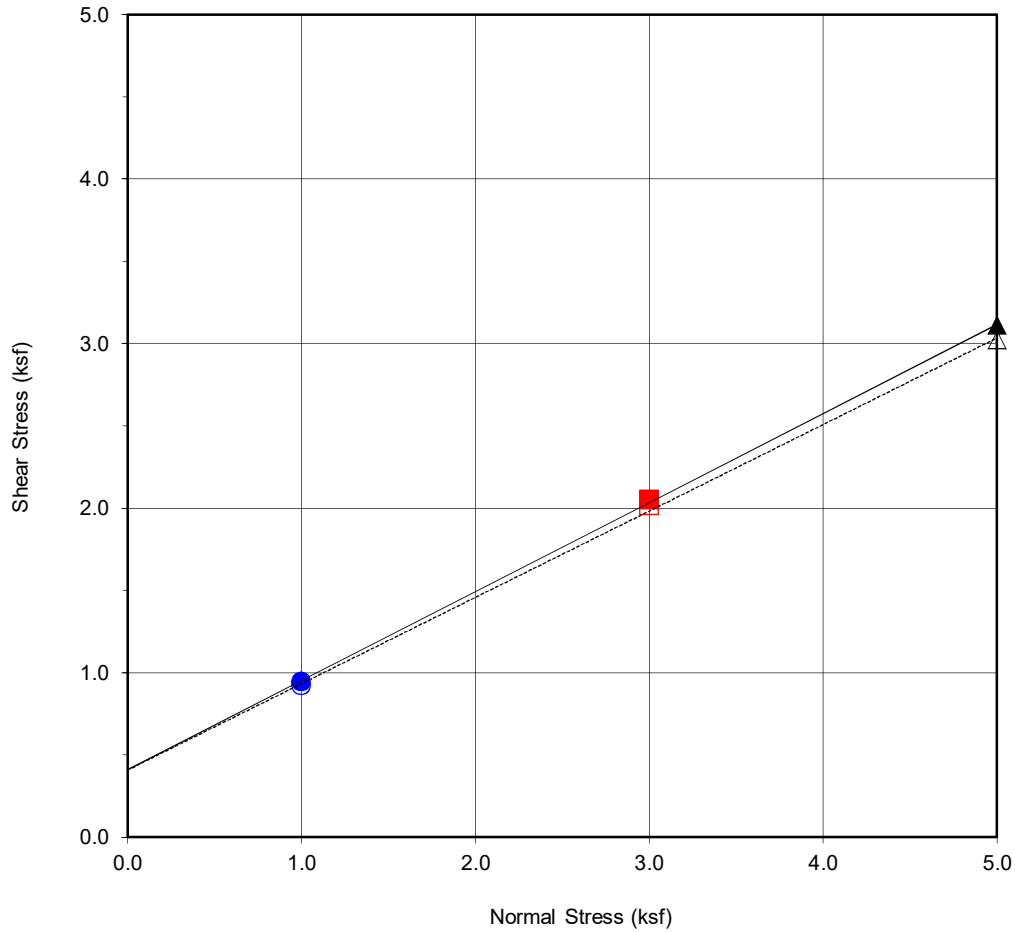

<b>Boring No.</b>	<b>B1</b>
<b>Sample No.</b>	<b>B1@1</b>
<b>Depth (ft)</b>	<b>1</b>
<u>Sample Type:</u>	Ring

<u>Soil Identification:</u>		
Yellowish Brown Silty Sand (SM)		
<b>Strength Parameters</b>		
	C (psf)	$\phi$ ( $^{\circ}$ )
Peak	410	28.4
Ultimate	408	27.7

Normal Stress (kip/ft <sup>2</sup> )	1	3	5
Peak Shear Stress (kip/ft <sup>2</sup> )	● 0.94	■ 2.05	▲ 3.11
Shear Stress @ End of Test (ksf)	○ 0.92	□ 2.01	△ 3.02
Deformation Rate (in./min.)	0.05	0.05	0.05
Initial Sample Height (in.)	1.0	1.0	1.0
Ring Inside Diameter (in.)	2.375	2.375	2.375
Initial Moisture Content (%)	13.3	16.6	15.4
Initial Dry Density (pcf)	87.2	88.7	85.0
Initial Degree of Saturation (%)	38.5	49.7	42.3
Soil Height Before Shearing (in.)	1.2	1.2	1.2
Final Moisture Content (%)	25.3	22.7	22.4



**DIRECT SHEAR TEST RESULTS**  
Consolidated Drained ASTM D-3080

Checked by: JMH

Project No.: W1251-06-01  
Lawrence Drive &  
Corporate Center Drive  
Thousand Oaks, CA

DEC. 2020 Figure B3

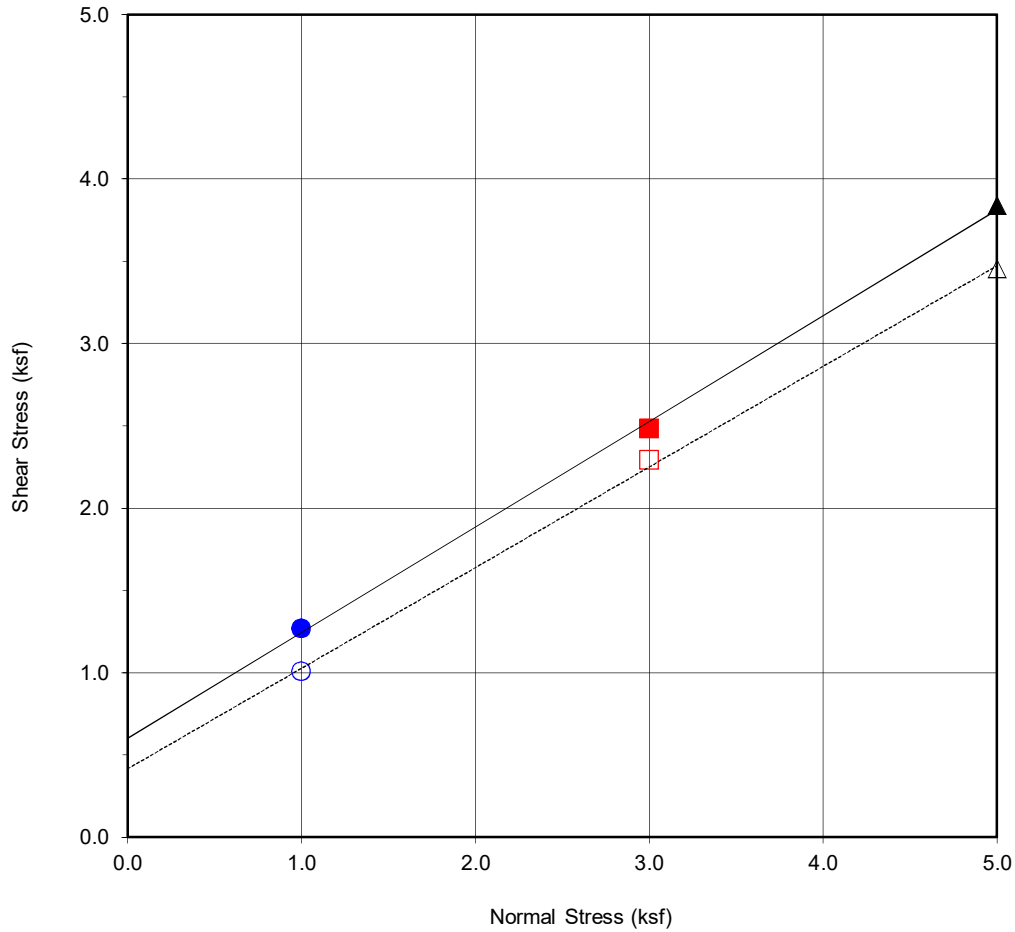

<b>Boring No.</b>	<b>B6</b>
<b>Sample No.</b>	<b>B6@5</b>
<b>Depth (ft)</b>	<b>5</b>
<u>Sample Type:</u>	Ring

<u>Soil Identification:</u>		
Yellowish Brown Well Graded Sand (SW)		
<b>Strength Parameters</b>		
	C (psf)	$\phi$ ( $^{\circ}$ )
Peak	601	32.7
Ultimate	415	31.4

Normal Stress (kip/ft <sup>2</sup> )	1	3	5
Peak Shear Stress (kip/ft <sup>2</sup> )	● 1.27	■ 2.48	▲ 3.84
Shear Stress @ End of Test (ksf)	○ 1.01	□ 2.29	△ 3.45
Deformation Rate (in./min.)	0.05	0.05	0.05
Initial Sample Height (in.)	1.0	1.0	1.0
Ring Inside Diameter (in.)	2.375	2.375	2.375
Initial Moisture Content (%)	13.1	15.1	11.3
Initial Dry Density (pcf)	110.6	94.7	103.5
Initial Degree of Saturation (%)	67.7	52.2	48.7
Soil Height Before Shearing (in.)	1.2	1.2	1.2
Final Moisture Content (%)	17.2	16.6	18.0



**DIRECT SHEAR TEST RESULTS**  
Consolidated Drained ASTM D-3080

Checked by: JMH

Project No.: W1251-06-01  
Lawrence Drive &  
Corporate Center Drive  
Thousand Oaks, CA  
DEC. 2020 Figure B4

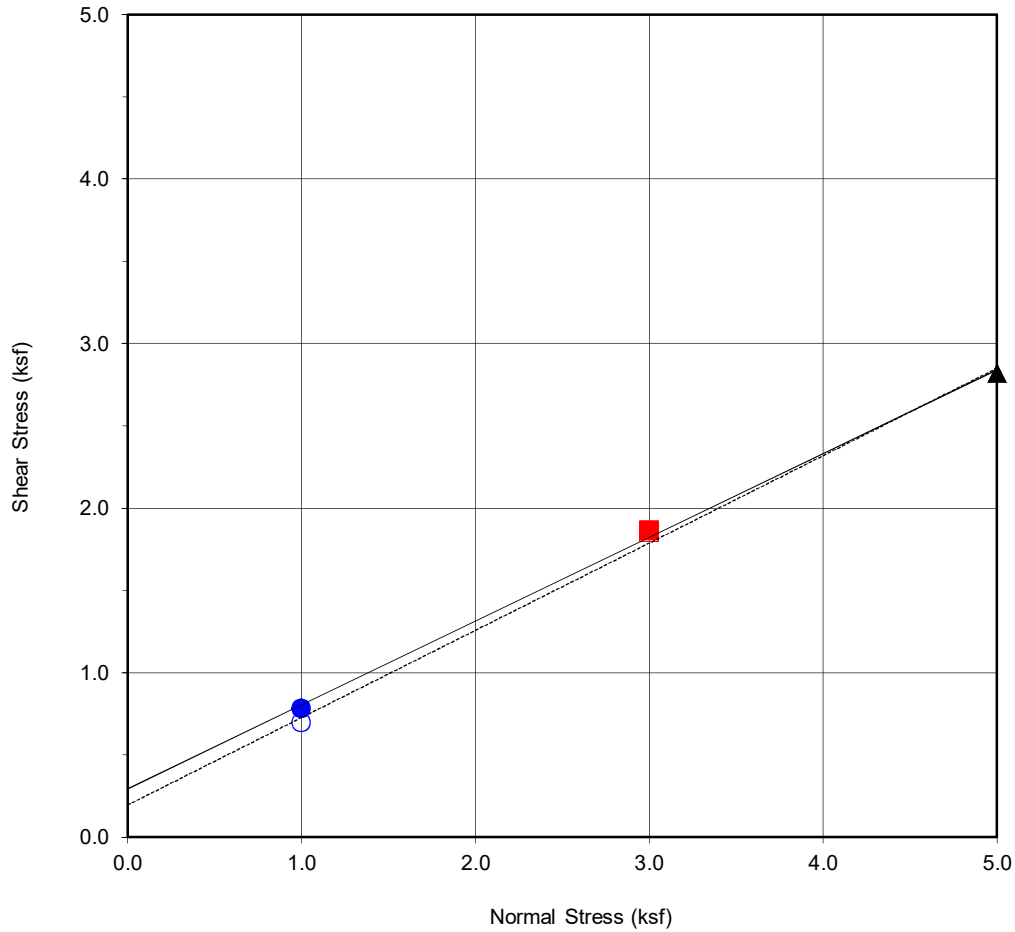

<b>Boring No.</b>	<b>B6&amp;B8</b>
<b>Sample No.</b>	<b>B6&amp;B8@0-5</b>
<b>Depth (ft)</b>	<b>0-5</b>
<u>Sample Type:</u>	Ring

<u>Soil Identification:</u>		
Yellowish Brown Silty Sand with Clay (SM)		
<b>Strength Parameters</b>		
	C (psf)	$\phi$ ( $^{\circ}$ )
Peak	294	27.0
Ultimate	195	28.0

Normal Stress (kip/ft <sup>2</sup> )	1	3	5
Peak Shear Stress (kip/ft <sup>2</sup> )	● 0.78	■ 1.86	▲ 2.82
Shear Stress @ End of Test (ksf)	○ 0.70	□ 1.85	△ 2.82
Deformation Rate (in./min.)	0.05	0.05	0.05
Initial Sample Height (in.)	1.0	1.0	1.0
Ring Inside Diameter (in.)	2.375	2.375	2.375
Initial Moisture Content (%)	11.6	11.7	11.7
Initial Dry Density (pcf)	109.0	109.0	109.0
Initial Degree of Saturation (%)	57.5	58.0	57.7
Soil Height Before Shearing (in.)	1.2	1.2	1.2
Final Moisture Content (%)	21.4	19.8	19.2



**DIRECT SHEAR TEST RESULTS**  
Consolidated Drained ASTM D-3080

Checked by: JMH

Project No.: W1251-06-01  
Lawrence Drive &  
Corporate Center Drive  
Thousand Oaks, CA

DEC. 2020 Figure B5



WATER ADDED AT 2.0 KSF

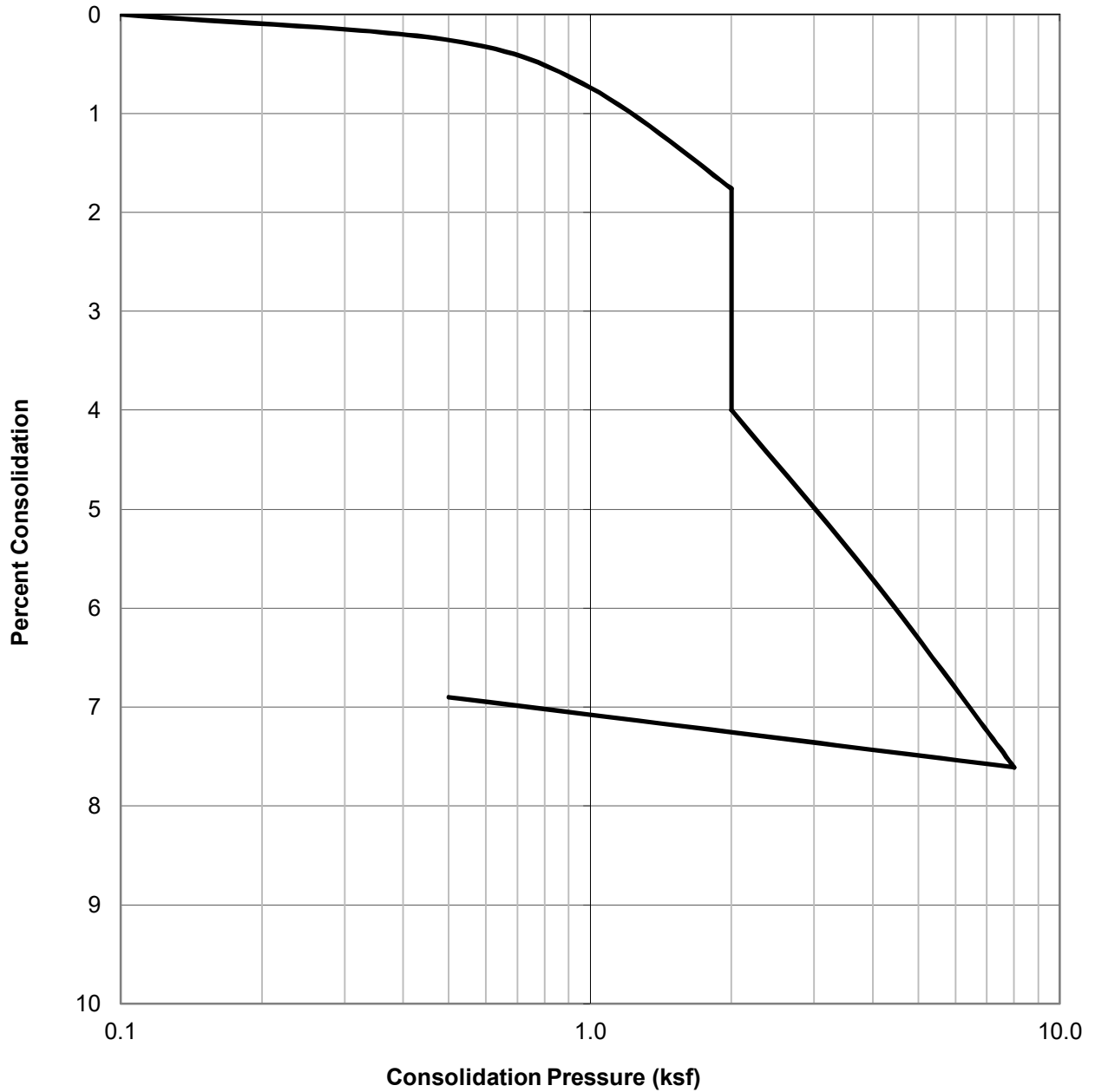

SAMPLE ID.	SOIL TYPE	DRY DENSITY (PCF)	INITIAL MOISTURE (%)	FINAL MOISTURE (%)
B1@1	Yellowish Brown Silty Sand (SM)	94.0	11.4	20.9

	<b>CONSOLIDATION TEST RESULTS</b> ASTM D-2435	Project No.: W1251-06-01
	Checked by: JMH	Lawrence Drive & Corporate Center Drive Thousand Oaks, CA
		DEC. 2020

WATER ADDED AT 2.0 KSF

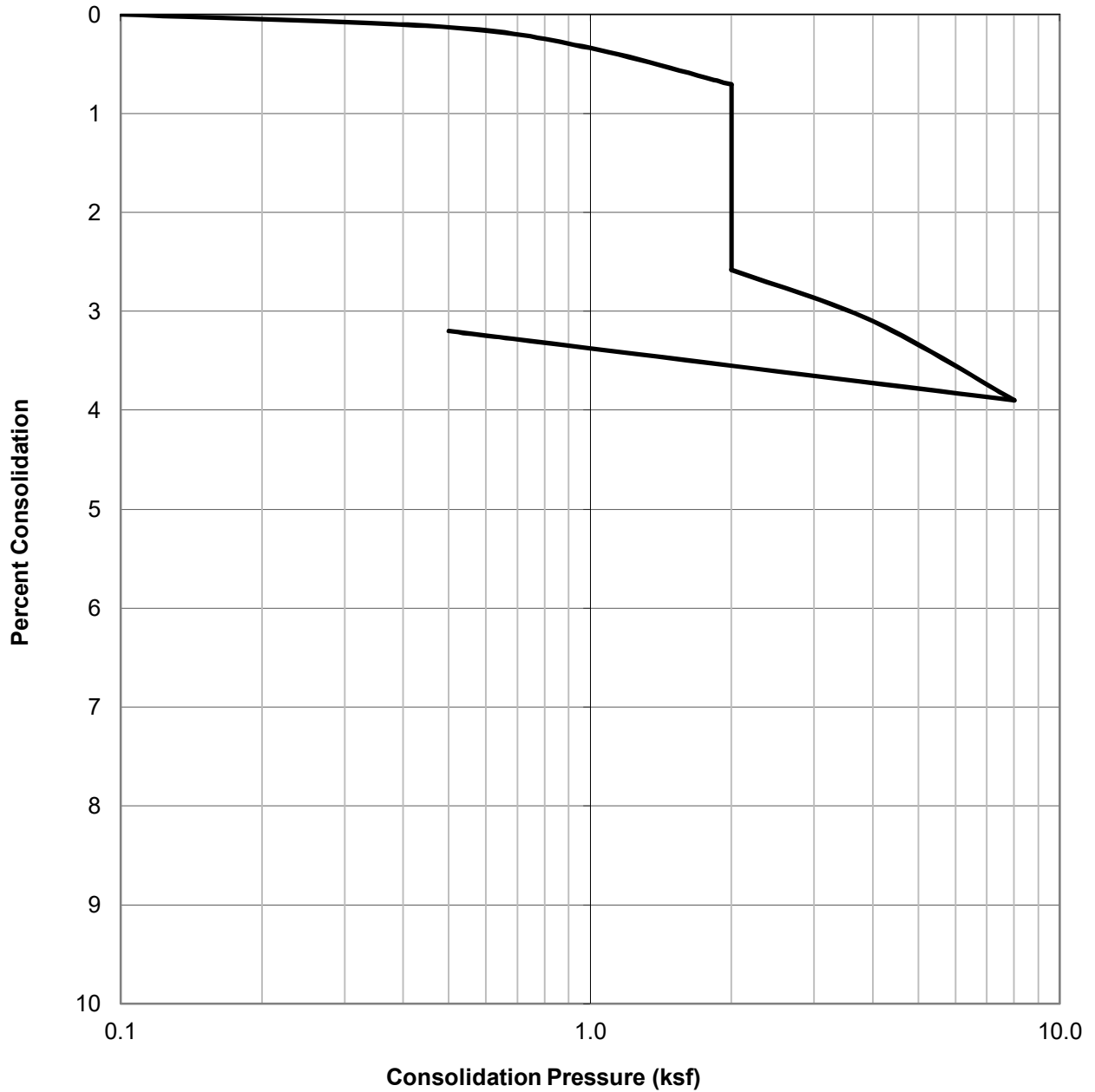

SAMPLE ID.	SOIL TYPE	DRY DENSITY (PCF)	INITIAL MOISTURE (%)	FINAL MOISTURE (%)
B1@6.5	Reddish Brown Well Graded Sand (SW)	100.8	11.4	18.5

	<b>CONSOLIDATION TEST RESULTS</b> ASTM D-2435	Project No.: W1251-06-01
		Lawrence Drive & Corporate Center Drive Thousand Oaks, CA
	Checked by: JMH	DEC. 2020

WATER ADDED AT 2.0 KSF

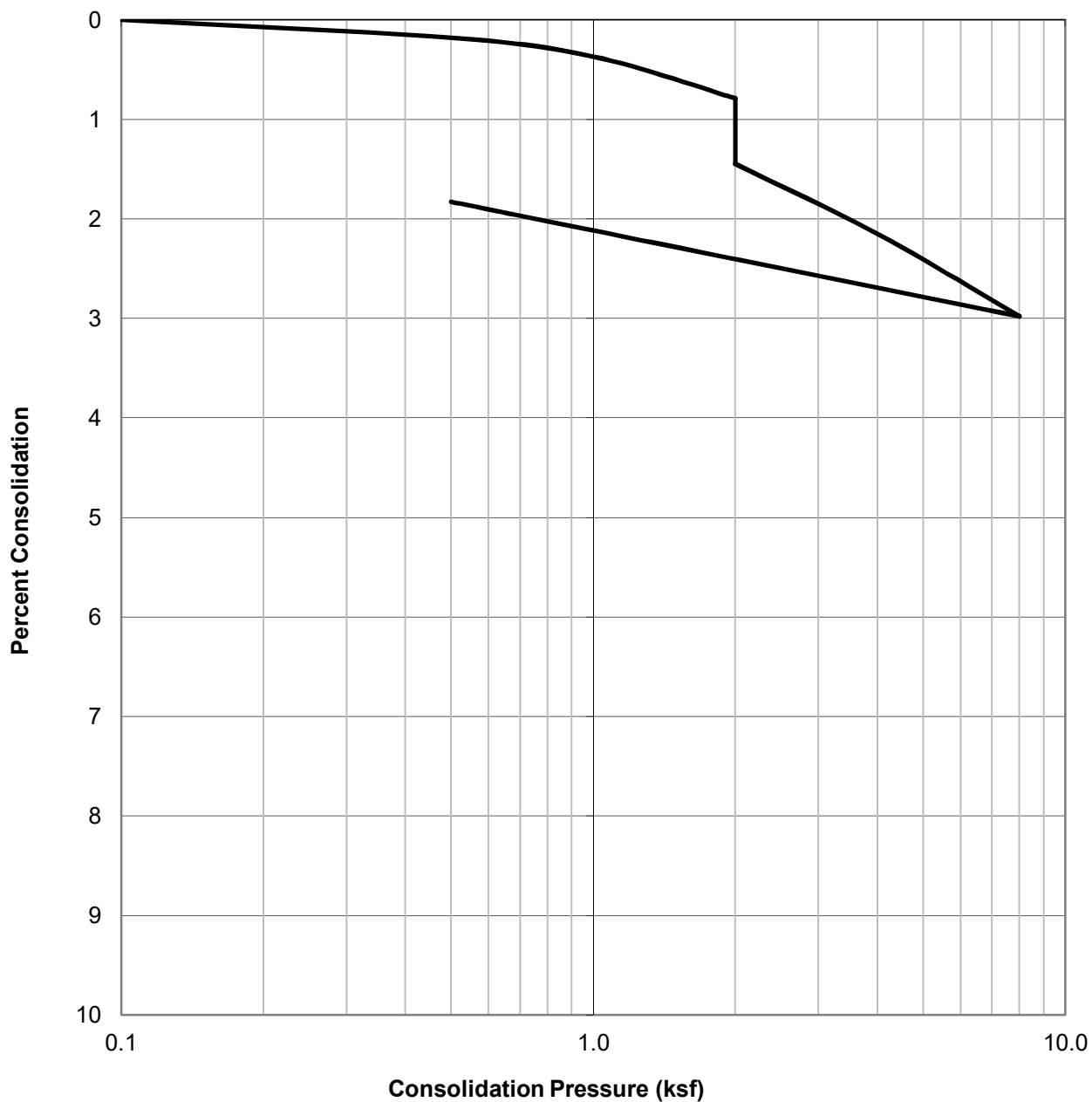

SAMPLE ID.	SOIL TYPE	DRY DENSITY (PCF)	INITIAL MOISTURE (%)	FINAL MOISTURE (%)
B1@10	Yellowish Brown Silty Sand (SM)	101.3	16.4	21.3

 <b>GEOCON</b>	<b>CONSOLIDATION TEST RESULTS</b> ASTM D-2435	Project No.: W1251-06-01
	Checked by: JMH	Lawrence Drive & Corporate Center Drive Thousand Oaks, CA
		DEC. 2020

WATER ADDED AT 2.0 KSF

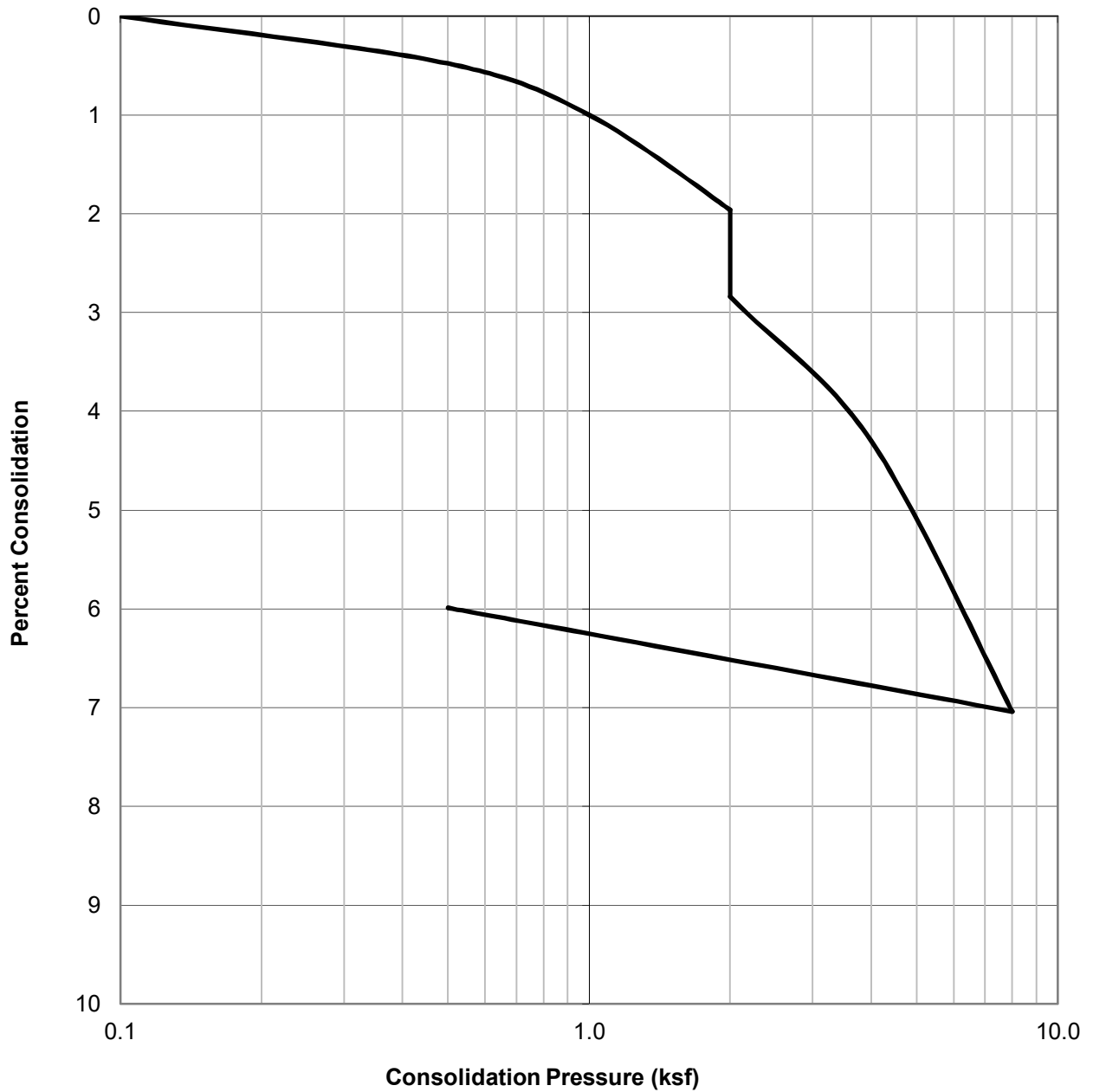

SAMPLE ID.	SOIL TYPE	DRY DENSITY (PCF)	INITIAL MOISTURE (%)	FINAL MOISTURE (%)
B1@20	Gray Silty Sand with Clay (SM)	98.4	15.0	20.6



**CONSOLIDATION TEST RESULTS**  
 ASTM D-2435  
 Checked by: JMH

Project No.: W1251-06-01  
 Lawrence Drive &  
 Corporate Center Drive  
 Thousand Oaks, CA  
 DEC. 2020 Figure B9

WATER ADDED AT 2.0 KSF

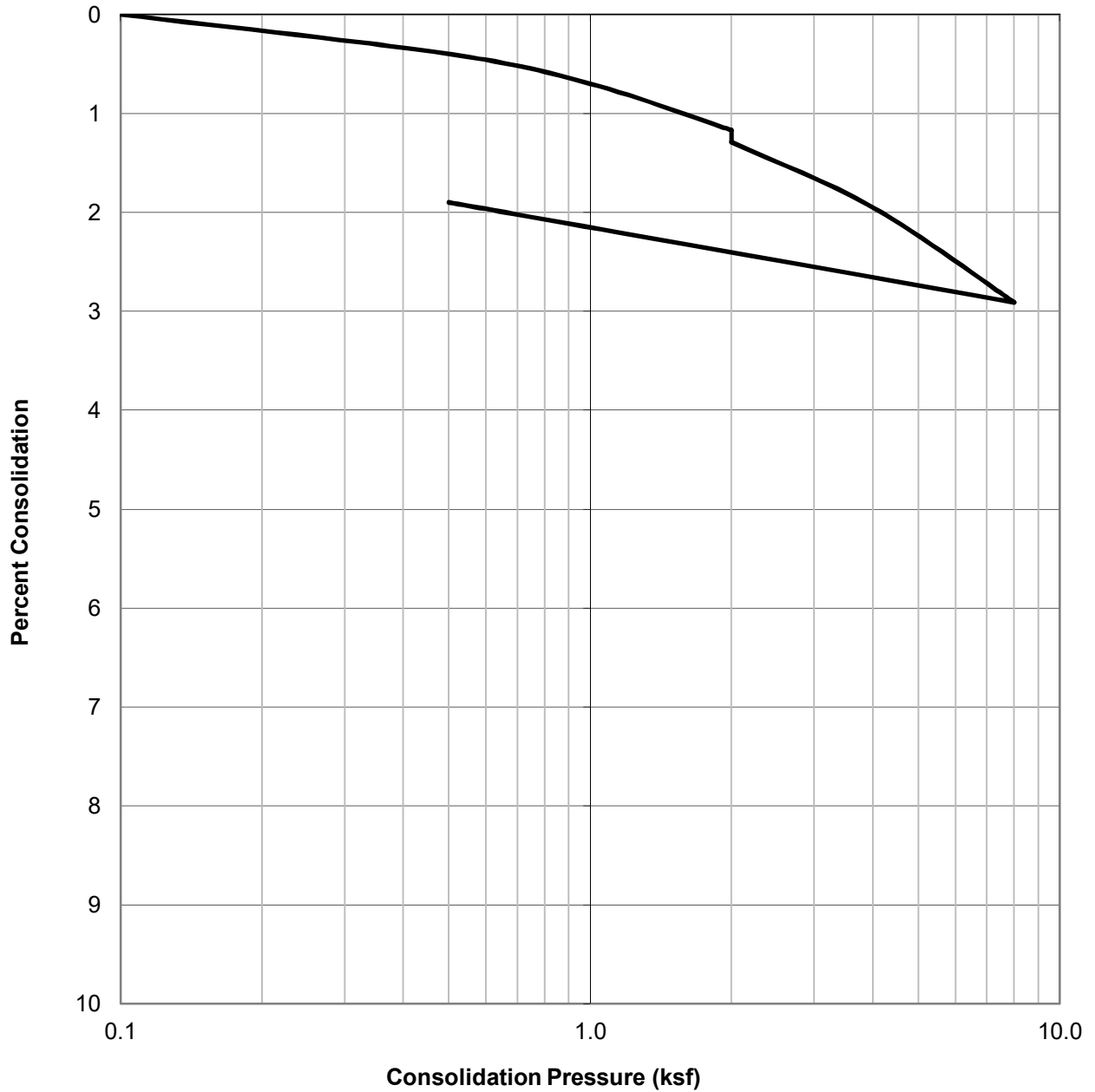

SAMPLE ID.	SOIL TYPE	DRY DENSITY (PCF)	INITIAL MOISTURE (%)	FINAL MOISTURE (%)
B3@5	Yellowish Brown Silty Sand (SM)	105.6	19.7	20.7



**CONSOLIDATION TEST RESULTS**

ASTM D-2435

Checked by: JMH

Project No.: W1251-06-01

Lawrence Drive &  
Corporate Center Drive  
Thousand Oaks, CA

DEC. 2020

Figure B10

WATER ADDED AT 2.0 KSF

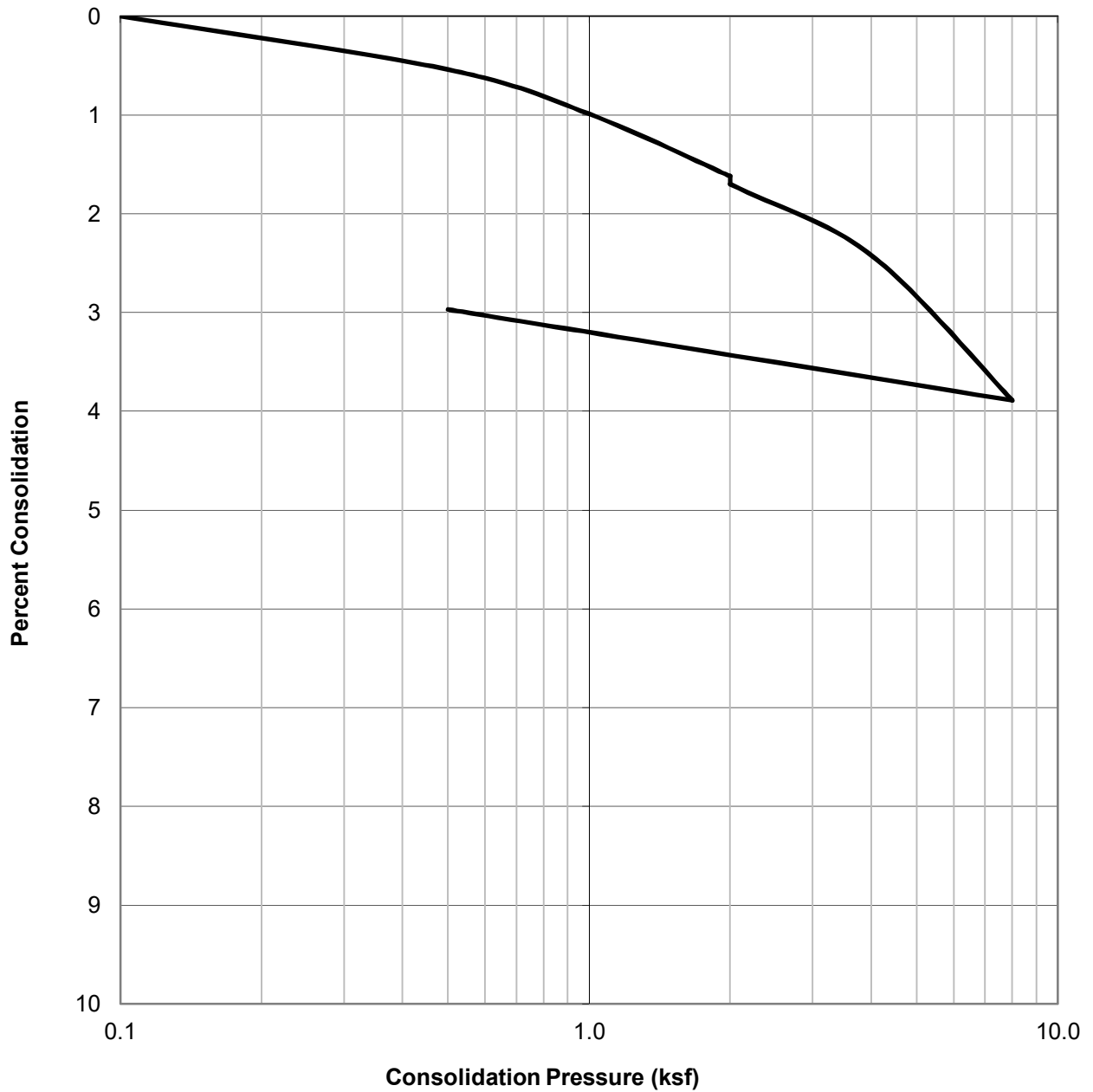

SAMPLE ID.	SOIL TYPE	DRY DENSITY (PCF)	INITIAL MOISTURE (%)	FINAL MOISTURE (%)
B3@10	Reddish Brown Poorly Graded Sand (SP)	101.5	20.2	22.7

	<b>CONSOLIDATION TEST RESULTS</b> ASTM D-2435	Project No.: W1251-06-01
		Lawrence Drive & Corporate Center Drive Thousand Oaks, CA
	Checked by: JMH	DEC. 2020

WATER ADDED AT 2.0 KSF

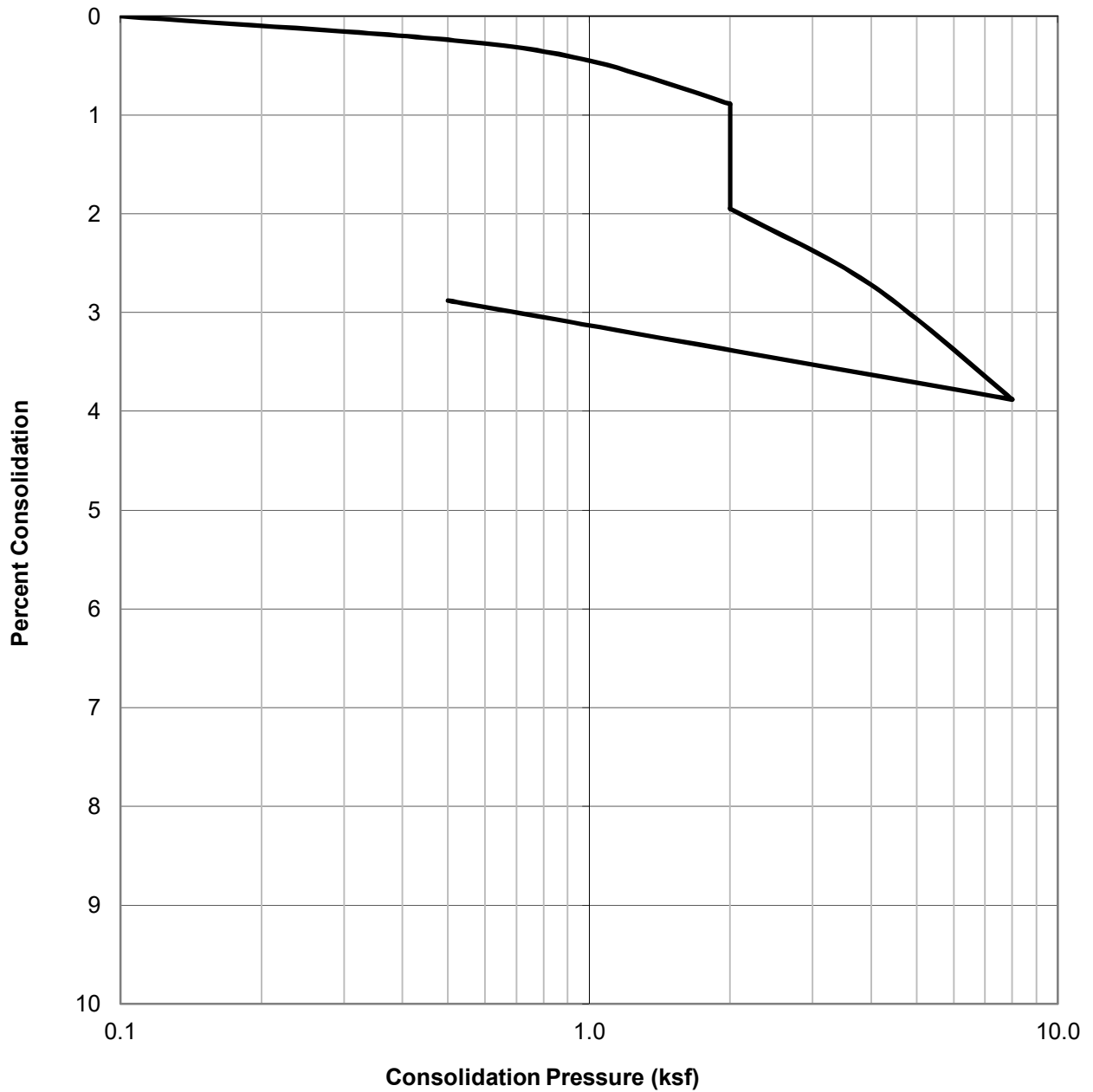

SAMPLE ID.	SOIL TYPE	DRY DENSITY (PCF)	INITIAL MOISTURE (%)	FINAL MOISTURE (%)
B3@20	Yellowish Brown Well Graded Sand (SW)	93.3	17.5	21.9

	<b>CONSOLIDATION TEST RESULTS</b> ASTM D-2435	Project No.: W1251-06-01
	Checked by: JM	Lawrence Drive & Corporate Center Drive Thousand Oaks, CA
	DEC. 2020	Figure B12

WATER ADDED AT 2.0 KSF

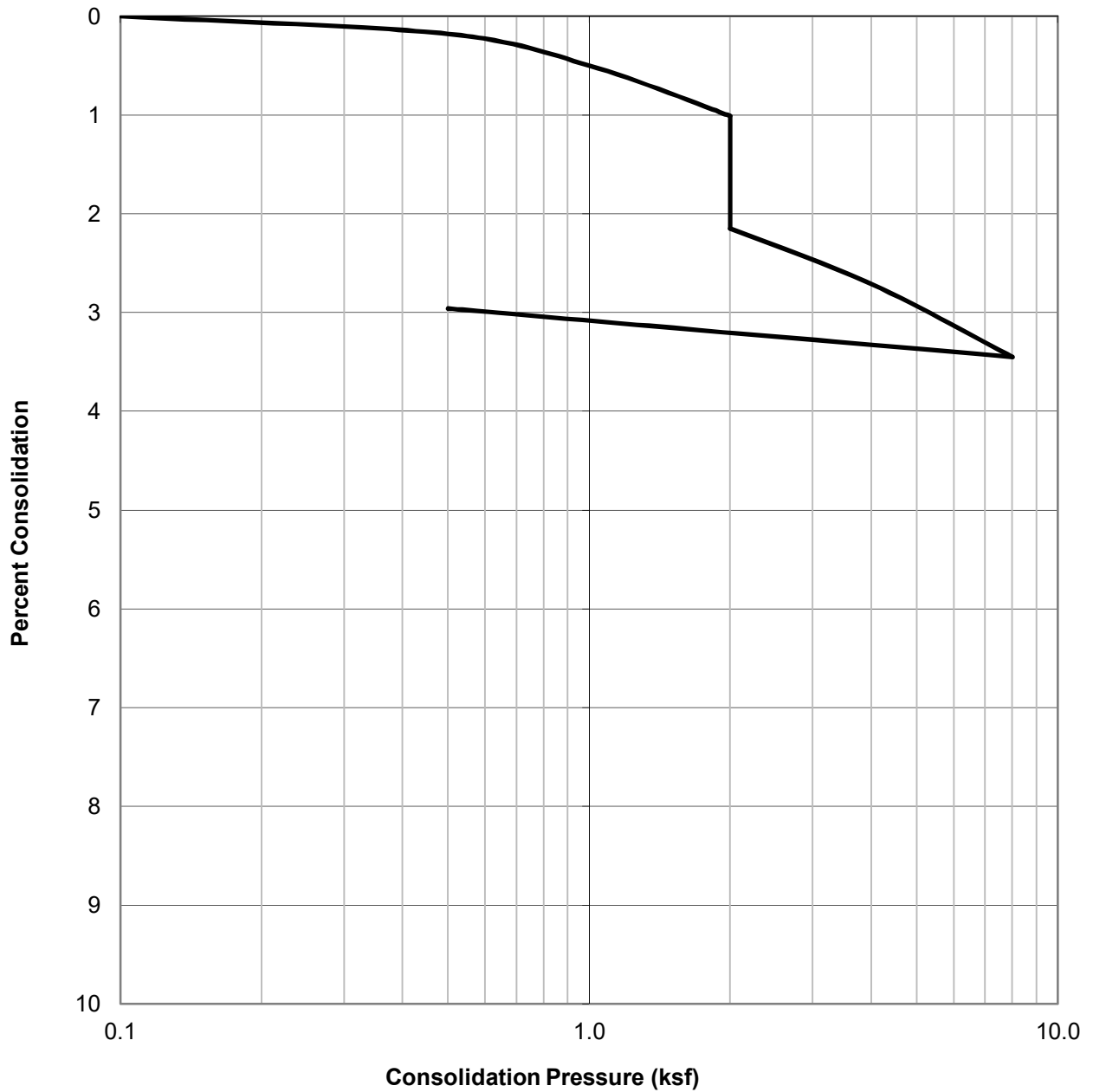

SAMPLE ID.	SOIL TYPE	DRY DENSITY (PCF)	INITIAL MOISTURE (%)	FINAL MOISTURE (%)
B4@9.5	Yellowish Brown Silty Sand (SM)	97.1	8.3	18.8

	<b>CONSOLIDATION TEST RESULTS</b> ASTM D-2435	Project No.: W1251-06-01
		Lawrence Drive & Corporate Center Drive Thousand Oaks, CA
	Checked by: JMH	DEC. 2020



WATER ADDED AT 2.0 KSF

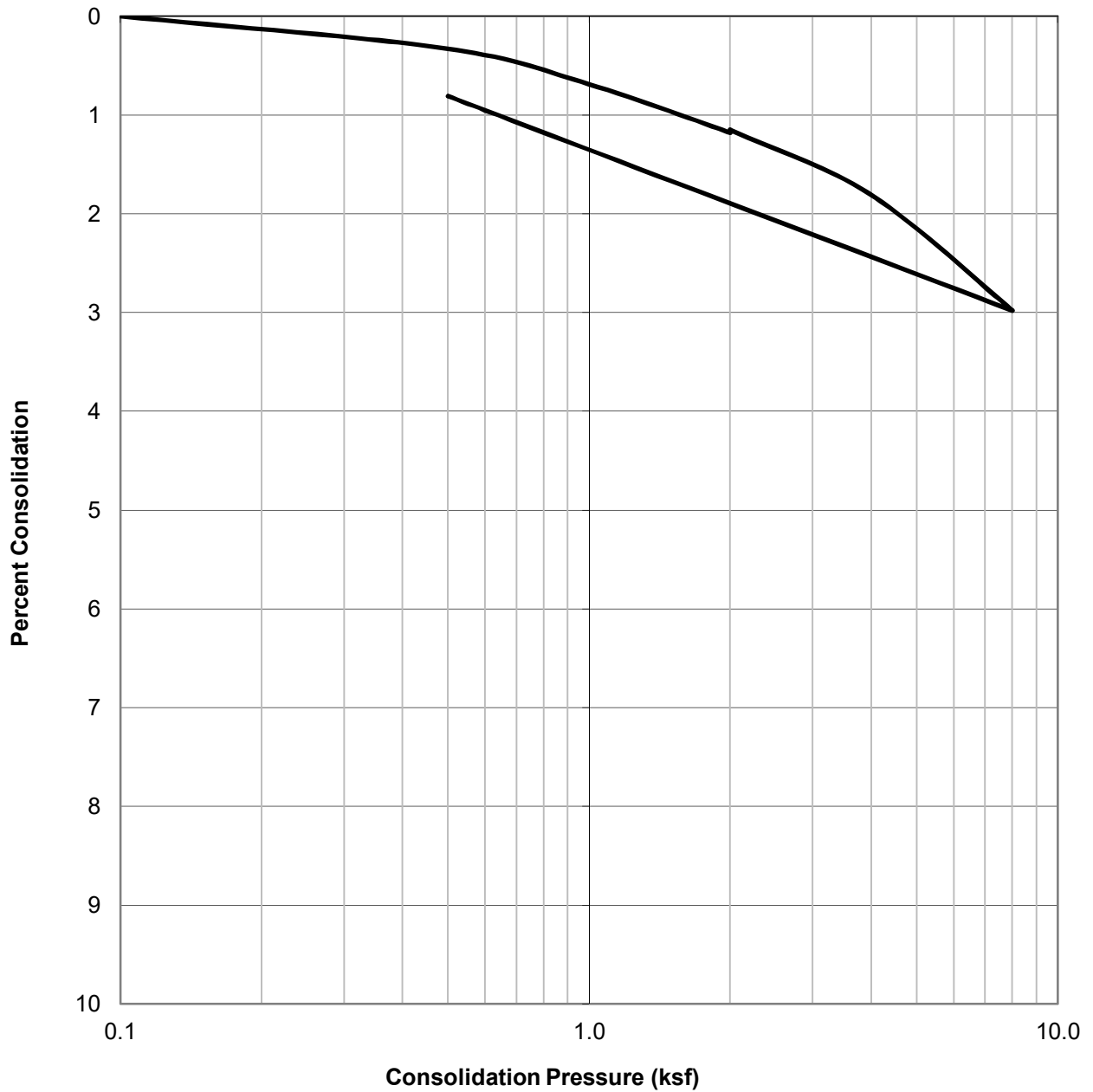

SAMPLE ID.	SOIL TYPE	DRY DENSITY (PCF)	INITIAL MOISTURE (%)	FINAL MOISTURE (%)
B4@20	Yellowish Brown Silty Sand with Clay (SM)	101.4	22.1	24.7

	<b>CONSOLIDATION TEST RESULTS</b> ASTM D-2435	Project No.: W1251-06-01
	Checked by: JMH	Lawrence Drive & Corporate Center Drive Thousand Oaks, CA
		DEC. 2020 <span style="float: right;">Figure B14</span>

WATER ADDED AT 2.0 KSF

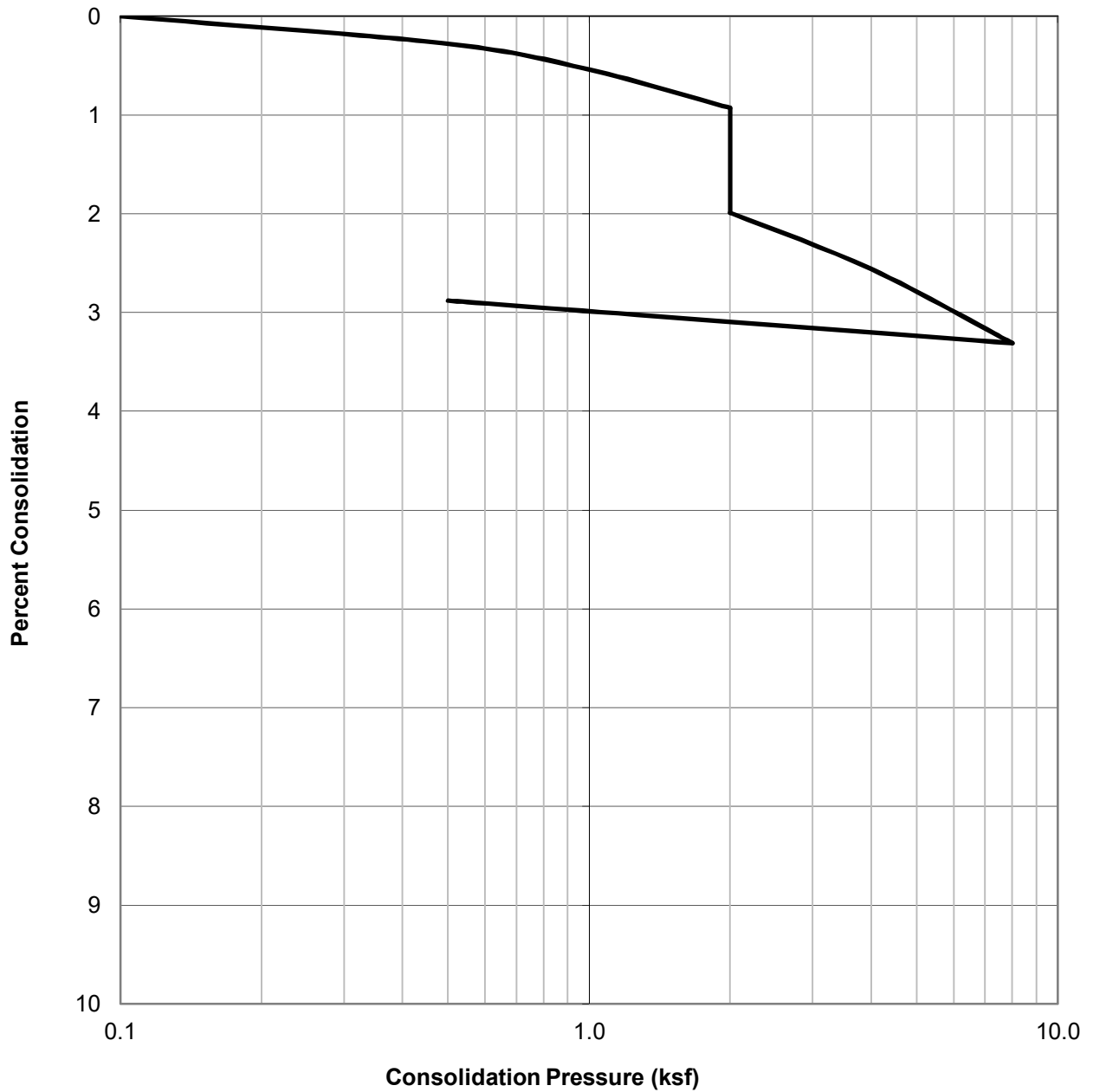

SAMPLE ID.	SOIL TYPE	DRY DENSITY (PCF)	INITIAL MOISTURE (%)	FINAL MOISTURE (%)
B6@5	Yellowish Brown Well Graded Sand (SW)	108.5	10.3	16.6

	<b>CONSOLIDATION TEST RESULTS</b> ASTM D-2435	Project No.: W1251-06-01
	Checked by: JMH	Lawrence Drive & Corporate Center Drive Thousand Oaks, CA
		DEC. 2020 <span style="float: right;">Figure B15</span>

WATER ADDED AT 2.0 KSF

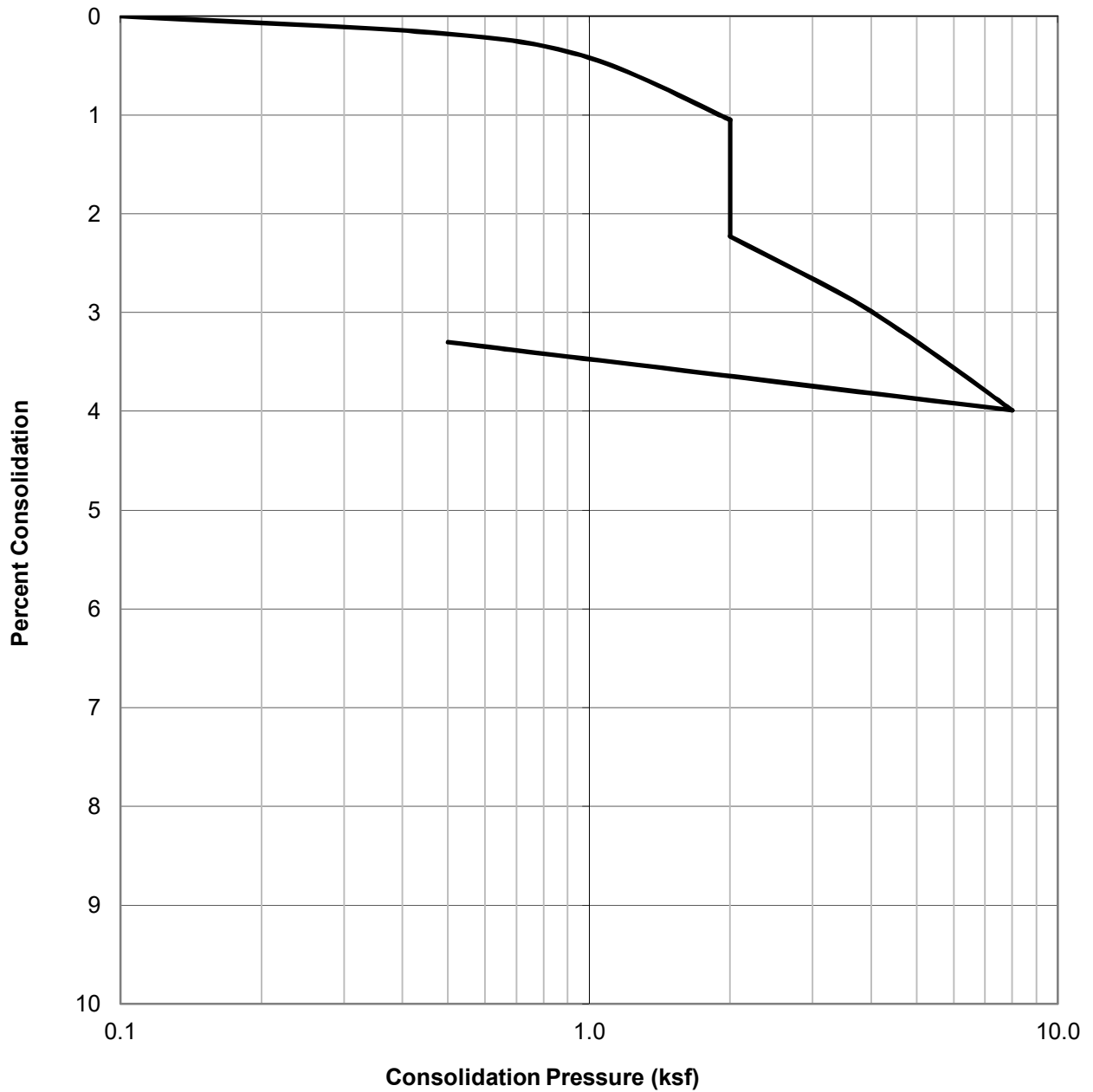

SAMPLE ID.	SOIL TYPE	DRY DENSITY (PCF)	INITIAL MOISTURE (%)	FINAL MOISTURE (%)
B6@10	Yellowish Brown Poorly Graded Sand (SP)	91.6	13.1	21.7

	<b>CONSOLIDATION TEST RESULTS</b> ASTM D-2435	Project No.: W1251-06-01
	Checked by: JMH	Lawrence Drive & Corporate Center Drive Thousand Oaks, CA
		DEC. 2020

WATER ADDED AT 2.0 KSF

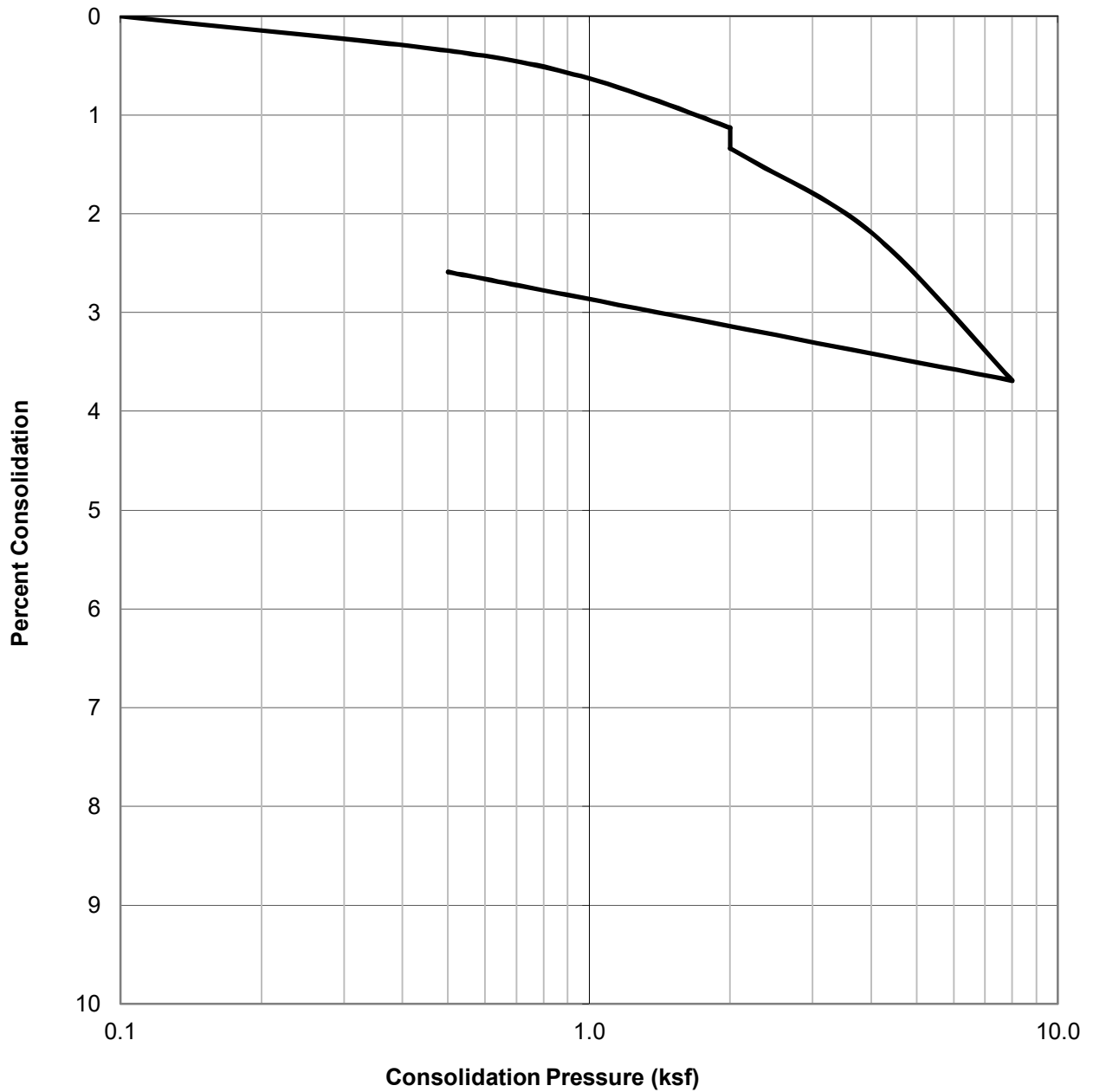

SAMPLE ID.	SOIL TYPE	DRY DENSITY (PCF)	INITIAL MOISTURE (%)	FINAL MOISTURE (%)
B6@20	Yellowish Brown Poorly Graded Sand (SP)	104.4	17.5	20.5



**CONSOLIDATION TEST RESULTS**  
 ASTM D-2435  
 Checked by: JMH

Project No.: W1251-06-01  
 Lawrence Drive &  
 Corporate Center Drive  
 Thousand Oaks, CA  
 DEC. 2020 Figure B17

WATER ADDED AT 2.0 KSF

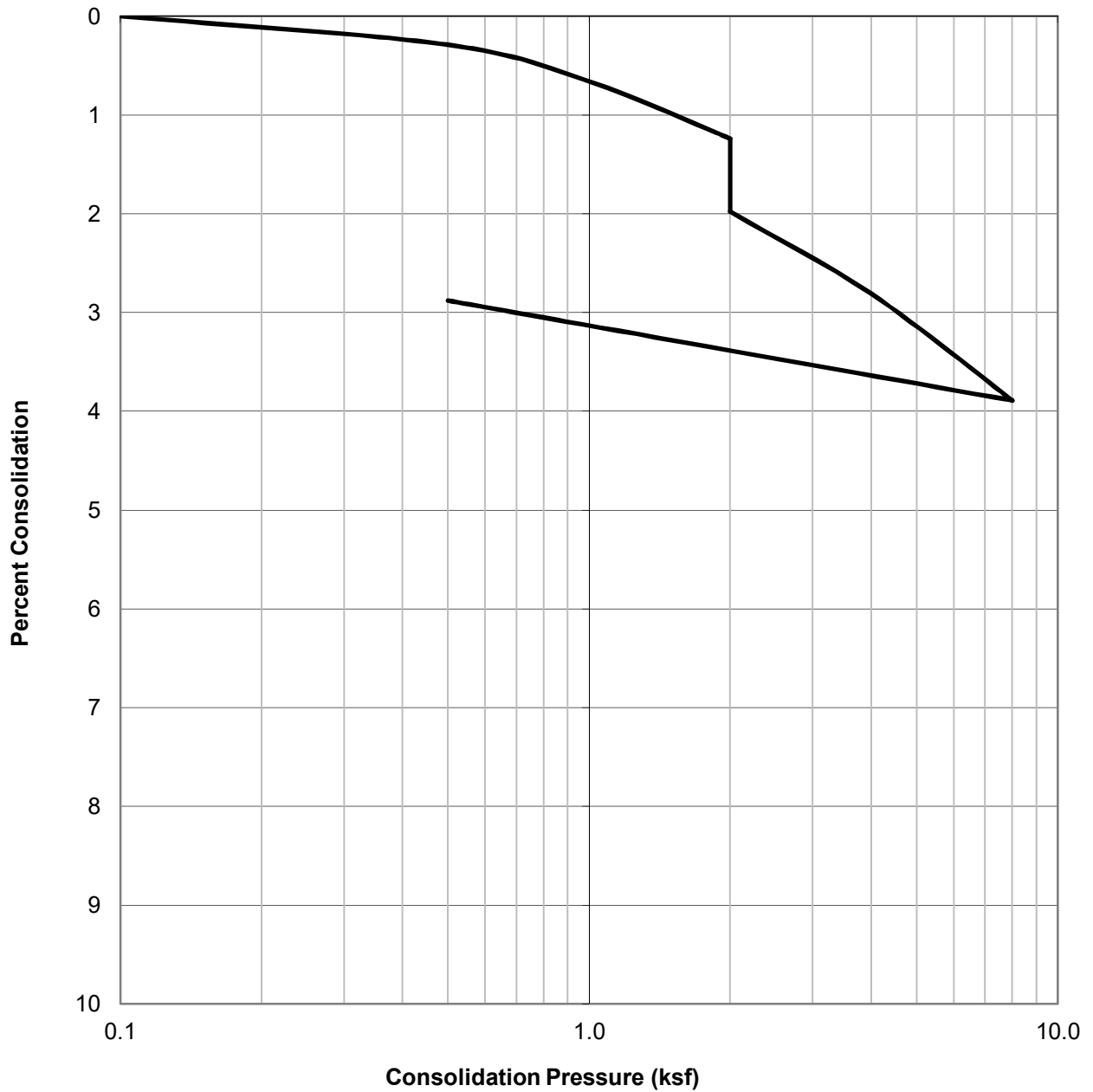

SAMPLE ID.	SOIL TYPE	DRY DENSITY (PCF)	INITIAL MOISTURE (%)	FINAL MOISTURE (%)
B8@10	Yellowish Brown Sand w/ Silt (SP-SM)	101.0	20.1	22.3

	<b>CONSOLIDATION TEST RESULTS</b> ASTM D-2435	Project No.: W1251-06-01
		Lawrence Drive & Corporate Center Drive Thousand Oaks, CA
	Checked by: JMH	DEC. 2020

WATER ADDED AT 2.0 KSF

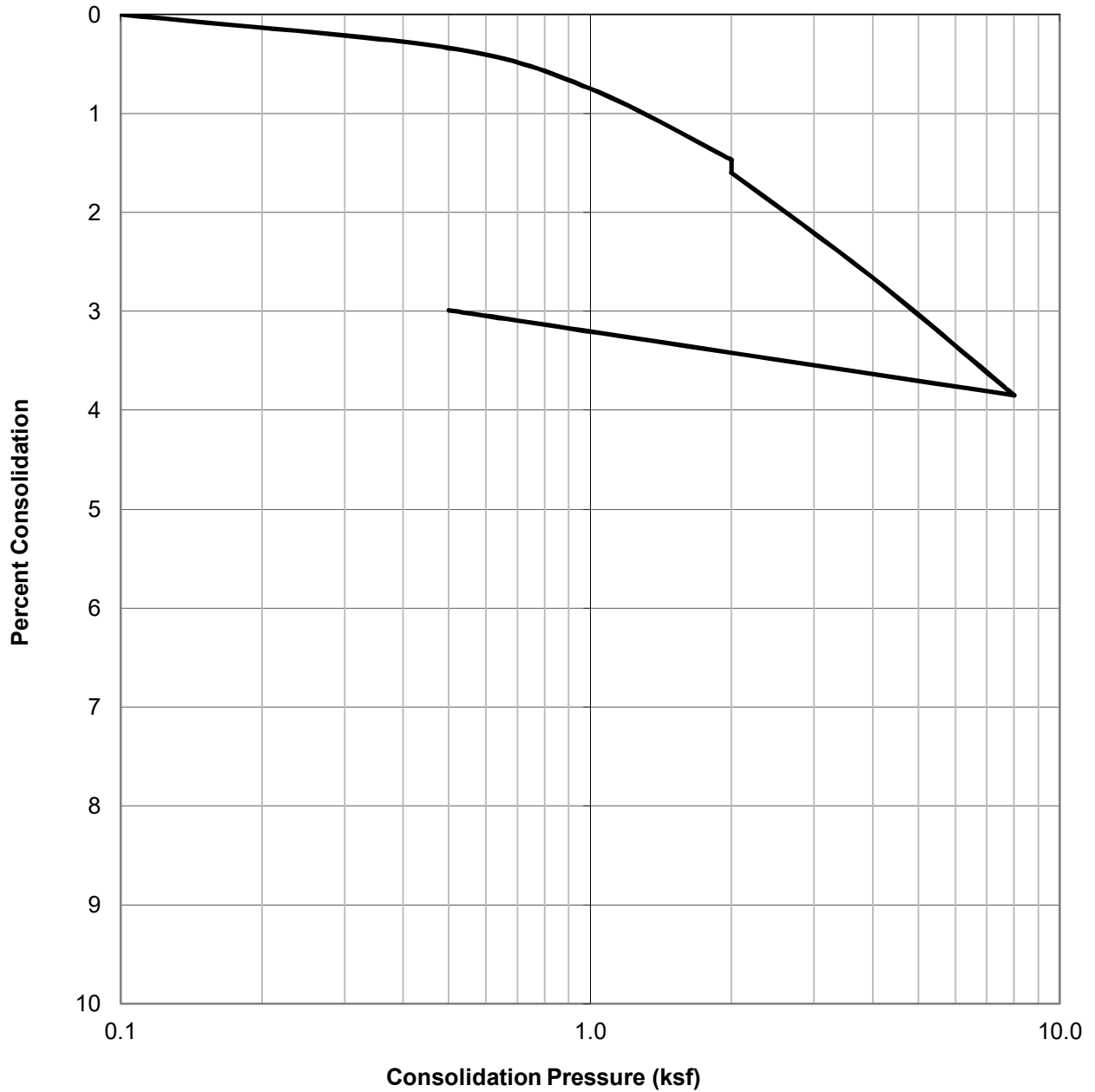

SAMPLE ID.	SOIL TYPE	DRY DENSITY (PCF)	INITIAL MOISTURE (%)	FINAL MOISTURE (%)
B8@20	Yellowish Brown Sand w/ Silt (SP-SM)	102.9	21.2	21.3

	<b>CONSOLIDATION TEST RESULTS</b> ASTM D-2435	Project No.: W1251-06-01
		Lawrence Drive & Corporate Center Drive Thousand Oaks, CA
	Checked by: JMH	DEC. 2020

## B2&B4 @ 0-5'

MOLDED SPECIMEN		BEFORE TEST	AFTER TEST
Specimen Diameter	(in.)	4.0	4.0
Specimen Height	(in.)	1.0	1.1
Wt. Comp. Soil + Mold	(gm)	733.6	787.6
Wt. of Mold	(gm)	367.8	367.8
Specific Gravity	(Assumed)	2.7	2.7
Wet Wt. of Soil + Cont.	(gm)	487.5	787.6
Dry Wt. of Soil + Cont.	(gm)	451.8	322.3
Wt. of Container	(gm)	187.5	367.8
Moisture Content	(%)	13.5	30.3
Wet Density	(pcf)	110.3	126.5
Dry Density	(pcf)	97.2	97.1
Void Ratio		0.7	0.9
Total Porosity		0.4	0.5
Pore Volume	(cc)	87.6	104.7
Degree of Saturation	(%) [ $S_{meas}$ ]	50.1	93.1

Date	Time	Pressure (psi)	Elapsed Time (min)	Dial Readings (in.)
10/27/2020	10:00	1.0	0	0.2575
10/27/2020	10:10	1.0	10	0.2575
Add Distilled Water to the Specimen				
10/28/2020	10:00	1.0	1430	0.34
10/28/2020	11:00	1.0	1490	0.34

Expansion Index (EI meas) =	82.5
Expansion Index ( Report ) =	<b>83</b>

Expansion Index, $EI_{50}$	CBC CLASSIFICATION *	UBC CLASSIFICATION **
0-20	Non-Expansive	Very Low
21-50	Expansive	Low
51-90	Expansive	Medium
91-130	Expansive	High
>130	Expansive	Very High

\* Reference: 2019 California Building Code, Section 1803.5.3

\*\* Reference: 1997 Uniform Building Code, Table 18-I-B.

	<b>EXPANSION INDEX TEST RESULTS</b>	Project No.: W1251-06-01
	ASTM D-4829	Lawrence Drive & Corporate Center Drive Thousand Oaks, CA
	Checked by: JMH	DEC. 2020 <span style="float: right;">Figure B20</span>

## B6&B8 @ 0-5'

MOLDED SPECIMEN		BEFORE TEST	AFTER TEST
Specimen Diameter	(in.)	4.0	4.0
Specimen Height	(in.)	1.0	1.1
Wt. Comp. Soil + Mold	(gm)	746.5	796.3
Wt. of Mold	(gm)	368.1	368.1
Specific Gravity	(Assumed)	2.7	2.7
Wet Wt. of Soil + Cont.	(gm)	487.5	796.3
Dry Wt. of Soil + Cont.	(gm)	456.8	339.7
Wt. of Container	(gm)	187.5	368.1
Moisture Content	(%)	11.4	26.1
Wet Density	(pcf)	114.1	129.0
Dry Density	(pcf)	102.5	102.3
Void Ratio		0.6	0.7
Total Porosity		0.4	0.4
Pore Volume	(cc)	81.2	93.3
Degree of Saturation	(%) [ $S_{meas}$ ]	48.1	94.9

Date	Time	Pressure (psi)	Elapsed Time (min)	Dial Readings (in.)
10/26/2020	10:00	1.0	0	0.2965
10/26/2020	10:10	1.0	10	0.296
Add Distilled Water to the Specimen				
10/27/2020	10:00	1.0	1430	0.3545
10/27/2020	11:00	1.0	1490	0.3545

Expansion Index (EI meas) =	<b>58.5</b>
Expansion Index ( Report ) =	<b>59</b>

Expansion Index, $EI_{50}$	CBC CLASSIFICATION *	UBC CLASSIFICATION **
0-20	Non-Expansive	Very Low
21-50	Expansive	Low
51-90	Expansive	Medium
91-130	Expansive	High
>130	Expansive	Very High

\* Reference: 2019 California Building Code, Section 1803.5.3

\*\* Reference: 1997 Uniform Building Code, Table 18-I-B.

	<b>EXPANSION INDEX TEST RESULTS</b>	Project No.: W1251-06-01
	ASTM D-4829	Lawrence Drive & Corporate Center Drive Thousand Oaks, CA
	Checked by: JMH	DEC. 2020 <span style="float: right;">Figure B21</span>



Sample No:

<b>B2&amp;B4 @ 0-5'</b>	Grayish Brown Silty Sand with Clay (SM)
-------------------------	-----------------------------------------

TEST NO.		1	2	3	4	5	6
Wt. Compacted Soil + Mold	(g)	6078	6130	6112	5960		
Weight of Mold	(g)	4136	4136	4136	4136		
Net Weight of Soil	(g)	1942	1994	1976	1824		
Wet Weight of Soil + Cont.	(g)	699.7	717.7	690.9	643.8		
Dry Weight of Soil + Cont.	(g)	640.9	646.7	614.8	599.2		
Weight of Container	(g)	133.2	126.7	124.6	137.0		
Moisture Content	(%)	11.6	13.7	15.5	9.6		
Wet Density	(pcf)	128.5	131.9	130.7	120.6		
Dry Density	(pcf)	115.1	116.0	113.1	110.0		

<b>Maximum Dry Density (pcf)</b>	<b>116.5</b>
<b>Bulk Specific Gravity (dry)</b>	<b>2.65</b>
<b>Corrected Maximum Dry Density (pcf)</b>	<b>118.5</b>

<b>Optimum Moisture Content (%)</b>	<b>12.5</b>
<b>Oversized Fraction (%)</b>	<b>6.0</b>
<b>Corrected Moisture Content (%)</b>	<b>12.0</b>

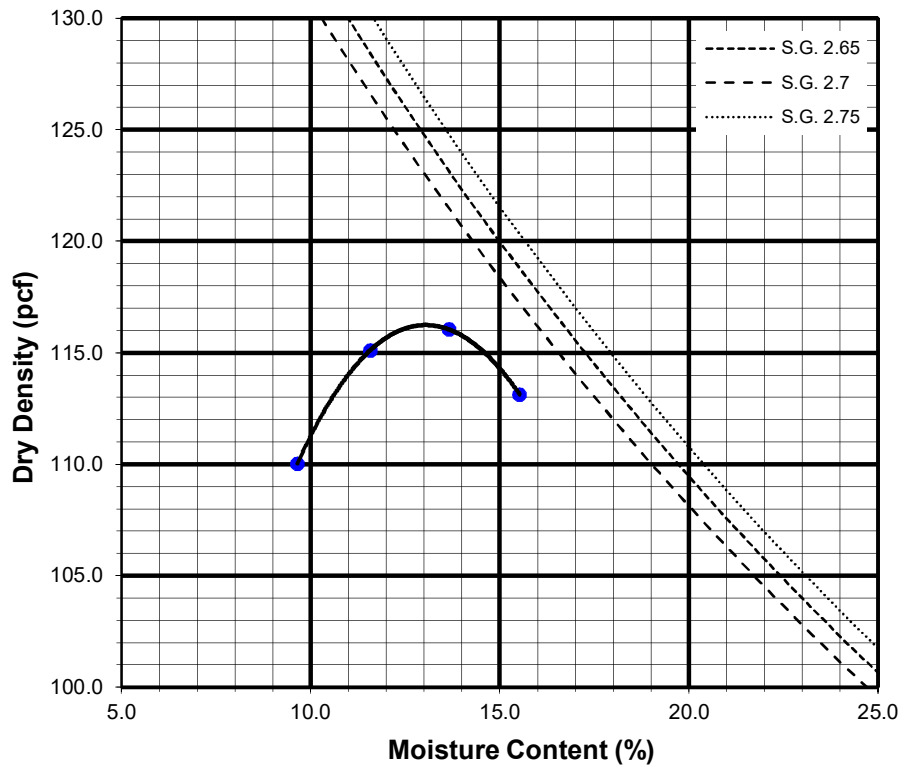

Preparation Method: A

 <b>GEOCON</b>	<b>MODIFIED COMPACTION TEST OF SOILS</b> ASTM D-1557	Project No.: W1251-06-01
	Checked by: JMH	Lawrence Drive & Corporate Center Drive Thousand Oaks, CA DEC. 2020 <span style="float: right;">Figure B22</span>

Sample No:

<b>B6&amp;B8 @ 0-5'</b>	Yellowish Brown Silty Sand with Clay (SM)
-------------------------	-------------------------------------------

TEST NO.		1	2	3	4	5	6
Wt. Compacted Soil + Mold	(g)	6180	6175	6045	5927		
Weight of Mold	(g)	4136	4136	4136	4136		
Net Weight of Soil	(g)	2044	2039	1909	1791		
Wet Weight of Soil + Cont.	(g)	656.6	621.3	644.6	599.8		
Dry Weight of Soil + Cont.	(g)	602.9	561.6	601.4	566.6		
Weight of Container	(g)	148.5	135.7	146.7	133.3		
Moisture Content	(%)	11.8	14.0	9.5	7.7		
Wet Density	(pcf)	135.2	134.9	126.3	118.5		
Dry Density	(pcf)	120.9	118.3	115.3	110.0		

<b>Maximum Dry Density (pcf)</b>	<b>121.0</b>
<b>Bulk Specific Gravity (dry)</b>	<b>2.65</b>
<b>Corrected Maximum Dry Density (pcf)</b>	<b>123.5</b>

<b>Optimum Moisture Content (%)</b>	<b>12.0</b>
<b>Oversized Fraction (%)</b>	<b>7.0</b>
<b>Corrected Moisture Content (%)</b>	<b>11.0</b>

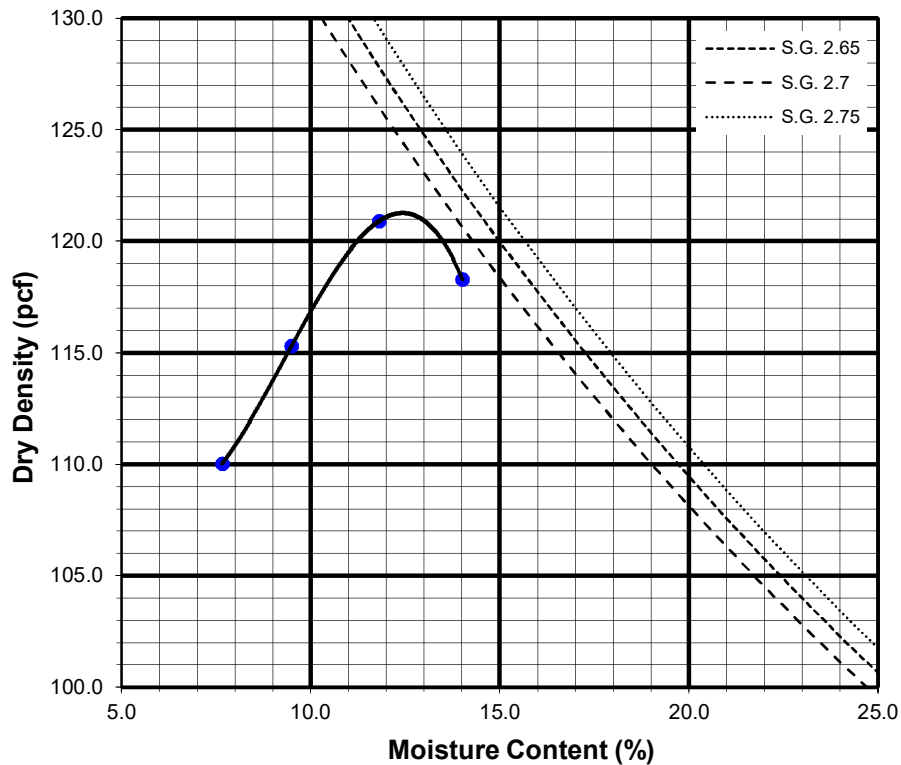

Preparation Method: A

 <b>GEOCON</b>	<b>MODIFIED COMPACTION TEST OF SOILS</b> ASTM D-1557	Project No.: W1251-06-01
	Checked by: JMH	Lawrence Drive & Corporate Center Drive Thousand Oaks, CA DEC. 2020 <span style="float: right;">Figure B23</span>

SUMMARY OF LABORATORY POTENTIAL  
OF HYDROGEN (pH) AND RESISTIVITY TEST RESULTS  
CALIFORNIA TEST NO. 643

Sample No.	pH	Resistivity (ohm centimeters)
B2&B4 @ 0-5'	6.9	1000 (Severely Corrosive)
B6&B8 @ 0-5'	7.5	1300 (Corrosive)

SUMMARY OF LABORATORY CHLORIDE CONTENT TEST RESULTS  
EPA NO. 325.3

Sample No.	Chloride Ion Content (%)
B2&B4 @ 0-5'	0.007
B6&B8 @ 0-5'	0.008

SUMMARY OF LABORATORY WATER SOLUBLE SULFATE TEST RESULTS  
CALIFORNIA TEST NO. 417

Sample No.	Water Soluble Sulfate (% SQ <sub>4</sub> )	Sulfate Exposure*
B2&B4 @ 0-5'	0.000	S0
B6&B8 @ 0-5'	0.000	S0

	<b>CORROSIVITY TEST RESULTS</b>	Project No.: W1251-06-01
	Checked by: JMH	Lawrence Drive & Corporate Center Drive Thousand Oaks, CA
		DEC. 2020 <span style="float: right;">Figure B24</span>



Project No. W1251-06-01  
March 22, 2022

Mr. Thomas Wood  
Cruzan Properties – Investments, LLC  
505 N. Brand Blvd., Suite 210  
Glendale, CA 91203

Subject: PERCOLATION TEST RESULTS  
PROPOSED INDUSTRIAL DISTRIBUTION CENTER  
LAWRENCE DRIVE & CORPORATE CENTER DRIVE  
THOUSAND OAKS, CALIFORNIA  
APN: 667 0172 015, 667 0172 025, 667 0172 035

Reference: *Geotechnical Investigation*, prepared by Geocon West, Inc., dated December 8, 2020.

Dear Mr. Wood:

In accordance with your authorization of our proposal dated March 4, 2022, this letter has been prepared to present the results of the percolation testing performed at the subject site located at the southeast corner of the intersection of Lawrence Drive and Corporate Center Drive in the City of Thousand Oaks, California.

Based on information provided by the design engineer, it is our understanding that the proposed stormwater infiltration system consists of a deep drywell infiltration system that will introduce water into the soil at a depth between 15 and 50 feet below the existing ground surface.

The site was explored on March 19, 2022, by drilling one 8-inch diameter boring with a truck mounted hollow stem auger, denoted on the Site Plan as B9 (see Figure 1), to depths of 60½ feet below the existing ground. The boring logs are provided herein as Appendix A. The boring was over excavated to collect soil samples and was backfilled to the proposed invert elevation with a bentonite seal placed at the bottom of the invert. Slotted casing was set into the boring and the annular space between the casing and excavation was filled with gravel. The boring was then filled with water to pre-saturate the soils. The casing was refilled with water and percolation test readings were performed after repeated flooding of the cased excavation.

Based on the test results, the field-measured percolation rate and the design infiltration rate are provided in the following table. The Reduction Factor (Rf), to convert the field-measured percolation rate to an infiltration rate, is also shown in the table below. This value has been calculated in accordance with the Boring Percolation Test Procedure in the County of Los Angeles Department of Public Works GMED Guidelines for Design, Investigation, and Reporting Low Impact Development Stormwater Infiltration (June 2021). Calculations of the percolation rate, reduction factor, and infiltration rate are provided on Figure 2.

<b>Boring</b>	<b>Soil Type</b>	<b>Infiltration Depth (ft)</b>	<b>Measured Percolation Rate (in / hour)</b>	<b>Design Infiltration Rate (in / hour)</b>
B9	Older Alluvium	15-50	0.07	0.02

Based on the test method utilized (Boring Percolation Test), the reduction factor Rf<sub>t</sub> may be taken as 1.0 in the infiltration system design. Based on the number of tests performed and consistency of the soils throughout the site, it is suggested that the reduction factor Rf<sub>v</sub> be taken as 1.0. In addition, provided proper maintenance is performed to minimize long-term siltation and plugging, the reduction factor Rf<sub>s</sub> may be taken as 1.0. Additional correction factors may be required and should be applied by the engineer in responsible charge of the design of the stormwater infiltration system and based on applicable guidelines.

The results of the percolation testing indicated that the infiltration rate within the alluvial soils at the location and depths listed in the table above is less than the generally accepted minimally required infiltration rate of 0.3 inches per hour. The slow infiltration rate is likely the result of the very dense soils that are present within the tested layers, which are typically not conducive to rapid infiltration. Based on these considerations, a stormwater infiltration system is not recommended for this development. It is suggested that stormwater be retained, filtered and discharged in accordance with the requirements of the local governing agency.

If you have any questions regarding this letter, or if we may be of further service, please contact the undersigned.

Should you have any questions regarding this letter, or if we may be of further service, please contact the undersigned at your convenience.

Very truly yours,

**GEOCON WEST, INC.**



Joe Hicks, M.S.  
PE 93183



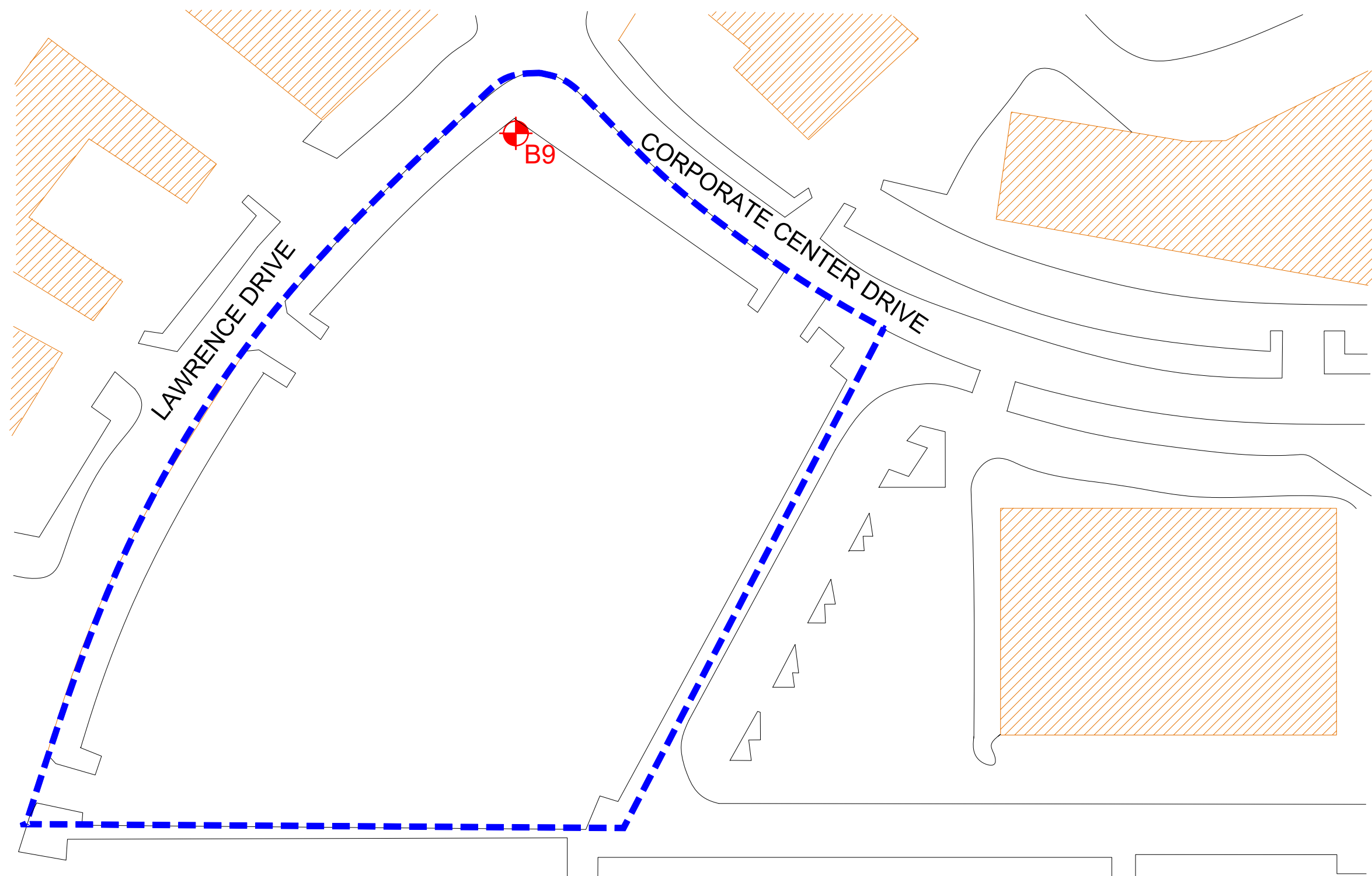

Neal Berliner  
GE 2576

Attachments: Figure 1, Site Plan  
Figure 2, Percolation Test Calculations  
Figure A1, Boring Log



Legend

-  B9 Boring Locations
-  Limit of Proposed Improvements
-  Existing Off-Site Structures



<b>GEOCON</b> WEST, INC.		
ENVIRONMENTAL GEOTECHNICAL MATERIALS 3303 N. SAN FERNANDO BLVD. - SUITE 100 - BURBANK, CA 91504 PHONE (818) 841-8388 - FAX (818) 841-1704		
DRAFTED BY: JMH	CHECKED BY: NDB	

<b>SITE PLAN</b>		
Lawrence Drive & Corporate Center Drive Thousand Oaks, CA		
MARCH 2022	PROJECT NO: W1251-06-01	FIG. 1

**BORING PERCOLATION TEST FIELD LOG**

<p>Date: <u>Saturday, March 19, 2022</u></p> <p>Project Number: <u>W1251-06-01</u></p> <p>Project Location: <u>Corporate Center Drive</u></p> <p>Earth Description: <u>SM</u></p> <p>Tested By: <u>MR</u></p> <p>Liquid Description: <u>Clear Clean Tap Water</u></p> <p>Measurement Method: <u>Sounder</u></p> <p>Start Time for Pre-Soak: <u>9:30 AM</u></p> <p>Start Time for Standard: <u>10:30 AM</u></p>	<p>Boring/Test Number: <u>Boring 9 / Test 1</u></p> <p>Diameter of Boring: <u>8</u> inches</p> <p>Diameter of Casing: <u>2</u> inches</p> <p>Depth of Boring: <u>50</u> feet</p> <p>Depth to Invert of BMP: <u>15</u> feet</p> <p>Depth to Water Table: <u>100</u> feet</p> <p>Depth to Initial Water Depth (d<sub>1</sub>): <u>177.6</u> inches</p> <p>Water Remaining in Boring (Y/N): <u>Yes</u></p> <p>Standard Time Interval Between Readings: <u>30 min</u></p>
----------------------------------------------------------------------------------------------------------------------------------------------------------------------------------------------------------------------------------------------------------------------------------------------------------------------------------------------------------------------------------------------------------------	-----------------------------------------------------------------------------------------------------------------------------------------------------------------------------------------------------------------------------------------------------------------------------------------------------------------------------------------------------------------------------------------------------------------------------------------------------------------------

Reading Number	Time Start (hh:mm)	Time End (hh:mm)	Elapsed Time Δtime (min)	Water Drop During Standard Time Interval, Δd (in)	Soil Description Notes Comments
1	11:00 AM	11:30 AM	30	9.1	
2	11:30 AM	12:00 PM	30	9.7	
3	12:00 PM	12:30 PM	30	9.5	
4	12:30 PM	1:00 PM	30	7.4	
5	1:00 AM	1:30 AM	30	7.1	
6	1:30 AM	2:00 AM	30	7.0	Stabilized Readings
7	2:00 AM	2:30 AM	30	7.0	Achieved with Readings
8	2:30 AM	3:00 AM	30	7.0	6, 7, and 8

**MEASURED PERCOLATION RATE & DESIGN INFILTRATION RATE CALCULATIONS\***

\* Calculations Below Based on Stabilized Readings Only

Boring Radius, r: 4 inches  
 Test Section Height, h: 422.4 inches

Test Section Surface Area,  $A = 2\pi rh + \pi r^2$   
 $A = 10666 \text{ in}^2$

Discharged Water Volume,  $V = \pi r^2 \Delta d$

Percolation Rate =  $\left(\frac{V/A}{\Delta T}\right)$

Reading 6      V = 350 in<sup>3</sup>  
 Reading 7      V = 350 in<sup>3</sup>  
 Reading 8      V = 350 in<sup>3</sup>

Percolation Rate = 0.07 inches/hour  
 Percolation Rate = 0.07 inches/hour  
 Percolation Rate = 0.07 inches/hour

Measured Percolation Rate = 0.07 inches/hour

**Reduction Factors**

Boring Percolation Test, RF<sub>t</sub> = 1  
 Site Variability, RF<sub>v</sub> = 1  
 Long Term Siltation, RF<sub>s</sub> = 1

Total Reduction Factor,  $RF = RF_t + RF_v + RF_s$   
 Total Reduction Factor = 3

**Design Infiltration Rate**

Design Infiltration Rate = Measured Percolation Rate / RF

Design Infiltration Rate = 0.02 inches/hour







**FIGURE 2**



DEPTH IN FEET	SAMPLE NO.	LITHOLOGY	GROUNDWATER	SOIL CLASS (USCS)	<b>BORING 9</b>		PENETRATION RESISTANCE (BLOWS/FT*)	DRY DENSITY (P.C.F.)	MOISTURE CONTENT (%)
					ELEV. (MSL.) --	DATE COMPLETED <u>03/19/2022</u>			
					EQUIPMENT <u>HOLLOW STEM AUGER</u> BY: <u>MR</u>				
MATERIAL DESCRIPTION									
0					<b>AC: 4" BASE: 8" ARTIFICIAL FILL</b>				
2									
4									
6					<b>ALLUVIUM</b> Silty Sand, poorly graded, very dense, slightly moist, yellowish brown, fine-grained, some fine gravel, trace medium-grained.				
8									
10	B9@10'			SM				50 (6")	
12									
14									
16									
18									
20	B9@20'				Sandy Silt, hard, slightly moist, yellowish brown, fine-grained, some oxidation.				
22				ML				50 (5")	
24									
26					Silt with Sand, poorly graded, hard, yellowish brown, fine-grained, trace medium-grained and fine gravel.				
28	B9@29'			ML				50 (6")	

**Figure A1,**  
**Log of Boring 9, Page 1 of 3**

W1251-06-01 BORING LOGS.GPJ







<b>SAMPLE SYMBOLS</b>	 ... SAMPLING UNSUCCESSFUL	 ... STANDARD PENETRATION TEST	 ... DRIVE SAMPLE (UNDISTURBED)
	 ... DISTURBED OR BAG SAMPLE	 ... CHUNK SAMPLE	 ... WATER TABLE OR SEEPAGE

NOTE: THE LOG OF SUBSURFACE CONDITIONS SHOWN HEREON APPLIES ONLY AT THE SPECIFIC BORING OR TRENCH LOCATION AND AT THE DATE INDICATED. IT IS NOT WARRANTED TO BE REPRESENTATIVE OF SUBSURFACE CONDITIONS AT OTHER LOCATIONS AND TIMES.

DEPTH IN FEET	SAMPLE NO.	LITHOLOGY	GROUNDWATER	SOIL CLASS (USCS)	<b>BORING 9</b>		PENETRATION RESISTANCE (BLOWS/FT*)	DRY DENSITY (P.C.F.)	MOISTURE CONTENT (%)
					ELEV. (MSL.) --	DATE COMPLETED <u>03/19/2022</u>			
					EQUIPMENT <u>HOLLOW STEM AUGER</u> BY: <u>MR</u>				
MATERIAL DESCRIPTION									
30				ML					
32					Silt, hard, slightly moist, yellowish brown, trace fine-grained sand.				
34	B9@34.5'						50 (6")		
36				ML					
38									
40	B9@39'				- increase in silt		50 (5")		
42									
44	B9@44.5'			SP	Sand, poorly graded, very dense, slightly moist, yellowish brown, fine-grained, some silt.		50 (4")		
46									
48					Silt, hard, slightly moist, brown, light oxidation mottles.				
50	B9@50'						50 (6")		
52									
54	B9@54.5'			ML					
56									
58									

**Figure A1,**  
**Log of Boring 9, Page 2 of 3**

W1251-06-01 BORING LOGS.GPJ

SAMPLE SYMBOLS	 ... SAMPLING UNSUCCESSFUL	 ... STANDARD PENETRATION TEST	 ... DRIVE SAMPLE (UNDISTURBED)
	 ... DISTURBED OR BAG SAMPLE	 ... CHUNK SAMPLE	 ... WATER TABLE OR SEEPAGE

NOTE: THE LOG OF SUBSURFACE CONDITIONS SHOWN HEREON APPLIES ONLY AT THE SPECIFIC BORING OR TRENCH LOCATION AND AT THE DATE INDICATED.  
IT IS NOT WARRANTED TO BE REPRESENTATIVE OF SUBSURFACE CONDITIONS AT OTHER LOCATIONS AND TIMES.

DEPTH IN FEET	SAMPLE NO.	LITHOLOGY	GROUNDWATER	SOIL CLASS (USCS)	<b>BORING 9</b>		PENETRATION RESISTANCE (BLOWS/FT*)	DRY DENSITY (P.C.F.)	MOISTURE CONTENT (%)
					ELEV. (MSL.) --	DATE COMPLETED <u>03/19/2022</u>			
					EQUIPMENT <u>HOLLOW STEM AUGER</u> BY: <u>MR</u>				
MATERIAL DESCRIPTION									
60	B9@59.5'			ML			50 (4")		
					Total depth of boring: 60.5 feet Fill to 5 feet. No groundwater encountered. Backfilled with soil cuttings and tamped. AC patched with cold patch.  *Penetration resistance for 140-pound hammer falling 30 inches by auto-hammer. NOTE: The stratification lines presented herein represent the approximate boundary between earth types; the transitions may be gradual.				

**Figure A1,  
Log of Boring 9, Page 3 of 3**

W1251-06-01 BORING LOGS.GPJ

SAMPLE SYMBOLS	<input type="checkbox"/> ... SAMPLING UNSUCCESSFUL	<input type="checkbox"/> ... STANDARD PENETRATION TEST	<input type="checkbox"/> ... DRIVE SAMPLE (UNDISTURBED)
	<input checked="" type="checkbox"/> ... DISTURBED OR BAG SAMPLE	<input checked="" type="checkbox"/> ... CHUNK SAMPLE	<input checked="" type="checkbox"/> ... WATER TABLE OR SEEPAGE

NOTE: THE LOG OF SUBSURFACE CONDITIONS SHOWN HEREON APPLIES ONLY AT THE SPECIFIC BORING OR TRENCH LOCATION AND AT THE DATE INDICATED. IT IS NOT WARRANTED TO BE REPRESENTATIVE OF SUBSURFACE CONDITIONS AT OTHER LOCATIONS AND TIMES.

# Appendix D – LID and Grading Plan

W:\LAX20207\60Civil\CAD\Sheet\Planning\LAX202077\_Conceptual\_LID\_Plan.dwg 08/18/2022 3:12 PM AMM 1:1

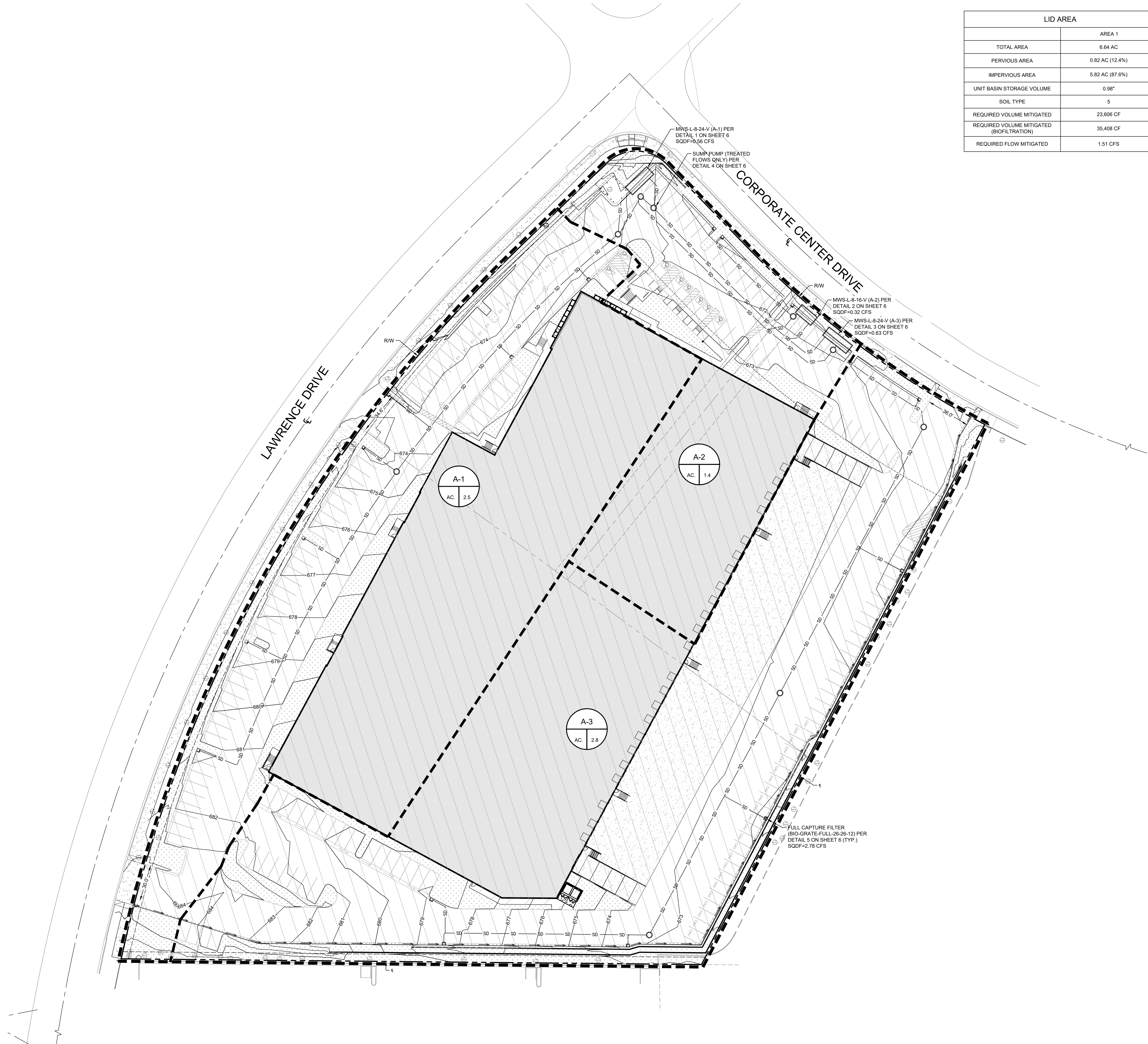

LID AREA	
	AREA 1
TOTAL AREA	6.64 AC
PERVIOUS AREA	0.82 AC (12.4%)
IMPERVIOUS AREA	5.82 AC (87.6%)
UNIT BASIN STORAGE VOLUME	0.98'
SOIL TYPE	5
REQUIRED VOLUME MITIGATED	23,608 CF
REQUIRED VOLUME MITIGATED (BIOFILTRATION)	35,408 CF
REQUIRED FLOW MITIGATED	1.51 CFS

- LEGEND**
- RIGHT OF WAY/ PROPERTY LINE
  - - - LID AREA BOUNDARY
  - ▨ IMPERVIOUS AREA
  - ▤ PERVIOUS AREA
  - FLOW PATH
  - ▭ PROPOSED BUILDING
  - SD STORM DRAIN
  - ◻ MODULAR WETLAND
  - STORM DRAIN MANHOLE
  - INLET

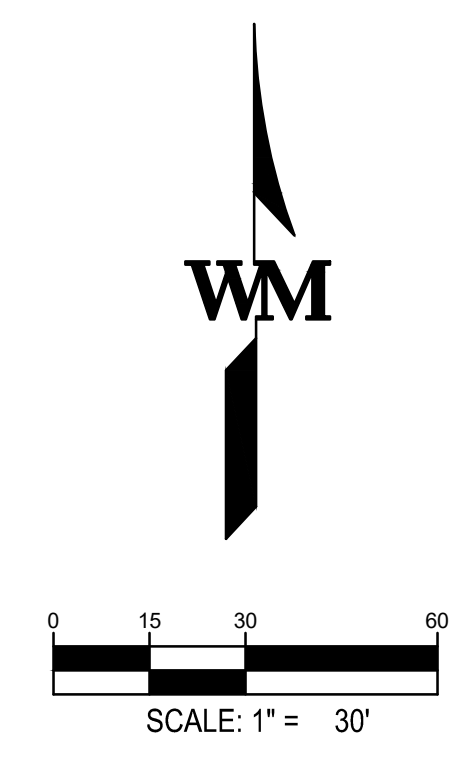

**WARE MALCOMB**  
 LEADING DESIGN FOR COMMERCIAL REAL ESTATE  
 915 Wilshire Blvd  
 Suite 2150  
 Los Angeles, CA 90017  
 P 310.803.4000  
 waramalcomb.com



FOR AND ON BEHALF OF WARE MALCOMB

1300 LAWRENCE DRIVE  
 1300 LAWRENCE DRIVE  
 THOUSAND OAKS, CA 91320

NO.	DATE	REVISIONS
	08/18/2022	PLANNING SUBMITTAL

JOB NO.:	LAX202077
PA / PM:	KM
DESIGNED:	AM
DATE:	08/18/2022
PLOT DATE:	08/18/22

SHEET  
**5**  
 of 6  
 NOT FOR CONSTRUCTION

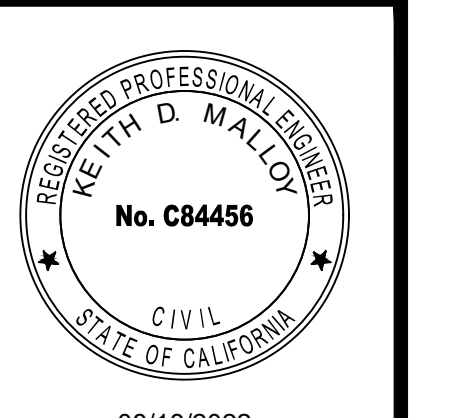

08/18/2022

FOR AND ON BEHALF OF WARE MALCOLM

SITE SPECIFIC DATA			
PROJECT NUMBER	LAX20-0077		
PROJECT NAME	Cruzan Thousand Oaks		
PROJECT LOCATION	1300 Lawrence Drive		
STRUCTURE ID	A-1		
TREATMENT REQUIRED	VOLUME BASED (CF)		
VOLUME BASED (CF)	FLOW BASED (CFS)		
N/A	0.58		
PEAK BYPASS REQUIRED (CFS) - IF APPLICABLE			
PIPE DATA	IE	MATERIAL	DIAMETER
INLET PIPE 1	N/A	N/A	N/A
INLET PIPE 2	N/A	N/A	N/A
OUTLET PIPE	PRETREATMENT BIOFILTRATION DISCHARGE		
RIM ELEVATION			
SURFACE LOAD			
FRAME & COVER	2EA #30" OPEN PLANTER	2EA #24"	
NOTES:	*PRELIMINARY NOT FOR CONSTRUCTION		

**INSTALLATION NOTES**

- CONTRACTOR TO PROVIDE ALL LABOR EQUIPMENT MATERIALS AND ACCESSORIES REQUIRED TO OUTFIT AND INSTALL THE SYSTEM AND APPURTENANCES IN ACCORDANCE WITH THIS DRAWING AND THE MANUFACTURERS SPECIFICATIONS, UNLESS OTHERWISE STATED IN MANUFACTURERS CONTRACT.
- UNIT MUST BE INSTALLED ON LEVEL BASE. MANUFACTURER RECOMMENDS A MINIMUM 6" LEVEL ROCK BASE UNLESS SPECIFIED BY THE PROJECT ENGINEER. CONTRACTOR IS RESPONSIBLE TO VERIFY PROJECT ENGINEERS RECOMMENDED BASE SPECIFICATIONS.
- CONTRACTOR TO SUPPLY AND INSTALL ALL EXTERNAL CONNECTING PIPES. ALL PIPES MUST BE FLUSH WITH INSIDE SURFACE OF CONCRETE. (PIPES CANNOT INTRUDE BEYOND FLOOR). INVERT OF OUTLET PIPE MUST BE FLUSH WITH DISCHARGE CHAMBER FLOOR. ALL PIPES SHALL BE SEALED WATER TIGHT PER MANUFACTURERS STANDARD CONNECTION DETAIL.
- CONTRACTOR RESPONSIBLE FOR INSTALLATION OF ALL RISERS, MANHOLES AND HATCHES. CONTRACTOR TO GROUT ALL MANHOLES AND HATCHES TO MATCH FINISHED SURFACE UNLESS SPECIFIED OTHERWISE.
- VEGETATION SUPPLIED AND INSTALLED BY OTHERS. ALL UNITS WITH VEGETATION MUST HAVE DRIP OR SPRAY IRRIGATION SUPPLIED AND INSTALLED BY OTHERS.
- CONTRACTOR RESPONSIBLE FOR CONTACTING BIO CLEAN FOR ACTIVATION OF UNIT. MANUFACTURERS WARRANTY IS VOID WITH OUT PROPER ACTIVATION BY A BIO CLEAN REPRESENTATIVE.

**GENERAL NOTES**

- MANUFACTURER TO PROVIDE ALL MATERIALS UNLESS OTHERWISE NOTED.
- ALL DIMENSIONS, ELEVATIONS, SPECIFICATIONS AND CAPACITIES ARE SUBJECT TO CHANGE. FOR PROJECT SPECIFIC DRAWINGS DETAILING EXACT DIMENSIONS, WEIGHTS AND ACCESSORIES PLEASE CONTACT BIO CLEAN.

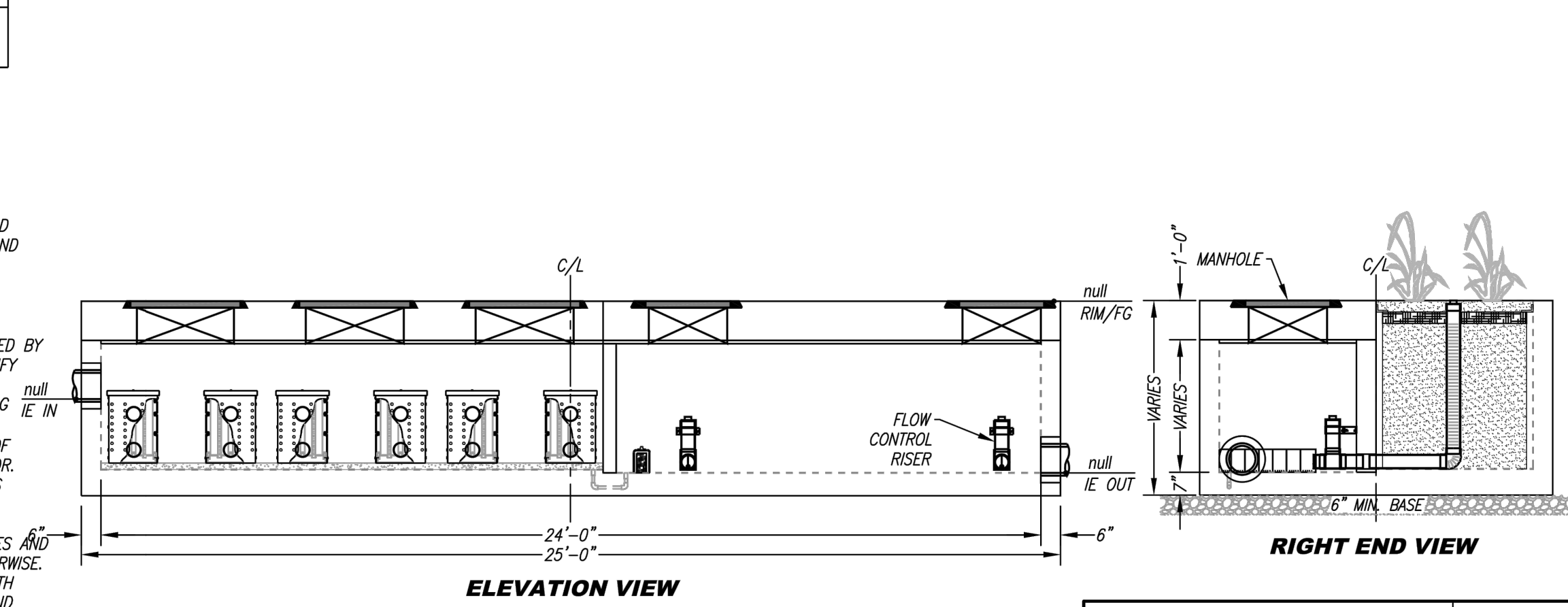
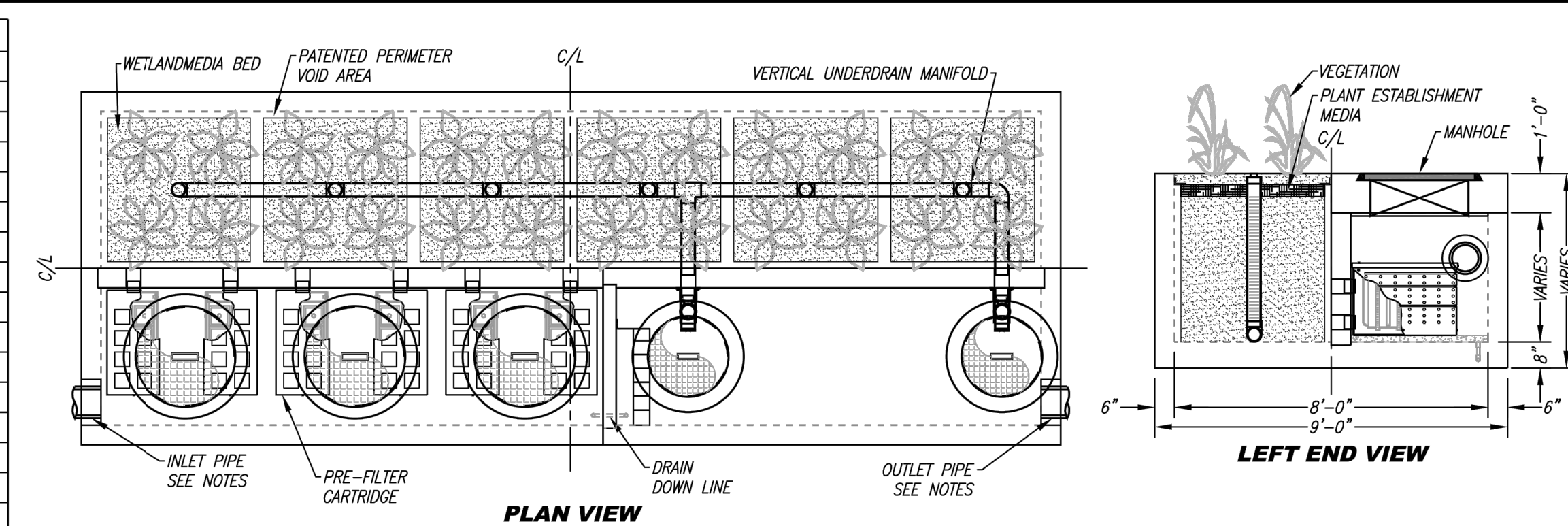

TREATMENT FLOW (CFS)	0.58
OPERATING HEAD (FT)	2.7
PRETREATMENT LOADING RATE (GPM/SF)	1.8
RETARD MEDIA LOADING RATE (GPM/SF)	1.8

MWS-L-8-24-V (A-1)

SCALE: N.T.S.

1

SITE SPECIFIC DATA			
PROJECT NUMBER	LAX20-0077		
PROJECT NAME	Cruzan Thousand Oaks		
PROJECT LOCATION	1300 Lawrence Drive		
STRUCTURE ID	A-3		
TREATMENT REQUIRED	VOLUME BASED (CF)		
VOLUME BASED (CF)	FLOW BASED (CFS)		
N/A	0.63		
PEAK BYPASS REQUIRED (CFS) - IF APPLICABLE			
PIPE DATA	IE	MATERIAL	DIAMETER
INLET PIPE 1	N/A	N/A	N/A
INLET PIPE 2	N/A	N/A	N/A
OUTLET PIPE	PRETREATMENT BIOFILTRATION DISCHARGE		
RIM ELEVATION			
SURFACE LOAD			
FRAME & COVER	3EA #30" OPEN PLANTER	2EA #24"	
NOTES:	*PRELIMINARY NOT FOR CONSTRUCTION		

**INSTALLATION NOTES**

- CONTRACTOR TO PROVIDE ALL LABOR EQUIPMENT MATERIALS AND ACCESSORIES REQUIRED TO OUTFIT AND INSTALL THE SYSTEM AND APPURTENANCES IN ACCORDANCE WITH THIS DRAWING AND THE MANUFACTURERS SPECIFICATIONS, UNLESS OTHERWISE STATED IN MANUFACTURERS CONTRACT.
- UNIT MUST BE INSTALLED ON LEVEL BASE. MANUFACTURER RECOMMENDS A MINIMUM 6" LEVEL ROCK BASE UNLESS SPECIFIED BY THE PROJECT ENGINEER. CONTRACTOR IS RESPONSIBLE TO VERIFY PROJECT ENGINEERS RECOMMENDED BASE SPECIFICATIONS.
- CONTRACTOR TO SUPPLY AND INSTALL ALL EXTERNAL CONNECTING PIPES. ALL PIPES MUST BE FLUSH WITH INSIDE SURFACE OF CONCRETE. (PIPES CANNOT INTRUDE BEYOND FLOOR). INVERT OF OUTLET PIPE MUST BE FLUSH WITH DISCHARGE CHAMBER FLOOR. ALL PIPES SHALL BE SEALED WATER TIGHT PER MANUFACTURERS STANDARD CONNECTION DETAIL.
- CONTRACTOR RESPONSIBLE FOR INSTALLATION OF ALL RISERS, MANHOLES AND HATCHES. CONTRACTOR TO GROUT ALL MANHOLES AND HATCHES TO MATCH FINISHED SURFACE UNLESS SPECIFIED OTHERWISE.
- VEGETATION SUPPLIED AND INSTALLED BY OTHERS. ALL UNITS WITH VEGETATION MUST HAVE DRIP OR SPRAY IRRIGATION SUPPLIED AND INSTALLED BY OTHERS.
- CONTRACTOR RESPONSIBLE FOR CONTACTING BIO CLEAN FOR ACTIVATION OF UNIT. MANUFACTURERS WARRANTY IS VOID WITH OUT PROPER ACTIVATION BY A BIO CLEAN REPRESENTATIVE.

**GENERAL NOTES**

- MANUFACTURER TO PROVIDE ALL MATERIALS UNLESS OTHERWISE NOTED.
- ALL DIMENSIONS, ELEVATIONS, SPECIFICATIONS AND CAPACITIES ARE SUBJECT TO CHANGE. FOR PROJECT SPECIFIC DRAWINGS DETAILING EXACT DIMENSIONS, WEIGHTS AND ACCESSORIES PLEASE CONTACT BIO CLEAN.

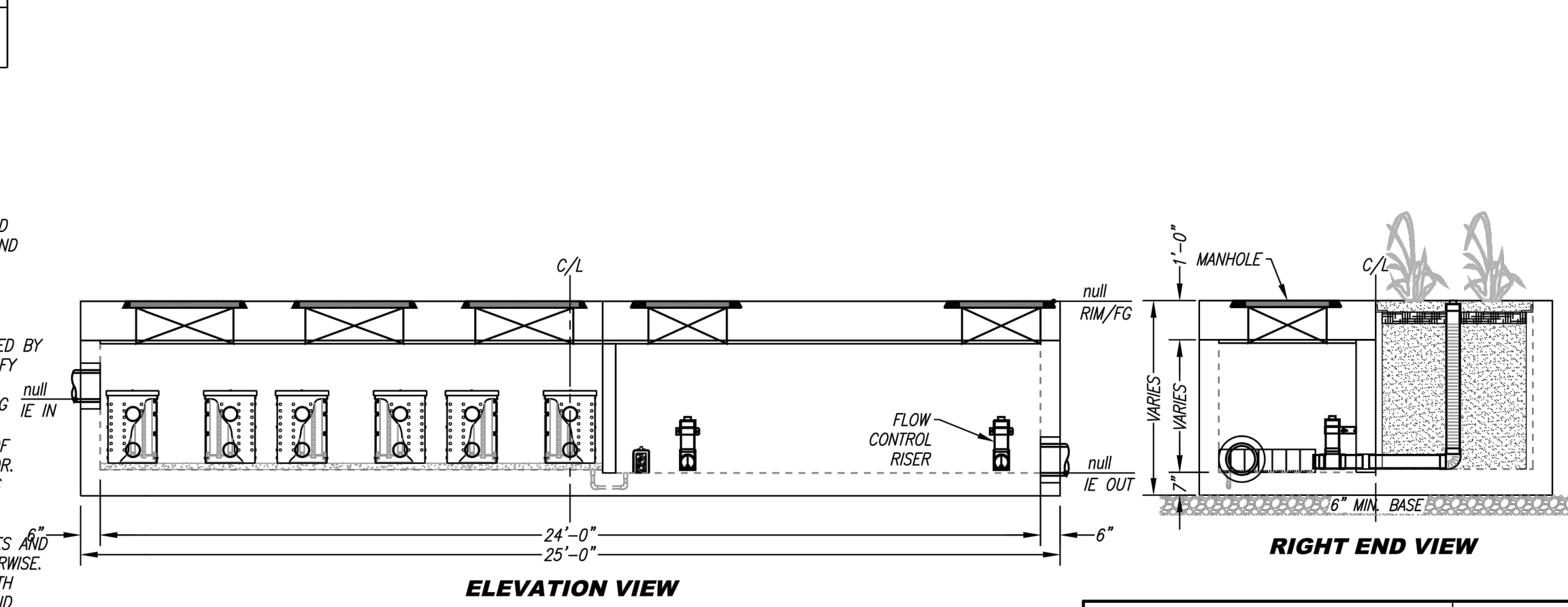
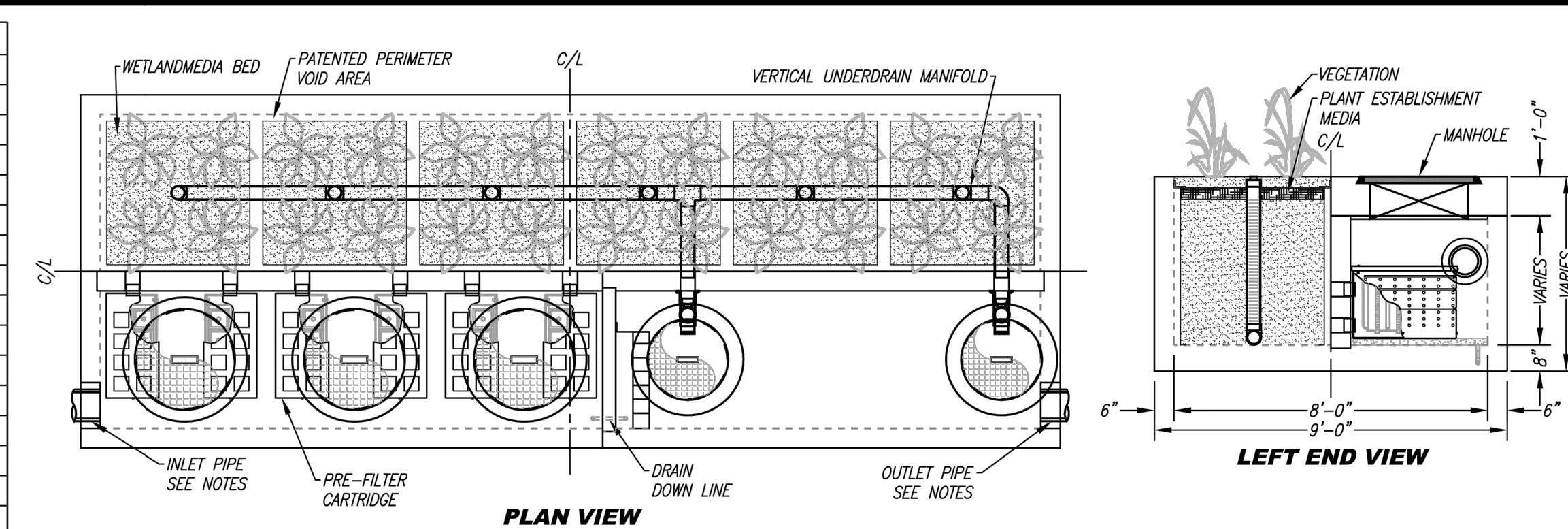

TREATMENT FLOW (CFS)	0.63
OPERATING HEAD (FT)	3.1
PRETREATMENT LOADING RATE (GPM/SF)	1.8
RETARD MEDIA LOADING RATE (GPM/SF)	1.8

MWS-L-8-24-V (A-3)

SCALE: N.T.S.

3

**BIO CLEAN FULL CAPTURE FILTER FOR USE IN GRATE INLETS**

**NOTES:**

- ALL HARDWARE, FLANGE, FRAME, SCREENS SHALL BE STAINLESS STEEL.
- HYDROPHOBIC BASK SHALL BE 2" DIAMETER AND CONNECTED MECHANICALLY TO THE FILTER FRAME WITH RAILS ALLOWING IT TO FLOAT.
- SEE PERFORMANCE REPORTS IN MANUFACTURERS SPECIFICATIONS.
- OTHER STANDARD AND CUSTOM MODEL SIZES AVAILABLE - CONTACT BIO CLEAN FOR MORE INFORMATION.
- BASED ON 1% OPEN AREA.
- CONSIDERS A LOCAL DISTRIBUTION FLOODING DEPTH OF 6 INCHES.
- STORAGE CAPACITY BASED ON THE BASKET FULL.
- CONCRETE STRUCTURES SOLD SEPARATELY.

MODEL #	TREATMENT FLOW (CF)	BYPASS FLOW (CF)	SOLIDS STORAGE CAPACITY (CF)
BIO-GRATE-FULL 15-18-12	0.97	1.55	0.14
BIO-GRATE-FULL 18-18-12	1.86	3.68	0.35
BIO-GRATE-FULL 26-26-12	2.78	4.83	0.60
BIO-GRATE-FULL 24-40-12	6.71	6.59	1.04
BIO-GRATE-FULL 26-26-24	9.49	4.83	1.80
BIO-GRATE-FULL 24-40-24	13.53	6.59	3.12
BIO-GRATE-FULL 36-36-24	17.14	7.60	4.45

**HEETS FULL CAPTURE REQUIREMENTS**

**BIO CLEAN**  
A Forterra Company

**PROJECT:**  
REVISIONS: [ ]  
DATE: [ ]

**DRAWING BIO CLEAN GRATE INLET FILTER DETAILS**  
TYPICAL NOTES: [ ]

**WARRANTY:** 1 YEAR MANUFACTURERS [ ]  
REVISIONS: [ ]  
DATE: [ ]

**BIO CLEAN ENVIRONMENTAL SERVICES, INC.**  
300 VIA VAN COTT DRIVE, SUITE 100, NORTH  
PHOENIX, AZ 85028-1740 FAX 760-433-3276  
REVISIONS: [ ]  
DATE: [ ]

**UNIT # INCHES**  
REVISIONS: [ ]  
DATE: [ ]

FULL CAPTURE FILTERS

SCALE: N.T.S.

5

SITE SPECIFIC DATA			
PROJECT NUMBER	LAX20-0077		
PROJECT NAME	Cruzan Thousand Oaks		
PROJECT LOCATION	1300 Lawrence Drive		
STRUCTURE ID	A-2		
TREATMENT REQUIRED	VOLUME BASED (CF)		
VOLUME BASED (CF)	FLOW BASED (CFS)		
N/A	0.32		
PEAK BYPASS REQUIRED (CFS) - IF APPLICABLE			
PIPE DATA	IE	MATERIAL	DIAMETER
INLET PIPE 1	N/A	N/A	N/A
INLET PIPE 2	N/A	N/A	N/A
OUTLET PIPE	PRETREATMENT BIOFILTRATION DISCHARGE		
RIM ELEVATION			
SURFACE LOAD			
FRAME & COVER	2EA #30" OPEN PLANTER	#24"	
NOTES:	*PRELIMINARY NOT FOR CONSTRUCTION		

**INSTALLATION NOTES**

- CONTRACTOR TO PROVIDE ALL LABOR EQUIPMENT MATERIALS AND ACCESSORIES REQUIRED TO OUTFIT AND INSTALL THE SYSTEM AND APPURTENANCES IN ACCORDANCE WITH THIS DRAWING AND THE MANUFACTURERS SPECIFICATIONS, UNLESS OTHERWISE STATED IN MANUFACTURERS CONTRACT.
- UNIT MUST BE INSTALLED ON LEVEL BASE. MANUFACTURER RECOMMENDS A MINIMUM 6" LEVEL ROCK BASE UNLESS SPECIFIED BY THE PROJECT ENGINEER. CONTRACTOR IS RESPONSIBLE TO VERIFY PROJECT ENGINEERS RECOMMENDED BASE SPECIFICATIONS.
- CONTRACTOR TO SUPPLY AND INSTALL ALL EXTERNAL CONNECTING PIPES. ALL PIPES MUST BE FLUSH WITH INSIDE SURFACE OF CONCRETE. (PIPES CANNOT INTRUDE BEYOND FLOOR). INVERT OF OUTLET PIPE MUST BE FLUSH WITH DISCHARGE CHAMBER FLOOR. ALL PIPES SHALL BE SEALED WATER TIGHT PER MANUFACTURERS STANDARD CONNECTION DETAIL.
- CONTRACTOR RESPONSIBLE FOR INSTALLATION OF ALL RISERS, MANHOLES AND HATCHES. CONTRACTOR TO GROUT ALL MANHOLES AND HATCHES TO MATCH FINISHED SURFACE UNLESS SPECIFIED OTHERWISE.
- VEGETATION SUPPLIED AND INSTALLED BY OTHERS. ALL UNITS WITH VEGETATION MUST HAVE DRIP OR SPRAY IRRIGATION SUPPLIED AND INSTALLED BY OTHERS.
- CONTRACTOR RESPONSIBLE FOR CONTACTING BIO CLEAN FOR ACTIVATION OF UNIT. MANUFACTURERS WARRANTY IS VOID WITH OUT PROPER ACTIVATION BY A BIO CLEAN REPRESENTATIVE.

**GENERAL NOTES**

- MANUFACTURER TO PROVIDE ALL MATERIALS UNLESS OTHERWISE NOTED.
- ALL DIMENSIONS, ELEVATIONS, SPECIFICATIONS AND CAPACITIES ARE SUBJECT TO CHANGE. FOR PROJECT SPECIFIC DRAWINGS DETAILING EXACT DIMENSIONS, WEIGHTS AND ACCESSORIES PLEASE CONTACT BIO CLEAN.

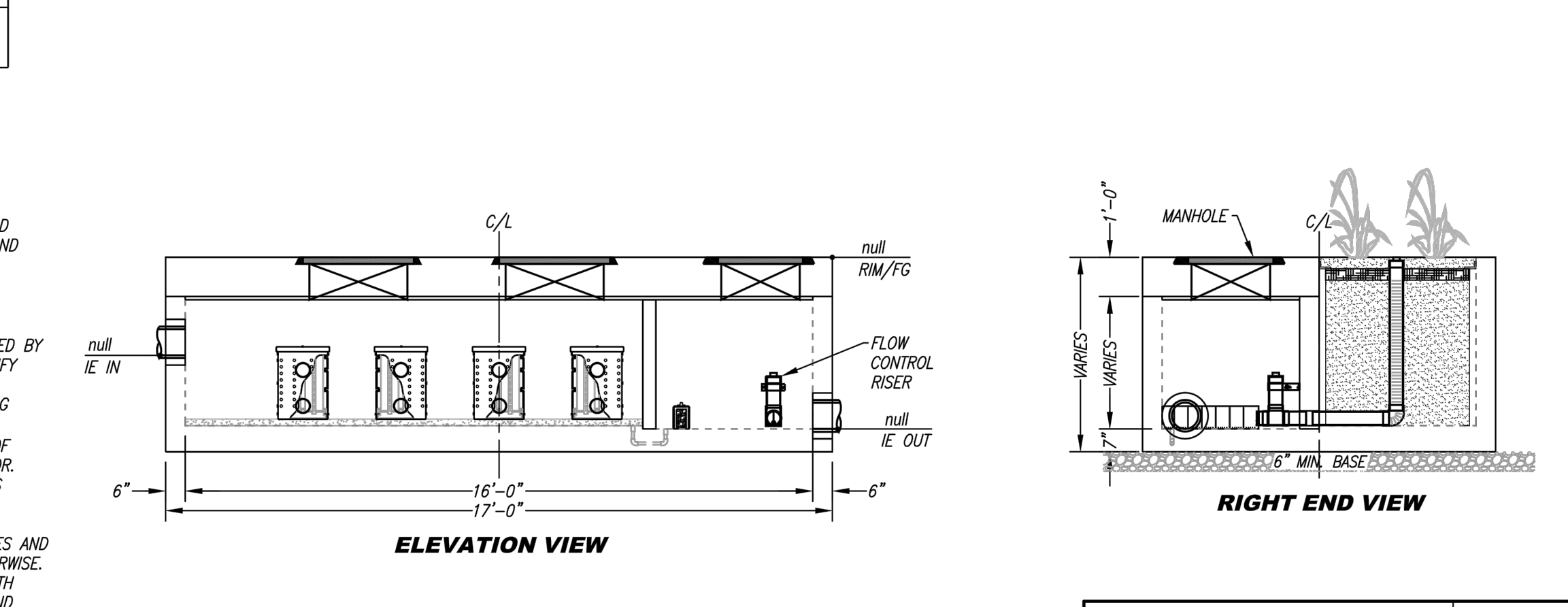
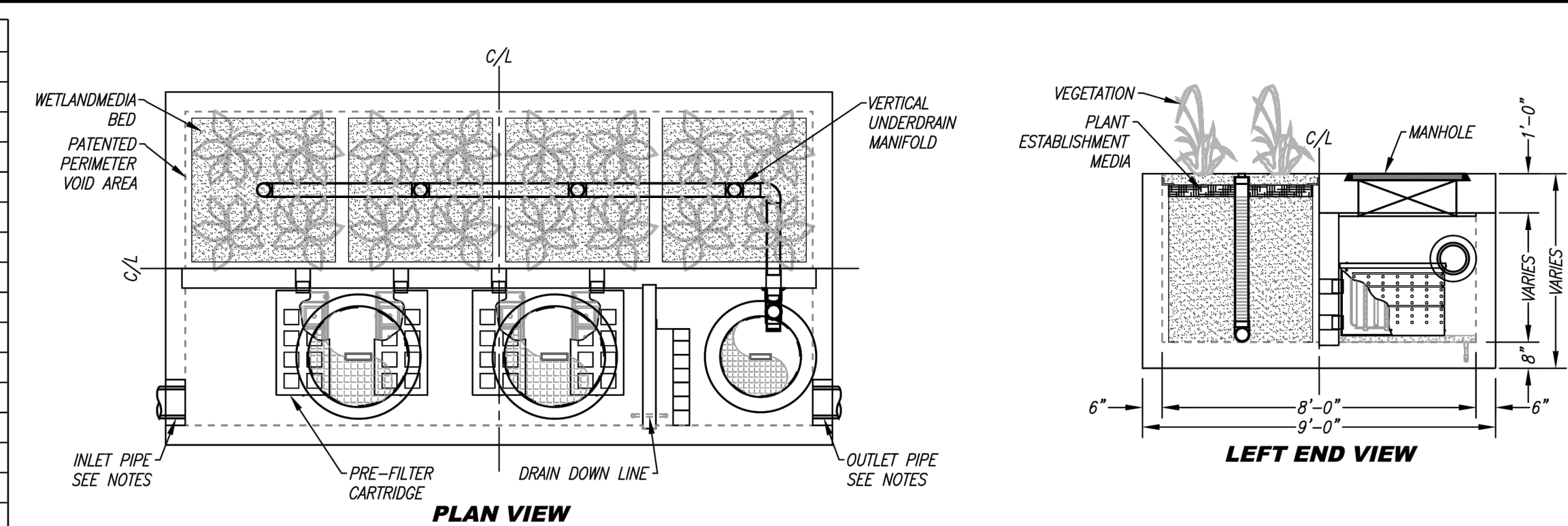

TREATMENT FLOW (CFS)	0.32
OPERATING HEAD (FT)	2.4
PRETREATMENT LOADING RATE (GPM/SF)	1.4
RETARD MEDIA LOADING RATE (GPM/SF)	1.0

MWS-L-8-16-V (A-2)

SCALE: N.T.S.

2

**PACKAGED PUMP LIFT STATION**  
1300 LAWRENCE DRIVE THOUSAND OAKS, CA 91320

**DESCRIPTION:** This unit is a self-contained pump lift station designed for the collection and removal of sanitary sewage from residential, commercial, and industrial buildings. The unit is designed to be installed in a concrete structure. The unit is designed to be installed in a concrete structure. The unit is designed to be installed in a concrete structure.

**PUMP:** The pump is a self-contained, submersible, centrifugal pump. The pump is designed to pump water to a discharge point. The pump is designed to pump water to a discharge point. The pump is designed to pump water to a discharge point.

**MATERIALS OF CONSTRUCTION:** The pump is constructed of cast iron. The pump is constructed of cast iron. The pump is constructed of cast iron. The pump is constructed of cast iron.

**MECHANICAL SEAL:** The pump has a mechanical seal. The pump has a mechanical seal. The pump has a mechanical seal. The pump has a mechanical seal.

**WARRANTY:** The pump is warranted for 1 year. The pump is warranted for 1 year. The pump is warranted for 1 year. The pump is warranted for 1 year.

**POWER CABLE AND CABLE ENTRANCE:** The pump has a power cable. The pump has a power cable. The pump has a power cable. The pump has a power cable.

**BIOPLEX ACTIVATING CONTROL SYSTEM:** The pump has a bioplex activating control system. The pump has a bioplex activating control system. The pump has a bioplex activating control system. The pump has a bioplex activating control system.

**OUTPUTS:** The pump has outputs. The pump has outputs. The pump has outputs. The pump has outputs.

**DOOR IN DOOR DEAD FRONT THROUGH DOOR MAIN ENCLOSURE:** The pump has a door in door dead front through door main enclosure. The pump has a door in door dead front through door main enclosure. The pump has a door in door dead front through door main enclosure. The pump has a door in door dead front through door main enclosure.

**INCLUDES EXHAUSTOR, RUN CONTROL, ALARM COUNTER AND FLOAT POSITION, X.**

SUMP PUMP

SCALE: N.T.S.

4

**STORM PUMP SYSTEM**

**PGC-666-60**

**PERFORMANCE:** 180 GPM AT 21.88 FT TDH

**LIFT STATION PROFILE & CALCULATIONS:**

ITEM	DESCRIPTION	HEIGHT (FT)	DIAMETER (IN)	LENGTH (FT)	LOSS (FT)
1	4" PVC PIPE	1.00	4	1.17	0.01
2	4" PVC 90 ELBOW	2.00	4	5.17	0.22
3	4" PVC 45 ELBOW	2.00	4	5.17	0.22
4	4" PVC TEE	0.00	4	21.87	0.81
5	4" BALL VALVE	0.00	4	2.71	0.11
6	4" OPEN VALVE	0.00	4	22.17	0.21
TOTAL EQUIVALENT LENGTH					58.71
FRICTION LOSS PER 100 FT 4" PVC					1.17
TOTAL FRICTION LOSS					6.87
STATIC HEAD					15.01
TOTAL HEAD					21.88

**HAZEN-WILLIAMS EQUATION HEAD LOSS IN WATER PIPE:**

$H_f = 0.002083 L Q^{1.85} / C^{1.49} D^{4.76}$

$H_f = 0.002083 (180)^{1.85} / 140^{1.49} 4^{4.76}$

$H_f = 1.17$

**PERFORMANCE:** 180 GPM @ 21.88 FT TDH

**HAZEN-WILLIAMS EQUATION HEAD LOSS IN WATER PIPE:**

$H_f = 0.002083 L Q^{1.85} / C^{1.49} D^{4.76}$

$H_f = 0.002083 (180)^{1.85} / 140^{1.49} 4^{4.76}$

$H_f = 1.17$

**PERFORMANCE:** 180 GPM @ 21.88 FT TDH

SUMP PUMP

SCALE: N.T.S.

4

**CONCEPT PLANS**  
**LID DETAILS**  
**ALL DETAILS**

NO.	DATE	DESCRIPTION
1	08/18/2022	PLANNING SUBMITTAL

JOB NO.:	LAX20-0077
PA/PM:	KM
DESIGNED BY:	AM
DATE:	08/18/2022
PLOT DATE:	08/18/2022



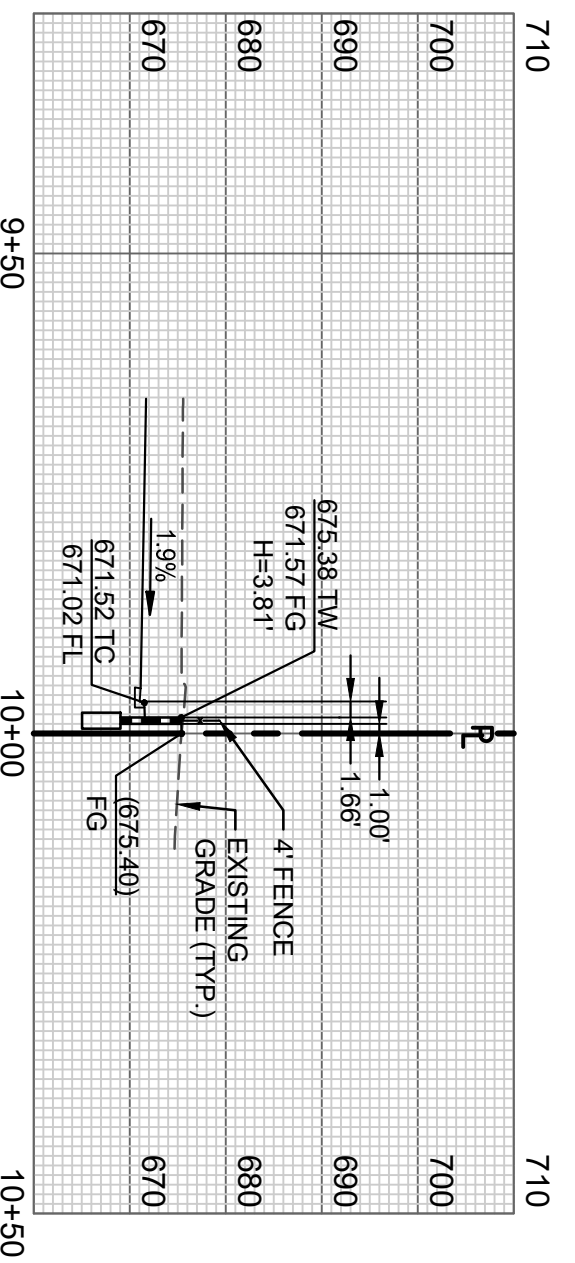
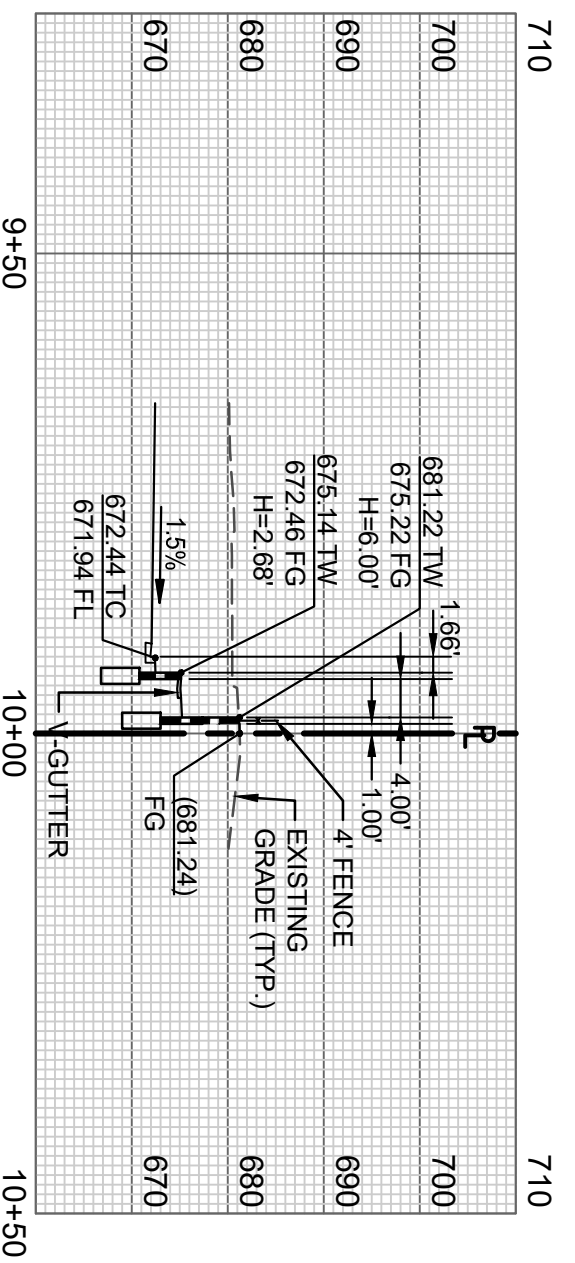
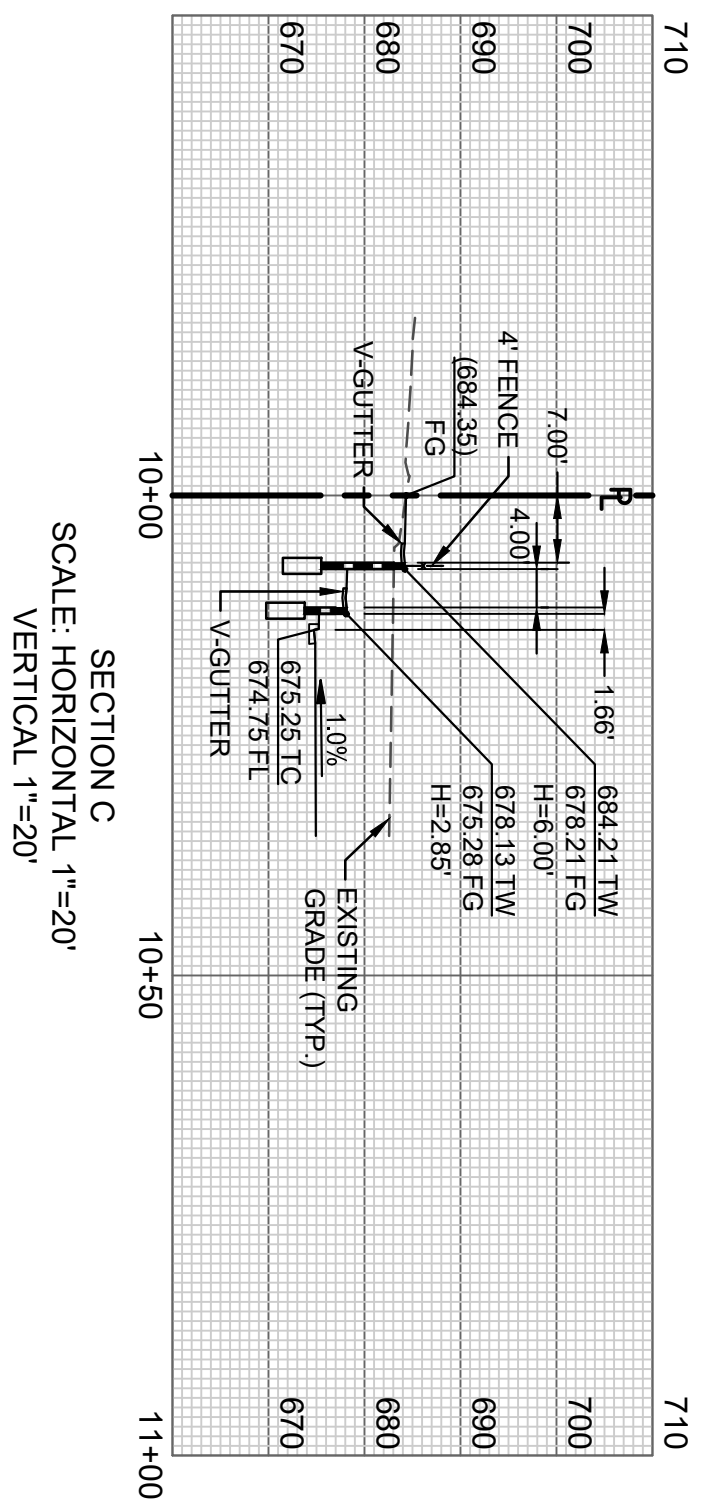
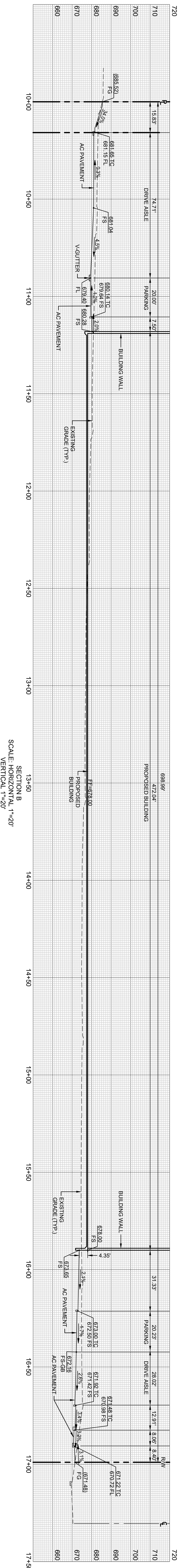
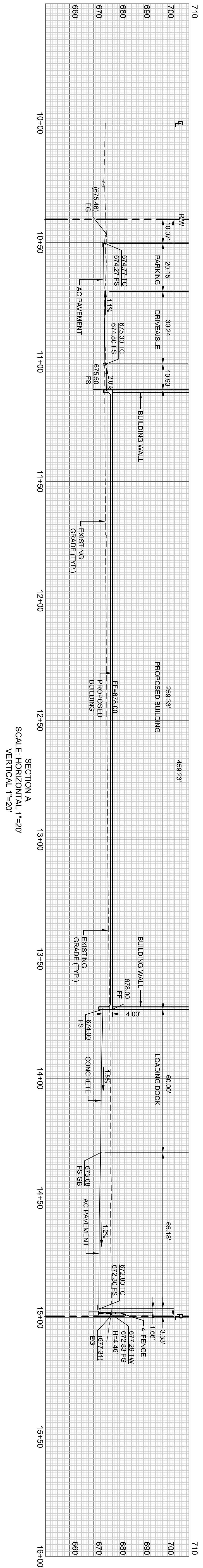

CAUTION: IF THIS SHEET IS NOT 30"x42" IT IS A REDUCED PRINT

<p><b>1300 LAWRENCE DRIVE</b></p> <p>1300 LAWRENCE DRIVE THOUSAND OAKS, CA 91320</p>			<p>915 wilshire Blvd. suite 2150 los angeles, ca 90017 p 310.903.4000 waremalcomb.com</p>	<p><b>WARE MALCOMB</b></p> <p>LEADING DESIGN FOR COMMERCIAL REAL ESTATE</p>
<p>THESE DRAWINGS AND SPECIFICATIONS ARE THE PROPERTY AND COPYRIGHT OF WARE MALCOMB AND SHALL NOT BE USED ON ANY OTHER WORK EXCEPT BY AGREEMENT WITH WARE MALCOMB. WRITTEN DIMENSIONS SHALL TAKE PRECEDENCE OVER SCALED DIMENSIONS AND SHALL BE VERIFIED ON THE JOB SITE. ANY DISCREPANCY SHALL BE BROUGHT TO THE NOTICE OF WARE MALCOMB PRIOR TO THE COMMENCEMENT OF ANY WORK.</p>				
<p>DATE: 08/18/2022 DESIGNED BY: AM DATE: 08/18/2022 FOOT DATE: 08/18/22</p>	<p>NO. 08/18/2022 DATE: 08/18/2022 PLANNING SUBMITTAL</p>	<p><b>CONCEPT PLANS SECTIONS</b></p>		
<p>SHEET</p> <p style="font-size: 2em; font-weight: bold;">2</p> <p>OF 6</p>				





## Appendix E – Soil Map



# Appendix F – Environmental Sensitive Area Map



**Legend**

- BIOL Designated Waterbody
- 303(d) Listed Waterbody
- Environmentally Sensitive Habitat Areas
- Lake
- National Forest
- Existing Urban Area**
- Santa Paula
- Simi Valley
- Thousand Oaks
- Port Hueneme
- Ventura
- Ojai
- Urban County
- Camarillo
- Fillmore
- Moorpark
- Oxnard
- Non-Urban County
- Adjacent County

10 5 0 10 Miles



**Environmentally Sensitive Areas**  
Ventura County, CA

**Geosyntec**  
consultants

Figure  
**B-2**

Oakland Office

June 2018

## Appendix G – VenturaTC Calculations

VENTURA COUNTY WATERSHED PROTECTION DISTRICT

TIME OF CONCENTRATION

TC Program Version: 2.64.0.37

Project: Cruzan - Pre-Development Hydrology

Date: 3/3/2022 1:52:09 PM

Engineer: AM

Consultant: Ware Malcomb

-----  
SUMMARY OF COMPUTATIONS  
-----

Watershed Name: Pre-Development Hydrology  
-----

Name	Zone	Storm	Soil	Area (acres)	TC (min)
Existing Hydrology	CON3	10	5.00	6.6 / 7	9.824 / 10

-----

---

Watershed Name: Pre-Development Hydrology

---

Sub-Area Name: Existing Hydrology

Tc: 9.824 Minutes

DATA FOR SUB AREA 1

---

SUB AREA TIME OF CONCENTRATION: 9.824 min. = 10 min.

---

SUB AREA INPUT DATA

---

Sub Area Name: Existing Hydrology

Total Area (ac): 6.64

Flood Zone: 3

Rainfall Zone: CON3

Storm Frequency (years): 10

Development Type: Industrial

Soil Type: 5.00

Percent Impervious: 88

SUB AREA OUTPUT

---

Intensity (in/hr): 1.944

C Total: 0.877

Sum Q Segments (cfs): 11.31

Q Total (cfs): 11.31

Sum Percent Area (%): 100.0

Sum of Flow Path Travel Times (sec): 589.45

Time of Concentration (min): 9.824

---



DATA FOR FLOW PATH 1

---

Flow Path Name: A1

FLOW PATH TRAVEL TIME (min): 2.4223

Flow Type: Overland

Length (ft): 72.67

Top Elevation (ft): 686.66

Bottom Elevation (ft): 682.77

Contributing Area (acres): 0.05

Percent of Sub-Area (%): 0.8

Overland Type: Mountain

Development Type: Industrial

Map Slope: 0.0535

Effective Slope: 0.0535

Q for Flow Path (cfs): 0.09

Avg Velocity (ft/s): 0.50

Passed Scour Check: N/A

---

DATA FOR FLOW PATH 2

---

Flow Path Name: A2

FLOW PATH TRAVEL TIME (min): 2.7866

Flow Type: Street

Length (ft): 509.82

Top Elevation (ft): 683.81

Bottom Elevation (ft): 674.82

Contributing Area (acres): 2.57

Percent of Sub-Area (%): 38.7

Street Width (ft): 32

Curb Height (in): 6

Map Slope: 0.0176

Q for Flow Path (cfs): 4.38

Q Top (cfs): 0.09

Q Bottom (cfs): 4.46

Velocity Top (ft/s): 1.10

Velocity Bottom (ft/s): 2.97

Avg Velocity (ft/s): 2.03

Wave Velocity (ft/s): 3.05

---

DATA FOR FLOW PATH 3

---

Flow Path Name: A3

FLOW PATH TRAVEL TIME (min): 1.8088

Flow Type: Street

Length (ft): 477.87

Top Elevation (ft): 680.28

Bottom Elevation (ft): 673.37

Contributing Area (acres): 1.66

Percent of Sub-Area (%): 25.0

Street Width (ft): 32

Curb Height (in): 6

Map Slope: 0.0145

Q for Flow Path (cfs): 2.83

Q Top (cfs): 4.46

Q Bottom (cfs): 7.29

Velocity Top (ft/s): 2.75

Velocity Bottom (ft/s): 3.12

Avg Velocity (ft/s): 2.94

Wave Velocity (ft/s): 4.40

---

DATA FOR FLOW PATH 4

---

Flow Path Name: A4

FLOW PATH TRAVEL TIME (min): 0.1567

Flow Type: Street

Length (ft): 71.02

Top Elevation (ft): 675.37

Bottom Elevation (ft): 671.72

Contributing Area (acres): 0.04

Percent of Sub-Area (%): 0.6

Street Width (ft): 32

Curb Height (in): 6

Map Slope: 0.0514

Q for Flow Path (cfs): 0.07

Q Top (cfs): 7.29

Q Bottom (cfs): 7.36

Velocity Top (ft/s): 5.03

Velocity Bottom (ft/s): 5.04

Avg Velocity (ft/s): 5.04

Wave Velocity (ft/s): 7.55

---

DATA FOR FLOW PATH 5

---

Flow Path Name: A5

FLOW PATH TRAVEL TIME (min): 1.6111

Flow Type: Street

Length (ft): 547.9

Top Elevation (ft): 683.81  
Bottom Elevation (ft): 671.72  
Contributing Area (acres): 1.18  
Percent of Sub-Area (%): 17.8  
Street Width (ft): 32  
Curb Height (in): 6  
Map Slope: 0.0221  
Q for Flow Path (cfs): 2.01  
Q Top (cfs): 7.36  
Q Bottom (cfs): 9.37  
Velocity Top (ft/s): 3.66  
Velocity Bottom (ft/s): 3.89  
Avg Velocity (ft/s): 3.78  
Wave Velocity (ft/s): 5.67

---

DATA FOR FLOW PATH 6

---

Flow Path Name: A6  
FLOW PATH TRAVEL TIME (min): 0.1033  
Flow Type: Street  
Length (ft): 48.7  
Top Elevation (ft): 674.15  
Bottom Elevation (ft): 671.8  
Contributing Area (acres): 0.07  
Percent of Sub-Area (%): 1.1  
Street Width (ft): 32  
Curb Height (in): 6  
Map Slope: 0.0483  
Q for Flow Path (cfs): 0.12

Q Top (cfs): 9.37

Q Bottom (cfs): 9.49

Velocity Top (ft/s): 5.23

Velocity Bottom (ft/s): 5.25

Avg Velocity (ft/s): 5.24

Wave Velocity (ft/s): 7.86

---

DATA FOR FLOW PATH 7

---

Flow Path Name: A7

FLOW PATH TRAVEL TIME (min): 0.8793

Flow Type: Street

Length (ft): 236.56

Top Elevation (ft): 675.81

Bottom Elevation (ft): 673.36

Contributing Area (acres): 0.85

Percent of Sub-Area (%): 12.8

Street Width (ft): 32

Curb Height (in): 6

Map Slope: 0.0104

Q for Flow Path (cfs): 1.45

Q Top (cfs): 9.49

Q Bottom (cfs): 10.94

Velocity Top (ft/s): 2.94

Velocity Bottom (ft/s): 3.04

Avg Velocity (ft/s): 2.99

Wave Velocity (ft/s): 4.48

---

DATA FOR FLOW PATH 8

---

Flow Path Name: A8

FLOW PATH TRAVEL TIME (min): 0.0562

Flow Type: Street

Length (ft): 39.12

Top Elevation (ft): 675.38

Bottom Elevation (ft): 670.63

Contributing Area (acres): 0.22

Percent of Sub-Area (%): 3.3

Street Width (ft): 32

Curb Height (in): 6

Map Slope: 0.1214

Q for Flow Path (cfs): 0.37

Q Top (cfs): 10.94

Q Bottom (cfs): 11.31

Velocity Top (ft/s): 7.70

Velocity Bottom (ft/s): 7.77

Avg Velocity (ft/s): 7.74

Wave Velocity (ft/s): 11.61

VENTURA COUNTY WATERSHED PROTECTION DISTRICT

TIME OF CONCENTRATION

TC Program Version: 2.64.0.37

Project: Cruzan - Pre-Development Hydrology

Date: 3/3/2022 1:52:09 PM

Engineer: AM

Consultant: Ware Malcomb

-----  
SUMMARY OF COMPUTATIONS  
-----

Watershed Name: Pre-Development Hydrology  
-----

Name	Zone	Storm	Soil	Area (acres)	TC (min)
Existing Hydrology	CON3	25	5.00	6.6 / 7	8.926 / 9

-----

---

Watershed Name: Pre-Development Hydrology

---

Sub-Area Name: Existing Hydrology

Tc: 8.926 Minutes

DATA FOR SUB AREA 1

---

SUB AREA TIME OF CONCENTRATION: 8.926 min. = 9 min.

---

SUB AREA INPUT DATA

---

Sub Area Name: Existing Hydrology

Total Area (ac): 6.64

Flood Zone: 3

Rainfall Zone: CON3

Storm Frequency (years): 25

Development Type: Industrial

Soil Type: 5.00

Percent Impervious: 88

SUB AREA OUTPUT

---

Intensity (in/hr): 2.460

C Total: 0.879

Sum Q Segments (cfs): 14.36

Q Total (cfs): 14.36

Sum Percent Area (%): 100.0

Sum of Flow Path Travel Times (sec): 535.56

Time of Concentration (min): 8.926

---



DATA FOR FLOW PATH 1

---

Flow Path Name: A1

FLOW PATH TRAVEL TIME (min): 1.9554

Flow Type: Overland

Length (ft): 72.67

Top Elevation (ft): 686.66

Bottom Elevation (ft): 682.77

Contributing Area (acres): 0.05

Percent of Sub-Area (%): 0.8

Overland Type: Mountain

Development Type: Industrial

Map Slope: 0.0535

Effective Slope: 0.0535

Q for Flow Path (cfs): 0.11

Avg Velocity (ft/s): 0.62

Passed Scour Check: N/A

---

DATA FOR FLOW PATH 2

---

Flow Path Name: A2

FLOW PATH TRAVEL TIME (min): 2.6242

Flow Type: Street

Length (ft): 509.82

Top Elevation (ft): 683.81

Bottom Elevation (ft): 674.82

Contributing Area (acres): 2.57

Percent of Sub-Area (%): 38.7

Street Width (ft): 32

Curb Height (in): 6

Map Slope: 0.0176

Q for Flow Path (cfs): 5.56

Q Top (cfs): 0.11

Q Bottom (cfs): 5.67

Velocity Top (ft/s): 1.16

Velocity Bottom (ft/s): 3.15

Avg Velocity (ft/s): 2.16

Wave Velocity (ft/s): 3.24

---

DATA FOR FLOW PATH 3

---

Flow Path Name: A3

FLOW PATH TRAVEL TIME (min): 1.7034

Flow Type: Street

Length (ft): 477.87

Top Elevation (ft): 680.28

Bottom Elevation (ft): 673.37

Contributing Area (acres): 1.66

Percent of Sub-Area (%): 25.0

Street Width (ft): 32

Curb Height (in): 6

Map Slope: 0.0145

Q for Flow Path (cfs): 3.59

Q Top (cfs): 5.67

Q Bottom (cfs): 9.26

Velocity Top (ft/s): 2.93

Velocity Bottom (ft/s): 3.31

Avg Velocity (ft/s): 3.12

Wave Velocity (ft/s): 4.68

---

DATA FOR FLOW PATH 4

---

Flow Path Name: A4

FLOW PATH TRAVEL TIME (min): 0.1476

Flow Type: Street

Length (ft): 71.02

Top Elevation (ft): 675.37

Bottom Elevation (ft): 671.72

Contributing Area (acres): 0.04

Percent of Sub-Area (%): 0.6

Street Width (ft): 32

Curb Height (in): 6

Map Slope: 0.0514

Q for Flow Path (cfs): 0.09

Q Top (cfs): 9.26

Q Bottom (cfs): 9.35

Velocity Top (ft/s): 5.34

Velocity Bottom (ft/s): 5.35

Avg Velocity (ft/s): 5.35

Wave Velocity (ft/s): 8.02

---

DATA FOR FLOW PATH 5

---

Flow Path Name: A5

FLOW PATH TRAVEL TIME (min): 1.5172

Flow Type: Street

Length (ft): 547.9

Top Elevation (ft): 683.81  
Bottom Elevation (ft): 671.72  
Contributing Area (acres): 1.18  
Percent of Sub-Area (%): 17.8  
Street Width (ft): 32  
Curb Height (in): 6  
Map Slope: 0.0221  
Q for Flow Path (cfs): 2.55  
Q Top (cfs): 9.35  
Q Bottom (cfs): 11.90  
Velocity Top (ft/s): 3.89  
Velocity Bottom (ft/s): 4.13  
Avg Velocity (ft/s): 4.01  
Wave Velocity (ft/s): 6.02

---

DATA FOR FLOW PATH 6

---

Flow Path Name: A6  
FLOW PATH TRAVEL TIME (min): 0.0973  
Flow Type: Street  
Length (ft): 48.7  
Top Elevation (ft): 674.15  
Bottom Elevation (ft): 671.8  
Contributing Area (acres): 0.07  
Percent of Sub-Area (%): 1.1  
Street Width (ft): 32  
Curb Height (in): 6  
Map Slope: 0.0483  
Q for Flow Path (cfs): 0.15

Q Top (cfs): 11.90

Q Bottom (cfs): 12.05

Velocity Top (ft/s): 5.55

Velocity Bottom (ft/s): 5.57

Avg Velocity (ft/s): 5.56

Wave Velocity (ft/s): 8.35

---

DATA FOR FLOW PATH 7

---

Flow Path Name: A7

FLOW PATH TRAVEL TIME (min): 0.8281

Flow Type: Street

Length (ft): 236.56

Top Elevation (ft): 675.81

Bottom Elevation (ft): 673.36

Contributing Area (acres): 0.85

Percent of Sub-Area (%): 12.8

Street Width (ft): 32

Curb Height (in): 6

Map Slope: 0.0104

Q for Flow Path (cfs): 1.84

Q Top (cfs): 12.05

Q Bottom (cfs): 13.89

Velocity Top (ft/s): 3.12

Velocity Bottom (ft/s): 3.23

Avg Velocity (ft/s): 3.17

Wave Velocity (ft/s): 4.76

---

DATA FOR FLOW PATH 8

---

Flow Path Name: A8

FLOW PATH TRAVEL TIME (min): 0.0529

Flow Type: Street

Length (ft): 39.12

Top Elevation (ft): 675.38

Bottom Elevation (ft): 670.63

Contributing Area (acres): 0.22

Percent of Sub-Area (%): 3.3

Street Width (ft): 32

Curb Height (in): 6

Map Slope: 0.1214

Q for Flow Path (cfs): 0.48

Q Top (cfs): 13.89

Q Bottom (cfs): 14.36

Velocity Top (ft/s): 8.18

Velocity Bottom (ft/s): 8.25

Avg Velocity (ft/s): 8.22

Wave Velocity (ft/s): 12.32

VENTURA COUNTY WATERSHED PROTECTION DISTRICT

TIME OF CONCENTRATION

TC Program Version: 2.64.0.37

Project: Cruzan - Pre-Development Hydrology

Date: 3/3/2022 1:52:09 PM

Engineer: AM

Consultant: Ware Malcomb

-----  
SUMMARY OF COMPUTATIONS  
-----

Watershed Name: Pre-Development Hydrology  
-----

Name	Zone	Storm	Soil	Area (acres)	TC (min)
Existing Hydrology	CON3	50	5.00	6.6 / 7	7.875 / 8

-----

---

Watershed Name: Pre-Development Hydrology

---

Sub-Area Name: Existing Hydrology

Tc: 7.875 Minutes

DATA FOR SUB AREA 1

---

SUB AREA TIME OF CONCENTRATION: 7.875 min. = 8 min.

---

SUB AREA INPUT DATA

---

Sub Area Name: Existing Hydrology

Total Area (ac): 6.64

Flood Zone: 3

Rainfall Zone: CON3

Storm Frequency (years): 50

Development Type: Industrial

Soil Type: 5.00

Percent Impervious: 88

SUB AREA OUTPUT

---

Intensity (in/hr): 2.933

C Total: 0.882

Sum Q Segments (cfs): 17.18

Q Total (cfs): 17.18

Sum Percent Area (%): 100.0

Sum of Flow Path Travel Times (sec): 472.52

Time of Concentration (min): 7.875

---



DATA FOR FLOW PATH 1

---

Flow Path Name: A1

FLOW PATH TRAVEL TIME (min): 1.2112

Flow Type: Overland

Length (ft): 72.67

Top Elevation (ft): 686.66

Bottom Elevation (ft): 682.77

Contributing Area (acres): 0.05

Percent of Sub-Area (%): 0.8

Overland Type: Mountain

Development Type: Industrial

Map Slope: 0.0535

Effective Slope: 0.0535

Q for Flow Path (cfs): 0.13

Avg Velocity (ft/s): 1.00

Passed Scour Check: N/A

---

DATA FOR FLOW PATH 2

---

Flow Path Name: A2

FLOW PATH TRAVEL TIME (min): 2.5088

Flow Type: Street

Length (ft): 509.82

Top Elevation (ft): 683.81

Bottom Elevation (ft): 674.82

Contributing Area (acres): 2.57

Percent of Sub-Area (%): 38.7

Street Width (ft): 32

Curb Height (in): 6

Map Slope: 0.0176

Q for Flow Path (cfs): 6.65

Q Top (cfs): 0.13

Q Bottom (cfs): 6.78

Velocity Top (ft/s): 1.22

Velocity Bottom (ft/s): 3.30

Avg Velocity (ft/s): 2.26

Wave Velocity (ft/s): 3.39

---

DATA FOR FLOW PATH 3

---

Flow Path Name: A3

FLOW PATH TRAVEL TIME (min): 1.6285

Flow Type: Street

Length (ft): 477.87

Top Elevation (ft): 680.28

Bottom Elevation (ft): 673.37

Contributing Area (acres): 1.66

Percent of Sub-Area (%): 25.0

Street Width (ft): 32

Curb Height (in): 6

Map Slope: 0.0145

Q for Flow Path (cfs): 4.29

Q Top (cfs): 6.78

Q Bottom (cfs): 11.07

Velocity Top (ft/s): 3.06

Velocity Bottom (ft/s): 3.46

Avg Velocity (ft/s): 3.26

Wave Velocity (ft/s): 4.89

---

DATA FOR FLOW PATH 4

---

Flow Path Name: A4

FLOW PATH TRAVEL TIME (min): 0.1411

Flow Type: Street

Length (ft): 71.02

Top Elevation (ft): 675.37

Bottom Elevation (ft): 671.72

Contributing Area (acres): 0.04

Percent of Sub-Area (%): 0.6

Street Width (ft): 32

Curb Height (in): 6

Map Slope: 0.0514

Q for Flow Path (cfs): 0.10

Q Top (cfs): 11.07

Q Bottom (cfs): 11.18

Velocity Top (ft/s): 5.59

Velocity Bottom (ft/s): 5.60

Avg Velocity (ft/s): 5.59

Wave Velocity (ft/s): 8.39

---

DATA FOR FLOW PATH 5

---

Flow Path Name: A5

FLOW PATH TRAVEL TIME (min): 1.4505

Flow Type: Street

Length (ft): 547.9

Top Elevation (ft): 683.81  
Bottom Elevation (ft): 671.72  
Contributing Area (acres): 1.18  
Percent of Sub-Area (%): 17.8  
Street Width (ft): 32  
Curb Height (in): 6  
Map Slope: 0.0221  
Q for Flow Path (cfs): 3.05  
Q Top (cfs): 11.18  
Q Bottom (cfs): 14.23  
Velocity Top (ft/s): 4.07  
Velocity Bottom (ft/s): 4.32  
Avg Velocity (ft/s): 4.20  
Wave Velocity (ft/s): 6.30

---

DATA FOR FLOW PATH 6

---

Flow Path Name: A6  
FLOW PATH TRAVEL TIME (min): 0.0930  
Flow Type: Street  
Length (ft): 48.7  
Top Elevation (ft): 674.15  
Bottom Elevation (ft): 671.8  
Contributing Area (acres): 0.07  
Percent of Sub-Area (%): 1.1  
Street Width (ft): 32  
Curb Height (in): 6  
Map Slope: 0.0483  
Q for Flow Path (cfs): 0.18

Q Top (cfs): 14.23

Q Bottom (cfs): 14.41

Velocity Top (ft/s): 5.81

Velocity Bottom (ft/s): 5.83

Avg Velocity (ft/s): 5.82

Wave Velocity (ft/s): 8.73

---

DATA FOR FLOW PATH 7

---

Flow Path Name: A7

FLOW PATH TRAVEL TIME (min): 0.7917

Flow Type: Street

Length (ft): 236.56

Top Elevation (ft): 675.81

Bottom Elevation (ft): 673.36

Contributing Area (acres): 0.85

Percent of Sub-Area (%): 12.8

Street Width (ft): 32

Curb Height (in): 6

Map Slope: 0.0104

Q for Flow Path (cfs): 2.20

Q Top (cfs): 14.41

Q Bottom (cfs): 16.61

Velocity Top (ft/s): 3.26

Velocity Bottom (ft/s): 3.38

Avg Velocity (ft/s): 3.32

Wave Velocity (ft/s): 4.98

---

DATA FOR FLOW PATH 8

---

Flow Path Name: A8

FLOW PATH TRAVEL TIME (min): 0.0506

Flow Type: Street

Length (ft): 39.12

Top Elevation (ft): 675.38

Bottom Elevation (ft): 670.63

Contributing Area (acres): 0.22

Percent of Sub-Area (%): 3.3

Street Width (ft): 32

Curb Height (in): 6

Map Slope: 0.1214

Q for Flow Path (cfs): 0.57

Q Top (cfs): 16.61

Q Bottom (cfs): 17.18

Velocity Top (ft/s): 8.56

Velocity Bottom (ft/s): 8.63

Avg Velocity (ft/s): 8.59

Wave Velocity (ft/s): 12.89

VENTURA COUNTY WATERSHED PROTECTION DISTRICT

TIME OF CONCENTRATION

TC Program Version: 2.64.0.37

Project: Cruzan - Post-Development Hydrology

Date: 7/28/2022 1:52:09 PM

Engineer: AM

Consultant: Ware Malcomb

-----  
SUMMARY OF COMPUTATIONS  
-----

Watershed Name: Post-Development Hydrology  
-----

Name	Zone	Storm	Soil	Area (acres)	TC (min)
Post Development Hydr	CON3	10	5.00	6.7 / 7	20.655 / 21

-----

---

Watershed Name: Post-Development Hydrology

---

Sub-Area Name: Post Development Hydrology

Tc: 20.655 Minutes

DATA FOR SUB AREA 1

---

SUB AREA TIME OF CONCENTRATION: 20.655 min. = 21 min.

---

SUB AREA INPUT DATA

---

Sub Area Name: Post Development Hydrology

Total Area (ac): 6.65

Flood Zone: 3

Rainfall Zone: CON3

Storm Frequency (years): 10

Development Type: Industrial

Soil Type: 5.00

Percent Impervious: 87

SUB AREA OUTPUT

---

Intensity (in/hr): 1.323

C Total: 0.860

Sum Q Segments (cfs): 7.57

Q Total (cfs): 7.57

Sum Percent Area (%): 100.0

Sum of Flow Path Travel Times (sec): 1,239.33

Time of Concentration (min): 20.655

---



DATA FOR FLOW PATH 1

---

Flow Path Name: A1

FLOW PATH TRAVEL TIME (min): 3.6267

Flow Type: Overland

Length (ft): 108.8

Top Elevation (ft): 686.66

Bottom Elevation (ft): 683.38

Contributing Area (acres): 0.1

Percent of Sub-Area (%): 1.5

Overland Type: Valley

Development Type: Industrial

Map Slope: 0.0301

Effective Slope: 0.0301

Q for Flow Path (cfs): 0.11

Avg Velocity (ft/s): 0.50

Passed Scour Check: N/A

---

DATA FOR FLOW PATH 2

---

Flow Path Name: A2

FLOW PATH TRAVEL TIME (min): 1.3113

Flow Type: Street

Length (ft): 180.44

Top Elevation (ft): 685

Bottom Elevation (ft): 680.61

Contributing Area (acres): 0.18

Percent of Sub-Area (%): 2.7

Street Width (ft): 32

Curb Height (in): 6

Map Slope: 0.0243

Q for Flow Path (cfs): 0.20

Q Top (cfs): 0.11

Q Bottom (cfs): 0.32

Velocity Top (ft/s): 1.33

Velocity Bottom (ft/s): 1.73

Avg Velocity (ft/s): 1.53

Wave Velocity (ft/s): 2.29

---

DATA FOR FLOW PATH 3

---

Flow Path Name: A3

FLOW PATH TRAVEL TIME (min): 1.3936

Flow Type: Street

Length (ft): 230.65

Top Elevation (ft): 684

Bottom Elevation (ft): 678.88

Contributing Area (acres): 0.31

Percent of Sub-Area (%): 4.7

Street Width (ft): 32

Curb Height (in): 6

Map Slope: 0.0222

Q for Flow Path (cfs): 0.35

Q Top (cfs): 0.32

Q Bottom (cfs): 0.67

Velocity Top (ft/s): 1.67

Velocity Bottom (ft/s): 2.01

Avg Velocity (ft/s): 1.84

Wave Velocity (ft/s): 2.76

---

DATA FOR FLOW PATH 4

---

Flow Path Name: A4

FLOW PATH TRAVEL TIME (min): 0.7959

Flow Type: Street

Length (ft): 151.8

Top Elevation (ft): 681.92

Bottom Elevation (ft): 678.35

Contributing Area (acres): 0.16

Percent of Sub-Area (%): 2.4

Street Width (ft): 32

Curb Height (in): 6

Map Slope: 0.0235

Q for Flow Path (cfs): 0.18

Q Top (cfs): 0.67

Q Bottom (cfs): 0.85

Velocity Top (ft/s): 2.06

Velocity Bottom (ft/s): 2.18

Avg Velocity (ft/s): 2.12

Wave Velocity (ft/s): 3.18

---

DATA FOR FLOW PATH 5

---

Flow Path Name: A5

FLOW PATH TRAVEL TIME (min): 0.7712

Flow Type: Street

Length (ft): 158.6

Top Elevation (ft): 680  
Bottom Elevation (ft): 676.07  
Contributing Area (acres): 0.17  
Percent of Sub-Area (%): 2.6  
Street Width (ft): 32  
Curb Height (in): 6  
Map Slope: 0.0248  
Q for Flow Path (cfs): 0.19  
Q Top (cfs): 0.85  
Q Bottom (cfs): 1.05  
Velocity Top (ft/s): 2.23  
Velocity Bottom (ft/s): 2.34  
Avg Velocity (ft/s): 2.29  
Wave Velocity (ft/s): 3.43

---

DATA FOR FLOW PATH 6

---

Flow Path Name: A6  
FLOW PATH TRAVEL TIME (min): 0.7064  
Flow Type: Street  
Length (ft): 147.01  
Top Elevation (ft): 677.36  
Bottom Elevation (ft): 674.02  
Contributing Area (acres): 0.15  
Percent of Sub-Area (%): 2.3  
Street Width (ft): 32  
Curb Height (in): 6  
Map Slope: 0.0227  
Q for Flow Path (cfs): 0.17

Q Top (cfs): 1.05

Q Bottom (cfs): 1.22

Velocity Top (ft/s): 2.27

Velocity Bottom (ft/s): 2.36

Avg Velocity (ft/s): 2.31

Wave Velocity (ft/s): 3.47

---

DATA FOR FLOW PATH 7

---

Flow Path Name: A7

FLOW PATH TRAVEL TIME (min): 0.3836

Flow Type: Street

Length (ft): 79.12

Top Elevation (ft): 675.01

Bottom Elevation (ft): 673.38

Contributing Area (acres): 0.08

Percent of Sub-Area (%): 1.2

Street Width (ft): 32

Curb Height (in): 6

Map Slope: 0.0206

Q for Flow Path (cfs): 0.09

Q Top (cfs): 1.22

Q Bottom (cfs): 1.31

Velocity Top (ft/s): 2.27

Velocity Bottom (ft/s): 2.31

Avg Velocity (ft/s): 2.29

Wave Velocity (ft/s): 3.44

---

DATA FOR FLOW PATH 8

---

Flow Path Name: A8

FLOW PATH TRAVEL TIME (min): 0.9326

Flow Type: Street

Length (ft): 131.46

Top Elevation (ft): 674.37

Bottom Elevation (ft): 673.48

Contributing Area (acres): 0.31

Percent of Sub-Area (%): 4.7

Street Width (ft): 32

Curb Height (in): 6

Map Slope: 0.0068

Q for Flow Path (cfs): 0.35

Q Top (cfs): 1.31

Q Bottom (cfs): 1.66

Velocity Top (ft/s): 1.52

Velocity Bottom (ft/s): 1.61

Avg Velocity (ft/s): 1.57

Wave Velocity (ft/s): 2.35

---

DATA FOR FLOW PATH 9

---

Flow Path Name: A9

FLOW PATH TRAVEL TIME (min): 0.2833

Flow Type: Street

Length (ft): 63.04

Top Elevation (ft): 674.25

Bottom Elevation (ft): 672.95

Contributing Area (acres): 0.08

Percent of Sub-Area (%): 1.2

Street Width (ft): 32

Curb Height (in): 6

Map Slope: 0.0206

Q for Flow Path (cfs): 0.09

Q Top (cfs): 1.66

Q Bottom (cfs): 1.75

Velocity Top (ft/s): 2.46

Velocity Bottom (ft/s): 2.49

Avg Velocity (ft/s): 2.47

Wave Velocity (ft/s): 3.71

-----  
DATA FOR FLOW PATH 10  
-----

Flow Path Name: A10

FLOW PATH TRAVEL TIME (min): 0.7260

Flow Type: Street

Length (ft): 167.8

Top Elevation (ft): 674.19

Bottom Elevation (ft): 670.59

Contributing Area (acres): 0.21

Percent of Sub-Area (%): 3.2

Street Width (ft): 32

Curb Height (in): 6

Map Slope: 0.0215

Q for Flow Path (cfs): 0.24

Q Top (cfs): 1.75

Q Bottom (cfs): 1.99

Velocity Top (ft/s): 2.53

Velocity Bottom (ft/s): 2.61

Avg Velocity (ft/s): 2.57

Wave Velocity (ft/s): 3.85

---

DATA FOR FLOW PATH 11

---

Flow Path Name: A11

FLOW PATH TRAVEL TIME (min): 0.6774

Flow Type: Street

Length (ft): 150.92

Top Elevation (ft): 673.54

Bottom Elevation (ft): 670.82

Contributing Area (acres): 0.19

Percent of Sub-Area (%): 2.9

Street Width (ft): 32

Curb Height (in): 6

Map Slope: 0.0180

Q for Flow Path (cfs): 0.22

Q Top (cfs): 1.99

Q Bottom (cfs): 2.21

Velocity Top (ft/s): 2.44

Velocity Bottom (ft/s): 2.51

Avg Velocity (ft/s): 2.48

Wave Velocity (ft/s): 3.71

---

DATA FOR FLOW PATH 12

---

Flow Path Name: A12

FLOW PATH TRAVEL TIME (min): 0.5546



Flow Type: Street

Length (ft): 125.66

Top Elevation (ft): 673.56

Bottom Elevation (ft): 671.32

Contributing Area (acres): 0.13

Percent of Sub-Area (%): 2.0

Street Width (ft): 32

Curb Height (in): 6

Map Slope: 0.0178

Q for Flow Path (cfs): 0.15

Q Top (cfs): 2.21

Q Bottom (cfs): 2.36

Velocity Top (ft/s): 2.50

Velocity Bottom (ft/s): 2.54

Avg Velocity (ft/s): 2.52

Wave Velocity (ft/s): 3.78

---

DATA FOR FLOW PATH 13

---

Flow Path Name: A13

FLOW PATH TRAVEL TIME (min): 0.5697

Flow Type: Street

Length (ft): 135.64

Top Elevation (ft): 673.68

Bottom Elevation (ft): 671.04

Contributing Area (acres): 0.14

Percent of Sub-Area (%): 2.1

Street Width (ft): 32

Curb Height (in): 6

Map Slope: 0.0195

Q for Flow Path (cfs): 0.16

Q Top (cfs): 2.36

Q Bottom (cfs): 2.51

Velocity Top (ft/s): 2.62

Velocity Bottom (ft/s): 2.67

Avg Velocity (ft/s): 2.65

Wave Velocity (ft/s): 3.97

---

DATA FOR FLOW PATH 14

---

Flow Path Name: A14

FLOW PATH TRAVEL TIME (min): 1.1943

Flow Type: Street

Length (ft): 170.17

Top Elevation (ft): 671.32

Bottom Elevation (ft): 670.52

Contributing Area (acres): 0.27

Percent of Sub-Area (%): 4.1

Street Width (ft): 32

Curb Height (in): 6

Map Slope: 0.0047

Q for Flow Path (cfs): 0.31

Q Top (cfs): 2.51

Q Bottom (cfs): 2.82

Velocity Top (ft/s): 1.56

Velocity Bottom (ft/s): 1.61

Avg Velocity (ft/s): 1.58

Wave Velocity (ft/s): 2.37

---

DATA FOR FLOW PATH 15

---

Flow Path Name: A15

FLOW PATH TRAVEL TIME (min): 1.7699

Flow Type: Street

Length (ft): 349.35

Top Elevation (ft): 673.97

Bottom Elevation (ft): 670.52

Contributing Area (acres): 0.69

Percent of Sub-Area (%): 10.4

Street Width (ft): 32

Curb Height (in): 6

Map Slope: 0.0099

Q for Flow Path (cfs): 0.79

Q Top (cfs): 2.82

Q Bottom (cfs): 3.61

Velocity Top (ft/s): 2.13

Velocity Bottom (ft/s): 2.26

Avg Velocity (ft/s): 2.19

Wave Velocity (ft/s): 3.29

---

DATA FOR FLOW PATH 16

---

Flow Path Name: A16

FLOW PATH TRAVEL TIME (min): 0.9230

Flow Type: Street

Length (ft): 263.74

Top Elevation (ft): 677.97

Bottom Elevation (ft): 671.81  
Contributing Area (acres): 0.39  
Percent of Sub-Area (%): 5.9  
Street Width (ft): 32  
Curb Height (in): 6  
Map Slope: 0.0234  
Q for Flow Path (cfs): 0.44  
Q Top (cfs): 3.61  
Q Bottom (cfs): 4.05  
Velocity Top (ft/s): 3.13  
Velocity Bottom (ft/s): 3.22  
Avg Velocity (ft/s): 3.17  
Wave Velocity (ft/s): 4.76

---

DATA FOR FLOW PATH 17

---

Flow Path Name: A17  
FLOW PATH TRAVEL TIME (min): 0.6371  
Flow Type: Street  
Length (ft): 195.42  
Top Elevation (ft): 678.37  
Bottom Elevation (ft): 673.17  
Contributing Area (acres): 0.21  
Percent of Sub-Area (%): 3.2  
Street Width (ft): 32  
Curb Height (in): 6  
Map Slope: 0.0266  
Q for Flow Path (cfs): 0.24  
Q Top (cfs): 4.05

Q Bottom (cfs): 4.29

Velocity Top (ft/s): 3.38

Velocity Bottom (ft/s): 3.43

Avg Velocity (ft/s): 3.41

Wave Velocity (ft/s): 5.11

---

DATA FOR FLOW PATH 18

---

Flow Path Name: A18

FLOW PATH TRAVEL TIME (min): 1.0459

Flow Type: Street

Length (ft): 299.1

Top Elevation (ft): 684.27

Bottom Elevation (ft): 678.29

Contributing Area (acres): 1.02

Percent of Sub-Area (%): 15.3

Street Width (ft): 32

Curb Height (in): 6

Map Slope: 0.0200

Q for Flow Path (cfs): 1.16

Q Top (cfs): 4.29

Q Bottom (cfs): 5.45

Velocity Top (ft/s): 3.08

Velocity Bottom (ft/s): 3.27

Avg Velocity (ft/s): 3.18

Wave Velocity (ft/s): 4.77

---

DATA FOR FLOW PATH 19

---

Flow Path Name: A19

FLOW PATH TRAVEL TIME (min): 0.9913

Flow Type: Street

Length (ft): 298.46

Top Elevation (ft): 680.55

Bottom Elevation (ft): 674.58

Contributing Area (acres): 0.89

Percent of Sub-Area (%): 13.4

Street Width (ft): 32

Curb Height (in): 6

Map Slope: 0.0200

Q for Flow Path (cfs): 1.01

Q Top (cfs): 5.45

Q Bottom (cfs): 6.46

Velocity Top (ft/s): 3.27

Velocity Bottom (ft/s): 3.42

Avg Velocity (ft/s): 3.35

Wave Velocity (ft/s): 5.02

---

DATA FOR FLOW PATH 20

---

Flow Path Name: A20

FLOW PATH TRAVEL TIME (min): 0.8597

Flow Type: Street

Length (ft): 268.75

Top Elevation (ft): 678.86

Bottom Elevation (ft): 673.48

Contributing Area (acres): 0.77

Percent of Sub-Area (%): 11.6

Street Width (ft): 32

Curb Height (in): 6

Map Slope: 0.0200

Q for Flow Path (cfs): 0.88

Q Top (cfs): 6.46

Q Bottom (cfs): 7.34

Velocity Top (ft/s): 3.42

Velocity Bottom (ft/s): 3.53

Avg Velocity (ft/s): 3.47

Wave Velocity (ft/s): 5.21

---

DATA FOR FLOW PATH 21

---

Flow Path Name: A21

FLOW PATH TRAVEL TIME (min): 0.5022

Flow Type: Street

Length (ft): 180.96

Top Elevation (ft): 683.38

Bottom Elevation (ft): 678.37

Contributing Area (acres): 0.2

Percent of Sub-Area (%): 3.0

Street Width (ft): 32

Curb Height (in): 6

Map Slope: 0.0277

Q for Flow Path (cfs): 0.23

Q Top (cfs): 7.34

Q Bottom (cfs): 7.57

Velocity Top (ft/s): 3.99

Velocity Bottom (ft/s): 4.02

Avg Velocity (ft/s): 4.00

Wave Velocity (ft/s): 6.01



VENTURA COUNTY WATERSHED PROTECTION DISTRICT

TIME OF CONCENTRATION

TC Program Version: 2.64.0.37

Project: Cruzan - Post-Development Hydrology

Date: 7/28/2022 1:52:09 PM

Engineer: AM

Consultant: Ware Malcomb

---

S U M M A R Y   O F   C O M P U T A T I O N S

---

Watershed Name: Post-Development Hydrology

---

Name	Zone	Storm	Soil	Area (acres)	TC (min)
Post Development Hydr	CON3	25	5.00	6.7 / 7	19.295 / 19

---

---

Watershed Name: Post-Development Hydrology

---

Sub-Area Name: Post Development Hydrology

Tc: 19.295 Minutes

DATA FOR SUB AREA 1

---

SUB AREA TIME OF CONCENTRATION: 19.295 min. = 19 min.

---

SUB AREA INPUT DATA

---

Sub Area Name: Post Development Hydrology

Total Area (ac): 6.65

Flood Zone: 3

Rainfall Zone: CON3

Storm Frequency (years): 25

Development Type: Industrial

Soil Type: 5.00

Percent Impervious: 87

SUB AREA OUTPUT

---

Intensity (in/hr): 1.680

C Total: 0.868

Sum Q Segments (cfs): 9.69

Q Total (cfs): 9.69

Sum Percent Area (%): 100.0

Sum of Flow Path Travel Times (sec): 1,157.69

Time of Concentration (min): 19.295

---

DATA FOR FLOW PATH 1

---

Flow Path Name: A1

FLOW PATH TRAVEL TIME (min): 3.2939

Flow Type: Overland

Length (ft): 108.8

Top Elevation (ft): 686.66

Bottom Elevation (ft): 683.38

Contributing Area (acres): 0.1

Percent of Sub-Area (%): 1.5

Overland Type: Valley

Development Type: Industrial

Map Slope: 0.0301

Effective Slope: 0.0301

Q for Flow Path (cfs): 0.15

Avg Velocity (ft/s): 0.55

Passed Scour Check: N/A

---

DATA FOR FLOW PATH 2

---

Flow Path Name: A2

FLOW PATH TRAVEL TIME (min): 1.2321

Flow Type: Street

Length (ft): 180.44

Top Elevation (ft): 685

Bottom Elevation (ft): 680.61

Contributing Area (acres): 0.18

Percent of Sub-Area (%): 2.7

Street Width (ft): 32

Curb Height (in): 6

Map Slope: 0.0243

Q for Flow Path (cfs): 0.26

Q Top (cfs): 0.15

Q Bottom (cfs): 0.41

Velocity Top (ft/s): 1.42

Velocity Bottom (ft/s): 1.84

Avg Velocity (ft/s): 1.63

Wave Velocity (ft/s): 2.44

---

DATA FOR FLOW PATH 3

---

Flow Path Name: A3

FLOW PATH TRAVEL TIME (min): 1.3095

Flow Type: Street

Length (ft): 230.65

Top Elevation (ft): 684

Bottom Elevation (ft): 678.88

Contributing Area (acres): 0.31

Percent of Sub-Area (%): 4.7

Street Width (ft): 32

Curb Height (in): 6

Map Slope: 0.0222

Q for Flow Path (cfs): 0.45

Q Top (cfs): 0.41

Q Bottom (cfs): 0.86

Velocity Top (ft/s): 1.77

Velocity Bottom (ft/s): 2.14

Avg Velocity (ft/s): 1.96

Wave Velocity (ft/s): 2.94

---

DATA FOR FLOW PATH 4

---

Flow Path Name: A4

FLOW PATH TRAVEL TIME (min): 0.7479

Flow Type: Street

Length (ft): 151.8

Top Elevation (ft): 681.92

Bottom Elevation (ft): 678.35

Contributing Area (acres): 0.16

Percent of Sub-Area (%): 2.4

Street Width (ft): 32

Curb Height (in): 6

Map Slope: 0.0235

Q for Flow Path (cfs): 0.23

Q Top (cfs): 0.86

Q Bottom (cfs): 1.09

Velocity Top (ft/s): 2.19

Velocity Bottom (ft/s): 2.32

Avg Velocity (ft/s): 2.26

Wave Velocity (ft/s): 3.38

---

DATA FOR FLOW PATH 5

---

Flow Path Name: A5

FLOW PATH TRAVEL TIME (min): 0.7246

Flow Type: Street

Length (ft): 158.6

Top Elevation (ft): 680  
Bottom Elevation (ft): 676.07  
Contributing Area (acres): 0.17  
Percent of Sub-Area (%): 2.6  
Street Width (ft): 32  
Curb Height (in): 6  
Map Slope: 0.0248  
Q for Flow Path (cfs): 0.25  
Q Top (cfs): 1.09  
Q Bottom (cfs): 1.34  
Velocity Top (ft/s): 2.37  
Velocity Bottom (ft/s): 2.49  
Avg Velocity (ft/s): 2.43  
Wave Velocity (ft/s): 3.65

---

DATA FOR FLOW PATH 6

---

Flow Path Name: A6  
FLOW PATH TRAVEL TIME (min): 0.6638  
Flow Type: Street  
Length (ft): 147.01  
Top Elevation (ft): 677.36  
Bottom Elevation (ft): 674.02  
Contributing Area (acres): 0.15  
Percent of Sub-Area (%): 2.3  
Street Width (ft): 32  
Curb Height (in): 6  
Map Slope: 0.0227  
Q for Flow Path (cfs): 0.22

Q Top (cfs): 1.34

Q Bottom (cfs): 1.56

Velocity Top (ft/s): 2.41

Velocity Bottom (ft/s): 2.51

Avg Velocity (ft/s): 2.46

Wave Velocity (ft/s): 3.69

---

DATA FOR FLOW PATH 7

---

Flow Path Name: A7

FLOW PATH TRAVEL TIME (min): 0.3605

Flow Type: Street

Length (ft): 79.12

Top Elevation (ft): 675.01

Bottom Elevation (ft): 673.38

Contributing Area (acres): 0.08

Percent of Sub-Area (%): 1.2

Street Width (ft): 32

Curb Height (in): 6

Map Slope: 0.0206

Q for Flow Path (cfs): 0.12

Q Top (cfs): 1.56

Q Bottom (cfs): 1.68

Velocity Top (ft/s): 2.42

Velocity Bottom (ft/s): 2.46

Avg Velocity (ft/s): 2.44

Wave Velocity (ft/s): 3.66

---

DATA FOR FLOW PATH 8

---

Flow Path Name: A8

FLOW PATH TRAVEL TIME (min): 0.8763

Flow Type: Street

Length (ft): 131.46

Top Elevation (ft): 674.37

Bottom Elevation (ft): 673.48

Contributing Area (acres): 0.31

Percent of Sub-Area (%): 4.7

Street Width (ft): 32

Curb Height (in): 6

Map Slope: 0.0068

Q for Flow Path (cfs): 0.45

Q Top (cfs): 1.68

Q Bottom (cfs): 2.13

Velocity Top (ft/s): 1.62

Velocity Bottom (ft/s): 1.72

Avg Velocity (ft/s): 1.67

Wave Velocity (ft/s): 2.50

---

DATA FOR FLOW PATH 9

---

Flow Path Name: A9

FLOW PATH TRAVEL TIME (min): 0.2662

Flow Type: Street

Length (ft): 63.04

Top Elevation (ft): 674.25

Bottom Elevation (ft): 672.95

Contributing Area (acres): 0.08



Percent of Sub-Area (%): 1.2

Street Width (ft): 32

Curb Height (in): 6

Map Slope: 0.0206

Q for Flow Path (cfs): 0.12

Q Top (cfs): 2.13

Q Bottom (cfs): 2.24

Velocity Top (ft/s): 2.61

Velocity Bottom (ft/s): 2.65

Avg Velocity (ft/s): 2.63

Wave Velocity (ft/s): 3.95

-----  
DATA FOR FLOW PATH 10  
-----

Flow Path Name: A10

FLOW PATH TRAVEL TIME (min): 0.6822

Flow Type: Street

Length (ft): 167.8

Top Elevation (ft): 674.19

Bottom Elevation (ft): 670.59

Contributing Area (acres): 0.21

Percent of Sub-Area (%): 3.2

Street Width (ft): 32

Curb Height (in): 6

Map Slope: 0.0215

Q for Flow Path (cfs): 0.31

Q Top (cfs): 2.24

Q Bottom (cfs): 2.55

Velocity Top (ft/s): 2.69

Velocity Bottom (ft/s): 2.78

Avg Velocity (ft/s): 2.73

Wave Velocity (ft/s): 4.10

---

DATA FOR FLOW PATH 11

---

Flow Path Name: A11

FLOW PATH TRAVEL TIME (min): 0.6365

Flow Type: Street

Length (ft): 150.92

Top Elevation (ft): 673.54

Bottom Elevation (ft): 670.82

Contributing Area (acres): 0.19

Percent of Sub-Area (%): 2.9

Street Width (ft): 32

Curb Height (in): 6

Map Slope: 0.0180

Q for Flow Path (cfs): 0.28

Q Top (cfs): 2.55

Q Bottom (cfs): 2.83

Velocity Top (ft/s): 2.60

Velocity Bottom (ft/s): 2.67

Avg Velocity (ft/s): 2.63

Wave Velocity (ft/s): 3.95

---

DATA FOR FLOW PATH 12

---

Flow Path Name: A12

FLOW PATH TRAVEL TIME (min): 0.5211

Flow Type: Street

Length (ft): 125.66

Top Elevation (ft): 673.56

Bottom Elevation (ft): 671.32

Contributing Area (acres): 0.13

Percent of Sub-Area (%): 2.0

Street Width (ft): 32

Curb Height (in): 6

Map Slope: 0.0178

Q for Flow Path (cfs): 0.19

Q Top (cfs): 2.83

Q Bottom (cfs): 3.02

Velocity Top (ft/s): 2.66

Velocity Bottom (ft/s): 2.70

Avg Velocity (ft/s): 2.68

Wave Velocity (ft/s): 4.02

---

DATA FOR FLOW PATH 13

---

Flow Path Name: A13

FLOW PATH TRAVEL TIME (min): 0.5353

Flow Type: Street

Length (ft): 135.64

Top Elevation (ft): 673.68

Bottom Elevation (ft): 671.04

Contributing Area (acres): 0.14

Percent of Sub-Area (%): 2.1

Street Width (ft): 32

Curb Height (in): 6

Map Slope: 0.0195

Q for Flow Path (cfs): 0.20

Q Top (cfs): 3.02

Q Bottom (cfs): 3.22

Velocity Top (ft/s): 2.79

Velocity Bottom (ft/s): 2.84

Avg Velocity (ft/s): 2.82

Wave Velocity (ft/s): 4.22

---

DATA FOR FLOW PATH 14

---

Flow Path Name: A14

FLOW PATH TRAVEL TIME (min): 1.1222

Flow Type: Street

Length (ft): 170.17

Top Elevation (ft): 671.32

Bottom Elevation (ft): 670.52

Contributing Area (acres): 0.27

Percent of Sub-Area (%): 4.1

Street Width (ft): 32

Curb Height (in): 6

Map Slope: 0.0047

Q for Flow Path (cfs): 0.39

Q Top (cfs): 3.22

Q Bottom (cfs): 3.61

Velocity Top (ft/s): 1.66

Velocity Bottom (ft/s): 1.71

Avg Velocity (ft/s): 1.68

Wave Velocity (ft/s): 2.53

---

DATA FOR FLOW PATH 15

---

Flow Path Name: A15

FLOW PATH TRAVEL TIME (min): 1.6631

Flow Type: Street

Length (ft): 349.35

Top Elevation (ft): 673.97

Bottom Elevation (ft): 670.52

Contributing Area (acres): 0.69

Percent of Sub-Area (%): 10.4

Street Width (ft): 32

Curb Height (in): 6

Map Slope: 0.0099

Q for Flow Path (cfs): 1.01

Q Top (cfs): 3.61

Q Bottom (cfs): 4.62

Velocity Top (ft/s): 2.26

Velocity Bottom (ft/s): 2.41

Avg Velocity (ft/s): 2.33

Wave Velocity (ft/s): 3.50

---

DATA FOR FLOW PATH 16

---

Flow Path Name: A16

FLOW PATH TRAVEL TIME (min): 0.8673

Flow Type: Street

Length (ft): 263.74

Top Elevation (ft): 677.97

Bottom Elevation (ft): 671.81  
Contributing Area (acres): 0.39  
Percent of Sub-Area (%): 5.9  
Street Width (ft): 32  
Curb Height (in): 6  
Map Slope: 0.0234  
Q for Flow Path (cfs): 0.57  
Q Top (cfs): 4.62  
Q Bottom (cfs): 5.19  
Velocity Top (ft/s): 3.33  
Velocity Bottom (ft/s): 3.43  
Avg Velocity (ft/s): 3.38  
Wave Velocity (ft/s): 5.07

---

DATA FOR FLOW PATH 17

---

Flow Path Name: A17  
FLOW PATH TRAVEL TIME (min): 0.5986  
Flow Type: Street  
Length (ft): 195.42  
Top Elevation (ft): 678.37  
Bottom Elevation (ft): 673.17  
Contributing Area (acres): 0.21  
Percent of Sub-Area (%): 3.2  
Street Width (ft): 32  
Curb Height (in): 6  
Map Slope: 0.0266  
Q for Flow Path (cfs): 0.31  
Q Top (cfs): 5.19

Q Bottom (cfs): 5.49

Velocity Top (ft/s): 3.60

Velocity Bottom (ft/s): 3.65

Avg Velocity (ft/s): 3.63

Wave Velocity (ft/s): 5.44

---

DATA FOR FLOW PATH 18

---

Flow Path Name: A18

FLOW PATH TRAVEL TIME (min): 0.9828

Flow Type: Street

Length (ft): 299.1

Top Elevation (ft): 684.27

Bottom Elevation (ft): 678.29

Contributing Area (acres): 1.02

Percent of Sub-Area (%): 15.3

Street Width (ft): 32

Curb Height (in): 6

Map Slope: 0.0200

Q for Flow Path (cfs): 1.49

Q Top (cfs): 5.49

Q Bottom (cfs): 6.98

Velocity Top (ft/s): 3.28

Velocity Bottom (ft/s): 3.48

Avg Velocity (ft/s): 3.38

Wave Velocity (ft/s): 5.07

---

DATA FOR FLOW PATH 19

---

Flow Path Name: A19

FLOW PATH TRAVEL TIME (min): 0.9314

Flow Type: Street

Length (ft): 298.46

Top Elevation (ft): 680.55

Bottom Elevation (ft): 674.58

Contributing Area (acres): 0.89

Percent of Sub-Area (%): 13.4

Street Width (ft): 32

Curb Height (in): 6

Map Slope: 0.0200

Q for Flow Path (cfs): 1.30

Q Top (cfs): 6.98

Q Bottom (cfs): 8.28

Velocity Top (ft/s): 3.48

Velocity Bottom (ft/s): 3.64

Avg Velocity (ft/s): 3.56

Wave Velocity (ft/s): 5.34

---

DATA FOR FLOW PATH 20

---

Flow Path Name: A20

FLOW PATH TRAVEL TIME (min): 0.8078

Flow Type: Street

Length (ft): 268.75

Top Elevation (ft): 678.86

Bottom Elevation (ft): 673.48

Contributing Area (acres): 0.77

Percent of Sub-Area (%): 11.6



Street Width (ft): 32

Curb Height (in): 6

Map Slope: 0.0200

Q for Flow Path (cfs): 1.12

Q Top (cfs): 8.28

Q Bottom (cfs): 9.40

Velocity Top (ft/s): 3.64

Velocity Bottom (ft/s): 3.76

Avg Velocity (ft/s): 3.70

Wave Velocity (ft/s): 5.55

---

DATA FOR FLOW PATH 21

---

Flow Path Name: A21

FLOW PATH TRAVEL TIME (min): 0.4719

Flow Type: Street

Length (ft): 180.96

Top Elevation (ft): 683.38

Bottom Elevation (ft): 678.37

Contributing Area (acres): 0.2

Percent of Sub-Area (%): 3.0

Street Width (ft): 32

Curb Height (in): 6

Map Slope: 0.0277

Q for Flow Path (cfs): 0.29

Q Top (cfs): 9.40

Q Bottom (cfs): 9.69

Velocity Top (ft/s): 4.24

Velocity Bottom (ft/s): 4.28

Avg Velocity (ft/s): 4.26

Wave Velocity (ft/s): 6.39

VENTURA COUNTY WATERSHED PROTECTION DISTRICT

TIME OF CONCENTRATION

TC Program Version: 2.64.0.37

Project: Cruzan - Post-Development Hydrology

Date: 7/28/2022 1:52:09 PM

Engineer: AM

Consultant: Ware Malcomb

---

S U M M A R Y O F C O M P U T A T I O N S

---

Watershed Name: Post-Development Hydrology

---

Name	Zone	Storm	Soil	Area (acres)	TC (min)
Post Development Hydr	CON3	50	5.00	6.7 / 7	17.097 / 17

---

---

Watershed Name: Post-Development Hydrology

---

Sub-Area Name: Post Development Hydrology

Tc: 17.097 Minutes

DATA FOR SUB AREA 1

---

SUB AREA TIME OF CONCENTRATION: 17.097 min. = 17 min.

---

SUB AREA INPUT DATA

---

Sub Area Name: Post Development Hydrology

Total Area (ac): 6.65

Flood Zone: 3

Rainfall Zone: CON3

Storm Frequency (years): 50

Development Type: Industrial

Soil Type: 5.00

Percent Impervious: 87

SUB AREA OUTPUT

---

Intensity (in/hr): 2.008

C Total: 0.871

Sum Q Segments (cfs): 11.63

Q Total (cfs): 11.63

Sum Percent Area (%): 100.0

Sum of Flow Path Travel Times (sec): 1,025.79

Time of Concentration (min): 17.097

---

DATA FOR FLOW PATH 1

---

Flow Path Name: A1

FLOW PATH TRAVEL TIME (min): 1.8133

Flow Type: Overland

Length (ft): 108.8

Top Elevation (ft): 686.66

Bottom Elevation (ft): 683.38

Contributing Area (acres): 0.1

Percent of Sub-Area (%): 1.5

Overland Type: Valley

Development Type: Industrial

Map Slope: 0.0301

Effective Slope: 0.0301

Q for Flow Path (cfs): 0.17

Avg Velocity (ft/s): 1.00

Passed Scour Check: N/A

---

DATA FOR FLOW PATH 2

---

Flow Path Name: A2

FLOW PATH TRAVEL TIME (min): 1.1769

Flow Type: Street

Length (ft): 180.44

Top Elevation (ft): 685

Bottom Elevation (ft): 680.61

Contributing Area (acres): 0.18

Percent of Sub-Area (%): 2.7

Street Width (ft): 32

Curb Height (in): 6

Map Slope: 0.0243

Q for Flow Path (cfs): 0.31

Q Top (cfs): 0.17

Q Bottom (cfs): 0.49

Velocity Top (ft/s): 1.48

Velocity Bottom (ft/s): 1.92

Avg Velocity (ft/s): 1.70

Wave Velocity (ft/s): 2.56

---

DATA FOR FLOW PATH 3

---

Flow Path Name: A3

FLOW PATH TRAVEL TIME (min): 1.2507

Flow Type: Street

Length (ft): 230.65

Top Elevation (ft): 684

Bottom Elevation (ft): 678.88

Contributing Area (acres): 0.31

Percent of Sub-Area (%): 4.7

Street Width (ft): 32

Curb Height (in): 6

Map Slope: 0.0222

Q for Flow Path (cfs): 0.54

Q Top (cfs): 0.49

Q Bottom (cfs): 1.03

Velocity Top (ft/s): 1.86

Velocity Bottom (ft/s): 2.24

Avg Velocity (ft/s): 2.05

Wave Velocity (ft/s): 3.07

---

DATA FOR FLOW PATH 4

---

Flow Path Name: A4

FLOW PATH TRAVEL TIME (min): 0.7144

Flow Type: Street

Length (ft): 151.8

Top Elevation (ft): 681.92

Bottom Elevation (ft): 678.35

Contributing Area (acres): 0.16

Percent of Sub-Area (%): 2.4

Street Width (ft): 32

Curb Height (in): 6

Map Slope: 0.0235

Q for Flow Path (cfs): 0.28

Q Top (cfs): 1.03

Q Bottom (cfs): 1.31

Velocity Top (ft/s): 2.29

Velocity Bottom (ft/s): 2.43

Avg Velocity (ft/s): 2.36

Wave Velocity (ft/s): 3.54

---

DATA FOR FLOW PATH 5

---

Flow Path Name: A5

FLOW PATH TRAVEL TIME (min): 0.6921

Flow Type: Street

Length (ft): 158.6

Top Elevation (ft): 680  
Bottom Elevation (ft): 676.07  
Contributing Area (acres): 0.17  
Percent of Sub-Area (%): 2.6  
Street Width (ft): 32  
Curb Height (in): 6  
Map Slope: 0.0248  
Q for Flow Path (cfs): 0.30  
Q Top (cfs): 1.31  
Q Bottom (cfs): 1.61  
Velocity Top (ft/s): 2.48  
Velocity Bottom (ft/s): 2.61  
Avg Velocity (ft/s): 2.55  
Wave Velocity (ft/s): 3.82

---

DATA FOR FLOW PATH 6

---

Flow Path Name: A6  
FLOW PATH TRAVEL TIME (min): 0.6340  
Flow Type: Street  
Length (ft): 147.01  
Top Elevation (ft): 677.36  
Bottom Elevation (ft): 674.02  
Contributing Area (acres): 0.15  
Percent of Sub-Area (%): 2.3  
Street Width (ft): 32  
Curb Height (in): 6  
Map Slope: 0.0227  
Q for Flow Path (cfs): 0.26



Q Top (cfs): 1.61

Q Bottom (cfs): 1.87

Velocity Top (ft/s): 2.53

Velocity Bottom (ft/s): 2.63

Avg Velocity (ft/s): 2.58

Wave Velocity (ft/s): 3.86

---

DATA FOR FLOW PATH 7

---

Flow Path Name: A7

FLOW PATH TRAVEL TIME (min): 0.3443

Flow Type: Street

Length (ft): 79.12

Top Elevation (ft): 675.01

Bottom Elevation (ft): 673.38

Contributing Area (acres): 0.08

Percent of Sub-Area (%): 1.2

Street Width (ft): 32

Curb Height (in): 6

Map Slope: 0.0206

Q for Flow Path (cfs): 0.14

Q Top (cfs): 1.87

Q Bottom (cfs): 2.01

Velocity Top (ft/s): 2.53

Velocity Bottom (ft/s): 2.58

Avg Velocity (ft/s): 2.55

Wave Velocity (ft/s): 3.83

---

DATA FOR FLOW PATH 8

---

Flow Path Name: A8

FLOW PATH TRAVEL TIME (min): 0.8370

Flow Type: Street

Length (ft): 131.46

Top Elevation (ft): 674.37

Bottom Elevation (ft): 673.48

Contributing Area (acres): 0.31

Percent of Sub-Area (%): 4.7

Street Width (ft): 32

Curb Height (in): 6

Map Slope: 0.0068

Q for Flow Path (cfs): 0.54

Q Top (cfs): 2.01

Q Bottom (cfs): 2.55

Velocity Top (ft/s): 1.69

Velocity Bottom (ft/s): 1.80

Avg Velocity (ft/s): 1.75

Wave Velocity (ft/s): 2.62

---

DATA FOR FLOW PATH 9

---

Flow Path Name: A9

FLOW PATH TRAVEL TIME (min): 0.2542

Flow Type: Street

Length (ft): 63.04

Top Elevation (ft): 674.25

Bottom Elevation (ft): 672.95

Contributing Area (acres): 0.08

Percent of Sub-Area (%): 1.2

Street Width (ft): 32

Curb Height (in): 6

Map Slope: 0.0206

Q for Flow Path (cfs): 0.14

Q Top (cfs): 2.55

Q Bottom (cfs): 2.69

Velocity Top (ft/s): 2.74

Velocity Bottom (ft/s): 2.77

Avg Velocity (ft/s): 2.76

Wave Velocity (ft/s): 4.13

---

DATA FOR FLOW PATH 10

---

Flow Path Name: A10

FLOW PATH TRAVEL TIME (min): 0.6516

Flow Type: Street

Length (ft): 167.8

Top Elevation (ft): 674.19

Bottom Elevation (ft): 670.59

Contributing Area (acres): 0.21

Percent of Sub-Area (%): 3.2

Street Width (ft): 32

Curb Height (in): 6

Map Slope: 0.0215

Q for Flow Path (cfs): 0.37

Q Top (cfs): 2.69

Q Bottom (cfs): 3.06

Velocity Top (ft/s): 2.82

Velocity Bottom (ft/s): 2.91

Avg Velocity (ft/s): 2.86

Wave Velocity (ft/s): 4.29

---

DATA FOR FLOW PATH 11

---

Flow Path Name: A11

FLOW PATH TRAVEL TIME (min): 0.6080

Flow Type: Street

Length (ft): 150.92

Top Elevation (ft): 673.54

Bottom Elevation (ft): 670.82

Contributing Area (acres): 0.19

Percent of Sub-Area (%): 2.9

Street Width (ft): 32

Curb Height (in): 6

Map Slope: 0.0180

Q for Flow Path (cfs): 0.33

Q Top (cfs): 3.06

Q Bottom (cfs): 3.39

Velocity Top (ft/s): 2.72

Velocity Bottom (ft/s): 2.79

Avg Velocity (ft/s): 2.76

Wave Velocity (ft/s): 4.14

---

DATA FOR FLOW PATH 12

---

Flow Path Name: A12

FLOW PATH TRAVEL TIME (min): 0.4977

Flow Type: Street

Length (ft): 125.66

Top Elevation (ft): 673.56

Bottom Elevation (ft): 671.32

Contributing Area (acres): 0.13

Percent of Sub-Area (%): 2.0

Street Width (ft): 32

Curb Height (in): 6

Map Slope: 0.0178

Q for Flow Path (cfs): 0.23

Q Top (cfs): 3.39

Q Bottom (cfs): 3.62

Velocity Top (ft/s): 2.78

Velocity Bottom (ft/s): 2.83

Avg Velocity (ft/s): 2.81

Wave Velocity (ft/s): 4.21

---

DATA FOR FLOW PATH 13

---

Flow Path Name: A13

FLOW PATH TRAVEL TIME (min): 0.5113

Flow Type: Street

Length (ft): 135.64

Top Elevation (ft): 673.68

Bottom Elevation (ft): 671.04

Contributing Area (acres): 0.14

Percent of Sub-Area (%): 2.1

Street Width (ft): 32

Curb Height (in): 6

Map Slope: 0.0195

Q for Flow Path (cfs): 0.24

Q Top (cfs): 3.62

Q Bottom (cfs): 3.87

Velocity Top (ft/s): 2.92

Velocity Bottom (ft/s): 2.97

Avg Velocity (ft/s): 2.95

Wave Velocity (ft/s): 4.42

---

DATA FOR FLOW PATH 14

---

Flow Path Name: A14

FLOW PATH TRAVEL TIME (min): 1.0718

Flow Type: Street

Length (ft): 170.17

Top Elevation (ft): 671.32

Bottom Elevation (ft): 670.52

Contributing Area (acres): 0.27

Percent of Sub-Area (%): 4.1

Street Width (ft): 32

Curb Height (in): 6

Map Slope: 0.0047

Q for Flow Path (cfs): 0.47

Q Top (cfs): 3.87

Q Bottom (cfs): 4.34

Velocity Top (ft/s): 1.74

Velocity Bottom (ft/s): 1.79

Avg Velocity (ft/s): 1.76

Wave Velocity (ft/s): 2.65

---

DATA FOR FLOW PATH 15

---

Flow Path Name: A15

FLOW PATH TRAVEL TIME (min): 1.5885

Flow Type: Street

Length (ft): 349.35

Top Elevation (ft): 673.97

Bottom Elevation (ft): 670.52

Contributing Area (acres): 0.69

Percent of Sub-Area (%): 10.4

Street Width (ft): 32

Curb Height (in): 6

Map Slope: 0.0099

Q for Flow Path (cfs): 1.21

Q Top (cfs): 4.34

Q Bottom (cfs): 5.55

Velocity Top (ft/s): 2.37

Velocity Bottom (ft/s): 2.52

Avg Velocity (ft/s): 2.44

Wave Velocity (ft/s): 3.67

---

DATA FOR FLOW PATH 16

---

Flow Path Name: A16

FLOW PATH TRAVEL TIME (min): 0.8284

Flow Type: Street

Length (ft): 263.74

Top Elevation (ft): 677.97

Bottom Elevation (ft): 671.81  
Contributing Area (acres): 0.39  
Percent of Sub-Area (%): 5.9  
Street Width (ft): 32  
Curb Height (in): 6  
Map Slope: 0.0234  
Q for Flow Path (cfs): 0.68  
Q Top (cfs): 5.55  
Q Bottom (cfs): 6.23  
Velocity Top (ft/s): 3.49  
Velocity Bottom (ft/s): 3.59  
Avg Velocity (ft/s): 3.54  
Wave Velocity (ft/s): 5.31

---

DATA FOR FLOW PATH 17

---

Flow Path Name: A17  
FLOW PATH TRAVEL TIME (min): 0.5718  
Flow Type: Street  
Length (ft): 195.42  
Top Elevation (ft): 678.37  
Bottom Elevation (ft): 673.17  
Contributing Area (acres): 0.21  
Percent of Sub-Area (%): 3.2  
Street Width (ft): 32  
Curb Height (in): 6  
Map Slope: 0.0266  
Q for Flow Path (cfs): 0.37  
Q Top (cfs): 6.23



Q Bottom (cfs): 6.59

Velocity Top (ft/s): 3.77

Velocity Bottom (ft/s): 3.83

Avg Velocity (ft/s): 3.80

Wave Velocity (ft/s): 5.70

---

DATA FOR FLOW PATH 18

---

Flow Path Name: A18

FLOW PATH TRAVEL TIME (min): 0.9387

Flow Type: Street

Length (ft): 299.1

Top Elevation (ft): 684.27

Bottom Elevation (ft): 678.29

Contributing Area (acres): 1.02

Percent of Sub-Area (%): 15.3

Street Width (ft): 32

Curb Height (in): 6

Map Slope: 0.0200

Q for Flow Path (cfs): 1.78

Q Top (cfs): 6.59

Q Bottom (cfs): 8.38

Velocity Top (ft/s): 3.43

Velocity Bottom (ft/s): 3.65

Avg Velocity (ft/s): 3.54

Wave Velocity (ft/s): 5.31

---

DATA FOR FLOW PATH 19

---

Flow Path Name: A19

FLOW PATH TRAVEL TIME (min): 0.8897

Flow Type: Street

Length (ft): 298.46

Top Elevation (ft): 680.55

Bottom Elevation (ft): 674.58

Contributing Area (acres): 0.89

Percent of Sub-Area (%): 13.4

Street Width (ft): 32

Curb Height (in): 6

Map Slope: 0.0200

Q for Flow Path (cfs): 1.56

Q Top (cfs): 8.38

Q Bottom (cfs): 9.94

Velocity Top (ft/s): 3.65

Velocity Bottom (ft/s): 3.81

Avg Velocity (ft/s): 3.73

Wave Velocity (ft/s): 5.59

---

DATA FOR FLOW PATH 20

---

Flow Path Name: A20

FLOW PATH TRAVEL TIME (min): 0.7715

Flow Type: Street

Length (ft): 268.75

Top Elevation (ft): 678.86

Bottom Elevation (ft): 673.48

Contributing Area (acres): 0.77

Percent of Sub-Area (%): 11.6

Street Width (ft): 32

Curb Height (in): 6

Map Slope: 0.0200

Q for Flow Path (cfs): 1.35

Q Top (cfs): 9.94

Q Bottom (cfs): 11.28

Velocity Top (ft/s): 3.81

Velocity Bottom (ft/s): 3.93

Avg Velocity (ft/s): 3.87

Wave Velocity (ft/s): 5.81

---

DATA FOR FLOW PATH 21

---

Flow Path Name: A21

FLOW PATH TRAVEL TIME (min): 0.4507

Flow Type: Street

Length (ft): 180.96

Top Elevation (ft): 683.38

Bottom Elevation (ft): 678.37

Contributing Area (acres): 0.2

Percent of Sub-Area (%): 3.0

Street Width (ft): 32

Curb Height (in): 6

Map Slope: 0.0277

Q for Flow Path (cfs): 0.35

Q Top (cfs): 11.28

Q Bottom (cfs): 11.63

Velocity Top (ft/s): 4.44

Velocity Bottom (ft/s): 4.48

Avg Velocity (ft/s): 4.46

Wave Velocity (ft/s): 6.69