

---

# Appendix F2

## Drainage



**PRELIMINARY DRAINAGE REPORT**  
**Fenton Parkway Bridge**  
**City of San Diego, CA**  
**March 23, 2023**  
**PRJ#XXXXXX**

Prepared For:

**Robert Schultz**  
5500 Campanile Drive  
San Diego, CA 92182  
Phone: 619-594-6017

Prepared By:



**PROJECT DESIGN  
CONSULTANTS**  
a **Bowman** company

701 B Street, Suite 800  
San Diego, CA 92101  
619.235.6471

PDC Job No. 4497



Prepared by: J. Maynard  
*Under the supervision of*

---

Chelisa Pack, PE RCE 71026  
Registration Expires 06/30/25

## **TABLE OF CONTENTS**

1. INTRODUCTION .....	1
2. EXISTING AND PROPOSED DRAINAGE PATTERNS AND IMPROVEMENTS.....	3
2.1 Existing Drainage Patterns.....	3
2.2 Proposed Drainage Improvements.....	4
3. HYDROLOGY CRITERIA, METHODOLOGY, AND RESULTS.....	4
3.1 Hydrology Criteria.....	5
3.2 Hydrologic Methodology.....	5
3.3 Description of Hydrologic Modeling Software .....	6
3.4 Hydrology Results .....	6
4. HYDRAULIC ANALYSIS .....	7
5. CONCLUSION.....	7

### **TABLES**

Table 1: Hydrology Criteria.....	5
Table 2: Hydrology Results .....	6

### **APPENDICES**

1	Intensity Duration Frequency Curve, Runoff Coefficients and FEMA FIRMette
2	Proposed Conditions 100-year Rational Method Computer Output
3	Drainage Exhibits
4	As-Builts and SDSU MV Drainage Report Reference



## 1. INTRODUCTION

This preliminary drainage report has been prepared in support of the preliminary 30% design submittal for the Fenton Parkway Bridge development (the Project), which is located in the City of San Diego, California. The purpose of this report is to determine the hydrologic impact, if any, to the existing storm drain facilities or natural drainage, and to provide peak 100-year discharge values for the project.

The drainage analysis presented herein reflects a preliminary 30% design level-of-effort, which includes peak 100-year storm event hydrologic analyses using preliminary grades. Hydraulic analyses for inlets, pipe sizes and inverts, and HGL's will be provided during final engineering. Therefore, the purpose of this report submittal is to acquire from the City of San Diego: 1) concept approval of the proposed storm drain layout, 2) approval of the methodology used in the evaluation of the project storm drain system hydrology, and 3) identification of critical path drainage issues that need to be addressed during final engineering.

The Fenton Parkway Bridge Project is a bridge proposed to connect Fenton Parkway, which currently terminates north of the river channel, with Camino del Rio North, south of the river channel. The Fenton Parkway bridge (bridge) would span the San Diego River (river) in the Mission Valley community of the City of San Diego (City). The proposed bridge will be constructed on real property owned by the City of San Diego and upon the completion of construction, the City of San Diego will own, operate, and maintain the proposed bridge.

The proposed bridge is located in the northeast portion of the Mission Valley Community, in the central portion of the City of San Diego metropolitan area.

The vicinity map is shown in Figure 1.

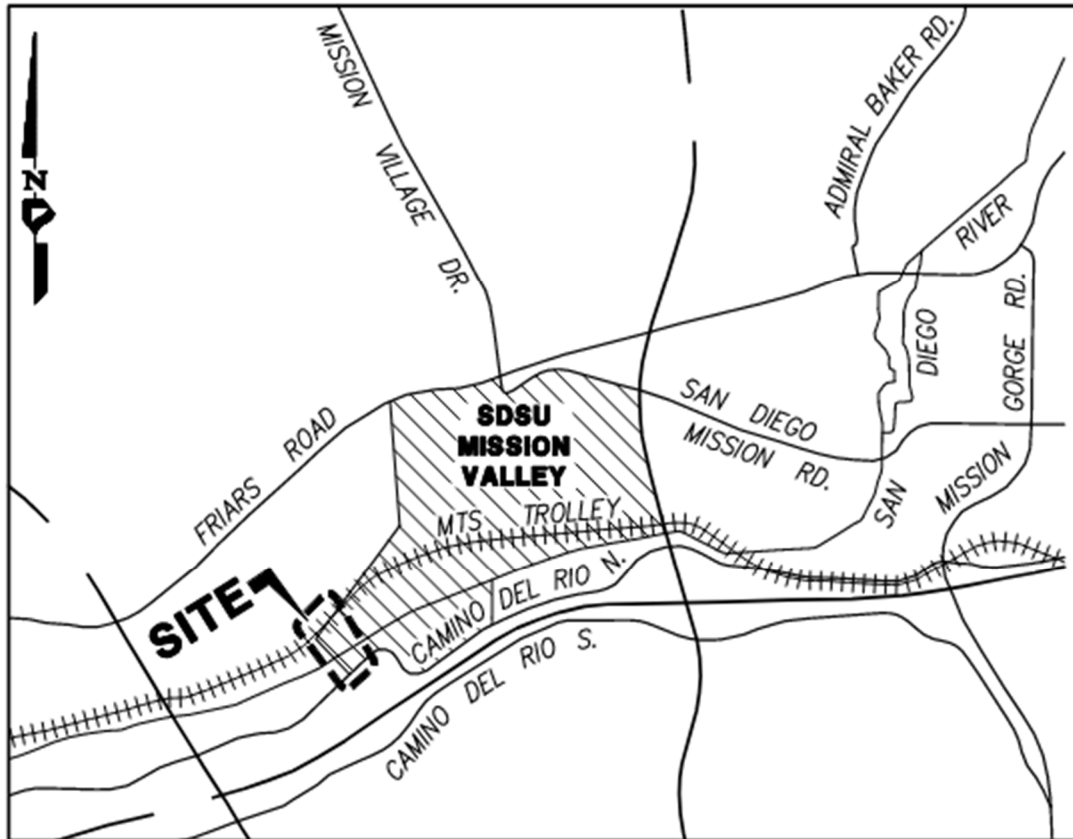

*Figure 1: Vicinity Map*

Treatment of onsite storm water of the buildings prior to discharging into the downstream systems will be facilitated by a single biofiltration basin and a modular wetland unit. For a detailed discussion of the project's stormwater quality BMPs, refer to the Preliminary Stormwater Quality Management Plan (SWQMP) report. The final post-construction BMP design will be provided during final engineering.

This project is subject to the Clean Water Act (CWA) Sections 401 and 404 since there will be filling of material into an existing riparian streambed which converges with the San Diego River. Drainage from an existing storm drain system along Fenton Parkway and Mission City Parkway discharge into this streambed.

The project's storm drain system will discharge into the San Diego River. Refer to the FEMA Firm Panel in Appendix 1. FEMA shaded Zone AE and Zone X areas exist along the boundary of the project improvements.

## **2. EXISTING AND PROPOSED DRAINAGE PATTERNS AND IMPROVEMENTS**

The following sections provide descriptions of the existing and proposed drainage patterns and improvements for the project.

### **2.1 Existing Drainage Patterns**

There are two discharge locations for this project's drainage which are an existing 8'x7' reinforced concrete box (RCB) which transitions into a 96" reinforced concrete pipe (RCP) on Fenton Parkway that outfalls at the riprap lined streambed. On the the Mission City Parkway side of the San Diego River, the main line is a 54" RCP storm drain that outfall directly into the river.

Runon from Fenton Parkway is as follows:

Within Fenton Parkway, there are two storm drain laterals that connect to the RCB, an 18" RCP and a 36" RCP. Each lateral conveys drainage from a Type A-1 sag inlet. Both laterals have drainage connections that connect to the back of the inlets. In addition to the street drainage, the 18" RCP lateral conveys drainage from the Del Rio apartment complex and the 36" RCP conveys drainage from the Mission Valley Library and the IKEA loading dock entryway (Northside Drive). Furthermore, two modular wetland units collect runon at the intersection of River Park Road and half of Fenton Parkway which connect to the existing 96" RCP storm drain. Fenton Parkway is a crowned road, thus, at the intersection, the other half of the road drains down River Park Road to an existing Biofiltration Basin. (See Appendix 4 for more information).

Runon from Mission City Parkway is as follows:

There is an existing high point from the existing bridge south of Mission City Parkway. Mission City Parkway is crowned. One side of the road drains to an existing curb inlet that connects into

an existing 54” RCP storm drain. The other side of the crowned street flows into the intersection of Camino Del Rio North and Mission City Parkway. Water then enters a 54" RCP system that discharges into the San Diego River.

The pre-project conditions for the Fenton Bridge project are represented by the post-project conditions of the Fenton proposed SDSU MISSION VALLEY- FENTON PARKWAY EXTENSION project, which extended Fenton Parkway through the trolley crossing per Public Improvement Plan (PRJ #1040531, DWG#100044-D). For further information about that project, refer to the previous approved drainage study for that project prepared by Project Design Consultants and dated November 15, 2022.

## **2.2 Proposed Drainage Improvements**

The proposed drainage patterns will mimic the existing conditions with exception of more area included due to the addition of the Fenton Parkway Bridge. Under proposed conditions, the proposed bridge has a highpoint near the southern end. Therefore, runoff will be collected on both Mission City Parkway and Fenton Parkway.

Fenton Parkway bridge runoff will mimic the same path of travel with the exception of runoff draining to a biofiltration basin before entering the 96” RCP pipe that will be extended to drain closer to the river.

Mission City Parkway runoff will mimic the existing drainage patterns with the exception of an additional inlet that will be added to the western side of the crowned street. Runoff will then be treated in a proposed modular wetland system before entering the existing 54” RCP storm drain that will be relocated west of the proposed bridge.

The bridge will include deck drains to collect flows on the bridge to minimize gutter flow, but for this drainage study they are deemed insignificant in terms of high flows and due to potential inlet clogging. The proposed gutter flows on the bridge will comply with the City of San Diego flow depth requirements even without deck drains.

## **3. HYDROLOGY CRITERIA, METHODOLOGY, AND RESULTS**

### 3.1 Hydrology Criteria

Table 1 summarizes the key assumptions and criteria used for the hydrologic modeling. See Table 1 below.

**Table 1: Hydrology Criteria**

Proposed Hydrology:	100-year storm frequency
Soil Type:	Hydrologic Soil Group D
Land Use / Runoff Coefficients:	Based on criteria presented in the <u>2017 City of San Diego Drainage Design Manual</u> .
Rainfall intensity:	Based on intensity duration frequency relationships presented in the <u>2017 City of San Diego Drainage Design Manual</u>

### 3.2 Hydrologic Methodology

Hydrology calculations were completed for proposed conditions accounting for all areas draining to the onsite storm drain systems. Drainage areas were defined from existing and proposed topographic maps of the area. Hydrologic analysis was completed utilizing the Rational Method, outlined in the 2017 City of San Diego Drainage Design Manual. The goal of the Rational Method analysis was to determine the peak 100-year flow rates for the storm drain pipes by developing a node link model of the contributing drainage area and applying the intensity-duration-frequency (IDF) curve to the areas. See Appendix 1 for the City of San Diego IDF curve.

The project drainage areas are represented with two overall systems draining to the same ultimate outfall area of concern. For the proposed condition, System 1000 represents the project site conveyed to the proposed Biofiltration Basin and System 2000 represents the project site conveyed to the east. (See Exhibits in Appendix 3 for details). Both systems discharge into the San Diego River.

Existing conditions calculations are not included in this report because they are unnecessary in terms of comparison. Comparison is not needed for this project because all runoff still mimics the

existing condition of draining into the San Diego River. Thus, any minor increase of flow in the proposed condition is not deemed detrimental to the project.

City of San Diego Drainage Design Manual runoff coefficients, based on land use and anticipated imperviousness for each subarea, were assigned for each drainage sub-basin within CivilD.

### 3.3 Description of Hydrologic Modeling Software

The Civil-D Rational Method Program was used to perform the Rational Method hydrologic calculations. This section provides a brief explanation of the computational procedure used in the computer model.

The Civil-D Modified Rational Method Hydrology Program is a computer-aided design program where the user develops a node link model of the watershed. Developing independent node link models for each interior watershed and linking these sub-models together at confluence points creates the node link model. The intensity-duration-frequency relationships are applied to each of the drainage areas in the model to get the peak flow rates at each point of interest.

### 3.4 Hydrology Results

The Rational Method was used to determine the peak 100-year storm flow rates for the design of the proposed onsite storm drain system. Table 2 below summarizes the Rational Method results for the proposed condition.

*Table 2: Hydrology Results*

PROPOSED CONDITION				PROPOSED CONDITION			
SYSTEM	AREA (ac)	Q100 (cfs)	TC (min)	SYSTEM	AREA (ac)	Q100 (cfs)	TC (min)
1000	1.4	3.5	11.2	2000	1.4	4.8	8.6
<b>TOTAL</b>	<b>2.8</b>	<b>8.3</b>	<b>19.8</b>				

#### **4. HYDRAULIC ANALYSIS**

Hydraulic analyses provided during final engineering will include inlet sizing, HGL determination, spread calculations and riprap sizing.

#### **5. CONCLUSION**

This drainage report supports the preliminary 30% design for the proposed Fenton Parkway Bridge development. This report was prepared to provide peak 100-year design flows for the project. The drainage system will be designed appropriately to accommodate the peak-flow conditions for the site.





## **APPENDIX 1**

### **Intensity Duration Frequency Curve, Runoff Coefficients and FEMA Firmette**



## APPENDIX A: RATIONAL METHOD AND MODIFIED RATIONAL METHOD

Table A-1. Runoff Coefficients for Rational Method

Land Use	Runoff Coefficient (C)
	Soil Type <sup>(1)</sup>
<b>Residential:</b>	
Single Family	0.55
Multi-Units	0.70
Mobile Homes	0.65
Rural (lots greater than 1/2 acre)	0.45
<b>Commercial <sup>(2)</sup></b>	
80% Impervious	0.85
<b>Industrial <sup>(2)</sup></b>	
90% Impervious	0.95

**Note:**

<sup>(1)</sup> Type D soil to be used for all areas.

<sup>(2)</sup> Where actual conditions deviate significantly from the tabulated imperviousness values of 80% or 90%, the values given for coefficient C, may be revised by multiplying 80% or 90% by the ratio of actual imperviousness to the tabulated imperviousness. However, in case shall the final coefficient be less than 0.50. For example: Consider commercial property on D soil.

Actual imperviousness	=	50%
Tabulated imperviousness	=	80%
Revised C	=	$(50/80) \times 0.85 = 0.53$

The values in Table A-1 are typical for urban areas. However, if the basin contains rural or agricultural land use, parks, golf courses, or other types of nonurban land use that are expected to be permanent, the appropriate value should be selected based upon the soil and cover and approved by the City.

### A.1.3. Rainfall Intensity

The rainfall intensity (I) is the rainfall in inches per hour (in/hr.) for a duration equal to the  $T_c$  for a selected storm frequency. Once a particular storm frequency has been selected for design and a  $T_c$  calculated for the drainage area, the rainfall intensity can be determined from the Intensity-Duration-Frequency Design Chart (Figure A-1).



APPENDIX A: RATIONAL METHOD AND MODIFIED RATIONAL METHOD

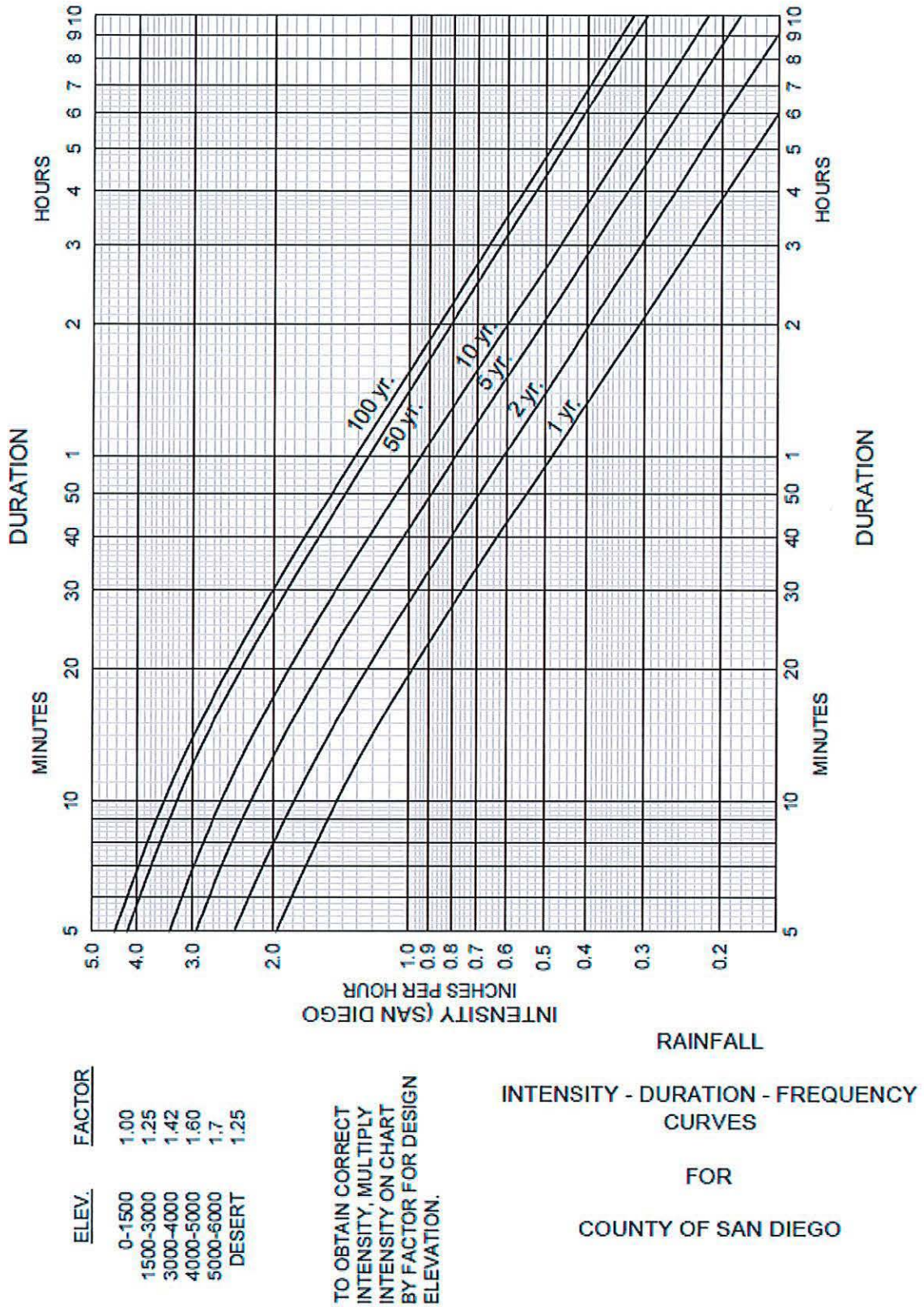

Figure A-1. Intensity-Duration-Frequency Design Chart





**NOTES TO USERS**

This map is for use in administering the National Flood Insurance Program. It does not necessarily identify all areas subject to flooding, particularly from local drainage sources of small size. The community map repository should be consulted for possible updated or additional flood hazard information.

To obtain more detailed information in areas where **Base Flood Elevations (BFEs)** and **flowways** have been determined, users are encouraged to consult the Flood Profiles and Floodway Data and/or Summary of Stillwater Elevations tables contained within the Flood Insurance Study (FIS) report that accompanies this FIRM. Users should be aware that BFEs shown on the FIRM represent rounded whole-foot elevations. These BFEs are intended for flood insurance rating purposes only and should not be used as the sole source of flood elevation information. Accordingly, flood elevation data presented in the FIS report should be utilized in conjunction with the FIRM for purposes of construction and/or floodplain management.

**Coastal Base Flood Elevations (BFEs)** shown on this map apply only to landward of 0.0' North American Vertical Datum of 1988 (NAVD 88). Users of this FIRM should be aware that coastal flood elevations are also provided in the Summary of Stillwater Elevations table in the Flood Insurance Study report for this jurisdiction. Elevations shown in the Summary of Stillwater Elevations table should be used for construction and/or floodplain management purposes when they are higher than the elevations shown on this FIRM.

Boundaries of the **flowways** were computed at cross sections and interpolated between cross sections. The flowways were based on hydraulic considerations with regard to requirements of the National Flood Insurance Program. Flowway widths and other pertinent flowway data are provided in the Flood Insurance Study report for this jurisdiction.

Certain areas not in Special Flood Hazard Areas may be protected by **flood control structures**. Refer to Section 2.4 "Flood Protection Measures" of the Flood Insurance Study report for information on flood control structures for this jurisdiction.

The projection used in the preparation of this map was Universal Transverse Mercator (UTM) Zone 11. The horizontal datum was NAD83, GRS1980 spheroid. Differences in datum, spheroid, projection or UTM zones used in the production of FIRMs for adjacent jurisdictions may result in slight positional differences in map features across jurisdiction boundaries. These differences do not affect the accuracy of this FIRM.

Flood elevations on this map are referenced to the North American Vertical Datum of 1988. These flood elevations must be compared to structure and ground elevations referenced to the same vertical datum. For information regarding conversion between the National Geodetic Vertical Datum of 1929 and the North American Vertical Datum of 1988, visit the National Geodetic Survey website at <http://www.ngs.noaa.gov/> or contact the National Geodetic Survey at the following address:

NGS Information Services  
NOAA, NGS12  
National Geodetic Survey  
SSM/C-3 #0202  
1315 East-West Highway  
Silver Spring, Maryland 20910-3282  
(301) 713-3242

To obtain current elevation, description, and/or location information for **bench marks** shown on this map, please contact the Information Services Branch of the National Geodetic Survey at (301) 713-3242 or visit its website at <http://www.ngs.noaa.gov/>.

**Base map information** shown on this FIRM was provided in digital format by the USDA National Agriculture Imagery Program (NAIP). This information was photogrammetrically compiled at a scale of 1:24,000 from aerial photography dated 2009.

This map reflects more detailed and up-to-date stream channel configurations than those shown on the previous FIRM for this jurisdiction. The floodplains and flowways that were transferred from the previous FIRM may have been adjusted to conform to these new stream channel configurations. As a result, the Flood Profiles and Floodway Data tables in the Flood Insurance Study report (which contains authoritative hydraulic data) may reflect stream channel distances that differ from what is shown on this map.

**Corporate limits** shown on this map are based on the best data available at the time of publication. Because changes due to annexations or de-annexations may have occurred after this map was published, map users should contact appropriate community officials to verify current corporate limit locations.

Please refer to the separately printed **Map Index** for an overview map of the county showing the layout of map panels; community map repository addresses; and a listing of Communities table containing National Flood Insurance Program dates for each community as well as a listing of the panels on which each community is located.

Contact the **FEMA Map Service Center** at 1-877-FEMA MAP (1-877-338-2627) for information on available products associated with this FIRM. Available products may include previously issued Letters of Map Change, a Flood Insurance Study report, and/or digital versions of this map. The FEMA Map Service Center may also be reached by Fax at 1-800-358-9620 and its website at <http://msc.fema.gov/>.

If you have questions about this map or questions concerning the National Flood Insurance Program in general, please call 1-877-FEMA MAP (1-877-338-2627) or visit the FEMA website at <http://www.fema.gov/business/nfip/>.

The "profile base lines" depicted on this map represent the hydraulic modeling baselines that match the flood profiles in the FIS report. As a result of improved topographic data, the "profile base line", in some cases, may deviate significantly from the channel centerline or appear outside the SFHA.

Provisionally Accredited Levee Notes to Users: Check with your local community to obtain more information, such as the estimated level of protection provided (which may exceed the 1-percent-annual-chance level) and Emergency Action Plan, on the levee system(s) shown as providing protection for areas on this panel. To maintain accreditation, the levee owner or community is required to submit the data and documentation necessary to comply with Section 55.10 of the NFIP regulations by May 16, 2012. If the community or owner does not provide the necessary data and documentation or if the data and documentation provided indicate the levee system does not comply with Section 55.10 requirements, FEMA will revise the flood hazard and risk information for this area to reflect de-accreditation of the levee system. To mitigate flood risk in residual risk areas, property owners and residents are encouraged to consider flood insurance and floodproofing or other protective measures. For more information on flood insurance, interested parties should visit the FEMA Website at <http://www.fema.gov/business/nfip/index.htm>.

NOTE: THIS AREA IS SHOWN AS BEING PROTECTED FROM THE 1-PERCENT ANNUAL CHANCE OR GREATER FLOOD HAZARD BY A LEVEE SYSTEM THAT HAS BEEN PROVISIONALLY ACCREDITED. OVERTOPPING OR FAILURE OF ANY LEVEE SYSTEM IS POSSIBLE FOR ADDITIONAL INFORMATION, SEE THE "PROVISIONALLY ACCREDITED LEVEE NOTE" IN NOTES TO USERS.

NOTE: THIS AREA IS SHOWN AS BEING PROTECTED FROM THE 1-PERCENT ANNUAL CHANCE OR GREATER FLOOD HAZARD BY A LEVEE SYSTEM THAT HAS BEEN PROVISIONALLY ACCREDITED. OVERTOPPING OR FAILURE OF ANY LEVEE SYSTEM IS POSSIBLE FOR ADDITIONAL INFORMATION, SEE THE "PROVISIONALLY ACCREDITED LEVEE NOTE" IN NOTES TO USERS.

NOTE: THIS AREA IS SHOWN AS BEING PROTECTED FROM THE 1-PERCENT ANNUAL CHANCE OR GREATER FLOOD HAZARD BY A LEVEE SYSTEM THAT HAS BEEN PROVISIONALLY ACCREDITED. OVERTOPPING OR FAILURE OF ANY LEVEE SYSTEM IS POSSIBLE FOR ADDITIONAL INFORMATION, SEE THE "PROVISIONALLY ACCREDITED LEVEE NOTE" IN NOTES TO USERS.

NOTE: MAP AREA SHOWN ON THIS PANEL IS LOCATED WITHIN THE RANCHO PUEBLO LANDS OF SAN DIEGO LAND GRANT AND THE MISSION RANCHO SAN DIEGO LAND GRANT.



**LEGEND**

**SPECIAL FLOOD HAZARD AREAS SUBJECT TO INUNDATION BY THE 1% ANNUAL CHANCE FLOOD**

The 1% annual chance flood (100-year flood), also known as the base flood, is the flood that has a 1% chance of being equaled or exceeded in any given year. The Special Flood Hazard Area is the area subject to flooding by the 1% annual chance flood. Areas of Special Flood Hazard include Zones A, AE, AH, AO, AR, A99, V, and VE. The Base Flood Elevation is the water-surface elevation of the 1% annual chance flood.

**ZONE A** No Base Flood Elevations determined.

**ZONE AE** Base Flood Elevations determined.

**ZONE AH** Flood depths of 1 to 3 feet (usually areas of ponding); Base Flood Elevations determined.

**ZONE AO** Flood depths of 1 to 3 feet (usually sheet flow on sloping terrain); average depths determined. For areas of alluvial fan flooding, velocities also determined.

**ZONE AR** Special Flood Hazard Area formerly protected from the 1% annual chance flood by a flood control system that was subsequently identified. Zone AR indicates that the former flood control system is being restored to provide protection from the 1% annual chance or greater flood.

**ZONE A99** Areas to be protected from 1% annual chance flood event by a Federal flood protection system under construction; no Base Flood Elevations determined.

**ZONE V** Coastal flood zone with velocity hazard (wave action); no Base Flood Elevations determined.

**ZONE VE** Coastal flood zone with velocity hazard (wave action); Base Flood Elevations determined.

**FLOODWAY AREAS IN ZONE AE**

The flowway is the channel of a stream plus any adjacent floodplain areas that must be kept free of encroachment so that the 1% annual chance flood can be carried without substantial increases in flood heights.

**OTHER FLOOD AREAS**

**ZONE X** Areas of 0.2% annual chance flood; areas of 1% annual chance flood with average depths of less than 1 foot or with drainage areas less than 1 square mile; and areas protected by levees from 1% annual chance flood.

**OTHER AREAS**

**ZONE X** Areas determined to be outside the 0.2% annual chance floodplain.

**ZONE D** Areas in which flood hazards are undetermined, but possible.

**COASTAL BARRIER RESOURCES SYSTEM (CBRS) AREAS**

**OTHERWISE PROTECTED AREAS (OPAs)**

CBRS areas and OPAs are normally located within or adjacent to Special Flood Hazard Areas.

1% annual chance floodplain boundary  
0.2% annual chance floodplain boundary  
Flowway boundary  
Zone D boundary  
CBRS and OPA boundary  
Boundary dividing Special Flood Hazard Area Zones and boundary dividing Special Flood Hazard Areas of different Base Flood Elevations, flood depths, or flood velocities  
Base Flood Elevation line and value; elevation in feet  
Base Flood Elevation value where uniform within zone; elevation in feet

Referenced to the North American Vertical Datum of 1988

**A** Cross section line  
**25** Transsect line

Geographic coordinates referenced to the North American Datum of 1983 (NAD 83), Western Hemisphere  
1000-meter Universal Transverse Mercator grid ticks, zone 11  
5000-foot grid values: California State Plane coordinate system, Zone VI (FIPSZONE = 406), Lambert projection  
Bench mark (see explanation in Notes to Users section of this FIRM panel)  
DX5510  
River Mile  
MAP REPOSITORIES  
Refer to Map Repositories list on Map Index

EFFECTIVE DATE OF COUNTYWIDE FLOOD INSURANCE RATE MAP  
June 19, 1997

EFFECTIVE DATE(S) OF REVISION(S) TO THIS PANEL  
May 16, 2012 - to update corporate limits, to add roads and road names, to incorporate previously issued Letters of Map Revision, and to update map elevations to North American Vertical Datum of 1988.

For community map revision history prior to countywide mapping, refer to the Community Map History table located in the Flood Insurance Study report for this jurisdiction.

To determine if flood insurance is available in this community, contact your insurance agent or call the National Flood Insurance Program at 1-800-638-6620.

**MAP SCALE 1" = 500'**

250 0 250 500 750 1000 FEET  
100 0 100 200 METERS

**NATIONAL FLOOD INSURANCE PROGRAM**

**PANEL 1619G**

**FIRM**  
FLOOD INSURANCE RATE MAP  
SAN DIEGO COUNTY,  
CALIFORNIA  
AND INCORPORATED AREAS

**PANEL 1619 OF 2375**  
(SEE MAP INDEX FOR FIRM PANEL LAYOUT)

**CONTAINS:**

COMMUNITY	NUMBER	PANEL	SUFFIX
SAN DIEGO, CITY OF	060295	1619	G

Notice to User: The Map Number shown below should be used when placing map orders. The Community Number shown above should be used on insurance applications for the subject community.

**MAP NUMBER 06073C1619G**  
**MAP REVISED MAY 16, 2012**

**Federal Emergency Management Agency**







## **APPENDIX 2**

### **Proposed Conditions Rational Method Computer Output**



FENTON PARKWAY BRIDGE

San Diego County Rational Hydrology Program

CIVILCADD/CIVILDESIGN Engineering Software,(c)1991-2003 Version 6.3

Rational method hydrology program based on  
San Diego County Flood Control Division 1985 hydrology manual  
Rational Hydrology Study Date: 05/17/23

-----  
4497 FENTON BRIDGE  
SYSTEM 1000  
PROPOSED CONDITIONS  
FILE: 1000P100  
-----

\*\*\*\*\* Hydrology Study Control Information \*\*\*\*\*  
-----

Program License Serial Number 4049

-----  
Rational hydrology study storm event year is 100.0  
English (in-lb) input data Units used  
English (in) rainfall data used

Standard intensity of Appendix I-B used for year and  
Elevation 0 - 1500 feet  
Factor (to multiply \* intensity) = 1.000  
Only used if inside City of San Diego  
San Diego hydrology manual 'C' values used  
Runoff coefficients by rational method

-----  
\*\*\*\*\*  
Process from Point/Station 1000.000 to Point/Station 1001.000  
\*\*\*\* INITIAL AREA EVALUATION \*\*\*\*

Decimal fraction soil group A = 0.000  
Decimal fraction soil group B = 0.000  
Decimal fraction soil group C = 0.000  
Decimal fraction soil group D = 1.000

[INDUSTRIAL area type ]  
Initial subarea flow distance = 97.000(Ft.)

Highest elevation = 66.390(Ft.)

Lowest elevation = 65.450(Ft.)

Elevation difference = 0.940(Ft.)

Time of concentration calculated by the urban

areas overland flow method (App X-C) = 2.69 min.

TC =  $[1.8 * (1.1 - C) * \text{distance}(\text{Ft.})^{.5}] / (\% \text{ slope}^{1/3})$

TC =  $[1.8 * (1.1 - 0.9500) * (97.000^{.5})] / (0.969^{1/3}) = 2.69$

Setting time of concentration to 5 minutes

Rainfall intensity (I) = 4.389(In/Hr) for a 100.0 year storm

Effective runoff coefficient used for area (Q=KCIA) is C = 0.950

Subarea runoff = 0.250(CFS)

Total initial stream area = 0.060(Ac.)

PROPOSED SYSTEM 1000

FENTON PARKWAY BRIDGE

-----  
\*\*\*\*\*  
Process from Point/Station 1001.000 to Point/Station 1002.000  
\*\*\*\* IRREGULAR CHANNEL FLOW TRAVEL TIME \*\*\*\*

-----  
Estimated mean flow rate at midpoint of channel = 0.813(CFS)  
Depth of flow = 0.110(Ft.), Average velocity = 1.354(Ft/s)  
\*\*\*\*\* Irregular Channel Data \*\*\*\*\*  
-----

Information entered for subchannel number 1 :  
Point number 'X' coordinate 'Y' coordinate  
1 0.00 3.35  
2 1.00 3.35  
3 1.00 0.68  
4 13.00 0.50  
5 13.17 0.00  
6 29.00 0.16

Manning's 'N' friction factor = 0.015

-----  
Sub-Channel flow = 0.813(CFS)  
' ' flow top width = 10.918(Ft.)  
' ' velocity = 1.354(Ft/s)  
' ' area = 0.600(Sq.Ft)  
' ' Froude number = 1.018

Upstream point elevation = 65.450(Ft.)

Downstream point elevation = 61.840(Ft.)

Flow length = 400.000(Ft.)

Travel time = 4.92 min.

Time of concentration = 9.92 min.

Depth of flow = 0.110(Ft.)

Average velocity = 1.354(Ft/s)

Total irregular channel flow = 0.813(CFS)

Irregular channel normal depth above invert elev. = 0.110(Ft.)

Average velocity of channel(s) = 1.354(Ft/s)

Sub-Channel No. 1 Critical depth = 0.110(Ft.)  
' ' Critical flow top width = 10.955(Ft.)  
' ' Critical flow velocity = 1.345(Ft/s)  
' ' Critical flow area = 0.604(Sq.Ft)

Adding area flow to channel

Decimal fraction soil group A = 0.000

Decimal fraction soil group B = 0.000

Decimal fraction soil group C = 0.000

Decimal fraction soil group D = 1.000

[INDUSTRIAL area type ]

Rainfall intensity = 3.384(In/Hr) for a 100.0 year storm

Runoff coefficient used for sub-area, Rational method, Q=KCIA, C = 0.950

Subarea runoff = 0.868(CFS) for 0.270(Ac.)

Total runoff = 1.118(CFS) Total area = 0.33(Ac.)

PROPOSED SYSTEM 1000

FENTON PARKWAY BRIDGE

\*\*\*\*\*  
 Process from Point/Station 1003.000 to Point/Station 1002.000  
 \*\*\*\* SUBAREA FLOW ADDITION \*\*\*\*

Decimal fraction soil group A = 0.000  
 Decimal fraction soil group B = 0.000  
 Decimal fraction soil group C = 0.000  
 Decimal fraction soil group D = 1.000  
 [INDUSTRIAL area type ]  
 Time of concentration = 9.92 min.  
 Rainfall intensity = 3.384(In/Hr) for a 100.0 year storm  
 Runoff coefficient used for sub-area, Rational method,Q=KCIA, C = 0.950  
 Subarea runoff = 1.061(CFS) for 0.330(Ac.)  
 Total runoff = 2.179(CFS) Total area = 0.66(Ac.)

\*\*\*\*\*  
 Process from Point/Station 1002.000 to Point/Station 1004.000  
 \*\*\*\* PIPEFLOW TRAVEL TIME (Program estimated size) \*\*\*\*

Upstream point/station elevation = 56.530(Ft.)  
 Downstream point/station elevation = 54.000(Ft.)  
 Pipe length = 73.00(Ft.) Manning's N = 0.013  
 No. of pipes = 1 Required pipe flow = 2.179(CFS)  
 Nearest computed pipe diameter = 9.00(In.)  
 Calculated individual pipe flow = 2.179(CFS)  
 Normal flow depth in pipe = 5.59(In.)  
 Flow top width inside pipe = 8.73(In.)  
 Critical Depth = 7.97(In.)  
 Pipe flow velocity = 7.56(Ft/s)  
 Travel time through pipe = 0.16 min.  
 Time of concentration (TC) = 10.08 min.

\*\*\*\*\*  
 Process from Point/Station 1004.000 to Point/Station 1005.000  
 \*\*\*\* SUBAREA FLOW ADDITION \*\*\*\*

Decimal fraction soil group A = 0.000  
 Decimal fraction soil group B = 0.000  
 Decimal fraction soil group C = 0.000  
 Decimal fraction soil group D = 1.000  
 [SINGLE FAMILY area type ]  
 Time of concentration = 10.08 min.  
 Rainfall intensity = 3.364(In/Hr) for a 100.0 year storm  
 Runoff coefficient used for sub-area, Rational method,Q=KCIA, C = 0.550  
 Subarea runoff = 0.259(CFS) for 0.140(Ac.)  
 Total runoff = 2.438(CFS) Total area = 0.80(Ac.)

\*\*\*\*\*  
 Process from Point/Station 1007.000 to Point/Station 1007.000

FENTON PARKWAY BRIDGE

\*\*\*\* SUBAREA FLOW ADDITION \*\*\*\*

Decimal fraction soil group A = 0.000  
 Decimal fraction soil group B = 0.000  
 Decimal fraction soil group C = 0.000  
 Decimal fraction soil group D = 1.000  
 [INDUSTRIAL area type ]  
 Time of concentration = 10.08 min.  
 Rainfall intensity = 3.364(In/Hr) for a 100.0 year storm  
 Runoff coefficient used for sub-area, Rational method,Q=KCIA, C = 0.950  
 Subarea runoff = 0.352(CFS) for 0.110(Ac.)  
 Total runoff = 2.789(CFS) Total area = 0.91(Ac.)

\*\*\*\*\*  
 Process from Point/Station 1007.000 to Point/Station 1005.000  
 \*\*\*\* PIPEFLOW TRAVEL TIME (User specified size) \*\*\*\*

Upstream point/station elevation = 44.650(Ft.)  
 Downstream point/station elevation = 43.840(Ft.)  
 Pipe length = 147.00(Ft.) Manning's N = 0.013  
 No. of pipes = 1 Required pipe flow = 2.789(CFS)  
 Given pipe size = 96.00(In.)  
 Calculated individual pipe flow = 2.789(CFS)  
 Normal flow depth in pipe = 4.47(In.)  
 Flow top width inside pipe = 40.44(In.)  
 Critical depth could not be calculated.  
 Pipe flow velocity = 3.30(Ft/s)  
 Travel time through pipe = 0.74 min.  
 Time of concentration (TC) = 10.83 min.

\*\*\*\*\*  
 Process from Point/Station 1008.000 to Point/Station 1005.000  
 \*\*\*\* SUBAREA FLOW ADDITION \*\*\*\*

Decimal fraction soil group A = 0.000  
 Decimal fraction soil group B = 0.000  
 Decimal fraction soil group C = 0.000  
 Decimal fraction soil group D = 1.000  
 [RURAL(greater than 0.5 Ac, 0.2 ha) area type]  
 Time of concentration = 10.83 min.  
 Rainfall intensity = 3.279(In/Hr) for a 100.0 year storm  
 Runoff coefficient used for sub-area, Rational method,Q=KCIA, C = 0.450  
 Subarea runoff = 0.693(CFS) for 0.470(Ac.)  
 Total runoff = 3.483(CFS) Total area = 1.38(Ac.)

\*\*\*\*\*  
 Process from Point/Station 1005.000 to Point/Station 1006.000  
 \*\*\*\* PIPEFLOW TRAVEL TIME (User specified size) \*\*\*\*

FENTON PARKWAY BRIDGE

---

Upstream point/station elevation = 43.840(Ft.)  
Downstream point/station elevation = 43.450(Ft.)  
Pipe length = 78.00(Ft.) Manning's N = 0.013  
No. of pipes = 1 Required pipe flow = 3.483(CFS)  
Given pipe size = 96.00(In.)  
Calculated individual pipe flow = 3.483(CFS)  
Normal flow depth in pipe = 5.07(In.)  
Flow top width inside pipe = 42.95(In.)  
Critical Depth = 5.32(In.)  
Pipe flow velocity = 3.42(Ft/s)  
Travel time through pipe = 0.38 min.  
Time of concentration (TC) = 11.21 min.  
End of computations, total study area = 1.380 (Ac.)

FENTON PARKWAY BRIDGE

San Diego County Rational Hydrology Program

CIVILCADD/CIVILDESIGN Engineering Software,(c)1991-2003 Version 6.3

Rational method hydrology program based on
San Diego County Flood Control Division 1985 hydrology manual
Rational Hydrology Study Date: 05/17/23

4497 FENTON BRIDGE
SYSTEM 2000
PROPOSED CONDITIONS
FILE: 2000P100

\*\*\*\*\* Hydrology Study Control Information \*\*\*\*\*

Program License Serial Number 4049

Rational hydrology study storm event year is 100.0
English (in-lb) input data Units used
English (in) rainfall data used

Standard intensity of Appendix I-B used for year and
Elevation 0 - 1500 feet
Factor (to multiply \* intensity) = 1.000
Only used if inside City of San Diego
San Diego hydrology manual 'C' values used
Runoff coefficients by rational method

\*\*\*\*\*
Process from Point/Station 2000.000 to Point/Station 2001.000
\*\*\*\* INITIAL AREA EVALUATION \*\*\*\*

Decimal fraction soil group A = 0.000
Decimal fraction soil group B = 0.000
Decimal fraction soil group C = 0.000
Decimal fraction soil group D = 1.000

[INDUSTRIAL area type ]
Initial subarea flow distance = 69.000(Ft.)
Highest elevation = 87.000(Ft.)
Lowest elevation = 86.000(Ft.)
Elevation difference = 1.000(Ft.)

Time of concentration calculated by the urban
areas overland flow method (App X-C) = 1.98 min.
TC = [1.8\*(1.1-C)\*distance(Ft.)^0.5]/(% slope^(1/3))
TC = [1.8\*(1.1-0.9500)\*( 69.000^0.5)/( 1.449^(1/3))]= 1.98

Setting time of concentration to 5 minutes
Rainfall intensity (I) = 4.389(In/Hr) for a 100.0 year storm
Effective runoff coefficient used for area (Q=KCIA) is C = 0.950
Subarea runoff = 0.167(CFS)
Total initial stream area = 0.040(Ac.)

PROPOSED SYSTEM 2000

FENTON PARKWAY BRIDGE

\*\*\*\*\*
Process from Point/Station 2001.000 to Point/Station 2002.000
\*\*\*\* STREET FLOW TRAVEL TIME + SUBAREA FLOW ADDITION \*\*\*\*

Top of street segment elevation = 86.000(Ft.)
End of street segment elevation = 63.000(Ft.)
Length of street segment = 538.000(Ft.)
Height of curb above gutter flowline = 6.0(In.)
Width of half street (curb to crown) = 20.000(Ft.)
Distance from crown to crossfall grade break = 10.000(Ft.)
Slope from gutter to grade break (v/hz) = 0.020
Slope from grade break to crown (v/hz) = 0.020
Street flow is on [1] side(s) of the street
Distance from curb to property line = 10.000(Ft.)
Slope from curb to property line (v/hz) = 0.020
Gutter width = 1.500(Ft.)

Gutter hike from flowline = 1.500(In.)
Manning's N in gutter = 0.0150
Manning's N from gutter to grade break = 0.0150
Manning's N from grade break to crown = 0.0150
Estimated mean flow rate at midpoint of street = 0.203(CFS)
Depth of flow = 0.110(Ft.), Average velocity = 2.800(Ft/s)
Streetflow hydraulics at midpoint of street travel:
Halfstreet flow width = 1.500(Ft.)
Flow velocity = 2.80(Ft/s)
Travel time = 3.20 min. TC = 8.20 min.

Adding area flow to street
Decimal fraction soil group A = 0.000
Decimal fraction soil group B = 0.000
Decimal fraction soil group C = 0.000
Decimal fraction soil group D = 1.000
[INDUSTRIAL area type ]
Rainfall intensity = 3.626(In/Hr) for a 100.0 year storm
Runoff coefficient used for sub-area, Rational method,Q=KCIA, C = 0.950
Subarea runoff = 1.481(CFS) for 0.430(Ac.)
Total runoff = 1.648(CFS) Total area = 0.47(Ac.)
Street flow at end of street = 1.648(CFS)
Half street flow at end of street = 1.648(CFS)
Depth of flow = 0.221(Ft.), Average velocity = 3.533(Ft/s)
Flow width (from curb towards crown)= 6.287(Ft.)

\*\*\*\*\*
Process from Point/Station 2003.000 to Point/Station 2002.000
\*\*\*\* SUBAREA FLOW ADDITION \*\*\*\*

Decimal fraction soil group A = 0.000
Decimal fraction soil group B = 0.000
Decimal fraction soil group C = 0.000
Decimal fraction soil group D = 1.000
[INDUSTRIAL area type ]
Time of concentration = 8.20 min.

PROPOSED SYSTEM 2000

FENTON PARKWAY BRIDGE

Rainfall intensity = 3.626(In/Hr) for a 100.0 year storm  
Runoff coefficient used for sub-area, Rational method,Q=KCIA, C = 0.950  
Subarea runoff = 1.343(CFS) for 0.390(Ac.)  
Total runoff = 2.992(CFS) Total area = 0.86(Ac.)

\*\*\*\*\*  
Process from Point/Station 2004.000 to Point/Station 2002.000  
\*\*\*\* SUBAREA FLOW ADDITION \*\*\*\*

Decimal fraction soil group A = 0.000  
Decimal fraction soil group B = 0.000  
Decimal fraction soil group C = 0.000  
Decimal fraction soil group D = 1.000  
[INDUSTRIAL area type ]  
Time of concentration = 8.20 min.  
Rainfall intensity = 3.626(In/Hr) for a 100.0 year storm  
Runoff coefficient used for sub-area, Rational method,Q=KCIA, C = 0.950  
Subarea runoff = 1.791(CFS) for 0.520(Ac.)  
Total runoff = 4.783(CFS) Total area = 1.38(Ac.)

\*\*\*\*\*  
Process from Point/Station 2002.000 to Point/Station 2005.000  
\*\*\*\* PIPEFLOW TRAVEL TIME (User specified size) \*\*\*\*

Upstream point/station elevation = 44.600(Ft.)  
Downstream point/station elevation = 42.000(Ft.)  
Pipe length = 154.00(Ft.) Manning's N = 0.013  
No. of pipes = 1 Required pipe flow = 4.783(CFS)  
Given pipe size = 54.00(In.)  
Calculated individual pipe flow = 4.783(CFS)  
Normal flow depth in pipe = 5.13(In.)  
Flow top width inside pipe = 31.66(In.)  
Critical depth could not be calculated.  
Pipe flow velocity = 6.24(Ft/s)  
Travel time through pipe = 0.41 min.  
Time of concentration (TC) = 8.61 min.  
End of computations, total study area = 1.380 (Ac.)





## **APPENDIX 3**

### **Drainage Exhibits**



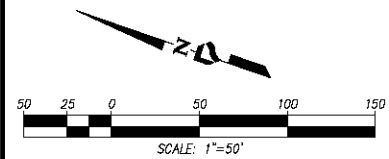
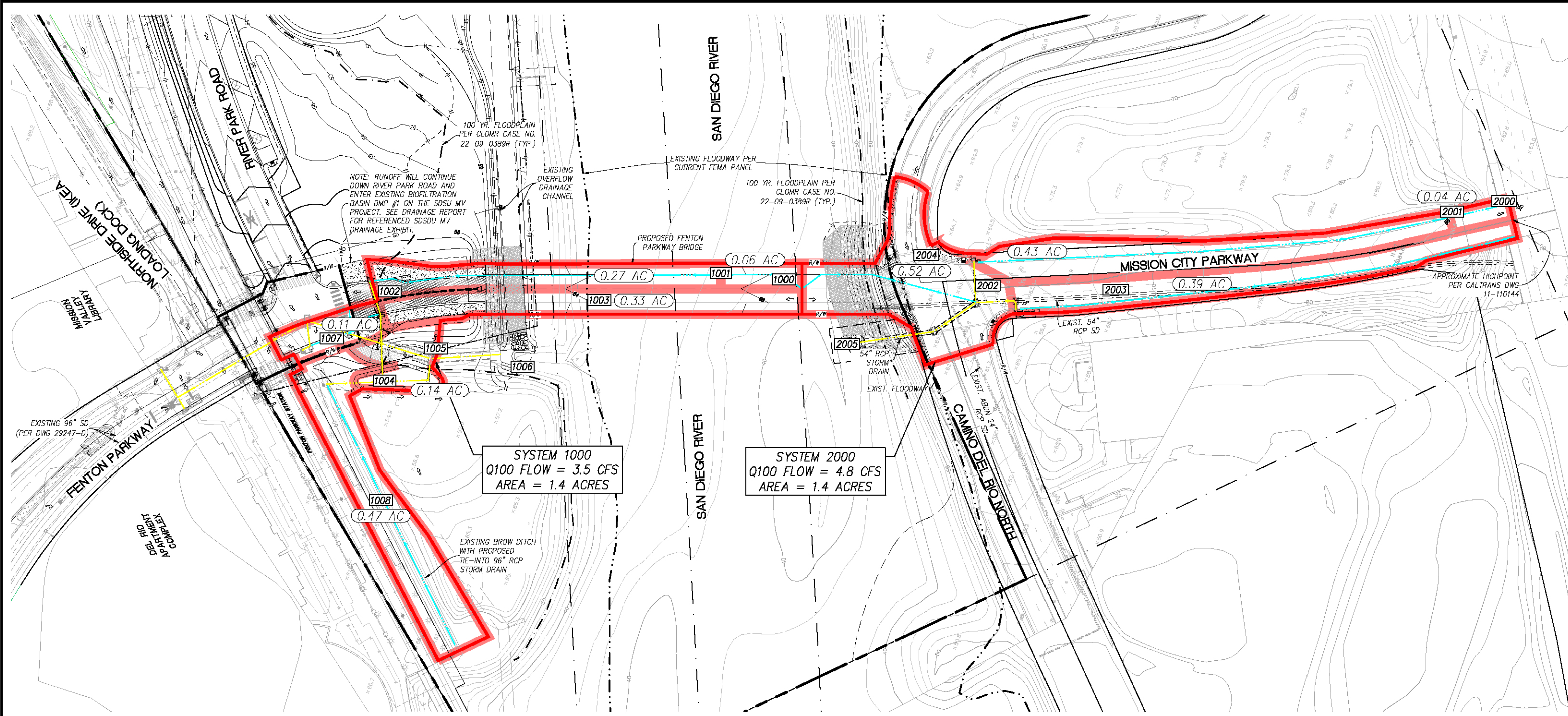

**LEGEND**

- DRAINAGE SUBAREA
- DRAINAGE SYSTEM
- HYDROLOGY NODE XXXX
- AREA FROM UPSTREAM TO DOWNSTREAM NODE X.XX AC
- DRAINAGE FLOW ARROW  →
- SURFACE FLOW
- PIPE FLOW

SCALE: 1"=50'

JOB #: 4497.00

CREATED: 5/23/2023

PREPARED BY:

**PROJECT DESIGN CONSULTANTS**  
Planning | Landscape Architecture | Engineering | Survey

701 B Street, Suite 900  
San Diego, CA 92101  
619.296.6671 Tx  
619.224.0999 Fax

**CITY OF SAN DIEGO**  
**FENTON PARKWAY BRIDGE**

DRAINAGE MAP  
PROPOSED CONDITIONS  
EXHIBIT B



## **APPENDIX 4**

### **As-Builts and SDSU MV Drainage Report Reference**



**FOR REFERENCE  
ONLY  
MISSION CITY  
PARKWAY  
BRIDGE  
AS-BUILT**





I-805-1(87)18

DIST	COUNTY	ROUTE	POST MILES-TOTAL PROJECT	SHEET	TOTAL SHEETS
11	SD	805	11.24 to 12.5	371	382

DATE: July 23, 1968

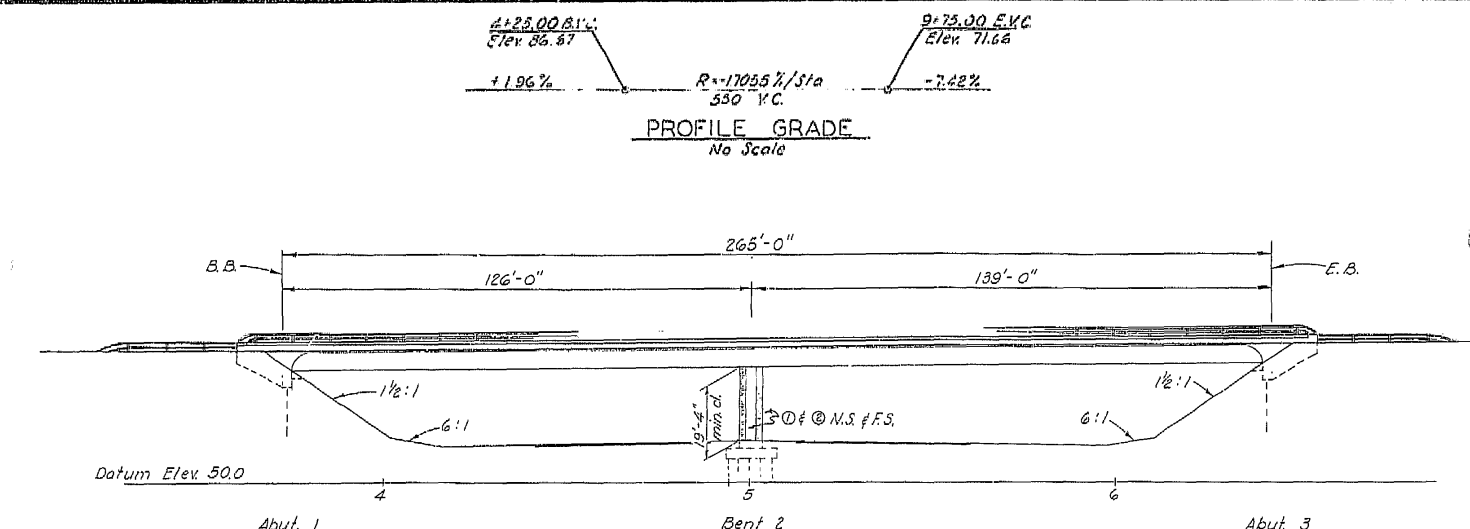

65 Ton 10BP57 Steel H Piles

Location	Spec. Tip	Est. Tip
Abut. 1	+15.0	+10.0
Bent 2	-5.0	-10.0
Abut. 3	-5.0	-10.0

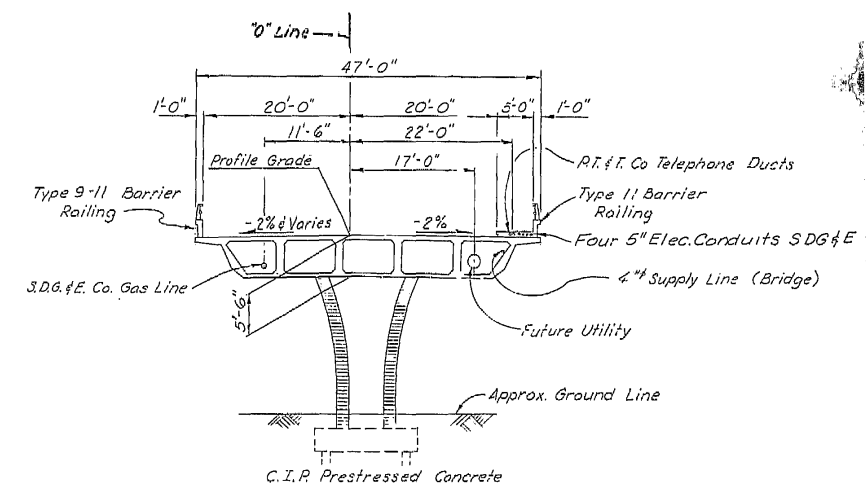

**AS BUILT**  
 CORRECTED BY G.C. Smith R.E.  
 CONTROL BY F. Hearsh  
 DATE 6/27/73

INDEX TO PLANS

SHEET NO.	TITLE
1.	GENERAL PLAN
2.	GRID GRADES
3.	FOUNDATION PLAN
4.	ABUTMENT DETAILS
5.	BENT 2 DETAILS
6.	TYPICAL SECTION
7.	GIRDER LAYOUT
8.	UTILITY DETAIL NO. 1
9.	BARRIER RAILING (TYPE 9)
10.	BRIDGE APPROACH GUARD RAILING (TYPE B) (LAYOUT)
11.	BRIDGE APPROACH GUARD RAILING (TYPE B) (DETAILS)
12.	LOG OF TEST BORINGS

STANDARD PLANS DATED FEB., 1968

A62-B2	EXCAVATION AND BACKFILL, BRIDGES AND WALLS - LIMITS OF PAYMENT
B7-1	BOX GIRDER DETAILS NO. 1
B11-42	BARRIER RAILING TYPE 11
B11-43	BARRIER RAILING DETAILS - TYPES 9, 10, 11 & 12

APPROXIMATE QUANTITIES

4" SUPPLY LINE (BRIDGE)	300 LF
FURNISHING STEEL PILING (10BP57)	3,450 LF
DRIVING STEEL PILES (10BP57)	49 EA
PRESTRESSING CIP CONCRETE	LUMP SUM
CONTRAST TREATMENT	470 SY
BRIDGE APPROACH GUARD RAILING (TYPE B)	77 LF
BARRIER RAILING (TYPE 9-11)	298 LF
BARRIER RAILING (TYPE 11)(5')	298 LF

FINAL QUANTITIES

STRUCTURE EXCAVATION (BRIDGE)	260 CY
STRUCTURE BACKFILL (BRIDGE)	125 CY
CLASS "A" CONCRETE (BRIDGE)	170 CY
CIP PRESTRESSED CONCRETE	810 CY
BAR REINFORCING STEEL (BRIDGE)	170,000 LBS

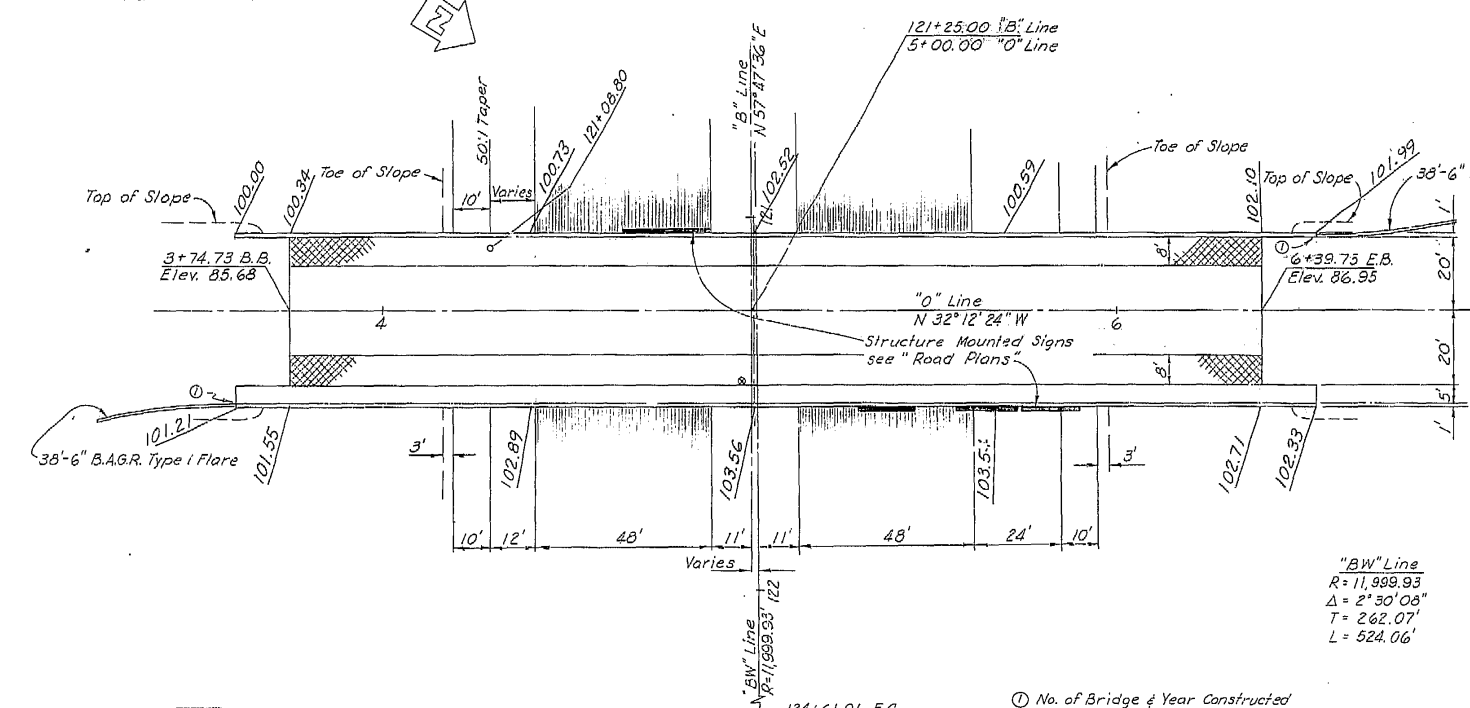

**AS BUILT PLANS**  
 Contract No. 11-110144  
 Date Completed \_\_\_\_\_  
 Document No. A0002519

- ① No. of Bridge & Year Constructed
- ② Name of Bridge
- ⊗ indicates min. vert. cl.
- ⊞ indicates Contrast Treatment

BRIDGE DEPARTMENT		<b>DESIGN SECTION 16</b>		STATE OF CALIFORNIA HIGHWAY TRANSPORTATION AGENCY DEPARTMENT OF PUBLIC WORKS DIVISION OF HIGHWAYS	
Section Supervisor: <i>[Signature]</i>				<b>CAMINO DEL RIO OVERCROSSING</b>	
Project Designer: <i>[Signature]</i>				LOCATED IN THE CITY OF SAN DIEGO, ALONG ROUTE 8, APPROX. 1/2 MI. E. OF THE ADOPTED ALIGNMENT OF ROUTE 805 IN SAN DIEGO COUNTY	
DESIGN: <i>[Signature]</i>				<b>GENERAL PLAN</b>	
DETAILS: <i>[Signature]</i>				BRIDGE NO. 57-758	
LAYOUT: <i>[Signature]</i>				POST MILE 5.0	
QUANTITIES: <i>[Signature]</i>				DRAWING NO. 57758-1	
SPECIFICATIONS: <i>[Signature]</i>				SHEET 1 OF 12	
Approval Recommended by: <i>[Signature]</i>				SECTION DATE: <i>[Signature]</i>	

I HEREBY CERTIFY THAT THIS IS A TRUE AND ACCURATE COPY OF THE ABOVE DOCUMENT TAKEN UNDER MY DIRECTION AND CONTROL ON THIS DATE IN SACRAMENTO, CALIFORNIA PURSUANT TO AUTHORIZATION BY THE DIRECTOR OF TRANSPORTATION.

8-10-73 *[Signature]*

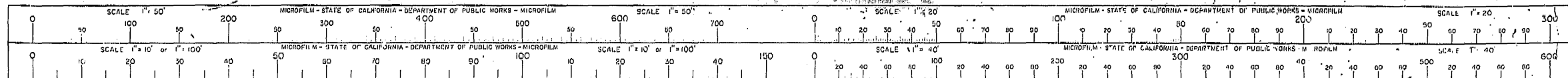

**NOTE: MILLY WAY IS**

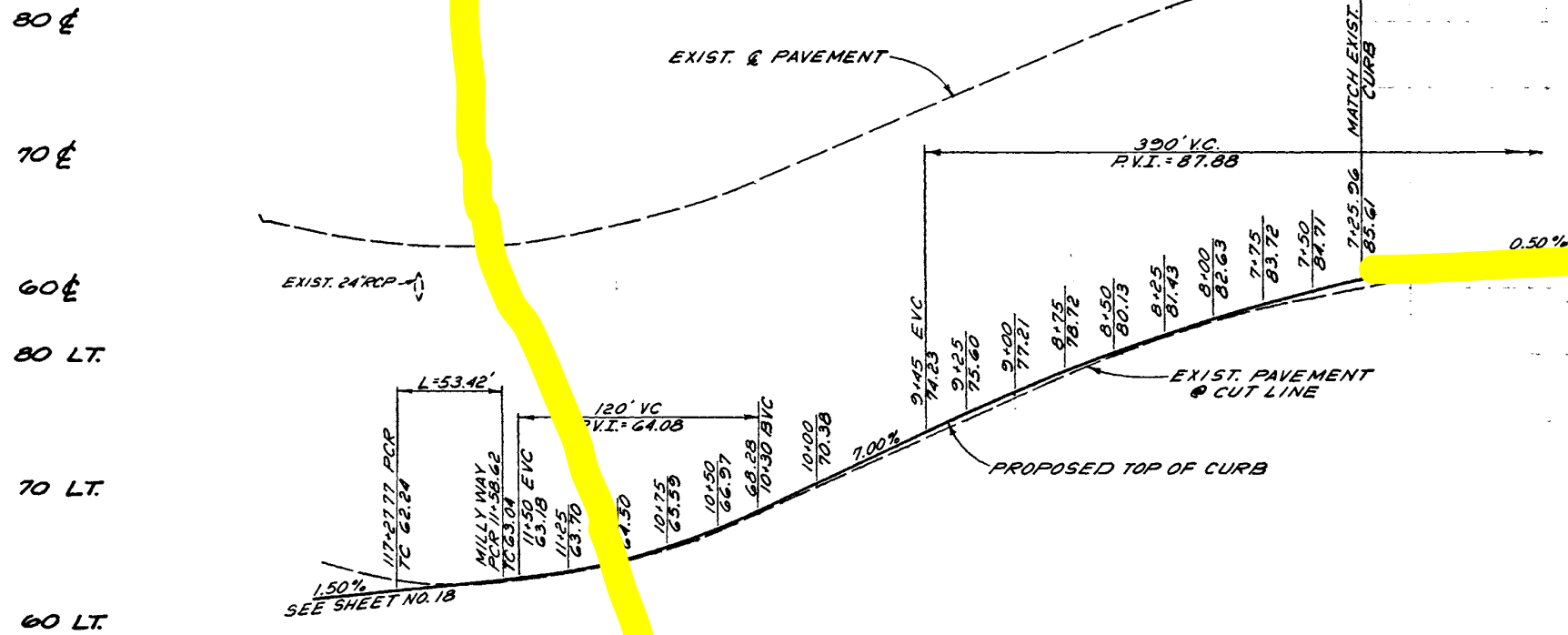

**MILLY WAY PROFILE**  
VERT. : 1"=6'  
HORIZ. : 1"=40'

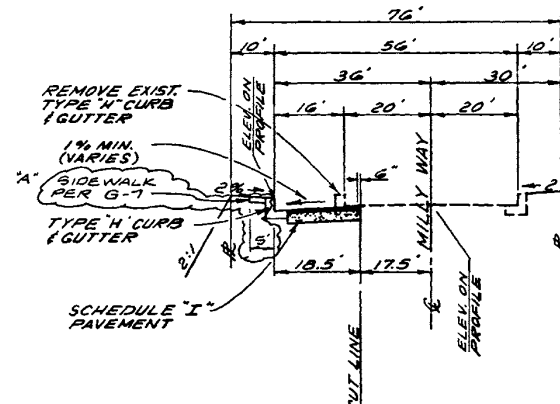

**TYPICAL SECTION W/ CURB & GUTTER**  
STA 7+25.96 TO 11+20.00  
(NO SCALE)

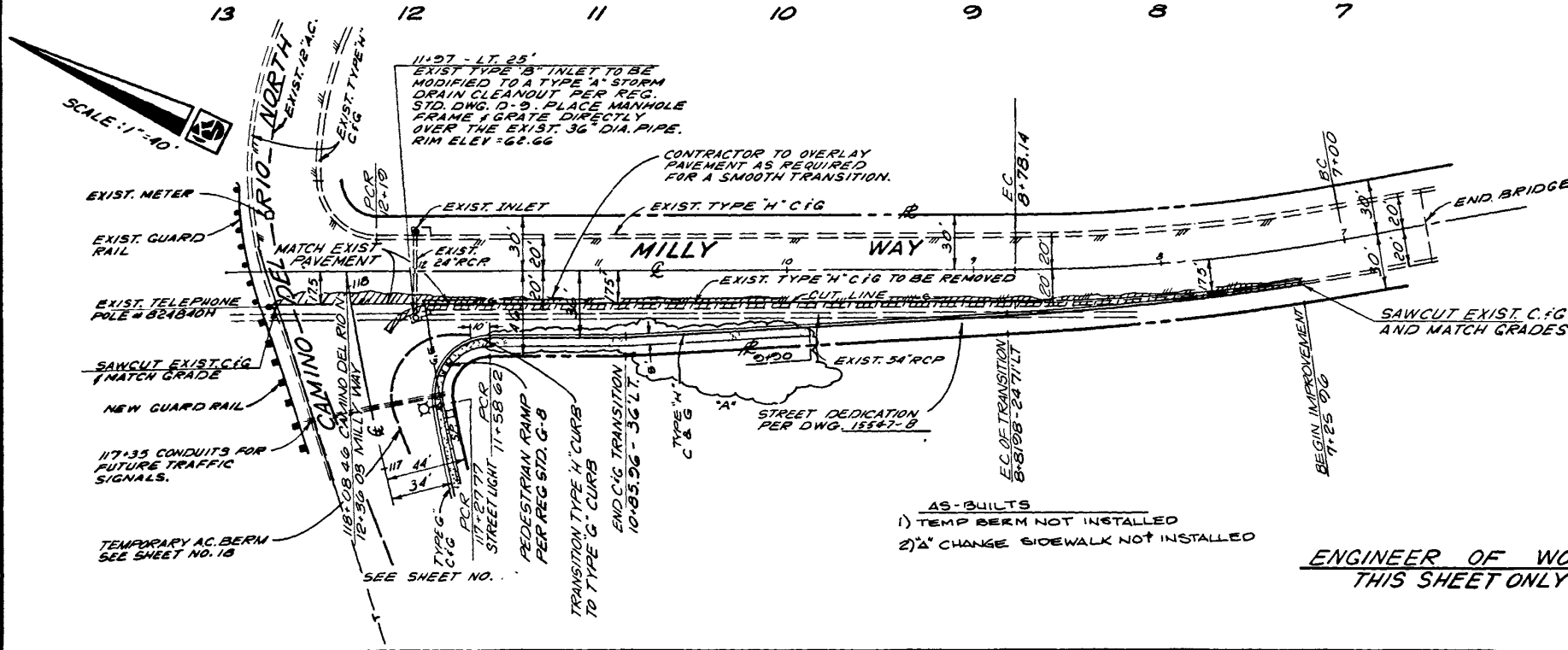

- AS-BUILTS**
- 1) TEMP BERM NOT INSTALLED
  - 2) A' CHANGE SIDEWALK NOT INSTALLED

**ENGINEER OF WORK**  
**THIS SHEET ONLY**

**BENCH MARK # 122**  
MISSION VALLEY CRT FEEDPOT DORY  
BRASS PLUG IN NORTHERLY HEAD  
WALL OF CATTLE UNDERPASS  
ELEV 54.258 DATUM M.S.L.

KLASSE, STEVENS AND ASSOCIATES, INC. Civil Engineers And Land Surveyors 620 E Main St. Suite 200 • El Cajon, Calif 92020 • (714) 440-8453	PROJECT NO. 351-818	SHEET 22 OF 26
DR BY RAS CHK BY MJS	DATE 9/29/81	RCE 25293

PRIVATE CONTRACT				
IMPROVEMENT PLAN FOR:				
CENTERSIDE				
CITY OF SAN DIEGO, CALIFORNIA ENGINEERING DEPARTMENT SHEET 22 OF 26 SHEETS			T.M. 77-259 W.O. NO. 70757	
C.R. Lockhart CITY ENGINEER		12-8-81 DATE		
DESCRIPTION	BY	APPROVED	DATE	FILED
ORIGINAL				
A' CHANGE	K.S. ADOOR		12/22/81	
AS-BUILT	R.G. GARDNER		12/22/81	
CONTRACTOR: GOLDEN			DATE STARTED: 1-16-82	LABOURY COORDINATOR: 222-1722
INSPECTOR: R. SMITH			DATE COMPLETED: 11-8-82	17936-22-D

A' CHANGE - ADD CONC SIDEWALK PER G-7  
**AS-BUILT W&W SHEET**

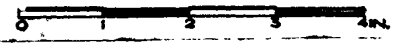

**FOR REFERENCE**  
**ONLY SDSU MV DRAINAGE**  
**EXHIBIT FROM SDSU MISSION VALLEY**  
**DRAINAGE REPORT DATED MAY 21,**  
**2021 (REDUCED COPY)**



MATCH LINE SHEET 1

LOW FLOW SPLITTER

RIPRAP ENERGY DISSIPATOR  
PER SDD-104  
ROCK CLASS = NO.2  
BACKING

BIOFILTRATION  
BASIN BMP #1

BIOFILTRATION BASIN  
BMP #2

BUBBLER OUTLET

RIPRAP ENERGY DISSIPATOR  
PER SDD-104  
ROCK CLASS = NO.2  
BACKING

EXISTING 36"  
OUTFALL TO REMAIN

SYSTEM 1000  
AREA=11.7 AC  
Q(100)= 15.3 CFS  
TC(100)= 14.9 MIN  
Q(10)=11.1 CFS  
TC(10)=15.2 MIN

SYSTEM 2000  
AREA=81.9 AC  
Q(100)= 202.1 CFS  
TC(100)= 18.0 MIN  
Q(10)=155.5 CFS  
TC(10)=16.8 MIN

NOTE: RUNOFF COEFFICIENT OF FUTURE  
PACES WAS ASSUMED TO BE 0.85

**LEGEND**

- PROPERTY BOUNDARY
- DRAINAGE SUBAREA
- DRAINAGE SYSTEM BOUNDARY
- HYDROLOGY NODE
- AREA FROM UPSTREAM TO DOWNSTREAM NODE
- BIOFILTRATION BMP

SCALE: 1"=60'

PREPARED BY:

JOB # 4284.20

CREATED: 07/18/19

**PROJECT DESIGN CONSULTANTS**  
Planning | Landscape Architecture | Engineering | Survey

WE DESIGN, BUILD, AND  
OPERATE THE  
INFRASTRUCTURE  
FOR THE  
CITY OF SAN DIEGO

**CITY OF SAN DIEGO**  
**SDSU MISSION VALLEY**  
**DRAINAGE MAP**  
**PROPOSED ULT. CONDITION (PHASE 4)**  
**EXHIBIT B-2**

MATCH LINE SHEET 4

