



1/4/2023

Stormwater Quality Management Plan (SWQMP)

Priority Development Project
for the County of San Diego

Rockvill Street
Development Permit Review DR2022-1



Kappa Surveying and Engineering
8402 NORTH MAGNOLIA AVE. SUITE C. CA, 92701

CITY OF SANTEE

**PRIORITY DEVELOPMENT PROJECT (PDP)
STORM WATER QUALITY MANAGEMENT PLAN (SWQMP)
FOR
ROCKVILL STREET**

**10756 ROCKVILL STREET
SANTEE, CA, 92071**

**ASSESSOR'S PARCEL NUMBER(S):
384 470 09
ENGINEER OF WORK: WILLIAM R. DICK, PE: 34563**



WILLIAM R. DICK, PE:34563

PREPARED FOR:

**AGENT: RYAN CLARK
(619)442 3343**

PDP SWQMP PREPARED BY:

**KAPPA SURVEYING & ENGINEERING
8402 NORTH MAGNOLIA AVE, SUITE C
SANTEE, CA, 92071
(619)449 2600**

**DATE OF SWQMP:
JANUARY 4, 2023**

**PLANS PREPARED BY:
KAPPA SURVEYING & ENGINEERING
8402 NORTH MAGNOLIA AVE, SUITE C
SANTEE, CA, 92071
(619)449 2600**

SWQMP PREPARER'S CERTIFICATION PAGE

Project Name: ROCKVILL STREET

Permit Application Number: Development Permit Review DR2022-1

PREPARER'S CERTIFICATION

I hereby declare that I am the Engineer in Responsible Charge of design of storm water best management practices (BMPs) for this project, and that I have exercised responsible charge over the design of the BMPs as defined in Section 6703 of the Business and Professions Code, and that the design is consistent with the PDP requirements of the City of Santee BMP Design Manual, which is a design manual for compliance with local City of Santee and regional MS4 Permit (California Regional Water Quality Control Board San Diego Region Order No. R9-2015-0100) requirements for storm water management.

I have read and understand that the [City Engineer] has adopted minimum requirements for managing urban runoff, including storm water, from land development activities, as described in the BMP Design Manual. I certify that this PDP SWQMP has been completed to the best of my ability and accurately reflects the project being proposed and the applicable BMPs proposed to minimize the potentially negative impacts of this project's land development activities on water quality. I understand and acknowledge that the plan check review of this PDP SWQMP by the [City Engineer] is confined to a review and does not relieve me, as the Engineer in Responsible Charge of design of storm water BMPs for this project, of my responsibilities for project design.

23
RCE 34563, 9-30-22



Engineer of Work's Signature, PE Number & Expiration Date

William R. Dick, PE

Print Name

Kappa Surveying & Engineering

Company

~~7/26/2021~~ 1/4/23

Date

Engineer's Seal:

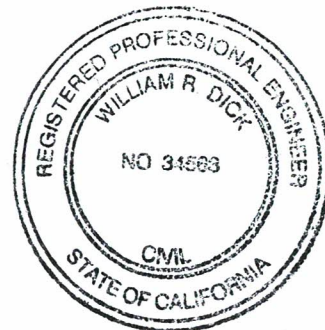

PDP SWQMP Template Date: February 2016
PDP SWQMP Preparation Date: [July 26, 2021]

Page intentionally blank

TABLE OF CONTENTS

Acronym Sheet

PDP SWQMP Preparer's Certification Page

PDP SWQMP Project Owner's Certification Page

Submittal Record

Project Vicinity Map

FORM I-1 Applicability of Permanent, Post-Construction Storm Water BMP Requirements

FORM I-2 Project Type Determination Checklist (Standard Project or PDP)

FORM I-3B Site Information Checklist for PDPs

FORM I-4 Source Control BMP Checklist for All Development Projects

FORM I-5 Site Design BMP Checklist for All Development Projects

FORM I-6 Summary of PDP Structural BMPs

Attachment 1: Backup for PDP Pollutant Control BMPs

Attachment 1a: DMA Exhibit

Attachment 1b: Tabular Summary of DMAs and Design Capture Volume Calculations

Attachment 1c: Harvest and Use Feasibility Screening (when applicable)

Attachment 1d: Categorization of Infiltration Feasibility Condition (when applicable)

Attachment 1e: Pollutant Control BMP Design Worksheets / Calculations

Attachment 2: Backup for PDP Hydromodification Control Measures

Attachment 2a: Hydromodification Management Exhibit

Attachment 2b: Management of Critical Coarse Sediment Yield Areas

Attachment 2c: Geomorphic Assessment of Receiving Channels

Attachment 2d: Flow Control Facility Design

Attachment 3: Structural BMP Maintenance Plan

Attachment 3a: B Structural BMP Maintenance Thresholds and Actions

Attachment 3b: Draft Maintenance Agreement (when applicable)

Attachment 4: Copy of Plan Sheets Showing Permanent Storm Water BMPs

ACRONYMS

| | |
|---------|--|
| APN | Assessor's Parcel Number |
| BMP | Best Management Practice |
| HMP | Hydromodification Management Plan |
| HSG | Hydrologic Soil Group |
| MS4 | Municipal Separate Storm Sewer System |
| N/A | Not Applicable |
| NRCS | Natural Resources Conservation Service |
| PDP | Priority Development Project |
| PE | Professional Engineer |
| SC | Source Control |
| SD | Site Design |
| SDRWQCB | San Diego Regional Water Quality Control Board |
| SIC | Standard Industrial Classification |
| SWQMP | Storm Water Quality Management Plan |

SWQMP PREPARER'S CERTIFICATION PAGE

Project Name: ROCKVILL STREET

Permit Application Number: Development Permit Review DR2022-1

PREPARER'S CERTIFICATION

I hereby declare that I am the Engineer in Responsible Charge of design of storm water best management practices (BMPs) for this project, and that I have exercised responsible charge over the design of the BMPs as defined in Section 6703 of the Business and Professions Code, and that the design is consistent with the PDP requirements of the City of Santee BMP Design Manual, which is a design manual for compliance with local City of Santee and regional MS4 Permit (California Regional Water Quality Control Board San Diego Region Order No. R9-2015-0100) requirements for storm water management.

I have read and understand that the [City Engineer] has adopted minimum requirements for managing urban runoff, including storm water, from land development activities, as described in the BMP Design Manual. I certify that this PDP SWQMP has been completed to the best of my ability and accurately reflects the project being proposed and the applicable BMPs proposed to minimize the potentially negative impacts of this project's land development activities on water quality. I understand and acknowledge that the plan check review of this PDP SWQMP by the [City Engineer] is confined to a review and does not relieve me, as the Engineer in Responsible Charge of design of storm water BMPs for this project, of my responsibilities for project design.

RCE 34563, 9-30-22

Engineer of Work's Signature, PE Number & Expiration Date

William R. Dick, PE

Print Name

Kappa Surveying & Engineering

Company

7/26/2021

Date

Engineer's Seal:

Page intentionally blank

SWQMP PROJECT OWNER'S CERTIFICATION PAGE

Project Name: ROCKVILL STREET

Permit Application Number: Development Permit Review DR2022-1

PROJECT OWNER'S CERTIFICATION

This PDP SWQMP has been prepared for Agent: Ryan Clark by Kappa Surveying & Engineering. The PDP SWQMP is intended to comply with the PDP requirements of the City of Santee BMP Design Manual, which is a design manual for compliance with local City of Santee and regional MS4 Permit (California Regional Water Quality Control Board San Diego Region Order No. R9-2015-0100) requirements for storm water management.

The undersigned, while it owns the subject property, is responsible for the implementation of the provisions of this plan. Once the undersigned transfers its interests in the property, its successor-in-interest shall bear the aforementioned responsibility to implement the best management practices (BMPs) described within this plan, including ensuring on-going operation and maintenance of structural BMPs. A signed copy of this document shall be available on the subject property into perpetuity.

Project Owner's Signature

Print Name

Company

Date

Page intentionally blank

SUBMITTAL RECORD

Use this Table to keep a record of submittals of this PDP SWQMP. Each time the PDP SWQMP is re-submitted, provide the date and status of the project. In column 4 summarize the changes that have been made or indicate if response to plancheck comments is included. When applicable, insert response to plancheck comments behind this page.

| Submittal Number | Date | Project Status | Summary of Changes |
|------------------|------------|--|--------------------|
| 1 | 7/26/2021 | <input checked="" type="checkbox"/> Preliminary Design / Planning/ CEQA <input type="checkbox"/> Final Design | Initial Submittal |
| 2 | 6-10-2022 | <input type="checkbox"/> Preliminary Design / Planning/ CEQA <input checked="" type="checkbox"/> Final Design | |
| 3 | 10-14-2022 | <input type="checkbox"/> Preliminary Design / Planning/ CEQA <input checked="" type="checkbox"/> Final Design | |
| 4 | 1-4-2023 | <input type="checkbox"/> Preliminary Design / Planning/ CEQA <input checked="" type="checkbox"/> Final Design | |

PROJECT VICINITY MAP

Project Name: ROCKVLL STREET

Permit Application Number: Development Permit Review DR2022-1



| Applicability of Permanent, Post-Construction Storm Water BMP Requirements (Storm Water Intake Form for all Development Permit Applications) | | Form I-1 Model BMP Design Manual [August 31, 2015] |
|---|---|---|
| Project Identification | | |
| Project Name: ROCKVILL STREET | | |
| Permit Application Number: Development Permit Review DR2022-1 | | Date: 7/26/2021 |
| Project Address: 10756 Rockvill Street | | |
| Determination of Requirements | | |
| <p>The purpose of this form is to identify permanent, post-construction requirements that apply to the project. This form serves as a short <u>summary</u> of applicable requirements, in some cases referencing separate forms that will serve as the backup for the determination of requirements.</p> <p>Answer each step below, starting with Step 1 and progressing through each step until reaching "Stop". Upon reaching a Stop, do not complete further Steps beyond the Stop.</p> <p>Refer to BMP Design Manual sections and/or separate forms referenced in each step below.</p> | | |
| Step | Answer | Progression |
| Step 1: Is the project a "development project"? See Section 1.3 of the BMP Design Manual for guidance. | <input checked="" type="checkbox"/> Yes | Go to Step 2. |
| | <input type="checkbox"/> No | Stop. Permanent BMP requirements do not apply. No SWQMP will be required. Provide discussion below. |
| Discussion / justification if the project is <u>not</u> a "development project" (e.g., the project includes <i>only</i> interior remodels within an existing building): | | |
| Step 2: Is the project a Standard Project, Priority Development Project (PDP), or exception to PDP definitions? To answer this item, see Section 1.4 of the BMP Design Manual <i>in its entirety</i> for guidance, AND complete Form I-2, Project Type Determination. | <input type="checkbox"/> Standard Project | Stop. <u>Only Standard Project requirements apply, including Standard Project SWQMP.</u> |
| | <input checked="" type="checkbox"/> PDP | <u>Standard and PDP requirements apply, including PDP SWQMP.</u> Go to Step 3. |
| | <input type="checkbox"/> Exception to PDP definitions | Stop. <u>Standard Project requirements apply, and any additional requirements specific to the type of project.</u> Provide discussion and list any additional requirements below. Prepare <u>Standard Project SWQMP.</u> |

[Step 2 Continued from Page 1] Discussion / justification, and additional requirements for exceptions to PDP definitions, if applicable:

| | | |
|---|--|---|
| Step 3 (PDPs only). Is the project subject to earlier PDP requirements due to a prior lawful approval? See Section 1.10 of the BMP Design Manual for guidance. | <input type="checkbox"/> Yes | Consult the [City Engineer] to determine requirements. Provide discussion and identify requirements below. Go to Step 4. |
| | <input checked="" type="checkbox"/> No | BMP Design Manual PDP requirements apply. Go to Step 4. |

Discussion / justification of prior lawful approval, and identify requirements (*not required if prior lawful approval does not apply*):

| | | |
|--|--|--|
| Step 4 (PDPs only). Do hydromodification control requirements apply? See Section 1.6 of the BMP Design Manual for guidance. | <input type="checkbox"/> Yes | PDP structural BMPs required for pollutant control (Chapter 5) and hydromodification control (Chapter 6). Go to Step 5. |
| | <input checked="" type="checkbox"/> No | Stop. PDP structural BMPs required for pollutant control (Chapter 5) only. Provide brief discussion of exemption to hydromodification control below. |

Discussion / justification if hydromodification control requirements do not apply:

The site fronts an exempt system that the development will tap in a SDRSD-D-63 Concrete Lug.

| | | |
|--|------------------------------|--|
| Step 5 (PDPs subject to hydromodification control requirements only). Does protection of critical coarse sediment yield areas apply based on review of WMAA Potential Critical Coarse Sediment Yield Area Map? See Section 6.2 of the BMP Design Manual for guidance. | <input type="checkbox"/> Yes | Management measures required for protection of critical coarse sediment yield areas (Chapter 6.2). Stop. |
| | <input type="checkbox"/> No | Management measures not required for protection of critical coarse sediment yield areas. Provide brief discussion below. Stop. |

| Priority Determination Form | | Form I-2 Model BMP Design Manual [August 31, 2015] | |
|---|---|---|---|
| Project Information | | | |
| Project Name: ROCKVILL STREET | | | |
| Permit Application Number: Development Permit Review DR2022-1 | | Date: 7/26/2021 | |
| Project Address: 10756 Rockvill Street | | | |
| Project Type Determination: Standard Project or Priority Development Project (PDP) | | | |
| The project is (select one): <input checked="" type="checkbox"/> New Development <input type="checkbox"/> Redevelopment | | | |
| The total proposed newly created or replaced impervious area is: <u>68765</u> ft ² (<u>1.57</u>) acres | | | |
| Is the project in any of the following categories, (a) through (f)? | | | |
| Yes <input checked="" type="checkbox"/> | No <input type="checkbox"/> | (a) | New development projects that create 10,000 square feet or more of impervious surfaces (collectively over the entire project site). This includes commercial, industrial, residential, mixed-use, and public development projects on public or private land. |
| Yes <input type="checkbox"/> | No <input checked="" type="checkbox"/> | (b) | Redevelopment projects that create and/or replace 5,000 square feet or more of impervious surface (collectively over the entire project site on an existing site of 10,000 square feet or more of impervious surfaces). This includes commercial, industrial, residential, mixed-use, and public development projects on public or private land. |
| Yes <input checked="" type="checkbox"/> | No <input type="checkbox"/> | (c) | <p>New and redevelopment projects that create and/or replace 5,000 square feet or more of impervious surface (collectively over the entire project site), and support one or more of the following uses:</p> <ul style="list-style-type: none"> (i) Restaurants. This category is defined as a facility that sells prepared foods and drinks for consumption, including stationary lunch counters and refreshment stands selling prepared foods and drinks for immediate consumption (Standard Industrial Classification (SIC) code 5812). (ii) Hillside development projects. This category includes development on any natural slope that is twenty-five percent or greater. (iii) Parking lots. This category is defined as a land area or facility for the temporary parking or storage of motor vehicles used personally, for business, or for commerce. (iv) Streets, roads, highways, freeways, and driveways. This category is defined as any paved impervious surface used for the transportation of automobiles, trucks, motorcycles, and other vehicles. |

Form I-2 Page 2, Form Template Date: August 31, 2015

| | | | |
|--|---|-----|--|
| Yes <input type="checkbox"/> | No <input checked="" type="checkbox"/> | (d) | <p>New or redevelopment projects that create and/or replace 2,500 square feet or more of impervious surface (collectively over the entire project site), and discharging directly to an Environmentally Sensitive Area (ESA). "Discharging directly to" includes flow that is conveyed overland a distance of 200 feet or less from the project to the ESA, or conveyed in a pipe or open channel any distance as an isolated flow from the project to the ESA (i.e. not commingled with flows from adjacent lands).</p> <p><i>Note: ESAs are areas that include but are not limited to all Clean Water Act Section 303(d) impaired water bodies; areas designated as Areas of Special Biological Significance by the State Water Board and San Diego Water Board; State Water Quality Protected Areas; water bodies designated with the RARE beneficial use by the State Water Board and San Diego Water Board; and any other equivalent environmentally sensitive areas which have been identified by the Copermittees. See BMP Design Manual Section 1.4.2 for additional guidance.</i></p> |
| Yes <input type="checkbox"/> | No <input checked="" type="checkbox"/> | (e) | <p>New development projects, or redevelopment projects that create and/or replace 5,000 square feet or more of impervious surface, that support one or more of the following uses:</p> <ul style="list-style-type: none"> (i) Automotive repair shops. This category is defined as a facility that is categorized in any one of the following SIC codes: 5013, 5014, 5541, 7532-7534, or 7536-7539. (ii) Retail gasoline outlets (RGOs). This category includes RGOs that meet the following criteria: (a) 5,000 square feet or more or (b) a projected Average Daily Traffic (ADT) of 100 or more vehicles per day. |
| Yes <input checked="" type="checkbox"/> | No <input type="checkbox"/> | (f) | <p>New or redevelopment projects that result in the disturbance of one or more acres of land and are expected to generate pollutants post construction.</p> <p><i>Note: See BMP Design Manual Section 1.4.2 for additional guidance.</i></p> |

Does the project meet the definition of one or more of the Priority Development Project categories (a) through (f) listed above?

No – the project is not a Priority Development Project (Standard Project).

Yes – the project is a Priority Development Project (PDP).

The following is for redevelopment PDPs only:

The area of existing (pre-project) impervious area at the project site is: _____ ft² (A)

The total proposed newly created or replaced impervious area is _____ ft² (B)

Percent impervious surface created or replaced (B/A)*100: _____%

The percent impervious surface created or replaced is (select one based on the above calculation):

less than or equal to fifty percent (50%) – only new impervious areas are considered PDP

OR

greater than fifty percent (50%) – the entire project site is a PDP

**Site Design Checklist
For PDPs**

Form I-3B (PDPs)
Model BMP Design Manual
[August 31, 2015]

Project Summary Information

| | |
|---|--|
| Project Name | ROCKVILL STREET |
| Project Address | 10756 Rockvill Street |
| Assessor's Parcel Number(s) (APN(s)) | 384 470 09 |
| Permit Application Number | Development Permit Review DR2022-1 |
| Project Hydrologic Unit | Select One: <input type="checkbox"/> Santa Margarita 902 <input type="checkbox"/> San Luis Rey 903 <input type="checkbox"/> Carlsbad 904 <input type="checkbox"/> San Dieguito 905 <input type="checkbox"/> Penasquitos 906 <input checked="" type="checkbox"/> San Diego 907 <input type="checkbox"/> Pueblo San Diego 908 <input type="checkbox"/> Sweetwater 909 <input type="checkbox"/> Otay 910 <input type="checkbox"/> Tijuana 911 |
| Project Watershed (Complete Hydrologic Unit, Area, and Subarea Name with Numeric Identifier) | Watershed – Lower San Diego River, Hydro Unit – San Diego, Hydro Area – Lower San Diego, Subarea – Santee, 907.12 |
| Parcel Area (total area of Assessor's Parcel(s) associated with the project) | <u>2.08</u> Acres (<u>90,6004</u> Square Feet) |
| Area to be Disturbed by the Project (Project Area) | <u>1.67</u> Acres (<u>73065</u> Square Feet) |
| Project Proposed Impervious Area (subset of Project Area) | <u>1.57</u> Acres (<u>68765</u> Square Feet) |
| Project Proposed Pervious Area (subset of Project Area) | <u>0.09</u> Acres (<u>4300</u> Square Feet) |
| Note: Proposed Impervious Area + Proposed Pervious Area = Area to be Disturbed by the Project. This may be less than the Parcel Area. | |

Description of Existing Site Condition

Current Status of the Site (select all that apply):

- Existing development
- Previously graded but not built out
- Demolition completed without new construction
- Agricultural or other non-impervious use
- Vacant, undeveloped/natural

Description / Additional Information:

Existing Land Cover Includes (select all that apply):

- Vegetative Cover
- Non-Vegetated Pervious Areas
- Impervious Areas

Description / Additional Information:

Underlying Soil belongs to Hydrologic Soil Group (select all that apply):

- NRCS Type A
- NRCS Type B
- NRCS Type C
- NRCS Type D

SOURCE: TerraPacific Consultants Inc.

Approximate Depth to Groundwater (GW):

- GW Depth < 5 feet
- 5 feet < GW Depth < 10 feet
- 10 feet < GW Depth < 20 feet
- GW Depth > 20 feet

No observed ground water in the depths of excavation. Note testing denotes that fill was only 3ft and then Granite soil.

SOURCE: TerraPacific Consultants Inc.

Existing Natural Hydrologic Features (select all that apply):

Watercourses

Seeps

Springs

Wetlands

None

Description / Additional Information:

Description of Existing Site Drainage Patterns

How is storm water runoff conveyed from the site? At a minimum, this description should answer:

- (1) whether existing drainage conveyance is natural or urban;
- (2) Is runoff from offsite conveyed through the site? if yes, quantify all offsite drainage areas, design flows, and locations where offsite flows enter the project site, and summarize how such flows are conveyed through the site;
- (3) Provide details regarding existing project site drainage conveyance network, including any existing storm drains, concrete channels, swales, detention facilities, storm water treatment facilities, natural or constructed channels; and
- (4) Identify all discharge locations from the existing project site along with a summary of conveyance system size and capacity for each of the discharge locations. Provide summary of the pre-project drainage areas and design flows to each of the existing runoff discharge locations.

Describe existing site drainage patterns:

The existing drainage conveyance is natural rockpile and runoff from offsite is conveyed through the undeveloped graded site. The existing project drainage conveyance network consists of natural topographic sheet flow conveyance. The discharge location at its current state is the entire west property line. Flow direction can be seen in the DAS. At its current state, the site borders a street at the west of the property line, buildings on the north/northwestern and southern borders of the property line and it exempt from hydromodification because its proximity to an exempt system city storm drain.

Description of Proposed Site Development

Project Description / Proposed Land Use and/or Activities:

The purpose of this project is to develop a natural lot for commercial use coming from Rockvill street. The project site will consist of a commercial building and a parking lot.

List/describe proposed impervious features of the project (e.g., buildings, roadways, parking lots, courtyards, athletic courts, other impervious features):

This project will include a parking lot and a commercial building.

List/describe proposed pervious features of the project (e.g., landscape areas):

Landscape areas and treatment areas.

Does the project include grading and changes to site topography?

Yes

No

Description / Additional Information:

This project includes grading and changes to site topography due to the construction of the parking lot and commercial building.

Description of Proposed Site Drainage Patterns

Does the project include changes to site drainage (e.g., installation of new storm water conveyance systems)?

- Yes
- No

If yes, provide details regarding the proposed project site drainage conveyance network, including storm drains, concrete channels, swales, detention facilities, storm water treatment facilities, natural or constructed channels, and the method for conveying offsite flows through or around the proposed project site. Identify all discharge locations from the proposed project site along with a summary of the conveyance system size and capacity for each of the discharge locations. Provide a summary of pre- and post-project drainage areas and design flows to each of the runoff discharge locations. Reference the drainage study for detailed calculations.

Describe proposed site drainage patterns:

The proposed project site drainage conveyance network consists of sheet flow, which will lead off into trench flow. From trench flow, the drainage conveyance network will lead to a BMP.

Identify whether any of the following features, activities, and/or pollutant source areas will be present (select all that apply):

- On-site storm drain inlets
- Interior floor drains and elevator shaft sump pumps
- Interior parking garages
- Need for future indoor & structural pest control
- Landscape/Outdoor Pesticide Use
- Pools, spas, ponds, decorative fountains, and other water features
- Food service
- Refuse areas
- Industrial processes
- Outdoor storage of equipment or materials
- Vehicle and Equipment Cleaning
- Vehicle/Equipment Repair and Maintenance
- Fuel Dispensing Areas
- Loading Docks
- Fire Sprinkler Test Water
- Miscellaneous Drain or Wash Water
- Plazas, sidewalks, and parking lots

Description / Additional Information:

Identification and Narrative of Receiving Water and Pollutants of Concern

Describe flow path of storm water from the project site discharge location(s), through urban storm conveyance systems as applicable, to receiving creeks, rivers, and lagoons as applicable, and ultimate discharge to the Pacific Ocean (or bay, lagoon, lake or reservoir, as applicable):

Runoff will lead to various catch basins spread throughout the developed site and eventually led to a BMP. From the BMP, the runoff will flow to Forrester Creek and then to the San Diego River. Once hitting the San Diego River, it will lead into Mission Bay and then into the Pacific Ocean.

List any 303(d) impaired water bodies within the path of storm water from the project site to the Pacific Ocean (or bay, lagoon, lake or reservoir, as applicable), identify the pollutant(s)/stressor(s) causing impairment, and identify any TMDLs and/or Highest Priority Pollutants from the WQIP for the impaired water bodies:

| 303(d) Impaired Water Body | Pollutant(s)/Stressor(s) | TMDLs / WQIP Highest Priority Pollutant |
|-----------------------------------|---|--|
| Forrester Creek | Nitrogen, Phosphorus, Selenium, Benthic Community Effects, Indicator Bacteria, Total Dissolved Solids | YES |
| | | |
| | | |

Identification of Project Site Pollutants*

***Identification of project site pollutants is only required if flow-thru treatment BMPs are implemented onsite in lieu of retention or biofiltration BMPs (note the project must also participate in an alternative compliance program unless prior lawful approval to meet earlier PDP requirements is demonstrated)**

Identify pollutants expected from the project site based on all proposed use(s) of the site (see BMP Design Manual Appendix B.6):

| Pollutant | Not Applicable to the Project Site | Expected from the Project Site | Also a Receiving Water Pollutant of Concern |
|-----------------------------|---|---------------------------------------|--|
| Sediment | | | |
| Nutrients | | | |
| Heavy Metals | | | |
| Organic Compounds | | | |
| Trash & Debris | | | |
| Oxygen Demanding Substances | | | |
| Oil & Grease | | | |
| Bacteria & Viruses | | | |
| Pesticides | | | |

Caltrans Water Quality Planning Tool

The Water Quality Planning Tool was created to help planners and designers comply with environmental permits. It uses a map interface to find information based on a project's location. **This application is being updated for digital accessibility and will continue to function while updates are in progress.**

Layers

- 303(d) List and TMDLs 2014-2016 ([Legend](#))
- Areas of Special Biological Significance
- Arid and Semi-Arid Regions
- Caltrans Districts
- Caltrans Facilities
- Caltrans Tier 1 Monitoring Sites
- Calwater Watersheds
- Coastal Zone
- Counties
- Geologic Map ([Legend](#))
- High Risk
- Receiving Watersheds
- Monthly Precipitation
- MS4 Areas

Information

Hover over a layer name for a description. Additional information, tables, coordinates, and links are below the



map.
[Help](#)

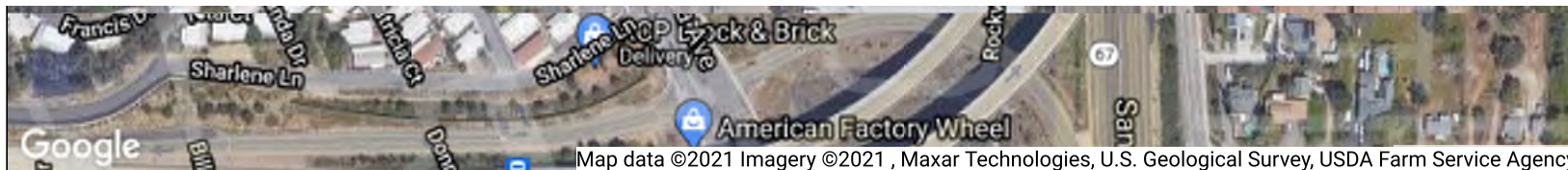

Watershed Information

CALWATER WATERSHED

Hydrologic Unit SAN DIEGO Hydrologic Area Lower San Diego Hydrologic Sub-Area # 907.12
Hydrologic Sub-Area Name Santee Planning Watershed 4907120000 HSA Area (acres) 40149
Latitude, Longitude 32.8356, -116.9638

WATERSHED BOUNDARY DATASET

Watershed Lower San Diego River Subwatershed San Vicente Creek-San Diego River Hydrologic Unit Code 180703040703
Average Annual Precipitation (inches) 14.54

TMDLs & 303(d) Listed Water Bodies (2014 - 2016 List)

Key: Water body on 303(d) list Water body with a TMDL

| Name | Pollutant | Size | Status |
|---|---------------------------|------------|--|
| Eucalyptus Hills Creek | Diazinon | 2.8 Miles | TMDL required |
| Eucalyptus Hills Creek | Indicator Bacteria | 2.8 Miles | TMDL required |
| Forester Creek | Benthic Community Effects | 6.36 Miles | TMDL required |
| Forester Creek | Indicator Bacteria | 6.36 Miles | Being addressed with USEPA approved TMDL |
| Forester Creek | Nitrogen | 6.36 Miles | TMDL required |
| Forester Creek | Phosphorus | 6.36 Miles | TMDL required |
| Forester Creek | Selenium | 6.36 Miles | TMDL required |
| Forester Creek | Total Dissolved Solids | 6.36 Miles | TMDL required |
| Los Coches Creek | Indicator Bacteria | 8.8 Miles | TMDL required |
| Los Coches Creek | Nitrogen | 8.8 Miles | TMDL required |
| Los Coches Creek | Phosphorus | 8.8 Miles | TMDL required |
| Los Coches Creek | Selenium | 8.8 Miles | TMDL required |
| San Diego River (Lower) | Benthic Community Effects | 16 Miles | TMDL required |
| San Diego River (Lower) | Cadmium | 16 Miles | TMDL required |
| San Diego River (Lower) | Indicator Bacteria | 16 Miles | Being addressed with USEPA approved TMDL |
| San Diego River (Lower) | Nitrogen | 16 Miles | TMDL required |
| San Diego River (Lower) | Oxygen, Dissolved | 16 Miles | TMDL required |
| San Diego River (Lower) | Phosphorus | 16 Miles | TMDL required |
| San Diego River (Lower) | Total Dissolved Solids | 16 Miles | TMDL required |

| | | | |
|---|--------------------|---------------|---------------|
| San Diego River (Lower) | Toxicity | 16 Miles | TMDL required |
| San Diego River (Upper) | Indicator Bacteria | 31.96 Miles | TMDL required |
| San Diego River (Upper) | Oxygen, Dissolved | 31.96 Miles | TMDL required |
| San Diego River (Upper) | Sulfates | 31.96 Miles | TMDL required |
| San Vicente Reservoir | Chloride | 1057.59 Acres | TMDL required |
| San Vicente Reservoir | Color | 1057.59 Acres | TMDL required |
| San Vicente Reservoir | Nitrogen | 1057.59 Acres | TMDL required |
| San Vicente Reservoir | pH | 1057.59 Acres | TMDL required |
| San Vicente Reservoir | Sulfates | 1057.59 Acres | TMDL required |
| Sycamore Canyon | Oxygen, Dissolved | 8.3 Miles | TMDL required |

Water Quality Objectives

The following waterbodies are in or near HSA 907.12. Click on the waterbody to get information on water quality objectives and beneficial uses

| Waterbody Name | Beneficial Uses | Sediment-Sensitive Waterbody |
|--|--|------------------------------|
| Alvarado Canyon | AGR, COLD, IND, REC1, REC2, WARM, WILD | False |
| Beeler Creek | AGR, COLD, IND, REC1, REC2, WARM, WILD | False |
| Chicarita Creek | AGR, COLD, IND, REC1, REC2, WARM, WILD | False |
| Clark Canyon | AGR, COLD, IND, RARE, REC1, REC2, WARM, WILD | False |
| Cypress Canyon | AGR, COLD, IND, REC1, REC2, WARM, WILD | False |
| Dana Point Harbor | COMM, IND, MAR, MIGR, NAV, RARE, REC1, REC2, SHELL, SPWN, WILD | False |
| Del Mar Boat Basin | COMM, IND, MAR, MIGR, NAV, RARE, REC1, REC2, SHELL, SPWN, WILD | False |
| Featherstone Canyon | AGR, COLD, IND, MUN, PROC, REC1, REC2, WARM, WILD | False |
| Forrester Creek | COLD, IND, MUN, REC1, REC2, WARM, WILD | False |
| Forrester Creek | COLD, IND, MUN, REC1, REC2, WARM, WILD | False |
| Foster Canyon | AGR, COLD, IND, MUN, PROC, REC1, REC2, WARM, WILD | False |
| Lake Jennings | COLD, IND, MUN, REC1, REC2, WILD | False |
| Lake Murray | COLD, IND, MUN, POW, REC1, REC2, WARM, WILD | False |
| Little Sycamore Canyon | AGR, COLD, IND, REC1, REC2, WARM, WILD | False |
| Los Coches | COLD, IND, MUN, REC1, REC2, WARM, WILD | False |
| Los Coches Creek | COLD, IND, MUN, REC1, REC2, WARM, WILD | False |
| Los Penasquitos Creek | AGR, COLD, IND, REC1, REC2, WARM, WILD | False |
| Lower San Diego | ALL | False |
| Mission Bay | COMM, EST, IND, MAR, MIGR, RARE, REC1, REC2, SHELL, WILD | False |
| Mission San Diego | ALL | False |
| Mouth of San Diego River | COMM, EST, MAR, MIGR, RARE, REC1, REC2, SHELL, WILD | False |
| Murphy Canyon | AGR, COLD, IND, RARE, REC1, REC2, WARM, WILD | False |
| Murray Canyon | AGR, COLD, IND, REC1, REC2, WARM, WILD | False |
| Oak Canyon | AGR, COLD, IND, REC1, REC2, WARM, WILD | False |

| | | |
|---|--|-------|
| Oceanside Harbor | COMM, IND, MAR, MIGR, NAV, RARE, REC1, REC2, SHELL, SPWN, WILD | False |
| Pacific Ocean | AQUA, BIOL, COMM, IND, MAR, MIGR, NAV, RARE, REC1, REC2, SHELL, SPWN, WILD | False |
| Padre Barona Creek | AGR, COLD, IND, MUN, PROC, REC1, REC2, WARM, WILD | False |
| Poway Creek | AGR, COLD, IND, REC1, REC2, WARM, WILD | False |
| Quail Canyon | COLD, IND, MUN, REC1, REC2, WARM, WILD | False |
| Rattlesnake Creek | AGR, COLD, IND, REC1, REC2, WARM, WILD | False |
| Rios Canyon | COLD, IND, MUN, REC1, REC2, WARM, WILD | False |
| San Diego Bay | BIOL, COMM, EST, IND, MAR, MIGR, NAV, RARE, REC1, REC2, SHELL, WILD | False |
| San Diego River | AGR, COLD, IND, RARE, REC1, REC2, WARM, WILD | False |
| San Diego River | COLD, IND, MUN, RARE, REC1, REC2, WARM, WILD | False |
| San Diego River | COLD, IND, MUN, RARE, REC1, REC2, WARM, WILD | False |
| San Diego River - Unnamed Tributary | AGR, COLD, IND, RARE, REC1, REC2, WARM, WILD | False |
| San Vicente Creek | COLD, IND, MUN, REC1, REC2, WARM, WILD | False |
| San Vicente Reservoir | AGR, COLD, IND, MUN, PROC, REC1, REC2, WARM, WILD | False |
| Santee | ALL | False |
| Shepherd Canyon | AGR, COLD, IND, REC1, REC2, WARM, WILD | False |
| Slaughterhouse Canyon | COLD, IND, MUN, REC1, REC2, WARM, WILD | False |
| Spring Canyon | AGR, COLD, IND, RARE, REC1, REC2, WARM, WILD | False |
| Sycamore Canyon | AGR, COLD, IND, RARE, REC1, REC2, WARM, WILD | False |
| Sycamore Canyon - Unnamed Tributary | COLD, IND, MUN, RARE, REC1, REC2, WARM, WILD | False |
| West Branch San Vicente Creek | AGR, COLD, IND, MUN, PROC, REC1, REC2, WARM, WILD | False |
| West Sycamore Canyon | AGR, COLD, IND, REC1, REC2, WARM, WILD | False |
| Wildcat Canyon | COLD, IND, MUN, REC1, REC2, WARM, WILD | False |
| Wright Canyon | AGR, COLD, IND, MUN, PROC, REC1, REC2, WARM, WILD | False |

Caltrans Facilities

MAINTENANCE STATIONS

Name Address

FREEWAYS AND HIGHWAYS

Route Length (miles)

52 3.7
67 8.1
125 1.9

PARK & RIDE LOTS

| Name | District | County | Route | Post Mile |
|--------------|----------|--------|-------|-----------|
| RIVERFORD RD | 11 | SD | 67 | R3.95 |
| MAPLEVIEW | 11 | SD | 67 | R5.5 |

REST AREAS

| Name | District | County | Route | Post Mile |
|------|----------|--------|-------|-----------|
|------|----------|--------|-------|-----------|

| | | | | |
|-------------------------|----|----|----|--------|
| MISSION GORGE/ BIG ROCK | 11 | SD | 52 | 13.972 |
| MAGNOLIA / ALEXANDER | 11 | SD | 67 | R2.4 |

Additional Information

[Help](#) for the Water Quality Planning Tool

[TMDL](#) information from the SWRCB

[Construction General Permit](#) information from the SWRCB

[Groundwater Depth](#) information from the California Department of Water Resources

R Factor erosivity [calculations](#)

Hydromodification Management Requirements

Do hydromodification management requirements apply (see Section 1.6 of the BMP Design Manual)?

- Yes, hydromodification management flow control structural BMPs required.
- No, the project will discharge runoff directly to existing underground storm drains discharging directly to water storage reservoirs, lakes, enclosed embayments, or the Pacific Ocean.
- No, the project will discharge runoff directly to conveyance channels whose bed and bank are concrete-lined all the way from the point of discharge to water storage reservoirs, lakes, enclosed embayments, or the Pacific Ocean.
- No, the project will discharge runoff directly to an area identified as appropriate for an exemption by the WMAA for the watershed in which the project resides.

Description / Additional Information (to be provided if a 'No' answer has been selected above):

SEE NEXT PAGE

Critical Coarse Sediment Yield Areas*

***This Section only required if hydromodification management requirements apply**

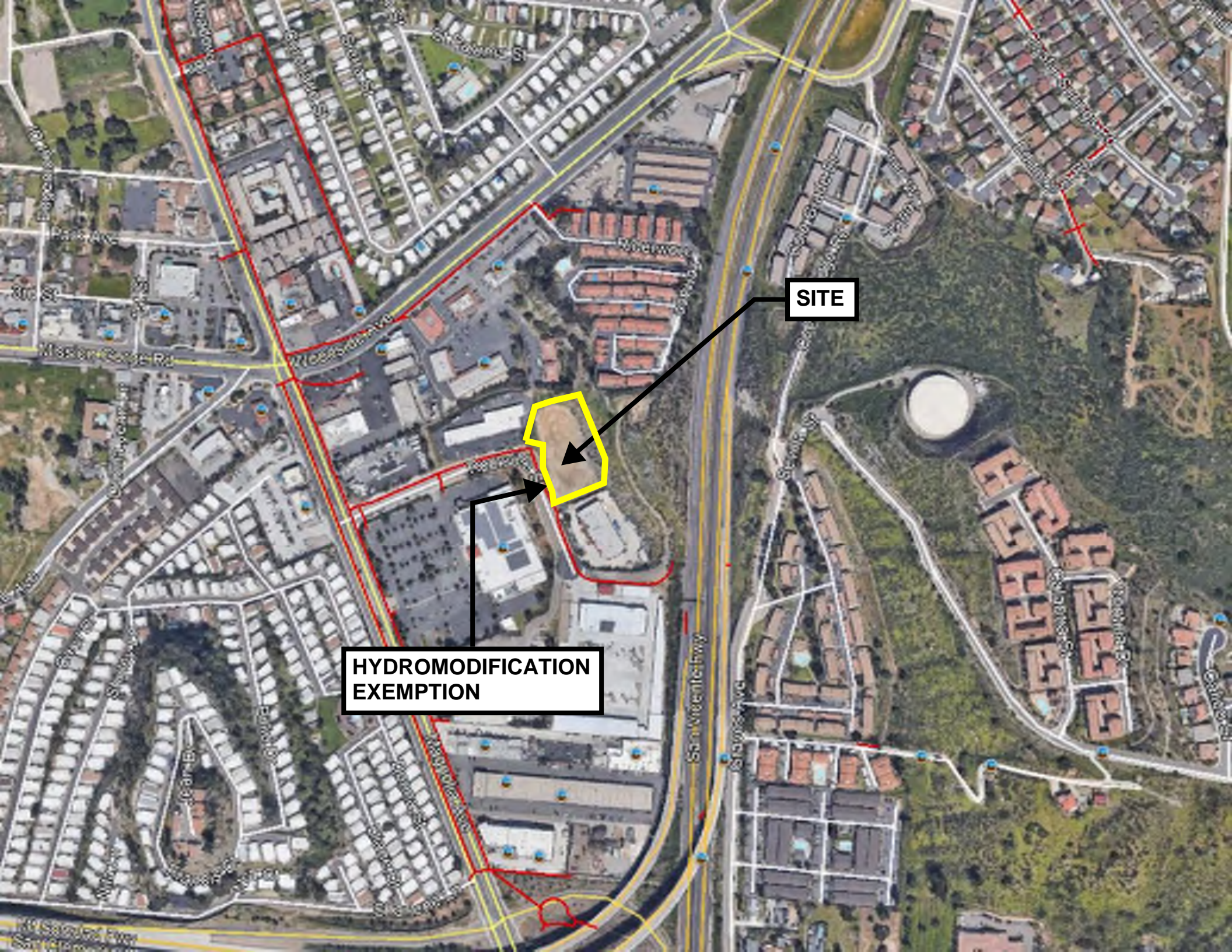

SITE

**HYDROMODIFICATION
EXEMPTION**

Based on the maps provided within the WMAA, do potential critical coarse sediment yield areas exist within the project drainage boundaries?

Yes

No, No critical coarse sediment yield areas to be protected based on WMAA maps

If yes, have any of the optional analyses presented in Section 6.2 of the BMP Design Manual been performed?

6.2.1 Verification of Geomorphic Landscape Units (GLUs) Onsite

6.2.2 Downstream Systems Sensitivity to Coarse Sediment

6.2.3 Optional Additional Analysis of Potential Critical Coarse Sediment Yield Areas Onsite

No optional analyses performed, the project will avoid critical coarse sediment yield areas identified based on WMAA maps

If optional analyses were performed, what is the final result?

No critical coarse sediment yield areas to be protected based on verification of GLUs onsite

Critical coarse sediment yield areas exist but additional analysis has determined that protection is not required. Documentation attached in Attachment 2.b of the SWQMP.

Critical coarse sediment yield areas exist and require protection. The project will implement management measures described in Sections 6.2.4 and 6.2.5 as applicable, and the areas are identified on the SWQMP Exhibit.

Discussion / Additional Information:

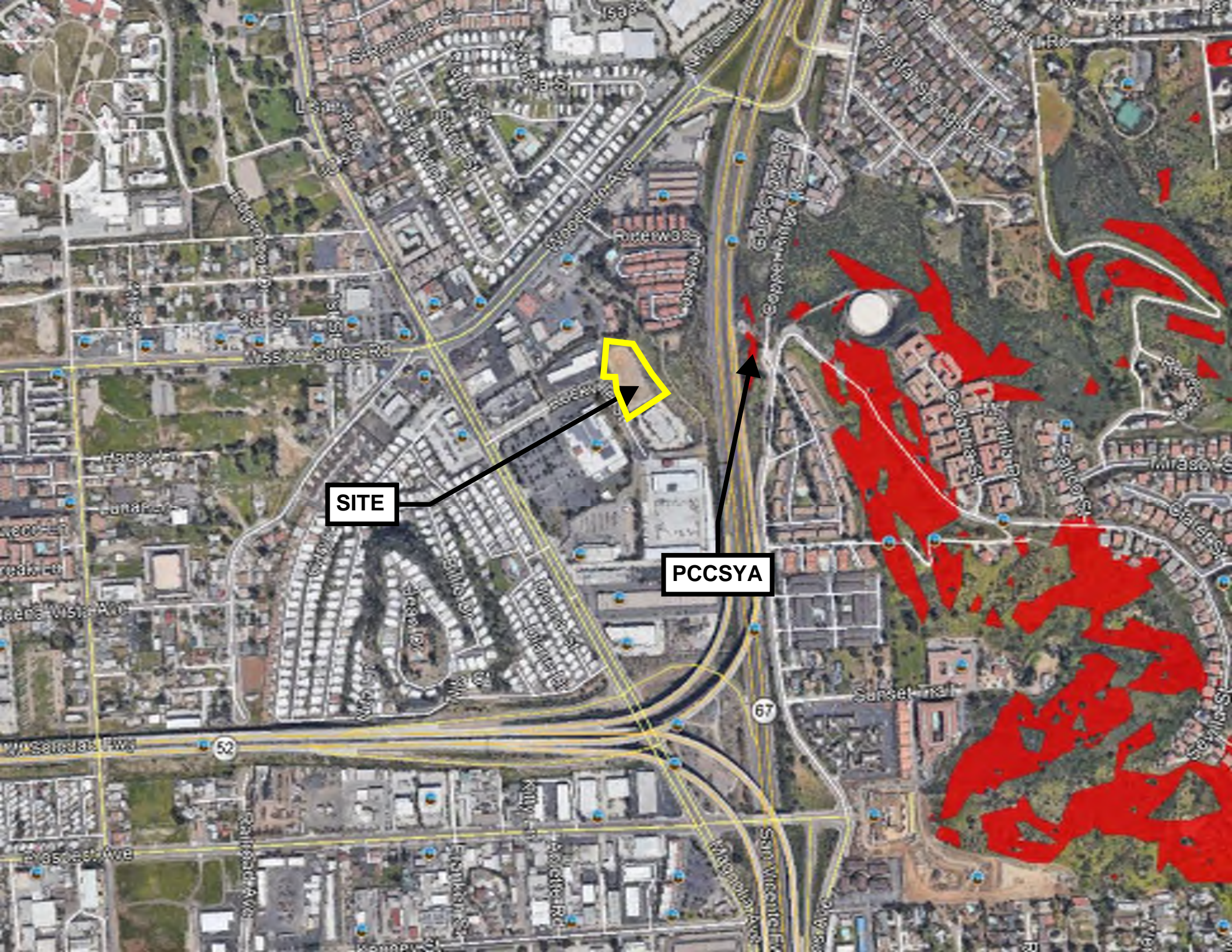

SITE

PCCSYA

Flow Control for Post-Project Runoff*

***This Section only required if hydromodification management requirements apply**

List and describe point(s) of compliance (POCs) for flow control for hydromodification management (see Section 6.3.1). For each POC, provide a POC identification name or number correlating to the project's HMP Exhibit and a receiving channel identification name or number correlating to the project's HMP Exhibit.

NOT APPLICABLE

Has a geomorphic assessment been performed for the receiving channel(s)?

- No, the low flow threshold is 0.1Q2 (default low flow threshold)
- Yes, the result is the low flow threshold is 0.1Q2
- Yes, the result is the low flow threshold is 0.3Q2
- Yes, the result is the low flow threshold is 0.5Q2

If a geomorphic assessment has been performed, provide title, date, and preparer:

NOT APPLICABLE

Discussion / Additional Information: (optional)

NOT APPLICABLE

Other Site Requirements and Constraints

When applicable, list other site requirements or constraints that will influence storm water management design, such as zoning requirements including setbacks and open space, or local codes governing minimum street width, sidewalk construction, allowable pavement types, and drainage requirements.

NOT APPLICABLE

Optional Additional Information or Continuation of Previous Sections As Needed

This space provided for additional information or continuation of information from previous sections as needed.

NOT APPLICABLE

| Source Control BMP Checklist for All Development Projects (Standard Projects and Priority Development Projects) | | Form I-4 Model BMP Design Manual [August 31, 2015] | |
|---|--|---|---|
| Project Identification | | | |
| Project Name: ROCKVILL STREET | | | |
| Permit Application Number Development Permit Review DR2022-1 | | | |
| Source Control BMPs | | | |
| All development projects must implement source control BMPs SC-1 through SC-6 where applicable and feasible. See Chapter 4 and Appendix E of the Model BMP Design Manual for information to implement source control BMPs shown in this checklist. | | | |
| Answer each category below pursuant to the following. | | | |
| <ul style="list-style-type: none"> • "Yes" means the project will implement the source control BMP as described in Chapter 4 and/or Appendix E of the Model BMP Design Manual. Discussion / justification is not required. • "No" means the BMP is applicable to the project but it is not feasible to implement. Discussion / justification must be provided. • "N/A" means the BMP is not applicable at the project site because the project does not include the feature that is addressed by the BMP (e.g., the project has no outdoor materials storage areas). Discussion / justification may be provided. | | | |
| Source Control Requirement | | Applied? | |
| SC-1 Prevention of Illicit Discharges into the MS4 | | <input checked="" type="checkbox"/> Yes | <input type="checkbox"/> No <input type="checkbox"/> N/A |
| Discussion / justification if SC-1 not implemented: | | | |
| SC-2 Storm Drain Stenciling or Signage | | <input checked="" type="checkbox"/> Yes | <input type="checkbox"/> No <input type="checkbox"/> N/A |
| Discussion / justification if SC-2 not implemented: | | | |
| SC-3 Protect Outdoor Materials Storage Areas from Rainfall, Run-On, Runoff, and Wind Dispersal | | <input type="checkbox"/> Yes | <input type="checkbox"/> No <input checked="" type="checkbox"/> N/A |
| Discussion / justification if SC-3 not implemented: | | | |
| No storage areas will be kept outside. | | | |
| SC-4 Protect Materials Stored in Outdoor Work Areas from Rainfall, Run-On, Runoff, and Wind Dispersal | | <input type="checkbox"/> Yes | <input type="checkbox"/> No <input checked="" type="checkbox"/> N/A |
| Discussion / justification if SC-4 not implemented: | | | |
| There will be no outdoor work areas. | | | |

| Source Control Requirement | Applied? | | |
|---|---|-----------------------------|------------------------------|
| SC-5 Protect Trash Storage Areas from Rainfall, Run-On, Runoff, and Wind Dispersal | <input checked="" type="checkbox"/> Yes | <input type="checkbox"/> No | <input type="checkbox"/> N/A |
| Discussion / justification if SC-5 not implemented: | | | |
| <p>SC-6 Additional BMPs Based on Potential Sources of Runoff Pollutants (must answer for each source listed below)</p> <ul style="list-style-type: none"> <input checked="" type="checkbox"/> On-site storm drain inlets <input type="checkbox"/> Interior floor drains and elevator shaft sump pumps <input type="checkbox"/> Interior parking garages <input checked="" type="checkbox"/> Need for future indoor & structural pest control <input type="checkbox"/> Landscape/Outdoor Pesticide Use <input type="checkbox"/> Pools, spas, ponds, decorative fountains, and other water features <input type="checkbox"/> Food service <input checked="" type="checkbox"/> Refuse areas <input type="checkbox"/> Industrial processes <input type="checkbox"/> Outdoor storage of equipment or materials <input type="checkbox"/> Vehicle and Equipment Cleaning <input type="checkbox"/> Vehicle/Equipment Repair and Maintenance <input type="checkbox"/> Fuel Dispensing Areas <input type="checkbox"/> Loading Docks <input checked="" type="checkbox"/> Fire Sprinkler Test Water <input checked="" type="checkbox"/> Miscellaneous Drain or Wash Water <input checked="" type="checkbox"/> Plazas, sidewalks, and parking lots | | | |

Discussion / justification if SC-6 not implemented. Clearly identify which sources of runoff pollutants are discussed. Justification must be provided for all "No" answers shown above.

| Site Design BMP Checklist for All Development Projects (Standard Projects and Priority Development Projects) | | Form I-5 Model BMP Design Manual [August 31, 2015] | |
|---|--|---|---|
| Project Identification | | | |
| Project Name: ROCKVILL STREET | | | |
| Permit Application Number Development Permit Review DR2022-1 | | | |
| Site Design BMPs | | | |
| <p>All development projects must implement site design BMPs SD-1 through SD-8 where applicable and feasible. See Chapter 4 and Appendix E of the Model BMP Design Manual for information to implement site design BMPs shown in this checklist.</p> <p>Answer each category below pursuant to the following.</p> <ul style="list-style-type: none"> • "Yes" means the project will implement the site design BMP as described in Chapter 4 and/or Appendix E of the Model BMP Design Manual. Discussion / justification is not required. • "No" means the BMP is applicable to the project but it is not feasible to implement. Discussion / justification must be provided. • "N/A" means the BMP is not applicable at the project site because the project does not include the feature that is addressed by the BMP (e.g., the project site has no existing natural areas to conserve). Discussion / justification may be provided. | | | |
| Site Design Requirement | | Applied? | |
| SD-1 Maintain Natural Drainage Pathways and Hydrologic Features | | <input checked="" type="checkbox"/> Yes | <input type="checkbox"/> No <input type="checkbox"/> N/A |
| Discussion / justification if SD-1 not implemented: | | | |
| SD-2 Conserve Natural Areas, Soils, and Vegetation | | <input checked="" type="checkbox"/> Yes | <input type="checkbox"/> No <input type="checkbox"/> N/A |
| Discussion / justification if SD-2 not implemented: | | | |
| Plans to develop most of the site. | | | |
| SD-3 Minimize Impervious Area | | <input checked="" type="checkbox"/> Yes | <input type="checkbox"/> No <input type="checkbox"/> N/A |
| Discussion / justification if SD-3 not implemented: | | | |
| Plans to develop most of the site. | | | |
| SD-4 Minimize Soil Compaction | | <input checked="" type="checkbox"/> Yes | <input type="checkbox"/> No <input type="checkbox"/> N/A |
| Discussion / justification if SD-4 not implemented: | | | |
| Plans to develop most of the site. | | | |
| SD-5 Impervious Area Dispersion | | <input type="checkbox"/> Yes | <input type="checkbox"/> No <input checked="" type="checkbox"/> N/A |
| Discussion / justification if SD-5 not implemented: | | | |

Form I-5 Page 2 of 2, Form Template Date: August 31, 2015

| Site Design Requirement | Applied? | | |
|---|---|-----------------------------|---|
| SD-6 Runoff Collection | <input type="checkbox"/> Yes | <input type="checkbox"/> No | <input checked="" type="checkbox"/> N/A |
| Discussion / justification if SD-6 not implemented: | | | |
| SD-7 Landscaping with Native or Drought Tolerant Species | <input checked="" type="checkbox"/> Yes | <input type="checkbox"/> No | <input type="checkbox"/> N/A |
| Discussion / justification if SD-7 not implemented: | | | |
| SD-8 Harvesting and Using Precipitation | <input type="checkbox"/> Yes | <input type="checkbox"/> No | <input checked="" type="checkbox"/> N/A |
| Discussion / justification if SD-8 not implemented: | | | |

| | |
|--|--|
| Summary of PDP Structural BMPs | Form I-6 (PDPs) Model BMP Design Manual [August 31, 2015] |
| Project Identification | |
| Project Name: ROCKVILL STREET | |
| Permit Application Number Development Permit Review DR2022-1 | |
| PDP Structural BMPs | |
| <p>All PDPs must implement structural BMPs for storm water pollutant control (see Chapter 5 of the BMP Design Manual). Selection of PDP structural BMPs for storm water pollutant control must be based on the selection process described in Chapter 5. PDPs subject to hydromodification management requirements must also implement structural BMPs for flow control for hydromodification management (see Chapter 6 of the BMP Design Manual). Both storm water pollutant control and flow control for hydromodification management can be achieved within the same structural BMP(s).</p> <p>PDP structural BMPs must be verified by the local jurisdiction at the completion of construction. This may include requiring the project owner or project owner's representative and engineer of record to certify construction of the structural BMPs (see Section 1.12 of the BMP Design Manual). PDP structural BMPs must be maintained into perpetuity, and the local jurisdiction must confirm the maintenance (see Section 7 of the BMP Design Manual).</p> <p>Use this form to provide narrative description of the general strategy for structural BMP implementation at the project site in the box below. Then complete the PDP structural BMP summary information sheet (page 3 of this form) for each structural BMP within the project (copy the BMP summary information page as many times as needed to provide summary information for each individual structural BMP).</p> <p>Describe the general strategy for structural BMP implementation at the site. This information must describe how the steps for selecting and designing storm water pollutant control BMPs presented in Section 5.1 of the BMP Design Manual were followed, and the results (type of BMPs selected). For projects requiring hydromodification flow control BMPs, indicate whether pollutant control and flow control BMPs are integrated or separate.</p> <p>After reading the Geotechnical Investigation prepared for Mr. Ryan T. Clark by TerraPacific Consultants and the grading plans, we were able to acquire all information needed to identify selecting the correct BMP for the project. It was determined that there was no self-mitigating, de minimis areas, and/or potential self-retaining DMA's. The DCV was calculated for all DMA's and the approximate potential runoff was then calculated too. It was decided that a BF 1.1 BMP would be the best fit for the property. The BMP dimensions were the calculated based off of the DCV and the potential runoff the property would experience after construction. There was no preliminary screening for infiltration because a D type soil does not need a preliminary screening because it can not handle infiltration. Later, tentative BMP locations were identified based off the configuration and grading of the site post-development. All reports, planning assessments, feasibility assessments, and opportunity assessments were documented.</p> <p>(Continue on page 2 as necessary.)</p> | |

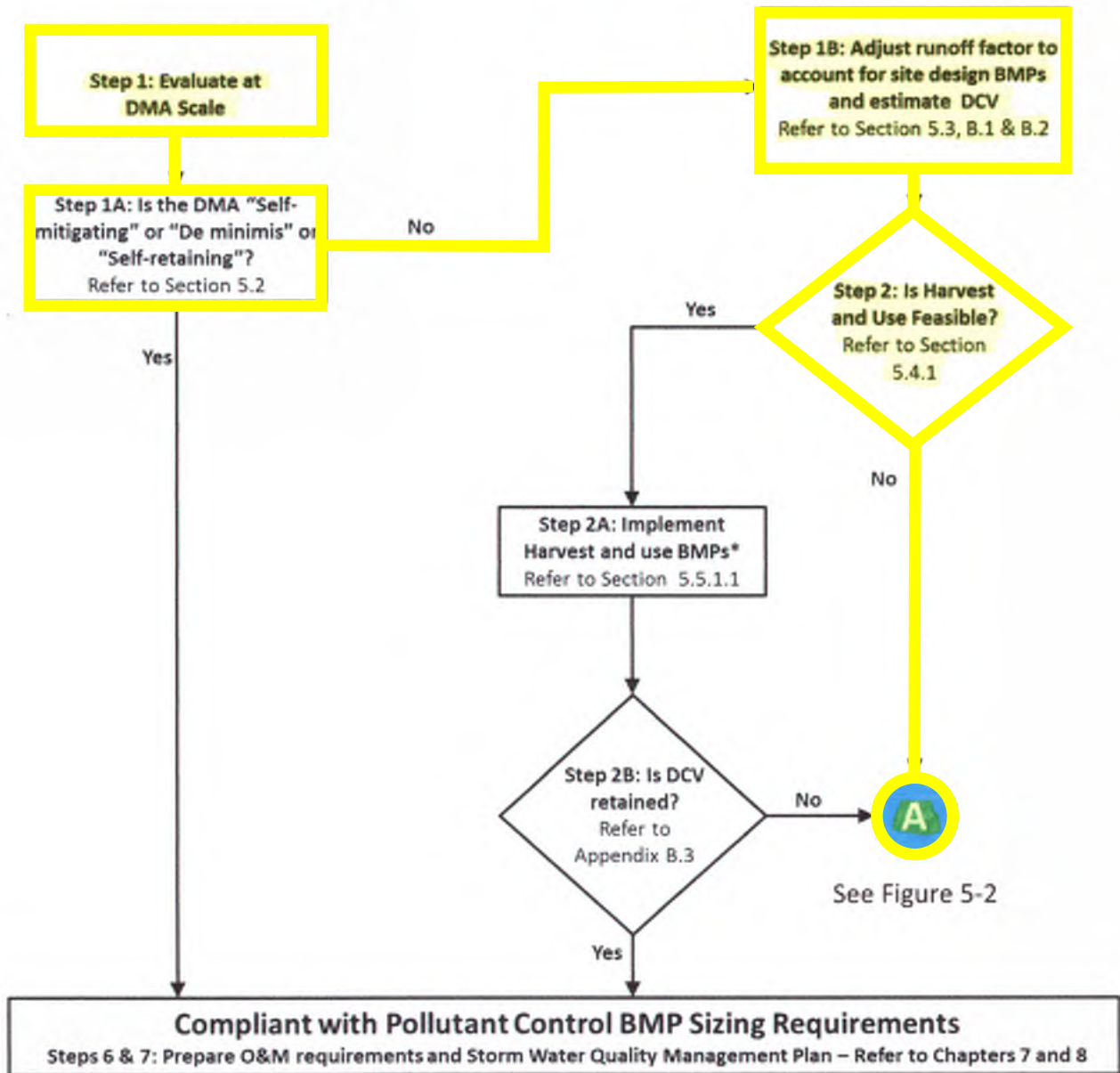

* Step 2C: Project applicant has an option to also conduct feasibility analysis for infiltration and if infiltration is fully or partially feasible has an option to choose between infiltration and harvest and use BMPs. But if infiltration is not feasible and harvest and use is feasible, project applicant must implement harvest and use BMPs

FIGURE 0-1. Storm Water Pollutant Control BMP Selection Flow Chart

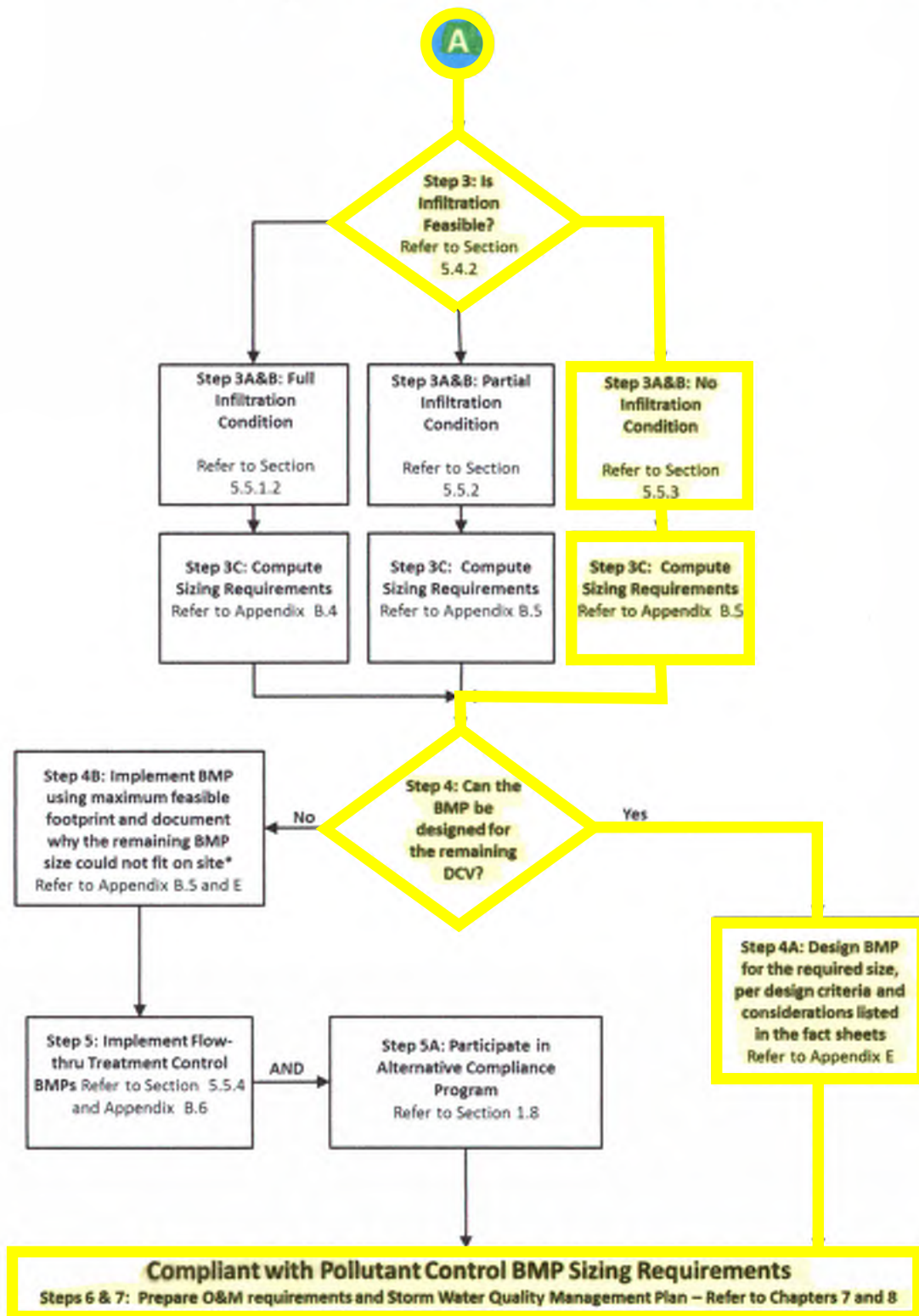

* Project approval at the discretion of [City Engineer]

FIGURE 0-2. Storm Water Pollutant Control BMP Selection Flow Chart

Structural BMP Summary Information
(Copy this page as needed to provide information for each individual proposed structural BMP)

Structural BMP ID No.

Construction Plan Sheet No.

Type of structural BMP:

- Retention by harvest and use (HU-1)
- Retention by infiltration basin (INF-1)
- Retention by bioretention (INF-2)
- Retention by permeable pavement (INF-3)
- Partial retention by biofiltration with partial retention (PR-1)
- Biofiltration (BF-1)
- Biofiltration with Nutrient Sensitive Media Design (BF-2)
- Proprietary Biofiltration (BF-3) meeting all requirements of Appendix F
- Flow-thru treatment control with prior lawful approval to meet earlier PDP requirements (provide BMP type/description in discussion section below)
- Flow-thru treatment control included as pre-treatment/forebay for an onsite retention or biofiltration BMP (provide BMP type/description and indicate which onsite retention or biofiltration BMP it serves in discussion section below)
- Flow-thru treatment control with alternative compliance (provide BMP type/description in discussion section below)
- Detention pond or vault for hydromodification management
- Other (describe in discussion section below)

Purpose:

- Pollutant control only
- Hydromodification control only
- Combined pollutant control and hydromodification control
- Pre-treatment/forebay for another structural BMP
- Other (describe in discussion section below)

Who will certify construction of this BMP?
 Provide name and contact information for the party responsible to sign BMP verification forms if required by the [City Engineer] (See Section 1.12 of the BMP Design Manual)

KAPPA SURVEYING & ENGINEERING
 (619)449-2600

Who will be the final owner of this BMP?

PROPERTY OWNER

Who will maintain this BMP into perpetuity?

PROPERTY OWNER

What is the funding mechanism for maintenance?

PROPERTY OWNER

ATTACHMENT 1 BACKUP FOR PDP POLLUTANT CONTROL BMPS

This is the cover sheet for Attachment 1.

Indicate which Items are Included behind this cover sheet:

| Attachment Sequence | Contents | Checklist |
|---------------------|--|---|
| Attachment 1a | DMA Exhibit (Required) See DMA Exhibit Checklist on the back of this Attachment cover sheet. | <input checked="" type="checkbox"/> Included |
| Attachment 1b | Tabular Summary of DMAs Showing DMA ID matching DMA Exhibit, DMA Area, and DMA Type (Required)* *Provide table in this Attachment OR on DMA Exhibit in Attachment 1a | <input checked="" type="checkbox"/> Included on DMA Exhibit in Attachment 1a <input type="checkbox"/> Included as Attachment 1b, separate from DMA Exhibit |
| Attachment 1c | Form I-7, Harvest and Use Feasibility Screening Checklist (Required unless the entire project will use infiltration BMPs) Refer to Appendix B.3-1 of the BMP Design Manual to complete Form I-7. | <input checked="" type="checkbox"/> Included <input type="checkbox"/> Not included because the entire project will use infiltration BMPs |
| Attachment 1d | Form I-8, Categorization of Infiltration Feasibility Condition (Required unless the project will use harvest and use BMPs) Refer to Appendices C and D of the BMP Design Manual to complete Form I-8. | <input checked="" type="checkbox"/> Included <input type="checkbox"/> Not included because the entire project will use harvest and use BMPs |
| Attachment 1e | Pollutant Control BMP Design Worksheets / Calculations (Required) Refer to Appendices B and E of the BMP Design Manual for structural pollutant control BMP design guidelines | <input checked="" type="checkbox"/> Included |

Use this checklist to ensure the required information has been included on the DMA Exhibit:

The DMA Exhibit must identify:

- Underlying hydrologic soil group
- Approximate depth to groundwater
- Existing natural hydrologic features (watercourses, seeps, springs, wetlands)
- Critical coarse sediment yield areas to be protected
- Existing topography and impervious areas
- Existing and proposed site drainage network and connections to drainage offsite
- Proposed demolition
- Proposed grading
- Proposed impervious features
- Proposed design features and surface treatments used to minimize imperviousness
- Drainage management area (DMA) boundaries, DMA ID numbers, and DMA areas (square footage or acreage), and DMA type (i.e., drains to BMP, self-retaining, or self-mitigating)
- Potential pollutant source areas and corresponding required source controls (see Chapter 4, Appendix E.1, and Form I-3B)
- Structural BMPs (identify location, type of BMP, and size/detail)

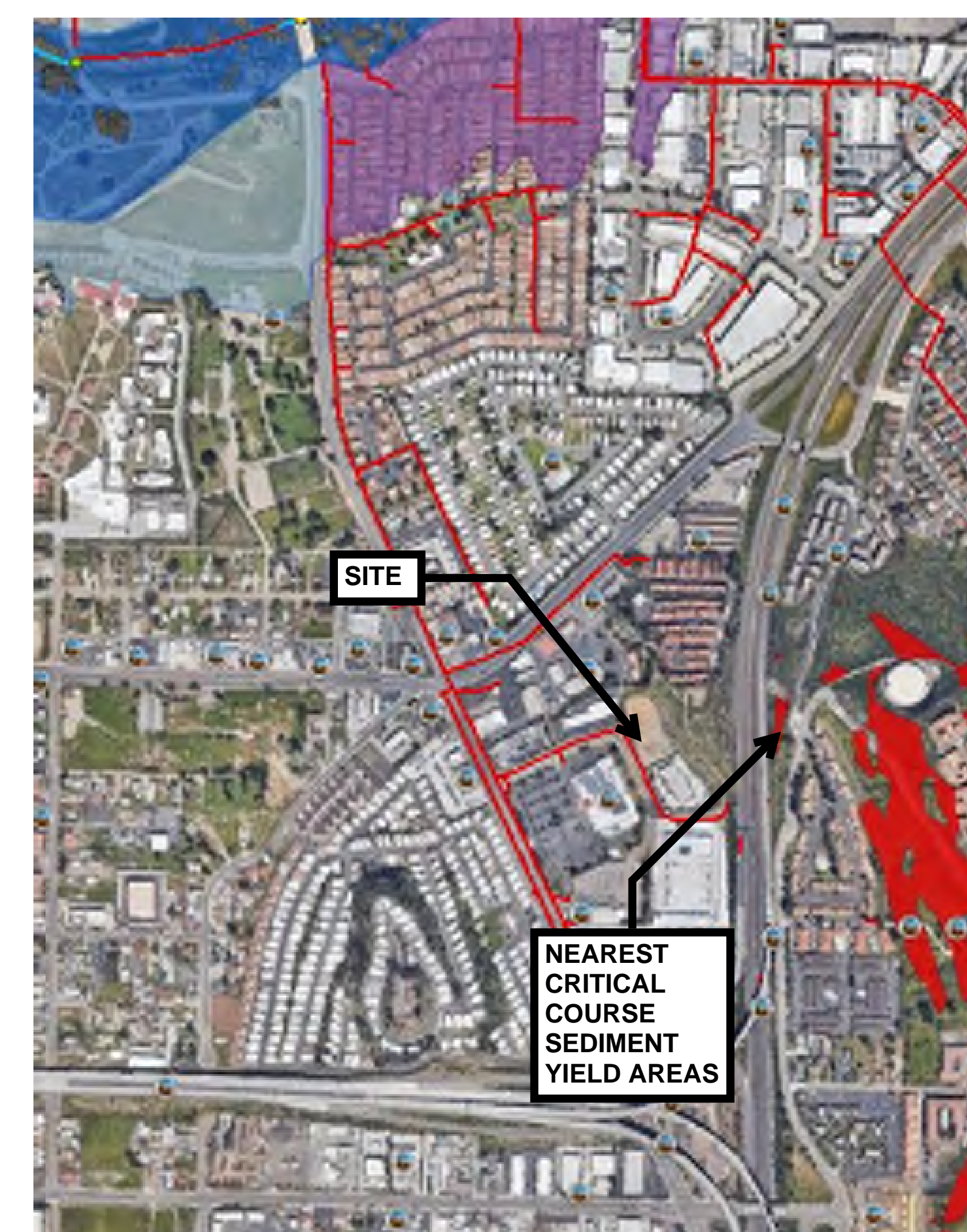
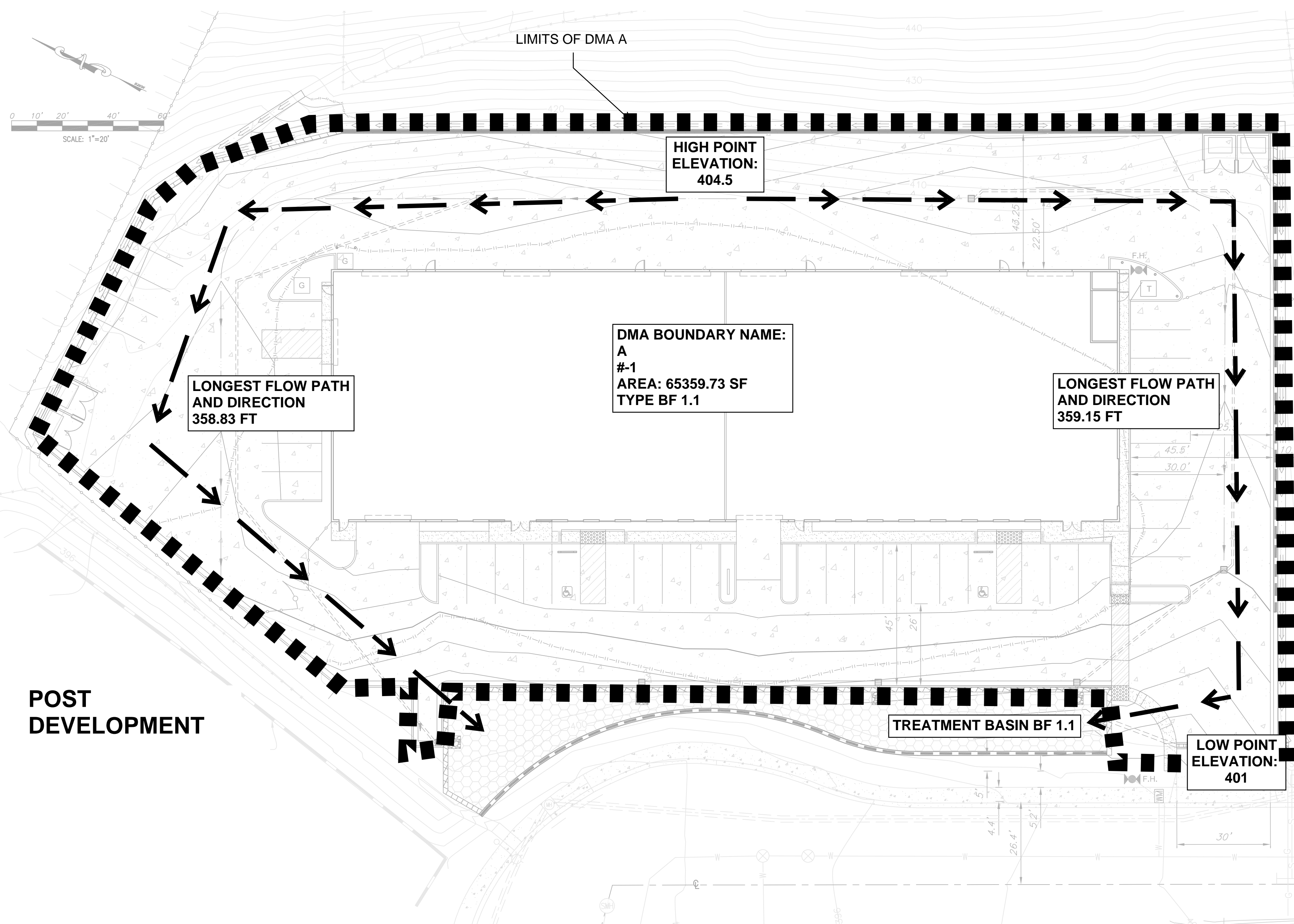

POST DEVELOPMENT

PREEXISTING DEVELOPMENT

Runoff Coefficient for proposed site condition (Post-Development)

| Surface Types | sq ft | ac | Site Contribution (%) |
|---------------------------|--------------|-------------|-----------------------|
| Roof (IMP) | 20000 | 0.46 | 0.2737 |
| Concrete or Asphalt (IMP) | 48765 | 1.12 | 0.6674 |
| Unit Pavers (IMP) | 0 | 0.00 | 0.0000 |
| DG/Cobbles/Crushed Agg. | 0 | 0.00 | 0.0000 |
| Pool | 0 | 0.00 | 0.0000 |
| Mulched Soil/Landscape | 4300 | 0.10 | 0.0589 |
| Natural Areas | 18645 | 0.43 | 0.2552 |
| Totals | 91710 | 2.11 | |
| Impervious total | 68765 | | 94% |
| Pervious total | 4300 | | 6% |

Runoff Coefficient for existing site condition (Pre-Development)

| Surface Types | sq ft | ac | Site Contribution Area (%) |
|---------------------------|--------------|-------------|----------------------------|
| Roof (IMP) | 0 | 0.00 | 0.0000 |
| Concrete or Asphalt (IMP) | 0 | 0.00 | 0.0000 |
| Unit Pavers (IMP) | 0 | 0.00 | 0.0000 |
| DG/Cobbles/Crushed Agg. | 0 | 0.00 | 0.0000 |
| Pool | 0 | 0.00 | 0.0000 |
| Mulched Soil/Landscape | 0 | 0.00 | 0.0000 |
| Natural Areas | 73065 | 1.68 | 1.0000 |
| Totals | 73065 | 1.68 | |
| Impervious total | 0 | | 0% |
| Pervious total | 73065 | | 100% |

Description of Map Units
Kgr Cretaceous-aged granite
 NO GROUND WATER OBSERVED

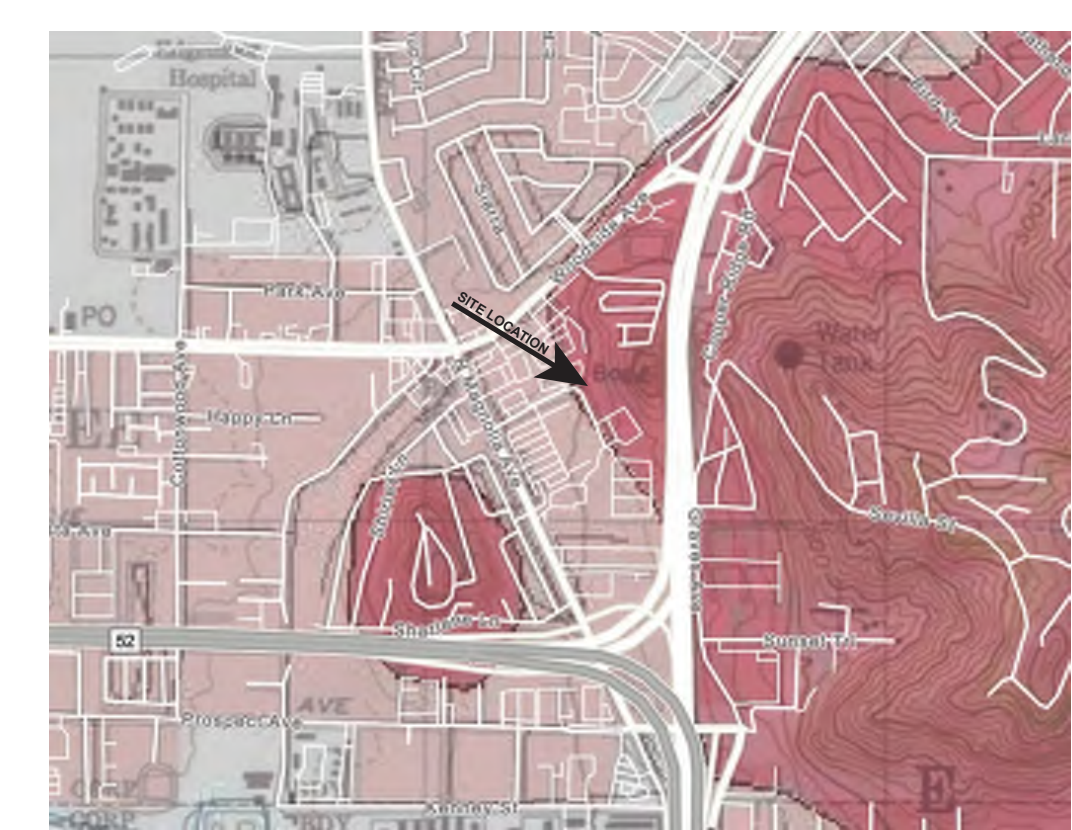

ROCKVILL STREET

| REVISIONS | BY |
|-----------|----|
| 5-14-21 | |
| 1 | |
| 2 | |
| 3 | |
| 4 | |



ATTACHMENT 1

PRELIMINARY DESIGN
 GRADING & DRAINAGE

Date: 7-14-21
 Scale: NOTED
 Drawn:
 Approved:
 Job: #2106
 SOUTHWEST SIGNAL

1A

PRELIMINARY DESIGN 7-14-21

Appendix B: Storm Water Pollutant Control Hydrologic Calculations and Sizing Methods

Worksheet B.2-1. DCV

| Design Capture Volume | | Worksheet B-2.1 | | |
|-----------------------|---|-----------------|------|------------|
| 1 | 85th percentile 24-hr storm depth from Figure B.1-1 | d= | 0.51 | inches |
| 2 | Area tributary to BMP (s) | A= | 1.68 | acres |
| 3 | Area weighted runoff factor (estimate using Appendix B.1.1 and B.2.1) | C= | 0.30 | unitless |
| 4 | Street trees volume reduction | TCV= | 0 | cubic-feet |
| 5 | Rain barrels volume reduction | RCV= | 0 | cubic-feet |
| 6 | Calculate DCV = (3630 x C x d x A) – TCV - RCV | DCV= | 932 | cubic-feet |

PRE CONDITION

| Proposed Condition | A acres | C Runoff | A*C |
|-------------------------------------|------------|-------------|-------|
| Roof | 0.000 | 0.90 | 0.000 |
| Concrete or AC | 0.000 | 0.90 | 0.000 |
| Unit Pavers | 0.000 | 0.90 | 0.000 |
| DG,Cobbles/Crushed Agg. | 0.000 | 0.30 | 0.000 |
| Ammended, Mulched Soil or Landscape | 0.000 | 0.10 | 0.000 |
| Natural (A Soil) | 0.000 | 0.10 | 0.000 |
| Natural (B Soil) | 0.000 | 0.14 | 0.000 |
| Natural (C Soil) | 0.000 | 0.23 | 0.000 |
| Natural (D Soil) | 1.670 | 0.30 | 0.501 |

C= 0.30

| Surface | Runoff Factor |
|--|---------------|
| Roofs ¹ | 0.90 |
| Concrete or Asphalt ¹ | 0.90 |
| Unit Pavers (grouted) ¹ | 0.90 |
| Decomposed Granite | 0.30 |
| Cobbles or Crushed Aggregate | 0.30 |
| Amended, Mulched Soils or Landscape | 0.10 |
| Compacted Soil (e.g., unpaved parking) | 0.30 |



Figure 1 b

Appendix B: Storm Water Pollutant Control Hydrologic Calculations and Sizing Methods

Worksheet B.2-1. DCV

| Design Capture Volume | | Worksheet B-2.1 | | |
|-----------------------|---|-----------------|------|------------|
| 1 | 85th percentile 24-hr storm depth from Figure B.1-1 | d= | 0.51 | inches |
| 2 | Area tributary to BMP (s) | A= | 1.68 | acres |
| 3 | Area weighted runoff factor (estimate using Appendix B.1.1 and B.2.1) | C= | 0.85 | unitless |
| 4 | Street trees volume reduction | TCV= | 0 | cubic-feet |
| 5 | Rain barrels volume reduction | RCV= | 0 | cubic-feet |
| 6 | Calculate DCV = (3630 x C x d x A) – TCV - RCV | DCV= | 2649 | cubic-feet |

POST CONDITION

| Proposed Condition | A acres | C Runoff | A*C |
|-------------------------------------|------------|-------------|-------|
| Roof | 0.459 | 0.90 | 0.413 |
| Concrete or AC | 1.119 | 0.90 | 1.008 |
| Unit Pavers | 0.000 | 0.90 | 0.000 |
| DG,Cobbles/Crushed Agg. | 0.000 | 0.30 | 0.000 |
| Ammended, Mulched Soil or Landscape | 0.099 | 0.10 | 0.010 |
| Natural (A Soil) | 0.000 | 0.10 | 0.000 |
| Natural (B Soil) | 0.000 | 0.14 | 0.000 |
| Natural (C Soil) | 0.000 | 0.23 | 0.000 |
| Natural (D Soil) | 0.000 | 0.30 | 0.000 |

C= 0.85

| Surface | Runoff Factor |
|--|---------------|
| Roofs ¹ | 0.90 |
| Concrete or Asphalt ¹ | 0.90 |
| Unit Pavers (grouted) ¹ | 0.90 |
| Decomposed Granite | 0.30 |
| Cobbles or Crushed Aggregate | 0.30 |
| Amended, Mulched Soils or Landscape | 0.10 |
| Compacted Soil (e.g., unpaved parking) | 0.30 |



Harvest and Use Feasibility Checklist

Form I-7

1. Is there a demand for harvested water (check all that apply) at the project site that is reliably present during the wet season?

- Toilet and urinal flushing
 Landscape irrigation
 Other: _____

2. If there is a demand; estimate the anticipated average wet season demand over a period of 36 hours. Guidance for planning level demand calculations for toilet/urinal flushing and landscape irrigation is provided in Section B.3.2.

Demand calculated per the Water Efficient Landscape Worksheet, attached. The Estimated Total Water Use (ETWU) in a year is 78,787 gal. The demand at a 36hr mark would be about 323 gallons.

3. Calculate the DCV using worksheet B-2.1.

DCV = 2649 (cubic feet)

3a. Is the 36 hour demand greater than or equal to the DCV?
 Yes / No ⇒
 ↓

3b. Is the 36 hour demand greater than 0.25DCV but less than the full DCV?
 Yes / No ⇒
 ↓

3c. Is the 36 hour demand less than 0.25DCV?
 Yes
 ↓

Harvest and use appears to be feasible. Conduct more detailed evaluation and sizing calculations to confirm that DCV can be used at an adequate rate to meet drawdown criteria.

Harvest and use may be feasible. Conduct more detailed evaluation and sizing calculations to determine feasibility. Harvest and use may only be able to be used for a portion of the site, or (optionally) the storage may need to be upsized to meet long term capture targets while draining in longer than 36 hours.

Harvest and use is considered to be infeasible.

Is harvest and use feasible based on further evaluation?

- Yes, refer to Appendix E to select and size harvest and use BMPs.
 No, select alternate BMPs.

Appendix C: Geotechnical and Groundwater Investigation Requirements

Worksheet 0-1: Categorization of Infiltration Feasibility Condition

| Categorization of Infiltration Feasibility Condition | | Worksheet C.4-1 | |
|---|---|-----------------|----|
| <p><u>Part 1 - Full Infiltration Feasibility Screening Criteria</u></p> <p>Would infiltration of the full design volume be feasible from a physical perspective without any undesirable consequences that cannot be reasonably mitigated?</p> | | | |
| Criteria | Screening Question | Yes | No |
| 1 | <p>Is the estimated reliable infiltration rate below proposed facility locations greater than 0.5 inches per hour? The response to this Screening Question shall be based on a comprehensive evaluation of the factors presented in Appendix C.2 and Appendix D.</p> | | X |
| <p>Provide basis:</p> <p style="text-align: center; padding-left: 40px;">No, Per the Geotechnical Report the site observed Granite rock at a depth of 3ft of fill. Granite rock has a Hydrological Soil classification of Soil type D.</p> <p>Summarize findings of studies; provide reference to studies, calculations, maps, data sources, etc. Provide narrative discussion of study/data source applicability.</p> | | | |
| 2 | <p>Can infiltration greater than 0.5 inches per hour be allowed without increasing risk of geotechnical hazards (slope stability, groundwater mounding, utilities, or other factors) that cannot be mitigated to an acceptable level? The response to this Screening Question shall be based on a comprehensive evaluation of the factors presented in Appendix C.2.</p> | | |
| <p>Provide basis:</p> <p>Summarize findings of studies; provide reference to studies, calculations, maps, data sources, etc. Provide narrative discussion of study/data source applicability.</p> | | | |

Appendix C: Geotechnical and Groundwater Investigation Requirements

| Worksheet C.4-1 Page 2 of 4 | | | |
|--|---|--|----|
| Criteria | Screening Question | Yes | No |
| 3 | <p>Can infiltration greater than 0.5 inches per hour be allowed without increasing risk of groundwater contamination (shallow water table, storm water pollutants or other factors) that cannot be mitigated to an acceptable level? The response to this Screening Question shall be based on a comprehensive evaluation of the factors presented in Appendix C.3.</p> | | |
| <p>Provide basis:</p> <p>Summarize findings of studies; provide reference to studies, calculations, maps, data sources, etc. Provide narrative discussion of study/data source applicability.</p> | | | |
| 4 | <p>Can infiltration greater than 0.5 inches per hour be allowed without causing potential water balance issues such as change of seasonality of ephemeral streams or increased discharge of contaminated groundwater to surface waters? The response to this Screening Question shall be based on a comprehensive evaluation of the factors presented in Appendix C.3.</p> | | |
| <p>Provide basis:</p> <p>Summarize findings of studies; provide reference to studies, calculations, maps, data sources, etc. Provide narrative discussion of study/data source applicability.</p> | | | |
| Part 1 Result* | <p>If all answers to rows 1 - 4 are "Yes" a full infiltration design is potentially feasible. The feasibility screening category is Full Infiltration</p> <p>If any answer from row 1-4 is "No", infiltration may be possible to some extent but would not generally be feasible or desirable to achieve a "full infiltration" design. Proceed to Part 2</p> | <p>No, infiltration is not feasible</p> | |

*To be completed using gathered site information and best professional judgment considering the definition of MEP in the MS4 Permit. Additional testing and/or studies may be required by City Engineer to substantiate findings.

Appendix C: Geotechnical and Groundwater Investigation Requirements

Worksheet C.4-1 Page 3 of 4

Part 2 – Partial Infiltration vs. No Infiltration Feasibility Screening Criteria

Would infiltration of water in any appreciable amount be physically feasible without any negative consequences that cannot be reasonably mitigated?

| Criteria | Screening Question | Yes | No |
|----------|---|-----|----|
| 5 | <p>Do soil and geologic conditions allow for infiltration in any appreciable rate or volume? The response to this Screening Question shall be based on a comprehensive evaluation of the factors presented in Appendix C.2 and Appendix D.</p> | | |

Provide basis:

Summarize findings of studies; provide reference to studies, calculations, maps, data sources, etc. Provide narrative discussion of study/data source applicability and why it was not feasible to mitigate low infiltration rates.

| | | | |
|---|--|--|--|
| 6 | <p>Can Infiltration in any appreciable quantity be allowed without increasing risk of geotechnical hazards (slope stability, groundwater mounding, utilities, or other factors) that cannot be mitigated to an acceptable level? The response to this Screening Question shall be based on a comprehensive evaluation of the factors presented in Appendix C.2.</p> | | |
|---|--|--|--|

Provide basis:

Summarize findings of studies; provide reference to studies, calculations, maps, data sources, etc. Provide narrative discussion of study/data source applicability and why it was not feasible to mitigate low infiltration rates.

Appendix C: Geotechnical and Groundwater Investigation Requirements

| Worksheet C.4-1 Page 4 of 4 | | | |
|---|--|-----|-------------------|
| Criteria | Screening Question | Yes | No |
| 7 | <p>Can Infiltration in any appreciable quantity be allowed without posing significant risk for groundwater related concerns (shallow water table, storm water pollutants or other factors)? The response to this Screening Question shall be based on a comprehensive evaluation of the factors presented in Appendix C.3.</p> | | |
| <p>Provide basis:</p> <p>Summarize findings of studies; provide reference to studies, calculations, maps, data sources, etc. Provide narrative discussion of study/data source applicability and why it was not feasible to mitigate low infiltration rates.</p> | | | |
| 8 | <p>Can infiltration be allowed without violating downstream water rights? The response to this Screening Question shall be based on a comprehensive evaluation of the factors presented in Appendix C.3.</p> | | |
| <p>Provide basis:</p> <p>Summarize findings of studies; provide reference to studies, calculations, maps, data sources, etc. Provide narrative discussion of study/data source applicability and why it was not feasible to mitigate low infiltration rates.</p> | | | |
| Part 2 Result* | <p>If all answers from row 1-4 are yes then partial infiltration design is potentially feasible. The feasibility screening category is Partial Infiltration.</p> <p>If any answer from row 5-8 is no, then infiltration of any volume is considered to be infeasible within the drainage area. The feasibility screening category is No Infiltration.</p> | | Infeasible |

*To be completed using gathered site information and best professional judgment considering the definition of MEP in the Permit. Additional testing and/or studies may be required by Agency/Jurisdictions to substantiate findings

Appendix B: Storm Water Pollutant Control Hydrologic Calculations and Sizing Methods

Worksheet B.5-1: Simple Sizing Method for Biofiltration BMPs

| Simple Sizing Method for Biofiltration BMPs | | Worksheet B.5-1 | |
|--|---|-----------------|------------|
| 1 | Remaining DCV after implementing retention BMPs | 2649 | cubic-feet |
| Partial Retention | | | |
| 2 | Infiltration rate from Worksheet D.5-1 if partial infiltration is feasible | 0 | in/hr. |
| 3 | Allowable drawdown time for aggregate storage below the underdrain | 36 | hours |
| 4 | Depth of runoff that can be infiltrated [Line 2 x Line 3] | 0 | inches |
| 5 | Aggregate pore space | 0.4 | in/in |
| 6 | Required depth of gravel below the underdrain [Line 4/ Line 5] | 0 | inches |
| 7 | Assumed surface area of the biofiltration BMP | 1012 | sq-ft |
| 8 | Media retained pore space | 0.1 | in/in |
| 9 | Volume retained by BMP $[(\text{Line 4} + (\text{Line 12} \times \text{Line 8}))/12] \times \text{Line 7}$ | 152 | cubic-feet |
| 10 | DCV that requires biofiltration [Line 1 – Line 9] | 2497 | cubic-feet |
| BMP Parameters | | | |
| 11 | Surface Ponding [6 inch minimum, 12 inch maximum] | 6 | inches |
| 12 | Media Thickness [18 inches minimum] | 18 | inches |
| 13 | Aggregate Storage above underdrain invert (12 inches typical) – use 0 inches for sizing if the aggregate is not over the entire bottom surface area | 12 | inches |
| 14 | Media available pore space | 0.2 | in/in |
| 15 | Media filtration rate to be used for sizing | 5 | in/hr. |
| Baseline Calculations | | | |
| 16 | Allowable Routing Time for sizing | 6 | hours |
| 17 | Depth filtered during storm [Line 15 x Line 16] | 30 | inches |
| 18 | Depth of Detention Storage [Line 11 + (Line 12 x Line 14) + (Line 13 x Line 5)] | 14.4 | inches |
| 19 | Total Depth Treated [Line 17 + Line 18] | 44.4 | inches |
| Option 1 – Biofilter 1.5 times the DCV | | | |
| 20 | Required biofiltered volume [1.5 x Line 10] | 3745 | cubic-feet |
| 21 | Required Footprint [Line 20/ Line 19] x 12 | 1012 | sq-ft |
| Option 2 - Store 0.75 of remaining DCV in pores and ponding | | | |
| 22 | Required Storage (surface + pores) Volume [0.75 x Line 10] | 1873 | cubic-feet |
| 23 | Required Footprint [Line 22/ Line 18] x 12 | 1560 | sq-ft |
| Footprint of the BMP | | | |
| 24 | Area draining to the BMP | 73065 | sq-ft |
| 25 | Adjusted Runoff Factor for drainage area (Refer to Appendix B.1 and B.2) | 0.85 | |
| 26 | Minimum BMP Footprint [Line 24 x Line 25 x 0.03] | 1870 | sq-ft |
| 27 | Footprint of the BMP = Maximum(Minimum(Line 21, Line 23), Line 26) | | sq-ft |

Note: Line 7 is used to estimate the amount of volume retained by the BMP. Update assumed surface area in Line 7 until its equivalent to the required biofiltration footprint (either Line 21 or Line 23)





WATER EFFICIENT LANDSCAPE WORKSHEET

DEPARTMENT OF DEVELOPMENT SERVICES
10601 Magnolia Avenue, Santee, CA 92071-1266, (619) 258-4100 ext. 168

This worksheet is filled out by the project applicant for each Point of Connection/Water Meter. Please complete all sections of the worksheet and use additional worksheets if necessary.

1. Project Information

Applicant: 10756 Rockvill, LLC Phone: 619-442-3343
Address: PO BOX 1297 Fax: _____
El Cajon, CA 92022 Email: rclark@southwestsignal.com

Property Owner: 10756 Rockvill, LLC Phone: 619-442-3343
Address: PO BOX 1297 Fax: _____
El Cajon, CA 92022 Email: rclark@southwestsignal.com

Project Address: 10756 Rockvill St, Santee, CA 92071 **Project Type:** Commercial
Assessor's Parcel Number: 3844700900 **Water Supply Type**
(Potable, recycled, well) Potable
Total Landscape Area: 8,880 sf **Water Purveyor:** Padre Dam Municipal Water

2. Applicant's/Property Owner's Certification

The design of this project complies with the requirements of the City of Santee Water Efficient Landscape Ordinance.

Lindsay Chiccone PLA 6271 3-9-22
Applicant's/Property Owner's Signature Date:

3. Landscape Documentation Package Checklist:

- Water Efficient Landscape Worksheet
- Soil Management Report
- Landscape Design Plan
- Irrigation Design Plan
- Grading Design Plan

4. Maximum Applied Water Allowance (MAWA) Reference Evapotranspiration (ET_o) _____

| Hydrozone # /Planting Description ^a | Plant Factor (PF) | Irrigation Method ^b | Irrigation Efficiency (IE) ^c | ETAF (PF/IE) | Landscape Area (sq. ft.) | ETAF x Area | Estimated Total Water Use (ETWU) ^e |
|---|-------------------|--------------------------------|---|--------------|--------------------------|-------------|---|
| Regular Landscape Areas | | | | | | | |
| Shrub - Low | 0.2 | Drip | 0.81 | 0.25 | 4633 | 1,158 | 36,759 |
| Shrub - Med | 0.4 | Drip | 0.81 | 0.49 | 957 | 469 | 14,887 |
| Shrub - Low | 0.2 | Spray | 0.75 | 0.26 | 3290 | 855 | 27,141 |
| | | | | Totals | (A) | (B) | 78,787 |
| Special Landscape Areas | | | | | | | |
| | | | | 1 | | | |
| | | | | 1 | | | |
| | | | | 1 | | | |
| | | | | Totals | (C) | (D) | 0 |
| ETWU Total | | | | | | | 78,787 |
| Maximum Allowed Water Allowance (MAWA)^e | | | | | | | 126,849 |

^a Hydrozone #/Planting Description

- E.g.
 1) front lawn
 2) low water use plantings
 3) medium water use planting

^b Irrigation Method

Overhead spray
 or drip

^c Irrigation Efficiency

0.75 for spray head
 0.81 for drip

^d ETWU (Annual Gallons Required) =

Eto x 0.62 x ETAF x Area
 where 0.62 is a conversion
 factor that converts acre-inches per
 acre per year to gallons per acre
 per square foot per year

^e MAWA (Annual Gallons Allowed) = (Eto) (0.62) [(ETAF x LA)
 + ((1 - ETAF) x SLA)]

where 0.62 is a conversion factor that converts acre-inches per
 acre per year to gallons per acre per square foot per year; LA is
 the total landscape area in square feet; SLA is the total special
 landscape area in square feet, and ETAF is 0.55 for residential
 areas and 0.45 for non-residential areas

MAWA = (51.2) (0.62) (0.45 x 8,880) = 126, 849

ETAF Calculations

Regular Landscape Areas

| | | |
|---------------------|--------------|------|
| Total ETAF x Area | (B) | 2482 |
| Total Area | (A) | 8880 |
| Average ETAF | B + A | 0.28 |

Average ETAF for Regular Landscape Areas must be 0.55
 or below for residential areas, and 0.45 or below for non-
 residential areas

All Landscape Areas

| | | |
|----------------------|--------------------------|------|
| Total ETAF x Area | (B + D) | 2482 |
| Total Area | (A + C) | 8880 |
| Sitewide ETAF | (B + D) + (A + C) | 0.28 |

B.4.1 Simple Method

Stepwise Instructions:

1. Compute DCV using Worksheet B.4-1
2. Estimate design infiltration rate using Worksheet D.5-1
3. Design BMP(s) to ensure that the DCV is fully retained (i.e., no surface discharge during the design event) and the stored effective depth draws down in no longer than 36 hours.

Worksheet 0-1: Simple Sizing Method for Infiltration BMPs

| Simple Sizing Method for Infiltration BMPs | | Worksheet B.4-1 | | |
|--|---|-----------------------|-------|------------|
| 1 | DCV (Worksheet B-2.1) | DCV= | 2649 | cubic-feet |
| 2 | Estimated design infiltration rate (Worksheet D.5-1) | $K_{\text{design}} =$ | 0 | in/hr |
| 3 | Available BMP surface area | $A_{\text{BMP}} =$ | 1012 | sq-ft |
| 4 | Average effective depth in the BMP footprint (DCV/A_{BMP}) | $D_{\text{avg}} =$ | 2.62 | feet |
| 5 | Drawdown time, T ($D_{\text{avg}} * 12 / K_{\text{design}}$) | T= | 31.44 | hours |
| 6 | Provide alternative calculation of drawdown time, if needed. | | | |

Notes:

- Drawdown time must be less than 36 hours. This criterion was set to achieve average annual capture of 80% to account for back to back storms (See rationale in Section B.4.3). In order to use a different drawdown time, BMPs should be sized using the percent capture method (Section B.4.2).
- The average effective depth calculation should account for any aggregate/media in the BMP. For example, 4 feet of stone at a porosity of 0.4 would equate to 1.6 feet of effective depth.
- This method may overestimate drawdown time for BMPs that drain through both the bottom and walls of the system. BMP specific calculations of drawdown time may be provided that account for BMP-specific geometry.



GEOTECHNICAL INVESTIGATION

Proposed Commercial Property
10756 Rockvill Street
Santee, California

prepared for:

Mr. Ryan T. Clark
Southwest Signal Service
PO Box 1297
El Cajon, CA 92071

by:

TerraPacific Consultants, Inc.
4010 Morena Boulevard, Suite 108
San Diego, CA 92117

March 16, 2021
File No. 21-032



TABLE OF CONTENTS

| | | |
|------|---|----|
| 1.0 | INTRODUCTION..... | 1 |
| 1.1 | General..... | 1 |
| 1.2 | Scope of Services | 1 |
| 2.0 | PROJECT BACKGROUND..... | 2 |
| 2.1 | Site Description and Development History | 2 |
| 2.2 | Proposed Development..... | 2 |
| 3.0 | SITE INVESTIGATION | 2 |
| 3.1 | Site Reconnaissance..... | 2 |
| 3.2 | Subsurface Exploration | 3 |
| 3.3 | Laboratory Testing | 3 |
| 4.0 | SITE GEOLOGY | 3 |
| 4.1 | Geologic Setting | 3 |
| 4.2 | Site Stratigraphy..... | 4 |
| 4.3 | Groundwater | 4 |
| 5.0 | SEISMICITY | 5 |
| 5.1 | Regional Seismicity..... | 5 |
| 5.2 | Probabilistic Ground Acceleration | 5 |
| 5.3 | Hazard Assessment | 6 |
| 6.0 | CONCLUSIONS | 7 |
| 7.0 | RECOMMENDATIONS..... | 8 |
| 7.1 | Site Preparation and Grading | 8 |
| 7.2 | Temporary Excavations..... | 9 |
| 7.3 | Foundation Recommendations..... | 9 |
| 7.4 | Soil Design Criteria..... | 9 |
| 7.5 | Retaining Walls..... | 10 |
| 7.6 | Earthquake Design Parameters..... | 11 |
| 7.7 | Foundation and Retaining Wall Design Guidelines | 12 |
| 7.8 | Trench Backfill..... | 14 |
| 7.9 | Site Drainage | 14 |
| 7.10 | Plan Review and Geotechnical Observation | 14 |
| 8.0 | CLOSURE..... | 15 |
| 8.1 | Limits of Investigation..... | 15 |

APPENDICES

- Appendix A: Figures
- Appendix B: References
- Appendix C: Subsurface Excavation Logs
- Appendix D: Laboratory Test Results
- Appendix E: Summary of Active Faults
- Appendix F: Standard Grading Guidelines



1.0 INTRODUCTION

1.1 General

The following report presents the findings of a geotechnical investigation performed at 10756 Rockvill Street in Santee, California. The location of the property is presented on the Site Location Plan, Figure 1 in Appendix A. The purpose of the investigation was to evaluate the subsurface conditions at the site to provide recommendations and soil design parameters for the proposed construction, consisting of an approximate 20,000 square foot commercial building with a parking lot, staging and loading area, drive lanes, and associated appurtenances.

1.2 Scope of Services

The scope of the investigation consisted of field reconnaissance, subsurface exploration, laboratory testing, and engineering and geologic analysis of the obtained data. The following tasks were performed during the investigation:

- Site reconnaissance and review of published geologic, seismologic, and geotechnical reports and maps pertinent to the project. A list of references is provided in Appendix B.
- Logging/sampling of five backhoe test pits on the building pad. The Geotechnical Plan, Figure 2 in Appendix A, presents the approximate subsurface exploration locations. The excavation logs are presented in Appendix C.
- Representative soil samples from selected depths within the excavations transported to our laboratory for testing.
- Laboratory testing of samples collected from the test excavations. The testing included in-situ moisture and density, direct shear, expansion index, maximum density/optimum moisture and sulfate and chloride levels, and maximum density/optimum moisture. The laboratory data is presented in Appendix D.
- Engineering and geologic analysis of data acquired from the investigation, which provided the basis for our conclusions and recommendations; and
- Preparation of this report presenting our findings and recommendations.



2.0 PROJECT BACKGROUND

2.1 Site Description and Development History

The subject property is located on the east side of Rockville Street Street in Santee, California. The roughly rectangular-shaped lot is bordered by commercial properties to the south and north/northwest, Rockville Street to the west, and an ascending slope at variable inclination to the east. The site primarily consists of a relatively flat building pad with steeply sloping terrain on the east side and a variable height fill slope on the west side. Based on a review of the as-built grading plans for the lot on file with the County of San Diego, the pad was created by typical cut-fill techniques. Most of the lot required cutting; however, some fill placement on the northwest side of the property was required to achieve the existing pad grade. The ascending 1.5:1 slope on the east side required cuts up to approximately 25 feet in depth and the descending slope at the northwest side required up to 14 feet of fill during the original grading. The lot was graded in the early 1980s and has never been developed.

2.2 Proposed Development

Based on our review of the current site plan, a new approximate 20,000 square foot commercial building with a parking lot, staging and loading area, and drive lanes will be constructed. It is assumed additional associated appurtenances (e.g., flatwork, fences/walls, etc.) will be constructed as part of the development. In addition, an approximate 15-foot-high crib wall is proposed on the east side of the lot that will require further cutting into the slope.

3.0 SITE INVESTIGATION

The site investigation conducted on February 19, 2021 consisted of visual reconnaissance and subsurface exploration. The purpose of the investigation was to expose the existing subsurface conditions in the vicinity of the proposed construction.

3.1 Site Reconnaissance

Our site reconnaissance consisted of walking the site to determine if any indications of adverse geologic conditions were present. No outward signs of distress indicating adverse geologic conditions were noted.



3.2 Subsurface Exploration

The subsurface exploration consisted of five backhoe test pits excavated and backfilled with a Case 580 backhoe. The test pits (T-1 through T-5) were excavated in the approximate areas of the proposed structure to the machine refusal at respective final depths of 7.0, 3.2, 3.5, 3.5, and 3.2 feet below ground surface (bgs), respectively. The approximate excavation locations are presented on the Geotechnical Plan, Figure 2 in Appendix A. The borings were logged and sampled by a California licensed geologist from our office.

In general, the subsurface exploration revealed that the site is mantled by shallow fill soil underlain by Cretaceous-aged granitic bedrock. Groundwater was not encountered in any of the excavations during our exploration. Descriptions of each material are detailed in Section 4.2 Site Stratigraphy, and the subsurface excavation logs are provided in Appendix C.

3.3 Laboratory Testing

Soil samples collected during the field exploration were transported to our laboratory for testing. The purpose of the testing was to characterize the soil types and evaluate the engineering properties of the soil. The laboratory testing included in-situ moisture and density, expansion index, direct shear, sulfate and chloride levels, and maximum density/optimum moisture. Each of the laboratory tests was performed in accordance with ASTM specifications or other accepted testing procedures. The results of the laboratory tests are presented in Appendix D.

4.0 SITE GEOLOGY

4.1 Geologic Setting

The site is located within the inland portion of the Peninsular Ranges Geomorphic Province of California. This province, which extends 900 miles from Southern California to the southern tip of Baja California, is characterized by northwest-trending structural blocks. The inland portion of the province in San Diego County is typically comprised of granitic rocks of the Southern California Batholith.

According to the geologic literature (Kennedy and Tan, 2008), the site is underlain by Cretaceous-aged granitic bedrock. The uppermost portions of the granitic bedrock are commonly weathered and are referred to as decomposed granite or DG, becoming harder with depth. The project location is presented on the Geologic Map (Figure 3 in Appendix A).



4.2 Site Stratigraphy

The subsurface descriptions presented below are interpreted from the conditions exposed during the field investigation and/or inferred from local geologic literature. In addition to the following descriptions, detailed exploration logs are presented in Appendix C.

Fill Soil - Fill soil is earth material that has been placed using mechanical means such as dozers or other large earthmovers. Typically, the fill soil has been removed from topographically high locations and placed in low-lying areas to create level building pads. When properly compacted, fill soil can be used to support structures. However, it is typically more compressible than natural formational soils.

Fill soils were encountered in each of the excavations. Test pit T-1 revealed fill soils to approximately 6.5 feet bgs near the northwest corner of the proposed building. Shallow fill soils were encountered within the approximate upper 1 to 3 feet of the excavations of test pit T-2 through T-5. The fill soils were relatively consistent and generally described as a medium brown coarse sand that was slightly moist and dense in consistency.

Bedrock (Granite) – Cretaceous-aged granitic bedrock was encountered in each of the test pits underlying the fill soils to the final excavation depths. The upper approximate 2 feet of this material was described as weathered with increasing rock hardness with depth. The bedrock was generally described as a gray, slightly moist to dry, hard granite. Excavations up 2.5 feet deep were conducted within this material utilizing a backhoe; however, localized outcroppings of crystalline bedrock and/or very hard boulders were observed on the building pad and along the slope face. Excavation of the very hard bedrock materials utilizing conventional earth-moving equipment is generally not feasible. Rock-breaking techniques will likely be required to achieve the proposed cut for the crib wall and possibly for some over-excavation on the east side of the lot.

4.3 Groundwater

Groundwater was not encountered within the depths of our excavations, which extended up to approximately 7.0 feet below the existing ground surface. Each of the excavations was left open for some time after completion to evaluate groundwater presence further. It should be mentioned that transient perched groundwater conditions can develop at different soil profile levels due to future irrigation patterns, periods of prolonged rainfall, and/or other conditions related to on or off-site development.



5.0 SEISMICITY

5.1 Regional Seismicity

Generally, the seismicity within California can be attributed to the regional tectonic movement taking place along the San Andreas Fault Zone, which includes the San Andreas Fault and most parallel and sub-parallel faulting within the state. A majority of Southern California, which includes the subject site, is considered seismically active. Seismic hazards can be attributed to potential ground shaking from earthquake events along nearby faults or more distant faulting.

According to regional geologic literature, the closest known active faults are located within the Rose Canyon Fault Zone. The Rose Canyon Fault Zone consists of a complex zone of several en echelon strike slip, oblique, reverse, and normal faults, extending onshore in San Diego, from San Diego Bay north to La Jolla Bay, and offshore along North County San Diego. Several other potentially active and pre-Quaternary faults also occur within the regional vicinity. Currently, the geologic literature presents varying opinions regarding the seismicity of these faults. As such, the following seismic analysis only considers the effects of nearby faults currently considered active.

5.2 Probabilistic Ground Acceleration

A deterministic seismic hazard analysis was performed for the site using the computer program EQFault (Blake, 2000). The analysis considers the maximum movement magnitude earthquake for active faults within the specified search radius to provide a maximum expected earthquake event for the known tectonic structure. For this site, we specified a search radius of 62.4 miles (100 km) and the conservative attenuation equation of Campbell & Bozorgnia (1997 Rev.) for soft rock. The results of the analysis for the faults most likely to affect the site are presented in Appendix E, Summary of Active Faults.

In addition to the deterministic analysis, a simplified probabilistic seismic hazard analysis was performed for the site. The United States Geological Survey has a webpage that allows a user to calculate the ground motion at a site with both a 2 percent and 10 percent probability of exceedance in a 50-year period. The results of the output indicate the site has calculated peak ground accelerations of 0.328g and 0.172g, respectively.



The ground acceleration values provided are for comparing the potential for seismic shaking due to fault activity most likely to affect the site. Other factors should be considered when completing seismic design, such as duration of shaking, the period of the structure, design category, etc. The designer and/or structural engineer should consider the information provided herein and evaluate the structure(s) in accordance with the California Building Code (CBC) and guidelines of the City of Santee. The earthquake design parameters based on the 2019 CBC applicable to the site are provided in Section 7.6.

5.3 Hazard Assessment

Faulting/Fault Rupture Hazard - An “active” fault as defined by the Alquist-Priolo Earthquake Fault Zoning Act is a fault that has had surface rupture within Holocene time (the past 11,000 years). A “potentially active” fault is defined as any fault that showed evidence of surface displacement during Quaternary time (last approximate 1.6 million years), but not since Holocene time.

According to the Quaternary Fault Map from the USGS Earthquake Hazards Program, the subject parcel is located approximately 13.4 miles east of an “active” portion of the Rose Canyon Fault Zone. The site is not located within an Alquist-Priolo fault zone, and according to geologic literature, is not intersected by any faults.

Seismically Induced Settlement - Within the depths of our exploration, the soils encountered consisted of hard granitic bedrock. Based on the anticipated earthquake effect and the stratigraphy of the site, seismically induced settlement is expected to be minor and within tolerable limits. Structures designed and constructed in accordance with applicable building codes are expected to perform well with respect to settlement associated with predictable seismic events.

Liquefaction - Liquefaction involves the substantial loss of shear strength in saturated soil, usually taking place within a saturated medium exhibiting a uniform fine-grained characteristic, loose consistency, and low confining pressure when subjected to impact by seismic or dynamic loading. Based on the presence of hard granitic bedrock underlying the site and the absence of shallow groundwater, the site is considered a negligible risk for liquefaction.

Lurching and Shallow Ground Rupture - Rupturing of the ground is not likely due to the absence of known active fault traces within the project limits. Due to the generally active seismicity of Southern California, however, the possibility for ground lurching or rupture cannot be completely ruled out. In this light, “flexible” design for on-site utility lines and connections should be considered.



Landsliding - At the time of our investigation, there was no evidence of landsliding observed at the site. Given the site geology consisting of granitic bedrock, the possibility for landsliding is believed to be remote. Furthermore, the geologic literature does not depict any known landslides within or near the site. The geotechnical consultant should review the exposed rock at the cuts on the east side of the lot during grading for excessive fractures or joints in the rock.

Seiches and Flooding - At the time of our investigation, there were no nearby contained bodies of water that could produce seiches (“tidal” waves in confined bodies of water) that may affect the site. No seiche or flooding potential was identified.

6.0 CONCLUSIONS

Based on our investigation results, it is our opinion that the proposed development is feasible from a geotechnical standpoint, provided the recommendations presented in the following sections are adopted and incorporated into the project plans and specifications.

The following sections provide recommendations for the proposed site development. The architect, civil, and/or structural engineer should use this information during the planning and design of the proposed construction. Once the plans and details have been prepared, they should be forwarded to this office for review and comment.

A key aspect of the site, which will need to be considered during the design, is the presence of very hard granitic bedrock underlying the site. Based on our investigation, the proposed cut depths are expected to be accomplished with conventional grading and excavation equipment; however, localized areas of very hard crystalline rock outcroppings and/or hard rock floaters will likely be encountered during construction. As such, chemical fracturing and/or hard rock breaking techniques will likely be required locally. It is recommended that remedial grading be conducted across the lot to re-process the upper portion of the existing fill soils and to remove the hard rock transition on the east side of the lot. Footings for the proposed commercial building should be supported on a minimum 18 inches of compacted fill soil. This will mitigate potential transitional effects on the building structure by eliminating having portions founded in fill soils and others in bedrock. The proposed crib wall may be founded completely on the native granitic bedrock.



7.0 RECOMMENDATIONS

The following sections provide our recommendations for site preparation, design, and construction of the proposed foundation systems. Once the plans and details have been prepared, they should be forwarded to this office for review and comment.

7.1 Site Preparation and Grading

In order to prepare the site for the new construction, clearing and grubbing of any debris and/or vegetation within the areas of new work should occur. Once cleared, remedial grading should include over-excavation and placement of compacted fill for the footprint of the proposed building. This will require removal of shallow bedrock and replacement with compacted fill on the east side of the lot and re-processing of the existing compacted soils in the remaining areas on the lot to receive settlement-sensitive structures.

As previously mentioned, grading should be conducted to provide a uniform fill mat for the proposed commercial property. This will require removals and/or over-excavations to expose competent granitic bedrock or extend a minimum of 18 inches below proposed foundation bottoms, whichever is deeper. The removals should extend a minimum of 5 feet beyond the structural footprint, unless limited by property line constraints, and into the competent older native paralic deposits.

In areas where less critical structures such as site walls, driveways, and walkway slabs are proposed, it is recommended that the upper approximate 18 inches of existing subgrade soils be moisture conditioned and recompacted. This will help provide more uniform bearing support for these types of appurtenant structures.

Once the removal bottoms have been established, the bottoms should be scarified a minimum of 6 inches, moisture-conditioned, and compacted to at least 90 percent of the ASTM D-1557 maximum density value.

The on-site soil, less any organic debris, may be used for fill, provided that it is placed in thin lifts (not exceeding 8 inches in loose thickness). All soil should be properly moisture conditioned and mechanically compacted to a minimum of 90 percent of the laboratory maximum dry density per ASTM D-1557 and at or slightly above optimum moisture condition. The removal bottoms, fill placement, and compaction should be observed and tested by the geotechnical consultant. Standard guidelines for grading are provided in Appendix F.



7.2 Temporary Excavations

Foundation excavations, utility trenches, or other temporary vertical cuts may be conducted in compacted engineered fill to a maximum height of 4 feet. Any temporary cuts beyond the above height restraint could experience sloughing or caving and, therefore, should either be shored or laid-back. Temporary vertical cuts in granitic bedrock over 4 feet in height may be allowed pending review of the geotechnical consultant. Laid-back slopes should have a maximum inclination of 1:1 (horizontal: vertical) and not exceed a vertical height of 10 feet without further input from the geotechnical consultant. In addition, no excavation should undercut a 1:1 projection below the foundation for any existing improvements, i.e., existing building foundations both on and off-site. Regional safety measures should be enforced, and all excavations should be conducted in strict accordance with OSHA guidelines.

Excavation spoils should not be stockpiled adjacent to excavations as they can surcharge the soils and trigger failure. In addition, proper erosion protection, including runoff diversion, is recommended to reduce the possibility of erosion of slopes during grading and building construction. Ultimately, it is the contractor's responsibility to maintain safe working conditions for persons on-site.

7.3 Foundation Recommendations

The following sections provide the soil parameters and general guidelines for foundation design and construction. It is anticipated that all new construction will be supported by conventional continuous and spread footings. As previously mentioned, the new foundation for the proposed commercial building should be supported on competent engineered fill in accordance with Section 7.1. The proposed crib wall may be supported directly on the native granitic bedrock.

The foundation design parameters and guidelines provided below are considered to be "minimums" in keeping with the current standard-of-practice. They do not preclude more restrictive criteria that may be required by the governing agency or structural engineer. The architect or structural engineer should evaluate the foundation configurations and reinforcement requirements for structural loading, concrete shrinkage, and temperature stress.

7.4 Soil Design Criteria

The following soil design criteria are provided for the design and construction of the conventional foundations for the proposed concrete tilt-up construction of the commercial building. The parameters provided assume foundation embedment in competent engineered fill material with an expansion index classification no higher than "low."



Conventional Foundations

Allowable bearing capacity for square or continuous footings in engineered fill....2,000 psf

Minimum embedment depth for footings in engineered fill24 in

Minimum width for continuous footings..... 18 in

Minimum width for square footings 2.5 ft

Note: The bearing capacity value may be increased by one-third for transient loads such as wind and seismic. In addition, the value provided may be increased by 500 psf for each additional foot of width or depth beyond the minimums provided. The increased bearing capacity should not exceed 5,000 psf.

Coefficient of friction against sliding0.45

Passive resistance300 psf/ft up to a maximum of 2,500 psf

7.5 Retaining Walls

Lateral Loading and Resistance Parameters

For proposed retaining walls, e.g., the 15-foot-high crib wall on the east side of the property, the following bearing capacity, minimum foundation dimensions, and the additional design parameters for lateral loading and resistance are provided below:

Allowable bearing capacity for crib wall footings on granitic bedrock..... 3,000 psf

Minimum embedment depth for crib wall into granitic bedrock 12 in

Active earth pressure for level backfill (non-restrained walls) 32 psf/ft

Active earth pressure for 1.5:1 sloping backfill (non-restrained walls) 68 psf/ft

At-rest earth pressure for level backfill (restrained walls) 55 psf/ft

Note: The active and at-rest pressures are provided assuming granular soil, like the type encountered on-site, is used for backfill. Backfill and subdrain recommendations are provided in the following sections.

Passive resistance in competent engineered fill or granitic bedrock..... 350 psf/ft

Coefficient of friction against sliding0.47



Note: The passive resistance and coefficient of friction may be used in combination if there is a fixed structure, such as a concrete slab over the toe of the retaining wall. If the two values are used in combination, the passive resistance value should be reduced by one-third.

Earthquake Loads

Seismic loading for retaining walls should be evaluated by a structural engineer, considering the overall height of the wall and the appropriate lateral loading parameters provided above for analysis and design. The seismic load is additional to the typical earth pressure loads applied to retaining walls based on the loading parameters provided herein.

For the subject site, an appropriate seismic load can be approximated by applying 17 psf/ft in an inverse triangle shape where the lateral force at the bottom of the wall is equal to zero, and the lateral force at the top of the retaining wall is equal to 17 psf times the height of the wall. The resultant seismic load is then applied from the bottom of the wall at a distance of 0.6 times the overall height of the wall.

7.6 Earthquake Design Parameters

Earthquake-resistant design parameters may be determined from the California Building Code (2019 Edition). Based on our investigation and characterization of the site, the following design parameters may be adopted:

| | |
|---|---|
| Site coordinates | Latitude: 32.837810, Longitude: -116.963780 |
| Site classification | C |
| Site coefficient F_a | 1.200 |
| Site coefficient F_v | 1.500 |
| Spectral response acceleration at short periods S_s | 0.766 |
| Spectral response acceleration at 1-second period S_1 | 0.282 |
| Maximum spectral response accelerations at short periods S_{ms} | 0.919 |
| Maximum spectral response accelerations at 1-second period S_{m1} | 0.423 |
| Design spectral response accelerations at short periods S_{ds} | 0.613 |
| Design spectral response accelerations at 1-second period S_{d1} | 0.282 |



7.7 Foundation and Retaining Wall Design Guidelines

The following guidelines are provided for assistance in the design of the various foundation elements and are based on the anticipated low expansion potential of the bearing soils. As is always the case, where more restrictive, the structural and/or architectural design criteria should take precedent.

Foundations - Continuous footings for the proposed concrete tilt-up building should be embedded a minimum of 24 inches deep. Reinforcement should consist of a minimum of four No. 5 rebar, two placed at the top and two at the bottom of the footing. All footing embedments should be verified by the geotechnical consultant.

Slabs-on-Grade - The interior slab-on-grade for the proposed concrete tilt-up building should be a minimum of 4 inches thick and reinforced with No. 3 rebar placed at a maximum spacing of 16 inches on center, both ways. Additional reinforcement requirements and an increase in slab thickness may be necessary based upon the proposed loading conditions in the structure, e.g., heavy storage racks and/or fork-lift traffic. They should be further evaluated by the project architect and/or engineers.

Exterior slabs should also be a minimum of 4-inches thick and reinforced with No. 3 rebar placed at a maximum spacing of 16 inches on center, both ways. The steel reinforcement should be placed at the midpoint or slightly above the midpoint in the slab section. For exterior slabs, control joints should be installed at a maximum spacing of 10 feet in each direction. Prior to the construction of slabs, the subgrade should be moistened to approximately 12 inches in depth at least 24 hours before placing the concrete. The above recommendations are considered minimums for the site soil. Consideration should be given to construct slabs that abut soil/planter areas with a 12-inch deep by 12-inch-wide thickened edge to help mitigate lateral moisture migration.

All interior floor slabs should be underlain by 2 inches of clean sand followed by a minimum 15-mil PVC vapor retarder (Stego Wrap or similar). The vapor retarder should be further underlain by a 4-inch-thick layer of gravel or crushed rock. Also, the vapor retarder should be properly lapped and sealed around all plumbing penetrations.

Preliminary Driveway and Parking Pavement Design - The proposed construction will incorporate new driveways and parking areas which we assume will be flexible pavement primarily composed of asphalt concrete (AC). Based on an assumed minimum R-value of 25 for the on-site soil, a Traffic index (TI) of 5.0 for the auto-drive lanes and parking areas, and a TI of 7.0 for the truck drive lanes, the minimum structural section recommended for the on-site pavement are as follows:



- Auto drive lanes/parking areas: 3-inches of AC over 5.5-inches of Class 2 aggregate base material, or an alternate 6.5-inch full depth AC section.
- Truck drive lanes/loading areas: 3-inches of AC over 10-inches of Class 2 aggregate base material, or an alternate 9.0-inch full depth AC section

The above recommendations assume the upper 12 inches of subgrade soils and all Class 2 aggregate base material will be moisture conditioned and compacted to a minimum of 95 percent of the ASTM D-1557 dry density value. If rigid pavement, i.e., Portland cement concrete (PCC), is desired, the minimum thickness should be 7 inches for the auto/parking areas and 7.5 inches for truck drive lanes/loading areas. Final pavement design may require adjustment based on R-value testing of the representative subgrade soils at the time of rough grading.

Retaining Walls - Retaining walls should be provided with a gravel subdrain system. The drain system should start with a minimum 4-inch diameter perforated PVC Schedule 40 or ABS pipe, placed at the heel of the wall footing and below the adjacent slab level. The pipe should be sloped at least 1 percent to a suitable outlet, such as an approved site drainage system or off-site storm drain. The pipe should be surrounded by a gravel backfill consisting of tamped $\frac{3}{4}$ -inch sized gravel. This gravel backfill zone should be a minimum of 12 inches wide and should incorporate a minimum of 3 cubic feet of gravel per linear foot of subdrain. The entire gravel section should be wrapped in a filter cloth such as Mirafi 140 NS, or similar, to prevent contamination with fines. In addition, any CMU block walls should be properly moisture-proofed per the project architect. See the example Retaining Wall Drain Details, Figure 4 in Appendix A.

Foundation and Slab Concrete - The results of the corrosion tests indicate negligible levels of sulfates and chlorides within the on-site soils. The concrete should be mixed and placed in accordance with ACI specifications. Water should not be added to the concrete at the site, as this can reduce the mix and lead to increased porosity and shrinkage cracking.

Proper curing techniques and a reduction in mixing water can help reduce cracking and concrete permeability. To further reduce shrinkage cracking and slab permeability, consideration should be given to using a concrete mix that possesses a maximum water-cement ratio of 0.5.

It should be noted that TCI does not consult in the field of corrosion engineering. Thus, the client, project architect, and/or structural design engineer should evaluate the level of corrosion protection required for the project and seek consultation from a qualified professional, as warranted.



Appurtenances - Other site appurtenances such as planter walls, site walls, etc., can be constructed on continuous footings. Footings for such appurtenances should be a minimum of 12 inches deep, 12 inches wide, and minimally reinforced with four No. 4 bars, two top, and two bottom. The bearing capacity for such appurtenances is 1,500 psf.

7.8 Trench Backfill

Trench excavations for utility lines should be properly backfilled and compacted. Utilities should be properly bedded and backfilled with clean sand or approved granular soil to a depth of at least 1 foot over the pipe. This backfill should be uniformly watered and compacted to a firm condition for both vertical and lateral pipe support. The remainder of the backfill may be typical on-site soil or low expansive import placed near optimum moisture content in lifts not exceeding 8 inches in thickness and mechanically compacted to at least 90 percent relative compaction.

7.9 Site Drainage

Drainage should be designed to direct surface water away from structures and onto an approved disposal area. For earth areas, a minimum gradient of 2 percent should be maintained, with drainage directed away from slopes and towards approved swales or collection facilities. To reduce saturation of the building foundation soils, positive drainage should be maintained within an away gradient of at least 5 percent for a minimum distance of 10 feet from foundations. Where property line constraints prohibit this distance, a 5 percent gradient to an approved drainage diversion (i.e., area drains or swales) should be provided. Impervious surfaces within 10 feet of the building foundation should be sloped a minimum of 2 percent away from the building. Drainage patterns approved after grading should be maintained throughout the life of the development. In addition, it is recommended that roof gutters be installed with downspouts that discharge to hardscaped surfaces directed toward surface drain inlets or are directly tied into a tight lined system for surface drainage.

7.10 Plan Review and Geotechnical Observation

When the grading and foundation plans are completed, they should be reviewed by TCI for compliance with the recommendations herein. Observation by TCI or another company's geotechnical representative is essential during grading and/or construction to confirm conditions anticipated by the preliminary investigation, adjust designs to actual field conditions, and determine that grading is conducted in general accordance with our recommendations. In addition, all foundation excavations should be reviewed for conformance with the plans prior to the placement of forms, reinforcement, or concrete. Observation, testing, and engineering consulting services are provided by our firm and should be budgeted within the cost of development.



8.0 CLOSURE

8.1 Limits of Investigation

Our investigation was performed using the skill and degree of care ordinarily exercised, under similar circumstances, by reputable soils engineers and engineering geologists practicing in this or similar localities. No warranty, expressed or implied, is made as to the conclusions and professional advice in this report. This report is prepared for the sole use of our client and may not be assigned to others without the written consent of the client and TCI.

The samples taken and used for testing, and the observations made, are believed representative of the site conditions; however, soil and geologic conditions can vary significantly between test excavations and surface exposures. As in most projects, conditions revealed by construction excavations may vary with the preliminary findings. If this occurs, the geotechnical engineer should evaluate the changed conditions and adjust recommendations and designs as necessary.

This report is issued with the understanding that it is the responsibility of the owner or their representative to ensure that the information and recommendations contained herein are brought to the attention of the project architect and engineer. Appropriate recommendations should be incorporated into the structural plans and the necessary steps taken to see that the contractor and subcontractors carry out such recommendations in the field.

The findings of this report are valid as of the present date. However, the conditions can change with the passage of time, whether they are due to natural processes or the works of man. In addition, changes in applicable or appropriate standards may occur from legislation or the broadening of knowledge. Accordingly, the findings of this report may be invalidated wholly or partially by changes outside of our control. This report is subject to review and should be updated after a period of 3 years.

*** * * TerraPacific Consultants, Inc. * * ***



APPENDIX A

Figures

LOCATION:
 10756 Rockvill St.
 Santee CA 92071

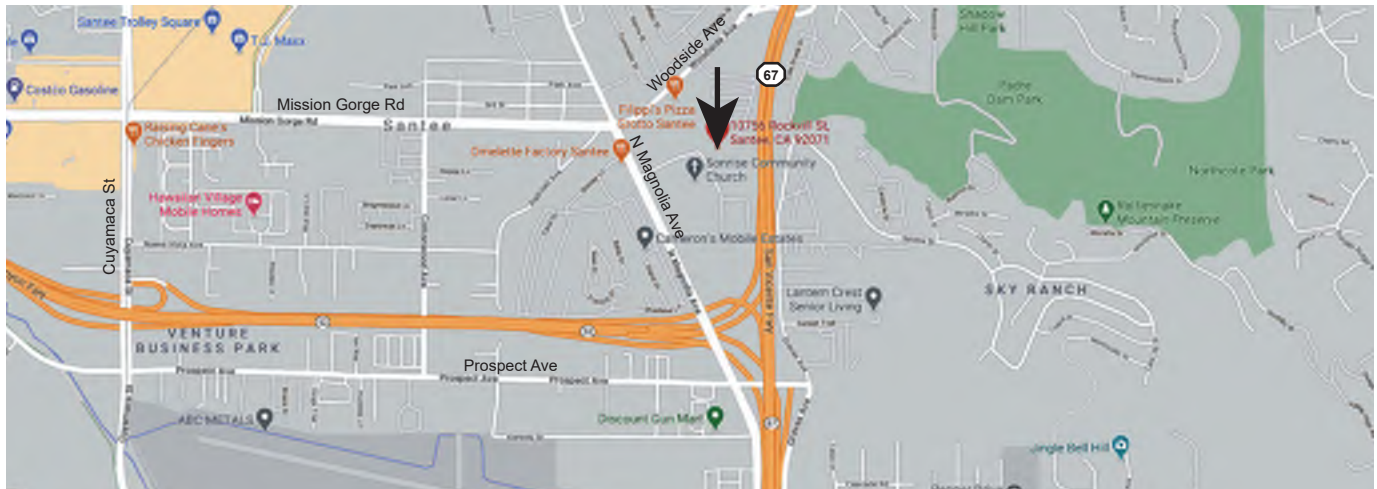
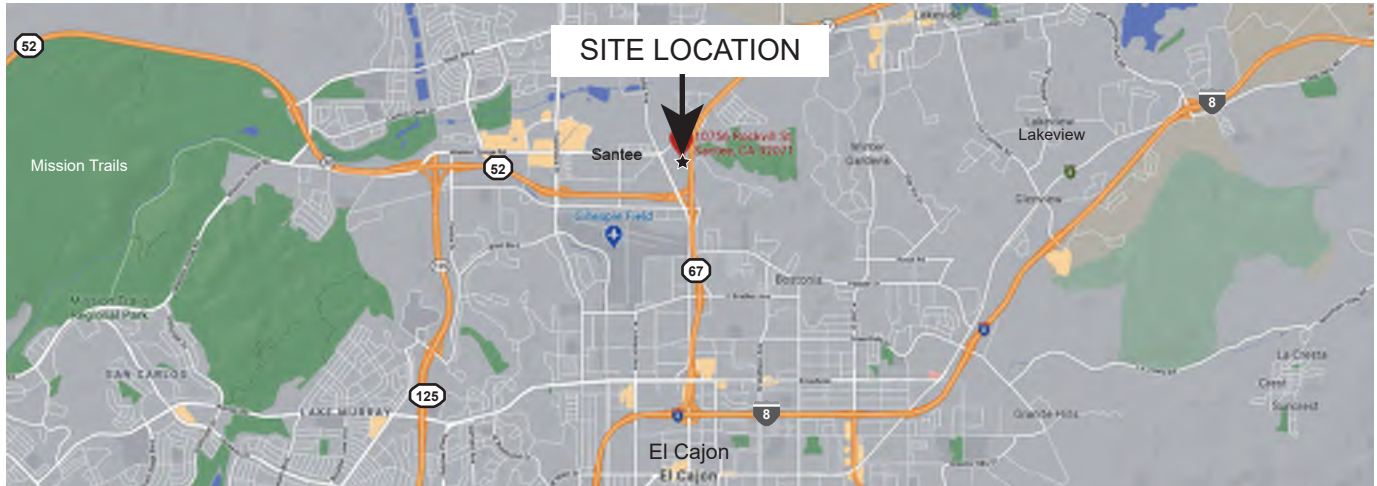

REFERENCE: Google Maps



Morton, D.M. and Miller, F.K., 2006, Geologic map of the San Bernardino and Santa Ana 30' x 60' quadrangles, California, U.S. Geological Survey,

Description of Map Units

Kgr Cretaceous-aged granite

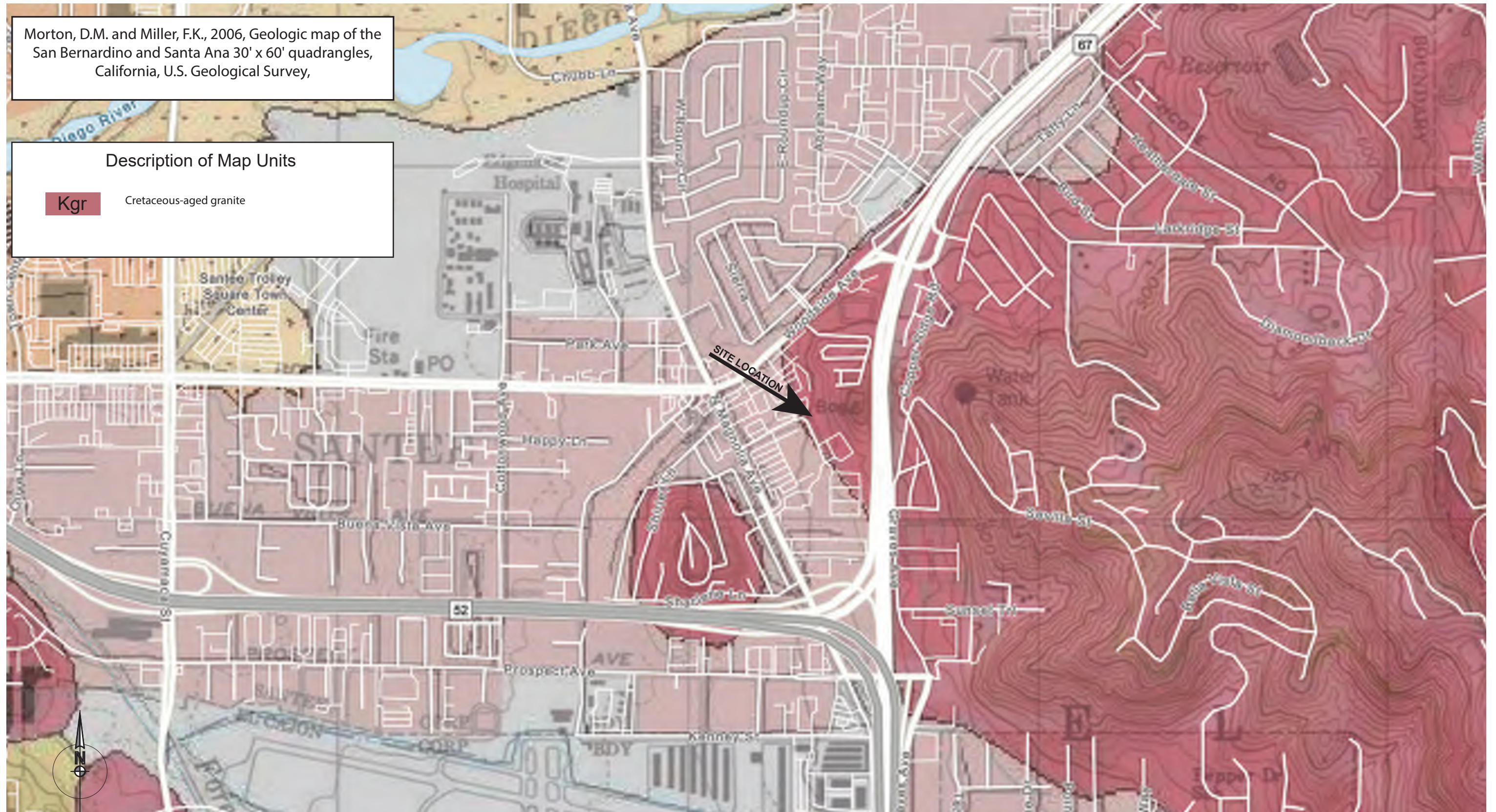

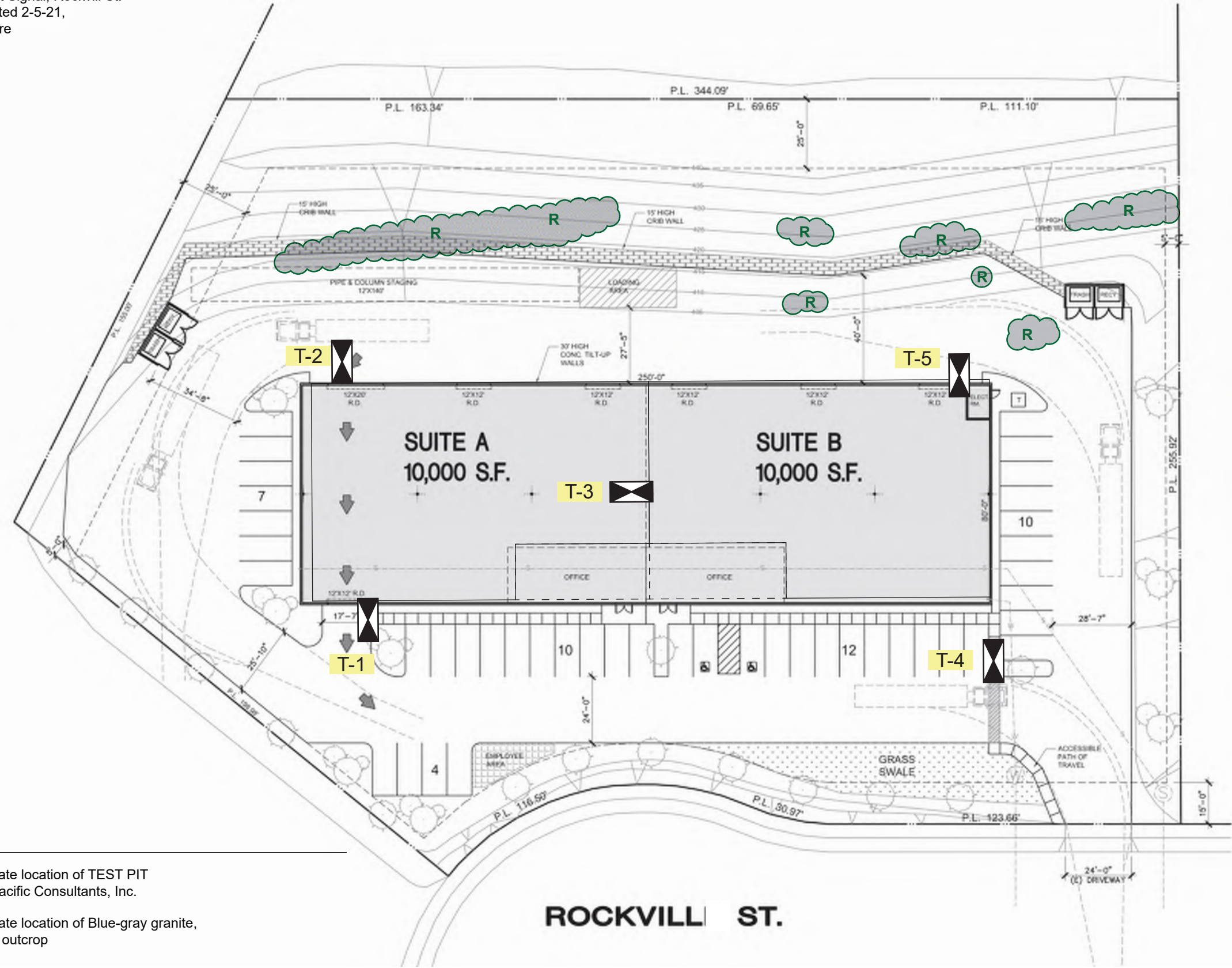

0 0.2 mile

REFERENCE:
 Preliminary Site Plan, Southwest Signal, Rockvill St.
 Santee CA 92071, Sheet A1, dated 2-5-21,
 prepared by Mansour Architecture



LEGEND

T-5  Approximate location of TEST PIT by TerraPacific Consultants, Inc.

 Approximate location of Blue-gray granite, very-hard outcrop

ROCKVILL ST.



ROCK & FABRIC ALTERNATIVE

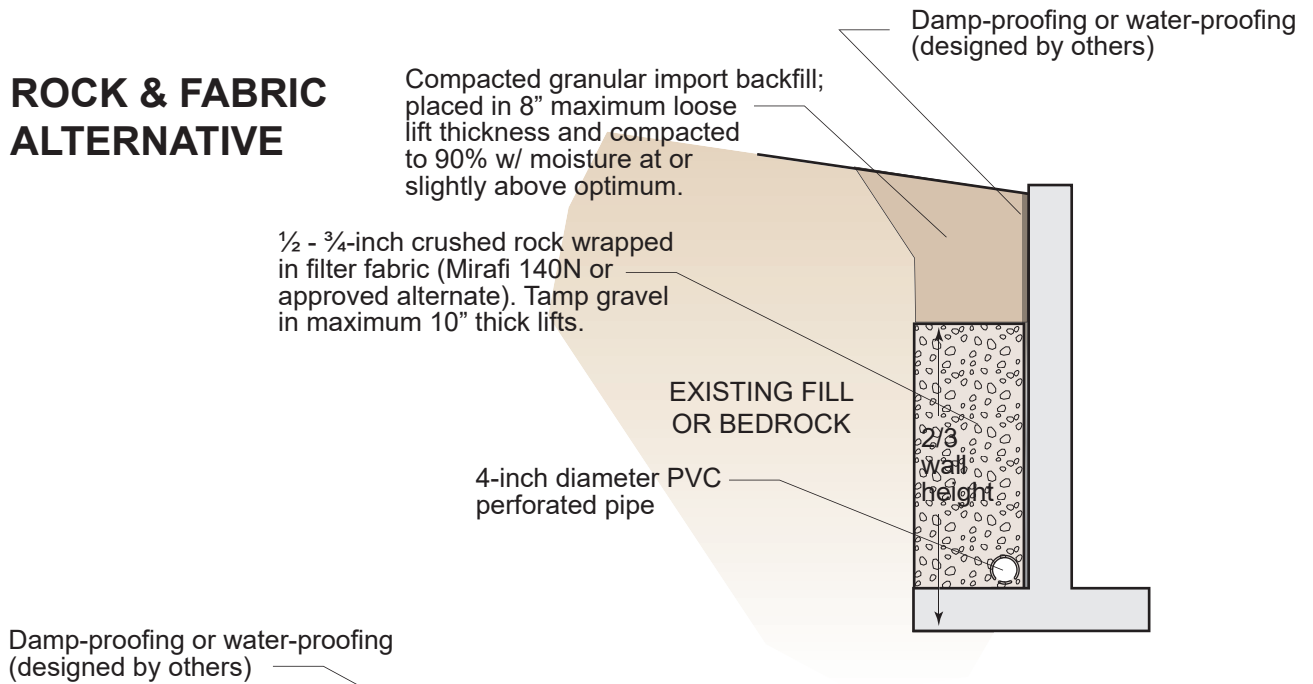

PANEL DRAIN ALTERNATIVE

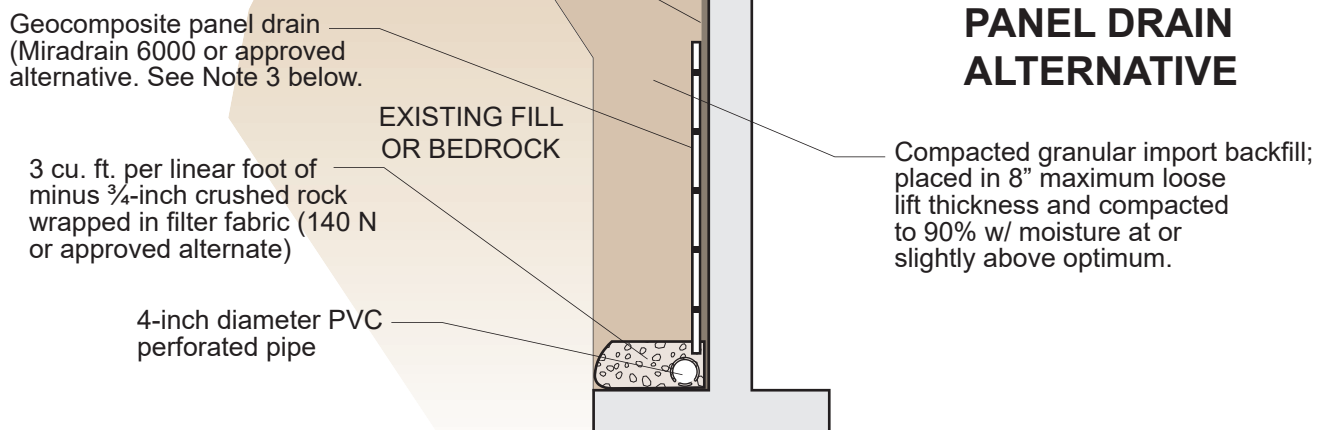

NOTES:

- 1) Perforated pipe should outlet through to a solid pipe at maximum 25 foot centers to a free gravity outfall. Perforated pipe and outlet pipe should have a fall of at least 1%.
- 2) Filter fabric should consist of Mirafi 140N or similar approved fabric. Filter fabric should be overlapped at least 6-inches.
- 3) Geocomposite panel drain should consist of Miradrain 6000, Mirafi G100N, J-Drain 400, or approved similar product.
- 4) Drain installation should be observed by the geotechnical consultant prior to backfilling.

NOT TO SCALE



APPENDIX B

References



REFERENCES

- 1) American Society of Civil Engineers, Minimum Design Loads for Buildings and Other Structures, ASCE Standard 7-05, 2006.
- 2) American Society for Testing and Materials, Annual Books of ASTM Standards, Section 4, Construction, Volume 04.08 Soil and Rock (I): D 420 – D 4914, West Conshohocken, PA, 2008.
- 3) Bing or Google, 2020, Site Location Map for 10756 Rockvill Street Santee, California 92071.
- 4) Blake, T.F., EQFAULT, EQSEARCH, FRISK: Computer Programs for Estimation of Peak Horizontal Acceleration from Southern California Historic Earthquakes, 2000.
- 5) California Building Standards Commission, California Building Code, 2019 Edition.
- 6) California Department of Conservation, Fault-Rupture Hazard Zones in California, Alquist-Priolo Earthquake Fault Zoning Act with Index to Earthquake Fault Zones Maps, Special Publication 42, California Geological Survey, Interim Revision 2007.
- 7) California Geological Survey, Guidelines for Evaluating and Mitigating Seismic Hazards in California, Special Publication 117, 2008.
- 8) California Geological Survey, Probabilistic Seismic Hazards Mapping Ground Motion Page, California Geological Survey website.
- 9) City of San Diego, Guidelines for Geotechnical Reports, 2011.
- 10) Grading and Drainage Plans for Rockwood Industrial Park, Sheet 7 of 9, prepared by Roger D. Simpson, as-built date December 4, 1980.
- 11) Harden, D., California Geology, 1997.
- 12) Jennings, C.W., 1994, Fault Activity Map of California and Adjacent Areas, California Division of Mines and Geology, Map No. 6, Scale 1:750,000.
- 13) Kennedy, Michael P. and Peterson, G.L., 2001 Re-Print, Geology of San Diego Metropolitan Area, California, California Department of Conservatory Division of Mines and Geology, Bulletin 200.
- 14) Kennedy, M.P. and Tan, S.S., 2008, Geologic Map of the San Diego 30' by 60' Quadrangle, California, California Geological Survey, Regional Geologic Map Series, 1:100,000 Scale, Map No. 3, San Diego Quadrangle.
- 15) Leyendecker, Frankel, and Rukstales, Earthquake Ground Motion Parameters Version 5.0.9a, dated November 13, 2009.
- 16) Mansour Architecture, Schematic Site Plan for Southwest Signal Service 10756 Rockvill Street Santee, California 92071.



REFERENCES

- 17) Norris, Robert M. and Webb, Robert W., 1976, Geology of California, John Wiley & Sons.
- 18) Tan, Siang S., Geologic Map of The El Cajon 7.5' Quadrangle, San Diego, County, California, California Geologic Survey, 2002.
- 19) Todd, V.R., Preliminary Geologic Map of the El Cajon 30' x 60' Quadrangle, Southern California, Version 1.0, USGS Open File Report 2004-1361, 2004
- 20) Treiman, J.A., The Rose Canyon Fault Zone, Southern California, California Department of Conservation, Division of Mines and Geology, DMG open-file report 93-02, 1993.
- 21) United States Department of Agriculture, Soil Quality Indicators, June 2008.
- 22) United States Geological Survey, California-Nevada Active Faults Index Map, <http://quake.wr.usgs.gov/info/faultmaps/index.html>.
- 23) United States Geological Survey, Earthquake Hazards Program, Seismic Hazards Maps and Data, <http://earthquake.usgs.gov/hazards>.
- 24) United States Geological Survey, Earthquake Hazards Program, 2010 Fault Activity Map of California, <http://www.quake.ca.gov/gmaps/FAM/faultactivitymap.html>.
- 25) Wesnousky, S.G., 1986, Earthquakes, Quaternary Faults and Seismic Hazard in California, Journal of Geophysical Research, Vol. 91, No. B12, pp. 2587-2631.





APPENDIX C

Subsurface Excavation Logs

Test Pit Log
Test Pit No: T-1

| | |
|---|---|
| Project No: 21-032 | Date: 2/19/21 |
| Project Name: Southwest Signal Service | Logged By: D. Thomas |
| Location: Northwest Corner of Lot | Excavating Company: K+C Excavation |
| Sample Method: Modified California Sampler | Excavator: Kenny |
| Instrumentation: None installed | Excavation Method: Hand labor |
| Elevation: Pad | Hammer Wt. & Drop: 35 lbs. for 30" |

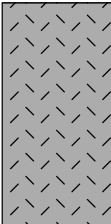
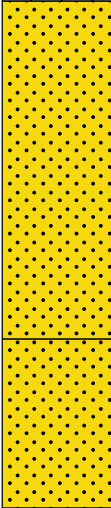
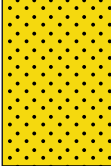
| Depth (ft) | Lithology | DESCRIPTION & REMARKS | USCS | Sample Type | Blow Counts | Dry Density (pcf) | Moisture (%) |
|------------|-----------|-----------------------|------|-------------|-------------|-------------------|--------------|
|------------|-----------|-----------------------|------|-------------|-------------|-------------------|--------------|



| | | | | | | | |
|----|---|--|--|------|----|-------|-----|
| 0 |  | FILL: From 0.0', Sand, medium brown, moist, dense, medium coarse grained | | Ring | -- | 127.9 | 5.1 |
| 1 | | | | | | | |
| 2 |  | FILL: From 2.0', Sand, medium brown, slightly moist, dense to very dense, medium to coarse grained, with 8" granitic clast up to 12" | | Bulk | -- | 112.2 | 6.8 |
| 3 | | | | Ring | -- | -- | -- |
| 4 | | | | | | | |
| 5 |  | FILL: From 5.0', Sand, medium brown, slightly moist, dense, medium to coarse grained, with increase in rock content | | Ring | -- | 117.3 | 7.2 |
| 6 | | | | | | | |
| 7 |  | NATIVE: From 6.5', Granite, gray, dry, very hard @ 7.0', Refusal | | | | | |
| 8 | | | | | | | |
| 9 | | | | | | | |
| 10 | | | | | | | |

| | |
|--------------------------------|--|
| Total Depth: 7.0' | Test Pit T-1 Page 1 of 1 |
| Water: No | |
| Caving: No | |
| Footing Dimensions: N/A | |

Test Pit Log
Test Pit No: T-2

| | |
|---|---|
| Project No: 21-032 | Date: 2/19/21 |
| Project Name: Southwest Signal Service | Logged By: D. Thomas |
| Location: Northwest Corner of Proposed Structure | Excavating Company: K+C Excavation |
| Sample Method: Modified California Sampler | Excavator: Kenny |
| Instrumentation: None installed | Excavation Method: Hand labor |
| Elevation: Pad | Hammer Wt. & Drop: 35 lbs. for 30" |

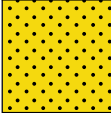
| Depth (ft) | Lithology | DESCRIPTION & REMARKS | USCS | Sample Type | Blow Counts | Dry Density (pcf) | Moisture (%) |
|------------|-----------|-----------------------|------|-------------|-------------|-------------------|--------------|
|------------|-----------|-----------------------|------|-------------|-------------|-------------------|--------------|

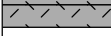
| | | | | | | | |
|----|---|--|--|--|--|--|--|
| 0 |  | FILL: From 0.0', Sand, medium brown to gray brown, slightly moist, dense, medium to coarse grained | | | | | |
| 1 |  | NATIVE: From 1.0', Granite, gray, slightly moist, hard, weathered | | | | | |
| 3 |  | NATIVE: From 3.0', Granite, gray, dry, very hard | | | | | |
| 4 | | | | | | | |
| 5 | | | | | | | |
| 6 | | | | | | | |
| 7 | | | | | | | |
| 8 | | | | | | | |
| 9 | | | | | | | |
| 10 | | | | | | | |

| | |
|--------------------------------|-------------------------------|
| Total Depth: 3.2' | Test Pit T-2 |
| Water: No | |
| Caving: No | |
| Footing Dimensions: N/A | |
| Page 1 of 1 | |

Test Pit Log
Test Pit No: T-3

| | |
|---|---|
| Project No: 21-032 | Date: 2/19/21 |
| Project Name: Southwest Signal Service | Logged By: D. Thomas |
| Location: Middle of Proposed Structure | Excavating Company: K+C Excavation |
| Sample Method: Modified California Sampler | Excavator: Kenny |
| Instrumentation: None installed | Excavation Method: Hand labor |
| Elevation: Pad | Hammer Wt. & Drop: 35 lbs. for 30" |

| Depth (ft) | Lithology | DESCRIPTION & REMARKS | USCS | Sample Type | Blow Counts | Dry Density (pcf) | Moisture (%) |
|------------|-----------|-----------------------|------|-------------|-------------|-------------------|--------------|
|------------|-----------|-----------------------|------|-------------|-------------|-------------------|--------------|

| | | | | | | | |
|----|---|---|--|------|----|-------|-----|
| 0 | FILL: From 0.0', Sand, medium brown, slightly moist, dense, medium to coarse grained, with some 4" granitic clast | 0 | | Bulk | -- | -- | -- |
| 1 | | | | Ring | -- | 125.3 | 6.4 |
| 2 | | | | Ring | -- | 134.2 | 4.2 |
| 3 | NATIVE: From 2.5', Granite, gray, dry, hard, weathered, moderately fractured | | | | | | |
| 4 | NATIVE: From 3.5', Granite, gray, dry, very hard, refusal | | | | | | |
| 5 | | | | | | | |
| 6 | | | | | | | |
| 7 | | | | | | | |
| 8 | | | | | | | |
| 9 | | | | | | | |
| 10 | | | | | | | |

| | |
|---|--|
| Total Depth: 3.5' Water: No Caving: No Footing Dimensions: N/A | Test Pit T-3 Page 1 of 1 |
|---|--|

Test Pit Log
Test Pit No: T-4

| | |
|---|---|
| Project No: 21-032 | Date: 2/19/21 |
| Project Name: Southwest Signal Service | Logged By: D. Thomas |
| Location: Southwest Corner of Proposed Structure | Excavating Company: K+C Excavation |
| Sample Method: Modified California Sampler | Excavator: Kenny |
| Instrumentation: None installed | Excavation Method: Hand labor |
| Elevation: Pad | Hammer Wt. & Drop: 35 lbs. for 30" |

| Depth (ft) | Lithology | DESCRIPTION & REMARKS | USCS | Sample Type | Blow Counts | Dry Density (pcf) | Moisture (%) |
|------------|-----------|-----------------------|------|-------------|-------------|-------------------|--------------|
|------------|-----------|-----------------------|------|-------------|-------------|-------------------|--------------|

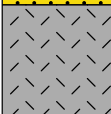
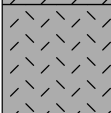
| | | | | | | | |
|----|--|---|--|------|----|----|----|
| 0 |  | FILL: From 0.0', Sand, medium brown, slightly moist, dense, medium to coarse sand | | Bulk | -- | -- | -- |
| 1 | | | | | | | |
| 2 |  | NATIVE: From 1.5', Granite, gray, hard, dry, moderately fractured, weathered | | | | | |
| 3 |  | NATIVE: From 2.5', Granite, gray, hard, dry | | | | | |
| 4 | | | | | | | |
| 5 | | | | | | | |
| 6 | | | | | | | |
| 7 | | | | | | | |
| 8 | | | | | | | |
| 9 | | | | | | | |
| 10 | | | | | | | |

| | |
|---|--|
| Total Depth: 3.5' Water: No Caving: No Footing Dimensions: N/A | Test Pit T-4 Page 1 of 1 |
|---|--|

Test Pit Log
Test Pit No: T-5

| | |
|---|---|
| Project No: 21-032 | Date: 2/19/21 |
| Project Name: Southwest Signal Service | Logged By: D. Thomas |
| Location: Southeast Corner of Proposed Structure | Excavating Company: K+C Excavation |
| Sample Method: Modified California Sampler | Excavator: Kenny |
| Instrumentation: None installed | Excavation Method: Hand labor |
| Elevation: Pad | Hammer Wt. & Drop: 35 lbs. for 30" |

| Depth (ft) | Lithology | DESCRIPTION & REMARKS | USCS | Sample Type | Blow Counts | Dry Density (pcf) | Moisture (%) |
|------------|-----------|-----------------------|------|-------------|-------------|-------------------|--------------|
|------------|-----------|-----------------------|------|-------------|-------------|-------------------|--------------|

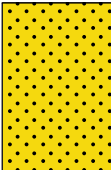
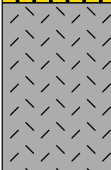
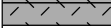
| | | | | | | | |
|----|---|--|--|------|---|-------|-----|
| 0 |  | FILL: From 0.0', Sand, medium brown, slightly moist, dense | | Ring | - | 129.2 | 4.5 |
| 1 | | | | | | | |
| 2 |  | NATIVE: From 1.5', Granite, gray, slightly moist, hard, highly weathered, slightly fractured | | | | | |
| 3 |  | NATIVE: From 3.0', Granite, gray, slightly moist, very hard @ 3.2', Refusal | | | | | |
| 4 | | | | | | | |
| 5 | | | | | | | |
| 6 | | | | | | | |
| 7 | | | | | | | |
| 8 | | | | | | | |
| 9 | | | | | | | |
| 10 | | | | | | | |

| | |
|--------------------------------|--|
| Total Depth: 3.2' | Test Pit T-5 Page 1 of 1 |
| Water: No | |
| Caving: No | |
| Footing Dimensions: N/A | |



APPENDIX D

Laboratory Test Results

Southwest Signal Service
Summary of Laboratory Test Results

FN: 21-032

| Sample Location | | | Corrosivity Series | | ASTM D 1557 | | ASTM D 2937 | | ASTM D 3080 | | ASTM D 4829 | |
|-----------------|--------------|-------------|--------------------|-----------------|---------------------|--------------------|-------------|------------------|-------------|--------|-----------------|---------------------|
| | | | CTM422 | CTM 417 | | | | | | | | |
| Location | Sample Depth | Sample Type | Chloride Content | Sulfate Content | Maximum Dry Density | Opt. Moist Content | Dry Density | Moisture Content | Peak ϕ | Peak c | Expansion Index | Expansion Potential |
| T-1 | 6" | Ring | -- | -- | -- | -- | 127.9 | 5.1 | -- | -- | -- | -- |
| T-1 | 2.5' | Ring | -- | -- | -- | -- | 112.2 | 6.8 | 35.0 | 550.0 | -- | -- |
| T-1 | 4.5' | Ring | -- | -- | -- | -- | 117.3 | 7.2 | -- | -- | -- | -- |
| T-3 | SG | Ring | -- | -- | -- | -- | 125.3 | 6.4 | -- | -- | -- | -- |
| T-3 | 0-2' | LB | -- | -- | 136.5 | 8.5 | -- | -- | -- | -- | -- | -- |
| T-3 | 2.0' | Ring | -- | -- | -- | -- | 134.2 | 4.2 | -- | -- | -- | -- |
| T-4 | 0-1' | SB | <0.003 | 0.002 | -- | -- | -- | -- | -- | -- | 3 | Very Low |
| T-5 | 6" | Ring | -- | -- | -- | -- | 129.2 | 4.5 | -- | -- | -- | -- |

DIRECT SHEAR TEST
Laboratory Report

File Name: Southwest Signal Service
 File No.: 21-032
 Date: 2/23/2021
 Technician: JMS

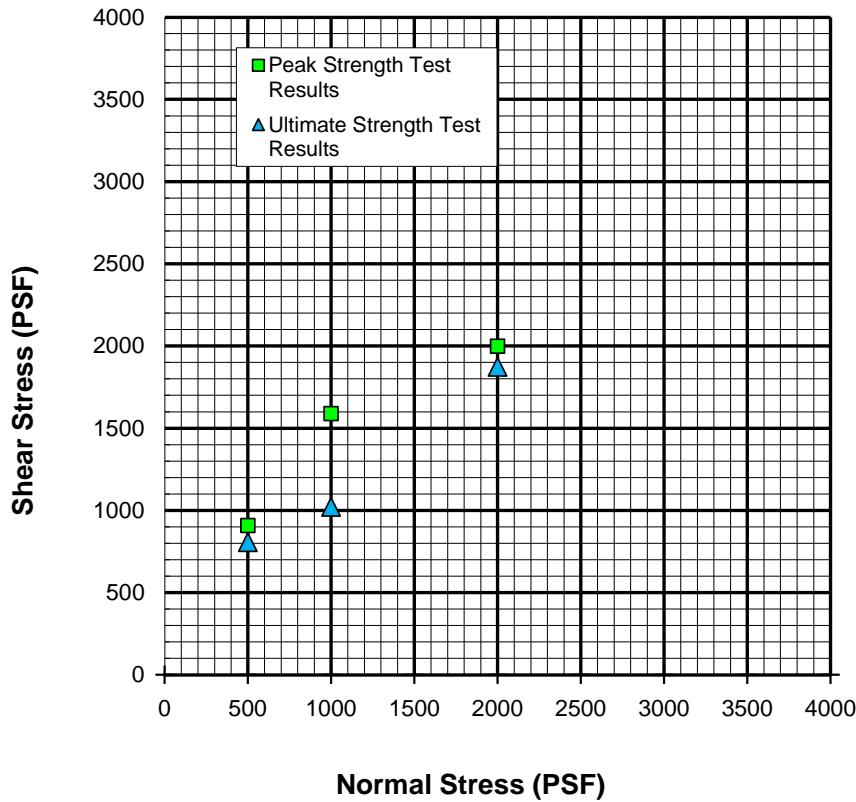
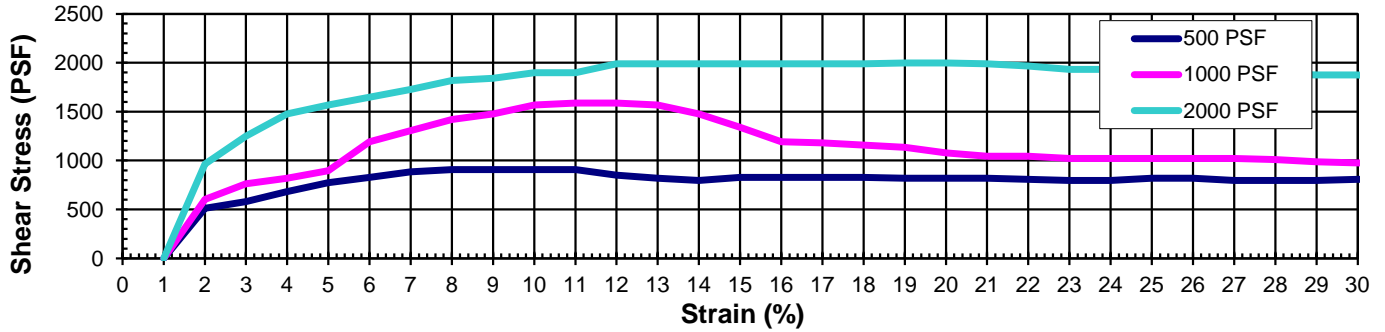

| | |
|------------------------|-------------------|
| Sample No. & Location: | T-1 @ 2.5' |
| Soil Description: | Medium Brown Sand |
| Sample Type: | Intact |
| Specimen Preparation: | Inundated |

| | Peak | Ultimate |
|------------------------------|------|----------|
| Friction Angle Φ' (deg) | 35 | 34 |
| Cohesion C' (psf) | 550 | 460 |

COMPACTION TEST

**ASTM D 1557
Modified Proctor**

Project Name: Southwest Signal Servic
 Project No. : 21-032
 Boring No.: T-3 @ 0-2'
 Technician: JMS
 Date: 3/2/2021
 Visual Sample Description: Darke Grey Sand

X Manual Ram

Ram Weight 10 LBS Drop 18 inches

| TEST NO. | | 1 | 2 | 3 | 4 | 5 | 6 |
|----------|-------------------------------|-------------------------------|---------|---------|---------|---------|---|
| A | Wt. Comp. Soil + Mold (gm.) | 3885.00 | 3980.00 | 4051.00 | 4069.00 | | |
| B | Wt. of Mold (gm.) | 1794.00 | 1794.00 | 1794.00 | 1794.00 | | |
| C | Net Wt. of Soil (gm.) | A - B | 2091.00 | 2186.00 | 2257.00 | 2275.00 | |
| D | Wet Wt. of Soil + Cont. (gm.) | | 1507.5 | 1921.9 | 1715.1 | 1783.2 | |
| E | Dry Wt. of Soil + Cont. (gm.) | | 1449.8 | 1823.6 | 1596.4 | 1633.2 | |
| F | Wt. of Container (gm.) | | 141.3 | 302.9 | 185.1 | 186.7 | |
| G | Moisture Content (%) | $\frac{[(D-F)-(E-F)]}{(E-F)}$ | 4.4 | 6.5 | 8.4 | 10.4 | |
| H | Wet Density (pcf) | $\frac{C \cdot 29.76}{453.6}$ | 137.2 | 143.4 | 148.1 | 149.3 | |
| I | Dry Density (pcf) | $\frac{H}{(1+G/100)}$ | 131.4 | 134.7 | 136.6 | 135.2 | |

Maximum Dry Density (pcf) **136.5**

8.5

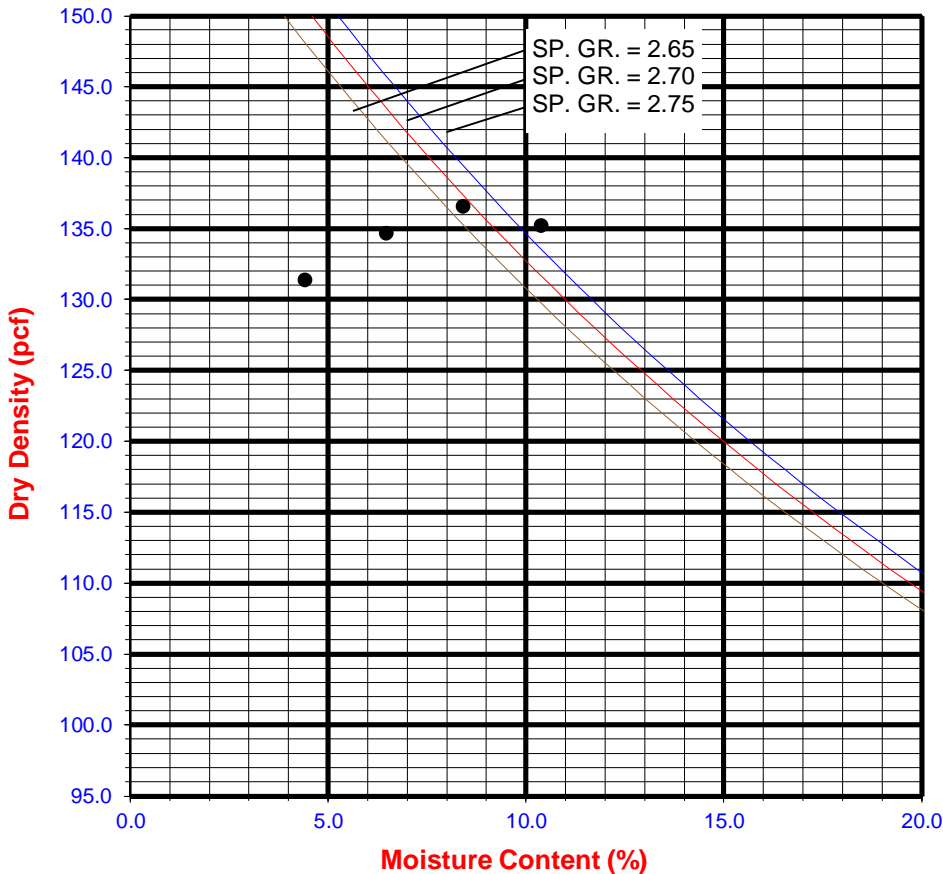

PROCEDURE USED
Procedure A



APPENDIX E

Summary of Active Faults

CALIFORNIA FAULT MAP

Southwest Signal Service

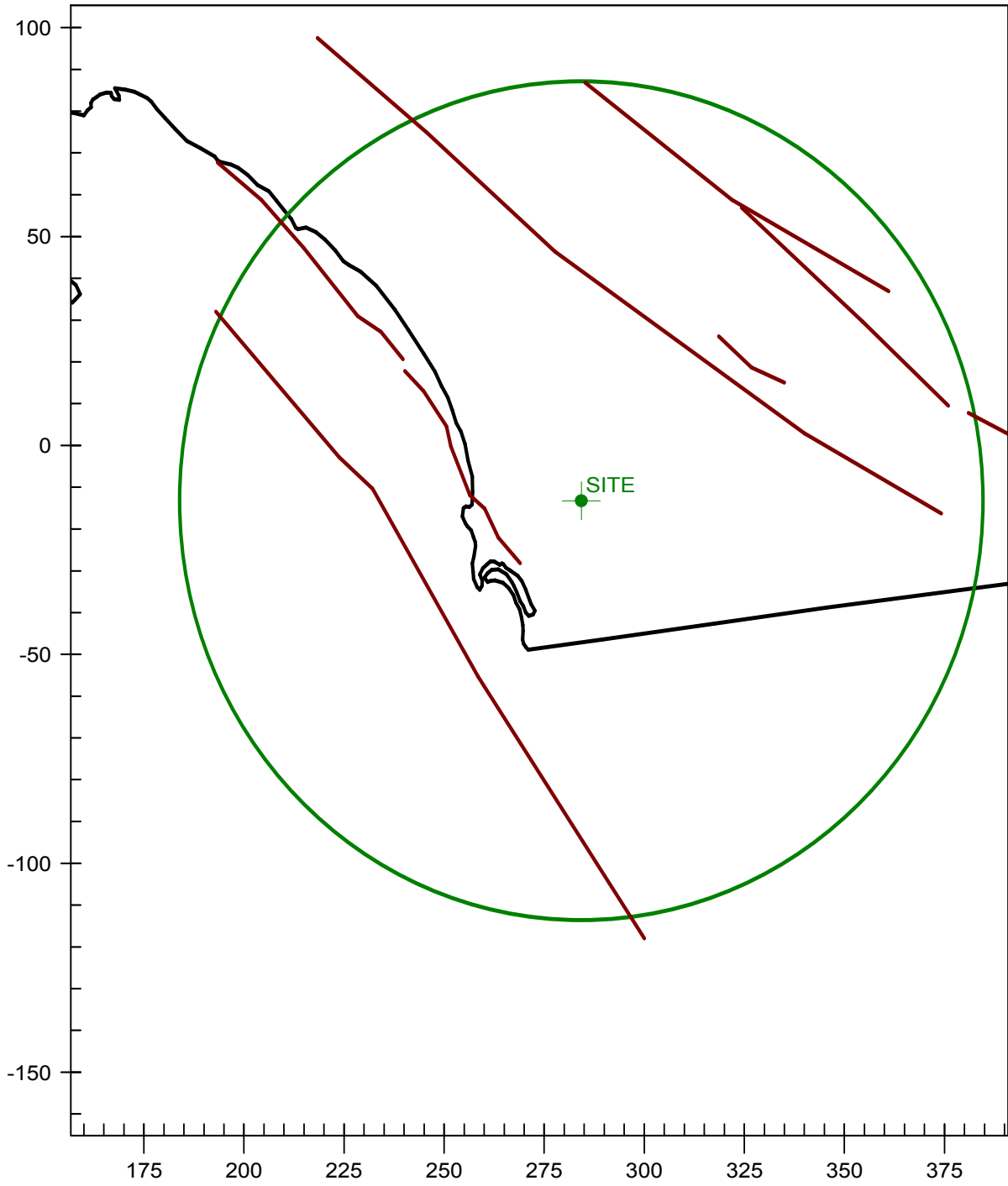

TEST.OUT

```
*****  
*           *  
*   E Q F A U L T   *  
*           *  
*   Version 3.00   *  
*           *  
*****
```

DETERMINISTIC ESTIMATION OF
PEAK ACCELERATION FROM DIGITIZED FAULTS

JOB NUMBER: 21-032

DATE: 02-24-2021

JOB NAME: Southwest Signal Service

CALCULATION NAME: Test Run Analysis

FAULT-DATA-FILE NAME: C:\Program Files\EQFAULT1\CDMGFLTE_new.dat

SITE COORDINATES:

SITE LATITUDE: 32.8378
SITE LONGITUDE: 116.9638

SEARCH RADIUS: 62.4 mi

ATTENUATION RELATION: 15) Campbell & Bozorgnia (1997 Rev.) - Soft Rock
UNCERTAINTY (M=Median, S=Sigma): M Number of Sigmas: 0.0
DISTANCE MEASURE: cdist
SCOND: 0
Basement Depth: 5.00 km Campbell SSR: 1 Campbell SHR: 0
COMPUTE PEAK HORIZONTAL ACCELERATION

FAULT-DATA FILE USED: C:\Program Files\EQFAULT1\CDMGFLTE_new.dat

MINIMUM DEPTH VALUE (km): 3.0

EQFAULT SUMMARY

DETERMINISTIC SITE PARAMETERS

Page 1

| ABBREVIATED FAULT NAME | APPROXIMATE DISTANCE mi (km) | ESTIMATED MAX. EARTHQUAKE EVENT | | |
|---------------------------------|------------------------------------|------------------------------------|--------------------------|--------------------------------------|
| | | MAXIMUM EARTHQUAKE MAG. (Mw) | PEAK SITE ACCEL. g | EST. SITE INTENSITY MOD. MERC. |
| ROSE CANYON | 13.4(21.6) | 7.2 | 0.234 | IX |
| CORONADO BANK | 27.1(43.6) | 7.6 | 0.137 | VIII |
| ELSINORE-JULIAN | 28.1(45.2) | 7.1 | 0.088 | VII |
| EARTHQUAKE VALLEY | 32.6(52.4) | 6.5 | 0.043 | VI |
| NEWPORT-INGLEWOOD (offshore) | 34.9(56.1) | 7.1 | 0.065 | VI |
| ELSINORE-COYOTE MOUNTAIN | 36.1(58.1) | 6.8 | 0.048 | VI |
| ELSINORE-TEMECULA | 37.4(60.2) | 6.8 | 0.045 | VI |
| SAN JACINTO-COYOTE CREEK | 49.2(79.1) | 6.8 | 0.030 | V |
| SAN JACINTO-ANZA | 50.6(81.5) | 7.2 | 0.041 | V |
| SAN JACINTO - BORREGO | 51.3(82.5) | 6.6 | 0.024 | V |
| ELSINORE-GLEN IVY | 60.0(96.5) | 6.8 | 0.023 | IV |
| SUPERSTITION MTN. (San Jacinto) | 61.5(98.9) | 6.6 | 0.018 | IV |

-END OF SEARCH- 12 FAULTS FOUND WITHIN THE SPECIFIED SEARCH RADIUS.

THE ROSE CANYON FAULT IS CLOSEST TO THE SITE.
IT IS ABOUT 13.4 MILES (21.6 km) AWAY.

LARGEST MAXIMUM-EARTHQUAKE SITE ACCELERATION: 0.2343 g



APPENDIX F

Standard Grading Guidelines

STANDARD GUIDELINES FOR GRADING PROJECTS

TABLE OF CONTENTS

| | <u>Page</u> |
|------------------------------|-------------|
| GENERAL..... | F-1 |
| DEFINITIONS OF TERMS..... | F-1 |
| OBLIGATIONS OF PARTIES | F-4 |
| SITE PREPARATION..... | F-4 |
| SITE PROTECTION | F-5 |
| EXCAVATIONS..... | F-6 |
| Unsuitable Materials | F-6 |
| Cut Slopes..... | F-6 |
| Pad Areas..... | F-6 |
| COMPACTED FILL | F-7 |
| Placement | F-7 |
| Moisture | F-8 |
| Fill Material | F-8 |
| Fill Slopes | F-10 |
| Off-Site Fill | F-11 |
| DRAINAGE..... | F-11 |
| STAKING | F-11 |
| SLOPE MAINTENANCE | F-12 |
| Landscape Plants..... | F-12 |
| Irrigation..... | F-12 |
| Maintenance | F-12 |
| Repairs | F-12 |
| TRENCH BACKFILL | F-13 |
| STATUS OF GRADING..... | F-13 |

GENERAL

The guidelines contained herein and the standard details attached hereto represent this firm's standard recommendations for grading and other associated operations on construction projects. These guidelines should be considered a portion of the project specifications.

All plates attached hereto shall be considered as part of these guidelines.

The Contractor should not vary from these guidelines without prior recommendation by the Geotechnical Consultant and the approval of the Client or his authorized representative. Recommendation by the Geotechnical Consultant and/or Client should not be considered to preclude requirements for approval by the controlling agency prior to the execution of any changes.

These Standard Grading Guidelines and Standard Details may be modified and/or superseded by recommendations contained in the text of the preliminary geotechnical report and/or subsequent reports.

If disputes arise out of the interpretation of these grading guidelines or standard details, the Geotechnical Consultant shall provide the governing interpretation.

DEFINITIONS OF TERMS

ALLUVIUM - Unconsolidated soil deposits resulting from flow of water, including sediments deposited in river beds, canyons, flood plains, lakes, fans and estuaries.

AS-GRADED (AS-BUILT) - The surface and subsurface conditions at completion of grading.

BACKCUT - A temporary construction slope at the rear of earth retaining structures such as buttresses, shear keys, stabilization fills or retaining walls.

BACKDRAIN - Generally a pipe and gravel or similar drainage system placed behind earth retaining structures such as buttresses, stabilization fills, and retaining walls.

BEDROCK - Relatively undisturbed formational rock, more or less solid, either at the surface or beneath superficial deposits of soil.

BENCH - A relatively level step and near vertical rise excavated into sloping ground on which fill is to be placed.

BORROW (Import) - Any fill material hauled to the project site from off-site areas.

BUTTRESS FILL - A fill mass, the configuration of which is designed by engineering calculations to retain slope conditions containing adverse geologic features. A buttress is generally specified by minimum key width and depth and by maximum backcut angle. A buttress normally contains a back-drainage system.

CIVIL ENGINEER - The Registered Civil Engineer or consulting firm responsible for preparation of the grading plans, surveying and verifying as-graded topographic conditions.

CLIENT - The Developer or his authorized representative who is chiefly in charge of the project. He shall have the responsibility of reviewing the findings and recommendations made by the Geotechnical Consultant and shall authorize the Contractor and/or other consultants to perform work and/or provide services.

COLLUVIUM - Generally loose deposits usually found near the base of slopes and brought there chiefly by gravity through slow continuous downhill creep (also see Slope Wash).

COMPACTION - Densification of man-placed fill by mechanical means.

CONTRACTOR - A person or company under contract or otherwise retained by the Client to perform demolition, grading and other site improvements.

DEBRIS - All products of clearing, grubbing, demolition, contaminated soil materials unsuitable for reuse as compacted fill and/or any other material so designated by the Geotechnical Consultant.

ENGINEERING GEOLOGIST - A licensed Engineering Geologist who applies scientific methods, engineering and geologic principles and professional experience to the acquisition, interpretation and use of knowledge of materials of the earth's crust for the evaluation of engineering problems. Geotechnical Engineering encompasses many of the engineering aspects of soil mechanics, rock mechanics, geology, geophysics, hydrology and related sciences.

ENGINEERED FILL - A fill of which the Geotechnical Consultant or his representative, during grading, has made sufficient tests to enable him to conclude that the fill has been placed in substantial compliance with the recommendations of the Geotechnical Consultant and the governing agency requirements.

EROSION - The wearing away of the ground surface as a result of the movement of wind and/or water.

EXCAVATION - The mechanical removal of earth materials.

EXISTING GRADE - The ground surface configuration prior to grading.

FILL - Any deposits of soil, rock, soil-rock blends or other similar materials placed by man.

FINISH GRADE - The ground surface configuration at which time the surface elevations conform to the approved plan.

GEOFABRIC - Any engineering textile utilized in geotechnical applications including subgrade stabilization and filtering.

GEOLOGIST - A representative of the Geotechnical Consultant educated and trained in the field of geology.

GEOTECHNICAL CONSULTANT - The Geotechnical Engineering and Engineering Geology consulting firm retained to provide technical services for the project. For the purpose of these specifications, observations by the Geotechnical Consultant include observations by the Soil Engineer, Geotechnical Engineer, Engineering Geologist and those performed by persons employed by and responsible to the Geotechnical Consultants.

GEOTECHNICAL ENGINEER - A licensed Geotechnical Engineer or Civil Engineer who applies scientific methods, engineering principles and professional experience to the acquisition, interpretation and use of knowledge of materials of the earth's crust for the evaluation of engineering problems. Geotechnical Engineering encompasses many of the engineering aspects of soil mechanics, rock mechanics, geology, geophysics, hydrology and related sciences.

GRADING - Any operation consisting of excavation, filling or combinations thereof and associated operations.

LANDSLIDE DEBRIS - Material, generally porous and of low density, produced from instability of natural or man-made slopes.

MAXIMUM DENSITY - Standard laboratory test for maximum dry unit weight. Unless otherwise specified, the maximum dry unit weight shall be determined in accordance with ASTM Method of Test D 1557-09.

OPTIMUM MOISTURE - Soil moisture content at the test maximum density.

RELATIVE COMPACTION - The degree of compaction (expressed as a percentage) of dry unit weight of a material as compared to the maximum dry unit weight of the material.

ROUGH GRADE - The ground surface configuration at which time the surface elevations approximately conform to the approved plan.

SITE - The particular parcel of land where grading is being performed.

SHEAR KEY - Similar to buttress, however, it is generally constructed by excavating a slot within a natural slope in order to stabilize the upper portion of the slope without grading encroaching into the lower portion of the slope.

SLOPE - An inclined ground surface the steepness of which is generally specified as a ratio of horizontal:vertical (e.g., 2:1).

SLOPE WASH - Soil and/or rock material that has been transported down a slope by action of gravity assisted by runoff water not confined by channels (also see Colluvium).

SOIL - Naturally occurring deposits of sand, silt, clay, etc., or combinations thereof.

SOIL ENGINEER - Licensed Geotechnical Engineer or Civil Engineer experienced in soil mechanics (also see Geotechnical Engineer).

STABILIZATION FILL - A fill mass, the configuration of which is typically related to slope height and is specified by the standards of practice for enhancing the stability of locally adverse conditions. A stabilization fill is normally specified by minimum key width and depth and by maximum backcut angle. A stabilization fill may or may not have a back drainage system specified.

SUBDRAIN - Generally a pipe and gravel or similar drainage system placed beneath a fill in the alignment of canyons or former drainage channels.

SLOUGH - Loose, non-compacted fill material generated during grading operations.

TAILINGS - Non-engineered fill which accumulates on or adjacent to equipment haul-roads.

TERRACE - Relatively level step constructed in the face of graded slope surface for drainage control and maintenance purposes.

TOPSOIL - The presumable fertile upper zone of soil which is usually darker in color and loose.

WINDROW - A string of large rocks buried within engineered fill in accordance with guidelines set forth by the Geotechnical Consultant.

OBLIGATIONS OF PARTIES

The Geotechnical Consultant should provide observation and testing services and should make evaluations in order to advise the Client on geotechnical matters. The Geotechnical Consultant should report his findings and recommendations to the Client or his authorized representative.

The client should be chiefly responsible for all aspects of the project. He or his authorized representative has the responsibility of reviewing the findings and recommendations of the Geotechnical Consultant. He shall authorize or cause to have authorized the Contractor and/or other consultants to perform work and/or provide services. During grading the Client or his authorized representative should remain on-site or should remain reasonably accessible to all concerned parties in order to make decisions necessary to maintain the flow of the project.

The Contractor should be responsible for the safety of the project and satisfactory completion of all grading and other associated operations on construction projects, including but not limited to, earthwork in accordance with the project plans, specifications and controlling agency requirements. During grading, the Contractor or his authorized representative should remain on-site. Overnight and on days off, the Contractor should remain accessible.

SITE PREPARATION

The Client, prior to any site preparation or grading, should arrange and attend a meeting among the Grading Contractor, the Design Engineer, the Geotechnical Consultant, representatives of the appropriate governing authorities as well as any other concerned parties. All parties should be given at least 48 hours notice.

Clearing and grubbing should consist of the removal of vegetation such as brush, grass, woods, stumps, trees, roots of trees and otherwise deleterious natural materials from the areas to be graded. Clearing and grubbing should extend to the outside of all proposed excavation and fill areas.

Demolition should include removal of buildings, structures, foundations, reservoirs, utilities (including underground pipelines, septic tanks, leach fields, seepage pits, cisterns, mining shafts, tunnels, etc.) and other man-made surface and subsurface improvements from the areas to be graded. Demolition of utilities should include proper capping and/or re-routing pipelines at the project perimeter and cutoff and capping of wells in accordance with the requirements of the governing authorities and the recommendations of the Geotechnical Consultant at the time of demolition.

Trees, plants or man-made improvements not planned to be removed or demolished should be protected by the Contractor from damage or injury.

Debris generated during clearing, grubbing and/or demolition operations should be wasted from areas to be graded and disposed off-site. Clearing, grubbing and demolition operations should be performed under the observation of the Geotechnical Consultant.

The Client or Contractor should obtain the required approvals from the controlling authorities for the project prior, during and/or after demolition, site preparation and removals, etc. The appropriate approvals should be obtained prior to proceeding with grading operations.

SITE PROTECTION

Protection of the site during the period of grading should be the responsibility of the Contractor. Unless other provisions are made in writing and agreed upon among the concerned parties, completion of a portion of the project should not be considered to preclude that portion or adjacent areas from the requirements for site protection until such time as the entire project is complete as identified by the Geotechnical Consultant, the Client and the regulating agencies.

The Contractor should be responsible for the stability of all temporary excavations. Recommendations by the Geotechnical Consultant pertaining to temporary excavations (e.g., backcuts) are made in consideration of stability of the completed project and, therefore, should not be considered to preclude the responsibilities of the Contractor. Recommendations by the Geotechnical Consultant should not be considered to preclude more restrictive requirements by the regulating agencies.

Precautions should be taken during the performance of site clearing, excavations and grading to protect the work site from flooding, ponding, or inundation by poor or improper surface drainage. Temporary provisions should be made during the rainy season to adequately direct surface drainage away from and off the work site. Where low areas can not be avoided, pumps should be kept on hand to continually remove water during periods of rainfall.

During periods of rainfall, plastic sheeting should be kept reasonably accessible to prevent unprotected slopes from becoming saturated. Where necessary during periods of rainfall, the Contractor should install check dams, desilting basins, riprap, sand bags or other devices or methods necessary to control erosion and provide safe conditions.

During periods of rainfall, the Geotechnical Consultant should be kept informed by the Contractor as to the nature of remedial or preventative work being performed (e.g., pumping, placement of sandbags or plastic sheeting, other labor, dozing, etc.).

Following periods of rainfall, the Contractor should contact the Geotechnical Consultant and arrange a walk-over of the site in order to visually assess rain related damage. The Geotechnical Consultant may also recommend excavations and testing in order to aid in his assessments. At the request of the Geotechnical Consultant, the Contractor shall make excavations in order to evaluate the extent of rain related damage.

Rain related damage should be considered to include, but may not be limited to, erosion, silting, saturation, swelling, structural distress and other adverse conditions identified by the Geotechnical Consultant. Soil adversely affected should be classified as Unsuitable Materials and should be subject to over-excavation and replacement with compacted fill or other remedial grading as recommended by the Geotechnical Consultant.

Relatively level areas, where saturated soils and/or erosion gullies exist to depths of greater than 1-foot, should be over-excavated to unaffected, competent material. Where less than 1-foot in depth, unsuitable materials may be processed in-place to achieve near optimum moisture conditions, then thoroughly recompacted in accordance with the applicable specifications. If the desired results are not achieved, the affected materials should be over-excavated, then replaced in accordance with the applicable specifications.

In slope areas, where saturated soil and/or erosion gullies exist to depths of greater than 1

foot, they should be over-excavated and replaced as compacted fill in accordance with the applicable specifications. Where affected materials exist to depths of 1 foot or less below proposed finished grade, remedial grading by moisture conditioning in-place, followed by thorough recompaction in accordance with the applicable grading guidelines herein may be attempted. If the desired results are not achieved, all affected materials should be over-excavated and replaced as compacted fill in accordance with the slope repair recommendations herein. As field conditions dictate, other slope repair procedures may be recommended by the Geotechnical Consultant.

EXCAVATIONS

Unsuitable Materials

Materials which are unsuitable should be excavated under observation and recommendations of the Geotechnical Consultant. Unsuitable materials include, but may not be limited to, dry, loose, soft, wet, organic compressible natural soils and fractured, weathered, soft bedrock and non-engineered or otherwise deleterious fill materials.

Material identified by the Geotechnical Consultant as unsatisfactory due to its moisture conditions should be over-excavated, watered or dried, as needed, and thoroughly blended to a uniform near optimum moisture condition (per Moisture guidelines presented herein) prior to placement as compacted fill.

Cut Slopes

Unless otherwise recommended by the Geotechnical Consultant and approved by the regulating agencies, permanent cut slopes should not be steeper than 2:1 (horizontal:vertical).

If excavations for cut slopes expose loose, cohesionless, significantly fractured or otherwise unsuitable material, over-excavation and replacement of the unsuitable materials with a compacted stabilization fill should be accomplished as recommended by the Geotechnical Consultant. Unless otherwise specified by the Geotechnical Consultant, stabilization fill construction should conform to the requirements of the Standard Details.

The Geotechnical Consultant should review cut slopes during excavation. The Geotechnical Consultant should be notified by the contractor prior to beginning slope excavations.

If, during the course of grading, adverse or potentially adverse geotechnical conditions are encountered which were not anticipated in the preliminary report, the Geotechnical Consultant should explore, analyze and make recommendations to treat these problems.

When cut slopes are made in the direction of the prevailing drainage, a non-erodible diversion swale (brow ditch) should be provided at the top-of-cut.

Pad Areas

All lot pad areas, including side yard terraces, above stabilization fills or buttresses should be over-excavated to provide for a minimum of 3-feet (refer to Standard Details) of compacted fill over the entire pad area. Pad areas with both fill and cut materials exposed and pad areas containing both very shallow (less than 3-feet) and deeper fill should be over-excavated to provide for a uniform compacted fill blanket with a minimum of 3-feet in thickness (refer to Standard Details).

Cut areas exposing significantly varying material types should also be over-excavated to

provide for at least a 3-foot thick compacted fill blanket. Geotechnical conditions may require greater depth of over-excavation. The actual depth should be delineated by the Geotechnical Consultant during grading.

For pad areas created above cut or natural slopes, positive drainage should be established away from the top-of-slope. This may be accomplished utilizing a berm and/or an appropriate pad gradient. A gradient in soil areas away from the top-of-slopes of 2 percent or greater is recommended.

COMPACTED FILL

All fill materials should be compacted as specified below or by other methods specifically recommended by the Geotechnical Consultant. Unless otherwise specified, the minimum degree of compaction (relative compaction) should be 90 percent of the laboratory maximum density.

Placement

Prior to placement of compacted fill, the Contractor should request a review by the Geotechnical Consultant of the exposed ground surface. Unless otherwise recommended, the exposed ground surface should then be scarified (6-inches minimum), watered or dried as needed, thoroughly blended to achieve near optimum moisture conditions, then thoroughly compacted to a minimum of 90 percent of the maximum density. The review by the Geotechnical Consultant should not be considered to preclude requirements of inspection and approval by the governing agency.

Compacted fill should be placed in thin horizontal lifts not exceeding 8-inches in loose thickness prior to compaction. Each lift should be watered or dried as needed, thoroughly blended to achieve near optimum moisture conditions then thoroughly compacted by mechanical methods to a minimum of 90 percent of laboratory maximum dry density. Each lift should be treated in a like manner until the desired finished grades are achieved.

The Contractor should have suitable and sufficient mechanical compaction equipment and watering apparatus on the job site to handle the amount of fill being placed in consideration of moisture retention properties of the materials. If necessary, excavation equipment should be "shut down" temporarily in order to permit proper compaction of fills. Earth moving equipment should only be considered a supplement and not substituted for conventional compaction equipment.

When placing fill in horizontal lifts adjacent to areas sloping steeper than 5:1 (horizontal:vertical), horizontal keys and vertical benches should be excavated into the adjacent slope area. Keying and benching should be sufficient to provide at least 6-foot wide benches and minimum of 4-feet of vertical bench height within the firm natural ground, firm bedrock or engineered compacted fill. No compacted fill should be placed in an area subsequent to keying and benching until the area has been reviewed by the Geotechnical Consultant.

Material generated by the benching operation should be moved sufficiently away from the bench area to allow for the recommended review of the horizontal bench prior to placement of fill. Typical keying and benching details have been included within the accompanying Standard Details.

Within a single fill area where grading procedures dictate two or more separate fills,

temporary slopes (false slopes) may be created. When placing fill adjacent to a false slope, benching should be conducted in the same manner as above described. At least a 3-foot vertical bench should be established within the firm core of adjacent approved compacted fill prior to placement of additional fill. Benching should proceed in at least 3-foot vertical increments until the desired finished grades are achieved.

Fill should be tested for compliance with the recommended relative compaction and moisture conditions. Field density testing should conform to ASTM Method of Test D 1556-07, and/or D 6938-10. Tests should be provided for about every 2 vertical feet or 1,000 cubic yards of fill placed. Actual test intervals may vary as field conditions dictate. Fill found not to be in conformance with the grading recommendations should be removed or otherwise handled as recommended by the Geotechnical Consultant.

The Contractor should assist the Geotechnical Consultant and/or his representative by digging test pits for removal determinations and/or for testing compacted fill.

As recommended by the Geotechnical Consultant, the Contractor should "shut down" or remove grading equipment from an area being tested.

The Geotechnical Consultant should maintain a plan with estimated locations of field tests. Unless the client provides for actual surveying of test locations, the estimated locations by the Geotechnical Consultant should only be considered rough estimates and should not be utilized for the purpose of preparing cross sections showing test locations or in any case for the purpose of after-the-fact evaluating of the sequence of fill placement.

Moisture

For field testing purposes, "near optimum" moisture will vary with material type and other factors including compaction procedures. "Near optimum" may be specifically recommended in Preliminary Investigation Reports and/or may be evaluated during grading.

Prior to placement of additional compacted fill following an overnight or other grading delay, the exposed surface or previously compacted fill should be processed by scarification, watered or dried as needed, thoroughly blended to near-optimum moisture conditions, then recompacted to a minimum of 90 percent of laboratory maximum dry density. Where wet or other dry or other unsuitable materials exist to depths of greater than 1 foot, the unsuitable materials should be over-excavated.

Following a period of flooding, rainfall or overwatering by other means, no additional fill should be placed until damage assessments have been made and remedial grading performed as described herein.

Fill Material

Excavated on-site materials which are acceptable to the Geotechnical Consultant may be utilized as compacted fill, provided trash, vegetation and other deleterious materials are removed prior to placement.

Where import materials are required for use on-site, the Geotechnical Consultant should be notified at least 72 hours in advance of importing, in order to sample and test materials from proposed borrow sites. No import materials should be delivered for use on-site without prior sampling and testing by Geotechnical Consultant.

Where oversized rock or similar irreducible material is generated during grading, it is

recommended, where practical, to waste such material off-site or on-site in areas designated as "nonstructural rock disposal areas". Rock placed in disposal areas should be placed with sufficient fines to fill voids. The rock should be compacted in lifts to an unyielding condition. The disposal area should be covered with at least 3 feet of compacted fill which is free of oversized material. The upper 3 feet should be placed in accordance with the guidelines for compacted fill herein.

Rocks 8 inches in maximum dimension and smaller may be utilized within the compacted fill, provided they are placed in such a manner that nesting of the rock is avoided. Fill should be placed and thoroughly compacted over and around all rock. The amount of rock should not exceed 40 percent by dry weight passing the $\frac{3}{4}$ -inch sieve size. The 12-inch and 40 percent recommendations herein may vary as field conditions dictate.

During the course of grading operations, rocks or similar irreducible materials greater than 8-inches maximum dimension (oversized material) may be generated. These rocks should not be placed within the compacted fill unless placed as recommended by the Geotechnical Consultant.

Where rocks or similar irreducible materials of greater than 8 inches but less than 4 feet of maximum dimension are generated during grading, or otherwise desired to be placed within an engineered fill, special handling in accordance with the accompanying Standard Details is recommended. Rocks greater than 4 feet should be broken down or disposed off-site. Rocks up to 4 feet maximum dimension should be placed below the upper 10 feet of any fill and should not be closer than 20-feet to any slope face. These recommendations could vary as locations of improvements dictate. Where practical, oversized material should not be placed below areas where structures or deep utilities are proposed.

Oversized material should be placed in windrows on a clean, over-excavated or unyielding compacted fill or firm natural ground surface. Select native or imported granular soil (S.E. 30 or higher) should be placed and thoroughly flooded over and around all windrowed rock, such that voids are filled. Windrows of oversized material should be staggered so that successive strata of oversized material are not in the same vertical plane.

It may be possible to dispose of individual larger rock as field conditions dictate and as recommended by the Geotechnical Consultant at the time of placement. Material that is considered unsuitable by the Geotechnical Consultant should not be utilized in the compacted fill.

During grading operations, placing and mixing the materials from the cut and/or borrow areas may result in soil mixtures which possess unique physical properties. Testing may be required of samples obtained directly from the fill areas in order to verify conformance with the specifications. Processing of these additional samples may take two or more working days. The Contractor may elect to move the operation to other areas within the project, or may continue placing compacted fill pending laboratory and field test results. Should he elect the second alternative, fill placed is done so at the Contractor's risk.

Any fill placed in areas not previously reviewed and evaluated by the Geotechnical Consultant, and/or in other areas, without prior notification to the Geotechnical Consultant may require removal and recompaction at the Contractor's expense. Determination of over-excavations should be made upon review of field conditions by the Geotechnical Consultant.

Fill Slopes

Unless otherwise recommended by the Geotechnical Consultant and approved by the regulating agencies, permanent fill slopes should not be steeper than 2:1 (horizontal to vertical).

Except as specifically recommended otherwise or as otherwise provided for in these grading guidelines (Reference Fill Materials), compacted fill slopes should be overbuilt and cut back to grade, exposing the firm, compacted fill inner core. The actual amount of overbuilding may vary as field conditions dictate. If the desired results are not achieved, the existing slopes should be over-excavated and reconstructed under the guidelines of the Geotechnical Consultant. The degree of overbuilding shall be increased until the desired compacted slope surface condition is achieved. Care should be taken by the Contractor to provide thorough mechanical compaction to the outer edge of the overbuilt slope surface.

Although no construction procedure produces a slope free from risk of future movement, overfilling and cutting back of slope to a compacted inner core is, given no other constraints, the most desirable procedure. Other constraints, however, must often be considered. These constraints may include property line situations, access, the critical nature of the development and cost. Where such constraints are identified, slope face compaction may be attempted by conventional construction procedures including back rolling techniques upon specific recommendation by the Geotechnical Consultant.

As a second-best alternative for slopes of 2:1 (horizontal to vertical) or flatter, slope construction may be attempted as outlined herein. Fill placement should proceed in thin lifts, (i.e., 6 to 8-inch loose thickness). Each lift should be moisture conditioned and thoroughly compacted. The desired moisture condition should be maintained and/or reestablished, where necessary, during the period between successive lifts. Selected lifts should be tested to ascertain that desired compaction is being achieved. Care should be taken to extend compactive effort to the outer edge of the slope. Each lift should extend horizontally to the desired finished slope surface or more as needed to ultimately establish desired grades. Grade during construction should not be allowed to roll off at the edge of the slope. It may be helpful to elevate slightly the outer edge of the slope.

Slough resulting from the placement of individual lifts should not be allowed to drift down over previous lifts. At intervals not exceeding 4 feet in vertical slope height or the capability of available equipment, whichever is less, fill slopes should be thoroughly backrolled utilizing a conventional sheeps foot-type roller. Care should be taken to maintain the desired moisture conditions and/or reestablishing same as needed prior to backrolling. Upon achieving final grade, the slopes should again be moisture conditioned and thoroughly backrolled. The use of a side-boom roller will probably be necessary and vibratory methods are strongly recommended. Without delay, so as to avoid (if possible) further moisture conditioning, the slopes should then be grid-rolled to achieve a relatively smooth surface and uniformly compact condition.

In order to monitor slope construction procedures, moisture and density tests will be taken at regular intervals. Failure to achieve the desired results will likely result in a recommendation by the Geotechnical Consultant to over-excavate the slope surfaces followed by reconstruction of the slopes utilizing overfilling and cutting back procedures and/or further attempt at the conventional backrolling approach. Other recommendations may also be provided which would be commensurate with field conditions.

Where placement of fill above a natural slope or above a cut slope is proposed, the fill slope configuration as presented in the accompanying Standard Details should be adopted.

For pad areas above fill slopes, positive drainage should be established away from the top-of-slope. This may be accomplished utilizing a berm and pad gradients of at least 2 percent in soil areas.

Off-Site Fill

Off-site fill should be treated in the same manner as recommended in these specifications for site preparation, excavation, drains, compaction, etc.

Off-site canyon fill should be placed in preparation for future additional fill, as shown in the accompanying Standard Details.

Off-site fill subdrains temporarily terminated (up canyon) should be surveyed for future relocation and connection.

DRAINAGE

Canyon subdrain systems specified by the Geotechnical Consultant should be installed in accordance with the Standard Details.

Typical subdrains for compacted fill buttresses, slope stabilization or sidehill masses, should be installed in accordance with the specifications of the accompanying Standard Details.

Roof, pad and slope drainage should be directed away from slopes and areas of structures to suitable disposal areas via non-erodible devices (i.e., gutters, downspouts, concrete swales).

For drainage over soil areas immediately away from structures (i.e., within 4 feet), a minimum of 4 percent gradient should be maintained. Pad drainage of at least 2 percent should be maintained over soil areas. Pad drainage may be reduced to at least 1 percent for projects where no slopes exist, either natural or man-made, or greater than 10-feet in height and where no slopes are planned, either natural or man-made, steeper than 2:1 (horizontal to vertical slope ratio).

Drainage patterns established at the time of fine grading should be maintained throughout the life of the project. Property owners should be made aware that altering drainage patterns can be detrimental to slope stability and foundation performance.

STAKING

In all fill areas, the fill should be compacted prior to the placement of the stakes. This particularly is important on fill slopes. Slope stakes should not be placed until the slope is thoroughly compacted (backrolled). If stakes must be placed prior to the completion of compaction procedures, it must be recognized that they will be removed and/or demolished at such time as compaction procedures resume.

In order to allow for remedial grading operations, which could include over-excavations or slope stabilization, appropriate staking offsets should be provided. For finished slope and stabilization backcut areas, we recommend at least a 10-foot setback from proposed toes and tops-of-cut.

SLOPE MAINTENANCE

Landscape Plants

In order to enhance surficial slope stability, slope planting should be accomplished at the completion of grading. Slope planting should consist of deep-rooting vegetation requiring little watering. Plants native to the southern California area and plants relative to native plants are generally desirable. Plants native to other semi-arid and arid areas may also be appropriate. A Landscape Architect would be the best party to consult regarding actual types of plants and planting configuration.

Irrigation

Irrigation pipes should be anchored to slope faces, not placed in trenches excavated into slope faces.

Slope irrigation should be minimized. If automatic timing devices are utilized on irrigation systems, provisions should be made for interrupting normal irrigation during periods of rainfall.

Though not a requirement, consideration should be given to the installation of near-surface moisture monitoring control devices. Such devices can aid in the maintenance of relatively uniform and reasonably constant moisture conditions.

Property owners should be made aware that overwatering of slopes is detrimental to slope stability.

Maintenance

Periodic inspections of landscaped slope areas should be planned and appropriate measures should be taken to control weeds and enhance growth of the landscape plants. Some areas may require occasional replanting and/or reseeding.

Terrace drains and down drains should be periodically inspected and maintained free of debris. Damage to drainage improvements should be repaired immediately.

Property owners should be made aware that burrowing animals can be detrimental to slope stability. A preventative program should be established to control burrowing animals.

As a precautionary measure, plastic sheeting should be readily available, or kept on hand, to protect all slope areas from saturation by periods of heavy or prolonged rainfall. This measure is strongly recommended, beginning with the period of time prior to landscape planting.

Repairs

If slope failures occur, the Geotechnical Consultant should be contacted for a field review of site conditions and development of recommendations for evaluation and repair.

If slope failures occur as a result of exposure to periods of heavy rainfall, the failure area and currently unaffected areas should be covered with plastic sheeting to protect against additional saturation.

In the accompanying Standard Details, appropriate repair procedures are illustrated for superficial slope failures (i.e., occurring typically within the outer 1 foot to 3 feet of a slope face).

TRENCH BACKFILL

Utility trench backfill should, unless otherwise recommended, be compacted by mechanical means. Unless otherwise recommended, the degree of compaction should be a minimum of 90 percent of the laboratory maximum density.

Backfill of exterior and interior trenches extending below a 1:1 projection from the outer edge of foundations should be mechanically compacted to a minimum of 90 percent of the laboratory maximum density.

In cases where clean granular materials are proposed for use in lieu of native materials or where flooding or jetting is proposed, the procedures should be considered subject to review by the Geotechnical Consultant.

Clean Granular backfill and/or bedding are not recommended in slope areas unless provisions are made for a drainage system to mitigate the potential build-up of seepage forces.

STATUS OF GRADING

Prior of proceeding with any grading operation, the Geotechnical Consultant should be notified at least two working days in advance in order to schedule the necessary observation and testing services.

Prior to any significant expansion or cut back in the grading operation, the Geotechnical Consultant should be provided with adequate notice (i.e., two days) in order to make appropriate adjustments in observation and testing services.

Following completion of grading operations and/or between phases of a grading operation, the Geotechnical Consultant should be provided with at least two working days notice in advance of commencement of additional grading operations.

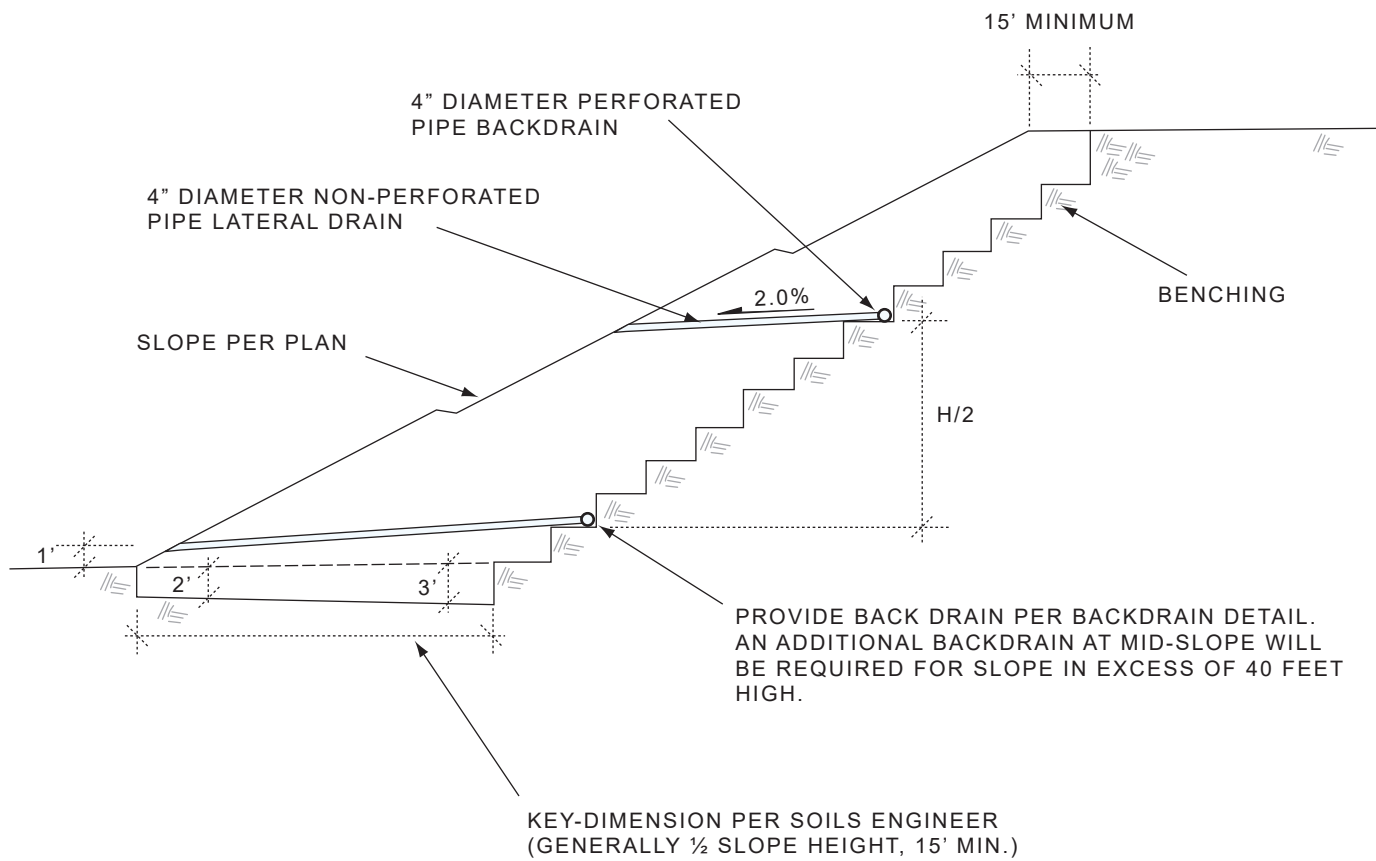

TYPICAL STABILIZATION FILL DETAIL

NOT TO SCALE

FIGURE 1

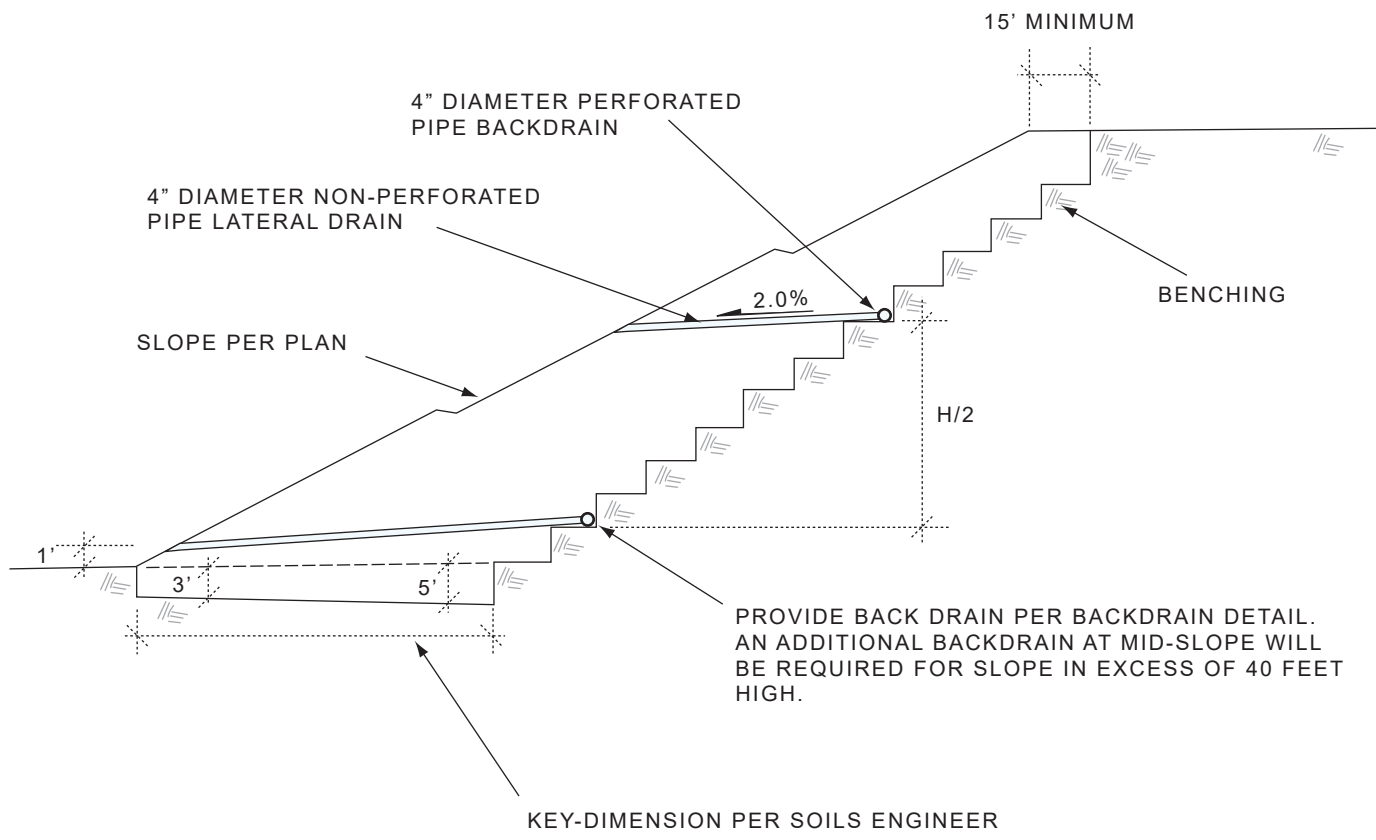

TYPICAL BUTTRESS FILL DETAIL

NOT TO SCALE

FIGURE 2

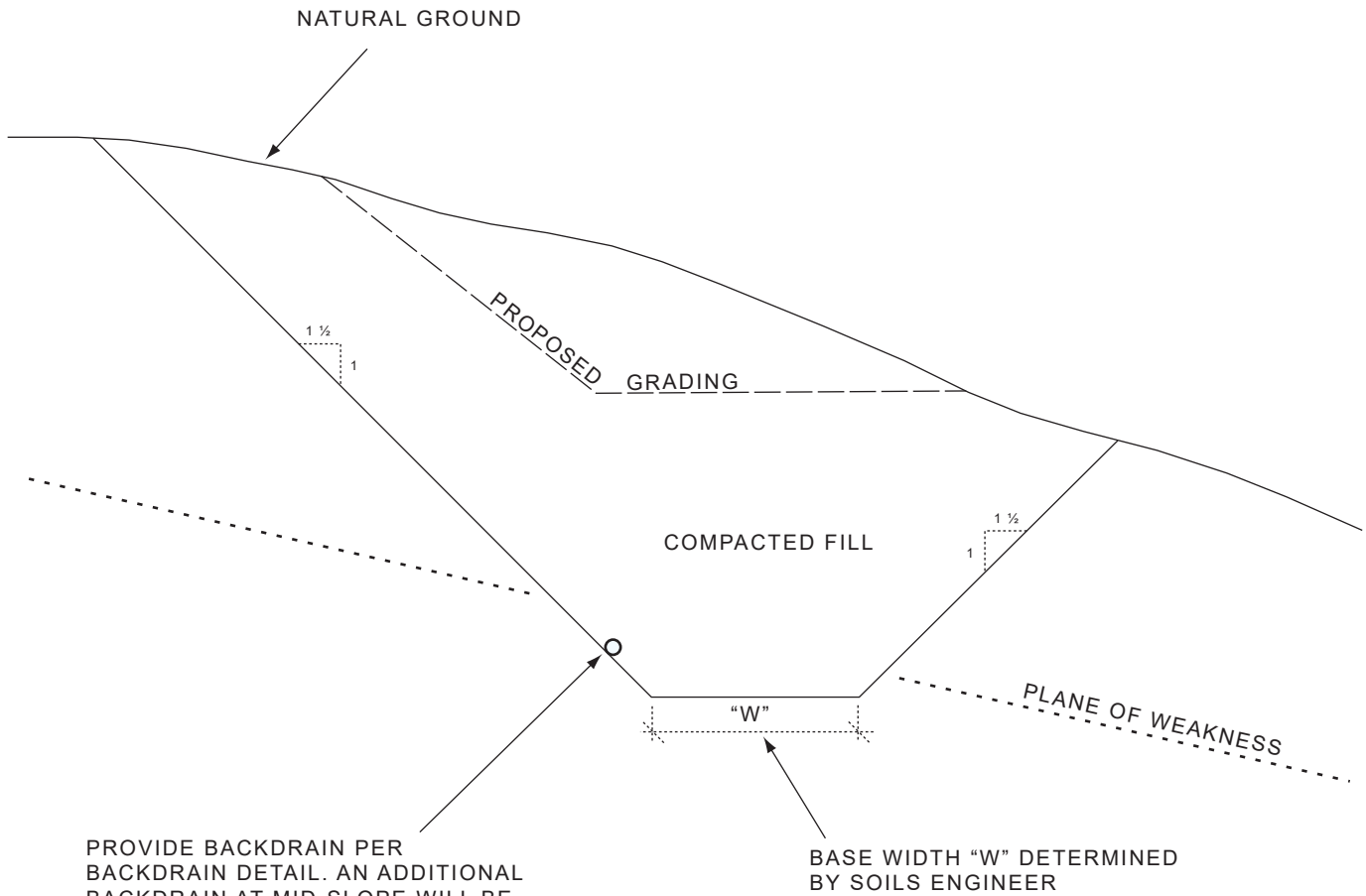

PROVIDE BACKDRAIN PER BACKDRAIN DETAIL. AN ADDITIONAL BACKDRAIN AT MID-SLOPE WILL BE REQUIRED FOR BACK SLOPES IN EXCESS OF 40 FEET HIGH. LOCATIONS OF BACKDRAINS AND OUTLETS PER SOILS ENGINEER AND/OR ENGINEERING GEOLOGIST DURING GRADING.

BASE WIDTH "W" DETERMINED BY SOILS ENGINEER

TYPICAL SHEAR KEY DETAIL

NOT TO SCALE

FIGURE 3

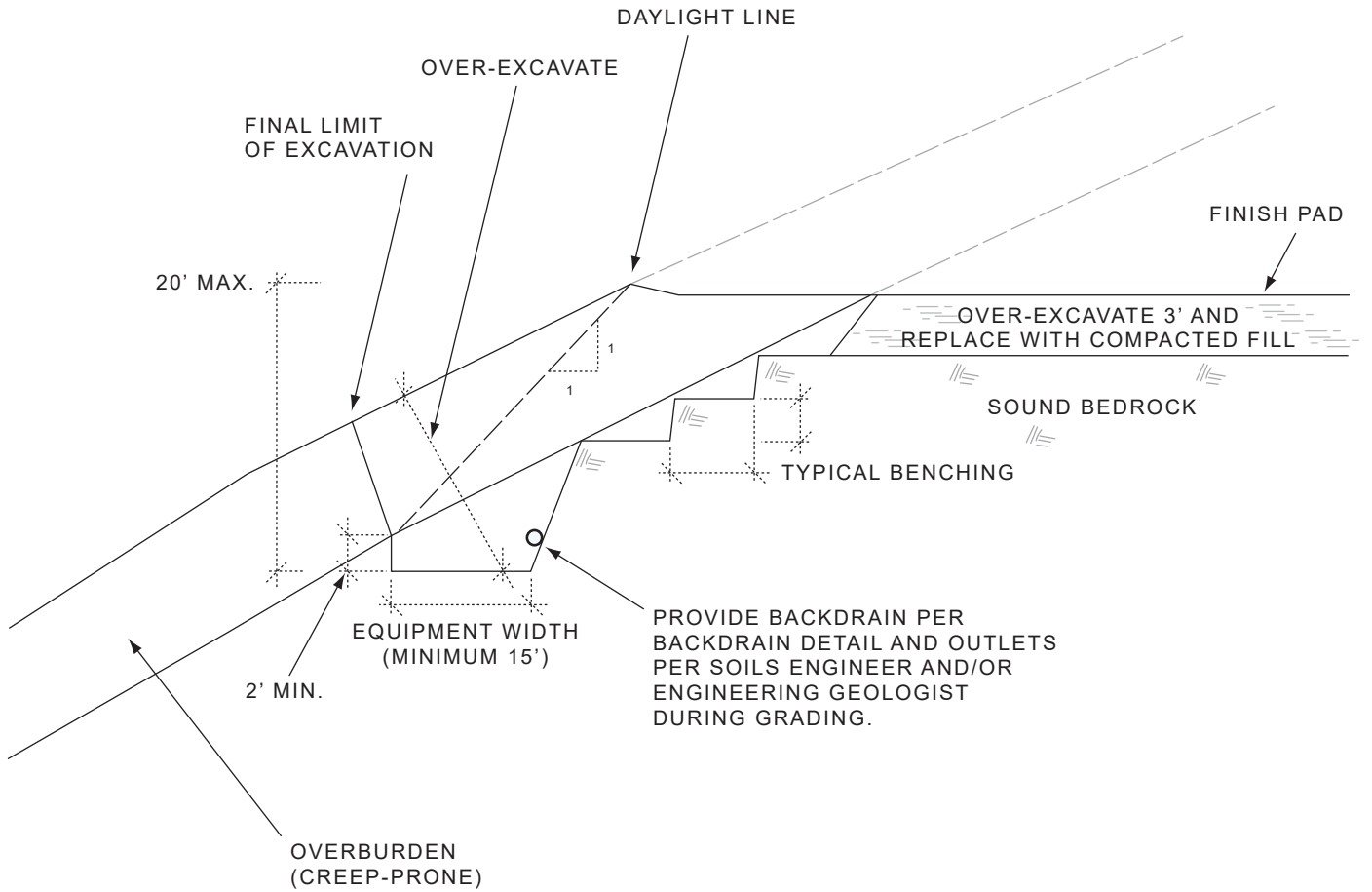

DAYLIGHT SHEAR KEY DETAIL

NOT TO SCALE

FIGURE 4

BENCHING FILL OVER NATURAL

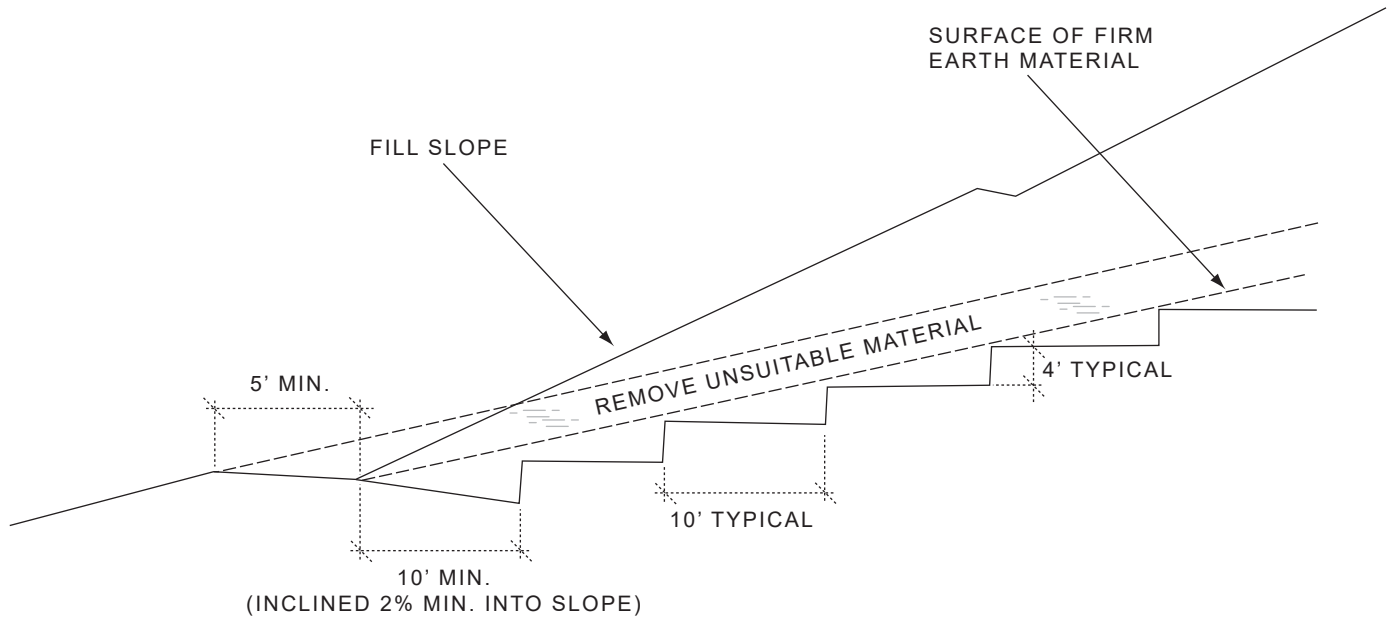

BENCHING FILL OVER CUT

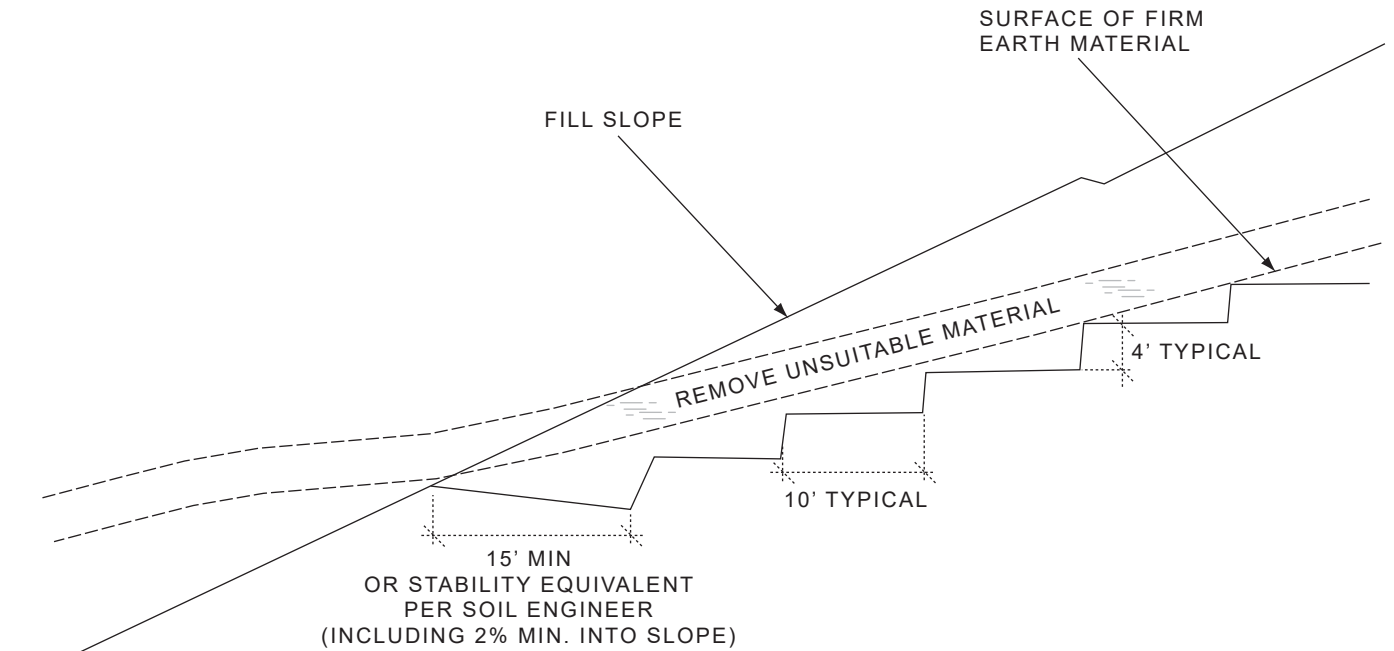

BENCHING FOR COMPACTED FILL DETAIL

NOT TO SCALE

FIGURE 5

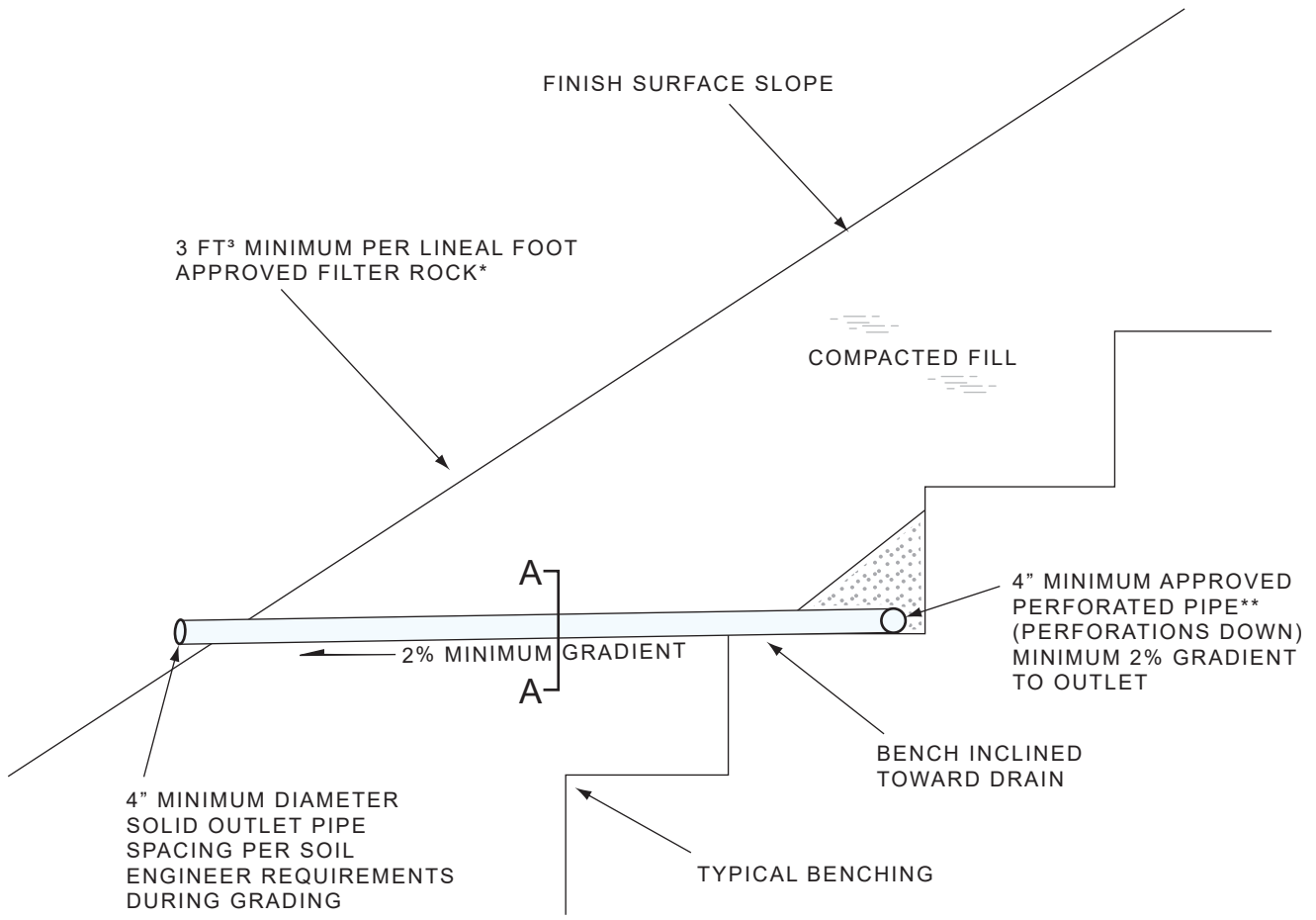

DETAIL A-A

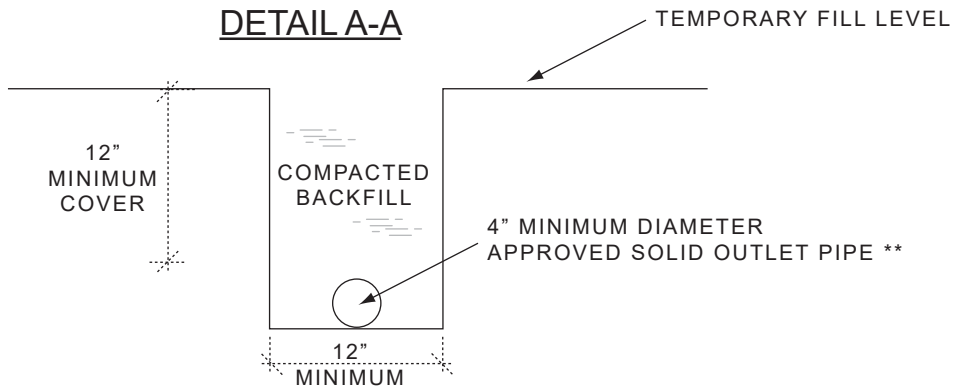

* Filter rock to meet following specifications or approved equal.

| Sieve | % Passing |
|--------|-----------|
| 1" | 100 |
| 3/4" | 90-100 |
| 3/8" | 40-100 |
| No.4 | 25-40 |
| No.30 | 5-15 |
| No.50 | 0-7 |
| No.200 | 0-3 |

** APPROVED PIPE TYPE

Schedule 40 polyvinyl chloride (P.V.C.) or approved equal. Min. crush strength 1000 PSI.

TYPICAL BACKDRAIN DETAIL

NOT TO SCALE

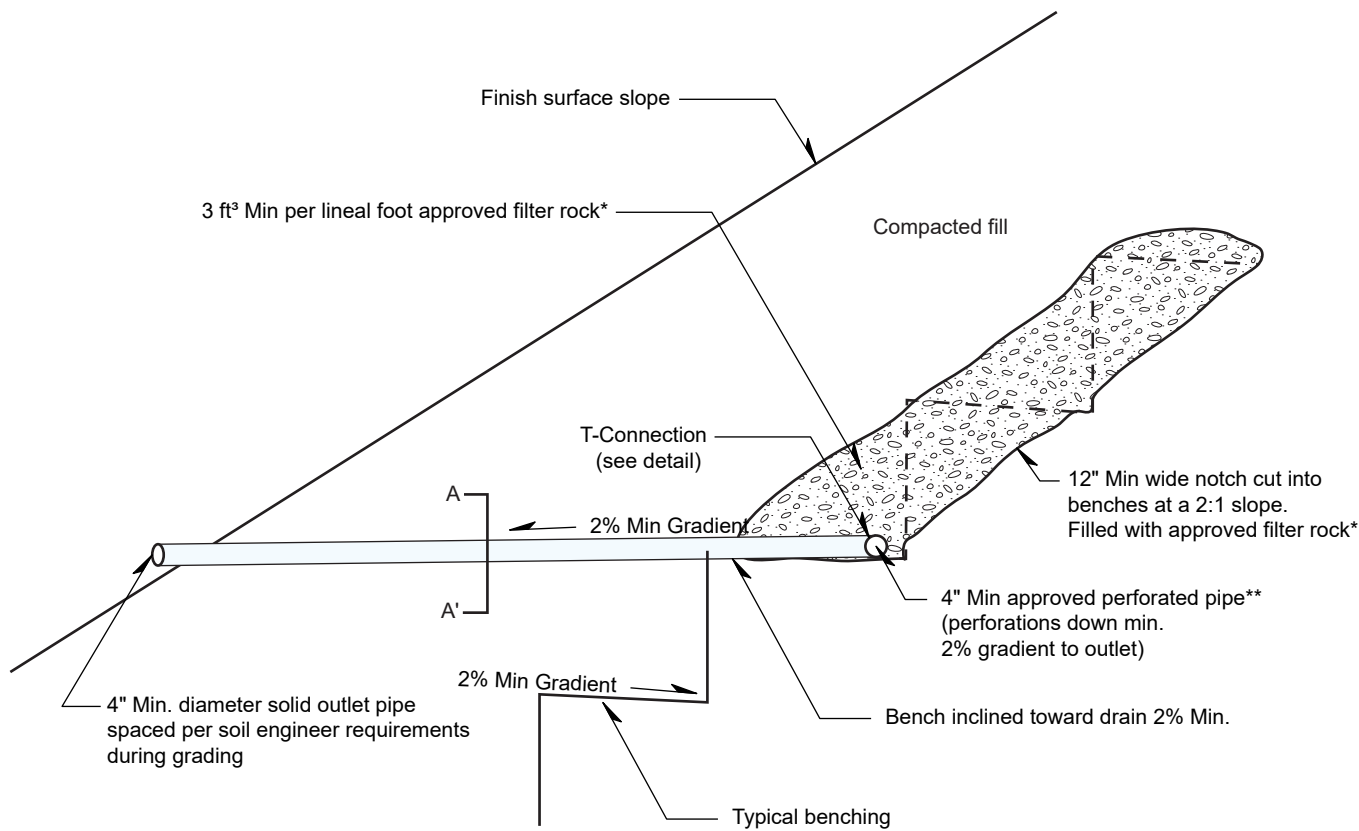

* Filter rock to meet following specifications or approved equal.

| Sieve | % Passing |
|--------|-----------|
| 1" | 100 |
| 3/4" | 90-100 |
| 3/8" | 40-100 |
| No.4 | 25-40 |
| No.30 | 5-15 |
| No.50 | 0-7 |
| No.200 | 0-3 |

** Approved pipe type:

Schedule 40 polyvinyl chloride (P.V.C.) or approved equal.
Min. crush strength 1000 PSI.

BACKDRAIN DETAIL (GEOFABRIC)

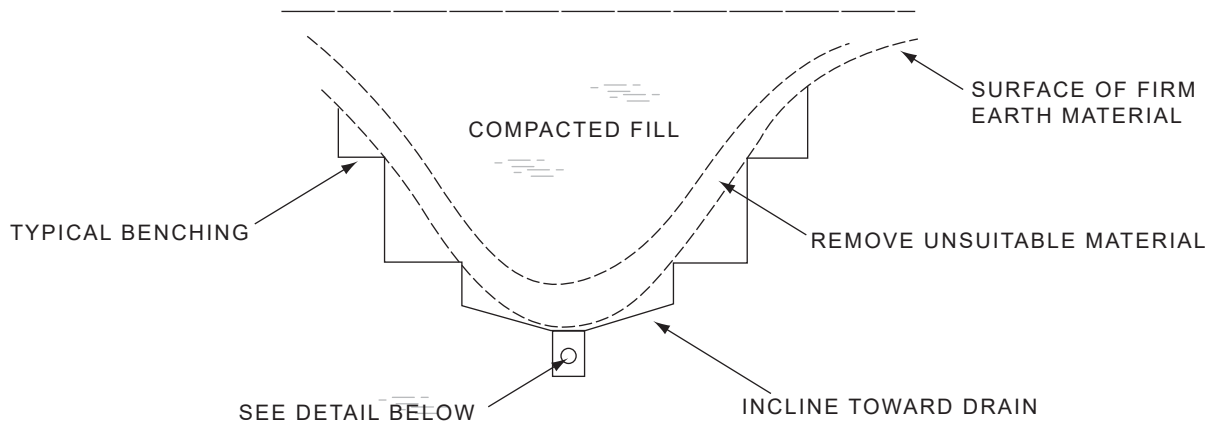

DETAIL

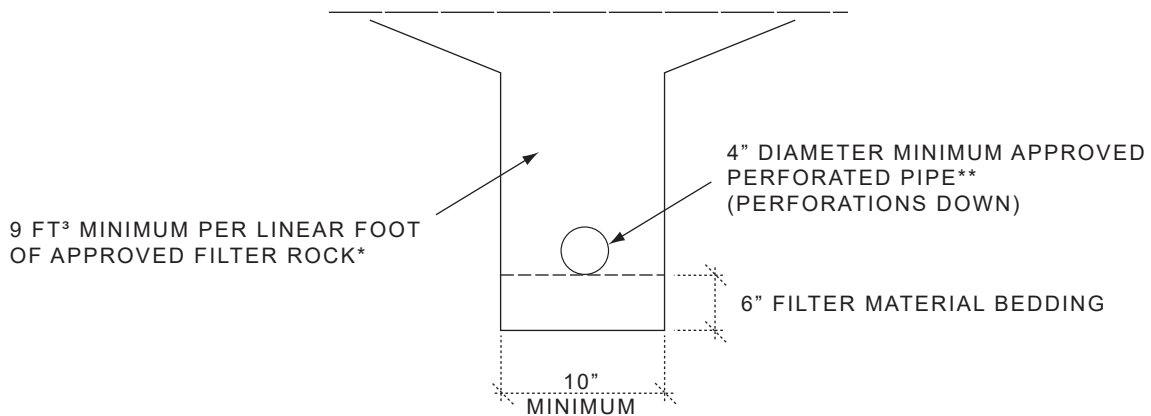

* Filter rock to meet following specifications or approved equal.

| <u>Sieve</u> | <u>% Passing</u> |
|--------------|------------------|
| 1" | 100 |
| 3/4" | 90-100 |
| 3/8" | 40-100 |
| No.4 | 25-40 |
| No.30 | 5-15 |
| No.50 | 0-7 |
| No.200 | 0-3 |

**** APPROVED PIPE TYPE**

Schedule 40 polyvinyl chloride (P.V.C.) or approved equal. Min. crush strength 1000 PSI.

Pipe diameter to meet the following criteria. Subject to field review based on actual geotechnical conditions encountered during grading.

| <u>Length of Run</u> | <u>Pipe Diameter</u> |
|----------------------|----------------------|
| Upper 500' | 4" |
| Next 1000' | 6" |
| >1500' | 8" |

TYPICAL CANYON SUBDRAIN DETAIL

NOT TO SCALE

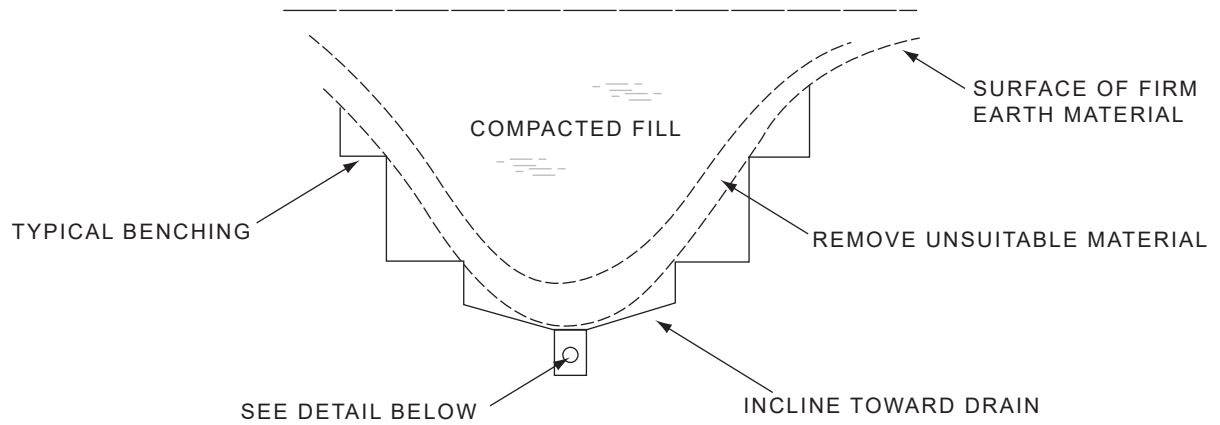

TRENCH DETAIL

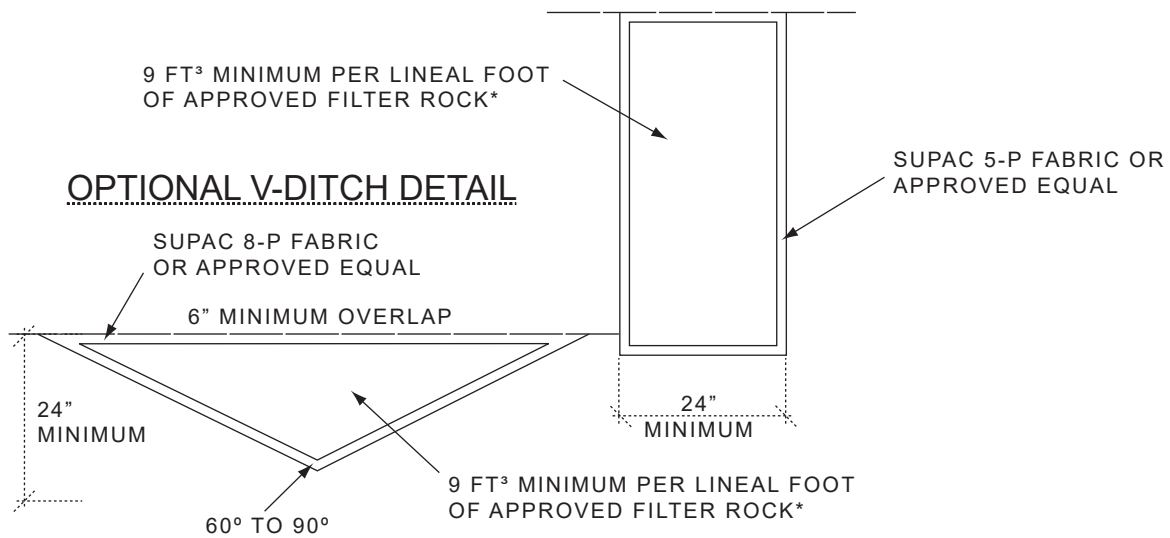

* Drainage material to meet following specifications or approved equal.

| Sieve | % Passing |
|--------|-----------|
| 1 1/2" | 88-100 |
| 1" | 5-40 |
| 3/4" | 0-17 |
| 3/8" | 0-7 |
| No.200 | 0-3 |

ADD MINIMUM 4" DIAMETER APPROVED PERFORATED PIPE WHEN GRADIENT IS LESS THAN 2%

APPROVED PIPE TO BE SCHEDULE 40 POLY-VINYL-CHLORIDE (P.V.C.) OR APPROVED EQUAL. MINIMUM CRUSH STRENGTH 1000 psi.

GEOFABRIC SUBDRAIN

NOT TO SCALE

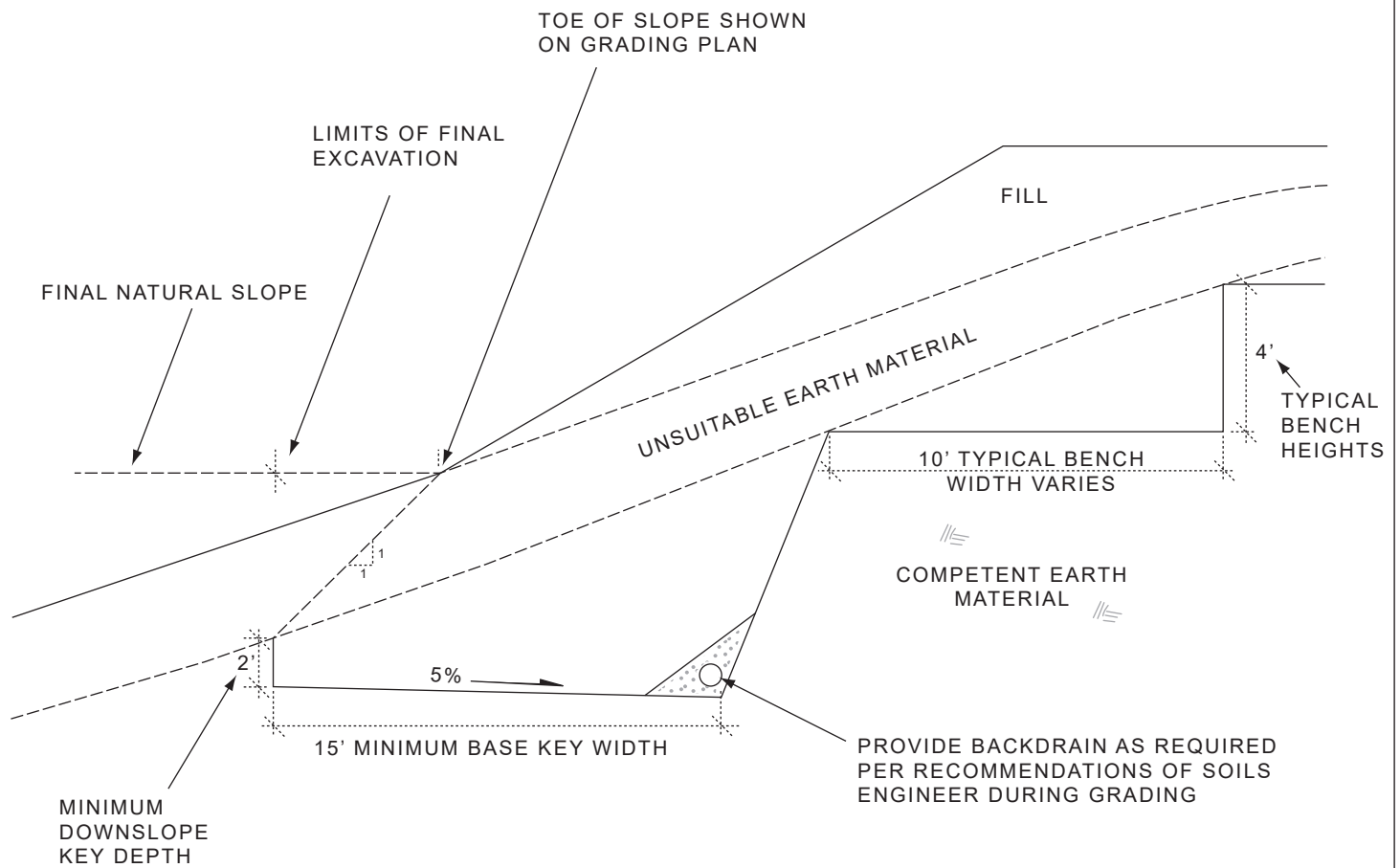

WHERE NATURAL SLOPE GRADIENT IS 5:1 OR LESS, BENCHING IS NOT NECESSARY. HOWEVER, FILL IS NOT TO BE PLACED ON COMPRESSIBLE OR UNSUITABLE MATERIAL.

FILL SLOPE ABOVE NATURAL GROUND DETAIL

NOT TO SCALE

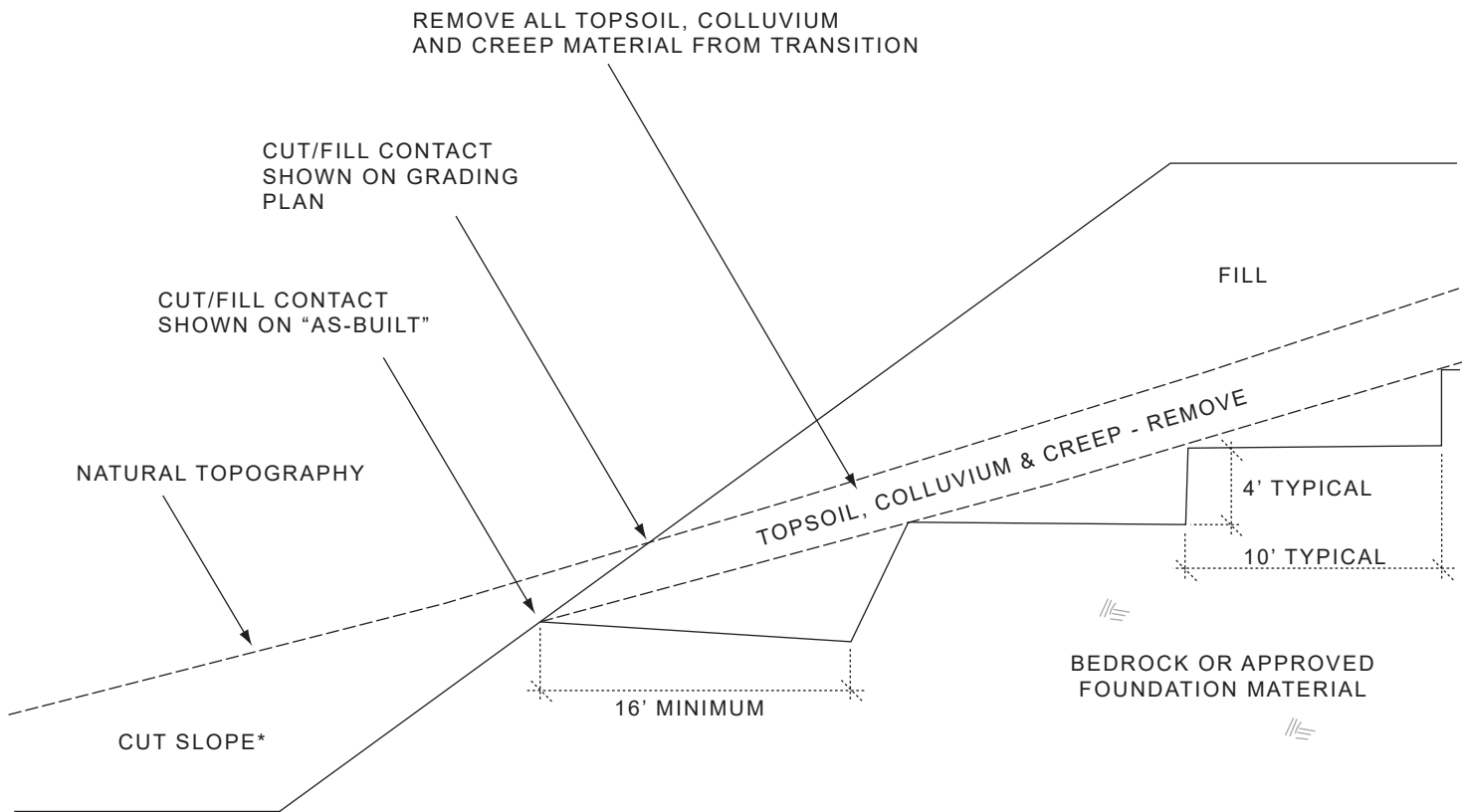

NOTE:
 CUT SLOPE PORTION SHALL BE MADE
 PRIOR TO PLACEMENT OF FILL

FILL SLOPE ABOVE CUT SLOPE DETAIL

NOT TO SCALE

CUT LOT

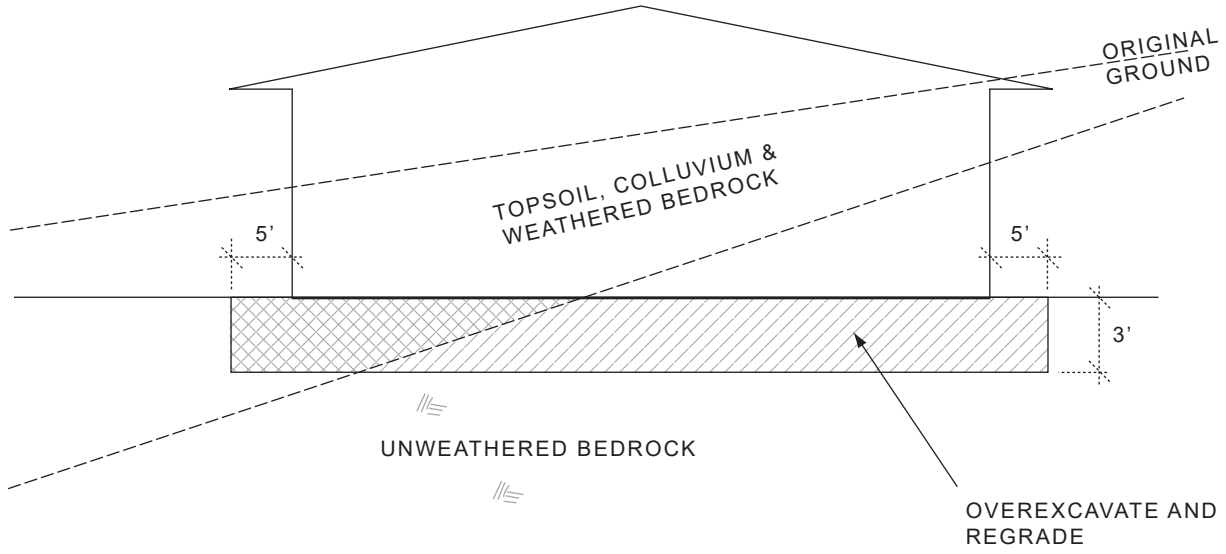

CUT/FILL LOT (TRANSITION)

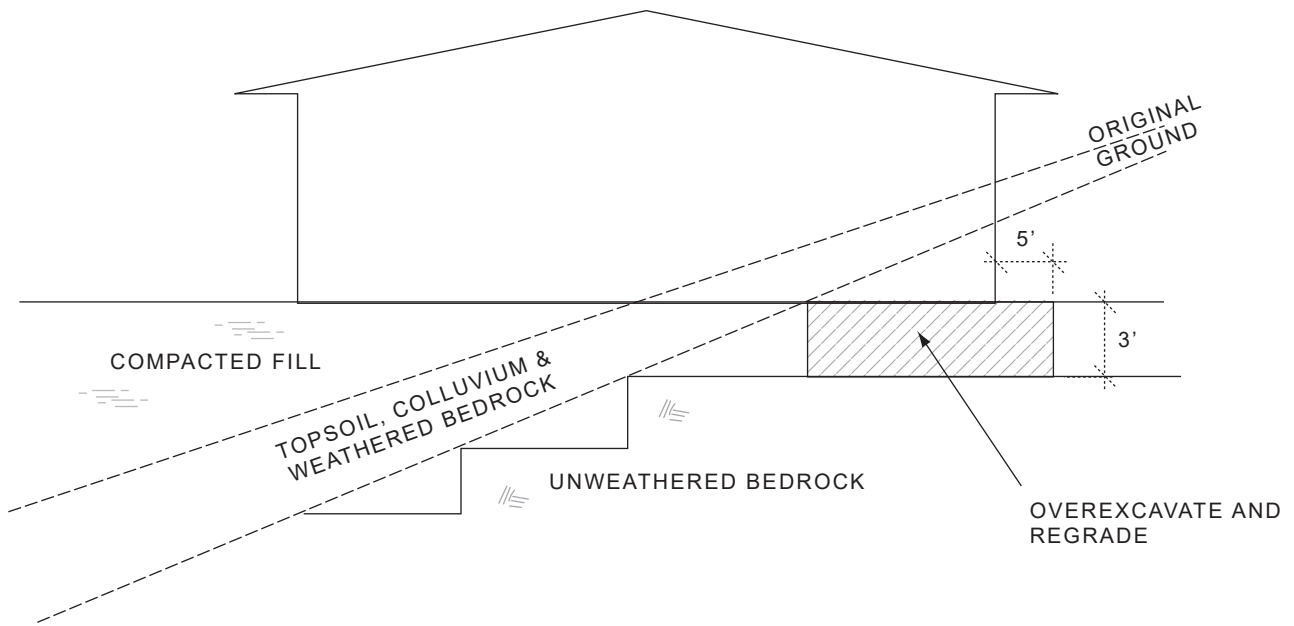

TRANSITION LOT DETAIL

NOT TO SCALE

BUILDING

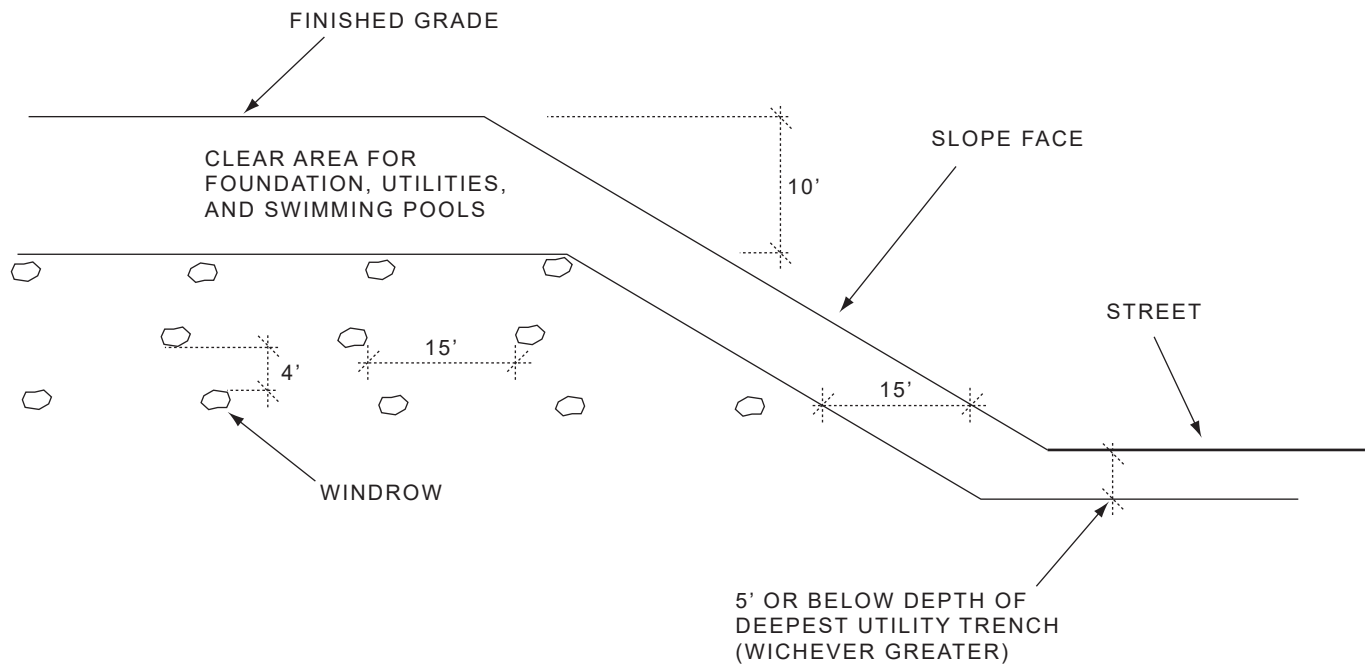

TYPICAL WINDROW DETAIL (EDGE VIEW)

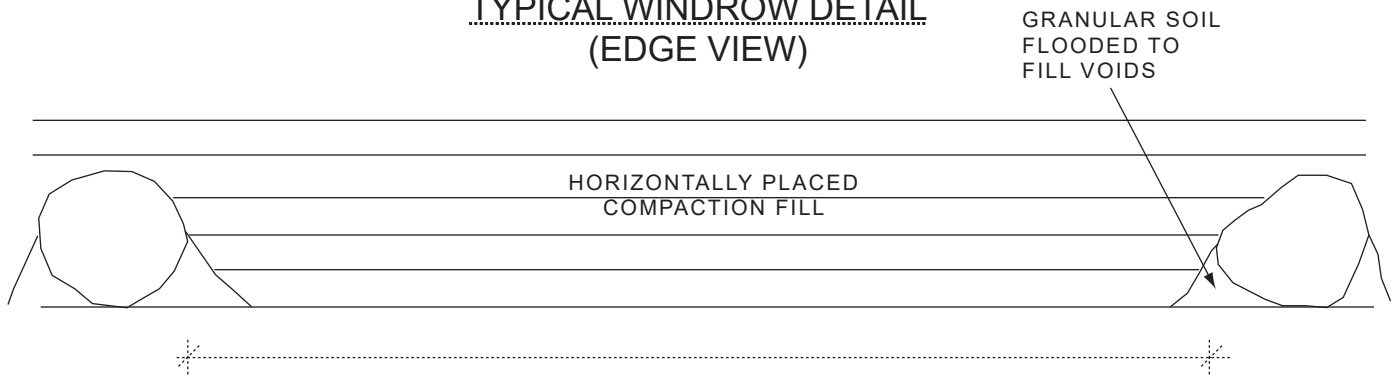

(PROFILE VIEW)

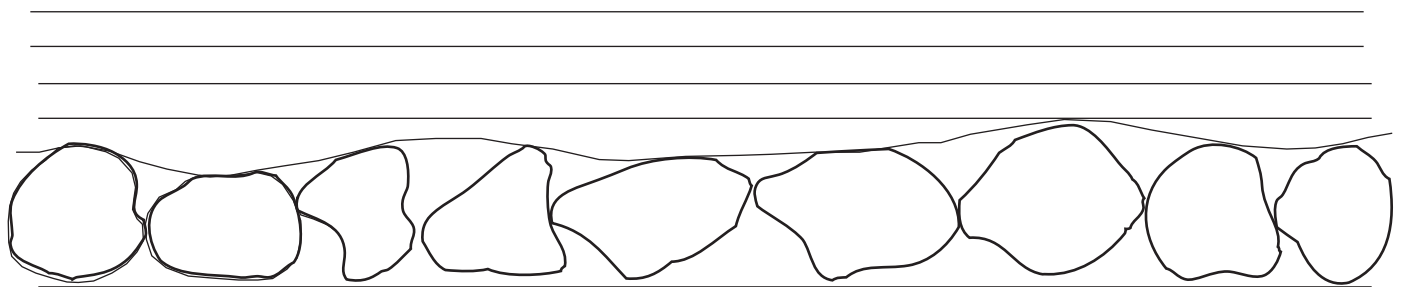

ROCK DISPOSAL DETAIL

NOT TO SCALE

ATTACHMENT 2

BACKUP FOR PDP HYDROMODIFICATION CONTROL MEASURES

This is the cover sheet for Attachment 2.

☒ Mark this box if this attachment is empty because the project is exempt from PDP hydromodification management requirements.

Indicate which Items are Included behind this cover sheet:

| Attachment Sequence | Contents | Checklist |
|---------------------|--|---|
| Attachment 2a | Hydromodification Management Exhibit (Required) | <input type="checkbox"/> Included See Hydromodification Management Exhibit Checklist on the back of this Attachment cover sheet. |
| Attachment 2b | Management of Critical Coarse Sediment Yield Areas (WMAA Exhibit is required, additional analyses are optional) See Section 6.2 of the BMP Design Manual. | <input type="checkbox"/> Exhibit showing project drainage boundaries marked on WMAA Critical Coarse Sediment Yield Area Map (Required) Optional analyses for Critical Coarse Sediment Yield Area Determination <input type="checkbox"/> 6.2.1 Verification of Geomorphic Landscape Units Onsite <input type="checkbox"/> 6.2.2 Downstream Systems Sensitivity to Coarse Sediment <input type="checkbox"/> 6.2.3 Optional Additional Analysis of Potential Critical Coarse Sediment Yield Areas Onsite |
| Attachment 2c | Geomorphic Assessment of Receiving Channels (Optional) See Section 6.3.4 of the BMP Design Manual. | <input type="checkbox"/> Not performed <input type="checkbox"/> Included <input type="checkbox"/> Submitted as separate stand-alone document |
| Attachment 2d | Flow Control Facility Design, including Structural BMP Drawdown Calculations and Overflow Design Summary (Required) See Chapter 6 and Appendix G of the BMP Design Manual | <input type="checkbox"/> Included <input type="checkbox"/> Submitted as separate stand-alone document |
| Attachment 2e | Vector Control Plan (Required when structural BMPs will not drain in 96 hours) | <input type="checkbox"/> Included <input type="checkbox"/> Not required because BMPs will drain in less than 96 hours |

ATTACHMENT 3
Structural BMP Maintenance Information

This is the cover sheet for Attachment 3.

Indicate which Items are Included behind this cover sheet:

| Attachment Sequence | Contents | Checklist |
|----------------------------|--|--|
| Attachment 3a | Structural BMP Maintenance Thresholds and Actions (Required) | <input checked="" type="checkbox"/> Included See Structural BMP Maintenance Information Checklist on the back of this Attachment cover sheet. |
| Attachment 3b | Draft Maintenance Agreement (when applicable) | <input type="checkbox"/> Included <input checked="" type="checkbox"/> Not Applicable |

Use this checklist to ensure the required information has been included in the Structural BMP Maintenance Information Attachment:

X Preliminary Design / Planning / CEQA level submittal:

Attachment 3a must identify:

- X Typical maintenance indicators and actions for proposed structural BMP(s) based on Section 7.7 of the BMP Design Manual

Attachment 3b is not required for preliminary design / planning / CEQA level submittal.

□ Final Design level submittal:

Attachment 3a must identify:

- Specific maintenance indicators and actions for proposed structural BMP(s). This shall be based on Section 7.7 of the BMP Design Manual and enhanced to reflect actual proposed components of the structural BMP(s)
- How to access the structural BMP(s) to inspect and perform maintenance
- Features that are provided to facilitate inspection (e.g., observation ports, cleanouts, silt posts, or other features that allow the inspector to view necessary components of the structural BMP and compare to maintenance thresholds)
- Manufacturer and part number for proprietary parts of structural BMP(s) when applicable
- Maintenance thresholds specific to the structural BMP(s), with a location-specific frame of reference (e.g., level of accumulated materials that triggers removal of the materials, to be identified based on viewing marks on silt posts or measured with a survey rod with respect to a fixed benchmark within the BMP)
- Recommended equipment to perform maintenance
- When applicable, necessary special training or certification requirements for inspection and maintenance personnel such as confined space entry or hazardous waste management

Attachment 3b: For private entity operation and maintenance, Attachment 3b shall include a draft maintenance agreement in the local jurisdiction's standard format (PDP applicant to contact the [City Engineer] to obtain the current maintenance agreement forms).

BF-1 Biofiltration

SUMMARY OF STANDARD INSPECTION AND MAINTENANCE FOR BF-1 BIOFILTRATION

The property owner is responsible to ensure inspection, operation and maintenance of permanent BMPs on their property unless responsibility has been formally transferred to an agency, community facilities district, homeowners association, property owners association, or other special district.

Maintenance frequencies listed in this table are average/typical frequencies. Actual maintenance needs are site-specific, and maintenance may be required more frequently. Maintenance must be performed whenever needed, based on maintenance indicators presented in this table. The BMP owner is responsible for conducting regular inspections to see when maintenance is needed based on the maintenance indicators. During the first year of operation of a structural BMP, inspection is recommended at least once prior to August 31 and then monthly from September through May. Inspection during a storm event is also recommended. After the initial period of frequent inspections, the minimum inspection and maintenance frequency can be determined based on the results of the first year inspections.

| Threshold/Indicator | Maintenance Action | Typical Maintenance Frequency |
|---|--|--|
| Accumulation of sediment, litter, or debris | Remove and properly dispose of accumulated materials, without damage to the vegetation or compaction of the media layer. | <ul style="list-style-type: none"> • Inspect monthly. If the BMP is 25% full* or more in one month, increase inspection frequency to monthly plus after every 0.1-inch or larger storm event. • Remove any accumulated materials found at each inspection. |
| Obstructed inlet or outlet structure | Clear blockage. | <ul style="list-style-type: none"> • Inspect monthly and after every 0.5-inch or larger storm event. • Remove any accumulated materials found at each inspection. |
| Damage to structural components such as weirs, inlet or outlet structures | Repair or replace as applicable | <ul style="list-style-type: none"> • Inspect annually. • Maintenance when needed. |
| Poor vegetation establishment | Re-seed, re-plant, or re-establish vegetation per original plans. | <ul style="list-style-type: none"> • Inspect monthly. • Maintenance when needed. |
| Dead or diseased vegetation | Remove dead or diseased vegetation, re-seed, re-plant, or re-establish vegetation per original plans. | <ul style="list-style-type: none"> • Inspect monthly. • Maintenance when needed. |
| Overgrown vegetation | Mow or trim as appropriate. | <ul style="list-style-type: none"> • Inspect monthly. • Maintenance when needed. |
| 2/3 of mulch has decomposed, or mulch has been removed | Remove decomposed fraction and top off with fresh mulch to a total depth of 3 inches. | <ul style="list-style-type: none"> • Inspect monthly. • Replenish mulch annually, or more frequently when needed based on inspection. |

*"25% full" is defined as ¼ of the depth from the design bottom elevation to the crest of the outflow structure (e.g., if the height to the outflow opening is 12 inches from the bottom elevation, then the materials must be removed when there is 3 inches of accumulation – this should be marked on the outflow structure).

BF-1

Biofiltration

| SUMMARY OF STANDARD INSPECTION AND MAINTENANCE FOR BF-1 BIOFILTRATION (Continued from previous page) | | |
|---|--|---|
| Threshold/Indicator | Maintenance Action | Typical Maintenance Frequency |
| Erosion due to concentrated irrigation flow | Repair/re-seed/re-plant eroded areas and adjust the irrigation system. | <ul style="list-style-type: none"> • Inspect monthly. • Maintenance when needed. |
| Erosion due to concentrated storm water runoff flow | Repair/re-seed/re-plant eroded areas, and make appropriate corrective measures such as adding erosion control blankets, adding stone at flow entry points, or minor re-grading to restore proper drainage according to the original plan. If the issue is not corrected by restoring the BMP to the original plan and grade, the [City Engineer] shall be contacted prior to any additional repairs or reconstruction. | <ul style="list-style-type: none"> • Inspect after every 0.5-inch or larger storm event. If erosion due to storm water flow has been observed, increase inspection frequency to after every 0.1-inch or larger storm event. • Maintenance when needed. If the issue is not corrected by restoring the BMP to the original plan and grade, the [City Engineer] shall be contacted prior to any additional repairs or reconstruction. |
| <p>Standing water in BMP for longer than 24 hours following a storm event</p> <p>Surface ponding longer than approximately 24 hours following a storm event may be detrimental to vegetation health</p> | Make appropriate corrective measures such as adjusting irrigation system, removing obstructions of debris or invasive vegetation, clearing underdrains, or repairing/replacing clogged or compacted soils. | <ul style="list-style-type: none"> • Inspect monthly and after every 0.5-inch or larger storm event. If standing water is observed, increase inspection frequency to after every 0.1-inch or larger storm event. • Maintenance when needed. |
| <p>Presence of mosquitos/larvae</p> <p>For images of egg rafts, larva, pupa, and adult mosquitos, see http://www.mosquito.org/biology</p> | <p>If mosquitos/larvae are observed: first, immediately remove any standing water by dispersing to nearby landscaping; second, make corrective measures as applicable to restore BMP drainage to prevent standing water.</p> <p>If mosquitos persist following corrective measures to remove standing water, or if the BMP design does not meet the 96-hour drawdown criteria due to release rates controlled by an orifice installed on the underdrain, the [City Engineer] shall be contacted to determine a solution. A different BMP type, or a Vector Management Plan prepared with concurrence from the County of San Diego Department of Environmental Health, may be required.</p> | <ul style="list-style-type: none"> • Inspect monthly and after every 0.5-inch or larger storm event. If mosquitos are observed, increase inspection frequency to after every 0.1-inch or larger storm event. • Maintenance when needed. |
| Underdrain clogged | Clear blockage. | <ul style="list-style-type: none"> • Inspect if standing water is observed for longer than 24-96 hours following a storm event. • Maintenance when needed. |

BF-1 Biofiltration

| | | |
|------------------------------|------------|--|
| Date: | Inspector: | BMP ID No.: |
| Permit No.: | APN(s): | |
| Property / Development Name: | | Responsible Party Name and Phone Number: |
| Property Address of BMP: | | Responsible Party Address: |

| INSPECTION AND MAINTENANCE CHECKLIST FOR BF-1 BIOFILTRATION PAGE 1 of 5 | | | |
|---|---|------|--------------------------------------|
| Threshold/Indicator | Maintenance Recommendation | Date | Description of Maintenance Conducted |
| Accumulation of sediment, litter, or debris Maintenance Needed? <input type="checkbox"/> YES <input type="checkbox"/> NO <input type="checkbox"/> N/A | <input type="checkbox"/> Remove and properly dispose of accumulated materials, without damage to the vegetation <input type="checkbox"/> If sediment, litter, or debris accumulation exceeds 25% of the surface ponding volume within one month (25% full*), add a forebay or other pre-treatment measures within the tributary area draining to the BMP to intercept the materials. <input type="checkbox"/> Other / Comments: | | |
| Poor vegetation establishment Maintenance Needed? <input type="checkbox"/> YES <input type="checkbox"/> NO <input type="checkbox"/> N/A | <input type="checkbox"/> Re-seed, re-plant, or re-establish vegetation per original plans <input type="checkbox"/> Other / Comments: | | |

*"25% full" is defined as ¼ of the depth from the design bottom elevation to the crest of the outflow structure (e.g., if the height to the outflow opening is 12 inches from the bottom elevation, then the materials must be removed when there is 3 inches of accumulation – this should be marked on the outflow structure).

BF-1

Biofiltration

| | | |
|-------------|------------|-------------|
| Date: | Inspector: | BMP ID No.: |
| Permit No.: | APN(s): | |

| INSPECTION AND MAINTENANCE CHECKLIST FOR BF-1 BIOFILTRATION PAGE 2 of 5 | | | |
|--|---|------|--------------------------------------|
| Threshold/Indicator | Maintenance Recommendation | Date | Description of Maintenance Conducted |
| Dead or diseased vegetation Maintenance Needed? <input type="checkbox"/> YES <input type="checkbox"/> NO <input type="checkbox"/> N/A | <input type="checkbox"/> Remove dead or diseased vegetation, re-seed, re-plant, or re-establish vegetation per original plans <input type="checkbox"/> Other / Comments: | | |
| Overgrown vegetation Maintenance Needed? <input type="checkbox"/> YES <input type="checkbox"/> NO <input type="checkbox"/> N/A | <input type="checkbox"/> Mow or trim as appropriate <input type="checkbox"/> Other / Comments: | | |
| 2/3 of mulch has decomposed, or mulch has been removed Maintenance Needed? <input type="checkbox"/> YES <input type="checkbox"/> NO <input type="checkbox"/> N/A | <input type="checkbox"/> Remove decomposed fraction and top off with fresh mulch to a total depth of 3 inches <input type="checkbox"/> Other / Comments: | | |

BF-1 Biofiltration

| | | |
|-------------|------------|-------------|
| Date: | Inspector: | BMP ID No.: |
| Permit No.: | APN(s): | |

| INSPECTION AND MAINTENANCE CHECKLIST FOR BF-1 BIOFILTRATION PAGE 3 of 5 | | | |
|---|---|------|--------------------------------------|
| Threshold/Indicator | Maintenance Recommendation | Date | Description of Maintenance Conducted |
| Erosion due to concentrated irrigation flow Maintenance Needed? <input type="checkbox"/> YES <input type="checkbox"/> NO <input type="checkbox"/> N/A | <input type="checkbox"/> Repair/re-seed/re-plant eroded areas and adjust the irrigation system <input type="checkbox"/> Other / Comments: | | |
| Erosion due to concentrated storm water runoff flow Maintenance Needed? <input type="checkbox"/> YES <input type="checkbox"/> NO <input type="checkbox"/> N/A | <input type="checkbox"/> Repair/re-seed/re-plant eroded areas, and make appropriate corrective measures such as adding erosion control blankets, adding stone at flow entry points, or minor re-grading to restore proper drainage according to the original plan <input type="checkbox"/> If the issue is not corrected by restoring the BMP to the original plan and grade, the [City Engineer] shall be contacted prior to any additional repairs or reconstruction <input type="checkbox"/> Other / Comments: | | |

BF-1 Biofiltration

| | | |
|-------------|------------|-------------|
| Date: | Inspector: | BMP ID No.: |
| Permit No.: | APN(s): | |

| INSPECTION AND MAINTENANCE CHECKLIST FOR BF-1 BIOFILTRATION PAGE 4 of 5 | | | |
|---|--|------|--------------------------------------|
| Threshold/Indicator | Maintenance Recommendation | Date | Description of Maintenance Conducted |
| Obstructed inlet or outlet structure Maintenance Needed? <input type="checkbox"/> YES <input type="checkbox"/> NO <input type="checkbox"/> N/A | <input type="checkbox"/> Clear blockage <input type="checkbox"/> Other / Comments: | | |
| Underdrain clogged (inspect underdrain if standing water is observed for longer than 24-96 hours following a storm event) Maintenance Needed? <input type="checkbox"/> YES <input type="checkbox"/> NO <input type="checkbox"/> N/A | <input type="checkbox"/> Clear blockage <input type="checkbox"/> Other / Comments: | | |
| Damage to structural components such as weirs, inlet or outlet structures Maintenance Needed? <input type="checkbox"/> YES <input type="checkbox"/> NO <input type="checkbox"/> N/A | <input type="checkbox"/> Repair or replace as applicable <input type="checkbox"/> Other / Comments: | | |

BF-1 Biofiltration

| | | |
|-------------|------------|-------------|
| Date: | Inspector: | BMP ID No.: |
| Permit No.: | APN(s): | |

| INSPECTION AND MAINTENANCE CHECKLIST FOR BF-1 BIOFILTRATION PAGE 5 of 5 | | | |
|---|---|------|--------------------------------------|
| Threshold/Indicator | Maintenance Recommendation | Date | Description of Maintenance Conducted |
| <p>Standing water in BMP for longer than 24-96 hours following a storm event*</p> <p>Surface ponding longer than approximately 24 hours following a storm event may be detrimental to vegetation health</p> <p>Maintenance Needed?</p> <p><input type="checkbox"/> YES <input type="checkbox"/> NO <input type="checkbox"/> N/A</p> | <p><input type="checkbox"/> Make appropriate corrective measures such as adjusting irrigation system, removing obstructions of debris or invasive vegetation, clearing underdrains, or repairing/replacing clogged or compacted soils</p> <p><input type="checkbox"/> Other / Comments:</p> | | |
| <p>Presence of mosquitos/larvae</p> <p>For images of egg rafts, larva, pupa, and adult mosquitos, see http://www.mosquito.org/biology</p> <p>Maintenance Needed?</p> <p><input type="checkbox"/> YES <input type="checkbox"/> NO <input type="checkbox"/> N/A</p> | <p><input type="checkbox"/> Apply corrective measures to remove standing water in BMP when standing water occurs for longer than 24-96 hours following a storm event.**</p> <p><input type="checkbox"/> Other / Comments:</p> | | |

*Surface ponding longer than approximately 24 hours following a storm event may be detrimental to vegetation health, and surface ponding longer than approximately 96 hours following a storm event poses a risk of vector (mosquito) breeding. Poor drainage can result from clogging of the media layer, filter course, aggregate storage layer, underdrain, or outlet structure. The specific cause of the drainage issue must be determined and corrected.

**If mosquitos persist following corrective measures to remove standing water, or if the BMP design does not meet the 96-hour drawdown criteria due to release rates controlled by an orifice installed on the underdrain, the [City Engineer] shall be contacted to determine a solution. A different BMP type, or a Vector Management Plan prepared with concurrence from the County of San Diego Department of Environmental Health, may be required.

ATTACHMENT 4

Copy of Plan Sheets Showing Permanent Storm Water BMPs

This is the cover sheet for Attachment 4.

Use this checklist to ensure the required information has been included on the plans:

The plans must identify:

- Structural BMP(s) with ID numbers matching Form I-6 Summary of PDP Structural BMPs
- The grading and drainage design shown on the plans must be consistent with the delineation of DMAs shown on the DMA exhibit
- Details and specifications for construction of structural BMP(s)
- Signage indicating the location and boundary of structural BMP(s) as required by the [City Engineer]
- How to access the structural BMP(s) to inspect and perform maintenance
- Features that are provided to facilitate inspection (e.g., observation ports, cleanouts, silt posts, or other features that allow the inspector to view necessary components of the structural BMP and compare to maintenance thresholds)
- Manufacturer and part number for proprietary parts of structural BMP(s) when applicable
- Maintenance thresholds specific to the structural BMP(s), with a location-specific frame of reference (e.g., level of accumulated materials that triggers removal of the materials, to be identified based on viewing marks on silt posts or measured with a survey rod with respect to a fixed benchmark within the BMP)
- Recommended equipment to perform maintenance
- When applicable, necessary special training or certification requirements for inspection and maintenance personnel such as confined space entry or hazardous waste management
- Include landscaping plan sheets showing vegetation requirements for vegetated structural BMP(s)
- All BMPs must be fully dimensioned on the plans
- When proprietary BMPs are used, site-specific cross section with outflow, inflow, and model number shall be provided. Photocopies of general brochures are not acceptable.

GENERAL NOTES

1. SUBDIVISION MONUMENTATION SHALL BE PROTECTED AT ALL TIMES. PRIOR TO ISSUANCE OF GRADING PERMIT THE SUBDIVISION BOUNDARY SHALL BE STAKED AND FLAGGED, WITH LATHS AT LEAST THREE FEET IN HEIGHT, AT ALL SUBDIVISION CORNERS, ANGLE POINTS, AND POINTS OF CURVE. WHERE BOUNDARY LINES EXCEED THREE HUNDRED FEET IN LENGTH STAKES SHALL BE PLACED ON LINE AT NOT OVER THREE HUNDRED FOOT INTERVALS. WHERE PERMISSION FOR OFFSITE GRADING HAS BEEN GRANTED THE LIMITS OF OFF-SITE WORK SHALL BE STAKED AND FLAGGED ALSO. OFF-SITE WORK SHALL BE CLEARLY IDENTIFIED WITH DIFFERENT COLOR FLAGGING OR MARKINGS FROM THE SUBDIVISION BOUNDARY FLAGGING. THE CONTRACTOR SHALL AT ALL TIMES PROTECT THE SUBDIVISION BOUNDARY AND OFF-SITE MARKERS AND SHALL IMMEDIATELY REPLACE ANY MARKERS THAT ARE DISTURBED OR DESTROYED.
2. ACCEPTANCE OF THIS GRADING PLAN DOES NOT CONSTITUTE ACCEPTANCE OF VERTICAL OR HORIZONTAL ALIGNMENT OF ANY PRIVATE ROAD SHOWN HEREON FOR PUBLIC ROAD PURPOSES.
3. FINAL ACCEPTANCE OF THESE GRADING PLANS IS SUBJECT TO FINAL ACCEPTANCE OF THE ASSOCIATED IMPROVEMENT PLANS WHERE APPLICABLE. FINAL CURB GRADE ELEVATIONS MAY REQUIRE CHANGES IN THESE PLANS.
4. IMPORT MATERIAL SHALL BE OBTAINED FROM A LEGAL SITE.
5. WASTE MATERIAL GENERATED FROM GRADING OPERATIONS SHALL BE HAULED TO A LEGAL DUMP SITE AS APPROVED BY THE DIRECTOR OF DEVELOPMENT SERVICES.
6. AN ENCROACHMENT PERMIT IS REQUIRED PRIOR TO ANY WORK BEING PERFORMED WITHIN THE LIMITS OF THE PUBLIC RIGHT OF WAY.
7. ALL SLOPES OVER THREE FEET IN HEIGHT SHALL BE LANDSCAPED AND IRRIGATED IN ACCORDANCE WITH CITY SPECIFICATIONS.
8. THE CONTRACTOR SHALL VERIFY THE EXISTENCE AND LOCATION OF ALL UTILITIES BEFORE COMMENCING WORK. NOTICE OF PROPOSED WORK SHALL BE GIVEN TO THE FOLLOWING AGENCIES:

| | |
|--|----------------|
| SAN DIEGO GAS & ELECTRIC | 1-800-336-7343 |
| AT&T | 1-800-422-4133 |
| COX COMMUNICATIONS | 619-263-5793 |
| PADRE DAM MUNICIPAL WATER DISTRICT (water and sewer) | 619-258-4600 |
9. REQUESTS FOR RELEASE OF GRADING AND EROSION CONTROL SECURITIES UPON COMPLETION OF THE WORK SHALL BE MADE IN ACCORDANCE WITH THE REQUIREMENTS SET FORTH IN THE CITY OF SANTEE LAND DEVELOPMENT MANUAL.
10. ACCEPTANCE OF THESE PLANS BY THE CITY ENGINEER DOES NOT AUTHORIZE ANY WORK OR GRADING TO BE PERFORMED UNTIL THE PROPERTY OWNER'S PERMISSION HAS BEEN OBTAINED AND A VALID GRADING PERMIT HAS BEEN ISSUED.
11. THE CITY ENGINEER'S ACCEPTANCE OF THESE PLANS DOES NOT CONSTITUTE THE BUILDING OFFICIALS' ACCEPTANCE OF ANY FOUNDATION FOR STRUCTURES TO BE PLACED IN THE AREA COVERED BY THESE PLANS. NO WAIVER OF THE GRADING ORDINANCE REQUIREMENTS CONCERNING MINIMUM COVER OVER EXPANSIVE SOILS IS MADE OR IMPLIED (SECTION 15.58.590, SANTEE MUNICIPAL CODE).
12. ALL OPERATIONS CONDUCTED ON THE PREMISES, INCLUDING THE WARMING UP, REPAIR, ARRIVAL, DEPARTURE OR RUNNING OF TRUCKS, EARTHMOVING EQUIPMENT, CONSTRUCTION EQUIPMENT AND ANY OTHER ASSOCIATED CONSTRUCTION ACTIVITY SHALL BE LIMITED TO THE PERIOD BETWEEN 7:00 A.M. AND 7:00 P.M. EACH DAY, MONDAY THROUGH FRIDAY. NO EARTHMOVING OR GRADING OPERATIONS SHALL BE CONDUCTED ON THE PREMISES ON SUNDAY OR CITY HOLIDAYS. WORK ON SATURDAY REQUIRES THE WRITTEN APPROVAL OF THE CITY ENGINEER.
13. ALL MAJOR SLOPES SHALL BE ROUNDED INTO EXISTING TERRAIN TO PRODUCE A SMOOTH CONToured TRANSITION FROM CUT OR FILL FACES TO NATURAL GROUND AND ABUTTING CUT OR FILL SURFACES.
14. NOTWITHSTANDING THE MINIMUM STANDARDS SET FORTH IN THE GRADING ORDINANCE AND NOTWITHSTANDING THE ACCEPTANCE OF THESE GRADING PLANS, THE PERMITTEE IS RESPONSIBLE FOR THE PREVENTION OF DAMAGE TO ADJACENT PROPERTY. NO PERSON SHALL EXCAVATE ON LAND SO CLOSE TO THE PROPERTY LINE AS TO ENDANGER ANY ADJOINING PUBLIC STREET, SIDEWALK, ALLEY, FUNCTION OF ANY SEWAGE DISPOSAL SYSTEM, OR ANY OTHER PUBLIC OR PRIVATE PROPERTY WITHOUT SUPPORTING AND PROTECTING SUCH PROPERTY FROM SETTLING, CRACKING, EROSION, SILTING, SCOUR OR OTHER DAMAGE WHICH MIGHT RESULT FROM GRADING DESCRIBED ON THIS PLAN. THE CITY WILL HOLD THE PERMITTEE RESPONSIBLE FOR CORRECTION ON NON-DEDICATED IMPROVEMENTS WHICH DAMAGE ADJACENT PROPERTY.
15. ALL OFFSITE HAUL ROUTES ARE SUBJECT TO THE ACCEPTANCE OF THE CITY ENGINEER. THE CONTRACTOR SHALL MAKE APPLICATION FOR A HAUL PERMIT, IN A FORMAT SUITABLE TO THE DEPARTMENT OF DEVELOPMENT SERVICES, A MINIMUM OF 72 HOURS PRIOR TO BEGINNING WORK. THE GRADING PERMIT SHALL NOT BE ISSUED PRIOR TO ISSUANCE OF THE HAUL PERMIT.
16. SPECIAL CONDITIONS: IF ANY ARCHAEOLOGICAL RESOURCES ARE DISCOVERED ON THE SITE OF THIS GRADING DURING GRADING OPERATIONS, SUCH OPERATIONS WILL CEASE IMMEDIATELY, AND THE PERMITTEE WILL NOTIFY THE CITY ENGINEER OF THE DISCOVERY. GRADING OPERATIONS WILL NOT COMMENCE UNTIL THE PERMITTEE HAS RECEIVED WRITTEN AUTHORITY FROM THE CITY ENGINEER TO DO SO.
17. ALL GRADING SHOWN ON THESE PLANS SHALL BE COMPLETED AS A SINGLE UNIT WITH NO PROVISION FOR PARTIAL RELEASES. IF ANY PORTION OF THIS PROJECT IS TO BE COMPLETED SEPARATELY, A SEPARATE PLAN AND PERMIT APPLICATION SHALL BE SUBMITTED FOR ACCEPTANCE.
18. FINISH GRADING AND PLANTING SHALL BE ACCOMPLISHED ON ALL SLOPES PRIOR TO OCTOBER 1 OR IMMEDIATELY UPON COMPLETION OF ANY SLOPES BETWEEN OCTOBER 1 AND APRIL 1. ALL LANDSCAPING SHALL BE DONE IN ACCORDANCE WITH THE ACCEPTED LANDSCAPING AND IRRIGATION PLANS.

19. THE CONTRACTOR SHALL NOTIFY THE CITY OF SANTEE-DEPARTMENT OF DEVELOPMENT SERVICES AT (619) 258-4100 A MINIMUM OF 48 HOURS BEFORE ANY WORK COMMENCES AND 24 HOURS PRIOR TO REQUESTS FOR INSPECTION. CALL (619) 258-4100 x 168 FOR ALL INSPECTION REQUESTS. ALL WORK PERFORMED UNDER THIS PERMIT IS SUBJECT TO THE INSPECTION REQUIREMENTS OF THE SANTEE GRADING ORDINANCE. THE CONTRACTOR IS REFERRED TO SECTION 15.58.930 OF THE SANTEE MUNICIPAL CODE FOR A LIST OF DETAILED INSPECTION REQUIREMENTS. FAILURE TO PROVIDE ADEQUATE NOTIFICATION TO THE DEPARTMENT OF DEVELOPMENT SERVICES REQUESTING INSPECTION OF THE WORK AT THE APPROPRIATE TIMES MAY RESULT IN ISSUANCE OF A STOP WORK ORDER FOR THE GRADING OPERATIONS.
20. TO ENSURE COMPLIANCE WITH THE ACCEPTED GRADING PLAN AND AS A CONDITION OF ACCEPTANCE OF THE GRADING PLAN, THE OWNER, ITS TENANTS, ITS CONTRACTORS, AND ITS SUB-CONTRACTORS SHALL MAINTAIN THE PREMISES SUBJECT TO THE GRADING PLAN OPEN FOR INSPECTION BY CITY REPRESENTATIVES AT ALL TIMES GRADING OPERATIONS ARE OCCURRING, AND AT ALL OTHER TIMES, UPON REASONABLE DEMAND BY THE CITY.
21. UPON COMPLETION OF THE GRADING WORK SHOWN ON THESE PLANS AND PRIOR TO FINAL ACCEPTANCE OF THE WORK BY THE CITY, THE OWNER SHALL HAVE AS-BUILT GRADING PLANS PREPARED. PLANS SHALL BE PREPARED IN ACCORDANCE WITH THE CITY OF SANTEE-DEPARTMENT OF DEVELOPMENT SERVICES POLICY REGARDING CONSTRUCTION CHANGES AND AS-BUILT DRAWINGS FOR PRIVATE DEVELOPMENT.
22. SLOPE RATIOS:
 CUT 2:1 FILL 2:1
 EXCAVATION: 3:1 SLOPE C.Y. FILL: 2:00 C.Y. WASTE/IMPORT: 2:360 C.Y.
 (Note: A separate void permit must exist for either waste or import areas).
 SHRINKAGE/EXPANSION N/A %
23. ACCEPTANCE OF THESE PLANS BY THE CITY OF SANTEE IS VALID FOR ONE YEAR FROM THE DATE OF ACCEPTANCE. FAILURE TO COMMENCE CONSTRUCTION WITHIN ONE YEAR Voids ACCEPTANCE OF THE PLANS.
24. THE FOLLOWING SOILS REPORT(S) SHALL BE CONSIDERED PART OF THIS GRADING PLAN. ALL GRADING SHALL BE DONE IN ACCORDANCE WITH THE RECOMMENDATIONS AND SPECIFICATIONS CONTAINED IN SAID REPORT(S).
 (a) list all soils reports stating the title, date prepared, and name of firm preparing the report)

STORMWATER POLLUTION PREVENTION NOTES:

1. APPROPRIATE EROSION PREVENTION AND SEDIMENT CONTROL MEASURES WILL BE IMPLEMENTED AT ALL TIMES.
2. THE TOPS OF ALL SLOPES SHALL HAVE A DIKE OR TRENCH TO PREVENT WATER FROM FLOWING OVER THE SLOPES.
3. CLEAN GRAVEL ONLY WILL BE USED IN GRAVEL BAGS.
4. CATCH BASINS, DESILTING BASINS, GRAVEL BAGS, CHECK DAMS AND STORM DRAIN SYSTEMS SHALL BE INSTALLED TO THE SATISFACTION OF THE CITY ENGINEER. THESE FACILITIES SHALL BE CLEANED ON A REGULAR BASIS, AND KEPT FREE OF SOIL ACCUMULATION.
5. GRAVEL BAG CHECK DAMS SHALL BE PLACED IN UNPAVED AREAS WITH GRADIENTS IN EXCESS OF 2%. IN OTHER GRADED OR EXCAVATED AREAS AS REQUIRED BY THE DEPARTMENT OF DEVELOPMENT SERVICES, AND AT OR NEAR EVERY POINT WHERE CONCENTRATED FLOWS LEAVE THE DEVELOPMENT.
6. GRAVEL BAGS SHALL BE PLACED ON THE UPSTREAM SIDE OF ALL DRAINAGE INLETS TO MINIMIZE SILT BUILDUP IN THE INLETS AND PIPES.
7. THE CONTRACTOR SHALL IMMEDIATELY REPAIR ANY ERODED SLOPES.
8. ROADWAYS AND ENTRANCES TO AND FROM THE SITE SHALL BE SWEEPED ON A REGULAR BASIS TO KEEP THEM FREE OF SOIL ACCUMULATION.
9. CONTRACTOR SHALL HAVE WATER TRUCKS AND EQUIPMENT ON-SITE TO MINIMIZE AIRBORNE DUST CREATED FROM GRADING AND HAULING OPERATIONS OR EXCESSIVE WIND CONDITIONS. WATERING SHALL BE PERFORMED ON A CONTINUOUS BASIS ANY TIME THESE CONDITIONS ARE PRESENT AND AT ALL OTHER TIMES AS DIRECTED BY THE CITY ENGINEER. ADDITIONAL DUST CONTROL MEASURES SHALL BE IMPLEMENTED AS NEEDED.
10. STOCKPILES SHALL BE COVERED AT THE END OF EACH WORKING DAY AND PRIOR TO PREDICTED RAIN EVENTS. ASPHALT SHALL BE STORED ON A LAYER OF PLASTIC SHEETING OR EQUIVALENT.
11. ALL PORTABLE TOILETS SHALL HAVE A SECONDARY CONTAINMENT AND NOT BE LOCATED NEAR A STORM DRAIN (I.E. CATCH BASIN OR STREET).
12. INACTIVE SLOPES SHALL BE PROTECTED AND STABILIZED WITHIN 10 CALENDAR DAYS OF LAST BEING WORKED, OR ON THE DIRECTION OF THE CITY. ACTIVE SLOPES SHALL BE STABILIZED DURING RAIN.
13. EROSION CONTROL ON SLOPES SHALL BE MITIGATED BY INSTALLING LANDSCAPING AS PER APPROVED LANDSCAPE PLANS AS REQUIRED BY THE DEVELOPMENT REVIEW CONDITIONS, OR BY TEMPORARY EROSION CONTROL CONFORMING TO THE FOLLOWING:

| NON-IRRIGATED HYDROSEED MIX | | |
|-----------------------------|-------------------|----------------------|
| LBS. PER ACRE | % PURITY PER ACRE | SEED SPECIES |
| 20 | 70% PLS. | ATRIPLEX GLAUCO |
| 30 | | PLANTAGE INSULARIS |
| 9 | | ENCLEIS FERMOSA |
| 6 | SCARIFIED | LOTUS SCOPARIUS |
| 7 | 50% PLS. | EXCHSCHOLTZIA CALIF. |
| 91 LBS. | | |

14. VEHICLE MAINTENANCE, REPAIR AND STORAGE Bmps WILL BE IMPLEMENTED INCLUDING: USE OF DRIP PANS OR EQUIVALENT UNDER VEHICLE STORED OVERNIGHT; DAILY INSPECTION FOR LEAKS AND SPILLS; PROMPT REMOVAL OF SPILLS; AVAILABILITY OF OIL-ABSORBENT SPILL REMOVAL MATERIALS ON SITE.
15. HEAVY EQUIPMENT WILL NOT BE STORED ON THE PUBLIC RIGHT-OF-WAY.
16. TRASH SHALL BE PLACED IN DUMPSTERS. OFFCUTS FROM FRAMING WILL BE STORED APPROPRIATELY AND NOT ALLOWED TO ACCUMULATE IN STOCKPILES AROUND THE SITE.
17. TRASH DUMPSTERS WILL HAVE LIDS. THE LIDS WILL REMAIN CLOSED AND THE DUMPSTERS WILL NOT BE OVERTILLED. ADDITIONAL TRASH PICK UPS SHALL BE MADE AS NECESSARY.
18. LIQUID MATERIALS WILL BE STORED IN CLOSED CONTAINERS IN SECONDARY CONTAINMENT AND UNDER COVERS. SOLID MATERIALS WILL BE STORED ON PALLETS AND BE COVERED DURING RAIN.
19. A MATERIALS WASHOUT WILL BE AVAILABLE ON SITE WHENEVER LIQUID MATERIALS ARE USED. THE WASHOUT WILL FULLY CONTAIN THOSE MATERIALS AND THE SURROUNDING AREA SHALL BE KEPT FREE OF SPILLS.
20. DISCHARGE OF POTABLE WATER (SUCH AS FROM POWERWASHING OR FILLING WATER TRUCKS) WILL BE PREVENTED.
21. 125 PERCENT OF THE MATERIALS REQUIRED TO MAINTAIN STORM WATER Bmps SHALL BE PRESENT ON THE SITE AT ALL TIMES.
22. STORMWATER CONTROL MEASURES SHOWN HEREON ARE BEST MANAGEMENT PRACTICES FOR THIS SITE BASED ON THE ANTICIPATED PROGRESS OF THE WORK. ADDITIONAL MEASURES MAY BE REQUIRED AT ANY TIME AT THE DISCRETION OF THE CITY ENGINEER AS THE WORK PROGRESSES. IT IS THE CONTRACTOR'S RESPONSIBILITY TO ENSURE ADEQUATE PROTECTION IS IN PLACE AT ALL TIMES TO PREVENT ANY DISCHARGE OF POLLUTANTS, INCLUDING SEDIMENT, FROM THE EXPOSED SITE AREAS. Bmps WILL BE MAINTAINED UNTIL REMOVAL.

PAVING NOTES:

1. A MINIMUM OF SEVEN DAYS PRIOR TO THE PLACEMENT OF ROADWAY BASE MATERIAL THE CONTRACTOR SHALL SUBMIT A CERTIFIED SOILS REPORT FROM A REGISTERED CIVIL OR GEOTECHNICAL ENGINEER CERTIFYING ALL ROADWAY AND UTILITY TRENCHING HAS BEEN COMPACTED TO THE MINIMUM REQUIREMENTS SPECIFIED IN THE STANDARD SPECIFICATIONS FOR PUBLIC WORKS CONSTRUCTION AND THE RECOMMENDATIONS CONTAINED IN THE PROJECT'S SOILS REPORT.
2. A FINAL PAVEMENT STRUCTURAL SECTION DESIGN SHALL BE SUBMITTED TO THE CITY ENGINEER FOR APPROVAL A MINIMUM OF TEN DAYS PRIOR TO PLACEMENT OF BASE MATERIAL. THE DESIGN REPORT SHALL CONFORM TO CITY FORM 435 - PAVEMENT DESIGN AND R-VALUE TEST SUBMITTAL PROCEDURES. THE DESIGN SHALL ADHERE TO THE METHODOLOGY SET FORTH IN CHAPTER 600 OF THE CALTRANS HIGHWAY DESIGN MANUAL AND UTILIZE THE "R" VALUE METHOD. DESIGN SHALL BE SUBMITTED IN REPORT FORM AND MUST INCLUDE ALL SUPPORTING CALCULATIONS AND TEST RESULTS. THE "R" VALUE TESTS SHALL BE CONDUCTED IN ACCORDANCE WITH CALIFORNIA TEST NO. 301 AND SHALL BE PERFORMED BY A REGISTERED CIVIL ENGINEER WHOSE PRIMARY PROFESSIONAL ACTIVITY IS PERFORMING SUCH TESTS. THE NUMBER AND LOCATION OF R-VALUE TESTS SHALL BE COORDINATED WITH THE CITY PROJECT INSPECTOR AND BE SUBJECT TO APPROVAL OF THE CITY PROJECT ENGINEER.
3. THE FOLLOWING MINIMUM STRUCTURAL THICKNESS ARE BASED ON AN R-VALUE OF 30. TRAFFIC INDEXES ARE BASED ON CITY PUBLIC WORKS STANDARDS AND SHALL BE USED FOR PAVEMENT DESIGN BASED ON ACTUAL R-VALUES OBTAINED AT TIME OF CONSTRUCTION.

| STREET NAME | TRAFFIC INDEX | ANTICIPATED STRUCTURAL SECTION |
|-----------------------|---------------|--------------------------------|
| ARTERIAL | 9.0 | 5" AC / 12" AB |
| MAJOR | 8.5 | 4" AC / 12" AB |
| COLLECTOR | 8.0 | 4" AC / 11" AB |
| INDUSTRIAL | 7.0 | 3" AC / 11" AB |
| RESIDENTIAL COLLECTOR | 6.0 | 3" AC / 8" AB |
| LOCAL | 5.0 | 3" AC / 8" AB |
| CUL-DE-SAC | 4.5 | 3" AC / 7" AB |

- THE MINIMUM SECTIONS LISTED ABOVE ARE FOR ESTIMATION AND DESIGN PURPOSES ONLY AND ARE SUBJECT TO CHANGE FOLLOWING SUBMITTAL OF THE FINAL PAVEMENT DESIGN REPORT.
4. ASPHALT CONCRETE SHALL CONFORM TO ALL PROVISIONS OF SECTION 39 OF THE CURRENT CALTRANS STANDARD SPECIFICATIONS. SURFACE COURSE SHALL BE A MINIMUM THICKNESS IS 2 INCHES, MAXIMUM THICKNESS IS 3 INCHES. ASPHALT CONCRETE SECTIONS GREATER THAN 3 INCHES SHALL CONTAIN A BASE COURSE OF ASPHALT, A MINIMUM THICKNESS OF 2 INCHES.

| ACCEPTED UNTREATED BASE MATERIALS INCLUDE: | |
|---|---------------------------------|
| PER SECTION 200-2.2 | CRUSHED AGGREGATE BASE |
| PER SECTION 200-2.4 | CRUSHED MISCELLANEOUS BASE |
| CALTRANS | CLASS 2 - AGGREGATE BASE |
| PROCESSED MISCELLANEOUS BASE PER THE GREEN BOOK AND CALTRANS CLASS 2 RECYCLED BASE ARE NOT PERMITTED. | |
| ACCEPTED ASPHALT BASE COURSE MIXES INCLUDE: | |
| PER CALTRANS 39 | PG 64-10 - 3/4" MAXIMUM, COARSE |
| ACCEPTED ASPHALT SURFACE COURSE MIXES INCLUDE: | |
| PER CALTRANS 39 | PG 64-10 - 1/2" MAXIMUM, COARSE |

GENERAL STANDARDS OF CONSTRUCTION

UNLESS OTHERWISE NOTED ON THE PLANS, ALL WORK SHALL CONFORM WITH THE FOLLOWING STANDARD SPECIFICATIONS AND DRAWINGS:

- STANDARD SPECIFICATIONS:
1. STANDARD SPECIFICATIONS FOR PUBLIC WORKS CONSTRUCTION, LATEST EDITION.
 2. STANDARD SPECIAL PROVISIONS.
 3. CITY OF SANTEE PUBLIC WORKS STANDARDS, SEPTEMBER 1982.
 4. CALIFORNIA DEPARTMENT OF TRANSPORTATION, "MANUAL OF TRAFFIC CONTROLS FOR CONSTRUCTION AND MAINTENANCE WORK ZONES," LATEST EDITION.
 5. STANDARD SPECIFICATIONS OF THE PADRE DAM MUNICIPAL WATER DISTRICT, WATER AGENCY STANDARDS, W.A.S.
 6. CALIFORNIA STORMWATER QUALITY ASSOCIATION (CASQA), STORMWATER BEST MANAGEMENT PRACTICE HANDBOOK CONSTRUCTION, LATEST EDITION.
- STANDARD DRAWINGS:
1. CITY OF SANTEE STANDARD DRAWINGS.
 2. SAN DIEGO REGIONAL STANDARD DRAWINGS (S.D.R.S.D.) AS RECOMMENDED BY THE REGIONAL STANDARDS COMMITTEE, MAINTAINED AND PUBLISHED BY THE SAN DIEGO COUNTY DEPARTMENT OF PUBLIC WORKS, LATEST EDITION.
 3. STANDARD DRAWINGS OF THE PADRE DAM MUNICIPAL WATER DISTRICT, WATER AGENCY STANDARDS, W.A.S.

LEGEND

| SYMBOL | DESCRIPTION |
|----------|---|
| (Symbol) | EXISTING SEWER |
| (Symbol) | EXISTING WATER METER |
| (Symbol) | EXISTING WATER |
| (Symbol) | EXISTING ELEVATION |
| (Symbol) | EXISTING CONTOUR |
| (Symbol) | EXISTING FIRE HYDRANT |
| (Symbol) | EXISTING SEWER MANHOLE |
| (Symbol) | PROPOSED CUT& FILL/DAYLIGHT LINE |
| (Symbol) | PROPOSED CONTOUR |
| (Symbol) | PROPOSED CURB AND GUTTER |
| (Symbol) | PROPOSED CURB |
| (Symbol) | PROPERTY LINE |
| (Symbol) | ROCKVILL STREET CENTERLINE |
| (Symbol) | PROPOSED MASONRY WALL |
| (Symbol) | PROPOSED KEYSTONE WALL |
| (Symbol) | PROPOSED STRUCTURAL WALL |
| (Symbol) | PROPOSED WALL (TYPE BE DETERMINED) |
| (Symbol) | PROPOSED STORM DRAIN PIPE (TYPE AND SIZE PER PLAN) |
| (Symbol) | PROPOSED 24" SQUARE CATCH BASIN |
| (Symbol) | "BROOKS OR EQUAL" WITH TRAFFIC RATED GRATE |
| (Symbol) | PROPOSED DRAINAGE DIRECTION OF FLOW |
| (Symbol) | PROPOSED 4'x4' ROCK PROTECTION PAD |
| (Symbol) | PROPOSED 12" TRENCH DRAIN, ACO K300 OR EQUAL |
| (Symbol) | WHEEL STOP |
| (Symbol) | PROPOSED TRUNCATED DOMES |
| (Symbol) | PROPOSED TYPE A BROW DITCH |
| (Symbol) | PROPOSED FIRE HYDRANT |
| (Symbol) | PROPOSED WATERLINE (SIZE AND TYPE PER PLAN) |
| (Symbol) | PROPOSED SEWERLINE (SIZE AND TYPE PER PLAN) |
| (Symbol) | PROPOSED STORMWATER TREATMENT BASIN AREA |
| (Symbol) | PROPOSED PRIVATE SIDEWALK/FLATWORK AREAS (PER GEOTECHNICAL RECOMMENDATIONS) |
| (Symbol) | PROPOSED PRIVATE CONCRETE STRUCTURAL SECTION (PER GEOTECHNICAL RECOMMENDATIONS) |
| (Symbol) | EXISTING GROUND |
| (Symbol) | FINISH SURFACE |
| (Symbol) | TOP OF CURB |
| (Symbol) | FLOWLINE |
| (Symbol) | TOP OF GRATE |
| (Symbol) | TOP OF WALL |
| (Symbol) | BOTTOM OF WALL |
| (Symbol) | TOP OF FOOTING |

SHEET INDEX

| | |
|---------|------------------------------|
| SHEET 1 | TITLE SHEET |
| SHEET 2 | GRADING AND DRAINAGE |
| SHEET 3 | WATER AND SEWER IMPROVEMENTS |
| SHEET 4 | EROSION CONTROL |

| REVISIONS | BY |
|-----------|----|
| 3-14-21 | |
| | |
| | |
| | |
| | |
| | |
| | |

MANSOUR Architecture
 6498 Weathers Place Suite 100
 San Diego, California 92121
 858-568-1509 fax 858-568-9221
 mansourarchitecture.com

SOUTHWEST SIGNAL
 ROCKVILL ST.
 SANTEE CA 92071

PRELIMINARY DESIGN TITLE SHEET

| | |
|-------------|------------------------|
| Date: | 7-30-21 |
| Scale: | NOTED |
| Drawn: | |
| Approved: | |
| Job: | #2106 SOUTHWEST SIGNAL |
| Sheet: | C1 |
| Of 4 Sheets | |

CELEBRATING 40 YEARS 1979 - 2019

KAPPA SURVEYING & ENGINEERING, INC.
 8402 N. MAGNOLIA AVE., SUITE C, SANTEE, CA 92071 (619) 465-8948 FAX: (619) 465-6410

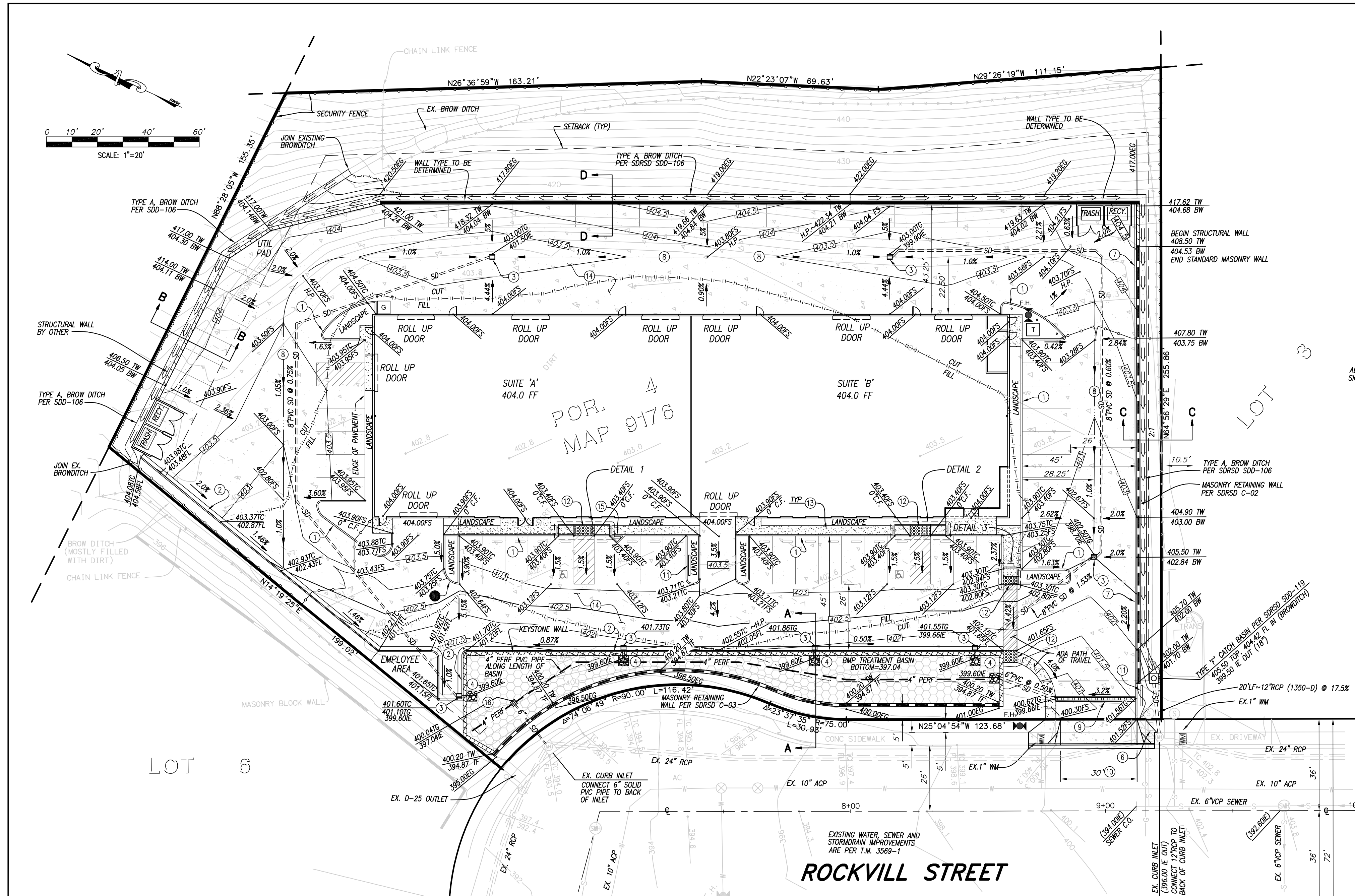

- CONSTRUCTION KEYNOTES**
- 6" CURB PER SDRSD SDD-150
 - CURB AND GUTTER PER SDRSD G-151
 - 24" SQUARE CATCH BASIN "BROOKS OR EQUAL" WITH RATED TRAFFIC GRATE
 - 4"x4", 3" TO 4" RIVER ROCK PROTECTION PAD, 1" IN DEPTH
 - 4" WIDE X 8' LONG RRAP ENERGY DISSIPATOR PER SDRSD SDD-104
 - WING TYPE HEADWALL PER SDRSD D-34 (18')
 - 8"x18" CONCRETE HEADER, REFER TO SECTION C-C FOR DETAIL ON THIS SHEET
 - CONCRETE SIALE @ 1.0% MIN.
 - 12" TRENCH DRAIN, ACO K300 OR EQUAL
 - REMOVE EXISTING DRIVEWAY AND CONSTRUCT 30" WIDE COMMERCIAL DRIVEWAY PER SDRSD SDG-163
 - MONUMENT SIGN BY ARCHITECT
 - TRUNCATED DOME PER SDRSD SDG-130
 - SIDEWALK PER SDRSD SDG-155
 - CONCRETE STRUCTURAL SECTION PER GEOTECHNICAL RECOMMENDATIONS
 - CONSTRUCT DIAMOND CONC STOOP FOR ELECTRIC VEHICLE CHARGER PEDESTAL
 - 36" SQUARE OVERFLOW CATCH BASIN, INVERT PER PLAN

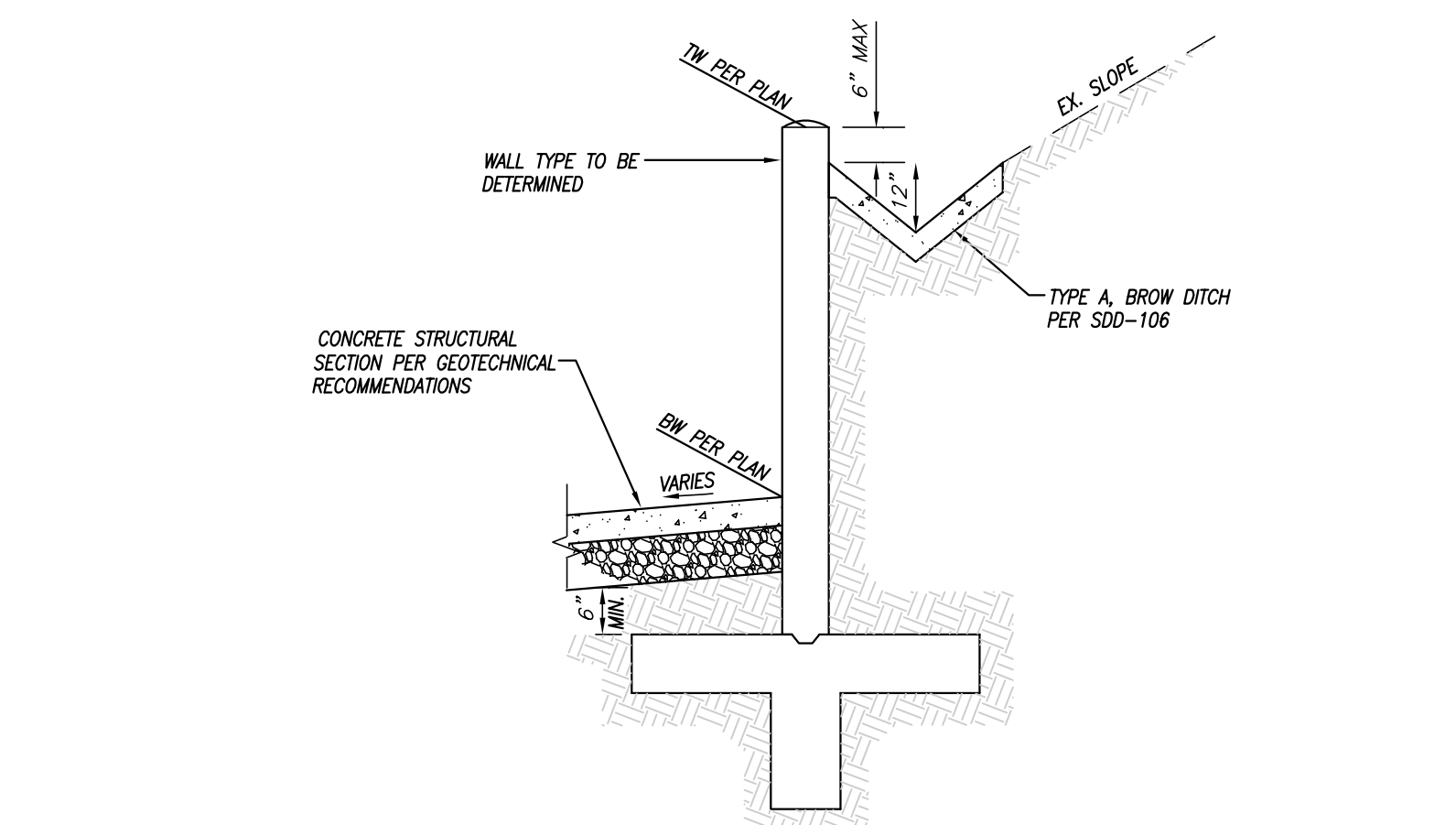
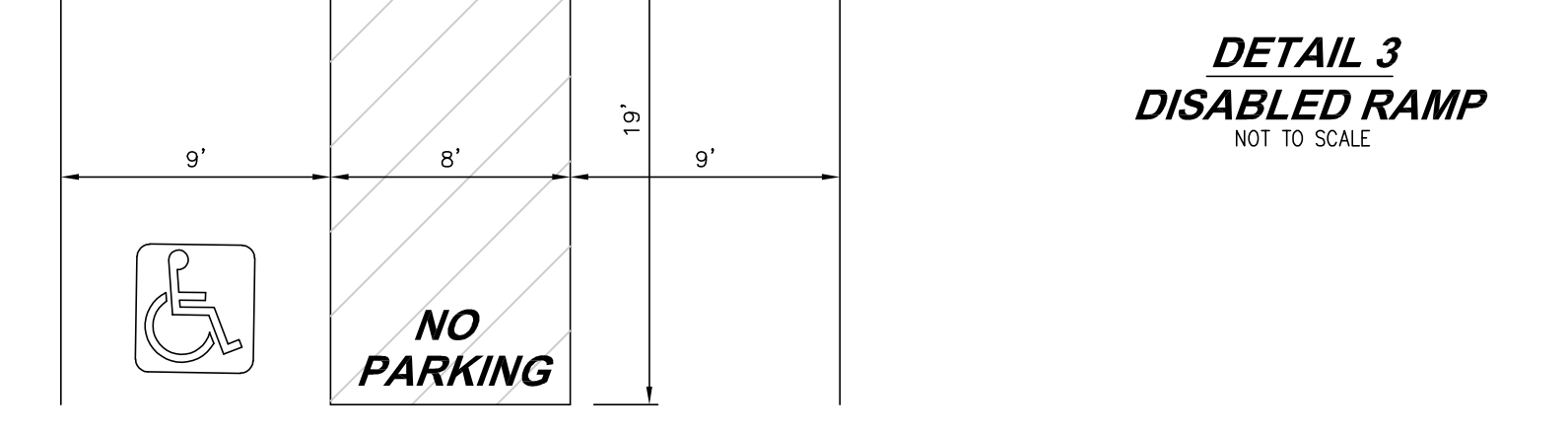
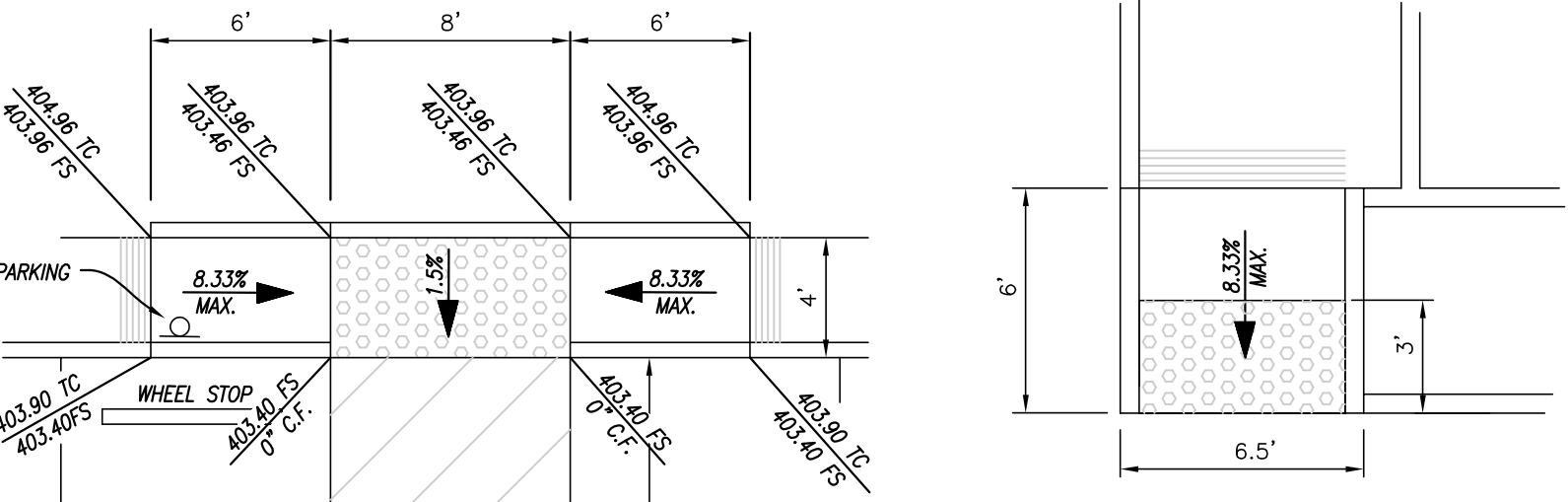

SECTION D-D
SCALE: 1"=2'

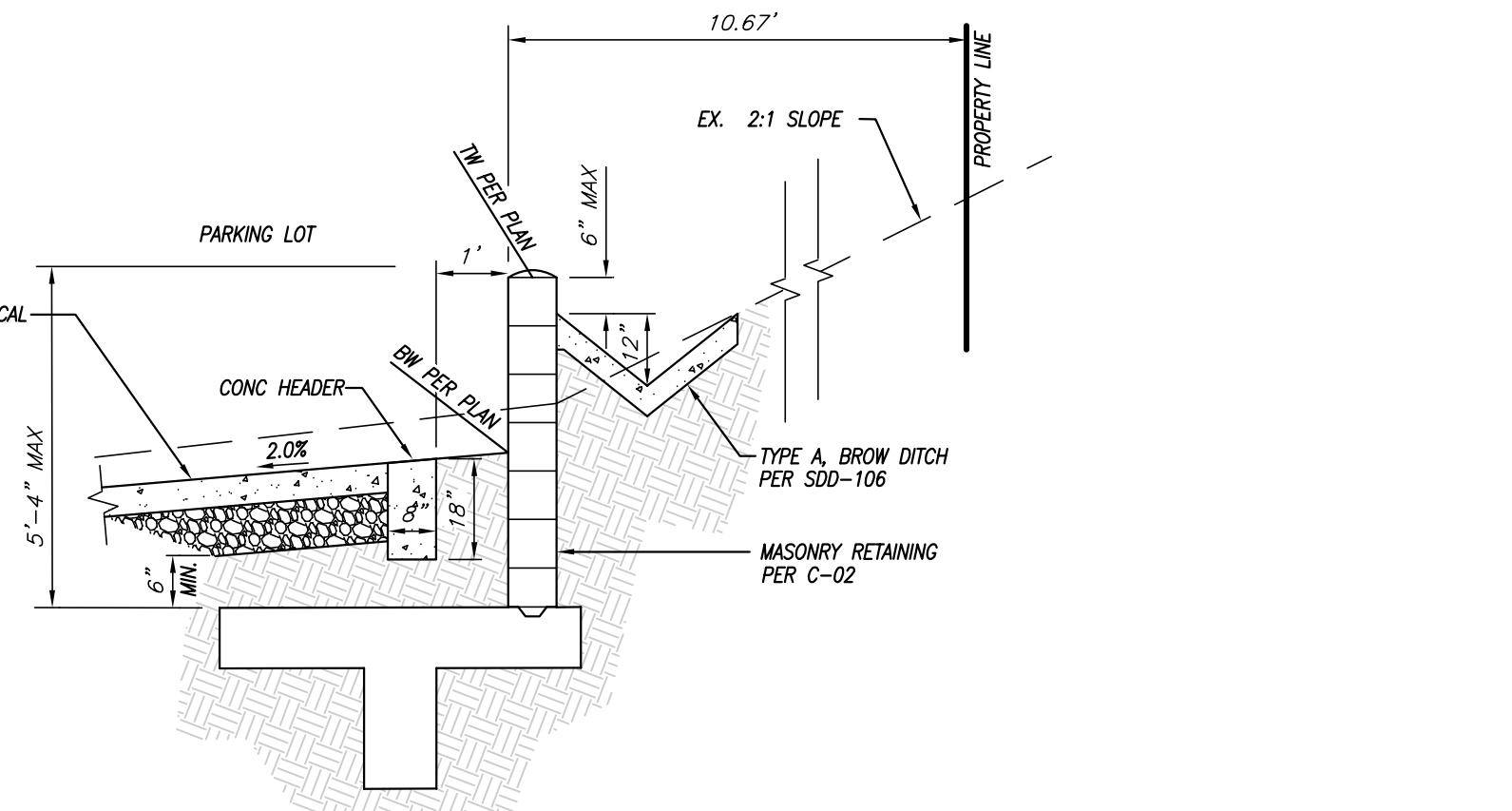

SECTION C-C
SCALE: 1"=2'

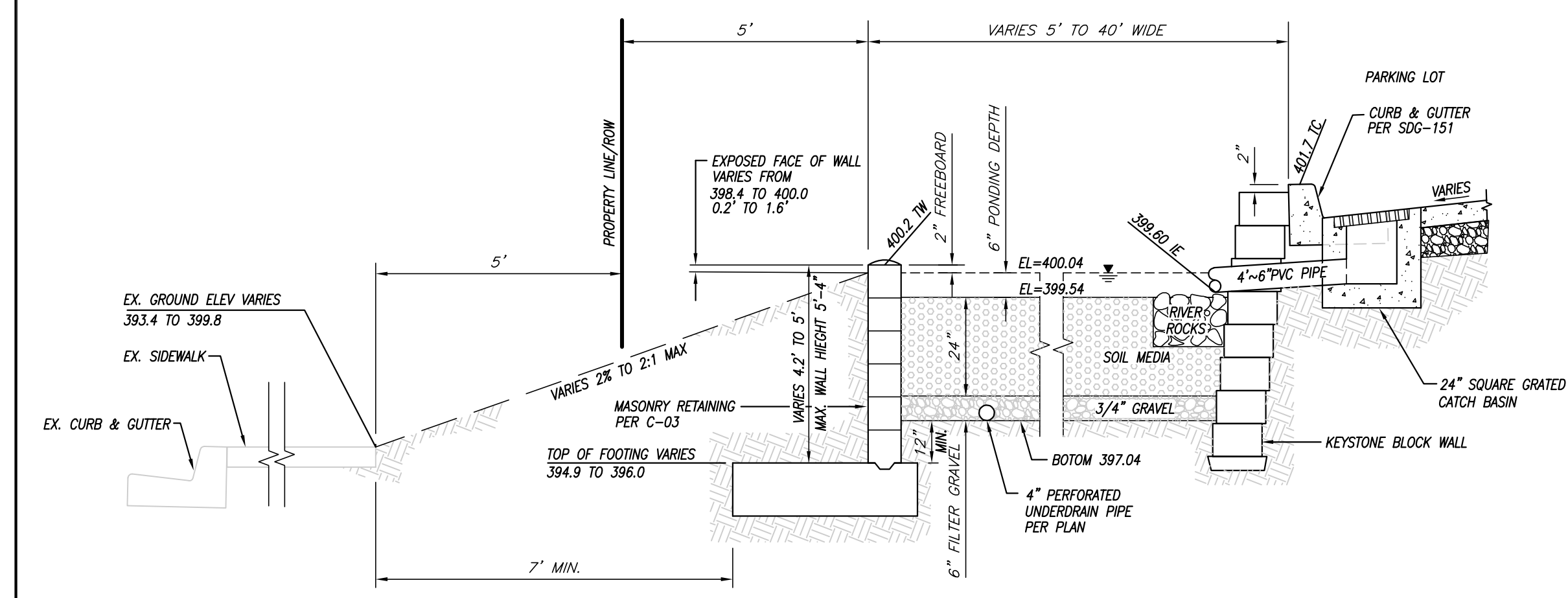

SECTION A-A BMP TREATMENT BASIN
SCALE: 1"=2'

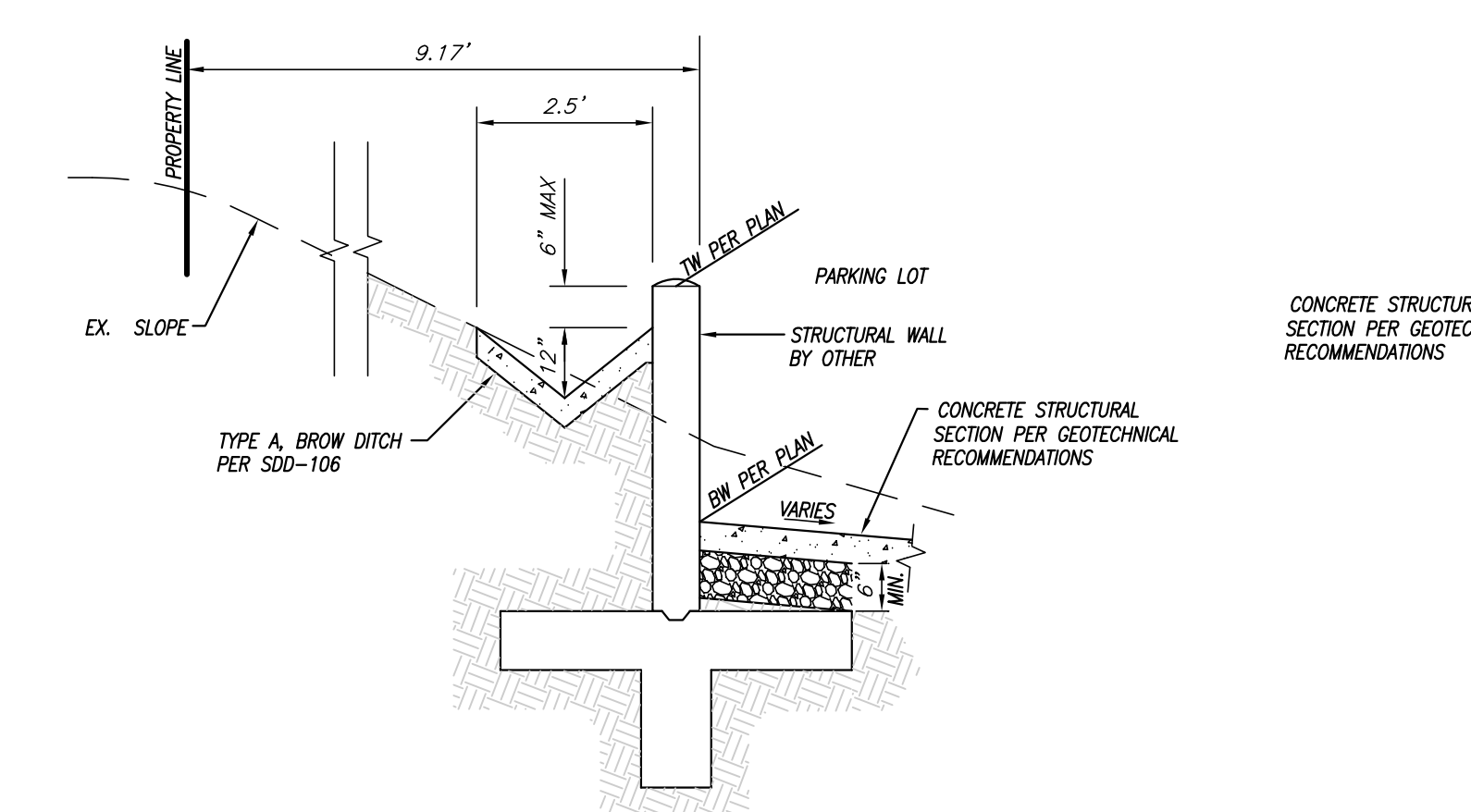

SECTION B-B
SCALE: 1"=2'

| REVISIONS | BY |
|-----------|---------|
| 1 | 5-14-21 |
| 2 | |
| 3 | |
| 4 | |
| 5 | |
| 6 | |
| 7 | |
| 8 | |
| 9 | |
| 10 | |
| 11 | |
| 12 | |
| 13 | |
| 14 | |
| 15 | |
| 16 | |

MANSOUR Architecture
6498 Weathers Place
San Diego, California 92121
858.566.1509
mansourarchitecture.com

SOUTHWEST SIGNAL
ROCKVILL ST
SANTEE CA 92071

PRELIMINARY DESIGN GRADING & DRAINAGE

Date: 7-30-21
Scale: NOTED
Drawn:
Approved:
Job: #2106 SOUTHWEST SIGNAL
Sheet: **C2**



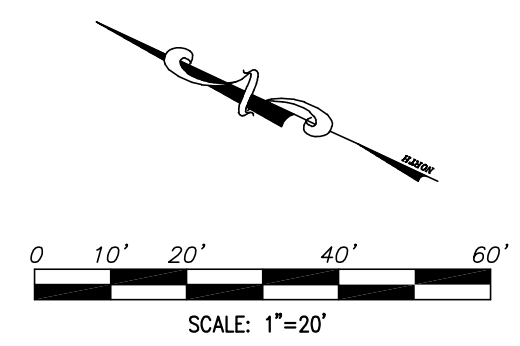

CONSTRUCTION KEYNOTES

- ① INSTALL RPOA
- ② INSTALL BACKFLOW PREVENTER

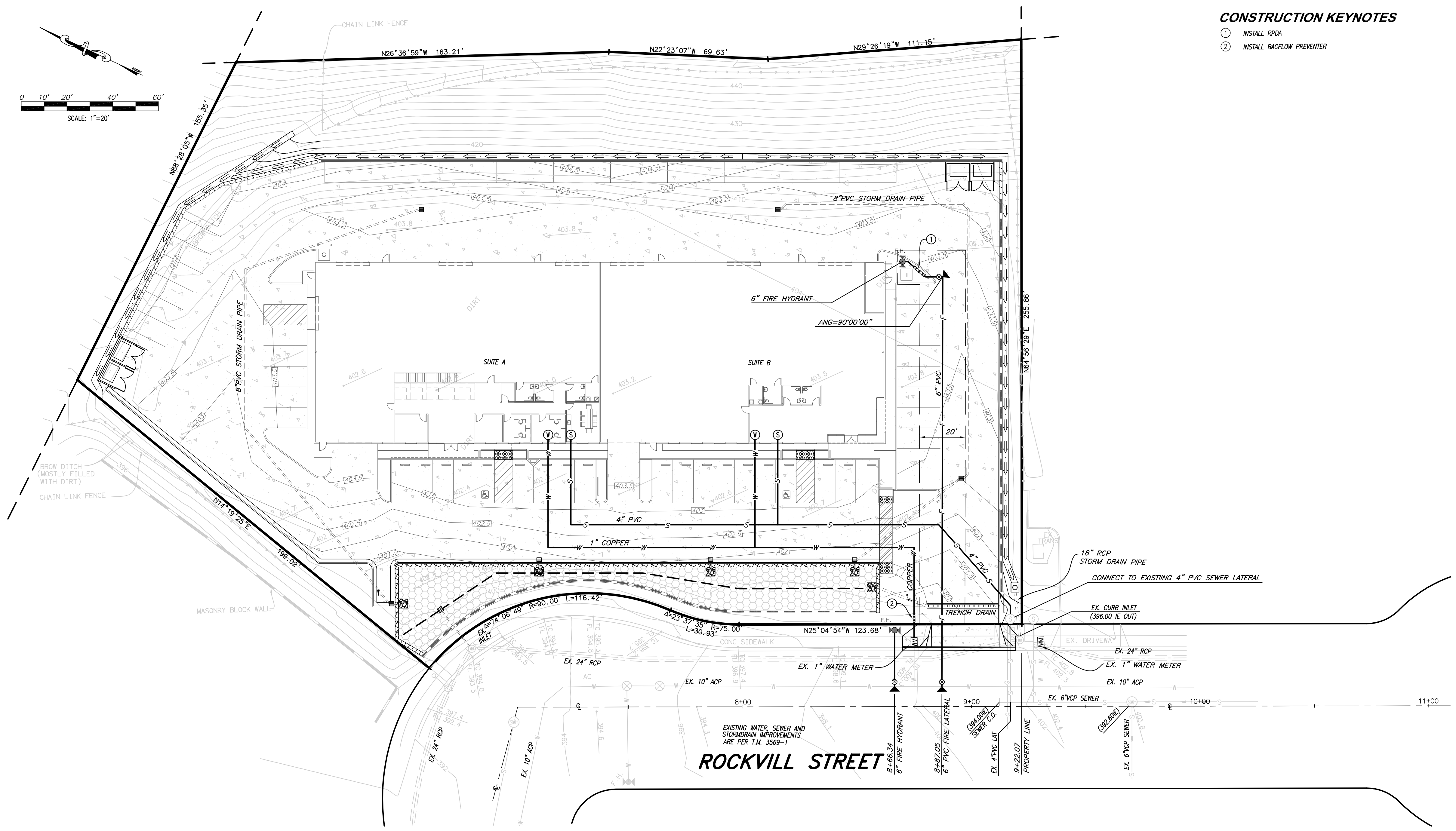

WATER AND SEWER IMPROVEMENTS

| REVISIONS | BY |
|-----------|----|
| 5-14-21 | |
| | |
| | |
| | |
| | |
| | |
| | |
| | |
| | |

MANSOUR
Architecture
6498 Weathers Place
Suite 100
San Diego, California 92121
858.566.1509
858.568.1509
mansourarchitecture.com

SOUTHWEST SIGNAL
ROCKVILL ST
SANTEE CA 92071

PRELIMINARY DESIGN
WATER AND SEWER

Date: 7-30-21
Scale: NOTED
Drawn:
Approved:
Job: #2106 SOUTHWEST SIGNAL
Sheet: **C3**
of 4 Sheets



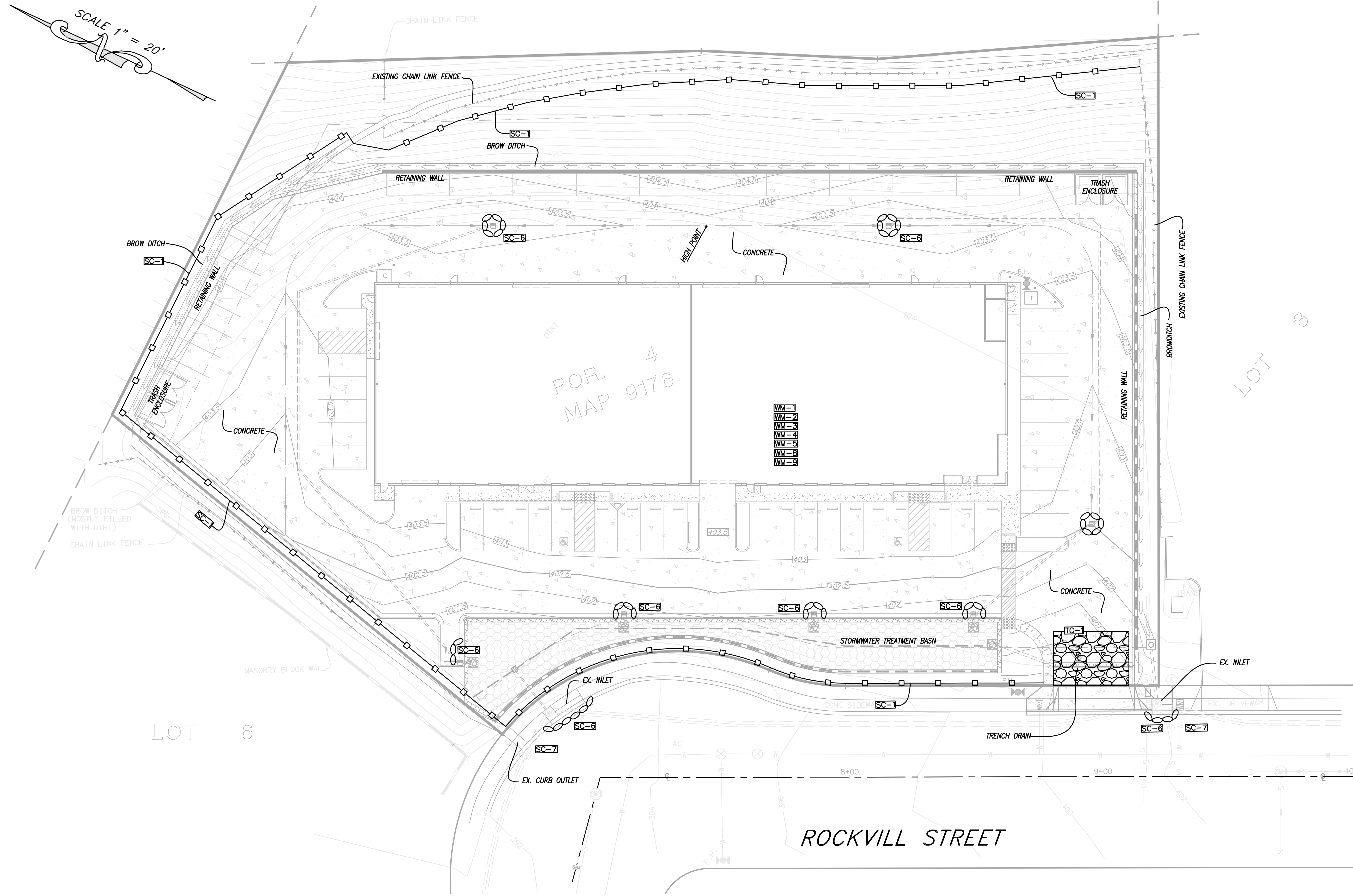

EROSION CONTROL SPECIFICATIONS

EROSION CONTROL PROTECTION DEVICES (BEST MANAGEMENT PRACTICES) ARE TO BE USED DURING CONSTRUCTION TO PREVENT SILTATION, EROSION AND OTHER STORMWATER RELATED POLLUTION FROM LEAVING THIS CONSTRUCTION SITE. THE FOLLOWING BMPs ARE TO BE USED FOR PROTECTION AGAINST STORMWATER POLLUTION.

EROSION CONTROL LEGEND

THE FOLLOWING EROSION CONTROL BMPs WILL BE USED ON THIS PROJECT, ALONG WITH ALL ELEMENTS OF THE PROJECT'S WATER POLLUTION CONTROL PLAN (WPCP).

| TEMPORARY BMP NAME | BMP DWG NO |
|---|------------|
| SOIL STABILIZATION | |
| SCHEDULING | SS-1 |
| TEMPORARY SOIL STABILIZATION | |
| SILT FENCE | SC-1 |
| GRAVEL BAGS | SC-2 |
| STREET SWEEPING | SC-7 |
| WIND EROSION CONTROL | |
| WIND EROSION CONTROL | WE-1 |
| TRACKING CONTROL | |
| STABILIZED CONSTRUCTION ENTRANCE / EXIT | TC-1 |
| STREET SWEEPING | SC-7 |
| NON-STORM WATER MANAGEMENT | |
| WATER CONSERVATION PRACTICES | NS-1 |
| ILLEGAL CONNECTION / ILLEGAL DISCHARGE DETECTION AND REPORTING | NS-2 |
| POTABLE WATER / IRRIGATION | NS-7 |
| CONCRETE CURING / TREATMENT | NS-12 |
| CONCRETE FINISHING | NS-14 |
| WASTE MANAGEMENT AND MATERIALS POLLUTION CONTROL | |
| MATERIAL DELIVERY AND STORAGE (NO LOCATION DESIGNATED YET) | WM-1 |
| MATERIAL USE (NO LOCATION DESIGNATED YET) | WM-2 |
| STOCKPILE MANAGEMENT (NO LOCATION DESIGNATED YET) | WM-3 |
| SPILL PREVENTION | WM-4 |
| SOLID WASTE MANAGEMENT (NO LOCATION DESIGNATED YET) | WM-5 |
| CONCRETE WASTE MANAGEMENT (NO LOCATION DESIGNATED YET) | WM-8 |
| SANITARY / SEPTIC WASTE MANAGEMENT (NO LOCATION DESIGNATED YET) | WM-9 |

EROSION CONTROL NOTES

- IN CASE EMERGENCY WORK IS REQUIRED, CONTACT: FRANK CHARLES COZZA, 9941 PROSPECT AVENUE, SANTEE, CA 92071
- EQUIPMENT AND WORKERS FOR EMERGENCY WORK SHALL BE MADE AVAILABLE AT ALL TIMES. ALL NECESSARY MATERIALS SHALL BE STOCKPILED ON SITE AT CONVENIENT LOCATIONS TO FACILITATE RAPID CONSTRUCTION OF TEMPORARY DEVICES WHEN RAIN IS IMMINENT.
- EROSION CONTROL DEVICES SHOWN ON PLANS SHALL NOT BE MOVED OR MODIFIED WITHOUT APPROVAL OF THE ENGINEERING INSPECTOR OR CITY STORM WATER COMPLIANCE INSPECTOR. THE CONTRACTOR SHALL RESTORE ALL EROSION CONTROL DEVICES TO THE WORKING ORDER DURING AND AFTER EACH RUN-OFF PRODUCING RAINFALL.
- EROSION AND SEDIMENT CONTROL DEVICES SHALL BE INSTALLED AND MAINTAINED TO THE SATISFACTION OF THE CITY ENGINEER OR CITY STORM WATER COMPLIANCE INSPECTOR. MAINTENANCE SHALL INCLUDE REMOVAL OF SILT FROM BARRIERS AND SEDIMENTATION DEVICES, SEEDING OR MULCHING OF DAMAGED STABILIZED AREAS AND REPLACEMENT OR REPAIR OF WORN OR DAMAGED GEOTEXTILE FABRIC.
- ALL EROSION CONTROL DEVICES PROVIDED PER THE APPROVED GRADING PLAN SHALL BE INCORPORATED HEREON. THE CONTRACTOR SHALL INSTALL ADDITIONAL EROSION CONTROL MEASURES AS MAY BE REQUIRED BY THE ENGINEERING CONSTRUCTION INSPECTOR OR CITY STORM WATER COMPLIANCE INSPECTOR.
- ALL REMOVABLE PROTECTIVE DEVICES SHOWN SHALL BE IN PLACE AT THE END OF EACH WORKING DAY WHEN THERE IS A FIFTY PERCENT (50%) CHANCE OF RAIN WITHIN A FORTY-EIGHT (48) HOUR PERIOD. SILT AND DEBRIS SHALL BE REMOVED AFTER EACH RAINFALL.
- DURING THE RAINY SEASON THE AMOUNT OF EXPOSED SOIL ALLOWED AT ONE TIME SHALL NOT EXCEED THAT WHICH CAN BE ADEQUATELY PROTECTED IN THE EVENT OF A RAINSTORM. ADDITIONAL SUPPLIES NEEDED FOR BMP MEASURES SHALL BE RETAINED ON THE JOB SITE IN A MANNER THAT ALLOWS FULL DEPLOYMENT AND COMPLETE INSTALLATION IN FORTY EIGHT (48) HOURS OR LESS OF A FORECASTED RAIN.
- ALL BARE SLOPES AND DISTURBED AREAS SHALL BE PLANTED AS EACH STAGE OF GRADING IS COMPLETE. SUITABLE MEASURES TO PREVENT SLOPE EROSION, INCLUDING, BUT NOT LIMITED TO, RAPID GROWING VEGETATION SUFFICIENT TO STABILIZE THE SOILS SHOULD BE INSTALLED ON ALL AREAS, AND/OR SUCH AREAS SHOULD BE MULCHED, WHILE THE PERMANENT VEGETATION COVERS MATURES ENOUGH TO PROVIDE STABILITY.
- ANY EXPOSED SOIL, INCLUDING SOIL STOCKPILES, THAT WILL NOT BE DISTURBED FOR FOURTEEN (14) DAYS OR MORE SHALL BE FULLY PROTECTED FROM EROSION UNTIL ADEQUATE LONG-TERM PROTECTIONS ARE INSTALLED. ALL EROSION CONTROL MEASURES SHALL REMAIN INSTALLED AND MAINTAINED DURING ANY INACTIVE PERIOD.
- ANY SLOPES WITH DISTURBED SOILS OR DENUDED OF VEGETATION MUST BE STABILIZED SO AS TO INHIBIT EROSION BY WIND AND WATER.
- PROVIDE VELOCITY CHECK DAMS IN ALL UNPAVED GRADED CHANNELS AND ALONG THE GUTTER OF PAVED STREET AREAS. VELOCITY CHECK DAMS MAY BE CONSTRUCTED OF GRAVEL BAGS, TIMBER, OR OTHER MATERIAL APPROVED BY THE CITY ENGINEER. VELOCITY CHECK DAMS MAY ALSO SERVE AS SEDIMENT TRAPS. CHECK DAMS WILL BE INSTALLED PER THE FOLLOWING:
GRADE OF THE CHANNEL/STREET:
LESS THAN 3% 100 FEET
3% TO 6% 50 FEET
OVER 6% 25 FEET
- PROVIDE GRAVEL BAG, SILT BASIN, OR TRAP OR OTHER APPROVED DEVICE BY EVERY STORM DRAIN INLET TO PREVENT SEDIMENT FROM ENTERING THE STORM DRAIN SYSTEM. CHECK DAMS SHALL BE INSTALLED IN THE STREET GUTTER UPSTREAM OF CURB INLETS IN ACCORDANCE TO THE SPACING PROVIDED ABOVE, AT MINIMUM.
- GRADED AREAS AROUND THE PROJECT PERIMETER MUST DRAIN AWAY FROM THE FACE OF SLOPE AT THE CONCLUSION OF EACH WORKING DAY.
- ALL GRAVEL BAGS SHALL BE BURLAP TYPE WITH 0.5 TO 1 INCH CRUSHED ROCK.
- CONSTRUCTION DEBRIS AND SEDIMENT ON THE STREET AND GUTTER SHALL BE SWEEPED OR VACUUMED AND DISPOSED OF PROPERLY AT CLOSE OF BUSINESS EACH DAY. FREQUENCY SHALL BE INCREASED IF DEBRIS AND SEDIMENT ARE NOTICABLE WITHIN THE TRAVELLED WAY.
- TRASH AND CONSTRUCTION RELATED SOLID WASTES SHALL BE DEPOSITED INTO A COVERED RECEPTACLE OR COVERED AND CONTAINED TO PREVENT CONTAMINATION OF RAINWATER AND DISPERSAL BY WIND.
- CONSTRUCTION MATERIALS SHALL BE STORED IN STAGING AREAS ON-SITE UNTIL NEEDED FOR INSTALLATION. WASTE WILL EITHER BE PLACED IN DUMPSTERS OR IN WASTE MANAGEMENT AREAS. ALL WASTE SHALL BE TRANSPORTED OFF-SITE IN A TIMELY MANNER TO APPROVED WASTE DISPOSAL AREAS (DUMPS). STORAGE, HANDLING AND TRANSPORTATION OF WASTE SHALL BE IN ACCORDANCE WITH ALL FEDERAL, STATE, AND LOCAL LAWS.
- CONSTRUCTION MATERIAL SHALL BE STORED IN DESIGNATED AREA WITH APPROPRIATE CONTAINMENT MEASURES. WASTE PILES THAT ARE NOT IN USE AND INACTIVE STOCKPILES SHALL BE PROTECTED. THE CONTRACTOR SHALL STORE THE MATERIALS AS TO MINIMIZE THE RISK OF STORM WATER POLLUTION, GROUND WATER POLLUTION, SOIL CONTAMINATION, AND INJURY TO WORKERS AND VISITORS.
- EQUIPMENT TO BE STORED, FUELED AND MAINTAINED ON SITE SHALL BE KEPT AWAY FROM ANY DRAINAGE COURSES. CONTRACTOR SHALL USE A DRAINAGE PAN OR DROP CLOTH TO CATCH ANY LEAKS OR SPLILLS AT A MINIMUM.
- MATERIAL OR DEBRIS RESULTING FROM CONSTRUCTION ACTIVITIES (I.E. SAW CUTTING, CONCRETE/ASPHALT GRINDING, ETC.) SHALL BE RECLAIMED AND DISPOSED OF APPROPRIATELY.
- THE TOPS OF ALL SLOPES SHALL BE DIKED OR TRENCHED TO PREVENT WATER FROM FLOWING OVER THE CREST OF SLOPES.

| REVISIONS | BY |
|-----------|----|
| 1 | |
| 2 | |
| 3 | |
| 4 | |
| 5 | |
| 6 | |
| 7 | |
| 8 | |
| 9 | |
| 10 | |
| 11 | |
| 12 | |
| 13 | |
| 14 | |
| 15 | |
| 16 | |
| 17 | |
| 18 | |
| 19 | |
| 20 | |
| 21 | |

MANSOUR Architecture
 6498 Weathers Place, Suite 100
 San Diego, California 92121
 858-568-1509 fax 858-568-9221
 mansourarchitecture.com

SOUTHWEST SIGNAL
 ROCKVILL ST.
 SANTEE CA 92071

PRELIMINARY DESIGN
 EROSION CONTROL

| | |
|-------------|------------------------|
| Date: | 7-30-21 |
| Scale: | NOTED |
| Drawn: | |
| Approved: | |
| Job: | #2106 SOUTHWEST SIGNAL |
| Sheet: | C4 |
| Of 4 Sheets | |

CELEBRATING 40 YEARS
 1979 - 2019
KAPPA SURVEYING & ENGINEERING, INC.
 8402 N. MAGNOLIA AVE., SUITE C, SANTEE, CA 92071 (619) 465-8948 FAX: (619) 465-6410