

WCP DEVELOPERS, LLC – 280-LOT RESIDENTIAL SUBDIVISION (LEMOORE, CA)

Tentative Tract Map No. 939

Major Site Plan Review No. 2022-02

Planned Unit Development No. 2022-01

INITIAL STUDY / MITIGATED NEGATIVE DECLARATION

*Initial Study prepared in accordance with the
California Environmental Quality Act (CEQA) Guidelines*

Prepared for

City of Lemoore
Community Development Department
711 West Cinnamon Drive
Lemoore, CA 93245

Prepared by

Precision Civil Engineering, Inc.
1234 O Street
Fresno, CA 93721

August 2023





Table of Contents

1	INTRODUCTION	7
1.1	Regulatory Information	7
1.2	Document Format	8
2	ENVIRONMENTAL CHECKLIST FORM	9
2.1	Project Title	9
2.2	Lead Agency Name and Address	9
2.3	Contact Person and Phone Number	9
2.4	Initial Study Prepared By	9
2.5	Project Location	9
2.6	Latitude and Longitude	9
2.7	General Plan Designation	12
2.8	Zoning	12
2.9	Description of Project	15
2.10	Surrounding Land Uses	18
2.11	Required Project Approvals	18
2.12	Technical Studies	19
2.13	Consultation with California Native American Tribes	20
3	DETERMINATION	21
3.1	Environmental Factors Potentially Affected	21
3.2	Determination	21
4	EVALUATION OF ENVIRONMENTAL IMPACTS	23
4.1	AESTHETICS	23
4.1.1	Environmental Setting	23
4.1.2	Impact Assessment	27
4.1.3	Mitigation Measures	28
4.2	AGRICULTURE AND FORESTRY RESOURCES	29
4.2.1	Environmental Setting	29
4.2.2	Impact Assessment	32
4.2.3	Mitigation Measures	33



4.3 AIR QUALITY 34

 4.3.1 Environmental Setting 34

 4.3.2 Impact Assessment 38

 4.3.3 Mitigation Measures 45

4.4 BIOLOGICAL RESOURCES 46

 4.4.1 Environmental Setting 47

 4.4.2 Impact Assessment 47

 4.4.3 Mitigation Measures 53

4.5 CULTURAL RESOURCES 54

 4.5.1 Environmental Setting 54

 4.5.2 Impact Assessment 55

 4.5.3 Mitigation Measures 57

4.6 ENERGY 58

 4.6.1 Environmental Setting 58

 4.6.2 Impact Assessment 59

 4.6.3 Mitigation Measures 61

4.7 GEOLOGY AND SOILS 62

 4.7.1 Environmental Setting 63

 4.7.2 Impact Assessment 65

 4.7.3 Mitigation Measures 67

4.8 GREENHOUSE GAS EMISSIONS 68

 4.8.1 Environmental Setting 68

 4.8.2 Impact Assessment 69

 4.8.3 Mitigation Measures 79

4.9 HAZARDOUS AND HAZARDOUS MATERIAL 80

 4.9.1 Environmental Setting 80

 4.9.2 Impact Assessment 83

 4.9.3 Mitigation Measures 85

4.10 HYDROLOGY AND WATER QUALITY 86

 4.10.1 Environmental Setting 87



4.10.2	Impact Assessment	87
4.10.3	Mitigation Measures	91
4.11	LAND USE PLANNING	92
4.11.1	Environmental Setting	92
4.11.2	Impact Assessment	92
4.11.3	Mitigation Measures	94
4.12	MINERAL RESOURCES	95
4.12.1	Environmental Setting	95
4.12.2	Impact Assessment	95
4.12.3	Mitigation Measures	96
4.13	NOISE	97
4.13.1	Environmental Setting	97
4.13.2	Impact Assessment	102
4.13.3	Mitigation Measures	104
4.14	POPULATION AND HOUSING	105
4.14.1	Environmental Setting	105
4.14.2	Impact Assessment	105
4.14.3	Mitigation Measures	106
4.15	PUBLIC SERVICES	107
4.15.1	Environmental Setting	107
4.15.2	Impact Assessment	108
4.15.3	Mitigation Measures	109
4.16	RECREATION	110
4.16.1	Environmental Setting	110
4.16.2	Impact Assessment	111
4.16.3	Mitigation Measures	111
4.17	TRANSPORTATION	112
4.17.1	Environmental Setting	112
4.17.2	Impact Assessment	118
4.17.3	Mitigation Measures	121



4.18	TRIBAL CULTURAL RESOURCES	123
4.18.1	Environmental Setting	123
4.18.2	Impact Assessment	123
4.18.3	Mitigation Measures	124
4.19	UTILITIES AND SERVICE SYSTEMS.....	125
4.19.1	Environmental Setting	125
4.19.2	Impact Assessment	127
4.19.3	Mitigation Measures	129
4.20	WILDFIRE.....	130
4.20.1	Environmental Setting	130
4.20.2	Impact Assessment	131
4.20.3	Mitigation Measures	131
4.21	MANDATORY FINDINGS OF SIGNIFICANCE	132
4.21.1	Impact Assessment	132
5	MITIGATION MONITORING AND REPORTING PROGRAM.....	134
6	REPORT PREPARATION	147
7	APPENDICES	148
7.1	Appendix A: Air Quality and Greenhouse Gas Analysis Technical Memorandum	148
7.2	Appendix B: Biological Resource Assessment	149
7.3	Appendix C: Cultural Resource Assessment and NAHC Correspondence	151
7.4	Appendix D: Acoustical Analysis.....	152
7.5	Appendix E: Traffic Impact Analysis	153

Figures

Figure 2-1	Regional Location Map of Project Site	10
Figure 2-2	Vicinity Map of Project Site.....	11
Figure 2-3	City of Lemoore General Plan Land Use Designation Map.....	13
Figure 2-4	City of Lemoore Zone District Map	14
Figure 2-5	Tentative Tract Map No. 939 (Proposed).....	17
Figure 4-1	Farmland Mapping and Monitoring Program, Project Site Land Classifications	31



Tables

Table 2-1 Existing Uses, General Plan Designations, and Zone Districts of Surrounding Properties	18
Table 2-2 Proposed Standards Pursuant to LMC Section 9-5A-4 for RLD Zone District	19
Table 4-1 Summary of Construction-Generated Emissions of Criteria Air Pollutants - Unmitigated	38
Table 4-2 Summary of Operational Emissions of Criteria Air Pollutants - Unmitigated	39
Table 4-3 Localized Concentrations of PM10, PM2.5, CO, and NOX for Construction.....	39
Table 4-4 Localized Concentrations of PM10, PM2.5, CO, and NOx for Operations.....	40
Table 4-5 Summary of Health Impacts from Unmitigated Construction of the Proposed Project.....	42
Table 4-6 Prioritization Tool Health Risk Screening Results	43
Table 4-7 Project Energy Consumption.....	60
Table 4-8 Summary of Construction-Generated GHG Emissions	69
Table 4-9 Unmitigated Project Operational GHG Emissions (Buildout Scenario).....	71
Table 4-10 Unmitigated Project Operational GHG Emissions (Year 2030 Scenario)	72
Table 4-11 Consistency with SB 32 2017 Scoping Plan Update.....	75
Table 4-12: 2022 Scoping Plan Consistency Analysis	77
Table 4-13 Discussion on Land Use Policies in the General Plan.....	93
Table 4-14 Traffic Impact Analysis	119



1 INTRODUCTION

Precision Civil Engineering, Inc. (PCE) has prepared this Initial Study/Mitigated Negative Declaration (IS/MND) on behalf of City of Lemoore (City) to address the environmental effects of the proposed 280-Lot Residential Subdivision (Tentative Tract Map No. 939, Major Site Plan Review No. 2022-02, and Planned Unit Development No. 2022-01) (Project). This document has been prepared in accordance with the California Environmental Quality Act (CEQA), Public Resources Code Section 21000 et. seq. The City of Lemoore (City) is the Lead Agency for this proposed Project. The site and the proposed Project are described in detail in **SECTION Error! Reference source not found. PROJECT DESCRIPTION.**

1.1 Regulatory Information

An Initial Study (IS) is a document prepared by a lead agency to determine whether a project may have a significant effect on the environment. In accordance with California Code of Regulations Title 14 (Chapter 3, Section 15000, et seq.), also known as the CEQA Guidelines, Section 15064 (a)(1) states that an environmental impact report (EIR) must be prepared if there is substantial evidence in light of the whole record that the proposed Project under review may have a significant effect on the environment and should be further analyzed to determine mitigation measures or project alternatives that might avoid or reduce project impacts to less than significant levels. A negative declaration (ND) may be prepared instead if the lead agency finds that there is no substantial evidence in light of the whole record that the project may have a significant effect on the environment. An ND is a written statement describing the reasons why a proposed Project, not otherwise exempt from CEQA, would not have a significant effect on the environment and, therefore, why it would not require the preparation of an EIR (CEQA Guidelines Section 15371). According to CEQA Guidelines Section 15070, a ND or mitigated ND shall be prepared for a project subject to CEQA when either:

- a. *The IS shows there is no substantial evidence, in light of the whole record before the agency, that the proposed Project may have a significant effect on the environment, or*
- b. *The IS identified potentially significant effects, but:*
 1. *Revisions in the project plans or proposals made by or agreed to by the applicant before the proposed MND and IS is released for public review would avoid the effects or mitigate the effects to a point where clearly no significant effects would occur is prepared, and*
 2. *There is no substantial evidence, in light of the whole record before the agency, that the proposed Project as revised may have a significant effect on the environment.*

1.2 Document Format

This IS/MND contains five chapters plus appendices. **SECTION 1 INTRODUCTION** provides bases of the IS/MND's regulatory information and an overview of the proposed Project. **SECTION Error! Reference source not found. Error! Reference source not found.** provides a detailed description of proposed Project components. **SECTION 3 DETERMINATION** concludes that the Initial Study is a mitigated negative declaration, identifies the environmental factors potentially affected based on the analyses contained in this IS, and includes with the Lead Agency's determination based upon those analyses. **SECTION 4 EVALUATION OF ENVIRONMENTAL IMPACTS** presents the CEQA checklist and environmental analyses for all impact areas and the mandatory findings of significance. A brief discussion of the reasons why the Project impact is anticipated to be potentially significant, less than significant with mitigation incorporated, less than significant, or why no impacts are expected is included. **SECTION 5 MITIGATION MONITORING AND REPORTING PROGRAM** presents the mitigation measures recommended in the IS/MND for the Project. The Air Quality/Greenhouse Gas Analysis Technical Memorandum- **Appendix A**, Biological Resource Assessment- **Appendix B**, Cultural Resource Assessment and NAHC Correspondence- **Appendix C**, Acoustical Analysis **Appendix D**, and a Traffic Impact Analysis- **Appendix E** are provided at the end of this document.

2 ENVIRONMENTAL CHECKLIST FORM

This section describes the components of the proposed Project in more detail, including project location, project objectives, and required project approvals.

2.1 Project Title

WCP Developers, LLC 280-Lot Residential Subdivision (Tentative Tract Map No. 939, Major Site Plan Review No. 2022-02, and Planned Unit Development No. 2022-01)

2.2 Lead Agency Name and Address

City of Lemoore
Community Development Department
711 W. Cinnamon Drive
Lemoore, CA 93245

2.3 Contact Person and Phone Number

Lead Agency

City of Lemoore
Community Development Department
Attn. Steve Brandt, City Planner
(559) 924-6744

Applicant

WCP Developers, LLC
2505 Alluvial Avenue
Clovis, CA 93611
Attn. Eric Gibbons
(559) 432-8181

2.4 Initial Study Prepared By

Precision Civil Engineering
1234 O Street
Fresno, CA 93721

2.5 Project Location

The Project site is within the jurisdiction of the City of Lemoore, Kings County, California (see [Figure 2-1](#)). The site is located on the west side of Madrid Drive between East Bush Street and State Route (SR)-198 at 488 East Bush Street, Lemoore, CA 93245 (see [Figure 2-2](#)). The site consists of one (1) parcel identified by the Kings County Assessor as Assessor's Parcel Number (APN) 023-040-058 totaling approximately 54.11 acres (gross). The site is a portion of Section 11, Township 19 South, Range 20 East, Mount Diablo Base and Meridian.

2.6 Latitude and Longitude

The centroid of the Project area is 36.29448525667421, -119.7735828979695.

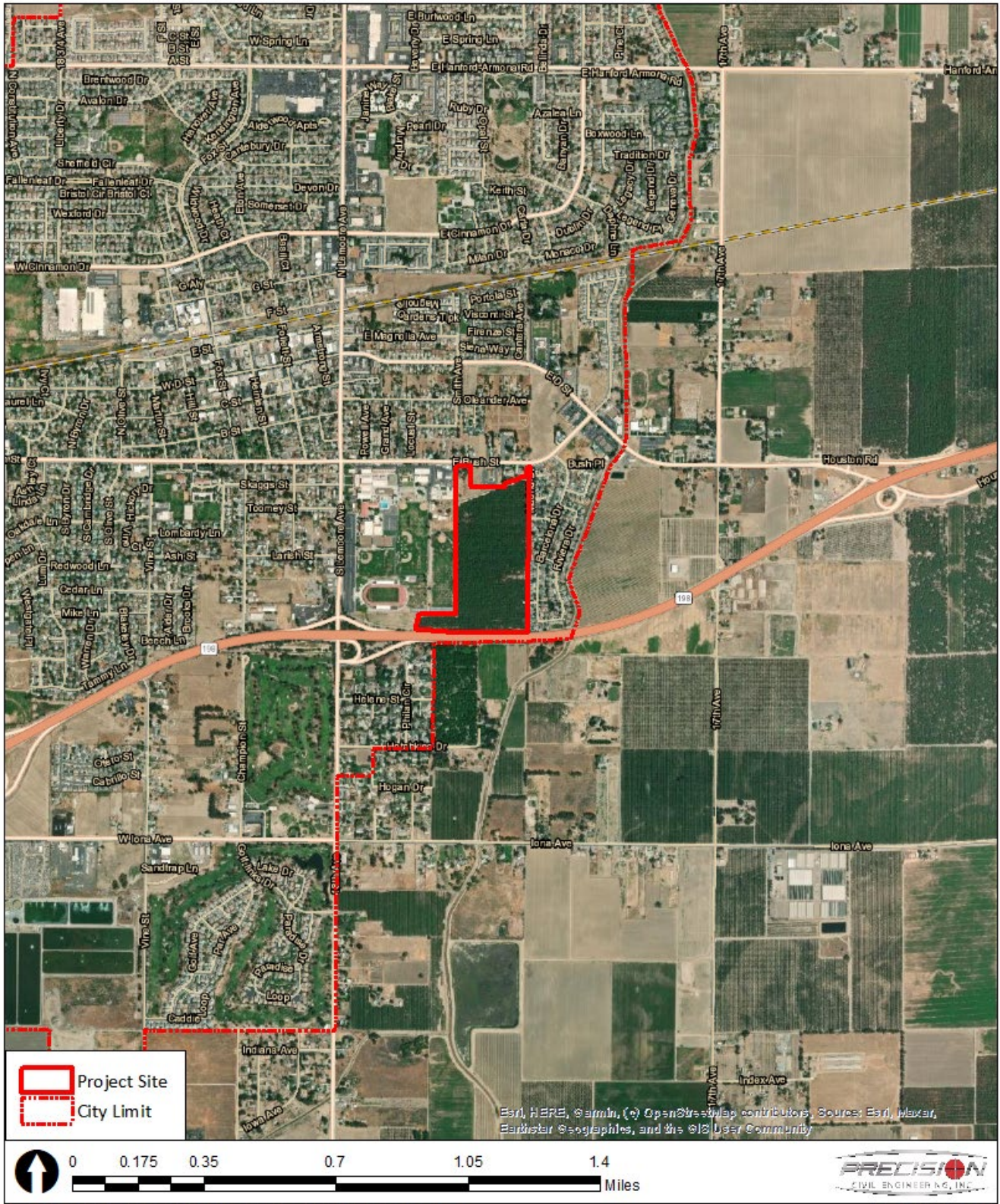

CITY OF LEMOORE - WATHEN CASTANOS HOMES RESIDENTIAL SUBDIVISION
INITIAL STUDY

CREATED 4/12/2023

Figure 2-1 Regional Location Map of Project Site

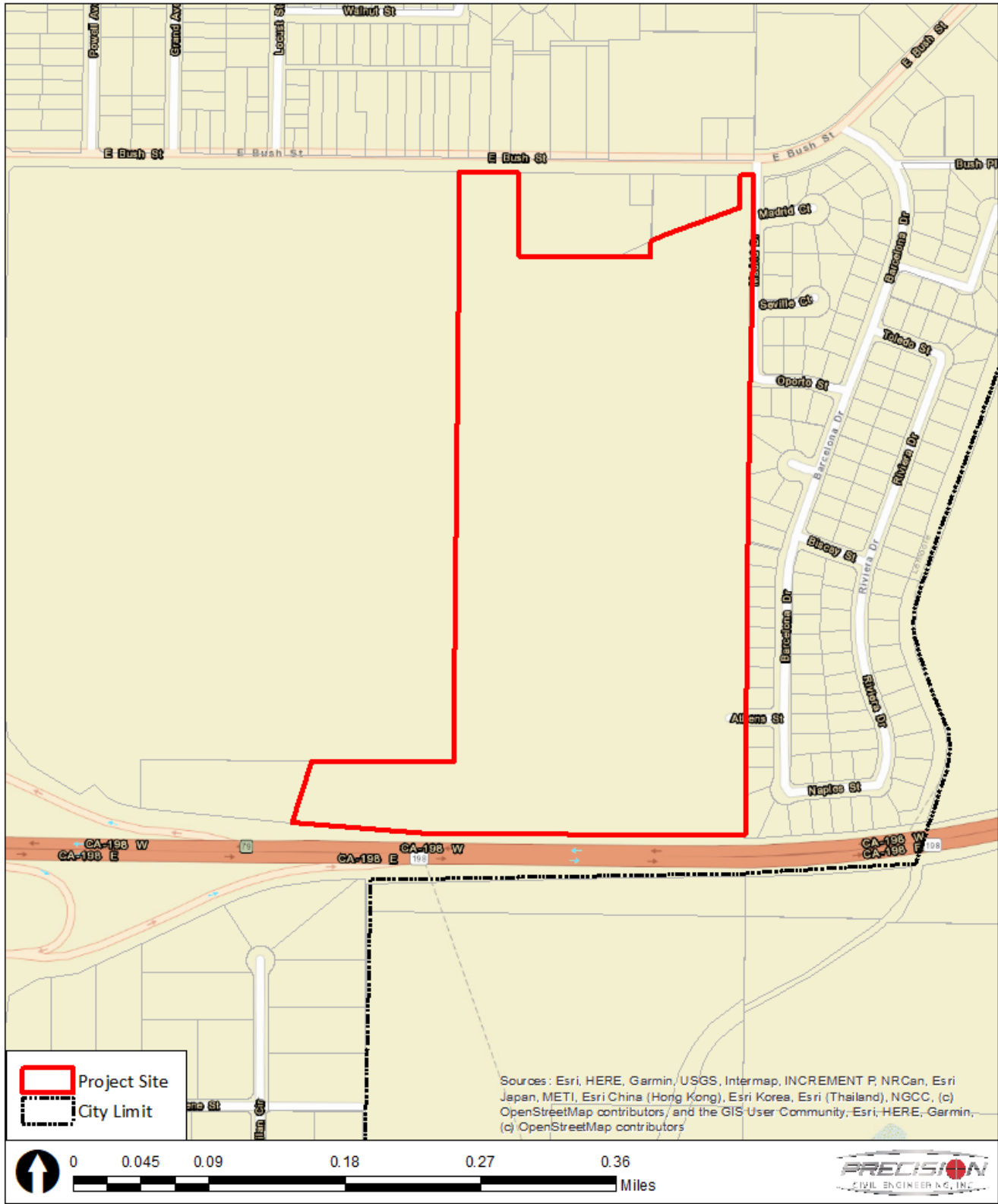

CITY OF LEMOORE - WATHEN CASTANOS HOMES RESIDENTIAL SUBDIVISION
 INITIAL STUDY

CREATED 4/12/2023

Figure 2-2 Vicinity Map of Project Site

2.7 General Plan Designation

The Project site has a Lemoore General Plan land use designation of Low Density Single Family Residential, Parks & Recreation, and Greenway/Detention Basin (see [Figure 2-3](#) *Error! Reference source not found.*). The Low Density Single Family Residential land use designation accounts for a majority of the site, with approximately 3.54 acres designated for Parks & Recreation and Greenway/Detention Basin. No land use change is proposed.

According to the Lemoore General Plan, the residential density for the Low Density Single Family Residential land use designation is typical of a single-family residential subdivision and range from 3 to 7 units per gross acre. Lot sizes within this designation range from 7,000 to 15,000 square feet (sf.). The Project proposes 280 residential lots with a residential density of 6.05 dwelling units (du) per acre.

The Parks & Recreation land use designation is intended for improved and unimproved park facilities, including neighborhood, community, and regional parks; public golf courses; and recreational facilities that provide visual open space and serve the outdoor recreational needs of the community. The Project proposes approximately 154,207 square feet (or 3.54 acres) of park/trail area.

The Greenway/Detention Basin land use designation includes greenspace that acts as a visual buffer between new residential and the freeway and railroad; it also provides stormwater ponding capacity. The Project proposes an onsite drainage basin identified as Outlot F – “Basin” (133,162 sf. or 2.03 acres) located along the southern site boundary between the residential uses and SR-198.

2.8 Zoning

The Project site is in the RLD – Low Density Residential and PR – Parks and Recreation/Ponding Basin Zone Districts (see [Figure 2-4](#)). The City Municipal Code (LMC) allows residential uses, such as single-family dwellings, caretaker housing, employee housing, residential care facilities, supportive housing, and transitional housing in the RLD zone district. Other permitted uses include parks and public plazas, public schools, utility infrastructure, etc. No zone change is proposed.

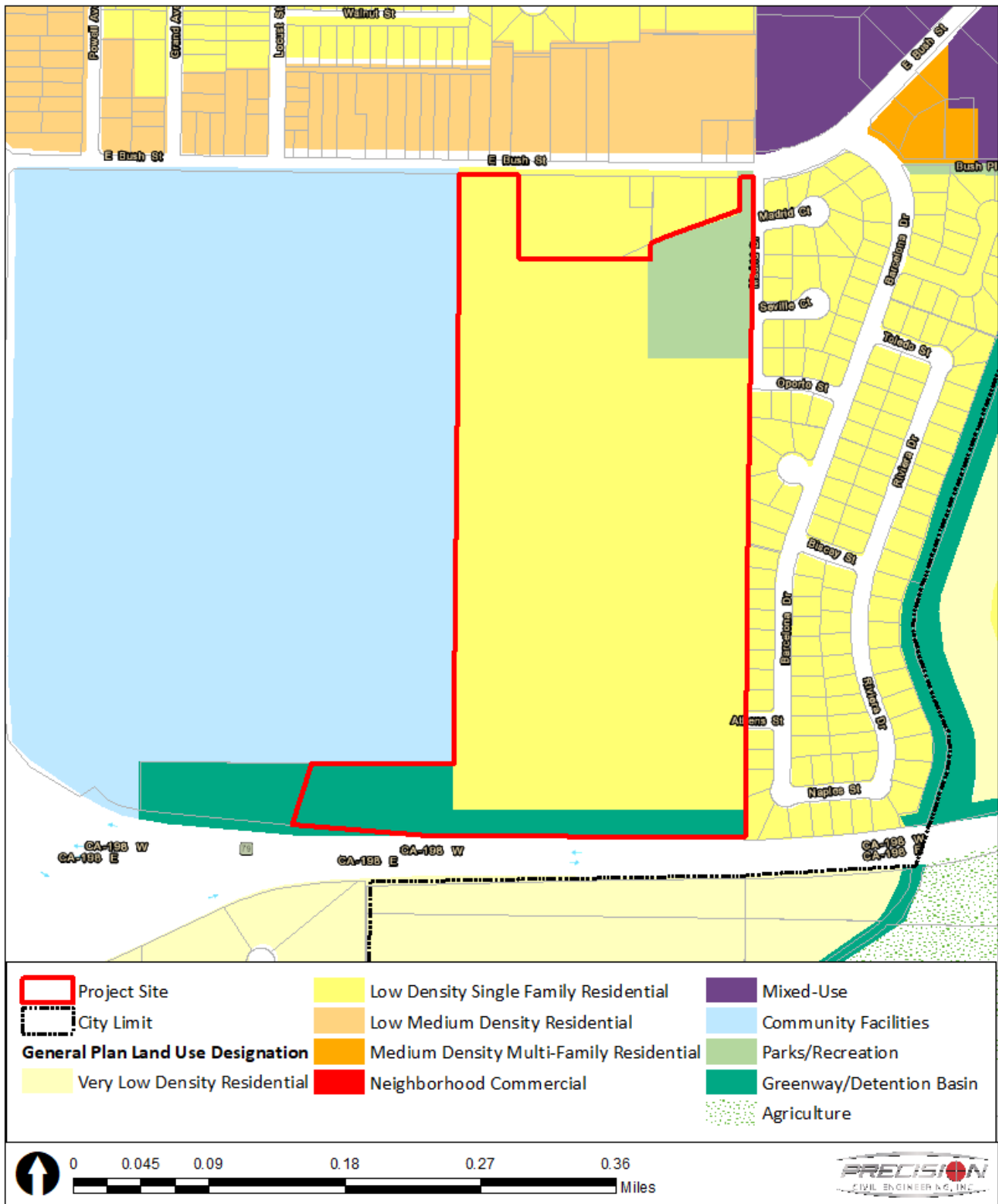

Figure 2-3 City of Lemoore General Plan Land Use Designation Map

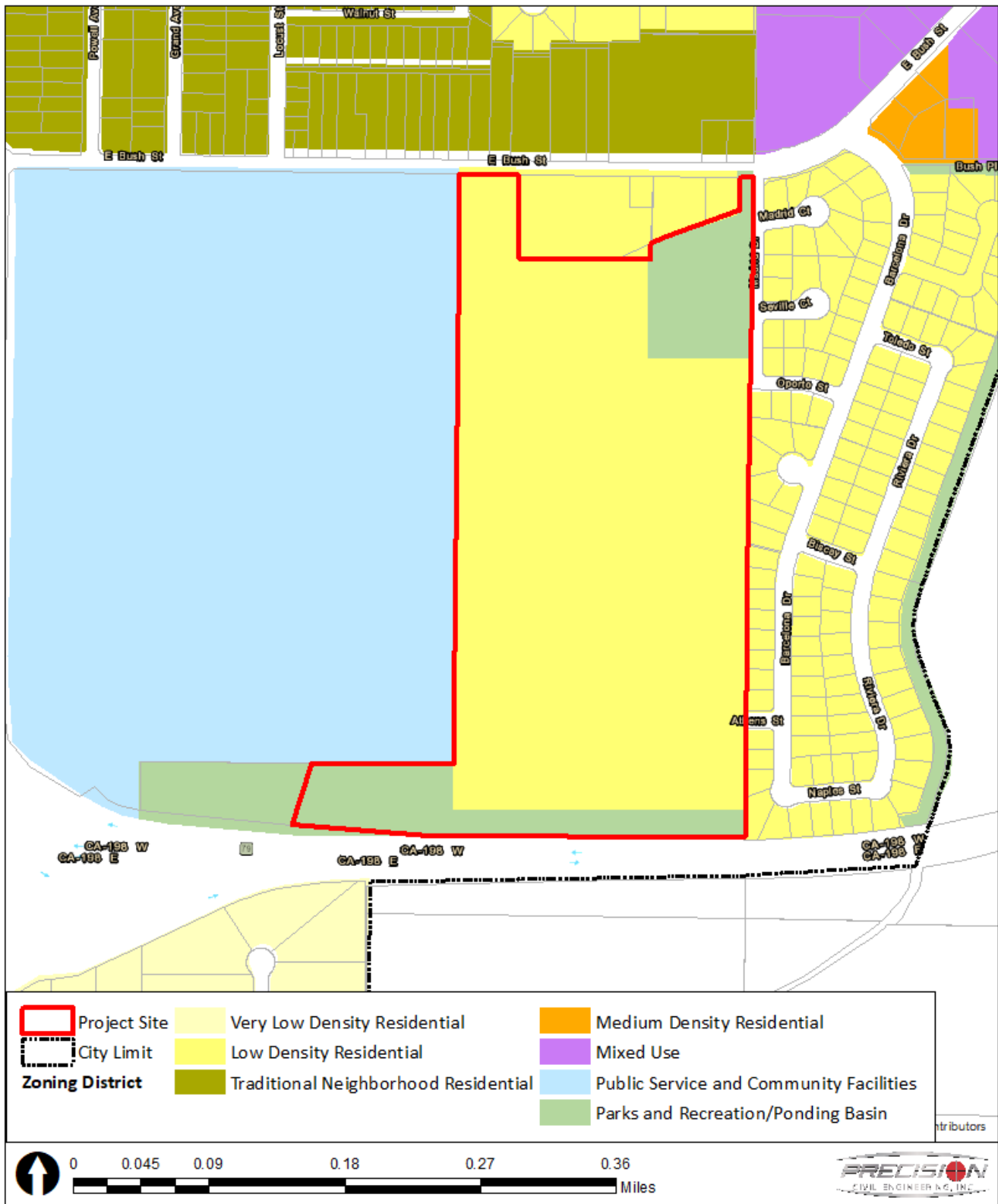

Figure 2-4 City of Lemoore Zone District Map

2.9 Description of Project

WCP Developers, LLC (Applicant/Property Owner) proposes TTM No. 939, Major Site Plan Review No. 2022-02, and Planned Unit Development No. 2022-01 to facilitate the development of a residential subdivision consisting of 280 single-family lots to occupy one (1) parcel totaling approximately 52.61 acres (6.05 du/acre).

The Project site currently contains a single-family residence and a shed on the northwest corner of the site. The single-family residence is proposed to be demolished as part of the Project. The remainder of the site south of a man-made irrigation canal, the “Fox Ditch” is currently under cultivation as an orchard. The orchard would be removed as part of site preparation and development. The Fox Ditch is proposed to be rerouted and piped underground within the subdivision, creating a pedestrian trail.

Street frontage is limited to East Bush Street, which is a 2-lane, east-west arterial with existing curb, gutter, and sidewalk. A PG&E easement is located adjacent to the single-family residence, along the site’s western boundary. SR-198, an east-west state highway, forms the site’s southern boundary.

TTM No. 939 would facilitate the subdivision of the Project site into 280 single-family lots that range with an average lot area of 3,977 sf. (Figure 2-5). The Project also proposes approximately 3.54 acres of park/trail area (Outlot A, B, C, D, and E) and 2.03 acres for an onsite detention basin (Outlot F). The onsite detention basin was sized to adequately capture stormwater runoff resulting from the proposed Project and the projected rainfall depth pursuant to the City’s rainfall data.

The Project also proposes an internal network of local streets that would connect to the existing circulation system including East Bush Street (arterial), Oporto Street (local), and Athens Street (local). Connections to Oporto Street and Athens Street would provide access between the proposed subdivision and the existing subdivision (Tract No. 700) adjoining the Project site to the east. All future local roads within the subdivision are proposed in accordance with City Standards. Approximately 6.55 acres of the Project site (Remainder) would remain undeveloped.

Planned Unit Development No. 2022-01 and Major Site Plan Review No. 2022-02 requests a deviation from minimum site development standards under LMC Section 9-5A-4 specific to 1) lot size, 2) lot width, 3) lot depth, and 4) front yard setback. The minimum lot size proposed is 2,809 sf. (7,000-sf. minimum permitted) and the maximum lot size proposed is 15,401 sf. (15,000-sf. maximum permitted). In addition, the Project proposes a minimum lot width of 42 ft. (60-ft. minimum permitted) and minimum lot depth of 70 ft. (100-ft. minimum permitted). Lastly, the Project proposes a general front yard setback of 10 ft. (18 ft.-minimum permitted), front yard setback to garage of 18 ft. (20 ft.-minimum permitted). The deviations are requested in order to build at the required density for the Low Density Single Family Residential land use designation that allows a density range of 3 to 7 du/acre. In addition, smaller lots allow for reduced landscaping and therefore greater water conservation.

The Project site is within city limits and thus, would be required to connect to water, wastewater, and stormwater services. The City provides water service and wastewater collection services. The Lemoore Canal and Irrigation Company is responsible for stormwater management. Natural gas, electricity, telecommunications, and solid waste services would be provided by private companies. Minor trenching and digging activities would be required for the installation of necessary pipelines and infrastructure connections. All utility plans would be required to be reviewed and approved by the appropriate agency and/or department to ensure that installation occurs to pertinent codes and regulations. Other infrastructure would include fire hydrants spaced throughout the development as required by the City Fire Department.

TENTATIVE TRACT MAP NO. 939

IN THE CITY OF LEMOORE, KINGS COUNTY, STATE OF CALIFORNIA
 SURVEYED ON JANUARY 21ST, 2022
 BY PRECISION CIVIL ENGINEERING, INC.

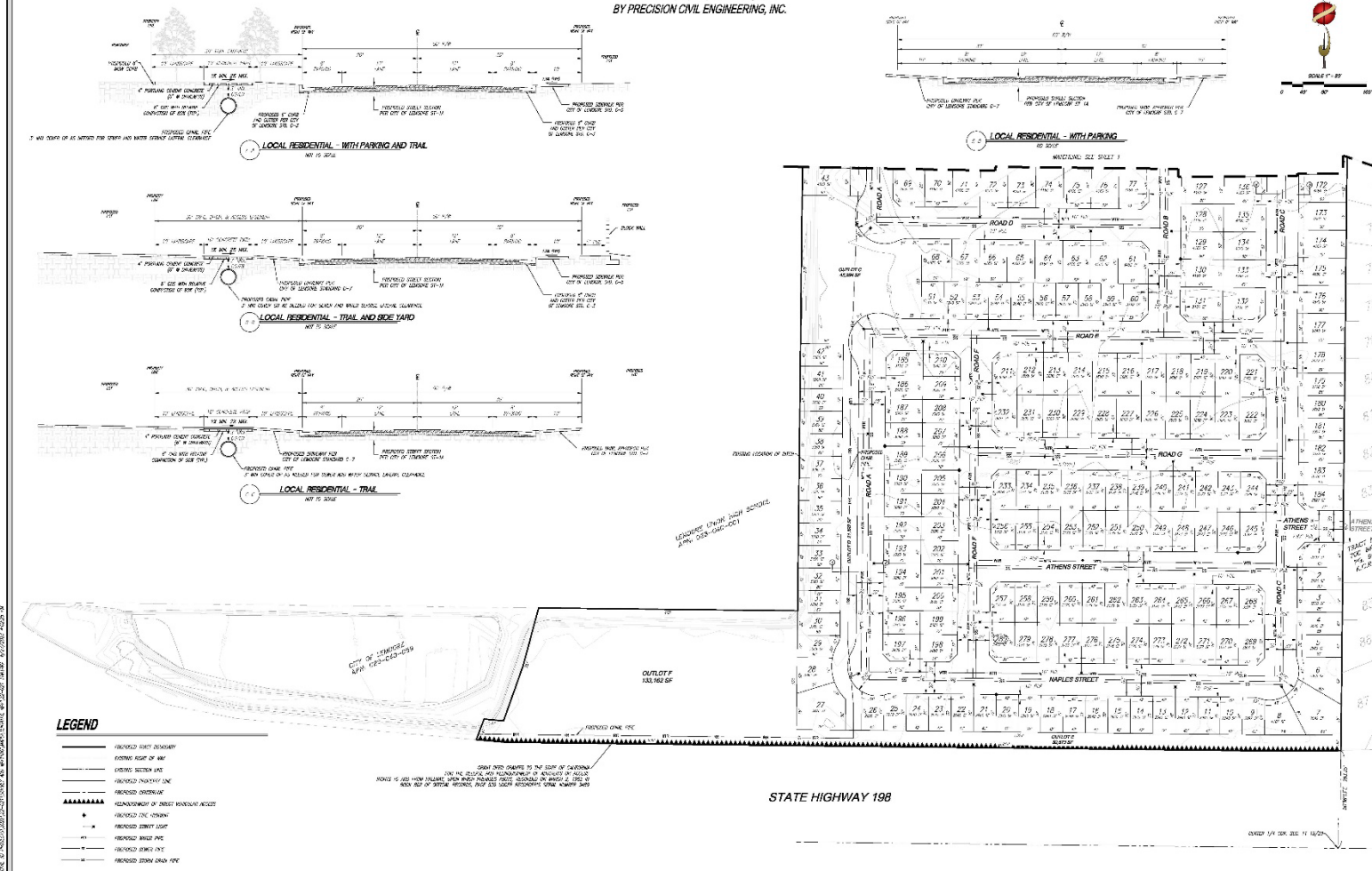

PLANNING & ENGINEERING & CIVIL ENGINEERING
 1704 G STREET, FRESNO, CALIFORNIA 93711
 TEL: 559-233-8888 FAX: 559-233-8889
 WWW.PRECISIONCIVIL.COM

PRECISION
 CIVIL ENGINEERING & ARCHITECTURE

TRACT 939
 TENTATIVE MAP
 COUNTY OF
 KINGS

PROJECT SITE
 STREET INFORMATION
 CITY OF
 LEMOORE

APPROVED FOR
 WATERSHED CLAYTONS HOMES
 17000 ALLEGRA DRIVE
 CLAYTON, CA 94515
 (925)426-8171

REVISIONS

DESIGNED BY: JAG
 CHECKED BY: DF
 DATE: 05-15-2023

PRECISION CIVIL ENGINEERING & ARCHITECTURE
 1704 G STREET, FRESNO, CA 93711
 559-233-8888

SHEET NUMBER
 2 OF 2
 JOB NUMBER
 22-021

Figure 2-5 Tentative Tract Map No. 939 (Proposed)

Site preparation would include removal of the existing orchard and rerouting and undergrounding the irrigation canal. Site preparation would include typical grading activities to ensure an adequately graded site for drainage purposes. Site preparation would also include minor excavation for the installation of utility infrastructure, for conveyance of water, sewer, stormwater, and irrigation. Site preparation would also include demolition of the existing residential dwelling and shed. The site would be constructed in one phase with an approximate construction start date of August 1, 2023, and an approximate construction end date of December 31, 2029.

2.10 Surrounding Land Uses

The Project site is generally surrounded by a mix of uses including single-family residential (north, east), commercial (west), religious (north), educational (east), and agricultural uses (south) in addition to vacant land immediately adjacent to the east of the site. As referenced in **Table 2-1**, the surrounding properties are planned for residential uses and community facilities.

Table 2-1 Existing Uses, General Plan Designations, and Zone Districts of Surrounding Properties

Direction from the Project site	Existing Use	General Plan Designation	Zone District
North	Public/Institutional (Life Way Church, Assembly of God Church), Low Density Single Family Residential	Low Density Single Family Residential	RLD – Low Density Residential
East	Low Density Single Family Residential	Low Density Single Family Residential	RLD – Low Density Residential
South	Agricultural/Rural Residential	Very Low Density Residential	AL10 – Limited Agriculture (County)
West	Public/Institutional (Lemoore High School)	Community Facilities	CF - Public Service and Community Facilities

2.11 Required Project Approvals

The City requires the following review, permits, and/or approvals for the proposed Project. Other approvals not listed below may be required as identified through the entitlement process. In addition, other agencies may have the authority to issue permits prior to implementation of the Project as listed below.

- Tentative Tract Map No 939
- Final Tract Map
- Planned Unit Development No. 2022-01.
- Major Site Plan Review No. 2022-02
- Building Permit
- Grading Permit
- Construction Permit and Encroachment Permit
- Site Utilities Permit

The Project includes the Planned Unit Development and Major Site Plan Review to allow for a deviation from LMC standards as shown in **Table 2-2**. In particular, the Project requests deviations from 1) lot size, 2) lot width, 3) lot depth, and 4) front yard setback pursuant to Section 9-5A-4 of the LMC. The deviations are requested in order to build at the required density.

Table 2-2 Proposed Standards Pursuant to LMC Section 9-5A-4 for RLD Zone District

Residential Low Density (RLD) Development Standards		
	LMC Standard	Proposed Project
Lot dimensions:		
Lot size, minimum (sf.)	7,000	2,940
Lot size, maximum (sf.)	15,000	18,053
Lot width, minimum (ft.)	60	42
Lot depth, minimum (ft.)	100	70
Setbacks, minimum:		
Front yard:		
Generally	18	10
To garage, front facing	20	18
To garage, side load	15	No change
To porch	12	No change
Side yard:		
Interior side	5	5
Street side	15	10
Combined both sides	10	10
Rear yard:		
Generally	10	10
To detached alley loaded garage	5	No change
Abutting a street	20	No change

In addition, other agencies may have the authority to issue permits prior to implementation.

- San Joaquin Valley Air Pollution Control District
- Kings County Department of Public Health
- Regional Water Quality Control Board - Central
- California Department of Fish and Wildlife
- US Army Corps of Engineers

2.12 Technical Studies

The analysis of the Project throughout this Initial Study relied in part on the technical studies listed below prepared for the Project, as well as other sources, including, but not limited to, Lemoore 2030 General Plan Environmental Impact Report (PEIR) SCH No. 2006081113 prepared for the City 2030 General Plan.

- **Appendix A:** Air Quality/Greenhouse Gas Analysis Technical Memorandum
- **Appendix B:** Biological Resource Assessment
- **Appendix C:** Cultural Resource Assessment and NAHC Correspondence
- **Appendix D:** Acoustical Analysis
- **Appendix E:** Traffic Impact Analysis

2.13 Consultation with California Native American Tribes

The State requires lead agencies to consider the potential effects of proposed projects and consult with California Native American tribes during the local planning process for the purpose of protecting Traditional Tribal Cultural Resources through the California Environmental Quality Act (CEQA) Guidelines. Pursuant to PRC Section 21080.3.1, the lead agency shall begin consultation with the California Native American tribe that is traditionally and culturally affiliated with the geographical area of the proposed project. Such significant cultural resources are either sites, features, places, cultural landscapes, sacred places, and objects with cultural value to a tribe which is either on or eligible for inclusion in the California Historic Register or local historic register, or, the lead agency, at its discretion, and support by substantial evidence, choose to treat the resources as a Tribal Cultural Resources (PRC Section 21074(a)(1-2)). According to the most recent census data, California is home to 109 currently recognized Indian tribes. Tribes in California currently have nearly 100 separate reservations or Rancherias.

Conducting consultation early in the CEQA process allows tribal governments, lead agencies, and project proponents to discuss the level of environmental review, identify and address potential adverse impacts to tribal cultural resources, and reduce the potential for delay and conflict in the environmental review process. (See PRC Section 21083.3.2.) Information may also be available from the California Native American Heritage Commission's (NAHC) Sacred Lands File (SLF) per PRC Section 5097.96 and the California Historical Resources Information System administered by the California Office of Historic Preservation. Please also note that PRC Section 21082.3(c) contains provisions specific to confidentiality.

The City conducted formal tribal consultation pursuant to Assembly Bill (AB) 52 on September 28, 2022, to the Santa Rosa Rancheria Tachi Yokut Tribal Government. A response was received from the Santa Rosa Rancheria Tachi Yokut Tribal Government on October 19, 2022, stating that "the Tribe has major concerns for this project and is requesting to be retained for cultural presentation for all construction staff and the landowner(s), to have a Native American monitor onsite for all ground disturbance related to the project/site, and to have burial treatment plan and curation agreement in place. The Tribe is also requesting that an archeological record search, an archeological survey, and a Sacred Lands File with the NAHC be completed if not already done so, and to have the results sent to us as well." Further consultation was not requested by the Tribe.

3 DETERMINATION

3.1 Environmental Factors Potentially Affected

The environmental factors checked below would be potentially affected by this project, involving at least one impact that is a "Potentially Significant Impact" as indicated by the checklist on the following pages.

- | | |
|---|--|
| <input type="checkbox"/> Aesthetics | <input type="checkbox"/> Land Use Planning |
| <input type="checkbox"/> Agriculture and Forestry Resources | <input type="checkbox"/> Mineral Resources |
| <input type="checkbox"/> Air Quality | <input type="checkbox"/> Noise |
| <input type="checkbox"/> Biological Resources | <input type="checkbox"/> Population and Housing |
| <input type="checkbox"/> Cultural Resources | <input type="checkbox"/> Public Services |
| <input type="checkbox"/> Energy | <input type="checkbox"/> Recreation |
| <input type="checkbox"/> Geology and Soils | <input type="checkbox"/> Transportation |
| <input type="checkbox"/> Greenhouse Gas Emissions | <input type="checkbox"/> Tribal and Cultural Resources |
| <input type="checkbox"/> Hazards and Hazardous Materials | <input type="checkbox"/> Utilities and Service Systems |
| <input type="checkbox"/> Hydrology and Water Quality | <input type="checkbox"/> Wildfire |

For purposes of this Initial Study, the following answers have the corresponding meanings:

“No Impact” means the specific impact category does not apply to the project, or that the record sufficiently demonstrates that project specific factors or general standards applicable to the project will result in no impact for the threshold under consideration.

“Less Than Significant Impact” means there is an impact related to the threshold under consideration, but that impact is less than significant.

“Less Than Significant with Mitigation Incorporation” means there is a potentially significant impact related to the threshold under consideration, however, with the mitigation incorporated into the project, the impact is less than significant. For purposes of this Initial Study “mitigation incorporated into the project” means mitigation originally described in the GP PEIR and applied to an individual project, as well as mitigation developed specifically for an individual project.

“Potentially Significant Impact” means there is substantial evidence that an effect may be significant related to the threshold under consideration.

3.2 Determination

On the basis of this initial evaluation (to be completed by the Lead Agency):

- I find that the proposed project COULD NOT have a significant effect on the environment, and a NEGATIVE DECLARATION will be prepared.
- I find that although the proposed project could have a significant effect on the environment, there will not be a significant effect in this case because revisions in the project have been made by or agreed to by the project proponent. A MITIGATED NEGATIVE DECLARATION will be prepared.
- I find that the proposed project MAY have a significant effect on the environment, and an ENVIRONMENTAL IMPACT REPORT (EIR) is required.

- I find that the proposed project MAY have a “potentially significant impact” or “potentially significant unless mitigated” impact on the environment, but at least one effect 1) has been adequately analyzed in an earlier document pursuant to applicable legal standards, and 2) has been addressed by mitigation measures based on the earlier analysis as described on attached sheets. An EIR is required, but it must analyze only the effects that remain to be addressed.
- I find that although the proposed project could have a significant effect on the environment, because all potentially significant effects (a) have been analyzed adequately in an earlier EIR or NEGATIVE DECLARATION pursuant to applicable standards, and (b) have been avoided or mitigated pursuant to that earlier EIR or NEGATIVE DECLARATION, including revisions or mitigation measures that are imposed upon the proposed project, nothing further is required.

Approved By:

Nathan Olson, City Manager
City of Lemoore

Date

4 EVALUATION OF ENVIRONMENTAL IMPACTS

4.1 AESTHETICS

Except as provided in Public Resources Code Section 21099, would the project:	Potentially Significant Impact	Less than Significant with Mitigation Incorporated	Less than Significant Impact	No Impact
a) Have a substantial adverse effect on a scenic vista?				X
b) Substantially damage scenic resources, including, but not limited to, trees, rock out-croppings, and historic buildings within a state scenic highway?				X
c) In non-urbanized areas, substantially degrade the existing visual character or quality public views of the site and its surroundings? (Public views are those that are experienced from publicly accessible vantage point). If the project is in an urbanized area, would the project conflict with applicable zoning and other regulations governing scenic quality?			X	
d) Create a new source of substantial light or glare which would adversely affect day or nighttime views in the area?			X	

4.1.1 Environmental Setting

The City is located within Kings County in the San Joaquin Valley in central California. The City has a generally flat topography with low-rise buildings and visual skyline features includes 75 to 100 feet high wireless towers on school grounds and the Coalinga Mountains to the west of the city. Visual features in the city are primarily trees, structures, and landscaping along straight roadways and farmland and grassland at the edge of built areas.

General Plan

The General Plan Community Design Element addresses the physical character and visual quality of the City's built environment. The General Plan identified the south portion of the Project site along SR 198 as a greenway. The Element also established several guiding policies and implementing actions to maintain Lemoore's sense of place, ensure pedestrian-oriented development, promote visually appealing architecture, and protect the city's environmental assets. The policies and actions that are applicable to the Project are listed below.

Implementing Actions CD-I-17 Work with Caltrans to identify needed improvements to its highway facilities. Improvements include:

- *Creating a green buffer along parts of SR-198 and SR-41 adjoining residential land;*

Guiding Policy CD-G-11 *Encourage development of diverse and distinctive neighborhoods.*

Guiding Policy CD-G-12 *Develop a sense of neighborhood identity through design elements and neighborhood focal points, such as commercial areas, schools, parks, community centers, or a combination of these elements.*

Implementing Actions CD-I-44 *Ensure that new residential development enhances Lemoore’s neighborhood character and connectivity by establishing the following standards in the subdivision ordinance:*

- *Maximum block length: 500 feet, except for blocks with single-family residential uses that may be up to 600 feet long (750 feet with a mid-block pedestrian connection);*
- *Required connectivity: All new streets and alleys must connect to other streets and alleys to form a continuous vehicular and pedestrian network. Local, internal streets should be narrow and designed with traffic calming features to control speed.*
- *Cul-de-sacs: Limit use of cul-de-sacs to no more than ten percent of the length of all streets in a subdivision map, where constrained by surrounding land attributes.*
- *Loop-outs: Encourage use of loop-out streets rather than cul-de-sacs.*

Implementing Actions CD-I-45 *Establish residential design guidelines for new subdivisions to include but not be limited to:*

- *Require building facades with distinctive architectural features like windows, chimneys, and other such elements. Use articulation of building massing to reveal internal organization of building elements such as stairs and atriums, internal gathering spaces and major interior spaces;*
- *Require corner buildings to have wrap-around façade architectural details; and*
- *For single-family housing: Ensure adjacent units are different in size, composition and/or design. Designs used in a subdivision should be substantially different from one another so that no plan/elevation should look similar to another.*
- *Homes built in pre-existing neighborhoods should be built in similar scale and design to existing neighborhood as determined by the Planning Department.*

Policy CD-I-48 *Minimize the visual dominance of garages by establishing specific standards in the Zoning Ordinance, including:*

- *Limiting the front width of a house that can be occupied with a garage to be no more than one-half the building width;*
- *Encourage garage setbacks from the front façade, permitting a range of setbacks none of which may extend more than 5 feet in front of the building;*
- *Requiring additional setback or off-setting of such garages if more than a two-car garage entrance is provided;*
- *Encouraging use of alleys in new development, with garages accessed from the rear, yet maintain backyards; and*
- *Incorporating design elements on the second level above the garages such as accessory dwelling units, bay windows or balconies.*

Implementing Actions CD-I-51 Require residential neighborhoods to incorporate architecture and site plan considerations into the design and location of cluster mailboxes to ensure design compatibility and increase social contact in the neighborhood.

Implementing Actions CD-I-53 Require new housing to provide transitions between the street and building, with variable front setbacks, building articulation and massing.

Implementing Actions CD-I-54 Design local streets not only to accommodate traffic, but also to serve as comfortable pedestrian environments. These should include, but not be limited to:

- Along Arterial, Parkway, and Collector Streets, street tree planting adjacent to curb between the street and sidewalk (the “parkway strip”) to provide a buffer between the pedestrian and the automobile, as well as in the landscaped buffer between the sidewalk and adjacent buildings/walls, where appropriate.
- Along Local Streets, provide a landscape parkway between the curb and back of walk. Additionally, provide a street tree at the rate of one per single family dwelling unit or 30 feet for other uses. This street tree may be located either within the parkway, behind the sidewalk within the utility easement, or in the front yard setback at the choice of the developer or property owner.
- Sidewalks on both sides of streets.

Implementing Actions CD-I-55 Promote use of design elements that signify neighborhood identity.

Implementing Actions CD-I-56 Include the following standards and regulations for fences and walls in residential areas in the Zoning Ordinance:

- Fences located in front yards shall be limited to no more than 3’ in height with at least 50% permeability in front of the main building structure. Chain link fences shall be allowed in this area;
- Fences along interior side or rear yards can be solid up to 7’ so long as they are located behind the main building structure(s) along the property line of interior lots.
- Fences on corner lots can install solid architecturally detailed side yard fences taller than 3’ once they are even or in back of the main structure and placed at least 3’ behind the back sidewalk. Landscaping shall be required between the sidewalk and the fence and properly maintained by the owner. If proposed fencing placement would obstruct sight lines for vehicular traffic causing a hazardous traffic condition, the location must be altered. Chain link fence shall not be allowed in this area; • Properties that abut existing perimeter subdivision walls or fences facing public streets must use materials and height consistent with adjacent or abutting neighbors and get approval from the Planning Department prior to installation;
- New single family subdivision shall only use decorative masonry perimeter walls/fences when abutting arterial streets, highways, commercial or industrial zone land, or areas where such installation is needed to adequately reduce noise impacts to acceptable levels;
- Gated communities that restrict public access to multi-family and single family residential areas are prohibited.
- Trash containers shall be kept behind solid fences or landscaping to screen from public view, with appropriate access for cleaning and refuse removal.

Implementing Actions CD-I-57 Require new developments to incorporate security and defensible space considerations in the design of residential units and neighborhoods.

The Element also established several guiding policies and implementing actions to maintain scenic vistas, including Implementing Actions CD-I-2 and CD-I-4.

Implementing Actions CD-I-2: Maintain views into the agricultural lands on the rural side of the roadways by not planting within the right-of-way and spacing trees farther apart.

Implementing Actions CD-I-4: Maintain scenic vistas to the Coalinga Mountains, other natural features, and landmark buildings.

Municipal Code

Lemoore Municipal Code (LMC) Section 9-5B-4 – *Outdoor Lighting* contains enforceable requirements for all new development intended to prevent light and glare impacts.

C. *General Lighting Requirements: The requirements listed below shall apply to all outdoor lighting:*

1. *Nuisance Prevention: All outdoor lighting shall be designed, located, installed, and maintained in order to prevent glare, light trespass, and light pollution.*
2. *Lighting Study Required For Limited Land Uses: A lighting study or plan (often referred to as a photometric study or plan) shall only be required for those land uses that are most likely to have a negative impact on surrounding sensitive receptors, such as residential dwellings. As such, a lighting study or plan shall only be required for fueling stations, apartment complexes, and uses with parking lots that contain more than one hundred (100) spaces.*
3. *Shielding: Except as otherwise exempt, all outdoor lighting shall be recessed and/or constructed with full downward shielding in order to reduce light and glare impacts on trespass to adjoining properties and public rights of way. Each fixture shall be directed downward and away from adjoining properties and public rights of way, so that no light fixture directly illuminates an area outside of the project site.*
4. *Level Of Illumination: Outdoor lighting shall be designed to illuminate at the minimum level necessary for safety and security and to avoid harsh contrasts in lighting levels between the project site and adjacent properties.*
5. *Maximum Height Of Freestanding Outdoor Light Fixtures: The maximum height of freestanding outdoor light fixtures less than ten feet (10') from a property line abutting residential development shall be eighteen feet (18'). Otherwise, the maximum height for freestanding outdoor light structures shall be twenty four feet (24'). Height shall be measured from the finish grade, inclusive of the pedestal, to the top of the fixture. The designated approving authority may allow greater heights upon finding that there are special circumstances that affect the feasibility of meeting this standard.*
6. *Energy Efficient Fixtures Required: Outdoor lighting shall utilize energy efficient fixtures and lamps, such as high pressure sodium, metal halide, low pressure sodium, hardwired compact fluorescent, or other lighting technology that is of equal or greater efficiency. All new outdoor lighting fixtures shall be energy efficient with a rated average bulb life of not less than ten thousand (10,000) hours.*
7. *Accent Lighting: Architectural features may be illuminated by uplighting, provided that the lamps are low intensity to produce a subtle lighting effect and no glare or light trespass is produced. Wherever feasible, solar powered fixtures should be used.*

California Scenic Highway Program

The California Scenic Highway Program was established in 1963 with the purpose of protecting and enhancing the natural scenic beauty of California highways and adjacent corridors, through special conservation treatment. A

highway may be designated scenic depending upon how much of the natural landscape can be seen by travelers, the scenic quality of the landscape, and the extent to which development intrudes upon the traveler's enjoyment of the view. There are no officially designated State Scenic Highways in the city of Salinas, inclusive of the Project area. However, SR 198 is an eligible State Scenic Highway, located approximately 20.6 miles east of the Project site.¹

4.1.2 Impact Assessment

Would the project:

a) Have a substantial adverse effect on a scenic vista?

No Impact. A scenic vista is a viewpoint that provides a distant view of highly valued natural or man-made landscape features for the benefit of the general public. Typical scenic vistas are locations where views of rivers, hillsides, and open space areas can be obtained as well as locations where valued urban landscape features can be viewed in the distance. The City's 2030 General Plan established an implementation action to maintain scenic vistas to the Coalinga Mountains, other natural features, and landmarks on the urban/rural edge (*Implementing Actions CD-I-2 and CD-I-4*).

In particular, the Project site and vicinity is generally flat and does not contain any natural features, landmarks, buildings, or historic resources. Existing urban development, including commercial and institutional structures west of Project site, effectively obstructs long-distance viewsheds of the Coalinga Mountains ranges. Thus, given the flat topography and limited long-distance viewsheds, scenic views from the Project area and site are insignificant. As a result, the Project would not adversely affect scenic vistas, thus there is no impact.

b) Substantially damage scenic resources, including, but not limited to, trees, rock out-croppings, and historic buildings within a state scenic highway?

No Impact. According to the California State Scenic Highway Program, there are no officially designated State Scenic Highways in the City of Lemoore. The nearest eligible State Scenic Highway, SR-198, is approximately 20.6 miles east of the Project site and would not be impacted by the Project. As such, the proposed Project would not damage scenic resources, including trees, rock out-croppings, and historic buildings within a state scenic highway and no impact would occur as a result of the Project.

c) In non-urbanized areas, substantially degrade the existing visual character or quality of public views of the site and its surroundings? (Public views are those that are experienced from publicly accessible vantage point). If the project is in an urbanized area, would the project conflict with applicable zoning and other regulations governing scenic quality?

Less than Significant Impact. The Project site is within an urbanized area surrounded by residential and commercial uses, and agricultural lands. The Project proposes to construct a residential subdivision within the RLD – Low Density Single Family Residential zone district, which is permitted to use. A deviation from the current zoning development standards is also proposed, including a smaller lot size, lot width, lot depth, and front and rear setbacks. However, this deviation would not cause significant impact to scenic quality since the Project is still subject to compliance with applicable zoning and other regulations governing scenic quality including but not limited to the California

¹ Caltrans. California State Scenic Highway System Map. Accessed on April 12, 2023, <https://caltrans.maps.arcgis.com/apps/webappviewer/index.html?id=465dfd3d807c46cc8e8057116f1aaca>

Building Code (CBC), General Plan, and LMC. The LMC and General Plan objectives and policies on individual projects include streetscape plans for properties fronting streets and site and building design, which would be implemented through the review process. Compliance with these regulations would ensure that the Project would not conflict with regulations governing scenic quality. In addition, the visual character of the Project is compatible with the existing residential development in the area and thus would not substantially degrade existing visual character due to its size and character. Through compliance with the General Plan and Zoning Ordinance, it can be determined that the visual character of the Project would be compatible with the existing development in the area and thus would not substantially degrade existing visual character due to its size and character. Therefore, the Project would have a less than significant impact.

d) Create a new source of substantial light or glare which would adversely affect day or nighttime views in the area?

Less than Significant Impact. Generally, lighting impacts are associated with artificial lighting in evening hours either through interior lighting from windows or exterior lighting (e.g., street lighting, parking lot lighting, landscape lighting, cars, and trucks). Development of the Project site would incrementally increase the amount of light from streetlights, exterior lighting, and vehicular headlights. Such sources could create adverse effects on day or nighttime views in the area.

Future development would be subject to site development standards contained in LMC *Section 9-5B-4 – Outdoor Lighting*, specifically sub-section C which contains specific, enforceable requirements intended to prevent light and glare impacts. In addition, future development would be required to comply with Title 24 lighting requirements which would also reduce impacts related to nighttime light. The Title 24 lighting requirements cover outdoor spaces including regulations for mounted luminaires (i.e., high efficacy, motion sensor controlled, time clocks, energy management control systems, etc.). As such, conditions imposed on future development by the City pursuant to the LMC and Title 24 would reduce light and glare impacts to a less than significant impact.

4.1.3 Mitigation Measures

None required.

4.2 AGRICULTURE AND FORESTRY RESOURCES

Would the project:	Potentially Significant Impact	Less than Significant with Mitigation Incorporated	Less than Significant Impact	No Impact
a) Convert Prime Farmland, Unique Farmland, or Farmland of Statewide Importance (Farm-land), as shown on the maps prepared pursuant to the Farmland Mapping and Monitoring Program of the California Resources Agency, to non-agricultural use?			X	
b) Conflict with existing zoning for agricultural use, or a Williamson Act contract?				X
c) Conflict with existing zoning for, or cause rezoning of, forest land (as defined in Public Resources Code section 12220(g)), timberland (as defined by Public Resources Code section 4526), or timberland zoned Timberland Production (as defined by Government Code section 51104(g))?				X
d) Result in the loss of forest land or conversion of forest land to non-forest use?				X
e) Involve other changes in the existing environment which, due to their location or nature, could result in conversion of Farmland, to non-agricultural use or conversion of forest land to non-forest use?			X	

4.2.1 Environmental Setting

The Project site is located within the City limits and is planned and zoned for residential, parks, and detention basin uses. The majority of the Project site is currently under crop cultivation as an orchard. The land north of the canal has been disced and graded in recent years and is currently vacant. The orchard would be removed as part of site preparation and development. The Project site does not contain any forestry resources such as forest land or timberland.

Farmland Monitoring and Mapping Program

The California Department of Conservation manages the Farmland Mapping and Monitoring Program (FMMP) that provides maps and data for analyzing land use impacts to farmland. The FMMP produces the Important Farmland

Finder as a resource map that shows quality (soils) and land use information. Agricultural land is rated according to soil quality and irrigation status, in addition to many other physical and chemical characteristics. The highest quality land is called “Prime Farmland” which is defined by the FMMP as “*farmland with the best combination of physical and chemical features able to sustain long term agricultural production. This land has the soil quality, growing season, and moisture supply needed to produce sustained high yields. Land must have been used for irrigated agricultural production at some time during the four years prior to the mapping date.*”² According to the FMMP, California Important Farmland Finder, the Project site contains approximately 2.1 acres of “Unique Farmland,” 5.2 acres of “Urban and Built-Up Land,” 5.4 acres of “Prime Farmland,” and 41.4 acres of “Farmland of Statewide Importance.”³ The land classifications are defined below and shown in **Figure 4-1**.

- *Prime Farmland (P)*: *Farmland with the best combination of physical and chemical features able to sustain long term agricultural production. This land has the soil quality, growing season, and moisture supply needed to produce sustained high yields. Land must have been used for irrigated agricultural production at some time during the four years prior to the mapping date.*
- *Farmland of Statewide Importance (S)*: *Farmland similar to Prime Farmland but with minor shortcomings, such as greater slopes or less ability to store soil moisture. Land must have been used for irrigated agricultural production at some time during the four years prior to the mapping date.*
- *Unique Farmland (U)*: *Farmland of lesser quality soils used for the production of the state's leading agricultural crops. This land is usually irrigated, but may include nonirrigated orchards or vineyards as found in some climatic zones in California. Land must have been cropped at some time during the four years prior to the mapping date.*
- *Urban and Built-up Land (D)*: *Land occupied by structures with a building density of at least 1 unit to 1.5 acres, or approximately 6 structures to a 10-acre parcel. This land is used for residential, industrial, commercial, construction, institutional, public administration, railroad and other transportation yards, cemeteries, airports, golf courses, sanitary landfills, sewage treatment, water control structures, and other developed purposes.*

California Land Conservation Act

The California Land Conservation Act of 1965 (i.e., the Williamson Act) allows local governments to enter contracts with private landowners to restrict parcels of land agricultural or open space uses. In return, property tax assessments of the restricted parcels are lower than full market value. The minimum length of a Williamson Act contract is 10 years and automatically renews upon its anniversary date; as such, the contract length is essentially indefinite. The Project site is not subject to the Williamson Act Land Use contract.

² California Department of Conservation. Important Farmland Categories. Accessed on April 12, 2023, <https://www.conservation.ca.gov/dlrp/fmmp/Pages/Important-Farmland-Categories.aspx>

³ California Department of Conservation. (2018). California Important Farmland Finder. Accessed on April 12, 2023, <https://maps.conservation.ca.gov/DLRP/CIFF/>

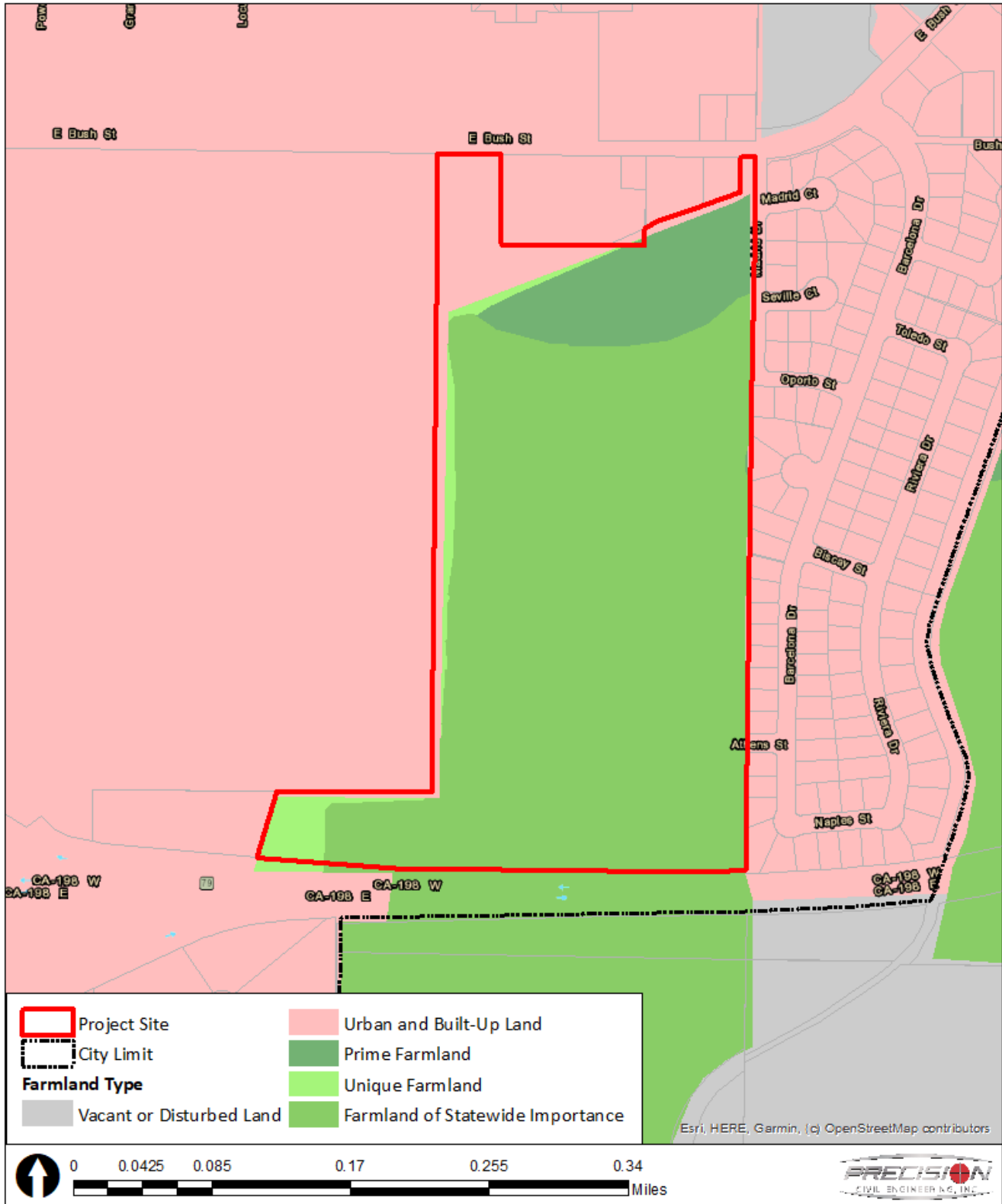

CITY OF LEMOORE - WATHEN CASTANOS HOMES RESIDENTIAL SUBDIVISION
INITIAL STUDY

CREATED 4/12/2023

Figure 4-1 Farmland Mapping and Monitoring Program, Project Site Land Classifications

4.2.2 Impact Assessment

- a) *Convert Prime Farmland, Unique Farmland, or Farmland of Statewide Importance (Farmland), as shown on the maps prepared pursuant to the Farmland Mapping and Monitoring Program of the California Resources Agency, to non-agricultural use?*

Less than Significant Impact. According to the FMMP, California Important Farmland Finder, the Project site contains approximately 5.4 acres of “Prime Farmland,” 2.1 acres of “Unique Farmland,” and 41.4 acres of “Farmland of Statewide Importance.” Development of the Project site would convert approximately 48.9 acres of prime farmland, unique farmland, and farmland of statewide importance to a non-agricultural use.

The Project is located within the Sphere of Influence and City limits, with a land use designation and zone classification for residential uses. While the Project would result in the conversion of agricultural lands to non-agricultural uses, this conversion was evaluated under the Lemoore General Plan Update EIR and subsequent Statements of Overriding Considerations and Findings of Significant and Unavoidable Impacts. While the General Plan established that Prime Farmland is not needed to accommodate urban growth should be preserved (*Policy COS-G-5*), the proposed Project is accommodating planned urban growth under the General Plan and does not identify as lands for preservation stated in *Policy COS-G-5*. As such, the development of the Project would have a less than significant impact.

- b) *Conflict with existing zoning for agricultural use or a Williamson Act contract?*

No Impact. The Project site is not zoned for agricultural use and is not subject to a Williamson Act Land Use contract. Therefore, the Project would not conflict with existing zoning for agricultural use, or a Williamson Act contract and no impact would occur.

- c) *Conflict with existing zoning for, or cause rezoning of, forest land (as defined in Public Resources Code section 12220(g)), timberland (as defined by Public Resources Code section 4526), or timberland zoned Timberland Production (as defined by Government Code section 51104(g))?*

No Impact. The Project site is not planned or zoned for forest land or timberland as defined by PRC 12220 (g). Further, the Project site would not cause the rezoning of forest land, timberland, or timberland zoned Timberland Production. As a result, the Project would not conflict with existing zoning for, or cause rezoning of, forest land, timberland, or timberland zoned Timberland Production as defined by PRC 4526 or GC 5110(g), and no impact would occur.

- d) *Result in the loss of forest land or conversion of forest land to non-forest use?*

No Impact. The Project site does not contain forest land and is not planned or zoned for forest land or forest uses. Implementation of the Project would therefore not result in the loss of forest land or conversion of forest land to non-forest use. As a result, no impact would occur.

- e) *Involve other changes in the existing environment, which, due to their location or nature, could result in conversion of Farmland to non-agricultural use or conversion of forest land to non-forest use?*

Less than Significant Impact. As noted above, the Project site does not contain agricultural or forestry uses or resources. The properties immediately adjacent to the south and east of the Project site are also planned and zoned for residential uses and do not contain agricultural or forestry uses or resources. According to the FMMP the Project

site, and the properties immediately adjacent to the south and east are classified as “Urban and Built-Up Land.” Therefore, future development of the Project site with residential uses would be generally consistent with the existing environment of the surrounding uses. As a result, the Project would not involve other changes in the existing environment that could result in the conversion of farmland to non-agricultural use or conversion of forest land to non-forest use. Therefore, a less than significant impact would occur because of the Project.

4.2.3 Mitigation Measures

None required.

4.3 AIR QUALITY

Would the project:	Potentially Significant Impact	Less than Significant with Mitigation Incorporated	Less than Significant Impact	No Impact
a) Conflict with or obstruct implementation of the applicable air quality plan (e.g., by having potential emissions of regulated criterion pollutants which exceed the San Joaquin Valley Air Pollution Control Districts (SJVAPCD) adopted thresholds for these pollutants)?			X	
b) Result in a cumulatively considerable net increase of any criteria pollutant for which the project region is non-attainment under an applicable federal or state ambient air quality standard?			X	
c) Expose sensitive receptors to substantial pollutant concentrations?			X	
d) Result in other emissions (such as those leading to odors) adversely affecting a substantial number of people?			X	

4.3.1 Environmental Setting

The Project is located within the San Joaquin Valley Air Basin (SJVAB). The San Joaquin Valley Air Pollution Control District (SJVAPCD) regulates air quality in eight (8) counties including: Fresno, Kern, Kings, Madera, Merced, San Joaquin, Stanislaus, and Tulare, and oversees the SJVAB.

Impacts on air quality result from emissions generated during short-term activities (construction) and long-term activities (operations). Construction-related emissions consist mainly of exhaust emissions (NOx and PM) from construction equipment and other mobile sources, and fugitive dust (PM) emissions from earth moving activities. Operational emissions are source specific and consist of permitted equipment and activities and non-permitted equipment and activities.

Air pollution in the SJVAB can be attributed to both human-related (anthropogenic) and natural (non-anthropogenic) activities that produce emissions. Air pollution from significant anthropogenic activities in the SJVAB includes a variety of industrial-based sources as well as on- and off-road mobile sources. Four (4) main sources of air pollutant emissions in the SJVAB are motor vehicles, industrial plants, agricultural activities, and construction activities. All four of the major pollutant sources affect ambient air quality throughout the SJVAB.

These sources, coupled with geographical and meteorological conditions unique to the area, stimulate the formation of unhealthy air. Air pollutants can remain in the atmosphere for long periods and can build to

unhealthful levels when stagnant conditions that are common in the San Joaquin Valley occur. Pollutants are transported downwind from urban areas with many emission sources which are also recirculated back to the urban areas.

Further, the SJVAB is in non-attainment for ozone, PM₁₀, and PM_{2.5}, which means that certain pollutants' exposure levels are often higher than the normal air quality requirements. Air quality standards have been set to protect public health, particularly the health of vulnerable people. Therefore, if the concentration of those contaminants exceeds the norm, some susceptible individuals in the population are likely to experience health effects. Concentration of the pollutant in the air, the length of time exposed and the individual's reaction are factors that affect the extent and nature of the health effects.

San Joaquin Valley Air Pollution Control District

The SJVAPCD is the agency primarily responsible for ensuring that the National Ambient Air Quality Standards (NAAQS and California Ambient Air Quality Standards (CAAQS) are not exceeded and that air quality conditions are maintained in the SJVAB, within which the Project is located. Responsibilities of the SJVAPCD include, but are not limited to, preparing plans for the attainment of ambient air quality standards, adopting and enforcing rules and regulations concerning sources of air pollution, issuing permits for stationary sources of air pollution, inspecting stationary sources of air pollution and responding to citizen complaints, monitoring ambient air quality and meteorological conditions, and implementing programs and regulations required by the Federal Clean Air Act (FCAA) and the California Clean Air Act (CCAA). The SJVAPCD rules and regulations that may apply to future development resulting from Project implementation include but are not limited to:

***Rule 2010 – Permits Required.** The purpose of this rule is to require any person constructing, altering, replacing or operating any source operation which emits, may emit, or may reduce emissions to obtain an Authority to Construct or a Permit to Operate. This rule also explains the posting requirements for a Permit to Operate and the illegality of a person willfully altering, defacing, forging, counterfeiting or falsifying any Permit to Operate.*

***Rule 2201 – New and Modified Stationary Source Review Rule.** The purpose of this rule is to provide for the following: The review of new and modified Stationary Sources of air pollution and to provide mechanisms including emission trade-offs by which Authorities to Construct such sources may be granted, without interfering with the attainment or maintenance of Ambient Air Quality Standards; and No net increase in emissions above specified thresholds from new and modified Stationary Sources of all nonattainment pollutants and their precursors.*

***Rule 4001 – New Source Performance Standards.** This rule incorporates the New Source Performance Standards from Part 60, Chapter 1, Title 40, Code of Federal Regulations (CFR).*

***Rule 4002 – National Emission Standards for Hazardous Air Pollutants.** This rule incorporates the National Emission Standards for Hazardous Air Pollutants from Part 61, Chapter I, Subchapter C, Title 40, Code of Federal Regulations (CFR) and the National Emission Standards for Hazardous Air Pollutants for Source Categories from Part 63, Chapter I, Subchapter C, Title 40, Code of Federal Regulations (CFR).*

***Rule 4102 – Nuisance.** The purpose of this rule is to protect the health and safety of the public and applies to any source operation that emits or may emit air contaminants or other materials.*

Rule 4601 – Architectural Coatings. The purpose of this rule is to limit Volatile Organic Compounds (VOC) emissions from architectural coatings. This rule specifies architectural coatings storage, cleanup, and labeling requirements.

Rule 4641 – Cutback, Slow Cure, and Emulsified Asphalt, Paving and Maintenance Operations. The purpose of this rule is to limit VOC emissions from asphalt paving and maintenance operations. This rule applies to the manufacture and use of cutback asphalt, slow cure asphalt and emulsified asphalt for paving and maintenance operations.

Regulation VIII – Fugitive PM₁₀ Prohibitions. The purpose of Regulation VIII (Fugitive PM₁₀ Prohibitions) is to reduce ambient concentrations of fine particulate matter (PM₁₀) by requiring actions to prevent, reduce or mitigate anthropogenic fugitive dust emissions.

Rule 9510 – Indirect Source Review. The purposes of this rule are to:

1. Fulfill the District’s emission reduction commitments in the PM₁₀ and Ozone Attainment Plans.
2. Achieve emission reductions from the construction and use of development projects through design features and on-site measures.
3. Provide a mechanism for reducing emissions from the construction of and use of development projects through off-site measures.

General Plan

The General Plan Conservation and Open Space outlines policies for addressing air quality. Applicable policies are as follows.

Policy COS-G-12 Make air quality a priority in land use planning by implementing emissions reduction efforts targeting mobile sources, stationary sources and construction related sources.

Policy COS-G-13 Minimize exposure to toxic air pollutant emissions and noxious odors from industrial, manufacturing and processing facilities.

Policy COS-G-14 Utilize diverse and creative mitigation approaches to manage remaining levels of air pollution that cannot be reduced or avoided.

Policy COS-I-42 Conforming to the SJVAPCD Fugitive Dust Rule, require developers to use best management practices (BMPs) to reduce particulate emission as a condition of approval for subdivision maps, site plans and all grading permits. BMPs include:

- During clearing, grading, earth-moving or excavation operations, fugitive dust emissions shall be controlled by regular watering, paving of construction roads, or other dust-preventive measures;
- All materials excavated or graded shall be either sufficiently watered or covered by canvas or plastic sheeting to prevent excessive amounts of dust;
- All materials transported off-site shall be either sufficiently watered or covered by canvas or plastic sheeting to prevent excessive amounts of dust;
- All motorized vehicles shall have their tires watered before exiting a construction site;

- *The area disturbed by demolition, clearing, grading, earth-moving, or excavation shall be minimized at all times; and*
- *All construction-related equipment shall be maintained in good working order to reduce exhaust.*

Municipal Code

Section 9-5B-2 – Noise, Odor, and Vibration Performance Standards of the Lemoore Municipal Code codifies the following performance standards related to odor, particulate matter, and air contaminants.

C. Odors, Particulate Matter, And Air Contaminants Standards:

- 1. Odor: No obnoxious odors or fumes shall be emitted that are perceptible without instruments by a reasonable person at the property line of the site.*
- 2. Particulate Matter And Air Contaminants: The operation of facilities shall not directly or indirectly discharge air contaminants into the atmosphere, including smoke, sulfur compounds, dust, soot, carbon, noxious acids, gases, mist, odors, or particulate matter, or other air contaminants or combinations which exceed any local, State, or Federal air quality standards. Particulate matter shall not be discharged into the atmosphere in excess of the standards of the Federal Environmental Protection Agency, the California Air Resources Board, or the Regional Air Quality Management District.*
- 3. Odor Easement Required: All new subdivisions of land approved through tentative subdivision map or tentative parcel map as provided in title 8, chapter 7, article F, "Tentative Maps", of the Municipal Code shall be required as a condition of approval to record at time of final or parcel map an odor easement on all lots created. Such easement shall identify the presence of industrial uses in the vicinity of the lot and be in a form satisfactory to the City.*

Air Quality and Greenhouse Gas Technical Memorandum

An Air Quality and Greenhouse Gas Technical Memorandum was completed for the Project, and is provided in **Appendix A**. The analysis utilized CalEEMod version 2020.4.0 to estimate construction and operational impacts and AERMOD (version 22112) was used to estimate levels of air emissions at sensitive receptor locations from potential sources of toxic air contaminants.

Modeling Parameters and Assumptions

The following criteria air pollutants were assessed in this analysis: reactive organic gases (ROG), oxides of nitrogen (NO_x), particulate matter less than 10 microns in diameter (PM₁₀), and particulate matter less than 2.5 microns in diameter (PM_{2.5}). Note that the proposed project would emit ozone precursors ROG and NO_x. However, the proposed project would not directly emit ozone since it is formed in the atmosphere during the photochemical reaction of ozone precursors.

4.3.2 Impact Assessment

Would the project:

- a) *Would the project conflict with or obstruct implementation of the applicable air quality plan (e.g., by having potential emissions of regulated criterion pollutants which exceed the San Joaquin Valley Air Pollution Control Districts (SJVAPCD) adopted thresholds for these pollutants)?*

Less than Significant Impact. Air Quality Plans (AQP) are plans for reaching attainment of air quality standards. The assumptions, inputs, and control measures are analyzed to determine if the Air Basin can reach attainment for the ambient air quality standards. The proposed project site is located within the jurisdictional boundaries of the SJVAPCD. To show attainment of the standards, the SJVAPCD analyzes the growth projections in the Valley, contributing factors in air pollutant emissions and formations, and existing and adopted emissions controls. The SJVAPCD then formulates a control strategy to reach attainment that includes both State and SJVAPCD regulations and other local programs and measures.

The CEQA Guidelines indicate that a significant impact would occur if the project would conflict with or obstruct implementation of the applicable air quality plan. The Guidance for Assessing and Mitigating Air Quality Impacts(GAMAQI) indicates that projects that do not exceed SJVAPCD regional criteria pollutant emissions quantitative thresholds would not conflict with or obstruct the applicable AQP.

As shown in **Table 4-1** and **Table 4-2**Table 4-2, the Project’s regional construction and operational emissions would not exceed SJVAPCD’s regional criteria pollutant emissions quantitative thresholds. Therefore, the proposed Project would not be considered in conflict with or obstruct implementation of the applicable air quality plan and a less than significant impact would occur.

Table 4-1 Summary of Construction-Generated Emissions of Criteria Air Pollutants - Unmitigated

Construction Activity	Emissions (Tons/Year)					
	ROG	NOx	CO	Sox	PM10	PM2.5
Construction (2023)	0.18	2.43	1.51	0.01	0.54	0.25
Construction (2024)	0.24	2.46	2.55	0.01	0.41	0.17
Construction (2025)	0.21	1.72	2.31	0.01	0.27	0.12
Construction (2026)	0.21	1.71	2.29	0.01	0.27	0.12
Construction (2027)	0.21	1.71	2.26	0.01	0.27	0.12
Construction (2028)	0.20	1.70	2.23	0.01	0.27	0.11
Construction (2029)	1.69	0.88	1.21	<0.01	0.15	0.06
Total Emissions	2.94	12.61	14.36	0.06	2.18	0.95
Maximum Annual Emissions	1.69	1.72	2.55	0.01	0.54	0.25
Average Annual Emissions	0.46	1.97	2.24	0.01	0.34	0.15
Significance Thresholds	10	10	100	27	15	15
Exceed Significance Thresholds in Either Scenario?	No	No	No	No	No	No

Notes:

PM10 and PM2.5 emissions are from the mitigated output to reflect compliance with Regulation VIII—Fugitive PM10 Prohibitions. Source of Emissions: CalEEMod Output (Attachment A).

1 Total construction emissions were divided by the construction duration in years (6.4 years) to estimate average annual emissions.

Source of Thresholds: San Joaquin Valley Air Pollution Control District (SJVAPCD). 2015. Guidance for Assessing and Mitigating Air Quality Impacts. February 19. Website: <https://www.valleyair.org/transportation/GAMAQI-2015/FINAL-DRAFT-GAMAQI.PDF> Accessed October 9, 2022 and May 10, 2023.

Table 4-2 Summary of Operational Emissions of Criteria Air Pollutants - Unmitigated

Source	Emissions (Tons/Year)					
	ROG	NOx	CO	SOx	PM10	PM2.5
Area	2.20	0.13	2.11	<0.01	0.02	0.02
Energy	0.04	0.31	0.13	<0.01	0.03	0.03
Mobile (Vehicle Trips)	0.77	1.47	9.29	0.03	2.81	0.76
Annual Total	3.01	0.91	11.53	0.03	2.86	0.81
Significance Thresholds	10	10	100	27	15	15
Exceed Significance Thresholds in Either Scenario?	No	No	No	No	No	No

Notes:

Emissions were quantified using the earliest operational year for the proposed project.

Source: CalEEMod Output (Attachment A).

Source of Thresholds: San Joaquin Valley Air Pollution Control District (SJVAPCD). 2015. Guidance for Assessing and Mitigating Air Quality Impacts. February 19. Website: <https://www.valleyair.org/transportation/GAMAQI-2015/FINAL-DRAFT-GAMAQI.PDF> Accessed October 9, 2022 and May 10, 2023.

Localized Concentrations

Emissions occurring at or near the project have the potential to create a localized impact also referred to as an air pollutant hotspot. Localized emissions are considered significant if when combined with background emissions, they would result in exceedance of any health-based air quality standard. In locations that already exceed standards for these pollutants, significance is based on a significant impact level (SIL) that represents the amount that is considered a cumulatively considerable contribution to an existing violation of an air quality standard. The pollutants of concern for localized impact in the SJVAB are NO₂, SO_x, and CO.

The SJVAPCD has provided guidance for screening localized impacts in the GAMAQI that establishes a screening threshold of 100 pounds per day of any criteria pollutant. If a project exceeds 100 pounds per day of any criteria pollutant, then ambient air quality modeling would be necessary. If the project does not exceed 100 pounds per day of any criteria pollutant, then it can be assumed that it would not cause a violation of an ambient air quality standard.

Local construction impacts would be short-term in nature lasting only during the duration of construction. Construction is anticipated to begin in 2023 with site preparation, followed by grading, paving, building construction (vertical home construction), and architectural coating (painting) for clearing and grading of the site. All construction-related assumptions including the schedule, equipment, and trips are provided in **Appendix A**. As shown in **Table 4-3** below, on-site construction emissions would be less than 100 pounds per day for each of the criteria pollutants. To present a conservative estimate, on-site emissions for on-road construction vehicles were included in the localized analysis. Based on the SJVAPCD’s guidance, the construction emissions would not cause an ambient air quality standard violation.

Table 4-3 Localized Concentrations of PM10, PM2.5, CO, and NOX for Construction

Source	ROG	NOx	CO	PM10	PM2.5
	Maximum On-site Daily (2023)	3.56	38.23	31.06	10.12
Maximum On-site Daily (2024)	3.45	36.07	30.70	5.57	2.90
Maximum On-site Daily (2025)	1.45	11.43	15.26	0.54	0.45
Maximum On-site Daily (2026)	1.43	11.42	15.21	0.54	0.45
Maximum On-site Daily (2027)	1.41	11.41	15.16	0.54	0.45

Maximum On-site Daily (2028)	1.40	11.40	15.12	0.54	0.45
Maximum On-site Daily (2029)	22.62	12.55	17.08	0.60	0.50
Maximum Daily On-Site Emissions	22.62	38.23	31.06	10.12	5.74
Significance Thresholds	--	100	100	100	100
Exceed Significance Thresholds in Either Scenario?	--	No	No	No	No

Note: Assumptions regarding dates of construction activities are based on the construction schedule shown in Table 1. Maximum daily emissions of NO_x, CO, PM₁₀, and PM_{2.5} were highest in the Winter scenario. Maximum daily emissions of ROG (shown for informational purposes) were highest in the Summer scenario. Source of Emissions: CalEEMod Output and Additional Supporting Information (Attachment A). Source of Thresholds: San Joaquin Valley Air Pollution Control District (SJVAPCD). 2015. Guidance for Assessing and Mitigating Air Quality Impacts. February 19. Website: <https://www.valleyair.org/transportation/GAMAQI-2015/FINAL-DRAFT-GAMAQI.PDF> Accessed October 21, 2022 and May 10, 2023.

Localized impacts could occur in areas with a single large source of emissions such as a power plant or with multiple sources concentrated in a small area such as a distribution center.

As shown in Table 4-4 below, operational modeling of on-site emissions for the project indicate that the project would not exceed 100 pounds per day for each of the criteria pollutants. Therefore, based on the SJVAPCD’s guidance, the operational emissions would not cause an ambient air quality standard violation. As such, impacts would be less than significant.

Table 4-4 Localized Concentrations of PM10, PM2.5, CO, and NOx for Operations

Source	On-site Emissions (pounds per day)				
	ROG	NOx	CO	PM10	PM2.5
Area	12.64	2.82	41.01	0.33	0.33
Energy	0.20	1.70	0.72	0.14	0.14
Mobile (Vehicle Trips) ¹	4.67	2.95	19.32	1.07	0.30
Annual Total	17.51	7.47	61.05	1.54	0.77
Significance Thresholds	--	100	100	100	100
Exceed Significance Thresholds in Either Scenario?	--	No	No	No	No

Note

¹On-site + Localized Vehicle Emissions

Source of Emissions: CalEEMod Output and Additional Supporting Information (Attachment A). Maximum daily emissions of NO_x, CO, PM₁₀, and PM_{2.5} were highest in the Winter scenario. Maximum daily emissions of ROG (shown for informational purposes) were highest in the Summer scenario. Source of Thresholds: San Joaquin Valley Air Pollution Control District (SJVAPCD). 2015. Guidance for Assessing and Mitigating Air Quality Impacts. February 19. Website: <https://www.valleyair.org/transportation/GAMAQI-2015/FINAL-DRAFT-GAMAQI.PDF> Accessed October 9, 2022 and May 11, 2023.

b) Result in a cumulatively considerable net increase of any criteria pollutant for which the project region is non-attainment under an applicable federal or state ambient air quality standard?

Less than Significant Impact. To result in a less than significant impact, emissions of nonattainment pollutants must be below the SJVAPCD’s regional significance thresholds. This is an approach recommended by the SJVAPCD’s in its GAMAQI. The primary pollutants of concern during project construction and operation are ROG, NO_x, PM₁₀, and PM_{2.5}. The SJVAPCD GAMAQI adopted in 2015 contains thresholds for CO, NO_x, ROG, SO_x, PM₁₀, and PM_{2.5}.

Air pollutant emissions have both regional and localized effects. As shown in Table 4-1 and Table 4-2, the project’s regional emissions would not exceed the applicable regional criteria pollutant emissions quantitative thresholds.

c) Expose sensitive receptors to substantial pollutant concentrations?

Less than Significant Impact. Emissions occurring at or near the project have the potential to create a localized impact that could expose sensitive receptors to substantial pollutant concentrations. The SJVAPCD considers a sensitive receptor to be a location that houses or attracts children, the elderly, people with illnesses, or others who are especially sensitive to the effects of air pollutants. Examples of sensitive receptors include hospitals, residences, convalescent facilities, and schools.

The SJVAPCD's GAMAQI includes screening thresholds for identifying projects that need detailed analysis for localized impacts. Projects with on-site emission increases from construction activities or operational activities that exceed the 100 pounds per day screening level of any criteria pollutant after implementation of all enforceable mitigation measures would require additional analysis to determine if the preparation of an ambient air quality analysis is needed. The criteria pollutants of concern for localized impact in the Air Basin are PM₁₀, PM_{2.5}, NO_x, and CO. There is no localized emission standard for ROG.

As shown in **Table 4-3**, the Project would not exceed the emission screening thresholds during Project construction. Therefore, the Project's localized criteria pollutant impacts from construction of the Project would be less than significant.

As shown in **Table 4-4**, the Project would not exceed SJVAPCD screening thresholds for localized criteria pollutant impacts; therefore, the Project's localized criteria pollutant impacts from long-term operations would be less than significant.

Toxic Air Contaminants

Construction

As discussed above, criteria pollutant emissions during construction would not exceed the SJVAPCD's significance thresholds and would not be expected to result in concentrations that would exceed ambient standards or contribute substantially to an existing exceedance of an ambient air quality standard. Therefore, construction of the proposed Project would not result in localized emissions that, if when combined with background emissions, would result in exceedance of any health-based air quality standard for any criteria pollutant. As such, health risk impacts related to criteria pollutants emitted during the construction period of the proposed Project would be less than significant.

Construction-related activities would result in temporary, short-term project-generated emissions of diesel particulate matter (DPM) from the exhaust of off-road, heavy-duty diesel equipment for site preparation (e.g., clearing, grading); soil hauling truck traffic; paving; home construction; application of architectural coatings; and other miscellaneous activities. For construction activity, DPM is the primary air toxic of concern. Particulate exhaust emissions from diesel-fueled engines (i.e., DPM) were identified as a toxic air contaminant (TAC) by the California Air Resources Board (CARB) in 1998.⁴ Due to the proposed Project's proximity to existing sensitive receptors, a health risk assessment was performed to assess impacts from DPM emissions resulting from construction of the Project.

⁴ California Air Resources Board (CARB). 1998. The Toxic Air Contaminant Identification Process: Toxic Air Contaminant Emissions from Diesel-fueled Engines. Website: www.arb.ca.gov/toxics/dieseltac/factsht1.pdf

The results of the HRA prepared for project construction for cancer risk and long-term chronic cancer risk are summarized below. Construction emissions were estimated assuming adherence to all applicable rules, regulations, and project design features. The construction emissions were assumed to be distributed over the Project Area with a working schedule of eight (8) hours per day and five (5) days per week. Emissions were adjusted by a factor of 4.2 to convert for use with a 24-hour-per-day, 365 day-per-year averaging period. Detailed parameters and complete calculations are included in [Appendix A](#).

The Maximally Exposed Receptor (MER) during project construction was determined to be an existing residence located directly adjacent to the project boundary, east of the southeast portion of the Project site. The estimated health and hazard impacts at the MER from the Project’s construction emissions are provided in [Table 4-5](#). As noted in [Table 4-5](#), calculated health metrics from the proposed Project’s construction DPM emissions would not exceed the cancer risk significance threshold or non-cancer hazard index significance threshold. Therefore, the proposed project would not result in a significant impact on nearby sensitive receptors from TACs during construction.

Table 4-5 Summary of Health Impacts from Unmitigated Construction of the Proposed Project

Exposure Scenario	Maximum Cancer Risk (Risk per Million)	Chronic Non-Cancer Hazard Index	Acute Non-Cancer Hazard Index
Risks and Hazards at the MER	12.11	0.0047	0.0000
Significance Threshold	20	1	1
Thresholds Exceeded in Any Scenario?	No	No	No

Note:

MER = maximally exposed receptor

MER Location (Latitude, Longitude): 36°17'31.7"N 119°46'18.3"W

Source: Construction Health Risk Assessment (Attachment B).

Operations

PM₁₀ and PM_{2.5} are commonly used as proxies for Diesel Particulate Matter (DPM), which would be the toxic air containment of concern emitted by the Project. Based on the screening analyzes presented in [Table 4-4](#)Table 4-2, estimated localized emissions generated by the proposed project would not reach levels high enough to necessitate further analysis. As such, it is not expected that any TAC concentrations would reach levels that would cause an exceedance of the SJVAPCD’s health risk thresholds.

Unlike warehouses or distribution centers, the daily vehicle trips generated by the proposed single-family residential subdivision project would be primarily generated by passenger vehicles. Passenger vehicles typically use gasoline engines rather than the diesel engines that are found in heavy-duty trucks. Nonetheless, operational DPM emissions from diesel trucks were estimated using EMFAC2021 emission factors and estimated truck travel and idling at the Project site. The emissions were entered into the SJVAPCD Prioritization Screening Tool to determine the risk scores, with complete calculations and assumptions included as part of [Appendix A](#). The results of the screening analysis are provided in [Table 4-6](#).

As shown in [Table 4-6](#), the Project would not exceed the cancer risk or chronic hazard threshold levels. The primary source of the emissions responsible for chronic risk are from diesel trucks. DPM does not have an acute risk factor. Since the Project does not exceed the applicable SJVAPCD screening thresholds for cancer risk, acute risk, or chronic risk, this impact would be less than significant.

Table 4-6 Prioritization Tool Health Risk Screening Results

Impact Source	Cancer Risk Score	Chronic Risk Score	Acute Risk Score
Diesel Trucks	4.651	0.008	0.000
Total Risk from Project Operations	4.651	0.008	0.000
Screening Risk Score Threshold	10	1	1
Screening Thresholds Exceeded?	No	No	No

Source: Modeling Assumptions, CalEEMod Output Files, Operational Screening Results (Appendix A)

Valley Fever

Valley fever, or coccidioidomycosis, is an infection caused by inhalation of the spores of the fungus, *Coccidioides immitis* (*C. immitis*). The spores live in soil and can live for an extended time in harsh environmental conditions. Activities or conditions that increase the amount of fugitive dust contribute to greater exposure, and they include dust storms, grading, and recreational off-road activities.

The Project is situated on a site that has been previously disturbed. Specifically, the site has historically been used for agricultural purposes and occupied by an orchard. All existing trees will be properly fallowed prior to construction. The existing conditions do not provide a suitable habitat for spores. Specifically, the conditions are not favorable for the occurrence of *C. immitis* because the Project site has been previously disturbed from being tilled. Therefore, development of the proposed project would have a low probability of the site having *C. immitis* growth sites and exposure to the spores from disturbed soil.

Although conditions are not favorable, construction activities could generate fugitive dust that contain *C. immitis* spores. The Project will minimize the generation of fugitive dust during construction activities by complying with SJVAPCD’s Regulation VIII. Therefore, this regulation, combined with the relatively low probability of the presence of *C. immitis* spores would reduce Valley fever impacts to less than significant.

During operations, dust emissions are anticipated to be relatively small, because most of the Project area where operational activities would occur would be occupied by the proposed residential homes and pavement. This condition would substantially lessen the possibility of the project from providing habitat suitable for *C. immitis* spores and for generating fugitive dust that may contribute to Valley fever exposure. Impacts would be less than significant.

Naturally Occurring Asbestos

Review of the map of areas where naturally occurring asbestos in California are likely to occur found no such areas in the Project Area. Therefore, development of the project is not anticipated to expose receptors to naturally occurring asbestos. Impacts would be less than significant.

Operations—The Project’s Potential to Locate Sensitive Receptor Near Existing Sources of TACs

As a residential project, the Project would locate sensitive receptors to a site where future Project residents could be subject to existing sources of TACs at the Project site. However, the California Supreme Court concluded in *California Building Industry Association (CBIA) v. Bay Area Air Quality Management District (BAAQMD)* that agencies subject to CEQA are not required to analyze the impact of existing environmental conditions on a Project’s future users or residents. Therefore, this impact will not be further addressed in this document.

In summary, the Project would not exceed SJVAPCD localized emission daily screening levels for any criteria pollutant. The Project would not be a significant source of TAC emissions during construction and operation. The

Project is not in an area with suitable habitat for Valley fever spores and is not in area known to have naturally occurring asbestos. Therefore, the Project would not result in significant impacts to sensitive receptors and a less than significant impact would occur because of the Project.

d) Result in other emissions (such as those leading to odors) adversely affecting a substantial number of people?

Less than Significant Impact. Two (2) situations create a potential for odor impact. The first occurs when a new odor source is located near an existing sensitive receptor. The second occurs when a new sensitive receptor locates near an existing source of odor. According to the CBIA v. BAAQMD ruling, impacts of existing sources of odors on the Project are not subject to CEQA review. Therefore, the analysis to determine if the Project would locate new sensitive receptors near an existing source of odor is provided for informational purposes only.

Odor impacts on residential areas and other sensitive receptors, such as hospitals, day-care centers, schools, etc. warrant the closest scrutiny, but consideration should also be given to other land uses where people may congregate, such as recreational facilities, worksites, and commercial areas.

For projects involving new receptors locating near an existing odor source where there is currently no nearby development and for new odor sources locating near existing receptors, the SJVAPCD recommends that the analysis should be based on a review of odor complaints for similar facilities. In assessing potential odor impacts, consideration also should be given to local meteorological conditions, particularly the intensity and direction of prevailing winds.

Lead Agencies can also make a determination of significance based on a review of SJVAPCD complaint records. For a project located near an existing source of odors, the impact is potentially significant when the project site is at least as close as any other site that has already experienced significant odor problems related to the odor source.

Significant odor problems are defined by the SJVAPCD as:

- *More than one confirmed complaint per year averaged over a three-year period, or*
- *Three unconfirmed complaints per year averaged over a three-year period.*

An unconfirmed complaint means that either the odor/air contaminant release could not be detected, or the source/facility cannot be determined. Because of the subjective nature of odor impacts and the lack of quantitative or formulaic methodologies, the significance determination of potential odor impacts should be considered on a case-by-case basis.

Although the Project is less than one mile from the nearest sensitive receptor, the Project is not expected to be a significant source of odors. Impacts from construction and operations of the proposed Project are discussed as follows.

Construction

During construction, various diesel-powered vehicles and equipment in use on-site would create localized odors. These odors would be temporary and intermittent, which would decrease the likelihood of the odors concentrating in a single area or lingering for any notable period of time. As such, these odors would likely not be noticeable for extended periods of time beyond the project's site boundaries. The potential for odor impacts from construction of the proposed Project would, therefore, be less than significant.

Operations

Project as a Generator: The occurrence and severity of odor impacts depend on numerous factors, including the nature, frequency, and intensity of the source; wind speed and direction; and the presence of sensitive receptors. Although offensive odors rarely cause any physical harm, they still can be very unpleasant, leading to considerable distress and often generating citizen complaints to local governments and regulatory agencies. The Project is residential in nature, and project operations would not be anticipated to produce odorous emissions. Therefore, Project operations would not create objectionable odors affecting a substantial number of people; the impact would be less than significant.

Project as a Receptor: With the CBIA v. BAAQMD ruling, analysis of odor impacts on receivers is not required for CEQA compliance. Therefore, the following analysis is provided for informational purposes only, while the significance determination for the odor is whether the project would consider an odor generator. As a residential development, the Project has the potential to place sensitive receptors near existing and new odor sources.

There are no major odor-generating sources that have received complaints to an extent that would exceed SJVAPCD-recommended thresholds for assessing odor impacts from odor generators. Furthermore, there are existing residential uses located within the screening distances for all the potential sources in the project vicinity. Considering this information, the uses in the vicinity of the project would not result in substantial odor impacts to the Project.

In summary, a less than significant impact would occur because of the Project.

4.3.3 Mitigation Measures

None required.

4.4 BIOLOGICAL RESOURCES

Would the project:	Potentially Significant Impact	Less than Significant with Mitigation Incorporated	Less than Significant Impact	No Impact
a) Have a substantial adverse effect, either directly or through habitat modifications, on any species identified as a candidate, sensitive, or special status species in local or regional plans, policies, or regulations, or by the California Department of Fish and Game or U.S. Fish and Wildlife Service?				
b) Have a substantial adverse effect on any riparian habitat or other sensitive natural community identified in local or regional plans, policies, regulations or by the California Department of Fish and Game or US Fish and Wildlife Service?				X
c) Have a substantial adverse effect on state or federally protected wetlands (including, but not limited to, marsh, vernal pool, coastal, etc.) through direct removal, filling, hydrological interruption, or other means?		X		
d) Interfere substantially with the movement of any native resident or migratory fish or wildlife species or with established native resident or migratory wildlife corridors, or impede the use of native wildlife nursery sites?		X		
e) Conflict with any local policies or ordinances protecting biological resources, such as a tree preservation policy or ordinance?				X
f) Conflict with provisions of an adopted Habitat Conservation Plan, Natural Community Conservation Plan, or other approved local, regional, or state habitat conservation plan.				X

4.4.1 Environmental Setting

The Project site is currently cultivated as an orchard and there is a man-made irrigation canal, “Fox Ditch.” The land north of the canal has been disced and graded in recent years and is currently vacant. The orchard would be removed as part of site preparation and development. The irrigation canal will be rerouted, piped, and undergrounded. Street frontage is limited to East Bush Street, which is a two (2)-lane, east-west arterial with existing curb, gutter, and sidewalk. A PG&E easement is located adjacent to the single-family residence, along the site’s western boundary. SR-198, forms the site’s southern boundary.

The Project site has historically been used for agricultural crops (orchards). Approximately 3.4 acres of the site can be characterized as disturbed, ruderal habitat. There are two (2) mature Valley oak trees at the northern boundary of the site. These trees are part of the area that will not be developed and would not be removed or disturbed by the Project. There are also trees, shrubs, and herbaceous vegetation surrounding the existing single-family residence that would not be removed or disturbed by the Project. Topography of the site is generally flat. The site’s soil consists of stable Kimberlina fine sandy loam and Nord complex soil types that are well-drained with medium runoff and more than 80-inch water table depths.

Biological Resource Assessment

A Biological Resource Assessment was conducted and is provided in [Appendix B](#). The assessment includes review of online databases, literature review, aerial photography, wetland mapping, and a site investigation.

4.4.2 Impact Assessment

Would the project:

- a) *Have a substantial adverse effect, either directly or through habitat modifications, on any species identified as a candidate, sensitive, or special status species in local or regional plans, policies, or regulations, or by the California Department of Fish and Wildlife or the U.S. Fish and Wildlife Service?*

Less than Significant Impact with Mitigation Incorporated. According to the General Plan, California Department of Fish and Wildlife (CDFW), and U.S. Fish and Wildlife Service (USFWS) databases, there are no known or recorded occurrences of any species identified as a candidate, sensitive, or special status species on the Project site. Based on the analysis and findings of the Biological Resource Assessment, the existing biotic conditions and resources of the site would not support the habitat of candidate, sensitive, or special status species. There are two (2) mature Valley oak trees at the northern boundary of the site as well as trees, shrubs, and herbaceous vegetation surrounding the existing single-family residence; however, no raptor nests were observed during the site assessment.

There is potential for seven special-status wildlife species to be present in the area and subject to impacts by Project activities. There is also potential for nesting migratory birds and nesting and foraging raptors to be present on and near the Project site. Compliance with Mitigation Measures MM BIO-1 through MM BIO-5 would protect, avoid, and minimize impacts to special-status wildlife species and nesting migratory birds and nesting and foraging raptors. When implemented, these measures would reduce impacts to these species to below significant levels.

MM BIO-1: Prior to ground-disturbing activities, a qualified wildlife biologist shall conduct a biological clearance survey between 14 and 30 days prior to the onset of construction.

The clearance survey shall include walking transects to identify presence of San Joaquin kit fox, burrowing owl, nesting birds, and other special-status species. The pre-construction survey shall be walked by no greater than 30-foot transects for 100 percent coverage of the Project and a 50-foot buffer, where feasible. If no evidence of special-status species is detected, no further action is required except MM BIO-4 and BIO-6 shall be implemented.

MM BIO-2: The following avoidance and minimization measures shall be implemented during all phases of the Project to reduce the potential for impact from the Project. They are modified from the U.S. Fish and Wildlife Service Standardized Recommendations for Protection of the Endangered SJKF Prior to or During Ground Disturbance (USFWS 2011, Appendix F).

- a. All food-related trash items such as wrappers, cans, bottles, and food scraps shall be disposed of in securely closed containers. All food-related trash items such as wrappers, cans, bottles, and food scraps shall be disposed of in securely closed containers and removed at least once a week from the construction of the Project site.
- b. Construction-related vehicle traffic shall be restricted to established roads and predetermined ingress and egress corridors, staging, and parking areas. Vehicle speeds shall not exceed 20 miles per hour (mph) within the Project site.
- c. To prevent inadvertent entrapment of kit fox or other animals during construction, the contractor shall cover all excavated, steep-walled holes or trenches more than two feet deep at the close of each workday with plywood or similar materials. If holes or trenches cannot be covered, one or more escape ramps constructed of earthen fill or wooden planks shall be installed in the trench. Before such holes or trenches are filled, the contractor shall thoroughly inspect them for entrapped animals. All construction-related pipes, culverts, or similar structures with a diameter of four inches or greater that are stored on the Project site shall be thoroughly inspected for wildlife before the pipe is subsequently buried, capped, or otherwise used or moved in any way. If at any time an entrapped or injured kit fox is discovered, work in the immediate area shall be temporarily halted, and USFWS and CDFW shall be consulted.
- d. Kit foxes are attracted to den-like structures such as pipes and may enter stored pipes and become trapped or injured. All construction pipes, culverts, or similar structures with a diameter of four inches or greater that are stored at a construction site for one or more overnight periods shall be thoroughly inspected for kit foxes before the pipe is subsequently buried, capped, or otherwise used or moved in any way. If a kit fox is discovered inside a pipe, that section of pipe shall not be moved until the USFWS and CDFW have been consulted. If necessary, and under the direct supervision of the biologist, the pipe may be moved only once to remove it from the path of construction activity until the fox has escaped.
- e. No pets, such as dogs or cats, shall be permitted on the Project sites to prevent harassment, mortality of kit foxes, destruction of dens.
- f. Use of anti-coagulant rodenticides and herbicides in project sites shall be restricted. This is necessary to prevent primary or secondary poisoning of kit foxes and the depletion of prey populations on which they depend. All uses of such compounds shall observe labels and other restrictions mandated by the U.S. Environmental Protection Agency, California Department of Food and Agriculture, and other State and federal legislation, as well as additional Project-related restrictions deemed necessary by the USFWS and

CDFW. If rodent control must be conducted, zinc phosphide shall be used because of the proven lower risk to kit foxes.

- g. A representative shall be appointed by the Project proponent who will be the contact source for any employee or contractor who might inadvertently kill or injure a kit fox or who finds a dead, injured, or entrapped kit fox. The representative shall be identified during the employee education program, and their name and telephone number shall be provided to the USFWS.
- h. The Sacramento Fish and Wildlife Office of USFWS and CDFW shall be notified in writing within three working days of the accidental death or injury to a SJKF during Project-related activities. Notification must include the date, time, and location of the incident or of the finding of a dead or injured animal and any other pertinent information. The USFWS contact is the Chief of the Division of Endangered Species at the addresses and telephone numbers below. The CDFW contact can be reached at (559) 243-4014 and R4CESA@wildlifeca.gov.
- i. All sightings of the SJKF shall be reported to the California Natural Diversity Database (CNDDDB). A copy of the reporting form and a topographic map clearly marked with the location of where the kit fox was observed shall also be provided to the Service at the address below.
- j. Any Project-related information required by the USFWS or questions concerning the above conditions or their implementation may be directed in writing to the U.S. Fish and Wildlife Service at: Endangered Species Division, 2800 Cottage Way, Suite W 2605, Sacramento, California 95825-1846, phone: (916) 414-6620 or (916) 414-6600.
- k. New sightings of SJKF should be reported to the CNDDDB.

MM BIO-3: Within 14 days prior to the start of Project ground-disturbing activities, a pre-activity survey with a 500-foot buffer shall be conducted by a qualified biologist knowledgeable in the identification of these species and approved by the CDFW. If dens/burrows that could support any of these species are discovered during the pre-activity survey conducted under MM BIO-1, the avoidance buffers outlined below should be established. No work would occur within these buffers unless the biologist approves and monitors the activity.

San Joaquin Kit Fox

- Potential or Atypical den – 50 feet
- Known den – 100 feet
- Natal or pupping den – 500 feet, unless otherwise specified by CDFW

MM BIO-4: If construction is planned outside the nesting period for raptors (other than burrowing owl) and migratory birds (February 15 to August 31), no mitigation shall be required. If construction is planned during the nesting season for migratory birds and raptors, a pre-construction survey to identify active bird nests shall be conducted by a qualified biologist to evaluate the site and a 250-foot buffer for migratory birds and a 500-foot buffer for raptors. If nesting birds are identified during the survey, active raptor nests shall be avoided by 500 feet and all other migratory bird nests shall be avoided by 250 feet. Avoidance buffers may be reduced if a qualified on-site monitor determines that encroachment into the buffer area is not affecting nest building, the rearing of young, or otherwise affecting the breeding behaviors of the resident birds. Because nesting birds can establish new nests or produce a second or even third clutch at any time during the nesting season, nesting bird surveys shall be repeated every 30 days as construction activities are occurring throughout the nesting season.

No construction or earth-moving activity shall occur within a non-disturbance buffer until it is determined by a qualified biologist that the young have fledged (left the nest) and have attained sufficient flight skills to avoid project construction areas. Once the migratory birds or raptors have completed nesting and young have fledged, disturbance buffers will no longer be needed and may be removed, and monitoring may cease.

MM BIO-5: A qualified biologist shall conduct a pre-construction survey on the project site and within 500 feet of its perimeter, where feasible, to identify the presence of the western burrowing owl. The survey shall be conducted between 14 and 30 days prior to the start of construction activities. If any burrowing owl burrows are observed during the pre-construction survey, avoidance measures shall be consistent with those included in the CDFW Staff Report on Burrowing Owl Mitigation (CDFG 2012). If occupied burrowing owl burrows are observed outside of the breeding season (September 1 through January 31) and within 250 feet of proposed construction activities, a passive relocation effort may be instituted in accordance with the guidelines established by the California Burrowing Owl Consortium (1993) and the California Department of Fish and Wildlife (2012). During the breeding season (February 1 through August 31), a 500-foot (minimum) buffer zone shall be maintained unless a qualified biologist verifies through non-invasive methods that either the birds have not begun egg laying and incubation or that juveniles from the occupied burrows are foraging independently and are capable of independent survival.

In addition, impacts to occupied burrowing owl burrows shall be avoided in accordance with the following table unless a qualified biologist approved by CDFW verifies through non-invasive methods that either: (1) the birds have not begun egg laying and incubation; or (2) that juveniles from the occupied burrows are foraging independently and are capable of independent survival.

Location	Time of Year	Level of Disturbance		
		Low	Med	High
Nesting sites	April 1 – Aug 15	200 m	500 m	500 m
Nesting sites	Aug 16 – Oct 15	200 m	200 m	500 m
Nesting sites	Oct 16 – Mar 31	50 m	100 m	500 m

MM BIO-6: Prior to ground-disturbance activities, or within one week of being deployed at the Project site for newly hired workers, all construction workers at the Project site shall attend a Construction Worker Environmental Awareness Training and Education Program developed and presented by a qualified biologist.

The Construction Worker Environmental Awareness Training and Education Program shall be presented by the biologist and shall include information on the life histories of special-status wildlife and plant species that may be encountered during construction activities, their legal protections, the definition of “take” under the Endangered Species Act, measures the project operator is implementing to protect the species, reporting requirements, specific measures that each worker must employ to avoid take of the species, and penalties for violation of the Act. Identification and information regarding special status or other sensitive species with the potential to occur on the Project site shall also be provided to construction personnel. The program shall include:

- *An acknowledgment form signed by each worker indicating that environmental training has been completed.*
- *A copy of the training transcript and/or training video/CD, as well as a list of the names of all personnel who attended the training and copies of the signed acknowledgment forms, shall be maintained on-site for the duration of construction activities.*

b) Have a substantial adverse effect on any riparian habitat or other sensitive natural community identified in local or regional plans, policies, or regulations or by the California Department of Fish and Wildlife or the U.S. Fish and Wildlife Service?

No Impact. According to the General Plan, CDFW, and U.S. Fish and Wildlife Service databases, there are no known or recorded riparian habitat or other sensitive natural community on the Project site. Based on the analysis and findings of the Biological Resource Assessment, the site does not contain any natural water features that would provide habitat for riparian habitat or natural communities. In addition, the site is heavily impacted by agricultural and residential uses and would not support any riparian habitat or natural community. Therefore, the Project would not have any adverse effect on any riparian habitat or other sensitive natural community identified in local or regional plans, policies, or regulations, or by the CDFW or U.S. Fish and Wildlife Service and no impact would occur because of the Project.

c) Have a substantial adverse effect on state or federally protected wetlands (including, but not limited to, marsh, vernal pool, coastal, etc.) through direct removal, filling, hydrological interruption, or other means?

Less than Significant with Mitigation Incorporated. According to the National Wetlands Inventory, the Project site does not contain any protected wetlands. Typically, the primary wetland indicators include hydrophytic vegetation, hydric soils, and surface hydrology. Based on the analysis and findings of the Biological Resource Assessment, the site lacks hydrophytic vegetation, hydric soils, and surface hydrology. While the Project would include the relocation of an existing man-made irrigation canal, it has been assessed that the canal is not connected to any National or State waters, thus removal should not affect state or federally protected wetlands/waters. However, the canal may connect to the Lemoore Canal to the east which would require delineation. Therefore, the Project shall incorporate MM BIO-7 prior to issuance of grading or building permits. Lastly, based on the historical use of the site and surrounding properties for agricultural purposes, it can be determined that the man-made irrigation canal is and has been used for agriculture and thereby does not provide essential habitat for any species. For these reasons, the Project would not have a substantial adverse effect on state or federally protected wetlands including but not limited to marsh, vernal pool, coastal waters through direct removal, filling, hydrological interruption, or other means and no impact would occur because of the Project.

MM BIO-7. *Prior to issuance of any grading or building permit, the Project proponent/developer shall submit a Delineation report to the City of Lemoore. The report shall include information as shown below as a plan if necessary and shall outline compliance to the following:*

1. *Delineation of all jurisdictional feature (Fox Ditch) at the project site. Potential jurisdictional features within the project boundary identified in the jurisdictional delineation report may be shown in plan form.*
2. *If the Project has a potential to directly or indirectly impact jurisdictional aquatic resources, a formal aquatic resource delineation of these areas shall be performed by a qualified professional to determine the extent of agency jurisdiction and permits/authorizations from the appropriate regulating agencies (Central Valley*

Regional Water Quality Control Board (RWQCB), CDFW and US Army Corps of Engineers (USACE) shall be obtained prior to disturbance to jurisdictional features.

If it is determined that drainage is jurisdictional and cannot be avoided, the Project proponent shall obtain a Section 401 Waters Quality Certification from the RWQCB, a Section 404 permit from USACE and a Lake and Streambed Alteration Agreement from the CDFW, if required prior to impacting any waters.

As part of these authorizations, compensatory mitigation may be required by the regulating agencies to offset the loss of aquatic resources. If so, and as part of the permit application process, a qualified professional shall draft a Mitigation and Monitoring Plan to address implementation and monitoring requirements under the permit to ensure that the Project would result in no net loss of habitat functions and values. The Plan shall contain, at a minimum, mitigation goals and objectives, mitigation location, a discussion of actions to be implemented to mitigate the impact, monitoring methods and performance criteria, extent of monitoring to be conducted, actions to be taken in the event that the mitigation is not successful, and reporting requirements. The Plan shall be approved by the appropriate regulating agencies and compensatory mitigation shall take place either on site or at an appropriate off-site location.

3. *Any material/spoils generated from project activities containing hazardous materials shall be located away from jurisdictional areas or special-status habitat and protected from storm water run-off using temporary perimeter sediment barriers such as berms, silt fences, fiber rolls, covers, sand/gravel bags, and straw bale barriers, as appropriate. Protection measures should follow project-specific criteria as developed in a Stormwater Pollution Prevention and Protection Plan (SWPPP).*
4. *Equipment containing hazardous liquid materials shall be stored on impervious surfaces or plastic ground covers to prevent any spills or leakage from contaminating the ground and at least 50 feet outside the delineated boundary of jurisdictional water features.*
5. *Any spillage of material shall be stopped if it can be done safely. The contaminated area shall be cleaned, and any contaminated materials properly disposed. For all spills, the project foreman or designated environmental representative shall be notified.*

d) Would the project interfere substantially with the movement of any native resident or migratory fish or wildlife species or with established native resident or migratory wildlife corridors, or impede the use of native wildlife nursery sites?

Less than Significant with Mitigation Incorporated. Wildlife movement corridors are linear habitats that function to connect two (2) or more areas of significant wildlife habitat. These corridors may function on a local level as links between small habitat patches (e.g., streams in urban settings) or may provide critical connections between regionally significant habitats (e.g., deer movement corridors).

Wildlife corridors typically include vegetation and topography that facilitate the movements of wild animals from one area of suitable habitat to another, in order to fulfill foraging, breeding, and territorial needs. These corridors often provide cover and protection from predators that may be lacking in surrounding habitats. Wildlife corridors generally include riparian zones and similar linear expanses of contiguous habitat. Local irrigation canals and ditches

may be used by local wildlife to travel through the vicinity. To reduce impacts to biological resources, BIO-1 through BIO-6 shall be implemented. Impacts would be less than significant with mitigation incorporated.

e) Conflict with any local policies or ordinances protecting biological resources, such as a tree preservation policy or ordinance?

No Impact. The General Plan outlines policies related to the conservation of biological resources, focusing on protection of wetlands and rare and endangered species. Since the Project site does not include wetlands and does not support habitat for wildlife species, the Project would not conflict with the General Plan policies protecting biological resources. Thus, the Project would have no impact.

f) Conflict with the provisions of an adopted Habitat Conservation Plan, Natural Community Conservation Plan, or other approved local, regional, or state habitat conservation plan?

No Impact. The Project site is within the PG&E San Joaquin Valley Operation and Maintenance Habitat Conservation Plan (HCP). The HCP covers PG&E's routine operations and maintenance activities and minor new construction, on any PG&E gas and electrical transmission and distribution facilities, easements, private access routes, or lands owned by PG&E. The Project is not covered and therefore would not be in conflict or interfere with this HCP. The Project is also located in the planning area of the Recovery Plan for Upland Species of the San Joaquin Valley, which addresses recovery goals for several species. The Project would not conflict with the plan since the site does not provide appropriate habitat for the species mentioned and would comply to applicable General Plan policies regarding habitat conservation.

The City does not have any other adopted or approved plans for habitat or natural community conservation. For these reasons, the Project would have no impact.

4.4.3 Mitigation Measures

The proposed project shall implement and incorporate, as applicable, the biological resources related mitigation measures as identified in the attached Mitigation Monitoring and Reporting Program (MMRP) August 2023. .

4.5 CULTURAL RESOURCES

Would the project:	Potentially Significant Impact	Less than Significant with Mitigation Incorporated	Less than Significant Impact	No Impact
a) Cause a substantial adverse change in the significance of a historical resource as defined in Section 15064.5?		X		
b) Cause a substantial adverse change in the significance of an archaeological resource pursuant to Section 15064.5?		X		
c) Disturb any human remains, including those interred outside of formal cemeteries?		X		

4.5.1 Environmental Setting

Generally, the term ‘cultural resources’ describes property types such as prehistoric and historical archaeological sites, buildings, bridges, roadways, and tribal cultural resources. As defined by CEQA, cultural resources are considered “historical resources” that meet criteria in *Section 15064.5(a)* of the CEQA Guidelines. If a Lead Agency determines that a project may have a significant effect on a historical resource, then the project is determined to have a significant impact on the environment. No further environmental review is required if a cultural resource is not found to be a historical resource.

Tribal Consultation

The City of Lemoore conducted formal tribal consultation pursuant to AB 52 on September 28, 2022, to the Santa Rosa Rancheria Tachi Yokut Tribal Government. A response was received from the Santa Rosa Rancheria Tachi Yokut Tribal Government on October 19, 2022, stating that “the Tribe has major concerns for this project and is requesting to be retained for cultural presentation for all construction staff and the landowner(s), to have a Native American monitor onsite for all ground disturbance related to the project/site, and to have burial treatment plan and curation agreement in place. The Tribe is also requesting that an archeological record search, an archeological survey, and a Sacred Lands File with the NAHC be completed if not already done so, and to have the results sent to us as well.” Further consultation was not requested by the Tribe. Mitigation measures have been incorporated to address these concerns.

California Native American Heritage Commission (NAHC)

A Sacred Lands File (SLF) was requested from the NAHC and results were received on November 28, 2022. The result of the check conducted was positive. The NAHC recommended that the Santa Rosa Rancheria Tachi Yokut Tribal Government be contacted. The NAHC correspondence was sent by the City of Lemoore on November 30, 2022. No response was received from the tribe. The NAHC correspondence is provided in [Appendix C](#).

Cultural Resource Assessment

A Cultural Resource Assessment was conducted and is provided in **Appendix D**. The assessment includes a regulatory context, cultural setting, and results of a field survey and California Historical Resources Information System (CHRIS) record search. The field survey was completed on August 18, 2022, and the CHRIS record search was conducted on August 15, 2022 (RS#22-310).

4.5.2 Impact Assessment

Would the project:

- a) *Cause a substantial adverse change in the significance of a historical resource pursuant to Section 15064.5?*

Less than Significant with Mitigation Incorporated.

The results and conclusions of the assessment are as follows.

- *The field survey indicates the land to be mostly flat with a large, mature walnut orchard that was likely leveled for irrigation. An irrigation ditch was surveyed and appears to date to the 1920s or earlier. A residence was recently removed from the northwestern corner of the site. Other than segments of the ditch that are recorded within the survey area (i.e., to the east of the project area) there were no historical or prehistoric artifacts, features, or other resources. The ditch cannot be considered significant under any of the criteria of the California Register of Historical Resources.*
- *The CHRIS record search reports that the project area has never been formally surveyed, and four surveys have been conducted within 0.25 miles of the project area. The USGS topographic map shows a building in the northern portion of the project, but the residential building is no longer present. The Lemoore Ditch is recorded to the east of the project area as P-16-000129.*

The Cultural Resource Assessment was provided to the Santa Rosa Rancheria Tachi Yokut Tribal Government by the City of Lemoore on November 30, 2022.

Based on the field survey and the Cultural Resource Assessment, it can be concluded that there are no historical resources within the Project site. The Lemoore Ditch (P-16-000129) is located to the east and will not be impacted by the Project. The Assessment concluded that there will be no impact to important cultural resources from the implementation of the project. However, while there is no evidence that historical resources exist on the Project site, there is some possibility that hidden and buried resources may exist on the Project site with no surface evidence. Thus, to further assure construction activities do not result in significant impacts to any potential cultural resources discovered below ground surface, the Project shall incorporate **Mitigation Measure CUL-1** and **Mitigation Measure CUL-2**. Thus, if such resources were discovered, implementation of the required mitigation measure would reduce the impact to less than significant. As a result, the Project will have a less than significant impact with mitigation incorporated.

MM CUL-1: *In the event that cultural resources are discovered during construction . Construction shall stop within 100 feet of the find, and a qualified archeologist shall determine whether the resource requires further study. The qualified archaeologist shall determine the measures that shall be implemented to protect the discovered resources, including but not limited to excavation of the finds and evaluation of the finds in accordance with §15064.5 of the CEQA Guidelines. Mitigation measures may include avoidance, preservation in-place, recordation, additional*

archaeological testing, and data recovery, among other options. Any previously undiscovered resources found during construction within the project area shall be recorded on appropriate Department of Parks and Recreation forms and evaluated for significance. No further ground disturbance shall occur in the immediate vicinity of the discovery until approved by the qualified archaeologist.

No further grading shall occur in the area of the discovery until the Lead Agency approves the measures to protect these resources. Any historical artifacts recovered as a result of mitigation shall be provided to a City-approved institution or person who is capable of providing long-term preservation to allow future scientific study.

MM CUL-2: *Upon coordination with the City any archaeological artifacts recovered shall be donated to an appropriate Tribal custodian or a qualified scientific institution where they would be afforded applicable cultural resources laws and guidelines.*

b) Cause a substantial adverse change in the significance of an archaeological resource pursuant to Section 15064.5?

Less than Significant Impact with Mitigation Incorporated. Based on the field survey conducted on August 18, 2022 and the Cultural Resource Assessment conducted on August 29, 2022, there is no evidence that cultural resources of any type (including historical, or archaeological) exist on the Project site. Nevertheless, there is some possibility that a non-visible, buried archeological resource may exist and may be uncovered during ground disturbing construction activities which would constitute a significant impact. Disturbance of any deposits that have the potential to provide significant cultural data would be considered a significant impact. To reduce the potential impacts of the Project on cultural resources, the following measures are recommended. MM CUL-2 requires that a tribal monitor be present to conduct a surface inspection of the site prior to construction activities and also be present during initial grading and construction activities. . The Project proposal shall have a burial treatment plan and curation agreement in place as well. This ensures that a qualified individual is present to identify and address cultural resources prior to and during project construction and reduce potential adverse impacts on cultural resources. Additionally, MM CUL-3 provides the implementation of procedure should human remains be unearthed during project construction. With implementation of MM CUL-1 through MM CUL-3, impacts to cultural resources would be less than significant.

MM CUL-3: *Prior to any ground disturbance, the applicant shall offer interested tribes the opportunity to provide a Native American Monitor during ground-disturbing activities during construction. Tribal participation would be dependent upon the availability and interest of the tribe. The project proposal shall have a burial treatment plan and curation agreement in place as well.*

Upon coordination with the Lead Agency, any archaeological artifacts recovered shall be donated to an appropriate Tribal Custodian or a qualified scientific institution where they would be afforded long-term preservation. Documentation for the work shall be provided in accordance with applicable cultural resource laws and guidelines.

MM CUL-4: *If requested, prior to any ground disturbance, a surface inspection of the site shall be conducted by a Tribal Monitor. The Tribal Monitor shall monitor the site during initial grading or ground-disturbance activities. The Tribal Cultural Staff shall provide preconstruction briefings to supervisory personnel and any excavation contractor, which will include information on potential cultural material finds and, on the procedures, to be enacted if resources are found. Tribal participation would be dependent upon the availability and interest of the tribe.*

If prehistoric or historic-era cultural materials are encountered during construction activities, all work in the immediate vicinity of the find shall halt until a qualified archaeologist can evaluate the find and make recommendations. Cultural resource materials may include prehistoric resources such as flaked and ground stone tools and debris, shell, bone, ceramics, and fire-affected rock as well as historic resources such as glass, metal, wood, brick, or structural remnants. If the qualified archaeologist determines that the discovery represents a potentially significant cultural resource, additional investigations may be required to mitigate adverse impacts from project implementation. These additional studies may include avoidance, testing, and evaluation or data recovery excavation. Implementation of the mitigation measure would ensure that the proposed project would not cause a substantial adverse change in the significance of a historical resource.

The Lead Agency along with other relevant or tribal officials shall be contacted upon the discovery of cultural resources to begin coordination on the disposition of the find(s). Treatment of any significant cultural resources shall be undertaken with the approval of the Lead Agency.

c) Disturb any human remains, including those interred outside of formal cemeteries?

Less than Significant Impact with Mitigation Incorporated. There is no evidence that human remains exist on the Project site. Nevertheless, there is some possibility that a non-visible buried site may exist and may be uncovered during ground disturbing construction activities which would constitute a significant impact. If any human remains are discovered during construction, CCR *Section 15064.5(e)*, PRC *Section 5097.98*, and California Health and Safety Code *Section 7050.5* will mitigate the impacts. To further assure future construction activities do not result in significant impacts to any potential resources or human remains discovered below ground surface, the Project shall incorporate MM CUL-5. Therefore, if any human remains were discovered, implementation of this mitigation and referenced regulations would reduce the Project's impact to less than significant. Therefore, if any human remains were discovered, implementation of this mitigation and referenced regulations would reduce the Project's impact to less than significant.

MM CUL-5: *If human remains are discovered during construction or operational activities, further excavation or disturbance shall be prohibited pursuant to Section 7050.5 of the California Health and Safety Code. The specific protocol, guidelines, and channels of communication outlined by the Native American Heritage Commission, in accordance with Section 7050.5 of the Health and Safety Code, Section 5097.98 of the Public Resources Code (Chapter 1492, Statutes of 1982, Senate Bill 297), and Senate Bill 447 (Chapter 44, Statutes of 1987), shall be followed. Section 7050.5(c) shall guide the potential Native American involvement, in the event of discovery of human remains, at the direction of the county coroner.*

4.5.3 Mitigation Measures

The proposed project shall implement and incorporate, as applicable, the cultural resources related mitigation measures as identified in the attached MMRP dated August 2023.

4.6 ENERGY

Would the project:	Potentially Significant Impact	Less than Significant with Mitigation Incorporated	Less than Significant Impact	No Impact
a) Result in potentially significant environmental impact due to wasteful, inefficient, or unnecessary consumption of energy resources, during project construction or operation?			X	
b) Conflict with or obstruct a state or local plan for renewable energy or energy efficiency?			X	

4.6.1 Environmental Setting

The California Energy Commission updates the Building Energy Efficiency Standards (Title 24, Parts 6 and 11) apply for new construction of, and additions and alterations to, residential and nonresidential buildings and relate to various energy efficiencies including but not limited to ventilation, air conditioning, and lighting.⁵ The 2022 California Green Building Standards Code (CALGreen), Part 11, Title 24, California Code of Regulations, encourages energy efficiency to meet the State goals for reducing Greenhouse Gas emissions pursuant to AB32. CALGreen covers five (5) categories: planning and design, energy efficiency, water efficiency and conservation, material and resource efficiency, and indoor environmental quality.⁶ Additionally, the California Air Resources Board (CARB) oversees air pollution control efforts, regulations, and programs that contribute to reduction of energy consumption. Compliance with these energy efficiency regulations and programs ensure that development will not result in wasteful, inefficient, or unnecessary consumption of energy sources. Lastly, the Energy Action Plan (EAP) for California was approved in 2003 by the California Public Utilities Commission (PUC). The EAP established goals and next steps to integrate and coordinate energy efficiency demand and response programs and actions.⁷

General Plan

The Lemoore General Plan Community Design Element identifies the following goal and policies related to energy efficiency and conservation.

Policy CD-I-58 Require new development to incorporate passive heating and natural lighting strategies if feasible and practical. These strategies should include, but are not limited to, the following:

⁵ California Energy Commission. 2019 Building Energy Efficiency Standards. Accessed on September 12, 2022, <https://www.energy.ca.gov/programs-and-topics/programs/building-energy-efficiency-standards/2019-building-energy-efficiency>

⁶ California Department of General Services. (2020). 2019 California Green Building Standards Code. Accessed on September 12, 2022, <https://codes.iccsafe.org/content/CGBC2019P3>

⁷ State of California. (2008). Energy Action Plan 2008 Update. Accessed on September 14, 2022, https://docs.cpuc.ca.gov/word_pdf/REPORT/28715.pdf

- *Using building orientation, mass and form, including façade, roof, and choice of building materials, color, type of glazing, and insulation to minimize heat loss during winter months and heat gain during summer months;*
- *Designing building openings to regulate internal climate and maximize natural lighting, while keeping glare to a minimum; and*
- *Reducing heat-island effect of large concrete roofs and parking surfaces.*

Policy CD-I-60 *Incorporate green building standards into the Zoning Ordinance and building code to ensure a high level of energy efficiency in new development, retrofitting projects, and City facilities. These standards should include, but are not limited to, the following:*

- *Require the use of Energy Star® appliances and equipment in new and substantial renovations of residential development, commercial development, and City facilities;*
- *Require all new development incorporate green building methods to qualify for the equivalent of LEED Certified “Silver” rating or better (passive solar orientation must be a minimum component);*
- *Require all new residential development to be pre-wired for optional photovoltaic energy systems and/or solar water heating on south facing roofs; and*
- *Require all new projects that will use more than 40,000 kilowatt hours per year of electricity to install photovoltaic energy systems.*

Policy CD-I-62 *Facilitate environmentally sensitive construction practices by:*

- *Restricting use of chlorofluorocarbons (CFCs), hydrochlorofluorocarbons (HCFCs) and halons in mechanical equipment and building materials;*
- *Promoting use of products that are durable and allow efficient end-of-life disposal (recyclable);*
- *Requiring subdivision applications on sites greater than five acres to submit a construction waste management plan for City approval;*
- *Promoting the purchase of locally or regionally available materials; and*
- *Promoting the use of cost-effective design and construction strategies that reduce resource and environmental impacts*

4.6.2 Impact Assessment

Would the project:

- a) Result in potentially significant environmental impact due to wasteful, inefficient, or unnecessary consumption of energy resources, during project construction or operation?***

Less than Significant Impact Future development that results from Project implementation would consume energy resources. Energy would be consumed through future construction and operations. Construction activities typically include site preparation, demolition, grading, paving, architectural coating, and trenching. The primary source of energy for construction activities are diesel and gasoline, from the transportation of building materials and equipment and construction worker trips. Operations would involve heating, cooling, equipment, and vehicle trips typical of residential uses. Energy consumption related to operations would be associated with natural gas, electricity, and fuel.

Construction:

All construction equipment and operational activities shall conform to current emissions standards and related fuel efficiencies, including applicable CARB regulations (Airborne Toxic Control Measure), California Code of Regulations (Title 13, Motor Vehicles), and Title 24 standards that include a broad set of energy conservation requirements (e.g., Lighting Power Density requirements). Compliance with such regulations would ensure that the short-term, temporary construction activities and long-term operational activities do not result in wasteful, inefficient, or unnecessary consumption of energy resources.

Energy outputs for short-term construction and long-term operations were estimated using CalEEMod (Appendix A) and Project assumptions. Traffic impacts related to vehicle trips were considered through a Vehicle Miles Traveled (VMT) analysis contained in Section 4.17.

Operations:

Once constructed, the Project site would be served by PG&E for both electricity and natural gas. Kings County consumed approximately 1,980.7 GWh of electricity, or 0.7 percent of electricity generated in California in 2021 (280,738.4 GWh) and approximately 6,400,428.3 MMBtu, or 0.5 percent of natural gas generated in California in 2020 (1,192,270,564.2).⁸ The Project would implement Title 24 Energy Efficiency Standards and CalGreen Code requirements for new construction that may include rooftop solar, double-pane windows, electric vehicle charging, LED lights, low-flow toilets, faucets drip irrigation, and the use of drought-tolerant landscaping to increase water conservation.

Table 4-7 shows the estimated electricity and natural gas consumption for the Project. Development of the Project would consume less than one percent of the total electricity use in Kings County in 2021 and less than one percent of the total natural gas use in Kings County in 2021. These results indicates the Project would have a less than significant impact related to energy consumption.

Table 4-7 Project Energy Consumption

Energy Consumption	Electricity (GWh per year)	Natural Gas (MMBtu per year)
Project	2.2	6,634.4
Kings County	1,980.7	6,400,428.3
Project Percentage (%)	0.1	0.1

Regarding energy consumed through vehicle trips, development of the Project site to the maximum permitted density would generate a VMT per capita of 7.19 (See Section 4.17) which is less than the County’s 15 percent below average VMT per capita of 8.2. As such, it can be concluded that, based upon KCAG’s VMT Mapping Tool, the Project’s VMT impact would be less than significant because VMT associated with the Project would be below the 15 percent-below-existing-development threshold. Therefore, energy consumed through vehicle trips would be less than significant.

⁸ California Energy Commission. “Electricity Consumption by County.” Accessed on November 4, 2022, <http://ecdms.energy.ca.gov/electbycounty.aspx>

Overall, energy consumption for the Project would be less than significant. In addition, through compliance with applicable CARB regulations (Airborne Toxic Control Measure), California Code of Regulations (Title 13, Motor Vehicles), and Title 24 standards, it can be determined that the proposed Project would not consume energy in a manner that is wasteful, inefficient, or unnecessary. For these reasons, the Project would result in a less than significant impact.

b) Conflict with or obstruct a state or local plan for renewable energy or energy efficiency?

Less than Significant Impact. As discussed under criterion a), the construction and operations of the Project would be subject to compliance with applicable energy efficiency regulations. The proposed Project would comply with all applicable federal, State, and local regulations regulating energy usage. The Project would comply with Title 24 Energy Efficiency Standards and CalGreen Code requirements for double-pane windows, electric vehicle charging, LED lights, low-flow toilets, and faucets to increase water conservation. Energy would also be indirectly conserved through water-efficient landscaping requirements consistent with the City’s adopted Water Efficient Landscaping Ordinance with the use of drip irrigation and drought-tolerant landscaping.

Stringent solid waste recycling requirements applicable to both Project construction and operation would reduce energy consumed in solid waste disposal. In summary, the Project would implement all mandatory federal, State, and local conservation measures, and project design features, and voluntary energy conservation measures will further reduce energy demands. Therefore, the Project would not conflict with or obstruct a State or local plan for renewable energy or energy efficiency. Therefore, the Project would not conflict with or obstruct any State or local plan for energy efficiency and Project-related impacts are less than significant.

4.6.3 Mitigation Measures

None required.

4.7 GEOLOGY AND SOILS

Would the project:	Potentially Significant Impact	Less than Significant with Mitigation Incorporated	Less than Significant Impact	No Impact
<p>a) Directly or Indirectly cause potential substantial adverse effects, including the risk of loss, injury, or death involving:</p> <p>i. Rupture of a known earthquake fault, as delineated on the most recent Alquist-Priolo Earthquake Fault Zoning Map issued by the State Geologist for the area or based on other substantial evidence of a known fault? Refer to Division of Mines and Geology Special Publication 42.</p>				X
<p>ii. Strong seismic ground shaking?</p>			X	
<p>iii. Seismic-related ground failure, including liquefaction?</p>			X	
<p>iv. Landslides?</p>				X
<p>b) Result in substantial soil erosion or the loss of topsoil?</p>			X	
<p>c) Be located on a geologic unit or soil that is unstable, or that would become unstable as a result of the project, and potentially result in on- or off-site landslide, lateral spreading, subsidence, liquefaction or collapse?</p>			X	
<p>d) Be located on expansive soil, as defined in Table 18-1-B of the Uniform Building Code (1994), creating substantial risks to life or property?</p>				X
<p>e) Have soils incapable of adequately supporting the use of septic tanks or alternative wastewater disposal systems where sewers are not available for the disposal of waste water?</p>				X
<p>f) Directly or indirectly destroy a unique paleontological resource or site or unique geologic feature?</p>		X		

4.7.1 Environmental Setting

The Project site is in the San Joaquin Valley which is one of the two large valleys comprising the Great Valley Geomorphic Province. The San Joaquin Valley is surrounded by Sierra Nevada (east), Coast Ranges (west), Tehachapi (south), and the Sacramento Valley (north). A brief discussion of the likelihood of seismic activities to occur in or affect the City of Lemoore is provided below. The discussion incorporates data and information from the Lemoore General Plan and the Kings County Local Hazard Mitigation Plan (HMP).⁹

Erosion

Soil erosion is a process whereby soil materials are worn away and transported to another area, either by wind or water. Rates of erosion can vary depending on the soil material and structure, placement, and human activity. Soil containing high amounts of silt can be easily eroded, while sandy soils are less susceptible. Excessive soil erosion can eventually damage building foundations and roadways. Erosion is most likely to occur on sloped areas with exposed soil, especially where unnatural slopes are created by cut-and-fill activities. Soil erosion rates can be higher during the construction phase. Typically, the soil erosion potential is reduced once the soil is graded and covered with concrete, structures, or asphalt.

Subsidence

Subsidence is the gradual settling or sinking of the earth's surface with little or no horizontal motion. Subsidence typically occurs in areas that overlie an aquifer where the groundwater level is gradually and consistently decreasing. Additionally, subsidence may also occur in the presence of oil or natural gas extraction. Areas of substantial subsidence occur on the west side of the Kings River, outside the city limits, and predominately relate to groundwater withdrawal.

Expansive Soils

Expansive soils possess a "shrink-swell" characteristic. Shrink-swell is the cyclic change in volume (expansion and contraction) that occurs in fine-grained clay sediments from the process of wetting and drying. Structural damage may occur over a long period of time, usually the result of inadequate soil and foundation engineering, or the placement of structures directly on expansive soils. Several portions within the city have soil with high to moderate shrink-swell potential.

A search of the Web Soil Survey by the USDA Natural Resources Conservation Service indicates that the following soils comprise the Project site.¹⁰

130: Kimberlina fine sandy loam, saline-alkali, 0 to 2 percent slopes, well drained, medium runoff, with no potential of flooding or ponding. The depth to water table is more than 80 inches. The 130 soils account for 72.0% of the Project site.

⁹ Howell Consulting. (2012). Kings County Multi-Jurisdictional Local Hazard Mitigation Plan. Assessed April 12, 2023, <https://www.countyofkings.com/home/showpublisheddocument/23875/637298992208470000>

¹⁰ United States Department of Agriculture. (2023). Web Soil Survey. Assessed April 12, 2023, <https://websoilsurvey.nrcs.usda.gov/app/WebSoilSurvey.aspx>

137: Lemoore sandy loam, partially drained, 0 to 1 percent slopes, somewhat poorly drained, low runoff, with no potential of flooding or ponding. The depth to water table is more than 80 inches. The 137 soils accounted for 6.1% of the Project site.

149: Nord complex, 0 to 2 percent slopes, well drained, low runoff, with no potential of flooding or ponding. The depth to water table is more than 80 inches. The 149 soils account for 10.5% of the Project site.

167: Urban land, accounts for 11.4% of the Project site. Urban land is defined as “areas with a specific percentage of impervious cover, such as pavement, driveways, and buildings.”

Fault Zones and Ground Shaking

There are no known active seismic faults in Lemoore or its immediate vicinity. The nearest active faults include Nunez Fault (approximately 32 miles southwest), San Andreas Fault (approximately 40 miles southwest) and the Sierra Nevada Fault Zone (approximately 83 miles to the east).¹¹ Potential hazards related to major earthquakes include ground shaking and related secondary ground failures.

Secondary natural hazards associated with earthquakes result from the interaction of ground shaking with existing ground instabilities, and include liquefaction, settlement or subsidence, landslides and seiches. None of these hazards are considered of particular concern to the City of Lemoore due to its distance from the San Andreas Fault, lack of steep slopes, and clay composition of area soils. In addition, all new structures are required to adhere to the California Building Code which includes provisions for adequate design, construction, and maintenance of structures to prevent exposure to major geologic hazards.

California Building Code

The CCR Title 24 is assigned to the California Building Standards Commission, which, by law, is responsible for coordinating all building standards. The CBC incorporates by reference the International Building Code with necessary California amendments. The California Building Standards Code also focuses for California earthquake conditions. Lemoore Municipal Code *Section 8-7H-3* also requires that the application for vesting tentative map submits geological studies to include detailed soils reports, seismic analysis, bank stabilization, and other factors to ensure the safety from earthquake related effected emanating from fault activity is considered during design.

General Plan

The General Plan includes guiding policies and implementing policies relevant to natural hazards in the Safety and Noise Element, including some that are applicable to the Project.

Guiding Policy SN-G-1 Minimize risks of property damage and personal injury posed by seismic hazards, soil hazards, and erosion.

Implementing Policy SN-I-1 Review proposed development sites at the earliest stage of the planning process to locate any potential geologic or seismic hazard.

¹¹ California Department of Conservation. Fault Activity Map of California. Accessed on July 29, 2022, <https://maps.conservation.ca.gov/cgs/fam/>

Implementing Policy SN-I-2 Maintain and enforce appropriate building standards and codes to avoid or reduce risks associated with geologic constraints and to ensure that all new construction is designed to meet current safety regulations.

Implementing Policy SN-I-6 Control erosion of graded areas with vegetation or other acceptable methods.

4.7.2 Impact Assessment

Would the project:

- a) *Directly or indirectly cause potential substantial adverse effects, including the risk of loss, injury, or death involving:*
 - i. *Rupture of a known earthquake fault, as delineated on the most recent Alquist-Priolo Earthquake Fault Zoning Map issued by the State Geologist for the area or based on other substantial evidence of a known fault? Refer to Division of Mines and Geology Special Publication 42.*

No Impact. There are no known active earthquake faults in Lemoore (inclusive of the Project site), nor is Lemoore within an Alquist-Priolo earthquake fault zone as established by the Alquist-Priolo Fault Zoning Act or shown on the most recent Alquist-Priolo Earthquake Fault Zoning Map.

The General Plan contains a number of policies that would minimize impacts relating to the rupture of a known fault. Development of the proposed Project would adhere to all applicable policies of the General Plan and Title 24 building codes for accepted structural standards and minimize the risk of loss, injury, or death. Therefore, there would be no impacts..

- ii. *Strong seismic ground shaking?*

Less than Significant Impact. There are no known active earthquake faults in Lemoore, inclusive of the Project site. Potential hazards related to major earthquakes include ground shaking and related secondary ground failures. Since there are no known faults within or near the Project vicinity, ground shaking from surface faulting would be minimal in the area. In addition, the Project site is relatively flat and has stable, native soils and is not in close proximity to any fault lines. To minimize potential risks from seismic ground shaking, the Project would be required to conform to current seismic protection standards in the CBC that is codified in the LMC. Thus, through compliance with the applicable local and State codes and regulations, the Project would have a less than significant impact.

- iii. *Seismic-related ground failure, including liquefaction?*

Less than Significant Impact. There are also no geologic hazards or unstable soil conditions known to exist on the Project site. The site is relatively flat with stable soils and no apparent unique or significant landforms. For this reason, liquefaction or seismically induced settlement or bearing loss is considered unlikely, even if there should be a substantial increase in ground water level. Lastly, development of the Project site would be required to comply with the City's grading and drainage standards that would further reduce the likelihood of settlement or bearing loss. The potential magnitude/geographic extent of expansive liquefaction erosion was deemed 'negligible' and its significance 'low' throughout the City. Liquefaction is possible in local areas during a strong earthquake or other seismic ground shaking, where unconsolidated sediments coincide with a high-water table. However, the groundwater occurs below 90 feet which means liquefaction potential would be low. For these reasons, the Project does not have any aspect that could result in seismic-related ground failure including liquefaction and a less than significant impact would occur because of the Project.

iv. Landslides?

Less than Significant Impact. The topography of the Project site is relatively flat with stable, native soils, and the site is not in the immediate vicinity of rivers or creeks that would be more susceptible to landslides. In addition, the Project does not have any aspect that could result in landslides. Therefore, no impact would occur because of the Project.

b) Result in substantial soil erosion or the loss of topsoil?

Less Than Significant Impact. Soil erosion and loss of topsoil can be caused by natural factors, such as wind and flowing water, and human activity. Development of the Project site would require typical site preparation activities such as grading and trenching which may result in the potential for short-term soil disturbance or erosion impacts. Excessive soil erosion could cause damage to existing structures and roadways. In the case of the Project's proposed residential development, erosion would most likely occur during the construction phase and would be reduced once the site is graded and paved or landscaped.

The likelihood of erosion occurring during construction would be reduced through site grading and surfacing, which would be subject to review and approval by the City for compliance with applicable standards. The likelihood of erosion would be further reduced through compliance with regulations set by the State Water Resources Control Board (SWRCB). Namely, the SWRCB requires sites larger than one (1) acre to comply with the General Permit for Discharges of Storm Water Associated with Construction Activity (i.e., General Permit Order No. 2012-0006-DWQ). The General Permit requires the development and approval of a Storm Water Pollution Prevention Plan (SWPPP) by a certified Qualified SWPPP Developer (QSD). The SWPPP estimates the sediment risk associated with construction activities and includes best management practices (BMP) to control erosion. BMPs specific to erosion control cover erosion, sediment, tracking, and waste management controls. Implementation of the SWPPP minimizes the potential for the Project to result in substantial soil erosion or loss of topsoil.

Once constructed, the Project would have both impermeable surfaces as well as permeable surfaces. Impermeable surfaces would include roadways, driveways, parking lots, and building sites. Permeable surfaces would include any landscaped areas and open spaces. As noted above, the Project will include the installation of a 2.03-acre onsite detention basin (Outlot F), and stormwater would be directed to the basin. Overall, the development of the Project would not result in conditions where substantial surface soils would be exposed to wind and water erosion.

With these provisions in place, impacts to soil and topsoil by the Project would be considered less than significant.

c) Be located on a geologic unit or soil that is unstable, or that would become unstable as a result of the project, and potentially result in on- or off-site landslide, lateral spreading, subsidence, liquefaction, or collapse?

Less than Significant Impact. See Impact (iii) and (iv), above. Ground subsidence is the settling or sinking of surface soil deposits with little or no horizontal motion. Soils with high silt or clay content are subject to subsidence. Subsidence typically occurs in areas with groundwater withdrawal or oil or natural gas extraction. The topography of the site is relatively flat with stable, native soils and no apparent unique or significant landforms. Future development of the Project site would be required to comply with current seismic protection standards in the CBC which would significantly limit potential seismic-related hazards such as landslides, lateral spreading, subsidence, liquefaction, or collapse. Compliance with the CBC would ensure a less than significant impact.

d) Be located on expansive soil, as defined in Table 18-1-B of the Uniform Building Code (1994, as updated), creating substantial direct or indirect risks to life or property?

No Impact. The Project site is relatively flat and stable, native soils of primarily sandy loam. Sandy loam soils are not classified as expansive soil, as defined in Table 18-1-B of the Uniform Building Code and would not create substantial direct or indirect risks to life or property. Thus, no impact would occur because of the Project.

e) Have soils incapable of adequately supporting the use of septic tanks or alternative wastewater disposal systems where sewers are not available for the disposal of wastewater?

No Impact. Since the Project site is within city limits, the site will be connected to the City's water and sewer systems. Thus, no septic tanks or alternative wastewater disposal systems would be installed, and no impact would occur because of the Project.

f) Directly or indirectly destroy a unique paleontological resource or site or unique geologic feature?

Less than Significant Impact with Mitigation Incorporated. There are no known paleontological resources or unique geological features known to the City on this site. Nevertheless, there is some possibility that a non-visible, buried site may exist and may be uncovered during ground disturbing construction activities which would constitute a significant impact. However, MM GEO-1 requires that if unknown paleontological resources are discovered during construction activities, work within a 25-foot buffer would cease until a qualified paleontologist determined the appropriate course of action. With implementation of MM GEO-1, the Project would have a less-than-significant impact. Mitigation Measure

MM GEO-1: *If any paleontological resources are encountered during ground-disturbance activities, all work within 25 feet of the find shall halt until a qualified paleontologist as defined by the Society of Vertebrate Paleontology Standard Procedures for the Assessment and Mitigation of Adverse Impacts to Paleontological Resources (2010), can evaluate the find and make recommendations regarding treatment. Paleontological resource materials may include resources such as fossils, plant impressions, or animal tracks preserved in rock. The qualified paleontologist shall contact the Natural History Museum of Los Angeles County or another appropriate facility regarding any discoveries of paleontological resources.*

If the qualified paleontologist determines that the discovery represents a potentially significant paleontological resource, additional investigations, and fossil recovery may be required to mitigate adverse impacts from project implementation. If avoidance is not feasible, the paleontological resources shall be evaluated for their significance. If the resources are not significant, avoidance is not necessary. If the resources are significant, they shall be avoided to ensure no adverse effects or such effects must be mitigated. Construction in that area shall not resume until the resource-appropriate measures are recommended or the materials are determined to be less than significant. If the resource is significant and fossil recovery is the identified form of treatment, then the fossil shall be deposited in an accredited and permanent scientific institution. Copies of all correspondence and reports shall be submitted to the Lead Agency.

4.7.3 Mitigation Measures

The proposed project shall implement and incorporate the geology and soils related mitigation measure as identified in the attached MMRP August 2023.

4.8 GREENHOUSE GAS EMISSIONS

Would the project:	Potentially Significant Impact	Less than Significant with Mitigation Incorporated	Less than Significant Impact	No Impact
a) Generate greenhouse gas emissions, either directly or indirectly, that may have a significant impact on the environment?			X	
b) Conflict with an applicable plan, policy or regulation adopted for the purpose of reducing the emissions of greenhouse gases?			X	

4.8.1 Environmental Setting

An Air Quality and Greenhouse Gas Technical Memorandum was completed by JJM Air Quality Consulting Services dated November 1, 2022, revised May 11, 2023, and is incorporated herein by reference. The Air Quality and Greenhouse Gas Technical Memorandum is provided in **Appendix A**. The analysis contained in the memorandum utilized the tiered approach to analyzing project significance with respect to GHG emissions contained in SJVAPCD’s Guidance for Valley Land Use Agencies in Addressing GHG Emission Impacts for New Projects under CEQA. All impacts were found to be less than significant as further described below.

Project-level Thresholds

Section 15064.4(b) of the CEQA Guidelines’ amendments for GHG emissions states that a lead agency may take into account the following three considerations in assessing the significance of impacts from GHG emissions.

- Consideration #1: The extent to which the project may increase or reduce GHG emissions as compared to the existing environmental setting.
- Consideration #2: Whether the project emissions exceed a threshold of significance that the lead agency determines applies to the project.
- Consideration #3: The extent to which the project complies with regulations or requirements adopted to implement a statewide, regional, or local plan for the reduction or mitigation of GHG emissions. Such regulations or requirements must be adopted by the relevant public agency through a public review process and must include specific requirements that reduce or mitigate the project’s incremental contribution of GHG emissions. If there is substantial evidence that the possible effects of a particular project are still cumulatively considerable notwithstanding compliance with the adopted regulations or requirements, an Environmental Impact Report (EIR) must be prepared for the project.

The SJVAPCD’s Guidance for Valley Land-use Agencies in Addressing GHG Emission Impacts for New Projects under CEQA includes thresholds based on whether the project will reduce or mitigate GHG levels by 29 percent from “business-as-usual” BAU levels compared with 2005 levels by 2020. This level of GHG reduction is based on the target established by CARB’s AB 32 Scoping Plan, approved in 2008. First occupancy at the project site is expected to occur after the AB 32 2020 milestone year. Given recent legislative and legal scrutiny on post-2020 compliance,

additional discussion is provided to show progress towards GHG reduction goals identified in CARB’s 2017 Scoping Plan for the year 2030. Additionally, although not included in a formal GHG reduction plan, Executive Order S-3-05 also includes a goal of reducing GHG emissions 80 percent below 1990 levels by 2050 and Executive Order B-55-18 set the goal to achieve carbon neutrality statewide by 2045. The analysis in the Air Quality and Greenhouse Gas Technical Memorandum briefly addresses the proposed Project’s consistency with those two Executive Orders.

4.8.2 Impact Assessment

Would the project:

- a) *Generate greenhouse gas emissions, either directly or indirectly, that may have a significant impact on the environment?*

Less than Significant Impact. To determine significance the analysis first quantifies project-related GHG emissions under a BAU scenario, and then compares these emissions with those emissions that would occur when all Project-related design features are accounted for, and when compliance with applicable regulatory measures is assumed. The standards and methodology are explained in further detail in **Appendix A**.

Construction

GHG emissions generated during all phases of construction were combined and are shown in **Table 4-8**. Neither the City of Lemoore nor the SJVAPCD have adopted thresholds of significance for construction-related emissions. In addition, GHG emission reduction measures for construction equipment are relatively limited. To assess construction emissions, the Sacramento Metropolitan Air Quality Management District’s screening threshold of 1,100 MT CO₂e per year is applied in this analysis. The Project’s maximum annual GHG emissions, as well as the Project’s average annual GHG emissions are compared against the applied threshold in **Table 4-8**.

Table 4-8 Summary of Construction-Generated GHG Emissions

Construction Activity	MT CO ₂ e Per Year
Project Construction 2023	591
Project Construction 2024	680
Project Construction 2025	520
Project Construction 2026	514
Project Construction 2027	508
Project Construction 2028	501
Project Construction 2029	263
Total Construction MTCO₂e	3,577
Annual Average GHG Emissions (MT CO ₂ e/year) ¹	559
Maximum Annual Emissions (MT CO ₂ e/year)	680
Annual Threshold (MT CO ₂ e/year)	1,100
Potentially Significant Impact in Either Scenario?	No

Notes:

MT CO₂e = metric tons of carbon dioxide equivalent

¹*Total construction emissions were divided by the construction duration in years (6.4 years) to estimate average annual emissions.*

Source: CalEEMod Output (Appendix A).

Operations

Operational or long-term emissions occur over the life of the Project. Sources of emissions may include motor vehicles and trucks, energy usage, water usage, waste generation, and area sources, such as landscaping activities

and residential woodburning. Operational GHG emissions associated with the proposed Project were estimated using CalEEMod 2020.4.0.

Business-as-Usual Operational Emissions

Operational emissions under the business-as-usual scenario were modeled using CalEEMod 2020.4.0. Modeling assumptions for the year 2005 were used to represent business as usual conditions (without the benefit of regulations adopted to reduce GHG emissions). CARB and SJVAPCD guidance recommend using regulatory conditions in 2002-2004 in the baseline scenario to represent conditions as if regulations had not been adopted to allow the effect of projected growth on achieving reduction targets to be clearly defined. CalEEMod defaults were used for project energy usage, water usage, waste generation, and area sources (architectural coating, consumer products, and landscaping). The vehicle fleet mixes were revised to reflect the project fleet mix identified for the buildout year.

Buildout Year Operational Emissions

Operational emissions for full project buildout were modeled for the full buildout in the earliest operational year (2024) and 2030 operational year scenarios using CalEEMod. CalEEMod assumes compliance with some, but not all, applicable rules and regulations regarding energy efficiency, vehicle fuel efficiency, renewable energy usage, and other GHG reduction policies, as described in the CalEEMod User's Guide.

The reductions obtained from each regulation and the source of the reduction amount used in the analysis are described below.

The following regulations are incorporated into the CalEEMod emission factors:

- *Pavley I and Pavley II (LEV III) motor vehicle emission standards*
- *CARB Medium and Heavy-Duty Vehicle Regulation*
- *2005, 2008, 2013, 2016, and 2019 Title 24 Energy Efficiency Standards*

The following regulations have not been incorporated into the CalEEMod emission factors and require alternative methods to account for emission reductions provided by the regulations:

- *Renewables Portfolio Standard (RPS) requirements for year 2030*
- *2022 Title 24 Energy Efficiency Standards*
- *Green Building Code Standards (indoor water use)*
- *California Model Water Efficient Landscape Ordinance (outdoor water)*
- *CalRecycle 75 Percent Initiative (solid waste)*

Title 24 reductions for 2013 and 2016 updates were added to CalEEMod 2016.3.2 and were carried into CalEEMod 2020.4.0. Title 24 reductions for 2019 were added to CalEEMod 2020.4.0; however, the additions do not account for on-site renewable energy that would be included as part of single-family residential projects. Therefore, the CalEEMod mitigation component was used to account for rooftop solar included as part of the proposed project.

RPS is not accounted for in CalEEMod 2020.4.0. Reductions from RPS for operational years 2030 and beyond are addressed by revising the electricity emission intensity factor in CalEEMod to account for the utility RPS rate forecast for 2030. The utilities will be required by SB 100 to increase the use of renewable energy sources to 60 percent by 2030. Data for PG&E was used to estimate a revised CO₂ intensity factor for use in the modeling.

Reductions in emissions from solid waste are based on the County achieving the CalRecycle 75 Percent Initiative by 2020 compared with a 50 percent baseline for 2005. No additional reductions were accounted for in the emission estimates prepared for the project.

Energy savings from water conservation resulting from the Green Building Code Standards for indoor water use and California Model Water Efficient Landscape Ordinance for outdoor water use are not included in CalEEMod. The Water Conservation Act of 2009 mandates a 20 percent reduction in urban water use that is implemented with these regulations. Benefits of the water conservation regulations are applied in the CalEEMod mitigation component.

GHG reductions from some design features and compliance with regulations that are not otherwise accounted for can be quantified in CalEEMod. Note that CalEEMod nominally treats these design elements and conditions as “mitigation measures,” despite their inclusion in the project description. Therefore, reported operational emissions are considered to represent unmitigated project conditions.

Operational GHG emissions by source are shown in **Table 4-9** for the buildout year scenarios. As operations are expected to begin as early as 2024, full buildout of the Project was modeled from the 2024 operational year to provide a conservative estimate of emissions and associated impacts.

Table 4-9 Unmitigated Project Operational GHG Emissions (Buildout Scenario)

Emission Source	Emissions (MT CO ₂ e per year)	
	Business as Usual Total Emissions (MT CO ₂ e per year)	Buildout Year Total Emissions with Regulations and Design Features (MT CO ₂ e per year)
Area	126	125
Energy	1,163	393
Mobile (On-road Vehicles)	3,510	2,462
Waste	145	145
Water	69	31
Total (MT CO₂e per year)	5,013	3,156
Reduction from BAU (MT CO ₂ e per year)		1,857
Percent Reduction		37.0%
Significance Threshold		29%
Significant Impact?		No

MT CO₂e = metric tons of carbon dioxide equivalent.

Totals were calculated using unrounded emissions; totals may not appear to sum exactly due to rounding.

Source of Significance Threshold: San Joaquin Valley Air Pollution Control District (SJVAPCD). 2015. Final Draft Guidance for Assessing and Mitigating Air Quality Impacts. Website: <https://www.valleyair.org/transportation/GAMAQI-2015/FINAL-DRAFT-GAMAQI.PDF> Accessed October 9, 2022 and May 10, 2023.

Source of Business-as-Usual Emissions: CalEEMod output for the 2024 BAU scenario (see Attachment A).

Source of Buildout Year Emissions: CalEEMod output for project buildout in 2024 (Attachment A).

As shown in **Table 4-9**, the Proposed project’s total GHG annual emissions under the full buildout scenario in the earliest operational year (2024) achieve the required reduction from BAU and would be considered to have a less-than-significant impact in regards to the Project’s generation of GHG emissions.

The 2030 operational year scenarios are summarized in **Table 4-10**. As previously noted, the 2030 operational year was used to assess the project’s consistency with the SB 32 2030 target.

Table 4-10 Unmitigated Project Operational GHG Emissions (Year 2030 Scenario)

Emission Source	Emissions (MT CO ₂ e per year)	
	Business as Usual Total Emissions (MT CO ₂ e per year)	2030 Year Total Emissions with Regulations and Design Features (MT CO ₂ e per year)
Area	126	125
Energy	1,163	391
Mobile (On-road Vehicles)	3,510	2,087
Waste	145	145
Water	69	31
Total (MT CO₂e per year)	5,013	2,779
Reduction from BAU (MT CO ₂ e per year)		2,234
Percent Reduction		44.6%
Significance Threshold		29%
Significant Impact?		No

MT CO₂e = metric tons of carbon dioxide equivalent.

Totals were calculated using unrounded emissions; totals may not appear to sum exactly due to rounding.

¹ *Adjusted threshold to account for 2017 Scoping Plan Update 40 percent reduction goal by 2030.*

Source of Business-as-Usual Emissions: CalEEMod output for the 2030 BAU scenario (see [Appendix A](#)).

Source of 2030 Emissions: CalEEMod output for the year 2030 ([Appendix A](#)).

As shown, the Project would achieve a 37.0 percent reduction from BAU at project buildout (2024) and a 44.6 percent reduction from BAU by the year 2030 with adopted regulations and design features incorporated. These amounts are both exceed the 29 percent reduction required by the SJVAPCD threshold, and above the required 21.7 percent average reduction from all GHG emission sources to meet the AB 32 targets. CARB originally identified a reduction of 29 percent from business as usual as needed to achieve AB 32 targets. The 2008 recession and slower growth in the years since 2008 have reduced the growth forecasted for 2020 and the amount needed to be reduced to achieve 1990 levels as required by AB 32; the target was revised to 21.7 percent.

The 37.0 percent reduction from BAU is 15.3 percent beyond the average reduction required by the State from all sources to achieve the AB 32 2020 target, and the percent reduction is 8.0 percent beyond the SJVAPCD’s threshold. This surplus addresses the Supreme Court’s concern in the Newhall case that new development must do more than average to meet its fair share of emission reductions.

By 2030, the proposed Project would achieve a 44.6 percent reduction from BAU or 22.9 percent above the 21.7 percent reduction necessary to meet the 2020 target (15.6 percent above the SJVAPCD’s percent reduction threshold).

The Project’s occupancy is anticipated to begin as early as 2024; thus, an additional analysis is provided to show consistency with post-2020 State legislative GHG goals. The SB 32 goal of 40 percent below 1990 emission levels by 2030 is the target established by the 2017 Scoping Plan Update. Although CARB adopted the 2022 Scoping Plan in December 2022 that addresses long-term GHG goals set forth by AB 1279, the 2017 Scoping Plan addresses a future GHG goal (2030) and remains relevant to assess GHG impacts from the proposed Project.

The 2017 Scoping Plan includes new strategies that are not incorporated in the analysis above. Many measures that are likely to proceed include zero net energy buildings in future updates to Title 24 and enhanced motor vehicle fuel efficiency standards beyond 2025. The 2017 Scoping Plan identified an emission limit of 260 million metric tons of carbon dioxide equivalents (MMTCO₂e). The 2030 BAU Inventory is estimated to be 392 MMTCO₂e. The 2017

Scoping Plan identified that the bulk of its reductions would come from the Electric Power, Industrial fuel combustion, and Transportation. The continuance of the Cap and Trade would provide additional reductions. Although the 2017 Scoping Plan largely relies on state actions to achieve the GHG emissions limit, the CARB considers local governments partners in achieving the State's goals for reducing GHG emissions. The 2017 Scoping Plan suggests that all new land use development implement feasible measures to reduce GHG emissions, however, it does not define feasible measures nor assign a required reduction amount to new development. An evaluation of the Project's consistency with the 2022 Scoping Plan is included under Impact GHG-2. A fair share quantitative threshold based on the 2017 Scoping Plan or the 2022 Scoping Plan is not presently feasible as the nexus between a project's contribution and its fair share mitigation is not well defined.

Based on the 37.0 percent reduction from BAU for Project buildout in the earliest operational year (2024), the proposed project would not have a significant impact on GHG emissions as it would meet the SJVAPCD's threshold of 29 percent and exceed the CARB's 21.7 percent reduction necessary from all sources to meet the AB 32 emissions limit.

The Project achieves a 44.6 percent reduction from BAU for the year 2030, which demonstrates substantial progress towards achieving the 2030 target.

Regarding the years 2045 and 2050, there have been Executive Orders issued to address carbon neutrality and GHG reduction targets, respectively for those years, however, there are no existing GHG reduction plans that specifically address those Orders. Historically, the State would take the lead in developing regulatory and market measures to achieve the required reductions. The proposed Project would participate in the reductions through adherence with regulations and continued improvements to the motor vehicle efficiencies accessing the project site. Studies have shown that in order to meet the 2050 targets, aggressive pursuit of technologies in the transportation and energy sectors, including electrification and the decarbonization of fuel, will be required. Because of the technological shifts required and the unknown parameters of the regulatory framework in 2050, quantitatively analyzing the proposed Project's impacts further relative to the 2050 goals is speculative for purposes of CEQA.

In summary, the proposed Project meets the required 29 percent below BAU guidance provided by the SJVAPCD. Furthermore, the proposed project shows substantial reductions in the year 2030 to suggest that it would not inhibit the State's progress in achieving the 2030 GHG emissions target. The GHG emissions impact would be less than significant with respect to Consideration #1 and #2. Therefore, a less than significant impact would occur because of the Project.

b) Conflict with an applicable plan, policy or regulation adopted for the purpose of reducing the emissions of greenhouse gases?

Less than Significant Impact. The following analysis assesses the proposed project's compliance with Consideration No. 3 regarding consistency with adopted plans to reduce GHG emissions. The City of Lemoore has not adopted a GHG reduction plan. In addition, the City has not completed the GHG inventory, benchmarking, or goal-setting process required to identify a reduction target and take advantage of the streamlining provisions contained in the CEQA Guidelines amendments adopted for SB 97 and clarifications provided in the CEQA Guidelines amendments adopted on December 28, 2018. The SJVAPCD has adopted a Climate Action Plan, but it does not contain measures that are applicable to the project. Therefore, the SJVAPCD Climate Action Plan cannot be applied to the project. Since no other local or regional GHG reduction plan is in place, the Project is assessed for its consistency with ARB's

adopted 2008, 2017, and 2022 Scoping Plans. This would be achieved with an assessment of the proposed Project's compliance with Scoping Plan measures contained in the 2017 Scoping Plan, as well an evaluation of the proposed Project's consistency with the 2022 Scoping Plan.

Consistency with AB 32

The State's regulatory program implementing the 2008 Scoping Plan is now fully mature. All regulations envisioned in the Scoping Plan have been adopted, and the effectiveness of those regulations has been estimated by the agencies during the adoption process and then tracked to verify their effectiveness after implementation. The combined effect of this successful effort is that the State now projects that it will meet the 2020 target and achieve continued progress toward meeting post-2020 targets. Governor Brown, in the introduction to Executive Order B-30-15, stated "California is on track to meet or exceed the current target of reducing greenhouse gas emissions to 1990 levels by 2020, as established in the California Global Warming Solutions Act of 2006 (AB 32)."

Consistency with SB 32 and the 2017 Scoping Plan

The 2017 Climate Change Scoping Plan Update (2017 Scoping Plan) includes the strategy that the State intends to pursue to achieve the 2030 targets of Executive Order S-3-05 and SB 32. Although CARB adopted the 2022 Scoping Plan in December 2022 that addresses long-term GHG goals set forth by AB 1279, the 2017 Scoping Plan addresses a future GHG goal and remains relevant to the proposed Project. The 2017 Scoping Plan includes the following summary of its overall strategy for reaching the 2030 target:

- *SB 350*
 - *Achieve 50 percent Renewables Portfolio Standard (RPS) by 2030.*
 - *Doubling of energy efficiency savings by 2030.*
- *Low Carbon Fuel Standard (LCFS)*
 - *Increased stringency (reducing carbon intensity 18 percent by 2030, up from 10 percent in 2020).*
- *Mobile Source Strategy (Cleaner Technology and Fuels Scenario)*
 - *Maintaining existing GHG standards for light- and heavy-duty vehicles.*
 - *Put 4.2 million zero-emission vehicles (ZEVs) on the roads.*
 - *Increase ZEV buses, delivery, and other trucks.*
- *Sustainable Freight Action Plan*
 - *Improve freight system efficiency.*
 - *Maximize use of near-zero emission vehicles and equipment powered by renewable energy.*
 - *Deploy over 100,000 zero-emission trucks and equipment by 2030.*
- *Short-Lived Climate Pollutant (SLCP) Reduction Strategy*
 - *Reduce emissions of methane and hydrofluorocarbons 40 percent below 2013 levels by 2030.*
 - *Reduce emissions of black carbon 50 percent below 2013 levels by 2030.*
- *SB 375 Sustainable Communities Strategies*
 - *Increased stringency of 2035 targets.*
- *Post-2020 Cap-and-Trade Program*
 - *Declining caps, continued linkage with Québec, and linkage to Ontario, Canada.*
 - *CARB will look for opportunities to strengthen the program to support more air quality co-benefits, including specific program design elements. In Fall 2016, CARB staff described potential future*

amendments including reducing the offset usage limit, redesigning the allocation strategy to reduce free allocation to support increased technology and energy investment at covered entities and reducing allocation if the covered entity increases criteria or toxics emissions over some baseline.

- By 2018, develop Integrated Natural and Working Lands Action Plan to secure California’s land base as a net carbon sink

Table 4-11 provides an analysis of the Project’s consistency with the 2017 Scoping Plan Update measures.

Table 4-11 Consistency with SB 32 2017 Scoping Plan Update

Scoping Plan Measure	Project Consistency
SB 350 50% Renewable Mandate. Utilities subject to the legislation will be required to increase their renewable energy mix from 33% in 2020 to 50% in 2030. (The requirement is now 60% in 2030 per SB 100.)	Consistent. The Project will purchase electricity from a utility subject to the SB 350 Renewable Mandate.
SB 350 Double Building Energy Efficiency by 2030. This is equivalent to a 20 percent reduction from 2014 building energy usage compared to current projected 2030 levels.	Not Applicable. This measure applies to existing buildings. New structures, including new single-family homes, are required to comply with Title 24 Energy Efficiency Standards that are expected to increase in stringency until residential housing achieves zero net energy. The Project consists of the construction of new single-family homes and does not include renovations to existing structures.
Low Carbon Fuel Standard. This measure requires fuel providers to meet an 18 percent reduction in carbon content by 2030.	Consistent. Vehicles accessing the Project site will use fuel containing lower carbon content as the fuel standard is implemented.
Mobile Source Strategy (Cleaner Technology and Fuels Scenario). Vehicle manufacturers will be required to meet existing regulations mandated by the LEV III and Heavy-Duty Vehicle programs. The strategy includes a goal of having 4.2 million ZEVs on the road by 2030 and increasing numbers of ZEV trucks and buses.	Consistent. Future residents can be expected to purchase increasing numbers of more fuel efficient and zero emission cars and trucks each year. The CALGreen Code requires electrical service in new single-family housing to be EV charger-ready. In addition, home deliveries will be made by increasing numbers of ZEV delivery trucks.
Sustainable Freight Action Plan. The plan’s target is to improve freight system efficiency 25 percent by increasing the value of goods and services produced from the freight sector, relative to the amount of carbon that it produces by 2030. This would be achieved by deploying over 100,000 freight vehicles and equipment capable of zero emission operation and maximize near-zero emission freight vehicles and equipment powered by renewable energy by 2030.	Not Applicable. The measure applies to owners and operators of trucks and freight operations. The Project is residential in nature and would not support freight operations. However, home deliveries are expected to be made by increasing number of ZEV delivery trucks.
Short-Lived Climate Pollutant (SLCP) Reduction Strategy. The strategy requires the reduction of SLCPs by 40 percent from 2013 levels by 2030 and the reduction of black carbon by 50 percent from 2013 levels by 2030.	Consistent. The Project will only include natural gas hearths that produce very little black carbon compared with wood burning fireplaces and heaters in-line with the SJVAPCD’s Guidance for Assessing and Mitigating Air Quality Impacts mitigation measures. ¹

Scoping Plan Measure	Project Consistency
<p>SB 375 Sustainable Communities Strategies. Requires Regional Transportation Plans to include a sustainable communities strategy for reduction of per capita vehicle miles traveled.</p>	<p>Not applicable. The Project includes the construction and development of a residential subdivision and does not include the development of a regional transportation plan.</p>
<p>Post-2020 Cap-and-Trade Program. The Post 2020 Cap-and-Trade Program continues the existing program for another 10 years. The Cap-and-Trade Program applies to large industrial sources such as power plants, refineries, and cement manufacturers.</p>	<p>Consistent. The post-2020 Cap-and-Trade Program indirectly affects people who use the products and services produced by the regulated industrial sources when increased cost of products or services (such as electricity and fuel) are transferred to the consumers. The Cap-and-Trade Program covers the GHG emissions associated with electricity consumed in California, whether generated in-state or imported. Accordingly, GHG emissions associated with CEQA projects' electricity usage are covered by the Cap-and-Trade Program. The Cap-and-Trade Program also covers fuel suppliers (natural gas and propane fuel providers and transportation fuel providers) to address emissions from such fuels and from combustion of other fossil fuels not directly covered at large sources in the program's first compliance period.</p>
<p>Natural and Working Lands Action Plan. The ARB is working in coordination with several other agencies at the federal, state, and local levels, stakeholders, and with the public, to develop measures as outlined in the Scoping Plan Update and the governor's Executive Order B-30-15 to reduce GHG emissions and to cultivate net carbon sequestration potential for California's natural and working land.</p>	<p>Not Applicable. The Project is residential development and will not be considered natural or working lands.</p>

Source: California Air Resources Board (CARB). 2017. *The 2017 Climate Change Scoping Plan Update*. January 20. Website: https://www.arb.ca.gov/cc/scopingplan/2030sp_pp_final.pdf. Accessed October 9, 2022.

¹San Joaquin Valley Air Pollution Control District (SJVAPCD). 2015. *Guidance for Assessing and Mitigating Air Quality Impacts*. Website: <https://www.valleyair.org/transportation/GAMAQI-2015/FINAL-DRAFT-GAMA>. Accessed October 9, 2022 and May 10, 2023

Consistency Regarding GHG Reduction Goals for 2050 under Executive Order S-3-05 and GHG Reduction Goals for 2045 under the 2022 Scoping Plan

CARB adopted the 2022 Scoping Plan in December 2022 that addresses long-term GHG goals set forth by AB 1279. The 2022 Scoping Plan outlines the State's pathway to achieve carbon neutrality and an 85 percent reduction in 1990 emissions goal by 2045. In the 2022 Scoping Plan, CARB advocates for compliance with a local GHG reduction strategy consistent with CEQA Guidelines *section 15183.5*. The 2022 Scoping Plan also provides guidance regarding the role of local governments (such as the lead agency) in achieving the State's climate goals, particularly as it concerns the approval of new land use development projects and their environmental review under CEQA.

The 2022 Scoping Plan outlines approaches that lead agencies may consider for evaluating the consistency of proposed plans and residential and mixed-use projects with the State's climate goals. In other words, the 2022 Scoping Plan considers the following approaches to evaluate whether a project may have a less than significant impact on GHG emissions, though it notes that these approaches are recommendations only and that they do not

supplant lead agencies’ discretion to develop their own evidence-based approaches for determining whether a project would result in a potentially significant impact on GHG emissions.

One approach outlined in the 2022 Scoping Plan involves assessing the project’s consistency with key project attributes identified in the 2022 Scoping Plan that have been demonstrated to reduce operational GHG emissions. The project attributes are intended as a guide to help local jurisdictions, such as the City of Lemoore, identify residential and mixed-use projects that are clearly consistent with the State’s climate goals. The 2022 Scoping Plan considers residential and mixed-use development projects incorporating the following key project attributes (listed in **Table 4-12**) to be aligned with the State’s priority GHG reduction strategies for local climate action and therefore consistent with the 2022 Scoping Plan and other plans, policies, or regulations adopted for the purposes of reducing GHG emissions.

The project’s consistency with the 2022 Scoping Plan is provided below in **Table 4-12**.

Table 4-12: 2022 Scoping Plan Consistency Analysis

Key Residential and Mixed-use Attribute Identified in the 2022 Scoping Plan	Project Consistency
Transportation Electrification	
Provides EV charging infrastructure that, at minimum, meets the most ambitious voluntary standard in the California Green Building Standards Code at the time of project approval.	Consistent. The new residential homes included as part of the proposed Project would include EV charging infrastructure as required by 2022 California Green Buildings Standards Code (CALGreen), which is enforced at the project level by the City of Lemoore.
Vehicle Miles Traveled Reduction	
Is located on infill sites that are surrounded by existing urban uses and reuses or redevelops previously undeveloped or underutilized land that is presently served by existing utilities and essential public services (e.g., transit, streets, water, sewer).	Consistent. The Project site is primarily surrounded by existing built-up urban uses and is located near a mix of residential, public, and commercial uses. As there are currently no homes occupying the project site, the project would increase density at this site compared to existing uses.
Does not result in the loss or conversion of natural and working lands.	Consistent. The Project site is not considered natural or working lands; therefore, the proposed project would not result in the loss or conversion of natural or working lands.
Consists of transit-supportive densities (minimum 20 residential dwelling units per acre), or Is in proximity to existing transit stops (within a half mile), or Satisfies more detailed and stringent criteria specified in the region’s Sustainable Communities Strategy (SCS).	Not applicable. The Project site consists of approximately 52.61 acres located north of SR 198 and east of South Lemoore Avenue (APN 023-040-058-000). The site is zoned PR and RLD with a planned land use of Low Density Residential and Parks and Recreation. No public transit facilities are proposed as part of the Project.
Reduces parking requirements by: <ul style="list-style-type: none"> • <i>Eliminating parking requirements or including maximum allowable parking ratios (i.e., the ratio of parking spaces to residential units or square feet).</i> • <i>Providing residential parking at a ratio of less than one parking space per dwelling unit.</i> 	Consistent. The proposed project does not propose any parking lots or other standalone parking areas. Parking areas would be included as part of the single-family homes (such as garages and driveways), with additional on-street parking available. In addition, the pProject will be built to meet all existing applicable regulations.

For multi-family residential development, requiring parking costs to be unbundled from costs to rent or own a residential unit.	
At least 20 percent of units included are affordable to lower-income residents.	Not applicable. Affordable units are not noted in the Project description; therefore, it was assumed that this key attribute may not be met to provide a conservative evaluation of project impacts.
Does not result in a net loss of existing affordable units.	Consistent. The Project would not remove any existing affordable units and, therefore, would not result in a net loss of existing affordable units.
Building Decarbonization	
Uses all-electric appliances without any natural gas connections and does not use propane or other fossil fuels for space heating, water heating, or indoor cooking.	Not applicable. The proposed Project would be built to code, which does not currently require an all-electric design.

Source of Key Attributes: California Air Resources Board (CARB). 2022. 2022 Scoping Plan. Table 3, Appendix D. November 16. Website: <https://ww2.arb.ca.gov/resources/documents/2022-scoping-plan-documents> . Accessed May 10, 2023.

As noted in **Table 4-12** above, the proposed project is consistent with several key project attributes identified in the 2022 Scoping Plan. Specifically, the proposed project is consistent with five of the eight applicable key attributes. The 2022 Scoping Plan acknowledges that projects incorporating some, but not all, of the key project attributes may still be consistent with the State’s climate goals, at the discretion of the lead agency. The project would comply with all applicable regulations, including those implemented to minimize the adverse impacts of growth and development on climate change. Based on the proposed project’s consistency with a majority of the key project attributes (as detailed in **Table 4-12**) and that fact that it would comply with all existing regulations, the proposed project is considered consistent with the 2022 Scoping Plan and AB 1279’s goal of achieving Statewide carbon net neutrality by 2045.

Regarding goals for 2050 under Executive Order S-3-05, at this time it is not possible to quantify the emissions savings from future regulatory measures, as they have not yet been developed; nevertheless, it can be anticipated that operation of the Project would comply with whatever measures are enacted that state lawmakers decide would lead to an 80 percent reduction below 1990 levels by 2050. In its 2008 Scoping Plan, CARB acknowledged that the “measures needed to meet the 2050 are too far in the future to define in detail.” In the First Scoping Plan Update; however, CARB generally described the type of activities required to achieve the 2050 target: “energy demand reduction through efficiency and activity changes; large scale electrification of on-road vehicles, buildings, and industrial machinery; decarbonizing electricity and fuel supplies; and rapid market penetration of efficiency and clean energy technologies that requires significant efforts to deploy and scale markets for the cleanest technologies immediately.” The 2017 Scoping Plan provides an intermediate target that is intended to achieve reasonable progress toward the 2050 target. In addition, the 2022 Scoping Plan outlines objectives, regulations, planning efforts, and investments in clean technologies and infrastructure that outlines how the State can achieve carbon-neutrality by 2045.

Accordingly, taking into account the proposed Project’s emissions, Project design features, and the progress being made by the State towards reducing emissions in key sectors such as transportation, industry, and electricity, the project would be consistent with State GHG Plans and would further the State’s goals of reducing GHG emissions

to 1990 levels by 2020, 40 percent below 1990 levels by 2030, carbon neutral by 2045, and 80 percent below 1990 levels by 2050, and does not obstruct their attainment. Impacts would be less than significant.

Overall, the proposed Project would not conflict with CARB's adopted 2017 Scoping Plan or CARB's 2022 Scoping Plan. Because the Project would be consistent with CARB's adopted 2017 and 2022 Scoping Plan, it follows that the Project would not conflict with any applicable plan, policy or regulation adopted for the purpose of reducing the emissions of GHGs. Therefore, impacts would be less than significant.

4.8.3 Mitigation Measures

None required.

4.9 HAZARDOUS AND HAZARDOUS MATERIAL

Would the project:	Potentially Significant Impact	Less than Significant with Mitigation Incorporated	Less than Significant Impact	No Impact
a) Create a significant hazard to the public or the environment through the routine transport, use, or disposal of hazardous materials?			X	
b) Create a significant hazard to the public or the environment through reasonably foreseeable upset and accident conditions involving the release of hazardous materials into the environment?			X	
c) Emit hazardous emissions or handle hazardous or acutely hazardous materials, substances, or waste within one-quarter mile of an existing or proposed school?			X	
d) Be located on a site which is included on a list of hazardous materials sites compiled pursuant to Government Code Section 65962.5 and, as a result, would it create a significant hazard to the public or the environment?				X
e) For a project located within an airport land use plan or, where such a plan has not been adopted, within two miles of a public airport or public use airport, would the project result in a safety hazard for people residing or working in the project area?				X
f) Impair implementation of or physically interfere with an adopted emergency response plan or emergency evacuation plan?			X	
g) Expose people or structures, either directly or indirectly, to a significant risk of loss, injury or death involving wildland fires?			X	

4.9.1 Environmental Setting

For the purposes of this section, the term “hazardous materials” refers to "injurious substances," which include flammable liquids and gases, poisons, corrosives, explosives, oxidizers, radioactive materials, and medical supplies

and waste. These materials are either generated or used by various commercial and industrial activities. Hazardous wastes are injurious substances that have been or will be disposed. Potential hazards arise from the transport of hazardous materials, including leakage and accidents involving transporting vehicles. There also are hazards associated with the use and storage of these materials and wastes. Hazardous materials are grouped into the following four categories based on their properties:

- *Toxic: causes human health effect*
- *Ignitable: has the ability to burn*
- *Corrosive: causes severe burns or damage to materials*
- *Reactive: causes explosions or generates toxic gases*

“Hazardous wastes” are defined in California Health and Safety Code Section 25141(b) as wastes that: “...because of their quantity, concentration, or physical, chemical, or infectious characteristics, [may either] cause or significantly contribute to an increase in mortality or an increase in serious illness or pose a substantial present or potential hazard to human health or the environment when improperly treated, stored, transported, disposed of, or otherwise managed.” A hazardous waste is any hazardous material that is discarded, abandoned, or slated to be recycled. If improperly handled, hazardous materials and hazardous waste can result in public health hazards if released into the soil or groundwater or through airborne releases in vapors, fumes, or dust. Soil and groundwater having concentrations of hazardous constituents higher than specific regulatory levels must be handled and disposed of as hazardous waste when excavated or pumped from an aquifer. The California Code of Regulations, Title 22, Sections 66261.20-24 contains technical descriptions of toxic characteristics that could cause soil or groundwater to be classified as hazardous waste.

Hazardous waste generators may include industries, businesses, public and private institutions, and households. Federal, state, and local agencies maintain comprehensive databases that identify the location of facilities using large quantities of hazardous materials, as well as facilities generating hazardous waste. Some of these facilities use certain classes of hazardous materials that require risk management plans to protect surrounding land uses. The release of hazardous materials would be subject to existing federal, State, and local regulations and is similar to the transport, use, and disposal of hazard materials.

Record Search

The United States Environmental Protection Agency (EPA) Superfund National Priorities List (NPL)¹², California Department of Toxic Substance Control’s EnviroStor database¹³, and the State Water Resources Control Board’s GeoTracker database¹⁴ include hazardous release and contamination sites. A search of each database was conducted on July 29, 2022. The searches revealed no hazardous material release sites on or near the Project site.

¹² United States Environmental Protection Agency. Superfund National Priorities List. Accessed July 29, 2022 <https://epa.maps.arcgis.com/apps/webappviewer/index.html?id=33cebcdfdd1b4c3a8b51d416956c41f1>

¹³ California Department of Toxic Substances Control. Envirostor. Accessed July 29, 2022, <https://www.envirostor.dtsc.ca.gov/public/>

¹⁴ California State Water Resources Control Board. GeoTracker. Accessed July 29, 2022, <https://geotracker.waterboards.ca.gov/>

General Plan

The General Plan Safety and Noise Element includes the following policies related to fire, hazards, and hazardous waste.

Guiding Policy SN-G-3 *Protect Lemoore’s residents and businesses from potential wildfire hazards.*

Implementing Policy SN-I-13 *Ensure Fire Department personnel are trained in wildfire prevention, response and evacuation procedures.*

Implementing Policy SN-I-14 *Continue the City’s Weed Abatement Program administered by the Volunteer Fire Department to reduce fire hazards before the fire season.*

Implementing Policy SN-I-15 *Enforce the Uniform Fire Code through the approval of construction plans and final occupancy permits.*

Implementing Policy SN-I-16 *Utilize existing or new public awareness programs through the Volunteer Fire Department to highlight the dangers of open burning and how home owners can protect their properties from wildfires.*

Implementing Policy SN-I-17 *Update news media and City residents on current wildfire threat levels during drought periods.*

Guiding Policy SN-G-4 *Protect Lemoore’s ecology and residents from harm resulting from the improper production, use, storage, disposal, or transportation of hazardous materials.*

Implementing Policy SN-I-19 *Require remediation and cleanup of sites contaminated with hazardous substances.*

Implementing Policy SN-I-21 *Promote the reduction, recycling and safe disposal of household and business hazardous wastes through public education and awareness.*

Naval Air Station Lemoore Land Use Compatibility Plan

The Naval Air Station Lemoore (NASL) is located approximately 7.5 miles southwest of the Project site at 700 Avenger Ave, Lemoore, CA 93245. The Air Installation Compatible Use Zones (AICUZ) Report for NASL responds to the growing incompatible urban development around military airfields. The AICUZ Report aims to protect the health, safety, and welfare of civilians and military personnel by encouraging compatible land uses with aircraft operations, reducing noise impacts, and public education.¹⁵ The AICUZ program is a Department of Defense discretionary program designed to promote development compatible with military flight operations.¹⁶ All Clear

¹⁵ Department of Navy. (2010). Air Installations Compatible Use Zones Report: Naval Air Station Lemoore, California. Accessed on July 25, 2023, https://cnrsw.cnrc.navy.mil/Portals/84/NAS_Lemoore/Documents/20101210_Final_Lemoore_AICUZ.pdf?ver=44B5ZAN9NSJK3T_g0enQQ%3D%3D

¹⁶ Air Force Civil Engineer Center. AICUZ Program Frequently Asked Questions. Accessed July 25, 2023, <https://www.afcec.af.mil/About-Us/Fact-Sheets/Display/Article/2388269/aicuz-program-frequently-asked-questions/#:~:text=The%20Air%20Installations%20Compatible%20Use,compatible%20with%20military%20flight%20operations.>

Zone and Accident Potential Zone (APZ) are outside city limits near the runways of the NASL, and all AICUZ noise contours and incompatible noise contour areas are located west of SR 41 and south of SR 198.

The General Plan also established *Implementing Actions LU-I-3* controlling growth south of the city limits and west of SR-41 related to the AICUZ study.

Implementing Actions LU-I-3 Do not accept any applications for annexation or development in the area south of the existing (May 2008) City limits and west of SR-41 until after completion of the Navy's Air Installation Compatible Use Zone (AICUZ) study for the Naval Air Station Lemoore and completion of flood hazard studies by the Federal Emergency Management Agency (FEMA).

Emergency Operations Plan

The City adopted an Emergency Operations Plan (EOP) in 2005. The City's EOP provides guidance to City staff in the event of extraordinary emergency situation associated with natural disaster and technological incidents. The EOP concentrates on operation concepts and response procedures relative to large-scale disasters. In the event of a county-wide disaster, the City is to assume its role assigned in the Kings County EOP. The Kings County EOP addresses the County's planned response to extraordinary emergency situations associated with natural disasters, technological incidents, and national security emergencies in or affecting the County of Kings.¹⁷

4.9.2 Impact Assessment

Would the project:

- a) *Create a significant hazard to the public or the environment through the routine transport, use, or disposal of hazardous materials?*

Less than Significant Impact. The Project proposes a residential development. The type of hazardous materials that would be associated with Project operations are those typical of residential uses such as cleaning supplies and HVAC equipment. Because of the proposed residential use, it is not expected that the Project would routinely transport, use, or dispose of hazardous materials other than those typical of residential uses and such materials would not be of the type of quantity that would pose a significant hazard to the public.

Potential impacts during construction of the Project could result from the use of fuels and lubricants for construction equipment. However, these impacts would be short-term and temporary, and would be reduced to less than significant levels through compliance with local, state, and federal regulations including but not limited to compliance with EPA's oil spills prevention and preparedness regulations, California Office of Emergency Services implementation of hazardous materials accident prevention, and California Department of Toxic Substance Control permitting, and regulations as administered by Kings County, in addition to standard equipment operating practices as indicated in operator manuals. Therefore, the Project would have a less than significant impact.

Some appliances and electronics used or stored by residents may contain hazardous components (e.g., refrigerants, oils, etc.); however, these hazardous components are regulated by the EPA under the Toxic Substances Control Act and Clean Air Act and transport of such components are regulated by the U.S. Department of Transportation, Office

¹⁷ County of Kings Office of Emergency Management. (2015). Emergency Operations Plan. Accessed April 12, 2023 <https://www.countyofkings.com/home/showpublisheddocument/15207/636165315566800000>

of Hazardous Materials Safety as implemented in California by Title 13 of the CCR, California Building Code, and Uniform Fire Code, as adopted by the City. Through compliance with regulations, appliances and electronics associated with the Project are not expected to create a significant hazard to the public or the environment.

Potential impacts during construction of the Project could result from the use of fuels and lubricants for construction equipment. However, these impacts would be short-term and temporary, and would be reduced to less than significant levels through compliance with local, state, and federal regulations including but not limited to compliance with EPA's oil spills prevention and preparedness regulations, California Office of Emergency Services implementation of hazardous materials accident prevention, and California Department of Toxic Substance Control permitting, and regulations as administered by Kings County, in addition to standard equipment operating practices as indicated in operator manuals. Therefore, the Project would have a less than significant impact.

b) Create a significant hazard to the public or the environment through reasonably foreseeable upset and accident conditions involving the release of hazardous materials into the environment?

Less than Significant Impact. As described under criterion a), it is not anticipated that the Project itself would involve any operations that would require routine transport, use, or disposal of hazardous materials and therefore is not anticipated to create a significant hazard to the public or the environment through release of hazardous materials, including any reasonably foreseeable upset and accident conditions involving the release of hazardous materials into the environment. While potential impacts would occur through construction-related transport and disposal of hazardous materials, such impacts would be short-term and temporary, and would be reduced to less than significant levels through compliance with local, State, and federal regulations in addition to standard equipment operating practices as described under criterion a). Therefore, the Project would have a less than significant impact.

c) Emit hazardous emissions or handle hazardous or acutely hazardous materials, substances, or waste within one-quarter mile of an existing or proposed school?

Less than Significant Impact. Schools within one-quarter mile of the Project site include Jamison High School that is immediately adjacent to the west of the site. As described under criteria a) and b), the Project is not anticipated to create a significant hazard to the public or the environment through the routine transport, use, or disposal of hazardous materials and would not create upset and accident conditions involving the release of hazardous materials into the environment. Therefore, no impact would occur.

d) Be located on a site which is included on a list of hazardous materials sites compiled pursuant to Government Code Section 65962.5 and, as a result, would it create a significant hazard to the public or the environment?

No Impact. According to EnviroStor and GeoTracker, the Project is not located on a site that is included on a list of hazardous materials sites compiled pursuant to Government Code Section 65962.5. Therefore, the Project would not create a significant hazard to the public of the environment and there would be no impact.

e) For a project located within an airport land use plan or, where such a plan has not been adopted, within two miles of a public airport or public use airport, would the project result in a safety hazard for people residing or working in the project area?

No Impact. There are no public airports within two (2) miles of the Project site. The nearest public airport is the Naval Air Station Lemoore, a military air station, approximately 7.8 miles southwest, and the Hanford Municipal

Airport, approximately 8.1 miles northeast. The Project is not within an Airport Land Use Compatibility Plan hazard zone or any AICUZ zones. Since the Project is not located within two (2) miles of public airports or public use airports, it can be determined that the Project would not result in a safety hazard for people residing or working in the Project Area and no impact would occur.

f) Impair implementation of or physically interfere with an adopted emergency response plan or emergency evacuation plan?

Less than Significant Impact. The Project would not involve any new or altered infrastructure associated with evacuation, emergency response, and emergency access routes within the City or County. Construction may require lane closures on East Bush Street. However, construction would be short-term and access through both roadways would be maintained through standard traffic control as required by an encroachment permit. Furthermore, future development of the Project site would be subject to compliance with applicable standards for on-site emergency access including turn radii and fire access as well as applicable measures identified in the EOP and General Plan. For these reasons, it can be determined that Project would not impair implementation of or physically interfere with an adopted emergency response plan or emergency evacuation plan and impacts would be less than significant.

g) Expose people or structures, either directly or indirectly, to a significant risk of loss, injury, or death involving wildland fires?

Less than Significant Impact. The Project site is within an Local Responsibility Area (LRA) and is not identified by Cal Fire to be in a Moderate, High, or Very High Fire Hazard Severity Zone (FHSZ). As such, surrounding sites are served by existing infrastructure such as roads and utilities. Construction of structures that would be occupied by humans would be required to be constructed in adherence to the Wildland Urban Interface Codes and Standards of the California Building Code Chapter 7A. Compliance with such regulations would ensure that the Project meets standards to help prevent loss, injury, or death involving wildland fires. For these reasons, the Project would have a less than significant impact.

4.9.3 Mitigation Measures

None required.

4.10 HYDROLOGY AND WATER QUALITY

Would the project:	Potentially Significant Impact	Less than Significant with Mitigation Incorporated	Less than Significant Impact	No Impact
a) Violate any water quality standards or waste discharge requirements or otherwise substantially degrade surface or ground water quality?			X	
b) Substantially decrease groundwater supplies or interfere substantially with groundwater recharge such that the project may impede sustainable groundwater management of the basin?			X	
c) Substantially alter the existing drainage pattern of the site or area, including through the alteration of the course of a stream or river, or through the addition of impervious surfaces, in a manner which would:			X	
i. <i>Result in a substantial erosion or siltation on- or off-site;</i>			X	
ii. <i>Substantially increase the rate or amount of surface runoff in a manner which would result in flooding on- or off-site:</i>			X	
iii. <i>Create or contribute runoff water which would exceed the capacity of existing or planned stormwater drainage systems or provide substantial additional sources of polluted runoff; or</i>			X	
iv. <i>Impede or redirect flood flows?</i>			X	
d) In flood hazard, tsunami, or seiche zones, risk release of pollutants due to project inundation?			X	
e) Conflict with or obstruct implementation of a water quality control plan or sustainable groundwater management plan?			X	

4.10.1 Environmental Setting

The Project site is within city limits and thus, will be required to connect to water and stormwater services. The City and responsible agencies have reviewed the Project to determine adequate capacity in these systems and ensure compliance with applicable connection and discharge requirements. Overall, the review of the Project by the City and responsible agencies indicates that the Project would not require or result in the relocation or construction of new or expanded facilities.

Water

The City Water Department manages and operates the City's water system. Lemoore meets its demand for domestic water from a sole source of local groundwater. Groundwater is accessed from the Tulare Lake Subbasin of the San Joaquin Valley Groundwater Basin and via six (6) active groundwater wells within city limits and two (2) wellfields north of the City. The City operates a separate system to supply industrial water. The City maintains four (4) ground-level storage reservoirs within the distribution system, with a total capacity of 4.4 million gallons (MG).

Stormwater

The City of Lemoore holds a small share of the Lemoore Canal and Irrigation Company to use its canals, as well as Dockstader and Fox Ditches drainage channels, to collect stormwater runoff in Lemoore. The City adopted a Storm Water Management Plan in 2008 to identify appropriate storm water pollution prevention programs and establish Best Management Practices to protect water quality.

4.10.2 Impact Assessment

- a) Violate any water quality standards or waste discharge requirements or otherwise substantially degrade surface or ground water quality?*

Less than Significant Impact. As noted previously, because the site is greater than one-acre in size, the developer is required to prepare and implement an approved SWPPP during construction in compliance with the National Pollutant Discharge Elimination system (NPDES) stormwater program. The SWPPP estimates the sediment risk associated with construction activities and includes BMPs to control erosion. BMPs specific to erosion control cover erosion, sediment, tracking, and waste management controls. Implementation of the SWPPP minimizes the potential for the Project to result in substantial soil erosion or loss of topsoil and impacts would be less than significant.

The City is under the jurisdiction of the California Regional Water Quality Control Board (RWQCB) Central Valley NPDES Permit and Waste Discharge Requirements General Permit for Discharges from Municipal Separate Storm Sewer Systems (MS4), Order Number 2012-0006-DWQ ("MS4 Permit"). The MS4 Permit requires compliance with stormwater quality controls as identified in the City's Storm Water Management Plan. Compliance would reduce the potential for discharge of pollutants in violation of water quality standards or waste discharge requirements and impacts would be less than significant.

Stormwater infiltration has the potential to affect groundwater quality whereby rainfall and stormwater runoff flow into and through the subsurface soil. A majority of the Project site would be of impervious surface. Runoff from the site would be collected and diverted to the storm drainage system through existing drainage services. Further, runoff resulting from the Project would be managed by the City in compliance with the Storm Water Management

Plan in addition to approved grading and drainage plans. Therefore, potential for stormwater infiltration reaching subsurface soils and impacting groundwater quality is limited and impacts would be less than significant.

b) Substantially decrease groundwater supplies or interfere substantially with groundwater recharge such that the project may impede sustainable groundwater management of the basin?

Less than Significant Impact. The City currently utilizes local groundwater as its sole source of municipal water supply. The City’s long-term water resource planning for existing and future demand is addressed in the City’s 2015 Urban Water Management Plan (UWMP).¹⁸ The projections on population growth and the adopted General Plan form the factual basis for the analysis contained in the UWMP. Therefore, the development of the Project site to the intensity allowed within the site’s planned land use designation was previously analyzed under the General Plan and subsequently contemplated in the UWMP. No land use change would result from the Project.

According to the UWMP, the groundwater subbasin underlying the city, and thus the Project site, is the Tulare Lake Subbasin (Groundwater Basin No. 5-22.12). The estimated water storage capacity of the subbasin is 17.1 million acre-feet (AF) to a depth of 300 feet and 82.5 million AF to the base of fresh groundwater. The UWMP calculates the existing groundwater supply available to the City to be 178,228 MG for each of the projected years (up to 2040), and in its supply and demand assessment, future water supplies are anticipated to not only meet but far exceed demands through the year 2040.

Potable water demands for the Project were estimated using the California Department of Water Resources (DWR) Indoor Residential Water Use Study and the American Community Survey 5-Year Estimates (2021). The DWR study reports that the current Statewide median indoor residential water use is 48 gallons per capita per day and the American Community Survey estimates the average household size for Lemoore to be 2.95.¹⁹ ²⁰ Therefore, the Project’s expected daily water usage is 39,648 gallons per capita per day (48 gpd x 2.95 people x 280 homes), or 14,471,520 gallons per capita per year (or 44.41 AF), which is less than 0.01 percent of the city’s available groundwater supply. In comparison, the estimated water usage for the current use (i.e., crop production) is 150 AF per year based on the crop type and health of the orchard. Based on this estimate the Project would be able to be served by the existing system without substantially decreasing supplies and impacts would be less than significant.

Furthermore, adherence to connection requirements and recommendations pursuant to water supply planning efforts (e.g., compliance with California Plumbing Code, efficient appliances, efficient landscaping, etc.) should not negatively impact water supply or impede water management. In particular, the Project would be built accordance with all mandatory outdoor water use requirements as outlined in the applicable California Green Building Standards Code, Title 24, Part 11, Section 4.304 – Outdoor Water Use and verified through the building permit process. Landscaping would also be required to comply with the updated Model Water Efficient Landscape Ordinance (MWELO) (California Code of Regulations, Title 23, Chapter 2.7, Division 2), as implemented and

¹⁸ City of Lemoore. (2017). 2015 Urban Water Management Plan. Accessed on August 8, 2022, https://lemoore.com/wp-content/uploads/2018/02/lemoore_2015_uwmp_final.pdf

¹⁹ California Department of Water Resources. (2021). Indoor Residential Water Use Study Findings. Accessed on June 26, 2023, <https://water.ca.gov/-/media/DWR-Website/Web-Pages/Programs/Water-Use-And-Efficiency/AB-1668-and-SB-606-Conservation/IRWUS-Public-Review-Draft-ReportPA07May21-v1.pdf>

²⁰ American Community Survey. (2021). American Community Survey 5-Year Estimates (2021): S1101 Households and Families. Accessed on June 26, 2023, <https://data.census.gov/>

enforced through the building permit process. Therefore, through compliance, the potential for the Project to substantially decrease groundwater supplies is limited and impacts would be less than significant.

In addition, development of the Project site would increase impervious surfaces, which could increase stormwater runoff and reduce groundwater recharge. Runoff from the site would be collected and stored in the proposed onsite basin in compliance with the City's Storm Water Master Plan in addition to approved grading and drainage plans. Therefore, potential for the Project to interfere substantially with groundwater recharge such that the Project would impede sustainable groundwater management of the basin is limited and impacts would be less than significant.

Overall, based on the UWMP, it can be presumed that the existing and planned water distribution system and supplies should be adequate to serve the Project, and the Project would thereby not decrease groundwater supplies, interfere substantially with groundwater recharge, or impede sustainable groundwater management of the basin. In addition, adherence to connection requirements and recommendations pursuant to water supply planning efforts (i.e., compliance with California Plumbing Code, efficient appliances, efficient landscaping, etc.) should not negatively impact the City's water provision. For these reasons, a less than significant impact would occur because of the Project.

- c) *Substantially alter the existing drainage pattern of the site or area, including through the alteration of the course of a stream or river, or through the addition of impervious surfaces, in a manner which would:*
 - i. *Result in substantial erosion or siltation on- or off-site?*

Less than Significant Impact. Erosion is a natural process in which soil is moved from place to place by wind or from flowing water. The effects of erosion on the Project site can be accelerated by ground-disturbing activities associated with development. Siltation is the settling of sediment to the bed of a stream or lake that increases the turbidity of water. Turbid water can have harmful effects to aquatic life by clogging fish gills, reducing spawning habitat, and suppress aquatic vegetation growth.

Implementation of the proposed Project would result in the development of current agricultural lands. Bare soils, common within farmlands, are more susceptible to erosion than a=developed urban land, thus it is expected erosion would occur on-site. During construction activities, and in compliance with the Project's SWPPP construction-related erosion controls and BMPs would be implemented to reduce potential impacts related to erosion and siltation. These BMPs would include, but are not limited to, covering and/or binding soil surfaces to prevent soil from being detached and transported by water or wind, and the use of barriers such as straw bales and sandbags to control sediment. Together, the controls and BMPs are intended to limit soil transportation and erosion and construction impacts related to on- or off-site.

Soil erosion and loss of topsoil can be caused by natural factors, such as wind and flowing water, and human activity. Implementation of the proposed Project would require typical site preparation activities such as grading and trenching which may result in the potential for short-term soil disturbance or erosion impacts. Soil disturbance during construction is largely caused by the use of water. Excessive soil erosion could cause damage to existing structures and roadways. During construction activities, and in compliance with the Project's SWPPP, construction-related erosion controls and BMPs would be implemented to reduce potential impacts related to erosion and siltation. These BMPs would include, but are not limited to, covering and/or binding soil surfaces to prevent soil

from being detached and transported by water or wind, and the use of barriers such as straw bales and sandbags to control sediment. Together, the controls and BMPs are intended to limit soil transportation and erosion.

Development of the site would also result in an increase in the amount of impervious surface, which could increase the volume of runoff. However, the impervious surface area would significantly reduce the amount of exposed soil which would minimize the potential for erosion and siltation. In addition, the Project would be required to maintain the overall site drainage pattern and direct runoff to the proposed onsite drainage system in compliance with the Storm Water Master Plan and approved grading and drainage plans. Therefore, compliance with requirements would reduce or eliminate the Project's potential to substantially alter the existing drainage pattern of the site as to cause substantial erosion or siltation and impacts would be less than significant.

ii. Substantially increase the rate or amount of surface runoff in a manner, which would result in flooding on- or off-site?

Less than Significant Impact. During construction, the site's vegetation and soil would be disturbed, thereby temporarily altering the natural hydrology of the site. In turn, this could increase the volume and velocity of stormwater runoff which could increase the potential for flooding on- or off-site. As previously discussed, development of the site would require compliance with the SWPPP, MS4, and implementation of BMPs that would control and direct runoff. Compliance would ensure that construction impacts related to the alteration of the site's natural hydrology and the potential increase in runoff that would result in flooding on- or off-site would be less than significant.

While the development of the site would permanently increase the impervious surface area, the Project would be required to maintain the overall site drainage pattern and direct runoff to the onsite drainage system. Prior to the issuance of building permits, the developer would be required to submit grading and drainage plans for review and approval by the City, in addition to payment of required drainage fees. Review and approval of these plans and payment of drainage fees would ensure that the site drainage pattern is maintained, facilities conform to City requirements, and the stormwater system would be capable of receiving and conveying runoff from the site. Compliance with the Storm Water Master Plan would ensure that operational impacts related to the site's drainage pattern and the potential increase in runoff that would result in flooding on- of off-site would be less than significant.

iii. Create or contribute runoff water, which would exceed the capacity of existing or planned stormwater drainage systems or provide substantial additional sources of polluted runoff?

Less than Significant Impact. Development of the site would disturb the site's vegetation and soil and temporarily alter the natural hydrology of the site. However, compliance with the MS4 permit and implementation of the SWPPP would reduce construction impacts related to alteration of the site's natural hydrology and the potential increase in runoff or polluted runoff in excess of existing or planned stormwater drainage systems. Therefore, construction would not result in the creation or contribution of additional sources of runoff or polluted runoff in exceedance of the existing or planned stormwater drainage systems and impacts would be less than significant.

Regarding operational impacts, development of the site would result in an increase in the impervious surface area which would increase runoff from the site. However, compliance with the Storm Water Master Plan, approved grading and drainage plans, and stormwater quality controls under the MS4 permit would reduce the potential for

the Project to cause substantial additional polluted runoff or runoff in excess of existing or planned stormwater drainage systems. A less than significant impact would occur.

iv. Impede or redirect flood flows?

Less than Significant Impact. Although the construction of the proposed Project would increase impervious surfaces, the Project would be required to maintain the site’s drainage pattern through Project-specific grading and drainage plans that would be reviewed and approved by the City prior to the issuance of building permits. The site would also be required to utilize onsite drainage services as previously described. Through compliance, the potential for the Project to impede or redirect flood flows would be minimized or eliminated and a less than significant impact would occur.

b) In flood hazard, tsunami, or seiche zones, risk release of pollutants due to project inundation?

Less than Significant Impact. The Project site is not in a flood hazard, tsunami, or seiche zone (i.e., standing waves on river, reservoirs, ponds, and lakes); there are no oceans, rivers, reservoirs, ponds, or lakes on or within the site and its vicinity. The Project site is designated as Zone X on the most recent Flood Insurance Rate Map (FIRM) No. 06031C0170D dated September 16, 2015. Zone X is an area of minimal flood hazards with a 0.2 percent-annual-chance of flood (i.e., 500-year flood). In addition, the Project area as well as the City as a whole has historically been subject to low to moderate ground shaking and has a relatively low probability of shaking. As such, seiches are unlikely to form due to the low seismic energy produced in the area. Therefore, as a low-risk area, a less than significant impact as it relates to the risk release of pollutants due to project inundations would occur as a result of the Project.

c) Conflict with or obstruct implementation of a water quality control plan or sustainable groundwater management plan?

Less than Significant Impact. The City is a member of the South Fork Kings Groundwater Sustainability Agency. The Tulare Lake Subbasin Groundwater Sustainability Plan (GSP) (dated 2020) and its Addendum (dated 2022) have been prepared but have not been adopted or certified to-date. Therefore, the applicable water quality control plan is the UWMP. As previously discussed above, the Project would not decrease groundwater supplies, interfere substantially with groundwater recharge, or impede sustainable groundwater management of the basin. Therefore, a less than significant impact would occur.

4.10.3 Mitigation Measures

None required.

4.11 LAND USE PLANNING

Would the project:	Potentially Significant Impact	Less than Significant with Mitigation Incorporated	Less than Significant Impact	No Impact
a) Physically divide an established community?			X	
b) Cause a significant environmental impact due to a conflict with any land use plan, policy, or regulation adopted for the purpose of avoiding or mitigating an environmental effect?			X	

4.11.1 Environmental Setting

The Project site is within the City limits and is planned for single-family residential uses in addition to parks/recreation and greenway/detention basin uses.

4.11.2 Impact Assessment

Would the project:

a) *Physically divide an established community?*

Less than Significant Impact. Typically, physical division of an established community would occur if a project introduced new incompatible uses inconsistent with the planned or existing land uses or created a physical barrier that impeded access within the community. Typical examples of physical barriers include the introduction of new, intersecting roadways, roadway closures, and construction of new major utility infrastructure (e.g., transmission lines, storm channels, etc.).

Surrounding Land Uses

The Project site is generally surrounded by a mix of uses including single-family residential (north, east), commercial (west), religious (north), educational (east), and agricultural uses (south) in addition to vacant land immediately adjacent to the east of the site. The surrounding properties are planned for residential uses and community facilities. The Project does not propose a General Plan Amendment or Rezone. Therefore, developing the site with residential uses and park and recreational facilities would generally be compatible with the existing and planned uses within the immediate vicinity of the Project.

Circulation System

Existing street frontage of the Project site is limited to East Bush Street, which is a two (2)-lane, east-west arterial with existing curb, gutter, and sidewalk. SR-198, an east-west state highway, forms the site’s southern boundary. Implementation of the Project would result in an internal network of local streets that would connect to the existing circulation system including East Bush Street (arterial) Oporto Street (local), and Athens Street (local). Connections to Oporto Street and Athens Street would provide access between the proposed subdivision and the existing subdivision (Tract No. 700) adjoining the Project site to the east. All future local roads within the subdivision are proposed in accordance with City Standards and would not result in the introduction of new, intersecting roadways or permanent roadway closures. As such, the proposed circulation system would not constitute a physical barrier.

Utility Infrastructure

Since the Project site is within the city limits, development would be required to connect to the City’s water, sewer, stormwater, and wastewater services. Natural gas, electricity, and telecommunications are provided by private companies. Utility systems are described and analyzed in **Section 4.10** and **Section 4.15**. Based on the analysis, implementation of the Project would not result in the construction of new, major utility infrastructure.

As such, the Project does not represent a significant change in the surrounding area as it will develop the site with residential and park & recreational uses that are consistent and compatible with existing and planned uses surrounding the Project site. In addition, the new roadways would be internal to the development and are necessary to provide for safe internal circulation and access to the existing circulation system. Lastly, the Project would not result in any new, major utility infrastructure. For these reasons, the Project would not result in the physical divide of an established community and would thereby have a less than significant impact.

b) Cause a significant environmental impact due to a conflict with any land use plan, policy, or regulation adopted for the purpose of avoiding or mitigating an environmental effect?

Less than Significant Impact. The proposed use is consistent with the underlying land use and zoning designation. Through the entitlement process, the Project is reviewed and conditioned by the City and responsible agencies to ensure compliance with land use plans, policies, and regulations adopted for the purpose of avoiding or mitigating an environmental effect. Conflicts with such plans, policies, and regulations would be considered to be environmental impacts if they would result in direct physical impacts. Potential physical impacts of the proposed Project are discussed in this initial study under specific resource/issue areas (i.e., biological, cultural, tribal cultural resources, etc.) and no significant impacts were identified. Further, a comparison of the Project’s characteristics to applicable General Plan policies is included in **Table 4-13**. As discussed below, the proposed Project is generally consistent with the General Plan as it relates to land use issues. As such, the Project would have a less than significant impact.

Table 4-13 Discussion on Land Use Policies in the General Plan

General Plan Policy	Project Consistency
<p>Policy LU-G-4 Provide for residential development with strong community identity, appropriate and compatible scale, identifiable centers and edges and well-defined public spaces for recreation and civic activities.</p>	<p>Consistent. The Project proposes residential and park & recreational uses consistent with the underlying land use designation that are also compatible with surrounding existing and planned uses. Implementation of the Project would introduce new housing opportunities as well as public spaces for recreational activities that are appropriate and compatible scale for the Project Area.</p>
<p>Policy LU-G-5 Provide for a full range of housing types and prices within each neighborhood, including minimum and maximum requirements for traditional and small-lot single family homes, townhouses, duplexes, triplexes, and multi-family housing to ensure that the economic needs of all segments of the community are met and a jobs-housing balance is provided.</p>	<p>Consistent. The Project proposes a mix of lot sizes, including minimum and maximum requirements for traditional and small-lot single family homes. By providing a range of housing opportunities, the Project contributes to the economic needs of various segments of the community while also increasing the employment base in closer proximity to jobs.</p>

<p>LU-G-6 Provide for a transition between higher density and lower density residential areas, or require buffers of varying size between residential uses and nonresidential uses without restricting pedestrian and bicycle access.</p>	<p>Consistent. The Project proposes lower density single-family residential uses within a predominately residential area comprising low density, low-medium density, and a mix of planned land uses. Therefore, the Project would provide for a transition between higher and lower density residential areas.</p>
--	---

4.11.3 Mitigation Measures

None required.

4.12 MINERAL RESOURCES

Would the project:	Potentially Significant Impact	Less than Significant with Mitigation Incorporated	Less than Significant Impact	No Impact
a) Result in the loss of availability of a known mineral resource that would be of value to the region and the residents of the state?				X
b) Result in the loss of availability of a locally-important mineral resource recovery site delineated on a local general plan, specific plan or other land use plan?				X

4.12.1 Environmental Setting

For the purposes of CEQA, mineral resources are land areas or deposits deemed significant by the California Department of Conservation (DOC). Mineral resources include oil, natural gas, and metallic and nonmetallic deposits, including aggregate resources. The California Geological Survey (CGS) classifies and designates areas within California that contain or potentially contain significant mineral resources. Lands are classified into Aggregate and Mineral Resource Zones (MRZs), which identify known or inferred significant mineral resources. According to the California Department of Conservation, CGS’s Surface Mining and Reclamation Act (SMARA) Mineral Lands Classification (MLC) data portal, the City of Lemoore and surrounding areas have no mapped mineral resources. The City of Lemoore does not have mine facilities or California Geologic Energy Management Division (CalGEM)-recognized oilfields.²¹ In addition, the Project does not include mineral extraction.

4.12.2 Impact Assessment

Would the project:

- a) *Result in the loss of availability of a known mineral resource that would be of value to the region and the residents of the state?*

No Impact. The Project site is not located in an area designated for mineral resource preservation or recovery. Therefore, the Project would not result in the loss of availability of a known mineral resource that would be of value to the region and the residents of the state. Therefore, no impact would occur because of the Project.

- b) *Result in the loss of availability of a locally important mineral resource recovery site delineated on a local general plan, specific plan, or other land use plan?*

No Impact. As described above, the Project site is not located in an area designated for mineral resource preservation or recovery and as a result, the Project would not result in the loss of availability of a known mineral resource that would be of value to the region and the residents of the state. Further, the site is not delineated on

²¹ Geologic Energy Management Division (CalGEM). Well Finder. Accessed on July 29, 2022, <https://www.conservation.ca.gov/calgem/Pages/WellFinder.aspx>

the General Plan, a Specific Plan, or other land use plan as a locally important mineral resource recovery site, thus it would not result in the loss of availability of a locally important mineral resource. Therefore, no impact would occur because of the Project.

4.12.3 Mitigation Measures

None required.

4.13 NOISE

Would the project:	Potentially Significant Impact	Less than Significant with Mitigation Incorporated	Less than Significant Impact	No Impact
a) Generation of a substantial temporary or permanent increase in ambient noise levels in the vicinity of the project in excess of standards established in the local general plan or noise ordinance, or applicable standards of other agencies?		X		
b) Generation of excessive groundborne vibration or groundborne noise levels?			X	
c) For a project located within the vicinity of a private airstrip or an airport land use plan or, where such a plan has not been adopted, within two miles of a public airport or public use airport, would the project expose people residing or working in the project area to excessive noise levels?			X	

4.13.1 Environmental Setting

An Acoustical Analysis of the Project was prepared by WJV Acoustics, Inc. (WJVA) for the Project. The full report is provided in **Appendix D**

General Plan

The Lemoore General Plan Safety and Noise Element outlines policies and regulations to mitigate potential impacts of noise sources through both preventive and responsive measures. Applicable policies include:

Guiding Policy SN-G-6 Strive to achieve an acceptable noise environment for present and future residents of Lemoore.

Guiding Policy SN-G-7 Ensure new development is compatible with the noise environment.

Guiding Policy SN-G-8 Protect especially sensitive uses from excessive noise, including schools, hospitals, and senior care facilities.

Implementing Policy SN-I-32 Use the community noise compatibility standards, shown in Table 8.6, as review criteria for new land uses.

Implementing Policy SN-I-33 Consider an increase of five or more dBA to be “significant” if the resulting noise level would exceed that described as “normally acceptable” in Table 8.6.

Implementing Policy SN-I-34 Apply performance-based noise standards within zoning classifications likely to encompass sensitive land uses.

Implementing Policy SN-I-35 Require that all new residential development achieve noise level reductions to meet the land use compatibility standards through acoustical design and construction of the building elements:

- Residential building designs must be based upon a minimum interior design noise level reduction of 40 dB in all habitable areas (i.e., garages, storage areas, etc. are excepted). The 40 dB criteria must provide a minimum constructed noise level reduction of 35 dB; and
- Residential building designs must also be based upon a minimum design noise level reduction of 45 dB in all bedrooms. The 45 dB criteria must provide a minimum constructed noise level reduction of 40 dB.

Implementing Policy SN-I-40 Require developers to mitigate the noise impacts of new development on adjacent properties as a condition of permit approval through appropriate means, including, but not limited to:

- Screen and control noise sources, such as parking and loading facilities, outdoor activities, and mechanical equipment;
- Increase setbacks for noise sources from adjacent dwellings;
- Retain fences, walls, and landscaping that serve as noise buffers;
- Use soundproofing materials and double-glazed windows;
- Use open space, building orientation and design, landscaping and running water to mask sounds;
- Control hours of operation, including deliveries and trash pickup, to minimize noise impacts; and
- As a last resort, construct noise walls along highways and arterials when compatible with aesthetic concerns and neighborhood character. This would be a developer responsibility.

Implementing Policy SN-I-41 Promote the use of noise attenuation measures to improve the acoustic environment inside residences where existing single-family residential development is located on an arterial street. These measures may include those listed under policy SN-I-36.

Implementing Policy SN-I-42 Establish criteria for evaluating applications from residents for exceptions to residential noise level requirements for the operation of standby electrical equipment used to meet medical needs. This assumes that equipment noise will be mitigated to reduce the noise level at the property line to the 60 decibel level requirement.

Implementing Policy SN-I-43 Require new noise sources to use best available control technology (BACT) to minimize noise emissions.

Implementing Policy SN-I-44 Require noise from permanent mechanical equipment to be reduced by soundproofing materials and sound-deadening installation.

Implementing Policy SN-I-45 Minimize vehicular and stationary noise sources and noise emanating from temporary activities, such as those arising from construction work.

Table 8.6 Land Use Compatibility For Community Noise Environments

Land Use Category	Community Noise Exposure, L_{dn} or CNEL, dB						
	55	60	65	70	75	80	85
Residential – Low Density Single Family			Normally Acceptable	Normally Acceptable	Normally Unacceptable	Clearly Unacceptable	Clearly Unacceptable
Residential – Multi Family			Normally Unacceptable	Normally Unacceptable	Clearly Unacceptable	Clearly Unacceptable	Clearly Unacceptable
Mixed-Use and High Density Residential			Normally Unacceptable	Normally Unacceptable	Clearly Unacceptable	Clearly Unacceptable	Clearly Unacceptable
Transient Lodging – Motels, Hotels			Normally Unacceptable	Normally Unacceptable	Clearly Unacceptable	Clearly Unacceptable	Clearly Unacceptable
Schools, Libraries, Churches, Hospitals, Nursing Homes			Normally Unacceptable	Normally Unacceptable	Clearly Unacceptable	Clearly Unacceptable	Clearly Unacceptable
Auditoriums, Concerts, Halls, Amphitheaters	Clearly Unacceptable	Clearly Unacceptable	Clearly Unacceptable	Clearly Unacceptable	Clearly Unacceptable	Clearly Unacceptable	Clearly Unacceptable
Sports Area, Outdoor Spectator Sports	Clearly Unacceptable	Clearly Unacceptable	Clearly Unacceptable	Clearly Unacceptable	Clearly Unacceptable	Clearly Unacceptable	Clearly Unacceptable
Playgrounds, Neighborhood Parks				Normally Unacceptable	Clearly Unacceptable	Clearly Unacceptable	Clearly Unacceptable
Golf Courses, Riding Stables, Water Recreation, Cemeteries					Normally Unacceptable	Clearly Unacceptable	Clearly Unacceptable
Office Buildings, Businesses Commercial and Professional				Normally Unacceptable	Clearly Unacceptable	Clearly Unacceptable	Clearly Unacceptable
Industrial, Manufacturing Utilities, Agriculture					Clearly Unacceptable	Clearly Unacceptable	Clearly Unacceptable

Legend:

	Normally Acceptable	Specified land use is satisfactory, based upon the assumption that any building involved is of normal conventional construction, without any special noise insulation requirements.
	Conditionally Acceptable	New construction or development should be undertaken only after a detailed analysis of the noise reduction requirements is made and needed noise insulation features included in the design. Conventional construction, but with closed windows and fresh air supply systems or air conditioning will normally suffice.
	Normally Unacceptable	New construction or development should generally be discouraged. If new construction or development does proceed, a detailed analysis of the noise reduction requirements must be made and needed noise insulation features included in the design.
	Clearly Unacceptable	New construction or development should not be undertaken.

Table 8.6 Land Use Compatibility For Community Noise Environments

Land Use Category	Community Noise Exposure, L_{dn} or CNEL, dB					
	55	60	65	70	75	80

Source: City of Lemoore, 2007.

Source: Lemoore General Plan Safety and Noise Element

Municipal Code

Section 9-5B-2 of the Lemoore Municipal Code codifies performance standards for all permanent and temporary land uses within the city relative to noise and vibration. The intent is to provide compatibility between neighboring land uses by minimizing various potential impacts. The standards apply to all new and existing land uses within the city.

B. Noise Standards:

1. *Applicability: In addition to the provision contained within this section, all uses shall comply with the noise standards set forth in the city's general plan and in title 5, chapter 6, "Noise", of the municipal code. Unless otherwise specified in this section or the general plan, all noise measurements shall be based upon the community noise equivalent level (CNEL).*

2. *Generally: No use, activity, or process shall exceed the maximum allowable noise levels established by this section, except for the following noise sources:*

- a. Public safety warning devices (e.g., ambulance, fire, and police sirens), sound for alerting persons to the existence of an emergency, or the performance of authorized emergency work;*
- b. Any activity whose noise levels are regulated by state or federal law;*
- c. Construction, maintenance, and/or repair operations by public agencies and/or utility companies or their contractors that are serving public interests, and/or protecting the public health, safety, and general welfare;*
- d. Public agency sanctioned recreational activities and programs conducted in public parks; and*
- e. The authorized collection of solid waste.*

3. *Maximum Allowable Noise Levels:*

a. No use shall exceed the standard noise levels established in table 9-5B-2-B1, "Land Use Noise Standards" of this section. Necessary measures shall be incorporated into all development projects to attenuate exterior and/or interior noise levels to these standards

Table 9-5B-2-B1 Land Use Noise Standards

Land Use	Noise Standards (dB CNEL)	
	Interior Noise	Exterior Noise
Residential uses	45	65 ¹
Residential uses in mixed use zones	45	70
Commercial	-	70
Office	50	70
Industrial	55	75
Public facilities	50	70
Parks	-	70
Schools	50	65

Note

¹In outdoor living areas, e.g., backyards

Source: Lemoore Municipal Code, Section 9-5B-2: Noise, Odor, and Vibration Performance Standards

4. *Acoustical Analysis Required: Where the City determines that a proposed project may generate noise in excess of any limit established above, and/or where the use may generate noise in outdoor areas in excess of sixty decibels (60 dB CNEL), the land use permit application for the use shall include an acoustical analysis by a qualified professional approved by the City. The following measure shall be considered where feasible to reduce noise level below acceptable standards:*

a. Site layout, including setbacks, open space separation, and shielding of noise sensitive uses with non-noise sensitive uses;

b. Acoustical treatment of buildings; or

c. Structural measures such as constructed of earth berms and/or wood or concrete barriers or masonry walls.

5. *Limitation On Hours Of Construction: To ensure that nearby residents as well as nonresidential activities are not disturbed by noise from early morning or late night activities, the following limits on construction are established:*

a. Monday through Saturday, seven o'clock (7:00) A.M. to eight o'clock (8:00) P.M.

b. Extended construction hours may only be allowed by the review authority through conditions of approval between eight o'clock (8:00) P.M. and ten o'clock (10:00) P.M.

c. On Sundays and national holidays, construction activities may only be allowed by the review authority through conditions of approval between nine o'clock (9:00) A.M. and five o'clock (5:00) P.M.

6. *Limitation On Truck Deliveries: Truck deliveries to a commercial or industrial parcel adjacent to a conforming residential use shall be limited to the hours between seven o'clock (7:00) A.M. and seven o'clock (7:00) P.M., unless the Planning Director authorizes other delivery times based on the determination that there is either no feasible alternative, or there are overriding transportation and traffic management benefits to scheduling deliveries at night.*

7. *Locating A New Sensitive Land Use: Where noise sensitive land use is proposed in an area exposed to existing or projected noise levels in excess of sixty five decibels (65 dB CNEL), the City may require an acoustical analysis so that noise reduction measures may be included in the project design.*

8. *Noise Easement Required: All new subdivisions of land approved through tentative subdivision map or parcel map as provided in title 8, chapter 7, article F, "Tentative Maps", of the Municipal Code shall be required, as a condition of approval, to record at time of final or parcel map an easement on all lots created. Such easement shall identify that the property is near a military installation subject to high aircraft noise, low level aircraft, aircraft tests, and/or other military related issues. Such easement shall also identify that the property is near a railroad line and near industrial uses that produce periodic noise.*

D. Vibration Standards: Uses that generate vibrations that may be considered a nuisance or hazard on any adjacent property shall be cushioned or isolated to prevent generation of vibrations. Uses shall be operated in compliance with the following provisions:

1. Uses shall not generate ground vibration that is perceptible without instruments by the average person at any point along or beyond the property line of the parcel containing the activities;

2. Uses, activities, and processes shall not generate vibrations that cause discomfort or annoyance to reasonable persons of normal sensitivity or which endanger the comfort, repose, health, or peace of residents whose properties abut the property lines of the subject parcel;
3. Uses shall not generate ground vibration that interferes with the operations of equipment and facilities of adjoining parcels; and
4. Vibrations from temporary construction/demolition and vehicles that leave the subject parcel (e.g., trucks, trains, and aircraft) are exempt from the provisions of this section.

4.13.2 Impact Assessment

Would the project:

- a) ***Generation of a substantial temporary or permanent increase in ambient noise levels in the vicinity of the project in excess of standards established in the local general plan or noise ordinance, or in other applicable local, state, or federal standards?***

Less than Significant Impact with Mitigation Incorporated. In general, the Project site is in an urbanized area surrounded by a mix of uses including single-family residential and adjacent to SR 198 (north, east), commercial (west), churches (north), school (east), and agricultural uses (south). Because the surrounding area is largely developed, there are existing temporary or permanent ambient noise sources typical of these uses.

Traffic Noise Exposure

The Project site is exposed to traffic noise associated with SR-198. Noise exposure from traffic on SR 198 was calculated for existing and future traffic conditions using the FHWA Traffic Noise Model, traffic data provided by Caltrans, and findings of on-site noise level measurements ([Appendix D](#)). The calculations indicate that exterior noise exposure would be approximately 68 dB L_{dn} and 71 dB L_{dn} for 2020 and future 2040 traffic conditions, respectively, from a setback distance of 100 feet from the roadway centerline. The City's exterior noise level standard for residential land uses is 65 dB L_{dn}. The calculations exceed the City's standard by more than 5 dBA, per General Plan ***Implementing Policy SN-1-33***. The calculated noise exposure would fall within the "conditionally accepted" standard for the proposed use, which necessitates analysis of noise reduction and insulation requirements. The following mitigation measures, MMs NOI-1 and NOI-2, were recommended by the noise analysis to mitigate exterior noise exposure impacts related to vehicular noise to less than significant levels.

MM NOI-1. A sound wall (or berm wall combination) with a minimum height of 7 feet relative to the adjacent roadway elevation shall be constructed along the lot property lines adjacent to SR-198. It should be noted, the Project site elevation varies, and is generally approximately two to three (2-3) feet below the grade of SR-198 along the Project roadway frontage. The sound wall shall be constructed to a finished height of 7 feet above the adjacent roadway elevation. In order to be effective, the sound wall should be turned inward (northward) at the western and eastern extents of the Project site. Suitable construction materials include concrete blocks, masonry or stucco on both sides of a wood or steel stud wall. Construction shall be verified during the building permit process.

MM NOI-2. If two-story construction is proposed for the first row of homes facing SR-198, second story balconies shall be prohibited.

Implementation of the Project would result in the development of the site with residential uses. Such uses would have noise generating activities typical of temporary or permanent ambient noise currently generated by surrounding residential uses (e.g., household equipment such as refrigerators and HVAC systems, vehicle traffic, etc.). Development of the site with residential uses would be compatible with the existing noise environment. Exterior noise exposure related to the use would be less than significant.

Interior Noise Exposure

The City's interior noise level standard is 45 dB. The worst-case future noise exposure within the development would be approximately 71 dB as described above (2040 conditions). This means that the proposed residential construction for units located within the 100-foot setback from the SR-198 centerline must be capable of providing a minimum outdoor-to-indoor noise level reduction (NLR) of approximately 26 dB ($71-45=26$). A specific analysis of interior noise levels was not performed. However, it may be assumed that residential construction methods complying with current building code requirements would reduce exterior noise levels by approximately 25 dB if windows and doors are closed. Therefore, construction methods plus incorporation of MM NOI-1 and NOI-2 would be sufficient for compliance with the City's 45 dB L_{dn} interior standard. As a result, the Project would have a less than significant impact with mitigation incorporated.

Construction Noise Exposure

Construction noise would occur at various locations within the Project site throughout the buildout period. Existing sensitive receptors could be located as close as 25 feet from construction activities. Construction noise is not considered to be a significant impact if construction is limited to daytime hours and construction equipment is adequately maintained and muffled. The City of Lemoore limits hours of construction to occur only between the hours of 7:00 a.m. to 8:00 p.m., Monday through Saturday. Construction noise impacts could result in annoyance or sleep disruption for nearby residents if nighttime operations were to occur outside of the allowable construction hours, or if equipment is not properly muffled or maintained.

Further, the Project would be subject to compliance with the General Plan Safety and Noise Element and LMC requirements to ensure that the ambient noise level does not rise to a level of significance. Therefore, short-term construction related impacts associated with the exposure of persons to or the generation of noise levels in excess of standards established in the General Plan or LMC would be less than significant."

b) Generation of excessive groundborne vibration or groundborne noise levels?

Less than Significant Impact. Ground borne vibration may result from operations and/or construction, depending on the use of equipment (e.g., pile drivers, bulldozers, jackhammers, etc.), distance to affected structures, and soil type. Depending on the method, equipment-generated vibrations could spread through the ground and affect nearby structures. There are approximately 21 structures (i.e., single-family residences, religious institutions) adjacent to the Project site. Future operations are not expected to generate groundborne vibration or groundborne noise levels due to the nature of the use (i.e., residential). Potential vibration impacts from future construction would be short-term, temporary, and subject to compliance with Section 9-5B-2 of the Lemoore Municipal Code. Compliance with these measures would ensure that potential vibration impacts related to construction are reduced to levels that are less than significant. As a result, the Project would have a less than significant impact.

c) For a project located within an airport land use plan or, where such a plan has not been adopted, within two miles of a public airport or public use airport, would the project expose people residing or working in the project area to excessive noise levels?

No Impact. There are no public airports within two (2) miles of the Project site. The nearest public airport is the NAWS- Lemoore, a military air station, approximately 7.8 miles southwest, and the Hanford Municipal Airport, approximately 8.1 miles northeast. The Project site is not located within an ALUCP or within two (2) miles of a public airport or public use airport and therefore, would not expose people residing or working in the Project area to excessive noise levels. As a result, no impact would occur.

4.13.3 Mitigation Measures

The proposed project shall implement and incorporate, as applicable, the noise related mitigation measures as identified in the attached MMRP August 2023.

4.14 POPULATION AND HOUSING

Would the project:	Potentially Significant Impact	Less than Significant with Mitigation Incorporated	Less than Significant Impact	No Impact
a) Induce substantial unplanned population growth in an area, either directly (for example, by proposing new homes and businesses) or indirectly (for example, through extension of roads or other infrastructure)?			X	
b) Displace substantial numbers of existing people or housing, necessitating the construction of replacement housing elsewhere?				X

4.14.1 Environmental Setting

CEQA Guidelines *Section 15126.2(d)* requires that a CEQA document discuss the ways in which the proposed Project could foster economic or population growth, or the construction of additional housing, either directly or indirectly, in the surrounding environment. The CEQA Guidelines provide an example of a major expansion of a wastewater treatment plant that may allow for more construction within the service area. The CEQA Guidelines also note that the evaluation of growth inducement should consider the characteristics of a project that may encourage or facilitate other activities that could significantly affect the environment. Direct and Indirect Growth Inducement consists of activities that directly facilitate population growth, such as construction of new dwelling units. A key consideration in evaluating growth inducement is whether the activity in question constitutes “planned growth.”

4.14.2 Impact Assessment

Would the project:

- a) *Induce substantial unplanned population growth in an area, either directly (for example, by proposing new homes and businesses) or indirectly (for example, through extension of roads or other infrastructure)?*

Less than Significant Impact. Implementation of the Project would result in a 280-lot residential subdivision and various park and recreational amenities as allowed by the planned land use designation and zone district. The use and intensification of the Project site for residential and park and recreational uses was previously contemplated under the General Plan and related EIR under a 23-year planning horizon from 2007 to 2030. The General Plan accommodates 16,300 housing units and a population of 48,250 at buildout, where population at buildout was calculated assuming 3.1 persons per household. According to the California Department of Finance 2023 estimate (released May 2023), the City’s population is 26,609 with 9,633 total households.²² Using the same assumptions as

²² California Department of Finance. (May 2023). Estimates-E1 Population and Housing Estimates for Cities, Counties, and the State – January 1, 2022 and 2023. Accessed on July 24, 2023, <https://dof.ca.gov/forecasting/demographics/estimates-e1/>

the General Plan and related EIR, the Project would generate an approximate population of 868 (280 units multiplied by 3.1 persons per household). Therefore, the population and housing units generated by the proposed Project would be within the General Plan projections for the City and thereby would not constitute unplanned population growth.

Further, the Project site is within an urbanized area surrounded by a mix of uses including single-family residential (north, east), commercial (west), religious (north), educational (east), and agricultural uses (south) in addition to vacant land immediately adjacent to the east of the site. As such, surrounding sites are served by existing infrastructure such as roads and utilities. Development of the site would result in installation and maintenance of new infrastructure (e.g., roadways, utilities), but such infrastructure would serve as extensions of and connections to the existing, surrounding infrastructure. For these reasons, it can be determined that the Project would not induce substantial unplanned population growth directly or indirectly and a less than significant impact would occur.

b) Displace substantial numbers of existing people or housing, necessitating the construction of replacement housing elsewhere?

No Impact. The Project site is currently developed as an orchard south of a man-made irrigation canal, “Fox Ditch.” The land north of the canal has been disced and graded in recent years and is currently vacant. The orchard and man-made irrigation canal would be removed as part of site preparation and development.

The site does not contain any existing housing or residential uses. Since the site does not currently provide housing, future development of the Project site would not result in the physical displacement of people or housing. No impact would occur because of the Project.

4.14.3 Mitigation Measures

None required.

4.15 PUBLIC SERVICES

Would the project:	Potentially Significant Impact	Less than Significant with Mitigation Incorporated	Less than Significant Impact	No Impact
a) Result in substantial adverse physical impacts associated with the provision of new or physically altered governmental facilities, need for new or physically altered governmental facilities, the construction of which could cause significant environmental impacts, in order to maintain acceptable service ratios, response times or other performance objectives for any of the public services:				
i. Fire protection?			X	
ii. Police protection?			X	
iii. Schools?			X	
iv. Parks?			X	
v. Other public facilities?			X	

4.15.1 Environmental Setting

The Project is located within Lemoore city limits and thus, would be subject to fees for the construction, acquisition, and improvements for such services. These services and fees include:

Fire Protection Services

Fire Protection Services in the city are provided by the Lemoore Volunteer Fire Department (LVFD). The LVFD is an all-volunteer department that operates two fire stations that serve a nine -square-mile area, located at 210 Fox Street and 41 Cinnamon Drive. Both stations are located approximately 0.70 miles from the Project site. Fire response times average between four and six minutes. To address impacts to fire protection services, new development is subject to a Development Impact Fee to pay the “fair share” of fire department facilities. The development impact fee for single-family residential uses is currently \$431 per single-family unit.

Police Protection Services

Police Protection Services in the city are provided by the Lemoore Police Department (LPD). The LPD is located at 657 Fox Street, approximately one mile northwest of the Project site. According to the 2021 Annual Report for the LPD, the department’s average response time for 2021 was 5.37 minutes. To address impacts to police protection services, new development is subject to a Development Impact Free to pay the “fair share” of police department facilities. The development impact fee for single-family residential uses is currently \$804 per single-family unit.

Schools

The development and management of school sites are the responsibility of school districts and elected governing school boards. Funding for schools and school facilities impacts is outlined in Education Code Section 17620 and Government Code Section 65995 et. seq., which governs the amount of fees that can be levied against new development. These fees are used to construct new or expanded school facilities. Payment of fees authorized by the statute is deemed “full and complete mitigation.”

Parks and Recreation

Park and recreational facilities are overseen by the City of Lemoore Parks and Recreation Department. The Parks and Recreation Department maintains approximately 88 acres of parkland plus approximately 38 acres of open space operated as ponding basins. Ponding basins are available for recreational use on a seasonal basis. The City’s current park standard for public parkland is five acres per 1,000 residents. To address impacts to park and recreational facilities, new development is subject to a Development Impact Fee to pay the “fair share” of park and recreational facilities. The development impact fee for single-family residential uses is currently \$1,803 per single-family unit. An on-site park is also required to be developed.

4.15.2 Impact Assessment

a) Would the project result in substantial adverse physical impacts associated with the provision of new or physically altered governmental facilities, or the need for new or physically altered governmental facilities, the construction of which could cause significant environmental impacts, in order to maintain acceptable service ratios, response times, or other performance objectives for any of the public services:

i. Fire protection?

Less than Significant Impact. The Project site is within the City limits and therefore would be served by the LVFD. The Project’s proximity to existing development served by the LVFD in addition to proximity to existing stations would support adequate service ratios, response times, and other performance objectives for fire protection services. In addition, the Project has been reviewed by the LVFD for compliance with City requirements related to water supply, fire hydrants, and emergency access. Further, the Project would be subject to the Development Impact Fee for fire department facilities, which would reduce impacts to service provision and facilities. For these reasons, it can be determined that the Project would not result in the need for new or altered facilities and as a result, a less than significant impact would occur.

ii. Police protection?

Less than Significant Impact. The Project site is within the city limits and therefore would be served by the LPD. The Project’s proximity to existing development served by the LPD in addition to proximity to the existing station would support adequate service ratios, response times, and other performance objectives. Further, the Project would be subject to the Development Impact Fee for police department facilities, which would reduce impacts to service provision and facilities. For these reasons, it can be determined that the Project would not result in the need for new or altered facilities and as a result, a less than significant impact would occur.

iii. Schools?

Less than Significant Impact. Educational services within the Project area are primarily served by Lemoore Union Elementary School District and Lemoore Union High School District. Schools within a one -mile radius of the Project

site include Jamison High School, Lemoore High School, Kings Christian Elementary School, Cinnamon Elementary School, and Lemoore Elementary School.

School Impact Fees would be assessed for future development of the Project site based on the Developer Fee rates in place at the time payment is due. In addition, the site is planned and zoned for residential development and has been previously accounted for in siting school facilities; the proposed development would not exceed this number. For these reasons, it can be determined that the Project, a less than significant impact would occur.

iv. Parks?

Less than Significant Impact. Park and recreational facilities are typically impacted by an increase in use. According to the General Plan, the existing City standard for parkland dedication established in the City Subdivision Ordinance is five acres of parkland per 1,000 residents. The Project proposes a 280-lot residential subdivision with approximately 3.54 acres of park/trail area. The Project would generate approximately 868 residents (See [Section 4.14](#)). Using the City's parkland ratio, the Project would require at least 4.34 acres of parkland and/or payment of impact fees for City-owned and operated parks and recreation facilities that serve all residents ($868/1,000 = 0.868 \times 5 = 4.34$ acres). Based on the City's parkland ratio, the Project would not meet the requirement by 0.80 acres. Therefore, the developer would be required to pay in lieu fees in accordance with the General Plan and LMC to offset impacts to existing park and recreational facilities. Therefore, it can be determined that the Project would not increase the use of existing park and recreational facilities such that substantial physical deterioration of the facility would occur or be accelerated. For these reasons, the Project would have a less than significant impact.

v. Other public facilities

Less than Significant Impact. Development of the Project would increase the demand for other public services. As a new development, the Project would be subject to payment of Development Impact Fees related to municipal facilities and services such as libraries, hospitals, or emergency medical facilities. Payment of applicable fees would reduce impacts to other public facilities. Thus, the Project would have a less than significant impact.

4.15.3 Mitigation Measures

None required.

4.16 RECREATION

Would the project:	Potentially Significant Impact	Less than Significant with Mitigation Incorporated	Less than Significant Impact	No Impact
a) Increase the use of existing neighborhood and regional parks or other recreational facilities such that substantial physical deterioration of the facility would occur or be accelerated?			X	
b) Does the project include recreational facilities or require the construction or expansion of recreational facilities which might have an adverse physical effect on the environment?			X	

4.16.1 Environmental Setting

Park and recreational facilities are overseen by the City of Lemoore Parks and Recreation Department. The Parks and Recreation Department maintains approximately 88 acres of parkland plus approximately 38 acres of open space operated as ponding basins. The City’s current park standard for public parkland is five acres per 1,000 residents. To address impacts to park and recreational facilities, new development is subject to a Development Impact Free to pay the “fair share” of park and recreational facilities. The development impact fee for single-family residential uses is currently \$1,803 per single-family unit. Onsite open space is also required.

General Plan

The Lemoore General Plan Parks, Schools, and Community Facilities Element includes the following policies related to park and recreational facilities.

***Guiding Policy PSCF-G-1** Create and maintain a high-quality public park system for Lemoore.*

***Implementing Policy PSCF-I-1** Establish a goal of 6 acres of parkland per thousand residents to be met by: Dedication and reservation requirements consistent with the Quimby Act, for landscaped open spaces, parks, trail systems, and/or special community service facilities in new residential developments based on a standard of 5 acres of developed parkland per thousand residents; and A standard of one acre per thousand residents to be met with an impact fee for City-owned and operated parks and special recreation areas that serve all residents.*

***Implementing Policy PSCF-I-2** Require that at least 75 percent of new residents live within a half mile or less of a public park facility, using the development permit review and approval processes.*

***Implementing Policy PSCF-I-4** Develop new parks with high quality facilities, universal accessibility, durability and low maintenance in mind. Existing parks will be improved, if feasible and economically justified, to reduce maintenance cost and water use, as well as improve park safety and aesthetics.*

Implementing Policy PSCF-I-6 Use existing natural and man-made features of the community, such as creeks, canals and railroad corridors when possible to enhance the parks and open space network.

Implementing Policy PSCF-I-7 Develop a system of consistent, recognizable and pedestrian-scale signage for the parks and trail system throughout the City, including bikeways, pathways and sidewalks that link key community resources (e.g. schools, public facilities, and transit) to the parks and open space network.

Implementing Policy PSCF-I-8 Provide lighted facilities for certain specialized community recreation areas (e.g. tennis courts, basketball courts, pathways) in order to extend usable hours. When possible, design electric lighting to be light-sensitive (dims during the day), solar powered, and to allow as little light pollution as possible.

Implementing Policy PSCF-I-9 Incorporate shallow ponding basins in community parks and large neighborhood parks, where feasible, to promote the efficient use of land.

Municipal Code

Article N – Dedications of Land for Parks and Recreation Facilities of the Lemoore Municipal Code codifies the land dedication and payment of fees required in accordance with the Lemoore General Plan Parks, Schools, and Community Facilities Element.

4.16.2 Impact Assessment

Would the project:

- a) *Increase the use of existing neighborhood and regional parks or other recreational facilities such that substantial physical deterioration of the facility would occur or be accelerated?*

Less than Significant Impact. As noted previously, park and recreational facilities are typically impacted by an increase in use. The Project proposes a 280-lot residential subdivision with approximately 3.54 acres of park/trail area. The park and recreational facilities would primarily serve the neighborhood and residents of the surrounding area. Further, as discussed in Section 4.15, the Project would not meet the City’s parkland ratio by 0.80 acres and payment of impact fees would be required in accordance with the General Plan and LMC to offset impacts to existing park and recreational facilities. Therefore, through compliance, it can be determined that the Project would not increase the use of existing park and recreational facilities such that substantial physical deterioration of the facility would occur or be accelerated. For these reasons, the Project would have a less than significant impact.

- b) *Include recreational facilities or require the construction or expansion of recreational facilities that might have an adverse physical effect on the environment?*

Less than Significant Impact. The Project would result in the construction of new recreational facilities, which have been included in the analysis in this initial study. The provision of facilities is in accordance with the underlying land use designation and zone district. Therefore, inclusion of the facilities at a ratio and scale previously analyzed by the City’s long-range planning document would not result in an adverse physical effect on the environment. For these reasons, the Project would have a less than significant impact.

4.16.3 Mitigation Measures

None required.

4.17 TRANSPORTATION

Would the project:	Potentially Significant Impact	Less than Significant with Mitigation Incorporated	Less than Significant Impact	No Impact
a) Conflict with a program, plan, ordinance or policy addressing the circulation system, including transit, roadway, bicycle and pedestrian facilities?		X		
b) Conflict or be inconsistent with CEQA Guidelines § 15064.3, subdivision (b)?			X	
c) Substantially increase hazards due to a geometric design feature (e.g., sharp curves or dangerous intersections) or incompatible uses (e.g., farm equipment)?			X	
d) Result in inadequate emergency access?			X	

4.17.1 Environmental Setting

Street frontage for the Project site is limited to East Bush Street, which is a two (2)-lane, east-west arterial with existing curb, gutter, and sidewalk. Other than the existing sidewalk, there are no other existing pedestrian facilities (e.g., trails or paths) or bicycle facilities adjacent to or connected to the site. There are no existing or planned transit facilities adjacent to or in proximity to the Project site as identified in the General Plan and by Kings Area Regional Transit (KART). The nearest KART transit route to the Project site is Route 20 which has a bus stop within a quarter mile of the site, generally located at West Bush Street and Follett Street to the west of the site. Route 20 operates every 30 minutes, Monday through Saturday with connections to Hanford-Armona, Hanford, and Lemoore.

General Plan

The General Plan classifies East Bush Street as an arterial (See General Plan definition below). The General Plan identifies planned improvements to the segment of East Bush Street that fronts the Project site. The improvements include striping and widening East Bush Street from Lemoore Avenue to East D Street from two (2) to four (4) lanes.

***Arterial Streets.** Arterial streets are designed to move large volumes of traffic between highways and other arterials in Lemoore and to adjacent jurisdictions. Major arterials are access controlled roadways emphasizing mobility between major portions of the City and to regional freeways and highways. The only major arterial the City has is on a portion of Hanford-Armona Road from Blake Street (near Lemoore Avenue) to the Lemoore Canal. Minor arterials provide mobility through the City and access to major residential, employment, and activity centers. On-street parking should not be provided on major arterials but may be appropriate for minor arterials that emphasize accessibility over mobility. Minor arterials should provide two lanes and striped bike lanes in each direction of travel. Where inadequate room exists to stripe bike*

lanes in the street, large sidewalks should be installed to protect children walking or bicycling to school. Driveway access should be minimized, consistent with the primary function of arterials to move through traffic. Landscaped parkway strips, sidewalks, and transit facilities may also be accommodated within the right-of-way of minor arterials, depending on the right-of-way width. Lemoore Avenue, 19th Avenue, Bush Street, D Street, Belle Haven Drive, Iona Avenue, College Drive, Pedersen Avenue, Marsh Drive, Semas Drive (which is also a parkway), Jackson Avenue west of 19th Avenue, and portions of Hanford-Armona Road are examples of this category. Where older streets cannot accommodate parkways, street trees will be planted in tree wells within sidewalks while maintaining adequate handicapped access. (Lemoore Avenue is a perfect example of a street with challenges.)

The Circulation Element includes the following guiding policies and implementing actions related to the circulation system.

C-G-5 Guiding Policies:

Overall Circulation System Planning

Policy C-G-6 Provide a wide variety of transportation alternatives and modes serving all residents and businesses to enhance the quality of life and increase pedestrian safety.

Policy C-G-7 Make efficient use of all transportation facilities and, through coordinated land use planning, strive to improve accessibility to shops, schools, parks and employment centers and reduce the total vehicle miles traveled per household to minimize vehicle emissions and save energy.

Policy C-G-8 Improve the aesthetic character of transportation corridors in the City.

Traffic Level of Service

Policy C-G-9 Maintain acceptable levels of service and ensure that future development and the circulation system are in balance.

Policy C-G-10 Ensure that new development pays its fair share of the costs of transportation facilities.

C-G-11 Implementing Actions:

Overall Circulation System Planning

Policy C-I-1 Adopt street standards that provide flexibility in design, especially in residential neighborhoods. Revise right-of-way and pavement standards to reflect adjacent land use and/or anticipated traffic, and permit reduced right-of-way dimensions where necessary to maintain neighborhood character.

Policy C-I-2 Require all new developments to provide right-of-way and improvements consistent with the General Plan street designations and street cross-section standards. Further, ensure that either the City Capital Improvement Program Budget or new developments carries out the planned improvements included in Table 4.3 of the General Plan. Alternative improvements shall be considered if supported by a traffic assessment conducted under the guidance of City staff.

Policy C-I-3 Provide for greater street connectivity by:

- Incorporating in subdivision regulations requirements for a minimum number of access points to existing local or collector streets for each development (e.g. at least two access points for every 10 acres of development, with additional access, if warranted, for multi-family housing);
- Encouraging the construction of roundabouts instead of traffic signals and 4- way stop signs, where feasible;
- Requiring bicycle and pedestrian connections from cul-de-sacs to nearby public areas and main streets; and
- Requiring new residential communities on undeveloped land planned for urban uses to provide stubs for future connections to the edge of the property line. Where stubs exist on adjacent properties, new streets within the development should connect to these stubs.

Policy C-I-4 Develop a multi-modal transit system map integrating bicycle, public transportation, pedestrian and vehicle linkages within the City to ensure circulation gaps are being met. Safe Routes to School and any necessary related improvements will also be shown on this map, and costs and priorities indicated based on need.

Policy C-I-5 Use traffic calming measures to reduce speeds in existing and future residential areas.

Traffic Level of Service

Policy C-I-7 Develop and manage the roadway system to obtain Level of Service (LOS) D or better for two hour peak periods (a.m. and p.m.) on all major roadways and arterial intersections in the City. This policy does not extend to local residential streets (i.e., streets with direct driveway access to homes) or state highways and their intersections, where Caltrans policies apply. Exceptions to LOS D policy may be allowed by the City Council in areas, such as Downtown, where allowing a lower LOS would result in clear public benefits, social interaction and economic vitality, and help reduce overall automobile use. No new development will be approved unless it can be shown that required LOS can be maintained on affected roadways either through this General Plan documentation or more specific traffic studies conducted through the City where appropriate.

Policy C-I-8 Develop and manage local residential streets (i.e., streets with direct driveway access to homes) to limit average daily vehicle traffic volumes to 1,100 or less and 85th percentile speeds to 25 miles per hour or less. An average daily traffic volume of 1,100 is considered the threshold for a local residential street. Traffic volumes above this level tend to change the street from a residential street where children can play to a traffic street with the primary task of moving traffic.

Funding for Improvements

Policy C-I-13 Continue to require that new development pay its fair share of the costs of street and other traffic improvements based on traffic generated and its impact on traffic service levels.

Policy C-I-14 Establish city-wide traffic impact fees to provide additional funding for transportation improvements needed to serve new development, including new interchanges and ramps. Provide for automatic annual adjustments in traffic fees to reflect increases in construction costs (e.g. materials, rate of inflation, etc.).

Kings County Regional Active Transportation Plan

The Kings County Regional Active Transportation Plan (ATP) was adopted in 2019 to identify pedestrian and bicycle projects and programs and recognize the benefits of active transportation and its contribution to a balanced transportation system.²³ The City of Lemoore was identified as a focus area community with city-specific recommendations. As indicated in the ATP, bikeways and pedestrian improvements are proposed for East Bush Street.

VMT Impacts Under CEQA Guidelines

Under Senate Bill 743 (SB743), traffic impacts are related to Vehicle Miles Traveled (VMT). The VMT metric became mandatory on July 1, 2020. Senate Bill (SB) 743 requires that relevant CEQA analysis of transportation impacts be conducted using a metric known as vehicle miles traveled (VMT) instead of Level of Service (LOS). VMT measures how much actual automobile travel (additional miles driven) a proposed Project would create on California roads. If the project adds excessive automobile travel onto roads, then the project may cause a significant transportation impact. Therefore, LOS measures of impacts on traffic facilities are no longer a relevant CEQA criteria for transportation impacts.

To implement SB 743, the CEQA Guidelines were amended by adding Section 15064.3. According to Section 15064.3, VMT measures the automobile travel generated from a proposed project (i.e., the additional miles driven). Here, ‘automobile’ refers to on-road passenger vehicles such as cars and light-duty trucks. If a proposed project adds excessive automobile travel on California roads thereby exceeding an applicable threshold of significance, then the project may cause a significant transportation impact.

Among its provisions, Section 15064.3(b) establishes criteria for analyzing transportation impacts. Specifically, Section 15064.3(b) (1) establishes a less than significant presumption for certain land use projects that are proposed within ½-mile of an existing major transit stop or along a high-quality transit corridor. If this presumption does not apply to a land use project, then the VMT can be qualitatively or quantitatively analyzed.

In the case that quantitative models or methods are not available to the lead agency to estimate the VMT for the project being considered, provisions of CEQA Guidelines Section 15064.3(b)(3) permits the lead agency to conduct a qualitative analysis. The qualitative analysis may evaluate factors including but not limited to the availability of transit, proximity to other destinations, and construction traffic.

Lastly, Section 15064.3(b)(4) of the CEQA Guidelines states that “[a] lead agency has discretion to evaluate a project’s vehicle miles traveled, including whether to express the change in absolute terms, per capita, per household or in any other measure. A lead agency may use models to estimate a project’s vehicle miles traveled and may revise those estimates to reflect professional judgment based on substantial evidence. Any assumptions used to estimate vehicle miles traveled and any revision to model outputs should be documented and explained in the environmental document prepared for the project. The standard of adequacy in Section 15151 shall apply to the analysis described in this section.”

²³ Kings County Association of Governments. (2019). Kings County Regional Active Transportation Plan. Accessed on November 4, 2022, https://www.kingscog.org/vertical/Sites/%7BC427AE30-9936-4733-B9D4-140709AD3BBF%7D/uploads/2019-03_KCAG_RATP_Final.pdf

SB 743 Technical Advisory for VMT Impacts

In April 2018, the Governor's Office of Planning and Research (OPR) issued the Technical Advisory on Evaluating Transportation Impacts in CEQA (Technical Advisory) (revised December 2018) to provide technical recommendations regarding VMT, thresholds of significance, and mitigation measures for a variety of land use project types.

The Technical Advisory includes screening thresholds for agencies to use in order to identify when a project should be expected to cause a less-than-significant impact without conducting a detailed study.

- *Screening Thresholds for Small Project.* Absent substantial evidence indicating that a project would generate a potentially significant level of VMT, or inconsistency with a Sustainable Communities Strategy (SCS) or general plan, projects that generate or attract fewer than 110 trips per day generally may be assumed to cause a less-than significant transportation impact. This threshold is based on a CEQA categorical exemption for existing facilities, including additions to existing structures of up to 10,00 square feet, so long as the project is in an area where public infrastructure is available to allow for maximum planned development and the project is not in an environmentally sensitive area.
- *Map-Based Screening Threshold for Residential and Office Projects.* Residential and office projects that locate in areas with low VMT, and that incorporate similar features (i.e., density, mix of uses, transit accessibility), will tend to exhibit similarly low VMT. Maps created with VMT data, for example from a travel survey or a travel demand model, can illustrate areas that are currently below threshold VMT. Because new development in such locations would likely result in a similar level of VMT, such maps can be used to screen out residential and office projects from needing to prepare a detailed VMT analysis.
- *Presumption of Less Than Significant Impact Near Transit Thresholds.* Proposed CEQA Guideline Section 15064.3, subdivision (b)(1), states that lead agencies generally should presume that certain projects (including residential, retail, and office projects, as well as projects that are a mix of these uses) proposed within ½ mile of an existing major transit stop²⁰ or an existing stop along a high quality transit corridor will have a less-than-significant impact on VMT. This presumption would not apply, however, if project-specific or location-specific information indicates that the project will still generate significant levels of VMT.
- *Presumption of Less Than Significant Impact for Affordable Residential Development.* Adding affordable housing to infill locations generally improves jobs-housing match, in turn shortening commutes and reducing VMT. Therefore, a project consisting of a high percentage of affordable housing may be a basis for the lead agency to find a less-than-significant impact on VMT.

The Technical Advisory also includes recommended numerical thresholds for land use projects. For residential projects, the recommended threshold is as follows:

“A proposed project exceeding a level of 15 percent below existing VMT per capita may indicate a significant transportation impact. Existing VMT per capita may be measured as regional VMT per capita or as city VMT per capita. Proposed development referencing a threshold based on city VMT per capita (rather than regional VMT per capita) should not cumulatively exceed the number of units specified in the SCS for that city, and should be consistent with the SCS.”

Therefore, residential development that would generate vehicle travel that is 15 or more percent below the existing residential VMT per capita, measured against the region or city, may indicate a less-than-significant transportation impact.

According to the Technical Advisory, lead agencies, using more location-specific information, may develop their own more specific thresholds, which may include other land use types. The City recently adopted VMT thresholds after the project application was deemed complete by the City. As a result, the threshold procedures in effect at the time of application completeness shall be used to analyze VMT-related impacts. Therefore, the thresholds identified in the OPR Technical Advisory are utilized for assessing the traffic impacts of the proposed Project.

Kings County Online VMT Mapping Tool

The KCAG created an online VMT mapping tool that identifies VMT per capita and VMT per employee by traffic analysis zone (TAZ).²⁴ KCAG's mapping tool was created utilizing trip-based transportation models created for the eight (8) San Joaquin Valley Metropolitan Planning Organizations to satisfy the requirements of SB 375. The modeling process is described in the "User's Guide for the Eight San Joaquin Valley MPO Traffic Models to Meet the Requirements of SB 375," dated August 30, 2012 and incorporated herein by reference.²⁵ According to KCAG's 2018 Regional Transportation Plan (RTP), the trip-based transportation models from 2012 were revalidated and applied to a 2015 base year as described in Appendix VIII: Air Quality Conformity Analysis.²⁶ The revalidation is based on several criteria including vehicle miles traveled (VMT), total volume by road type, and percent of links within acceptable limits and utilizes traffic data for each jurisdiction within the County, including the City of Lemoore. The VMT projection process for KCAG's VMT Mapping Tool is outlined in Appendix VIII:

"Vehicle miles of travel (VMT) were estimated from the travel demand model by multiplying link volumes by link distances. The model estimates intrazonal trips (trips remaining within a TAZ) but does not assign these trips to the model road network. The intrazonal trips were multiplied by the estimated intrazonal distances to calculate intrazonal VMT."

The resulting VMT Mapping Tool illustrates areas that are currently below or above threshold VMT (i.e., 15 percent below per capita/per employee) and thereby constitutes a map-based screening threshold for residential and office projects as described in the OPR Technical Advisory. The VMT Mapping Tool is utilized for assessing the traffic impacts for the proposed Project pursuant to CEQA.

Traffic Impact Analysis

A Traffic Impact Analysis Report was prepared for the Project, which evaluated potential traffic impacts of the Project and can be found in **Appendix E**.

²⁴ Kings County Association of Governments. 2022. "Kings County Online VMT Mapping Tool." Accessed on November 4, 2022, <https://www.arcgis.com/apps/webappviewer/index.html?id=84b4b47b08ac41af88779212180ff36c>

²⁵ Kern Council of Governments. 2012. "Eight San Joaquin Valley MPO Traffic Models to Meet the Requirements of SB 375." Accessed on November 4, 2022, https://www.kerncog.org/wp-content/uploads/2009/11/MIP_Model_User_Guide_201208.pdf

²⁶ Kings County Association of Governments. 2018. "Regional Transportation Plan/Sustainable Communities Strategy." Accessed on November 4, 2022, https://www.kingscog.org/vertical/Sites/%7BC427AE30-9936-4733-B9D4-140709AD3BBF%7D/uploads/KCAG_2018_RTPSCS_Full_Document.pdf

4.17.2 Impact Assessment

Would the project:

- a) *Conflict with a program, plan, ordinance or policy addressing the circulation system, including transit, roadway, bicycle and pedestrian facilities?*

Less than Significant Impact with Mitigation Incorporated. The Project would be required to comply with all project-level requirements implemented by a program, plan, ordinance, or policy addressing the circulation system, including transit, roadway, bicycle, and pedestrian facilities. Compliance is further discussed below. Overall, the Project would not conflict with a program plan, ordinance, or policy addressing the circulation system and a less than significant impact would occur.

Roadway Facilities

Street frontage for the Project site is limited to East Bush Street, which is a two (2)-lane, east-west arterial with existing curb, gutter, and sidewalk. Per the Lemoore Circulation Element, driveway access should be minimized, consistent with the primary function of the classification to move through traffic. Landscaped parkway strips, sidewalks, and transit facilities may also be accommodated within the right-of-way, depending on the right-of-way width. Improvements identified in the Circulation Element for Bush Street include striping and widening of the street from Lemoore Avenue to East D Street.

As indicated in the Traffic Impact Analysis report, all access points would be located at points that minimize traffic operational impacts to existing and future roadway networks. The City of Lemoore 2030 General Plan does not currently have any adopted LOS standard. However, recent traffic studies have utilized LOS D as the acceptable level of traffic congestion. Therefore, LOS D is used to evaluate the potential significant of LOS impacts to City of Lemoore roadway facilities.

At present, all intersections studied operate at an acceptable LOS during both peak periods. **Table 4-14** shows the existing and future traffic conditions of these studied intersections. From the analysis, we can conclude that:

- *Under the existing plus project traffic conditions, the study intersection of 17th Avenue at Houston Avenue is projected to exceed its LOS threshold during the AM peak period; the addition of lanes and modification of traffic control mechanisms are recommended.*
- *Under the near term plus project traffic conditions, all study intersections are projected to operate at an acceptable LOS during both peak periods.*
- *Under the cumulative year 2042 plus project traffic conditions, the study intersection of Bush Street at D Street is projected to exceed its LOS threshold during both peak periods. The modification of lanes and traffic control mechanisms are recommended.*
- *The Report also finds that the location of the proposed access points relative to the existing local roads and driveways are located at points that minimize traffic operational impacts to the existing roadway network.*

Table 4-14 Traffic Impact Analysis

Intersection	Intersection Control	AM (7-9) Peak Hour		PM (4-6) Peak Hour	
		Average Delay (sec/veh)	LOS	Average Delay (sec/veh)	LOS
<i>Existing Traffic Conditions: Intersection LOS</i>					
Lemoore Avenue / D Street	Traffic Signal	22.6	C	21.1	C
Bush Street / D Street	Two-Way Stop	24.3	C	17.6	C
Lemoore Avenue / Bush Street	Traffic Signal	28.7	C	17.1	B
17 th Avenue / Houston Avenue	All-Way Stop	34.2	D	19.3	C
Lemoore Avenue / SR 198 WB Ramps	Traffic Signal	23.8	C	25.3	C
Lemoore Avenue / SR 198 EB Ramps	Traffic Signal	20.4	C	23.1	C
<i>Existing plus Project Traffic Conditions: Intersection LOS</i>					
Lemoore Avenue / D Street	Traffic Signal	22.8	C	21.3	C
Bush Street / D Street	Two-Way Stop	27.1	D	21.6	C
Lemoore Avenue / Bush Street	Traffic Signal	30.8	C	17.8	B
17th Avenue / Houston Avenue	All-Way Stop	40.9	E	26.8	D
	Traffic Signal (Improved)	17.4	B	11.3	B
Lemoore Avenue / SR 198 WB Ramps	Traffic Signal	23.6	C	24.6	C
Lemoore Avenue / SR 198 EB Ramps	Traffic Signal	20.3	c	23.9	C
<i>Near Term plus Project Traffic Conditions: Intersection LOS</i>					
Lemoore Avenue / D Street	Traffic Signal	23.2	C	20.7	C
Bush Street / D Street	Two-Way Stop	28.4	D	22.2	C
Lemoore Avenue / Bush Street	Traffic Signal	31.4	C	17.0	B
17th Avenue / Houston Avenue	Traffic Signal	17.7	B	11.3	B
Lemoore Avenue / SR 198 WB Ramps	Traffic Signal	22.1	C	24.0	C
Lemoore Avenue / SR 198 EB Ramps	Traffic Signal	23.7	C	23.4	C
<i>Cumulative Year 2042 plus Project Traffic Conditions: Intersection LOS</i>					
Lemoore Avenue / D Street	Traffic Signal	43.3	D	40.8	D
Bush Street / D Street	Two-Way Stop	> 120.0	F	74.9	F
	Traffic Signal (Improved)	36.0	D	22.2	C
	Roundabout (Improved)	12.3	B	10.7	B
Lemoore Avenue / Bush Street	Traffic Signal	46.8	D	23.6	C
17th Avenue / Houston Avenue	Traffic Signal	34.2	C	17.5	B
Lemoore Avenue / SR 198 WB Ramps	Traffic Signal	25.1	C	32.6	C
Lemoore Avenue / SR 198 EB Ramps	Traffic Signal	22.1	C	33.3	C

LOS = Level of Service based on average delay on signalized intersections and All-Way STOP Controls.

LOS for two-way STOP controlled intersections are based on the worst approach/movement of the minor street.

To mitigate the intersections that are projected to operate below the adopted LOS, the report recommends improvements to 17th Avenue/Houston Avenue and Bush Street/D Street. Therefore, to mitigate the impacts to these intersections, the Project shall incorporate MM TRA-1 as described below. For any off-site improvements, the developer would be required to submit Public Improvement Plans through the Building Permit process, for review and approval by the City to ensure improvements would be consistent with adopted City Standards, Specifications, and the approved street plans. Through compliance, the Project would result in improvements to the roadway network consistent with the goals, objectives, and policies of the General Plan (*Policy C-G-6, Policy C-*

G-7, Policy C-G-8, Policy C-I-2, Policy C-1-3, and Policy C-1-13) related to overall circulation system planning and funding improvements.

Therefore, through incorporated mitigation the existing roadway network could accommodate an acceptable peak hour vehicle LOS (General Plan *Policy C-I-7, C-I-8*) and the Project would thereby result in the redevelopment of a site at an intensity that can be accommodated by transportation modes while avoiding excessive or incompatible traffic. Overall, the Project would be consistent with the General Plan and would not conflict with a program plan, ordinance, or policy addressing roadway facilities and impacts would be less than significant with mitigation incorporated.

Pedestrian and Bicycle Facilities

Other than the existing sidewalk, there are no other existing pedestrian facilities (e.g., trails or paths) or bicycle facilities adjacent to or connected to the site. As previously mentioned, the Traffic Impact Analysis report recommends implementation of a class II bike lane along Bush Street. The recommended facilities would help achieve the ATP's goal for a balanced transportation system and reduce VMT. Therefore, to mitigate the impacts to these intersections, the Project shall incorporate *MM TRA-2* as described below. For any off-site improvements conditioned on the Project, the developer would be required to submit Public Improvement Plans through the Building Permit process, for review and approval by the City to ensure improvements would be consistent with adopted City Standards, Specifications, and the approved street plans. Therefore, the Project would not conflict with a program, plan, ordinance, or policy addressing pedestrian and bicycle facilities.

Transit Facilities

There are no existing or planned transit facilities adjacent to or in proximity to the Project site as identified in the General Plan and by KART. The nearest KART transit route to the Project site is Route 20 which has a bus stop within a quarter mile of the site, generally located at West Bush Street and Follett Street to the west of the site. Route 20 operates every 30 minutes, Monday through Saturday with connections to Hanford-Armona, Hanford, and Lemoore. Therefore, the Project would not conflict with a program, plan, ordinance, or policy addressing transit facilities.

Mitigation Measure TRA-1:

a) Prior to the issuance of building permits, the developer shall construct the following improvements to improve LOS at the intersection.

- *17th Avenue/Houston Avenue*
 - *Modify the eastbound through and right-turn lane to a combined through-right lane;*
 - *Add a southbound right-turn lane;*
 - *Modify the southbound left-through-right lane to a through-right line; and*
 - *Signalize the intersection with protective left-turn phasing in the eastbound and westbound directions.*

b) Pay traffic impact fees in accordance with the City's Impact Fees Ordinance and Policies.

Mitigation Measure TRA-2: Prior to the issuance of building permits, the developer shall construct a Class II bike lane along its frontage to Bush Street. If it is determined that a Class II lane is not feasible, then a Class III lane should be

installed. The developer shall submit the engineered plans for the bike lane to the City for review and approval prior to construction.

c) Would the project conflict or be inconsistent with CEQA Guidelines section 15064.3, subdivision (b)?

Less than Significant Impact. According to the Kings County Online VMT Mapping Tool, which was the available at the time the analysis was done and the Project application was deemed complete, the Project site is located within TAZ 853 and has an average VMT per capita of 7.19, which is less than the County's 15 percent below average VMT per capita of 8.2. As such, it can be concluded that, based upon KCAG's VMT Mapping Tool, the Project's VMT impact would be less than significant because VMT associated with the Project would be below the 15 percent-below-existing-development threshold. Therefore, the Project may be presumed to cause a less than significant impact pursuant to CEQA Guidelines *Section 15064.3(b)*.

d) Substantially increase hazards due to a geometric design feature (e.g., sharp curves or dangerous intersections) or incompatible uses (e.g., farm equipment)?

Less than Significant Impact. The Project design does not contain any geometric design features that would create hazards. Implementation of the Project would not require the improvement and expansion of the roadway network serving the Project site. The Project proposes an internal network of local streets that would connect to the existing circulation system including East Bush Street (arterial) Oporto Street (local), and Athens Street (local). Connections to Oporto Street and Athens Street would provide access between the proposed subdivision and the existing subdivision (Tract No. 700) adjoining the Project site to the east. All future local roads within the subdivision are proposed in accordance with City Standards. Further, as indicated in the Traffic Impact Analysis Report, all access points would be located at points that minimize traffic operational impacts to existing and future roadway networks.

In addition, the Project would be required to submit Public Improvement Plans through the Building Permit process for review and approval by the City to ensure offsite improvements would be consistent with adopted City Standards, Specifications, and the approved street plans. Compliance with such standards, specifications, and plans would ensure that any traffic hazards are minimized. Lastly, the Project proposes a residential development of a site that is planned and zoned for residential use within an area comprising existing and planned residential uses. Therefore, the Project does not propose an incompatible use because it is consistent with the existing development in the area and is similar in nature to the surrounding uses. As a result, implementation of the Project would result in a less than significant impact related to hazards due to roadway design features or incompatible uses.

e) Result in inadequate emergency access?

Less than Significant Impact. The Project does not involve a change to any emergency response plan. In addition, the City's Engineering Department and Fire Department have reviewed the Project and imposed standard conditions to ensure adequate site access including emergency access in addition to adequately sized emergency access lanes to accommodate emergency vehicles. In the case that Project construction requires lane closures, access through East Bush Street would be maintained through standard traffic control and therefore, potential lane closures would not affect emergency evacuation plans. Thus, a less than significant impact would occur because of the Project.

4.17.3 Mitigation Measures

The proposed Project shall implement and incorporate the transportation related mitigation measures as identified in the attached MMRP dated August 2023.

4.18 TRIBAL CULTURAL RESOURCES

<p>Would the project: Cause a substantial adverse change in the significance of a tribal cultural resource, defined in PRC section 21074 as either a site, feature, place, cultural landscape that is geographically defined in terms of the size and scope of the landscape, sacred place, or object with cultural value to a California Native American tribe, and that is:</p>	<p>Potentially Significant Impact</p>	<p>Less than Significant with Mitigation Incorporated</p>	<p>Less than Significant Impact</p>	<p>No Impact</p>
<p>a) Listed or eligible for listing in the California Register of Historical Resources, or in a local register of historical resources as defined in PRC section 5020.1(k), or,</p>		<p>X</p>		
<p>b) A resource determined by the lead agency, in its discretion and supported by substantial evidence, to be significant pursuant to criteria set forth in subdivision (c) of PRC section 5024.1. In applying the criteria set forth in subdivision (c) of PRC section 5024.1, the lead agency shall consider the significance of the resource to a California Native American tribe.</p>		<p>X</p>		

4.18.1 Environmental Setting

See **Section 4.5. Cultural Resources.**

4.18.2 Impact Assessment

Would the project cause a substantial adverse change in the significance of a tribal cultural resource, defined in Public Resources Code section 21074 as either a site, feature, place, cultural landscape that is geographically defined in terms of the size and scope of the landscape, sacred place, or object with cultural value to a California Native American tribe, and that is:

- a) *Listed or eligible for listing in the California Register of Historical Resources, or in a local register of historical resources as defined in Public Resources Code section 5020.1(k), or*

Less than Significant Impact with Mitigation Incorporated. As discussed in **Section 4.5**, the Project site does not contain any property or site features that are eligible for listing in the California Register of Historical Sources, or in a local register of historical resources as defined in PRC *Section 5020.1(k)*. Nevertheless, there is some possibility that a non-visible, buried site may exist and may be uncovered during ground disturbing construction activities which would constitute a significant impact. As such, implementation of *MM CUL-1 through CUL-5* as described in **Section 4.5** would reduce any impacts to less than significant.

- b) A resource determined by the lead agency, in its discretion and supported by substantial evidence, to be significant pursuant to criteria set forth in subdivision (c) of Public Resources Code Section 5024.1. In applying the criteria set forth in subdivision (c) of Public Resource Code Section 5024.1, the lead agency shall consider the significance of the resource to a California Native American tribe.*

Less than Significant Impact with Mitigation Incorporated. The Project site has not been determined by the City of Lemoore to be a significant resource pursuant to Public Resources Code *Section 5024.1* and to-date, no substantial information has been provided to the city to indicate otherwise. However, there is some possibility that a non-visible, buried site may exist and may be uncovered during ground disturbing construction activities which would constitute a significant impact. Implementation of *MM CUL-1 through CUL-5* as described in **Section 4.5** would reduce any impacts to less than significant.

4.18.3 Mitigation Measures

The proposed project shall implement and incorporate, as applicable, the cultural resources related mitigation measures as identified in the attached MMRP dated August 2023.

4.19 UTILITIES AND SERVICE SYSTEMS

Would the project:	Potentially Significant Impact	Less than Significant with Mitigation Incorporated	Less than Significant Impact	No Impact
a) Require or result in the relocation or construction of new or expanded water, wastewater treatment or storm water drainage, electric power, natural gas, or telecommunications facilities, the construction or relocation of which could cause significant environmental effect?			X	
b) Have sufficient water supplies available to serve the project and reasonably foreseeable future development during normal, dry and multiple dry years?			X	
c) Result in a determination by the wastewater treatment provider, which serves or may serve the project that it has adequate capacity to serve the project's projected demand in addition to the provider's existing commitments?			X	
d) Generate solid waste in excess of state or local standards, or in excess of the capacity of local infrastructure, or otherwise impair the attainment of solid waste reduction goals?			X	
e) Comply with federal, state, and local management and reduction statutes and regulations related to solid waste?			X	

4.19.1 Environmental Setting

The Project site is within city limits. Development would be required to connect to water, sewer, stormwater, and wastewater services. Natural gas, electricity, and telecommunications are provided by private companies. Each utility system is described below.

Water

The City Water Department manages and operates the City's water system. Lemoore meets its demand for domestic water from a sole source of local groundwater. Groundwater is accessed from the Tulare Lake Subbasin of the San Joaquin Valley Groundwater Basin and via six active groundwater wells within city limits and two wellfields north of the City. The City operates a separate system to supply industrial water. The City maintains four ground-level storage reservoirs within the distribution system, with a total capacity of 4.4 MG.

Wastewater

The City of Lemoore Public Works Department (PWD) is responsible for planning and managing wastewater service in Lemoore. The City's wastewater treatment plant (WWTP) is located south of Iona Avenue, between Vine Street and 19th Avenue in the southwestern portion of the city. The WWTP is a secondary treatment facility with a disinfection system that includes headworks, aerated lagoons, and effluent chlorination. Per the Lemoore General Plan, the facility has a maximum capacity of 4.5 million gallons per day (mgd). According to the 2015 UWMP, the total wastewater collected from the UWMP Service Area in 2015 was 689 MG. Domestic wastewater is collected from all development within the city via a network of collection pipelines, treated at the WWTP, and discharged via a six (6)-mile pipeline to the Westlake Canal. The average influent flow to serve development in accordance with the General Plan is projected to rise to 6.3 mgd in 2030, requiring expansion and replacement of facilities. Improvements will be funded through wastewater impact fees and increased sewer rates.

Solid Waste

The City of Lemoore PWD Refuse Division provides refuse, recyclable, and green waste collection services managed by Kings Waste and Recycling Authority (KWRA). Non-hazardous waste is taken to the Kettleman Hills Landfill operated by Chemical Waste Management, Inc. As of 2020, the facility has an available capacity of 15.6 million cubic yards with a maximum permitted throughout of 9,000 cubic yards per day.

Stormwater

The City of Lemoore PWD is responsible for providing stormwater services. holds a small share of the Lemoore Canal and Irrigation Company to use its canals, as well as Dockstader and Fox Ditches drainage channels, to collect stormwater runoff in Lemoore. The City of Lemoore adopted a Storm Water Management Plan in 2008 to identify appropriate storm water pollution prevention programs and establish Best Management Practices to protect water quality.

Natural Gas and Electricity

PG&E, the natural gas and electric service provider for the area, incrementally expands and updates its service system as needed to serve its users.

Telecommunications

Accordingly, telecommunications providers in the area incrementally expand and update their service systems in response to usage and demand.

4.19.2 Impact Assessment

Would the project:

- a) *Require or result in the relocation or construction of new or expanded water, wastewater treatment or storm water drainage, electric power, natural gas, or telecommunications facilities, the construction or relocation of which could cause significant environmental effects?*

Less than Significant Impact. The Project site is within city limits and thus, would be required to connect to water, stormwater, solid waste, and wastewater services. Natural gas, electricity, and telecommunications would be provided by private companies including PG&E and Mid Valley Disposal. The City has reviewed the Project to determine adequate capacity in these systems and ensure compliance with applicable connection requirements. In addition to connections to water, stormwater, solid waste, and wastewater services, the Project would be served by PG&E for natural gas and electricity and by the appropriate telecommunications provider for the Project Area. Therefore, all wet and dry public utilities, facilities, and infrastructure are in place and available to serve the Project site without the need for relocated, new, or expanded facilities. While new utility and service connections would need to be extended to and from the Project site (e.g., sewer, stormwater runoff, electrical), these new connections would not result in a need to modify the larger off-site infrastructure. Therefore, the Project would not require or result in the relocation or construction of new or expanded facilities and as such, and impact would be less than significant.

- b) *Have sufficient water supplies available to serve the project and reasonably foreseeable future development during normal, dry and multiple dry years?*

Less than Significant Impact. The City currently utilizes local groundwater as its sole source of municipal water supply. As discussed in detail in [Section 4.10](#), the City's long-term water resource planning is addressed in the City's 2015 UWMP. The projections on population growth and the adopted General Plan form the factual basis for the analysis contained in the UWMP. Therefore, the development of the Project site to the intensity allowed within the site's planned land use designation was previously analyzed under the General Plan and subsequently contemplated in the UWMP. No land use change would result from the Project.

According to the UWMP, the groundwater subbasin underlying the city, and thus the Project site, is the Tulare Lake Subbasin (Groundwater Basin No. 5-22.12). The estimated water storage capacity of the subbasin is 17.1 million acre-feet (AF) to a depth of 300 feet and 82.5 million AF to the base of fresh groundwater. The UWMP calculates the existing groundwater supply available to the City to be 178,228 MG. UWMP projections for the supply and demand assessment found normal water year, single dry water year, and five-year consecutive drought period supplies to remain reliable in all hydrologic conditions after meeting demands.

As described in [Section 4.10](#), potable water demands for the Project were estimated using the DWR Indoor Residential Water Use Study and the American Community Survey 5-Year Estimates (2021). The DWR study reports that the current statewide median indoor residential water use is 48 gallons per capita per day and the American

Community Survey estimates the average household size for Lemoore to be 2.95.²⁷ ²⁸ Therefore, the Project's expected daily water usage is 39,648 gallons per capita per day (48 gpd x 2.95 people x 280 homes), or 14,471,520 gallons per capita per year. Based on this estimate the Project would be able to be served by the existing system without substantially decreasing supplies.

Based on these projections, it can be inferred that the Project would not negatively impact the City's ability to provide water assuming adherence to requirements and recommendations from the City's water resources planning efforts. Overall, based on the information collected from the UWMP, the Project would not generate significantly greater water demand as to substantially decrease groundwater supplies. As a result, it can be presumed that the existing and planned water distribution system should be adequate to serve the Project during normal, dry, and multiple dry years. In addition, adherence to connection requirements and recommendations pursuant to water supply planning efforts (i.e., compliance with California Plumbing Code, efficient appliances, efficient landscaping, etc.) should not negatively impact the City's water provision. For these reasons, a less than significant impact would occur because of the Project.

- c) Result in a determination by the wastewater treatment provider, which serves or may serve the project that it has adequate capacity to serve the project's projected demand in addition to the provider's existing commitments?*

Less than Significant Impact. The Project is in city limits and therefore would connect to the existing sewer system serving the city. The Project is consistent with the planned land use designation previously accounted for and analyzed in the General Plan and subsequent utility master plans including wastewater. New trunk lines and sewer subsystems must be planned where growth is expected to occur. Such improvements will be funded through wastewater impact fees as well as increased sewer rates. The wastewater impacts for the Project were evaluated and conditioned by the City Engineer to ensure compliance with the City's wastewater treatment requirements and capacity. Through compliance with installation requirements and payment of impact fees, the Project would not exceed wastewater treatment requirements such that a new facility would be required, nor would the existing treatment facilities need to be expanded. As such, the Project would have a less than significant impact.

- d) Generate solid waste in excess of State or local standards, or in excess of the capacity of local infrastructure, or otherwise impair the attainment of solid waste reduction goals?*

Less than Significant Impact. The City PWD Refuse Division provides refuse, recyclable, and green waste collection services managed by KWRA. As noted previously, non-hazardous waste is taken to the Kettleman Hills Landfill, which has an available capacity to meet the demands of the Project. The General Plan Public Utilities Chapter contains policies addressing waste collection, service, and reduction in compliance with the Federal Resource Conservation and Recovery Act, California Integrated Waste Management Act, and Kings County Integrated Waste Management Plan. These policies are designed to reduce the potential environmental effects associated with solid waste disposal.

²⁷ California Department of Water Resources. (2021). Indoor Residential Water Use Study Findings. Accessed on June 26, 2023, <https://water.ca.gov/-/media/DWR-Website/Web-Pages/Programs/Water-Use-And-Efficiency/AB-1668-and-SB-606-Conservation/IRWUS-Public-Review-Draft-ReportPAO7May21-v1.pdf>

²⁸ American Community Survey. (2021). American Community Survey 5-Year Estimates (2021): S1101 Households and Families. Accessed on June 26, 2023, <https://data.census.gov/>

Construction

CALGreen mandates locally permitted new residential building construction and demolition to recycle and/or salvage for reuse a minimum 65% of the nonhazardous construction and demolition debris generated during the Project. Further, the recycling of construction and demolition materials is required for any City-issued building or demolition permit that generates at least eight cubic yards of material by volume. Therefore, the Project would be required to implement techniques to reduce and recycle waste during construction activities in accordance with mandatory requirements under CALGreen as implemented through the building permit process. Compliance would be ensured through the building permit process. Therefore, through compliance, solid waste generated through construction activities is not anticipated to generate solid waste in excess of state or local standards, in excess of the capacity of the local infrastructure, or otherwise impair the attainment of solid waste reduction goals. Therefore, the Project would have a less than significant impact.

Operations

Project operations would be subject to Title 4, Chapter 1 of the LMC, which regulates solid waste activities including disposal, sorting, and recycling of materials, in addition to the solid waste related policies of the General Plan. Future residents would be provided with refuse, recycling, and green waste collection services and service fees would be charged per residence. All activities generating solid waste would be subject to compliance with the applicable measures and policies which would serve to reduce impacts of solid waste by promoting regular collection and encouraging the recycling of materials. As such, Project operations are not anticipated to generate solid waste in excess of state or local standards, in excess of the capacity of the local infrastructure, or otherwise impair the attainment of solid waste reduction goals. Therefore, the Project would have a less than significant impact.

e) Comply with federal, state, and local management and reduction statutes and regulations related to solid waste?

Less than Significant Impact. The 1989 California Integrated Waste Management Act (AB 939) requires Kings County to attain specific waste diversion goals. In addition, the California Solid Waste Reuse and Recycling Access Act of 1991, as amended, requires expanded or new development projects to incorporate storage areas for recycling bins into the proposed project design. Reuse and recycling of construction debris would reduce operating expenses and save valuable landfill space.

As described under criterion d), Project construction and operational activities that generate solid waste would be handled, transported, and disposed of in accordance with CALGreen, LMC, and General Plan policies and regulations related to solid waste. Compliance would be ensured through the building permit process. Therefore, through compliance, the Project would comply with laws and regulations that would ensure impacts related to solid waste are reduced to less than significant levels.

4.19.3 Mitigation Measures

None required.

4.20 WILDFIRE

If located in or near state responsibility or lands classified as very high fire hazard severity zones, Would the project:	Potentially Significant Impact	Less than Significant with Mitigation Incorporated	Less than Significant Impact	No Impact
a) Substantially impair an adopted emergency response plan or emergency evacuation plan?				X
b) Due to slope, prevailing winds, and other factors, exacerbate wildfire risks, and thereby expose project occupants to pollutant concentrations from a wildfire or the uncontrolled spread of a wildfire?				X
c) Require the installation or maintenance of associated infrastructure (such as roads, fuel breaks, emergency water sources, power lines or other utilities) that may exacerbate fire risk or that may result in temporary or ongoing impacts to the environment?				X
d) Expose people or structures to significant risks, including downslope or downstream flooding or landslides, as a result of runoff, post-fire slope instability, or drainage changes?				X

4.20.1 Environmental Setting

Fire hazard potential is largely dependent on the extent and type of vegetation, known as surface fuels, that exists within a region. Fire hazards are typically highest in heavily wooded, undeveloped areas as trees are a greater source of fuel than low-lying brush or grassland. Suburban, urban areas or rocky barren areas have minimal surface fuels and therefore typically have the lowest fire hazard. In general, Lemoore is categorized as having either little or no threat or a moderate threat of wildfire. In addition, the site nor the city of Lemoore are identified by Cal Fire as being in a Very High Fire Hazard Severity Zone (VHFHSZ). Rather, the city, inclusive of the Project site, is in an LRA that is an area of low fire risk.²⁹ As such, the LVFD is responsible for providing fire protection services (See **Section 4.15**).

²⁹ Cal Fire, “FHSZ Viewer.” Accessed on August 9, 2022, <https://egis.fire.ca.gov/FHSZ/>

4.20.2 Impact Assessment

If located in or near state responsibility areas or lands classified as very high fire hazard severity zones, **would the project:**

a) *Substantially impair an adopted emergency response plan or emergency evacuation plan?*

No Impact. The Project would not impair access to the existing roadway network. Construction may require lane closure; however, these activities would be short-term and access through East Bush Street would be maintained through standard traffic control. Following construction, this roadway would continue to provide access to the site. Safe and convenient vehicular and pedestrian circulation would be provided in addition to adequate access for emergency vehicles. To determine and ensure adequate vehicular and pedestrian circulation and emergency vehicle access, the Project has been reviewed and conditioned by the City for compliance with applicable code and regulations including applicable emergency response and evacuation plans. Therefore, the Project would not substantially impair any emergency response plan or emergency evacuation plan and no impact would occur.

b) *Due to slope, prevailing winds, and other factors, exacerbate wildfire risks, and thereby expose project occupants to pollutant concentrations from a wildfire or the uncontrolled spread of a wildfire?*

No Impact. The Project site is located on a relatively flat property with minimal slope and is not in an area that is subject to strong prevailing winds or other factors that would exacerbate wildfire risks. The site is highly disturbed and is not located within a wildland (i.e., wild, uncultivated, and uninhabited land), which precludes the risk of wildfire. Further, the Project site is within an LRA and is not identified by Cal Fire to be in a VHFHSZ. For these reasons, no impact would occur as a result of this Project.

c) *Require the installation or maintenance of associated infrastructure (such as roads, fuel breaks, emergency water sources, power lines or other utilities) that may exacerbate fire risk or that may result in temporary or ongoing impacts to the environment?*

No Impact. The Project is located within city limits in an area with existing infrastructure such as roads and utilities that are maintained accordingly. As previously discussed, all proposed project components (including utilities, roadway, buildings, walls, and landscaping) would be located within the boundaries of the Project site and have been reviewed and/or conditioned by the City for compliance with applicable codes and regulations. Through compliance, such infrastructure would not exacerbate fire risk or result in temporary or ongoing impacts to the environment and no impact would occur.

d) *Expose people or structures to significant risks, including downslope or downstream flooding or landslides, as a result of runoff, post-fire slope instability, or drainage changes?*

No Impact. The city inclusive of the Project site is not located in or near state responsibility or lands classified as very high fire hazard severity zones. The topography of the Project site is relatively flat with stable, native soils, and the site is not in the immediate vicinity of rivers or creeks that would be more susceptible to landslides. Therefore, no impact would occur because of the Project.

4.20.3 Mitigation Measures

None required.

4.21 MANDATORY FINDINGS OF SIGNIFICANCE

Would the project:	Potentially Significant Impact	Less than Significant with Mitigation Incorporated	Less than Significant Impact	No Impact
a) Does the project have the potential to degrade the quality of the environment, substantially reduce the habitat of a fish or wildlife species, cause a fish or wildlife population to drop below self-sustaining levels, threaten to eliminate a plant or animal community, reduce the number or restrict the range of a rare or endangered plant or animal or eliminate important examples of the major periods of California history or prehistory?		X		
b) Does the project have impacts that are individually limited, but cumulatively considerable? ("Cumulatively considerable" means that the incremental effects of a project are considerable when viewed in connection with the effects of past projects, the effects of other current projects, and the effects of probable future projects)?		X		
c) Does the project have environmental effects which will cause substantial adverse effects on human beings, either directly or indirectly?		X		

4.21.1 Impact Assessment

- a) *Does the project have the potential to substantially degrade the quality of the environment, substantially reduce the habitat of a fish or wildlife species, cause a fish or wildlife population to drop below self-sustaining levels, threaten to eliminate a plant or animal community, substantially reduce the number or restrict the range of an endangered, rare, or threatened species, or eliminate important examples of the major periods of California history or prehistory?*

Less than Significant Impact with Mitigation Incorporated. The analyses of environmental issues contained in this Initial Study indicate that the Project is not expected to have substantial impact on the environment or on any resources identified in the Initial Study. Standard requirements that will be implemented through the entitlement process and the attached mitigation monitoring and reporting program have been incorporated in the project to reduce all potentially significant impacts to less than significant, including *Mitigation Measures BIO-1-BIO-6, CUL-1-CUL-5, NOI-1-NOI-2, and TRA-1-TRA-2*. Therefore, the Project would have a less than significant impact with mitigation incorporated.

b)) *Does the project have impacts that are individually limited, but cumulatively considerable? (“Cumulatively considerable” means that the incremental effects of a project are considerable when viewed in connection with the effects of past projects, the effects of other current projects, and the effects of probable future projects.)*

Less than Significant Impact with Mitigation Incorporated. CEQA Guidelines *Section 15064(i)* states that a Lead Agency shall consider whether the cumulative impact of a project is significant and whether the effects of the project are cumulatively considerable. The assessment of the significance of the cumulative effects of a project must, therefore, be conducted in connection with the effects of past projects, other current projects, and probable future projects. Due to the nature of the Project and consistency with environmental policies, incremental contributions to impacts are considered less than cumulatively considerable. Standard requirements that will be implemented through the entitlement process and the attached mitigation monitoring and reporting program have been incorporated in the project to reduce all potentially significant impacts to less than significant, including *Mitigation Measures BIO-1-BIO-6, CUL-1-CUL-5, NOI-1-NOI-2, and TRA-1-TRA-2*. The Project would not contribute substantially to adverse cumulative conditions, or create any substantial indirect impacts (i.e., increase in population could lead to an increased need for housing, increase in traffic, air pollutants, etc.). As such, Project impacts are not considered to be cumulatively considerable given the insignificance of project induced impacts. The impact is therefore less than significant with mitigation incorporated.

c) *Does the project have environmental effects that will cause substantial adverse effects on human beings, either directly or indirectly?*

Less than Significant Impact with Mitigation Incorporated. The analyses of environmental issues contained in this Initial Study indicate that the project is not expected to have substantial impact on human beings, either directly or indirectly. Standard requirements that will be implemented through the entitlement process and the attached mitigation monitoring and reporting program have been incorporated in the project to reduce all potentially significant impacts to less than significant, including *Mitigation Measures BIO-1-BIO-6, CUL-1-CUL-5, NOI-1-NOI-2, and TRA-1-TRA-2*. Therefore, the Project would have a less than significant impact with mitigation incorporated.

5 MITIGATION MONITORING AND REPORTING PROGRAM

This mitigation measure monitoring and reporting checklist was prepared pursuant to California Environmental Quality Act (CEQA) Guidelines *Section 15097* and *Section 21081.6* of the PRC (PRC). The timing of implementing each mitigation measure is identified in in the checklist, as well as identifies the entity responsible for verifying that the mitigation measures applied to a project are performed. Project applicants are responsible for providing evidence that mitigation measures are implemented. As lead agency, the City of Lemoore is responsible for verifying that mitigation is performed/completed.

Mitigation Monitoring and Reporting Program

WCP Developers, LLC: 280-Lot Residential Subdivision

Tentative Tract Map No. 939, Major Site Plan Review No. 2022-02, and Planned Unit Development No. 2022-01

Dated August 2023

Mitigation Measures	Timing of Verification	Responsible for Verification	Verification of Completion	
			Date	Initials
Biological Resources				
<p>MM BIO-1: <i>Prior to ground-disturbing activities, a qualified wildlife biologist shall conduct a biological clearance survey between 14 and 30 days prior to the onset of construction.</i></p> <p><i>The clearance survey shall include walking transects to identify presence of San Joaquin kit fox, burrowing owl, nesting birds, and other special-status species. The pre-construction survey shall be walked by no greater than 30-foot transects for 100 percent coverage of the Project and a 50-foot buffer, where feasible. If no evidence of special-status species is detected, no further action is required except MM BIO-4 and BIO-6 shall be implemented.</i></p>	<p>Community Development Department/Planning Division to review construction specifications to ensure inclusion of provisions included in mitigation measure.</p>	<p>Community Development Department/Planning Division</p>		
<p>MM BIO-2: <i>The following avoidance and minimization measures shall be implemented during all phases of the Project to reduce the potential for impact from the Project. They are modified from the U.S. Fish and Wildlife Service Standardized Recommendations for Protection of the Endangered SJKF Prior to or During Ground Disturbance (USFWS 2011, Appendix F).</i></p> <p><i>a. All food-related trash items such as wrappers, cans, bottles, and food scraps shall be disposed of in securely</i></p>	<p>Community Development Department/Planning Division to review construction specifications to ensure inclusion of provisions included in mitigation measure.</p>	<p>Community Development Department/Planning Division</p>		

<p><i>closed containers. All food-related trash items such as wrappers, cans, bottles, and food scraps shall be disposed of in securely closed containers and removed at least once a week from the construction of the Project site.</i></p> <p><i>b. Construction-related vehicle traffic shall be restricted to established roads and predetermined ingress and egress corridors, staging, and parking areas. Vehicle speeds shall not exceed 20 miles per hour (mph) within the Project site.</i></p> <p><i>c. To prevent inadvertent entrapment of kit fox or other animals during construction, the contractor shall cover all excavated, steep-walled holes or trenches more than two feet deep at the close of each workday with plywood or similar materials. If holes or trenches cannot be covered, one or more escape ramps constructed of earthen fill or wooden planks shall be installed in the trench. Before such holes or trenches are filled, the contractor shall thoroughly inspect them for entrapped animals. All construction-related pipes, culverts, or similar structures with a diameter of four inches or greater that are stored on the Project site shall be thoroughly inspected for wildlife before the pipe is subsequently buried, capped, or otherwise used or moved in any way. If at any time an entrapped or injured kit fox is discovered, work in the immediate area shall be temporarily halted, and USFWS and CDFW shall be consulted.</i></p> <p><i>d. Kit foxes are attracted to den-like structures such as pipes and may enter stored pipes and become trapped or injured. All construction pipes, culverts, or similar structures with a diameter of four inches or greater that are stored at a construction site for one or more overnight periods shall be thoroughly inspected for kit foxes before the pipe is subsequently buried, capped, or otherwise used or moved in any way. If a kit fox is discovered inside a pipe, that section of pipe shall not be moved until the USFWS</i></p>				
---	--	--	--	--

<p><i>and CDFW have been consulted. If necessary, and under the direct supervision of the biologist, the pipe may be moved only once to remove it from the path of construction activity until the fox has escaped.</i></p> <p><i>e. No pets, such as dogs or cats, shall be permitted on the Project sites to prevent harassment, mortality of kit foxes, destruction of dens.</i></p> <p><i>f. Use of anti-coagulant rodenticides and herbicides in project sites shall be restricted. This is necessary to prevent primary or secondary poisoning of kit foxes and the depletion of prey populations on which they depend. All uses of such compounds shall observe labels and other restrictions mandated by the U.S. Environmental Protection Agency, California Department of Food and Agriculture, and other State and federal legislation, as well as additional Project-related restrictions deemed necessary by the USFWS and CDFW. If rodent control must be conducted, zinc phosphide shall be used because of the proven lower risk to kit foxes.</i></p> <p><i>g. A representative shall be appointed by the Project proponent who will be the contact source for any employee or contractor who might inadvertently kill or injure a kit fox or who finds a dead, injured, or entrapped kit fox. The representative shall be identified during the employee education program, and their name and telephone number shall be provided to the USFWS.</i></p> <p><i>h. The Sacramento Fish and Wildlife Office of USFWS and CDFW shall be notified in writing within three working days of the accidental death or injury to a SJKF during Project-related activities. Notification must include the date, time, and location of the incident or of the finding of a dead or injured animal and any other pertinent information. The USFWS contact is the Chief of the Division of Endangered</i></p>				
---	--	--	--	--

<p><i>Species at the addresses and telephone numbers below. The CDFW contact can be reached at (559) 243-4014 and R4CESA@wildlifeca.gov.</i></p> <p><i>i. All sightings of the SJKF shall be reported to the California Natural Diversity Database (CNDDDB). A copy of the reporting form and a topographic map clearly marked with the location of where the kit fox was observed shall also be provided to the Service at the address below.</i></p> <p><i>j. Any Project-related information required by the USFWS or questions concerning the above conditions or their implementation may be directed in writing to the U.S. Fish and Wildlife Service at: Endangered Species Division, 2800 Cottage Way, Suite W 2605, Sacramento, California 95825-1846, phone: (916) 414-6620 or (916) 414-6600.</i></p> <p><i>k. New sightings of SJKF should be reported to the CNDDDB.</i></p>				
<p><i>MM BIO-3:</i> <i>Within 14 days prior to the start of Project ground-disturbing activities, a pre-activity survey with a 500-foot buffer shall be conducted by a qualified biologist knowledgeable in the identification of these species and approved by the CDFW. If dens/burrows that could support any of these species are discovered during the pre-activity survey conducted under MM BIO-1, the avoidance buffers outlined below should be established. No work would occur within these buffers unless the biologist approves and monitors the activity.</i></p> <p><i>San Joaquin Kit Fox</i></p> <ul style="list-style-type: none"> • <i>Potential or Atypical den – 50 feet</i> • <i>Known den – 100 feet</i> • <i>Natal or pupping den – 500 feet, unless otherwise specified by CDFW</i> 	<p>Community Development Department/Planning Division to review construction specifications to ensure inclusion of provisions included in mitigation measure.</p>	<p>Community Development Department/Planning Division</p>		

<p>MM BIO-4: <i>If construction is planned outside the nesting period for raptors (other than burrowing owl) and migratory birds (February 15 to August 31), no mitigation shall be required. If construction is planned during the nesting season for migratory birds and raptors, a pre-construction survey to identify active bird nests shall be conducted by a qualified biologist to evaluate the site and a 250-foot buffer for migratory birds and a 500-foot buffer for raptors. If nesting birds are identified during the survey, active raptor nests shall be avoided by 500 feet and all other migratory bird nests shall be avoided by 250 feet. Avoidance buffers may be reduced if a qualified on-site monitor determines that encroachment into the buffer area is not affecting nest building, the rearing of young, or otherwise affecting the breeding behaviors of the resident birds. Because nesting birds can establish new nests or produce a second or even third clutch at any time during the nesting season, nesting bird surveys shall be repeated every 30 days as construction activities are occurring throughout the nesting season.</i></p> <p><i>No construction or earth-moving activity shall occur within a non-disturbance buffer until it is determined by a qualified biologist that the young have fledged (left the nest) and have attained sufficient flight skills to avoid project construction areas. Once the migratory birds or raptors have completed nesting and young have fledged, disturbance buffers will no longer be needed and may be removed, and monitoring may cease.</i></p>	<p>Community Development Department/Planning Division to review construction specifications to ensure inclusion of provisions included in mitigation measure.</p>	<p>Community Development Department/Planning Division</p>		
<p>MM BIO-5: <i>A qualified biologist shall conduct a pre-construction survey on the project site and within 500 feet of its perimeter, where feasible, to identify the presence of the</i></p>	<p>Community Development Department/Planning Division to review construction specifications to ensure</p>	<p>Community Development Department/Planning Division</p>		

western burrowing owl. The survey shall be conducted between 14 and 30 days prior to the start of construction activities. If any burrowing owl burrows are observed during the pre-construction survey, avoidance measures shall be consistent with those included in the CDFW Staff Report on Burrowing Owl Mitigation (CDFG 2012). If occupied burrowing owl burrows are observed outside of the breeding season (September 1 through January 31) and within 250 feet of proposed construction activities, a passive relocation effort may be instituted in accordance with the guidelines established by the California Burrowing Owl Consortium (1993) and the California Department of Fish and Wildlife (2012). During the breeding season (February 1 through August 31), a 500-foot (minimum) buffer zone shall be maintained unless a qualified biologist verifies through non-invasive methods that either the birds have not begun egg laying and incubation or that juveniles from the occupied burrows are foraging independently and are capable of independent survival.

In addition, impacts to occupied burrowing owl burrows shall be avoided in accordance with the following table unless a qualified biologist approved by CDFW verifies through non-invasive methods that either: (1) the birds have not begun egg laying and incubation; or (2) that juveniles from the occupied burrows are foraging independently and are capable of independent survival.

Location	Time of Year	Level of Disturbance		
		Low	Med	High
Nesting sites	April 1 – Aug 15	200 m	500 m	500 m
Nesting sites	Aug 16 – Oct 15	200 m	200 m	500 m
Nesting sites	Oct 16 – Mar 31	50 m	100 m	500 m

inclusion of provisions included in mitigation measure.

<p>MM BIO-6: Prior to ground-disturbance activities, or within one week of being deployed at the Project site for newly hired workers, all construction workers at the Project site shall attend a Construction Worker Environmental Awareness Training and Education Program developed and presented by a qualified biologist.</p> <p>The Construction Worker Environmental Awareness Training and Education Program shall be presented by the biologist and shall include information on the life histories of special-status wildlife and plant species that may be encountered during construction activities, their legal protections, the definition of “take” under the Endangered Species Act, measures the project operator is implementing to protect the species, reporting requirements, specific measures that each worker must employ to avoid take of the species, and penalties for violation of the Act. Identification and information regarding special status or other sensitive species with the potential to occur on the Project site shall also be provided to construction personnel. The program shall include:</p> <ul style="list-style-type: none"> • An acknowledgment form signed by each worker indicating that environmental training has been completed. • A copy of the training transcript and/or training video/CD, as well as a list of the names of all personnel who attended the training and copies of the signed acknowledgment forms, shall be maintained on-site for the duration of construction activities. 	<p>Community Development Department/Planning Division to review construction specifications to ensure inclusion of provisions included in mitigation measure.</p>	<p>Community Development Department/Planning Division</p>		
Cultural Resources				
<p>MM CUL-1: In the event that cultural resources are discovered during construction or decommissioning. Operations shall stop</p>	<p>Community Development Department/Planning Division</p>	<p>Community Development</p>		

<p><i>within 100 feet of the find, and a qualified archeologist shall determine whether the resource requires further study. The qualified archaeologist shall determine the measures that shall be implemented to protect the discovered resources, including but not limited to excavation of the finds and evaluation of the finds in accordance with §15064.5 of the CEQA Guidelines. Mitigation measures may include avoidance, preservation in-place, recordation, additional archaeological testing, and data recovery, among other options. Any previously undiscovered resources found during construction within the project area shall be recorded on appropriate Department of Parks and Recreation forms and evaluated for significance. No further ground disturbance shall occur in the immediate vicinity of the discovery until approved by the qualified archaeologist. No further grading shall occur in the area of the discovery until the Lead Agency approves the measures to protect these resources. Any historical artifacts recovered as a result of mitigation shall be provided to a City-approved institution or person who is capable of providing long-term preservation to allow future scientific study.</i></p>	<p>to review contract specifications to ensure inclusion of provisions included in project-specific mitigation measure.</p> <p>Following discovery of previously unknown resource, a qualified historical resources specialist shall prepare recommendations and submit to the Community Development Department/Planning Division.</p>	<p>Department/Planning Division</p>		
<p>MM CUL-2: <i>Upon coordination with the City any archaeological artifacts recovered shall be donated to an appropriate Tribal custodian or a qualified scientific institution where they would be afforded applicable cultural resources laws and guidelines.</i></p>	<p>Community Development Department/Planning Division to review contract specifications to ensure inclusion of provisions included in project-specific mitigation measure.</p>	<p>Community Development Department/Planning Division</p>		
<p>MM CUL-3: <i>Prior to any ground disturbance, the applicant shall offer interested tribes the opportunity to provide a Native American Monitor during ground-disturbing activities during construction. Tribal participation would be dependent upon</i></p>	<p>Community Development Department/Planning Division to review construction specifications to ensure</p>	<p>Community Development Department/Planning Division</p>		

<p><i>the availability and interest of the tribe. The project proposal shall have a burial treatment plan and curation agreement in place as well.</i></p> <p><i>Upon coordination with the Lead Agency, any archaeological artifacts recovered shall be donated to an appropriate Tribal Custodian or a qualified scientific institution where they would be afforded long-term preservation. Documentation for the work shall be provided in accordance with applicable cultural resource laws and guidelines.</i></p>	<p>inclusion of provisions included in mitigation measure.</p>			
<p>MM CUL-4: <i>If requested, prior to any ground disturbance, a surface inspection of the site shall be conducted by a Tribal Monitor. The Tribal Monitor shall monitor the site during initial grading or ground-disturbance activities. The Tribal Cultural Staff shall provide preconstruction briefings to supervisory personnel and any excavation contractor, which will include information on potential cultural material finds and, on the procedures, to be enacted if resources are found. Tribal participation would be dependent upon the availability and interest of the tribe.</i></p> <p><i>If prehistoric or historic-era cultural materials are encountered during construction activities, all work in the immediate vicinity of the find shall halt until a qualified archaeologist can evaluate the find and make recommendations. Cultural resource materials may include prehistoric resources such as flaked and ground stone tools and debris, shell, bone, ceramics, and fire-affected rock as well as historic resources such as glass, metal, wood, brick, or structural remnants. If the qualified archaeologist determines that the discovery represents a potentially significant cultural resource,</i></p>	<p>Community Development Department/Planning Division to review construction specifications to ensure inclusion of provisions included in mitigation measure.</p>	<p>Community Development Department/Planning Division</p>		

<p><i>additional investigations may be required to mitigate adverse impacts from project implementation. These additional studies may include avoidance, testing, and evaluation or data recovery excavation. Implementation of the mitigation measure would ensure that the proposed project would not cause a substantial adverse change in the significance of a historical resource.</i></p> <p><i>The Lead Agency along with other relevant or tribal officials shall be contacted upon the discovery of cultural resources to begin coordination on the disposition of the find(s). Treatment of any significant cultural resources shall be undertaken with the approval of the Lead Agency.</i></p>				
<p>MM CUL-5: <i>If human remains are discovered during construction or operational activities, further excavation or disturbance shall be prohibited pursuant to Section 7050.5 of the California Health and Safety Code. The specific protocol, guidelines, and channels of communication outlined by the Native American Heritage Commission, in accordance with Section 7050.5 of the Health and Safety Code, Section 5097.98 of the Public Resources Code (Chapter 1492, Statutes of 1982, Senate Bill 297), and Senate Bill 447 (Chapter 44, Statutes of 1987), shall be followed. Section 7050.5(c) shall guide the potential Native American involvement, in the event of discovery of human remains, at the direction of the county coroner.</i></p>	<p>Community Development Department/Planning Division to review construction specifications to ensure inclusion of provisions included in mitigation measure.</p>	<p>Community Development Department/Planning Division</p>		
<p>Noise</p>				
<p>MM NO1-1. <i>A sound wall (or berm wall combination) with a minimum height of seven feet (7') relative to the adjacent roadway elevation shall be constructed along the lot property lines adjacent to SR 198. It should be noted, the project site</i></p>	<p>Community Development Department/Planning Division to review construction specifications to ensure</p>	<p>Community Development Department/Planning Division</p>		

<p><i>elevation varies, and is generally approximately two to three (2-3) feet below the grade of SR 98 along the project roadway frontage. The sound wall shall be constructed to a finished height of 7 feet above the adjacent roadway elevation. In order to be effective, the sound wall should be turned inward (northward) at the western and eastern extents of the Project site. Suitable construction materials include concrete blocks, masonry or stucco on both sides of a wood or steel stud wall.</i></p>	<p>inclusion of provisions included in mitigation measure.</p>			
<p>MM NOI-2. <i>If two-story construction is proposed for the first row of homes facing SR 198, second story balconies shall be prohibited.</i></p>	<p>Community Development Department/Planning Division to review construction specifications to ensure inclusion of provisions included in mitigation measure.</p>	<p>Community Development Department/Planning Division</p>		
<p>Transportation</p>				
<p>MM TRA-1: <i>a) Prior to the issuance of building permits, the developer shall construct the following improvements to improve LOS at the intersection.</i></p> <ul style="list-style-type: none"> • <i>17th Avenue/Houston Avenue</i> <ul style="list-style-type: none"> ○ <i>Modify the eastbound through and right-turn lane to a combined through-right lane;</i> ○ <i>Add a southbound right-turn lane;</i> ○ <i>Modify the southbound left-through-right lane to a through-right line; and</i> ○ <i>Signalize the intersection with protective left-turn phasing in the eastbound and westbound directions.</i> <p><i>c) Pay traffic impact fees in accordance with the City's Impact Fees Ordinance and Policies.</i></p>	<p>Public Works Department</p>	<p>Public Works Department</p>		

▪				
<i>MM TRA-2: Prior to the issuance of building permits, the developer shall construct a Class II bike lane along its frontage to Bush Street to reduce VMT. If it is determined that a Class II lane is not feasible, then a Class III route should be installed.</i>	Public Works Department	Public Works Department		
Tribal Cultural Resources				
See Cultural Resources				

6 REPORT PREPARATION

Names of Persons Who Prepared or Participated in the Initial Study:

Lead Agency		
Lead Agency	City of Lemoore, Community Development Department	
Initial Study Consultant		
Initial Study	Precision Civil Engineering, Inc. 1234 O Street Fresno, CA 93721 (559) 449-4500	Bonique Emerson, AICP, VP of Planning Jenna Chilingirian, Senior Planner Shin Tu, Associate Planner
Air Quality and Greenhouse Gas Technical Analysis		
Air Quality/Greenhouse Gas Analysis	Johnson Johnson & Miller Air Quality Consulting Services	Kimber Johnson, Air Quality Specialist/Owner
Biological Assessment Report		
Biological Assessment	Argonaut Ecological, Inc.	Kathy Kinsland, Owner/ Senior Scientist
Cultural Resources Assessment		
Cultural Resource Assessment	Peak & Associates, Inc.	Melinda A. Peak Senior Historian/Archeologist
Acoustical Analysis		
Acoustical Analysis	WJV Acoustics, Inc.	Walter J Van Groningen, President
Traffic Impact Analysis		
Traffic Impact Analysis	JLB Traffic Engineering	Jose Luis Benavides, P.E., T.E. President

7 APPENDICES

7.1 Appendix A: Air Quality and Greenhouse Gas Analysis Technical Memorandum

Prepared by Johnson Johnson & Miller Air Quality Consulting Services dated November 1, 2022, revised May 11, 2023.

To: Wathen Castanos Homes
Attn: Alison Baker, Land Developer
Project Manager
22505 Alluvial Avenue
Clovis, CA 93611
alisonb@wchomes.com

From: Johnson Johnson and Miller Air Quality
Consulting Services
Richard Miller, Managing Air Quality and
Climate Change Specialist
rmiller.jjm.environmental@gmail.com
Kimber Johnson, Air Quality Specialist
kjohnson.jjm.environmental@gmail.com

TTM 22-021 Project located in the City of Lemoore

Date: November 1, 2022 (Revised May 11, 2023)

Subject: Air Quality and Greenhouse Gas Technical Memorandum

This Air Quality and Greenhouse Gas Emissions Technical Memorandum was prepared to evaluate the estimated criteria air pollutant, ozone precursor, toxic air contaminant (TAC), and greenhouse gas (GHG) emissions generated from construction and operation of the TTM 22-021 Project (proposed project or project). The respective analyses were conducted within the context of the California Environmental Quality Act (CEQA) (California Public Resources Code [PRC] § 21000, et seq.). The methodology follows the Guidance for Assessing and Mitigating Air Quality Impacts (GAMAQI) prepared by the San Joaquin Valley Air Pollution Control District (SJVAPCD) for the quantification of emissions and evaluation of potential impacts to air resources.¹ The GHG Analysis follows and the SJVAPCD's Guidance for Valley Land-Use Agencies in Addressing GHG Emission Impacts for New Projects under the California Environmental Quality Act (CEQA)² to determine significance.

Project Location and Description

The proposed project includes a Tentative Tract Map to facilitate a residential development in the City of Lemoore. The project proposes to develop a single-family residential subdivision with approximately 280 lots and 3.2 acres of public parks. Based on information provided in the project description prepared for the environmental review for the proposed project, the project is consistent with the City's General Plan.

The project site consists of approximately 52.61 acres located north of SR 198 and east of South Lemoore Avenue (APN 023-040-058-000). The site is zoned PR and RLD with a planned land use of Low Density Residential and Parks and Recreation. The Applicant is proposing a concurrent Planned Unit Development (PUD) to deviate from certain development standards in order to remain within the permitted density range of the existing zone district. The permitted density range is 3 to 7 dwelling units per acre; the project proposes a density of 5.32 dwelling units per acre.

Aside from the deviations requested in the PUD, which are reduced setbacks and parking/garage development standards, the project will comply with all City standards. The project site has an open space obligation and will provide that elsewhere on site to avoid a general plan amendment and remain consistent with the current General Plan.

¹ San Joaquin Valley Air Pollution Control District (SJVAPCD). 2015. Guidance for Assessing and Mitigating Air Quality Impacts. February 19. Website: <https://www.valleyair.org/transportation/GAMAQI-2015/FINAL-DRAFT-GAMAQI.PDF>. Accessed October 9, 2022 and May 10, 2023.

² San Joaquin Valley Air Pollution Control District (SJVAPCD). 2009. Guidance for Valley Land-use Agencies in Addressing GHG Emission Impacts for New Projects under CEQA. December 17. Website: <https://www.valleyair.org/Programs/CCAP/12-17-09/3%20CCAP%20-%20FINAL%20LU%20Guidance%20-%20Dec%2017%202009.pdf>. Accessed October 9, 2022.

The project does not currently propose phasing. The project site does not currently have any structures; it is used for agricultural purposes and all existing trees will be properly fallowed prior to construction. The project will be required to comply with the provisions of CalGreen Code and any requirements for sustainable practices for residential projects.

The vicinity map is shown in Figure 1, while an aerial view of the project site with the site plan overlaid is shown in Figure 2. These figures, as well as the project site plan, are included as part of Attachment A.



Figure 1 – Vicinity Map



Figure 2 – Project Site Plan Overlaid at the Project Site

Modeling Parameters and Assumptions

The following modeling parameters and assumptions were used to generate criteria air pollutant and greenhouse gas (GHG) emissions for the proposed project.

Air Pollutants and GHGs Assessed

Criteria Pollutants Assessed

The following criteria air pollutants were assessed in this analysis: reactive organic gases (ROG), oxides of nitrogen (NO_x), particulate matter less than 10 microns in diameter (PM₁₀), and particulate matter less than 2.5 microns in diameter (PM_{2.5}). Note that the proposed project would emit ozone precursors ROG and NO_x. However, the proposed project would not directly emit ozone since it is formed in the atmosphere during the photochemical reaction of ozone precursors.

GHGs Assessed

This analysis was restricted to GHGs identified by AB 32, which include carbon dioxide (CO₂), methane (CH₄), nitrous oxide (N₂O), hydrofluorocarbons (HFCs), perfluorocarbons (PFCs), sulfur hexafluoride (SF₆), and nitrogen trifluoride (NF₃). The proposed project would generate a variety of GHGs, including several defined by AB 32 such as CO₂, CH₄, and N₂O.

Certain GHGs defined by AB 32 would not be emitted by the proposed project, which is residential in nature. HFCs, PFCs, SF₆, and NF₃ are typically used in industrial applications, none of which would be used for during operations of typical residential uses. Therefore, it is not anticipated that the proposed project would emit those GHGs.

GHG emissions associated with the proposed project construction as well as future operations were estimated using CO₂ equivalent (CO₂e) emissions as a proxy for all GHG emissions. In order to obtain the CO₂e, an individual GHG is multiplied by its Global Warming Potential (GWP). The GWP designates on a pound for pound basis the potency of the GHG compared to CO₂.

Model Selection

Criteria Pollutants and GHG Emissions

The California Emissions Estimator Model (CalEEMod) is a statewide land use emissions computer model designed to provide a uniform platform for government agencies, land use planners, and environmental professionals to quantify potential criteria pollutant and GHG emissions associated with both construction and operations from a variety of land use projects. CalEEMod quantifies direct emissions from construction and operation activities (including vehicle use), as well as indirect emissions, such as GHG emissions from energy use, solid waste disposal, vegetation planting and/or removal, and water use. Further, CalEEMod identifies mitigation measures to reduce criteria pollutant and GHG emissions along with calculating the benefits achieved from measures chosen by the user.

CalEEMod was developed for the California Air Pollution Control Officers Association (CAPCOA) in collaboration with the California Air Districts. Default data (e.g., emission factors, trip lengths, meteorology, source inventory, etc.) have been provided by the various California Air Districts to account for local requirements and conditions.

CalEEMod is a comprehensive tool for quantifying air quality impacts from land use projects located throughout California. The model can be used for a variety of situations where an air quality analysis is necessary or desirable such as preparing CEQA or National Environmental Policy Act documents, conducting pre-project planning, and, verifying compliance with local air quality rules and regulations, etc.

CalEEMod version 2020.4.0 was used to estimate construction and operational impacts of the proposed project. CalEEMod version 2020.4.0 was the most recent version currently adopted version of CalEEMod at the time emissions were estimated (October 2022). Although the web-based version of CalEEMod is available, it is currently in soft release. Furthermore, the SJVAPCD is currently accepting and recommending the use of CalEEMod version 2020.4.0.

Construction DPM emissions (represented as PM₁₀ exhaust) were estimated using CalEEMod Version 2020.4.0. Emissions were estimated for the unmitigated scenario.

Toxic Air Containments—Model Selection and Parameters

An air dispersion model is a mathematical formulation used to estimate the air quality impacts at specific locations (receptors) surrounding a source of emissions given the rate of emissions and prevailing meteorological conditions. The air dispersion model applied in this assessment was the United States Environmental Protection Agency (EPA) AERMOD (version 22112) air dispersion model. Specifically, the AERMOD model was used to estimate levels of air emissions at sensitive receptor locations from potential sources of project-generated TACs during the construction period. The use of the AERMOD model provides a refined methodology for estimating construction impacts by utilizing long-term, measured representative meteorological data for the project site and a representative construction schedule.

The modeling analysis also considered the spatial distribution and elevation of each emitting source in relation to the sensitive receptors. Direction-dependent calculations were obtained by identifying the Universal Transverse Mercator (UTM) coordinates for each source location. Terrain elevations were obtained for the project site using the AERMAP model, the AERMOD terrain data pre-processor. To evaluate the proposed project's localized impacts at the point of maximum impact, all receptors were placed within the breathing zone at 1.2 meters above ground level to present a conservative estimate of concentration and associated health risks.

For the construction period, construction emissions were assumed to be distributed over the project site with a working schedule of eight hours per day and five days per week. Emissions were adjusted by a factor of 4.2 to convert for use with a 24-hour-per-day, 365 day-per-year averaging period. Project operations were assessed assuming a 24-hour-per-day, and seven day-per-week schedule. Detailed parameters and complete calculations are contained in Attachment B.

Assumptions

Construction Modeling Assumptions

Schedule

The proposed project would require construction activities, including site preparation, grading, paving, building construction (vertical home construction), and architectural coating (painting) for clearing and grading of approximately project site and the construction of a single-family residential subdivision with approximately 280 lots and 3.2 acres of public parks. The project site does not currently have any structures and would not require demolition. The project site has historically been used for agricultural purposes and all existing trees will be properly fallowed prior to construction. The developer provided the following construction dates: earliest estimated construction start date, earliest anticipates first occupancy date, and complete project buildout date. The construction parameters were based on project-specific details, where available, while remaining data was based on CalEEMod-provided default values. and Table 1 shows a summary of the anticipated construction schedule, while a more detailed construction schedule is included in Attachment A. The construction schedule utilized in the analysis represents a "worst-case" analysis scenario since emission factors for construction equipment decrease as the

analysis year increases, due to improvements in technology and more stringent regulatory requirements. Therefore, construction emissions would decrease if the construction schedule moved to later years. The duration of construction activity and associated equipment represent a reasonable approximation of the expected construction fleet as required per CEQA guidelines. The site-specific construction fleet may vary due to specific project needs at the time of construction.

Table 1: Project Construction Schedule

Construction Phase	Start Date	End Date	Construction Days
Site Preparation	8/1/2023	9/25/2023	40
Grading	9/26/2023	2/26/2024	110
Paving	2/27/2024	6/10/2024	75
Building Construction	6/11/2024	6/18/2029	1,310
Architectural Coating	6/5/2029	12/31/2029	150
Note: The construction schedule presented in this table and utilized in the analysis represents a “worst-case” analysis scenario since emission factors for construction equipment decrease as the analysis year increases, due to improvements in technology and more stringent regulatory requirements. Therefore, construction emissions would decrease if the construction schedule moved to later years. Source: CalEEMod Output and Additional Supporting Information (Attachment A).			

Equipment

Construction equipment for each construction activity is shown in Attachment A.

Vehicles Trips

Table 2 provides a summary of the construction-related vehicle trips, while the detailed assumptions are provided in Attachment A.

The fleet mix for worker trips is light-duty passenger vehicles to light-duty trucks. The vendor trips fleet mix is composed of a mixture of medium and heavy-duty diesel trucks. The hauling trips were assumed to be 100 percent heavy-duty diesel truck trips. CalEEMod default trip lengths for a project in Kings County and an urban setting were used for the construction trips.

Table 2: Construction Vehicle Trips

Construction Task	Maximum Worker Trips per Day	Maximum Vendor Trips per Day	Total Haul Truck Trips
Site Preparation	18	0	14
Grading	20	0	17,814
Paving	15	0	12
Building Construction	159	53	18
Architectural Coating	32	0	2
Notes: Cubic yards of cut to be exported (based on applicant-provided estimates): 90,000 cubic yards Cubic yards of cut to be exported (based on applicant-provided estimates): 90,000 cubic yards Additional truck trips were added to each phase for mobilization/demobilization. Source: CalEEMod Output and Additional Supporting Information (Attachment A).			

Operational Modeling Assumptions

Operational emissions are those emissions that occur during long-term operations of the proposed project.

Motor Vehicles

Motor vehicle emissions refer to exhaust and road dust emissions from the automobiles that would travel to and from the proposed project site. Consistent with the trip generation rates included in the traffic analysis prepared for the project,³ it was assumed that the project would generate 2,642 weekday trips.

Trip Lengths

The CalEEMod default round trip lengths for an urban setting in Kings County were used in this analysis. Trip lengths are for primary trips. Trip purposes are primary, diverted, and pass-by trips. Diverted trips take a slightly different path than a primary trip. The CalEEMod default rates for percentages of primary, diverted, and pass-by trips were used.

Vehicle Fleet Mix

The vehicle fleet mix is defined as the mix of motor vehicle classes active during the operation of the proposed project. Emission factors are assigned to the expected vehicle mix as a function of vehicle class, speed, and fuel use (gasoline- and diesel-powered vehicles). The vehicle fleet mix was revised to reflect the residential fleet mix approved by SJVAPCD for each year analyzed.

Area Sources

Hearths

The proposed project would not include woodburning fireplaces in the residences. The residences would be built in compliance with SJVAPCD Rule 4910.

Consumer Products

Consumer products are various solvents used in non-industrial applications, which emit VOCs during their product use. “Consumer Product” means a chemically formulated product used by household and institutional consumers, including but not limited to: detergents; cleaning compounds; polishes; floor finishes; cosmetics; personal care products; home, lawn, and garden products; disinfectants; sanitizers; aerosol paints; and automotive specialty products. It does not include other paint products, furniture coatings, or architectural coatings. CalEEMod includes default consumer product use rates based on building square footage. The default emission factors developed for CalEEMod were used for consumer products associated with parking uses and the general consumer product category.

Architectural Coatings (Painting)

Paints release VOC emissions. The parking lot lines and buildings (residential apartment complex and other project buildings) may be repainted on occasion. The project is required to comply with the SJVAPCD Rule 4601—Architectural Coatings. The rule required flat paints to meet a standard of 50 grams per liter (g/l) and gloss paints 100 g/l by 2012 for an average rate of 65 g/l. Effective January 1, 2022, nonflat gloss and semigloss paints are also required to meet the 50 g/l standard, providing lower VOC emissions for buildings constructed after that date. Therefore, the analysis uses the 50 g/l emission factor for the analysis.

³ JLB Traffic Engineering, Inc. 2023. TTM 22-021 (Single-Family Housing) Traffic Impact Analysis. March 22.

Landscaping Emissions

CalEEMod estimates a total of 180 days for which landscaping equipment would be used to estimate potential emissions for the proposed project.

Indirect Emissions

For GHG emissions, CalEEMod contains calculations to estimate indirect GHG emissions. Indirect emissions are emissions where the location of consumption or activity is different from where actual emissions are generated. For example, electricity would be consumed at the proposed project site; however, emissions associated with producing that electricity are typically generated off-site at a power plant. Since the electricity can vary greatly based on locations, the user should override these values if they have more specific information regarding their specific water supply and treatment.

Energy Use

The emissions associated with the building electricity and natural gas usage (non-hearth) were estimated based on the land use type and size. Values for a project served by Pacific Gas and Electric (PG&E) were used in the analysis.

The carbon dioxide intensity factor for Pacific Gas & Electric (from the CEC's year 2006 data) is as follows:

- Carbon dioxide: 641.35 pounds per megawatt hour (lbs/MWh)

The Renewable Electricity Standards took effect in 2020. The Renewable Electricity Standard requires that electricity providers include a minimum of 33 percent renewable energy in their portfolios by the year 2020. Pacific Gas & Electric provides estimates of its emission factor per megawatt hour of electricity delivered to its customers. PG&E provides emission factors for the electricity it provides to customers for its energy portfolio that is used to estimate project emissions. CalEEMod 2020.4.0 includes PG&E emission factor based on actual rates reported by the utility.

The 2020.4.0 CalEEMod default emission factors for PG&E are as follows:

- Carbon dioxide: 203.98 lbs/MWh
- Methane: 0.033 lb/MWh
- Nitrous oxide: 0.004 lb/MWh

The utilities in California will be required to increase the use of renewable energy sources to 60 percent by 2030.

Other Indirect Emissions (Water Use, Wastewater Use, and Solid Waste)

CalEEMod includes calculations for indirect GHG emissions for electricity consumption, water consumption, and solid waste disposal. For water consumption, CalEEMod calculates embedded energy (e.g., treatment, conveyance, distribution) associated with providing each gallon of potable water to the project. For solid waste disposal, GHG emissions are associated with the disposal of solid waste generated by the proposed project into landfills. CalEEMod default data were used for inputs associated with solid waste.

Thresholds

Air pollutant emissions have regional effects and localized effects. This analysis assesses the regional effects of the project's criteria pollutant emissions in comparison to SJVAPCD thresholds of significance for short-term construction activities and long-term operation of the project. Localized emissions from

project construction and operation are also assessed using concentration-based thresholds that determine if the project would result in a localized exceedance of any ambient air quality standards or would make a cumulatively considerable contribution to an existing exceedance.

The primary pollutants of concern during project construction and operation are ROG, NO_x, PM₁₀, and PM_{2.5}. The SJVAPCD GAMAQI adopted in 2015 contains thresholds for ROG and NO_x; SO_x, CO, PM₁₀, and PM_{2.5}.

Ozone is a secondary pollutant that can be formed miles away from the source of emissions through reactions of ROG and NO_x emissions in the presence of sunlight. Therefore, ROG and NO_x are termed ozone precursors. The SJVAB often exceeds the state and national ozone standards. Therefore, if the project emits a substantial quantity of ozone precursors, the project may contribute to an exceedance of the ozone standard. The SJVAB also exceeds air quality standards for PM₁₀, and PM_{2.5}; therefore, substantial project emissions may contribute to an exceedance for these pollutants.

The SJVAPCD adopted significance thresholds for construction-related and operational ROG, NO_x, PM, CO, and SO_x, these thresholds are included in Table 3.

Table 3: SJVAPCD Proposed Project-Level Air Quality CEQA Thresholds of Significance

Pollutant	Significance Threshold	
	Construction Emissions (tons/year)	Operational Emission (tons/year)
CO	100	100
NO _x	10	10
ROG	10	10
SO _x	27	27
PM ₁₀	15	15
PM _{2.5}	15	15

Source: SJVAPCD. 2015. Guidance for Assessing and Mitigating Air Quality Impacts. Website: <https://www.valleyair.org/transportation/GAMAQI-2015/FINAL-DRAFT-GAMAQI.PDF>. Accessed October 9, 2022 and May 10, 2023.

Fugitive Dust

Construction

Fugitive dust would be generated from site grading and other earth-moving activities. Most of this fugitive dust would remain localized and would be deposited near the project site. However, the potential for impacts from fugitive dust exists unless control measures are implemented to reduce the emissions from the project site. Therefore, adherence to Regulation VIII would be required during construction of the proposed project. Regulation VIII would require fugitive dust control measures that are consistent with best management practices (BMPs) established by the SJVAPCD to reduce the proposed project's construction-generated fugitive dust impacts to a less than significant level.

The SJVAPCD (SJVAPCD or District) adopted Regulation VIII in 1993 and its most recent amendments became effective on October 1, 2004.⁴ This is a basic summary of the regulation's requirements as they

⁴ San Joaquin Valley Air Pollution Control District (SJVAPCD). 2022. Current District Rules and Regulations. Website: <https://www.valleyair.org/rules/1ruleslist.htm#reg8>. Accessed October 9, 2022.

apply to construction sites. These regulations affect all workers at a regulated construction site, including everyone from the landowner to the subcontractors. Violations of Regulation VIII are subject to enforcement action including fines.⁵

Visible Dust Emissions may not exceed 20 percent opacity during periods when soil is being disturbed by equipment or by wind at any time. Visible Dust Emissions opacity of 20 percent means dust that would obstruct an observer's view of an object by 20 percent. District inspectors are state certified to evaluate visible emissions. Dust control may be achieved by applying water before/during earthwork and onto unpaved traffic areas, phasing work to limit dust, and setting up wind fences to limit windblown dust.

Soil Stabilization is required at regulated construction sites after normal working hours and on weekends and holidays. This requirement also applies to inactive construction areas such as phased projects where disturbed land is left unattended. Applying water to form a visible crust on the soil and restricting vehicle access are often effective for short-term stabilization of disturbed surface areas. Long-term methods including applying dust suppressants and establishing vegetative cover.

Carryout and Trackout occur when materials from emptied or loaded vehicles falls onto a paved surface or shoulder of a public road or when materials adhere to vehicle tires and are deposited onto a paved surface or shoulder of a public road. Should either occur, the material must be cleaned up at least daily, and immediately if it extends more than 50 feet from the exit point onto a paved road. The appropriate clean-up methods require the complete removal and cleanup of mud and dirt from the paved surface and shoulder. Using a blower device or dry sweeping with any mechanical device other than a PM10-efficient street sweeper is a violation. Larger construction sites, or sites with a high amount of traffic on one or more days, must prevent carryout and trackout from occurring by installing gravel pads, grizzlies, wheel washers, paved interior roads, or a combination thereof at each exit point from the site. In many cases, cleaning up trackout with water is also prohibited as it may lead to plugged storm drains. Prevention is the best method.

Unpaved Access and Haul Roads, as well as unpaved vehicle and equipment traffic areas at construction sites must have dust control. Speed limit signs limiting vehicle speed to 15 mph or less at construction sites must be posted every 500 feet on uncontrolled and unpaved roads.

Storage Piles and Bulk Materials have handling, storage, and transportation requirements that include applying water when handling materials, wetting or covering stored materials, and installing wind barriers to limit visible dust emissions. Also, limiting vehicle speeds, loading haul trucks with a freeboard of six inches or greater along with applying water to the top of the load, and covering the cargo compartments are effective measures for reducing visible dust emissions and carryout from vehicles transporting bulk materials.

Dust Control Plans identify the dust sources and describe the dust control measures that will be implemented before, during, and after any dust generating activity for the duration of the project. Owners or operators are required to submit plans to the SJVAPCD at least 30 days prior to commencing the work for the following:

- Residential developments of ten or more acres of disturbed surface area.
- Non-residential developments of five or more acres of disturbed surface area.
- The relocation of more than 2,500 cubic yards per day of materials on at least three days.

As the project would be considered a residential development that would disturb more than ten acres of surface area, a Dust Control Plan would be required. Dust-generating activities may not commence until

⁵ San Joaquin Valley Air Pollution Control District (SJVAPCD). 2007. Compliance Assistance Bulletin. Website: <http://www.valleyair.org/busind/comply/pm10/forms/RegVIIIICAB.pdf>. Accessed October 9, 2022.

the SJAVPCD has approved the Dust Control Plan. A copy of the plan must be on site and available to workers and District employees. All work on the site is subject to the requirements of the approved dust control plan. A failure to abide by the plan by anyone on site may be subject to enforcement action.

Record Keeping is required to document compliance with the rules and must be kept for each day any dust control measure is used. The SJVAPCD has developed record forms for water application, street sweeping, and “permanent” controls such as applying long term dust palliatives, vegetation, ground cover materials, paving, or other durable materials. Records must be kept for one year after the end of dust generating activities (Title V sources must keep records for five years).

Exemptions exist for several activities. Those occurring above 3,000 feet in elevation are exempt from all Regulation VIII requirements. Further, Rule 8021 – Construction, Demolition, Excavation, Extraction, and Other Earthmoving Activities exempts the following construction and earthmoving activities:

- Blasting activities permitted by California Division of Industrial Safety.
- Maintenance or remodeling of existing buildings provided the addition is less than 50% of the size of the existing building or less than 10,000 square feet (due to asbestos concerns, contact the SJVAPCD at least two weeks ahead of time).
- Additions to single family dwellings.
- The disking of weeds and vegetation for fire prevention on sites smaller than ½ acre.
- Spreading of daily landfill cover to preserve public health and safety and to comply with California Integrated Waste Management Board requirements.

Nuisances are prohibited at all times because District Rule 4102 – Nuisance applies to all construction sources of fugitive dust, whether or not they are exempt from Regulation VIII. It is important to monitor dust-generating activities and implement appropriate dust control measures to limit the public’s exposure to fugitive dust.

Criteria Pollutant Emission Estimates

Construction Emissions (Regional)

Construction emissions associated with the project are shown in Table 4. As shown in Table 4, the emissions are below the significance thresholds and, therefore, are less than significant on a project basis.

Table 4: Summary of Construction-Generated Emissions of Criteria Air Pollutants – Unmitigated

Construction Activity	Emissions (Tons/Year)					
	ROG	NO _x	CO	SO _x	PM ₁₀	PM _{2.5}
Construction (2023)	0.18	2.43	1.51	0.01	0.54	0.25
Construction (2024)	0.24	2.46	2.55	0.01	0.41	0.17
Construction (2025)	0.21	1.72	2.31	0.01	0.27	0.12
Construction (2026)	0.21	1.71	2.29	0.01	0.27	0.12
Construction (2027)	0.21	1.71	2.26	0.01	0.27	0.12
Construction (2028)	0.20	1.70	2.23	0.01	0.27	0.11
Construction (2029)	1.69	0.88	1.21	< 0.01	0.15	0.06

Total Emissions	2.94	12.61	14.36	0.06	2.18	0.95
Average Annual Emissions¹	0.46	1.97	2.24	0.01	0.34	0.15
Significance Thresholds	10	10	100	27	15	15
Exceed Significance Thresholds in Either Scenario?	No	No	No	No	No	No
Notes: PM ₁₀ and PM _{2.5} emissions are from the mitigated output to reflect compliance with Regulation VIII—Fugitive PM ₁₀ Prohibitions. Source of Emissions: CalEEMod Output (Attachment A). ¹ Total construction emissions were divided by the construction duration in years (6.4 years) to estimate average annual emissions. Source of Thresholds: San Joaquin Valley Air Pollution Control District (SJVAPCD). 2015. Guidance for Assessing and Mitigating Air Quality Impacts. February 19. Website: https://www.valleyair.org/transportation/GAMAQI-2015/FINAL-DRAFT-GAMAQI.PDF . Accessed October 9, 2022 and May 10, 2023.						

Operational Emissions (Regional)

Operational emissions occur over the lifetime of the project. Operational emissions are shown in Table 5. The SJVAPCD considers construction and operational emissions separately when making significance determinations.

The emissions output for project operation at full buildout assessed in the 2024 operational year are summarized in Table 5. Full buildout is not expected until 2029; however, operations are anticipated to begin as early as 2024. The use of an earlier operational year represents a conservative estimate of emissions, as emissions for the same level of activity for a typical development are expected to decrease in future years due to regulations and advancements and adoption of newer technology. As shown in Table 5, the operational emissions would be less than the thresholds of significance for all criteria air pollutants.

Table 5: Summary of Operational Emissions of Criteria Air Pollutants – Unmitigated

Source	Emissions (tons/year)					
	ROG	NO _x	CO	SO _x	PM ₁₀	PM _{2.5}
Area	2.20	0.13	2.11	<0.01	0.02	0.02
Energy	0.04	0.31	0.13	<0.01	0.03	0.03
Mobile (Vehicle Trips)	0.77	1.47	9.29	0.03	2.81	0.76
Annual Total	3.01	1.91	11.53	0.03	2.86	0.81
Significance Thresholds	10	10	100	27	15	15
Exceed Significance Thresholds?	No	No	No	No	No	No
Notes: Emissions were quantified using the earliest operational year for the proposed project. Source: CalEEMod Output (Attachment A). Source of Thresholds: San Joaquin Valley Air Pollution Control District (SJVAPCD). 2015. Guidance for Assessing and Mitigating Air Quality Impacts. February 19. Website: https://www.valleyair.org/transportation/GAMAQI-2015/FINAL-DRAFT-GAMAQI.PDF . Accessed October 9, 2022 and May 10, 2023.						

Localized Impacts

Emissions occurring at or near the project have the potential to create a localized impact also referred to as an air pollutant hotspot. Localized emissions are considered significant if when combined with background emissions, they would result in exceedance of any health-based air quality standard. In locations that already exceed standards for these pollutants, significance is based on a significant impact level (SIL) that represents the amount that is considered a cumulatively considerable contribution to an existing violation of an air quality standard. The pollutants of concern for localized impact in the SJVAB are NO₂, SO_x, and CO.

The SJVAPCD has provided guidance for screening localized impacts in the GAMAQI that establishes a screening threshold of 100 pounds per day of any criteria pollutant. If a project exceeds 100 pounds per day of any criteria pollutant, then ambient air quality modeling would be necessary. If the project does not exceed 100 pounds per day of any criteria pollutant, then it can be assumed that it would not cause a violation of an ambient air quality standard.

Construction: Localized Concentrations of PM₁₀, PM_{2.5}, CO, and NO_x

Local construction impacts would be short-term in nature lasting only during the duration of construction. As shown in Table 6 below, on-site construction emissions would be less than 100 pounds per day for each of the criteria pollutants. To present a conservative estimate, on-site emissions for on-road construction vehicles were included in the localized analysis. Based on the SJVAPCD’s guidance, the construction emissions would not cause an ambient air quality standard violation.

Table 6: Localized Concentrations of PM₁₀, PM_{2.5}, CO, and NO_x for Construction

Source	On-site Emissions (pounds per day)				
	ROG	NO _x	CO	PM ₁₀	PM _{2.5}
Maximum On-site Daily (2023)	3.56	38.23	31.06	10.12	5.71
Maximum On-site Daily (2024)	3.45	36.07	30.70	5.57	2.90
Maximum On-site Daily (2025)	1.45	11.43	15.26	0.54	0.45
Maximum On-site Daily (2026)	1.43	11.42	15.21	0.54	0.45
Maximum On-site Daily (2027)	1.41	11.41	15.16	0.54	0.45
Maximum On-site Daily (2028)	1.40	11.40	15.12	0.54	0.45
Maximum On-site Daily (2029)	22.62	12.55	17.08	0.60	0.50
Maximum Daily On-site Emissions	22.62	38.23	31.06	10.12	5.71
Significance Thresholds	—	100	100	100	100
Exceed Significance Thresholds?	—	No	No	No	No
Note: Assumptions regarding dates of construction activities are based on the construction schedule shown in Table 1. Maximum daily emissions of NO _x , CO, PM ₁₀ , and PM _{2.5} were highest in the Winter scenario. Maximum daily emissions of ROG (shown for informational purposes) were highest in the Summer scenario. Source of Emissions: CalEEMod Output and Additional Supporting Information (Attachment A). Source of Thresholds: San Joaquin Valley Air Pollution Control District (SJVAPCD). 2015. Guidance for Assessing and Mitigating Air Quality Impacts. February 19. Website: https://www.valleyair.org/transportation/GAMAQI-2015/FINAL-DRAFT-GAMAQI.PDF . Accessed October 21, 2022 and May 10, 2023.					

Operation: Localized Concentrations of PM₁₀, PM_{2.5}, CO, and NO_x

Localized impacts could occur in areas with a single large source of emissions such as a power plant or with multiple sources concentrated in a small area such as a distribution center.

As shown in Table 7 below, operational modeling of on-site emissions for the project indicate that the project would not exceed 100 pounds per day for each of the criteria pollutants. Therefore, based on the SJVAPCD’s guidance, the operational emissions would not cause an ambient air quality standard violation. As such, impacts would be less than significant.

Table 7: Localized Concentrations of PM₁₀, PM_{2.5}, CO, and NO_x for Operations

Source	On-site Emissions (pounds per day)				
	ROG	NO _x	CO	PM ₁₀	PM _{2.5}
Area	12.64	2.82	41.01	0.33	0.33
Energy	0.20	1.70	0.72	0.14	0.14
Mobile (Vehicles) ¹	4.67	2.95	19.32	1.07	0.30
Daily Total	17.51	7.47	61.05	1.54	0.77
Significance Thresholds	—	100	100	100	100
Exceed Significance Thresholds?	—	No	No	No	No

Notes: ¹On-site + Localized Vehicle Emissions
Source of Emissions: CalEEMod Output and Additional Supporting Information (Attachment A).
Maximum daily emissions of NO_x, CO, PM₁₀, and PM_{2.5} were highest in the Winter scenario. Maximum daily emissions of ROG (shown for informational purposes) were highest in the Summer scenario.
Source of Thresholds: San Joaquin Valley Air Pollution Control District (SJVAPCD). 2015. Guidance for Assessing and Mitigating Air Quality Impacts. February 19. Website: <https://www.valleyair.org/transportation/GAMAQI-2015/FINAL-DRAFT-GAMAQI.PDF>. Accessed October 9, 2022 and May 11, 2023.

Addressing Air Quality CEQA Impact Questions

Table 8: Summary of Air Quality Impact Analysis

Air Quality <i>Where available, the significance criteria established by the applicable air quality management district or air pollution control district may be relied upon to make the following determinations.</i>	
Would the project:	Significance Finding
a) Conflict with or obstruct implementation of the applicable air quality plan?	Less than Significant Impact
b) Result in a cumulatively considerable net increase of any criteria pollutant for which the project region is nonattainment under an applicable federal or State ambient air quality standard?	Less than Significant Impact
c) Expose sensitive receptors to substantial pollutant concentrations?	Less than Significant Impact
d) Result in other emissions (such as those leading to odors or) adversely affecting a substantial number of people?	Less than Significant Impact

a) Conflict with or obstruct implementation of the applicable air quality plan?

Less Than Significant Impact.

Air Quality Plans (AQPs) are plans for reaching attainment of air quality standards. The assumptions, inputs, and control measures are analyzed to determine if the Air Basin can reach attainment for the ambient air quality standards. The proposed project site is located within the jurisdictional boundaries of the SJVAPCD. To show attainment of the standards, the SJVAPCD analyzes the growth projections in the Valley, contributing factors in air pollutant emissions and formations, and existing and adopted emissions controls. The SJVAPCD then formulates a control strategy to reach attainment that includes both State and SJVAPCD regulations and other local programs and measures.

The CEQA Guidelines indicate that a significant impact would occur if the project would conflict with or obstruct implementation of the applicable air quality plan. The GAMAQI indicates that projects that do not exceed SJVAPCD regional criteria pollutant emissions quantitative thresholds would not conflict with or obstruct the applicable AQP.

As shown above in Table 4 and Table 5, the project's construction and operational regional emissions would not exceed SJVAPCD's regional criteria pollutant emissions quantitative thresholds. Therefore, the proposed project would not be considered in conflict with or obstruct implementation of the applicable air quality plan.

b) Result in a cumulatively considerable net increase of any criteria pollutant for which the project region is nonattainment under an applicable federal or State ambient air quality standard?

Less Than Significant Impact.

To result in a less than significant impact, emissions of nonattainment pollutants must be below the SJVAPCD's regional significance thresholds. This is an approach recommended by the SJVAPCD's in its GAMAQI. The primary pollutants of concern during project construction and operation are ROG, NO_x, PM₁₀, and PM_{2.5}. The SJVAPCD GAMAQI adopted in 2015 contains thresholds for CO, NO_x, ROG, SO_x, PM₁₀, and PM_{2.5}.

Air pollutant emissions have both regional and localized effects. As shown in Table 6 and Table 7, the project's regional emissions would not exceed the applicable regional criteria pollutant emissions quantitative thresholds.

c) Expose sensitive receptors to substantial pollutant concentrations?

Less Than Significant Impact.

Emissions occurring at or near the project have the potential to create a localized impact that could expose sensitive receptors to substantial pollutant concentrations. The SJVAPCD considers a sensitive receptor to be a location that houses or attracts children, the elderly, people with illnesses, or others who are especially sensitive to the effects of air pollutants. Examples of sensitive receptors include hospitals, residences, convalescent facilities, and schools.

The SJVAPCD's GAMAQI includes screening thresholds for identifying projects that need detailed analysis for localized impacts. Projects with on-site emission increases from construction activities or operational activities that exceed the 100 pounds per day screening level of any criteria pollutant after implementation of all enforceable mitigation measures would require additional analysis to determine if the preparation of an ambient air quality analysis is needed. The criteria pollutants of concern for localized impact in the Air Basin are PM₁₀, PM_{2.5}, NO_x, and CO. There is no localized emission standard for ROG.

As shown in Table 6, the project would not exceed the emission screening thresholds during project construction. Therefore, the project's localized criteria pollutant impacts from construction of the project would be less than significant.

As shown in Table 7, the project would not exceed SJVAPCD screening thresholds for localized criteria pollutant impacts; therefore, the project's localized criteria pollutant impacts from long-term operations would be less than significant.

Toxic Air Contaminants

Construction

As discussed above, criteria pollutant emissions during construction would not exceed the SJVAPCD's significance thresholds and would not be expected to result in concentrations that would exceed ambient standards or contribute substantially to an existing exceedance of an ambient air quality standard. Therefore, construction of the proposed project would not result in localized emissions that, if when combined with background emissions, would result in exceedance of any health-based air quality standard for any criteria pollutant. As such, health risk impacts related to criteria pollutants emitted during the construction period of the proposed project would be less than significant.

Construction-related activities would result in temporary, short-term project-generated emissions of diesel particulate matter (DPM) from the exhaust of off-road, heavy-duty diesel equipment for site preparation (e.g., clearing, grading); soil hauling truck traffic; paving; home construction; application of architectural coatings; and other miscellaneous activities. For construction activity, DPM is the primary air toxic of concern. Particulate exhaust emissions from diesel-fueled engines (i.e., DPM) were identified as a toxic air contaminant (TAC) by the California Air Resources Board (CARB) in 1998.⁶ Due to proposed project's proximity to existing sensitive receptors, a health risk assessment was performed to assess impacts from DPM emissions resulting from construction of the project. The results of the health risk assessment are

⁶ California Air Resources Board (CARB). 1998. The Toxic Air Contaminant Identification Process: Toxic Air Contaminant Emissions from Diesel-fueled Engines. Website: www.arb.ca.gov/toxics/dieseltac/factsht1.pdf.

summarized below, while the calculations used for the health risk assessment are provided as Attachment B.

The construction HRA evaluated DPM (represented as exhaust PM_{10}) emissions generated during construction of the proposed project and the related health risk impacts for sensitive receptors located within approximately ¼-mile (1,320 feet) of the project boundary. A project would result in a significant impact if it would individually expose sensitive receptors to TACs resulting in an increased cancer risk greater than 20 in one million or an increased non-cancer risk of greater than 1.0 on the hazard index. It should be noted that the SJVAPCD's latest threshold of significance for TAC emissions is an increase in cancer risk for the maximally exposed individual of 20 in one million (formerly 10 in one million).

To estimate the potential cancer risk associated with construction of the proposed project from equipment exhaust (including DPM), a dispersion model⁷ (AERMOD) was used to translate an emission rate from the source location to concentrations at the receptor locations of interest (i.e., receptors at nearby residences). AERMOD provides a refined methodology for estimating localized impacts by utilizing long-term, measured representative meteorological data for the project site and a representative construction schedule. A graphical representation of AERMOD inputs, including the locations of modeled sensitive receptor locations, is included as part of Attachment B.

Cancer Risk

The Office of Environmental Health Hazard Assessment (OEHHA) has developed guidance for estimating cancer risks that considers the increased sensitivity of infants and adults to TAC emissions, different breathing rates, and time spent at home. This guidance was applied in estimating cancer risks from the construction of the proposed project.

The recommended method for the estimation of cancer risk is shown in the equations.

$$\text{Cancer Risk} = C_{\text{DPM}} \times \text{Inhalation Exposure Factor} \quad (\text{EQ-1})$$

Where:

Cancer Risk = Total individual excess cancer risk defined as the cancer risk a hypothetical individual faces if exposed to carcinogenic emissions from a particular source for specified exposure durations; this risk is defined as an excess risk because it is above and beyond the background cancer risk to the population; cancer risk is expressed in terms of risk per million exposed individuals.

C_{DPM} = Period average DPM air concentration calculated from the air dispersion model in $\mu\text{g}/\text{m}^3$

Inhalation is the most important exposure pathway to impact human health from DPM and the inhalation exposure factor is defined as follows:

$$\text{Inhalation Exposure Factor} = \text{CPF} \times \text{EF} \times \text{ED} \times \text{DBR} \times \text{AAF/AT} \quad (\text{EQ-2})$$

⁷ An air dispersion model is a mathematical formulation used to estimate air quality impacts at specific locations (receptors) surrounding a source of emissions given the rate of emissions and prevailing meteorological conditions. The air dispersion model applied in this assessment was the EPA American Meteorological Society Regulatory Model (AERMOD), Version 22112, which is approved by the SJVAPCD for air dispersion assessments.

Where:

CPF = Inhalation cancer potency factor for the TAC: $1.1 \text{ (mg/kg-day)}^{-1}$ for DPM

EF = Exposure frequency (days/year)

ED = Exposure duration (years of construction)

AAF = set of age-specific adjustment factors that include age sensitivity factors (ASF), daily breathing rates (DBR), and time at home factors (TAH)

AT = Averaging time period over which exposure is averaged (days)

Chronic Non-Cancer Hazard

Non-cancer chronic impacts are calculated by dividing the annual average concentration by the Reference Exposure Level (REL) for that substance. The REL is defined as the concentration at which no adverse non-cancer health effects are anticipated. The following equation was used to determine the non-cancer risk:

$$\text{Hazard Quotient} = C_i/\text{REL}_i$$

Where:

C_i = Concentration in the air of substance i (annual average concentration in $\mu\text{g}/\text{m}^3$)

REL_i = Chronic noncancer Reference Exposure Level for substance i ($\mu\text{g}/\text{m}^3$)

Construction Health Risk Assessment Results

The results of the HRA prepared for project construction for cancer risk and long-term chronic cancer risk are summarized below. Construction emissions were estimated assuming adherence to all applicable rules, regulations, and project design features. The construction emissions were assumed to be distributed over the project area with a working schedule of eight hours per day and five days per week. Emissions were adjusted by a factor of 4.2 to convert for use with a 24-hour-per-day, 365 day-per-year averaging period. Detailed parameters and complete calculations are included in Attachment B.

The Maximally Exposed Receptor (MER) during project construction was determined to be an existing residence located directly adjacent to the project boundary, east of the southeast portion of the project site (see Attachment B). The estimated health and hazard impacts at the MER from the project's construction emissions are provided in Table 9.

Table 9: Summary of the Health Impacts from Unmitigated Construction of the Proposed Project

Exposure Scenario	Maximum Cancer Risk (Risk per Million)	Chronic Non-Cancer Hazard Index	Acute Non-Cancer Hazard Index
Risks and Hazards at the MER	12.11	0.0047	0.0000
Significance Threshold	20	1	1
Threshold Exceeded in Any Scenario?	No	No	No
Notes: MER = maximally exposed receptor MER Location (Latitude, Longitude): 36°17'31.7"N 119°46'18.3"W Source: Construction Health Risk Assessment (Attachment B).			

As noted in Table 9, calculated health metrics from the proposed project's construction DPM emissions would not exceed the cancer risk significance threshold or non-cancer hazard index significance threshold. Therefore, the proposed project would not result in a significant impact on nearby sensitive receptors from TACs during construction.

Operations

PM₁₀ and PM_{2.5} are commonly used as proxies for Diesel Particulate Matter (DPM), which would be the toxic air containment of concern emitted by the project. Based on the screening analyzes presented in Table 7, estimated localized emissions generated by the proposed project would not reach levels high enough to necessitate further analysis. As such, it is not expected that any TAC concentrations would reach levels that would cause an exceedance of the SJVAPCD's health risk thresholds.

Unlike warehouses or distribution centers, the daily vehicle trips generated by the proposed single-family residential subdivision project would be primarily generated by passenger vehicles. Passenger vehicles typically use gasoline engines rather than the diesel engines that are found in heavy-duty trucks. Nonetheless, operational DPM emissions from diesel trucks were estimated using EMFAC2021 emission factors and estimated truck travel and idling at the project site. The emissions were entered into the SJVAPCD Prioritization Screening Tool to determine the risk scores, with complete calculations and assumptions included as part of Attachment A. The results of the screening analysis are provided in Table 10.

Table 10: Prioritization Tool Health Risk Screening Results

Impact Source	Cancer Risk Score	Chronic Risk Score	Acute Risk Score
Diesel Trucks	4.651	0.008	0.000
Total Risk from Project Operations	4.651	0.008	0.000
Screening Risk Score Threshold	10	1	1
Screening Thresholds Exceeded?	No	No	No
Source: Attachment A – Modeling Assumptions, CalEEMod Output files, and Operational Screening Results			

As shown in Table 10, the project would not exceed the cancer risk or chronic hazard threshold levels. The primary source of the emissions responsible for chronic risk are from diesel trucks. DPM does not

have an acute risk factor. Since the project does not exceed the applicable SJVAPCD screening thresholds for cancer risk, acute risk, or chronic risk, this impact would be less than significant.

Valley Fever

Valley fever, or coccidioidomycosis, is an infection caused by inhalation of the spores of the fungus, *Coccidioides immitis* (*C. immitis*). The spores live in soil and can live for an extended time in harsh environmental conditions. Activities or conditions that increase the amount of fugitive dust contribute to greater exposure, and they include dust storms, grading, and recreational off-road activities.

The San Joaquin Valley is considered an endemic area for Valley fever. The San Joaquin Valley is considered an endemic area for Valley fever. During 2000–2018, a total of 65,438 coccidioidomycosis cases were reported in California; median statewide annual incidence was 7.9 per 100,000 population and varied by region from 1.1 in Northern and Eastern California to 90.6 in the Southern San Joaquin Valley, with the largest increase (15-fold) occurring in the Northern San Joaquin Valley. Incidence has been consistently high in six counties in the Southern San Joaquin Valley (Fresno, Kern, Kings, Madera, Tulare, and Merced counties) and Central Coast (San Luis Obispo County) regions.⁸ California experienced 8,222 new probable or confirmed cases of Valley fever in 2021. A total of 169 Valley fever cases were reported in Kings County in 2021.⁹

The distribution of *C. immitis* within endemic areas is not uniform and growth sites are commonly small (a few tens of meters) and widely scattered. Known sites appear to have some ecological factors in common suggesting that certain physical, chemical, and biological conditions are more favorable for *C. immitis* growth. Avoidance, when possible, of sites favorable for the occurrence of *C. immitis* is a prudent risk management strategy. Listed below are ecologic factors and sites favorable for the occurrence of *C. immitis*:

- 1) Rodent burrows (often a favorable site for *C. immitis*, perhaps because temperatures are more moderate and humidity higher than on the ground surface)
- 2) Old (prehistoric) Indian campsites near fire pits
- 3) Areas with sparse vegetation and alkaline soils
- 4) Areas with high salinity soils
- 5) Areas adjacent to arroyos (where residual moisture may be available)
- 6) Packrat middens
- 7) Upper 30 centimeters of the soil horizon, especially in virgin undisturbed soils
- 8) Sandy, well-aerated soil with relatively high water-holding capacities

Sites within endemic areas less favorable for the occurrence of *C. immitis* include:

- 1) Cultivated fields
- 2) Heavily vegetated areas (e.g., grassy lawns)

⁸ Centers for Disease Control and Prevention (CDC). 2020. Regional Analysis of Coccidioidomycosis Incidence—California, 2000–2018. Website: https://www.cdc.gov/mmwr/volumes/69/wr/mm6948a4.htm?s_cid=mm6948a4_e. Accessed October 9, 2022.

⁹ California Department of Public Health (CDPH). 2022. Coccidioidomycosis in California Provisional Monthly Report: January – August 2022. August 31. Website: <https://www.cdph.ca.gov/Programs/CID/DCDC/CDPH%20Document%20Library/CoccinCAProvisionalMonthlyReport.pdf>. Accessed October 9, 2022.

- 3) Higher elevations (above 7,000 feet)
- 4) Areas where commercial fertilizers (e.g., ammonium sulfate) have been applied
- 5) Areas that are continually wet
- 6) Paved (asphalt or concrete) or oiled areas
- 7) Soils containing abundant microorganisms
- 8) Heavily urbanized areas where there is little undisturbed virgin soil.¹⁰

The project is situated on a site that has been previously disturbed. Specifically, the site has historically been used for agricultural purposes and occupied by an orchard. All existing trees will be properly fallowed prior to construction. The existing conditions do not provide a suitable habitat for spores. Specifically, the conditions are not favorable for the occurrence of *C. immitis* because the project site has been previously disturbed from being tilled. Therefore, development of the proposed project would have a low probability of the site having *C. immitis* growth sites and exposure to the spores from disturbed soil.

Although conditions are not favorable, construction activities could generate fugitive dust that contain *C. immitis* spores. The project will minimize the generation of fugitive dust during construction activities by complying with SJVAPCD's Regulation VIII. Therefore, this regulation, combined with the relatively low probability of the presence of *C. immitis* spores would reduce Valley fever impacts to less than significant.

During operations, dust emissions are anticipated to be relatively small, because most of the project area where operational activities would occur would be occupied by the proposed residential homes and pavement. This condition would substantially lessen the possibility of the project from providing habitat suitable for *C. immitis* spores and for generating fugitive dust that may contribute to Valley fever exposure. Impacts would be less than significant.

Naturally Occurring Asbestos

Review of the map of areas where naturally occurring asbestos in California are likely to occur found no such areas in the project area. Therefore, development of the project is not anticipated to expose receptors to naturally occurring asbestos.¹¹ Impacts would be less than significant.

Operations—The Project's Potential to Locate Sensitive Receptor Near Existing Sources of TACs

As a residential project, the project would locate sensitive receptors to a site where future project residents could be subject to existing sources of TACs at the project site. However, the California Supreme Court concluded in *California Building Industry Association (CBIA) v. Bay Area Air Quality Management District (BAAQMD)* that agencies subject to CEQA are not required to analyze the impact of existing environmental conditions on a project's future users or residents. Therefore, this impact will not be further addressed in this document.

Impact Analysis Summary

¹⁰ United States Geological Survey (USGS). 2000. Operational Guidelines (Version 1.0) for Geological Fieldwork in Areas Endemic for Coccidioidomycosis (Valley Fever), 2000, Open-File Report 2000-348. Website: <https://pubs.usgs.gov/of/2000/0348/pdf/of00-348.pdf>. Accessed October 9, 2022.

¹¹ U.S. Geological Survey. 2011. Van Gosen, B.S., and Clinkenbeard, J.P. California Geological Survey Map Sheet 59. Reported Historic Asbestos Mines, Historic Asbestos Prospects, and Other Natural Occurrences of Asbestos in California. Open-File Report 2011-1188 Website: <https://pubs.usgs.gov/of/2011/1188/>. Accessed October 9, 2022.

In summary, the project would not exceed SJVAPCD localized emission daily screening levels for any criteria pollutant. The project would not be a significant source of TAC emissions during construction and operation. The project is not in an area with suitable habitat for Valley fever spores and is not in area known to have naturally occurring asbestos. Therefore, the project would not result in significant impacts to sensitive receptors.

d) Result in other emissions (such as those leading to odors or) adversely affecting a substantial number of people?

Less Than Significant Impact.

Two situations create a potential for odor impact. The first occurs when a new odor source is located near an existing sensitive receptor. The second occurs when a new sensitive receptor locates near an existing source of odor. According to the *CBIA v. BAAQMD* ruling, impacts of existing sources of odors on the project are not subject to CEQA review. Therefore, the analysis to determine if the project would locate new sensitive receptors near an existing source of odor is provided for informational purposes only.

Odor impacts on residential areas and other sensitive receptors, such as hospitals, day-care centers, schools, etc. warrant the closest scrutiny, but consideration should also be given to other land uses where people may congregate, such as recreational facilities, worksites, and commercial areas.

For projects involving new receptors locating near an existing odor source where there is currently no nearby development and for new odor sources locating near existing receptors, the SJVAPCD recommends that the analysis should be based on a review of odor complaints for similar facilities. In assessing potential odor impacts, consideration also should be given to local meteorological conditions, particularly the intensity and direction of prevailing winds.

Lead Agencies can also make a determination of significance based on a review of SJVAPCD complaint records. For a project locating near an existing source of odors, the impact is potentially significant when the project site is at least as close as any other site that has already experienced significant odor problems related to the odor source.

Significant odor problems are defined by the SJVAPCD as:

- More than one confirmed complaint per year averaged over a three-year period, or
- Three unconfirmed complaints per year averaged over a three-year period.

An unconfirmed complaint means that either the odor/air contaminant release could not be detected, or the source/facility cannot be determined. Because of the subjective nature of odor impacts and the lack of quantitative or formulaic methodologies, the significance determination of potential odor impacts should be considered on a case-by-case basis.

Although the project is less than one mile from the nearest sensitive receptor, the project is not expected to be a significant source of odors. The screening levels for these land use types are shown in Table 11.

Table 11: Screening Levels for Potential Odor Sources

Odor Generator	Screening Distance
Wastewater Treatment Facilities	2 miles
Sanitary Landfill	1 mile
Transfer Station	1 mile
Composting Facility	1 mile
Petroleum Refinery	2 miles
Asphalt Batch Plant	1 mile
Chemical Manufacturing	1 mile
Fiberglass Manufacturing	1 mile
Painting/Coating Operations (e.g., auto body shop)	1 mile
Food Processing Facility	1 mile
Feed Lot/Dairy	1 mile
Rendering Plant	1 mile
Source of Screening Distances: San Joaquin Valley Air Pollution Control District (SJVAPCD). 2015. Guidance for Assessing and Mitigating Air Quality Impacts. February 19. Website: https://www.valleyair.org/transportation/GAMAQI-2015/FINAL-DRAFT-GAMAQI.PDF . Accessed October 9, 2022 and May 10, 2023.	

Impacts from construction and operations of the proposed project are discussed separately below.

Construction

During construction, various diesel-powered vehicles and equipment in use on-site would create localized odors. These odors would be temporary and intermittent, which would decrease the likelihood of the odors concentrating in a single area or lingering for any notable period of time. As such, these odors would likely not be noticeable for extended periods of time beyond the project’s site boundaries. The potential for odor impacts from construction of the proposed project would, therefore, be less than significant.

Operations

Project as a Generator

The occurrence and severity of odor impacts depend on numerous factors, including the nature, frequency, and intensity of the source; wind speed and direction; and the presence of sensitive receptors. Although offensive odors rarely cause any physical harm, they still can be very unpleasant, leading to considerable distress and often generating citizen complaints to local governments and regulatory agencies. The project is residential in nature, and project operations would not be anticipated to produce odorous emissions. Therefore, project operations would not create objectionable odors affecting a substantial number of people; the impact would be less than significant.

Project as a Receptor

With the *CBIA v. BAAQMD* ruling, analysis of odor impacts on receivers is not required for CEQA compliance. Therefore, the following analysis is provided for informational purposes only, while the significance determination for the odor is whether the project would consider an odor generator. As a residential development, the project has the potential to place sensitive receptors near existing and new odor sources.

There are no major odor-generating sources that have received complaints to an extent that would exceed SJVAPCD-recommended thresholds for assessing odor impacts from odor generators. Furthermore, there are existing residential uses located within the screening distances for all the potential sources in the project vicinity. Considering this information, the uses in the vicinity of the project would not result in substantial odor impacts to the project.

Greenhouse Gas Emissions Estimation Summary and Greenhouse Gas Impact Analysis

CEQA Guidelines

The CEQA Guidelines define a significant effect on the environment as “a substantial, or potentially substantial, adverse change in the environment.” To determine if a project would have a significant impact on GHGs, the type, level, and impact of emissions generated by the project must be evaluated.

The following GHG significance thresholds are contained in Appendix G of the CEQA Guidelines:

- a. Generate greenhouse gas emissions, either directly or indirectly, that may have a significant impact on the environment; or
- b. Conflict with any applicable plan, policy or regulation of an agency adopted for the purpose of reducing the emissions of greenhouse gases.

Thresholds of Significance

San Joaquin Valley Air Pollution Control District

The SJVAPCD’s Guidance for Valley Land-use Agencies in Addressing GHG Emission Impacts for New Projects under CEQA presents a tiered approach to analyzing project significance with respect to GHG emissions. Project GHG emissions are considered less than significant if they can meet any of the following conditions:

- Project is exempt from CEQA requirements;
- Project complies with an approved GHG emission reduction plan or GHG mitigation program;
- Project implements Best Performance Standards (BPS); or
- Project demonstrates that specific GHG emissions would be reduced or mitigated by at least 29 percent compared to Business-as-Usual (BAU), including GHG emission reductions achieved since the 2002-2004 baseline period.

Newhall Ranch

The California Supreme Court decision in the *Center for Biological Diversity et al. vs. California Department of Fish and Wildlife, the Newhall Land and Farming Company* (62 Cal.4th 204 [2015], and known as the Newhall Ranch decision), confirmed that the use of BAU analysis (e.g., 29 percent below BAU), a performance-based approach, would be satisfactory. However, for a project-level analysis that uses CARB’s statewide BAU targets, substantial evidence must be presented to support the use of those targets for a particular project at a specific location. The court noted that this may require examination of the data behind the statewide model and adjustment to the levels of reduction from BAU used for project evaluation. To date, neither CARB nor any lead agencies have provided any guidance on how to adjust AB 32’s statewide BAU target for use at the project level.

The regulations in the State’s 2008 Scoping Plan have been adopted and the State achieved the 2020 target and is on track achieve continued progress towards meeting the 2017 Scoping Plan target for 2030 and beyond.

In the Newhall case, the Supreme Court was concerned that new development may need to reduce GHG emissions more than existing development to demonstrate it is meeting its fair share of reductions. New development does do more than its fair share through compliance with enhanced regulations, particularly with respect to motor vehicles, energy efficiency, and electricity generation. If no additional reductions are

required from an individual project beyond that achieved by regulations, then the amount needed to reach the AB 32 target is the amount of GHG emissions a project must reduce to comply with Statewide goals.

Project-level Thresholds

Section 15064.4(b) of the CEQA Guidelines' amendments for GHG emissions states that a lead agency may take into account the following three considerations in assessing the significance of impacts from GHG emissions.

- Consideration #1: The extent to which the project may increase or reduce GHG emissions as compared to the existing environmental setting.
- Consideration #2: Whether the project emissions exceed a threshold of significance that the lead agency determines applies to the project.
- Consideration #3: The extent to which the project complies with regulations or requirements adopted to implement a statewide, regional, or local plan for the reduction or mitigation of GHG emissions. Such regulations or requirements must be adopted by the relevant public agency through a public review process and must include specific requirements that reduce or mitigate the project's incremental contribution of GHG emissions. If there is substantial evidence that the possible effects of a particular project are still cumulatively considerable notwithstanding compliance with the adopted regulations or requirements, an Environmental Impact Report (EIR) must be prepared for the project.

The SJVAPCD's Guidance for Valley Land-use Agencies in Addressing GHG Emission Impacts for New Projects under CEQA includes thresholds based on whether the project will reduce or mitigate GHG levels by 29 percent from BAU levels compared with 2005 levels by 2020.¹² This level of GHG reduction is based on the target established by CARB's AB 32 Scoping Plan, approved in 2008. First occupancy at the project site is expected to occur after the AB 32 2020 milestone year. Given recent legislative and legal scrutiny on post-2020 compliance, additional discussion is provided to show progress towards GHG reduction goals identified in CARB's 2017 Scoping Plan for the year 2030. Additionally, although not included in a formal GHG reduction plan, Executive Order S-3-05 also includes a goal of reducing GHG emissions 80 percent below 1990 levels by 2050 and Executive Order B-55-18 set the goal to achieve carbon neutrality statewide by 2045. The analysis briefly addresses the proposed project's consistency with those two Executive Orders.

¹² San Joaquin Valley Air Pollution Control District (SJVAPCD). 2009. "Final Staff Report, Addressing Greenhouse Gas Emissions Impacts under the California Environmental Quality Act." Website: http://www.valleyair.org/programs/CCAP/11-05-09/1_CCAP_FINAL_CEQA_GHG_Draft_Staff_Report_Nov_05_2009.pdf. December 2009. Accessed October 9, 2022.

Addressing Greenhouse Gas CEQA Impact Questions

Table 12: Summary of Greenhouse Gas Impact Analysis

Greenhouse Gas Emissions	
Would the project:	Significance Finding
a) Generate greenhouse gas emissions, either directly or indirectly, that may have a significant impact on the environment?	Less than Significant Impact
b) Conflict with any applicable plan, policy or regulation adopted for the purpose of reducing the emissions of greenhouse gases?	Less than Significant Impact

a) Generate greenhouse gas emissions, either directly or indirectly, that may have a significant impact on the environment?

Less Than Significant Impact.

To determine significance the analysis first quantifies project-related GHG emissions under a business-as-usual scenario, and then compare these emissions with those emissions that would occur when all project-related design features are accounted for, and when compliance with applicable regulatory measures is assumed. The standards and methodology are explained in further detail, below.

Construction

GHG emissions generated during all phases of construction were combined and are shown in Table 13. Neither the City of Lemoore nor the SJVAPCD have adopted thresholds of significance for construction-related emissions. In addition, GHG emission reduction measures for construction equipment are relatively limited. To assess construction emissions, the Sacramento Metropolitan Air Quality Management District's screening threshold of 1,100 MT CO_{2e} per year is applied in this analysis. The project's maximum annual GHG emissions, as well as the project's average annual GHG emissions are compared against the applied threshold in Table 13.

Table 13: Summary of Construction-Generated Greenhouse Gas Emissions

Construction Activity	MT CO _{2e} per Year
Project Construction 2023	591
Project Construction 2024	680
Project Construction 2025	520
Project Construction 2026	514
Project Construction 2027	508
Project Construction 2028	501
Project Construction 2029	263
Total Construction MTCO_{2e}	3,577
Annual Average GHG Emissions (MT CO _{2e} /year) ¹	559
Maximum Annual Emissions (MT CO _{2e} /year)	680
Annual Threshold (MT CO _{2e} /year)	1,100
Potentially Significant Impact in Either Scenario?	No
Notes: MT CO _{2e} = metric tons of carbon dioxide equivalent	

¹ Total construction emissions were divided by the construction duration in years (6.4 years) to estimate average annual emissions.
Source: CalEEMod Output (Attachment A).

Operations

Operational or long-term emissions occur over the life of the project. Sources of emissions may include motor vehicles and trucks, energy usage, water usage, waste generation, and area sources, such as landscaping activities and residential woodburning. Operational GHG emissions associated with the proposed project were estimated using CalEEMod 2020.4.0.

Business-as-Usual Operational Emissions

Operational emissions under the business-as-usual scenario were modeled using CalEEMod 2020.4.0. Modeling assumptions for the year 2005 were used to represent business as usual conditions (without the benefit of regulations adopted to reduce GHG emissions). CARB and SJVAPCD guidance recommend using regulatory conditions in 2002-2004 in the baseline scenario to represent conditions as if regulations had not been adopted to allow the effect of projected growth on achieving reduction targets to be clearly defined. CalEEMod defaults were used for project energy usage, water usage, waste generation, and area sources (architectural coating, consumer products, and landscaping). The vehicle fleet mixes were revised to reflect the project fleet mix identified for the buildout year.

Buildout Year Operational Emissions

Operational emissions for full project buildout were modeled for the full buildout in the earliest operational year (2024) and 2030 operational year scenarios using CalEEMod. CalEEMod assumes compliance with some, but not all, applicable rules and regulations regarding energy efficiency, vehicle fuel efficiency, renewable energy usage, and other GHG reduction policies, as described in the CalEEMod User's Guide.¹³

The reductions obtained from each regulation and the source of the reduction amount used in the analysis are described below.

The following regulations are incorporated into the CalEEMod emission factors:

- Pavley I and Pavley II (LEV III) motor vehicle emission standards
- CARB Medium and Heavy-Duty Vehicle Regulation
- 2005, 2008, 2013, 2016, and 2019 Title 24 Energy Efficiency Standards

The following regulations have not been incorporated into the CalEEMod emission factors and require alternative methods to account for emission reductions provided by the regulations:

- Renewables Portfolio Standard (RPS) requirements for year 2030
- 2022 Title 24 Energy Efficiency Standards
- Green Building Code Standards (indoor water use)
- California Model Water Efficient Landscape Ordinance (outdoor water)
- CalRecycle 75 Percent Initiative (solid waste)

Title 24 reductions for 2013 and 2016 updates were added to CalEEMod 2016.3.2 and were carried into CalEEMod 2020.4.0. Title 24 reductions for 2019 were added to CalEEMod 2020.4.0; however, the

¹³ California Air Pollution Control Officers Association (CAPCOA). 2021. California Emission Estimator Model (CalEEMod) Version 2020.4.0 User's Guide. Website: https://www.aqmd.gov/docs/default-source/caleemod/user-guide-2021/01_user-39-s-guide2020-4-0.pdf?sfvrsn=6. Accessed October 9, 2022.

additions do not account for on-site renewable energy that would be included as part of single-family residential projects. Therefore, the CalEEMod mitigation component was used to account for rooftop solar included as part of the proposed project.

RPS is not accounted for in CalEEMod 2020.4.0. Reductions from RPS for operational years 2030 and beyond are addressed by revising the electricity emission intensity factor in CalEEMod to account for the utility RPS rate forecast for 2030. The utilities will be required by SB 100 to increase the use of renewable energy sources to 60 percent by 2030. Data for PG&E was used to estimate a revised CO₂ intensity factor for use in the modeling.

Reductions in emissions from solid waste are based on the County achieving the CalRecycle 75 Percent Initiative by 2020 compared with a 50 percent baseline for 2005.¹⁴ No additional reductions were accounted for in the emission estimates prepared for the project.

Energy savings from water conservation resulting from the Green Building Code Standards for indoor water use and California Model Water Efficient Landscape Ordinance for outdoor water use are not included in CalEEMod. The Water Conservation Act of 2009 mandates a 20 percent reduction in urban water use that is implemented with these regulations.¹⁵ Benefits of the water conservation regulations are applied in the CalEEMod mitigation component.

GHG reductions from some design features and compliance with regulations that are not otherwise accounted for can be quantified in CalEEMod. Note that CalEEMod nominally treats these design elements and conditions as “mitigation measures,” despite their inclusion in the project description. Therefore, reported operational emissions are considered to represent unmitigated project conditions.

Operational GHG emissions by source are shown in Table 14 for the buildout year scenarios. As operations are expected to begin as early as 2024, full buildout of the project was modeled for the 2024 operational year to provide a conservative estimate of emissions and associated impacts.

Table 14: Unmitigated Project Operational GHG Emissions (Buildout Year Scenario)

Emission Source	Emissions (MT CO ₂ e per year)	
	Business as Usual Total Emissions (MT CO ₂ e per year)	Buildout Year Total Emissions with Regulations and Design Features (MT CO ₂ e per year)
Area	126	125
Energy	1,163	393
Mobile (On-road Vehicles)	3,510	2,462
Waste	145	145
Water	69	31
Total (MT CO₂e per year)	5,013	3,156
Reduction from BAU (MT CO ₂ e per year)		1,857
Percent Reduction		37.0%

¹⁴ California Department of Resources Recycling and Recovery (CalRecycle). 2016. California’s 75 Percent Initiative: Defining the Future. Website: <https://www.calrecycle.ca.gov/75percent#:~:text=The%20Legislature%20and%20Governor%20Brown,decreasing%20California's%20reliance%20on%20landfills>. Accessed October 9, 2022.

¹⁵ California Department of Water Resources (CDWR). 2013. California Water Plan Update 2013, Chapter 3 Urban Water Use Efficiency.

Emission Source	Emissions (MT CO ₂ e per year)	
	Business as Usual Total Emissions (MT CO ₂ e per year)	Buildout Year Total Emissions with Regulations and Design Features (MT CO ₂ e per year)
Significance Threshold		29%
Significant Impact?		No
MT CO ₂ e = metric tons of carbon dioxide equivalent. Totals were calculated using unrounded emissions; totals may not appear to sum exactly due to rounding. Source of Significance Threshold: San Joaquin Valley Air Pollution Control District (SJVAPCD). 2015. Final Draft Guidance for Assessing and Mitigating Air Quality Impacts. Website: https://www.valleyair.org/transportation/GAMAQI-2015/FINAL-DRAFT-GAMAQI.PDF . Accessed October 9, 2022 and May 10, 2023. Source of Business-as-Usual Emissions: CalEEMod output for the 2024 BAU scenario (see Attachment A). Source of Buildout Year Emissions: CalEEMod output for project buildout in 2024 (Attachment A).		

As shown in Table 14, the proposed project's total GHG annual emissions under the full buildout scenario in the earliest operational year (2024) achieve the required reduction from BAU and would be considered to have a less-than-significant impact in regards to the project's generation of GHG emissions.

The 2030 operational year scenarios are summarized in Table 15. As previously noted, the 2030 operational year was used to assess the project's consistency with the SB 32 2030 target.

Table 15: Unmitigated Project Operational GHG Emissions (Year 2030 Scenario)

Emission Source	Emissions (MT CO ₂ e per year)	
	Business as Usual Total Emissions (MT CO ₂ e per year)	2030 Year Total Emissions with Regulations and Design Features (MT CO ₂ e per year)
Area	126	125
Energy	1,163	391
Mobile (On-road Vehicles)	3,510	2,087
Waste	145	145
Water	69	31
Total (MT CO₂e per year)	5,013	2,779
Reduction from BAU (MT CO ₂ e per year)		2,234
Percent Reduction		44.6%
Significance Threshold		29%
Significant Impact?		No
MT CO ₂ e = metric tons of carbon dioxide equivalent. Totals were calculated using unrounded emissions; totals may not appear to sum exactly due to rounding. ¹ Adjusted threshold to account for 2017 Scoping Plan Update 40 percent reduction goal by 2030. Source of Business-as-Usual Emissions: CalEEMod output for the 2030 BAU scenario (see Attachment A). Source of 2030 Emissions: CalEEMod output for the year 2030 (Attachment A).		

As shown in Table 14 and Table 15, the project would achieve a 37.0 percent reduction from BAU at project buildout (2024) and a 44.6 percent reduction from BAU by the year 2030 with adopted regulations and design features incorporated. These amounts are both exceed the 29 percent reduction required by the SJVAPCD threshold, and above the required 21.7 percent average reduction from all GHG emission sources to meet the AB 32 targets. CARB originally identified a reduction of 29 percent from business as usual as needed to achieve AB 32 targets. The 2008 recession and slower growth in the years since 2008 have reduced the growth forecasted for 2020 and the amount needed to be reduced to achieve 1990 levels as required by AB 32; the target was revised to 21.7 percent.

The 37.0 percent reduction from BAU is 15.3 percent beyond the average reduction required by the State from all sources to achieve the AB 32 2020 target, and the percent reduction is 8.0 percent beyond the SJVAPCD's threshold. This surplus addresses the Supreme Court's concern in the Newhall case that new development must do more than average to meet its fair share of emission reductions.

By 2030, the proposed project would achieve a 44.6 percent reduction from BAU or 22.9 percent above the 21.7 percent reduction necessary to meet the 2020 target (15.6 percent above the SJVAPCD's percent reduction threshold).

The project's occupancy is anticipated begin as early as 2024; thus, an additional analysis is provided to show consistency with post-2020 State legislative GHG goals. The SB 32 goal of 40 percent below 1990 emission levels by 2030 is the target established by the 2017 Scoping Plan Update. Although CARB adopted the 2022 Scoping Plan in December 2022 that addresses long-term GHG goals set forth by AB 1279,¹⁶ the 2017 Scoping Plan addresses a future GHG goal (2030) and remains relevant to assess GHG impacts from the proposed project.

The 2017 Scoping Plan includes new strategies that are not incorporated in the analysis above. Many measures that are likely to proceed include zero net energy buildings in future updates to Title 24 and enhanced motor vehicle fuel efficiency standards beyond 2025. The 2017 Scoping Plan identified an emission limit of 260 million metric tons of carbon dioxide equivalents (MMTCO_{2e}). The 2030 BAU Inventory is estimated to be 392 MMTCO_{2e}. The 2017 Scoping Plan identified that the bulk of its reductions would come from the Electric Power, Industrial fuel combustion, and Transportation. The continuance of the Cap and Trade would provide additional reductions. Although the 2017 Scoping Plan largely relies on state actions to achieve the GHG emissions limit, the CARB considers local governments partners in achieving the State's goals for reducing GHG emissions. The 2017 Scoping Plan suggests that all new land use development implement feasible measures to reduce GHG emissions, however, it does not define feasible measures nor assign a required reduction amount to new development. An evaluation of the project's consistency with the 2022 Scoping Plan is included under Impact GHG-2. A fair share quantitative threshold based on the 2017 Scoping Plan or the 2022 Scoping Plan is not presently feasible as the nexus between a project's contribution and its fair share mitigation is not well defined.

Based on the 37.0 percent reduction from BAU for project buildout in the earliest operational year (2024), the proposed project would not have a significant impact on GHG emissions as it would meet the SJVAPCD's threshold of 29 percent and exceed the CARB's 21.7 percent reduction necessary from all sources to meet the AB 32 emissions limit.

The project achieves a 44.6 percent reduction from BAU for the year 2030, which demonstrates substantial progress towards achieving the 2030 target.

Regarding the years 2045 and 2050, there have been Executive Orders issued to address carbon neutrality and GHG reduction targets, respectively for those years, however, there are no existing GHG reduction plans that specifically address those Orders. Historically, the State would take the lead in

¹⁶ The Final 2022 Scoping Plan was released on November 16, 2022 and adopted by CARB on December 15, 2022.

developing regulatory and market measures to achieve the required reductions. The proposed project would participate in the reductions through adherence with regulations and continued improvements to the motor vehicle efficiencies accessing the project site. Studies have shown that in order to meet the 2050 targets, aggressive pursuit of technologies in the transportation and energy sectors, including electrification and the decarbonization of fuel, will be required. Because of the technological shifts required and the unknown parameters of the regulatory framework in 2050, quantitatively analyzing the proposed project's impacts further relative to the 2050 goals is speculative for purposes of CEQA.

Impact Analysis Summary

In summary, the proposed project meets the required 29 percent below BAU guidance provided by the SJVAPCD. Furthermore, the proposed project shows substantial reductions in the year 2030 to suggest that it would not inhibit the State's progress in achieving the 2030 GHG emissions target. The GHG emissions impact would be less than significant with respect to Consideration #1 and #2.

b) Conflict with any applicable plan, policy or regulation adopted for the purpose of reducing the emissions of greenhouse gases?

Less than Significant Impact.

The following analysis assesses the proposed project's compliance with Consideration No. 3 regarding consistency with adopted plans to reduce GHG emissions. The City of Lemoore has not adopted a GHG reduction plan. In addition, the City has not completed the GHG inventory, benchmarking, or goal-setting process required to identify a reduction target and take advantage of the streamlining provisions contained in the CEQA Guidelines amendments adopted for SB 97 and clarifications provided in the CEQA Guidelines amendments adopted on December 28, 2018. The SJVAPCD has adopted a Climate Action Plan, but it does not contain measures that are applicable to the project. Therefore, the SJVAPCD Climate Action Plan cannot be applied to the project. Since no other local or regional GHG reduction plan is in place, the project is assessed for its consistency with ARB's adopted 2008, 2017, and 2022 Scoping Plans. This would be achieved with an assessment of the proposed project's compliance with Scoping Plan measures contained in the 2017 Scoping Plan, as well an evaluation of the proposed project's consistency with the 2022 Scoping Plan.

AB 32

The State's regulatory program implementing the 2008 Scoping Plan is now fully mature. All regulations envisioned in the Scoping Plan have been adopted, and the effectiveness of those regulations has been estimated by the agencies during the adoption process and then tracked to verify their effectiveness after implementation. The combined effect of this successful effort is that the State now projects that it will meet the 2020 target and achieve continued progress toward meeting post-2020 targets. Governor Brown, in the introduction to Executive Order B-30-15, stated "California is on track to meet or exceed the current target of reducing greenhouse gas emissions to 1990 levels by 2020, as established in the California Global Warming Solutions Act of 2006 (AB 32)."

Consistency with SB 32 and the 2017 Scoping Plan

The 2017 Climate Change Scoping Plan Update (2017 Scoping Plan) includes the strategy that the State intends to pursue to achieve the 2030 targets of Executive Order S-3-05 and SB 32. Although CARB adopted the 2022 Scoping Plan in December 2022 that addresses long-term GHG goals set forth by AB 1279,¹⁷ the 2017 Scoping Plan addresses a future GHG goal and remains relevant to the proposed

¹⁷ The Final 2022 Scoping Plan was released on November 16, 2022 and adopted by CARB on December 15, 2022.

project. The 2017 Scoping Plan includes the following summary of its overall strategy for reaching the 2030 target:

- SB 350
 - Achieve 50 percent Renewables Portfolio Standard (RPS) by 2030.
 - Doubling of energy efficiency savings by 2030.
- Low Carbon Fuel Standard (LCFS)
 - Increased stringency (reducing carbon intensity 18 percent by 2030, up from 10 percent in 2020).
- Mobile Source Strategy (Cleaner Technology and Fuels Scenario)
 - Maintaining existing GHG standards for light- and heavy-duty vehicles.
 - Put 4.2 million zero-emission vehicles (ZEVs) on the roads.
 - Increase ZEV buses, delivery, and other trucks.
- Sustainable Freight Action Plan
 - Improve freight system efficiency.
 - Maximize use of near-zero emission vehicles and equipment powered by renewable energy.
 - Deploy over 100,000 zero-emission trucks and equipment by 2030.
- Short-Lived Climate Pollutant (SLCP) Reduction Strategy
 - Reduce emissions of methane and hydrofluorocarbons 40 percent below 2013 levels by 2030.
 - Reduce emissions of black carbon 50 percent below 2013 levels by 2030.
- SB 375 Sustainable Communities Strategies
 - Increased stringency of 2035 targets.
- Post-2020 Cap-and-Trade Program
 - Declining caps, continued linkage with Québec, and linkage to Ontario, Canada.
 - CARB will look for opportunities to strengthen the program to support more air quality co-benefits, including specific program design elements. In Fall 2016, CARB staff described potential future amendments including reducing the offset usage limit, redesigning the allocation strategy to reduce free allocation to support increased technology and energy investment at covered entities and reducing allocation if the covered entity increases criteria or toxics emissions over some baseline.
- By 2018, develop Integrated Natural and Working Lands Action Plan to secure California's land base as a net carbon sink

Table 16 provides an analysis of the project's consistency with the 2017 Scoping Plan Update measures.

Table 16: Consistency with SB 32 2017 Scoping Plan Update

Scoping Plan Measure	Project Consistency
<p>SB 350 50% Renewable Mandate. Utilities subject to the legislation will be required to increase their renewable energy mix from 33% in 2020 to 50% in 2030. <i>(The requirement is now 60% in 2030 per SB 100.)</i></p>	<p>Consistent. The project will purchase electricity from a utility subject to the SB 350 Renewable Mandate.</p>
<p>SB 350 Double Building Energy Efficiency by 2030. This is equivalent to a 20 percent reduction from 2014 building energy usage compared to current projected 2030 levels.</p>	<p>Not Applicable. This measure applies to existing buildings. New structures, including new single-family homes, are required to comply with Title 24 Energy Efficiency Standards that are expected to increase in stringency until residential housing achieves zero net energy. The project consists of the construction of new single-family homes and does not include renovations to existing structures.</p>
<p>Low Carbon Fuel Standard. This measure requires fuel providers to meet an 18 percent reduction in carbon content by 2030.</p>	<p>Consistent. Vehicles accessing the project site will use fuel containing lower carbon content as the fuel standard is implemented.</p>
<p>Mobile Source Strategy (Cleaner Technology and Fuels Scenario). Vehicle manufacturers will be required to meet existing regulations mandated by the LEV III and Heavy-Duty Vehicle programs. The strategy includes a goal of having 4.2 million ZEVs on the road by 2030 and increasing numbers of ZEV trucks and buses.</p>	<p>Consistent. Future residents can be expected to purchase increasing numbers of more fuel efficient and zero emission cars and trucks each year. The CALGreen Code requires electrical service in new single-family housing to be EV charger-ready. In addition, home deliveries will be made by increasing numbers of ZEV delivery trucks.</p>
<p>Sustainable Freight Action Plan. The plan's target is to improve freight system efficiency 25 percent by increasing the value of goods and services produced from the freight sector, relative to the amount of carbon that it produces by 2030. This would be achieved by deploying over 100,000 freight vehicles and equipment capable of zero emission operation and maximize near-zero emission freight vehicles and equipment powered by renewable energy by 2030.</p>	<p>Not Applicable. The measure applies to owners and operators of trucks and freight operations. The project is residential in nature and would not support freight operations. However, home deliveries are expected to be made by increasing number of ZEV delivery trucks.</p>
<p>Short-Lived Climate Pollutant (SLCP) Reduction Strategy. The strategy requires the reduction of SLCPs by 40 percent from 2013 levels by 2030 and the reduction of black carbon by 50 percent from 2013 levels by 2030.</p>	<p>Consistent. The project will only include natural gas hearths that produce very little black carbon compared with wood burning fireplaces and heaters in-line with the SJVAPCD's Guidance for Assessing and Mitigating Air Quality Impacts mitigation measures.¹</p>
<p>SB 375 Sustainable Communities Strategies. Requires Regional Transportation Plans to include a sustainable communities strategy for reduction of per capita vehicle miles traveled.</p>	<p>Not applicable. The project includes the construction and development of a residential subdivision and does not include the development of a regional transportation plan.</p>
<p>Post-2020 Cap-and-Trade Program. The Post 2020 Cap-and-Trade Program continues the existing program for another 10 years. The Cap-and-Trade Program applies to large industrial sources such as power plants, refineries, and cement manufacturers.</p>	<p>Consistent. The post-2020 Cap-and-Trade Program indirectly affects people who use the products and services produced by the regulated industrial sources when increased cost of products or services (such as electricity and fuel) are transferred to the consumers. The Cap-and-Trade Program covers the GHG emissions associated with electricity consumed in California, whether generated in-state or imported. Accordingly,</p>

Scoping Plan Measure	Project Consistency
	GHG emissions associated with CEQA projects' electricity usage are covered by the Cap-and-Trade Program. The Cap-and-Trade Program also covers fuel suppliers (natural gas and propane fuel providers and transportation fuel providers) to address emissions from such fuels and from combustion of other fossil fuels not directly covered at large sources in the program's first compliance period.
Natural and Working Lands Action Plan. CARB is working in coordination with several other agencies at the federal, state, and local levels, stakeholders, and with the public, to develop measures as outlined in the Scoping Plan Update and the governor's Executive Order B-30-15 to reduce GHG emissions and to cultivate net carbon sequestration potential for California's natural and working land.	Not Applicable. The project is residential development and will not be considered natural or working lands.
<p>Source: California Air Resources Board (CARB). 2017. The 2017 Climate Change Scoping Plan Update. January 20. Website: https://www.arb.ca.gov/cc/scopingplan/2030sp_pp_final.pdf. Accessed October 9, 2022.</p> <p>¹ San Joaquin Valley Air Pollution Control District (SJVAPCD). 2015. Guidance for Assessing and Mitigating Air Quality Impacts. Website: https://www.valleyair.org/transportation/GAMAQI-2015/FINAL-DRAFT-GAMA. Accessed October 9, 2022 and May 10, 2023.</p>	

Consistency Regarding GHG Reduction Goals for 2050 under Executive Order S-3-05 and GHG Reduction Goals for 2045 under the 2022 Scoping Plan

CARB adopted the 2022 Scoping Plan in December 2022 that addresses long-term GHG goals set forth by AB 1279.¹⁸ The 2022 Scoping Plan outlines the State's pathway to achieve carbon neutrality and an 85 percent reduction in 1990 emissions goal by 2045. In the 2022 Scoping Plan, CARB advocates for compliance with a local GHG reduction strategy consistent with CEQA Guidelines section 15183.5. The 2022 Scoping Plan also provides guidance regarding the role of local governments (such as the lead agency) in achieving the State's climate goals, particularly as it concerns the approval of new land use development projects and their environmental review under CEQA.

The 2022 Scoping Plan outlines approaches that lead agencies may consider for evaluating the consistency of proposed plans and residential and mixed-use projects with the State's climate goals. In other words, the 2022 Scoping Plan considers the following approaches to evaluate whether a project may have a less than significant impact on GHG emissions, though it notes that these approaches are recommendations only and that they do not supplant lead agencies' discretion to develop their own evidence-based approaches for determining whether a project would result in a potentially significant impact on GHG emissions.

One approach outlined in the 2022 Scoping Plan involves assessing the project's consistency with key project attributes identified in the 2022 Scoping Plan that have been demonstrated to reduce operational GHG emissions. The project attributes are intended as a guide to help local jurisdictions, such as the City of Lemoore, identify residential and mixed-use projects that are clearly consistent with the State's climate goals. The 2022 Scoping Plan considers residential and mixed-use development projects incorporating the following key project attributes (listed in Table 17) to be aligned with the State's priority GHG reduction

¹⁸ The Final 2022 Scoping Plan was released on November 16, 2022 and adopted by CARB on December 15, 2022.

strategies for local climate action and therefore consistent with the 2022 Scoping Plan and other plans, policies, or regulations adopted for the purposes of reducing GHG emissions.

The project’s consistency with the 2022 Scoping Plan is provided below in Table 17.

Table 17: 2022 Scoping Plan Consistency Analysis

Key Residential and Mixed-use Attribute Identified in the 2022 Scoping Plan	Project Consistency
Transportation Electrification	
Provides EV charging infrastructure that, at minimum, meets the most ambitious voluntary standard in the California Green Building Standards Code at the time of project approval.	Consistent. The new residential homes included as part of the proposed project would include EV charging infrastructure as required by 2022 California Green Buildings Standards Code (CALGreen), which is enforced at the project level by the City of Lemoore.
Vehicle Miles Traveled Reduction	
Is located on infill sites that are surrounded by existing urban uses and reuses or redevelops previously undeveloped or underutilized land that is presently served by existing utilities and essential public services (e.g., transit, streets, water, sewer).	Consistent. The project site is primarily surrounded by existing built-up urban uses and is located near a mix of residential, public, and commercial uses. As there are currently no homes occupying the project site, the project would increase density at this site compared to existing uses.
Does not result in the loss or conversion of natural and working lands.	Consistent. The project site is not considered natural or working lands; therefore, the proposed project would not result in the loss or conversion of natural or working lands.
<p>Consists of transit-supportive densities (minimum 20 residential dwelling units per acre), or</p> <p>Is in proximity to existing transit stops (within a half mile), or</p> <p>Satisfies more detailed and stringent criteria specified in the region’s Sustainable Communities Strategy (SCS).</p>	Not proposed. The project site consists of approximately 52.61 acres located north of SR 198 and east of South Lemoore Avenue (APN 023-040-058-000). The site is zoned PR and RLD with a planned land use of Low Density Residential and Parks and Recreation. The Applicant is proposing a concurrent Planned Unit Development (PUD) to deviate from certain development standards in order to remain within the permitted density range of the existing zone district. The permitted density range is 3 to 7 dwelling units per acre; the project proposes a density of 5.32 dwelling units per acre.
<p>Reduces parking requirements by:</p> <ul style="list-style-type: none"> ● Eliminating parking requirements or including maximum allowable parking ratios (i.e., the ratio of parking spaces to residential units or square feet). ● Providing residential parking at a ratio of less than one parking space per dwelling unit. <p>For multi-family residential development, requiring parking costs to be unbundled from costs to rent or own a residential unit.</p>	Consistent. The proposed project does not propose any parking lots or other standalone parking areas. Parking areas would be included as part of the single-family homes (such as garages and driveways), with additional on-street parking available. In addition, the project will be built to meet all existing applicable regulations.
At least 20 percent of units included are affordable to lower-income residents.	Not proposed. Affordable units are not noted in the project description; therefore, it was assumed that this key attribute may not be met to provide a conservative evaluation of project impacts.

Key Residential and Mixed-use Attribute Identified in the 2022 Scoping Plan	Project Consistency
Does not result in a net loss of existing affordable units.	Consistent. The project would not remove any existing affordable units and, therefore, would not result in a net loss of existing affordable units.
Building Decarbonization	
Uses all-electric appliances without any natural gas connections and does not use propane or other fossil fuels for space heating, water heating, or indoor cooking.	Not proposed. The proposed project would be built to code, which does not currently require an all-electric design.
Source of Key Attributes: California Air Resources Board (CARB). 2022. 2022 Scoping Plan. Table 3, Appendix D. November 16. Website: https://ww2.arb.ca.gov/resources/documents/2022-scoping-plan-documents . Accessed May 10, 2023.	

As noted in Table 17 above, the proposed project is consistent with several key project attributes identified in the 2022 Scoping Plan. Specifically, the proposed project is consistent with five of the eight applicable key attributes. The 2022 Scoping Plan acknowledges that projects incorporating some, but not all, of the key project attributes may still be consistent with the State’s climate goals, at the discretion of the lead agency. The project would comply with all applicable regulations, including those implemented to minimize the adverse impacts of growth and development on climate change. Based on the proposed project’s consistency with a majority of the key project attributes (as detailed in Table 17) and that fact that it would comply with all existing regulations, the proposed project is considered consistent with the 2022 Scoping Plan and AB 1279’s goal of achieving Statewide carbon net neutrality by 2045.

Regarding goals for 2050 under Executive Order S-3-05, at this time it is not possible to quantify the emissions savings from future regulatory measures, as they have not yet been developed; nevertheless, it can be anticipated that operation of the project would comply with whatever measures are enacted that state lawmakers decide would lead to an 80 percent reduction below 1990 levels by 2050. In its 2008 Scoping Plan, CARB acknowledged that the “measures needed to meet the 2050 are too far in the future to define in detail.” In the First Scoping Plan Update; however, CARB generally described the type of activities required to achieve the 2050 target: “energy demand reduction through efficiency and activity changes; large scale electrification of on-road vehicles, buildings, and industrial machinery; decarbonizing electricity and fuel supplies; and rapid market penetration of efficiency and clean energy technologies that requires significant efforts to deploy and scale markets for the cleanest technologies immediately.” The 2017 Scoping Plan provides an intermediate target that is intended to achieve reasonable progress toward the 2050 target. In addition, the 2022 Scoping Plan outlines objectives, regulations, planning efforts, and investments in clean technologies and infrastructure that outlines how the State can achieve carbon-neutrality by 2045.

Accordingly, taking into account the proposed project’s emissions, project design features, and the progress being made by the State towards reducing emissions in key sectors such as transportation, industry, and electricity, the project would be consistent with State GHG Plans and would further the State’s goals of reducing GHG emissions to 1990 levels by 2020, 40 percent below 1990 levels by 2030, carbon neutral by 2045, and 80 percent below 1990 levels by 2050, and does not obstruct their attainment. Impacts would be less than significant.

Impact Analysis Summary

The proposed project would not conflict with CARB’s adopted 2017 Scoping Plan or CARB’s 2022 Scoping Plan. Because the project would be consistent with CARB’s adopted 2017 and 2022 Scoping

Plans, it follows that the project would not conflict with any applicable plan, policy or regulation adopted for the purpose of reducing the emissions of GHGs. Therefore, impacts would be less than significant.

Attachments

Attachment A – Modeling Assumptions, CalEEMod Output files, and Operational Screening Results

Attachment B – Construction Health Risk Assessment

ATTACHMENT A

Modeling Assumptions, CalEEMod Output files, and Operational Screening Results

Modeling Assumptions, CalEEMod Output files, and Operational Screening Results

Table of Contents

CalEEMod Output Files

- **Unmitigated Construction — Annual**
- **Project Building Operations in the Earliest Year of Operation (2024) — Annual**
- **On-site Construction Emissions (Maximum Daily Localized Construction Emissions)**
- **On-site Operational Emissions (Maximum Daily Localized Operational Emissions)**
- **Business as Usual Scenario – 2024 Buildout Operational Year Scenario**
- **Business as Usual Scenario – 2030 Operational Year Scenario**
- **2030 Operational Scenario**

Operational Health Risk Screening

- **Screening Calculations and Prioritization**

Additional Supporting Information

- **Project Construction Assumptions**
- **Project Site Vicinity Map**
- **Project Site Plan Overlaid at the Project Site**
- **Project Site Plan**

Lemoore 54 - Unmitigated Construction - Kings County, Annual

EMFAC Off-Model Adjustment Factors for Gasoline Light Duty Vehicle to Account for the SAFE Vehicle Rule Not Applied

Lemoore 54 - Unmitigated Construction

Kings County, Annual

1.0 Project Characteristics

1.1 Land Usage

Land Uses	Size	Metric	Lot Acreage	Floor Surface Area	Population
City Park	3.20	Acre	3.20	139,392.00	0
Single Family Housing	280.00	Dwelling Unit	49.41	504,000.00	801

1.2 Other Project Characteristics

Urbanization	Urban	Wind Speed (m/s)	2.2	Precipitation Freq (Days)	37
Climate Zone	3			Operational Year	2029
Utility Company	Pacific Gas and Electric Company				
CO2 Intensity (lb/MWhr)	203.98	CH4 Intensity (lb/MWhr)	0.033	N2O Intensity (lb/MWhr)	0.004

1.3 User Entered Comments & Non-Default Data

Project Characteristics -

Land Use - Project site is approximately 52.61 acres
280-lot single family subdivision and 3.2 acres of public parks at full buildout

Construction Phase - No demolition
Adjusted schedule to match applicant-provided construction start date and construction duration
08/01/2023-12-31/2029

Off-road Equipment - Adjusted construction equipment usage to match CalEEMod default total building construction HP hours.

Trips and VMT - Additional truck trips were added to each phase for mobilization/demobilization of on-site equipment (two trips per piece of equipment).

Grading - Amount of import and export associated with cut and fill:

Cubic yards of cut to be exported: 90,000 cubic yards

Cubic yards of fill to be imported: 90,000 cubic yards

Architectural Coating - Rule 4601 Architectural Coatings

Vehicle Trips - Construction run only (operations assessed in a separate run)

Lemoore 54 - Unmitigated Construction - Kings County, Annual

EMFAC Off-Model Adjustment Factors for Gasoline Light Duty Vehicle to Account for the SAFE Vehicle Rule Not Applied

Vehicle Emission Factors -

Vehicle Emission Factors -

Vehicle Emission Factors -

Woodstoves - Construction run only (operations only parameters zeroed out)

Consumer Products - Construction run only

Area Coating - Construction run only

Landscape Equipment - Construction run only

Energy Use - Construction run only

Water And Wastewater - Construction run only

Solid Waste - Construction run only

Construction Off-road Equipment Mitigation - Compliance with SJVAPCD Regulation VIII

Area Mitigation -

Fleet Mix -

Table Name	Column Name	Default Value	New Value
tblArchitecturalCoating	EF_Residential_Exterior	150.00	50.00
tblArchitecturalCoating	EF_Residential_Interior	150.00	50.00
tblAreaCoating	Area_EF_Residential_Exterior	150	50
tblAreaCoating	Area_EF_Residential_Interior	150	50
tblAreaCoating	ReapplicationRatePercent	10	0
tblConstDustMitigation	WaterUnpavedRoadVehicleSpeed	0	15
tblConstructionPhase	NumDays	1,110.00	1,310.00
tblConstructionPhase	NumDays	75.00	150.00
tblConsumerProducts	ROG_EF	2.14E-05	1E-07
tblConsumerProducts	ROG_EF_Degreaser	3.542E-07	1E-10
tblConsumerProducts	ROG_EF_PesticidesFertilizers	5.152E-08	1E-11
tblEnergyUse	LightingElect	1,608.84	0.00
tblEnergyUse	NT24E	6,155.97	0.00
tblEnergyUse	NT24NG	3,723.00	0.00

Lemoore 54 - Unmitigated Construction - Kings County, Annual

EMFAC Off-Model Adjustment Factors for Gasoline Light Duty Vehicle to Account for the SAFE Vehicle Rule Not Applied

tblEnergyUse	T24E	209.15	0.00
tblEnergyUse	T24NG	20,314.55	0.00
tblFireplaces	FireplaceWoodMass	3,078.40	0.00
tblFireplaces	NumberGas	154.00	0.00
tblGrading	MaterialExported	0.00	90,000.00
tblGrading	MaterialImported	0.00	90,000.00
tblLandscapeEquipment	NumberSummerDays	180	1
tblLandUse	LotAcreage	90.91	49.41
tblOffRoadEquipment	UsageHours	7.00	5.90
tblOffRoadEquipment	UsageHours	8.00	6.80
tblOffRoadEquipment	UsageHours	8.00	6.80
tblOffRoadEquipment	UsageHours	7.00	5.90
tblOffRoadEquipment	UsageHours	8.00	6.80
tblSolidWaste	SolidWasteGenerationRate	0.28	0.00
tblSolidWaste	SolidWasteGenerationRate	288.36	0.00
tblTripsAndVMT	HaulingTripNumber	0.00	14.00
tblTripsAndVMT	HaulingTripNumber	17,798.00	17,814.00
tblTripsAndVMT	HaulingTripNumber	0.00	12.00
tblTripsAndVMT	HaulingTripNumber	0.00	18.00
tblTripsAndVMT	HaulingTripNumber	0.00	2.00
tblVehicleTrips	ST_TR	1.96	0.00
tblVehicleTrips	ST_TR	9.54	0.00
tblVehicleTrips	SU_TR	2.19	0.00
tblVehicleTrips	SU_TR	8.55	0.00
tblVehicleTrips	WD_TR	0.78	0.00
tblVehicleTrips	WD_TR	9.44	0.00
tblWater	IndoorWaterUseRate	18,243,127.17	0.00
tblWater	OutdoorWaterUseRate	3,812,740.32	0.00
tblWater	OutdoorWaterUseRate	11,501,101.91	0.00

Lemoore 54 - Unmitigated Construction - Kings County, Annual

EMFAC Off-Model Adjustment Factors for Gasoline Light Duty Vehicle to Account for the SAFE Vehicle Rule Not Applied

tblWoodstoves	WoodstoveWoodMass	3,019.20	0.00
---------------	-------------------	----------	------

2.0 Emissions Summary

2.1 Overall Construction

Unmitigated Construction

	ROG	NOx	CO	SO2	Fugitive PM10	Exhaust PM10	PM10 Total	Fugitive PM2.5	Exhaust PM2.5	PM2.5 Total	Bio- CO2	NBio- CO2	Total CO2	CH4	N2O	CO2e
Year	tons/yr										MT/yr					
2023	0.1829	2.4337	1.5092	6.2300e-003	0.8806	0.0813	0.9618	0.3639	0.0750	0.4389	0.0000	574.4983	574.4983	0.0835	0.0494	591.2958
2024	0.2408	2.4578	2.5481	7.3200e-003	0.4825	0.0885	0.5710	0.1368	0.0824	0.2192	0.0000	665.2815	665.2815	0.0972	0.0418	680.1567
2025	0.2129	1.7198	2.3144	5.7100e-003	0.2128	0.0611	0.2739	0.0576	0.0575	0.1151	0.0000	511.7626	511.7626	0.0639	0.0224	520.0413
2026	0.2093	1.7145	2.2891	5.6500e-003	0.2128	0.0611	0.2739	0.0576	0.0575	0.1151	0.0000	506.1213	506.1213	0.0636	0.0218	514.2179
2027	0.2059	1.7093	2.2631	5.5800e-003	0.2128	0.0610	0.2738	0.0576	0.0574	0.1150	0.0000	500.1977	500.1977	0.0633	0.0213	508.1160
2028	0.2021	1.6987	2.2332	5.5000e-003	0.2120	0.0607	0.2727	0.0574	0.0571	0.1145	0.0000	492.8606	492.8606	0.0628	0.0207	500.5861
2029	1.6872	0.8775	1.2074	2.9000e-003	0.1180	0.0322	0.1501	0.0318	0.0305	0.0623	0.0000	258.9579	258.9579	0.0305	9.7000e-003	262.6105
Maximum	1.6872	2.4578	2.5481	7.3200e-003	0.8806	0.0885	0.9618	0.3639	0.0824	0.4389	0.0000	665.2815	665.2815	0.0972	0.0494	680.1567

Lemoore 54 - Unmitigated Construction - Kings County, Annual

EMFAC Off-Model Adjustment Factors for Gasoline Light Duty Vehicle to Account for the SAFE Vehicle Rule Not Applied

2.1 Overall Construction

Mitigated Construction

	ROG	NOx	CO	SO2	Fugitive PM10	Exhaust PM10	PM10 Total	Fugitive PM2.5	Exhaust PM2.5	PM2.5 Total	Bio- CO2	NBio- CO2	Total CO2	CH4	N2O	CO2e
Year	tons/yr										MT/yr					
2023	0.1829	2.4337	1.5092	6.2300e-003	0.4539	0.0813	0.5351	0.1795	0.0750	0.2545	0.0000	574.4980	574.4980	0.0835	0.0494	591.2955
2024	0.2408	2.4578	2.5481	7.3200e-003	0.3184	0.0885	0.4069	0.0891	0.0824	0.1715	0.0000	665.2811	665.2811	0.0972	0.0418	680.1563
2025	0.2129	1.7198	2.3144	5.7100e-003	0.2128	0.0611	0.2739	0.0576	0.0575	0.1151	0.0000	511.7623	511.7623	0.0639	0.0224	520.0410
2026	0.2093	1.7144	2.2891	5.6500e-003	0.2128	0.0611	0.2739	0.0576	0.0575	0.1151	0.0000	506.1210	506.1210	0.0636	0.0218	514.2176
2027	0.2059	1.7093	2.2631	5.5800e-003	0.2128	0.0610	0.2738	0.0576	0.0574	0.1150	0.0000	500.1974	500.1974	0.0633	0.0213	508.1156
2028	0.2021	1.6987	2.2332	5.5000e-003	0.2120	0.0607	0.2727	0.0574	0.0571	0.1145	0.0000	492.8603	492.8603	0.0628	0.0207	500.5858
2029	1.6872	0.8775	1.2074	2.9000e-003	0.1180	0.0322	0.1501	0.0318	0.0305	0.0623	0.0000	258.9577	258.9577	0.0305	9.7000e-003	262.6103
Maximum	1.6872	2.4578	2.5481	7.3200e-003	0.4539	0.0885	0.5351	0.1795	0.0824	0.2545	0.0000	665.2811	665.2811	0.0972	0.0494	680.1563

	ROG	NOx	CO	SO2	Fugitive PM10	Exhaust PM10	PM10 Total	Fugitive PM2.5	Exhaust PM2.5	PM2.5 Total	Bio- CO2	NBio-CO2	Total CO2	CH4	N2O	CO2e
Percent Reduction	0.00	0.00	0.00	0.00	25.34	0.00	21.28	30.43	0.00	19.66	0.00	0.00	0.00	0.00	0.00	0.00

Quarter	Start Date	End Date	Maximum Unmitigated ROG + NOX (tons/quarter)	Maximum Mitigated ROG + NOX (tons/quarter)
1	8-1-2023	10-31-2023	1.3592	1.3592
2	11-1-2023	1-31-2024	1.9044	1.9044
3	2-1-2024	4-30-2024	0.7666	0.7666
4	5-1-2024	7-31-2024	0.4421	0.4421

Lemoore 54 - Unmitigated Construction - Kings County, Annual

EMFAC Off-Model Adjustment Factors for Gasoline Light Duty Vehicle to Account for the SAFE Vehicle Rule Not Applied

5	8-1-2024	10-31-2024	0.5191	0.5191
6	11-1-2024	1-31-2025	0.5114	0.5114
7	2-1-2025	4-30-2025	0.4722	0.4722
8	5-1-2025	7-31-2025	0.4849	0.4849
9	8-1-2025	10-31-2025	0.4865	0.4865
10	11-1-2025	1-31-2026	0.4890	0.4890
11	2-1-2026	4-30-2026	0.4699	0.4699
12	5-1-2026	7-31-2026	0.4825	0.4825
13	8-1-2026	10-31-2026	0.4842	0.4842
14	11-1-2026	1-31-2027	0.4867	0.4867
15	2-1-2027	4-30-2027	0.4678	0.4678
16	5-1-2027	7-31-2027	0.4803	0.4803
17	8-1-2027	10-31-2027	0.4820	0.4820
18	11-1-2027	1-31-2028	0.4846	0.4846
19	2-1-2028	4-30-2028	0.4712	0.4712
20	5-1-2028	7-31-2028	0.4785	0.4785
21	8-1-2028	10-31-2028	0.4801	0.4801
22	11-1-2028	1-31-2029	0.4827	0.4827
23	2-1-2029	4-30-2029	0.4643	0.4643
24	5-1-2029	7-31-2029	0.7109	0.7109
25	8-1-2029	9-30-2029	0.4891	0.4891
		Highest	1.9044	1.9044

Lemoore 54 - Unmitigated Construction - Kings County, Annual

EMFAC Off-Model Adjustment Factors for Gasoline Light Duty Vehicle to Account for the SAFE Vehicle Rule Not Applied

2.2 Overall Operational

Unmitigated Operational

	ROG	NOx	CO	SO2	Fugitive PM10	Exhaust PM10	PM10 Total	Fugitive PM2.5	Exhaust PM2.5	PM2.5 Total	Bio- CO2	NBio- CO2	Total CO2	CH4	N2O	CO2e
Category	tons/yr										MT/yr					
Area	9.5400e-003	1.3000e-004	0.0115	0.0000		6.0000e-005	6.0000e-005		6.0000e-005	6.0000e-005	0.0000	0.0189	0.0189	2.0000e-005	0.0000	0.0193
Energy	0.0000	0.0000	0.0000	0.0000		0.0000	0.0000		0.0000	0.0000	0.0000	0.0000	0.0000	0.0000	0.0000	0.0000
Mobile	0.0000	0.0000	0.0000	0.0000	0.0000	0.0000	0.0000	0.0000	0.0000	0.0000	0.0000	0.0000	0.0000	0.0000	0.0000	0.0000
Waste						0.0000	0.0000		0.0000	0.0000	0.0000	0.0000	0.0000	0.0000	0.0000	0.0000
Water						0.0000	0.0000		0.0000	0.0000	0.0000	0.0000	0.0000	0.0000	0.0000	0.0000
Total	9.5400e-003	1.3000e-004	0.0115	0.0000	0.0000	6.0000e-005	6.0000e-005	0.0000	6.0000e-005	6.0000e-005	0.0000	0.0189	0.0189	2.0000e-005	0.0000	0.0193

Lemoore 54 - Unmitigated Construction - Kings County, Annual

EMFAC Off-Model Adjustment Factors for Gasoline Light Duty Vehicle to Account for the SAFE Vehicle Rule Not Applied

2.2 Overall Operational

Mitigated Operational

	ROG	NOx	CO	SO2	Fugitive PM10	Exhaust PM10	PM10 Total	Fugitive PM2.5	Exhaust PM2.5	PM2.5 Total	Bio- CO2	NBio- CO2	Total CO2	CH4	N2O	CO2e
Category	tons/yr										MT/yr					
Area	9.5400e-003	1.3000e-004	0.0115	0.0000		6.0000e-005	6.0000e-005		6.0000e-005	6.0000e-005	0.0000	0.0189	0.0189	2.0000e-005	0.0000	0.0193
Energy	0.0000	0.0000	0.0000	0.0000		0.0000	0.0000		0.0000	0.0000	0.0000	0.0000	0.0000	0.0000	0.0000	0.0000
Mobile	0.0000	0.0000	0.0000	0.0000	0.0000	0.0000	0.0000	0.0000	0.0000	0.0000	0.0000	0.0000	0.0000	0.0000	0.0000	0.0000
Waste						0.0000	0.0000		0.0000	0.0000	0.0000	0.0000	0.0000	0.0000	0.0000	0.0000
Water						0.0000	0.0000		0.0000	0.0000	0.0000	0.0000	0.0000	0.0000	0.0000	0.0000
Total	9.5400e-003	1.3000e-004	0.0115	0.0000	0.0000	6.0000e-005	6.0000e-005	0.0000	6.0000e-005	6.0000e-005	0.0000	0.0189	0.0189	2.0000e-005	0.0000	0.0193

	ROG	NOx	CO	SO2	Fugitive PM10	Exhaust PM10	PM10 Total	Fugitive PM2.5	Exhaust PM2.5	PM2.5 Total	Bio- CO2	NBio- CO2	Total CO2	CH4	N2O	CO2e
Percent Reduction	0.00	0.00	0.00	0.00	0.00	0.00	0.00	0.00	0.00	0.00	0.00	0.00	0.00	0.00	0.00	0.00

3.0 Construction Detail

Construction Phase

Phase Number	Phase Name	Phase Type	Start Date	End Date	Num Days Week	Num Days	Phase Description
1	Site Preparation	Site Preparation	8/1/2023	9/25/2023	5	40	
2	Grading	Grading	9/26/2023	2/26/2024	5	110	
3	Paving	Paving	2/27/2024	6/10/2024	5	75	

Lemoore 54 - Unmitigated Construction - Kings County, Annual

EMFAC Off-Model Adjustment Factors for Gasoline Light Duty Vehicle to Account for the SAFE Vehicle Rule Not Applied

4	Building Construction	Building Construction	6/11/2024	6/18/2029	5	1310	Extended to match total duration
5	Architectural Coating	Architectural Coating	6/5/2029	12/31/2029	5	150	Anticipated to occur throughout building construction

Acres of Grading (Site Preparation Phase): 60

Acres of Grading (Grading Phase): 330

Acres of Paving: 0

Residential Indoor: 1,020,600; Residential Outdoor: 340,200; Non-Residential Indoor: 2; Non-Residential Outdoor: 1; Striped Parking Area: 0 (Architectural Coating – sqft)

OffRoad Equipment

Phase Name	Offroad Equipment Type	Amount	Usage Hours	Horse Power	Load Factor
Site Preparation	Rubber Tired Dozers	3	8.00	247	0.40
Site Preparation	Tractors/Loaders/Backhoes	4	8.00	97	0.37
Grading	Excavators	2	8.00	158	0.38
Grading	Graders	1	8.00	187	0.41
Grading	Rubber Tired Dozers	1	8.00	247	0.40
Grading	Scrapers	2	8.00	367	0.48
Grading	Tractors/Loaders/Backhoes	2	8.00	97	0.37
Paving	Pavers	2	8.00	130	0.42
Paving	Paving Equipment	2	8.00	132	0.36
Paving	Rollers	2	8.00	80	0.38
Building Construction	Cranes	1	5.90	231	0.29
Building Construction	Forklifts	3	6.80	89	0.20
Building Construction	Generator Sets	1	6.80	84	0.74
Building Construction	Tractors/Loaders/Backhoes	3	5.90	97	0.37
Building Construction	Welders	1	6.80	46	0.45
Architectural Coating	Air Compressors	1	6.00	78	0.48

Trips and VMT

Lemoore 54 - Unmitigated Construction - Kings County, Annual

EMFAC Off-Model Adjustment Factors for Gasoline Light Duty Vehicle to Account for the SAFE Vehicle Rule Not Applied

Phase Name	Offroad Equipment Count	Worker Trip Number	Vendor Trip Number	Hauling Trip Number	Worker Trip Length	Vendor Trip Length	Hauling Trip Length	Worker Vehicle Class	Vendor Vehicle Class	Hauling Vehicle Class
Site Preparation	7	18.00	0.00	14.00	10.80	7.30	20.00	LD_Mix	HDT_Mix	HHDT
Grading	8	20.00	0.00	17,814.00	10.80	7.30	20.00	LD_Mix	HDT_Mix	HHDT
Paving	6	15.00	0.00	12.00	10.80	7.30	20.00	LD_Mix	HDT_Mix	HHDT
Building Construction	9	159.00	53.00	18.00	10.80	7.30	20.00	LD_Mix	HDT_Mix	HHDT
Architectural Coating	1	32.00	0.00	2.00	10.80	7.30	20.00	LD_Mix	HDT_Mix	HHDT

3.1 Mitigation Measures Construction

Water Exposed Area

Reduce Vehicle Speed on Unpaved Roads

3.2 Site Preparation - 2023

Unmitigated Construction On-Site

	ROG	NOx	CO	SO2	Fugitive PM10	Exhaust PM10	PM10 Total	Fugitive PM2.5	Exhaust PM2.5	PM2.5 Total	Bio- CO2	NBio- CO2	Total CO2	CH4	N2O	CO2e
Category	tons/yr										MT/yr					
Fugitive Dust					0.3931	0.0000	0.3931	0.2021	0.0000	0.2021	0.0000	0.0000	0.0000	0.0000	0.0000	0.0000
Off-Road	0.0532	0.5505	0.3649	7.6000e-004		0.0253	0.0253		0.0233	0.0233	0.0000	66.9014	66.9014	0.0216	0.0000	67.4423
Total	0.0532	0.5505	0.3649	7.6000e-004	0.3931	0.0253	0.4185	0.2021	0.0233	0.2253	0.0000	66.9014	66.9014	0.0216	0.0000	67.4423

Lemoore 54 - Unmitigated Construction - Kings County, Annual

EMFAC Off-Model Adjustment Factors for Gasoline Light Duty Vehicle to Account for the SAFE Vehicle Rule Not Applied

3.2 Site Preparation - 2023

Unmitigated Construction Off-Site

	ROG	NOx	CO	SO2	Fugitive PM10	Exhaust PM10	PM10 Total	Fugitive PM2.5	Exhaust PM2.5	PM2.5 Total	Bio- CO2	NBio- CO2	Total CO2	CH4	N2O	CO2e
Category	tons/yr										MT/yr					
Hauling	1.0000e-005	8.6000e-004	1.9000e-004	0.0000	1.2000e-004	1.0000e-005	1.3000e-004	3.0000e-005	1.0000e-005	4.0000e-005	0.0000	0.3914	0.3914	0.0000	6.0000e-005	0.4098
Vendor	0.0000	0.0000	0.0000	0.0000	0.0000	0.0000	0.0000	0.0000	0.0000	0.0000	0.0000	0.0000	0.0000	0.0000	0.0000	0.0000
Worker	1.0900e-003	7.5000e-004	8.9000e-003	2.0000e-005	2.8900e-003	1.0000e-005	2.9100e-003	7.7000e-004	1.0000e-005	7.8000e-004	0.0000	2.2753	2.2753	7.0000e-005	7.0000e-005	2.2969
Total	1.1000e-003	1.6100e-003	9.0900e-003	2.0000e-005	3.0100e-003	2.0000e-005	3.0400e-003	8.0000e-004	2.0000e-005	8.2000e-004	0.0000	2.6667	2.6667	7.0000e-005	1.3000e-004	2.7066

Mitigated Construction On-Site

	ROG	NOx	CO	SO2	Fugitive PM10	Exhaust PM10	PM10 Total	Fugitive PM2.5	Exhaust PM2.5	PM2.5 Total	Bio- CO2	NBio- CO2	Total CO2	CH4	N2O	CO2e
Category	tons/yr										MT/yr					
Fugitive Dust					0.1769	0.0000	0.1769	0.0909	0.0000	0.0909	0.0000	0.0000	0.0000	0.0000	0.0000	0.0000
Off-Road	0.0532	0.5505	0.3649	7.6000e-004		0.0253	0.0253		0.0233	0.0233	0.0000	66.9013	66.9013	0.0216	0.0000	67.4422
Total	0.0532	0.5505	0.3649	7.6000e-004	0.1769	0.0253	0.2022	0.0909	0.0233	0.1142	0.0000	66.9013	66.9013	0.0216	0.0000	67.4422

Lemoore 54 - Unmitigated Construction - Kings County, Annual

EMFAC Off-Model Adjustment Factors for Gasoline Light Duty Vehicle to Account for the SAFE Vehicle Rule Not Applied

3.2 Site Preparation - 2023

Mitigated Construction Off-Site

	ROG	NOx	CO	SO2	Fugitive PM10	Exhaust PM10	PM10 Total	Fugitive PM2.5	Exhaust PM2.5	PM2.5 Total	Bio- CO2	NBio- CO2	Total CO2	CH4	N2O	CO2e
Category	tons/yr										MT/yr					
Hauling	1.0000e-005	8.6000e-004	1.9000e-004	0.0000	1.2000e-004	1.0000e-005	1.3000e-004	3.0000e-005	1.0000e-005	4.0000e-005	0.0000	0.3914	0.3914	0.0000	6.0000e-005	0.4098
Vendor	0.0000	0.0000	0.0000	0.0000	0.0000	0.0000	0.0000	0.0000	0.0000	0.0000	0.0000	0.0000	0.0000	0.0000	0.0000	0.0000
Worker	1.0900e-003	7.5000e-004	8.9000e-003	2.0000e-005	2.8900e-003	1.0000e-005	2.9100e-003	7.7000e-004	1.0000e-005	7.8000e-004	0.0000	2.2753	2.2753	7.0000e-005	7.0000e-005	2.2969
Total	1.1000e-003	1.6100e-003	9.0900e-003	2.0000e-005	3.0100e-003	2.0000e-005	3.0400e-003	8.0000e-004	2.0000e-005	8.2000e-004	0.0000	2.6667	2.6667	7.0000e-005	1.3000e-004	2.7066

3.3 Grading - 2023

Unmitigated Construction On-Site

	ROG	NOx	CO	SO2	Fugitive PM10	Exhaust PM10	PM10 Total	Fugitive PM2.5	Exhaust PM2.5	PM2.5 Total	Bio- CO2	NBio- CO2	Total CO2	CH4	N2O	CO2e
Category	tons/yr										MT/yr					
Fugitive Dust					0.3827	0.0000	0.3827	0.1331	0.0000	0.1331	0.0000	0.0000	0.0000	0.0000	0.0000	0.0000
Off-Road	0.1146	1.1908	0.9678	2.1400e-003		0.0491	0.0491		0.0452	0.0452	0.0000	188.1465	188.1465	0.0609	0.0000	189.6677
Total	0.1146	1.1908	0.9678	2.1400e-003	0.3827	0.0491	0.4319	0.1331	0.0452	0.1783	0.0000	188.1465	188.1465	0.0609	0.0000	189.6677

Lemoore 54 - Unmitigated Construction - Kings County, Annual

EMFAC Off-Model Adjustment Factors for Gasoline Light Duty Vehicle to Account for the SAFE Vehicle Rule Not Applied

3.3 Grading - 2023

Unmitigated Construction Off-Site

	ROG	NOx	CO	SO2	Fugitive PM10	Exhaust PM10	PM10 Total	Fugitive PM2.5	Exhaust PM2.5	PM2.5 Total	Bio- CO2	NBio- CO2	Total CO2	CH4	N2O	CO2e
Category	tons/yr										MT/yr					
Hauling	0.0119	0.6894	0.1504	3.2500e-003	0.0961	6.7300e-003	0.1029	0.0264	6.4400e-003	0.0329	0.0000	312.4228	312.4228	8.2000e-004	0.0491	327.0768
Vendor	0.0000	0.0000	0.0000	0.0000	0.0000	0.0000	0.0000	0.0000	0.0000	0.0000	0.0000	0.0000	0.0000	0.0000	0.0000	0.0000
Worker	2.0900e-003	1.4300e-003	0.0171	5.0000e-005	5.5400e-003	3.0000e-005	5.5700e-003	1.4700e-003	3.0000e-005	1.5000e-003	0.0000	4.3609	4.3609	1.3000e-004	1.3000e-004	4.4023
Total	0.0140	0.6908	0.1675	3.3000e-003	0.1017	6.7600e-003	0.1084	0.0279	6.4700e-003	0.0344	0.0000	316.7837	316.7837	9.5000e-004	0.0492	331.4791

Mitigated Construction On-Site

	ROG	NOx	CO	SO2	Fugitive PM10	Exhaust PM10	PM10 Total	Fugitive PM2.5	Exhaust PM2.5	PM2.5 Total	Bio- CO2	NBio- CO2	Total CO2	CH4	N2O	CO2e
Category	tons/yr										MT/yr					
Fugitive Dust					0.1722	0.0000	0.1722	0.0599	0.0000	0.0599	0.0000	0.0000	0.0000	0.0000	0.0000	0.0000
Off-Road	0.1146	1.1908	0.9678	2.1400e-003		0.0491	0.0491		0.0452	0.0452	0.0000	188.1463	188.1463	0.0609	0.0000	189.6675
Total	0.1146	1.1908	0.9678	2.1400e-003	0.1722	0.0491	0.2214	0.0599	0.0452	0.1051	0.0000	188.1463	188.1463	0.0609	0.0000	189.6675

Lemoore 54 - Unmitigated Construction - Kings County, Annual

EMFAC Off-Model Adjustment Factors for Gasoline Light Duty Vehicle to Account for the SAFE Vehicle Rule Not Applied

3.3 Grading - 2023

Mitigated Construction Off-Site

	ROG	NOx	CO	SO2	Fugitive PM10	Exhaust PM10	PM10 Total	Fugitive PM2.5	Exhaust PM2.5	PM2.5 Total	Bio- CO2	NBio- CO2	Total CO2	CH4	N2O	CO2e
Category	tons/yr										MT/yr					
Hauling	0.0119	0.6894	0.1504	3.2500e-003	0.0961	6.7300e-003	0.1029	0.0264	6.4400e-003	0.0329	0.0000	312.4228	312.4228	8.2000e-004	0.0491	327.0768
Vendor	0.0000	0.0000	0.0000	0.0000	0.0000	0.0000	0.0000	0.0000	0.0000	0.0000	0.0000	0.0000	0.0000	0.0000	0.0000	0.0000
Worker	2.0900e-003	1.4300e-003	0.0171	5.0000e-005	5.5400e-003	3.0000e-005	5.5700e-003	1.4700e-003	3.0000e-005	1.5000e-003	0.0000	4.3609	4.3609	1.3000e-004	1.3000e-004	4.4023
Total	0.0140	0.6908	0.1675	3.3000e-003	0.1017	6.7600e-003	0.1084	0.0279	6.4700e-003	0.0344	0.0000	316.7837	316.7837	9.5000e-004	0.0492	331.4791

3.3 Grading - 2024

Unmitigated Construction On-Site

	ROG	NOx	CO	SO2	Fugitive PM10	Exhaust PM10	PM10 Total	Fugitive PM2.5	Exhaust PM2.5	PM2.5 Total	Bio- CO2	NBio- CO2	Total CO2	CH4	N2O	CO2e
Category	tons/yr										MT/yr					
Fugitive Dust					0.2984	0.0000	0.2984	0.0868	0.0000	0.0868	0.0000	0.0000	0.0000	0.0000	0.0000	0.0000
Off-Road	0.0660	0.6637	0.5683	1.2700e-003		0.0274	0.0274		0.0252	0.0252	0.0000	111.7650	111.7650	0.0362	0.0000	112.6687
Total	0.0660	0.6637	0.5683	1.2700e-003	0.2984	0.0274	0.3258	0.0868	0.0252	0.1119	0.0000	111.7650	111.7650	0.0362	0.0000	112.6687

Lemoore 54 - Unmitigated Construction - Kings County, Annual

EMFAC Off-Model Adjustment Factors for Gasoline Light Duty Vehicle to Account for the SAFE Vehicle Rule Not Applied

3.3 Grading - 2024

Unmitigated Construction Off-Site

	ROG	NOx	CO	SO2	Fugitive PM10	Exhaust PM10	PM10 Total	Fugitive PM2.5	Exhaust PM2.5	PM2.5 Total	Bio- CO2	NBio- CO2	Total CO2	CH4	N2O	CO2e
Category	tons/yr										MT/yr					
Hauling	7.0600e-003	0.4091	0.0890	1.9000e-003	0.0571	4.0300e-003	0.0612	0.0157	3.8600e-003	0.0196	0.0000	182.2574	182.2574	4.8000e-004	0.0287	190.8062
Vendor	0.0000	0.0000	0.0000	0.0000	0.0000	0.0000	0.0000	0.0000	0.0000	0.0000	0.0000	0.0000	0.0000	0.0000	0.0000	0.0000
Worker	1.1400e-003	7.5000e-004	9.3600e-003	3.0000e-005	3.2900e-003	2.0000e-005	3.3100e-003	8.8000e-004	1.0000e-005	8.9000e-004	0.0000	2.5087	2.5087	7.0000e-005	7.0000e-005	2.5314
Total	8.2000e-003	0.4098	0.0983	1.9300e-003	0.0604	4.0500e-003	0.0645	0.0166	3.8700e-003	0.0205	0.0000	184.7660	184.7660	5.5000e-004	0.0287	193.3376

Mitigated Construction On-Site

	ROG	NOx	CO	SO2	Fugitive PM10	Exhaust PM10	PM10 Total	Fugitive PM2.5	Exhaust PM2.5	PM2.5 Total	Bio- CO2	NBio- CO2	Total CO2	CH4	N2O	CO2e
Category	tons/yr										MT/yr					
Fugitive Dust					0.1343	0.0000	0.1343	0.0390	0.0000	0.0390	0.0000	0.0000	0.0000	0.0000	0.0000	0.0000
Off-Road	0.0660	0.6637	0.5683	1.2700e-003		0.0274	0.0274		0.0252	0.0252	0.0000	111.7649	111.7649	0.0362	0.0000	112.6686
Total	0.0660	0.6637	0.5683	1.2700e-003	0.1343	0.0274	0.1617	0.0390	0.0252	0.0642	0.0000	111.7649	111.7649	0.0362	0.0000	112.6686

Lemoore 54 - Unmitigated Construction - Kings County, Annual

EMFAC Off-Model Adjustment Factors for Gasoline Light Duty Vehicle to Account for the SAFE Vehicle Rule Not Applied

3.3 Grading - 2024

Mitigated Construction Off-Site

	ROG	NOx	CO	SO2	Fugitive PM10	Exhaust PM10	PM10 Total	Fugitive PM2.5	Exhaust PM2.5	PM2.5 Total	Bio- CO2	NBio- CO2	Total CO2	CH4	N2O	CO2e
Category	tons/yr										MT/yr					
Hauling	7.0600e-003	0.4091	0.0890	1.9000e-003	0.0571	4.0300e-003	0.0612	0.0157	3.8600e-003	0.0196	0.0000	182.2574	182.2574	4.8000e-004	0.0287	190.8062
Vendor	0.0000	0.0000	0.0000	0.0000	0.0000	0.0000	0.0000	0.0000	0.0000	0.0000	0.0000	0.0000	0.0000	0.0000	0.0000	0.0000
Worker	1.1400e-003	7.5000e-004	9.3600e-003	3.0000e-005	3.2900e-003	2.0000e-005	3.3100e-003	8.8000e-004	1.0000e-005	8.9000e-004	0.0000	2.5087	2.5087	7.0000e-005	7.0000e-005	2.5314
Total	8.2000e-003	0.4098	0.0983	1.9300e-003	0.0604	4.0500e-003	0.0645	0.0166	3.8700e-003	0.0205	0.0000	184.7660	184.7660	5.5000e-004	0.0287	193.3376

3.4 Paving - 2024

Unmitigated Construction On-Site

	ROG	NOx	CO	SO2	Fugitive PM10	Exhaust PM10	PM10 Total	Fugitive PM2.5	Exhaust PM2.5	PM2.5 Total	Bio- CO2	NBio- CO2	Total CO2	CH4	N2O	CO2e
Category	tons/yr										MT/yr					
Off-Road	0.0371	0.3572	0.5485	8.6000e-004		0.0176	0.0176		0.0162	0.0162	0.0000	75.0995	75.0995	0.0243	0.0000	75.7067
Paving	0.0000					0.0000	0.0000		0.0000	0.0000	0.0000	0.0000	0.0000	0.0000	0.0000	0.0000
Total	0.0371	0.3572	0.5485	8.6000e-004		0.0176	0.0176		0.0162	0.0162	0.0000	75.0995	75.0995	0.0243	0.0000	75.7067

Lemoore 54 - Unmitigated Construction - Kings County, Annual

EMFAC Off-Model Adjustment Factors for Gasoline Light Duty Vehicle to Account for the SAFE Vehicle Rule Not Applied

3.4 Paving - 2024

Unmitigated Construction Off-Site

	ROG	NOx	CO	SO2	Fugitive PM10	Exhaust PM10	PM10 Total	Fugitive PM2.5	Exhaust PM2.5	PM2.5 Total	Bio- CO2	NBio- CO2	Total CO2	CH4	N2O	CO2e
Category	tons/yr										MT/yr					
Hauling	1.0000e-005	7.4000e-004	1.6000e-004	0.0000	1.0000e-004	1.0000e-005	1.1000e-004	3.0000e-005	1.0000e-005	4.0000e-005	0.0000	0.3294	0.3294	0.0000	5.0000e-005	0.3448
Vendor	0.0000	0.0000	0.0000	0.0000	0.0000	0.0000	0.0000	0.0000	0.0000	0.0000	0.0000	0.0000	0.0000	0.0000	0.0000	0.0000
Worker	1.5700e-003	1.0300e-003	0.0128	4.0000e-005	4.5200e-003	2.0000e-005	4.5400e-003	1.2000e-003	2.0000e-005	1.2200e-003	0.0000	3.4418	3.4418	1.0000e-004	1.0000e-004	3.4729
Total	1.5800e-003	1.7700e-003	0.0130	4.0000e-005	4.6200e-003	3.0000e-005	4.6500e-003	1.2300e-003	3.0000e-005	1.2600e-003	0.0000	3.7711	3.7711	1.0000e-004	1.5000e-004	3.8177

Mitigated Construction On-Site

	ROG	NOx	CO	SO2	Fugitive PM10	Exhaust PM10	PM10 Total	Fugitive PM2.5	Exhaust PM2.5	PM2.5 Total	Bio- CO2	NBio- CO2	Total CO2	CH4	N2O	CO2e
Category	tons/yr										MT/yr					
Off-Road	0.0371	0.3572	0.5485	8.6000e-004		0.0176	0.0176		0.0162	0.0162	0.0000	75.0994	75.0994	0.0243	0.0000	75.7066
Paving	0.0000					0.0000	0.0000		0.0000	0.0000	0.0000	0.0000	0.0000	0.0000	0.0000	0.0000
Total	0.0371	0.3572	0.5485	8.6000e-004		0.0176	0.0176		0.0162	0.0162	0.0000	75.0994	75.0994	0.0243	0.0000	75.7066

Lemoore 54 - Unmitigated Construction - Kings County, Annual

EMFAC Off-Model Adjustment Factors for Gasoline Light Duty Vehicle to Account for the SAFE Vehicle Rule Not Applied

3.4 Paving - 2024

Mitigated Construction Off-Site

	ROG	NOx	CO	SO2	Fugitive PM10	Exhaust PM10	PM10 Total	Fugitive PM2.5	Exhaust PM2.5	PM2.5 Total	Bio- CO2	NBio- CO2	Total CO2	CH4	N2O	CO2e
Category	tons/yr										MT/yr					
Hauling	1.0000e-005	7.4000e-004	1.6000e-004	0.0000	1.0000e-004	1.0000e-005	1.1000e-004	3.0000e-005	1.0000e-005	4.0000e-005	0.0000	0.3294	0.3294	0.0000	5.0000e-005	0.3448
Vendor	0.0000	0.0000	0.0000	0.0000	0.0000	0.0000	0.0000	0.0000	0.0000	0.0000	0.0000	0.0000	0.0000	0.0000	0.0000	0.0000
Worker	1.5700e-003	1.0300e-003	0.0128	4.0000e-005	4.5200e-003	2.0000e-005	4.5400e-003	1.2000e-003	2.0000e-005	1.2200e-003	0.0000	3.4418	3.4418	1.0000e-004	1.0000e-004	3.4729
Total	1.5800e-003	1.7700e-003	0.0130	4.0000e-005	4.6200e-003	3.0000e-005	4.6500e-003	1.2300e-003	3.0000e-005	1.2600e-003	0.0000	3.7711	3.7711	1.0000e-004	1.5000e-004	3.8177

3.5 Building Construction - 2024

Unmitigated Construction On-Site

	ROG	NOx	CO	SO2	Fugitive PM10	Exhaust PM10	PM10 Total	Fugitive PM2.5	Exhaust PM2.5	PM2.5 Total	Bio- CO2	NBio- CO2	Total CO2	CH4	N2O	CO2e
Category	tons/yr										MT/yr					
Off-Road	0.0910	0.8306	0.9993	1.6700e-003		0.0379	0.0379		0.0357	0.0357	0.0000	143.2564	143.2564	0.0338	0.0000	144.1020
Total	0.0910	0.8306	0.9993	1.6700e-003		0.0379	0.0379		0.0357	0.0357	0.0000	143.2564	143.2564	0.0338	0.0000	144.1020

Lemoore 54 - Unmitigated Construction - Kings County, Annual

EMFAC Off-Model Adjustment Factors for Gasoline Light Duty Vehicle to Account for the SAFE Vehicle Rule Not Applied

3.5 Building Construction - 2024

Unmitigated Construction Off-Site

	ROG	NOx	CO	SO2	Fugitive PM10	Exhaust PM10	PM10 Total	Fugitive PM2.5	Exhaust PM2.5	PM2.5 Total	Bio- CO2	NBio- CO2	Total CO2	CH4	N2O	CO2e
Category	tons/yr										MT/yr					
Hauling	0.0000	1.2000e-004	3.0000e-005	0.0000	2.0000e-005	0.0000	2.0000e-005	0.0000	0.0000	1.0000e-005	0.0000	0.0551	0.0551	0.0000	1.0000e-005	0.0577
Vendor	4.6100e-003	0.1733	0.0556	7.9000e-004	0.0258	1.1500e-003	0.0269	7.4400e-003	1.1000e-003	8.5400e-003	0.0000	75.5490	75.5490	2.8000e-004	0.0109	78.8045
Worker	0.0324	0.0212	0.2650	7.7000e-004	0.0933	4.5000e-004	0.0937	0.0248	4.2000e-004	0.0252	0.0000	71.0194	71.0194	2.0400e-003	1.9900e-003	71.6618
Total	0.0370	0.1947	0.3207	1.5600e-003	0.1190	1.6000e-003	0.1206	0.0322	1.5200e-003	0.0337	0.0000	146.6234	146.6234	2.3200e-003	0.0129	150.5240

Mitigated Construction On-Site

	ROG	NOx	CO	SO2	Fugitive PM10	Exhaust PM10	PM10 Total	Fugitive PM2.5	Exhaust PM2.5	PM2.5 Total	Bio- CO2	NBio- CO2	Total CO2	CH4	N2O	CO2e
Category	tons/yr										MT/yr					
Off-Road	0.0910	0.8306	0.9993	1.6700e-003		0.0379	0.0379		0.0357	0.0357	0.0000	143.2562	143.2562	0.0338	0.0000	144.1018
Total	0.0910	0.8306	0.9993	1.6700e-003		0.0379	0.0379		0.0357	0.0357	0.0000	143.2562	143.2562	0.0338	0.0000	144.1018

Lemoore 54 - Unmitigated Construction - Kings County, Annual

EMFAC Off-Model Adjustment Factors for Gasoline Light Duty Vehicle to Account for the SAFE Vehicle Rule Not Applied

3.5 Building Construction - 2024

Mitigated Construction Off-Site

	ROG	NOx	CO	SO2	Fugitive PM10	Exhaust PM10	PM10 Total	Fugitive PM2.5	Exhaust PM2.5	PM2.5 Total	Bio- CO2	NBio- CO2	Total CO2	CH4	N2O	CO2e
Category	tons/yr										MT/yr					
Hauling	0.0000	1.2000e-004	3.0000e-005	0.0000	2.0000e-005	0.0000	2.0000e-005	0.0000	0.0000	1.0000e-005	0.0000	0.0551	0.0551	0.0000	1.0000e-005	0.0577
Vendor	4.6100e-003	0.1733	0.0556	7.9000e-004	0.0258	1.1500e-003	0.0269	7.4400e-003	1.1000e-003	8.5400e-003	0.0000	75.5490	75.5490	2.8000e-004	0.0109	78.8045
Worker	0.0324	0.0212	0.2650	7.7000e-004	0.0933	4.5000e-004	0.0937	0.0248	4.2000e-004	0.0252	0.0000	71.0194	71.0194	2.0400e-003	1.9900e-003	71.6618
Total	0.0370	0.1947	0.3207	1.5600e-003	0.1190	1.6000e-003	0.1206	0.0322	1.5200e-003	0.0337	0.0000	146.6234	146.6234	2.3200e-003	0.0129	150.5240

3.5 Building Construction - 2025

Unmitigated Construction On-Site

	ROG	NOx	CO	SO2	Fugitive PM10	Exhaust PM10	PM10 Total	Fugitive PM2.5	Exhaust PM2.5	PM2.5 Total	Bio- CO2	NBio- CO2	Total CO2	CH4	N2O	CO2e
Category	tons/yr										MT/yr					
Off-Road	0.1511	1.3774	1.7773	2.9800e-003		0.0583	0.0583		0.0548	0.0548	0.0000	256.1727	256.1727	0.0601	0.0000	257.6757
Total	0.1511	1.3774	1.7773	2.9800e-003		0.0583	0.0583		0.0548	0.0548	0.0000	256.1727	256.1727	0.0601	0.0000	257.6757

Lemoore 54 - Unmitigated Construction - Kings County, Annual

EMFAC Off-Model Adjustment Factors for Gasoline Light Duty Vehicle to Account for the SAFE Vehicle Rule Not Applied

3.5 Building Construction - 2025

Unmitigated Construction Off-Site

	ROG	NOx	CO	SO2	Fugitive PM10	Exhaust PM10	PM10 Total	Fugitive PM2.5	Exhaust PM2.5	PM2.5 Total	Bio- CO2	NBio- CO2	Total CO2	CH4	N2O	CO2e
Category	tons/yr										MT/yr					
Hauling	0.0000	2.2000e-004	5.0000e-005	0.0000	3.0000e-005	0.0000	3.0000e-005	1.0000e-005	0.0000	1.0000e-005	0.0000	0.0963	0.0963	0.0000	2.0000e-005	0.1009
Vendor	8.0500e-003	0.3084	0.0971	1.3900e-003	0.0461	2.0500e-003	0.0481	0.0133	1.9600e-003	0.0153	0.0000	132.8093	132.8093	4.8000e-004	0.0191	138.5140
Worker	0.0538	0.0338	0.4399	1.3400e-003	0.1667	7.7000e-004	0.1675	0.0443	7.0000e-004	0.0450	0.0000	122.6843	122.6843	3.2800e-003	3.3000e-003	123.7507
Total	0.0618	0.3424	0.5371	2.7300e-003	0.2128	2.8200e-003	0.2156	0.0576	2.6600e-003	0.0603	0.0000	255.5899	255.5899	3.7600e-003	0.0224	262.3655

Mitigated Construction On-Site

	ROG	NOx	CO	SO2	Fugitive PM10	Exhaust PM10	PM10 Total	Fugitive PM2.5	Exhaust PM2.5	PM2.5 Total	Bio- CO2	NBio- CO2	Total CO2	CH4	N2O	CO2e
Category	tons/yr										MT/yr					
Off-Road	0.1511	1.3774	1.7773	2.9800e-003		0.0583	0.0583		0.0548	0.0548	0.0000	256.1724	256.1724	0.0601	0.0000	257.6754
Total	0.1511	1.3774	1.7773	2.9800e-003		0.0583	0.0583		0.0548	0.0548	0.0000	256.1724	256.1724	0.0601	0.0000	257.6754

Lemoore 54 - Unmitigated Construction - Kings County, Annual

EMFAC Off-Model Adjustment Factors for Gasoline Light Duty Vehicle to Account for the SAFE Vehicle Rule Not Applied

3.5 Building Construction - 2025

Mitigated Construction Off-Site

	ROG	NOx	CO	SO2	Fugitive PM10	Exhaust PM10	PM10 Total	Fugitive PM2.5	Exhaust PM2.5	PM2.5 Total	Bio- CO2	NBio- CO2	Total CO2	CH4	N2O	CO2e
Category	tons/yr										MT/yr					
Hauling	0.0000	2.2000e-004	5.0000e-005	0.0000	3.0000e-005	0.0000	3.0000e-005	1.0000e-005	0.0000	1.0000e-005	0.0000	0.0963	0.0963	0.0000	2.0000e-005	0.1009
Vendor	8.0500e-003	0.3084	0.0971	1.3900e-003	0.0461	2.0500e-003	0.0481	0.0133	1.9600e-003	0.0153	0.0000	132.8093	132.8093	4.8000e-004	0.0191	138.5140
Worker	0.0538	0.0338	0.4399	1.3400e-003	0.1667	7.7000e-004	0.1675	0.0443	7.0000e-004	0.0450	0.0000	122.6843	122.6843	3.2800e-003	3.3000e-003	123.7507
Total	0.0618	0.3424	0.5371	2.7300e-003	0.2128	2.8200e-003	0.2156	0.0576	2.6600e-003	0.0603	0.0000	255.5899	255.5899	3.7600e-003	0.0224	262.3655

3.5 Building Construction - 2026

Unmitigated Construction On-Site

	ROG	NOx	CO	SO2	Fugitive PM10	Exhaust PM10	PM10 Total	Fugitive PM2.5	Exhaust PM2.5	PM2.5 Total	Bio- CO2	NBio- CO2	Total CO2	CH4	N2O	CO2e
Category	tons/yr										MT/yr					
Off-Road	0.1511	1.3774	1.7773	2.9800e-003		0.0583	0.0583		0.0548	0.0548	0.0000	256.1727	256.1727	0.0601	0.0000	257.6757
Total	0.1511	1.3774	1.7773	2.9800e-003		0.0583	0.0583		0.0548	0.0548	0.0000	256.1727	256.1727	0.0601	0.0000	257.6757

Lemoore 54 - Unmitigated Construction - Kings County, Annual

EMFAC Off-Model Adjustment Factors for Gasoline Light Duty Vehicle to Account for the SAFE Vehicle Rule Not Applied

3.5 Building Construction - 2026

Unmitigated Construction Off-Site

	ROG	NOx	CO	SO2	Fugitive PM10	Exhaust PM10	PM10 Total	Fugitive PM2.5	Exhaust PM2.5	PM2.5 Total	Bio- CO2	NBio- CO2	Total CO2	CH4	N2O	CO2e
Category	tons/yr										MT/yr					
Hauling	0.0000	2.2000e-004	5.0000e-005	0.0000	3.0000e-005	0.0000	3.0000e-005	1.0000e-005	0.0000	1.0000e-005	0.0000	0.0942	0.0942	0.0000	1.0000e-005	0.0986
Vendor	7.9000e-003	0.3064	0.0952	1.3700e-003	0.0461	2.0400e-003	0.0481	0.0133	1.9500e-003	0.0153	0.0000	130.5442	130.5442	4.7000e-004	0.0187	136.1325
Worker	0.0503	0.0305	0.4165	1.3000e-003	0.1667	7.4000e-004	0.1674	0.0443	6.8000e-004	0.0450	0.0000	119.3103	119.3103	3.0000e-003	3.1100e-003	120.3111
Total	0.0582	0.3371	0.5118	2.6700e-003	0.2128	2.7800e-003	0.2156	0.0576	2.6300e-003	0.0602	0.0000	249.9486	249.9486	3.4700e-003	0.0218	256.5421

Mitigated Construction On-Site

	ROG	NOx	CO	SO2	Fugitive PM10	Exhaust PM10	PM10 Total	Fugitive PM2.5	Exhaust PM2.5	PM2.5 Total	Bio- CO2	NBio- CO2	Total CO2	CH4	N2O	CO2e
Category	tons/yr										MT/yr					
Off-Road	0.1511	1.3774	1.7773	2.9800e-003		0.0583	0.0583		0.0548	0.0548	0.0000	256.1724	256.1724	0.0601	0.0000	257.6754
Total	0.1511	1.3774	1.7773	2.9800e-003		0.0583	0.0583		0.0548	0.0548	0.0000	256.1724	256.1724	0.0601	0.0000	257.6754

Lemoore 54 - Unmitigated Construction - Kings County, Annual

EMFAC Off-Model Adjustment Factors for Gasoline Light Duty Vehicle to Account for the SAFE Vehicle Rule Not Applied

3.5 Building Construction - 2026

Mitigated Construction Off-Site

	ROG	NOx	CO	SO2	Fugitive PM10	Exhaust PM10	PM10 Total	Fugitive PM2.5	Exhaust PM2.5	PM2.5 Total	Bio- CO2	NBio- CO2	Total CO2	CH4	N2O	CO2e
Category	tons/yr										MT/yr					
Hauling	0.0000	2.2000e-004	5.0000e-005	0.0000	3.0000e-005	0.0000	3.0000e-005	1.0000e-005	0.0000	1.0000e-005	0.0000	0.0942	0.0942	0.0000	1.0000e-005	0.0986
Vendor	7.9000e-003	0.3064	0.0952	1.3700e-003	0.0461	2.0400e-003	0.0481	0.0133	1.9500e-003	0.0153	0.0000	130.5442	130.5442	4.7000e-004	0.0187	136.1325
Worker	0.0503	0.0305	0.4165	1.3000e-003	0.1667	7.4000e-004	0.1674	0.0443	6.8000e-004	0.0450	0.0000	119.3103	119.3103	3.0000e-003	3.1100e-003	120.3111
Total	0.0582	0.3371	0.5118	2.6700e-003	0.2128	2.7800e-003	0.2156	0.0576	2.6300e-003	0.0602	0.0000	249.9486	249.9486	3.4700e-003	0.0218	256.5421

3.5 Building Construction - 2027

Unmitigated Construction On-Site

	ROG	NOx	CO	SO2	Fugitive PM10	Exhaust PM10	PM10 Total	Fugitive PM2.5	Exhaust PM2.5	PM2.5 Total	Bio- CO2	NBio- CO2	Total CO2	CH4	N2O	CO2e
Category	tons/yr										MT/yr					
Off-Road	0.1511	1.3774	1.7773	2.9800e-003		0.0583	0.0583		0.0548	0.0548	0.0000	256.1727	256.1727	0.0601	0.0000	257.6757
Total	0.1511	1.3774	1.7773	2.9800e-003		0.0583	0.0583		0.0548	0.0548	0.0000	256.1727	256.1727	0.0601	0.0000	257.6757

Lemoore 54 - Unmitigated Construction - Kings County, Annual

EMFAC Off-Model Adjustment Factors for Gasoline Light Duty Vehicle to Account for the SAFE Vehicle Rule Not Applied

3.5 Building Construction - 2027

Unmitigated Construction Off-Site

	ROG	NOx	CO	SO2	Fugitive PM10	Exhaust PM10	PM10 Total	Fugitive PM2.5	Exhaust PM2.5	PM2.5 Total	Bio- CO2	NBio- CO2	Total CO2	CH4	N2O	CO2e
Category	tons/yr										MT/yr					
Hauling	0.0000	2.2000e-004	5.0000e-005	0.0000	3.0000e-005	0.0000	3.0000e-005	1.0000e-005	0.0000	1.0000e-005	0.0000	0.0919	0.0919	0.0000	1.0000e-005	0.0962
Vendor	7.7600e-003	0.3041	0.0937	1.3400e-003	0.0461	2.0200e-003	0.0481	0.0133	1.9300e-003	0.0152	0.0000	128.0860	128.0860	4.6000e-004	0.0183	133.5529
Worker	0.0471	0.0277	0.3920	1.2600e-003	0.1667	7.0000e-004	0.1674	0.0443	6.4000e-004	0.0449	0.0000	115.8472	115.8472	2.7400e-003	2.9400e-003	116.7911
Total	0.0548	0.3320	0.4858	2.6000e-003	0.2128	2.7200e-003	0.2155	0.0576	2.5700e-003	0.0602	0.0000	244.0250	244.0250	3.2000e-003	0.0213	250.4402

Mitigated Construction On-Site

	ROG	NOx	CO	SO2	Fugitive PM10	Exhaust PM10	PM10 Total	Fugitive PM2.5	Exhaust PM2.5	PM2.5 Total	Bio- CO2	NBio- CO2	Total CO2	CH4	N2O	CO2e
Category	tons/yr										MT/yr					
Off-Road	0.1511	1.3774	1.7773	2.9800e-003		0.0583	0.0583		0.0548	0.0548	0.0000	256.1724	256.1724	0.0601	0.0000	257.6754
Total	0.1511	1.3774	1.7773	2.9800e-003		0.0583	0.0583		0.0548	0.0548	0.0000	256.1724	256.1724	0.0601	0.0000	257.6754

Lemoore 54 - Unmitigated Construction - Kings County, Annual

EMFAC Off-Model Adjustment Factors for Gasoline Light Duty Vehicle to Account for the SAFE Vehicle Rule Not Applied

3.5 Building Construction - 2027

Mitigated Construction Off-Site

	ROG	NOx	CO	SO2	Fugitive PM10	Exhaust PM10	PM10 Total	Fugitive PM2.5	Exhaust PM2.5	PM2.5 Total	Bio- CO2	NBio- CO2	Total CO2	CH4	N2O	CO2e
Category	tons/yr										MT/yr					
Hauling	0.0000	2.2000e-004	5.0000e-005	0.0000	3.0000e-005	0.0000	3.0000e-005	1.0000e-005	0.0000	1.0000e-005	0.0000	0.0919	0.0919	0.0000	1.0000e-005	0.0962
Vendor	7.7600e-003	0.3041	0.0937	1.3400e-003	0.0461	2.0200e-003	0.0481	0.0133	1.9300e-003	0.0152	0.0000	128.0860	128.0860	4.6000e-004	0.0183	133.5529
Worker	0.0471	0.0277	0.3920	1.2600e-003	0.1667	7.0000e-004	0.1674	0.0443	6.4000e-004	0.0449	0.0000	115.8472	115.8472	2.7400e-003	2.9400e-003	116.7911
Total	0.0548	0.3320	0.4858	2.6000e-003	0.2128	2.7200e-003	0.2155	0.0576	2.5700e-003	0.0602	0.0000	244.0250	244.0250	3.2000e-003	0.0213	250.4402

3.5 Building Construction - 2028

Unmitigated Construction On-Site

	ROG	NOx	CO	SO2	Fugitive PM10	Exhaust PM10	PM10 Total	Fugitive PM2.5	Exhaust PM2.5	PM2.5 Total	Bio- CO2	NBio- CO2	Total CO2	CH4	N2O	CO2e
Category	tons/yr										MT/yr					
Off-Road	0.1505	1.3721	1.7705	2.9700e-003		0.0581	0.0581		0.0546	0.0546	0.0000	255.1912	255.1912	0.0599	0.0000	256.6885
Total	0.1505	1.3721	1.7705	2.9700e-003		0.0581	0.0581		0.0546	0.0546	0.0000	255.1912	255.1912	0.0599	0.0000	256.6885

Lemoore 54 - Unmitigated Construction - Kings County, Annual

EMFAC Off-Model Adjustment Factors for Gasoline Light Duty Vehicle to Account for the SAFE Vehicle Rule Not Applied

3.5 Building Construction - 2028

Unmitigated Construction Off-Site

	ROG	NOx	CO	SO2	Fugitive PM10	Exhaust PM10	PM10 Total	Fugitive PM2.5	Exhaust PM2.5	PM2.5 Total	Bio- CO2	NBio- CO2	Total CO2	CH4	N2O	CO2e
Category	tons/yr										MT/yr					
Hauling	0.0000	2.1000e-004	5.0000e-005	0.0000	3.0000e-005	0.0000	3.0000e-005	1.0000e-005	0.0000	1.0000e-005	0.0000	0.0893	0.0893	0.0000	1.0000e-005	0.0935
Vendor	7.6300e-003	0.3012	0.0922	1.3100e-003	0.0459	2.0000e-003	0.0479	0.0133	1.9100e-003	0.0152	0.0000	125.2572	125.2572	4.5000e-004	0.0179	130.5880
Worker	0.0440	0.0253	0.3704	1.2200e-003	0.1661	6.5000e-004	0.1667	0.0441	6.0000e-004	0.0447	0.0000	112.3229	112.3229	2.5000e-003	2.7900e-003	113.2161
Total	0.0516	0.3267	0.4627	2.5300e-003	0.2120	2.6500e-003	0.2146	0.0574	2.5100e-003	0.0599	0.0000	237.6695	237.6695	2.9500e-003	0.0207	243.8976

Mitigated Construction On-Site

	ROG	NOx	CO	SO2	Fugitive PM10	Exhaust PM10	PM10 Total	Fugitive PM2.5	Exhaust PM2.5	PM2.5 Total	Bio- CO2	NBio- CO2	Total CO2	CH4	N2O	CO2e
Category	tons/yr										MT/yr					
Off-Road	0.1505	1.3721	1.7705	2.9700e-003		0.0581	0.0581		0.0546	0.0546	0.0000	255.1909	255.1909	0.0599	0.0000	256.6882
Total	0.1505	1.3721	1.7705	2.9700e-003		0.0581	0.0581		0.0546	0.0546	0.0000	255.1909	255.1909	0.0599	0.0000	256.6882

Lemoore 54 - Unmitigated Construction - Kings County, Annual

EMFAC Off-Model Adjustment Factors for Gasoline Light Duty Vehicle to Account for the SAFE Vehicle Rule Not Applied

3.5 Building Construction - 2028

Mitigated Construction Off-Site

	ROG	NOx	CO	SO2	Fugitive PM10	Exhaust PM10	PM10 Total	Fugitive PM2.5	Exhaust PM2.5	PM2.5 Total	Bio- CO2	NBio- CO2	Total CO2	CH4	N2O	CO2e
Category	tons/yr										MT/yr					
Hauling	0.0000	2.1000e-004	5.0000e-005	0.0000	3.0000e-005	0.0000	3.0000e-005	1.0000e-005	0.0000	1.0000e-005	0.0000	0.0893	0.0893	0.0000	1.0000e-005	0.0935
Vendor	7.6300e-003	0.3012	0.0922	1.3100e-003	0.0459	2.0000e-003	0.0479	0.0133	1.9100e-003	0.0152	0.0000	125.2572	125.2572	4.5000e-004	0.0179	130.5880
Worker	0.0440	0.0253	0.3704	1.2200e-003	0.1661	6.5000e-004	0.1667	0.0441	6.0000e-004	0.0447	0.0000	112.3229	112.3229	2.5000e-003	2.7900e-003	113.2161
Total	0.0516	0.3267	0.4627	2.5300e-003	0.2120	2.6500e-003	0.2146	0.0574	2.5100e-003	0.0599	0.0000	237.6695	237.6695	2.9500e-003	0.0207	243.8976

3.5 Building Construction - 2029

Unmitigated Construction On-Site

	ROG	NOx	CO	SO2	Fugitive PM10	Exhaust PM10	PM10 Total	Fugitive PM2.5	Exhaust PM2.5	PM2.5 Total	Bio- CO2	NBio- CO2	Total CO2	CH4	N2O	CO2e
Category	tons/yr										MT/yr					
Off-Road	0.0701	0.6385	0.8240	1.3800e-003		0.0270	0.0270		0.0254	0.0254	0.0000	118.7620	118.7620	0.0279	0.0000	119.4589
Total	0.0701	0.6385	0.8240	1.3800e-003		0.0270	0.0270		0.0254	0.0254	0.0000	118.7620	118.7620	0.0279	0.0000	119.4589

Lemoore 54 - Unmitigated Construction - Kings County, Annual

EMFAC Off-Model Adjustment Factors for Gasoline Light Duty Vehicle to Account for the SAFE Vehicle Rule Not Applied

3.5 Building Construction - 2029

Unmitigated Construction Off-Site

	ROG	NOx	CO	SO2	Fugitive PM10	Exhaust PM10	PM10 Total	Fugitive PM2.5	Exhaust PM2.5	PM2.5 Total	Bio- CO2	NBio- CO2	Total CO2	CH4	N2O	CO2e
Category	tons/yr										MT/yr					
Hauling	0.0000	1.0000e-004	2.0000e-005	0.0000	1.0000e-005	0.0000	2.0000e-005	0.0000	0.0000	0.0000	0.0000	0.0405	0.0405	0.0000	1.0000e-005	0.0424
Vendor	3.5000e-003	0.1393	0.0425	6.0000e-004	0.0214	9.2000e-004	0.0223	6.1700e-003	8.8000e-004	7.0500e-003	0.0000	57.2418	57.2418	2.0000e-004	8.1300e-003	59.6711
Worker	0.0192	0.0108	0.1643	5.6000e-004	0.0773	2.8000e-004	0.0776	0.0205	2.6000e-004	0.0208	0.0000	50.9929	50.9929	1.0700e-003	1.2400e-003	51.3901
Total	0.0227	0.1502	0.2067	1.1600e-003	0.0987	1.2000e-003	0.0999	0.0267	1.1400e-003	0.0278	0.0000	108.2753	108.2753	1.2700e-003	9.3800e-003	111.1036

Mitigated Construction On-Site

	ROG	NOx	CO	SO2	Fugitive PM10	Exhaust PM10	PM10 Total	Fugitive PM2.5	Exhaust PM2.5	PM2.5 Total	Bio- CO2	NBio- CO2	Total CO2	CH4	N2O	CO2e
Category	tons/yr										MT/yr					
Off-Road	0.0701	0.6385	0.8240	1.3800e-003		0.0270	0.0270		0.0254	0.0254	0.0000	118.7619	118.7619	0.0279	0.0000	119.4587
Total	0.0701	0.6385	0.8240	1.3800e-003		0.0270	0.0270		0.0254	0.0254	0.0000	118.7619	118.7619	0.0279	0.0000	119.4587

Lemoore 54 - Unmitigated Construction - Kings County, Annual

EMFAC Off-Model Adjustment Factors for Gasoline Light Duty Vehicle to Account for the SAFE Vehicle Rule Not Applied

3.5 Building Construction - 2029

Mitigated Construction Off-Site

	ROG	NOx	CO	SO2	Fugitive PM10	Exhaust PM10	PM10 Total	Fugitive PM2.5	Exhaust PM2.5	PM2.5 Total	Bio- CO2	NBio- CO2	Total CO2	CH4	N2O	CO2e
Category	tons/yr										MT/yr					
Hauling	0.0000	1.0000e-004	2.0000e-005	0.0000	1.0000e-005	0.0000	2.0000e-005	0.0000	0.0000	0.0000	0.0000	0.0405	0.0405	0.0000	1.0000e-005	0.0424
Vendor	3.5000e-003	0.1393	0.0425	6.0000e-004	0.0214	9.2000e-004	0.0223	6.1700e-003	8.8000e-004	7.0500e-003	0.0000	57.2418	57.2418	2.0000e-004	8.1300e-003	59.6711
Worker	0.0192	0.0108	0.1643	5.6000e-004	0.0773	2.8000e-004	0.0776	0.0205	2.6000e-004	0.0208	0.0000	50.9929	50.9929	1.0700e-003	1.2400e-003	51.3901
Total	0.0227	0.1502	0.2067	1.1600e-003	0.0987	1.2000e-003	0.0999	0.0267	1.1400e-003	0.0278	0.0000	108.2753	108.2753	1.2700e-003	9.3800e-003	111.1036

3.6 Architectural Coating - 2029

Unmitigated Construction On-Site

	ROG	NOx	CO	SO2	Fugitive PM10	Exhaust PM10	PM10 Total	Fugitive PM2.5	Exhaust PM2.5	PM2.5 Total	Bio- CO2	NBio- CO2	Total CO2	CH4	N2O	CO2e
Category	tons/yr										MT/yr					
Archit. Coating	1.5768					0.0000	0.0000		0.0000	0.0000	0.0000	0.0000	0.0000	0.0000	0.0000	0.0000
Off-Road	0.0128	0.0859	0.1357	2.2000e-004		3.8600e-003	3.8600e-003		3.8600e-003	3.8600e-003	0.0000	19.1494	19.1494	1.0400e-003	0.0000	19.1755
Total	1.5897	0.0859	0.1357	2.2000e-004		3.8600e-003	3.8600e-003		3.8600e-003	3.8600e-003	0.0000	19.1494	19.1494	1.0400e-003	0.0000	19.1755

Lemoore 54 - Unmitigated Construction - Kings County, Annual

EMFAC Off-Model Adjustment Factors for Gasoline Light Duty Vehicle to Account for the SAFE Vehicle Rule Not Applied

3.6 Architectural Coating - 2029

Unmitigated Construction Off-Site

	ROG	NOx	CO	SO2	Fugitive PM10	Exhaust PM10	PM10 Total	Fugitive PM2.5	Exhaust PM2.5	PM2.5 Total	Bio- CO2	NBio- CO2	Total CO2	CH4	N2O	CO2e
Category	tons/yr										MT/yr					
Hauling	0.0000	1.2000e-004	3.0000e-005	0.0000	2.0000e-005	0.0000	2.0000e-005	0.0000	0.0000	1.0000e-005	0.0000	0.0488	0.0488	0.0000	1.0000e-005	0.0510
Vendor	0.0000	0.0000	0.0000	0.0000	0.0000	0.0000	0.0000	0.0000	0.0000	0.0000	0.0000	0.0000	0.0000	0.0000	0.0000	0.0000
Worker	4.7900e-003	2.7000e-003	0.0410	1.4000e-004	0.0193	7.0000e-005	0.0194	5.1200e-003	6.0000e-005	5.1900e-003	0.0000	12.7224	12.7224	2.7000e-004	3.1000e-004	12.8215
Total	4.7900e-003	2.8200e-003	0.0410	1.4000e-004	0.0193	7.0000e-005	0.0194	5.1200e-003	6.0000e-005	5.2000e-003	0.0000	12.7711	12.7711	2.7000e-004	3.2000e-004	12.8725

Mitigated Construction On-Site

	ROG	NOx	CO	SO2	Fugitive PM10	Exhaust PM10	PM10 Total	Fugitive PM2.5	Exhaust PM2.5	PM2.5 Total	Bio- CO2	NBio- CO2	Total CO2	CH4	N2O	CO2e
Category	tons/yr										MT/yr					
Archit. Coating	1.5768					0.0000	0.0000		0.0000	0.0000	0.0000	0.0000	0.0000	0.0000	0.0000	0.0000
Off-Road	0.0128	0.0859	0.1357	2.2000e-004		3.8600e-003	3.8600e-003		3.8600e-003	3.8600e-003	0.0000	19.1494	19.1494	1.0400e-003	0.0000	19.1755
Total	1.5897	0.0859	0.1357	2.2000e-004		3.8600e-003	3.8600e-003		3.8600e-003	3.8600e-003	0.0000	19.1494	19.1494	1.0400e-003	0.0000	19.1755

Lemoore 54 - Unmitigated Construction - Kings County, Annual

EMFAC Off-Model Adjustment Factors for Gasoline Light Duty Vehicle to Account for the SAFE Vehicle Rule Not Applied

3.6 Architectural Coating - 2029

Mitigated Construction Off-Site

	ROG	NOx	CO	SO2	Fugitive PM10	Exhaust PM10	PM10 Total	Fugitive PM2.5	Exhaust PM2.5	PM2.5 Total	Bio- CO2	NBio- CO2	Total CO2	CH4	N2O	CO2e
Category	tons/yr										MT/yr					
Hauling	0.0000	1.2000e-004	3.0000e-005	0.0000	2.0000e-005	0.0000	2.0000e-005	0.0000	0.0000	1.0000e-005	0.0000	0.0488	0.0488	0.0000	1.0000e-005	0.0510
Vendor	0.0000	0.0000	0.0000	0.0000	0.0000	0.0000	0.0000	0.0000	0.0000	0.0000	0.0000	0.0000	0.0000	0.0000	0.0000	0.0000
Worker	4.7900e-003	2.7000e-003	0.0410	1.4000e-004	0.0193	7.0000e-005	0.0194	5.1200e-003	6.0000e-005	5.1900e-003	0.0000	12.7224	12.7224	2.7000e-004	3.1000e-004	12.8215
Total	4.7900e-003	2.8200e-003	0.0410	1.4000e-004	0.0193	7.0000e-005	0.0194	5.1200e-003	6.0000e-005	5.2000e-003	0.0000	12.7711	12.7711	2.7000e-004	3.2000e-004	12.8725

4.0 Operational Detail - Mobile

4.1 Mitigation Measures Mobile

Lemoore 54 - Unmitigated Construction - Kings County, Annual

EMFAC Off-Model Adjustment Factors for Gasoline Light Duty Vehicle to Account for the SAFE Vehicle Rule Not Applied

	ROG	NOx	CO	SO2	Fugitive PM10	Exhaust PM10	PM10 Total	Fugitive PM2.5	Exhaust PM2.5	PM2.5 Total	Bio- CO2	NBio- CO2	Total CO2	CH4	N2O	CO2e
Category	tons/yr										MT/yr					
Mitigated	0.0000	0.0000	0.0000	0.0000	0.0000	0.0000	0.0000	0.0000	0.0000	0.0000	0.0000	0.0000	0.0000	0.0000	0.0000	0.0000
Unmitigated	0.0000	0.0000	0.0000	0.0000	0.0000	0.0000	0.0000	0.0000	0.0000	0.0000	0.0000	0.0000	0.0000	0.0000	0.0000	0.0000

4.2 Trip Summary Information

Land Use	Average Daily Trip Rate			Unmitigated	Mitigated
	Weekday	Saturday	Sunday	Annual VMT	Annual VMT
City Park	0.00	0.00	0.00		
Single Family Housing	0.00	0.00	0.00		
Total	0.00	0.00	0.00		

4.3 Trip Type Information

Land Use	Miles			Trip %			Trip Purpose %		
	H-W or C-W	H-S or C-C	H-O or C-NW	H-W or C-W	H-S or C-C	H-O or C-NW	Primary	Diverted	Pass-by
City Park	9.50	7.30	7.30	33.00	48.00	19.00	66	28	6
Single Family Housing	10.80	7.30	7.50	42.30	19.60	38.10	86	11	3

4.4 Fleet Mix

Land Use	LDA	LDT1	LDT2	MDV	LHD1	LHD2	MHD	HHD	OBUS	UBUS	MCY	SBUS	MH
City Park	0.524038	0.053970	0.173802	0.143485	0.025178	0.006202	0.008102	0.037193	0.000573	0.000185	0.023331	0.001015	0.002925
Single Family Housing	0.524038	0.053970	0.173802	0.143485	0.025178	0.006202	0.008102	0.037193	0.000573	0.000185	0.023331	0.001015	0.002925

5.0 Energy Detail

Lemoore 54 - Unmitigated Construction - Kings County, Annual

EMFAC Off-Model Adjustment Factors for Gasoline Light Duty Vehicle to Account for the SAFE Vehicle Rule Not Applied

Historical Energy Use: N

5.1 Mitigation Measures Energy

	ROG	NOx	CO	SO2	Fugitive PM10	Exhaust PM10	PM10 Total	Fugitive PM2.5	Exhaust PM2.5	PM2.5 Total	Bio- CO2	NBio- CO2	Total CO2	CH4	N2O	CO2e
Category	tons/yr										MT/yr					
Electricity Mitigated						0.0000	0.0000		0.0000	0.0000	0.0000	0.0000	0.0000	0.0000	0.0000	0.0000
Electricity Unmitigated						0.0000	0.0000		0.0000	0.0000	0.0000	0.0000	0.0000	0.0000	0.0000	0.0000
Natural Gas Mitigated	0.0000	0.0000	0.0000	0.0000		0.0000	0.0000		0.0000	0.0000	0.0000	0.0000	0.0000	0.0000	0.0000	0.0000
Natural Gas Unmitigated	0.0000	0.0000	0.0000	0.0000		0.0000	0.0000		0.0000	0.0000	0.0000	0.0000	0.0000	0.0000	0.0000	0.0000

Lemoore 54 - Unmitigated Construction - Kings County, Annual

EMFAC Off-Model Adjustment Factors for Gasoline Light Duty Vehicle to Account for the SAFE Vehicle Rule Not Applied

5.2 Energy by Land Use - NaturalGas

Unmitigated

	NaturalGas Use	ROG	NOx	CO	SO2	Fugitive PM10	Exhaust PM10	PM10 Total	Fugitive PM2.5	Exhaust PM2.5	PM2.5 Total	Bio- CO2	NBio- CO2	Total CO2	CH4	N2O	CO2e
Land Use	kBTU/yr	tons/yr										MT/yr					
City Park	0	0.0000	0.0000	0.0000	0.0000		0.0000	0.0000		0.0000	0.0000	0.0000	0.0000	0.0000	0.0000	0.0000	0.0000
Single Family Housing	0	0.0000	0.0000	0.0000	0.0000		0.0000	0.0000		0.0000	0.0000	0.0000	0.0000	0.0000	0.0000	0.0000	0.0000
Total		0.0000	0.0000	0.0000	0.0000		0.0000	0.0000		0.0000	0.0000	0.0000	0.0000	0.0000	0.0000	0.0000	0.0000

Mitigated

	NaturalGas Use	ROG	NOx	CO	SO2	Fugitive PM10	Exhaust PM10	PM10 Total	Fugitive PM2.5	Exhaust PM2.5	PM2.5 Total	Bio- CO2	NBio- CO2	Total CO2	CH4	N2O	CO2e
Land Use	kBTU/yr	tons/yr										MT/yr					
City Park	0	0.0000	0.0000	0.0000	0.0000		0.0000	0.0000		0.0000	0.0000	0.0000	0.0000	0.0000	0.0000	0.0000	0.0000
Single Family Housing	0	0.0000	0.0000	0.0000	0.0000		0.0000	0.0000		0.0000	0.0000	0.0000	0.0000	0.0000	0.0000	0.0000	0.0000
Total		0.0000	0.0000	0.0000	0.0000		0.0000	0.0000		0.0000	0.0000	0.0000	0.0000	0.0000	0.0000	0.0000	0.0000

Lemoore 54 - Unmitigated Construction - Kings County, Annual

EMFAC Off-Model Adjustment Factors for Gasoline Light Duty Vehicle to Account for the SAFE Vehicle Rule Not Applied

5.3 Energy by Land Use - Electricity

Unmitigated

	Electricity Use	Total CO2	CH4	N2O	CO2e
Land Use	kWh/yr	MT/yr			
City Park	0	0.0000	0.0000	0.0000	0.0000
Single Family Housing	0	0.0000	0.0000	0.0000	0.0000
Total		0.0000	0.0000	0.0000	0.0000

Mitigated

	Electricity Use	Total CO2	CH4	N2O	CO2e
Land Use	kWh/yr	MT/yr			
City Park	0	0.0000	0.0000	0.0000	0.0000
Single Family Housing	0	0.0000	0.0000	0.0000	0.0000
Total		0.0000	0.0000	0.0000	0.0000

6.0 Area Detail

Lemoore 54 - Unmitigated Construction - Kings County, Annual

EMFAC Off-Model Adjustment Factors for Gasoline Light Duty Vehicle to Account for the SAFE Vehicle Rule Not Applied

6.1 Mitigation Measures Area

	ROG	NOx	CO	SO2	Fugitive PM10	Exhaust PM10	PM10 Total	Fugitive PM2.5	Exhaust PM2.5	PM2.5 Total	Bio- CO2	NBio- CO2	Total CO2	CH4	N2O	CO2e
Category	tons/yr										MT/yr					
Mitigated	9.5400e-003	1.3000e-004	0.0115	0.0000		6.0000e-005	6.0000e-005		6.0000e-005	6.0000e-005	0.0000	0.0189	0.0189	2.0000e-005	0.0000	0.0193
Unmitigated	9.5400e-003	1.3000e-004	0.0115	0.0000		6.0000e-005	6.0000e-005		6.0000e-005	6.0000e-005	0.0000	0.0189	0.0189	2.0000e-005	0.0000	0.0193

Lemoore 54 - Unmitigated Construction - Kings County, Annual

EMFAC Off-Model Adjustment Factors for Gasoline Light Duty Vehicle to Account for the SAFE Vehicle Rule Not Applied

6.2 Area by SubCategory

Unmitigated

	ROG	NOx	CO	SO2	Fugitive PM10	Exhaust PM10	PM10 Total	Fugitive PM2.5	Exhaust PM2.5	PM2.5 Total	Bio- CO2	NBio- CO2	Total CO2	CH4	N2O	CO2e
SubCategory	tons/yr										MT/yr					
Architectural Coating	0.0000					0.0000	0.0000		0.0000	0.0000	0.0000	0.0000	0.0000	0.0000	0.0000	0.0000
Consumer Products	9.2000e-003					0.0000	0.0000		0.0000	0.0000	0.0000	0.0000	0.0000	0.0000	0.0000	0.0000
Hearth	0.0000	0.0000	0.0000	0.0000		0.0000	0.0000		0.0000	0.0000	0.0000	0.0000	0.0000	0.0000	0.0000	0.0000
Landscaping	3.5000e-004	1.3000e-004	0.0115	0.0000		6.0000e-005	6.0000e-005		6.0000e-005	6.0000e-005	0.0000	0.0189	0.0189	2.0000e-005	0.0000	0.0193
Total	9.5500e-003	1.3000e-004	0.0115	0.0000		6.0000e-005	6.0000e-005		6.0000e-005	6.0000e-005	0.0000	0.0189	0.0189	2.0000e-005	0.0000	0.0193

Lemoore 54 - Unmitigated Construction - Kings County, Annual

EMFAC Off-Model Adjustment Factors for Gasoline Light Duty Vehicle to Account for the SAFE Vehicle Rule Not Applied

6.2 Area by SubCategory

Mitigated

	ROG	NOx	CO	SO2	Fugitive PM10	Exhaust PM10	PM10 Total	Fugitive PM2.5	Exhaust PM2.5	PM2.5 Total	Bio- CO2	NBio- CO2	Total CO2	CH4	N2O	CO2e
SubCategory	tons/yr										MT/yr					
Architectural Coating	0.0000					0.0000	0.0000		0.0000	0.0000	0.0000	0.0000	0.0000	0.0000	0.0000	0.0000
Consumer Products	9.2000e-003					0.0000	0.0000		0.0000	0.0000	0.0000	0.0000	0.0000	0.0000	0.0000	0.0000
Hearth	0.0000	0.0000	0.0000	0.0000		0.0000	0.0000		0.0000	0.0000	0.0000	0.0000	0.0000	0.0000	0.0000	0.0000
Landscaping	3.5000e-004	1.3000e-004	0.0115	0.0000		6.0000e-005	6.0000e-005		6.0000e-005	6.0000e-005	0.0000	0.0189	0.0189	2.0000e-005	0.0000	0.0193
Total	9.5500e-003	1.3000e-004	0.0115	0.0000		6.0000e-005	6.0000e-005		6.0000e-005	6.0000e-005	0.0000	0.0189	0.0189	2.0000e-005	0.0000	0.0193

7.0 Water Detail

7.1 Mitigation Measures Water

Lemoore 54 - Unmitigated Construction - Kings County, Annual

EMFAC Off-Model Adjustment Factors for Gasoline Light Duty Vehicle to Account for the SAFE Vehicle Rule Not Applied

	Total CO2	CH4	N2O	CO2e
Category	MT/yr			
Mitigated	0.0000	0.0000	0.0000	0.0000
Unmitigated	0.0000	0.0000	0.0000	0.0000

7.2 Water by Land Use

Unmitigated

	Indoor/Outdoor Use	Total CO2	CH4	N2O	CO2e
Land Use	Mgal	MT/yr			
City Park	0 / 0	0.0000	0.0000	0.0000	0.0000
Single Family Housing	0 / 0	0.0000	0.0000	0.0000	0.0000
Total		0.0000	0.0000	0.0000	0.0000

Lemoore 54 - Unmitigated Construction - Kings County, Annual

EMFAC Off-Model Adjustment Factors for Gasoline Light Duty Vehicle to Account for the SAFE Vehicle Rule Not Applied

7.2 Water by Land Use

Mitigated

	Indoor/Outdoor Use	Total CO2	CH4	N2O	CO2e
Land Use	Mgal	MT/yr			
City Park	0 / 0	0.0000	0.0000	0.0000	0.0000
Single Family Housing	0 / 0	0.0000	0.0000	0.0000	0.0000
Total		0.0000	0.0000	0.0000	0.0000

8.0 Waste Detail

8.1 Mitigation Measures Waste

Category/Year

	Total CO2	CH4	N2O	CO2e
	MT/yr			
Mitigated	0.0000	0.0000	0.0000	0.0000
Unmitigated	0.0000	0.0000	0.0000	0.0000

Lemoore 54 - Unmitigated Construction - Kings County, Annual

EMFAC Off-Model Adjustment Factors for Gasoline Light Duty Vehicle to Account for the SAFE Vehicle Rule Not Applied

8.2 Waste by Land Use

Unmitigated

	Waste Disposed	Total CO2	CH4	N2O	CO2e
Land Use	tons	MT/yr			
City Park	0	0.0000	0.0000	0.0000	0.0000
Single Family Housing	0	0.0000	0.0000	0.0000	0.0000
Total		0.0000	0.0000	0.0000	0.0000

Mitigated

	Waste Disposed	Total CO2	CH4	N2O	CO2e
Land Use	tons	MT/yr			
City Park	0	0.0000	0.0000	0.0000	0.0000
Single Family Housing	0	0.0000	0.0000	0.0000	0.0000
Total		0.0000	0.0000	0.0000	0.0000

9.0 Operational Offroad

Lemoore 54 - Unmitigated Construction - Kings County, Annual

EMFAC Off-Model Adjustment Factors for Gasoline Light Duty Vehicle to Account for the SAFE Vehicle Rule Not Applied

Equipment Type	Number	Hours/Day	Days/Year	Horse Power	Load Factor	Fuel Type
----------------	--------	-----------	-----------	-------------	-------------	-----------

10.0 Stationary Equipment

Fire Pumps and Emergency Generators

Equipment Type	Number	Hours/Day	Hours/Year	Horse Power	Load Factor	Fuel Type
----------------	--------	-----------	------------	-------------	-------------	-----------

Boilers

Equipment Type	Number	Heat Input/Day	Heat Input/Year	Boiler Rating	Fuel Type
----------------	--------	----------------	-----------------	---------------	-----------

User Defined Equipment

Equipment Type	Number
----------------	--------

11.0 Vegetation

Lemoore 54 - Full Buildout Operations in the Earliest Operational Year - Kings County, Annual

EMFAC Off-Model Adjustment Factors for Gasoline Light Duty Vehicle to Account for the SAFE Vehicle Rule Not Applied

Lemoore 54 - Full Buildout Operations in the Earliest Operational Year

Kings County, Annual

1.0 Project Characteristics

1.1 Land Usage

Land Uses	Size	Metric	Lot Acreage	Floor Surface Area	Population
City Park	3.20	Acre	3.20	139,392.00	0
Single Family Housing	280.00	Dwelling Unit	49.41	504,000.00	801

1.2 Other Project Characteristics

Urbanization	Urban	Wind Speed (m/s)	2.2	Precipitation Freq (Days)	37
Climate Zone	3			Operational Year	2024
Utility Company	Pacific Gas and Electric Company				
CO2 Intensity (lb/MWhr)	203.98	CH4 Intensity (lb/MWhr)	0.033	N2O Intensity (lb/MWhr)	0.004

1.3 User Entered Comments & Non-Default Data

Project Characteristics - Lemoore 54 - Full Buildout Operations in the Earliest Operational Year

Land Use - Project site is approximately 52.61 acres
280-lot single family subdivision and 3.2 acres of public parks at full buildout

Construction Phase - Operational run only - zeroed out construction only parameters

Off-road Equipment - Operational run only

Trips and VMT - Operational run only

Architectural Coating - Rule 4601 Architectural Coatings

Vehicle Trips - Trip rates for project trips consistent with the trip generation provided in the traffic report (JLB Traffic Engineering, 2023)
ITE Trip Generation Manual, 11th Ed (ITE Land Uses 210 and 411)

Woodstoves - SJVAPCD Rule 4901 Woodburning

Area Coating - Rule 4601 Architectural Coatings

Construction Off-road Equipment Mitigation -

Lemoore 54 - Full Buildout Operations in the Earliest Operational Year - Kings County, Annual

EMFAC Off-Model Adjustment Factors for Gasoline Light Duty Vehicle to Account for the SAFE Vehicle Rule Not Applied

Area Mitigation - Rule 4601 Architectural Coatings, no woodburning fireplaces (only natural gas hearth), and building code standards (outside outlets)

Energy Mitigation - Single-family homes to be built with rooftop solar to provide on-site renewable energy (80% of electricity use generated applied)

Water Mitigation - Compliance with Green Building Code Standards and California Model Water Efficient Landscape Ordinance

Fleet Mix - SJVAPCD-approved Residential Fleet Mix for the 2024 operational year

Water And Wastewater -

Solid Waste -

Table Name	Column Name	Default Value	New Value
tblArchitecturalCoating	EF_Nonresidential_Exterior	150.00	50.00
tblArchitecturalCoating	EF_Nonresidential_Interior	150.00	50.00
tblArchitecturalCoating	EF_Residential_Exterior	150.00	50.00
tblArchitecturalCoating	EF_Residential_Interior	150.00	50.00
tblAreaCoating	Area_EF_Nonresidential_Exterior	150	50
tblAreaCoating	Area_EF_Nonresidential_Interior	150	50
tblAreaCoating	Area_EF_Residential_Exterior	150	50
tblAreaCoating	Area_EF_Residential_Interior	150	50
tblConstructionPhase	NumDays	75.00	1.00
tblFireplaces	FireplaceWoodMass	3,078.40	0.00
tblFleetMix	HHD	0.04	0.02
tblFleetMix	LDA	0.50	0.53
tblFleetMix	LDT1	0.05	0.21
tblFleetMix	LDT2	0.17	0.17
tblFleetMix	LHD1	0.03	9.0000e-004
tblFleetMix	LHD2	6.7450e-003	9.0000e-004
tblFleetMix	MCY	0.02	2.5000e-003
tblFleetMix	MDV	0.16	0.06
tblFleetMix	MH	3.5200e-003	2.0000e-003
tblFleetMix	MHD	8.2690e-003	8.0000e-003
tblFleetMix	OBUS	6.2000e-004	0.00

Lemoore 54 - Full Buildout Operations in the Earliest Operational Year - Kings County, Annual

EMFAC Off-Model Adjustment Factors for Gasoline Light Duty Vehicle to Account for the SAFE Vehicle Rule Not Applied

tblFleetMix	SBUS	1.1520e-003	2.0000e-004
tblFleetMix	UBUS	1.8900e-004	4.3000e-003
tblLandUse	LotAcreage	90.91	49.41
tblOffRoadEquipment	OffRoadEquipmentUnitAmount	1.00	0.00
tblOffRoadEquipment	UsageHours	6.00	0.00
tblTripsAndVMT	WorkerTripNumber	32.00	0.00
tblVehicleTrips	ST_TR	9.54	9.48
tblVehicleTrips	SU_TR	8.55	8.48
tblVehicleTrips	WD_TR	9.44	9.43
tblWoodstoves	WoodstoveWoodMass	3,019.20	0.00

2.0 Emissions Summary

Lemoore 54 - Full Buildout Operations in the Earliest Operational Year - Kings County, Annual

EMFAC Off-Model Adjustment Factors for Gasoline Light Duty Vehicle to Account for the SAFE Vehicle Rule Not Applied

2.1 Overall Construction

Unmitigated Construction

	ROG	NOx	CO	SO2	Fugitive PM10	Exhaust PM10	PM10 Total	Fugitive PM2.5	Exhaust PM2.5	PM2.5 Total	Bio- CO2	NBio- CO2	Total CO2	CH4	N2O	CO2e
Year	tons/yr										MT/yr					
2023	1.5768	0.0000	0.0000	0.0000	0.0000	0.0000	0.0000	0.0000	0.0000	0.0000	0.0000	0.0000	0.0000	0.0000	0.0000	0.0000
Maximum	1.5768	0.0000	0.0000	0.0000	0.0000	0.0000	0.0000	0.0000	0.0000	0.0000	0.0000	0.0000	0.0000	0.0000	0.0000	0.0000

Mitigated Construction

	ROG	NOx	CO	SO2	Fugitive PM10	Exhaust PM10	PM10 Total	Fugitive PM2.5	Exhaust PM2.5	PM2.5 Total	Bio- CO2	NBio- CO2	Total CO2	CH4	N2O	CO2e
Year	tons/yr										MT/yr					
2023	1.5768	0.0000	0.0000	0.0000	0.0000	0.0000	0.0000	0.0000	0.0000	0.0000	0.0000	0.0000	0.0000	0.0000	0.0000	0.0000
Maximum	1.5768	0.0000	0.0000	0.0000	0.0000	0.0000	0.0000	0.0000	0.0000	0.0000	0.0000	0.0000	0.0000	0.0000	0.0000	0.0000

	ROG	NOx	CO	SO2	Fugitive PM10	Exhaust PM10	PM10 Total	Fugitive PM2.5	Exhaust PM2.5	PM2.5 Total	Bio- CO2	NBio- CO2	Total CO2	CH4	N2O	CO2e
Percent Reduction	0.00	0.00	0.00	0.00	0.00	0.00	0.00	0.00	0.00	0.00	0.00	0.00	0.00	0.00	0.00	0.00

Lemoore 54 - Full Buildout Operations in the Earliest Operational Year - Kings County, Annual

EMFAC Off-Model Adjustment Factors for Gasoline Light Duty Vehicle to Account for the SAFE Vehicle Rule Not Applied

Quarter	Start Date	End Date	Maximum Unmitigated ROG + NOX (tons/quarter)	Maximum Mitigated ROG + NOX (tons/quarter)
1	3-2-2023	6-1-2023	1.1263	1.1263
		Highest	1.1263	1.1263

2.2 Overall Operational

Unmitigated Operational

	ROG	NOx	CO	SO2	Fugitive PM10	Exhaust PM10	PM10 Total	Fugitive PM2.5	Exhaust PM2.5	PM2.5 Total	Bio- CO2	NBio- CO2	Total CO2	CH4	N2O	CO2e
Category	tons/yr										MT/yr					
Area	2.2021	0.1287	2.1228	7.8000e-004		0.0200	0.0200		0.0200	0.0200	0.0000	124.6942	124.6942	5.5800e-003	2.2200e-003	125.4965
Energy	0.0363	0.3101	0.1320	1.9800e-003		0.0251	0.0251		0.0251	0.0251	0.0000	565.7445	565.7445	0.0403	0.0106	569.9215
Mobile	0.7721	1.4655	9.2945	0.0259	2.7939	0.0196	2.8135	0.7444	0.0183	2.7627	0.0000	2,422.1717	2,422.1717	0.1610	0.1187	2,461.5704
Waste						0.0000	0.0000		0.0000	0.0000	58.5913	0.0000	58.5913	3.4627	0.0000	145.1575
Water						0.0000	0.0000		0.0000	0.0000	5.7877	14.0925	19.8802	0.5967	0.0143	39.0637
Total	3.0105	1.9043	11.5492	0.0287	2.7939	0.0647	2.8586	0.7444	0.0634	2.8078	64.3790	3,126.7029	3,191.0819	4.2662	0.1459	3,341.2095

Lemoore 54 - Full Buildout Operations in the Earliest Operational Year - Kings County, Annual

EMFAC Off-Model Adjustment Factors for Gasoline Light Duty Vehicle to Account for the SAFE Vehicle Rule Not Applied

2.2 Overall Operational

Mitigated Operational

	ROG	NOx	CO	SO2	Fugitive PM10	Exhaust PM10	PM10 Total	Fugitive PM2.5	Exhaust PM2.5	PM2.5 Total	Bio- CO2	NBio- CO2	Total CO2	CH4	N2O	CO2e
Category	tons/yr										MT/yr					
Area	2.2012	0.1285	2.1078	7.8000e-004		0.0199	0.0199		0.0199	0.0199	0.0000	124.6636	124.6636	5.5400e-003	2.2200e-003	125.4647
Energy	0.0363	0.3101	0.1320	1.9800e-003		0.0251	0.0251		0.0251	0.0251	0.0000	390.1527	390.1527	0.0119	7.1900e-003	392.5934
Mobile	0.7721	1.4655	9.2945	0.0259	2.7939	0.0196	2.8135	0.7444	0.0183	0.7627	0.0000	2,422.1717	2,422.1717	0.1610	0.1187	2,461.5704
Waste						0.0000	0.0000		0.0000	0.0000	58.5913	0.0000	58.5913	3.4627	0.0000	145.1575
Water						0.0000	0.0000		0.0000	0.0000	4.6302	11.2740	15.9042	0.4774	0.0115	31.2509
Total	3.0096	1.9041	11.5342	0.0287	2.7939	0.0646	2.8585	0.7444	0.0633	0.8077	63.2215	2,948.2619	3,011.4834	4.1184	0.1396	3,156.0369

	ROG	NOx	CO	SO2	Fugitive PM10	Exhaust PM10	PM10 Total	Fugitive PM2.5	Exhaust PM2.5	PM2.5 Total	Bio- CO2	NBio- CO2	Total CO2	CH4	N2O	CO2e
Percent Reduction	0.03	0.01	0.13	0.00	0.00	0.14	0.00	0.00	0.14	0.01	1.80	5.71	5.63	3.46	4.33	5.54

3.0 Construction Detail

Construction Phase

Phase Number	Phase Name	Phase Type	Start Date	End Date	Num Days Week	Num Days	Phase Description
1	Architectural Coating	Architectural Coating	3/2/2023	3/2/2023	5	1	

Acres of Grading (Site Preparation Phase): 0

Lemoore 54 - Full Buildout Operations in the Earliest Operational Year - Kings County, Annual

EMFAC Off-Model Adjustment Factors for Gasoline Light Duty Vehicle to Account for the SAFE Vehicle Rule Not Applied

Acres of Grading (Grading Phase): 0

Acres of Paving: 0

Residential Indoor: 1,020,600; Residential Outdoor: 340,200; Non-Residential Indoor: 2; Non-Residential Outdoor: 1; Striped Parking Area: 0 (Architectural Coating – sqft)

OffRoad Equipment

Phase Name	Offroad Equipment Type	Amount	Usage Hours	Horse Power	Load Factor
Architectural Coating	Air Compressors	0	0.00	78	0.48

Trips and VMT

Phase Name	Offroad Equipment Count	Worker Trip Number	Vendor Trip Number	Hauling Trip Number	Worker Trip Length	Vendor Trip Length	Hauling Trip Length	Worker Vehicle Class	Vendor Vehicle Class	Hauling Vehicle Class
Architectural Coating	0	0.00	0.00	0.00	10.80	7.30	20.00	LD_Mix	HDT_Mix	HHDT

3.1 Mitigation Measures Construction

3.2 Architectural Coating - 2023

Unmitigated Construction On-Site

	ROG	NOx	CO	SO2	Fugitive PM10	Exhaust PM10	PM10 Total	Fugitive PM2.5	Exhaust PM2.5	PM2.5 Total	Bio- CO2	NBio- CO2	Total CO2	CH4	N2O	CO2e
Category	tons/yr										MT/yr					
Archit. Coating	1.5768					0.0000	0.0000		0.0000	0.0000	0.0000	0.0000	0.0000	0.0000	0.0000	0.0000
Off-Road	0.0000	0.0000	0.0000	0.0000		0.0000	0.0000		0.0000	0.0000	0.0000	0.0000	0.0000	0.0000	0.0000	0.0000
Total	1.5768	0.0000	0.0000	0.0000		0.0000	0.0000		0.0000	0.0000	0.0000	0.0000	0.0000	0.0000	0.0000	0.0000

Lemoore 54 - Full Buildout Operations in the Earliest Operational Year - Kings County, Annual

EMFAC Off-Model Adjustment Factors for Gasoline Light Duty Vehicle to Account for the SAFE Vehicle Rule Not Applied

3.2 Architectural Coating - 2023

Unmitigated Construction Off-Site

	ROG	NOx	CO	SO2	Fugitive PM10	Exhaust PM10	PM10 Total	Fugitive PM2.5	Exhaust PM2.5	PM2.5 Total	Bio- CO2	NBio- CO2	Total CO2	CH4	N2O	CO2e
Category	tons/yr										MT/yr					
Hauling	0.0000	0.0000	0.0000	0.0000	0.0000	0.0000	0.0000	0.0000	0.0000	0.0000	0.0000	0.0000	0.0000	0.0000	0.0000	0.0000
Vendor	0.0000	0.0000	0.0000	0.0000	0.0000	0.0000	0.0000	0.0000	0.0000	0.0000	0.0000	0.0000	0.0000	0.0000	0.0000	0.0000
Worker	0.0000	0.0000	0.0000	0.0000	0.0000	0.0000	0.0000	0.0000	0.0000	0.0000	0.0000	0.0000	0.0000	0.0000	0.0000	0.0000
Total	0.0000	0.0000	0.0000	0.0000	0.0000	0.0000	0.0000	0.0000	0.0000	0.0000	0.0000	0.0000	0.0000	0.0000	0.0000	0.0000

Mitigated Construction On-Site

	ROG	NOx	CO	SO2	Fugitive PM10	Exhaust PM10	PM10 Total	Fugitive PM2.5	Exhaust PM2.5	PM2.5 Total	Bio- CO2	NBio- CO2	Total CO2	CH4	N2O	CO2e
Category	tons/yr										MT/yr					
Archit. Coating	1.5768					0.0000	0.0000		0.0000	0.0000	0.0000	0.0000	0.0000	0.0000	0.0000	0.0000
Off-Road	0.0000	0.0000	0.0000	0.0000		0.0000	0.0000		0.0000	0.0000	0.0000	0.0000	0.0000	0.0000	0.0000	0.0000
Total	1.5768	0.0000	0.0000	0.0000		0.0000	0.0000		0.0000	0.0000	0.0000	0.0000	0.0000	0.0000	0.0000	0.0000

Lemoore 54 - Full Buildout Operations in the Earliest Operational Year - Kings County, Annual

EMFAC Off-Model Adjustment Factors for Gasoline Light Duty Vehicle to Account for the SAFE Vehicle Rule Not Applied

3.2 Architectural Coating - 2023

Mitigated Construction Off-Site

	ROG	NOx	CO	SO2	Fugitive PM10	Exhaust PM10	PM10 Total	Fugitive PM2.5	Exhaust PM2.5	PM2.5 Total	Bio- CO2	NBio- CO2	Total CO2	CH4	N2O	CO2e
Category	tons/yr										MT/yr					
Hauling	0.0000	0.0000	0.0000	0.0000	0.0000	0.0000	0.0000	0.0000	0.0000	0.0000	0.0000	0.0000	0.0000	0.0000	0.0000	0.0000
Vendor	0.0000	0.0000	0.0000	0.0000	0.0000	0.0000	0.0000	0.0000	0.0000	0.0000	0.0000	0.0000	0.0000	0.0000	0.0000	0.0000
Worker	0.0000	0.0000	0.0000	0.0000	0.0000	0.0000	0.0000	0.0000	0.0000	0.0000	0.0000	0.0000	0.0000	0.0000	0.0000	0.0000
Total	0.0000	0.0000	0.0000	0.0000	0.0000	0.0000	0.0000	0.0000	0.0000	0.0000	0.0000	0.0000	0.0000	0.0000	0.0000	0.0000

4.0 Operational Detail - Mobile

4.1 Mitigation Measures Mobile

Lemoore 54 - Full Buildout Operations in the Earliest Operational Year - Kings County, Annual

EMFAC Off-Model Adjustment Factors for Gasoline Light Duty Vehicle to Account for the SAFE Vehicle Rule Not Applied

	ROG	NOx	CO	SO2	Fugitive PM10	Exhaust PM10	PM10 Total	Fugitive PM2.5	Exhaust PM2.5	PM2.5 Total	Bio- CO2	NBio- CO2	Total CO2	CH4	N2O	CO2e
Category	tons/yr										MT/yr					
Mitigated	0.7721	1.4655	9.2945	0.0259	2.7939	0.0196	2.8135	0.7444	0.0183	0.7627	0.0000	2,422.1717	2,422.1717	0.1610	0.1187	2,461.5704
Unmitigated	0.7721	1.4655	9.2945	0.0259	2.7939	0.0196	2.8135	0.7444	0.0183	0.7627	0.0000	2,422.1717	2,422.1717	0.1610	0.1187	2,461.5704

4.2 Trip Summary Information

Land Use	Average Daily Trip Rate			Unmitigated	Mitigated
	Weekday	Saturday	Sunday	Annual VMT	Annual VMT
City Park	2.50	6.27	7.01	7,856	7,856
Single Family Housing	2,640.40	2,654.40	2374.40	7,454,441	7,454,441
Total	2,642.90	2,660.67	2,381.41	7,462,297	7,462,297

4.3 Trip Type Information

Land Use	Miles			Trip %			Trip Purpose %		
	H-W or C-W	H-S or C-C	H-O or C-NW	H-W or C-W	H-S or C-C	H-O or C-NW	Primary	Diverted	Pass-by
City Park	9.50	7.30	7.30	33.00	48.00	19.00	66	28	6
Single Family Housing	10.80	7.30	7.50	42.30	19.60	38.10	86	11	3

4.4 Fleet Mix

Land Use	LDA	LDT1	LDT2	MDV	LHD1	LHD2	MHD	HHD	OBUS	UBUS	MCY	SBUS	MH
City Park	0.504365	0.051424	0.168544	0.163993	0.029850	0.006745	0.008269	0.036653	0.000620	0.000189	0.024675	0.001152	0.003520
Single Family Housing	0.527700	0.209000	0.167500	0.055600	0.000900	0.000900	0.008000	0.021400	0.000000	0.004300	0.002500	0.000200	0.002000

5.0 Energy Detail

Lemoore 54 - Full Buildout Operations in the Earliest Operational Year - Kings County, Annual

EMFAC Off-Model Adjustment Factors for Gasoline Light Duty Vehicle to Account for the SAFE Vehicle Rule Not Applied

Historical Energy Use: N

5.1 Mitigation Measures Energy

Percent of Electricity Use Generated with Renewable Energy

	ROG	NOx	CO	SO2	Fugitive PM10	Exhaust PM10	PM10 Total	Fugitive PM2.5	Exhaust PM2.5	PM2.5 Total	Bio- CO2	NBio- CO2	Total CO2	CH4	N2O	CO2e
Category	tons/yr										MT/yr					
Electricity Mitigated						0.0000	0.0000		0.0000	0.0000	0.0000	30.9868	30.9868	5.0100e-003	6.1000e-004	31.2932
Electricity Unmitigated						0.0000	0.0000		0.0000	0.0000	0.0000	206.5786	206.5786	0.0334	4.0500e-003	208.6213
NaturalGas Mitigated	0.0363	0.3101	0.1320	1.9800e-003		0.0251	0.0251		0.0251	0.0251	0.0000	359.1659	359.1659	6.8800e-003	6.5800e-003	361.3002
NaturalGas Unmitigated	0.0363	0.3101	0.1320	1.9800e-003		0.0251	0.0251		0.0251	0.0251	0.0000	359.1659	359.1659	6.8800e-003	6.5800e-003	361.3002

Lemoore 54 - Full Buildout Operations in the Earliest Operational Year - Kings County, Annual

EMFAC Off-Model Adjustment Factors for Gasoline Light Duty Vehicle to Account for the SAFE Vehicle Rule Not Applied

5.2 Energy by Land Use - NaturalGas

Unmitigated

	NaturalGas Use	ROG	NOx	CO	SO2	Fugitive PM10	Exhaust PM10	PM10 Total	Fugitive PM2.5	Exhaust PM2.5	PM2.5 Total	Bio- CO2	NBio- CO2	Total CO2	CH4	N2O	CO2e
Land Use	kBTU/yr	tons/yr										MT/yr					
City Park	0	0.0000	0.0000	0.0000	0.0000		0.0000	0.0000		0.0000	0.0000	0.0000	0.0000	0.0000	0.0000	0.0000	0.0000
Single Family Housing	6.73051e+006	0.0363	0.3101	0.1320	1.9800e-003		0.0251	0.0251		0.0251	0.0251	0.0000	359.1659	359.1659	6.8800e-003	6.5800e-003	361.3002
Total		0.0363	0.3101	0.1320	1.9800e-003		0.0251	0.0251		0.0251	0.0251	0.0000	359.1659	359.1659	6.8800e-003	6.5800e-003	361.3002

Mitigated

	NaturalGas Use	ROG	NOx	CO	SO2	Fugitive PM10	Exhaust PM10	PM10 Total	Fugitive PM2.5	Exhaust PM2.5	PM2.5 Total	Bio- CO2	NBio- CO2	Total CO2	CH4	N2O	CO2e
Land Use	kBTU/yr	tons/yr										MT/yr					
City Park	0	0.0000	0.0000	0.0000	0.0000		0.0000	0.0000		0.0000	0.0000	0.0000	0.0000	0.0000	0.0000	0.0000	0.0000
Single Family Housing	6.73051e+006	0.0363	0.3101	0.1320	1.9800e-003		0.0251	0.0251		0.0251	0.0251	0.0000	359.1659	359.1659	6.8800e-003	6.5800e-003	361.3002
Total		0.0363	0.3101	0.1320	1.9800e-003		0.0251	0.0251		0.0251	0.0251	0.0000	359.1659	359.1659	6.8800e-003	6.5800e-003	361.3002

Lemoore 54 - Full Buildout Operations in the Earliest Operational Year - Kings County, Annual

EMFAC Off-Model Adjustment Factors for Gasoline Light Duty Vehicle to Account for the SAFE Vehicle Rule Not Applied

5.3 Energy by Land Use - Electricity

Unmitigated

	Electricity Use	Total CO2	CH4	N2O	CO2e
Land Use	kWh/yr	MT/yr			
City Park	0	0.0000	0.0000	0.0000	0.0000
Single Family Housing	2.23271e+006	206.5786	0.0334	4.0500e-003	208.6213
Total		206.5786	0.0334	4.0500e-003	208.6213

Mitigated

	Electricity Use	Total CO2	CH4	N2O	CO2e
Land Use	kWh/yr	MT/yr			
City Park	0	0.0000	0.0000	0.0000	0.0000
Single Family Housing	334906	30.9868	5.0100e-003	6.1000e-004	31.2932
Total		30.9868	5.0100e-003	6.1000e-004	31.2932

6.0 Area Detail

Lemoore 54 - Full Buildout Operations in the Earliest Operational Year - Kings County, Annual

EMFAC Off-Model Adjustment Factors for Gasoline Light Duty Vehicle to Account for the SAFE Vehicle Rule Not Applied

6.1 Mitigation Measures Area

Use Electric Lawnmower

Use Electric Leafblower

Use Electric Chainsaw

Use Low VOC Paint - Residential Interior

Use Low VOC Paint - Residential Exterior

Use Low VOC Paint - Non-Residential Interior

Use Low VOC Paint - Non-Residential Exterior

Use only Natural Gas Hearths

	ROG	NOx	CO	SO2	Fugitive PM10	Exhaust PM10	PM10 Total	Fugitive PM2.5	Exhaust PM2.5	PM2.5 Total	Bio- CO2	NBio- CO2	Total CO2	CH4	N2O	CO2e
Category	tons/yr										MT/yr					
Mitigated	2.2012	0.1285	2.1078	7.8000e-004		0.0199	0.0199		0.0199	0.0199	0.0000	124.6636	124.6636	5.5400e-003	2.2200e-003	125.4647
Unmitigated	2.2021	0.1287	2.1228	7.8000e-004		0.0200	0.0200		0.0200	0.0200	0.0000	124.6942	124.6942	5.5800e-003	2.2200e-003	125.4965

Lemoore 54 - Full Buildout Operations in the Earliest Operational Year - Kings County, Annual

EMFAC Off-Model Adjustment Factors for Gasoline Light Duty Vehicle to Account for the SAFE Vehicle Rule Not Applied

6.2 Area by SubCategory

Unmitigated

	ROG	NOx	CO	SO2	Fugitive PM10	Exhaust PM10	PM10 Total	Fugitive PM2.5	Exhaust PM2.5	PM2.5 Total	Bio- CO2	NBio- CO2	Total CO2	CH4	N2O	CO2e
SubCategory	tons/yr										MT/yr					
Architectural Coating	0.1577					0.0000	0.0000		0.0000	0.0000	0.0000	0.0000	0.0000	0.0000	0.0000	0.0000
Consumer Products	1.9697					0.0000	0.0000		0.0000	0.0000	0.0000	0.0000	0.0000	0.0000	0.0000	0.0000
Hearth	0.0123	0.1047	0.0446	6.7000e-004		8.4700e-003	8.4700e-003		8.4700e-003	8.4700e-003	0.0000	121.2981	121.2981	2.3200e-003	2.2200e-003	122.0189
Landscaping	0.0625	0.0239	2.0782	1.1000e-004		0.0115	0.0115		0.0115	0.0115	0.0000	3.3961	3.3961	3.2600e-003	0.0000	3.4776
Total	2.2021	0.1287	2.1228	7.8000e-004		0.0200	0.0200		0.0200	0.0200	0.0000	124.6942	124.6942	5.5800e-003	2.2200e-003	125.4965

Lemoore 54 - Full Buildout Operations in the Earliest Operational Year - Kings County, Annual

EMFAC Off-Model Adjustment Factors for Gasoline Light Duty Vehicle to Account for the SAFE Vehicle Rule Not Applied

6.2 Area by SubCategory

Mitigated

	ROG	NOx	CO	SO2	Fugitive PM10	Exhaust PM10	PM10 Total	Fugitive PM2.5	Exhaust PM2.5	PM2.5 Total	Bio- CO2	NBio- CO2	Total CO2	CH4	N2O	CO2e
SubCategory	tons/yr										MT/yr					
Architectural Coating	0.1577					0.0000	0.0000		0.0000	0.0000	0.0000	0.0000	0.0000	0.0000	0.0000	0.0000
Consumer Products	1.9697					0.0000	0.0000		0.0000	0.0000	0.0000	0.0000	0.0000	0.0000	0.0000	0.0000
Hearth	0.0123	0.1047	0.0446	6.7000e-004		8.4700e-003	8.4700e-003		8.4700e-003	8.4700e-003	0.0000	121.2981	121.2981	2.3200e-003	2.2200e-003	122.0189
Landscaping	0.0616	0.0238	2.0632	1.1000e-004		0.0114	0.0114		0.0114	0.0114	0.0000	3.3655	3.3655	3.2100e-003	0.0000	3.4458
Total	2.2012	0.1285	2.1078	7.8000e-004		0.0199	0.0199		0.0199	0.0199	0.0000	124.6636	124.6636	5.5300e-003	2.2200e-003	125.4647

7.0 Water Detail

7.1 Mitigation Measures Water

Apply Water Conservation Strategy

Lemoore 54 - Full Buildout Operations in the Earliest Operational Year - Kings County, Annual

EMFAC Off-Model Adjustment Factors for Gasoline Light Duty Vehicle to Account for the SAFE Vehicle Rule Not Applied

	Total CO2	CH4	N2O	CO2e
Category	MT/yr			
Mitigated	15.9042	0.4774	0.0115	31.2509
Unmitigated	19.8802	0.5967	0.0143	39.0637

7.2 Water by Land Use

Unmitigated

	Indoor/Outdoor Use	Total CO2	CH4	N2O	CO2e
Land Use	Mgal	MT/yr			
City Park	0 / 3.81274	1.2347	2.0000e-004	2.0000e-005	1.2469
Single Family Housing	18.2431 / 11.5011	18.6455	0.5965	0.0143	37.8168
Total		19.8802	0.5967	0.0143	39.0637

Lemoore 54 - Full Buildout Operations in the Earliest Operational Year - Kings County, Annual

EMFAC Off-Model Adjustment Factors for Gasoline Light Duty Vehicle to Account for the SAFE Vehicle Rule Not Applied

7.2 Water by Land Use

Mitigated

	Indoor/Outdoor Use	Total CO2	CH4	N2O	CO2e
Land Use	Mgal	MT/yr			
City Park	0 / 3.05019	0.9878	1.6000e-004	2.0000e-005	0.9975
Single Family Housing	14.5945 / 9.20088	14.9164	0.4772	0.0114	30.2534
Total		15.9041	0.4774	0.0115	31.2509

8.0 Waste Detail

8.1 Mitigation Measures Waste

Category/Year

	Total CO2	CH4	N2O	CO2e
	MT/yr			
Mitigated	58.5913	3.4627	0.0000	145.1575
Unmitigated	58.5913	3.4627	0.0000	145.1575

Lemoore 54 - Full Buildout Operations in the Earliest Operational Year - Kings County, Annual

EMFAC Off-Model Adjustment Factors for Gasoline Light Duty Vehicle to Account for the SAFE Vehicle Rule Not Applied

8.2 Waste by Land Use

Unmitigated

	Waste Disposed	Total CO2	CH4	N2O	CO2e
Land Use	tons	MT/yr			
City Park	0.28	0.0568	3.3600e-003	0.0000	0.1408
Single Family Housing	288.36	58.5345	3.4593	0.0000	145.0167
Total		58.5913	3.4627	0.0000	145.1575

Mitigated

	Waste Disposed	Total CO2	CH4	N2O	CO2e
Land Use	tons	MT/yr			
City Park	0.28	0.0568	3.3600e-003	0.0000	0.1408
Single Family Housing	288.36	58.5345	3.4593	0.0000	145.0167
Total		58.5913	3.4627	0.0000	145.1575

9.0 Operational Offroad

Lemoore 54 - Full Buildout Operations in the Earliest Operational Year - Kings County, Annual

EMFAC Off-Model Adjustment Factors for Gasoline Light Duty Vehicle to Account for the SAFE Vehicle Rule Not Applied

Equipment Type	Number	Hours/Day	Days/Year	Horse Power	Load Factor	Fuel Type
----------------	--------	-----------	-----------	-------------	-------------	-----------

10.0 Stationary Equipment

Fire Pumps and Emergency Generators

Equipment Type	Number	Hours/Day	Hours/Year	Horse Power	Load Factor	Fuel Type
----------------	--------	-----------	------------	-------------	-------------	-----------

Boilers

Equipment Type	Number	Heat Input/Day	Heat Input/Year	Boiler Rating	Fuel Type
----------------	--------	----------------	-----------------	---------------	-----------

User Defined Equipment

Equipment Type	Number
----------------	--------

11.0 Vegetation

Unmitigated Construction - Localized Assessment - Kings County, Summer

EMFAC Off-Model Adjustment Factors for Gasoline Light Duty Vehicle to Account for the SAFE Vehicle Rule Not Applied

Unmitigated Construction - Localized Assessment

Kings County, Summer

1.0 Project Characteristics

1.1 Land Usage

Land Uses	Size	Metric	Lot Acreage	Floor Surface Area	Population
City Park	3.20	Acre	3.20	139,392.00	0
Single Family Housing	280.00	Dwelling Unit	49.41	504,000.00	801

1.2 Other Project Characteristics

Urbanization	Urban	Wind Speed (m/s)	2.2	Precipitation Freq (Days)	37
Climate Zone	3			Operational Year	2029
Utility Company	Pacific Gas and Electric Company				
CO2 Intensity (lb/MWhr)	203.98	CH4 Intensity (lb/MWhr)	0.033	N2O Intensity (lb/MWhr)	0.004

1.3 User Entered Comments & Non-Default Data

Project Characteristics - Lemoore 54 - Unmitigated Construction - Localized Assessment

Land Use - Project site is approximately 52.61 acres
280-lot single family subdivision and 3.2 acres of public parks at full buildout

Construction Phase - No demolition
Adjusted schedule to match applicant-provided construction start date and construction duration
08/01/2023-12-31/2029

Off-road Equipment - Adjusted construction equipment usage to match CalEEMod default total building construction HP hours.

Trips and VMT - Trip lengths updated to 0.5 mile to account for on-site and localized emissions from construction vehicles.

Grading - Amount of import and export associated with cut and fill:

Cubic yards of cut to be exported: 90,000 cubic yards

Cubic yards of fill to be imported: 90,000 cubic yards

Architectural Coating - Rule 4601 Architectural Coatings

Vehicle Trips - Construction run only (operations assessed in a separate run)

Unmitigated Construction - Localized Assessment - Kings County, Summer

EMFAC Off-Model Adjustment Factors for Gasoline Light Duty Vehicle to Account for the SAFE Vehicle Rule Not Applied

Vehicle Emission Factors -

Vehicle Emission Factors -

Vehicle Emission Factors -

Woodstoves - Construction run only (operations only parameters zeroed out)

Consumer Products - Construction run only

Area Coating - Construction run only

Landscape Equipment - Construction run only

Energy Use - Construction run only

Water And Wastewater - Construction run only

Solid Waste - Construction run only

Construction Off-road Equipment Mitigation - Compliance with SJVAPCD Regulation VIII

Area Mitigation -

Fleet Mix -

Table Name	Column Name	Default Value	New Value
tblArchitecturalCoating	EF_Residential_Exterior	150.00	50.00
tblArchitecturalCoating	EF_Residential_Interior	150.00	50.00
tblAreaCoating	Area_EF_Residential_Exterior	150	50
tblAreaCoating	Area_EF_Residential_Interior	150	50
tblAreaCoating	ReapplicationRatePercent	10	1
tblConstDustMitigation	WaterUnpavedRoadVehicleSpeed	0	15
tblConstructionPhase	NumDays	1,110.00	1,310.00
tblConstructionPhase	NumDays	75.00	150.00
tblConsumerProducts	ROG_EF	2.14E-05	1E-07
tblConsumerProducts	ROG_EF_Degreaser	3.542E-07	1E-10
tblConsumerProducts	ROG_EF_PesticidesFertilizers	5.152E-08	1E-11
tblEnergyUse	LightingElect	1,608.84	0.00
tblEnergyUse	NT24E	6,155.97	0.00
tblEnergyUse	NT24NG	3,723.00	0.00

Unmitigated Construction - Localized Assessment - Kings County, Summer

EMFAC Off-Model Adjustment Factors for Gasoline Light Duty Vehicle to Account for the SAFE Vehicle Rule Not Applied

tblEnergyUse	T24E	209.15	0.00
tblEnergyUse	T24NG	20,314.55	0.00
tblFireplaces	FireplaceWoodMass	3,078.40	0.00
tblFireplaces	NumberGas	154.00	0.00
tblGrading	MaterialExported	0.00	90,000.00
tblGrading	MaterialImported	0.00	90,000.00
tblLandscapeEquipment	NumberSummerDays	180	1
tblLandUse	LotAcreage	90.91	49.41
tblOffRoadEquipment	UsageHours	7.00	5.90
tblOffRoadEquipment	UsageHours	8.00	6.80
tblOffRoadEquipment	UsageHours	8.00	6.80
tblOffRoadEquipment	UsageHours	7.00	5.90
tblOffRoadEquipment	UsageHours	8.00	6.80
tblSolidWaste	SolidWasteGenerationRate	0.28	0.00
tblSolidWaste	SolidWasteGenerationRate	288.36	0.00
tblTripsAndVMT	HaulingTripLength	20.00	0.50
tblTripsAndVMT	HaulingTripLength	20.00	0.50
tblTripsAndVMT	HaulingTripLength	20.00	0.50
tblTripsAndVMT	HaulingTripLength	20.00	0.50
tblTripsAndVMT	HaulingTripLength	20.00	0.50
tblTripsAndVMT	HaulingTripNumber	0.00	14.00
tblTripsAndVMT	HaulingTripNumber	17,798.00	17,814.00
tblTripsAndVMT	HaulingTripNumber	0.00	12.00
tblTripsAndVMT	HaulingTripNumber	0.00	18.00
tblTripsAndVMT	HaulingTripNumber	0.00	2.00
tblTripsAndVMT	VendorTripLength	7.30	0.50
tblTripsAndVMT	VendorTripLength	7.30	0.50
tblTripsAndVMT	VendorTripLength	7.30	0.50
tblTripsAndVMT	VendorTripLength	7.30	0.50

Unmitigated Construction - Localized Assessment - Kings County, Summer

EMFAC Off-Model Adjustment Factors for Gasoline Light Duty Vehicle to Account for the SAFE Vehicle Rule Not Applied

tblTripsAndVMT	VendorTripLength	7.30	0.50
tblTripsAndVMT	WorkerTripLength	10.80	0.50
tblTripsAndVMT	WorkerTripLength	10.80	0.50
tblTripsAndVMT	WorkerTripLength	10.80	0.50
tblTripsAndVMT	WorkerTripLength	10.80	0.50
tblTripsAndVMT	WorkerTripLength	10.80	0.50
tblVehicleTrips	ST_TR	1.96	0.00
tblVehicleTrips	ST_TR	9.54	0.00
tblVehicleTrips	SU_TR	2.19	0.00
tblVehicleTrips	SU_TR	8.55	0.00
tblVehicleTrips	WD_TR	0.78	0.00
tblVehicleTrips	WD_TR	9.44	0.00
tblWater	IndoorWaterUseRate	18,243,127.17	0.00
tblWater	OutdoorWaterUseRate	3,812,740.32	0.00
tblWater	OutdoorWaterUseRate	11,501,101.91	0.00
tblWoodstoves	WoodstoveWoodMass	3,019.20	0.00

2.0 Emissions Summary

Unmitigated Construction - Localized Assessment - Kings County, Summer

EMFAC Off-Model Adjustment Factors for Gasoline Light Duty Vehicle to Account for the SAFE Vehicle Rule Not Applied

2.1 Overall Construction (Maximum Daily Emission)

Unmitigated Construction

	ROG	NOx	CO	SO2	Fugitive PM10	Exhaust PM10	PM10 Total	Fugitive PM2.5	Exhaust PM2.5	PM2.5 Total	Bio- CO2	NBio- CO2	Total CO2	CH4	N2O	CO2e
Year	lb/day										lb/day					
2023	3.5624	37.9317	30.9368	0.0691	19.6642	1.4312	20.9303	10.1044	1.3169	11.2692	0.0000	6,752.003 2	6,752.003 2	1.9563	0.1160	6,835.487 4
2024	3.4541	35.7743	30.5834	0.0689	9.2858	1.3421	10.6279	3.6766	1.2350	4.9116	0.0000	6,735.619 1	6,735.619 1	1.9555	0.1137	6,818.391 6
2025	1.4499	11.3601	14.9692	0.0251	0.0879	0.4489	0.5368	0.0242	0.4223	0.4466	0.0000	2,403.648 5	2,403.648 5	0.5258	0.0336	2,426.798 7
2026	1.4306	11.3499	14.9296	0.0251	0.0879	0.4489	0.5368	0.0242	0.4223	0.4465	0.0000	2,398.216 2	2,398.216 2	0.5245	0.0326	2,421.051 2
2027	1.4135	11.3410	14.8924	0.0250	0.0879	0.4488	0.5367	0.0242	0.4222	0.4465	0.0000	2,392.723 5	2,392.723 5	0.5234	0.0318	2,415.267 7
2028	1.3984	11.3335	14.8612	0.0250	0.0879	0.4487	0.5366	0.0242	0.4222	0.4464	0.0000	2,387.600 0	2,387.600 0	0.5225	0.0309	2,409.880 7
2029	22.6177	12.4836	16.7815	0.0280	0.1004	0.5003	0.6007	0.0276	0.4737	0.5013	0.0000	2,678.680 9	2,678.680 9	0.5392	0.0318	2,701.642 2
Maximum	22.6177	37.9317	30.9368	0.0691	19.6642	1.4312	20.9303	10.1044	1.3169	11.2692	0.0000	6,752.003 2	6,752.003 2	1.9563	0.1160	6,835.487 4

Unmitigated Construction - Localized Assessment - Kings County, Summer

EMFAC Off-Model Adjustment Factors for Gasoline Light Duty Vehicle to Account for the SAFE Vehicle Rule Not Applied

2.1 Overall Construction (Maximum Daily Emission)

Mitigated Construction

	ROG	NOx	CO	SO2	Fugitive PM10	Exhaust PM10	PM10 Total	Fugitive PM2.5	Exhaust PM2.5	PM2.5 Total	Bio- CO2	NBio- CO2	Total CO2	CH4	N2O	CO2e
Year	lb/day										lb/day					
2023	3.5624	37.9317	30.9368	0.0691	8.8528	1.4312	10.1190	4.5480	1.3169	5.7129	0.0000	6,752.003 2	6,752.003 2	1.9563	0.1160	6,835.487 3
2024	3.4541	35.7743	30.5834	0.0689	4.2238	1.3421	5.5659	1.6670	1.2350	2.9020	0.0000	6,735.619 0	6,735.619 0	1.9555	0.1137	6,818.391 6
2025	1.4499	11.3601	14.9692	0.0251	0.0879	0.4489	0.5368	0.0242	0.4223	0.4466	0.0000	2,403.648 4	2,403.648 4	0.5258	0.0336	2,426.798 7
2026	1.4306	11.3499	14.9296	0.0251	0.0879	0.4489	0.5368	0.0242	0.4223	0.4465	0.0000	2,398.216 2	2,398.216 2	0.5245	0.0326	2,421.051 2
2027	1.4135	11.3410	14.8924	0.0250	0.0879	0.4488	0.5367	0.0242	0.4222	0.4465	0.0000	2,392.723 4	2,392.723 4	0.5234	0.0318	2,415.267 7
2028	1.3984	11.3335	14.8612	0.0250	0.0879	0.4487	0.5366	0.0242	0.4222	0.4464	0.0000	2,387.600 0	2,387.600 0	0.5225	0.0309	2,409.880 7
2029	22.6177	12.4836	16.7815	0.0280	0.1004	0.5003	0.6007	0.0276	0.4737	0.5013	0.0000	2,678.680 9	2,678.680 9	0.5392	0.0318	2,701.642 2
Maximum	22.6177	37.9317	30.9368	0.0691	8.8528	1.4312	10.1190	4.5480	1.3169	5.7129	0.0000	6,752.003 2	6,752.003 2	1.9563	0.1160	6,835.487 3

	ROG	NOx	CO	SO2	Fugitive PM10	Exhaust PM10	PM10 Total	Fugitive PM2.5	Exhaust PM2.5	PM2.5 Total	Bio- CO2	NBio-CO2	Total CO2	CH4	N2O	CO2e
Percent Reduction	0.00	0.00	0.00	0.00	53.99	0.00	46.27	54.41	0.00	40.97	0.00	0.00	0.00	0.00	0.00	0.00

Unmitigated Construction - Localized Assessment - Kings County, Summer

EMFAC Off-Model Adjustment Factors for Gasoline Light Duty Vehicle to Account for the SAFE Vehicle Rule Not Applied

2.2 Overall Operational

Unmitigated Operational

	ROG	NOx	CO	SO2	Fugitive PM10	Exhaust PM10	PM10 Total	Fugitive PM2.5	Exhaust PM2.5	PM2.5 Total	Bio- CO2	NBio- CO2	Total CO2	CH4	N2O	CO2e
Category	lb/day										lb/day					
Area	0.8298	0.2658	23.0788	1.2200e-003		0.1281	0.1281		0.1281	0.1281	0.0000	41.5953	41.5953	0.0398	0.0000	42.5912
Energy	0.0000	0.0000	0.0000	0.0000		0.0000	0.0000		0.0000	0.0000		0.0000	0.0000	0.0000	0.0000	0.0000
Mobile	0.0000	0.0000	0.0000	0.0000	0.0000	0.0000	0.0000	0.0000	0.0000	0.0000		0.0000	0.0000	0.0000	0.0000	0.0000
Total	0.8298	0.2658	23.0788	1.2200e-003	0.0000	0.1281	0.1281	0.0000	0.1281	0.1281	0.0000	41.5953	41.5953	0.0398	0.0000	42.5912

Mitigated Operational

	ROG	NOx	CO	SO2	Fugitive PM10	Exhaust PM10	PM10 Total	Fugitive PM2.5	Exhaust PM2.5	PM2.5 Total	Bio- CO2	NBio- CO2	Total CO2	CH4	N2O	CO2e
Category	lb/day										lb/day					
Area	0.8298	0.2658	23.0788	1.2200e-003		0.1281	0.1281		0.1281	0.1281	0.0000	41.5953	41.5953	0.0398	0.0000	42.5912
Energy	0.0000	0.0000	0.0000	0.0000		0.0000	0.0000		0.0000	0.0000		0.0000	0.0000	0.0000	0.0000	0.0000
Mobile	0.0000	0.0000	0.0000	0.0000	0.0000	0.0000	0.0000	0.0000	0.0000	0.0000		0.0000	0.0000	0.0000	0.0000	0.0000
Total	0.8298	0.2658	23.0788	1.2200e-003	0.0000	0.1281	0.1281	0.0000	0.1281	0.1281	0.0000	41.5953	41.5953	0.0398	0.0000	42.5912

Unmitigated Construction - Localized Assessment - Kings County, Summer

EMFAC Off-Model Adjustment Factors for Gasoline Light Duty Vehicle to Account for the SAFE Vehicle Rule Not Applied

	ROG	NOx	CO	SO2	Fugitive PM10	Exhaust PM10	PM10 Total	Fugitive PM2.5	Exhaust PM2.5	PM2.5 Total	Bio- CO2	NBio-CO2	Total CO2	CH4	N2O	CO2e
Percent Reduction	0.00	0.00	0.00	0.00	0.00	0.00	0.00	0.00	0.00	0.00	0.00	0.00	0.00	0.00	0.00	0.00

3.0 Construction Detail

Construction Phase

Phase Number	Phase Name	Phase Type	Start Date	End Date	Num Days Week	Num Days	Phase Description
1	Site Preparation	Site Preparation	8/1/2023	9/25/2023	5	40	
2	Grading	Grading	9/26/2023	2/26/2024	5	110	
3	Paving	Paving	2/27/2024	6/10/2024	5	75	
4	Building Construction	Building Construction	6/11/2024	6/18/2029	5	1310	Extended to match total duration
5	Architectural Coating	Architectural Coating	6/5/2029	12/31/2029	5	150	Anticipated to occur throughout building construction

Acres of Grading (Site Preparation Phase): 60

Acres of Grading (Grading Phase): 330

Acres of Paving: 0

Residential Indoor: 1,020,600; Residential Outdoor: 340,200; Non-Residential Indoor: 2; Non-Residential Outdoor: 1; Striped Parking Area: 0 (Architectural Coating – sqft)

OffRoad Equipment

Phase Name	Offroad Equipment Type	Amount	Usage Hours	Horse Power	Load Factor
Site Preparation	Rubber Tired Dozers	3	8.00	247	0.40
Site Preparation	Tractors/Loaders/Backhoes	4	8.00	97	0.37
Grading	Excavators	2	8.00	158	0.38
Grading	Graders	1	8.00	187	0.41
Grading	Rubber Tired Dozers	1	8.00	247	0.40
Grading	Scrapers	2	8.00	367	0.48

Unmitigated Construction - Localized Assessment - Kings County, Summer

EMFAC Off-Model Adjustment Factors for Gasoline Light Duty Vehicle to Account for the SAFE Vehicle Rule Not Applied

Grading	Tractors/Loaders/Backhoes	2	8.00	97	0.37
Paving	Pavers	2	8.00	130	0.42
Paving	Paving Equipment	2	8.00	132	0.36
Paving	Rollers	2	8.00	80	0.38
Building Construction	Cranes	1	5.90	231	0.29
Building Construction	Forklifts	3	6.80	89	0.20
Building Construction	Generator Sets	1	6.80	84	0.74
Building Construction	Tractors/Loaders/Backhoes	3	5.90	97	0.37
Building Construction	Welders	1	6.80	46	0.45
Architectural Coating	Air Compressors	1	6.00	78	0.48

Trips and VMT

Phase Name	Offroad Equipment Count	Worker Trip Number	Vendor Trip Number	Hauling Trip Number	Worker Trip Length	Vendor Trip Length	Hauling Trip Length	Worker Vehicle Class	Vendor Vehicle Class	Hauling Vehicle Class
Site Preparation	7	18.00	0.00	14.00	0.50	0.50	0.50	LD_Mix	HDT_Mix	HHDT
Grading	8	20.00	0.00	17,814.00	0.50	0.50	0.50	LD_Mix	HDT_Mix	HHDT
Paving	6	15.00	0.00	12.00	0.50	0.50	0.50	LD_Mix	HDT_Mix	HHDT
Building Construction	9	159.00	53.00	18.00	0.50	0.50	0.50	LD_Mix	HDT_Mix	HHDT
Architectural Coating	1	32.00	0.00	2.00	0.50	0.50	0.50	LD_Mix	HDT_Mix	HHDT

3.1 Mitigation Measures Construction

Water Exposed Area

Reduce Vehicle Speed on Unpaved Roads

Unmitigated Construction - Localized Assessment - Kings County, Summer

EMFAC Off-Model Adjustment Factors for Gasoline Light Duty Vehicle to Account for the SAFE Vehicle Rule Not Applied

3.2 Site Preparation - 2023

Unmitigated Construction On-Site

	ROG	NOx	CO	SO2	Fugitive PM10	Exhaust PM10	PM10 Total	Fugitive PM2.5	Exhaust PM2.5	PM2.5 Total	Bio- CO2	NBio- CO2	Total CO2	CH4	N2O	CO2e
Category	lb/day										lb/day					
Fugitive Dust					19.6570	0.0000	19.6570	10.1025	0.0000	10.1025			0.0000			0.0000
Off-Road	2.6595	27.5242	18.2443	0.0381		1.2660	1.2660		1.1647	1.1647		3,687.308 1	3,687.308 1	1.1926		3,717.121 9
Total	2.6595	27.5242	18.2443	0.0381	19.6570	1.2660	20.9230	10.1025	1.1647	11.2672		3,687.308 1	3,687.308 1	1.1926		3,717.121 9

Unmitigated Construction Off-Site

	ROG	NOx	CO	SO2	Fugitive PM10	Exhaust PM10	PM10 Total	Fugitive PM2.5	Exhaust PM2.5	PM2.5 Total	Bio- CO2	NBio- CO2	Total CO2	CH4	N2O	CO2e
Category	lb/day										lb/day					
Hauling	4.4000e-004	7.3600e-003	5.9900e-003	1.0000e-005	1.6000e-004	1.0000e-005	1.8000e-004	4.0000e-005	1.0000e-005	6.0000e-005		1.5772	1.5772	2.0000e-005	2.5000e-004	1.6516
Vendor	0.0000	0.0000	0.0000	0.0000	0.0000	0.0000	0.0000	0.0000	0.0000	0.0000		0.0000	0.0000	0.0000	0.0000	0.0000
Worker	0.0338	9.8600e-003	0.1010	1.0000e-004	7.0100e-003	1.2000e-004	7.1300e-003	1.8800e-003	1.1000e-004	1.9900e-003		9.6833	9.6833	2.0900e-003	1.1800e-003	10.0875
Total	0.0342	0.0172	0.1070	1.1000e-004	7.1700e-003	1.3000e-004	7.3100e-003	1.9200e-003	1.2000e-004	2.0500e-003		11.2605	11.2605	2.1100e-003	1.4300e-003	11.7391

Unmitigated Construction - Localized Assessment - Kings County, Summer

EMFAC Off-Model Adjustment Factors for Gasoline Light Duty Vehicle to Account for the SAFE Vehicle Rule Not Applied

3.2 Site Preparation - 2023

Mitigated Construction On-Site

	ROG	NOx	CO	SO2	Fugitive PM10	Exhaust PM10	PM10 Total	Fugitive PM2.5	Exhaust PM2.5	PM2.5 Total	Bio- CO2	NBio- CO2	Total CO2	CH4	N2O	CO2e
Category	lb/day										lb/day					
Fugitive Dust					8.8457	0.0000	8.8457	4.5461	0.0000	4.5461			0.0000			0.0000
Off-Road	2.6595	27.5242	18.2443	0.0381		1.2660	1.2660		1.1647	1.1647	0.0000	3,687.308 1	3,687.308 1	1.1926		3,717.121 9
Total	2.6595	27.5242	18.2443	0.0381	8.8457	1.2660	10.1117	4.5461	1.1647	5.7108	0.0000	3,687.308 1	3,687.308 1	1.1926		3,717.121 9

Mitigated Construction Off-Site

	ROG	NOx	CO	SO2	Fugitive PM10	Exhaust PM10	PM10 Total	Fugitive PM2.5	Exhaust PM2.5	PM2.5 Total	Bio- CO2	NBio- CO2	Total CO2	CH4	N2O	CO2e
Category	lb/day										lb/day					
Hauling	4.4000e-004	7.3600e-003	5.9900e-003	1.0000e-005	1.6000e-004	1.0000e-005	1.8000e-004	4.0000e-005	1.0000e-005	6.0000e-005		1.5772	1.5772	2.0000e-005	2.5000e-004	1.6516
Vendor	0.0000	0.0000	0.0000	0.0000	0.0000	0.0000	0.0000	0.0000	0.0000	0.0000		0.0000	0.0000	0.0000	0.0000	0.0000
Worker	0.0338	9.8600e-003	0.1010	1.0000e-004	7.0100e-003	1.2000e-004	7.1300e-003	1.8800e-003	1.1000e-004	1.9900e-003		9.6833	9.6833	2.0900e-003	1.1800e-003	10.0875
Total	0.0342	0.0172	0.1070	1.1000e-004	7.1700e-003	1.3000e-004	7.3100e-003	1.9200e-003	1.2000e-004	2.0500e-003		11.2605	11.2605	2.1100e-003	1.4300e-003	11.7391

Unmitigated Construction - Localized Assessment - Kings County, Summer

EMFAC Off-Model Adjustment Factors for Gasoline Light Duty Vehicle to Account for the SAFE Vehicle Rule Not Applied

3.3 Grading - 2023

Unmitigated Construction On-Site

	ROG	NOx	CO	SO2	Fugitive PM10	Exhaust PM10	PM10 Total	Fugitive PM2.5	Exhaust PM2.5	PM2.5 Total	Bio- CO2	NBio- CO2	Total CO2	CH4	N2O	CO2e
Category	lb/day										lb/day					
Fugitive Dust					9.2036	0.0000	9.2036	3.6538	0.0000	3.6538			0.0000			0.0000
Off-Road	3.3217	34.5156	28.0512	0.0621		1.4245	1.4245		1.3105	1.3105		6,011.4777	6,011.4777	1.9442		6,060.0836
Total	3.3217	34.5156	28.0512	0.0621	9.2036	1.4245	10.6281	3.6538	1.3105	4.9643		6,011.4777	6,011.4777	1.9442		6,060.0836

Unmitigated Construction Off-Site

	ROG	NOx	CO	SO2	Fugitive PM10	Exhaust PM10	PM10 Total	Fugitive PM2.5	Exhaust PM2.5	PM2.5 Total	Bio- CO2	NBio- CO2	Total CO2	CH4	N2O	CO2e
Category	lb/day										lb/day					
Hauling	0.2031	3.4051	2.7733	6.8900e-003	0.0744	6.5500e-003	0.0810	0.0207	6.2700e-003	0.0270		729.7663	729.7663	9.7700e-003	0.1147	764.1955
Vendor	0.0000	0.0000	0.0000	0.0000	0.0000	0.0000	0.0000	0.0000	0.0000	0.0000		0.0000	0.0000	0.0000	0.0000	0.0000
Worker	0.0376	0.0110	0.1123	1.1000e-004	7.7900e-003	1.3000e-004	7.9200e-003	2.0900e-003	1.2000e-004	2.2100e-003		10.7592	10.7592	2.3200e-003	1.3100e-003	11.2083
Total	0.2406	3.4161	2.8856	7.0000e-003	0.0822	6.6800e-003	0.0889	0.0228	6.3900e-003	0.0292		740.5255	740.5255	0.0121	0.1160	775.4038

Unmitigated Construction - Localized Assessment - Kings County, Summer

EMFAC Off-Model Adjustment Factors for Gasoline Light Duty Vehicle to Account for the SAFE Vehicle Rule Not Applied

3.3 Grading - 2023

Mitigated Construction On-Site

	ROG	NOx	CO	SO2	Fugitive PM10	Exhaust PM10	PM10 Total	Fugitive PM2.5	Exhaust PM2.5	PM2.5 Total	Bio- CO2	NBio- CO2	Total CO2	CH4	N2O	CO2e
Category	lb/day										lb/day					
Fugitive Dust					4.1416	0.0000	4.1416	1.6442	0.0000	1.6442			0.0000			0.0000
Off-Road	3.3217	34.5156	28.0512	0.0621		1.4245	1.4245		1.3105	1.3105	0.0000	6,011.4777	6,011.4777	1.9442		6,060.0836
Total	3.3217	34.5156	28.0512	0.0621	4.1416	1.4245	5.5661	1.6442	1.3105	2.9547	0.0000	6,011.4777	6,011.4777	1.9442		6,060.0836

Mitigated Construction Off-Site

	ROG	NOx	CO	SO2	Fugitive PM10	Exhaust PM10	PM10 Total	Fugitive PM2.5	Exhaust PM2.5	PM2.5 Total	Bio- CO2	NBio- CO2	Total CO2	CH4	N2O	CO2e
Category	lb/day										lb/day					
Hauling	0.2031	3.4051	2.7733	6.8900e-003	0.0744	6.5500e-003	0.0810	0.0207	6.2700e-003	0.0270		729.7663	729.7663	9.7700e-003	0.1147	764.1955
Vendor	0.0000	0.0000	0.0000	0.0000	0.0000	0.0000	0.0000	0.0000	0.0000	0.0000		0.0000	0.0000	0.0000	0.0000	0.0000
Worker	0.0376	0.0110	0.1123	1.1000e-004	7.7900e-003	1.3000e-004	7.9200e-003	2.0900e-003	1.2000e-004	2.2100e-003		10.7592	10.7592	2.3200e-003	1.3100e-003	11.2083
Total	0.2406	3.4161	2.8856	7.0000e-003	0.0822	6.6800e-003	0.0889	0.0228	6.3900e-003	0.0292		740.5255	740.5255	0.0121	0.1160	775.4038

Unmitigated Construction - Localized Assessment - Kings County, Summer

EMFAC Off-Model Adjustment Factors for Gasoline Light Duty Vehicle to Account for the SAFE Vehicle Rule Not Applied

3.3 Grading - 2024

Unmitigated Construction On-Site

	ROG	NOx	CO	SO2	Fugitive PM10	Exhaust PM10	PM10 Total	Fugitive PM2.5	Exhaust PM2.5	PM2.5 Total	Bio- CO2	NBio- CO2	Total CO2	CH4	N2O	CO2e
Category	lb/day										lb/day					
Fugitive Dust					9.2036	0.0000	9.2036	3.6538	0.0000	3.6538			0.0000			0.0000
Off-Road	3.2181	32.3770	27.7228	0.0621		1.3354	1.3354		1.2286	1.2286		6,009.7487	6,009.7487	1.9437		6,058.3405
Total	3.2181	32.3770	27.7228	0.0621	9.2036	1.3354	10.5390	3.6538	1.2286	4.8823		6,009.7487	6,009.7487	1.9437		6,058.3405

Unmitigated Construction Off-Site

	ROG	NOx	CO	SO2	Fugitive PM10	Exhaust PM10	PM10 Total	Fugitive PM2.5	Exhaust PM2.5	PM2.5 Total	Bio- CO2	NBio- CO2	Total CO2	CH4	N2O	CO2e
Category	lb/day										lb/day					
Hauling	0.2016	3.3873	2.7537	6.7600e-003	0.0744	6.5900e-003	0.0810	0.0207	6.3000e-003	0.0270		715.4579	715.4579	9.6900e-003	0.1125	749.2148
Vendor	0.0000	0.0000	0.0000	0.0000	0.0000	0.0000	0.0000	0.0000	0.0000	0.0000		0.0000	0.0000	0.0000	0.0000	0.0000
Worker	0.0344	0.0100	0.1069	1.0000e-004	7.7900e-003	1.2000e-004	7.9200e-003	2.0900e-003	1.1000e-004	2.2100e-003		10.4125	10.4125	2.1300e-003	1.2400e-003	10.8363
Total	0.2360	3.3973	2.8606	6.8600e-003	0.0822	6.7100e-003	0.0889	0.0228	6.4100e-003	0.0292		725.8704	725.8704	0.0118	0.1137	760.0511

Unmitigated Construction - Localized Assessment - Kings County, Summer

EMFAC Off-Model Adjustment Factors for Gasoline Light Duty Vehicle to Account for the SAFE Vehicle Rule Not Applied

3.3 Grading - 2024

Mitigated Construction On-Site

	ROG	NOx	CO	SO2	Fugitive PM10	Exhaust PM10	PM10 Total	Fugitive PM2.5	Exhaust PM2.5	PM2.5 Total	Bio- CO2	NBio- CO2	Total CO2	CH4	N2O	CO2e
Category	lb/day										lb/day					
Fugitive Dust					4.1416	0.0000	4.1416	1.6442	0.0000	1.6442			0.0000			0.0000
Off-Road	3.2181	32.3770	27.7228	0.0621		1.3354	1.3354		1.2286	1.2286	0.0000	6,009.7487	6,009.7487	1.9437		6,058.3405
Total	3.2181	32.3770	27.7228	0.0621	4.1416	1.3354	5.4770	1.6442	1.2286	2.8728	0.0000	6,009.7487	6,009.7487	1.9437		6,058.3405

Mitigated Construction Off-Site

	ROG	NOx	CO	SO2	Fugitive PM10	Exhaust PM10	PM10 Total	Fugitive PM2.5	Exhaust PM2.5	PM2.5 Total	Bio- CO2	NBio- CO2	Total CO2	CH4	N2O	CO2e
Category	lb/day										lb/day					
Hauling	0.2016	3.3873	2.7537	6.7600e-003	0.0744	6.5900e-003	0.0810	0.0207	6.3000e-003	0.0270		715.4579	715.4579	9.6900e-003	0.1125	749.2148
Vendor	0.0000	0.0000	0.0000	0.0000	0.0000	0.0000	0.0000	0.0000	0.0000	0.0000		0.0000	0.0000	0.0000	0.0000	0.0000
Worker	0.0344	0.0100	0.1069	1.0000e-004	7.7900e-003	1.2000e-004	7.9200e-003	2.0900e-003	1.1000e-004	2.2100e-003		10.4125	10.4125	2.1300e-003	1.2400e-003	10.8363
Total	0.2360	3.3973	2.8606	6.8600e-003	0.0822	6.7100e-003	0.0889	0.0228	6.4100e-003	0.0292		725.8704	725.8704	0.0118	0.1137	760.0511

Unmitigated Construction - Localized Assessment - Kings County, Summer

EMFAC Off-Model Adjustment Factors for Gasoline Light Duty Vehicle to Account for the SAFE Vehicle Rule Not Applied

3.4 Paving - 2024

Unmitigated Construction On-Site

	ROG	NOx	CO	SO2	Fugitive PM10	Exhaust PM10	PM10 Total	Fugitive PM2.5	Exhaust PM2.5	PM2.5 Total	Bio- CO2	NBio- CO2	Total CO2	CH4	N2O	CO2e
Category	lb/day										lb/day					
Off-Road	0.9882	9.5246	14.6258	0.0228		0.4685	0.4685		0.4310	0.4310		2,207.547 2	2,207.547 2	0.7140		2,225.396 3
Paving	0.0000					0.0000	0.0000		0.0000	0.0000			0.0000			0.0000
Total	0.9882	9.5246	14.6258	0.0228		0.4685	0.4685		0.4310	0.4310		2,207.547 2	2,207.547 2	0.7140		2,225.396 3

Unmitigated Construction Off-Site

	ROG	NOx	CO	SO2	Fugitive PM10	Exhaust PM10	PM10 Total	Fugitive PM2.5	Exhaust PM2.5	PM2.5 Total	Bio- CO2	NBio- CO2	Total CO2	CH4	N2O	CO2e
Category	lb/day										lb/day					
Hauling	2.0000e-004	3.3500e-003	2.7200e-003	1.0000e-005	7.0000e-005	1.0000e-005	8.0000e-005	2.0000e-005	1.0000e-005	3.0000e-005		0.7069	0.7069	1.0000e-005	1.1000e-004	0.7402
Vendor	0.0000	0.0000	0.0000	0.0000	0.0000	0.0000	0.0000	0.0000	0.0000	0.0000		0.0000	0.0000	0.0000	0.0000	0.0000
Worker	0.0258	7.5200e-003	0.0802	8.0000e-005	5.8500e-003	9.0000e-005	5.9400e-003	1.5700e-003	8.0000e-005	1.6500e-003		7.8094	7.8094	1.5900e-003	9.3000e-004	8.1273
Total	0.0260	0.0109	0.0829	9.0000e-005	5.9200e-003	1.0000e-004	6.0200e-003	1.5900e-003	9.0000e-005	1.6800e-003		8.5162	8.5162	1.6000e-003	1.0400e-003	8.8675

Unmitigated Construction - Localized Assessment - Kings County, Summer

EMFAC Off-Model Adjustment Factors for Gasoline Light Duty Vehicle to Account for the SAFE Vehicle Rule Not Applied

3.4 Paving - 2024

Mitigated Construction On-Site

	ROG	NOx	CO	SO2	Fugitive PM10	Exhaust PM10	PM10 Total	Fugitive PM2.5	Exhaust PM2.5	PM2.5 Total	Bio- CO2	NBio- CO2	Total CO2	CH4	N2O	CO2e
Category	lb/day										lb/day					
Off-Road	0.9882	9.5246	14.6258	0.0228		0.4685	0.4685		0.4310	0.4310	0.0000	2,207.547 2	2,207.547 2	0.7140		2,225.396 3
Paving	0.0000					0.0000	0.0000		0.0000	0.0000			0.0000			0.0000
Total	0.9882	9.5246	14.6258	0.0228		0.4685	0.4685		0.4310	0.4310	0.0000	2,207.547 2	2,207.547 2	0.7140		2,225.396 3

Mitigated Construction Off-Site

	ROG	NOx	CO	SO2	Fugitive PM10	Exhaust PM10	PM10 Total	Fugitive PM2.5	Exhaust PM2.5	PM2.5 Total	Bio- CO2	NBio- CO2	Total CO2	CH4	N2O	CO2e
Category	lb/day										lb/day					
Hauling	2.0000e-004	3.3500e-003	2.7200e-003	1.0000e-005	7.0000e-005	1.0000e-005	8.0000e-005	2.0000e-005	1.0000e-005	3.0000e-005		0.7069	0.7069	1.0000e-005	1.1000e-004	0.7402
Vendor	0.0000	0.0000	0.0000	0.0000	0.0000	0.0000	0.0000	0.0000	0.0000	0.0000		0.0000	0.0000	0.0000	0.0000	0.0000
Worker	0.0258	7.5200e-003	0.0802	8.0000e-005	5.8500e-003	9.0000e-005	5.9400e-003	1.5700e-003	8.0000e-005	1.6500e-003		7.8094	7.8094	1.5900e-003	9.3000e-004	8.1273
Total	0.0260	0.0109	0.0829	9.0000e-005	5.9200e-003	1.0000e-004	6.0200e-003	1.5900e-003	9.0000e-005	1.6800e-003		8.5162	8.5162	1.6000e-003	1.0400e-003	8.8675

Unmitigated Construction - Localized Assessment - Kings County, Summer

EMFAC Off-Model Adjustment Factors for Gasoline Light Duty Vehicle to Account for the SAFE Vehicle Rule Not Applied

3.5 Building Construction - 2024

Unmitigated Construction On-Site

	ROG	NOx	CO	SO2	Fugitive PM10	Exhaust PM10	PM10 Total	Fugitive PM2.5	Exhaust PM2.5	PM2.5 Total	Bio- CO2	NBio- CO2	Total CO2	CH4	N2O	CO2e
Category	lb/day										lb/day					
Off-Road	1.2461	11.3782	13.6888	0.0228		0.5192	0.5192		0.4884	0.4884		2,163.1934	2,163.1934	0.5107		2,175.9619
Total	1.2461	11.3782	13.6888	0.0228		0.5192	0.5192		0.4884	0.4884		2,163.1934	2,163.1934	0.5107		2,175.9619

Unmitigated Construction Off-Site

	ROG	NOx	CO	SO2	Fugitive PM10	Exhaust PM10	PM10 Total	Fugitive PM2.5	Exhaust PM2.5	PM2.5 Total	Bio- CO2	NBio- CO2	Total CO2	CH4	N2O	CO2e
Category	lb/day										lb/day					
Hauling	2.0000e-005	2.9000e-004	2.3000e-004	0.0000	1.0000e-005	0.0000	1.0000e-005	0.0000	0.0000	0.0000		0.0607	0.0607	0.0000	1.0000e-005	0.0636
Vendor	0.0404	0.7366	0.5469	1.5400e-003	0.0259	1.4100e-003	0.0273	7.6000e-003	1.3500e-003	8.9600e-003		162.8820	162.8820	2.4800e-003	0.0247	170.3022
Worker	0.2735	0.0798	0.8501	8.2000e-004	0.0620	9.8000e-004	0.0629	0.0166	9.0000e-004	0.0175		82.7794	82.7794	0.0169	9.8900e-003	86.1488
Total	0.3139	0.8166	1.3972	2.3600e-003	0.0879	2.3900e-003	0.0903	0.0242	2.2500e-003	0.0265		245.7221	245.7221	0.0194	0.0346	256.5146

Unmitigated Construction - Localized Assessment - Kings County, Summer

EMFAC Off-Model Adjustment Factors for Gasoline Light Duty Vehicle to Account for the SAFE Vehicle Rule Not Applied

3.5 Building Construction - 2024

Mitigated Construction On-Site

	ROG	NOx	CO	SO2	Fugitive PM10	Exhaust PM10	PM10 Total	Fugitive PM2.5	Exhaust PM2.5	PM2.5 Total	Bio- CO2	NBio- CO2	Total CO2	CH4	N2O	CO2e
Category	lb/day										lb/day					
Off-Road	1.2461	11.3782	13.6888	0.0228		0.5192	0.5192		0.4884	0.4884	0.0000	2,163.1934	2,163.1934	0.5107		2,175.9619
Total	1.2461	11.3782	13.6888	0.0228		0.5192	0.5192		0.4884	0.4884	0.0000	2,163.1934	2,163.1934	0.5107		2,175.9619

Mitigated Construction Off-Site

	ROG	NOx	CO	SO2	Fugitive PM10	Exhaust PM10	PM10 Total	Fugitive PM2.5	Exhaust PM2.5	PM2.5 Total	Bio- CO2	NBio- CO2	Total CO2	CH4	N2O	CO2e
Category	lb/day										lb/day					
Hauling	2.0000e-005	2.9000e-004	2.3000e-004	0.0000	1.0000e-005	0.0000	1.0000e-005	0.0000	0.0000	0.0000		0.0607	0.0607	0.0000	1.0000e-005	0.0636
Vendor	0.0404	0.7366	0.5469	1.5400e-003	0.0259	1.4100e-003	0.0273	7.6000e-003	1.3500e-003	8.9600e-003		162.8820	162.8820	2.4800e-003	0.0247	170.3022
Worker	0.2735	0.0798	0.8501	8.2000e-004	0.0620	9.8000e-004	0.0629	0.0166	9.0000e-004	0.0175		82.7794	82.7794	0.0169	9.8900e-003	86.1488
Total	0.3139	0.8166	1.3972	2.3600e-003	0.0879	2.3900e-003	0.0903	0.0242	2.2500e-003	0.0265		245.7221	245.7221	0.0194	0.0346	256.5146

Unmitigated Construction - Localized Assessment - Kings County, Summer

EMFAC Off-Model Adjustment Factors for Gasoline Light Duty Vehicle to Account for the SAFE Vehicle Rule Not Applied

3.5 Building Construction - 2025

Unmitigated Construction On-Site

	ROG	NOx	CO	SO2	Fugitive PM10	Exhaust PM10	PM10 Total	Fugitive PM2.5	Exhaust PM2.5	PM2.5 Total	Bio- CO2	NBio- CO2	Total CO2	CH4	N2O	CO2e
Category	lb/day										lb/day					
Off-Road	1.1579	10.5544	13.6193	0.0228		0.4466	0.4466		0.4201	0.4201		2,163.8470	2,163.8470	0.5078		2,176.5431
Total	1.1579	10.5544	13.6193	0.0228		0.4466	0.4466		0.4201	0.4201		2,163.8470	2,163.8470	0.5078		2,176.5431

Unmitigated Construction Off-Site

	ROG	NOx	CO	SO2	Fugitive PM10	Exhaust PM10	PM10 Total	Fugitive PM2.5	Exhaust PM2.5	PM2.5 Total	Bio- CO2	NBio- CO2	Total CO2	CH4	N2O	CO2e
Category	lb/day										lb/day					
Hauling	2.0000e-005	2.9000e-004	2.3000e-004	0.0000	1.0000e-005	0.0000	1.0000e-005	0.0000	0.0000	0.0000		0.0594	0.0594	0.0000	1.0000e-005	0.0622
Vendor	0.0398	0.7320	0.5399	1.5100e-003	0.0259	1.4100e-003	0.0273	7.6000e-003	1.3500e-003	8.9500e-003		159.7565	159.7565	2.4400e-003	0.0242	167.0251
Worker	0.2523	0.0734	0.8098	7.9000e-004	0.0620	9.3000e-004	0.0629	0.0166	8.6000e-004	0.0175		79.9856	79.9856	0.0155	9.3800e-003	83.1683
Total	0.2921	0.8057	1.3499	2.3000e-003	0.0879	2.3400e-003	0.0903	0.0242	2.2100e-003	0.0264		239.8015	239.8015	0.0179	0.0336	250.2556

Unmitigated Construction - Localized Assessment - Kings County, Summer

EMFAC Off-Model Adjustment Factors for Gasoline Light Duty Vehicle to Account for the SAFE Vehicle Rule Not Applied

3.5 Building Construction - 2025

Mitigated Construction On-Site

	ROG	NOx	CO	SO2	Fugitive PM10	Exhaust PM10	PM10 Total	Fugitive PM2.5	Exhaust PM2.5	PM2.5 Total	Bio- CO2	NBio- CO2	Total CO2	CH4	N2O	CO2e
Category	lb/day										lb/day					
Off-Road	1.1579	10.5544	13.6193	0.0228		0.4466	0.4466		0.4201	0.4201	0.0000	2,163.8470	2,163.8470	0.5078		2,176.5431
Total	1.1579	10.5544	13.6193	0.0228		0.4466	0.4466		0.4201	0.4201	0.0000	2,163.8470	2,163.8470	0.5078		2,176.5431

Mitigated Construction Off-Site

	ROG	NOx	CO	SO2	Fugitive PM10	Exhaust PM10	PM10 Total	Fugitive PM2.5	Exhaust PM2.5	PM2.5 Total	Bio- CO2	NBio- CO2	Total CO2	CH4	N2O	CO2e
Category	lb/day										lb/day					
Hauling	2.0000e-005	2.9000e-004	2.3000e-004	0.0000	1.0000e-005	0.0000	1.0000e-005	0.0000	0.0000	0.0000		0.0594	0.0594	0.0000	1.0000e-005	0.0622
Vendor	0.0398	0.7320	0.5399	1.5100e-003	0.0259	1.4100e-003	0.0273	7.6000e-003	1.3500e-003	8.9500e-003		159.7565	159.7565	2.4400e-003	0.0242	167.0251
Worker	0.2523	0.0734	0.8098	7.9000e-004	0.0620	9.3000e-004	0.0629	0.0166	8.6000e-004	0.0175		79.9856	79.9856	0.0155	9.3800e-003	83.1683
Total	0.2921	0.8057	1.3499	2.3000e-003	0.0879	2.3400e-003	0.0903	0.0242	2.2100e-003	0.0264		239.8015	239.8015	0.0179	0.0336	250.2556

Unmitigated Construction - Localized Assessment - Kings County, Summer

EMFAC Off-Model Adjustment Factors for Gasoline Light Duty Vehicle to Account for the SAFE Vehicle Rule Not Applied

3.5 Building Construction - 2026

Unmitigated Construction On-Site

	ROG	NOx	CO	SO2	Fugitive PM10	Exhaust PM10	PM10 Total	Fugitive PM2.5	Exhaust PM2.5	PM2.5 Total	Bio- CO2	NBio- CO2	Total CO2	CH4	N2O	CO2e
Category	lb/day										lb/day					
Off-Road	1.1579	10.5544	13.6193	0.0228		0.4466	0.4466		0.4201	0.4201		2,163.8470	2,163.8470	0.5078		2,176.5431
Total	1.1579	10.5544	13.6193	0.0228		0.4466	0.4466		0.4201	0.4201		2,163.8470	2,163.8470	0.5078		2,176.5431

Unmitigated Construction Off-Site

	ROG	NOx	CO	SO2	Fugitive PM10	Exhaust PM10	PM10 Total	Fugitive PM2.5	Exhaust PM2.5	PM2.5 Total	Bio- CO2	NBio- CO2	Total CO2	CH4	N2O	CO2e
Category	lb/day										lb/day					
Hauling	2.0000e-005	2.8000e-004	2.3000e-004	0.0000	1.0000e-005	0.0000	1.0000e-005	0.0000	0.0000	0.0000		0.0580	0.0580	0.0000	1.0000e-005	0.0607
Vendor	0.0393	0.7273	0.5341	1.4800e-003	0.0259	1.4000e-003	0.0273	7.6000e-003	1.3400e-003	8.9400e-003		156.6139	156.6139	2.4200e-003	0.0237	163.7301
Worker	0.2334	0.0680	0.7760	7.7000e-004	0.0620	8.9000e-004	0.0629	0.0166	8.2000e-004	0.0175		77.6973	77.6973	0.0143	8.9400e-003	80.7172
Total	0.2728	0.7955	1.3103	2.2500e-003	0.0879	2.2900e-003	0.0902	0.0242	2.1600e-003	0.0264		234.3692	234.3692	0.0167	0.0326	244.5080

Unmitigated Construction - Localized Assessment - Kings County, Summer

EMFAC Off-Model Adjustment Factors for Gasoline Light Duty Vehicle to Account for the SAFE Vehicle Rule Not Applied

3.5 Building Construction - 2026

Mitigated Construction On-Site

	ROG	NOx	CO	SO2	Fugitive PM10	Exhaust PM10	PM10 Total	Fugitive PM2.5	Exhaust PM2.5	PM2.5 Total	Bio- CO2	NBio- CO2	Total CO2	CH4	N2O	CO2e
Category	lb/day										lb/day					
Off-Road	1.1579	10.5544	13.6193	0.0228		0.4466	0.4466		0.4201	0.4201	0.0000	2,163.8470	2,163.8470	0.5078		2,176.5431
Total	1.1579	10.5544	13.6193	0.0228		0.4466	0.4466		0.4201	0.4201	0.0000	2,163.8470	2,163.8470	0.5078		2,176.5431

Mitigated Construction Off-Site

	ROG	NOx	CO	SO2	Fugitive PM10	Exhaust PM10	PM10 Total	Fugitive PM2.5	Exhaust PM2.5	PM2.5 Total	Bio- CO2	NBio- CO2	Total CO2	CH4	N2O	CO2e
Category	lb/day										lb/day					
Hauling	2.0000e-005	2.8000e-004	2.3000e-004	0.0000	1.0000e-005	0.0000	1.0000e-005	0.0000	0.0000	0.0000		0.0580	0.0580	0.0000	1.0000e-005	0.0607
Vendor	0.0393	0.7273	0.5341	1.4800e-003	0.0259	1.4000e-003	0.0273	7.6000e-003	1.3400e-003	8.9400e-003		156.6139	156.6139	2.4200e-003	0.0237	163.7301
Worker	0.2334	0.0680	0.7760	7.7000e-004	0.0620	8.9000e-004	0.0629	0.0166	8.2000e-004	0.0175		77.6973	77.6973	0.0143	8.9400e-003	80.7172
Total	0.2728	0.7955	1.3103	2.2500e-003	0.0879	2.2900e-003	0.0902	0.0242	2.1600e-003	0.0264		234.3692	234.3692	0.0167	0.0326	244.5080

Unmitigated Construction - Localized Assessment - Kings County, Summer

EMFAC Off-Model Adjustment Factors for Gasoline Light Duty Vehicle to Account for the SAFE Vehicle Rule Not Applied

3.5 Building Construction - 2027

Unmitigated Construction On-Site

	ROG	NOx	CO	SO2	Fugitive PM10	Exhaust PM10	PM10 Total	Fugitive PM2.5	Exhaust PM2.5	PM2.5 Total	Bio- CO2	NBio- CO2	Total CO2	CH4	N2O	CO2e
Category	lb/day										lb/day					
Off-Road	1.1579	10.5544	13.6193	0.0228		0.4466	0.4466		0.4201	0.4201		2,163.8470	2,163.8470	0.5078		2,176.5431
Total	1.1579	10.5544	13.6193	0.0228		0.4466	0.4466		0.4201	0.4201		2,163.8470	2,163.8470	0.5078		2,176.5431

Unmitigated Construction Off-Site

	ROG	NOx	CO	SO2	Fugitive PM10	Exhaust PM10	PM10 Total	Fugitive PM2.5	Exhaust PM2.5	PM2.5 Total	Bio- CO2	NBio- CO2	Total CO2	CH4	N2O	CO2e
Category	lb/day										lb/day					
Hauling	2.0000e-005	2.8000e-004	2.3000e-004	0.0000	1.0000e-005	0.0000	1.0000e-005	0.0000	0.0000	0.0000		0.0566	0.0566	0.0000	1.0000e-005	0.0593
Vendor	0.0390	0.7229	0.5293	1.4500e-003	0.0259	1.3800e-003	0.0273	7.6000e-003	1.3200e-003	8.9300e-003		153.4019	153.4019	2.4000e-003	0.0232	160.3652
Worker	0.2167	0.0634	0.7436	7.5000e-004	0.0620	8.5000e-004	0.0628	0.0166	7.8000e-004	0.0174		75.4179	75.4179	0.0132	8.5700e-003	78.3001
Total	0.2557	0.7866	1.2731	2.2000e-003	0.0879	2.2300e-003	0.0901	0.0242	2.1000e-003	0.0263		228.8765	228.8765	0.0156	0.0318	238.7246

Unmitigated Construction - Localized Assessment - Kings County, Summer

EMFAC Off-Model Adjustment Factors for Gasoline Light Duty Vehicle to Account for the SAFE Vehicle Rule Not Applied

3.5 Building Construction - 2027

Mitigated Construction On-Site

	ROG	NOx	CO	SO2	Fugitive PM10	Exhaust PM10	PM10 Total	Fugitive PM2.5	Exhaust PM2.5	PM2.5 Total	Bio- CO2	NBio- CO2	Total CO2	CH4	N2O	CO2e
Category	lb/day										lb/day					
Off-Road	1.1579	10.5544	13.6193	0.0228		0.4466	0.4466		0.4201	0.4201	0.0000	2,163.8470	2,163.8470	0.5078		2,176.5431
Total	1.1579	10.5544	13.6193	0.0228		0.4466	0.4466		0.4201	0.4201	0.0000	2,163.8470	2,163.8470	0.5078		2,176.5431

Mitigated Construction Off-Site

	ROG	NOx	CO	SO2	Fugitive PM10	Exhaust PM10	PM10 Total	Fugitive PM2.5	Exhaust PM2.5	PM2.5 Total	Bio- CO2	NBio- CO2	Total CO2	CH4	N2O	CO2e
Category	lb/day										lb/day					
Hauling	2.0000e-005	2.8000e-004	2.3000e-004	0.0000	1.0000e-005	0.0000	1.0000e-005	0.0000	0.0000	0.0000		0.0566	0.0566	0.0000	1.0000e-005	0.0593
Vendor	0.0390	0.7229	0.5293	1.4500e-003	0.0259	1.3800e-003	0.0273	7.6000e-003	1.3200e-003	8.9300e-003		153.4019	153.4019	2.4000e-003	0.0232	160.3652
Worker	0.2167	0.0634	0.7436	7.5000e-004	0.0620	8.5000e-004	0.0628	0.0166	7.8000e-004	0.0174		75.4179	75.4179	0.0132	8.5700e-003	78.3001
Total	0.2557	0.7866	1.2731	2.2000e-003	0.0879	2.2300e-003	0.0901	0.0242	2.1000e-003	0.0263		228.8765	228.8765	0.0156	0.0318	238.7246

Unmitigated Construction - Localized Assessment - Kings County, Summer

EMFAC Off-Model Adjustment Factors for Gasoline Light Duty Vehicle to Account for the SAFE Vehicle Rule Not Applied

3.5 Building Construction - 2028

Unmitigated Construction On-Site

	ROG	NOx	CO	SO2	Fugitive PM10	Exhaust PM10	PM10 Total	Fugitive PM2.5	Exhaust PM2.5	PM2.5 Total	Bio- CO2	NBio- CO2	Total CO2	CH4	N2O	CO2e
Category	lb/day										lb/day					
Off-Road	1.1579	10.5544	13.6193	0.0228		0.4466	0.4466		0.4201	0.4201		2,163.8470	2,163.8470	0.5078		2,176.5431
Total	1.1579	10.5544	13.6193	0.0228		0.4466	0.4466		0.4201	0.4201		2,163.8470	2,163.8470	0.5078		2,176.5431

Unmitigated Construction Off-Site

	ROG	NOx	CO	SO2	Fugitive PM10	Exhaust PM10	PM10 Total	Fugitive PM2.5	Exhaust PM2.5	PM2.5 Total	Bio- CO2	NBio- CO2	Total CO2	CH4	N2O	CO2e
Category	lb/day										lb/day					
Hauling	2.0000e-005	2.8000e-004	2.3000e-004	0.0000	1.0000e-005	0.0000	1.0000e-005	0.0000	0.0000	0.0000		0.0553	0.0553	0.0000	1.0000e-005	0.0579
Vendor	0.0387	0.7193	0.5258	1.4200e-003	0.0259	1.3700e-003	0.0273	7.6000e-003	1.3100e-003	8.9200e-003		150.3194	150.3194	2.3900e-003	0.0227	157.1369
Worker	0.2019	0.0596	0.7158	7.3000e-004	0.0620	7.9000e-004	0.0628	0.0166	7.3000e-004	0.0174		73.3784	73.3784	0.0122	8.2500e-003	76.1428
Total	0.2406	0.7791	1.2419	2.1500e-003	0.0879	2.1600e-003	0.0901	0.0242	2.0400e-003	0.0263		223.7530	223.7530	0.0146	0.0309	233.3376

Unmitigated Construction - Localized Assessment - Kings County, Summer

EMFAC Off-Model Adjustment Factors for Gasoline Light Duty Vehicle to Account for the SAFE Vehicle Rule Not Applied

3.5 Building Construction - 2028

Mitigated Construction On-Site

	ROG	NOx	CO	SO2	Fugitive PM10	Exhaust PM10	PM10 Total	Fugitive PM2.5	Exhaust PM2.5	PM2.5 Total	Bio- CO2	NBio- CO2	Total CO2	CH4	N2O	CO2e
Category	lb/day										lb/day					
Off-Road	1.1579	10.5544	13.6193	0.0228		0.4466	0.4466		0.4201	0.4201	0.0000	2,163.8470	2,163.8470	0.5078		2,176.5431
Total	1.1579	10.5544	13.6193	0.0228		0.4466	0.4466		0.4201	0.4201	0.0000	2,163.8470	2,163.8470	0.5078		2,176.5431

Mitigated Construction Off-Site

	ROG	NOx	CO	SO2	Fugitive PM10	Exhaust PM10	PM10 Total	Fugitive PM2.5	Exhaust PM2.5	PM2.5 Total	Bio- CO2	NBio- CO2	Total CO2	CH4	N2O	CO2e
Category	lb/day										lb/day					
Hauling	2.0000e-005	2.8000e-004	2.3000e-004	0.0000	1.0000e-005	0.0000	1.0000e-005	0.0000	0.0000	0.0000		0.0553	0.0553	0.0000	1.0000e-005	0.0579
Vendor	0.0387	0.7193	0.5258	1.4200e-003	0.0259	1.3700e-003	0.0273	7.6000e-003	1.3100e-003	8.9200e-003		150.3194	150.3194	2.3900e-003	0.0227	157.1369
Worker	0.2019	0.0596	0.7158	7.3000e-004	0.0620	7.9000e-004	0.0628	0.0166	7.3000e-004	0.0174		73.3784	73.3784	0.0122	8.2500e-003	76.1428
Total	0.2406	0.7791	1.2419	2.1500e-003	0.0879	2.1600e-003	0.0901	0.0242	2.0400e-003	0.0263		223.7530	223.7530	0.0146	0.0309	233.3376

Unmitigated Construction - Localized Assessment - Kings County, Summer

EMFAC Off-Model Adjustment Factors for Gasoline Light Duty Vehicle to Account for the SAFE Vehicle Rule Not Applied

3.5 Building Construction - 2029

Unmitigated Construction On-Site

	ROG	NOx	CO	SO2	Fugitive PM10	Exhaust PM10	PM10 Total	Fugitive PM2.5	Exhaust PM2.5	PM2.5 Total	Bio- CO2	NBio- CO2	Total CO2	CH4	N2O	CO2e
Category	lb/day										lb/day					
Off-Road	1.1579	10.5544	13.6193	0.0228		0.4466	0.4466		0.4201	0.4201		2,163.8470	2,163.8470	0.5078		2,176.5431
Total	1.1579	10.5544	13.6193	0.0228		0.4466	0.4466		0.4201	0.4201		2,163.8470	2,163.8470	0.5078		2,176.5431

Unmitigated Construction Off-Site

	ROG	NOx	CO	SO2	Fugitive PM10	Exhaust PM10	PM10 Total	Fugitive PM2.5	Exhaust PM2.5	PM2.5 Total	Bio- CO2	NBio- CO2	Total CO2	CH4	N2O	CO2e
Category	lb/day										lb/day					
Hauling	2.0000e-005	2.8000e-004	2.3000e-004	0.0000	1.0000e-005	0.0000	1.0000e-005	0.0000	0.0000	0.0000		0.0540	0.0540	0.0000	1.0000e-005	0.0565
Vendor	0.0384	0.7156	0.5227	1.4000e-003	0.0259	1.3600e-003	0.0273	7.6000e-003	1.3000e-003	8.9000e-003		147.3282	147.3282	2.3800e-003	0.0222	154.0050
Worker	0.1881	0.0563	0.6909	7.1000e-004	0.0620	7.5000e-004	0.0627	0.0166	6.9000e-004	0.0173		71.5511	71.5511	0.0114	7.9800e-003	74.2146
Total	0.2266	0.7721	1.2138	2.1100e-003	0.0879	2.1100e-003	0.0900	0.0242	1.9900e-003	0.0262		218.9332	218.9332	0.0138	0.0302	228.2762

Unmitigated Construction - Localized Assessment - Kings County, Summer

EMFAC Off-Model Adjustment Factors for Gasoline Light Duty Vehicle to Account for the SAFE Vehicle Rule Not Applied

3.5 Building Construction - 2029

Mitigated Construction On-Site

	ROG	NOx	CO	SO2	Fugitive PM10	Exhaust PM10	PM10 Total	Fugitive PM2.5	Exhaust PM2.5	PM2.5 Total	Bio- CO2	NBio- CO2	Total CO2	CH4	N2O	CO2e
Category	lb/day										lb/day					
Off-Road	1.1579	10.5544	13.6193	0.0228		0.4466	0.4466		0.4201	0.4201	0.0000	2,163.8470	2,163.8470	0.5078		2,176.5431
Total	1.1579	10.5544	13.6193	0.0228		0.4466	0.4466		0.4201	0.4201	0.0000	2,163.8470	2,163.8470	0.5078		2,176.5431

Mitigated Construction Off-Site

	ROG	NOx	CO	SO2	Fugitive PM10	Exhaust PM10	PM10 Total	Fugitive PM2.5	Exhaust PM2.5	PM2.5 Total	Bio- CO2	NBio- CO2	Total CO2	CH4	N2O	CO2e
Category	lb/day										lb/day					
Hauling	2.0000e-005	2.8000e-004	2.3000e-004	0.0000	1.0000e-005	0.0000	1.0000e-005	0.0000	0.0000	0.0000		0.0540	0.0540	0.0000	1.0000e-005	0.0565
Vendor	0.0384	0.7156	0.5227	1.4000e-003	0.0259	1.3600e-003	0.0273	7.6000e-003	1.3000e-003	8.9000e-003		147.3282	147.3282	2.3800e-003	0.0222	154.0050
Worker	0.1881	0.0563	0.6909	7.1000e-004	0.0620	7.5000e-004	0.0627	0.0166	6.9000e-004	0.0173		71.5511	71.5511	0.0114	7.9800e-003	74.2146
Total	0.2266	0.7721	1.2138	2.1100e-003	0.0879	2.1100e-003	0.0900	0.0242	1.9900e-003	0.0262		218.9332	218.9332	0.0138	0.0302	228.2762

Unmitigated Construction - Localized Assessment - Kings County, Summer

EMFAC Off-Model Adjustment Factors for Gasoline Light Duty Vehicle to Account for the SAFE Vehicle Rule Not Applied

3.6 Architectural Coating - 2029

Unmitigated Construction On-Site

	ROG	NOx	CO	SO2	Fugitive PM10	Exhaust PM10	PM10 Total	Fugitive PM2.5	Exhaust PM2.5	PM2.5 Total	Bio- CO2	NBio- CO2	Total CO2	CH4	N2O	CO2e
Category	lb/day										lb/day					
Archit. Coating	21.0245					0.0000	0.0000		0.0000	0.0000			0.0000			0.0000
Off-Road	0.1709	1.1455	1.8091	2.9700e-003		0.0515	0.0515		0.0515	0.0515		281.4481	281.4481	0.0154		281.8319
Total	21.1954	1.1455	1.8091	2.9700e-003		0.0515	0.0515		0.0515	0.0515		281.4481	281.4481	0.0154		281.8319

Unmitigated Construction Off-Site

	ROG	NOx	CO	SO2	Fugitive PM10	Exhaust PM10	PM10 Total	Fugitive PM2.5	Exhaust PM2.5	PM2.5 Total	Bio- CO2	NBio- CO2	Total CO2	CH4	N2O	CO2e
Category	lb/day										lb/day					
Hauling	2.0000e-005	2.7000e-004	2.2000e-004	0.0000	1.0000e-005	0.0000	1.0000e-005	0.0000	0.0000	0.0000		0.0524	0.0524	0.0000	1.0000e-005	0.0548
Vendor	0.0000	0.0000	0.0000	0.0000	0.0000	0.0000	0.0000	0.0000	0.0000	0.0000		0.0000	0.0000	0.0000	0.0000	0.0000
Worker	0.0379	0.0113	0.1391	1.4000e-004	0.0125	1.5000e-004	0.0126	3.3500e-003	1.4000e-004	3.4900e-003		14.4002	14.4002	2.2900e-003	1.6100e-003	14.9363
Total	0.0379	0.0116	0.1393	1.4000e-004	0.0125	1.5000e-004	0.0126	3.3500e-003	1.4000e-004	3.4900e-003		14.4526	14.4526	2.2900e-003	1.6200e-003	14.9911

Unmitigated Construction - Localized Assessment - Kings County, Summer

EMFAC Off-Model Adjustment Factors for Gasoline Light Duty Vehicle to Account for the SAFE Vehicle Rule Not Applied

3.6 Architectural Coating - 2029

Mitigated Construction On-Site

	ROG	NOx	CO	SO2	Fugitive PM10	Exhaust PM10	PM10 Total	Fugitive PM2.5	Exhaust PM2.5	PM2.5 Total	Bio- CO2	NBio- CO2	Total CO2	CH4	N2O	CO2e
Category	lb/day										lb/day					
Archit. Coating	21.0245					0.0000	0.0000		0.0000	0.0000			0.0000			0.0000
Off-Road	0.1709	1.1455	1.8091	2.9700e-003		0.0515	0.0515		0.0515	0.0515	0.0000	281.4481	281.4481	0.0154		281.8319
Total	21.1954	1.1455	1.8091	2.9700e-003		0.0515	0.0515		0.0515	0.0515	0.0000	281.4481	281.4481	0.0154		281.8319

Mitigated Construction Off-Site

	ROG	NOx	CO	SO2	Fugitive PM10	Exhaust PM10	PM10 Total	Fugitive PM2.5	Exhaust PM2.5	PM2.5 Total	Bio- CO2	NBio- CO2	Total CO2	CH4	N2O	CO2e
Category	lb/day										lb/day					
Hauling	2.0000e-005	2.7000e-004	2.2000e-004	0.0000	1.0000e-005	0.0000	1.0000e-005	0.0000	0.0000	0.0000		0.0524	0.0524	0.0000	1.0000e-005	0.0548
Vendor	0.0000	0.0000	0.0000	0.0000	0.0000	0.0000	0.0000	0.0000	0.0000	0.0000		0.0000	0.0000	0.0000	0.0000	0.0000
Worker	0.0379	0.0113	0.1391	1.4000e-004	0.0125	1.5000e-004	0.0126	3.3500e-003	1.4000e-004	3.4900e-003		14.4002	14.4002	2.2900e-003	1.6100e-003	14.9363
Total	0.0379	0.0116	0.1393	1.4000e-004	0.0125	1.5000e-004	0.0126	3.3500e-003	1.4000e-004	3.4900e-003		14.4526	14.4526	2.2900e-003	1.6200e-003	14.9911

Unmitigated Construction - Localized Assessment - Kings County, Summer

EMFAC Off-Model Adjustment Factors for Gasoline Light Duty Vehicle to Account for the SAFE Vehicle Rule Not Applied

4.0 Operational Detail - Mobile

4.1 Mitigation Measures Mobile

	ROG	NOx	CO	SO2	Fugitive PM10	Exhaust PM10	PM10 Total	Fugitive PM2.5	Exhaust PM2.5	PM2.5 Total	Bio- CO2	NBio- CO2	Total CO2	CH4	N2O	CO2e
Category	lb/day										lb/day					
Mitigated	0.0000	0.0000	0.0000	0.0000	0.0000	0.0000	0.0000	0.0000	0.0000	0.0000		0.0000	0.0000	0.0000	0.0000	0.0000
Unmitigated	0.0000	0.0000	0.0000	0.0000	0.0000	0.0000	0.0000	0.0000	0.0000	0.0000		0.0000	0.0000	0.0000	0.0000	0.0000

4.2 Trip Summary Information

Land Use	Average Daily Trip Rate			Unmitigated	Mitigated
	Weekday	Saturday	Sunday	Annual VMT	Annual VMT
City Park	0.00	0.00	0.00		
Single Family Housing	0.00	0.00	0.00		
Total	0.00	0.00	0.00		

4.3 Trip Type Information

Land Use	Miles			Trip %			Trip Purpose %		
	H-W or C-W	H-S or C-C	H-O or C-NW	H-W or C-W	H-S or C-C	H-O or C-NW	Primary	Diverted	Pass-by
City Park	9.50	7.30	7.30	33.00	48.00	19.00	66	28	6
Single Family Housing	10.80	7.30	7.50	42.30	19.60	38.10	86	11	3

4.4 Fleet Mix

Unmitigated Construction - Localized Assessment - Kings County, Summer

EMFAC Off-Model Adjustment Factors for Gasoline Light Duty Vehicle to Account for the SAFE Vehicle Rule Not Applied

Land Use	LDA	LDT1	LDT2	MDV	LHD1	LHD2	MHD	HHD	OBUS	UBUS	MCY	SBUS	MH
City Park	0.524038	0.053970	0.173802	0.143485	0.025178	0.006202	0.008102	0.037193	0.000573	0.000185	0.023331	0.001015	0.002925
Single Family Housing	0.524038	0.053970	0.173802	0.143485	0.025178	0.006202	0.008102	0.037193	0.000573	0.000185	0.023331	0.001015	0.002925

5.0 Energy Detail

Historical Energy Use: N

5.1 Mitigation Measures Energy

	ROG	NOx	CO	SO2	Fugitive PM10	Exhaust PM10	PM10 Total	Fugitive PM2.5	Exhaust PM2.5	PM2.5 Total	Bio- CO2	NBio- CO2	Total CO2	CH4	N2O	CO2e
Category	lb/day										lb/day					
NaturalGas Mitigated	0.0000	0.0000	0.0000	0.0000		0.0000	0.0000		0.0000	0.0000		0.0000	0.0000	0.0000	0.0000	0.0000
NaturalGas Unmitigated	0.0000	0.0000	0.0000	0.0000		0.0000	0.0000		0.0000	0.0000		0.0000	0.0000	0.0000	0.0000	0.0000

Unmitigated Construction - Localized Assessment - Kings County, Summer

EMFAC Off-Model Adjustment Factors for Gasoline Light Duty Vehicle to Account for the SAFE Vehicle Rule Not Applied

5.2 Energy by Land Use - NaturalGas

Unmitigated

	NaturalGas Use	ROG	NOx	CO	SO2	Fugitive PM10	Exhaust PM10	PM10 Total	Fugitive PM2.5	Exhaust PM2.5	PM2.5 Total	Bio- CO2	NBio- CO2	Total CO2	CH4	N2O	CO2e
Land Use	kBTU/yr	lb/day										lb/day					
City Park	0	0.0000	0.0000	0.0000	0.0000		0.0000	0.0000		0.0000	0.0000		0.0000	0.0000	0.0000	0.0000	0.0000
Single Family Housing	0	0.0000	0.0000	0.0000	0.0000		0.0000	0.0000		0.0000	0.0000		0.0000	0.0000	0.0000	0.0000	0.0000
Total		0.0000	0.0000	0.0000	0.0000		0.0000	0.0000		0.0000	0.0000		0.0000	0.0000	0.0000	0.0000	0.0000

Mitigated

	NaturalGas Use	ROG	NOx	CO	SO2	Fugitive PM10	Exhaust PM10	PM10 Total	Fugitive PM2.5	Exhaust PM2.5	PM2.5 Total	Bio- CO2	NBio- CO2	Total CO2	CH4	N2O	CO2e
Land Use	kBTU/yr	lb/day										lb/day					
City Park	0	0.0000	0.0000	0.0000	0.0000		0.0000	0.0000		0.0000	0.0000		0.0000	0.0000	0.0000	0.0000	0.0000
Single Family Housing	0	0.0000	0.0000	0.0000	0.0000		0.0000	0.0000		0.0000	0.0000		0.0000	0.0000	0.0000	0.0000	0.0000
Total		0.0000	0.0000	0.0000	0.0000		0.0000	0.0000		0.0000	0.0000		0.0000	0.0000	0.0000	0.0000	0.0000

6.0 Area Detail

Unmitigated Construction - Localized Assessment - Kings County, Summer

EMFAC Off-Model Adjustment Factors for Gasoline Light Duty Vehicle to Account for the SAFE Vehicle Rule Not Applied

6.1 Mitigation Measures Area

	ROG	NOx	CO	SO2	Fugitive PM10	Exhaust PM10	PM10 Total	Fugitive PM2.5	Exhaust PM2.5	PM2.5 Total	Bio- CO2	NBio- CO2	Total CO2	CH4	N2O	CO2e
Category	lb/day										lb/day					
Mitigated	0.8298	0.2658	23.0788	1.2200e-003		0.1281	0.1281		0.1281	0.1281	0.0000	41.5953	41.5953	0.0398	0.0000	42.5912
Unmitigated	0.8298	0.2658	23.0788	1.2200e-003		0.1281	0.1281		0.1281	0.1281	0.0000	41.5953	41.5953	0.0398	0.0000	42.5912

Unmitigated Construction - Localized Assessment - Kings County, Summer

EMFAC Off-Model Adjustment Factors for Gasoline Light Duty Vehicle to Account for the SAFE Vehicle Rule Not Applied

6.2 Area by SubCategory

Unmitigated

	ROG	NOx	CO	SO2	Fugitive PM10	Exhaust PM10	PM10 Total	Fugitive PM2.5	Exhaust PM2.5	PM2.5 Total	Bio- CO2	NBio- CO2	Total CO2	CH4	N2O	CO2e
SubCategory	lb/day										lb/day					
Architectural Coating	0.0864					0.0000	0.0000		0.0000	0.0000			0.0000			0.0000
Consumer Products	0.0504					0.0000	0.0000		0.0000	0.0000			0.0000			0.0000
Hearth	0.0000	0.0000	0.0000	0.0000		0.0000	0.0000		0.0000	0.0000	0.0000	0.0000	0.0000	0.0000	0.0000	0.0000
Landscaping	0.6930	0.2658	23.0788	1.2200e-003		0.1281	0.1281		0.1281	0.1281		41.5953	41.5953	0.0398		42.5912
Total	0.8298	0.2658	23.0788	1.2200e-003		0.1281	0.1281		0.1281	0.1281	0.0000	41.5953	41.5953	0.0398	0.0000	42.5912

Unmitigated Construction - Localized Assessment - Kings County, Summer

EMFAC Off-Model Adjustment Factors for Gasoline Light Duty Vehicle to Account for the SAFE Vehicle Rule Not Applied

6.2 Area by SubCategory

Mitigated

	ROG	NOx	CO	SO2	Fugitive PM10	Exhaust PM10	PM10 Total	Fugitive PM2.5	Exhaust PM2.5	PM2.5 Total	Bio- CO2	NBio- CO2	Total CO2	CH4	N2O	CO2e
SubCategory	lb/day										lb/day					
Architectural Coating	0.0864					0.0000	0.0000		0.0000	0.0000			0.0000			0.0000
Consumer Products	0.0504					0.0000	0.0000		0.0000	0.0000			0.0000			0.0000
Hearth	0.0000	0.0000	0.0000	0.0000		0.0000	0.0000		0.0000	0.0000	0.0000	0.0000	0.0000	0.0000	0.0000	0.0000
Landscaping	0.6930	0.2658	23.0788	1.2200e-003		0.1281	0.1281		0.1281	0.1281		41.5953	41.5953	0.0398		42.5912
Total	0.8298	0.2658	23.0788	1.2200e-003		0.1281	0.1281		0.1281	0.1281	0.0000	41.5953	41.5953	0.0398	0.0000	42.5912

7.0 Water Detail

7.1 Mitigation Measures Water

Unmitigated Construction - Localized Assessment - Kings County, Summer

EMFAC Off-Model Adjustment Factors for Gasoline Light Duty Vehicle to Account for the SAFE Vehicle Rule Not Applied

8.0 Waste Detail

8.1 Mitigation Measures Waste

9.0 Operational Offroad

Equipment Type	Number	Hours/Day	Days/Year	Horse Power	Load Factor	Fuel Type
----------------	--------	-----------	-----------	-------------	-------------	-----------

10.0 Stationary Equipment

Fire Pumps and Emergency Generators

Equipment Type	Number	Hours/Day	Hours/Year	Horse Power	Load Factor	Fuel Type
----------------	--------	-----------	------------	-------------	-------------	-----------

Boilers

Equipment Type	Number	Heat Input/Day	Heat Input/Year	Boiler Rating	Fuel Type
----------------	--------	----------------	-----------------	---------------	-----------

User Defined Equipment

Equipment Type	Number
----------------	--------

11.0 Vegetation

Unmitigated Construction - Localized Assessment - Kings County, Winter

EMFAC Off-Model Adjustment Factors for Gasoline Light Duty Vehicle to Account for the SAFE Vehicle Rule Not Applied

Unmitigated Construction - Localized Assessment

Kings County, Winter

1.0 Project Characteristics

1.1 Land Usage

Land Uses	Size	Metric	Lot Acreage	Floor Surface Area	Population
City Park	3.20	Acre	3.20	139,392.00	0
Single Family Housing	280.00	Dwelling Unit	49.41	504,000.00	801

1.2 Other Project Characteristics

Urbanization	Urban	Wind Speed (m/s)	2.2	Precipitation Freq (Days)	37
Climate Zone	3			Operational Year	2029
Utility Company	Pacific Gas and Electric Company				
CO2 Intensity (lb/MWhr)	203.98	CH4 Intensity (lb/MWhr)	0.033	N2O Intensity (lb/MWhr)	0.004

1.3 User Entered Comments & Non-Default Data

Project Characteristics - Lemoore 54 - Unmitigated Construction - Localized Assessment

Land Use - Project site is approximately 52.61 acres
280-lot single family subdivision and 3.2 acres of public parks at full buildout

Construction Phase - No demolition
Adjusted schedule to match applicant-provided construction start date and construction duration
08/01/2023-12-31/2029

Off-road Equipment - Adjusted construction equipment usage to match CalEEMod default total building construction HP hours.

Trips and VMT - Trip lengths updated to 0.5 mile to account for on-site and localized emissions from construction vehicles.

Grading - Amount of import and export associated with cut and fill:

Cubic yards of cut to be exported: 90,000 cubic yards

Cubic yards of fill to be imported: 90,000 cubic yards

Architectural Coating - Rule 4601 Architectural Coatings

Vehicle Trips - Construction run only (operations assessed in a separate run)

Unmitigated Construction - Localized Assessment - Kings County, Winter

EMFAC Off-Model Adjustment Factors for Gasoline Light Duty Vehicle to Account for the SAFE Vehicle Rule Not Applied

Vehicle Emission Factors -

Vehicle Emission Factors -

Vehicle Emission Factors -

Woodstoves - Construction run only (operations only parameters zeroed out)

Consumer Products - Construction run only

Area Coating - Construction run only

Landscape Equipment - Construction run only

Energy Use - Construction run only

Water And Wastewater - Construction run only

Solid Waste - Construction run only

Construction Off-road Equipment Mitigation - Compliance with SJVAPCD Regulation VIII

Area Mitigation -

Fleet Mix -

Table Name	Column Name	Default Value	New Value
tblArchitecturalCoating	EF_Residential_Exterior	150.00	50.00
tblArchitecturalCoating	EF_Residential_Interior	150.00	50.00
tblAreaCoating	Area_EF_Residential_Exterior	150	50
tblAreaCoating	Area_EF_Residential_Interior	150	50
tblAreaCoating	ReapplicationRatePercent	10	1
tblConstDustMitigation	WaterUnpavedRoadVehicleSpeed	0	15
tblConstructionPhase	NumDays	1,110.00	1,310.00
tblConstructionPhase	NumDays	75.00	150.00
tblConsumerProducts	ROG_EF	2.14E-05	1E-07
tblConsumerProducts	ROG_EF_Degreaser	3.542E-07	1E-10
tblConsumerProducts	ROG_EF_PesticidesFertilizers	5.152E-08	1E-11
tblEnergyUse	LightingElect	1,608.84	0.00
tblEnergyUse	NT24E	6,155.97	0.00
tblEnergyUse	NT24NG	3,723.00	0.00

Unmitigated Construction - Localized Assessment - Kings County, Winter

EMFAC Off-Model Adjustment Factors for Gasoline Light Duty Vehicle to Account for the SAFE Vehicle Rule Not Applied

tblEnergyUse	T24E	209.15	0.00
tblEnergyUse	T24NG	20,314.55	0.00
tblFireplaces	FireplaceWoodMass	3,078.40	0.00
tblFireplaces	NumberGas	154.00	0.00
tblGrading	MaterialExported	0.00	90,000.00
tblGrading	MaterialImported	0.00	90,000.00
tblLandscapeEquipment	NumberSummerDays	180	1
tblLandUse	LotAcreage	90.91	49.41
tblOffRoadEquipment	UsageHours	7.00	5.90
tblOffRoadEquipment	UsageHours	8.00	6.80
tblOffRoadEquipment	UsageHours	8.00	6.80
tblOffRoadEquipment	UsageHours	7.00	5.90
tblOffRoadEquipment	UsageHours	8.00	6.80
tblSolidWaste	SolidWasteGenerationRate	0.28	0.00
tblSolidWaste	SolidWasteGenerationRate	288.36	0.00
tblTripsAndVMT	HaulingTripLength	20.00	0.50
tblTripsAndVMT	HaulingTripLength	20.00	0.50
tblTripsAndVMT	HaulingTripLength	20.00	0.50
tblTripsAndVMT	HaulingTripLength	20.00	0.50
tblTripsAndVMT	HaulingTripLength	20.00	0.50
tblTripsAndVMT	HaulingTripNumber	0.00	14.00
tblTripsAndVMT	HaulingTripNumber	17,798.00	17,814.00
tblTripsAndVMT	HaulingTripNumber	0.00	12.00
tblTripsAndVMT	HaulingTripNumber	0.00	18.00
tblTripsAndVMT	HaulingTripNumber	0.00	2.00
tblTripsAndVMT	VendorTripLength	7.30	0.50
tblTripsAndVMT	VendorTripLength	7.30	0.50
tblTripsAndVMT	VendorTripLength	7.30	0.50
tblTripsAndVMT	VendorTripLength	7.30	0.50

Unmitigated Construction - Localized Assessment - Kings County, Winter

EMFAC Off-Model Adjustment Factors for Gasoline Light Duty Vehicle to Account for the SAFE Vehicle Rule Not Applied

tblTripsAndVMT	VendorTripLength	7.30	0.50
tblTripsAndVMT	WorkerTripLength	10.80	0.50
tblTripsAndVMT	WorkerTripLength	10.80	0.50
tblTripsAndVMT	WorkerTripLength	10.80	0.50
tblTripsAndVMT	WorkerTripLength	10.80	0.50
tblTripsAndVMT	WorkerTripLength	10.80	0.50
tblVehicleTrips	ST_TR	1.96	0.00
tblVehicleTrips	ST_TR	9.54	0.00
tblVehicleTrips	SU_TR	2.19	0.00
tblVehicleTrips	SU_TR	8.55	0.00
tblVehicleTrips	WD_TR	0.78	0.00
tblVehicleTrips	WD_TR	9.44	0.00
tblWater	IndoorWaterUseRate	18,243,127.17	0.00
tblWater	OutdoorWaterUseRate	3,812,740.32	0.00
tblWater	OutdoorWaterUseRate	11,501,101.91	0.00
tblWoodstoves	WoodstoveWoodMass	3,019.20	0.00

2.0 Emissions Summary

Unmitigated Construction - Localized Assessment - Kings County, Winter

EMFAC Off-Model Adjustment Factors for Gasoline Light Duty Vehicle to Account for the SAFE Vehicle Rule Not Applied

2.1 Overall Construction (Maximum Daily Emission)

Unmitigated Construction

	ROG	NOx	CO	SO2	Fugitive PM10	Exhaust PM10	PM10 Total	Fugitive PM2.5	Exhaust PM2.5	PM2.5 Total	Bio- CO2	NBio- CO2	Total CO2	CH4	N2O	CO2e
Year	lb/day										lb/day					
2023	3.5238	38.2268	31.0573	0.0692	19.6642	1.4314	20.9303	10.1044	1.3171	11.2692	0.0000	6,764.9866	6,764.9866	1.9560	0.1184	6,849.1593
2024	3.4167	36.0675	30.7020	0.0690	9.2858	1.3423	10.6282	3.6766	1.2352	4.9118	0.0000	6,748.3694	6,748.3694	1.9551	0.1160	6,831.8140
2025	1.3631	11.4269	15.2578	0.0251	0.0879	0.4490	0.5369	0.0242	0.4224	0.4466	0.0000	2,399.4286	2,399.4286	0.5314	0.0352	2,423.1853
2026	1.3492	11.4155	15.2074	0.0250	0.0879	0.4489	0.5368	0.0242	0.4223	0.4465	0.0000	2,394.1344	2,394.1344	0.5296	0.0341	2,417.5456
2027	1.3370	11.4056	15.1609	0.0250	0.0879	0.4488	0.5367	0.0242	0.4223	0.4465	0.0000	2,388.7855	2,388.7855	0.5281	0.0332	2,411.8803
2028	1.3262	11.3972	15.1216	0.0249	0.0879	0.4488	0.5367	0.0242	0.4222	0.4464	0.0000	2,383.7845	2,383.7845	0.5268	0.0324	2,406.5933
2029	22.5367	12.5487	17.0788	0.0280	0.1004	0.5004	0.6008	0.0276	0.4738	0.5014	0.0000	2,673.8112	2,673.8112	0.5441	0.0334	2,697.3616
Maximum	22.5367	38.2268	31.0573	0.0692	19.6642	1.4314	20.9303	10.1044	1.3171	11.2692	0.0000	6,764.9866	6,764.9866	1.9560	0.1184	6,849.1593

Unmitigated Construction - Localized Assessment - Kings County, Winter

EMFAC Off-Model Adjustment Factors for Gasoline Light Duty Vehicle to Account for the SAFE Vehicle Rule Not Applied

2.1 Overall Construction (Maximum Daily Emission)

Mitigated Construction

	ROG	NOx	CO	SO2	Fugitive PM10	Exhaust PM10	PM10 Total	Fugitive PM2.5	Exhaust PM2.5	PM2.5 Total	Bio- CO2	NBio- CO2	Total CO2	CH4	N2O	CO2e
Year	lb/day										lb/day					
2023	3.5238	38.2268	31.0573	0.0692	8.8528	1.4314	10.1190	4.5480	1.3171	5.7129	0.0000	6,764.9866	6,764.9866	1.9560	0.1184	6,849.1593
2024	3.4167	36.0675	30.7020	0.0690	4.2238	1.3423	5.5662	1.6670	1.2352	2.9022	0.0000	6,748.3694	6,748.3694	1.9551	0.1160	6,831.8140
2025	1.3631	11.4269	15.2578	0.0251	0.0879	0.4490	0.5369	0.0242	0.4224	0.4466	0.0000	2,399.4286	2,399.4286	0.5314	0.0352	2,423.1853
2026	1.3492	11.4155	15.2074	0.0250	0.0879	0.4489	0.5368	0.0242	0.4223	0.4465	0.0000	2,394.1344	2,394.1344	0.5296	0.0341	2,417.5456
2027	1.3370	11.4056	15.1609	0.0250	0.0879	0.4488	0.5367	0.0242	0.4223	0.4465	0.0000	2,388.7855	2,388.7855	0.5281	0.0332	2,411.8803
2028	1.3262	11.3972	15.1216	0.0249	0.0879	0.4488	0.5367	0.0242	0.4222	0.4464	0.0000	2,383.7845	2,383.7845	0.5268	0.0324	2,406.5933
2029	22.5367	12.5487	17.0788	0.0280	0.1004	0.5004	0.6008	0.0276	0.4738	0.5014	0.0000	2,673.8112	2,673.8112	0.5441	0.0334	2,697.3616
Maximum	22.5367	38.2268	31.0573	0.0692	8.8528	1.4314	10.1190	4.5480	1.3171	5.7129	0.0000	6,764.9866	6,764.9866	1.9560	0.1184	6,849.1593

	ROG	NOx	CO	SO2	Fugitive PM10	Exhaust PM10	PM10 Total	Fugitive PM2.5	Exhaust PM2.5	PM2.5 Total	Bio- CO2	NBio-CO2	Total CO2	CH4	N2O	CO2e
Percent Reduction	0.00	0.00	0.00	0.00	53.99	0.00	46.27	54.41	0.00	40.97	0.00	0.00	0.00	0.00	0.00	0.00

Unmitigated Construction - Localized Assessment - Kings County, Winter

EMFAC Off-Model Adjustment Factors for Gasoline Light Duty Vehicle to Account for the SAFE Vehicle Rule Not Applied

2.2 Overall Operational

Unmitigated Operational

	ROG	NOx	CO	SO2	Fugitive PM10	Exhaust PM10	PM10 Total	Fugitive PM2.5	Exhaust PM2.5	PM2.5 Total	Bio- CO2	NBio- CO2	Total CO2	CH4	N2O	CO2e
Category	lb/day										lb/day					
Area	0.8298	0.2658	23.0788	1.2200e-003		0.1281	0.1281		0.1281	0.1281	0.0000	41.5953	41.5953	0.0398	0.0000	42.5912
Energy	0.0000	0.0000	0.0000	0.0000		0.0000	0.0000		0.0000	0.0000		0.0000	0.0000	0.0000	0.0000	0.0000
Mobile	0.0000	0.0000	0.0000	0.0000	0.0000	0.0000	0.0000	0.0000	0.0000	0.0000		0.0000	0.0000	0.0000	0.0000	0.0000
Total	0.8298	0.2658	23.0788	1.2200e-003	0.0000	0.1281	0.1281	0.0000	0.1281	0.1281	0.0000	41.5953	41.5953	0.0398	0.0000	42.5912

Mitigated Operational

	ROG	NOx	CO	SO2	Fugitive PM10	Exhaust PM10	PM10 Total	Fugitive PM2.5	Exhaust PM2.5	PM2.5 Total	Bio- CO2	NBio- CO2	Total CO2	CH4	N2O	CO2e
Category	lb/day										lb/day					
Area	0.8298	0.2658	23.0788	1.2200e-003		0.1281	0.1281		0.1281	0.1281	0.0000	41.5953	41.5953	0.0398	0.0000	42.5912
Energy	0.0000	0.0000	0.0000	0.0000		0.0000	0.0000		0.0000	0.0000		0.0000	0.0000	0.0000	0.0000	0.0000
Mobile	0.0000	0.0000	0.0000	0.0000	0.0000	0.0000	0.0000	0.0000	0.0000	0.0000		0.0000	0.0000	0.0000	0.0000	0.0000
Total	0.8298	0.2658	23.0788	1.2200e-003	0.0000	0.1281	0.1281	0.0000	0.1281	0.1281	0.0000	41.5953	41.5953	0.0398	0.0000	42.5912

Unmitigated Construction - Localized Assessment - Kings County, Winter

EMFAC Off-Model Adjustment Factors for Gasoline Light Duty Vehicle to Account for the SAFE Vehicle Rule Not Applied

	ROG	NOx	CO	SO2	Fugitive PM10	Exhaust PM10	PM10 Total	Fugitive PM2.5	Exhaust PM2.5	PM2.5 Total	Bio- CO2	NBio-CO2	Total CO2	CH4	N2O	CO2e
Percent Reduction	0.00	0.00	0.00	0.00	0.00	0.00	0.00	0.00	0.00	0.00	0.00	0.00	0.00	0.00	0.00	0.00

3.0 Construction Detail

Construction Phase

Phase Number	Phase Name	Phase Type	Start Date	End Date	Num Days Week	Num Days	Phase Description
1	Site Preparation	Site Preparation	8/1/2023	9/25/2023	5	40	
2	Grading	Grading	9/26/2023	2/26/2024	5	110	
3	Paving	Paving	2/27/2024	6/10/2024	5	75	
4	Building Construction	Building Construction	6/11/2024	6/18/2029	5	1310	Extended to match total duration
5	Architectural Coating	Architectural Coating	6/5/2029	12/31/2029	5	150	Anticipated to occur throughout building construction

Acres of Grading (Site Preparation Phase): 60

Acres of Grading (Grading Phase): 330

Acres of Paving: 0

Residential Indoor: 1,020,600; Residential Outdoor: 340,200; Non-Residential Indoor: 2; Non-Residential Outdoor: 1; Striped Parking Area: 0 (Architectural Coating – sqft)

OffRoad Equipment

Phase Name	Offroad Equipment Type	Amount	Usage Hours	Horse Power	Load Factor
Site Preparation	Rubber Tired Dozers	3	8.00	247	0.40
Site Preparation	Tractors/Loaders/Backhoes	4	8.00	97	0.37
Grading	Excavators	2	8.00	158	0.38
Grading	Graders	1	8.00	187	0.41
Grading	Rubber Tired Dozers	1	8.00	247	0.40
Grading	Scrapers	2	8.00	367	0.48

Unmitigated Construction - Localized Assessment - Kings County, Winter

EMFAC Off-Model Adjustment Factors for Gasoline Light Duty Vehicle to Account for the SAFE Vehicle Rule Not Applied

Grading	Tractors/Loaders/Backhoes	2	8.00	97	0.37
Paving	Pavers	2	8.00	130	0.42
Paving	Paving Equipment	2	8.00	132	0.36
Paving	Rollers	2	8.00	80	0.38
Building Construction	Cranes	1	5.90	231	0.29
Building Construction	Forklifts	3	6.80	89	0.20
Building Construction	Generator Sets	1	6.80	84	0.74
Building Construction	Tractors/Loaders/Backhoes	3	5.90	97	0.37
Building Construction	Welders	1	6.80	46	0.45
Architectural Coating	Air Compressors	1	6.00	78	0.48

Trips and VMT

Phase Name	Offroad Equipment Count	Worker Trip Number	Vendor Trip Number	Hauling Trip Number	Worker Trip Length	Vendor Trip Length	Hauling Trip Length	Worker Vehicle Class	Vendor Vehicle Class	Hauling Vehicle Class
Site Preparation	7	18.00	0.00	14.00	0.50	0.50	0.50	LD_Mix	HDT_Mix	HHDT
Grading	8	20.00	0.00	17,814.00	0.50	0.50	0.50	LD_Mix	HDT_Mix	HHDT
Paving	6	15.00	0.00	12.00	0.50	0.50	0.50	LD_Mix	HDT_Mix	HHDT
Building Construction	9	159.00	53.00	18.00	0.50	0.50	0.50	LD_Mix	HDT_Mix	HHDT
Architectural Coating	1	32.00	0.00	2.00	0.50	0.50	0.50	LD_Mix	HDT_Mix	HHDT

3.1 Mitigation Measures Construction

Water Exposed Area

Reduce Vehicle Speed on Unpaved Roads

Unmitigated Construction - Localized Assessment - Kings County, Winter

EMFAC Off-Model Adjustment Factors for Gasoline Light Duty Vehicle to Account for the SAFE Vehicle Rule Not Applied

3.2 Site Preparation - 2023

Unmitigated Construction On-Site

	ROG	NOx	CO	SO2	Fugitive PM10	Exhaust PM10	PM10 Total	Fugitive PM2.5	Exhaust PM2.5	PM2.5 Total	Bio- CO2	NBio- CO2	Total CO2	CH4	N2O	CO2e
Category	lb/day										lb/day					
Fugitive Dust					19.6570	0.0000	19.6570	10.1025	0.0000	10.1025			0.0000			0.0000
Off-Road	2.6595	27.5242	18.2443	0.0381		1.2660	1.2660		1.1647	1.1647		3,687.308 1	3,687.308 1	1.1926		3,717.121 9
Total	2.6595	27.5242	18.2443	0.0381	19.6570	1.2660	20.9230	10.1025	1.1647	11.2672		3,687.308 1	3,687.308 1	1.1926		3,717.121 9

Unmitigated Construction Off-Site

	ROG	NOx	CO	SO2	Fugitive PM10	Exhaust PM10	PM10 Total	Fugitive PM2.5	Exhaust PM2.5	PM2.5 Total	Bio- CO2	NBio- CO2	Total CO2	CH4	N2O	CO2e
Category	lb/day										lb/day					
Hauling	3.8000e-004	7.9900e-003	6.1800e-003	2.0000e-005	1.6000e-004	1.0000e-005	1.8000e-004	4.0000e-005	1.0000e-005	6.0000e-005		1.6071	1.6071	2.0000e-005	2.5000e-004	1.6829
Vendor	0.0000	0.0000	0.0000	0.0000	0.0000	0.0000	0.0000	0.0000	0.0000	0.0000		0.0000	0.0000	0.0000	0.0000	0.0000
Worker	0.0229	0.0117	0.1320	9.0000e-005	7.0100e-003	1.2000e-004	7.1300e-003	1.8800e-003	1.1000e-004	1.9900e-003		8.9052	8.9052	2.8600e-003	1.3300e-003	9.3725
Total	0.0233	0.0197	0.1382	1.1000e-004	7.1700e-003	1.3000e-004	7.3100e-003	1.9200e-003	1.2000e-004	2.0500e-003		10.5123	10.5123	2.8800e-003	1.5800e-003	11.0554

Unmitigated Construction - Localized Assessment - Kings County, Winter

EMFAC Off-Model Adjustment Factors for Gasoline Light Duty Vehicle to Account for the SAFE Vehicle Rule Not Applied

3.2 Site Preparation - 2023

Mitigated Construction On-Site

	ROG	NOx	CO	SO2	Fugitive PM10	Exhaust PM10	PM10 Total	Fugitive PM2.5	Exhaust PM2.5	PM2.5 Total	Bio- CO2	NBio- CO2	Total CO2	CH4	N2O	CO2e
Category	lb/day										lb/day					
Fugitive Dust					8.8457	0.0000	8.8457	4.5461	0.0000	4.5461			0.0000			0.0000
Off-Road	2.6595	27.5242	18.2443	0.0381		1.2660	1.2660		1.1647	1.1647	0.0000	3,687.308 1	3,687.308 1	1.1926		3,717.121 9
Total	2.6595	27.5242	18.2443	0.0381	8.8457	1.2660	10.1117	4.5461	1.1647	5.7108	0.0000	3,687.308 1	3,687.308 1	1.1926		3,717.121 9

Mitigated Construction Off-Site

	ROG	NOx	CO	SO2	Fugitive PM10	Exhaust PM10	PM10 Total	Fugitive PM2.5	Exhaust PM2.5	PM2.5 Total	Bio- CO2	NBio- CO2	Total CO2	CH4	N2O	CO2e
Category	lb/day										lb/day					
Hauling	3.8000e-004	7.9900e-003	6.1800e-003	2.0000e-005	1.6000e-004	1.0000e-005	1.8000e-004	4.0000e-005	1.0000e-005	6.0000e-005		1.6071	1.6071	2.0000e-005	2.5000e-004	1.6829
Vendor	0.0000	0.0000	0.0000	0.0000	0.0000	0.0000	0.0000	0.0000	0.0000	0.0000		0.0000	0.0000	0.0000	0.0000	0.0000
Worker	0.0229	0.0117	0.1320	9.0000e-005	7.0100e-003	1.2000e-004	7.1300e-003	1.8800e-003	1.1000e-004	1.9900e-003		8.9052	8.9052	2.8600e-003	1.3300e-003	9.3725
Total	0.0233	0.0197	0.1382	1.1000e-004	7.1700e-003	1.3000e-004	7.3100e-003	1.9200e-003	1.2000e-004	2.0500e-003		10.5123	10.5123	2.8800e-003	1.5800e-003	11.0554

Unmitigated Construction - Localized Assessment - Kings County, Winter

EMFAC Off-Model Adjustment Factors for Gasoline Light Duty Vehicle to Account for the SAFE Vehicle Rule Not Applied

3.3 Grading - 2023

Unmitigated Construction On-Site

	ROG	NOx	CO	SO2	Fugitive PM10	Exhaust PM10	PM10 Total	Fugitive PM2.5	Exhaust PM2.5	PM2.5 Total	Bio- CO2	NBio- CO2	Total CO2	CH4	N2O	CO2e
Category	lb/day										lb/day					
Fugitive Dust					9.2036	0.0000	9.2036	3.6538	0.0000	3.6538			0.0000			0.0000
Off-Road	3.3217	34.5156	28.0512	0.0621		1.4245	1.4245		1.3105	1.3105		6,011.4777	6,011.4777	1.9442		6,060.0836
Total	3.3217	34.5156	28.0512	0.0621	9.2036	1.4245	10.6281	3.6538	1.3105	4.9643		6,011.4777	6,011.4777	1.9442		6,060.0836

Unmitigated Construction Off-Site

	ROG	NOx	CO	SO2	Fugitive PM10	Exhaust PM10	PM10 Total	Fugitive PM2.5	Exhaust PM2.5	PM2.5 Total	Bio- CO2	NBio- CO2	Total CO2	CH4	N2O	CO2e
Category	lb/day										lb/day					
Hauling	0.1765	3.6983	2.8594	7.0200e-003	0.0744	6.7900e-003	0.0812	0.0207	6.4900e-003	0.0272		743.6143	743.6143	8.5400e-003	0.1169	778.6619
Vendor	0.0000	0.0000	0.0000	0.0000	0.0000	0.0000	0.0000	0.0000	0.0000	0.0000		0.0000	0.0000	0.0000	0.0000	0.0000
Worker	0.0255	0.0130	0.1467	1.0000e-004	7.7900e-003	1.3000e-004	7.9200e-003	2.0900e-003	1.2000e-004	2.2100e-003		9.8947	9.8947	3.1800e-003	1.4800e-003	10.4139
Total	0.2020	3.7112	3.0061	7.1200e-003	0.0822	6.9200e-003	0.0891	0.0228	6.6100e-003	0.0294		753.5089	753.5089	0.0117	0.1184	789.0758

Unmitigated Construction - Localized Assessment - Kings County, Winter

EMFAC Off-Model Adjustment Factors for Gasoline Light Duty Vehicle to Account for the SAFE Vehicle Rule Not Applied

3.3 Grading - 2023

Mitigated Construction On-Site

	ROG	NOx	CO	SO2	Fugitive PM10	Exhaust PM10	PM10 Total	Fugitive PM2.5	Exhaust PM2.5	PM2.5 Total	Bio- CO2	NBio- CO2	Total CO2	CH4	N2O	CO2e
Category	lb/day										lb/day					
Fugitive Dust					4.1416	0.0000	4.1416	1.6442	0.0000	1.6442			0.0000			0.0000
Off-Road	3.3217	34.5156	28.0512	0.0621		1.4245	1.4245		1.3105	1.3105	0.0000	6,011.4777	6,011.4777	1.9442		6,060.0836
Total	3.3217	34.5156	28.0512	0.0621	4.1416	1.4245	5.5661	1.6442	1.3105	2.9547	0.0000	6,011.4777	6,011.4777	1.9442		6,060.0836

Mitigated Construction Off-Site

	ROG	NOx	CO	SO2	Fugitive PM10	Exhaust PM10	PM10 Total	Fugitive PM2.5	Exhaust PM2.5	PM2.5 Total	Bio- CO2	NBio- CO2	Total CO2	CH4	N2O	CO2e
Category	lb/day										lb/day					
Hauling	0.1765	3.6983	2.8594	7.0200e-003	0.0744	6.7900e-003	0.0812	0.0207	6.4900e-003	0.0272		743.6143	743.6143	8.5400e-003	0.1169	778.6619
Vendor	0.0000	0.0000	0.0000	0.0000	0.0000	0.0000	0.0000	0.0000	0.0000	0.0000		0.0000	0.0000	0.0000	0.0000	0.0000
Worker	0.0255	0.0130	0.1467	1.0000e-004	7.7900e-003	1.3000e-004	7.9200e-003	2.0900e-003	1.2000e-004	2.2100e-003		9.8947	9.8947	3.1800e-003	1.4800e-003	10.4139
Total	0.2020	3.7112	3.0061	7.1200e-003	0.0822	6.9200e-003	0.0891	0.0228	6.6100e-003	0.0294		753.5089	753.5089	0.0117	0.1184	789.0758

Unmitigated Construction - Localized Assessment - Kings County, Winter

EMFAC Off-Model Adjustment Factors for Gasoline Light Duty Vehicle to Account for the SAFE Vehicle Rule Not Applied

3.3 Grading - 2024

Unmitigated Construction On-Site

	ROG	NOx	CO	SO2	Fugitive PM10	Exhaust PM10	PM10 Total	Fugitive PM2.5	Exhaust PM2.5	PM2.5 Total	Bio- CO2	NBio- CO2	Total CO2	CH4	N2O	CO2e
Category	lb/day										lb/day					
Fugitive Dust					9.2036	0.0000	9.2036	3.6538	0.0000	3.6538			0.0000			0.0000
Off-Road	3.2181	32.3770	27.7228	0.0621		1.3354	1.3354		1.2286	1.2286		6,009.7487	6,009.7487	1.9437		6,058.3405
Total	3.2181	32.3770	27.7228	0.0621	9.2036	1.3354	10.5390	3.6538	1.2286	4.8823		6,009.7487	6,009.7487	1.9437		6,058.3405

Unmitigated Construction Off-Site

	ROG	NOx	CO	SO2	Fugitive PM10	Exhaust PM10	PM10 Total	Fugitive PM2.5	Exhaust PM2.5	PM2.5 Total	Bio- CO2	NBio- CO2	Total CO2	CH4	N2O	CO2e
Category	lb/day										lb/day					
Hauling	0.1753	3.6787	2.8390	6.8800e-003	0.0744	6.8200e-003	0.0812	0.0207	6.5200e-003	0.0272		729.0441	729.0441	8.4700e-003	0.1146	763.4073
Vendor	0.0000	0.0000	0.0000	0.0000	0.0000	0.0000	0.0000	0.0000	0.0000	0.0000		0.0000	0.0000	0.0000	0.0000	0.0000
Worker	0.0233	0.0119	0.1403	9.0000e-005	7.7900e-003	1.2000e-004	7.9200e-003	2.0900e-003	1.1000e-004	2.2100e-003		9.5766	9.5766	2.9100e-003	1.4000e-003	10.0662
Total	0.1985	3.6906	2.9792	6.9700e-003	0.0822	6.9400e-003	0.0892	0.0228	6.6300e-003	0.0295		738.6208	738.6208	0.0114	0.1160	773.4735

Unmitigated Construction - Localized Assessment - Kings County, Winter

EMFAC Off-Model Adjustment Factors for Gasoline Light Duty Vehicle to Account for the SAFE Vehicle Rule Not Applied

3.3 Grading - 2024

Mitigated Construction On-Site

	ROG	NOx	CO	SO2	Fugitive PM10	Exhaust PM10	PM10 Total	Fugitive PM2.5	Exhaust PM2.5	PM2.5 Total	Bio- CO2	NBio- CO2	Total CO2	CH4	N2O	CO2e
Category	lb/day										lb/day					
Fugitive Dust					4.1416	0.0000	4.1416	1.6442	0.0000	1.6442			0.0000			0.0000
Off-Road	3.2181	32.3770	27.7228	0.0621		1.3354	1.3354		1.2286	1.2286	0.0000	6,009.7487	6,009.7487	1.9437		6,058.3405
Total	3.2181	32.3770	27.7228	0.0621	4.1416	1.3354	5.4770	1.6442	1.2286	2.8728	0.0000	6,009.7487	6,009.7487	1.9437		6,058.3405

Mitigated Construction Off-Site

	ROG	NOx	CO	SO2	Fugitive PM10	Exhaust PM10	PM10 Total	Fugitive PM2.5	Exhaust PM2.5	PM2.5 Total	Bio- CO2	NBio- CO2	Total CO2	CH4	N2O	CO2e
Category	lb/day										lb/day					
Hauling	0.1753	3.6787	2.8390	6.8800e-003	0.0744	6.8200e-003	0.0812	0.0207	6.5200e-003	0.0272		729.0441	729.0441	8.4700e-003	0.1146	763.4073
Vendor	0.0000	0.0000	0.0000	0.0000	0.0000	0.0000	0.0000	0.0000	0.0000	0.0000		0.0000	0.0000	0.0000	0.0000	0.0000
Worker	0.0233	0.0119	0.1403	9.0000e-005	7.7900e-003	1.2000e-004	7.9200e-003	2.0900e-003	1.1000e-004	2.2100e-003		9.5766	9.5766	2.9100e-003	1.4000e-003	10.0662
Total	0.1985	3.6906	2.9792	6.9700e-003	0.0822	6.9400e-003	0.0892	0.0228	6.6300e-003	0.0295		738.6208	738.6208	0.0114	0.1160	773.4735

Unmitigated Construction - Localized Assessment - Kings County, Winter

EMFAC Off-Model Adjustment Factors for Gasoline Light Duty Vehicle to Account for the SAFE Vehicle Rule Not Applied

3.4 Paving - 2024

Unmitigated Construction On-Site

	ROG	NOx	CO	SO2	Fugitive PM10	Exhaust PM10	PM10 Total	Fugitive PM2.5	Exhaust PM2.5	PM2.5 Total	Bio- CO2	NBio- CO2	Total CO2	CH4	N2O	CO2e
Category	lb/day										lb/day					
Off-Road	0.9882	9.5246	14.6258	0.0228		0.4685	0.4685		0.4310	0.4310		2,207.547 2	2,207.547 2	0.7140		2,225.396 3
Paving	0.0000					0.0000	0.0000		0.0000	0.0000			0.0000			0.0000
Total	0.9882	9.5246	14.6258	0.0228		0.4685	0.4685		0.4310	0.4310		2,207.547 2	2,207.547 2	0.7140		2,225.396 3

Unmitigated Construction Off-Site

	ROG	NOx	CO	SO2	Fugitive PM10	Exhaust PM10	PM10 Total	Fugitive PM2.5	Exhaust PM2.5	PM2.5 Total	Bio- CO2	NBio- CO2	Total CO2	CH4	N2O	CO2e
Category	lb/day										lb/day					
Hauling	1.7000e-004	3.6300e-003	2.8000e-003	1.0000e-005	7.0000e-005	1.0000e-005	8.0000e-005	2.0000e-005	1.0000e-005	3.0000e-005		0.7203	0.7203	1.0000e-005	1.1000e-004	0.7542
Vendor	0.0000	0.0000	0.0000	0.0000	0.0000	0.0000	0.0000	0.0000	0.0000	0.0000		0.0000	0.0000	0.0000	0.0000	0.0000
Worker	0.0175	8.9000e-003	0.1052	7.0000e-005	5.8500e-003	9.0000e-005	5.9400e-003	1.5700e-003	8.0000e-005	1.6500e-003		7.1825	7.1825	2.1800e-003	1.0500e-003	7.5496
Total	0.0176	0.0125	0.1080	8.0000e-005	5.9200e-003	1.0000e-004	6.0200e-003	1.5900e-003	9.0000e-005	1.6800e-003		7.9028	7.9028	2.1900e-003	1.1600e-003	8.3039

Unmitigated Construction - Localized Assessment - Kings County, Winter

EMFAC Off-Model Adjustment Factors for Gasoline Light Duty Vehicle to Account for the SAFE Vehicle Rule Not Applied

3.4 Paving - 2024

Mitigated Construction On-Site

	ROG	NOx	CO	SO2	Fugitive PM10	Exhaust PM10	PM10 Total	Fugitive PM2.5	Exhaust PM2.5	PM2.5 Total	Bio- CO2	NBio- CO2	Total CO2	CH4	N2O	CO2e
Category	lb/day										lb/day					
Off-Road	0.9882	9.5246	14.6258	0.0228		0.4685	0.4685		0.4310	0.4310	0.0000	2,207.547 2	2,207.547 2	0.7140		2,225.396 3
Paving	0.0000					0.0000	0.0000		0.0000	0.0000			0.0000			0.0000
Total	0.9882	9.5246	14.6258	0.0228		0.4685	0.4685		0.4310	0.4310	0.0000	2,207.547 2	2,207.547 2	0.7140		2,225.396 3

Mitigated Construction Off-Site

	ROG	NOx	CO	SO2	Fugitive PM10	Exhaust PM10	PM10 Total	Fugitive PM2.5	Exhaust PM2.5	PM2.5 Total	Bio- CO2	NBio- CO2	Total CO2	CH4	N2O	CO2e
Category	lb/day										lb/day					
Hauling	1.7000e-004	3.6300e-003	2.8000e-003	1.0000e-005	7.0000e-005	1.0000e-005	8.0000e-005	2.0000e-005	1.0000e-005	3.0000e-005		0.7203	0.7203	1.0000e-005	1.1000e-004	0.7542
Vendor	0.0000	0.0000	0.0000	0.0000	0.0000	0.0000	0.0000	0.0000	0.0000	0.0000		0.0000	0.0000	0.0000	0.0000	0.0000
Worker	0.0175	8.9000e-003	0.1052	7.0000e-005	5.8500e-003	9.0000e-005	5.9400e-003	1.5700e-003	8.0000e-005	1.6500e-003		7.1825	7.1825	2.1800e-003	1.0500e-003	7.5496
Total	0.0176	0.0125	0.1080	8.0000e-005	5.9200e-003	1.0000e-004	6.0200e-003	1.5900e-003	9.0000e-005	1.6800e-003		7.9028	7.9028	2.1900e-003	1.1600e-003	8.3039

Unmitigated Construction - Localized Assessment - Kings County, Winter

EMFAC Off-Model Adjustment Factors for Gasoline Light Duty Vehicle to Account for the SAFE Vehicle Rule Not Applied

3.5 Building Construction - 2024

Unmitigated Construction On-Site

	ROG	NOx	CO	SO2	Fugitive PM10	Exhaust PM10	PM10 Total	Fugitive PM2.5	Exhaust PM2.5	PM2.5 Total	Bio- CO2	NBio- CO2	Total CO2	CH4	N2O	CO2e
Category	lb/day										lb/day					
Off-Road	1.2461	11.3782	13.6888	0.0228		0.5192	0.5192		0.4884	0.4884		2,163.1934	2,163.1934	0.5107		2,175.9619
Total	1.2461	11.3782	13.6888	0.0228		0.5192	0.5192		0.4884	0.4884		2,163.1934	2,163.1934	0.5107		2,175.9619

Unmitigated Construction Off-Site

	ROG	NOx	CO	SO2	Fugitive PM10	Exhaust PM10	PM10 Total	Fugitive PM2.5	Exhaust PM2.5	PM2.5 Total	Bio- CO2	NBio- CO2	Total CO2	CH4	N2O	CO2e
Category	lb/day										lb/day					
Hauling	1.0000e-005	3.1000e-004	2.4000e-004	0.0000	1.0000e-005	0.0000	1.0000e-005	0.0000	0.0000	0.0000		0.0619	0.0619	0.0000	1.0000e-005	0.0648
Vendor	0.0362	0.7902	0.5808	1.5600e-003	0.0259	1.4600e-003	0.0274	7.6000e-003	1.4000e-003	9.0000e-003		165.1100	165.1100	2.3700e-003	0.0251	172.6484
Worker	0.1850	0.0943	1.1150	7.5000e-004	0.0620	9.8000e-004	0.0629	0.0166	9.0000e-004	0.0175		76.1341	76.1341	0.0231	0.0111	80.0261
Total	0.2211	0.8848	1.6960	2.3100e-003	0.0879	2.4400e-003	0.0903	0.0242	2.3000e-003	0.0265		241.3060	241.3060	0.0255	0.0362	252.7393

Unmitigated Construction - Localized Assessment - Kings County, Winter

EMFAC Off-Model Adjustment Factors for Gasoline Light Duty Vehicle to Account for the SAFE Vehicle Rule Not Applied

3.5 Building Construction - 2024

Mitigated Construction On-Site

	ROG	NOx	CO	SO2	Fugitive PM10	Exhaust PM10	PM10 Total	Fugitive PM2.5	Exhaust PM2.5	PM2.5 Total	Bio- CO2	NBio- CO2	Total CO2	CH4	N2O	CO2e
Category	lb/day										lb/day					
Off-Road	1.2461	11.3782	13.6888	0.0228		0.5192	0.5192		0.4884	0.4884	0.0000	2,163.1934	2,163.1934	0.5107		2,175.9619
Total	1.2461	11.3782	13.6888	0.0228		0.5192	0.5192		0.4884	0.4884	0.0000	2,163.1934	2,163.1934	0.5107		2,175.9619

Mitigated Construction Off-Site

	ROG	NOx	CO	SO2	Fugitive PM10	Exhaust PM10	PM10 Total	Fugitive PM2.5	Exhaust PM2.5	PM2.5 Total	Bio- CO2	NBio- CO2	Total CO2	CH4	N2O	CO2e
Category	lb/day										lb/day					
Hauling	1.0000e-005	3.1000e-004	2.4000e-004	0.0000	1.0000e-005	0.0000	1.0000e-005	0.0000	0.0000	0.0000		0.0619	0.0619	0.0000	1.0000e-005	0.0648
Vendor	0.0362	0.7902	0.5808	1.5600e-003	0.0259	1.4600e-003	0.0274	7.6000e-003	1.4000e-003	9.0000e-003		165.1100	165.1100	2.3700e-003	0.0251	172.6484
Worker	0.1850	0.0943	1.1150	7.5000e-004	0.0620	9.8000e-004	0.0629	0.0166	9.0000e-004	0.0175		76.1341	76.1341	0.0231	0.0111	80.0261
Total	0.2211	0.8848	1.6960	2.3100e-003	0.0879	2.4400e-003	0.0903	0.0242	2.3000e-003	0.0265		241.3060	241.3060	0.0255	0.0362	252.7393

Unmitigated Construction - Localized Assessment - Kings County, Winter

EMFAC Off-Model Adjustment Factors for Gasoline Light Duty Vehicle to Account for the SAFE Vehicle Rule Not Applied

3.5 Building Construction - 2025

Unmitigated Construction On-Site

	ROG	NOx	CO	SO2	Fugitive PM10	Exhaust PM10	PM10 Total	Fugitive PM2.5	Exhaust PM2.5	PM2.5 Total	Bio- CO2	NBio- CO2	Total CO2	CH4	N2O	CO2e
Category	lb/day										lb/day					
Off-Road	1.1579	10.5544	13.6193	0.0228		0.4466	0.4466		0.4201	0.4201		2,163.8470	2,163.8470	0.5078		2,176.5431
Total	1.1579	10.5544	13.6193	0.0228		0.4466	0.4466		0.4201	0.4201		2,163.8470	2,163.8470	0.5078		2,176.5431

Unmitigated Construction Off-Site

	ROG	NOx	CO	SO2	Fugitive PM10	Exhaust PM10	PM10 Total	Fugitive PM2.5	Exhaust PM2.5	PM2.5 Total	Bio- CO2	NBio- CO2	Total CO2	CH4	N2O	CO2e
Category	lb/day										lb/day					
Hauling	1.0000e-005	3.1000e-004	2.4000e-004	0.0000	1.0000e-005	0.0000	1.0000e-005	0.0000	0.0000	0.0000		0.0605	0.0605	0.0000	1.0000e-005	0.0633
Vendor	0.0357	0.7854	0.5732	1.5300e-003	0.0259	1.4500e-003	0.0274	7.6000e-003	1.3900e-003	8.9900e-003		161.9478	161.9478	2.3400e-003	0.0246	169.3327
Worker	0.1696	0.0867	1.0651	7.3000e-004	0.0620	9.3000e-004	0.0629	0.0166	8.6000e-004	0.0175		73.5733	73.5733	0.0212	0.0106	77.2462
Total	0.2053	0.8725	1.6385	2.2600e-003	0.0879	2.3800e-003	0.0903	0.0242	2.2500e-003	0.0265		235.5816	235.5816	0.0235	0.0352	246.6422

Unmitigated Construction - Localized Assessment - Kings County, Winter

EMFAC Off-Model Adjustment Factors for Gasoline Light Duty Vehicle to Account for the SAFE Vehicle Rule Not Applied

3.5 Building Construction - 2025

Mitigated Construction On-Site

	ROG	NOx	CO	SO2	Fugitive PM10	Exhaust PM10	PM10 Total	Fugitive PM2.5	Exhaust PM2.5	PM2.5 Total	Bio- CO2	NBio- CO2	Total CO2	CH4	N2O	CO2e
Category	lb/day										lb/day					
Off-Road	1.1579	10.5544	13.6193	0.0228		0.4466	0.4466		0.4201	0.4201	0.0000	2,163.8470	2,163.8470	0.5078		2,176.5431
Total	1.1579	10.5544	13.6193	0.0228		0.4466	0.4466		0.4201	0.4201	0.0000	2,163.8470	2,163.8470	0.5078		2,176.5431

Mitigated Construction Off-Site

	ROG	NOx	CO	SO2	Fugitive PM10	Exhaust PM10	PM10 Total	Fugitive PM2.5	Exhaust PM2.5	PM2.5 Total	Bio- CO2	NBio- CO2	Total CO2	CH4	N2O	CO2e
Category	lb/day										lb/day					
Hauling	1.0000e-005	3.1000e-004	2.4000e-004	0.0000	1.0000e-005	0.0000	1.0000e-005	0.0000	0.0000	0.0000		0.0605	0.0605	0.0000	1.0000e-005	0.0633
Vendor	0.0357	0.7854	0.5732	1.5300e-003	0.0259	1.4500e-003	0.0274	7.6000e-003	1.3900e-003	8.9900e-003		161.9478	161.9478	2.3400e-003	0.0246	169.3327
Worker	0.1696	0.0867	1.0651	7.3000e-004	0.0620	9.3000e-004	0.0629	0.0166	8.6000e-004	0.0175		73.5733	73.5733	0.0212	0.0106	77.2462
Total	0.2053	0.8725	1.6385	2.2600e-003	0.0879	2.3800e-003	0.0903	0.0242	2.2500e-003	0.0265		235.5816	235.5816	0.0235	0.0352	246.6422

Unmitigated Construction - Localized Assessment - Kings County, Winter

EMFAC Off-Model Adjustment Factors for Gasoline Light Duty Vehicle to Account for the SAFE Vehicle Rule Not Applied

3.5 Building Construction - 2026

Unmitigated Construction On-Site

	ROG	NOx	CO	SO2	Fugitive PM10	Exhaust PM10	PM10 Total	Fugitive PM2.5	Exhaust PM2.5	PM2.5 Total	Bio- CO2	NBio- CO2	Total CO2	CH4	N2O	CO2e
Category	lb/day										lb/day					
Off-Road	1.1579	10.5544	13.6193	0.0228		0.4466	0.4466		0.4201	0.4201		2,163.8470	2,163.8470	0.5078		2,176.5431
Total	1.1579	10.5544	13.6193	0.0228		0.4466	0.4466		0.4201	0.4201		2,163.8470	2,163.8470	0.5078		2,176.5431

Unmitigated Construction Off-Site

	ROG	NOx	CO	SO2	Fugitive PM10	Exhaust PM10	PM10 Total	Fugitive PM2.5	Exhaust PM2.5	PM2.5 Total	Bio- CO2	NBio- CO2	Total CO2	CH4	N2O	CO2e
Category	lb/day										lb/day					
Hauling	1.0000e-005	3.1000e-004	2.4000e-004	0.0000	1.0000e-005	0.0000	1.0000e-005	0.0000	0.0000	0.0000		0.0591	0.0591	0.0000	1.0000e-005	0.0619
Vendor	0.0352	0.7804	0.5670	1.5000e-003	0.0259	1.4400e-003	0.0274	7.6000e-003	1.3800e-003	8.9800e-003		158.7660	158.7660	2.3100e-003	0.0241	165.9966
Worker	0.1561	0.0804	1.0209	7.1000e-004	0.0620	8.9000e-004	0.0629	0.0166	8.2000e-004	0.0175		71.4623	71.4623	0.0195	0.0101	74.9441
Total	0.1914	0.8611	1.5881	2.2100e-003	0.0879	2.3300e-003	0.0902	0.0242	2.2000e-003	0.0264		230.2874	230.2874	0.0218	0.0341	241.0025

Unmitigated Construction - Localized Assessment - Kings County, Winter

EMFAC Off-Model Adjustment Factors for Gasoline Light Duty Vehicle to Account for the SAFE Vehicle Rule Not Applied

3.5 Building Construction - 2026

Mitigated Construction On-Site

	ROG	NOx	CO	SO2	Fugitive PM10	Exhaust PM10	PM10 Total	Fugitive PM2.5	Exhaust PM2.5	PM2.5 Total	Bio- CO2	NBio- CO2	Total CO2	CH4	N2O	CO2e
Category	lb/day										lb/day					
Off-Road	1.1579	10.5544	13.6193	0.0228		0.4466	0.4466		0.4201	0.4201	0.0000	2,163.8470	2,163.8470	0.5078		2,176.5431
Total	1.1579	10.5544	13.6193	0.0228		0.4466	0.4466		0.4201	0.4201	0.0000	2,163.8470	2,163.8470	0.5078		2,176.5431

Mitigated Construction Off-Site

	ROG	NOx	CO	SO2	Fugitive PM10	Exhaust PM10	PM10 Total	Fugitive PM2.5	Exhaust PM2.5	PM2.5 Total	Bio- CO2	NBio- CO2	Total CO2	CH4	N2O	CO2e
Category	lb/day										lb/day					
Hauling	1.0000e-005	3.1000e-004	2.4000e-004	0.0000	1.0000e-005	0.0000	1.0000e-005	0.0000	0.0000	0.0000		0.0591	0.0591	0.0000	1.0000e-005	0.0619
Vendor	0.0352	0.7804	0.5670	1.5000e-003	0.0259	1.4400e-003	0.0274	7.6000e-003	1.3800e-003	8.9800e-003		158.7660	158.7660	2.3100e-003	0.0241	165.9966
Worker	0.1561	0.0804	1.0209	7.1000e-004	0.0620	8.9000e-004	0.0629	0.0166	8.2000e-004	0.0175		71.4623	71.4623	0.0195	0.0101	74.9441
Total	0.1914	0.8611	1.5881	2.2100e-003	0.0879	2.3300e-003	0.0902	0.0242	2.2000e-003	0.0264		230.2874	230.2874	0.0218	0.0341	241.0025

Unmitigated Construction - Localized Assessment - Kings County, Winter

EMFAC Off-Model Adjustment Factors for Gasoline Light Duty Vehicle to Account for the SAFE Vehicle Rule Not Applied

3.5 Building Construction - 2027

Unmitigated Construction On-Site

	ROG	NOx	CO	SO2	Fugitive PM10	Exhaust PM10	PM10 Total	Fugitive PM2.5	Exhaust PM2.5	PM2.5 Total	Bio- CO2	NBio- CO2	Total CO2	CH4	N2O	CO2e
Category	lb/day										lb/day					
Off-Road	1.1579	10.5544	13.6193	0.0228		0.4466	0.4466		0.4201	0.4201		2,163.8470	2,163.8470	0.5078		2,176.5431
Total	1.1579	10.5544	13.6193	0.0228		0.4466	0.4466		0.4201	0.4201		2,163.8470	2,163.8470	0.5078		2,176.5431

Unmitigated Construction Off-Site

	ROG	NOx	CO	SO2	Fugitive PM10	Exhaust PM10	PM10 Total	Fugitive PM2.5	Exhaust PM2.5	PM2.5 Total	Bio- CO2	NBio- CO2	Total CO2	CH4	N2O	CO2e
Category	lb/day										lb/day					
Hauling	1.0000e-005	3.1000e-004	2.4000e-004	0.0000	1.0000e-005	0.0000	1.0000e-005	0.0000	0.0000	0.0000		0.0577	0.0577	0.0000	1.0000e-005	0.0604
Vendor	0.0349	0.7759	0.5618	1.4700e-003	0.0259	1.4300e-003	0.0274	7.6000e-003	1.3600e-003	8.9700e-003		155.5159	155.5159	2.2900e-003	0.0236	162.5918
Worker	0.1442	0.0750	0.9796	6.9000e-004	0.0620	8.5000e-004	0.0628	0.0166	7.8000e-004	0.0174		69.3650	69.3650	0.0180	9.6300e-003	72.6850
Total	0.1791	0.8512	1.5416	2.1600e-003	0.0879	2.2800e-003	0.0902	0.0242	2.1400e-003	0.0264		224.9385	224.9385	0.0203	0.0332	235.3372

Unmitigated Construction - Localized Assessment - Kings County, Winter

EMFAC Off-Model Adjustment Factors for Gasoline Light Duty Vehicle to Account for the SAFE Vehicle Rule Not Applied

3.5 Building Construction - 2027

Mitigated Construction On-Site

	ROG	NOx	CO	SO2	Fugitive PM10	Exhaust PM10	PM10 Total	Fugitive PM2.5	Exhaust PM2.5	PM2.5 Total	Bio- CO2	NBio- CO2	Total CO2	CH4	N2O	CO2e
Category	lb/day										lb/day					
Off-Road	1.1579	10.5544	13.6193	0.0228		0.4466	0.4466		0.4201	0.4201	0.0000	2,163.8470	2,163.8470	0.5078		2,176.5431
Total	1.1579	10.5544	13.6193	0.0228		0.4466	0.4466		0.4201	0.4201	0.0000	2,163.8470	2,163.8470	0.5078		2,176.5431

Mitigated Construction Off-Site

	ROG	NOx	CO	SO2	Fugitive PM10	Exhaust PM10	PM10 Total	Fugitive PM2.5	Exhaust PM2.5	PM2.5 Total	Bio- CO2	NBio- CO2	Total CO2	CH4	N2O	CO2e
Category	lb/day										lb/day					
Hauling	1.0000e-005	3.1000e-004	2.4000e-004	0.0000	1.0000e-005	0.0000	1.0000e-005	0.0000	0.0000	0.0000		0.0577	0.0577	0.0000	1.0000e-005	0.0604
Vendor	0.0349	0.7759	0.5618	1.4700e-003	0.0259	1.4300e-003	0.0274	7.6000e-003	1.3600e-003	8.9700e-003		155.5159	155.5159	2.2900e-003	0.0236	162.5918
Worker	0.1442	0.0750	0.9796	6.9000e-004	0.0620	8.5000e-004	0.0628	0.0166	7.8000e-004	0.0174		69.3650	69.3650	0.0180	9.6300e-003	72.6850
Total	0.1791	0.8512	1.5416	2.1600e-003	0.0879	2.2800e-003	0.0902	0.0242	2.1400e-003	0.0264		224.9385	224.9385	0.0203	0.0332	235.3372

Unmitigated Construction - Localized Assessment - Kings County, Winter

EMFAC Off-Model Adjustment Factors for Gasoline Light Duty Vehicle to Account for the SAFE Vehicle Rule Not Applied

3.5 Building Construction - 2028

Unmitigated Construction On-Site

	ROG	NOx	CO	SO2	Fugitive PM10	Exhaust PM10	PM10 Total	Fugitive PM2.5	Exhaust PM2.5	PM2.5 Total	Bio- CO2	NBio- CO2	Total CO2	CH4	N2O	CO2e
Category	lb/day										lb/day					
Off-Road	1.1579	10.5544	13.6193	0.0228		0.4466	0.4466		0.4201	0.4201		2,163.8470	2,163.8470	0.5078		2,176.5431
Total	1.1579	10.5544	13.6193	0.0228		0.4466	0.4466		0.4201	0.4201		2,163.8470	2,163.8470	0.5078		2,176.5431

Unmitigated Construction Off-Site

	ROG	NOx	CO	SO2	Fugitive PM10	Exhaust PM10	PM10 Total	Fugitive PM2.5	Exhaust PM2.5	PM2.5 Total	Bio- CO2	NBio- CO2	Total CO2	CH4	N2O	CO2e
Category	lb/day										lb/day					
Hauling	1.0000e-005	3.1000e-004	2.4000e-004	0.0000	1.0000e-005	0.0000	1.0000e-005	0.0000	0.0000	0.0000		0.0563	0.0563	0.0000	1.0000e-005	0.0590
Vendor	0.0347	0.7721	0.5582	1.4400e-003	0.0259	1.4100e-003	0.0273	7.6000e-003	1.3500e-003	8.9500e-003		152.3950	152.3950	2.2900e-003	0.0231	159.3235
Worker	0.1336	0.0704	0.9439	6.7000e-004	0.0620	7.9000e-004	0.0628	0.0166	7.3000e-004	0.0174		67.4861	67.4861	0.0167	9.2800e-003	70.6677
Total	0.1683	0.8428	1.5023	2.1100e-003	0.0879	2.2000e-003	0.0901	0.0242	2.0800e-003	0.0263		219.9375	219.9375	0.0190	0.0324	230.0502

Unmitigated Construction - Localized Assessment - Kings County, Winter

EMFAC Off-Model Adjustment Factors for Gasoline Light Duty Vehicle to Account for the SAFE Vehicle Rule Not Applied

3.5 Building Construction - 2028

Mitigated Construction On-Site

	ROG	NOx	CO	SO2	Fugitive PM10	Exhaust PM10	PM10 Total	Fugitive PM2.5	Exhaust PM2.5	PM2.5 Total	Bio- CO2	NBio- CO2	Total CO2	CH4	N2O	CO2e
Category	lb/day										lb/day					
Off-Road	1.1579	10.5544	13.6193	0.0228		0.4466	0.4466		0.4201	0.4201	0.0000	2,163.8470	2,163.8470	0.5078		2,176.5431
Total	1.1579	10.5544	13.6193	0.0228		0.4466	0.4466		0.4201	0.4201	0.0000	2,163.8470	2,163.8470	0.5078		2,176.5431

Mitigated Construction Off-Site

	ROG	NOx	CO	SO2	Fugitive PM10	Exhaust PM10	PM10 Total	Fugitive PM2.5	Exhaust PM2.5	PM2.5 Total	Bio- CO2	NBio- CO2	Total CO2	CH4	N2O	CO2e
Category	lb/day										lb/day					
Hauling	1.0000e-005	3.1000e-004	2.4000e-004	0.0000	1.0000e-005	0.0000	1.0000e-005	0.0000	0.0000	0.0000		0.0563	0.0563	0.0000	1.0000e-005	0.0590
Vendor	0.0347	0.7721	0.5582	1.4400e-003	0.0259	1.4100e-003	0.0273	7.6000e-003	1.3500e-003	8.9500e-003		152.3950	152.3950	2.2900e-003	0.0231	159.3235
Worker	0.1336	0.0704	0.9439	6.7000e-004	0.0620	7.9000e-004	0.0628	0.0166	7.3000e-004	0.0174		67.4861	67.4861	0.0167	9.2800e-003	70.6677
Total	0.1683	0.8428	1.5023	2.1100e-003	0.0879	2.2000e-003	0.0901	0.0242	2.0800e-003	0.0263		219.9375	219.9375	0.0190	0.0324	230.0502

Unmitigated Construction - Localized Assessment - Kings County, Winter

EMFAC Off-Model Adjustment Factors for Gasoline Light Duty Vehicle to Account for the SAFE Vehicle Rule Not Applied

3.5 Building Construction - 2029

Unmitigated Construction On-Site

	ROG	NOx	CO	SO2	Fugitive PM10	Exhaust PM10	PM10 Total	Fugitive PM2.5	Exhaust PM2.5	PM2.5 Total	Bio- CO2	NBio- CO2	Total CO2	CH4	N2O	CO2e
Category	lb/day										lb/day					
Off-Road	1.1579	10.5544	13.6193	0.0228		0.4466	0.4466		0.4201	0.4201		2,163.8470	2,163.8470	0.5078		2,176.5431
Total	1.1579	10.5544	13.6193	0.0228		0.4466	0.4466		0.4201	0.4201		2,163.8470	2,163.8470	0.5078		2,176.5431

Unmitigated Construction Off-Site

	ROG	NOx	CO	SO2	Fugitive PM10	Exhaust PM10	PM10 Total	Fugitive PM2.5	Exhaust PM2.5	PM2.5 Total	Bio- CO2	NBio- CO2	Total CO2	CH4	N2O	CO2e
Category	lb/day										lb/day					
Hauling	1.0000e-005	3.0000e-004	2.3000e-004	0.0000	1.0000e-005	0.0000	1.0000e-005	0.0000	0.0000	0.0000		0.0550	0.0550	0.0000	1.0000e-005	0.0576
Vendor	0.0344	0.7683	0.5549	1.4200e-003	0.0259	1.4000e-003	0.0273	7.6000e-003	1.3400e-003	8.9400e-003		149.3653	149.3653	2.2800e-003	0.0226	156.1515
Worker	0.1241	0.0665	0.9115	6.5000e-004	0.0620	7.5000e-004	0.0627	0.0166	6.9000e-004	0.0173		65.7997	65.7997	0.0155	8.9800e-003	68.8625
Total	0.1585	0.8351	1.4666	2.0700e-003	0.0879	2.1500e-003	0.0901	0.0242	2.0300e-003	0.0263		215.2200	215.2200	0.0178	0.0316	225.0716

Unmitigated Construction - Localized Assessment - Kings County, Winter

EMFAC Off-Model Adjustment Factors for Gasoline Light Duty Vehicle to Account for the SAFE Vehicle Rule Not Applied

3.5 Building Construction - 2029

Mitigated Construction On-Site

	ROG	NOx	CO	SO2	Fugitive PM10	Exhaust PM10	PM10 Total	Fugitive PM2.5	Exhaust PM2.5	PM2.5 Total	Bio- CO2	NBio- CO2	Total CO2	CH4	N2O	CO2e
Category	lb/day										lb/day					
Off-Road	1.1579	10.5544	13.6193	0.0228		0.4466	0.4466		0.4201	0.4201	0.0000	2,163.8470	2,163.8470	0.5078		2,176.5431
Total	1.1579	10.5544	13.6193	0.0228		0.4466	0.4466		0.4201	0.4201	0.0000	2,163.8470	2,163.8470	0.5078		2,176.5431

Mitigated Construction Off-Site

	ROG	NOx	CO	SO2	Fugitive PM10	Exhaust PM10	PM10 Total	Fugitive PM2.5	Exhaust PM2.5	PM2.5 Total	Bio- CO2	NBio- CO2	Total CO2	CH4	N2O	CO2e
Category	lb/day										lb/day					
Hauling	1.0000e-005	3.0000e-004	2.3000e-004	0.0000	1.0000e-005	0.0000	1.0000e-005	0.0000	0.0000	0.0000		0.0550	0.0550	0.0000	1.0000e-005	0.0576
Vendor	0.0344	0.7683	0.5549	1.4200e-003	0.0259	1.4000e-003	0.0273	7.6000e-003	1.3400e-003	8.9400e-003		149.3653	149.3653	2.2800e-003	0.0226	156.1515
Worker	0.1241	0.0665	0.9115	6.5000e-004	0.0620	7.5000e-004	0.0627	0.0166	6.9000e-004	0.0173		65.7997	65.7997	0.0155	8.9800e-003	68.8625
Total	0.1585	0.8351	1.4666	2.0700e-003	0.0879	2.1500e-003	0.0901	0.0242	2.0300e-003	0.0263		215.2200	215.2200	0.0178	0.0316	225.0716

Unmitigated Construction - Localized Assessment - Kings County, Winter

EMFAC Off-Model Adjustment Factors for Gasoline Light Duty Vehicle to Account for the SAFE Vehicle Rule Not Applied

3.6 Architectural Coating - 2029

Unmitigated Construction On-Site

	ROG	NOx	CO	SO2	Fugitive PM10	Exhaust PM10	PM10 Total	Fugitive PM2.5	Exhaust PM2.5	PM2.5 Total	Bio- CO2	NBio- CO2	Total CO2	CH4	N2O	CO2e
Category	lb/day										lb/day					
Archit. Coating	21.0245					0.0000	0.0000		0.0000	0.0000			0.0000			0.0000
Off-Road	0.1709	1.1455	1.8091	2.9700e-003		0.0515	0.0515		0.0515	0.0515		281.4481	281.4481	0.0154		281.8319
Total	21.1954	1.1455	1.8091	2.9700e-003		0.0515	0.0515		0.0515	0.0515		281.4481	281.4481	0.0154		281.8319

Unmitigated Construction Off-Site

	ROG	NOx	CO	SO2	Fugitive PM10	Exhaust PM10	PM10 Total	Fugitive PM2.5	Exhaust PM2.5	PM2.5 Total	Bio- CO2	NBio- CO2	Total CO2	CH4	N2O	CO2e
Category	lb/day										lb/day					
Hauling	1.0000e-005	2.9000e-004	2.3000e-004	0.0000	1.0000e-005	0.0000	1.0000e-005	0.0000	0.0000	0.0000		0.0534	0.0534	0.0000	1.0000e-005	0.0559
Vendor	0.0000	0.0000	0.0000	0.0000	0.0000	0.0000	0.0000	0.0000	0.0000	0.0000		0.0000	0.0000	0.0000	0.0000	0.0000
Worker	0.0250	0.0134	0.1835	1.3000e-004	0.0125	1.5000e-004	0.0126	3.3500e-003	1.4000e-004	3.4900e-003		13.2427	13.2427	3.1200e-003	1.8100e-003	13.8591
Total	0.0250	0.0137	0.1837	1.3000e-004	0.0125	1.5000e-004	0.0126	3.3500e-003	1.4000e-004	3.4900e-003		13.2961	13.2961	3.1200e-003	1.8200e-003	13.9150

Unmitigated Construction - Localized Assessment - Kings County, Winter

EMFAC Off-Model Adjustment Factors for Gasoline Light Duty Vehicle to Account for the SAFE Vehicle Rule Not Applied

3.6 Architectural Coating - 2029

Mitigated Construction On-Site

	ROG	NOx	CO	SO2	Fugitive PM10	Exhaust PM10	PM10 Total	Fugitive PM2.5	Exhaust PM2.5	PM2.5 Total	Bio- CO2	NBio- CO2	Total CO2	CH4	N2O	CO2e
Category	lb/day										lb/day					
Archit. Coating	21.0245					0.0000	0.0000		0.0000	0.0000			0.0000			0.0000
Off-Road	0.1709	1.1455	1.8091	2.9700e-003		0.0515	0.0515		0.0515	0.0515	0.0000	281.4481	281.4481	0.0154		281.8319
Total	21.1954	1.1455	1.8091	2.9700e-003		0.0515	0.0515		0.0515	0.0515	0.0000	281.4481	281.4481	0.0154		281.8319

Mitigated Construction Off-Site

	ROG	NOx	CO	SO2	Fugitive PM10	Exhaust PM10	PM10 Total	Fugitive PM2.5	Exhaust PM2.5	PM2.5 Total	Bio- CO2	NBio- CO2	Total CO2	CH4	N2O	CO2e
Category	lb/day										lb/day					
Hauling	1.0000e-005	2.9000e-004	2.3000e-004	0.0000	1.0000e-005	0.0000	1.0000e-005	0.0000	0.0000	0.0000		0.0534	0.0534	0.0000	1.0000e-005	0.0559
Vendor	0.0000	0.0000	0.0000	0.0000	0.0000	0.0000	0.0000	0.0000	0.0000	0.0000		0.0000	0.0000	0.0000	0.0000	0.0000
Worker	0.0250	0.0134	0.1835	1.3000e-004	0.0125	1.5000e-004	0.0126	3.3500e-003	1.4000e-004	3.4900e-003		13.2427	13.2427	3.1200e-003	1.8100e-003	13.8591
Total	0.0250	0.0137	0.1837	1.3000e-004	0.0125	1.5000e-004	0.0126	3.3500e-003	1.4000e-004	3.4900e-003		13.2961	13.2961	3.1200e-003	1.8200e-003	13.9150

Unmitigated Construction - Localized Assessment - Kings County, Winter

EMFAC Off-Model Adjustment Factors for Gasoline Light Duty Vehicle to Account for the SAFE Vehicle Rule Not Applied

4.0 Operational Detail - Mobile

4.1 Mitigation Measures Mobile

	ROG	NOx	CO	SO2	Fugitive PM10	Exhaust PM10	PM10 Total	Fugitive PM2.5	Exhaust PM2.5	PM2.5 Total	Bio- CO2	NBio- CO2	Total CO2	CH4	N2O	CO2e
Category	lb/day										lb/day					
Mitigated	0.0000	0.0000	0.0000	0.0000	0.0000	0.0000	0.0000	0.0000	0.0000	0.0000		0.0000	0.0000	0.0000	0.0000	0.0000
Unmitigated	0.0000	0.0000	0.0000	0.0000	0.0000	0.0000	0.0000	0.0000	0.0000	0.0000		0.0000	0.0000	0.0000	0.0000	0.0000

4.2 Trip Summary Information

Land Use	Average Daily Trip Rate			Unmitigated	Mitigated
	Weekday	Saturday	Sunday	Annual VMT	Annual VMT
City Park	0.00	0.00	0.00		
Single Family Housing	0.00	0.00	0.00		
Total	0.00	0.00	0.00		

4.3 Trip Type Information

Land Use	Miles			Trip %			Trip Purpose %		
	H-W or C-W	H-S or C-C	H-O or C-NW	H-W or C-W	H-S or C-C	H-O or C-NW	Primary	Diverted	Pass-by
City Park	9.50	7.30	7.30	33.00	48.00	19.00	66	28	6
Single Family Housing	10.80	7.30	7.50	42.30	19.60	38.10	86	11	3

4.4 Fleet Mix

Unmitigated Construction - Localized Assessment - Kings County, Winter

EMFAC Off-Model Adjustment Factors for Gasoline Light Duty Vehicle to Account for the SAFE Vehicle Rule Not Applied

Land Use	LDA	LDT1	LDT2	MDV	LHD1	LHD2	MHD	HHD	OBUS	UBUS	MCY	SBUS	MH
City Park	0.524038	0.053970	0.173802	0.143485	0.025178	0.006202	0.008102	0.037193	0.000573	0.000185	0.023331	0.001015	0.002925
Single Family Housing	0.524038	0.053970	0.173802	0.143485	0.025178	0.006202	0.008102	0.037193	0.000573	0.000185	0.023331	0.001015	0.002925

5.0 Energy Detail

Historical Energy Use: N

5.1 Mitigation Measures Energy

	ROG	NOx	CO	SO2	Fugitive PM10	Exhaust PM10	PM10 Total	Fugitive PM2.5	Exhaust PM2.5	PM2.5 Total	Bio- CO2	NBio- CO2	Total CO2	CH4	N2O	CO2e
Category	lb/day										lb/day					
NaturalGas Mitigated	0.0000	0.0000	0.0000	0.0000		0.0000	0.0000		0.0000	0.0000		0.0000	0.0000	0.0000	0.0000	0.0000
NaturalGas Unmitigated	0.0000	0.0000	0.0000	0.0000		0.0000	0.0000		0.0000	0.0000		0.0000	0.0000	0.0000	0.0000	0.0000

Unmitigated Construction - Localized Assessment - Kings County, Winter

EMFAC Off-Model Adjustment Factors for Gasoline Light Duty Vehicle to Account for the SAFE Vehicle Rule Not Applied

5.2 Energy by Land Use - NaturalGas

Unmitigated

	NaturalGas Use	ROG	NOx	CO	SO2	Fugitive PM10	Exhaust PM10	PM10 Total	Fugitive PM2.5	Exhaust PM2.5	PM2.5 Total	Bio- CO2	NBio- CO2	Total CO2	CH4	N2O	CO2e
Land Use	kBTU/yr	lb/day										lb/day					
City Park	0	0.0000	0.0000	0.0000	0.0000		0.0000	0.0000		0.0000	0.0000		0.0000	0.0000	0.0000	0.0000	0.0000
Single Family Housing	0	0.0000	0.0000	0.0000	0.0000		0.0000	0.0000		0.0000	0.0000		0.0000	0.0000	0.0000	0.0000	0.0000
Total		0.0000	0.0000	0.0000	0.0000		0.0000	0.0000		0.0000	0.0000		0.0000	0.0000	0.0000	0.0000	0.0000

Mitigated

	NaturalGas Use	ROG	NOx	CO	SO2	Fugitive PM10	Exhaust PM10	PM10 Total	Fugitive PM2.5	Exhaust PM2.5	PM2.5 Total	Bio- CO2	NBio- CO2	Total CO2	CH4	N2O	CO2e
Land Use	kBTU/yr	lb/day										lb/day					
City Park	0	0.0000	0.0000	0.0000	0.0000		0.0000	0.0000		0.0000	0.0000		0.0000	0.0000	0.0000	0.0000	0.0000
Single Family Housing	0	0.0000	0.0000	0.0000	0.0000		0.0000	0.0000		0.0000	0.0000		0.0000	0.0000	0.0000	0.0000	0.0000
Total		0.0000	0.0000	0.0000	0.0000		0.0000	0.0000		0.0000	0.0000		0.0000	0.0000	0.0000	0.0000	0.0000

6.0 Area Detail

Unmitigated Construction - Localized Assessment - Kings County, Winter

EMFAC Off-Model Adjustment Factors for Gasoline Light Duty Vehicle to Account for the SAFE Vehicle Rule Not Applied

6.1 Mitigation Measures Area

	ROG	NOx	CO	SO2	Fugitive PM10	Exhaust PM10	PM10 Total	Fugitive PM2.5	Exhaust PM2.5	PM2.5 Total	Bio- CO2	NBio- CO2	Total CO2	CH4	N2O	CO2e
Category	lb/day										lb/day					
Mitigated	0.8298	0.2658	23.0788	1.2200e-003		0.1281	0.1281		0.1281	0.1281	0.0000	41.5953	41.5953	0.0398	0.0000	42.5912
Unmitigated	0.8298	0.2658	23.0788	1.2200e-003		0.1281	0.1281		0.1281	0.1281	0.0000	41.5953	41.5953	0.0398	0.0000	42.5912

Unmitigated Construction - Localized Assessment - Kings County, Winter

EMFAC Off-Model Adjustment Factors for Gasoline Light Duty Vehicle to Account for the SAFE Vehicle Rule Not Applied

6.2 Area by SubCategory

Unmitigated

	ROG	NOx	CO	SO2	Fugitive PM10	Exhaust PM10	PM10 Total	Fugitive PM2.5	Exhaust PM2.5	PM2.5 Total	Bio- CO2	NBio- CO2	Total CO2	CH4	N2O	CO2e
SubCategory	lb/day										lb/day					
Architectural Coating	0.0864					0.0000	0.0000		0.0000	0.0000			0.0000			0.0000
Consumer Products	0.0504					0.0000	0.0000		0.0000	0.0000			0.0000			0.0000
Hearth	0.0000	0.0000	0.0000	0.0000		0.0000	0.0000		0.0000	0.0000	0.0000	0.0000	0.0000	0.0000	0.0000	0.0000
Landscaping	0.6930	0.2658	23.0788	1.2200e-003		0.1281	0.1281		0.1281	0.1281		41.5953	41.5953	0.0398		42.5912
Total	0.8298	0.2658	23.0788	1.2200e-003		0.1281	0.1281		0.1281	0.1281	0.0000	41.5953	41.5953	0.0398	0.0000	42.5912

Unmitigated Construction - Localized Assessment - Kings County, Winter

EMFAC Off-Model Adjustment Factors for Gasoline Light Duty Vehicle to Account for the SAFE Vehicle Rule Not Applied

6.2 Area by SubCategory

Mitigated

	ROG	NOx	CO	SO2	Fugitive PM10	Exhaust PM10	PM10 Total	Fugitive PM2.5	Exhaust PM2.5	PM2.5 Total	Bio- CO2	NBio- CO2	Total CO2	CH4	N2O	CO2e
SubCategory	lb/day										lb/day					
Architectural Coating	0.0864					0.0000	0.0000		0.0000	0.0000			0.0000			0.0000
Consumer Products	0.0504					0.0000	0.0000		0.0000	0.0000			0.0000			0.0000
Hearth	0.0000	0.0000	0.0000	0.0000		0.0000	0.0000		0.0000	0.0000	0.0000	0.0000	0.0000	0.0000	0.0000	0.0000
Landscaping	0.6930	0.2658	23.0788	1.2200e-003		0.1281	0.1281		0.1281	0.1281		41.5953	41.5953	0.0398		42.5912
Total	0.8298	0.2658	23.0788	1.2200e-003		0.1281	0.1281		0.1281	0.1281	0.0000	41.5953	41.5953	0.0398	0.0000	42.5912

7.0 Water Detail

7.1 Mitigation Measures Water

Unmitigated Construction - Localized Assessment - Kings County, Winter

EMFAC Off-Model Adjustment Factors for Gasoline Light Duty Vehicle to Account for the SAFE Vehicle Rule Not Applied

8.0 Waste Detail

8.1 Mitigation Measures Waste

9.0 Operational Offroad

Equipment Type	Number	Hours/Day	Days/Year	Horse Power	Load Factor	Fuel Type
----------------	--------	-----------	-----------	-------------	-------------	-----------

10.0 Stationary Equipment

Fire Pumps and Emergency Generators

Equipment Type	Number	Hours/Day	Hours/Year	Horse Power	Load Factor	Fuel Type
----------------	--------	-----------	------------	-------------	-------------	-----------

Boilers

Equipment Type	Number	Heat Input/Day	Heat Input/Year	Boiler Rating	Fuel Type
----------------	--------	----------------	-----------------	---------------	-----------

User Defined Equipment

Equipment Type	Number
----------------	--------

11.0 Vegetation

Operations - Localized Assessment - Kings County, Summer

EMFAC Off-Model Adjustment Factors for Gasoline Light Duty Vehicle to Account for the SAFE Vehicle Rule Not Applied

Operations - Localized Assessment

Kings County, Summer

1.0 Project Characteristics

1.1 Land Usage

Land Uses	Size	Metric	Lot Acreage	Floor Surface Area	Population
City Park	3.20	Acre	3.20	139,392.00	0
Single Family Housing	280.00	Dwelling Unit	49.41	504,000.00	801

1.2 Other Project Characteristics

Urbanization	Urban	Wind Speed (m/s)	2.2	Precipitation Freq (Days)	37
Climate Zone	3			Operational Year	2024
Utility Company	Pacific Gas and Electric Company				
CO2 Intensity (lb/MWhr)	203.98	CH4 Intensity (lb/MWhr)	0.033	N2O Intensity (lb/MWhr)	0.004

1.3 User Entered Comments & Non-Default Data

Project Characteristics - Lemoore 54 - Full Buildout Operations in the Earliest Operational Year - Localized Assessment

Land Use - Project site is approximately 52.61 acres
280-lot single family subdivision and 3.2 acres of public parks at full buildout

Construction Phase - Operational run only - zeroed out construction only parameters

Off-road Equipment - Operational run only

Trips and VMT - Operational run only

Architectural Coating - Rule 4601 Architectural Coatings

Vehicle Trips - Trip lengths updated to 0.5 mile to account for on-site and localized emissions from mobile sources.
Trip rates for project trips consistent with the trip generation provided in the traffic report (JLB Traffic Engineering, 2023)

Woodstoves - SJVAPCD Rule 4901 Woodburning

Area Coating - Rule 4601 Architectural Coatings

Construction Off-road Equipment Mitigation -

Operations - Localized Assessment - Kings County, Summer

EMFAC Off-Model Adjustment Factors for Gasoline Light Duty Vehicle to Account for the SAFE Vehicle Rule Not Applied

Area Mitigation - Rule 4601 Architectural Coatings, no woodburning fireplaces (only natural gas hearth), and building code standards (outside outlets)

Energy Mitigation - Single-family homes to be built with rooftop solar to provide on-site renewable energy (80% of electricity use generated applied)

Water Mitigation - Compliance with Green Building Code Standards and California Model Water Efficient Landscape Ordinance

Fleet Mix - SJVAPCD-approved Residential Fleet Mix for the 2024 operational year

Water And Wastewater -

Solid Waste -

Table Name	Column Name	Default Value	New Value
tblArchitecturalCoating	EF_Nonresidential_Exterior	150.00	50.00
tblArchitecturalCoating	EF_Nonresidential_Interior	150.00	50.00
tblArchitecturalCoating	EF_Residential_Exterior	150.00	50.00
tblArchitecturalCoating	EF_Residential_Interior	150.00	50.00
tblAreaCoating	Area_EF_Nonresidential_Exterior	150	50
tblAreaCoating	Area_EF_Nonresidential_Interior	150	50
tblAreaCoating	Area_EF_Residential_Exterior	150	50
tblAreaCoating	Area_EF_Residential_Interior	150	50
tblConstructionPhase	NumDays	75.00	1.00
tblFireplaces	FireplaceWoodMass	3,078.40	0.00
tblFleetMix	HHD	0.04	0.02
tblFleetMix	LDA	0.50	0.53
tblFleetMix	LDT1	0.05	0.21
tblFleetMix	LDT2	0.17	0.17
tblFleetMix	LHD1	0.03	9.0000e-004
tblFleetMix	LHD2	6.7450e-003	9.0000e-004
tblFleetMix	MCY	0.02	2.5000e-003
tblFleetMix	MDV	0.16	0.06
tblFleetMix	MH	3.5200e-003	2.0000e-003
tblFleetMix	MHD	8.2690e-003	8.0000e-003
tblFleetMix	OBUS	6.2000e-004	0.00

Operations - Localized Assessment - Kings County, Summer

EMFAC Off-Model Adjustment Factors for Gasoline Light Duty Vehicle to Account for the SAFE Vehicle Rule Not Applied

tblFleetMix	SBUS	1.1520e-003	2.0000e-004
tblFleetMix	UBUS	1.8900e-004	4.3000e-003
tblLandUse	LotAcreage	90.91	49.41
tblOffRoadEquipment	OffRoadEquipmentUnitAmount	1.00	0.00
tblOffRoadEquipment	UsageHours	6.00	0.00
tblTripsAndVMT	WorkerTripNumber	32.00	0.00
tblVehicleTrips	DV_TP	11.00	0.00
tblVehicleTrips	HO_TL	7.50	0.50
tblVehicleTrips	HS_TL	7.30	0.50
tblVehicleTrips	HW_TL	10.80	0.50
tblVehicleTrips	PB_TP	3.00	0.00
tblVehicleTrips	PR_TP	86.00	100.00
tblVehicleTrips	ST_TR	9.54	9.48
tblVehicleTrips	SU_TR	8.55	8.48
tblVehicleTrips	WD_TR	9.44	9.43
tblWoodstoves	WoodstoveWoodMass	3,019.20	0.00

2.0 Emissions Summary

Operations - Localized Assessment - Kings County, Summer

EMFAC Off-Model Adjustment Factors for Gasoline Light Duty Vehicle to Account for the SAFE Vehicle Rule Not Applied

2.1 Overall Construction (Maximum Daily Emission)

Unmitigated Construction

	ROG	NOx	CO	SO2	Fugitive PM10	Exhaust PM10	PM10 Total	Fugitive PM2.5	Exhaust PM2.5	PM2.5 Total	Bio- CO2	NBio- CO2	Total CO2	CH4	N2O	CO2e
Year	lb/day										lb/day					
2023	3,153.6610	0.0000	0.0000	0.0000	0.0000	0.0000	0.0000	0.0000	0.0000	0.0000	0.0000	0.0000	0.0000	0.0000	0.0000	0.0000
Maximum	3,153.6610	0.0000	0.0000	0.0000	0.0000	0.0000	0.0000	0.0000	0.0000	0.0000	0.0000	0.0000	0.0000	0.0000	0.0000	0.0000

Mitigated Construction

	ROG	NOx	CO	SO2	Fugitive PM10	Exhaust PM10	PM10 Total	Fugitive PM2.5	Exhaust PM2.5	PM2.5 Total	Bio- CO2	NBio- CO2	Total CO2	CH4	N2O	CO2e
Year	lb/day										lb/day					
2023	3,153.6610	0.0000	0.0000	0.0000	0.0000	0.0000	0.0000	0.0000	0.0000	0.0000	0.0000	0.0000	0.0000	0.0000	0.0000	0.0000
Maximum	3,153.6610	0.0000	0.0000	0.0000	0.0000	0.0000	0.0000	0.0000	0.0000	0.0000	0.0000	0.0000	0.0000	0.0000	0.0000	0.0000

	ROG	NOx	CO	SO2	Fugitive PM10	Exhaust PM10	PM10 Total	Fugitive PM2.5	Exhaust PM2.5	PM2.5 Total	Bio- CO2	NBio- CO2	Total CO2	CH4	N2O	CO2e
Percent Reduction	0.00	0.00	0.00	0.00	0.00	0.00	0.00	0.00	0.00	0.00	0.00	0.00	0.00	0.00	0.00	0.00

Operations - Localized Assessment - Kings County, Summer

EMFAC Off-Model Adjustment Factors for Gasoline Light Duty Vehicle to Account for the SAFE Vehicle Rule Not Applied

2.2 Overall Operational

Unmitigated Operational

	ROG	NOx	CO	SO2	Fugitive PM10	Exhaust PM10	PM10 Total	Fugitive PM2.5	Exhaust PM2.5	PM2.5 Total	Bio- CO2	NBio- CO2	Total CO2	CH4	N2O	CO2e
Category	lb/day										lb/day					
Area	12.6501	2.8206	24.1780	0.0175		0.3345	0.3345		0.3345	0.3345	0.0000	3,302.7718	3,302.7718	0.1024	0.0598	3,323.1491
Energy	0.1989	1.6994	0.7231	0.0109		0.1374	0.1374		0.1374	0.1374		2,169.3841	2,169.3841	0.0416	0.0398	2,182.2756
Mobile	4.6700	2.6121	14.7941	0.0146	1.0477	0.0176	1.0653	0.2787	0.0163	0.2950		1,501.6245	1,501.6245	0.3112	0.2035	1,570.0516
Total	17.5189	7.1321	39.6953	0.0430	1.0477	0.4895	1.5372	0.2787	0.4882	0.7669	0.0000	6,973.7803	6,973.7803	0.4552	0.3031	7,075.4764

Mitigated Operational

	ROG	NOx	CO	SO2	Fugitive PM10	Exhaust PM10	PM10 Total	Fugitive PM2.5	Exhaust PM2.5	PM2.5 Total	Bio- CO2	NBio- CO2	Total CO2	CH4	N2O	CO2e
Category	lb/day										lb/day					
Area	12.6403	2.8190	24.0118	0.0175		0.3336	0.3336		0.3336	0.3336	0.0000	3,302.3972	3,302.3972	0.1019	0.0598	3,322.7602
Energy	0.1989	1.6994	0.7231	0.0109		0.1374	0.1374		0.1374	0.1374		2,169.3841	2,169.3841	0.0416	0.0398	2,182.2756
Mobile	4.6700	2.6121	14.7941	0.0146	1.0477	0.0176	1.0653	0.2787	0.0163	0.2950		1,501.6245	1,501.6245	0.3112	0.2035	1,570.0516
Total	17.5091	7.1304	39.5290	0.0430	1.0477	0.4885	1.5362	0.2787	0.4872	0.7659	0.0000	6,973.4057	6,973.4057	0.4547	0.3031	7,075.0875

Operations - Localized Assessment - Kings County, Summer

EMFAC Off-Model Adjustment Factors for Gasoline Light Duty Vehicle to Account for the SAFE Vehicle Rule Not Applied

	ROG	NOx	CO	SO2	Fugitive PM10	Exhaust PM10	PM10 Total	Fugitive PM2.5	Exhaust PM2.5	PM2.5 Total	Bio- CO2	NBio-CO2	Total CO2	CH4	N2O	CO2e
Percent Reduction	0.06	0.02	0.42	0.05	0.00	0.20	0.06	0.00	0.20	0.13	0.00	0.01	0.01	0.13	0.00	0.01

3.0 Construction Detail

Construction Phase

Phase Number	Phase Name	Phase Type	Start Date	End Date	Num Days Week	Num Days	Phase Description
1	Architectural Coating	Architectural Coating	3/2/2023	3/2/2023	5	1	

Acres of Grading (Site Preparation Phase): 0

Acres of Grading (Grading Phase): 0

Acres of Paving: 0

Residential Indoor: 1,020,600; Residential Outdoor: 340,200; Non-Residential Indoor: 2; Non-Residential Outdoor: 1; Striped Parking Area: 0 (Architectural Coating – sqft)

OffRoad Equipment

Phase Name	Offroad Equipment Type	Amount	Usage Hours	Horse Power	Load Factor
Architectural Coating	Air Compressors	0	0.00	78	0.48

Trips and VMT

Phase Name	Offroad Equipment Count	Worker Trip Number	Vendor Trip Number	Hauling Trip Number	Worker Trip Length	Vendor Trip Length	Hauling Trip Length	Worker Vehicle Class	Vendor Vehicle Class	Hauling Vehicle Class
Architectural Coating	0	0.00	0.00	0.00	10.80	7.30	20.00	LD_Mix	HDT_Mix	HHDT

3.1 Mitigation Measures Construction

Operations - Localized Assessment - Kings County, Summer

EMFAC Off-Model Adjustment Factors for Gasoline Light Duty Vehicle to Account for the SAFE Vehicle Rule Not Applied

3.2 Architectural Coating - 2023

Unmitigated Construction On-Site

	ROG	NOx	CO	SO2	Fugitive PM10	Exhaust PM10	PM10 Total	Fugitive PM2.5	Exhaust PM2.5	PM2.5 Total	Bio- CO2	NBio- CO2	Total CO2	CH4	N2O	CO2e
Category	lb/day										lb/day					
Archit. Coating	3,153.6610					0.0000	0.0000		0.0000	0.0000			0.0000			0.0000
Off-Road	0.0000	0.0000	0.0000	0.0000		0.0000	0.0000		0.0000	0.0000		0.0000	0.0000	0.0000		0.0000
Total	3,153.6610	0.0000	0.0000	0.0000		0.0000	0.0000		0.0000	0.0000		0.0000	0.0000	0.0000		0.0000

Unmitigated Construction Off-Site

	ROG	NOx	CO	SO2	Fugitive PM10	Exhaust PM10	PM10 Total	Fugitive PM2.5	Exhaust PM2.5	PM2.5 Total	Bio- CO2	NBio- CO2	Total CO2	CH4	N2O	CO2e
Category	lb/day										lb/day					
Hauling	0.0000	0.0000	0.0000	0.0000	0.0000	0.0000	0.0000	0.0000	0.0000	0.0000		0.0000	0.0000	0.0000	0.0000	0.0000
Vendor	0.0000	0.0000	0.0000	0.0000	0.0000	0.0000	0.0000	0.0000	0.0000	0.0000		0.0000	0.0000	0.0000	0.0000	0.0000
Worker	0.0000	0.0000	0.0000	0.0000	0.0000	0.0000	0.0000	0.0000	0.0000	0.0000		0.0000	0.0000	0.0000	0.0000	0.0000
Total	0.0000	0.0000	0.0000	0.0000	0.0000	0.0000	0.0000	0.0000	0.0000	0.0000		0.0000	0.0000	0.0000	0.0000	0.0000

Operations - Localized Assessment - Kings County, Summer

EMFAC Off-Model Adjustment Factors for Gasoline Light Duty Vehicle to Account for the SAFE Vehicle Rule Not Applied

3.2 Architectural Coating - 2023

Mitigated Construction On-Site

	ROG	NOx	CO	SO2	Fugitive PM10	Exhaust PM10	PM10 Total	Fugitive PM2.5	Exhaust PM2.5	PM2.5 Total	Bio- CO2	NBio- CO2	Total CO2	CH4	N2O	CO2e
Category	lb/day										lb/day					
Archit. Coating	3,153.6610					0.0000	0.0000		0.0000	0.0000			0.0000			0.0000
Off-Road	0.0000	0.0000	0.0000	0.0000		0.0000	0.0000		0.0000	0.0000	0.0000	0.0000	0.0000	0.0000		0.0000
Total	3,153.6610	0.0000	0.0000	0.0000		0.0000	0.0000		0.0000	0.0000	0.0000	0.0000	0.0000	0.0000		0.0000

Mitigated Construction Off-Site

	ROG	NOx	CO	SO2	Fugitive PM10	Exhaust PM10	PM10 Total	Fugitive PM2.5	Exhaust PM2.5	PM2.5 Total	Bio- CO2	NBio- CO2	Total CO2	CH4	N2O	CO2e
Category	lb/day										lb/day					
Hauling	0.0000	0.0000	0.0000	0.0000	0.0000	0.0000	0.0000	0.0000	0.0000	0.0000		0.0000	0.0000	0.0000	0.0000	0.0000
Vendor	0.0000	0.0000	0.0000	0.0000	0.0000	0.0000	0.0000	0.0000	0.0000	0.0000		0.0000	0.0000	0.0000	0.0000	0.0000
Worker	0.0000	0.0000	0.0000	0.0000	0.0000	0.0000	0.0000	0.0000	0.0000	0.0000		0.0000	0.0000	0.0000	0.0000	0.0000
Total	0.0000	0.0000	0.0000	0.0000	0.0000	0.0000	0.0000	0.0000	0.0000	0.0000		0.0000	0.0000	0.0000	0.0000	0.0000

Operations - Localized Assessment - Kings County, Summer

EMFAC Off-Model Adjustment Factors for Gasoline Light Duty Vehicle to Account for the SAFE Vehicle Rule Not Applied

4.0 Operational Detail - Mobile

4.1 Mitigation Measures Mobile

	ROG	NOx	CO	SO2	Fugitive PM10	Exhaust PM10	PM10 Total	Fugitive PM2.5	Exhaust PM2.5	PM2.5 Total	Bio- CO2	NBio- CO2	Total CO2	CH4	N2O	CO2e
Category	lb/day										lb/day					
Mitigated	4.6700	2.6121	14.7941	0.0146	1.0477	0.0176	1.0653	0.2787	0.0163	0.2950		1,501.6245	1,501.6245	0.3112	0.2035	1,570.0516
Unmitigated	4.6700	2.6121	14.7941	0.0146	1.0477	0.0176	1.0653	0.2787	0.0163	0.2950		1,501.6245	1,501.6245	0.3112	0.2035	1,570.0516

4.2 Trip Summary Information

Land Use	Average Daily Trip Rate			Unmitigated	Mitigated
	Weekday	Saturday	Sunday	Annual VMT	Annual VMT
City Park	2.50	6.27	7.01	7,856	7,856
Single Family Housing	2,640.40	2,654.40	2374.40	474,001	474,001
Total	2,642.90	2,660.67	2,381.41	481,857	481,857

4.3 Trip Type Information

Land Use	Miles			Trip %			Trip Purpose %		
	H-W or C-W	H-S or C-C	H-O or C-NW	H-W or C-W	H-S or C-C	H-O or C-NW	Primary	Diverted	Pass-by
City Park	9.50	7.30	7.30	33.00	48.00	19.00	66	28	6
Single Family Housing	0.50	0.50	0.50	42.30	19.60	38.10	100	0	0

4.4 Fleet Mix

Operations - Localized Assessment - Kings County, Summer

EMFAC Off-Model Adjustment Factors for Gasoline Light Duty Vehicle to Account for the SAFE Vehicle Rule Not Applied

Land Use	LDA	LDT1	LDT2	MDV	LHD1	LHD2	MHD	HHD	OBUS	UBUS	MCY	SBUS	MH
City Park	0.504365	0.051424	0.168544	0.163993	0.029850	0.006745	0.008269	0.036653	0.000620	0.000189	0.024675	0.001152	0.003520
Single Family Housing	0.527700	0.209000	0.167500	0.055600	0.000900	0.000900	0.008000	0.021400	0.000000	0.004300	0.002500	0.000200	0.002000

5.0 Energy Detail

Historical Energy Use: N

5.1 Mitigation Measures Energy

Percent of Electricity Use Generated with Renewable Energy

	ROG	NOx	CO	SO2	Fugitive PM10	Exhaust PM10	PM10 Total	Fugitive PM2.5	Exhaust PM2.5	PM2.5 Total	Bio- CO2	NBio- CO2	Total CO2	CH4	N2O	CO2e
Category	lb/day										lb/day					
NaturalGas Mitigated	0.1989	1.6994	0.7231	0.0109		0.1374	0.1374		0.1374	0.1374		2,169.384 1	2,169.384 1	0.0416	0.0398	2,182.275 6
NaturalGas Unmitigated	0.1989	1.6994	0.7231	0.0109		0.1374	0.1374		0.1374	0.1374		2,169.384 1	2,169.384 1	0.0416	0.0398	2,182.275 6

Operations - Localized Assessment - Kings County, Summer

EMFAC Off-Model Adjustment Factors for Gasoline Light Duty Vehicle to Account for the SAFE Vehicle Rule Not Applied

5.2 Energy by Land Use - NaturalGas

Unmitigated

	NaturalGas Use	ROG	NOx	CO	SO2	Fugitive PM10	Exhaust PM10	PM10 Total	Fugitive PM2.5	Exhaust PM2.5	PM2.5 Total	Bio- CO2	NBio- CO2	Total CO2	CH4	N2O	CO2e
Land Use	kBTU/yr	lb/day										lb/day					
City Park	0	0.0000	0.0000	0.0000	0.0000		0.0000	0.0000		0.0000	0.0000		0.0000	0.0000	0.0000	0.0000	0.0000
Single Family Housing	18439.8	0.1989	1.6994	0.7231	0.0109		0.1374	0.1374		0.1374	0.1374		2,169.3841	2,169.3841	0.0416	0.0398	2,182.2756
Total		0.1989	1.6994	0.7231	0.0109		0.1374	0.1374		0.1374	0.1374		2,169.3841	2,169.3841	0.0416	0.0398	2,182.2756

Mitigated

	NaturalGas Use	ROG	NOx	CO	SO2	Fugitive PM10	Exhaust PM10	PM10 Total	Fugitive PM2.5	Exhaust PM2.5	PM2.5 Total	Bio- CO2	NBio- CO2	Total CO2	CH4	N2O	CO2e
Land Use	kBTU/yr	lb/day										lb/day					
City Park	0	0.0000	0.0000	0.0000	0.0000		0.0000	0.0000		0.0000	0.0000		0.0000	0.0000	0.0000	0.0000	0.0000
Single Family Housing	18.4398	0.1989	1.6994	0.7231	0.0109		0.1374	0.1374		0.1374	0.1374		2,169.3841	2,169.3841	0.0416	0.0398	2,182.2756
Total		0.1989	1.6994	0.7231	0.0109		0.1374	0.1374		0.1374	0.1374		2,169.3841	2,169.3841	0.0416	0.0398	2,182.2756

6.0 Area Detail

Operations - Localized Assessment - Kings County, Summer

EMFAC Off-Model Adjustment Factors for Gasoline Light Duty Vehicle to Account for the SAFE Vehicle Rule Not Applied

6.1 Mitigation Measures Area

Use Electric Lawnmower

Use Electric Leafblower

Use Electric Chainsaw

Use Low VOC Paint - Residential Interior

Use Low VOC Paint - Residential Exterior

Use Low VOC Paint - Non-Residential Interior

Use Low VOC Paint - Non-Residential Exterior

Use only Natural Gas Hearths

	ROG	NOx	CO	SO2	Fugitive PM10	Exhaust PM10	PM10 Total	Fugitive PM2.5	Exhaust PM2.5	PM2.5 Total	Bio- CO2	NBio- CO2	Total CO2	CH4	N2O	CO2e
Category	lb/day										lb/day					
Mitigated	12.6403	2.8190	24.0118	0.0175		0.3336	0.3336		0.3336	0.3336	0.0000	3,302.3972	3,302.3972	0.1019	0.0598	3,322.7602
Unmitigated	12.6501	2.8206	24.1780	0.0175		0.3345	0.3345		0.3345	0.3345	0.0000	3,302.7718	3,302.7718	0.1024	0.0598	3,323.1491

Operations - Localized Assessment - Kings County, Summer

EMFAC Off-Model Adjustment Factors for Gasoline Light Duty Vehicle to Account for the SAFE Vehicle Rule Not Applied

6.2 Area by SubCategory

Unmitigated

	ROG	NOx	CO	SO2	Fugitive PM10	Exhaust PM10	PM10 Total	Fugitive PM2.5	Exhaust PM2.5	PM2.5 Total	Bio- CO2	NBio- CO2	Total CO2	CH4	N2O	CO2e
SubCategory	lb/day										lb/day					
Architectural Coating	0.8640					0.0000	0.0000		0.0000	0.0000			0.0000			0.0000
Consumer Products	10.7928					0.0000	0.0000		0.0000	0.0000			0.0000			0.0000
Hearth	0.2989	2.5546	1.0871	0.0163		0.2065	0.2065		0.2065	0.2065	0.0000	3,261.1765	3,261.1765	0.0625	0.0598	3,280.5560
Landscaping	0.6943	0.2661	23.0910	1.2200e-003		0.1280	0.1280		0.1280	0.1280		41.5953	41.5953	0.0399		42.5931
Total	12.6501	2.8206	24.1780	0.0175		0.3345	0.3345		0.3345	0.3345	0.0000	3,302.7718	3,302.7718	0.1024	0.0598	3,323.1491

Operations - Localized Assessment - Kings County, Summer

EMFAC Off-Model Adjustment Factors for Gasoline Light Duty Vehicle to Account for the SAFE Vehicle Rule Not Applied

6.2 Area by SubCategory

Mitigated

	ROG	NOx	CO	SO2	Fugitive PM10	Exhaust PM10	PM10 Total	Fugitive PM2.5	Exhaust PM2.5	PM2.5 Total	Bio- CO2	NBio- CO2	Total CO2	CH4	N2O	CO2e
SubCategory	lb/day										lb/day					
Architectural Coating	0.8640					0.0000	0.0000		0.0000	0.0000			0.0000			0.0000
Consumer Products	10.7928					0.0000	0.0000		0.0000	0.0000			0.0000			0.0000
Hearth	0.2989	2.5546	1.0871	0.0163		0.2065	0.2065		0.2065	0.2065	0.0000	3,261.1765	3,261.1765	0.0625	0.0598	3,280.5560
Landscaping	0.6845	0.2644	22.9247	1.2100e-003		0.1270	0.1270		0.1270	0.1270		41.2207	41.2207	0.0393		42.2042
Total	12.6403	2.8190	24.0118	0.0175		0.3335	0.3335		0.3335	0.3335	0.0000	3,302.3971	3,302.3971	0.1019	0.0598	3,322.7602

7.0 Water Detail

7.1 Mitigation Measures Water

Apply Water Conservation Strategy

Operations - Localized Assessment - Kings County, Summer

EMFAC Off-Model Adjustment Factors for Gasoline Light Duty Vehicle to Account for the SAFE Vehicle Rule Not Applied

8.0 Waste Detail

8.1 Mitigation Measures Waste

9.0 Operational Offroad

Equipment Type	Number	Hours/Day	Days/Year	Horse Power	Load Factor	Fuel Type
----------------	--------	-----------	-----------	-------------	-------------	-----------

10.0 Stationary Equipment

Fire Pumps and Emergency Generators

Equipment Type	Number	Hours/Day	Hours/Year	Horse Power	Load Factor	Fuel Type
----------------	--------	-----------	------------	-------------	-------------	-----------

Boilers

Equipment Type	Number	Heat Input/Day	Heat Input/Year	Boiler Rating	Fuel Type
----------------	--------	----------------	-----------------	---------------	-----------

User Defined Equipment

Equipment Type	Number
----------------	--------

11.0 Vegetation

Operations - Localized Assessment - Kings County, Winter

EMFAC Off-Model Adjustment Factors for Gasoline Light Duty Vehicle to Account for the SAFE Vehicle Rule Not Applied

Operations - Localized Assessment

Kings County, Winter

1.0 Project Characteristics

1.1 Land Usage

Land Uses	Size	Metric	Lot Acreage	Floor Surface Area	Population
City Park	3.20	Acre	3.20	139,392.00	0
Single Family Housing	280.00	Dwelling Unit	49.41	504,000.00	801

1.2 Other Project Characteristics

Urbanization	Urban	Wind Speed (m/s)	2.2	Precipitation Freq (Days)	37
Climate Zone	3			Operational Year	2024
Utility Company	Pacific Gas and Electric Company				
CO2 Intensity (lb/MWhr)	203.98	CH4 Intensity (lb/MWhr)	0.033	N2O Intensity (lb/MWhr)	0.004

1.3 User Entered Comments & Non-Default Data

Project Characteristics - Lemoore 54 - Full Buildout Operations in the Earliest Operational Year - Localized Assessment

Land Use - Project site is approximately 52.61 acres
280-lot single family subdivision and 3.2 acres of public parks at full buildout

Construction Phase - Operational run only - zeroed out construction only parameters

Off-road Equipment - Operational run only

Trips and VMT - Operational run only

Architectural Coating - Rule 4601 Architectural Coatings

Vehicle Trips - Trip lengths updated to 0.5 mile to account for on-site and localized emissions from mobile sources.
Trip rates for project trips consistent with the trip generation provided in the traffic report (JLB Traffic Engineering, 2023)

Woodstoves - SJVAPCD Rule 4901 Woodburning

Area Coating - Rule 4601 Architectural Coatings

Construction Off-road Equipment Mitigation -

Operations - Localized Assessment - Kings County, Winter

EMFAC Off-Model Adjustment Factors for Gasoline Light Duty Vehicle to Account for the SAFE Vehicle Rule Not Applied

Area Mitigation - Rule 4601 Architectural Coatings, no woodburning fireplaces (only natural gas hearth), and building code standards (outside outlets)

Energy Mitigation - Single-family homes to be built with rooftop solar to provide on-site renewable energy (80% of electricity use generated applied)

Water Mitigation - Compliance with Green Building Code Standards and California Model Water Efficient Landscape Ordinance

Fleet Mix - SJVAPCD-approved Residential Fleet Mix for the 2024 operational year

Water And Wastewater -

Solid Waste -

Table Name	Column Name	Default Value	New Value
tblArchitecturalCoating	EF_Nonresidential_Exterior	150.00	50.00
tblArchitecturalCoating	EF_Nonresidential_Interior	150.00	50.00
tblArchitecturalCoating	EF_Residential_Exterior	150.00	50.00
tblArchitecturalCoating	EF_Residential_Interior	150.00	50.00
tblAreaCoating	Area_EF_Nonresidential_Exterior	150	50
tblAreaCoating	Area_EF_Nonresidential_Interior	150	50
tblAreaCoating	Area_EF_Residential_Exterior	150	50
tblAreaCoating	Area_EF_Residential_Interior	150	50
tblConstructionPhase	NumDays	75.00	1.00
tblFireplaces	FireplaceWoodMass	3,078.40	0.00
tblFleetMix	HHD	0.04	0.02
tblFleetMix	LDA	0.50	0.53
tblFleetMix	LDT1	0.05	0.21
tblFleetMix	LDT2	0.17	0.17
tblFleetMix	LHD1	0.03	9.0000e-004
tblFleetMix	LHD2	6.7450e-003	9.0000e-004
tblFleetMix	MCY	0.02	2.5000e-003
tblFleetMix	MDV	0.16	0.06
tblFleetMix	MH	3.5200e-003	2.0000e-003
tblFleetMix	MHD	8.2690e-003	8.0000e-003
tblFleetMix	OBUS	6.2000e-004	0.00

Operations - Localized Assessment - Kings County, Winter

EMFAC Off-Model Adjustment Factors for Gasoline Light Duty Vehicle to Account for the SAFE Vehicle Rule Not Applied

tblFleetMix	SBUS	1.1520e-003	2.0000e-004
tblFleetMix	UBUS	1.8900e-004	4.3000e-003
tblLandUse	LotAcreage	90.91	49.41
tblOffRoadEquipment	OffRoadEquipmentUnitAmount	1.00	0.00
tblOffRoadEquipment	UsageHours	6.00	0.00
tblTripsAndVMT	WorkerTripNumber	32.00	0.00
tblVehicleTrips	DV_TP	11.00	0.00
tblVehicleTrips	HO_TL	7.50	0.50
tblVehicleTrips	HS_TL	7.30	0.50
tblVehicleTrips	HW_TL	10.80	0.50
tblVehicleTrips	PB_TP	3.00	0.00
tblVehicleTrips	PR_TP	86.00	100.00
tblVehicleTrips	ST_TR	9.54	9.48
tblVehicleTrips	SU_TR	8.55	8.48
tblVehicleTrips	WD_TR	9.44	9.43
tblWoodstoves	WoodstoveWoodMass	3,019.20	0.00

2.0 Emissions Summary

Operations - Localized Assessment - Kings County, Winter

EMFAC Off-Model Adjustment Factors for Gasoline Light Duty Vehicle to Account for the SAFE Vehicle Rule Not Applied

2.1 Overall Construction (Maximum Daily Emission)

Unmitigated Construction

	ROG	NOx	CO	SO2	Fugitive PM10	Exhaust PM10	PM10 Total	Fugitive PM2.5	Exhaust PM2.5	PM2.5 Total	Bio- CO2	NBio- CO2	Total CO2	CH4	N2O	CO2e
Year	lb/day										lb/day					
2023	3,153.6610	0.0000	0.0000	0.0000	0.0000	0.0000	0.0000	0.0000	0.0000	0.0000	0.0000	0.0000	0.0000	0.0000	0.0000	0.0000
Maximum	3,153.6610	0.0000	0.0000	0.0000	0.0000	0.0000	0.0000	0.0000	0.0000	0.0000	0.0000	0.0000	0.0000	0.0000	0.0000	0.0000

Mitigated Construction

	ROG	NOx	CO	SO2	Fugitive PM10	Exhaust PM10	PM10 Total	Fugitive PM2.5	Exhaust PM2.5	PM2.5 Total	Bio- CO2	NBio- CO2	Total CO2	CH4	N2O	CO2e
Year	lb/day										lb/day					
2023	3,153.6610	0.0000	0.0000	0.0000	0.0000	0.0000	0.0000	0.0000	0.0000	0.0000	0.0000	0.0000	0.0000	0.0000	0.0000	0.0000
Maximum	3,153.6610	0.0000	0.0000	0.0000	0.0000	0.0000	0.0000	0.0000	0.0000	0.0000	0.0000	0.0000	0.0000	0.0000	0.0000	0.0000

	ROG	NOx	CO	SO2	Fugitive PM10	Exhaust PM10	PM10 Total	Fugitive PM2.5	Exhaust PM2.5	PM2.5 Total	Bio- CO2	NBio- CO2	Total CO2	CH4	N2O	CO2e
Percent Reduction	0.00	0.00	0.00	0.00	0.00	0.00	0.00	0.00	0.00	0.00	0.00	0.00	0.00	0.00	0.00	0.00

Operations - Localized Assessment - Kings County, Winter

EMFAC Off-Model Adjustment Factors for Gasoline Light Duty Vehicle to Account for the SAFE Vehicle Rule Not Applied

2.2 Overall Operational

Unmitigated Operational

	ROG	NOx	CO	SO2	Fugitive PM10	Exhaust PM10	PM10 Total	Fugitive PM2.5	Exhaust PM2.5	PM2.5 Total	Bio- CO2	NBio- CO2	Total CO2	CH4	N2O	CO2e
Category	lb/day										lb/day					
Area	12.6501	2.8206	24.1780	0.0175		0.3345	0.3345		0.3345	0.3345	0.0000	3,302.7718	3,302.7718	0.1024	0.0598	3,323.1491
Energy	0.1989	1.6994	0.7231	0.0109		0.1374	0.1374		0.1374	0.1374		2,169.3841	2,169.3841	0.0416	0.0398	2,182.2756
Mobile	3.2172	2.9503	19.3150	0.0138	1.0477	0.0177	1.0654	0.2787	0.0164	0.2951		1,416.5132	1,416.5132	0.4116	0.2239	1,493.5383
Total	16.0662	7.4703	44.2162	0.0421	1.0477	0.4896	1.5373	0.2787	0.4883	0.7670	0.0000	6,888.6691	6,888.6691	0.5556	0.3235	6,998.9631

Mitigated Operational

	ROG	NOx	CO	SO2	Fugitive PM10	Exhaust PM10	PM10 Total	Fugitive PM2.5	Exhaust PM2.5	PM2.5 Total	Bio- CO2	NBio- CO2	Total CO2	CH4	N2O	CO2e
Category	lb/day										lb/day					
Area	12.6403	2.8190	24.0118	0.0175		0.3336	0.3336		0.3336	0.3336	0.0000	3,302.3972	3,302.3972	0.1019	0.0598	3,322.7602
Energy	0.1989	1.6994	0.7231	0.0109		0.1374	0.1374		0.1374	0.1374		2,169.3841	2,169.3841	0.0416	0.0398	2,182.2756
Mobile	3.2172	2.9503	19.3150	0.0138	1.0477	0.0177	1.0654	0.2787	0.0164	0.2951		1,416.5132	1,416.5132	0.4116	0.2239	1,493.5383
Total	16.0564	7.4687	44.0499	0.0421	1.0477	0.4886	1.5363	0.2787	0.4873	0.7660	0.0000	6,888.2944	6,888.2944	0.5550	0.3235	6,998.5742

Operations - Localized Assessment - Kings County, Winter

EMFAC Off-Model Adjustment Factors for Gasoline Light Duty Vehicle to Account for the SAFE Vehicle Rule Not Applied

	ROG	NOx	CO	SO2	Fugitive PM10	Exhaust PM10	PM10 Total	Fugitive PM2.5	Exhaust PM2.5	PM2.5 Total	Bio- CO2	NBio-CO2	Total CO2	CH4	N2O	CO2e
Percent Reduction	0.06	0.02	0.38	0.05	0.00	0.20	0.06	0.00	0.20	0.13	0.00	0.01	0.01	0.10	0.00	0.01

3.0 Construction Detail

Construction Phase

Phase Number	Phase Name	Phase Type	Start Date	End Date	Num Days Week	Num Days	Phase Description
1	Architectural Coating	Architectural Coating	3/2/2023	3/2/2023	5	1	

Acres of Grading (Site Preparation Phase): 0

Acres of Grading (Grading Phase): 0

Acres of Paving: 0

Residential Indoor: 1,020,600; Residential Outdoor: 340,200; Non-Residential Indoor: 2; Non-Residential Outdoor: 1; Striped Parking Area: 0 (Architectural Coating – sqft)

OffRoad Equipment

Phase Name	Offroad Equipment Type	Amount	Usage Hours	Horse Power	Load Factor
Architectural Coating	Air Compressors	0	0.00	78	0.48

Trips and VMT

Phase Name	Offroad Equipment Count	Worker Trip Number	Vendor Trip Number	Hauling Trip Number	Worker Trip Length	Vendor Trip Length	Hauling Trip Length	Worker Vehicle Class	Vendor Vehicle Class	Hauling Vehicle Class
Architectural Coating	0	0.00	0.00	0.00	10.80	7.30	20.00	LD_Mix	HDT_Mix	HHDT

3.1 Mitigation Measures Construction

Operations - Localized Assessment - Kings County, Winter

EMFAC Off-Model Adjustment Factors for Gasoline Light Duty Vehicle to Account for the SAFE Vehicle Rule Not Applied

3.2 Architectural Coating - 2023

Unmitigated Construction On-Site

	ROG	NOx	CO	SO2	Fugitive PM10	Exhaust PM10	PM10 Total	Fugitive PM2.5	Exhaust PM2.5	PM2.5 Total	Bio- CO2	NBio- CO2	Total CO2	CH4	N2O	CO2e
Category	lb/day										lb/day					
Archit. Coating	3,153.6610					0.0000	0.0000		0.0000	0.0000			0.0000			0.0000
Off-Road	0.0000	0.0000	0.0000	0.0000		0.0000	0.0000		0.0000	0.0000		0.0000	0.0000	0.0000		0.0000
Total	3,153.6610	0.0000	0.0000	0.0000		0.0000	0.0000		0.0000	0.0000		0.0000	0.0000	0.0000		0.0000

Unmitigated Construction Off-Site

	ROG	NOx	CO	SO2	Fugitive PM10	Exhaust PM10	PM10 Total	Fugitive PM2.5	Exhaust PM2.5	PM2.5 Total	Bio- CO2	NBio- CO2	Total CO2	CH4	N2O	CO2e
Category	lb/day										lb/day					
Hauling	0.0000	0.0000	0.0000	0.0000	0.0000	0.0000	0.0000	0.0000	0.0000	0.0000		0.0000	0.0000	0.0000	0.0000	0.0000
Vendor	0.0000	0.0000	0.0000	0.0000	0.0000	0.0000	0.0000	0.0000	0.0000	0.0000		0.0000	0.0000	0.0000	0.0000	0.0000
Worker	0.0000	0.0000	0.0000	0.0000	0.0000	0.0000	0.0000	0.0000	0.0000	0.0000		0.0000	0.0000	0.0000	0.0000	0.0000
Total	0.0000	0.0000	0.0000	0.0000	0.0000	0.0000	0.0000	0.0000	0.0000	0.0000		0.0000	0.0000	0.0000	0.0000	0.0000

Operations - Localized Assessment - Kings County, Winter

EMFAC Off-Model Adjustment Factors for Gasoline Light Duty Vehicle to Account for the SAFE Vehicle Rule Not Applied

3.2 Architectural Coating - 2023

Mitigated Construction On-Site

	ROG	NOx	CO	SO2	Fugitive PM10	Exhaust PM10	PM10 Total	Fugitive PM2.5	Exhaust PM2.5	PM2.5 Total	Bio- CO2	NBio- CO2	Total CO2	CH4	N2O	CO2e
Category	lb/day										lb/day					
Archit. Coating	3,153.6610					0.0000	0.0000		0.0000	0.0000			0.0000			0.0000
Off-Road	0.0000	0.0000	0.0000	0.0000		0.0000	0.0000		0.0000	0.0000	0.0000	0.0000	0.0000	0.0000		0.0000
Total	3,153.6610	0.0000	0.0000	0.0000		0.0000	0.0000		0.0000	0.0000	0.0000	0.0000	0.0000	0.0000		0.0000

Mitigated Construction Off-Site

	ROG	NOx	CO	SO2	Fugitive PM10	Exhaust PM10	PM10 Total	Fugitive PM2.5	Exhaust PM2.5	PM2.5 Total	Bio- CO2	NBio- CO2	Total CO2	CH4	N2O	CO2e
Category	lb/day										lb/day					
Hauling	0.0000	0.0000	0.0000	0.0000	0.0000	0.0000	0.0000	0.0000	0.0000	0.0000		0.0000	0.0000	0.0000	0.0000	0.0000
Vendor	0.0000	0.0000	0.0000	0.0000	0.0000	0.0000	0.0000	0.0000	0.0000	0.0000		0.0000	0.0000	0.0000	0.0000	0.0000
Worker	0.0000	0.0000	0.0000	0.0000	0.0000	0.0000	0.0000	0.0000	0.0000	0.0000		0.0000	0.0000	0.0000	0.0000	0.0000
Total	0.0000	0.0000	0.0000	0.0000	0.0000	0.0000	0.0000	0.0000	0.0000	0.0000		0.0000	0.0000	0.0000	0.0000	0.0000

Operations - Localized Assessment - Kings County, Winter

EMFAC Off-Model Adjustment Factors for Gasoline Light Duty Vehicle to Account for the SAFE Vehicle Rule Not Applied

4.0 Operational Detail - Mobile

4.1 Mitigation Measures Mobile

	ROG	NOx	CO	SO2	Fugitive PM10	Exhaust PM10	PM10 Total	Fugitive PM2.5	Exhaust PM2.5	PM2.5 Total	Bio- CO2	NBio- CO2	Total CO2	CH4	N2O	CO2e
Category	lb/day										lb/day					
Mitigated	3.2172	2.9503	19.3150	0.0138	1.0477	0.0177	1.0654	0.2787	0.0164	0.2951		1,416,513 2	1,416,513 2	0.4116	0.2239	1,493,538 3
Unmitigated	3.2172	2.9503	19.3150	0.0138	1.0477	0.0177	1.0654	0.2787	0.0164	0.2951		1,416,513 2	1,416,513 2	0.4116	0.2239	1,493,538 3

4.2 Trip Summary Information

Land Use	Average Daily Trip Rate			Unmitigated	Mitigated
	Weekday	Saturday	Sunday	Annual VMT	Annual VMT
City Park	2.50	6.27	7.01	7,856	7,856
Single Family Housing	2,640.40	2,654.40	2374.40	474,001	474,001
Total	2,642.90	2,660.67	2,381.41	481,857	481,857

4.3 Trip Type Information

Land Use	Miles			Trip %			Trip Purpose %		
	H-W or C-W	H-S or C-C	H-O or C-NW	H-W or C-W	H-S or C-C	H-O or C-NW	Primary	Diverted	Pass-by
City Park	9.50	7.30	7.30	33.00	48.00	19.00	66	28	6
Single Family Housing	0.50	0.50	0.50	42.30	19.60	38.10	100	0	0

4.4 Fleet Mix

Operations - Localized Assessment - Kings County, Winter

EMFAC Off-Model Adjustment Factors for Gasoline Light Duty Vehicle to Account for the SAFE Vehicle Rule Not Applied

Land Use	LDA	LDT1	LDT2	MDV	LHD1	LHD2	MHD	HHD	OBUS	UBUS	MCY	SBUS	MH
City Park	0.504365	0.051424	0.168544	0.163993	0.029850	0.006745	0.008269	0.036653	0.000620	0.000189	0.024675	0.001152	0.003520
Single Family Housing	0.527700	0.209000	0.167500	0.055600	0.000900	0.000900	0.008000	0.021400	0.000000	0.004300	0.002500	0.000200	0.002000

5.0 Energy Detail

Historical Energy Use: N

5.1 Mitigation Measures Energy

Percent of Electricity Use Generated with Renewable Energy

	ROG	NOx	CO	SO2	Fugitive PM10	Exhaust PM10	PM10 Total	Fugitive PM2.5	Exhaust PM2.5	PM2.5 Total	Bio- CO2	NBio- CO2	Total CO2	CH4	N2O	CO2e
Category	lb/day										lb/day					
NaturalGas Mitigated	0.1989	1.6994	0.7231	0.0109		0.1374	0.1374		0.1374	0.1374		2,169.384 1	2,169.384 1	0.0416	0.0398	2,182.275 6
NaturalGas Unmitigated	0.1989	1.6994	0.7231	0.0109		0.1374	0.1374		0.1374	0.1374		2,169.384 1	2,169.384 1	0.0416	0.0398	2,182.275 6

Operations - Localized Assessment - Kings County, Winter

EMFAC Off-Model Adjustment Factors for Gasoline Light Duty Vehicle to Account for the SAFE Vehicle Rule Not Applied

5.2 Energy by Land Use - NaturalGas

Unmitigated

	NaturalGas Use	ROG	NOx	CO	SO2	Fugitive PM10	Exhaust PM10	PM10 Total	Fugitive PM2.5	Exhaust PM2.5	PM2.5 Total	Bio- CO2	NBio- CO2	Total CO2	CH4	N2O	CO2e
Land Use	kBTU/yr	lb/day										lb/day					
City Park	0	0.0000	0.0000	0.0000	0.0000		0.0000	0.0000		0.0000	0.0000		0.0000	0.0000	0.0000	0.0000	0.0000
Single Family Housing	18439.8	0.1989	1.6994	0.7231	0.0109		0.1374	0.1374		0.1374	0.1374		2,169.3841	2,169.3841	0.0416	0.0398	2,182.2756
Total		0.1989	1.6994	0.7231	0.0109		0.1374	0.1374		0.1374	0.1374		2,169.3841	2,169.3841	0.0416	0.0398	2,182.2756

Mitigated

	NaturalGas Use	ROG	NOx	CO	SO2	Fugitive PM10	Exhaust PM10	PM10 Total	Fugitive PM2.5	Exhaust PM2.5	PM2.5 Total	Bio- CO2	NBio- CO2	Total CO2	CH4	N2O	CO2e
Land Use	kBTU/yr	lb/day										lb/day					
City Park	0	0.0000	0.0000	0.0000	0.0000		0.0000	0.0000		0.0000	0.0000		0.0000	0.0000	0.0000	0.0000	0.0000
Single Family Housing	18.4398	0.1989	1.6994	0.7231	0.0109		0.1374	0.1374		0.1374	0.1374		2,169.3841	2,169.3841	0.0416	0.0398	2,182.2756
Total		0.1989	1.6994	0.7231	0.0109		0.1374	0.1374		0.1374	0.1374		2,169.3841	2,169.3841	0.0416	0.0398	2,182.2756

6.0 Area Detail

Operations - Localized Assessment - Kings County, Winter

EMFAC Off-Model Adjustment Factors for Gasoline Light Duty Vehicle to Account for the SAFE Vehicle Rule Not Applied

6.1 Mitigation Measures Area

Use Electric Lawnmower

Use Electric Leafblower

Use Electric Chainsaw

Use Low VOC Paint - Residential Interior

Use Low VOC Paint - Residential Exterior

Use Low VOC Paint - Non-Residential Interior

Use Low VOC Paint - Non-Residential Exterior

Use only Natural Gas Hearths

	ROG	NOx	CO	SO2	Fugitive PM10	Exhaust PM10	PM10 Total	Fugitive PM2.5	Exhaust PM2.5	PM2.5 Total	Bio- CO2	NBio- CO2	Total CO2	CH4	N2O	CO2e
Category	lb/day										lb/day					
Mitigated	12.6403	2.8190	24.0118	0.0175		0.3336	0.3336		0.3336	0.3336	0.0000	3,302.3972	3,302.3972	0.1019	0.0598	3,322.7602
Unmitigated	12.6501	2.8206	24.1780	0.0175		0.3345	0.3345		0.3345	0.3345	0.0000	3,302.7718	3,302.7718	0.1024	0.0598	3,323.1491

Operations - Localized Assessment - Kings County, Winter

EMFAC Off-Model Adjustment Factors for Gasoline Light Duty Vehicle to Account for the SAFE Vehicle Rule Not Applied

6.2 Area by SubCategory

Unmitigated

	ROG	NOx	CO	SO2	Fugitive PM10	Exhaust PM10	PM10 Total	Fugitive PM2.5	Exhaust PM2.5	PM2.5 Total	Bio- CO2	NBio- CO2	Total CO2	CH4	N2O	CO2e
SubCategory	lb/day										lb/day					
Architectural Coating	0.8640					0.0000	0.0000		0.0000	0.0000			0.0000			0.0000
Consumer Products	10.7928					0.0000	0.0000		0.0000	0.0000			0.0000			0.0000
Hearth	0.2989	2.5546	1.0871	0.0163		0.2065	0.2065		0.2065	0.2065	0.0000	3,261.1765	3,261.1765	0.0625	0.0598	3,280.5560
Landscaping	0.6943	0.2661	23.0910	1.2200e-003		0.1280	0.1280		0.1280	0.1280		41.5953	41.5953	0.0399		42.5931
Total	12.6501	2.8206	24.1780	0.0175		0.3345	0.3345		0.3345	0.3345	0.0000	3,302.7718	3,302.7718	0.1024	0.0598	3,323.1491

Operations - Localized Assessment - Kings County, Winter

EMFAC Off-Model Adjustment Factors for Gasoline Light Duty Vehicle to Account for the SAFE Vehicle Rule Not Applied

6.2 Area by SubCategory

Mitigated

	ROG	NOx	CO	SO2	Fugitive PM10	Exhaust PM10	PM10 Total	Fugitive PM2.5	Exhaust PM2.5	PM2.5 Total	Bio- CO2	NBio- CO2	Total CO2	CH4	N2O	CO2e
SubCategory	lb/day										lb/day					
Architectural Coating	0.8640					0.0000	0.0000		0.0000	0.0000			0.0000			0.0000
Consumer Products	10.7928					0.0000	0.0000		0.0000	0.0000			0.0000			0.0000
Hearth	0.2989	2.5546	1.0871	0.0163		0.2065	0.2065		0.2065	0.2065	0.0000	3,261.1765	3,261.1765	0.0625	0.0598	3,280.5560
Landscaping	0.6845	0.2644	22.9247	1.2100e-003		0.1270	0.1270		0.1270	0.1270		41.2207	41.2207	0.0393		42.2042
Total	12.6403	2.8190	24.0118	0.0175		0.3335	0.3335		0.3335	0.3335	0.0000	3,302.3971	3,302.3971	0.1019	0.0598	3,322.7602

7.0 Water Detail

7.1 Mitigation Measures Water

Apply Water Conservation Strategy

Operations - Localized Assessment - Kings County, Winter

EMFAC Off-Model Adjustment Factors for Gasoline Light Duty Vehicle to Account for the SAFE Vehicle Rule Not Applied

8.0 Waste Detail

8.1 Mitigation Measures Waste

9.0 Operational Offroad

Equipment Type	Number	Hours/Day	Days/Year	Horse Power	Load Factor	Fuel Type
----------------	--------	-----------	-----------	-------------	-------------	-----------

10.0 Stationary Equipment

Fire Pumps and Emergency Generators

Equipment Type	Number	Hours/Day	Hours/Year	Horse Power	Load Factor	Fuel Type
----------------	--------	-----------	------------	-------------	-------------	-----------

Boilers

Equipment Type	Number	Heat Input/Day	Heat Input/Year	Boiler Rating	Fuel Type
----------------	--------	----------------	-----------------	---------------	-----------

User Defined Equipment

Equipment Type	Number
----------------	--------

11.0 Vegetation

Lemoore 54 - Buildout (2024) Operations BAU Scenario - Kings County, Annual

EMFAC Off-Model Adjustment Factors for Gasoline Light Duty Vehicle to Account for the SAFE Vehicle Rule Not Applied

Lemoore 54 - Buildout (2024) Operations BAU Scenario

Kings County, Annual

1.0 Project Characteristics

1.1 Land Usage

Land Uses	Size	Metric	Lot Acreage	Floor Surface Area	Population
City Park	3.20	Acre	3.20	139,392.00	0
Single Family Housing	280.00	Dwelling Unit	49.41	504,000.00	801

1.2 Other Project Characteristics

Urbanization	Urban	Wind Speed (m/s)	2.2	Precipitation Freq (Days)	37
Climate Zone	3			Operational Year	2005
Utility Company	Pacific Gas and Electric Company				
CO2 Intensity (lb/MWhr)	641.35	CH4 Intensity (lb/MWhr)	0.033	N2O Intensity (lb/MWhr)	0.004

1.3 User Entered Comments & Non-Default Data

Project Characteristics - Lemoore 54 - Buildout Operations BAU Scenario (Buildout in the Earliest Operational Year - 2024)

Land Use - Project site is approximately 52.61 acres
280-lot single family subdivision and 3.2 acres of public parks at full buildout

Construction Phase - Operational run only - zeroed out construction only parameters

Off-road Equipment - Operational run only

Trips and VMT - Operational run only

Architectural Coating - Rule 4601 Architectural Coatings

Vehicle Trips - Trip rates for project trips consistent with the trip generation provided in the traffic report (JLB Traffic Engineering, 2023)
ITE Trip Generation Manual, 11th Ed (ITE Land Uses 210 and 411)

Vehicle Emission Factors -

Vehicle Emission Factors -

Vehicle Emission Factors -

Lemoore 54 - Buildout (2024) Operations BAU Scenario - Kings County, Annual

EMFAC Off-Model Adjustment Factors for Gasoline Light Duty Vehicle to Account for the SAFE Vehicle Rule Not Applied

Woodstoves - SJVAPCD Rule 4901 Woodburning

Area Coating -

Energy Use -

Construction Off-road Equipment Mitigation -

Area Mitigation -

Energy Mitigation -

Water Mitigation -

Fleet Mix - 2024 fleet mixes

SJVAPCD-approved Residential Fleet Mix for the 2024 operational year for the single-family residential land use

Water And Wastewater -

Solid Waste -

Table Name	Column Name	Default Value	New Value
tblArchitecturalCoating	EF_Nonresidential_Exterior	150.00	50.00
tblArchitecturalCoating	EF_Nonresidential_Interior	150.00	50.00
tblArchitecturalCoating	EF_Residential_Exterior	150.00	50.00
tblArchitecturalCoating	EF_Residential_Interior	150.00	50.00
tblConstructionPhase	NumDays	75.00	1.00
tblFireplaces	FireplaceWoodMass	3,078.40	0.00
tblFleetMix	HHD	0.03	0.04
tblFleetMix	HHD	0.03	0.02
tblFleetMix	LDA	0.47	0.53
tblFleetMix	LDA	0.47	0.51
tblFleetMix	LDT1	0.08	0.05
tblFleetMix	LDT1	0.08	0.22
tblFleetMix	LDT2	0.16	0.17
tblFleetMix	LDT2	0.16	0.17
tblFleetMix	LHD1	0.04	0.02
tblFleetMix	LHD1	0.04	8.0000e-004
tblFleetMix	LHD2	5.5940e-003	6.1110e-003

Lemoore 54 - Buildout (2024) Operations BAU Scenario - Kings County, Annual

EMFAC Off-Model Adjustment Factors for Gasoline Light Duty Vehicle to Account for the SAFE Vehicle Rule Not Applied

tblFleetMix	LHD2	5.5940e-003	1.0000e-003
tblFleetMix	MCY	0.02	0.02
tblFleetMix	MCY	0.02	2.5000e-003
tblFleetMix	MDV	0.17	0.14
tblFleetMix	MDV	0.17	0.06
tblFleetMix	MH	8.9040e-003	2.8410e-003
tblFleetMix	MH	8.9040e-003	3.0000e-003
tblFleetMix	MHD	0.01	8.0280e-003
tblFleetMix	MHD	0.01	7.4000e-003
tblFleetMix	OBUS	6.9300e-004	5.6800e-004
tblFleetMix	OBUS	6.9300e-004	0.00
tblFleetMix	SBUS	1.0620e-003	9.9100e-004
tblFleetMix	SBUS	1.0620e-003	1.2000e-003
tblFleetMix	UBUS	5.3000e-005	1.8400e-004
tblFleetMix	UBUS	5.3000e-005	4.4000e-003
tblLandUse	LotAcreage	90.91	49.41
tblOffRoadEquipment	OffRoadEquipmentUnitAmount	1.00	0.00
tblOffRoadEquipment	UsageHours	6.00	0.00
tblProjectCharacteristics	CO2IntensityFactor	203.98	641.35
tblTripsAndVMT	WorkerTripNumber	32.00	0.00
tblVehicleTrips	ST_TR	9.54	9.48
tblVehicleTrips	SU_TR	8.55	8.48
tblVehicleTrips	WD_TR	9.44	9.43
tblWoodstoves	WoodstoveWoodMass	3,019.20	0.00

2.0 Emissions Summary

Lemoore 54 - Buildout (2024) Operations BAU Scenario - Kings County, Annual

EMFAC Off-Model Adjustment Factors for Gasoline Light Duty Vehicle to Account for the SAFE Vehicle Rule Not Applied

2.1 Overall Construction

Unmitigated Construction

	ROG	NOx	CO	SO2	Fugitive PM10	Exhaust PM10	PM10 Total	Fugitive PM2.5	Exhaust PM2.5	PM2.5 Total	Bio- CO2	NBio- CO2	Total CO2	CH4	N2O	CO2e
Year	tons/yr										MT/yr					
2023											0.0000	0.0000	0.0000	0.0000	0.0000	0.0000
Maximum											0.0000	0.0000	0.0000	0.0000	0.0000	0.0000

Mitigated Construction

	ROG	NOx	CO	SO2	Fugitive PM10	Exhaust PM10	PM10 Total	Fugitive PM2.5	Exhaust PM2.5	PM2.5 Total	Bio- CO2	NBio- CO2	Total CO2	CH4	N2O	CO2e
Year	tons/yr										MT/yr					
2023											0.0000	0.0000	0.0000	0.0000	0.0000	0.0000
Maximum											0.0000	0.0000	0.0000	0.0000	0.0000	0.0000

	ROG	NOx	CO	SO2	Fugitive PM10	Exhaust PM10	PM10 Total	Fugitive PM2.5	Exhaust PM2.5	PM2.5 Total	Bio- CO2	NBio- CO2	Total CO2	CH4	N2O	CO2e
Percent Reduction	0.00	0.00	0.00	0.00	0.00	0.00	0.00	0.00	0.00	0.00	0.00	0.00	0.00	0.00	0.00	0.00

Quarter	Start Date	End Date	Maximum Unmitigated ROG + NOX (tons/quarter)	Maximum Mitigated ROG + NOX (tons/quarter)

Lemoore 54 - Buildout (2024) Operations BAU Scenario - Kings County, Annual

EMFAC Off-Model Adjustment Factors for Gasoline Light Duty Vehicle to Account for the SAFE Vehicle Rule Not Applied

		Highest	
--	--	---------	--

2.2 Overall Operational

Unmitigated Operational

	ROG	NOx	CO	SO2	Fugitive PM10	Exhaust PM10	PM10 Total	Fugitive PM2.5	Exhaust PM2.5	PM2.5 Total	Bio- CO2	NBio- CO2	Total CO2	CH4	N2O	CO2e
Category	tons/yr										MT/yr					
Area											0.0000	124.6942	124.6942	7.7600e-003	2.2200e-003	125.5510
Energy											0.0000	1,157.5480	1,157.5480	0.0431	0.0134	1,162.6160
Mobile											0.0000	3,374.3263	3,374.3263	0.5317	0.4098	3,509.7427
Waste											58.5913	0.0000	58.5913	3.4627	0.0000	145.1575
Water											5.7877	44.3093	50.0970	0.5967	0.0143	69.2805
Total											64.3790	4,700.8778	4,765.2568	4.6419	0.4397	5,012.3477

Lemoore 54 - Buildout (2024) Operations BAU Scenario - Kings County, Annual

EMFAC Off-Model Adjustment Factors for Gasoline Light Duty Vehicle to Account for the SAFE Vehicle Rule Not Applied

2.2 Overall Operational

Mitigated Operational

	ROG	NOx	CO	SO2	Fugitive PM10	Exhaust PM10	PM10 Total	Fugitive PM2.5	Exhaust PM2.5	PM2.5 Total	Bio- CO2	NBio- CO2	Total CO2	CH4	N2O	CO2e
Category	tons/yr										MT/yr					
Area											0.0000	124.6942	124.6942	7.7600e-003	2.2200e-003	125.5510
Energy											0.0000	1,157.5480	1,157.5480	0.0431	0.0134	1,162.6160
Mobile											0.0000	3,374.3263	3,374.3263	0.5317	0.4098	3,509.7427
Waste											58.5913	0.0000	58.5913	3.4627	0.0000	145.1575
Water											5.7877	44.3093	50.0970	0.5967	0.0143	69.2805
Total											64.3790	4,700.8778	4,765.2568	4.6419	0.4397	5,012.3477

	ROG	NOx	CO	SO2	Fugitive PM10	Exhaust PM10	PM10 Total	Fugitive PM2.5	Exhaust PM2.5	PM2.5 Total	Bio- CO2	NBio- CO2	Total CO2	CH4	N2O	CO2e
Percent Reduction	0.00	0.00	0.00	0.00	0.00	0.00	0.00	0.00	0.00	0.00	0.00	0.00	0.00	0.00	0.00	0.00

3.0 Construction Detail

Construction Phase

Phase Number	Phase Name	Phase Type	Start Date	End Date	Num Days Week	Num Days	Phase Description
1	Architectural Coating	Architectural Coating	3/2/2023	3/2/2023	5	1	

Acres of Grading (Site Preparation Phase): 0

Lemoore 54 - Buildout (2024) Operations BAU Scenario - Kings County, Annual

EMFAC Off-Model Adjustment Factors for Gasoline Light Duty Vehicle to Account for the SAFE Vehicle Rule Not Applied

Acres of Grading (Grading Phase): 0

Acres of Paving: 0

Residential Indoor: 1,020,600; Residential Outdoor: 340,200; Non-Residential Indoor: 2; Non-Residential Outdoor: 1; Striped Parking Area: 0 (Architectural Coating – sqft)

OffRoad Equipment

Phase Name	Offroad Equipment Type	Amount	Usage Hours	Horse Power	Load Factor
Architectural Coating	Air Compressors	0	0.00	78	0.48

Trips and VMT

Phase Name	Offroad Equipment Count	Worker Trip Number	Vendor Trip Number	Hauling Trip Number	Worker Trip Length	Vendor Trip Length	Hauling Trip Length	Worker Vehicle Class	Vendor Vehicle Class	Hauling Vehicle Class
Architectural Coating	0	0.00	0.00	0.00	10.80	7.30	20.00	LD_Mix	HDT_Mix	HHDT

3.1 Mitigation Measures Construction

3.2 Architectural Coating - 2023

Unmitigated Construction On-Site

	ROG	NOx	CO	SO2	Fugitive PM10	Exhaust PM10	PM10 Total	Fugitive PM2.5	Exhaust PM2.5	PM2.5 Total	Bio- CO2	NBio- CO2	Total CO2	CH4	N2O	CO2e
Category	tons/yr										MT/yr					
Archit. Coating											0.0000	0.0000	0.0000	0.0000	0.0000	0.0000
Off-Road											0.0000	0.0000	0.0000	0.0000	0.0000	0.0000
Total											0.0000	0.0000	0.0000	0.0000	0.0000	0.0000

Lemoore 54 - Buildout (2024) Operations BAU Scenario - Kings County, Annual

EMFAC Off-Model Adjustment Factors for Gasoline Light Duty Vehicle to Account for the SAFE Vehicle Rule Not Applied

3.2 Architectural Coating - 2023

Unmitigated Construction Off-Site

	ROG	NOx	CO	SO2	Fugitive PM10	Exhaust PM10	PM10 Total	Fugitive PM2.5	Exhaust PM2.5	PM2.5 Total	Bio- CO2	NBio- CO2	Total CO2	CH4	N2O	CO2e
Category	tons/yr										MT/yr					
Hauling											0.0000	0.0000	0.0000	0.0000	0.0000	0.0000
Vendor											0.0000	0.0000	0.0000	0.0000	0.0000	0.0000
Worker											0.0000	0.0000	0.0000	0.0000	0.0000	0.0000
Total											0.0000	0.0000	0.0000	0.0000	0.0000	0.0000

Mitigated Construction On-Site

	ROG	NOx	CO	SO2	Fugitive PM10	Exhaust PM10	PM10 Total	Fugitive PM2.5	Exhaust PM2.5	PM2.5 Total	Bio- CO2	NBio- CO2	Total CO2	CH4	N2O	CO2e
Category	tons/yr										MT/yr					
Archit. Coating											0.0000	0.0000	0.0000	0.0000	0.0000	0.0000
Off-Road											0.0000	0.0000	0.0000	0.0000	0.0000	0.0000
Total											0.0000	0.0000	0.0000	0.0000	0.0000	0.0000

Lemoore 54 - Buildout (2024) Operations BAU Scenario - Kings County, Annual

EMFAC Off-Model Adjustment Factors for Gasoline Light Duty Vehicle to Account for the SAFE Vehicle Rule Not Applied

3.2 Architectural Coating - 2023

Mitigated Construction Off-Site

	ROG	NOx	CO	SO2	Fugitive PM10	Exhaust PM10	PM10 Total	Fugitive PM2.5	Exhaust PM2.5	PM2.5 Total	Bio- CO2	NBio- CO2	Total CO2	CH4	N2O	CO2e
Category	tons/yr										MT/yr					
Hauling											0.0000	0.0000	0.0000	0.0000	0.0000	0.0000
Vendor											0.0000	0.0000	0.0000	0.0000	0.0000	0.0000
Worker											0.0000	0.0000	0.0000	0.0000	0.0000	0.0000
Total											0.0000	0.0000	0.0000	0.0000	0.0000	0.0000

4.0 Operational Detail - Mobile

4.1 Mitigation Measures Mobile

Lemoore 54 - Buildout (2024) Operations BAU Scenario - Kings County, Annual

EMFAC Off-Model Adjustment Factors for Gasoline Light Duty Vehicle to Account for the SAFE Vehicle Rule Not Applied

	ROG	NOx	CO	SO2	Fugitive PM10	Exhaust PM10	PM10 Total	Fugitive PM2.5	Exhaust PM2.5	PM2.5 Total	Bio- CO2	NBio- CO2	Total CO2	CH4	N2O	CO2e
Category	tons/yr										MT/yr					
Mitigated											0.0000	3,374.3263	3,374.3263	0.5317	0.4098	3,509.7427
Unmitigated											0.0000	3,374.3263	3,374.3263	0.5317	0.4098	3,509.7427

4.2 Trip Summary Information

Land Use	Average Daily Trip Rate			Unmitigated	Mitigated
	Weekday	Saturday	Sunday	Annual VMT	Annual VMT
City Park	2.50	6.27	7.01	7,856	7,856
Single Family Housing	2,640.40	2,654.40	2374.40	7,454,441	7,454,441
Total	2,642.90	2,660.67	2,381.41	7,462,297	7,462,297

4.3 Trip Type Information

Land Use	Miles			Trip %			Trip Purpose %		
	H-W or C-W	H-S or C-C	H-O or C-NW	H-W or C-W	H-S or C-C	H-O or C-NW	Primary	Diverted	Pass-by
City Park	9.50	7.30	7.30	33.00	48.00	19.00	66	28	6
Single Family Housing	10.80	7.30	7.50	42.30	19.60	38.10	86	11	3

4.4 Fleet Mix

Land Use	LDA	LDT1	LDT2	MDV	LHD1	LHD2	MHD	HHD	OBUS	UBUS	MCY	SBUS	MH
City Park	0.526829	0.054483	0.174820	0.140491	0.024491	0.006111	0.008028	0.037066	0.000568	0.000184	0.023099	0.000991	0.002841
Single Family Housing	0.511000	0.223100	0.169000	0.059300	0.000800	0.001000	0.007400	0.017300	0.000000	0.004400	0.002500	0.001200	0.003000

5.0 Energy Detail

Lemoore 54 - Buildout (2024) Operations BAU Scenario - Kings County, Annual

EMFAC Off-Model Adjustment Factors for Gasoline Light Duty Vehicle to Account for the SAFE Vehicle Rule Not Applied

Historical Energy Use: Y

5.1 Mitigation Measures Energy

	ROG	NOx	CO	SO2	Fugitive PM10	Exhaust PM10	PM10 Total	Fugitive PM2.5	Exhaust PM2.5	PM2.5 Total	Bio- CO2	NBio- CO2	Total CO2	CH4	N2O	CO2e
Category	tons/yr										MT/yr					
Electricity Mitigated											0.0000	647.2333	647.2333	0.0333	4.0400e-003	649.2688
Electricity Unmitigated											0.0000	647.2333	647.2333	0.0333	4.0400e-003	649.2688
NaturalGas Mitigated											0.0000	510.3146	510.3146	9.7800e-003	9.3600e-003	513.3472
NaturalGas Unmitigated											0.0000	510.3146	510.3146	9.7800e-003	9.3600e-003	513.3472

Lemoore 54 - Buildout (2024) Operations BAU Scenario - Kings County, Annual

EMFAC Off-Model Adjustment Factors for Gasoline Light Duty Vehicle to Account for the SAFE Vehicle Rule Not Applied

5.2 Energy by Land Use - NaturalGas

Unmitigated

	NaturalGas Use	ROG	NOx	CO	SO2	Fugitive PM10	Exhaust PM10	PM10 Total	Fugitive PM2.5	Exhaust PM2.5	PM2.5 Total	Bio- CO2	NBio- CO2	Total CO2	CH4	N2O	CO2e
Land Use	kBTU/yr	tons/yr										MT/yr					
City Park	0											0.0000	0.0000	0.0000	0.0000	0.0000	0.0000
Single Family Housing	9.56294e+006											0.0000	510.3146	510.3146	9.7800e-003	9.3600e-003	513.3472
Total												0.0000	510.3146	510.3146	9.7800e-003	9.3600e-003	513.3472

Mitigated

	NaturalGas Use	ROG	NOx	CO	SO2	Fugitive PM10	Exhaust PM10	PM10 Total	Fugitive PM2.5	Exhaust PM2.5	PM2.5 Total	Bio- CO2	NBio- CO2	Total CO2	CH4	N2O	CO2e
Land Use	kBTU/yr	tons/yr										MT/yr					
City Park	0											0.0000	0.0000	0.0000	0.0000	0.0000	0.0000
Single Family Housing	9.56294e+006											0.0000	510.3146	510.3146	9.7800e-003	9.3600e-003	513.3472
Total												0.0000	510.3146	510.3146	9.7800e-003	9.3600e-003	513.3472

Lemoore 54 - Buildout (2024) Operations BAU Scenario - Kings County, Annual

EMFAC Off-Model Adjustment Factors for Gasoline Light Duty Vehicle to Account for the SAFE Vehicle Rule Not Applied

5.3 Energy by Land Use - Electricity

Unmitigated

	Electricity Use	Total CO2	CH4	N2O	CO2e
Land Use	kWh/yr	MT/yr			
City Park	0	0.0000	0.0000	0.0000	0.0000
Single Family Housing	2.22485e+006	647.2333	0.0333	4.0400e-003	649.2688
Total		647.2333	0.0333	4.0400e-003	649.2688

Mitigated

	Electricity Use	Total CO2	CH4	N2O	CO2e
Land Use	kWh/yr	MT/yr			
City Park	0	0.0000	0.0000	0.0000	0.0000
Single Family Housing	2.22485e+006	647.2333	0.0333	4.0400e-003	649.2688
Total		647.2333	0.0333	4.0400e-003	649.2688

6.0 Area Detail

Lemoore 54 - Buildout (2024) Operations BAU Scenario - Kings County, Annual

EMFAC Off-Model Adjustment Factors for Gasoline Light Duty Vehicle to Account for the SAFE Vehicle Rule Not Applied

6.1 Mitigation Measures Area

	ROG	NOx	CO	SO2	Fugitive PM10	Exhaust PM10	PM10 Total	Fugitive PM2.5	Exhaust PM2.5	PM2.5 Total	Bio- CO2	NBio- CO2	Total CO2	CH4	N2O	CO2e
Category	tons/yr										MT/yr					
Mitigated											0.0000	124.6942	124.6942	7.7600e-003	2.2200e-003	125.5510
Unmitigated											0.0000	124.6942	124.6942	7.7600e-003	2.2200e-003	125.5510

Lemoore 54 - Buildout (2024) Operations BAU Scenario - Kings County, Annual

EMFAC Off-Model Adjustment Factors for Gasoline Light Duty Vehicle to Account for the SAFE Vehicle Rule Not Applied

6.2 Area by SubCategory

Unmitigated

	ROG	NOx	CO	SO2	Fugitive PM10	Exhaust PM10	PM10 Total	Fugitive PM2.5	Exhaust PM2.5	PM2.5 Total	Bio- CO2	NBio- CO2	Total CO2	CH4	N2O	CO2e
SubCategory	tons/yr										MT/yr					
Architectural Coating											0.0000	0.0000	0.0000	0.0000	0.0000	0.0000
Consumer Products											0.0000	0.0000	0.0000	0.0000	0.0000	0.0000
Hearth											0.0000	121.2981	121.2981	2.3200e-003	2.2200e-003	122.0189
Landscaping											0.0000	3.3961	3.3961	5.4400e-003	0.0000	3.5321
Total											0.0000	124.6942	124.6942	7.7600e-003	2.2200e-003	125.5510

Lemoore 54 - Buildout (2024) Operations BAU Scenario - Kings County, Annual

EMFAC Off-Model Adjustment Factors for Gasoline Light Duty Vehicle to Account for the SAFE Vehicle Rule Not Applied

6.2 Area by SubCategory

Mitigated

	ROG	NOx	CO	SO2	Fugitive PM10	Exhaust PM10	PM10 Total	Fugitive PM2.5	Exhaust PM2.5	PM2.5 Total	Bio- CO2	NBio- CO2	Total CO2	CH4	N2O	CO2e
SubCategory	tons/yr										MT/yr					
Architectural Coating											0.0000	0.0000	0.0000	0.0000	0.0000	0.0000
Consumer Products											0.0000	0.0000	0.0000	0.0000	0.0000	0.0000
Hearth											0.0000	121.2981	121.2981	2.3200e-003	2.2200e-003	122.0189
Landscaping											0.0000	3.3961	3.3961	5.4400e-003	0.0000	3.5321
Total											0.0000	124.6942	124.6942	7.7600e-003	2.2200e-003	125.5510

7.0 Water Detail

7.1 Mitigation Measures Water

Lemoore 54 - Buildout (2024) Operations BAU Scenario - Kings County, Annual

EMFAC Off-Model Adjustment Factors for Gasoline Light Duty Vehicle to Account for the SAFE Vehicle Rule Not Applied

	Total CO2	CH4	N2O	CO2e
Category	MT/yr			
Mitigated	50.0970	0.5967	0.0143	69.2805
Unmitigated	50.0970	0.5967	0.0143	69.2805

7.2 Water by Land Use

Unmitigated

	Indoor/Outdoor Use	Total CO2	CH4	N2O	CO2e
Land Use	Mgal	MT/yr			
City Park	0 / 3.81274	3.8821	2.0000e-004	2.0000e-005	3.8943
Single Family Housing	18.2431 / 11.5011	46.2149	0.5965	0.0143	65.3862
Total		50.0970	0.5967	0.0143	69.2805

Lemoore 54 - Buildout (2024) Operations BAU Scenario - Kings County, Annual

EMFAC Off-Model Adjustment Factors for Gasoline Light Duty Vehicle to Account for the SAFE Vehicle Rule Not Applied

7.2 Water by Land Use

Mitigated

	Indoor/Outdoor Use	Total CO2	CH4	N2O	CO2e
Land Use	Mgal	MT/yr			
City Park	0 / 3.81274	3.8821	2.0000e-004	2.0000e-005	3.8943
Single Family Housing	18.2431 / 11.5011	46.2149	0.5965	0.0143	65.3862
Total		50.0970	0.5967	0.0143	69.2805

8.0 Waste Detail

8.1 Mitigation Measures Waste

Category/Year

	Total CO2	CH4	N2O	CO2e
	MT/yr			
Mitigated	58.5913	3.4627	0.0000	145.1575
Unmitigated	58.5913	3.4627	0.0000	145.1575

Lemoore 54 - Buildout (2024) Operations BAU Scenario - Kings County, Annual

EMFAC Off-Model Adjustment Factors for Gasoline Light Duty Vehicle to Account for the SAFE Vehicle Rule Not Applied

8.2 Waste by Land Use

Unmitigated

	Waste Disposed	Total CO2	CH4	N2O	CO2e
Land Use	tons	MT/yr			
City Park	0.28	0.0568	3.3600e-003	0.0000	0.1408
Single Family Housing	288.36	58.5345	3.4593	0.0000	145.0167
Total		58.5913	3.4627	0.0000	145.1575

Mitigated

	Waste Disposed	Total CO2	CH4	N2O	CO2e
Land Use	tons	MT/yr			
City Park	0.28	0.0568	3.3600e-003	0.0000	0.1408
Single Family Housing	288.36	58.5345	3.4593	0.0000	145.0167
Total		58.5913	3.4627	0.0000	145.1575

9.0 Operational Offroad

Lemoore 54 - Buildout (2024) Operations BAU Scenario - Kings County, Annual

EMFAC Off-Model Adjustment Factors for Gasoline Light Duty Vehicle to Account for the SAFE Vehicle Rule Not Applied

Equipment Type	Number	Hours/Day	Days/Year	Horse Power	Load Factor	Fuel Type
----------------	--------	-----------	-----------	-------------	-------------	-----------

10.0 Stationary Equipment

Fire Pumps and Emergency Generators

Equipment Type	Number	Hours/Day	Hours/Year	Horse Power	Load Factor	Fuel Type
----------------	--------	-----------	------------	-------------	-------------	-----------

Boilers

Equipment Type	Number	Heat Input/Day	Heat Input/Year	Boiler Rating	Fuel Type
----------------	--------	----------------	-----------------	---------------	-----------

User Defined Equipment

Equipment Type	Number
----------------	--------

11.0 Vegetation

Lemoore 54 - 2030 Operations BAU Scenario - Kings County, Annual

EMFAC Off-Model Adjustment Factors for Gasoline Light Duty Vehicle to Account for the SAFE Vehicle Rule Not Applied

**Lemoore 54 - 2030 Operations BAU Scenario
Kings County, Annual**

1.0 Project Characteristics

1.1 Land Usage

Land Uses	Size	Metric	Lot Acreage	Floor Surface Area	Population
City Park	3.20	Acre	3.20	139,392.00	0
Single Family Housing	280.00	Dwelling Unit	49.41	504,000.00	801

1.2 Other Project Characteristics

Urbanization	Urban	Wind Speed (m/s)	2.2	Precipitation Freq (Days)	37
Climate Zone	3			Operational Year	2005
Utility Company	Pacific Gas and Electric Company				
CO2 Intensity (lb/MWhr)	641.35	CH4 Intensity (lb/MWhr)	0.033	N2O Intensity (lb/MWhr)	0.004

1.3 User Entered Comments & Non-Default Data

Project Characteristics - Lemoore 54 - 2030 Operations BAU Scenario

Land Use - Project site is approximately 52.61 acres
280-lot single family subdivision and 3.2 acres of public parks at full buildout

Construction Phase - Operational run only - zeroed out construction only parameters

Off-road Equipment - Operational run only

Trips and VMT - Operational run only

Architectural Coating - Rule 4601 Architectural Coatings

Vehicle Trips - Trip rates for project trips consistent with the trip generation provided in the traffic report (JLB Traffic Engineering, 2023)
ITE Trip Generation Manual, 11th Ed (ITE Land Uses 210 and 411)

Vehicle Emission Factors -

Vehicle Emission Factors -

Vehicle Emission Factors -

Lemoore 54 - 2030 Operations BAU Scenario - Kings County, Annual

EMFAC Off-Model Adjustment Factors for Gasoline Light Duty Vehicle to Account for the SAFE Vehicle Rule Not Applied

Woodstoves - SJVAPCD Rule 4901 Woodburning

Area Coating -

Energy Use -

Water And Wastewater -

Solid Waste -

Construction Off-road Equipment Mitigation -

Area Mitigation -

Energy Mitigation -

Water Mitigation -

Fleet Mix - 2030 fleet mixes

SJVAPCD-approved Residential Fleet Mix for the 2030 operational year for the single-family residential land use

Table Name	Column Name	Default Value	New Value
tblArchitecturalCoating	EF_Nonresidential_Exterior	150.00	50.00
tblArchitecturalCoating	EF_Nonresidential_Interior	150.00	50.00
tblArchitecturalCoating	EF_Residential_Exterior	150.00	50.00
tblArchitecturalCoating	EF_Residential_Interior	150.00	50.00
tblConstructionPhase	NumDays	75.00	1.00
tblFireplaces	FireplaceWoodMass	3,078.40	0.00
tblFleetMix	HHD	0.03	0.04
tblFleetMix	HHD	0.03	0.02
tblFleetMix	LDA	0.47	0.53
tblFleetMix	LDA	0.47	0.51
tblFleetMix	LDT1	0.08	0.05
tblFleetMix	LDT1	0.08	0.22
tblFleetMix	LDT2	0.16	0.17
tblFleetMix	LDT2	0.16	0.17
tblFleetMix	LHD1	0.04	0.02
tblFleetMix	LHD1	0.04	8.0000e-004
tblFleetMix	LHD2	5.5940e-003	6.1110e-003

Lemoore 54 - 2030 Operations BAU Scenario - Kings County, Annual

EMFAC Off-Model Adjustment Factors for Gasoline Light Duty Vehicle to Account for the SAFE Vehicle Rule Not Applied

tblFleetMix	LHD2	5.5940e-003	1.0000e-003
tblFleetMix	MCY	0.02	0.02
tblFleetMix	MCY	0.02	2.5000e-003
tblFleetMix	MDV	0.17	0.14
tblFleetMix	MDV	0.17	0.06
tblFleetMix	MH	8.9040e-003	2.8410e-003
tblFleetMix	MH	8.9040e-003	3.0000e-003
tblFleetMix	MHD	0.01	8.0280e-003
tblFleetMix	MHD	0.01	7.4000e-003
tblFleetMix	OBUS	6.9300e-004	5.6800e-004
tblFleetMix	OBUS	6.9300e-004	0.00
tblFleetMix	SBUS	1.0620e-003	9.9100e-004
tblFleetMix	SBUS	1.0620e-003	1.2000e-003
tblFleetMix	UBUS	5.3000e-005	1.8400e-004
tblFleetMix	UBUS	5.3000e-005	4.4000e-003
tblLandUse	LotAcreage	90.91	49.41
tblOffRoadEquipment	OffRoadEquipmentUnitAmount	1.00	0.00
tblOffRoadEquipment	UsageHours	6.00	0.00
tblProjectCharacteristics	CO2IntensityFactor	203.98	641.35
tblTripsAndVMT	WorkerTripNumber	32.00	0.00
tblVehicleTrips	ST_TR	9.54	9.48
tblVehicleTrips	SU_TR	8.55	8.48
tblVehicleTrips	WD_TR	9.44	9.43
tblWoodstoves	WoodstoveWoodMass	3,019.20	0.00

2.0 Emissions Summary

Lemoore 54 - 2030 Operations BAU Scenario - Kings County, Annual

EMFAC Off-Model Adjustment Factors for Gasoline Light Duty Vehicle to Account for the SAFE Vehicle Rule Not Applied

2.1 Overall Construction

Unmitigated Construction

	ROG	NOx	CO	SO2	Fugitive PM10	Exhaust PM10	PM10 Total	Fugitive PM2.5	Exhaust PM2.5	PM2.5 Total	Bio- CO2	NBio- CO2	Total CO2	CH4	N2O	CO2e
Year	tons/yr										MT/yr					
2023											0.0000	0.0000	0.0000	0.0000	0.0000	0.0000
Maximum											0.0000	0.0000	0.0000	0.0000	0.0000	0.0000

Mitigated Construction

	ROG	NOx	CO	SO2	Fugitive PM10	Exhaust PM10	PM10 Total	Fugitive PM2.5	Exhaust PM2.5	PM2.5 Total	Bio- CO2	NBio- CO2	Total CO2	CH4	N2O	CO2e
Year	tons/yr										MT/yr					
2023											0.0000	0.0000	0.0000	0.0000	0.0000	0.0000
Maximum											0.0000	0.0000	0.0000	0.0000	0.0000	0.0000

	ROG	NOx	CO	SO2	Fugitive PM10	Exhaust PM10	PM10 Total	Fugitive PM2.5	Exhaust PM2.5	PM2.5 Total	Bio- CO2	NBio- CO2	Total CO2	CH4	N2O	CO2e
Percent Reduction	0.00	0.00	0.00	0.00	0.00	0.00	0.00	0.00	0.00	0.00	0.00	0.00	0.00	0.00	0.00	0.00

Quarter	Start Date	End Date	Maximum Unmitigated ROG + NOX (tons/quarter)	Maximum Mitigated ROG + NOX (tons/quarter)

Lemoore 54 - 2030 Operations BAU Scenario - Kings County, Annual

EMFAC Off-Model Adjustment Factors for Gasoline Light Duty Vehicle to Account for the SAFE Vehicle Rule Not Applied

		Highest	
--	--	---------	--

2.2 Overall Operational

Unmitigated Operational

	ROG	NOx	CO	SO2	Fugitive PM10	Exhaust PM10	PM10 Total	Fugitive PM2.5	Exhaust PM2.5	PM2.5 Total	Bio- CO2	NBio- CO2	Total CO2	CH4	N2O	CO2e
Category	tons/yr										MT/yr					
Area											0.0000	124.6942	124.6942	7.7600e-003	2.2200e-003	125.5510
Energy											0.0000	1,157.5480	1,157.5480	0.0431	0.0134	1,162.6160
Mobile											0.0000	3,374.3263	3,374.3263	0.5317	0.4098	3,509.7427
Waste											58.5913	0.0000	58.5913	3.4627	0.0000	145.1575
Water											5.7877	44.3093	50.0970	0.5967	0.0143	69.2805
Total											64.3790	4,700.8778	4,765.2568	4.6419	0.4397	5,012.3477

Lemoore 54 - 2030 Operations BAU Scenario - Kings County, Annual

EMFAC Off-Model Adjustment Factors for Gasoline Light Duty Vehicle to Account for the SAFE Vehicle Rule Not Applied

2.2 Overall Operational

Mitigated Operational

	ROG	NOx	CO	SO2	Fugitive PM10	Exhaust PM10	PM10 Total	Fugitive PM2.5	Exhaust PM2.5	PM2.5 Total	Bio- CO2	NBio- CO2	Total CO2	CH4	N2O	CO2e
Category	tons/yr										MT/yr					
Area											0.0000	124.6942	124.6942	7.7600e-003	2.2200e-003	125.5510
Energy											0.0000	1,157.5480	1,157.5480	0.0431	0.0134	1,162.6160
Mobile											0.0000	3,374.3263	3,374.3263	0.5317	0.4098	3,509.7427
Waste											58.5913	0.0000	58.5913	3.4627	0.0000	145.1575
Water											5.7877	44.3093	50.0970	0.5967	0.0143	69.2805
Total											64.3790	4,700.8778	4,765.2568	4.6419	0.4397	5,012.3477

	ROG	NOx	CO	SO2	Fugitive PM10	Exhaust PM10	PM10 Total	Fugitive PM2.5	Exhaust PM2.5	PM2.5 Total	Bio- CO2	NBio- CO2	Total CO2	CH4	N2O	CO2e
Percent Reduction	0.00	0.00	0.00	0.00	0.00	0.00	0.00	0.00	0.00	0.00	0.00	0.00	0.00	0.00	0.00	0.00

3.0 Construction Detail

Construction Phase

Phase Number	Phase Name	Phase Type	Start Date	End Date	Num Days Week	Num Days	Phase Description
1	Architectural Coating	Architectural Coating	3/2/2023	3/2/2023	5	1	

Acres of Grading (Site Preparation Phase): 0

Lemoore 54 - 2030 Operations BAU Scenario - Kings County, Annual

EMFAC Off-Model Adjustment Factors for Gasoline Light Duty Vehicle to Account for the SAFE Vehicle Rule Not Applied

Acres of Grading (Grading Phase): 0

Acres of Paving: 0

Residential Indoor: 1,020,600; Residential Outdoor: 340,200; Non-Residential Indoor: 2; Non-Residential Outdoor: 1; Striped Parking Area: 0 (Architectural Coating – sqft)

OffRoad Equipment

Phase Name	Offroad Equipment Type	Amount	Usage Hours	Horse Power	Load Factor
Architectural Coating	Air Compressors	0	0.00	78	0.48

Trips and VMT

Phase Name	Offroad Equipment Count	Worker Trip Number	Vendor Trip Number	Hauling Trip Number	Worker Trip Length	Vendor Trip Length	Hauling Trip Length	Worker Vehicle Class	Vendor Vehicle Class	Hauling Vehicle Class
Architectural Coating	0	0.00	0.00	0.00	10.80	7.30	20.00	LD_Mix	HDT_Mix	HHDT

3.1 Mitigation Measures Construction

3.2 Architectural Coating - 2023

Unmitigated Construction On-Site

	ROG	NOx	CO	SO2	Fugitive PM10	Exhaust PM10	PM10 Total	Fugitive PM2.5	Exhaust PM2.5	PM2.5 Total	Bio- CO2	NBio- CO2	Total CO2	CH4	N2O	CO2e
Category	tons/yr										MT/yr					
Archit. Coating											0.0000	0.0000	0.0000	0.0000	0.0000	0.0000
Off-Road											0.0000	0.0000	0.0000	0.0000	0.0000	0.0000
Total											0.0000	0.0000	0.0000	0.0000	0.0000	0.0000

Lemoore 54 - 2030 Operations BAU Scenario - Kings County, Annual

EMFAC Off-Model Adjustment Factors for Gasoline Light Duty Vehicle to Account for the SAFE Vehicle Rule Not Applied

3.2 Architectural Coating - 2023

Unmitigated Construction Off-Site

	ROG	NOx	CO	SO2	Fugitive PM10	Exhaust PM10	PM10 Total	Fugitive PM2.5	Exhaust PM2.5	PM2.5 Total	Bio- CO2	NBio- CO2	Total CO2	CH4	N2O	CO2e
Category	tons/yr										MT/yr					
Hauling											0.0000	0.0000	0.0000	0.0000	0.0000	0.0000
Vendor											0.0000	0.0000	0.0000	0.0000	0.0000	0.0000
Worker											0.0000	0.0000	0.0000	0.0000	0.0000	0.0000
Total											0.0000	0.0000	0.0000	0.0000	0.0000	0.0000

Mitigated Construction On-Site

	ROG	NOx	CO	SO2	Fugitive PM10	Exhaust PM10	PM10 Total	Fugitive PM2.5	Exhaust PM2.5	PM2.5 Total	Bio- CO2	NBio- CO2	Total CO2	CH4	N2O	CO2e
Category	tons/yr										MT/yr					
Archit. Coating											0.0000	0.0000	0.0000	0.0000	0.0000	0.0000
Off-Road											0.0000	0.0000	0.0000	0.0000	0.0000	0.0000
Total											0.0000	0.0000	0.0000	0.0000	0.0000	0.0000

Lemoore 54 - 2030 Operations BAU Scenario - Kings County, Annual

EMFAC Off-Model Adjustment Factors for Gasoline Light Duty Vehicle to Account for the SAFE Vehicle Rule Not Applied

3.2 Architectural Coating - 2023

Mitigated Construction Off-Site

	ROG	NOx	CO	SO2	Fugitive PM10	Exhaust PM10	PM10 Total	Fugitive PM2.5	Exhaust PM2.5	PM2.5 Total	Bio- CO2	NBio- CO2	Total CO2	CH4	N2O	CO2e
Category	tons/yr										MT/yr					
Hauling											0.0000	0.0000	0.0000	0.0000	0.0000	0.0000
Vendor											0.0000	0.0000	0.0000	0.0000	0.0000	0.0000
Worker											0.0000	0.0000	0.0000	0.0000	0.0000	0.0000
Total											0.0000	0.0000	0.0000	0.0000	0.0000	0.0000

4.0 Operational Detail - Mobile

4.1 Mitigation Measures Mobile

Lemoore 54 - 2030 Operations BAU Scenario - Kings County, Annual

EMFAC Off-Model Adjustment Factors for Gasoline Light Duty Vehicle to Account for the SAFE Vehicle Rule Not Applied

	ROG	NOx	CO	SO2	Fugitive PM10	Exhaust PM10	PM10 Total	Fugitive PM2.5	Exhaust PM2.5	PM2.5 Total	Bio- CO2	NBio- CO2	Total CO2	CH4	N2O	CO2e
Category	tons/yr										MT/yr					
Mitigated											0.0000	3,374.3263	3,374.3263	0.5317	0.4098	3,509.7427
Unmitigated											0.0000	3,374.3263	3,374.3263	0.5317	0.4098	3,509.7427

4.2 Trip Summary Information

Land Use	Average Daily Trip Rate			Unmitigated	Mitigated
	Weekday	Saturday	Sunday	Annual VMT	Annual VMT
City Park	2.50	6.27	7.01	7,856	7,856
Single Family Housing	2,640.40	2,654.40	2374.40	7,454,441	7,454,441
Total	2,642.90	2,660.67	2,381.41	7,462,297	7,462,297

4.3 Trip Type Information

Land Use	Miles			Trip %			Trip Purpose %		
	H-W or C-W	H-S or C-C	H-O or C-NW	H-W or C-W	H-S or C-C	H-O or C-NW	Primary	Diverted	Pass-by
City Park	9.50	7.30	7.30	33.00	48.00	19.00	66	28	6
Single Family Housing	10.80	7.30	7.50	42.30	19.60	38.10	86	11	3

4.4 Fleet Mix

Land Use	LDA	LDT1	LDT2	MDV	LHD1	LHD2	MHD	HHD	OBUS	UBUS	MCY	SBUS	MH
City Park	0.526829	0.054483	0.174820	0.140491	0.024491	0.006111	0.008028	0.037066	0.000568	0.000184	0.023099	0.000991	0.002841
Single Family Housing	0.511000	0.223100	0.169000	0.059300	0.000800	0.001000	0.007400	0.017300	0.000000	0.004400	0.002500	0.001200	0.003000

5.0 Energy Detail

Lemoore 54 - 2030 Operations BAU Scenario - Kings County, Annual

EMFAC Off-Model Adjustment Factors for Gasoline Light Duty Vehicle to Account for the SAFE Vehicle Rule Not Applied

Historical Energy Use: Y

5.1 Mitigation Measures Energy

	ROG	NOx	CO	SO2	Fugitive PM10	Exhaust PM10	PM10 Total	Fugitive PM2.5	Exhaust PM2.5	PM2.5 Total	Bio- CO2	NBio- CO2	Total CO2	CH4	N2O	CO2e
Category	tons/yr										MT/yr					
Electricity Mitigated											0.0000	647.2333	647.2333	0.0333	4.0400e-003	649.2688
Electricity Unmitigated											0.0000	647.2333	647.2333	0.0333	4.0400e-003	649.2688
NaturalGas Mitigated											0.0000	510.3146	510.3146	9.7800e-003	9.3600e-003	513.3472
NaturalGas Unmitigated											0.0000	510.3146	510.3146	9.7800e-003	9.3600e-003	513.3472

Lemoore 54 - 2030 Operations BAU Scenario - Kings County, Annual

EMFAC Off-Model Adjustment Factors for Gasoline Light Duty Vehicle to Account for the SAFE Vehicle Rule Not Applied

5.2 Energy by Land Use - NaturalGas

Unmitigated

	NaturalGas Use	ROG	NOx	CO	SO2	Fugitive PM10	Exhaust PM10	PM10 Total	Fugitive PM2.5	Exhaust PM2.5	PM2.5 Total	Bio- CO2	NBio- CO2	Total CO2	CH4	N2O	CO2e
Land Use	kBTU/yr	tons/yr										MT/yr					
City Park	0											0.0000	0.0000	0.0000	0.0000	0.0000	0.0000
Single Family Housing	9.56294e+006											0.0000	510.3146	510.3146	9.7800e-003	9.3600e-003	513.3472
Total												0.0000	510.3146	510.3146	9.7800e-003	9.3600e-003	513.3472

Mitigated

	NaturalGas Use	ROG	NOx	CO	SO2	Fugitive PM10	Exhaust PM10	PM10 Total	Fugitive PM2.5	Exhaust PM2.5	PM2.5 Total	Bio- CO2	NBio- CO2	Total CO2	CH4	N2O	CO2e
Land Use	kBTU/yr	tons/yr										MT/yr					
City Park	0											0.0000	0.0000	0.0000	0.0000	0.0000	0.0000
Single Family Housing	9.56294e+006											0.0000	510.3146	510.3146	9.7800e-003	9.3600e-003	513.3472
Total												0.0000	510.3146	510.3146	9.7800e-003	9.3600e-003	513.3472

Lemoore 54 - 2030 Operations BAU Scenario - Kings County, Annual

EMFAC Off-Model Adjustment Factors for Gasoline Light Duty Vehicle to Account for the SAFE Vehicle Rule Not Applied

5.3 Energy by Land Use - Electricity

Unmitigated

	Electricity Use	Total CO2	CH4	N2O	CO2e
Land Use	kWh/yr	MT/yr			
City Park	0	0.0000	0.0000	0.0000	0.0000
Single Family Housing	2.22485e+006	647.2333	0.0333	4.0400e-003	649.2688
Total		647.2333	0.0333	4.0400e-003	649.2688

Mitigated

	Electricity Use	Total CO2	CH4	N2O	CO2e
Land Use	kWh/yr	MT/yr			
City Park	0	0.0000	0.0000	0.0000	0.0000
Single Family Housing	2.22485e+006	647.2333	0.0333	4.0400e-003	649.2688
Total		647.2333	0.0333	4.0400e-003	649.2688

6.0 Area Detail

Lemoore 54 - 2030 Operations BAU Scenario - Kings County, Annual

EMFAC Off-Model Adjustment Factors for Gasoline Light Duty Vehicle to Account for the SAFE Vehicle Rule Not Applied

6.1 Mitigation Measures Area

	ROG	NOx	CO	SO2	Fugitive PM10	Exhaust PM10	PM10 Total	Fugitive PM2.5	Exhaust PM2.5	PM2.5 Total	Bio- CO2	NBio- CO2	Total CO2	CH4	N2O	CO2e
Category	tons/yr										MT/yr					
Mitigated											0.0000	124.6942	124.6942	7.7600e-003	2.2200e-003	125.5510
Unmitigated											0.0000	124.6942	124.6942	7.7600e-003	2.2200e-003	125.5510

Lemoore 54 - 2030 Operations BAU Scenario - Kings County, Annual

EMFAC Off-Model Adjustment Factors for Gasoline Light Duty Vehicle to Account for the SAFE Vehicle Rule Not Applied

6.2 Area by SubCategory

Unmitigated

	ROG	NOx	CO	SO2	Fugitive PM10	Exhaust PM10	PM10 Total	Fugitive PM2.5	Exhaust PM2.5	PM2.5 Total	Bio- CO2	NBio- CO2	Total CO2	CH4	N2O	CO2e
SubCategory	tons/yr										MT/yr					
Architectural Coating											0.0000	0.0000	0.0000	0.0000	0.0000	0.0000
Consumer Products											0.0000	0.0000	0.0000	0.0000	0.0000	0.0000
Hearth											0.0000	121.2981	121.2981	2.3200e-003	2.2200e-003	122.0189
Landscaping											0.0000	3.3961	3.3961	5.4400e-003	0.0000	3.5321
Total											0.0000	124.6942	124.6942	7.7600e-003	2.2200e-003	125.5510

Lemoore 54 - 2030 Operations BAU Scenario - Kings County, Annual

EMFAC Off-Model Adjustment Factors for Gasoline Light Duty Vehicle to Account for the SAFE Vehicle Rule Not Applied

6.2 Area by SubCategory

Mitigated

	ROG	NOx	CO	SO2	Fugitive PM10	Exhaust PM10	PM10 Total	Fugitive PM2.5	Exhaust PM2.5	PM2.5 Total	Bio- CO2	NBio- CO2	Total CO2	CH4	N2O	CO2e
SubCategory	tons/yr										MT/yr					
Architectural Coating											0.0000	0.0000	0.0000	0.0000	0.0000	0.0000
Consumer Products											0.0000	0.0000	0.0000	0.0000	0.0000	0.0000
Hearth											0.0000	121.2981	121.2981	2.3200e-003	2.2200e-003	122.0189
Landscaping											0.0000	3.3961	3.3961	5.4400e-003	0.0000	3.5321
Total											0.0000	124.6942	124.6942	7.7600e-003	2.2200e-003	125.5510

7.0 Water Detail

7.1 Mitigation Measures Water

Lemoore 54 - 2030 Operations BAU Scenario - Kings County, Annual

EMFAC Off-Model Adjustment Factors for Gasoline Light Duty Vehicle to Account for the SAFE Vehicle Rule Not Applied

	Total CO2	CH4	N2O	CO2e
Category	MT/yr			
Mitigated	50.0970	0.5967	0.0143	69.2805
Unmitigated	50.0970	0.5967	0.0143	69.2805

7.2 Water by Land Use

Unmitigated

	Indoor/Outdoor Use	Total CO2	CH4	N2O	CO2e
Land Use	Mgal	MT/yr			
City Park	0 / 3.81274	3.8821	2.0000e-004	2.0000e-005	3.8943
Single Family Housing	18.2431 / 11.5011	46.2149	0.5965	0.0143	65.3862
Total		50.0970	0.5967	0.0143	69.2805

Lemoore 54 - 2030 Operations BAU Scenario - Kings County, Annual

EMFAC Off-Model Adjustment Factors for Gasoline Light Duty Vehicle to Account for the SAFE Vehicle Rule Not Applied

7.2 Water by Land Use

Mitigated

	Indoor/Outdoor Use	Total CO2	CH4	N2O	CO2e
Land Use	Mgal	MT/yr			
City Park	0 / 3.81274	3.8821	2.0000e-004	2.0000e-005	3.8943
Single Family Housing	18.2431 / 11.5011	46.2149	0.5965	0.0143	65.3862
Total		50.0970	0.5967	0.0143	69.2805

8.0 Waste Detail

8.1 Mitigation Measures Waste

Category/Year

	Total CO2	CH4	N2O	CO2e
	MT/yr			
Mitigated	58.5913	3.4627	0.0000	145.1575
Unmitigated	58.5913	3.4627	0.0000	145.1575

Lemoore 54 - 2030 Operations BAU Scenario - Kings County, Annual

EMFAC Off-Model Adjustment Factors for Gasoline Light Duty Vehicle to Account for the SAFE Vehicle Rule Not Applied

8.2 Waste by Land Use

Unmitigated

	Waste Disposed	Total CO2	CH4	N2O	CO2e
Land Use	tons	MT/yr			
City Park	0.28	0.0568	3.3600e-003	0.0000	0.1408
Single Family Housing	288.36	58.5345	3.4593	0.0000	145.0167
Total		58.5913	3.4627	0.0000	145.1575

Mitigated

	Waste Disposed	Total CO2	CH4	N2O	CO2e
Land Use	tons	MT/yr			
City Park	0.28	0.0568	3.3600e-003	0.0000	0.1408
Single Family Housing	288.36	58.5345	3.4593	0.0000	145.0167
Total		58.5913	3.4627	0.0000	145.1575

9.0 Operational Offroad

Lemoore 54 - 2030 Operations BAU Scenario - Kings County, Annual

EMFAC Off-Model Adjustment Factors for Gasoline Light Duty Vehicle to Account for the SAFE Vehicle Rule Not Applied

Equipment Type	Number	Hours/Day	Days/Year	Horse Power	Load Factor	Fuel Type
----------------	--------	-----------	-----------	-------------	-------------	-----------

10.0 Stationary Equipment

Fire Pumps and Emergency Generators

Equipment Type	Number	Hours/Day	Hours/Year	Horse Power	Load Factor	Fuel Type
----------------	--------	-----------	------------	-------------	-------------	-----------

Boilers

Equipment Type	Number	Heat Input/Day	Heat Input/Year	Boiler Rating	Fuel Type
----------------	--------	----------------	-----------------	---------------	-----------

User Defined Equipment

Equipment Type	Number
----------------	--------

11.0 Vegetation

Lemoore 54 - 2030 Operational Year Scenario - Kings County, Annual

EMFAC Off-Model Adjustment Factors for Gasoline Light Duty Vehicle to Account for the SAFE Vehicle Rule Not Applied

**Lemoore 54 - 2030 Operational Year Scenario
Kings County, Annual**

1.0 Project Characteristics

1.1 Land Usage

Land Uses	Size	Metric	Lot Acreage	Floor Surface Area	Population
City Park	3.20	Acre	3.20	139,392.00	0
Single Family Housing	280.00	Dwelling Unit	49.41	504,000.00	801

1.2 Other Project Characteristics

Urbanization	Urban	Wind Speed (m/s)	2.2	Precipitation Freq (Days)	37
Climate Zone	3			Operational Year	2030
Utility Company	Pacific Gas and Electric Company				
CO2 Intensity (lb/MWhr)	191	CH4 Intensity (lb/MWhr)	0.033	N2O Intensity (lb/MWhr)	0.004

1.3 User Entered Comments & Non-Default Data

Project Characteristics - Lemoore 54 - Full Buildout Operations in the Year 2030

Land Use - Project site is approximately 52.61 acres
280-lot single family subdivision and 3.2 acres of public parks at full buildout

Construction Phase - Operational run only - zeroed out construction only parameters

Off-road Equipment - Operational run only

Trips and VMT - Operational run only

Architectural Coating - Rule 4601 Architectural Coatings

Vehicle Trips - Trip rates for project trips consistent with the trip generation provided in the traffic report (JLB Traffic Engineering, 2023)
ITE Trip Generation Manual, 11th Ed (ITE Land Uses 210 and 411)

Vehicle Emission Factors -

Vehicle Emission Factors -

Vehicle Emission Factors -

Lemoore 54 - 2030 Operational Year Scenario - Kings County, Annual

EMFAC Off-Model Adjustment Factors for Gasoline Light Duty Vehicle to Account for the SAFE Vehicle Rule Not Applied

Woodstoves - SJVAPCD Rule 4901 Woodburning

Area Coating - Rule 4601 Architectural Coatings

Construction Off-road Equipment Mitigation -

Area Mitigation - Rule 4601 Architectural Coatings, no woodburning fireplaces (only natural gas hearth), and building code standards (outside outlets)

Energy Mitigation - Single-family homes to be built with rooftop solar to provide on-site renewable energy (80% of electricity use generated applied)

Water Mitigation - Compliance with Green Building Code Standards and California Model Water Efficient Landscape Ordinance

Fleet Mix - SJVAPCD-approved Residential Fleet Mix for the 2030 operational year applied to the single-family housing land use

Water And Wastewater -

Solid Waste -

Table Name	Column Name	Default Value	New Value
tblArchitecturalCoating	EF_Nonresidential_Exterior	150.00	50.00
tblArchitecturalCoating	EF_Nonresidential_Interior	150.00	50.00
tblArchitecturalCoating	EF_Residential_Exterior	150.00	50.00
tblArchitecturalCoating	EF_Residential_Interior	150.00	50.00
tblAreaCoating	Area_EF_Nonresidential_Exterior	150	50
tblAreaCoating	Area_EF_Nonresidential_Interior	150	50
tblAreaCoating	Area_EF_Residential_Exterior	150	50
tblAreaCoating	Area_EF_Residential_Interior	150	50
tblConstructionPhase	NumDays	75.00	1.00
tblFireplaces	FireplaceWoodMass	3,078.40	0.00
tblFleetMix	HHD	0.04	0.02
tblFleetMix	LDA	0.53	0.51
tblFleetMix	LDT1	0.05	0.22
tblFleetMix	LDT2	0.17	0.17
tblFleetMix	LHD1	0.02	8.0000e-004
tblFleetMix	LHD2	6.1110e-003	1.0000e-003
tblFleetMix	MCY	0.02	2.5000e-003
tblFleetMix	MDV	0.14	0.06

Lemoore 54 - 2030 Operational Year Scenario - Kings County, Annual

EMFAC Off-Model Adjustment Factors for Gasoline Light Duty Vehicle to Account for the SAFE Vehicle Rule Not Applied

tblFleetMix	MH	2.8410e-003	3.0000e-003
tblFleetMix	MHD	8.0280e-003	7.4000e-003
tblFleetMix	OBUS	5.6800e-004	0.00
tblFleetMix	SBUS	9.9100e-004	1.2000e-003
tblFleetMix	UBUS	1.8400e-004	4.4000e-003
tblLandUse	LotAcreage	90.91	49.41
tblOffRoadEquipment	OffRoadEquipmentUnitAmount	1.00	0.00
tblOffRoadEquipment	UsageHours	6.00	0.00
tblProjectCharacteristics	CO2IntensityFactor	203.98	191
tblTripsAndVMT	WorkerTripNumber	32.00	0.00
tblVehicleTrips	ST_TR	9.54	9.48
tblVehicleTrips	SU_TR	8.55	8.48
tblVehicleTrips	WD_TR	9.44	9.43
tblWoodstoves	WoodstoveWoodMass	3,019.20	0.00

2.0 Emissions Summary

Lemoore 54 - 2030 Operational Year Scenario - Kings County, Annual

EMFAC Off-Model Adjustment Factors for Gasoline Light Duty Vehicle to Account for the SAFE Vehicle Rule Not Applied

2.1 Overall Construction

Unmitigated Construction

	ROG	NOx	CO	SO2	Fugitive PM10	Exhaust PM10	PM10 Total	Fugitive PM2.5	Exhaust PM2.5	PM2.5 Total	Bio- CO2	NBio- CO2	Total CO2	CH4	N2O	CO2e
Year	tons/yr										MT/yr					
2023											0.0000	0.0000	0.0000	0.0000	0.0000	0.0000
Maximum											0.0000	0.0000	0.0000	0.0000	0.0000	0.0000

Mitigated Construction

	ROG	NOx	CO	SO2	Fugitive PM10	Exhaust PM10	PM10 Total	Fugitive PM2.5	Exhaust PM2.5	PM2.5 Total	Bio- CO2	NBio- CO2	Total CO2	CH4	N2O	CO2e
Year	tons/yr										MT/yr					
2023											0.0000	0.0000	0.0000	0.0000	0.0000	0.0000
Maximum											0.0000	0.0000	0.0000	0.0000	0.0000	0.0000

	ROG	NOx	CO	SO2	Fugitive PM10	Exhaust PM10	PM10 Total	Fugitive PM2.5	Exhaust PM2.5	PM2.5 Total	Bio- CO2	NBio- CO2	Total CO2	CH4	N2O	CO2e
Percent Reduction	0.00	0.00	0.00	0.00	0.00	0.00	0.00	0.00	0.00	0.00	0.00	0.00	0.00	0.00	0.00	0.00

Quarter	Start Date	End Date	Maximum Unmitigated ROG + NOX (tons/quarter)	Maximum Mitigated ROG + NOX (tons/quarter)

Lemoore 54 - 2030 Operational Year Scenario - Kings County, Annual

EMFAC Off-Model Adjustment Factors for Gasoline Light Duty Vehicle to Account for the SAFE Vehicle Rule Not Applied

		Highest	
--	--	---------	--

2.2 Overall Operational
Unmitigated Operational

	ROG	NOx	CO	SO2	Fugitive PM10	Exhaust PM10	PM10 Total	Fugitive PM2.5	Exhaust PM2.5	PM2.5 Total	Bio- CO2	NBio- CO2	Total CO2	CH4	N2O	CO2e
Category	tons/yr										MT/yr					
Area											0.0000	124.6942	124.6942	5.5600e-003	2.2200e-003	125.4959
Energy											0.0000	552.5991	552.5991	0.0403	0.0106	556.7762
Mobile											0.0000	2,056.9544	2,056.9544	0.1252	0.0917	2,087.4172
Waste											58.5913	0.0000	58.5913	3.4627	0.0000	145.1575
Water											5.7877	13.1957	18.9834	0.5967	0.0143	38.1669
Total											64.3790	2,747.4434	2,811.8225	4.2304	0.1189	2,953.0137

Lemoore 54 - 2030 Operational Year Scenario - Kings County, Annual

EMFAC Off-Model Adjustment Factors for Gasoline Light Duty Vehicle to Account for the SAFE Vehicle Rule Not Applied

2.2 Overall Operational

Mitigated Operational

	ROG	NOx	CO	SO2	Fugitive PM10	Exhaust PM10	PM10 Total	Fugitive PM2.5	Exhaust PM2.5	PM2.5 Total	Bio- CO2	NBio- CO2	Total CO2	CH4	N2O	CO2e
Category	tons/yr										MT/yr					
Area											0.0000	124.6636	124.6636	5.5100e-003	2.2200e-003	125.4642
Energy											0.0000	388.1809	388.1809	0.0119	7.1900e-003	390.6216
Mobile											0.0000	2,056.9544	2,056.9544	0.1252	0.0917	2,087.4172
Waste											58.5913	0.0000	58.5913	3.4627	0.0000	145.1575
Water											4.6302	10.5566	15.1867	0.4774	0.0115	30.5335
Total											63.2215	2,580.3554	2,643.5769	4.0826	0.1126	2,779.1940

	ROG	NOx	CO	SO2	Fugitive PM10	Exhaust PM10	PM10 Total	Fugitive PM2.5	Exhaust PM2.5	PM2.5 Total	Bio- CO2	NBio- CO2	Total CO2	CH4	N2O	CO2e
Percent Reduction	0.00	0.00	0.00	0.00	0.00	0.00	0.00	0.00	0.00	0.00	1.80	6.08	5.98	3.49	5.31	5.89

3.0 Construction Detail

Construction Phase

Phase Number	Phase Name	Phase Type	Start Date	End Date	Num Days Week	Num Days	Phase Description
1	Architectural Coating	Architectural Coating	3/2/2023	3/2/2023	5	1	

Acres of Grading (Site Preparation Phase): 0

Lemoore 54 - 2030 Operational Year Scenario - Kings County, Annual

EMFAC Off-Model Adjustment Factors for Gasoline Light Duty Vehicle to Account for the SAFE Vehicle Rule Not Applied

Acres of Grading (Grading Phase): 0

Acres of Paving: 0

Residential Indoor: 1,020,600; Residential Outdoor: 340,200; Non-Residential Indoor: 2; Non-Residential Outdoor: 1; Striped Parking Area: 0 (Architectural Coating – sqft)

OffRoad Equipment

Phase Name	Offroad Equipment Type	Amount	Usage Hours	Horse Power	Load Factor
Architectural Coating	Air Compressors	0	0.00	78	0.48

Trips and VMT

Phase Name	Offroad Equipment Count	Worker Trip Number	Vendor Trip Number	Hauling Trip Number	Worker Trip Length	Vendor Trip Length	Hauling Trip Length	Worker Vehicle Class	Vendor Vehicle Class	Hauling Vehicle Class
Architectural Coating	0	0.00	0.00	0.00	10.80	7.30	20.00	LD_Mix	HDT_Mix	HHDT

3.1 Mitigation Measures Construction

3.2 Architectural Coating - 2023

Unmitigated Construction On-Site

	ROG	NOx	CO	SO2	Fugitive PM10	Exhaust PM10	PM10 Total	Fugitive PM2.5	Exhaust PM2.5	PM2.5 Total	Bio- CO2	NBio- CO2	Total CO2	CH4	N2O	CO2e
Category	tons/yr										MT/yr					
Archit. Coating											0.0000	0.0000	0.0000	0.0000	0.0000	0.0000
Off-Road											0.0000	0.0000	0.0000	0.0000	0.0000	0.0000
Total											0.0000	0.0000	0.0000	0.0000	0.0000	0.0000

Lemoore 54 - 2030 Operational Year Scenario - Kings County, Annual

EMFAC Off-Model Adjustment Factors for Gasoline Light Duty Vehicle to Account for the SAFE Vehicle Rule Not Applied

3.2 Architectural Coating - 2023

Unmitigated Construction Off-Site

	ROG	NOx	CO	SO2	Fugitive PM10	Exhaust PM10	PM10 Total	Fugitive PM2.5	Exhaust PM2.5	PM2.5 Total	Bio- CO2	NBio- CO2	Total CO2	CH4	N2O	CO2e
Category	tons/yr										MT/yr					
Hauling											0.0000	0.0000	0.0000	0.0000	0.0000	0.0000
Vendor											0.0000	0.0000	0.0000	0.0000	0.0000	0.0000
Worker											0.0000	0.0000	0.0000	0.0000	0.0000	0.0000
Total											0.0000	0.0000	0.0000	0.0000	0.0000	0.0000

Mitigated Construction On-Site

	ROG	NOx	CO	SO2	Fugitive PM10	Exhaust PM10	PM10 Total	Fugitive PM2.5	Exhaust PM2.5	PM2.5 Total	Bio- CO2	NBio- CO2	Total CO2	CH4	N2O	CO2e
Category	tons/yr										MT/yr					
Archit. Coating											0.0000	0.0000	0.0000	0.0000	0.0000	0.0000
Off-Road											0.0000	0.0000	0.0000	0.0000	0.0000	0.0000
Total											0.0000	0.0000	0.0000	0.0000	0.0000	0.0000

Lemoore 54 - 2030 Operational Year Scenario - Kings County, Annual

EMFAC Off-Model Adjustment Factors for Gasoline Light Duty Vehicle to Account for the SAFE Vehicle Rule Not Applied

3.2 Architectural Coating - 2023

Mitigated Construction Off-Site

	ROG	NOx	CO	SO2	Fugitive PM10	Exhaust PM10	PM10 Total	Fugitive PM2.5	Exhaust PM2.5	PM2.5 Total	Bio- CO2	NBio- CO2	Total CO2	CH4	N2O	CO2e
Category	tons/yr										MT/yr					
Hauling											0.0000	0.0000	0.0000	0.0000	0.0000	0.0000
Vendor											0.0000	0.0000	0.0000	0.0000	0.0000	0.0000
Worker											0.0000	0.0000	0.0000	0.0000	0.0000	0.0000
Total											0.0000	0.0000	0.0000	0.0000	0.0000	0.0000

4.0 Operational Detail - Mobile

4.1 Mitigation Measures Mobile

Lemoore 54 - 2030 Operational Year Scenario - Kings County, Annual

EMFAC Off-Model Adjustment Factors for Gasoline Light Duty Vehicle to Account for the SAFE Vehicle Rule Not Applied

	ROG	NOx	CO	SO2	Fugitive PM10	Exhaust PM10	PM10 Total	Fugitive PM2.5	Exhaust PM2.5	PM2.5 Total	Bio- CO2	NBio- CO2	Total CO2	CH4	N2O	CO2e
Category	tons/yr										MT/yr					
Mitigated											0.0000	2,056.9544	2,056.9544	0.1252	0.0917	2,087.4172
Unmitigated											0.0000	2,056.9544	2,056.9544	0.1252	0.0917	2,087.4172

4.2 Trip Summary Information

Land Use	Average Daily Trip Rate			Unmitigated	Mitigated
	Weekday	Saturday	Sunday	Annual VMT	Annual VMT
City Park	2.50	6.27	7.01	7,856	7,856
Single Family Housing	2,640.40	2,654.40	2374.40	7,454,441	7,454,441
Total	2,642.90	2,660.67	2,381.41	7,462,297	7,462,297

4.3 Trip Type Information

Land Use	Miles			Trip %			Trip Purpose %		
	H-W or C-W	H-S or C-C	H-O or C-NW	H-W or C-W	H-S or C-C	H-O or C-NW	Primary	Diverted	Pass-by
City Park	9.50	7.30	7.30	33.00	48.00	19.00	66	28	6
Single Family Housing	10.80	7.30	7.50	42.30	19.60	38.10	86	11	3

4.4 Fleet Mix

Land Use	LDA	LDT1	LDT2	MDV	LHD1	LHD2	MHD	HHD	OBUS	UBUS	MCY	SBUS	MH
City Park	0.526829	0.054483	0.174820	0.140491	0.024491	0.006111	0.008028	0.037066	0.000568	0.000184	0.023099	0.000991	0.002841
Single Family Housing	0.511000	0.223100	0.169000	0.059300	0.000800	0.001000	0.007400	0.017300	0.000000	0.004400	0.002500	0.001200	0.003000

5.0 Energy Detail

Lemoore 54 - 2030 Operational Year Scenario - Kings County, Annual

EMFAC Off-Model Adjustment Factors for Gasoline Light Duty Vehicle to Account for the SAFE Vehicle Rule Not Applied

Historical Energy Use: N

5.1 Mitigation Measures Energy

Percent of Electricity Use Generated with Renewable Energy

	ROG	NOx	CO	SO2	Fugitive PM10	Exhaust PM10	PM10 Total	Fugitive PM2.5	Exhaust PM2.5	PM2.5 Total	Bio- CO2	NBio- CO2	Total CO2	CH4	N2O	CO2e
Category	tons/yr										MT/yr					
Electricity Mitigated											0.0000	29.0150	29.0150	5.0100e-003	6.1000e-004	29.3214
Electricity Unmitigated											0.0000	193.4333	193.4333	0.0334	4.0500e-003	195.4760
NaturalGas Mitigated											0.0000	359.1659	359.1659	6.8800e-003	6.5800e-003	361.3002
NaturalGas Unmitigated											0.0000	359.1659	359.1659	6.8800e-003	6.5800e-003	361.3002

Lemoore 54 - 2030 Operational Year Scenario - Kings County, Annual

EMFAC Off-Model Adjustment Factors for Gasoline Light Duty Vehicle to Account for the SAFE Vehicle Rule Not Applied

5.2 Energy by Land Use - NaturalGas

Unmitigated

	NaturalGas Use	ROG	NOx	CO	SO2	Fugitive PM10	Exhaust PM10	PM10 Total	Fugitive PM2.5	Exhaust PM2.5	PM2.5 Total	Bio- CO2	NBio- CO2	Total CO2	CH4	N2O	CO2e
Land Use	kBTU/yr	tons/yr										MT/yr					
City Park	0											0.0000	0.0000	0.0000	0.0000	0.0000	0.0000
Single Family Housing	6.73051e+006											0.0000	359.1659	359.1659	6.8800e-003	6.5800e-003	361.3002
Total												0.0000	359.1659	359.1659	6.8800e-003	6.5800e-003	361.3002

Mitigated

	NaturalGas Use	ROG	NOx	CO	SO2	Fugitive PM10	Exhaust PM10	PM10 Total	Fugitive PM2.5	Exhaust PM2.5	PM2.5 Total	Bio- CO2	NBio- CO2	Total CO2	CH4	N2O	CO2e
Land Use	kBTU/yr	tons/yr										MT/yr					
City Park	0											0.0000	0.0000	0.0000	0.0000	0.0000	0.0000
Single Family Housing	6.73051e+006											0.0000	359.1659	359.1659	6.8800e-003	6.5800e-003	361.3002
Total												0.0000	359.1659	359.1659	6.8800e-003	6.5800e-003	361.3002

Lemoore 54 - 2030 Operational Year Scenario - Kings County, Annual

EMFAC Off-Model Adjustment Factors for Gasoline Light Duty Vehicle to Account for the SAFE Vehicle Rule Not Applied

5.3 Energy by Land Use - Electricity

Unmitigated

	Electricity Use	Total CO2	CH4	N2O	CO2e
Land Use	kWh/yr	MT/yr			
City Park	0	0.0000	0.0000	0.0000	0.0000
Single Family Housing	2.23271e+006	193.4333	0.0334	4.0500e-003	195.4760
Total		193.4333	0.0334	4.0500e-003	195.4760

Mitigated

	Electricity Use	Total CO2	CH4	N2O	CO2e
Land Use	kWh/yr	MT/yr			
City Park	0	0.0000	0.0000	0.0000	0.0000
Single Family Housing	334906	29.0150	5.0100e-003	6.1000e-004	29.3214
Total		29.0150	5.0100e-003	6.1000e-004	29.3214

6.0 Area Detail

Lemoore 54 - 2030 Operational Year Scenario - Kings County, Annual

EMFAC Off-Model Adjustment Factors for Gasoline Light Duty Vehicle to Account for the SAFE Vehicle Rule Not Applied

6.1 Mitigation Measures Area

- Use Electric Lawnmower
- Use Electric Leafblower
- Use Electric Chainsaw
- Use Low VOC Paint - Residential Interior
- Use Low VOC Paint - Residential Exterior
- Use Low VOC Paint - Non-Residential Interior
- Use Low VOC Paint - Non-Residential Exterior
- Use only Natural Gas Hearths

	ROG	NOx	CO	SO2	Fugitive PM10	Exhaust PM10	PM10 Total	Fugitive PM2.5	Exhaust PM2.5	PM2.5 Total	Bio- CO2	NBio- CO2	Total CO2	CH4	N2O	CO2e
Category	tons/yr										MT/yr					
Mitigated											0.0000	124.6636	124.6636	5.5100e-003	2.2200e-003	125.4642
Unmitigated											0.0000	124.6942	124.6942	5.5600e-003	2.2200e-003	125.4959

Lemoore 54 - 2030 Operational Year Scenario - Kings County, Annual

EMFAC Off-Model Adjustment Factors for Gasoline Light Duty Vehicle to Account for the SAFE Vehicle Rule Not Applied

6.2 Area by SubCategory

Unmitigated

	ROG	NOx	CO	SO2	Fugitive PM10	Exhaust PM10	PM10 Total	Fugitive PM2.5	Exhaust PM2.5	PM2.5 Total	Bio- CO2	NBio- CO2	Total CO2	CH4	N2O	CO2e
SubCategory	tons/yr										MT/yr					
Architectural Coating											0.0000	0.0000	0.0000	0.0000	0.0000	0.0000
Consumer Products											0.0000	0.0000	0.0000	0.0000	0.0000	0.0000
Hearth											0.0000	121.2981	121.2981	2.3200e-003	2.2200e-003	122.0189
Landscaping											0.0000	3.3961	3.3961	3.2400e-003	0.0000	3.4770
Total											0.0000	124.6942	124.6942	5.5600e-003	2.2200e-003	125.4959

Lemoore 54 - 2030 Operational Year Scenario - Kings County, Annual

EMFAC Off-Model Adjustment Factors for Gasoline Light Duty Vehicle to Account for the SAFE Vehicle Rule Not Applied

6.2 Area by SubCategory

Mitigated

	ROG	NOx	CO	SO2	Fugitive PM10	Exhaust PM10	PM10 Total	Fugitive PM2.5	Exhaust PM2.5	PM2.5 Total	Bio- CO2	NBio- CO2	Total CO2	CH4	N2O	CO2e
SubCategory	tons/yr										MT/yr					
Architectural Coating											0.0000	0.0000	0.0000	0.0000	0.0000	0.0000
Consumer Products											0.0000	0.0000	0.0000	0.0000	0.0000	0.0000
Hearth											0.0000	121.2981	121.2981	2.3200e-003	2.2200e-003	122.0189
Landscaping											0.0000	3.3655	3.3655	3.1900e-003	0.0000	3.4453
Total											0.0000	124.6636	124.6636	5.5100e-003	2.2200e-003	125.4642

7.0 Water Detail

7.1 Mitigation Measures Water

Apply Water Conservation Strategy

Lemoore 54 - 2030 Operational Year Scenario - Kings County, Annual

EMFAC Off-Model Adjustment Factors for Gasoline Light Duty Vehicle to Account for the SAFE Vehicle Rule Not Applied

	Total CO2	CH4	N2O	CO2e
Category	MT/yr			
Mitigated	15.1867	0.4774	0.0115	30.5335
Unmitigated	18.9834	0.5967	0.0143	38.1669

7.2 Water by Land Use

Unmitigated

	Indoor/Outdoor Use	Total CO2	CH4	N2O	CO2e
Land Use	Mgal	MT/yr			
City Park	0 / 3.81274	1.1561	2.0000e-004	2.0000e-005	1.1683
Single Family Housing	18.2431 / 11.5011	17.8273	0.5965	0.0143	36.9986
Total		18.9834	0.5967	0.0143	38.1669

Lemoore 54 - 2030 Operational Year Scenario - Kings County, Annual

EMFAC Off-Model Adjustment Factors for Gasoline Light Duty Vehicle to Account for the SAFE Vehicle Rule Not Applied

7.2 Water by Land Use

Mitigated

	Indoor/Outdoor Use	Total CO2	CH4	N2O	CO2e
Land Use	Mgal	MT/yr			
City Park	0 / 3.05019	0.9249	1.6000e-004	2.0000e-005	0.9347
Single Family Housing	14.5945 / 9.20088	14.2618	0.4772	0.0114	29.5989
Total		15.1867	0.4774	0.0115	30.5335

8.0 Waste Detail

8.1 Mitigation Measures Waste

Category/Year

	Total CO2	CH4	N2O	CO2e
	MT/yr			
Mitigated	58.5913	3.4627	0.0000	145.1575
Unmitigated	58.5913	3.4627	0.0000	145.1575

Lemoore 54 - 2030 Operational Year Scenario - Kings County, Annual

EMFAC Off-Model Adjustment Factors for Gasoline Light Duty Vehicle to Account for the SAFE Vehicle Rule Not Applied

8.2 Waste by Land Use

Unmitigated

	Waste Disposed	Total CO2	CH4	N2O	CO2e
Land Use	tons	MT/yr			
City Park	0.28	0.0568	3.3600e-003	0.0000	0.1408
Single Family Housing	288.36	58.5345	3.4593	0.0000	145.0167
Total		58.5913	3.4627	0.0000	145.1575

Mitigated

	Waste Disposed	Total CO2	CH4	N2O	CO2e
Land Use	tons	MT/yr			
City Park	0.28	0.0568	3.3600e-003	0.0000	0.1408
Single Family Housing	288.36	58.5345	3.4593	0.0000	145.0167
Total		58.5913	3.4627	0.0000	145.1575

9.0 Operational Offroad

Lemoore 54 - 2030 Operational Year Scenario - Kings County, Annual

EMFAC Off-Model Adjustment Factors for Gasoline Light Duty Vehicle to Account for the SAFE Vehicle Rule Not Applied

Equipment Type	Number	Hours/Day	Days/Year	Horse Power	Load Factor	Fuel Type
----------------	--------	-----------	-----------	-------------	-------------	-----------

10.0 Stationary Equipment

Fire Pumps and Emergency Generators

Equipment Type	Number	Hours/Day	Hours/Year	Horse Power	Load Factor	Fuel Type
----------------	--------	-----------	------------	-------------	-------------	-----------

Boilers

Equipment Type	Number	Heat Input/Day	Heat Input/Year	Boiler Rating	Fuel Type
----------------	--------	----------------	-----------------	---------------	-----------

User Defined Equipment

Equipment Type	Number
----------------	--------

11.0 Vegetation

Health Risk Screening

Screening Calculations and Prioritization

Lemoore 54 Project (TTM 22-021) Residential Project—Health Risk Screening Analysis for Project Operations

Diesel Truck Trips

	Trucks Onsite Daily	Avg Daily Trips
Heavy Truck Trips	40.78	81.56 (40.31 incoming and 40.31 outgoing)

Truck Assumptions

Trucks Onsite per Day	40.78
Trucks Onsite per Year	14,884.2
Idling Events per Truck per day	2
Idling Time per Event (min.)	15
Idling Minutes/Year	446,527
Idling Hours/Year	7,442

	Truck Entering	Trucks Exiting	Total
Average Travel Distance Onsite (ft)	660	660	1,320

(0.25 mile on-site and 0.25 mile off-site assumed for this localized assessment - residential project)

	Miles/Trip	Truck Trips/Year	Miles/Year
Offsite Miles Estimate	0.25	29,768.5	7,442.1

	Distance Onsite (ft) in and out	Distance to Receptor Meters	Direction to Receptor	Idling Emissions (lbs/year)	Running Emissions (lbs/yr)	Total Truck Emissions (lbs/year)	Grand Total (lbs/yr)	Average Lbs/Day	Max Lbs/Day*	Max lbs/Hr
Emissions	1,320	<100 M	All	0.44	1.57	2.0135	2.01	0.00552	0.01655	0.00138

*Max daily assumed to be 3 times the daily average. Max hr based on 12 hrs/day

Running Emission Calculations

EMFAC2021 Rates

Idling Emission Rate for Diesel g/day	0.55193
g/lb conversion factor	0.00220
HDT Onsite Running Emissions 5 mph g/mile	0.11655
HDT Running Emissions Onroad 5-25 mph	0.03738

EMFAC2021 PM10 running emissions Aggregated Fleet Age in Year 2024

EMFAC2021 Average Running Emissions

	PM10_RUNEX	PM10 RUNEX
	5-25 MPH	5 MPH
Weighted Averages (Based on Project Fleet)	0.03738	0.11655

	Distance (Feet)	Distance (Miles)	Miles/Year/ Truck	Trucks/Day	Emission (g/mi)	Emissions g/year	Emission lbs/year	Emissions lbs/hour
Onsite Running Emissions	1,320.00	0.25	91.3	40.8	0.11655	433.68	0.96	0.000218287
Offsite Running Emissions	2,640.00	0.50	182.50	40.8	0.03738	278.20	0.61	0.000140027
Total Running							1.56942	0.00036

EMFAC2021 PM10 PMBW Aggregated Fleet Age in Year 2024

EMFAC2021 Average PMBW Emissions (Non-exhaust Source)

	PM10_PMBW	PM10 PMBW
	5-25 MPH	5 MPH
Weighted Averages (Based on Project Fleet)	0.11203	0.12687

	Distance (Feet)	Distance (Miles)	Miles/Year/ Truck	Trucks/Day	PMBW rate (g/mi)	Emissions g/year	Emission lbs/year	Emissions lbs/hour
Onsite Running Emissions	1,320.00	0.25	91.25	40.78	0.12687	472.08	1.04	0.000237617
Offsite Running Emissions	2,640.00	0.50	182.50	40.8	0.11203	833.73	1.84	0.00041965
Total PMBW (non-exhaust/non-DPM)							2.87883	0.00066

Total Emissions	Lbs/Year	Max Lbs/Hours	
Onsite Running Emissions	0.9561	0.0002183	
Offsite Running Emissions	0.6133	0.0001400	
Idling Emissions	0.4441	0.0013791	
Total	2.0135459	0.0017375	2.013545869 0.001737455

Health Risk Prioritization Results (Receptor 0-100 M)

	Cancer Score	Chronic Score	Acute Score
Prioritization Score Truck Run and Idle	4.651	0.008	0.000

Lemoore 54 Project (TTM 22-021)—Project-generated Operational Trips

Average Daily Truck Trips

Lemoore 54 Project (TTM 22-021) - Buildout Operations in the Earliest Operational Year

Project Trips for Emission Estimates

Description	Weekday (Trips per Day)	Saturday (Trips per Day)	Sunday (Trips per Day)
Park	2.50	6.27	7.01
Single Family Housing	2,640.40	2,654.40	2,374.40
Proposed Project	2,642.90	2,660.67	2,381.41

	Weekday	Saturday	Sunday	Average Daily
Park	2.50	6.27	7.01	3.68
Single Family Housing	2,640.40	2,654.40	2,374.40	2,604.40
Proposed Project	2,642.90	2,660.67	2,381.41	2,608.08

	Average Daily Trips
Park	3.68
Single Family Housing	2604.40
Total Average Trips	2608.08

By Vehicle Type

	LDA	LDT1	LDT2	MDV	LHD1	LHD2	MHD	HHD	OBUS	UBUS	MCY	SBUS	MH	Total
Park														
Percentage	0.504365	0.051424	0.168544	0.163993	0.029850	0.006745	0.008269	0.036653	0.000620	0.000189	0.024675	0.001152	0.003520	1.00
Daily Trips	1.857504	0.189387	0.620723	0.603963	0.109933	0.024841	0.030454	0.134988	0.002283	0.000696	0.090875	0.004243	0.012964	3.68
Single Family Housing														
Percentage	0.527700	0.209000	0.167500	0.055600	0.000900	0.000900	0.008000	0.021400	0.000000	0.004300	0.002500	0.000200	0.002000	1.00
Daily Trips	1374.341880	544.319600	436.237000	144.804640	2.343960	2.343960	20.835200	55.734160	0.000000	11.198920	6.511000	0.520880	5.208800	2604.40
Project Total														
Daily Trips	1376.199384	544.508987	436.857723	145.408603	2.453893	2.368801	20.865654	55.869148	0.002283	11.199616	6.601875	0.525123	5.221764	2608.08
Trucks Only														
	LHD1	LHD2	MHD	HHD	Total									
	2.454	2.369	20.866	55.869	81.557495									

On-site Truck Running and Idling Emissions for the Health Risk Screening Analysis—Lemoore 54 Project (TTM 22-021)

Source: EMFAC2021 (v1.0.2) Emission Rates

Region Type: County

Region: Kings

Calendar Year: 2024

Season: Annual

Vehicle Classification: EMFAC2007 Categories

Units: miles/year for CVMT and EVMT, g/mile for RUNEX, PMBW and PMTW, mph for Speed, kWh/mile for Energy Consumption, gallon/mile for Fuel Consumption. PHEV calculated based on total VMT.

Region	Calendar Year	Vehicle Category	Model Year	Speed	Fuel	VMT	NOx_RUNEX	PM2.5_RUNEX	PM10_RUNEX	CO2_RUNEX	CH4_RUNEX	N2O_RUNEX	ROG_RUNEX	TOG_RUNEX	CO_RUNEX	SOx_RUNEX	PM10_PMBW	PM2.5_PMBW
Kings	2024	HHDT	Aggregate	5	Diesel	152.7301566	18.47821155	0.130069907	0.135951091	3448.460154	0.026682207	0.543306302	0.574460591	0.653979654	1.367561069	0.032654856	0.155008927	0.054253125
Kings	2024	HHDT	Aggregate	10	Diesel	4330.509203	8.374008062	0.015630181	0.016336908	2795.364835	0.004437807	0.440410868	0.095544758	0.108770434	0.754001143	0.026470433	0.140027971	0.04900979
Kings	2024	HHDT	Aggregate	15	Diesel	10496.20897	5.353653491	0.00883561	0.009235118	2259.944929	0.001857076	0.356055244	0.039982329	0.045516838	0.40640145	0.021400327	0.137186623	0.048015318
Kings	2024	HHDT	Aggregate	20	Diesel	15944.24114	4.041864051	0.007073034	0.007392845	2008.959121	0.001263644	0.316512328	0.027205904	0.030971851	0.295902658	0.019023642	0.108148363	0.037851934
Kings	2024	HHDT	Aggregate	25	Diesel	12704.50884	3.176902963	0.006689413	0.006991879	1799.303878	0.000888164	0.283481059	0.01912192	0.02176885	0.215582652	0.017038332	0.130948659	0.045832031
			Total			39.42464012	0.168298145	0.17590784	0.17590784	12312.03292	0.035128896	1.9397658	0.756315502	0.861007627	3.039448971	0.116587589	0.671320562	0.234962197
Kings	2024	LHDT1	Aggregate	5	Diesel	1787.567134	2.656496117	0.106986493	0.111823947	1208.575476	0.022293935	0.190411558	0.479975288	0.546419955	1.551406198	0.011451867	0.078000022	0.027300008
Kings	2024	LHDT1	Aggregate	10	Diesel	5944.475452	2.459538158	0.087422006	0.091374841	1046.854914	0.018227308	0.164933994	0.392423208	0.446747732	1.235834316	0.009919577	0.078000022	0.027300008
Kings	2024	LHDT1	Aggregate	15	Diesel	12874.03087	2.292253927	0.071890166	0.075140721	877.8723211	0.015083091	0.138309142	0.324730066	0.369683591	0.991820323	0.008318286	0.078000022	0.027300008
Kings	2024	LHDT1	Aggregate	20	Diesel	14114.09612	2.148290041	0.059274603	0.061954737	759.0545006	0.012565853	0.119589346	0.270535426	0.307986596	0.797366178	0.007192427	0.078000022	0.027300008
Kings	2024	LHDT1	Aggregate	25	Diesel	15105.84826	2.038231663	0.048945899	0.051159015	659.8395697	0.01050903	0.103957993	0.226253238	0.25757427	0.640234897	0.006252315	0.078000022	0.027300008
			Total			11.59480991	0.374519167	0.391453261	0.391453261	4552.206782	0.078679217	0.717202032	1.693917226	1.928412143	5.216661913	0.043134473	0.390000112	0.136500039
Kings	2024	LHDT2	Aggregate	5	Diesel	581.5624931	2.141181328	0.081720017	0.085415034	1426.717007	0.017346881	0.224779845	0.373468125	0.425168631	1.194176865	0.013518869	0.091000026	0.031850009
Kings	2024	LHDT2	Aggregate	10	Diesel	1933.960352	1.940761215	0.067590388	0.070646526	1244.204301	0.014483074	0.196024894	0.311812056	0.354977295	0.96306698	0.011789468	0.091000026	0.031850009
Kings	2024	LHDT2	Aggregate	15	Diesel	4188.404086	1.768306837	0.056143678	0.058682246	1060.885002	0.012207656	0.167142864	0.26282364	0.299207241	0.778690999	0.010052425	0.091000026	0.031850009
Kings	2024	LHDT2	Aggregate	20	Diesel	4591.843726	1.61888021	0.046693763	0.048805048	918.6102517	0.010338714	0.144727419	0.222586436	0.253399858	0.627866274	0.008704299	0.091000026	0.031850009
Kings	2024	LHDT2	Aggregate	25	Diesel	4914.497814	1.500457567	0.038853803	0.0406106	798.5637721	0.008773688	0.125814047	0.188892332	0.215041362	0.503361858	0.007566798	0.091000026	0.031850009
			Total			8.969587156	0.291001651	0.304159454	0.304159454	5448.9803323	0.063150013	0.858489071	1.35958259	1.547794387	4.067141076	0.051631858	0.45500013	0.159250046
Kings	2024	MHDT	Aggregate	5	Diesel	154.5995063	9.177102239	0.065709859	0.068680968	2365.547746	0.015208139	0.372693011	0.327427071	0.372750796	0.546289041	0.022400323	0.061495877	0.021523557
Kings	2024	MHDT	Aggregate	10	Diesel	1222.595461	4.107021962	0.04652633	0.046671627	1996.187984	0.008958355	0.31450023	0.192870934	0.219568877	0.443303443	0.018902707	0.061495877	0.021523557
Kings	2024	MHDT	Aggregate	15	Diesel	2007.320372	2.518061957	0.028359934	0.029642244	1570.258554	0.004472873	0.247394875	0.096299927	0.109629909	0.286951112	0.01486941	0.061495877	0.021523557
Kings	2024	MHDT	Aggregate	20	Diesel	2568.648404	1.887155721	0.018169867	0.018991428	1335.840842	0.002183458	0.210462269	0.047009243	0.053516445	0.206414397	0.012649614	0.060630201	0.02122057
Kings	2024	MHDT	Aggregate	25	Diesel	3535.32552	1.587501247	0.014356876	0.01500603	1201.650277	0.001575974	0.189320491	0.033930289	0.038627051	0.165797707	0.01137891	0.049809241	0.017433234
			Total			19.27684313	0.171249169	0.178992297	0.178992297	8469.485403	0.032398799	1.334370874	0.697537264	0.794099078	1.6487557	0.080200962	0.294927074	0.103224476
Running Emissions 5-25 MPH Averaged							NOx_RUNEX	PM2.5_RUNEX	PM10_RUNEX	CO2_RUNEX	CH4_RUNEX	N2O_RUNEX	ROG_RUNEX	TOG_RUNEX	CO_RUNEX	SOx_RUNEX	PM10_PMBW	PM2.5_PMBW
			HHDT			7.8849	0.0337	0.0352	2462.4066	0.0070	0.3880	0.1513	0.1722	0.6079	0.0233	0.1343	0.0470	
			LHDT1			2.3190	0.0749	0.0783	910.4414	0.0157	0.1434	0.3388	0.3857	1.0433	0.0086	0.0780	0.0273	
			LHDT2			1.7939	0.0582	0.0608	1089.7961	0.0126	0.1717	0.2719	0.3096	0.8134	0.0103	0.0910	0.0319	
			MHDT			3.8554	0.0342	0.0358	1693.8971	0.0065	0.2669	0.1395	0.1588	0.0160	0.0590	0.0206		
		HHDT	LHDT1		LHDT2		MHDT											
Localized Miles per Trip	0.50				Miles per Trip	0.50			Miles per Trip	0.50								
Daily Trucks	27.93		Daily Trucks	1.23	Daily Trucks	1.18			Daily Trucks	10.43								
Daily Trips	55.87		Daily Trips	2.45	Daily Trips	2.37			Daily Trips	20.87								
Onsite Truck																		
Max Daily Emissions						ROG	NOx	CO	SO2	PM10	PM2.5							
HHDT - Running (g/day)	4.2255		220.2621		16.9811		0.6514		0.9828		0.9403							
LHDT1 - Running (g/day)	0.4157		2.8452		1.2801		0.1006		0.0919		0.0919							
LHDT2 - Running (g/day)	0.3221		2.1247		0.9634		0.1022		0.0720		0.0689							
MHDT - Running (g/day)	1.4555		40.2224		3.4402		0.1673		0.3735		0.3573							
HHDT - PMBW (g/day)	0.0000		0.0000		0.0000		0.0000		3.7506		1.3127							
LHDT1 - PMBW (g/day)	0.0000		0.0000		0.0000		0.0000		0.0957		0.0335							
LHDT2 - PMBW (g/day)	0.0000		0.0000		0.0000		0.0000		0.1078		0.0377							
MHDT - PMBW (g/day)	0.0000		0.0000		0.0000		0.0000		0.6154		0.2154							
Total Trucks (g/day)	6.4187		265.4545		22.6649		0.8415		6.0938		3.0577							
Running Emissions lbs/day	0.0142		0.5852		0.0500		0.0019		0.0134		0.0067							
Idling Emissions lbs/Day	0.362		4.457		5.362		0.008		0.002		0.002							
Total Emissions/Day	0.377		5.043		5.412		0.0103		0.015		0.009							
g/lb conversion factor							0.00220											

Idling Minutes/Day Per Truck	15
Max Trucks per Day	40.78
Number Idling Trucks per Day	40.78
Max Trucks per Day—HHDT	27.93
Max Trucks per Day—LHDT1	1.23
Max Trucks per Day—LHDT2	1.18
Max Trucks per Day—MHDT	10.43

Idling Emissions	Calendar Year	Season	Vehicle Category	Fuel	Pollutant	g/vehicle/day	g/day	Max lbs/day
IDLEX	2023	Annual	HHDT	DSL	ROG	5.8518	163.4678	0.360385
IDLEX	2023	Annual	LHDT1	DSL	ROG	0.1098	0.1347	0.000297
IDLEX	2023	Annual	LHDT2	DSL	ROG	0.1098	0.1300	0.000287
IDLEX	2023	Annual	MHDT	DSL	ROG	0.0656	0.6846	0.001509
IDLEX	2023	Annual	HHDT	DSL	NOx	70.4062	1,966.7682	4.335983
IDLEX	2023	Annual	LHDT1	DSL	NOx	2.2570	2.7692	0.006105
IDLEX	2023	Annual	LHDT2	DSL	NOx	2.2218	2.6316	0.005802
IDLEX	2023	Annual	MHDT	DSL	NOx	4.7589	49.6484	0.109456
IDLEX	2023	Annual	HHDT	DSL	CO	86.1079	2,405.3868	5.302971
IDLEX	2023	Annual	LHDT1	DSL	CO	0.9097	1.1162	0.002461
IDLEX	2023	Annual	LHDT2	DSL	CO	0.9097	1.0775	0.002375
IDLEX	2023	Annual	MHDT	DSL	CO	2.3434	24.4486	0.053900
IDLEX	2023	Annual	HHDT	DSL	SO2	0.1335	3.7294	0.008222
IDLEX	2023	Annual	LHDT1	DSL	SO2	0.0013	0.0016	0.000003
IDLEX	2023	Annual	LHDT2	DSL	SO2	0.0021	0.0024	0.000005
IDLEX	2023	Annual	MHDT	DSL	SO2	0.0072	0.0749	0.000165
IDLEX	2023	Annual	HHDT	DSL	PM10	0.0285	0.7964	0.001756
IDLEX	2023	Annual	LHDT1	DSL	PM10	0.0277	0.0340	0.000075
IDLEX	2023	Annual	LHDT2	DSL	PM10	0.0278	0.0329	0.000073
IDLEX	2023	Annual	MHDT	DSL	PM10	0.0043	0.0444	0.000098
IDLEX	2023	Annual	HHDT	DSL	PM2.5	0.0273	0.7620	0.001680
IDLEX	2023	Annual	LHDT1	DSL	PM2.5	0.0265	0.0326	0.000072
IDLEX	2023	Annual	LHDT2	DSL	PM2.5	0.0266	0.0315	0.000069
IDLEX	2023	Annual	MHDT	DSL	PM2.5	0.0041	0.0425	0.000094

For Weighted Average for Project (5-25 MPH)

	NOX_RUNEX	PM2.5_RUNEX	PM10_RUNEX	CO2_RUNEX	CH4_RUNEX	N2O_RUNEX	ROG_RUNEX	TOG_RUNEX	CO_RUNEX	SOX_RUNEX	PM10_PMBW	PM2.5_PMBW
Weighted Average Using Project Truck Fleet Percentages												
HHDT	7.884928023	0.033659629	0.035181568	2462.406583	0.007025779	0.38795316	0.1512631	0.172201525	0.607889794	0.023317518	0.134264112	0.046992439
LHDT1	2.318961981	0.074903833	0.078290652	910.4413563	0.015735843	0.143440406	0.338783445	0.385682429	1.043332383	0.008626895	0.078000022	0.027300008
LHDT2	1.793917431	0.05820033	0.060831891	1089.796067	0.012630003	0.171697814	0.271916518	0.309558877	0.813428215	0.010326372	0.091000026	0.031850009
MHDT	3.855368625	0.034249834	0.035798459	1693.897081	0.00647976	0.266874175	0.139507453	0.158818616	0.32975114	0.016040192	0.058985415	0.020644895
HHDT	220.2621044	0.940267391	0.98278211	68786.27863	0.196262149	10.83730621	4.225470254	4.810376236	16.98114237	0.651364925	3.750610768	1.312713769
LHDT1	2.845242618	0.091903007	0.096058453	1117.062966	0.01930704	0.175993725	0.415669211	0.473211761	1.280113164	0.010584739	0.095701866	0.033495653
LHDT2	2.124716587	0.068932496	0.072049318	1290.754936	0.01495898	0.203358966	0.322058042	0.366641669	0.963424732	0.012230559	0.107780471	0.037723165
MHDT	40.22239301	0.357322584	0.373479126	17672.13481	0.067602212	2.784252037	1.455457089	1.656927104	3.440236522	0.167344549	0.615384614	0.215384615
Total	265.4544566	1.458425479	1.524369007	88866.23134	0.298130382	14.00091094	6.418654596	7.30715677	22.66491679	0.841524772	4.569477718	1.599317201
Weighted Average	6.509627475	0.035764352	0.037381457	2179.229042	0.007310925	0.343338423	0.157401955	0.179190318	0.555802178	0.020636356	0.112055371	0.03921938
Max Trucks per Day—HHDT	27.93											
Max Trucks per Day—LHDT1	1.23											
Max Trucks per Day—LHDT2	1.18											
Max Trucks per Day—MHDT	10.43											
Total	40.78											

For Weighted Average for Project (5 MPH)

	NOX_RUNEX	PM2.5_RUNEX	PM10_RUNEX	CO2_RUNEX	CH4_RUNEX	N2O_RUNEX	ROG_RUNEX	TOG_RUNEX	CO_RUNEX	SOX_RUNEX	PM10_PMBW	PM2.5_PMBW
Weighted Average Using Project Truck Fleet Percentages												
HHDT	18.47821155	0.130069907	0.135951091	3448.460154	0.026682207	0.543306302	0.574460591	0.653979654	1.367561069	0.032654856	0.155008927	0.054253125
LHDT1	2.656496117	0.106986493	0.111823947	1208.575476	0.022293935	0.190411558	0.479975288	0.546419955	1.551406198	0.011451867	0.078000022	0.027300008
LHDT2	2.141181328	0.081720017	0.085415034	1426.717007	0.017346881	0.224779845	0.373468125	0.425168631	1.194176865	0.013518869	0.091000026	0.031850009
MHDT	9.177102239	0.065709859	0.068680968	2365.547746	0.015208139	0.372693011	0.327427071	0.372750796	0.546289041	0.022400323	0.061495877	0.021523557
HHDT	516.1809657	3.633447413	3.797735782	96331.26495	0.745356071	15.17703002	16.04731182	18.26864296	38.20223572	0.912199474	4.330108336	1.515537918
LHDT1	3.259378992	0.131266718	0.137202016	1482.857623	0.027353468	0.233624822	0.588904068	0.670428129	1.903492627	0.01405083	0.095701866	0.033495653
LHDT2	2.536016098	0.096789224	0.101165603	1689.804245	0.020545653	0.266229347	0.44233581	0.503569911	1.4143836	0.016011754	0.107780471	0.037723165
MHDT	95.74311794	0.685539581	0.716536639	24679.34986	0.158663884	3.888241621	3.415989909	3.88844482	5.699338928	0.233698685	0.641575836	0.224551543
Total	617.7194787	4.547042936	4.75264004	124183.2767	0.951919076	19.56512581	20.49454161	23.33148549	47.21945087	1.175960743	5.175166508	1.811308278
Weighted Average	15.14807377	0.111505213	0.116546984	3045.294021	0.023343509	0.479787313	0.502578984	0.57214816	1.157942642	0.028837588	0.126908422	0.044417948
Max Trucks per Day—HHDT	27.93											
Max Trucks per Day—LHDT1	1.23											
Max Trucks per Day—LHDT2	1.18											
Max Trucks per Day—MHDT	10.43											
Total	40.78											

For Weighted Average for Project (Idle)

	PM10_IDLEX (g/d)
Weighted Average Using Project Truck Fleet Percentages	
HHDT	0.78643305
LHDT1	0.034662681
LHDT2	0.032674775
MHDT	0.043814123
HHDT	21.96867215
LHDT1	0.04252926
LHDT2	0.038700018
MHDT	0.457105161
Total	22.50700659
Weighted Average	0.551929812

Diesel PM Screening

Prioritization Calculator

Applicability	Use to provide a Prioritization score based on the emission potency method. Entries required in yellow areas, output in grey areas.		
Author (Prioritization Calculator)	Matthew Cegielski	Last Update	October 13, 2016
Date Updated with Project Emissions	May 11, 2023		
Facility:	Lemoore 54 Project (TTM 22-021) Residential Project (Diesel PM Screening Analysis)		
ID#:	—		
Project #:	Truck Run and Idle Emissions		
Unit and Process#	Mobile Source Diesel (Trucks Visiting the Residential + Park Land Uses)		

Operating Hours hr/yr	7,355.85	(operating hours assumed based on idle hours)			
Receptor Proximity and Proximity Factors	Cancer Score	Chronic Score	Acute Score	Max Score	Receptor proximity is in meters. Prioritization scores are calculated by multiplying the total scores summed below by the proximity factors. Record the Max score for your receptor distance. If the substance list for the unit is longer than the number of rows here or if there are multiple processes use additional worksheets and sum the totals of the Max Scores.
0 < R < 100 1.000	4.65E+00	8.21E-03	0.00E+00	4.65E+00	
100 ≤ R < 250 0.250	1.16E+00	2.05E-03	0.00E+00	1.16E+00	
250 ≤ R < 500 0.040	1.86E-01	3.28E-04	0.00E+00	1.86E-01	
500 ≤ R < 1000 0.011	5.12E-02	9.03E-05	0.00E+00	5.12E-02	
1000 ≤ R < 1500 0.003	1.40E-02	2.46E-05	0.00E+00	1.40E-02	
1500 ≤ R < 2000 0.002	9.30E-03	1.64E-05	0.00E+00	9.30E-03	
2000 < R 0.001	4.65E-03	8.21E-06	0.00E+00	4.65E-03	

Enter the unit's CAS# of the substances emitted and their amounts. Prioritization score for each substance generated below. Totals on last row.

Substance	CAS#	Annual Emissions (lbs/yr)	Maximum Hourly (lbs/hr)	Average Hourly (lbs/hr)	Cancer	Chronic	Acute
Diesel engine exhaust, particulate matter (Diesel PM)	9901	2.01E+00	1.74E-03	2.74E-04	4.65E+00	8.21E-03	0.00E+00
				0.00E+00	0.00E+00	0.00E+00	0.00E+00
				0.00E+00	0.00E+00	0.00E+00	0.00E+00
				0.00E+00	0.00E+00	0.00E+00	0.00E+00
				0.00E+00	0.00E+00	0.00E+00	0.00E+00
				0.00E+00	0.00E+00	0.00E+00	0.00E+00
				0.00E+00	0.00E+00	0.00E+00	0.00E+00
				0.00E+00	0.00E+00	0.00E+00	0.00E+00
				0.00E+00	0.00E+00	0.00E+00	0.00E+00
				0.00E+00	0.00E+00	0.00E+00	0.00E+00
				0.00E+00	0.00E+00	0.00E+00	0.00E+00
				0.00E+00	0.00E+00	0.00E+00	0.00E+00
				0.00E+00	0.00E+00	0.00E+00	0.00E+00
				0.00E+00	0.00E+00	0.00E+00	0.00E+00
				0.00E+00	0.00E+00	0.00E+00	0.00E+00
				0.00E+00	0.00E+00	0.00E+00	0.00E+00
				0.00E+00	0.00E+00	0.00E+00	0.00E+00
				0.00E+00	0.00E+00	0.00E+00	0.00E+00
				0.00E+00	0.00E+00	0.00E+00	0.00E+00
Totals					4.65E+00	8.21E-03	0.00E+00

Attachment A

Additional Modeling Assumptions and Other Supporting Information

Lemoore 54 Project (TTM 22-021) Construction Assumptions

Construction Phase Phase Name	Start Date	End Date	Num Days	
			Week	Num Days
Site Preparation	8/1/2023	9/25/2023	5	40
Grading	9/26/2023	2/26/2024	5	110
Paving	2/27/2024	6/10/2024	5	75
Building Construction	6/11/2024	6/18/2029	5	1,310
Architectural Coating	6/5/2029	12/31/2029	5	150

Notes: No demolition

Adjusted schedule to match applicant-provided construction start date and construction duration

OffRoad Equipment

Phase Name	Offroad Equipment Type	Amount	Usage Hours	Horse Power	Load Factor
Site Preparation	Rubber Tired Dozers	3	8	247	0.40
Site Preparation	Tractors/Loaders/Backhoes	4	8	97	0.37
Grading	Excavators	2	8	158	0.38
Grading	Graders	1	8	187	0.41
Grading	Rubber Tired Dozers	1	8	247	0.40
Grading	Scrapers	2	8	367	0.48
Grading	Tractors/Loaders/Backhoes	2	8	97	0.37
Paving	Pavers	2	8	130	0.42
Paving	Paving Equipment	2	8	132	0.36
Paving	Rollers	2	8	80	0.38
Building Construction	Cranes	1	5.9	231	0.29
Building Construction	Forklifts	3	6.8	89	0.20
Building Construction	Generator Sets	1	6.8	84	0.74
Building Construction	Tractors/Loaders/Backhoes	3	5.9	97	0.37
Building Construction	Welders	1	6.8	46	0.45
Architectural Coating	Air Compressors	1	6	78	0.48

Construction Trips and VMT

Phase Name	Worker Trip	Vendor Trip	Hauling Trip	Worker Trip	Vendor Trip	Hauling Trip
	Number	Number	Number	Length	Length	Length
Site Preparation	18	0	14	10.8	7.3	20
Grading	20	0	17,814	10.8	7.3	20
Paving	15	0	12	10.8	7.3	20
Building Construction	159	53	18	10.8	7.3	20
Architectural Coating	32	0	2	10.8	7.3	20

Notes:

Cubic yards of cut to be exported: 90,000 cubic yards

Cubic yards of fill to be imported: 90,000 cubic yards

Additional truck trips were added to each phase for mobilization/demobilization.

Calculations for Adjustments to Conserve Default HP Hours—Lemoore 54 Project (TTM 22-021)

	Duration	
	CalEEMod Defaults	Revisions to Match Schedule
Building Construction	1,110	1,310

CalEEMod Defaults						Revisions						Cross-Check	
Building Construction						Building Construction							
Equipment	Amount	Usage Hours	Horsepower	Load Factor	HP Hours	Equipment	Amount	Usage Hours	Horsepower	Load Factor	HP Hours	Goal HP Hours	Difference
Cranes	1	7.0	231	0.29	520,512	Cranes	1	5.9	231	0.29	520,512	520,512	-
Forklifts	3	8.0	89	0.20	474,192	Forklifts	3	6.8	89	0.20	474,192	474,192	-
Generator Sets	1	8.0	84	0.74	551,981	Generator Sets	1	6.8	84	0.74	551,981	551,981	-
Tractors/Loaders/Backhoes	3	7.0	97	0.37	836,596	Tractors/Loaders/Backhoes	3	5.9	97	0.37	836,596	836,596	-
Welders	1	8.0	46	0.45	183,816	Welders	1	6.8	46	0.45	183,816	183,816	-
				Total	2,567,097					Total	2,567,097	2,567,097	-

Adjusted construction equipment usage to match CalEEMod default total building construction HP hours.

Project Vicinity Map

Legend

- Project Site



Google Earth

Site Plan Overlaid at the Project Site

Legend

Project Site



SITE INFORMATION

GENERAL PLAN LAND USE DESIGNATION: RESIDENTIAL
EXISTING USE: AGRICULTURAL/RESIDENTIAL
 LOW DENSITY SINGLE FAMILY RESIDENTIAL
PROPOSED USE: LOW DENSITY SINGLE FAMILY RESIDENTIAL
EXISTING ZONING: PARKS AND RECREATION/PREPARING BASKET (PR)
 LOW DENSITY RESIDENTIAL (MLO)
PROPOSED ZONING: PARKS AND RECREATION/PREPARING BASKET (PR)
 LOW DENSITY RESIDENTIAL (MLO)
FORM FLOOD MAP ZONE: X PER FLOOD MAP 0603101670
SITE AREA: 1.5241 ACRES
NUMBER OF LOTS: 280
AVERAGE LOT AREA: 5,434.1 SQ. FT.
DENSITY: 16.025 UNITS PER ACRE
ASSESSOR'S PARCEL NUMBER: 033-040-008
SITE LOCATION: NORTH OF STATE ROUTE 198 AND EAST OF SOUTH LEMOORE AVENUE
MAP ADDRESS: 408 EAST BUSH STREET, LEMOORE, CA 93248
APPLICANT: MOP DEVELOPERS, LLC
 2505 ALLUVIAL AVENUE
 CLACK, CA 95021
 (559)432-8181
OWNER(S): WATHEN CASTAVOS; PETERSON CASTAVO, LP
 2505 ALLUVIAL AVENUE
 CLACK, CA 95021
 (559)432-8181
 JFA INVESTMENTS, LLC
 2505 ALLUVIAL AVENUE
 CLACK, CA 95021
 (559)432-8181

GENERAL NOTES

- RESIDES THE WELL ALREADY OWNED AND OPERATED BY THE CITY OF LEMOORE AND THE EXISTING SUELD TO BE DEMOLISHED, THERE ARE NO EXISTING STRUCTURES HERE.
- ALL BUILDING SETBACKS SHALL BE IN ACCORDANCE WITH CITY OF LEMOORE ZONING CODES.
 SETBACKS ARE INDICATED AS FOLLOWS:
 EXISTING SIDE SETBACKS:
 10' TO CORNER FRONT FRONTAGE
 10' TO LIVING SIDE
 5' TO WALKWAY SIDE
 5' MIN. TO INTERIOR SIDE
 5' MIN. TO STREET SIDE
 5' TO WALKWAY SIDE
 5' TO STREET SIDE
 5' TO WALKWAY SIDE
- ALL UTILITY SERVICES ARE PROPOSED TO BE PROVIDED BY THE FOLLOWING AGENCIES:
 SANITARY SEWER: CITY OF LEMOORE
 STORM DRAINAGE: CITY OF LEMOORE
 DOMESTIC WATER: CITY OF LEMOORE
 FIRE PROTECTION: CITY OF LEMOORE
 ELECTRICITY: PGE
 GAS: AEGE
 TELEPHONE: AEGE
 CABLE: COMCAST
 WASTE DISPOSAL: CITY OF LEMOORE
- TRACT MAP PERMITS FOR BUILDINGS WITH SOUTHERN EXPOSURE FOR NATURAL HEATING DURING THE WINTER MONTHS WITH MINIMUM SPACE FOR RECREATIONAL SHADE TREES FOR NATURAL COOLING DURING THE SUMMER MONTHS.
- PROPOSED STREET IMPROVEMENTS SHALL BE INSTALLED IN CONFORMANCE WITH CITY OF LEMOORE STANDARDS.
- ALL PUBLIC UTILITIES (GAS, TELEPHONE, CABLE, WATER AND SEWER) SHALL BE INSTALLED.
- ALL IMPROVEMENTS PROPOSED (SEWER, WATER, STORM DRAIN, GASE, CABLE, TELEPHONE, SIGNALING, AND FURNISHMENT) PRESENTED SHALL BE CONSIDERED BY CITY ENGINEERS.

OUTLOT/PARK

NUMBER OF OUTLOTS = 6
 TOTAL PARCEL AREA = 141,267 SF
 OUTLOT A: LANDSCAPED ENTRY = 7,155 SF
 OUTLOT B: TRAIL = 6,625 SF
 OUTLOT C: PARK = 43,085 SF
 OUTLOT D: TRAIL = 21,489 SF
 OUTLOT E: DOD PARK = 20,273 SF
 OUTLOT F: WALKWAY = 114,625 SF
 REMAINDER: 61.30 ACRES

LEGEND

- TENTATIVE TRACT BOUNDARY
- EXISTING RIGHT OF WAY
- EXISTING SECTION LINE
- PROPOSED PROPERTY LINE
- PROPOSED CENTERLINE
- REINFORCEMENT OF EXISTING VEHICULAR ACCESS
- PROPOSED FIRE MANDATE
- PROPOSED STREET LIGHT
- PROPOSED WATER PIPE
- PROPOSED SEWER PIPE
- PROPOSED STORM DRAIN PIPE

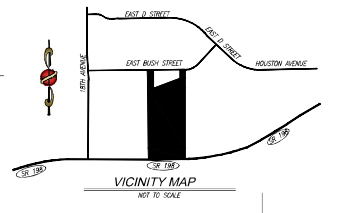

TENTATIVE TRACT MAP NO. 939

IN THE CITY OF LEMOORE, KINGS COUNTY, STATE OF CALIFORNIA
 SURVEYED ON JANUARY 21ST, 2022
 BY PRECISION CIVIL ENGINEERING, INC.

LEGAL DESCRIPTION

THE LAND REFERRED TO IS SITUATED IN THE COUNTY OF KINGS, CITY OF LEMOORE, STATE OF CALIFORNIA, AND IS DESCRIBED AS FOLLOWS:

THE NORTHWEST QUARTER OF SECTION 11, TOWNSHIP 19 SOUTH, RANGE 20 EAST, MOUNT Diablo BASE AND MERIDIAN, ACCORDING TO U.S.C. GOVERNMENT TOWNSHIP PLAT.

EXCEPTING THE NORTH 2102.97 FEET OF THE WEST 1/4th FEET THEREOF.

AND ALSO EXCEPTING THAT PORTION OF THE NORTHWEST QUARTER OF SECTION 11, TOWNSHIP 19 SOUTH, RANGE 20 EAST, MOUNT Diablo BASE AND MERIDIAN, DESCRIBED AS FOLLOWS:

BEGINNING AT THE WEST QUARTER CORNER OF SAID SECTION SAID WEST QUARTER CORNER BEING AT COORDINATES Y=346250.841 FEET, AND X=1,778,509.9 FEET;

THENCE (1) ALONG THE WEST LINE OF SAID SECTION, NORTH 0° 30' 48" EAST, 143.29 FEET, TO THE SOUTH LINE OF THE LAND DESCRIBED IN THE DEED TO LEMOORE UNION HIGH SCHOOL DISTRICT, RECORDED IN BOOK 684 PAGE 348, KINGS COUNTY OFFICIAL RECORDS;

THENCE (2) ALONG SAID SOUTH LINE, SOUTH BY 2° 11' 15" EAST, 548.13 FEET;

THENCE (3) AT RIGHT ANGLES SOUTH 0° 00' 00" WEST, 166.83 FEET;

THENCE (4) NORTH 78° 40' 37" WEST, 95.18 FEET;

THENCE (5) NORTH 61° 30' 20" WEST, 46.57 FEET;

THENCE (6) NORTH 52° 08' 40" EAST, 61.22 FEET;

THENCE (7) AT RIGHT ANGLES, NORTH 37° 51' 14" WEST, 50.00 FEET;

THENCE (8) NORTH 47° 30' 20" EAST, 124.18 FEET;

THENCE (9) SOUTH 78° 40' 37" WEST, 166.83 FEET;

THENCE (10) SOUTH 84° 50' 20" EAST, 594.81 FEET, TO A POINT 71 FEET LEFT OF ENGINEERS STATION 630+58.21 IN THE CENTERLINE OF THE CENTERLINE OF FURLOO WORKS SURVEY FROM LEMOORE AN STATION TO POINT 135, ROAD 60+100-10+6;

THENCE (11) SOUTH 84° 50' 20" EAST, 594.81 FEET, TO A POINT 71 FEET LEFT OF ENGINEERS STATION 630+58.21 IN THE CENTERLINE OF THE CENTERLINE OF FURLOO WORKS SURVEY FROM LEMOORE AN STATION TO POINT 135, ROAD 60+100-10+6;

THENCE (12) ALONG A LINE PARALLEL WITH AND 71 FEET NORTH, MEASURED AT RIGHT ANGLES, FROM SAID CENTERLINE, SOUTH BY 21° 14' EAST, 1418.95 FEET;

THENCE (13) EASTWARD ALONG A TANGENT CURVE COMMENCING NORTHERLY WITH A RADIUS OF 4079 FEET, THROUGH AN ANGLE OF 1° 42' 48" AN ARC DISTANCE OF 147.28 FEET TO THE EAST LINE OF THE NORTHWEST QUARTER OF SAID SECTION;

THENCE (14) ALONG SAID EAST LINE SOUTH 0° 30' 48" EAST, 2832.21 FEET TO THE SOUTH LINE OF THE NORTHWEST QUARTER OF SAID SECTION;

THENCE (15) ALONG SAID SOUTH LINE NORTH BY 21° 14' WEST, 2832.21 FEET TO THE POINT OF BEGINNING.

AND ALSO EXCEPTING THAT PORTION OF THE NORTHWEST QUARTER OF SECTION 11, TOWNSHIP 19 SOUTH, RANGE 20 EAST, MOUNT Diablo BASE AND MERIDIAN, DESCRIBED AS FOLLOWS:

COMMENCING FOR REFERENCE AT THE SOUTHWEST CORNER OF THE NORTHWEST QUARTER OF SAID SECTION, SAID SOUTHWEST CORNER BEING AT COORDINATES Y=346250.841 FEET AND X=1,778,509.9 FEET;

THENCE (1) ALONG THE WEST LINE OF SAID SECTION, NORTH 0° 30' 48" EAST, 143.29 FEET, TO THE SOUTH LINE OF THE LAND DESCRIBED IN THE DEED TO LEMOORE UNION HIGH SCHOOL DISTRICT, RECORDED IN BOOK 684 PAGE 348, KINGS COUNTY OFFICIAL RECORDS;

THENCE (2) ALONG SAID SOUTH LINE, SOUTH BY 2° 11' 15" EAST, 126.13 FEET;

THENCE (3) SOUTH 47° 30' 20" EAST, 70.13 FEET;

THENCE (4) SOUTH 47° 30' 20" EAST, 143.29 FEET, TO THE TRUE POINT OF BEGINNING;

THENCE (5) CONTINUING ALONG SAID LINE, SOUTH BY 2° 11' 15" EAST, 126.13 FEET;

THENCE (6) SOUTH 78° 40' 37" WEST, 166.83 FEET;

THENCE (7) SOUTH 84° 50' 20" EAST, 450.00 FEET TO THE WEST LINE OF THE EXISTING DITCH RIGHT OF WAY;

THENCE (8) ALONG SAID WEST LINE NORTH 20° 22' 22" EAST, 41.18 FEET;

THENCE (9) NORTH 84° 50' 20" WEST, 458.41 FEET;

THENCE (10) NORTH 84° 50' 20" WEST, 16.44 FEET;

THENCE (11) NORTH 61° 30' 20" WEST, 46.57 FEET;

THENCE (12) NORTH 52° 08' 40" EAST, 61.22 FEET;

THENCE (13) NORTH 37° 51' 14" WEST, 50.00 FEET;

THENCE (14) SOUTH 52° 08' 40" EAST, 71.83 FEET, TO TRUE POINT OF BEGINNING.

AND ALSO EXCEPTING THEREFROM THE FOLLOWING:

COMMENCING AT THE NORTH QUARTER CORNER OF SAID NORTHWEST QUARTER, THENCE NORTH BY 26° 41' WEST, TO THE POINT OF BEGINNING, THENCE CONTINUING ALONG SAID NORTH LINE NORTH BY 26° 41' WEST, A DISTANCE OF 306.19 FEET, THENCE SOUTH BY 37° 51' WEST, PARALLEL WITH THE EAST LINE OF SAID NORTHWEST QUARTER A DISTANCE OF 269.19 FEET, THENCE NORTH BY 37° 51' EAST, A DISTANCE OF 153.00 FEET, MORE OR LESS, TO A POINT WHICH BEARS SOUTH 01° 30' 00" WEST PARALLEL WITH THE EAST LINE OF SAID NORTHWEST QUARTER, A DISTANCE OF 143 FEET TO THE TRUE POINT OF BEGINNING.

AND ALSO EXCEPTING THEREFROM THAT PORTION OF THE NORTHWEST QUARTER OF SECTION 11, TOWNSHIP 19 SOUTH, RANGE 20 EAST, MOUNT Diablo BASE AND MERIDIAN, IN THE COUNTY OF KINGS, STATE OF CALIFORNIA, ACCORDING TO GOVERNMENT TOWNSHIP PLAT APPROVED OCTOBER 28, 1984, DESCRIBED AS FOLLOWS:

COMMENCING AT THE NORTH QUARTER CORNER OF SAID SECTION 11, THENCE NORTH BY 26° 41' WEST ALONG THE NORTH LINE OF SAID SECTION 11, 365.19 FEET, THENCE SOUTH BY 37° 51' WEST, 269.19 FEET, TO A POINT ON THE SOUTH RIGHT OF WAY LINE OF SAID SOUTH STREET BEING THE TRUE POINT OF BEGINNING OF THIS DESCRIPTION, SAID POINT ALSO BEING IN THE WEST LINE OF THE PROPERTY DESCRIBED IN THE DEED DATED MAY 3, 1984, FROM THOMAS J. POTOSI AND MARY J. POTOSI, HUSBAND AND WIFE, TO CENTRAL MARIQUON CONSULTING ASSOCIATION OF SAID 2810 ANGELES, A RELIGIOUS CORPORATION, ACCORDING MAP NO. 1284, IN BOOK 684 AT PAGE 488 OF OFFICIAL RECORDS, AS DOCUMENT NO. 7358, THENCE CONTINUING SOUTH BY 37° 51' WEST, 348.39 FEET, THENCE NORTH BY 84° 51' WEST PARALLEL WITH THE SAID NORTH LINE OF SAID SECTION 11, 200.00 FEET, THENCE NORTH BY 37° 51' WEST, 348.39 FEET, MORE OR LESS, TO A POINT ON THE SOUTH RIGHT OF WAY LINE OF SAID SOUTH STREET, THENCE SOUTH BY 26° 41' EAST ALONG THE SAID SOUTH RIGHT OF WAY LINE 250.00 FEET, MORE OR LESS, TO THE POINT OF BEGINNING.

AND ALSO EXCEPTING THEREFROM THAT PORTION OF THE NORTHWEST QUARTER OF SECTION 11, TOWNSHIP 19 SOUTH, RANGE 20 EAST, MOUNT Diablo BASE AND MERIDIAN, IN THE COUNTY OF KINGS, STATE OF CALIFORNIA, DESCRIBED AS FOLLOWS: 1/4 ON THAT CERTAIN PARCEL, MAP FILED MARCH 31, 1936 IN BOOK 4 PAGE 47 OF PARCEL MAP NO. KINGS COUNTY RECORDS.

AND ALSO EXCEPTING THEREFROM THAT PORTION GRANTED TO THE CITY OF LEMOORE, A MUNICIPAL CORPORATION, BY THAT CERTAIN CHARTER FILED RECORDED JUNE 16, 1999 AS DOCUMENT NO. 189251, KINGS COUNTY RECORDS, DESCRIBED AS FOLLOWS:

THAT PORTION OF THE NORTHWEST QUARTER OF SECTION 11, TOWNSHIP 19 SOUTH, RANGE 20 EAST, MOUNT Diablo BASE AND MERIDIAN, IN THE COUNTY OF KINGS, STATE OF CALIFORNIA, MORE PARTICULARLY DESCRIBED AS FOLLOWS:

COMMENCING FOR REFERENCE AT THE SOUTHWEST CORNER OF SAID NORTHWEST QUARTER;

THENCE, NORTH BY 0° DEGREES 30' 48" EAST, ALONG THE WEST LINE OF SAID NORTHWEST QUARTER, 548.13 FEET, TO THE SOUTHWEST CORNER OF THAT CERTAIN PARCEL OF LAND GRANTED TO THE LEMOORE UNION HIGH SCHOOL DISTRICT, PER DEED RECORDED IN VOLUME 870 PAGE 348, KINGS COUNTY RECORDS, WHICH POINT IS STRAIGHT ALONG NORTH, MEASURED AT RIGHT ANGLES FROM THE NORTHERLY RIGHT OF WAY LINE OF STATE HIGHWAY 99, ACCORDING TO STATE HIGHWAY DOCUMENT MAP, SHEET # 6 OF 21, DATED NOVEMBER 3, 1965;

THENCE, SOUTH 89 DEGREES 22' 15" EAST, ALONG THE SOUTH LINE OF SAID LEMOORE HIGH SCHOOL, 548.13 FEET, TO THE TRUE POINT OF BEGINNING OF THE PARCEL TO BE DESCRIBED;

THENCE, AT RIGHT ANGLES, SOUTH 0° DEGREES 30' 48" WEST, 166.83 FEET, TO A POINT ON THE NORTHERLY LINE OF A 40 FOOT EASEMENT FOR CANAL, PARCELS GRANTED TO THE LEMOORE SHAL AND WROUGHT COMPANY, PER DEED RECORDED IN VOLUME 870 PAGE 348, KINGS COUNTY RECORDS, WHICH POINT IS STRAIGHT ALONG NORTH, MEASURED AT RIGHT ANGLES FROM THE NORTHERLY RIGHT OF WAY LINE OF STATE HIGHWAY 99, ACCORDING TO STATE HIGHWAY DOCUMENT MAP, SHEET # 6 OF 21, DATED NOVEMBER 3, 1965;

THENCE, NORTH 19 DEGREES 33' 00" EAST, ALONG SAID CENTERLINE, 1066 FEET, TO AN ANGLE POINT ON SAID CENTERLINE;

THENCE, CONTINUING ALONG SAID CENTERLINE, NORTH 15 DEGREES 01' 45" EAST, 117.72 FEET, TO A POINT ON SAID SOUTH LINE OF THE LEMOORE HIGH SCHOOL;

THENCE, NORTH 89 DEGREES 22' 15" WEST, ALONG SAID SOUTH LINE, 596.35 FEET, MORE OR LESS, TO THE TRUE POINT OF BEGINNING.

APN 033-040-008-000

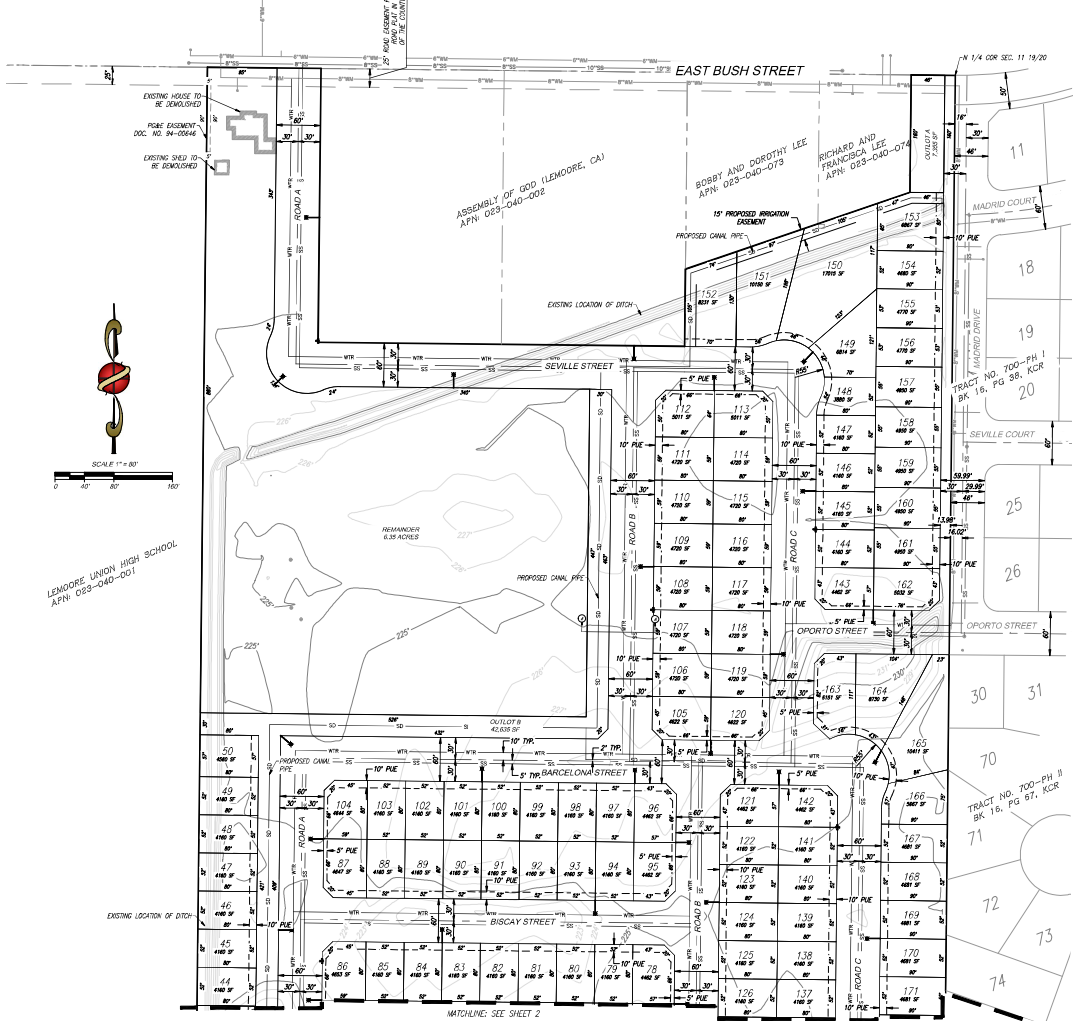

PLANNING & SURVEYING CIVIL ENGINEERING
 1514 O STREET, PLEASANTON, CALIFORNIA 94571
 TEL: 510-466-8889 FAX: 510-466-9415
 WWW.PRECISIONCIVIL.COM

PRECISION CIVIL ENGINEERING, INC.

PROJECT TITLE: TRACT 639
 SHEET DESCRIPTION: TENTATIVE MAP
 COUNTY OF: KINGS

PREPARED FOR: WATHEN CASTAVOS HOMES
 2505 ALLUVIAL AVE
 CLACK, CA 95021
 (559)432-8181

REVISIONS:

DRAWN BY: JAUG
 CHECKED BY: DY
 DATE: 08-24-2022

SHEET NUMBER: 1 OF 2
 JOB NUMBER: 22-021

REGISTERED PROFESSIONAL ENGINEER
 CIVIL ENGINEERING
 No. 5188
 State of California

LEGEND

- PROPOSED TRACT BOUNDARY
- - - - - EXISTING RIGHT OF WAY
- - - - - EXISTING SECTION LINE
- - - - - PROPOSED PROPERTY LINE
- - - - - PROPOSED CENTERLINE
- ▬▬▬▬▬▬▬ REINFORCEMENT OF STREET VEHICULAR ACCESS
- ◆ PROPOSED FIRE HYDRANT
- PROPOSED STREET LIGHT
- PROPOSED WATER PIPE
- PROPOSED SEWER PIPE
- PROPOSED STORM DRAIN PIPE

TENTATIVE TRACT MAP NO. 939

IN THE CITY OF LEMOORE, KINGS COUNTY, STATE OF CALIFORNIA
 SURVEYED ON JANUARY 21ST, 2022
 BY PRECISION CIVIL ENGINEERING, INC.

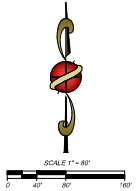

PLANNING & SURVEYING CIVIL ENGINEERING
 1314 O STREET, FRESNO, CALIFORNIA 93721
 TEL: 559-469-8888 FAX: 559-469-8415
 WWW.PRECISIONCIVIL.COM



TRACT 839
 TENTATIVE MAP
 COUNTY OF KINGS

PROJECT TITLE:
 SHEET DESCRIPTION:
 CITY OF LEMOORE

PREPARED FOR:
 WATHEN CASTANOS HOMES
 2908 ALLUVIAL AVE
 CLONING, CA 98911
 (509)426-9181

REVISIONS

DRAWN BY: JAG
 CHECKED BY: DY
 DATE: 08-24-2022

SHEET NUMBER:
 2 OF 2
 JOB NUMBER:
 22-021

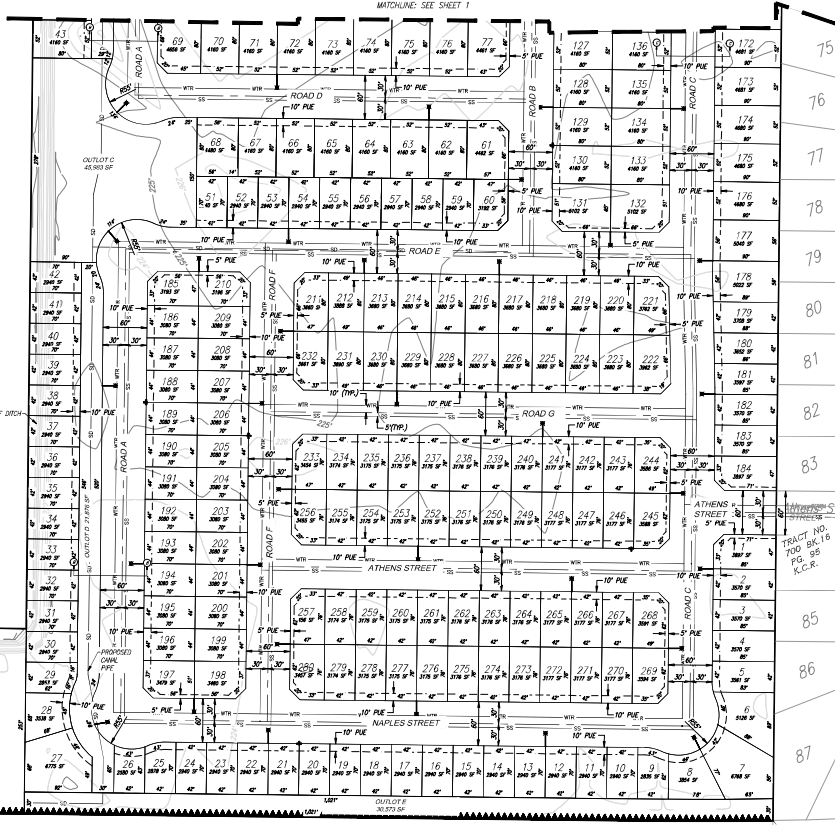
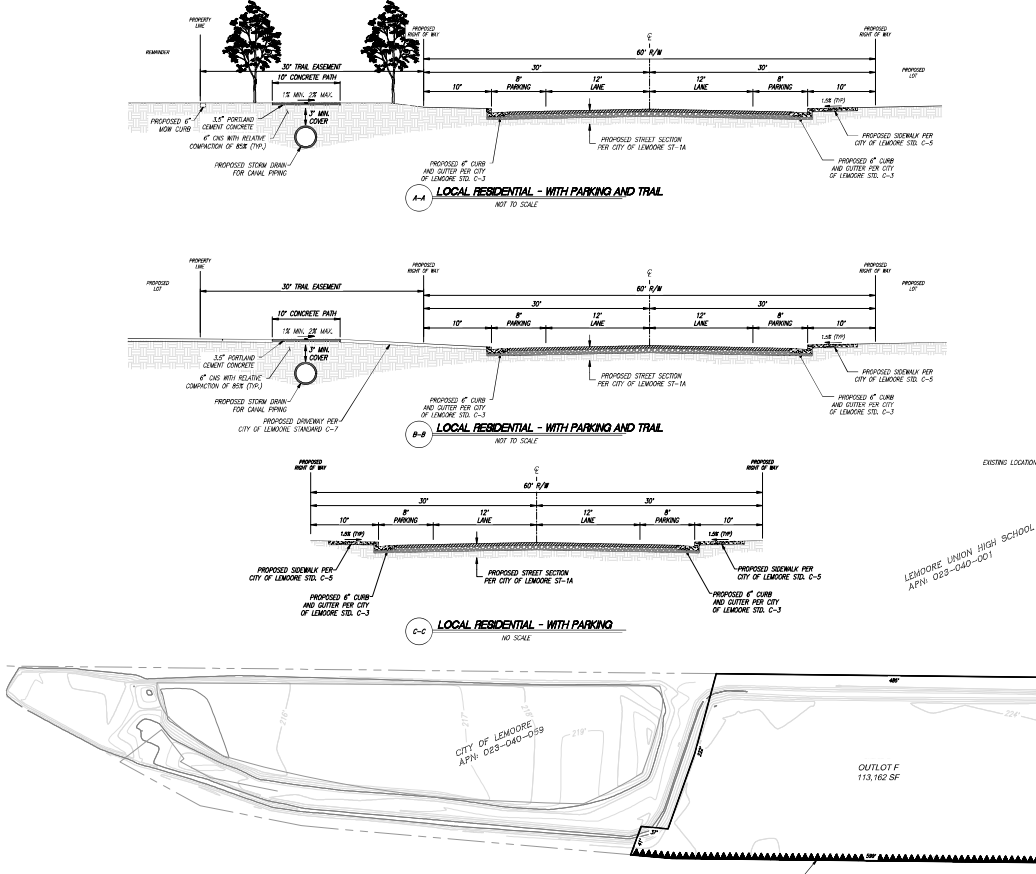

SCALE: 3/4" = 100' (VERTICALS) 2022-21-001 (HORIZONTALS) 2022-21-001 (PLAN) 08/24/2022 11:38:56 AM

GRANT DEED GRANTED TO THE STATE OF CALIFORNIA FOR THE RELEASE AND REINFORCEMENT OF INTERESTS ON ACCESS RIGHTS TO AND FROM FREIGHTY, UPON WHICH FREIGHTY RIGHTS, RECORDED ON MARCH 5, 1946 IN BOOK 852 OF OFFICIAL RECORDS, PAGE 536 UNDER RECORDER'S SERIAL NUMBER 3489

STATE HIGHWAY 198

CENTER 1/4 COR. SEC. 11 T. 18 N. R. 20 E.

ATTACHMENT B

Construction Health Risk Assessment

Health Risk Assessment

General Parameters

PROJECT TITLE:

Air Dispersion Trend from On-site Construction—Unit Emissions

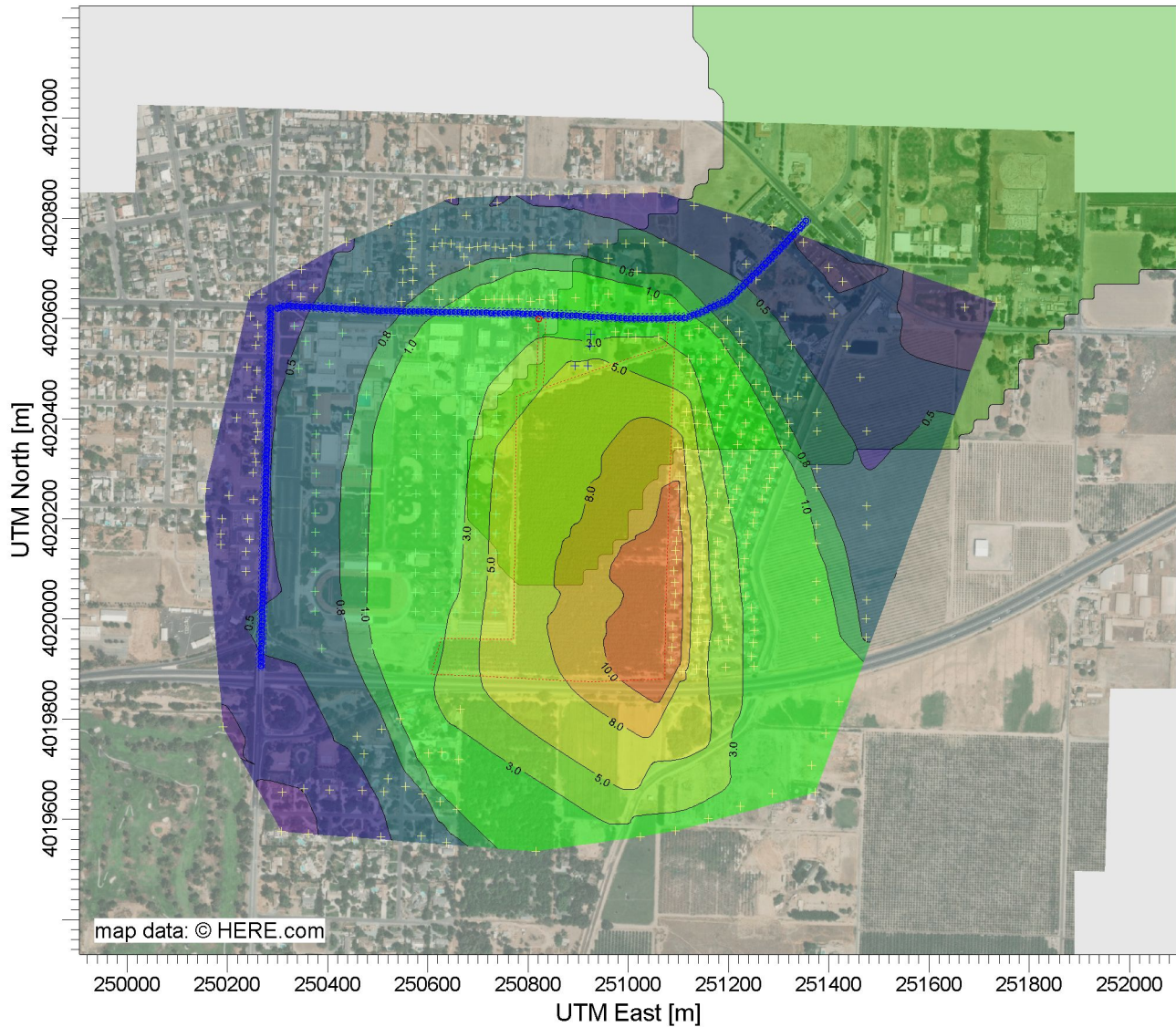

PLOT FILE OF ANNUAL VALUES AVERAGED ACROSS 5 YEARS FOR SOURCE GROUP: SITE

ug/m³

Max: 12.4 [ug/m³] at (251084.62, 4019917.97)

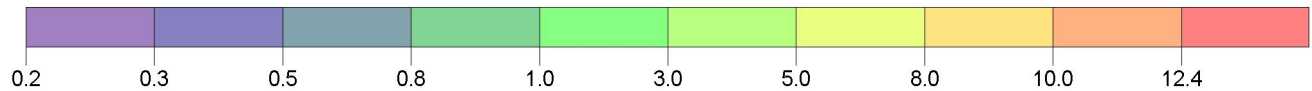

COMMENTS:	SOURCES:		
	3		
	RECEPTORS:		
	414		
OUTPUT TYPE:	SCALE:	1:13,777	
Concentration	0 0.5 km		
MAX:	DATE:	PROJECT NO.:	
12.4 ug/m³	10/29/2022		

WIND ROSE PLOT:

Wind Rose - Station #23110 – Blowing From

DISPLAY:

**Wind Speed
Direction (blowing from)**

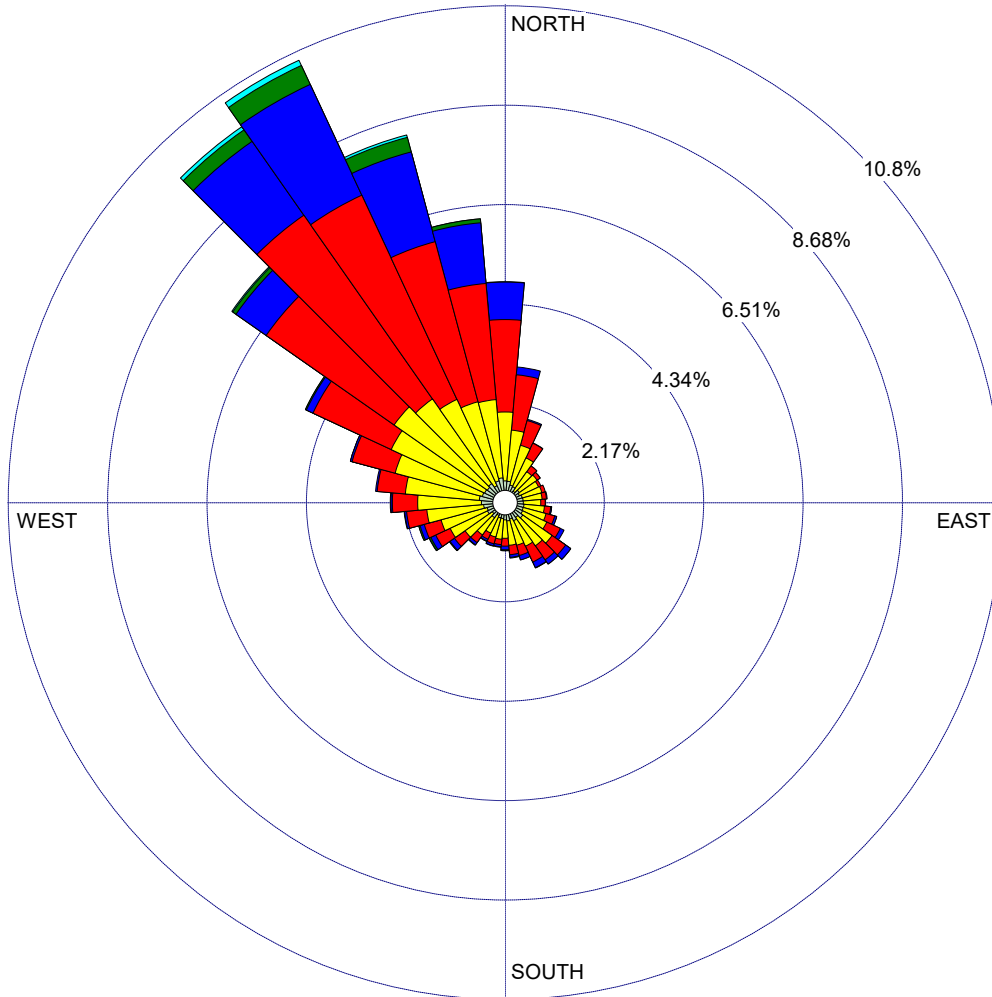

**WIND SPEED
(m/s)**

- >= 11.10
 - 8.80 - 11.10
 - 5.70 - 8.80
 - 3.60 - 5.70
 - 2.10 - 3.60
 - 0.50 - 2.10
- Calms: 2.34%

COMMENTS:

DATA PERIOD:

**Start Date: 1/1/2012 - 00:00
End Date: 12/31/2016 - 23:59**

CALM WINDS:

2.34%

AVG. WIND SPEED:

3.72 m/s

TOTAL COUNT:

43257 hrs.

DATE:

10/29/2022

PROJECT NO.:

WIND ROSE PLOT:

Wind Rose - Station #23110 - Blowing To

DISPLAY:

**Wind Speed
Flow Vector (blowing to)**

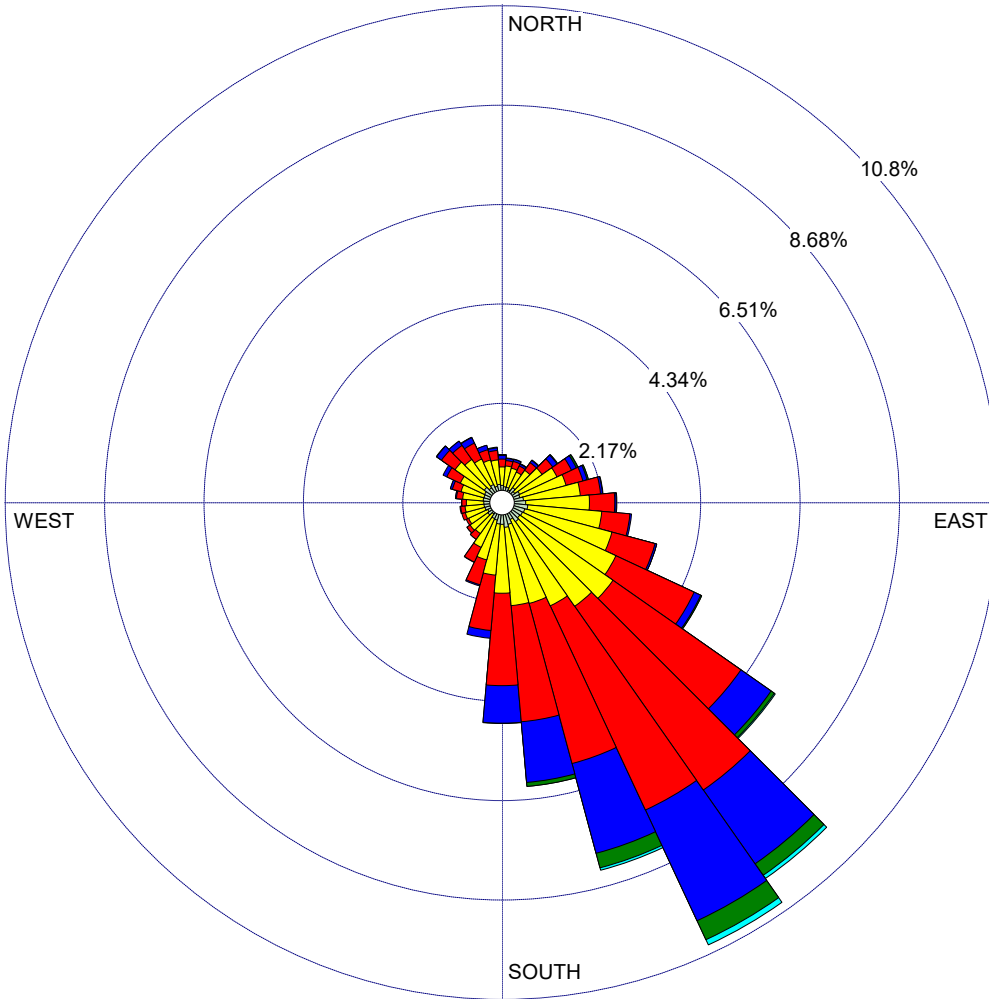

WIND SPEED
(m/s)

- >= 11.10
- 8.80 - 11.10
- 5.70 - 8.80
- 3.60 - 5.70
- 2.10 - 3.60
- 0.50 - 2.10

Calms: 2.34%

COMMENTS:

DATA PERIOD:

**Start Date: 1/1/2012 - 00:00
End Date: 12/31/2016 - 23:59**

CALM WINDS:

2.34%

AVG. WIND SPEED:

3.72 m/s

TOTAL COUNT:

43257 hrs.

DATE:

10/29/2022

PROJECT NO.:

Wind Class Frequency Distribution

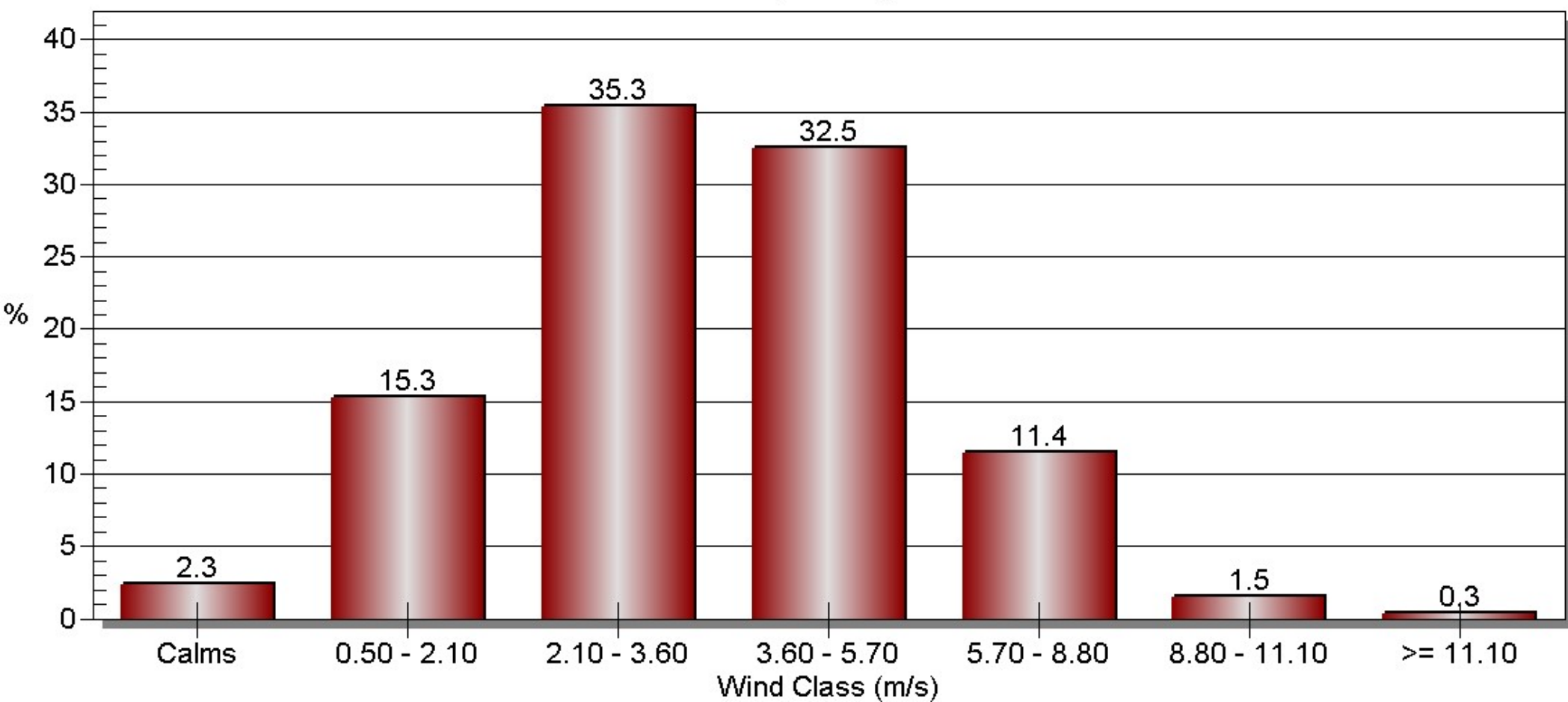

Maximally Exposed Receptor

Exposure from Construction of the Proposed Project

Legend

-  Maximally Exposed Receptor
-  Project Site



Google Earth

Maximally Exposed Receptor (Zoomed In)

Exposure from Construction of the Proposed Project

Legend

-  Maximally Exposed Receptor
-  Project Site



Maximally Exposed Receptor

198

198

198

198

198

Google Earth



600 ft

Health Risk Assessment

Unmitigated Construction

Lemoore 54 Project (TTM 22-021) — Unmitigated Construction

Estimation of Annual Onsite Construction Emissions

Start of Construction	8/1/2023	
End of Construction	12/31/2029	Total
Number of Days	2,344	2344
Number of Hours	56,256	56,256

Size of the construction area source: 203,365.9 sq-meters

Year	On-site Construction Activity	Unmitigated On-site DPM (tons)
2023	On-site Site Preparation	0.02530
2023	On-site Grading	0.04910
2024	On-site Grading	0.02740
2024	On-site Paving	0.01760
2024	On-site Building Construction	0.03790
2025	On-site Building Construction	0.05830
2026	On-site Building Construction	0.05830
2027	On-site Building Construction	0.05830
2028	On-site Building Construction	0.05810
2029	On-site Building Construction	0.02700
2029	On-site Architectural Coating	0.00386

Total Unmitigated DPM (On-site) 4.212E-01 tons

Factor in AERMOD to Account for 5 days per week/8 hours per day: 4.2

Average Emission for AREA1
 3.824E+05 grams
 1.888E-03 grams/sec
 9.285E-09 grams/m2-sec

Tons/Construction Period	4.212E-01
Pounds/Construction Period	8.423E+02
Pounds/Day	3.594E-01
Pounds/Hour	1.497E-02
Pounds/Year	1.312E+02
Years	6.421917808

Lemoore 54 Project (TTM 22-021) — Unmitigated Construction

Estimation of Annual Offsite Construction DPM Emissions (Unmitigated)

Start of Construction	8/1/2023	
End of Construction	12/31/2029	Total
Number of Days	2,344	2344
Number of Hours	56,256	56,256

	2023	2023	2024	2024	2024	
	Site				Building	
Construction Trip Type	Preparation	Grading	Grading	Paving	Construction	
Haul Truck	0.00001	0.00673	0.00403	0.00001	0.00000	
Vendor Truck	0.00000	0.00000	0.00000	0.00000	0.00150	
Worker	0.00001	0.00003	0.00002	0.00002	0.00057	
Total	0.00002	0.00676	0.00405	0.00003	0.00207	

	2025	2026	2027	2028	2029	2029
	Building	Building	Building	Building	Building	Architectural
Construction Trip Type	Construction	Construction	Construction	Construction	Construction	Coating
Haul Truck	0.00000	0.00000	0.00000	0.00000	0.00000	0.00000
Vendor Truck	0.00267	0.00265	0.00263	0.00260	0.00120	0.00000
Worker	0.00096	0.00093	0.00088	0.00082	0.00035	0.00009
Total	0.00363	0.00358	0.00351	0.00342	0.00155	0.00009

	Haul Truck (tons)	Vendor Truck (tons)	Worker (tons)	Total (tons)
Total DPM	1.078E-02	1.325E-02	4.680E-03	2.871E-02
Average Emissions				
Grams	9.788E+03	1.203E+04	4.249E+03	
Grams/sec	4.833E-05	5.941E-05	2.098E-05	

Default Distance 20 7.3 10.8 Default Vehicle Travel Distance in CalEEMod

Vehicle Travel Distances in the Construction HRA (miles)

Road Segment 1 (mi)	0.71	0.71	0.71	miles
Road Segment 2 (mi)	0.45	0.45	0.45	miles

Trip Distribution (percent)

Off-site Road Segment 1	100.0%	100.0%	100.0%	off-site
Off-site Road Segment 2	100.0%	100.0%	100.0%	off-site

Total Average Offsite Vehicle Emissions Along Travel Distance (g/sec)

				Total	
Road Segment 1	1.709E-06	5.757E-06	1.374E-06	8.840E-06	Rd1
Road Segment 2	1.082E-06	3.643E-06	8.696E-07	5.594E-06	Rd2

	Grams/sec	Pounds/Hour	Pounds/Day	Pounds/year	Tons/year	Max Pounds/Hour
Road Segment 1	8.840E-06	7.016E-05	1.684E-03	3.947E+00	1.974E-03	2.105E-04
Road Segment 2	5.594E-06	4.440E-05	1.066E-03	2.498E+00	1.249E-03	1.332E-04

Health Risk Summary - Unmitigated Construction (Summary of HARP2 Results)

Lemoore 54 Project (TTM 22-021) — Unmitigated Construction

	RISK_SUM	Cancer Risk/million	MAXHI NonCancer Chronic	MAXHI Acute
Maximum Risk	1.2105E-05	12.105	4.7081E-03	0.00E+00

	X	Y
Construction MEI UTM	251084.62	4019917.97
Latitude, Longitude	36°17'31.7"N 119°46'18.3"W	
Receptor # 1		

*HARP - HRA Calc v22118 11/1/2022 8:07:35 AM - Cancer Risk - Input File: F:\0019.0007 L54\01b - HARP Unmit\LEMOORE UNMIT CONSTRUCTION\hra\L54-Unmit ConHRAInput.hra

*HARP - HRA Calc v22118 11/1/2022 8:07:35 AM - Chronic Risk - Input File: F:\0019.0007 L54\01b - HARP Unmit\LEMOORE UNMIT CONSTRUCTION\hra\L54-Unmit ConHRAInput.hra

*HARP - HRA Calc v22118 11/1/2022 8:07:35 AM - Acute Risk - Input File: F:\0019.0007 L54\01b - HARP Unmit\LEMOORE UNMIT CONSTRUCTION\hra\L54-Unmit ConHRAInput.hra

REC	GRP	X	Y	RISK_SUM	SCENARIO	MAXHI NonCancerChronic	MAXHI Acute
1	ALL	251084.62	4019917.97	1.211E-05	6.422YrCancerHighEnd_InhSoilDermMMilkCropsChickenEgg	4.71E-03	0.00E+00
2	ALL	251087.35	4019943.41	1.191E-05	6.422YrCancerHighEnd_InhSoilDermMMilkCropsChickenEgg	4.63E-03	0.00E+00
3	ALL	251109.56	4019894.54	8.128E-06	6.422YrCancerHighEnd_InhSoilDermMMilkCropsChickenEgg	3.16E-03	0.00E+00
4	ALL	251137.64	4019952.57	6.146E-06	6.422YrCancerHighEnd_InhSoilDermMMilkCropsChickenEgg	2.39E-03	0.00E+00
5	ALL	251194.74	4019904.23	3.633E-06	6.422YrCancerHighEnd_InhSoilDermMMilkCropsChickenEgg	1.41E-03	0.00E+00
6	ALL	251245.33	4019925.96	2.575E-06	6.422YrCancerHighEnd_InhSoilDermMMilkCropsChickenEgg	1.00E-03	0.00E+00
7	ALL	251250.41	4019906.06	2.492E-06	6.422YrCancerHighEnd_InhSoilDermMMilkCropsChickenEgg	9.69E-04	0.00E+00
8	ALL	251094.39	4019576.66	2.227E-06	6.422YrCancerHighEnd_InhSoilDermMMilkCropsChickenEgg	8.66E-04	0.00E+00
9	ALL	251158.96	4019601.55	2.227E-06	6.422YrCancerHighEnd_InhSoilDermMMilkCropsChickenEgg	8.66E-04	0.00E+00
10	ALL	251223.53	4019626.45	2.03E-06	6.422YrCancerHighEnd_InhSoilDermMMilkCropsChickenEgg	7.83E-04	0.00E+00
11	ALL	251288.1	4019651.34	1.681E-06	6.422YrCancerHighEnd_InhSoilDermMMilkCropsChickenEgg	6.54E-04	0.00E+00
12	ALL	251366.25	4019708.07	1.301E-06	6.422YrCancerHighEnd_InhSoilDermMMilkCropsChickenEgg	5.06E-04	0.00E+00
13	ALL	251393.4	4019771.72	1.181E-06	6.422YrCancerHighEnd_InhSoilDermMMilkCropsChickenEgg	4.59E-04	0.00E+00
14	ALL	251420.55	4019835.38	1.040E-06	6.422YrCancerHighEnd_InhSoilDermMMilkCropsChickenEgg	4.04E-04	0.00E+00
15	ALL	251024.55	4019565.41	2.144E-06	6.422YrCancerHighEnd_InhSoilDermMMilkCropsChickenEgg	8.34E-04	0.00E+00
16	ALL	250734.73	4020013.14	6.054E-06	6.422YrCancerHighEnd_InhSoilDermMMilkCropsChickenEgg	2.35E-03	0.00E+00
17	ALL	250734.99	4020052.42	5.825E-06	6.422YrCancerHighEnd_InhSoilDermMMilkCropsChickenEgg	2.27E-03	0.00E+00
18	ALL	250735.26	4020091.7	5.745E-06	6.422YrCancerHighEnd_InhSoilDermMMilkCropsChickenEgg	2.23E-03	0.00E+00
19	ALL	250735.53	4020130.98	5.696E-06	6.422YrCancerHighEnd_InhSoilDermMMilkCropsChickenEgg	2.22E-03	0.00E+00
20	ALL	250735.79	4020170.26	5.629E-06	6.422YrCancerHighEnd_InhSoilDermMMilkCropsChickenEgg	2.19E-03	0.00E+00
21	ALL	250736.06	4020209.54	5.554E-06	6.422YrCancerHighEnd_InhSoilDermMMilkCropsChickenEgg	2.16E-03	0.00E+00
22	ALL	250736.33	4020248.82	5.446E-06	6.422YrCancerHighEnd_InhSoilDermMMilkCropsChickenEgg	2.12E-03	0.00E+00
23	ALL	250736.59	4020288.1	5.293E-06	6.422YrCancerHighEnd_InhSoilDermMMilkCropsChickenEgg	2.06E-03	0.00E+00
24	ALL	250736.86	4020327.38	5.083E-06	6.422YrCancerHighEnd_InhSoilDermMMilkCropsChickenEgg	1.98E-03	0.00E+00
25	ALL	250737.13	4020366.66	4.790E-06	6.422YrCancerHighEnd_InhSoilDermMMilkCropsChickenEgg	1.86E-03	0.00E+00
26	ALL	250737.39	4020405.94	4.374E-06	6.422YrCancerHighEnd_InhSoilDermMMilkCropsChickenEgg	1.70E-03	0.00E+00
27	ALL	250737.66	4020445.22	3.799E-06	6.422YrCancerHighEnd_InhSoilDermMMilkCropsChickenEgg	1.48E-03	0.00E+00
28	ALL	250694.73	4020013.41	4.139E-06	6.422YrCancerHighEnd_InhSoilDermMMilkCropsChickenEgg	1.61E-03	0.00E+00
29	ALL	250695	4020052.69	3.792E-06	6.422YrCancerHighEnd_InhSoilDermMMilkCropsChickenEgg	1.48E-03	0.00E+00
30	ALL	250695.26	4020091.97	3.678E-06	6.422YrCancerHighEnd_InhSoilDermMMilkCropsChickenEgg	1.43E-03	0.00E+00
31	ALL	250695.53	4020131.25	3.629E-06	6.422YrCancerHighEnd_InhSoilDermMMilkCropsChickenEgg	1.41E-03	0.00E+00
32	ALL	250695.8	4020170.53	3.590E-06	6.422YrCancerHighEnd_InhSoilDermMMilkCropsChickenEgg	1.40E-03	0.00E+00
33	ALL	250696.06	4020209.81	3.534E-06	6.422YrCancerHighEnd_InhSoilDermMMilkCropsChickenEgg	1.37E-03	0.00E+00
34	ALL	250696.33	4020249.09	3.471E-06	6.422YrCancerHighEnd_InhSoilDermMMilkCropsChickenEgg	1.35E-03	0.00E+00
35	ALL	250696.6	4020288.37	3.384E-06	6.422YrCancerHighEnd_InhSoilDermMMilkCropsChickenEgg	1.32E-03	0.00E+00
36	ALL	250696.86	4020327.65	3.266E-06	6.422YrCancerHighEnd_InhSoilDermMMilkCropsChickenEgg	1.27E-03	0.00E+00
37	ALL	250697.13	4020366.93	3.118E-06	6.422YrCancerHighEnd_InhSoilDermMMilkCropsChickenEgg	1.21E-03	0.00E+00
38	ALL	250697.4	4020406.21	2.920E-06	6.422YrCancerHighEnd_InhSoilDermMMilkCropsChickenEgg	1.14E-03	0.00E+00
39	ALL	250697.66	4020445.49	2.670E-06	6.422YrCancerHighEnd_InhSoilDermMMilkCropsChickenEgg	1.04E-03	0.00E+00
40	ALL	250654.73	4020013.68	3.183E-06	6.422YrCancerHighEnd_InhSoilDermMMilkCropsChickenEgg	1.24E-03	0.00E+00
41	ALL	250655	4020052.96	2.796E-06	6.422YrCancerHighEnd_InhSoilDermMMilkCropsChickenEgg	1.09E-03	0.00E+00
42	ALL	250655.26	4020092.24	2.667E-06	6.422YrCancerHighEnd_InhSoilDermMMilkCropsChickenEgg	1.04E-03	0.00E+00
43	ALL	250655.53	4020131.52	2.615E-06	6.422YrCancerHighEnd_InhSoilDermMMilkCropsChickenEgg	1.02E-03	0.00E+00
44	ALL	250655.8	4020170.8	2.576E-06	6.422YrCancerHighEnd_InhSoilDermMMilkCropsChickenEgg	1.00E-03	0.00E+00
45	ALL	250656.06	4020210.08	2.547E-06	6.422YrCancerHighEnd_InhSoilDermMMilkCropsChickenEgg	9.91E-04	0.00E+00
46	ALL	250656.33	4020249.36	2.510E-06	6.422YrCancerHighEnd_InhSoilDermMMilkCropsChickenEgg	9.76E-04	0.00E+00
47	ALL	250656.6	4020288.64	2.459E-06	6.422YrCancerHighEnd_InhSoilDermMMilkCropsChickenEgg	9.56E-04	0.00E+00
48	ALL	250656.86	4020327.92	2.390E-06	6.422YrCancerHighEnd_InhSoilDermMMilkCropsChickenEgg	9.29E-04	0.00E+00
49	ALL	250657.13	4020367.2	2.302E-06	6.422YrCancerHighEnd_InhSoilDermMMilkCropsChickenEgg	8.95E-04	0.00E+00
50	ALL	250657.4	4020406.48	2.192E-06	6.422YrCancerHighEnd_InhSoilDermMMilkCropsChickenEgg	8.52E-04	0.00E+00
51	ALL	250657.66	4020445.76	2.063E-06	6.422YrCancerHighEnd_InhSoilDermMMilkCropsChickenEgg	8.02E-04	0.00E+00
52	ALL	250614.73	4020013.96	2.502E-06	6.422YrCancerHighEnd_InhSoilDermMMilkCropsChickenEgg	9.73E-04	0.00E+00
53	ALL	250615	4020053.24	2.188E-06	6.422YrCancerHighEnd_InhSoilDermMMilkCropsChickenEgg	8.51E-04	0.00E+00
54	ALL	250615.26	4020092.52	2.068E-06	6.422YrCancerHighEnd_InhSoilDermMMilkCropsChickenEgg	8.04E-04	0.00E+00
55	ALL	250615.53	4020131.8	2.012E-06	6.422YrCancerHighEnd_InhSoilDermMMilkCropsChickenEgg	7.83E-04	0.00E+00
56	ALL	250615.8	4020171.08	1.985E-06	6.422YrCancerHighEnd_InhSoilDermMMilkCropsChickenEgg	7.72E-04	0.00E+00
57	ALL	250616.06	4020210.36	1.964E-06	6.422YrCancerHighEnd_InhSoilDermMMilkCropsChickenEgg	7.64E-04	0.00E+00
58	ALL	250616.33	4020249.64	1.940E-06	6.422YrCancerHighEnd_InhSoilDermMMilkCropsChickenEgg	7.55E-04	0.00E+00
59	ALL	250616.6	4020288.92	1.909E-06	6.422YrCancerHighEnd_InhSoilDermMMilkCropsChickenEgg	7.43E-04	0.00E+00
60	ALL	250616.86	4020328.2	1.865E-06	6.422YrCancerHighEnd_InhSoilDermMMilkCropsChickenEgg	7.25E-04	0.00E+00
61	ALL	250617.13	4020367.48	1.816E-06	6.422YrCancerHighEnd_InhSoilDermMMilkCropsChickenEgg	7.06E-04	0.00E+00
62	ALL	250617.4	4020406.76	1.754E-06	6.422YrCancerHighEnd_InhSoilDermMMilkCropsChickenEgg	6.82E-04	0.00E+00
63	ALL	250617.66	4020446.04	1.685E-06	6.422YrCancerHighEnd_InhSoilDermMMilkCropsChickenEgg	6.55E-04	0.00E+00
64	ALL	250664.77	4019819.62	3.861E-06	6.422YrCancerHighEnd_InhSoilDermMMilkCropsChickenEgg	1.50E-03	0.00E+00
65	ALL	250574.73	4020014.23	1.904E-06	6.422YrCancerHighEnd_InhSoilDermMMilkCropsChickenEgg	7.41E-04	0.00E+00
66	ALL	250575	4020053.51	1.747E-06	6.422YrCancerHighEnd_InhSoilDermMMilkCropsChickenEgg	6.79E-04	0.00E+00
67	ALL	250575.26	4020092.79	1.665E-06	6.422YrCancerHighEnd_InhSoilDermMMilkCropsChickenEgg	6.48E-04	0.00E+00

68	ALL	250575.53	4020132.07	1.622E-06	6.422YrCancerHighEnd_InhSoilDermMMilkCropsChickenEgg	6.31E-04	0.00E+00
69	ALL	250575.8	4020171.35	1.599E-06	6.422YrCancerHighEnd_InhSoilDermMMilkCropsChickenEgg	6.22E-04	0.00E+00
70	ALL	250576.06	4020210.63	1.581E-06	6.422YrCancerHighEnd_InhSoilDermMMilkCropsChickenEgg	6.15E-04	0.00E+00
71	ALL	250576.33	4020249.91	1.563E-06	6.422YrCancerHighEnd_InhSoilDermMMilkCropsChickenEgg	6.08E-04	0.00E+00
72	ALL	250576.6	4020289.19	1.545E-06	6.422YrCancerHighEnd_InhSoilDermMMilkCropsChickenEgg	6.01E-04	0.00E+00
73	ALL	250576.86	4020328.47	1.521E-06	6.422YrCancerHighEnd_InhSoilDermMMilkCropsChickenEgg	5.91E-04	0.00E+00
74	ALL	250577.13	4020367.75	1.490E-06	6.422YrCancerHighEnd_InhSoilDermMMilkCropsChickenEgg	5.80E-04	0.00E+00
75	ALL	250577.4	4020407.03	1.455E-06	6.422YrCancerHighEnd_InhSoilDermMMilkCropsChickenEgg	5.66E-04	0.00E+00
76	ALL	250577.66	4020446.31	1.420E-06	6.422YrCancerHighEnd_InhSoilDermMMilkCropsChickenEgg	5.52E-04	0.00E+00
77	ALL	250488.43	4019940.62	1.050E-06	6.422YrCancerHighEnd_InhSoilDermMMilkCropsChickenEgg	4.08E-04	0.00E+00
78	ALL	250544.3	4019800.6	1.034E-06	6.422YrCancerHighEnd_InhSoilDermMMilkCropsChickenEgg	4.02E-04	0.00E+00
79	ALL	250600.27	4019732.32	1.155E-06	6.422YrCancerHighEnd_InhSoilDermMMilkCropsChickenEgg	4.49E-04	0.00E+00
80	ALL	250627.14	4019734.98	1.406E-06	6.422YrCancerHighEnd_InhSoilDermMMilkCropsChickenEgg	5.47E-04	0.00E+00
81	ALL	250661.58	4019719.67	1.623E-06	6.422YrCancerHighEnd_InhSoilDermMMilkCropsChickenEgg	6.31E-04	0.00E+00
82	ALL	250474.73	4020014.91	1.043E-06	6.422YrCancerHighEnd_InhSoilDermMMilkCropsChickenEgg	4.06E-04	0.00E+00
83	ALL	250475	4020054.19	1.054E-06	6.422YrCancerHighEnd_InhSoilDermMMilkCropsChickenEgg	4.10E-04	0.00E+00
84	ALL	250475.27	4020093.47	1.058E-06	6.422YrCancerHighEnd_InhSoilDermMMilkCropsChickenEgg	4.12E-04	0.00E+00
85	ALL	250475.53	4020132.75	1.060E-06	6.422YrCancerHighEnd_InhSoilDermMMilkCropsChickenEgg	4.12E-04	0.00E+00
86	ALL	250475.8	4020172.03	1.059E-06	6.422YrCancerHighEnd_InhSoilDermMMilkCropsChickenEgg	4.12E-04	0.00E+00
87	ALL	250476.07	4020211.31	1.057E-06	6.422YrCancerHighEnd_InhSoilDermMMilkCropsChickenEgg	4.11E-04	0.00E+00
88	ALL	250476.33	4020250.59	1.053E-06	6.422YrCancerHighEnd_InhSoilDermMMilkCropsChickenEgg	4.09E-04	0.00E+00
89	ALL	250476.6	4020289.87	1.047E-06	6.422YrCancerHighEnd_InhSoilDermMMilkCropsChickenEgg	4.07E-04	0.00E+00
90	ALL	250440.93	4020329.15	9.483E-07	6.422YrCancerHighEnd_InhSoilDermMMilkCropsChickenEgg	3.69E-04	0.00E+00
91	ALL	250441.2	4020368.43	9.422E-07	6.422YrCancerHighEnd_InhSoilDermMMilkCropsChickenEgg	3.66E-04	0.00E+00
92	ALL	250441.46	4020407.71	9.378E-07	6.422YrCancerHighEnd_InhSoilDermMMilkCropsChickenEgg	3.65E-04	0.00E+00
93	ALL	250477.67	4020446.99	1.025E-06	6.422YrCancerHighEnd_InhSoilDermMMilkCropsChickenEgg	3.98E-04	0.00E+00
94	ALL	250388.44	4019941.3	7.436E-07	6.422YrCancerHighEnd_InhSoilDermMMilkCropsChickenEgg	2.89E-04	0.00E+00
95	ALL	250458.27	4019766.28	6.150E-07	6.422YrCancerHighEnd_InhSoilDermMMilkCropsChickenEgg	2.39E-04	0.00E+00
96	ALL	250472.24	4019731.27	5.933E-07	6.422YrCancerHighEnd_InhSoilDermMMilkCropsChickenEgg	2.31E-04	0.00E+00
97	ALL	250520.64	4019680.96	6.360E-07	6.422YrCancerHighEnd_InhSoilDermMMilkCropsChickenEgg	2.47E-04	0.00E+00
98	ALL	250555.08	4019665.65	7.124E-07	6.422YrCancerHighEnd_InhSoilDermMMilkCropsChickenEgg	2.77E-04	0.00E+00
99	ALL	250589.52	4019650.34	8.018E-07	6.422YrCancerHighEnd_InhSoilDermMMilkCropsChickenEgg	3.12E-04	0.00E+00
100	ALL	250623.96	4019635.03	9.007E-07	6.422YrCancerHighEnd_InhSoilDermMMilkCropsChickenEgg	3.50E-04	0.00E+00
101	ALL	250658.39	4019619.72	1.004E-06	6.422YrCancerHighEnd_InhSoilDermMMilkCropsChickenEgg	3.90E-04	0.00E+00
102	ALL	250374.74	4020015.59	8.124E-07	6.422YrCancerHighEnd_InhSoilDermMMilkCropsChickenEgg	3.16E-04	0.00E+00
103	ALL	250375	4020054.87	8.394E-07	6.422YrCancerHighEnd_InhSoilDermMMilkCropsChickenEgg	3.27E-04	0.00E+00
104	ALL	250375.27	4020094.15	8.594E-07	6.422YrCancerHighEnd_InhSoilDermMMilkCropsChickenEgg	3.34E-04	0.00E+00
105	ALL	250375.54	4020133.43	8.745E-07	6.422YrCancerHighEnd_InhSoilDermMMilkCropsChickenEgg	3.40E-04	0.00E+00
106	ALL	250375.8	4020172.71	8.862E-07	6.422YrCancerHighEnd_InhSoilDermMMilkCropsChickenEgg	3.45E-04	0.00E+00
107	ALL	250376.07	4020211.99	8.946E-07	6.422YrCancerHighEnd_InhSoilDermMMilkCropsChickenEgg	3.48E-04	0.00E+00
108	ALL	250376.34	4020251.27	8.994E-07	6.422YrCancerHighEnd_InhSoilDermMMilkCropsChickenEgg	3.50E-04	0.00E+00
109	ALL	250376.6	4020290.55	9.013E-07	6.422YrCancerHighEnd_InhSoilDermMMilkCropsChickenEgg	3.51E-04	0.00E+00
110	ALL	250376.87	4020329.83	8.999E-07	6.422YrCancerHighEnd_InhSoilDermMMilkCropsChickenEgg	3.50E-04	0.00E+00
111	ALL	250377.14	4020369.11	8.955E-07	6.422YrCancerHighEnd_InhSoilDermMMilkCropsChickenEgg	3.48E-04	0.00E+00
112	ALL	250377.4	4020408.39	8.898E-07	6.422YrCancerHighEnd_InhSoilDermMMilkCropsChickenEgg	3.46E-04	0.00E+00
113	ALL	250377.67	4020447.67	8.886E-07	6.422YrCancerHighEnd_InhSoilDermMMilkCropsChickenEgg	3.46E-04	0.00E+00
114	ALL	250704.38	4020491.09	2.447E-06	6.422YrCancerHighEnd_InhSoilDermMMilkCropsChickenEgg	9.52E-04	0.00E+00
115	ALL	250919.31	4020505.76	5.802E-06	6.422YrCancerHighEnd_InhSoilDermMMilkCropsChickenEgg	2.26E-03	0.00E+00
116	ALL	250748.31	4020513.02	2.932E-06	6.422YrCancerHighEnd_InhSoilDermMMilkCropsChickenEgg	1.14E-03	0.00E+00
117	ALL	250893.84	4020505.06	5.569E-06	6.422YrCancerHighEnd_InhSoilDermMMilkCropsChickenEgg	2.17E-03	0.00E+00
118	ALL	250922.62	4020544.79	3.811E-06	6.422YrCancerHighEnd_InhSoilDermMMilkCropsChickenEgg	1.48E-03	0.00E+00
119	ALL	250747.46	4020553.01	2.602E-06	6.422YrCancerHighEnd_InhSoilDermMMilkCropsChickenEgg	1.01E-03	0.00E+00
120	ALL	250680.68	4020501.38	2.103E-06	6.422YrCancerHighEnd_InhSoilDermMMilkCropsChickenEgg	8.18E-04	0.00E+00
121	ALL	250800.68	4020581.05	3.444E-06	6.422YrCancerHighEnd_InhSoilDermMMilkCropsChickenEgg	1.34E-03	0.00E+00
122	ALL	250924.49	4020568.12	3.372E-06	6.422YrCancerHighEnd_InhSoilDermMMilkCropsChickenEgg	1.31E-03	0.00E+00
123	ALL	250973.66	4020572.86	3.497E-06	6.422YrCancerHighEnd_InhSoilDermMMilkCropsChickenEgg	1.36E-03	0.00E+00
124	ALL	250999.19	4020569.72	3.584E-06	6.422YrCancerHighEnd_InhSoilDermMMilkCropsChickenEgg	1.39E-03	0.00E+00
125	ALL	251015.32	4020562.13	3.762E-06	6.422YrCancerHighEnd_InhSoilDermMMilkCropsChickenEgg	1.46E-03	0.00E+00
126	ALL	251060.57	4020562.93	3.773E-06	6.422YrCancerHighEnd_InhSoilDermMMilkCropsChickenEgg	1.47E-03	0.00E+00
127	ALL	250746.6	4020593	3.001E-06	6.422YrCancerHighEnd_InhSoilDermMMilkCropsChickenEgg	1.17E-03	0.00E+00
128	ALL	250708.42	4020563.71	2.276E-06	6.422YrCancerHighEnd_InhSoilDermMMilkCropsChickenEgg	8.85E-04	0.00E+00
129	ALL	250652.19	4020529.45	1.822E-06	6.422YrCancerHighEnd_InhSoilDermMMilkCropsChickenEgg	7.09E-04	0.00E+00
130	ALL	250732.1	4020638.4	1.768E-06	6.422YrCancerHighEnd_InhSoilDermMMilkCropsChickenEgg	6.88E-04	0.00E+00
131	ALL	250657.68	4020579.78	2.176E-06	6.422YrCancerHighEnd_InhSoilDermMMilkCropsChickenEgg	8.47E-04	0.00E+00
132	ALL	250623.7	4020557.53	1.757E-06	6.422YrCancerHighEnd_InhSoilDermMMilkCropsChickenEgg	6.84E-04	0.00E+00
133	ALL	250600.68	4020501.92	1.516E-06	6.422YrCancerHighEnd_InhSoilDermMMilkCropsChickenEgg	5.90E-04	0.00E+00
134	ALL	250804.97	4020634.19	2.079E-06	6.422YrCancerHighEnd_InhSoilDermMMilkCropsChickenEgg	8.09E-04	0.00E+00
135	ALL	250848.08	4020646.5	1.693E-06	6.422YrCancerHighEnd_InhSoilDermMMilkCropsChickenEgg	6.59E-04	0.00E+00
136	ALL	250894.82	4020640.63	1.766E-06	6.422YrCancerHighEnd_InhSoilDermMMilkCropsChickenEgg	6.87E-04	0.00E+00
137	ALL	250934.54	4020627.42	2.089E-06	6.422YrCancerHighEnd_InhSoilDermMMilkCropsChickenEgg	8.12E-04	0.00E+00
138	ALL	250960.13	4020648.9	1.520E-06	6.422YrCancerHighEnd_InhSoilDermMMilkCropsChickenEgg	5.91E-04	0.00E+00
139	ALL	251017.26	4020695.1	9.227E-07	6.422YrCancerHighEnd_InhSoilDermMMilkCropsChickenEgg	3.59E-04	0.00E+00
140	ALL	251049.21	4020634.76	1.638E-06	6.422YrCancerHighEnd_InhSoilDermMMilkCropsChickenEgg	6.37E-04	0.00E+00
141	ALL	251082.06	4020630.17	1.635E-06	6.422YrCancerHighEnd_InhSoilDermMMilkCropsChickenEgg	6.36E-04	0.00E+00
142	ALL	250735.22	4020742.81	7.992E-07	6.422YrCancerHighEnd_InhSoilDermMMilkCropsChickenEgg	3.11E-04	0.00E+00
143	ALL	250682.42	4020706.59	9.347E-07	6.422YrCancerHighEnd_InhSoilDermMMilkCropsChickenEgg	3.64E-04	0.00E+00
144	ALL	250610.58	4020689.04	9.415E-07	6.422YrCancerHighEnd_InhSoilDermMMilkCropsChickenEgg	3.66E-04	0.00E+00
145	ALL	250547.53	4020633.98	1.542E-06	6.422YrCancerHighEnd_InhSoilDermMMilkCropsChickenEgg	6.00E-04	0.00E+00
146	ALL	250526.99	4020566.15	1.494E-06	6.422YrCancerHighEnd_InhSoilDermMMilkCropsChickenEgg	5.81E-04	0.00E+00
147	ALL	250502.33	4020506.57	1.136E-06	6.422YrCancerHighEnd_InhSoilDermMMilkCropsChickenEgg	4.42E-04	0.00E+00
148	ALL	250808.59	4020745.68	7.916E-07	6.422YrCancerHighEnd_InhSoilDermMMilkCropsChickenEgg	3.08E-04	0.00E+00
149	ALL	250845.94	4020746.48	7.794E-07	6.422YrCancerHighEnd_InhSoilDermMMilkCropsChickenEgg	3.03E-04	0.00E+00
150	ALL	250883.29	4020747.28	7.596E-07	6.422YrCancerHighEnd_InhSoilDermMMilkCropsChickenEgg	2.95E-04	0.00E+00
151	ALL	250920.64	4020748.08	7.327E-07	6.422YrCancerHighEnd_InhSoilDermMMilkCropsChickenEgg	2.85E-04	0.00E+00
152	ALL	250957.99	4020748.88	7.014E-07	6.422YrCancerHighEnd_InhSoilDermMMilkCropsChickenEgg	2.73E-04	0.00E+00
153	ALL	250995.34	4020749.67	6.666E-07	6.422YrCancerHighEnd_InhSoilDermMMilkCropsChickenEgg	2.59E-04	0.00E+00
154	ALL	251032.69	4020750.47	6.319E-07	6.422YrCancerHighEnd_InhSoilDermMMilkCropsChickenEgg	2.46E-04	0.00E+00

155	ALL	251070.04	4020751.27	5.997E-07	6.422YrCancerHighEnd_InhSoilDermMMilkCropsChickenEgg	2.33E-04	0.00E+00
156	ALL	250738.4	4020831.62	5.308E-07	6.422YrCancerHighEnd_InhSoilDermMMilkCropsChickenEgg	2.06E-04	0.00E+00
157	ALL	250676.99	4020805.15	5.887E-07	6.422YrCancerHighEnd_InhSoilDermMMilkCropsChickenEgg	2.29E-04	0.00E+00
158	ALL	250615.58	4020778.67	6.311E-07	6.422YrCancerHighEnd_InhSoilDermMMilkCropsChickenEgg	2.45E-04	0.00E+00
159	ALL	250568.01	4020754.29	6.600E-07	6.422YrCancerHighEnd_InhSoilDermMMilkCropsChickenEgg	2.57E-04	0.00E+00
160	ALL	250479.97	4020694.83	7.574E-07	6.422YrCancerHighEnd_InhSoilDermMMilkCropsChickenEgg	2.95E-04	0.00E+00
161	ALL	250454.4	4020633.04	1.558E-06	6.422YrCancerHighEnd_InhSoilDermMMilkCropsChickenEgg	6.06E-04	0.00E+00
162	ALL	250428.82	4020571.25	1.303E-06	6.422YrCancerHighEnd_InhSoilDermMMilkCropsChickenEgg	5.07E-04	0.00E+00
163	ALL	250403.25	4020509.46	9.376E-07	6.422YrCancerHighEnd_InhSoilDermMMilkCropsChickenEgg	3.65E-04	0.00E+00
164	ALL	250806.46	4020845.66	4.902E-07	6.422YrCancerHighEnd_InhSoilDermMMilkCropsChickenEgg	1.91E-04	0.00E+00
165	ALL	250843.8	4020846.46	4.785E-07	6.422YrCancerHighEnd_InhSoilDermMMilkCropsChickenEgg	1.86E-04	0.00E+00
166	ALL	250881.15	4020847.25	4.644E-07	6.422YrCancerHighEnd_InhSoilDermMMilkCropsChickenEgg	1.81E-04	0.00E+00
167	ALL	250918.5	4020848.05	4.488E-07	6.422YrCancerHighEnd_InhSoilDermMMilkCropsChickenEgg	1.75E-04	0.00E+00
168	ALL	250955.85	4020848.85	4.328E-07	6.422YrCancerHighEnd_InhSoilDermMMilkCropsChickenEgg	1.68E-04	0.00E+00
169	ALL	250993.2	4020849.65	4.169E-07	6.422YrCancerHighEnd_InhSoilDermMMilkCropsChickenEgg	1.62E-04	0.00E+00
170	ALL	251030.55	4020850.45	4.017E-07	6.422YrCancerHighEnd_InhSoilDermMMilkCropsChickenEgg	1.56E-04	0.00E+00
171	ALL	251067.9	4020851.25	3.873E-07	6.422YrCancerHighEnd_InhSoilDermMMilkCropsChickenEgg	1.51E-04	0.00E+00
172	ALL	251120.89	4020469.46	4.480E-06	6.422YrCancerHighEnd_InhSoilDermMMilkCropsChickenEgg	1.74E-03	0.00E+00
173	ALL	251116.33	4020413.72	6.105E-06	6.422YrCancerHighEnd_InhSoilDermMMilkCropsChickenEgg	2.37E-03	0.00E+00
174	ALL	251112.26	4020391.53	6.985E-06	6.422YrCancerHighEnd_InhSoilDermMMilkCropsChickenEgg	2.72E-03	0.00E+00
175	ALL	251116.08	4020338.75	7.135E-06	6.422YrCancerHighEnd_InhSoilDermMMilkCropsChickenEgg	2.78E-03	0.00E+00
176	ALL	251118.28	4020306.41	7.179E-06	6.422YrCancerHighEnd_InhSoilDermMMilkCropsChickenEgg	2.79E-03	0.00E+00
177	ALL	251099.56	4020259.33	1.021E-05	6.422YrCancerHighEnd_InhSoilDermMMilkCropsChickenEgg	3.97E-03	0.00E+00
178	ALL	251113.2	4020220	8.269E-06	6.422YrCancerHighEnd_InhSoilDermMMilkCropsChickenEgg	3.22E-03	0.00E+00
179	ALL	251104.92	4020197.27	9.512E-06	6.422YrCancerHighEnd_InhSoilDermMMilkCropsChickenEgg	3.70E-03	0.00E+00
180	ALL	251096.6	4020155.51	1.100E-05	6.422YrCancerHighEnd_InhSoilDermMMilkCropsChickenEgg	4.28E-03	0.00E+00
181	ALL	251096.47	4020118.02	1.104E-05	6.422YrCancerHighEnd_InhSoilDermMMilkCropsChickenEgg	4.29E-03	0.00E+00
182	ALL	251093.14	4020072.69	1.161E-05	6.422YrCancerHighEnd_InhSoilDermMMilkCropsChickenEgg	4.51E-03	0.00E+00
183	ALL	251093.35	4020028.16	1.139E-05	6.422YrCancerHighEnd_InhSoilDermMMilkCropsChickenEgg	4.43E-03	0.00E+00
184	ALL	251139.21	4019998.51	6.153E-06	6.422YrCancerHighEnd_InhSoilDermMMilkCropsChickenEgg	2.39E-03	0.00E+00
185	ALL	251137.31	4019973.5	6.228E-06	6.422YrCancerHighEnd_InhSoilDermMMilkCropsChickenEgg	2.42E-03	0.00E+00
186	ALL	251144.48	4020479.75	2.768E-06	6.422YrCancerHighEnd_InhSoilDermMMilkCropsChickenEgg	1.08E-03	0.00E+00
187	ALL	251156.33	4020413.59	3.126E-06	6.422YrCancerHighEnd_InhSoilDermMMilkCropsChickenEgg	1.22E-03	0.00E+00
188	ALL	251136.97	4020390.41	4.507E-06	6.422YrCancerHighEnd_InhSoilDermMMilkCropsChickenEgg	1.75E-03	0.00E+00
189	ALL	251159.29	4020333.27	3.802E-06	6.422YrCancerHighEnd_InhSoilDermMMilkCropsChickenEgg	1.48E-03	0.00E+00
190	ALL	251148.75	4020307.31	4.589E-06	6.422YrCancerHighEnd_InhSoilDermMMilkCropsChickenEgg	1.78E-03	0.00E+00
191	ALL	251124.26	4020245.39	6.901E-06	6.422YrCancerHighEnd_InhSoilDermMMilkCropsChickenEgg	2.68E-03	0.00E+00
192	ALL	251177.91	4020250.82	3.582E-06	6.422YrCancerHighEnd_InhSoilDermMMilkCropsChickenEgg	1.39E-03	0.00E+00
193	ALL	251162.49	4020207.91	4.447E-06	6.422YrCancerHighEnd_InhSoilDermMMilkCropsChickenEgg	1.73E-03	0.00E+00
194	ALL	251147.62	4020150.47	5.465E-06	6.422YrCancerHighEnd_InhSoilDermMMilkCropsChickenEgg	2.13E-03	0.00E+00
195	ALL	251146.43	4020106.21	5.672E-06	6.422YrCancerHighEnd_InhSoilDermMMilkCropsChickenEgg	2.12E-03	0.00E+00
196	ALL	251139.89	4020084.05	6.131E-06	6.422YrCancerHighEnd_InhSoilDermMMilkCropsChickenEgg	2.38E-03	0.00E+00
197	ALL	251144.76	4020041.93	5.835E-06	6.422YrCancerHighEnd_InhSoilDermMMilkCropsChickenEgg	2.27E-03	0.00E+00
198	ALL	251141.78	4020019.41	6.012E-06	6.422YrCancerHighEnd_InhSoilDermMMilkCropsChickenEgg	2.34E-03	0.00E+00
199	ALL	251184.48	4020479.62	1.703E-06	6.422YrCancerHighEnd_InhSoilDermMMilkCropsChickenEgg	6.62E-04	0.00E+00
200	ALL	251120.8	4020566.17	2.526E-06	6.422YrCancerHighEnd_InhSoilDermMMilkCropsChickenEgg	9.82E-04	0.00E+00
201	ALL	251182.51	4020407.05	2.310E-06	6.422YrCancerHighEnd_InhSoilDermMMilkCropsChickenEgg	8.98E-04	0.00E+00
202	ALL	251178.45	4020382.88	2.627E-06	6.422YrCancerHighEnd_InhSoilDermMMilkCropsChickenEgg	1.02E-03	0.00E+00
203	ALL	251207.49	4020331	2.256E-06	6.422YrCancerHighEnd_InhSoilDermMMilkCropsChickenEgg	8.78E-04	0.00E+00
204	ALL	251198.42	4020304.94	2.630E-06	6.422YrCancerHighEnd_InhSoilDermMMilkCropsChickenEgg	1.02E-03	0.00E+00
205	ALL	251189.91	4020268.94	3.077E-06	6.422YrCancerHighEnd_InhSoilDermMMilkCropsChickenEgg	1.20E-03	0.00E+00
206	ALL	251201.63	4020221.58	2.971E-06	6.422YrCancerHighEnd_InhSoilDermMMilkCropsChickenEgg	1.16E-03	0.00E+00
207	ALL	251193.61	4020197.91	3.301E-06	6.422YrCancerHighEnd_InhSoilDermMMilkCropsChickenEgg	1.28E-03	0.00E+00
208	ALL	251178	4020154.97	3.993E-06	6.422YrCancerHighEnd_InhSoilDermMMilkCropsChickenEgg	1.55E-03	0.00E+00
209	ALL	251172.89	4020108.22	4.339E-06	6.422YrCancerHighEnd_InhSoilDermMMilkCropsChickenEgg	1.69E-03	0.00E+00
210	ALL	251174.9	4020085.7	4.305E-06	6.422YrCancerHighEnd_InhSoilDermMMilkCropsChickenEgg	1.67E-03	0.00E+00
211	ALL	251181.55	4020041.08	4.115E-06	6.422YrCancerHighEnd_InhSoilDermMMilkCropsChickenEgg	1.60E-03	0.00E+00
212	ALL	251194.97	4020001.1	3.702E-06	6.422YrCancerHighEnd_InhSoilDermMMilkCropsChickenEgg	1.44E-03	0.00E+00
213	ALL	251200.28	4019958.68	3.545E-06	6.422YrCancerHighEnd_InhSoilDermMMilkCropsChickenEgg	1.38E-03	0.00E+00
214	ALL	251215.6	4020485.9	1.288E-06	6.422YrCancerHighEnd_InhSoilDermMMilkCropsChickenEgg	5.01E-04	0.00E+00
215	ALL	251193.13	4020536.83	1.351E-06	6.422YrCancerHighEnd_InhSoilDermMMilkCropsChickenEgg	5.25E-04	0.00E+00
216	ALL	251141.42	4020578.92	2.129E-06	6.422YrCancerHighEnd_InhSoilDermMMilkCropsChickenEgg	8.28E-04	0.00E+00
217	ALL	251240.27	4020433.55	1.256E-06	6.422YrCancerHighEnd_InhSoilDermMMilkCropsChickenEgg	4.89E-04	0.00E+00
218	ALL	251234.72	4020391.13	1.489E-06	6.422YrCancerHighEnd_InhSoilDermMMilkCropsChickenEgg	5.79E-04	0.00E+00
219	ALL	251250.39	4020337.37	1.534E-06	6.422YrCancerHighEnd_InhSoilDermMMilkCropsChickenEgg	5.97E-04	0.00E+00
220	ALL	251235.96	4020300.87	1.890E-06	6.422YrCancerHighEnd_InhSoilDermMMilkCropsChickenEgg	7.35E-04	0.00E+00
221	ALL	251216.59	4020259.93	2.435E-06	6.422YrCancerHighEnd_InhSoilDermMMilkCropsChickenEgg	9.47E-04	0.00E+00
222	ALL	251252.08	4020213.3	1.982E-06	6.422YrCancerHighEnd_InhSoilDermMMilkCropsChickenEgg	7.71E-04	0.00E+00
223	ALL	251238.53	4020168.26	2.355E-06	6.422YrCancerHighEnd_InhSoilDermMMilkCropsChickenEgg	9.16E-04	0.00E+00
224	ALL	251235.46	4020150.92	2.463E-06	6.422YrCancerHighEnd_InhSoilDermMMilkCropsChickenEgg	9.58E-04	0.00E+00
225	ALL	251231.56	4020120.99	2.619E-06	6.422YrCancerHighEnd_InhSoilDermMMilkCropsChickenEgg	1.02E-03	0.00E+00
226	ALL	251228.92	4020070.49	2.780E-06	6.422YrCancerHighEnd_InhSoilDermMMilkCropsChickenEgg	1.08E-03	0.00E+00
227	ALL	251234.6	4020045.37	2.705E-06	6.422YrCancerHighEnd_InhSoilDermMMilkCropsChickenEgg	1.05E-03	0.00E+00
228	ALL	251250.27	4019999	2.471E-06	6.422YrCancerHighEnd_InhSoilDermMMilkCropsChickenEgg	9.61E-04	0.00E+00
229	ALL	251254.61	4020468.5	1.042E-06	6.422YrCancerHighEnd_InhSoilDermMMilkCropsChickenEgg	4.05E-04	0.00E+00
230	ALL	251225.73	4020550.01	1.100E-06	6.422YrCancerHighEnd_InhSoilDermMMilkCropsChickenEgg	4.28E-04	0.00E+00
231	ALL	251197.57	4020596.11	1.557E-06	6.422YrCancerHighEnd_InhSoilDermMMilkCropsChickenEgg	6.06E-04	0.00E+00
232	ALL	251283.23	4020419.12	9.884E-07	6.422YrCancerHighEnd_InhSoilDermMMilkCropsChickenEgg	3.84E-04	0.00E+00
233	ALL	251267.82	4020378.67	1.209E-06	6.422YrCancerHighEnd_InhSoilDermMMilkCropsChickenEgg	4.70E-04	0.00E+00
234	ALL	251295.32	4020329.34	1.144E-06	6.422YrCancerHighEnd_InhSoilDermMMilkCropsChickenEgg	4.45E-04	0.00E+00
235	ALL	251291.25	4020302.22	1.252E-06	6.422YrCancerHighEnd_InhSoilDermMMilkCropsChickenEgg	4.87E-04	0.00E+00
236	ALL	251275.83	4020263.25	1.514E-06	6.422YrCancerHighEnd_InhSoilDermMMilkCropsChickenEgg	5.89E-04	0.00E+00
237	ALL	251266.9	4020240.03	1.691E-06	6.422YrCancerHighEnd_InhSoilDermMMilkCropsChickenEgg	6.58E-04	0.00E+00
238	ALL	251249.15	4020192.05	2.098E-06	6.422YrCancerHighEnd_InhSoilDermMMilkCropsChickenEgg	8.16E-04	0.00E+00
239	ALL	251251.78	4019977.65	2.460E-06	6.422YrCancerHighEnd_InhSoilDermMMilkCropsChickenEgg	9.57E-04	0.00E+00
240	ALL	251249.19	4019952.5	2.511E-06	6.422YrCancerHighEnd_InhSoilDermMMilkCropsChickenEgg	9.76E-04	0.00E+00
241	ALL	251355.73	4020482.06	6.175E-07	6.422YrCancerHighEnd_InhSoilDermMMilkCropsChickenEgg	2.40E-04	0.00E+00

242	ALL	251325.14	4020546.46	6.625E-07	6.422YrCancerHighEnd_InhSoilDermMMilkCropsChickenEgg	2.58E-04	0.00E+00
243	ALL	251312.31	4020603.95	7.142E-07	6.422YrCancerHighEnd_InhSoilDermMMilkCropsChickenEgg	2.78E-04	0.00E+00
244	ALL	251255.71	4020677.65	2.063E-06	6.422YrCancerHighEnd_InhSoilDermMMilkCropsChickenEgg	8.02E-04	0.00E+00
245	ALL	251235.46	4020708.67	1.038E-06	6.422YrCancerHighEnd_InhSoilDermMMilkCropsChickenEgg	4.04E-04	0.00E+00
246	ALL	251131.93	4020726.73	6.418E-07	6.422YrCancerHighEnd_InhSoilDermMMilkCropsChickenEgg	2.50E-04	0.00E+00
247	ALL	251376.33	4020412.87	6.287E-07	6.422YrCancerHighEnd_InhSoilDermMMilkCropsChickenEgg	2.45E-04	0.00E+00
248	ALL	251376.2	4020375.38	6.727E-07	6.422YrCancerHighEnd_InhSoilDermMMilkCropsChickenEgg	2.62E-04	0.00E+00
249	ALL	251375.96	4020300.41	7.779E-07	6.422YrCancerHighEnd_InhSoilDermMMilkCropsChickenEgg	3.03E-04	0.00E+00
250	ALL	251375.83	4020262.92	8.359E-07	6.422YrCancerHighEnd_InhSoilDermMMilkCropsChickenEgg	3.25E-04	0.00E+00
251	ALL	251375.59	4020187.95	9.539E-07	6.422YrCancerHighEnd_InhSoilDermMMilkCropsChickenEgg	3.71E-04	0.00E+00
252	ALL	251375.46	4020150.46	1.009E-06	6.422YrCancerHighEnd_InhSoilDermMMilkCropsChickenEgg	3.92E-04	0.00E+00
253	ALL	251375.22	4020075.49	1.109E-06	6.422YrCancerHighEnd_InhSoilDermMMilkCropsChickenEgg	4.31E-04	0.00E+00
254	ALL	251375.09	4020038	1.150E-06	6.422YrCancerHighEnd_InhSoilDermMMilkCropsChickenEgg	4.47E-04	0.00E+00
255	ALL	251374.85	4019963.03	1.214E-06	6.422YrCancerHighEnd_InhSoilDermMMilkCropsChickenEgg	4.72E-04	0.00E+00
256	ALL	251463.14	4020481.88	4.100E-07	6.422YrCancerHighEnd_InhSoilDermMMilkCropsChickenEgg	1.59E-04	0.00E+00
257	ALL	251436.54	4020545.59	4.194E-07	6.422YrCancerHighEnd_InhSoilDermMMilkCropsChickenEgg	1.63E-04	0.00E+00
258	ALL	251409.93	4020609.31	4.413E-07	6.422YrCancerHighEnd_InhSoilDermMMilkCropsChickenEgg	1.72E-04	0.00E+00
259	ALL	251400.91	4020643.41	4.534E-07	6.422YrCancerHighEnd_InhSoilDermMMilkCropsChickenEgg	1.76E-04	0.00E+00
260	ALL	251349.62	4020752.23	1.183E-06	6.422YrCancerHighEnd_InhSoilDermMMilkCropsChickenEgg	4.60E-04	0.00E+00
261	ALL	251286.36	4020785.08	6.287E-07	6.422YrCancerHighEnd_InhSoilDermMMilkCropsChickenEgg	2.45E-04	0.00E+00
262	ALL	251196.26	4020800.35	4.420E-07	6.422YrCancerHighEnd_InhSoilDermMMilkCropsChickenEgg	1.72E-04	0.00E+00
263	ALL	251132.08	4020825.8	4.050E-07	6.422YrCancerHighEnd_InhSoilDermMMilkCropsChickenEgg	1.58E-04	0.00E+00
264	ALL	251476.2	4020375.05	4.533E-07	6.422YrCancerHighEnd_InhSoilDermMMilkCropsChickenEgg	1.76E-04	0.00E+00
265	ALL	251475.71	4020225.11	5.720E-07	6.422YrCancerHighEnd_InhSoilDermMMilkCropsChickenEgg	2.22E-04	0.00E+00
266	ALL	251475.59	4020187.62	6.025E-07	6.422YrCancerHighEnd_InhSoilDermMMilkCropsChickenEgg	2.34E-04	0.00E+00
267	ALL	251475.09	4020037.67	7.144E-07	6.422YrCancerHighEnd_InhSoilDermMMilkCropsChickenEgg	2.78E-04	0.00E+00
268	ALL	251474.97	4020000.18	7.381E-07	6.422YrCancerHighEnd_InhSoilDermMMilkCropsChickenEgg	2.87E-04	0.00E+00
269	ALL	251474.85	4019962.7	7.606E-07	6.422YrCancerHighEnd_InhSoilDermMMilkCropsChickenEgg	2.96E-04	0.00E+00
270	ALL	250236.77	4020095.48	9.893E-07	6.422YrCancerHighEnd_InhSoilDermMMilkCropsChickenEgg	3.85E-04	0.00E+00
271	ALL	250237.04	4020134.76	9.898E-07	6.422YrCancerHighEnd_InhSoilDermMMilkCropsChickenEgg	3.85E-04	0.00E+00
272	ALL	250244.22	4020159.23	1.134E-06	6.422YrCancerHighEnd_InhSoilDermMMilkCropsChickenEgg	4.41E-04	0.00E+00
273	ALL	250240.04	4020199.5	1.031E-06	6.422YrCancerHighEnd_InhSoilDermMMilkCropsChickenEgg	4.01E-04	0.00E+00
274	ALL	250251.66	4020238.28	1.293E-06	6.422YrCancerHighEnd_InhSoilDermMMilkCropsChickenEgg	5.03E-04	0.00E+00
275	ALL	250250.94	4020291.88	1.235E-06	6.422YrCancerHighEnd_InhSoilDermMMilkCropsChickenEgg	4.80E-04	0.00E+00
276	ALL	250254.66	4020331.16	1.316E-06	6.422YrCancerHighEnd_InhSoilDermMMilkCropsChickenEgg	5.12E-04	0.00E+00
277	ALL	250259.87	4020373.89	1.459E-06	6.422YrCancerHighEnd_InhSoilDermMMilkCropsChickenEgg	5.68E-04	0.00E+00
278	ALL	250251.74	4020409.72	1.164E-06	6.422YrCancerHighEnd_InhSoilDermMMilkCropsChickenEgg	4.53E-04	0.00E+00
279	ALL	250257.44	4020457.39	1.275E-06	6.422YrCancerHighEnd_InhSoilDermMMilkCropsChickenEgg	4.96E-04	0.00E+00
280	ALL	250259.15	4020496.53	1.280E-06	6.422YrCancerHighEnd_InhSoilDermMMilkCropsChickenEgg	4.98E-04	0.00E+00
281	ALL	250256.76	4020546.85	1.132E-06	6.422YrCancerHighEnd_InhSoilDermMMilkCropsChickenEgg	4.40E-04	0.00E+00
282	ALL	250260.32	4020587.08	1.118E-06	6.422YrCancerHighEnd_InhSoilDermMMilkCropsChickenEgg	4.35E-04	0.00E+00
283	ALL	250191.22	4019784.14	2.977E-07	6.422YrCancerHighEnd_InhSoilDermMMilkCropsChickenEgg	1.16E-04	0.00E+00
284	ALL	250507.57	4019780.3	7.826E-07	6.422YrCancerHighEnd_InhSoilDermMMilkCropsChickenEgg	3.04E-04	0.00E+00
285	ALL	250469.15	4019657.34	4.946E-07	6.422YrCancerHighEnd_InhSoilDermMMilkCropsChickenEgg	1.92E-04	0.00E+00
286	ALL	250309.05	4019653.5	3.096E-07	6.422YrCancerHighEnd_InhSoilDermMMilkCropsChickenEgg	1.20E-04	0.00E+00
287	ALL	251399.47	4020701.28	4.528E-07	6.422YrCancerHighEnd_InhSoilDermMMilkCropsChickenEgg	1.76E-04	0.00E+00
288	ALL	251428.16	4020673.52	3.787E-07	6.422YrCancerHighEnd_InhSoilDermMMilkCropsChickenEgg	1.47E-04	0.00E+00
289	ALL	251671.54	4020621.69	1.959E-07	6.422YrCancerHighEnd_InhSoilDermMMilkCropsChickenEgg	7.62E-05	0.00E+00
290	ALL	251734.47	4020632.8	1.727E-07	6.422YrCancerHighEnd_InhSoilDermMMilkCropsChickenEgg	6.72E-05	0.00E+00
291	ALL	251172.3	4020582.62	1.693E-06	6.422YrCancerHighEnd_InhSoilDermMMilkCropsChickenEgg	6.58E-04	0.00E+00
292	ALL	251120.01	4020519.97	3.337E-06	6.422YrCancerHighEnd_InhSoilDermMMilkCropsChickenEgg	1.30E-03	0.00E+00
293	ALL	251124.45	4020491.86	3.671E-06	6.422YrCancerHighEnd_InhSoilDermMMilkCropsChickenEgg	1.43E-03	0.00E+00
294	ALL	251145.17	4020518.49	2.229E-06	6.422YrCancerHighEnd_InhSoilDermMMilkCropsChickenEgg	8.67E-04	0.00E+00
295	ALL	251176.24	4020518.49	1.598E-06	6.422YrCancerHighEnd_InhSoilDermMMilkCropsChickenEgg	6.22E-04	0.00E+00
296	ALL	251190.06	4020558.94	1.378E-06	6.422YrCancerHighEnd_InhSoilDermMMilkCropsChickenEgg	5.36E-04	0.00E+00
297	ALL	251221.63	4020573.25	1.164E-06	6.422YrCancerHighEnd_InhSoilDermMMilkCropsChickenEgg	4.53E-04	0.00E+00
298	ALL	251227.05	4020522.93	1.107E-06	6.422YrCancerHighEnd_InhSoilDermMMilkCropsChickenEgg	4.31E-04	0.00E+00
299	ALL	251221.63	4020505.18	1.179E-06	6.422YrCancerHighEnd_InhSoilDermMMilkCropsChickenEgg	4.59E-04	0.00E+00
300	ALL	251134.31	4020417.37	4.327E-06	6.422YrCancerHighEnd_InhSoilDermMMilkCropsChickenEgg	1.68E-03	0.00E+00
301	ALL	251157.5	4020389.25	3.344E-06	6.422YrCancerHighEnd_InhSoilDermMMilkCropsChickenEgg	1.30E-03	0.00E+00
302	ALL	251190.06	4020426.74	1.980E-06	6.422YrCancerHighEnd_InhSoilDermMMilkCropsChickenEgg	7.70E-04	0.00E+00
303	ALL	251200.41	4020447.46	1.656E-06	6.422YrCancerHighEnd_InhSoilDermMMilkCropsChickenEgg	6.44E-04	0.00E+00
304	ALL	251209.29	4020467.69	1.429E-06	6.422YrCancerHighEnd_InhSoilDermMMilkCropsChickenEgg	5.56E-04	0.00E+00
305	ALL	251272.93	4020454.37	9.662E-07	6.422YrCancerHighEnd_InhSoilDermMMilkCropsChickenEgg	3.76E-04	0.00E+00
306	ALL	251296.11	4020445	8.677E-07	6.422YrCancerHighEnd_InhSoilDermMMilkCropsChickenEgg	3.38E-04	0.00E+00
307	ALL	251318.31	4020440.06	7.822E-07	6.422YrCancerHighEnd_InhSoilDermMMilkCropsChickenEgg	3.04E-04	0.00E+00
308	ALL	251338.53	4020445.49	7.035E-07	6.422YrCancerHighEnd_InhSoilDermMMilkCropsChickenEgg	2.74E-04	0.00E+00
309	ALL	251098.66	4020342.42	9.767E-06	6.422YrCancerHighEnd_InhSoilDermMMilkCropsChickenEgg	3.80E-03	0.00E+00
310	ALL	251140.71	4020334.93	4.859E-06	6.422YrCancerHighEnd_InhSoilDermMMilkCropsChickenEgg	1.89E-03	0.00E+00
311	ALL	251101.81	4020285.17	9.703E-06	6.422YrCancerHighEnd_InhSoilDermMMilkCropsChickenEgg	3.77E-03	0.00E+00
312	ALL	251224.9	4020368.89	1.728E-06	6.422YrCancerHighEnd_InhSoilDermMMilkCropsChickenEgg	6.72E-04	0.00E+00
313	ALL	251217.78	4020347.92	1.955E-06	6.422YrCancerHighEnd_InhSoilDermMMilkCropsChickenEgg	7.60E-04	0.00E+00
314	ALL	251193.87	4020287.54	2.855E-06	6.422YrCancerHighEnd_InhSoilDermMMilkCropsChickenEgg	1.11E-03	0.00E+00
315	ALL	251230.36	4020281.25	2.070E-06	6.422YrCancerHighEnd_InhSoilDermMMilkCropsChickenEgg	8.05E-04	0.00E+00
316	ALL	251167.04	4020226.74	4.149E-06	6.422YrCancerHighEnd_InhSoilDermMMilkCropsChickenEgg	1.61E-03	0.00E+00
317	ALL	251208.97	4020238.06	2.709E-06	6.422YrCancerHighEnd_InhSoilDermMMilkCropsChickenEgg	1.05E-03	0.00E+00
318	ALL	251243.31	4020318.13	1.708E-06	6.422YrCancerHighEnd_InhSoilDermMMilkCropsChickenEgg	6.64E-04	0.00E+00
319	ALL	251255.15	4020357.1	1.402E-06	6.422YrCancerHighEnd_InhSoilDermMMilkCropsChickenEgg	5.45E-04	0.00E+00
320	ALL	251099.72	4020176.92	1.041E-05	6.422YrCancerHighEnd_InhSoilDermMMilkCropsChickenEgg	4.05E-03	0.00E+00
321	ALL	251093.67	4020136.64	1.155E-05	6.422YrCancerHighEnd_InhSoilDermMMilkCropsChickenEgg	4.49E-03	0.00E+00
322	ALL	251148.56	4020168.36	5.350E-06	6.422YrCancerHighEnd_InhSoilDermMMilkCropsChickenEgg	2.08E-03	0.00E+00
323	ALL	251174.93	4020130.22	4.192E-06	6.422YrCancerHighEnd_InhSoilDermMMilkCropsChickenEgg	1.63E-03	0.00E+00
324	ALL	251091.17	4020095.65	1.199E-05	6.422YrCancerHighEnd_InhSoilDermMMilkCropsChickenEgg	4.66E-03	0.00E+00
325	ALL	251094.38	4020051.1	1.131E-05	6.422YrCancerHighEnd_InhSoilDermMMilkCropsChickenEgg	4.40E-03	0.00E+00
326	ALL	251146.77	4020126.3	5.593E-06	6.422YrCancerHighEnd_InhSoilDermMMilkCropsChickenEgg	2.18E-03	0.00E+00
327	ALL	251145.7	4020060.72	5.773E-06	6.422YrCancerHighEnd_InhSoilDermMMilkCropsChickenEgg	2.25E-03	0.00E+00
328	ALL	251177.07	4020061.79	4.258E-06	6.422YrCancerHighEnd_InhSoilDermMMilkCropsChickenEgg	1.66E-03	0.00E+00

329	ALL	251088.67	4019986.58	1.198E-05	6.422YrCancerHighEnd_InhSoilDermMMilkCropsChickenEgg	4.66E-03	0.00E+00
330	ALL	251089.39	4019963.41	1.171E-05	6.422YrCancerHighEnd_InhSoilDermMMilkCropsChickenEgg	4.55E-03	0.00E+00
331	ALL	251146.43	4020106.21	5.672E-06	6.422YrCancerHighEnd_InhSoilDermMMilkCropsChickenEgg	2.21E-03	0.00E+00
332	ALL	251135.63	4019900.16	6.029E-06	6.422YrCancerHighEnd_InhSoilDermMMilkCropsChickenEgg	2.35E-03	0.00E+00
333	ALL	251155.94	4019899.09	4.959E-06	6.422YrCancerHighEnd_InhSoilDermMMilkCropsChickenEgg	1.93E-03	0.00E+00
334	ALL	251197.32	4019983.91	3.635E-06	6.422YrCancerHighEnd_InhSoilDermMMilkCropsChickenEgg	1.41E-03	0.00E+00
335	ALL	251157.36	4019954.8	5.067E-06	6.422YrCancerHighEnd_InhSoilDermMMilkCropsChickenEgg	1.97E-03	0.00E+00
336	ALL	251179.07	4019956.28	4.193E-06	6.422YrCancerHighEnd_InhSoilDermMMilkCropsChickenEgg	1.63E-03	0.00E+00
337	ALL	250307.92	4019575.43	2.639E-07	6.422YrCancerHighEnd_InhSoilDermMMilkCropsChickenEgg	1.03E-04	0.00E+00
338	ALL	250850.88	4020634.66	1.994E-06	6.422YrCancerHighEnd_InhSoilDermMMilkCropsChickenEgg	7.76E-04	0.00E+00
339	ALL	250823.3	4020638	1.938E-06	6.422YrCancerHighEnd_InhSoilDermMMilkCropsChickenEgg	7.54E-04	0.00E+00
340	ALL	250781.18	4020638.6	1.896E-06	6.422YrCancerHighEnd_InhSoilDermMMilkCropsChickenEgg	7.37E-04	0.00E+00
341	ALL	250762.08	4020638.3	1.853E-06	6.422YrCancerHighEnd_InhSoilDermMMilkCropsChickenEgg	7.21E-04	0.00E+00
342	ALL	250960.58	4020720.42	8.332E-07	6.422YrCancerHighEnd_InhSoilDermMMilkCropsChickenEgg	3.24E-04	0.00E+00
343	ALL	250747.55	4020638.66	1.803E-06	6.422YrCancerHighEnd_InhSoilDermMMilkCropsChickenEgg	7.01E-04	0.00E+00
344	ALL	250714.79	4020637.88	1.738E-06	6.422YrCancerHighEnd_InhSoilDermMMilkCropsChickenEgg	6.76E-04	0.00E+00
345	ALL	250675.89	4020637.36	1.670E-06	6.422YrCancerHighEnd_InhSoilDermMMilkCropsChickenEgg	6.49E-04	0.00E+00
346	ALL	250732.14	4020682.63	1.147E-06	6.422YrCancerHighEnd_InhSoilDermMMilkCropsChickenEgg	4.46E-04	0.00E+00
347	ALL	250650.65	4020638.65	1.583E-06	6.422YrCancerHighEnd_InhSoilDermMMilkCropsChickenEgg	6.16E-04	0.00E+00
348	ALL	250623.43	4020637.04	1.572E-06	6.422YrCancerHighEnd_InhSoilDermMMilkCropsChickenEgg	6.11E-04	0.00E+00
349	ALL	250568.47	4020648.18	1.246E-06	6.422YrCancerHighEnd_InhSoilDermMMilkCropsChickenEgg	4.85E-04	0.00E+00
350	ALL	250570.72	4020699.41	8.397E-07	6.422YrCancerHighEnd_InhSoilDermMMilkCropsChickenEgg	3.27E-04	0.00E+00
351	ALL	250607.89	4020704.85	8.602E-07	6.422YrCancerHighEnd_InhSoilDermMMilkCropsChickenEgg	3.35E-04	0.00E+00
352	ALL	250609.69	4020657.46	1.188E-06	6.422YrCancerHighEnd_InhSoilDermMMilkCropsChickenEgg	4.62E-04	0.00E+00
353	ALL	250570.2	4020675.97	9.644E-07	6.422YrCancerHighEnd_InhSoilDermMMilkCropsChickenEgg	3.75E-04	0.00E+00
354	ALL	250549.81	4020672.54	9.595E-07	6.422YrCancerHighEnd_InhSoilDermMMilkCropsChickenEgg	3.73E-04	0.00E+00
355	ALL	250550.23	4020697.29	8.243E-07	6.422YrCancerHighEnd_InhSoilDermMMilkCropsChickenEgg	3.21E-04	0.00E+00
356	ALL	250565.33	4020722.88	7.462E-07	6.422YrCancerHighEnd_InhSoilDermMMilkCropsChickenEgg	2.90E-04	0.00E+00
357	ALL	250698.47	4020743.77	7.810E-07	6.422YrCancerHighEnd_InhSoilDermMMilkCropsChickenEgg	3.04E-04	0.00E+00
358	ALL	250612.73	4020743.85	7.235E-07	6.422YrCancerHighEnd_InhSoilDermMMilkCropsChickenEgg	2.81E-04	0.00E+00
359	ALL	250628.67	4020750.14	7.162E-07	6.422YrCancerHighEnd_InhSoilDermMMilkCropsChickenEgg	2.79E-04	0.00E+00
360	ALL	250645.87	4020748.89	7.318E-07	6.422YrCancerHighEnd_InhSoilDermMMilkCropsChickenEgg	2.85E-04	0.00E+00
361	ALL	250664.33	4020742.59	7.653E-07	6.422YrCancerHighEnd_InhSoilDermMMilkCropsChickenEgg	2.98E-04	0.00E+00
362	ALL	250568.14	4020738.34	7.023E-07	6.422YrCancerHighEnd_InhSoilDermMMilkCropsChickenEgg	2.73E-04	0.00E+00
363	ALL	250566.72	4020769.71	6.227E-07	6.422YrCancerHighEnd_InhSoilDermMMilkCropsChickenEgg	2.42E-04	0.00E+00
364	ALL	250682.78	4020740.92	7.831E-07	6.422YrCancerHighEnd_InhSoilDermMMilkCropsChickenEgg	3.05E-04	0.00E+00
365	ALL	250715.04	4020745.11	7.834E-07	6.422YrCancerHighEnd_InhSoilDermMMilkCropsChickenEgg	3.05E-04	0.00E+00
366	ALL	250749.98	4020740.12	8.138E-07	6.422YrCancerHighEnd_InhSoilDermMMilkCropsChickenEgg	3.17E-04	0.00E+00
367	ALL	250768.17	4020744.4	7.979E-07	6.422YrCancerHighEnd_InhSoilDermMMilkCropsChickenEgg	3.10E-04	0.00E+00
368	ALL	250784.21	4020742.62	8.065E-07	6.422YrCancerHighEnd_InhSoilDermMMilkCropsChickenEgg	3.14E-04	0.00E+00
369	ALL	250764.96	4020721.94	9.059E-07	6.422YrCancerHighEnd_InhSoilDermMMilkCropsChickenEgg	3.52E-04	0.00E+00
370	ALL	250672.25	4020722.65	8.490E-07	6.422YrCancerHighEnd_InhSoilDermMMilkCropsChickenEgg	3.30E-04	0.00E+00
371	ALL	250348.02	4020697.55	6.199E-07	6.422YrCancerHighEnd_InhSoilDermMMilkCropsChickenEgg	2.41E-04	0.00E+00
372	ALL	250436.9	4020752.39	5.602E-07	6.422YrCancerHighEnd_InhSoilDermMMilkCropsChickenEgg	2.18E-04	0.00E+00
373	ALL	250522.93	4020787.37	5.597E-07	6.422YrCancerHighEnd_InhSoilDermMMilkCropsChickenEgg	2.18E-04	0.00E+00
374	ALL	250645.84	4020840.31	5.099E-07	6.422YrCancerHighEnd_InhSoilDermMMilkCropsChickenEgg	1.98E-04	0.00E+00
375	ALL	250404.16	4019658.45	4.067E-07	6.422YrCancerHighEnd_InhSoilDermMMilkCropsChickenEgg	1.58E-04	0.00E+00
376	ALL	250352.16	4019661.28	3.550E-07	6.422YrCancerHighEnd_InhSoilDermMMilkCropsChickenEgg	1.38E-04	0.00E+00
377	ALL	250511.8	4019655.11	5.755E-07	6.422YrCancerHighEnd_InhSoilDermMMilkCropsChickenEgg	2.24E-04	0.00E+00
378	ALL	250362.15	4019570.86	3.023E-07	6.422YrCancerHighEnd_InhSoilDermMMilkCropsChickenEgg	1.18E-04	0.00E+00
379	ALL	250449.15	4019564.25	3.829E-07	6.422YrCancerHighEnd_InhSoilDermMMilkCropsChickenEgg	1.49E-04	0.00E+00
380	ALL	250506.83	4019565.19	4.625E-07	6.422YrCancerHighEnd_InhSoilDermMMilkCropsChickenEgg	1.80E-04	0.00E+00
381	ALL	250587.2	4019566.14	6.238E-07	6.422YrCancerHighEnd_InhSoilDermMMilkCropsChickenEgg	2.43E-04	0.00E+00
382	ALL	250636.37	4019553.84	7.324E-07	6.422YrCancerHighEnd_InhSoilDermMMilkCropsChickenEgg	2.85E-04	0.00E+00
383	ALL	250815.61	4019536.33	1.306E-06	6.422YrCancerHighEnd_InhSoilDermMMilkCropsChickenEgg	5.08E-04	0.00E+00
384	ALL	251373.39	4019653.8	1.223E-06	6.422YrCancerHighEnd_InhSoilDermMMilkCropsChickenEgg	4.75E-04	0.00E+00
385	ALL	250355.87	4020554.58	1.060E-06	6.422YrCancerHighEnd_InhSoilDermMMilkCropsChickenEgg	4.12E-04	0.00E+00
386	ALL	250333.71	4020584.89	1.341E-06	6.422YrCancerHighEnd_InhSoilDermMMilkCropsChickenEgg	5.22E-04	0.00E+00
387	ALL	250341.59	4020500	1.002E-06	6.422YrCancerHighEnd_InhSoilDermMMilkCropsChickenEgg	3.90E-04	0.00E+00
388	ALL	250245.78	4020604.9	7.862E-07	6.422YrCancerHighEnd_InhSoilDermMMilkCropsChickenEgg	3.06E-04	0.00E+00
389	ALL	250261.25	4020563.67	1.23E-06	6.422YrCancerHighEnd_InhSoilDermMMilkCropsChickenEgg	4.76E-04	0.00E+00
390	ALL	250267.81	4020649.47	7.172E-07	6.422YrCancerHighEnd_InhSoilDermMMilkCropsChickenEgg	2.79E-04	0.00E+00
391	ALL	250420.36	4020654.9	1.004E-06	6.422YrCancerHighEnd_InhSoilDermMMilkCropsChickenEgg	3.90E-04	0.00E+00
392	ALL	250371.98	4020661.32	8.900E-07	6.422YrCancerHighEnd_InhSoilDermMMilkCropsChickenEgg	3.46E-04	0.00E+00
393	ALL	250329.52	4020666.25	7.889E-07	6.422YrCancerHighEnd_InhSoilDermMMilkCropsChickenEgg	3.07E-04	0.00E+00
394	ALL	250346.8	4020643.05	1.243E-06	6.422YrCancerHighEnd_InhSoilDermMMilkCropsChickenEgg	4.83E-04	0.00E+00
395	ALL	250244.11	4020647	6.092E-07	6.422YrCancerHighEnd_InhSoilDermMMilkCropsChickenEgg	2.37E-04	0.00E+00
396	ALL	250239.18	4020503.34	8.634E-07	6.422YrCancerHighEnd_InhSoilDermMMilkCropsChickenEgg	3.36E-04	0.00E+00
397	ALL	250248.06	4020443.11	1.054E-06	6.422YrCancerHighEnd_InhSoilDermMMilkCropsChickenEgg	4.10E-04	0.00E+00
398	ALL	250257.44	4020391.76	1.349E-06	6.422YrCancerHighEnd_InhSoilDermMMilkCropsChickenEgg	5.25E-04	0.00E+00
399	ALL	250256.9	4020359.08	1.365E-06	6.422YrCancerHighEnd_InhSoilDermMMilkCropsChickenEgg	5.31E-04	0.00E+00
400	ALL	250256.46	4020313.27	1.395E-06	6.422YrCancerHighEnd_InhSoilDermMMilkCropsChickenEgg	5.43E-04	0.00E+00
401	ALL	250202.64	4020247.11	6.447E-07	6.422YrCancerHighEnd_InhSoilDermMMilkCropsChickenEgg	2.51E-04	0.00E+00
402	ALL	250218.44	4020402.13	7.179E-07	6.422YrCancerHighEnd_InhSoilDermMMilkCropsChickenEgg	2.79E-04	0.00E+00
403	ALL	251306.89	4020347.38	1.020E-06	6.422YrCancerHighEnd_InhSoilDermMMilkCropsChickenEgg	3.97E-04	0.00E+00
404	ALL	251320.73	4020390.18	8.562E-07	6.422YrCancerHighEnd_InhSoilDermMMilkCropsChickenEgg	3.33E-04	0.00E+00
405	ALL	251320.31	4020370.88	8.953E-07	6.422YrCancerHighEnd_InhSoilDermMMilkCropsChickenEgg	3.48E-04	0.00E+00
406	ALL	251282.55	4020280.65	1.393E-06	6.422YrCancerHighEnd_InhSoilDermMMilkCropsChickenEgg	5.42E-04	0.00E+00
407	ALL	251228.54	4020099.28	2.732E-06	6.422YrCancerHighEnd_InhSoilDermMMilkCropsChickenEgg	1.06E-03	0.00E+00
408	ALL	251245.41	4020023.16	2.532E-06	6.422YrCancerHighEnd_InhSoilDermMMilkCropsChickenEgg	9.85E-04	0.00E+00
409	ALL	251187.15	4020024.64	3.936E-06	6.422YrCancerHighEnd_InhSoilDermMMilkCropsChickenEgg	1.53E-03	0.00E+00
410	ALL	250155.94	4020204.09	4.744E-07	6.422YrCancerHighEnd_InhSoilDermMMilkCropsChickenEgg	1.85E-04	0.00E+00
411	ALL	250156.6	4020260.76	4.806E-07	6.422YrCancerHighEnd_InhSoilDermMMilkCropsChickenEgg	1.87E-04	0.00E+00
412	ALL	250186.24	4020169.83	5.651E-07	6.422YrCancerHighEnd_InhSoilDermMMilkCropsChickenEgg	2.20E-04	0.00E+00
413	ALL	250188.88	4020199.48	5.782E-07	6.422YrCancerHighEnd_InhSoilDermMMilkCropsChickenEgg	2.25E-04	0.00E+00
414	ALL	250186.24	4020148.09	5.616E-07	6.422YrCancerHighEnd_InhSoilDermMMilkCropsChickenEgg	2.18E-04	0.00E+00

HARP2 - HRACalc (dated 22118) 11/1/2022 8:07:35 AM - Output Log

GLCs loaded successfully
Pollutants loaded successfully
Pathway receptors loaded successfully

RISK SCENARIO SETTINGS

Receptor Type: Resident
Scenario: All
Calculation Method: HighEnd

EXPOSURE DURATION PARAMETERS FOR CANCER

Start Age: -0.25
Total Exposure Duration: 6.422

Exposure Duration Bin Distribution
3rd Trimester Bin: 0.25
0<2 Years Bin: 2
2<9 Years Bin: 4.422
2<16 Years Bin: 0
16<30 Years Bin: 0
16 to 70 Years Bin: 0

PATHWAYS ENABLED

NOTE: Inhalation is always enabled and used for all assessments. The remaining pathways are only used for cancer and noncancer chronic assessments.

Inhalation: True
Soil: True
Dermal: True
Mother's milk: True
Water: False
Fish: False
Homegrown crops: True

Beef: False
Dairy: False
Pig: False
Chicken: True
Egg: True

INHALATION

Daily breathing rate: LongTerm24HR

Worker Adjustment Factors
Worker adjustment factors enabled: NO

Fraction at time at home
3rd Trimester to 16 years: OFF
16 years to 70 years: OFF

SOIL & DERMAL PATHWAY SETTINGS

Deposition rate (m/s): 0.02
Soil mixing depth (m): 0.01
Dermal climate: Mixed

HOMEGROWN CROP PATHWAY SETTINGS

Household type: HouseholdsthatGarden
Fraction leafy: 0.137
Fraction exposed: 0.137
Fraction protected: 0.137
Fraction root: 0.137

PIG, CHICKEN, & EGG PATHWAY SETTINGS

Surface area (m²): 0
Volume (kg): 0

Volume changes per year: 0

Pig

Fraction consumed from contaminated water source: 0
Fraction consumed of contaminated leafy crop: 0.25
Fraction consumed of contaminated exposed crop: 0.25
Fraction consumed of contaminated protected crop: 0.25
Fraction consumed of contaminated root crop: 0.25

Chicken

Fraction consumed from contaminated water source: 0
Fraction consumed of contaminated leafy crop: 0.25
Fraction consumed of contaminated exposed crop: 0.25
Fraction consumed of contaminated protected crop: 0.25
Fraction consumed of contaminated root crop: 0.25

Egg

Fraction consumed from contaminated water source: 0
Fraction consumed of contaminated leafy crop: 0.25
Fraction consumed of contaminated exposed crop: 0.25
Fraction consumed of contaminated protected crop: 0.25
Fraction consumed of contaminated root crop: 0.25

TIER 2 SETTINGS

Tier2 adjustments were used in this assessment. Please see the input file for details.

Tier2 - What was changed: ED or start age changed|

Calculating cancer risk

Cancer risk breakdown by pollutant and receptor saved to: F:\0019.0007 L54\01b - HARP Unmit\LEMOORE UNMIT CONSTRUCTION\hra\L54-Unmit ConCancerRisk.csv

Cancer risk total by receptor saved to: F:\0019.0007 L54\01b - HARP Unmit\LEMOORE UNMIT CONSTRUCTION\hra\L54-Unmit ConCancerRiskSumByRec.csv

Calculating chronic risk

Chronic risk breakdown by pollutant and receptor saved to: F:\0019.0007 L54\01b - HARP Unmit\LEMOORE UNMIT CONSTRUCTION\hra\L54-Unmit ConNCChronicRisk.csv

Chronic risk total by receptor saved to: F:\0019.0007 L54\01b - HARP Unmit\LEMOORE UNMIT CONSTRUCTION\hra\L54-Unmit ConNCChronicRiskSumByRec.csv

Calculating acute risk

Acute risk breakdown by pollutant and receptor saved to: F:\0019.0007 L54\01b - HARP Unmit\LEMOORE UNMIT
CONSTRUCTION\hra\L54-Unmit ConNCAcuteRisk.csv
Acute risk total by receptor saved to: F:\0019.0007 L54\01b - HARP Unmit\LEMOORE UNMIT
CONSTRUCTION\hra\L54-Unmit ConNCAcuteRiskSumByRec.csv
HRA ran successfully

7.2 Appendix B: Biological Resource Assessment

Prepared by Argonaut Ecological, Inc., dated September 1, 2022.

BIOLOGICAL RESOURCE ASSESSMENT

Tentative Tract Map 939

E Bush Avenue, City of Lemoore, California, Kings County

Prepared For:



September 1, 2022

BIOLOGICAL RESOURCE ASSESSMENT
Tentative Tract Map 939
E Bush Avenue, Lemoore, Ca.

Prepared For:



Prepared By:

ARGONAUT
ECOLOGICAL
CONSULTING, INC. 
2377 Gold Meadow Way, Suite 100
Gold River, CA 95670

September 1, 2022

Table of Contents

<u>1.0 EXECUTIVE SUMMARY AND INTRODUCTION</u>	<u>0</u>
EXECUTIVE SUMMARY	0
1.1 INTRODUCTION.....	0
1.2 STUDY OBJECTIVES	0
1.3 REGULATORY JURISDICTION AND BACKGROUND.....	3
WETLAND PROTECTION	3
LISTED PROTECTED SPECIES AND HABITAT PROTECTION	4
CALIFORNIA ENDANGERED SPECIES ACT.....	6
CALIFORNIA ENVIRONMENTAL QUALITY ACT.....	6
LAND USE ENTITLEMENTS.....	6
<u>2.0 RESOURCES CONSULTED, METHODS, AND RESULTS.....</u>	<u>7</u>
2.1 DATA AND LITERATURE REVIEW	7
2.2 AERIAL PHOTOGRAPHY AND WETLAND MAPPING	7
2.3 FIELD INVESTIGATION	7
<u>3.0 RESULTS AND CONCLUSIONS.....</u>	<u>8</u>
3.1 PHYSICAL RESOURCES AND ELEMENTS	8
CLIMATE.....	8
TOPOGRAPHY/SOILS/DRAINAGE	8
LAND USE	9
HABITAT	9
WATERS/WETLAND.....	9
SPECIAL STATUS SPECIES	11
3.3 CONCLUSIONS.....	13
List of Figures	
FIGURE 1: LOCATION.....	2
FIGURE 2: NATIONAL WETLAND INVENTORY MAP	9
FIGURE 3: HABITAT MAP	10
FIGURE 4: CNDDDB BIO RECORDS IN THE VICINITY OF THE STUDY AREA	11
List of Tables	
TABLE 1: SOILS	9
TABLE 2: SUMMARY OF SPECIAL STATUS SPECIES	12

Appendices

ATTACHMENT A: PHOTOGRAPHS

ATTACHMENT B: CNDDDB/IPAC DATA BASE AND SPECIES LIST

1.0 EXECUTIVE SUMMARY AND INTRODUCTION

EXECUTIVE SUMMARY

Argonaut Ecological, Inc. conducted a biological evaluation of a proposed development (TTM 939) of a 52.6 acre study area located immediately north of Highway 198 and east of South Lemoore Avenue (Figure 1). The assessment included assessing the types of habitats present and sensitive species associated with those habitats. The biological evaluation focused on mapping existing habitat types based on a field review and reviewing public and commercial databases, aerial photographs (current and historical), and other published information and available data.

The Study Area has been in agricultural production for several decades and the site does not support suitable habitat for any special status species. There is a canal within the Study Area that would be taken out of service, but the canal is a man-made feature with no connection to downstream waters of the U.S. or State.

1.1 INTRODUCTION

The project proponent (“Project”) proposes to develop the parcel into single family homes (276 units) with a density of roughly 6.04 units per acre. The development would include 2 parks totaling 239,580 square feet and includes a trail/park and a dual use park/basin.

1.2 STUDY OBJECTIVES

This report provides an overall assessment of the biological resources present within and adjacent to the Study Area, describes the area's biological characteristics, and evaluates the Study Area's likelihood to support sensitive biological resources (such as wetlands, creeks/drainages, and special status species). This evaluation used available literature, aerial photography, historic topographic and aerial maps, and a site visits. For purposes of this study, wetland habitat includes those areas possibly considered to be "waters of the U.S." as defined by the U.S. Army Corps of Engineers (Army Corps) or Waters of the State of California. As described in Section 1.2.1, wetlands are a subset of "Waters of the U.S." under the Federal Clean Water Act.

FIGURE 1

This report assesses the Project's potential effects on biological resources and evaluates whether any associated regulatory approvals or permits are required. This report also evaluates potential impacts site development may have on protected habitat, species protected by the Federal Endangered Species Act, or those protected under the California Environmental Quality Act or California Endangered Species Act.

1.3 REGULATORY JURISDICTION AND BACKGROUND

Several agencies share regulatory jurisdiction over biological resources. The following is a brief description of the primary agencies and their respective jurisdiction.

Wetland Protection

U.S. Army Corps of Engineers

Wetlands are a type of Waters of the U.S. The U.S. Army Corps of Engineers (Army Corps) and the U.S. Environmental Protection Agency regulate the placement of fill into the Waters of the U.S. under Section 404 of the Federal Clean Water Act and Section 10 of the Rivers and Harbor Act. For this purpose, the term "Waters of the U.S." is legally defined under Section 404 of the Federal Clean Water Act and includes interstate streams, creeks, and adjacent wetlands. The Army Corps defines wetlands as "*those areas that are inundated or saturated by surface or groundwater at a frequency and duration sufficient to support, and that under normal circumstances do support, a prevalence of vegetation typically adapted for life in saturated soil conditions*" (Environmental Laboratory 1987). In California, seasonally inundated areas that meet the criteria of all three wetland parameters (soils, hydrology, and vegetation), as defined in the recently issued Wetland Delineation Manual for the Arid West (USACE 2006), are also considered jurisdictional wetlands.

Since 2001, several U.S. Supreme Court rulings regarding the regulation of isolated, intrastate waters by the Army Corps have limited the scope of federal jurisdiction under the Federal Clean Water Act and excluded many California wetlands from federal regulation.

In December 2019, the U.S. Environmental Protection Agency and the U.S. Army published the final rule to repeal the 2015 Clean Water Rule. The "Clean Water Rule" clarified what constitutes waters of the U.S., and presumably, more precisely define and make permitting more predictable, thus less costly, and more straightforward.

After several challenges to the "Clean Water Rule," a revised rule became effective on June 22, 2020; however, in 2021, the Army Corps announced that the Clean Water Rules was rescinded and the regulations in effect before 2015 would be restored. On November 18, 2021, the U.S. Environmental Protection Agency and the Department of the Army announced the signing of a proposed rule to revise the definition of "waters of the United States." In doing so, the agencies propose to put back into place the pre-2015 "(pre-Obama-era rules) definition of "waters of the United States," updated to reflect consideration of Supreme Court decisions.

California State Water Resources Control Board

Since 1993, California has had a Wetlands Conservation Policy (a.k.a., the Executive Order W-51 59-93) and is commonly referred to as the *No Net Loss policy* for wetlands. This order establishes a state mandate for developing and adopting a policy framework and strategy to protect the state's wetland ecosystems. The policy was to be implemented voluntarily and was expressly not to be implemented on a "project-by-project" basis (See EO W-59-93, Section III).

In 2020 California adopted the State Wetland Definition and Procedures for Discharges of Dredged or Fill Material to Waters of the State. The State definition of wetland differs from the Federal definition in that the state definition includes areas with no vegetation, assuming the other criteria are met. Wetlands of the State include 1) natural wetlands, 2) wetlands created by modification of water of the state (at any point in history), and 3) artificial wetlands that meet specific criteria. The State definition only exempts a few types of waters. Examples of water features excluded from the state's definition include industrial or municipal wastewater, certain stormwater treatment facilities, agricultural crop irrigation, industrial processing or cooling, and fields flooded for rice growing.

Listed Protected Species and Habitat Protection

U.S. Fish and Wildlife Service

The U.S. Fish and Wildlife Service (USFWS) implements the Migratory Bird Treaty Act (16 USC Section 703-711), Bald and Golden Eagle Protection Act (16 United States Code [USC] Section 668), and Federal Endangered Species Act (FESA; 16 USC § 153 *et seq.*).

The **Migratory Bird Treaty Act (MBTA)** was first enacted in 1918 to protect migratory birds between the United States and Great Britain (acting on behalf of Canada). The MBTA makes it illegal for anyone to take, possess, import, transport, purchase, barter, or offer for sale or purchase any migratory birds, nests, or eggs unless a federal agency has issued a permit. The USFWS has statutory authority and responsibility for enforcing the MBTA. The MBTA was reformed in 2004 to include all species native to the U.S. or its territories due to natural biological or ecological processes (70 FR 12710, March 15, 2005). The Act does not include non-native species whose occurrences in the U.S. are solely the result of intentional or unintentional human introduction. The USFWS maintains a list of bird species not protected under the MBTA.

In January 2021, the USFWS published a new rule in the Federal Register. Under the rule change, the unintentional killing of migratory birds does not violate the MBTA. Only the intentional "pursuing, hunting, taking, capturing, killing, or attempting to do the same ... directed at migratory birds, their nests, or their eggs" would be illegal under the changes.

The **Federal Endangered Species Act** prohibits "take" "of any federally listed wildlife species (the destruction of federally listed plants on private property is not prohibited and does not require a permit). "Take" under the federal definition means to harass, harm, pursue, hunt, shoot, wound,

kill, trap, capture, or collect, or to attempt to engage in any such conduct. "Incidental take" is harm or death that may occur during the implementation of an otherwise lawful activity. "Candidate species" do not have the full protection of FESA. However, the USFWS advises project applicants that it is prudent to address these species since they could be elevated to "listed status" before completion of projects with long planning or development schedules.

Projects that would result in "take" of any federally-listed threatened or endangered species can obtain authorization from the USFWS through either Section 7 (interagency consultation) or Section 10(a) (incidental take permit) of FESA. The authorization process determines if a project would jeopardize a listed species' continued existence and what mitigation measures would be required to avoid jeopardizing the species.

An Incidental Take Permit or Take Permit is required when an activity would either kill, harm, harass, or interrupt a listed species' breeding or nesting. The ESA definition of "harm" is somewhat less definitive since it includes ubiquitous activities. In 1999 the USFWS clarified the term "harm" as it applies to the ESA in the Federal Register. As stated, the final rule defined the term "harm" "to include any act which causes actual harm (kills or injures fish or wildlife) and emphasizes that such actions may have significant habitat modification or degradation that significantly impairs essential behavioral patterns of fish or wildlife.

California Department of Fish and Wildlife

The California Department of Fish and Wildlife (CDFW) is a Trustee Agency responsible under CEQA to review and evaluate projects impacts on plant and wildlife resources. Under the Fish and Game Code Section 1802, the CDFW has jurisdiction over the conservation, protection, and management of fish, wildlife, native plants, and habitat necessary for biologically sustainable populations. The California Fish and Game Code also provides authority for the CDFW to regulate projects that could result in the "take" of any species listed by the state as threatened or endangered (Section 2081). CDFW also has authority over all state streams, as described below.

Perennial and intermittent streams also fall under the jurisdiction of CDFW according to Sections 1601-1603 of the Fish and Game Code (Streambed Alteration Agreements). CDFW's jurisdictional extent includes work within the stream zone, including the diversion or obstruction of the natural flow or changes in the channel, bed, or bank of any river, stream, or lake. Before issuing a 1601 or 1603 Streambed Alteration Agreement, the CDFW must demonstrate compliance with CEQA. In most cases, CDFW relies on the CEQA review performed by the local lead agency. However, in cases where no CEQA review was required for the project, CDFW would act as the lead agency under CEQA.

The CDFW also has authority for the protection of state-listed species issues under Section 2081 Incidental Take Permit if a project has the potential to negatively affect state-protected plant or animal species or their habitats, either directly or indirectly. Protected species include those "listed" by the state as endangered or threatened. Besides listed species, other species protection categories include "fully protected" and California Species of Special Concern (CSC). Adverse impacts to species that are "fully protected" are prohibited.

Under the California Fish & Game Code (FGC Section 3503), "it is unlawful to take, possess, or needlessly destroy the nest or eggs of any bird...." Birds of prey (falcons, hawks, owls, and eagles) get extra protection under the law (FGC Section 3503.5).

As is the case with USFWS, CDFW does not have the authority to require a landowner to apply for an Incidental Take Permit (ITP) authorizing take. Instead, the landowner has the legal obligation to avoid any take of state-listed species if it does not seek an ITP. That said, CDFW (and USFWS) can initiate an enforcement action if they believe that an illegal take has occurred or will occur.

California Endangered Species Act

The California Endangered Species Act (CESA) protects candidate plants and animal species and those listed under CESA as rare, threatened, or endangered. This Act prohibits the take of any such species unless authorized. Section 2081 authorizes the state to issue incidental take permits. The state definition of taking applies only to acts that result in death or adverse impacts to protected species. The CAESA mirrors the federal regulation as it relates to "take"; however, there is no state equivalent definition of "harm" or "harass." Incidental take is also not defined by the CAESA statute or regulation. Unlike the federal ESA, CAESA does not qualify that incidental take "is not prohibited "if it is the result of an act that occurs on a farm or ranch in the course of an otherwise lawful routine and ongoing agricultural activity." Where disagreement occurs (and in some cases, this has been the subject of court cases) is in the common understanding of "routine and ongoing agricultural activity."

California Environmental Quality Act

The CEQA Guidelines require a review of projects to determine their environmental effects and identify mitigation measures to reduce impacts to a less than significant level. The Guidelines state that an effect may be significant if it affects rare and endangered species. Section 15380 of the Guidelines defines *rare* to include listed species and allows agencies to consider rare species other than those designated as State or Federal threatened or endangered, but that meet the standards for rare under the Federal or State endangered species acts. On this basis, plants designated as rare by non-regulatory organizations (e.g., California Native Plant Society), species of special concern as defined by CDFW, candidate species as defined by USFWS, and other designations need to be considered in CEQA analyses.

Land Use Entitlements

City of Lemoore

The City of Lemoore is responsible for all local land-use decisions within its jurisdiction and compliance with the California Environmental Quality Act (CEQA). A portion of the project is within the City's jurisdiction, but part of the Study Area lies within the County boundary. As the lead agency under CEQA, the city will consider other responsible agencies' recommendations during the CEQA review.

2.0 RESOURCES CONSULTED AND METHODS

The following section describes the methods used to assess the Study Area and includes data review and evaluation, field studies, and aerial photograph interpretations.

2.1 DATA AND LITERATURE REVIEW

Documents and sources of information used to prepare this evaluation include the following:

- U.S. Department of Agriculture, Natural Resources Conservation Service, Soil Survey of Fresno Area (Soils mapper).
- Aerial photography (Google Earth®, Bing®, and historic aerials).
- California Department of Fish and Wildlife, California Natural Diversity Database (CNDDDB/RareFind - Recent version with updates)
- U.S. Fish and Wildlife Service, National Wetland Inventory Map.
- U.S. Fish and Wildlife Service, Information for Planning and Consultation (IPaC).
- U.S. Geological Survey, Historical Topographic Map, Lemoore Quadrangle, 1919, University of Texas, Austin, Perry-Castañeda Map Collection

Before conducting a site review, the California Natural Diversity Database/ RareFind (CNDDDB) and the USFWS IPaC were consulted to determine the species potentially present within the Study Area based on location. The purpose of the review was to assess the likelihood of special status species being present on the site based on the site's distance from documented species occurrences and the presence or absence of habitat types utilized by such species. The CNDDDB includes records of reported observations for special status plant and animal species and is queried based on a search radius of USGS quadrangle maps. Before conducting the fieldwork, high-resolution aerial photographs were also reviewed to determine if any areas on the site appear to support the presence of Waters of the U.S.

2.2 AERIAL PHOTOGRAPHY AND WETLAND MAPPING

Historical aerial photographs dating back to the 1980s of the Study Area were reviewed to identify site features and determine land-use changes over time. Also reviewed were wetland mapping and aerial photographs to determine if the Study Area recently supported wetlands.

2.3 FIELD INVESTIGATION

A site investigation was performed on August 6, 2022. The entire Study Area was reviewed, and all habitat features were mapped. Soils, vegetation, and drainage patterns within the Study Area

were inspected to determine the habitat present and suitability for species of concern. Photographs are included in Attachment A:

3.0 RESULTS AND CONCLUSIONS

Section 3.1, below, describes the physical features (i.e., land use, soils, vegetation, hydrology, etc.) and the study area's biological features. The physical components and land use strongly influence the types of plants and animals present. This section also describes the habitats present and the specific biological resources observed during the site review.

Section 3.2 presents our conclusions, and Section 3.3 contains recommended avoidance and minimization measures to avoid potential impacts.

The following is not an exhaustive inventory of plants and animals present. Instead, the discussion provides sufficient information to identify biological resources that are considered unique, sensitive, or protected by current law and the potential impacts on those resources due to site development.

3.1 PHYSICAL RESOURCES AND ELEMENTS

Climate

The Study Area climate is typical of the central San Joaquin Valley, with long, hot, and dry summers and winters that are cool and mild. In the winter, rainfall averages approximately 10.9 inches per year, falling mainly between November and April (Western Regional Climate Center, 2004). During 2020 total rainfall in Fresno totaled 7.8 inches, as recorded at Fresno State University, Fresno. Since September 2022 to current (August 2022) the Fresno region has had a total of 7.3 inches of rainfall (roughly 3 ½ inches below average for the year).

Topography and Soils

Topography:

The Study Area lies within the San Joaquin Valley and is relatively flat, but slopes toward the southwest. In 1919 the topography of the site was at roughly elevation 230 mean sea level. The topography has remained relatively unchanged.

Soils:

The site is made up of two soil types as shown in Table 1. The soils are primary sandy loam and loam. These soils are generally well drained. None of the soils are classified as hydric, indicating a low potential for drainage or wetland features.

Table 1 Soil Types Within the Study Area		
Soil Type	Classified as Hydric?	% of Study Area
Kimberlin fine sandy loam saline-alkali	No	68.5
Lemoore sandy loam, partially drained	No	5.9
Nord complex	No	10

Land Use

The Study Area is in a historically rural, agricultural area of Kings County in the City of Lemoore. Lands north and east of the Study Area are residential. The land immediately west of the Study Area is used for Lemoore High School property. There are two homes and a church along the northern edge of the Study Area (between the Study Area and N. Bush Avenue). The Study Area is developed as an orchard south of an irrigation canal.

Waters/Wetland

According to the National Wetland Inventory Map (Figure 2), the only identified waters is the irrigation canal that runs within the Study Area. This irrigation ditch appears to be unnamed. Figure 2 shows the canal crossing through the northern half of the Study Area, the turning south on the adjacent high school property. However, it the southern leg of the canal has either been relocated off the school property and a new channel appears to have been excavated along the western edge of this Study Area or the location shown on the NWI is inaccurate.

The National Wetland Inventory Maps lists the canal as “riverine” habitat but there does not appear to be any hydrologic connection of the canal to any upstream or downstream waters of the U.S. The canal is a trapezoidal channel and delivers irrigation water. There is a mixture of upland and wetland vegetation along the interior edges of the canal. It is unlikely this canal is a waters of the U.S./State given its lack on connectivity to downstream waters. The proposed site plan proposes to remove the irrigation canal from service.

Habitat

There are several California habitat classification systems. Most of these classification systems describe natural communities and do not have established classifications for developed or agricultural habitats. The Study Area is historically farmed (orchards and row crops) for at least 30 years. There are two areas with disturbed/ ruderal habitat, dominated by bare ground or weedy species (tumbleweed (*Amaranthus albus*), tree of heaven (*Ailanthus altissima*), rescue grass (*Bromus catharticus*), dove weed (*Croton setigerus*), mustard (*Brassica sp.*), star-thistle

(*Centaurea sp.*), This habitat is found along the irrigation canal and in the open vacant portion of the Study Area. There are two large valley oak (*Quercus lobata*) on the northern portion of the Study Area, north of the irrigation canal. Both trees are greater than 24” diameter at breast height “dbh”. The remainder of the Study Area is in orchard production (See Figure 3).

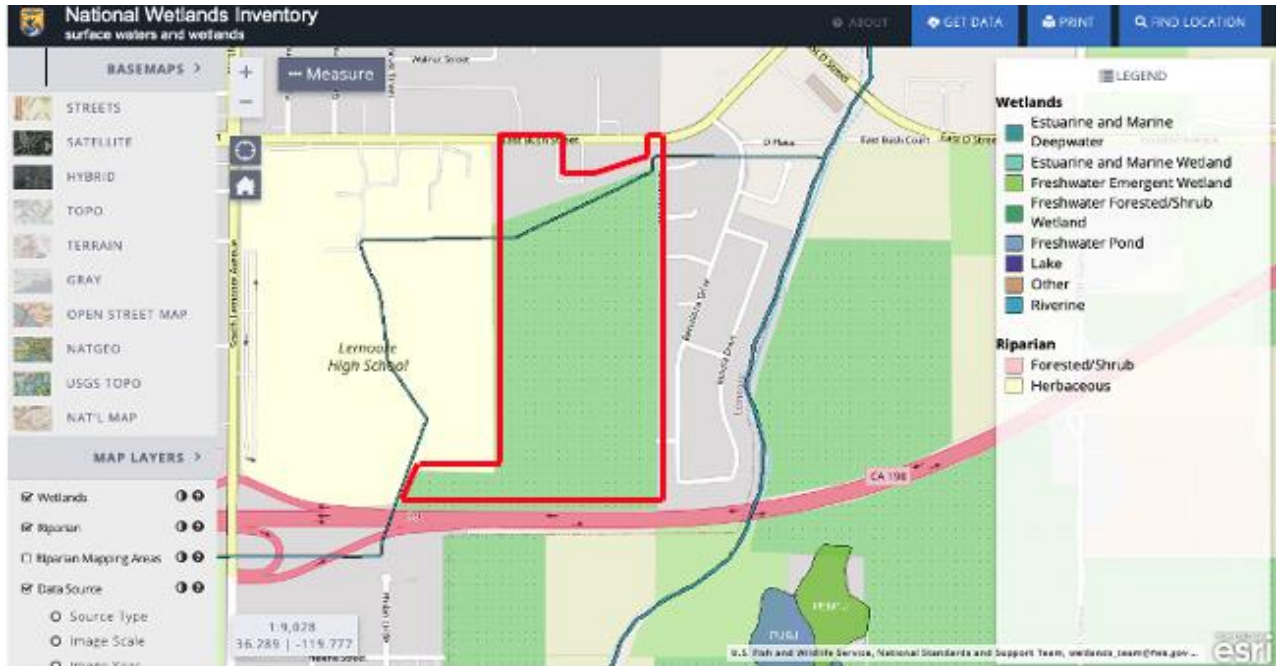

Figure 2 ↑

National Wetland Inventory Map

Study Area

Special Status Species

The California Natural Diversity Database (CNDDDB) and USFWS IPac was queried to determine which special status species could be present within the Study Area. There is no critical habitat within or near the Study Area, nor is there any rare or unique habitats or wetlands. The CNDDDB Bios mapping (Figure 4) shows the location of known records of special status species near the Study Area and Table 2 includes a summary of the CNDDDB query results.

There are 7 potential special status species within the region, but no suitable habitat for any of the species, except for San Joaquin kit fox (SJKF). SJKF could pass through the Study Area and forage for prey, but it is highly unlikely. There is no denning habitat for the species present. The likelihood for the species to be present is very low. No potential impacts to species status species are expected to result from site development.

VICINITY AND LOCATION MAP

PROJECT NAME: Bush Street - Lemoore
PROJECT LOCATION: Part of Sections 11 & 12-19-20
Kings County, California

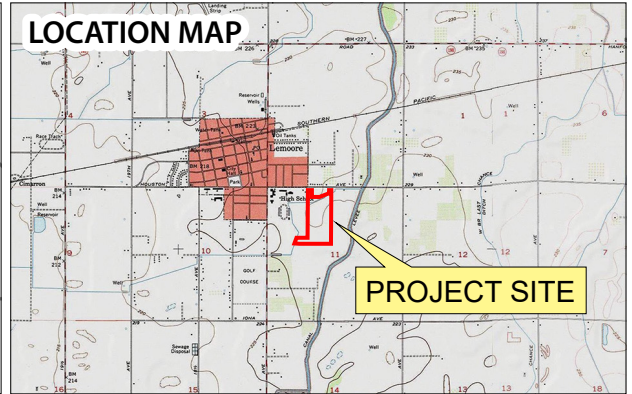
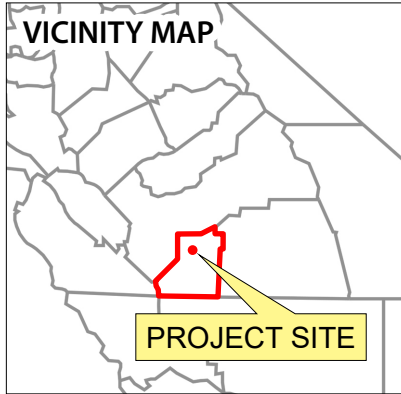

Legend

 APPROXIMATE BOUNDARY (54.11 AC)

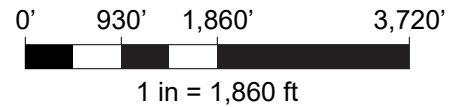
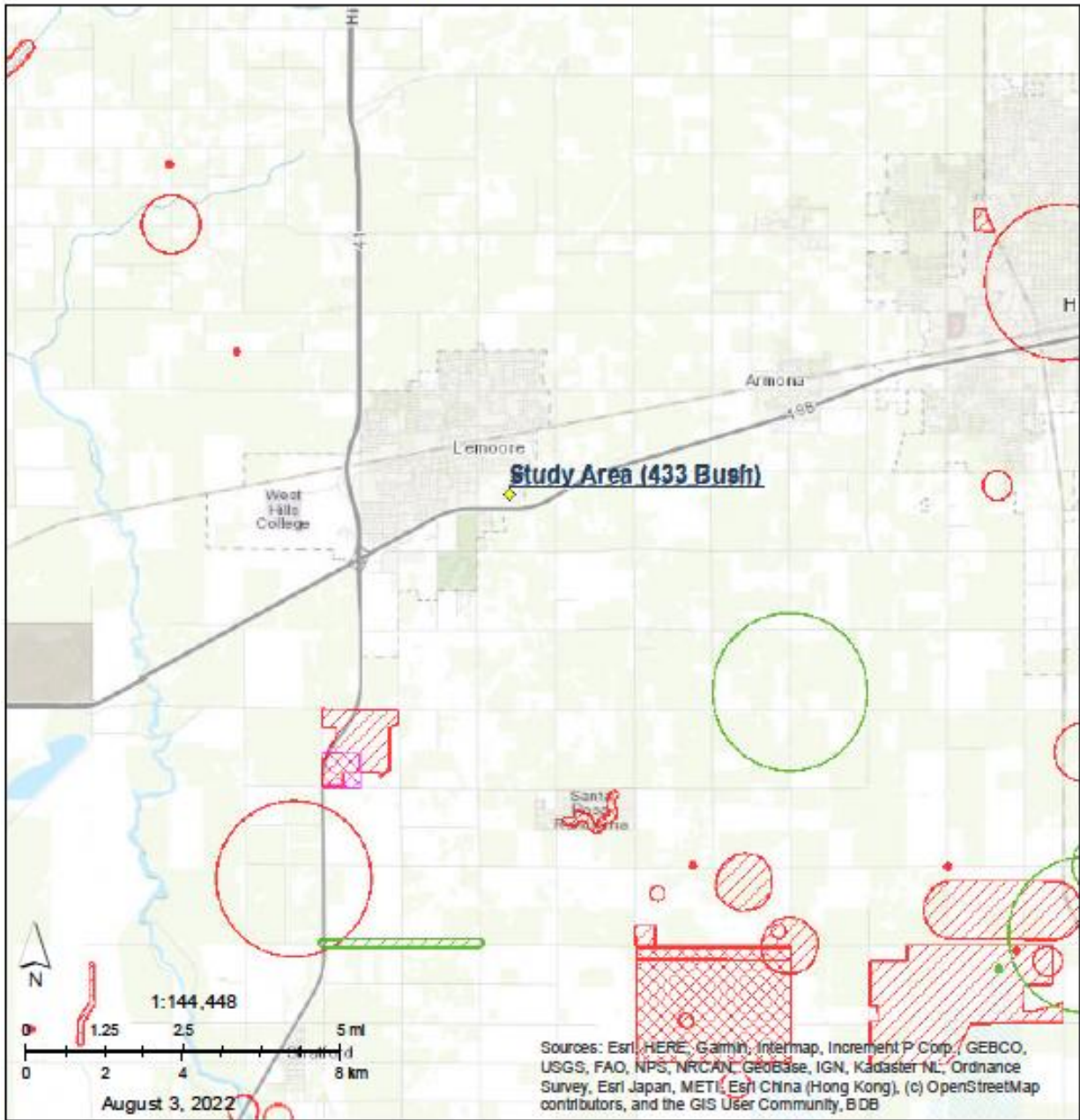

Figure 4 BIOS Map



Sources: Esri, HERE, Garmin, Intermap, increment P Corp., GEBCO, USGS, FAO, NPS, NRCAN, GEBCO, IGN, Kadaster NL, Ordnance Survey, Esri Japan, METI, Esri China (Hong Kong), (c) OpenStreetMap contributors, and the GIS User Community, BDB

California Natural Diversity Database (CNDDB) Commercial [ds85]

- Plant (80m)
- Plant (specific)
- Plant (non-specific)
- Plant (circular)
- Animal (80m)
- Animal (specific)

- Animal (non-specific)
- Animal (circular)
- Terrestrial Comm. (80m)
- Terrestrial Comm. (specific)
- Terrestrial Comm. (non-specific)
- Terrestrial Comm. (circular)

- Aquatic Comm. (80m)
- Aquatic Comm. (specific)
- Aquatic Comm. (non-specific)
- Aquatic Comm. (circular)
- Multiple (80m)
- Multiple (specific)
- Multiple (non-specific)

- Multiple (circular)
- Sensitive EO's (Commercial only)

Author: Kathy Kivland
 Printed from <http://bios.dfg.ca.gov>

Table 2
Special Status Species Summary for TM 939

<i>Common Name</i>	<i>Scientific Name</i>	<i>Status</i> ¹	<i>Effects</i> ²	<i>Occurrence in the Study Area</i> ³
Birds				
Swainson's hawk	<i>Buteo swainsoni</i>	--/CT	NE	Absent. Nests in mature trees. Two suitable nest trees within Study Area, but no nests present, likely because of the lack of suitable prey base.
Mammals				
Fresno kangaroo rat	<i>Dipodomys nitratoides</i>	FE/CE	NE	Absent. Alkali sink-open grassland habitats. Single record near Lemoore Naval Station location. Requires bare alkaline clay-based soils subject to seasonal inundation, with friable soil mounds around shrubs/ grasses. No suitable habitat present.
Tipton kangaroo rat	<i>Dipodomys nitratoides nitratoides</i>	FE/CE	NE	Absent. Saltbrush scrub and sink scrub communities in the Tulare Lake Basin of the southern San Joaquin Valley. Digs burrows in elevated soil mounds at the base of shrubs. No suitable habitat present.
San Joaquin kit fox	<i>Vulpes macrotis mutica</i>	FE/CT	NE	Likely Absent. No denning habitat within or near the Study Area. Could occasionally forage on the site if the species in the area. Numerous records within Kings County but none near Lemoore.
Amphibians, Reptiles, and Invertebrates)				
Blunt-nosed leopard lizard	<i>Gambelia silus</i>	FE/CE	NE	Absent. Resident of sparsely vegetated alkali and desert scrub habitats, in areas of low topographic relief. Seeks cover in mammal burrows, under shrubs or structures such as fence posts; they do not excavate their own burrows.
Vernal pool tadpole shrimp	<i>Lepidurus packardii</i>	FE/--	NE	Absent. No vernal pools or seasonal wetland habitat present within the Study Area.
Vernal pool fairy shrimp	<i>Branchinecta lynchi</i>	FT/--	NE	Absent. No vernal pools or seasonal wetland habitat present within the Study Area.

1 Status= Listing of special status species, unless otherwise indicated

- CE: California listed as Endangered
- CT: California listed as Threatened
- SSC: California Species of Special Concern
- FE: Federally listed as Endangered
- FT: Federally listed as Threatened
- 1B.1, 1B.2, 2B.2, 2B.3: California Native Plant Society Ranking

2 Effects = Effect determination

- NE: No Effect
- ME: May Effect, not likely to adversely effect

3 Definition of Occurrence Indicators: Present/Potentially: Species recorded in the area and some habitat elements present within Study Area similar to known occurrences. **Absent/Likely Absent:** Species not recorded in Study Area and/or suitable habitat or critical habitat components not present.

Source: *CNDDDB = California Natural Diversity Database provided by CDFG and USFWS IPaC.*

3.3 CONCLUSIONS AND RECOMMENDATIONS

- The Study Area has historically been used for agricultural crops (orchards). A small portion of the Study Area. (3.4 acres) is disturbed/ruderal habitat
- There are two mature Valley oak trees at the northern boundary of the Study Area. Both trees are large and healthy. There are no raptor nests within the trees.
- There is an irrigation canal within the Study Area. The canal is a man-made feature and will be removed as a result of the proposed project.
- The agricultural lands and disturbed/ruderal habitat do not support habitat associated with special status species.

Attachment A: Photographs



Photographic Documentation

Client: Wathan Castanos Homes
Project: TTM 939
Photographer: Kathy Kinsland

Photographs: August 2022



Photograph 1

View of NW corner of Study Area, looking south from Bush Avenue



Photograph 2

View looking east from photograph 1 of an Valley oak tree.



Photographic Documentation

Client: Wathan Castanos Homes
Project: TTM 939
Photographer: Kathy Kinsland

Photographs: August 2022



Photograph 3

View of disturbed/ruderal habitat in NW corner of Study Area



Photograph 4

View of access road crossing over irrigation canal. Orchards to the south.



Photographic Documentation

Client: Wathan Castanos Homes
Project: TTM 939
Photographer: Kathy Kinsland

Photographs: August 2022



Photograph 5

View of irrigation canal,
looking east.



Photograph 6

View of east edge of Study Area
along orchard, looking south.



Client: Wathan Castanos Homes
Project: TTM 939
Photographer: Kathy Kinsland

Photographs: August 2022



Photograph 7

View of west edge of Study Area. High school on the left side and orchard on the right.



Photograph 8

View of interior of the orchard.

Walnut orchard
Argonaut Ecological, Inc

433 Bush St Lemoore
06 Aug 2022 08:23:54

Client: Wathan Castanos Homes
Project: TTM 939
Photographer: Kathy Kinsland

Photographs: August 2022

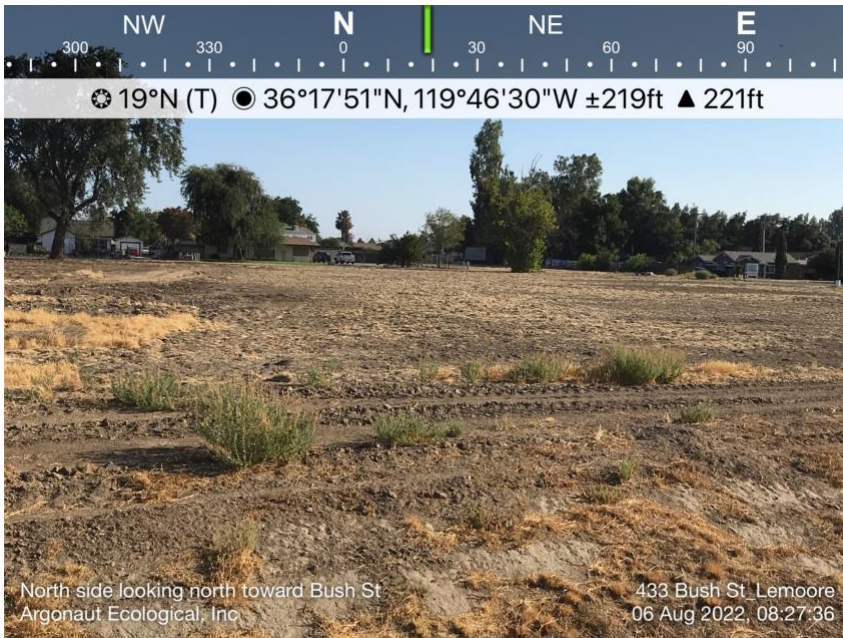

Photograph 9

View of the disturbed/ruderal habitat in the NE corner of the Study Area. Bush Avenue in the background.



Photograph 10

View of irrigation canal culvert at eastern edge of Study Area, immediately south of Photo 9.



Summary Table Report

California Department of Fish and Wildlife

California Natural Diversity Database



Query Criteria: Quad IS (Lemoore (3611937))

433 Bush Avenue, Lemoore_WCH

Name (Scientific/Common)	CNDDDB Ranks	Listing Status (Fed/State)	Other Lists	Elev. Range (ft.)	Total EO's	Element Occ. Ranks						Population Status		Presence		
						A	B	C	D	X	U	Historic > 20 yr	Recent <= 20 yr	Extant	Poss. Extirp.	Extirp.
<i>Buteo swainsoni</i> Swainson's hawk	G5 S3	None Threatened	BLM_S-Sensitive IUCN_LC-Least Concern	223 223	2548 S:1	0	0	0	0	0	1	0	1	1	0	0
<i>Dipodomys nitratoides nitratoides</i> Tipton kangaroo rat	G3T1T2 S1S2	Endangered Endangered	IUCN_VU-Vulnerable	215 215	81 S:1	0	1	0	0	0	0	0	1	1	0	0
<i>Vulpes macrotis mutica</i> San Joaquin kit fox	G4T2 S2	Endangered Threatened		215 220	1020 S:2	0	0	1	0	0	1	2	0	2	0	0



United States Department of the Interior



FISH AND WILDLIFE SERVICE
Sacramento Fish And Wildlife Office
Federal Building
2800 Cottage Way, Room W-2605
Sacramento, CA 95825-1846
Phone: (916) 414-6600 Fax: (916) 414-6713

In Reply Refer To:
Project Code: 2022-0079527
Project Name: Tract 939 Lemoore CA

August 26, 2022

Subject: List of threatened and endangered species that may occur in your proposed project location or may be affected by your proposed project

To Whom It May Concern:

The enclosed species list identifies threatened, endangered, proposed and candidate species, as well as proposed and final designated critical habitat, that may occur within the boundary of your proposed project and/or may be affected by your proposed project. The species list fulfills the requirements of the U.S. Fish and Wildlife Service (Service) under section 7(c) of the Endangered Species Act (Act) of 1973, as amended (16 U.S.C. 1531 *et seq.*).

New information based on updated surveys, changes in the abundance and distribution of species, changed habitat conditions, or other factors could change this list. Please feel free to contact us if you need more current information or assistance regarding the potential impacts to federally proposed, listed, and candidate species and federally designated and proposed critical habitat. Please note that under 50 CFR 402.12(e) of the regulations implementing section 7 of the Act, the accuracy of this species list should be verified after 90 days. This verification can be completed formally or informally as desired. The Service recommends that verification be completed by visiting the ECOS-IPaC website at regular intervals during project planning and implementation for updates to species lists and information. An updated list may be requested through the ECOS-IPaC system by completing the same process used to receive the enclosed list.

The purpose of the Act is to provide a means whereby threatened and endangered species and the ecosystems upon which they depend may be conserved. Under sections 7(a)(1) and 7(a)(2) of the Act and its implementing regulations (50 CFR 402 *et seq.*), Federal agencies are required to utilize their authorities to carry out programs for the conservation of threatened and endangered species and to determine whether projects may affect threatened and endangered species and/or designated critical habitat.

A Biological Assessment is required for construction projects (or other undertakings having similar physical impacts) that are major Federal actions significantly affecting the quality of the human environment as defined in the National Environmental Policy Act (42 U.S.C. 4332(2))

(c)). For projects other than major construction activities, the Service suggests that a biological evaluation similar to a Biological Assessment be prepared to determine whether the project may affect listed or proposed species and/or designated or proposed critical habitat. Recommended contents of a Biological Assessment are described at 50 CFR 402.12.

If a Federal agency determines, based on the Biological Assessment or biological evaluation, that listed species and/or designated critical habitat may be affected by the proposed project, the agency is required to consult with the Service pursuant to 50 CFR 402. In addition, the Service recommends that candidate species, proposed species and proposed critical habitat be addressed within the consultation. More information on the regulations and procedures for section 7 consultation, including the role of permit or license applicants, can be found in the "Endangered Species Consultation Handbook" at:

<http://www.fws.gov/endangered/esa-library/pdf/TOC-GLOS.PDF>

Migratory Birds: In addition to responsibilities to protect threatened and endangered species under the Endangered Species Act (ESA), there are additional responsibilities under the Migratory Bird Treaty Act (MBTA) and the Bald and Golden Eagle Protection Act (BGEPA) to protect native birds from project-related impacts. Any activity, intentional or unintentional, resulting in take of migratory birds, including eagles, is prohibited unless otherwise permitted by the U.S. Fish and Wildlife Service (50 C.F.R. Sec. 10.12 and 16 U.S.C. Sec. 668(a)). For more information regarding these Acts see <https://www.fws.gov/birds/policies-and-regulations.php>.

The MBTA has no provision for allowing take of migratory birds that may be unintentionally killed or injured by otherwise lawful activities. It is the responsibility of the project proponent to comply with these Acts by identifying potential impacts to migratory birds and eagles within applicable NEPA documents (when there is a federal nexus) or a Bird/Eagle Conservation Plan (when there is no federal nexus). Proponents should implement conservation measures to avoid or minimize the production of project-related stressors or minimize the exposure of birds and their resources to the project-related stressors. For more information on avian stressors and recommended conservation measures see <https://www.fws.gov/birds/bird-enthusiasts/threats-to-birds.php>.

In addition to MBTA and BGEPA, Executive Order 13186: *Responsibilities of Federal Agencies to Protect Migratory Birds*, obligates all Federal agencies that engage in or authorize activities that might affect migratory birds, to minimize those effects and encourage conservation measures that will improve bird populations. Executive Order 13186 provides for the protection of both migratory birds and migratory bird habitat. For information regarding the implementation of Executive Order 13186, please visit <https://www.fws.gov/birds/policies-and-regulations/executive-orders/e0-13186.php>.

We appreciate your concern for threatened and endangered species. The Service encourages Federal agencies to include conservation of threatened and endangered species into their project planning to further the purposes of the Act. Please include the Consultation Code in the header of this letter with any request for consultation or correspondence about your project that you submit to our office.

Attachment(s):

- Official Species List

Official Species List

This list is provided pursuant to Section 7 of the Endangered Species Act, and fulfills the requirement for Federal agencies to "request of the Secretary of the Interior information whether any species which is listed or proposed to be listed may be present in the area of a proposed action".

This species list is provided by:

Sacramento Fish And Wildlife Office

Federal Building
2800 Cottage Way, Room W-2605
Sacramento, CA 95825-1846
(916) 414-6600

Project Summary

Project Code: 2022-0079527
Project Name: Tract 939 Lemoore CA
Project Type: Residential Construction
Project Description: Residential development
Project Location:

Approximate location of the project can be viewed in Google Maps: <https://www.google.com/maps/@36.29503155000004,-119.77356445734728,14z>



Counties: Kings County, California

Endangered Species Act Species

There is a total of 8 threatened, endangered, or candidate species on this species list.

Species on this list should be considered in an effects analysis for your project and could include species that exist in another geographic area. For example, certain fish may appear on the species list because a project could affect downstream species.

IPaC does not display listed species or critical habitats under the sole jurisdiction of NOAA Fisheries¹, as USFWS does not have the authority to speak on behalf of NOAA and the Department of Commerce.

See the "Critical habitats" section below for those critical habitats that lie wholly or partially within your project area under this office's jurisdiction. Please contact the designated FWS office if you have questions.

1. [NOAA Fisheries](#), also known as the National Marine Fisheries Service (NMFS), is an office of the National Oceanic and Atmospheric Administration within the Department of Commerce.

Mammals

NAME	STATUS
Fresno Kangaroo Rat <i>Dipodomys nitratoides exilis</i> There is final critical habitat for this species. The location of the critical habitat is not available. Species profile: https://ecos.fws.gov/ecp/species/5150	Endangered
San Joaquin Kit Fox <i>Vulpes macrotis mutica</i> No critical habitat has been designated for this species. Species profile: https://ecos.fws.gov/ecp/species/2873	Endangered
Tipton Kangaroo Rat <i>Dipodomys nitratoides nitratoides</i> No critical habitat has been designated for this species. Species profile: https://ecos.fws.gov/ecp/species/7247	Endangered

Reptiles

NAME	STATUS
Blunt-nosed Leopard Lizard <i>Gambelia silus</i> No critical habitat has been designated for this species. Species profile: https://ecos.fws.gov/ecp/species/625	Endangered

Fishes

NAME	STATUS
Delta Smelt <i>Hypomesus transpacificus</i> There is final critical habitat for this species. The location of the critical habitat is not available. Species profile: https://ecos.fws.gov/ecp/species/321	Threatened

Insects

NAME	STATUS
Monarch Butterfly <i>Danaus plexippus</i> No critical habitat has been designated for this species. Species profile: https://ecos.fws.gov/ecp/species/9743	Candidate

Crustaceans

NAME	STATUS
Vernal Pool Fairy Shrimp <i>Branchinecta lynchi</i> There is final critical habitat for this species. The location of the critical habitat is not available. Species profile: https://ecos.fws.gov/ecp/species/498	Threatened
Vernal Pool Tadpole Shrimp <i>Lepidurus packardii</i> There is final critical habitat for this species. The location of the critical habitat is not available. Species profile: https://ecos.fws.gov/ecp/species/2246	Endangered

Critical habitats

THERE ARE NO CRITICAL HABITATS WITHIN YOUR PROJECT AREA UNDER THIS OFFICE'S JURISDICTION.

IPaC User Contact Information

Agency: Argonaut Ecological, Inc.
Name: Kathy Kinsland
Address: 2377 Gold Meadow Way
Address Line 2: Suite 100
City: Gold River
State: CA
Zip: 95670
Email: kathy@argoconsult.net
Phone: 9168031454

7.3 Appendix C: Cultural Resource Assessment and NAHC Correspondence

Prepared by Peak and Associates, Inc. on August 29, 2022.

**CULTURAL RESOURCE ASSESSMENT FOR THE
TRACT 939 PROJECT, CITY OF LEMOORE,
KINGS COUNTY, CALIFORNIA**

Prepared by

Melinda A. Peak
Peak & Associates, Inc.
3941 Park Drive, Suite 20-329
El Dorado Hills, CA 95762
(916) 939-2405

Prepared for

Alison Baker
Land Development Project Manager
WC Developers, LLC
2505 Alluvial Avenue
Clovis, CA 93611
(559) 432-8181

August 29, 2022
(Job #22-058)

INTRODUCTION

The project involves a tract of 52.61 acres proposed for the residential development of 276 family residences within the City of Lemoore in Kings County. The project area is mapped in the west half of Section 11, Township 19 South, Range 20 East, mapped on the Lemoore United States Geological Survey 7.5-minute topographic quadrangle (Figures 1, 2 and 3).

Melinda A. Peak, senior historian/archeologist with Peak & Associates, Inc. served as principal investigator for the study, with archeologist Michael Lawson completing the field survey (resumes, Appendix 1).

REGULATORY CONTEXT

State historic preservation regulations affecting this project include the statutes and guidelines contained in the California Environmental Quality Act (CEQA; Public Resources Code sections 21083.2 and 21084.1 and sections 15064.5 and 15126.4 (b) of the CEQA Guidelines). CEQA Section 15064.5 requires that lead agencies determine whether projects may have a significant effect on archaeological and historical resources. Public Resources Code Section 21098.1 further cites: A project that may cause a substantial adverse change in the significance of an historical resource is a project that may have a significant effect on the environment.

An “historical resource” includes, but is not limited to, any object, building, structure, site, area, place, record or manuscript that is historically or archaeologically significant (Public Resources Code section 5020.1).

Advice on procedures to identify such resources, evaluate their importance, and estimate potential effects is given in several agency publications such as the series produced by the Governor’s Office of Planning and Research (OPR), *CEQA and Archaeological Resources*, 1994. The technical advice series produced by OPR strongly recommends that Native American concerns and the concerns of other interested persons and corporate entities, including, but not limited to, museums, historical commissions, associations and societies be solicited as part of the process of cultural resources inventory. In addition, California law protects Native American burials, skeletal remains, and associated grave goods regardless of the antiquity and provides for the sensitive treatment and disposition of those remains (California Health and Safety Code Section 7050.5, California Public Resources Codes Sections 5097.94 et al).

The California Register of Historical Resources (Public Resources Code Section 5020 et seq.)

The State Historic Preservation Office (SHPO) maintains the California Register of Historical Resources (CRHR). Properties listed, or formally designated as eligible for listing, in the National Register of Historic Places are automatically listed on the CRHR, as well as State Landmarks and

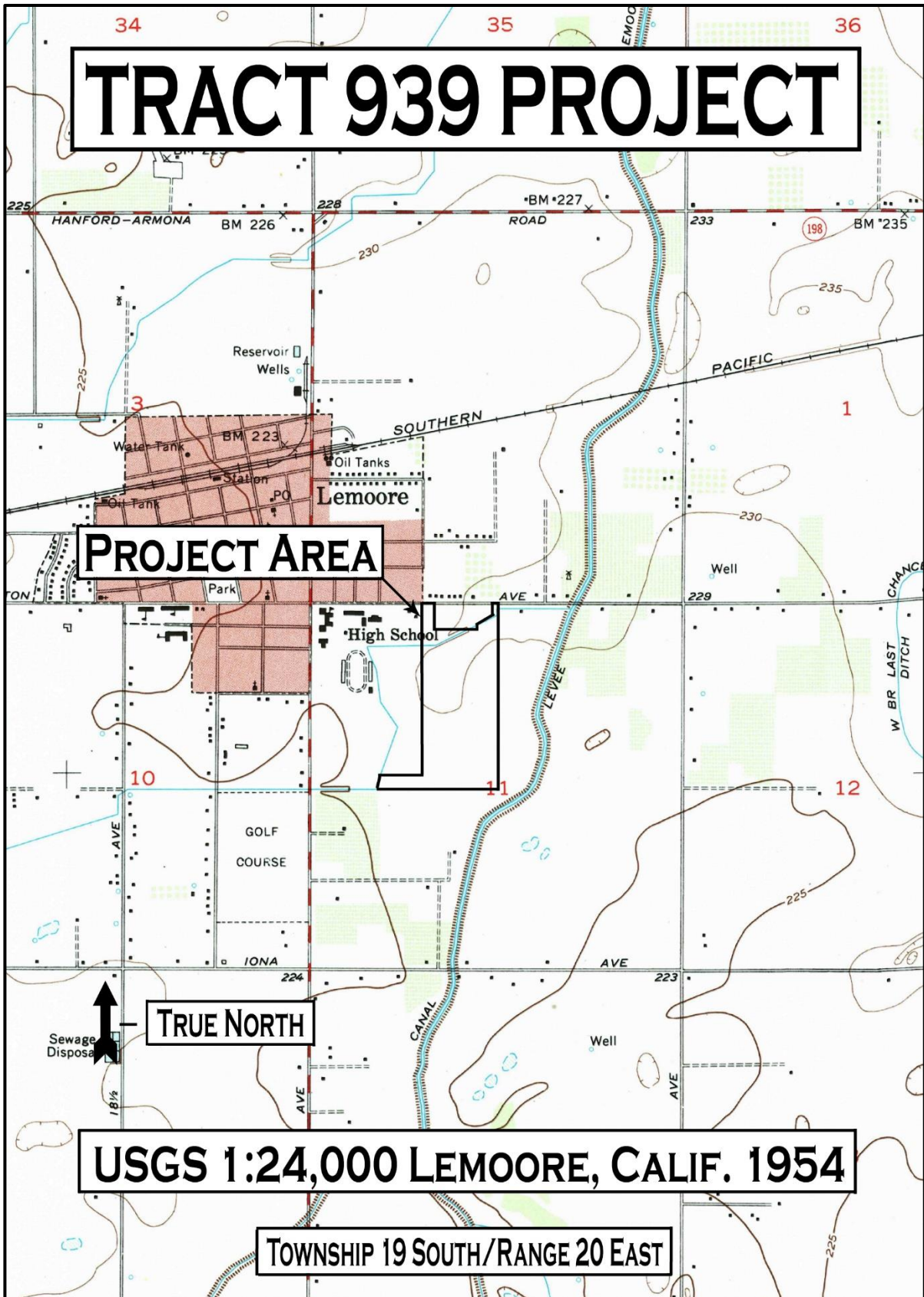

Figure 1

TENTATIVE MAP NO. 939

IN THE CITY OF LAKESIDE, SAN DIEGO COUNTY, STATE OF CALIFORNIA
 SUBMITTED ON JANUARY 27, 2022
 BY PRECISION CIVIL ENGINEERING, INC.

LEGEND

- PROPOSED TRAIL PATHWAY
- EXISTING RIGHT OF WAY
- PROPOSED RIGHT OF WAY
- PROPOSED IMPROVEMENT LINE
- PROPOSED EASEMENT

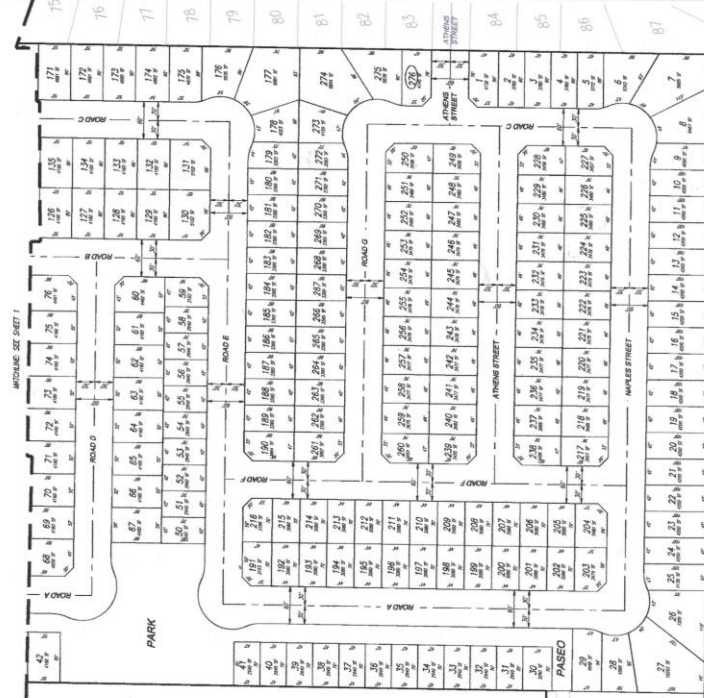

NOTES:
 1. THIS MAP IS SUBJECT TO THE CITY OF LAKESIDE'S ZONING ORDINANCES AND THE LAKESIDE CITY ENGINEERING DEPARTMENT'S REVIEW AND APPROVAL.
 2. THIS MAP IS NOT VALID UNLESS IT IS APPROVED BY THE CITY OF LAKESIDE'S ZONING COMMISSION AND THE LAKESIDE CITY ENGINEERING DEPARTMENT.
 3. THIS MAP IS NOT VALID UNLESS IT IS APPROVED BY THE CITY OF LAKESIDE'S ZONING COMMISSION AND THE LAKESIDE CITY ENGINEERING DEPARTMENT.

PLANNING & SURVEYING & CIVIL ENGINEERING 15140 ENCINITAS BLVD., SUITE 200, ENCINITAS, CA 92036 TEL: 949-459-4500 FAX: 949-459-4515 WWW.PRECISIONCIVIL.COM		PROJECT NO. 2022-001
		PROJECT TITLE: LAKESIDE 939
PREPARED FOR: WATSON CASHMOS HOMES 2508 ALLIANCE AVE CLAYTON, CA 92011 (951) 432-8181		SHEET DESCRIPTION: TENTATIVE MAP
COUNTY OF: LAKESIDE		JOB NUMBER: 22-001
DRAWN BY: JAD		DATE: 06-20-2022
CHECKED BY: JAD		SHEET NUMBER: 2 OF 2
DATE: 06-20-2022		JOB NUMBER: 22-001

FIGURE 3

Points of Interest. The CRHR also includes properties designated under local ordinances or identified through local historical resource surveys.

For the purposes of CEQA, an historical resource is a resource listed in, or determined eligible for listing in the California Register of Historical Resources. When a project will impact a site, it needs to be determined whether the site is an historical resource. The criteria are set forth in Section 15064.5(a) (3) of the CEQA Guidelines, and are defined as any resource that does any of the following:

- A. Is associated with events that have made a significant contribution to the broad patterns of California's history and cultural heritage;
- B. Is associated with the lives of persons important in our past;
- C. Embodies the distinctive characteristics of a type, period, region, or method of construction, or represents the work of an important creative individual, or possesses high artistic values; or
- D. Has yielded, or may be likely to yield, information important in prehistory or history.

In addition, the CEQA Guidelines, Section 15064.5(a) (4) states:

The fact that a resource is not listed in, or determined to be eligible for listing in the California Register of Historical Resources, not included in a local register of historical resources (pursuant to section 5020.1(k) of the Public Resources Code), or identified in an historical resources survey (meeting the criteria in section 5024.1(g) of the Public Resources Code) does not preclude a lead agency from determining that the resource may be an historical resource as defined in Public Resources Code section 5020.1(j) or 5024.1.

California Health and Safety Code Sections 7050.5, 7051, And 7054

These sections collectively address the illegality of interference with human burial remains, as well as the disposition of Native American burials in archaeological sites. The law protects such remains from disturbance, vandalism, or inadvertent destruction, and establishes procedures to be implemented if Native American skeletal remains are discovered during construction of a project, including the treatment of remains prior to, during, and after evaluation, and reburial procedures.

California Public Resources Code Section 15064.5(e)

This law addresses the disposition of Native American burials in archaeological sites and protects such remains from disturbance, vandalism, or inadvertent destruction. The section establishes procedures to be implemented if Native American skeletal remains are discovered during construction of a project and establishes the Native American Heritage Commission as the entity responsible to resolve disputes regarding the disposition of such remains.

Assembly Bill 52

Assembly Bill (AB) 52 establishes a formal consultation process for California tribes as part of CEQA and equates significant impacts on tribal cultural resources with significant environmental impacts. AB 52 defines a “California Native American Tribe” as a Native American tribe located in California that is on the contact list maintained by the Native American Heritage Commission. AB 52 requires formal consultation with California Native American Tribes prior to determining the level of environmental document if a tribe has requested to be informed by the lead agency of proposed projects. AB 52 also requires that consultation address project alternatives, mitigation measures, for significant effects, if requested by the California Native American Tribe, and that consultation be considered concluded when either the parties agree to measures to mitigate or avoid a significant effect, or the agency concludes that mutual agreement cannot be reached. Under AB 52, such measures shall be recommended for inclusion in the environmental document and adopted mitigation monitoring program if determined to avoid or lessen a significant impact on a tribal cultural resource.

CULTURAL SETTING

Archeology

The Central Valley region was among the first in the state to attract intensive fieldwork, and research has continued to the present day. This has resulted in a substantial accumulation of data, but the emphasis has been in the northern portion of the valley. In the early decades of the 1900s, E.J. Dawson explored numerous sites near Stockton and Lodi, later collaborating with W.E. Schenck (Schenck and Dawson 1929). By 1933, the focus of work was directed to the Cosumnes locality, where survey and excavation were conducted by the Sacramento Junior College (Lillard and Purves 1936). Excavation data, in particular from the stratified Windmill site (CA-Sac-107), suggested two temporally distinct cultural traditions. Later work at other mounds by Sacramento Junior College and the University of California, Berkeley, enabled the investigators to identify a third cultural tradition, intermediate between the previously postulated Early and Late Horizons. The three-horizon sequence, based on discrete changes in ornamental artifacts and mortuary practices, as well as on observed differences in soils within sites (Lillard, Heizer and Fenenga 1939), was later refined by Beardsley (1954). An expanded definition of artifacts diagnostic of each time period was developed, and its application extended to parts of the central California coast. Traits held in common allow the application of this system within certain limits of time and space to other areas of prehistoric central California.

In the southern San Joaquin Valley, with the exception of Hewes’s excavation at CA-FRE-48 (the Tranquility Site), the foci of early investigations have been the old shorelines of the interior lakes: Tulare, Kern, and Buena Vista. In 1899, Dr. P. M. Jones directed fieldwork in the Buena Vista-Tulare Lake area of Kern County. Jones investigated 150 mounds and conducted trenching of several sites including CA-Ker-53. In 1909, N. C. Nelson investigated prehistoric Site CA-Ker-

49, which is located to the west of Buena Vista Lake. Later, four surveys and excavations were conducted in the same locale under the auspices of the University of California. A compilation of these investigation results was published in 1926 by Gifford and Schenck.

As a result of this early work, an elaborate culture complex was defined for the late prehistoric period. This complex can be ascribed probably to the Yokuts and their direct ancestors. The material culture of this late temporal period complex included steatite vessels and beads, finely-made projectile points, pottery, shaped stone mortars, *Tivela* disc beads, use of asphaltum, and the presence of metates and manos. Flexed burials were the predominant interment mode. Earlier complexes underlying the late cultural expressions were represented by chipped stone crescents, large projectile points, atlatl spurs, and weights. Mortuary practices, generally thought to be related, include extended rather than flexed burial position, a situation analogous to that of the northern valley (Gifford and Schenck 1926; Lillard, Heizer, and Fenenga 1939; Moratto 1972).

Presence of "Early Man," although not found in direct association with extinct animals, is demonstrated by the frequency of chipped stone crescents and fluted points similar to those of the Clovis-Folsom Complex in the American Southwest. Although fluted points have been found near the shores of Tulare Lake, an area that has also produced surface finds of extinct mammal bone of Pleistocene age, the association is not substantiated by controlled excavations and remains speculative (Riddell and Olsen 1969). Most of the point collection had been acquired by D. Witt over a period of 30 years.

Under the direction of Wedel (1941), the Civil Works Administration, in conjunction with the Smithsonian Institution, initiated the first major excavations using stratigraphic controls. Investigations of CA-KER-39 and CA-KER-60 as well as several smaller sites near Buena Vista Lake produced evidence of two distinct cultural entities or occupation periods. Wedel lacked methods for dating these two entities by cross-comparison of the assemblages, he tentatively stated that the early occupation at Buena Vista Lake appeared to be temporally older and less developed than the Early Horizon (Windmill Pattern) of the Delta region. He compared this early component to the Oak Grove or Milling Stone culture of the Santa Barbara area (Rogers 1939). He divided the later cultural entity into two distinct phases, both clearly distinguished from the earlier cultural phase by artifact types. Wedel (1941:144-145) estimated that neither of these cultural periods exceeded 1500 B.P. (years Before the Present). Later, other investigators proposed far earlier ages for these early occupations, with dates ranging from 2000 to 7000 B.P. (Baumhoff and Olmstead 1963, 1964; Heizer 1964; Meighan 1959).

Later investigations in 1963 and 1964 at CA-KER-116 near Buena Vista Lake produced materials similar to Wedel's early occupation. These materials occurred in the lower levels of the "upper deposit," while an even deeper cultural deposit yielded materials similar to those of the San Dieguito Complex. Artifacts included a chipped stone crescent, crude point fragments, and an atlatl spur. Radiocarbon age determinations on shell from the lowest cultural levels returned a date of circa 8200 B.P. (Fredrickson and Grossman 1966, 1977; Fredrickson 1967).

Despite the previously mentioned investigations, the prehistory of the southern San Joaquin remains as yet poorly understood, without a tightly defined chronological sequence of cultural development.

Ethnology

Ethnographic literature is often uncertain in definition of cultural boundaries for Indian groups. Early displacement by white intrusion resulted in population shifts to avoid conflict with the Spanish, and later with the miners and settlers. The ravages of disease and warfare decimated the native people, further weakening cultural identity. Informants were often uncertain of original territories of the various tribal groupings.

The Southern Valley Yokuts were members of the Penutian language family which held all of the Central Valley, San Francisco Bay Area, and the Pacific Coast from Marin County to near Point Sur. The Yokuts differed from other ethnographic groups in California as they had true tribal divisions with group names. The project area was occupied by the Tachi. Each tribe spoke a particular dialect, common to its members, but similar enough to other Yokuts that they were mutually intelligible (Kroeber 1925; Wallace 1978).

Trade was well developed, with mutually beneficial interchange of needed or desired goods. Obsidian, rare in the San Joaquin Valley, was obtained by trade with Paiute and Shoshoni groups on the eastern side of the Sierra Nevada, where numerous sources of this material are located, and to some extent from the Napa Valley to the north. Shell beads, obtained by the Yokuts from coastal people, and acorns, rare in the Great Basin, were among many items exported to the east by Yokuts traders (Davis 1961).

Economic subsistence was based on the acorn, with substantial dependency on gathering and processing of wild seeds and other vegetable foods. The rivers, streams, and sloughs which formed a maze within the valley provided abundant food resources such as fish, shellfish, and turtles. Game, wild fowl, and small mammals were trapped and hunted to provide protein augmentation of the diet. In general, the eastern portion of the San Joaquin Valley provided a lush environment of varied food resources, with the estimated large population centers reflecting this abundance (Cook 1955; Baumhoff 1963).

Settlements were oriented along the water ways, with their village sites normally placed adjacent to these features for their nearby water and food resources. House structures varied in size and shape (Latta 1949; Kroeber 1925). The housepit depressions ranged in diameter between three to eighteen meters.

Latta (1949:99) reported that a village of 200 to 300 Yokuts might have four or five large houses that were used for ten or twelve years or until a family member died, at which time the Indians burned the house in which the death had occurred. If a sick or aged person died outside the dwelling, the family did not burn the house. When a Northern Yokuts died, his body was cremated or buried in a flexed position. Southern tribes normally buried their dead, although they did

cremate shamans, persons who died away from their village and, among the Tachi, persons of great importance.

The Yokuts experienced severe depopulation after contact with the Spanish and subsequent explores. The most devastating impacts of the Spanish colonization effort were not the result of military conflicts, but came from Old World diseases newly introduced to the native people.

Historical Background

An increasing number of Euro-American enter the San Joaquin Valley after 1824 accelerating cultural change and the loss of cultural integrity by the native peoples. Although cultural retention was apparent until the early 1900s, there was a gradual weakening of attachment to the old lifeways and greater adoption of white styles.

More significant in terms of cultural deterioration were the ravages of disease--in particular, the documented drastic disease epidemic of 1831-1833 (Cook 1955). Native people had no natural immunity to introduced diseases, and nearly 75 percent of the valley population succumbed during the early 1830s to an illness Cook and other authorities believe to have been malaria. Decimation of the valley people essentially destroyed the Yokuts culture, with only partial continuation possible.

Although the immediate effects of the Gold Rush overleapt the Southern Central Valley, the decline of mining was accompanied by a shift of white attention to the rich agricultural promise of the valley. The remaining Valley Yokuts people became pressured from the lands they held, usually those with highest farming potential, and driven into the mountains. White newcomers quickly recognized the agricultural promise of the valley and began an intensive alteration of the area that made it increasingly suitable for cultivation. Farmers and ranchers drained the marshes and lakes and established irrigation systems. Today, the valley floor, for the most part, bears little resemblance to its pre-contact condition. The oak groves are gone and lakes are dry. The vast marshes, once the refuge for enormous flocks of waterfowl, no longer exist. The grazing lands of the elk and antelope have become cultivated fields, producing a wide variety of crops. The native faunal community, with the exception of burrowing mammals, has been replaced by domestic livestock.

The early interior route used by the Spanish to travel from El Pueblo de Los Angeles to the San Francisco Bay Area, followed the routes of earlier antelope and Indian trails. This roadway, known to the early Hispanic inhabitants of the San Joaquin Valley as El Camino Viejo á Los Angeles, was traversed by ox-cart, with individuals stopping their teams at the various watering holes along the west side of the Central Valley. Later, portions of the trail were turned into wagon roads (Latta 1936).

Dr. Lavern Lee Moore proposed that post office be opened at the small agricultural community of La Tache, located on the north end of Tulare Lake. The post office opened in 1875, with the Postal

Service creating a new name from the name of the petitioner. Ten years later, the population center moved a short distance to the branch railroad built through the area, crossing the Kings River to the Huron Plains and the important sheep-shearing center at Poso Chana. In 1890, Lemoore was considered the largest center for shipping wool in the United States.

Kings County was organized from lands of Tulare County in 1893, with Hanford becoming the County seat. A second railroad was built through Hanford in 1897. This line serves as the main north-south line of the BNSF Railway through the San Joaquin Valley.

Since 1961, Lemoore is the site of a large Naval Air Station (Hoover, Rensch and Rensch 1970). Lemoore continues to serve as the commercial and cultural center for the widespread agricultural region.

RESEARCH

A record search was conducted for the project area at the Southern San Joaquin Valley Information Center (SSJVIC) of the California Historical Resources Information System on August 15, 2022 (RS#22-310; Appendix 2).

The USGS topographic map shows a building in the northern portion of the project, but the residential building is no longer present. The Lemoore Ditch is recorded to the east of the project area as P-16-000129.

The SSJVIC reported that the project area has never been formally surveyed, and four surveys have been conducted within 0.25 miles of the project area.

FIELD ASSESSMENT

Michael Lawson (resume, Appendix 1) completed a field survey of the project site on August 18, 2022 with a complete inspection of the proposed project site (Figure 4).

The project is set in a mixed residential and rural area. The survey area is surrounded by housing, a high school, and a freeway.

The land is mostly flat, largely a mature walnut orchard that was probably leveled for irrigation. The 1957 USGS map shows slightly higher land near the center and north-east portions of the parcel, but this is no longer observable on site. An irrigation ditch is within the survey parcel, and appears on the older topographic map, as well. This ditch dates to the 1920s or earlier, and has been recorded (Appendix 3).

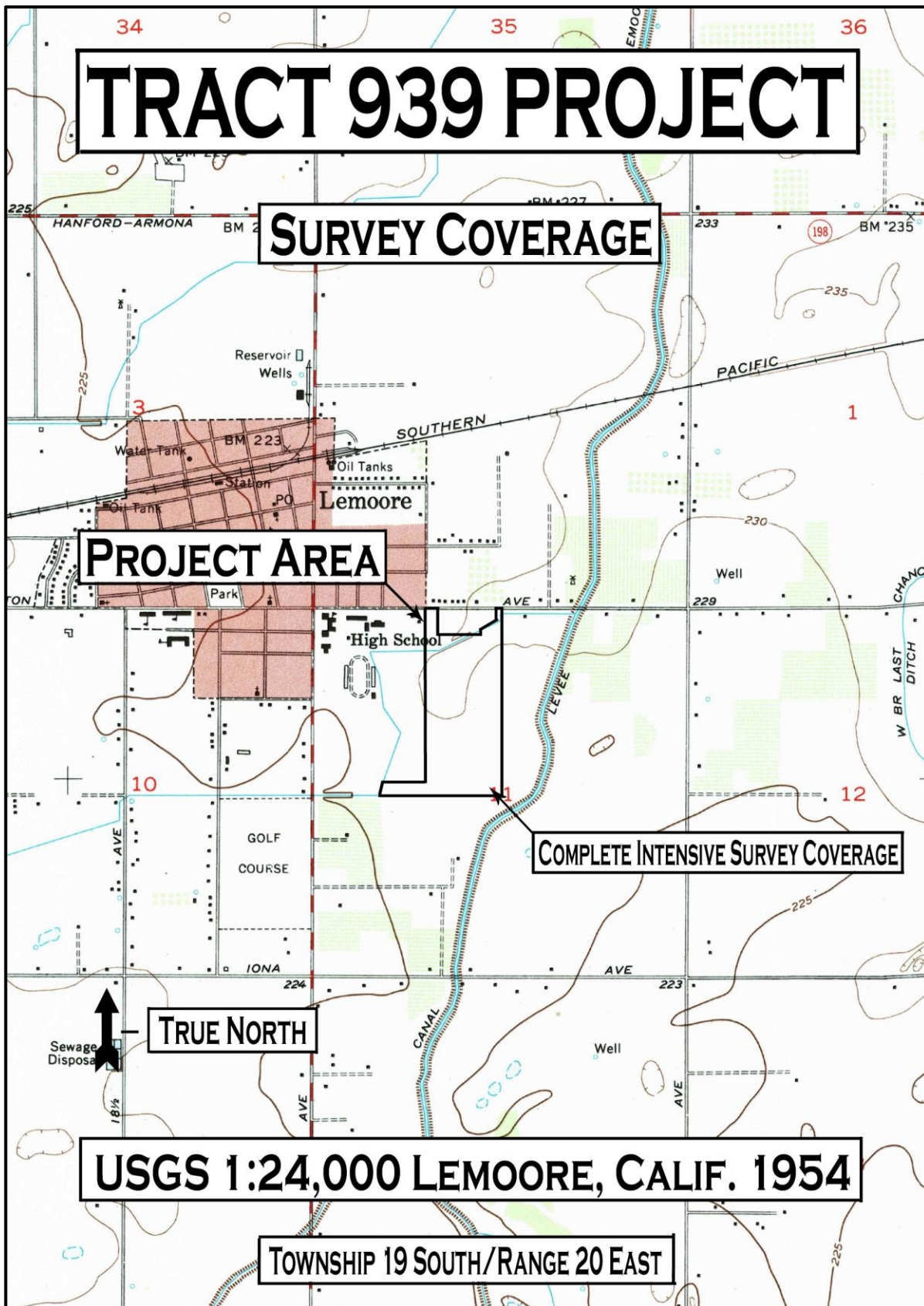

Figure 4

The dirt access road surrounding the orchard is higher in elevation than the orchard by approximately 18-22 inches. Two rectangular access corridors of different sizes are included in the survey area, heading south from E. Bush Street. Both are currently vacant, and the western lot is empty, after a residence was recently removed.

Soil within former lot on the northwest corner, where residence was, is light brown sandy loam with imported road base gravel mixed in through plowing and other mechanical activities. Natural pebble and cobble content is moderate, with composition being mostly sandstone and quartzite.

Soil on the rest of the property is uniformly light in color and is probably silt, with sandy layers beneath it at varying depths, observed by examination of animal burrows and the walls of a ditch. Natural pebble and cobble content and composition is similar to the lot with the former residence.

Vegetation in the project area is largely imported. In the orchard, that has been groomed or weeded recently, non-native grasses grow between the rows. The walnut trees are green and healthy. Along the perimeter of the survey area are a variety of native and introduced bushes, grasses and other plants, including scrub oak, datura, sunflowers and oleander.

Soil visibility was generally good. Large and small animal burrowing, plowing, and vehicular travel has provided ample visibility of the soil.

The survey strategy involved walking parallel transects space no more than ten meters apart in open areas, with closer inspection of disturbed soil, dry ditches and roadways.

Other than segments of the ditch, noted above, within the survey area there were no historical or prehistoric artifacts, features, or other resources.

The Ditch: ML-22-30

The resource consists of a segment of an unlined, earthen irrigation feature (ditch) located in the southeastern portion of the community of Lemoore. The irrigation feature's source of water is the Lemoore Canal, with the diversion point just south of Houston Avenue. The irrigation feature continued generally westward from the Lemoore Canal for several miles, including feeding a small reservoir. The irrigation feature appears on the 1927 Lemoore USGS topographic map quadrangle, based on a 1924 survey, and again on the later 1952 edition.

The route appeared to be largely unchanged until the late 1980s when the development of the Donald C. Jamison High School to the east of Lemoore High School rerouted a section eastward onto the western and southwestern edges of the current project area. The current recordation is for an approximately 3,800-foot segment of this irrigation system including the pre-1924 era northern segment (approximately 1,200 foot long) and remaining newer segment.

The irrigation feature averages about 18 feet across the top, 10 feet across the bottom, and is about 5 feet deep. The site form is included in Appendix 3.

RESOURCE EVALUATION

Under Criterion A of the California Register of Historical Resources (CRHR), a resource must be associated with events that have made a significant contribution to the broad patterns of California's history and cultural heritage. The ditch is one of the many thousands of miles of ditches moving water to allow more agricultural productivity in a wider area. This is not a named ditch and small in carrying capacity, so apparently it made no contribution to local history.

Criterion B calls for association with an important personage. As an unnamed ditch, no such association with any person could be found.

Criterion C requires the resource to be representative of some specific design, or have qualities of a unique design. This ditch is a standard unlined ditch, utilitarian in design. In addition, the ditch has been altered with the location of a section changing in the past. This affects the integrity of location and setting of the resource.

Criterion D of the CRHR applies primarily to archeological resources rather than structures and buildings.

The ditch cannot be considered significant under any of the criteria of the CRHR.

A site form has been prepared for this segment of the resource and it will be submitted to the South San Joaquin Valley Information Center for the permanent record (Appendix 3).

CONCLUSIONS

The site present on the property is not significant, and there are no historical resources within the project area. For the purposes of CEQA, we conclude that there will be no impact to important cultural resources from implementation of the project.

RECOMMENDATIONS

There is always a possibility that a site may exist in the project and be obscured by vegetation, siltation or historic activities, leaving no surface evidence. If artifacts, exotic rock, shell or bone are uncovered during the construction, work should stop in that area immediately. A qualified archeologist should

be contacted to examine and evaluate the deposit, and consult with the appropriate Native American groups.

Discovery of Human Remains

In the event of discovery or recognition of any human remains in any location other than a dedicated cemetery, there shall be no further excavation or disturbance of the site or any nearby area suspected to overlie adjacent remains until the Kings County Coroner has determined that the remains are not subject to any provisions of law concerning investigation of the circumstances, manner and cause of death, and the recommendations concerning the treatment and disposition of the human remains have been made to the person responsible for the excavation, or to his or her authorized representative. The coroner shall make his or her determination within two working days from the time the person responsible for the excavation, or his or her authorized representative, notifies the coroner of the discovery or recognition of the human remains.

If the Kings County Coroner determines that the remains are not subject to his or her authority and if the Coroner recognizes the human remains to be those of a Native American, or has reason to believe that they are those of a Native American, he or she shall contact, by telephone within 24 hours, the Native American Heritage Commission (NAHC).

After notification, the NAHC will follow the procedures outlined in Public Resources Code Section 5097.98, that include notification of most likely descendants (MLDs), and recommendations for treatment of the remains.

REFERENCES

Baumhoff, Martin A.

- 1963 Ecological Determinants of Aboriginal California Populations. *University of California Publications in American Archaeology and Ethnology* 49(2): 155-236. Berkeley.

Baumhoff, Martin A., and David Olmsted

- 1963 Radiocarbon support for Glottochronology. *American Anthropologist* 65(2): 278-284.
- 1964 Notes on Palaihnihan Culture History: Glottochronology and Archaeology. *Studies in California linguistics*, edited by William Bright, pp. 1-12. *University of California Publications in Linguistics* 34. Berkeley.

Beardsley, Richard K.

- 1954 Temporal and Areal Relationships in Central California Archeology (parts 1 and 2). *University of California Archaeological Survey Reports* 24, 25. Berkeley.

Cook, Sherburne F.

- 1960 Colonial Expeditions to the Interior of California: Central Valley 1800-1820. *University of California Anthropological Records* 16(6): 239-292. Berkeley.
- 1955a The Aboriginal Populations of the San Joaquin Valley, California. *University of California Press Anthropological Records* 16(2). Berkeley.
- 1955b The Epidemic of 1830-33 in California and Oregon. *University of California Publications in American Archaeology and Ethnology* 43(3): 303-326. Berkeley.

Davis, James T.

- 1961 Trade Routes and Economic Exchange among the Indians of California. *University of California Archaeological Survey Reports* 54:1-71. Berkeley.

Fredrickson, David A.

- 1967 Additional C-14 dates for Water Resources Investigations at Buena Vista Lake. *Society for California Archaeology Newsletter* 1(5).

Fredrickson, David A., and J. Grossman

- 1966 Radiocarbon Dating of an Early Site at Buena Vista Lake, California. Paper read before the annual meeting of the Society for American Archaeology, Reno.
- 1977 A San Dieguito Component at Buena Vista Lake, California. *The Journal of California Anthropology* 4(2): 173-190.

- Frickstad, Walter
1955 *A Century of California Post Offices*. Pacific Rotapress Printing Company, Oakland.
- Gifford, E. W., and W. E. Schenck
1926 *Archaeology of the Southern San Joaquin Valley, California*. *University of California Publications in American Archaeology and Ethnology*, Vol. 23, No. 1. Berkeley.
- Gudde, Erwin
1969 *California Place Names* (Third Edition). University of California Press, Berkeley.
- Hoover, Mildred, Hero E. Rensch, Ethel G. Rensch (William N. Abeloe, editor)
1970 *Historic Spots in California* (Third Edition). Stanford University Press, Stanford.
- Kroeber, Alfred L.
1925 *Handbook of the Indians of California*. *Bureau of American Ethnology Bulletin 78*. Washington, D.C.
- Latta, Franklin F.
1949 *Handbook of the Yokuts Indians*. Bear State Books, Oildale, California.
- Lillard, Jeremiah B., Robert F. Heizer and Franklin Fenenga
1939 *An Introduction to the Archaeology of Central California*. *Sacramento Junior College, Department of Anthropology Bulletin 2*. Sacramento.
- Lillard, Jeremiah B. and William K. Purves
1936 *The Archeology of the Deer Creek-Cosumnes Area, Sacramento County, California*. *Sacramento Junior College, Department of Anthropology Bulletin 1*.
- Meighan, Clement W.
1959 *California Cultures and the Concept of an Archaic Stage*. *American Antiquity* 24(3): 289-318.
- Meyer, Jack and Jeffery S Rosenthal
2008 *A Geoarchaeological Overview and Assessment of Caltrans District 3: Cultural Resources Inventory of Caltrans District 3 Rural Conventional Highways*. Ms. on file, Northeast Information Center, California State University, Chico.
- Moratto, Michael J.
1984 *California Archaeology*. Academic Press, Inc., New York.

Riddell, Francis A. and William H. Olsen

1969 An Early Man Site in the San Joaquin Valley, California. *American Antiquity* 34(2): 121-131. Washington, D.C.

Rosenthal, Jeffery S., and Jack Meyer

2004 Cultural Resources Inventory of Caltrans District 10 Rural Conventional Highways, Volume III: Geoarchaeological Study Landscape Evolution and the Archaeological Record of Central California. Ms. on file, Central California Information Center, California State University, Stanislaus.

Rogers, Malcolm J.

1939 Early Lithic Industries of the Lower Basin of the Colorado River and Adjacent Desert Areas. *San Diego Museum Papers* 3. San Diego.

Schenck, W. Egbert and Elmer Dawson

1929 Archaeology of the Northern San Joaquin Valley. *University of California Publications in American Archaeology and Ethnology* 25(4): 289-413. Berkeley.

Smith, Wallace

1960 *Garden of the Sun*. Eighth edition. Privately printed.

Wallace, William J.

1978 Southern Valley Yokuts. In: *Handbook of North American Indians: California*, Volume 8, edited by Robert F. Heizer, pp. 448-461. William G. Sturtevant, general editor. Smithsonian Institution, Washington, D. C.

Wedel, Waldo R.

1941 Archaeological Investigations at Buena Vista Lake, Kern County, California. *Bureau of American Ethnology Bulletin* 130. Washington, D.C.

APPENDIX 1

Resumes

PEAK & ASSOCIATES, INC.
RESUME

MELINDA A. PEAK
Senior Historian/Archeologist
3941 Park Drive, Suite 20 #329
El Dorado Hills, CA 95762
(916) 939-2405

January 2022

PROFESSIONAL EXPERIENCE

Ms. Peak has served as the principal investigator on a wide range of prehistoric and historic excavations throughout California. She has directed laboratory analyses of archeological materials, including the historic period. She has also conducted a wide variety of cultural resource assessments in California, including documentary research, field survey, Native American consultation and report preparation.

In addition, Ms. Peak has developed a second field of expertise in applied history, specializing in site-specific research for historic period resources. She is a registered professional historian and has completed a number of historical research projects for a wide variety of site types.

Through her education and experience, Ms. Peak meets the Secretary of Interior Standards for historian, architectural historian, prehistoric archeologist and historic archeologist.

EDUCATION

M.A. - History - California State University, Sacramento, 1989
Thesis: *The Bellevue Mine: A Historical Resources Management Site Study in Plumas and Sierra Counties, California*
B.A. - Anthropology - University of California, Berkeley

PROJECTS

In recent years, Ms. Peak has led the team completing the cultural resource sections for General Plan and General Plan Updates, for a number of cities/neighborhoods including Campbell, Milpitas, Yountville, Manteca, The Springs, Sebastopol, Martinez, Brentwood, Colusa County and Foster City. Older General Plan efforts include Wheatland, Rocklin, Sheridan, Granite Bay and South Sutter County.

In recent months, Ms. Peak has completed a number of determinations of eligibility and effect documents in coordination with the Corps of Engineers for projects requiring federal permits, assessing the eligibility of a number of sites for the National Register of Historic Places.

She has also completed historical research projects on a wide variety of topics for a number of projects including the development of a winery in a ranch in Folsom, commercial buildings in the City of Davis, a lumber mill in Clovis, older farmhouses dating to the 1860s, an early roadhouse, bridges, canals, former small-town site, and a section of an electric railway line.

In recent years, Ms. Peak has prepared a number of cultural resource overviews and predictive models for blocks of land proposed for future development for general and specific plans. She has been able to direct a number of surveys of these areas, allowing the model to be tested.

Ms. Peak completed the cultural resource research and contributed to the text prepared for the DeSabra-Centerville PAD for the initial stage of the FERC relicensing. She also served cultural resource project manager for the FERC relicensing of the Beardsley-Donnells Project. For the South Feather Power Project and the Woodleaf-Palermo and Sly Creek Transmission Lines, her team completing the technical work for the project.

She served as principal investigator for the multi-phase Twelve Bridges Golf Club project in Placer County. She served as liaison with the various agencies, helped prepare the historic properties treatment plan, managed the various phases of test and data recovery excavations, and completed the final report on the analysis of the test phase excavations of a number of prehistoric sites.

Ms. Peak has served as project manager for a number of major survey and excavation projects in recent years, including the many surveys and site definition excavations for the 172-mile-long Pacific Pipeline proposed for construction in Santa Barbara, Ventura and Los Angeles counties. She also completed an archival study in the City of Los Angeles for the project, and served as principal investigator for a major coaxial cable removal project for AT&T.

Additionally, she completed a number of small surveys, served as a construction monitor at several urban sites, and conducted emergency recovery excavations for sites found during monitoring. She has directed the excavations of several historic complexes in Sacramento, Placer and El Dorado Counties.

Ms. Peak is the author of a chapter and two sections of a published history (1999) of Sacramento County, *Sacramento: Gold Rush Legacy, Metropolitan Legacy*. She served as the consultant for a children's book on California, published by Capstone Press in 2003 in the Land of Liberty series.

PEAK & ASSOCIATES, INC.
RESUME

MICHAEL LAWSON

January 2022

Archeological Specialist

3941 Park Drive, Suite 20-329

El Dorado Hills, CA 95672

(916) 939-2405

PROFESSIONAL EXPERIENCE

Mr. Lawson has compiled an excellent record of supervision of excavation and survey projects for both the public and private sectors over the past twenty-four years. He has conducted a number of surveys throughout northern and central California, as well as serving as an archeological technician and crew chief for a number of excavation projects.

EDUCATION

B.A. - Anthropology - California State University, Sacramento

Special Course: Comparative Osteology. University of Tennessee, Knoxville. Forensic Anthropology Center. January 2018.

Intensive lab and outdoor study with human example from outdoor research facility, including typical and non-metric examples, compared with fifty non-human species most commonly confused with human remains. Outdoor research facility "The Body Farm" study included survey, photography, collection and identification of faunal and human bone fragments, with a Power Point presentation discussing finds.

EXPERIENCE

- Extensive monitoring of open space, streets and project development areas for prehistoric period and historic period resources. Areas monitored include Sutter Street in Folsom; Mud Creek Archeological District in Chico; Camp Roberts, San Luis Obispo County; Avila Beach, San Luis Obispo County; Edgewood Golf Course, South Lake Tahoe; Davis Water Project, Davis; Star Bend levee section, Sutter County; Feather River levees, Sutter County; Bodega Bay, Sonoma County; San Jose BART line extension, Santa Clara County; and numerous sites for PG&E in San Francisco.
- Over twenty years of experience working in CRM, volunteer, and academic settings in California historic, proto-historic, and prehistoric archaeology.
- Expertise in pedestrian survey, excavation, feature (including burial) exposure, laboratory techniques, research. Field positions include crew chief and lead technician.

APPENDIX 2

SSJVIC Record Search



8/15/2022

Robert Gerry
Peak & Associates, Inc.
3941 Park Drive Ste 30-329
El Dorado Hills, CA 95762

Re: Lemoore Subdivision
Records Search File No.: 22-310

The Southern San Joaquin Valley Information Center received your record search request for the project area referenced above, located on the Lemoore USGS 7.5' quad. The following reflects the results of the records search for the project area and the 0.25 mile radius:

As indicated on the data request form, the locations of resources and reports are provided in the following format: custom GIS maps GIS data

Resources within project area:	None
Resources within 0.25 mile radius:	P-16-000129
Reports within project area:	None
Reports within 0.25 mile radius:	KI-00011, 00096, 00158, 00189

Resource Database Printout (list): enclosed not requested nothing listed

Resource Database Printout (details): enclosed not requested nothing listed

Resource Digital Database Records: enclosed not requested nothing listed

Report Database Printout (list): enclosed not requested nothing listed

Report Database Printout (details): enclosed not requested nothing listed

Report Digital Database Records: enclosed not requested nothing listed

Resource Record Copies: enclosed not requested nothing listed

Report Copies: enclosed not requested nothing listed

OHP Built Environment Resources Directory: enclosed not requested nothing listed

Archaeological Determinations of Eligibility: enclosed not requested nothing listed

CA Inventory of Historic Resources (1976): enclosed not requested nothing listed

Caltrans Bridge Survey: Not available at SSJVIC; please see
<https://dot.ca.gov/programs/environmental-analysis/cultural-studies/california-historical-bridges-tunnels>

Ethnographic Information: Not available at SSJVIC

Historical Literature: Not available at SSJVIC

Historical Maps: Not available at SSJVIC; please see

<http://historicalmaps.arcgis.com/usgs/>

Local Inventories: Not available at SSJVIC

GLO and/or Rancho Plat Maps: Not available at SSJVIC; please see

<http://www.glorerecords.blm.gov/search/default.aspx#searchTabIndex=0&searchByTypeIndex=1> and/or

<http://www.oac.cdlib.org/view?docId=hb8489p15p;developer=local;style=oac4;doc.view=items>

Shipwreck Inventory: Not available at SSJVIC; please see

<https://www.slc.ca.gov/shipwrecks/>

Soil Survey Maps: Not available at SSJVIC; please see

<http://websoilsurvey.nrcs.usda.gov/app/WebSoilSurvey.aspx>

Please forward a copy of any resulting reports from this project to the office as soon as possible. Due to the sensitive nature of archaeological site location data, we ask that you do not include resource location maps and resource location descriptions in your report if the report is for public distribution. If you have any questions regarding the results presented herein, please contact the office at the phone number listed above.

The provision of CHRIS Data via this records search response does not in any way constitute public disclosure of records otherwise exempt from disclosure under the California Public Records Act or any other law, including, but not limited to, records related to archeological site information maintained by or on behalf of, or in the possession of, the State of California, Department of Parks and Recreation, State Historic Preservation Officer, Office of Historic Preservation, or the State Historical Resources Commission.

Due to processing delays and other factors, not all of the historical resource reports and resource records that have been submitted to the Office of Historic Preservation are available via this records search. Additional information may be available through the federal, state, and local agencies that produced or paid for historical resource management work in the search area. Additionally, Native American tribes have historical resource information not in the CHRIS Inventory, and you should contact the California Native American Heritage Commission for information on local/regional tribal contacts.

Should you require any additional information for the above referenced project, reference the record search number listed above when making inquiries. Invoices for Information Center services will be sent under separate cover from the California State University, Bakersfield Accounting Office.

Thank you for using the California Historical Resources Information System (CHRIS).

Sincerely,



Jeremy E David
Assistant Coordinator

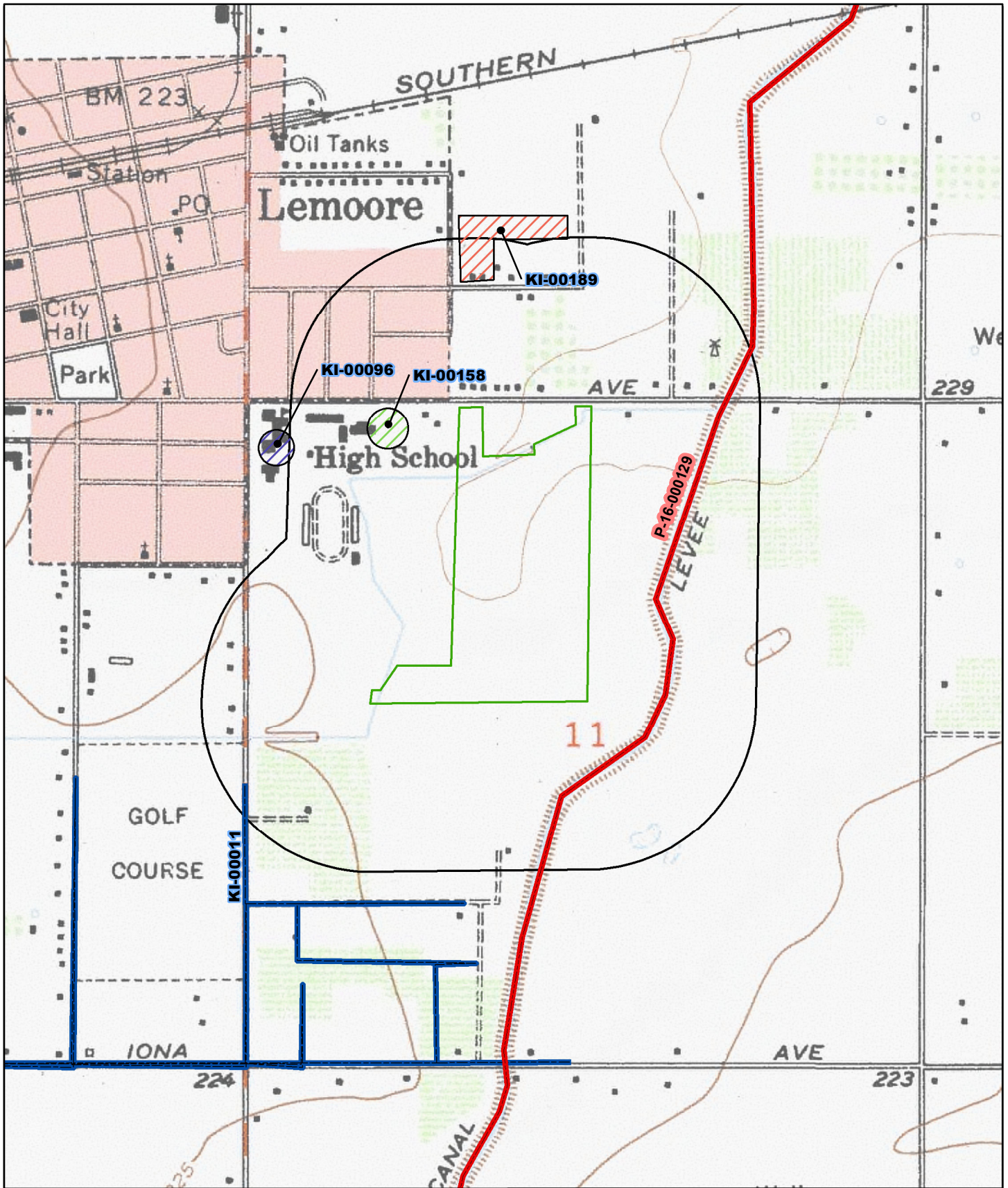

May depict confidential cultural resource locations.
Do not distribute.

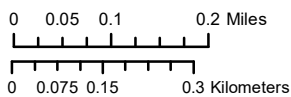

- Project Area
- Record Search radius

SSJV Information Center Record Search 22-310
Requester: Robert Gerry, Peak & Associates, Inc.
Project Name: Lemoore Subdivision
USGS 7.5' Quad(s): Lemoore
County: Kings

Resource List

SSJVIC Record Search 22-310

Primary No.	Trinomial	Other IDs	Type	Age	Attribute codes	Recorded by	Reports
P-16-000129	CA-KIN-000192H	Resource Name - Lemoore Canal	Structure	Historic	AH06; HP20	2001 (Bai "Tom" Tang, Daniel Ballester, CRM Tech); 2017 (Ryan Tubbs, Kristina Lindgren, ECORP Consulting, Inc.); 2017 (Jessica Jones, Applied EarthWorks, Inc.)	KI-00310, KI-00319

Report List

SSJVIC Record Search 22-310

Report No.	Other IDs	Year	Author(s)	Title	Affiliation	Resources
KI-00011	NADB-R - 1141253	1978	Chavez, David	Cultural Resources Evaluation for the South Lemoore, Central Union School and Santa Rosa Rancheria Wastewater Project, Kings County, California	Consulting Archaeologist	
KI-00096	Submitter - Project Number 00S-300	2000	Pastron, Allen G. and Brown, Keith R.	Historical and Cultural Resource Assessment Proposed Telecommunications Facility Lemoore, Site No. CV-630-05	Browns and Mills, Inc. Geotechnical and Environmental Consultants	
KI-00158		2005	John Holson	Archaeological Assessment of the Proposed DT Lemoore Cingular Wireless Cell Site (FS-590-01), Kings County, California (PL# 1170-96)	Pacific Legacy, Inc.	
KI-00189	Submitter - Job #08-103	2008	Peak, Michael A.	Determination of Eligibility and Effect for the 532 Oleander Avenue Apartments Project, City of Lemoore, Kings County, California	Peak and Associates, Inc.	

APPENDIX 3

DPR 523 Site Record for Ditch

Other Listings
Review Code

Reviewer

Date

Page 1 of 6

*Resource Name or #: ML-22-30

P1. Other Identifier:

*P2. Location: Not for Publication Unrestricted

*a. County: Kings

and (P2b and P2c or P2d. Attach a Location Map as necessary.)

*b. USGS 7.5' Quad: Lemoore, Calif. Date: 1954 T 19S; R 20E ; ¼ of NW ¼ of Sec 11; M.D. B.M.

c. Address:

City:

Zip:

d. UTM: Zone: 10 ; Point A, 251096; Point B, 250888; Point C, 250864; Point D, 250709; Point E, 250686; and, Point F, 250662
mE/ Point A, 4020547; Point B, 4020429; Point C, 4019761; Point D, 4019764; Point E, 4019708; and, Point F, 4019713 mN (G.P.S.)

e. Other Locational Data: (e.g., parcel #, directions to resource, elevation, etc., as appropriate) Elevation: 230 Feet. The segment of the resource within the current project area is located in the southeastern portion of the community of Lemoore in Kings County.

*P3a. Description: (Describe resource and its major elements. Include design, materials, condition, alterations, size, setting, and boundaries)
The resource consists of a segment of an unlined, earthen irrigation feature (ditch) located in the southeastern portion of the community of Lemoore. The irrigation feature's source of water is the Lemoore Canal, with the diversion point just south of Houston Avenue. The irrigation feature continued generally westward from the Lemoore Canal for several miles, including feeding a small reservoir. The irrigation feature appears on the 1927 Lemoore USGS topographic map quadrangle, based on a 1924 survey, and again on the later 1952 edition.

The route appeared to be largely unchanged until the late 1980s when the development of the Donald C. Jamison High School to the east of Lemoore High School rerouted a section eastward onto the western and southwestern edges of the current project area. The current recordation is for an approximately 3,800-foot segment of this irrigation system including the pre-1924 era northern segment (approximately 1.200 foot long) and remaining newer segment.

The irrigation feature averages about 18 feet across the top, 10 feet across the bottom, and is about 5 feet deep.

*P3b. Resource Attributes: (List attributes and codes) HP20 – Canal/aqueduct

*P4. Resources Present: Building Structure Object Site District Element of District Other (Isolates, etc.)



P5b. Description of Photo: (View, date, accession #) View looking south of a typical section of the irrigation feature along the western edge of the project area. 8-8-2022. Acc. #2022IMG8380

*P6. Date Constructed/Age and Sources: Historic

Prehistoric Both

Northern section appears on 1927 Lemoore USGS topographic map that was based on a 1924 survey.

*P7. Owner and Address:

Unknown

*P8. Recorded by: (Name, affiliation, and address) Mchael Lawson, Peak & Associates, Inc. 3941 Park Drive, Suite 20 PMB 329, El Dorado Hills, CA 95762

*P9. Date Recorded: 8-18-2022

*P10. Survey Type: (Describe) Complete, intensive.

*P11. Report Citation: (Cite survey report and other sources, or enter

"none.") *Cultural Resource Assessment of the Tract 939 Project, City of Lemoore, Kings County, California.* Peak & Associates, Inc. 2022

*Attachments: NONE Location Map Sketch Map Continuation Sheet Building, Structure, and Object Record
 Archaeological Record District Record Linear Feature Record Milling Station Record Rock Art Record
 Artifact Record Photograph Record Other (List):

L1. Historic and/or Common Name:

L2a. Portion Described: Entire Resource Segment Point Observation **Designation:** ML-22-30

b. Location of point or segment: (Provide UTM coordinates, legal description, and any other useful locational data. Show the area that has been field inspected on a Location Map) See pages 1/6, 5/6 and 6/6 for UTM information.

L3. Description: (Describe construction details, materials, and artifacts found at this segment/point. Provide plans/sections as appropriate.)
The resource is an unlined earthen ditch used for irrigation.

L4. Dimensions: (In feet for historic features and meters for prehistoric features)

a. Top Width: 18 Feet

b. Bottom Width: 10 Feet

c. Height or Depth: 5 Feet

d. Length of Segment: (est) 3,800 Feet

L5. Associated Resources: None observed

L6. Setting: (Describe natural features, landscape characteristics, slope, etc., as appropriate.) The resource is located in the community of Lemoore in the San Joaquin Valley of California.

L4e. Sketch of Cross-Section (include scale) Facing: North

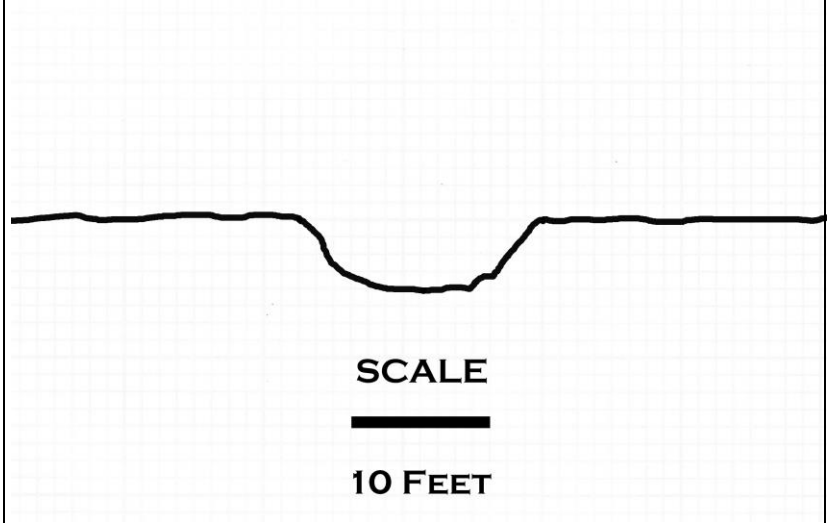

L7. Integrity Considerations: The northern portion of the irrigation feature between UTM points A and B appears on the 1927 USGS 1:31,680 Lemoore topographic quadrangle that was inspected in 1924 and has remained in the same location. The western portion of the pre 1924 era route has been moved east to now parallel the western boundary of the current project area. The alteration looks to have been done in conjunction with the development of the Donald C. Jamison High School that was opened in 1991. The overall integrity of this segment is therefore not very good.



L8b. Description of Photo, Map, or Drawing (View, scale, etc.)
View looking north of a typical section of the irrigation feature along the western side of the project. 8-18-22. Acc. #2022IIIMG8382

L9. Remarks:

L10. Form Prepared by: (Name, affiliation, and address) Neal Neuenschwander Peak & Associates, Inc. 3161 Godman Avenue, Chico, CA 95973

L11. Date: 8-18-22

DPR 523E (1/95)

CONTINUATION SHEET



A) View looking west of the irrigation feature at the eastern edge of the project area. 8-18-2022. Acc. #2022IMG8377



B) View looking east of the irrigation feature at the eastern edge of the project area. 8-18-2022. Acc. #2022IMG8378

CONTINUATION SHEET



C) View looking west of the irrigation feature near the western edge of the project area. 8-18-2022. Acc. #2022IMG8380

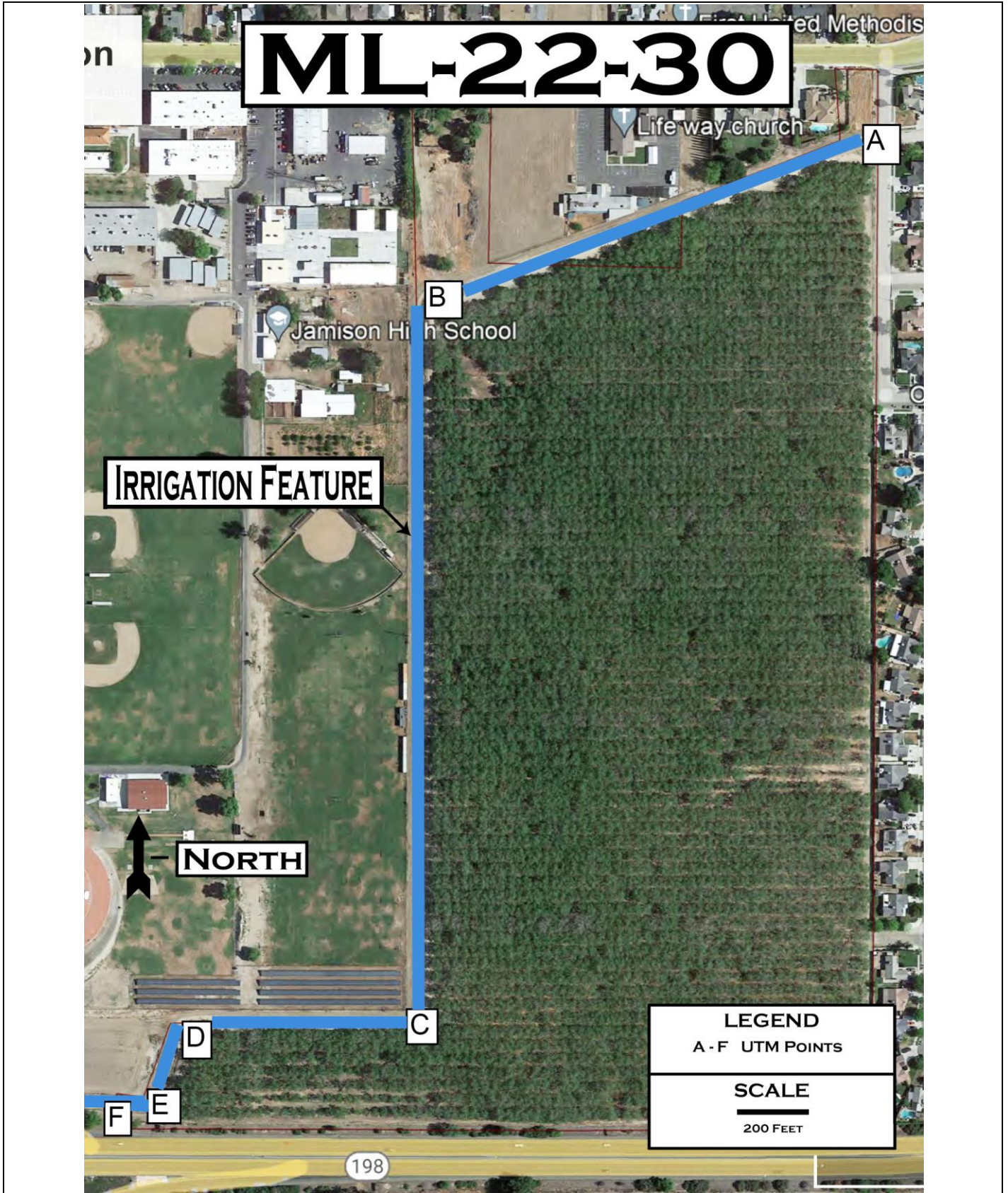

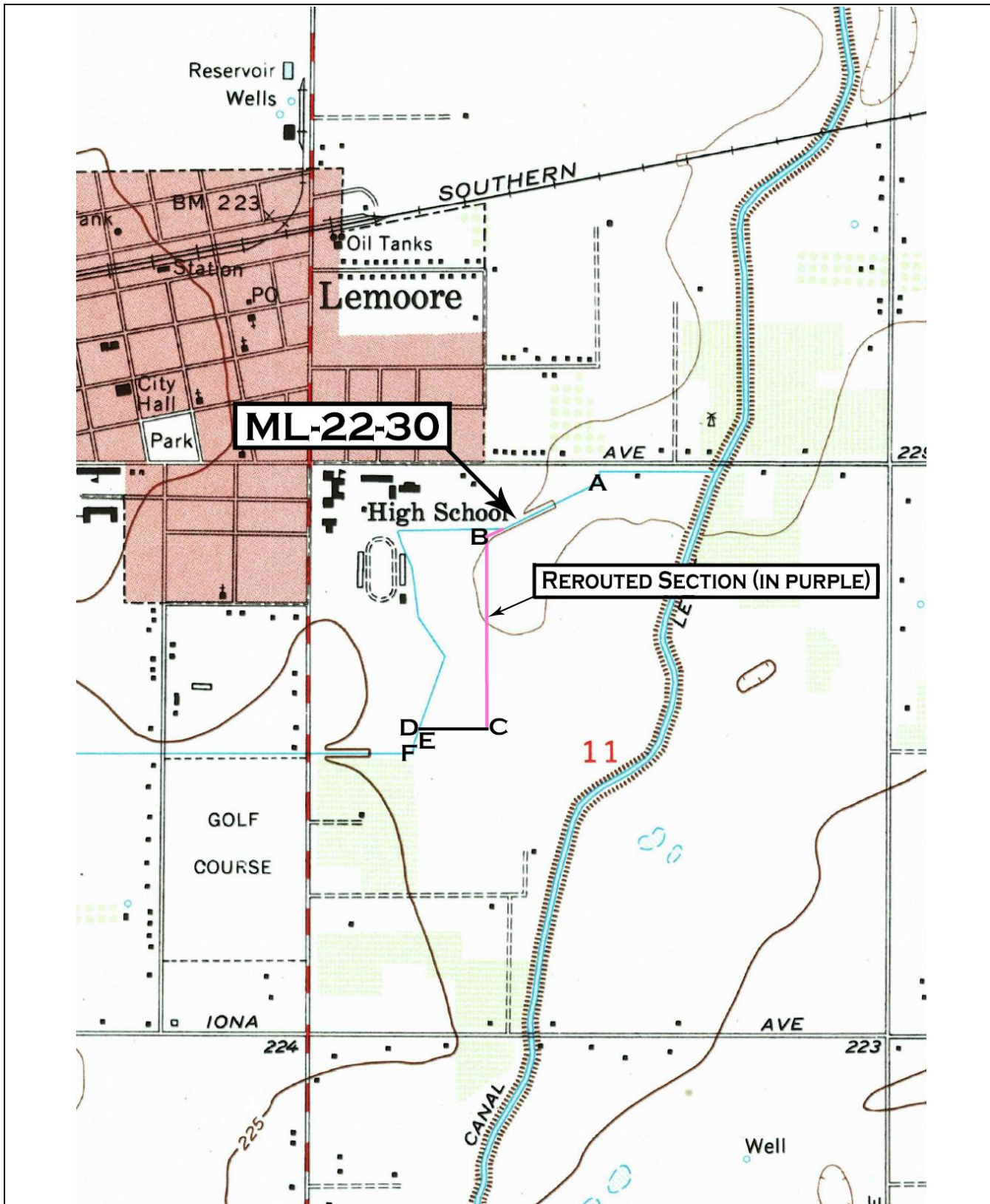

7.4 Appendix D: Acoustical Analysis

Prepared by WJV Acoustics, Inc. dated January 24, 2022.

ACOUSTICAL ANALYSIS

**FOX DITCH & MADRID RESIDENTIAL DEVELOPMENT
LEMOORE, CALIFORNIA**

WJVA Project No. 22-05

PREPARED FOR

**WATHEN CASTANOS HOMES
1446 TOLLHOUSE ROAD, SUITE 103
CLOVIS, CA 93611**

PREPARED BY

**WJV ACOUSTICS, INC.
VISALIA, CALIFORNIA**



wjv acoustics

JANUARY 24, 2022

INTRODUCTION

The project is a proposed residential development in Lemoore, California. The project applicant (Wathen Castanos Homes) has requested an acoustical analysis to quantify project site noise exposure and determine noise mitigation requirements. This analysis, prepared by WJV Acoustics, Inc. (WJVA), is based upon preliminary project site data provided by the project applicant, traffic data provided by the California Department of Transportation (Caltrans) and the findings of on-site noise level measurements. At the time this analysis was prepared, a site plan was not available. The project area is demarcated on a Kings County Assessor's Parcel Map, provided as Figure 1.

Appendix A provides a description of the acoustical terminology used in this report. Unless otherwise stated, all sound levels reported are in A-weighted decibels (dB). A-weighting de-emphasizes the very low and very high frequencies of sound in a manner similar to the human ear. Most community noise standards utilize A-weighting, as it provides a high degree of correlation with human annoyance and health effects. Appendix B provides typical A-weighted sound levels for common noise sources.

NOISE EXPOSURE CRITERIA

General Plan

The City of Lemoore General Plan (adopted May, 2008) Noise Element provides exterior noise level criteria for land use compatibility for community noise environments. The General Plan sets noise compatibility standards for transportation noise sources in terms of the Day-Night Average Level (L_{dn}) or Community Noise Equivalent Level (CNEL). Both the L_{dn} and CNEL represent the time-weighted energy average noise level for a 24-hour day, with a 10 dB penalty added to noise levels occurring during the nighttime hours (10:00 p.m.-7:00 a.m.). The CNEL includes an additional penalty of 5 dB (technically 4.77 dB) that is added to noise levels occurring during the evening hours between 7:00 p.m. and 10:00 p.m. Both the L_{dn} and CNEL represent cumulative exposure to noise over an extended period of time and are therefore calculated based upon *annual average* conditions. The L_{dn} and CNEL are considered to be equivalent descriptors of the community noise environment for the purposes of this study.

Table I provides the General Plan Land Use Noise Compatibility Guidelines for exterior noise levels. Additionally, the General Plan states *“Consider an increase of five or more dBA to be “significant” if the resulting noise level would exceed that described as “normally acceptable” in Table 8.6.”* (Table I below). The Table indicates that a noise exposure level up to 60 dB L_{dn} is considered “Conditionally Acceptable” However, The General Plan provides “Criteria For Significance” which states *“State and federal agencies set the 65 db exterior CNEL noise exposure as the maximum normally acceptable level above which residential uses may be incompatible if not acoustically treated”*. For the purpose of this analysis, a maximum noise exposure for new residential land uses is considered to be 65 dB L_{dn} /CNEL. This is compatible with the noise standards provided in the City of Lemoore Municipal Code (described below).

Table I: City of Lemoore Land Use Noise Compatibility Guidelines

Table 8.6 Land Use Compatibility For Community Noise Environments

Land Use Category	Community Noise Exposure, L_{dn} or CNEL, dB						
	55	60	65	70	75	80	85
Residential – Low Density Single Family			Normally Acceptable	Normally Acceptable	Normally Unacceptable	Clearly Unacceptable	Clearly Unacceptable
Residential – Multi Family			Normally Unacceptable	Normally Unacceptable	Clearly Unacceptable	Clearly Unacceptable	Clearly Unacceptable
Mixed-Use and High Density Residential			Normally Unacceptable	Normally Unacceptable	Clearly Unacceptable	Clearly Unacceptable	Clearly Unacceptable
Transient Lodging – Motels, Hotels		Normally Unacceptable	Normally Unacceptable	Clearly Unacceptable	Clearly Unacceptable	Clearly Unacceptable	Clearly Unacceptable
Schools, Libraries, Churches, Hospitals, Nursing Homes		Normally Unacceptable	Normally Unacceptable	Clearly Unacceptable	Clearly Unacceptable	Clearly Unacceptable	Clearly Unacceptable
Auditoriums, Concerts, Halls, Amphitheaters	Clearly Unacceptable	Clearly Unacceptable	Clearly Unacceptable	Clearly Unacceptable	Clearly Unacceptable	Clearly Unacceptable	Clearly Unacceptable
Sports Area, Outdoor Spectator Sports	Clearly Unacceptable	Clearly Unacceptable	Clearly Unacceptable	Clearly Unacceptable	Clearly Unacceptable	Clearly Unacceptable	Clearly Unacceptable
Playgrounds, Neighborhood Parks				Normally Unacceptable	Clearly Unacceptable	Clearly Unacceptable	Clearly Unacceptable
Golf Courses, Riding Stables, Water Recreation, Cemeteries					Normally Unacceptable	Clearly Unacceptable	Clearly Unacceptable
Office Buildings, Businesses Commercial and Professional				Normally Unacceptable	Clearly Unacceptable	Clearly Unacceptable	Clearly Unacceptable
Industrial, Manufacturing Utilities, Agriculture					Clearly Unacceptable	Clearly Unacceptable	Clearly Unacceptable

Legend:

	Normally Acceptable	Specified land use is satisfactory, based upon the assumption that any building involved is of normal conventional construction, without any special noise insulation requirements.
	Conditionally Acceptable	New construction or development should be undertaken only after a detailed analysis of the noise reduction requirements is made and needed noise insulation features included in the design. Conventional construction, but with closed windows and fresh air supply systems or air conditioning will normally suffice.
	Normally Unacceptable	New construction or development should generally be discouraged. If new construction or development does proceed, a detailed analysis of the noise reduction requirements must be made and needed noise insulation features included in the design.
	Clearly Unacceptable	New construction or development should not be undertaken.

Municipal Code

Section 9-5B-2 (Noise, Odor and Vibration Performance Standards) of The City of Lemoore Municipal Code provides additional exterior and interior noise level standards. The Municipal Code sets noise compatibility standards in terms of the Community Noise Equivalent Level (CNEL). Both the L_{dn} and CNEL represent the time-weighted energy average noise level for a 24-hour day, with a 10 dB penalty added to noise levels occurring during the nighttime hours (10:00 p.m.-7:00 a.m.). The CNEL includes an additional penalty of 5 dB (technically 4.77 dB) that is added to noise levels occurring during the evening hours between 7:00 p.m. and 10:00 p.m. Both the L_{dn} and CNEL represent cumulative exposure to noise over an extended period of time and are therefore calculated based upon *annual average* conditions. The L_{dn} and CNEL are considered to be equivalent descriptors of the community noise environment for the purposes of this study. Table II provides the interior and exterior noise level standards provided in the City’s Municipal Code.

TABLE II INTERIOR AND EXTERIOR NOISE LEVEL STANDARDS, dBA CITY OF LEMOORE MUNICIPAL CODE		
Land Use	Noise Standards (dB L_{dn} /CNEL)	
	Interior Noise	Exterior Noise
Residential Uses	45	65 ¹
Professional Uses In Mixed-Use Zones	45	70
Commercial	--	70
Office	50	70
Industrial	55	75
Public Facilities	50	70
Parks	--	70
Schools	50	65

¹Outdoor Living Areas e.g., backyards

PROJECT SITE NOISE EXPOSURE

The project site is located north of (and adjacent to) California State Route 198 (SR 198), within the City of Lemoore. The project site is bound to the west by Lemoore High School, to the north by rural residential and church land uses, to the east by existing residential land uses and to the south by SR 198. The project site is exposed traffic noise associated with vehicles on SR 198.

Traffic Noise Exposure:

Noise exposure from traffic on SR 198 (at the project site frontage) was calculated for existing and future traffic conditions using the FHWA Traffic Noise Model, traffic data provided by Caltrans and the findings of on-site noise level measurements.

WJVA utilized the Federal Highway Administration (FHWA) Highway Traffic Noise Prediction Model (FHWA-RD-77-108). The FHWA Model is a standard analytical method used for roadway traffic noise calculations. The model is based upon reference energy emission levels for automobiles, medium trucks (2 axles) and heavy trucks (3 or more axles), with consideration given to vehicle volume, speed, roadway configuration, distance to the receiver, and the acoustical characteristics of the site. The FHWA Model was developed to predict hourly L_{eq} values for free-flowing traffic conditions, and is generally considered to be accurate within ± 1.5 dB. To predict L_{dn} values, it is necessary to determine the hourly distribution of traffic for a typical day and adjust the traffic volume input data to yield an equivalent hourly traffic volume.

Noise level measurements and concurrent traffic counts were conducted by WJVA staff within the project site. The purpose of the measurement was to evaluate the accuracy of the FHWA Model in describing traffic noise exposure within the project site. The measurement site was located within the project site at a distance of approximately 175 feet from the centerline of SR 198. The speed limit in the project vicinity was 65 mph (miles per hour). The project vicinity and noise monitoring site location are provided as Figure 2. A photograph showing the noise measurement site is provided as Figure 3.

Noise monitoring equipment consisted of Larson-Davis Laboratories Model LDL-820 sound level analyzer equipped with a B&K Type 4176 1/2" microphone. The equipment complies with the specifications of the American National Standards Institute (ANSI) for Type I (Precision) sound level meters. The meter was calibrated in the field prior to use with a B&K Type 4230 acoustic calibrator to ensure the accuracy of the measurements. The microphone was located on a tripod at 5 feet above the ground. The project site presently consists of undeveloped land.

Noise measurements were conducted in terms of the equivalent energy sound level (L_{eq}). Measured L_{eq} values were compared to L_{eq} values calculated (predicted) by the FHWA Model using as inputs the traffic volumes, truck mix and vehicle speed observed during the noise measurements. The results of the comparison are shown in Table III.

From Table III it may be determined that the traffic noise levels predicted by the FHWA Model were 5.3 dB higher than those measured for the traffic conditions observed at the time of the

noise measurements for SR 198. This overprediction of the noise model is result of a topographic difference between the roadway and the project site, as well as the noise attenuation provided by the median concrete barriers (approximately 3 feet in height). A conservative off set of 5 dB will be applied to project-site noise exposure calculations.

TABLE III COMPARISON OF MEASURED AND PREDICTED (FHWA MODEL) NOISE LEVELS FOX DITCH & MADRID, LEMOORE	
	CA STATE ROUTE 198
Measurement Start Time	7:45 a.m.
Observed # Autos/Hr.	1572
Observed # Medium Trucks/Hr.	72
Observed # Heavy Trucks/Hr.	84
Observed Speed (MPH)	65
Distance, ft. (from center of roadway)	175
L _{eq} , dBA (Measured)	61.6
L _{eq} , dBA (Predicted)	66.9
Difference between Measured and Predicted L_{eq}, dBA	-5.3

Note: FHWA "soft" site assumed for calculations.
Source: WJV Acoustics, Inc.

Exterior Noise Exposure:

Annual Average Daily Traffic (AADT) data for SR 198 as well as the percentages of trucks in the project vicinity was obtained from Caltrans. The day/night distribution of traffic was estimated by WJVA, based upon previous studies conducted in the project vicinity since project-specific data were not available from government sources. In order to estimate future traffic volumes, WJVA applied an annual rate of increase noted by Caltrans traffic counts between 2013 and 2020 to estimate future (2040) traffic volumes in the project vicinity. Table IV summarizes annual average traffic data used to model noise exposure within the project site.

TABLE IV		
TRAFFIC NOISE MODELING ASSUMPTIONS FOX DITCH & MADRID RESIDENTIAL, LEMOORE		
	SR 198	
	Existing	2040
Annual Avenue Daily Traffic (AADT)	28,500	54,338
Day/Night Split (%)	85/10	
Assumed Vehicle Speed (mph)	65	
% Medium Trucks (% AADT)	5.0	
% Heavy Trucks (% AADT)	5.5	

Sources: Caltrans
WJV Acoustics, Inc.

Using data from Table IV, the FHWA Model, annual average traffic noise exposure was calculated for the various setback distances. As a project-specific site plan / lot layout plan has not been provided at the time this analysis was prepared, WJVA staff assumed a lot setback distance of 100 feet from the centerline of SR 198. The calculated noise exposures for 2020 and future 2040 traffic conditions at a setback distance of 100 feet from the roadway centerline were approximately 68 dB L_{dn} and 71 dB L_{dn}, respectively. Calculated noise exposure for existing and 2040 traffic conditions exceed the City’s 65 dB L_{dn} exterior noise level standard for residential land uses, and mitigation is therefore required.

Exterior Noise Mitigation:

The City’s exterior noise level standard is 65 dB L_{dn}. To mitigate exterior traffic noise exposure along SR 198, it will be necessary to construct a sound wall along the project roadway frontage. The sound wall would provide acoustical shielding of the outdoor activity areas (backyards) located closest to the roadway.

A sound wall insertion loss program based on the FHWA Model was used to calculate the insertion loss (noise reduction) provided by the residential buildings to the closest proposed outdoor activity areas to SR 198. The model calculates the insertion loss of a barrier of given height based on the effective height of the noise source, height of the receiver, distance from the

receiver to the wall, and distance from the noise source to the wall. The standard assumptions used in the barrier calculations are effective source heights of 8, 2 and 0 feet above the roadway for heavy trucks, medium trucks and automobiles, respectively. The standard height of a residential receiver is five feet above the ground elevation.

Based upon the above-described assumptions and method of analysis, the noise level insertion loss values for sound walls of various heights were calculated. The calculations indicated that a sound wall (or berm and wall combination) along the project site's SR 198 frontage, to a minimum height of seven feet (7') relative to the roadway elevation, would reduce traffic noise exposure within individual backyards by approximately 7 dB, resulting in a projected future noise exposure of approximately 64 dB L_{dn} . It should be noted, the project site elevation varies, and is generally approximately two to three (2-3) feet below the grade of SR 98 along the project frontage. The sound wall must be constructed to a finished height of 7 feet above the adjacent roadway elevation. In order to be effective, the sound wall should be turned inward (northward) at the western and eastern extents of the project site.

It should be noted, the above-described sound wall would be effective at first-floor receiver locations only, and would not provide acoustical shielding to any proposed second-floor receivers. Therefore, individual second-floor balconies should not be constructed facing SR 198 for the first row of homes adjacent to the roadway.

Interior Noise Exposure:

The City of Lemoore interior noise level standard is 45 dB L_{dn} . The worst-case future noise exposure within the proposed residential development would be approximately 71 dB L_{dn} . This means that the proposed residential construction must be capable of providing a minimum outdoor-to-indoor noise level reduction (NLR) of approximately 26 dB ($71-45=26$).

A specific analysis of interior noise levels was not performed as a project site plan and construction details were not available at the time this analysis was prepared. It may be assumed that residential construction methods complying with current building code requirements will reduce exterior noise levels by approximately 25 dB if windows and doors are closed. The required level of noise reduction for the worst-case exposures would be 26 dB L_{dn} . Therefore, it will be necessary to conduct a review of interior noise levels once project-specific details are available.

CONCLUSIONS

Exterior Noise Compliance:

Project-specific site plan / lot layout design as well as construction details were not available at the time this analysis was prepared. For the purpose of this analysis, it was assumed that residential setbacks would be 100 feet from the centerline of State Route 198 (SR 198). The following conclusions are based upon this assumed 100-foot residential setback distance. In order to comply with City of Lemoore exterior noise level standards, the following mitigation measures will be required:

- A sound wall (or berm wall combination) with a minimum height of seven feet (7') relative to the adjacent roadway elevation is constructed along the lot property lines adjacent to SR 198. It should be noted, the project site elevation varies, and is generally approximately two to three (2-3) feet below the grade of SR 98 along the project roadway frontage. The sound wall must be constructed to a finished height of 7 feet above the adjacent roadway elevation. In order to be effective, the sound wall should be turned inward (northward) at the western and eastern extents of the project site. Suitable construction materials include concrete blocks, masonry or stucco on both sides of a wood or steel stud wall.
- If two-story construction is proposed for the first row of homes facing SR 198, second story balconies should not be incorporated into project design, for the first row of homes adjacent to SR 198, facing the roadway.

Interior Noise Compliance:

Project-specific site plan / lot layout design as well as construction details were not available at the time this analysis was prepared. Based upon calculated exterior noise levels, the construction details should be analyzed by a qualified acoustical consultant to determine interior noise level compliance.

The conclusions and recommendations of this acoustical analysis are based upon the best information known to WJV Acoustics Inc. (WJVA) at the time the analysis was prepared concerning the proposed site plan, project site elevation, traffic volumes and roadway configurations. Any significant changes in these factors will require a reevaluation of the findings of this report. Additionally, any significant future changes in motor vehicle technology, noise regulations or other factors beyond WJVA's control may result in long-term noise results different from those described by this analysis.

Respectfully submitted,

A handwritten signature in black ink, appearing to read "Walter J. Van Groningen". The signature is fluid and cursive, with a long horizontal stroke extending to the right.

Walter J. Van Groningen
President

WJV:wjv

FIGURE 1: KINGS COUNTY ASSESSOR'S PARCEL MAP

Provided by:

 THIS MAP IS FOR ASSESSMENT PURPOSES ONLY.
 IT IS NOT TO BE CONSTRUED AS PORTRAYING
 LEGAL OWNERSHIP OF DIVISIONS OF LAND FOR
 PURPOSES OF ZONING OR SUBDIVISION LAW.
 JULY 2017

KINGS COUNTY ASSESSOR'S MAP
 SEC. 11 & 12-19-20

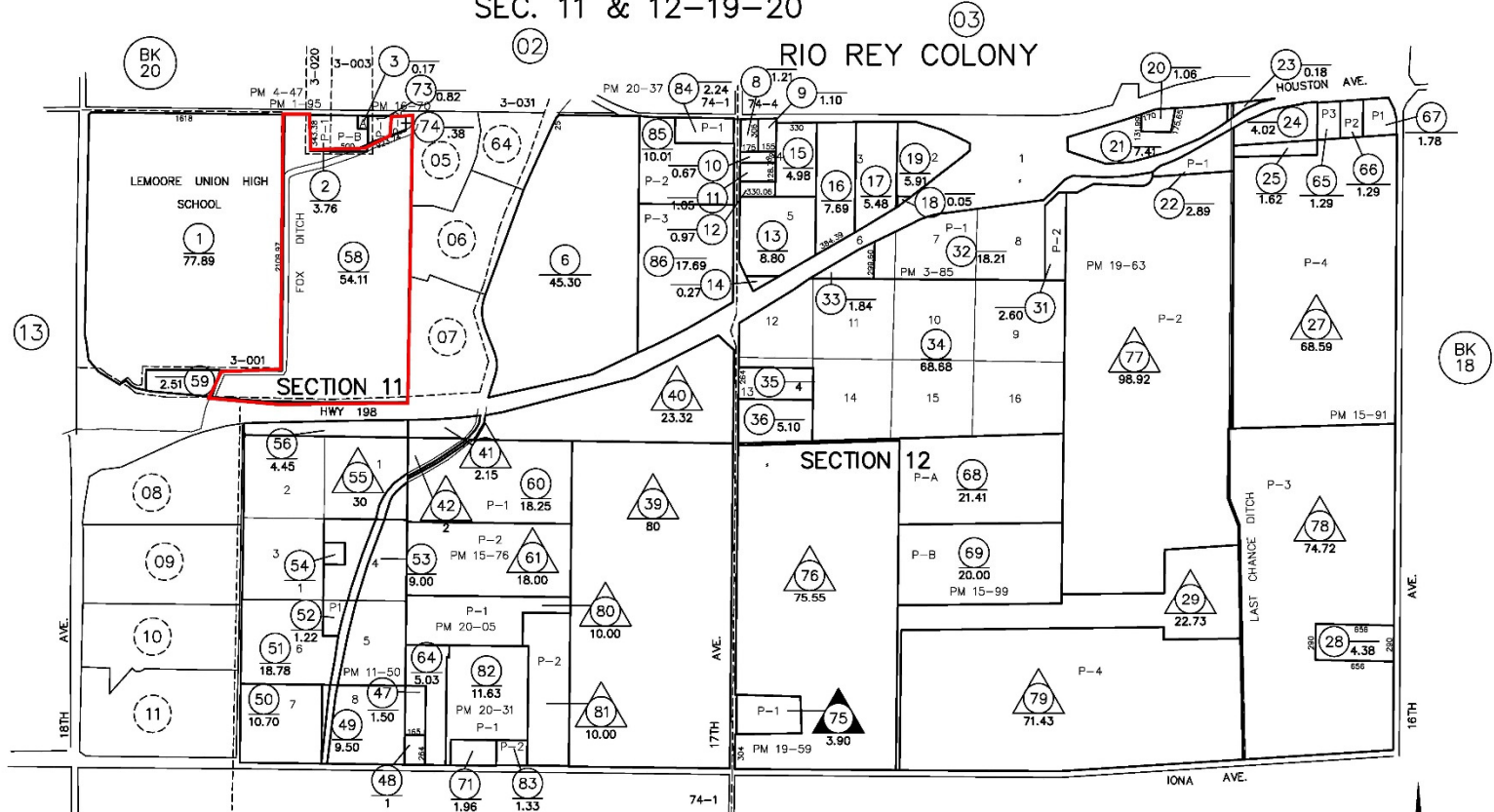
23-04



 LAND PRESERVE  NON-RENEWAL

Copyright © 1997, Kings County Assessor's Office
 All rights reserved

1" = 800'

FIGURE 2: PROJECT SITE VICINITY AND NOISE MEASUREMENT LOCATION

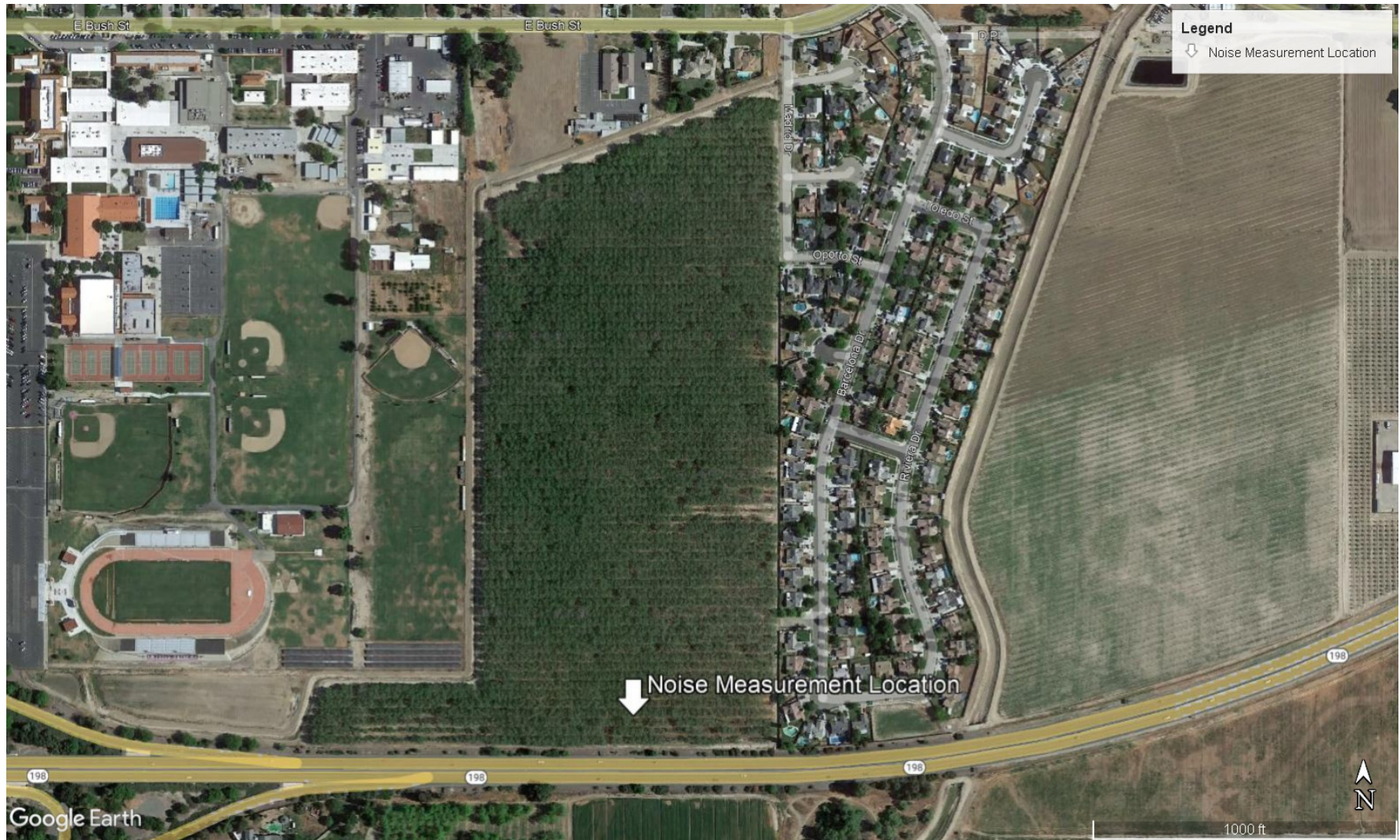

FIGURE 3: NOISE MEASUREMENT SITE



APPENDIX A

ACOUSTICAL TERMINOLOGY

AMBIENT NOISE LEVEL:	The composite of noise from all sources near and far. In this context, the ambient noise level constitutes the normal or existing level of environmental noise at a given location.
CNEL:	Community Noise Equivalent Level. The average equivalent sound level during a 24-hour day, obtained after addition of approximately five decibels to sound levels in the evening from 7:00 p.m. to 10:00 p.m. and ten decibels to sound levels in the night before 7:00 a.m. and after 10:00 p.m.
DECIBEL, dB:	A unit for describing the amplitude of sound, equal to 20 times the logarithm to the base 10 of the ratio of the pressure of the sound measured to the reference pressure, which is 20 micropascals (20 micronewtons per square meter).
DNL/L_{dn}:	Day/Night Average Sound Level. The average equivalent sound level during a 24-hour day, obtained after addition of ten decibels to sound levels in the night after 10:00 p.m. and before 7:00 a.m.
L_{eq}:	Equivalent Sound Level. The sound level containing the same total energy as a time varying signal over a given sample period. L _{eq} is typically computed over 1, 8 and 24-hour sample periods.
NOTE:	The CNEL and DNL represent daily levels of noise exposure averaged on an annual basis, while L _{eq} represents the average noise exposure for a shorter time period, typically one hour.
L_{max}:	The maximum noise level recorded during a noise event.
L_n:	The sound level exceeded "n" percent of the time during a sample interval (L ₉₀ , L ₅₀ , L ₁₀ , etc.). For example, L ₁₀ equals the level exceeded 10 percent of the time.

A-2

ACOUSTICAL TERMINOLOGY

NOISE EXPOSURE

CONTOURS:

Lines drawn about a noise source indicating constant levels of noise exposure. CNEL and L_{dn} contours are frequently utilized to describe community exposure to noise.

NOISE LEVEL

REDUCTION (NLR):

The noise reduction between indoor and outdoor environments or between two rooms that is the numerical difference, in decibels, of the average sound pressure levels in those areas or rooms. A measurement of “noise level reduction” combines the effect of the transmission loss performance of the structure plus the effect of acoustic absorption present in the receiving room.

SEL or SENEL:

Sound Exposure Level or Single Event Noise Exposure Level. The level of noise accumulated during a single noise event, such as an aircraft overflight, with reference to a duration of one second. More specifically, it is the time-integrated A-weighted squared sound pressure for a stated time interval or event, based on a reference pressure of 20 micropascals and a reference duration of one second.

SOUND LEVEL:

The sound pressure level in decibels as measured on a sound level meter using the A-weighting filter network. The A-weighting filter de-emphasizes the very low and very high frequency components of the sound in a manner similar to the response of the human ear and gives good correlation with subjective reactions to noise.

SOUND TRANSMISSION

CLASS (STC):

The single-number rating of sound transmission loss for a construction element (window, door, etc.) over a frequency range where speech intelligibility largely occurs.

7.5 Appendix E: Traffic Impact Analysis

Prepared by JBL Traffic Engineering, Inc., dated March 22, 2023.

Traffic Impact Analysis

TTM 22-021 (Single-Family Housing)

**Located on the Southeast Quadrant of
Lemoore Avenue and Bush Street**

In the City of Lemoore, California

Prepared for:

Wathen Castanos Homes
2505 Alluvial Avenue
Clovis, CA 93611

March 22, 2023

Project No. 039-004



Traffic Engineering, Transportation Planning, & Parking Solutions

516 W. Shaw Ave., Ste. 103

Fresno, CA 93704

Phone: (559) 570-8991

www.JLBtraffic.com



Traffic Engineering, Transportation Planning, & Parking Solutions

Traffic Impact Analysis

For TTM 22-021 located on the Southeast Quadrant of Lemoore Avenue and Bush Street

In the City of Lemoore, CA

March 22, 2023

This Traffic Impact Analysis has been prepared under the direction of a licensed Traffic Engineer. The licensed Traffic Engineer attests to the technical information contained therein and has judged the qualifications of any technical specialists providing engineering data from which recommendations, conclusions, and decisions are based.

Prepared by:

A handwritten signature in black ink that reads 'Jose L Benavides'.

Jose Luis Benavides, PE, TE

President



Traffic Engineering, Transportation Planning, & Parking Solutions

516 W. Shaw Ave., Ste. 103
Fresno, CA 93704
Phone: (559) 570-8991
www.JLBtraffic.com

Table of Contents

Introduction and Summary.....	1
Introduction	1
Summary	1
Existing Traffic Conditions.....	1
Existing plus Project Traffic Conditions.....	1
Near Term plus Project Traffic Conditions.....	1
Cumulative Year 2042 plus Project Traffic Conditions.....	2
Queuing Analysis.....	2
Scope of Work	3
Study Facilities	3
Study Intersections	4
Project Only Trip Assignment to State Facilities	4
Study Scenarios.....	4
Existing Traffic Conditions.....	4
Existing plus Project Traffic Conditions.....	4
Near Term plus Project Traffic Conditions.....	4
Cumulative Year 2042 plus Project Traffic Conditions.....	4
Level of Service Analysis Methodology	5
Criteria of Significance	5
Operational Analysis Assumptions and Defaults	6
Existing Traffic Conditions	7
Roadway Network.....	7
Traffic Signal Warrants.....	8
Results of Existing Level of Service Analysis	9
Existing plus Project Traffic Conditions	12
Project Description.....	12
Project Access	12
Trip Generation.....	12
Trip Distribution.....	13
Bikeways	13

Transit 14

Safe Routes to School 14

Traffic Signal Warrants..... 15

Results of Existing plus Project Level of Service Analysis 15

Near Term plus Project Traffic Conditions.....20

 Description of Approved and Pipeline Projects 20

 Traffic Signal Warrants..... 20

 Results of Near Term plus Project Level of Service Analysis..... 21

Cumulative Year 2042 plus Project Traffic Conditions.....24

 Traffic Signal Warrants..... 24

 Results of Cumulative Year 2042 plus Project Level of Service Analysis 24

 Project Only Trip Assignment to State Facilities 25

Queuing Analysis29

Conclusions and Recommendations.....32

 Existing Traffic Conditions..... 32

 Existing plus Project Traffic Conditions..... 32

 Near Term plus Project Traffic Conditions..... 32

 Cumulative Year 2042 plus Project Traffic Conditions..... 33

 Queuing Analysis..... 33

Study Participants.....34

References.....35



List of Figures

Figure 1: Vicinity Map	10
Figure 2: Existing - Traffic Volumes, Geometrics and Controls.....	11
Figure 3: Project Site Plan	17
Figure 4: Project Only Trips	18
Figure 5: Existing plus Project - Traffic Volumes, Geometrics and Controls	19
Figure 6: Near Term Projects' Trip Assignment	22
Figure 7: Near Term plus Project - Traffic Volumes, Geometrics and Controls.....	23
Figure 8: Cumulative Year 2042 plus Project - Traffic Volumes, Geometrics and Controls.....	26
Figure 9: State Route 198 at Lemoore Avenue - Project Only trips.....	27
Figure 10: State Route 198 and Houston Avenue - Project Only Trips	28

List of Tables

Table I: Existing Intersection LOS Results	9
Table II: Analyzed Trip Generation.....	13
Table III: Project Trip Generation	13
Table IV: Difference in Trip Generation.....	13
Table V: Existing plus Project Intersection LOS Results	16
Table VI: Near Term Projects' Trip Generation.....	20
Table VII: Near Term plus Project Intersection LOS Results.....	21
Table VIII: Cumulative Year 2042 plus Project Intersection LOS Results	25
Table IX: Queuing Analysis.....	29

List of Appendices

- Appendix A: Scope of Work
- Appendix B: Traffic Counts
- Appendix C: Traffic Modeling
- Appendix D: Methodology
- Appendix E: Existing Traffic Conditions
- Appendix F: Existing plus Project Traffic Conditions
- Appendix G: Near Term plus Project Traffic Conditions
- Appendix H: Cumulative Year 2042 plus Project Traffic Conditions
- Appendix I: Signal Warrants

Introduction and Summary

Introduction

This report describes a Traffic Impact Analysis (TIA) prepared by JLB Traffic Engineering, Inc. (JLB) for TTM 22-021 (Project) located on the southeast quadrant of Lemoore Avenue and Bush Street in the City of Lemoore. The Project proposes to develop approximately 52.61 acres with 280 single family residential units and approximately 3.2 acres of public parks. Based on information provided to JLB, the Project is consistent with the City of Lemoore's *2030 General Plan*. Figure 1 shows the location of the proposed Project site relative to the surrounding roadway network.

The purpose of this TIA is to evaluate the potential on-site and off-site traffic impacts, identify short-term roadway and circulation needs, determine potential mitigation measures and identify any critical traffic issues that should be addressed in the on-going planning process. The TIA primarily focused on evaluating traffic conditions at study intersections that may potentially be impacted by the proposed Project. The Scope of Work was prepared via consultation with City of Lemoore, County of Kings and Caltrans staff.

Summary

The potential traffic impacts of the proposed Project were evaluated in accordance with the standards set forth by the Level of Service (LOS) policy of the City of Lemoore and County of Kings.

Existing Traffic Conditions

- At present, all study intersections operate at an acceptable LOS during both peak periods.

Existing plus Project Traffic Conditions

- JLB analyzed the location of the proposed access points relative to the existing local roads and driveways in the Project's vicinity. A review of the Project access points indicates that they are located at points that minimize traffic operational impacts to the existing roadway network.
- The proposed Project is estimated to generate a maximum of 2,642 daily trips, 196 AM peak hour trips and 263 PM peak hour trips.
- It is recommended that the Project implement a Class II Bike Lane along its frontage to Bush Street in order to encourage multi modal transportation and reduce VMT.
- Under this scenario, the study intersection of 17th Avenue at Houston Avenue is projected to exceed its LOS threshold during the AM peak period. The addition of lanes and modification of traffic control mechanisms are recommended. Additional details as to the recommended improvements are presented later in this Report.

Near Term plus Project Traffic Conditions

- The total trip generation for the Near Term Projects is 26,613 daily trips, 1,995 AM peak hour trips and 2,341 PM peak hour trips.
- Under this scenario, all study intersections are projected to operate at an acceptable LOS during both peak periods.

Cumulative Year 2042 plus Project Traffic Conditions

- Under this scenario, the study intersection of Bush Street at D Street is projected to exceed its LOS threshold during both peak periods. The modification of lanes and traffic control mechanisms are recommended. Additional details as to the recommended improvements are presented later in this Report.

Queuing Analysis

- It is recommended that the City consider left-turn and right-turn lane storage lengths as indicated in the Queuing Analysis.

Scope of Work

The TIA primarily focused on evaluating traffic conditions at study intersections that may potentially be impacted by the proposed Project. On August 10, 2022, a Draft Scope of Work for the preparation of a Traffic Impact Analysis for this Project was provided to the City of Lemoore, County of Kings and Caltrans for their review and comment. Any comments to the Draft Scope of Work were requested to be provided by August 31, 2022.

On August 16, 2022, the County of Kings responded to the Draft Scope of Work with no comment. On August 22, 2022, the City of Lemoore responded to the Draft Scope of Work requesting that JLB include three near term projects (Tract 935, Tract 920, and Bush/19th Commercial) to the near term analysis and include project trip distribution at access points to the north and east. On August 31, 2022, Caltrans responded to the Draft Scope of Work requesting that JLB not utilize HCM 2000 methodologies, include an opening day analysis of the Project, include the intersections for the State Route 198 at Lemoore Avenue ramps in the analysis, and include a VMT Analysis. On September 6, 2022, JLB reached out to Caltrans to determine if the Existing plus Project would suffice for the opening day analysis. Caltrans responded that an Existing plus Project scenario would suffice.

Based on comments received, this TIA includes the three near term projects, a Project trip distribution at project driveways, the two intersections of the State Route 198 Ramps at Lemoore Avenue. This TIA does not include HCM 2000 methodologies. Additionally, based on information provided to JLB by Precision Civil Engineering, Inc., the Project has been screened out of a VMT analysis and as such this TIA does not contain further information related to VMT. The Draft Scope of Work and the comments received from the lead agency and responsible agencies are included in Appendix A.

Study Facilities

The existing intersection peak hour turning movement and segment volume counts were conducted at the study intersections in September 2022 while schools the vicinity of the Project site were in session. The intersection turning movement counts included pedestrian and bicycle volumes. The traffic counts for the existing study intersections are contained in Appendix B. The existing intersection turning movement volumes, intersection geometrics and traffic controls are illustrated in Figure 2.

Study Intersections

1. Lemoore Avenue / D Street
2. Bush Street / D Street
3. Lemoore Avenue / Bush Street
4. 17th Avenue / Houston Avenue
5. Lemoore Avenue / State Route 198 Westbound Ramps
6. Lemoore Avenue / State Route 198 Eastbound Ramps

Project Only Trip Assignment to State Facilities

1. State Route 198 / Lemoore Avenue
2. State Route 198 / Houston Avenue

Study Scenarios

Existing Traffic Conditions

This scenario evaluates the Existing Traffic Conditions based on existing traffic volumes and roadway conditions from traffic counts and field surveys conducted in September 2022.

Existing plus Project Traffic Conditions

This scenario evaluates total traffic volumes and roadway conditions based on the Existing plus Project Traffic Conditions. The Existing plus Project traffic volumes were obtained by adding the Project Only Trips to the Existing Traffic Conditions scenario. The Project Only Trips to the study facilities were developed based on the Kings CAG Select Zone, existing travel patterns, the existing roadway network, engineering judgement, data provided by the developer, knowledge of the study area, existing residential and commercial densities, anticipated school boundaries and the City of Lemoore's 2030 General Plan Circulation Element in the vicinity of the Project site.

Near Term plus Project Traffic Conditions

This scenario evaluates total traffic volumes and roadway conditions based on the Near Term plus Project Traffic Conditions. The Near Term plus Project traffic volumes were obtained by adding the near term related trips to the Existing plus Project Traffic Conditions scenario.

Cumulative Year 2042 plus Project Traffic Conditions

This scenario evaluates total traffic volumes and roadway conditions based on the Cumulative Year 2042 plus Project Traffic Conditions. JLB utilized the Kings County Association of Governments (KCAG) Base Year 2019 and Cumulative Year 2042 models to determine the increment which was used to forecast the Cumulative Year 2042 plus Project traffic volumes. However, as the increment between these scenarios was determined to be low, a historical growth rate was calculated. A historic count from 2016 and a current count from 2022 at the intersection of 17th Avenue at Houston Avenue were used to determine the historical growth rate. These counts resulted in a historical growth rate of 2.20%. The traffic volumes for the Cumulative Year 2042 plus Project were determined using the greater volume between the increment and the historical growth rate. The historic traffic count is contained in Appendix B. The Kings CAG model results are contained in Appendix C.

Level of Service Analysis Methodology

LOS is a qualitative index of the performance of an element of the transportation system. LOS is a rating scale running from “A” to “F”, with “A” indicating no congestion of any kind and “F” indicating unacceptable congestion and delays. LOS in this study describes the operating conditions for signalized and unsignalized intersections.

The *Highway Capacity Manual* (HCM) 7th Edition is the standard reference published by the Transportation Research Board and contains the specific criteria and methods to be used in assessing LOS. Synchro software was used to define LOS in this study. Details regarding these calculations are included in Appendix D.

Criteria of Significance

The City of Lemoore *2030 General Plan* does not currently have any adopted LOS standard. However, recent traffic studies have utilized LOS D as the acceptable level of traffic congestion. Therefore, LOS D is used to evaluate the potential significant of LOS impacts to City of Lemoore roadway facilities.

The County of Kings *2035 General Plan* has established a minimum LOS standard within the County, which shall be no lower than LOS E for urban areas and LOS D for rural areas. For this TIA, LOS D is used to evaluate the potential significance of LOS impacts to intersections within the County of Kings.

Caltrans no longer considers delay as a significant impact to the environment, for land use projects and plans. According to the Caltrans document VMT Focused Transportation Impact Study Guidelines dated May 2020, Caltrans review of land use projects and plans is focused on a VMT metric consistent with CEQA. Therefore, the City of Lemoore and the County of Kings rural LOS threshold of LOS D are utilized to evaluate potential significant impacts to LOS.

Operational Analysis Assumptions and Defaults

The following operational analysis values, assumptions and defaults were used in this study to ensure a consistent analysis of LOS among the various scenarios.

- Yellow time consistent with the California Manual of Uniform Traffic Control Devices (CA MUTCD) based on approach speeds
- Yellow time of 3.2 seconds for left-turn phases
- All-red clearance intervals of 1.0 second for all phases
- Walk intervals of 7.0 seconds
- Flashing Don't Walk based on 3.5 feet/second walking speed with yellow plus all-red clearance subtracted and 2.0 seconds added
- Timing schedule for Caltrans intersections are based on Caltrans Controller Timing Chart for those intersections.
- The existing intersections, the heavy vehicle factor observed for each intersection or a minimum of 3 percent were utilized under all scenarios
- An average of 10 pedestrian calls per hour at signalized intersections
- The number of observed pedestrians at existing intersections was utilized under all study scenarios
- At existing intersections, the observed approach Peak Hour Factor (PHF) is utilized in all scenarios

Existing Traffic Conditions

Roadway Network

The Project site and surrounding study area are illustrated in Figure 1. Important roadways serving the Project are discussed below.

Lemoore Avenue (18th Avenue) is an existing north-south four-lane arterial divided by a two-way left-turn lane in the vicinity of the proposed Project. Lemoore Avenue is a two-lane undivided arterial between Grangeville Boulevard and Spruce Avenue, a two-lane arterial divided by a two-way left-turn lane between Spruce Avenue and Hanford-Armona Road, a four-lane arterial divided by a two-way left-turn lane between Hanford-Armona Road and Cinnamon Drive, a four-lane undivided arterial between Cinnamon Drive and Bush Street, a four-lane arterial divided by a two-way left-turn between Bush Street and State Route 198, and a two-lane arterial divided by a two-way left-turn lane between State Route 198 and Iona Avenue. The City of Lemoore *2030 General Plan* designates Lemoore Avenue as a two-lane arterial between Grangeville Avenue and Hanford-Armona Road and a four-lane arterial between Hanford-Armona Drive and Iona Avenue.

17th Avenue is an existing north-south undivided two-lane local roadway in the vicinity of the proposed Project. In this area, 17th Avenue is an undivided local roadway that runs through the City of Lemoore SOI. The City of Lemoore *2030 General Plan* designates 17th Avenue as a two-lane local roadway throughout the City of Lemoore SOI.

Daphne Lane is an existing north-south undivided two-lane local roadway in the vicinity of the proposed Project. In this area, Daphne Lane is an undivided local roadway between Banyan Drive and D Street. The City of Lemoore *2030 General Plan* designates Daphne Lane as a two-lane local roadway between Banyan Drive and D Street.

D Street is an existing east-west two-lane arterial divided by a two-way left-turn lane in the vicinity of the proposed Project. In this area, D Street is a two-lane undivided arterial between Bush Street and 19th Avenue, a four-lane undivided arterial between 19th Avenue and Fox Street, a two-lane undivided arterial between Fox Street and Lemoore Avenue and a two-lane arterial divided by a two-way left-turn lane between Lemoore Avenue and Houston Avenue. The County of Kings *2035 General Plan* designates D Street as a two-lane arterial between Bush Street and 19th Avenue, a four-lane arterial between 19th Avenue and Fox Street, a two-lane arterial between Fox Street and Cantera Avenue and a four-lane arterial between Cantera Avenue and Houston Avenue.

Bush Street is an existing east-west two-lane undivided arterial adjacent to the proposed Project. In this area, Bush Street is a two- to four-lane undivided arterial between College Avenue and 19½ Avenue, a two-lane arterial divided by a two-way left-turn lane 19½ Avenue and 19th Avenue, a four-lane undivided arterial between 19th Avenue and Lemoore Avenue and a two-lane undivided arterial between Lemoore Avenue and D Street. The City of Lemoore *2030 General Plan* designates Bush Street as a four-lane arterial between Marsh Drive and College Avenue, a six- to eight-lane arterial between College Avenue and 19½ Avenue and a four-lane arterial between 19½ Avenue and D Street.

Houston Avenue is an existing east-west undivided two-lane minor arterial in the vicinity of the proposed Project. In this area, Houston Avenue is a two-lane undivided minor arterial between D Street and 10th Avenue and a two-lane undivided major collector between 10th Avenue and the eastern boundary of the County of Kings. The County of Kings *2035 General Plan* designates Houston Avenue as a minor arterial between D Street and 10th Avenue and a major collector between 10th Avenue and the eastern boundary of the County of Kings.

State Route (SR) 198 is an existing east-west four-lane freeway adjacent to the proposed Project. State Route 198 serves as the principal connection of Lemoore, Hanford and Visalia to the coast, I-5, SR 41, SR 43, SR 99, and Sequoia National Park and Forest.

Traffic Signal Warrants

The CA MUTCD indicates that an engineering study of traffic conditions, pedestrian characteristics and physical features of an intersection shall be conducted to determine whether installation of traffic signal controls are justified. The CA MUTCD provides a total of nine (9) warrants to evaluate the need for traffic signal controls. These warrants include 1) Eight-Hour Vehicular Volume, 2) Four-Hour Vehicular Volume, 3) Peak Hour, 4) Pedestrian Volume, 5) School Crossing, 6) Coordinated Signal System, 7) Crash Experience, 8) Roadway Network and 9) Intersection Near a Grade Crossing. Signalization of an intersection may be appropriate if one or more of the signal warrants is satisfied. However, the CA MUTCD also states that “[t]he satisfaction of a signal warrant or warrants shall not in itself require the installation of a traffic control signal” (California Department of Transportation, 2020b).

If traffic signal warrants are satisfied when an LOS threshold impact is identified at an unsignalized intersection, then installation of a traffic signal control may serve as an improvement measure. For instances where traffic signal warrants are satisfied, a traffic signal control is not considered to be the default improvement measure. Since installation of a traffic signal control typically requires construction of additional lanes, an attempt was first made to improve the intersection approach lane geometrics in order to improve its LOS while maintaining the existing intersection controls. If the additional lanes did not result in acceptable LOS at the intersection, then in those cases implementation of a traffic signal control would be considered.

Warrant 3 was prepared for the unsignalized intersections under the Existing Traffic Conditions scenario. These warrants are contained in Appendix I. Under this scenario, the intersection of 17th Avenue at Houston Avenue currently meet the peak hour warrant during both peak periods. The remaining unsignalized study intersections do not satisfy the peak hour signal warrant during any of the study peak periods. It should be noted that the County of Kings is working on the preparation of construction documents for the signalization of Houston Avenue at 17th Avenue and the plans are currently in the final stages of design. It’s anticipated that the intersection will be signalized by 2024.

Results of Existing Level of Service Analysis

Figure 2 illustrates the Existing Traffic Conditions turning movement volumes, intersection geometrics and traffic controls. LOS worksheets for the Existing Traffic Conditions scenario are provided in Appendix E. Table I presents a summary of the Existing peak hour LOS at the study intersections.

At present, all study intersections operate at an acceptable LOS during both peak periods.

Table I: Existing Intersection LOS Results

ID	Intersection	Intersection Control	AM (7-9) Peak Hour		PM (4-6) Peak Hour	
			Average Delay (sec/veh)	LOS	Average Delay (sec/veh)	LOS
1	Lemoore Avenue / D Street	Traffic Signal	22.6	C	21.1	C
2	Bush Street / D Street	Two-Way Stop	24.3	C	17.6	C
3	Lemoore Avenue / Bush Street	Traffic Signal	28.7	C	17.1	B
4	17th Avenue / Houston Avenue	All-Way Stop	34.2	D	19.3	C
5	Lemoore Avenue / SR 198 WB Ramps	Traffic Signal	23.8	C	25.3	C
6	Lemoore Avenue / SR 198 EB Ramps	Traffic Signal	20.4	C	23.1	C

Note: LOS = Level of Service based on average delay on signalized intersections and All-Way STOP Controls
 LOS for two-way and one-way STOP controlled intersections are based on the worst approach/movement of the minor street.

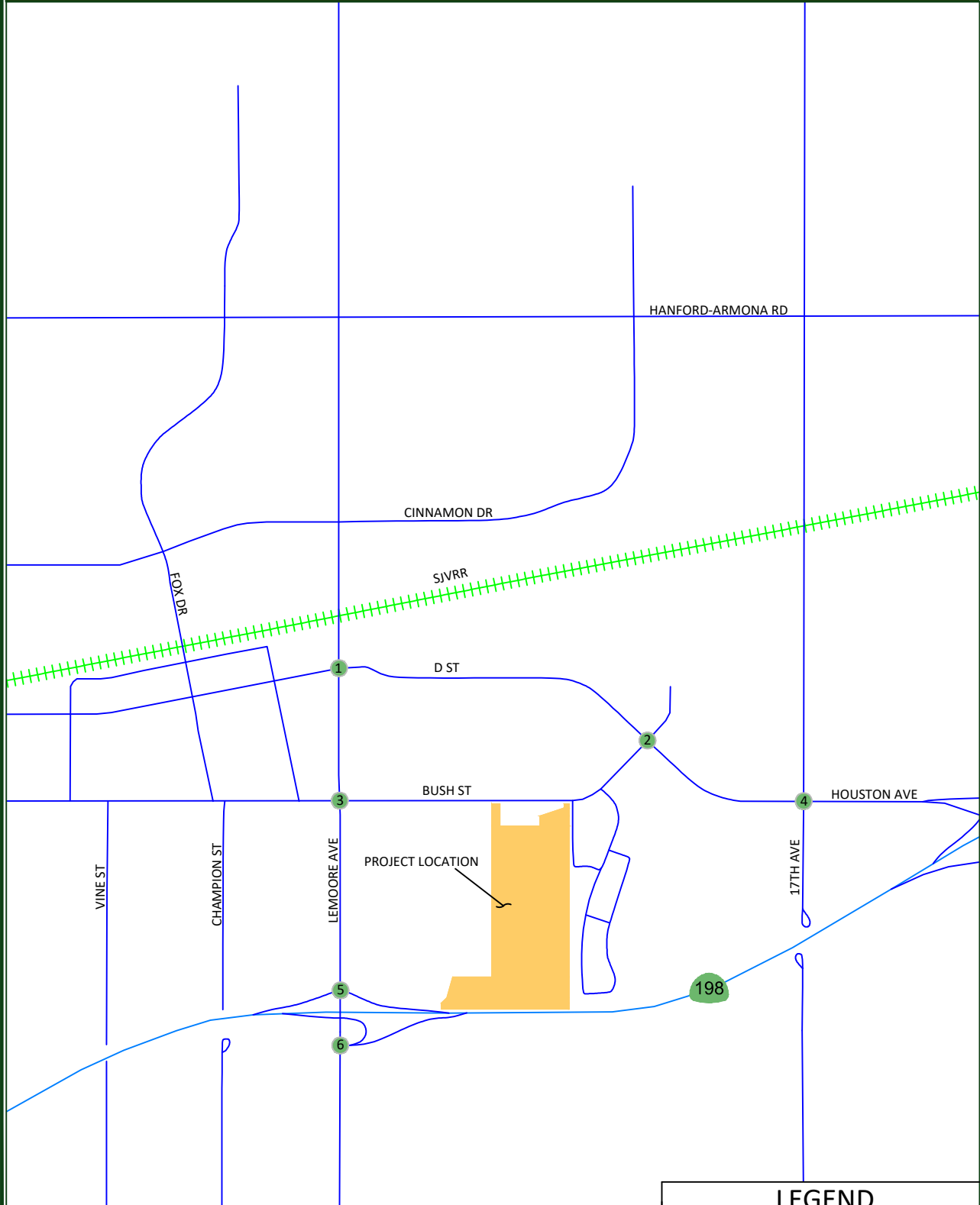

516 W. Shaw Ave., Ste. 103, Fresno, CA 93704
PHONE: (559) 570-8991, EMAIL: info@JLBtraffic.com, www.JLBtraffic.com

LEGEND

= STUDY INTERSECTION



Not To Scale

TTM 22-021 TIA - City of Lemoore

Existing - Traffic Volumes, Geometrics and Controls

Figure 2

<p>1. Lemoore Ave & D St</p> <p>65(86) 595(421) 170(173) 174(219) 173(143) 50(47) 57(92) 111(130) 40(36) 40(42) 451(448) 45(37)</p>	<p>2. Bush St & D St</p> <p>16(14) 7(3) 8(10) 10(23) 303(369) 176(87) 5(14) 264(263) 27(20) 31(21) 6(3) 137(73)</p>	<p>3. Lemoore Ave & Bush St</p> <p>112(96) 318(388) 146(27) 142(31) 157(83) 69(49) 123(78) 181(79) 101(170) 106(90) 215(391) 99(55)</p>	<p>4. 17th Ave & Houston Ave</p> <p>156(41) 1(0) 189(127) 86(186) 400(423) 1(0) 85(52) 372(316) 0(0) 2(0) 0(1) 1(0)</p>
---	---	---	---

<p>5. Lemoore Ave & SR 198 WB Ramps</p> <p>147(135) 380(385) 123(163) 0(0) 112(141) 19(15) 384(396)</p>	<p>6. Lemoore Ave & SR 198 EB Ramps</p> <p>323(338) 171(193) 153(181) 12(21) 252(228) 100(184)</p>	<p>HANFORD-ARMONA RD</p>
---	--	--------------------------



JLB TRAFFIC
ENGINEERING, INC.

516 W. Shaw Ave., Ste. 103, Fresno, CA 93704
PHONE: (559) 570-8991, EMAIL: info@JLBtraffic.com, www.JLBtraffic.com

LEGEND

- # = STUDY INTERSECTION
- XX = AM PEAK HOUR TRIPS
- (XX) = PM PEAK HOUR TRIPS
- = STOP SIGN
- 🚦 = TRAFFIC SIGNAL

IONA AVE

Not To Scale

Existing plus Project Traffic Conditions

Project Description

The Project proposes to develop approximately 52.61 acres on the southeast quadrant of Lemoore Avenue at Bush Street with 280 single family residential units and approximately 3.2 acres of public parks. Based on information provided to JLB, the Project is consistent with the City of Lemoore's *2030 General Plan*. Figure 3 illustrates the latest Project Site Plan.

Project Access

Based on the latest Project Site Plan, access to and from the Project site will be from three (3) main access points in total. Two (2) of the access points will be located along the east side of the Project and connect to existing roads. These (2) access points will connect to Madrid Drive and Barcelona Drive with full access. One (1) of the access points will be located along the north side of Glendale approximately 345 feet east of Lemoore Avenue and is proposed as full access. One (1) of the access points will be on the south side of Bush Street approximately 1,600 feet east of Lemoore Avenue. This access point is proposed to have full access to Lemoore Avenue. Project Trip distribution to these access points based on the trip generation of the latest site plan is illustrated in Figure 3.

Trip Generation

Trip generation rates for the proposed Project were obtained from the 11th Edition of the Trip Generation Manual published by the Institute of Transportation Engineers (ITE). Table II presents the trip generation for the analyzed Project with trip generation rates for 276 units of Single-Family Detached Housing (ITE Code 210) and 5.5 acres of Public Park (ITE Code 411). As can be seen in Table II, the analyzed Project is estimated to generate approximately 2,607 daily trips, 193 AM peak hour trips and 260 PM peak hour trips. Although this TIA analyzes 276 units of Single-Family Detached Housing and approximately 5.5 acres of Public Park, the Project proposes to construct 280 units of Single-Family Detached Housing and approximately 3.2 acres of Public Park. As can be seen in Table III, the proposed Project is estimated to generate approximately 2,642 daily trips, 196 AM peak hour trips and 263 PM peak hour trips. The difference in trip generation between the analyzed Project and the proposed Project is summarized in Table IV. The analyzed Project is estimated to generate less trips by approximately 35 daily trips, 3 AM peak hour trips and 3 PM peak hour trips. Based on the LOS and queuing analysis, it was determined that the recommendations of this analysis would not be different with the addition of four (4) dwelling units. As such, the conclusions and recommendations within this TIA would also be appropriate for the updated Project site plan with 280 single family residential lots and approximately 3.2 acres of parks.

Table II: Analyzed Trip Generation

Land Use (ITE Code)	Size	Unit	Daily		AM (7-9) Peak Hour						PM (4-6) Peak Hour					
			Rate	Total	Trip Rate	In	Out	In	Out	Total	Trip Rate	In	Out	In	Out	Total
						% %						% %				
Single-Family Detached Housing (210)	276	d.u.	9.43	2,603	0.70	26	74	50	143	193	0.94	63	37	163	96	259
Public Park (411)	5.5	acres	0.78	4	0.02	59	41	0	0	0	0.11	55	45	1	0	1
Total Project Trips				2,607				50	143	193				164	96	260

Note: d.u. = Dwelling Units

Table III: Project Trip Generation

Land Use (ITE Code)	Size	Unit	Daily		AM (7-9) Peak Hour						PM (4-6) Peak Hour					
			Rate	Total	Trip Rate	In	Out	In	Out	Total	Trip Rate	In	Out	In	Out	Total
						% %						% %				
Single-Family Detached Housing (210)	280	d.u.	9.43	2,640	0.70	26	74	51	145	196	0.94	63	37	166	97	263
Public Park (411)	3.2	acres	0.78	2	0.02	59	41	0	0	0	0.11	55	45	0	0	0
Total Project Trips				2,642				51	145	196				166	97	263

Note: d.u. = Dwelling Units

Table IV: Difference in Trip Generation

	Daily	AM (7-9) Peak Hour			PM (4-6) Peak Hour		
	Total	In	Out	Total	In	Out	Total
Analyzed Project	2,607	50	143	193	164	96	260
Proposed Project	2,642	51	145	196	166	97	263
Difference in Trip Generation	-35	-1	-2	-3	-2	-1	-3

Trip Distribution

The trip distribution assumptions were developed based on the Kings CAG Select Zone, existing travel patterns, the existing roadway network, engineering judgement, data provided by the developer, knowledge of the study area, existing residential and commercial densities, anticipated school boundaries and the City of Lemoore's 2030 General Plan Circulation Element in the vicinity of the Project site. Figure 4 illustrates the Project Only Trips to the study intersections.

Bikeways

Currently, Class II Bike Lanes exist in the vicinity of the proposed Project site along portions of Lemoore Avenue and D Street. The City of Lemoore 2030 General Plan propose Bike Lanes on portions Bush Street, D Street, Daphne Lane and surrounding Lemoore High School. However, the bike path anticipated to surround Lemoore High School has not been made. If a portion of the bike path adjacent to the Project is built, it would not connect to the greater bike network. Therefore, it is only recommended that the Project implement a Class II bike lane along its frontage to Bush Street. By implementing this recommendation, the City will be promoting alternative modes of transportation to and from the Project as well as reduce VMT.

Transit

Kings Area Rural Transit (KART), the transit operator in the City of Lemoore, provides fixed-route service. At present, there are two (2) KART routes that operate in the vicinity of the proposed Project. The closest is KART Route 20 – Lemoore, which runs on Bush Street, and the other is KART Route 12 – Hanford-Avenal, which runs on D Street. Route 20 operates at 30-minute intervals on Monday through Friday from 6:05 AM to 5:35 PM and 30-minute intervals on Saturday from 9:35 AM to 3:35 PM. The nearest stop to the Project site is located on the north side of Bush Street approximately 600 feet west of Lemoore Avenue. This Route provides a direct connection to the KART Transit Center, Armona Senior Center, Heritage Park, Pioneer Square, Lemoore High School, City Park, Lemoore Depot and Liberty Middle school. KART Route 12 operates at 30-minute intervals on Monday through Friday from 6:15 AM to 6:15 PM and 30-minute intervals on Saturday from 9:40 AM to 4:50 PM. The nearest stop to the Project site is located on the north side of E Street approximately 300 feet west of Follett Street. This Route provides a direct connection the KART Transit Center, West Hills College, Hanford, Stratford, Avenal and Kettleman City. Route Retention of the existing and expansion of future transit routes is dependent of transit ridership demand and available funding.

Safe Routes to School

Kindergarten through 12th grade students from the Project will be served by the Lemoore Union Unified Elementary School District (LUESD) and Lemoore Union High School District (LUHSD). LUESD and LUHSD provide transportation for students who live in excess of an established radius zone. The zone is a radius of three-fourths of a mile for Kindergarten through 3rd grade, one mile for 4th grade through 8th grade, and two miles for 9th grade through 12th grade.

Based on attendance area boundaries at the time of the preparation of this TIA, elementary school students would attend Lemoore Union Elementary School located on the southeast corner of Vine Street at Bush Street. Lemoore Union Elementary School is located 0.70 and 0.95 miles from the nearest and farthest future home on the Project. Therefore, it is anticipated that the majority of elementary school students will need to walk, bike or be driven to school.

The most direct path from the Project to the Lemoore Union Elementary School campus would begin from the northwest most end of the Project site along the south side of Bush Street. Students on Bush Street would proceed to travel west toward the intersection of Lemoore Avenue at Bush Street. The intersection of Lemoore Avenue at Bush Street is signalized and contains crosswalks on all four legs. Students would proceed to cross the south leg to reach the southwest corner of Lemoore Avenue at Bush Street. Students would proceed to travel west on the south side of Bush Street until reaching the entrance to the school.

Based on attendance area boundaries at the time of the preparation of this TIA, middle school students would attend Liberty Middle School located on the southeast quadrant of Liberty Drive at Hanford-Armona Road. Liberty Middle School is located 1.45 and 1.75 miles from the nearest and the farthest home on the Project. Therefore, it is anticipated that the majority of middle school students will be bussed to school.

Based on attendance area boundaries at the time of the preparation of this TIA, High School students would attend Lemoore High School located on the southeast corner of Lemoore Avenue at Bush Street. Lemoore High School is located 0.30 and 0.60 miles from the nearest and farthest home on the Project. Therefore, it is anticipated that all high school students will need to walk, bike or be driven to school.

The most direct path from the Project to the Lemoore High School campus would begin from the northwest most end of the Project site along the south side of Bush Street. Students on Bush Street would proceed to travel west until reaching the entrance to the school.

Traffic Signal Warrants

Warrant 3 was prepared for the unsignalized intersections under the Existing plus Project Traffic Conditions scenario. These warrants are contained in Appendix I. Under this scenario, the intersection of 17th Avenue at Houston Avenue currently meets the peak hour warrant during both peak periods. The remaining unsignalized study intersections do not satisfy the peak hour signal warrant during any peak period. It should be noted that the County of Kings is working on the preparation of construction documents for the signalization of Houston Avenue at 17th Avenue and the plans are currently in the final stages of design and it's anticipated that the intersection will be signalized by 2024.

Results of Existing plus Project Level of Service Analysis

The Existing plus Project Traffic Conditions scenario assumes that the Project is the only addition to the roadway network. Figure 5 illustrates the Existing plus Project turning movement volumes, intersection geometrics and traffic controls. LOS worksheets for the Existing plus Project Traffic Conditions scenario are provided in Appendix F. Table V presents a summary of the Existing plus Project peak hour LOS at the study intersections.

Under this scenario, the study intersection of 17th Avenue at Houston Avenue is projected to exceed its LOS threshold during the AM peak period. It is recommended that the following improvements be considered for implementation to improve the LOS at this intersection.

- 17th Avenue / Houston Avenue
 - Modify the eastbound through and right-turn lane to a combined through-right lane;
 - Add a southbound right-turn lane;
 - Modify the southbound left-through-right lane to a through-right lane; and
 - Signalize the intersection with protective left-turn phasing in the eastbound and westbound directions.

Furthermore, this intersection is currently in the process of being signalized by the County of Kings.

Table V: Existing plus Project Intersection LOS Results

ID	Intersection	Intersection Control	AM (7-9) Peak Hour		PM (4-6) Peak Hour	
			Average Delay (sec/veh)	LOS	Average Delay (sec/veh)	LOS
1	Lemoore Avenue / D Street	Traffic Signal	22.8	C	21.3	C
2	Bush Street / D Street	Two-Way Stop	27.1	D	21.6	C
3	Lemoore Avenue / Bush Street	Traffic Signal	30.8	C	17.8	B
4	17th Avenue / Houston Avenue	All-Way Stop	40.9	E	26.8	D
		Traffic Signal (Improved)	17.4	B	11.3	B
5	Lemoore Avenue / SR 198 WB Ramps	Traffic Signal	23.6	C	24.6	C
6	Lemoore Avenue / SR 198 EB Ramps	Traffic Signal	20.3	C	23.9	C

Note: LOS = Level of Service based on average delay on signalized intersections and All-Way STOP Controls
 LOS for two-way and one-way STOP controlled intersections are based on the worst approach/movement of the minor street.

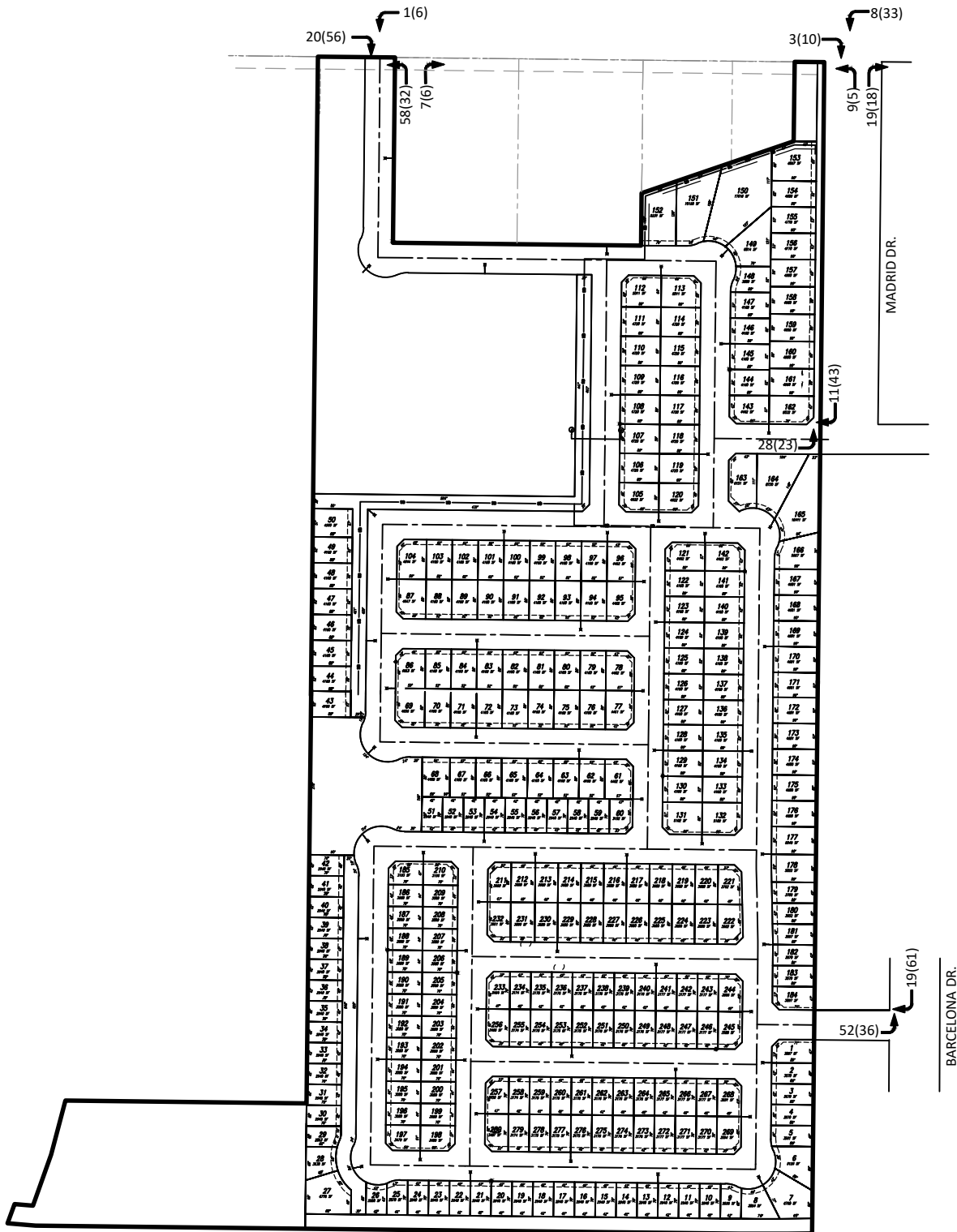

516 W. Shaw Ave., Ste. 103, Fresno, CA 93704
 PHONE: (559) 570-8991, EMAIL: info@JLBtraffic.com, www.JLBtraffic.com



Not To Scale

TTM 22-021 TIA - City of Lemoore Project Only Trips

Figure 4

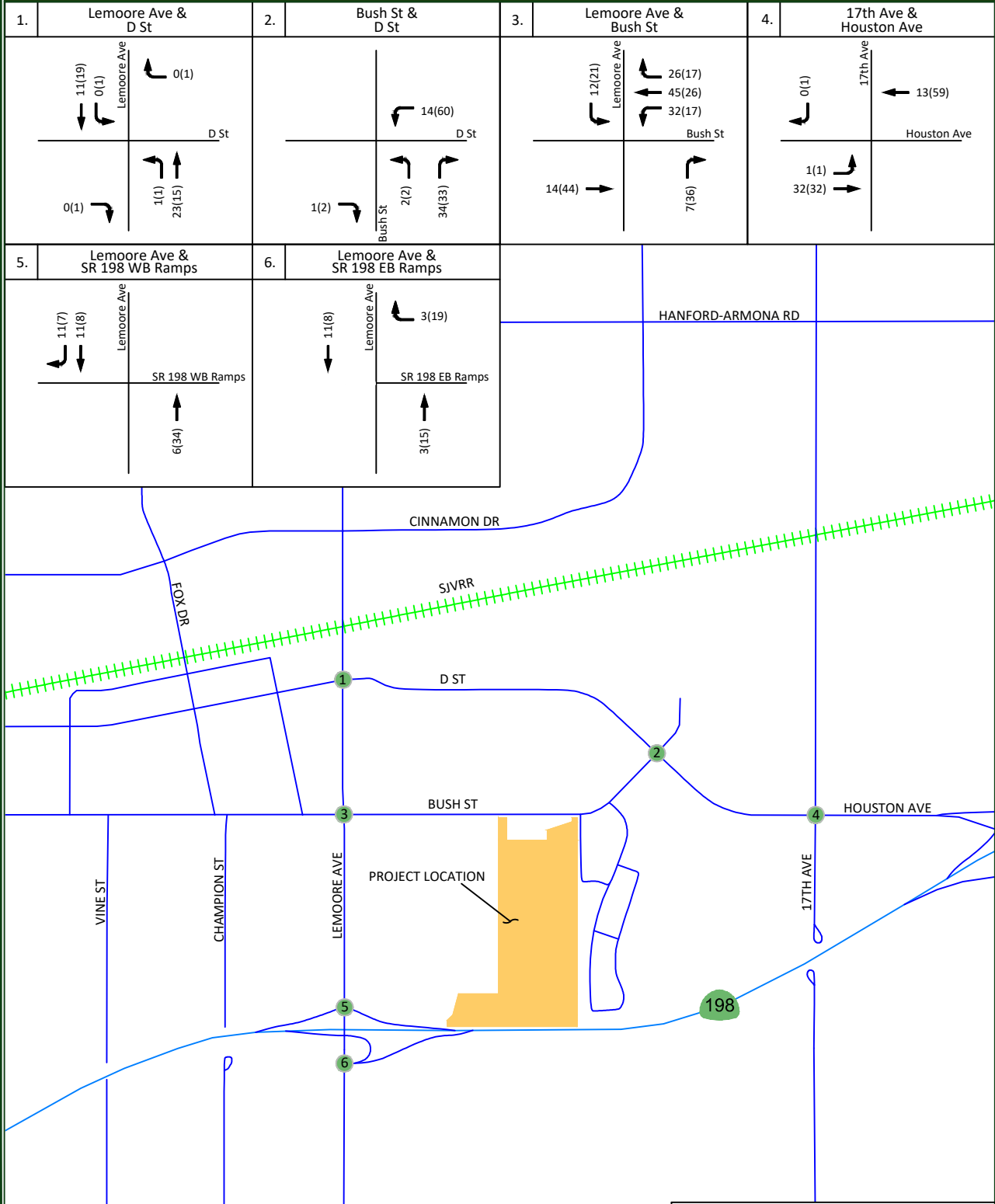

JLB TRAFFIC
ENGINEERING, INC.

516 W. Shaw Ave., Ste. 103, Fresno, CA 93704
PHONE:(559) 570-8991, EMAIL: info@JLBtraffic.com, www.JLBtraffic.com

LEGEND

- # = STUDY INTERSECTION
- XX = AM PROJECT ONLY TRIPS
- (XX) = PM PROJECT ONLY TRIPS

Not To Scale

TTM 22-021 TIA - City of Lemoore

Existing plus Project - Traffic Volumes, Geometrics and Controls

Figure 5

<p>1. Lemoore Ave & D St</p> <p>65(86) 606(440) 170(174) 174(220) 173(143) 50(47) 57(92) 111(130) 40(37) 41(43) 474(463) 45(37)</p>	<p>2. Bush St & D St</p> <p>16(14) 7(3) 8(10) 10(23) 303(369) 190(147) 5(14) 264(263) 28(22) 33(23) 6(3) 171(106)</p>	<p>3. Lemoore Ave & Bush St</p> <p>112(96) 318(388) 158(48) 168(48) 202(109) 101(66) 123(78) 195(123) 101(170) 106(90) 215(391) 106(91)</p>	<p>4. 17th Ave & Houston Ave</p> <p>156(42) 1(0) 189(127) 86(186) 413(482) 1(0) 86(53) 404(348) 0(0) 2(0) 0(1) 1(0)</p>
<p>5. Lemoore Ave & SR 198 WB Ramps</p> <p>158(142) 391(393) 123(163) 0(0) 112(141) 19(15) 390(430)</p>	<p>6. Lemoore Ave & SR 198 EB Ramps</p> <p>334(346) 171(193) 156(200) 12(21) 255(243) 100(184)</p>		



JLB TRAFFIC
ENGINEERING, INC.

516 W. Shaw Ave., Ste. 103, Fresno, CA 93704
PHONE: (559) 570-8991, EMAIL: info@JLBtraffic.com, www.JLBtraffic.com

LEGEND

- = STUDY INTERSECTION
- XX = AM PEAK HOUR TRIPS
- (XX) = PM PEAK HOUR TRIPS
- = STOP SIGN
- 🚦 = TRAFFIC SIGNAL

Not To Scale

Near Term plus Project Traffic Conditions

Description of Approved and Pipeline Projects

Approved and Pipeline Projects consist of developments that are either under construction, built but not fully occupied, are not built but have final site development review (SDR) approval, or for which the lead agency or responsible agencies have knowledge of. The City of Lemoore, County of Kings and Caltrans staff were consulted throughout the preparation of this TIA regarding approved and/or known projects that could potentially impact the study intersections. JLB staff conducted a reconnaissance of the surrounding area to confirm the Near Term Projects. Subsequently, it was agreed that the projects listed in Table VI were approved, near approval, or in the pipeline within the proximity of the proposed Project.

The trip generation listed in Table VI is that which is anticipated to be added to the streets and highways by these projects between the time of the preparation of this report and five years after buildout of the proposed Project. As shown in Table VI, the total trip generation for the Near Term Projects is 26,613 daily trips, 1,995 AM peak hour trips and 2,341 PM peak hour trips. Figure 6 illustrates the location of the approved, near approval, or pipeline projects and their combined trip assignment to the study intersections under the Near Term plus Project Traffic Conditions scenario.

Table VI: Near Term Projects' Trip Generation

<i>Approved Project Location</i>	<i>Approved or Pipeline Project Name</i>	<i>Daily Trips</i>	<i>AM Peak Hour</i>	<i>PM Peak Hour</i>
A	Bush at 19 th Commercial ²	5,671	463	447
B	Hanford-Armona Commercial ¹	6,775	471	488
C	Lacey Ranch Development ¹	7,362	554	730
D	Master Storage ²	165	16	20
E	Silva Estates ²	519	35	46
F	Victory Village ²	481	36	48
G	Tract 848 ²	3,414	254	340
H	Tract 920 ²	830	62	83
I	Tract 935 ²	1,396	104	139
Total Approved and Pipeline Project Trips		26,613	1,995	2,341

Note: 1 = Trip Generation prepared by JLB Traffic Engineering, Inc. based on readily available information
 2 = Trip Generation based on JLB Traffic Engineering, Inc. Traffic Impact Analysis Report

Traffic Signal Warrants

Warrant 3 was prepared for the unsignalized intersections under the Near Term plus Project Traffic Conditions scenario. These warrants are contained in Appendix I. Under this scenario, it is assumed that the signalization of the intersection of Houston Avenue at 17th Avenue will be completed by the County of Kings. Under this scenario, the remaining unsignalized intersection is not projected to satisfy Warrant 3. Based on the traffic signal warrants, operational analysis and engineering judgment, it is not recommended that the City consider implementing traffic signal controls at any of the unsignalized study intersections especially since these are projected to operate at an acceptable LOS during both peak periods under stop sign control.

Results of Near Term plus Project Level of Service Analysis

The Near Term plus Project Traffic Conditions scenario assumes that the Existing plus Project roadway geometrics and traffic controls will remain in place with one exception. It is anticipated that the intersection of 17th Avenue at Houston Avenue is signalized by this scenario. Figure 7 illustrates the Near Term plus Project turning movement volumes, intersection geometrics and traffic controls. LOS worksheets for the Near Term plus Project Traffic Conditions scenario are provided in Appendix G. Table VII presents a summary of the Near Term plus Project peak hour LOS at the study intersections.

Under this scenario, all study intersections are projected to operate at an acceptable LOS during both peak periods.

Table VII: Near Term plus Project Intersection LOS Results

ID	Intersection	Intersection Control	AM (7-9) Peak Hour		PM (4-6) Peak Hour	
			Average Delay (sec/veh)	LOS	Average Delay (sec/veh)	LOS
1	Lemoore Avenue / D Street	Traffic Signal	23.2	C	20.7	C
2	Bush Street / D Street	Two-Way Stop	28.4	D	22.2	C
3	Lemoore Avenue / Bush Street	Traffic Signal	31.4	C	17.0	B
4	17th Avenue / Houston Avenue	Traffic Signal	17.7	B	11.3	B
5	Lemoore Avenue / SR 198 WB Ramps	Traffic Signal	22.1	C	24.0	C
6	Lemoore Avenue / SR 198 EB Ramps	Traffic Signal	23.7	C	23.4	C

Note: LOS = Level of Service based on average delay on signalized intersections and All-Way STOP Controls
 LOS for two-way and one-way STOP controlled intersections are based on the worst approach/movement of the minor street.

TTM 22-021 TIA - City of Lemoore Near Term Projects' Trip Assignment

Figure 6

<p>1. Lemoore Ave & D St</p>	<p>2. Bush St & D St</p>	<p>3. Lemoore Ave & Bush St</p>	<p>4. 17th Ave & Houston Ave</p>
<p>5. Lemoore Ave & SR 198 WB Ramps</p>	<p>6. Lemoore Ave & SR 198 EB Ramps</p>		



JLB TRAFFIC
ENGINEERING, INC.

516 W. Shaw Ave., Ste. 103, Fresno, CA 93704
PHONE:(559) 570-8991, EMAIL: info@JLBtraffic.com, www.JLBtraffic.com

LEGEND

- = STUDY INTERSECTION
- XX = AM NEAR TERM TRIPS
- (XX) = PM NEAR TERM TRIPS
- Ⓝ = NEAR TERM PROJECT LOCATION

Not To Scale

TTM 22-021 TIA - City of Lemoore Near Term plus Project - Traffic Volumes, Geometrics and Controls

Figure 7

<p>1. Lemoore Ave & D St</p> <p>174(220) 173(143) 50(47)</p> <p>72(91) 677(480) 170(174)</p> <p>58(99) 111(130) 40(37)</p> <p>41(43) 501(522) 45(37)</p>	<p>2. Bush St & D St</p> <p>10(23) 303(369) 193(150)</p> <p>16(14) 8(4) 8(10)</p> <p>5(14) 264(263) 28(22)</p> <p>33(23) 7(4) 176(109)</p>	<p>3. Lemoore Ave & Bush St</p> <p>168(48) 209(116) 101(66)</p> <p>137(112) 364(413) 158(48)</p> <p>134(99) 202(130) 124(175)</p> <p>118(95) 235(429) 108(91)</p>	<p>4. 17th Ave & Houston Ave</p> <p>86(186) 415(484) 1(0)</p> <p>157(43) 1(0) 189(127)</p> <p>87(54) 408(350) 0(0)</p> <p>2(0) 0(1) 1(0)</p>
<p>5. Lemoore Ave & SR 198 WB Ramps</p> <p>123(163) 0(0) 112(141)</p> <p>158(142) 413(416)</p> <p>19(15) 396(469)</p>	<p>6. Lemoore Ave & SR 198 EB Ramps</p> <p>156(200) 12(21)</p> <p>353(369) 174(193)</p> <p>261(282) 100(184)</p>		



JLB TRAFFIC
ENGINEERING, INC.

516 W. Shaw Ave., Ste. 103, Fresno, CA 93704
PHONE: (559) 570-8991, EMAIL: info@JLBtraffic.com, www.JLBtraffic.com

LEGEND

- # = STUDY INTERSECTION
- XX = AM PEAK HOUR TRIPS
- (XX) = PM PEAK HOUR TRIPS
- = STOP SIGN
- 🚦 = TRAFFIC SIGNAL

IONA AVE

Not To Scale

Cumulative Year 2042 plus Project Traffic Conditions

Traffic Signal Warrants

Warrant 3 was prepared for the unsignalized intersections under the Cumulative Year 2042 plus Project Traffic Conditions scenario. These warrants are contained in Appendix I. Under this scenario, the intersection of Bush Street at D Street is projected to meet the peak hour warrant during both peak periods. Based on engineering judgement and operational analysis, signalization of this intersection is recommended.

Results of Cumulative Year 2042 plus Project Level of Service Analysis

The Cumulative Year 2042 plus Project Traffic Conditions scenario assumes that the Near Term plus Project roadway geometrics and traffic controls will remain in place. Figure 8 illustrates the Cumulative Year 2042 plus Project turning movement volumes, intersection geometrics and traffic controls. LOS worksheets for the Cumulative Year 2042 plus Project Traffic Conditions scenario are provided in Appendix H. Table VIII presents a summary of the Cumulative Year 2042 plus Project peak hour LOS at the study intersections.

Under this scenario, the study intersection of Bush Street at D Street is projected to operate at an unacceptable LOS during both peak periods. It is recommended that the following improvements be implemented to improve the LOS at this intersection.

- Bush Street / D Street
 - Option 1
 - Add a northbound left-turn lane;
 - Modify the northbound left-through-right lane to a through-right lane;
 - Add a southbound left-turn lane;
 - Modify the southbound left-through-right lane to a through-right lane; and
 - Signalize the intersection with protective left-turn phasing in all directions.
 - Option 2
 - Construct a roundabout with a single lane approach in each direction.

Table VIII: Cumulative Year 2042 plus Project Intersection LOS Results

ID	Intersection	Intersection Control	AM (7-9) Peak Hour		PM (4-6) Peak Hour	
			Average Delay (sec/veh)	LOS	Average Delay (sec/veh)	LOS
1	Lemoore Avenue / D Street	Traffic Signal	43.3	D	40.8	D
2	Bush Street / D Street	Two-Way Stop	>120.0	F	74.9	F
		Traffic Signal (Improved)	36.0	D	22.2	C
		Roundabout (Improved)	12.3	B	10.7	B
		Traffic Signal	46.8	D	23.6	C
3	Lemoore Avenue / Bush Street	Traffic Signal	46.8	D	23.6	C
4	17th Avenue / Houston Avenue	All-Way Stop	34.2	C	17.5	B
5	Lemoore Avenue / SR 198 WB Ramps	Traffic Signal	25.1	C	32.6	C
6	Lemoore Avenue / SR 198 EB Ramps	Traffic Signal	22.1	C	33.3	C

Note: LOS = Level of Service based on average delay on signalized intersections and All-Way STOP Controls.
 LOS for two-way STOP controlled intersections are based on the worst approach/movement of the minor street.

Project Only Trip Assignment to State Facilities

Figure 9 illustrates the Project Only Trips to the State Route 198 at Lemoore Avenue interchange. Similarly, Figure 10 illustrates the Project Only trips to the State Route 198 at Houston Avenue Interchange.

<p>1. Lemoore Ave & D St</p> <p>100(133) 930(669) 263(268) 269(339) 267(221) 77(73) 88(142) 172(201) 62(57) 63(66) 720(707) 70(57)</p>	<p>2. Bush St & D St</p> <p>25(22) 11(5) 12(15) 15(36) 468(570) 286(194) 8(22) 408(406) 43(34) 50(34) 19(5) 246(146)</p>	<p>3. Lemoore Ave & Bush St</p> <p>173(148) 491(599) 238(63) 245(65) 288(154) 139(93) 190(121) 294(166) 156(263) 164(139) 332(604) 160(121)</p>	<p>4. 17th Ave & Houston Ave</p> <p>241(64) 2(0) 292(196) 133(287) 631(713) 2(0) 132(81) 607(520) 0(0) 3(0) 0(2) 2(0)</p>
--	--	---	---

<p>5. Lemoore Ave & SR 198 WB Ramps</p> <p>238(216) 598(603) 190(252) 0(0) 173(218) 29(23) 599(646)</p>	<p>6. Lemoore Ave & SR 198 EB Ramps</p> <p>510(530) 264(298) 239(299) 19(32) 392(367) 155(284)</p>	<p>HANFORD-ARMONA RD</p>
---	--	--------------------------



JLB TRAFFIC
ENGINEERING, INC.

516 W. Shaw Ave., Ste. 103, Fresno, CA 93704
PHONE:(559) 570-8991, EMAIL: info@JLBtraffic.com, www.JLBtraffic.com

LEGEND

- # = STUDY INTERSECTION
- XX = AM PEAK HOUR TRIPS
- (XX) = PM PEAK HOUR TRIPS
- = STOP SIGN
- 🚦 = TRAFFIC SIGNAL

Not To Scale

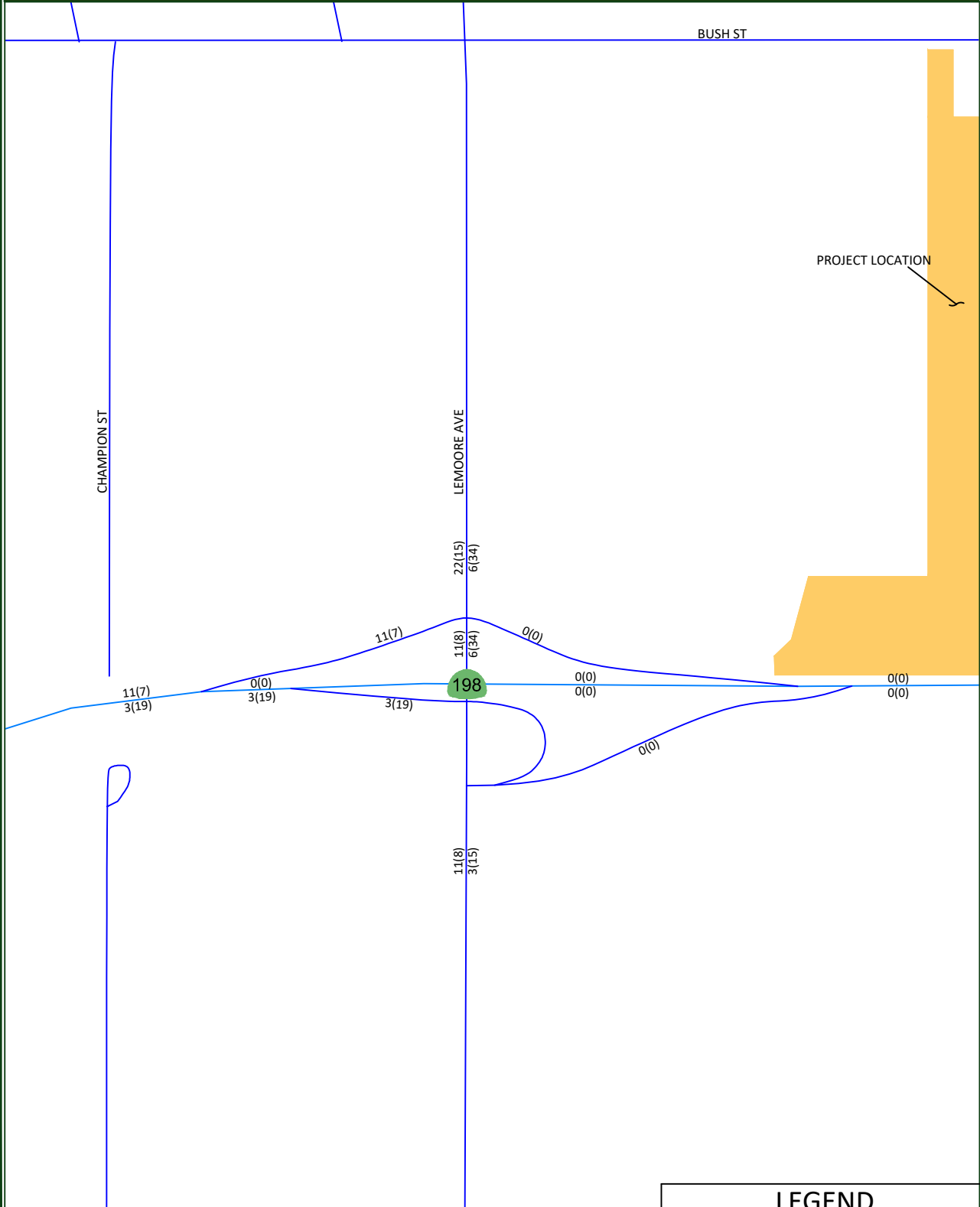

516 W. Shaw Ave., Ste. 103, Fresno, CA 93704
 PHONE: (559) 570-8991, EMAIL: info@JLBtraffic.com, www.JLBtraffic.com

LEGEND

XX = AM PROJECT ONLY TRIPS
 (XX) = PM PROJECT ONLY TRIPS



Not To Scale

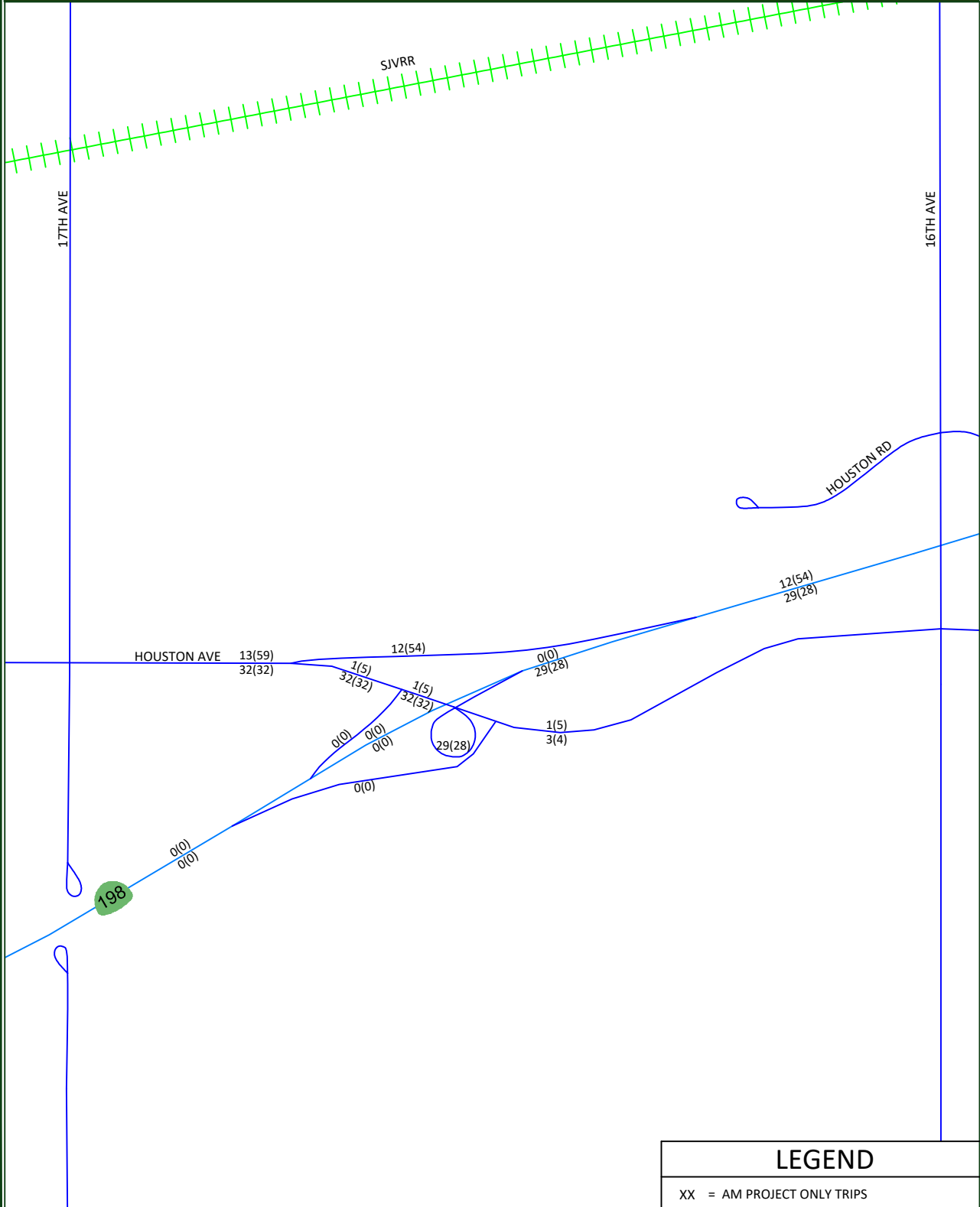

516 W. Shaw Ave., Ste. 103, Fresno, CA 93704
 PHONE: (559) 570-8991, EMAIL: info@JLBtraffic.com, www.JLBtraffic.com

LEGEND

XX = AM PROJECT ONLY TRIPS
 (XX) = PM PROJECT ONLY TRIPS



Not To Scale

Queuing Analysis

Table IX provides a queue length summary for left-turn and right-turn lanes at the study intersections under all study scenarios. The queuing analyses for the study intersections are contained in the LOS worksheets for the respective scenarios. Appendix D contains the methodologies used to evaluate these intersections. Queuing analyses were completed using Sim Traffic output information. Synchro provides both 50th and 95th percentile maximum queue lengths (in feet). According to the Synchro manual, “the 50th percentile maximum queue is the maximum back of queue on a typical cycle and the 95th percentile queue is the maximum back of queue with 95th percentile volumes.” The queues shown on Table IX are the 95th percentile queue lengths for the respective lane movements.

The Highway Design Manual (HDM) provides guidance for determining deceleration lengths for the left-turn and right-turn lanes based on design speeds. Per the HDM criteria, “tapers for right-turn lanes are usually un-necessary since the main line traffic need not be shifted laterally to provide space for the right-turn lane. If, in some rare instances, a lateral shift were needed, the approach taper would use the same formula as for a left-turn lane.” Therefore, a bay taper length pursuant to the Caltrans HDM would need to be added, as necessary, to the recommended storage lengths presented in Table IX.

Based on the SimTraffic output files and engineering judgement, it is recommended that the storage capacity for the following be considered for the Cumulative Year 2042 plus Project Traffic Conditions. At the remaining approaches, the existing storage capacity will be sufficient to accommodate the maximum queue.

Table IX: Queuing Analysis

ID	Intersection	Existing Queue Storage Length (ft.)		Existing		Existing plus Project		Near Term plus Project		Cumulative Year 2042 plus Project	
				AM	PM	AM	PM	AM	PM	AM	PM
1	Lemoore Avenue / D Street	EB Left	85	67	91	97	106	110	123	142	150
		EB Through-Right	>500	115	123	121	149	164	156	239	254
		WB Left	75	81	71	59	64	73	65	126	102
		WB Through	>500	148	108	141	131	207	140	275	229
		WB Right	75	137	128	111	130	141	141	196	191
		NB Left	60	49	66	90	82	108	93	120	130
		NB Through	>500	119	159	146	158	147	184	244	304
		NB Through-Right	>500	140	151	177	160	167	203	247	300
		SB Left	140	168	146	153	150	203	164	215	215
		SB Through	>500	190	126	161	113	264	145	394	338
		SB Through-Right	>500	184	167	164	145	224	167	387	308

Note: * = Does not exist or is not projected to exist

Table IX: Queuing Analysis (Continued)

ID	Intersection	Existing Queue Storage Length (ft.)		Existing		Existing plus Project		Near Term plus Project		Cumulative Year 2042 plus Project	
				AM	PM	AM	PM	AM	PM	AM	PM
2	Bush Street / D Street	EB Left	90	9	17	0	28	18	29	86	76
		EB Through-Right	>500	0	0	0	0	14	0	301	241
		WB Left	125	54	37	65	59	79	57	203	182
		WB Through-Right	>500	10	0	0	0	0	0	328	283
		NB Left	*	*	*	*	*	*	*	85	63
		NB Left-Through-Right	>500	84	75	112	70	80	87	*	*
		NB Through-Right	*	*	*	*	*	*	*	170	84
		SB Left	*	*	*	*	*	*	*	37	40
		SB Left-Through-Right	>500	49	54	43	48	55	45	*	*
		SB Through-Right	*	*	*	*	*	*	51	47	
3	Lemoore Avenue / Bush Street	EB Left	>300	122	98	147	93	154	91	180	124
		EB Through	>500	156	88	173	105	174	109	276	169
		EB Right	75	79	80	97	88	118	80	163	133
		WB Left	150	103	71	122	99	105	78	215	109
		WB Through	>500	121	74	200	111	161	101	282	129
		WB Right	60	86	27	129	37	126	71	154	104
		NB Left	100	114	93	110	114	103	97	168	126
		NB Through	>500	84	82	87	132	85	124	139	156
		NB Through	>500	75	98	102	146	89	120	156	186
		NB Right	105	74	64	75	97	68	43	123	123
		SB Left	135	150	55	175	80	171	70	223	115
		SB Through	>500	153	184	159	152	171	165	321	267
		SB Through-Right	>500	170	186	169	158	198	184	306	291
4	17 th Avenue / Houston Avenue	EB Left	50	68	52	89	59	127	57	170	99
		EB Through	>500	114	88	*	*	*	*	*	*
		EB Through-Right	*	*	*	182	104	197	97	415	170
		EB Right	15	0	0	*	*	*	*	*	*
		WB Left	150	0	0	14	0	0	0	0	0
		WB Through	>500	148	148	183	219	219	189	421	429
		WB Right	15	51	56	52	66	49	68	307	245
		NB Left-Through-Right	>500	13	9	24	0	22	9	15	10
		SB Left-Through	*	*	*	152	89	122	83	303	157
		SB Left-Through-Right	>500	97	86	*	*	*	*	*	*
		SB Right	*	*	*	127	44	93	42	187	73

Note: * = Does not exist or is not projected to exist

Table IX: Queuing Analysis (Continued)

ID	Intersection	Existing Queue Storage Length (ft.)		Existing		Existing plus Project		Near Term plus Project		Cumulative Year 2042 plus Project	
				AM	PM	AM	PM	AM	PM	AM	PM
5	Lemoore Avenue / SR 198 WB Ramps	WB Left-Through-Right	>500	200	188	153	209	163	221	281	444
		NB Left	200	47	37	50	51	65	39	52	65
		NB Through	>500	110	132	125	115	126	151	190	219
		SB Through	>500	155	176	162	204	191	192	341	325
		SB Right	75	90	130	124	116	109	101	146	165
6	Lemoore Avenue / SR 198 EB Ramps	WB Left	50	28	47	35	32	33	41	39	50
		WB Right	>300	62	75	63	68	70	86	115	120
		NB Through	>500	116	98	95	127	105	137	225	241
		NB Right	50	66	77	62	133	54	72	125	179
		SB Left	200	175	181	154	193	146	183	238	289
		SB Through	>500	145	114	76	75	61	141	227	223

Note: * = Does not exist or is not projected to exist

Conclusions and Recommendations

Conclusions and recommendations regarding the proposed Project are presented below.

Existing Traffic Conditions

- At present, all study intersections operate at an acceptable LOS during both peak periods.

Existing plus Project Traffic Conditions

- JLB analyzed the location of the proposed access points relative to the existing local roads and driveways in the Project's vicinity. A review of the Project access points indicates that they are located at points that minimize traffic operational impacts to the existing roadway network.
- The proposed Project is estimated to generate a maximum of 2,642 daily trips, 196 AM peak hour trips and 263 PM peak hour trips.
- It is recommended that the Project implement a Class II Bike Lane along its frontage to Bush Street in order to encourage multi modal transportation and reduce VMT.
- Under this scenario, the study intersection of 17th Avenue at Houston Avenue is projected to exceed its LOS threshold during the AM peak period. It is recommended that the following improvements be considered for implementation to improve the LOS at this intersection.
 - 17th Avenue / Houston Avenue
 - Modify the eastbound through and right-turn lane to a combined through-right lane;
 - Add a southbound right-turn lane;
 - Modify the southbound left-through-right lane to a through-right lane; and
 - Signalize the intersection with protective left-turn phasing in the eastbound and westbound directions.

Near Term plus Project Traffic Conditions

- The total trip generation for the Near Term Projects is 26,613 daily trips, 1,995 AM peak hour trips and 2,341 PM peak hour trips.
- Under this scenario, all study intersections are projected to operate at an acceptable LOS during both peak periods.

Cumulative Year 2042 plus Project Traffic Conditions

- Under this scenario, the study intersection of Bush Street at D Street is projected to operate at an unacceptable LOS during both peak periods. It is recommended that the following improvements be implemented to improve the LOS at this intersection.
 - Bush Street / D Street (two options are presented for the City's consideration)
 - Option 1
 - Add a northbound left-turn lane;
 - Modify the northbound left-through-right lane to a through-right lane;
 - Add a southbound left-turn lane;
 - Modify the southbound left-through-right lane to a through-right lane; and
 - Signalize the intersection with protective left-turn phasing in all directions.
 - Option 2
 - Construct a roundabout with a single lane approach in each direction.

Queuing Analysis

- It is recommended that the City consider left-turn and right-turn lane storage lengths as indicated in the Queuing Analysis.

Study Participants

JLB Traffic Engineering, Inc. Personnel:

Jose Luis Benavides, PE, TE	Project Manager
Matthew Arndt, EIT	Engineer I/II
Javier Rios	Engineer I/II
Dennis Wynn	Sr. Engineering Technician
Adrian Benavides	Engineering Aide
Christian Sanchez	Engineering Aide

Persons Consulted:

Alison Baker	Wathen Development Manager
Steve Brandt	City of Lemoore
Judy Holwell	City of Lemoore
Dominic Tyburski	County of Kings
David Padilla	Caltrans
Christopher Xiong	Caltrans
Mike Aronson	Kittelson & Associates

References

Caltrans. 2021. "California Manual on Uniform Traffic Control Devices". Sacramento: State of California.

Caltrans. 2020. "Vehicle Miles Traveled-Focused Transportation Impact Study Guide". Sacramento: State of California.

Caltrans. 2019. "Highway Design Manual". Sacramento: State of California.

City of Lemoore. 2008. "City of Lemoore 2030 General Plan". Lemoore: City of Lemoore, Ch. 4.

County of Kings. 2010. "2035 Kings County General Plan". Kings: County of Kings, Circulation Element.

County of Kings. 2011. "2011 Kings County Regional Bicycle Plan". Kings: County of Kings, pp.1-70.

Cubic ITS, Inc. 2019. "Synchro Studio 11 User Guide". Sugar Land: Trafficware, LLC.

Institute of Transportation Engineers. 2017. "Trip Generation Manual". Washington: Institute of Transportation Engineers. Vol. 1-3.

National Academies of Sciences, Engineering, and Medicine. 2022. "Highway Capacity Manual 7th Edition: A Guide for Multimodal Mobility Analysis" Washington: The National Academies Press.

Transportation Research Board. 2016. "Highway Capacity Manual". Washington: The National Academy of Sciences.

Appendix A: Scope of Work



www.JLBtraffic.com
info@JLBtraffic.com

516 W. Shaw Ave., Ste. 103
Fresno, CA 93704
(559) 570-8991

App / A

August 10, 2022

Steve Brandt
City Planner
City of Lemoore
711 West Cinnamon Drive
Lemoore, CA 93245

Via Email Only: steve.brandt@gkinc.com

Subject: Proposed Scope of Work for the Preparation of a Traffic Impact Analysis for TTM 22-021 at the Southeast Quadrant of Lemoore Avenue and Bush Street in the City of Lemoore (JLB Project 039-004)

Dear Mr. Brandt,

JLB Traffic Engineering, Inc. (JLB) hereby submits this Draft Scope of Work for the preparation of a Traffic Impact Analysis (TIA) for the TTM 22-021 (Project) located at the southeast quadrant of Lemoore Avenue and Bush Street in the City of Lemoore. The Project proposes to develop a single family residential subdivision with approximately 276-lots and 5.50 acres of public parks. Based on information provided to JLB, the Project is consistent with the City's General Plan. An aerial of the Project vicinity and Project Site Plan are shown in Exhibits A and Exhibit B, respectively.

The purpose of the TIA is to evaluate the potential on-site and off-site traffic impacts, identify short-term roadway and circulation needs, determine potential improvement measures and identify any critical traffic issues that should be addressed in the on-going planning process. To evaluate the on-site and off-site traffic impacts of the proposed Project, JLB proposes the following Scope of Work.

Scope of Work

- JLB will utilize a Kings Council Association of Governments (Kings CAG) traffic forecast model run for the Base Year 2022 and the Cumulative Year 2042 scenarios.
- JLB will obtain recent (less than 12 months) or schedule and conduct new traffic counts for the study facilities. These counts will include pedestrians and vehicles.
- JLB will conduct a qualitative safe route to school evaluation from the Project site to the K-12 school(s) which would most likely serve the Project on opening day.
- JLB will perform a site visit to observe existing traffic conditions, especially during the AM and PM peak hours. Existing roadway conditions including intersection geometrics and traffic controls will be verified.
- JLB will evaluate on-site circulation and provide recommendations as necessary to improve circulation to and within the Project site.
- JLB will prepare CA MUTCD Warrant 3 "Peak Hour" for unsignalized study intersections under all study scenarios.
- JLB will qualitatively analyze existing and planned transit routes in the vicinity of the Project.



www.JLBtraffic.com

info@JLBtraffic.com

516 W. Shaw Ave., Ste. 103

Fresno, CA 93704

(559) 570-8991

Page | 1

- JLB will qualitatively analyze existing and planned bikeways in the vicinity of the Project.
- JLB will forecast trip distribution based on turn count information and knowledge of the existing and planned circulation network in the vicinity of the Project.
- JLB will evaluate existing and forecasted levels of service (LOS) at the study intersection(s). JLB will use HCM 6th or HCM 2000 methodologies (as appropriate) within Synchro to perform this analysis for the AM and PM peak hours. JLB will identify the causes of poor LOS and proposed improvement measures (if any).

Study Scenarios

1. Existing Traffic Conditions with needed improvements (if any);
2. Existing plus Project Traffic Conditions with proposed improvement measures (if any);
3. Near Term plus Project Traffic Conditions with proposed improvement measures (if any); and
4. Cumulative Year 2042 plus Project Traffic Conditions with proposed improvement measures (if any).

Weekday peak hours to be analyzed (Tuesday, Wednesday or Thursday only)

1. 7 - 9 AM peak hour
2. 4 - 6 PM peak hour

Study Intersections

1. Lemoore Avenue / Bush Street
2. Bush Street / D Street
3. 17th Avenue / D Street (Houston Avenue)
4. Lemoore Avenue / D Street

Queuing analysis is included in the proposed Scope of Work for the study intersection(s) listed above under all study scenarios. This analysis will be utilized to recommend minimum storage lengths for left-turn and right-turn lanes at all study intersections.

Study Segments

1. none

Project Only Trip Assignment to State Facilities

1. State Route 198 / Lemoore Avenue
2. State Route 198 / Houston Avenue

Project Trip Generation

The trip generation rates for the proposed Project were obtained from the 11th Edition of the Trip Generation Manual published by the Institute of Transportation Engineers (ITE). Table I presents the trip generation for the proposed Project with trip generation rates for Single-Family Detached Housing and Public Park. At buildout, the proposed Project is estimated to generate a maximum of 2,607 daily trips, 193 AM peak hour trips and 260 PM peak hour trips.

Table I: Project Trip Generation

Land Use (ITE Code)	Size	Unit	Daily		AM (7-9) Peak Hour					PM (4-6) Peak Hour						
			Rate	Total	Trip Rate	In	Out	In	Out	Total	Trip Rate	In	Out	In	Out	Total
						%	%									
Single-Family Detached Housing (210)	276	d.u.	9.43	2,603	.70	26	74	50	143	193	.94	63	37	163	96	259
Public Park (411)	5.50	acres	0.78	4	0.02	59	41	0	0	0	0.11	55	45	1	0	1
Total Project Trips				2,607				50	143	193				164	96	260

Note: d.u. = Dwelling Units

Access to the Project

Access to and from the Project site will predominantly be from three (3) access points. One of the access points will be located along the south side of Bush Street approximately 940 feet west of Madrid Drive and is proposed as a full access point. The second access point will be located along the west side of Madrid Drive approximately at 720 feet south of Bush Street and is currently proposed as a full access point. The third access point will be located along the west side of Barcelona Drive at approximately 250 feet north of Naples Street and is proposed as a full access point. Additional Project details can be found on Exhibit B.

Near Term Projects to be Included

Based on our local knowledge of the study area and consulting with the City of Lemoore, County of Kings and Caltrans, JLB proposes to include near term projects in the vicinity of the proposed Project under the Near Term plus Project scenario. The near term projects proposed to be included in the Near Term scenario are:

<u>Project Name</u>	<u>General Location</u>
1. Hanford-Armona Commercial	SEC State Route 41 and Hanford-Armona Road
2. Tract 848	NEC of College Avenue and Pedersen Street
3. Master Storage	SEC of Commerce Way and Iona Avenue
4. Silva Estate #11	Between San Simeon Drive SR 41 and SR 198
5. Victory Village	NWC of West Hills College
6. Lacey Ranch Development	SEC of Lemoore Avenue and Lacey Boulevard

Other Near Term Projects in the City, County or Caltrans has knowledge and for which it is anticipated that said project(s) is/are projected to be whole or partially built by the Near Term Project Year 2027. City of Lemoore, County of Kings and Caltrans as appropriate would provide JLB with project details such as a project description, location, proposed land uses with breakdowns and type of residential units and amount of square footages for non-residential uses.

Mr. Brandt
TTM 22-021 TIA - Draft Scope of Work
August 10, 2022

The Scope of Work is based on our understanding of this Project and our experience with similar TIAs. In the absence of comments by August 31, 2022 it will be assumed that the Scope of Work is acceptable to the agency(ies) that have not submitted any comments. If you have any questions or require additional information, please contact me by phone at (559) 317-6249, or via email at jbenavides@JLBtraffic.com.

Sincerely,

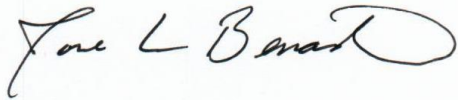

Jose Luis Benavides, P.E., T.E.
President

cc: Judy Holwell, City of Lemoore
Dominic Tyburski, County of Kings
David Padilla, Caltrans
Matthew Arndt, JLB Traffic Engineering, Inc.
Adrian Benavides, JLB Traffic Engineering, Inc.

Z:\01 Projects\039 Lemoore\039-004 TTM 22-021 TIA\Draft Scope of Work\L08102022 TTM 22-021 Draft Scope of Work.docx



www.JLBtraffic.com

info@JLBtraffic.com

516 W. Shaw Ave., Ste. 103

Fresno, CA 93704

(559) 570-8991

Page | 4

Exhibit A – Aerial

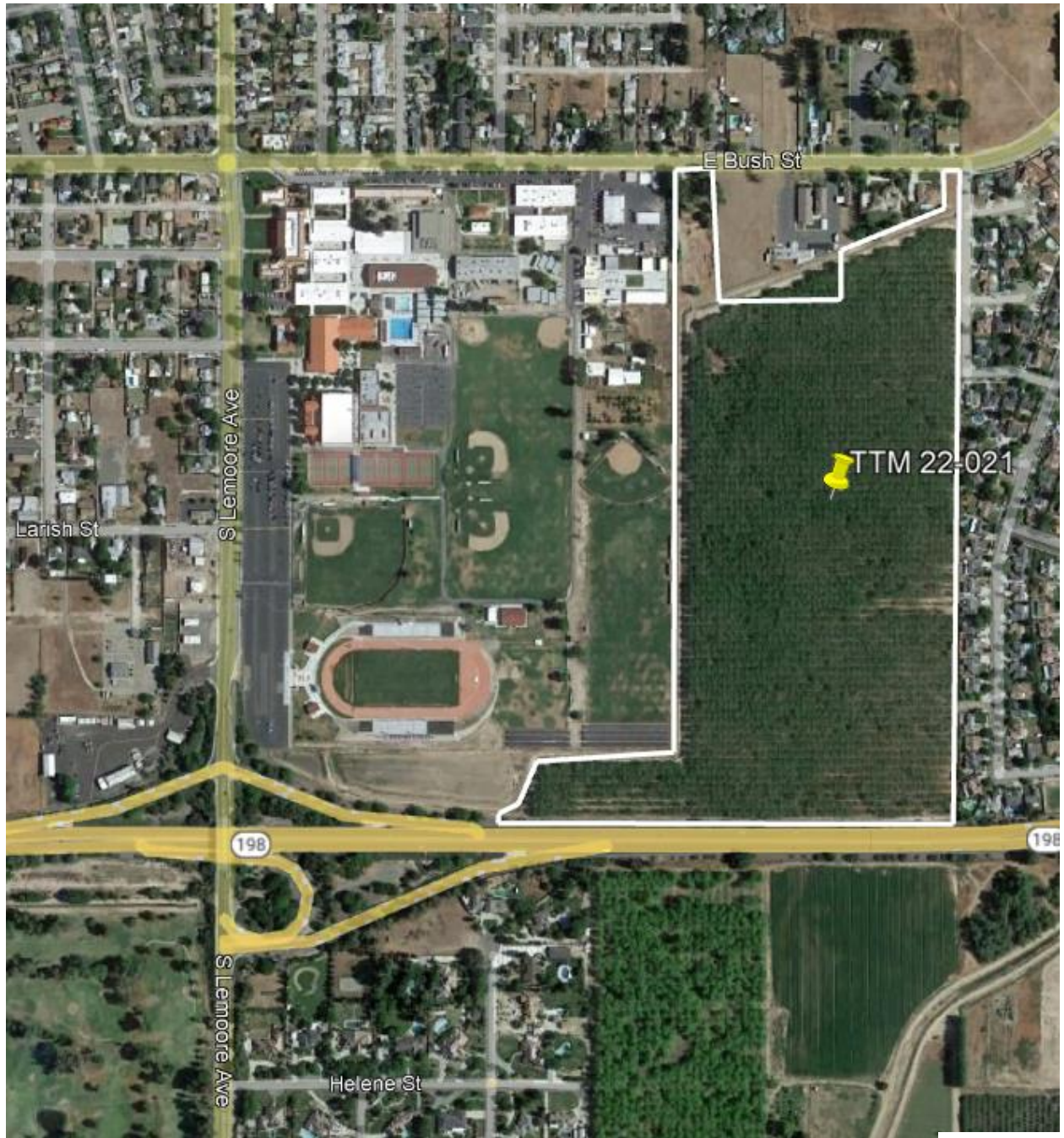

Exhibit B – Project Site Plan 1 of 2

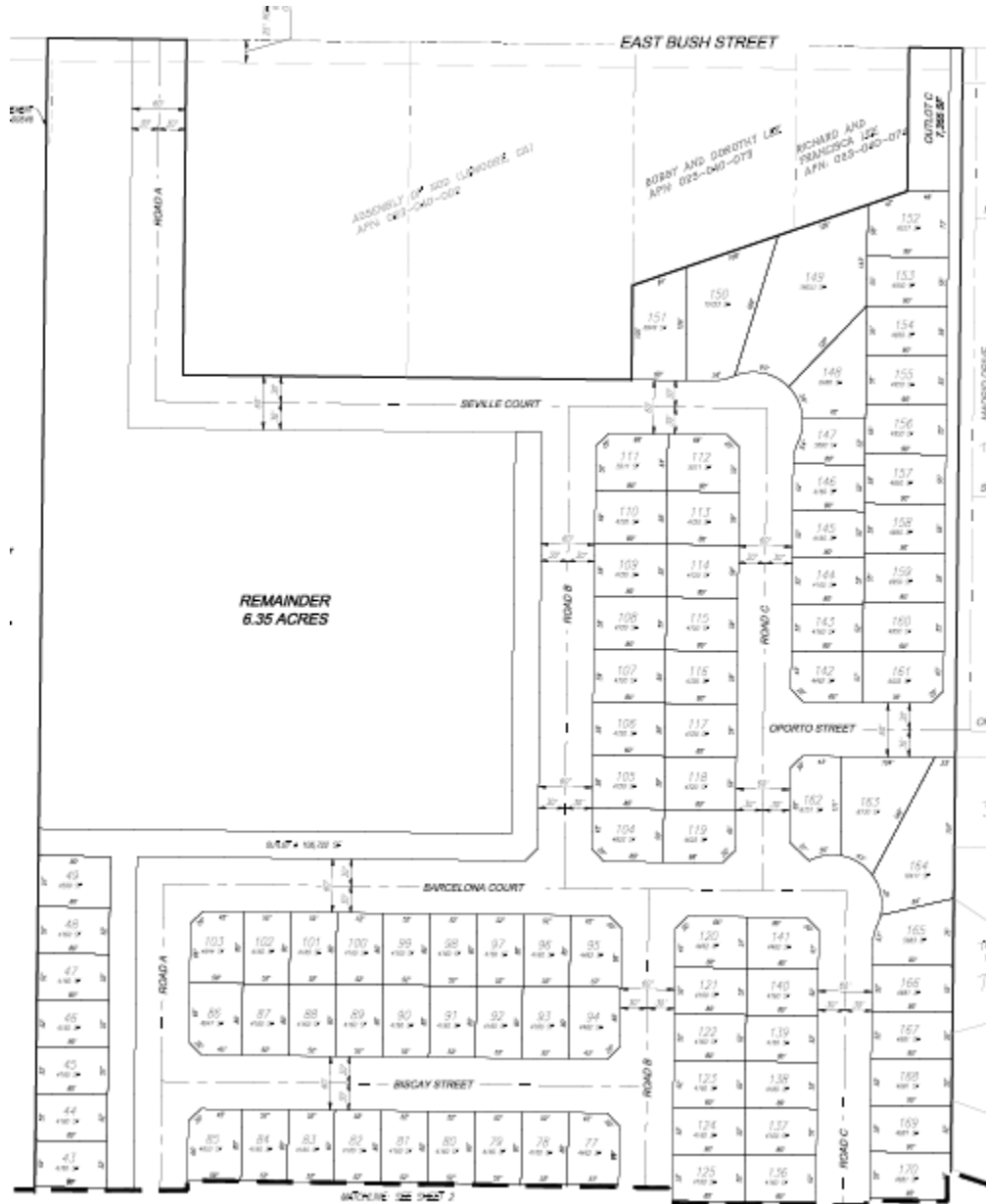
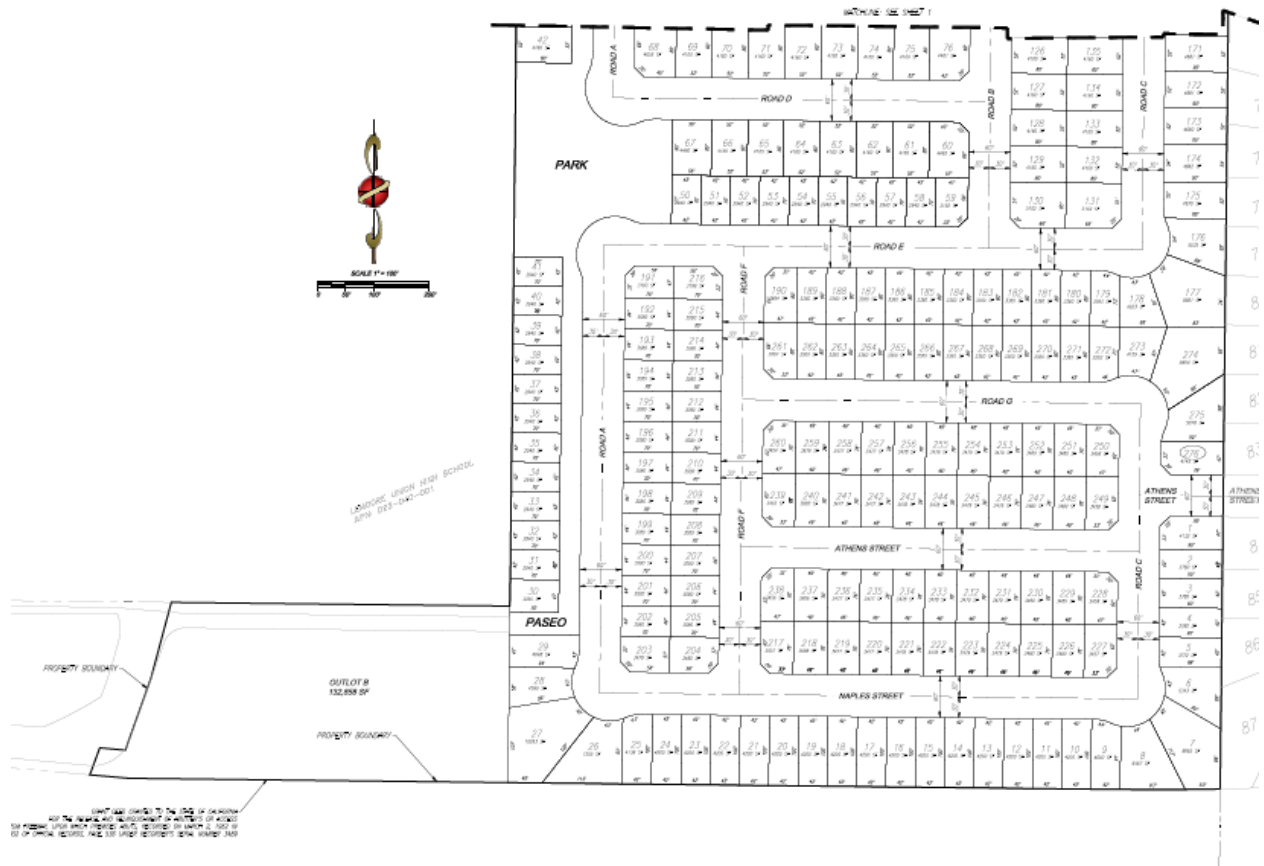

Exhibit B (continued) – Project Site Plan 2 of 2



Matt Arndt

From: Tyburski, Dominic <Dominic.Tyburski@co.kings.ca.us>
Sent: Tuesday, August 16, 2022 3:07 PM
To: Jose Benavides; Steve.Brandt@qkinc.com; Padilla, Dave@DOT
Cc: Matt Arndt; Adrian Benavides; jholwell@lemoore.com
Subject: RE: L08102022 TTM 22-021 Draft Scope of Work.pdf

No comments

Dominic Tyburski, P.E., MPA **Director | Public Works Department**

County of Kings | Public Works Department
1400 W. Lacey Blvd. | Hanford, CA 93230

Direct 559-852-2698 | Fax 559-582-2506
Dominic.Tyburski@co.kings.ca.us | www.countyofkings.com



From: Jose Benavides <jbenavides@jlbtraffic.com>
Sent: Wednesday, August 10, 2022 4:30 PM
To: Steve.Brandt@qkinc.com; Padilla, Dave@DOT <dave.padilla@dot.ca.gov>; Tyburski, Dominic <Dominic.Tyburski@co.kings.ca.us>
Cc: Matt Arndt <marndt@jlbtraffic.com>; Adrian Benavides <abenavides@jlbtraffic.com>; jholwell@lemoore.com
Subject: L08102022 TTM 22-021 Draft Scope of Work.pdf

Hello,

Attached you will find a Draft Scope of Work for the preparation of a Traffic Impact Analysis for TTM22-021 in the City of Lemoore.

We kindly ask that you take a moment to review and comment on the proposed Scope of Work. We hope that you are able to provide comments by August 31, 2022. In the absence of comments, it may be assumed that the proposed Scope of Work is acceptable to the agency(ies) that have not submitted any comments.

If you have any questions or require additional information, please contact me by phone at (559) 570-8991 or by responding to this email. We appreciate your time and attention to this matter and look forward to hearing from you soon.

Sincerely,

Jose Luis Benavides, P.E., T.E.
President



Traffic Engineering, Transportation Planning and Parking Solutions

Certified Disadvantaged Business Enterprise (DBE) and Small Business Enterprise (SBE)

516 W. Shaw Ave., Ste. 103

Fresno, CA 93704

Direct: (559) 317-6249

Main: (559) 570-8991

Cell: (559) 694-6000

Fax: (559) 317-6854

www.JLBtraffic.com

Matt Arndt

From: Steve Brandt <Steve.Brandt@qkinc.com>
Sent: Monday, August 22, 2022 4:24 PM
To: Jose Benavides; Padilla, Dave@DOT; Tyburski, Dominic
Cc: Matt Arndt; Adrian Benavides; kbaley@lemoore.com; Jeff Cowart
Subject: RE: [EXTERNAL]:L08102022 TTM 22-021 Draft Scope of Work.pdf

Hello Jose,

Thank you for the opportunity to review the TIA scope of work. Here are comments from the City of Lemoore:

The scope, study scenarios, and study intersections are acceptable. In anticipation of questions from the neighbors to the east, please have the TIA describe the three project access points and how you distributed the project trips among them. I'd like to have some objective numbers available to me if the question of additional trips in their neighborhood comes up.

For the near term projects, please add these three projects to your list:

- Tract 935 – 148 single-family homes located at the southeast corner of Liberty Drive(Avenue 18 ¾) and the extension of Glendale Avenue. Estimated opening in 2025.
- Tract 920, Unit II – 75 single-family lots located on the east side of Liberty Drive (Avenue 18 ¾) north of Hanford-Armona Road and Tract 920, Unit I. Estimated open end of 2023.
- Bush/19th Commercial – drive-thru car wash with 22 self-serve vacuum bays, 4,648 SF convenience store with drive-thru and 9 gas pumps, 3,509 SF restaurant/cafe with drive-thru located on the southwest corner of 19th Avenue and Bush Street. Estimated opening in 2023.

Also, the City has committed to signaling the Hanford-Armona Road / Liberty Drive intersection using City traffic impact fees. Exact timing unknown, but it should coincide with construction of Tract 935 and Lacey Ranch.

Thank you.

Steve Brandt, AICP
Principal Planner
(559) 733-0440 Office
(559) 259-1466 Mobile
www.QKinc.com

From: Jose Benavides <jbenavides@jlbtraffic.com>
Sent: Wednesday, August 10, 2022 4:30 PM
To: Steve Brandt <Steve.Brandt@qkinc.com>; Padilla, Dave@DOT <dave.padilla@dot.ca.gov>; Tyburski, Dominic <Dominic.Tyburski@co.kings.ca.us>
Cc: Matt Arndt <marndt@jlbtraffic.com>; Adrian Benavides <abenavides@jlbtraffic.com>; jholwell@lemoore.com
Subject: [EXTERNAL]:L08102022 TTM 22-021 Draft Scope of Work.pdf

CAUTION: This email originated from outside of the organization. Do not click links or open attachments unless you recognize the sender and know the content is safe.

Hello,

Attached you will find a Draft Scope of Work for the preparation of a Traffic Impact Analysis for TTM22-021 in the City of Lemoore.

We kindly ask that you take a moment to review and comment on the proposed Scope of Work. We hope that you are able to provide comments by August 31, 2022. In the absence of comments, it may be assumed that the proposed Scope of Work is acceptable to the agency(ies) that have not submitted any comments.

If you have any questions or require additional information, please contact me by phone at (559) 570-8991 or by responding to this email. We appreciate your time and attention to this matter and look forward to hearing from you soon.

Sincerely,

Jose Luis Benavides, P.E., T.E.
President



Traffic Engineering, Transportation Planning and Parking Solutions
Certified Disadvantaged Business Enterprise (DBE) and Small Business Enterprise (SBE)

516 W. Shaw Ave., Ste. 103
Fresno, CA 93704
Direct: (559) 317-6249
Main: (559) 570-8991
Cell: (559) 694-6000
Fax: (559) 317-6854
www.JLBtraffic.com

California Department of Transportation

DISTRICT 6 OFFICE
1352 WEST OLIVE AVENUE | P.O. BOX 12616 | FRESNO, CA 93778-2616
(559) 908-7064 | FAX (559) 488-4195 | TTY 711
www.dot.ca.gov



August 31, 2022

KIN-198-R10.968

Appl Elnv – Early Involvement

Scope of Work for TIA for TTM 22-021

<https://ld-igr-gts.dot.ca.gov/district/6/report/27298>

SENT VIA EMAIL

Jose Luis Benavides, President
JLB Traffic Engineering, Inc.
516 W. Shaw Ave., Ste. 103
Fresno, CA 93704

Dear Mx. Benavides:

Thank you for the opportunity to review the proposed Scope of Work for the preparation of a Traffic Impact Analysis (TIA) for Tentative Tract Map (TTM) 22-021 which is part of a project that proposes the development of a 276-lot single-family subdivision. The project is located on the southwest corner of Bush Street and Madrid Drive in the City of Lemoore, approximately 0.5 miles northeast of the State Route (SR) 198 and Lemoore Avenue interchange.

Caltrans provides the following comments consistent with the State's smart mobility goals that support a vibrant economy and sustainable communities:

Specific Comments:

1. On page 2, third bullet from the top, it states that "JLB will use HCM (Highway Capacity Manual) 6 or HCM 2000 methodologies..." For analysis on State Highway System (SHS) facilities, **it is recommended that all analysis be based on the HCM 6 or the 2016 HCM methodology.**
2. On page 2, under the Study Scenarios section, **it is recommended that the analysis period (AM and PM peak) also be conducted for the project opening day for SHS facilities.**
3. On page 2, under the Study Intersection section, **it is recommended that the two-ramp intersection at the SR 198 and Lemoore Avenue interchange be included in the analysis.** Please be advised that collision history for the ramp intersection on SHS facilities be **excluded** from the analysis.

4. The proposed project has potential to induce the vehicle miles traveled (VMT), **it is recommended that a VMT study be included in the TIA.**

General Comments

1. Caltrans recommends the City consider creating a VMT Mitigation Impact Fee to help reduce potential impacts on the State Highway System.
2. According to the Kings County Association of Governments' 2019 (KCAG) *Regional Active Transportation Plan*, a bikeway is planned for Bush Street (Page 77, Figure 5.5.2 and Page 128, Figure 6.5.1) which is directly north of this project site. The project proponents are encouraged to coordinate with the City in implementing non-motorized facilities that will connect the project to the city-wide network.
3. The Kings Area Regional Transit (KART) provides transit services to the City of Lemoore. Route 20 is the main line that runs through the City with a bus stop that is approximately 0.5 miles west of the project on Bush Street. The project proponents are encouraged to work with the City and KART in exploring/coordinating transit services for the project.
4. Alternative transportation policies should be applied to the development. An assessment of multimodal facilities should be conducted to develop an integrated multimodal transportation system to serve and help alleviate traffic congestion resulting from the project and related development in the area of the City. The assessment should include the following:
 - a. Pedestrian walkways should not only be limited to the project's internal connectivity but be connected to existing walkways and transit facilities outside the project area.
 - b. The project should consider coordinating connections to local and regional bicycle pathways to encourage the use of bicycles for commuter and recreational purposes.
 - c. If transit is not available within 1/4-mile of the project area, transit should be extended to provide services to high activity centers of the project.
5. As part of the statewide effort to reduce greenhouse gas emissions, the project proponent should consider providing the infrastructure for the installation of Level 2 Electric Vehicle (EV) charging for each of the single-family units proposed within the subdivision.

6. Active Transportation Plans and Smart Growth efforts support the state's 2050 Climate goals. Caltrans supports reducing VMT and GHG emissions in ways that increase the likelihood people will use and benefit from a multimodal transportation network.

If you have any other questions, please call or email Christopher Xiong at (559) 908-7064 or Christopher.Xiong@dot.ca.gov.

Sincerely,



DAVID PADILLA, Branch Chief
Transportation Planning – North

Matt Arndt

From: Xiong, Christopher@DOT <Christopher.Xiong@dot.ca.gov>
Sent: Tuesday, September 6, 2022 2:28 PM
To: Matt Arndt
Cc: Padilla, Dave@DOT; Jose Benavides
Subject: RE: TTM 22-021: Draft Scope of Work

Hi Matthew,

Existing plus Project scenario will suffice, we just want to make sure that the scenarios included the Caltrans facilities as well as the analysis periods (AM and PM Peak) on these facilities.

Best regards,

Christopher Xiong
Caltrans District 6
Christopher.Xiong@dot.ca.gov
(559) 908-7064

From: Matt Arndt <marndt@jlbtraffic.com>
Sent: Tuesday, September 6, 2022 11:58 AM
To: Xiong, Christopher@DOT <Christopher.Xiong@dot.ca.gov>
Cc: Padilla, Dave@DOT <dave.padilla@dot.ca.gov>; Jose Benavides <jbenavides@jlbtraffic.com>
Subject: TTM 22-021: Draft Scope of Work

EXTERNAL EMAIL. Links/attachments may not be safe.

Hello,

Attached are the comments we received from Caltrans regarding the TTM 22-021 TIA on 08/31/2022. I just have a question relating to specific comment 2.

We currently are proposing to analyze an Existing plus Project scenario. Is this comment requesting that we study a scenario with a small number of houses or will an Existing plus Project scenario suffice?

Thanks.

Sincerely,

Matthew Arndt



Traffic Engineering, Transportation Planning and Parking Solutions
Certified Disadvantaged Business Enterprise (DBE) and Small Business Enterprise (SBE)

516 W. Shaw Ave., Ste. 103

Appendix B: Traffic Counts



www.JLBtraffic.com
info@JLBtraffic.com

516 W. Shaw Ave., Ste. 103
Fresno, CA 93704
(559) 570-8991



Metro Traffic Data Inc.
 310 N. Irwin Street - Suite 20
 Hanford, CA 93230
 800-975-6938 Phone/Fax
 www.metrotrafficdata.com

Turning Movement Report

Prepared For:

JLB Traffic Engineering, Inc.
 516 W. Shaw Ave, Suite 103
 Fresno, CA 93704

LOCATION Lemoore Ave @ D St

LATITUDE 36.3025

COUNTY Kings

LONGITUDE -119.7808

COLLECTION DATE Thursday, September 29, 2022

WEATHER Clear

Time	Northbound					Southbound					Eastbound					Westbound				
	U-Turn	Left	Thru	Right	Trucks	U-Turn	Left	Thru	Right	Trucks	U-Turn	Left	Thru	Right	Trucks	U-Turn	Left	Thru	Right	Trucks
7:00 AM - 7:15 AM	0	4	41	4	1	0	24	78	9	2	0	7	8	1	0	0	8	9	19	1
7:15 AM - 7:30 AM	0	5	58	2	4	0	26	84	6	1	0	7	7	6	0	0	4	20	24	1
7:30 AM - 7:45 AM	0	5	74	13	6	0	43	98	13	3	0	9	21	5	1	0	11	40	50	2
7:45 AM - 8:00 AM	0	8	111	8	1	0	39	145	13	1	0	12	27	6	0	0	7	55	39	0
8:00 AM - 8:15 AM	0	16	124	12	1	0	45	198	21	2	0	16	32	19	1	0	17	35	40	2
8:15 AM - 8:30 AM	0	11	142	12	1	0	43	154	18	3	0	20	31	10	1	0	15	43	45	2
8:30 AM - 8:45 AM	0	6	95	4	1	0	27	64	17	1	0	15	32	9	4	0	7	23	38	2
8:45 AM - 9:00 AM	0	2	64	1	0	0	42	69	22	2	0	17	15	4	0	0	5	16	24	0
TOTAL	0	57	709	56	15	0	289	890	119	15	0	103	173	60	7	0	74	241	279	10

Time	Northbound					Southbound					Eastbound					Westbound				
	U-Turn	Left	Thru	Right	Trucks	U-Turn	Left	Thru	Right	Trucks	U-Turn	Left	Thru	Right	Trucks	U-Turn	Left	Thru	Right	Trucks
4:00 PM - 4:15 PM	0	17	121	9	1	0	34	81	21	4	0	28	43	6	1	0	15	34	64	0
4:15 PM - 4:30 PM	0	14	91	12	1	0	52	113	19	3	0	11	24	11	1	0	7	31	55	1
4:30 PM - 4:45 PM	0	14	97	10	1	0	48	91	25	1	0	27	20	16	1	0	12	30	53	0
4:45 PM - 5:00 PM	0	12	112	7	1	0	37	113	17	0	0	28	32	4	1	0	12	37	42	1
5:00 PM - 5:15 PM	0	12	111	8	1	0	42	99	17	1	0	27	49	9	1	0	14	35	66	0
5:15 PM - 5:30 PM	0	4	128	12	1	0	46	118	27	1	0	10	29	7	1	0	9	41	58	0
5:30 PM - 5:45 PM	0	8	89	8	3	0	42	106	13	2	0	20	27	10	1	0	11	28	66	1
5:45 PM - 6:00 PM	0	3	99	10	3	0	36	108	17	1	0	28	19	9	0	0	12	23	49	0
TOTAL	0	84	848	76	12	0	337	829	156	13	0	179	243	72	7	0	92	259	453	3

PEAK HOUR	Northbound					Southbound					Eastbound					Westbound				
	U-Turn	Left	Thru	Right	Trucks	U-Turn	Left	Thru	Right	Trucks	U-Turn	Left	Thru	Right	Trucks	U-Turn	Left	Thru	Right	Trucks
7:30 AM - 8:30 AM	0	40	451	45	9	0	170	595	65	9	0	57	111	40	3	0	50	173	174	6
4:30 PM - 5:30 PM	0	42	448	37	4	0	173	421	86	3	0	92	130	36	4	0	47	143	219	1

	PHF	Trucks
AM	0.857	1.4%
PM	0.958	0.6%

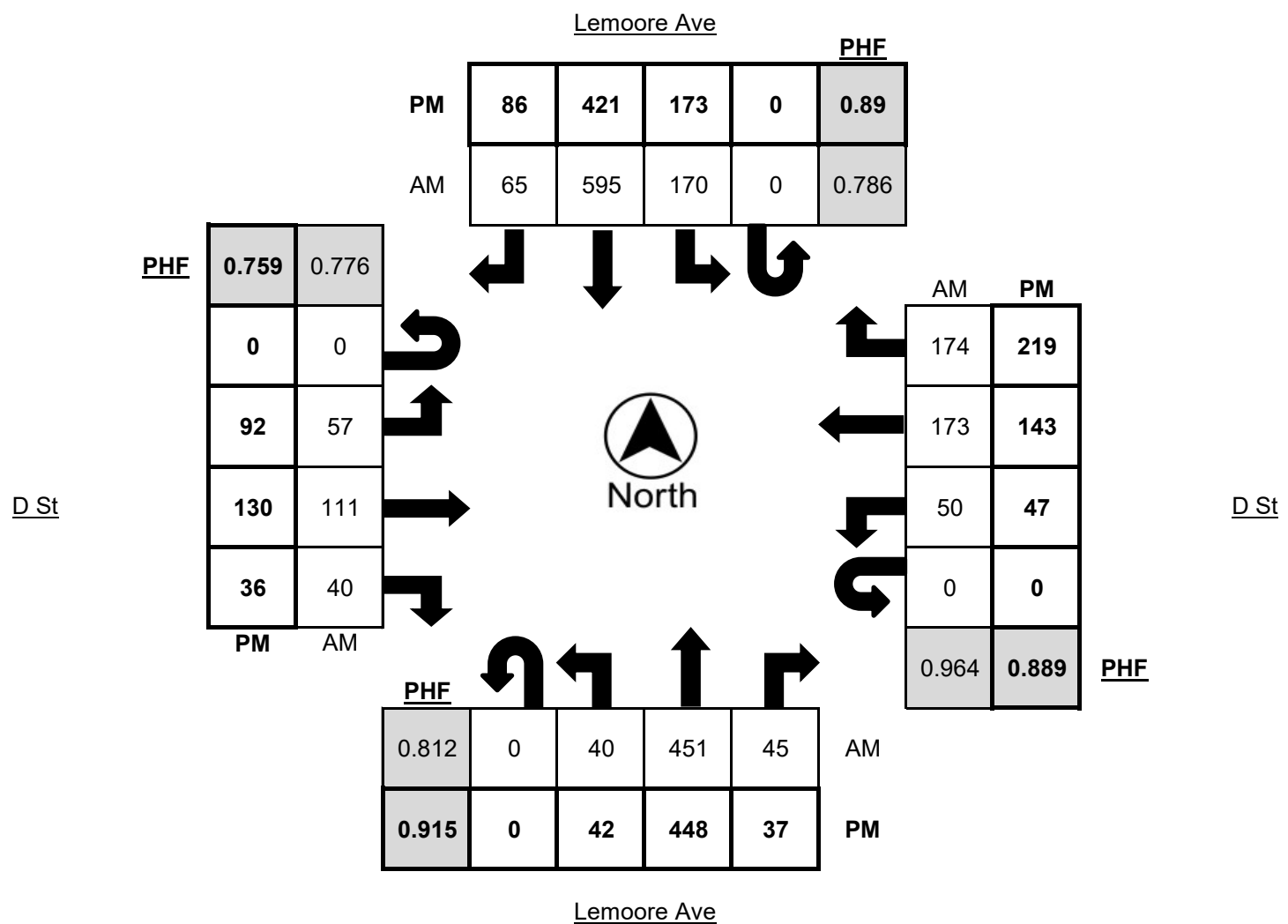



Metro Traffic Data Inc.
 310 N. Irwin Street - Suite 20
 Hanford, CA 93230
 800-975-6938 Phone/Fax
 www.metrotrafficdata.com

Turning Movement Report

Prepared For:

JLB Traffic Engineering, Inc.
 516 W. Shaw Ave, Suite 103
 Fresno, CA 93704

LOCATION Lemoore Ave @ D St
COUNTY Kings
COLLECTION DATE Thursday, September 29, 2022

LATITUDE 36.3025
LONGITUDE -119.7808
WEATHER Clear

Time	Northbound Bikes			N.Leg Peds	Southbound Bikes			S.Leg Peds	Eastbound Bikes			E.Leg Peds	Westbound Bikes			W.Leg Peds
	Left	Thru	Right		Left	Thru	Right		Left	Thru	Right		Left	Thru	Right	
7:00 AM - 7:15 AM	0	0	0	0	0	0	0	0	0	0	0	4	0	0	0	2
7:15 AM - 7:30 AM	0	0	0	1	0	0	0	2	0	0	0	6	0	0	0	0
7:30 AM - 7:45 AM	0	0	0	5	0	0	0	1	0	0	0	8	0	0	0	1
7:45 AM - 8:00 AM	0	0	0	0	0	0	0	1	0	0	0	4	0	0	0	1
8:00 AM - 8:15 AM	0	0	0	1	0	0	0	4	0	0	0	17	0	0	0	1
8:15 AM - 8:30 AM	0	0	0	4	0	0	0	2	0	0	0	9	0	0	0	2
8:30 AM - 8:45 AM	0	0	0	0	0	0	0	0	0	0	0	1	0	0	0	0
8:45 AM - 9:00 AM	0	0	0	1	0	0	0	1	0	0	0	3	0	0	0	1
TOTAL	0	0	0	12	0	0	0	11	0	0	0	52	0	0	0	8

Time	Northbound Bikes			N.Leg Peds	Southbound Bikes			S.Leg Peds	Eastbound Bikes			E.Leg Peds	Westbound Bikes			W.Leg Peds
	Left	Thru	Right		Left	Thru	Right		Left	Thru	Right		Left	Thru	Right	
4:00 PM - 4:15 PM	0	0	0	0	0	0	0	3	0	0	0	7	0	0	0	0
4:15 PM - 4:30 PM	0	0	0	2	0	0	0	1	0	0	0	0	0	0	0	0
4:30 PM - 4:45 PM	0	0	0	1	0	0	0	0	0	0	0	5	0	0	0	0
4:45 PM - 5:00 PM	0	0	0	3	0	0	0	1	0	0	0	1	0	0	0	2
5:00 PM - 5:15 PM	0	0	0	0	0	0	0	0	0	0	0	0	0	0	0	1
5:15 PM - 5:30 PM	0	0	0	1	0	0	0	1	0	0	0	6	0	0	0	1
5:30 PM - 5:45 PM	0	0	0	1	0	0	0	2	0	0	0	2	0	0	0	0
5:45 PM - 6:00 PM	0	0	0	0	0	0	0	0	0	0	0	1	0	0	0	3
TOTAL	0	0	0	8	0	0	0	8	0	0	0	22	0	0	0	7

PEAK HOUR	Northbound Bikes			N.Leg Peds	Southbound Bikes			S.Leg Peds	Eastbound Bikes			E.Leg Peds	Westbound Bikes			W.Leg Peds
	Left	Thru	Right		Left	Thru	Right		Left	Thru	Right		Left	Thru	Right	
7:30 AM - 8:30 AM	0	0	0	10	0	0	0	8	0	0	0	38	0	0	0	5
4:30 PM - 5:30 PM	0	0	0	5	0	0	0	2	0	0	0	12	0	0	0	4

	Bikes	Peds
AM Peak Total	0	61
PM Peak Total	0	23

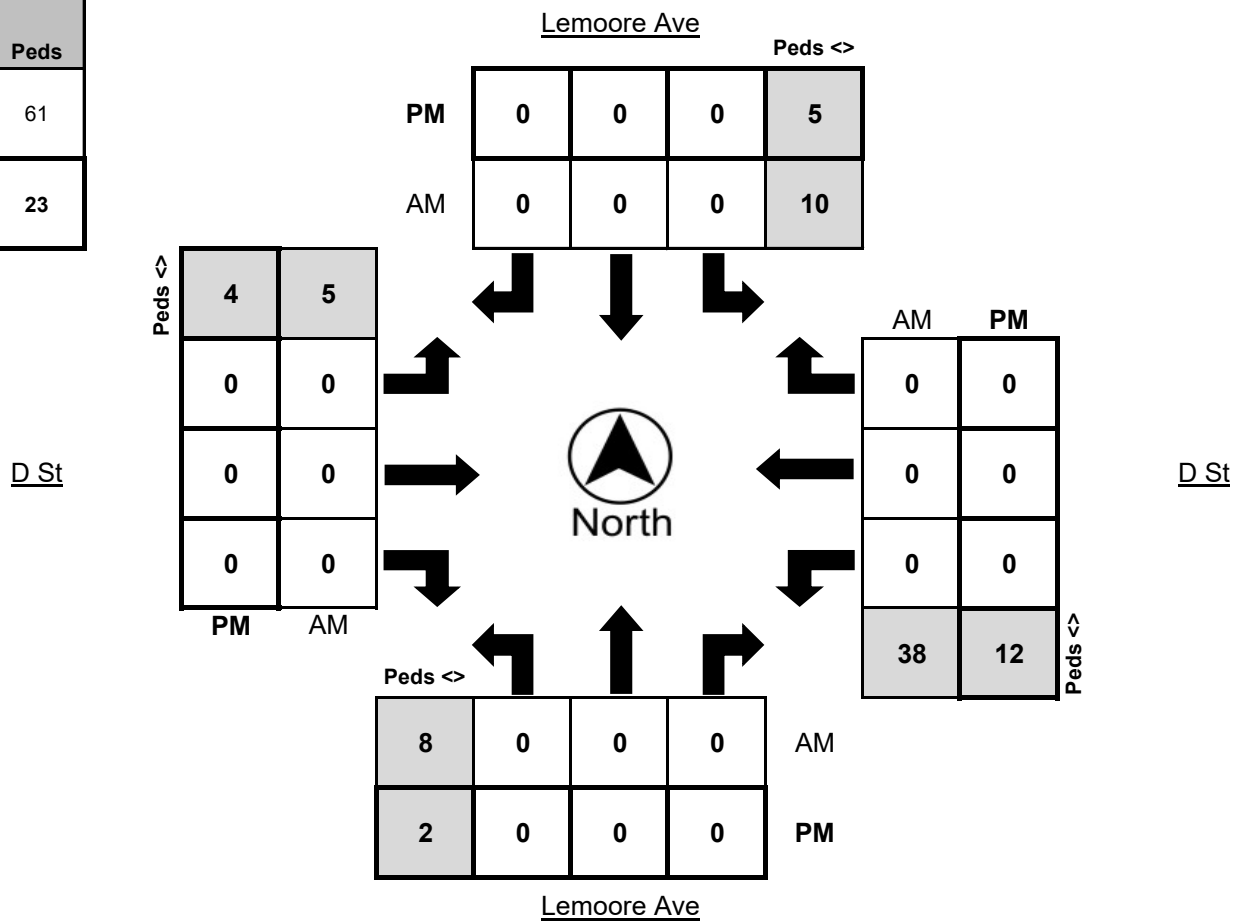



Metro Traffic Data Inc.
 310 N. Irwin Street - Suite 20
 Hanford, CA 93230
 800-975-6938 Phone/Fax
 www.metrotrafficdata.com

Turning Movement Report

Prepared For:

JLB Traffic Engineering, Inc.
 516 W. Shaw Ave, Suite 103
 Fresno, CA 93704

LOCATION Bush St @ D St

LATITUDE 36.3002

COUNTY Kings

LONGITUDE -119.7689

COLLECTION DATE Thursday, September 29, 2022

WEATHER Clear

Time	Northbound					Southbound					Eastbound					Westbound					
	U-Turn	Left	Thru	Right	Trucks	U-Turn	Left	Thru	Right	Trucks	U-Turn	Left	Thru	Right	Trucks	U-Turn	Left	Thru	Right	Trucks	
7:00 AM - 7:15 AM	0	6	0	9	2	0	3	0	0	0	0	2	36	0	0	0	0	8	28	0	1
7:15 AM - 7:30 AM	0	5	1	17	0	0	5	2	3	0	0	0	46	1	0	0	24	44	1	2	
7:30 AM - 7:45 AM	0	5	1	24	0	0	1	2	6	0	0	1	67	0	1	0	16	64	1	3	
7:45 AM - 8:00 AM	0	9	2	27	0	0	3	1	7	0	0	2	74	8	0	0	23	78	1	0	
8:00 AM - 8:15 AM	0	5	2	38	0	0	2	3	1	0	0	2	61	12	0	0	67	80	5	1	
8:15 AM - 8:30 AM	0	12	1	48	1	0	2	1	2	0	0	0	62	7	1	0	70	81	3	3	
8:30 AM - 8:45 AM	0	7	0	20	0	0	3	1	1	0	0	3	69	6	3	0	10	53	0	3	
8:45 AM - 9:00 AM	0	1	1	10	0	0	0	1	2	0	0	2	50	3	0	0	6	45	2	1	
TOTAL	0	50	8	193	3	0	19	11	22	0	0	12	465	37	5	0	224	473	13	14	

Time	Northbound					Southbound					Eastbound					Westbound				
	U-Turn	Left	Thru	Right	Trucks	U-Turn	Left	Thru	Right	Trucks	U-Turn	Left	Thru	Right	Trucks	U-Turn	Left	Thru	Right	Trucks
4:00 PM - 4:15 PM	0	12	3	26	0	0	1	0	5	0	0	5	56	7	0	0	17	92	2	1
4:15 PM - 4:30 PM	0	6	4	19	0	0	3	3	2	0	0	4	60	8	1	0	20	96	2	1
4:30 PM - 4:45 PM	0	2	2	26	1	0	2	0	4	0	0	4	55	10	0	0	18	72	3	0
4:45 PM - 5:00 PM	0	4	0	22	0	0	4	2	4	0	0	2	50	7	1	0	29	92	4	2
5:00 PM - 5:15 PM	0	4	0	16	0	0	2	0	3	0	0	5	89	3	0	0	20	94	6	1
5:15 PM - 5:30 PM	0	7	2	14	0	0	2	0	4	0	0	3	60	5	1	0	18	91	5	1
5:30 PM - 5:45 PM	0	6	1	21	1	0	2	1	3	0	0	4	64	5	0	0	20	92	8	0
5:45 PM - 6:00 PM	0	3	3	18	1	0	8	0	8	0	0	2	41	2	0	0	24	62	1	0
TOTAL	0	44	15	162	3	0	24	6	33	0	0	29	475	47	3	0	166	691	31	6

PEAK HOUR	Northbound					Southbound					Eastbound					Westbound				
	U-Turn	Left	Thru	Right	Trucks	U-Turn	Left	Thru	Right	Trucks	U-Turn	Left	Thru	Right	Trucks	U-Turn	Left	Thru	Right	Trucks
7:30 AM - 8:30 AM	0	31	6	137	1	0	8	7	16	0	0	5	264	27	2	0	176	303	10	7
4:45 PM - 5:45 PM	0	21	3	73	1	0	10	3	14	0	0	14	263	20	2	0	87	369	23	4

	PHF	Trucks
AM	0.856	1.0%
PM	0.930	0.8%

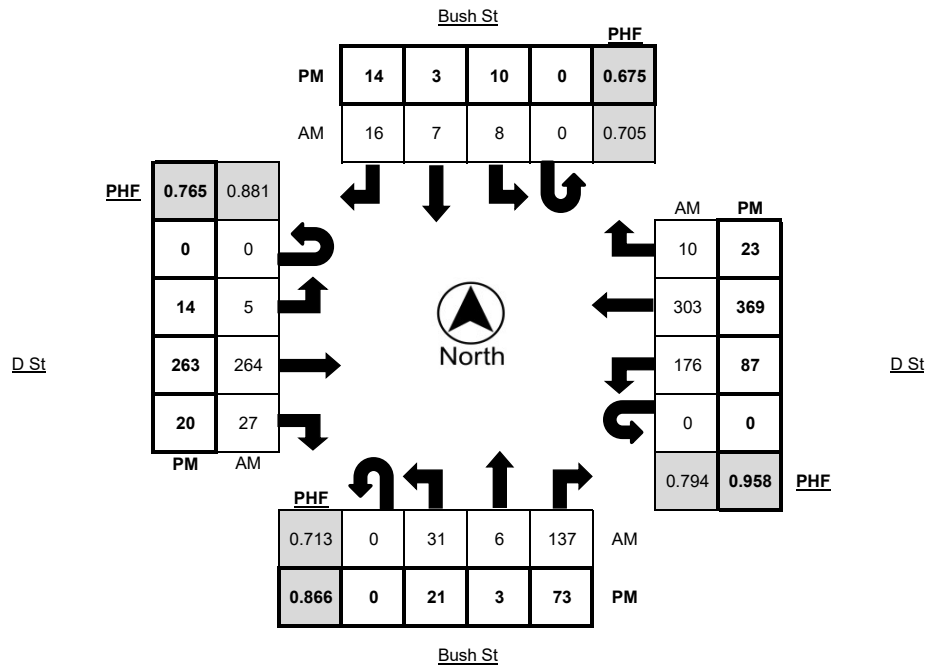



Metro Traffic Data Inc.
 310 N. Irwin Street - Suite 20
 Hanford, CA 93230
 800-975-6938 Phone/Fax
 www.metrotrafficdata.com

Turning Movement Report

Prepared For:

JLB Traffic Engineering, Inc.
 516 W. Shaw Ave, Suite 103
 Fresno, CA 93704

LOCATION Bush St @ D St
 COUNTY Kings
 COLLECTION DATE Thursday, September 29, 2022

LATITUDE 36.3002
 LONGITUDE -119.7689
 WEATHER Clear

Time	Northbound Bikes			N.Leg Peds	Southbound Bikes			S.Leg Peds	Eastbound Bikes			E.Leg Peds	Westbound Bikes			W.Leg Peds
	Left	Thru	Right		Left	Thru	Right		Left	Thru	Right		Left	Thru	Right	
7:00 AM - 7:15 AM	0	0	0	0	0	0	0	0	0	0	0	0	0	0	0	0
7:15 AM - 7:30 AM	0	0	0	0	0	0	0	0	0	0	0	0	0	0	0	0
7:30 AM - 7:45 AM	0	0	0	0	0	0	0	0	0	0	0	0	0	0	0	0
7:45 AM - 8:00 AM	0	0	0	0	0	0	0	0	0	0	0	2	0	0	0	0
8:00 AM - 8:15 AM	0	0	0	1	0	0	0	0	0	0	0	1	0	0	0	0
8:15 AM - 8:30 AM	0	0	0	0	0	0	0	0	0	0	0	0	0	0	0	0
8:30 AM - 8:45 AM	0	0	0	0	0	0	0	0	0	0	0	0	0	0	0	0
8:45 AM - 9:00 AM	0	0	0	0	0	0	0	0	0	0	0	0	0	0	0	0
TOTAL	0	0	0	1	0	0	0	0	0	0	0	3	0	0	0	0

Time	Northbound Bikes			N.Leg Peds	Southbound Bikes			S.Leg Peds	Eastbound Bikes			E.Leg Peds	Westbound Bikes			W.Leg Peds
	Left	Thru	Right		Left	Thru	Right		Left	Thru	Right		Left	Thru	Right	
4:00 PM - 4:15 PM	0	0	0	0	0	0	0	0	0	0	0	0	0	0	0	0
4:15 PM - 4:30 PM	0	0	0	0	0	0	0	0	0	0	0	0	0	0	0	0
4:30 PM - 4:45 PM	0	0	0	0	0	0	0	0	0	0	0	0	0	0	0	0
4:45 PM - 5:00 PM	0	0	0	0	0	0	0	0	0	0	0	0	0	0	0	0
5:00 PM - 5:15 PM	0	0	0	0	0	0	0	0	0	0	0	0	0	0	0	0
5:15 PM - 5:30 PM	0	0	0	0	0	0	0	0	0	0	0	0	0	0	0	0
5:30 PM - 5:45 PM	0	0	0	0	0	0	0	0	0	0	0	0	0	0	0	0
5:45 PM - 6:00 PM	0	0	0	0	0	0	0	0	0	0	0	0	0	0	0	0
TOTAL	0	0	0	0	0	0	0	0	0	0	0	0	0	0	0	0

PEAK HOUR	Northbound Bikes			N.Leg Peds	Southbound Bikes			S.Leg Peds	Eastbound Bikes			E.Leg Peds	Westbound Bikes			W.Leg Peds
	Left	Thru	Right		Left	Thru	Right		Left	Thru	Right		Left	Thru	Right	
7:30 AM - 8:30 AM	0	0	0	1	0	0	0	0	0	0	0	3	0	0	0	0
4:45 PM - 5:45 PM	0	0	0	0	0	0	0	0	0	0	0	0	0	0	0	0

	Bikes	Peds
AM Peak Total	0	4
PM Peak Total	0	0

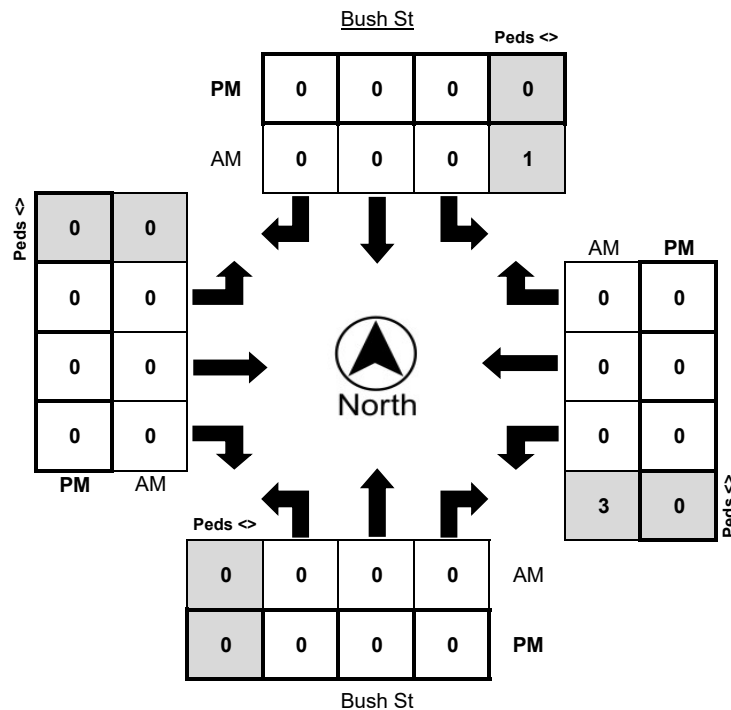



Metro Traffic Data Inc.
 310 N. Irwin Street - Suite 20
 Hanford, CA 93230
 800-975-6938 Phone/Fax
 www.metrotraffdata.com

Turning Movement Report

Prepared For:

JLB Traffic Engineering, Inc.
 516 W. Shaw Ave, Suite 103
 Fresno, CA 93704

LOCATION Lemoore Ave @ Bush St

LATITUDE 36.2983

COUNTY Kings

LONGITUDE -119.7808

COLLECTION DATE Thursday, September 29, 2022

WEATHER Clear

Time	Northbound					Southbound					Eastbound					Westbound				
	U-Turn	Left	Thru	Right	Trucks	U-Turn	Left	Thru	Right	Trucks	U-Turn	Left	Thru	Right	Trucks	U-Turn	Left	Thru	Right	Trucks
7:00 AM - 7:15 AM	0	5	29	2	3	0	2	76	15	2	0	13	6	13	0	0	5	5	5	0
7:15 AM - 7:30 AM	0	10	35	10	3	0	11	66	16	2	0	16	15	13	1	0	11	14	7	0
7:30 AM - 7:45 AM	0	18	48	12	4	0	24	76	19	3	0	19	19	24	1	0	15	27	16	1
7:45 AM - 8:00 AM	0	36	57	20	1	0	31	73	35	1	0	42	39	29	1	0	13	31	20	0
8:00 AM - 8:15 AM	0	29	47	26	0	0	54	89	32	3	0	37	67	29	5	0	17	43	44	2
8:15 AM - 8:30 AM	0	23	63	41	2	0	37	80	26	2	0	25	56	19	1	0	24	56	62	1
8:30 AM - 8:45 AM	0	9	47	5	0	0	13	57	13	3	0	5	11	5	0	0	13	24	23	1
8:45 AM - 9:00 AM	0	11	38	8	0	0	7	43	18	2	0	16	7	14	0	0	2	8	6	0
TOTAL	0	141	364	124	13	0	179	560	174	18	0	173	220	146	9	0	100	208	183	5

Time	Northbound					Southbound					Eastbound					Westbound				
	U-Turn	Left	Thru	Right	Trucks	U-Turn	Left	Thru	Right	Trucks	U-Turn	Left	Thru	Right	Trucks	U-Turn	Left	Thru	Right	Trucks
4:00 PM - 4:15 PM	0	17	94	17	1	0	4	88	21	5	0	32	18	33	0	0	9	16	14	0
4:15 PM - 4:30 PM	0	24	81	9	1	0	7	83	24	4	0	24	10	34	1	0	9	19	9	0
4:30 PM - 4:45 PM	0	13	99	10	1	0	8	88	21	2	0	15	16	42	1	0	12	19	10	0
4:45 PM - 5:00 PM	0	23	83	11	1	0	8	104	21	0	0	18	16	37	1	0	13	25	4	0
5:00 PM - 5:15 PM	0	28	107	13	1	0	5	99	27	2	0	26	18	45	0	0	13	23	6	0
5:15 PM - 5:30 PM	0	26	102	21	3	0	6	97	27	1	0	19	29	46	2	0	11	16	11	0
5:30 PM - 5:45 PM	0	28	74	9	3	0	17	86	25	3	0	21	23	25	0	0	13	19	11	0
5:45 PM - 6:00 PM	0	17	77	17	1	0	18	97	18	0	0	23	20	26	1	0	14	28	10	0
TOTAL	0	176	717	107	12	0	73	742	184	17	0	178	150	288	6	0	94	165	75	0

PEAK HOUR	Northbound					Southbound					Eastbound					Westbound				
	U-Turn	Left	Thru	Right	Trucks	U-Turn	Left	Thru	Right	Trucks	U-Turn	Left	Thru	Right	Trucks	U-Turn	Left	Thru	Right	Trucks
7:30 AM - 8:30 AM	0	106	215	99	7	0	146	318	112	9	0	123	181	101	8	0	69	157	142	4
4:30 PM - 5:30 PM	0	90	391	55	6	0	27	388	96	5	0	78	79	170	4	0	49	83	31	0

	PHF	Trucks
AM	0.860	1.6%
PM	0.935	1.0%

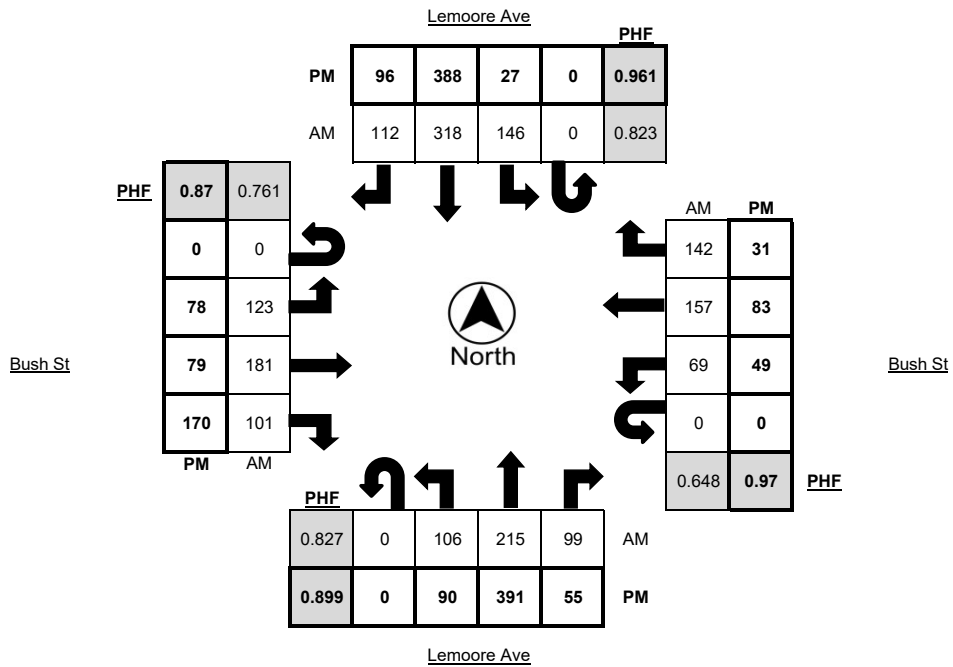



Metro Traffic Data Inc.
 310 N. Irwin Street - Suite 20
 Hanford, CA 93230
 800-975-6938 Phone/Fax
 www.metrotrafficdata.com

Turning Movement Report

Prepared For:

JLB Traffic Engineering, Inc.
 516 W. Shaw Ave, Suite 103
 Fresno, CA 93704

LOCATION Lemoore Ave @ Bush St
COUNTY Kings
COLLECTION DATE Thursday, September 29, 2022

LATITUDE 36.2983
LONGITUDE -119.7808
WEATHER Clear

Time	Northbound Bikes			N.Leg Peds	Southbound Bikes			S.Leg Peds	Eastbound Bikes			E.Leg Peds	Westbound Bikes			W.Leg Peds
	Left	Thru	Right		Left	Thru	Right		Left	Thru	Right		Left	Thru	Right	
7:00 AM - 7:15 AM	0	0	0	1	0	0	0	0	0	0	0	0	0	0	0	0
7:15 AM - 7:30 AM	0	0	0	1	0	0	0	2	0	0	0	0	0	0	0	0
7:30 AM - 7:45 AM	0	0	0	3	0	0	0	5	0	0	0	6	0	0	0	1
7:45 AM - 8:00 AM	0	0	0	19	0	0	0	17	0	0	0	12	0	0	0	2
8:00 AM - 8:15 AM	0	0	0	34	0	0	0	28	0	0	0	43	0	0	0	4
8:15 AM - 8:30 AM	0	0	0	39	0	0	0	37	0	0	0	48	0	0	0	2
8:30 AM - 8:45 AM	0	0	0	0	0	0	0	18	0	0	0	4	0	0	0	1
8:45 AM - 9:00 AM	0	0	0	0	0	1	0	0	0	0	0	1	0	0	0	0
TOTAL	0	0	0	97	0	1	0	107	0	0	0	114	0	0	0	10

Time	Northbound Bikes			N.Leg Peds	Southbound Bikes			S.Leg Peds	Eastbound Bikes			E.Leg Peds	Westbound Bikes			W.Leg Peds
	Left	Thru	Right		Left	Thru	Right		Left	Thru	Right		Left	Thru	Right	
4:00 PM - 4:15 PM	0	0	0	1	0	0	0	0	0	0	0	1	0	0	0	1
4:15 PM - 4:30 PM	0	0	0	0	0	0	0	1	0	0	0	2	0	0	0	0
4:30 PM - 4:45 PM	0	0	0	2	0	0	0	1	0	0	0	1	0	0	0	0
4:45 PM - 5:00 PM	0	0	0	1	0	0	0	0	0	0	0	1	0	0	0	0
5:00 PM - 5:15 PM	0	0	0	1	0	0	0	1	0	0	0	0	0	0	0	0
5:15 PM - 5:30 PM	0	0	0	2	0	0	0	0	0	0	0	2	0	0	0	0
5:30 PM - 5:45 PM	0	0	0	1	0	0	0	2	0	0	0	1	0	0	0	2
5:45 PM - 6:00 PM	0	0	0	1	0	0	0	0	0	0	0	0	0	0	0	0
TOTAL	0	0	0	9	0	0	0	5	0	0	0	8	0	0	0	3

PEAK HOUR	Northbound Bikes			N.Leg Peds	Southbound Bikes			S.Leg Peds	Eastbound Bikes			E.Leg Peds	Westbound Bikes			W.Leg Peds
	Left	Thru	Right		Left	Thru	Right		Left	Thru	Right		Left	Thru	Right	
7:30 AM - 8:30 AM	0	0	0	95	0	0	0	87	0	0	0	109	0	0	0	9
4:30 PM - 5:30 PM	0	0	0	6	0	0	0	2	0	0	0	4	0	0	0	0

	Bikes	Peds
AM Peak Total	0	300
PM Peak Total	0	12

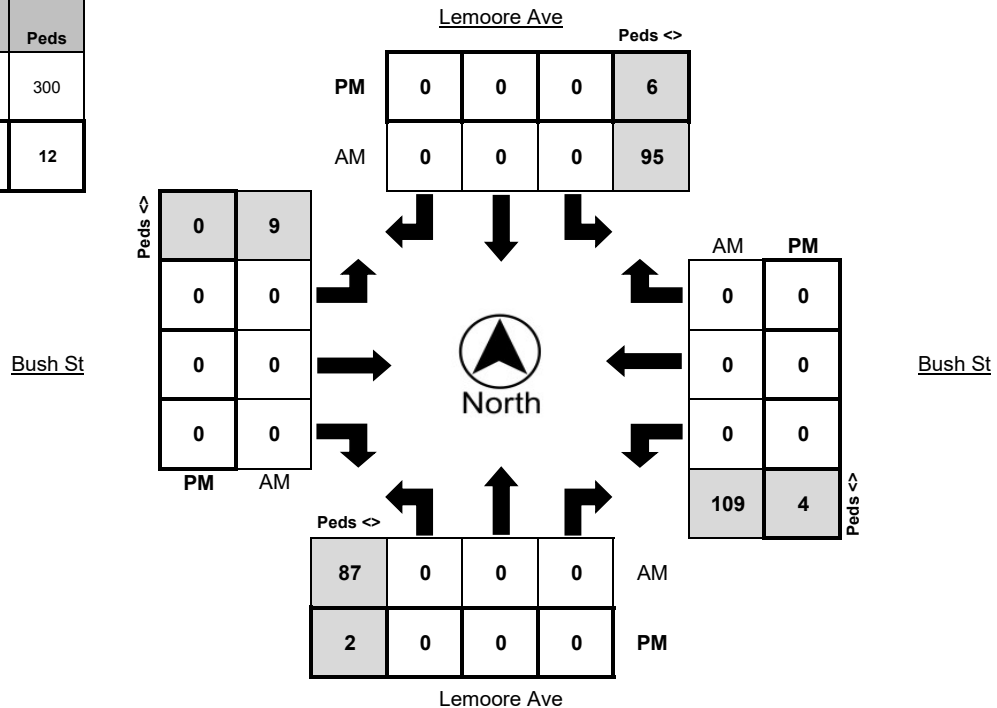

JLB Traffic Engineering, Inc.

516 W. Shaw Ave., Ste. 103
Fresno, CA, 93704

Traffic Engineering, Transportation Planning & Parking Solutions
www.JLBtraffic.com

File Name : 03 17th Avenue at D Street

Site Code : 00000000

Start Date : 9/22/2022

Page No : 2

Start Time	D STREET Eastbound					D STREET Westbound					17TH AVE Northbound					17TH AVE Southbound					Int. Total	
	Left	Thru	Right	Peds	App. Total	Left	Thru	Right	Peds	App. Total	Left	Thru	Right	Peds	App. Total	Left	Thru	Right	Peds	App. Total		
Peak Hour Analysis From 07:30 AM to 08:15 AM - Peak 1 of 1																						
Peak Hour for Entire Intersection Begins at 07:30 AM																						
07:30 AM	0	0	0	0	0	0	0	0	0	0	0	0	0	0	0	0	0	0	0	0	0	0
07:45 AM	0	0	0	0	0	0	0	0	0	0	0	0	0	0	0	0	0	0	0	0	0	0
08:00 AM	0	0	0	0	0	0	0	0	0	0	0	0	0	0	0	0	0	0	0	0	0	0
08:15 AM	0	0	0	0	0	0	0	0	0	0	0	0	0	0	0	0	0	0	0	0	0	0
Total Volume	0	0	0	0	0	0	0	0	0	0	0	0	0	0	0	0	0	0	0	0	0	0
% App. Total	0	0	0	0	0	0	0	0	0	0	0	0	0	0	0	0	0	0	0	0	0	0
PHF	.000	.000	.000	.000	.000	.000	.000	.000	.000	.000	.000	.000	.000	.000	.000	.000	.000	.000	.000	.000	.000	.000

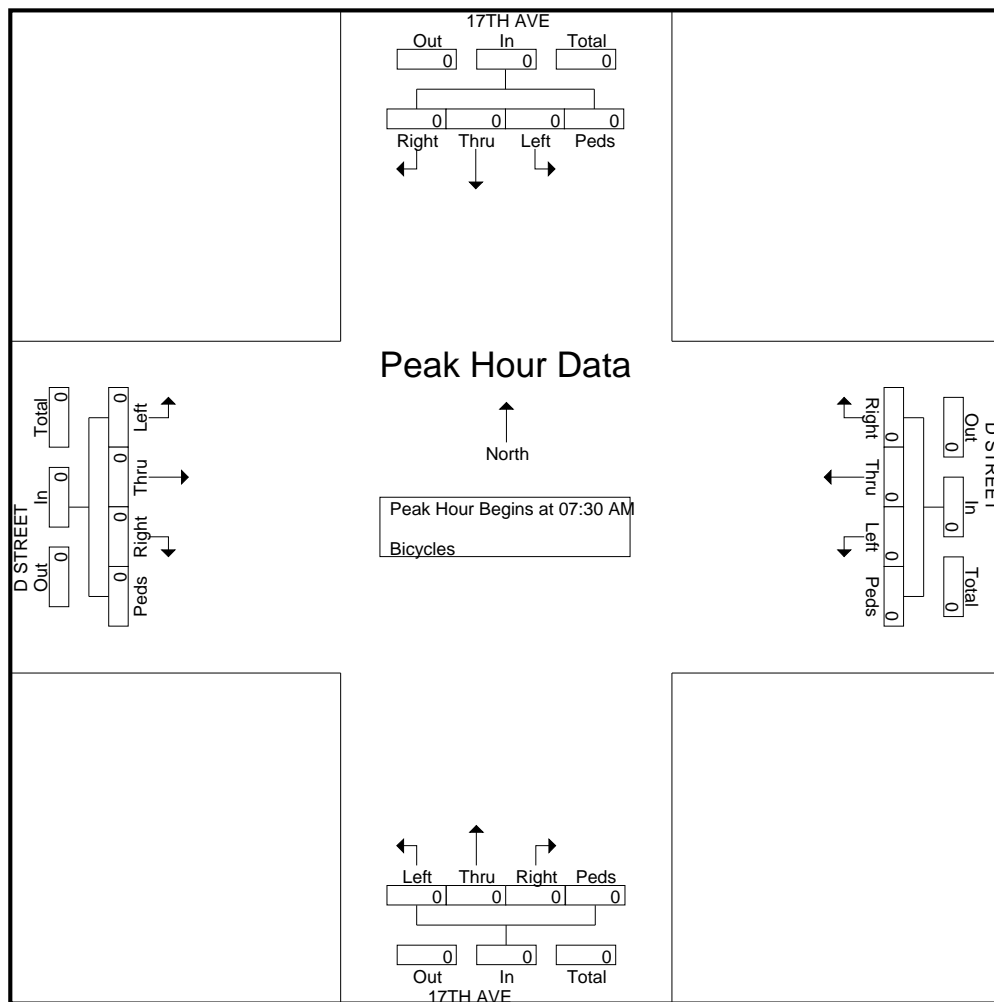

JLB Traffic Engineering, Inc.

516 W. Shaw Ave., Ste. 103
Fresno, CA, 93704

Traffic Engineering, Transportation Planning & Parking Solutions
www.JLBtraffic.com

File Name : 03 17th Avenue at D Street

Site Code : 00000000

Start Date : 9/22/2022

Page No : 3

Start Time	D STREET Eastbound					D STREET Westbound					17TH AVE Northbound					17TH AVE Southbound					Int. Total	
	Left	Thru	Right	Peds	App. Total	Left	Thru	Right	Peds	App. Total	Left	Thru	Right	Peds	App. Total	Left	Thru	Right	Peds	App. Total		
Peak Hour Analysis From 04:00 PM to 04:45 PM - Peak 1 of 1																						
Peak Hour for Entire Intersection Begins at 04:00 PM																						
04:00 PM	0	0	0	0	0	0	0	0	0	0	0	0	0	0	0	0	0	0	0	0	0	0
04:15 PM	0	0	0	0	0	0	0	0	0	0	0	0	0	0	0	0	0	0	0	0	0	0
04:30 PM	0	0	0	0	0	0	0	0	0	0	0	0	0	0	0	0	0	0	0	0	0	0
04:45 PM	0	0	0	0	0	0	0	0	0	0	0	0	0	0	0	0	0	0	0	0	0	0
Total Volume	0	0	0	0	0	0	0	0	0	0	0	0	0	0	0	0	0	0	0	0	0	0
% App. Total	0	0	0	0	0	0	0	0	0	0	0	0	0	0	0	0	0	0	0	0	0	0
PHF	.000	.000	.000	.000	.000	.000	.000	.000	.000	.000	.000	.000	.000	.000	.000	.000	.000	.000	.000	.000	.000	.000

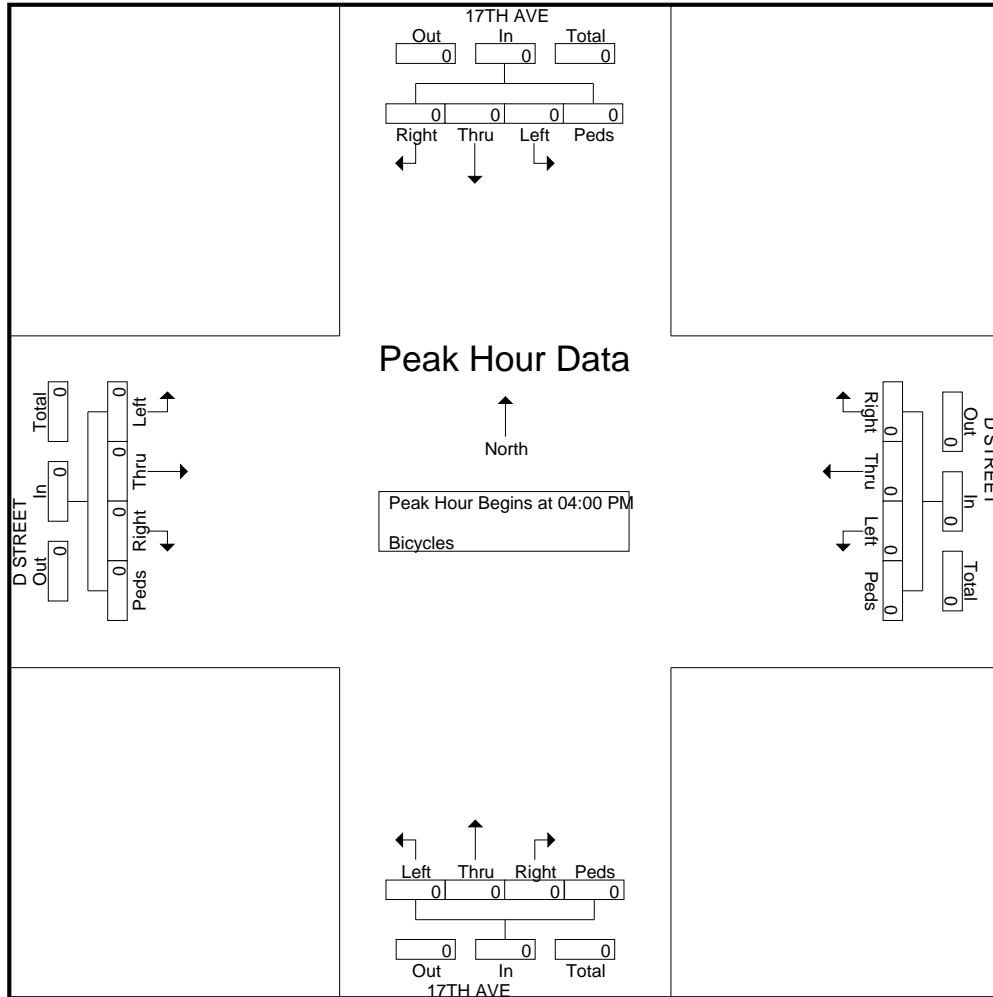

JLB Traffic Engineering, Inc.

516 W. Shaw Ave., Ste. 103
Fresno, CA, 93704

Traffic Engineering, Transportation Planning & Parking Solutions
www.JLBtraffic.com

File Name : 03 17th Avenue at D Street

Site Code : 00000000

Start Date : 9/22/2022

Page No : 1

Groups Printed- Unshifted

Start Time	D STREET Eastbound				D STREET Westbound				17TH AVE Northbound				17TH AVE Southbound				Int. Total
	Left	Thru	Right	Peds	Left	Thru	Right	Peds	Left	Thru	Right	Peds	Left	Thru	Right	Peds	
07:00 AM	2	44	0	0	0	42	11	0	0	0	0	0	43	1	6	0	149
07:15 AM	6	61	1	0	0	76	11	0	3	0	0	0	41	0	7	0	206
07:30 AM	10	79	0	0	0	80	25	0	0	0	1	0	67	1	16	0	279
07:45 AM	19	97	0	0	0	120	21	0	0	0	0	0	57	0	30	0	344
Total	37	281	1	0	0	318	68	0	3	0	1	0	208	2	59	0	978
08:00 AM	21	99	0	0	1	110	27	0	2	0	0	0	45	0	56	0	361
08:15 AM	35	97	0	0	0	90	13	0	0	0	0	0	20	0	54	0	309
08:30 AM	15	57	0	0	0	63	14	1	0	0	0	0	21	3	15	1	190
08:45 AM	6	44	0	0	1	56	16	0	0	0	0	0	28	0	5	0	156
Total	77	297	0	0	2	319	70	1	2	0	0	0	114	3	130	1	1016
*** BREAK ***																	
04:00 PM	24	94	0	0	0	127	39	0	0	0	0	0	28	0	15	0	327
04:15 PM	10	81	0	0	0	97	51	0	0	0	0	0	27	0	13	0	279
04:30 PM	15	70	0	0	0	95	39	0	0	1	0	0	39	0	5	0	264
04:45 PM	3	71	0	0	0	104	57	0	0	0	0	0	33	0	8	0	276
Total	52	316	0	0	0	423	186	0	0	1	0	0	127	0	41	0	1146
05:00 PM	17	87	0	0	0	91	65	0	0	0	2	0	21	1	13	0	297
05:15 PM	11	59	0	0	1	106	56	0	0	0	0	0	20	0	8	0	261
05:30 PM	11	43	0	0	1	97	55	0	0	0	0	0	32	0	7	0	246
05:45 PM	15	56	0	0	0	99	41	0	0	0	1	0	25	0	8	0	245
Total	54	245	0	0	2	393	217	0	0	0	3	0	98	1	36	0	1049
Grand Total	220	1139	1	0	4	1453	541	1	5	1	4	0	547	6	266	1	4189
Apprch %	16.2	83.8	0.1	0	0.2	72.7	27.1	0.1	50	10	40	0	66.7	0.7	32.4	0.1	
Total %	5.3	27.2	0	0	0.1	34.7	12.9	0	0.1	0	0.1	0	13.1	0.1	6.3	0	

JLB Traffic Engineering, Inc.

516 W. Shaw Ave., Ste. 103
Fresno, CA, 93704

Traffic Engineering, Transportation Planning & Parking Solutions
www.JLBtraffic.com

File Name : 03 17th Avenue at D Street

Site Code : 00000000

Start Date : 9/22/2022

Page No : 2

Start Time	D STREET Eastbound					D STREET Westbound					17TH AVE Northbound					17TH AVE Southbound					Int. Total
	Left	Thru	Right	Peds	App. Total	Left	Thru	Right	Peds	App. Total	Left	Thru	Right	Peds	App. Total	Left	Thru	Right	Peds	App. Total	
Peak Hour Analysis From 07:00 AM to 11:45 AM - Peak 1 of 1																					
Peak Hour for Entire Intersection Begins at 07:30 AM																					
07:30 AM	10	79	0	0	89	0	80	25	0	105	0	0	1	0	1	67	1	16	0	84	279
07:45 AM	19	97	0	0	116	0	120	21	0	141	0	0	0	0	0	57	0	30	0	87	344
08:00 AM	21	99	0	0	120	1	110	27	0	138	2	0	0	0	2	45	0	56	0	101	361
08:15 AM	35	97	0	0	132	0	90	13	0	103	0	0	0	0	0	20	0	54	0	74	309
Total Volume	85	372	0	0	457	1	400	86	0	487	2	0	1	0	3	189	1	156	0	346	1293
% App. Total	18.6	81.4	0	0		0.2	82.1	17.7	0		66.7	0	33.3	0		54.6	0.3	45.1	0		
PHF	.607	.939	.000	.000	.866	.250	.833	.796	.000	.863	.250	.000	.250	.000	.375	.705	.250	.696	.000	.856	.895

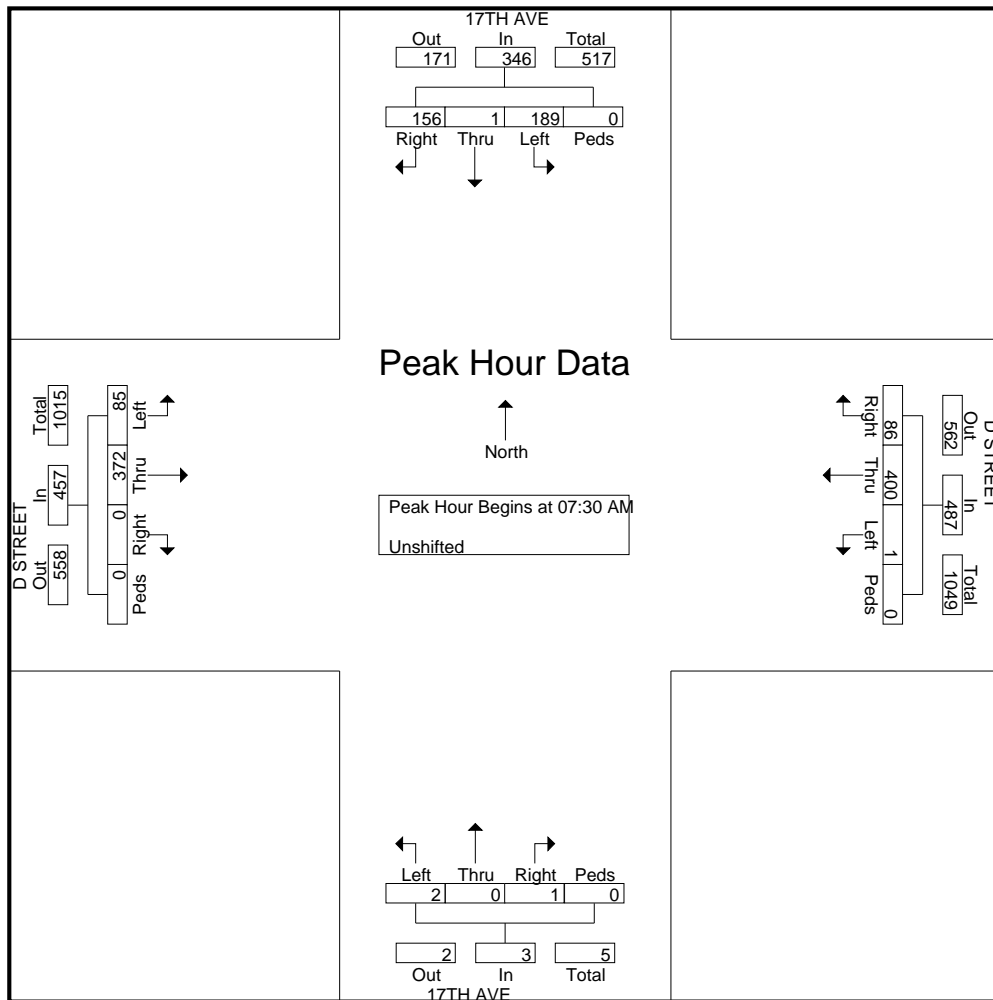

JLB Traffic Engineering, Inc.

516 W. Shaw Ave., Ste. 103
Fresno, CA, 93704

Traffic Engineering, Transportation Planning & Parking Solutions
www.JLBtraffic.com

File Name : 03 17th Avenue at D Street

Site Code : 00000000

Start Date : 9/22/2022

Page No : 3

Start Time	D STREET Eastbound					D STREET Westbound					17TH AVE Northbound					17TH AVE Southbound					Int. Total
	Left	Thru	Right	Peds	App. Total	Left	Thru	Right	Peds	App. Total	Left	Thru	Right	Peds	App. Total	Left	Thru	Right	Peds	App. Total	
Peak Hour Analysis From 12:00 PM to 05:45 PM - Peak 1 of 1																					
Peak Hour for Entire Intersection Begins at 04:00 PM																					
04:00 PM	24	94	0	0	118	0	127	39	0	166	0	0	0	0	0	28	0	15	0	43	327
04:15 PM	10	81	0	0	91	0	97	51	0	148	0	0	0	0	0	27	0	13	0	40	279
04:30 PM	15	70	0	0	85	0	95	39	0	134	0	1	0	0	1	39	0	5	0	44	264
04:45 PM	3	71	0	0	74	0	104	57	0	161	0	0	0	0	0	33	0	8	0	41	276
Total Volume	52	316	0	0	368	0	423	186	0	609	0	1	0	0	1	127	0	41	0	168	1146
% App. Total	14.1	85.9	0	0		0	69.5	30.5	0		0	100	0	0		75.6	0	24.4	0		
PHF	.542	.840	.000	.000	.780	.000	.833	.816	.000	.917	.000	.250	.000	.000	.250	.814	.000	.683	.000	.955	.876

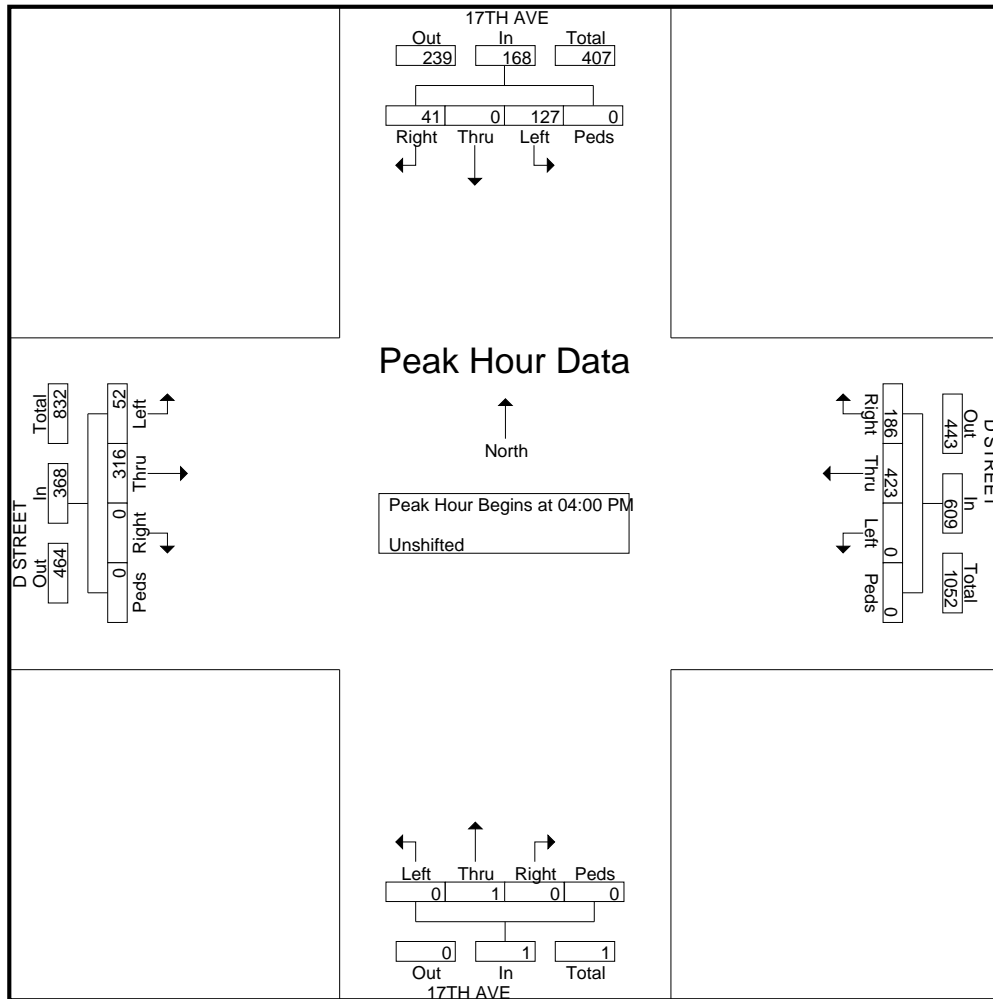



Metro Traffic Data Inc.
 310 N. Irwin Street - Suite 20
 Hanford, CA 93230
 800-975-6938 Phone/Fax
 www.metrotrafficdata.com

Turning Movement Report

Prepared For:

JLB Traffic Engineering, Inc.
 516 W. Shaw Ave, Suite 103
 Fresno, CA 93704

LOCATION Lemoore Ave @ SR198 WB Ramps

LATITUDE 36.2923

COUNTY Kings

LONGITUDE -119.7809

COLLECTION DATE Thursday, September 29, 2022

WEATHER Clear

Time	Northbound					Southbound					Eastbound					Westbound				
	U-Turn	Left	Thru	Right	Trucks	U-Turn	Left	Thru	Right	Trucks	U-Turn	Left	Thru	Right	Trucks	U-Turn	Left	Thru	Right	Trucks
7:00 AM - 7:15 AM	0	5	30	0	1	0	0	57	43	2	0	0	0	0	0	0	20	0	11	3
7:15 AM - 7:30 AM	0	10	46	0	2	0	0	58	40	3	0	0	0	0	0	0	26	0	16	1
7:30 AM - 7:45 AM	0	8	68	0	1	0	0	87	50	4	0	0	0	0	0	0	27	0	22	4
7:45 AM - 8:00 AM	0	3	94	0	3	0	0	91	31	1	0	0	0	0	0	0	32	0	33	0
8:00 AM - 8:15 AM	0	5	118	0	2	0	0	102	38	10	0	0	0	0	0	0	20	0	32	1
8:15 AM - 8:30 AM	0	3	104	0	4	0	0	100	28	6	0	0	0	0	0	0	33	0	36	0
8:30 AM - 8:45 AM	0	1	37	0	0	0	0	56	32	2	0	0	0	0	0	0	18	0	13	1
8:45 AM - 9:00 AM	0	5	45	0	2	0	0	43	18	0	0	0	0	0	0	0	29	0	17	1
TOTAL	0	40	542	0	15	0	0	594	280	28	0	0	0	0	0	0	205	0	180	11

Time	Northbound					Southbound					Eastbound					Westbound				
	U-Turn	Left	Thru	Right	Trucks	U-Turn	Left	Thru	Right	Trucks	U-Turn	Left	Thru	Right	Trucks	U-Turn	Left	Thru	Right	Trucks
4:00 PM - 4:15 PM	0	1	108	0	1	0	0	108	23	5	0	0	0	0	0	0	33	0	23	0
4:15 PM - 4:30 PM	0	5	92	0	2	0	0	83	27	1	0	0	0	0	0	0	32	0	33	1
4:30 PM - 4:45 PM	0	7	103	0	1	0	0	82	32	2	0	0	0	0	0	0	43	0	30	1
4:45 PM - 5:00 PM	0	2	95	0	1	0	0	96	35	1	0	0	0	0	0	0	30	0	53	0
5:00 PM - 5:15 PM	0	3	103	0	1	0	0	105	28	2	0	0	0	0	0	0	30	0	34	1
5:15 PM - 5:30 PM	0	3	95	0	5	0	0	102	40	1	0	0	0	0	0	0	38	0	46	1
5:30 PM - 5:45 PM	0	3	80	0	0	0	0	86	31	0	0	0	0	0	0	0	29	0	31	1
5:45 PM - 6:00 PM	0	2	94	0	2	0	0	89	32	0	0	0	0	0	0	0	31	0	25	0
TOTAL	0	26	770	0	13	0	0	751	248	12	0	0	0	0	0	0	266	0	275	5

PEAK HOUR	Northbound					Southbound					Eastbound					Westbound				
	U-Turn	Left	Thru	Right	Trucks	U-Turn	Left	Thru	Right	Trucks	U-Turn	Left	Thru	Right	Trucks	U-Turn	Left	Thru	Right	Trucks
7:30 AM - 8:30 AM	0	19	384	0	10	0	0	380	147	21	0	0	0	0	0	0	112	0	123	5
4:30 PM - 5:30 PM	0	15	396	0	8	0	0	385	135	6	0	0	0	0	0	0	141	0	163	3

	PHF	Trucks
AM	0.925	3.1%
PM	0.953	1.4%

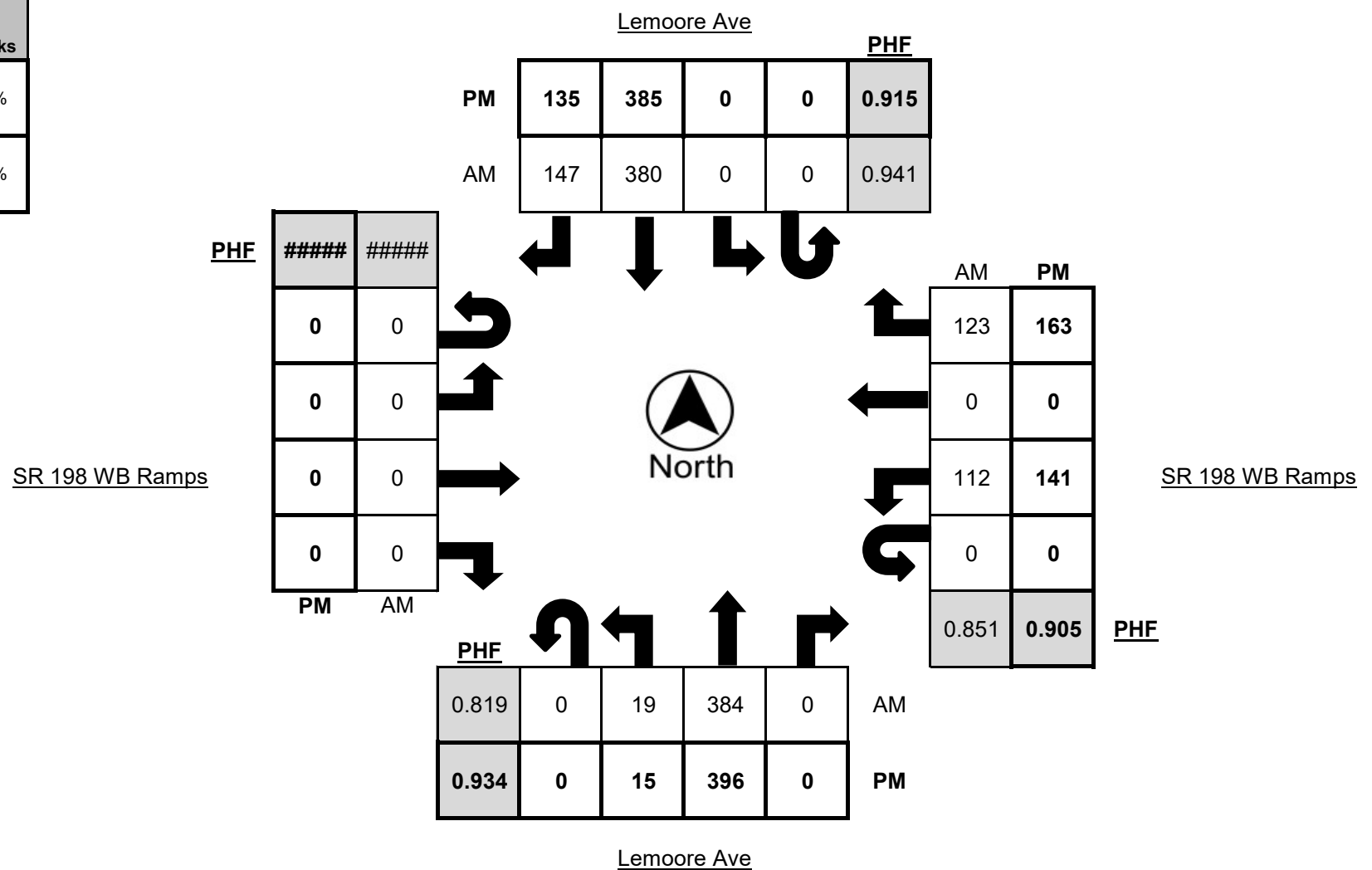



Metro Traffic Data Inc.
 310 N. Irwin Street - Suite 20
 Hanford, CA 93230
 800-975-6938 Phone/Fax
 www.metrotrafficdata.com

Turning Movement Report

Prepared For:

JLB Traffic Engineering, Inc.
 516 W. Shaw Ave, Suite 103
 Fresno, CA 93704

LOCATION Lemoore Ave @ SR198 WB Ramps
COUNTY Kings
COLLECTION DATE Thursday, September 29, 2022

LATITUDE 36.2923
LONGITUDE -119.7809
WEATHER Clear

Time	Northbound Bikes			N.Leg Peds	Southbound Bikes			S.Leg Peds	Eastbound Bikes			E.Leg Peds	Westbound Bikes			W.Leg Peds
	Left	Thru	Right		Left	Thru	Right		Left	Thru	Right		Left	Thru	Right	
7:00 AM - 7:15 AM	0	0	0	0	0	0	0	0	0	0	0	0	0	0	0	0
7:15 AM - 7:30 AM	0	0	0	0	0	0	0	0	0	0	0	0	0	0	0	0
7:30 AM - 7:45 AM	0	0	0	0	0	0	0	0	0	0	0	0	0	0	0	0
7:45 AM - 8:00 AM	0	0	0	0	0	0	0	0	0	0	0	0	0	0	0	0
8:00 AM - 8:15 AM	0	0	0	0	0	0	0	0	0	0	0	1	0	0	0	1
8:15 AM - 8:30 AM	0	1	0	0	0	0	0	0	0	0	0	1	0	0	0	2
8:30 AM - 8:45 AM	0	0	0	0	0	0	0	0	0	0	0	1	0	0	0	1
8:45 AM - 9:00 AM	0	0	0	0	0	1	0	0	0	0	0	0	0	0	0	0
TOTAL	0	1	0	0	0	1	0	0	0	0	0	3	0	0	0	4

Time	Northbound Bikes			N.Leg Peds	Southbound Bikes			S.Leg Peds	Eastbound Bikes			E.Leg Peds	Westbound Bikes			W.Leg Peds
	Left	Thru	Right		Left	Thru	Right		Left	Thru	Right		Left	Thru	Right	
4:00 PM - 4:15 PM	0	0	0	0	0	0	0	0	0	0	0	0	0	0	0	0
4:15 PM - 4:30 PM	0	0	0	0	0	0	0	0	0	0	0	0	0	0	0	0
4:30 PM - 4:45 PM	0	0	0	0	0	0	0	0	0	0	0	0	0	0	0	0
4:45 PM - 5:00 PM	0	0	0	0	0	0	0	0	0	0	0	0	0	0	0	0
5:00 PM - 5:15 PM	0	0	0	0	0	0	0	0	0	0	0	0	0	0	0	0
5:15 PM - 5:30 PM	0	0	0	0	0	0	0	0	0	0	0	0	0	0	0	0
5:30 PM - 5:45 PM	0	0	0	0	0	0	0	0	0	0	0	0	0	0	0	0
5:45 PM - 6:00 PM	0	0	0	0	0	0	0	0	0	0	0	0	0	0	0	0
TOTAL	0	0	0	0	0	0	0	0	0	0	0	0	0	0	0	0

PEAK HOUR	Northbound Bikes			N.Leg Peds	Southbound Bikes			S.Leg Peds	Eastbound Bikes			E.Leg Peds	Westbound Bikes			W.Leg Peds
	Left	Thru	Right		Left	Thru	Right		Left	Thru	Right		Left	Thru	Right	
7:30 AM - 8:30 AM	0	1	0	0	0	0	0	0	0	0	0	2	0	0	0	3
4:30 PM - 5:30 PM	0	0	0	0	0	0	0	0	0	0	0	0	0	0	0	0

	Bikes	Peds
AM Peak Total	1	5
PM Peak Total	0	0

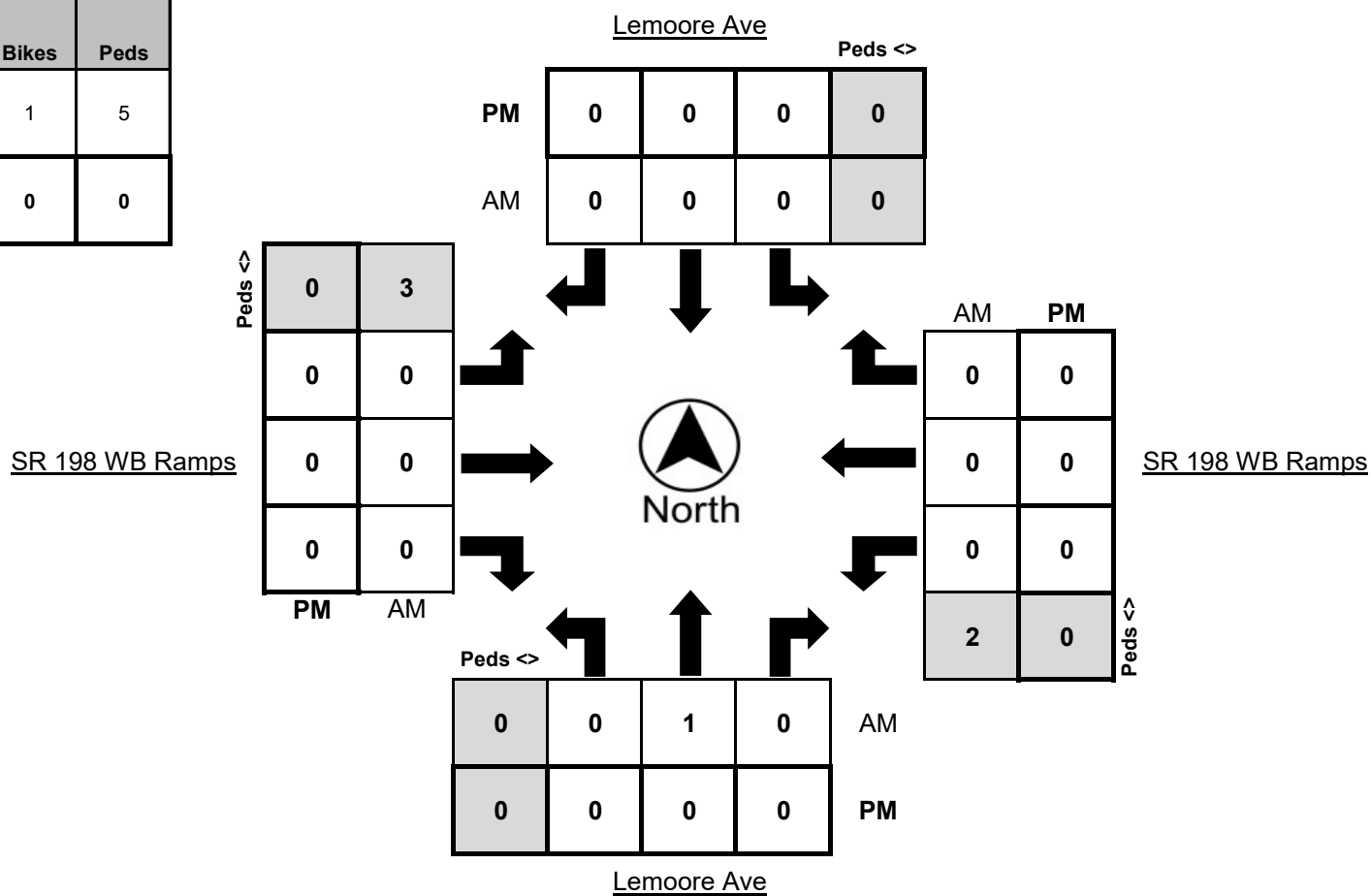



Metro Traffic Data Inc.
 310 N. Irwin Street - Suite 20
 Hanford, CA 93230
 800-975-6938 Phone/Fax
 www.metrotrafficdata.com

Turning Movement Report

Prepared For:

JLB Traffic Engineering, Inc.
 516 W. Shaw Ave, Suite 103
 Fresno, CA 93704

LOCATION Lemoore Ave @ SR198 EB Ramps

LATITUDE 36.2906

COUNTY Kings

LONGITUDE -119.7808

COLLECTION DATE Thursday, September 29, 2022

WEATHER Clear

Time	Northbound					Southbound					Eastbound					Westbound				
	U-Turn	Left	Thru	Right	Trucks	U-Turn	Left	Thru	Right	Trucks	U-Turn	Left	Thru	Right	Trucks	U-Turn	Left	Thru	Right	Trucks
7:00 AM - 7:15 AM	0	0	29	14	1	0	22	55	0	1	0	0	0	0	0	0	0	0	5	0
7:15 AM - 7:30 AM	0	0	36	18	0	0	29	53	0	2	0	0	0	0	0	0	1	0	19	0
7:30 AM - 7:45 AM	0	0	57	35	3	0	48	68	0	3	0	0	0	0	0	0	1	0	20	0
7:45 AM - 8:00 AM	0	0	70	25	2	0	41	85	0	0	0	0	0	0	0	0	3	0	30	2
8:00 AM - 8:15 AM	0	0	63	12	1	0	39	79	0	7	0	0	0	0	0	0	5	0	57	2
8:15 AM - 8:30 AM	0	0	62	28	4	0	43	91	0	5	0	0	0	0	0	0	3	0	46	2
8:30 AM - 8:45 AM	0	0	29	16	0	0	29	45	0	1	0	0	0	0	0	0	2	0	14	0
8:45 AM - 9:00 AM	0	0	31	20	1	0	18	51	0	1	0	0	0	0	0	0	4	0	20	2
TOTAL	0	0	377	168	12	0	269	527	0	20	0	0	0	0	0	0	19	0	211	8

Time	Northbound					Southbound					Eastbound					Westbound				
	U-Turn	Left	Thru	Right	Trucks	U-Turn	Left	Thru	Right	Trucks	U-Turn	Left	Thru	Right	Trucks	U-Turn	Left	Thru	Right	Trucks
4:00 PM - 4:15 PM	0	0	55	20	1	0	55	88	0	5	0	0	0	0	0	0	6	0	52	0
4:15 PM - 4:30 PM	0	0	53	25	0	0	37	76	0	4	0	0	0	0	0	0	4	0	46	2
4:30 PM - 4:45 PM	0	0	60	21	1	0	51	76	0	3	0	0	0	0	0	0	6	0	50	0
4:45 PM - 5:00 PM	0	0	46	24	1	0	46	83	0	2	0	0	0	0	0	0	5	0	49	0
5:00 PM - 5:15 PM	0	0	58	28	1	0	51	80	0	2	0	0	0	0	0	0	8	0	48	1
5:15 PM - 5:30 PM	0	0	64	111	3	0	45	99	0	0	0	0	0	0	0	0	2	0	34	3
5:30 PM - 5:45 PM	0	0	47	35	0	0	39	79	0	0	0	0	0	0	0	0	2	0	34	0
5:45 PM - 6:00 PM	0	0	52	26	2	0	36	85	0	0	0	0	0	0	0	0	3	0	44	1
TOTAL	0	0	435	290	9	0	360	666	0	16	0	0	0	0	0	0	36	0	357	7

PEAK HOUR	Northbound					Southbound					Eastbound					Westbound				
	U-Turn	Left	Thru	Right	Trucks	U-Turn	Left	Thru	Right	Trucks	U-Turn	Left	Thru	Right	Trucks	U-Turn	Left	Thru	Right	Trucks
7:30 AM - 8:30 AM	0	0	252	100	10	0	171	323	0	15	0	0	0	0	0	0	12	0	153	6
4:30 PM - 5:30 PM	0	0	228	184	6	0	193	338	0	7	0	0	0	0	0	0	21	0	181	4

	PHF	Trucks
AM	0.926	3.1%
PM	0.806	1.5%

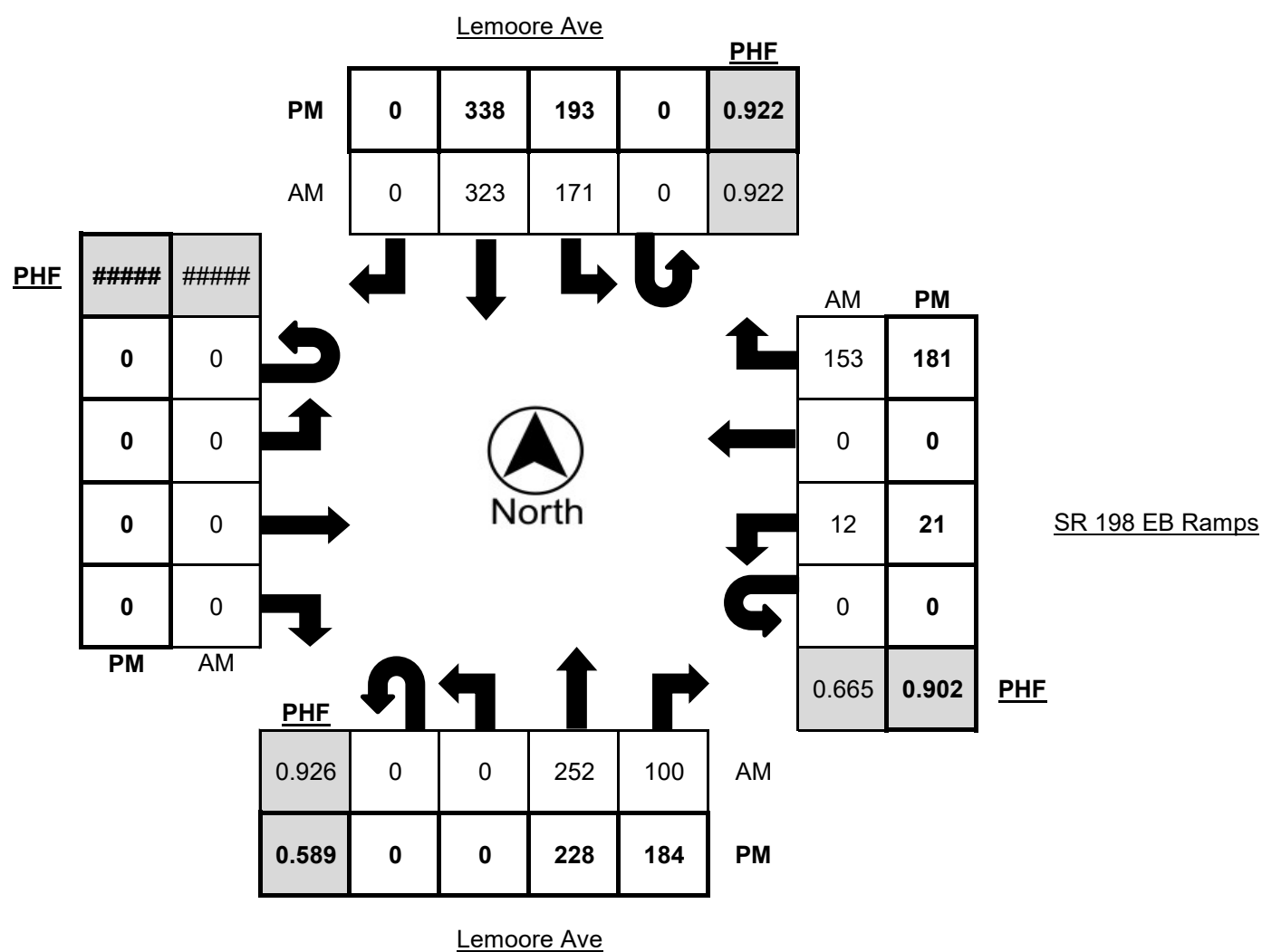



Metro Traffic Data Inc.
 310 N. Irwin Street - Suite 20
 Hanford, CA 93230
 800-975-6938 Phone/Fax
 www.metrotrafficdata.com

Turning Movement Report

Prepared For:

JLB Traffic Engineering, Inc.
 516 W. Shaw Ave, Suite 103
 Fresno, CA 93704

LOCATION Lemoore Ave @ SR198 EB Ramps
COUNTY Kings
COLLECTION DATE Thursday, September 29, 2022

LATITUDE 36.2906
LONGITUDE -119.7808
WEATHER Clear

Time	Northbound Bikes			N.Leg Peds	Southbound Bikes			S.Leg Peds	Eastbound Bikes			E.Leg Peds	Westbound Bikes			W.Leg Peds
	Left	Thru	Right		Left	Thru	Right		Left	Thru	Right		Left	Thru	Right	
7:00 AM - 7:15 AM	0	0	0	0	0	0	0	0	0	0	0	0	0	0	0	0
7:15 AM - 7:30 AM	0	0	0	0	0	0	0	0	0	0	0	0	0	0	0	0
7:30 AM - 7:45 AM	0	0	0	0	0	0	0	0	0	0	0	0	0	0	0	0
7:45 AM - 8:00 AM	0	0	0	0	0	0	0	0	0	0	0	0	0	0	0	0
8:00 AM - 8:15 AM	0	0	0	0	0	0	0	0	0	0	0	1	0	0	0	0
8:15 AM - 8:30 AM	0	0	0	0	0	0	0	0	0	0	0	0	0	0	0	0
8:30 AM - 8:45 AM	0	0	0	1	0	0	0	0	0	0	0	0	0	0	0	0
8:45 AM - 9:00 AM	0	0	0	0	0	1	0	0	0	0	0	0	0	0	0	0
TOTAL	0	0	0	1	0	1	0	0	0	0	0	1	0	0	0	0

Time	Northbound Bikes			N.Leg Peds	Southbound Bikes			S.Leg Peds	Eastbound Bikes			E.Leg Peds	Westbound Bikes			W.Leg Peds
	Left	Thru	Right		Left	Thru	Right		Left	Thru	Right		Left	Thru	Right	
4:00 PM - 4:15 PM	0	0	0	0	0	0	0	0	0	0	0	0	0	0	0	0
4:15 PM - 4:30 PM	0	0	0	0	0	0	0	0	0	0	0	0	0	0	0	0
4:30 PM - 4:45 PM	0	0	0	0	0	0	0	0	0	0	0	0	0	0	0	0
4:45 PM - 5:00 PM	0	0	0	0	0	0	0	0	0	0	0	0	0	0	0	0
5:00 PM - 5:15 PM	0	0	0	0	0	0	0	0	0	0	0	0	0	0	0	0
5:15 PM - 5:30 PM	0	0	0	0	0	0	0	0	0	0	0	0	0	0	0	0
5:30 PM - 5:45 PM	0	0	0	0	0	0	0	0	0	0	0	0	0	0	0	0
5:45 PM - 6:00 PM	0	0	0	0	0	0	0	0	0	0	0	0	0	0	0	0
TOTAL	0	0	0	0	0	0	0	0	0	0	0	0	0	0	0	0

PEAK HOUR	Northbound Bikes			N.Leg Peds	Southbound Bikes			S.Leg Peds	Eastbound Bikes			E.Leg Peds	Westbound Bikes			W.Leg Peds
	Left	Thru	Right		Left	Thru	Right		Left	Thru	Right		Left	Thru	Right	
7:30 AM - 8:30 AM	0	0	0	0	0	0	0	0	0	0	0	1	0	0	0	0
4:30 PM - 5:30 PM	0	0	0	0	0	0	0	0	0	0	0	0	0	0	0	0

	Bikes	Peds
AM Peak Total	0	1
PM Peak Total	0	0

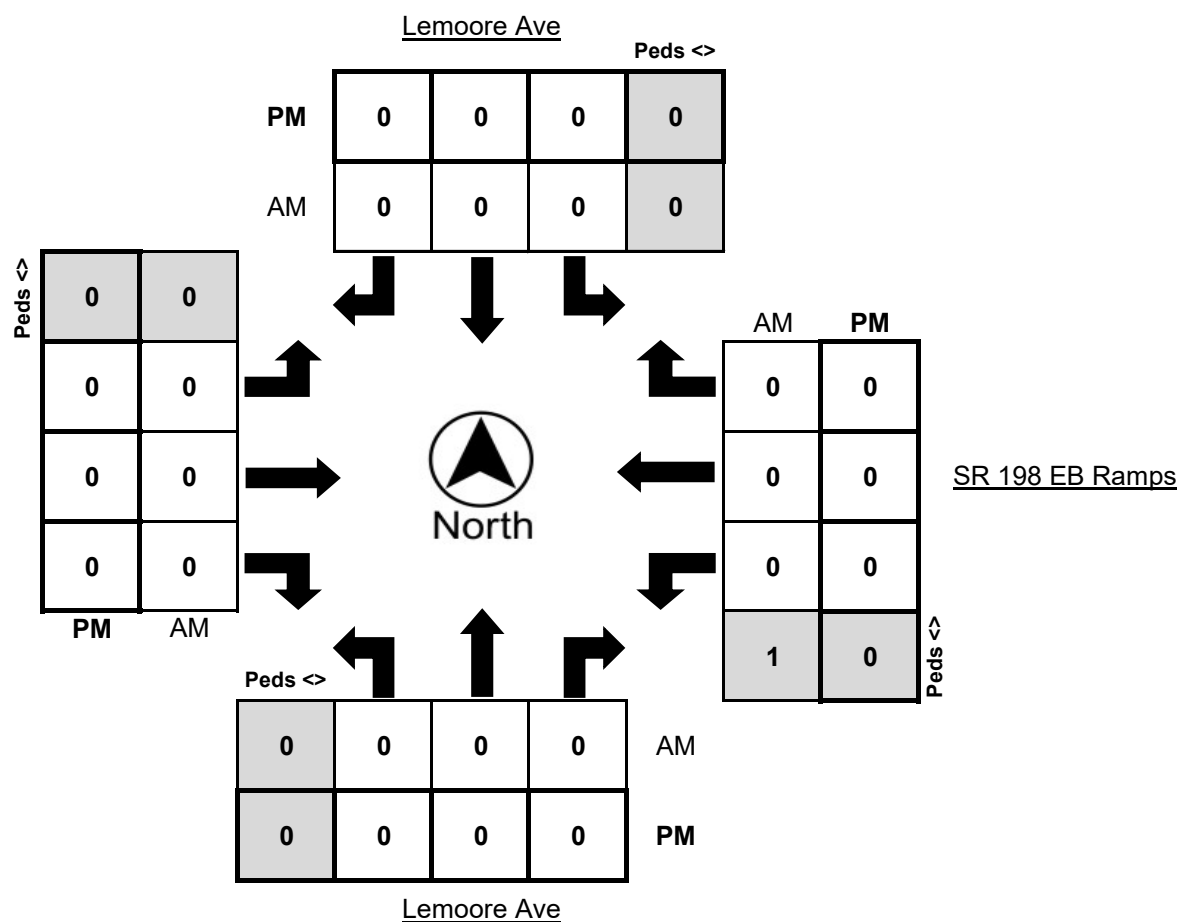

JLB Traffic Engineering, Inc.

516 W. Shaw Ave., Ste. 200

Fresno, CA 93704

(559) 570-8991

Traffic Engineering, Transportation Planning & Parking Solutions

File Name : 01 houston at 17th ave

Site Code : 00000000

Start Date : 1/26/2016

Page No : 1

Groups Printed- Unshifted

Start Time	17TH Southbound					HOUSTON Westbound					17TH Northbound					HOUSTON Eastbound					Int. Total
	Left	Thru	Right	Peds	App. Total	Left	Thru	Right	Peds	App. Total	Left	Thru	Right	Peds	App. Total	Left	Thru	Right	Peds	App. Total	
07:00 AM	24	0	10	0	34	0	40	24	0	64	0	0	0	0	0	3	37	0	0	40	138
07:15 AM	33	0	14	0	47	1	60	9	0	70	1	0	0	0	1	15	63	0	0	78	196
07:30 AM	29	0	27	0	56	0	84	21	0	105	0	0	0	0	0	18	98	0	0	116	277
07:45 AM	33	0	40	0	73	0	117	16	0	133	0	0	1	0	1	19	125	0	0	144	351
Total	119	0	91	0	210	1	301	70	0	372	1	0	1	0	2	55	323	0	0	378	962
08:00 AM	23	0	14	1	38	0	94	15	0	109	0	0	0	0	0	18	85	0	0	103	250
08:15 AM	24	0	24	0	48	0	69	11	0	80	2	0	1	0	3	12	71	1	0	84	215
08:30 AM	17	0	7	0	24	0	51	10	0	61	0	1	0	0	1	6	34	0	0	40	126
08:45 AM	17	0	9	0	26	0	50	6	0	56	0	0	0	0	0	6	42	0	0	48	130
Total	81	0	54	1	136	0	264	42	0	306	2	1	1	0	4	42	232	1	0	275	721

04:00 PM	23	0	12	0	35	0	111	39	0	150	1	0	0	0	1	17	67	0	0	84	270
04:15 PM	23	0	13	0	36	1	88	36	0	125	0	0	0	0	0	13	60	1	0	74	235
04:30 PM	17	0	10	0	27	0	87	43	2	132	0	1	0	0	1	13	58	0	0	71	231
04:45 PM	15	0	8	0	23	1	83	43	0	127	1	0	0	0	1	14	58	1	0	73	224
Total	78	0	43	0	121	2	369	161	2	534	2	1	0	0	3	57	243	2	0	302	960
05:00 PM	16	0	4	0	20	0	90	36	0	126	0	0	0	0	0	16	85	1	0	102	248
05:15 PM	21	0	17	0	38	1	89	37	2	129	0	0	0	0	0	14	65	0	0	79	246
05:30 PM	19	0	15	1	35	0	88	47	0	135	0	0	1	0	1	12	60	0	0	72	243
05:45 PM	26	2	21	0	49	0	82	42	0	124	0	0	1	0	1	11	56	3	0	70	244
Total	82	2	57	1	142	1	349	162	2	514	0	0	2	0	2	53	266	4	0	323	981

Grand Total	360	2	245	2	609	4	1283	435	4	1726	5	2	4	0	11	207	1064	7	0	1278	3624
Apprch %	59.1	0.3	40.2	0.3		0.2	74.3	25.2	0.2		45.5	18.2	36.4	0		16.2	83.3	0.5	0		
Total %	9.9	0.1	6.8	0.1	16.8	0.1	35.4	12	0.1	47.6	0.1	0.1	0.1	0	0.3	5.7	29.4	0.2	0	35.3	

JLB Traffic Engineering, Inc.

516 W. Shaw Ave., Ste. 200

Fresno, CA 93704

(559) 570-8991

Traffic Engineering, Transportation Planning & Parking Solutions

File Name : 01 houston at 17th ave

Site Code : 00000000

Start Date : 1/26/2016

Page No : 2

Start Time	17TH Southbound					HOUSTON Westbound					17TH Northbound					HOUSTON Eastbound					Int. Total
	Left	Thru	Right	Peds	App. Total	Left	Thru	Right	Peds	App. Total	Left	Thru	Right	Peds	App. Total	Left	Thru	Right	Peds	App. Total	
Peak Hour Analysis From 07:00 AM to 11:45 AM - Peak 1 of 1																					
Peak Hour for Entire Intersection Begins at 07:30 AM																					
07:30 AM	29	0	27	0	56	0	84	21	0	133	0	0	1	0	1	19	125	0	0	144	351
07:45 AM	33	0	40	0	73	0	117	16	0	133	0	0	1	0	1	19	125	0	0	144	351
08:00 AM	23	0	14	1																	
08:15 AM	24	0	24	0	48	0	69	11	0	80	2	0	1	0	3	12	71	1	0	84	215
Total Volume	109	0	105	1	215	0	364	63	0	427	2	0	2	0	4	67	379	1	0	447	1093
% App. Total	50.7	0	48.8	0.5		0	85.2	14.8	0		50	0	50	0		15	84.8	0.2	0		
PHF	.826	.000	.656	.250	.736	.000	.778	.750	.000	.803	.250	.000	.500	.000	.333	.882	.758	.250	.000	.776	.778

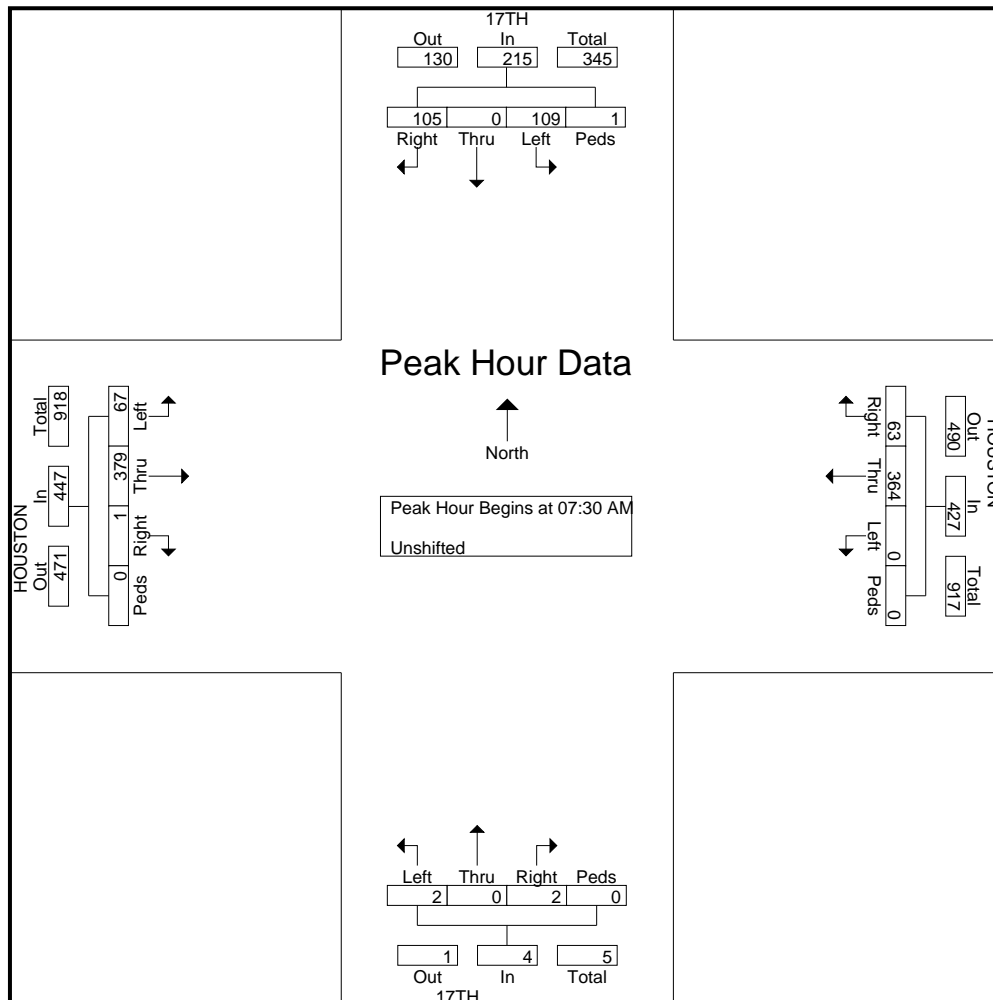

JLB Traffic Engineering, Inc.

516 W. Shaw Ave., Ste. 200

Fresno, CA 93704

(559) 570-8991

Traffic Engineering, Transportation Planning & Parking Solutions

File Name : 01 houston at 17th ave

Site Code : 00000000

Start Date : 1/26/2016

Page No : 3

Start Time	17TH Southbound					HOUSTON Westbound					17TH Northbound					HOUSTON Eastbound					Int. Total
	Left	Thru	Right	Peds	App. Total	Left	Thru	Right	Peds	App. Total	Left	Thru	Right	Peds	App. Total	Left	Thru	Right	Peds	App. Total	
05:00 PM	16	0	4	0	20	0	90	36	0	126	0	0	0	0	0	16	85	1	0	102	248
05:15 PM	21	0	17	0	38	1	90	36	2	129	0	0	0	0	0	12	60	0	0	72	243
05:30 PM	19	0	15	1	35	0	88	47	0	135	0	0	1	0	1	12	60	0	0	72	243
05:45 PM	26	2	21	49	0	82	42	0	124	0	0	1	0	1	1	11	56	3	0	70	243
Total Volume	82	2	57	1	142	1	349	162	2	514	0	0	2	0	2	53	266	4	0	323	981
% App. Total	57.7	1.4	40.1	0.7		0.2	67.9	31.5	0.4		0	0	100	0		16.4	82.4	1.2	0		
PHF	.788	.250	.679	.250	.724	.250	.969	.862	.250	.952	.000	.000	.500	.000	.500	.828	.782	.333	.000	.792	.989

Peak Hour Analysis From 12:00 PM to 06:30 AM - Peak 1 of 1

Peak Hour for Entire Intersection Begins at 05:00 PM

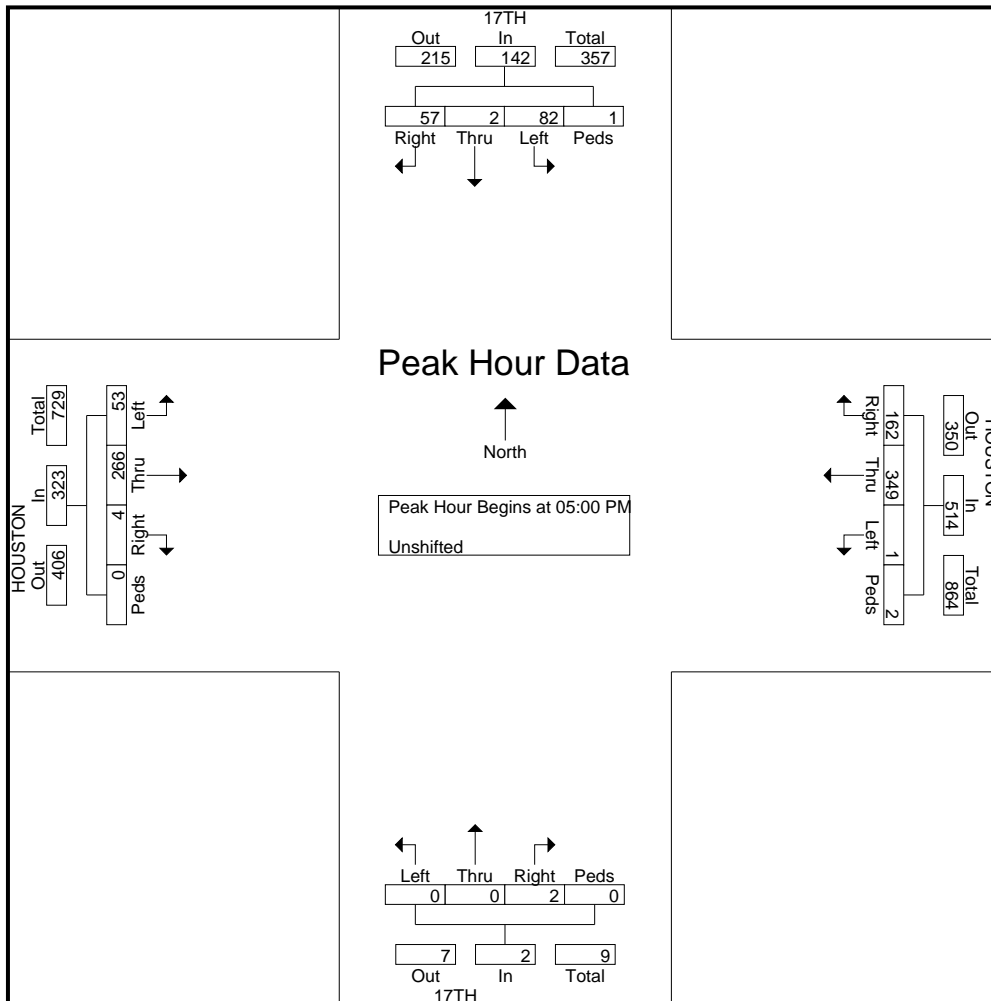

Appendix C: Traffic Modeling



www.JLBtraffic.com
info@JLBtraffic.com

516 W. Shaw Ave., Ste. 103
Fresno, CA 93704
(559) 570-8991

App | C

August 22, 2022

Mike Aronson, P.E.
Kittleson & Associates, Inc.
155 Grand Avenue, Suite 505
Oakland, CA 94612

Via Email Only: maronson@kittelson.com

Subject: Traffic Modeling Request for the Preparation of a Traffic Impact Analysis and Vehicle Miles Traveled Analysis for TTM 22-021 Located on the Southeast Quadrant of Lemoore Avenue and Bush Street in the City of Hanford (JLB Project 039-004)

Dear Mr. Aronson,

JLB Traffic Engineering, Inc. (JLB) hereby requests traffic modeling for the preparation of a Traffic Impact Analysis (TIA) for the proposed TTM 22-021 (Project) located on the southeast quadrant of Lemoore Avenue and Bush Street in the City of Lemoore. The Project proposes to develop a single family residential subdivision with approximately 276 lots and 5.50 acres of public parks. Based on information provided to JLB, the Project is consistent with the City of Lemoore General Plan. An aerial of the Project vicinity and Project Site plan are shown in Exhibit A and Exhibit B, respectively.

The purpose of the TIA is to evaluate the potential on-site and off-site traffic impacts, identify short-term roadway and circulation needs, determine potential mitigation measures and identify any critical traffic issues that should be addressed in the on-going planning process.

Scenarios:

The following scenarios are requested:

1. Base Year 2022 (with Link and TAZ modifications)
2. Cumulative Year 2042 plus Project Select Zone (with Link and TAZ modifications)
3. Differences between model runs 2 and 1 above

Changes and/or additions to the Model Network or TAZ's

JLB reviewed the Kings CAG model network for the Base Year 2022 and Cumulative Year 2042. Based on this review, JLB requests the following link and TAZ network modifications. Details on the requested Link and TAZ modifications for Base Year 2022 and Cumulative Year 2042 are illustrated in Exhibit C.



www.JLBtraffic.com
info@JLBtraffic.com

516 W. Shaw Ave., Ste. 103
Fresno, CA 93704
(559) 570-8991

LINK and TAZ MODIFICATIONS (Base Year 2022 and Cumulative Year 2042 plus Project Select Zone Scenarios):

1. Create SR 198 Westbound Off-Ramp between Node 11093 and Node 12450.
 - a. Classification: Collector Roadway
 - b. Lanes: One lane in the westbound direction
 - c. Speed: 35 MPH

LINK and Project MODIFICATIONS (Cumulative Year 2042 plus Project Select Zone Scenario Only):

1. Create TAZ A is generally located on the southeast quadrant of Lemoore Avenue and Bush Street. Taz A shall have a TAZ connector to Bush Street.

TAZ A Project Trip Generation

The trip generation rates for the proposed Project were obtained from the 11th Edition of the Trip Generation Manual published by the Institute of Transportation Engineers (ITE). Table I presents the trip generation for TAZ A of the proposed Project with trip generation rates for 276 Single-Family Detached Housing units and 5.5 acres of public park. At buildout, TAZ A of proposed Project is estimated to generate 2,607 daily trips, 193 AM peak hour trips and 260 PM peak hour trips.

Table I: TAZ A Trip Generation

Land Use (ITE Code)	Size	Unit	Daily		AM (7-9) Peak Hour					PM (4-6) Peak Hour						
			Rate	Total	Trip Rate	In		Out		Total	Trip Rate	In		Out		Total
						%		%				%				
Single-Family Detached Housing (210)	276	d.u.	9.43	2,603	0.70	26	74	50	143	193	0.94	63	37	163	96	259
Public Park (411)	5.50	Acres	0.78	4	0.02	59	41	0	0	0	0.11	55	54	1	0	1
Total Project Trips				2,607				50	143	193				164	96	260

Note: d.u. = Dwelling Units

Please feel welcome to contact me if you have any questions or require additional information. I can be reached by phone at (559) 317-6243, or via email at marndt@jlbtraffic.com.

Sincerely,



Matthew Arndt, EIT
 JLB Traffic Engineering, Inc.

cc: Jose Luis Benavides, JLB Traffic Engineering, Inc.

Z:\01 Projects\039 Lemoore\039-004 TTM 22-021 TIA\Model Request\01 Model Request\L08222022 Model Request (039-004).docx



www.JLBtraffic.com
 info@JLBtraffic.com

516 W. Shaw Ave., Ste. 103
 Fresno, CA 93704
 (559) 570-8991

Exhibit A – Project Site Aerial



Exhibit B – Project Site Plan (1 of 2)

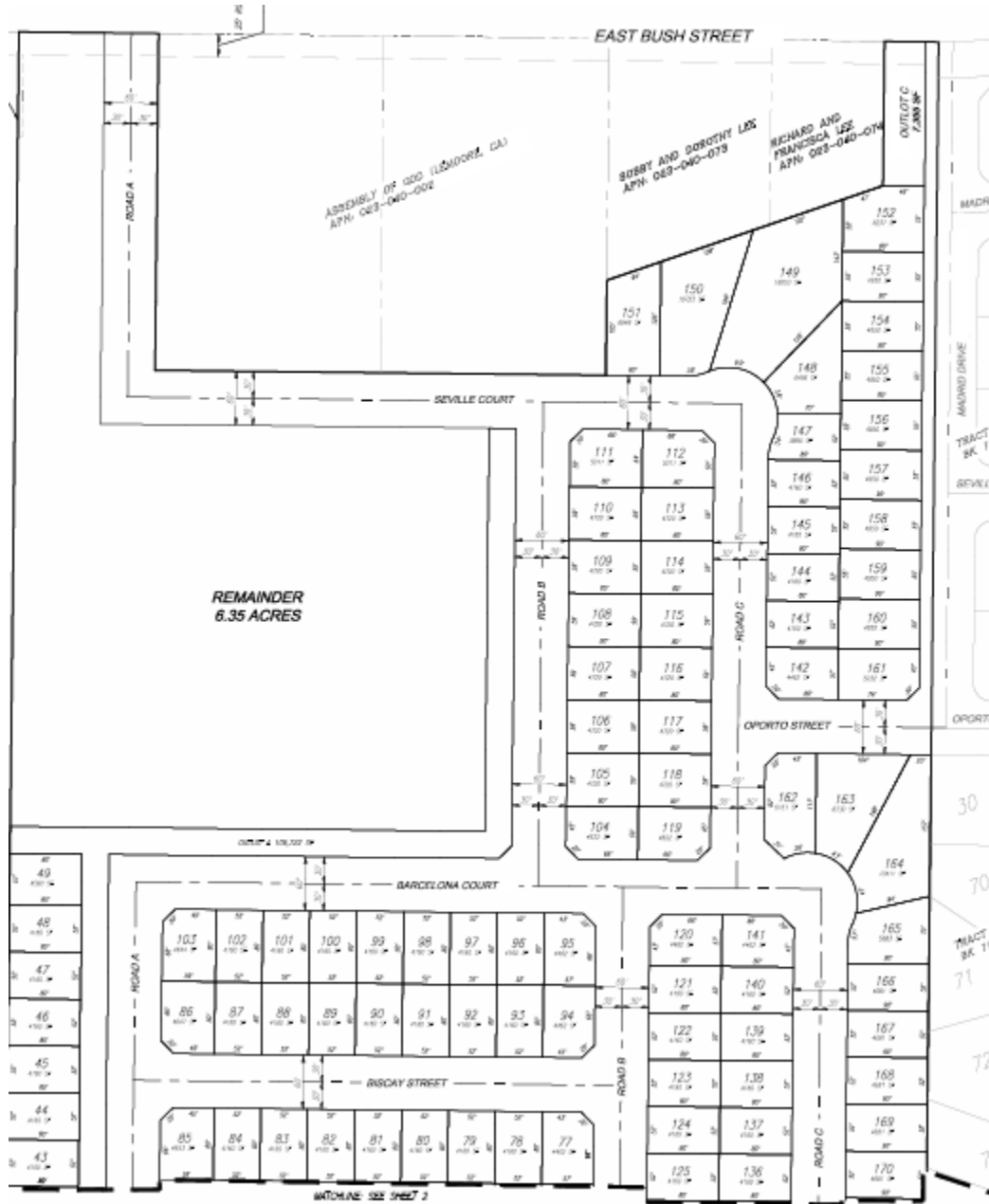

Exhibit B – Project Site Plan (2 of 2)

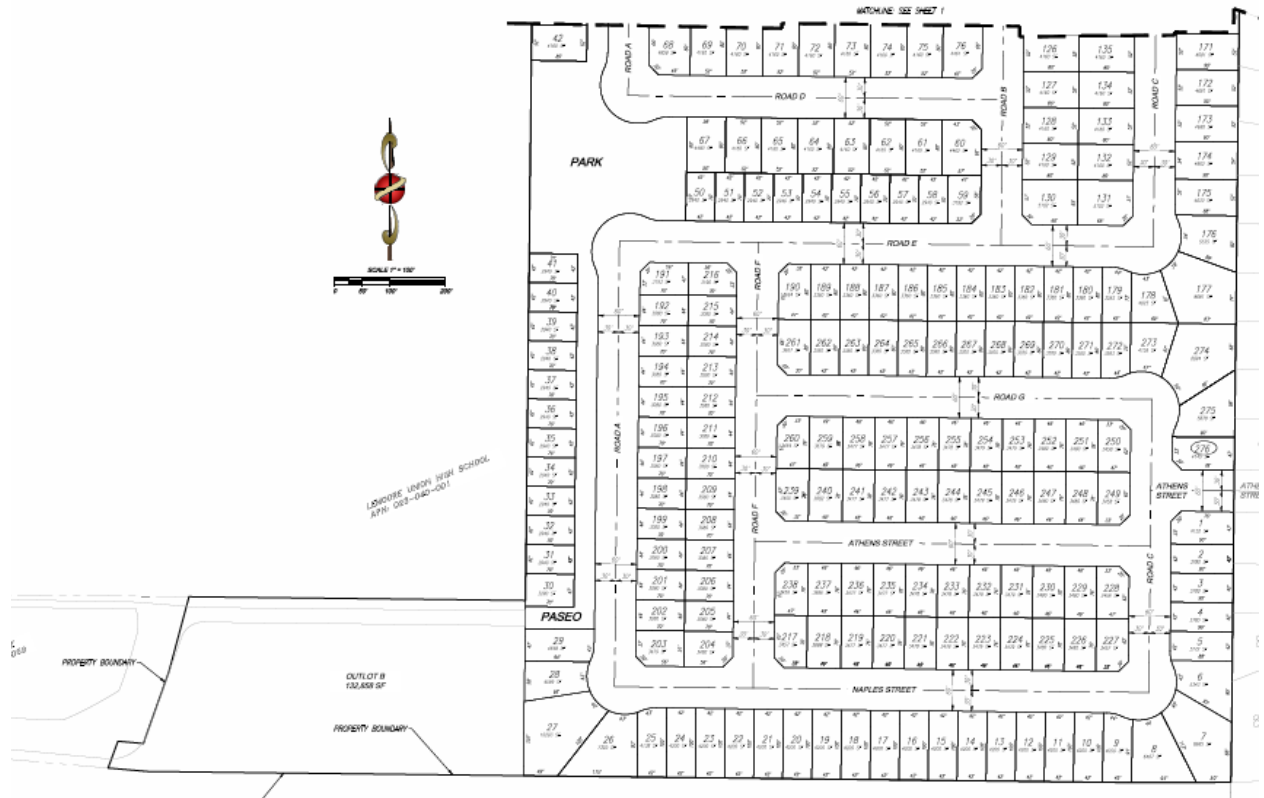
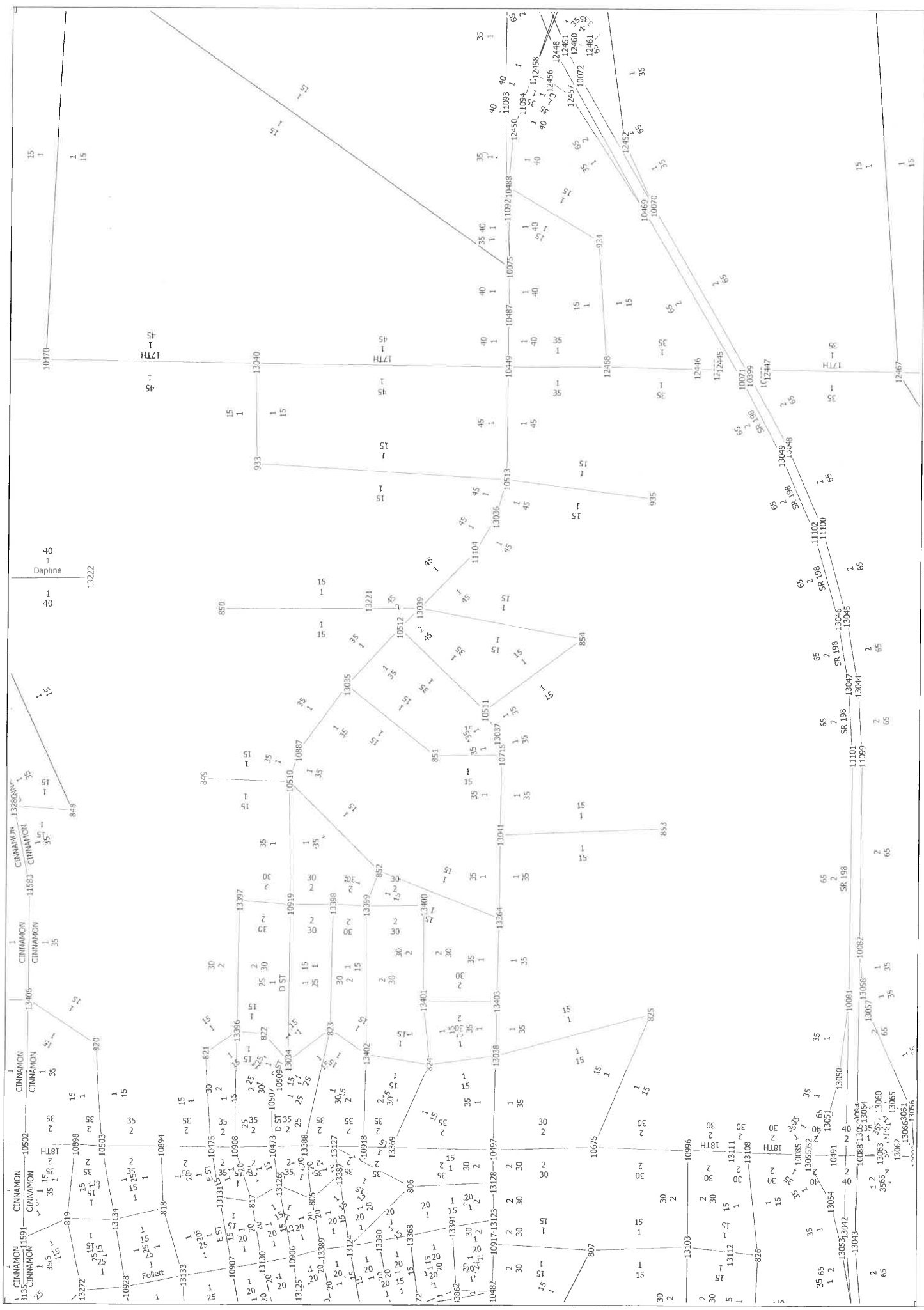

Exhibit C – Link and TAZ Modifications





TTM 22-021
 Base Year 2022
 Name, Lanes and Speed



(Licensed to JLB Traffic Engineering, Inc)

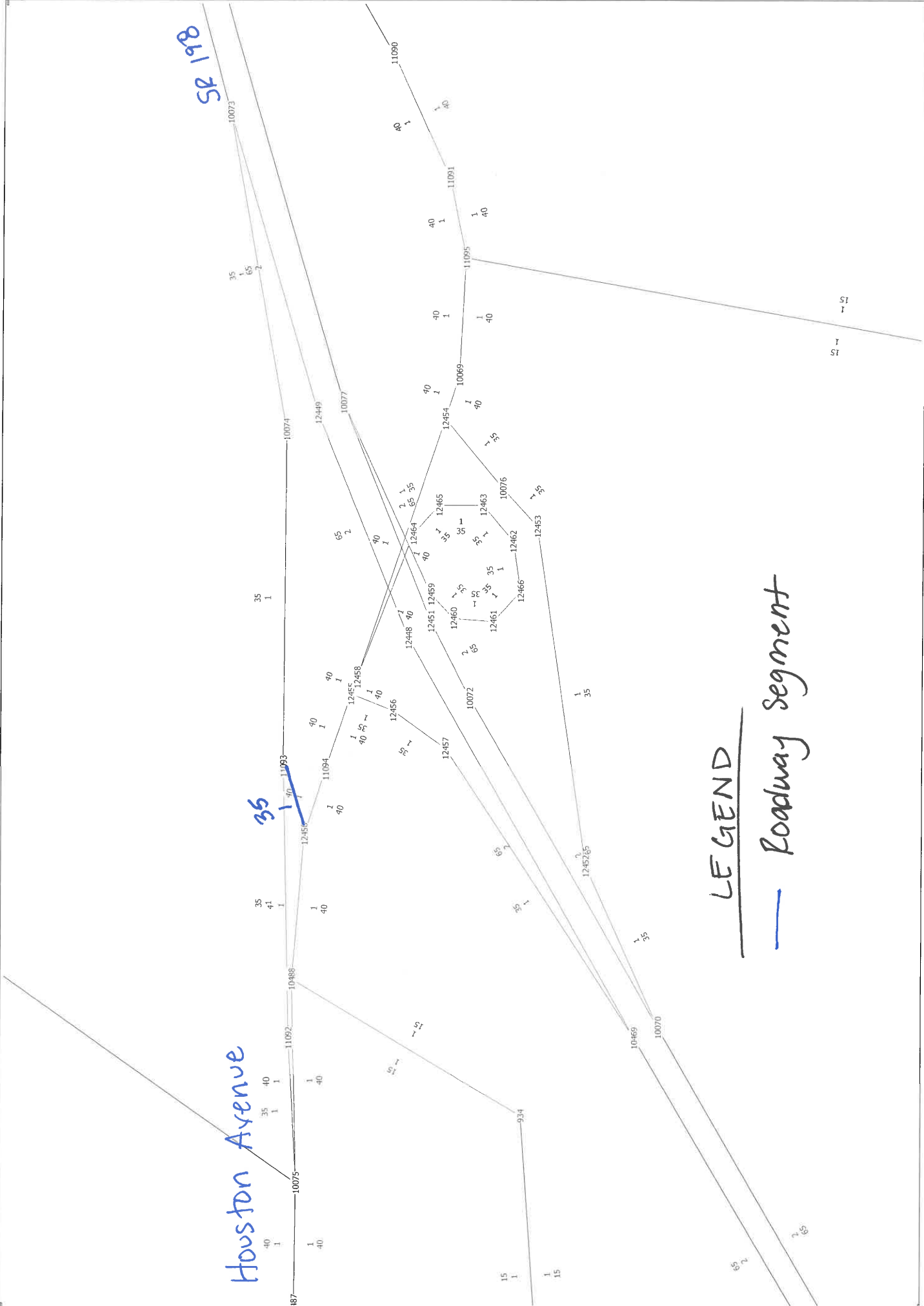

Houston Avenue

SR 198

35

LEGEND

— Roadway segment

TTM 22-021

Base Year 2022

Name, Lanes and Speed



(Licensed to JLB Traffic Engineering, Inc)

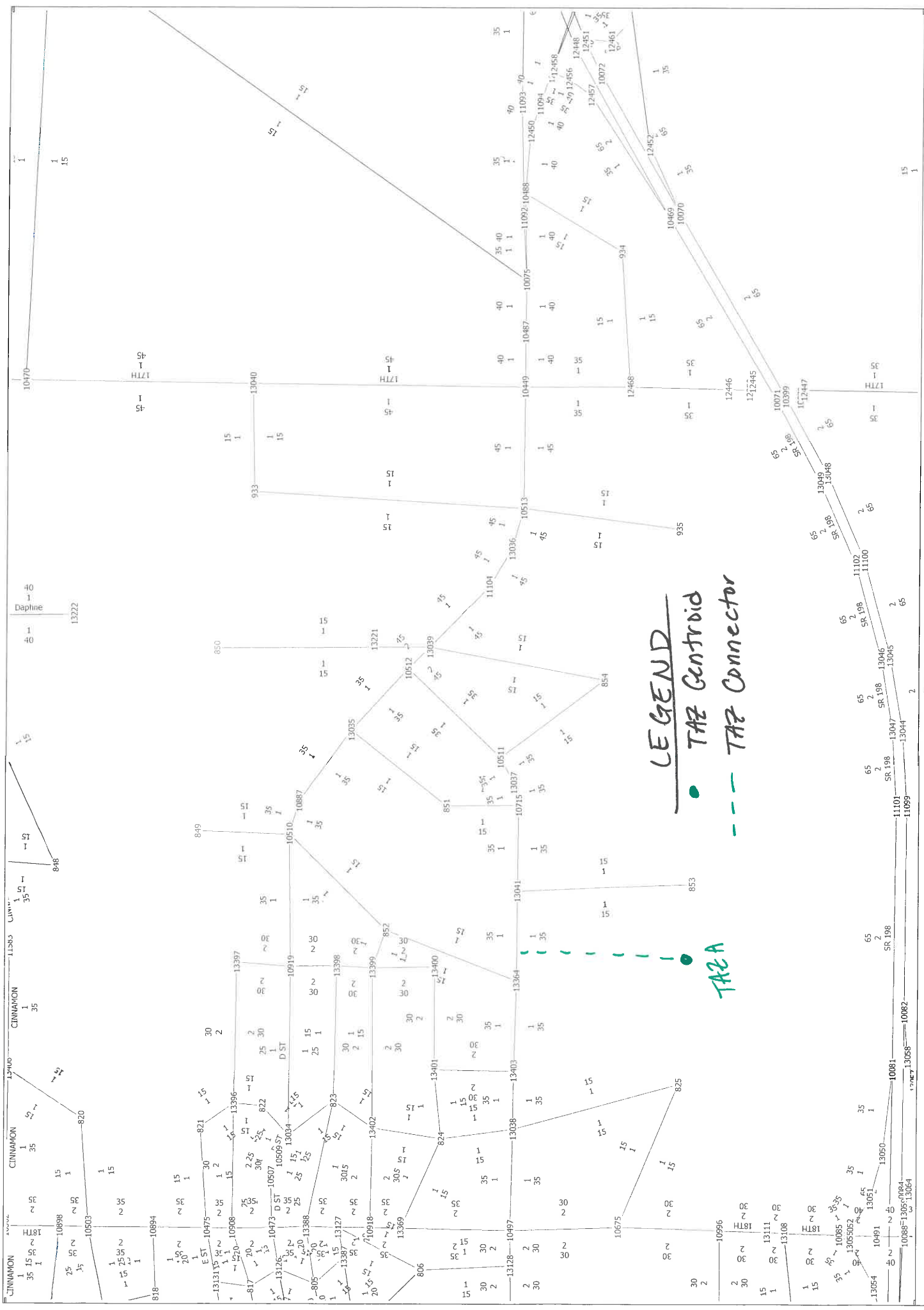

LEGEND

- TAZ Centroid
- TAZ Connector

TAZ A

TTM 22-021
 Cumulative Year 2042
 Name, Lanes and Speed



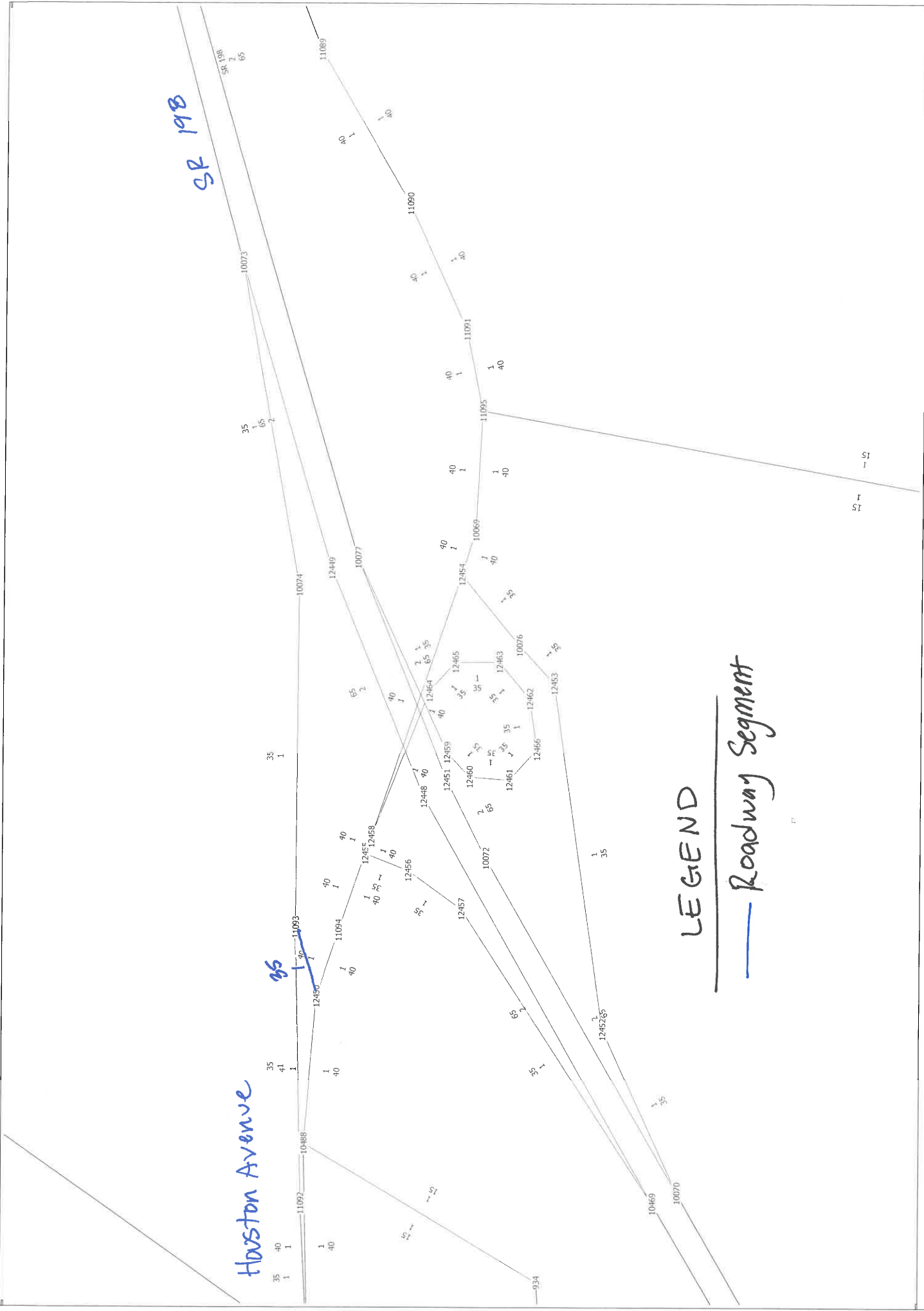

Houston Avenue

SR 19B

SR 95

LEGEND
 — Roadway Segment

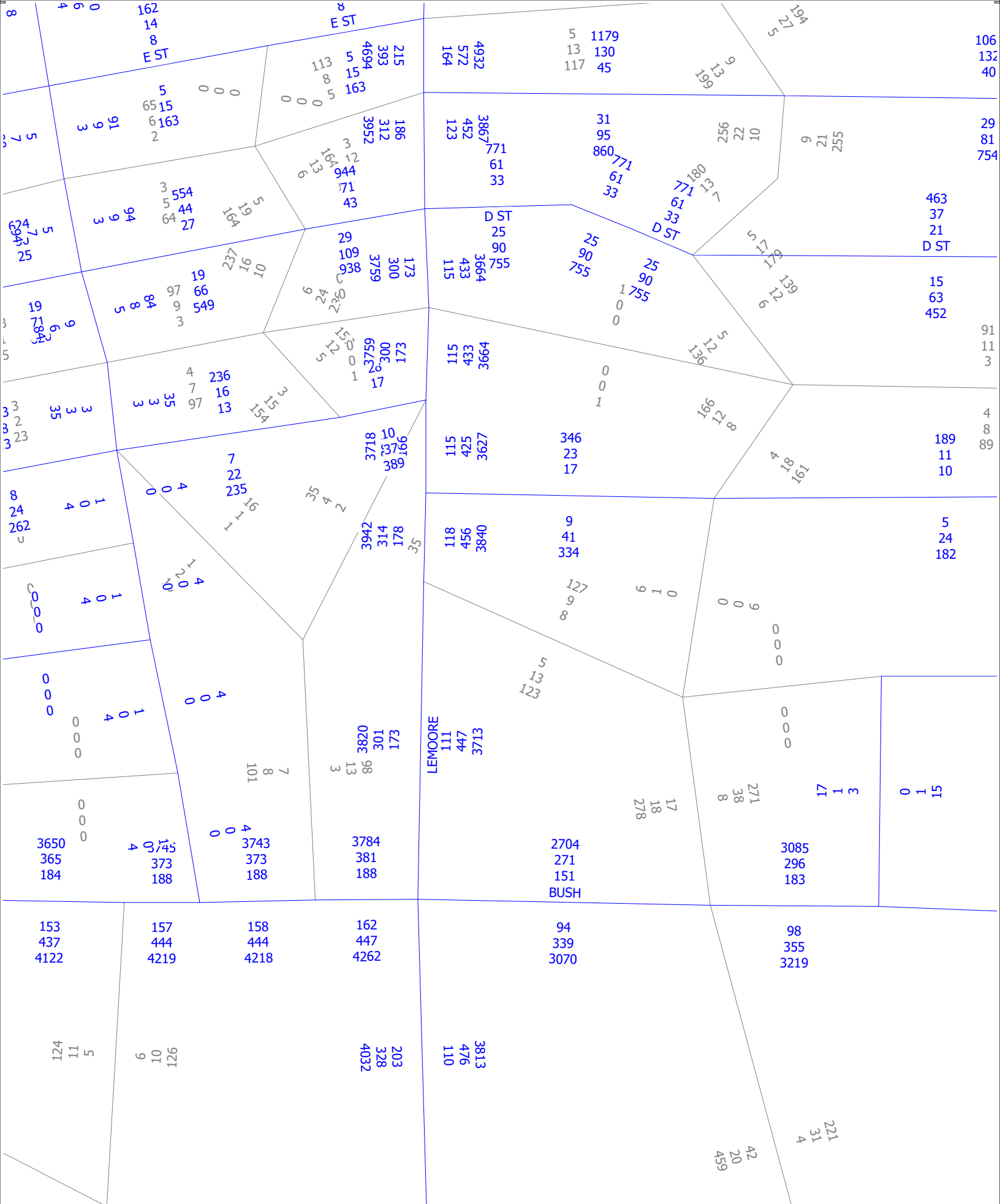

Base Year 2019
 TTM 22-021
 AM, PM and Daily Volumes



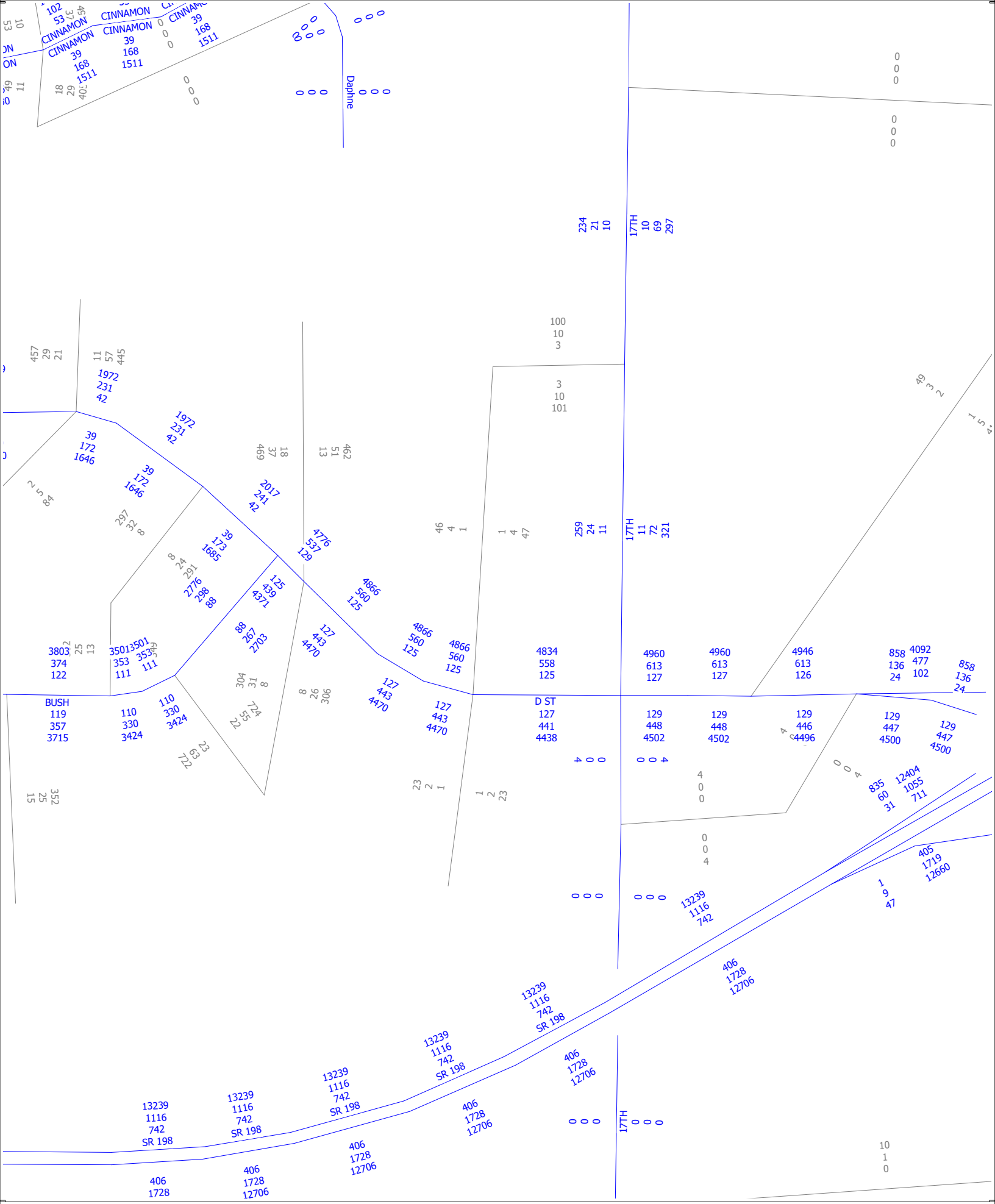

TTM 22-021
 Cumulative Year 2042
 AM, PM and Daily Volumes

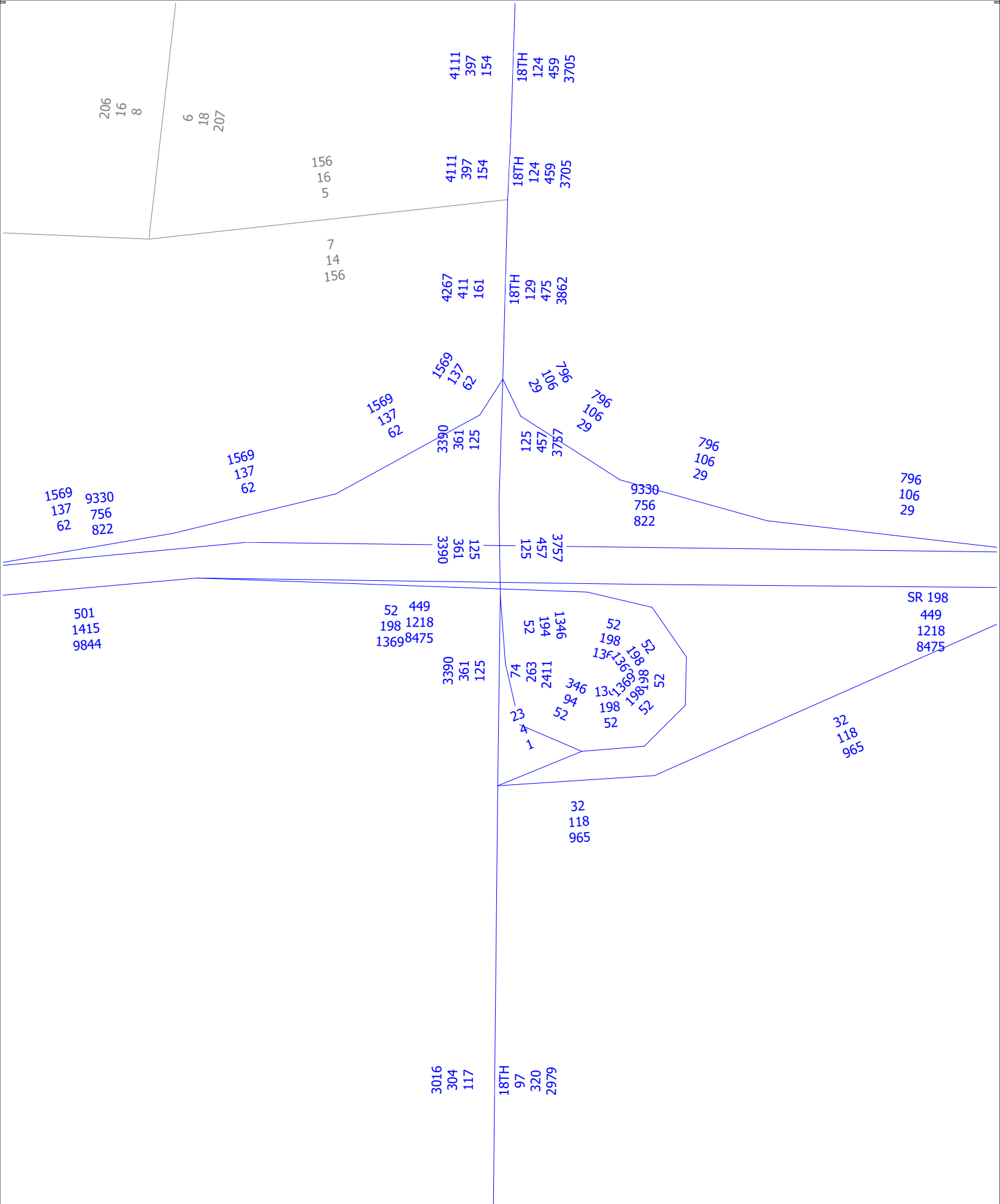

206
16
8

6
18
207

156
16
5

7
14
156

4111
397
154

4111
397
154

4267
411
161

18TH
124
459
3705

18TH
124
459
3705

18TH
129
475
3862

1569
137
62

62
601
694

1569
137
62

796
106
29

1569 9330
137 756
62 822

1569 9330
137 756
62 822

3390 361 125

125 457 3757

796 106 29

796 106 29

0666 3390 361 125

3757 457 125

501 1415 9844

52 449 198 1218 1369 8475

SR 198 449 1218 8475

3390 361 125

1346 194 52

52 198 136 136 198 52

74 1147 292

1346 198 52

23

32 118 965

32 118 965

3016 304 117

18TH 97 320 2979

Base Year 2019
TTM 22-021
AM, PM and Daily Volumes



(Licensed to JLB Traffic Engineering, Inc)

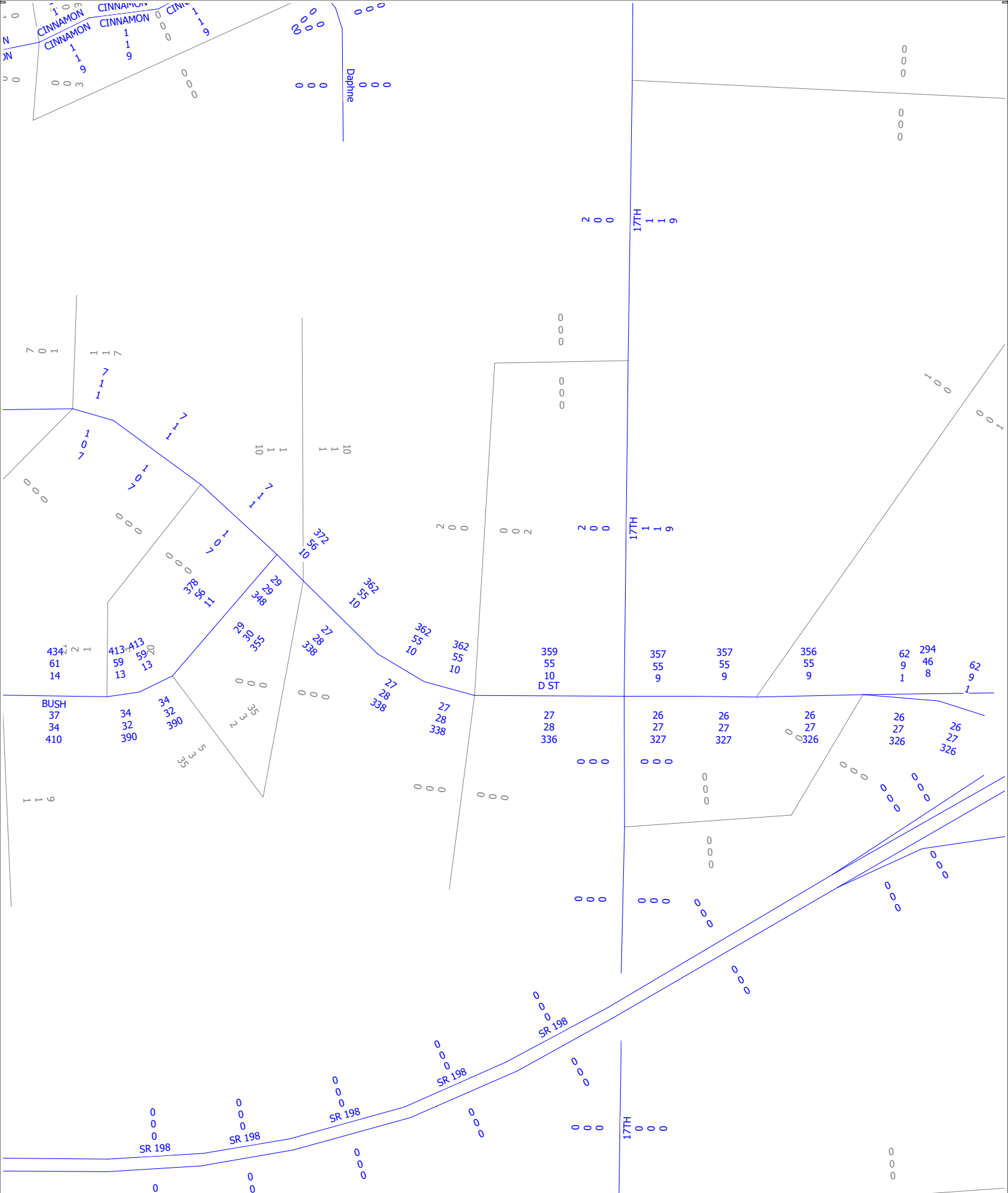

TTM 22-021
 Cumulative Year 2042
 Select Zone
 AM, PM and Daily Volumes



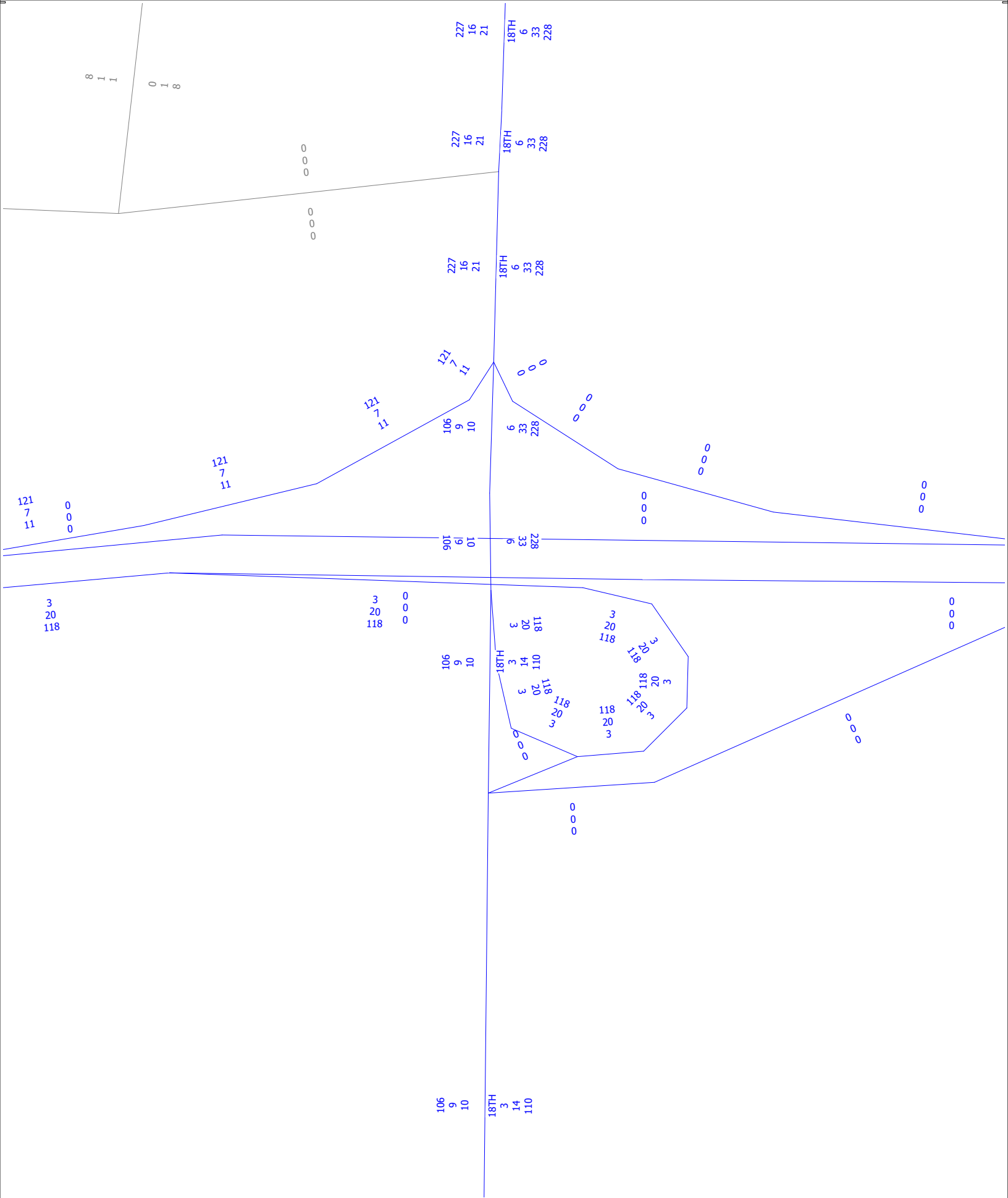

TTM 22-021
 Cumulative Year 2042
 Select Zone
 AM, PM and Daily Volumes



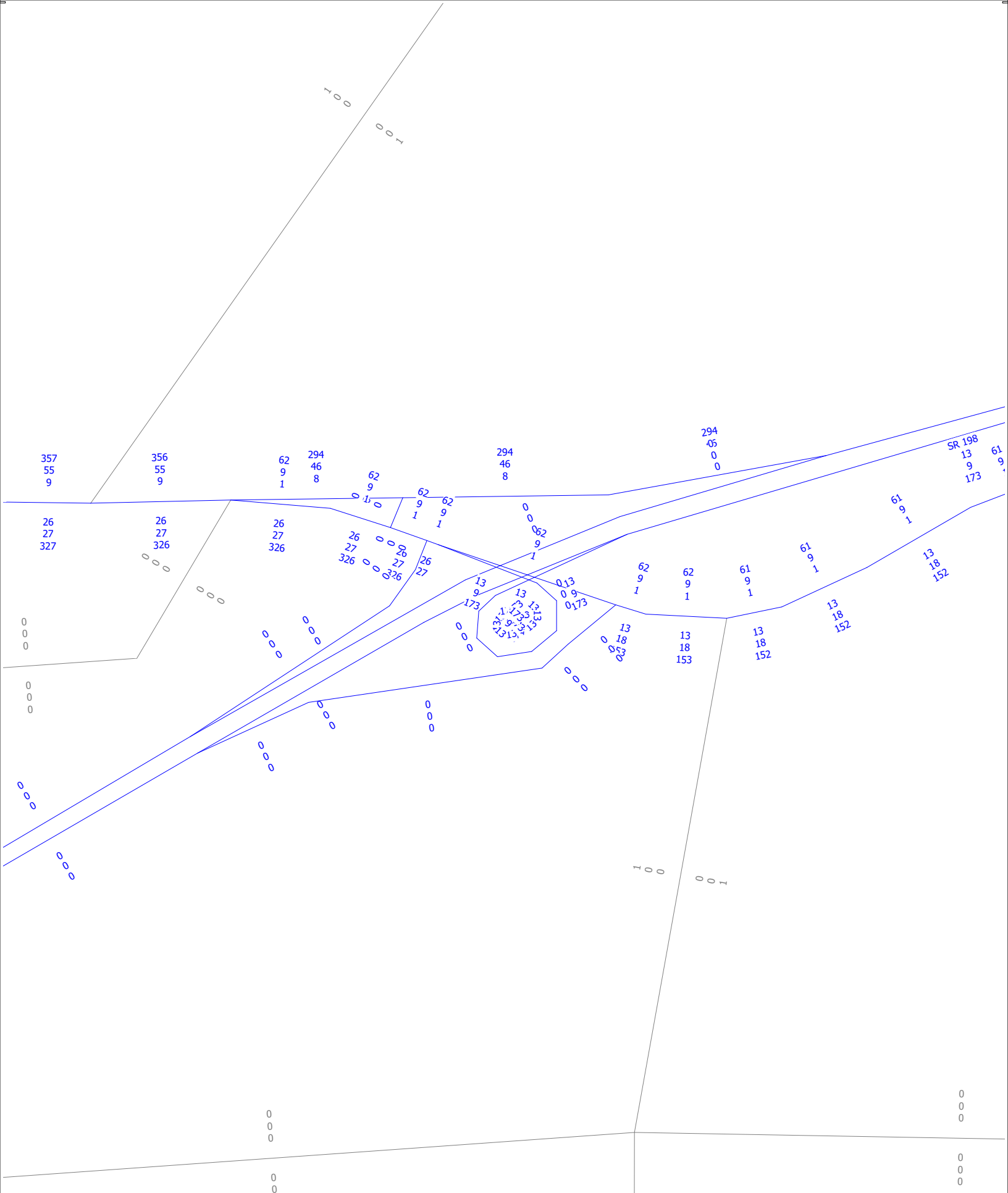

TTM 22-021
 Cumulative Year 2042
 Select Zone
 AM, PM and Daily Volumes



(Licensed to JLB Traffic Engineering, Inc)

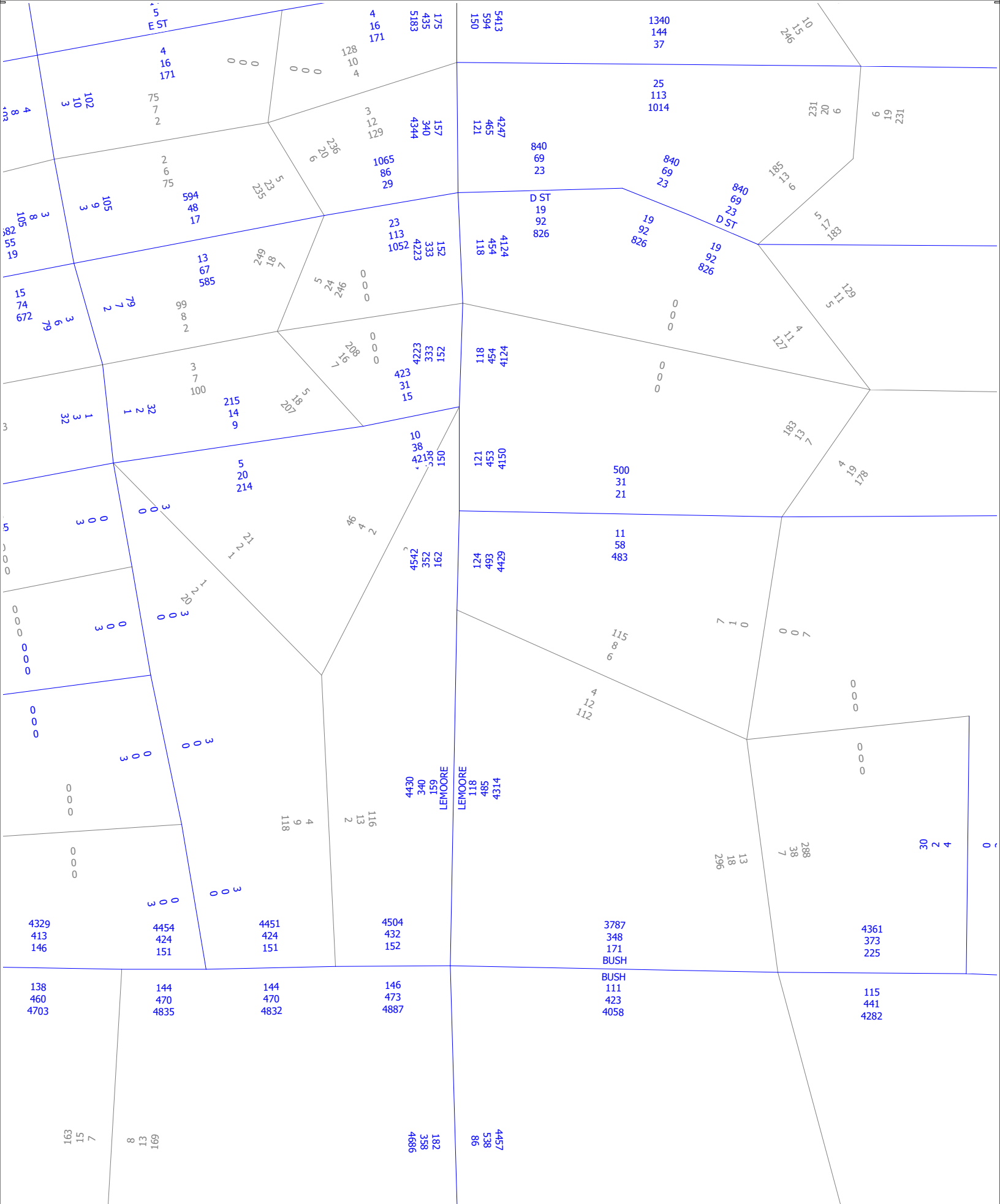

TTM 22-021
 Cumulative Year 2042
 AM, PM and Daily Volumes

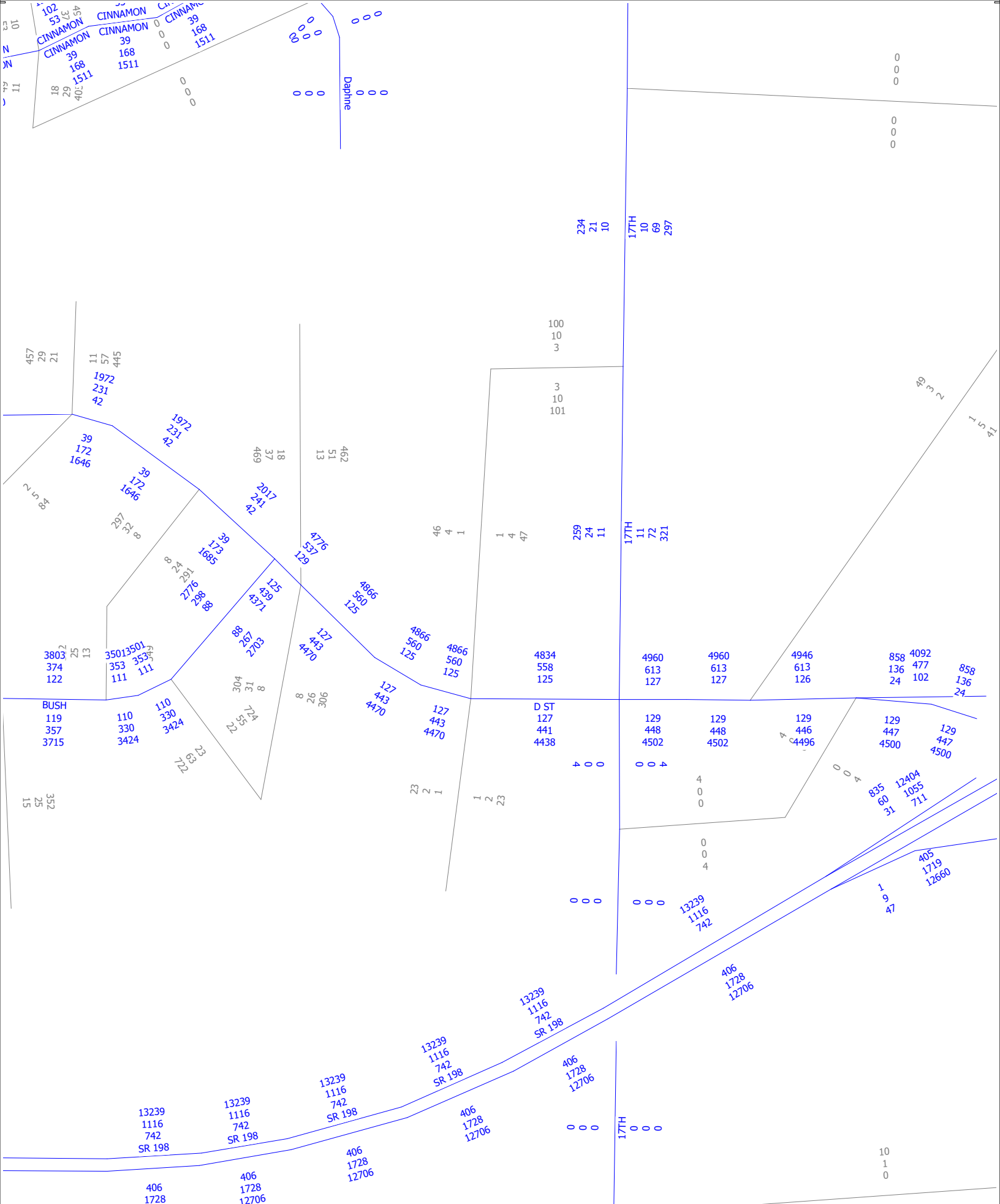

TTM 22-021
 Cumulative Year 2042
 AM, PM and Daily Volumes

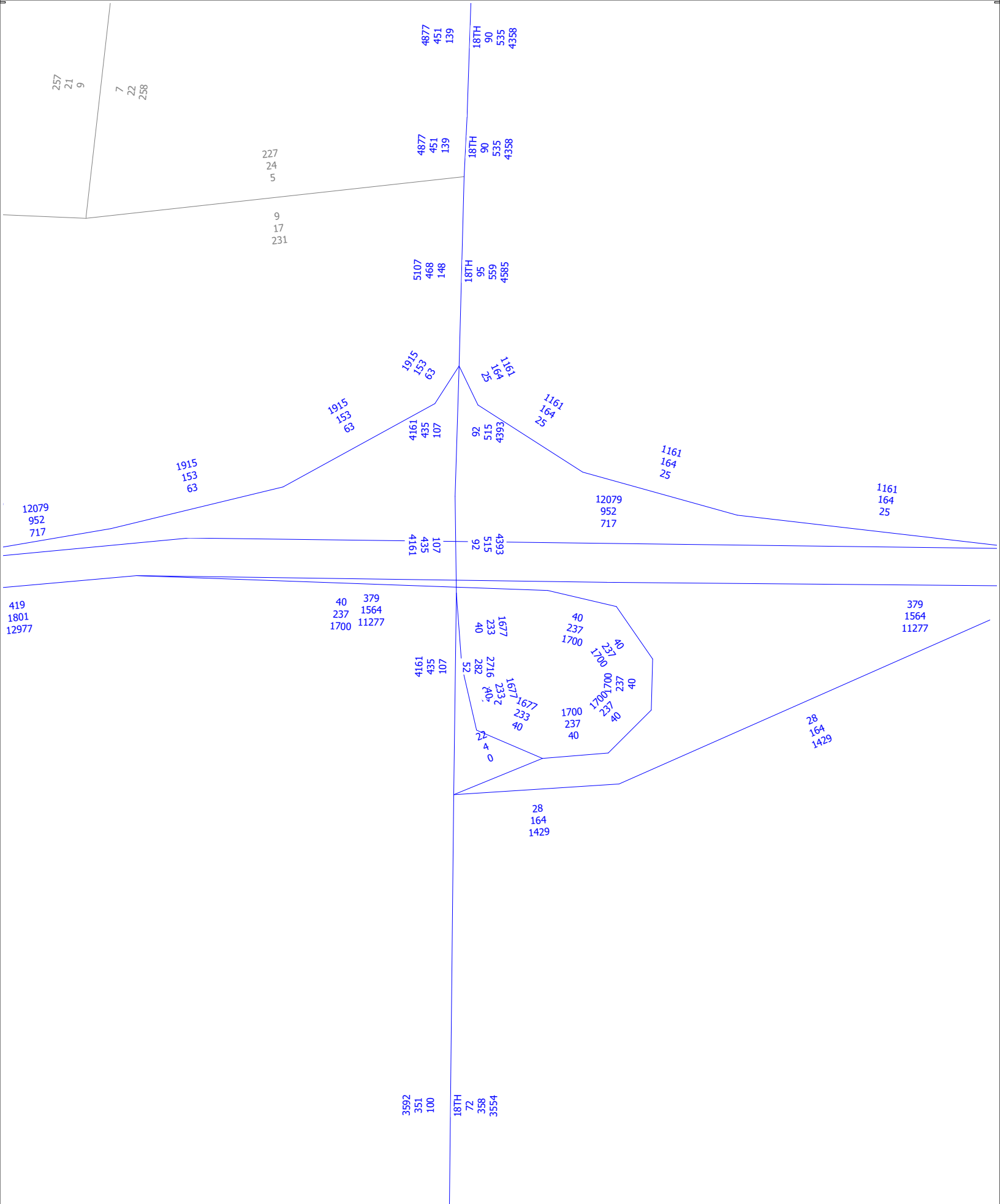

TTM 22-021
 Cumulative Year 2042
 AM, PM and Daily Volumes

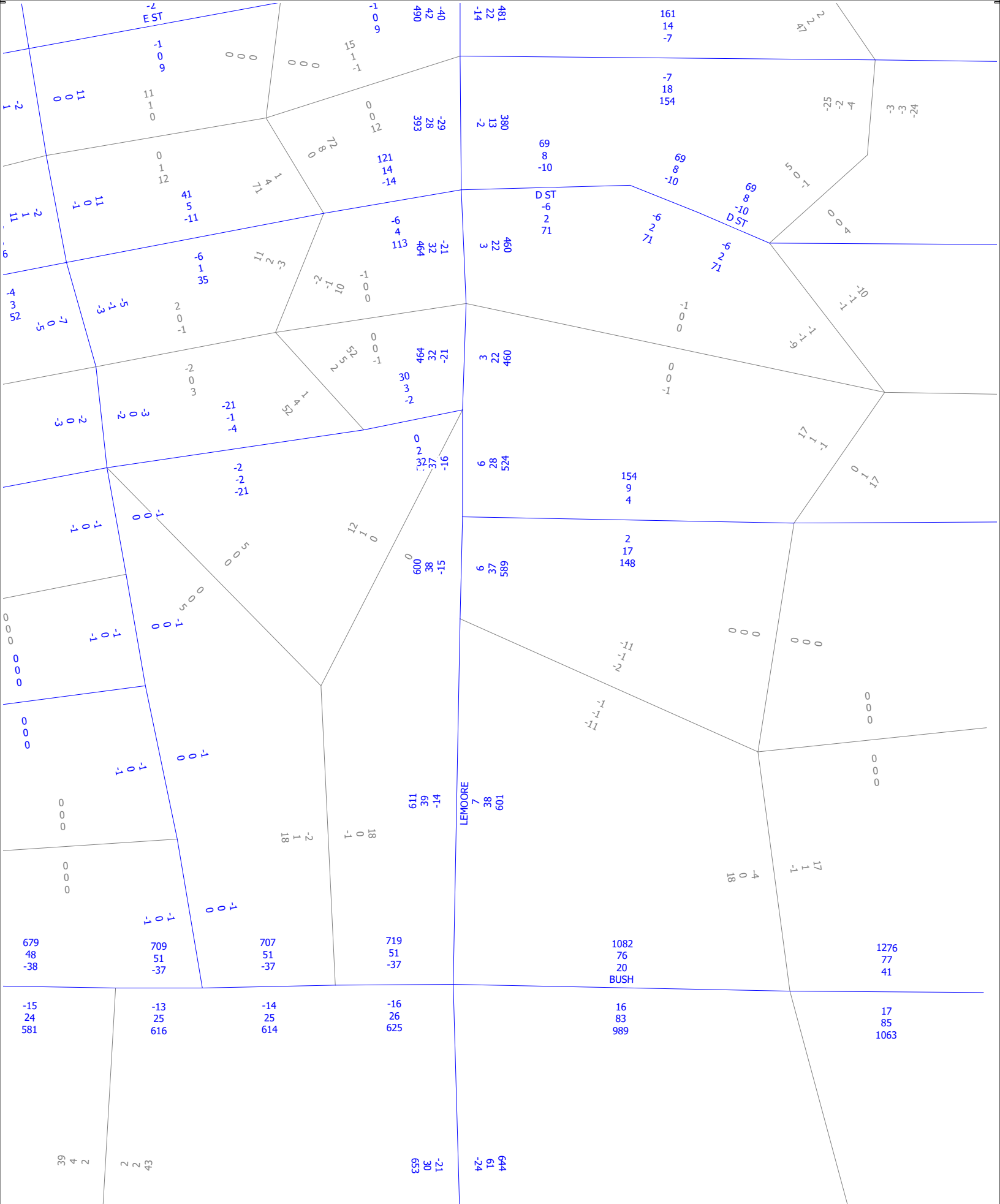

TTM 22-021
 2042 Increment
 AM, PM and Daily Volume



Appendix D: Methodology



www.JLBtraffic.com
info@JLBtraffic.com

516 W. Shaw Ave., Ste. 103
Fresno, CA 93704
(559) 570-8991

App | D

Levels of Service Methodology

The description and procedures for calculating capacity and level of service (LOS) are found in the Transportation Research Board, Highway Capacity Manual (HCM). The HCM 6th Edition represents the research on capacity and quality of service for transportation facilities.

Quality of service requires quantitative measures to characterize operational conditions within a traffic stream. Level of service is a quality measure describing operational conditions within a traffic stream, generally in terms of such service measures as speed and travel time, freedom to maneuver, traffic interruptions, comfort and convenience.

Six levels of service are defined for each type of facility that has analysis procedures available. Letters designate each level of service (LOS), from A to F, with LOS A representing the best operating conditions and LOS F the worst. Each LOS represents a range of operating conditions and the driver's perception of these conditions. Safety is not included in the measures that establish an LOS.

Intersection Levels of Service

One of the more important elements limiting and often interrupting the flow of traffic on a highway is the intersection. Flow on an interrupted facility is usually dominated by points of fixed operation such as traffic signals, stop signs and yield signs.

Signalized Intersections – Performance Measures

For signalized intersections, the performance measures include automobile volume-to-capacity ratio, automobile delay, queue storage length, ratio of pedestrian delay, pedestrian circulation area, pedestrian perception score, bicycle delay and bicycle perception score. LOS is also considered a performance measure. For the automobile mode, the average control delay per vehicle per approach is determined for the peak hour. A weighted average of control delay per vehicle is then determined for the intersection. An LOS designation is given to the weighted average control delay to better describe the level of operation. A description of LOS for signalized intersections is found in Table A-1.

Table A-1: Signalized Intersection Levels of Service Description (Automobile Mode)

<i>Level of Service</i>	<i>Description</i>	<i>Average Control Delay (Seconds per Vehicle)</i>
A	Operations with a control delay of 10 seconds/vehicle or less and a volume-to-capacity ratio no greater than 1.0. This level is typically assigned when the volume-to-capacity ratio is really low and either progression is exceptionally favorable or the cycle length is very short. If it's due to favorable progression, most vehicles arrive during the green indication and travel through the intersection without stopping.	≤10
B	Operations with control delay between 10.1 to 20.0 seconds/vehicle and a volume-to-capacity ratio no greater than 1.0. This level is typically assigned when the volume-to-capacity ratio is low and either progression is highly favorable or the cycle length is short. More vehicles stop than with LOS A.	>10.0 to 20.0
C	Operations with average control delays between 20.1 to 35.0 seconds/vehicle and a volume-to-capacity ratio no greater than 1.0. This level is typically assigned when the volume-to-capacity ratio no greater than 1.0, the progression is favorable or the cycle length is moderate. Individual cycle failures (i.e., one or more queued vehicles are not able to depart as a result of insufficient capacity during the cycle) may begin to appear at this level. The number of vehicles stopping is significant, although many vehicles still pass through the intersection without stopping.	>20 to 35
D	Operations with control delay between 35.1 to 55.0 seconds/vehicle and a volume-to-capacity ratio no greater than 1.0. This level is typically assigned when the volume-to-capacity ratio is high and either progression is ineffective or the cycle length is long. Many vehicles stop and individual cycle failures are noticeable.	>35 to 55
E	Operations with control delay between 55.1 to 80.0 seconds/vehicle and a volume-to-capacity ratio no greater than 1.0. This level is typically assigned when the volume-to-capacity ratio is high, progression is unfavorable and the cycle length is long. Individual cycle failures are frequent.	>55 to 80
F	Operations with unacceptable control delay exceeding 80.0 seconds/vehicle and a volume-to-capacity ratio greater than 1.0. This level is typically assigned when the volume-to-capacity ratio is very high, progression is very poor and the cycle length is long. Most cycles fail to clear the queue.	>80

Note: Source: Highway Capacity Manual 6th Edition

Unsignalized Intersections

The HCM 6th Edition procedures use control delay as a measure of effectiveness to determine level of service. Delay is a measure of driver discomfort, frustration, fuel consumption and increased travel time. The delay experienced by a motorist is made up of a number of factors that relate to control, traffic and incidents. Total delay is the difference between the travel time actually experienced and the reference travel time that would result during base conditions, i.e., in the absence of traffic control, geometric delay, any incidents and any other vehicles. Control delay is the increased time of travel for a vehicle approaching and passing through an unsignalized intersection, compared with a free-flow vehicle if it were not required to slow or stop at the intersection.



www.JLBtraffic.com
info@JLBtraffic.com

516 W. Shaw Ave., Ste. 103
Fresno, CA 93704
(559) 570-8991

All-Way Stop Controlled Intersections

All-way stop controlled intersections are a form of traffic controls in which all approaches to an intersection are required to stop. Similar to signalized intersections, at all-way stop controlled intersections the average control delay per vehicle per approach is determined for the peak hour. A weighted average of control delay per vehicle is then determined for the intersection as a whole. In other words, the delay measured for all-way stop controlled intersections is a measure of the average delay for all vehicles passing through the intersection during the peak hour. An LOS designation is given to the weighted average control delay to better describe the level of operation.

Two-Way Stop Controlled Intersections

Two-way stop controlled (TWSC) intersections in which stop signs are used to assign the right-of-way, are the most prevalent type of intersection in the United States. At TWSC intersections the stop-controlled approaches are referred to as the minor street approaches and can be either public streets or private driveways. The approaches that are not controlled by stop signs are referred to as the major street approaches.

The capacity of movements subject to delay are determined using the "critical gap" method of capacity analysis. Expected average control delay based on movement volume and movement capacity is calculated. An LOS for a TWSC intersection is determined by the computed or measured control delay for each minor movement. LOS is not defined for the intersection as a whole for three main reasons: (a) major-street through vehicles are assumed to experience zero delay; (b) the disproportionate number of major-street through vehicles at the typical TWSC intersection skews the weighted average of all movements, resulting in a very low overall average delay from all vehicles; and (c) the resulting low delay can mask important LOS deficiencies for minor movements. Table A-2 provides a description of LOS at unsignalized intersections.

Table A-2: Unsignalized Intersection Levels of Service Description (Automobile Mode)

<i>Control Delay (Seconds per Vehicle)</i>	<i>LOS by Volume-to-Capacity Ratio</i>	
	<i>v/c ≤ 1.0</i>	<i>v/c > 1.0</i>
≤10	A	F
>10 to 15	B	F
>15 to 25	C	F
>25 to 35	D	F
>35 to 50	E	F
>50	F	F

Note: Source: HCM 6th Edition, Exhibit 20-2.



www.JLBtraffic.com
info@JLBtraffic.com

516 W. Shaw Ave., Ste. 103
Fresno, CA 93704
(559) 570-8991

Roundabout Controlled Intersections

Roundabouts are intersections with a generally circular shape, characterized by yield on entry and circulation around a central island. Roundabouts have been used successfully throughout the world and are being used increasingly in the United States, especially since 1990. The procedure used to calculate LOS incorporates a combination of lane-based regression models and gap acceptance models for both single-lane and multi-lane roundabouts. As a result, the capacity models focus on one entry of a roundabout at a time. Table A-3 provides a description of LOS at roundabout intersections.

Table A-3: Roundabout Intersection Level of Service Description (Automobile Mode)

Control Delay (Seconds per Vehicle)	LOS by Volume-to-Capacity Ratio	
	$v/c \leq 1.0$	$v/c > 1.0$
≤10	A	F
>10 to 15	B	F
>15 to 25	C	F
>25 to 35	D	F
>35 to 50	E	F
>50	F	F

Note: Source: HCM 6th Edition, Exhibit 22-8.

Segment Levels of Service

Segments are portions of roads without any interruption of flow. These are typically studied as urban streets, basic freeways, multilane highways or two-lane highways. Each of these categories has further classification and the level of service analysis can differ between them.

Basic Freeway and Multilane Highway Segments

For segments of multilane highways and basic freeways outside the influence of merging, diverging and weaving maneuvers, LOS is defined by density. Density describes a motorist's proximity to other vehicles and is related to a motorist's freedom to maneuver within the traffic stream. Chapter 12 of the Highway Capacity Manual categorizes each LOS as follows:

LOS A describes free-flow operations. FFS prevails on the freeway or multilane highway, and vehicles are almost completely unimpeded in their ability to maneuver within the traffic stream. The effects of incidents or point breakdowns are easily absorbed.

LOS B represents reasonably free-flow operations, and FFS on the freeway or multilane highway is maintained. The ability to maneuver within the traffic stream is only slightly restricted, and the general level of physical and psychological comfort provided to drivers is still high. The effects of minor incidents are still easily absorbed.

LOS C provides for flow with speeds near the FFS of the freeway or multilane highway. Freedom to maneuver within the traffic stream is noticeably restricted, and lane changes require more care and vigilance on the part of the driver. Minor incidents may still be absorbed, but the local deterioration in service quality will be significant. Queues may be expected to form behind any significant blockages.

LOS D is the level at which speeds begin to decline with increasing flows, with density increasing more quickly. Freedom to maneuver within the traffic stream is seriously limited, and drivers experience reduced physical and psychological comfort levels. Even minor incidents can be expected to create queuing, because the traffic stream has little space to absorb disruptions.

LOS E describes operation at or near capacity. Operations on the freeway or multilane highway at this level are highly volatile because there are virtually no usable gaps within the traffic stream, leaving little room to maneuver within the traffic stream. Any disruption to the traffic stream, such as vehicles entering from a ramp or an access point or a vehicle changing lanes, can establish a disruption wave that propagates throughout the upstream traffic stream. Toward the upper boundary of LOS E, the traffic stream has no ability to dissipate even the most minor disruption, and any incident can be expected to produce a serious breakdown and substantial queuing. The physical and psychological comfort afforded to drivers is poor.

LOS F describes unstable flow. Such conditions exist within queues forming behind bottlenecks. Breakdowns occur for a number of reasons:

- Traffic incidents can temporarily reduce the capacity of a short segment so that the number of vehicles arriving at a point is greater than the number of vehicles that can move through it.
- Points of recurring congestion, such as merge or weaving segments and lane drops, experience very high demand in which the number of vehicles arriving is greater than the number of vehicles that can be discharged.
- In analyses using forecast volumes, the projected flow rate can exceed the estimated capacity of a given location.

Basic Freeway

Basic Freeway segments generally have four to eight lanes and posted speed limits between 50 and 75 mi/hr. The performance measures include capacity, free flow speed, demand and volume-to-capacity ratio, space mean speed, average density and LOS. The LOS is dependent on the number of lanes, base free-flow speed, lane width, right side lateral clearance, total ramp density, hourly demand volume, peak hour factor and total truck percentage. Table A-4 provides a description of LOS for Basic Freeway Segments.

Multilane Highway

Multilane Highway segments generally have four to six lanes and posted speed limits between 40 and 55 mi/hr. The performance measures include capacity, free flow speed, demand and volume-to-capacity ratio, space mean speed, average density and LOS. The LOS is dependent on the number of lanes, base free-flow speed, lane width, right side lateral clearance, left side lateral clearance, access point density, terrain type, median type, hourly demand volume, peak hour factor and total truck percentage. Table A-4 provides a description of LOS for Multilane Highway Segments.

Table A-4: Basic Freeway and Multilane Highway Segment Level of Service Description

<i>Level of Service</i>	<i>Density (Passenger Cars per Mile per Lane)</i>
A	≤11
B	>11 to 18
C	>18 to 26
D	>26 to 35
E	>35 to 45
F	>45 or Demand Exceeds Capacity

Note: Source: HCM 6th Edition, Exhibit 12-15.



www.JLBtraffic.com
info@JLBtraffic.com

516 W. Shaw Ave., Ste. 103
Fresno, CA 93704
(559) 570-8991

Two-Lane Highway Segments

Two-Lane Highways generally have one lane per direction and only allow passing maneuvers to take place in the opposing lane of traffic. If allowed, passing maneuvers are limited by the availability of gaps in the opposing traffic stream and by the availability of sufficient sight distance for a driver to discern the approach of an opposing vehicle safely. A principal measure of LOS is percent time spent following and follower density. This is the average percent of time that vehicles must travel in platoons behind slower vehicles due to the inability to pass. Chapter 15 of the Highway Capacity Manual categorizes each LOS as follows:

At **LOS A**, motorists experience high operating speeds on Class I highways and little difficulty in passing. Platoons of three or more vehicles are rare. On Class II highways, speed is controlled primarily by roadway conditions, but a small amount of platooning would be expected. On Class III highways, motorists can maintain operating speeds at or near the facility's FFS.

At **LOS B**, passing demand and passing capacity are balanced. On both Class I and Class II highways, the degree of platooning becomes noticeable. Some speed reductions are present on Class I highways. On Class III highways, maintenance of FFS operation becomes difficult, but the speed reduction is still relatively small.

At **LOS C**, most vehicles travel in platoons. Speeds are noticeably curtailed on all three classes of highways.

At **LOS D**, platooning increases significantly. Passing demand is high on both Class I and Class II facilities, but passing capacity approaches zero. A high percentage of vehicles travels in platoons, and PTSF is noticeable. On Class III highways, the fall-off from FFS is significant.

At **LOS E**, demand is approaching capacity. Passing on Class I and II highways is virtually impossible, and PTSF is more than 80%. Speeds are seriously curtailed. On Class III highways, speed is less than two-thirds of the FFS. The lower limit of LOSE represents capacity.

LOS F exists whenever demand flow in one or both directions exceeds the segment's capacity. Operating conditions are unstable and heavy congestion exists on all classes of two-lane highways.

Two-Lane Highway

The performance measures include average travel speed, segment travel time, percent followers, volume to capacity ratio, follower density and LOS. The LOS is dependent on Highway Class (I, II, or III), lane width, shoulder width, access point density, terrain type, free flow speed, passing lane length, demand flow rate, opposing demand flow rate peak hour factor and total truck percentage. Tables A-5 and A-6 provide a description of LOS for Two-Lane Highway Segments.

Table A-5: Two-Lane Highway Segment Level of Service Description

LOS	Class I Highways		Class II Highways	Class III Highways
	ATS (Mile per Hour)	PTSF (%)	PTSF (%)	PFFS (%)
A	>55	≤35	≤40	>91.7
B	>50 to 55	>35 to 50	>40 to 55	>83.3 to 91.7
C	>45 to 50	>50 to 65	>55 to 70	>75.0 to 83.3
D	>40 to 45	>65 to 80	>70 to 85	>66.7 to 75.0
E	≤40	>80	>85	≤66.7
F	Demand exceeds capacity			

Note: ATS = Average Travel Speed
 PTSF = Percent Time Spent Following
 PFFS = Percent of Free Flow Speed
 Source: HCM 6th Edition, Exhibit 15-3.

Table A-6: Two-Lane Highway Segment Level of Service Description

LOS	Follower Density (Followers per Mile per Lane)	
	High Speed Highways Posted Speed Limit ≥ 50 miles per hour	High Speed Highways Posted Speed Limit < 50 miles per hour
	A	≤2.0
B	>2.0 to 4.0	>2.5 to 5.0
C	>4.0 to 8.0	>5.0 to 10.0
D	>8.0 to 12.0	>10.0 to 15.0
E	>12.0	>15.0

Note: Source: NCHRP 'Improved Analysis of Two-Lane Highway Capacity and Operational Performance, Table 3-23.



www.JLBtraffic.com
 info@JLBtraffic.com

516 W. Shaw Ave., Ste. 103
 Fresno, CA 93704
 (559) 570-8991

Urban Streets (Automobile Mode)

The term “urban streets” refers to urban arterials and collectors, including those in downtown areas. Arterial streets are roads that primarily serve longer through trips. However, providing access to abutting commercial and residential land uses is also an important function of arterials. Collector streets provide both land access and traffic circulation within residential, commercial and industrial areas. Their access function is more important than that of arterials and unlike arterials their operation is not always dominated by traffic signals. Downtown streets are signalized facilities that often resemble arterials.

They not only move through traffic but also provide access to local businesses for passenger cars, transit buses and trucks. Pedestrian conflicts and lane obstructions created by stopping or standing taxicabs, buses, trucks and parking vehicles that cause turbulence in the traffic flow are typical of downtown streets.

Flow Characteristics

The speed of vehicles on urban streets is influenced by three main factors, street environment, interaction among vehicles and traffic control.

The street environment includes the geometric characteristics of the facility, the character of roadside activity and adjacent land uses. Thus, the environment reflects the number and width of lanes, type of median, driveway/access point density, spacing between signalized intersections, existence of parking, level of pedestrian and bicyclist activity and speed limit.

The interaction among vehicles is determined by traffic density, the proportion of trucks and buses and turning movements. This interaction affects the operation of vehicles at intersections and, to a lesser extent, between signals.

Traffic controls (including signals and signs) force a portion of all vehicles to slow or stop. The delays and speed changes caused by traffic control devices reduce vehicle speeds; however, such controls are needed to establish right-of-way.



www.JLBtraffic.com
info@JLBtraffic.com

516 W. Shaw Ave., Ste. 103
Fresno, CA 93704
(559) 570-8991

Urban Street Segments LOS

The average travel speed for through vehicles along an urban street is the determinant of the operating level of service (LOS). The travel speed along a segment, section or entire length of an urban street is dependent on the running speed between signalized intersections and the amount of control delay incurred at signalized intersections. Table A-7 provides a description of LOS for Urban Street Segments.

LOS A describes primarily free-flow operation. Vehicles are completely unimpeded in their ability to maneuver within the traffic stream. Control delay at signalized intersections is minimal. Travel speeds exceed 80 percent of the base free flow speed (FFS).

LOS B describes reasonably unimpeded operation. The ability to maneuver within the traffic stream is only slightly restricted and control delay at the boundary intersections is not significant. The travel speed is between 67 and 80 percent of the base FFS.

LOS C describes stable operations. The ability to maneuver and change lanes in midblock location may be more restricted than at LOS B. Longer queues at the boundary intersections may contribute to lower travel speeds. The travel speed is between 50 and 67 percent of the base FFS.

LOS D indicates a less stable condition in which small increases in flow may cause substantial increases in delay and decreases in travel speed. This operation may be due to adverse signal progression, high volumes or inappropriate signal timing at the boundary intersections. The travel speed is between 40 and 50 percent of the base FFS.

LOS E is characterized as an unstable operation and has significant delay. Such operations may be due to some combination of adverse progression, high volume and inappropriate signal timing at the boundary intersections. The travel speed is between 30 and 40 percent of the base FFS.

LOS F is characterized by street flow at extremely low speed. Congestion is likely occurring at the boundary intersections, as indicated by high delay and extensive queuing. The travel speed is 30 percent or less of the base FFS.

Table A-7: Urban Street Levels of Service (Automobile Mode)

LOS	Travel Speed Threshold by Base Free-Flow Speed (miles/hour)							Volume-to-Capacity Ratio
	55	50	45	40	35	30	25	
A	>44	>40	>36	>32	>28	>24	>20	≤ 1.0
B	>37	>34	>30	>27	>23	>20	>17	
C	>28	>25	>23	>20	>18	>15	>13	
D	>22	>20	>18	>16	>14	>12	>10	
E	>17	>15	>14	>12	>11	>9	>8	
F	≤17	≤15	≤14	≤12	≤11	≤9	≤8	
F	Any							> 1.0

Note: a = The Critical volume-to-capacity ratio is based on consideration of the through movement-to-capacity ratio at each boundary intersection in the subject direction of travel. The critical volume-to-capacity ratio is the largest ratio of those considered.
Source: Highway Capacity Manual 6th Edition, Exhibit 16-3.



www.JLBtraffic.com
info@JLBtraffic.com

516 W. Shaw Ave., Ste. 103
Fresno, CA 93704
(559) 570-8991

Appendix E: Existing Traffic Conditions



www.JLBtraffic.com
info@JLBtraffic.com

516 W. Shaw Ave., Ste. 103
Fresno, CA 93704
(559) 570-8991

A p p | E

HCM 6th Signalized Intersection Summary
1: Lemoore Avenue & D Street

Existing AM Peak
10/25/2022



Movement	EBL	EBT	EBR	WBL	WBT	WBR	NBL	NBT	NBR	SBL	SBT	SBR
Lane Configurations	↖	↗		↖	↖	↗	↖	↖↗		↖	↖↗	
Traffic Volume (veh/h)	57	111	40	50	173	174	40	451	45	170	595	65
Future Volume (veh/h)	57	111	40	50	173	174	40	451	45	170	595	65
Initial Q (Qb), veh	0	0	0	0	0	0	0	0	0	0	0	0
Ped-Bike Adj(A_pbT)	1.00		0.99	1.00		0.99	1.00		0.94	1.00		0.95
Parking Bus, Adj	1.00	1.00	1.00	1.00	1.00	1.00	1.00	1.00	1.00	1.00	1.00	1.00
Work Zone On Approach		No			No			No			No	
Adj Sat Flow, veh/h/ln	1856	1856	1856	1856	1856	1856	1856	1856	1856	1856	1856	1856
Adj Flow Rate, veh/h	66	129	47	58	201	202	47	524	52	198	692	76
Peak Hour Factor	0.86	0.86	0.86	0.86	0.86	0.86	0.86	0.86	0.86	0.86	0.86	0.86
Percent Heavy Veh, %	3	3	3	3	3	3	3	3	3	3	3	3
Cap, veh/h	149	271	99	139	379	317	122	1005	99	241	1208	132
Arrive On Green	0.08	0.21	0.21	0.08	0.20	0.20	0.07	0.31	0.31	0.14	0.38	0.38
Sat Flow, veh/h	1767	1292	471	1767	1856	1549	1767	3219	318	1767	3184	349
Grp Volume(v), veh/h	66	0	176	58	201	202	47	286	290	198	383	385
Grp Sat Flow(s),veh/h/ln	1767	0	1763	1767	1856	1549	1767	1763	1774	1767	1763	1771
Q Serve(g_s), s	2.3	0.0	5.6	2.0	6.2	7.6	1.6	8.5	8.6	7.0	11.0	11.0
Cycle Q Clear(g_c), s	2.3	0.0	5.6	2.0	6.2	7.6	1.6	8.5	8.6	7.0	11.0	11.0
Prop In Lane	1.00		0.27	1.00		1.00	1.00		0.18	1.00		0.20
Lane Grp Cap(c), veh/h	149	0	370	139	379	317	122	550	554	241	669	672
V/C Ratio(X)	0.44	0.00	0.48	0.42	0.53	0.64	0.38	0.52	0.52	0.82	0.57	0.57
Avail Cap(c_a), veh/h	244	0	690	216	697	582	216	734	739	244	762	765
HCM Platoon Ratio	1.00	1.00	1.00	1.00	1.00	1.00	1.00	1.00	1.00	1.00	1.00	1.00
Upstream Filter(I)	1.00	0.00	1.00	1.00	1.00	1.00	1.00	1.00	1.00	1.00	1.00	1.00
Uniform Delay (d), s/veh	27.8	0.0	22.1	28.0	22.7	23.2	28.4	18.0	18.1	26.8	15.7	15.7
Incr Delay (d2), s/veh	2.1	0.0	0.9	2.0	1.2	2.1	2.0	0.8	0.8	19.7	0.8	0.8
Initial Q Delay(d3),s/veh	0.0	0.0	0.0	0.0	0.0	0.0	0.0	0.0	0.0	0.0	0.0	0.0
%ile BackOfQ(50%),veh/ln	1.0	0.0	2.3	0.9	2.7	2.8	0.7	3.4	3.4	4.1	4.2	4.3
Unsig. Movement Delay, s/veh												
LnGrp Delay(d),s/veh	29.9	0.0	23.1	30.0	23.8	25.4	30.4	18.8	18.8	46.5	16.5	16.5
LnGrp LOS	C	A	C	C	C	C	C	B	B	D	B	B
Approach Vol, veh/h		242			461			623			966	
Approach Delay, s/veh		24.9			25.3			19.7			22.7	
Approach LOS		C			C			B			C	
Timer - Assigned Phs	1	2	3	4	5	6	7	8				
Phs Duration (G+Y+Rc), s	12.9	24.1	9.2	17.6	8.6	28.4	9.6	17.2				
Change Period (Y+Rc), s	* 4.2	* 4.2	* 4.2	* 4.2	* 4.2	* 4.2	* 4.2	* 4.2				
Max Green Setting (Gmax), s	* 8.8	* 27	* 7.8	* 25	* 7.8	* 28	* 8.8	* 24				
Max Q Clear Time (g_c+I1), s	9.0	10.6	4.0	7.6	3.6	13.0	4.3	9.6				
Green Ext Time (p_c), s	0.0	3.4	0.0	0.9	0.0	4.5	0.0	1.7				

Intersection Summary

HCM 6th Ctrl Delay	22.6
HCM 6th LOS	C

Notes

* HCM 6th computational engine requires equal clearance times for the phases crossing the barrier.

Intersection

Int Delay, s/veh 6.3

Movement	SEL	SET	SER	NWL	NWT	NWR	NEL	NET	NER	SWL	SWT	SWR
Lane Configurations	↖	↗		↖	↗			↕			↕	
Traffic Vol, veh/h	5	264	27	176	303	10	31	6	137	8	7	16
Future Vol, veh/h	5	264	27	176	303	10	31	6	137	8	7	16
Conflicting Peds, #/hr	1	0	0	0	0	1	0	0	3	3	0	0
Sign Control	Free	Free	Free	Free	Free	Free	Stop	Stop	Stop	Stop	Stop	Stop
RT Channelized	-	-	None	-	-	None	-	-	None	-	-	None
Storage Length	90	-	-	125	-	-	-	-	-	-	-	-
Veh in Median Storage, #	-	0	-	-	0	-	-	0	-	-	0	-
Grade, %	-	0	-	-	0	-	-	0	-	-	0	-
Peak Hour Factor	86	86	86	86	86	86	86	86	86	86	86	86
Heavy Vehicles, %	3	3	3	3	3	3	3	3	3	3	3	3
Mvmt Flow	6	307	31	205	352	12	36	7	159	9	8	19

























Major/Minor	Major1	Major2	Minor1	Minor2
Conflicting Flow All	365	0	0	338
Stage 1	-	-	-	-
Stage 2	-	-	-	-
Critical Hdwy	4.13	-	-	4.13
Critical Hdwy Stg 1	-	-	-	-
Critical Hdwy Stg 2	-	-	-	-
Follow-up Hdwy	2.227	-	-	2.227
Pot Cap-1 Maneuver	1188	-	-	1216
Stage 1	-	-	-	-
Stage 2	-	-	-	-
Platoon blocked, %	-	-	-	-
Mov Cap-1 Maneuver	1187	-	-	1216
Mov Cap-2 Maneuver	-	-	-	-
Stage 1	-	-	-	-
Stage 2	-	-	-	-

Approach	SE	NW	NE	SW
HCM Control Delay, s	0.1	3.1	22.8	24.3
HCM LOS			C	C

Minor Lane/Major Mvmt	NELn1	NWL	NWT	NWR	SEL	SET	SERSWLn1
Capacity (veh/h)	401	1216	-	-	1187	-	-
HCM Lane V/C Ratio	0.505	0.168	-	-	0.005	-	-
HCM Control Delay (s)	22.8	8.6	-	-	8	-	-
HCM Lane LOS	C	A	-	-	A	-	-
HCM 95th %tile Q(veh)	2.8	0.6	-	-	0	-	-

HCM 6th Signalized Intersection Summary
3: Lemoore Avenue & Bush Street

Existing AM Peak
10/25/2022

												
Movement	EBL	EBT	EBR	WBL	WBT	WBR	NBL	NBT	NBR	SBL	SBT	SBR
Lane Configurations												
Traffic Volume (veh/h)	123	181	101	69	157	142	106	215	99	146	318	112
Future Volume (veh/h)	123	181	101	69	157	142	106	215	99	146	318	112
Initial Q (Qb), veh	0	0	0	0	0	0	0	0	0	0	0	0
Ped-Bike Adj(A_pbT)	1.00		0.91	1.00		0.91	1.00		0.80	1.00		0.89
Parking Bus, Adj	1.00	1.00	1.00	1.00	1.00	1.00	1.00	1.00	1.00	1.00	1.00	1.00
Work Zone On Approach		No			No			No			No	
Adj Sat Flow, veh/h/ln	1856	1856	1856	1856	1856	1856	1856	1856	1856	1856	1856	1856
Adj Flow Rate, veh/h	143	210	117	80	183	165	123	250	115	170	370	130
Peak Hour Factor	0.86	0.86	0.86	0.86	0.86	0.86	0.86	0.86	0.86	0.86	0.86	0.86
Percent Heavy Veh, %	3	3	3	3	3	3	3	3	3	3	3	3
Cap, veh/h	178	597	461	142	559	429	160	959	342	208	745	255
Arrive On Green	0.10	0.32	0.32	0.08	0.30	0.30	0.09	0.27	0.27	0.12	0.30	0.30
Sat Flow, veh/h	1767	1856	1433	1767	1856	1424	1767	3526	1257	1767	2489	853
Grp Volume(v), veh/h	143	210	117	80	183	165	123	250	115	170	259	241
Grp Sat Flow(s),veh/h/ln	1767	1856	1433	1767	1856	1424	1767	1763	1257	1767	1763	1579
Q Serve(g_s), s	6.4	7.0	4.9	3.5	6.2	7.4	5.5	4.5	5.9	7.6	9.8	10.2
Cycle Q Clear(g_c), s	6.4	7.0	4.9	3.5	6.2	7.4	5.5	4.5	5.9	7.6	9.8	10.2
Prop In Lane	1.00		1.00	1.00		1.00	1.00		1.00	1.00		0.54
Lane Grp Cap(c), veh/h	178	597	461	142	559	429	160	959	342	208	528	472
V/C Ratio(X)	0.80	0.35	0.25	0.56	0.33	0.38	0.77	0.26	0.34	0.82	0.49	0.51
Avail Cap(c_a), veh/h	258	643	497	171	559	429	214	1073	383	280	602	539
HCM Platoon Ratio	1.00	1.00	1.00	1.00	1.00	1.00	1.00	1.00	1.00	1.00	1.00	1.00
Upstream Filter(I)	1.00	1.00	1.00	1.00	1.00	1.00	1.00	1.00	1.00	1.00	1.00	1.00
Uniform Delay (d), s/veh	35.5	20.9	20.2	35.8	21.9	22.3	35.9	23.0	23.6	34.8	23.3	23.4
Incr Delay (d2), s/veh	10.9	0.4	0.3	3.5	0.3	0.6	11.3	0.1	0.6	12.9	0.7	0.9
Initial Q Delay(d3),s/veh	0.0	0.0	0.0	0.0	0.0	0.0	0.0	0.0	0.0	0.0	0.0	0.0
%ile BackOfQ(50%),veh/ln	3.2	3.0	1.6	1.6	2.7	2.5	2.8	1.8	1.8	4.0	4.1	3.8
Unsig. Movement Delay, s/veh												
LnGrp Delay(d),s/veh	46.5	21.3	20.5	39.2	22.2	22.9	47.2	23.2	24.1	47.7	24.0	24.3
LnGrp LOS	D	C	C	D	C	C	D	C	C	D	C	C
Approach Vol, veh/h		470			428			488			670	
Approach Delay, s/veh		28.8			25.6			29.5			30.1	
Approach LOS		C			C			C			C	
Timer - Assigned Phs	1	2	3	4	5	6	7	8				
Phs Duration (G+Y+Rc), s	13.7	26.2	10.7	30.2	11.5	28.4	12.4	28.6				
Change Period (Y+Rc), s	* 4.2	* 4.2	* 4.2	* 4.2	* 4.2	* 4.2	* 4.2	* 4.2				
Max Green Setting (Gmax), s	* 13	* 25	* 7.8	* 28	* 9.8	* 28	* 12	* 24				
Max Q Clear Time (g_c+I1), s	9.6	7.9	5.5	9.0	7.5	12.2	8.4	9.4				
Green Ext Time (p_c), s	0.1	1.9	0.0	1.5	0.1	2.9	0.1	1.5				

Intersection Summary												
HCM 6th Ctrl Delay				28.7								
HCM 6th LOS				C								

Notes

* HCM 6th computational engine requires equal clearance times for the phases crossing the barrier.

Intersection

Intersection Delay, s/veh 34.2
Intersection LOS D

Movement	EBL	EBT	EBR	WBL	WBT	WBR	NBL	NBT	NBR	SBL	SBT	SBR
Lane Configurations	↘	↑	↗	↘	↑	↗		↕			↕	
Traffic Vol, veh/h	85	372	0	1	400	86	2	0	1	189	1	156
Future Vol, veh/h	85	372	0	1	400	86	2	0	1	189	1	156
Peak Hour Factor	0.90	0.90	0.90	0.90	0.90	0.90	0.90	0.90	0.90	0.90	0.90	0.90
Heavy Vehicles, %	3	3	3	3	3	3	3	3	3	3	3	3
Mvmt Flow	94	413	0	1	444	96	2	0	1	210	1	173
Number of Lanes	1	1	1	1	1	1	0	1	0	0	1	0

Approach	EB	WB	NB	SB
Opposing Approach	WB	EB	SB	NB
Opposing Lanes	3	3	1	1
Conflicting Approach Left SB		NB	EB	WB
Conflicting Lanes Left	1	1	3	3
Conflicting Approach Right NB		SB	WB	EB
Conflicting Lanes Right	1	1	3	3
HCM Control Delay	31.6	37.2	12	33.7
HCM LOS	D	E	B	D

Lane	NBLn1	EBLn1	EBLn2	EBLn3	WBLn1	WBLn2	WBLn3	SBLn1
Vol Left, %	67%	100%	0%	0%	100%	0%	0%	55%
Vol Thru, %	0%	0%	100%	100%	0%	100%	0%	0%
Vol Right, %	33%	0%	0%	0%	0%	0%	100%	45%
Sign Control	Stop	Stop	Stop	Stop	Stop	Stop	Stop	Stop
Traffic Vol by Lane	3	85	372	0	1	400	86	346
LT Vol	2	85	0	0	1	0	0	189
Through Vol	0	0	372	0	0	400	0	1
RT Vol	1	0	0	0	0	0	86	156
Lane Flow Rate	3	94	413	0	1	444	96	384
Geometry Grp	7	7	7	7	7	7	7	7
Degree of Util (X)	0.008	0.203	0.827	0	0.002	0.882	0.17	0.797
Departure Headway (Hd)	9.106	7.722	7.205	7.205	7.656	7.142	6.422	7.465
Convergence, Y/N	Yes	Yes	Yes	Yes	Yes	Yes	Yes	Yes
Cap	392	465	500	0	467	507	558	484
Service Time	6.895	5.476	4.959	4.959	5.407	4.893	4.172	5.209
HCM Lane V/C Ratio	0.008	0.202	0.826	0	0.002	0.876	0.172	0.793
HCM Control Delay	12	12.4	36	10	10.4	43	10.5	33.7
HCM Lane LOS	B	B	E	N	B	E	B	D
HCM 95th-tile Q	0	0.8	8.1	0	0	9.7	0.6	7.3

HCM 6th Signalized Intersection Summary
5: Lemoore Avenue & SR 198 WB Ramps

Existing AM Peak
10/25/2022



Movement	EBL	EBT	EBR	WBL	WBT	WBR	NBL	NBT	NBR	SBL	SBT	SBR
Lane Configurations					↕		↖	↗			↕	↗
Traffic Volume (veh/h)	0	0	0	112	0	123	19	384	0	0	380	147
Future Volume (veh/h)	0	0	0	112	0	123	19	384	0	0	380	147
Initial Q (Qb), veh				0	0	0	0	0	0	0	0	0
Ped-Bike Adj(A_pbT)				1.00		1.00	1.00		1.00	1.00		1.00
Parking Bus, Adj				1.00	1.00	1.00	1.00	1.00	1.00	1.00	1.00	1.00
Work Zone On Approach				No		No		No				
Adj Sat Flow, veh/h/ln				1856	1856	1856	1856	1856	0	0	1856	1856
Adj Flow Rate, veh/h				120	0	132	20	413	0	0	409	158
Peak Hour Factor				0.93	0.93	0.93	0.93	0.93	0.93	0.93	0.93	0.93
Percent Heavy Veh, %				3	3	3	3	3	0	0	3	3
Cap, veh/h				141	0	155	557	1260	0	0	542	460
Arrive On Green				0.18	0.00	0.18	0.63	1.00	0.00	0.00	0.29	0.29
Sat Flow, veh/h				790	0	869	1767	1856	0	0	1856	1572
Grp Volume(v), veh/h				252	0	0	20	413	0	0	409	158
Grp Sat Flow(s),veh/h/ln				1660	0	0	1767	1856	0	0	1856	1572
Q Serve(g_s), s				11.8	0.0	0.0	0.3	0.0	0.0	0.0	16.0	6.3
Cycle Q Clear(g_c), s				11.8	0.0	0.0	0.3	0.0	0.0	0.0	16.0	6.3
Prop In Lane				0.48		0.52	1.00		0.00	0.00		1.00
Lane Grp Cap(c), veh/h				296	0	0	557	1260	0	0	542	460
V/C Ratio(X)				0.85	0.00	0.00	0.04	0.33	0.00	0.00	0.75	0.34
Avail Cap(c_a), veh/h				400	0	0	557	1260	0	0	865	733
HCM Platoon Ratio				1.00	1.00	1.00	2.00	2.00	1.00	1.00	1.00	1.00
Upstream Filter(I)				1.00	0.00	0.00	0.94	0.94	0.00	0.00	1.00	1.00
Uniform Delay (d), s/veh				31.8	0.0	0.0	10.2	0.0	0.0	0.0	25.7	22.3
Incr Delay (d2), s/veh				12.2	0.0	0.0	0.0	0.7	0.0	0.0	9.4	2.0
Initial Q Delay(d3),s/veh				0.0	0.0	0.0	0.0	0.0	0.0	0.0	0.0	0.0
%ile BackOfQ(50%),veh/ln				5.2	0.0	0.0	0.1	0.2	0.0	0.0	8.1	2.5
Unsig. Movement Delay, s/veh												
LnGrp Delay(d),s/veh				44.1	0.0	0.0	10.2	0.7	0.0	0.0	35.1	24.3
LnGrp LOS				D	A	A	B	A	A	A	D	C
Approach Vol, veh/h					252			433			567	
Approach Delay, s/veh					44.1			1.1			32.1	
Approach LOS					D			A			C	
Timer - Assigned Phs		2			5	6		8				
Phs Duration (G+Y+Rc), s		60.0			30.9	29.1		20.0				
Change Period (Y+Rc), s		* 5.7			* 5.7	* 5.7		5.7				
Max Green Setting (Gmax), s		* 49			* 6.3	* 37		19.3				
Max Q Clear Time (g_c+I1), s		2.0			2.3	18.0		13.8				
Green Ext Time (p_c), s		3.8			0.0	5.4		0.6				

Intersection Summary

HCM 6th Ctrl Delay	23.8
HCM 6th LOS	C

Notes

* HCM 6th computational engine requires equal clearance times for the phases crossing the barrier.

HCM 6th Signalized Intersection Summary
6: Lemoore Avenue & SR 198 EB Ramps

Existing AM Peak
10/25/2022



Movement	WBL	WBR	NBT	NBR	SBL	SBT
Lane Configurations						
Traffic Volume (veh/h)	12	153	252	100	171	323
Future Volume (veh/h)	12	153	252	100	171	323
Initial Q (Qb), veh	0	0	0	0	0	0
Ped-Bike Adj(A_pbT)	1.00	1.00		1.00	1.00	
Parking Bus, Adj	1.00	1.00	1.00	1.00	1.00	1.00
Work Zone On Approach	No		No		No	
Adj Sat Flow, veh/h/ln	1856	1856	1856	1856	1856	1856
Adj Flow Rate, veh/h	13	165	271	108	184	347
Peak Hour Factor	0.93	0.93	0.93	0.93	0.93	0.93
Percent Heavy Veh, %	3	3	3	3	3	3
Cap, veh/h	228	203	378	320	802	1352
Arrive On Green	0.13	0.13	0.20	0.20	0.91	1.00
Sat Flow, veh/h	1767	1572	1856	1572	1767	1856
Grp Volume(v), veh/h	13	165	271	108	184	347
Grp Sat Flow(s),veh/h/ln	1767	1572	1856	1572	1767	1856
Q Serve(g_s), s	0.5	8.2	10.9	4.7	1.0	0.0
Cycle Q Clear(g_c), s	0.5	8.2	10.9	4.7	1.0	0.0
Prop In Lane	1.00	1.00		1.00	1.00	
Lane Grp Cap(c), veh/h	228	203	378	320	802	1352
V/C Ratio(X)	0.06	0.81	0.72	0.34	0.23	0.26
Avail Cap(c_a), veh/h	426	379	749	635	802	1352
HCM Platoon Ratio	1.00	1.00	1.00	1.00	2.00	2.00
Upstream Filter(I)	1.00	1.00	1.00	1.00	0.95	0.95
Uniform Delay (d), s/veh	30.6	33.9	29.7	27.2	2.1	0.0
Incr Delay (d2), s/veh	0.1	8.3	11.1	2.8	0.1	0.4
Initial Q Delay(d3),s/veh	0.0	0.0	0.0	0.0	0.0	0.0
%ile BackOfQ(50%),veh/ln	0.2	3.3	5.9	2.0	0.3	0.2
Unsig. Movement Delay, s/veh						
LnGrp Delay(d),s/veh	30.7	42.2	40.9	30.1	2.1	0.4
LnGrp LOS	C	D	D	C	A	A
Approach Vol, veh/h	178		379			531
Approach Delay, s/veh	41.3		37.8			1.0
Approach LOS	D		D			A
Timer - Assigned Phs	1	2			6	8
Phs Duration (G+Y+Rc), s	22.0	22.0			64.0	16.0
Change Period (Y+Rc), s	5.7	* 5.7			* 5.7	5.7
Max Green Setting (Gmax), s	32	* 32			* 49	19.3
Max Q Clear Time (g_c+1/3), s	12.9				2.0	10.2
Green Ext Time (p_c), s	0.2	3.4			4.5	0.4

Intersection Summary

HCM 6th Ctrl Delay	20.4
HCM 6th LOS	C

Notes

* HCM 6th computational engine requires equal clearance times for the phases crossing the barrier.

HCM 6th Signalized Intersection Summary
 1: Lemoore Avenue & D Street

Existing PM Peak
 10/25/2022



Movement	EBL	EBT	EBR	WBL	WBT	WBR	NBL	NBT	NBR	SBL	SBT	SBR
Lane Configurations	↖	↗		↖	↗	↖	↖	↗		↖	↗	
Traffic Volume (veh/h)	92	130	36	47	143	219	42	448	37	173	421	86
Future Volume (veh/h)	92	130	36	47	143	219	42	448	37	173	421	86
Initial Q (Qb), veh	0	0	0	0	0	0	0	0	0	0	0	0
Ped-Bike Adj(A_pbT)	1.00		0.99	1.00		0.99	1.00		0.98	1.00		0.98
Parking Bus, Adj	1.00	1.00	1.00	1.00	1.00	1.00	1.00	1.00	1.00	1.00	1.00	1.00
Work Zone On Approach		No			No			No			No	
Adj Sat Flow, veh/h/ln	1856	1856	1856	1856	1856	1856	1856	1856	1856	1856	1856	1856
Adj Flow Rate, veh/h	96	135	38	49	149	228	44	467	39	180	439	90
Peak Hour Factor	0.96	0.96	0.96	0.96	0.96	0.96	0.96	0.96	0.96	0.96	0.96	0.96
Percent Heavy Veh, %	3	3	3	3	3	3	3	3	3	3	3	3
Cap, veh/h	190	339	95	131	390	328	122	840	70	229	920	187
Arrive On Green	0.11	0.24	0.24	0.07	0.21	0.21	0.07	0.26	0.26	0.13	0.32	0.32
Sat Flow, veh/h	1767	1391	391	1767	1856	1561	1767	3288	274	1767	2907	591
Grp Volume(v), veh/h	96	0	173	49	149	228	44	250	256	180	265	264
Grp Sat Flow(s),veh/h/ln	1767	0	1782	1767	1856	1561	1767	1763	1799	1767	1763	1736
Q Serve(g_s), s	2.9	0.0	4.6	1.5	3.9	7.6	1.3	6.9	7.0	5.6	6.8	6.9
Cycle Q Clear(g_c), s	2.9	0.0	4.6	1.5	3.9	7.6	1.3	6.9	7.0	5.6	6.8	6.9
Prop In Lane	1.00		0.22	1.00		1.00	1.00		0.15	1.00		0.34
Lane Grp Cap(c), veh/h	190	0	434	131	390	328	122	450	460	229	558	549
V/C Ratio(X)	0.51	0.00	0.40	0.37	0.38	0.70	0.36	0.55	0.56	0.78	0.47	0.48
Avail Cap(c_a), veh/h	306	0	788	244	755	635	244	829	846	275	861	847
HCM Platoon Ratio	1.00	1.00	1.00	1.00	1.00	1.00	1.00	1.00	1.00	1.00	1.00	1.00
Upstream Filter(I)	1.00	0.00	1.00	1.00	1.00	1.00	1.00	1.00	1.00	1.00	1.00	1.00
Uniform Delay (d), s/veh	23.8	0.0	17.9	24.9	19.2	20.7	25.1	18.3	18.3	23.8	15.5	15.6
Incr Delay (d2), s/veh	2.1	0.0	0.6	1.8	0.6	2.7	1.8	1.1	1.1	11.7	0.6	0.7
Initial Q Delay(d3),s/veh	0.0	0.0	0.0	0.0	0.0	0.0	0.0	0.0	0.0	0.0	0.0	0.0
%ile BackOfQ(50%),veh/ln	1.3	0.0	1.8	0.7	1.6	2.8	0.6	2.8	2.8	2.9	2.6	2.6
Unsig. Movement Delay, s/veh												
LnGrp Delay(d),s/veh	25.9	0.0	18.5	26.7	19.8	23.3	26.9	19.3	19.3	35.5	16.2	16.2
LnGrp LOS	C	A	B	C	B	C	C	B	B	D	B	B
Approach Vol, veh/h		269			426			550			709	
Approach Delay, s/veh		21.1			22.5			19.9			21.1	
Approach LOS		C			C			B			C	
Timer - Assigned Phs	1	2	3	4	5	6	7	8				
Phs Duration (G+Y+Rc), s	11.5	18.6	8.4	18.0	8.1	22.1	10.3	16.1				
Change Period (Y+Rc), s	* 4.2	* 4.2	* 4.2	* 4.2	* 4.2	* 4.2	* 4.2	* 4.2				
Max Green Setting (Gmax), s	* 8.8	* 27	* 7.8	* 25	* 7.8	* 28	* 9.8	* 23				
Max Q Clear Time (g_c+I1), s	7.6	9.0	3.5	6.6	3.3	8.9	4.9	9.6				
Green Ext Time (p_c), s	0.1	3.0	0.0	0.9	0.0	3.3	0.1	1.4				

Intersection Summary												
HCM 6th Ctrl Delay				21.1								
HCM 6th LOS				C								

Notes

* HCM 6th computational engine requires equal clearance times for the phases crossing the barrier.

Intersection

Int Delay, s/veh 3.1

Movement	SEL	SET	SER	NWL	NWT	NWR	NEL	NET	NER	SWL	SWT	SWR
Lane Configurations	↖	↗		↖	↗			↕			↕	
Traffic Vol, veh/h	14	263	20	87	369	23	21	3	73	10	3	14
Future Vol, veh/h	14	263	20	87	369	23	21	3	73	10	3	14
Conflicting Peds, #/hr	0	0	0	0	0	0	0	0	0	0	0	0
Sign Control	Free	Free	Free	Free	Free	Free	Stop	Stop	Stop	Stop	Stop	Stop
RT Channelized	-	-	None	-	-	None	-	-	None	-	-	None
Storage Length	90	-	-	125	-	-	-	-	-	-	-	-
Veh in Median Storage, #	-	0	-	-	0	-	-	0	-	-	0	-
Grade, %	-	0	-	-	0	-	-	0	-	-	0	-
Peak Hour Factor	93	93	93	93	93	93	93	93	93	93	93	93
Heavy Vehicles, %	3	3	3	3	3	3	3	3	3	3	3	3
Mvmt Flow	15	283	22	94	397	25	23	3	78	11	3	15

























Major/Minor	Major1	Major2	Minor1	Minor2
Conflicting Flow All	422	0	0	305
Stage 1	-	-	-	-
Stage 2	-	-	-	-
Critical Hdwy	4.13	-	-	4.13
Critical Hdwy Stg 1	-	-	-	-
Critical Hdwy Stg 2	-	-	-	-
Follow-up Hdwy	2.227	-	-	2.227
Pot Cap-1 Maneuver	1132	-	-	1250
Stage 1	-	-	-	-
Stage 2	-	-	-	-
Platoon blocked, %	-	-	-	-
Mov Cap-1 Maneuver	1132	-	-	1250
Mov Cap-2 Maneuver	-	-	-	-
Stage 1	-	-	-	-
Stage 2	-	-	-	-

Approach	SE	NW	NE	SW
HCM Control Delay, s	0.4	1.5	14.8	17.6
HCM LOS			B	C

Minor Lane/Major Mvmt	NELn1	NWL	NWT	NWR	SEL	SET	SERSWLn1
Capacity (veh/h)	473	1250	-	-	1132	-	314
HCM Lane V/C Ratio	0.221	0.075	-	-	0.013	-	0.092
HCM Control Delay (s)	14.8	8.1	-	-	8.2	-	17.6
HCM Lane LOS	B	A	-	-	A	-	C
HCM 95th %tile Q(veh)	0.8	0.2	-	-	0	-	0.3

HCM 6th Signalized Intersection Summary
3: Lemoore Avenue & Bush Street

Existing PM Peak
10/25/2022

												
Movement	EBL	EBT	EBR	WBL	WBT	WBR	NBL	NBT	NBR	SBL	SBT	SBR
Lane Configurations												
Traffic Volume (veh/h)	78	79	170	49	83	31	90	391	55	27	388	96
Future Volume (veh/h)	78	79	170	49	83	31	90	391	55	27	388	96
Initial Q (Qb), veh	0	0	0	0	0	0	0	0	0	0	0	0
Ped-Bike Adj(A_pbT)	1.00		0.99	1.00		0.99	1.00		0.99	1.00		1.00
Parking Bus, Adj	1.00	1.00	1.00	1.00	1.00	1.00	1.00	1.00	1.00	1.00	1.00	1.00
Work Zone On Approach		No			No			No			No	
Adj Sat Flow, veh/h/ln	1856	1856	1856	1856	1856	1856	1856	1856	1856	1856	1856	1856
Adj Flow Rate, veh/h	83	84	181	52	88	33	96	416	59	29	413	102
Peak Hour Factor	0.94	0.94	0.94	0.94	0.94	0.94	0.94	0.94	0.94	0.94	0.94	0.94
Percent Heavy Veh, %	3	3	3	3	3	3	3	3	3	3	3	3
Cap, veh/h	190	392	329	142	342	287	205	1111	492	92	704	172
Arrive On Green	0.11	0.21	0.21	0.08	0.18	0.18	0.12	0.32	0.32	0.05	0.25	0.25
Sat Flow, veh/h	1767	1856	1559	1767	1856	1557	1767	3526	1563	1767	2805	686
Grp Volume(v), veh/h	83	84	181	52	88	33	96	416	59	29	258	257
Grp Sat Flow(s),veh/h/ln	1767	1856	1559	1767	1856	1557	1767	1763	1563	1767	1763	1728
Q Serve(g_s), s	2.2	1.8	5.1	1.4	2.0	0.9	2.5	4.5	1.3	0.8	6.3	6.4
Cycle Q Clear(g_c), s	2.2	1.8	5.1	1.4	2.0	0.9	2.5	4.5	1.3	0.8	6.3	6.4
Prop In Lane	1.00		1.00	1.00		1.00	1.00		1.00	1.00		0.40
Lane Grp Cap(c), veh/h	190	392	329	142	342	287	205	1111	492	92	443	434
V/C Ratio(X)	0.44	0.21	0.55	0.36	0.26	0.11	0.47	0.37	0.12	0.32	0.58	0.59
Avail Cap(c_a), veh/h	352	1055	887	280	980	822	352	2119	939	280	988	969
HCM Platoon Ratio	1.00	1.00	1.00	1.00	1.00	1.00	1.00	1.00	1.00	1.00	1.00	1.00
Upstream Filter(I)	1.00	1.00	1.00	1.00	1.00	1.00	1.00	1.00	1.00	1.00	1.00	1.00
Uniform Delay (d), s/veh	20.6	16.0	17.3	21.4	17.2	16.7	20.4	13.1	12.0	22.5	16.2	16.2
Incr Delay (d2), s/veh	1.6	0.3	1.4	1.6	0.4	0.2	1.7	0.2	0.1	2.0	1.2	1.3
Initial Q Delay(d3),s/veh	0.0	0.0	0.0	0.0	0.0	0.0	0.0	0.0	0.0	0.0	0.0	0.0
%ile BackOfQ(50%),veh/ln	0.9	0.7	1.8	0.6	0.8	0.3	1.0	1.6	0.4	0.4	2.4	2.4
Unsig. Movement Delay, s/veh												
LnGrp Delay(d),s/veh	22.2	16.3	18.8	23.0	17.6	16.9	22.0	13.3	12.1	24.5	17.4	17.5
LnGrp LOS	C	B	B	C	B	B	C	B	B	C	B	B
Approach Vol, veh/h		348			173			571			544	
Approach Delay, s/veh		19.0			19.1			14.6			17.8	
Approach LOS		B			B			B			B	
Timer - Assigned Phs	1	2	3	4	5	6	7	8				
Phs Duration (G+Y+Rc), s	6.8	19.7	8.2	14.6	9.9	16.6	9.5	13.3				
Change Period (Y+Rc), s	* 4.2	* 4.2	* 4.2	* 4.2	* 4.2	* 4.2	* 4.2	* 4.2				
Max Green Setting (Gmax), s	* 7.8	* 30	* 7.8	* 28	* 9.8	* 28	* 9.8	* 26				
Max Q Clear Time (g_c+I1), s	2.8	6.5	3.4	7.1	4.5	8.4	4.2	4.0				
Green Ext Time (p_c), s	0.0	3.0	0.0	1.0	0.1	3.2	0.1	0.5				

Intersection Summary

HCM 6th Ctrl Delay	17.1
HCM 6th LOS	B

Notes

* HCM 6th computational engine requires equal clearance times for the phases crossing the barrier.

Intersection

Intersection Delay, s/veh 19.3

Intersection LOS C

Movement	EBL	EBT	EBR	WBL	WBT	WBR	NBL	NBT	NBR	SBL	SBT	SBR
Lane Configurations												
Traffic Vol, veh/h	52	316	0	0	423	186	0	1	0	127	0	41
Future Vol, veh/h	52	316	0	0	423	186	0	1	0	127	0	41
Peak Hour Factor	0.88	0.88	0.88	0.88	0.88	0.88	0.88	0.88	0.88	0.88	0.88	0.88
Heavy Vehicles, %	3	3	3	3	3	3	3	3	3	3	3	3
Mvmt Flow	59	359	0	0	481	211	0	1	0	144	0	47
Number of Lanes	1	1	1	1	1	1	0	1	0	0	1	0

Approach	EB	WB	NB	SB
Opposing Approach	WB	EB	SB	NB
Opposing Lanes	3	3	1	1
Conflicting Approach Left SB		NB	EB	WB
Conflicting Lanes Left	1	1	3	3
Conflicting Approach Right NB		SB	WB	EB
Conflicting Lanes Right	1	1	3	3
HCM Control Delay	17.3	21.8	10.6	14.9
HCM LOS	C	C	B	B

Lane	NBLn1	EBLn1	EBLn2	EBLn3	WBLn1	WBLn2	WBLn3	SBLn1
Vol Left, %	0%	100%	0%	0%	0%	0%	0%	76%
Vol Thru, %	100%	0%	100%	100%	100%	100%	0%	0%
Vol Right, %	0%	0%	0%	0%	0%	0%	100%	24%
Sign Control	Stop	Stop	Stop	Stop	Stop	Stop	Stop	Stop
Traffic Vol by Lane	1	52	316	0	0	423	186	168
LT Vol	0	52	0	0	0	0	0	127
Through Vol	1	0	316	0	0	423	0	0
RT Vol	0	0	0	0	0	0	186	41
Lane Flow Rate	1	59	359	0	0	481	211	191
Geometry Grp	7	7	7	7	7	7	7	7
Degree of Util (X)	0.002	0.11	0.616	0	0	0.786	0.304	0.392
Departure Headway (Hd)	7.807	6.682	6.174	6.174	5.885	5.885	5.175	7.395
Convergence, Y/N	Yes	Yes	Yes	Yes	Yes	Yes	Yes	Yes
Cap	456	535	585	0	0	615	693	487
Service Time	5.592	4.434	3.926	3.926	3.629	3.629	2.919	5.152
HCM Lane V/C Ratio	0.002	0.11	0.614	0	0	0.782	0.304	0.392
HCM Control Delay	10.6	10.3	18.4	8.9	8.6	26.9	10.2	14.9
HCM Lane LOS		B	B	C	N	N	D	B
HCM 95th-tile Q		0	0.4	4.2	0	0	7.5	1.3

HCM 6th Signalized Intersection Summary
5: Lemoore Avenue & SR 198 WB Ramps

Existing PM Peak
10/25/2022



Movement	EBL	EBT	EBR	WBL	WBT	WBR	NBL	NBT	NBR	SBL	SBT	SBR
Lane Configurations					↕		↖	↗			↕	↗
Traffic Volume (veh/h)	0	0	0	141	0	163	15	396	0	0	385	135
Future Volume (veh/h)	0	0	0	141	0	163	15	396	0	0	385	135
Initial Q (Qb), veh				0	0	0	0	0	0	0	0	0
Ped-Bike Adj(A_pbT)				1.00		1.00	1.00		1.00	1.00		1.00
Parking Bus, Adj				1.00	1.00	1.00	1.00	1.00	1.00	1.00	1.00	1.00
Work Zone On Approach				No		No		No				
Adj Sat Flow, veh/h/ln				1856	1856	1856	1856	1856	0	0	1856	1856
Adj Flow Rate, veh/h				148	0	172	16	417	0	0	405	142
Peak Hour Factor				0.95	0.95	0.95	0.95	0.95	0.95	0.95	0.95	0.95
Percent Heavy Veh, %				3	3	3	3	3	0	0	3	3
Cap, veh/h				169	0	197	496	1181	0	0	528	448
Arrive On Green				0.22	0.00	0.22	0.56	1.00	0.00	0.00	0.28	0.28
Sat Flow, veh/h				766	0	891	1767	1856	0	0	1856	1572
Grp Volume(v), veh/h				320	0	0	16	417	0	0	405	142
Grp Sat Flow(s),veh/h/ln				1657	0	0	1767	1856	0	0	1856	1572
Q Serve(g_s), s				14.9	0.0	0.0	0.3	0.0	0.0	0.0	16.0	5.7
Cycle Q Clear(g_c), s				14.9	0.0	0.0	0.3	0.0	0.0	0.0	16.0	5.7
Prop In Lane				0.46		0.54	1.00		0.00	0.00		1.00
Lane Grp Cap(c), veh/h				366	0	0	496	1181	0	0	528	448
V/C Ratio(X)				0.87	0.00	0.00	0.03	0.35	0.00	0.00	0.77	0.32
Avail Cap(c_a), veh/h				462	0	0	496	1181	0	0	796	674
HCM Platoon Ratio				1.00	1.00	1.00	2.00	2.00	1.00	1.00	1.00	1.00
Upstream Filter(I)				1.00	0.00	0.00	0.90	0.90	0.00	0.00	1.00	1.00
Uniform Delay (d), s/veh				30.1	0.0	0.0	12.7	0.0	0.0	0.0	26.2	22.5
Incr Delay (d2), s/veh				14.2	0.0	0.0	0.0	0.7	0.0	0.0	10.2	1.9
Initial Q Delay(d3),s/veh				0.0	0.0	0.0	0.0	0.0	0.0	0.0	0.0	0.0
%ile BackOfQ(50%),veh/ln				6.7	0.0	0.0	0.1	0.2	0.0	0.0	8.2	2.3
Unsig. Movement Delay, s/veh												
LnGrp Delay(d),s/veh				44.2	0.0	0.0	12.7	0.7	0.0	0.0	36.4	24.4
LnGrp LOS				D	A	A	B	A	A	A	D	C
Approach Vol, veh/h					320			433			547	
Approach Delay, s/veh					44.2			1.2			33.3	
Approach LOS					D			A			C	
Timer - Assigned Phs		2			5	6		8				
Phs Duration (G+Y+Rc), s		56.6			28.2	28.5		23.4				
Change Period (Y+Rc), s		* 5.7			* 5.7	* 5.7		5.7				
Max Green Setting (Gmax), s		* 46			* 6.3	* 34		22.3				
Max Q Clear Time (g_c+I1), s		2.0			2.3	18.0		16.9				
Green Ext Time (p_c), s		3.9			0.0	4.8		0.8				

Intersection Summary

HCM 6th Ctrl Delay	25.3
HCM 6th LOS	C

Notes

* HCM 6th computational engine requires equal clearance times for the phases crossing the barrier.

HCM 6th Signalized Intersection Summary
6: Lemoore Avenue & SR 198 EB Ramps

Existing PM Peak
10/25/2022



Movement	WBL	WBR	NBT	NBR	SBL	SBT
Lane Configurations						
Traffic Volume (veh/h)	21	181	228	184	193	338
Future Volume (veh/h)	21	181	228	184	193	338
Initial Q (Qb), veh	0	0	0	0	0	0
Ped-Bike Adj(A_pbT)	1.00	1.00		1.00	1.00	
Parking Bus, Adj	1.00	1.00	1.00	1.00	1.00	1.00
Work Zone On Approach	No		No		No	
Adj Sat Flow, veh/h/ln	1856	1856	1856	1856	1856	1856
Adj Flow Rate, veh/h	26	223	281	227	238	417
Peak Hour Factor	0.81	0.81	0.81	0.81	0.81	0.81
Percent Heavy Veh, %	3	3	3	3	3	3
Cap, veh/h	292	260	407	345	709	1284
Arrive On Green	0.17	0.17	0.22	0.22	0.80	1.00
Sat Flow, veh/h	1767	1572	1856	1572	1767	1856
Grp Volume(v), veh/h	26	223	281	227	238	417
Grp Sat Flow(s),veh/h/ln	1767	1572	1856	1572	1767	1856
Q Serve(g_s), s	1.0	11.0	11.1	10.5	2.9	0.0
Cycle Q Clear(g_c), s	1.0	11.0	11.1	10.5	2.9	0.0
Prop In Lane	1.00	1.00		1.00	1.00	
Lane Grp Cap(c), veh/h	292	260	407	345	709	1284
V/C Ratio(X)	0.09	0.86	0.69	0.66	0.34	0.32
Avail Cap(c_a), veh/h	360	320	749	635	709	1284
HCM Platoon Ratio	1.00	1.00	1.00	1.00	2.00	2.00
Upstream Filter(I)	1.00	1.00	1.00	1.00	0.95	0.95
Uniform Delay (d), s/veh	28.3	32.5	28.7	28.5	5.0	0.0
Incr Delay (d2), s/veh	0.1	17.4	9.3	9.5	0.1	0.6
Initial Q Delay(d3),s/veh	0.0	0.0	0.0	0.0	0.0	0.0
%ile BackOfQ(50%),veh/ln	0.4	5.0	5.8	4.7	0.9	0.2
Unsig. Movement Delay, s/veh						
LnGrp Delay(d),s/veh	28.4	49.9	38.0	38.0	5.1	0.6
LnGrp LOS	C	D	D	D	A	A
Approach Vol, veh/h	249		508			655
Approach Delay, s/veh	47.7		38.0			2.3
Approach LOS	D		D			A
Timer - Assigned Phs	1	2			6	8
Phs Duration (G+Y+Rc), s	37.8	23.2			61.1	18.9
Change Period (Y+Rc), s	5.7	* 5.7			* 5.7	5.7
Max Green Setting (Gmax), s	32	* 32			* 52	16.3
Max Q Clear Time (g_c+14), s	13.1	13.1			2.0	13.0
Green Ext Time (p_c), s	0.2	4.4			5.7	0.3

Intersection Summary

HCM 6th Ctrl Delay		23.1	
HCM 6th LOS		C	

Notes

* HCM 6th computational engine requires equal clearance times for the phases crossing the barrier.

Intersection: 1: Lemoore Avenue & D Street

Movement	EB	EB	WB	WB	WB	NB	NB	NB	SB	SB	SB
Directions Served	L	TR	L	T	R	L	T	TR	L	T	TR
Maximum Queue (ft)	76	159	160	177	160	48	132	182	190	318	293
Average Queue (ft)	33	59	33	83	74	26	74	91	101	97	103
95th Queue (ft)	67	115	81	148	137	49	119	140	168	190	184
Link Distance (ft)		1631		2383			1433	1433		1665	1665
Upstream Blk Time (%)											
Queuing Penalty (veh)											
Storage Bay Dist (ft)	85		75		75	60			140		
Storage Blk Time (%)	0	3	0	16	3	0	15		3	1	
Queuing Penalty (veh)	0	2	1	37	7	0	6		10	2	

Intersection: 2: Bush Street/Daphne Lane & D Street

Movement	SE	NW	NW	NE	SW
Directions Served	L	L	TR	LTR	LTR
Maximum Queue (ft)	27	76	30	97	55
Average Queue (ft)	1	25	1	50	26
95th Queue (ft)	9	54	10	84	49
Link Distance (ft)			1268	1039	373
Upstream Blk Time (%)					
Queuing Penalty (veh)					
Storage Bay Dist (ft)	90	125			
Storage Blk Time (%)					
Queuing Penalty (veh)					

Intersection: 3: Lemoore Avenue & Bush Street

Movement	EB	EB	EB	WB	WB	WB	NB	NB	NB	NB	SB	SB
Directions Served	L	T	R	L	T	R	L	T	T	R	L	T
Maximum Queue (ft)	138	224	135	141	176	116	137	120	86	100	167	245
Average Queue (ft)	76	85	40	52	59	40	65	46	42	34	86	87
95th Queue (ft)	122	156	79	103	121	86	114	84	75	74	150	153
Link Distance (ft)	2569	2569			350			1768	1768			1433
Upstream Blk Time (%)												
Queuing Penalty (veh)												
Storage Bay Dist (ft)			75	150		60	100			105	135	
Storage Blk Time (%)		12	0	0	7	1	3	0	0	1	4	2
Queuing Penalty (veh)		12	0	0	16	2	3	0	0	1	6	2

Intersection: 3: Lemoore Avenue & Bush Street

Movement	SB
Directions Served	TR
Maximum Queue (ft)	249
Average Queue (ft)	103
95th Queue (ft)	170
Link Distance (ft)	1433
Upstream Blk Time (%)	
Queuing Penalty (veh)	
Storage Bay Dist (ft)	
Storage Blk Time (%)	
Queuing Penalty (veh)	

Intersection: 4: 17th Avenue & Houston Avenue

Movement	EB	EB	WB	WB	NB	SB
Directions Served	L	T	T	R	LTR	LTR
Maximum Queue (ft)	95	120	196	64	28	107
Average Queue (ft)	36	77	92	40	2	67
95th Queue (ft)	68	114	148	51	13	97
Link Distance (ft)		668	640		1215	3100
Upstream Blk Time (%)						
Queuing Penalty (veh)						
Storage Bay Dist (ft)	50			15		
Storage Blk Time (%)	1	31	38	4		
Queuing Penalty (veh)	5	26	33	15		

Intersection: 5: Lemoore Avenue & SR 198 WB Ramps

Movement	WB	NB	NB	SB	SB
Directions Served	LTR	L	T	T	R
Maximum Queue (ft)	252	53	117	227	150
Average Queue (ft)	112	19	58	73	33
95th Queue (ft)	200	47	110	155	90
Link Distance (ft)	1146		568	301	
Upstream Blk Time (%)					
Queuing Penalty (veh)					
Storage Bay Dist (ft)		200			75
Storage Blk Time (%)				6	0
Queuing Penalty (veh)				8	0

Intersection: 6: Lemoore Avenue & SR 198 EB Ramps

Movement	WB	WB	NB	NB	SB	SB
Directions Served	L	R	T	R	L	T
Maximum Queue (ft)	45	86	162	77	167	219
Average Queue (ft)	8	34	54	29	107	49
95th Queue (ft)	28	62	116	66	175	145
Link Distance (ft)		194	2460			568
Upstream Blk Time (%)						
Queuing Penalty (veh)						
Storage Bay Dist (ft)	50			50	200	
Storage Blk Time (%)	0	2	6	2		0
Queuing Penalty (veh)	1	0	6	4		0

Network Summary

Network wide Queuing Penalty: 207

Intersection: 1: Lemoore Avenue & D Street

Movement	EB	EB	WB	WB	WB	NB	NB	NB	SB	SB	SB
Directions Served	L	TR	L	T	R	L	T	TR	L	T	TR
Maximum Queue (ft)	118	137	74	136	133	109	192	173	169	144	186
Average Queue (ft)	53	68	36	63	72	32	84	95	81	72	99
95th Queue (ft)	91	123	71	108	128	66	159	151	146	126	167
Link Distance (ft)		1631		2383			1433	1433		1665	1665
Upstream Blk Time (%)											
Queuing Penalty (veh)											
Storage Bay Dist (ft)	85		75		75	60			140		
Storage Blk Time (%)	3	7	1	9	5	1	16		1	0	
Queuing Penalty (veh)	5	7	4	24	10	3	7		2	0	

Intersection: 2: Bush Street/Daphne Lane & D Street

Movement	SE	NW	NE	SW
Directions Served	L	L	LTR	LTR
Maximum Queue (ft)	29	53	77	55
Average Queue (ft)	3	12	41	23
95th Queue (ft)	17	37	75	54
Link Distance (ft)			1039	373
Upstream Blk Time (%)				
Queuing Penalty (veh)				
Storage Bay Dist (ft)	90	125		
Storage Blk Time (%)				
Queuing Penalty (veh)				

Intersection: 3: Lemoore Avenue & Bush Street

Movement	EB	EB	EB	WB	WB	WB	NB	NB	NB	NB	SB	SB
Directions Served	L	T	R	L	T	R	L	T	T	R	L	T
Maximum Queue (ft)	115	96	92	116	108	21	98	107	122	141	74	202
Average Queue (ft)	55	44	50	26	31	11	54	46	52	18	27	101
95th Queue (ft)	98	88	80	71	74	27	93	82	98	64	55	184
Link Distance (ft)	2569	2569			350			1768	1768			1433
Upstream Blk Time (%)												
Queuing Penalty (veh)												
Storage Bay Dist (ft)			75	150		60	100			105	135	
Storage Blk Time (%)		2	1		2		1	0	0			3
Queuing Penalty (veh)		3	1		2		2	0	0			1

Intersection: 3: Lemoore Avenue & Bush Street

Movement	SB
Directions Served	TR
Maximum Queue (ft)	237
Average Queue (ft)	106
95th Queue (ft)	186
Link Distance (ft)	1433
Upstream Blk Time (%)	
Queuing Penalty (veh)	
Storage Bay Dist (ft)	
Storage Blk Time (%)	
Queuing Penalty (veh)	

Intersection: 4: 17th Avenue & Houston Avenue

Movement	EB	EB	WB	WB	NB	SB
Directions Served	L	T	T	R	LTR	LTR
Maximum Queue (ft)	55	95	228	76	29	98
Average Queue (ft)	29	60	86	42	1	50
95th Queue (ft)	52	88	148	56	9	86
Link Distance (ft)		668	640		1215	3100
Upstream Blk Time (%)						
Queuing Penalty (veh)						
Storage Bay Dist (ft)	50			15		
Storage Blk Time (%)	0	21	31	6		
Queuing Penalty (veh)	1	11	58	25		

Intersection: 5: Lemoore Avenue & SR 198 WB Ramps

Movement	WB	NB	NB	SB	SB
Directions Served	LTR	L	T	T	R
Maximum Queue (ft)	198	52	154	194	150
Average Queue (ft)	118	12	75	88	46
95th Queue (ft)	188	37	132	176	130
Link Distance (ft)	1146		568	301	
Upstream Blk Time (%)					
Queuing Penalty (veh)					
Storage Bay Dist (ft)		200			75
Storage Blk Time (%)				9	1
Queuing Penalty (veh)				12	3

Intersection: 6: Lemoore Avenue & SR 198 EB Ramps

Movement	WB	WB	NB	NB	SB	SB
Directions Served	L	R	T	R	L	T
Maximum Queue (ft)	70	93	119	100	204	179
Average Queue (ft)	17	45	55	35	108	38
95th Queue (ft)	47	75	98	77	181	114
Link Distance (ft)		194	2460			568
Upstream Blk Time (%)						
Queuing Penalty (veh)						
Storage Bay Dist (ft)	50			50	200	
Storage Blk Time (%)	2	4	11	3	0	
Queuing Penalty (veh)	3	1	20	6	0	

Network Summary

Network wide Queuing Penalty: 212

Appendix F: Existing plus Project Traffic Conditions



www.JLBtraffic.com
info@JLBtraffic.com

516 W. Shaw Ave., Ste. 103
Fresno, CA 93704
(559) 570-8991

App | F

HCM 6th Signalized Intersection Summary
1: Lemoore Avenue & D Street

Existing plus Project AM Peak
10/26/2022



Movement	EBL	EBT	EBR	WBL	WBT	WBR	NBL	NBT	NBR	SBL	SBT	SBR
Lane Configurations												
Traffic Volume (veh/h)	57	111	40	50	173	174	41	474	45	170	606	65
Future Volume (veh/h)	57	111	40	50	173	174	41	474	45	170	606	65
Initial Q (Qb), veh	0	0	0	0	0	0	0	0	0	0	0	0
Ped-Bike Adj(A_pbT)	1.00		0.99	1.00		0.99	1.00		0.94	1.00		0.95
Parking Bus, Adj	1.00	1.00	1.00	1.00	1.00	1.00	1.00	1.00	1.00	1.00	1.00	1.00
Work Zone On Approach		No			No			No			No	
Adj Sat Flow, veh/h/ln	1856	1856	1856	1856	1856	1856	1856	1856	1856	1856	1856	1856
Adj Flow Rate, veh/h	66	129	47	58	201	202	48	551	52	198	705	76
Peak Hour Factor	0.86	0.86	0.86	0.86	0.86	0.86	0.86	0.86	0.86	0.86	0.86	0.86
Percent Heavy Veh, %	3	3	3	3	3	3	3	3	3	3	3	3
Cap, veh/h	148	271	99	138	378	316	123	1020	96	240	1217	131
Arrive On Green	0.08	0.21	0.21	0.08	0.20	0.20	0.07	0.32	0.32	0.14	0.38	0.38
Sat Flow, veh/h	1767	1292	471	1767	1856	1549	1767	3236	304	1767	3191	344
Grp Volume(v), veh/h	66	0	176	58	201	202	48	299	304	198	389	392
Grp Sat Flow(s),veh/h/ln	1767	0	1763	1767	1856	1549	1767	1763	1778	1767	1763	1772
Q Serve(g_s), s	2.3	0.0	5.6	2.0	6.2	7.7	1.7	9.0	9.1	7.0	11.3	11.3
Cycle Q Clear(g_c), s	2.3	0.0	5.6	2.0	6.2	7.7	1.7	9.0	9.1	7.0	11.3	11.3
Prop In Lane	1.00		0.27	1.00		1.00	1.00		0.17	1.00		0.19
Lane Grp Cap(c), veh/h	148	0	369	138	378	316	123	556	560	240	672	676
V/C Ratio(X)	0.44	0.00	0.48	0.42	0.53	0.64	0.39	0.54	0.54	0.82	0.58	0.58
Avail Cap(c_a), veh/h	242	0	685	214	692	578	214	729	735	242	756	760
HCM Platoon Ratio	1.00	1.00	1.00	1.00	1.00	1.00	1.00	1.00	1.00	1.00	1.00	1.00
Upstream Filter(I)	1.00	0.00	1.00	1.00	1.00	1.00	1.00	1.00	1.00	1.00	1.00	1.00
Uniform Delay (d), s/veh	28.0	0.0	22.3	28.3	22.9	23.5	28.6	18.2	18.2	27.0	15.8	15.8
Incr Delay (d2), s/veh	2.1	0.0	1.0	2.0	1.2	2.2	2.0	0.8	0.8	20.0	0.9	0.9
Initial Q Delay(d3),s/veh	0.0	0.0	0.0	0.0	0.0	0.0	0.0	0.0	0.0	0.0	0.0	0.0
%ile BackOfQ(50%),veh/ln	1.0	0.0	2.3	0.9	2.7	2.9	0.8	3.6	3.6	4.2	4.4	4.4
Unsig. Movement Delay, s/veh												
LnGrp Delay(d),s/veh	30.1	0.0	23.3	30.3	24.0	25.6	30.6	19.0	19.0	47.1	16.7	16.7
LnGrp LOS	C	A	C	C	C	C	C	B	B	D	B	B
Approach Vol, veh/h		242			461			651			979	
Approach Delay, s/veh		25.2			25.5			19.9			22.8	
Approach LOS		C			C			B			C	
Timer - Assigned Phs	1	2	3	4	5	6	7	8				
Phs Duration (G+Y+Rc), s	13.0	24.5	9.2	17.7	8.7	28.7	9.6	17.3				
Change Period (Y+Rc), s	* 4.2	* 4.2	* 4.2	* 4.2	* 4.2	* 4.2	* 4.2	* 4.2				
Max Green Setting (Gmax), s	* 8.8	* 27	* 7.8	* 25	* 7.8	* 28	* 8.8	* 24				
Max Q Clear Time (g_c+I1), s	9.0	11.1	4.0	7.6	3.7	13.3	4.3	9.7				
Green Ext Time (p_c), s	0.0	3.5	0.0	0.9	0.0	4.5	0.0	1.6				

Intersection Summary												
HCM 6th Ctrl Delay											22.8	
HCM 6th LOS											C	

Notes

* HCM 6th computational engine requires equal clearance times for the phases crossing the barrier.

Intersection

Int Delay, s/veh 7.7

Movement	SEL	SET	SER	NWL	NWT	NWR	NEL	NET	NER	SWL	SWT	SWR
Lane Configurations	↖	↗		↖	↗			↕			↕	
Traffic Vol, veh/h	5	264	28	190	303	10	33	6	171	8	7	16
Future Vol, veh/h	5	264	28	190	303	10	33	6	171	8	7	16
Conflicting Peds, #/hr	1	0	0	0	0	1	0	0	3	3	0	0
Sign Control	Free	Free	Free	Free	Free	Free	Stop	Stop	Stop	Stop	Stop	Stop
RT Channelized	-	-	None	-	-	None	-	-	None	-	-	None
Storage Length	90	-	-	125	-	-	-	-	-	-	-	-
Veh in Median Storage, #	-	0	-	-	0	-	-	0	-	-	0	-
Grade, %	-	0	-	-	0	-	-	0	-	-	0	-
Peak Hour Factor	86	86	86	86	86	86	86	86	86	86	86	86
Heavy Vehicles, %	3	3	3	3	3	3	3	3	3	3	3	3
Mvmt Flow	6	307	33	221	352	12	38	7	199	9	8	19

Major/Minor	Major1	Major2	Minor1	Minor2
Conflicting Flow All	365	0	0	340
Stage 1	-	-	-	-
Stage 2	-	-	-	-
Critical Hdwy	4.13	-	-	4.13
Critical Hdwy Stg 1	-	-	-	-
Critical Hdwy Stg 2	-	-	-	-
Follow-up Hdwy	2.227	-	-	2.227
Pot Cap-1 Maneuver	1188	-	-	1214
Stage 1	-	-	-	-
Stage 2	-	-	-	-
Platoon blocked, %	-	-	-	-
Mov Cap-1 Maneuver	1187	-	-	1214
Mov Cap-2 Maneuver	-	-	-	-
Stage 1	-	-	-	-
Stage 2	-	-	-	-

Approach	SE	NW	NE	SW
HCM Control Delay, s	0.1	3.3	26	27.1
HCM LOS			D	D

Minor Lane/Major Mvmt	NELn1	NWL	NWT	NWR	SEL	SET	SERSWLn1
Capacity (veh/h)	409	1214	-	-	1187	-	-
HCM Lane V/C Ratio	0.597	0.182	-	-	0.005	-	-
HCM Control Delay (s)	26	8.6	-	-	8	-	-
HCM Lane LOS	D	A	-	-	A	-	-
HCM 95th %tile Q(veh)	3.8	0.7	-	-	0	-	-

HCM 6th Signalized Intersection Summary
3: Lemoore Avenue & Bush Street

Existing plus Project AM Peak
10/26/2022

Movement	EBL	EBT	EBR	WBL	WBT	WBR	NBL	NBT	NBR	SBL	SBT	SBR
Lane Configurations												
Traffic Volume (veh/h)	123	195	101	101	202	168	106	215	106	158	318	112
Future Volume (veh/h)	123	195	101	101	202	168	106	215	106	158	318	112
Initial Q (Qb), veh	0	0	0	0	0	0	0	0	0	0	0	0
Ped-Bike Adj(A_pbT)	1.00		0.91	1.00		0.91	1.00		0.80	1.00		0.89
Parking Bus, Adj	1.00	1.00	1.00	1.00	1.00	1.00	1.00	1.00	1.00	1.00	1.00	1.00
Work Zone On Approach		No			No			No			No	
Adj Sat Flow, veh/h/ln	1856	1856	1856	1856	1856	1856	1856	1856	1856	1856	1856	1856
Adj Flow Rate, veh/h	143	227	117	117	235	195	123	250	123	184	370	130
Peak Hour Factor	0.86	0.86	0.86	0.86	0.86	0.86	0.86	0.86	0.86	0.86	0.86	0.86
Percent Heavy Veh, %	3	3	3	3	3	3	3	3	3	3	3	3
Cap, veh/h	177	588	454	155	565	434	157	939	333	222	754	259
Arrive On Green	0.10	0.32	0.32	0.09	0.30	0.30	0.09	0.27	0.27	0.13	0.30	0.30
Sat Flow, veh/h	1767	1856	1431	1767	1856	1425	1767	3526	1251	1767	2490	853
Grp Volume(v), veh/h	143	227	117	117	235	195	123	250	123	184	259	241
Grp Sat Flow(s),veh/h/ln	1767	1856	1431	1767	1856	1425	1767	1763	1251	1767	1763	1580
Q Serve(g_s), s	6.5	7.9	5.0	5.3	8.3	9.1	5.6	4.6	6.6	8.4	9.9	10.4
Cycle Q Clear(g_c), s	6.5	7.9	5.0	5.3	8.3	9.1	5.6	4.6	6.6	8.4	9.9	10.4
Prop In Lane	1.00		1.00	1.00		1.00	1.00		1.00	1.00		0.54
Lane Grp Cap(c), veh/h	177	588	454	155	565	434	157	939	333	222	534	479
V/C Ratio(X)	0.81	0.39	0.26	0.75	0.42	0.45	0.78	0.27	0.37	0.83	0.49	0.50
Avail Cap(c_a), veh/h	231	628	485	188	584	448	188	1006	357	274	588	528
HCM Platoon Ratio	1.00	1.00	1.00	1.00	1.00	1.00	1.00	1.00	1.00	1.00	1.00	1.00
Upstream Filter(I)	1.00	1.00	1.00	1.00	1.00	1.00	1.00	1.00	1.00	1.00	1.00	1.00
Uniform Delay (d), s/veh	36.4	22.0	21.0	36.8	22.9	23.2	36.9	23.9	24.7	35.3	23.5	23.7
Incr Delay (d2), s/veh	14.6	0.4	0.3	12.9	0.5	0.7	16.3	0.2	0.7	16.0	0.7	0.8
Initial Q Delay(d3),s/veh	0.0	0.0	0.0	0.0	0.0	0.0	0.0	0.0	0.0	0.0	0.0	0.0
%ile BackOfQ(50%),veh/ln	3.5	3.4	1.7	2.8	3.7	3.1	3.1	1.9	2.0	4.6	4.2	3.9
Unsig. Movement Delay, s/veh												
LnGrp Delay(d),s/veh	51.0	22.4	21.3	49.7	23.4	23.9	53.2	24.1	25.4	51.3	24.2	24.5
LnGrp LOS	D	C	C	D	C	C	D	C	C	D	C	C
Approach Vol, veh/h		487			547			496			684	
Approach Delay, s/veh		30.5			29.2			31.6			31.6	
Approach LOS		C			C			C			C	
Timer - Assigned Phs	1	2	3	4	5	6	7	8				
Phs Duration (G+Y+Rc), s	14.6	26.2	11.5	30.4	11.5	29.3	12.5	29.4				
Change Period (Y+Rc), s	* 4.2	* 4.2	* 4.2	* 4.2	* 4.2	* 4.2	* 4.2	* 4.2				
Max Green Setting (Gmax), s	* 13	* 24	* 8.8	* 28	* 8.8	* 28	* 11	* 26				
Max Q Clear Time (g_c+I1), s	10.4	8.6	7.3	9.9	7.6	12.4	8.5	11.1				
Green Ext Time (p_c), s	0.1	1.8	0.0	1.6	0.0	2.9	0.1	1.9				

Intersection Summary												
HCM 6th Ctrl Delay											30.8	
HCM 6th LOS											C	

Notes

* HCM 6th computational engine requires equal clearance times for the phases crossing the barrier.

Intersection	
Intersection Delay, s/veh	40.9
Intersection LOS	E

Movement	EBL	EBT	EBR	WBL	WBT	WBR	NBL	NBT	NBR	SBL	SBT	SBR
Lane Configurations												
Traffic Vol, veh/h	86	404	0	1	413	86	2	0	1	189	1	156
Future Vol, veh/h	86	404	0	1	413	86	2	0	1	189	1	156
Peak Hour Factor	0.90	0.90	0.90	0.90	0.90	0.90	0.90	0.90	0.90	0.90	0.90	0.90
Heavy Vehicles, %	3	3	3	3	3	3	3	3	3	3	3	3
Mvmt Flow	96	449	0	1	459	96	2	0	1	210	1	173
Number of Lanes	1	1	1	1	1	1	0	1	0	0	1	0

Approach	EB	WB	NB	SB
Opposing Approach	WB	EB	SB	NB
Opposing Lanes	3	3	1	1
Conflicting Approach Left SB		NB	EB	WB
Conflicting Lanes Left	1	1	3	3
Conflicting Approach Right NB		SB	WB	EB
Conflicting Lanes Right	1	1	3	3
HCM Control Delay	41.7	43.8	12.2	35.8
HCM LOS	E	E	B	E

Lane	NBLn1	EBLn1	EBLn2	EBLn3	WBLn1	WBLn2	WBLn3	SBLn1	
Vol Left, %		67%	100%	0%	0%	100%	0%	0%	55%
Vol Thru, %		0%	0%	100%	100%	0%	100%	0%	0%
Vol Right, %		33%	0%	0%	0%	0%	100%	45%	
Sign Control		Stop	Stop	Stop	Stop	Stop	Stop	Stop	Stop
Traffic Vol by Lane		3	86	404	0	1	413	86	346
LT Vol		2	86	0	0	1	0	0	189
Through Vol		0	0	404	0	0	413	0	1
RT Vol		1	0	0	0	0	86	156	
Lane Flow Rate		3	96	449	0	1	459	96	384
Geometry Grp		7	7	7	7	7	7	7	7
Degree of Util (X)		0.009	0.207	0.908	0	0.002	0.925	0.173	0.812
Departure Headway (Hd)		9.339	7.801	7.284	7.284	7.77	7.255	6.534	7.604
Convergence, Y/N		Yes	Yes	Yes	Yes	Yes	Yes	Yes	Yes
Cap		382	460	498	0	460	500	548	477
Service Time		7.138	5.563	5.045	5.045	5.529	5.014	4.293	5.355
HCM Lane V/C Ratio		0.008	0.209	0.902	0	0.002	0.918	0.175	0.805
HCM Control Delay		12.2	12.6	47.9	10	10.5	50.8	10.7	35.8
HCM Lane LOS		B	B	E	N	B	F	B	E
HCM 95th-tile Q		0	0.8	10.4	0	0	11	0.6	7.7

HCM 6th Signalized Intersection Summary
5: Lemoore Avenue & SR 198 WB Ramps

Existing plus Project AM Peak
10/26/2022



Movement	EBL	EBT	EBR	WBL	WBT	WBR	NBL	NBT	NBR	SBL	SBT	SBR
Lane Configurations					↕		↖	↗			↕	↗
Traffic Volume (veh/h)	0	0	0	112	0	123	19	390	0	0	391	158
Future Volume (veh/h)	0	0	0	112	0	123	19	390	0	0	391	158
Initial Q (Qb), veh				0	0	0	0	0	0	0	0	0
Ped-Bike Adj(A_pbT)				1.00		1.00	1.00		1.00	1.00		1.00
Parking Bus, Adj				1.00	1.00	1.00	1.00	1.00	1.00	1.00	1.00	1.00
Work Zone On Approach				No		No		No				
Adj Sat Flow, veh/h/ln				1856	1856	1856	1856	1856	0	0	1856	1856
Adj Flow Rate, veh/h				120	0	132	20	419	0	0	420	170
Peak Hour Factor				0.93	0.93	0.93	0.93	0.93	0.93	0.93	0.93	0.93
Percent Heavy Veh, %				3	3	3	3	3	0	0	3	3
Cap, veh/h				141	0	155	545	1260	0	0	556	471
Arrive On Green				0.18	0.00	0.18	0.62	1.00	0.00	0.00	0.30	0.30
Sat Flow, veh/h				790	0	869	1767	1856	0	0	1856	1572
Grp Volume(v), veh/h				252	0	0	20	419	0	0	420	170
Grp Sat Flow(s),veh/h/ln				1660	0	0	1767	1856	0	0	1856	1572
Q Serve(g_s), s				11.8	0.0	0.0	0.4	0.0	0.0	0.0	16.4	6.8
Cycle Q Clear(g_c), s				11.8	0.0	0.0	0.4	0.0	0.0	0.0	16.4	6.8
Prop In Lane				0.48		0.52	1.00		0.00	0.00		1.00
Lane Grp Cap(c), veh/h				296	0	0	545	1260	0	0	556	471
V/C Ratio(X)				0.85	0.00	0.00	0.04	0.33	0.00	0.00	0.76	0.36
Avail Cap(c_a), veh/h				400	0	0	545	1260	0	0	865	733
HCM Platoon Ratio				1.00	1.00	1.00	2.00	2.00	1.00	1.00	1.00	1.00
Upstream Filter(I)				1.00	0.00	0.00	0.93	0.93	0.00	0.00	1.00	1.00
Uniform Delay (d), s/veh				31.8	0.0	0.0	10.7	0.0	0.0	0.0	25.4	22.0
Incr Delay (d2), s/veh				12.2	0.0	0.0	0.0	0.7	0.0	0.0	9.3	2.1
Initial Q Delay(d3),s/veh				0.0	0.0	0.0	0.0	0.0	0.0	0.0	0.0	0.0
%ile BackOfQ(50%),veh/ln				5.2	0.0	0.0	0.1	0.2	0.0	0.0	8.3	2.7
Unsig. Movement Delay, s/veh												
LnGrp Delay(d),s/veh				44.1	0.0	0.0	10.7	0.7	0.0	0.0	34.6	24.2
LnGrp LOS				D	A	A	B	A	A	A	C	C
Approach Vol, veh/h					252			439			590	
Approach Delay, s/veh					44.1			1.1			31.6	
Approach LOS					D			A			C	
Timer - Assigned Phs		2			5	6		8				
Phs Duration (G+Y+Rc), s		60.0			30.4	29.7		20.0				
Change Period (Y+Rc), s		* 5.7			* 5.7	* 5.7		5.7				
Max Green Setting (Gmax), s		* 49			* 6.3	* 37		19.3				
Max Q Clear Time (g_c+I1), s		2.0			2.4	18.4		13.8				
Green Ext Time (p_c), s		3.9			0.0	5.6		0.6				

Intersection Summary

HCM 6th Ctrl Delay	23.6
HCM 6th LOS	C

Notes

* HCM 6th computational engine requires equal clearance times for the phases crossing the barrier.

HCM 6th Signalized Intersection Summary
6: Lemoore Avenue & SR 198 EB Ramps

Existing plus Project AM Peak
10/26/2022



Movement	WBL	WBR	NBT	NBR	SBL	SBT
Lane Configurations	↶	↶	↕	↷	↶	↷
Traffic Volume (veh/h)	12	156	255	100	171	334
Future Volume (veh/h)	12	156	255	100	171	334
Initial Q (Qb), veh	0	0	0	0	0	0
Ped-Bike Adj(A_pbT)	1.00	1.00		1.00	1.00	
Parking Bus, Adj	1.00	1.00	1.00	1.00	1.00	1.00
Work Zone On Approach	No		No		No	
Adj Sat Flow, veh/h/ln	1856	1856	1856	1856	1856	1856
Adj Flow Rate, veh/h	13	168	274	108	184	359
Peak Hour Factor	0.93	0.93	0.93	0.93	0.93	0.93
Percent Heavy Veh, %	3	3	3	3	3	3
Cap, veh/h	231	206	381	323	795	1348
Arrive On Green	0.13	0.13	0.21	0.21	0.90	1.00
Sat Flow, veh/h	1767	1572	1856	1572	1767	1856
Grp Volume(v), veh/h	13	168	274	108	184	359
Grp Sat Flow(s),veh/h/ln	1767	1572	1856	1572	1767	1856
Q Serve(g_s), s	0.5	8.3	11.0	4.7	1.1	0.0
Cycle Q Clear(g_c), s	0.5	8.3	11.0	4.7	1.1	0.0
Prop In Lane	1.00	1.00		1.00	1.00	
Lane Grp Cap(c), veh/h	231	206	381	323	795	1348
V/C Ratio(X)	0.06	0.82	0.72	0.33	0.23	0.27
Avail Cap(c_a), veh/h	426	379	749	635	795	1348
HCM Platoon Ratio	1.00	1.00	1.00	1.00	2.00	2.00
Upstream Filter(I)	1.00	1.00	1.00	1.00	0.94	0.94
Uniform Delay (d), s/veh	30.4	33.8	29.6	27.1	2.3	0.0
Incr Delay (d2), s/veh	0.1	8.2	11.1	2.8	0.1	0.5
Initial Q Delay(d3),s/veh	0.0	0.0	0.0	0.0	0.0	0.0
%ile BackOfQ(50%),veh/ln	0.2	3.3	5.9	2.0	0.3	0.2
Unsig. Movement Delay, s/veh						
LnGrp Delay(d),s/veh	30.5	42.1	40.8	29.9	2.3	0.5
LnGrp LOS	C	D	D	C	A	A
Approach Vol, veh/h	181		382			543
Approach Delay, s/veh	41.2		37.7			1.1
Approach LOS	D		D			A
Timer - Assigned Phs	1	2			6	8
Phs Duration (G+Y+Rc), s	17.7	22.1			63.8	16.2
Change Period (Y+Rc), s	5.7	* 5.7			* 5.7	5.7
Max Green Setting (Gmax), s	32	* 32			* 49	19.3
Max Q Clear Time (g_c+1), s	13.0				2.0	10.3
Green Ext Time (p_c), s	0.2	3.4			4.7	0.4

Intersection Summary

HCM 6th Ctrl Delay	20.3
HCM 6th LOS	C

Notes

* HCM 6th computational engine requires equal clearance times for the phases crossing the barrier.

HCM 6th Signalized Intersection Summary
1: Lemoore Avenue & D Street

Existing plus Project PM Peak
10/26/2022



Movement	EBL	EBT	EBR	WBL	WBT	WBR	NBL	NBT	NBR	SBL	SBT	SBR
Lane Configurations	↖	↗		↖	↗	↖	↖	↗		↖	↗	
Traffic Volume (veh/h)	92	130	37	47	143	220	43	463	37	174	440	86
Future Volume (veh/h)	92	130	37	47	143	220	43	463	37	174	440	86
Initial Q (Qb), veh	0	0	0	0	0	0	0	0	0	0	0	0
Ped-Bike Adj(A_pbT)	1.00		0.99	1.00		0.99	1.00		0.98	1.00		0.98
Parking Bus, Adj	1.00	1.00	1.00	1.00	1.00	1.00	1.00	1.00	1.00	1.00	1.00	1.00
Work Zone On Approach		No			No			No			No	
Adj Sat Flow, veh/h/ln	1856	1856	1856	1856	1856	1856	1856	1856	1856	1856	1856	1856
Adj Flow Rate, veh/h	96	135	39	49	149	229	45	482	39	181	458	90
Peak Hour Factor	0.96	0.96	0.96	0.96	0.96	0.96	0.96	0.96	0.96	0.96	0.96	0.96
Percent Heavy Veh, %	3	3	3	3	3	3	3	3	3	3	3	3
Cap, veh/h	189	336	97	131	390	328	123	853	69	228	933	182
Arrive On Green	0.11	0.24	0.24	0.07	0.21	0.21	0.07	0.26	0.26	0.13	0.32	0.32
Sat Flow, veh/h	1767	1382	399	1767	1856	1561	1767	3297	266	1767	2931	572
Grp Volume(v), veh/h	96	0	174	49	149	229	45	257	264	181	274	274
Grp Sat Flow(s),veh/h/ln	1767	0	1781	1767	1856	1561	1767	1763	1800	1767	1763	1740
Q Serve(g_s), s	2.9	0.0	4.7	1.5	3.9	7.7	1.4	7.2	7.3	5.7	7.2	7.3
Cycle Q Clear(g_c), s	2.9	0.0	4.7	1.5	3.9	7.7	1.4	7.2	7.3	5.7	7.2	7.3
Prop In Lane	1.00		0.22	1.00		1.00	1.00		0.15	1.00		0.33
Lane Grp Cap(c), veh/h	189	0	433	131	390	328	123	456	466	228	561	554
V/C Ratio(X)	0.51	0.00	0.40	0.38	0.38	0.70	0.37	0.56	0.57	0.79	0.49	0.49
Avail Cap(c_a), veh/h	304	0	782	242	749	630	242	823	841	273	854	843
HCM Platoon Ratio	1.00	1.00	1.00	1.00	1.00	1.00	1.00	1.00	1.00	1.00	1.00	1.00
Upstream Filter(I)	1.00	0.00	1.00	1.00	1.00	1.00	1.00	1.00	1.00	1.00	1.00	1.00
Uniform Delay (d), s/veh	24.0	0.0	18.1	25.1	19.3	20.8	25.3	18.3	18.3	24.1	15.7	15.7
Incr Delay (d2), s/veh	2.1	0.0	0.6	1.8	0.6	2.7	1.8	1.1	1.1	12.6	0.7	0.7
Initial Q Delay(d3),s/veh	0.0	0.0	0.0	0.0	0.0	0.0	0.0	0.0	0.0	0.0	0.0	0.0
%ile BackOfQ(50%),veh/ln	1.3	0.0	1.9	0.7	1.7	2.9	0.6	2.9	3.0	3.0	2.7	2.7
Unsig. Movement Delay, s/veh												
LnGrp Delay(d),s/veh	26.1	0.0	18.7	26.9	19.9	23.5	27.1	19.4	19.4	36.6	16.3	16.4
LnGrp LOS	C	A	B	C	B	C	C	B	B	D	B	B
Approach Vol, veh/h		270			427			566			729	
Approach Delay, s/veh		21.3			22.7			20.0			21.4	
Approach LOS		C			C			C			C	
Timer - Assigned Phs	1	2	3	4	5	6	7	8				
Phs Duration (G+Y+Rc), s	11.6	18.9	8.4	18.1	8.2	22.3	10.3	16.2				
Change Period (Y+Rc), s	* 4.2	* 4.2	* 4.2	* 4.2	* 4.2	* 4.2	* 4.2	* 4.2				
Max Green Setting (Gmax), s	* 8.8	* 27	* 7.8	* 25	* 7.8	* 28	* 9.8	* 23				
Max Q Clear Time (g_c+I1), s	7.7	9.3	3.5	6.7	3.4	9.3	4.9	9.7				
Green Ext Time (p_c), s	0.1	3.1	0.0	0.9	0.0	3.4	0.1	1.4				

Intersection Summary

HCM 6th Ctrl Delay	21.3
HCM 6th LOS	C

Notes

* HCM 6th computational engine requires equal clearance times for the phases crossing the barrier.

Intersection

Int Delay, s/veh 4.1

Movement	SEL	SET	SER	NWL	NWT	NWR	NEL	NET	NER	SWL	SWT	SWR
Lane Configurations	↖	↗		↖	↗			↕			↕	
Traffic Vol, veh/h	14	263	22	147	369	23	23	3	106	10	3	14
Future Vol, veh/h	14	263	22	147	369	23	23	3	106	10	3	14
Conflicting Peds, #/hr	0	0	0	0	0	0	0	0	0	0	0	0
Sign Control	Free	Free	Free	Free	Free	Free	Stop	Stop	Stop	Stop	Stop	Stop
RT Channelized	-	-	None	-	-	None	-	-	None	-	-	None
Storage Length	90	-	-	125	-	-	-	-	-	-	-	-
Veh in Median Storage, #	-	0	-	-	0	-	-	0	-	-	0	-
Grade, %	-	0	-	-	0	-	-	0	-	-	0	-
Peak Hour Factor	93	93	93	93	93	93	93	93	93	93	93	93
Heavy Vehicles, %	3	3	3	3	3	3	3	3	3	3	3	3
Mvmt Flow	15	283	24	158	397	25	25	3	114	11	3	15

Major/Minor	Major1	Major2	Minor1	Minor2
Conflicting Flow All	422	0	0	307
Stage 1	-	-	-	-
Stage 2	-	-	-	-
Critical Hdwy	4.13	-	-	4.13
Critical Hdwy Stg 1	-	-	-	-
Critical Hdwy Stg 2	-	-	-	-
Follow-up Hdwy	2.227	-	-	2.227
Pot Cap-1 Maneuver	1132	-	-	1248
Stage 1	-	-	-	-
Stage 2	-	-	-	-
Platoon blocked, %	-	-	-	-
Mov Cap-1 Maneuver	1132	-	-	1248
Mov Cap-2 Maneuver	-	-	-	-
Stage 1	-	-	-	-
Stage 2	-	-	-	-

Approach	SE	NW	NE	SW
HCM Control Delay, s	0.4	2.3	16.5	21.6
HCM LOS			C	C

Minor Lane/Major Mvmt	NELn1	NWL	NWT	NWR	SEL	SET	SERSWLn1
Capacity (veh/h)	453	1248	-	-	1132	-	246
HCM Lane V/C Ratio	0.313	0.127	-	-	0.013	-	0.118
HCM Control Delay (s)	16.5	8.3	-	-	8.2	-	21.6
HCM Lane LOS	C	A	-	-	A	-	C
HCM 95th %tile Q(veh)	1.3	0.4	-	-	0	-	0.4

HCM 6th Signalized Intersection Summary
3: Lemoore Avenue & Bush Street

Existing plus Project PM Peak
10/26/2022



Movement	EBL	EBT	EBR	WBL	WBT	WBR	NBL	NBT	NBR	SBL	SBT	SBR
Lane Configurations	↖	↗	↘	↖	↗	↘	↖	↗	↘	↖	↗	↘
Traffic Volume (veh/h)	78	123	170	66	109	48	90	391	91	48	388	96
Future Volume (veh/h)	78	123	170	66	109	48	90	391	91	48	388	96
Initial Q (Qb), veh	0	0	0	0	0	0	0	0	0	0	0	0
Ped-Bike Adj(A_pbT)	1.00		0.99	1.00		0.99	1.00		0.99	1.00		1.00
Parking Bus, Adj	1.00	1.00	1.00	1.00	1.00	1.00	1.00	1.00	1.00	1.00	1.00	1.00
Work Zone On Approach		No			No			No			No	
Adj Sat Flow, veh/h/ln	1856	1856	1856	1856	1856	1856	1856	1856	1856	1856	1856	1856
Adj Flow Rate, veh/h	83	131	181	70	116	51	96	416	97	51	413	102
Peak Hour Factor	0.94	0.94	0.94	0.94	0.94	0.94	0.94	0.94	0.94	0.94	0.94	0.94
Percent Heavy Veh, %	3	3	3	3	3	3	3	3	3	3	3	3
Cap, veh/h	189	375	315	171	357	300	203	1006	446	140	700	171
Arrive On Green	0.11	0.20	0.20	0.10	0.19	0.19	0.11	0.29	0.29	0.08	0.25	0.25
Sat Flow, veh/h	1767	1856	1558	1767	1856	1558	1767	3526	1561	1767	2805	686
Grp Volume(v), veh/h	83	131	181	70	116	51	96	416	97	51	258	257
Grp Sat Flow(s),veh/h/ln	1767	1856	1558	1767	1856	1558	1767	1763	1561	1767	1763	1728
Q Serve(g_s), s	2.2	3.0	5.2	1.9	2.7	1.4	2.5	4.8	2.4	1.4	6.4	6.5
Cycle Q Clear(g_c), s	2.2	3.0	5.2	1.9	2.7	1.4	2.5	4.8	2.4	1.4	6.4	6.5
Prop In Lane	1.00		1.00	1.00		1.00	1.00		1.00	1.00		0.40
Lane Grp Cap(c), veh/h	189	375	315	171	357	300	203	1006	446	140	440	431
V/C Ratio(X)	0.44	0.35	0.57	0.41	0.32	0.17	0.47	0.41	0.22	0.36	0.59	0.60
Avail Cap(c_a), veh/h	347	1040	874	276	966	811	347	2089	925	276	974	955
HCM Platoon Ratio	1.00	1.00	1.00	1.00	1.00	1.00	1.00	1.00	1.00	1.00	1.00	1.00
Upstream Filter(I)	1.00	1.00	1.00	1.00	1.00	1.00	1.00	1.00	1.00	1.00	1.00	1.00
Uniform Delay (d), s/veh	20.9	17.1	18.0	21.2	17.4	16.8	20.7	14.5	13.6	21.8	16.5	16.5
Incr Delay (d2), s/veh	1.6	0.6	1.7	1.6	0.5	0.3	1.7	0.3	0.2	1.6	1.2	1.3
Initial Q Delay(d3),s/veh	0.0	0.0	0.0	0.0	0.0	0.0	0.0	0.0	0.0	0.0	0.0	0.0
%ile BackOfQ(50%),veh/ln	0.9	1.2	1.9	0.8	1.1	0.5	1.1	1.7	0.8	0.6	2.5	2.5
Unsig. Movement Delay, s/veh												
LnGrp Delay(d),s/veh	22.5	17.7	19.6	22.8	17.9	17.1	22.4	14.7	13.8	23.4	17.7	17.8
LnGrp LOS	C	B	B	C	B	B	C	B	B	C	B	B
Approach Vol, veh/h		395			237			609			566	
Approach Delay, s/veh		19.6			19.2			15.8			18.3	
Approach LOS		B			B			B			B	
Timer - Assigned Phs	1	2	3	4	5	6	7	8				
Phs Duration (G+Y+Rc), s	8.2	18.5	9.0	14.3	9.9	16.7	9.5	13.8				
Change Period (Y+Rc), s	* 4.2	* 4.2	* 4.2	* 4.2	* 4.2	* 4.2	* 4.2	* 4.2				
Max Green Setting (Gmax), s	* 7.8	* 30	* 7.8	* 28	* 9.8	* 28	* 9.8	* 26				
Max Q Clear Time (g_c+I1), s	3.4	6.8	3.9	7.2	4.5	8.5	4.2	4.7				
Green Ext Time (p_c), s	0.0	3.1	0.0	1.3	0.1	3.2	0.1	0.8				

Intersection Summary

HCM 6th Ctrl Delay	17.8
HCM 6th LOS	B

Notes

* HCM 6th computational engine requires equal clearance times for the phases crossing the barrier.

Intersection												
Intersection Delay, s/veh	26.8											
Intersection LOS	D											

Movement	EBL	EBT	EBR	WBL	WBT	WBR	NBL	NBT	NBR	SBL	SBT	SBR
Lane Configurations	↖	↑	↗	↖	↑	↗		↕			↕	
Traffic Vol, veh/h	53	348	0	0	482	186	0	1	0	127	0	42
Future Vol, veh/h	53	348	0	0	482	186	0	1	0	127	0	42
Peak Hour Factor	0.88	0.88	0.88	0.88	0.88	0.88	0.88	0.88	0.88	0.88	0.88	0.88
Heavy Vehicles, %	3	3	3	3	3	3	3	3	3	3	3	3
Mvmt Flow	60	395	0	0	548	211	0	1	0	144	0	48
Number of Lanes	1	1	1	1	1	1	0	1	0	0	1	0

Approach	EB	WB	NB	SB
Opposing Approach	WB	EB	SB	NB
Opposing Lanes	3	3	1	1
Conflicting Approach Left	SB	NB	EB	WB
Conflicting Lanes Left	1	1	3	3
Conflicting Approach Right	NB	SB	WB	EB
Conflicting Lanes Right	1	1	3	3
HCM Control Delay	20.7	33.3	10.9	15.5
HCM LOS	C	D	B	C

Lane	NBLn1	EBLn1	EBLn2	EBLn3	WBLn1	WBLn2	WBLn3	SBLn1	
Vol Left, %	0%	100%	0%	0%	0%	0%	0%	75%	
Vol Thru, %	100%	0%	100%	100%	100%	100%	0%	0%	
Vol Right, %	0%	0%	0%	0%	0%	0%	100%	25%	
Sign Control	Stop	Stop	Stop	Stop	Stop	Stop	Stop	Stop	
Traffic Vol by Lane	1	53	348	0	0	482	186	169	
LT Vol	0	53	0	0	0	0	0	127	
Through Vol	1	0	348	0	0	482	0	0	
RT Vol	0	0	0	0	0	0	186	42	
Lane Flow Rate	1	60	395	0	0	548	211	192	
Geometry Grp	7	7	7	7	7	7	7	7	
Degree of Util (X)	0.003	0.114	0.693	0	0	0.91	0.309	0.406	
Departure Headway (Hd)	8.204	6.814	6.305	6.305	5.978	5.978	5.267	7.617	
Convergence, Y/N	Yes	Yes	Yes	Yes	Yes	Yes	Yes	Yes	
Cap	439	525	569	0	0	603	681	471	
Service Time	5.904	4.576	4.067	4.067	3.732	3.732	3.021	5.387	
HCM Lane V/C Ratio	0.002	0.114	0.694	0	0	0.909	0.31	0.408	
HCM Control Delay	10.9	10.5	22.2	9.1	8.7	42.1	10.4	15.5	
HCM Lane LOS		B	B	C	N	N	E	B	C
HCM 95th-tile Q		0	0.4	5.4	0	0	11.3	1.3	1.9

HCM 6th Signalized Intersection Summary
 5: Lemoore Avenue & SR 198 WB Ramps

Existing plus Project PM Peak
 10/26/2022



Movement	EBL	EBT	EBR	WBL	WBT	WBR	NBL	NBT	NBR	SBL	SBT	SBR
Lane Configurations					↕		↖	↗			↕	↗
Traffic Volume (veh/h)	0	0	0	141	0	163	15	430	0	0	393	142
Future Volume (veh/h)	0	0	0	141	0	163	15	430	0	0	393	142
Initial Q (Qb), veh				0	0	0	0	0	0	0	0	0
Ped-Bike Adj(A_pbT)				1.00		1.00	1.00		1.00	1.00		1.00
Parking Bus, Adj				1.00	1.00	1.00	1.00	1.00	1.00	1.00	1.00	1.00
Work Zone On Approach				No		No		No				
Adj Sat Flow, veh/h/ln				1856	1856	1856	1856	1856	0	0	1856	1856
Adj Flow Rate, veh/h				148	0	172	16	453	0	0	414	149
Peak Hour Factor				0.95	0.95	0.95	0.95	0.95	0.95	0.95	0.95	0.95
Percent Heavy Veh, %				3	3	3	3	3	0	0	3	3
Cap, veh/h				169	0	197	487	1181	0	0	538	456
Arrive On Green				0.22	0.00	0.22	0.55	1.00	0.00	0.00	0.29	0.29
Sat Flow, veh/h				766	0	891	1767	1856	0	0	1856	1572
Grp Volume(v), veh/h				320	0	0	16	453	0	0	414	149
Grp Sat Flow(s),veh/h/ln				1657	0	0	1767	1856	0	0	1856	1572
Q Serve(g_s), s				14.9	0.0	0.0	0.3	0.0	0.0	0.0	16.3	5.9
Cycle Q Clear(g_c), s				14.9	0.0	0.0	0.3	0.0	0.0	0.0	16.3	5.9
Prop In Lane				0.46		0.54	1.00		0.00	0.00		1.00
Lane Grp Cap(c), veh/h				366	0	0	487	1181	0	0	538	456
V/C Ratio(X)				0.87	0.00	0.00	0.03	0.38	0.00	0.00	0.77	0.33
Avail Cap(c_a), veh/h				462	0	0	487	1181	0	0	796	674
HCM Platoon Ratio				1.00	1.00	1.00	2.00	2.00	1.00	1.00	1.00	1.00
Upstream Filter(I)				1.00	0.00	0.00	0.88	0.88	0.00	0.00	1.00	1.00
Uniform Delay (d), s/veh				30.1	0.0	0.0	13.1	0.0	0.0	0.0	26.0	22.3
Incr Delay (d2), s/veh				14.2	0.0	0.0	0.0	0.8	0.0	0.0	10.2	1.9
Initial Q Delay(d3),s/veh				0.0	0.0	0.0	0.0	0.0	0.0	0.0	0.0	0.0
%ile BackOfQ(50%),veh/ln				6.7	0.0	0.0	0.1	0.3	0.0	0.0	8.4	2.4
Unsig. Movement Delay, s/veh												
LnGrp Delay(d),s/veh				44.2	0.0	0.0	13.1	0.8	0.0	0.0	36.1	24.2
LnGrp LOS				D	A	A	B	A	A	A	D	C
Approach Vol, veh/h					320			469			563	
Approach Delay, s/veh					44.2			1.3			33.0	
Approach LOS					D			A			C	
Timer - Assigned Phs		2			5	6		8				
Phs Duration (G+Y+Rc), s		56.6			27.7	28.9		23.4				
Change Period (Y+Rc), s		* 5.7			* 5.7	* 5.7		5.7				
Max Green Setting (Gmax), s		* 46			* 6.3	* 34		22.3				
Max Q Clear Time (g_c+I1), s		2.0			2.3	18.3		16.9				
Green Ext Time (p_c), s		4.3			0.0	4.9		0.8				

Intersection Summary

HCM 6th Ctrl Delay	24.6
HCM 6th LOS	C

Notes

* HCM 6th computational engine requires equal clearance times for the phases crossing the barrier.

HCM 6th Signalized Intersection Summary
6: Lemoore Avenue & SR 198 EB Ramps

Existing plus Project PM Peak
10/26/2022



Movement	WBL	WBR	NBT	NBR	SBL	SBT
Lane Configurations						
Traffic Volume (veh/h)	21	200	243	184	193	346
Future Volume (veh/h)	21	200	243	184	193	346
Initial Q (Qb), veh	0	0	0	0	0	0
Ped-Bike Adj(A_pbT)	1.00	1.00		1.00	1.00	
Parking Bus, Adj	1.00	1.00	1.00	1.00	1.00	1.00
Work Zone On Approach	No		No		No	
Adj Sat Flow, veh/h/ln	1856	1856	1856	1856	1856	1856
Adj Flow Rate, veh/h	26	247	300	227	238	427
Peak Hour Factor	0.81	0.81	0.81	0.81	0.81	0.81
Percent Heavy Veh, %	3	3	3	3	3	3
Cap, veh/h	318	283	427	362	665	1257
Arrive On Green	0.18	0.18	0.23	0.23	0.75	1.00
Sat Flow, veh/h	1767	1572	1856	1572	1767	1856
Grp Volume(v), veh/h	26	247	300	227	238	427
Grp Sat Flow(s),veh/h/ln	1767	1572	1856	1572	1767	1856
Q Serve(g_s), s	1.0	12.2	11.9	10.4	3.7	0.0
Cycle Q Clear(g_c), s	1.0	12.2	11.9	10.4	3.7	0.0
Prop In Lane	1.00	1.00		1.00	1.00	
Lane Grp Cap(c), veh/h	318	283	427	362	665	1257
V/C Ratio(X)	0.08	0.87	0.70	0.63	0.36	0.34
Avail Cap(c_a), veh/h	360	320	749	635	665	1257
HCM Platoon Ratio	1.00	1.00	1.00	1.00	2.00	2.00
Upstream Filter(I)	1.00	1.00	1.00	1.00	0.94	0.94
Uniform Delay (d), s/veh	27.3	31.9	28.3	27.7	6.6	0.0
Incr Delay (d2), s/veh	0.1	20.8	9.3	8.0	0.1	0.7
Initial Q Delay(d3),s/veh	0.0	0.0	0.0	0.0	0.0	0.0
%ile BackOfQ(50%),veh/ln	0.4	5.8	6.2	4.6	1.1	0.2
Unsig. Movement Delay, s/veh						
LnGrp Delay(d),s/veh	27.4	52.8	37.6	35.7	6.7	0.7
LnGrp LOS	C	D	D	D	A	A
Approach Vol, veh/h	273		527		665	
Approach Delay, s/veh	50.3		36.8		2.9	
Approach LOS	D		D		A	
Timer - Assigned Phs	1	2			6	8
Phs Duration (G+Y+Rc), s	35.8	24.1			59.9	20.1
Change Period (Y+Rc), s	5.7	* 5.7			* 5.7	5.7
Max Green Setting (Gmax), s	32	* 32			* 52	16.3
Max Q Clear Time (g_c+1/3), s	13.9				2.0	14.2
Green Ext Time (p_c), s	0.2	4.5			5.9	0.2

Intersection Summary

HCM 6th Ctrl Delay	23.9
HCM 6th LOS	C

Notes

* HCM 6th computational engine requires equal clearance times for the phases crossing the barrier.

HCM 6th Signalized Intersection Summary
4: 17th Avenue & Houston Avenue

Existing plus Project AM Peak
10/31/2022



Movement	EBL	EBT	EBR	WBL	WBT	WBR	NBL	NBT	NBR	SBL	SBT	SBR
Lane Configurations												
Traffic Volume (veh/h)	86	404	0	1	413	86	2	0	1	189	1	156
Future Volume (veh/h)	86	404	0	1	413	86	2	0	1	189	1	156
Initial Q (Qb), veh	0	0	0	0	0	0	0	0	0	0	0	0
Ped-Bike Adj(A_pbT)	1.00		1.00	1.00		1.00	1.00		1.00	1.00		1.00
Parking Bus, Adj	1.00	1.00	1.00	1.00	1.00	1.00	1.00	1.00	1.00	1.00	1.00	1.00
Work Zone On Approach		No			No			No			No	
Adj Sat Flow, veh/h/ln	1856	1856	1856	1856	1856	1856	1856	1856	1856	1856	1856	1856
Adj Flow Rate, veh/h	96	449	0	1	459	96	2	0	1	210	1	173
Peak Hour Factor	0.90	0.90	0.90	0.90	0.90	0.90	0.90	0.90	0.90	0.90	0.90	0.90
Percent Heavy Veh, %	3	3	3	3	3	3	3	3	3	3	3	3
Cap, veh/h	298	575	0	298	575	488	186	25	41	443	1	317
Arrive On Green	0.17	0.31	0.00	0.17	0.31	0.31	0.20	0.00	0.20	0.20	0.20	0.20
Sat Flow, veh/h	1767	1856	0	1767	1856	1572	282	125	203	1429	7	1572
Grp Volume(v), veh/h	96	449	0	1	459	96	3	0	0	211	0	173
Grp Sat Flow(s),veh/h/ln	1767	1856	0	1767	1856	1572	610	0	0	1436	0	1572
Q Serve(g_s), s	2.2	10.2	0.0	0.0	10.5	2.1	0.0	0.0	0.0	0.0	0.0	4.6
Cycle Q Clear(g_c), s	2.2	10.2	0.0	0.0	10.5	2.1	6.3	0.0	0.0	6.3	0.0	4.6
Prop In Lane	1.00		0.00	1.00		1.00	0.67		0.33	1.00		1.00
Lane Grp Cap(c), veh/h	298	575	0	298	575	488	252	0	0	444	0	317
V/C Ratio(X)	0.32	0.78	0.00	0.00	0.80	0.20	0.01	0.00	0.00	0.47	0.00	0.55
Avail Cap(c_a), veh/h	298	846	0	298	830	704	461	0	0	669	0	568
HCM Platoon Ratio	1.00	1.00	1.00	1.00	1.00	1.00	1.00	1.00	1.00	1.00	1.00	1.00
Upstream Filter(I)	1.00	1.00	0.00	1.00	1.00	1.00	1.00	0.00	0.00	1.00	0.00	1.00
Uniform Delay (d), s/veh	16.9	14.5	0.0	16.0	14.6	11.7	15.1	0.0	0.0	17.3	0.0	16.6
Incr Delay (d2), s/veh	0.6	2.8	0.0	0.0	3.5	0.2	0.0	0.0	0.0	0.8	0.0	1.5
Initial Q Delay(d3),s/veh	0.0	0.0	0.0	0.0	0.0	0.0	0.0	0.0	0.0	0.0	0.0	0.0
%ile BackOfQ(50%),veh/ln	0.8	3.7	0.0	0.0	3.8	0.6	0.0	0.0	0.0	1.8	0.0	1.4
Unsig. Movement Delay, s/veh												
LnGrp Delay(d),s/veh	17.5	17.4	0.0	16.0	18.2	11.9	15.1	0.0	0.0	18.1	0.0	18.0
LnGrp LOS	B	B	A	B	B	B	B	A	A	B	A	B
Approach Vol, veh/h		545			556			3			384	
Approach Delay, s/veh		17.4			17.1			15.1			18.1	
Approach LOS		B			B			B			B	
Timer - Assigned Phs		2	3	4		6	7	8				
Phs Duration (G+Y+Rc), s		14.6	12.0	19.6		14.6	12.0	19.6				
Change Period (Y+Rc), s		5.3	* 4.2	* 5.3		5.3	* 4.2	5.3				
Max Green Setting (Gmax), s		16.7	* 7.8	* 21		16.7	* 7.8	20.7				
Max Q Clear Time (g_c+I1), s		8.3	2.0	12.2		8.3	4.2	12.5				
Green Ext Time (p_c), s		0.0	0.0	1.7		1.1	0.1	1.9				

Intersection Summary

HCM 6th Ctrl Delay	17.4
HCM 6th LOS	B

Notes

* HCM 6th computational engine requires equal clearance times for the phases crossing the barrier.

HCM 6th Signalized Intersection Summary
4: 17th Avenue & Houston Avenue

Existing plus Project PM Peak
10/31/2022



Movement	EBL	EBT	EBR	WBL	WBT	WBR	NBL	NBT	NBR	SBL	SBT	SBR
Lane Configurations												
Traffic Volume (veh/h)	53	348	0	0	482	186	0	1	0	127	0	42
Future Volume (veh/h)	53	348	0	0	482	186	0	1	0	127	0	42
Initial Q (Qb), veh	0	0	0	0	0	0	0	0	0	0	0	0
Ped-Bike Adj(A_pbT)	1.00		1.00	1.00		1.00	1.00		1.00	1.00		1.00
Parking Bus, Adj	1.00	1.00	1.00	1.00	1.00	1.00	1.00	1.00	1.00	1.00	1.00	1.00
Work Zone On Approach		No			No			No			No	
Adj Sat Flow, veh/h/ln	1856	1856	1856	1856	1856	1856	1856	1856	1856	1856	1856	1856
Adj Flow Rate, veh/h	60	395	0	0	548	211	0	1	0	144	0	48
Peak Hour Factor	0.88	0.88	0.88	0.88	0.88	0.88	0.88	0.88	0.88	0.88	0.88	0.88
Percent Heavy Veh, %	3	3	3	3	3	3	3	3	3	3	3	3
Cap, veh/h	164	1060	0	4	707	599	0	337	0	422	0	286
Arrive On Green	0.09	0.57	0.00	0.00	0.38	0.38	0.00	0.18	0.00	0.18	0.00	0.18
Sat Flow, veh/h	1767	1856	0	1767	1856	1572	0	1856	0	1402	0	1572
Grp Volume(v), veh/h	60	395	0	0	548	211	0	1	0	144	0	48
Grp Sat Flow(s),veh/h/ln	1767	1856	0	1767	1856	1572	0	1856	0	1402	0	1572
Q Serve(g_s), s	1.4	5.0	0.0	0.0	11.1	4.1	0.0	0.0	0.0	4.0	0.0	1.1
Cycle Q Clear(g_c), s	1.4	5.0	0.0	0.0	11.1	4.1	0.0	0.0	0.0	4.0	0.0	1.1
Prop In Lane	1.00		0.00	1.00		1.00	0.00		0.00	1.00		1.00
Lane Grp Cap(c), veh/h	164	1060	0	4	707	599	0	337	0	422	0	286
V/C Ratio(X)	0.37	0.37	0.00	0.00	0.78	0.35	0.00	0.00	0.00	0.34	0.00	0.17
Avail Cap(c_a), veh/h	321	1128	0	321	1111	941	0	506	0	550	0	428
HCM Platoon Ratio	1.00	1.00	1.00	1.00	1.00	1.00	1.00	1.00	1.00	1.00	1.00	1.00
Upstream Filter(I)	1.00	1.00	0.00	0.00	1.00	1.00	0.00	1.00	0.00	1.00	0.00	1.00
Uniform Delay (d), s/veh	18.3	5.0	0.0	0.0	11.7	9.5	0.0	14.4	0.0	16.0	0.0	14.8
Incr Delay (d2), s/veh	1.4	0.2	0.0	0.0	1.9	0.4	0.0	0.0	0.0	0.5	0.0	0.3
Initial Q Delay(d3),s/veh	0.0	0.0	0.0	0.0	0.0	0.0	0.0	0.0	0.0	0.0	0.0	0.0
%ile BackOfQ(50%),veh/ln	0.5	1.0	0.0	0.0	3.3	1.0	0.0	0.0	0.0	1.1	0.0	0.3
Unsig. Movement Delay, s/veh												
LnGrp Delay(d),s/veh	19.6	5.2	0.0	0.0	13.5	9.9	0.0	14.4	0.0	16.5	0.0	15.1
LnGrp LOS	B	A	A	A	B	A	A	B	A	B	A	B
Approach Vol, veh/h		455			759			1				192
Approach Delay, s/veh		7.1			12.5			14.4				16.2
Approach LOS		A			B			B				B
Timer - Assigned Phs		2	3	4		6	7	8				
Phs Duration (G+Y+Rc), s		13.1	0.0	29.8		13.1	8.2	21.7				
Change Period (Y+Rc), s		5.3	* 4.2	* 5.3		5.3	* 4.2	5.3				
Max Green Setting (Gmax), s		11.7	* 7.8	* 26		11.7	* 7.8	25.7				
Max Q Clear Time (g_c+I1), s		2.0	0.0	7.0		6.0	3.4	13.1				
Green Ext Time (p_c), s		0.0	0.0	2.1		0.4	0.0	3.2				

Intersection Summary

HCM 6th Ctrl Delay	11.3
HCM 6th LOS	B

Notes

* HCM 6th computational engine requires equal clearance times for the phases crossing the barrier.

Intersection: 1: Lemoore Avenue & D Street

Movement	EB	EB	WB	WB	WB	NB	NB	NB	SB	SB	SB
Directions Served	L	TR	L	T	R	L	T	TR	L	T	TR
Maximum Queue (ft)	134	141	73	230	160	109	152	192	183	190	188
Average Queue (ft)	43	76	30	79	58	40	92	111	89	97	94
95th Queue (ft)	97	121	59	141	111	90	146	177	153	161	164
Link Distance (ft)		1631		2383			1433	1433		1665	1665
Upstream Blk Time (%)											
Queuing Penalty (veh)											
Storage Bay Dist (ft)	85		75		75	60			140		
Storage Blk Time (%)	1	6	0	11	2	2	15		3	1	
Queuing Penalty (veh)	1	4	1	26	6	5	6		9	2	

Intersection: 2: Bush Street/Daphne Lane & D Street

Movement	NW	NE	SW
Directions Served	L	LTR	LTR
Maximum Queue (ft)	76	139	31
Average Queue (ft)	33	66	19
95th Queue (ft)	65	112	43
Link Distance (ft)		1039	373
Upstream Blk Time (%)			
Queuing Penalty (veh)			
Storage Bay Dist (ft)	125		
Storage Blk Time (%)			
Queuing Penalty (veh)			

Intersection: 3: Lemoore Avenue & Bush Street

Movement	EB	EB	EB	WB	WB	WB	NB	NB	NB	NB	SB	SB
Directions Served	L	T	R	L	T	R	L	T	T	R	L	T
Maximum Queue (ft)	180	284	135	130	223	120	138	87	108	127	195	204
Average Queue (ft)	90	91	46	66	111	72	64	47	55	36	102	93
95th Queue (ft)	147	173	97	122	200	129	110	87	102	75	175	159
Link Distance (ft)	2569	2569			350			1768	1768			1433
Upstream Blk Time (%)												
Queuing Penalty (veh)												
Storage Bay Dist (ft)			75	150		60	100			105	135	
Storage Blk Time (%)		16	0	0	24	4	2	0	1	0	6	2
Queuing Penalty (veh)		16	1	0	63	12	2	0	1	0	9	3

Intersection: 3: Lemoore Avenue & Bush Street

Movement	SB
Directions Served	TR
Maximum Queue (ft)	205
Average Queue (ft)	101
95th Queue (ft)	169
Link Distance (ft)	1433
Upstream Blk Time (%)	
Queuing Penalty (veh)	
Storage Bay Dist (ft)	
Storage Blk Time (%)	
Queuing Penalty (veh)	

Intersection: 4: 17th Avenue & Houston Avenue

Movement	EB	EB	WB	WB	WB	NB	SB	SB
Directions Served	L	TR	L	T	R	LTR	LT	R
Maximum Queue (ft)	93	196	31	202	66	52	196	150
Average Queue (ft)	46	103	2	104	23	5	79	58
95th Queue (ft)	89	182	14	183	52	24	152	127
Link Distance (ft)		656		640		1215	3087	
Upstream Blk Time (%)								
Queuing Penalty (veh)								
Storage Bay Dist (ft)	75		75		150			90
Storage Blk Time (%)	3	13		16			6	0
Queuing Penalty (veh)	14	11		14			9	0

Intersection: 5: Lemoore Avenue & SR 198 WB Ramps

Movement	WB	NB	NB	SB	SB
Directions Served	LTR	L	T	T	R
Maximum Queue (ft)	225	54	163	184	150
Average Queue (ft)	85	18	60	78	45
95th Queue (ft)	153	50	125	162	124
Link Distance (ft)	1146		568	301	
Upstream Blk Time (%)					
Queuing Penalty (veh)					
Storage Bay Dist (ft)		200			75
Storage Blk Time (%)				6	
Queuing Penalty (veh)				9	

Intersection: 6: Lemoore Avenue & SR 198 EB Ramps

Movement	WB	WB	NB	NB	SB	SB
Directions Served	L	R	T	R	L	T
Maximum Queue (ft)	44	81	118	77	181	92
Average Queue (ft)	14	35	55	24	90	32
95th Queue (ft)	35	63	95	62	154	76
Link Distance (ft)		194	2460			568
Upstream Blk Time (%)						
Queuing Penalty (veh)						
Storage Bay Dist (ft)	50			50	200	
Storage Blk Time (%)	0	2	7	2	0	
Queuing Penalty (veh)	1	0	7	4	0	

Network Summary

Network wide Queuing Penalty: 237

Intersection: 1: Lemoore Avenue & D Street

Movement	EB	EB	WB	WB	WB	NB	NB	NB	SB	SB	SB
Directions Served	L	TR	L	T	R	L	T	TR	L	T	TR
Maximum Queue (ft)	135	226	69	228	160	109	199	198	170	145	162
Average Queue (ft)	58	73	32	63	79	38	81	88	95	67	83
95th Queue (ft)	106	149	64	131	130	82	158	160	150	113	145
Link Distance (ft)		1631		2383			1433	1433		1665	1665
Upstream Blk Time (%)											
Queuing Penalty (veh)											
Storage Bay Dist (ft)	85		75		75	60			140		
Storage Blk Time (%)	4	5	0	8	7	6	17		2	0	
Queuing Penalty (veh)	7	5	1	23	13	14	7		5	0	

Intersection: 2: Bush Street/Daphne Lane & D Street

Movement	SE	NW	NE	SW
Directions Served	L	L	LTR	LTR
Maximum Queue (ft)	29	71	74	53
Average Queue (ft)	8	30	45	18
95th Queue (ft)	28	59	70	48
Link Distance (ft)			1039	373
Upstream Blk Time (%)				
Queuing Penalty (veh)				
Storage Bay Dist (ft)	90	125		
Storage Blk Time (%)				
Queuing Penalty (veh)				

Intersection: 3: Lemoore Avenue & Bush Street

Movement	EB	EB	EB	WB	WB	WB	NB	NB	NB	NB	SB	SB
Directions Served	L	T	R	L	T	R	L	T	T	R	L	T
Maximum Queue (ft)	98	162	135	132	160	43	149	157	198	145	116	182
Average Queue (ft)	47	59	48	50	50	17	56	70	76	33	41	82
95th Queue (ft)	93	105	88	99	111	37	114	132	146	97	80	152
Link Distance (ft)	2569	2569			350			1768	1768			1433
Upstream Blk Time (%)												
Queuing Penalty (veh)												
Storage Bay Dist (ft)			75	150		60	100			105	135	
Storage Blk Time (%)		7	1	0	6	0	1	2	3		0	1
Queuing Penalty (veh)		11	1	0	7	0	3	2	3		0	0

Intersection: 3: Lemoore Avenue & Bush Street

Movement	SB
Directions Served	TR
Maximum Queue (ft)	207
Average Queue (ft)	91
95th Queue (ft)	158
Link Distance (ft)	1433
Upstream Blk Time (%)	
Queuing Penalty (veh)	
Storage Bay Dist (ft)	
Storage Blk Time (%)	
Queuing Penalty (veh)	

Intersection: 4: 17th Avenue & Houston Avenue

Movement	EB	EB	WB	WB	SB	SB
Directions Served	L	TR	T	R	LT	R
Maximum Queue (ft)	77	147	309	76	114	68
Average Queue (ft)	31	51	110	36	49	17
95th Queue (ft)	59	104	219	66	89	44
Link Distance (ft)		656	640		3087	
Upstream Blk Time (%)						
Queuing Penalty (veh)						
Storage Bay Dist (ft)	75			150		90
Storage Blk Time (%)	0	2	13		1	
Queuing Penalty (veh)	1	1	24		0	

Intersection: 5: Lemoore Avenue & SR 198 WB Ramps

Movement	WB	NB	NB	SB	SB
Directions Served	LTR	L	T	T	R
Maximum Queue (ft)	288	74	116	286	150
Average Queue (ft)	119	15	60	97	38
95th Queue (ft)	209	51	115	204	116
Link Distance (ft)	1146		568	301	
Upstream Blk Time (%)				0	
Queuing Penalty (veh)				0	
Storage Bay Dist (ft)		200			75
Storage Blk Time (%)				8	0
Queuing Penalty (veh)				12	1

Intersection: 6: Lemoore Avenue & SR 198 EB Ramps

Movement	WB	WB	NB	NB	SB	SB
Directions Served	L	R	T	R	L	T
Maximum Queue (ft)	42	82	205	175	220	98
Average Queue (ft)	11	41	63	61	120	26
95th Queue (ft)	32	68	127	133	193	75
Link Distance (ft)		194	2460			568
Upstream Blk Time (%)						
Queuing Penalty (veh)						
Storage Bay Dist (ft)	50			50	200	
Storage Blk Time (%)	1	3	8	5	0	
Queuing Penalty (veh)	1	1	15	13	1	

Network Summary

Network wide Queuing Penalty: 171

Appendix G: Near Term plus Project Traffic Conditions



www.JLBtraffic.com
info@JLBtraffic.com

516 W. Shaw Ave., Ste. 103
Fresno, CA 93704
(559) 570-8991

App | G

HCM 6th Signalized Intersection Summary
1: Lemoore Avenue & D Street

Near Term plus Project AM Peak

11/03/2022



Movement	EBL	EBT	EBR	WBL	WBT	WBR	NBL	NBT	NBR	SBL	SBT	SBR
Lane Configurations	↖	↗		↖	↖	↗	↖	↖↗		↖	↖↗	
Traffic Volume (veh/h)	58	111	40	50	173	174	41	501	45	170	677	72
Future Volume (veh/h)	58	111	40	50	173	174	41	501	45	170	677	72
Initial Q (Qb), veh	0	0	0	0	0	0	0	0	0	0	0	0
Ped-Bike Adj(A_pbT)	1.00		0.99	1.00		0.99	1.00		0.94	1.00		0.95
Parking Bus, Adj	1.00	1.00	1.00	1.00	1.00	1.00	1.00	1.00	1.00	1.00	1.00	1.00
Work Zone On Approach		No			No			No			No	
Adj Sat Flow, veh/h/ln	1856	1856	1856	1856	1856	1856	1856	1856	1856	1856	1856	1856
Adj Flow Rate, veh/h	67	129	47	58	201	202	48	583	52	198	787	84
Peak Hour Factor	0.86	0.86	0.86	0.86	0.86	0.86	0.86	0.86	0.86	0.86	0.86	0.86
Percent Heavy Veh, %	3	3	3	3	3	3	3	3	3	3	3	3
Cap, veh/h	149	270	99	138	377	315	123	1037	92	239	1229	131
Arrive On Green	0.08	0.21	0.21	0.08	0.20	0.20	0.07	0.32	0.32	0.14	0.38	0.38
Sat Flow, veh/h	1767	1292	471	1767	1856	1549	1767	3255	290	1767	3195	341
Grp Volume(v), veh/h	67	0	176	58	201	202	48	315	320	198	434	437
Grp Sat Flow(s),veh/h/ln	1767	0	1763	1767	1856	1549	1767	1763	1782	1767	1763	1773
Q Serve(g_s), s	2.3	0.0	5.7	2.0	6.3	7.8	1.7	9.6	9.7	7.1	13.1	13.1
Cycle Q Clear(g_c), s	2.3	0.0	5.7	2.0	6.3	7.8	1.7	9.6	9.7	7.1	13.1	13.1
Prop In Lane	1.00		0.27	1.00		1.00	1.00		0.16	1.00		0.19
Lane Grp Cap(c), veh/h	149	0	369	138	377	315	123	562	568	239	678	682
V/C Ratio(X)	0.45	0.00	0.48	0.42	0.53	0.64	0.39	0.56	0.56	0.83	0.64	0.64
Avail Cap(c_a), veh/h	239	0	678	212	686	572	212	722	730	239	749	753
HCM Platoon Ratio	1.00	1.00	1.00	1.00	1.00	1.00	1.00	1.00	1.00	1.00	1.00	1.00
Upstream Filter(I)	1.00	0.00	1.00	1.00	1.00	1.00	1.00	1.00	1.00	1.00	1.00	1.00
Uniform Delay (d), s/veh	28.3	0.0	22.6	28.6	23.1	23.7	28.9	18.4	18.4	27.3	16.3	16.3
Incr Delay (d2), s/veh	2.1	0.0	1.0	2.0	1.2	2.2	2.0	0.9	0.9	20.7	1.6	1.6
Initial Q Delay(d3),s/veh	0.0	0.0	0.0	0.0	0.0	0.0	0.0	0.0	0.0	0.0	0.0	0.0
%ile BackOfQ(50%),veh/ln	1.1	0.0	2.4	0.9	2.8	2.9	0.8	3.8	3.9	4.3	5.2	5.2
Unsig. Movement Delay, s/veh												
LnGrp Delay(d),s/veh	30.4	0.0	23.5	30.6	24.3	25.9	30.9	19.2	19.3	48.0	17.9	17.9
LnGrp LOS	C	A	C	C	C	C	C	B	B	D	B	B
Approach Vol, veh/h		243			461			683			1069	
Approach Delay, s/veh		25.4			25.8			20.1			23.5	
Approach LOS		C			C			C			C	
Timer - Assigned Phs	1	2	3	4	5	6	7	8				
Phs Duration (G+Y+Rc), s	13.0	24.9	9.3	17.8	8.7	29.2	9.7	17.4				
Change Period (Y+Rc), s	* 4.2	* 4.2	* 4.2	* 4.2	* 4.2	* 4.2	* 4.2	* 4.2				
Max Green Setting (Gmax), s	* 8.8	* 27	* 7.8	* 25	* 7.8	* 28	* 8.8	* 24				
Max Q Clear Time (g_c+I1), s	9.1	11.7	4.0	7.7	3.7	15.1	4.3	9.8				
Green Ext Time (p_c), s	0.0	3.6	0.0	0.9	0.0	4.8	0.0	1.6				

Intersection Summary

HCM 6th Ctrl Delay	23.2
HCM 6th LOS	C

Notes

* HCM 6th computational engine requires equal clearance times for the phases crossing the barrier.

Intersection

Int Delay, s/veh 8.1

Movement	SEL	SET	SER	NWL	NWT	NWR	NEL	NET	NER	SWL	SWT	SWR
Lane Configurations	↖	↗		↖	↗			↕			↕	
Traffic Vol, veh/h	5	264	28	193	303	10	33	7	176	8	8	16
Future Vol, veh/h	5	264	28	193	303	10	33	7	176	8	8	16
Conflicting Peds, #/hr	1	0	0	0	0	1	0	0	3	3	0	0
Sign Control	Free	Free	Free	Free	Free	Free	Stop	Stop	Stop	Stop	Stop	Stop
RT Channelized	-	-	None	-	-	None	-	-	None	-	-	None
Storage Length	90	-	-	125	-	-	-	-	-	-	-	-
Veh in Median Storage, #	-	0	-	-	0	-	-	0	-	-	0	-
Grade, %	-	0	-	-	0	-	-	0	-	-	0	-
Peak Hour Factor	86	86	86	86	86	86	86	86	86	86	86	86
Heavy Vehicles, %	3	3	3	3	3	3	3	3	3	3	3	3
Mvmt Flow	6	307	33	224	352	12	38	8	205	9	9	19

Major/Minor	Major1	Major2	Minor1	Minor2
Conflicting Flow All	365	0	0	340
Stage 1	-	-	-	-
Stage 2	-	-	-	-
Critical Hdwy	4.13	-	-	4.13
Critical Hdwy Stg 1	-	-	-	-
Critical Hdwy Stg 2	-	-	-	-
Follow-up Hdwy	2.227	-	-	2.227
Pot Cap-1 Maneuver	1188	-	-	1214
Stage 1	-	-	-	-
Stage 2	-	-	-	-
Platoon blocked, %	-	-	-	-
Mov Cap-1 Maneuver	1187	-	-	1214
Mov Cap-2 Maneuver	-	-	-	-
Stage 1	-	-	-	-
Stage 2	-	-	-	-

























Approach	SE	NW	NE	SW
HCM Control Delay, s	0.1	3.3	27.1	28.4
HCM LOS			D	D

Minor Lane/Major Mvmt	NELn1	NWL	NWT	NWR	SEL	SET	SERSWLn1
Capacity (veh/h)	407	1214	-	-	1187	-	-
HCM Lane V/C Ratio	0.617	0.185	-	-	0.005	-	-
HCM Control Delay (s)	27.1	8.6	-	-	8	-	-
HCM Lane LOS	D	A	-	-	A	-	-
HCM 95th %tile Q(veh)	4	0.7	-	-	0	-	-

HCM 6th Signalized Intersection Summary
3: Lemoore Avenue & Bush Street

Near Term plus Project AM Peak

11/03/2022

												
Movement	EBL	EBT	EBR	WBL	WBT	WBR	NBL	NBT	NBR	SBL	SBT	SBR
Lane Configurations												
Traffic Volume (veh/h)	134	202	124	101	209	168	118	235	108	158	364	137
Future Volume (veh/h)	134	202	124	101	209	168	118	235	108	158	364	137
Initial Q (Qb), veh	0	0	0	0	0	0	0	0	0	0	0	0
Ped-Bike Adj(A_pbT)	1.00		0.91	1.00		0.90	1.00		0.80	1.00		0.89
Parking Bus, Adj	1.00	1.00	1.00	1.00	1.00	1.00	1.00	1.00	1.00	1.00	1.00	1.00
Work Zone On Approach		No			No			No			No	
Adj Sat Flow, veh/h/ln	1856	1856	1856	1856	1856	1856	1856	1856	1856	1856	1856	1856
Adj Flow Rate, veh/h	156	235	144	117	243	195	137	273	126	184	423	159
Peak Hour Factor	0.86	0.86	0.86	0.86	0.86	0.86	0.86	0.86	0.86	0.86	0.86	0.86
Percent Heavy Veh, %	3	3	3	3	3	3	3	3	3	3	3	3
Cap, veh/h	191	589	454	155	551	422	170	939	333	222	718	265
Arrive On Green	0.11	0.32	0.32	0.09	0.30	0.30	0.10	0.27	0.27	0.13	0.30	0.30
Sat Flow, veh/h	1767	1856	1431	1767	1856	1422	1767	3526	1251	1767	2429	896
Grp Volume(v), veh/h	156	235	144	117	243	195	137	273	126	184	305	277
Grp Sat Flow(s),veh/h/ln	1767	1856	1431	1767	1856	1422	1767	1763	1251	1767	1763	1563
Q Serve(g_s), s	7.1	8.2	6.3	5.4	8.8	9.2	6.3	5.1	6.8	8.4	12.2	12.6
Cycle Q Clear(g_c), s	7.1	8.2	6.3	5.4	8.8	9.2	6.3	5.1	6.8	8.4	12.2	12.6
Prop In Lane	1.00		1.00	1.00		1.00	1.00		1.00	1.00		0.57
Lane Grp Cap(c), veh/h	191	589	454	155	551	422	170	939	333	222	521	462
V/C Ratio(X)	0.82	0.40	0.32	0.75	0.44	0.46	0.80	0.29	0.38	0.83	0.59	0.60
Avail Cap(c_a), veh/h	231	628	484	188	583	447	209	1005	357	273	567	502
HCM Platoon Ratio	1.00	1.00	1.00	1.00	1.00	1.00	1.00	1.00	1.00	1.00	1.00	1.00
Upstream Filter(I)	1.00	1.00	1.00	1.00	1.00	1.00	1.00	1.00	1.00	1.00	1.00	1.00
Uniform Delay (d), s/veh	36.1	22.1	21.4	36.9	23.5	23.7	36.6	24.1	24.8	35.3	24.8	25.0
Incr Delay (d2), s/veh	17.1	0.4	0.4	13.0	0.6	0.8	16.8	0.2	0.7	16.0	1.3	1.7
Initial Q Delay(d3),s/veh	0.0	0.0	0.0	0.0	0.0	0.0	0.0	0.0	0.0	0.0	0.0	0.0
%ile BackOfQ(50%),veh/ln	3.9	3.5	2.1	2.9	3.9	3.1	3.4	2.1	2.1	4.6	5.2	4.8
Unsig. Movement Delay, s/veh												
LnGrp Delay(d),s/veh	53.2	22.5	21.8	49.9	24.1	24.5	53.4	24.3	25.5	51.4	26.2	26.7
LnGrp LOS	D	C	C	D	C	C	D	C	C	D	C	C
Approach Vol, veh/h		535			555			536			766	
Approach Delay, s/veh		31.3			29.7			32.0			32.4	
Approach LOS		C			C			C			C	
Timer - Assigned Phs	1	2	3	4	5	6	7	8				
Phs Duration (G+Y+Rc), s	14.6	26.3	11.5	30.5	12.2	28.7	13.2	28.8				
Change Period (Y+Rc), s	* 4.2	* 4.2	* 4.2	* 4.2	* 4.2	* 4.2	* 4.2	* 4.2				
Max Green Setting (Gmax), s	* 13	* 24	* 8.8	* 28	* 9.8	* 27	* 11	* 26				
Max Q Clear Time (g_c+I1), s	10.4	8.8	7.4	10.2	8.3	14.6	9.1	11.2				
Green Ext Time (p_c), s	0.1	2.0	0.0	1.8	0.0	3.1	0.1	2.0				

Intersection Summary

HCM 6th Ctrl Delay	31.4
HCM 6th LOS	C

Notes

* HCM 6th computational engine requires equal clearance times for the phases crossing the barrier.

HCM 6th Signalized Intersection Summary
4: 17th Avenue & D Street/Houston Avenue

Near Term plus Project AM Peak
11/03/2022



Movement	EBL	EBT	EBR	WBL	WBT	WBR	NBL	NBT	NBR	SBL	SBT	SBR
Lane Configurations												
Traffic Volume (veh/h)	87	408	0	1	415	86	2	0	1	189	1	157
Future Volume (veh/h)	87	408	0	1	415	86	2	0	1	189	1	157
Initial Q (Qb), veh	0	0	0	0	0	0	0	0	0	0	0	0
Ped-Bike Adj(A_pbT)	1.00		1.00	1.00		1.00	1.00		1.00	1.00		1.00
Parking Bus, Adj	1.00	1.00	1.00	1.00	1.00	1.00	1.00	1.00	1.00	1.00	1.00	1.00
Work Zone On Approach		No			No			No			No	
Adj Sat Flow, veh/h/ln	1856	1856	1856	1856	1856	1856	1856	1856	1856	1856	1856	1856
Adj Flow Rate, veh/h	97	453	0	1	461	96	2	0	1	210	1	174
Peak Hour Factor	0.90	0.90	0.90	0.90	0.90	0.90	0.90	0.90	0.90	0.90	0.90	0.90
Percent Heavy Veh, %	3	3	3	3	3	3	3	3	3	3	3	3
Cap, veh/h	290	616	0	290	573	485	181	24	40	436	1	317
Arrive On Green	0.16	0.33	0.00	0.16	0.31	0.31	0.20	0.00	0.20	0.20	0.20	0.20
Sat Flow, veh/h	1767	1856	0	1767	1856	1572	273	121	197	1416	7	1572
Grp Volume(v), veh/h	97	453	0	1	461	96	3	0	0	211	0	174
Grp Sat Flow(s),veh/h/ln	1767	1856	0	1767	1856	1572	591	0	0	1423	0	1572
Q Serve(g_s), s	2.3	10.3	0.0	0.0	10.9	2.1	0.0	0.0	0.0	0.0	0.0	4.7
Cycle Q Clear(g_c), s	2.3	10.3	0.0	0.0	10.9	2.1	6.6	0.0	0.0	6.6	0.0	4.7
Prop In Lane	1.00		0.00	1.00		1.00	0.67		0.33	1.00		1.00
Lane Grp Cap(c), veh/h	290	616	0	290	573	485	245	0	0	438	0	317
V/C Ratio(X)	0.33	0.74	0.00	0.00	0.80	0.20	0.01	0.00	0.00	0.48	0.00	0.55
Avail Cap(c_a), veh/h	290	823	0	290	807	684	440	0	0	648	0	552
HCM Platoon Ratio	1.00	1.00	1.00	1.00	1.00	1.00	1.00	1.00	1.00	1.00	1.00	1.00
Upstream Filter(I)	1.00	1.00	0.00	1.00	1.00	1.00	1.00	0.00	0.00	1.00	0.00	1.00
Uniform Delay (d), s/veh	17.6	14.0	0.0	16.6	15.1	12.1	15.5	0.0	0.0	17.8	0.0	17.1
Incr Delay (d2), s/veh	0.7	2.4	0.0	0.0	4.1	0.2	0.0	0.0	0.0	0.8	0.0	1.5
Initial Q Delay(d3),s/veh	0.0	0.0	0.0	0.0	0.0	0.0	0.0	0.0	0.0	0.0	0.0	0.0
%ile BackOfQ(50%),veh/ln	0.8	3.7	0.0	0.0	4.1	0.6	0.0	0.0	0.0	1.9	0.0	1.5
Unsig. Movement Delay, s/veh												
LnGrp Delay(d),s/veh	18.3	16.4	0.0	16.6	19.2	12.3	15.5	0.0	0.0	18.6	0.0	18.5
LnGrp LOS	B	B	A	B	B	B	B	A	A	B	A	B
Approach Vol, veh/h		550			558			3			385	
Approach Delay, s/veh		16.7			18.0			15.5			18.6	
Approach LOS		B			B			B			B	
Timer - Assigned Phs		2	3	4		6	7	8				
Phs Duration (G+Y+Rc), s		14.9	12.0	20.7		14.9	12.7	20.0				
Change Period (Y+Rc), s		5.3	* 4.2	4.9		5.3	4.9	* 5.3				
Max Green Setting (Gmax), s		16.7	* 7.8	21.1		16.7	7.8	* 21				
Max Q Clear Time (g_c+11), s		8.6	2.0	12.3		8.6	4.3	12.9				
Green Ext Time (p_c), s		0.0	0.0	1.7		1.1	0.1	1.8				

Intersection Summary

HCM 6th Ctrl Delay	17.7
HCM 6th LOS	B

Notes

* HCM 6th computational engine requires equal clearance times for the phases crossing the barrier.

HCM 6th Signalized Intersection Summary
5: Lemoore Avenue & SR 198 WB Ramps

Near Term plus Project AM Peak

11/03/2022



Movement	EBL	EBT	EBR	WBL	WBT	WBR	NBL	NBT	NBR	SBL	SBT	SBR
Lane Configurations					↕		↖	↗			↕	↗
Traffic Volume (veh/h)	0	0	0	112	0	123	19	396	0	0	413	158
Future Volume (veh/h)	0	0	0	112	0	123	19	396	0	0	413	158
Initial Q (Qb), veh				0	0	0	0	0	0	0	0	0
Ped-Bike Adj(A_pbT)				1.00		1.00	1.00		1.00	1.00		1.00
Parking Bus, Adj				1.00	1.00	1.00	1.00	1.00	1.00	1.00	1.00	1.00
Work Zone On Approach				No		No		No				
Adj Sat Flow, veh/h/ln				1856	1856	1856	1856	1856	0	0	1856	1856
Adj Flow Rate, veh/h				120	0	132	20	426	0	0	444	170
Peak Hour Factor				0.93	0.93	0.93	0.93	0.93	0.93	0.93	0.93	0.93
Percent Heavy Veh, %				3	3	3	3	3	0	0	3	3
Cap, veh/h				141	0	155	473	1231	0	0	588	498
Arrive On Green				0.18	0.00	0.18	0.54	1.00	0.00	0.00	0.32	0.32
Sat Flow, veh/h				790	0	869	1767	1856	0	0	1856	1572
Grp Volume(v), veh/h				252	0	0	20	426	0	0	444	170
Grp Sat Flow(s),veh/h/ln				1660	0	0	1767	1856	0	0	1856	1572
Q Serve(g_s), s				10.6	0.0	0.0	0.4	0.0	0.0	0.0	15.5	6.0
Cycle Q Clear(g_c), s				10.6	0.0	0.0	0.4	0.0	0.0	0.0	15.5	6.0
Prop In Lane				0.48		0.52	1.00		0.00	0.00		1.00
Lane Grp Cap(c), veh/h				296	0	0	473	1231	0	0	588	498
V/C Ratio(X)				0.85	0.00	0.00	0.04	0.35	0.00	0.00	0.76	0.34
Avail Cap(c_a), veh/h				353	0	0	473	1231	0	0	858	727
HCM Platoon Ratio				1.00	1.00	1.00	2.00	2.00	1.00	1.00	1.00	1.00
Upstream Filter(I)				1.00	0.00	0.00	0.93	0.93	0.00	0.00	1.00	1.00
Uniform Delay (d), s/veh				28.7	0.0	0.0	12.3	0.0	0.0	0.0	22.1	18.8
Incr Delay (d2), s/veh				15.7	0.0	0.0	0.0	0.7	0.0	0.0	8.8	1.9
Initial Q Delay(d3),s/veh				0.0	0.0	0.0	0.0	0.0	0.0	0.0	0.0	0.0
%ile BackOfQ(50%),veh/ln				5.0	0.0	0.0	0.2	0.2	0.0	0.0	7.7	2.3
Unsig. Movement Delay, s/veh												
LnGrp Delay(d),s/veh				44.4	0.0	0.0	12.4	0.7	0.0	0.0	30.9	20.7
LnGrp LOS				D	A	A	B	A	A	A	C	C
Approach Vol, veh/h					252			446			614	
Approach Delay, s/veh					44.4			1.2			28.1	
Approach LOS					D			A			C	
Timer - Assigned Phs		2			5	6		8				
Phs Duration (G+Y+Rc), s		53.5			25.0	28.5		18.5				
Change Period (Y+Rc), s		* 5.7			* 5.7	* 5.7		5.7				
Max Green Setting (Gmax), s		* 45			* 6.3	* 33		15.3				
Max Q Clear Time (g_c+11), s		2.0			2.4	17.5		12.6				
Green Ext Time (p_c), s		4.0			0.0	5.3		0.3				

Intersection Summary

HCM 6th Ctrl Delay	22.1
HCM 6th LOS	C

Notes

* HCM 6th computational engine requires equal clearance times for the phases crossing the barrier.

HCM 6th Signalized Intersection Summary
6: Lemoore Avenue & SR 198 EB Ramps

Near Term plus Project AM Peak
11/03/2022



Movement	WBL	WBR	NBT	NBR	SBL	SBT
Lane Configurations						
Traffic Volume (veh/h)	12	156	261	100	174	353
Future Volume (veh/h)	12	156	261	100	174	353
Initial Q (Qb), veh	0	0	0	0	0	0
Ped-Bike Adj(A_pbT)	1.00	1.00		1.00	1.00	
Parking Bus, Adj	1.00	1.00	1.00	1.00	1.00	1.00
Work Zone On Approach	No		No		No	
Adj Sat Flow, veh/h/ln	1856	1856	1856	1856	1856	1856
Adj Flow Rate, veh/h	13	168	281	108	187	380
Peak Hour Factor	0.93	0.93	0.93	0.93	0.93	0.93
Percent Heavy Veh, %	3	3	3	3	3	3
Cap, veh/h	204	181	404	343	759	1348
Arrive On Green	0.12	0.12	0.22	0.22	0.86	1.00
Sat Flow, veh/h	1767	1572	1856	1572	1767	1856
Grp Volume(v), veh/h	13	168	281	108	187	380
Grp Sat Flow(s),veh/h/ln	1767	1572	1856	1572	1767	1856
Q Serve(g_s), s	0.5	7.6	10.1	4.2	1.4	0.0
Cycle Q Clear(g_c), s	0.5	7.6	10.1	4.2	1.4	0.0
Prop In Lane	1.00	1.00		1.00	1.00	
Lane Grp Cap(c), veh/h	204	181	404	343	759	1348
V/C Ratio(X)	0.06	0.93	0.70	0.32	0.25	0.28
Avail Cap(c_a), veh/h	204	181	858	727	759	1348
HCM Platoon Ratio	1.00	1.00	1.00	1.00	2.00	2.00
Upstream Filter(I)	1.00	1.00	1.00	1.00	0.94	0.94
Uniform Delay (d), s/veh	28.4	31.5	26.0	23.6	3.0	0.0
Incr Delay (d2), s/veh	0.1	46.4	9.5	2.4	0.1	0.5
Initial Q Delay(d3),s/veh	0.0	0.0	0.0	0.0	0.0	0.0
%ile BackOfQ(50%),veh/ln	0.2	4.9	5.3	1.7	0.4	0.2
Unsig. Movement Delay, s/veh						
LnGrp Delay(d),s/veh	28.5	77.9	35.5	26.0	3.1	0.5
LnGrp LOS	C	E	D	C	A	A
Approach Vol, veh/h	181		389			567
Approach Delay, s/veh	74.4		32.8			1.3
Approach LOS	E		C			A
Timer - Assigned Phs	1	2			6	8
Phs Duration (G+Y+Rc), s	36.6	21.4			58.0	14.0
Change Period (Y+Rc), s	5.7	* 5.7			* 5.7	5.7
Max Green Setting (Gmax), s	33	* 33			* 52	8.3
Max Q Clear Time (g_c+1), s	13.4	12.1			2.0	9.6
Green Ext Time (p_c), s	0.2	3.6			5.1	0.0

Intersection Summary

HCM 6th Ctrl Delay	23.7
HCM 6th LOS	C

Notes

* HCM 6th computational engine requires equal clearance times for the phases crossing the barrier.

HCM 6th Signalized Intersection Summary
1: Lemoore Avenue & D Street

Near Term plus Project PM Peak

11/03/2022



Movement	EBL	EBT	EBR	WBL	WBT	WBR	NBL	NBT	NBR	SBL	SBT	SBR
Lane Configurations												
Traffic Volume (veh/h)	99	130	37	47	143	220	43	522	37	174	480	91
Future Volume (veh/h)	99	130	37	47	143	220	43	522	37	174	480	91
Initial Q (Qb), veh	0	0	0	0	0	0	0	0	0	0	0	0
Ped-Bike Adj(A_pbT)	1.00		0.99	1.00		0.99	1.00		0.98	1.00		0.98
Parking Bus, Adj	1.00	1.00	1.00	1.00	1.00	1.00	1.00	1.00	1.00	1.00	1.00	1.00
Work Zone On Approach		No			No			No			No	
Adj Sat Flow, veh/h/ln	1856	1856	1856	1856	1856	1856	1856	1856	1856	1856	1856	1856
Adj Flow Rate, veh/h	103	135	39	49	149	229	45	544	39	181	500	95
Peak Hour Factor	0.96	0.96	0.96	0.96	0.96	0.96	0.96	0.96	0.96	0.96	0.96	0.96
Percent Heavy Veh, %	3	3	3	3	3	3	3	3	3	3	3	3
Cap, veh/h	198	229	66	213	324	272	229	929	66	233	828	156
Arrive On Green	0.11	0.17	0.17	0.12	0.17	0.17	0.13	0.28	0.28	0.13	0.28	0.28
Sat Flow, veh/h	1767	1381	399	1767	1856	1559	1767	3331	238	1767	2947	557
Grp Volume(v), veh/h	103	0	174	49	149	229	45	287	296	181	298	297
Grp Sat Flow(s),veh/h/ln	1767	0	1779	1767	1856	1559	1767	1763	1806	1767	1763	1741
Q Serve(g_s), s	3.0	0.0	5.0	1.4	4.0	5.2	1.3	7.8	7.8	5.5	8.1	8.2
Cycle Q Clear(g_c), s	3.0	0.0	5.0	1.4	4.0	5.2	1.3	7.8	7.8	5.5	8.1	8.2
Prop In Lane	1.00		0.22	1.00		1.00	1.00		0.13	1.00		0.32
Lane Grp Cap(c), veh/h	198	0	295	213	324	272	229	492	504	233	495	489
V/C Ratio(X)	0.52	0.00	0.59	0.23	0.46	0.84	0.20	0.58	0.59	0.78	0.60	0.61
Avail Cap(c_a), veh/h	312	0	802	248	769	646	248	845	866	280	877	866
HCM Platoon Ratio	1.00	1.00	1.00	1.00	1.00	1.00	1.00	1.00	1.00	1.00	1.00	1.00
Upstream Filter(I)	1.00	0.00	1.00	1.00	1.00	1.00	1.00	1.00	1.00	1.00	1.00	1.00
Uniform Delay (d), s/veh	23.2	0.0	21.4	22.1	20.6	9.6	21.6	17.2	17.3	23.3	17.3	17.3
Incr Delay (d2), s/veh	2.1	0.0	1.9	0.5	1.0	6.9	0.4	1.1	1.1	10.8	1.2	1.2
Initial Q Delay(d3),s/veh	0.0	0.0	0.0	0.0	0.0	0.0	0.0	0.0	0.0	0.0	0.0	0.0
%ile BackOfQ(50%),veh/ln	1.3	0.0	2.1	0.6	1.7	3.0	0.5	3.1	3.1	2.9	3.2	3.2
Unsig. Movement Delay, s/veh												
LnGrp Delay(d),s/veh	25.4	0.0	23.3	22.6	21.6	16.5	22.0	18.3	18.3	34.0	18.4	18.5
LnGrp LOS	C	A	C	C	C	B	C	B	B	C	B	B
Approach Vol, veh/h		277			427			628			776	
Approach Delay, s/veh		24.0			19.0			18.6			22.1	
Approach LOS		C			B			B			C	
Timer - Assigned Phs	1	2	3	4	5	6	7	8				
Phs Duration (G+Y+Rc), s	11.5	19.7	10.9	13.4	11.4	19.8	10.4	13.9				
Change Period (Y+Rc), s	* 4.2	* 4.2	* 4.2	* 4.2	* 4.2	* 4.2	* 4.2	* 4.2				
Max Green Setting (Gmax), s	* 8.8	* 27	* 7.8	* 25	* 7.8	* 28	* 9.8	* 23				
Max Q Clear Time (g_c+I1), s	7.5	9.8	3.4	7.0	3.3	10.2	5.0	7.2				
Green Ext Time (p_c), s	0.1	3.5	0.0	0.9	0.0	3.6	0.1	1.5				

Intersection Summary

HCM 6th Ctrl Delay	20.7
HCM 6th LOS	C

Notes

* HCM 6th computational engine requires equal clearance times for the phases crossing the barrier.

Intersection

Int Delay, s/veh 4.3

Movement	SEL	SET	SER	NWL	NWT	NWR	NEL	NET	NER	SWL	SWT	SWR
Lane Configurations	↖	↗		↖	↗			↕			↕	
Traffic Vol, veh/h	14	263	22	150	369	23	23	4	109	10	4	14
Future Vol, veh/h	14	263	22	150	369	23	23	4	109	10	4	14
Conflicting Peds, #/hr	0	0	0	0	0	0	0	0	0	0	0	0
Sign Control	Free	Free	Free	Free	Free	Free	Stop	Stop	Stop	Stop	Stop	Stop
RT Channelized	-	-	None	-	-	None	-	-	None	-	-	None
Storage Length	90	-	-	125	-	-	-	-	-	-	-	-
Veh in Median Storage, #	-	0	-	-	0	-	-	0	-	-	0	-
Grade, %	-	0	-	-	0	-	-	0	-	-	0	-
Peak Hour Factor	93	93	93	93	93	93	93	93	93	93	93	93
Heavy Vehicles, %	3	3	3	3	3	3	3	3	3	3	3	3
Mvmt Flow	15	283	24	161	397	25	25	4	117	11	4	15

Major/Minor	Major1	Major2	Minor1	Minor2
Conflicting Flow All	422	0	0	307
Stage 1	-	-	-	-
Stage 2	-	-	-	-
Critical Hdwy	4.13	-	-	4.13
Critical Hdwy Stg 1	-	-	-	-
Critical Hdwy Stg 2	-	-	-	-
Follow-up Hdwy	2.227	-	-	2.227
Pot Cap-1 Maneuver	1132	-	-	1248
Stage 1	-	-	-	-
Stage 2	-	-	-	-
Platoon blocked, %	-	-	-	-
Mov Cap-1 Maneuver	1132	-	-	1248
Mov Cap-2 Maneuver	-	-	-	-
Stage 1	-	-	-	-
Stage 2	-	-	-	-

Approach	SE	NW	NE	SW
HCM Control Delay, s	0.4	2.3	16.9	22.2
HCM LOS			C	C

Minor Lane/Major Mvmt	NELn1	NWL	NWT	NWR	SEL	SET	SERSWLn1
Capacity (veh/h)	448	1248	-	-	1132	-	239
HCM Lane V/C Ratio	0.326	0.129	-	-	0.013	-	0.126
HCM Control Delay (s)	16.9	8.3	-	-	8.2	-	22.2
HCM Lane LOS	C	A	-	-	A	-	C
HCM 95th %tile Q(veh)	1.4	0.4	-	-	0	-	0.4

HCM 6th Signalized Intersection Summary
3: Lemoore Avenue & Bush Street

Near Term plus Project PM Peak

11/03/2022



Movement	EBL	EBT	EBR	WBL	WBT	WBR	NBL	NBT	NBR	SBL	SBT	SBR
Lane Configurations	↖	↗	↘	↖	↗	↘	↖	↗	↘	↖	↗	↘
Traffic Volume (veh/h)	99	130	175	66	116	48	95	429	91	48	413	112
Future Volume (veh/h)	99	130	175	66	116	48	95	429	91	48	413	112
Initial Q (Qb), veh	0	0	0	0	0	0	0	0	0	0	0	0
Ped-Bike Adj(A_pbT)	1.00		0.99	1.00		0.99	1.00		0.99	1.00		1.00
Parking Bus, Adj	1.00	1.00	1.00	1.00	1.00	1.00	1.00	1.00	1.00	1.00	1.00	1.00
Work Zone On Approach		No			No			No			No	
Adj Sat Flow, veh/h/ln	1856	1856	1856	1856	1856	1856	1856	1856	1856	1856	1856	1856
Adj Flow Rate, veh/h	105	138	186	70	123	51	101	456	97	51	439	119
Peak Hour Factor	0.94	0.94	0.94	0.94	0.94	0.94	0.94	0.94	0.94	0.94	0.94	0.94
Percent Heavy Veh, %	3	3	3	3	3	3	3	3	3	3	3	3
Cap, veh/h	208	372	312	170	331	277	205	1051	466	139	715	192
Arrive On Green	0.12	0.20	0.20	0.10	0.18	0.18	0.12	0.30	0.30	0.08	0.26	0.26
Sat Flow, veh/h	1767	1856	1558	1767	1856	1557	1767	3526	1562	1767	2744	737
Grp Volume(v), veh/h	105	138	186	70	123	51	101	456	97	51	281	277
Grp Sat Flow(s),veh/h/ln	1767	1856	1558	1767	1856	1557	1767	1763	1562	1767	1763	1719
Q Serve(g_s), s	2.9	3.3	3.6	1.9	3.0	1.0	2.8	5.4	2.4	1.4	7.2	7.3
Cycle Q Clear(g_c), s	2.9	3.3	3.6	1.9	3.0	1.0	2.8	5.4	2.4	1.4	7.2	7.3
Prop In Lane	1.00		1.00	1.00		1.00	1.00		1.00	1.00		0.43
Lane Grp Cap(c), veh/h	208	372	312	170	331	277	205	1051	466	139	459	448
V/C Ratio(X)	0.50	0.37	0.60	0.41	0.37	0.18	0.49	0.43	0.21	0.37	0.61	0.62
Avail Cap(c_a), veh/h	406	1012	850	268	867	728	372	2033	900	268	913	890
HCM Platoon Ratio	1.00	1.00	1.00	1.00	1.00	1.00	1.00	1.00	1.00	1.00	1.00	1.00
Upstream Filter(I)	1.00	1.00	1.00	1.00	1.00	1.00	1.00	1.00	1.00	1.00	1.00	1.00
Uniform Delay (d), s/veh	21.2	17.7	7.9	21.8	18.6	8.9	21.3	14.5	13.5	22.4	16.7	16.7
Incr Delay (d2), s/veh	1.9	0.6	1.8	1.6	0.7	0.3	1.8	0.3	0.2	1.6	1.3	1.4
Initial Q Delay(d3),s/veh	0.0	0.0	0.0	0.0	0.0	0.0	0.0	0.0	0.0	0.0	0.0	0.0
%ile BackOfQ(50%),veh/ln	1.2	1.3	1.9	0.8	1.3	0.5	1.1	1.9	0.8	0.6	2.8	2.8
Unsig. Movement Delay, s/veh												
LnGrp Delay(d),s/veh	23.1	18.4	9.7	23.5	19.3	9.2	23.1	14.8	13.7	24.1	18.0	18.1
LnGrp LOS	C	B	A	C	B	A	C	B	B	C	B	B
Approach Vol, veh/h		429			244			654			609	
Approach Delay, s/veh		15.8			18.4			15.9			18.6	
Approach LOS		B			B			B			B	
Timer - Assigned Phs	1	2	3	4	5	6	7	8				
Phs Duration (G+Y+Rc), s	8.2	19.5	9.1	14.5	10.2	17.6	10.3	13.4				
Change Period (Y+Rc), s	* 4.2	* 4.2	* 4.2	* 4.2	* 4.2	* 4.2	* 4.2	* 4.2				
Max Green Setting (Gmax), s	* 7.8	* 30	* 7.8	* 28	* 11	* 27	* 12	* 24				
Max Q Clear Time (g_c+I1), s	3.4	7.4	3.9	5.6	4.8	9.3	4.9	5.0				
Green Ext Time (p_c), s	0.0	3.4	0.0	1.4	0.1	3.4	0.1	0.8				

Intersection Summary

HCM 6th Ctrl Delay	17.0
HCM 6th LOS	B

Notes

* HCM 6th computational engine requires equal clearance times for the phases crossing the barrier.

HCM 6th Signalized Intersection Summary
4: 17th Avenue & D Street/Houston Avenue

Near Term plus Project PM Peak
11/03/2022



Movement	EBL	EBT	EBR	WBL	WBT	WBR	NBL	NBT	NBR	SBL	SBT	SBR
Lane Configurations												
Traffic Volume (veh/h)	54	350	0	0	484	186	0	1	0	127	0	43
Future Volume (veh/h)	54	350	0	0	484	186	0	1	0	127	0	43
Initial Q (Qb), veh	0	0	0	0	0	0	0	0	0	0	0	0
Ped-Bike Adj(A_pbT)	1.00		1.00	1.00		1.00	1.00		1.00	1.00		1.00
Parking Bus, Adj	1.00	1.00	1.00	1.00	1.00	1.00	1.00	1.00	1.00	1.00	1.00	1.00
Work Zone On Approach	No			No			No			No		
Adj Sat Flow, veh/h/ln	1856	1856	1856	1856	1856	1856	1856	1856	1856	1856	1856	1856
Adj Flow Rate, veh/h	61	398	0	0	550	211	0	1	0	144	0	49
Peak Hour Factor	0.88	0.88	0.88	0.88	0.88	0.88	0.88	0.88	0.88	0.88	0.88	0.88
Percent Heavy Veh, %	3	3	3	3	3	3	3	3	3	3	3	3
Cap, veh/h	166	1063	0	4	708	600	0	336	0	421	0	285
Arrive On Green	0.09	0.57	0.00	0.00	0.38	0.38	0.00	0.18	0.00	0.18	0.00	0.18
Sat Flow, veh/h	1767	1856	0	1767	1856	1572	0	1856	0	1402	0	1572
Grp Volume(v), veh/h	61	398	0	0	550	211	0	1	0	144	0	49
Grp Sat Flow(s),veh/h/ln	1767	1856	0	1767	1856	1572	0	1856	0	1402	0	1572
Q Serve(g_s), s	1.4	5.0	0.0	0.0	11.2	4.1	0.0	0.0	0.0	4.0	0.0	1.1
Cycle Q Clear(g_c), s	1.4	5.0	0.0	0.0	11.2	4.1	0.0	0.0	0.0	4.0	0.0	1.1
Prop In Lane	1.00		0.00	1.00		1.00	0.00		0.00	1.00		1.00
Lane Grp Cap(c), veh/h	166	1063	0	4	708	600	0	336	0	421	0	285
V/C Ratio(X)	0.37	0.37	0.00	0.00	0.78	0.35	0.00	0.00	0.00	0.34	0.00	0.17
Avail Cap(c_a), veh/h	320	1124	0	320	1107	938	0	504	0	548	0	427
HCM Platoon Ratio	1.00	1.00	1.00	1.00	1.00	1.00	1.00	1.00	1.00	1.00	1.00	1.00
Upstream Filter(I)	1.00	1.00	0.00	0.00	1.00	1.00	0.00	1.00	0.00	1.00	0.00	1.00
Uniform Delay (d), s/veh	18.3	5.0	0.0	0.0	11.7	9.5	0.0	14.5	0.0	16.1	0.0	14.9
Incr Delay (d2), s/veh	1.4	0.2	0.0	0.0	1.9	0.4	0.0	0.0	0.0	0.5	0.0	0.3
Initial Q Delay(d3),s/veh	0.0	0.0	0.0	0.0	0.0	0.0	0.0	0.0	0.0	0.0	0.0	0.0
%ile BackOfQ(50%),veh/ln	0.5	1.0	0.0	0.0	3.4	1.0	0.0	0.0	0.0	1.1	0.0	0.3
Unsig. Movement Delay, s/veh												
LnGrp Delay(d),s/veh	19.7	5.2	0.0	0.0	13.6	9.9	0.0	14.5	0.0	16.6	0.0	15.2
LnGrp LOS	B	A	A	A	B	A	A	B	A	B	A	B
Approach Vol, veh/h	459			761			1			193		
Approach Delay, s/veh	7.1			12.6			14.5			16.2		
Approach LOS	A			B			B			B		
Timer - Assigned Phs	2	3	4	6	7	8						
Phs Duration (G+Y+Rc), s	13.1	0.0	30.0	13.1	8.2	21.7						
Change Period (Y+Rc), s	5.3	* 4.2	* 5.3	5.3	* 4.2	5.3						
Max Green Setting (Gmax), s	11.7	* 7.8	* 26	11.7	* 7.8	25.7						
Max Q Clear Time (g_c+1), s	2.0	0.0	7.0	6.0	3.4	13.2						
Green Ext Time (p_c), s	0.0	0.0	2.1	0.4	0.0	3.2						

Intersection Summary

HCM 6th Ctrl Delay	11.3
HCM 6th LOS	B

Notes

* HCM 6th computational engine requires equal clearance times for the phases crossing the barrier.

HCM 6th Signalized Intersection Summary
5: Lemoore Avenue & SR 198 WB Ramps

Near Term plus Project PM Peak

11/03/2022



Movement	EBL	EBT	EBR	WBL	WBT	WBR	NBL	NBT	NBR	SBL	SBT	SBR
Lane Configurations					↕		↖	↗			↕	↗
Traffic Volume (veh/h)	0	0	0	141	0	163	15	469	0	0	416	142
Future Volume (veh/h)	0	0	0	141	0	163	15	469	0	0	416	142
Initial Q (Qb), veh				0	0	0	0	0	0	0	0	0
Ped-Bike Adj(A_pbT)				1.00		1.00	1.00		1.00	1.00		1.00
Parking Bus, Adj				1.00	1.00	1.00	1.00	1.00	1.00	1.00	1.00	1.00
Work Zone On Approach				No		No		No			No	
Adj Sat Flow, veh/h/ln				1856	1856	1856	1856	1856	0	0	1856	1856
Adj Flow Rate, veh/h				148	0	172	16	494	0	0	438	149
Peak Hour Factor				0.95	0.95	0.95	0.95	0.95	0.95	0.95	0.95	0.95
Percent Heavy Veh, %				3	3	3	3	3	0	0	3	3
Cap, veh/h				169	0	197	464	1181	0	0	562	476
Arrive On Green				0.22	0.00	0.22	0.53	1.00	0.00	0.00	0.30	0.30
Sat Flow, veh/h				766	0	891	1767	1856	0	0	1856	1572
Grp Volume(v), veh/h				320	0	0	16	494	0	0	438	149
Grp Sat Flow(s),veh/h/ln				1657	0	0	1767	1856	0	0	1856	1572
Q Serve(g_s), s				14.9	0.0	0.0	0.4	0.0	0.0	0.0	17.2	5.8
Cycle Q Clear(g_c), s				14.9	0.0	0.0	0.4	0.0	0.0	0.0	17.2	5.8
Prop In Lane				0.46		0.54	1.00		0.00	0.00		1.00
Lane Grp Cap(c), veh/h				366	0	0	464	1181	0	0	562	476
V/C Ratio(X)				0.87	0.00	0.00	0.03	0.42	0.00	0.00	0.78	0.31
Avail Cap(c_a), veh/h				462	0	0	464	1181	0	0	796	674
HCM Platoon Ratio				1.00	1.00	1.00	2.00	2.00	1.00	1.00	1.00	1.00
Upstream Filter(I)				1.00	0.00	0.00	0.87	0.87	0.00	0.00	1.00	1.00
Uniform Delay (d), s/veh				30.1	0.0	0.0	14.1	0.0	0.0	0.0	25.5	21.5
Incr Delay (d2), s/veh				14.2	0.0	0.0	0.0	0.9	0.0	0.0	10.3	1.7
Initial Q Delay(d3),s/veh				0.0	0.0	0.0	0.0	0.0	0.0	0.0	0.0	0.0
%ile BackOfQ(50%),veh/ln				6.7	0.0	0.0	0.1	0.3	0.0	0.0	8.8	2.3
Unsig. Movement Delay, s/veh												
LnGrp Delay(d),s/veh				44.2	0.0	0.0	14.1	0.9	0.0	0.0	35.7	23.2
LnGrp LOS				D	A	A	B	A	A	A	D	C
Approach Vol, veh/h					320			510			587	
Approach Delay, s/veh					44.2			1.4			32.6	
Approach LOS					D			A			C	
Timer - Assigned Phs		2			5	6		8				
Phs Duration (G+Y+Rc), s		56.6			26.7	29.9		23.4				
Change Period (Y+Rc), s		* 5.7			* 5.7	* 5.7		5.7				
Max Green Setting (Gmax), s		* 46			* 6.3	* 34		22.3				
Max Q Clear Time (g_c+I1), s		2.0			2.4	19.2		16.9				
Green Ext Time (p_c), s		4.8			0.0	5.0		0.8				

Intersection Summary

HCM 6th Ctrl Delay	24.0
HCM 6th LOS	C

Notes

* HCM 6th computational engine requires equal clearance times for the phases crossing the barrier.

HCM 6th Signalized Intersection Summary
6: Lemoore Avenue & SR 198 EB Ramps

Near Term plus Project PM Peak
11/03/2022



Movement	WBL	WBR	NBT	NBR	SBL	SBT
Lane Configurations	↙	↘	↑	↗	↖	↑
Traffic Volume (veh/h)	21	200	282	184	193	369
Future Volume (veh/h)	21	200	282	184	193	369
Initial Q (Qb), veh	0	0	0	0	0	0
Ped-Bike Adj(A_pbT)	1.00	1.00		1.00	1.00	
Parking Bus, Adj	1.00	1.00	1.00	1.00	1.00	1.00
Work Zone On Approach	No		No		No	
Adj Sat Flow, veh/h/ln	1856	1856	1856	1856	1856	1856
Adj Flow Rate, veh/h	26	247	348	227	238	456
Peak Hour Factor	0.81	0.81	0.81	0.81	0.81	0.81
Percent Heavy Veh, %	3	3	3	3	3	3
Cap, veh/h	318	283	476	404	618	1257
Arrive On Green	0.18	0.18	0.26	0.26	0.70	1.00
Sat Flow, veh/h	1767	1572	1856	1572	1767	1856
Grp Volume(v), veh/h	26	247	348	227	238	456
Grp Sat Flow(s),veh/h/ln	1767	1572	1856	1572	1767	1856
Q Serve(g_s), s	1.0	12.2	13.7	10.0	4.4	0.0
Cycle Q Clear(g_c), s	1.0	12.2	13.7	10.0	4.4	0.0
Prop In Lane	1.00	1.00		1.00	1.00	
Lane Grp Cap(c), veh/h	318	283	476	404	618	1257
V/C Ratio(X)	0.08	0.87	0.73	0.56	0.39	0.36
Avail Cap(c_a), veh/h	360	320	749	635	618	1257
HCM Platoon Ratio	1.00	1.00	1.00	1.00	2.00	2.00
Upstream Filter(I)	1.00	1.00	1.00	1.00	0.93	0.93
Uniform Delay (d), s/veh	27.3	31.9	27.2	25.8	8.5	0.0
Incr Delay (d2), s/veh	0.1	20.8	9.5	5.6	0.1	0.8
Initial Q Delay(d3),s/veh	0.0	0.0	0.0	0.0	0.0	0.0
%ile BackOfQ(50%),veh/ln	0.4	5.8	7.1	4.2	1.4	0.3
Unsig. Movement Delay, s/veh						
LnGrp Delay(d),s/veh	27.4	52.8	36.7	31.4	8.6	0.8
LnGrp LOS	C	D	D	C	A	A
Approach Vol, veh/h	273		575			694
Approach Delay, s/veh	50.3		34.6			3.5
Approach LOS	D		C			A
Timer - Assigned Phs	1	2			6	8
Phs Duration (G+Y+Rc), s	33.7	26.2			59.9	20.1
Change Period (Y+Rc), s	5.7	* 5.7			* 5.7	5.7
Max Green Setting (Gmax), s	14	* 32			* 52	16.3
Max Q Clear Time (g_c+1/4), s	13.4	15.7			2.0	14.2
Green Ext Time (p_c), s	0.2	4.8			6.4	0.2

Intersection Summary

HCM 6th Ctrl Delay	23.4
HCM 6th LOS	C

Notes

* HCM 6th computational engine requires equal clearance times for the phases crossing the barrier.

Intersection: 1: Lemoore Avenue & D Street

Movement	EB	EB	WB	WB	WB	NB	NB	NB	SB	SB	SB
Directions Served	L	TR	L	T	R	L	T	TR	L	T	TR
Maximum Queue (ft)	135	219	77	330	160	109	177	174	190	318	267
Average Queue (ft)	47	90	43	102	70	46	88	96	110	145	137
95th Queue (ft)	110	164	73	207	141	108	147	167	203	264	224
Link Distance (ft)		1631		2383			1433	1433		1665	1665
Upstream Blk Time (%)											
Queuing Penalty (veh)											
Storage Bay Dist (ft)	85		75		75	60			140		
Storage Blk Time (%)	1	9	4	16	4	2	17		14	2	
Queuing Penalty (veh)	2	5	15	37	8	5	7		48	3	

Intersection: 2: Bush Street/Daphne Lane & D Street

Movement	SE	SE	NW	NE	SW
Directions Served	L	TR	L	LTR	LTR
Maximum Queue (ft)	31	41	88	112	69
Average Queue (ft)	3	1	39	53	26
95th Queue (ft)	18	14	79	80	55
Link Distance (ft)		1305		1039	373
Upstream Blk Time (%)					
Queuing Penalty (veh)					
Storage Bay Dist (ft)	90		125		
Storage Blk Time (%)					
Queuing Penalty (veh)					

Intersection: 3: Lemoore Avenue & Bush Street

Movement	EB	EB	EB	WB	WB	WB	NB	NB	NB	NB	SB	SB
Directions Served	L	T	R	L	T	R	L	T	T	R	L	T
Maximum Queue (ft)	178	237	135	128	188	120	116	89	110	88	183	178
Average Queue (ft)	91	95	60	58	90	66	70	45	50	33	109	114
95th Queue (ft)	154	174	118	105	161	126	103	85	89	68	171	171
Link Distance (ft)	2569	2569			350			1768	1768			1433
Upstream Blk Time (%)												
Queuing Penalty (veh)												
Storage Bay Dist (ft)			75	150		60	100			105	135	
Storage Blk Time (%)		16	1		18	3	3	0	0	0	7	5
Queuing Penalty (veh)		19	1		50	10	4	0	0	0	13	7

Intersection: 3: Lemoore Avenue & Bush Street

Movement	SB
Directions Served	TR
Maximum Queue (ft)	220
Average Queue (ft)	129
95th Queue (ft)	198
Link Distance (ft)	1433
Upstream Blk Time (%)	
Queuing Penalty (veh)	
Storage Bay Dist (ft)	
Storage Blk Time (%)	
Queuing Penalty (veh)	

Intersection: 4: 17th Avenue & D Street/Houston Avenue

Movement	EB	EB	WB	WB	NB	SB	SB
Directions Served	L	TR	T	R	LTR	LT	R
Maximum Queue (ft)	164	225	239	54	28	156	149
Average Queue (ft)	52	117	133	29	5	76	47
95th Queue (ft)	127	197	219	49	22	122	93
Link Distance (ft)		656	640		1215	3087	
Upstream Blk Time (%)							
Queuing Penalty (veh)							
Storage Bay Dist (ft)	75			150			90
Storage Blk Time (%)	2	15	24			5	0
Queuing Penalty (veh)	8	13	21			8	0

Intersection: 5: Lemoore Avenue & SR 198 WB Ramps

Movement	WB	NB	NB	SB	SB
Directions Served	LTR	L	T	T	R
Maximum Queue (ft)	218	106	163	294	150
Average Queue (ft)	89	21	62	78	40
95th Queue (ft)	163	65	126	191	109
Link Distance (ft)	1146		568	301	
Upstream Blk Time (%)				0	
Queuing Penalty (veh)				0	
Storage Bay Dist (ft)		200			75
Storage Blk Time (%)				6	0
Queuing Penalty (veh)				10	1

Intersection: 6: Lemoore Avenue & SR 198 EB Ramps

Movement	WB	WB	NB	NB	SB	SB
Directions Served	L	R	T	R	L	T
Maximum Queue (ft)	46	100	128	72	161	96
Average Queue (ft)	9	37	53	24	93	20
95th Queue (ft)	33	70	105	54	146	61
Link Distance (ft)		194	2460			568
Upstream Blk Time (%)						
Queuing Penalty (veh)						
Storage Bay Dist (ft)	50			50	200	
Storage Blk Time (%)	3	3	7	1		
Queuing Penalty (veh)	5	0	7	2		

Network Summary

Network wide Queuing Penalty: 310

Intersection: 1: Lemoore Avenue & D Street

Movement	EB	EB	WB	WB	WB	NB	NB	NB	SB	SB	SB
Directions Served	L	TR	L	T	R	L	T	TR	L	T	TR
Maximum Queue (ft)	134	264	76	176	160	109	246	238	189	232	219
Average Queue (ft)	68	79	28	74	79	41	101	116	95	79	98
95th Queue (ft)	123	156	65	140	141	93	184	203	164	145	167
Link Distance (ft)		1631		2383			1433	1433		1665	1665
Upstream Blk Time (%)											
Queuing Penalty (veh)											
Storage Bay Dist (ft)	85		75		75	60			140		
Storage Blk Time (%)	7	5	2	12	7	3	21		4	0	
Queuing Penalty (veh)	11	5	7	32	13	8	9		11	0	

Intersection: 2: Bush Street/Daphne Lane & D Street

Movement	SE	NW	NE	SW
Directions Served	L	L	LTR	LTR
Maximum Queue (ft)	50	53	115	52
Average Queue (ft)	7	26	51	18
95th Queue (ft)	29	57	87	45
Link Distance (ft)			1039	373
Upstream Blk Time (%)				
Queuing Penalty (veh)				
Storage Bay Dist (ft)	90	125		
Storage Blk Time (%)				
Queuing Penalty (veh)				

Intersection: 3: Lemoore Avenue & Bush Street

Movement	EB	EB	EB	WB	WB	WB	NB	NB	NB	NB	SB	SB
Directions Served	L	T	R	L	T	R	L	T	T	R	L	T
Maximum Queue (ft)	96	160	78	132	133	120	129	174	174	61	74	193
Average Queue (ft)	57	61	46	34	52	24	50	64	70	21	35	97
95th Queue (ft)	91	109	80	78	101	71	97	124	120	43	70	165
Link Distance (ft)	2569	2569			350			1768	1768			1433
Upstream Blk Time (%)												
Queuing Penalty (veh)												
Storage Bay Dist (ft)			75	150		60	100			105	135	
Storage Blk Time (%)		9	1	0	7	0	3	1	2			3
Queuing Penalty (veh)		16	1	0	8	0	6	1	1			2

Intersection: 3: Lemoore Avenue & Bush Street

Movement	SB
Directions Served	TR
Maximum Queue (ft)	195
Average Queue (ft)	105
95th Queue (ft)	184
Link Distance (ft)	1433
Upstream Blk Time (%)	
Queuing Penalty (veh)	
Storage Bay Dist (ft)	
Storage Blk Time (%)	
Queuing Penalty (veh)	

Intersection: 4: 17th Avenue & D Street/Houston Avenue

Movement	EB	EB	WB	WB	NB	SB	SB
Directions Served	L	TR	T	R	LTR	LT	R
Maximum Queue (ft)	66	112	247	87	27	111	67
Average Queue (ft)	29	50	96	37	1	41	18
95th Queue (ft)	57	97	189	68	9	83	42
Link Distance (ft)		656	640		1215	3087	
Upstream Blk Time (%)							
Queuing Penalty (veh)							
Storage Bay Dist (ft)	75			150			90
Storage Blk Time (%)	0	1	11			0	
Queuing Penalty (veh)	0	1	21			0	

Intersection: 5: Lemoore Avenue & SR 198 WB Ramps

Movement	WB	NB	NB	SB	SB
Directions Served	LTR	L	T	T	R
Maximum Queue (ft)	258	52	177	316	150
Average Queue (ft)	137	12	80	94	33
95th Queue (ft)	221	39	151	192	101
Link Distance (ft)	1146		568	301	
Upstream Blk Time (%)				0	
Queuing Penalty (veh)				2	
Storage Bay Dist (ft)		200			75
Storage Blk Time (%)				11	0
Queuing Penalty (veh)				16	0

Intersection: 6: Lemoore Avenue & SR 198 EB Ramps

Movement	WB	WB	NB	NB	SB	SB
Directions Served	L	R	T	R	L	T
Maximum Queue (ft)	46	120	181	79	183	201
Average Queue (ft)	16	49	75	36	119	54
95th Queue (ft)	41	86	137	72	183	141
Link Distance (ft)		194	2460			568
Upstream Blk Time (%)						
Queuing Penalty (veh)						
Storage Bay Dist (ft)	50			50	200	
Storage Blk Time (%)	3	6	12	3	0	0
Queuing Penalty (veh)	6	1	22	9	0	0

Intersection: 22: SR 198 EB Ramps

Movement
Directions Served
Maximum Queue (ft)
Average Queue (ft)
95th Queue (ft)
Link Distance (ft)
Upstream Blk Time (%)
Queuing Penalty (veh)
Storage Bay Dist (ft)
Storage Blk Time (%)
Queuing Penalty (veh)

Network Summary

Network wide Queuing Penalty: 209

Appendix H: Cumulative Year 2042 plus Project Traffic Conditions



www.JLBtraffic.com
info@JLBtraffic.com

516 W. Shaw Ave., Ste. 103
Fresno, CA 93704
(559) 570-8991

A p p | H

HCM 6th Signalized Intersection Summary
 1: Lemoore Avenue & D Street

Cumulative Year 2042 plus Project AM Peak

11/03/2022



Movement	EBL	EBT	EBR	WBL	WBT	WBR	NBL	NBT	NBR	SBL	SBT	SBR
Lane Configurations	↖	↗		↖	↗	↗	↖	↖↗		↖	↖↗	
Traffic Volume (veh/h)	88	172	62	77	267	269	63	720	70	263	930	100
Future Volume (veh/h)	88	172	62	77	267	269	63	720	70	263	930	100
Initial Q (Qb), veh	0	0	0	0	0	0	0	0	0	0	0	0
Ped-Bike Adj(A_pbT)	1.00		0.99	1.00		0.99	1.00		0.94	1.00		0.95
Parking Bus, Adj	1.00	1.00	1.00	1.00	1.00	1.00	1.00	1.00	1.00	1.00	1.00	1.00
Work Zone On Approach		No			No			No			No	
Adj Sat Flow, veh/h/ln	1856	1856	1856	1856	1856	1856	1856	1856	1856	1856	1856	1856
Adj Flow Rate, veh/h	102	200	72	90	310	313	73	837	81	306	1081	116
Peak Hour Factor	0.86	0.86	0.86	0.86	0.86	0.86	0.86	0.86	0.86	0.86	0.86	0.86
Percent Heavy Veh, %	3	3	3	3	3	3	3	3	3	3	3	3
Cap, veh/h	150	269	97	212	451	377	167	984	95	293	1200	129
Arrive On Green	0.08	0.21	0.21	0.12	0.24	0.24	0.09	0.31	0.31	0.17	0.38	0.38
Sat Flow, veh/h	1767	1297	467	1767	1856	1553	1767	3226	312	1767	3193	342
Grp Volume(v), veh/h	102	0	272	90	310	313	73	457	461	306	596	601
Grp Sat Flow(s),veh/h/ln	1767	0	1763	1767	1856	1553	1767	1763	1775	1767	1763	1772
Q Serve(g_s), s	4.7	0.0	12.0	3.9	12.7	15.9	3.3	20.3	20.3	13.8	26.6	26.7
Cycle Q Clear(g_c), s	4.7	0.0	12.0	3.9	12.7	15.9	3.3	20.3	20.3	13.8	26.6	26.7
Prop In Lane	1.00		0.26	1.00		1.00	1.00		0.18	1.00		0.19
Lane Grp Cap(c), veh/h	150	0	366	212	451	377	167	538	542	293	663	666
V/C Ratio(X)	0.68	0.00	0.74	0.42	0.69	0.83	0.44	0.85	0.85	1.05	0.90	0.90
Avail Cap(c_a), veh/h	165	0	529	212	557	466	167	563	566	293	689	693
HCM Platoon Ratio	1.00	1.00	1.00	1.00	1.00	1.00	1.00	1.00	1.00	1.00	1.00	1.00
Upstream Filter(I)	1.00	0.00	1.00	1.00	1.00	1.00	1.00	1.00	1.00	1.00	1.00	1.00
Uniform Delay (d), s/veh	37.0	0.0	30.9	34.0	28.7	29.9	35.6	27.2	27.2	34.8	24.5	24.6
Incr Delay (d2), s/veh	9.6	0.0	3.3	1.3	2.6	10.0	1.8	11.5	11.4	65.1	14.5	14.7
Initial Q Delay(d3),s/veh	0.0	0.0	0.0	0.0	0.0	0.0	0.0	0.0	0.0	0.0	0.0	0.0
%ile BackOfQ(50%),veh/ln	2.4	0.0	5.4	1.8	5.9	6.9	1.5	10.0	10.1	11.1	13.3	13.4
Unsig. Movement Delay, s/veh												
LnGrp Delay(d),s/veh	46.6	0.0	34.2	35.3	31.3	39.9	37.4	38.7	38.6	99.9	39.0	39.3
LnGrp LOS	D	A	C	D	C	D	D	D	D	F	D	D
Approach Vol, veh/h		374			713			991			1503	
Approach Delay, s/veh		37.6			35.6			38.6			51.5	
Approach LOS		D			D			D			D	
Timer - Assigned Phs	1	2	3	4	5	6	7	8				
Phs Duration (G+Y+Rc), s	18.0	29.6	14.2	21.5	12.1	35.5	11.3	24.5				
Change Period (Y+Rc), s	* 4.2	* 4.2	* 4.2	* 4.2	* 4.2	* 4.2	* 4.2	* 4.2				
Max Green Setting (Gmax), s	* 14	* 27	* 7.8	* 25	* 7.8	* 33	* 7.8	* 25				
Max Q Clear Time (g_c+I1), s	15.8	22.3	5.9	14.0	5.3	28.7	6.7	17.9				
Green Ext Time (p_c), s	0.0	2.3	0.0	1.2	0.0	2.7	0.0	1.9				

Intersection Summary

HCM 6th Ctrl Delay	43.3
HCM 6th LOS	D

Notes

* HCM 6th computational engine requires equal clearance times for the phases crossing the barrier.

Intersection

Int Delay, s/veh 149.1

Movement	SEL	SET	SER	NWL	NWT	NWR	NEL	NET	NER	SWL	SWT	SWR
Lane Configurations	↖	↗		↖	↗			↕			↕	
Traffic Vol, veh/h	8	408	43	286	468	15	50	19	246	12	11	25
Future Vol, veh/h	8	408	43	286	468	15	50	19	246	12	11	25
Conflicting Peds, #/hr	1	0	0	0	0	1	0	0	3	3	0	0
Sign Control	Free	Free	Free	Free	Free	Free	Stop	Stop	Stop	Stop	Stop	Stop
RT Channelized	-	-	None	-	-	None	-	-	None	-	-	None
Storage Length	90	-	-	125	-	-	-	-	-	-	-	-
Veh in Median Storage, #	-	0	-	-	0	-	-	0	-	-	0	-
Grade, %	-	0	-	-	0	-	-	0	-	-	0	-
Peak Hour Factor	86	86	86	86	86	86	86	86	86	86	86	86
Heavy Vehicles, %	3	3	3	3	3	3	3	3	3	3	3	3
Mvmt Flow	9	474	50	333	544	17	58	22	286	14	13	29

Major/Minor	Major1	Major2	Minor1	Minor2
Conflicting Flow All	562	0	0	524
Stage 1	-	-	-	-
Stage 2	-	-	-	-
Critical Hdwy	4.13	-	-	4.13
Critical Hdwy Stg 1	-	-	-	-
Critical Hdwy Stg 2	-	-	-	-
Follow-up Hdwy	2.227	-	-	2.227
Pot Cap-1 Maneuver	1004	-	-	1038
Stage 1	-	-	-	-
Stage 2	-	-	-	-
Platoon blocked, %	-	-	-	-
Mov Cap-1 Maneuver	1003	-	-	1038
Mov Cap-2 Maneuver	-	-	-	-
Stage 1	-	-	-	-
Stage 2	-	-	-	-

Approach	SE	NW	NE	SW
HCM Control Delay, s	0.2	3.8	\$ 686.7	\$ 371.6
HCM LOS			F	F

Minor Lane/Major Mvmt	NELn1	NWL	NWT	NWR	SEL	SET	SERSWLn1
Capacity (veh/h)	154	1038	-	-	1003	-	44
HCM Lane V/C Ratio	2.378	0.32	-	-	0.009	-	1.268
HCM Control Delay (s)	\$ 686.7	10.1	-	-	8.6	-	\$ 371.6
HCM Lane LOS	F	B	-	-	A	-	F
HCM 95th %tile Q(veh)	31	1.4	-	-	0	-	5.4

Notes

~: Volume exceeds capacity \$: Delay exceeds 300s +: Computation Not Defined *: All major volume in platoon

HCM 6th Signalized Intersection Summary
3: Lemoore Avenue & Bush Street

Cumulative Year 2042 plus Project AM Peak

11/03/2022



Movement	EBL	EBT	EBR	WBL	WBT	WBR	NBL	NBT	NBR	SBL	SBT	SBR
Lane Configurations	↖	↑	↗	↖	↑	↗	↖	↑↑	↗	↖	↑↔	
Traffic Volume (veh/h)	190	294	156	139	288	245	164	332	160	238	491	173
Future Volume (veh/h)	190	294	156	139	288	245	164	332	160	238	491	173
Initial Q (Qb), veh	0	0	0	0	0	0	0	0	0	0	0	0
Ped-Bike Adj(A_pbT)	1.00		0.91	1.00		0.89	1.00		0.79	1.00		0.88
Parking Bus, Adj	1.00	1.00	1.00	1.00	1.00	1.00	1.00	1.00	1.00	1.00	1.00	1.00
Work Zone On Approach		No			No			No			No	
Adj Sat Flow, veh/h/ln	1856	1856	1856	1856	1856	1856	1856	1856	1856	1856	1856	1856
Adj Flow Rate, veh/h	221	342	181	162	335	285	191	386	186	277	571	201
Peak Hour Factor	0.86	0.86	0.86	0.86	0.86	0.86	0.86	0.86	0.86	0.86	0.86	0.86
Percent Heavy Veh, %	3	3	3	3	3	3	3	3	3	3	3	3
Cap, veh/h	235	579	446	156	495	375	228	897	315	275	693	243
Arrive On Green	0.13	0.31	0.31	0.09	0.27	0.27	0.13	0.25	0.25	0.16	0.28	0.28
Sat Flow, veh/h	1767	1856	1429	1767	1856	1405	1767	3526	1236	1767	2465	864
Grp Volume(v), veh/h	221	342	181	162	335	285	191	386	186	277	408	364
Grp Sat Flow(s),veh/h/ln	1767	1856	1429	1767	1856	1405	1767	1763	1236	1767	1763	1566
Q Serve(g_s), s	11.0	13.8	6.0	7.8	14.3	16.5	9.4	8.1	11.7	13.8	19.2	19.3
Cycle Q Clear(g_c), s	11.0	13.8	6.0	7.8	14.3	16.5	9.4	8.1	11.7	13.8	19.2	19.3
Prop In Lane	1.00		1.00	1.00		1.00	1.00		1.00	1.00		0.55
Lane Grp Cap(c), veh/h	235	579	446	156	495	375	228	897	315	275	496	440
V/C Ratio(X)	0.94	0.59	0.41	1.04	0.68	0.76	0.84	0.43	0.59	1.01	0.82	0.83
Avail Cap(c_a), veh/h	235	586	452	156	503	380	228	939	329	275	529	470
HCM Platoon Ratio	1.00	1.00	1.00	1.00	1.00	1.00	1.00	1.00	1.00	1.00	1.00	1.00
Upstream Filter(I)	1.00	1.00	1.00	1.00	1.00	1.00	1.00	1.00	1.00	1.00	1.00	1.00
Uniform Delay (d), s/veh	38.0	25.7	10.9	40.4	29.1	29.9	37.7	27.6	29.0	37.4	29.8	29.8
Incr Delay (d2), s/veh	42.1	1.5	0.6	83.5	3.5	8.6	23.0	0.3	2.6	55.9	9.6	11.1
Initial Q Delay(d3),s/veh	0.0	0.0	0.0	0.0	0.0	0.0	0.0	0.0	0.0	0.0	0.0	0.0
%ile BackOfQ(50%),veh/ln	7.4	6.1	2.9	7.0	6.8	6.4	5.4	3.4	3.7	10.2	9.3	8.5
Unsig. Movement Delay, s/veh												
LnGrp Delay(d),s/veh	80.1	27.2	11.5	123.9	32.6	38.4	60.7	28.0	31.6	93.3	39.4	41.0
LnGrp LOS	F	C	B	F	C	D	E	C	C	F	D	D
Approach Vol, veh/h		744			782			763			1049	
Approach Delay, s/veh		39.1			53.6			37.0			54.1	
Approach LOS		D			D			D			D	
Timer - Assigned Phs	1	2	3	4	5	6	7	8				
Phs Duration (G+Y+Rc), s	18.0	26.8	12.0	31.8	15.6	29.1	16.0	27.8				
Change Period (Y+Rc), s	* 4.2	* 4.2	* 4.2	* 4.2	* 4.2	* 4.2	* 4.2	* 4.2				
Max Green Setting (Gmax), s	* 14	* 24	* 7.8	* 28	* 11	* 27	* 12	* 24				
Max Q Clear Time (g_c+I1), s	15.8	13.7	9.8	15.8	11.4	21.3	13.0	18.5				
Green Ext Time (p_c), s	0.0	2.4	0.0	2.2	0.0	2.4	0.0	1.6				

Intersection Summary												
HCM 6th Ctrl Delay			46.8									
HCM 6th LOS			D									

Notes

* HCM 6th computational engine requires equal clearance times for the phases crossing the barrier.

HCM 6th Signalized Intersection Summary
4: 17th Avenue & D Street/Houston Avenue

Cumulative Year 2042 plus Project AM Peak

11/03/2022



Movement	EBL	EBT	EBR	WBL	WBT	WBR	NBL	NBT	NBR	SBL	SBT	SBR
Lane Configurations												
Traffic Volume (veh/h)	132	607	0	2	631	133	3	0	2	292	2	241
Future Volume (veh/h)	132	607	0	2	631	133	3	0	2	292	2	241
Initial Q (Qb), veh	0	0	0	0	0	0	0	0	0	0	0	0
Ped-Bike Adj(A_pbT)	1.00		1.00	1.00		1.00	1.00		1.00	1.00		1.00
Parking Bus, Adj	1.00	1.00	1.00	1.00	1.00	1.00	1.00	1.00	1.00	1.00	1.00	1.00
Work Zone On Approach		No		No		No		No		No		No
Adj Sat Flow, veh/h/ln	1856	1856	1856	1856	1856	1856	1856	1856	1856	1856	1856	1856
Adj Flow Rate, veh/h	147	674	0	2	701	148	3	0	2	324	2	268
Peak Hour Factor	0.90	0.90	0.90	0.90	0.90	0.90	0.90	0.90	0.90	0.90	0.90	0.90
Percent Heavy Veh, %	3	3	3	3	3	3	3	3	3	3	3	3
Cap, veh/h	179	804	0	159	759	643	87	16	24	436	2	489
Arrive On Green	0.10	0.43	0.00	0.09	0.41	0.41	0.31	0.00	0.31	0.31	0.31	0.31
Sat Flow, veh/h	1767	1856	0	1767	1856	1572	66	51	78	1135	7	1572
Grp Volume(v), veh/h	147	674	0	2	701	148	5	0	0	326	0	268
Grp Sat Flow(s),veh/h/ln	1767	1856	0	1767	1856	1572	195	0	0	1142	0	1572
Q Serve(g_s), s	7.1	28.0	0.0	0.1	31.1	5.3	0.1	0.0	0.0	0.0	0.0	12.3
Cycle Q Clear(g_c), s	7.1	28.0	0.0	0.1	31.1	5.3	24.7	0.0	0.0	24.6	0.0	12.3
Prop In Lane	1.00		0.00	1.00		1.00	0.60		0.40	0.99		1.00
Lane Grp Cap(c), veh/h	179	804	0	159	759	643	127	0	0	438	0	489
V/C Ratio(X)	0.82	0.84	0.00	0.01	0.92	0.23	0.04	0.00	0.00	0.74	0.00	0.55
Avail Cap(c_a), veh/h	179	858	0	159	828	702	138	0	0	450	0	502
HCM Platoon Ratio	1.00	1.00	1.00	1.00	1.00	1.00	1.00	1.00	1.00	1.00	1.00	1.00
Upstream Filter(I)	1.00	1.00	0.00	1.00	1.00	1.00	1.00	0.00	0.00	1.00	0.00	1.00
Uniform Delay (d), s/veh	38.2	21.9	0.0	35.9	24.3	16.7	23.8	0.0	0.0	29.1	0.0	24.8
Incr Delay (d2), s/veh	25.0	7.0	0.0	0.0	15.1	0.2	0.1	0.0	0.0	6.5	0.0	1.2
Initial Q Delay(d3),s/veh	0.0	0.0	0.0	0.0	0.0	0.0	0.0	0.0	0.0	0.0	0.0	0.0
%ile BackOfQ(50%),veh/ln	4.2	12.5	0.0	0.0	15.2	1.8	0.1	0.0	0.0	6.9	0.0	4.4
Unsig. Movement Delay, s/veh												
LnGrp Delay(d),s/veh	63.2	28.9	0.0	36.0	39.5	16.9	23.9	0.0	0.0	35.5	0.0	26.0
LnGrp LOS	E	C	A	D	D	B	C	A	A	D	A	C
Approach Vol, veh/h		821		851		5		594				
Approach Delay, s/veh		35.0		35.5		23.9		31.2				
Approach LOS		D		D		C		C				
Timer - Assigned Phs		2	3	4		6	7	8				
Phs Duration (G+Y+Rc), s		32.2	12.0	42.5		32.2	13.7	40.8				
Change Period (Y+Rc), s		5.3	* 4.2	4.9		5.3	4.9	* 5.3				
Max Green Setting (Gmax), s		27.7	* 7.8	40.1		27.7	8.8	* 39				
Max Q Clear Time (g_c+1), s		26.7	2.1	30.0		26.6	9.1	33.1				
Green Ext Time (p_c), s		0.0	0.0	3.1		0.4	0.0	2.3				

Intersection Summary

HCM 6th Ctrl Delay	34.2
HCM 6th LOS	C

Notes

* HCM 6th computational engine requires equal clearance times for the phases crossing the barrier.

HCM 6th Signalized Intersection Summary
5: Lemoore Avenue & SR 198 WB Ramps

Cumulative Year 2042 plus Project AM Peak
11/03/2022



Movement	EBL	EBT	EBR	WBL	WBT	WBR	NBL	NBT	NBR	SBL	SBT	SBR
Lane Configurations					↕		↖	↗			↕	↗
Traffic Volume (veh/h)	0	0	0	173	0	190	29	599	0	0	598	238
Future Volume (veh/h)	0	0	0	173	0	190	29	599	0	0	598	238
Initial Q (Qb), veh				0	0	0	0	0	0	0	0	0
Ped-Bike Adj(A_pbT)				1.00		1.00	1.00		1.00	1.00		1.00
Parking Bus, Adj				1.00	1.00	1.00	1.00	1.00	1.00	1.00	1.00	1.00
Work Zone On Approach				No		No		No				
Adj Sat Flow, veh/h/ln				1856	1856	1856	1856	1856	0	0	1856	1856
Adj Flow Rate, veh/h				186	0	204	31	644	0	0	643	256
Peak Hour Factor				0.93	0.93	0.93	0.93	0.93	0.93	0.93	0.93	0.93
Percent Heavy Veh, %				3	3	3	3	3	0	0	3	3
Cap, veh/h				205	0	224	231	1112	0	0	737	625
Arrive On Green				0.26	0.00	0.26	0.26	1.00	0.00	0.00	0.40	0.40
Sat Flow, veh/h				792	0	868	1767	1856	0	0	1856	1572
Grp Volume(v), veh/h				390	0	0	31	644	0	0	643	256
Grp Sat Flow(s),veh/h/ln				1660	0	0	1767	1856	0	0	1856	1572
Q Serve(g_s), s				18.2	0.0	0.0	1.1	0.0	0.0	0.0	25.6	9.4
Cycle Q Clear(g_c), s				18.2	0.0	0.0	1.1	0.0	0.0	0.0	25.6	9.4
Prop In Lane				0.48		0.52	1.00		0.00	0.00		1.00
Lane Grp Cap(c), veh/h				429	0	0	231	1112	0	0	737	625
V/C Ratio(X)				0.91	0.00	0.00	0.13	0.58	0.00	0.00	0.87	0.41
Avail Cap(c_a), veh/h				463	0	0	231	1112	0	0	796	674
HCM Platoon Ratio				1.00	1.00	1.00	2.00	2.00	1.00	1.00	1.00	1.00
Upstream Filter(I)				1.00	0.00	0.00	0.84	0.84	0.00	0.00	1.00	1.00
Uniform Delay (d), s/veh				28.8	0.0	0.0	26.1	0.0	0.0	0.0	22.2	17.4
Incr Delay (d2), s/veh				21.0	0.0	0.0	0.1	1.9	0.0	0.0	13.5	2.0
Initial Q Delay(d3),s/veh				0.0	0.0	0.0	0.0	0.0	0.0	0.0	0.0	0.0
%ile BackOfQ(50%),veh/ln				8.9	0.0	0.0	0.4	0.6	0.0	0.0	13.1	3.6
Unsig. Movement Delay, s/veh												
LnGrp Delay(d),s/veh				49.7	0.0	0.0	26.2	1.9	0.0	0.0	35.7	19.3
LnGrp LOS				D	A	A	C	A	A	A	D	B
Approach Vol, veh/h				390				675			899	
Approach Delay, s/veh				49.7				3.0			31.1	
Approach LOS				D				A			C	
Timer - Assigned Phs		2			5	6		8				
Phs Duration (G+Y+Rc), s		53.6			16.1	37.5		26.4				
Change Period (Y+Rc), s		* 5.7			* 5.7	* 5.7		5.7				
Max Green Setting (Gmax), s		* 46			* 6.3	* 34		22.3				
Max Q Clear Time (g_c+I1), s		2.0			3.1	27.6		20.2				
Green Ext Time (p_c), s		7.0			0.0	4.2		0.4				

Intersection Summary

HCM 6th Ctrl Delay	25.1
HCM 6th LOS	C

Notes

* HCM 6th computational engine requires equal clearance times for the phases crossing the barrier.

HCM 6th Signalized Intersection Summary
6: Lemoore Avenue & SR 198 EB Ramps

Cumulative Year 2042 plus Project AM Peak

11/03/2022



Movement	WBL	WBR	NBT	NBR	SBL	SBT
Lane Configurations	↙	↙	↑	↗	↙	↑
Traffic Volume (veh/h)	19	239	392	155	264	510
Future Volume (veh/h)	19	239	392	155	264	510
Initial Q (Qb), veh	0	0	0	0	0	0
Ped-Bike Adj(A_pbT)	1.00	1.00		1.00	1.00	
Parking Bus, Adj	1.00	1.00	1.00	1.00	1.00	1.00
Work Zone On Approach	No		No		No	
Adj Sat Flow, veh/h/ln	1856	1856	1856	1856	1856	1856
Adj Flow Rate, veh/h	20	257	422	167	284	548
Peak Hour Factor	0.93	0.93	0.93	0.93	0.93	0.93
Percent Heavy Veh, %	3	3	3	3	3	3
Cap, veh/h	330	293	537	455	548	1245
Arrive On Green	0.19	0.19	0.29	0.29	0.62	1.00
Sat Flow, veh/h	1767	1572	1856	1572	1767	1856
Grp Volume(v), veh/h	20	257	422	167	284	548
Grp Sat Flow(s),veh/h/ln	1767	1572	1856	1572	1767	1856
Q Serve(g_s), s	0.7	12.7	16.7	6.8	7.2	0.0
Cycle Q Clear(g_c), s	0.7	12.7	16.7	6.8	7.2	0.0
Prop In Lane	1.00	1.00		1.00	1.00	
Lane Grp Cap(c), veh/h	330	293	537	455	548	1245
V/C Ratio(X)	0.06	0.88	0.79	0.37	0.52	0.44
Avail Cap(c_a), veh/h	382	340	726	615	548	1245
HCM Platoon Ratio	1.00	1.00	1.00	1.00	2.00	2.00
Upstream Filter(I)	1.00	1.00	1.00	1.00	0.76	0.76
Uniform Delay (d), s/veh	26.8	31.6	26.1	22.6	11.8	0.0
Incr Delay (d2), s/veh	0.1	20.0	11.0	2.3	0.3	0.9
Initial Q Delay(d3),s/veh	0.0	0.0	0.0	0.0	0.0	0.0
%ile BackOfQ(50%),veh/ln	0.3	5.9	8.7	2.7	2.2	0.3
Unsig. Movement Delay, s/veh						
LnGrp Delay(d),s/veh	26.9	51.6	37.2	24.9	12.1	0.9
LnGrp LOS	C	D	D	C	B	A
Approach Vol, veh/h	277		589			832
Approach Delay, s/veh	49.8		33.7			4.7
Approach LOS	D		C			A
Timer - Assigned Phs	1	2			6	8
Phs Duration (G+Y+Rc), s	30.5	28.9			59.4	20.6
Change Period (Y+Rc), s	5.7	* 5.7			* 5.7	5.7
Max Green Setting (Gmax), s	14	* 31			* 51	17.3
Max Q Clear Time (g_c+1/2), s	19.2	18.7			2.0	14.7
Green Ext Time (p_c), s	0.2	4.4			8.2	0.2

Intersection Summary

HCM 6th Ctrl Delay	22.1
HCM 6th LOS	C

Notes

User approved pedestrian interval to be less than phase max green.
* HCM 6th computational engine requires equal clearance times for the phases crossing the barrier.

HCM 6th Signalized Intersection Summary
1: Lemoore Avenue & D Street

Cumulative Year 2042 plus Project PM Peak

11/04/2022



Movement	EBL	EBT	EBR	WBL	WBT	WBR	NBL	NBT	NBR	SBL	SBT	SBR
Lane Configurations	↖	↗		↖	↗	↖	↖	↕	↕	↖	↗	
Traffic Volume (veh/h)	142	201	57	73	221	339	66	707	57	268	669	133
Future Volume (veh/h)	142	201	57	73	221	339	66	707	57	268	669	133
Initial Q (Qb), veh	0	0	0	0	0	0	0	0	0	0	0	0
Ped-Bike Adj(A_pbT)	1.00		0.99	1.00		0.99	1.00		0.98	1.00		0.98
Parking Bus, Adj	1.00	1.00	1.00	1.00	1.00	1.00	1.00	1.00	1.00	1.00	1.00	1.00
Work Zone On Approach		No			No			No			No	
Adj Sat Flow, veh/h/ln	1856	1856	1856	1856	1856	1856	1856	1856	1856	1856	1856	1856
Adj Flow Rate, veh/h	148	209	59	76	230	353	69	736	59	279	697	139
Peak Hour Factor	0.96	0.96	0.96	0.96	0.96	0.96	0.96	0.96	0.96	0.96	0.96	0.96
Percent Heavy Veh, %	3	3	3	3	3	3	3	3	3	3	3	3
Cap, veh/h	185	280	79	166	353	297	290	976	78	320	912	182
Arrive On Green	0.10	0.20	0.20	0.09	0.19	0.19	0.16	0.30	0.30	0.18	0.31	0.31
Sat Flow, veh/h	1767	1389	392	1767	1856	1560	1767	3300	264	1767	2919	582
Grp Volume(v), veh/h	148	0	268	76	230	353	69	393	402	279	421	415
Grp Sat Flow(s),veh/h/ln	1767	0	1781	1767	1856	1560	1767	1763	1801	1767	1763	1737
Q Serve(g_s), s	6.0	0.0	10.4	3.0	8.4	8.9	2.5	14.9	14.9	11.3	15.9	15.9
Cycle Q Clear(g_c), s	6.0	0.0	10.4	3.0	8.4	8.9	2.5	14.9	14.9	11.3	15.9	15.9
Prop In Lane	1.00		0.22	1.00		1.00	1.00		0.15	1.00		0.33
Lane Grp Cap(c), veh/h	185	0	359	166	353	297	290	521	533	320	551	543
V/C Ratio(X)	0.80	0.00	0.75	0.46	0.65	1.19	0.24	0.75	0.75	0.87	0.76	0.77
Avail Cap(c_a), veh/h	235	0	605	187	580	488	290	637	651	331	757	746
HCM Platoon Ratio	1.00	1.00	1.00	1.00	1.00	1.00	1.00	1.00	1.00	1.00	1.00	1.00
Upstream Filter(I)	1.00	0.00	1.00	1.00	1.00	1.00	1.00	1.00	1.00	1.00	1.00	1.00
Uniform Delay (d), s/veh	32.2	0.0	27.6	31.6	27.5	12.0	26.7	23.5	23.5	29.3	22.8	22.9
Incr Delay (d2), s/veh	14.1	0.0	3.1	2.0	2.0	102.5	0.4	4.1	4.0	21.2	3.1	3.2
Initial Q Delay(d3),s/veh	0.0	0.0	0.0	0.0	0.0	0.0	0.0	0.0	0.0	0.0	0.0	0.0
%ile BackOfQ(50%),veh/ln	3.3	0.0	4.6	1.3	3.8	11.3	1.1	6.5	6.7	6.6	6.8	6.7
Unsig. Movement Delay, s/veh												
LnGrp Delay(d),s/veh	46.3	0.0	30.7	33.5	29.5	114.5	27.2	27.5	27.5	50.5	26.0	26.0
LnGrp LOS	D	A	C	C	C	F	C	C	C	D	C	C
Approach Vol, veh/h		416			659			864			1115	
Approach Delay, s/veh		36.3			75.5			27.5			32.1	
Approach LOS		D			E			C			C	
Timer - Assigned Phs	1	2	3	4	5	6	7	8				
Phs Duration (G+Y+Rc), s	17.5	26.0	11.1	19.0	16.3	27.2	11.9	18.2				
Change Period (Y+Rc), s	* 4.2	* 4.2	* 4.2	* 4.2	* 4.2	* 4.2	* 4.2	* 4.2				
Max Green Setting (Gmax), s	* 14	* 27	* 7.8	* 25	* 8.8	* 32	* 9.8	* 23				
Max Q Clear Time (g_c+I1), s	13.3	16.9	5.0	12.4	4.5	17.9	8.0	10.9				
Green Ext Time (p_c), s	0.0	3.7	0.0	1.3	0.0	4.8	0.1	2.2				

Intersection Summary

HCM 6th Ctrl Delay	40.8
HCM 6th LOS	D

Notes

* HCM 6th computational engine requires equal clearance times for the phases crossing the barrier.

Intersection

Int Delay, s/veh 12.6

Movement	SEL	SET	SER	NWL	NWT	NWR	NEL	NET	NER	SWL	SWT	SWR
Lane Configurations	↖	↗		↖	↗			↕			↕	
Traffic Vol, veh/h	22	406	34	194	570	36	34	5	146	15	5	22
Future Vol, veh/h	22	406	34	194	570	36	34	5	146	15	5	22
Conflicting Peds, #/hr	0	0	0	0	0	0	0	0	0	0	0	0
Sign Control	Free	Free	Free	Free	Free	Free	Stop	Stop	Stop	Stop	Stop	Stop
RT Channelized	-	-	None	-	-	None	-	-	None	-	-	None
Storage Length	90	-	-	125	-	-	-	-	-	-	-	-
Veh in Median Storage, #	-	0	-	-	0	-	-	0	-	-	0	-
Grade, %	-	0	-	-	0	-	-	0	-	-	0	-
Peak Hour Factor	93	93	93	93	93	93	93	93	93	93	93	93
Heavy Vehicles, %	3	3	3	3	3	3	3	3	3	3	3	3
Mvmt Flow	24	437	37	209	613	39	37	5	157	16	5	24

Major/Minor	Major1	Major2	Minor1	Minor2
Conflicting Flow All	652	0	0	474
Stage 1	-	-	-	-
Stage 2	-	-	-	-
Critical Hdwy	4.13	-	-	4.13
Critical Hdwy Stg 1	-	-	-	-
Critical Hdwy Stg 2	-	-	-	-
Follow-up Hdwy	2.227	-	-	2.227
Pot Cap-1 Maneuver	930	-	-	1083
Stage 1	-	-	-	-
Stage 2	-	-	-	-
Platoon blocked, %	-	-	-	-
Mov Cap-1 Maneuver	930	-	-	1083
Mov Cap-2 Maneuver	-	-	-	-
Stage 1	-	-	-	-
Stage 2	-	-	-	-

Approach	SE	NW	NE	SW
HCM Control Delay, s	0.4	2.2	74.9	68.8
HCM LOS			F	F

Minor Lane/Major Mvmt	NELn1	NWL	NWT	NWR	SEL	SET	SERSWLn1
Capacity (veh/h)	229	1083	-	-	930	-	99
HCM Lane V/C Ratio	0.869	0.193	-	-	0.025	-	0.456
HCM Control Delay (s)	74.9	9.1	-	-	9	-	68.8
HCM Lane LOS	F	A	-	-	A	-	F
HCM 95th %tile Q(veh)	7	0.7	-	-	0.1	-	2

HCM 6th Signalized Intersection Summary
3: Lemoore Avenue & Bush Street

Cumulative Year 2042 plus Project PM Peak

11/04/2022



Movement	EBL	EBT	EBR	WBL	WBT	WBR	NBL	NBT	NBR	SBL	SBT	SBR
Lane Configurations	↖	↗	↘	↖	↗	↘	↖	↗	↘	↖	↗	↘
Traffic Volume (veh/h)	121	166	263	93	154	65	139	604	121	63	599	148
Future Volume (veh/h)	121	166	263	93	154	65	139	604	121	63	599	148
Initial Q (Qb), veh	0	0	0	0	0	0	0	0	0	0	0	0
Ped-Bike Adj(A_pbT)	1.00		0.99	1.00		0.99	1.00		0.99	1.00		1.00
Parking Bus, Adj	1.00	1.00	1.00	1.00	1.00	1.00	1.00	1.00	1.00	1.00	1.00	1.00
Work Zone On Approach		No			No			No			No	
Adj Sat Flow, veh/h/ln	1856	1856	1856	1856	1856	1856	1856	1856	1856	1856	1856	1856
Adj Flow Rate, veh/h	129	177	280	99	164	69	148	643	129	67	637	157
Peak Hour Factor	0.94	0.94	0.94	0.94	0.94	0.94	0.94	0.94	0.94	0.94	0.94	0.94
Percent Heavy Veh, %	3	3	3	3	3	3	3	3	3	3	3	3
Cap, veh/h	331	450	379	173	284	238	192	1151	510	146	842	207
Arrive On Green	0.19	0.24	0.24	0.10	0.15	0.15	0.11	0.33	0.33	0.08	0.30	0.30
Sat Flow, veh/h	1767	1856	1561	1767	1856	1554	1767	3526	1563	1767	2801	689
Grp Volume(v), veh/h	129	177	280	99	164	69	148	643	129	67	400	394
Grp Sat Flow(s),veh/h/ln	1767	1856	1561	1767	1856	1554	1767	1763	1563	1767	1763	1728
Q Serve(g_s), s	4.3	5.4	11.1	3.6	5.5	2.0	5.5	10.1	2.7	2.4	13.8	13.8
Cycle Q Clear(g_c), s	4.3	5.4	11.1	3.6	5.5	2.0	5.5	10.1	2.7	2.4	13.8	13.8
Prop In Lane	1.00		1.00	1.00		1.00	1.00		1.00	1.00		0.40
Lane Grp Cap(c), veh/h	331	450	379	173	284	238	192	1151	510	146	530	519
V/C Ratio(X)	0.39	0.39	0.74	0.57	0.58	0.29	0.77	0.56	0.25	0.46	0.76	0.76
Avail Cap(c_a), veh/h	331	774	651	205	746	625	284	1502	666	232	698	685
HCM Platoon Ratio	1.00	1.00	1.00	1.00	1.00	1.00	1.00	1.00	1.00	1.00	1.00	1.00
Upstream Filter(I)	1.00	1.00	1.00	1.00	1.00	1.00	1.00	1.00	1.00	1.00	1.00	1.00
Uniform Delay (d), s/veh	23.9	21.3	23.5	28.9	26.4	14.4	29.1	18.6	7.4	29.4	21.3	21.3
Incr Delay (d2), s/veh	0.7	0.6	2.8	3.0	1.9	0.7	7.3	0.4	0.3	2.2	3.4	3.5
Initial Q Delay(d3),s/veh	0.0	0.0	0.0	0.0	0.0	0.0	0.0	0.0	0.0	0.0	0.0	0.0
%ile BackOfQ(50%),veh/ln	1.8	2.3	4.2	1.6	2.5	1.0	2.6	3.9	1.4	1.1	5.9	5.8
Unsig. Movement Delay, s/veh												
LnGrp Delay(d),s/veh	24.7	21.8	26.3	31.9	28.3	15.0	36.4	19.1	7.7	31.6	24.6	24.8
LnGrp LOS	C	C	C	C	C	B	D	B	A	C	C	C
Approach Vol, veh/h		586			332			920			861	
Approach Delay, s/veh		24.6			26.6			20.2			25.2	
Approach LOS		C			C			C			C	
Timer - Assigned Phs	1	2	3	4	5	6	7	8				
Phs Duration (G+Y+Rc), s	9.8	26.1	10.8	20.5	11.5	24.4	16.8	14.5				
Change Period (Y+Rc), s	* 4.2	* 4.2	* 4.2	* 4.2	* 4.2	* 4.2	* 4.2	* 4.2				
Max Green Setting (Gmax), s	* 8.8	* 29	* 7.8	* 28	* 11	* 27	* 8.8	* 27				
Max Q Clear Time (g_c+I1), s	4.4	12.1	5.6	13.1	7.5	15.8	6.3	7.5				
Green Ext Time (p_c), s	0.0	4.5	0.0	1.8	0.1	4.0	0.1	1.1				

Intersection Summary

HCM 6th Ctrl Delay	23.6
HCM 6th LOS	C

Notes

* HCM 6th computational engine requires equal clearance times for the phases crossing the barrier.

HCM 6th Signalized Intersection Summary
4: 17th Avenue & D Street/Houston Avenue

Cumulative Year 2042 plus Project PM Peak

11/04/2022



Movement	EBL	EBT	EBR	WBL	WBT	WBR	NBL	NBT	NBR	SBL	SBT	SBR
Lane Configurations												
Traffic Volume (veh/h)	81	520	0	0	713	287	0	2	0	196	0	64
Future Volume (veh/h)	81	520	0	0	713	287	0	2	0	196	0	64
Initial Q (Qb), veh	0	0	0	0	0	0	0	0	0	0	0	0
Ped-Bike Adj(A_pbT)	1.00		1.00	1.00		1.00	1.00		1.00	1.00		1.00
Parking Bus, Adj	1.00	1.00	1.00	1.00	1.00	1.00	1.00	1.00	1.00	1.00	1.00	1.00
Work Zone On Approach		No			No			No			No	
Adj Sat Flow, veh/h/ln	1856	1856	1856	1856	1856	1856	1856	1856	1856	1856	1856	1856
Adj Flow Rate, veh/h	92	591	0	0	810	326	0	2	0	223	0	73
Peak Hour Factor	0.88	0.88	0.88	0.88	0.88	0.88	0.88	0.88	0.88	0.88	0.88	0.88
Percent Heavy Veh, %	3	3	3	3	3	3	3	3	3	3	3	3
Cap, veh/h	168	1208	0	3	917	777	0	357	0	375	0	303
Arrive On Green	0.09	0.65	0.00	0.00	0.49	0.49	0.00	0.19	0.00	0.19	0.00	0.19
Sat Flow, veh/h	1767	1856	0	1767	1856	1572	0	1856	0	1397	0	1572
Grp Volume(v), veh/h	92	591	0	0	810	326	0	2	0	223	0	73
Grp Sat Flow(s),veh/h/ln	1767	1856	0	1767	1856	1572	0	1856	0	1397	0	1572
Q Serve(g_s), s	3.4	11.0	0.0	0.0	26.5	9.0	0.0	0.1	0.0	10.3	0.0	2.7
Cycle Q Clear(g_c), s	3.4	11.0	0.0	0.0	26.5	9.0	0.0	0.1	0.0	10.4	0.0	2.7
Prop In Lane	1.00		0.00	1.00		1.00	0.00		0.00	1.00		1.00
Lane Grp Cap(c), veh/h	168	1208	0	3	917	777	0	357	0	375	0	303
V/C Ratio(X)	0.55	0.49	0.00	0.00	0.88	0.42	0.00	0.01	0.00	0.59	0.00	0.24
Avail Cap(c_a), veh/h	204	1208	0	204	1089	923	0	485	0	472	0	411
HCM Platoon Ratio	1.00	1.00	1.00	1.00	1.00	1.00	1.00	1.00	1.00	1.00	1.00	1.00
Upstream Filter(I)	1.00	1.00	0.00	0.00	1.00	1.00	0.00	1.00	0.00	1.00	0.00	1.00
Uniform Delay (d), s/veh	29.2	6.0	0.0	0.0	15.4	10.9	0.0	22.1	0.0	26.3	0.0	23.1
Incr Delay (d2), s/veh	2.8	0.3	0.0	0.0	7.8	0.4	0.0	0.0	0.0	1.5	0.0	0.4
Initial Q Delay(d3),s/veh	0.0	0.0	0.0	0.0	0.0	0.0	0.0	0.0	0.0	0.0	0.0	0.0
%ile BackOfQ(50%),veh/ln	1.5	2.9	0.0	0.0	10.5	2.5	0.0	0.0	0.0	3.3	0.0	0.9
Unsig. Movement Delay, s/veh												
LnGrp Delay(d),s/veh	32.0	6.4	0.0	0.0	23.1	11.3	0.0	22.1	0.0	27.8	0.0	23.5
LnGrp LOS	C	A	A	A	C	B	A	C	A	C	A	C
Approach Vol, veh/h		683			1136			2			296	
Approach Delay, s/veh		9.8			19.7			22.1			26.7	
Approach LOS		A			B			C			C	
Timer - Assigned Phs		2	3	4		6	7	8				
Phs Duration (G+Y+Rc), s		18.3	0.0	49.3		18.3	10.6	38.7				
Change Period (Y+Rc), s		5.3	* 4.2	* 5.3		5.3	* 4.2	5.3				
Max Green Setting (Gmax), s		17.7	* 7.8	* 40		17.7	* 7.8	39.7				
Max Q Clear Time (g_c+11), s		2.1	0.0	13.0		12.4	5.4	28.5				
Green Ext Time (p_c), s		0.0	0.0	3.9		0.6	0.0	4.9				

Intersection Summary

HCM 6th Ctrl Delay	17.5
HCM 6th LOS	B

Notes

* HCM 6th computational engine requires equal clearance times for the phases crossing the barrier.

HCM 6th Signalized Intersection Summary
5: Lemoore Avenue & SR 198 WB Ramps

Cumulative Year 2042 plus Project PM Peak
11/04/2022



Movement	EBL	EBT	EBR	WBL	WBT	WBR	NBL	NBT	NBR	SBL	SBT	SBR
Lane Configurations					↕		↖	↗			↕	↗
Traffic Volume (veh/h)	0	0	0	218	0	252	23	646	0	0	603	216
Future Volume (veh/h)	0	0	0	218	0	252	23	646	0	0	603	216
Initial Q (Qb), veh				0	0	0	0	0	0	0	0	0
Ped-Bike Adj(A_pbT)				1.00		1.00	1.00		1.00	1.00		1.00
Parking Bus, Adj				1.00	1.00	1.00	1.00	1.00	1.00	1.00	1.00	1.00
Work Zone On Approach				No		No		No				
Adj Sat Flow, veh/h/ln				1856	1856	1856	1856	1856	0	0	1856	1856
Adj Flow Rate, veh/h				229	0	265	24	680	0	0	635	227
Peak Hour Factor				0.95	0.95	0.95	0.95	0.95	0.95	0.95	0.95	0.95
Percent Heavy Veh, %				3	3	3	3	3	0	0	3	3
Cap, veh/h				226	0	262	199	1064	0	0	732	620
Arrive On Green				0.29	0.00	0.29	0.23	1.00	0.00	0.00	0.39	0.39
Sat Flow, veh/h				768	0	889	1767	1856	0	0	1856	1572
Grp Volume(v), veh/h				494	0	0	24	680	0	0	635	227
Grp Sat Flow(s),veh/h/ln				1657	0	0	1767	1856	0	0	1856	1572
Q Serve(g_s), s				25.3	0.0	0.0	0.9	0.0	0.0	0.0	27.1	8.8
Cycle Q Clear(g_c), s				25.3	0.0	0.0	0.9	0.0	0.0	0.0	27.1	8.8
Prop In Lane				0.46		0.54	1.00		0.00	0.00		1.00
Lane Grp Cap(c), veh/h				488	0	0	199	1064	0	0	732	620
V/C Ratio(X)				1.01	0.00	0.00	0.12	0.64	0.00	0.00	0.87	0.37
Avail Cap(c_a), veh/h				488	0	0	199	1064	0	0	805	682
HCM Platoon Ratio				1.00	1.00	1.00	2.00	2.00	1.00	1.00	1.00	1.00
Upstream Filter(I)				1.00	0.00	0.00	0.77	0.77	0.00	0.00	1.00	1.00
Uniform Delay (d), s/veh				30.4	0.0	0.0	29.9	0.0	0.0	0.0	24.0	18.4
Incr Delay (d2), s/veh				44.1	0.0	0.0	0.1	2.3	0.0	0.0	13.2	1.7
Initial Q Delay(d3),s/veh				0.0	0.0	0.0	0.0	0.0	0.0	0.0	0.0	0.0
%ile BackOfQ(50%),veh/ln				14.8	0.0	0.0	0.4	0.7	0.0	0.0	13.8	3.4
Unsig. Movement Delay, s/veh												
LnGrp Delay(d),s/veh				74.5	0.0	0.0	30.0	2.3	0.0	0.0	37.2	20.1
LnGrp LOS				F	A	A	C	A	A	A	D	C
Approach Vol, veh/h				494			704				862	
Approach Delay, s/veh				74.5			3.2				32.7	
Approach LOS				E			A				C	
Timer - Assigned Phs		2		5	6		8					
Phs Duration (G+Y+Rc), s		55.0		15.4	39.6		31.0					
Change Period (Y+Rc), s		* 5.7		* 5.7	* 5.7		5.7					
Max Green Setting (Gmax), s		* 49		* 6.3	* 37		25.3					
Max Q Clear Time (g_c+I1), s		2.0		2.9	29.1		27.3					
Green Ext Time (p_c), s		7.7		0.0	4.8		0.0					

Intersection Summary

HCM 6th Ctrl Delay	32.6
HCM 6th LOS	C

Notes

* HCM 6th computational engine requires equal clearance times for the phases crossing the barrier.

HCM 6th Signalized Intersection Summary
6: Lemoore Avenue & SR 198 EB Ramps

Cumulative Year 2042 plus Project PM Peak

11/04/2022



Movement	WBL	WBR	NBT	NBR	SBL	SBT
Lane Configurations						
Traffic Volume (veh/h)	32	299	367	284	298	530
Future Volume (veh/h)	32	299	367	284	298	530
Initial Q (Qb), veh	0	0	0	0	0	0
Ped-Bike Adj(A_pbT)	1.00	1.00		1.00	1.00	
Parking Bus, Adj	1.00	1.00	1.00	1.00	1.00	1.00
Work Zone On Approach	No		No		No	
Adj Sat Flow, veh/h/ln	1856	1856	1856	1856	1856	1856
Adj Flow Rate, veh/h	40	369	453	351	368	654
Peak Hour Factor	0.81	0.81	0.81	0.81	0.81	0.81
Percent Heavy Veh, %	3	3	3	3	3	3
Cap, veh/h	397	353	578	490	469	1193
Arrive On Green	0.22	0.22	0.31	0.31	0.53	1.00
Sat Flow, veh/h	1767	1572	1856	1572	1767	1856
Grp Volume(v), veh/h	40	369	453	351	368	654
Grp Sat Flow(s),veh/h/ln	1767	1572	1856	1572	1767	1856
Q Serve(g_s), s	1.5	19.3	19.1	17.0	14.4	0.0
Cycle Q Clear(g_c), s	1.5	19.3	19.1	17.0	14.4	0.0
Prop In Lane	1.00	1.00		1.00	1.00	
Lane Grp Cap(c), veh/h	397	353	578	490	469	1193
V/C Ratio(X)	0.10	1.05	0.78	0.72	0.78	0.55
Avail Cap(c_a), veh/h	397	353	718	609	469	1193
HCM Platoon Ratio	1.00	1.00	1.00	1.00	2.00	2.00
Upstream Filter(I)	1.00	1.00	1.00	1.00	0.72	0.72
Uniform Delay (d), s/veh	26.5	33.3	27.0	26.2	18.2	0.0
Incr Delay (d2), s/veh	0.1	60.3	10.2	8.7	5.8	1.3
Initial Q Delay(d3),s/veh	0.0	0.0	0.0	0.0	0.0	0.0
%ile BackOfQ(50%),veh/ln	0.6	12.5	9.8	7.3	4.7	0.4
Unsig. Movement Delay, s/veh						
LnGrp Delay(d),s/veh	26.6	93.7	37.2	35.0	24.0	1.3
LnGrp LOS	C	F	D	C	C	A
Approach Vol, veh/h	409		804		1022	
Approach Delay, s/veh	87.1		36.2		9.5	
Approach LOS	F		D		A	
Timer - Assigned Phs	1	2			6	8
Phs Duration (G+Y+Rc), s	28.5	32.5			61.0	25.0
Change Period (Y+Rc), s	5.7	* 5.7			* 5.7	5.7
Max Green Setting (Gmax), s	33	* 33			* 55	19.3
Max Q Clear Time (g_c+Y+Rc), s	21.1	21.1			2.0	21.3
Green Ext Time (p_c), s	0.0	5.7			10.8	0.0

Intersection Summary

HCM 6th Ctrl Delay	33.3
HCM 6th LOS	C

Notes

* HCM 6th computational engine requires equal clearance times for the phases crossing the barrier.

HCM 6th Signalized Intersection Summary
 2: Bush Street/Daphne Lane & D Street

Cumulative Year 2042 plus Project AM Peak

11/03/2022

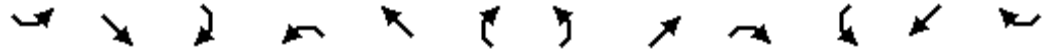

Movement	SEL	SET	SER	NWL	NWT	NWR	NEL	NET	NER	SWL	SWT	SWR
Lane Configurations												
Traffic Volume (veh/h)	8	408	43	286	468	15	50	19	246	12	11	25
Future Volume (veh/h)	8	408	43	286	468	15	50	19	246	12	11	25
Initial Q (Qb), veh	0	0	0	0	0	0	0	0	0	0	0	0
Ped-Bike Adj(A_pbT)	1.00		1.00	1.00		1.00	1.00		0.99	1.00		0.99
Parking Bus, Adj	1.00	1.00	1.00	1.00	1.00	1.00	1.00	1.00	1.00	1.00	1.00	1.00
Work Zone On Approach		No			No			No			No	
Adj Sat Flow, veh/h/ln	1856	1856	1856	1856	1856	1856	1856	1856	1856	1856	1856	1856
Adj Flow Rate, veh/h	9	474	50	333	544	17	58	22	286	14	13	29
Peak Hour Factor	0.86	0.86	0.86	0.86	0.86	0.86	0.86	0.86	0.86	0.86	0.86	0.86
Percent Heavy Veh, %	3	3	3	3	3	3	3	3	3	3	3	3
Cap, veh/h	31	517	55	371	905	28	124	26	335	46	94	209
Arrive On Green	0.02	0.31	0.31	0.21	0.51	0.51	0.07	0.23	0.23	0.03	0.18	0.18
Sat Flow, veh/h	1767	1650	174	1767	1789	56	1767	113	1467	1767	508	1133
Grp Volume(v), veh/h	9	0	524	333	0	561	58	0	308	14	0	42
Grp Sat Flow(s),veh/h/ln	1767	0	1824	1767	0	1845	1767	0	1580	1767	0	1641
Q Serve(g_s), s	0.4	0.0	22.3	14.8	0.0	17.4	2.5	0.0	15.1	0.6	0.0	1.7
Cycle Q Clear(g_c), s	0.4	0.0	22.3	14.8	0.0	17.4	2.5	0.0	15.1	0.6	0.0	1.7
Prop In Lane	1.00		0.10	1.00		0.03	1.00		0.93	1.00		0.69
Lane Grp Cap(c), veh/h	31	0	572	371	0	933	124	0	361	46	0	302
V/C Ratio(X)	0.29	0.00	0.92	0.90	0.00	0.60	0.47	0.00	0.85	0.30	0.00	0.14
Avail Cap(c_a), veh/h	171	0	622	390	0	933	171	0	471	171	0	497
HCM Platoon Ratio	1.00	1.00	1.00	1.00	1.00	1.00	1.00	1.00	1.00	1.00	1.00	1.00
Upstream Filter(I)	1.00	0.00	1.00	1.00	0.00	1.00	1.00	0.00	1.00	1.00	0.00	1.00
Uniform Delay (d), s/veh	39.1	0.0	26.6	31.0	0.0	14.1	36.0	0.0	29.8	38.5	0.0	27.5
Incr Delay (d2), s/veh	5.0	0.0	17.6	22.3	0.0	1.1	2.7	0.0	11.3	3.7	0.0	0.2
Initial Q Delay(d3),s/veh	0.0	0.0	0.0	0.0	0.0	0.0	0.0	0.0	0.0	0.0	0.0	0.0
%ile BackOfQ(50%),veh/ln	0.2	0.0	11.6	8.2	0.0	6.5	1.2	0.0	6.6	0.3	0.0	0.7
Unsig. Movement Delay, s/veh												
LnGrp Delay(d),s/veh	44.1	0.0	44.3	53.3	0.0	15.2	38.7	0.0	41.1	42.2	0.0	27.7
LnGrp LOS	D	A	D	D	A	B	D	A	D	D	A	C
Approach Vol, veh/h		533			894			366				56
Approach Delay, s/veh		44.2			29.4			40.7				31.3
Approach LOS		D			C			D				C
Timer - Assigned Phs	1	2	3	4	5	6	7	8				
Phs Duration (G+Y+Rc), s	5.6	45.6	6.3	23.0	21.1	30.2	9.9	19.4				
Change Period (Y+Rc), s	* 4.2	* 4.9	* 4.2	4.6	* 4.2	4.9	* 4.2	* 4.6				
Max Green Setting (Gmax), s	* 7.8	* 38	* 7.8	24.0	* 18	27.5	* 7.8	* 24				
Max Q Clear Time (g_c+I1), s	2.4	19.4	2.6	17.1	16.8	24.3	4.5	3.7				
Green Ext Time (p_c), s	0.0	3.3	0.0	1.0	0.1	1.0	0.0	0.1				

Intersection Summary

HCM 6th Ctrl Delay	36.0
HCM 6th LOS	D

Notes

* HCM 6th computational engine requires equal clearance times for the phases crossing the barrier.

HCM 6th Signalized Intersection Summary
2: Bush Street/Daphne Lane & D Street

Cumulative Year 2042 plus Project PM Peak

11/04/2022



Movement	SEL	SET	SER	NWL	NWT	NWR	NEL	NET	NER	SWL	SWT	SWR
Lane Configurations												
Traffic Volume (veh/h)	22	406	34	194	570	36	34	5	146	15	5	22
Future Volume (veh/h)	22	406	34	194	570	36	34	5	146	15	5	22
Initial Q (Qb), veh	0	0	0	0	0	0	0	0	0	0	0	0
Ped-Bike Adj(A_pbT)	1.00		1.00	1.00		1.00	1.00		1.00	1.00		1.00
Parking Bus, Adj	1.00	1.00	1.00	1.00	1.00	1.00	1.00	1.00	1.00	1.00	1.00	1.00
Work Zone On Approach		No			No			No			No	
Adj Sat Flow, veh/h/ln	1856	1856	1856	1856	1856	1856	1856	1856	1856	1856	1856	1856
Adj Flow Rate, veh/h	24	437	37	209	613	39	37	5	157	16	5	24
Peak Hour Factor	0.93	0.93	0.93	0.93	0.93	0.93	0.93	0.93	0.93	0.93	0.93	0.93
Percent Heavy Veh, %	3	3	3	3	3	3	3	3	3	3	3	3
Cap, veh/h	77	531	45	261	723	46	109	8	261	55	39	187
Arrive On Green	0.04	0.31	0.31	0.15	0.42	0.42	0.06	0.17	0.17	0.03	0.14	0.14
Sat Flow, veh/h	1767	1687	143	1767	1726	110	1767	49	1531	1767	278	1337
Grp Volume(v), veh/h	24	0	474	209	0	652	37	0	162	16	0	29
Grp Sat Flow(s),veh/h/ln	1767	0	1830	1767	0	1836	1767	0	1580	1767	0	1615
Q Serve(g_s), s	0.7	0.0	12.8	6.1	0.0	17.0	1.1	0.0	5.0	0.5	0.0	0.8
Cycle Q Clear(g_c), s	0.7	0.0	12.8	6.1	0.0	17.0	1.1	0.0	5.0	0.5	0.0	0.8
Prop In Lane	1.00		0.08	1.00		0.06	1.00		0.97	1.00		0.83
Lane Grp Cap(c), veh/h	77	0	576	261	0	768	109	0	269	55	0	226
V/C Ratio(X)	0.31	0.00	0.82	0.80	0.00	0.85	0.34	0.00	0.60	0.29	0.00	0.13
Avail Cap(c_a), veh/h	259	0	856	358	0	962	259	0	700	259	0	728
HCM Platoon Ratio	1.00	1.00	1.00	1.00	1.00	1.00	1.00	1.00	1.00	1.00	1.00	1.00
Upstream Filter(I)	1.00	0.00	1.00	1.00	0.00	1.00	1.00	0.00	1.00	1.00	0.00	1.00
Uniform Delay (d), s/veh	24.7	0.0	16.9	21.9	0.0	14.0	23.9	0.0	20.4	25.2	0.0	20.1
Incr Delay (d2), s/veh	2.2	0.0	4.1	8.8	0.0	6.0	1.8	0.0	2.2	2.9	0.0	0.3
Initial Q Delay(d3),s/veh	0.0	0.0	0.0	0.0	0.0	0.0	0.0	0.0	0.0	0.0	0.0	0.0
%ile BackOfQ(50%),veh/ln	0.3	0.0	5.0	2.8	0.0	6.6	0.5	0.0	1.8	0.2	0.0	0.3
Unsig. Movement Delay, s/veh												
LnGrp Delay(d),s/veh	26.9	0.0	21.0	30.7	0.0	19.9	25.8	0.0	22.6	28.2	0.0	20.3
LnGrp LOS	C	A	C	C	A	B	C	A	C	C	A	C
Approach Vol, veh/h		498			861			199				45
Approach Delay, s/veh		21.3			22.5			23.2				23.1
Approach LOS		C			C			C				C
Timer - Assigned Phs	1	2	3	4	5	6	7	8				
Phs Duration (G+Y+Rc), s	6.5	27.2	5.8	13.7	12.1	21.7	7.5	12.0				
Change Period (Y+Rc), s	* 4.2	4.9	* 4.2	4.6	* 4.2	4.9	* 4.2	* 4.6				
Max Green Setting (Gmax), s	* 7.8	27.9	* 7.8	23.6	* 11	24.9	* 7.8	* 24				
Max Q Clear Time (g_c+I1), s	2.7	19.0	2.5	7.0	8.1	14.8	3.1	2.8				
Green Ext Time (p_c), s	0.0	2.7	0.0	0.8	0.1	2.0	0.0	0.1				

Intersection Summary

HCM 6th Ctrl Delay	22.2
HCM 6th LOS	C

Notes

* HCM 6th computational engine requires equal clearance times for the phases crossing the barrier.

Intersection: 1: Lemoore Avenue & D Street

Movement	EB	EB	WB	WB	WB	NB	NB	NB	SB	SB	SB
Directions Served	L	TR	L	T	R	L	T	TR	L	T	TR
Maximum Queue (ft)	134	307	159	331	160	110	284	265	190	390	462
Average Queue (ft)	74	126	67	156	127	54	151	167	172	264	243
95th Queue (ft)	142	239	126	275	196	120	244	247	215	394	387
Link Distance (ft)		1631		2383			1433	1433		1665	1665
Upstream Blk Time (%)											
Queuing Penalty (veh)											
Storage Bay Dist (ft)	85		75		75	60			140		
Storage Blk Time (%)	7	20	9	31	15	7	35		32	16	
Queuing Penalty (veh)	16	18	46	107	51	24	22		148	43	

Intersection: 2: Bush Street/Daphne Lane & D Street

Movement	SE	SE	NW	NW	NE	NE	SW	SW
Directions Served	L	TR	L	TR	L	TR	L	TR
Maximum Queue (ft)	159	380	194	494	96	219	48	53
Average Queue (ft)	21	196	140	159	43	92	13	25
95th Queue (ft)	86	301	203	328	85	170	37	51
Link Distance (ft)		1298		1262		1039		377
Upstream Blk Time (%)								
Queuing Penalty (veh)								
Storage Bay Dist (ft)	90		125		250		250	
Storage Blk Time (%)		35	17	6				
Queuing Penalty (veh)		3	82	18				

Intersection: 3: Lemoore Avenue & Bush Street

Movement	EB	EB	EB	WB	WB	WB	NB	NB	NB	NB	SB	SB
Directions Served	L	T	R	L	T	R	L	T	T	R	L	T
Maximum Queue (ft)	214	332	135	299	346	120	172	188	205	145	195	326
Average Queue (ft)	115	155	84	110	173	100	104	70	83	62	164	201
95th Queue (ft)	180	276	163	215	282	154	168	139	156	123	223	321
Link Distance (ft)	2569	2569			350			1768	1768			1433
Upstream Blk Time (%)					0							
Queuing Penalty (veh)					0							
Storage Bay Dist (ft)			75	150		60	100			105	135	
Storage Blk Time (%)		32	3	1	36	13	11	4	4	0	37	14
Queuing Penalty (veh)		50	8	5	137	54	18	6	6	1	90	33

Intersection: 3: Lemoore Avenue & Bush Street

Movement	SB
Directions Served	TR
Maximum Queue (ft)	318
Average Queue (ft)	184
95th Queue (ft)	306
Link Distance (ft)	1433
Upstream Blk Time (%)	
Queuing Penalty (veh)	
Storage Bay Dist (ft)	
Storage Blk Time (%)	
Queuing Penalty (veh)	

Intersection: 4: 17th Avenue & D Street/Houston Avenue

Movement	EB	EB	WB	WB	NB	SB	SB
Directions Served	L	TR	T	R	LTR	LT	R
Maximum Queue (ft)	164	496	442	240	28	328	150
Average Queue (ft)	87	222	281	133	3	176	115
95th Queue (ft)	170	415	421	307	15	303	187
Link Distance (ft)		656	640		1215	3087	
Upstream Blk Time (%)							
Queuing Penalty (veh)							
Storage Bay Dist (ft)	75			150			90
Storage Blk Time (%)	10	25	42			27	10
Queuing Penalty (veh)	63	33	56			66	28

Intersection: 5: Lemoore Avenue & SR 198 WB Ramps

Movement	WB	NB	NB	SB	SB	B26
Directions Served	LTR	L	T	T	R	T
Maximum Queue (ft)	369	53	253	365	150	219
Average Queue (ft)	166	23	100	155	59	21
95th Queue (ft)	281	52	190	341	146	105
Link Distance (ft)	1146		568	301		1768
Upstream Blk Time (%)				3		
Queuing Penalty (veh)				27		
Storage Bay Dist (ft)		200			75	
Storage Blk Time (%)			1	13	0	
Queuing Penalty (veh)			0	31	0	

Intersection: 6: Lemoore Avenue & SR 198 EB Ramps

Movement	WB	WB	NB	NB	SB	SB
Directions Served	L	R	T	R	L	T
Maximum Queue (ft)	46	194	264	175	322	378
Average Queue (ft)	13	57	113	50	140	80
95th Queue (ft)	39	115	225	125	238	227
Link Distance (ft)		194	2460			568
Upstream Blk Time (%)		0				
Queuing Penalty (veh)		1				
Storage Bay Dist (ft)	50			50	200	
Storage Blk Time (%)	1	10	19	2	5	0
Queuing Penalty (veh)	3	2	29	9	23	0

Network Summary

Network wide Queuing Penalty: 1359

Intersection: 1: Lemoore Avenue & D Street

Movement	EB	EB	WB	WB	WB	NB	NB	NB	SB	SB	SB
Directions Served	L	TR	L	T	R	L	T	TR	L	T	TR
Maximum Queue (ft)	134	300	158	273	160	109	325	315	190	362	333
Average Queue (ft)	93	135	52	125	121	61	197	205	168	201	204
95th Queue (ft)	150	254	102	229	191	130	304	300	215	338	308
Link Distance (ft)		1631		2383			1433	1433		1665	1665
Upstream Blk Time (%)											
Queuing Penalty (veh)											
Storage Bay Dist (ft)	85		75		75	60			140		
Storage Blk Time (%)	14	22	5	18	25	12	42		34	6	
Queuing Penalty (veh)	35	31	26	76	74	41	28		115	16	

Intersection: 2: Bush Street/Daphne Lane & D Street

Movement	SE	SE	NW	NW	NE	NE	SW	SW
Directions Served	L	TR	L	TR	L	TR	L	TR
Maximum Queue (ft)	159	264	194	300	76	92	52	53
Average Queue (ft)	23	143	107	149	30	51	14	18
95th Queue (ft)	76	241	182	283	63	84	40	47
Link Distance (ft)		1298		1262		1039		377
Upstream Blk Time (%)								
Queuing Penalty (veh)								
Storage Bay Dist (ft)	90		125		250		250	
Storage Blk Time (%)	0	16	3	11				
Queuing Penalty (veh)	0	4	21	21				

Intersection: 3: Lemoore Avenue & Bush Street

Movement	EB	EB	EB	WB	WB	WB	NB	NB	NB	NB	SB	SB
Directions Served	L	T	R	L	T	R	L	T	T	R	L	T
Maximum Queue (ft)	162	226	135	129	149	120	146	174	244	145	194	262
Average Queue (ft)	73	87	77	59	68	39	74	98	109	53	54	165
95th Queue (ft)	124	169	133	109	129	104	126	156	186	123	115	267
Link Distance (ft)	2569	2569			350			1768	1768			1433
Upstream Blk Time (%)												
Queuing Penalty (veh)												
Storage Bay Dist (ft)			75	150		60	100			105	135	
Storage Blk Time (%)		12	3		17	1	4	7	10	0	0	18
Queuing Penalty (veh)		31	6		27	3	13	10	12	0	0	11

Intersection: 3: Lemoore Avenue & Bush Street

Movement	SB
Directions Served	TR
Maximum Queue (ft)	305
Average Queue (ft)	178
95th Queue (ft)	291
Link Distance (ft)	1433
Upstream Blk Time (%)	
Queuing Penalty (veh)	
Storage Bay Dist (ft)	
Storage Blk Time (%)	
Queuing Penalty (veh)	

Intersection: 4: 17th Avenue & D Street/Houston Avenue

Movement	EB	EB	WB	WB	NB	SB	SB
Directions Served	L	TR	T	R	LTR	LT	R
Maximum Queue (ft)	164	234	654	240	30	219	149
Average Queue (ft)	48	70	214	103	1	88	28
95th Queue (ft)	99	170	429	245	10	157	73
Link Distance (ft)		656	640		1215	3087	
Upstream Blk Time (%)			0				
Queuing Penalty (veh)			0				
Storage Bay Dist (ft)	75			150			90
Storage Blk Time (%)	3	4	25			11	0
Queuing Penalty (veh)	17	3	71			7	0

Intersection: 5: Lemoore Avenue & SR 198 WB Ramps

Movement	WB	NB	NB	SB	SB	B26
Directions Served	LTR	L	T	T	R	T
Maximum Queue (ft)	450	94	265	365	150	186
Average Queue (ft)	306	25	132	182	65	10
95th Queue (ft)	444	65	219	325	165	70
Link Distance (ft)	1146		568	301		1768
Upstream Blk Time (%)				2		
Queuing Penalty (veh)				20		
Storage Bay Dist (ft)		200			75	
Storage Blk Time (%)			1	23	0	
Queuing Penalty (veh)			0	50	1	

Intersection: 6: Lemoore Avenue & SR 198 EB Ramps

Movement	WB	WB	NB	NB	SB	SB
Directions Served	L	R	T	R	L	T
Maximum Queue (ft)	60	130	288	175	315	300
Average Queue (ft)	22	77	139	92	188	85
95th Queue (ft)	50	120	241	179	289	223
Link Distance (ft)		194	2460			568
Upstream Blk Time (%)						
Queuing Penalty (veh)						
Storage Bay Dist (ft)	50			50	200	
Storage Blk Time (%)	4	21	27	14	9	0
Queuing Penalty (veh)	11	7	77	53	49	1

Network Summary

Network wide Queuing Penalty: 966

Appendix I: Signal Warrants



www.JLBtraffic.com
info@JLBtraffic.com

516 W. Shaw Ave., Ste. 103
Fresno, CA 93704
(559) 570-8991

App | I

Warrant 3: Peak Hour (Urban)

Existing Traffic Conditions
2. D Street / Bush Street
AM (PM) Peak Hour

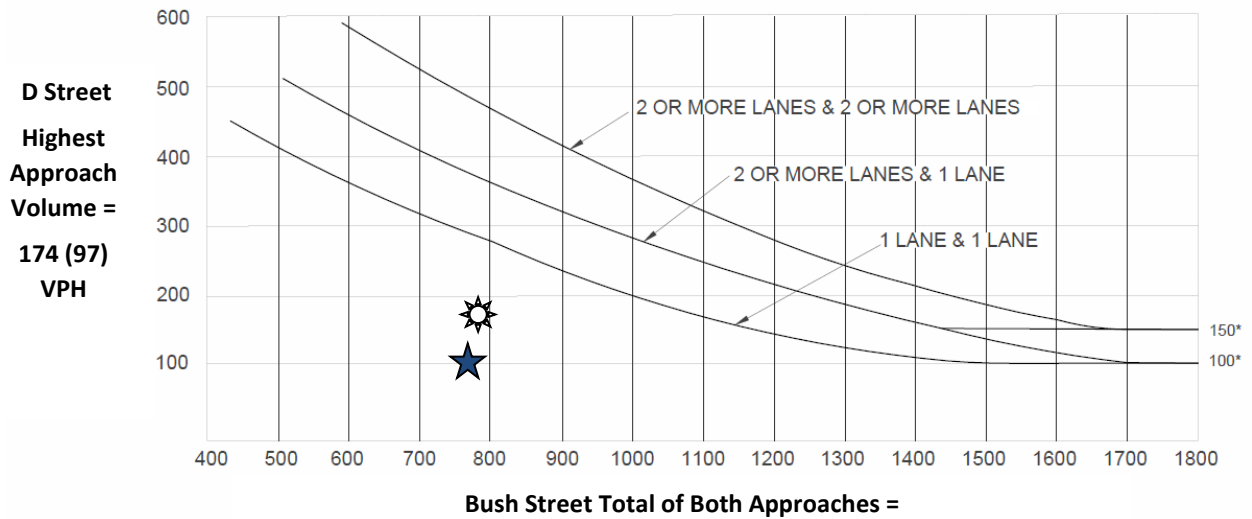

*Note: 150 vph applies as the lower threshold volume for a minor-street approach with two or more lanes and 100 vph applies as the lower threshold volume for a minor street approach with one lane.



AM Peak Hour – Signal Warrant is Not Met



PM Peak Hour – Signal Warrant is Not Met

Source: California Manual of Uniform Traffic Control Devices (CA MUTCD 2014 Edition)
Chapter 4C: Traffic Control Signal Needs Studies
Part 4: Highway Traffic Signals
November 7, 2014

Warrant 3: Peak Hour (Rural)

Existing Traffic Conditions 4. 17th Avenue / Houston Avenue AM (PM) Peak Hour

(COMMUNITY LESS THAN 10,000 POPULATION OR ABOVE 40 MPH ON MAJOR STREET)

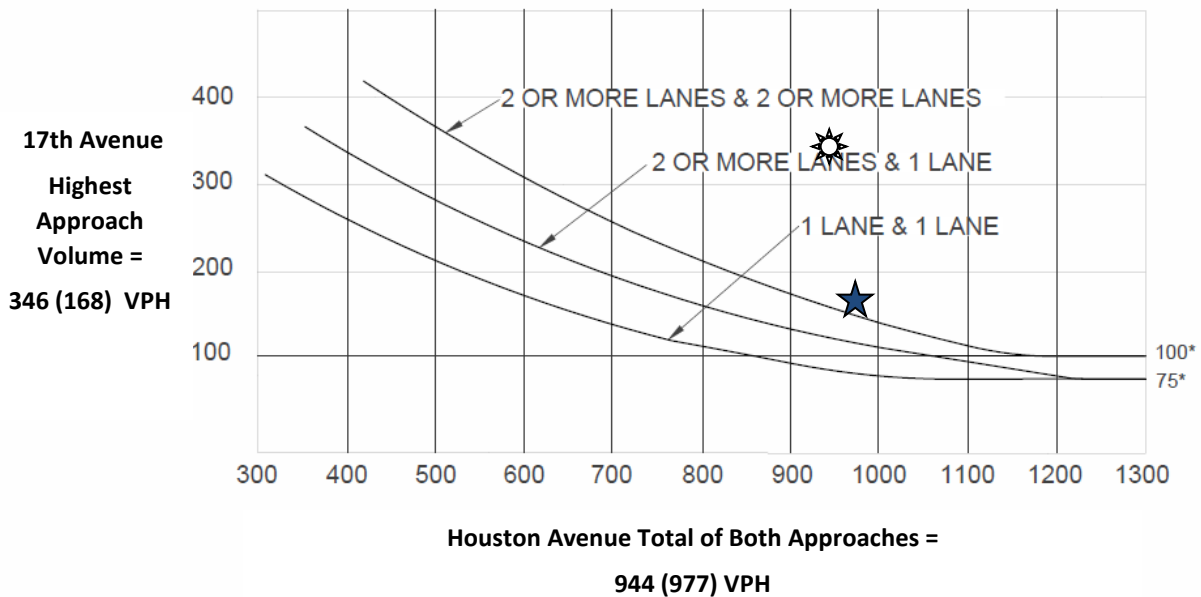

*Note: 100 vph applies as the lower threshold volume for a minor-street approach with two or more lanes and 75 vph applies as the lower threshold volume for a minor street approach with one lane.



AM Peak Hour – Signal Warrant is Met



PM Peak Hour – Signal Warrant is Met

Source: California Manual of Uniform Traffic Control Devices (CA MUTCD 2014 Edition)
Chapter 4C: Traffic Control Signal Needs Studies
Part 4: Highway Traffic Signals
November 7, 2014

Warrant 3: Peak Hour (Urban)

Existing Plus Project Traffic Conditions

2. D Street / Bush Street

AM (PM) Peak Hour

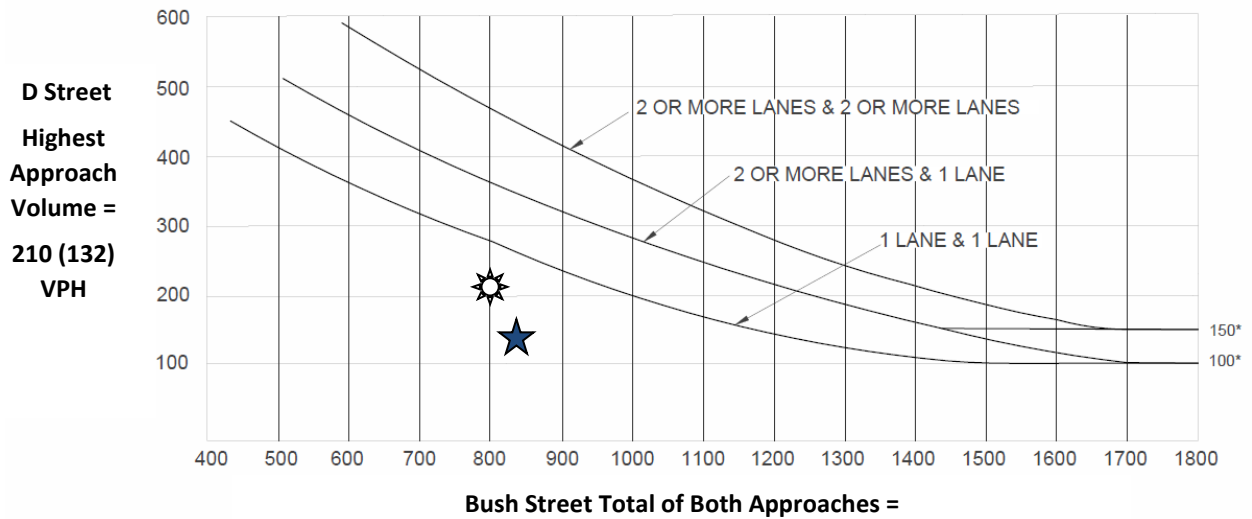

800 (838) VPH

*Note: 150 vph applies as the lower threshold volume for a minor-street approach with two or more lanes and 100 vph applies as the lower threshold volume for a minor street approach with one lane.



AM Peak Hour – Signal Warrant is Not Met



PM Peak Hour – Signal Warrant is Not Met

Source: California Manual of Uniform Traffic Control Devices (CA MUTCD 2014 Edition)
Chapter 4C: Traffic Control Signal Needs Studies
Part 4: Highway Traffic Signals
November 7, 2014

Warrant 3: Peak Hour (Rural)

Existing plus Project Traffic Conditions

4. 17th Avenue / Houston Avenue

AM (PM) Peak Hour

(COMMUNITY LESS THAN 10,000 POPULATION OR ABOVE 40 MPH ON MAJOR STREET)

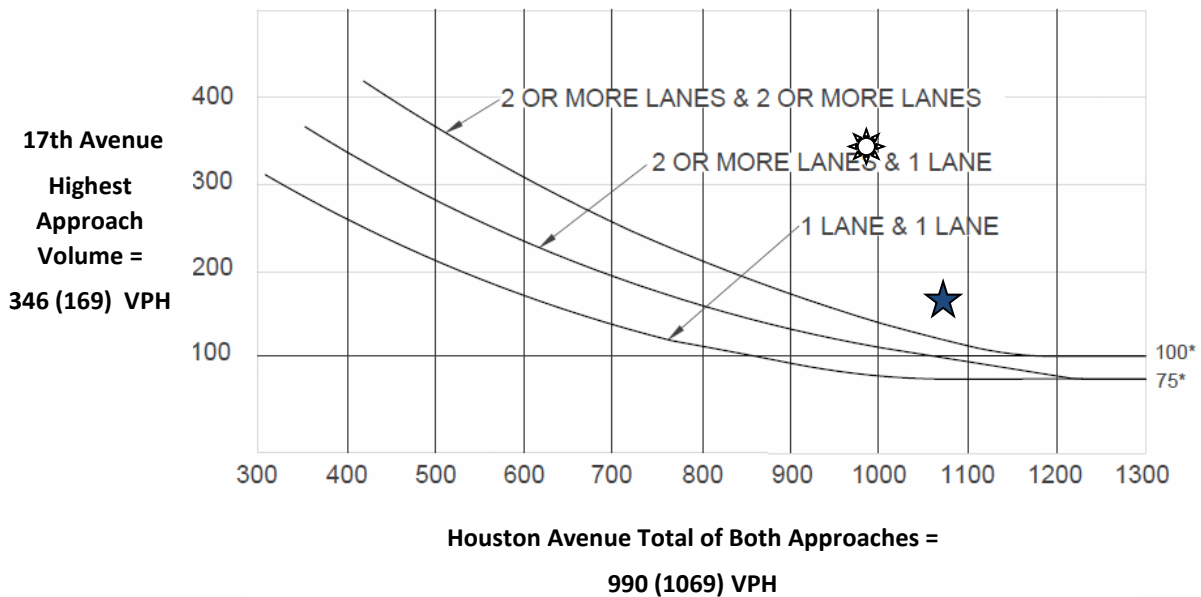

*Note: 100 vph applies as the lower threshold volume for a minor-street approach with two or more lanes and 75 vph applies as the lower threshold volume for a minor street approach with one lane.



AM Peak Hour – Signal Warrant is Met



PM Peak Hour – Signal Warrant is Met

Source: California Manual of Uniform Traffic Control Devices (CA MUTCD 2014 Edition)
Chapter 4C: Traffic Control Signal Needs Studies
Part 4: Highway Traffic Signals
November 7, 2014

Warrant 3: Peak Hour (Urban)

Near Term Plus Project Traffic Conditions

2. D Street / Bush Street

AM (PM) Peak Hour

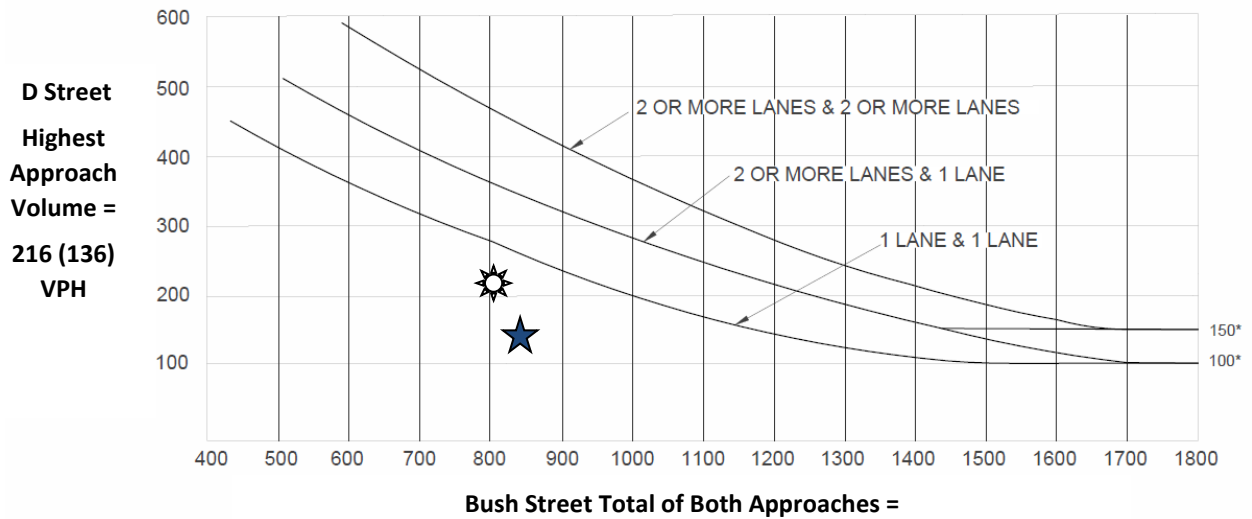

*Note: 150 vph applies as the lower threshold volume for a minor-street approach with two or more lanes and 100 vph applies as the lower threshold volume for a minor street approach with one lane.



AM Peak Hour – Signal Warrant is Not Met



PM Peak Hour – Signal Warrant is Not Met

Source: California Manual of Uniform Traffic Control Devices (CA MUTCD 2014 Edition)
Chapter 4C: Traffic Control Signal Needs Studies
Part 4: Highway Traffic Signals
November 7, 2014

Warrant 3: Peak Hour (Urban)

Cumulative Year 2042 Plus Project Traffic Conditions 2. D Street / Bush Street AM (PM) Peak Hour

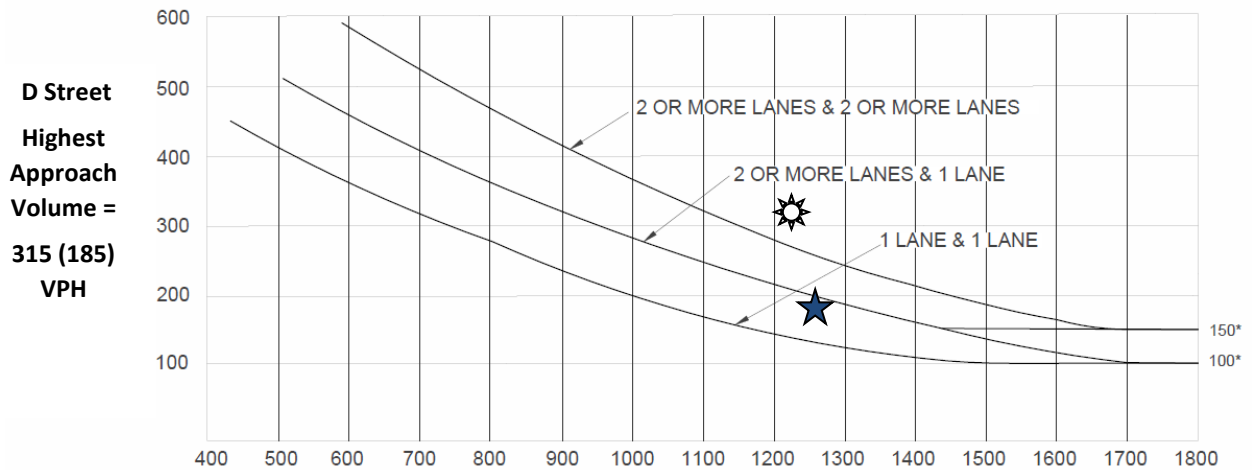

**Bush Street Total of Both Approaches =
1,228 (1,262) VPH**

*Note: 150 vph applies as the lower threshold volume for a minor-street approach with two or more lanes and 100 vph applies as the lower threshold volume for a minor street approach with one lane.



AM Peak Hour – Signal Warrant is Met



PM Peak Hour – Signal Warrant is Met

Source: California Manual of Uniform Traffic Control Devices (CA MUTCD 2014 Edition)
Chapter 4C: Traffic Control Signal Needs Studies
Part 4: Highway Traffic Signals
November 7, 2014