



March 23, 2022

Geotechnical  
Environmental  
Hydrogeology  
Material Testing  
Construction Inspection

Project No. 22-7435

Xebec Pursuits, LLC  
3010 Old Ranch Parkway, Suite 470  
Seal Beach, CA 90740

Attention: Jake Spring, Senior Vice President of Acquisitions

Subject: Geotechnical Investigation Report, Proposed Class A Warehouse Building 2223-2271  
North Locust Avenue, Rialto, California.

In accordance with your request and authorization, TGR Geotechnical, Inc. (TGR) has performed a geotechnical investigation for the proposed development at the subject site in the city of Rialto, California. The subject site consists of 2 parcels of land totaling 8.9 acres. The northernmost parcel is an asphalt dirt covered lot with a building along Locust Ave. and vehicle and tractor-trailer parking. The southernmost parcel is an asphalt and concrete covered lot with an RV and boat storage facility; a towing facility; and a construction services facility with associated buildings, parking lots and drive aisles. It is our understanding that the proposed development will consist of a 195,000 square foot Class A warehouse building with associated truck docks, drive aisles, vehicle parking and landscaped areas. This report presents the findings of our geotechnical investigation, including site seismicity and seismic settlement, and provides geotechnical design recommendations for the proposed improvements. The work was performed in general accordance with our proposal dated February 11, 2022.

Based on our investigation the proposed development is feasible from a geotechnical viewpoint provided the recommendations presented in this report are implemented during design and construction.

If you have any questions regarding this report, please do not hesitate to contact this office. We appreciate this opportunity to be of service.

Respectfully submitted,

**TGR GEOTECHNICAL, INC.**

Report prepared by:

Ryan Stewart  
Staff Geologist



Sanjay Govil, PhD, PE, GE 2382  
Principal Geotechnical Engineer



Edward L. Burrows, MS, PG, CEG 1750  
Principal Engineering Geologist

Distribution: (1) Addressee

**ATTACHMENTS**

Plate 1 – Boring Location Map

Figure 1 – Site Location Map

Figure 2 – Regional Geology Map

Figure 3 – Groundwater Monitoring Well Location Map

Figure 4 – Regional Fault Map

Figure 5 – Seismic Hazard Zone Map

Table 1 – Percolation Test Worksheet

Appendix A – References

Appendix B – Log of Borings

Appendix C – Laboratory Testing Procedures and Results

Appendix D – Site Seismic Design and Deaggregated Parameters

Appendix E – Standard Grading Specifications

## EXECUTIVE SUMMARY

Presented below are significant elements of our findings from a geotechnical viewpoint. These findings are based on our field exploration, laboratory testing, and geologic and engineering analysis.

### Geotechnical/Geologic Concerns

- There are no known faults passing through or adjacent to the subject site. The subject site is not located within an Alquist-Priolo Earthquake Fault Zone. The nearest faults to the subject site are the Lytle Creek fault mapped approximately 1.4 miles northeast of the site, the Rialto-Colton fault mapped approximately 3.6 miles to the southeast of the site, and an unnamed, inferred fault near Fontana mapped approximately 2.5 miles to the southwest of the site.
- The site is underlain by alluvium composed of gravels, cobbles, and boulders, in a sandy matrix. As such, oversized materials are anticipated to be encountered during grading operations.
- Due to their granular nature, onsite soils have an assumed “very low” expansion potential.
- All excavations shall be properly shored or laid back 1.5:1 (horizontal to vertical) or flatter.
- At the time of our drilling, groundwater was not encountered to a depth of 16.5 feet below ground surface. USGS groundwater data from wells nearest to the subject site indicate that groundwater historically is more than 85 feet below the surface. Groundwater is not expected to impact the proposed development.
- The subject site is not located within an area having a potential for liquefaction.
- All depressions resulting from demolition activities shall be properly backfilled with engineered fill at a minimum of ninety (90) percent relative compaction under the direction of the geotechnical consultant.

### Foundations

- The proposed buildings may be supported on conventional shallow pad or continuous foundation systems.
- An allowable bearing capacity of 2,500 psf may be utilized for foundation design for footings supported on minimum ninety (90) percent relative compacted engineered fill.
- The minimum recommended footing width is eighteen (18) inches for continuous footing and twenty-four (24) inches for pad footing.
- All shallow foundations should extend a minimum of twenty-four (24) inches below the lowest adjacent grade.
- All shallow foundations shall be supported on two (2) feet of engineered fill with minimum ninety (90) percent relative compaction at near optimum moisture content.

### Slab-on-Grade

- The subgrade material should be compacted to a minimum of ninety (90) percent of the maximum laboratory dry density (ASTM D1557) to a minimum depth of two (2) feet.
- Areas requiring moisture sensitive flooring shall be underlain by a minimum 15-mil Visqueen (Stego Wrap or equivalent).

### Preliminary Pavement Design

- Pavement subgrade material should be compacted to a minimum of ninety (90) percent of the maximum laboratory dry density (ASTM D1557) to a minimum depth of one (1) foot.
- The pavement section was developed based on a tested "R-Value" for compacted site subgrade soils of 78.

ASPHALT PAVEMENT SECTION					PCC PAVEMENT SECTION		
Pavement Utilization	Traffic Index	Asphalt (Inch)	Aggregate Base (Inch)	Total (Inch)	*PCC	Aggregate Base (Inch)	Total (Inch)
Parking Stalls	4.5	3.0	4.0	7.0	--	--	--
Auto Driveways	5.0	3.0	6.0	9.0	--	--	--
Truck Aisles/ Driveways	6.0	4.0	6.0	10.0	*7	-	7
Loading Dock	7.0	4.0	6.0	10.0	*7	-	7

\*Minimum concrete compressive strength of 3,500 psi.

## INTRODUCTION

### Site Descriptions and Proposed Project Development

The subject site is located at 2223 and 2271 North Locust Avenue (Figure 1) in the city of Rialto, California. The subject site consists of 2 parcels of land totaling 8.9 acres. The northernmost parcel is an asphalt dirt covered lot with a building along Locust Ave. and vehicle and tractor-trailer parking. The southernmost parcel is an asphalt and concrete covered lot with an RV and boat storage facility; a towing facility; and a construction services facility with associated buildings, parking lots and drive aisles. It is our understanding that the proposed development will consist of a 195,000 square foot Class A warehouse building with associated truck docks, drive aisles, vehicle parking and landscaped areas. We have assumed column loads of 100 kips and wall loads of 7 kips per linear foot, or less.

### Scope of Work

The scope of work for this geotechnical investigation included the following:

- Site reconnaissance to assess current site conditions, mark boring locations, call Dig-Alert for utility clearance and review of readily available previous geotechnical reports for the subject and/or adjacent properties.
- Sampling and logging nine (9) hollow stem auger borings utilizing a hollow stem drill rig to approximate depths ranging from 2 to 15.5 feet at the subject site to evaluate subsurface soil conditions. The borings were backfilled with cuttings and surface patched with concrete, where appropriate.
- Percolation testing of the near surface soils at two (2) locations from depths of 5-10 and 7-15 feet. The testing procedures followed the County of San Bernardino guidelines.
- Laboratory testing of selected samples to include in-situ moisture density, maximum density and optimum moisture content, shear, passing No. 200 sieve, corrosion series and R-value.
- Engineering analysis including site seismicity, foundation design, and settlement potential for the proposed development.
- Preparation of this report summarizing subsurface soil conditions, site seismicity, settlement potential and provide pertinent geotechnical/geologic information that may influence the proposed development.

### Field Investigation

Field exploration was performed on February 28<sup>th</sup> and March 1<sup>st</sup>, 2022 by members from our firm who logged the borings and obtained representative samples, which were subsequently transported to the laboratory for further review and testing. The approximate locations of the borings are indicated on the enclosed Boring Location Map (Plate 1).

The subsurface conditions were explored by drilling, sampling, and logging nine (9) borings with a truck mounted hollow stem auger drill rig. Borings B-1 through B-9 were advanced to an approximate depth ranging from 2 to 16.5 feet below existing grade. All borings with the exception of B-2 encountered refusal in cobbles and/or boulders. Subsequent to drilling, all borings were backfilled with excavated soil and surface patched with concrete, where appropriate. The log of borings presenting soil conditions and descriptions are presented in Appendix B.

The drill rig was equipped with a sampling apparatus to allow for recovery of driven modified California Ring Sampler (CRS), 3-inch outside diameter, and 2.42-inch inside diameter and SPT samples.

The samples were driven using an automatic 140-pound hammer falling freely from a height of 30 inches. The blow counts for CRS were converted to equivalent SPT blow counts. Soil descriptions were entered on the logs in general accordance with the Unified Soil Classification System (USCS). Driven samples and bulk samples of the earth materials encountered at selected intervals were recovered from the borings. The locations and depths of the soil samples recovered are indicated on the boring logs in Appendix B.

Two (2) percolation test borings, B-2 and B-5, were advanced to a depths of between approximately 11.5 and 16.5 feet below existing ground surface. Subsequent to percolation testing the borings were backfilled with excavated soils and surface tamped.

#### Percolation Testing

Upon completion of drilling and sampling each borehole was converted into a field percolation test well. Field percolation testing was performed in general accordance with the with the San Bernardino Technical Guidance for WQMP for sandy soils.

The boreholes were converted to field percolation test wells by placing approximately two inches of gravel at the bottom of the borehole, installing three-inch diameter PVC pipes and backfilling the annular space with gravel. A correction factor was applied to account for the placement of gravel.

Infiltration test rates were determined utilizing the referenced County of San Bernardino guidelines. Results of the infiltration testing are summarized in Table 1 below:

**Table 1 – Infiltration Rates**

Test Location	Test Depth (feet)	Infiltration Rate (Inches/hour)
B-2	5-10	6.05
B-5	7-15	10.53

#### Suitability Assessment Safety Factor

Factor values ( $v$ ), for Factor Category A, were assigned according to the San Bernardino Technical Guidance Document for WQMP, VII.4.

Table 2 (below) presents assigned factor values and the calculated Suitability Assessment Safety Factor ( $\Sigma p$ ) in Worksheet H from the San Bernardino Technical Guidance Document for WQMP Appendix VII.

Table 2 – Worksheet H

Factor Category		Factor Description	Assigned Weight (w)	Factor Value (v)	Product (p) $p = w * v$
A	Suitability Assessment	Soil assessment methods	0.25	2	0.5
		Predominant soil texture	0.25	1	0.25
		Site soil variability	0.25	1	0.25
		Depth to groundwater / impervious layer	0.25	1	0.25
		Suitability Assessment Safety Factor, $S_A = \sum p$			

The above values should be used in conjunction with Factor Category B parameters (to be determined by others) as specified in Worksheet H of the San Bernardino Technical Guidance Document for WQMP Appendix VII.

#### Laboratory Testing

Laboratory tests were performed on representative samples to verify the field classification of the recovered samples and to evaluate the geotechnical properties of the subsurface soils. The following tests were performed:

- In-situ Moisture Content (ASTM D2216) and Dry Density (ASTM D7263);
- Maximum Dry Density and Optimum Moisture Content (ASTM D1557);
- Direct Shear Strength (ASTM D3080);
- Passing No. 200 Sieve (ASTM 1140);
- R-value (CAL 301); and
- Corrosion series:
  1. Soluble Sulfate (CAL.417A);
  2. Soluble Chlorides (CAL.422);
  3. Minimum Resistivity (CAL.643); and
  4. pH (CAL 747)

Laboratory tests for geotechnical characteristics were performed in general accordance with the ASTM procedures. The results of the in-situ moisture content and density tests are shown on the borings logs. The results of other laboratory tests are presented in Appendix C.

## GEOTECHNICAL FINDINGS

### Geology

#### Regional Geologic Setting

The project site is located in the southeast portion of the Devore 7.5-minute quadrangle, San Bernardino County, California. Per the Geologic Map of the Devore quadrangle, California (Dibblee, 2003), the subject site is underlain by Quaternary alluvium, consisting of alluvial deposits of boulders and gravel near mountains and grading outwards into finer gravel and sand.. Figure 2 presents the Regional Geology Map.

#### Earth Units

Based on our subsurface investigation, the subject area is generally underlain by a light brown gravelly sand with varying degrees of gravel and cobbles and scattered boulders to 16.5 feet, the maximum depth explored. In borings B-2 and B-7, on the east side of the property, soils in the upper 5 to 10 feet tended to be finer, consisting of silty-sands and fine sands with gravel and scattered cobbles. Detailed descriptions of the earth units encountered in our borings are presented in the log of the borings. (Appendix B)

#### Groundwater

Subsurface water was not encountered to a depth of approximately 16.5 feet below existing grade during the subsurface exploration.

USGS groundwater data from wells nearest to the subject site indicate a historic high groundwater of between 85 feet below existing grade (USGS 340914117234905 001N005W22N005S) and 580 feet below existing grade (USGS 340814117253503 001N005W29Q003S). Figure 3 presents the Groundwater Monitoring Well Location Map.

Seasonal and long-term fluctuations in the groundwater may occur as a result of variations in subsurface conditions, rainfall, run-off conditions and other factors. Therefore, variations from our observations may occur. Static groundwater is not anticipated to impact the proposed development.

Static groundwater is not anticipated to impact the proposed development.

#### Seismic Review

##### Faulting and Seismicity

The subject site, like the rest of Southern California, is located within a seismically active region as a result of being located near the active margin between the North American and Pacific tectonic plates. The principal source of seismic activity is movement along the northwest-trending regional faults such as the San Andreas, San Jacinto and Elsinore fault zones. These fault systems produce approximately 5 to 35 millimeters per year of slip between the plates.

We consider the most significant geologic hazard to be the potential for moderate to strong seismic shaking that is likely to occur at the subject site. The subject site is located in the highly seismic Southern California region within the influence of several faults that are considered to be Holocene-active or pre-Holocene faults. A Holocene-active fault is defined by the State of California as a fault that has exhibited surface displacement within the Holocene time (about the last 11,700 years). A



pre-Holocene fault is defined by the State as a fault whose history of past movement is older than 11,700 years ago and does not meet the criteria for a Holocene-active fault.

These Holocene-active and pre-Holocene faults are capable of producing potentially damaging seismic shaking at the site. It is anticipated that the subject site will periodically experience ground acceleration as the result of small to moderate magnitude earthquakes. Other active faults without surface expression (blind faults) or other potentially active seismic sources that are not currently zoned and may be capable of generating an earthquake are known to be present under in the region.

The subject site is not included within any Earthquake Fault Zones as created by the Alquist-Priolo Earthquake Fault Zoning Act (Hart, 1997). Our review of geologic literature pertaining to the site area indicates that there are no known active or potentially active faults located within or immediately adjacent to the subject property.

The nearest fault to the subject site are the Lytle Creek fault mapped approximately 1.4 miles northeast of the site. Other nearby faults include the Rialto-Colton fault mapped approximately 3.6 miles to the southeast of the site and an unnamed, inferred fault near Fontana mapped approximately 2.5 miles to the southwest of the site. The Regional Fault Map, Figure 4, shows the location of the subject site in respect to the regional faults.

### Secondary Seismic Hazards

#### Surface Fault Rupture and Ground Shaking

Since no known faults are located within the site, surface fault rupture is not anticipated. However, due to the close proximity of known active and potentially active faults, severe ground shaking should be expected during the life of the proposed structures.

#### Liquefaction

Liquefaction is a seismic phenomenon in which loose, saturated, fine-grained granular soils behave similarly to a fluid when subjected to high-intensity ground shaking. Liquefaction occurs when these ground conditions exist: 1) Shallow groundwater; 2) Low density, fine, clean sandy soils; and 3) High-intensity ground motion. Effects of liquefaction can include sand boils, settlement, and bearing capacity failures below foundations.

A review of the San Bernardino County General Plan: Geologic Hazard Overlays, Map FH21-C indicates that the subject site is not located within an area mapped as having a potential for earthquake induced liquefaction (Figure 5).

Based on the above and depth to groundwater, potential for liquefaction is considered to be negligible.

#### Seismically Induced Settlement

Ground accelerations generated from a seismic event can produce settlements in sands or in granular earth materials both above and below the groundwater table. This phenomenon is often referred to as seismic settlement and is most common in relatively clean sands, although it can also occur in other soil materials. Seismic settlement is anticipated to be negligible.

### Landsliding

Landsliding involves downhill motion of earth materials during or subsequent to earth shaking. Historically, landslides triggered by earthquakes have been a significant cause of damage. Areas that are most susceptible to earthquake induced landslides are areas with steep slopes in poorly cemented or highly fractured bedrock, areas underlain by loose, weak soils, and areas on or adjacent to existing landslide deposits.

A review of the San Bernardino County General Plan: Geologic Hazard Overlays of San Bernardino South, this property is not located within a mapped zone of landsliding and the property and adjacent areas are situated on relatively flat topography. Based on the above, the general landslide susceptibility is considered to be negligible.

### Lateral Spreading

Seismically induced lateral spreading involves primarily movement of earth materials due to earth shaking. Lateral spreading is demonstrated by near-vertical cracks with predominantly horizontal movement of the soil mass involved. The topography in the vicinity of the subject site is relatively flat. Therefore, the potential for lateral spreading at the subject site is considered very low.

## DISCUSSIONS AND CONCLUSIONS

### General

Based on our field exploration, laboratory testing and engineering analysis, it is our opinion that the proposed structure and proposed grading will be safe against hazard from landslide, settlement, or slippage and the proposed construction will have no adverse effect on the geologic stability of the adjacent properties provided our recommendations presented in this report are followed.

### Conclusions

Based on our findings and analyses, the subject site is likely to be subjected to moderate to severe ground shaking due to the proximity of known active and potentially active faults. This may reasonably be expected during the life of the structure and should be designed accordingly.

The primary conditions affecting the proposed project site development are as follows:

- Potential for caving during excavation.
- The site is underlain by alluvium composed of gravels, cobbles, and boulders, in a sandy matrix. As such, oversized materials are anticipated to be encountered during grading operations.

The engineering evaluation performed concerning site preparation and the recommendations presented are based on information provided to us and obtained by us during our office and fieldwork. This report is prepared for the development of a 195,000 square foot Class A warehouse building with associated truck docks, drive aisles, vehicle parking and landscaped areas. In the event that any significant changes are made to the proposed development, the conclusions and recommendations contained in this report shall not be considered valid unless the changes are reviewed, and the recommendations of this report are verified or modified in writing by TGR.

## RECOMMENDATIONS

### Seismic Design Parameters

When reviewing the 2019 California Building Code the following data should be incorporated into the design.

Parameter	Value
Latitude (degree)	34.1408
Longitude (degree)	-117.4091
Site Class	D – Stiff Soil
Site Coefficient, $F_a$	1.0
Site Coefficient, $F_v$	N/A
Mapped Spectral Acceleration at 0.2-sec Period, $S_s$	2.19 g
Mapped Spectral Acceleration at 1.0-sec Period, $S_1$	0.775 g
Spectral Acceleration at 0.2-sec Period Adjusted for Site Class, $S_{MS}$	2.19 g
Spectral Acceleration at 1.0-sec Period Adjusted for Site Class, $S_{M1}$	N/A
Design Spectral Acceleration at 0.2-sec Period, $S_{DS}$	1.46 g
Design Spectral Acceleration at 1.0-sec Period, $S_{D1}$	N/A

### Site Specific Response Spectra

The USGS Unified Hazard tool, the USGS RTGM Calculator and the USGS App for Deterministic Spectra Acceleration were utilized to develop site specific ground motion spectra. The analysis was performed utilizing the following attenuation relationships that are part of NGA as required by 2019 CBC code requirements.

- Campbell & Bozorgnia (2014)
- Boore, Stewart, Seyhan & Atkinson (2014)
- Chiou & Youngs (2014)
- Abrahamson, Silva & Kamal (2014)

The results of the Site Specific Response Spectra are incorporated in Table 1 and on Figure 1 in Appendix D. The results include deterministic spectra at 5% damping, maximum rotated component at 0.84 fractile and the probabilistic spectra, maximum rotated component at 5% damping for a return period of 2475 year and subsequently multiplied by risk coefficient to obtain the MCER probabilistic spectral acceleration. The  $V_{s30}$  utilized was 260 m/s.

The probabilistic response spectrum was determined using the OSHPD generated seismic values and raw output generated from the U.S. Geological Survey Unified Hazard Tool. The spectral response acceleration data generated from the U.S. Geological Survey Unified Hazard Tool was entered into the U.S. Geological Survey Risk-Targeted Ground Motion Calculator tool for each time period. The data is presented on Table 2 in Appendix D.

The deterministic response spectrum was determined using the greatest Deaggregation Contributor from the U.S. Geological Survey Unified Hazard Tool. The largest contributing fault parameters were entered into the Pacific Earthquake Engineering Research Center NGAW2 tool with a user defined sigma + 5% damping. The data is presented on Table 3 in Appendix D.

The above generated spectral accelerations were compared against the minimum code requirements in ASCE7-16 (Chapters 11 and 21) resulting in the final design response spectra which is presented in Table 1 and on Figure 1 in Appendix D.

Based on Table 1 and Figure 1, the recommended Site Specific  $S_{DS}$  and  $S_{D1}$  are as follows:

$$\begin{aligned} S_{DS} &= 1.579 \\ S_{D1} &= 2.181 \end{aligned}$$

Mapped values may be used in lieu of site-specific values to design structures on Site Class D sites with an  $S_1$  greater than or equal to 0.2, provided the value of the seismic response coefficient  $C_s$  is determined by Eq. (12.8-2) for values of  $T \leq 1.5T_s$  and taken as equal to 1.5 times the value computed in accordance with either Eq. (12.8-3) for  $T_L \geq T > 1.5T_s$  or Eq. (12.8-4) for  $T > T_L$ .

The structural consultant should review the above parameters and the 2019 California Building Code to evaluate the seismic design.

Conformance to the criteria presented in the above table for seismic design does not constitute any type of guarantee or assurance that significant structural damage or ground failure will not occur during a large earthquake event. The intent of the code is "life safety" and not to completely prevent damage of the structure, since such design may be economically prohibitive.

#### Foundation Design Recommendations

The proposed buildings may be supported on continuous and/or spread footings. Bearing capacity recommendations for shallow foundations are presented below. These recommendations assume that the footings will be supported on a minimum of two (2) feet of engineered fill.

For foundations supported on two (2) feet of engineered fill with minimum ninety (90) percent relative compaction at near optimum moisture content, an allowable bearing pressure of 2,500 pounds per square foot may be used in design.

All shallow foundations should extend a minimum of twenty-four (24) inches below the lowest adjacent grade. The minimum recommended footing width is eighteen (18) inches for continuous footing and twenty-four (24) inches for pad footing. A minimum reinforcement of two (2) No. 4 steel bar top and two (2) No. 4 steel bar bottom is required for continuous footings from a geotechnical viewpoint. Foundation design details such as concrete strength, reinforcements, etc should be established by the Structural Engineer.

A one-third (1/3) increase on the aforementioned bearing pressure may be used in design for short-term wind or seismic loads.

The total and differential static settlement is anticipated to be 1 inch and 0.5 inches over 60 feet or less.

Resistance to lateral loads including wind and seismic forces may be provided by frictional resistance between the bottom of concrete and the underlying fill soils and by passive pressure against the sides of the foundations. A coefficient of friction of 0.46 may be used between concrete foundation and underlying soil. The recommended passive pressure of the engineered fill may be taken as an equivalent fluid pressure of 250 pounds per cubic foot (2,500 psf max).

Footings located near property lines where the lateral removal cannot be achieved shall be designed for a reduced bearing capacity of 1,500 pounds per square foot and the passive resistance shall be ignored.

#### Slab-On-Grade

The subgrade material should be compacted to a minimum of ninety (90) percent of the maximum laboratory dry density at optimum moisture content to a minimum depth of two (2) feet.

The thickness and reinforcement of the slab shall be designed by the structural engineer per the 2019 California Building Code and should include the anticipated loading condition (forklift etc.), the anticipated use of the building and the expansion index of the soil. For moisture sensitive flooring, the floor slab should be underlain by minimum 15-mil impermeable polyethylene membrane (Stego Wrap, Moistop Plus, or any equivalent meeting the requirements of ASTM E1745, Class A rating) as a capillary break. Sand may be placed above and below the impermeable polyethylene membrane at the discretion of the project structural engineer/concrete contractor for proper curing and finish of the concrete slab-on-grade and protection of the membrane and is considered outside the scope of geotechnical engineering.

#### Flatwork

Flatwork should be a minimum of 4-inches thick should be reinforced with a minimum of No. 3 reinforcing bar on 24-inch centers in two horizontally perpendicular directions. Reinforcing should be properly supported to ensure placement near the vertical midpoint of the slab. "Hooking" of the reinforcement is not considered an acceptable method of positioning the steel. The subgrade material should be compacted to a minimum of ninety (90) percent of the maximum laboratory dry density (ASTM D1557) to a minimum depth of one (1) foot. Prior to placement of concrete, the subgrade soils should be moistened to near percent of optimum moisture content and verified by our field representative. The actual thickness and reinforcement of the slab shall be designed by the structural engineer and should include the anticipated loading condition.

#### Modulus of Subgrade Reaction

The modulus of subgrade reaction may be taken as 200 pci ( $K_1$ ) for one (1) square foot footing/slab founded on site soils. This value should be reduced for change in size per the following formula:

$$K = K_1 \left( \frac{B+1}{B} \right)^2$$

Where B = Width of Mat;

K = Coefficient of Subgrade Reaction of Footings Measuring B (ft) x B (ft).

### Cement Type and Corrosion

Based on laboratory testing concrete used should be designed in accordance with the provisions of ACI 318-14, Chapter 19 for Exposure Class S0: Cement with a minimum unconfined compressive strength of 2,500 psi, and for Exposure Class C1 (Moderate) – Concrete exposed to moisture but not a significant source of chlorides, per ACI 318-14 Table 19.3.1.1.

Corrosion tests indicate a moderate corrosion potential for ferrous metals exposed to site soils.

TGR does not practice corrosion engineering. If needed, a qualified specialist should review the site conditions and evaluate the corrosion potential of the site soil to the proposed improvements and to provide the appropriate corrosion mitigations for the project.

### Expansive Soil

Due to their granular nature, onsite soils have an assumed “very low” expansion potential.

### Shrinkage/Subsidence

Removal and recompaction of the near surface soils is estimated to result in shrinkage ranging from 10 to 15 percent. Based on our previous experience with similar projects, additional volume loss can be anticipated due to the presence of oversized materials in the near surface soils. Minor ground subsidence is expected to occur in the soils below the zone of removal, due to settlement and machinery working. The subsidence is estimated to be between one and two tenths of a foot.

### Site Development Recommendations

#### General

During earthwork construction, all site preparation and the general procedures of the contractor should be observed, and the fill selectively tested by a representative of TGR. If unusual or unexpected conditions are exposed in the field, they should be reviewed by this office and if warranted, modified and/or additional recommendations will be offered. During demolition of the existing buildings, large concrete slab and associated site work, voids created from removal of buried elements (footings, pipelines, septic pits, etc.) shall be backfilled with engineered fill (minimum 90% relative compaction per ASTM D1557) under the observation of TGR.

#### Grading

All grading should conform to the guidelines presented in the California Building Code (2019 edition), except where specifically superseded in the text of this report. Prior to grading, TGR’s representative should be present at the pre-construction meeting to provide grading guidelines, if needed, and review any earthwork. Oversize particles may be encountered during grading. All particles greater than 4-inches shall be removed and disposed offsite.

Onsite concrete may be crushed to 1” minus and mixed with onsite soil in a controlled manner as recommended by the geotechnical consultant and used as engineered fill.

The footings and slab-on-grade shall be supported on a minimum two (2) feet of engineered fill. A minimum one (1) foot of engineered fill is recommended under flatwork and pavement. Site soils may be reused as engineered fill provided, they are free of oversized particles and the recommendations presented in this report are implemented. Exposed bottoms should be scarified a minimum of 6-inches, moisture conditioned to near optimum moisture and compacted to a minimum

ninety (90) percent relative compaction. Subsequently, site fill soils should be re-compacted to a minimum of ninety (90) percent relative compaction at near optimum moisture content. The lateral extent of removals beyond the building/structure/footing limits should be equal to at least 5 feet.

The depth of over-excavation should be reviewed by the Geotechnical Consultant during the actual construction. Any subsurface obstruction buried structural elements, and unsuitable material encountered during grading, should be immediately brought to the attention of the Geotechnical Consultant for proper exposure, removal and processing, as recommended.

#### Fill Placement

Prior to any fill placement TGR should observe the exposed surface soils. The site soils may be re-used as engineered fill provided, they are free of organic content and particle size greater than 4-inches. All particles greater than 4-inches shall be removed and disposed offsite. Fill shall be moisture conditioned to near optimum moisture and compacted to a minimum relative compaction of ninety (90) percent in accordance with ASTM D1557. Any import soils shall be non-expansive and approved by TGR Geotechnical Inc.

#### Compaction

Prior to fill placement, the exposed surface should be scarified to a minimum depth of six (6) inches, fill placed in eight (8) inch loose lifts moisture conditioned to near optimum moisture and compacted to a minimum relative compaction of ninety (90) percent in accordance with ASTM D1557.

#### Trenching

All excavations should conform to CAL-OSHA and local safety codes.

#### Temporary Excavation and Shoring

Due the granular nature of onsite soils, all cuts shall be properly shored or sloped back to at least 1.5H:1V (Horizontal: Vertical) or flatter. Some sloughing may be anticipated due to the granular nature of site soils. The exposed slope face should be kept moist (but not saturated) during construction to reduce local sloughing. No surcharge loads should be permitted within a horizontal distance equal to the height of cut from the toe of excavation unless the cut is properly shored. Excavations that extend below an imaginary plane inclined at 45 degrees below the edge of any nearby adjacent existing site facilities should be properly shored to maintain foundation support at the adjacent structures.

#### Utility Trench Backfill

All utility trench backfills in structural areas and beneath hardscape features should be brought to near optimum moisture content and compacted to a minimum relative compaction of ninety (90) percent of the laboratory standard. Flooding/jetting is not recommended.

Sand backfill, (unless trench excavation material), should not be allowed in parallel exterior trenches adjacent to and within an area extending below a 1:1 plane projected from the outside bottom edge of the footing. All trench excavations should minimally conform to CAL-OSHA and local safety codes. Soils generated from utility trench excavations may be used provided it is moisture conditioned and compacted to ninety (90) percent minimum relative compaction.



Drainage

Positive site drainage should be maintained at all times. Water should be directed away from foundations and not allowed to pond and/or seep into the ground. Pad drainage should be directed towards the street/parking or other approved area.

Preliminary Pavement Design

The Caltrans method of design was utilized to develop the following asphalt pavement section. The section was developed based on a tested "R-Value" for compacted site subgrade soils of 78.

Traffic indices of 4.5, 5, 6, and 7 were assumed for use in the evaluation of automobile parking stalls and driveways, and medium and heavy truck driveways, respectively. The traffic indices are subject to approval by controlling authorities and shall be approved by the project civil engineer.

ASPHALT PAVEMENT SECTION					PCC PAVEMENT SECTION		
Pavement Utilization	Traffic Index	Asphalt (Inch)	Aggregate Base (Inch)	Total (Inch)	*PCC	Aggregate Base (Inch)	Total (Inch)
Parking Stalls	4.5	3.0	4.0	7.0	--	--	--
Auto Driveways	5.0	3.0	6.0	9.0	--	--	--
Truck Aisles/ Driveways	6.0	4.0	6.0	10.0	*7	-	7
Loading Dock	7.0	4.0	6.0	10.0	*7	-	7

\*Minimum concrete compressive strength of 3,500 psi.

Aggregate base material for Asphalt Pavement should consist of CAB/CMB complying with the specifications in Section 200-2.2/200-2.4 of the current "Standard Specifications for Public Works Construction" and should be compacted to at least ninety-five (95) percent of the maximum dry density (ASTM D1557). The surface of the base should exhibit a firm and unyielding condition just prior to the placement of asphalt concrete paving. The asphalt concrete shall be compacted to a minimum of ninety-five (95) percent relative compaction.

The pavement subgrade should be constructed in accordance with the recommendations presented in the grading section of this report.

The R-value and the associated pavement section should be confirmed at the completion of site grading.

An increase in the PCC pavement slab thickness, placement of steel reinforcement (or other alternatives such as Fibermesh) and joint spacing due to loading conditions including shrinkage and thermal effects may be necessary and should be incorporated by the structural engineer as necessary to prevent adverse impact on pavement performance and maintenance.

### Geotechnical Review of Plans

All grading and foundation plans should be reviewed and accepted by the geotechnical consultant prior to construction. If significant time elapses since preparation of this report, the geotechnical consultant should verify the current site conditions, and provide any additional recommendations (if necessary) prior to construction.

### Geotechnical Observation/Testing During Construction

Per sections 1705.6 and table 1705.6 of the 2019 California Building Code, periodic special inspection shall be performed to:

- Verify materials below shallow foundations are adequate to achieve the design bearing capacity;
- Verify excavations are extended to the proper depth and have reached proper material;
- Verify classification and test compacted materials; and
- Prior to placement of compacted fill, inspect subgrade and verify that the site has been prepared properly.

Per sections 1705.6 and table 1705.6 of the 2019 California Building Code, continuous special inspection shall be performed to:

- Verify use of proper materials, densities and lift thickness during placement and compaction of compacted fill.

The geotechnical consultant should also perform observation and/or testing at the following stages:

- During any grading and fill placement;
- After foundation excavation and prior to placing concrete;
- Prior to placing slab and flatwork concrete;
- During placement of aggregate base and asphalt or Portland cement concrete; and
- When any unusual soil conditions are encountered during any construction operation subsequent to issuance of this report.

### Limitations

This report was prepared for a specific client and a specific project, based on the client's needs, directions and requirements at the time.

This report was necessarily based upon data obtained from a limited number of observances, site visits, soil and/or other samples, tests, analyses, histories of occurrences, spaced subsurface exploration and limited information on historical events and observations. Such information is necessarily incomplete. Variations can be experienced within small distances and under various climatic conditions. Changes in subsurface conditions can and do occur over time.

This report is not authorized for use by and is not to be relied upon by any party except the client with whom TGR contracted for the work. Use or reliance on this report by any other party is that party's sole risk. Unauthorized use of or reliance on this report constitutes an agreement to defend and indemnify TGR from and against any liability which may arise as a result of such use or reliance, regardless of any fault, negligence, or strict liability of TGR.



**B-9**  
 ● APPROXIMATE LOCATION OF EXPLORATORY BORING

500 Feet



**BORING LOCATION MAP**  
**2223 & 2271 NORTH LOCUST AVENUE**  
**RIALTO, CALIFORNIA**

PROJECT NO. 22-7435

**PLATE 1**



Geotechnical  
Environmental  
Hydrogeology  
Material Testing  
Construction Inspection

SITE LOCATION MAP  
2223 & 2271 NORTH LOCUST AVENUE  
RIALTO, CALIFORNIA

PROJECT NO. 22-7435

FIGURE 1

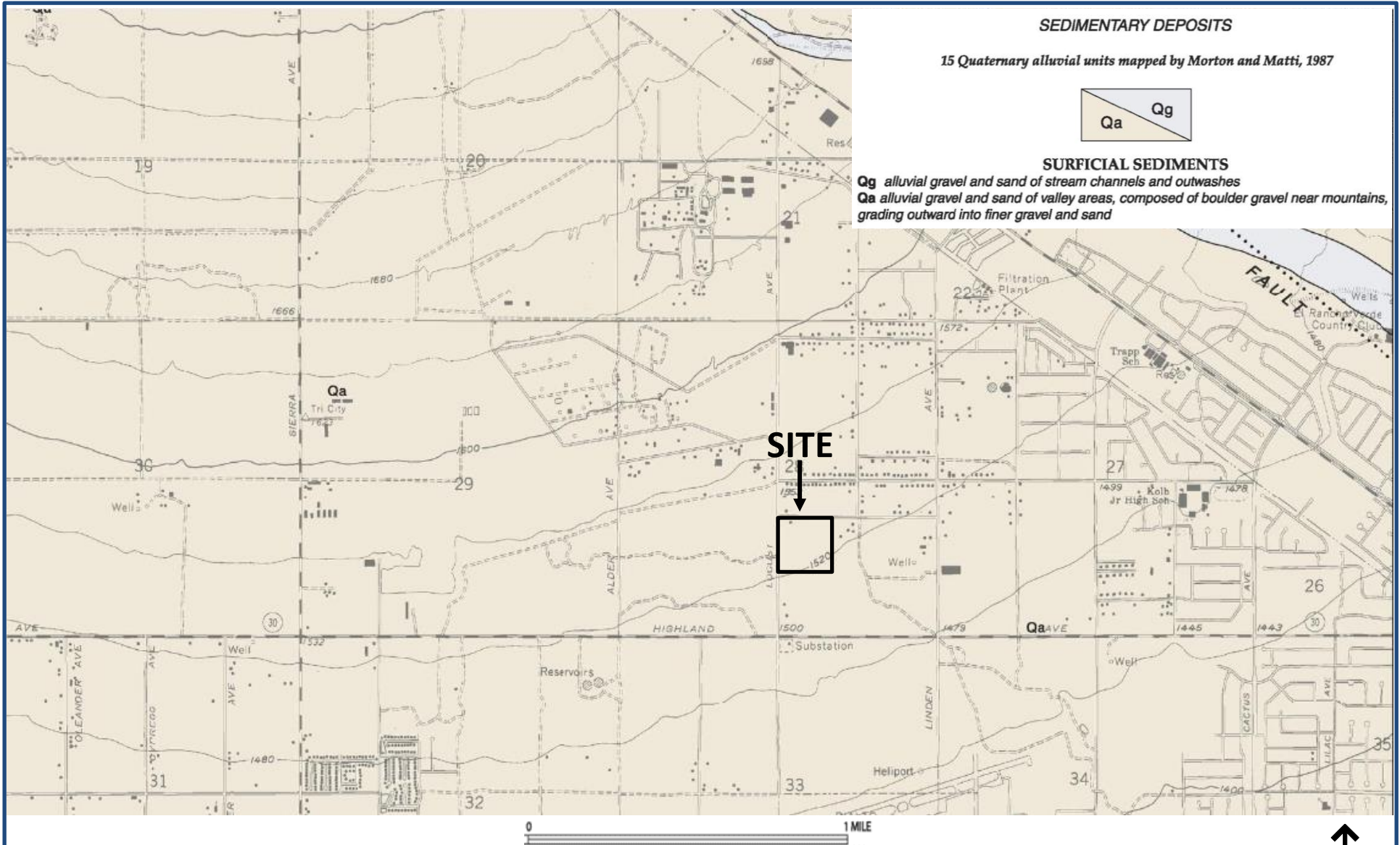



Geotechnical  
 Environmental  
 Hydrogeology  
 Material Testing  
 Construction Inspection

**GROUNDWATER MONITORING WELL LOCATION MAP**  
**2223 & 2271 NORTH LOCUST AVENUE**  
**RIALTO, CALIFORNIA**

PROJECT NO. 22-7435

FIGURE 3

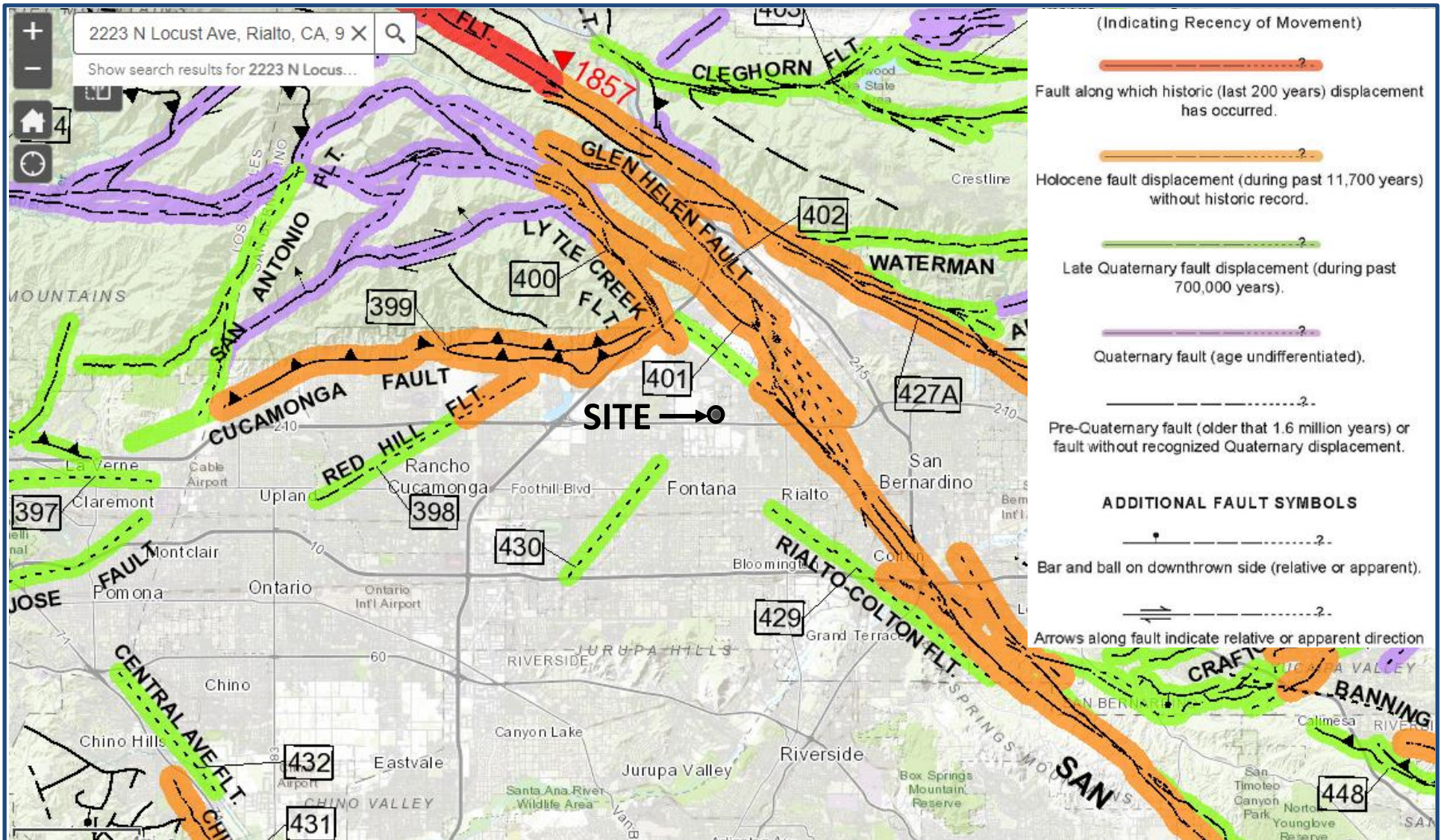

Modified From: Jennings, C. W., 2010, Fault Activity Map of California and Adjacent Areas, California Division of Mines and Geology, Geologic Data Map Series, No. 6, Scale 1:750,000.



**REGIONAL FAULT MAP**  
**2223 & 2271 NORTH LOCUST AVENUE**  
**RIALTO, CALIFORNIA**

PROJECT NO. 22-7435

FIGURE 4

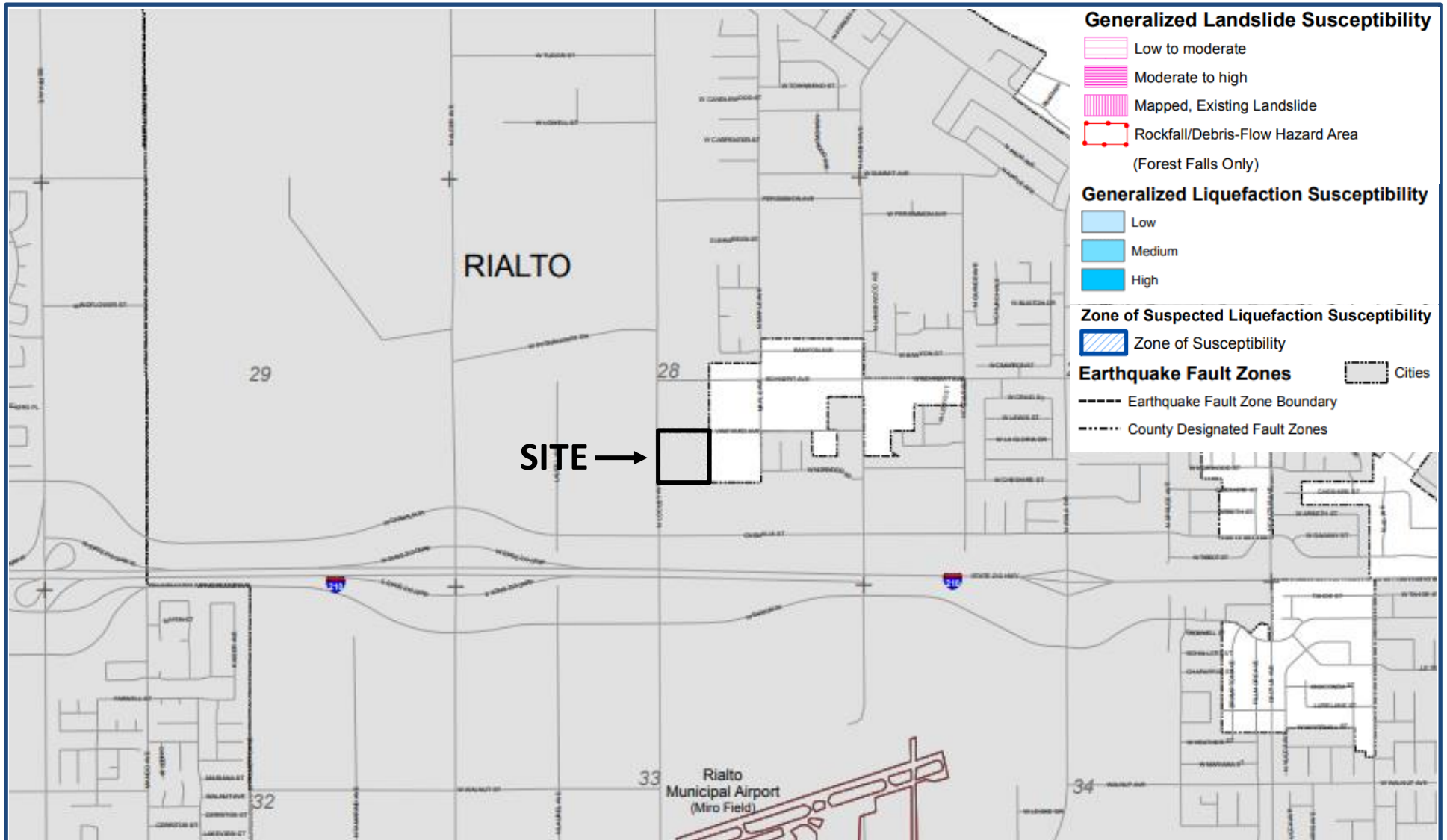

Modified From: San Bernardino County Land Use Plan, 2007, General Plan, Geologic Hazard Overlay, Map No. FH21-C.



**SEISMIC HAZARD ZONE MAP**  
**2223 & 2271 NORTH LOCUST AVENUE**  
**RIALTO, CALIFORNIA**

PROJECT NO. 22-7435

**FIGURE 5**



Test Hole	Total Depth (in)	Initial Depth (in)	Final Depth (in)	DWater Level (in)	Initial Time (min)	Final Time (min)	D Time (min)	Initial Height of Water (in)	Final Height of Water (in)	Average Height of Water (in)	Infiltration Rate (in/hr)
B-2	120	54	98	44	0.0	10.0	10.0	66	22	44.00	6.20
	120	56.75	99.125	42.375	0.0	10.0	10.0	63.25	20.875	42.06	6.23
	120	55	98.375	43.375	0.0	10.0	10.0	65	21.625	43.31	6.20
	120	55.75	98.125	42.375	0.0	10.0	10.0	64.25	21.875	43.06	6.09
	120	57.375	98.75	41.375	0.0	10.0	10.0	62.625	21.25	41.94	6.10
	120	56.625	98.25	41.625	0.0	10.0	10.0	63.375	21.75	42.56	6.05
B-5	180	86.75	172	85.25	0.0	10.0	10.0	93.25	8	50.63	10.50
	180	85.125	171	85.875	0.0	10.0	10.0	94.875	9	51.94	10.32
	180	85.875	170.625	84.75	0.0	10.0	10.0	94.125	9.375	51.75	10.22
	180	84.125	171.75	87.625	0.0	10.0	10.0	95.875	8.25	52.06	10.50
	180	84	172	88	0.0	10.0	10.0	96	8	52.00	10.56
	180	84	171.875	87.875	0.0	10.0	10.0	96	8.125	52.06	10.53

 $\Delta H$  = Change in height $\Delta t$  = Time interval

r = Radius

 $I_t$  = Infiltration Rate $H_{ave}$  = Average Head Height over the time interval

$$I_t = \frac{\Delta H(60r)}{\Delta t(r + 2H_{avg})}$$

**APPENDIX A  
REFERENCES**

## APPENDIX A

### References

- California Department of Conservation – California Geological Survey, 2018, Earthquake Fault Zones, A Guide for Government Agencies, Property Owners/Developers and Geoscience Practitioners for Assessing Fault Rupture Hazards in California, Special Publication 42
- California Department of Conservation – Division of Mines and Geology, 2008, Guidelines for Evaluating and Mitigating Seismic Hazards in California, CDMG Special Publication 117A.
- California Department of Conservation – Division of Mines and Geology, 1998, Maps of Known Active Fault Near – Source Zones in California and Adjacent Portions of Nevada.
- County of San Bernardino, 2013, Technical Guidance Document for Water Quality Management Plans, The County of San Bernardino Areawide Stormwater Program, Effective Date: September 19, 2013.
- County of San Bernardino, 2011, Technical Guidance Document Appendices, Appendix VII, Infiltration Rate Evaluation Protocol and Factor of Safety Recommendation, dated May 19, 2011.
- County of San Bernardino, 2010, San Bernardino County Land Use Plan, General Plan, Geologic Hazard Overlays, San Bernardino County, California, FH21-C Devore.
- Dibblee, T.W. and Minch, J.A., 2003, Geologic map of the Devore quadrangle, San Bernardino County, California, Dibblee Geological Foundation, Dibblee Foundation Map DF-105, 1:24,000.
- International Code Council (ICC), California Building Code, 2019 Edition.
- Jennings, C. W., 2010, Fault Activity Map of California and Adjacent Areas, California Division of Mines and Geology, Geologic Data Map Series, No. 6, Scale 1:750,000.

22-7435

**APPENDIX B  
LOG OF BORINGS**

TGR GEOTECHNICAL  
DBE & 8(a) firm  
3037 S. HARBOR BLVD  
SANTA ANA, CA 92704  
P 714.641.7189 F 714.641.7190  
[www.tgrgeotech.com](http://www.tgrgeotech.com)



THE FOLLOWING DESCRIBES THE TERMS AND SYMBOLS USED ON THE LOG  
OF BORINGS TO SUMMARIZE THE RESULTS OBTAINED IN THE FIELD  
INVESTIGATION AND SUBSEQUENT LABORATORY TESTING

**DENSITY AND CONSISTENCY**

The consistency of fine grained soils and the density of coarse grained soils are described on the basis of the Standard Penetration Test as follows:

COARSE GRAINED SOILS	ESTIMATED UNCONFINED COMPRESSIVE STRENGTH (Tsf)	FINE GRAINED SOILS
Very Loose < 4	< 0.25	Very Soft < 2
Loose 4 – 10	0.35 – 0.50	Soft 2 – 4
Medium 10 – 30	0.50 – 1.0	Firm (Medium) 4 – 8
Dense 30 – 50	1.0 – 2.0	Stiff 8 – 15
Very Dense > 50	2.0 – 4.0	Very Stiff 15 – 30
	> 4.0	Hard > 30

**PARTICLE SIZE DEFINITION (As per ASTM D2487 and D422)**

Boulder ⇒ Larger than 12 inches	Coarse Sands ⇒ No. 10 to No. 4 sieve
Cobbles ⇒ 3 to 12 inches	Medium Sands ⇒ No. 40 to No. 10 sieve
Coarse Gravel ⇒ 3/4 to 3 inches	Fine Sands ⇒ No. 200 to 40 sieve
Fine Gravel ⇒ No. 4 to 3/4 inches	Silt ⇒ 5µm to No. 200 sieve
	Clay ⇒ Smaller than 5µm

**SOIL CLASSIFICATION**

Soils and bedrock are classified and described based on their engineering properties and characteristics using ASTM D2487 and D2488.

Percentage description of minor components:

Trace	1 – 10%	Some	20 – 35%
Little	10 – 20%	And or y	25 – 50%

Stratified soils description:

Parting	0 to 1/16 inch thick	Layer	½ to 12 inches thick
Seam	1/16 to ½ inch thick	Stratum	> 12 inches thick

# SOIL CLASSIFICATION CHART

UNIFIED SOIL CLASSIFICATION AND SYMBOL CHART		
<b>COARSE-GRAINED SOILS</b> (more than 50% of material is larger than No. 200 sieve size.)		
Clean Gravels (Less than 5% fines)		
<b>GRAVELS</b> More than 50% of coarse fraction larger than No. 4 sieve size		GW Well-graded gravels, gravel-sand mixtures, little or no fines
		GP Poorly-graded gravels, gravel-sand mixtures, little or no fines
	Gravels with fines (More than 12% fines)	
		GM Silty gravels, gravel-sand-silt mixtures
		GC Clayey gravels, gravel-sand-clay mixtures
Clean Sands (Less than 5% fines)		
<b>SANDS</b> 50% or more of coarse fraction smaller than No. 4 sieve size		SW Well-graded sands, gravelly sands, little or no fines
		SP Poorly graded sands, gravelly sands, little or no fines
	Sands with fines (More than 12% fines)	
		SM Silty sands, sand-silt mixtures
		SC Clayey sands, sand-clay mixtures
<b>FINE-GRAINED SOILS</b> (50% or more of material is smaller than No. 200 sieve size.)		
<b>SILTS AND CLAYS</b> Liquid limit less than 50%		ML Inorganic silts and very fine sands, rock flour, silty of clayey fine sands or clayey silts with slight plasticity
		CL Inorganic clays of low to medium plasticity, gravelly clays, sandy clays, silty clays, lean clays
		OL Organic silts and organic silty clays of low plasticity
<b>SILTS AND CLAYS</b> Liquid limit 50% or greater		MH Inorganic silts, micaceous or diatomaceous fine sandy or silty soils, elastic silts
		CH Inorganic clays of high plasticity, fat clays
		OH Organic clays of medium to high plasticity, organic silts
<b>HIGHLY ORGANIC SOILS</b>		PT Peat and other highly organic soils

LABORATORY CLASSIFICATION CRITERIA		
GW	$C_u = \frac{D_{60}}{D_{10}}$ greater than 4; $C_c = \frac{D_{30}}{D_{10} \times D_{60}}$ between 1 and 3	
GP	Not meeting all gradation requirements for GW	
GM	Atterberg limits below "A" line or P.I. less than 4	Above "A" line with P.I. between 4 and 7 are borderline cases requiring use of dual symbols
GC	Atterberg limits above "A" line with P.I. greater than 7	
SW	$C_u = \frac{D_{60}}{D_{10}}$ greater than 4; $C_c = \frac{D_{30}}{D_{10} \times D_{60}}$ between 1 and 3	
SP	Not meeting all gradation requirements for GW	
SM	Atterberg limits below "A" line or P.I. less than 4	Limits plotting in shaded zone with P.I. between 4 and 7 are borderline cases requiring use of dual symbols.
SC	Atterberg limits above "A" line with P.I. greater than 7	

Determine percentages of sand and gravel from grain-size curve. Depending on percentage of fines (fraction smaller than No. 200 sieve size), coarse-grained soils are classified as follows:

Less than 5 percent ..... GW, GP, SW, SP  
 More than 12 percent ..... GM, GC, SM, SC  
 5 to 12 percent ..... Borderline cases requiring dual symbols

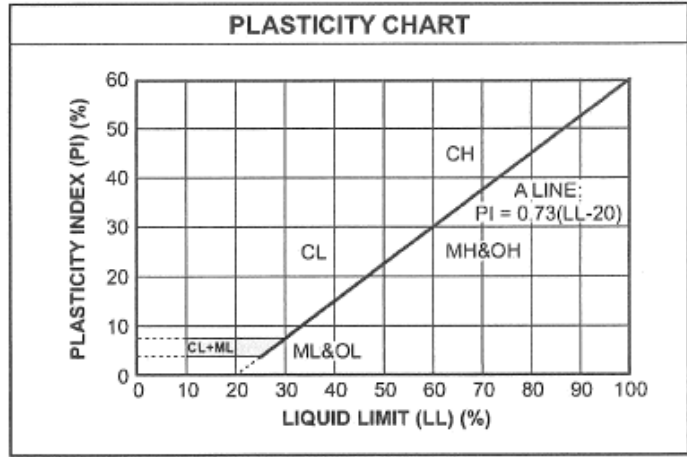

## PARTICLE SIZE LIMITS

COBBLES	GRAVEL		SAND			SILT OR CLAY
	coarse	fine	coarse	medium	fine	
	3"	¾"	NO. 4	NO. 10	NO. 40	NO. 200

## LOG OF EXPLORATORY BORING B-1

Sheet 1 of 1

Project Number: **22-7435**  
 Project Name: **2223 & 2271 Locust Ave, Rialto**  
 Date Drilled: **2/28/22 - 2/28/22**  
 Ground Elev:

Logged By: **RS**  
 Project Engineer: **SG**  
 Drill Type: **CME 75 Hollow Stem**  
 Drive Wt & Drop: **140lbs / 30in**

Depth (ft)	Graphic Log	FIELD RESULTS								LAB RESULTS		
		Bulk Sample	Drive Sample	SPT blows/ft (or equivalent N)	Pocket Pen (tsf)	USCS	<input type="checkbox"/> Shelby Tube	<input checked="" type="checkbox"/> Standard Split Spoon	<input type="checkbox"/> No recovery	Moisture Content (%)	Dry Density, (pcf)	Other Tests
							<input checked="" type="checkbox"/> Modified California	<input type="checkbox"/> Water Table ATD				

SUMMARY OF SUBSURFACE CONDITIONS

5						<p>Surface: Concrete 6"                      Sandy gravel with cobbles, light brown, slightly moist, very dense</p> <hr/> <p>Total Depth: 2 feet.                      No caving observed                      No groundwater observed                      Boring terminated due to refusal on boulder.                      Boring backfilled with soil cuttings upon completion                      Capped with concrete.</p>					
10											
15											
20											
25											

LOG OF BORING 22-7435 LOCUST, RIALTO.GPJ TGR GEOTECH.GDT 3/23/22

This Boring Log should be evaluated in conjunction with the complete geotechnical report. This Boring Log represents conditions observed at the specific location and date indicated, it is not warranted to be representative of subsurface conditions at other locations and times.

PLATE 2



# LOG OF EXPLORATORY BORING B-2

Sheet 1 of 1

Project Number: **22-7435**  
 Project Name: **2223 & 2271 Locust Ave, Rialto**  
 Date Drilled: **2/28/22 - 2/28/22**  
 Ground Elev: \_\_\_\_\_

Logged By: **RS**  
 Project Engineer: **SG**  
 Drill Type: **CME 75 Hollow Stem**  
 Drive Wt & Drop: **140lbs / 30in**

Depth (ft)	Graphic Log	FIELD RESULTS					LAB RESULTS		
		Bulk Sample	Drive Sample	SPT blows/ft (or equivalent N)	Pocket Pen (tsf)	USCS	Moisture Content (%)	Dry Density, (pcf)	Other Tests
						Shelby Tube Standard Split Spoon No recovery Modified California Water Table ATD			
SUMMARY OF SUBSURFACE CONDITIONS									

5			18	SPG	Surface: Concrete 7" Silty sand with gravel, brown, moist, dense			
					Fine sand with gravel and cobbles, brown, moist to slightly moist, medium dense	7	-200=17%	
10			70	SPG	Coarse sand with gravel, brown to tan, slightly moist, very dense	3		
15					Total Depth: 11.5 feet. No caving observed No groundwater observed Percolation testing performed from 5-10 feet Boring backfilled with soil cuttings upon completion Capped with concrete			
20								
25								

LOG OF BORING 22-7435 LOCUST, RIALTO.GPJ TGR GEOTECH.GDT 3/23/22

This Boring Log should be evaluated in conjunction with the complete geotechnical report. This Boring Log represents conditions observed at the specific location and date indicated, it is not warranted to be representative of subsurface conditions at other locations and times.

PLATE 3





# LOG OF EXPLORATORY BORING B-3

Sheet 1 of 1

Project Number: **22-7435**  
 Project Name: **2223 & 2271 Locust Ave, Rialto**  
 Date Drilled: **2/28/22 - 2/28/22**  
 Ground Elev:

Logged By: **RS**  
 Project Engineer: **SG**  
 Drill Type: **CME 75 Hollow Stem**  
 Drive Wt & Drop: **140lbs / 30in**

Depth (ft)	Graphic Log	FIELD RESULTS					LAB RESULTS				
		Bulk Sample	Drive Sample	SPT blows/ft (or equivalent N)	Pocket Pen (tsf)	USCS	<input type="checkbox"/> Shelby Tube	<input type="checkbox"/> Standard Split Spoon	<input type="checkbox"/> No recovery	Moisture Content (%)	Dry Density, (pcf)
SUMMARY OF SUBSURFACE CONDITIONS											

- Shelby Tube
- Standard Split Spoon
- No recovery
- Modified California
- Water Table ATD

Surface: Concrete 6"  
 Sandy gravel with cobbles, light brown, slightly moist, very dense

Total Depth: 2 feet.  
 No caving observed  
 No groundwater observed  
 Boring terminated due to refusal on boulder.  
 Boring backfilled with soil cuttings upon completion  
 Capped with concrete

LOG OF BORING 22-7435 LOCUST, RIALTO.GPJ TGR GEOTECH.GDT 3/23/22

This Boring Log should be evaluated in conjunction with the complete geotechnical report. This Boring Log represents conditions observed at the specific location and date indicated, it is not warranted to be representative of subsurface conditions at other locations and times.

PLATE 4



# LOG OF EXPLORATORY BORING B-4

Sheet 1 of 1

Project Number: **22-7435**  
 Project Name: **2223 & 2271 Locust Ave, Rialto**  
 Date Drilled: **2/28/22 - 2/28/22**  
 Ground Elev:

Logged By: **RS**  
 Project Engineer: **SG**  
 Drill Type: **CME 75 Hollow Stem**  
 Drive Wt & Drop: **140lbs / 30in**

Depth (ft)	Graphic Log	FIELD RESULTS					LAB RESULTS		
		Bulk Sample	Drive Sample	SPT blows/ft (or equivalent N)	Pocket Pen (tsf)	USCS		Moisture Content (%)	Dry Density, (pcf)
						Shelby Tube Standard Split Spoon No recovery Modified California Water Table ATD			
SUMMARY OF SUBSURFACE CONDITIONS									

5			21		SPG	Surface: Concrete 6" Gravelly sand, light brown, slightly moist, very dense			
10						Sandy gravel, light brown, slightly moist, very dense	3	119	
15						Total Depth: 7.5 feet. No caving observed No groundwater observed Boring terminated due to refusal on boulder. Boring backfilled with soil cuttings upon completion Capped with concrete	4	122	
20									
25									

LOG OF BORING 22-7435 LOCUST, RIALTO.GPJ TGR GEOTECH.GDT 3/23/22

This Boring Log should be evaluated in conjunction with the complete geotechnical report. This Boring Log represents conditions observed at the specific location and date indicated, it is not warranted to be representative of subsurface conditions at other locations and times.

## PLATE 5



## LOG OF EXPLORATORY BORING B-5

Sheet 1 of 1

Project Number: **22-7435**  
 Project Name: **2223 & 2271 Locust Ave, Rialto**  
 Date Drilled: **2/28/22 - 2/28/22**  
 Ground Elev: \_\_\_\_\_

Logged By: **RS**  
 Project Engineer: **SG**  
 Drill Type: **CME 75 Hollow Stem**  
 Drive Wt & Drop: **140lbs / 30in**

Depth (ft)	Graphic Log	FIELD RESULTS				USCS	LAB RESULTS		
		Bulk Sample	Drive Sample	SPT blows/ft (or equivalent N)	Pocket Pen (tsf)		Moisture Content (%)	Dry Density, (pcf)	Other Tests
<div style="display: flex; justify-content: space-around;"> <div style="text-align: center;">  Shelby Tube   Modified California                 </div> <div style="text-align: center;">  Standard Split Spoon   Water Table ATD                 </div> <div style="text-align: center;">  No recovery                 </div> </div>							SUMMARY OF SUBSURFACE CONDITIONS		
5			17	SPG		6	117		
10			21	SPG		3	114-200=2%		
15			>50	SPG		3	116		
Surface: dirt lot Gravely sand, brown, moist, dense  Sand with gravel, dark brown, slightly moist to moist, medium dense  Total Depth: 16.5 feet. Caving observed during infiltration testing. No groundwater observed. Boring terminated due to refusal on boulder. Boring backfilled with soil cuttings upon completion.									

LOG OF BORING 22-7435 LOCUST, RIALTO.GPJ TGR GEOTECH.GDT 3/23/22

This Boring Log should be evaluated in conjunction with the complete geotechnical report. This Boring Log represents conditions observed at the specific location and date indicated, it is not warranted to be representative of subsurface conditions at other locations and times.

### PLATE 6



# LOG OF EXPLORATORY BORING B-6

Project Number: **22-7435**  
 Project Name: **2223 & 2271 Locust Ave, Rialto**  
 Date Drilled: **2/28/22 - 2/28/22**  
 Ground Elev:

Logged By: **RS**  
 Project Engineer: **SG**  
 Drill Type: **CME 75 Hollow Stem**  
 Drive Wt & Drop: **140lbs / 30in**

Depth (ft)	Graphic Log	FIELD RESULTS					LAB RESULTS		
		Bulk Sample	Drive Sample	SPT blows/ft (or equivalent N)	Pocket Pen (tsf)	USCS	<input type="checkbox"/> Shelby Tube	<input type="checkbox"/> Standard Split Spoon	<input type="checkbox"/> No recovery
							<input type="checkbox"/> Modified California	<input type="checkbox"/> Water Table ATD	
SUMMARY OF SUBSURFACE CONDITIONS									

5	10	15	20	25		<p>Surface: dirt lot Gravelly sand with cobbles, light brown, slightly moist, very dense</p> <hr/> <p>Total Depth: 3.5 feet. No caving observed No groundwater observed Boring terminated due to refusal on boulder. Boring backfilled with soil cuttings upon completion</p>			Max, Shear
---	----	----	----	----	--	---	--	--	---------------

LOG OF BORING 22-7435 LOCUST, RIALTO.GPJ TGR GEOTECH.GDT 3/23/22

This Boring Log should be evaluated in conjunction with the complete geotechnical report. This Boring Log represents conditions observed at the specific location and date indicated, it is not warranted to be representative of subsurface conditions at other locations and times.

PLATE 7









# LOG OF EXPLORATORY BORING B-7

Sheet 1 of 1

Project Number: **22-7435**  
 Project Name: **2223 & 2271 Locust Ave, Rialto**  
 Date Drilled: **3/1/22 - 3/1/22**  
 Ground Elev:

Logged By: **RS**  
 Project Engineer: **SG**  
 Drill Type: **CME 75 Hollow Stem**  
 Drive Wt & Drop: **140lbs / 30in**

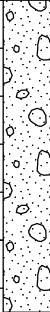
Depth (ft)	Graphic Log	FIELD RESULTS				LAB RESULTS			
		Bulk Sample	Drive Sample	SPT blows/ft (or equivalent N)	Pocket Pen (tsf)	USCS	Moisture Content (%)	Dry Density, (pcf)	Other Tests
						 Shelby Tube  Standard Split Spoon  No recovery  Modified California  Water Table ATD			
SUMMARY OF SUBSURFACE CONDITIONS									

5			>50		SPG	Surface: dirt lot Silty sand with gravel, brown, slightly moist, very dense	2	124	
10						Total Depth: 6.5 feet. No caving observed No groundwater observed Boring terminated due to refusal on boulder. Boring backfilled with soil cuttings upon completion			
15									
20									
25									

LOG OF BORING 22-7435 LOCUST, RIALTO.GPJ TGR GEOTECH.GDT 3/23/22

This Boring Log should be evaluated in conjunction with the complete geotechnical report. This Boring Log represents conditions observed at the specific location and date indicated, it is not warranted to be representative of subsurface conditions at other locations and times.

PLATE 8



# LOG OF EXPLORATORY BORING B-8

Sheet 1 of 1

Project Number: **22-7435**  
 Project Name: **2223 & 2271 Locust Ave, Rialto**  
 Date Drilled: **3/1/22 - 3/1/22**  
 Ground Elev:

Logged By: **RS**  
 Project Engineer: **SG**  
 Drill Type: **CME 75 Hollow Stem**  
 Drive Wt & Drop: **140lbs / 30in**

Depth (ft)	Graphic Log	FIELD RESULTS					LAB RESULTS			
		Bulk Sample	Drive Sample	SPT blows/ft (or equivalent N)	Pocket Pen (tsf)	USCS	<input type="checkbox"/> Shelby Tube <input checked="" type="checkbox"/> Modified California	<input checked="" type="checkbox"/> Standard Split Spoon <input type="checkbox"/> No recovery	<input type="checkbox"/> Water Table ATD	Moisture Content (%)

SUMMARY OF SUBSURFACE CONDITIONS

5			Surface: dirt lot Sand with gravel and cobbles, brown, slightly moist, very dense								
10			Total Depth: 2.5 feet. No caving observed No groundwater observed Boring terminated due to refusal on boulder. Boring backfilled with soil cuttings upon completion								
15											
20											
25											

LOG OF BORING 22-7435 LOCUST, RIALTO.GPJ TGR GEOTECH.GDT 3/23/22

This Boring Log should be evaluated in conjunction with the complete geotechnical report. This Boring Log represents conditions observed at the specific location and date indicated, it is not warranted to be representative of subsurface conditions at other locations and times.

## PLATE 9



## LOG OF EXPLORATORY BORING B-9

Sheet 1 of 1

Project Number: **22-7435**  
 Project Name: **2223 & 2271 Locust Ave, Rialto**  
 Date Drilled: **3/1/22 - 3/1/22**  
 Ground Elev:

Logged By: **RS**  
 Project Engineer: **SG**  
 Drill Type: **CME 75 Hollow Stem**  
 Drive Wt & Drop: **140lbs / 30in**

Depth (ft)	Graphic Log	FIELD RESULTS				Moisture Content (%)	LAB RESULTS	
		Bulk Sample	Drive Sample	SPT blows/ft (or equivalent N)	Pocket Pen (tsf)	USCS	Dry Density (pcf)	Other Tests
<div style="display: flex; justify-content: space-between;"> <div> <p>■ Shelby Tube</p> <p>◕ Modified California</p> </div> <div> <p>⊠ Standard Split Spoon</p> <p>▽ Water Table ATD</p> </div> <div> <p>⦿ No recovery</p> </div> </div>								
SUMMARY OF SUBSURFACE CONDITIONS								

5             10             15             20             25		<p>Gravelly sand with cobbles, light brown to brown, slightly moist, very dense</p>	<p>Total Depth: 3 feet.                  No caving observed                  No groundwater observed                  Boring terminated due to refusal on boulder.                  Boring backfilled with soil cuttings upon completion</p>	<p>R-Value, Corrosion</p>
---	--	---	--	---------------------------

LOG OF BORING 22-7435 LOCUST, RIALTO.GPJ TGR GEOTECH.GDT 3/23/22

This Boring Log should be evaluated in conjunction with the complete geotechnical report. This Boring Log represents conditions observed at the specific location and date indicated, it is not warranted to be representative of subsurface conditions at other locations and times.

### PLATE 10



TGR GEOTECHNICAL, INC.

22-7435

**APPENDIX C  
LABORATORY TEST RESULTS**

TGR GEOTECHNICAL  
DBE & 8(a) firm  
3037 S. HARBOR BLVD  
SANTA ANA, CA 92704  
P 714.641.7189 F 714.641.7190  
[www.tgrgeotech.com](http://www.tgrgeotech.com)





## APPENDIX C

### Laboratory Testing Procedures and Results

**In-Situ Moisture and Dry Density Determination (ASTM D2216 and D7263):** Moisture content and dry density determinations were performed on relatively undisturbed samples obtained from the test borings. The results of these tests are presented in the boring logs. Where applicable, only moisture content was determined from "undisturbed" or disturbed samples.

**Maximum Density and Optimum Moisture Content (ASTM D1557):** The maximum dry density and optimum moisture content of typical materials were determined in accordance with ASTM Test Method D1557. The results of these tests are presented in the table below:

Sample Location	Sample Description	Maximum Dry Density (pcf)	Optimum Moisture Content (%)
B-6 @ 0-3.5 feet	Gravelly Sand	138.3	5.2

**Direct Shear Strength (ASTM D3080):** Direct shear test was performed on selected remolded samples, which were soaked for a minimum of 24 hours under a surcharge equal to the applied normal force during testing. After transfer of the sample to the shear box, and reloading the sample, pore pressures set up in the sample due to the transfer were allowed to dissipate for a period of approximately 1-hour prior to application of shearing force. The sample was tested under various normal loads, a motor-driven, strain-controlled, direct-shear testing apparatus at a strain rate of less than 0.001 to 0.5 inches per minute (depending upon the soil type). The test results are presented in the test data and in the table below:

Sample Location	Sample Description	Friction Angle (degrees)	Apparent Cohesion (psf)
B-1 @ 0-5 feet	Gravelly Sand (Remolded)	35	102

**Soluble Sulfate (CAL 417A):** The soluble sulfate content of selected sample was determined by standard geochemical methods. The test results are presented in the test data and in the table below:

Sample Location	Sample Description	Water Soluble Sulfate in Soil, (% by Weight)	Sulfate Content (ppm)	Exposure Class*
B-9 @ 0-3 feet	Gravelly Sand	0.0156	156	S0

\* Based on the current version of ACI 318-14 Building Code, Table No. 19.3.1.1; Exposure Categories and Classes.

Corrosivity Tests (CAL 422, CAL 643 and CAL 747): Electrical conductivity, pH, and soluble chloride tests were conducted on representative samples and the results are provided in the test data and in the table below:

Sample Location	Sample Description	Soluble Chloride (CAL 422) (ppm)	Electrical Resistivity (CAL 643) (ohm-cm)	pH (CAL 747)	Potential Degree of Attack on Steel
B-9 @ 0-3 feet	Gravelly Sand	50	5,800	7.9	Moderate

Passing No. 200 Sieve (ASTM D1140): Typical materials were washed over No. 200 sieve. The test results are presented in the boring logs and in the table below:

Sample Location	% Passing No. 200 Sieve
B-2 @ 5 feet	17.0
B-5 @ 10 feet	2.0

R-Value: The resistance "R"-Value was determined by the California Materials Method No. 301 for subgrade soils. One sample was prepared, and exudation pressure and "R"-Value determined. The graphically determined "R"-Value at exudation pressure of 300 psi is summarized in the table below:

Sample Location	Sample Description	R-Value
B-9 @ 0-3 feet	Gravelly Sand	78

US COMPACTION 22-7435 LOCUST\_RIALTO.GPJ TGR GEOTECH.GDT 3/14/22

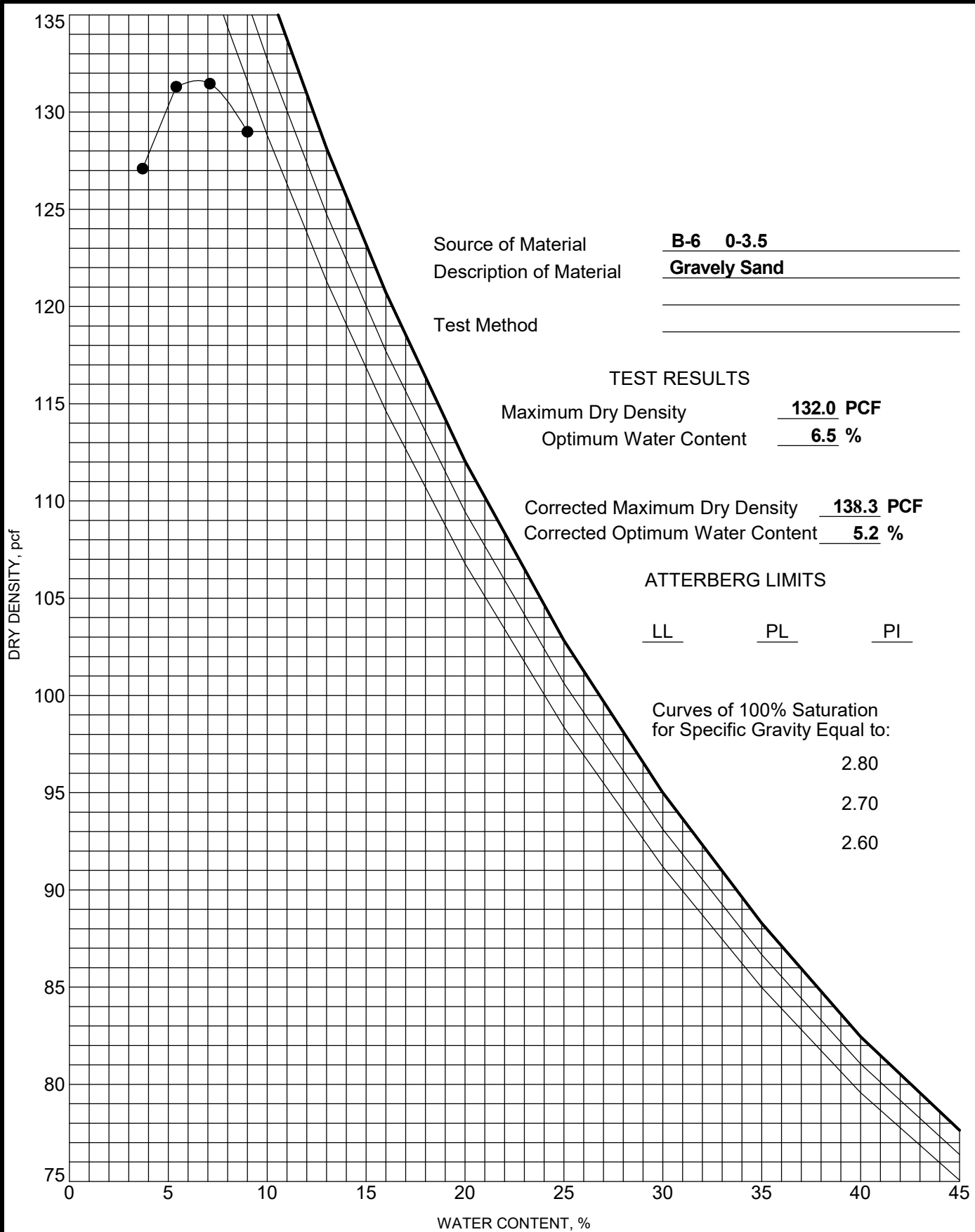

TGR GEOTECHNICAL, INC. Telephone: Fax:

**MOISTURE-DENSITY RELATIONSHIP**

Project Number: 22-7435  
 Project Name: 2223 & 2271 Locust Ave, Rialto

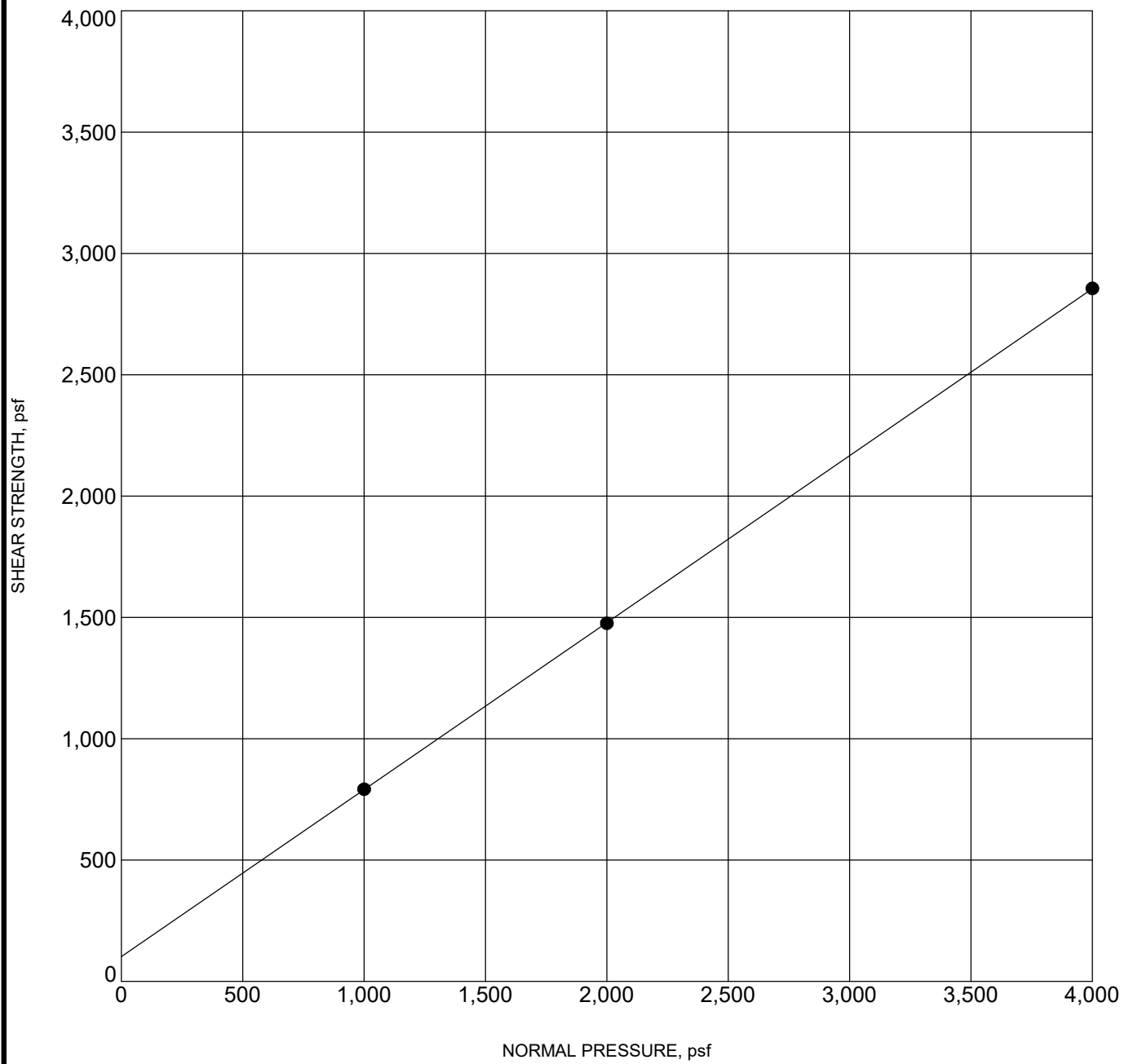

US DIRECT SHEAR 22-7435 LOCUST, RIALTO.GPJ TGR GEOTECH.GDT 3/18/22

Specimen Identification	Classification	$\gamma_d$	MC%	c	$\phi$
● B-6      0-3.5	Gravely Sand (Remolded)	125	5	102	35



TGR GEOTECHNICAL, INC. Telephone:      Fax:

**DIRECT SHEAR TEST**

Project Number: 22-7435

Project Name: 2223 & 2271 Locust Ave, Rialto

# ANAHEIM TEST LAB, INC

196 Technology Dr., Unit D  
Irvine, CA 92618  
Phone (949) 336-6544

TO:

TGR GEOTECHNICAL  
3037 S. HARBOR BLVD.  
SANTA ANA, CA 92704

DATE: 3/18/2022

P.O. NO: VERBAL

LAB NO: C-5776

SPECIFICATION: CTM-643/417/422

MATERIAL: Soil

---

Project No.: 22-7435  
Project: 2223 Locust Avenue, Rialto  
Sample ID: B9 @ 0-3'

## ANALYTICAL REPORT CORROSION SERIES SUMMARY OF DATA

pH	MIN. RESISTIVITY per CT. 643 ohm-cm	SOLUBLE SULFATES per CT. 417 ppm	SOLUBLE CHLORIDES per CT. 422 ppm
7.9	5,800	156	50

RESPECTFULLY SUBMITTED



---

WES BRIDGER LAB MANAGER

# ANAHEIM TEST LAB, INC

196 Technology Drive, Unit D  
Irvine, CA 92618  
Phone (949) 336-6544

TO:

TGR GEOTECHNICAL  
3037 S. HARBOR BLVD.  
SANTA ANA, CA. 92704

DATE: 3/18/2022

P.O. NO.: VERBAL

LAB NO.: C-5778

SPECIFICATION: CTM- 301

MATERIAL: Brown, Silty Sand w. Gravel

---

Project No.: 22-7435  
Project: 2223 Locust Avenue, Rialto  
Sample ID: B9 @ 0-3'

## ANALYTICAL REPORT

### "R" VALUE

BY EXUDATION

BY EXPANSION

79

78

RESPECTFULLY SUBMITTED



---

WES BRIDGER LAB MANAGER

**APPENDIX D  
SITE SEISMICITY AND DEAGGREGATED PARAMETERS**



# 22-7435

2271 N Locust Ave, Rialto, CA 92377, USA

Latitude, Longitude: 34.1407723, -117.4091169



<b>Date</b>	3/10/2022, 10:16:08 AM
<b>Design Code Reference Document</b>	ASCE7-16
<b>Risk Category</b>	II
<b>Site Class</b>	D - Stiff Soil

Type	Value	Description
$S_S$	2.19	$MCE_R$ ground motion. (for 0.2 second period)
$S_1$	0.775	$MCE_R$ ground motion. (for 1.0s period)
$S_{MS}$	2.19	Site-modified spectral acceleration value
$S_{M1}$	null -See Section 11.4.8	Site-modified spectral acceleration value
$S_{DS}$	1.46	Numeric seismic design value at 0.2 second SA
$S_{D1}$	null -See Section 11.4.8	Numeric seismic design value at 1.0 second SA

Type	Value	Description
SDC	null -See Section 11.4.8	Seismic design category
$F_a$	1	Site amplification factor at 0.2 second
$F_v$	null -See Section 11.4.8	Site amplification factor at 1.0 second
PGA	0.899	$MCE_G$ peak ground acceleration
$F_{PGA}$	1.1	Site amplification factor at PGA
$PGA_M$	0.989	Site modified peak ground acceleration
$T_L$	12	Long-period transition period in seconds
$S_sRT$	2.459	Probabilistic risk-targeted ground motion. (0.2 second)
$S_sUH$	2.696	Factored uniform-hazard (2% probability of exceedance in 50 years) spectral acceleration
$S_sD$	2.19	Factored deterministic acceleration value. (0.2 second)
$S_1RT$	0.983	Probabilistic risk-targeted ground motion. (1.0 second)
$S_1UH$	1.105	Factored uniform-hazard (2% probability of exceedance in 50 years) spectral acceleration.
$S_1D$	0.775	Factored deterministic acceleration value. (1.0 second)
PGAd	0.899	Factored deterministic acceleration value. (Peak Ground Acceleration)
$C_{RS}$	0.912	Mapped value of the risk coefficient at short periods
$C_{R1}$	0.889	Mapped value of the risk coefficient at a period of 1 s



## DISCLAIMER

While the information presented on this website is believed to be correct, SEAOC / OSHPD and its sponsors and contributors assume no responsibility or liability for its accuracy. The material presented in this web application should not be used or relied upon for any specific application without competent examination and verification of its accuracy, suitability and applicability by engineers or other licensed professionals. SEAOC / OSHPD do not intend that the use of this information replace the sound judgment of such competent professionals, having experience and knowledge in the field of practice, nor to substitute for the standard of care required of such professionals in interpreting and applying the results of the seismic data provided by this website. Users of the information from this website assume all liability arising from such use. Use of the output of this website does not imply approval by the governing building code bodies responsible for building code approval and interpretation for the building site described by latitude/longitude location in the search results of this website.

# Unified Hazard Tool



Please do not use this tool to obtain ground motion parameter values for the design code reference documents covered by the [U.S. Seismic Design Maps web tools](#) (e.g., the International Building Code and the ASCE 7 or 41 Standard). The values returned by the two applications are not identical.

## ^ Input

### Edition

### Spectral Period

### Latitude

Decimal degrees

### Time Horizon

Return period in years

### Longitude

Decimal degrees, negative values for western longitudes

### Site Class

# ^ Hazard Curve

Hazard Curves

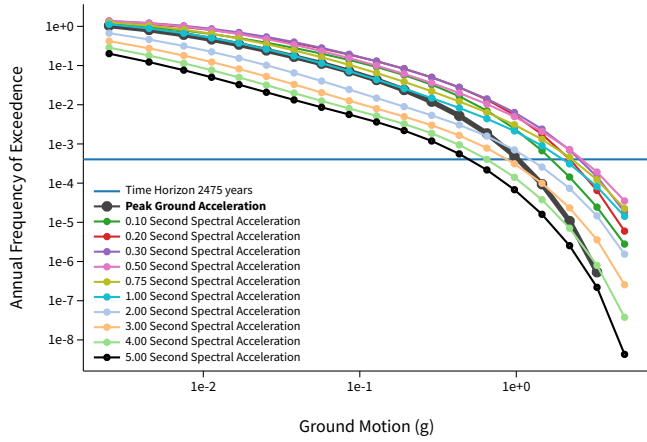

Uniform Hazard Response Spectrum

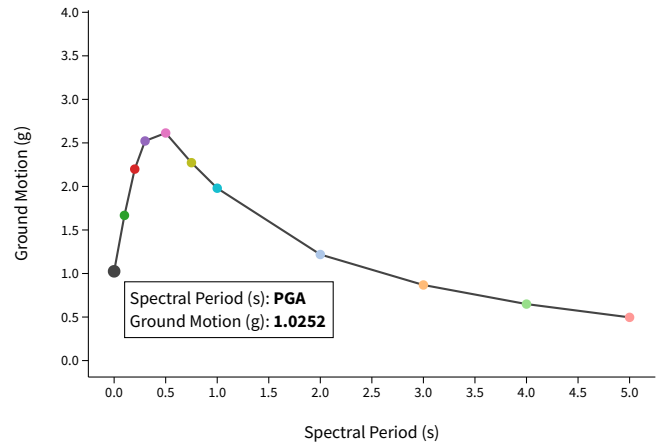

Component Curves for Peak Ground Acceleration

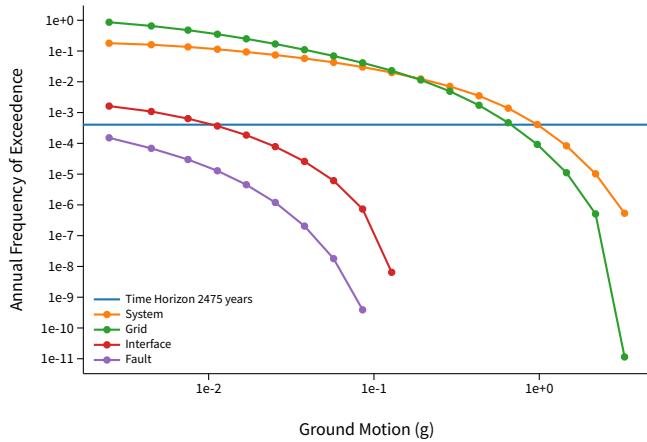

[View Raw Data](#)

# ^ Deaggregation

## Component

Total

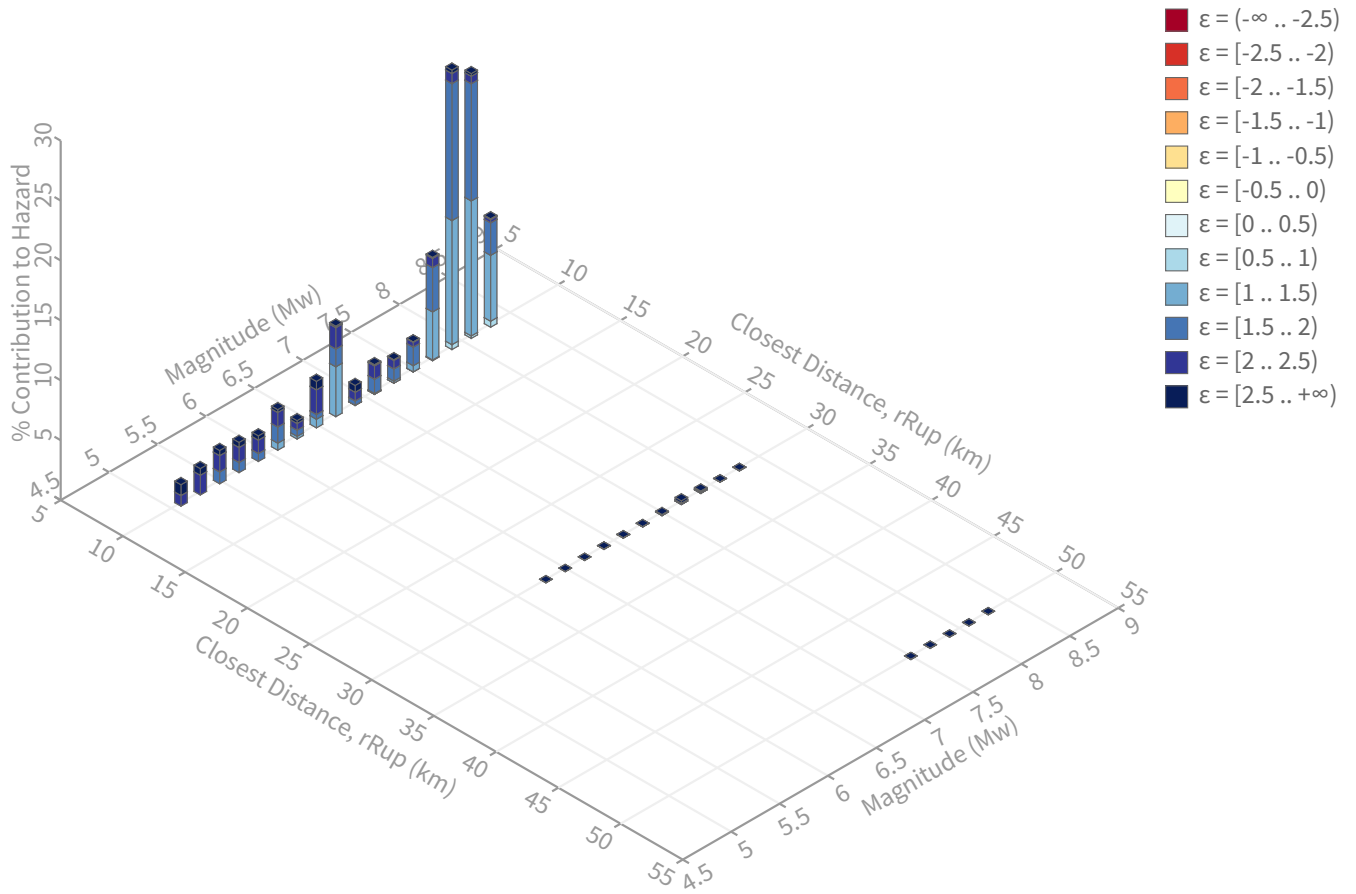

## Summary statistics for, Deaggregation: Total

### Deaggregation targets

---

**Return period:** 2475 yrs

**Exceedance rate:** 0.0004040404 yr<sup>-1</sup>

**PGA ground motion:** 1.0252171 g

### Recovered targets

---

**Return period:** 3298.9563 yrs

**Exceedance rate:** 0.00030312617 yr<sup>-1</sup>

### Totals

---

**Binned:** 100 %

**Residual:** 0 %

**Trace:** 0.02 %

### Mean (over all sources)

---

**m:** 7.4

**r:** 6.78 km

**ε<sub>0</sub>:** 1.67 σ

### Mode (largest m-r bin)

---

**m:** 7.9

**r:** 6.47 km

**ε<sub>0</sub>:** 1.51 σ

**Contribution:** 23.31 %

### Mode (largest m-r-ε<sub>0</sub> bin)

---

**m:** 7.91

**r:** 8.82 km

**ε<sub>0</sub>:** 1.72 σ

**Contribution:** 11.43 %

### Discretization

---

**r:** min = 0.0, max = 1000.0, Δ = 20.0 km

**m:** min = 4.4, max = 9.4, Δ = 0.2

**ε:** min = -3.0, max = 3.0, Δ = 0.5 σ

### Epsilon keys

---

**ε0:** [-∞ .. -2.5)

**ε1:** [-2.5 .. -2.0)

**ε2:** [-2.0 .. -1.5)

**ε3:** [-1.5 .. -1.0)

**ε4:** [-1.0 .. -0.5)

**ε5:** [-0.5 .. 0.0)

**ε6:** [0.0 .. 0.5)

**ε7:** [0.5 .. 1.0)

**ε8:** [1.0 .. 1.5)

**ε9:** [1.5 .. 2.0)

**ε10:** [2.0 .. 2.5)

**ε11:** [2.5 .. +∞]

## Deaggregation Contributors

Source Set ↴	Source	Type	r	m	$\epsilon_0$	lon	lat	az	%
UC33brAvg_FM31		System							42.29
	San Andreas (San Bernardino N) [3]		9.67	7.72	1.83	117.350°W	34.213°N	33.88	14.43
	San Jacinto (San Bernardino) [2]		4.75	8.02	1.37	117.369°W	34.163°N	56.42	14.02
	San Jacinto (Lytle Creek connector) [1]		2.20	7.97	1.16	117.398°W	34.150°N	44.01	5.38
	Fontana (Seismicity) [0]		1.76	6.61	1.37	117.411°W	34.146°N	342.49	3.69
	Cucamonga [0]		6.67	7.37	1.64	117.445°W	34.192°N	330.08	1.75
UC33brAvg_FM32		System							41.53
	San Andreas (San Bernardino N) [3]		9.67	7.73	1.83	117.350°W	34.213°N	33.88	14.55
	San Jacinto (San Bernardino) [2]		4.75	8.02	1.37	117.369°W	34.163°N	56.42	13.95
	San Jacinto (Lytle Creek connector) [1]		2.20	7.97	1.16	117.398°W	34.150°N	44.01	5.40
	Fontana (Seismicity) [0]		1.76	6.61	1.37	117.411°W	34.146°N	342.49	3.02
	Cucamonga [0]		6.67	7.39	1.64	117.445°W	34.192°N	330.08	1.64
UC33brAvg_FM31 (opt)		Grid							8.09
	PointSourceFinite: -117.409, 34.181		6.85	5.63	2.05	117.409°W	34.181°N	0.00	2.19
	PointSourceFinite: -117.409, 34.181		6.85	5.63	2.05	117.409°W	34.181°N	0.00	2.19
	PointSourceFinite: -117.409, 34.199		8.12	5.67	2.24	117.409°W	34.199°N	0.00	1.03
	PointSourceFinite: -117.409, 34.199		8.12	5.67	2.24	117.409°W	34.199°N	0.00	1.03
UC33brAvg_FM32 (opt)		Grid							8.09
	PointSourceFinite: -117.409, 34.181		6.85	5.63	2.05	117.409°W	34.181°N	0.00	2.19
	PointSourceFinite: -117.409, 34.181		6.85	5.63	2.05	117.409°W	34.181°N	0.00	2.19
	PointSourceFinite: -117.409, 34.199		8.12	5.67	2.24	117.409°W	34.199°N	0.00	1.03
	PointSourceFinite: -117.409, 34.199		8.12	5.67	2.24	117.409°W	34.199°N	0.00	1.03

**TABLE 1**  
**SITE SPECIFIC GROUND MOTION ANALYSIS**  
**21-7435 2223-2271 N. Locust Avenue, Rialto**

SA Period (sec)	Probabilistic Spectral Acceleration MCER (g)	Deterministic Spectral Acceleration (g)	Is Largest Deterministic Spectral Acceleration <1.5*Fa	Deterministic MCER	Site Specific MCER	2/3 of Site Specific MCER	80% Code Design	Site Specific Design Response Spectrum
	Rotated Maximum	Rotated Maximum 84th Percentile						
0	1.0879	0.9273	No	0.9273	0.9273	0.6182	0.4672	0.6182
0.1	1.8117	1.3167		1.3167	1.3167	0.8778	0.8633	0.8778
0.2	2.3837	1.7826		1.7826	1.7826	1.1884	1.1680	1.1884
0.3	2.7461	2.2450		2.2450	2.2450	1.4967	1.1680	1.4967
0.5	2.8623	2.6323		2.6323	2.6323	1.7549	1.1680	1.7549
0.75	2.5443	2.5101		2.5101	2.5101	1.6734	1.1680	1.6734
1	2.3088	2.3935		2.3935	2.3088	1.5392	1.0333	1.5392
2	1.4526	1.5889		1.5889	1.4526	0.9684	0.5167	0.9684
3	1.0640	1.1857		1.1857	1.0640	0.7093	0.3444	0.7093
4	0.8178	0.8910		0.8910	0.8178	0.5452	0.2583	0.5452
5	0.6510	0.6885		0.6885	0.6510	0.4340	0.2067	0.4340

Code Sds	1.460	Crs = 0.912	Code Ss = 2.19	<b>Site Specific Sds = 1.579</b>
Code Sd1	1.292	Cr1 = 0.889	Code S1 = 0.775	<b>Site Specific SD1 = 2.181</b>
To	0.18	Code Fa = 1	Sms = 2.19	
Ts	0.88	Code Fv = 2.5	Sm1 = 1.9375	
TL	12			
Input				

**FIGURE 1**  
**Site Specific Design Response Spectra**  
**21-7435 2223-2271 N. Locust Avenue, Rialto**

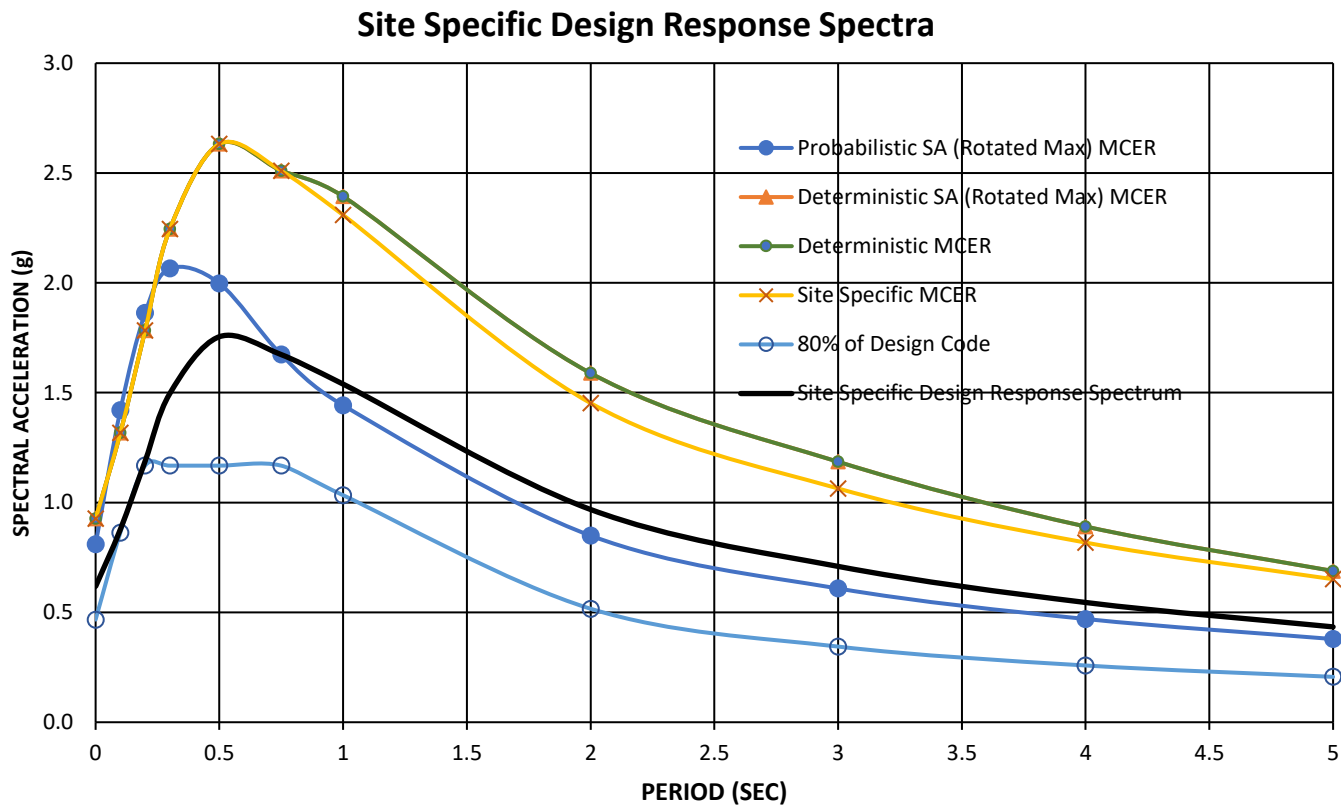

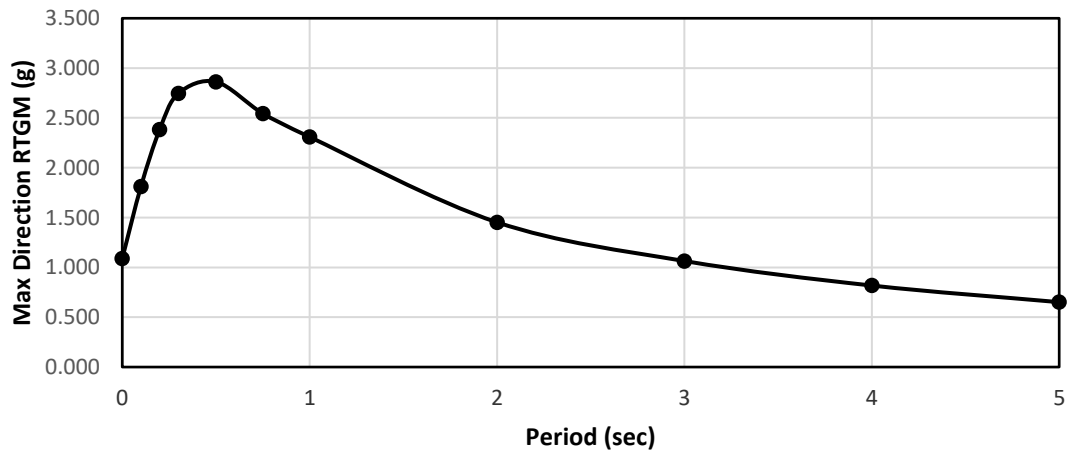

**TABLE 2**

**Probabilistic Response Spectrum ASCE 7-16 Method 2**  
**21-7435 2223-2271 N. Locust Avenue, Rialto**

Period (g)	UHGM (g)	RTGM (g)	Max Dir Scale factor	Max Dir RTGM (g)
0	1.025	0.989	1.1	1.088
0.1	1.668	1.647	1.1	1.812
0.2	2.199	2.167	1.1	2.384
0.3	2.522	2.441	1.125	2.746
0.5	2.614	2.436	1.175	2.862
0.75	2.273	2.056	1.2375	2.544
1	1.980	1.776	1.3	2.309
2	1.218	1.076	1.35	1.453
3	0.868	0.760	1.4	1.064
4	0.649	0.564	1.45	0.818
5	0.496	0.434	1.5	0.651

**Probabilistic Response Spectra per ASCE 7-16**

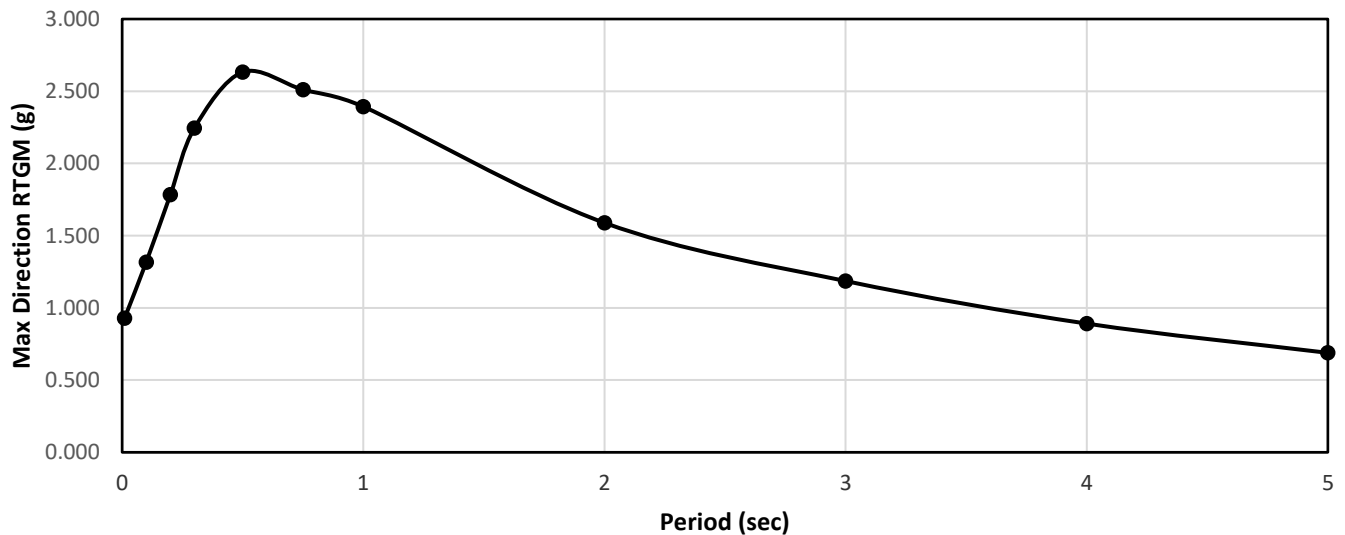

**TABLE 3**

**Deterministic Response Spectrum ASCE 7-16**  
**21-7435 2223-2271 N. Locust Avenue, Rialto**

Period (g)	84th-Percentile Spectral Acceleration (g)	Max Dir Scale factor	Max Dir Deterministic SA (g)
0.01	0.843	1.1	0.927
0.1	1.197	1.1	1.317
0.2	1.621	1.1	1.783
0.3	1.996	1.125	2.245
0.5	2.240	1.175	2.632
0.75	2.028	1.2375	2.510
1	1.841	1.3	2.393
2	1.177	1.35	1.589
3	0.847	1.4	1.186
4	0.614	1.45	0.891
5	0.459	1.5	0.688

**Deterministic Response Spectra per ASCE 7-16**





WEIGHTED AVERAGE of 2014 NGA WEST-2 GMPEs

Last updated: 04 14 15

by Emel Seyhan, PhD, PEER & UCLA -- email: emel.seyhan@gmail.com, peer\_center@berkeley.edu

Fontana Seismicity [0]

This excel file will be updated as necessary on the PEER website to fix any typos or other errors. Please check the website frequently for new versions at: <http://peer.berkeley.edu/ngawest2/databases/>

GMPE Averaging Geometric Weighted average of the natural logarithm of the spectral values

GMPEs	ASK14	BSSA14	CB14	CY14	I14
Weight	0.25	0.25	0.25	0.25	0
# of std. dev.	1				
Damping ratio (%)	5				

Modification factors are calculated in Sheet DSF

Legend	Pre-defined option	Main input variable	Calculated variable	Input var. flag	Internal variable
--------	--------------------	---------------------	---------------------	-----------------	-------------------

**ASK14** Abrahamson & Silva & Kamai 2014 NGA West-2 Model  
**BSSA14** Boore & Stewart & Seyhan & Atkinson 2014 NGA West-2 Model  
**CB14** Campbell & Bozorgnia 2014 NGA West-2 Model  
**CY14** Chiou & Youngs 2014 NGA West-2 Model  
**I14** Idriss 2014 NGA West-2 Model

RotD50 Horizontal Component of PGA, PGV and IMs

Input variables Errors and warnings

GMP	T (s)	Baseline: 5% Damping				User defined: 5% Damping				
		PSA Median for 5% damping	PSa Median + 1.0 for 5% damping	PSa Median - 1.0 for 5% damping	S <sub>d</sub> Median for 5% damping	PSa Median for 5% damping	PSa Median + 1.0 for 5% damping	PSa Median - 1.0 for 5% damping	S <sub>d</sub> Median for 5% damping	
M <sub>w</sub>	6.61	0.01	0.4766852	0.7850344	0.289451	0.001183	0.476685	0.7850344	0.289451	0.001183
R <sub>rup</sub> (km)	1.76	0.02	0.4777398	0.7900686	0.28888	0.004744	0.47774	0.7900686	0.28888	0.004744
R <sub>fb</sub> (km)	1.76	0.03	0.4789018	0.7950723	0.28846	0.010999	0.478902	0.7950723	0.28846	0.010999
R <sub>x</sub> (km)	1.76	0.05	0.5150301	0.8656331	0.30643	0.031962	0.514515	0.8647675	0.306124	0.03193
R <sub>y0</sub> (km)	999	0.075	0.5999914	1.0207207	0.352082	0.083779	0.601191	1.0227821	0.353387	0.083946
V <sub>30</sub> (m/sec)	260	0.1	0.6860732	1.1645645	0.404182	0.170309	0.687445	1.1668937	0.404991	0.170649
U (BSSA13)	0	0.15	0.8367512	1.3903253	0.503589	0.487353	0.839425	1.393106	0.504596	0.488288
F <sub>rv</sub>	1: reverse fault	0.2	0.9487532	1.5583392	0.577623	0.942062	0.949702	1.5598975	0.578201	0.943004
F <sub>rw</sub>	1: normal fault	0.4	1.0933646	1.8385832	0.6502	2.442721	1.093365	1.8385832	0.6502	2.442721
F <sub>hw</sub>	1: hanging wall side	0.4	1.0933646	1.8385832	0.6502	2.442721	1.093365	1.8385832	0.6502	2.442721
Dip (deg)	80	0.5	1.0933646	1.8385832	0.6502	2.442721	1.093365	1.8385832	0.6502	2.442721
Z <sub>top</sub> (km)	999	0.6	1.0933646	1.8385832	0.6502	2.442721	1.093365	1.8385832	0.6502	2.442721
Z <sub>hyp</sub> (km)	999	0.7	1.0933646	1.8385832	0.6502	2.442721	1.093365	1.8385832	0.6502	2.442721
Z <sub>1.0</sub> (km)	999	0.75	0.8385005	1.5717845	0.447315	1.170826	0.837662	1.5702127	0.446688	1.169655
Z <sub>2.5</sub> (km)	999	1	0.6868268	1.328116	0.355188	1.04958	0.685453	1.3254598	0.354478	1.04548
W (km)	14.9	1.5	0.4595543	0.9094134	0.232227	25.66763	0.459554	0.9094134	0.232227	25.66763
V <sub>30</sub> flag	measured	2	0.3302182	0.6609075	0.164991	32.78894	0.329558	0.6595857	0.164661	32.72336
F <sub>AS</sub>	no	3	0.195681	0.3936807	0.097218	43.71771	0.19529	0.3930809	0.097023	43.63027
Region	California	4	0.121751	0.2427107	0.061074	48.35663	0.121629	0.242488	0.061013	48.30858
Option for Sa value	1	5	0.0804871	0.1607868	0.04029	49.94968	0.080165	0.1601437	0.040129	49.74988
		7.5	0.0332638	0.0662678	0.016897	46.44738	0.033297	0.0663341	0.016714	46.49383
		10	0.0182081	0.035933	0.009226	45.19929	0.018154	0.0358252	0.009199	45.0637
PGA (g)	0	0.4737481	0.7796519	0.287869	0.001176	0.476685	0.7850344	0.289451	0.001183	
PGV (cm/s)	-1	67.742391	119.37851	38.44102	0.168162	NA	NA	NA	NA	

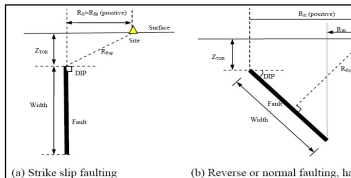
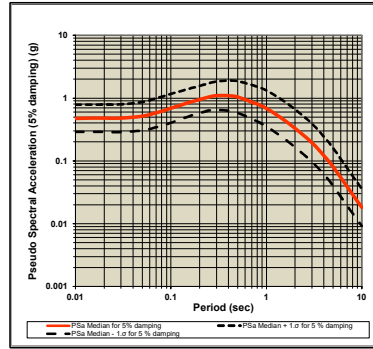

(a) Strike slip faulting

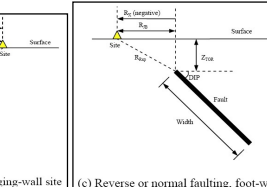

(b) Reverse or normal faulting, hanging-wall site

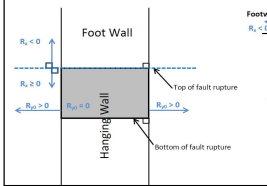

(c) Reverse or normal faulting, foot-wall site

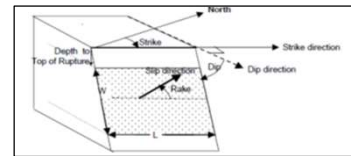

Definition of Parameters

- Damping ratio** = Viscous damping ratio (%) See Sanaz et al. (2012) PEER Report
- PSA** = Pseudo-absolute acceleration response spectrum (g)
- PGA** = Peak ground acceleration (g)
- PGV** = Peak ground velocity (cm/s)
- S<sub>d</sub>** = Relative displacement response spectrum (cm)
- M<sub>w</sub>** = Moment magnitude
- R<sub>rup</sub>** = Closest distance to coseismic rupture (km), used in ASK13, CB13 and CY13. See Figures a, b and c for illustration
- R<sub>fb</sub>** = Closest distance to surface projection of coseismic rupture (km). See Figures a, b and c for illustration
- R<sub>x</sub>** = Horizontal distance from top of rupture measured perpendicular to fault strike (km). See Figures a, b and c for illustration
- R<sub>y0</sub>** = The horizontal distance off the end of the rupture measured parallel to strike (km)
- V<sub>30</sub>** = The average shear-wave velocity (m/s) over a subsurface depth of 30 m
- U** = Unspecified-mechanism factor: 1 for unspecified; 0 otherwise
- F<sub>rv</sub>** = Reverse-faulting factor: 0 for strike slip, normal, normal-oblique; 1 for reverse, reverse-oblique and thrust
- F<sub>rw</sub>** = Normal-faulting factor: 0 for strike slip, reverse, reverse-oblique, thrust and normal-oblique; 1 for normal
- F<sub>hw</sub>** = Hanging-wall factor: 1 for site on down-slip side of top of rupture; 0 otherwise
- Dip** = Average dip of rupture plane (degrees)
- Z<sub>top</sub>** = Depth to top of coseismic rupture (km)
- Z<sub>hyp</sub>** = Hypocentral depth from the earthquake
- Z<sub>1.0</sub>** = Depth to V<sub>s</sub>=1 km/sec
- Z<sub>2.5</sub>** = Depth to V<sub>s</sub>=2.5 km/sec
- W** = Fault rupture width (km)
- V<sub>30</sub>flag** = 1 for measured, 0 for inferred V<sub>30</sub>
- F<sub>AS</sub>** = 0 for mainshock; 1 for aftershock
- Region** = Specific regions considered in the models. Click on Region to see codes
- ADPP** = Directivity term, direct point parameters; uses 0 for median predictions
- PGA<sub>r</sub> (g)** = Peak ground acceleration on rock (g), this specific cell is updated in the cell for BSSA14 and CB14, for others it is taken account for in the macros
- Z<sub>bot</sub> (km)** = The depth to the bottom of the seismicogenic crust
- Z<sub>bot</sub> (km)** = The depth to the bottom of the rupture plane
- SS** = 1 for strike slip, automatically updated in the cell

Input variables with defaults (if entered 999 as input):

DEFAULTs	USER defined	ASK14	BSSA14	CB14	CY14	I14
W (km)	14.90			14.565		
Z <sub>1.0</sub> (km)	999.000	0.475			0.485	
Z <sub>2.5</sub> (km)	0.000		0.000			
Z <sub>1.0</sub> (V <sub>30</sub> =1100)(km)	999.000			0.398		
Z <sub>2.5</sub> (V <sub>30</sub> )(km)	999.000			2.070		
Z <sub>top</sub> (km)	999.000			9.567		
Z <sub>bot</sub> (km)	999.000			0.656	0.656	
Z <sub>crit</sub> (km)	-			15.000		

ACKNOWLEDGEMENTS



Nick Gregor, Bechtel  
Silvia Mazzoni, Consultant

All NGA West-2 participants are acknowledged for their constructive comments and feedback.



WEIGHTED AVERAGE of 2014 NGA WEST-2 GMPEs

Last updated: 04 14 15

by Emel Seyhan, PhD, PEER & UCLA -- email: emel.seyhan@gmail.com, peer\_center@berkeley.edu

Lytle Creek Connector [1]

This excel file will be updated as necessary on the PEER website to fix any typos or other errors. Please check the website frequently for new versions at: <http://peer.berkeley.edu/ngawest2/databases/>

GMPE Averaging Geometric Weighted average of the natural logarithm of the spectral values

GMPEs	ASK14	BSSA14	CB14	CY14	I14
Weight	0.25	0.25	0.25	0	0
# of std. dev.	1				
Damping ratio (%)	5				

Modification factors are calculated in Sheet DSF

Legend	Pre-defined option	Main input variable	Calculated variable	Input var. flag	Internal variable
ASK14	Abrahamson & Silva & Kamai 2014 NGA West-2 Model				
BSSA14	Boore & Stewart & Seyhan & Atkinson 2014 NGA West-2 Model				
CB14	Campbell & Bozorgnia 2014 NGA West-2 Model				
CY14	Chiu & Youngs 2014 NGA West-2 Model				
I14	Idriss 2014 NGA West-2 Model				

RotD50 Horizontal Component of PGA, PGV and IMs

Input variables Errors and warnings

$M_w$	7.97	
$R_{rup}$ (km)	2.2	
$R_{10}$ (km)	2.2	
$R_x$ (km)	2.2	
$R_{y0}$ (km)	999	If unknown use 999
$V_{30}$ (m/sec)	260	
$U$ (BSSA13)	0	1: Unspecified fault mech.
$F_{rv}$	0	1: reverse fault
$F_{nr}$	0	1: normal fault
$F_{hw}$	0	1: hanging wall side
Dip (deg)	90	
$Z_{TOR}$ (km)	999	If unknown use 999
$Z_{HYP}$ (km)	999	If unknown use 999
$Z_{1.0}$ (km)	999	If unknown use 999
$Z_{2.5}$ (km)	999	If unknown use 999
$W$ (km)	14.49	If unknown use 999
$V_{30}Flag$	measured	Choose options for $V_{30}$ from the list
$F_{AS}$	no	Aftershock effect is not applicable.
Region	California	Choose region from the list

T (s)	Baseline: 5% Damping				User defined: 5% Damping			
	PSA Median for 5% damping	PSa Median + 1.0 for 5% damping	PSa Median - 1.0 for 5% damping	$S_d$ Median for 5% damping	PSa Median for 5% damping	PSa Median + 1.0 for 5% damping	PSa Median - 1.0 for 5% damping	$S_d$ Median for 5% damping
0.01	0.5135167	0.8429968	0.312812	0.001275	0.5135157	0.8429968	0.312812	0.001275
0.02	0.5130307	0.8458012	0.311185	0.005094	0.513031	0.8458012	0.311185	0.005094
0.03	0.510758	0.8456406	0.308492	0.011411	0.510247	0.844795	0.308184	0.0114
0.05	0.5392133	0.9042242	0.321547	0.033463	0.538674	0.90332	0.321226	0.03343
0.075	0.6197296	1.0521783	0.365019	0.085335	0.621588	1.053349	0.366119	0.086794
0.1	0.7044493	1.1933784	0.415835	0.17487	0.706563	1.196985	0.417083	0.173595
0.15	0.9801265	1.4259611	0.51882	0.480409	0.862707	1.430239	0.520777	0.48185
0.2	0.9875352	1.617306	0.602994	0.980571	0.98951	1.6205406	0.6042	0.982532
0.25	1.1031629	1.81284	0.671305	1.711536	1.09782	1.823717	0.675333	1.721805
0.3	1.1917264	1.9935465	0.712405	2.662474	1.192918	1.99554	0.713117	2.665137
0.4	1.2646326	2.1665005	0.731441	5.022656	1.267162	2.169735	0.732904	5.032901
0.5	1.2612764	2.2379693	0.710822	7.827383	1.262558	2.2402373	0.711532	7.835211
0.75	1.0911753	2.0304266	0.586411	15.23644	1.090084	2.0283961	0.585824	15.2212
1	0.9607831	1.8448378	0.500371	23.85018	0.958861	1.8411481	0.499371	23.80248
1.5	0.7436362	1.4633966	0.377884	41.53454	0.743636	1.4633966	0.377884	41.53454
2	0.5922117	1.1804761	0.297096	58.80351	0.590435	1.1769346	0.296205	58.6271
3	0.4224642	0.8478006	0.210517	94.36409	0.420242	0.8469928	0.210306	94.28971
4	0.3091576	0.6144801	0.155541	122.7909	0.309158	0.6144801	0.155541	122.7909
5	0.2311214	0.4603535	0.116035	143.4321	0.230428	0.4589724	0.115687	143.0018
7.5	0.1161906	0.2308021	0.058493	162.2408	0.116074	0.2305713	0.058434	162.0785
10	0.0677106	0.1332412	0.034409	168.0826	0.067507	0.1328415	0.034306	167.5784

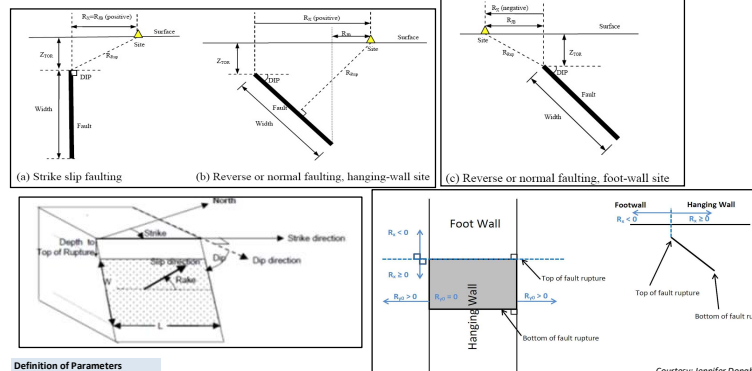
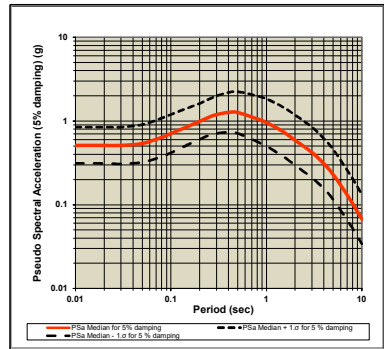

**Definition of Parameters**

**Damping ratio** = Viscous damping ratio (%) See Sanaz et al. (2012) PEER Report

**PSA** = Pseudo-absolute acceleration response spectrum (g)

**PGA** = Peak ground acceleration (g)

**PGV** = Peak ground velocity (cm/s)

**$S_d$**  = Relative displacement response spectrum (cm)

**$M_w$**  = Moment magnitude

**$R_{rup}$**  = Closest distance to coseismic rupture (km), used in ASK13, CB13 and CY13. See Figures a, b and c for illustration

**$R_{10}$**  = Closest distance to surface projection of coseismic rupture (km). See Figures a, b and c for illustration

**$R_x$**  = Horizontal distance from top of rupture measured perpendicular to fault strike (km). See Figures a, b and c for illustration

**$R_{y0}$**  = The horizontal distance off the end of the rupture measured parallel to strike (km)

**$V_{30}$**  = The average shear-wave velocity (m/s) over a subsurface depth of 30 m

**$U$**  = Unspecified-mechanism factor: 1 for unspecified; 0 otherwise

**$F_{rv}$**  = Reverse-faulting factor: 0 for strike slip, normal, normal-oblique; 1 for reverse, reverse-oblique and thrust

**$F_{nr}$**  = Normal-faulting factor: 0 for strike slip, reverse, reverse-oblique, thrust and normal-oblique; 1 for normal

**$F_{hw}$**  = Hanging-wall factor: 1 for site on down-dip side of top of rupture; 0 otherwise

**Dip** = Average dip of rupture plane (degrees)

**$Z_{TOR}$**  = Depth to top of coseismic rupture (km)

**$Z_{HYP}$**  = Hypocentral depth from the earthquake

**$Z_{1.0}$**  = Depth to  $V_{30} > 1$  km/sec

**$Z_{2.5}$**  = Depth to  $V_{30} > 2.5$  km/sec

**$W$**  = Fault rupture width (km)

**$V_{30}Flag$**  = 1 for measured, 0 for inferred  $V_{30}$

**$F_{AS}$**  = 0 for mainshock; 1 for aftershock

**Region** = Specific regions considered in the models. Click on Region to see codes

**$\Delta DPP$**  = Directivity term, direct point parameter; uses 0 for median predictions

**PGA, (g)** = Peak ground acceleration on rock (g), this specific cell is updated in the cell for BSSA14 and CB14, for others it is taken account for in the macros

**$Z_{BOT}$  (km)** = The depth to the bottom of the seismicogenic crust

**$Z_{BOR}$  (km)** = The depth to the bottom of the rupture plane

**SS** = 1 for strike slip, automatically updated in the cell

Calculated Variables/Flags

$\Delta DPP$	Always 0 for median calcs.
0	
PGA, (g)	0.490
$Z_{BOT}$ (km) (CB14)	Enter for default $W$ calcs
15	
SS	1 auto calculated
$V_{30}Flag$	1 measured
$F_{AS}$	0 Aftershock effect is not applicable.
Region	0 California
Option for $S_a$ value	1 Weighted average of the natural logarithm of the spectral values

DEFAULTs	USER defined	ASK14	BSSA14	CB14	CY14	I14
$W$ (km)	14.49			15.000		
$Z_{1.0}$ (km)	999.000	0.475			0.485	
$Z_{2.5}$ (km)	0.000		0.000			
$Z_{1.0}$ ( $V_{30} > 1.000$ ) (km)	999.000			0.398		
$Z_{2.5}$ ( $V_{30} > 2.5$ ) (km)	999.000			2.070		
$Z_{BOR}$ (km)	999.000			10.227		
$Z_{BOT}$ (km)	999.000			0.000	0.000	
$Z_{BOR}$ (km)	-			15.000		

ACKNOWLEDGEMENTS



All NGA West-2 participants are acknowledged for their constructive comments and feedback.



WEIGHTED AVERAGE of 2014 NGA WEST-2 GMPEs

Last updated: 04 14 15

by Emel Seyhan, PhD, PEER & UCLA -- email: emel.seyhan@gmail.com, peer\_center@berkeley.edu

San Bernardino [2]

This excel file will be updated as necessary on the PEER website to fix any typos or other errors. Please check the website frequently for new versions at: <http://peer.berkeley.edu/ngawest2/databases/>

GMPE Averaging Geometric Weighted average of the natural logarithm of the spectral values

GMPEs	ASK14	BSSA14	CB14	CY14	I14
Weight	0.25	0.25	0.25	0	0
# of std. dev.	1				
Damping ratio (%)	5				

Modification factors are calculated in Sheet DSF

Legend	Pre-defined option	Main input variable	Calculated variable	Input var. flag	Internal variable
--------	--------------------	---------------------	---------------------	-----------------	-------------------

- ASK14** Abrahamson & Silva & Kamai 2014 NGA West-2 Model
- BSSA14** Boore & Stewart & Seyhan & Atkinson 2014 NGA West-2 Model
- CB14** Campbell & Bozorgnia 2014 NGA West-2 Model
- CY14** Chiou & Youngs 2014 NGA West-2 Model
- I14** Idriss 2014 NGA West-2 Model

RotD50 Horizontal Component of PGA, PGV and IMs

Input variables Errors and warnings

$M_w$	8.02	
$R_{rup}$ (km)	4.75	
$R_{10}$ (km)	4.75	
$R_x$ (km)	4.75	
$R_{y0}$ (km)	999	If unknown use 999
$V_{s30}$ (m/sec)	260	
$U$ (BSSA13)	0	1: Unspecified fault mech.
$F_{rv}$	0	1: reverse fault
$F_{rw}$	0	1: normal fault
$F_{hw}$	0	1: hanging wall side
Dip (deg)	90	
$Z_{TOR}$ (km)	999	If unknown use 999
$Z_{HYP}$ (km)	999	If unknown use 999
$Z_{1.0}$ (km)	999	If unknown use 999
$Z_{2.5}$ (km)	999	If unknown use 999
$W$ (km)	15.52	If unknown use 999
$V_{s30}^{reg}$	measured	Choose options for $V_{s30}$ from the list
$F_{AS}$	no	After shock effect is not applicable.
Region	California	Choose region from the list

T (s)	Baseline: 5% Damping				User defined: 5% Damping			
	PSA Median for 5% damping	PSa Median + 1.0 for 5% damping	PSa Median - 1.0 for 5% damping	$S_d$ Median for 5% damping	PSa Median for 5% damping	PSa Median + 1.0 for 5% damping	PSa Median - 1.0 for 5% damping	$S_d$ Median for 5% damping
0.01	0.4685769	0.7717879	0.284488	0.001163	0.468577	0.7717879	0.284488	0.001163
0.02	0.4672075	0.7728393	0.282443	0.004639	0.467207	0.7728393	0.282443	0.004639
0.03	0.4655344	0.7732731	0.280266	0.010401	0.465534	0.7724998	0.279986	0.01039
0.05	0.4927954	0.8286748	0.293055	0.030583	0.492795	0.8286748	0.293055	0.030583
0.075	0.5698329	0.969373	0.334845	0.079568	0.571542	0.9726392	0.33585	0.079806
0.1	0.6513435	1.1060191	0.383581	0.161687	0.653297	1.1093372	0.384732	0.162173
0.15	0.8004187	1.3307478	0.481436	0.44706	0.80282	1.3347401	0.48288	0.448401
0.2	0.9200509	1.5118297	0.559913	0.913562	0.921891	1.5148533	0.561033	0.915389
0.25	1.0210175	1.6841809	0.618981	1.584089	1.026123	1.6926018	0.622076	1.592009
0.3	1.0951726	1.8394395	0.652048	2.44676	1.097363	1.8431184	0.653352	2.451654
0.4	1.1512941	1.9977591	0.663402	4.572699	1.153597	2.0017546	0.664009	4.581944
0.5	1.1414956	2.0320113	0.641244	7.084039	1.142598	2.0340433	0.641885	7.091123
0.75	0.9702613	1.8099959	0.520116	13.54807	0.970261	1.8099959	0.520116	13.54807
1	0.8476307	1.6307527	0.440581	21.04132	0.846783	1.6291219	0.44014	21.02028
1.5	0.6561926	1.2927122	0.333089	36.65052	0.656193	1.2927122	0.333089	36.65052
2	0.5248493	1.0466306	0.263194	52.11478	0.5238	1.0445373	0.262668	52.01055
3	0.3757418	0.7540568	0.18723	83.94567	0.375306	0.7533027	0.187043	83.86172
4	0.2783273	0.5532113	0.14003	110.5458	0.278049	0.5526881	0.13989	110.4352
5	0.2097622	0.4178098	0.105312	130.1768	0.209133	0.4165563	0.104996	129.7863
7.5	0.1077052	0.2139466	0.054221	150.3923	0.10749	0.2135187	0.054113	150.0915
10	0.0626237	0.1232312	0.031824	155.4551	0.062373	0.1227383	0.031697	154.8333

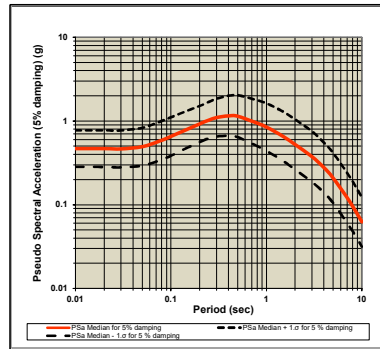

PGA (g)	0	0.4657978	0.7666721	0.282999	0.001156	0.468577	0.7717879	0.284488	0.001163
PGV (cm/s)	-1	92.638337	163.25985	52.56566	0.229963	NA	NA	NA	NA

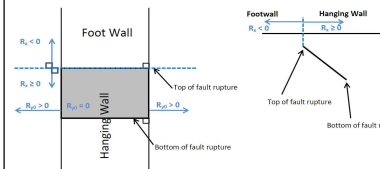
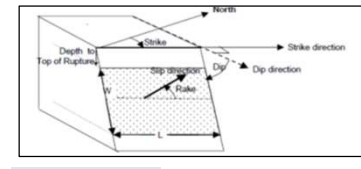
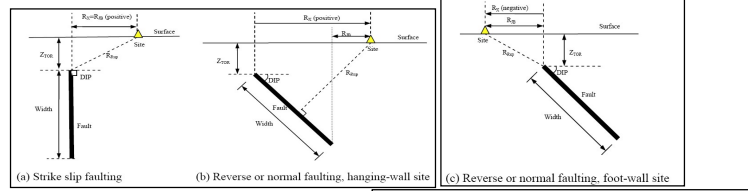

- Definition of Parameters**
- Damping ratio** = Viscous damping ratio (%) See Sanaz et al. (2012) PEER Report
  - PSA** = Pseudo-absolute acceleration response spectrum (g)
  - PGA** = Peak ground acceleration (g)
  - PGV** = Peak ground velocity (cm/s)
  - $S_d$**  = Relative displacement response spectrum (cm)
  - $M_w$**  = Moment magnitude
  - $R_{rup}$**  = Closest distance to coseismic rupture (km), used in ASK13, CB13 and CY13. See Figures a, b and c for illustration
  - $R_{10}$**  = Closest distance to surface projection of coseismic rupture (km). See Figures a, b and c for illustration
  - $R_x$**  = Horizontal distance from top of rupture measured perpendicular to fault strike (km). See Figures a, b and c for illustration
  - $R_{y0}$**  = The horizontal distance off the end of the rupture measured parallel to strike (km)
  - $V_{s30}$**  = The average shear-wave velocity (m/s) over a subsurface depth of 30 m
  - $U$**  = Unspecified-mechanism factor: 1 for unspecified; 0 otherwise
  - $F_{rv}$**  = Reverse-faulting factor: 0 for strike slip, normal, normal-oblique; 1 for reverse, reverse-oblique and thrust
  - $F_{rw}$**  = Normal-faulting factor: 0 for strike slip, reverse, reverse-oblique, thrust and normal-oblique; 1 for normal
  - $F_{hw}$**  = Hanging-wall factor: 1 for site on down-dip side of top of rupture; 0 otherwise
  - Dip** = Average dip of rupture plane (degrees)
  - $Z_{TOR}$**  = Depth to top of coseismic rupture (km)
  - $Z_{HYP}$**  = Hypocentral depth from the earthquake
  - $Z_{1.0}$**  = Depth to  $V_{s1.0}$  km/sec
  - $Z_{2.5}$**  = Depth to  $V_{s2.5}$  km/sec
  - $W$**  = Fault rupture width (km)
  - $V_{s30}^{reg}$**  = 1 for measured, 0 for inferred  $V_{s30}$
  - $F_{AS}$**  = 0 for mainshock; 1 for aftershock
  - Region** = Specific regions considered in the models. Click on Region to see codes
  - $\Delta DPP$**  = Directivity term, direct point parameters; uses 0 for median predictions
  - PGA, (g)** = Peak ground acceleration on rock (g), this specific cell is updated in the cell for BSSA14 and CB14, for others it is taken account for in the macros
  - $Z_{BOT}$  (km)** = The depth to the bottom of the seismicogenic crust
  - $Z_{BOR}$  (km)** = The depth to the bottom of the rupture plane
  - SS** = 1 for strike slip, automatically updated in the cell

Input variables with defaults (If entered 999 as input):

DEFAULTs	USER defined	ASK14	BSSA14	CB14	CY14	I14
$W$ (km)	15.52			15.000		
$Z_{1.0}$ (km)	999.000	0.475			0.485	
$Z_{2.5}$ (km)	0.000		0.000			
$Z_{1.0}$ ( $V_{s1.0}$ =1100)(km)	999.000			0.398		
$Z_{2.5}$ ( $V_{s2.5}$ )(km)	999.000			2.070		
$Z_{BOT}$ (km)	999.000			10.227		
$Z_{BOR}$ (km)	999.000			0.000	0.000	
$Z_{TOR}$ (km)	-					15.000

ACKNOWLEDGEMENTS



Nick Gregor, Bechtel  
Silvia Mazzoni, Consultant

All NGA West-2 participants are acknowledged for their constructive comments and feedback.

This excel file will be updated as necessary on the PEER website to fix any typos or other errors. Please check the website frequently for new versions at: <http://peer.berkeley.edu/ngawest2/databases/>

Legend	Pre-defined option	Main input variable	Calculated variable	Input var. flag	Internal variable
--------	--------------------	---------------------	---------------------	-----------------	-------------------

GMPE Averaging		Geometric				
Weighted average of the natural logarithm of the spectral values						
GMPEs	ASK14	BSSA14	CB14	CY14	I14	
Weight	0.25	0.25	0.25	0	0	
# of std. dev.	1					
Damping ratio (%)	5					Modification factors are calculated in Sheet DSF

- ASK14** Abrahamson & Silva & Kamai 2014 NGA West-2 Model
- BSSA14** Boore & Stewart & Seyhan & Atkinson 2014 NGA West-2 Model
- CB14** Campbell & Bozorgnia 2014 NGA West-2 Model
- CY14** Chiou & Youngs 2014 NGA West-2 Model
- I14** Idriss 2014 NGA West-2 Model

RotD50 Horizontal Component of PGA, PGV and IMs

Input variables Errors and warnings

GMP	T (s)	Baseline: 5% Damping				User defined: 5% Damping			
		PSA Median for 5% damping	PSa Median + 1.0 for 5% damping	PSa Median - 1.0 for 5% damping	S <sub>d</sub> Median for 5% damping	PSa Median for 5% damping	PSa Median + 1.0 for 5% damping	PSa Median - 1.0 for 5% damping	S <sub>d</sub> Median for 5% damping
M <sub>w</sub>	7.72	0.3685159	0.6128529	0.221593	0.000915	0.368516	0.6128529	0.221593	0.000915
R <sub>rup</sub> (km)	9.87	0.3666603	0.612466	0.219506	0.003641	0.36666	0.612466	0.219506	0.003641
R <sub>10</sub> (km)	9.67	0.3673099	0.6161102	0.218981	0.008206	0.366943	0.6154941	0.218762	0.008198
R <sub>x</sub> (km)	9.67	0.3945352	0.6694081	0.232531	0.024485	0.394535	0.6694081	0.232531	0.024485
R <sub>y0</sub> (km)	999	0.4644189	0.7967649	0.272701	0.064848	0.465812	0.7991551	0.271513	0.065043
V <sub>30</sub> (m/sec)	260	0.1	0.5381881	0.9214847	0.314326	0.133598	0.539803	0.9242491	0.315269
U (BSSA13)	0	0.0695791	1.1239894	0.398879	0.373982	0.670918	1.1282374	0.399677	0.37473
F <sub>rv</sub>	0	0.2	0.7676946	1.2752233	0.462158	0.762281	1.2777738	0.463083	0.763805
F <sub>rw</sub>	0	0.25	0.835898	1.3949625	0.500892	1.29668	1.3991473	0.502395	1.30077
F <sub>rw</sub>	0	0.3	0.8773337	1.4912196	0.516164	1.960079	0.879088	1.494202	0.517197
Dip (deg)	90	0.4	0.8884105	1.5574263	0.506878	0.890187	1.5605412	0.507794	0.508538
Z <sub>10R</sub> (km)	999	0.5	0.8584939	1.5420523	0.477942	0.832747	0.859352	1.5435943	0.47842
Z <sub>10P</sub> (km)	999	0.75	0.696456	1.3083211	0.370744	0.72485	0.696457	1.3083211	0.370744
Z <sub>1.5</sub> (km)	999	1	0.5873356	1.1360371	0.303655	14.57984	0.586748	1.134901	0.303351
Z <sub>2.5</sub> (km)	999	1.5	0.4361134	0.8616767	0.220727	24.35838	0.43655	0.8625384	0.220947
Z <sub>5</sub> (km)	999	2	0.3406684	0.6801161	0.17064	33.82659	0.339987	0.6787558	0.170299
W (km)	12.8	3	0.2350441	0.4717361	0.117111	52.51196	0.234909	0.4712943	0.116994
V <sub>30</sub> flag	measured	4	0.1714415	0.3407646	0.086254	68.09295	0.17127	0.3404239	0.086167
F <sub>AS</sub>	no	5	0.1275751	0.2541073	0.064049	79.17209	0.127192	0.2533449	0.063857
Region	California	7.5	0.0654974	0.1301046	0.032973	91.45614	0.065301	0.1297143	0.032874
Option for Sa value	1	10	0.0376888	0.0741643	0.019153	93.55758	0.037538	0.0738676	0.019076
PGA (g)	0	0.3684792	0.6090322	0.220525	0.00091	0.368516	0.6128529	0.221593	0.000915
PGV (cm/s)	-1	61.587847	108.85297	34.84255	0.152884	NA	NA	NA	NA

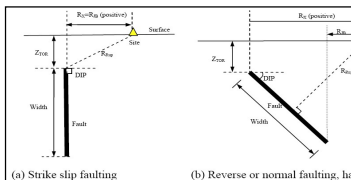
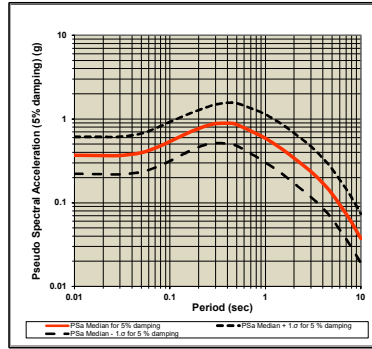

(a) Strike slip faulting

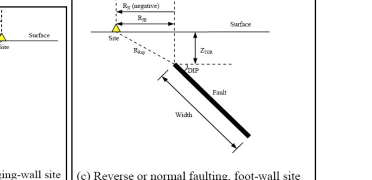

(b) Reverse or normal faulting, hanging-wall site

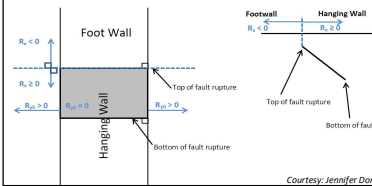

(c) Reverse or normal faulting, foot-wall site

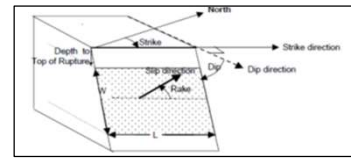

Definition of Parameters

- Damping ratio** = Viscous damping ratio (%) See Sanaz et al. (2012) PEER Report
- PSA** = Pseudo-absolute acceleration response spectrum (g)
- PGA** = Peak ground acceleration (g)
- PGV** = Peak ground velocity (cm/s)
- S<sub>d</sub>** = Relative displacement response spectrum (cm)
- M<sub>w</sub>** = Moment magnitude
- R<sub>rup</sub>** = Closest distance to coseismic rupture (km), used in ASK13, CB13 and CY13. See Figures a, b and c for illustration
- R<sub>10</sub>** = Closest distance to surface projection of coseismic rupture (km). See Figures a, b and c for illustration
- R<sub>x</sub>** = Horizontal distance from top of rupture measured perpendicular to fault strike (km). See Figures a, b and c for illustration
- R<sub>y0</sub>** = The horizontal distance off the end of the rupture measured parallel to strike (km)
- V<sub>30</sub>** = The average shear-wave velocity (m/s) over a subsurface depth of 30 m
- U** = Unspecified-mechanism factor: 1 for unspecified; 0 otherwise
- F<sub>rv</sub>** = Reverse-faulting factor: 0 for strike slip, normal, normal-oblique; 1 for reverse, reverse-oblique and thrust
- F<sub>rw</sub>** = Normal-faulting factor: 0 for strike slip, reverse, reverse-oblique, thrust and normal-oblique; 1 for normal
- F<sub>rw</sub>** = Hanging-wall factor: 1 for site on down-dip side of top of rupture; 0 otherwise
- Dip** = Average dip of rupture plane (degrees)
- Z<sub>10R</sub>** = Depth to top of coseismic rupture (km)
- Z<sub>10P</sub>** = Hypocentral depth from the earthquake
- Z<sub>1.5</sub>** = Depth to V>=1 km/sec
- Z<sub>2.5</sub>** = Depth to V>=2.5 km/sec
- W** = Fault rupture width (km)
- V<sub>30</sub>flag** = 1 for measured, 0 for inferred V<=30
- F<sub>AS</sub>** = 0 for mainshock; 1 for aftershock
- Region** = Specific regions considered in the models. Click on Region to see codes
- ADPP** = Directivity term, direct point parameter; uses 0 for median predictions
- PGA<sub>r</sub> (g)** = Peak ground acceleration on rock (g), this specific cell is updated in the cell for BSSA14 and CB14, for others it is taken account for in the macros
- Z<sub>807</sub> (km)** = The depth to the bottom of the seismicogenic crust
- Z<sub>808</sub> (km)** = The depth to the bottom of the rupture plane
- SS** = 1 for strike slip, automatically updated in the cell

Input variables with defaults (If entered 999 as input):	Red colored value: The value is used in the code when input is unknown	ASK14	BSSA14	CB14	CY14	I14
W (km)	12.80			15.000		
Z <sub>1.5</sub> (km)	999.000	0.475			0.485	
Z <sub>2.5</sub> (km)	0.000		0.000			
Z <sub>1.5</sub> (V<=1100)(km)	999.000			0.398		
Z <sub>2.5</sub> (V<=1100)(km)	999.000			2.070		
Z <sub>10R</sub> (km)	999.000			10.227		
Z <sub>10P</sub> (km)	999.000			0.000	0.000	
Z <sub>808</sub> (km)	-			15.000		

ACKNOWLEDGEMENTS



Nick Gregor, Bechtel  
Silvia Mazzoni, Consultant

All NGA West-2 participants are acknowledged for their constructive comments and feedback.

**APPENDIX E  
STANDARD GRADING GUIDELINES**

## **STANDARD GRADING SPECIFICATIONS**

These specifications present the usual and minimum requirements for grading operations performed under the observation and testing of TGR Geotechnical, Inc.

No deviation from these specifications will be allowed, except where specifically superseded in the Preliminary Geotechnical Investigation report, or in other written communication signed by the Soils Engineer or Engineering Geologist.

### **1.0 GENERAL**

- The Soils Engineer and Engineering Geologist are the Owner's or Builder's representatives on the project. For the purpose of these specifications, observation and testing by the Soils Engineer includes that observation and testing performed by any person or persons employed by, and responsible to, the licensed Geotechnical Engineer or Geologist signing the grading report.
- All clearing, site preparation or earthwork performed on the project shall be conducted by the Contractor under the observation of the Geotechnical Engineer.
- It is the Contractor's responsibility to prepare the ground surface to receive the fills to the satisfaction of the Geotechnical Engineer and to place, spread, mix, water and compact the fill in accordance with the specifications of the Geotechnical Engineer. The Contractor shall also remove all material considered unsatisfactory by the Geotechnical Engineer.
- It is also the Contractor's responsibility to have suitable and sufficient compaction equipment on the job site to handle the amount of fill being placed. If necessary, excavation equipment will be shut down to permit completion of Compaction. Sufficient watering apparatus will also be provided by the Contractor, with due consideration for the fill material, rate of placement and time of year.
- A final report will be issued by the Geotechnical Engineer and Engineering Geologist attesting to the Contractor's conformance with these specifications.



**2.0 SITE PREPARATION**

- All vegetation and deleterious material such as rubbish shall be disposed of off-site. The removal must be concluded prior to placing fill.
- The Civil Engineer shall locate all houses, sheds, sewage disposal systems, large trees or structures on the site, or on the grading plan to the best of his knowledge prior to preparing the ground surface.
- Soil, alluvium or rock materials determined by the Geotechnical Engineer as being unsuitable for placement in compacted fills shall be removed and wasted from the site. Any material incorporated as part of a compacted fill must be approved by the Geotechnical Engineer.
- After the ground surface to receive fill has been cleared, it shall be scarified, disced or bladed by the Contractor until it is uniform and free from ruts, hollows, hummocks or other uneven features which may prevent uniform compaction.

The scarified ground surface shall then be brought to optimum moisture content, mixed as required, and compacted as specified. If the scarified zone is greater than twelve inches in depth, the excess shall be removed and placed in lifts restricted to six inches. Prior to placing fill, the ground surface to receive fill shall be inspected, tested and approved by the Geotechnical Engineer.

- Any underground structures such as cesspools, cisterns, mining shafts, tunnels, septic tanks, wells, pipe lines or others not located prior to grading are to be removed or treated in a manner prescribed by the Geotechnical Engineer.

**3.0 COMPACTED FILLS**

- Any material imported or excavated on the property may be utilized in the fill, provided each material has been determined to be suitable by the Geotechnical Engineer. Roots, tree branches and other matter missed during clearing shall be removed from the fill as directed by the Geotechnical Engineer.
- Rock fragments less than six inches in diameter may be utilized in the fill, provided:

- They are not placed in concentrated pockets.
  - There is a sufficient percentage of fine-grained material to surround the rocks.
  - The distribution of the rocks is observed by the Geotechnical Engineer.
- Rocks greater than six inches in diameter shall be taken off-site, or placed in accordance with the recommendations of the Geotechnical Engineer in areas designated as suitable for rock disposal. Details for rock disposal such as location, moisture control, percentage of the rock placed, etc., will be referred to in the “Conclusions and Recommendations” section of the Geotechnical Report, if applicable.

If rocks greater than six inches in diameter were not anticipated in the Preliminary Geotechnical report, rock disposal recommendations may not have been made in the “Conclusions and Recommendations” section. In this case, the Contractor shall notify the Geotechnical Engineer if rocks greater than six inches in diameter are encountered. The Geotechnical Engineer will then prepare a rock disposal recommendation or request that such rocks be taken off-site.

- Material that is spongy, subject to decay, or otherwise considered unsuitable shall not be used in the compacted fill.
- Representative samples of materials to be utilized as compacted fill shall be analyzed in the laboratory by the Geotechnical Engineer to determine their physical properties. If any material other than that previously tested is encountered during grading, the appropriate analysis of this material shall be conducted by the Geotechnical Engineer as soon as possible.
- Material used in the compacting process shall be evenly spread, watered or dried, processed and compacted in thin lifts not to exceed six inches in thickness to obtain a uniformly dense layer. The fill shall be placed and compacted on a horizontal plane, unless otherwise approved by the Geotechnical Engineer.

- If the moisture content or relative compaction varies from that required by the Geotechnical Engineer, the Contractor shall rework the fill until it is approved by the Geotechnical Engineer.
- Each layer shall be compacted to 90 percent of the maximum dry density in compliance with the testing method specified by the controlling governmental agency; (in general, ASTM D1557 will be used.)

If compaction to a lesser percentage is authorized by the controlling governmental agency because of a specific land use or expansive soil conditions, the area to receive fill compacted to less than 90 percent shall either be delineated on the grading plan or appropriate reference made to the area in the grading report.

- All fill shall be keyed and benched through all topsoil, colluvium, alluvium or creep material, into sound bedrock or firm material where the slope receiving fill exceeds a ratio of five horizontal to one vertical, in accordance with the recommendations of the Geotechnical Engineer.
- The key for side hill fills shall be a minimum of 15 feet within bedrock or firm materials, unless otherwise specified in the Preliminary report. (See details)
- Drainage terraces and subdrainage devices shall be constructed in compliance with the ordinances of the controlling governmental agency, or with the recommendation of the Geotechnical Engineer and Engineer Geologist.
- The Contractor will be required to obtain a minimum relative compaction of 90 percent out to the finish slope face of fill slopes, buttresses and stabilization fills. This may be achieved by either overbuilding the slope and cutting back to the compacted core, or by direct compaction of the slope face with suitable equipment, or by any other procedure which produces the required compaction.

The Contractor shall prepare a written detailed description of the method or methods he will employ to obtain the required slope compaction. Such documents shall be submitted to the Geotechnical Engineer for review and comments prior to the start of grading.

If a method other than overbuilding and cutting back to the compacted core is to be employed, slope tests will be made by the Geotechnical Engineer during construction of the slopes to determine if the required compaction is being achieved. Where failing tests occur or other field problems arise, the contractor will be notified by the Geotechnical Engineer.

If the method of achieving the required slope compaction selected by the Contractor fails to produce the necessary results, the Contractor shall rework or rebuild such slopes until the required degree of compaction is obtained, at no additional cost to the Owner or Geotechnical Engineer.

- All fill slopes should be planted or protected from erosion by methods specified in the preliminary report or by means approved by the governing authorities.
- Fill-over-cut slopes shall be properly keyed through topsoil, colluvium or creep material into rock or firm materials; and the transition shall be stripped of all soil prior to placing fill. (See detail)

#### **4.0 CUT SLOPES**

- The Engineering Geologist shall inspect all cut slopes excavated in rock, lithified or formation material at vertical intervals not exceeding ten feet.
- If any conditions not anticipated in the preliminary report such as perched water, seepage, lenticular or confined strata of a potentially adverse nature, unfavorably inclined bedding, joints or fault planes are encountered during grading, these

conditions shall be analyzed by the Engineering Geologist and Geotechnical Engineer; and recommendations shall be made to treat these problems.

- Cut slopes that face in the same direction as the prevailing drainage shall be protected from slope wash by a non-erosive interceptor swale placed at the top of the slope.
- Unless otherwise specified in the soils and geological report, no cut slopes shall be excavated higher or steeper than that allowed by the ordinances of controlling governmental agencies.
- Drainage terraces shall be constructed in compliance with the ordinances of controlling governmental agencies, or with the recommendations of the Geotechnical Engineer or Engineering Geologist.

## **5.0 GRADING CONTROL**

- Inspection of the fill placement shall be provided by the Geotechnical Engineer during the progress of grading.
- In general, density tests should be made at intervals not exceeding two feet of fill height or every 500 cubic yards of fill placed. This criteria will vary depending on soil conditions and the size of the job. In any event, an adequate number of field density tests shall be made to verify that the required compaction of being achieved.
- Density tests should be made on the surface material to receive fill as required by the Geotechnical Engineer.
- All cleanout, processed ground to receive fill, key excavations, subdrains and rock disposal must be inspected and approved by the Geotechnical Engineer (and often by the governing authorities) prior to placing any fill. It shall be the Contractor's responsibility to notify the Geotechnical Engineer and governing authorities when such areas are ready for inspection.

**6.0 CONSTRUCTION CONSIDERATIONS**

- Erosion control measures, when necessary, shall be provided by the Contractor during grading and prior to the completion and construction of permanent drainage controls.
- Upon completion of grading and termination of observations by the Geotechnical Engineer, no further filling or excavating, including that necessary for footings, foundations, large tree wells, retaining walls, or other features shall be performed without the approval of the Geotechnical Engineer or Engineering Geologist.
- Care shall be taken by the Contractor during final grading to preserve any berms, drainage terraces, interceptor swales, or other devices of a permanent nature on or adjacent to the property.

# TYPICAL OVEREXCAVATION OF DAYLIGHT LINE

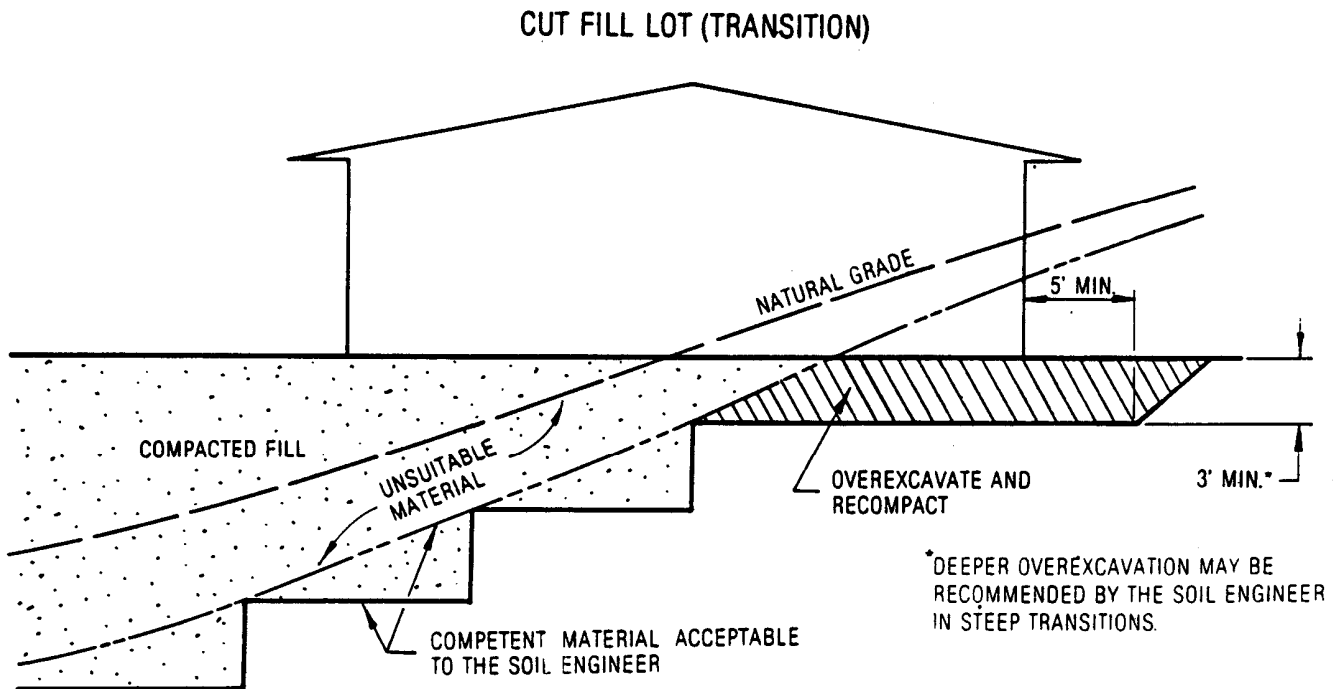
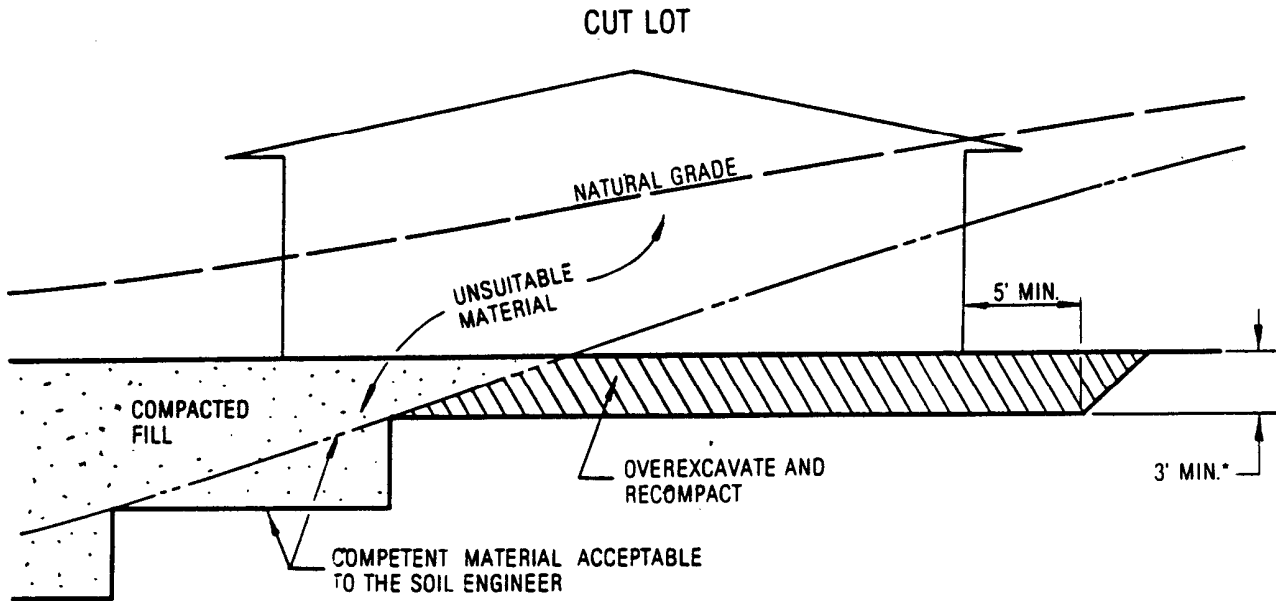

# TYPICAL FILL OVER NATURAL SLOPE

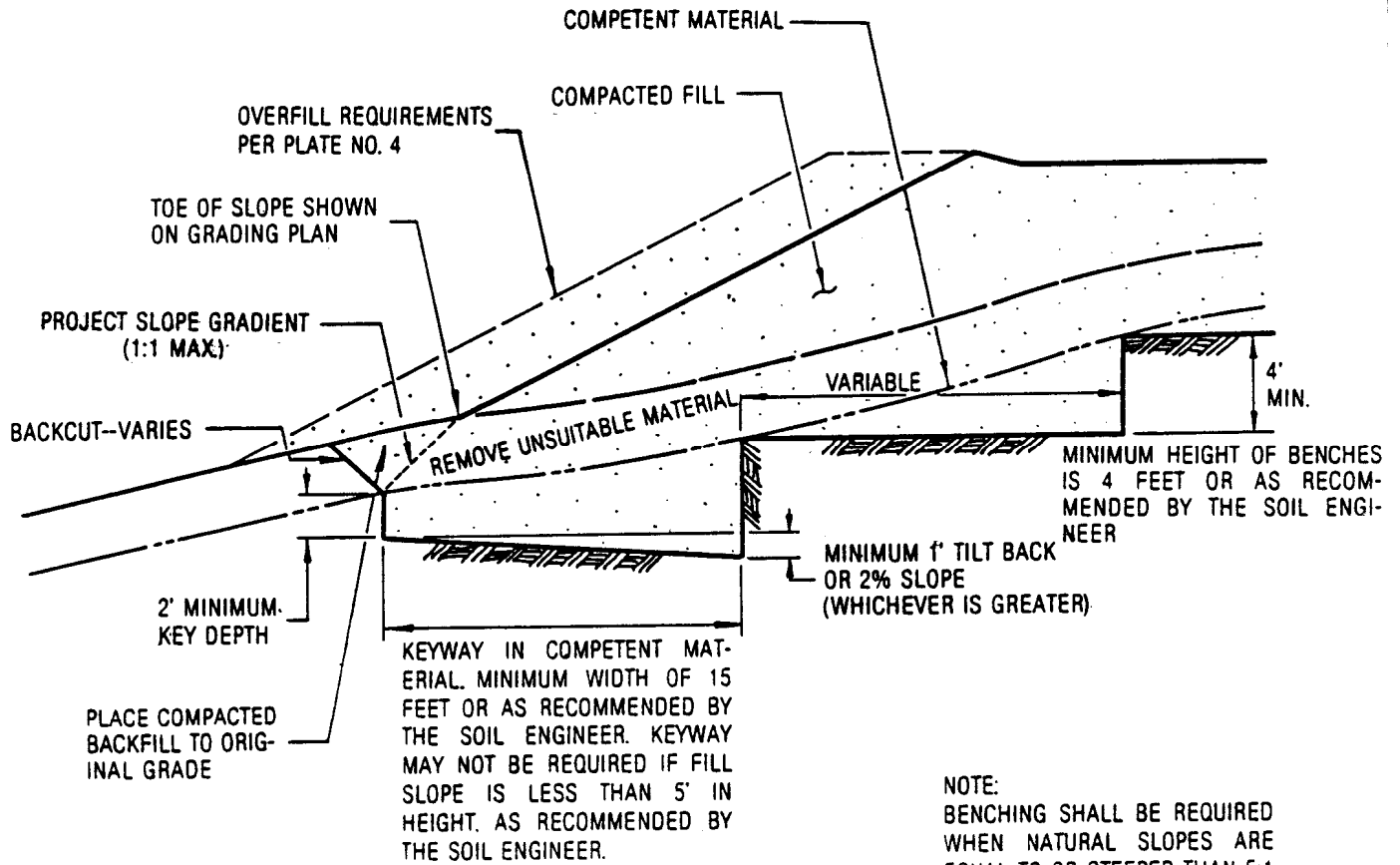

NOTE:  
 BENCHING SHALL BE REQUIRED  
 WHEN NATURAL SLOPES ARE  
 EQUAL TO OR STEEPER THAN 5:1  
 OR WHEN RECOMMENDED BY  
 THE SOIL ENGINEER.



# TYPICAL FILL-OVER-CUT SLOPE

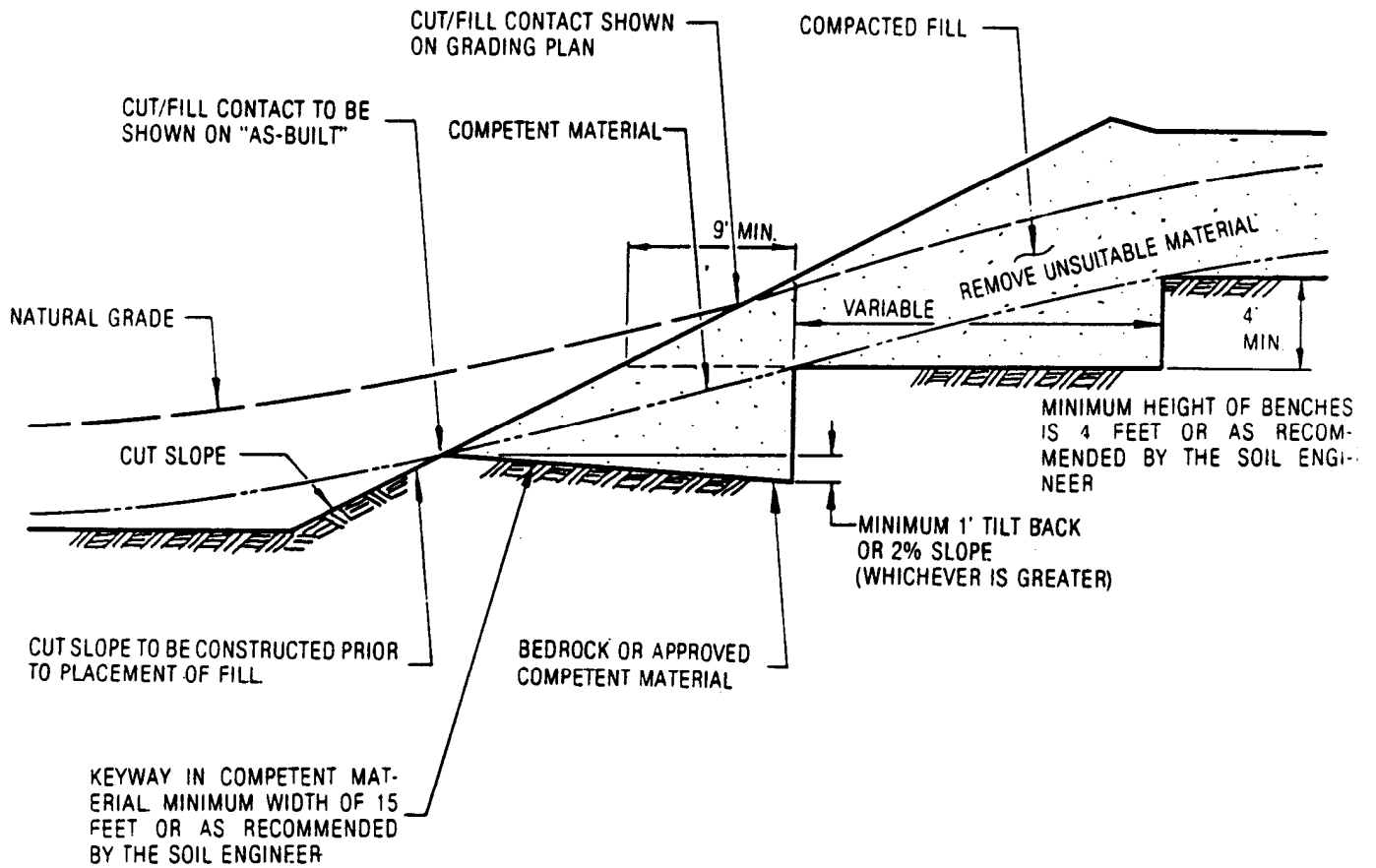

# TYPICAL FILL SLOPE CONSTRUCTION

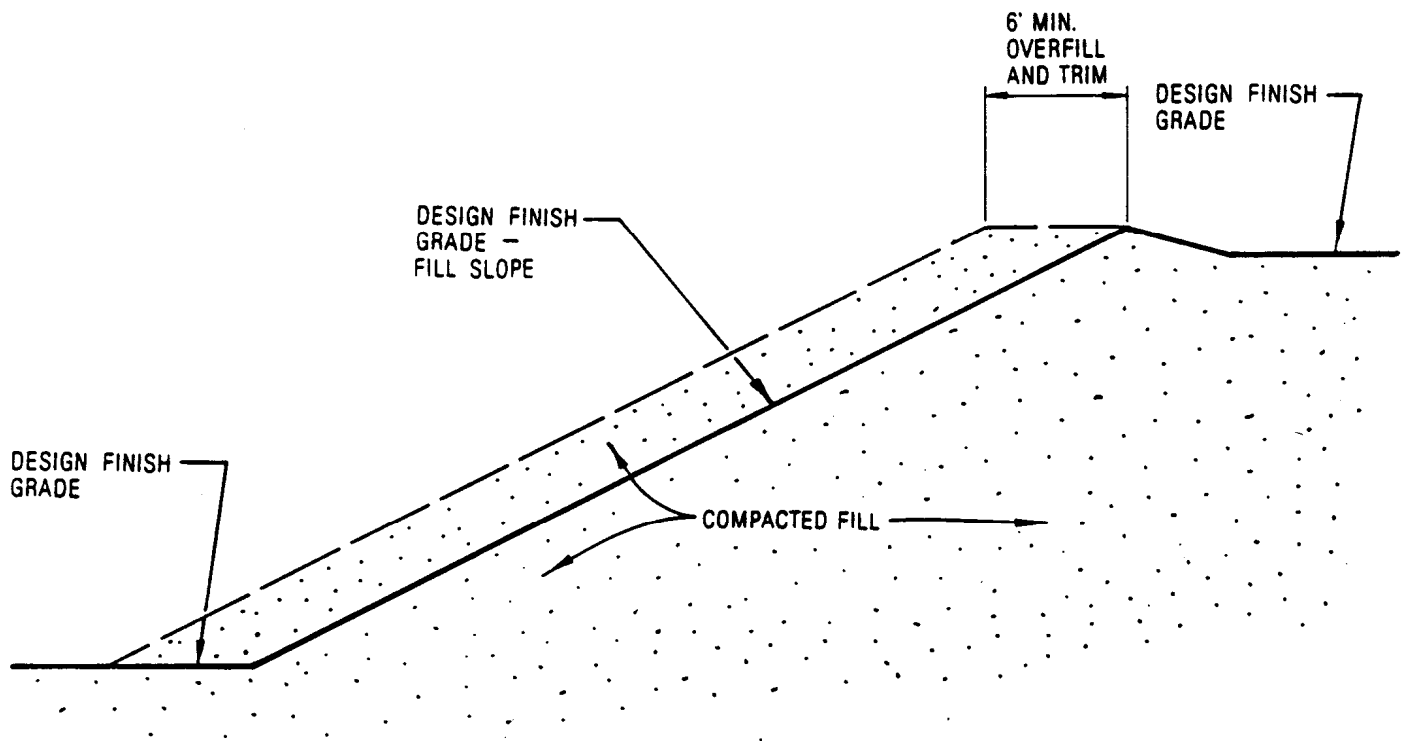

## NOTES:

1. ALL FILL SLOPES, INCLUDING BUTTRESS AND STABILIZATION FILLS, SHALL BE OVERFILLED A MINIMUM OF SIX FEET HORIZONTALLY WITH COMPACTED FILL AND TRIMMED TO THE DESIGN FINISH GRADE.

### EXCEPTIONS:

- A. FILL SLOPE OVER CUT SLOPE.
  - B. FILL SLOPE ADJACENT TO EXISTING IMPROVEMENTS.
2. THE EXCEPTIONS ABOVE WHICH DO NOT HAVE THE 6 FOOT SLOPE OVERFILL AND TRIM SHALL BE COMPACTED AS STATED IN THE PROJECT SPECIFICATIONS.

# TYPICAL STABILIZATION FILL

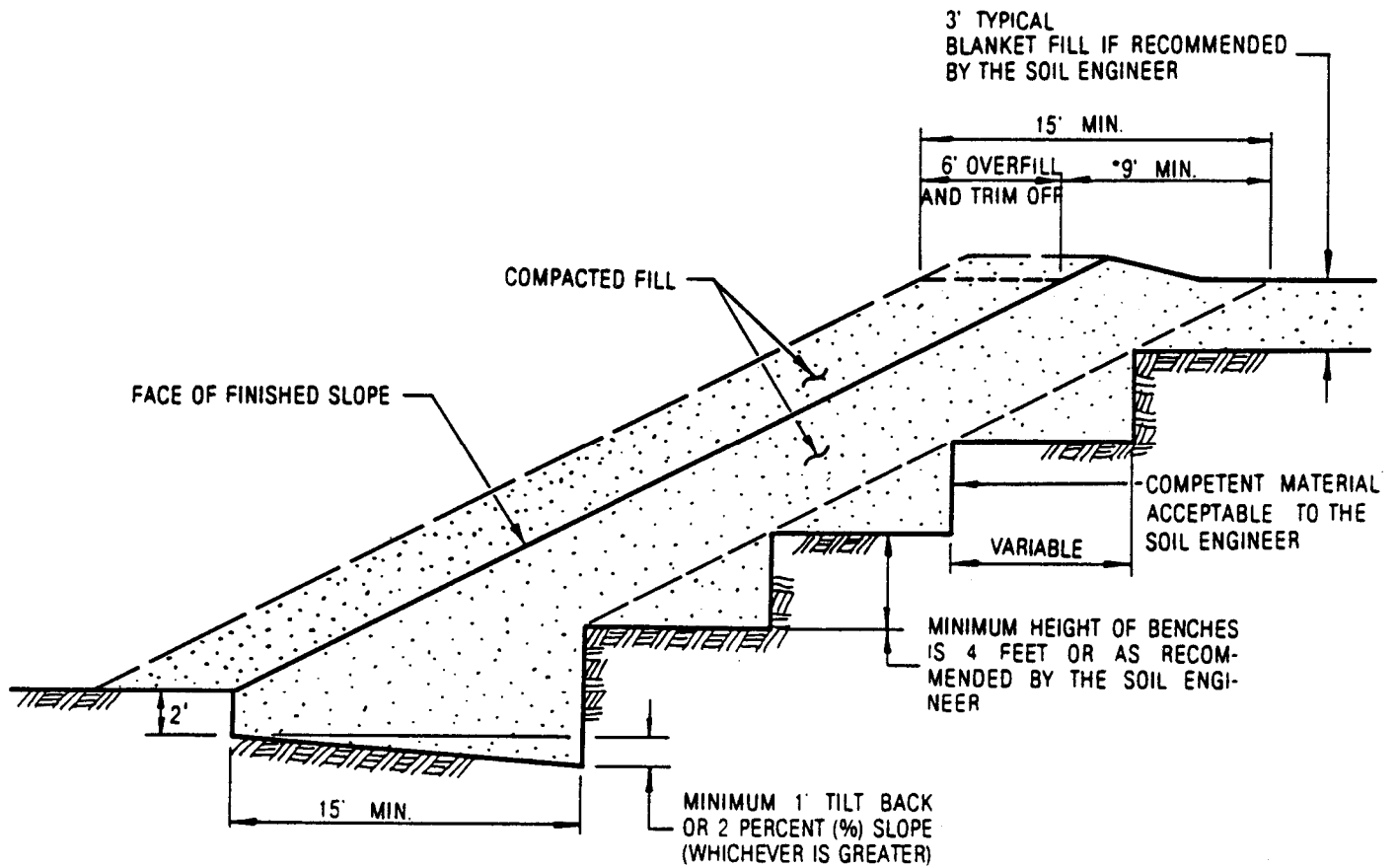

NOTE:  
SEE PLATE 6 FOR TYPICAL  
SUBDRAIN DETAILS FOR STA-  
BILIZATION FILLS. IF RECOM-  
MENDED BY THE SOIL ENGI-  
NEER.

\*GREATER THAN 9' IF RECOM-  
MENDED BY THE SOIL ENGINEER.  
15' WHERE NO 6' OVERFILL

# TYPICAL CANYON SUBDRAIN

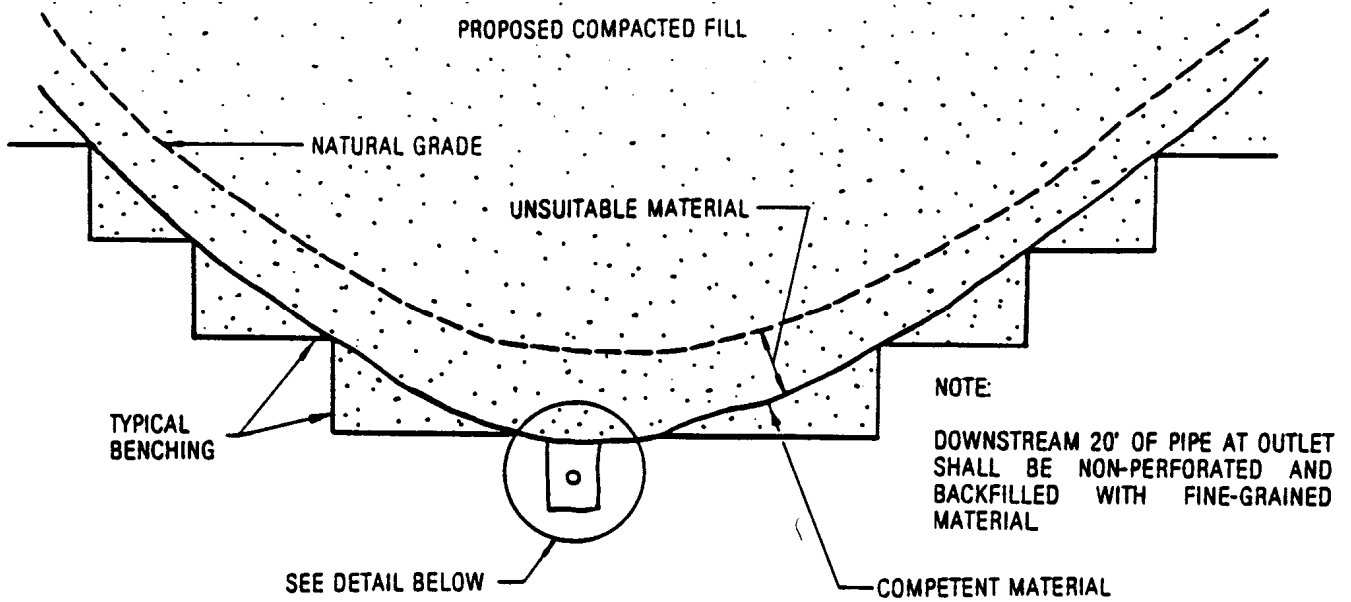

NOTES:  
PIPE SHALL BE A MINIMUM OF 4 INCHES DIAMETER AND RUNS OF 500 FEET OR MORE USE 6-INCH DIAMETER PIPE, OR AS RECOMMENDED BY THE SOIL ENGINEER

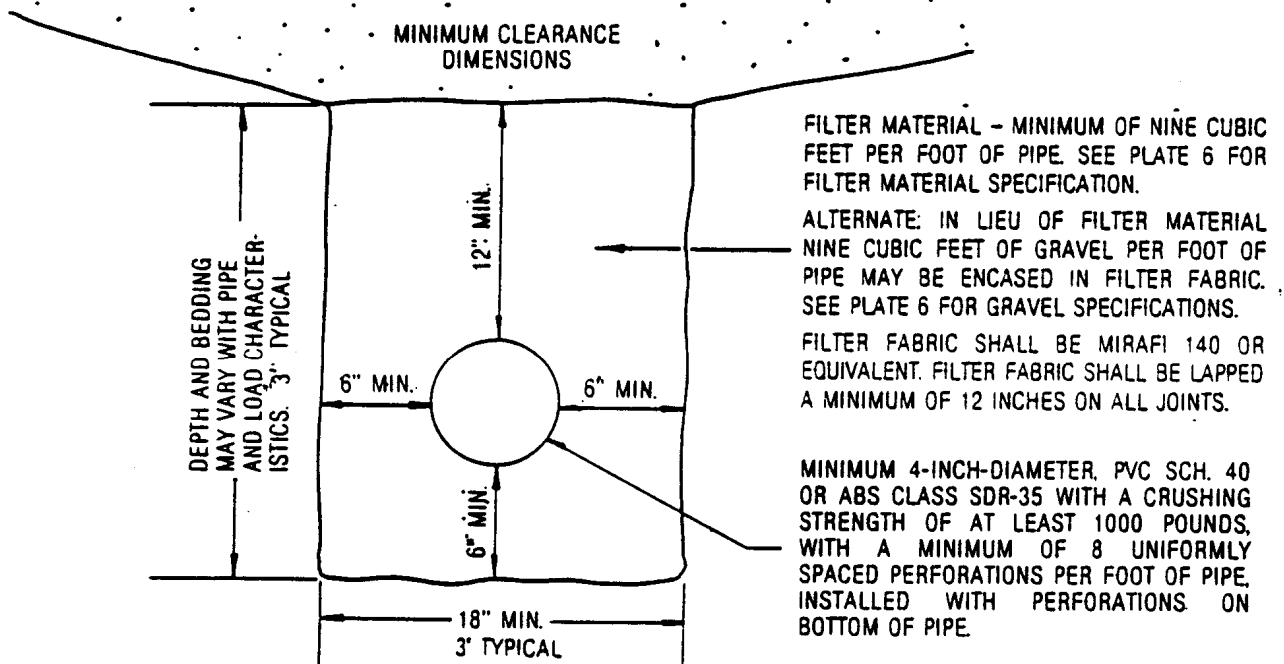

# SUBDRAIN OUTLET MARKER

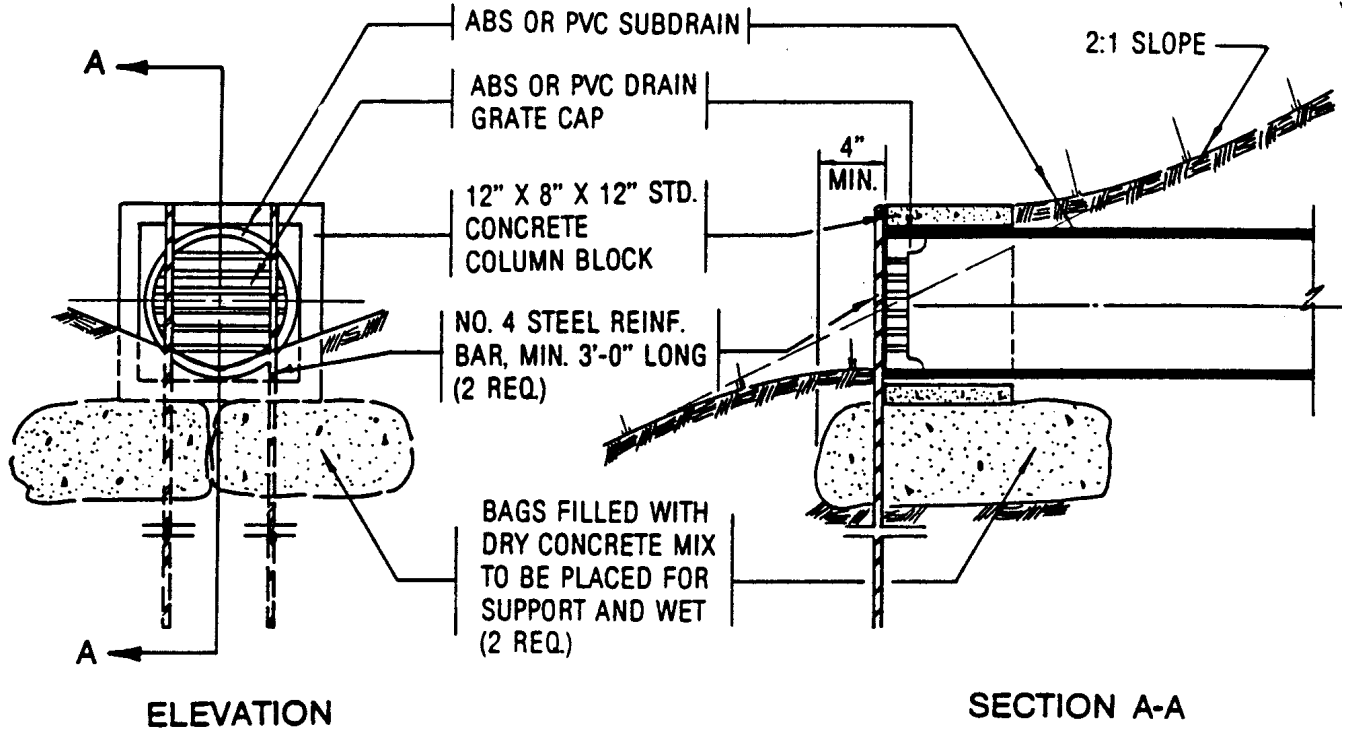

# SUBDRAIN OUTLET MARKER FOR 6" AND 8" PIPES

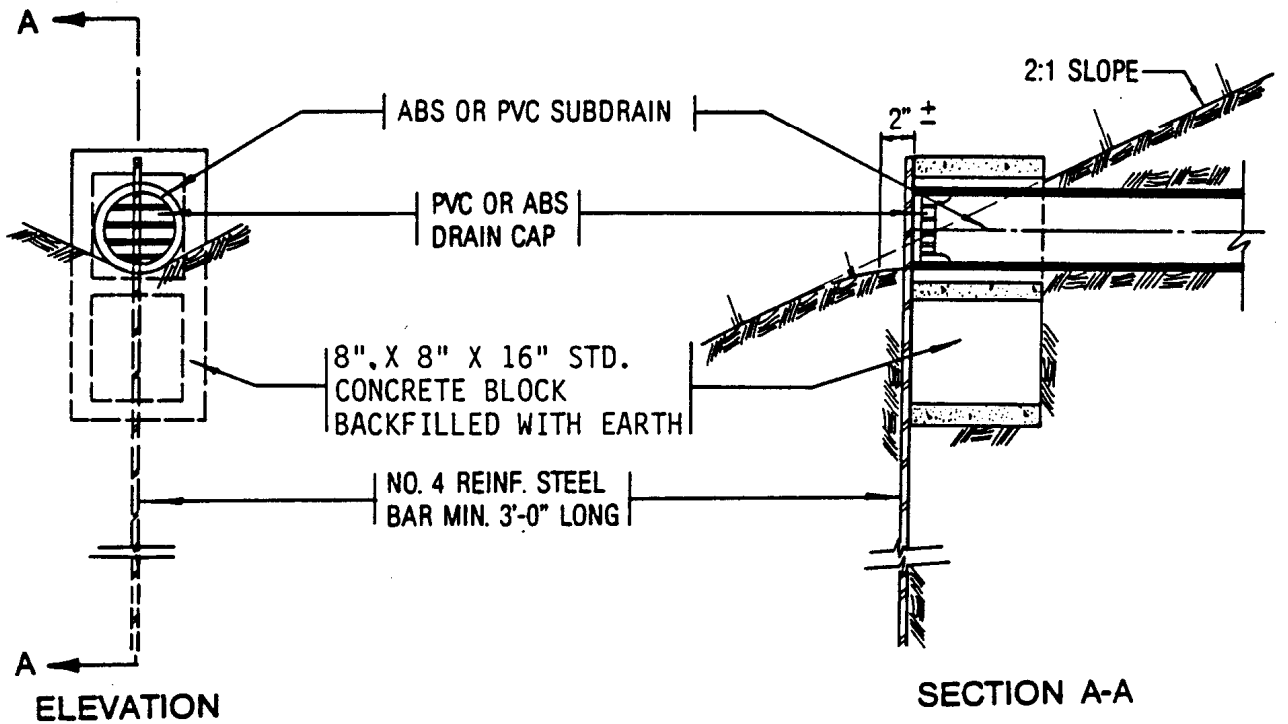

# SUBDRAIN OUTLET MARKER - 4" PIPE

# TYPICAL STABILIZATION AND BUTTRESS FILL SUBDRAIN

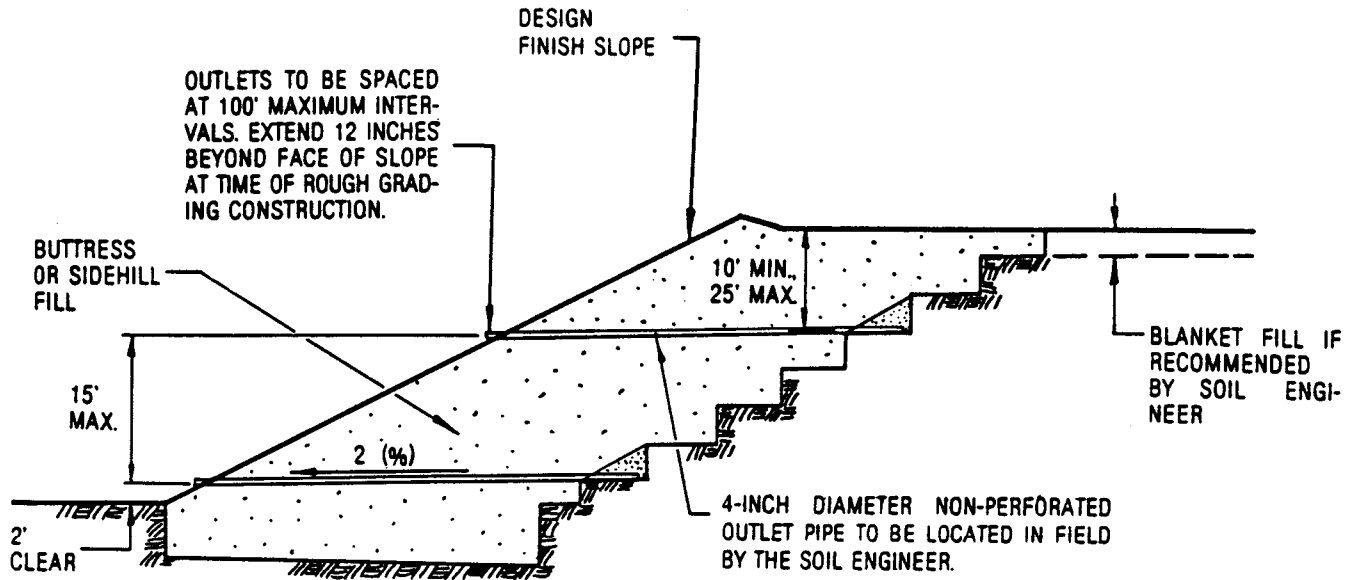

FILTER MATERIAL TO MEET FOLLOWING SPECIFICATION OR APPROVED EQUIVALENT: (CONFORMS TO MA STD. PLAN 323)

SIEVE SIZE	PERCENTAGE PASSING
1"	100
3/4"	90-100
3/8"	40-100
NO. 4	25-40
NO. 8	18-33
NO. 30	5-15
NO. 50	0-7
NO. 200	0-3

"GRAVEL" TO MEET FOLLOWING SPECIFICATION OR APPROVED EQUIVALENT:

SIEVE SIZE	MAXIMUM PERCENTAGE PASSING
1 1/2"	100
NO. 4	50
NO. 200	8

SAND EQUIVALENT = MINIMUM OF 50

FILTER MATERIAL - MINIMUM OF FIVE CUBIC FEET PER FOOT OF PIPE. SEE ABOVE FOR FILTER MATERIAL SPECIFICATION.

ALTERNATIVE: IN LIEU OF FILTER MATERIAL FIVE CUBIC FEET OF GRAVEL PER FOOT OF PIPE MAY BE ENCASED IN FILTER FABRIC. SEE ABOVE FOR GRAVEL SPECIFICATION.

FILTER FABRIC SHALL BE MIRAFI 140 OR EQUIVALENT. FILTER FABRIC SHALL BE LAPPED A MINIMUM OF 12 INCHES ON ALL JOINTS.

MINIMUM 4-INCH DIAMETER PVC SCH 40 OR ABS CLASS SDR 35 WITH A CRUSHING STRENGTH OF AT LEAST 1,000 POUNDS, WITH A MINIMUM OF 8 UNIFORMLY SPACED PERFORATIONS PER FOOT OF PIPE INSTALLED WITH PERFORATIONS ON BOTTOM OF PIPE. PROVIDE CAP AT UPSTREAM END OF PIPE. SLOPE AT 2 PERCENT TO OUTLET PIPE.

OUTLET PIPE TO BE CONNECTED TO SUBDRAIN PIPE WITH TEE OR ELBOW

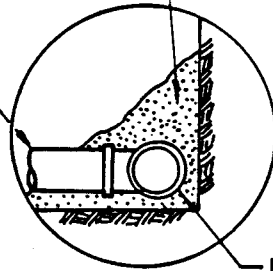

## NOTES:

- TRENCH FOR OUTLET PIPES TO BE BACKFILLED WITH ON-SITE SOIL.

# TYPICAL CUT AND FILL GRADING DETAILS

## TYPICAL GRADING WITHIN PROPOSED DEEP BEDROCK CUT AREAS

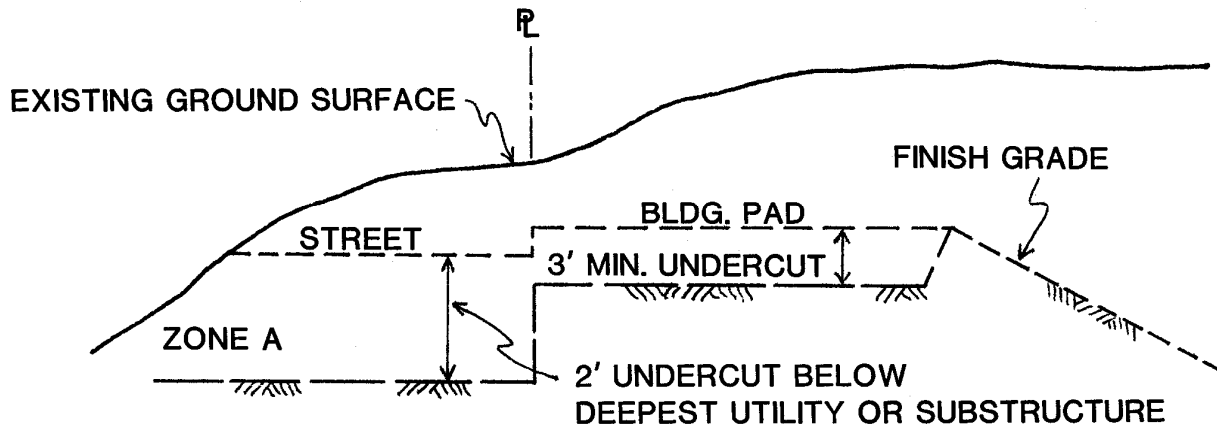

## TYPICAL GRADING WITHIN PROPOSED FILL AREAS

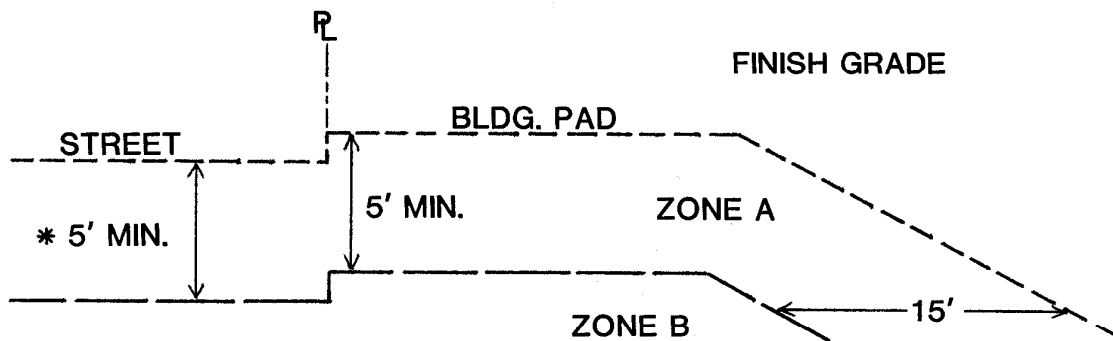

### LEGEND

ZONE A ..... "SOIL" FILL PLACED IN ACCORDANCE WITH THE RECOMMENDATIONS PRESENTED IN SECTION 11.2.3 OF THIS REPORT

ZONE B ..... "SOIL-ROCK" AND/OR "ROCK" FILL PLACED IN ACCORDANCE WITH THE RECOMMENDATIONS PRESENTED IN SECTION 11.2.3 OF THIS REPORT

\* 5' OR 1' BELOW DEEPEST UTILITY, WHICHEVER IS GREATER

# TYPICAL OVERSIZE ROCK DISPOSAL – “SOIL-ROCK” FILL

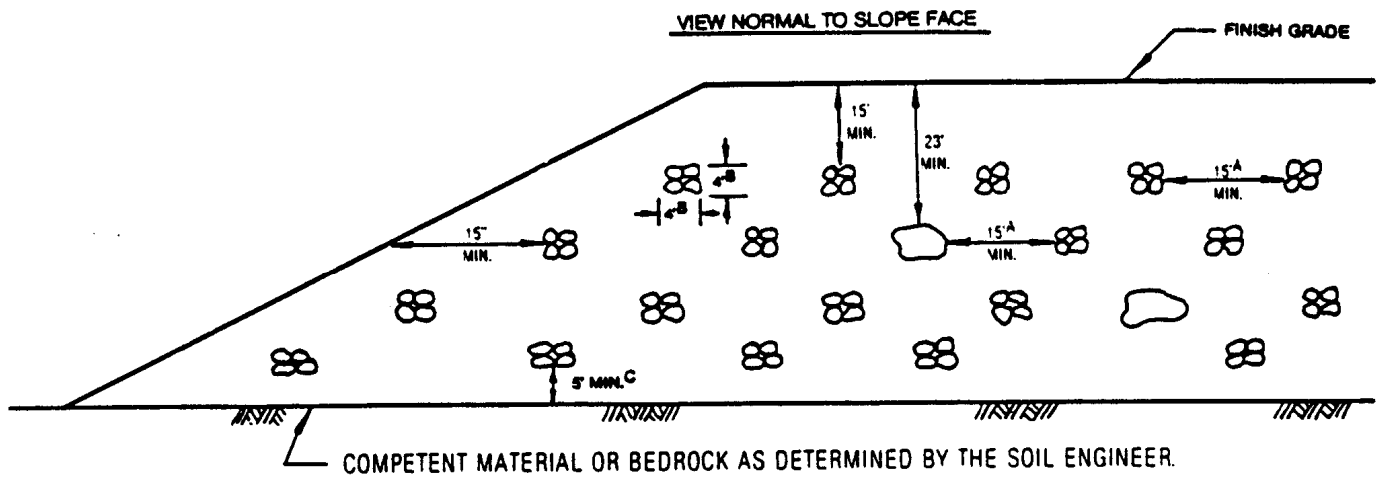

NOTE:  
ORIENTATION OF WINDROWS MAY VARY BUT SHALL BE AS RECOMMENDED BY SOIL ENGINEER.

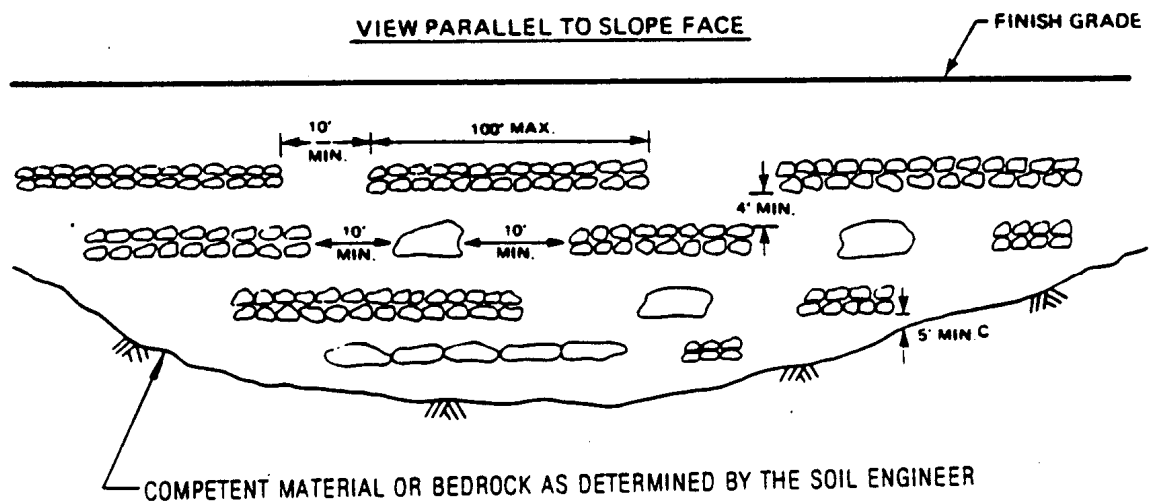

NOTES:

- A. ONE EQUIPMENT WIDTH OR A MINIMUM OF 15 FEET.
- B. HEIGHT AND WIDTH MAY VARY DEPENDING ON ROCK SIZE AND TYPE OF EQUIPMENT.
- C. IF APPROVED BY THE SOIL ENGINEER, WINDROWS MAY BE PLACED DIRECTLY ON COMPETENT MATERIALS OR BEDROCK PROVIDING ADEQUATE SPACE IS AVAILABLE FOR COMPACTION.
- D. VOIDS IN WINDROW TO BE FILLED BY FLOODING GRANULAR SOIL INTO PLACE. GRANULAR SOIL SHALL MEAN ANY SOIL WHICH HAS A UNIFIED SOIL CLASSIFICATION SYSTEM (UBC 29-1) DESIGNATION OF SM, SP, SW, GM, GP, OR GW.
- E. AFTER FILL BETWEEN WINDROWS IS PLACED AND COMPACTED WITH THE LIFT OF FILL COVERING WINDROW, WINDROW SHALL BE PROOF-ROLLED WITH D-9 DOZER OR EQUIVALENT.
- F. OVERSIZED ROCK IS DEFINED AS LARGER THAN 12" IN SIZE.