

West Santa Ana Branch Transit Corridor

Draft EIS/EIR Appendix B: Final Advanced Conceptual Alignment Design
Part 2

If you experience difficulty accessing the information in this document,
please contact: Phone (213) 922-6262 or email wsab@metro.net



09-FEB-2021

wspw04-pw-sv23:23

Pentable-bw.plt

B-28091AG01.plt
Plot Driver-MTA-half.pen

CITY OF
LOS ANGELES

CITY OF
LOS ANGELES

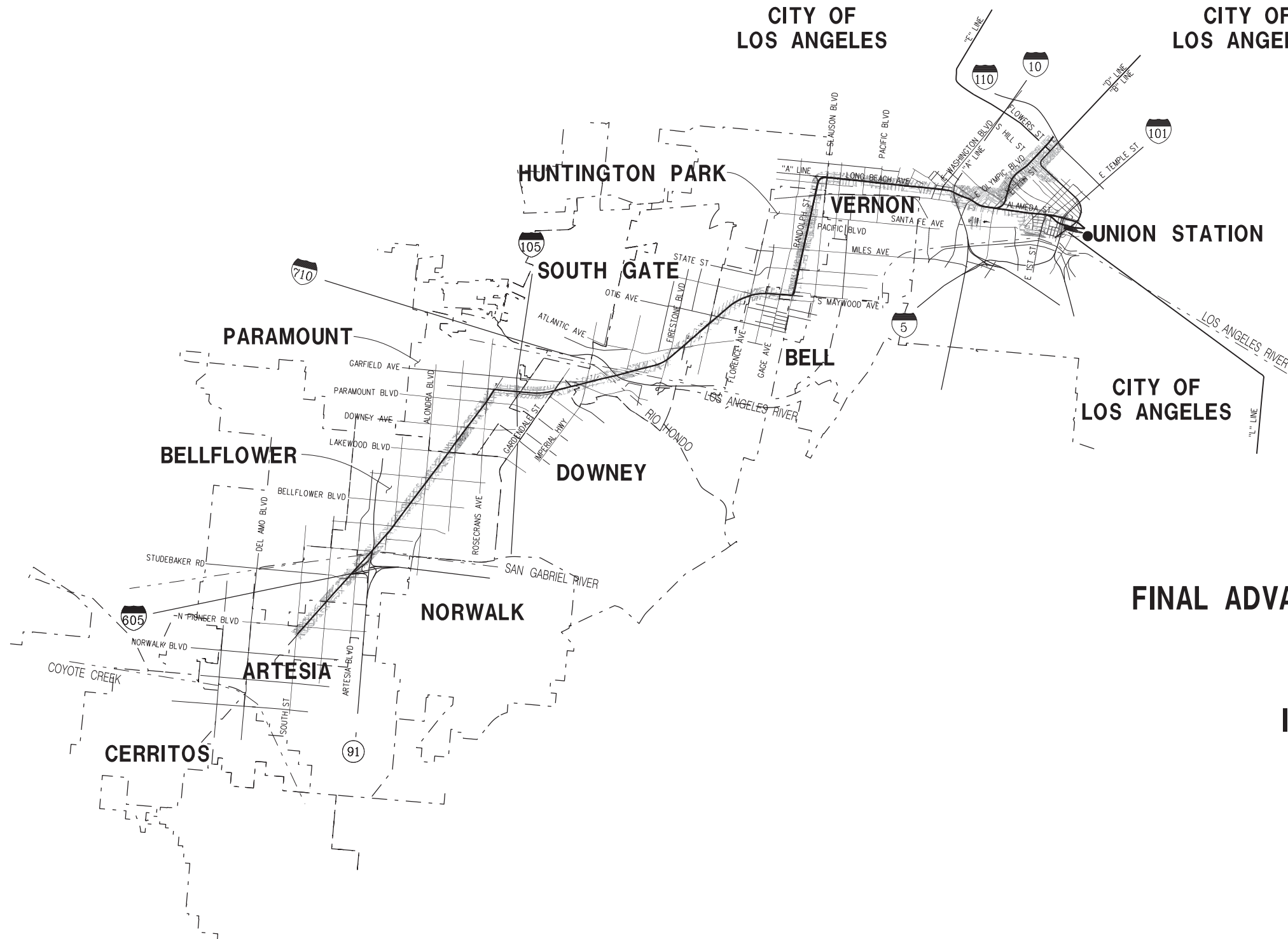

FINAL ADVANCED CONCEPTUAL ENGINEERING

GRADE CROSSINGS

ISSUE: AUGUST 26, 2020

WEST SANTA ANA BRANCH TRANSIT CORRIDOR PROJECT

444 South Flower Street
Suite 800
Los Angeles, CA 90071
TEL (213) 362-9470



LOS ANGELES COUNTY
METROPOLITAN TRANSPORTATION AUTHORITY

INDEX OF DRAWINGS

SHT NO	DWG NO	DWG TITLE
GENERAL		
1	G-002	GENERAL INDEX
2	G-003	GENERAL ABBREVIATIONS, GENERAL NOTES AND LEGENDS
GRADE CROSSING		
3	CS-101	GRADE CROSSING SANTA FE AVE & ALAMEDA ST PLAN
4	CS-102	GRADE CROSSING MALABAR ST & PACIFIC BLVD PLAN
5	CS-103	GRADE CROSSING SEVILLE AVE & MILES AVE PLAN
6	CS-104	GRADE CROSSING ARBUTUS AVE & HOLMES ST PLAN
7	CS-105	GRADE CROSSING STATE ST PLAN
8	CS-201	GRADE CROSSING GAGE AVE & BELL AVE PLAN
9	CS-202	GRADE CROSSING FLORENCE AVE & OTIS AVE PLAN
10	CS-203	GRADE CROSSING SANTA ANNA ST & ARDINE ST PLAN
11	CS-204	GRADE CROSSING ATLANTIC AVE & FIRESTONE BLVD PLAN
12	CS-205	GRADE CROSSING RAYO AVE & SOUTHERN AVE PLAN
13	CS-206	PRIVATE GRADE CROSSINGS MILLER WAY & PRIVATE DRIVE PLAN
14	CS-207	GRADE CROSSING GARFIELD AVE & IMPERIAL HWY PLAN
15	CS-208	GRADE CROSSING GARDENDALE ST & MAIN ST PLAN
16	CS-209	GRADE CROSSING CENTURY BLVD & ROSECRANS/PARAMOUNT PLAN
17	CS-210	GRADE CROSSING DOWNEY AVE & SOMERSET BLVD PLAN
18	CS-211	GRADE CROSSING LAKEWOOD BLVD & BELLFLOWER BLVD PLAN
19	CS-212	GRADE CROSSING CLARK AVE & ALONDRA BLVD PLAN
20	CS-213	GRADE CROSSING FLOWER ST & WOODRUFF AVE PLAN
21	CS-214	GRADE CROSSING ARTESIA BLVD & STUDEBAKER RD PLAN
22	CS-215	GRADE CROSSING GRIDLEY/183RD & 186TH ST PLAN
23	CS-216	GRADE CROSSING 187TH ST & PIONEER BLVD PLAN
24	CS-217	GRADE CROSSING ROSECRANS AVE & PARAMOUNT MSF LEAD TRACK

09-FEB-2021 B-28091AG02.plt
wsppw04-pw-svc 2:3:15

FINAL ADVANCED CONCEPTUAL ENGINEERING GRADE CROSSINGS - 8/26/2020

NOT FOR CONSTRUCTION

THE PREPARATION OF THIS DRAWING HAS BEEN FINANCED IN PART THROUGH A GRANT FROM THE U.S. DEPARTMENT OF TRANSPORTATION FEDERAL TRANSIT ADMINISTRATION (FTA), UNDER THE FEDERAL TRANSIT ACT OF 1964, AS AMENDED, AND IN PART BY THE TAXES OF THE CITIZENS OF LOS ANGELES COUNTY AND OF THE STATE OF CALIFORNIA.	<table border="1" style="width: 100%; border-collapse: collapse;"> <tr><td>DESIGNED BY</td><td>AM</td></tr> <tr><td>DRAWN BY</td><td>DR</td></tr> <tr><td>CHECKED BY</td><td>BO</td></tr> <tr><td>IN CHARGE</td><td>NM</td></tr> <tr><td>DATE</td><td>8/26/2020</td></tr> </table>	DESIGNED BY	AM	DRAWN BY	DR	CHECKED BY	BO	IN CHARGE	NM	DATE	8/26/2020	 LOS ANGELES COUNTY METROPOLITAN TRANSPORTATION AUTHORITY	WEST SANTA ANA BRANCH LRT GENERAL INDEX	<table border="1" style="width: 100%; border-collapse: collapse;"> <tr><td colspan="2">CONTRACT NO</td><td>AE5999300</td></tr> <tr><td>DRAWING NO</td><td>G-002</td><td>REV</td></tr> <tr><td colspan="3">SCALE</td></tr> <tr><td colspan="3">SHEET NO</td></tr> <tr><td colspan="2">1</td><td>OF 24</td></tr> </table>	CONTRACT NO		AE5999300	DRAWING NO	G-002	REV	SCALE			SHEET NO			1		OF 24
DESIGNED BY	AM																												
DRAWN BY	DR																												
CHECKED BY	BO																												
IN CHARGE	NM																												
DATE	8/26/2020																												
CONTRACT NO		AE5999300																											
DRAWING NO	G-002	REV																											
SCALE																													
SHEET NO																													
1		OF 24																											
<table border="1" style="width: 100%; border-collapse: collapse;"> <thead> <tr> <th>REV</th> <th>DATE</th> <th>BY</th> <th>APP</th> <th>REG NO.</th> <th>EXPIRES</th> <th>SEAL HOLDER</th> <th>DESCRIPTION</th> </tr> </thead> <tbody> <tr> <td>0</td> <td>8/26/2020</td> <td></td> <td></td> <td></td> <td></td> <td></td> <td>FINAL ACE SUBMITTAL</td> </tr> </tbody> </table>	REV	DATE	BY	APP	REG NO.	EXPIRES	SEAL HOLDER	DESCRIPTION	0	8/26/2020						FINAL ACE SUBMITTAL		<table border="1" style="width: 100%; border-collapse: collapse;"> <tr> <td style="width: 50%; vertical-align: top;"> 444 South Flower Street Suite 800 Los Angeles, CA 90071 TEL (213) 362-9470 </td> <td style="width: 50%; vertical-align: top;"> SUBMITTED _____ APPROVED _____ </td> </tr> </table>	444 South Flower Street Suite 800 Los Angeles, CA 90071 TEL (213) 362-9470	SUBMITTED _____ APPROVED _____									
REV	DATE	BY	APP	REG NO.	EXPIRES	SEAL HOLDER	DESCRIPTION																						
0	8/26/2020						FINAL ACE SUBMITTAL																						
444 South Flower Street Suite 800 Los Angeles, CA 90071 TEL (213) 362-9470	SUBMITTED _____ APPROVED _____																												

LIST OF ABBREVIATIONS

AVE	Avenue	NB	North Bound
BLVD	Boulevard	OH	Overhead
CL	Centerline	PL	Place, Planade
C&S	Communications and Signals	R/W	Right of Way
CPUC	California Public Utilities Commission	RD	Road
DWY	Driveway	RT	Right
EXIST	Existing	SB	South Bound
FLS	Fire Life Safety	ST	Street
HWY	Highway	SW	Sidewalk
I	Interstate	TYP	Typical
LRT	Light Rail Transit	VAR	Varies
LT	Left	WSAB	West Santa Ana Branch
MSF	Maintenance and Storage Facilities		











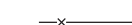



GENERAL NOTES

- DESIGN IS CONCEPTUAL IN NATURE, FOR PURPOSE OF ESTABLISHING ENVIRONMENTAL FOOTPRINT AND GAINING INFORMAL CONCURRENCE FROM CPUC ON GRADE CROSSING TREATMENTS. NEXT STEPS INCLUDE PRELIMINARY AND FINAL DESIGN AND CPUC APPLICATIONS.
- FURTHER COORDINATION REQUIRED WITH PROJECTS AS LISTED:
RAIL TO RAIL/RIVER CORRIDOR SEGMENT A AND B, I-710 CORRIDOR BIKE PATH PROJECT, HOLLYDALE VILLAGE SPECIFIC PLAN, RANCHO LOS AMIGOS RE-DEVELOPMENT, BELLFLOWER-PARAMOUNT JOINT BIKE AND TRAIL MASTER PLAN.
- COORDINATION NEEDED WITH FREIGHT RAILROADS AND CALTRANS.
- REFER TO FINAL REVISED ADVANCED CONCEPTUAL ENGINEERING ALIGNMENT DRAWINGS DATED 2/28/20 FOR ALIGNMENT DESIGN.
- SIGNAGE TO CONFORM TO THE LATEST EDITION OF THE CALIFORNIA MANUAL ON UNIFORM TRAFFIC CONTROL DEVICES. DETAILS TO BE DEVELOPED DURING FUTURE DESIGN PHASE.
- MAINTENANCE PARKING ASSUMED TO BE ADJACENT TO CROSSING HOUSES. DETAILS FOR MAINTENANCE PARKING TO BE DEVELOPED DURING FUTURE DESIGN PHASE.
- EXISTING PROPERTY LINES ARE APPROXIMATE.

SIGNAGE LEGEND

- ① TRAIN ACTIVATED LOOK BOTH WAYS
- ② MUTCD R3-1 NO RIGHT TURN BLANK OUT SIGN
- ③ MUTCD W10-1 PASSIVE SIGN
- ④ SUICIDE PREVENTION SIGNS
- ⑤ PEDESTRIAN 'DO NOT ENTER CROSSING'
- ⑥ NO TRESPASSING
- ⑦ PASSIVE LOOK BOTH WAYS
- ⑧ MUTCD R1-2 YIELD
- ⑨ DO NOT STOP ON TRACKS
- ⑩ ACTIVE DO NOT STOP ON TRACKS
- ⑪ CANTILEVER MOUNTED RAILROAD FLASHER

SYMBOLOLOGY LEGEND

-  PROPOSED RETAINING WALL
-  PROPOSED FENCE LINE
-  PROPOSED SOUND WALL
-  EXIST FREIGHT TRACK
-  PROPOSED RELOCATED FREIGHT TRACK
-  EXISTING PROPERTY LINE
-  PROPOSED LRT TRACK CENTERLINE
-  PROPOSED SIGNAL
-  EXIST SIGNALIZATION
-  PROPOSED QUEUE CUTTER
-  PEDESTRIAN CROSSING GATE
-  CROSSING GATE
-  GRADE CROSSING HOUSE (11'x9')
-  W10-1 SIGNAGE
-  RR CROSSING PAVEMENT MARKERS

wsppw04-pw-svc 23:14 09-FEB-2021 B-28091AG03.plg

FINAL ADVANCED CONCEPTUAL ENGINEERING GRADE CROSSINGS - 8/26/2020

NOT FOR CONSTRUCTION

THE PREPARATION OF THIS DRAWING HAS BEEN FINANCED IN PART THROUGH A GRANT FROM THE U.S. DEPARTMENT OF TRANSPORTATION FEDERAL TRANSIT ADMINISTRATION (FTA), UNDER THE FEDERAL TRANSIT ACT OF 1964, AS AMENDED, AND IN PART BY THE TAXES OF THE CITIZENS OF LOS ANGELES COUNTY AND OF THE STATE OF CALIFORNIA.

REV	DATE	BY	APP	REG NO.	EXPIRES	SEAL HOLDER	DESCRIPTION
0	8/26/2020						FINAL ACE SUBMITTAL

DESIGNED BY AM
DRAWN BY DR
CHECKED BY BO
IN CHARGE NM
DATE 8/26/2020



**LOS ANGELES COUNTY
METROPOLITAN TRANSPORTATION AUTHORITY**

wsp 444 South Flower Street
Suite 800
Los Angeles, CA 90071
TEL (213) 362-9470

SUBMITTED _____

APPROVED _____

**WEST SANTA ANA BRANCH LRT
GENERAL**

ABBREVIATIONS, GENERAL NOTES
AND LEGENDS

CONTRACT NO AE5999300	
DRAWING NO G-003	REV
SCALE NO SCALE	
SHEET NO 2	OF 24

09-FEB-2021 B-28091ACS101.plg
 wspdw04-pw-svc 23:35

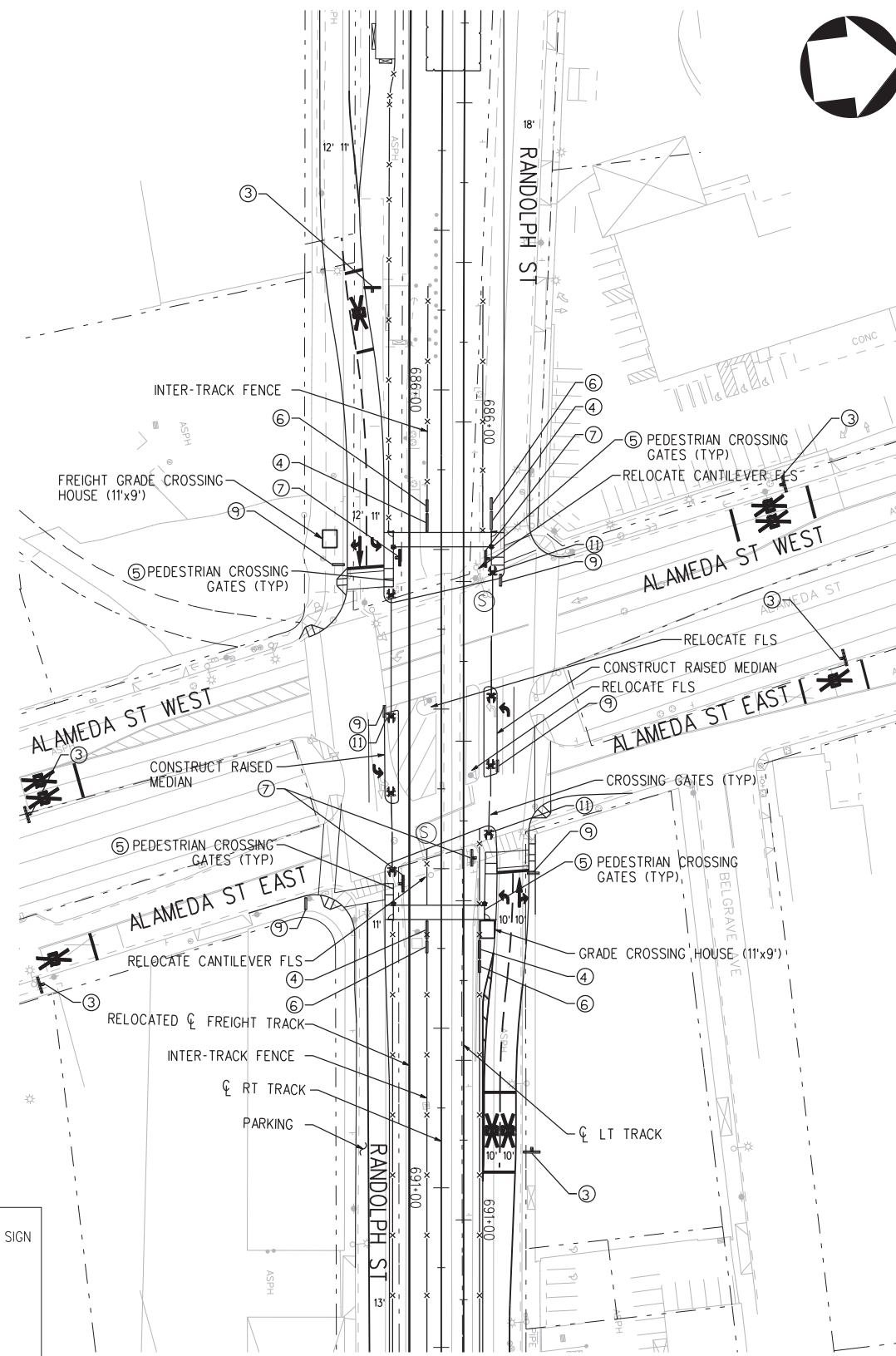

ALAMEDA ST/RANDOLPH ST GRADE CROSSING

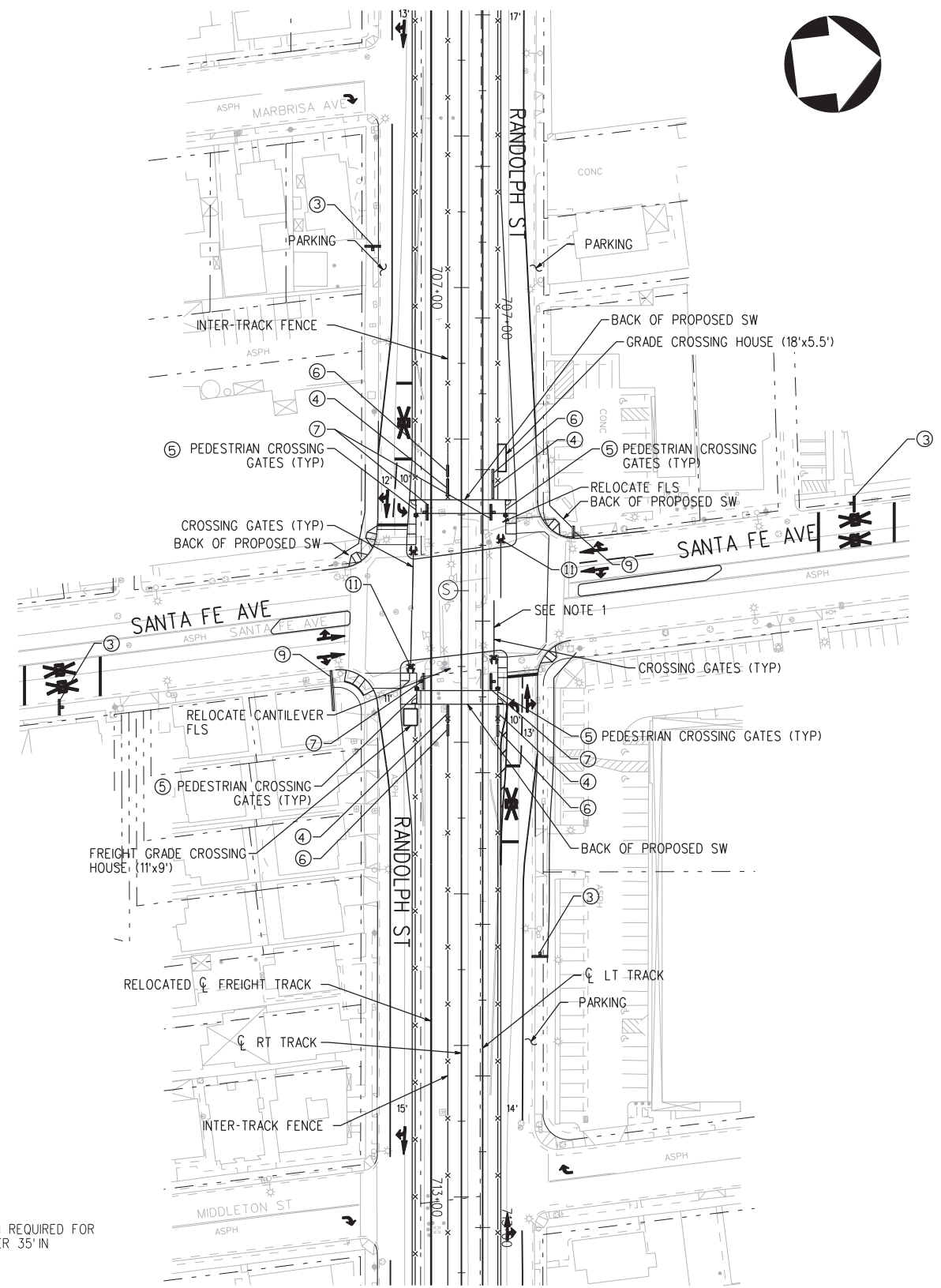

SANTA FE AVE/RANDOLPH ST GRADE CROSSING

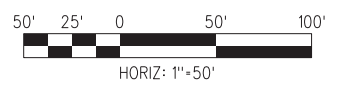

NOTES:
 1. MRDC DEVIATION REQUIRED FOR GATE ARMS OVER 35' IN LENGTH.

SIGNAGE LEGEND

- ① TRAIN ACTIVATED LOOK BOTH WAYS
- ② MUTCD R3-1 NO RIGHT TURN BLANK OUT SIGN
- ③ MUTCD W10-1 PASSIVE SIGN
- ④ SUICIDE PREVENTION SIGNS
- ⑤ PEDESTRIAN 'DO NOT ENTER CROSSING'
- ⑥ NO TRESPASSING
- ⑦ PASSIVE LOOK BOTH WAYS
- ⑧ MUTCD R1-2 YIELD
- ⑨ DO NOT STOP ON TRACKS
- ⑩ ACTIVE DO NOT STOP ON TRACKS
- ⑪ CANTILEVER MOUNTED RAILROAD FLASHER

FINAL ADVANCED CONCEPTUAL ENGINEERING GRADE CROSSINGS - 826/2020

REV	DATE	BY	APP	REG NO.	EXPIRES	SEAL HOLDER	DESCRIPTION
0	8/26/2020						FINAL ACE SUBMITTAL

DESIGNED BY AM
DRAWN BY MF
CHECKED BY BO
IN CHARGE NM
DATE 8/26/2020

PLAN

M Metro
LOS ANGELES COUNTY METROPOLITAN TRANSPORTATION AUTHORITY

wsp 444 South Flower Street
 Suite 800
 Los Angeles, CA 90071
 TEL (213) 362-9470

SUBMITTED _____
 APPROVED _____

WEST SANTA ANA BRANCH LRT
 GRADE CROSSING
 SANTA FE AVE & ALAMEDA ST
 PLAN

CONTRACT NO. AE5999300	REV
DRAWING NO. CS-101	
SCALE HOR: 1"=50'	
SHEET NO. 3	OF 24

NOT FOR CONSTRUCTION

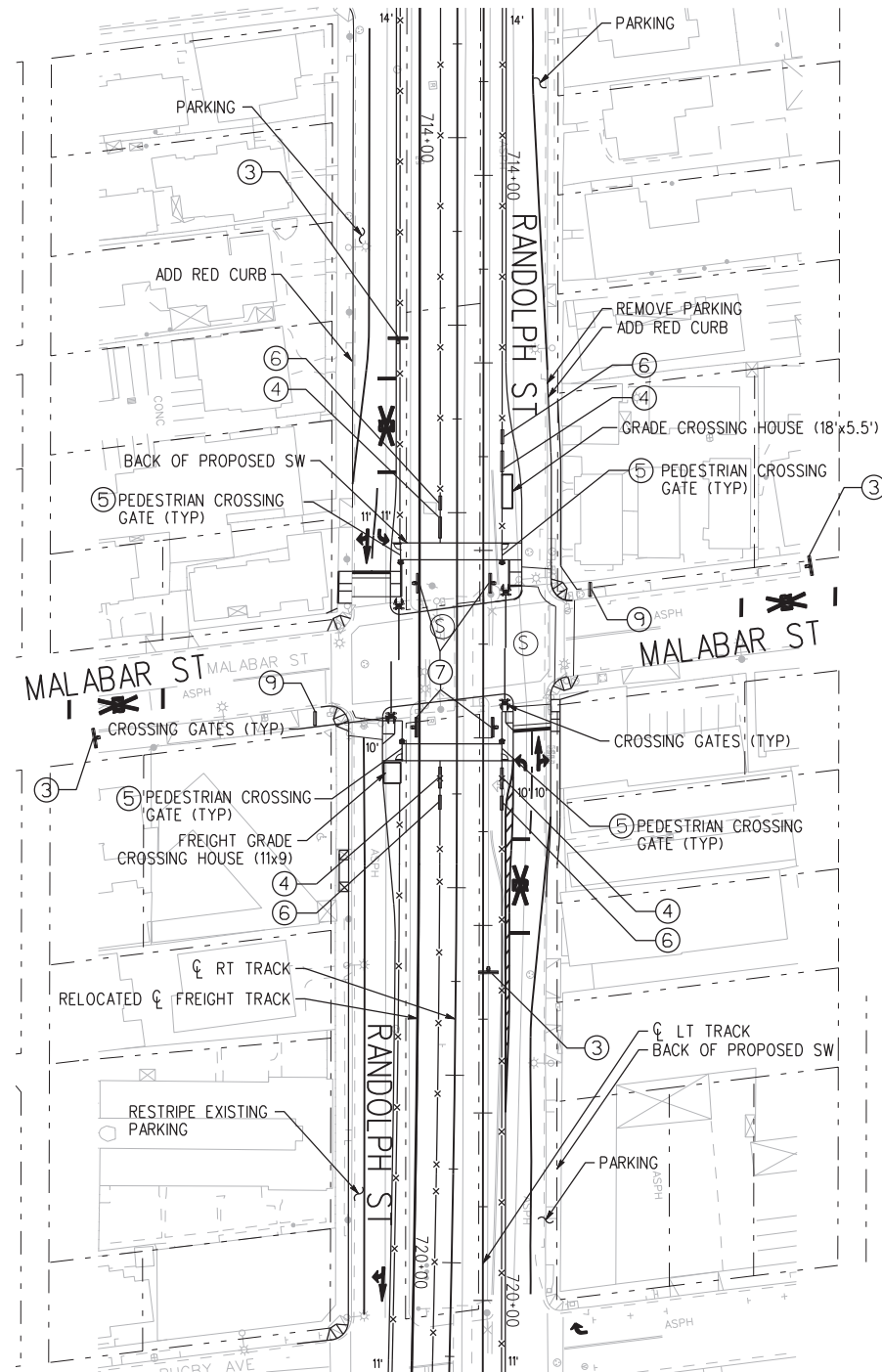

MALABAR ST/RANDOLPH ST GRADE CROSSING



SIGNAGE LEGEND

- ① TRAIN ACTIVATED LOOK BOTH WAYS
- ② MUTCD R3-1 NO RIGHT TURN BLANK OUT SIGN
- ③ MUTCD W10-1 PASSIVE SIGN
- ④ SUICIDE PREVENTION SIGNS
- ⑤ PEDESTRIAN 'DO NOT ENTER CROSSING'
- ⑥ NO TRESPASSING
- ⑦ PASSIVE LOOK BOTH WAYS
- ⑧ MUTCD R1-2 YIELD
- ⑨ DO NOT STOP ON TRACKS
- ⑩ ACTIVE DO NOT STOP ON TRACKS
- ⑪ CANTILEVER MOUNTED RAILROAD FLASHER

NOTES:

1. ALL LEFT-TURN MOVEMENT OF TRUCKS AT THIS INTERSECTION TO BE PROHIBITED PENDING FURTHER COORDINATION WITH CPUC AND HUNTINGTON PARK.
2. MRDC DEVIATION MAY BE REQUIRED FOR GATE ARMS OVER 35' IN LENGTH.
3. APPROXIMATE LOCATION IS 200 FEET. TOPO WOULD BE PROVIDED IN FUTURE DESIGN PHASE.

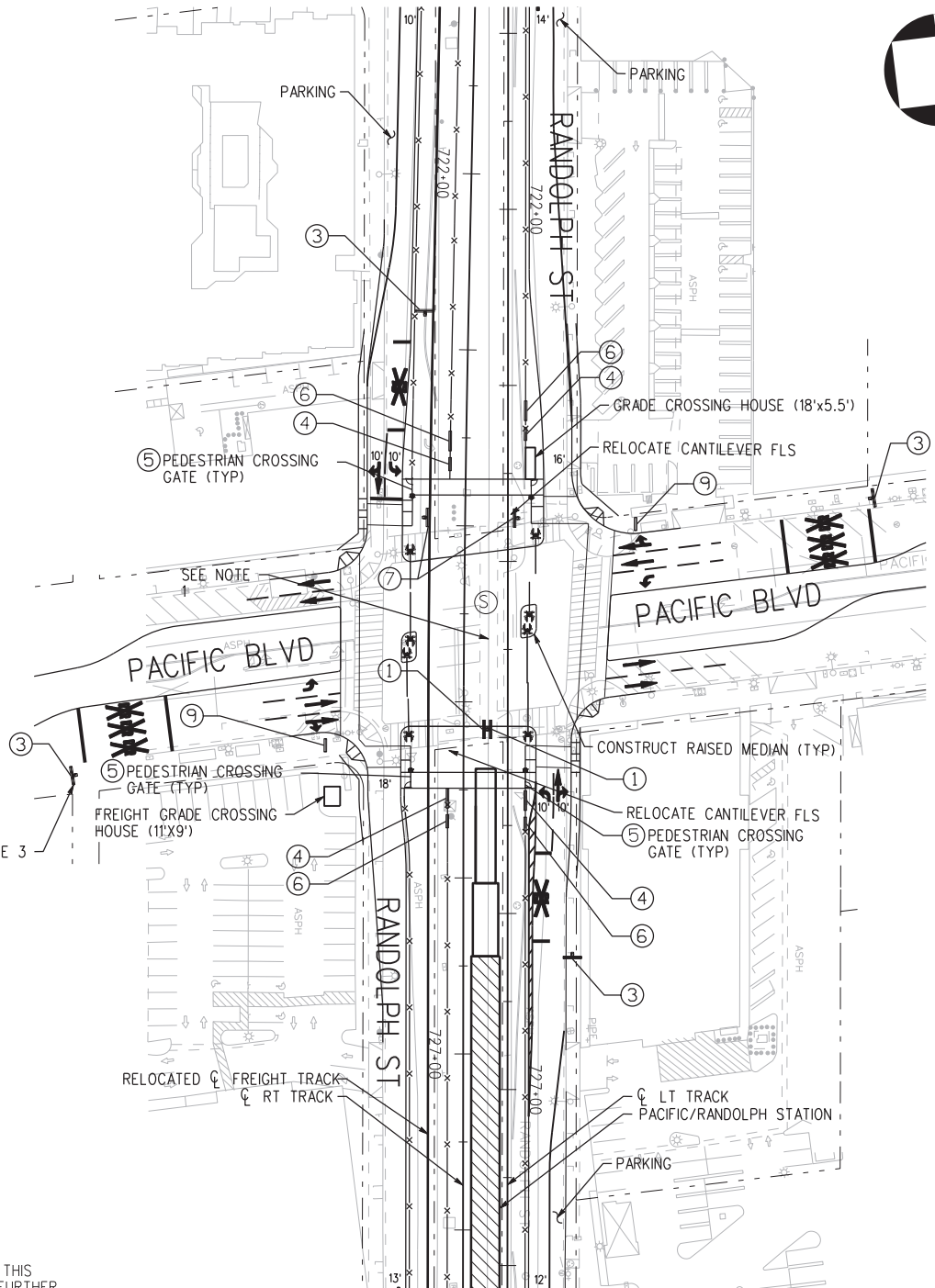

PACIFIC BLVD/RANDOLPH ST GRADE CROSSING



NOT FOR CONSTRUCTION

PLAN

FINAL ADVANCED CONCEPTUAL ENGINEERING GRADE CROSSINGS - 8/26/2020

THE PREPARATION OF THIS DRAWING HAS BEEN FINANCED IN PART THROUGH A GRANT FROM THE U.S. DEPARTMENT OF TRANSPORTATION FEDERAL TRANSIT ADMINISTRATION (FTA), UNDER THE FEDERAL TRANSIT ACT OF 1964, AS AMENDED, AND IN PART BY THE TAXES OF THE CITIZENS OF LOS ANGELES COUNTY AND OF THE STATE OF CALIFORNIA.		DESIGNED BY AM
0	8/26/2020	DRAWN BY MF
REV	DATE	CHECKED BY BO
BY	APP	IN CHARGE NM
REG NO.	EXPIRES	DATE 8/26/2020
SEAL HOLDER	DESCRIPTION	FINAL ACE SUBMITTAL

DESIGNED BY AM
DRAWN BY MF
CHECKED BY BO
IN CHARGE NM
DATE 8/26/2020



Metro

LOS ANGELES COUNTY METROPOLITAN TRANSPORTATION AUTHORITY



444 South Flower Street
Suite 800
Los Angeles, CA 90071
TEL (213) 362-9470

SUBMITTED _____

APPROVED _____

WEST SANTA ANA BRANCH LRT
GRADE CROSSING
MALABAR ST & PACIFIC BLVD
PLAN

CONTRACT NO. AE5999300
DRAWING NO. CS-102
SCALE HOR: 1"=50'
SHEET NO. 4 OF 24

wspdw04-pw-svc 23:35 09-FEB-2021 B-28091ACS103.plg

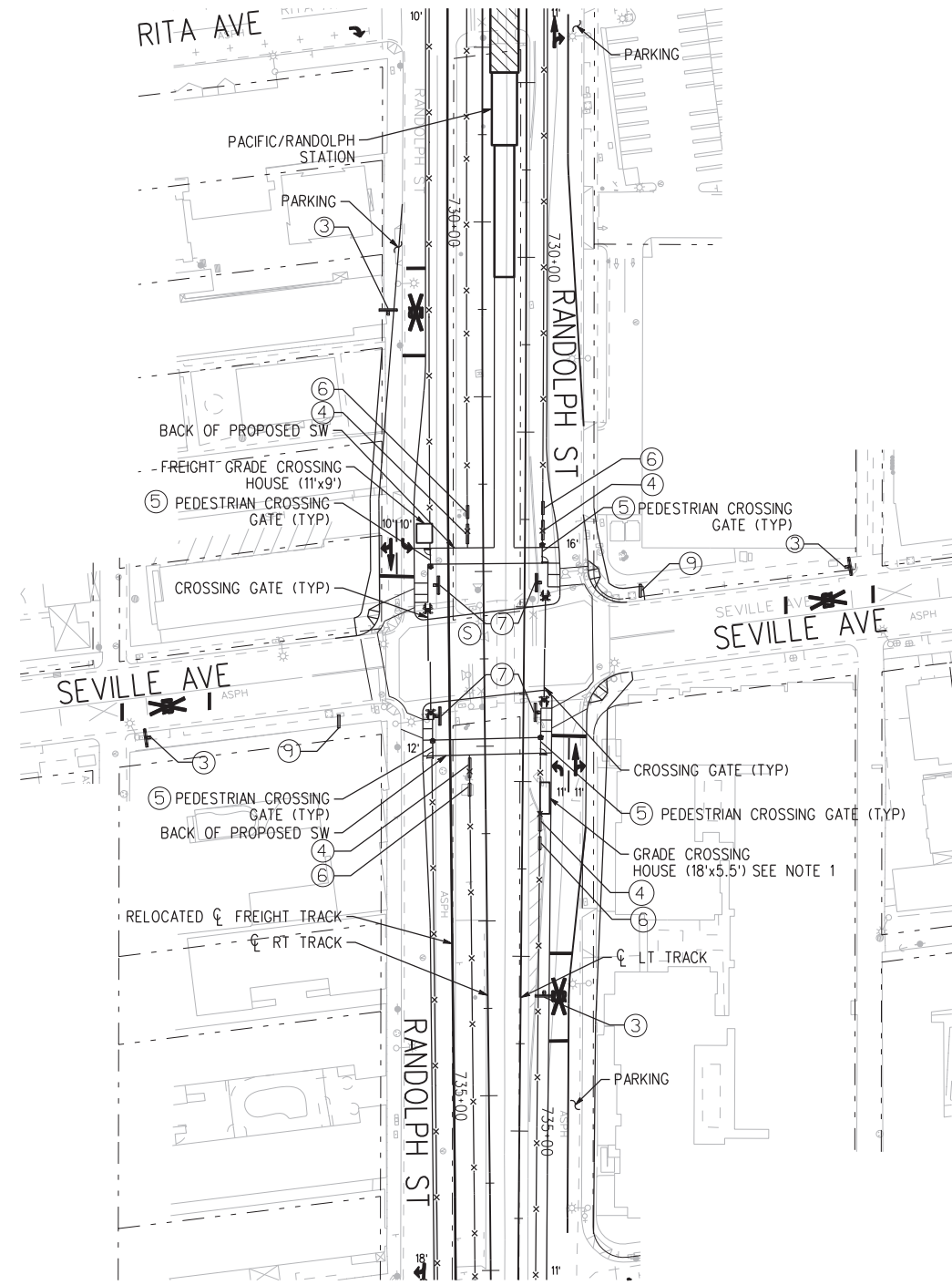

SEVILLE AVE/RANDOLPH ST GRADE CROSSING

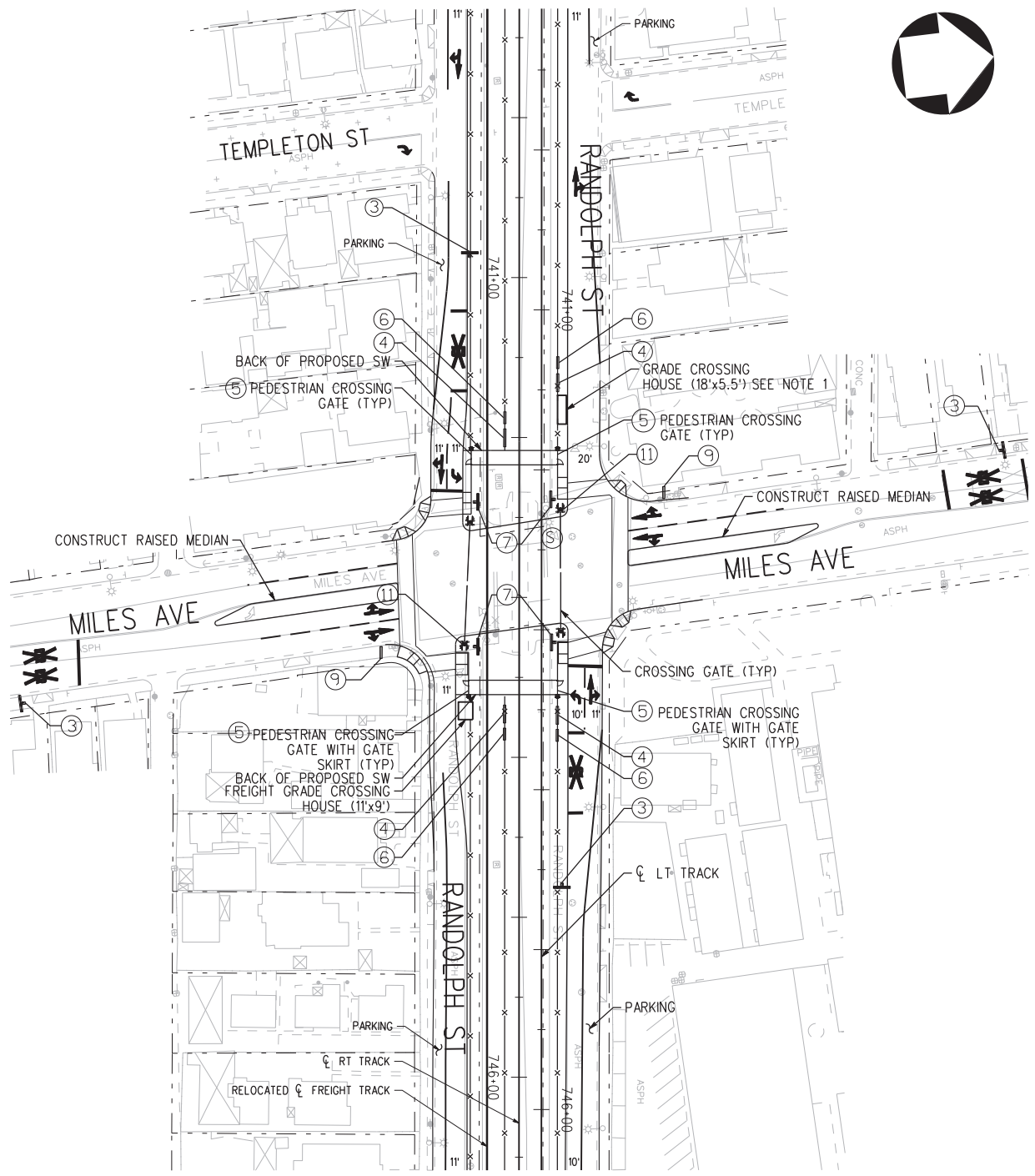

MILES AVE/RANDOLPH ST GRADE CROSSING

SIGNAGE LEGEND

- ① TRAIN ACTIVATED LOOK BOTH WAYS
- ② MUTCD R3-1 NO RIGHT TURN BLANK OUT SIGN
- ③ MUTCD W10-1 PASSIVE SIGN
- ④ SUICIDE PREVENTION SIGNS
- ⑤ PEDESTRIAN 'DO NOT ENTER CROSSING'
- ⑥ NO TRESPASSING
- ⑦ PASSIVE LOOK BOTH WAYS
- ⑧ MUTCD R1-2 YIELD
- ⑨ DO NOT STOP ON TRACKS
- ⑩ ACTIVE DO NOT STOP ON TRACKS
- ⑪ CANTILEVER MOUNTED RAILROAD FLASHER

NOTES:

1. MRDC DEVIATION MAY BE REQUIRED.

FINAL ADVANCED CONCEPTUAL ENGINEERING GRADE CROSSINGS - 8/26/2020

PLAN

NOT FOR CONSTRUCTION

THE PREPARATION OF THIS DRAWING HAS BEEN FINANCED IN PART THROUGH A GRANT FROM THE U.S. DEPARTMENT OF TRANSPORTATION FEDERAL TRANSIT ADMINISTRATION (FTA), UNDER THE FEDERAL TRANSIT ACT OF 1964, AS AMENDED, AND IN PART BY THE TAXES OF THE CITIZENS OF LOS ANGELES COUNTY AND OF THE STATE OF CALIFORNIA.							DESIGNED BY AM
							DRAWN BY MF
							CHECKED BY BO
							IN CHARGE NM
							DATE 8/26/2020
REV	DATE	BY	APP	REG NO.	EXPIRES	SEAL HOLDER	DESCRIPTION
0	8/26/2020						FINAL ACE SUBMITTAL

M Metro
LOS ANGELES COUNTY METROPOLITAN TRANSPORTATION AUTHORITY

wsp 444 South Flower Street Suite 800 Los Angeles, CA 90071 TEL (213) 362-9470

SUBMITTED _____
 APPROVED _____

WEST SANTA ANA BRANCH LRT GRADE CROSSING SEVILLE AVE & MILES AVE PLAN

CONTRACT NO. **AE5999300**
 DRAWING NO. **CS-103** REV _____
 SCALE **HOR: 1"=50'**
 SHEET NO. **5 OF 24**

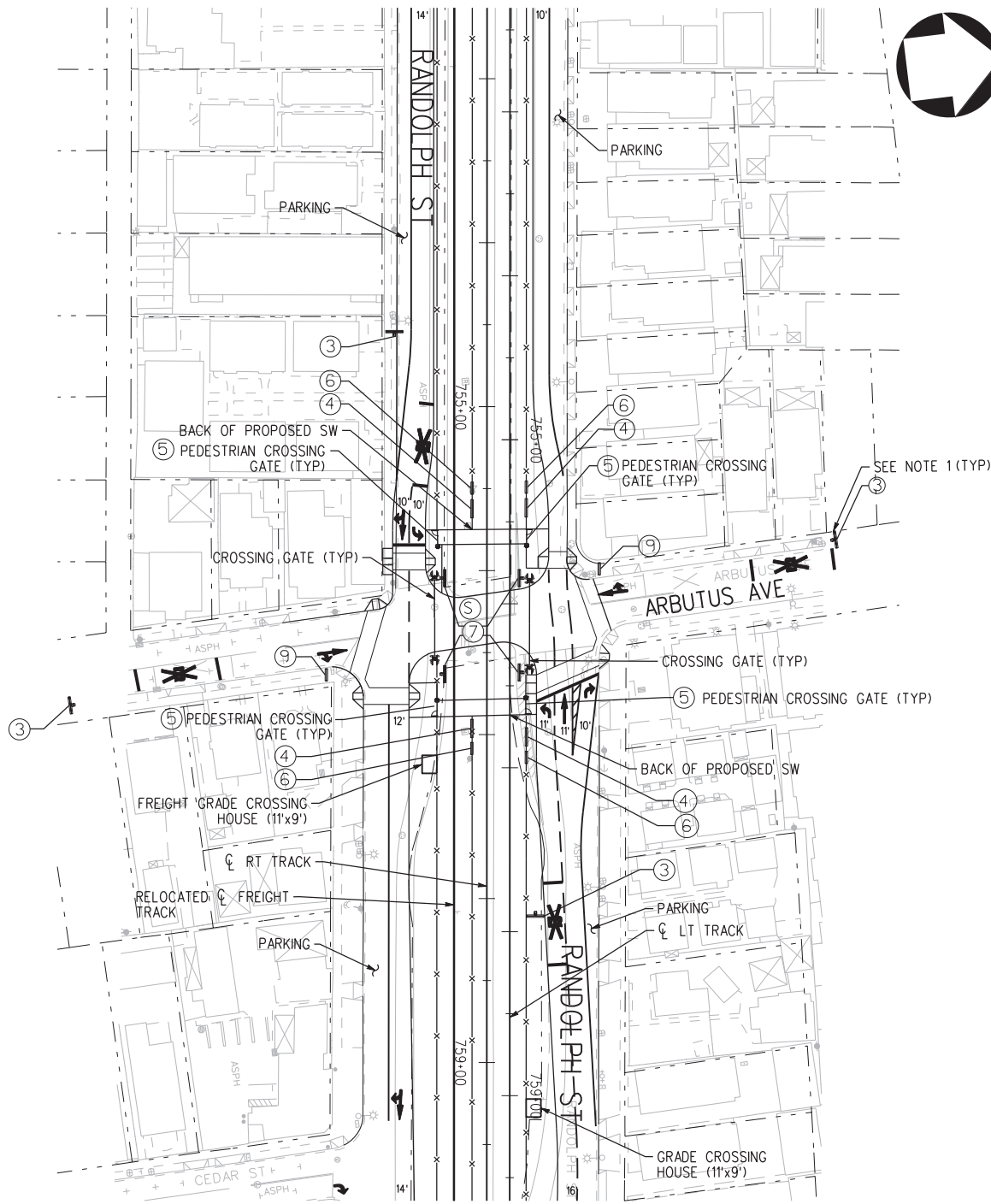

ARBUTUS AVE/RANDOLPH ST GRADE CROSSING

NOTES:

1. APPROXIMATE LOCATION IS 200 FEET. TOPO WOULD BE PROVIDED IN FUTURE DESIGN PHASE.
2. LRT TRACKS GRADE SEPARATED ABOVE INTERSECTION. GRADE CROSSING IS OF FREIGHT TRACKS ONLY.
3. METRO, CPUC, AND COUNTY OF LA TO COORDINATE ON WHETHER TO RELOCATE EXISTING MEDIANS, OR USE LONG CROSSING GATE ARMS.

SIGNAGE LEGEND

- | | |
|---|---|
| ① | TRAIN ACTIVATED LOOK BOTH WAYS |
| ② | MUTCD R3-1 NO RIGHT TURN BLANK OUT SIGN |
| ③ | MUTCD W10-1 PASSIVE SIGN |
| ④ | SUICIDE PREVENTION SIGNS |
| ⑤ | PEDESTRIAN 'DO NOT ENTER CROSSING' |
| ⑥ | NO TRESPASSING |
| ⑦ | PASSIVE LOOK BOTH WAYS |
| ⑧ | MUTCD R1-2 YIELD |
| ⑨ | DO NOT STOP ON TRACKS |
| ⑩ | ACTIVE DO NOT STOP ON TRACKS |
| ⑪ | CANTILEVER MOUNTED RAILROAD FLASHER |

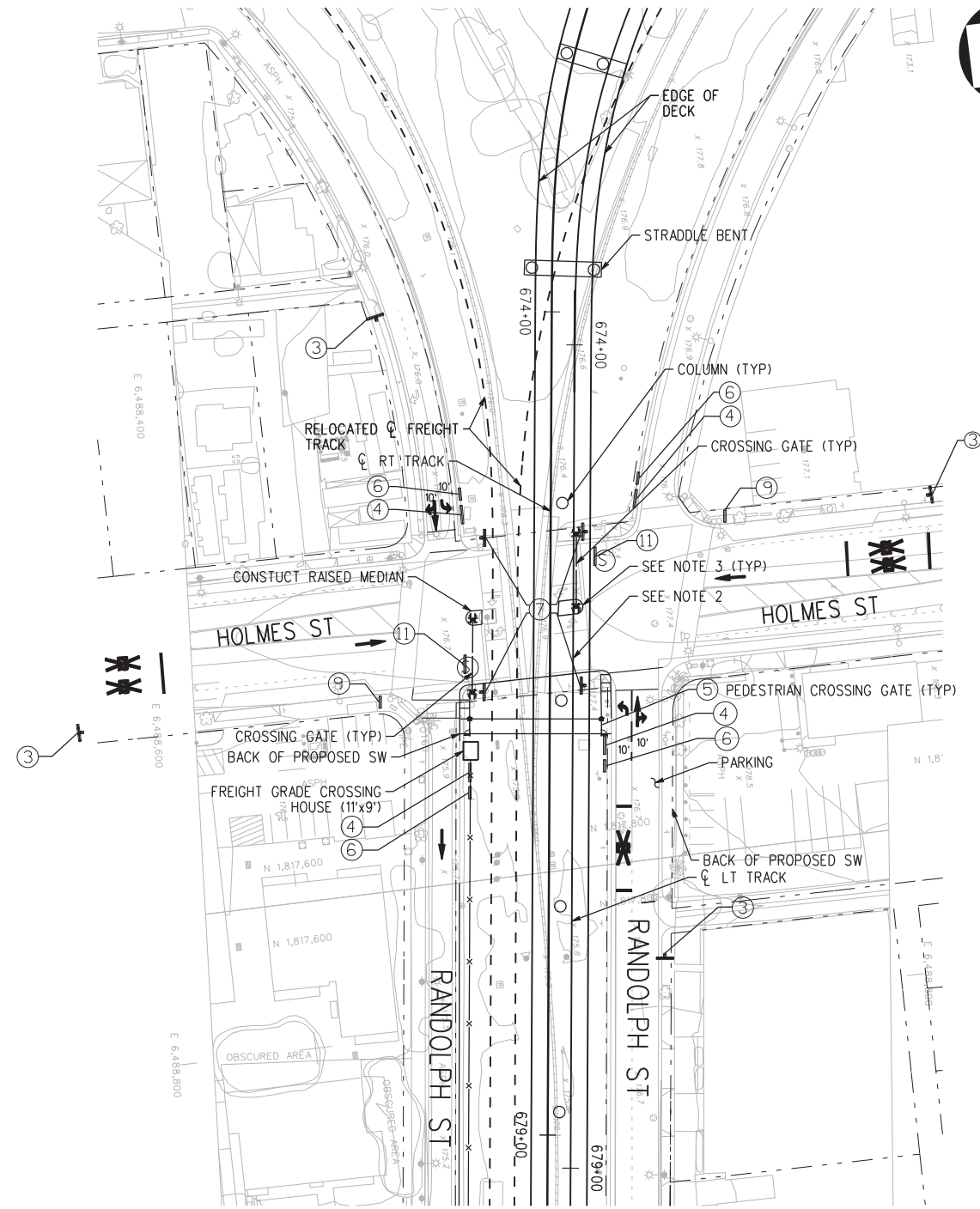

HOLMES ST/RANDOLPH ST GRADE CROSSING



NOT FOR CONSTRUCTION

PLAN

wspdw04-pw-svc 23:36 09-FEB-2021 B-28091ACS104.plg

FINAL ADVANCED CONCEPTUAL ENGINEERING GRADE CROSSINGS - 8/26/2020

THE PREPARATION OF THIS DRAWING HAS BEEN FINANCED IN PART THROUGH A GRANT FROM THE U.S. DEPARTMENT OF TRANSPORTATION FEDERAL TRANSIT ADMINISTRATION (FTA), UNDER THE FEDERAL TRANSIT ACT OF 1964, AS AMENDED, AND IN PART BY THE TAXES OF THE CITIZENS OF LOS ANGELES COUNTY AND OF THE STATE OF CALIFORNIA.

REV	DATE	BY	APP	REG NO.	EXPIRES	SEAL HOLDER	DESCRIPTION
0	8/26/2020						FINAL ACE SUBMITTAL

DESIGNED BY	AM
DRAWN BY	MF
CHECKED BY	BO
IN CHARGE	NM
DATE	8/26/2020



Metro

LOS ANGELES COUNTY METROPOLITAN TRANSPORTATION AUTHORITY



444 South Flower Street Suite 800 Los Angeles, CA 90071 TEL (213) 362-9470

SUBMITTED _____

APPROVED _____

WEST SANTA ANA BRANCH LRT GRADE CROSSING ARBUTUS AVE & HOLMES ST PLAN

CONTRACT NO	AE5999300
DRAWING NO	CS-104
SCALE	HOR: 1"=50'
SHEET NO	6 OF 24



SIGNAGE LEGEND

- ① TRAIN ACTIVATED LOOK BOTH WAYS
- ② MUTCD R3-1 NO RIGHT TURN BLANK OUT SIGN
- ③ MUTCD W10-1 PASSIVE SIGN
- ④ SUICIDE PREVENTION SIGNS
- ⑤ PEDESTRIAN 'DO NOT ENTER CROSSING'
- ⑥ NO TRESPASSING
- ⑦ PASSIVE LOOK BOTH WAYS
- ⑧ MUTCD R1-2 YIELD
- ⑨ DO NOT STOP ON TRACKS
- ⑩ ACTIVE DO NOT STOP ON TRACKS
- ⑪ CANTILEVER MOUNTED RAILROAD FLASHER

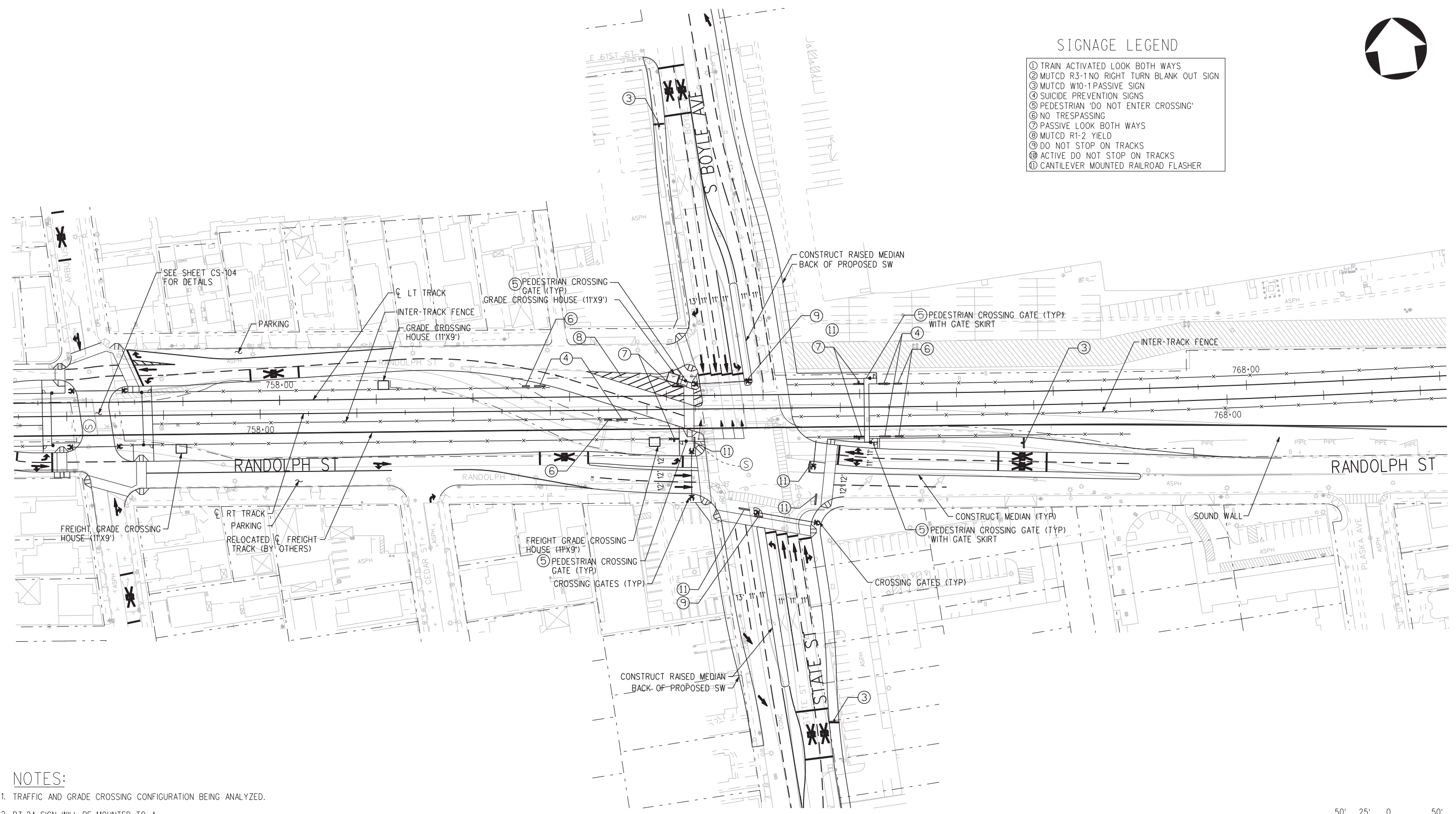

NOTES:

- 1. TRAFFIC AND GRADE CROSSING CONFIGURATION BEING ANALYZED.
- 2. R3-2A SIGN WILL BE MOUNTED TO A SIGNAL MAST ARMS OR RR GATES. DETAILS TO BE PROVIDED IN SUBSEQUENT DESIGN PACKAGE.



FINAL ADVANCED CONCEPTUAL ENGINEERING GRADE CROSSINGS - 8/26/2020

PLAN

NOT FOR CONSTRUCTION

THE PREPARATION OF THIS DRAWING HAS BEEN FINANCED IN PART THROUGH A GRANT FROM THE U.S. DEPARTMENT OF TRANSPORTATION FEDERAL TRANSIT ADMINISTRATION (FTA), UNDER THE FEDERAL TRANSIT ACT OF 1964, AS AMENDED, AND IN PART BY THE TAXES OF THE CITIZENS OF LOS ANGELES COUNTY AND OF THE STATE OF CALIFORNIA.										DESIGNED BY AM		LOS ANGELES COUNTY METROPOLITAN TRANSPORTATION AUTHORITY		WEST SANTA ANA BRANCH LRT GRADE CROSSING STATE ST PLAN		CONTRACT NO. AE5999300	
REV 0 8/26/2020 BY APP REG NO. EXPIRES SEAL HOLDER DESCRIPTION FINAL ACE SUBMITTAL										DRAWING NO. CS-105						REV	
Plot Driver=MTA-half.pen Pentable=bw.plt										CHECKED BY BO		444 South Flower Street Suite 800 Los Angeles, CA 90071 TEL (213) 362-9470		SCALE HOR: 1"=50'		SHEET NO. 7 OF 24	
										IN CHARGE NM				SUBMITTED _____			
										DATE 8/26/2020		APPROVED _____					

09-FEB-2021 B-28091ACS105.plt

SIGNAGE LEGEND

- ① TRAIN ACTIVATED LOOK BOTH WAYS
- ② MUTCD R3-1 NO RIGHT TURN BLANK OUT SIGN
- ③ MUTCD W10-1 PASSIVE SIGN
- ④ SUICIDE PREVENTION SIGNS
- ⑤ PEDESTRIAN 'DO NOT ENTER CROSSING'
- ⑥ NO TRESPASSING
- ⑦ PASSIVE LOOK BOTH WAYS
- ⑧ MUTCD R1-2 YIELD
- ⑨ DO NOT STOP ON TRACKS
- ⑩ ACTIVE DO NOT STOP ON TRACKS
- ⑪ CANTILEVER MOUNTED RAILROAD FLASHER

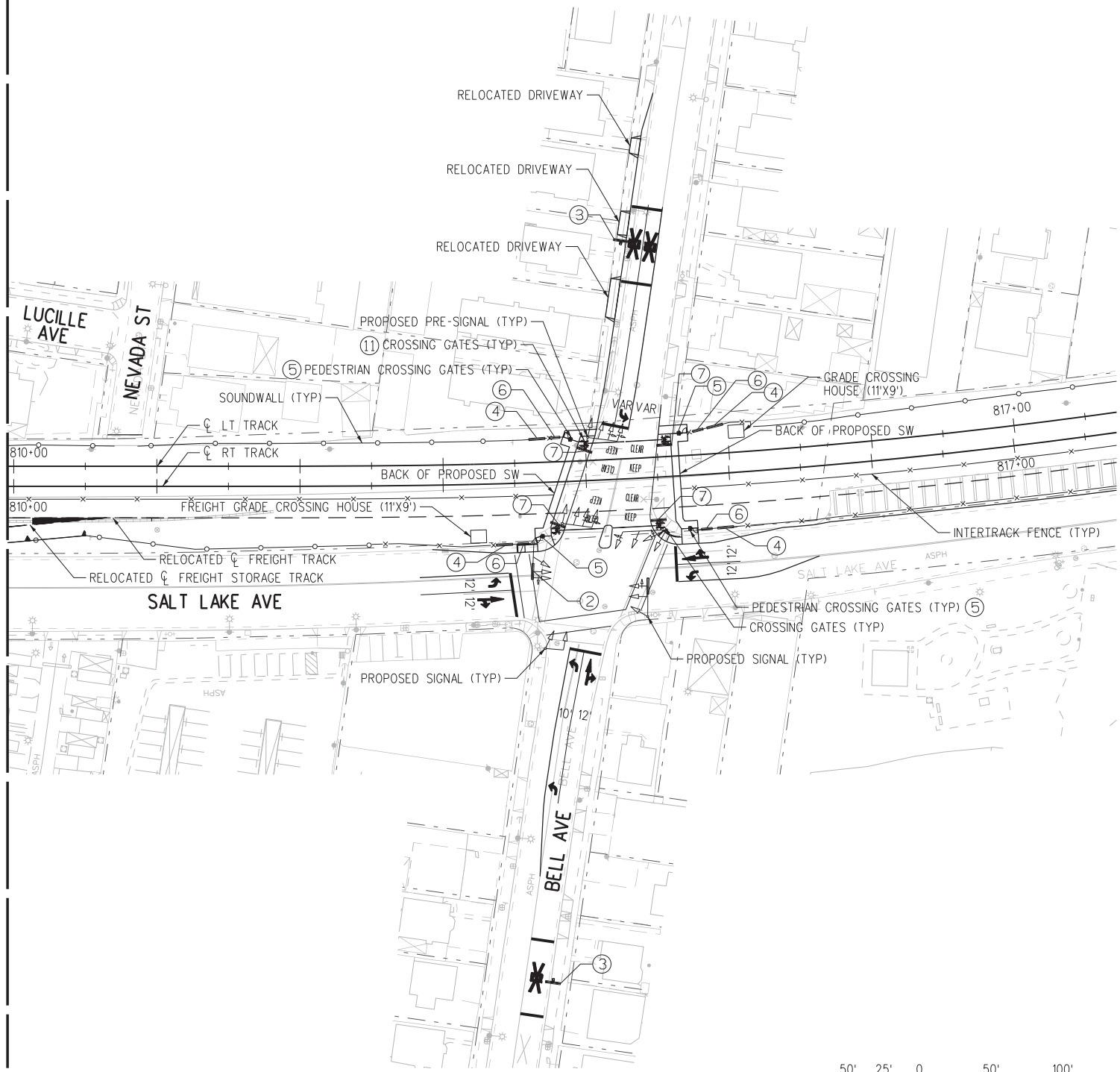
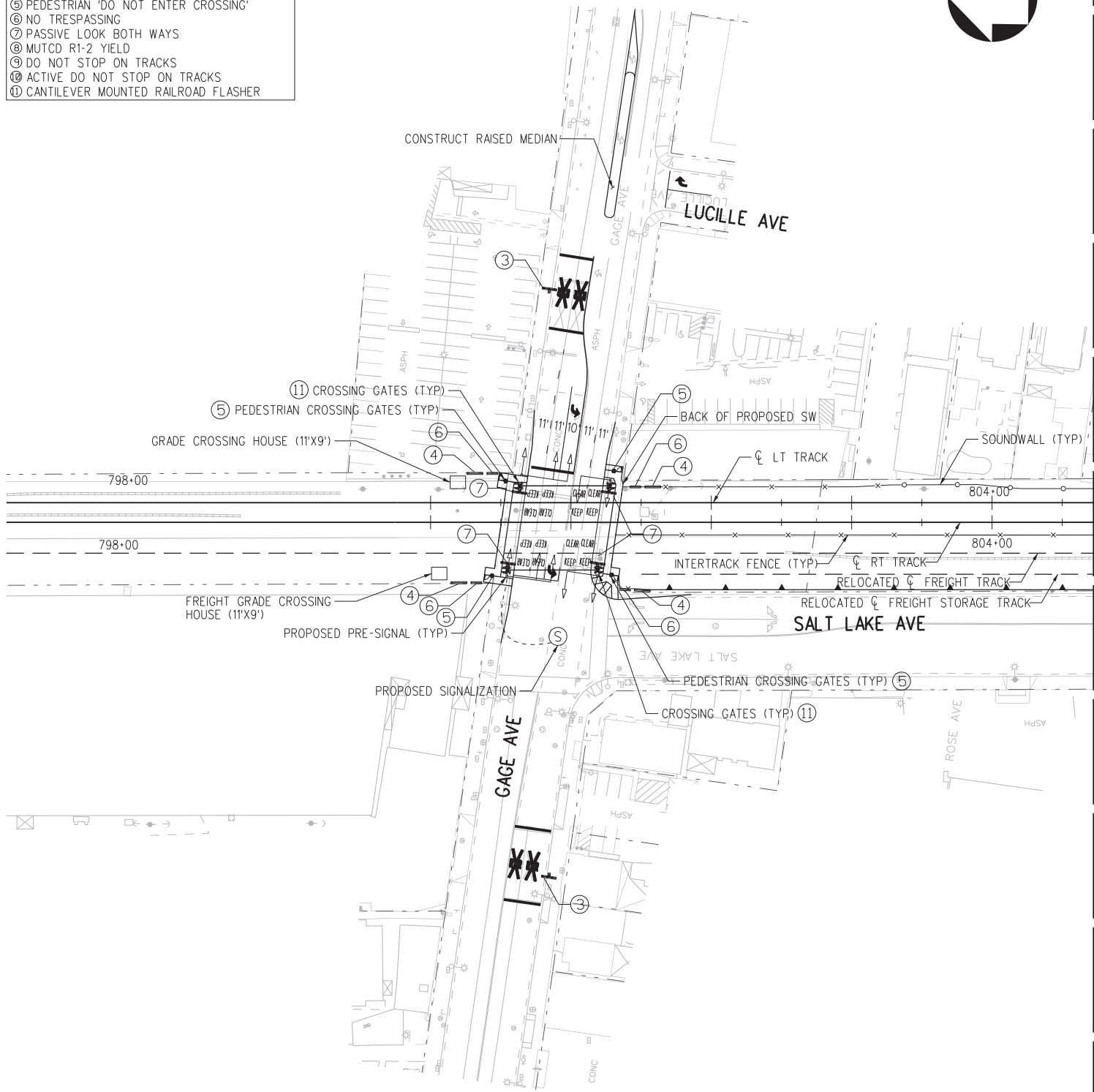

NOTES:
1. LRT GRADE CROSSING EQUIPMENT TO BE LOCATED WITHIN TRAIN CONTROL HOUSE.

FINAL ADVANCED CONCEPTUAL ENGINEERING GRADE CROSSINGS - 826/2020

THE PREPARATION OF THIS DRAWING HAS BEEN FINANCED IN PART THROUGH A GRANT FROM THE U.S. DEPARTMENT OF TRANSPORTATION FEDERAL TRANSIT ADMINISTRATION (FTA), UNDER THE FEDERAL TRANSIT ACT OF 1964, AS AMENDED, AND IN PART BY THE TAKES OF THE CITIZENS OF LOS ANGELES COUNTY AND OF THE STATE OF CALIFORNIA.		DESIGNED BY CB	DATE 8/26/2020	DESCRIPTION FINAL ACE SUBMITTAL			
REV	DATE	BY	APP	REG NO.	EXPIRES	SEAL HOLDER	DESCRIPTION
0	8/26/2020						FINAL ACE SUBMITTAL

M Metro
LOS ANGELES COUNTY METROPOLITAN TRANSPORTATION AUTHORITY

wsp 444 South Flower Street Suite 800 Los Angeles, CA 90071 TEL (213) 362-9470

SUBMITTED _____
APPROVED _____

WEST SANTA ANA BRANCH LRT
GRADE CROSSING
GAGE AVE & BELL AVE
PLAN

CONTRACT NO. AE5999300	REV
DRAWING NO. CS-201	
SCALE HOR: 1"=50'	
SHEET NO. 8	OF 24

09-FEB-2021 B-28091ACS201.plg
wspw04-pw-svc 23:18
Plot Driver=MTA-half.pen Pentable=bw.plt

SIGNAGE LEGEND

- ① TRAIN ACTIVATED LOOK BOTH WAYS
- ② MUTCD R3-1 NO RIGHT TURN BLANK OUT SIGN
- ③ MUTCD W10-1 PASSIVE SIGN
- ④ SUICIDE PREVENTION SIGNS
- ⑤ PEDESTRIAN 'DO NOT ENTER CROSSING'
- ⑥ NO TRESPASSING
- ⑦ PASSIVE LOOK BOTH WAYS
- ⑧ MUTCD R1-2 YIELD
- ⑨ DO NOT STOP ON TRACKS
- ⑩ ACTIVE DO NOT STOP ON TRACKS
- ⑪ CANTILEVER MOUNTED RAILROAD FLASHER

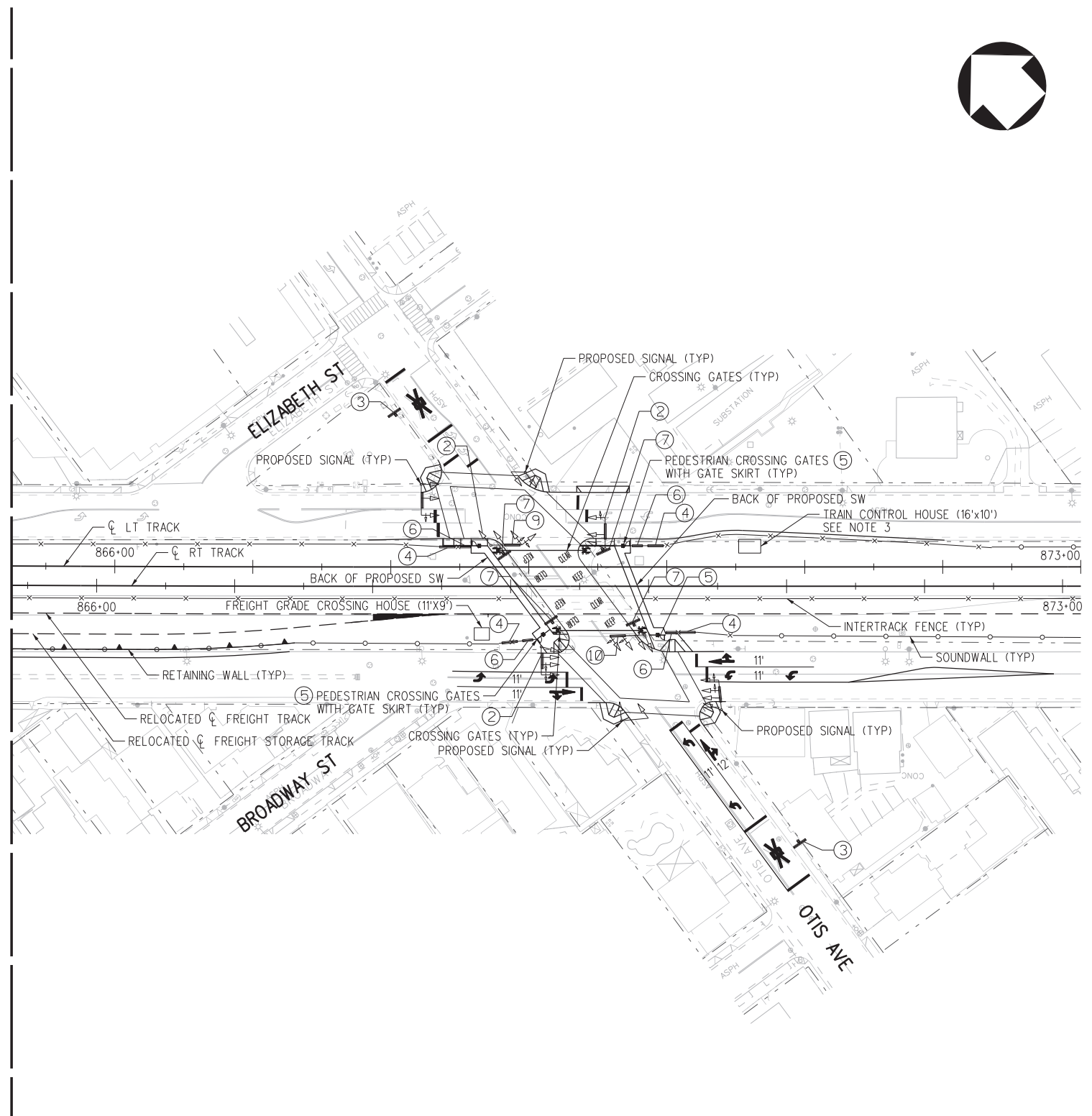
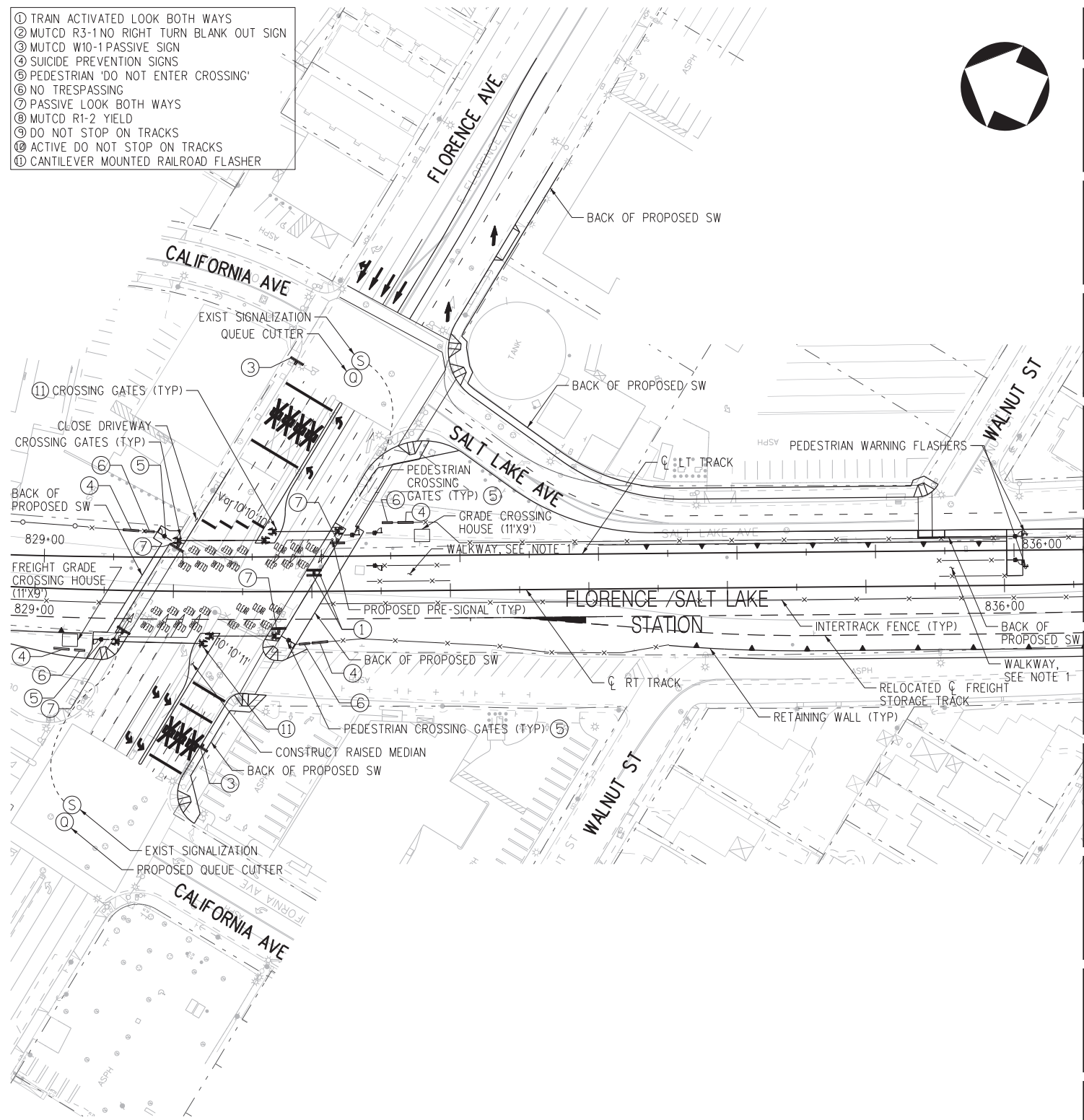

- NOTES:
1. PROTECTION OF PEDESTRIAN GRADE CROSSING AND STATION ACCESS TO BE DETERMINED IN LATER PHASE.
 2. LRT CROSSING CONTROLS MAY BE ACCOMMODATED IN STATION C&S HOUSE.
 3. LRT GRADE CROSSING EQUIPMENT TO BE LOCATED WITHIN TRAIN CONTROL HOUSE.
 4. GREEN EXTENSION TO CLEAR SOUTHBOUND TRAFFIC FROM TRACK AREA DURING PREEMPTION.

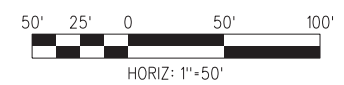

NOT FOR CONSTRUCTION

FINAL ADVANCED CONCEPTUAL ENGINEERING GRADE CROSSINGS - 8262020

THE PREPARATION OF THIS DRAWING HAS BEEN FINANCED IN PART THROUGH A GRANT FROM THE U.S. DEPARTMENT OF TRANSPORTATION FEDERAL TRANSIT ADMINISTRATION (FTA), UNDER THE FEDERAL TRANSIT ACT OF 1964, AS AMENDED, AND IN PART BY THE TAXES OF THE CITIZENS OF LOS ANGELES COUNTY AND OF THE STATE OF CALIFORNIA.		DESIGNED BY CB
0	8/26/2020	DRAWN BY RM
REV	DATE	CHECKED BY BO
	BY	IN CHARGE NM
	APP	DATE 8/26/2020
	REG NO.	
	EXPIRES	
	SEAL HOLDER	
	DESCRIPTION	FINAL ACE SUBMITTAL

DESIGNED BY CB
DRAWN BY RM
CHECKED BY BO
IN CHARGE NM
DATE 8/26/2020

LOS ANGELES COUNTY METROPOLITAN TRANSPORTATION AUTHORITY

wsp 444 South Flower Street Suite 800 Los Angeles, CA 90071 TEL (213) 362-9470

SUBMITTED	_____
APPROVED	_____

WEST SANTA ANA BRANCH LRT GRADE CROSSING FLORENCE AVE & OTIS AVE PLAN	
CONTRACT NO AE5999300	REV
DRAWING NO CS-202	
SCALE HOR: 1"=50'	
SHEET NO 9	OF 24

09-FEB-2021 B-28091ACS202.plg
wspw04-pw-svc 23:17
Plot Driver=MTA-half.pen Pentable=bw.plt

SIGNAGE LEGEND

- ① TRAIN ACTIVATED LOOK BOTH WAYS
- ② MUTCD R3-1 NO RIGHT TURN BLANK OUT SIGN
- ③ MUTCD W10-1 PASSIVE SIGN
- ④ SUICIDE PREVENTION SIGNS
- ⑤ PEDESTRIAN 'DO NOT ENTER CROSSING'
- ⑥ NO TRESPASSING
- ⑦ PASSIVE LOOK BOTH WAYS
- ⑧ MUTCD R1-2 YIELD
- ⑨ DO NOT STOP ON TRACKS
- ⑩ ACTIVE DO NOT STOP ON TRACKS
- ⑪ CANTILEVER MOUNTED RAILROAD FLASHER

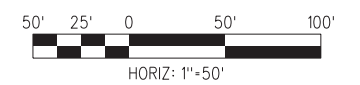
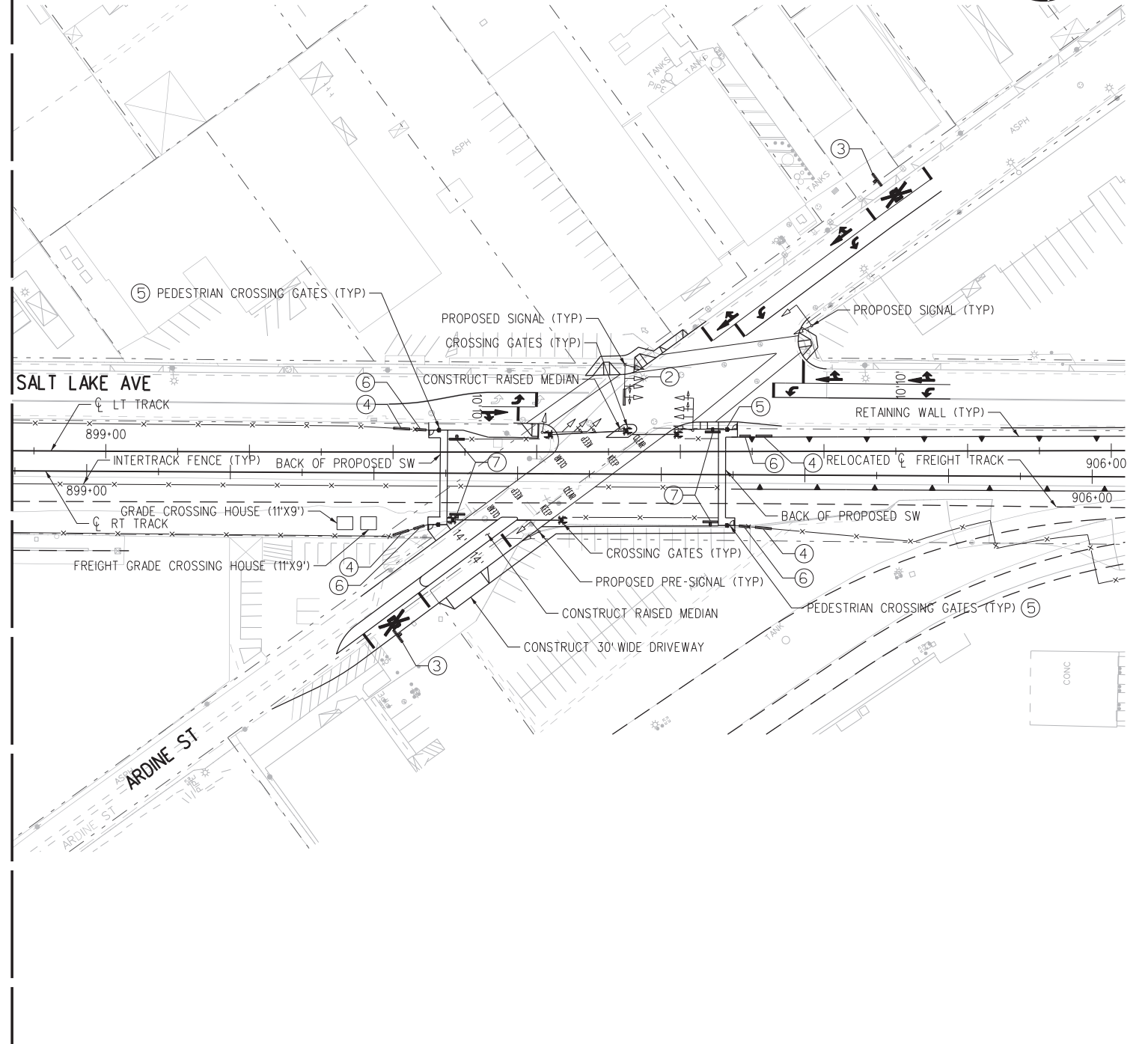
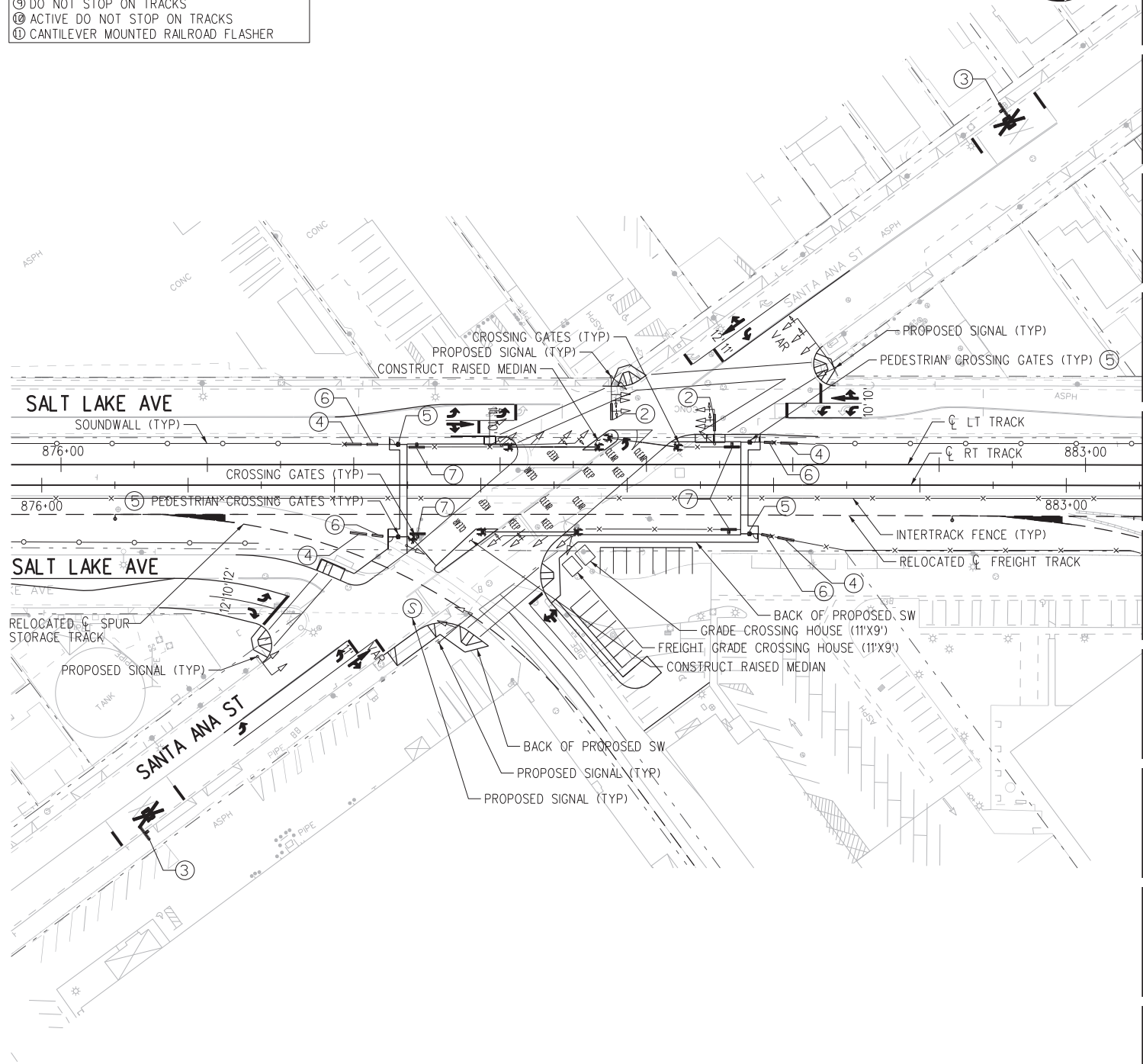

FINAL ADVANCED CONCEPTUAL ENGINEERING GRADE CROSSINGS - 8/26/2020

THE PREPARATION OF THIS DRAWING HAS BEEN FINANCED IN PART THROUGH A GRANT FROM THE U.S. DEPARTMENT OF TRANSPORTATION FEDERAL TRANSIT ADMINISTRATION (FTA), UNDER THE FEDERAL TRANSIT ACT OF 1964, AS AMENDED, AND IN PART BY THE TAXES OF THE CITIZENS OF LOS ANGELES COUNTY AND OF THE STATE OF CALIFORNIA.						
REV	DATE	BY	APP	REG NO.	EXPIRES	SEAL HOLDER
0	8/26/2020					FINAL ACE SUBMITTAL
						DESCRIPTION

DESIGNED BY CB
DRAWN BY RM
CHECKED BY BO
IN CHARGE NM
DATE 8/26/2020

Metro

**LOS ANGELES COUNTY
METROPOLITAN TRANSPORTATION AUTHORITY**

wsp 444 South Flower Street
Suite 800
Los Angeles, CA 90071
TEL (213) 362-9470

SUBMITTED _____

APPROVED _____

**WEST SANTA ANA BRANCH LRT
GRADE CROSSING
SANTA ANNA ST & ARDINE ST
PLAN**

CONTRACT NO AE5999300	REV
DRAWING NO CS-203	
SCALE HOR: 1"=50'	
SHEET NO 10	OF 24

09-FEB-2021 B-28091ACS203.plg
wsppw04-pw-svc 23:16
Plot Driver=MTA-half.pen Pentable=bw.plt

SIGNAGE LEGEND

- ① TRAIN ACTIVATED LOOK BOTH WAYS
- ② MUTCD R3-1 NO RIGHT TURN BLANK OUT SIGN
- ③ MUTCD W10-1 PASSIVE SIGN
- ④ SUICIDE PREVENTION SIGNS
- ⑤ PEDESTRIAN 'DO NOT ENTER CROSSING'
- ⑥ NO TRESPASSING
- ⑦ PASSIVE LOOK BOTH WAYS
- ⑧ MUTCD R1-2 YIELD
- ⑨ DO NOT STOP ON TRACKS
- ⑩ ACTIVE DO NOT STOP ON TRACKS
- ⑪ CANTILEVER MOUNTED RAILROAD FLASHER

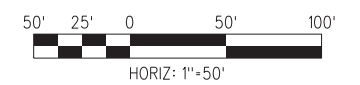
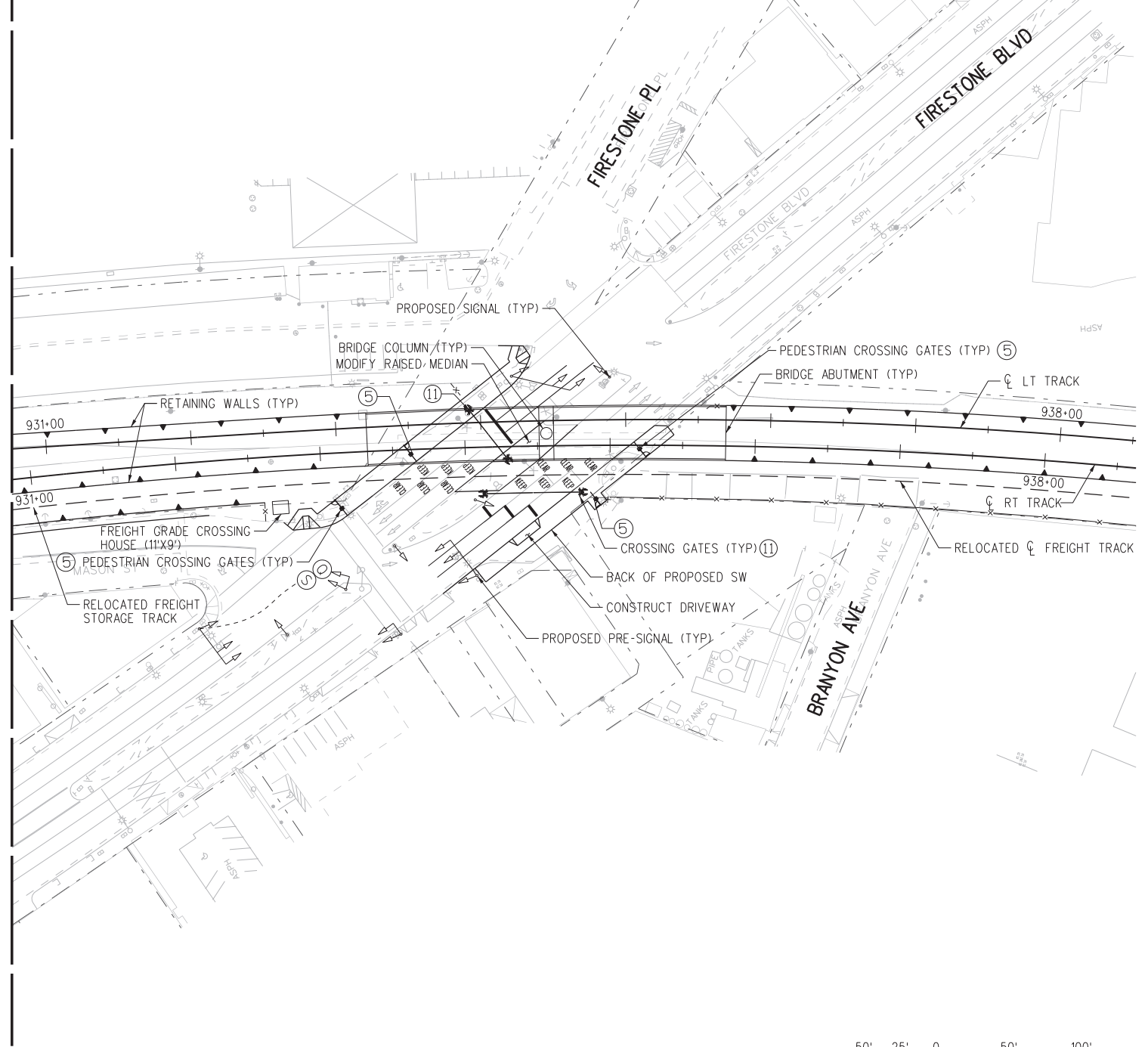
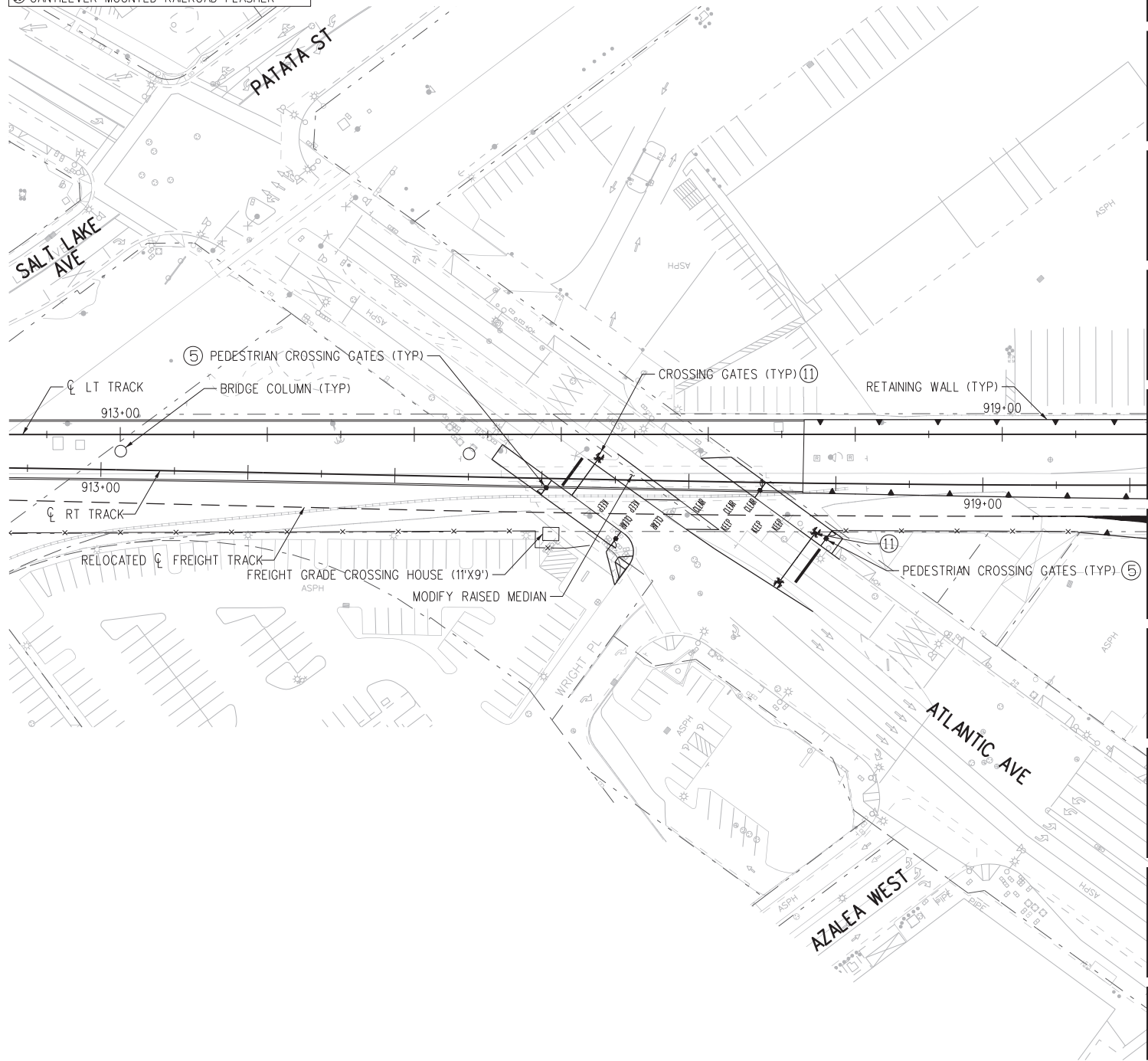

FINAL ADVANCED CONCEPTUAL ENGINEERING GRADE CROSSINGS - 8/26/2020

NOT FOR CONSTRUCTION

09-FEB-2021 B-28091ACS204.plg

wspw04-pw-svc 23:17

THE PREPARATION OF THIS DRAWING HAS BEEN FINANCED IN PART THROUGH A GRANT FROM THE U.S. DEPARTMENT OF TRANSPORTATION FEDERAL TRANSIT ADMINISTRATION (FTA), UNDER THE FEDERAL TRANSIT ACT OF 1964, AS AMENDED, AND IN PART BY THE TAXES OF THE CITIZENS OF LOS ANGELES COUNTY AND OF THE STATE OF CALIFORNIA.							
REV	DATE	BY	APP	REG NO.	EXPIRES	SEAL HOLDER	DESCRIPTION
0	8/26/2020						FINAL ACE SUBMITTAL

DESIGNED BY CB
DRAWN BY RM
CHECKED BY BO
IN CHARGE NM
DATE 8/26/2020

LOS ANGELES COUNTY METROPOLITAN TRANSPORTATION AUTHORITY

444 South Flower Street
Suite 800
Los Angeles, CA 90071
TEL (213) 362-9470

SUBMITTED _____

APPROVED _____

CONTRACT NO AE5999300	
DRAWING NO CS-204	REV
SCALE HOR: 1"=50'	
SHEET NO 11	OF 24

SIGNAGE LEGEND

- ① TRAIN ACTIVATED LOOK BOTH WAYS
- ② MUTCD R3-1 NO RIGHT TURN BLANK OUT SIGN
- ③ MUTCD W10-1 PASSIVE SIGN
- ④ SUICIDE PREVENTION SIGNS
- ⑤ PEDESTRIAN 'DO NOT ENTER CROSSING'
- ⑥ NO TRESPASSING
- ⑦ PASSIVE LOOK BOTH WAYS
- ⑧ MUTCD R1-2 YIELD
- ⑨ DO NOT STOP ON TRACKS
- ⑩ ACTIVE DO NOT STOP ON TRACKS
- ⑪ CANTILEVER MOUNTED RAILROAD FLASHER

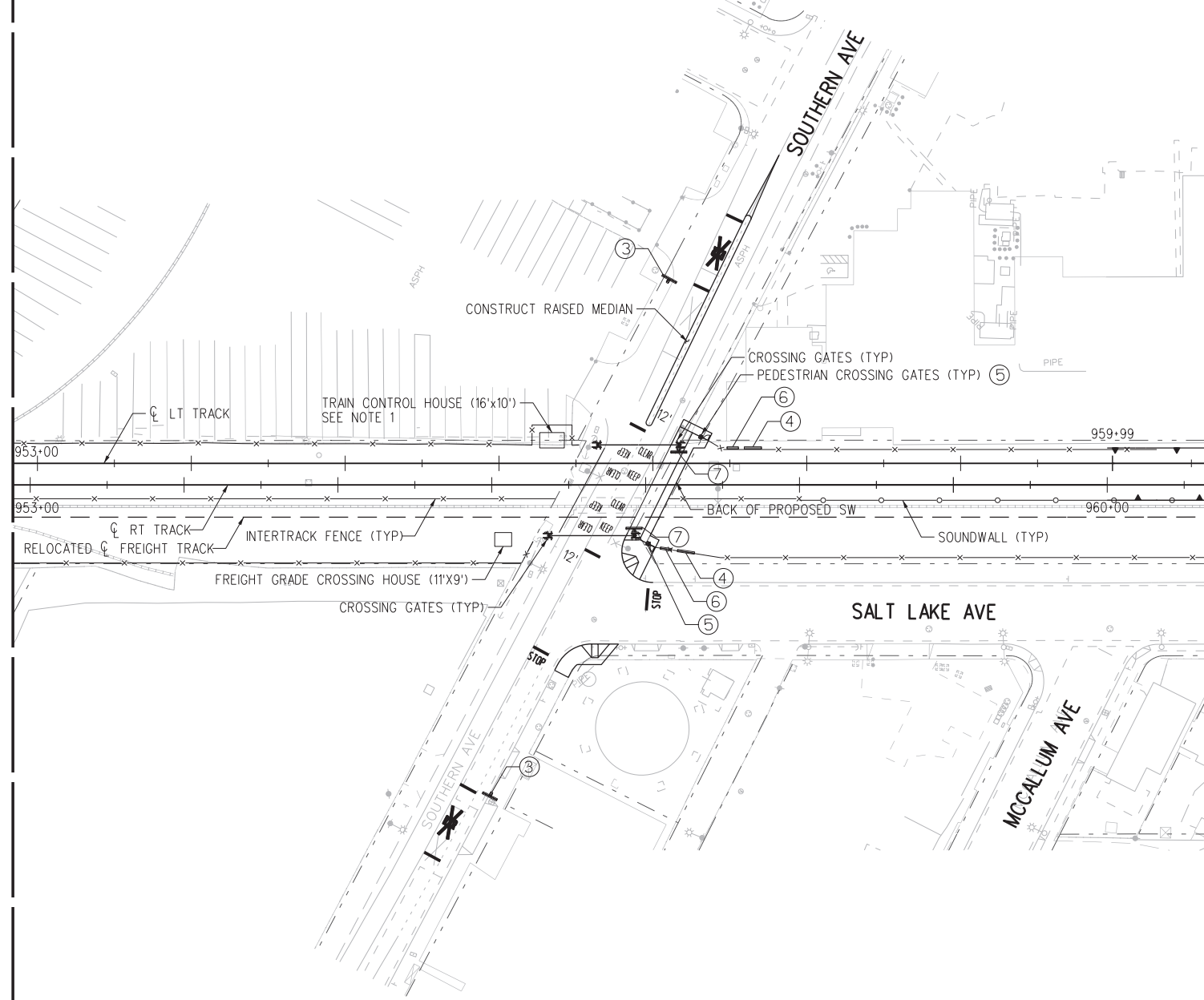
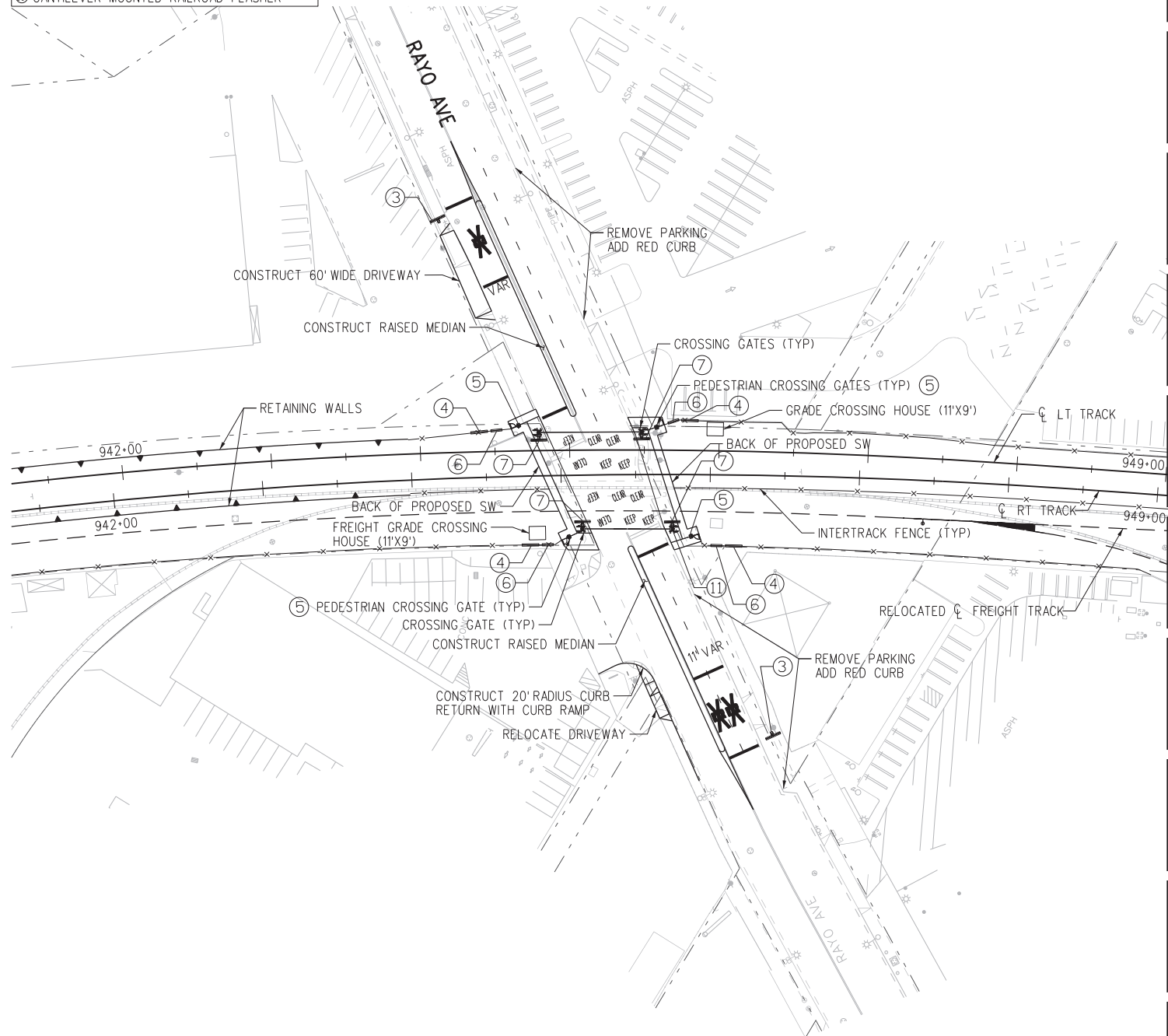

NOTES:
 1. LRT GRADE CROSSING EQUIPMENT TO BE LOCATED WITHIN TRAIN CONTROL HOUSE.



NOT FOR CONSTRUCTION

FINAL ADVANCED CONCEPTUAL ENGINEERING GRADE CROSSINGS - 826/2020

THE PREPARATION OF THIS DRAWING HAS BEEN FINANCED IN PART THROUGH A GRANT FROM THE U.S. DEPARTMENT OF TRANSPORTATION FEDERAL TRANSIT ADMINISTRATION (FTA), UNDER THE FEDERAL TRANSIT ACT OF 1964, AS AMENDED, AND IN PART BY THE TAKES OF THE CITIZENS OF LOS ANGELES COUNTY AND OF THE STATE OF CALIFORNIA.		DESIGNED BY CB
0	8/26/2020	DRAWN BY RM
REV	DATE	CHECKED BY BO
BY	APP	IN CHARGE NM
REG NO.	EXPIRES	DATE 8/26/2020
SEAL HOLDER	DESCRIPTION	FINAL ACE SUBMITTAL

DESIGNED BY CB
DRAWN BY RM
CHECKED BY BO
IN CHARGE NM
DATE 8/26/2020

M Metro
LOS ANGELES COUNTY METROPOLITAN TRANSPORTATION AUTHORITY

wsp 444 South Flower Street Suite 800 Los Angeles, CA 90071 TEL (213) 362-9470

SUBMITTED _____
 APPROVED _____

WEST SANTA ANA BRANCH LRT GRADE CROSSING RAYO AVE & SOUTHERN AVE PLAN

CONTRACT NO. AE5999300
DRAWING NO. CS-205
SCALE HOR: 1"=50'
SHEET NO. 12 OF 24

09-FEB-2021 B-28091ACS205.plg
 wppw04-pw-svc 23:19
 Plot Driver=MTA-half.pen
 Pentable=bw.plt

SIGNAGE LEGEND

- ① TRAIN ACTIVATED LOOK BOTH WAYS
- ② MUTCD R3-1 NO RIGHT TURN BLANK OUT SIGN
- ③ MUTCD W10-1 PASSIVE SIGN
- ④ SUICIDE PREVENTION SIGNS
- ⑤ PEDESTRIAN 'DO NOT ENTER CROSSING'
- ⑥ NO TRESPASSING
- ⑦ PASSIVE LOOK BOTH WAYS
- ⑧ MUTCD R1-2 YIELD
- ⑨ DO NOT STOP ON TRACKS
- ⑩ ACTIVE DO NOT STOP ON TRACKS
- ⑪ CANTILEVER MOUNTED RAILROAD FLASHER

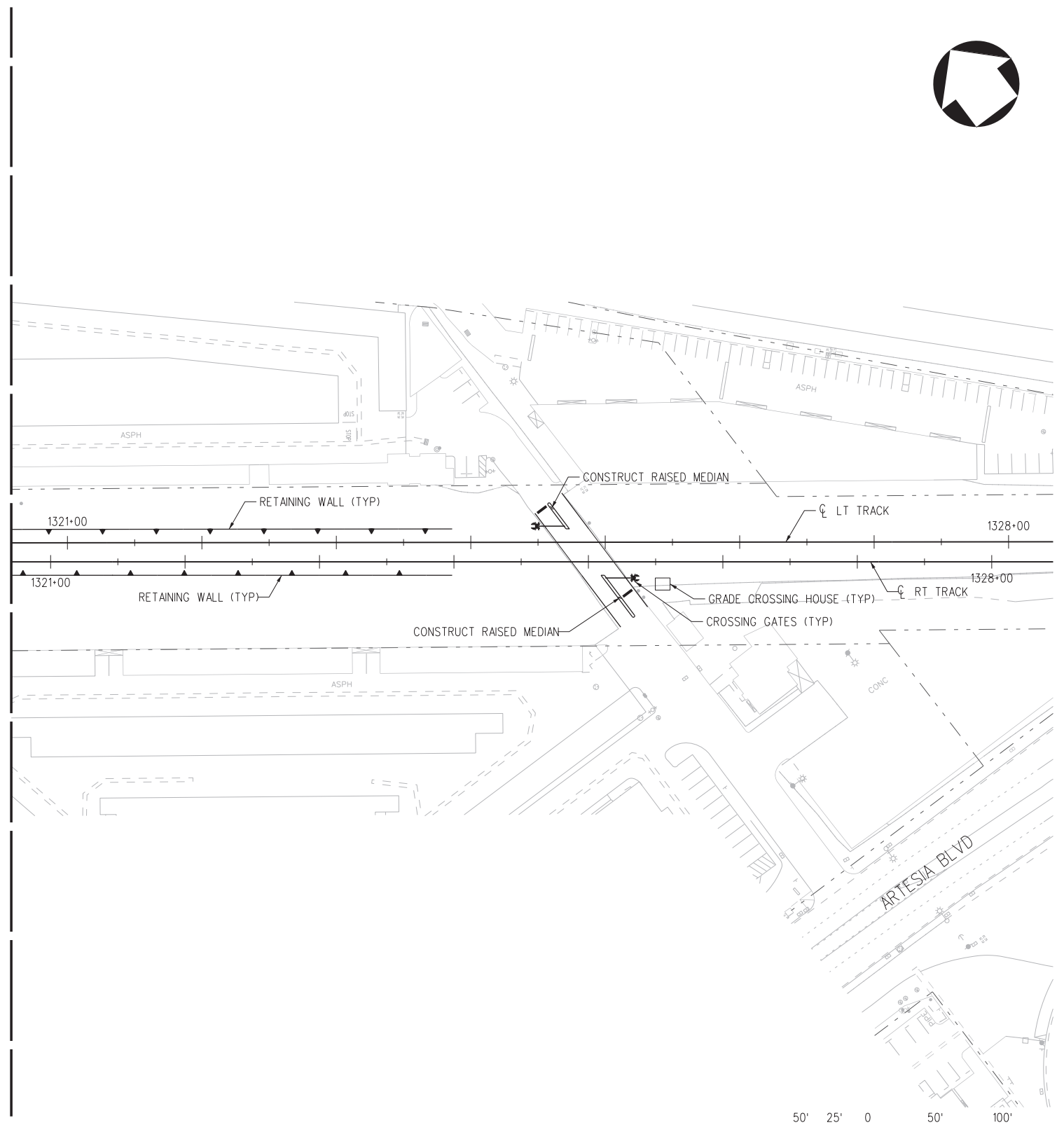
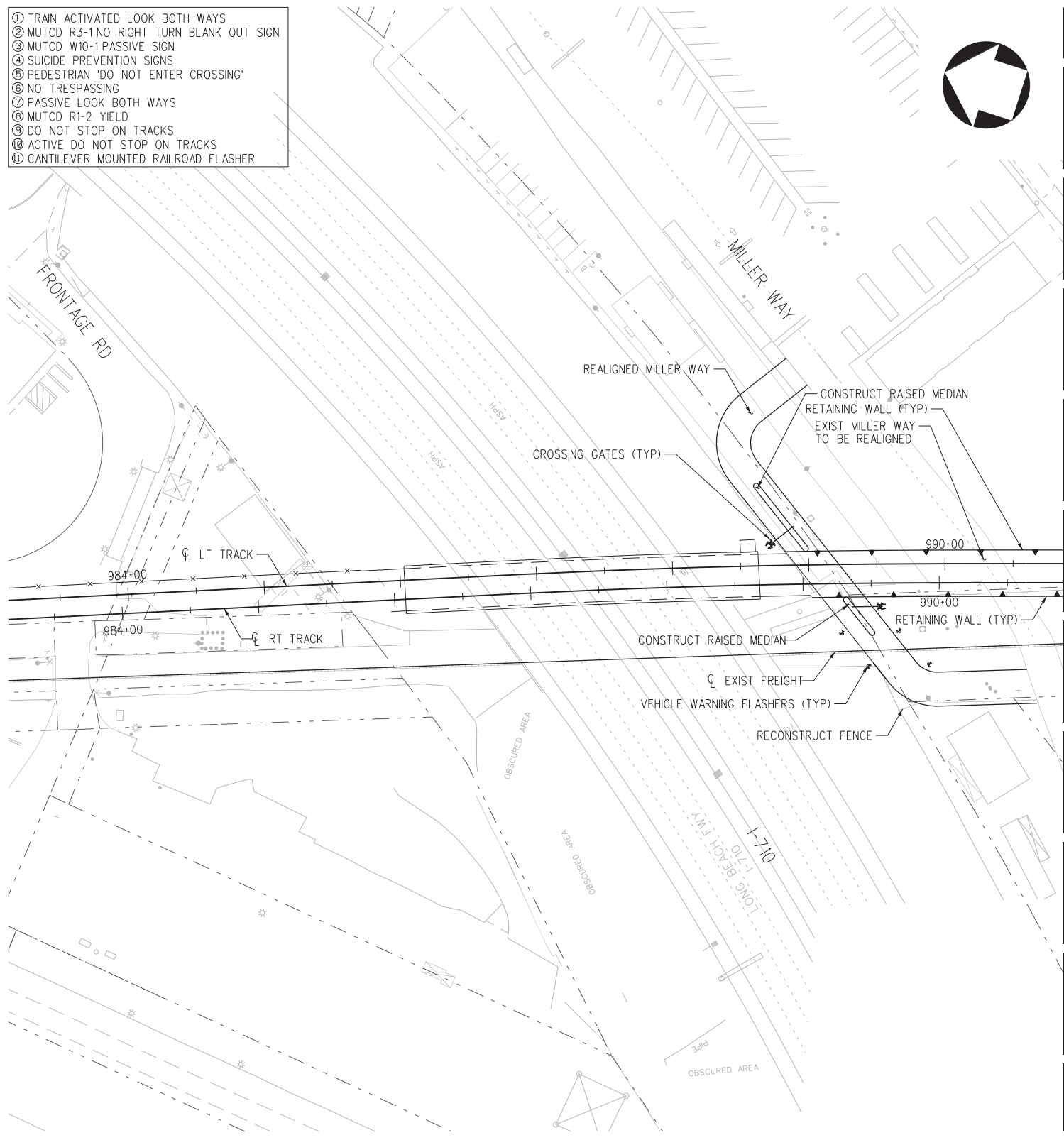

FINAL ADVANCED CONCEPTUAL ENGINEERING GRADE CROSSINGS - 826/2020

NOT FOR CONSTRUCTION

09-FEB-2021 B-28091ACS206.plt
wspw04-pw-svc 23:19
Plot Driver=MTA-half.pen

THE PREPARATION OF THIS DRAWING HAS BEEN FINANCED IN PART THROUGH A GRANT FROM THE U.S. DEPARTMENT OF TRANSPORTATION FEDERAL TRANSIT ADMINISTRATION (FTA), UNDER THE FEDERAL TRANSIT ACT OF 1964, AS AMENDED, AND IN PART BY THE TAKES OF THE CITIZENS OF LOS ANGELES COUNTY AND OF THE STATE OF CALIFORNIA.		DESIGNED BY CB
0	8/26/2020	DRAWN BY RM
REV	DATE	CHECKED BY BO
BY	APP	IN CHARGE NM
REG NO.	EXPIRES	DATE 8/26/2020
SEAL HOLDER	DESCRIPTION	FINAL ACE SUBMITTAL

DESIGNED BY CB
DRAWN BY RM
CHECKED BY BO
IN CHARGE NM
DATE 8/26/2020

LOS ANGELES COUNTY METROPOLITAN TRANSPORTATION AUTHORITY

wsp 444 South Flower Street Suite 800 Los Angeles, CA 90071 TEL (213) 362-9470

SUBMITTED	_____
APPROVED	_____

WEST SANTA ANA BRANCH LRT PRIVATE GRADE CROSSINGS MILLER WAY & PRIVATE DRIVE PLAN	
CONTRACT NO AE5999300	REV
DRAWING NO CS-206	
SCALE HOR: 1"=50'	
SHEET NO 13	OF 24

SIGNAGE LEGEND

- ① TRAIN ACTIVATED LOOK BOTH WAYS
- ② MUTCD R3-1 NO RIGHT TURN BLANK OUT SIGN
- ③ MUTCD W10-1 PASSIVE SIGN
- ④ SUICIDE PREVENTION SIGNS
- ⑤ PEDESTRIAN 'DO NOT ENTER CROSSING'
- ⑥ NO TRESPASSING
- ⑦ PASSIVE LOOK BOTH WAYS
- ⑧ MUTCD R1-2 YIELD
- ⑨ DO NOT STOP ON TRACKS
- ⑩ ACTIVE DO NOT STOP ON TRACKS
- ⑪ CANTILEVER MOUNTED RAILROAD FLASHER

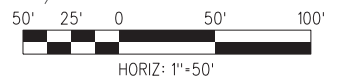
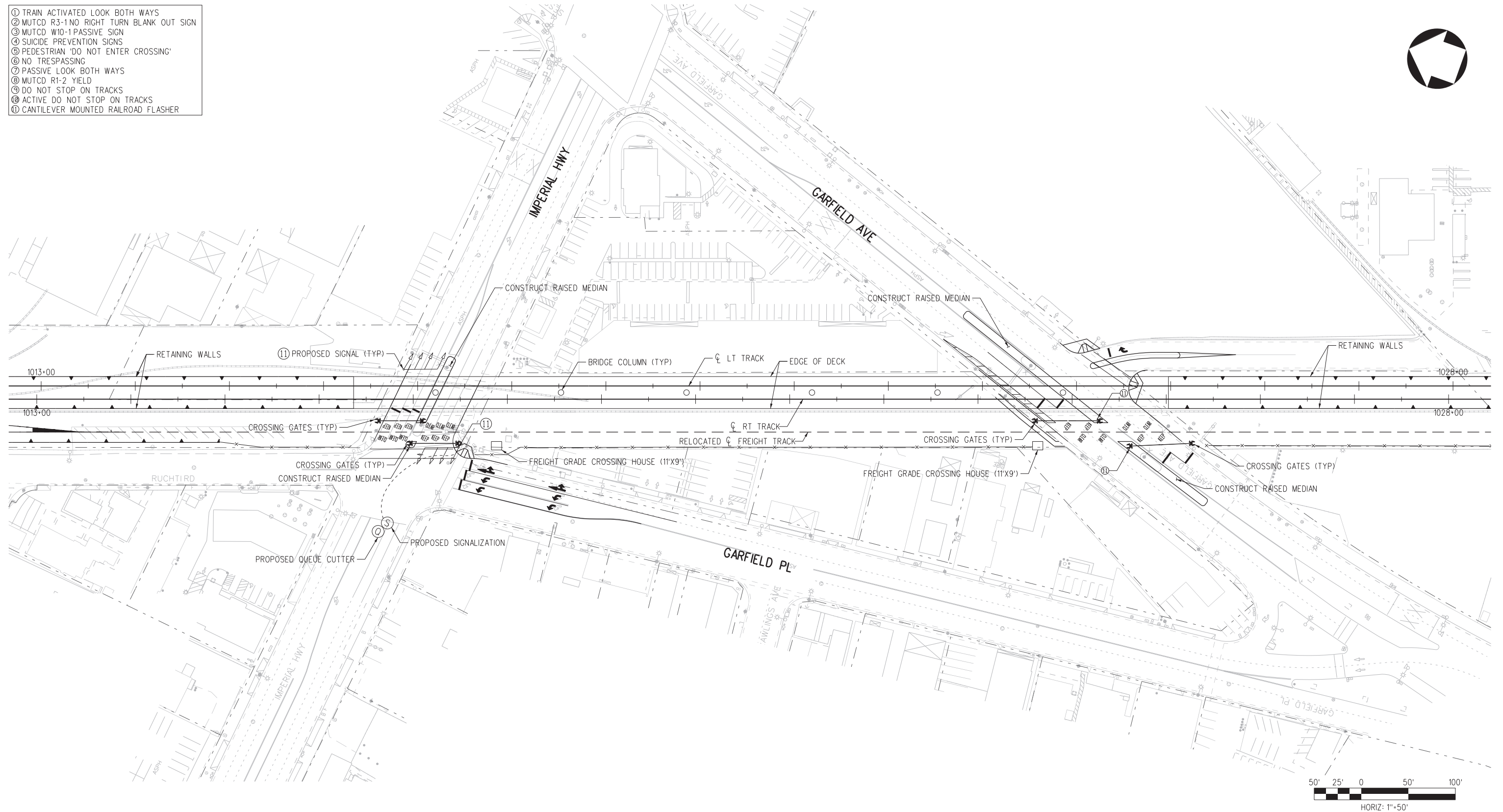

FINAL ADVANCED CONCEPTUAL ENGINEERING GRADE CROSSINGS - 826/2020

NOT FOR CONSTRUCTION

THE PREPARATION OF THIS DRAWING HAS BEEN FINANCED IN PART THROUGH A GRANT FROM THE U.S. DEPARTMENT OF TRANSPORTATION FEDERAL TRANSIT ADMINISTRATION (FTA), UNDER THE FEDERAL TRANSIT ACT OF 1964, AS AMENDED, AND IN PART BY THE TAKES OF THE CITIZENS OF LOS ANGELES COUNTY AND OF THE STATE OF CALIFORNIA.

REV	DATE	BY	APP	REG NO.	EXPIRES	SEAL HOLDER	DESCRIPTION
0	8/26/2020						FINAL ACE SUBMITTAL

DESIGNED BY CB
DRAWN BY RM
CHECKED BY BO
IN CHARGE NM
DATE 8/26/2020

Metro

**LOS ANGELES COUNTY
METROPOLITAN TRANSPORTATION AUTHORITY**

444 South Flower Street
Suite 800
Los Angeles, CA 90071
TEL (213) 362-9470

SUBMITTED _____

APPROVED _____

CONTRACT NO AE5999300	
DRAWING NO CS-207	REV
SCALE HOR: 1"=50'	
SHEET NO 14	OF 24

09-FEB-2021 B-28091ACS207.plg
wspdw04-pw-svc 23:16
Plot Driver=MTA-half.pen Pentable=bw.plt

SIGNAGE LEGEND

- ① TRAIN ACTIVATED LOOK BOTH WAYS
- ② MUTCD R3-1 NO RIGHT TURN BLANK OUT SIGN
- ③ MUTCD W10-1 PASSIVE SIGN
- ④ SUICIDE PREVENTION SIGNS
- ⑤ PEDESTRIAN 'DO NOT ENTER CROSSING'
- ⑥ NO TRESPASSING
- ⑦ PASSIVE LOOK BOTH WAYS
- ⑧ MUTCD R1-2 YIELD
- ⑨ DO NOT STOP ON TRACKS
- ⑩ ACTIVE DO NOT STOP ON TRACKS
- ⑪ CANTILEVER MOUNTED RAILROAD FLASHER

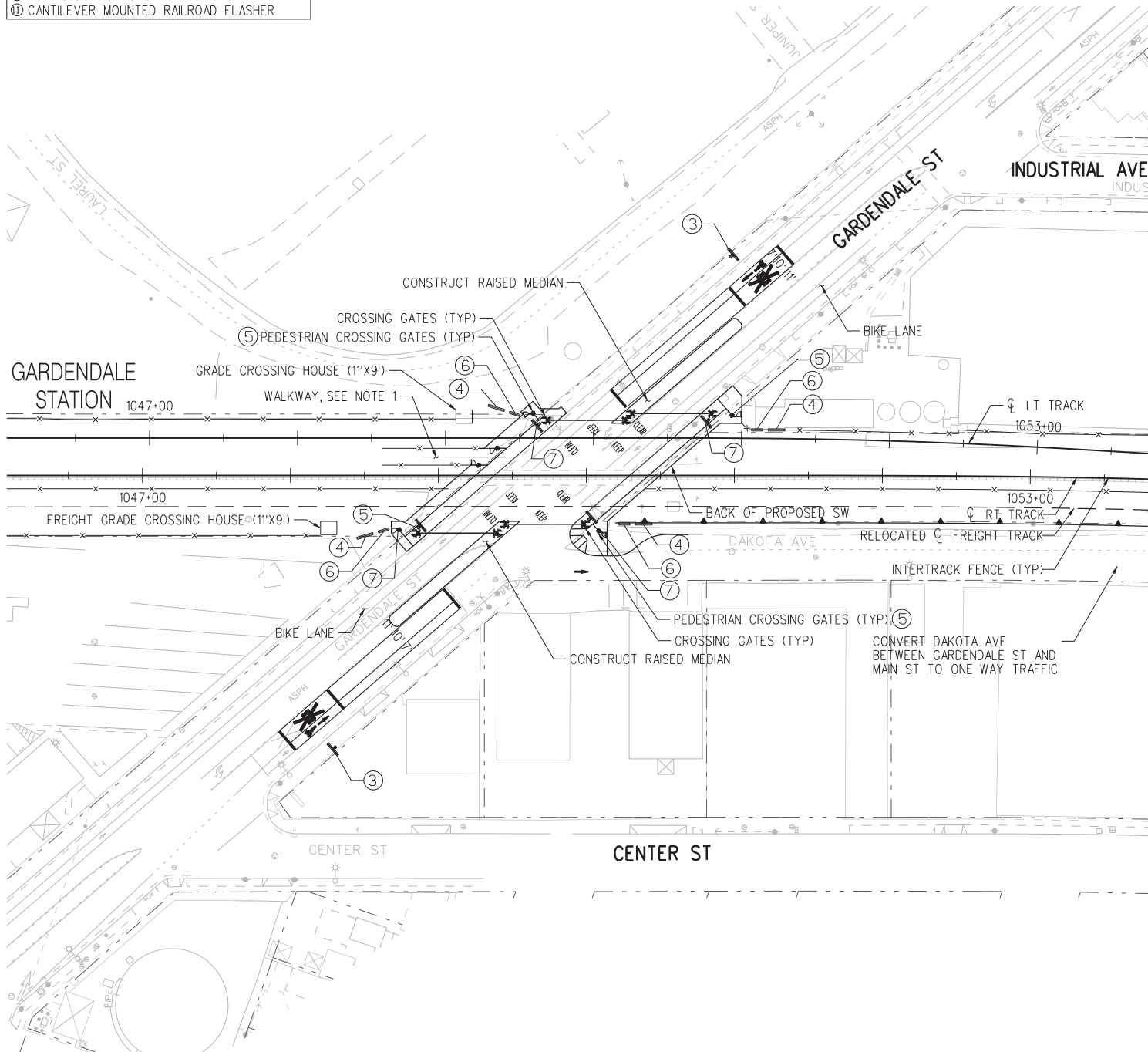

- NOTES:
1. PROTECTION OF PEDESTRIAN GRADE CROSSING AND STATION ACCESS TO BE DETERMINED IN LATER PHASE.
 2. LRT CROSSING CONTROLS MAY BE ACCOMMODATED IN STATION C&S HOUSE.
 3. LRT GRADE CROSSING EQUIPMENT TO BE LOCATED WITHIN TRAIN CONTROL HOUSE.

FINAL ADVANCED CONCEPTUAL ENGINEERING GRADE CROSSINGS - 826/2020

THE PREPARATION OF THIS DRAWING HAS BEEN FINANCED IN PART THROUGH A GRANT FROM THE U.S. DEPARTMENT OF TRANSPORTATION FEDERAL TRANSIT ADMINISTRATION (FTA), UNDER THE FEDERAL TRANSIT ACT OF 1964, AS AMENDED, AND IN PART BY THE TAKES OF THE CITIZENS OF LOS ANGELES COUNTY AND OF THE STATE OF CALIFORNIA.		DESIGNED BY CB	DATE 8/26/2020
REV	DATE	BY	DESCRIPTION
0	8/26/2020		FINAL ACE SUBMITTAL
		APP	REG NO.
		EXPIRES	SEAL HOLDER

M Metro
LOS ANGELES COUNTY METROPOLITAN TRANSPORTATION AUTHORITY

wsp 444 South Flower Street Suite 800 Los Angeles, CA 90071 TEL (213) 362-9470

SUBMITTED _____
APPROVED _____

WEST SANTA ANA BRANCH LRT GRADE CROSSING GARDENDALE ST & MAIN ST PLAN

CONTRACT NO. AE5999300
DRAWING NO. CS-208
SCALE: HOR: 1"=50'
SHEET NO. 15 OF 24

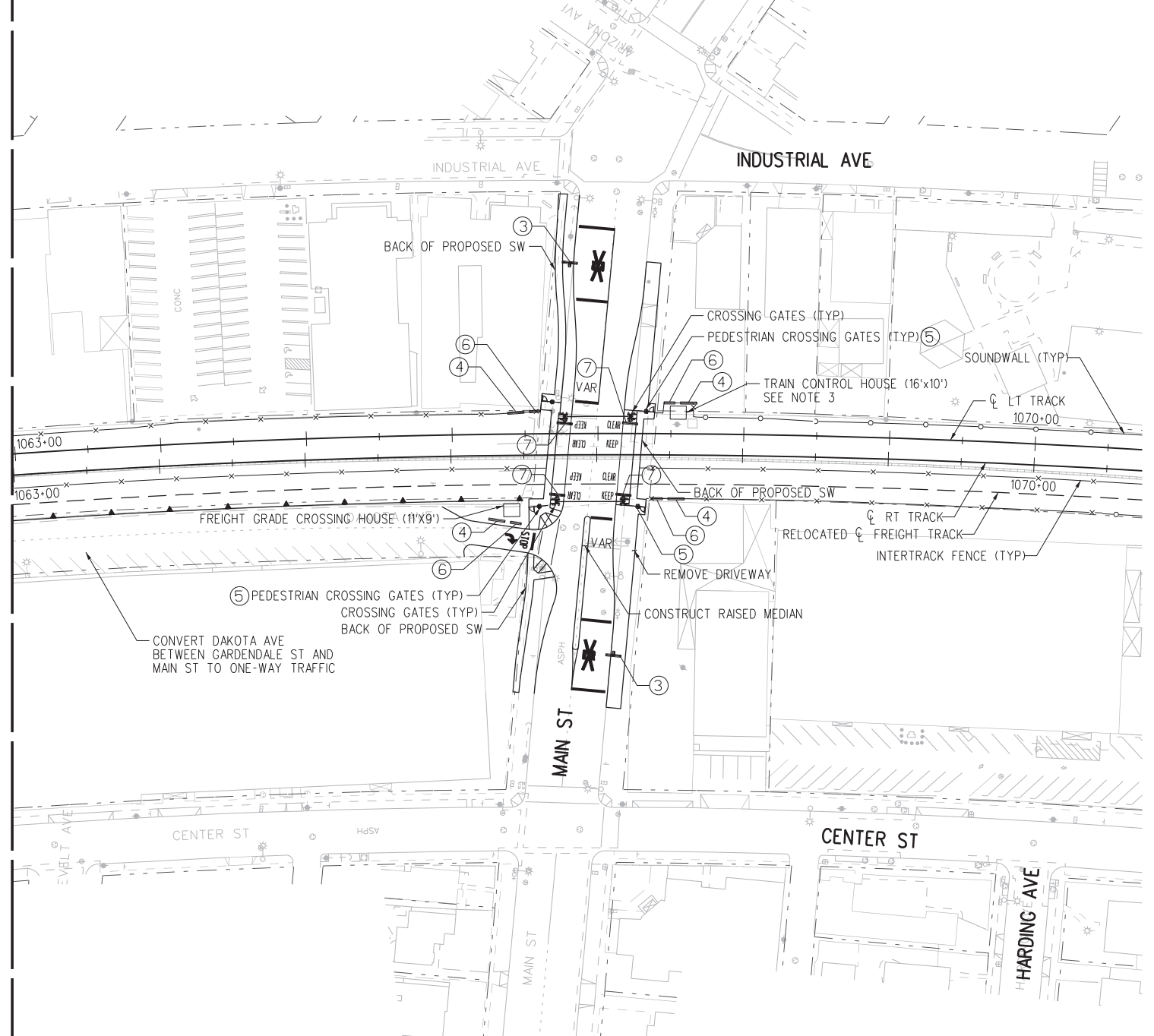

NOT FOR CONSTRUCTION

09-FEB-2021 B-28091ACS208.plg
wspdw04-pw-svc 23:18
Plot Driver=MTA-half.pen
Pentable=bw.plt

SIGNAGE LEGEND

- ① TRAIN ACTIVATED LOOK BOTH WAYS
- ② MUTCD R3-1 NO RIGHT TURN BLANK OUT SIGN
- ③ MUTCD W10-1 PASSIVE SIGN
- ④ SUICIDE PREVENTION SIGNS
- ⑤ PEDESTRIAN 'DO NOT ENTER CROSSING'
- ⑥ NO TRESPASSING
- ⑦ PASSIVE LOOK BOTH WAYS
- ⑧ MUTCD R1-2 YIELD
- ⑨ DO NOT STOP ON TRACKS
- ⑩ ACTIVE DO NOT STOP ON TRACKS
- ⑪ CANTILEVER MOUNTED RAILROAD FLASHER

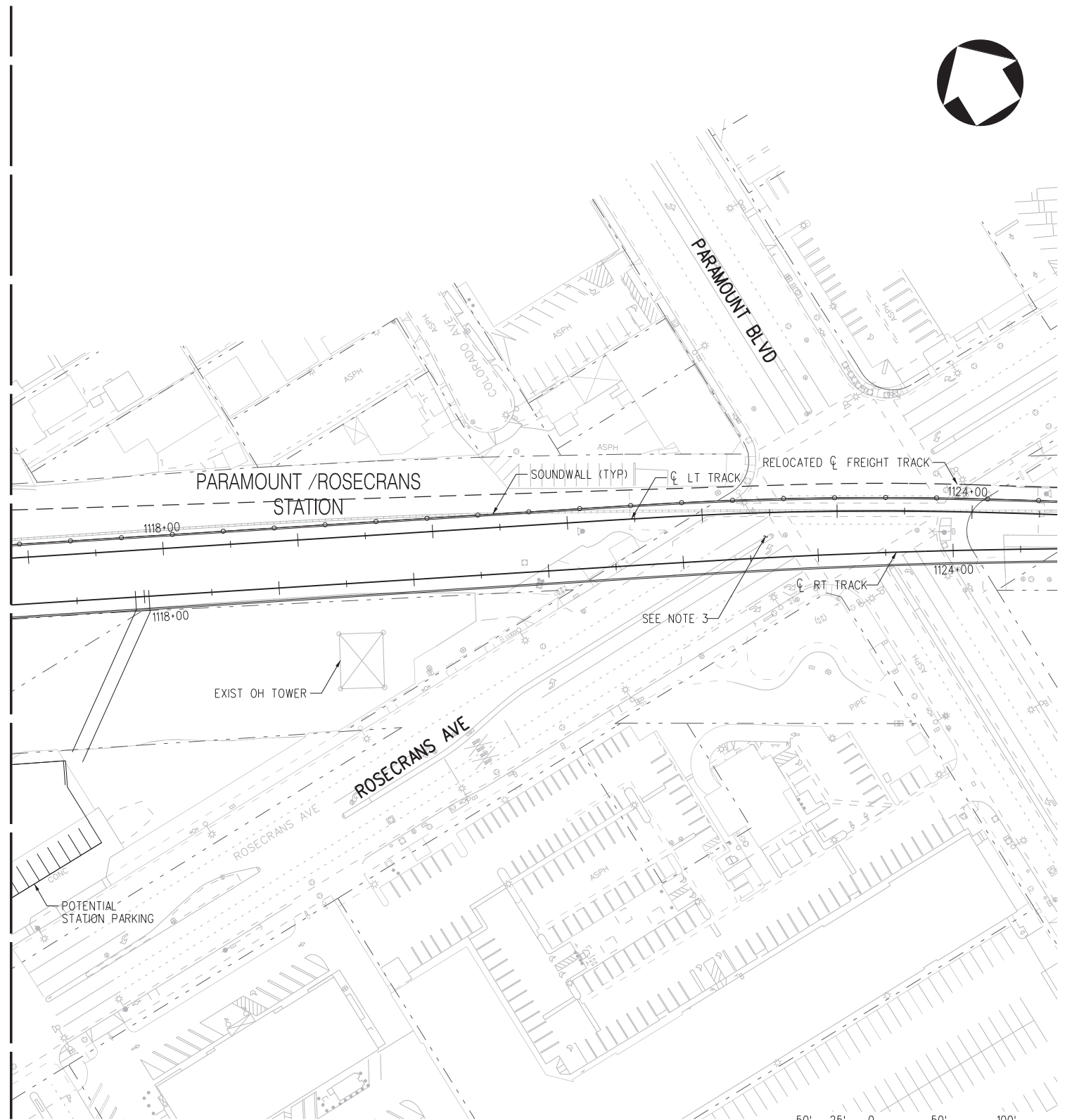
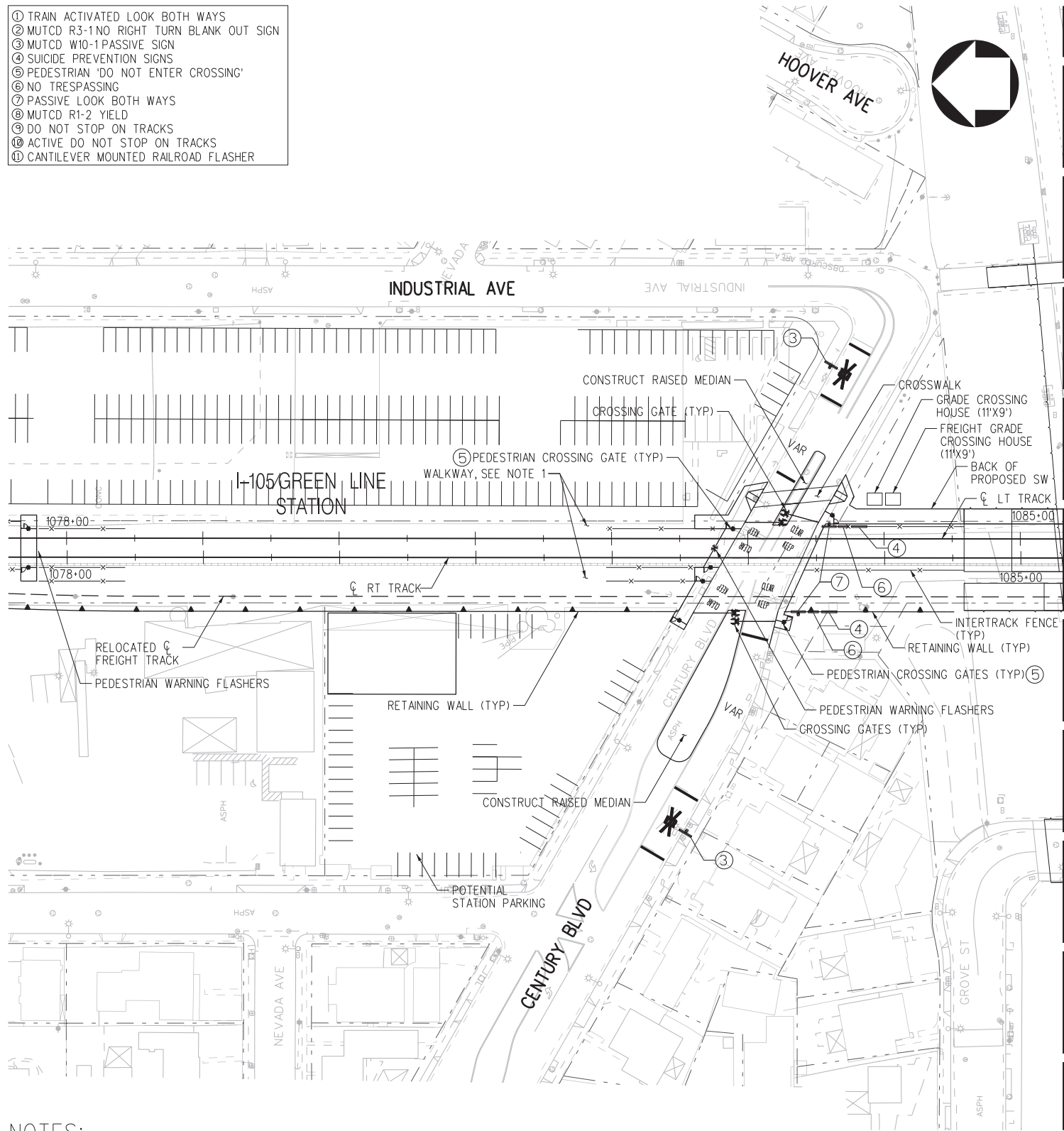

- NOTES:
1. PROTECTION OF PEDESTRIAN GRADE CROSSING AND STATION ACCESS TO BE DETERMINED IN LATER PHASE.
 2. LRT CROSSING CONTROLS MAY BE ACCOMMODATED IN STATION C&S HOUSE.
 3. THE WSAB ALIGNMENT IS GRADE SEPARATED FROM THE ROSECRANS AVE/PARAMOUNT BLVD INTERSECTION.

FINAL ADVANCED CONCEPTUAL ENGINEERING GRADE CROSSINGS - 8262020

THE PREPARATION OF THIS DRAWING HAS BEEN FINANCED IN PART THROUGH A GRANT FROM THE U.S. DEPARTMENT OF TRANSPORTATION FEDERAL TRANSIT ADMINISTRATION (FTA), UNDER THE FEDERAL TRANSIT ACT OF 1964, AS AMENDED, AND IN PART BY THE TAXES OF THE CITIZENS OF LOS ANGELES COUNTY AND OF THE STATE OF CALIFORNIA.		DESIGNED BY CB	DATE 8/26/2020	DESCRIPTION FINAL ACE SUBMITTAL			
REV	DATE	BY	APP	REG NO.	EXPIRES	SEAL HOLDER	
0	8/26/2020						

DRAWN BY RM	CHECKED BY BO	IN CHARGE NM	DATE 8/26/2020
----------------	------------------	-----------------	-------------------

M Metro LOS ANGELES COUNTY METROPOLITAN TRANSPORTATION AUTHORITY

wsp 444 South Flower Street Suite 800 Los Angeles, CA 90071 TEL (213) 362-9470

SUBMITTED _____

APPROVED _____

WEST SANTA ANA BRANCH LRT GRADE CROSSING CENTURY BLVD & ROSECRANS/PARAMOUNT PLAN

CONTRACT NO. AE5999300

DRAWING NO. CS-209

SCALE HOR: 1"=50'

SHEET NO. 16 OF 24

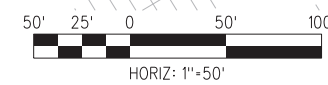

NOT FOR CONSTRUCTION

09-FEB-2021 B-28091ACS209.plg

SIGNAGE LEGEND

- ① TRAIN ACTIVATED LOOK BOTH WAYS
- ② MUTCD R3-1 NO RIGHT TURN BLANK OUT SIGN
- ③ MUTCD W10-1 PASSIVE SIGN
- ④ SUICIDE PREVENTION SIGNS
- ⑤ PEDESTRIAN 'DO NOT ENTER CROSSING'
- ⑥ NO TRESPASSING
- ⑦ PASSIVE LOOK BOTH WAYS
- ⑧ MUTCD R1-2 YIELD
- ⑨ DO NOT STOP ON TRACKS
- ⑩ ACTIVE DO NOT STOP ON TRACKS
- ⑪ CANTILEVER MOUNTED RAILROAD FLASHER

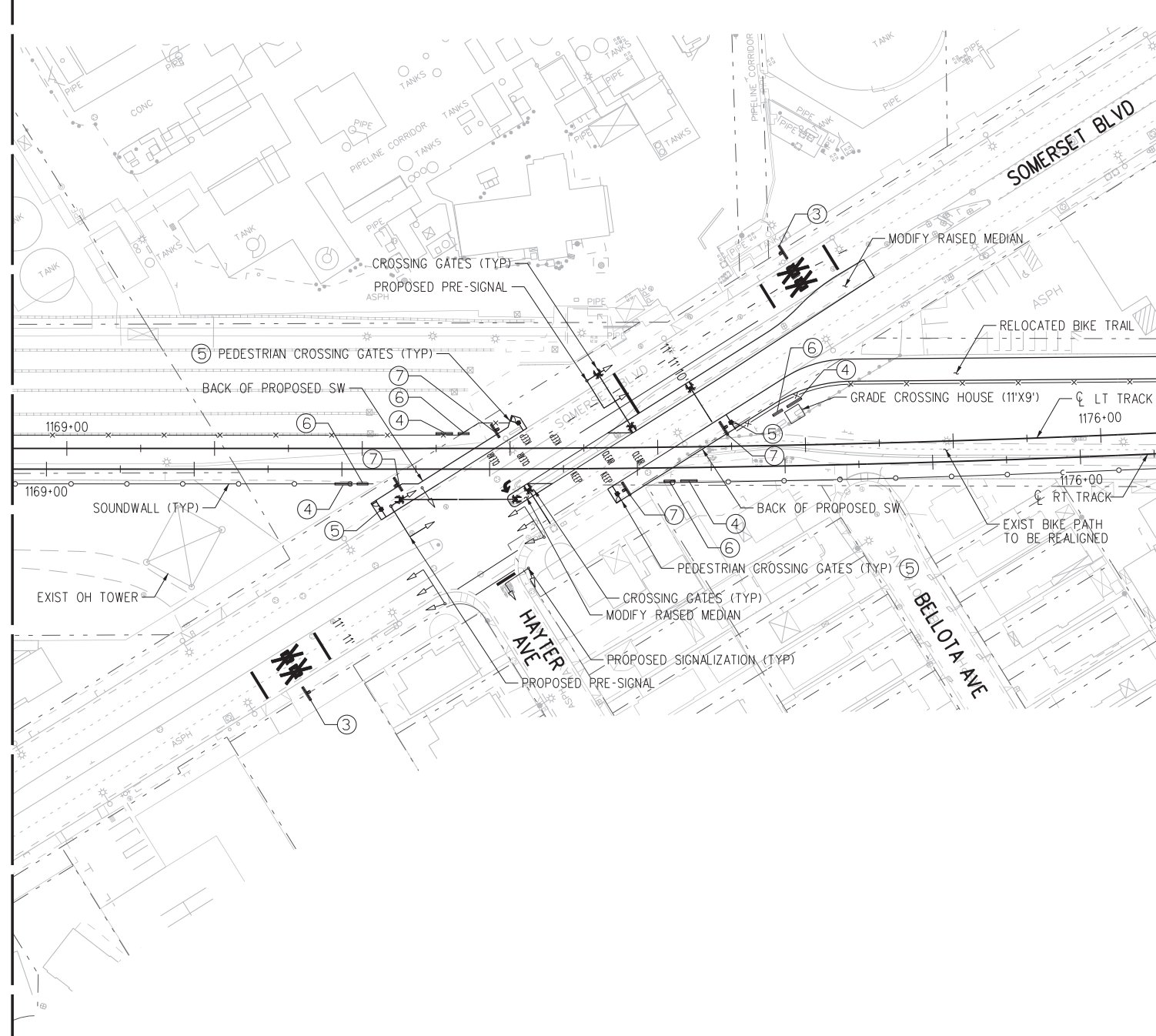
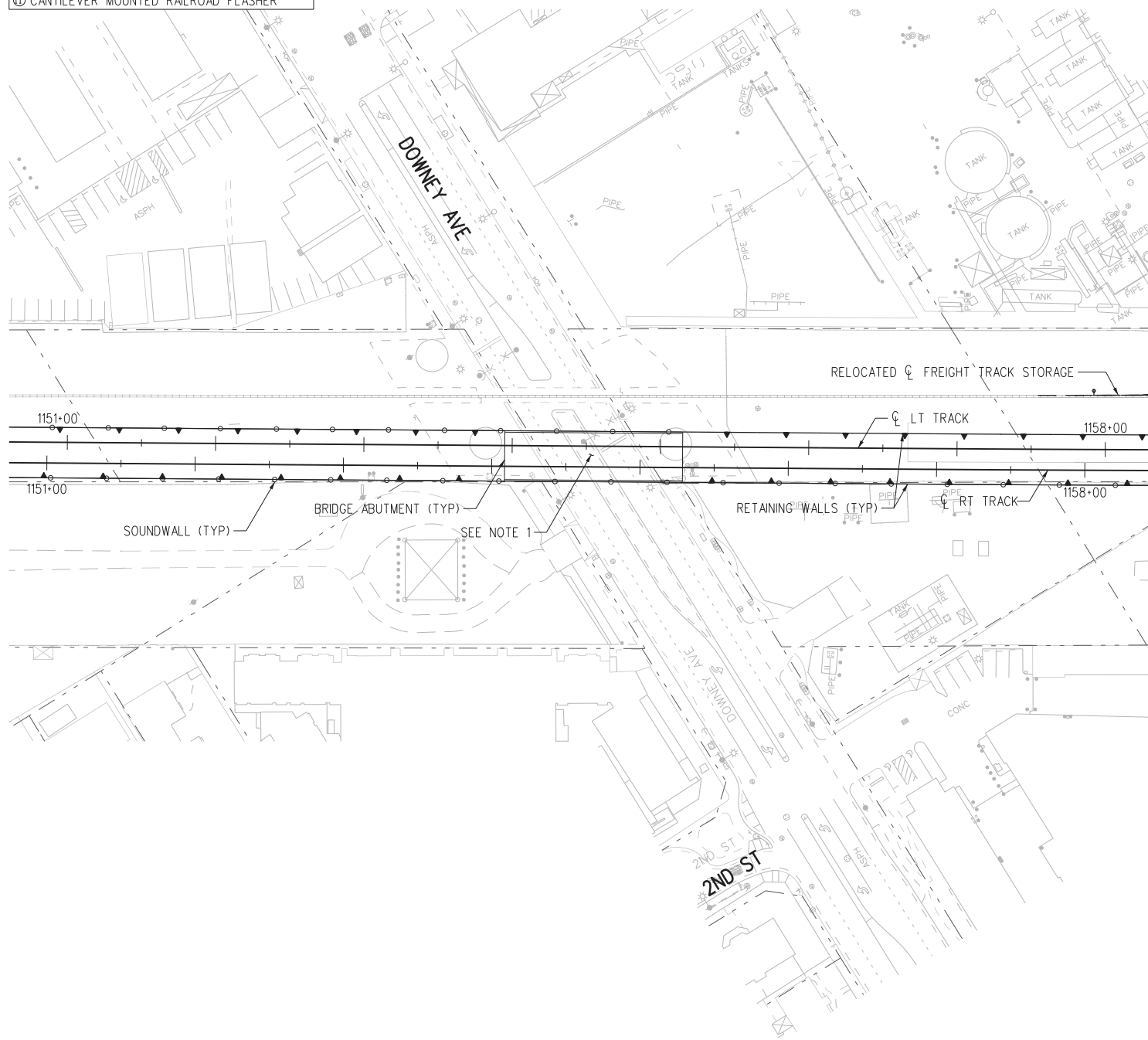

NOTES:

1. THE WSAB ALIGNMENT IS GRADE SEPARATED FROM DOWNEY AVE.



NOT FOR CONSTRUCTION

FINAL ADVANCED CONCEPTUAL ENGINEERING GRADE CROSSINGS - 826/2020

THE PREPARATION OF THIS DRAWING HAS BEEN FINANCED IN PART THROUGH A GRANT FROM THE U.S. DEPARTMENT OF TRANSPORTATION FEDERAL TRANSIT ADMINISTRATION (FTA), UNDER THE FEDERAL TRANSIT ACT OF 1964, AS AMENDED, AND IN PART BY THE TAXES OF THE CITIZENS OF LOS ANGELES COUNTY AND OF THE STATE OF CALIFORNIA.

REV	DATE	BY	APP	REG NO.	EXPIRES	SEAL HOLDER	DESCRIPTION
0	8/26/2020						FINAL ACE SUBMITTAL

DESIGNED BY CB
DRAWN BY RM
CHECKED BY BO
IN CHARGE NM
DATE 8/26/2020



LOS ANGELES COUNTY METROPOLITAN TRANSPORTATION AUTHORITY



444 South Flower Street Suite 800 Los Angeles, CA 90071 TEL (213) 362-9470

SUBMITTED _____

APPROVED _____

WEST SANTA ANA BRANCH LRT
GRADE CROSSING
DOWNEY AVE & SOMERSET BLVD
PLAN

CONTRACT NO. AE5999300
DRAWING NO. CS-210
SCALE HOR: 1"=50'
SHEET NO. 17 OF 24

09-FEB-2021 B-28091ACS210.plg
wspdw04-pw-svc 23:17

SIGNAGE LEGEND

- ① TRAIN ACTIVATED LOOK BOTH WAYS
- ② MUTCD R3-1 NO RIGHT TURN BLANK OUT SIGN
- ③ MUTCD W10-1 PASSIVE SIGN
- ④ SUICIDE PREVENTION SIGNS
- ⑤ PEDESTRIAN 'DO NOT ENTER CROSSING'
- ⑥ NO TRESPASSING
- ⑦ PASSIVE LOOK BOTH WAYS
- ⑧ MUTCD R1-2 YIELD
- ⑨ DO NOT STOP ON TRACKS
- ⑩ ACTIVE DO NOT STOP ON TRACKS
- ⑪ CANTILEVER MOUNTED RAILROAD FLASHER

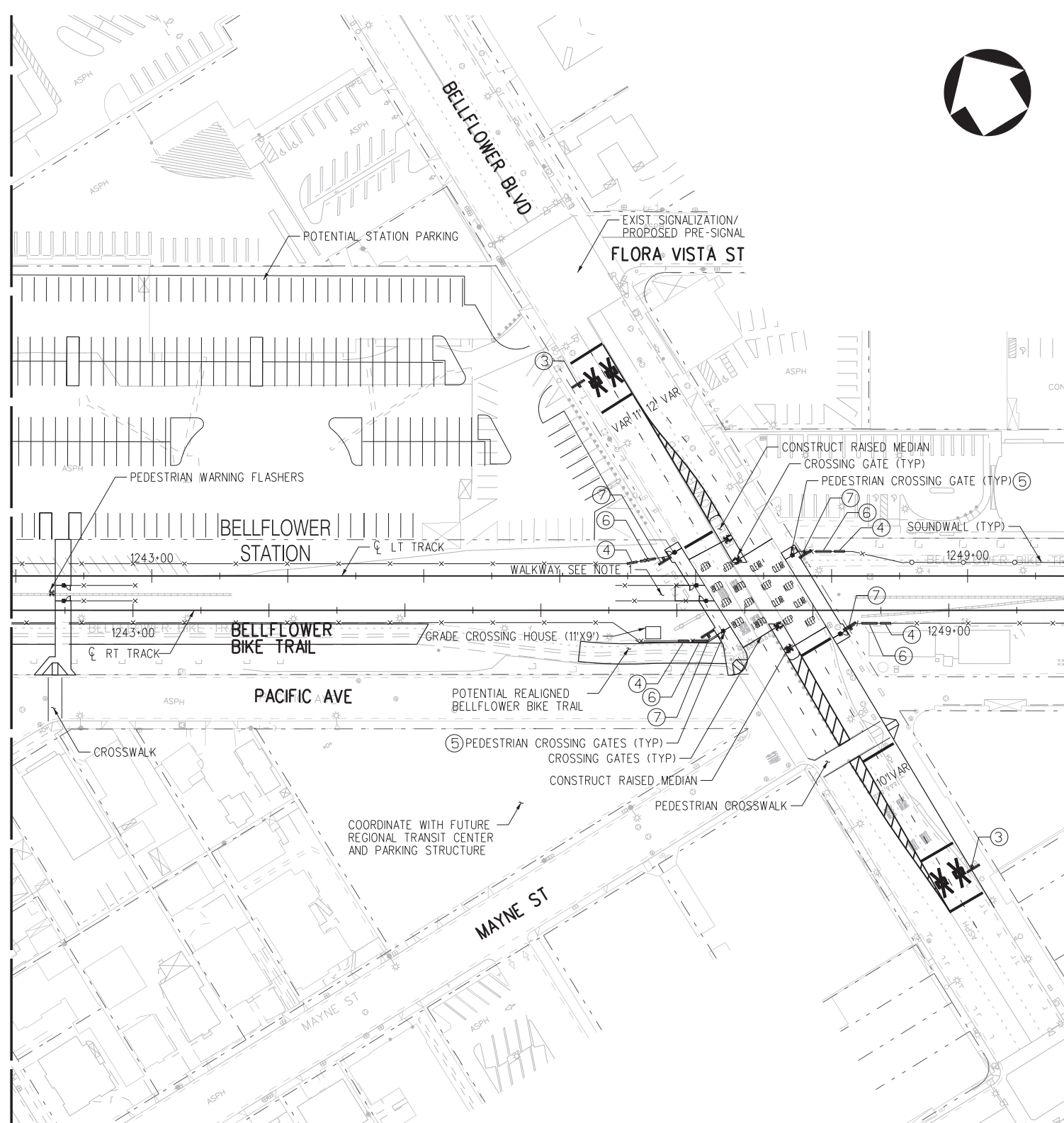
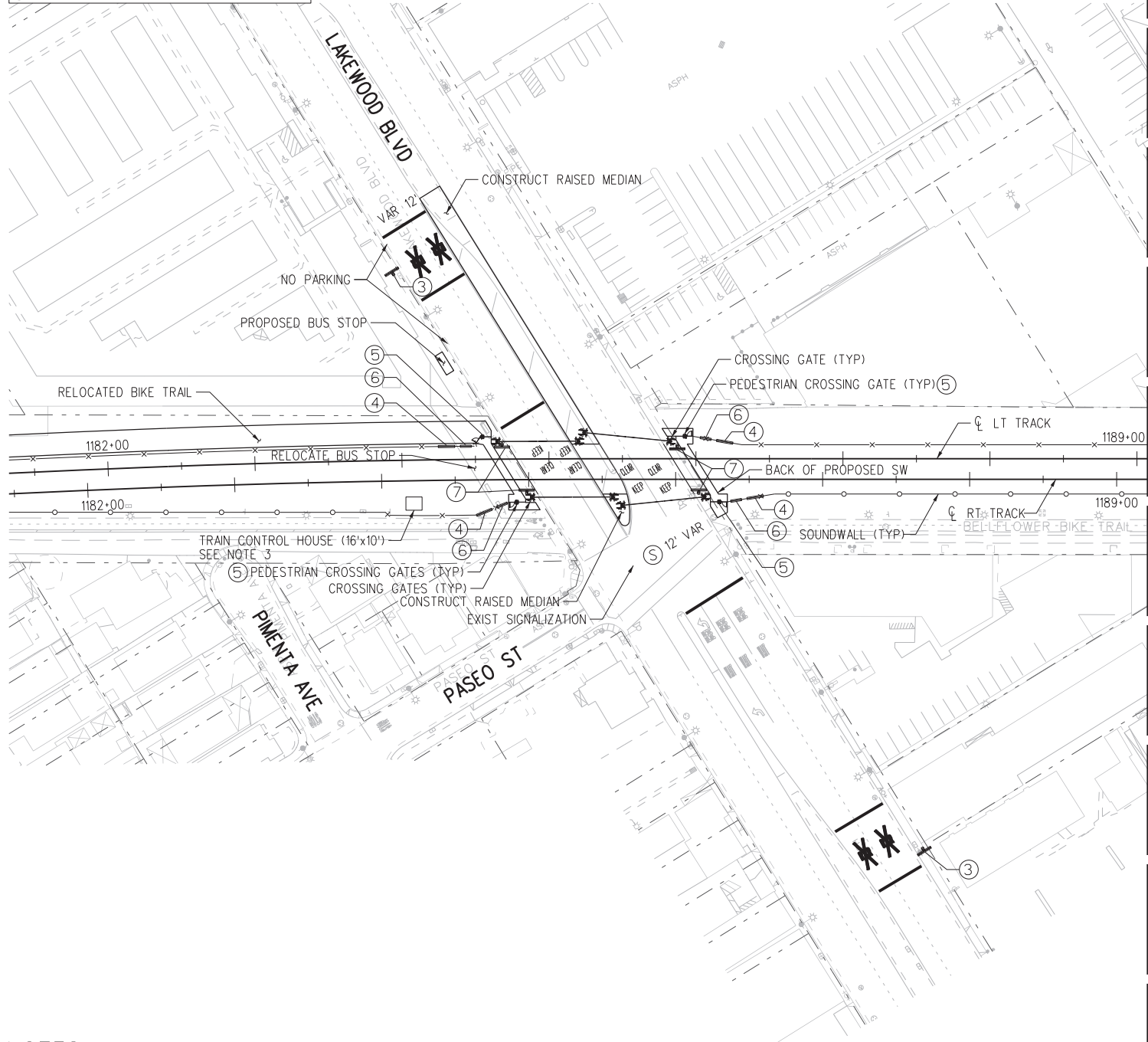

NOTES:
 1. PROTECTION OF PEDESTRIAN GRADE CROSSING AND STATION ACCESS TO BE DETERMINED IN LATER PHASE.
 2. LRT CROSSING CONTROLS MAY BE ACCOMMODATED IN STATION C&S HOUSE.
 3. LRT GRADE CROSSING EQUIPMENT TO BE LOCATED WITHIN TRAIN CONTROL HOUSE.



NOT FOR CONSTRUCTION

FINAL ADVANCED CONCEPTUAL ENGINEERING GRADE CROSSINGS - 8/26/2020

THE PREPARATION OF THIS DRAWING HAS BEEN FINANCED IN PART THROUGH A GRANT FROM THE U.S. DEPARTMENT OF TRANSPORTATION FEDERAL TRANSIT ADMINISTRATION (FTA), UNDER THE FEDERAL TRANSIT ACT OF 1964, AS AMENDED, AND IN PART BY THE TAXES OF THE CITIZENS OF LOS ANGELES COUNTY AND OF THE STATE OF CALIFORNIA.		DESIGNED BY CB
0	8/26/2020	DRAWN BY RM
REV	DATE	CHECKED BY BO
BY	APP	IN CHARGE NM
REG NO.	EXPIRES	DATE 8/26/2020
SEAL HOLDER	DESCRIPTION	
	FINAL ACE SUBMITTAL	

DESIGNED BY CB
DRAWN BY RM
CHECKED BY BO
IN CHARGE NM
DATE 8/26/2020

M Metro
LOS ANGELES COUNTY METROPOLITAN TRANSPORTATION AUTHORITY

wsp 444 South Flower Street Suite 800 Los Angeles, CA 90071 TEL (213) 362-9470

SUBMITTED _____
 APPROVED _____

WEST SANTA ANA BRANCH LRT GRADE CROSSING LAKEWOOD BLVD & BELLFLOWER BLVD PLAN

CONTRACT NO AE5999300	REV
DRAWING NO CS-211	SCALE HOR: 1"=50'
SHEET NO 18	OF 24

09-FEB-2021 B-28091ACS211.plt
 wspdw04-pw-svc 23:17
 Plot Driver=MTA-half.pen
 Pentable=bw.plt

SIGNAGE LEGEND

- ① TRAIN ACTIVATED LOOK BOTH WAYS
- ② MUTCD R3-1 NO RIGHT TURN BLANK OUT SIGN
- ③ MUTCD W10-1 PASSIVE SIGN
- ④ SUICIDE PREVENTION SIGNS
- ⑤ PEDESTRIAN 'DO NOT ENTER CROSSING'
- ⑥ NO TRESPASSING
- ⑦ PASSIVE LOOK BOTH WAYS
- ⑧ MUTCD R1-2 YIELD
- ⑨ DO NOT STOP ON TRACKS
- ⑩ ACTIVE DO NOT STOP ON TRACKS
- ⑪ CANTILEVER MOUNTED RAILROAD FLASHER

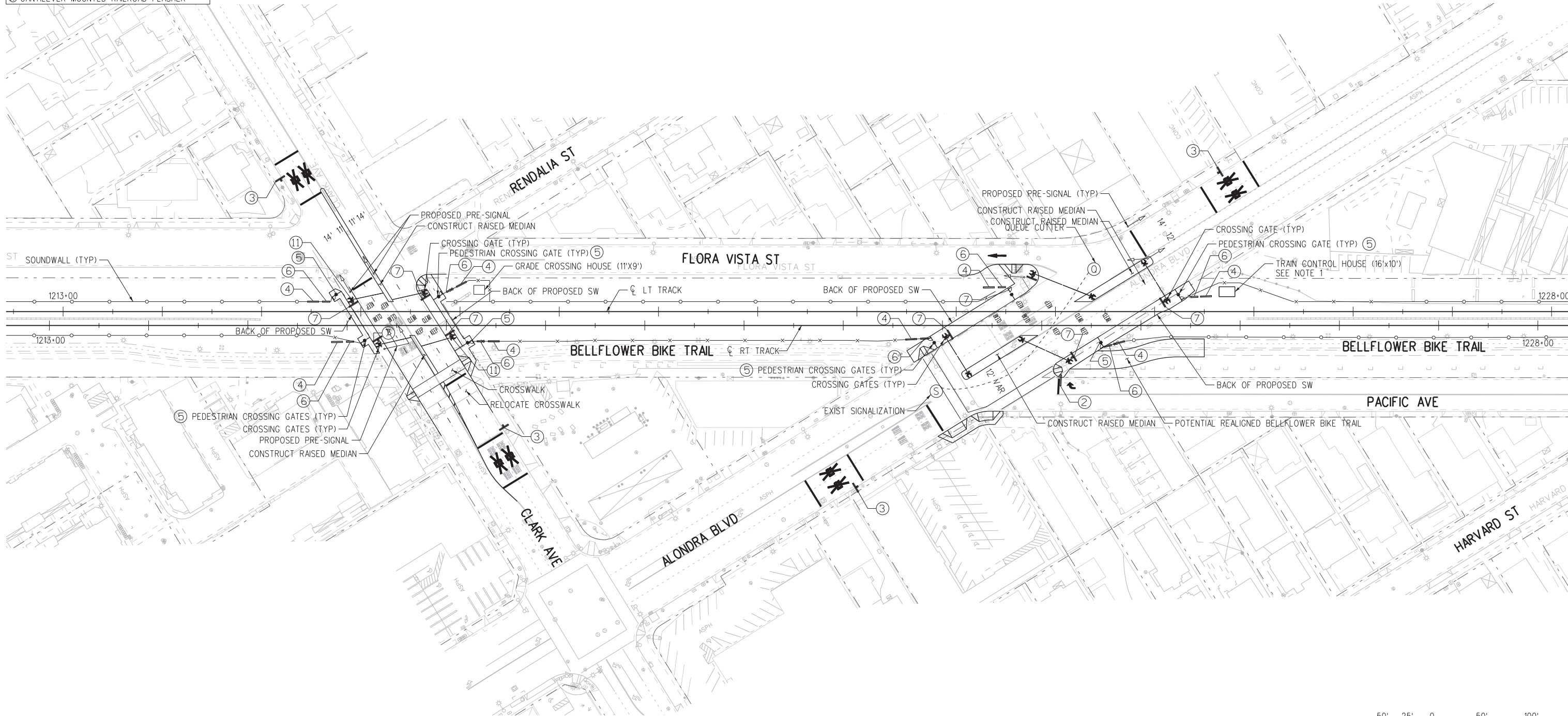

NOTES:
 1. LRT GRADE CROSSING EQUIPMENT TO BE LOCATED WITHIN TRAIN CONTROL HOUSE.

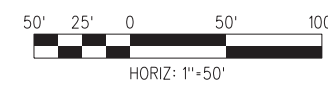

FINAL ADVANCED CONCEPTUAL ENGINEERING GRADE CROSSINGS - 826/2020

NOT FOR CONSTRUCTION

09-FEB-2021 B-28091ACS212.plg

wspdw04-pw-svc 23:18

THE PREPARATION OF THIS DRAWING HAS BEEN FINANCED IN PART THROUGH A GRANT FROM THE U.S. DEPARTMENT OF TRANSPORTATION FEDERAL TRANSIT ADMINISTRATION (FTA), UNDER THE FEDERAL TRANSIT ACT OF 1964, AS AMENDED, AND IN PART BY THE TAXES OF THE CITIZENS OF LOS ANGELES COUNTY AND OF THE STATE OF CALIFORNIA.		DESIGNED BY CB					
REV	DATE	BY	APP	REG NO.	EXPIRES	SEAL HOLDER	DESCRIPTION
0	8/26/2020						FINAL ACE SUBMITTAL

DRAWN BY RM
CHECKED BY BO
IN CHARGE NM
DATE 8/26/2020

LOS ANGELES COUNTY METROPOLITAN TRANSPORTATION AUTHORITY

wsp 444 South Flower Street Suite 800 Los Angeles, CA 90071 TEL (213) 362-9470

SUBMITTED	_____
APPROVED	_____

CONTRACT NO AE5999300	
DRAWING NO CS-212	REV
SCALE HOR: 1"=50'	
SHEET NO 19	OF 24

**WEST SANTA ANA BRANCH LRT
 GRADE CROSSING
 CLARK AVE & ALONDRA BLVD
 PLAN**

SIGNAGE LEGEND

- ① TRAIN ACTIVATED LOOK BOTH WAYS
- ② MUTCD R3-1 NO RIGHT TURN BLANK OUT SIGN
- ③ MUTCD W10-1 PASSIVE SIGN
- ④ SUICIDE PREVENTION SIGNS
- ⑤ PEDESTRIAN 'DO NOT ENTER CROSSING'
- ⑥ NO TRESPASSING
- ⑦ PASSIVE LOOK BOTH WAYS
- ⑧ MUTCD R1-2 YIELD
- ⑨ DO NOT STOP ON TRACKS
- ⑩ ACTIVE DO NOT STOP ON TRACKS
- ⑪ CANTILEVER MOUNTED RAILROAD FLASHER

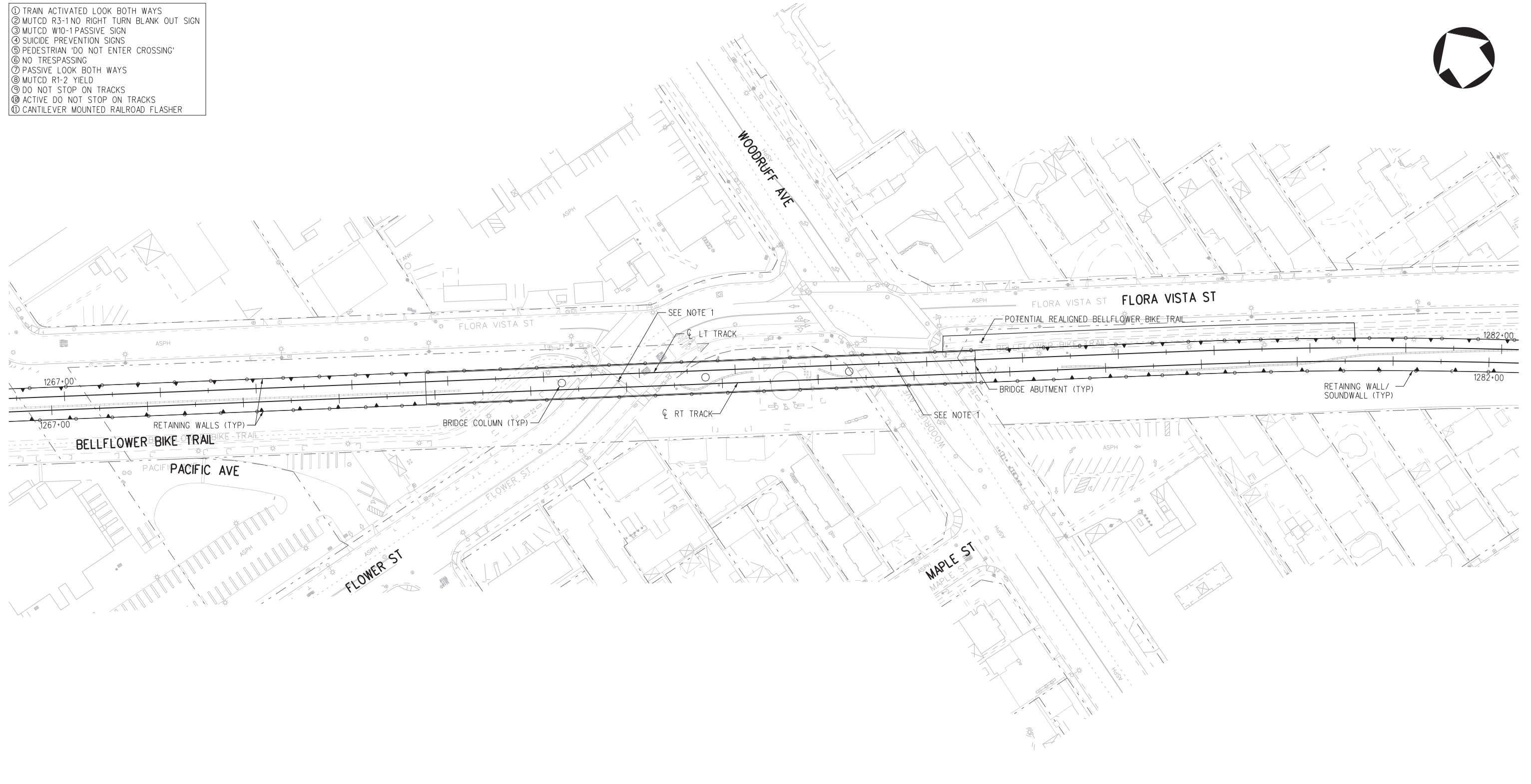

NOTES:

1. THE WSAB ALIGNMENT IS GRADE SEPARATED FROM THE FLOWER ST/WOODRUFF AVE INTERSECTION.

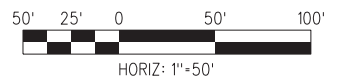

NOT FOR CONSTRUCTION

FINAL ADVANCED CONCEPTUAL ENGINEERING GRADE CROSSINGS - 8/26/2020

THE PREPARATION OF THIS DRAWING HAS BEEN FINANCED IN PART THROUGH A GRANT FROM THE U.S. DEPARTMENT OF TRANSPORTATION FEDERAL TRANSIT ADMINISTRATION (FTA), UNDER THE FEDERAL TRANSIT ACT OF 1964, AS AMENDED, AND IN PART BY THE TAXES OF THE CITIZENS OF LOS ANGELES COUNTY AND OF THE STATE OF CALIFORNIA.

REV	DATE	BY	APP	REG NO.	EXPIRES	SEAL HOLDER	DESCRIPTION
0	8/26/2020						FINAL ACE SUBMITTAL

DESIGNED BY CB
DRAWN BY RM
CHECKED BY BO
IN CHARGE NM
DATE 8/26/2020



LOS ANGELES COUNTY
METROPOLITAN TRANSPORTATION AUTHORITY



444 South Flower Street
Suite 800
Los Angeles, CA 90071
TEL (213) 362-9470

SUBMITTED _____

APPROVED _____

WEST SANTA ANA BRANCH LRT
GRADE CROSSING
FLOWER ST & WOODRUFF AVE
PLAN

CONTRACT NO AE5999300	
DRAWING NO CS-213	REV
SCALE HOR: 1"=50'	
SHEET NO 20	OF 24

09-FEB-2021 B-28091ACS213.plg

SIGNAGE LEGEND

- ① TRAIN ACTIVATED LOOK BOTH WAYS
- ② MUTCD R3-1 NO RIGHT TURN BLANK OUT SIGN
- ③ MUTCD W10-1 PASSIVE SIGN
- ④ SUICIDE PREVENTION SIGNS
- ⑤ PEDESTRIAN 'DO NOT ENTER CROSSING'
- ⑥ NO TRESPASSING
- ⑦ PASSIVE LOOK BOTH WAYS
- ⑧ MUTCD R1-2 YIELD
- ⑨ DO NOT STOP ON TRACKS
- ⑩ ACTIVE DO NOT STOP ON TRACKS
- ⑪ CANTILEVER MOUNTED RAILROAD FLASHER

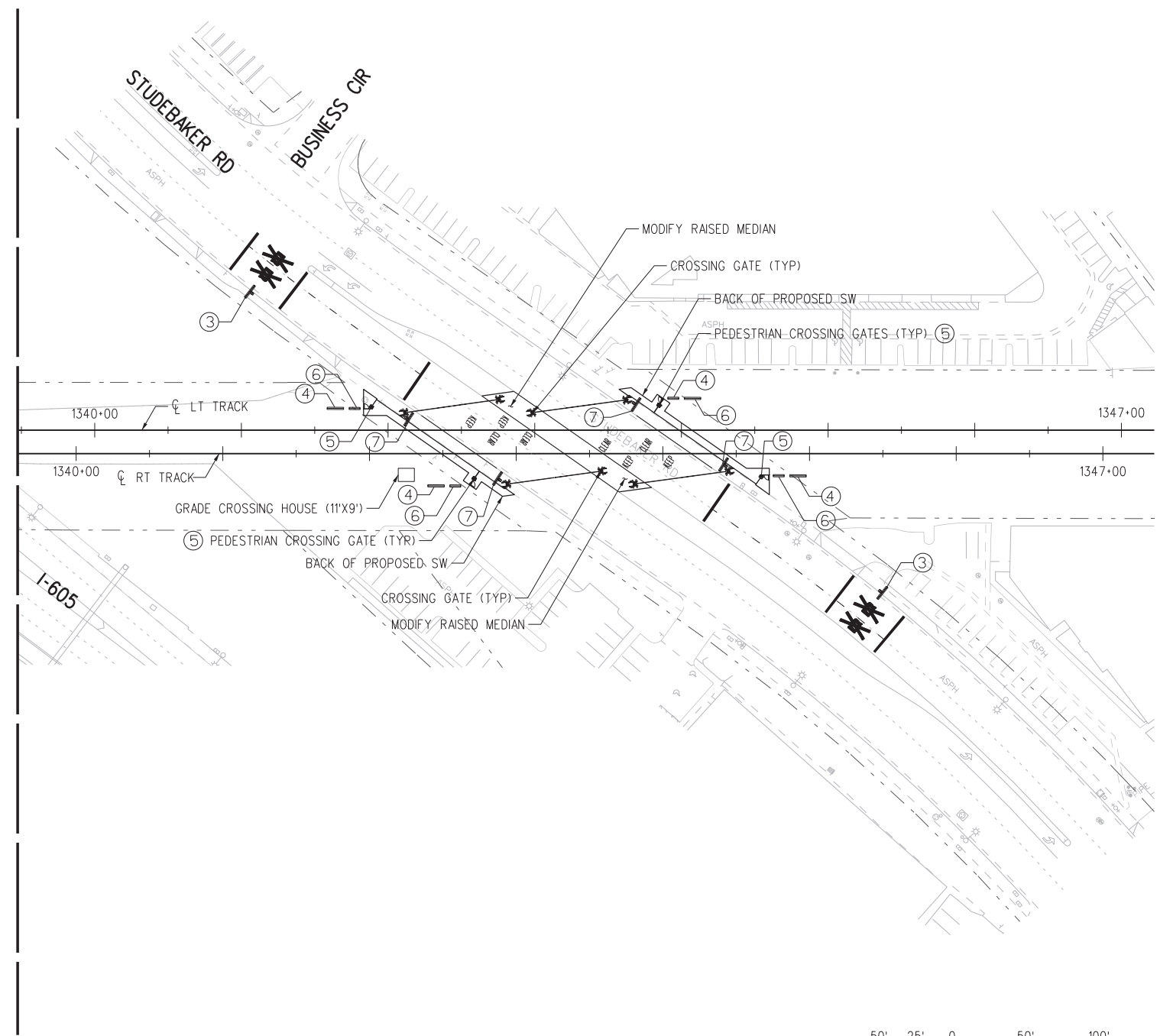
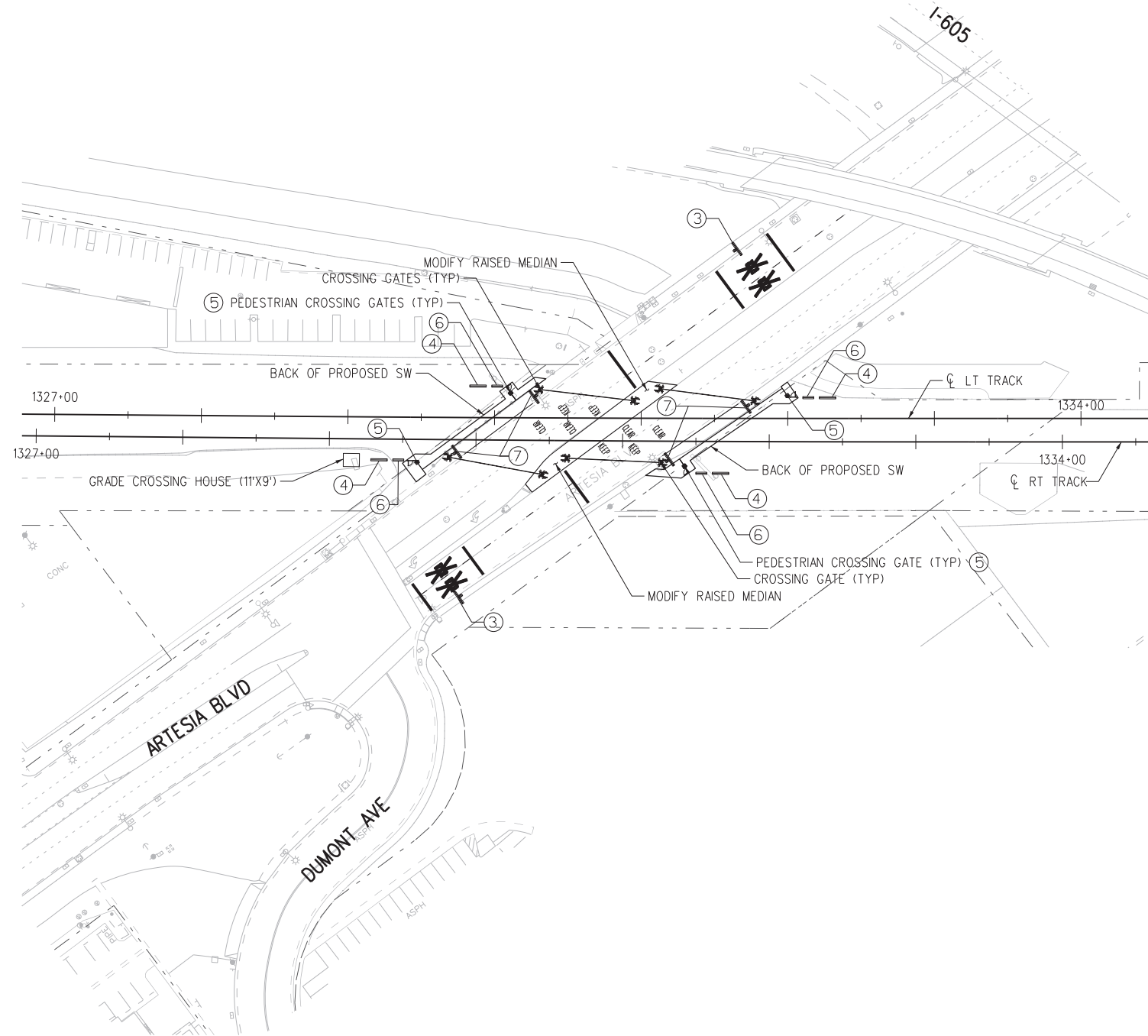



FINAL ADVANCED CONCEPTUAL ENGINEERING GRADE CROSSINGS - 826/2020

NOT FOR CONSTRUCTION

09-FEB-2021 B-28091ACS214.plg

wspdw04-pw-svc 23:17

THE PREPARATION OF THIS DRAWING HAS BEEN FINANCED IN PART THROUGH A GRANT FROM THE U.S. DEPARTMENT OF TRANSPORTATION FEDERAL TRANSIT ADMINISTRATION (FTA), UNDER THE FEDERAL TRANSIT ACT OF 1964, AS AMENDED, AND IN PART BY THE TAXES OF THE CITIZENS OF LOS ANGELES COUNTY AND OF THE STATE OF CALIFORNIA.		DESIGNED BY CB
0	8/26/2020	DRAWN BY RM
REV	DATE	CHECKED BY BO
BY	APP	IN CHARGE NM
REG NO.	EXPIRES	DATE 8/26/2020
SEAL HOLDER	DESCRIPTION	
	FINAL ACE SUBMITTAL	

 Metro 	LOS ANGELES COUNTY METROPOLITAN TRANSPORTATION AUTHORITY 444 South Flower Street Suite 800 Los Angeles, CA 90071 TEL (213) 362-9470	SUBMITTED _____ APPROVED _____
---	--	---------------------------------------

WEST SANTA ANA BRANCH LRT GRADE CROSSING ARTESIA BLVD & STUDEBAKER RD PLAN		CONTRACT NO AE5999300
DRAWING NO CS-214		REV
SCALE HOR: 1"=50'		SHEET NO 21 OF 24

SIGNAGE LEGEND

- ① TRAIN ACTIVATED LOOK BOTH WAYS
- ② MUTCD R3-1 NO RIGHT TURN BLANK OUT SIGN
- ③ MUTCD W10-1 PASSIVE SIGN
- ④ SUICIDE PREVENTION SIGNS
- ⑤ PEDESTRIAN 'DO NOT ENTER CROSSING'
- ⑥ NO TRESPASSING
- ⑦ PASSIVE LOOK BOTH WAYS
- ⑧ MUTCD R1-2 YIELD
- ⑨ DO NOT STOP ON TRACKS
- ⑩ ACTIVE DO NOT STOP ON TRACKS
- ⑪ CANTILEVER MOUNTED RAILROAD FLASHER

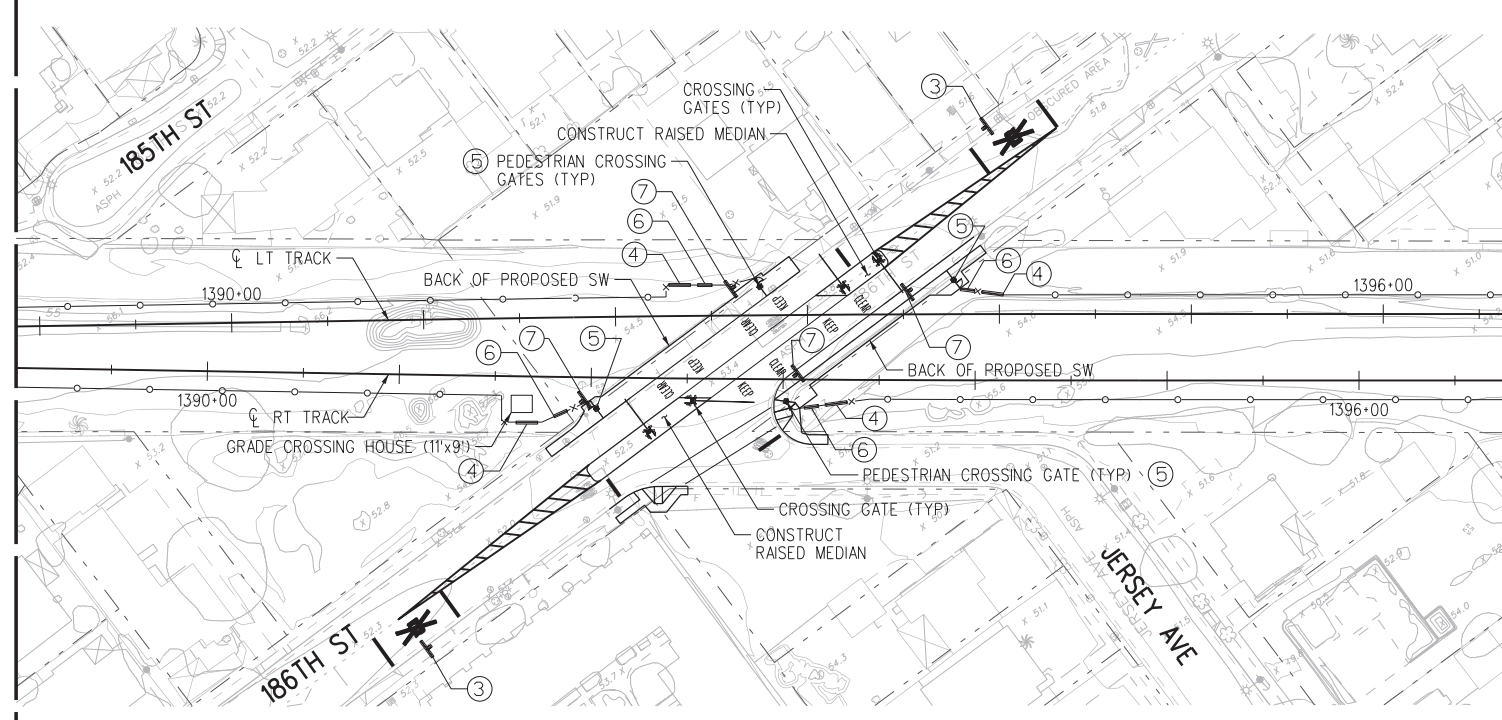
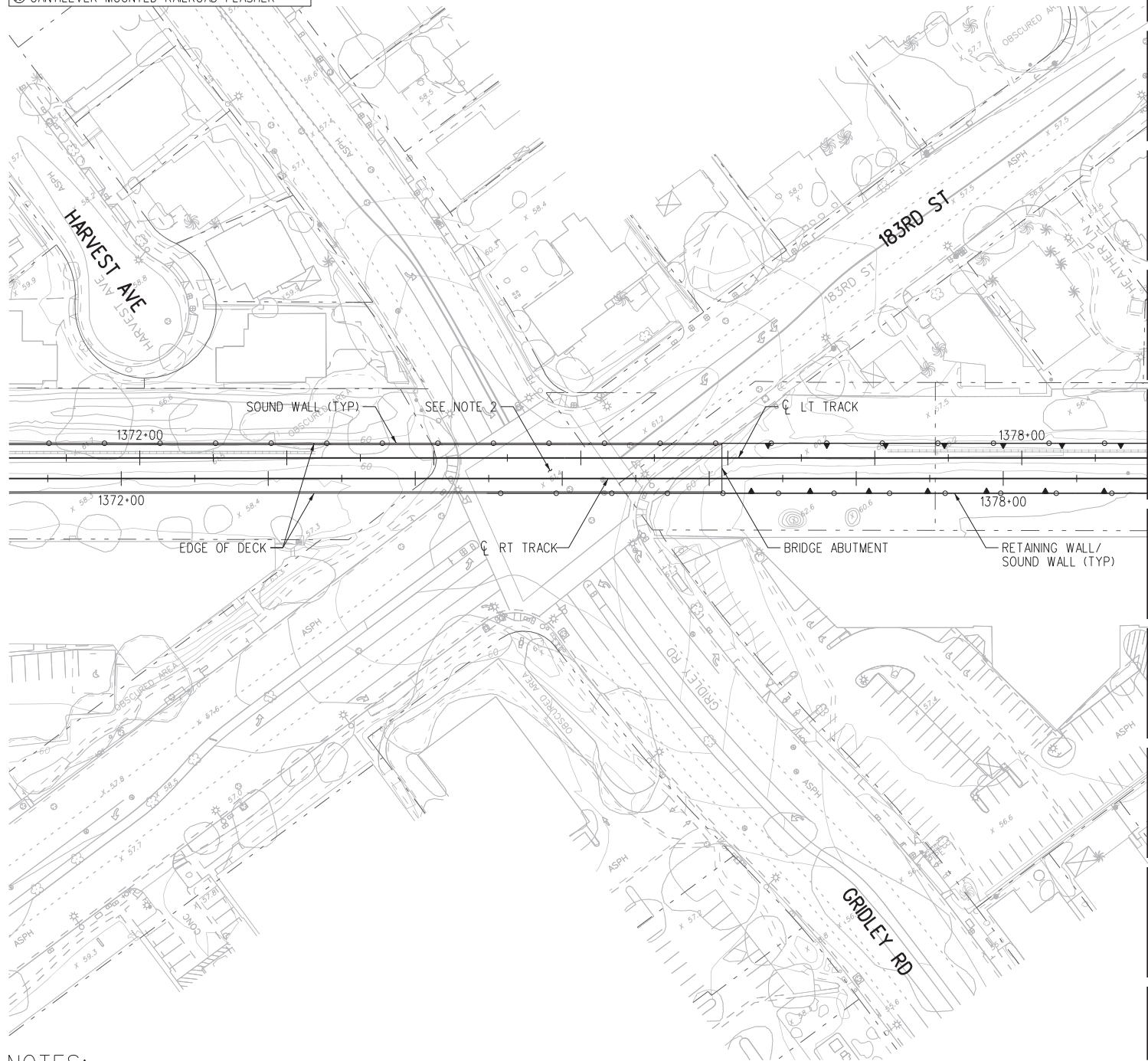

- NOTES:
1. LRT GRADE CROSSING EQUIPMENT TO BE LOCATED WITHIN TRAIN CONTROL HOUSE.
 2. THE WSAB ALIGNMENT IS GRADE SEPARATED FROM THE 18RD ST/GRIDLEY RD INTERSECTION.



NOT FOR CONSTRUCTION

FINAL ADVANCED CONCEPTUAL ENGINEERING GRADE CROSSINGS - 8/26/2020

THE PREPARATION OF THIS DRAWING HAS BEEN FINANCED IN PART THROUGH A GRANT FROM THE U.S. DEPARTMENT OF TRANSPORTATION FEDERAL TRANSIT ADMINISTRATION (FTA), UNDER THE FEDERAL TRANSIT ACT OF 1964, AS AMENDED, AND IN PART BY THE TAKES OF THE CITIZENS OF LOS ANGELES COUNTY AND OF THE STATE OF CALIFORNIA.

REV	DATE	BY	APP	REG NO.	EXPIRES	SEAL HOLDER	DESCRIPTION
0	8/26/2020						FINAL ACE SUBMITTAL

DESIGNED BY CB
DRAWN BY RM
CHECKED BY BO
IN CHARGE NM
DATE 8/26/2020

M Metro
LOS ANGELES COUNTY METROPOLITAN TRANSPORTATION AUTHORITY

wsp 444 South Flower Street Suite 800 Los Angeles, CA 90071 TEL (213) 362-9470

SUBMITTED _____
 APPROVED _____

WEST SANTA ANA BRANCH LRT
 GRADE CROSSING
 GRIDLEY/183RD & 186TH ST
 PLAN

CONTRACT NO AE5999300	REV
DRAWING NO CS-215	
SCALE HOR: 1"=50'	
SHEET NO 22	OF 24

09-FEB-2021 B-28091ACS215.plg
 wspdw04-pw-svc 23:18
 Plot Driver=MTA-half.pen Pentable=bw.plt

SIGNAGE LEGEND

- ① TRAIN ACTIVATED LOOK BOTH WAYS
- ② MUTCD R3-1 NO RIGHT TURN BLANK OUT SIGN
- ③ MUTCD W10-1 PASSIVE SIGN
- ④ SUICIDE PREVENTION SIGNS
- ⑤ PEDESTRIAN 'DO NOT ENTER CROSSING'
- ⑥ NO TRESPASSING
- ⑦ PASSIVE LOOK BOTH WAYS
- ⑧ MUTCD R1-2 YIELD
- ⑨ DO NOT STOP ON TRACKS
- ⑩ ACTIVE DO NOT STOP ON TRACKS
- ⑪ CANTILEVER MOUNTED RAILROAD FLASHER

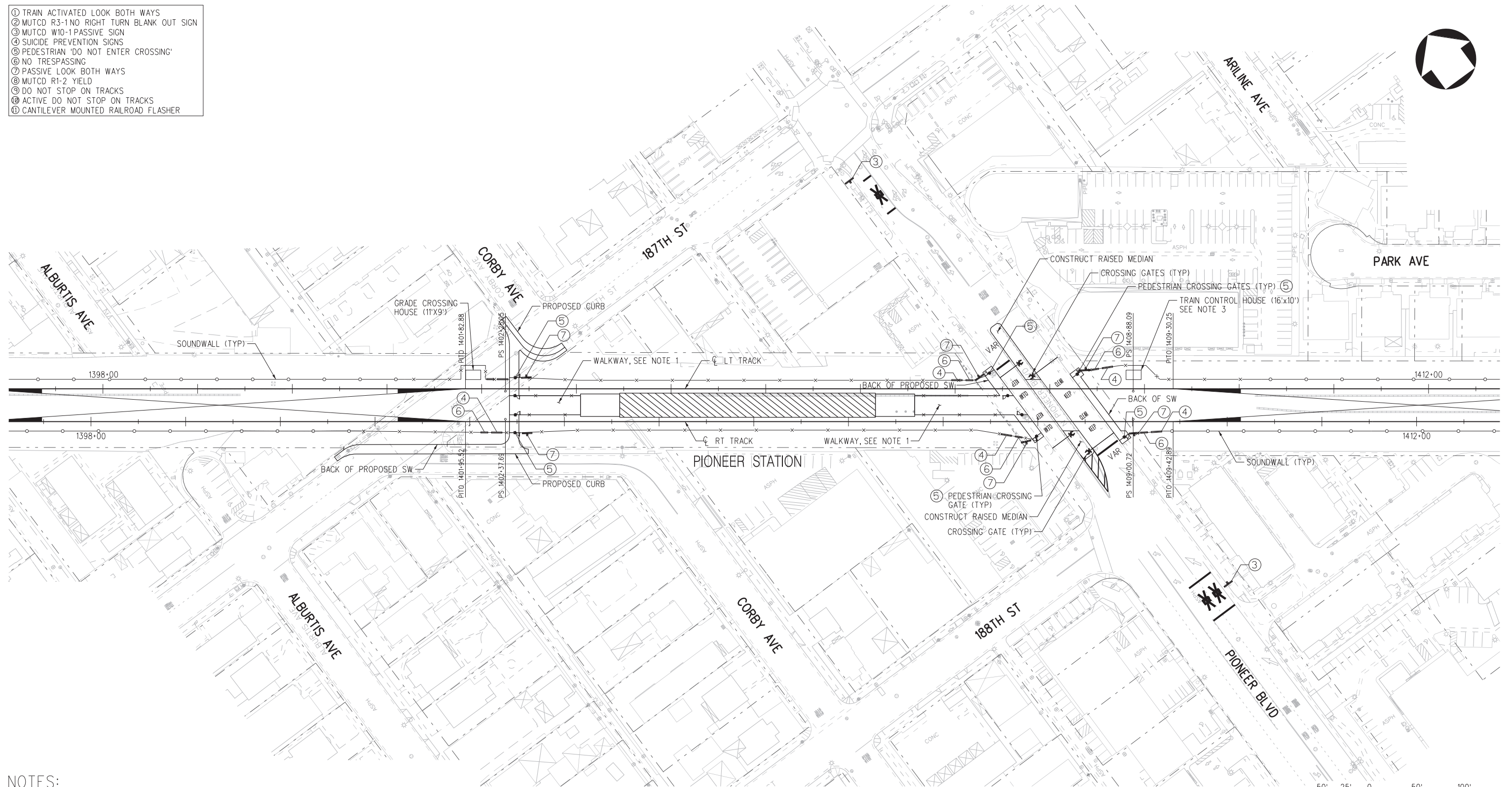

- NOTES:
1. PROTECTION OF PEDESTRIAN GRADE CROSSING AND STATION ACCESS TO BE DETERMINED IN LATER PHASE.
 2. LRT CROSSING CONTROLS MAY BE ACCOMMODATED IN STATION C&S HOUSE.
 3. LRT GRADE CROSSING EQUIPMENT TO BE LOCATED WITHIN TRAIN CONTROL HOUSE.

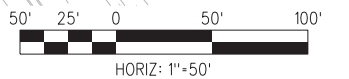

FINAL ADVANCED CONCEPTUAL ENGINEERING GRADE CROSSINGS - 826/2020

NOT FOR CONSTRUCTION

09-FEB-2021 B-28091ACS216.plg

wspdw04-pw-svc 23:18

THE PREPARATION OF THIS DRAWING HAS BEEN FINANCED IN PART THROUGH A GRANT FROM THE U.S. DEPARTMENT OF TRANSPORTATION FEDERAL TRANSIT ADMINISTRATION (FTA), UNDER THE FEDERAL TRANSIT ACT OF 1964, AS AMENDED, AND IN PART BY THE TAXES OF THE CITIZENS OF LOS ANGELES COUNTY AND OF THE STATE OF CALIFORNIA.		DESIGNED BY CB					
REV	DATE	BY	APP	REG NO.	EXPIRES	SEAL HOLDER	DESCRIPTION
0	8/26/2020						FINAL ACE SUBMITTAL

DRAWN BY RM
CHECKED BY BO
IN CHARGE NM
DATE 8/26/2020

LOS ANGELES COUNTY METROPOLITAN TRANSPORTATION AUTHORITY

444 South Flower Street
Suite 800
Los Angeles, CA 90071
TEL (213) 362-9470

SUBMITTED _____

APPROVED _____

CONTRACT NO AE5999300	
DRAWING NO CS-216	REV
SCALE HOR: 1"=50'	
SHEET NO 23	OF 24

SIGNAGE LEGEND

- ① TRAIN ACTIVATED LOOK BOTH WAYS
- ② MUTCD R3-1 NO RIGHT TURN BLANK OUT SIGN
- ③ MUTCD W10-1 PASSIVE SIGN
- ④ SUICIDE PREVENTION SIGNS
- ⑤ PEDESTRIAN 'DO NOT ENTER CROSSING'
- ⑥ NO TRESPASSING
- ⑦ PASSIVE LOOK BOTH WAYS
- ⑧ MUTCD R1-2 YIELD
- ⑨ DO NOT STOP ON TRACKS
- ⑩ ACTIVE DO NOT STOP ON TRACKS
- ⑪ CANTILEVER MOUNTED RAILROAD FLASHER

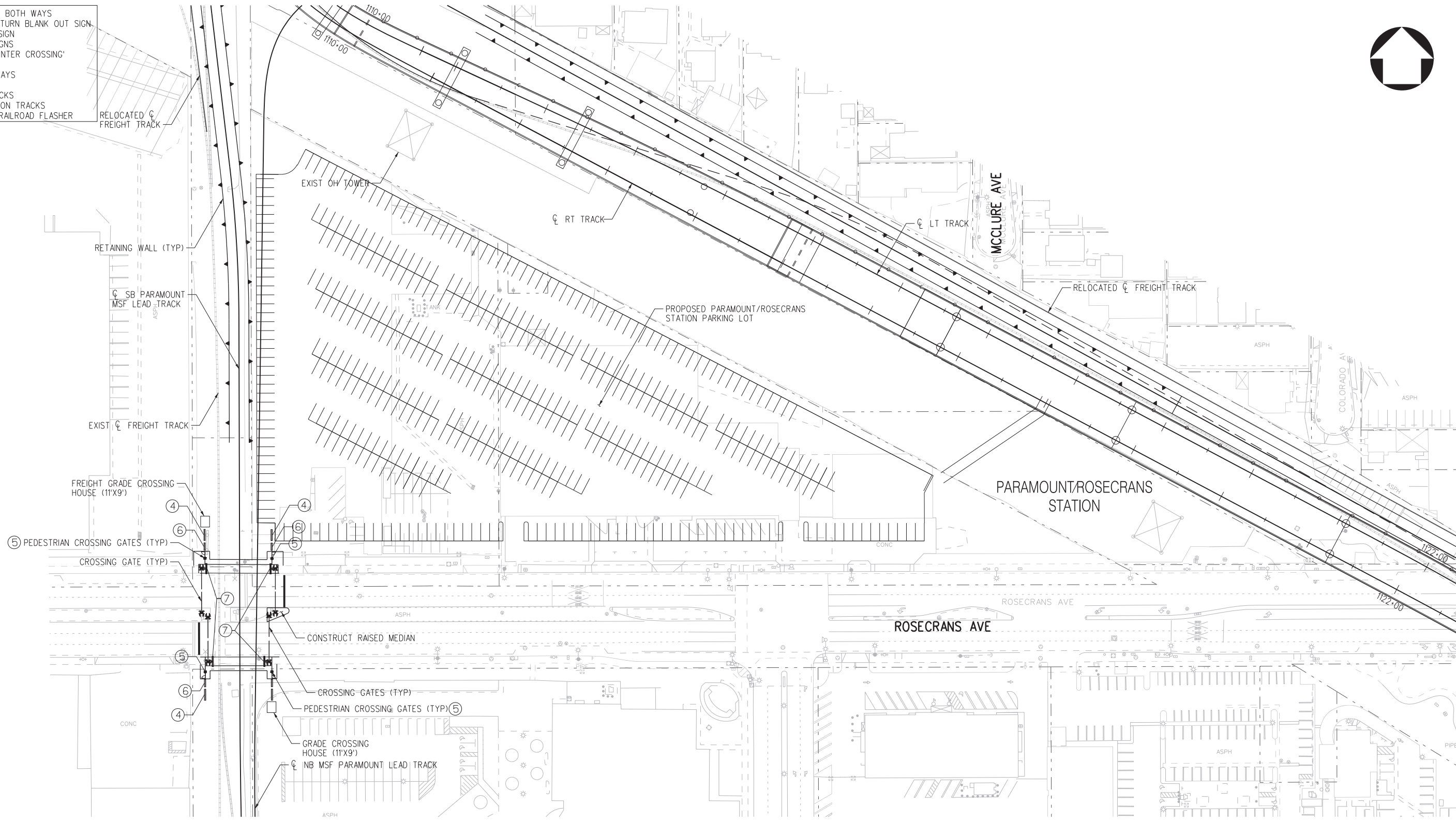

NOTES:

1. GRADE CROSSING IS CONCEPTUAL AND HAS NOT UNDERGONE MILESTONE 1 AND 2 ANALYSIS. FURTHER ANALYSIS WILL BE COMPLETED SHOULD THE PARAMOUNT MSF SITE BE SELECTED.

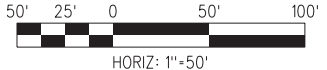

FINAL ADVANCED CONCEPTUAL ENGINEERING GRADE CROSSINGS - 826/2020

NOT FOR CONSTRUCTION

THE PREPARATION OF THIS DRAWING HAS BEEN FINANCED IN PART THROUGH A GRANT FROM THE U.S. DEPARTMENT OF TRANSPORTATION FEDERAL TRANSIT ADMINISTRATION (FTA), UNDER THE FEDERAL TRANSIT ACT OF 1964, AS AMENDED, AND IN PART BY THE TAXES OF THE CITIZENS OF LOS ANGELES COUNTY AND OF THE STATE OF CALIFORNIA.

REV	DATE	BY	APP	REG NO.	EXPIRES	SEAL HOLDER	DESCRIPTION
0	8/26/2020						FINAL ACE SUBMITTAL

DESIGNED BY
CB
DRAWN BY
RM
CHECKED BY
BO
IN CHARGE
NM
DATE
8/26/2020



LOS ANGELES COUNTY METROPOLITAN TRANSPORTATION AUTHORITY



444 South Flower Street Suite 800 Los Angeles, CA 90071 TEL (213) 362-9470

SUBMITTED _____
APPROVED _____

WEST SANTA ANA BRANCH LRT
GRADE CROSSING
ROSECRANS AVE &
PARAMOUNT MSF LEAD TRACK
PLAN

CONTRACT NO AE5999300	
DRAWING NO CS-217	REV
SCALE HOR: 1"=50'	
SHEET NO 24	OF 24

09-FEB-2021 B-28091ACS217.plg

15-NOV-2019

svc-projectwise 22:41

Pentable-bw.plt

C-28091AGF001.plg
Plot Driver=MTA-half.pen

CITY OF
LOS ANGELES

CITY OF
LOS ANGELES

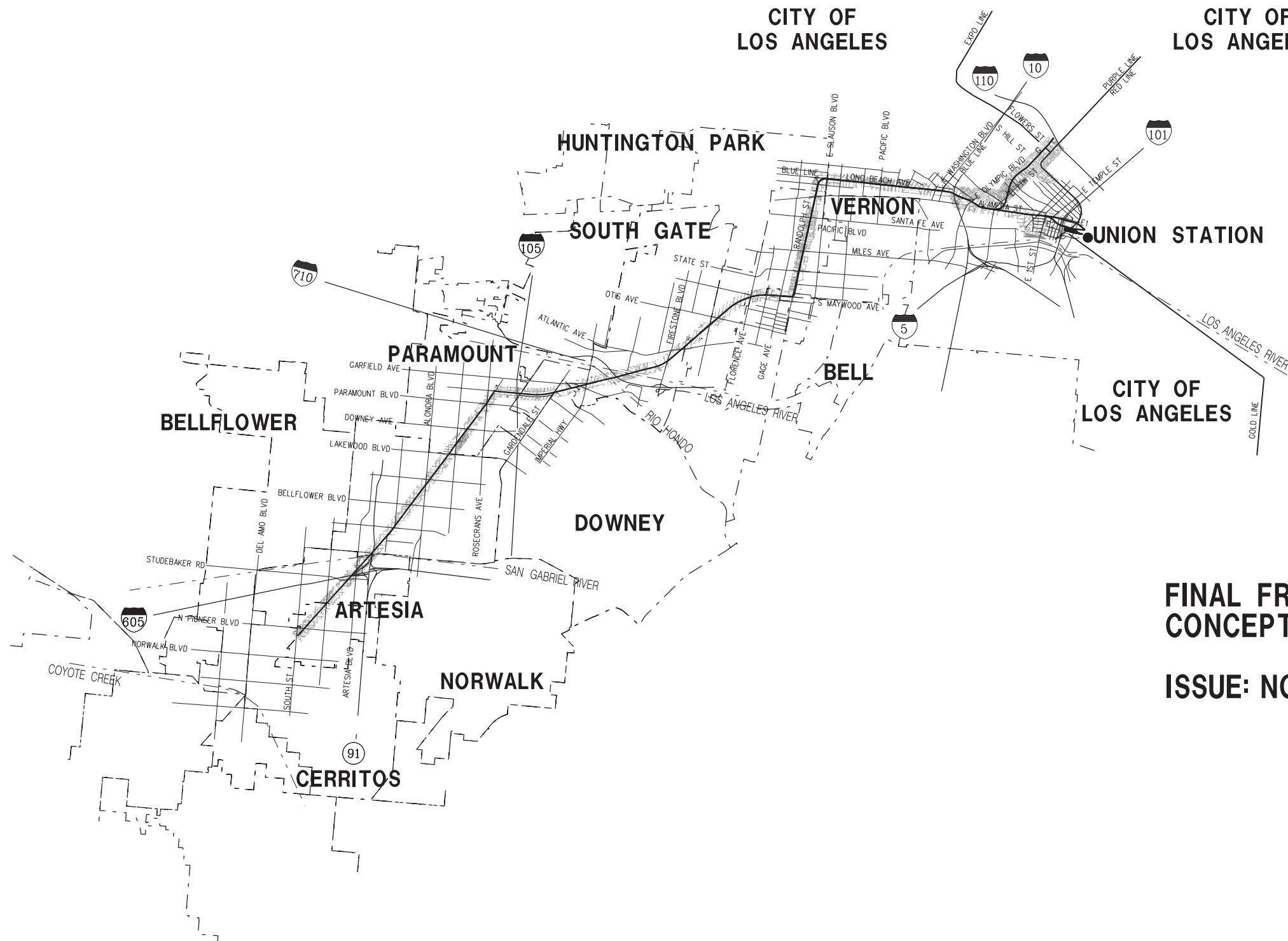

**FINAL FREIGHT ALIGNMENT
CONCEPTUAL DESIGN**

ISSUE: NOVEMBER 15, 2019

NOT FOR CONSTRUCTION

WEST SANTA ANA BRANCH TRANSIT CORRIDOR PROJECT

444 South Flower Street
Suite 800
Los Angeles, CA 90071
TEL (213) 362-9470



LOS ANGELES COUNTY
METROPOLITAN TRANSPORTATION AUTHORITY

INDEX OF DRAWINGS

SHT NO	DWG NO	DWG TITLE
GENERAL		
1	107 GF-002	GENERAL INDEX OF DRAWINGS
2	107 GF-003	GENERAL KEY MAP
3	107 GF-004	GENERAL ABBREVIATIONS
4	107 W-101	PROJECT MAPPING CONTROL SURVEY CONTROL PLAN

SHT NO	DWG NO	DWG TITLE
TRACKWORK		
5	107 TC-001	TRACK ALIGNMENT TRACK CHART
6	107 TC-002	TRACK ALIGNMENT TRACK CHART
7	107 TC-003	TRACK ALIGNMENT TRACK CHART
8	107 TC-004	TRACK ALIGNMENT TRACK CHART
9	107 TF-118	TRACK ALIGNMENT WILLMINGTON BRANCH
10	107 TF-117	TRACK ALIGNMENT WILLMINGTON BRANCH
11	107 TF-120	TRACK ALIGNMENT WILLMINGTON BRANCH
12	107 TF-121	TRACK ALIGNMENT WILLMINGTON BRANCH
13	107 TF-122	TRACK ALIGNMENT WILLMINGTON BRANCH
14	107 TF-123	TRACK ALIGNMENT WILLMINGTON BRANCH
15	107 TF-124	TRACK ALIGNMENT WILLMINGTON BRANCH
16	107 TF-125	TRACK ALIGNMENT WILLMINGTON BRANCH
17	107 TF-126	TRACK ALIGNMENT WILLMINGTON BRANCH
18	107 TF-127	TRACK ALIGNMENT WILLMINGTON/LA HABRA BRANCH
19	107 TF-128	TRACK ALIGNMENT LA HABRA BRANCH
20	107 TF-129	TRACK ALIGNMENT LA HABRA BRANCH
21	107 TF-130	TRACK ALIGNMENT LA HABRA BRANCH
22	107 TF-131	TRACK ALIGNMENT LA HABRA BRANCH
23	107 TF-132	TRACK ALIGNMENT LA HABRA BRANCH
24	107 TF-133	TRACK ALIGNMENT LA HABRA BRANCH
25	107 TF-134	TRACK ALIGNMENT LA HABRA BRANCH
26	107 TF-135	TRACK ALIGNMENT LA HABRA BRANCH
27	107 TF-136	TRACK ALIGNMENT LA HABRA BRANCH
28	107 TF-137	TRACK ALIGNMENT LA HABRA BRANCH
29	107 TF-138	TRACK ALIGNMENT LA HABRA BRANCH
30	107 TF-139	TRACK ALIGNMENT LA HABRA BRANCH
31	107 TF-139A	TRACK ALIGNMENT SAN PEDRO BRANCH
32	107 TF-140	TRACK ALIGNMENT SAN PEDRO BRANCH
33	107 TF-201	TRACK ALIGNMENT SAN PEDRO BRANCH
34	107 TF-202	TRACK ALIGNMENT SAN PEDRO BRANCH
35	107 TF-203	TRACK ALIGNMENT SAN PEDRO BRANCH
36	107 TF-204	TRACK ALIGNMENT SAN PEDRO BRANCH
37	107 TF-205	TRACK ALIGNMENT SAN PEDRO BRANCH
38	107 TF-206	TRACK ALIGNMENT SAN PEDRO BRANCH
39	107 TF-207	TRACK ALIGNMENT SAN PEDRO BRANCH
40	107 TF-208	TRACK ALIGNMENT SAN PEDRO BRANCH
41	107 TF-209	TRACK ALIGNMENT SAN PEDRO BRANCH
42	107 TF-210	TRACK ALIGNMENT SAN PEDRO BRANCH
43	107 TF-211	TRACK ALIGNMENT SAN PEDRO BRANCH
44	107 TF-212	TRACK ALIGNMENT SAN PEDRO BRANCH
45	107 TF-213	TRACK ALIGNMENT SAN PEDRO BRANCH
46	107 TF-214	TRACK ALIGNMENT SAN PEDRO BRANCH
47	107 TF-215	TRACK ALIGNMENT SAN PEDRO BRANCH
48	107 TF-216	TRACK ALIGNMENT SAN PEDRO BRANCH
49	107 TF-217	TRACK ALIGNMENT SAN PEDRO BRANCH
50	107 TF-218	TRACK ALIGNMENT SAN PEDRO BRANCH
51	107 TF-219	TRACK ALIGNMENT SAN PEDRO BRANCH
52	107 TF-220	TRACK ALIGNMENT SAN PEDRO BRANCH
53	107 TF-221	TRACK ALIGNMENT SAN PEDRO BRANCH
54	107 TF-222	TRACK ALIGNMENT SAN PEDRO BRANCH
55	107 TF-223	TRACK ALIGNMENT SAN PEDRO BRANCH
56	107 TF-224	TRACK ALIGNMENT SAN PEDRO BRANCH
57	107 TF-225	TRACK ALIGNMENT SAN PEDRO BRANCH
58	107 TF-226	TRACK ALIGNMENT SAN PEDRO BRANCH
59	107 TF-227	TRACK ALIGNMENT SAN PEDRO BRANCH
60	107 TF-228	TRACK ALIGNMENT SAN PEDRO BRANCH
61	107 TF-229	TRACK ALIGNMENT SAN PEDRO BRANCH
62	107 TF-230	TRACK ALIGNMENT SAN PEDRO BRANCH

SHT NO	DWG NO	DWG TITLE
TRACKWORK CONT.		
63	107 TF-231	TRACK ALIGNMENT SAN PEDRO BRANCH
64	107 TF-232	TRACK ALIGNMENT SAN PEDRO BRANCH
65	107 TF-233	TRACK ALIGNMENT SAN PEDRO BRANCH/PEROW
66	107 TF-234	TRACK ALIGNMENT PEROW
67	107 TF-235	TRACK ALIGNMENT PEROW
68	107 TF-236	TRACK ALIGNMENT PEROW
69	107 TF-237	TRACK ALIGNMENT PEROW
70	107 TF-238	TRACK ALIGNMENT PEROW
71	107 TF-239	TRACK ALIGNMENT PEROW
72	107 TF-240	TRACK ALIGNMENT PEROW

SHT NO	DWG NO	DWG TITLE
CROSS SECTIONS		
73	107 TX-101	CROSS SECTIONS NORTHERN ALIGNMENT OPTION 1 (20' OFFSET)
74	107 TX-102	CROSS SECTIONS NORTHERN ALIGNMENT OPTION 1 (20' OFFSET)
75	107 TX-103	CROSS SECTIONS NORTHERN ALIGNMENT OPTION 1 (20' OFFSET)
76	107 TX-104	CROSS SECTIONS NORTHERN ALIGNMENT OPTION 1 (20' OFFSET)
77	107 TX-105	CROSS SECTIONS NORTHERN ALIGNMENT OPTION 1 (20' OFFSET)
78	107 TX-106	CROSS SECTIONS NORTHERN ALIGNMENT OPTION 1 (20' OFFSET)
79	107 TX-107	CROSS SECTIONS NORTHERN ALIGNMENT OPTION 1 (20' OFFSET)
80	107 TX-108	CROSS SECTIONS NORTHERN ALIGNMENT OPTION 1 (20' OFFSET)
81	107 TX-107	CROSS SECTIONS NORTHERN ALIGNMENT OPTION 1 (20' OFFSET)
82	107 TX-110	CROSS SECTIONS NORTHERN ALIGNMENT OPTION 1 (20' OFFSET)
83	107 TX-111	CROSS SECTIONS NORTHERN ALIGNMENT OPTION 1 (20' OFFSET)
84	107 TX-112	CROSS SECTIONS NORTHERN ALIGNMENT OPTION 1 (20' OFFSET)
85	107 TX-113	CROSS SECTIONS NORTHERN ALIGNMENT OPTION 1 (20' OFFSET)
86	107 TX-114	CROSS SECTIONS NORTHERN ALIGNMENT OPTION 1 (20' OFFSET)
87	107 TX-115	CROSS SECTIONS NORTHERN ALIGNMENT OPTION 1 (20' OFFSET)
88	107 TX-116	CROSS SECTIONS NORTHERN ALIGNMENT OPTION 1 (20' OFFSET)
89	107 TX-201	CROSS SECTIONS SOUTHERN ALIGNMENT OPTION 1 (20' OFFSET)
90	107 TX-202	CROSS SECTIONS SOUTHERN ALIGNMENT OPTION 1 (20' OFFSET)
91	107 TX-203	CROSS SECTIONS SOUTHERN ALIGNMENT OPTION 1 (20' OFFSET)
92	107 TX-204	CROSS SECTIONS SOUTHERN ALIGNMENT OPTION 1 (20' OFFSET)
93	107 TX-205	CROSS SECTIONS SOUTHERN ALIGNMENT OPTION 1 (20' OFFSET)
94	107 TX-206	CROSS SECTIONS SOUTHERN ALIGNMENT OPTION 1 (20' OFFSET)
95	107 TX-207	CROSS SECTIONS SOUTHERN ALIGNMENT OPTION 1 (20' OFFSET)
96	107 TX-208	CROSS SECTIONS SOUTHERN ALIGNMENT OPTION 1 (20' OFFSET)
97	107 TX-209	CROSS SECTIONS SOUTHERN ALIGNMENT OPTION 1 (20' OFFSET)
98	107 TX-210	CROSS SECTIONS SOUTHERN ALIGNMENT OPTION 1 (20' OFFSET)
99	107 TX-211	CROSS SECTIONS SOUTHERN ALIGNMENT OPTION 1 (20' OFFSET)
100	107 TX-212	CROSS SECTIONS SOUTHERN ALIGNMENT OPTION 1 (20' OFFSET)
101	107 TX-213	CROSS SECTIONS SOUTHERN ALIGNMENT OPTION 1 (20' OFFSET)
102	107 TX-214	CROSS SECTIONS SOUTHERN ALIGNMENT OPTION 1 (20' OFFSET)

SHT NO	DWG NO	DWG TITLE
CONSTRUCTION STAGING		
103	107 CS-001	TRACK ALIGNMENT CONSTRUCTION STAGING LA HABRA BRANCH
104	107 CS-002	TRACK ALIGNMENT CONSTRUCTION STAGING SAN PEDRO BRANCH 1
105	107 CS-003	TRACK ALIGNMENT CONSTRUCTION STAGING SAN PEDRO BRANCH 2
106	107 CS-004	TRACK ALIGNMENT CONSTRUCTION STAGING SAN PEDRO BRANCH 3
107	107 CS-005	TRACK ALIGNMENT CONSTRUCTION STAGING PEROW

NOT FOR CONSTRUCTION

WEST SANTA ANA BRANCH FREIGHT TRACK		CONTRACT NO AE5999300
GENERAL		DRAWING NO GF-002
INDEX OF DRAWINGS		SCALE NO SCALE
		SHEET NO 1 OF 107

15-NOV-2019 22:36 C-28091AGF002.plg

DESIGNED BY J. SANCHEZ	
DRAWN BY C. CHEUK	
CHECKED BY R. LOYA	
IN CHARGE N. MAACK	
DATE 11/15/2019	

DESIGNED BY J. SANCHEZ	
DRAWN BY C. CHEUK	
CHECKED BY R. LOYA	
IN CHARGE N. MAACK	
DATE 11/15/2019	

LOS ANGELES COUNTY METROPOLITAN TRANSPORTATION AUTHORITY

wsp 444 South Flower Street Suite 800 Los Angeles, CA 90071 TEL (213) 362-9470

SUBMITTED	_____
APPROVED	_____

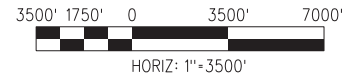
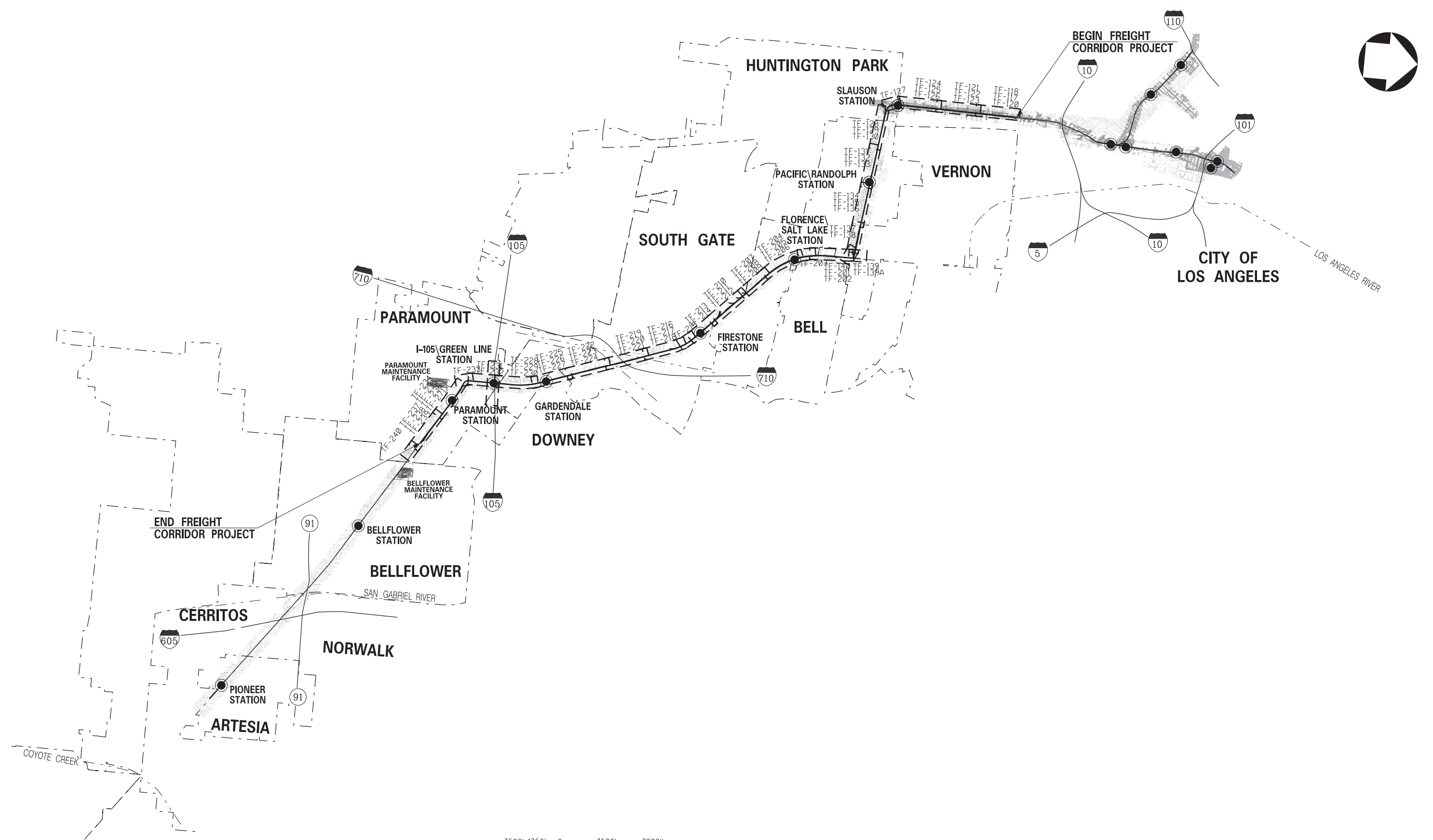

PLAN

NOT FOR CONSTRUCTION

15-NOV-2019 C-28091AGF003.plg
svc-projectwise 22:39

THE PREPARATION OF THIS DRAWING HAS BEEN FINANCED IN PART THROUGH A GRANT FROM THE U.S. DEPARTMENT OF TRANSPORTATION FEDERAL TRANSIT ADMINISTRATION (FTA), UNDER THE FEDERAL TRANSIT ACT OF 1964, AS AMENDED, AND IN PART BY THE TAXES OF THE CITIZENS OF LOS ANGELES COUNTY AND OF THE STATE OF CALIFORNIA.	
0	11/15/19
	FINAL CONCEPTUAL DESIGN

DESIGNED BY J. SANCHEZ
DRAWN BY C. CHEUK
CHECKED BY R. LOYA
IN CHARGE N. MAACK
DATE 11/15/2019

M Metro
LOS ANGELES COUNTY METROPOLITAN TRANSPORTATION AUTHORITY

wsp 444 South Flower Street Suite 800 Los Angeles, CA 90071 TEL (213) 362-9470

SUBMITTED _____
APPROVED _____

WEST SANTA ANA BRANCH FREIGHT TRACK
GENERAL
KEY MAP

CONTRACT NO AE5999300	
DRAWING NO GF-003	REV
SCALE HOR: 1"=35000'	
SHEET NO 2	OF 107

LIST OF ABBREVIATIONS

ALT	Alternative	N	North
ANT	Antenna	NTS	Not to scale
APPROX	Approximate	OCS	Overhead Catenary System
ART	Arts District South Station	OG	Original Ground/Grade
BC	Beginning of curve	OH	Overhead
BDRY	Boundary	OPP	Opposite
BEG	Begin	PED	Pedestrian
BLDG	Building	PG	Profile Grade
BM	Bench mark	PI	Point of intersection
BOW	Back of Sidewalk	PITO	Point of intersection of turnout
BVC	Begin of Vertical Curve	PL	Property line
B/W	Back of wall	PP	Power pole
C/C	Center to center	PS	Point of switch
CIDH	Cast-in-drilled-hole	PVC	Point of Vertical Curve
CL	Clearance, center line	PVI	Point of Vertical Intersection
COL	Column	PVMT	Pavement
CONC	Concrete	PVT	Point of vertical tangency
Dc	Degree of Curve	R	Radius
Delta	Central Angle	RR	Railroad
DWY	Driveway	RT	Right
E	East	RW	Retaining Wall
Ea	Actual Superelevation	R/W	Right-of-way
EB	Eastbound	SD	Storm drain
EC	End of curve	SOE	Support of excavation
EL	Elevation	SS	Sanitary sewer
EP	Edge of pavement	STA	Station, Stationing
ESMT	Easement	SW	Sidewalk
Eu	Unbalanced Superlevation	TCL	Track centerlines distance
EVC	End of vertical curb/curve	TOPO	Topography
EXC	Excavation	TP	Traction Power
EXIST	Existing	TPSS	Traction Power Substation
FG	Finished grade	TOR	Top of Rail
FS	Finished surface	T/R	Top of Rail
GR	Grade	TYP	Typical
H	High or Height	UPE	Under Platform Exhaust
HORIZ	Horizontal	V	Speed, Algebraic difference in grade
JT	Joint	VAR	Varies
L	Length, Length of curve	VC	Vertical Curve
LA	Los Angeles	WB	Westbound
LRT	Light Rail Transit	XO	Crossover
Ls	Length of Spiral	XSEC	Cross section
LT	Left		
MED	Median		
Min	Minimum		
MISC	Miscellaneous		
MWD	Metropolitan Water district		

GENERAL NOTES

- THIS PLAN SET DEPICTS A MIN. 20' OFFSET BETWEEN FREIGHT TRACK AND THE NEAREST LRT TRACK.
- DESIGN IS CONCEPTUAL IN NATURE, FOR PURPOSE OF ESTABLISHING ENVIRONMENTAL FOOTPRINT.
- MAJOR UTILITY LOCATIONS AND IMPACTS REQUIRE FURTHER COORDINATION AND REVIEW.
- PLACEMENT OF COLUMNS AND OUTRIGGERS IS PRELIMINARY AND MAY BE ADJUSTED DURING A FUTURE DESIGN PHASE.
- COORDINATION NEEDED WITH FREIGHT RAILROADS AND CALTRANS.
- FURTHER COORDINATION REQUIRED WITH PROJECTS AS LISTED:
RAIL TO RAIL/RIVER CORRIDOR, HOLLYDALE VILLAGE SPECIFIC PLAN, RANCHO LOS AMIGOS RE-DEVELOPMENT, BELLFLOWER-PARAMOUNT JOINT BIKE AND TRAIL MASTER PLAN.
- GRADE CROSSING, EXISTING UTILITIES, AND STATION DESIGNS ARE IN SEPARATE DRAWING SETS.
- STATIONS FOR THE CROSS SECTIONS ARE BASED ON THE EXIST FREIGHT TRACK 1 ϕ OR THE RELOCATED ϕ FREIGHT TRACK.

SYMBOLGY LEGEND

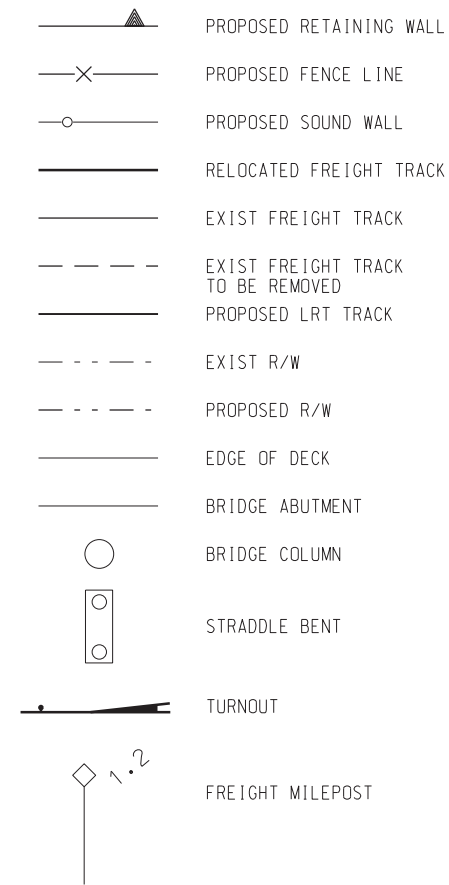

NOT FOR CONSTRUCTION

THE PREPARATION OF THIS DRAWING HAS BEEN FINANCED IN PART THROUGH A GRANT FROM THE U.S. DEPARTMENT OF TRANSPORTATION FEDERAL TRANSIT ADMINISTRATION (FTA), UNDER THE FEDERAL TRANSIT ACT OF 1964, AS AMENDED, AND IN PART BY THE TAKES OF THE CITIZENS OF LOS ANGELES COUNTY AND OF THE STATE OF CALIFORNIA.		DESIGNED BY J. SANCHEZ	LOS ANGELES COUNTY METROPOLITAN TRANSPORTATION AUTHORITY 444 South Flower Street Suite 800 Los Angeles, CA 90071 TEL (213) 362-9470		WEST SANTA ANA BRANCH FREIGHT TRACK		CONTRACT NO AE5999300
		DRAWN BY C. CHEUK			DRAWING NO GF-004	REV	
		CHECKED BY R. LOYA			SCALE NO SCALE		
		IN CHARGE N. MAACK			SHEET NO 3 OF 107		
0 11/15/19		DATE 11/15/2019			SUBMITTED _____		
		FINAL CONCEPTUAL DESIGN			APPROVED _____		ABBREVIATIONS

15-NOV-2019 C-28091AGF004.plg



BASIS OF GEODETIC COORDINATES

GEODETIC COORDINATES SHOWN HEREON ARE BASED UPON THE NORTH AMERICAN DATUM OF 1983 (2011), CSRS EPOCH 2017.5, CALIFORNIA COORDINATE SYSTEM ZONE 5, US SURVEY FT, AS REALIZED THROUGH THE CALIFORNIA REAL TIME NETWORK PRIMARY CONTROL STATIONS SHOWN HEREON. GNSS DERIVED ORTHOMETRIC HEIGHTS SHOWN HEREON ARE BASED UPON GRS80 ELLIPSOIDAL HEIGHTS AS REALIZED THROUGH THE AFOREMENTIONED NAD83, EPOCH 2017.5 PRIMARY CONTROL STATIONS WITH THE ABSOLUTE APPLICATION OF GEOID12B.

PRIMARY CONTROL POINTS

STATION	NORTHING	EASTING	HEIGHT	DESCRIPTION
ELSC	1833267.68	6498516.35	318.54	CRTN STATION EAST LA SCIENCE CENTER
MHMS	1800292.28	6487619.47	111.60	CRTN STATION MARKHAM MIDDLE SCHOOL
OXYC	1869323.45	6498929.40	803.15	CRTN STATION OCCIDENTAL COLLEGE
RHCL	1829315.58	6553739.69	696.72	CRTN STATION RHCL_SCGN_CS1998
BLSA	1749431.99	6552957.21	42.90	CRTN STATION BOLSA CHICA CHANNEL
VDCY	1887437.69	6495130.10	1157.22	CRTN STATION VERDUGO CANYON

PROJECT CONTROL POINTS

STATION	NORTHING	EASTING	HEIGHT	DESCRIPTION
CALA	1861875.98	6488475.52	399.83	SMARTNET STATION LOS ANGELES
CAPE	1730270.02	6476524.52	73.84	SMARTNET STATION SAN PEDRO
CASF	1800797.08	6537293.01	157.77	SMARTNET STATION SANTA FE SPRINGS
CASM	1829162.10	6418731.03	218.14	SMARTNET STATION SANTA MONICA
GPSI01	1771565.09	6536661.91	50.57	SET REBAR WITH RED CAP STAMPED "RSE CONTROL"
GPSI02	1796253.19	6510496.66	97.34	SET REBAR WITH RED CAP STAMPED "RSE CONTROL"
GPSI03	1816342.25	6499678.36	160.79	SET REBAR WITH RED CAP STAMPED "RSE CONTROL"
GPSI04	1827794.23	6488015.80	217.12	SET REBAR WITH RED CAP STAMPED "RSE CONTROL"

PLAN

NOT FOR CONSTRUCTION

15-NOV-2019 C-28091AW101.plg
22:43
svc-projectwise

THE PREPARATION OF THIS DRAWING HAS BEEN FINANCED IN PART THROUGH A GRANT FROM THE U.S. DEPARTMENT OF TRANSPORTATION FEDERAL TRANSIT ADMINISTRATION (FTA), UNDER THE FEDERAL TRANSIT ACT OF 1964, AS AMENDED, AND IN PART BY THE TAXES OF THE CITIZENS OF LOS ANGELES COUNTY AND OF THE STATE OF CALIFORNIA.		DESIGNED BY C. FESTA
		DRAWN BY C. CHEUK
		CHECKED BY R. LOYA
		IN CHARGE N. MAACK
		DATE 11/15/2019
0	11/15/19	FINAL CONCEPTUAL DESIGN

M Metro
wsp 444 South Flower Street
 Suite 800
 Los Angeles, CA 90071
 TEL (213) 362-9470

LOS ANGELES COUNTY METROPOLITAN TRANSPORTATION AUTHORITY

WEST SANTA ANA BRANCH FREIGHT TRACK PROJECT MAPPING CONTROL

SUBMITTED _____

APPROVED _____

WEST SANTA ANA BRANCH FREIGHT TRACK PROJECT MAPPING CONTROL

SURVEY CONTROL PLAN

CONTRACT NO AE5999300	
DRAWING NO GF-005	REV
SCALE NO SCALE	
SHEET NO 4	OF 107

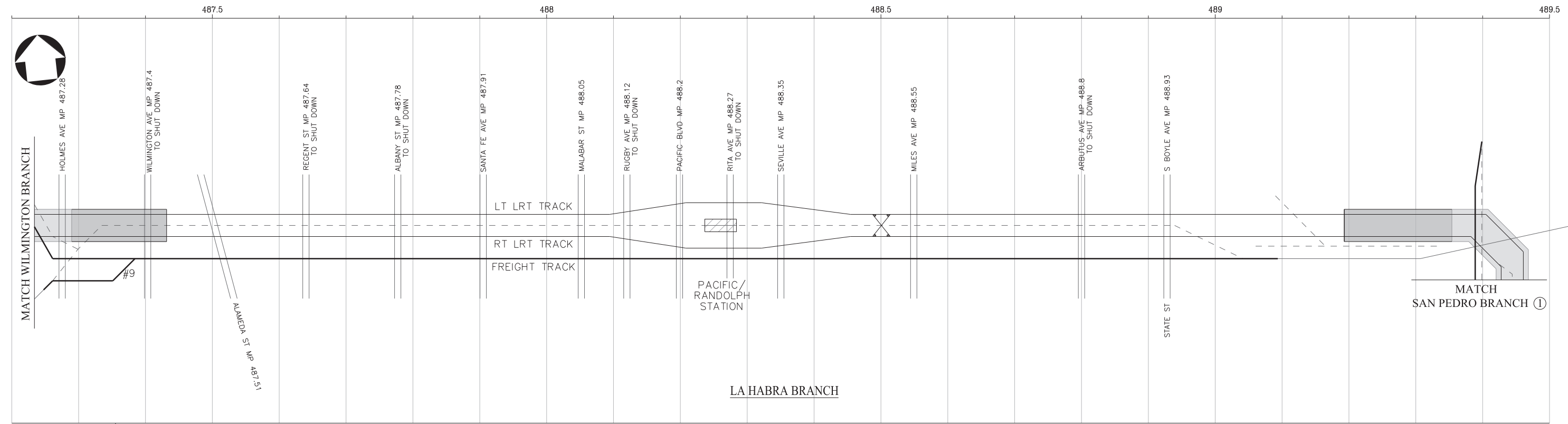
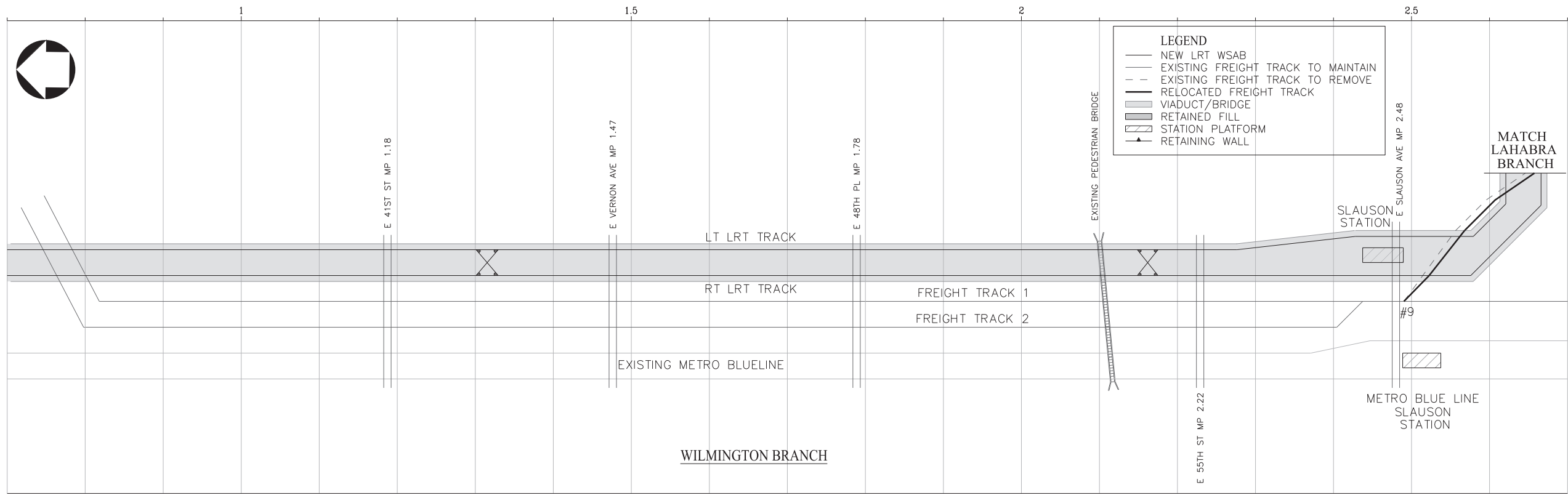

NOT FOR CONSTRUCTION

15-NOV-2019 C-28091ATC001.plg
svc-projectwise 22:38

THE PREPARATION OF THIS DRAWING HAS BEEN FINANCED IN PART THROUGH A GRANT FROM THE U.S. DEPARTMENT OF TRANSPORTATION FEDERAL TRANSIT ADMINISTRATION (FTA), UNDER THE FEDERAL TRANSIT ACT OF 1964, AS AMENDED, AND IN PART BY THE TAXES OF THE CITIZENS OF LOS ANGELES COUNTY AND OF THE STATE OF CALIFORNIA.	
0	11/15/19
	FINAL CONCEPTUAL DESIGN

DESIGNED BY J. SANCHEZ
DRAWN BY A. LEE
CHECKED BY R. LOYA
IN CHARGE N. MAACK
DATE 11/15/2019

M Metro LOS ANGELES COUNTY METROPOLITAN TRANSPORTATION AUTHORITY

wsp 444 South Flower Street Suite 800 Los Angeles, CA 90071 TEL (213) 362-9470

SUBMITTED _____

APPROVED _____

WEST SANTA ANA BRANCH FREIGHT TRACK TRACK ALIGNMENT

TRACK CHART

CONTRACT NO AE5999300
DRAWING NO TC-001
SCALE HOR: 1"=400' 1"=400'
SHEET NO 5 OF 107

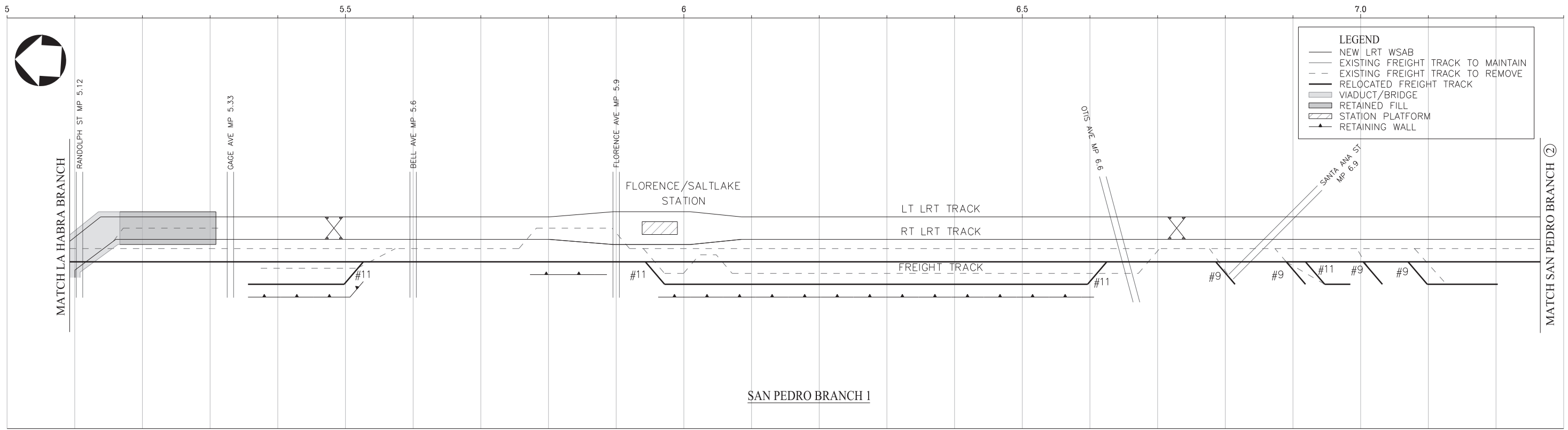

SAN PEDRO BRANCH 1

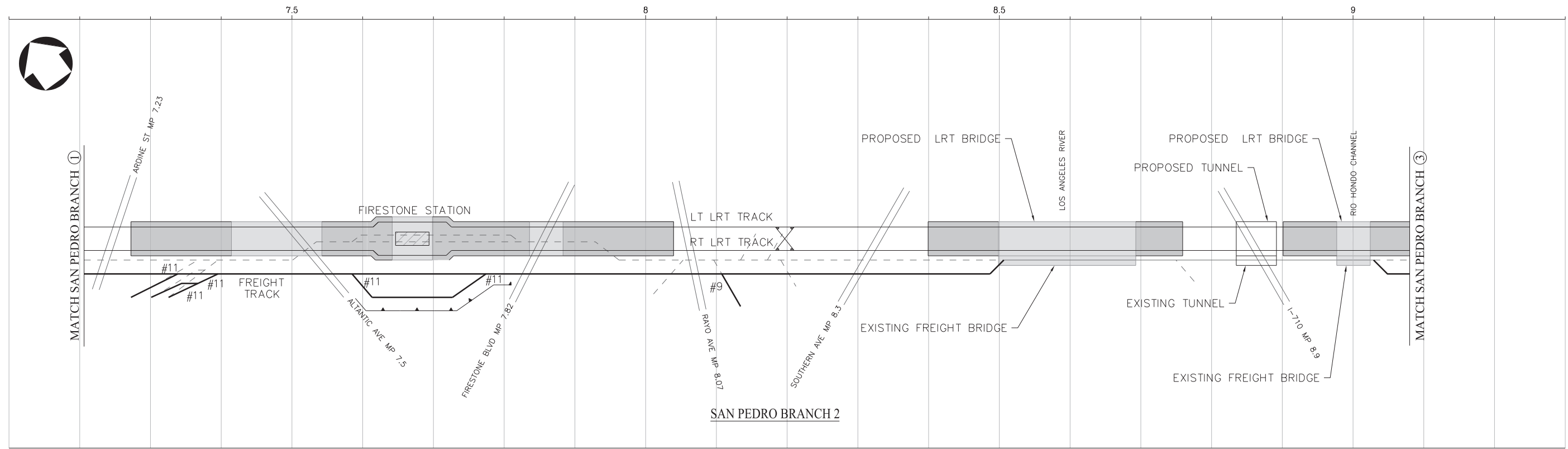

SAN PEDRO BRANCH 2

LEGEND

- NEW LRT WSAB
- EXISTING FREIGHT TRACK TO MAINTAIN
- - - EXISTING FREIGHT TRACK TO REMOVE
- - - RELOCATED FREIGHT TRACK
- ▬ VIADUCT/BRIDGE
- ▬ RETAINED FILL
- ▨ STATION PLATFORM
- ▲ RETAINING WALL

NOT FOR CONSTRUCTION

15-NOV-2019 C-28091ATC002.plg

svc-projectwise 22:40

THE PREPARATION OF THIS DRAWING HAS BEEN FINANCED IN PART THROUGH A GRANT FROM THE U.S. DEPARTMENT OF TRANSPORTATION FEDERAL TRANSIT ADMINISTRATION (FTA), UNDER THE FEDERAL TRANSIT ACT OF 1964, AS AMENDED, AND IN PART BY THE TAXES OF THE CITIZENS OF LOS ANGELES COUNTY AND OF THE STATE OF CALIFORNIA.	
0	11/15/19
	FINAL CONCEPTUAL DESIGN

DESIGNED BY J. SANCHEZ
DRAWN BY A. LEE
CHECKED BY R. LOYA
IN CHARGE N. MAACK
DATE 11/15/2019

M Metro

LOS ANGELES COUNTY METROPOLITAN TRANSPORTATION AUTHORITY

wsp 444 South Flower Street Suite 800 Los Angeles, CA 90071 TEL (213) 362-9470

SUBMITTED _____

APPROVED _____

WEST SANTA ANA BRANCH FREIGHT TRACK TRACK ALIGNMENT

TRACK CHART

CONTRACT NO AE5999300
DRAWING NO TC-002
SCALE HOR: 1"=400' 1"=400'
SHEET NO 6 OF 107

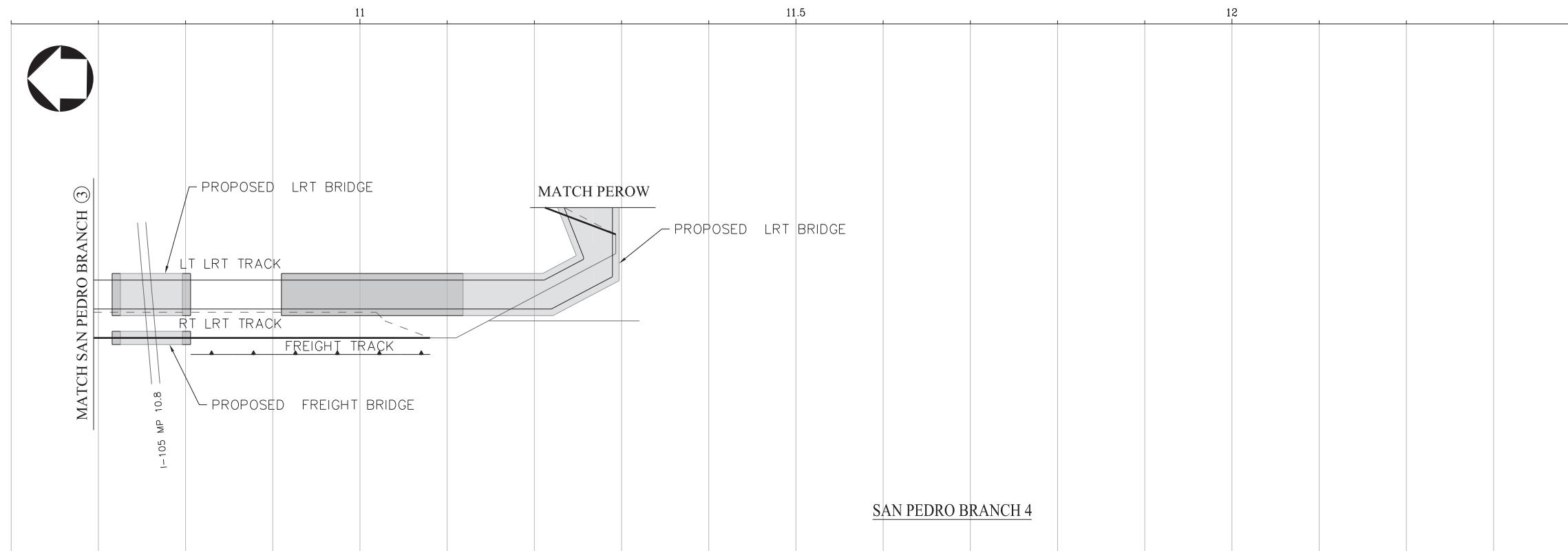
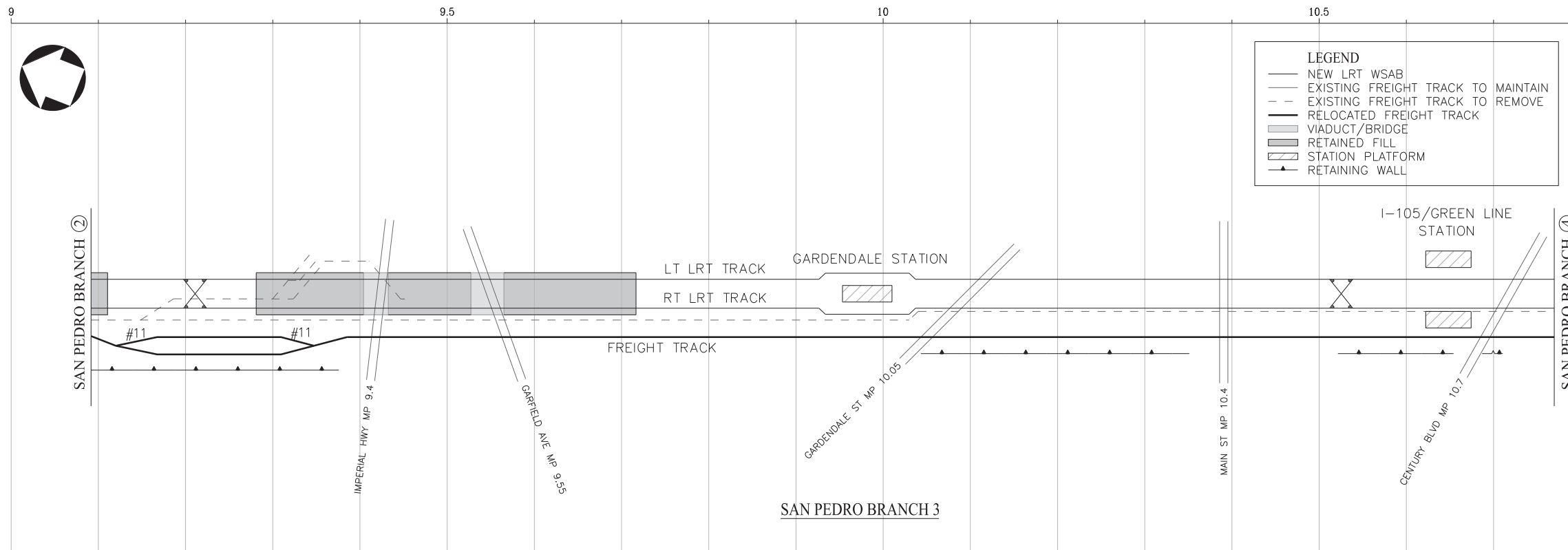

NOT FOR CONSTRUCTION

15-NOV-2019 C-28091ATC003.plg
22:38
svc-projectwise

THE PREPARATION OF THIS DRAWING HAS BEEN FINANCED IN PART THROUGH A GRANT FROM THE U.S. DEPARTMENT OF TRANSPORTATION FEDERAL TRANSIT ADMINISTRATION (FTA), UNDER THE FEDERAL TRANSIT ACT OF 1964, AS AMENDED, AND IN PART BY THE TAXES OF THE CITIZENS OF LOS ANGELES COUNTY AND OF THE STATE OF CALIFORNIA.	
0	11/15/19
	FINAL CONCEPTUAL DESIGN

DESIGNED BY J. SANCHEZ
DRAWN BY A. LEE
CHECKED BY R. LOYA
IN CHARGE N. MAACK
DATE 11/15/2019

M Metro LOS ANGELES COUNTY METROPOLITAN TRANSPORTATION AUTHORITY

wsp 444 South Flower Street Suite 800 Los Angeles, CA 90071 TEL (213) 362-9470

SUBMITTED _____

APPROVED _____

WEST SANTA ANA BRANCH FREIGHT TRACK TRACK ALIGNMENT

TRACK CHART

CONTRACT NO AE5999300
DRAWING NO TC-003
SCALE HOR: 1"=400' 1"=400'
SHEET NO 7 OF 107

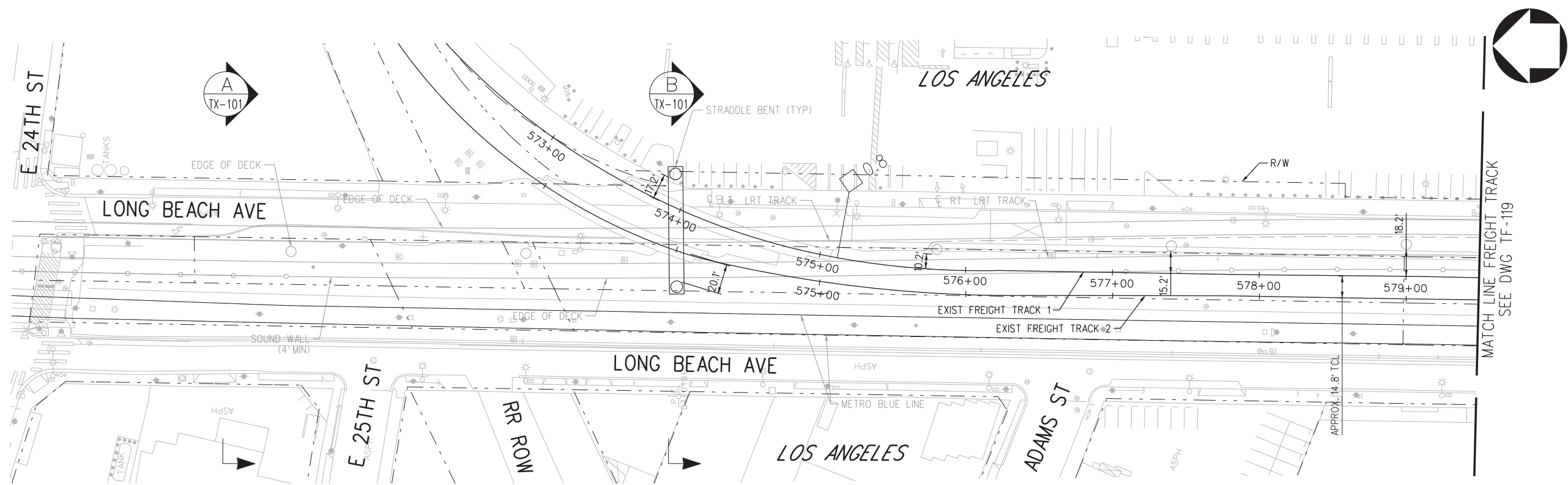

PLAN

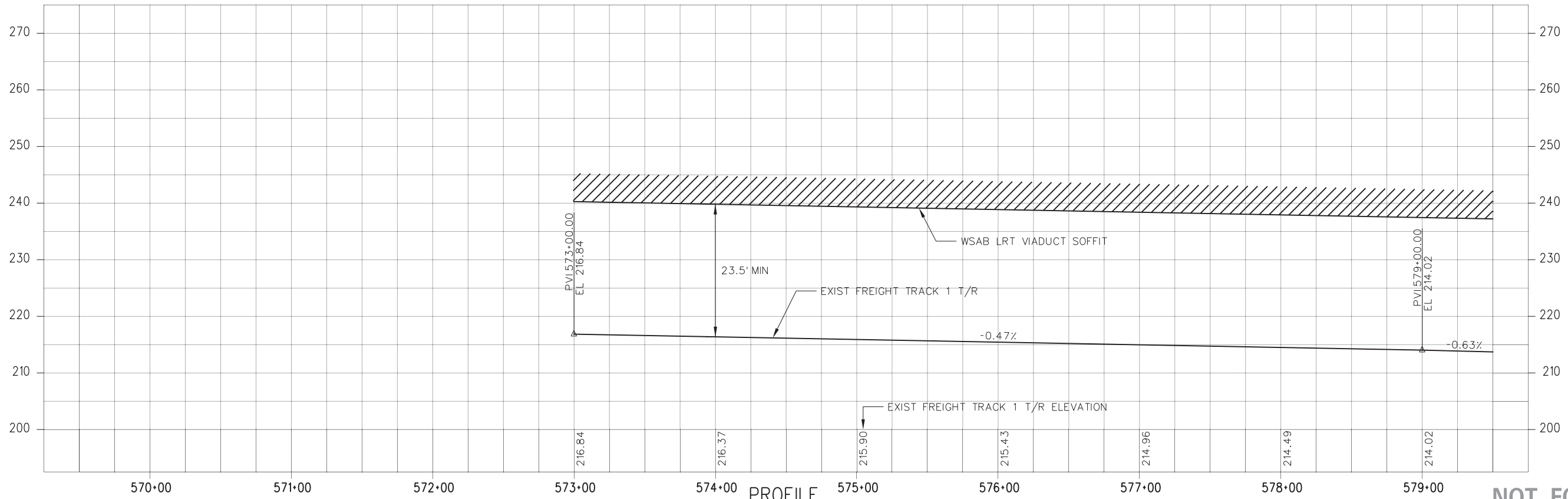

PROFILE

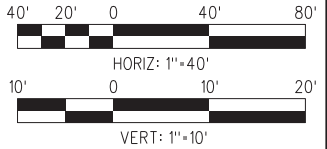

NOT FOR CONSTRUCTION

15-NOV-2019 C-28091ATF118.plg
svc-projectwise 22:37

THE PREPARATION OF THIS DRAWING HAS BEEN FINANCED IN PART THROUGH A GRANT FROM THE U.S. DEPARTMENT OF TRANSPORTATION FEDERAL TRANSIT ADMINISTRATION (FTA), UNDER THE FEDERAL TRANSIT ACT OF 1964, AS AMENDED, AND IN PART BY THE TAXES OF THE CITIZENS OF LOS ANGELES COUNTY AND OF THE STATE OF CALIFORNIA.		DESIGNED BY J. SANCHEZ
0	11/15/19	DRAWN BY C. CHEUK
		CHECKED BY R. LOYA
		IN CHARGE N. MAACK
	FINAL CONCEPTUAL DESIGN	DATE 11/15/2019

M Metro
444 South Flower Street
Suite 800
Los Angeles, CA 90071
TEL (213) 362-9470

wsp

SUBMITTED _____
APPROVED _____

**WEST SANTA ANA BRANCH FREIGHT TRACK
TRACK ALIGNMENT
WILLMINGTON BRANCH
PLAN & PROFILE
STA 569+50 TO STA 579+50**

CONTRACT NO AE5999300	
DRAWING NO TF-118	REV
SCALE HOR: 1"=40' VERT: 1"=10'	
SHEET NO 9	OF 107

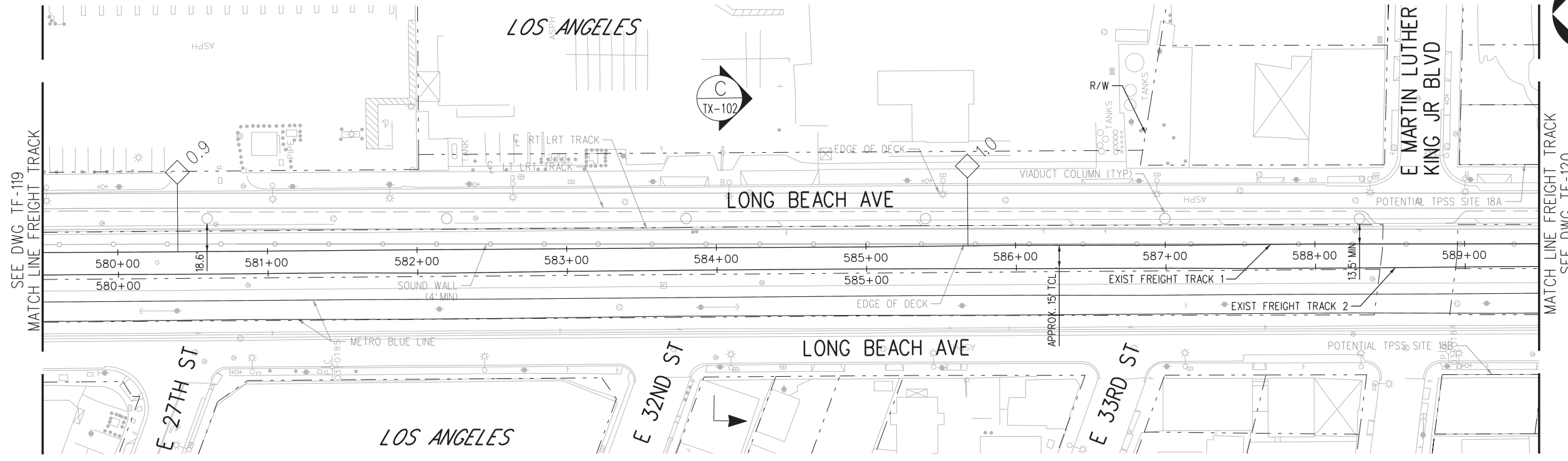

PLAN

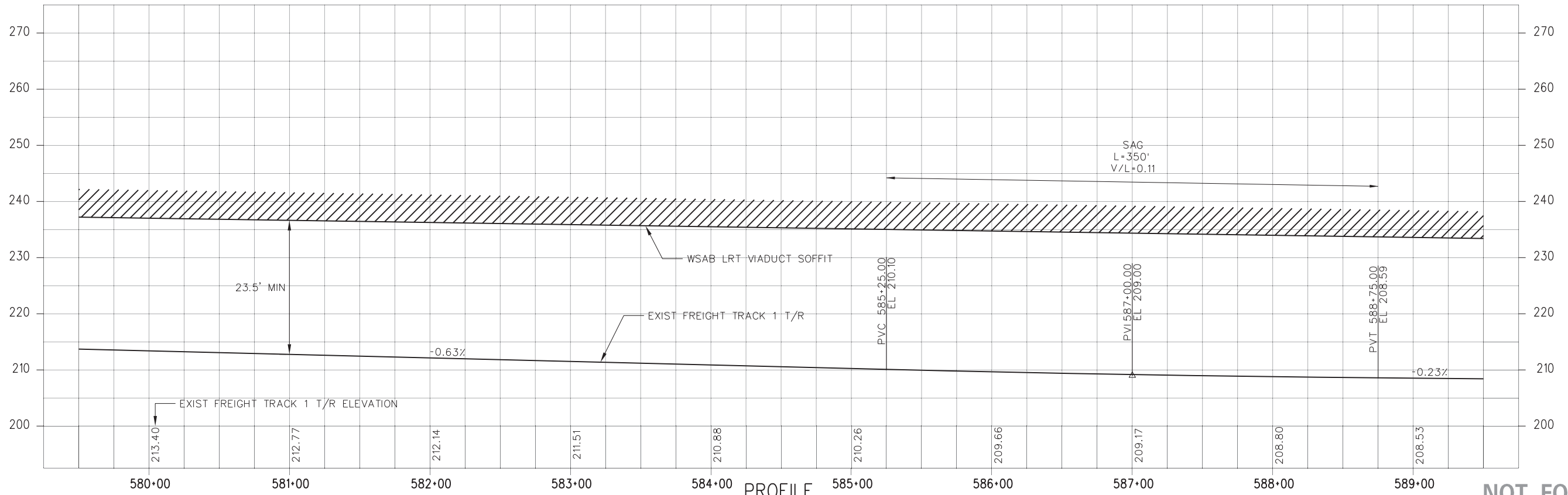

PROFILE

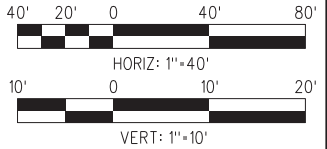

NOT FOR CONSTRUCTION

15-NOV-2019 C-28091ATF119.plg
svc-projectwise 22:35

THE PREPARATION OF THIS DRAWING HAS BEEN FINANCED IN PART THROUGH A GRANT FROM THE U.S. DEPARTMENT OF TRANSPORTATION FEDERAL TRANSIT ADMINISTRATION (FTA), UNDER THE FEDERAL TRANSIT ACT OF 1964, AS AMENDED, AND IN PART BY THE TAXES OF THE CITIZENS OF LOS ANGELES COUNTY AND OF THE STATE OF CALIFORNIA.	
0	11/15/19
	FINAL CONCEPTUAL DESIGN

DESIGNED BY J. SANCHEZ
DRAWN BY C. CHEUK
CHECKED BY R. LOYA
IN CHARGE N. MAACK
DATE 11/15/2019

M Metro
LOS ANGELES COUNTY METROPOLITAN TRANSPORTATION AUTHORITY

wsp 444 South Flower Street Suite 800 Los Angeles, CA 90071 TEL (213) 362-9470

SUBMITTED _____
APPROVED _____

WEST SANTA ANA BRANCH FREIGHT TRACK
TRACK ALIGNMENT
WILLMINGTON BRANCH
PLAN & PROFILE
STA 579+50 TO STA 589+50

CONTRACT NO. AE5999300
DRAWING NO. TF-119
SCALE HORIZ: 1"=40' VERT: 1"=10'
SHEET NO. 10 OF 107

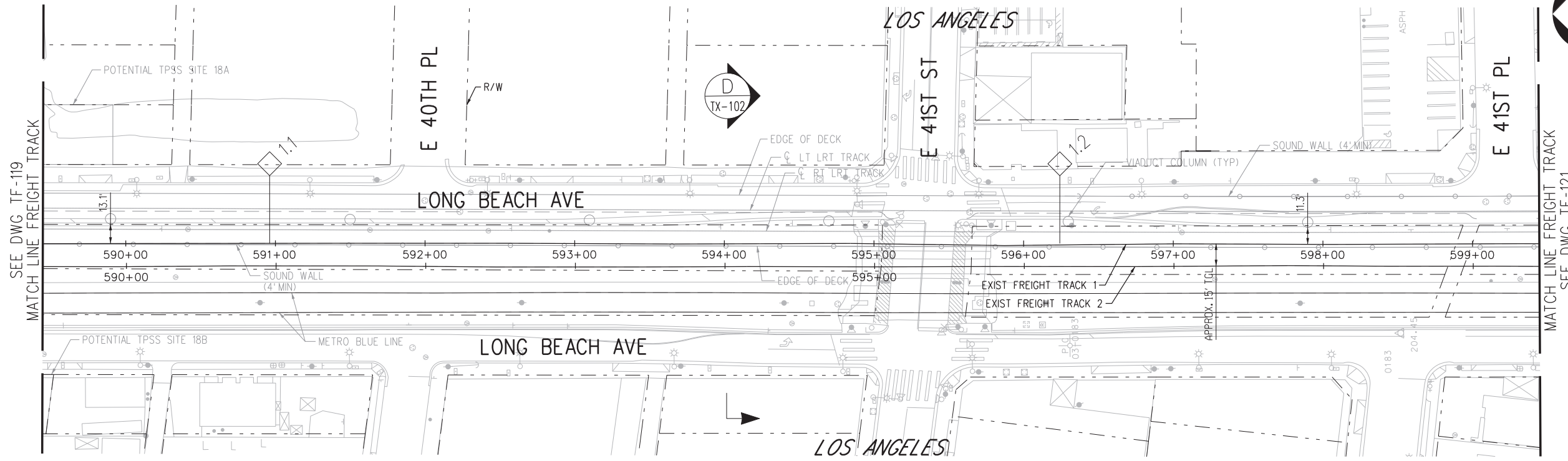

PLAN

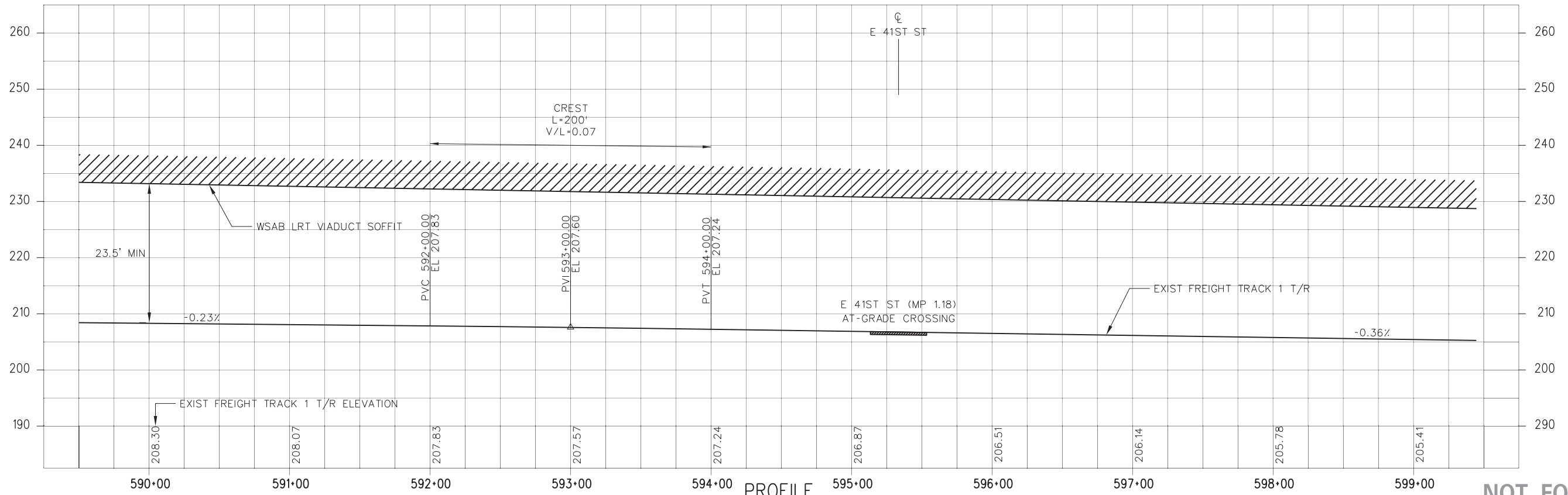

PROFILE

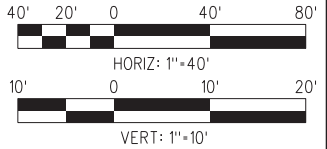

NOT FOR CONSTRUCTION

15-NOV-2019 C-28091ATF120.plg
svc-projectwise 22:38

THE PREPARATION OF THIS DRAWING HAS BEEN FINANCED IN PART THROUGH A GRANT FROM THE U.S. DEPARTMENT OF TRANSPORTATION FEDERAL TRANSIT ADMINISTRATION (FTA), UNDER THE FEDERAL TRANSIT ACT OF 1964, AS AMENDED, AND IN PART BY THE TAXES OF THE CITIZENS OF LOS ANGELES COUNTY AND OF THE STATE OF CALIFORNIA.	
0	11/15/19
	FINAL CONCEPTUAL DESIGN

DESIGNED BY J. SANCHEZ
DRAWN BY C. CHEUK
CHECKED BY R. LOYA
IN CHARGE N. MAACK
DATE 11/15/2019

M Metro
LOS ANGELES COUNTY METROPOLITAN TRANSPORTATION AUTHORITY

wsp 444 South Flower Street Suite 800 Los Angeles, CA 90071 TEL (213) 362-9470

SUBMITTED _____
 APPROVED _____

WEST SANTA ANA BRANCH FREIGHT TRACK
TRACK ALIGNMENT
WILLMINGTON BRANCH
PLAN & PROFILE
STA 589+50 TO STA 599+50

CONTRACT NO. AE5999300
DRAWING NO. TF-120
SCALE HOR: 1"=40' VERT: 1"=10'
SHEET NO. 11 OF 107

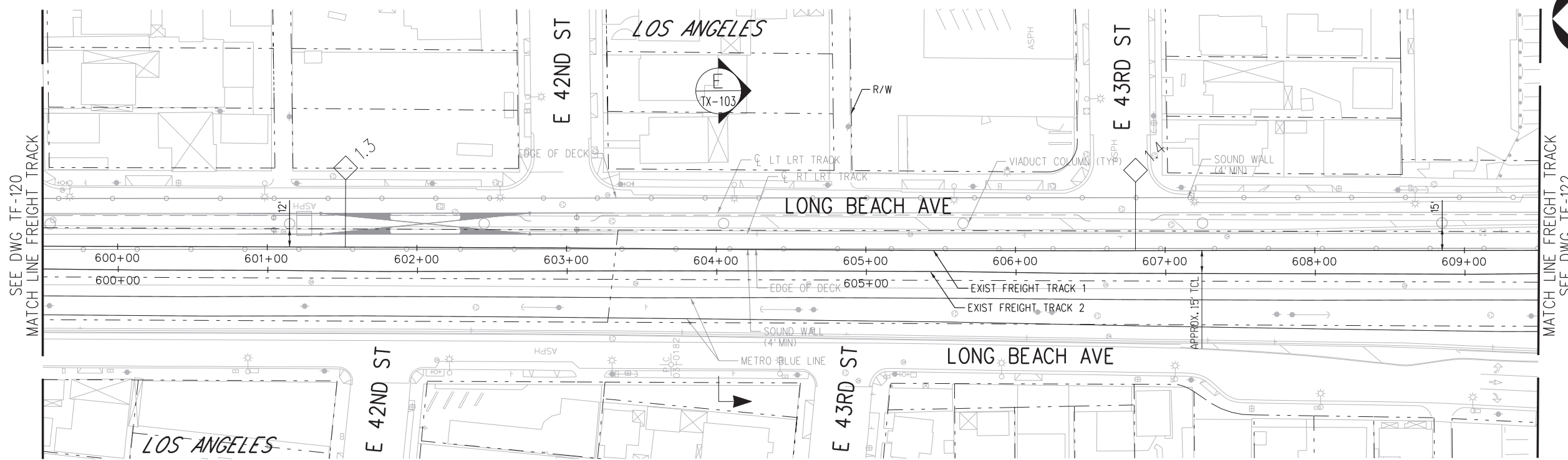

PLAN

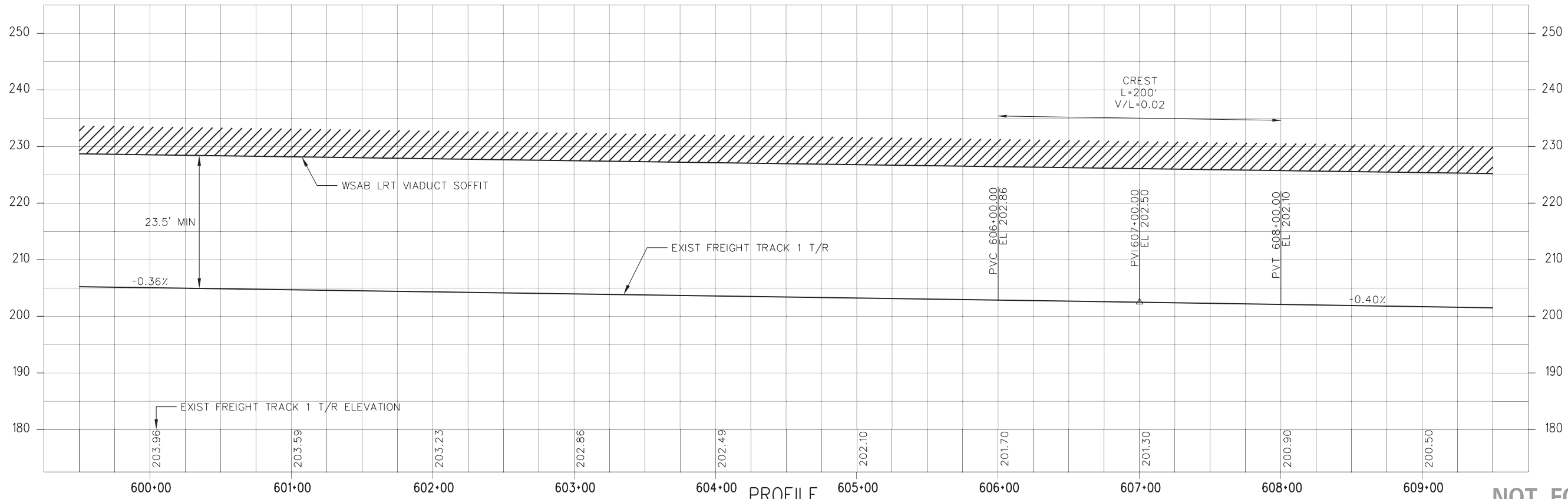

PROFILE

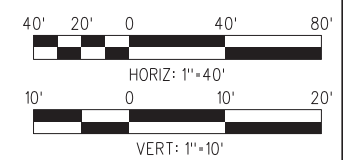

NOT FOR CONSTRUCTION

15-NOV-2019 C-28091ATF121.plg
svc-projectwise 22:36

THE PREPARATION OF THIS DRAWING HAS BEEN FINANCED IN PART THROUGH A GRANT FROM THE U.S. DEPARTMENT OF TRANSPORTATION FEDERAL TRANSIT ADMINISTRATION (FTA), UNDER THE FEDERAL TRANSIT ACT OF 1964, AS AMENDED, AND IN PART BY THE TAXES OF THE CITIZENS OF LOS ANGELES COUNTY AND OF THE STATE OF CALIFORNIA.		DESIGNED BY J. SANCHEZ DRAWN BY C. CHEUK CHECKED BY R. LOYA IN CHARGE N. MAACK DATE 11/15/2019
0	11/15/19	FINAL CONCEPTUAL DESIGN

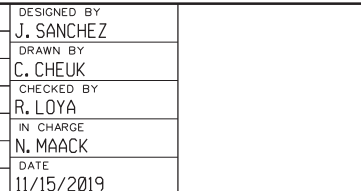

WSP 444 South Flower Street
 Suite 800
 Los Angeles, CA 90071
 TEL (213) 362-9470

SUBMITTED _____
 APPROVED _____

WEST SANTA ANA BRANCH FREIGHT TRACK
TRACK ALIGNMENT
WILLMINGTON BRANCH
PLAN & PROFILE
STA 599+50 TO STA 609+50

CONTRACT NO.	AE5999300
DRAWING NO.	TF-121
SCALE	HORIZ: 1"=40' VERT: 1"=10'
SHEET NO.	12 OF 107

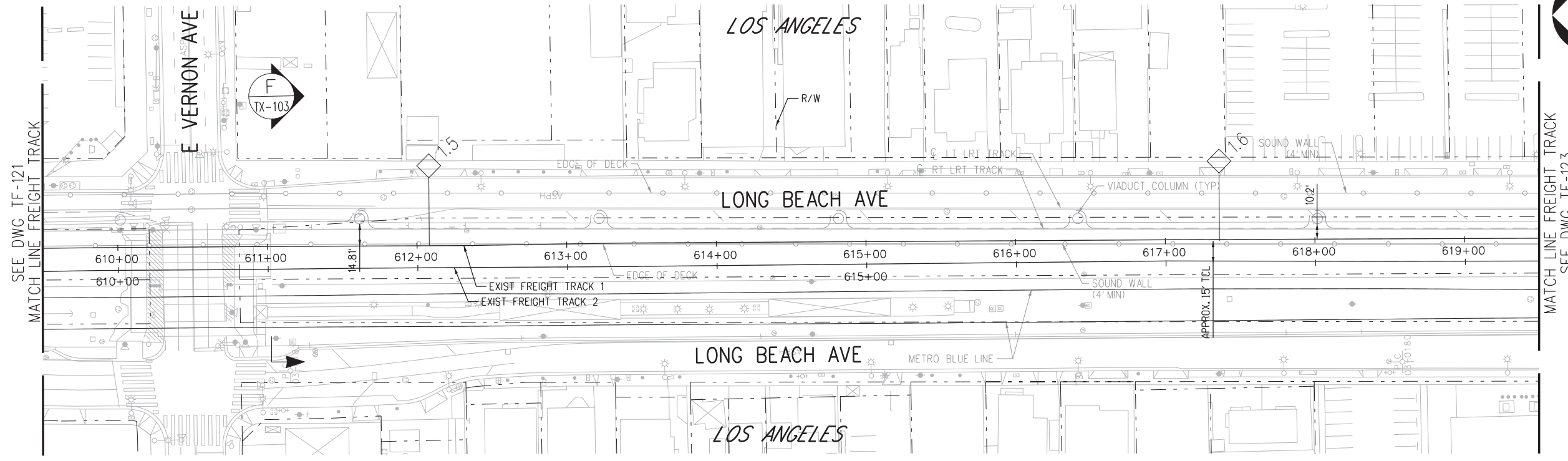

PLAN

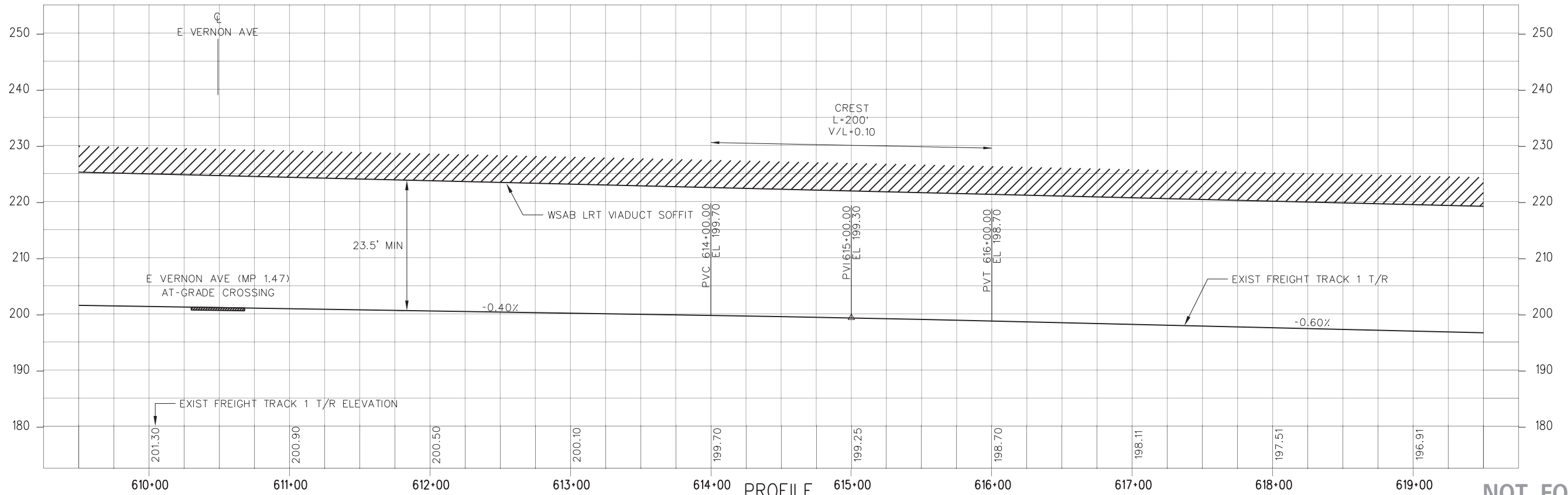

PROFILE

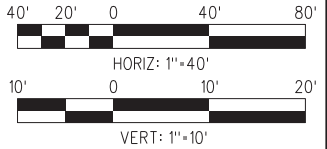

NOT FOR CONSTRUCTION

15-NOV-2019 C-28091ATF122.plg
svc-projectwise 22:37

THE PREPARATION OF THIS DRAWING HAS BEEN FINANCED IN PART THROUGH A GRANT FROM THE U.S. DEPARTMENT OF TRANSPORTATION FEDERAL TRANSIT ADMINISTRATION (FTA), UNDER THE FEDERAL TRANSIT ACT OF 1964, AS AMENDED, AND IN PART BY THE TAXES OF THE CITIZENS OF LOS ANGELES COUNTY AND OF THE STATE OF CALIFORNIA.	
0	11/15/19
	FINAL CONCEPTUAL DESIGN

DESIGNED BY J. SANCHEZ
DRAWN BY C. CHEUK
CHECKED BY R. LOYA
IN CHARGE N. MAACK
DATE 11/15/2019

M Metro
wsp 444 South Flower Street
 Suite 800
 Los Angeles, CA 90071
 TEL (213) 362-9470

SUBMITTED _____
 APPROVED _____

WEST SANTA ANA BRANCH FREIGHT TRACK
TRACK ALIGNMENT
WILLMINGTON BRANCH
PLAN & PROFILE
STA 609+50 TO STA 619+50

CONTRACT NO
AE5999300

DRAWING NO
TF-122 REV

SCALE
HORIZ: 1"=40'
VERT: 1"=10'

SHEET NO
13 OF **107**

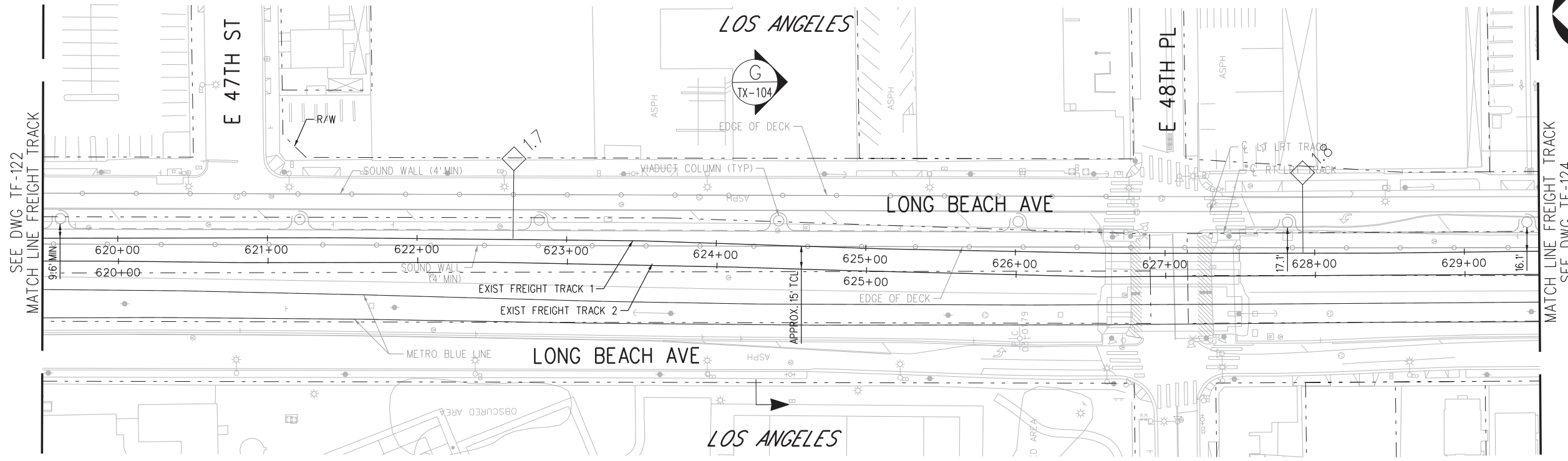

PLAN

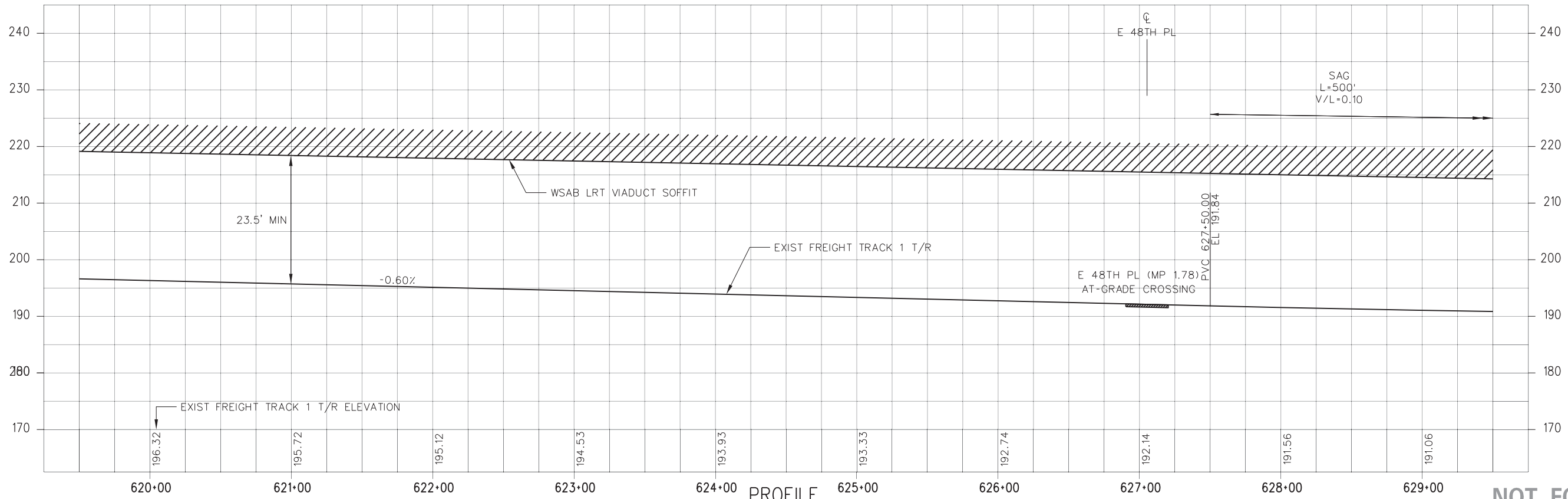

PROFILE

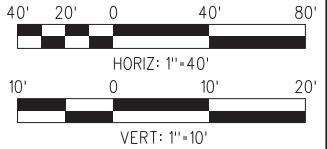

NOT FOR CONSTRUCTION

15-NOV-2019 C-28091ATF123.plg
svc-projectwise 22:36

THE PREPARATION OF THIS DRAWING HAS BEEN FINANCED IN PART THROUGH A GRANT FROM THE U.S. DEPARTMENT OF TRANSPORTATION FEDERAL TRANSIT ADMINISTRATION (FTA), UNDER THE FEDERAL TRANSIT ACT OF 1964, AS AMENDED, AND IN PART BY THE TAXES OF THE CITIZENS OF LOS ANGELES COUNTY AND OF THE STATE OF CALIFORNIA.		DESIGNED BY J. SANCHEZ DRAWN BY C. CHEUK CHECKED BY R. LOYA IN CHARGE N. MAACK DATE 11/15/2019
0	11/15/19	FINAL CONCEPTUAL DESIGN

LOS ANGELES COUNTY METROPOLITAN TRANSPORTATION AUTHORITY

 444 South Flower Street
 Suite 800
 Los Angeles, CA 90071
 TEL (213) 362-9470

SUBMITTED _____ APPROVED _____	CONTRACT NO AE5999300 DRAWING NO TF-123 SCALE HOR: 1"=40' VERT: 1"=10' SHEET NO 14 OF 107
-----------------------------------	---

WEST SANTA ANA BRANCH FREIGHT TRACK
TRACK ALIGNMENT
WILLMINGTON BRANCH
PLAN & PROFILE
STA 619+50 TO STA 629+50

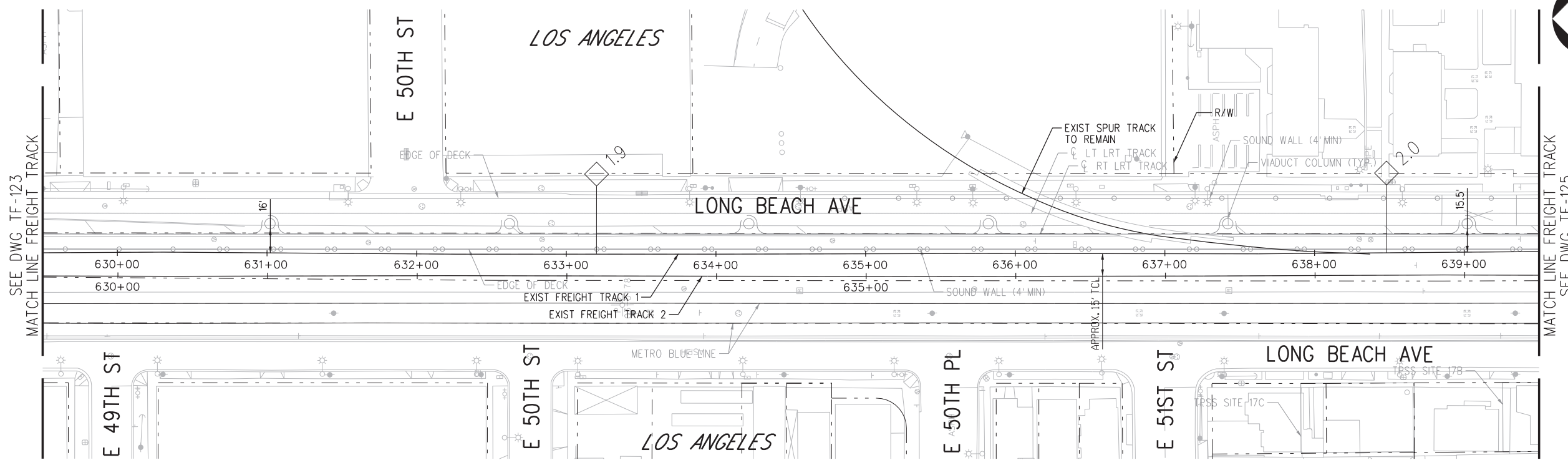

PLAN

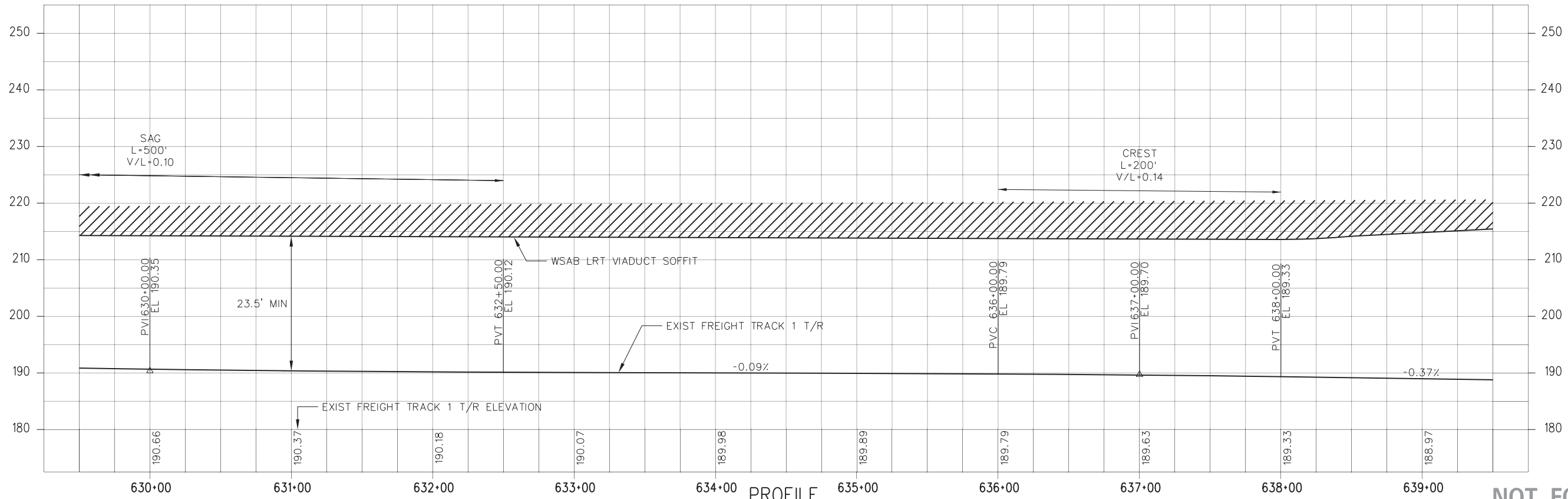

PROFILE

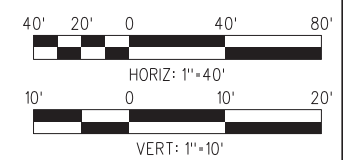

NOT FOR CONSTRUCTION

15-NOV-2019 C-28091ATF124.plg
svc-projectwise 22:37

THE PREPARATION OF THIS DRAWING HAS BEEN FINANCED IN PART THROUGH A GRANT FROM THE U.S. DEPARTMENT OF TRANSPORTATION FEDERAL TRANSIT ADMINISTRATION (FTA), UNDER THE FEDERAL TRANSIT ACT OF 1964, AS AMENDED, AND IN PART BY THE TAXES OF THE CITIZENS OF LOS ANGELES COUNTY AND OF THE STATE OF CALIFORNIA.	
0	11/15/19
	FINAL CONCEPTUAL DESIGN

DESIGNED BY J. SANCHEZ
DRAWN BY C. CHEUK
CHECKED BY R. LOYA
IN CHARGE N. MAACK
DATE 11/15/2019

M Metro
wsp 444 South Flower Street Suite 800
 Los Angeles, CA 90071
 TEL (213) 362-9470

SUBMITTED _____
 APPROVED _____

**WEST SANTA ANA BRANCH FREIGHT TRACK
 TRACK ALIGNMENT
 WILLMINGTON BRANCH
 PLAN & PROFILE
 STA 629+50 TO STA 639+50**

CONTRACT NO. AE5999300
DRAWING NO. TF-124
SCALE HORIZ: 1"=40' VERT: 1"=10'
SHEET NO. 15 OF 107

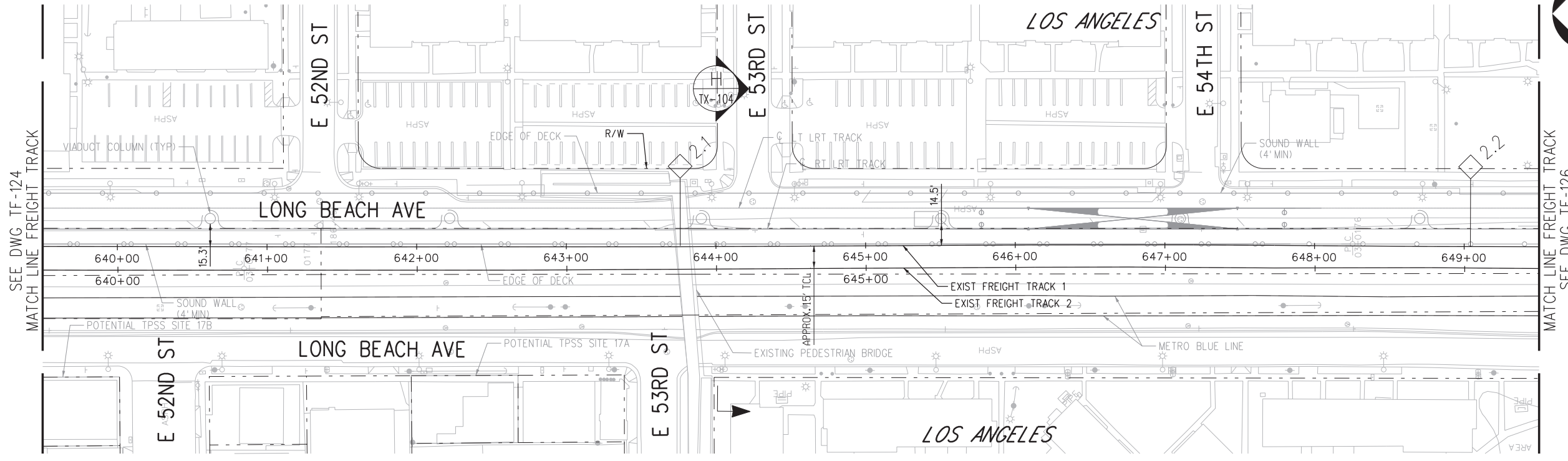

PLAN

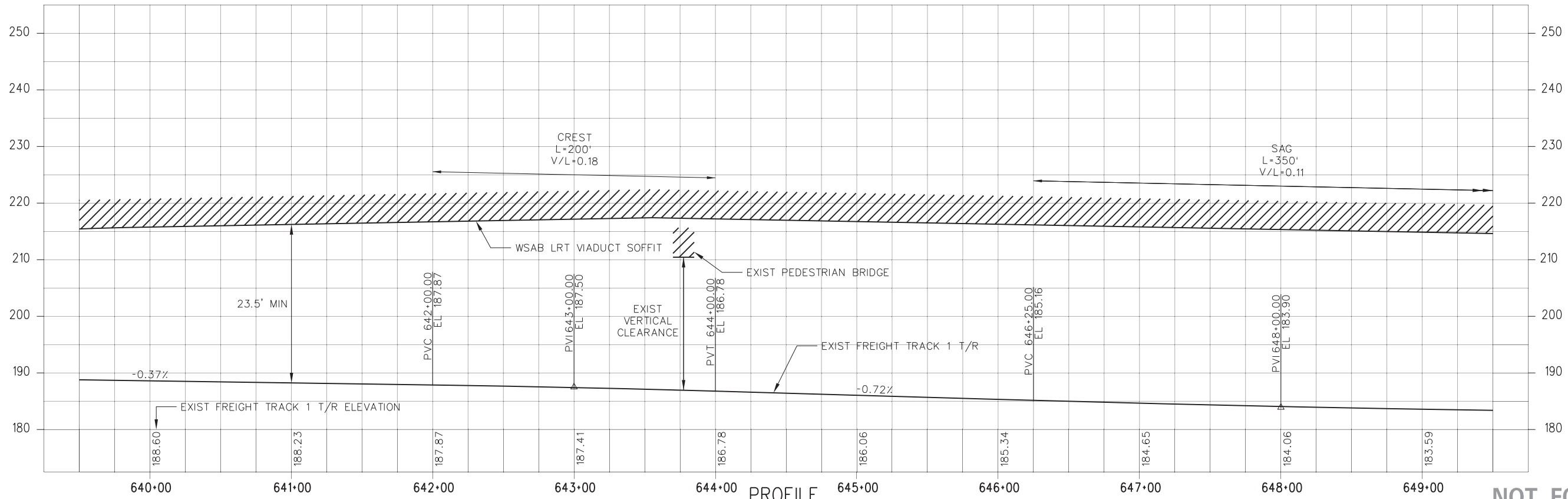

PROFILE

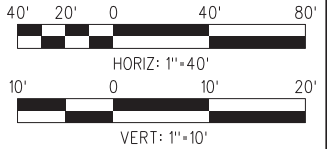



NOT FOR CONSTRUCTION

15-NOV-2019 C-28091ATF125.plg
svc-projectwise 22:36

THE PREPARATION OF THIS DRAWING HAS BEEN FINANCED IN PART THROUGH A GRANT FROM THE U.S. DEPARTMENT OF TRANSPORTATION FEDERAL TRANSIT ADMINISTRATION (FTA), UNDER THE FEDERAL TRANSIT ACT OF 1964, AS AMENDED, AND IN PART BY THE TAXES OF THE CITIZENS OF LOS ANGELES COUNTY AND OF THE STATE OF CALIFORNIA.

DESIGNED BY	J. SANCHEZ
DRAWN BY	C. CHEUK
CHECKED BY	R. LOYA
IN CHARGE	N. MAACK
DATE	11/15/2019
	FINAL CONCEPTUAL DESIGN

LOS ANGELES COUNTY METROPOLITAN TRANSPORTATION AUTHORITY

 444 South Flower Street
 Suite 800
 Los Angeles, CA 90071
 TEL (213) 362-9470

SUBMITTED _____
 APPROVED _____

WEST SANTA ANA BRANCH FREIGHT TRACK
TRACK ALIGNMENT
WILLMINGTON BRANCH
PLAN & PROFILE
STA 639+50 TO STA 649+50

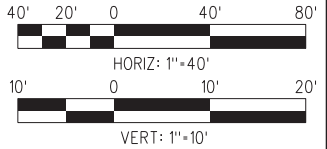
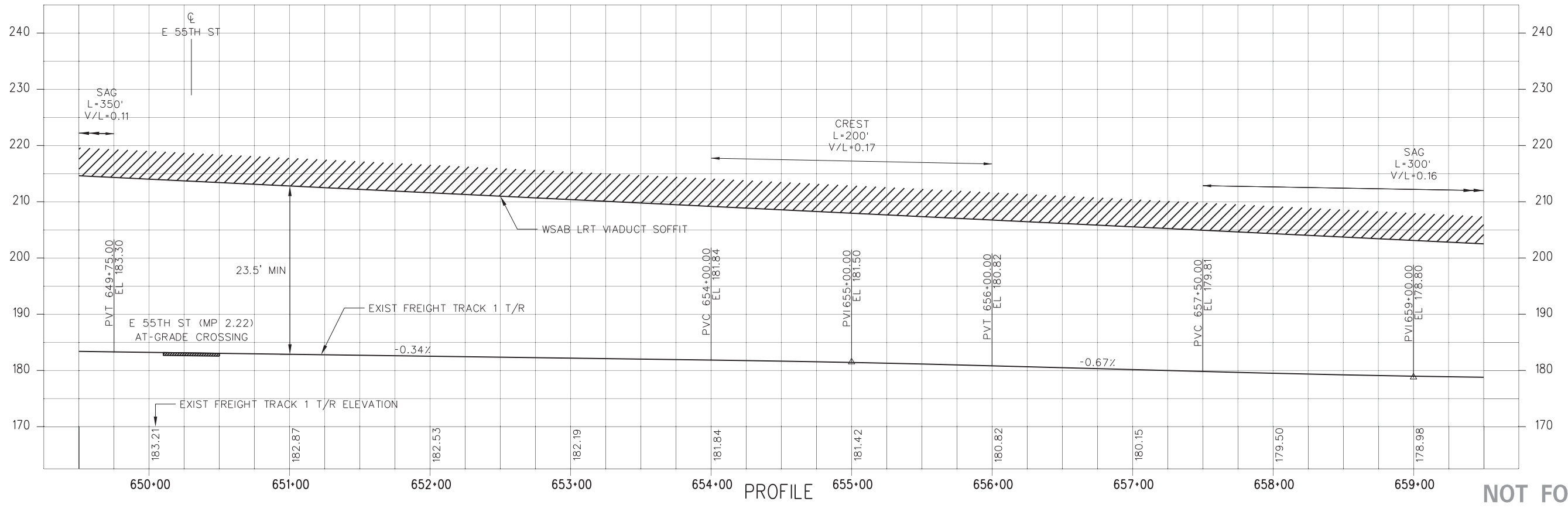
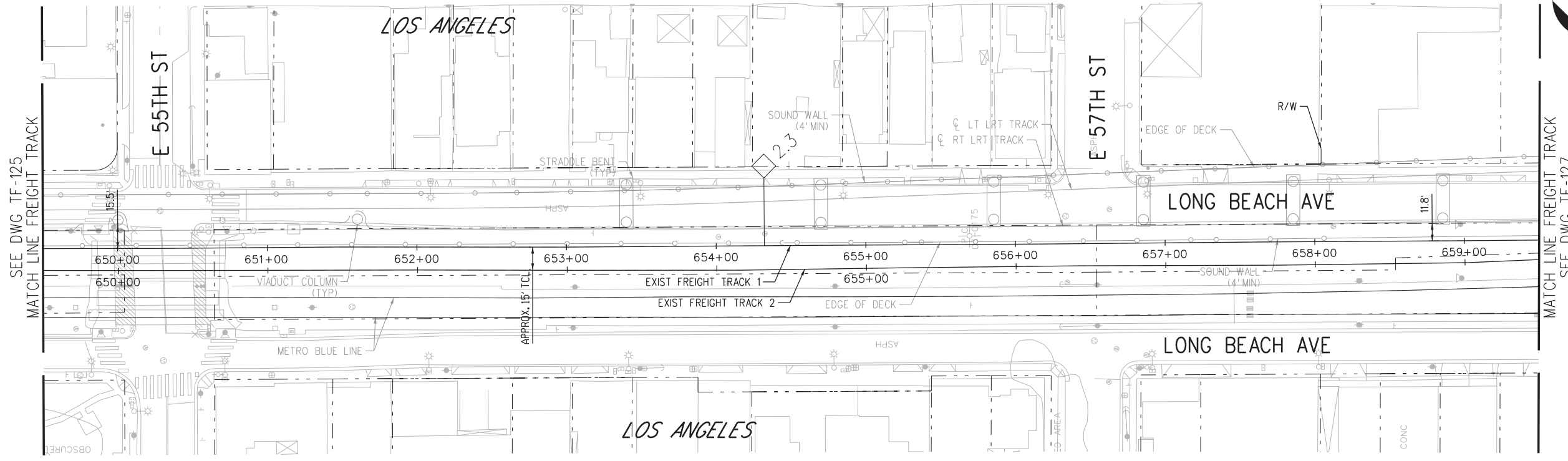
CONTRACT NO.	AE5999300
DRAWING NO.	TF-125
SCALE	HORIZ: 1"=40' VERT: 1"=10'
SHEET NO.	16 OF 107



NOT FOR CONSTRUCTION

THE PREPARATION OF THIS DRAWING HAS BEEN FINANCED IN PART THROUGH A GRANT FROM THE U.S. DEPARTMENT OF TRANSPORTATION FEDERAL TRANSIT ADMINISTRATION (FTA), UNDER THE FEDERAL TRANSIT ACT OF 1964, AS AMENDED, AND IN PART BY THE TAXES OF THE CITIZENS OF LOS ANGELES COUNTY AND OF THE STATE OF CALIFORNIA.

DESIGNED BY	J. SANCHEZ
DRAWN BY	C. CHEUK
CHECKED BY	R. LOYA
IN CHARGE	N. MAACK
DATE	11/15/2019
	FINAL CONCEPTUAL DESIGN

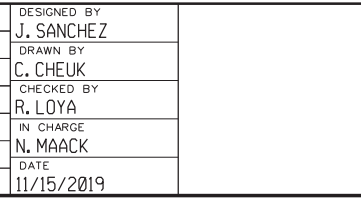

LOS ANGELES COUNTY METROPOLITAN TRANSPORTATION AUTHORITY

WEST SANTA ANA BRANCH FREIGHT TRACK TRACK ALIGNMENT WILLMINGTON BRANCH PLAN & PROFILE STA 649+50 TO STA 659+50

CONTRACT NO. AE5999300

DRAWING NO. TF-126

SCALE: HOR: 1"=40' VERT: 1"=10'

SHEET NO. 17 OF 107

SUBMITTED _____

APPROVED _____



NOTES:

- 1. EXISTING TRACK WILL BE LINE AND SURFACE 200' BEYOND THE END OF NEW CONSTRUCTION.

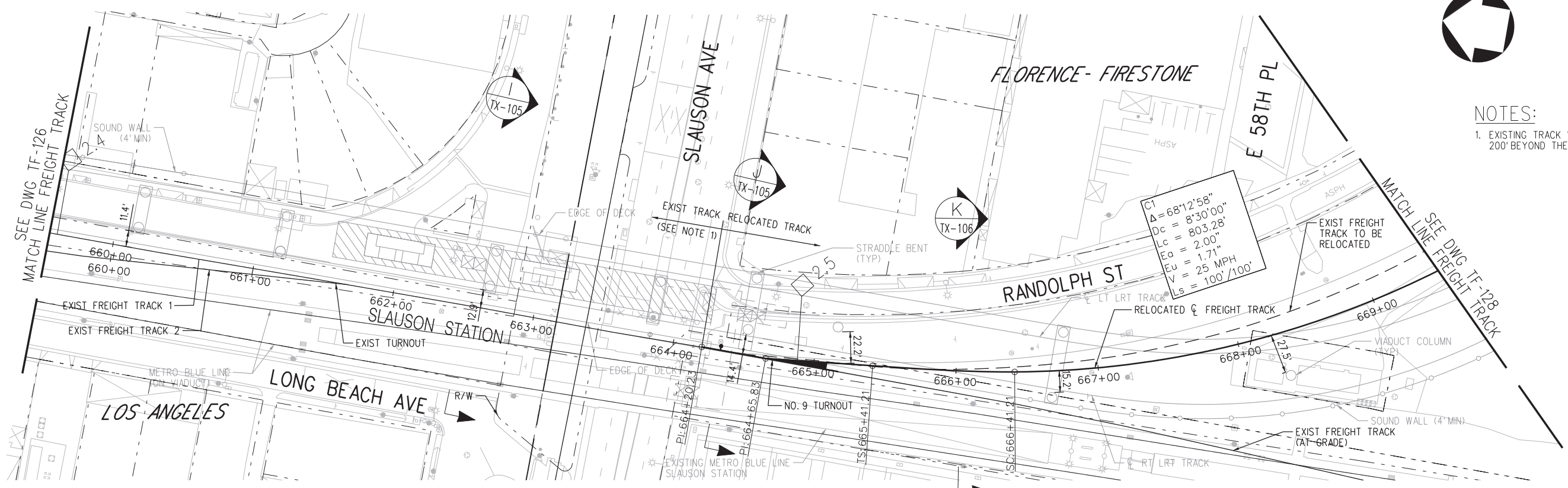

PLAN

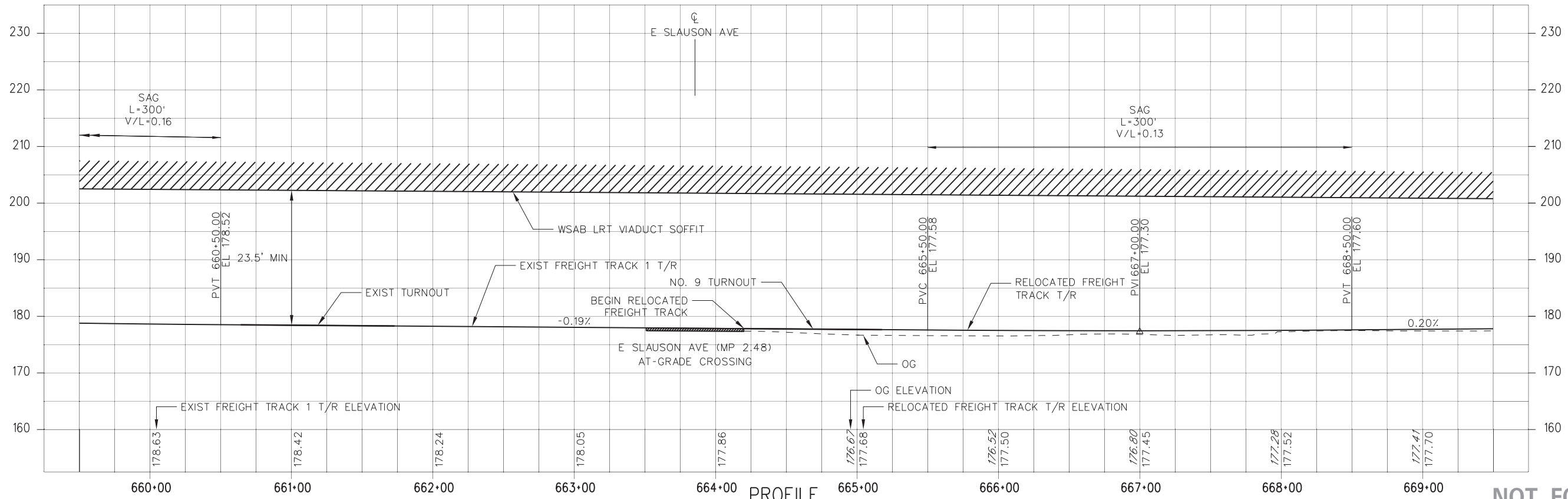

PROFILE

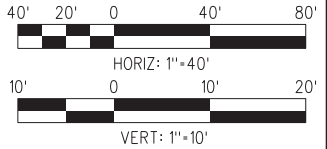



NOT FOR CONSTRUCTION

15-NOV-2019 C-28091ATF127.plg
svc-projectwise 22:36

THE PREPARATION OF THIS DRAWING HAS BEEN FINANCED IN PART THROUGH A GRANT FROM THE U.S. DEPARTMENT OF TRANSPORTATION FEDERAL TRANSIT ADMINISTRATION (FTA), UNDER THE FEDERAL TRANSIT ACT OF 1964, AS AMENDED, AND IN PART BY THE TAXES OF THE CITIZENS OF LOS ANGELES COUNTY AND OF THE STATE OF CALIFORNIA.

DESIGNED BY	J. SANCHEZ
DRAWN BY	C. CHEUK
CHECKED BY	R. LOYA
IN CHARGE	N. MAACK
DATE	11/15/2019
FINAL CONCEPTUAL DESIGN	

LOS ANGELES COUNTY METROPOLITAN TRANSPORTATION AUTHORITY

 444 South Flower Street
 Suite 800
 Los Angeles, CA 90071
 TEL (213) 362-9470

SUBMITTED _____
 APPROVED _____

WEST SANTA ANA BRANCH FREIGHT TRACK
TRACK ALIGNMENT
WILLMINGTON/LA HABRA BRANCH
PLAN & PROFILE
STA 659+50 TO STA 669+50

CONTRACT NO.	AE5999300
DRAWING NO.	TF-127
SCALE	HOR: 1"=40' VERT: 1"=10'
SHEET NO.	18 OF 107



NOTE:
1. REFER TO ADVANCED CONCEPTUAL ENGINEERING GRADE CROSSING PLANS.

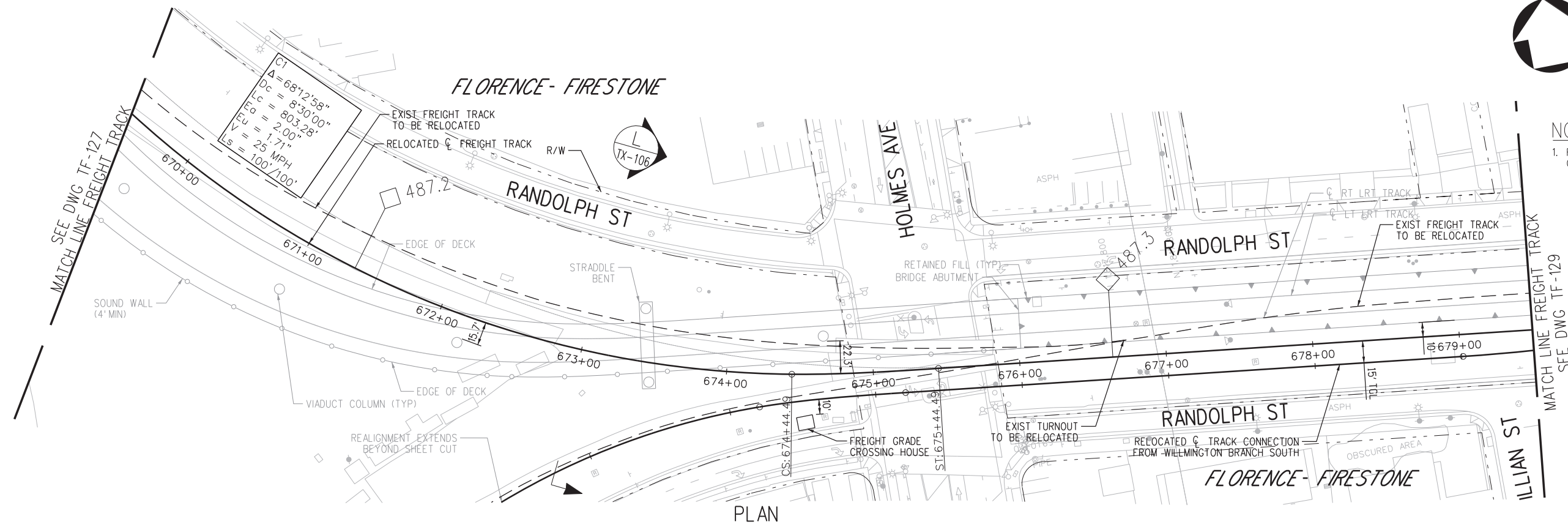

PLAN

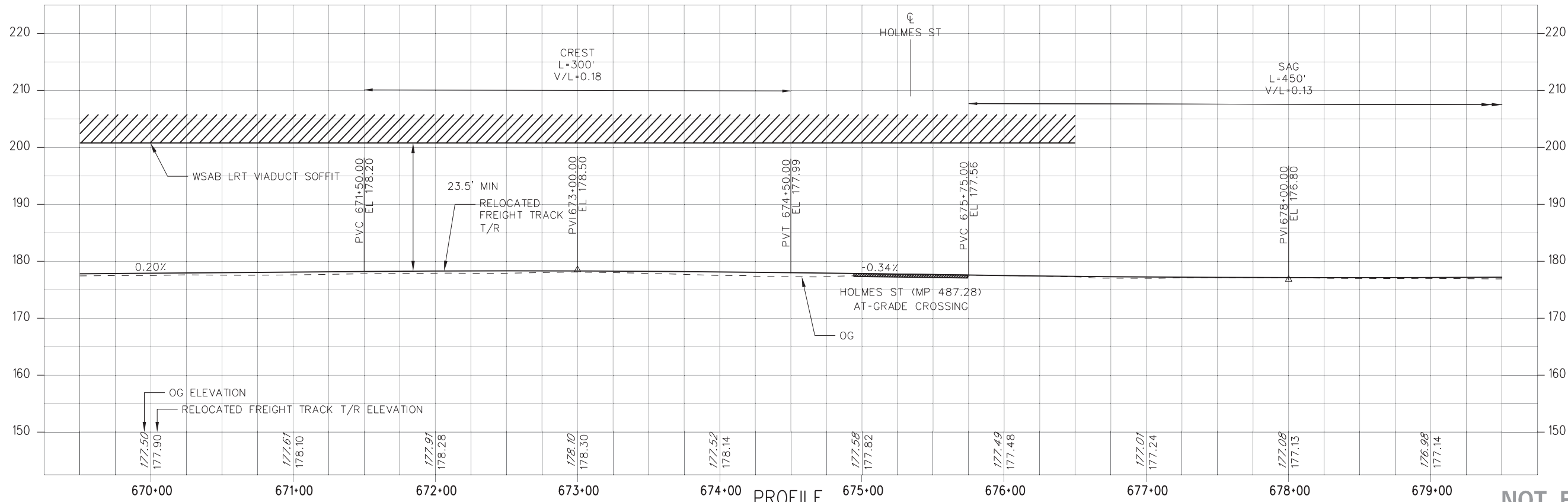

PROFILE

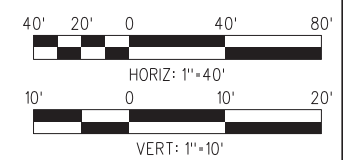

NOT FOR CONSTRUCTION

15-NOV-2019 C-28091ATF128.plg
22:38
svc-projectwise

THE PREPARATION OF THIS DRAWING HAS BEEN FINANCED IN PART THROUGH A GRANT FROM THE U.S. DEPARTMENT OF TRANSPORTATION FEDERAL TRANSIT ADMINISTRATION (FTA), UNDER THE FEDERAL TRANSIT ACT OF 1964, AS AMENDED, AND IN PART BY THE TAXES OF THE CITIZENS OF LOS ANGELES COUNTY AND OF THE STATE OF CALIFORNIA.		DESIGNED BY J. SANCHEZ
0	11/15/19	DRAWN BY C. CHEUK
		CHECKED BY R. LOYA
		IN CHARGE N. MAACK
		DATE 11/15/2019
		FINAL CONCEPTUAL DESIGN

		444 South Flower Street Suite 800 Los Angeles, CA 90071 TEL (213) 362-9470
SUBMITTED _____		APPROVED _____

LOS ANGELES COUNTY METROPOLITAN TRANSPORTATION AUTHORITY	
WEST SANTA ANA BRANCH FREIGHT TRACK	
TRACK ALIGNMENT	
LA HABRA BRANCH	
PLAN & PROFILE	
STA 669+50 TO STA 679+50	

CONTRACT NO AE5999300	
DRAWING NO TF-128	REV
SCALE HOR: 1"=40' VERT: 1"=10'	
SHEET NO 19	OF 107



NOTE:
1. REFER TO ADVANCED CONCEPTUAL ENGINEERING GRADE CROSSING PLANS.

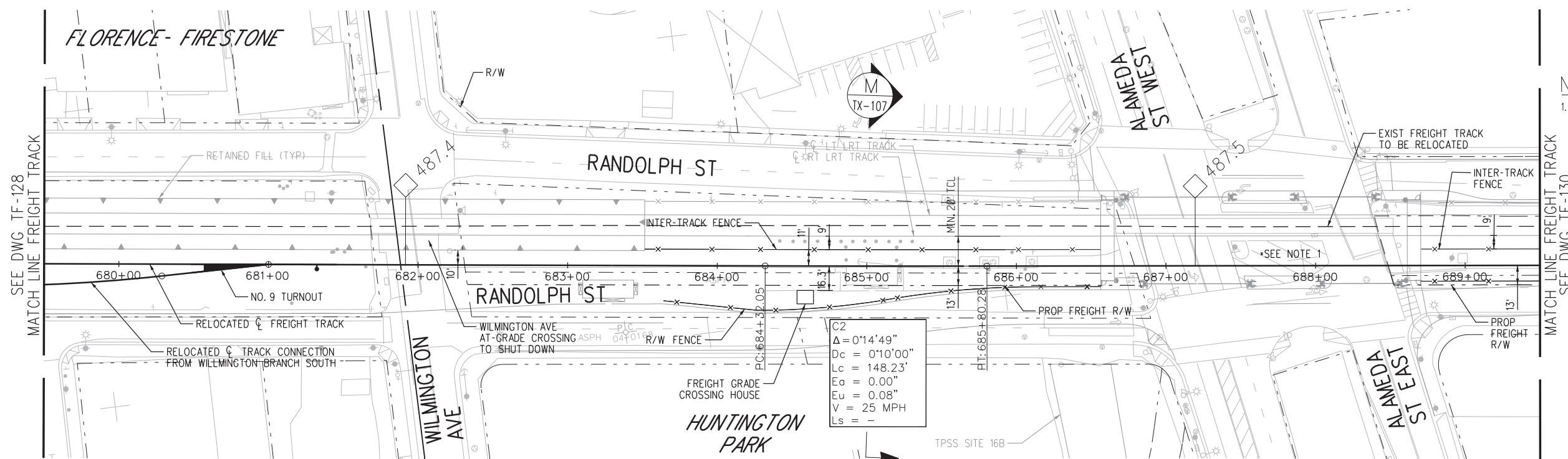

PLAN

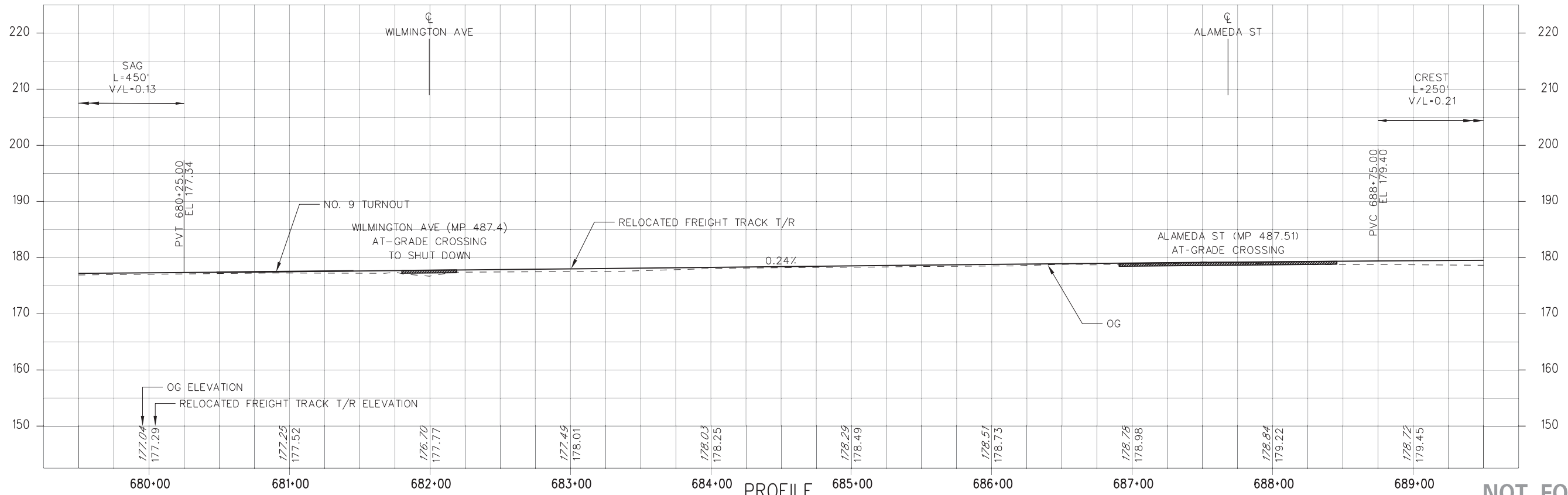

PROFILE

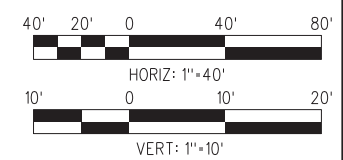

NOT FOR CONSTRUCTION

15-NOV-2019 C-28091ATF129.plg
svc-projectwise 22:36

THE PREPARATION OF THIS DRAWING HAS BEEN FINANCED IN PART THROUGH A GRANT FROM THE U.S. DEPARTMENT OF TRANSPORTATION FEDERAL TRANSIT ADMINISTRATION (FTA), UNDER THE FEDERAL TRANSIT ACT OF 1964, AS AMENDED, AND IN PART BY THE TAXES OF THE CITIZENS OF LOS ANGELES COUNTY AND OF THE STATE OF CALIFORNIA.		DESIGNED BY J. SANCHEZ
		DRAWN BY C. CHEUK
		CHECKED BY R. LOYA
		IN CHARGE N. MAACK
		DATE 11/15/2019
0	11/15/19	FINAL CONCEPTUAL DESIGN

LOS ANGELES COUNTY
Metro
METROPOLITAN TRANSPORTATION AUTHORITY

wsp 444 South Flower Street
Suite 800
Los Angeles, CA 90071
TEL (213) 362-9470

SUBMITTED _____
APPROVED _____

WEST SANTA ANA BRANCH FREIGHT TRACK
TRACK ALIGNMENT
LA HABRA BRANCH
PLAN & PROFILE
STA 679+50 TO STA 689+50

CONTRACT NO. AE5999300	REV
DRAWING NO. TF-129	
SCALE HORIZ: 1"=40' VERT: 1"=10'	
SHEET NO. 20	OF 107

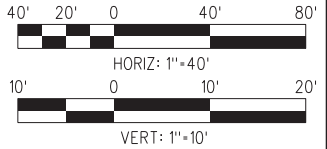
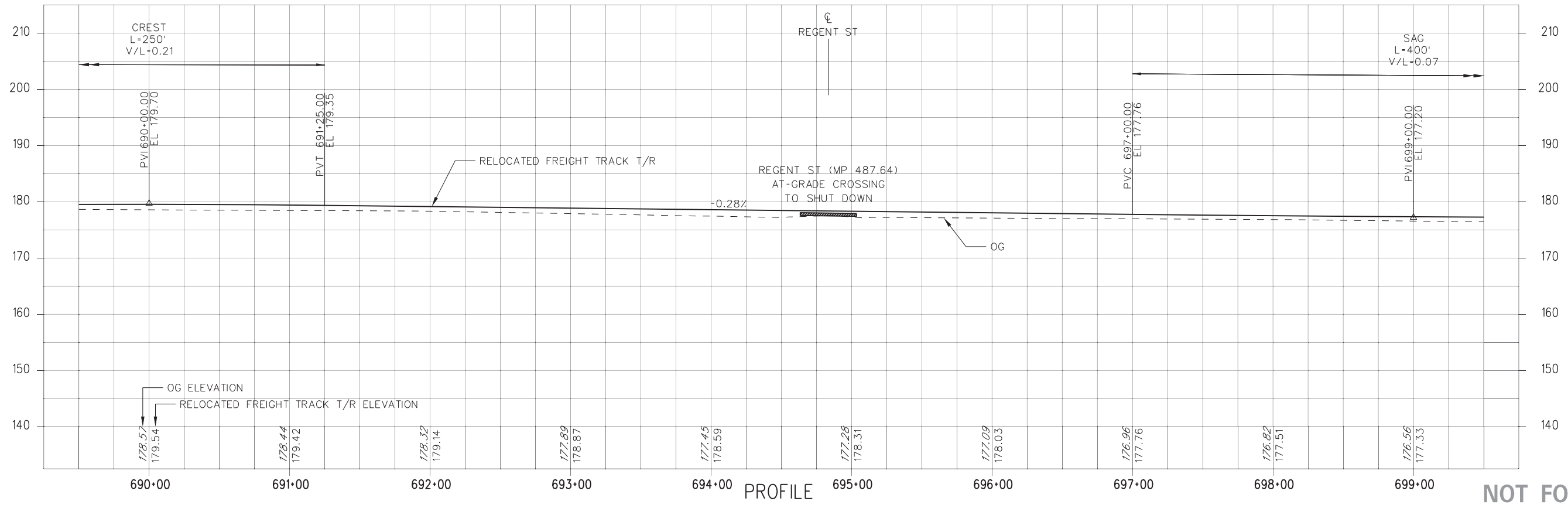
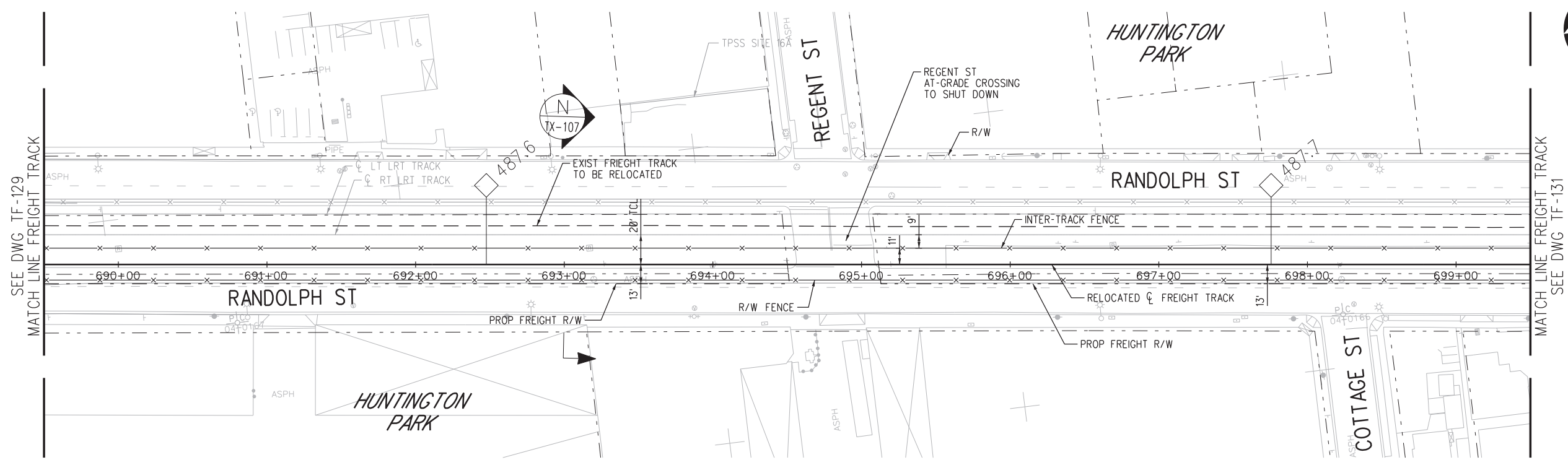

NOT FOR CONSTRUCTION

15-NOV-2019 C-28091ATF130.plg
svc-projectwise 22:37

THE PREPARATION OF THIS DRAWING HAS BEEN FINANCED IN PART THROUGH A GRANT FROM THE U.S. DEPARTMENT OF TRANSPORTATION FEDERAL TRANSIT ADMINISTRATION (FTA), UNDER THE FEDERAL TRANSIT ACT OF 1964, AS AMENDED, AND IN PART BY THE TAXES OF THE CITIZENS OF LOS ANGELES COUNTY AND OF THE STATE OF CALIFORNIA.		DESIGNED BY J. SANCHEZ DRAWN BY C. CHEUK CHECKED BY R. LOYA IN CHARGE N. MAACK DATE 11/15/2019
0	11/15/19	FINAL CONCEPTUAL DESIGN

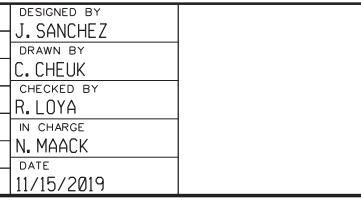

LOS ANGELES COUNTY METROPOLITAN TRANSPORTATION AUTHORITY

444 South Flower Street
Suite 800
Los Angeles, CA 90071
TEL (213) 362-9470

SUBMITTED _____
APPROVED _____

WEST SANTA ANA BRANCH FREIGHT TRACK TRACK ALIGNMENT LA HABRA BRANCH PLAN & PROFILE STA 689+50 TO STA 699+50

CONTRACT NO	AE5999300
DRAWING NO	TF-130
SCALE	HOR: 1"=40' VERT: 1"=10'
SHEET NO	21 OF 107

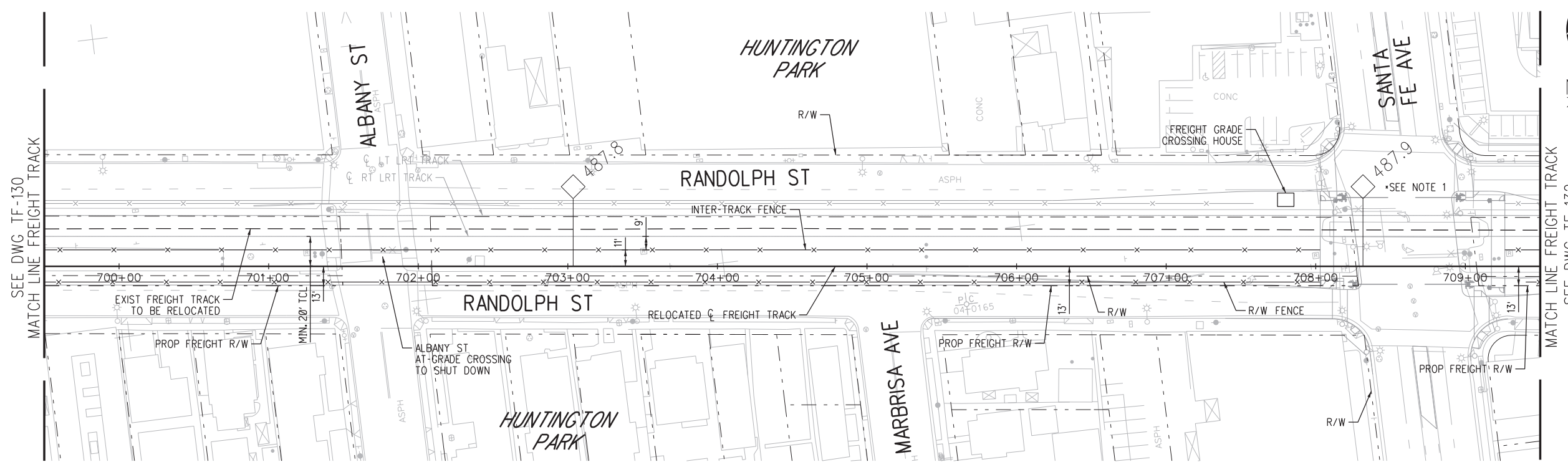

NOTE:
 1. REFER TO ADVANCED CONCEPTUAL ENGINEERING GRADE CROSSING PLANS.

PLAN

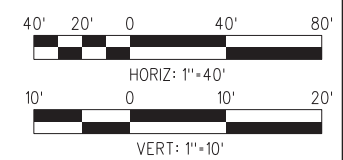
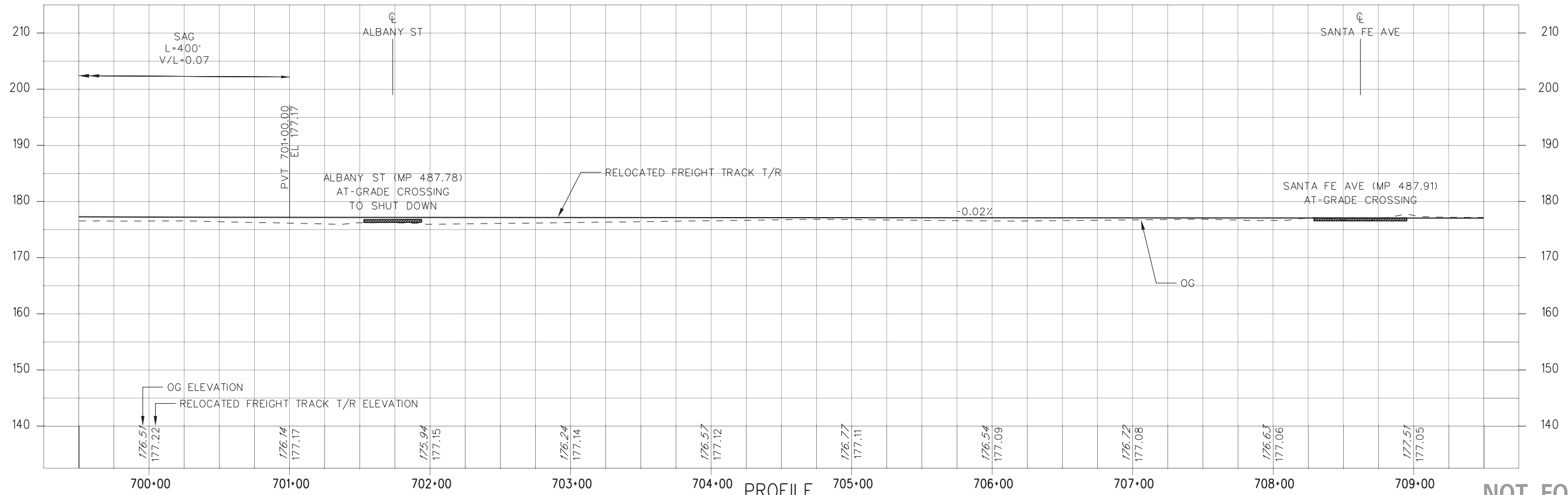

NOT FOR CONSTRUCTION

15-NOV-2019 C-28091ATF131.plg
 svc-projectwise 22:36

THE PREPARATION OF THIS DRAWING HAS BEEN FINANCED IN PART THROUGH A GRANT FROM THE U.S. DEPARTMENT OF TRANSPORTATION FEDERAL TRANSIT ADMINISTRATION (FTA), UNDER THE FEDERAL TRANSIT ACT OF 1964, AS AMENDED, AND IN PART BY THE TAXES OF THE CITIZENS OF LOS ANGELES COUNTY AND OF THE STATE OF CALIFORNIA.

DESIGNED BY	J. SANCHEZ
DRAWN BY	C. CHEUK
CHECKED BY	R. LOYA
IN CHARGE	N. MAACK
DATE	11/15/2019
PROJECT	FINAL CONCEPTUAL DESIGN
DATE	11/15/19

M Metro
 444 South Flower Street
 Suite 800
 Los Angeles, CA 90071
 TEL (213) 362-9470

wsp

CONTRACT NO. AE5999300
 DRAWING NO. TF-131
 SCALE: HOR: 1"=40' VERT: 1"=10'
 SHEET NO. 22 OF 107

**WEST SANTA ANA BRANCH FREIGHT TRACK
 TRACK ALIGNMENT
 LA HABRA BRANCH
 PLAN & PROFILE
 STA 699+50 TO STA 709+50**

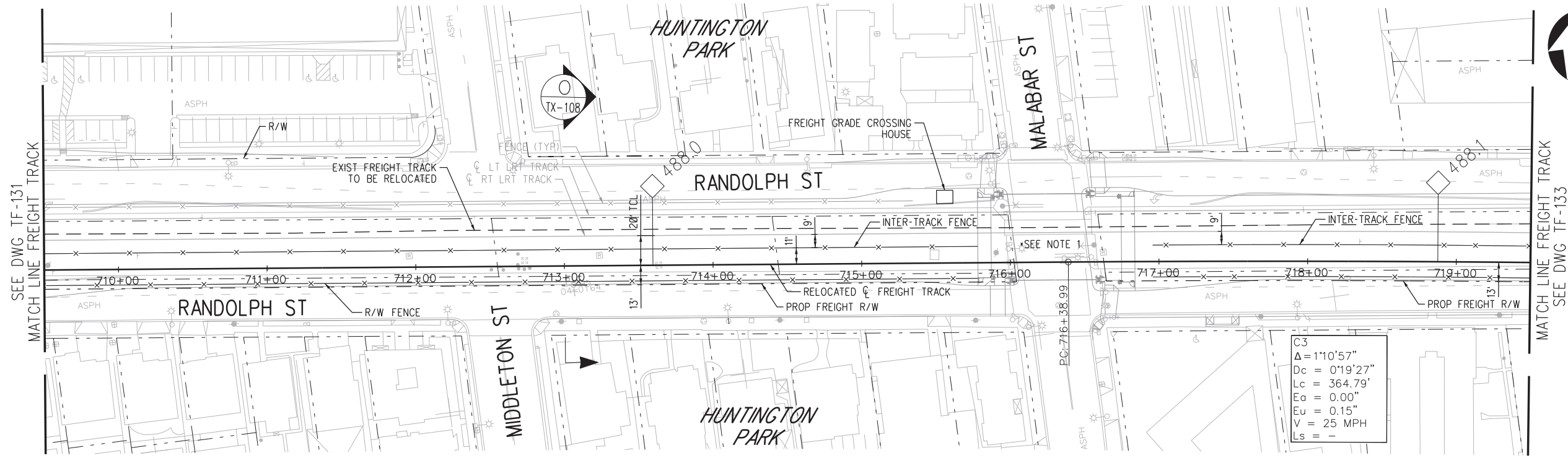

NOTE:
1. REFER TO ADVANCED CONCEPTUAL ENGINEERING GRADE CROSSING PLANS.

PLAN

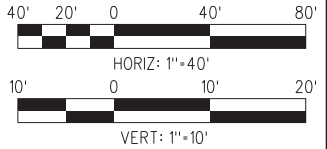
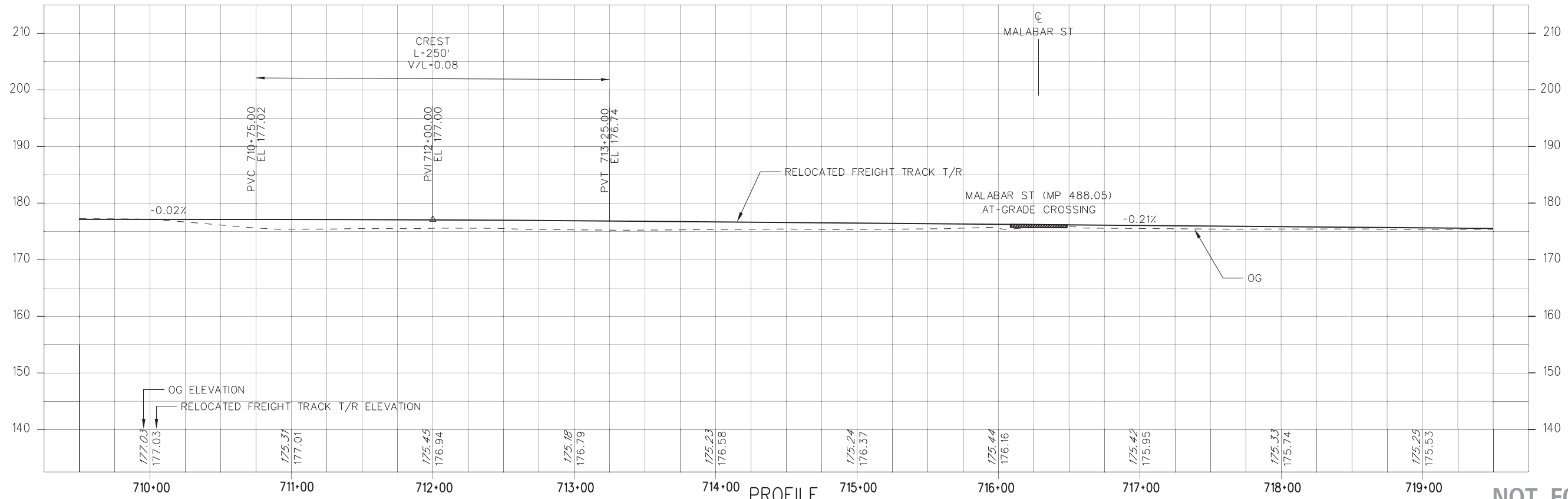

NOT FOR CONSTRUCTION

15-NOV-2019 C-28091ATF132.plg
svc-projectwise 22:38

THE PREPARATION OF THIS DRAWING HAS BEEN FINANCED IN PART THROUGH A GRANT FROM THE U.S. DEPARTMENT OF TRANSPORTATION FEDERAL TRANSIT ADMINISTRATION (FTA), UNDER THE FEDERAL TRANSIT ACT OF 1964, AS AMENDED, AND IN PART BY THE TAXES OF THE CITIZENS OF LOS ANGELES COUNTY AND OF THE STATE OF CALIFORNIA.

DESIGNED BY	J. SANCHEZ
DRAWN BY	C. CHEUK
CHECKED BY	R. LOYA
IN CHARGE	N. MAACK
DATE	11/15/2019
	FINAL CONCEPTUAL DESIGN

DESIGNED BY
J. SANCHEZ
DRAWN BY
C. CHEUK
CHECKED BY
R. LOYA
IN CHARGE
N. MAACK
DATE
11/15/2019

M Metro
LOS ANGELES COUNTY METROPOLITAN TRANSPORTATION AUTHORITY

wsp 444 South Flower Street Suite 800 Los Angeles, CA 90071 TEL (213) 362-9470

SUBMITTED _____
APPROVED _____

WEST SANTA ANA BRANCH FREIGHT TRACK
TRACK ALIGNMENT
LA HABRA BRANCH
PLAN & PROFILE
STA 709+50 TO STA 719+50

CONTRACT NO	AE5999300
DRAWING NO	TF-132
SCALE	HOR: 1"=40' VERT: 1"=10'
SHEET NO	23 OF 107

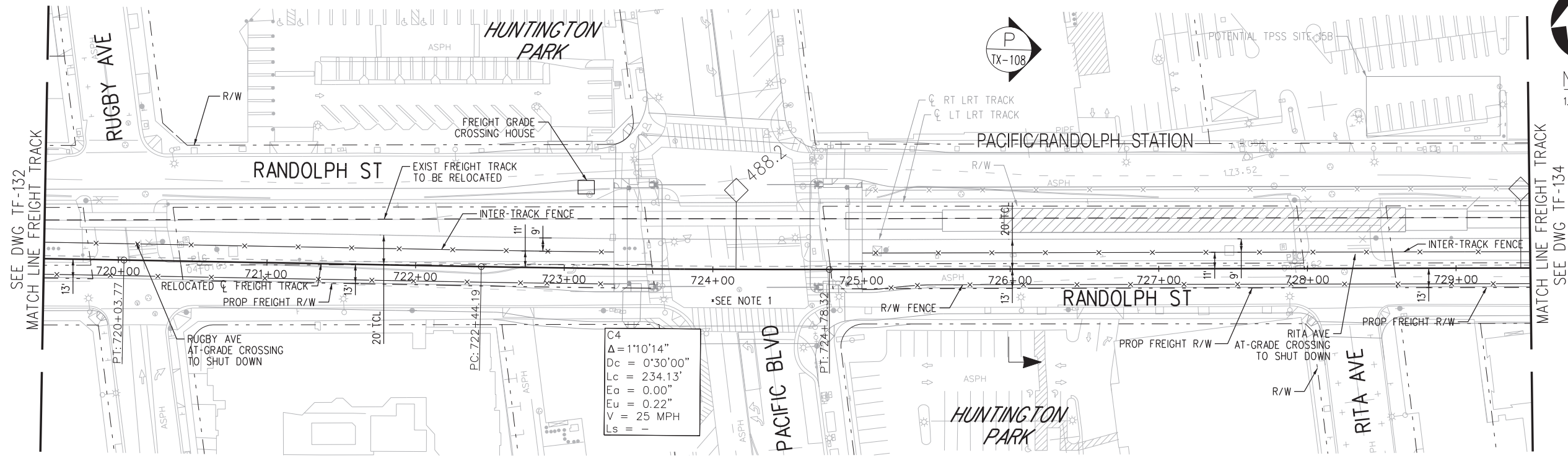

C4
 $\Delta = 1'10'14"$
 $D_c = 0'30'00"$
 $L_c = 234.13'$
 $E_a = 0.00'$
 $E_u = 0.22'$
 $V = 25 \text{ MPH}$
 $L_s = -$

NOTE:
 1. REFER TO ADVANCED CONCEPTUAL ENGINEERING GRADE CROSSING PLANS.

PLAN

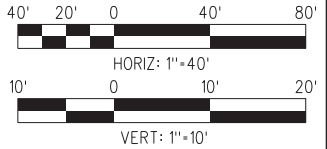
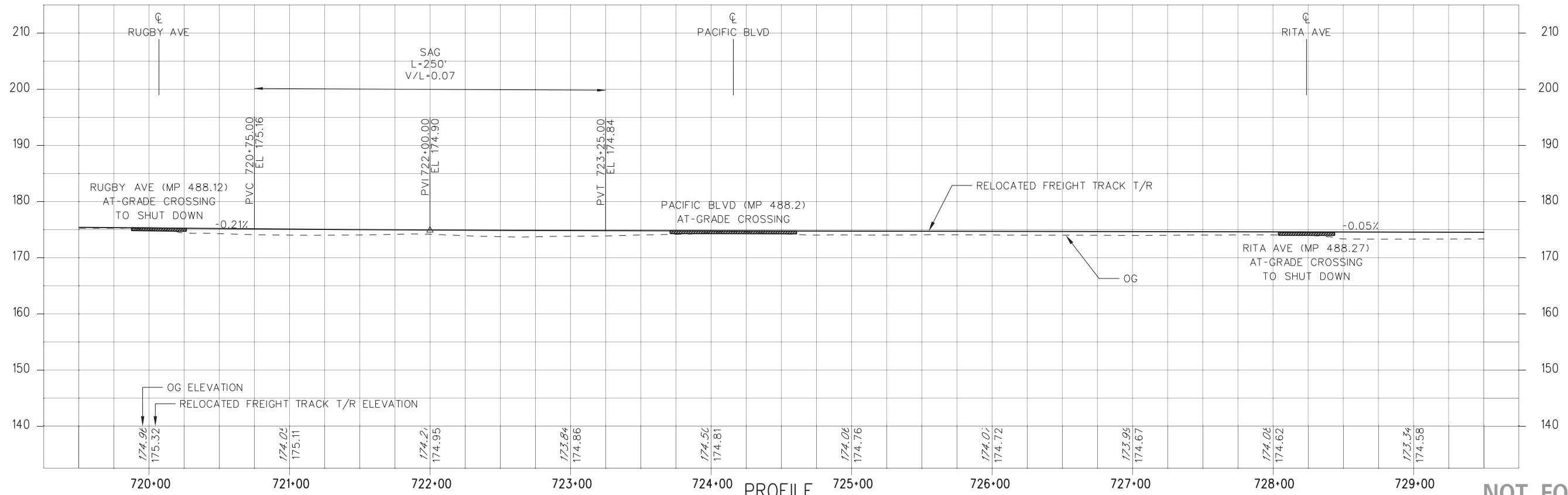

NOT FOR CONSTRUCTION

15-NOV-2019 C-28091ATF133.plg
 svc-projectwise 22:36

THE PREPARATION OF THIS DRAWING HAS BEEN FINANCED IN PART THROUGH A GRANT FROM THE U.S. DEPARTMENT OF TRANSPORTATION FEDERAL TRANSIT ADMINISTRATION (FTA), UNDER THE FEDERAL TRANSIT ACT OF 1964, AS AMENDED, AND IN PART BY THE TAKES OF THE CITIZENS OF LOS ANGELES COUNTY AND OF THE STATE OF CALIFORNIA.	
0	11/15/19
	FINAL CONCEPTUAL DESIGN

DESIGNED BY J. SANCHEZ
DRAWN BY C. CHEUK
CHECKED BY R. LOYA
IN CHARGE N. MAACK
DATE 11/15/2019

M Metro
LOS ANGELES COUNTY METROPOLITAN TRANSPORTATION AUTHORITY

wsp 444 South Flower Street Suite 800 Los Angeles, CA 90071 TEL (213) 362-9470

SUBMITTED _____
 APPROVED _____

WEST SANTA ANA BRANCH FREIGHT TRACK
TRACK ALIGNMENT
LA HABRA BRANCH
PLAN & PROFILE
STA 719+50 TO STA 729+50

CONTRACT NO. **AE5999300**
 DRAWING NO. **TF-133** REV _____
 SCALE **HOR: 1"=40'**
VERT: 1"=10'
 SHEET NO. **24** OF **107**

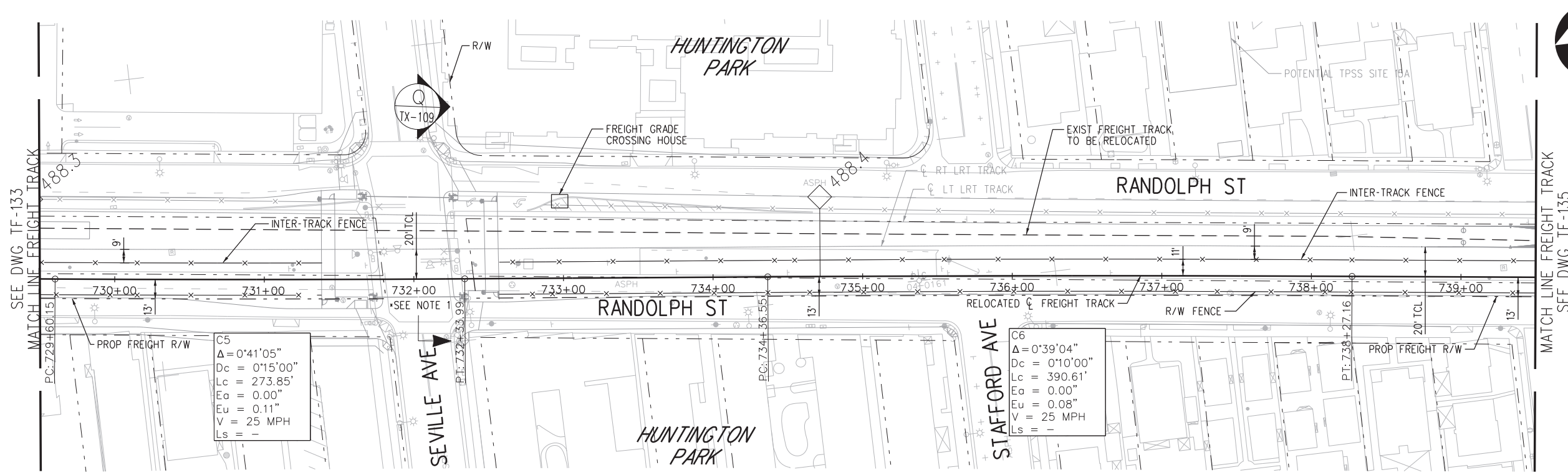

NOTE:
1. REFER TO ADVANCED CONCEPTUAL ENGINEERING GRADE CROSSING PLANS.

C5
 $\Delta = 0'41'05''$
 $D_c = 0'15'00''$
 $L_c = 273.85'$
 $E_c = 0.00''$
 $E_v = 0.11''$
 $\angle = 25$ MPH
 $L_s = -$

C6
 $\Delta = 0'39'04''$
 $D_c = 0'10'00''$
 $L_c = 390.61'$
 $E_c = 0.00''$
 $E_v = 0.08''$
 $\angle = 25$ MPH
 $L_s = -$

PLAN

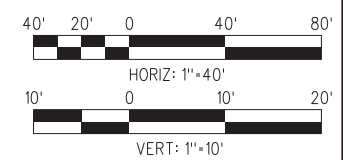
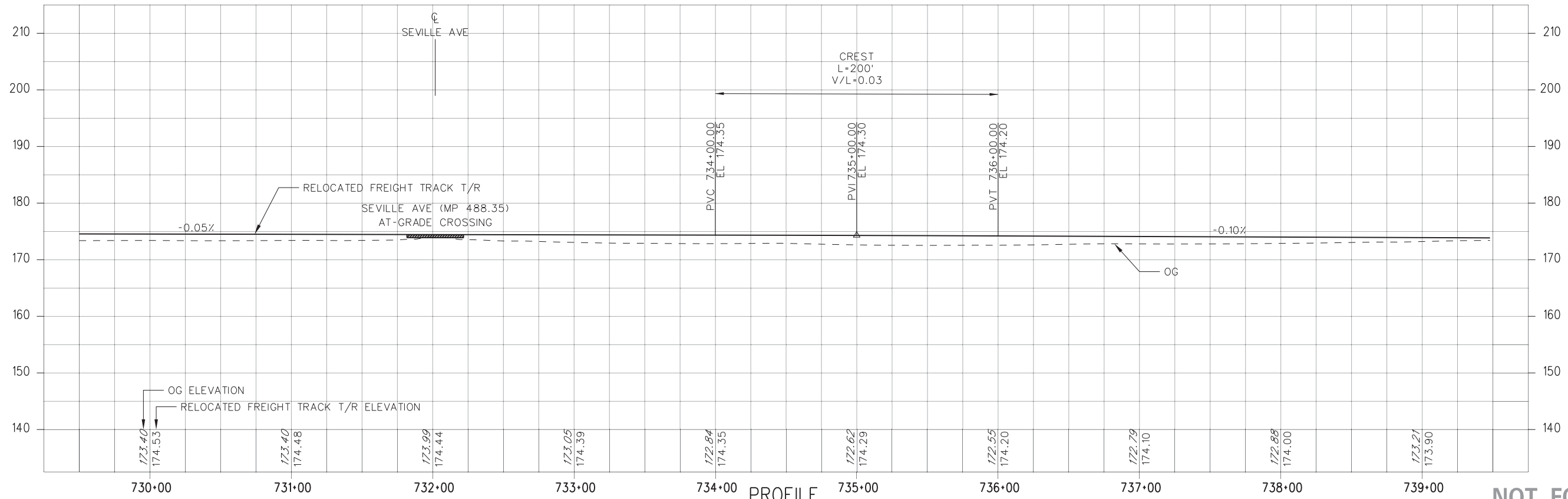

NOT FOR CONSTRUCTION

15-NOV-2019 C-28091ATF134.plg
 svc-projectwise 22:39

THE PREPARATION OF THIS DRAWING HAS BEEN FINANCED IN PART THROUGH A GRANT FROM THE U.S. DEPARTMENT OF TRANSPORTATION FEDERAL TRANSIT ADMINISTRATION (FTA), UNDER THE FEDERAL TRANSIT ACT OF 1964, AS AMENDED, AND IN PART BY THE TAKES OF THE CITIZENS OF LOS ANGELES COUNTY AND OF THE STATE OF CALIFORNIA.	
0	11/15/19
	FINAL CONCEPTUAL DESIGN

DESIGNED BY J. SANCHEZ
DRAWN BY C. CHEUK
CHECKED BY R. LOYA
IN CHARGE N. MAACK
DATE 11/15/2019

M Metro
Los Angeles County Metropolitan Transportation Authority

wsp 444 South Flower Street Suite 800 Los Angeles, CA 90071 TEL (213) 362-9470

SUBMITTED _____
 APPROVED _____

WEST SANTA ANA BRANCH FREIGHT TRACK
TRACK ALIGNMENT
LA HABRA BRANCH
PLAN & PROFILE
STA 729+50 TO STA 739+50

CONTRACT NO. **AE5999300**
 DRAWING NO. **TF-134** REV _____
 SCALE **HOR: 1"=40'**
VERT: 1"=10'
 SHEET NO. **25** OF **107**

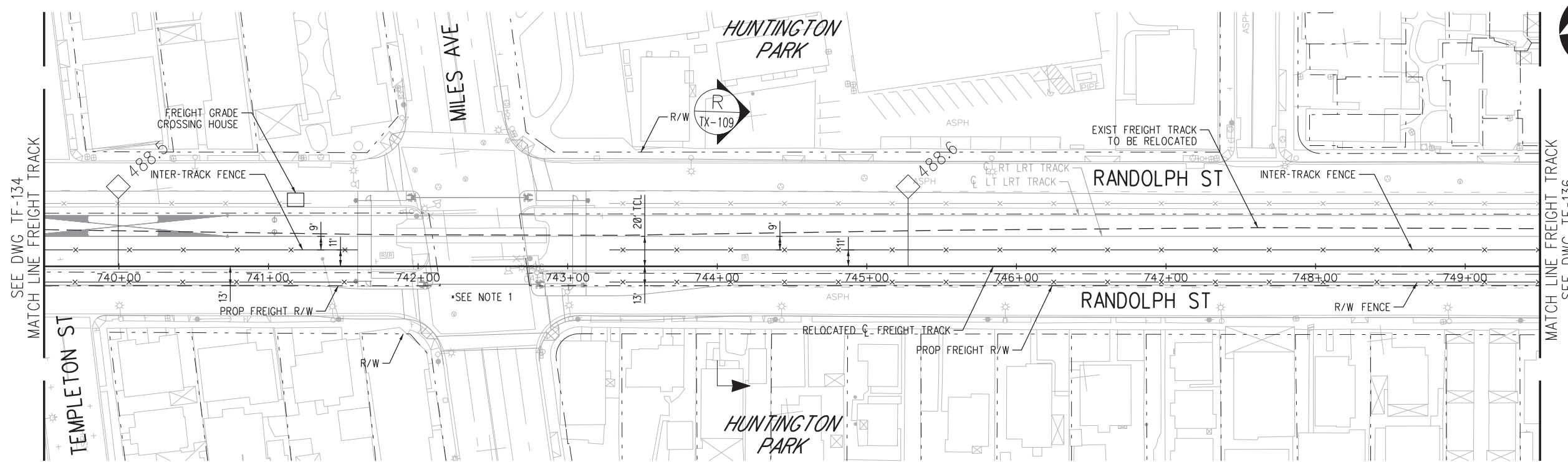

NOTE:
 1. REFER TO ADVANCED CONCEPTUAL ENGINEERING GRADE CROSSING PLANS.

PLAN

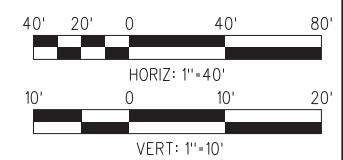
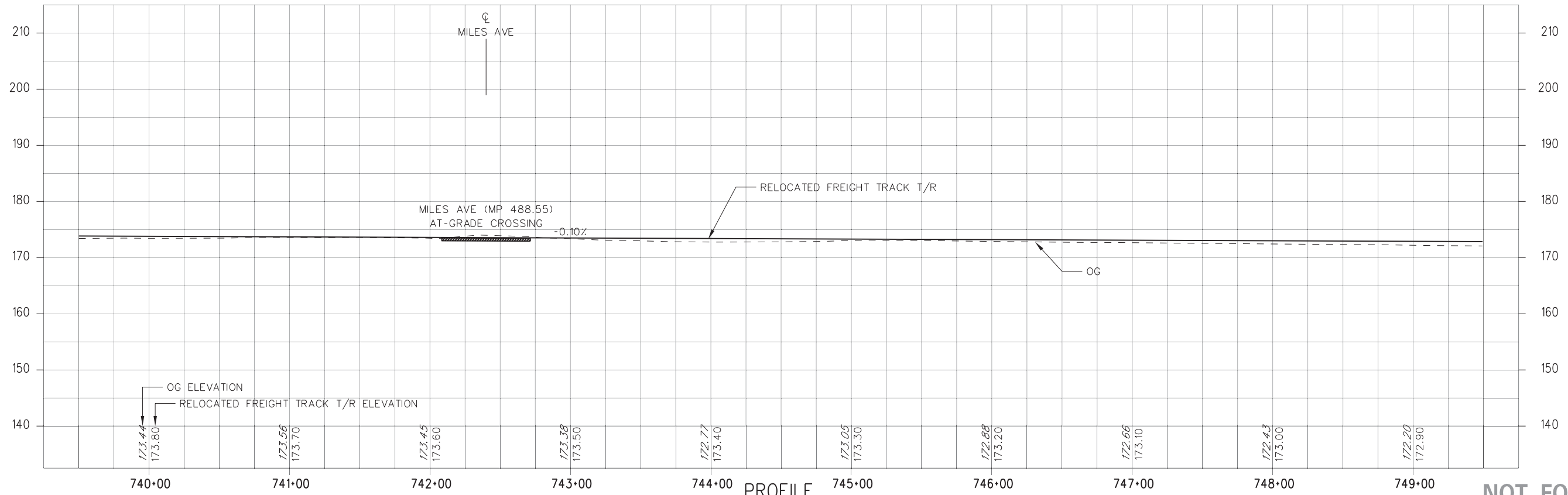

PROFILE

NOT FOR CONSTRUCTION

15-NOV-2019 C-28091ATF135.plg
 svc-projectwise 22:36

THE PREPARATION OF THIS DRAWING HAS BEEN FINANCED IN PART THROUGH A GRANT FROM THE U.S. DEPARTMENT OF TRANSPORTATION FEDERAL TRANSIT ADMINISTRATION (FTA), UNDER THE FEDERAL TRANSIT ACT OF 1964, AS AMENDED, AND IN PART BY THE TAXES OF THE CITIZENS OF LOS ANGELES COUNTY AND OF THE STATE OF CALIFORNIA.		DESIGNED BY J. SANCHEZ
0	11/15/19	DRAWN BY C. CHEUK
		CHECKED BY R. LOYA
		IN CHARGE N. MAACK
		DATE 11/15/2019
		FINAL CONCEPTUAL DESIGN

Metro
 LOS ANGELES COUNTY METROPOLITAN TRANSPORTATION AUTHORITY

wsp
 444 South Flower Street
 Suite 800
 Los Angeles, CA 90071
 TEL (213) 362-9470

SUBMITTED _____
 APPROVED _____

WEST SANTA ANA BRANCH FREIGHT TRACK
TRACK ALIGNMENT
LA HABRA BRANCH
PLAN & PROFILE
STA 739+50 TO STA 749+50

CONTRACT NO AE5999300	
DRAWING NO TF-135	REV
SCALE HOR: 1"=40' VERT: 1"=10'	
SHEET NO 26	OF 107

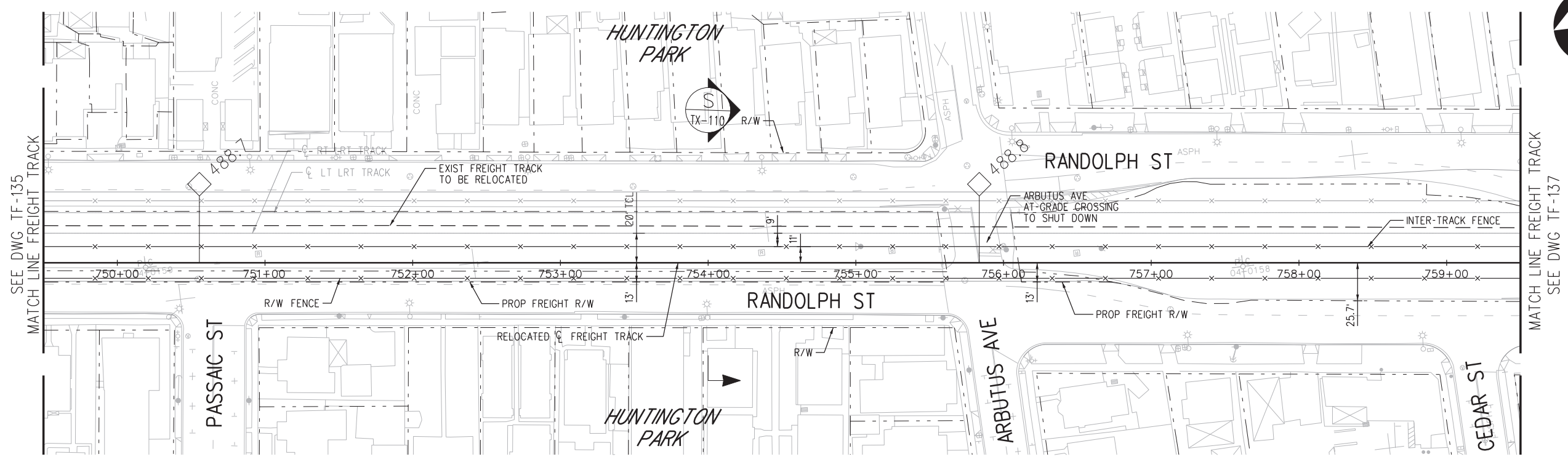

PLAN

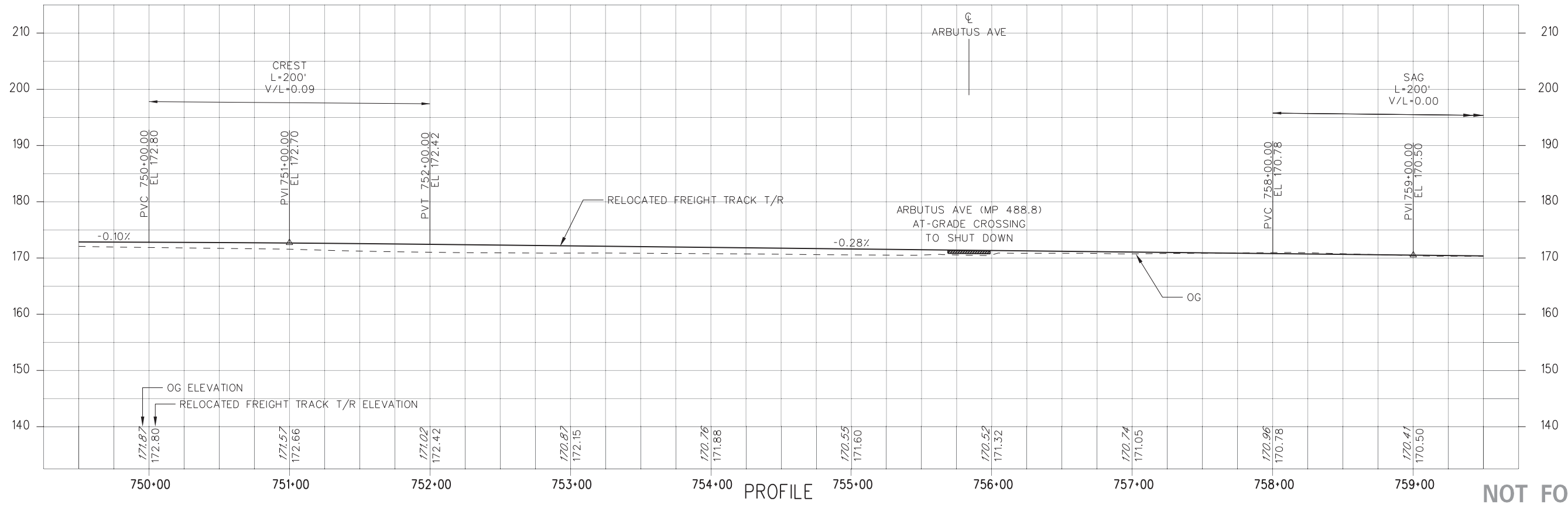

PROFILE

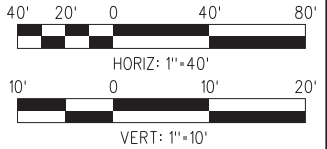

NOT FOR CONSTRUCTION

15-NOV-2019 C-28091ATF136.plg
22:38
svc-projectwise

THE PREPARATION OF THIS DRAWING HAS BEEN FINANCED IN PART THROUGH A GRANT FROM THE U.S. DEPARTMENT OF TRANSPORTATION FEDERAL TRANSIT ADMINISTRATION (FTA), UNDER THE FEDERAL TRANSIT ACT OF 1964, AS AMENDED, AND IN PART BY THE TAXES OF THE CITIZENS OF LOS ANGELES COUNTY AND OF THE STATE OF CALIFORNIA.		DESIGNED BY J. SANCHEZ DRAWN BY C. CHEUK CHECKED BY R. LOYA IN CHARGE N. MAACK DATE 11/15/2019
0	11/15/19	FINAL CONCEPTUAL DESIGN

LOS ANGELES COUNTY METROPOLITAN TRANSPORTATION AUTHORITY

 444 South Flower Street
 Suite 800
 Los Angeles, CA 90071
 TEL (213) 362-9470

SUBMITTED _____ APPROVED _____

WEST SANTA ANA BRANCH FREIGHT TRACK
TRACK ALIGNMENT
LA HABRA BRANCH
PLAN & PROFILE
STA 749+50 TO STA 759+50

CONTRACT NO AE5999300
DRAWING NO TF-136
SCALE HORZ: 1"=40' VERT: 1"=10'
SHEET NO 27 OF 107



NOTE:
1. REFER TO ADVANCED CONCEPTUAL ENGINEERING GRADE CROSSING PLANS.

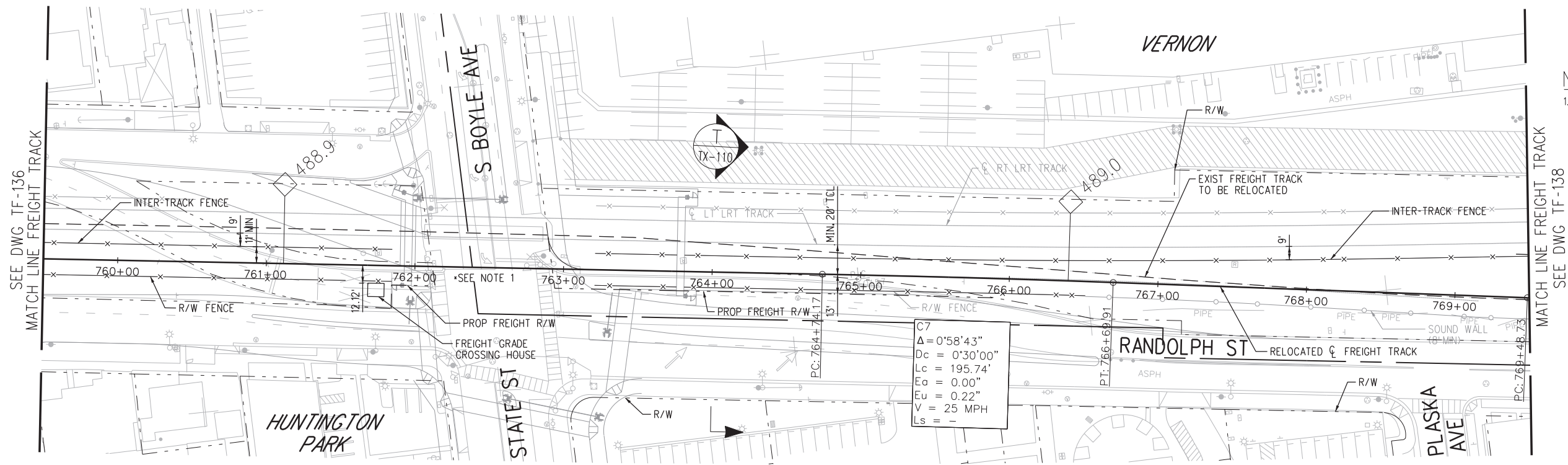

PLAN

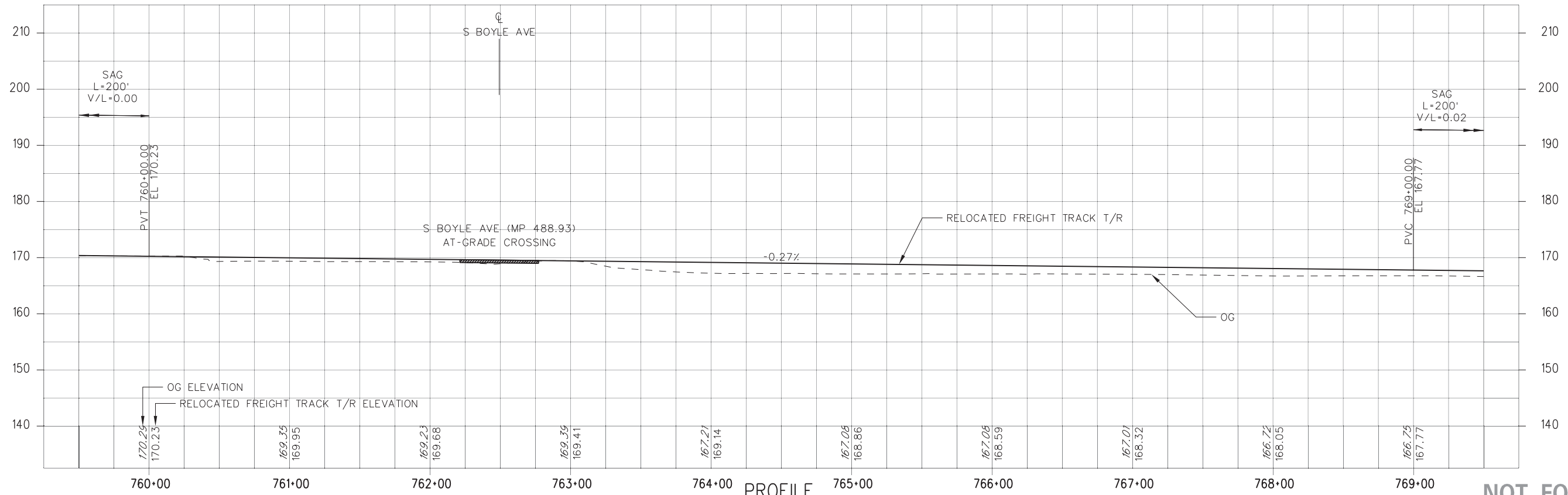

PROFILE

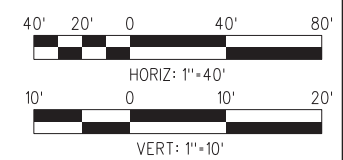

NOT FOR CONSTRUCTION

15-NOV-2019 C-28091ATF137.plg
svc-projectwise 22:36

THE PREPARATION OF THIS DRAWING HAS BEEN FINANCED IN PART THROUGH A GRANT FROM THE U.S. DEPARTMENT OF TRANSPORTATION FEDERAL TRANSIT ADMINISTRATION (FTA), UNDER THE FEDERAL TRANSIT ACT OF 1964, AS AMENDED, AND IN PART BY THE TAXES OF THE CITIZENS OF LOS ANGELES COUNTY AND OF THE STATE OF CALIFORNIA.	
0	11/15/19
	FINAL CONCEPTUAL DESIGN

DESIGNED BY J. SANCHEZ
DRAWN BY C. CHEUK
CHECKED BY R. LOYA
IN CHARGE N. MAACK
DATE 11/15/2019

M Metro
LOS ANGELES COUNTY METROPOLITAN TRANSPORTATION AUTHORITY

wsp 444 South Flower Street Suite 800 Los Angeles, CA 90071 TEL (213) 362-9470

SUBMITTED _____
APPROVED _____

WEST SANTA ANA BRANCH FREIGHT TRACK
TRACK ALIGNMENT
LA HABRA BRANCH
PLAN & PROFILE
STA 759+50 TO STA 769+50

CONTRACT NO. AE5999300
DRAWING NO. TF-137
SCALE HOR: 1"=40' VERT: 1"=10'
SHEET NO. 28 OF 107



NOTE:
 1. EXISTING TRACK WILL BE LINE AND SURFACE 200' BEYOND THE END OF NEW CONSTRUCTION.

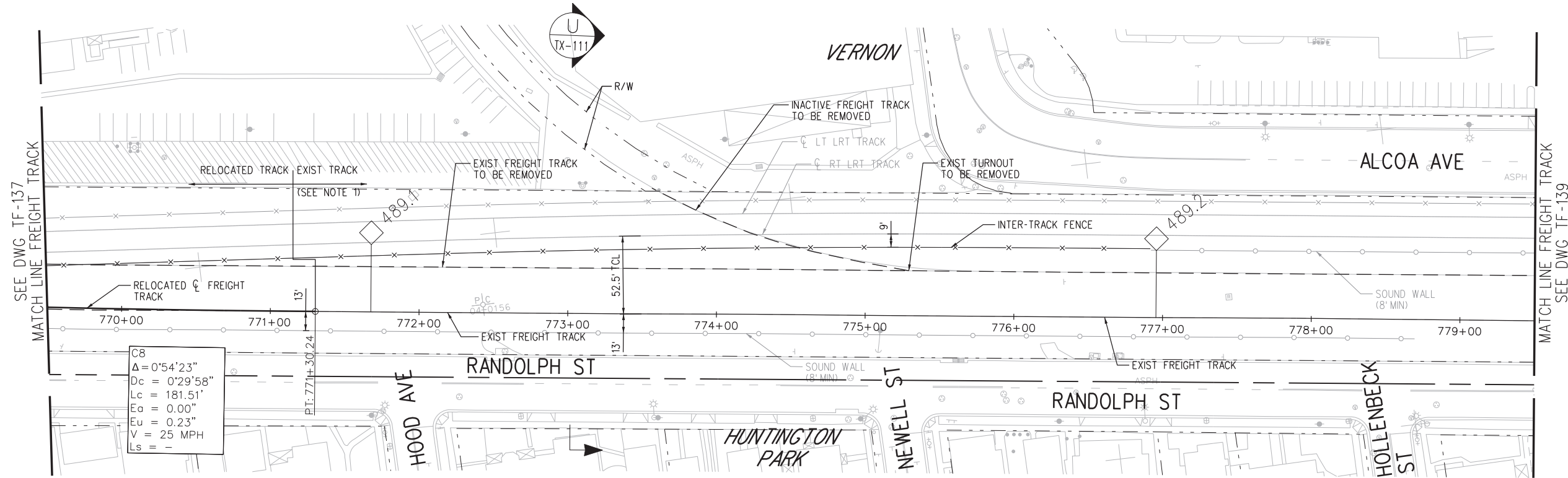

PLAN

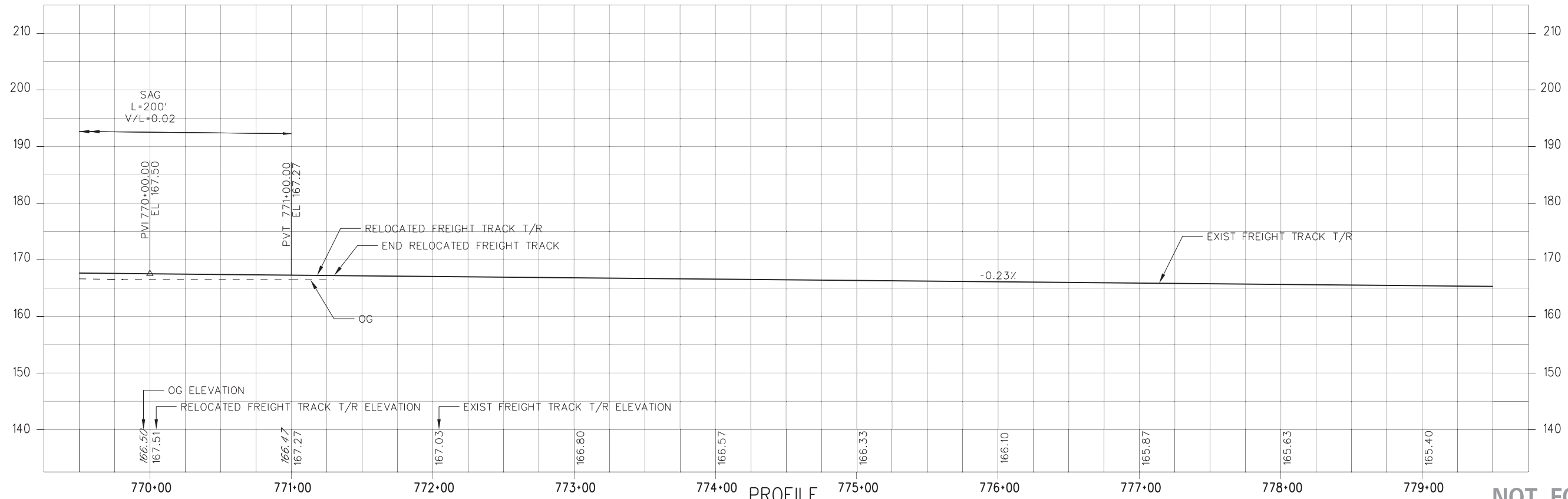

PROFILE

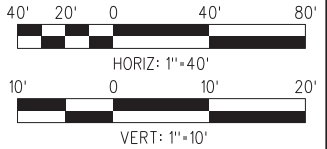

NOT FOR CONSTRUCTION

15-NOV-2019 C-28091ATF138.plg
 svc-projectwise 22:37

THE PREPARATION OF THIS DRAWING HAS BEEN FINANCED IN PART THROUGH A GRANT FROM THE U.S. DEPARTMENT OF TRANSPORTATION FEDERAL TRANSIT ADMINISTRATION (FTA), UNDER THE FEDERAL TRANSIT ACT OF 1964, AS AMENDED, AND IN PART BY THE TAXES OF THE CITIZENS OF LOS ANGELES COUNTY AND OF THE STATE OF CALIFORNIA.		DESIGNED BY J. SANCHEZ
0	11/15/19	DRAWN BY C. CHEUK
		CHECKED BY R. LOYA
		IN CHARGE N. MAACK
		DATE 11/15/2019
		FINAL CONCEPTUAL DESIGN

LOS ANGELES COUNTY METROPOLITAN TRANSPORTATION AUTHORITY

 444 South Flower Street
 Suite 800
 Los Angeles, CA 90071
 TEL (213) 362-9470

CONTRACT NO. AE5999300	REV
DRAWING NO. TF-138	
SCALE HOR: 1"=40' VERT: 1"=10'	
SHEET NO. 29	OF 107

WEST SANTA ANA BRANCH FREIGHT TRACK
TRACK ALIGNMENT
LA HABRA BRANCH
PLAN & PROFILE
STA 769+50 TO STA 779+50

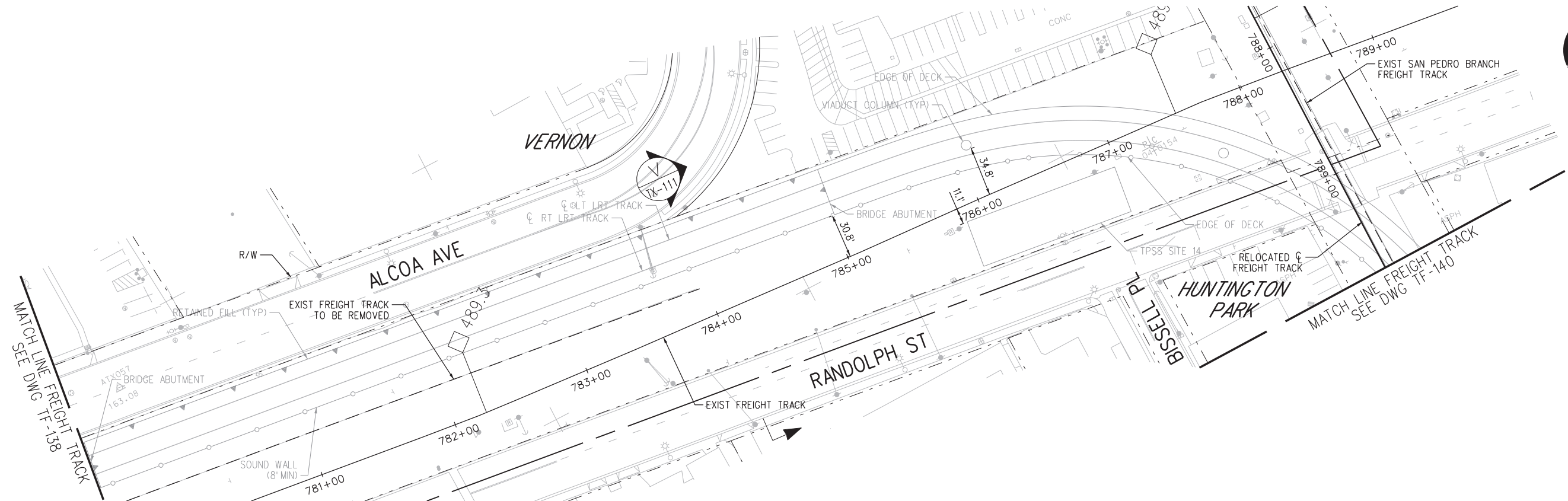

PLAN

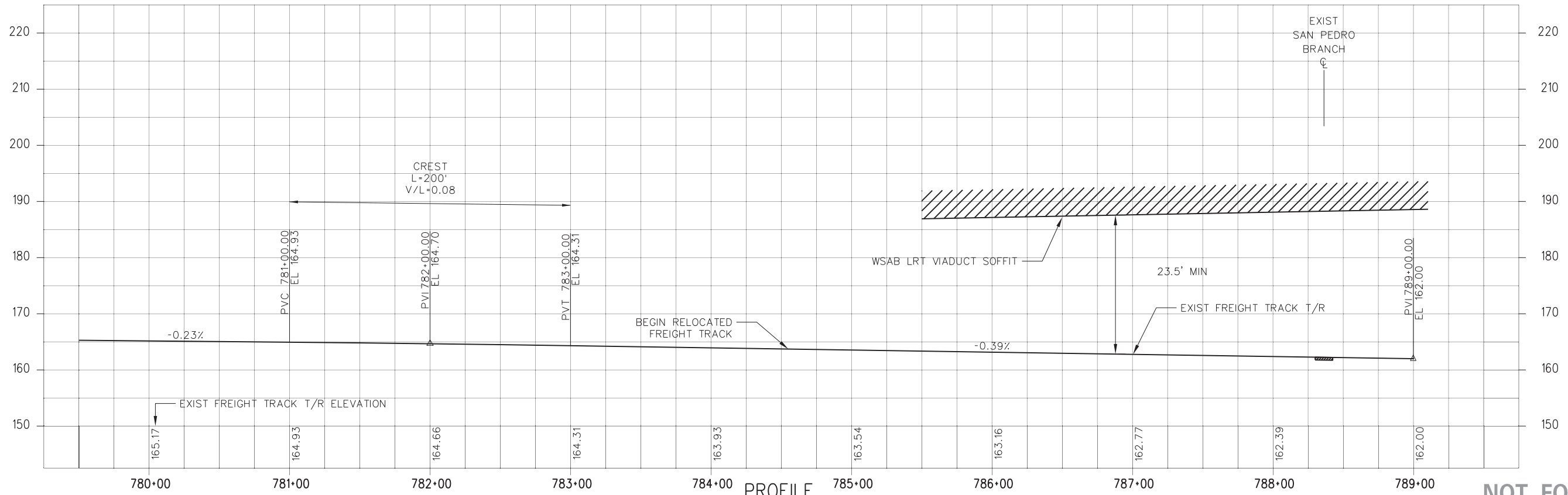

PROFILE

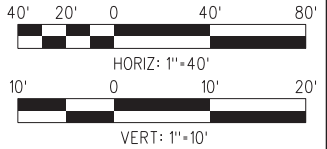

NOT FOR CONSTRUCTION

15-NOV-2019 C-28091ATF139.plg
svc-projectwise 22:40

THE PREPARATION OF THIS DRAWING HAS BEEN FINANCED IN PART THROUGH A GRANT FROM THE U.S. DEPARTMENT OF TRANSPORTATION FEDERAL TRANSIT ADMINISTRATION (FTA), UNDER THE FEDERAL TRANSIT ACT OF 1964, AS AMENDED, AND IN PART BY THE TAXES OF THE CITIZENS OF LOS ANGELES COUNTY AND OF THE STATE OF CALIFORNIA.

DESIGNED BY	J. SANCHEZ
DRAWN BY	C. CHEUK
CHECKED BY	R. LOYA
IN CHARGE	N. MAACK
DATE	11/15/2019
PROJECT	FINAL CONCEPTUAL DESIGN
DATE	11/15/19

Plot Driver=MTA-half.pen
Pentable=bw.plt

M Metro
LOS ANGELES COUNTY METROPOLITAN TRANSPORTATION AUTHORITY

wsp 444 South Flower Street Suite 800 Los Angeles, CA 90071 TEL (213) 362-9470

SUBMITTED _____
 APPROVED _____

WEST SANTA ANA BRANCH FREIGHT TRACK TRACK ALIGNMENT LA HABRA BRANCH PLAN & PROFILE STA 779+50 TO STA 789+50

CONTRACT NO	AE5999300
DRAWING NO	TF-139
SCALE	HOR: 1"=40' VERT: 1"=10'
SHEET NO	30 OF 107



- NOTES:**
1. REFER TO ADVANCED CONCEPTUAL ENGINEERING GRADE CROSSING PLANS.
 2. EXISTING TRACK WILL BE LINE AND SURFACE 200' BEYOND THE END OF NEW CONSTRUCTION.

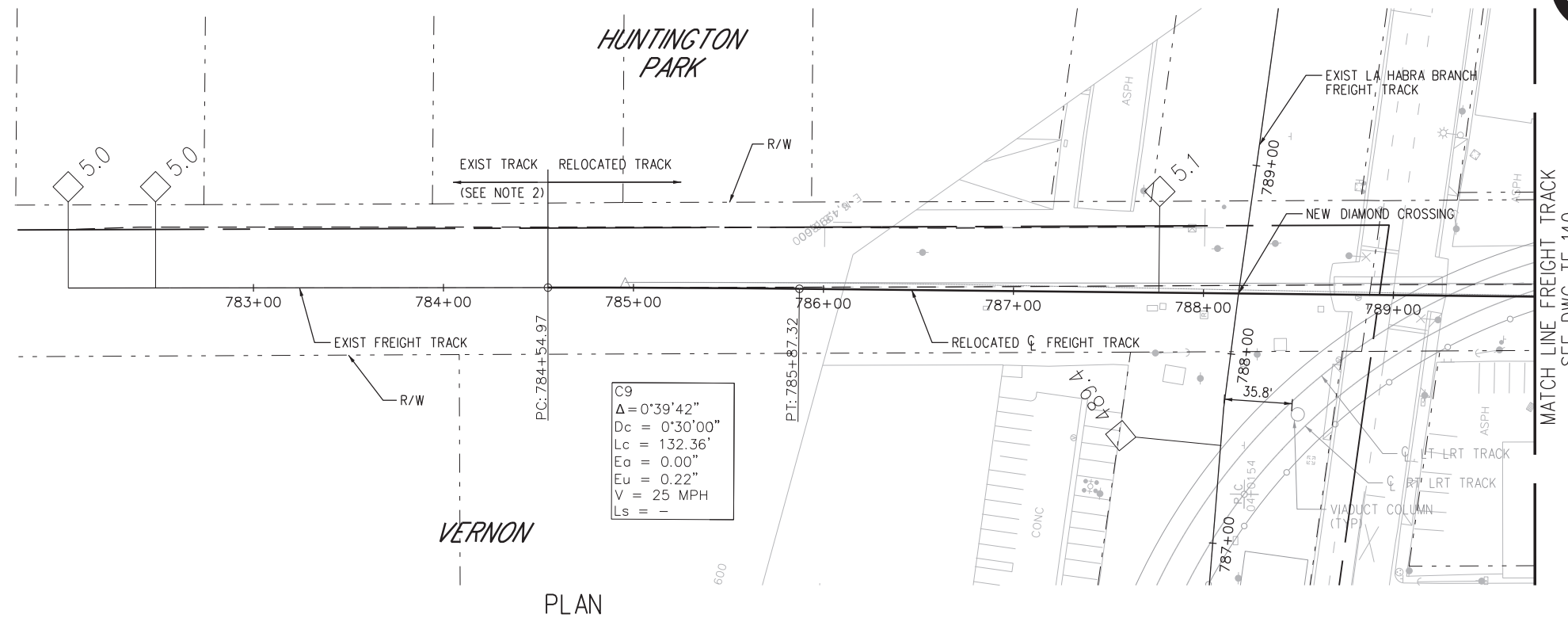

PLAN

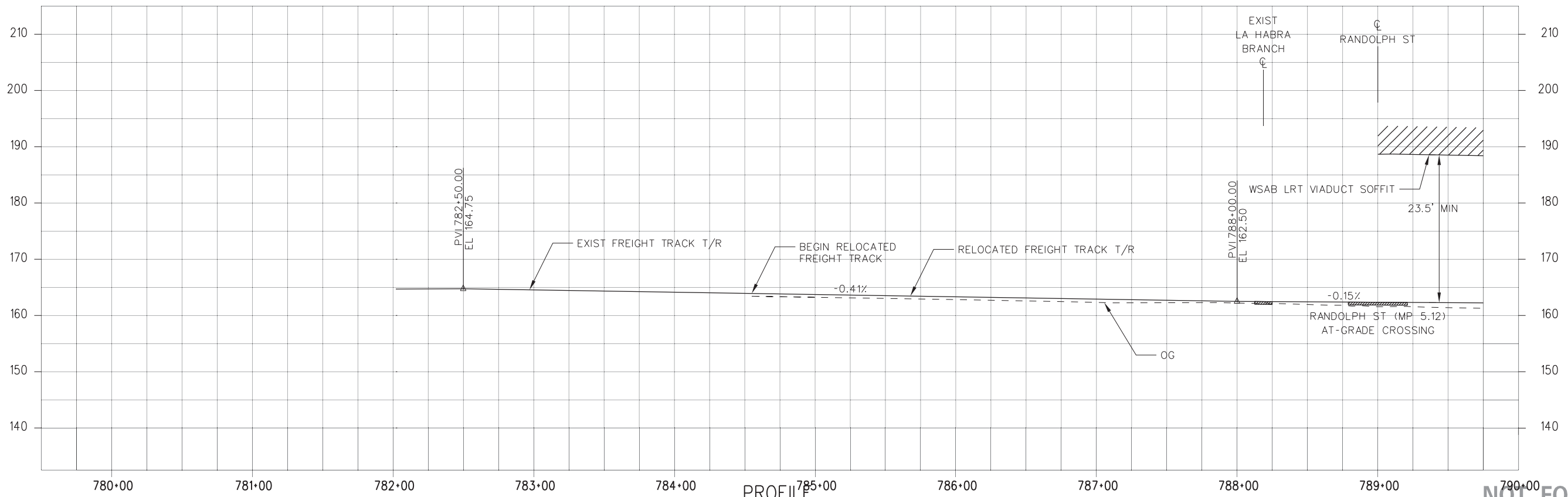

PROFILE

NOT FOR CONSTRUCTION

15-NOV-2019 C-28091ATF139A.plg

THE PREPARATION OF THIS DRAWING HAS BEEN FINANCED IN PART THROUGH A GRANT FROM THE U.S. DEPARTMENT OF TRANSPORTATION FEDERAL TRANSIT ADMINISTRATION (FTA), UNDER THE FEDERAL TRANSIT ACT OF 1964, AS AMENDED, AND IN PART BY THE TAXES OF THE CITIZENS OF LOS ANGELES COUNTY AND OF THE STATE OF CALIFORNIA.		DESIGNED BY J. SANCHEZ
0	11/15/19	DRAWN BY C. CHEUK
		CHECKED BY R. LOYA
		IN CHARGE N. MAACK
		DATE 11/15/2019
		FINAL CONCEPTUAL DESIGN

M Metro

444 South Flower Street
Suite 800
Los Angeles, CA 90071
TEL (213) 362-9470

LOS ANGELES COUNTY METROPOLITAN TRANSPORTATION AUTHORITY

WEST SANTA ANA BRANCH FREIGHT TRACK
TRACK ALIGNMENT
SAN PEDRO BRANCH
PLAN & PROFILE
STA 782+00 TO STA 790+00

CONTRACT NO
AE5999300

DRAWING NO
TF-139A

SCALE
HORIZ: 1"=40'
VERT: 1"=10'

SHEET NO
31 OF 107

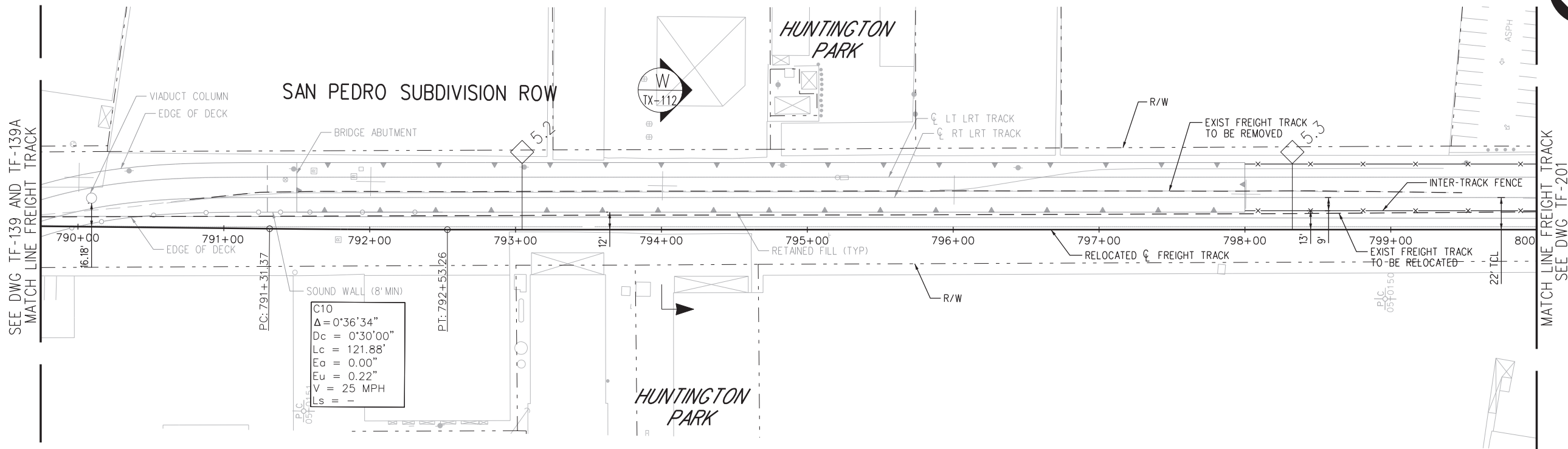

PLAN

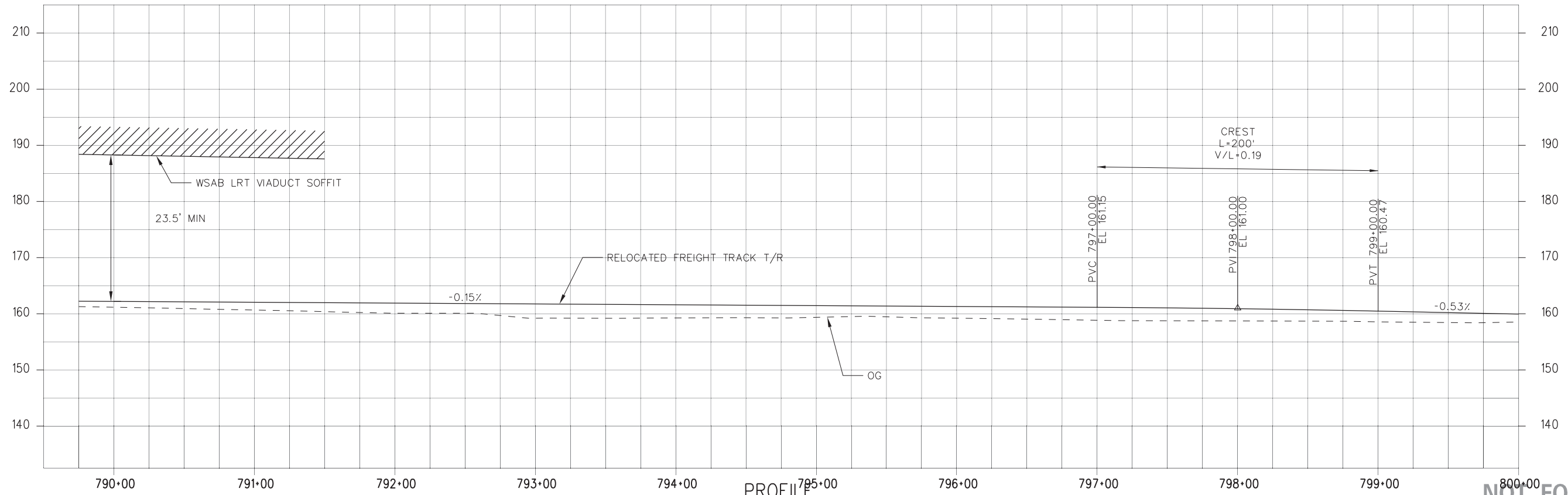

PROFILE

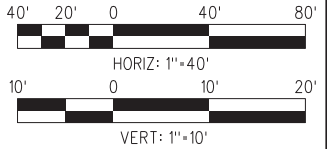

NOT FOR CONSTRUCTION

15-NOV-2019 C-28091ATF140.plg
svc-projectwise 22:36

THE PREPARATION OF THIS DRAWING HAS BEEN FINANCED IN PART THROUGH A GRANT FROM THE U.S. DEPARTMENT OF TRANSPORTATION FEDERAL TRANSIT ADMINISTRATION (FTA), UNDER THE FEDERAL TRANSIT ACT OF 1964, AS AMENDED, AND IN PART BY THE TAXES OF THE CITIZENS OF LOS ANGELES COUNTY AND OF THE STATE OF CALIFORNIA.	
0	11/15/19
	FINAL CONCEPTUAL DESIGN

DESIGNED BY J. SANCHEZ
DRAWN BY C. CHEUK
CHECKED BY R. LOYA
IN CHARGE N. MAACK
DATE 11/15/2019

M Metro
wsp 444 South Flower Street
 Suite 800
 Los Angeles, CA 90071
 TEL (213) 362-9470

SUBMITTED _____
 APPROVED _____

WEST SANTA ANA BRANCH FREIGHT TRACK
TRACK ALIGNMENT
SAN PEDRO BRANCH
PLAN & PROFILE
STA 789+50 TO STA 800+00

CONTRACT NO. AE5999300	REV
DRAWING NO. TF-140	
SCALE HORIZ: 1"=40' VERT: 1"=10'	
SHEET NO. 32	OF 107

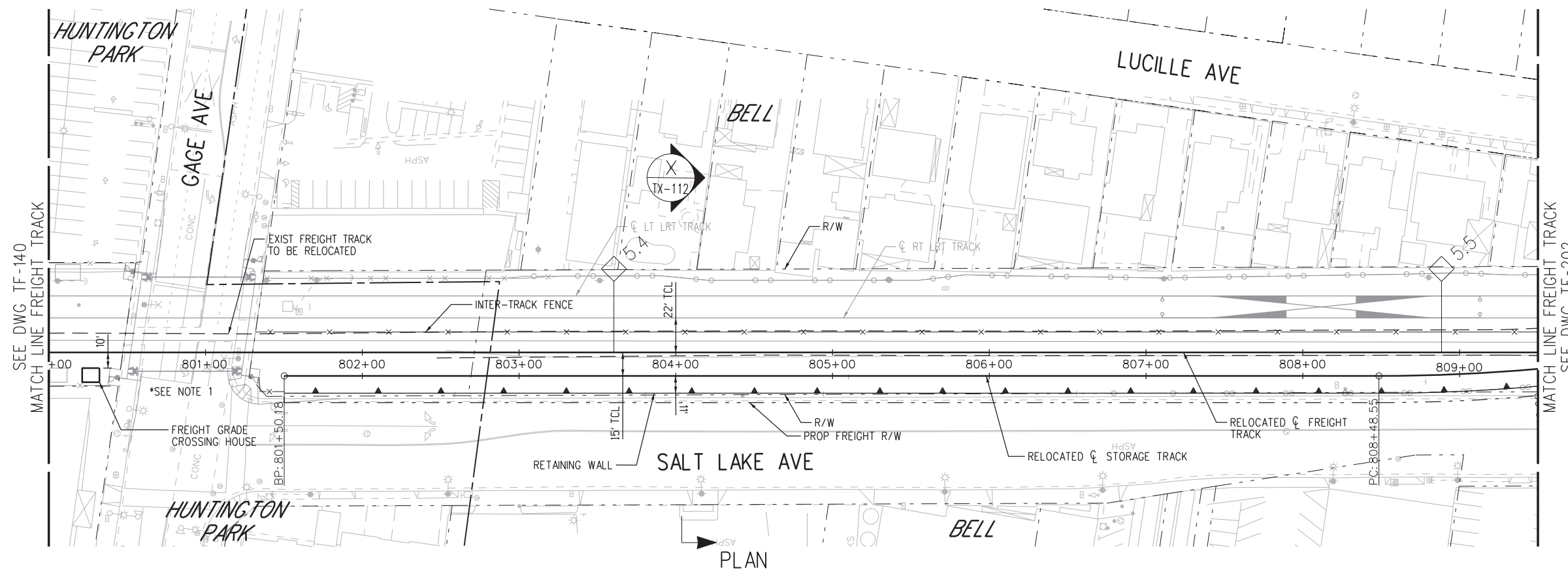

NOTE:
 1. REFER TO ADVANCED CONCEPTUAL ENGINEERING GRADE CROSSING PLANS.

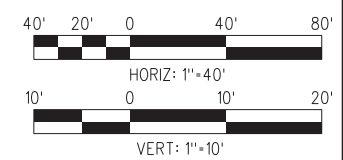
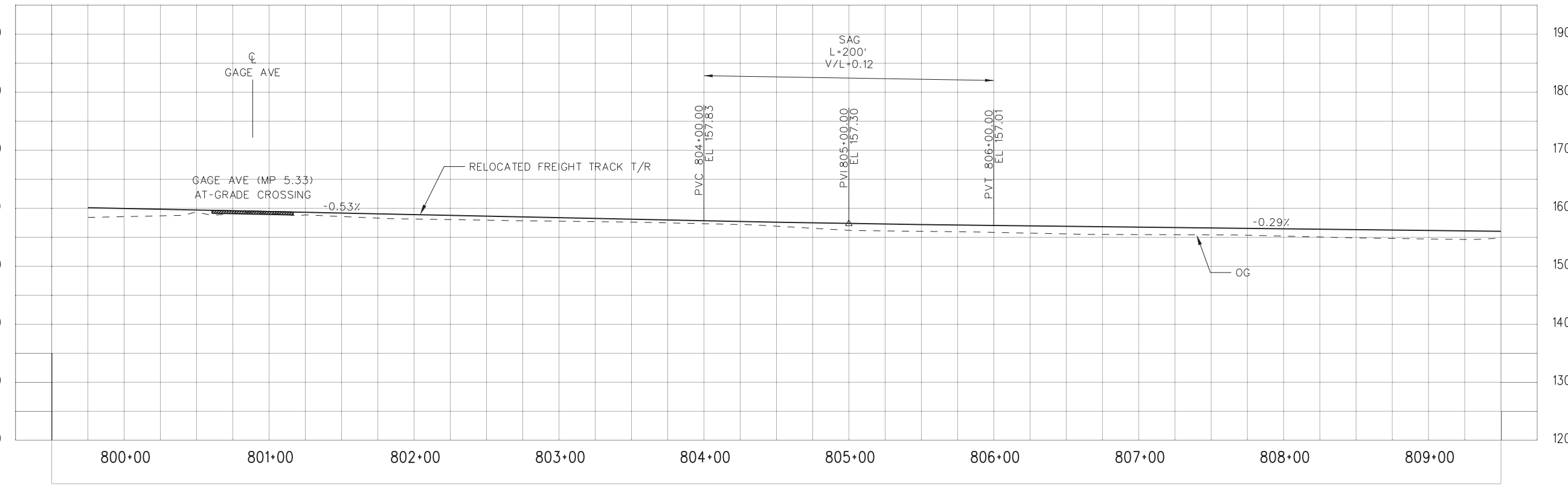

PROFILE

NOT FOR CONSTRUCTION

15-NOV-2019 C-28091ATF 201.plg
 svc-projectwise 22:37

THE PREPARATION OF THIS DRAWING HAS BEEN FINANCED IN PART THROUGH A GRANT FROM THE U.S. DEPARTMENT OF TRANSPORTATION FEDERAL TRANSIT ADMINISTRATION (FTA), UNDER THE FEDERAL TRANSIT ACT OF 1964, AS AMENDED, AND IN PART BY THE TAXES OF THE CITIZENS OF LOS ANGELES COUNTY AND OF THE STATE OF CALIFORNIA.		DESIGNED BY J. SANCHEZ
		DRAWN BY C. CHEUK
		CHECKED BY R. LOYA
		IN CHARGE N. MAACK
		DATE 11/15/2019
0	11/15/19	FINAL CONCEPTUAL DESIGN

 LOS ANGELES COUNTY METROPOLITAN TRANSPORTATION AUTHORITY	
 444 South Flower Street Suite 800 Los Angeles, CA 90071 TEL (213) 362-9470	SUBMITTED _____ APPROVED _____

WEST SANTA ANA BRANCH FREIGHT TRACK TRACK ALIGNMENT SAN PEDRO BRANCH PLAN & PROFILE STA 800+00 TO STA 809+50	
CONTRACT NO. AE5999300	REV
DRAWING NO. TF-201	
SCALE HOR: 1"=40' VERT: 1"=10'	
SHEET NO. 33	OF 107



NOTE:

1. REFER TO ADVANCED CONCEPTUAL ENGINEERING GRADE CROSSING PLANS.

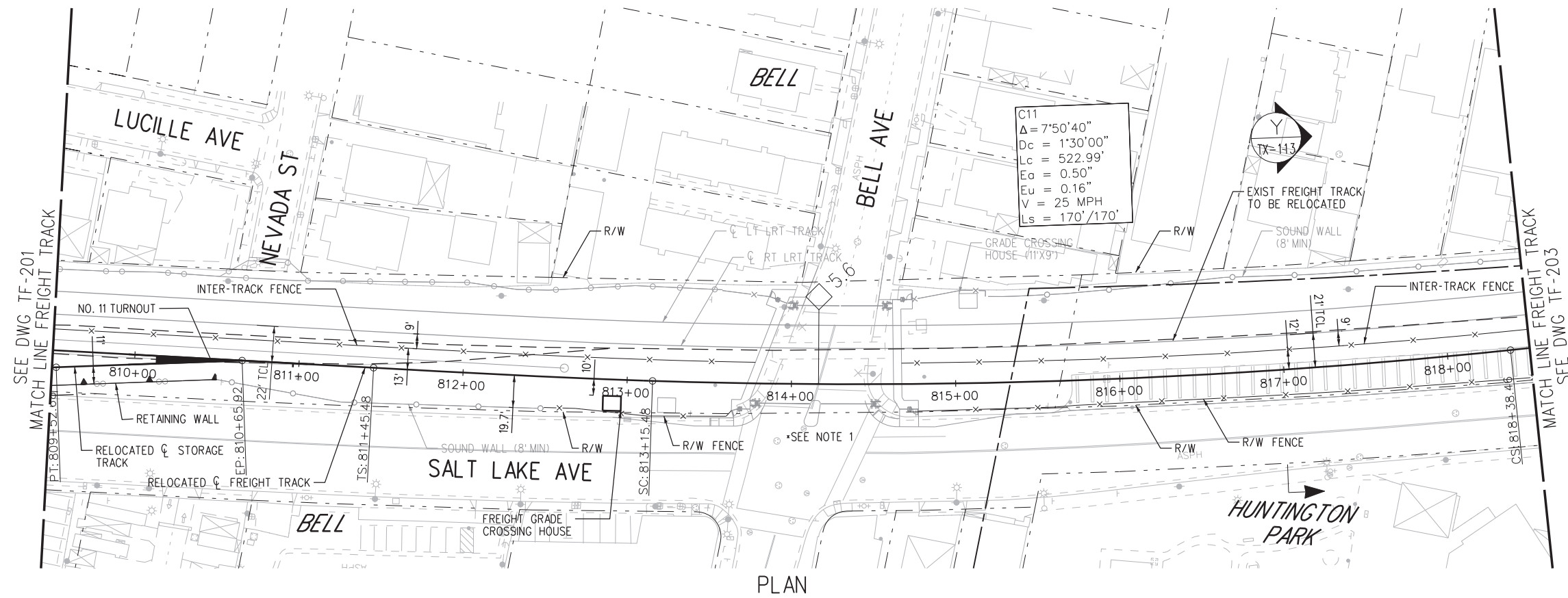

PLAN

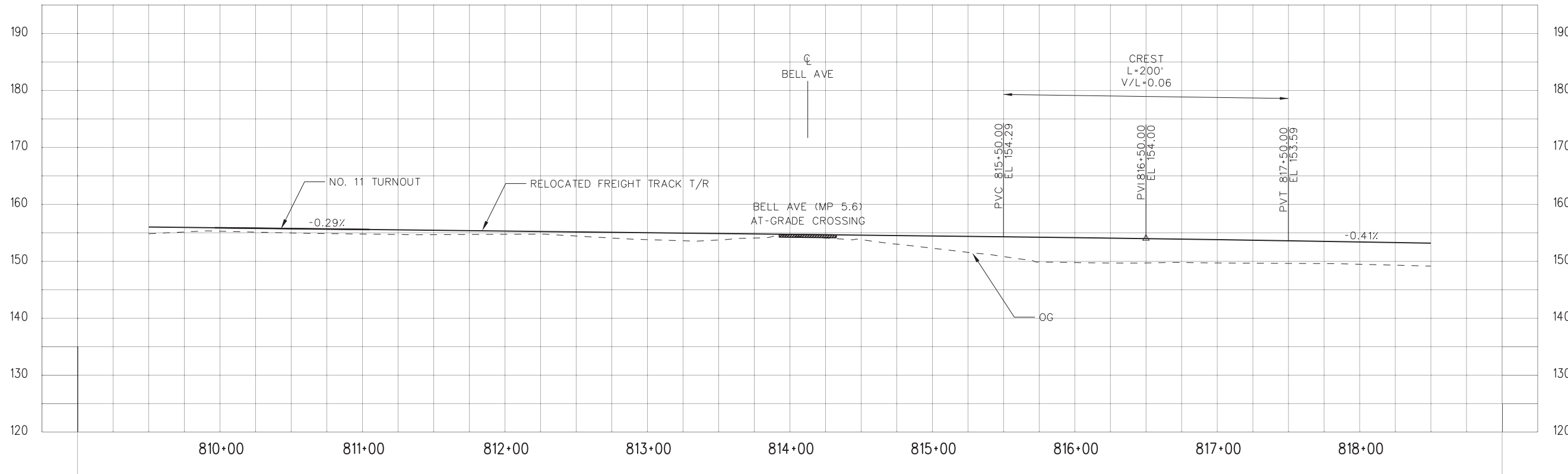

PROFILE

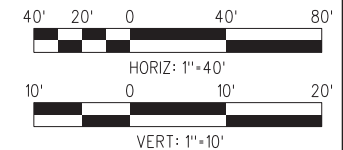

NOT FOR CONSTRUCTION

15-NOV-2019 C-28091ATF 202.plg
svc-projectwise 22:39

THE PREPARATION OF THIS DRAWING HAS BEEN FINANCED IN PART THROUGH A GRANT FROM THE U.S. DEPARTMENT OF TRANSPORTATION FEDERAL TRANSIT ADMINISTRATION (FTA), UNDER THE FEDERAL TRANSIT ACT OF 1964, AS AMENDED, AND IN PART BY THE TAKES OF THE CITIZENS OF LOS ANGELES COUNTY AND OF THE STATE OF CALIFORNIA.

DESIGNED BY	J. SANCHEZ
DRAWN BY	C. CHEUK
CHECKED BY	R. LOYA
IN CHARGE	N. MAACK
DATE	11/15/2019
DESCRIPTION	FINAL CONCEPTUAL DESIGN

M Metro

wsp 444 South Flower Street
Suite 800
Los Angeles, CA 90071
TEL (213) 362-9470

LOS ANGELES COUNTY METROPOLITAN TRANSPORTATION AUTHORITY

WEST SANTA ANA BRANCH FREIGHT TRACK
TRACK ALIGNMENT
SAN PEDRO BRANCH
PLAN & PROFILE
STA 809+50 TO STA 818+50

CONTRACT NO. AE5999300
DRAWING NO. TF-202
SCALE: HORIZ: 1"=40'
VERT: 1"=10'
SHEET NO. 34 OF 107

DESIGNED BY: J. SANCHEZ
DRAWN BY: C. CHEUK
CHECKED BY: R. LOYA
IN CHARGE: N. MAACK
DATE: 11/15/2019

444 South Flower Street
Suite 800
Los Angeles, CA 90071
TEL (213) 362-9470

SUBMITTED: _____
APPROVED: _____

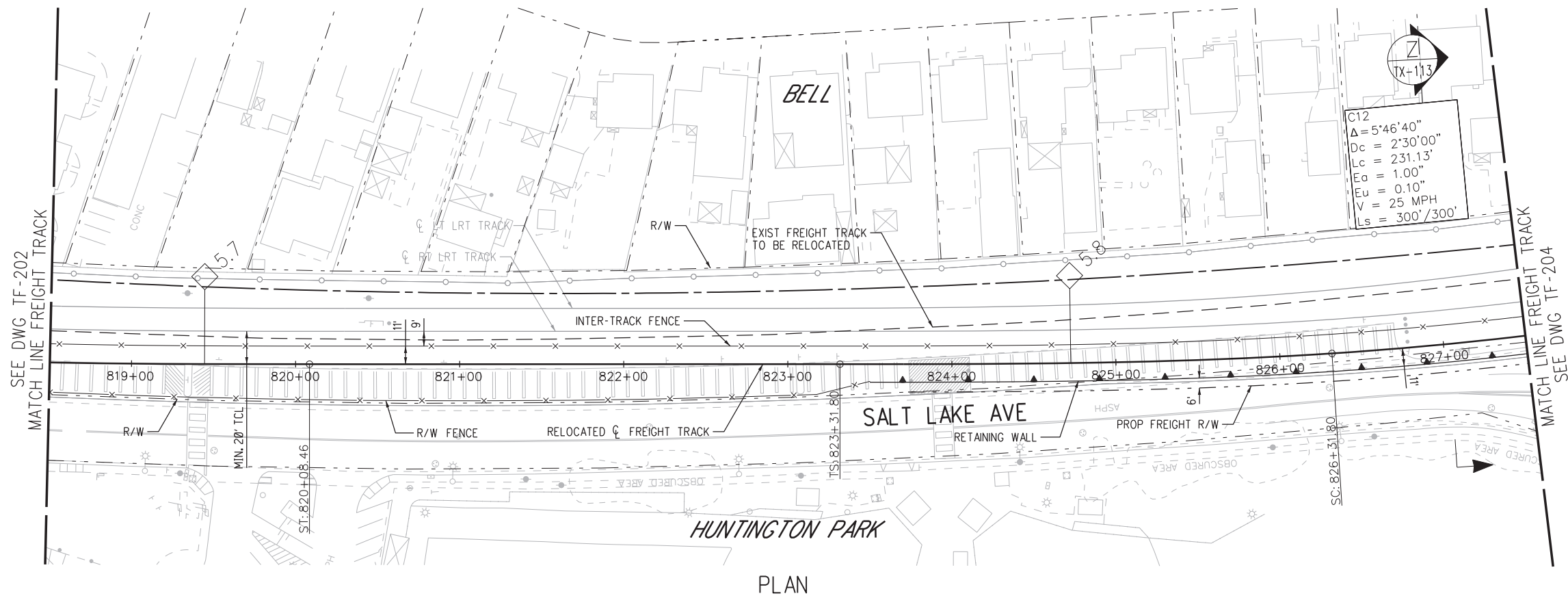

PLAN

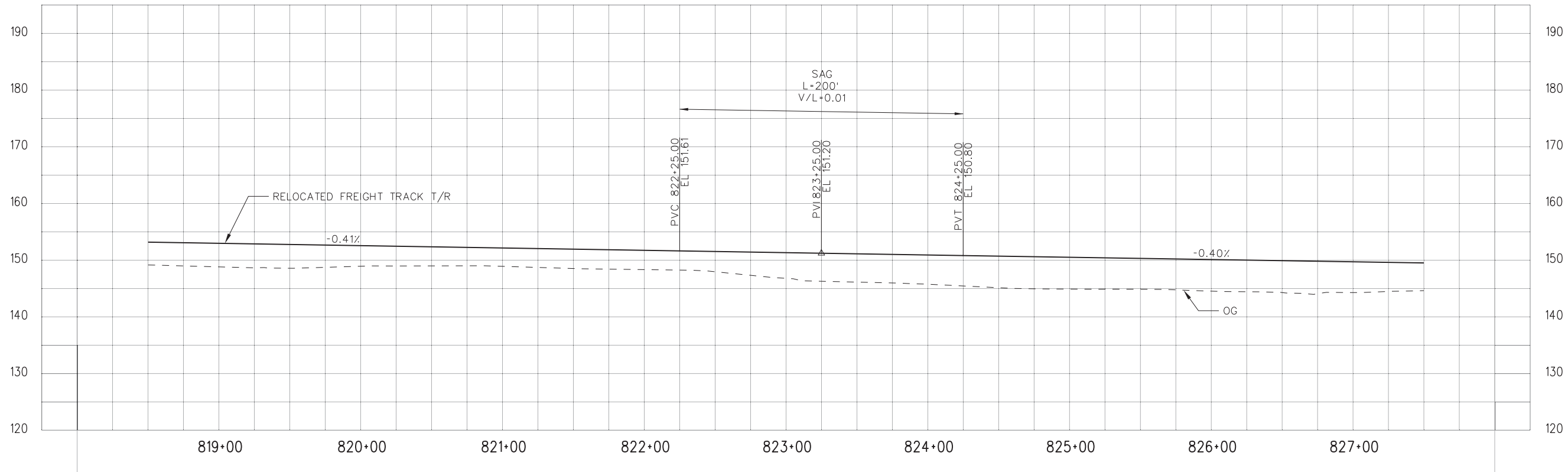

PROFILE

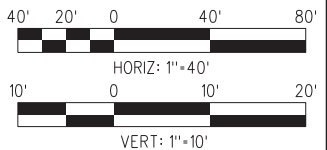

NOT FOR CONSTRUCTION

15-NOV-2019 C-28091ATF 203.plg
svc-projectwise 22:37

THE PREPARATION OF THIS DRAWING HAS BEEN FINANCED IN PART THROUGH A GRANT FROM THE U.S. DEPARTMENT OF TRANSPORTATION FEDERAL TRANSIT ADMINISTRATION (FTA), UNDER THE FEDERAL TRANSIT ACT OF 1964, AS AMENDED, AND IN PART BY THE TAXES OF THE CITIZENS OF LOS ANGELES COUNTY AND OF THE STATE OF CALIFORNIA.	
0	11/15/19
	FINAL CONCEPTUAL DESIGN

DESIGNED BY J. SANCHEZ
DRAWN BY C. CHEUK
CHECKED BY R. LOYA
IN CHARGE N. MAACK
DATE 11/15/2019

M Metro
wsp 444 South Flower Street
 Suite 800
 Los Angeles, CA 90071
 TEL (213) 362-9470

SUBMITTED _____
 APPROVED _____

WEST SANTA ANA BRANCH FREIGHT TRACK
 TRACK ALIGNMENT
 SAN PEDRO BRANCH
 PLAN & PROFILE
 STA 818+50 TO STA 827+50

CONTRACT NO AE5999300
DRAWING NO TF-203
SCALE HORIZ: 1"=40' VERT: 1"=10'
SHEET NO 35 OF 107



NOTE:

1. REFER TO ADVANCED CONCEPTUAL ENGINEERING GRADE CROSSING PLANS.

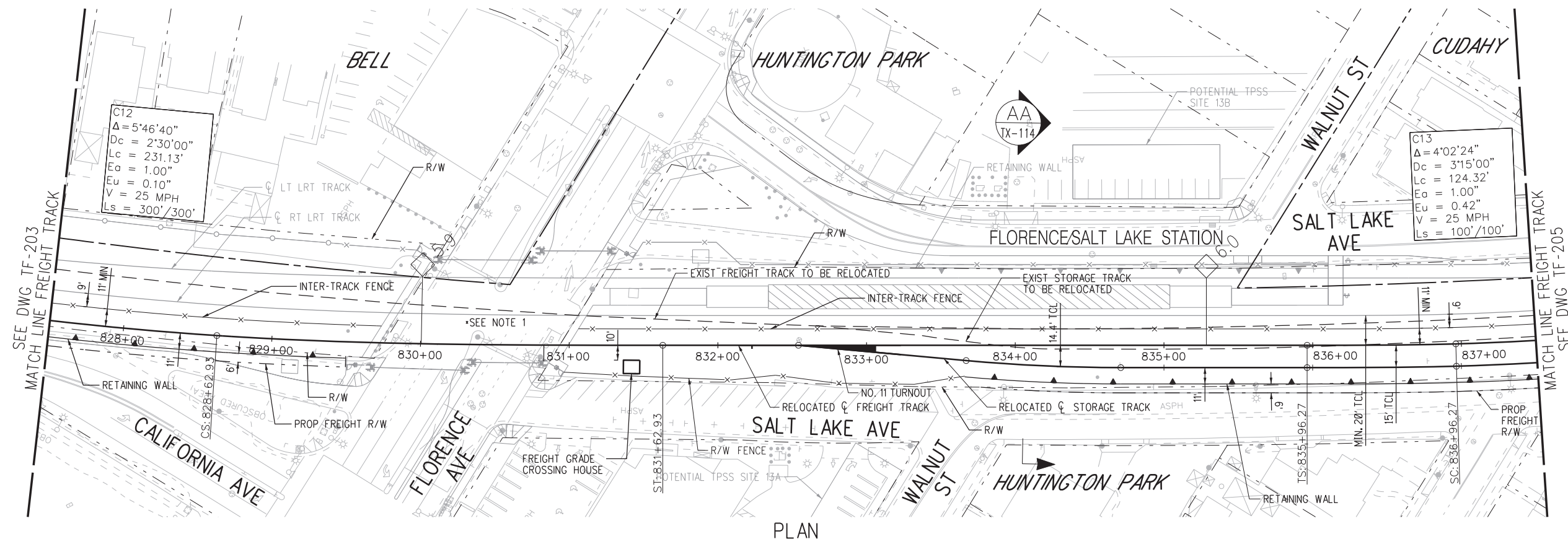

PLAN

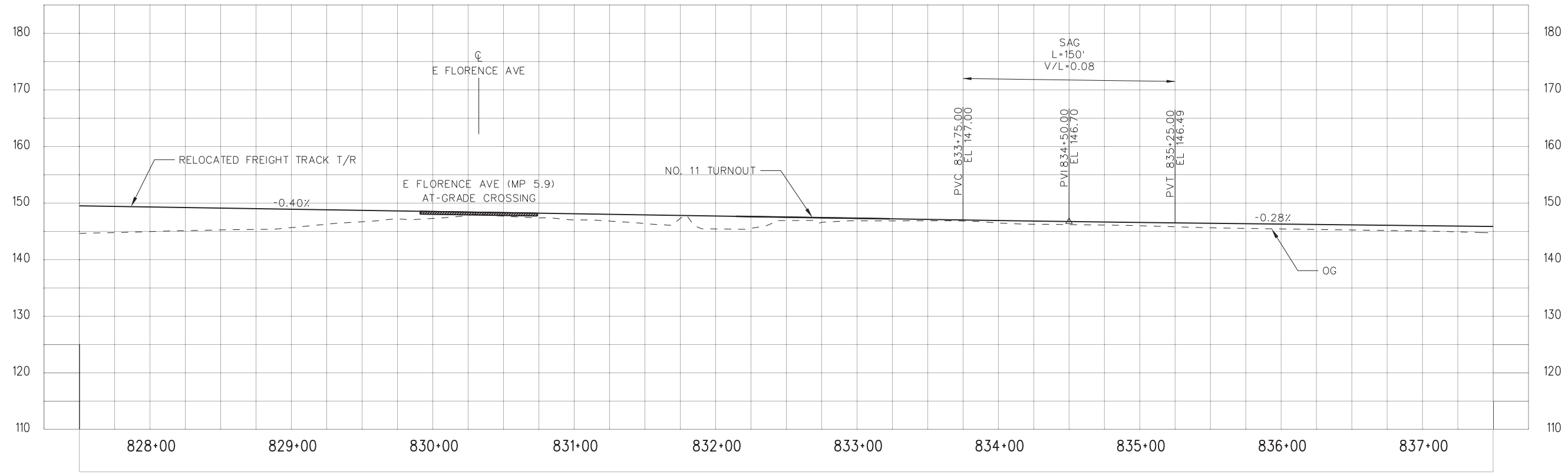

PROFILE

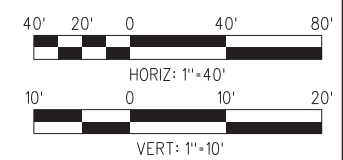

NOT FOR CONSTRUCTION

15-NOV-2019 C-28091ATF 204.plg
22:37
svc-projectwise

THE PREPARATION OF THIS DRAWING HAS BEEN FINANCED IN PART THROUGH A GRANT FROM THE U.S. DEPARTMENT OF TRANSPORTATION FEDERAL TRANSIT ADMINISTRATION (FTA), UNDER THE FEDERAL TRANSIT ACT OF 1964, AS AMENDED, AND IN PART BY THE TAXES OF THE CITIZENS OF LOS ANGELES COUNTY AND OF THE STATE OF CALIFORNIA.		DESIGNED BY J. SANCHEZ
		DRAWN BY C. CHEUK
		CHECKED BY R. LOYA
		IN CHARGE N. MAACK
		DATE 11/15/2019
0	11/15/19	FINAL CONCEPTUAL DESIGN

M Metro
 444 South Flower Street
 Suite 800
 Los Angeles, CA 90071
 TEL (213) 362-9470

wsp

CONTRACT NO
AE5999300

DRAWING NO
TF-204

SCALE
HORIZ: 1"=40'
VERT: 1"=10'

SHEET NO
36 OF 107

WEST SANTA ANA BRANCH FREIGHT TRACK
TRACK ALIGNMENT
SAN PEDRO BRANCH
PLAN & PROFILE
STA 827+50 TO STA 837+50

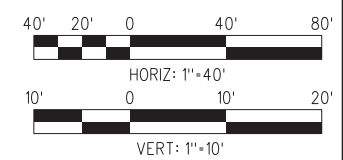
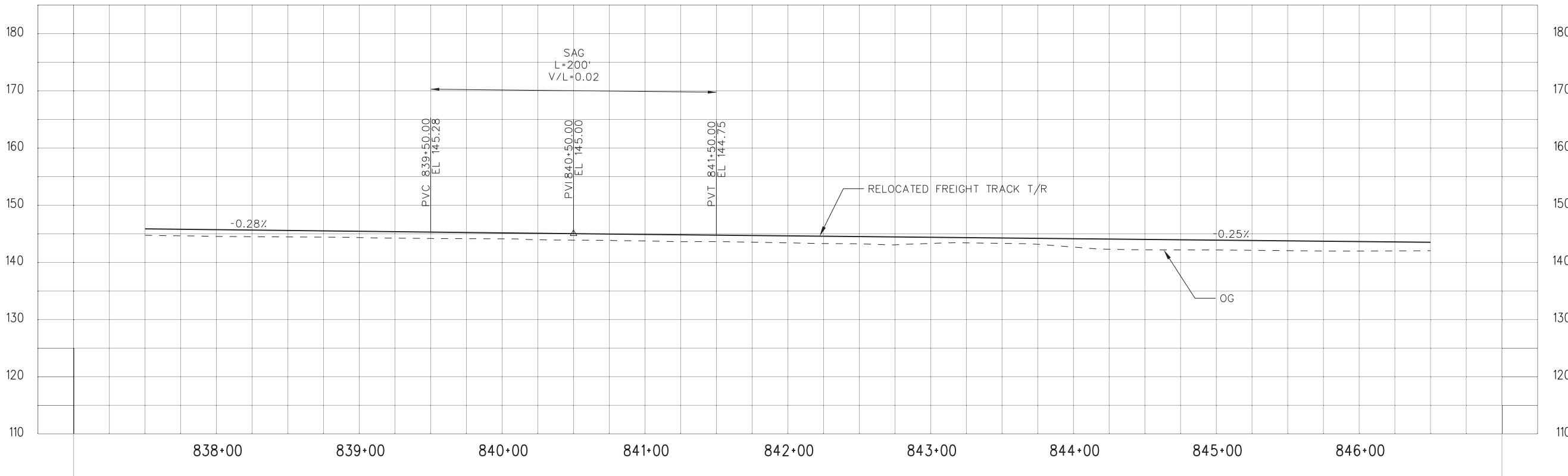
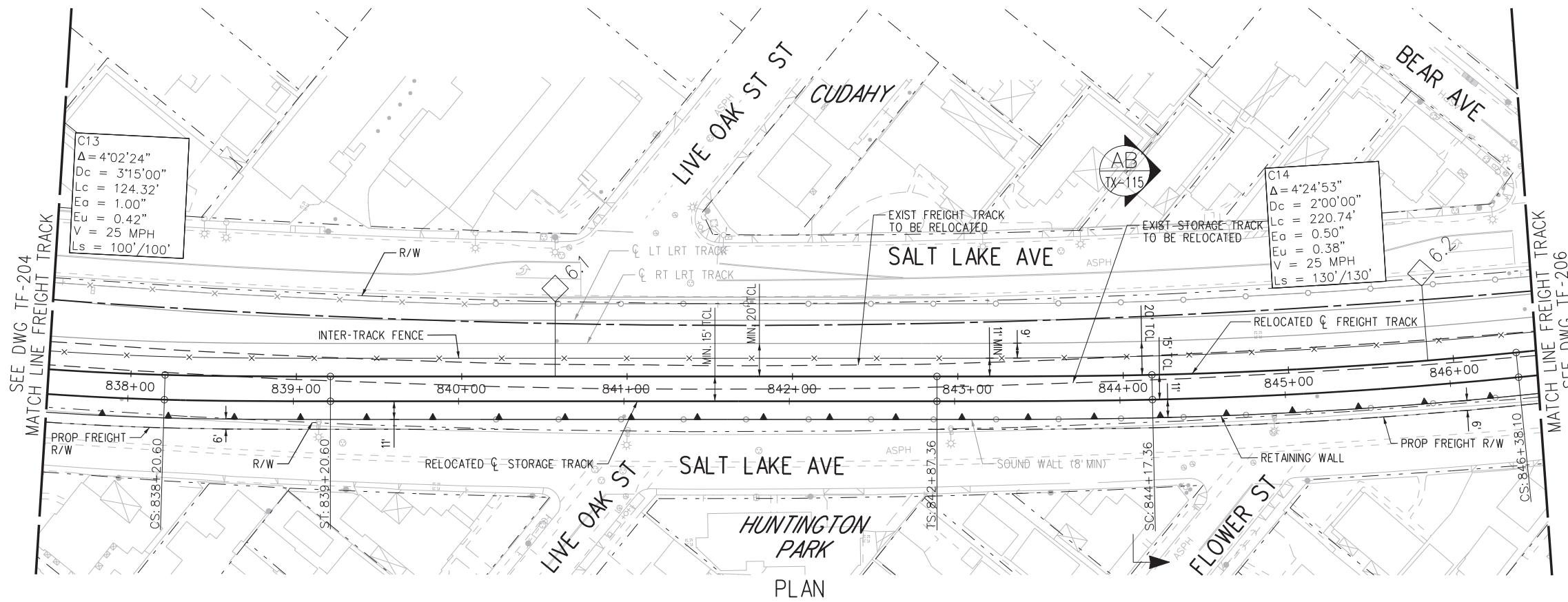

PROFILE

NOT FOR CONSTRUCTION

15-NOV-2019 C-28091ATF 205.plg
 svc-projectwise 22:41

THE PREPARATION OF THIS DRAWING HAS BEEN FINANCED IN PART THROUGH A GRANT FROM THE U.S. DEPARTMENT OF TRANSPORTATION FEDERAL TRANSIT ADMINISTRATION (FTA), UNDER THE FEDERAL TRANSIT ACT OF 1964, AS AMENDED, AND IN PART BY THE TAKES OF THE CITIZENS OF LOS ANGELES COUNTY AND OF THE STATE OF CALIFORNIA.		DESIGNED BY J. SANCHEZ
		DRAWN BY C. CHEUK
		CHECKED BY R. LOYA
		IN CHARGE N. MAACK
		DATE 11/15/2019
0	11/15/19	FINAL CONCEPTUAL DESIGN

M Metro
 LOS ANGELES COUNTY METROPOLITAN TRANSPORTATION AUTHORITY

wsp 444 South Flower Street Suite 800 Los Angeles, CA 90071 TEL (213) 362-9470

SUBMITTED _____
 APPROVED _____

WEST SANTA ANA BRANCH FREIGHT TRACK
 TRACK ALIGNMENT
 SAN PEDRO BRANCH
 PLAN & PROFILE
 STA 837+50 TO STA 846+50

CONTRACT NO
AE5999300

DRAWING NO
TF-205

SCALE
 HOR: 1"=40'
 VERT: 1"=10'

SHEET NO
 37 OF 107

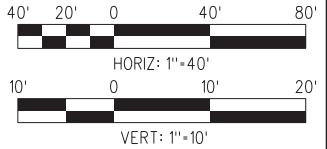
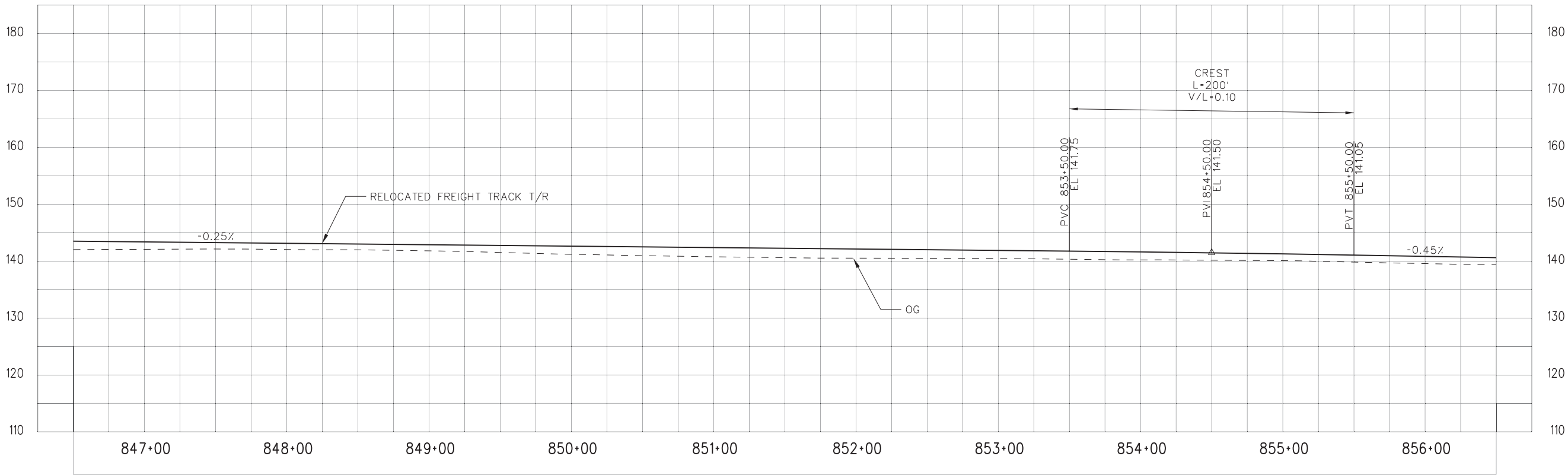
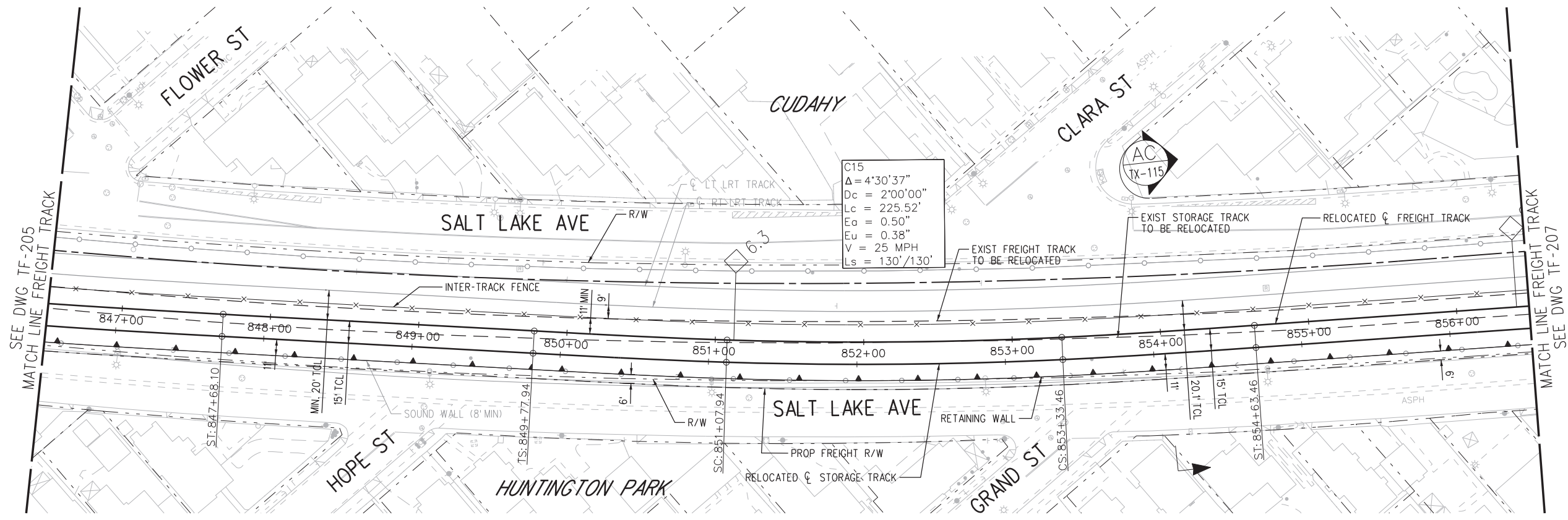

NOT FOR CONSTRUCTION

15-NOV-2019 C-28091ATF 206.plg
 svc-projectwise 22:39

THE PREPARATION OF THIS DRAWING HAS BEEN FINANCED IN PART THROUGH A GRANT FROM THE U.S. DEPARTMENT OF TRANSPORTATION FEDERAL TRANSIT ADMINISTRATION (FTA), UNDER THE FEDERAL TRANSIT ACT OF 1964, AS AMENDED, AND IN PART BY THE TAKES OF THE CITIZENS OF LOS ANGELES COUNTY AND OF THE STATE OF CALIFORNIA.		DESIGNED BY J. SANCHEZ
0	11/15/19	DRAWN BY C. CHEUK
		CHECKED BY R. LOYA
		IN CHARGE N. MAACK
		DATE 11/15/2019
		FINAL CONCEPTUAL DESIGN

LOS ANGELES COUNTY METROPOLITAN TRANSPORTATION AUTHORITY

Metro

wsp 444 South Flower Street Suite 800 Los Angeles, CA 90071 TEL (213) 362-9470

SUBMITTED _____

APPROVED _____

WEST SANTA ANA BRANCH FREIGHT TRACK

TRACK ALIGNMENT

SAN PEDRO BRANCH

PLAN & PROFILE

STA 846+50 TO STA 856+50

CONTRACT NO. AE5999300	REV
DRAWING NO. TF-206	
SCALE HOR: 1"=40' VERT: 1"=10'	
SHEET NO. 38	OF 107

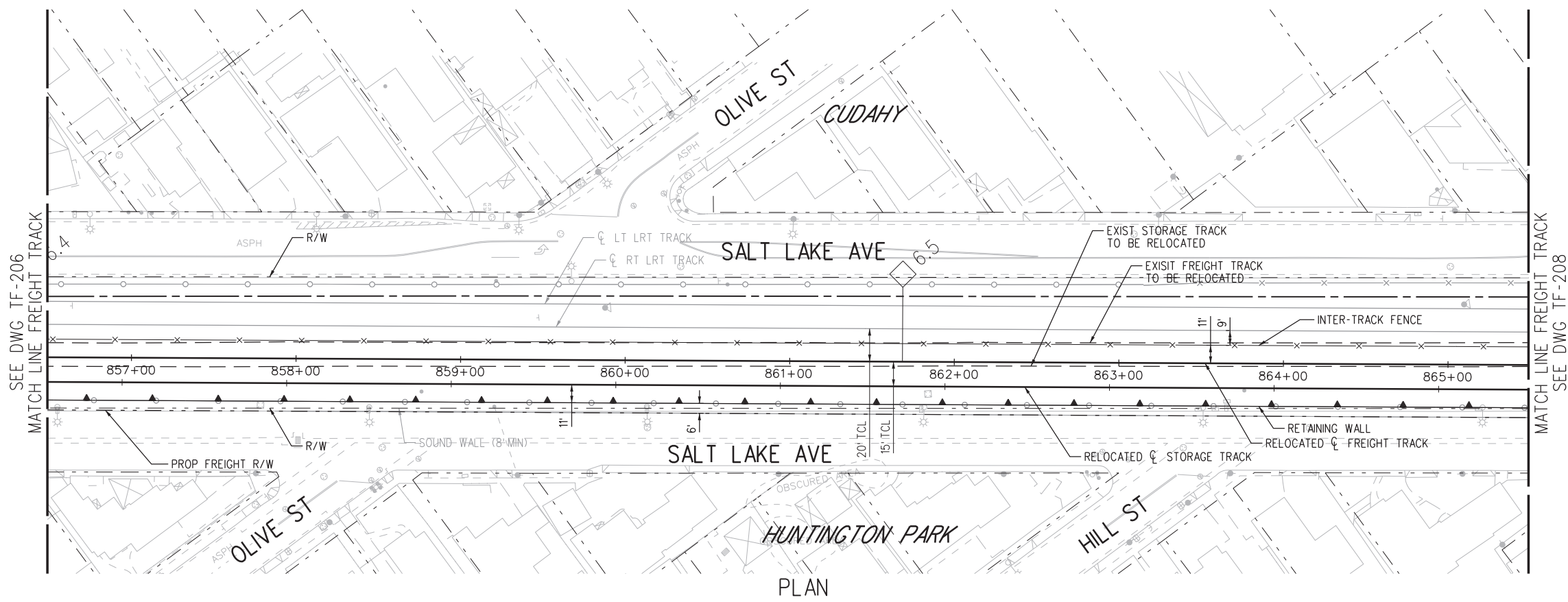

PLAN

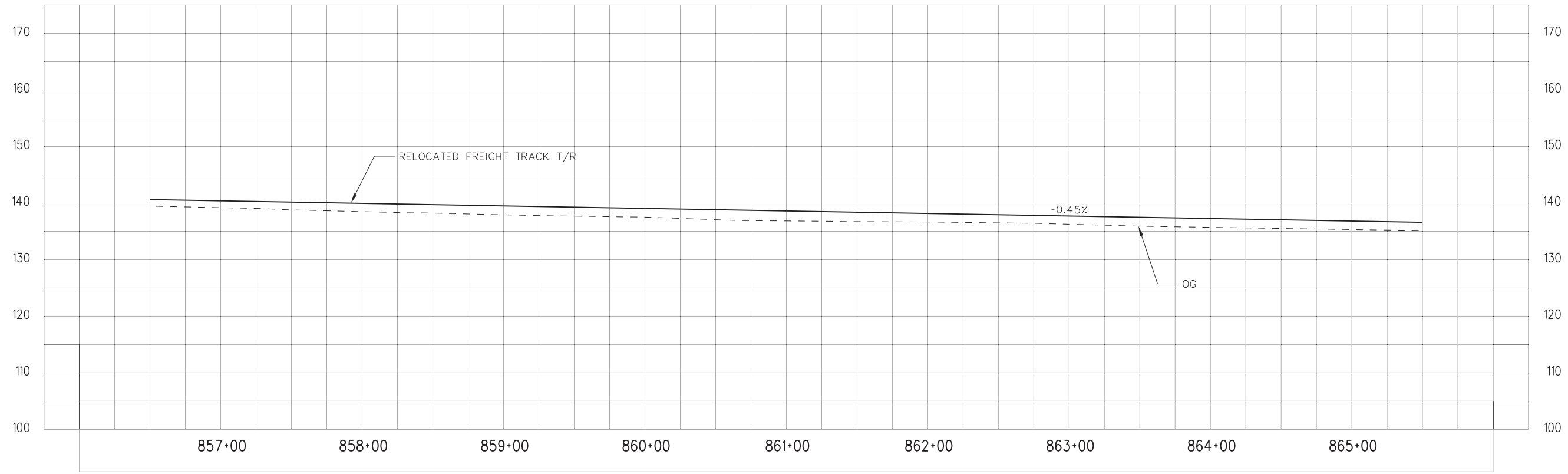

PROFILE

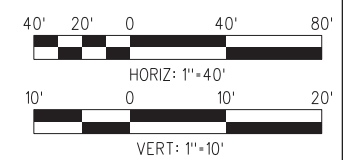

NOT FOR CONSTRUCTION

15-NOV-2019 C-28091ATF 207.plg
svc-projectwise 22:38

THE PREPARATION OF THIS DRAWING HAS BEEN FINANCED IN PART THROUGH A GRANT FROM THE U.S. DEPARTMENT OF TRANSPORTATION FEDERAL TRANSIT ADMINISTRATION (FTA), UNDER THE FEDERAL TRANSIT ACT OF 1964, AS AMENDED, AND IN PART BY THE TAXES OF THE CITIZENS OF LOS ANGELES COUNTY AND OF THE STATE OF CALIFORNIA.		DESIGNED BY J. SANCHEZ
		DRAWN BY C. CHEUK
		CHECKED BY R. LOYA
		IN CHARGE N. MAACK
		DATE 11/15/2019
0	11/15/19	FINAL CONCEPTUAL DESIGN

M Metro
444 South Flower Street
Suite 800
Los Angeles, CA 90071
TEL (213) 362-9470

wsp

SUBMITTED _____
APPROVED _____

**WEST SANTA ANA BRANCH FREIGHT TRACK
TRACK ALIGNMENT
SAN PEDRO BRANCH
PLAN & PROFILE
STA 856+50 TO STA 865+50**

CONTRACT NO. AE5999300	REV
DRAWING NO. TF-207	
SCALE HOR: 1"=40' VERT: 1"=10'	
SHEET NO. 39	OF 107

15-NOV-2019 C-28091ATF 208.plg

svc-projectwise 22:43

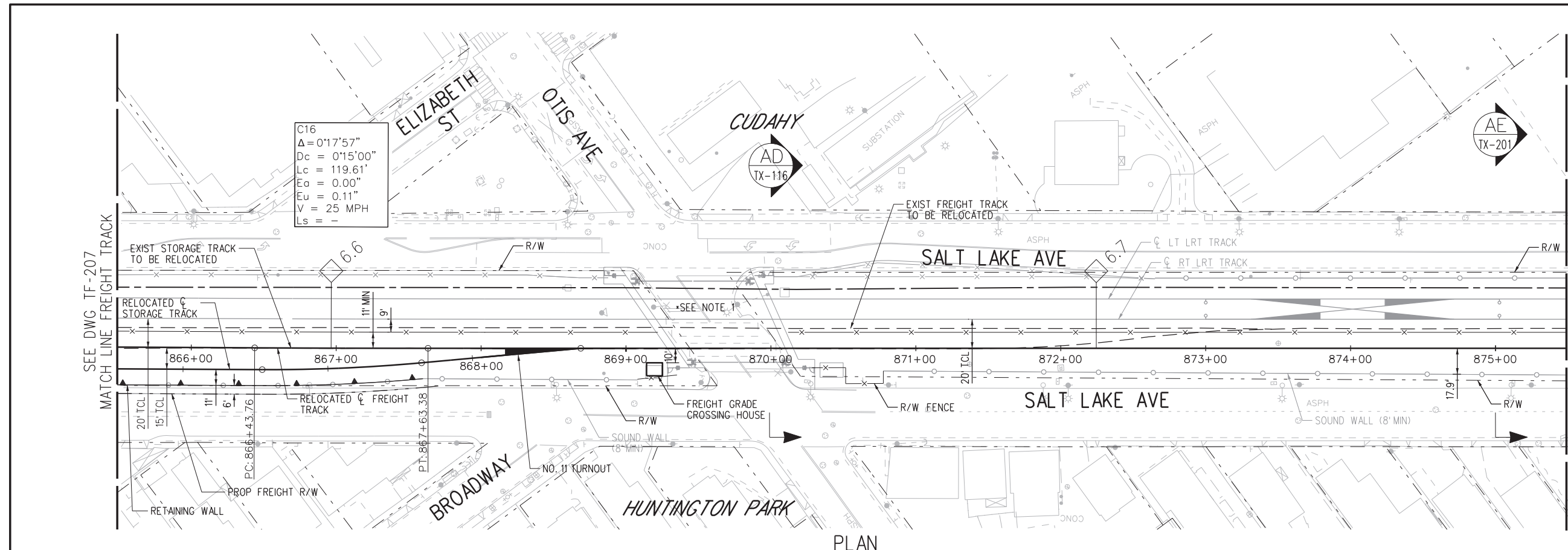

NOTE:
1. REFER TO ADVANCED CONCEPTUAL ENGINEERING GRADE CROSSING PLANS.

PLAN

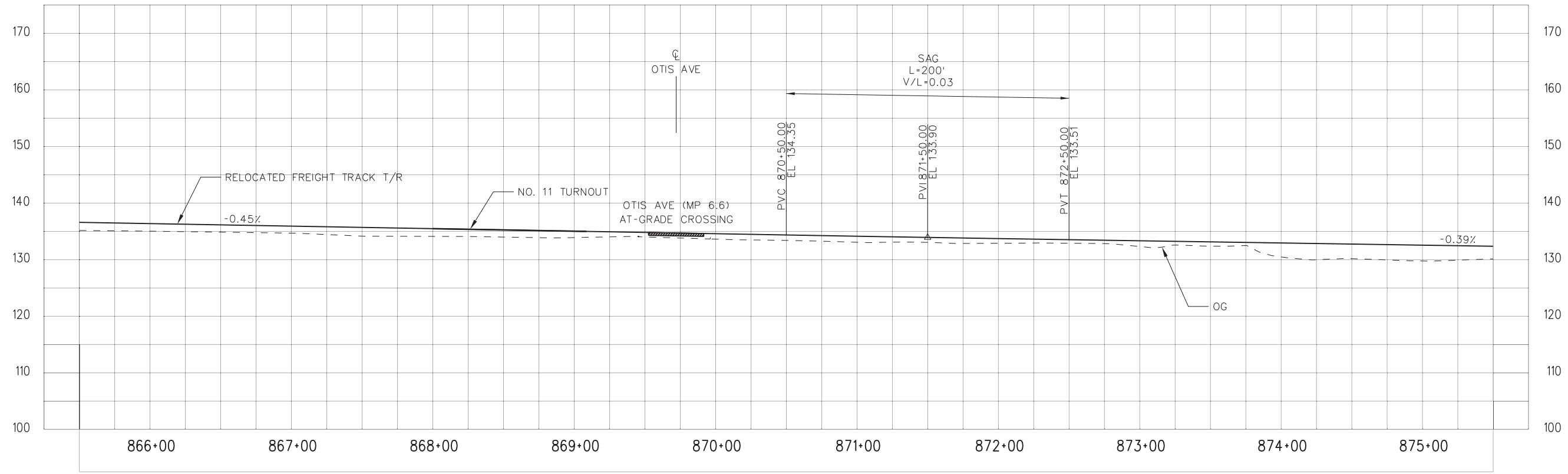

PROFILE

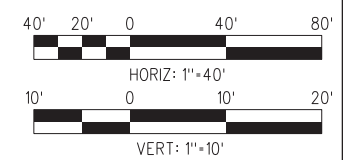

NOT FOR CONSTRUCTION

THE PREPARATION OF THIS DRAWING HAS BEEN FINANCED IN PART THROUGH A GRANT FROM THE U.S. DEPARTMENT OF TRANSPORTATION FEDERAL TRANSIT ADMINISTRATION (FTA), UNDER THE FEDERAL TRANSIT ACT OF 1964, AS AMENDED, AND IN PART BY THE TAXES OF THE CITIZENS OF LOS ANGELES COUNTY AND OF THE STATE OF CALIFORNIA.

DESIGNED BY	J. SANCHEZ
DRAWN BY	C. CHEUK
CHECKED BY	R. LOYA
IN CHARGE	N. MAACK
DATE	11/15/2019
PROJECT	FINAL CONCEPTUAL DESIGN
DATE	11/15/19

DESIGNED BY
J. SANCHEZ
DRAWN BY
C. CHEUK
CHECKED BY
R. LOYA
IN CHARGE
N. MAACK
DATE
11/15/2019

M Metro
LOS ANGELES COUNTY METROPOLITAN TRANSPORTATION AUTHORITY

wsp 444 South Flower Street Suite 800 Los Angeles, CA 90071 TEL (213) 362-9470

SUBMITTED _____
APPROVED _____

WEST SANTA ANA BRANCH FREIGHT TRACK
TRACK ALIGNMENT
SAN PEDRO BRANCH
PLAN & PROFILE
STA 865+50 TO STA 875+50

CONTRACT NO.	AE5999300
DRAWING NO.	TF-208
SCALE	HOR: 1"=40' VERT: 1"=10'
SHEET NO.	40 OF 107

Plot Driver=MTA-half.pen

Pentable=bw.plt



NOTE:

1. REFER TO ADVANCED CONCEPTUAL ENGINEERING GRADE CROSSING PLANS.

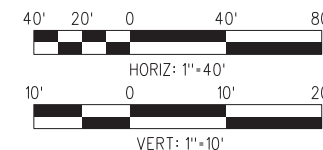
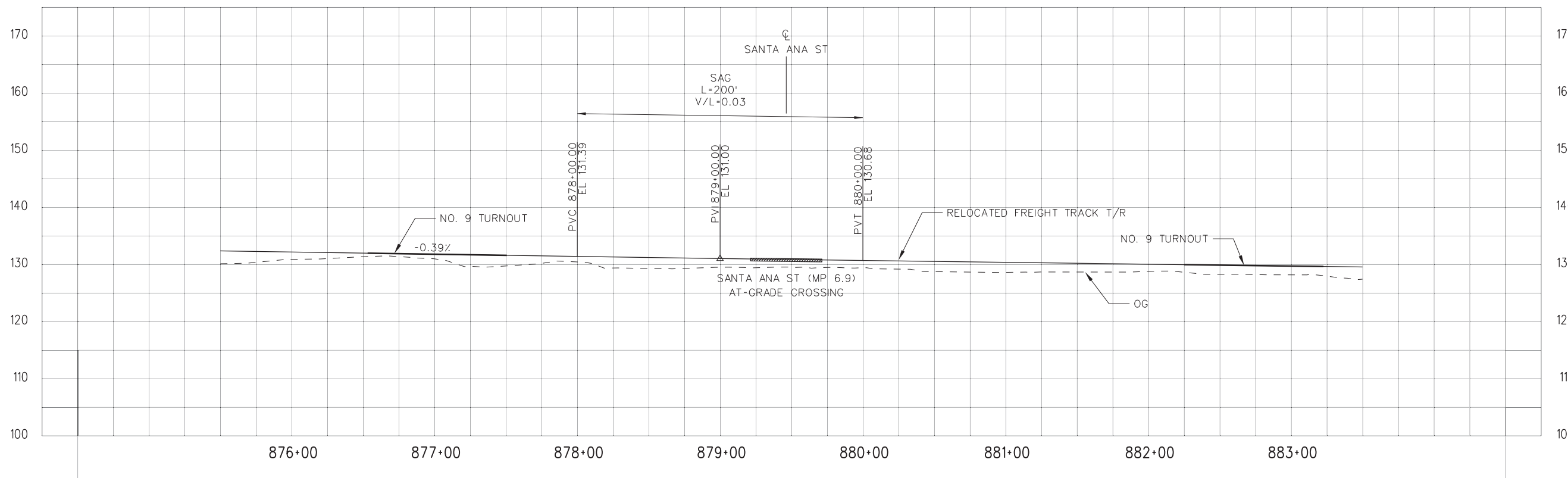
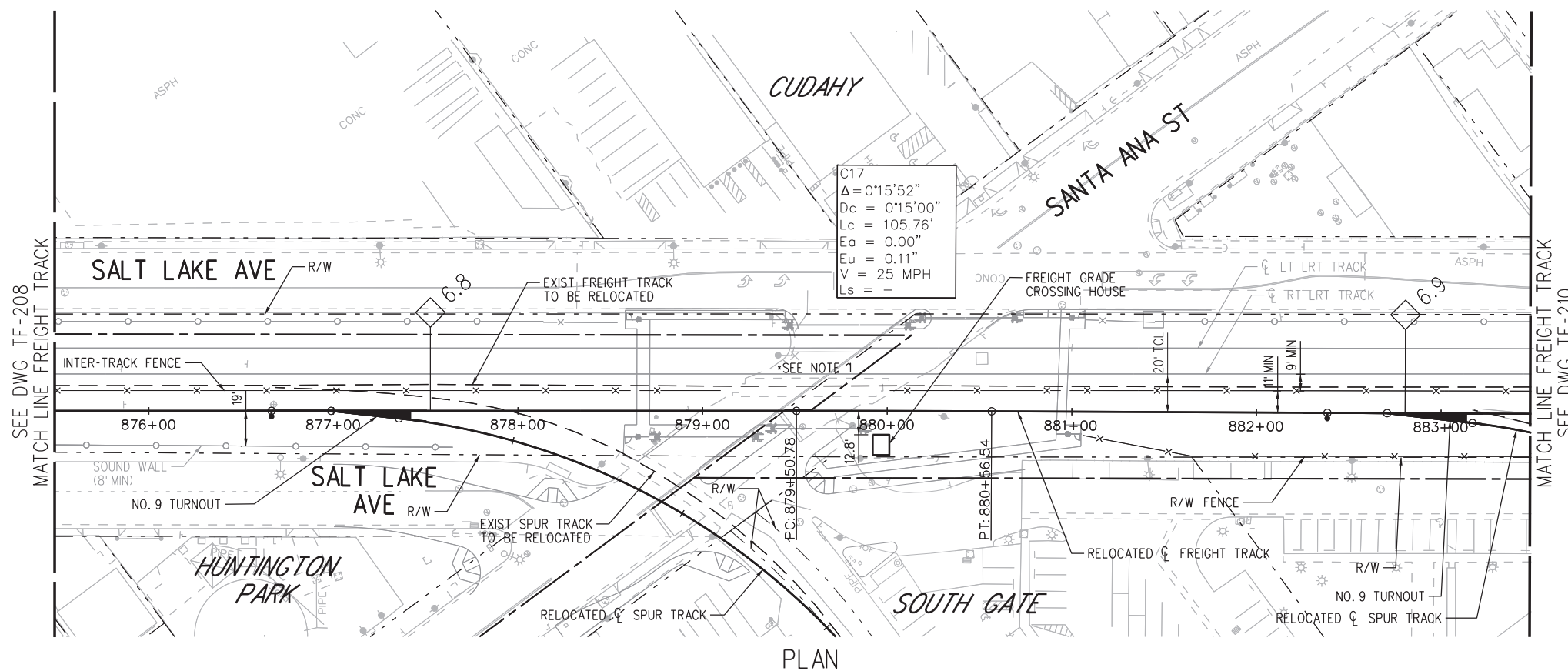

NOT FOR CONSTRUCTION

15-NOV-2019 C-28091ATF 209.plt
22:38

THE PREPARATION OF THIS DRAWING HAS BEEN FINANCED IN PART THROUGH A GRANT FROM THE U.S. DEPARTMENT OF TRANSPORTATION FEDERAL TRANSIT ADMINISTRATION (FTA), UNDER THE FEDERAL TRANSIT ACT OF 1964, AS AMENDED, AND IN PART BY THE TAXES OF THE CITIZENS OF LOS ANGELES COUNTY AND OF THE STATE OF CALIFORNIA.		DESIGNED BY J. SANCHEZ
0	11/15/19	DRAWN BY C. CHEUK
		CHECKED BY R. LOYA
		IN CHARGE N. MAACK
		DATE 11/15/2019
		FINAL CONCEPTUAL DESIGN

M Metro

444 South Flower Street
Suite 800
Los Angeles, CA 90071
TEL (213) 362-9470

wsp

SUBMITTED _____

APPROVED _____

WEST SANTA ANA BRANCH FREIGHT TRACK

TRACK ALIGNMENT

SAN PEDRO BRANCH

PLAN & PROFILE

STA 875+50 TO STA 883+50

CONTRACT NO. AE5999300	REV
DRAWING NO. TF-209	
SCALE HOR: 1"=40' VERT: 1"=10'	
SHEET NO. 41 OF 107	

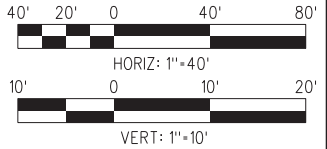
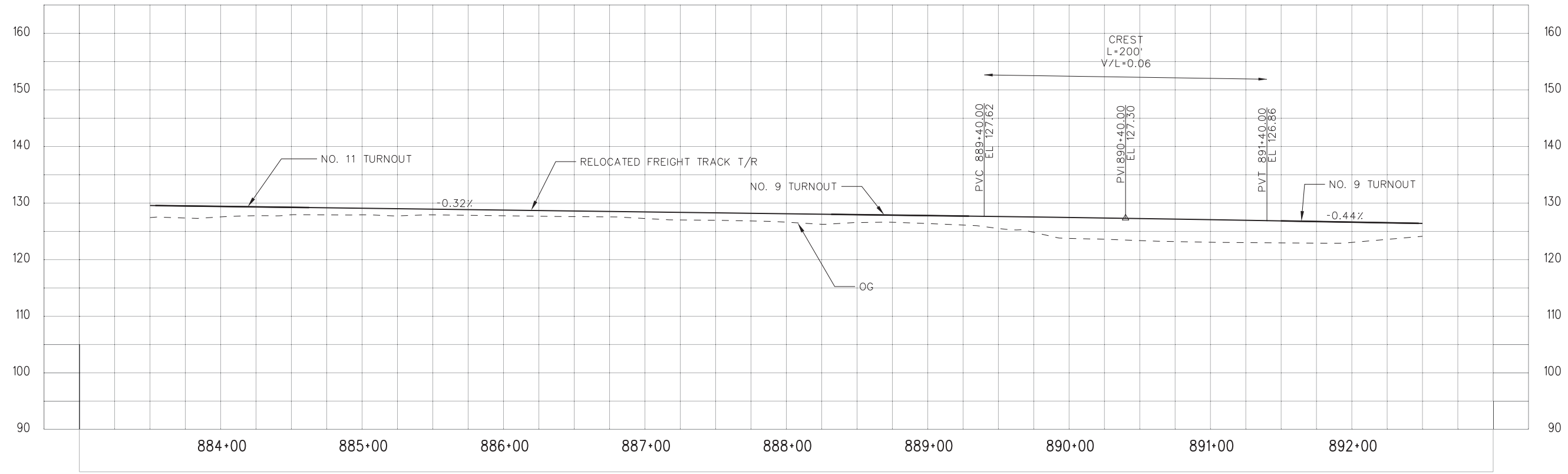
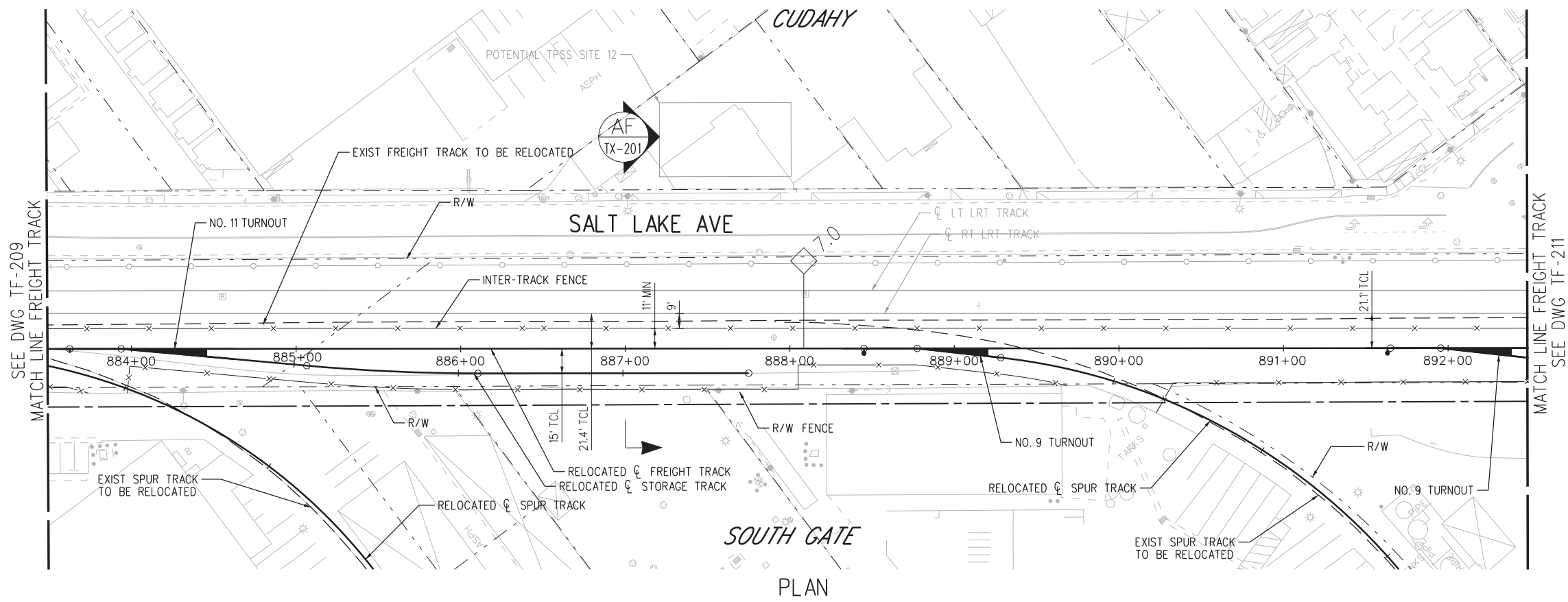

NOT FOR CONSTRUCTION

15-NOV-2019 C-28091ATF 210.plg
svc-projectwise 22:40

THE PREPARATION OF THIS DRAWING HAS BEEN FINANCED IN PART THROUGH A GRANT FROM THE U.S. DEPARTMENT OF TRANSPORTATION FEDERAL TRANSIT ADMINISTRATION (FTA), UNDER THE FEDERAL TRANSIT ACT OF 1964, AS AMENDED, AND IN PART BY THE TAXES OF THE CITIZENS OF LOS ANGELES COUNTY AND OF THE STATE OF CALIFORNIA.		DESIGNED BY J. SANCHEZ
0	11/15/19	DRAWN BY C. CHEUK
		CHECKED BY R. LOYA
		IN CHARGE N. MAACK
		DATE 11/15/2019
		FINAL CONCEPTUAL DESIGN

M Metro

444 South Flower Street
Suite 800
Los Angeles, CA 90071
TEL (213) 362-9470

SUBMITTED _____
APPROVED _____

LOS ANGELES COUNTY METROPOLITAN TRANSPORTATION AUTHORITY

WEST SANTA ANA BRANCH FREIGHT TRACK

TRACK ALIGNMENT
SAN PEDRO BRANCH
PLAN & PROFILE
STA 883+50 TO STA 892+50

CONTRACT NO AE5999300	
DRAWING NO TF-210	REV
SCALE HORIZ: 1"=40' VERT: 1"=10'	
SHEET NO 42	OF 107

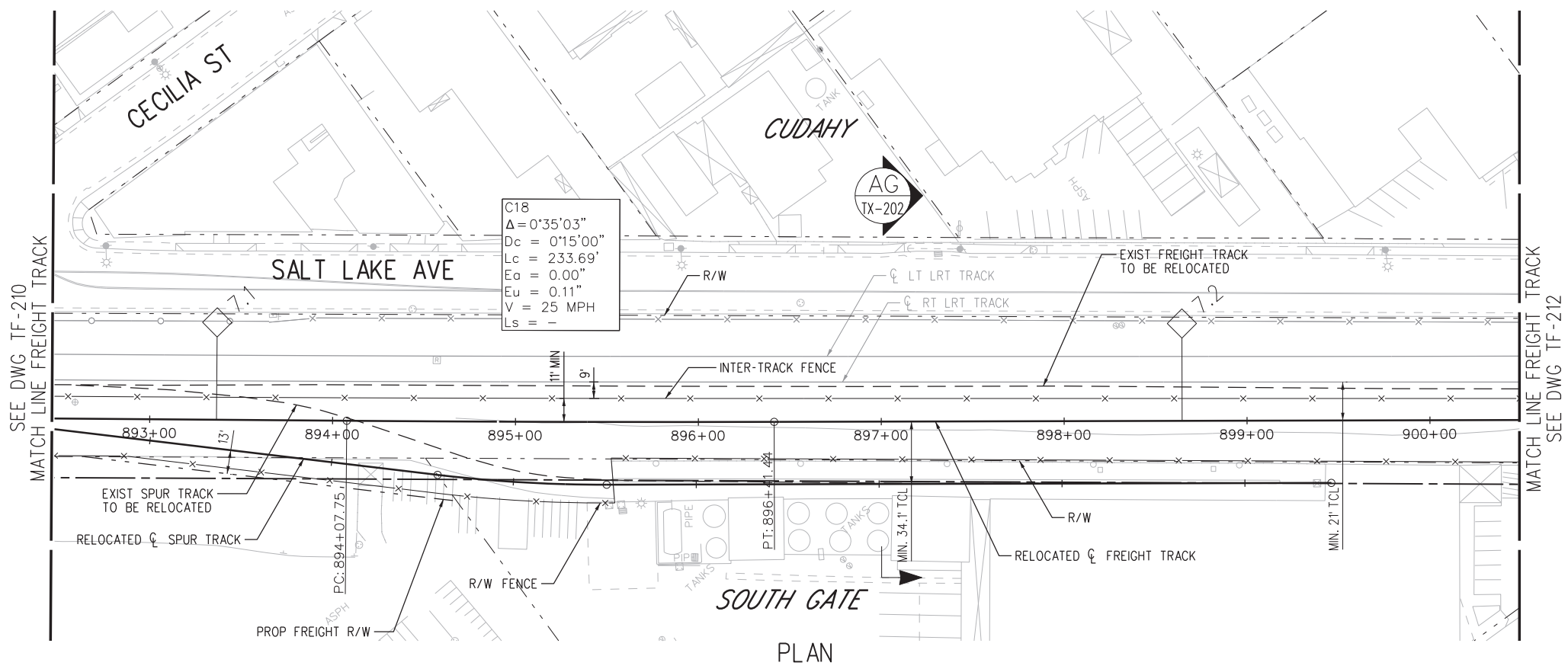

PLAN

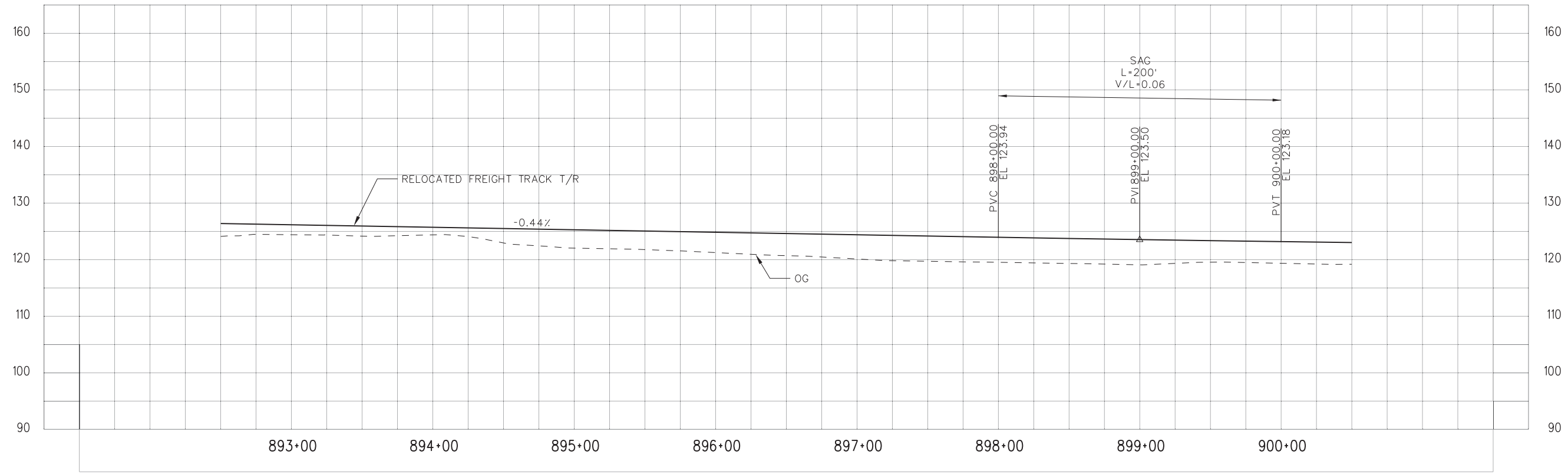

PROFILE

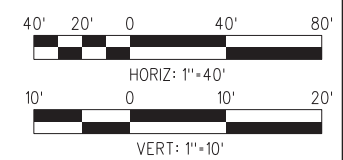

NOT FOR CONSTRUCTION

15-NOV-2019 C-28091ATF 211.plg
svc-projectwise 22:38

THE PREPARATION OF THIS DRAWING HAS BEEN FINANCED IN PART THROUGH A GRANT FROM THE U.S. DEPARTMENT OF TRANSPORTATION FEDERAL TRANSIT ADMINISTRATION (FTA), UNDER THE FEDERAL TRANSIT ACT OF 1964, AS AMENDED, AND IN PART BY THE TAXES OF THE CITIZENS OF LOS ANGELES COUNTY AND OF THE STATE OF CALIFORNIA.	
0	11/15/19
	FINAL CONCEPTUAL DESIGN

DESIGNED BY	J. SANCHEZ
DRAWN BY	C. CHEUK
CHECKED BY	R. LOYA
IN CHARGE	N. MAACK
DATE	11/15/2019

M Metro
LOS ANGELES COUNTY METROPOLITAN TRANSPORTATION AUTHORITY

wsp 444 South Flower Street Suite 800 Los Angeles, CA 90071 TEL (213) 362-9470

SUBMITTED _____
 APPROVED _____

WEST SANTA ANA BRANCH FREIGHT TRACK
TRACK ALIGNMENT
SAN PEDRO BRANCH
PLAN & PROFILE
STA 892+50 TO STA 900+50

CONTRACT NO	AE5999300
DRAWING NO	TF-211
SCALE	HORIZ: 1"=40' VERT: 1"=10'
SHEET NO	43 OF 107



NOTE:
1. REFER TO ADVANCED CONCEPTUAL ENGINEERING GRADE CROSSING PLANS.

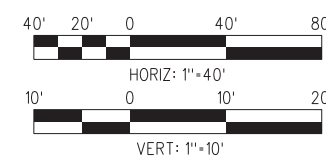
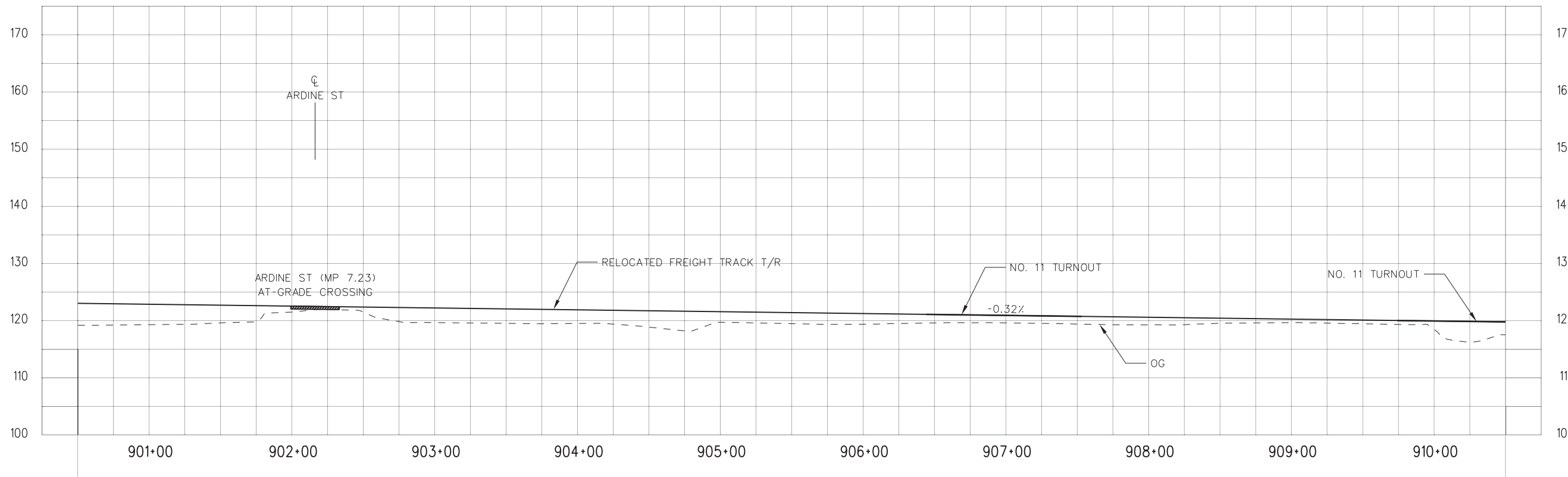
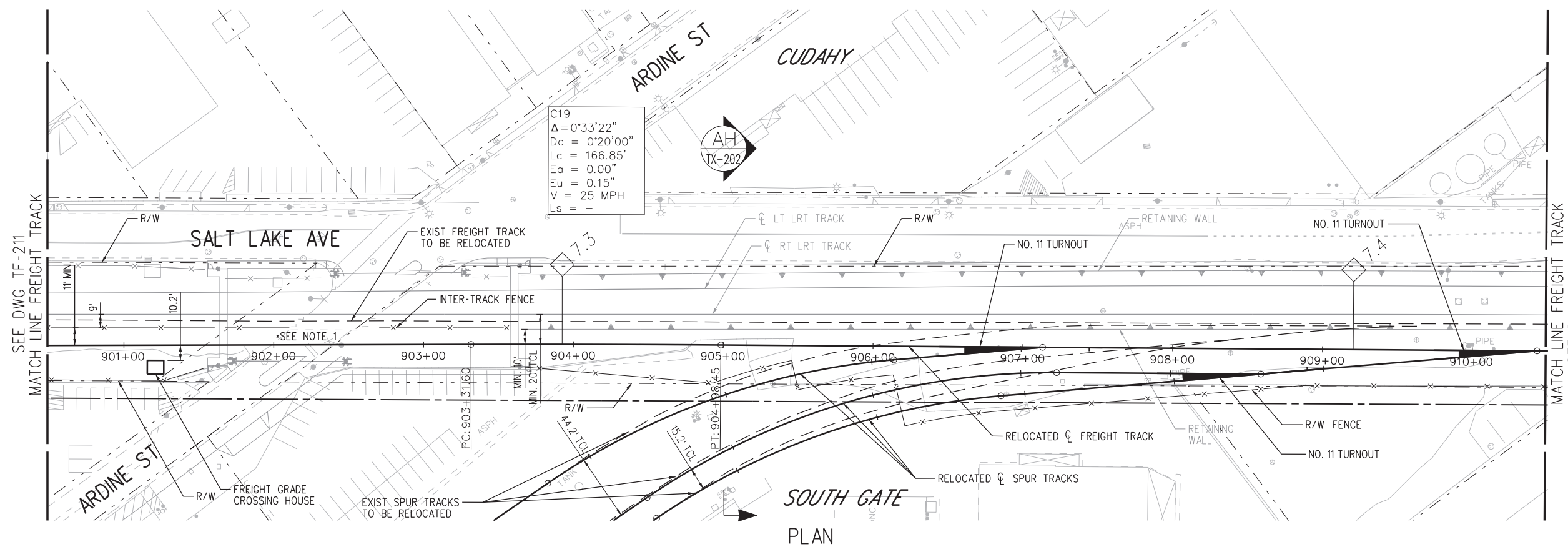

PROFILE

NOT FOR CONSTRUCTION

15-NOV-2019 C-28091ATF 212.plg
svc-projectwise 22:41

THE PREPARATION OF THIS DRAWING HAS BEEN FINANCED IN PART THROUGH A GRANT FROM THE U.S. DEPARTMENT OF TRANSPORTATION FEDERAL TRANSIT ADMINISTRATION (FTA), UNDER THE FEDERAL TRANSIT ACT OF 1964, AS AMENDED, AND IN PART BY THE TAXES OF THE CITIZENS OF LOS ANGELES COUNTY AND OF THE STATE OF CALIFORNIA.		DESIGNED BY J. SANCHEZ	 444 South Flower Street Suite 800 Los Angeles, CA 90071 TEL (213) 362-9470	CONTRACT NO. AE5999300
		DRAWN BY C. CHEUK		DRAWING NO. TF-212
		CHECKED BY R. LOYA		SCALE HOR: 1"=40' VERT: 1"=10'
		IN CHARGE N. MAACK		SHEET NO. 44 OF 107
0	11/15/19	DATE 11/15/2019		

Plot Driver=MTA-half.pen Pentable=bw.plt



NOTE:
1. REFER TO ADVANCED CONCEPTUAL ENGINEERING GRADE CROSSING PLANS.

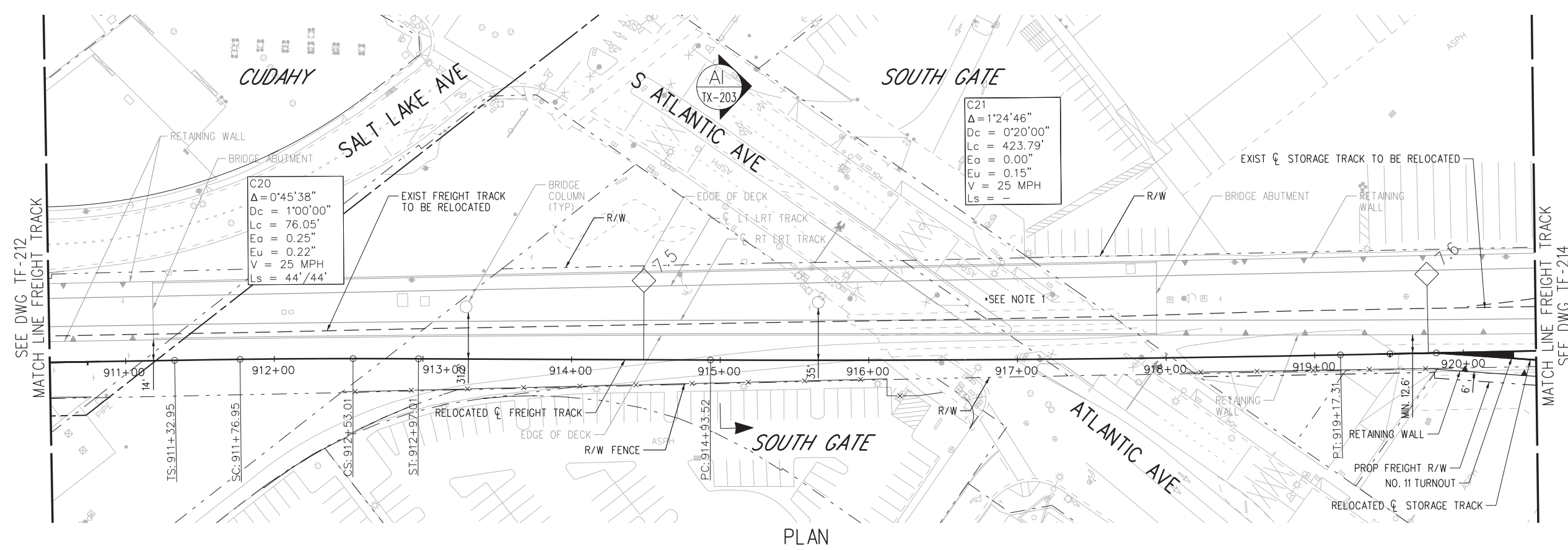

PLAN

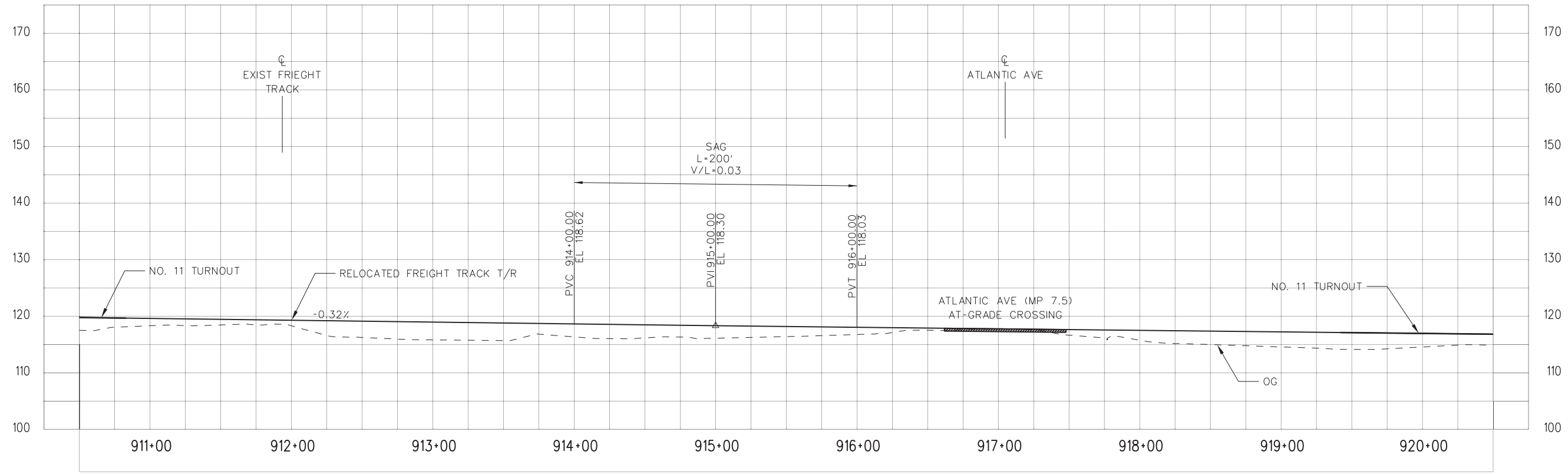

PROFILE

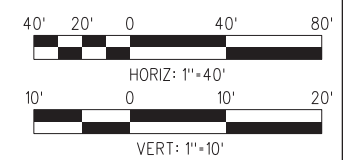

NOT FOR CONSTRUCTION

15-NOV-2019 C-28091ATF 213.plg
svc-projectwise 22:38

THE PREPARATION OF THIS DRAWING HAS BEEN FINANCED IN PART THROUGH A GRANT FROM THE U.S. DEPARTMENT OF TRANSPORTATION FEDERAL TRANSIT ADMINISTRATION (FTA), UNDER THE FEDERAL TRANSIT ACT OF 1964, AS AMENDED, AND IN PART BY THE TAXES OF THE CITIZENS OF LOS ANGELES COUNTY AND OF THE STATE OF CALIFORNIA.		DESIGNED BY J. SANCHEZ
0	11/15/19	DRAWN BY C. CHEUK
		CHECKED BY R. LOYA
		IN CHARGE N. MAACK
		DATE 11/15/2019
		FINAL CONCEPTUAL DESIGN

M Metro
 444 South Flower Street
 Suite 800
 Los Angeles, CA 90071
 TEL (213) 362-9470

wsp

SUBMITTED _____
 APPROVED _____

**WEST SANTA ANA BRANCH FREIGHT TRACK
 TRACK ALIGNMENT
 SAN PEDRO BRANCH
 PLAN & PROFILE
 STA 910+50 TO STA 920+50**

CONTRACT NO. AE5999300	REV
DRAWING NO. TF-213	
SCALE HOR: 1"=40' VERT: 1"=10'	
SHEET NO. 45 OF 107	

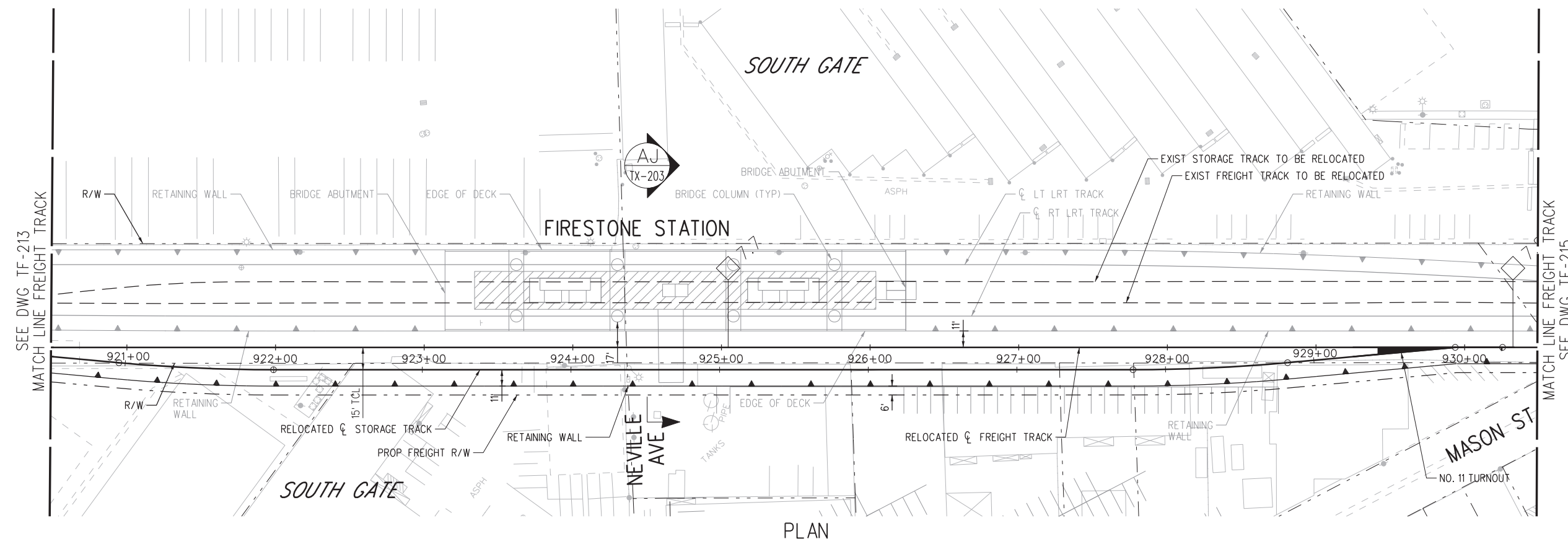

PLAN

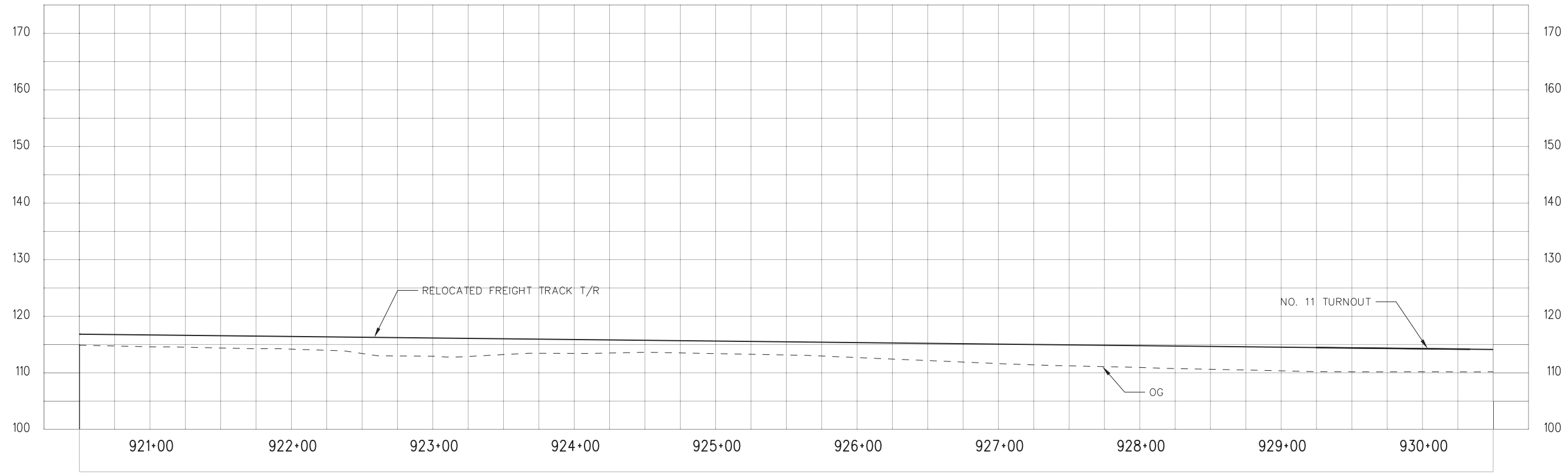

PROFILE

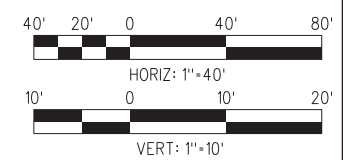

NOT FOR CONSTRUCTION

15-NOV-2019 C-28091ATF 214.plg

svc-projectwise 22:40

THE PREPARATION OF THIS DRAWING HAS BEEN FINANCED IN PART THROUGH A GRANT FROM THE U.S. DEPARTMENT OF TRANSPORTATION FEDERAL TRANSIT ADMINISTRATION (FTA), UNDER THE FEDERAL TRANSIT ACT OF 1964, AS AMENDED, AND IN PART BY THE TAXES OF THE CITIZENS OF LOS ANGELES COUNTY AND OF THE STATE OF CALIFORNIA.		DESIGNED BY J. SANCHEZ	 LOS ANGELES COUNTY METROPOLITAN TRANSPORTATION AUTHORITY	CONTRACT NO. AE5999300
		DRAWN BY C. CHEUK		DRAWING NO. TF-214
		CHECKED BY R. LOYA		SCALE HORIZ: 1"=40' VERT: 1"=10'
		IN CHARGE N. MAACK		SHEET NO. 46 OF 107
0	11/15/19	DATE 11/15/2019		

FINAL CONCEPTUAL DESIGN

 444 South Flower Street Suite 800 Los Angeles, CA 90071 TEL (213) 362-9470	SUBMITTED _____ APPROVED _____
---	-----------------------------------

**WEST SANTA ANA BRANCH FREIGHT TRACK
 TRACK ALIGNMENT
 SAN PEDRO BRANCH
 PLAN & PROFILE
 STA 920+50 TO STA 930+50**



NOTE:
1. REFER TO ADVANCED CONCEPTUAL ENGINEERING GRADE CROSSING PLANS.

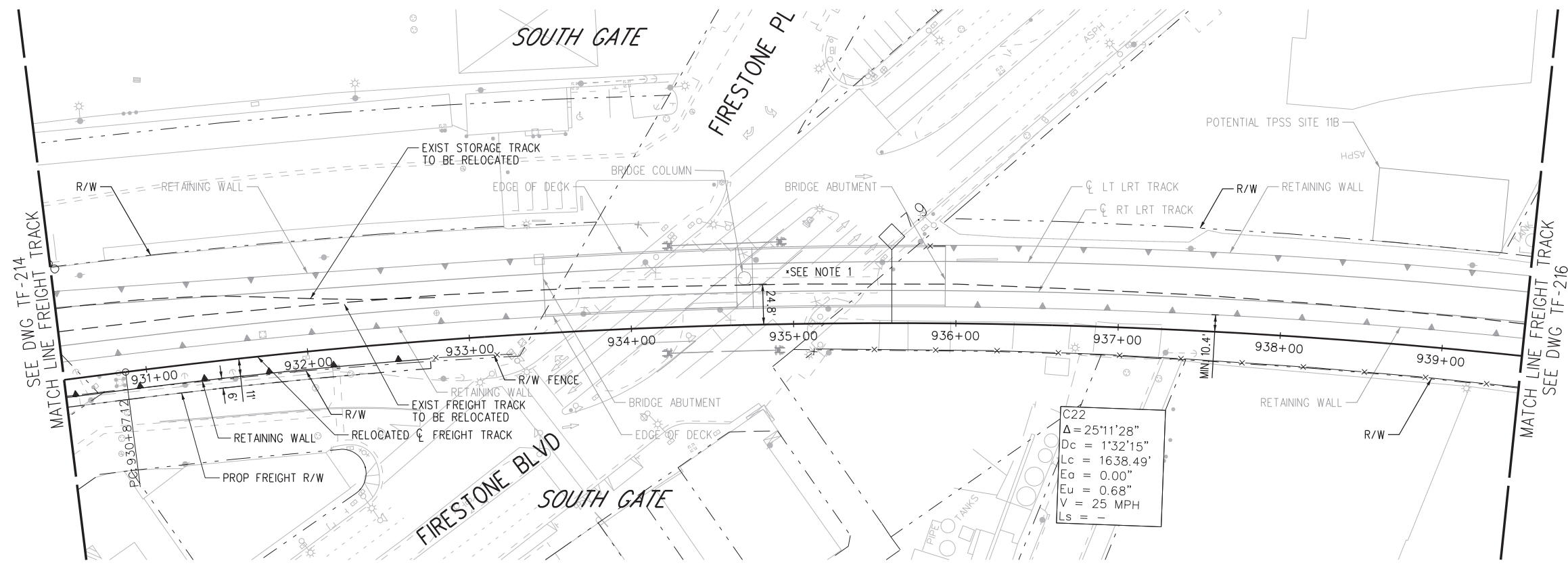

C22
 $\Delta = 25'11'28''$
 $Dc = 1'32'15''$
 $Lc = 1638.49'$
 $Ea = 0.00''$
 $Eu = 0.68''$
 $V = 25 \text{ MPH}$
 $Ls = -$

PLAN

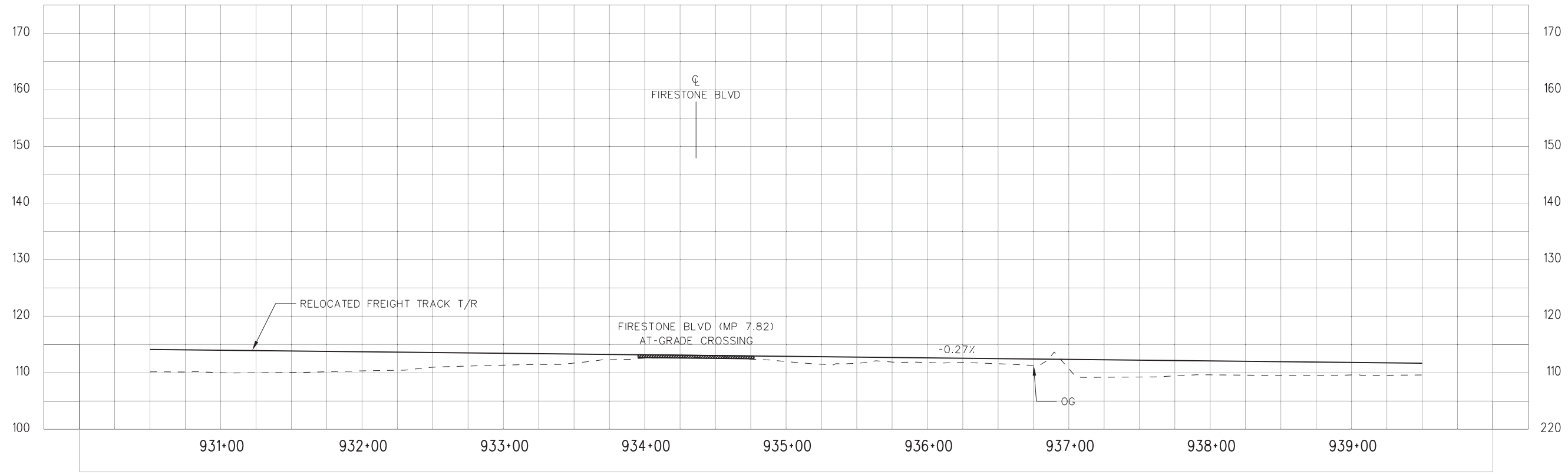

PROFILE

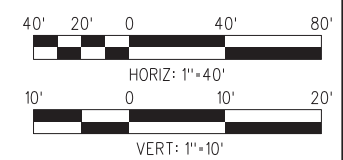

NOT FOR CONSTRUCTION

15-NOV-2019 C-28091ATF 215.plg
 svc-projectwise 22:38

THE PREPARATION OF THIS DRAWING HAS BEEN FINANCED IN PART THROUGH A GRANT FROM THE U.S. DEPARTMENT OF TRANSPORTATION FEDERAL TRANSIT ADMINISTRATION (FTA), UNDER THE FEDERAL TRANSIT ACT OF 1964, AS AMENDED, AND IN PART BY THE TAXES OF THE CITIZENS OF LOS ANGELES COUNTY AND OF THE STATE OF CALIFORNIA.		DESIGNED BY J. SANCHEZ
		DRAWN BY C. CHEUK
		CHECKED BY R. LOYA
		IN CHARGE N. MAACK
		DATE 11/15/2019
0	11/15/19	FINAL CONCEPTUAL DESIGN

 LOS ANGELES COUNTY METROPOLITAN TRANSPORTATION AUTHORITY	
 444 South Flower Street Suite 800 Los Angeles, CA 90071 TEL (213) 362-9470	SUBMITTED _____ APPROVED _____

WEST SANTA ANA BRANCH FREIGHT TRACK CONTRACT NO. AE5999300	
DRAWING NO. TF-215 SCALE: HOR: 1"=40' VERT: 1"=10'	REV SHEET NO. 47 OF 107

TRACK ALIGNMENT SAN PEDRO BRANCH PLAN & PROFILE STA 930+50 TO STA 939+50	
---	--

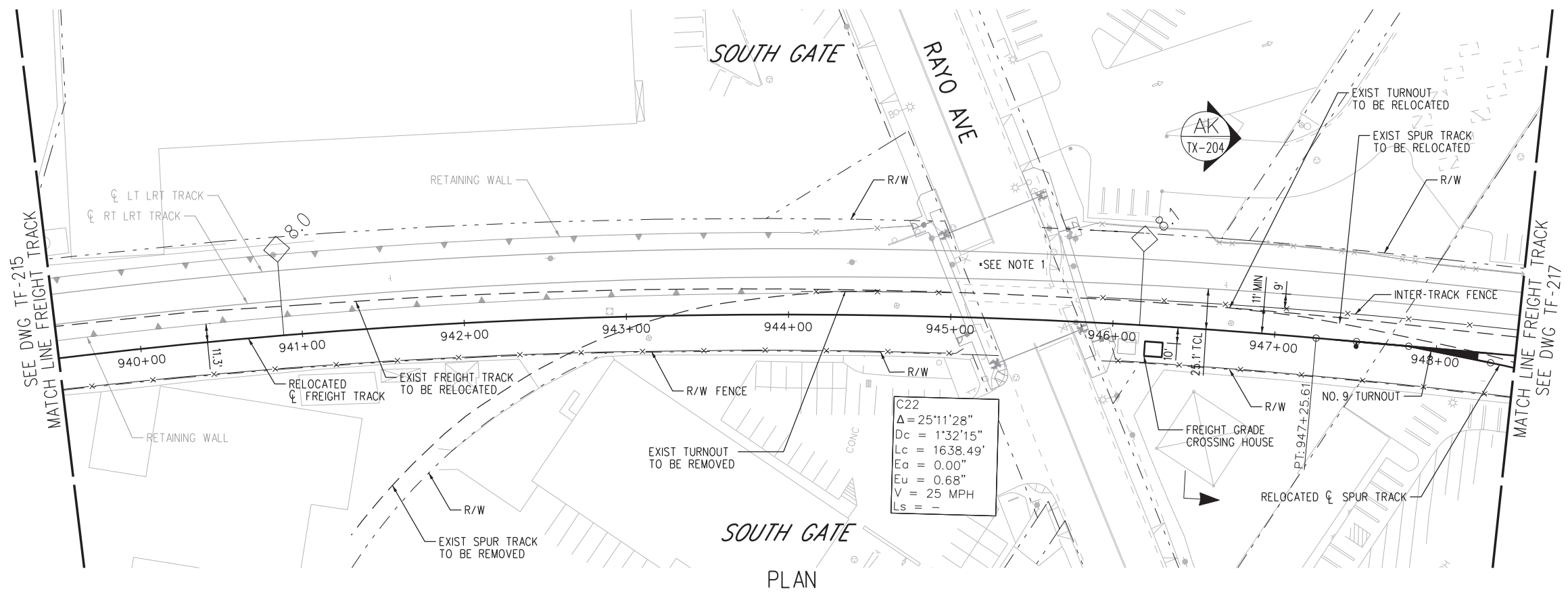

NOTE:
1. REFER TO ADVANCED CONCEPTUAL ENGINEERING GRADE CROSSING PLANS.

C22
 $\Delta = 25'11.28"$
 $Dc = 1'32.15"$
 $Lc = 1638.49'$
 $Ea = 0.00"$
 $Eu = 0.68"$
 $V = 25 \text{ MPH}$
 $Ls = -$

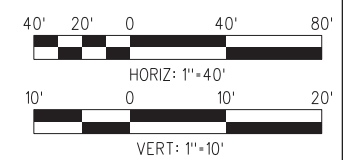
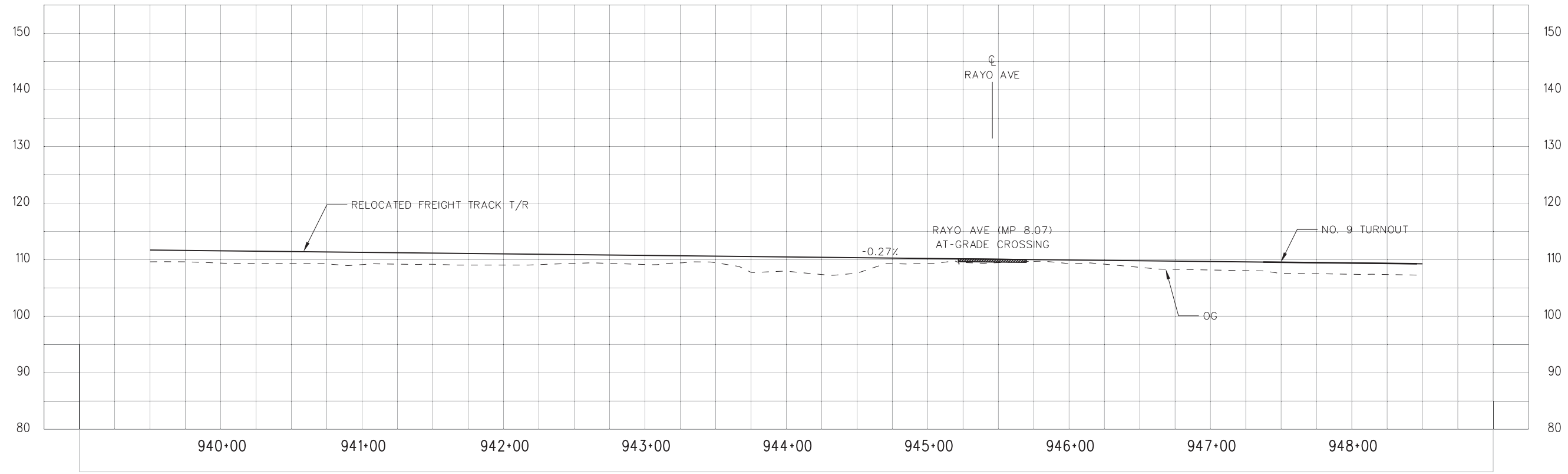

NOT FOR CONSTRUCTION

15-NOV-2019 C-28091ATF 216.plt
 svc-projectwise 22:40

THE PREPARATION OF THIS DRAWING HAS BEEN FINANCED IN PART THROUGH A GRANT FROM THE U.S. DEPARTMENT OF TRANSPORTATION FEDERAL TRANSIT ADMINISTRATION (FTA), UNDER THE FEDERAL TRANSIT ACT OF 1964, AS AMENDED, AND IN PART BY THE TAXES OF THE CITIZENS OF LOS ANGELES COUNTY AND OF THE STATE OF CALIFORNIA.		DESIGNED BY J. SANCHEZ
		DRAWN BY C. CHEUK
		CHECKED BY R. LOYA
		IN CHARGE N. MAACK
		DATE 11/15/2019
0	11/15/19	FINAL CONCEPTUAL DESIGN

LOS ANGELES COUNTY METROPOLITAN TRANSPORTATION AUTHORITY	
444 South Flower Street Suite 800 Los Angeles, CA 90071 TEL (213) 362-9470	SUBMITTED _____ APPROVED _____

WEST SANTA ANA BRANCH FREIGHT TRACK TRACK ALIGNMENT SAN PEDRO BRANCH PLAN & PROFILE STA 939+50 TO STA 948+50	
CONTRACT NO. AE5999300	REV
DRAWING NO. TF-216	
SCALE HORIZ: 1"=40' VERT: 1"=10'	
SHEET NO. 48	OF 107



NOTE:

1. REFER TO ADVANCED CONCEPTUAL ENGINEERING GRADE CROSSING PLANS.

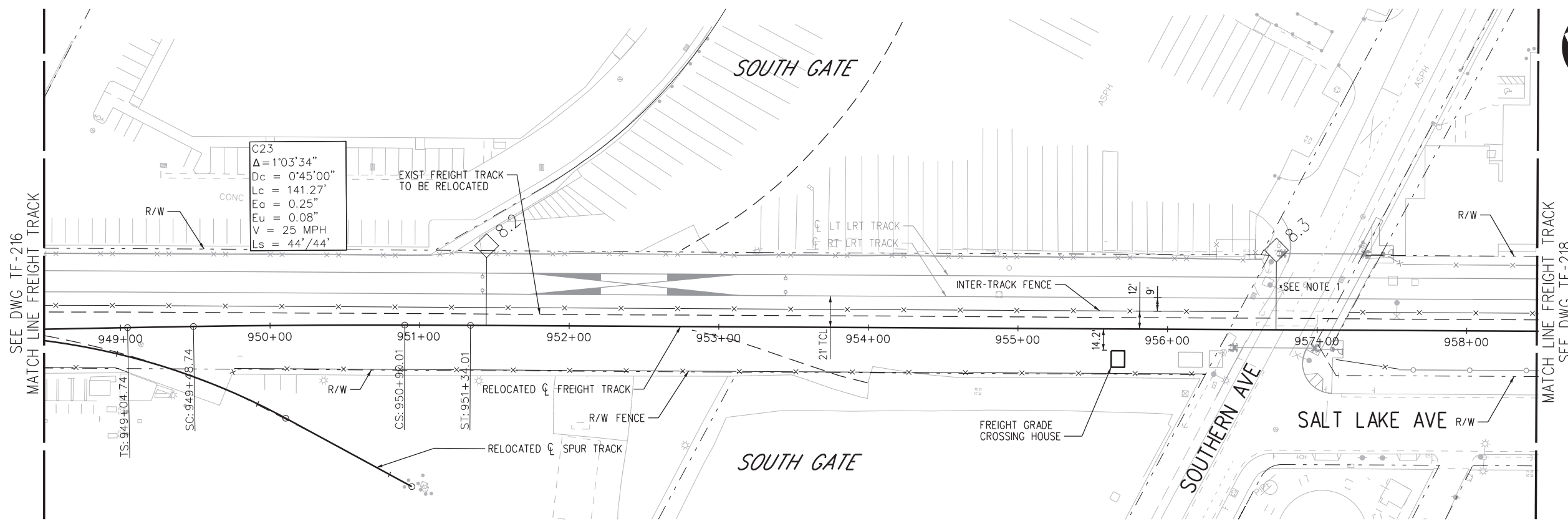

PLAN

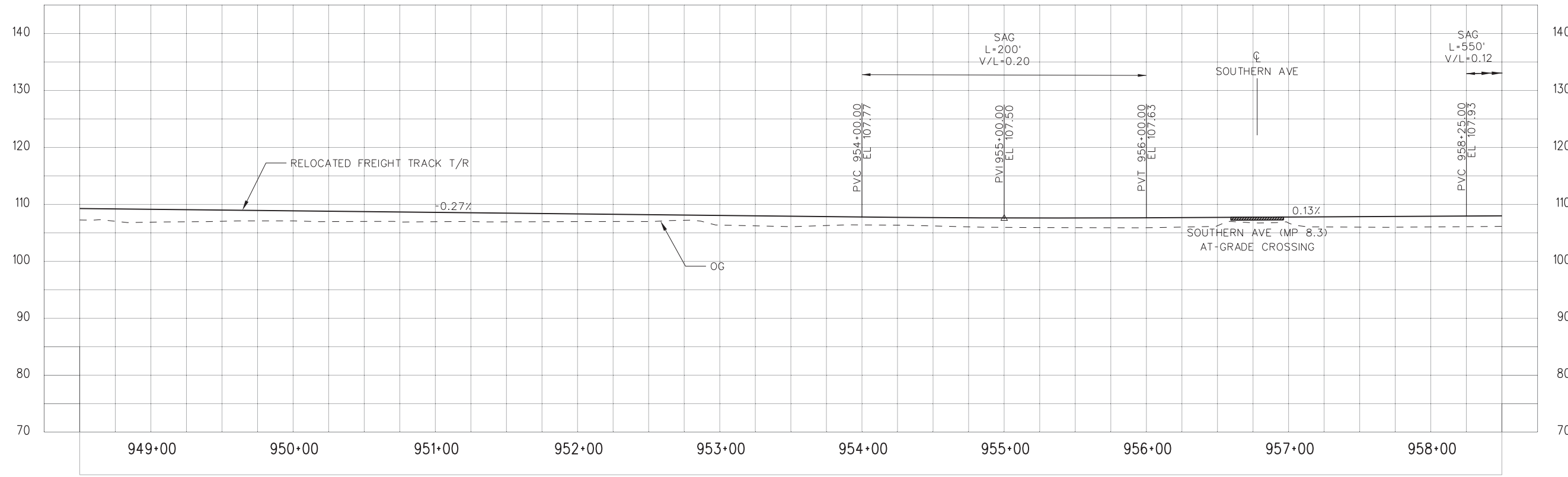

PROFILE

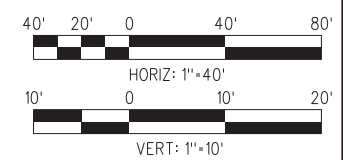

NOT FOR CONSTRUCTION

15-NOV-2019 C-28091ATF 217.plg
svc-projectwise 22:39

THE PREPARATION OF THIS DRAWING HAS BEEN FINANCED IN PART THROUGH A GRANT FROM THE U.S. DEPARTMENT OF TRANSPORTATION FEDERAL TRANSIT ADMINISTRATION (FTA), UNDER THE FEDERAL TRANSIT ACT OF 1964, AS AMENDED, AND IN PART BY THE TAXES OF THE CITIZENS OF LOS ANGELES COUNTY AND OF THE STATE OF CALIFORNIA.	
0	11/15/19
	FINAL CONCEPTUAL DESIGN

DESIGNED BY J. SANCHEZ
DRAWN BY C. CHEUK
CHECKED BY R. LOYA
IN CHARGE N. MAACK
DATE 11/15/2019

M Metro
wsp 444 South Flower Street Suite 800 Los Angeles, CA 90071 TEL (213) 362-9470

SUBMITTED _____
 APPROVED _____

WEST SANTA ANA BRANCH FREIGHT TRACK
TRACK ALIGNMENT
SAN PEDRO BRANCH
PLAN & PROFILE
STA 948+50 TO STA 958+50

CONTRACT NO
AE5999300

DRAWING NO
TF-217

SCALE
HORIZ: 1"=40'
VERT: 1"=10'

SHEET NO
49 OF 107

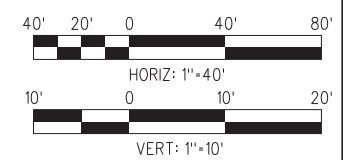
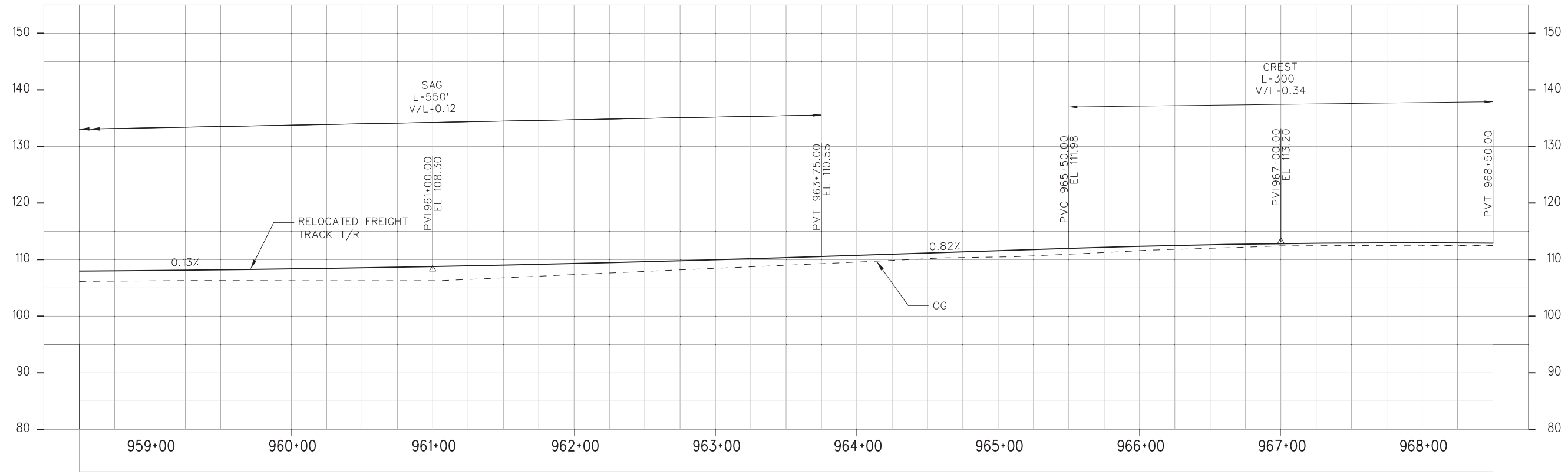
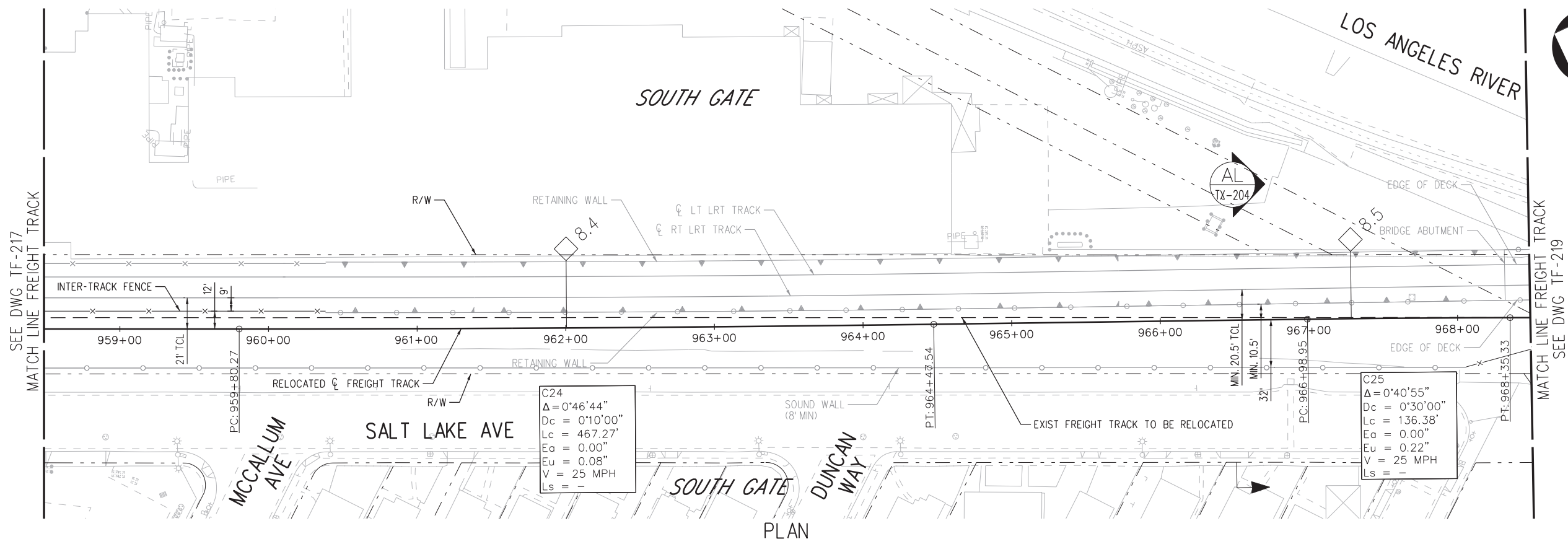

NOT FOR CONSTRUCTION

15-NOV-2019 C-28091ATF 218.plg
 svc-projectwise 22:40

THE PREPARATION OF THIS DRAWING HAS BEEN FINANCED IN PART THROUGH A GRANT FROM THE U.S. DEPARTMENT OF TRANSPORTATION FEDERAL TRANSIT ADMINISTRATION (FTA), UNDER THE FEDERAL TRANSIT ACT OF 1964, AS AMENDED, AND IN PART BY THE TAXES OF THE CITIZENS OF LOS ANGELES COUNTY AND OF THE STATE OF CALIFORNIA.		DESIGNED BY J. SANCHEZ
		DRAWN BY C. CHEUK
		CHECKED BY R. LOYA
		IN CHARGE N. MAACK
		DATE 11/15/2019
0	11/15/19	FINAL CONCEPTUAL DESIGN

Metro

wsp

444 South Flower Street
 Suite 800
 Los Angeles, CA 90071
 TEL (213) 362-9470

SUBMITTED _____

APPROVED _____

LOS ANGELES COUNTY METROPOLITAN TRANSPORTATION AUTHORITY

WEST SANTA ANA BRANCH FREIGHT TRACK

TRACK ALIGNMENT

SAN PEDRO BRANCH

PLAN & PROFILE

STA 958+50 TO STA 968+50

CONTRACT NO AE5999300	
DRAWING NO TF-218	REV
SCALE HORIZ: 1"=40' VERT: 1"=10'	
SHEET NO 50	OF 107



NOTE:
 1. EXISTING TRACK WILL BE LINE AND SURFACE 200' BEYOND THE END OF NEW CONSTRUCTION.

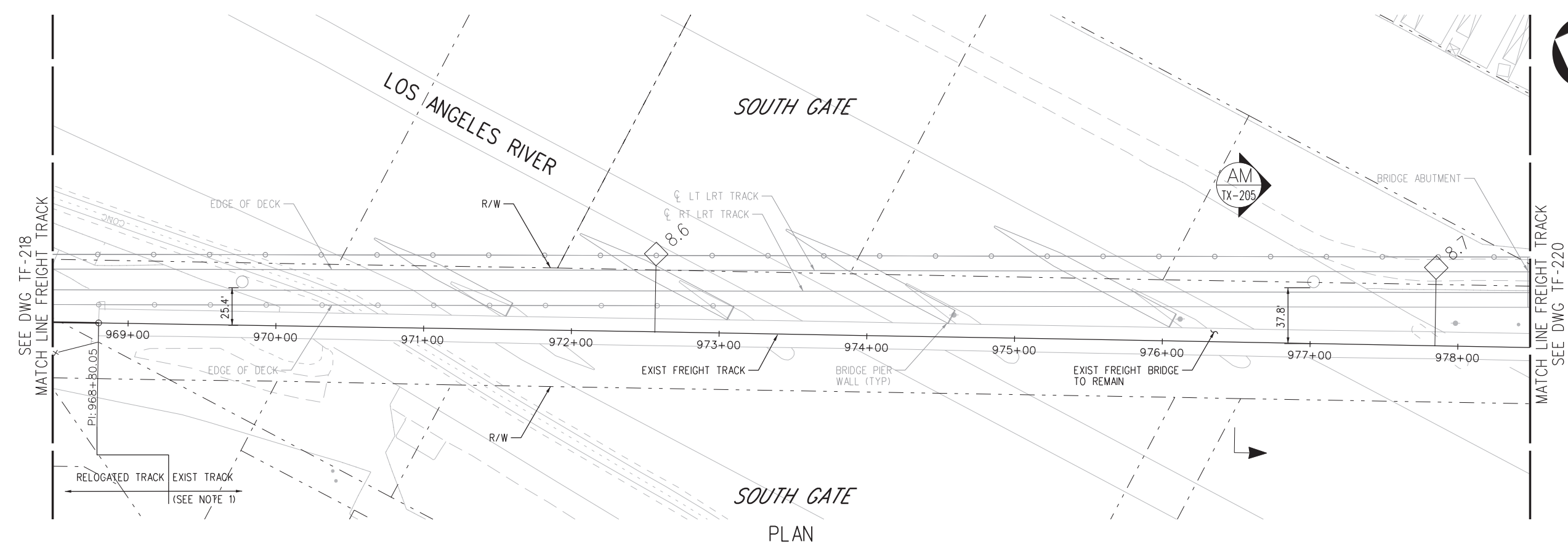

PLAN

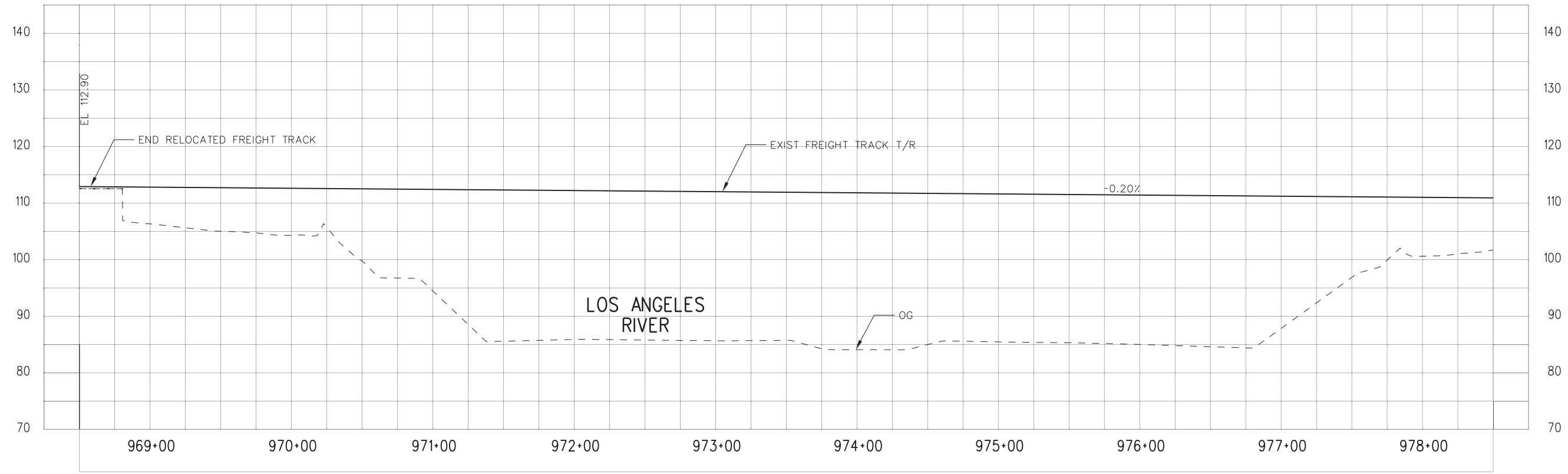

PROFILE

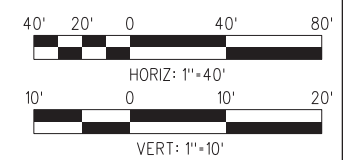

NOT FOR CONSTRUCTION

15-NOV-2019 C-28091ATF 219.plt
 svc-projectwise 22:36

THE PREPARATION OF THIS DRAWING HAS BEEN FINANCED IN PART THROUGH A GRANT FROM THE U.S. DEPARTMENT OF TRANSPORTATION FEDERAL TRANSIT ADMINISTRATION (FTA), UNDER THE FEDERAL TRANSIT ACT OF 1964, AS AMENDED, AND IN PART BY THE TAXES OF THE CITIZENS OF LOS ANGELES COUNTY AND OF THE STATE OF CALIFORNIA.		DESIGNED BY J. SANCHEZ	 LOS ANGELES COUNTY METROPOLITAN TRANSPORTATION AUTHORITY	CONTRACT NO. AE5999300
		DRAWN BY C. CHEUK		DRAWING NO. TF-219
		CHECKED BY R. LOYA		SCALE HOR: 1"=40' VERT: 1"=10'
		IN CHARGE N. MAACK		SHEET NO. 51 OF 107
0	11/15/19	DATE 11/15/2019		

FINAL CONCEPTUAL DESIGN

wsp 444 South Flower Street Suite 800 Los Angeles, CA 90071 TEL (213) 362-9470

SUBMITTED _____

APPROVED _____

**WEST SANTA ANA BRANCH FREIGHT TRACK
 TRACK ALIGNMENT
 SAN PEDRO BRANCH
 PLAN & PROFILE
 STA 968+50 TO STA 978+50**

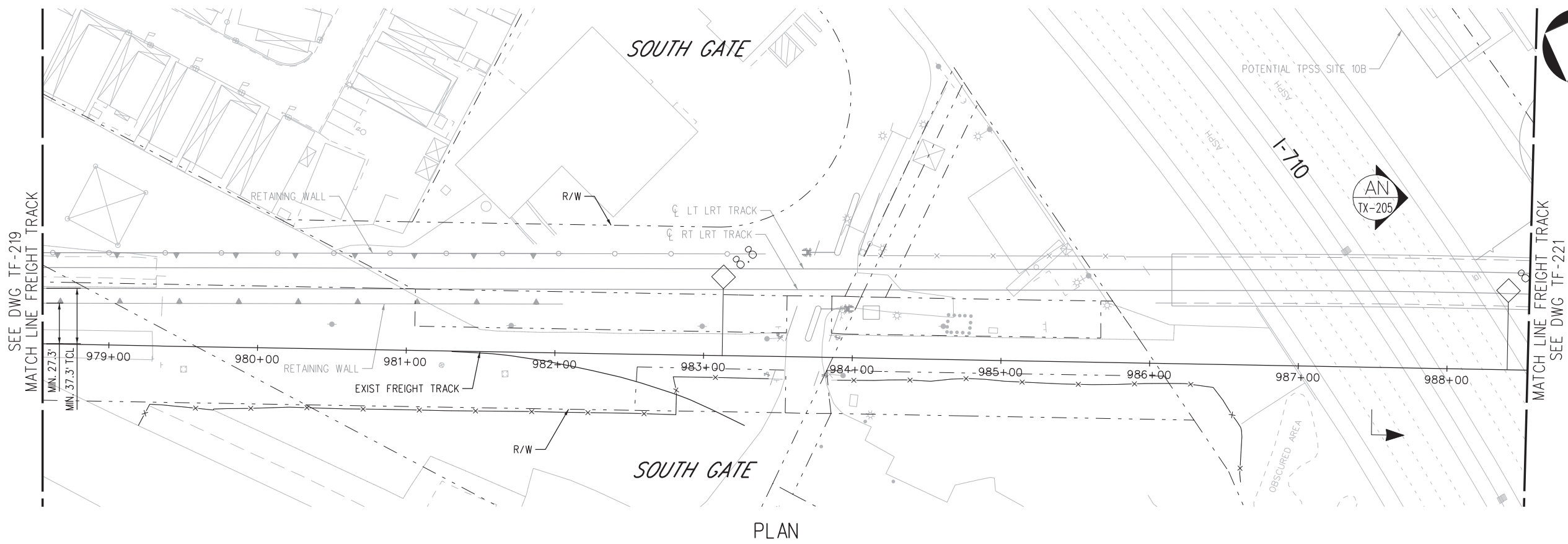

PLAN

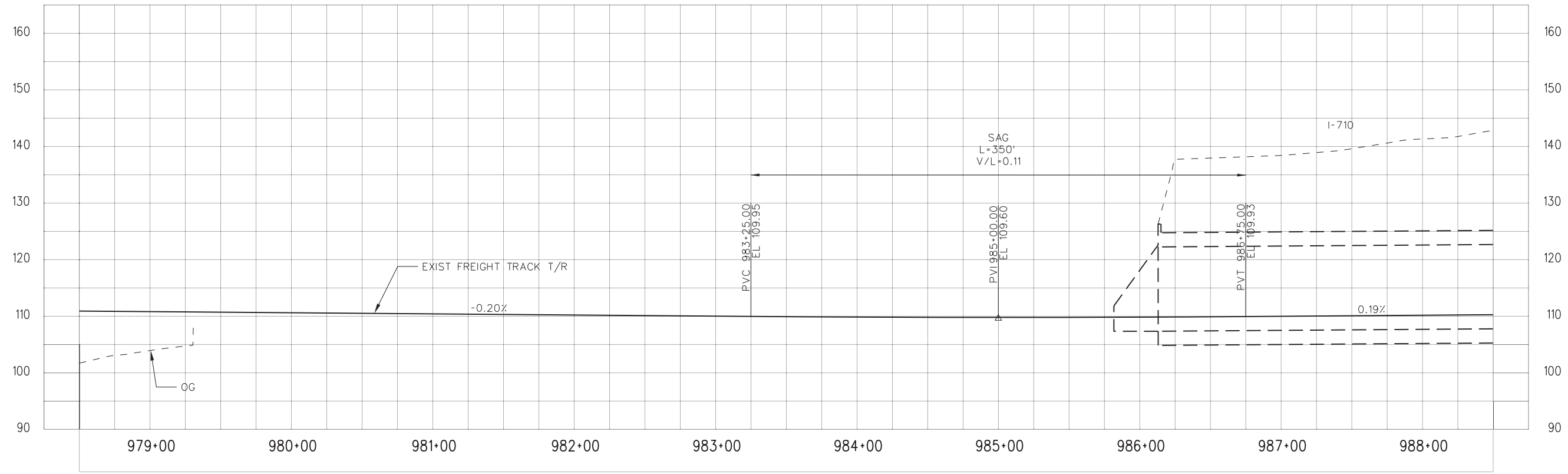

PROFILE

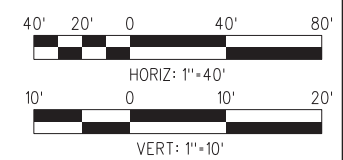

NOT FOR CONSTRUCTION

15-NOV-2019 C-28091ATF220.plg
svc-projectwise 22:36

THE PREPARATION OF THIS DRAWING HAS BEEN FINANCED IN PART THROUGH A GRANT FROM THE U.S. DEPARTMENT OF TRANSPORTATION FEDERAL TRANSIT ADMINISTRATION (FTA), UNDER THE FEDERAL TRANSIT ACT OF 1964, AS AMENDED, AND IN PART BY THE TAKES OF THE CITIZENS OF LOS ANGELES COUNTY AND OF THE STATE OF CALIFORNIA.		DESIGNED BY J. SANCHEZ
		DRAWN BY C. CHEUK
		CHECKED BY R. LOYA
		IN CHARGE N. MAACK
		DATE 11/15/2019
0	11/15/19	FINAL CONCEPTUAL DESIGN

M Metro
444 South Flower Street
Suite 800
Los Angeles, CA 90071
TEL (213) 362-9470

wsp

SUBMITTED _____
APPROVED _____

**WEST SANTA ANA BRANCH FREIGHT TRACK
TRACK ALIGNMENT
SAN PEDRO BRANCH
PLAN & PROFILE
STA 978+50 TO STA 988+50**

CONTRACT NO. AE5999300	REV
DRAWING NO. TF-220	
SCALE HORIZ: 1"=40' VERT: 1"=10'	
SHEET NO. 52 OF 107	

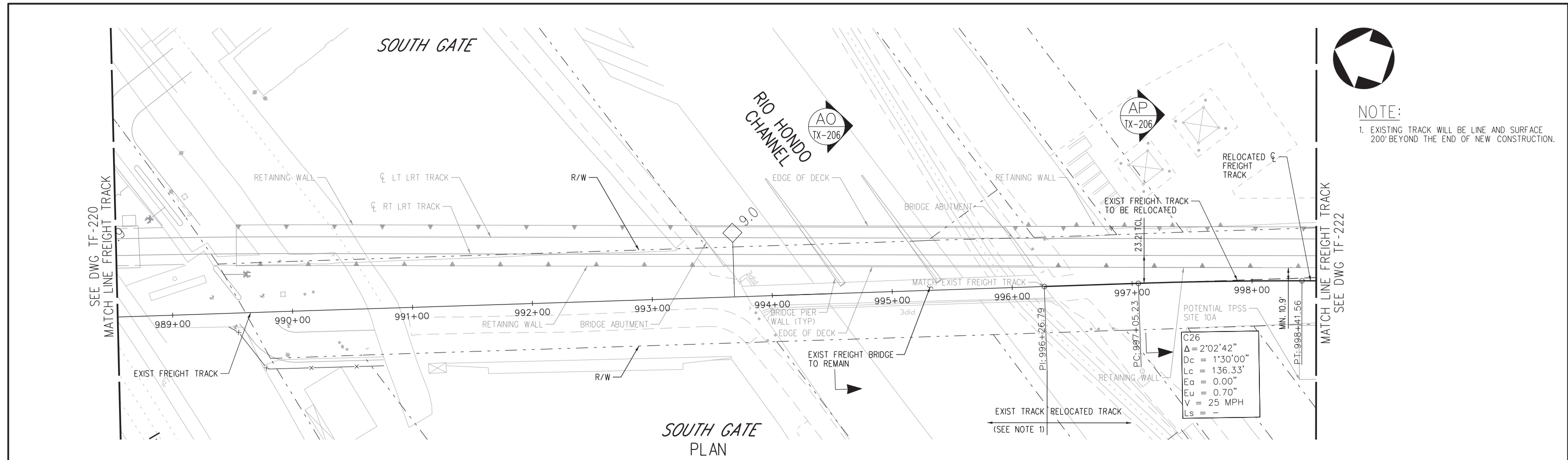

NOTE:
 1. EXISTING TRACK WILL BE LINE AND SURFACE 200' BEYOND THE END OF NEW CONSTRUCTION.

SOUTH GATE PLAN

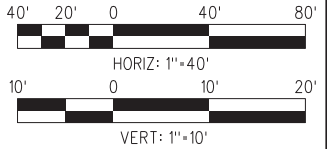
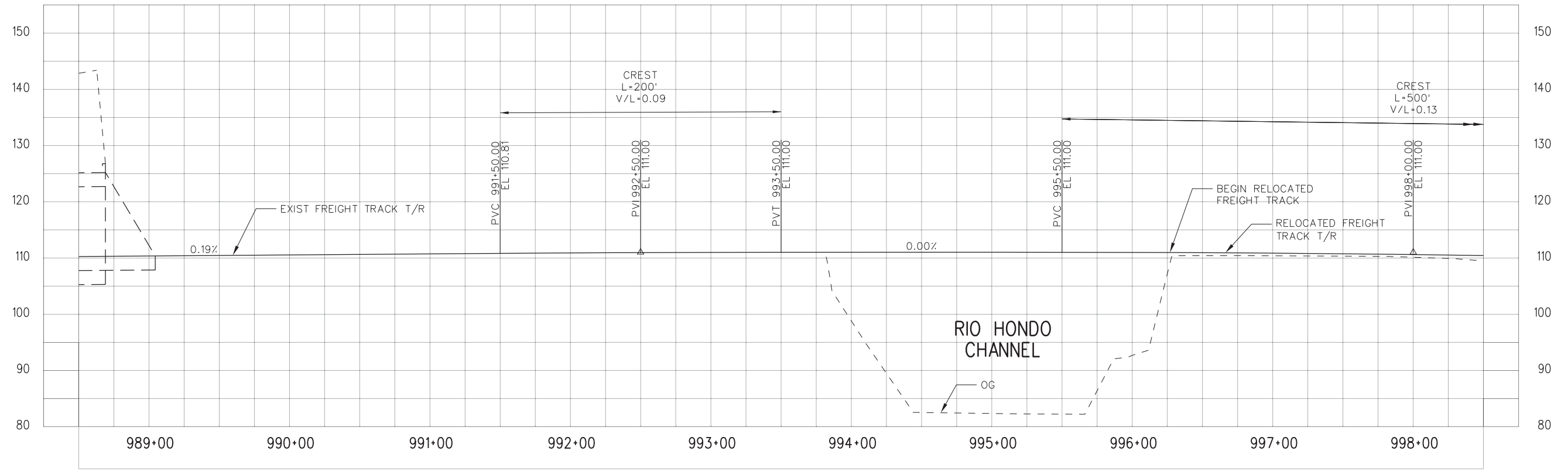

PROFILE

NOT FOR CONSTRUCTION

15-NOV-2019 C-28091ATF 221.plg
 svc-projectwise 22:39

THE PREPARATION OF THIS DRAWING HAS BEEN FINANCED IN PART THROUGH A GRANT FROM THE U.S. DEPARTMENT OF TRANSPORTATION FEDERAL TRANSIT ADMINISTRATION (FTA), UNDER THE FEDERAL TRANSIT ACT OF 1964, AS AMENDED, AND IN PART BY THE TAXES OF THE CITIZENS OF LOS ANGELES COUNTY AND OF THE STATE OF CALIFORNIA.		DESIGNED BY J. SANCHEZ DRAWN BY C. CHEUK CHECKED BY R. LOYA IN CHARGE N. MAACK DATE 11/15/2019
0	11/15/19	FINAL CONCEPTUAL DESIGN

LOS ANGELES COUNTY METROPOLITAN TRANSPORTATION AUTHORITY

 444 South Flower Street Suite 800 Los Angeles, CA 90071 TEL (213) 362-9470

SUBMITTED _____ APPROVED _____	CONTRACT NO AE5999300 DRAWING NO TF-221 SCALE HOR: 1"=40' VERT: 1"=10' SHEET NO 53 OF 107
-----------------------------------	--

WEST SANTA ANA BRANCH FREIGHT TRACK
TRACK ALIGNMENT
SAN PEDRO BRANCH
PLAN & PROFILE
STA 988+50 TO STA 998+50

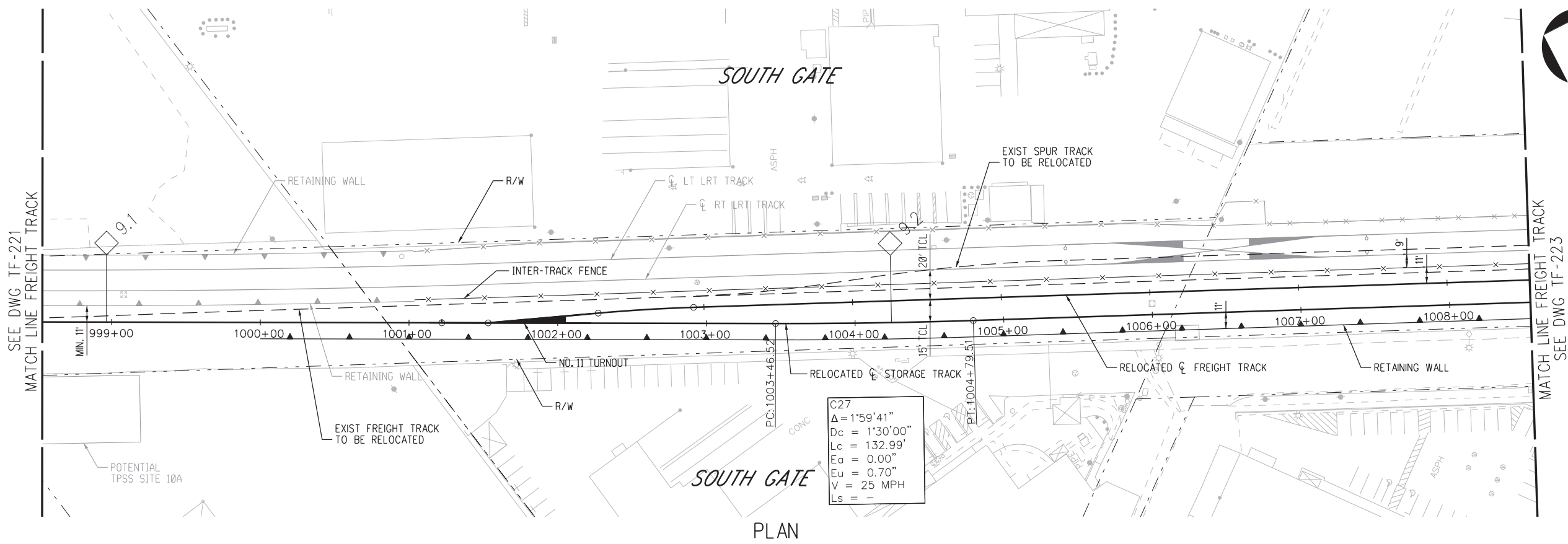

PLAN

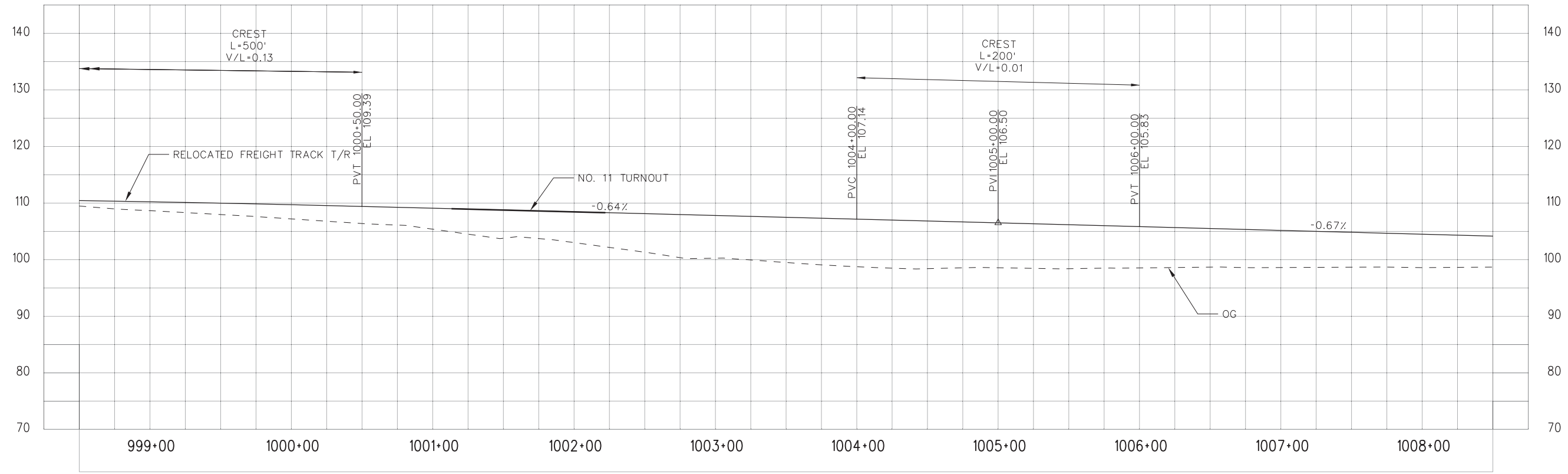

PROFILE

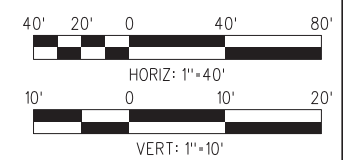

NOT FOR CONSTRUCTION

15-NOV-2019 C-28091ATF222.plg
svc-projectwise 22:37

THE PREPARATION OF THIS DRAWING HAS BEEN FINANCED IN PART THROUGH A GRANT FROM THE U.S. DEPARTMENT OF TRANSPORTATION FEDERAL TRANSIT ADMINISTRATION (FTA), UNDER THE FEDERAL TRANSIT ACT OF 1964, AS AMENDED, AND IN PART BY THE TAXES OF THE CITIZENS OF LOS ANGELES COUNTY AND OF THE STATE OF CALIFORNIA.		DESIGNED BY J. SANCHEZ
		DRAWN BY C. CHEUK
		CHECKED BY R. LOYA
		IN CHARGE N. MAACK
		DATE 11/15/2019
0	11/15/19	FINAL CONCEPTUAL DESIGN

M Metro
444 South Flower Street
Suite 800
Los Angeles, CA 90071
TEL (213) 362-9470

wsp

SUBMITTED _____
APPROVED _____

**WEST SANTA ANA BRANCH FREIGHT TRACK
TRACK ALIGNMENT
SAN PEDRO BRANCH
PLAN & PROFILE
STA 998+50 TO STA 1008+50**

CONTRACT NO. AE5999300	REV
DRAWING NO. TF-222	
SCALE HORIZ: 1"=40' VERT: 1"=10'	
SHEET NO. 54 OF 107	



NOTE:

1. REFER TO ADVANCED CONCEPTUAL ENGINEERING GRADE CROSSING PLANS.

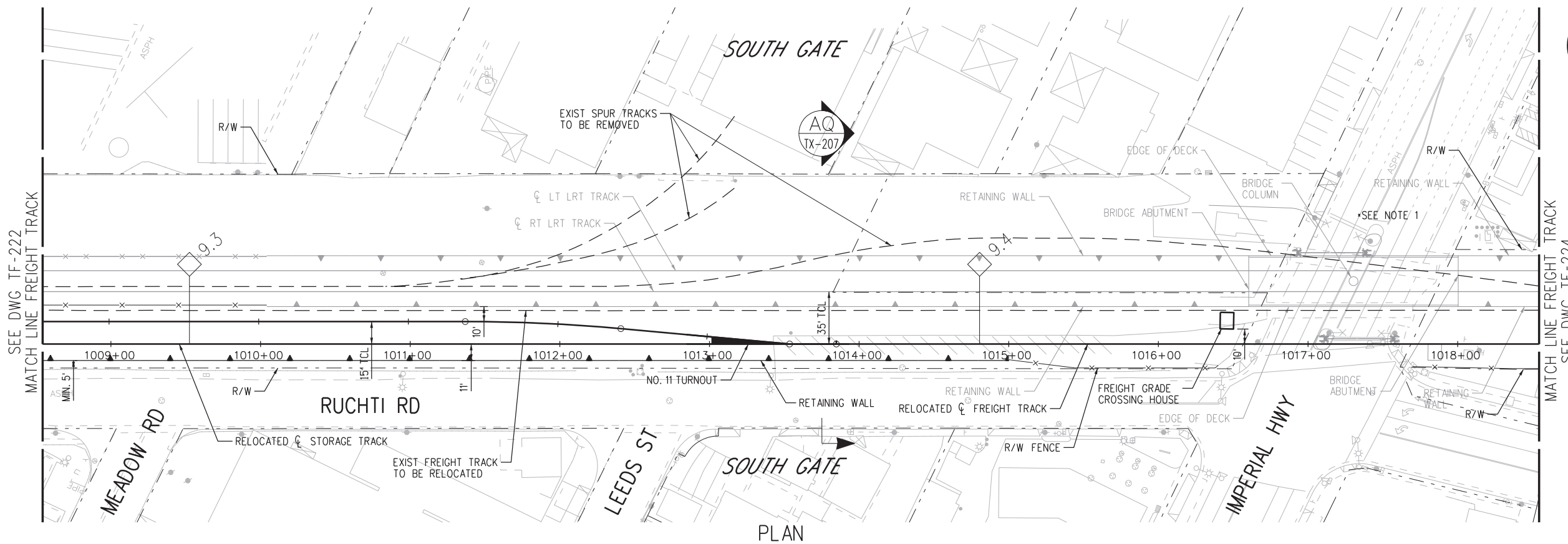

PLAN

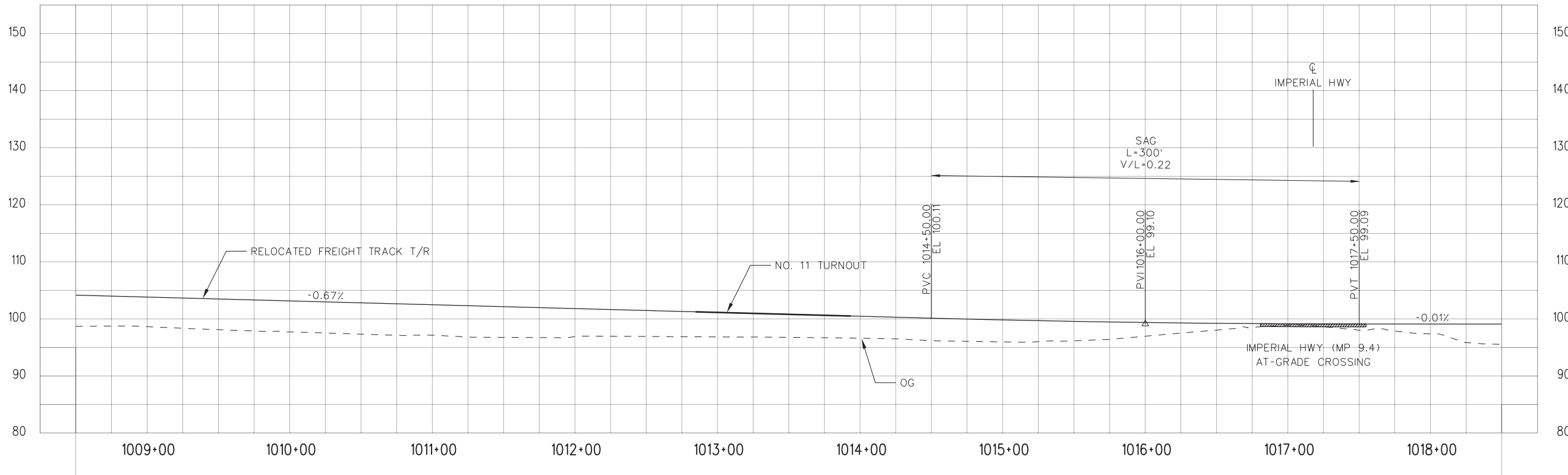

PROFILE

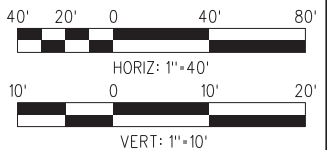

NOT FOR CONSTRUCTION

15-NOV-2019 C-28091ATF 223.plg
svc-projectwise 22:39

THE PREPARATION OF THIS DRAWING HAS BEEN FINANCED IN PART THROUGH A GRANT FROM THE U.S. DEPARTMENT OF TRANSPORTATION FEDERAL TRANSIT ADMINISTRATION (FTA), UNDER THE FEDERAL TRANSIT ACT OF 1964, AS AMENDED, AND IN PART BY THE TAXES OF THE CITIZENS OF LOS ANGELES COUNTY AND OF THE STATE OF CALIFORNIA.		DESIGNED BY J. SANCHEZ
		DRAWN BY C. CHEUK
		CHECKED BY R. LOYA
		IN CHARGE N. MAACK
		DATE 11/15/2019
0	11/15/19	FINAL CONCEPTUAL DESIGN

		LOS ANGELES COUNTY METROPOLITAN TRANSPORTATION AUTHORITY	
444 South Flower Street Suite 800 Los Angeles, CA 90071 TEL (213) 362-9470		SUBMITTED	_____
		APPROVED	_____

WEST SANTA ANA BRANCH FREIGHT TRACK TRACK ALIGNMENT SAN PEDRO BRANCH PLAN & PROFILE STA 1008+50 TO STA 1018+50		CONTRACT NO. AE5999300
DRAWING NO. TF-223		REV
SCALE HOR: 1"=40' VERT: 1"=10'		
SHEET NO. 55 OF 107		

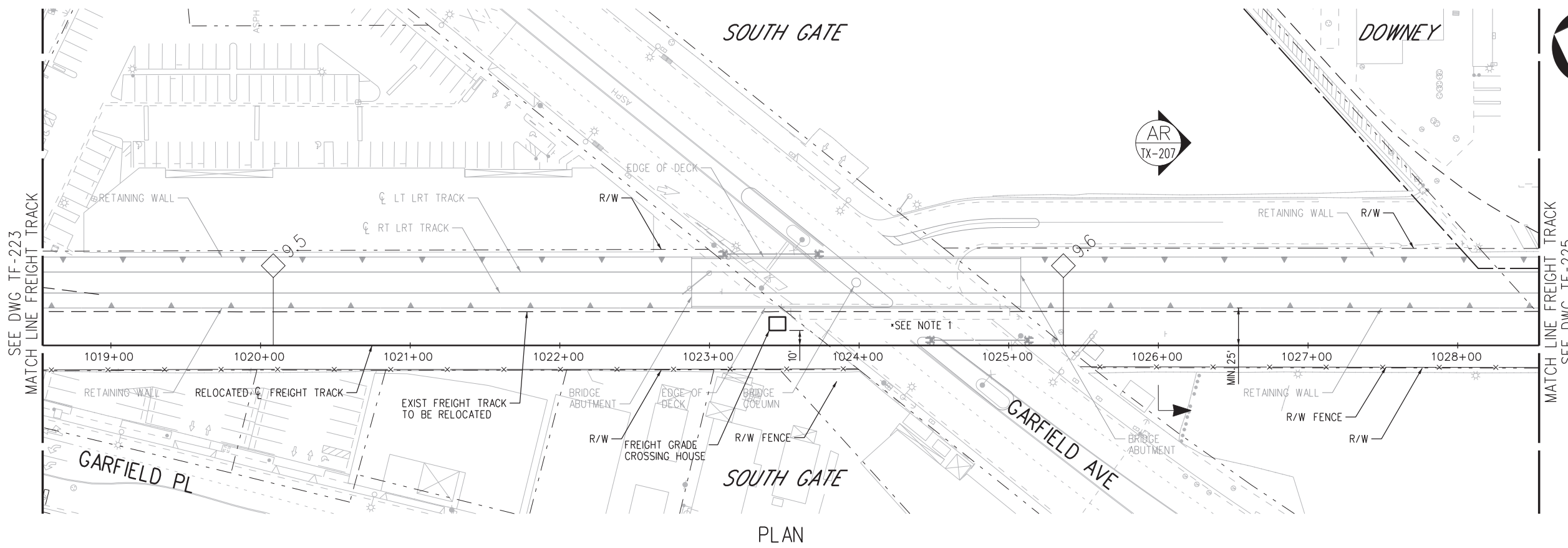

NOTE:
1. REFER TO ADVANCED CONCEPTUAL ENGINEERING GRADE CROSSING PLANS.

PLAN

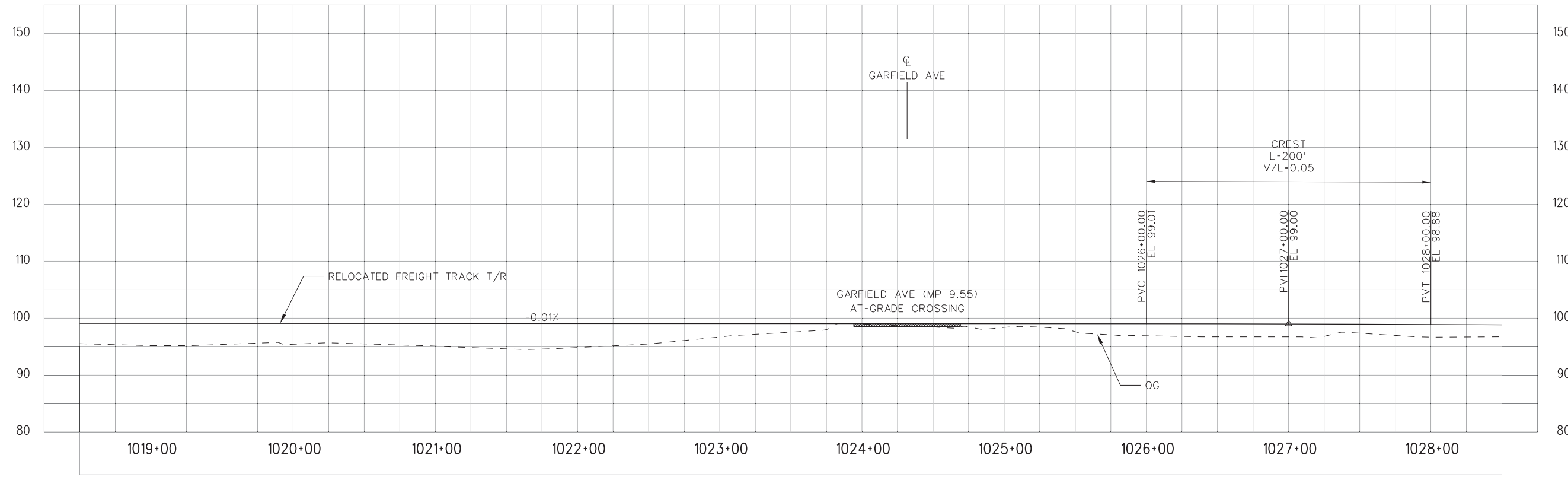

PROFILE

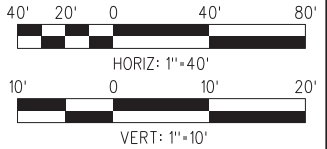

NOT FOR CONSTRUCTION

15-NOV-2019 C-28091ATF 224.plg
svc-projectwise 22:37

THE PREPARATION OF THIS DRAWING HAS BEEN FINANCED IN PART THROUGH A GRANT FROM THE U.S. DEPARTMENT OF TRANSPORTATION FEDERAL TRANSIT ADMINISTRATION (FTA), UNDER THE FEDERAL TRANSIT ACT OF 1964, AS AMENDED, AND IN PART BY THE TAXES OF THE CITIZENS OF LOS ANGELES COUNTY AND OF THE STATE OF CALIFORNIA.		DESIGNED BY J. SANCHEZ
0	11/15/19	DRAWN BY C. CHEUK
		CHECKED BY R. LOYA
		IN CHARGE N. MAACK
		DATE 11/15/2019
		FINAL CONCEPTUAL DESIGN

LOS ANGELES COUNTY METROPOLITAN TRANSPORTATION AUTHORITY	
444 South Flower Street Suite 800 Los Angeles, CA 90071 TEL (213) 362-9470	SUBMITTED _____ APPROVED _____

WEST SANTA ANA BRANCH FREIGHT TRACK TRACK ALIGNMENT SAN PEDRO BRANCH PLAN & PROFILE STA 1018+50 TO STA 1028+50		CONTRACT NO AE5999300 DRAWING NO TF-224 SCALE HOR: 1"=40' VERT: 1"=10' SHEET NO 56 OF 107
---	--	---

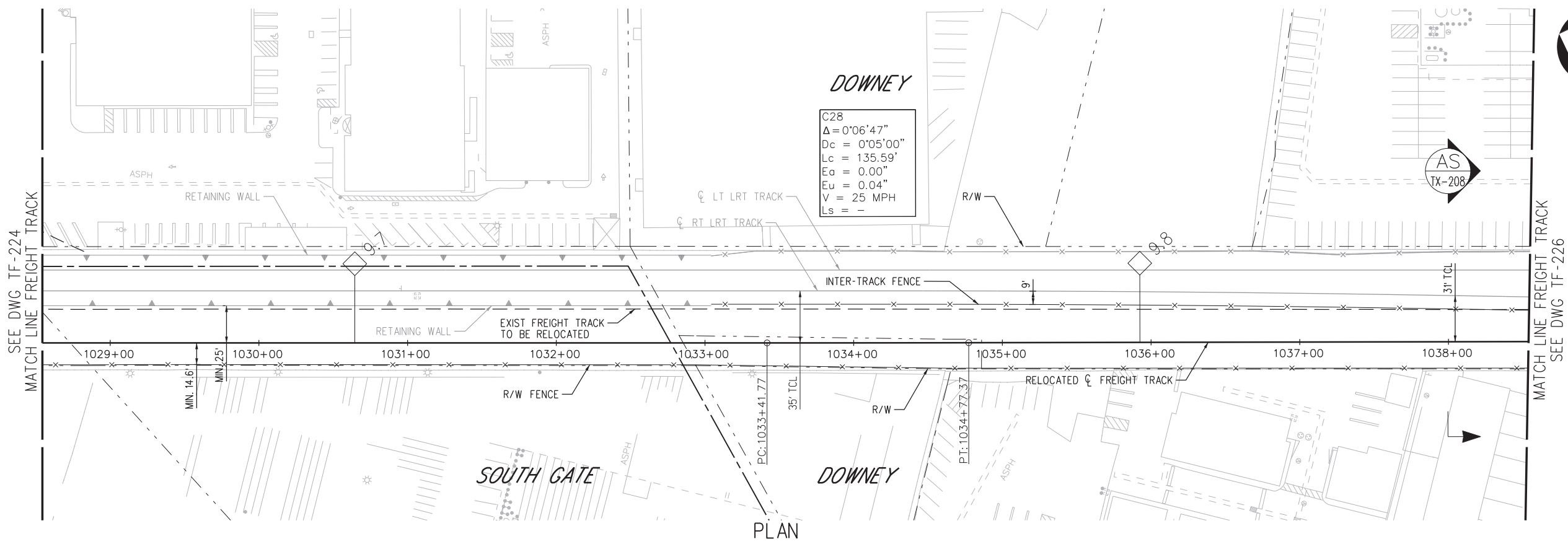

C28
 $\Delta = 0^{\circ}06'47''$
 $D_c = 0^{\circ}05'00''$
 $L_c = 135.59'$
 $E_a = 0.00''$
 $E_u = 0.04''$
 $V = 25 \text{ MPH}$
 $L_s = -$

PLAN

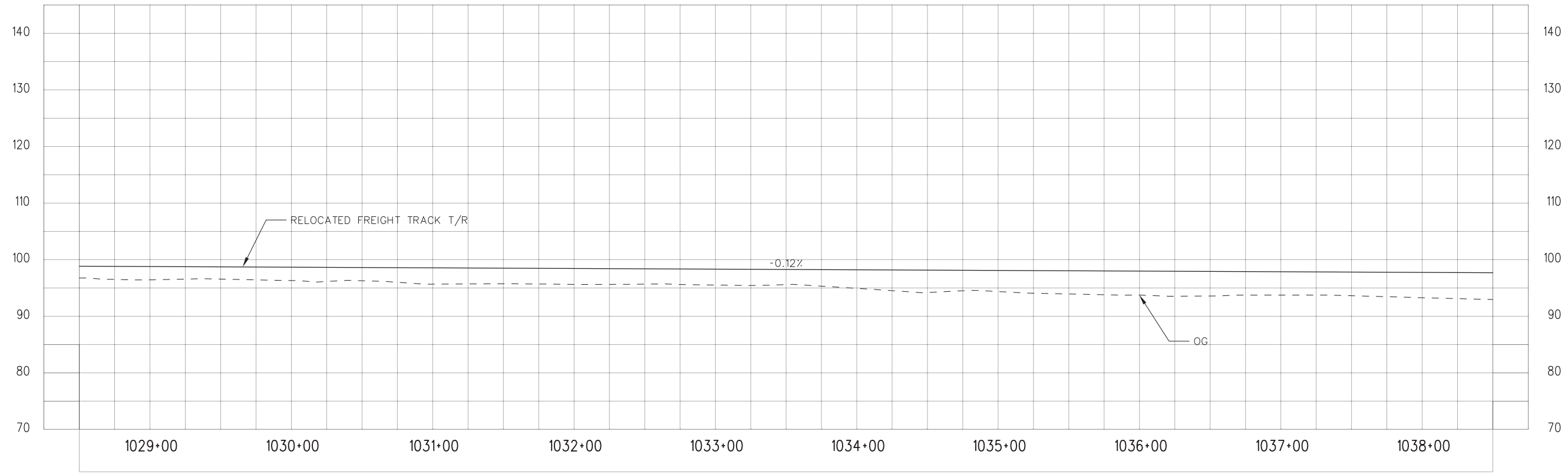

PROFILE

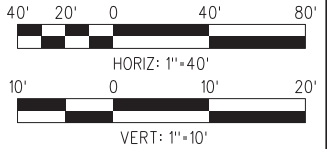

NOT FOR CONSTRUCTION

15-NOV-2019 C-28091ATF 225.plg
 svc-projectwise 22:39

THE PREPARATION OF THIS DRAWING HAS BEEN FINANCED IN PART THROUGH A GRANT FROM THE U.S. DEPARTMENT OF TRANSPORTATION FEDERAL TRANSIT ADMINISTRATION (FTA), UNDER THE FEDERAL TRANSIT ACT OF 1964, AS AMENDED, AND IN PART BY THE TAXES OF THE CITIZENS OF LOS ANGELES COUNTY AND OF THE STATE OF CALIFORNIA.		DESIGNED BY J. SANCHEZ	 LOS ANGELES COUNTY METROPOLITAN TRANSPORTATION AUTHORITY 444 South Flower Street Suite 800 Los Angeles, CA 90071 TEL (213) 362-9470	CONTRACT NO. AE5999300
		DRAWN BY C. CHEUK		DRAWING NO. TF-225
		CHECKED BY R. LOYA		SCALE HORIZ: 1"=40' VERT: 1"=10'
		IN CHARGE N. MAACK		SHEET NO. 57 OF 107
0	11/15/19	DATE 11/15/2019		

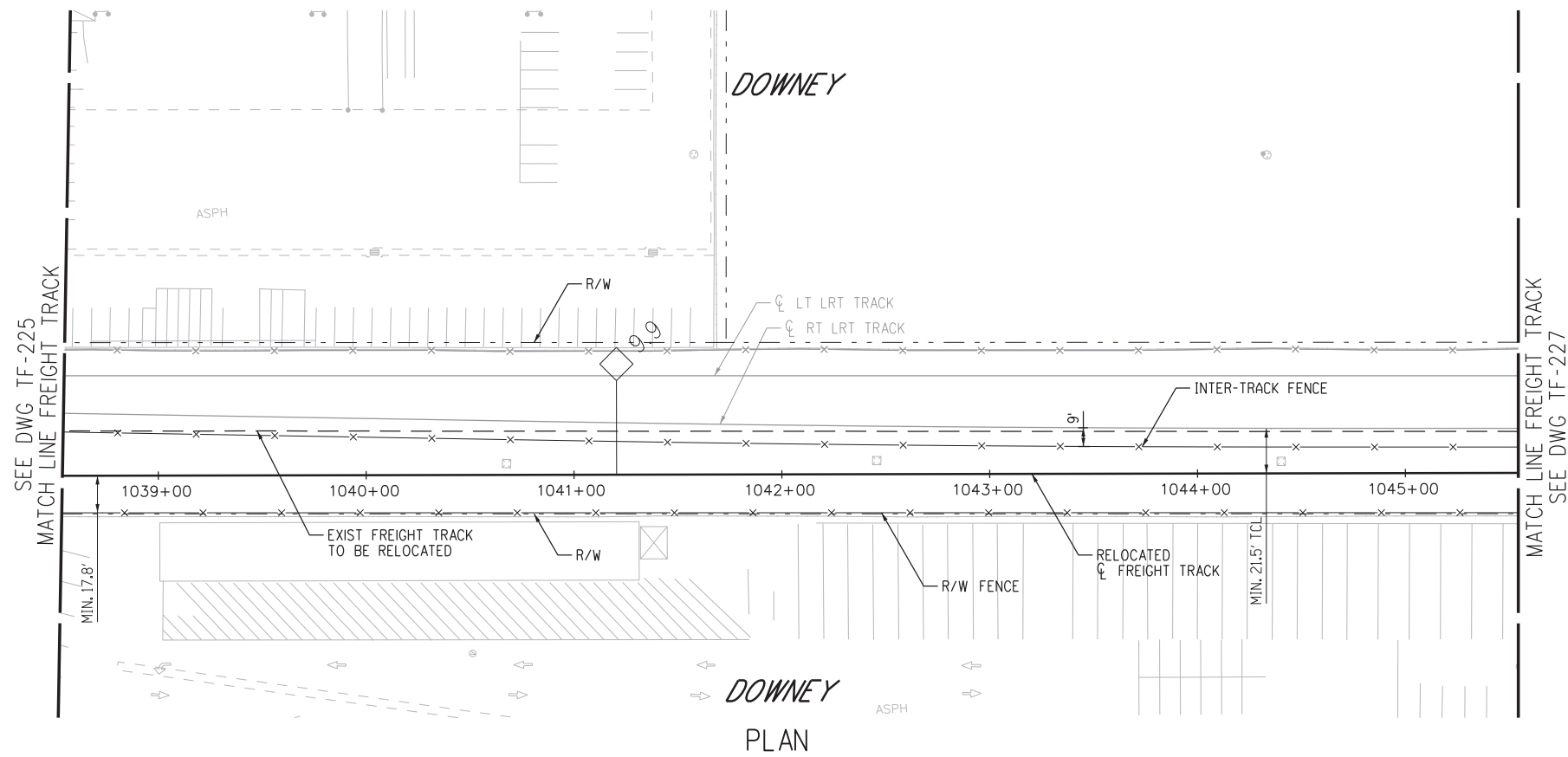

PLAN

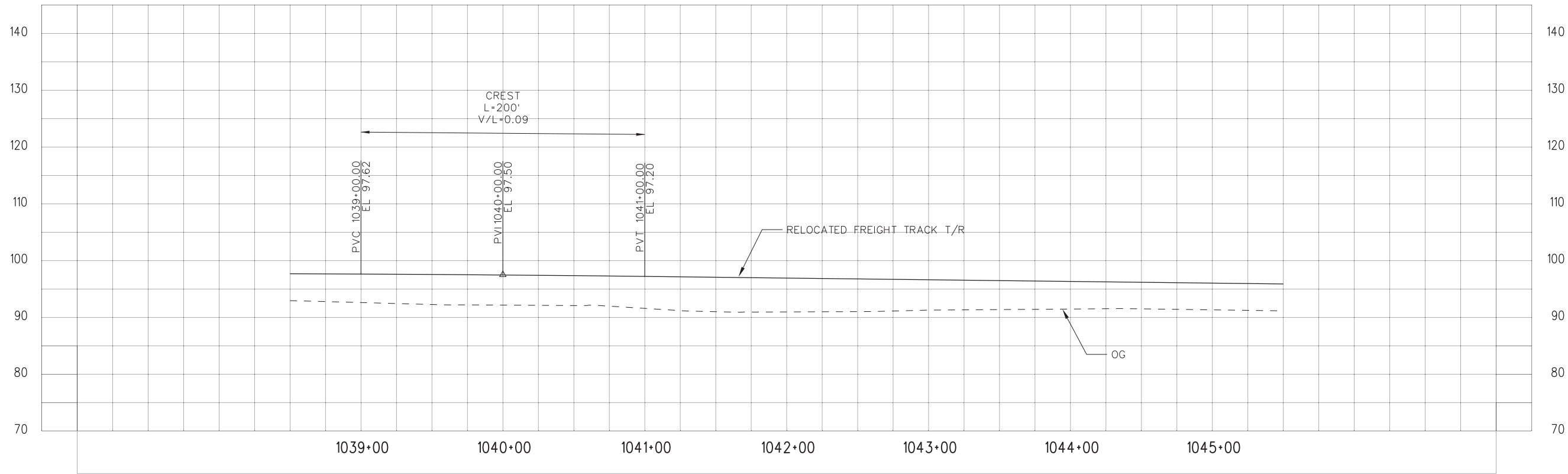

PROFILE

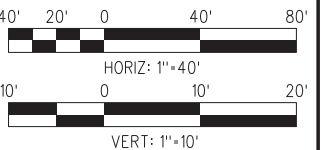

NOT FOR CONSTRUCTION

15-NOV-2019 C-28091ATF 226.plg

svc-projectwise 22:37

THE PREPARATION OF THIS DRAWING HAS BEEN FINANCED IN PART THROUGH A GRANT FROM THE U.S. DEPARTMENT OF TRANSPORTATION FEDERAL TRANSIT ADMINISTRATION (FTA), UNDER THE FEDERAL TRANSIT ACT OF 1964, AS AMENDED, AND IN PART BY THE TAXES OF THE CITIZENS OF LOS ANGELES COUNTY AND OF THE STATE OF CALIFORNIA.	
0	11/15/19
	FINAL CONCEPTUAL DESIGN

DESIGNED BY J. SANCHEZ
DRAWN BY C. CHEUK
CHECKED BY R. LOYA
IN CHARGE N. MAACK
DATE 11/15/2019

LOS ANGELES COUNTY METROPOLITAN TRANSPORTATION AUTHORITY

444 South Flower Street
Suite 800
Los Angeles, CA 90071
TEL (213) 362-9470

SUBMITTED _____

APPROVED _____

WEST SANTA ANA BRANCH FREIGHT TRACK		CONTRACT NO. AE5999300
TRACK ALIGNMENT SAN PEDRO BRANCH PLAN & PROFILE		DRAWING NO. TF-226
STA 1038+50 TO STA 1045+50		SCALE HOR: 1"=40' VERT: 1"=10'
		SHEET NO. 58 OF 107

15-NOV-2019 C-28091ATF 227.plg
 svc-projectwise 22:39

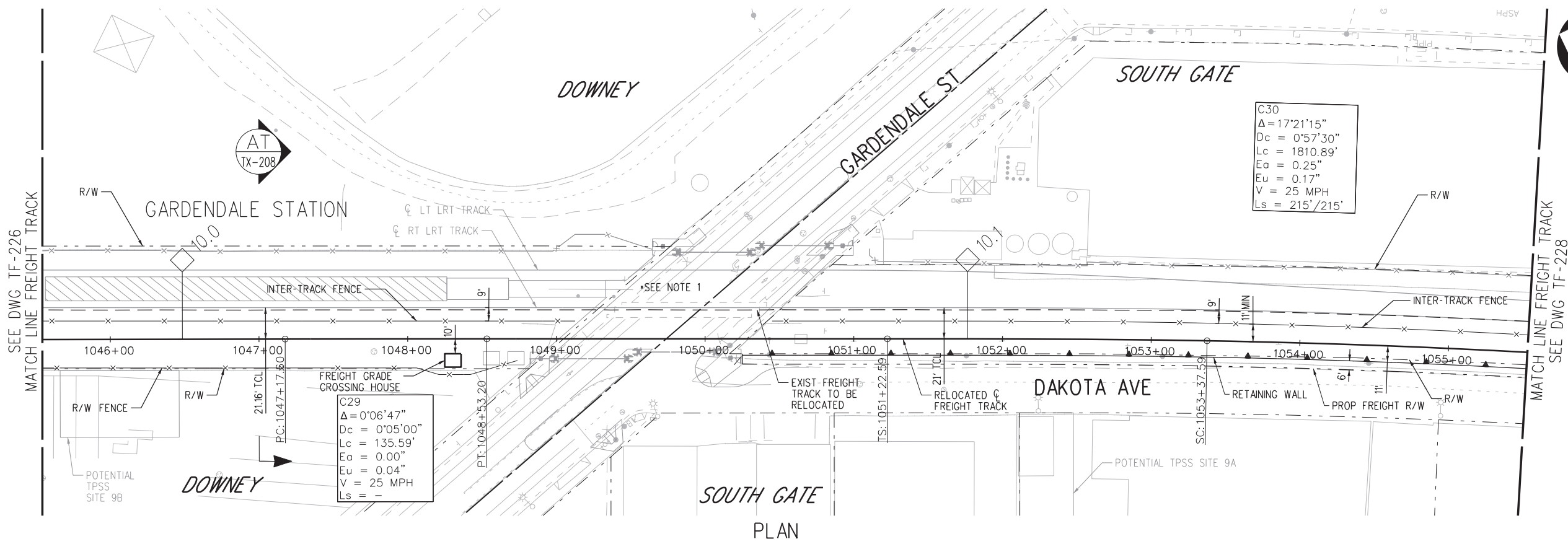

NOTE:
 1. REFER TO ADVANCED CONCEPTUAL ENGINEERING GRADE CROSSING PLANS.

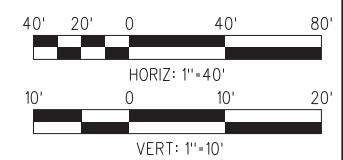
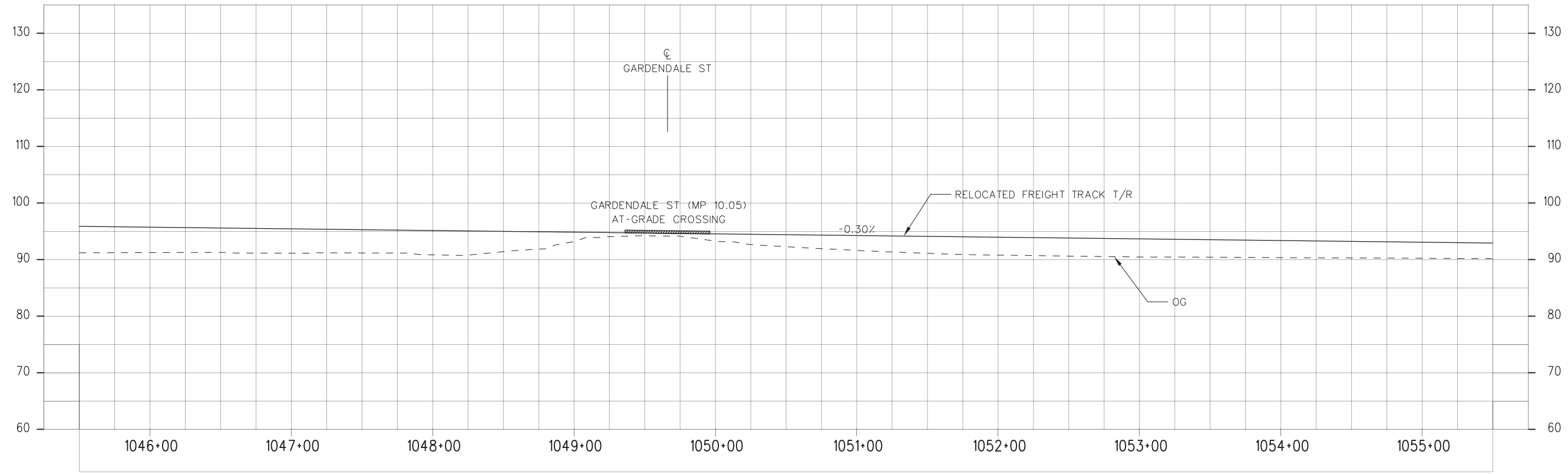

NOT FOR CONSTRUCTION

THE PREPARATION OF THIS DRAWING HAS BEEN FINANCED IN PART THROUGH A GRANT FROM THE U.S. DEPARTMENT OF TRANSPORTATION FEDERAL TRANSIT ADMINISTRATION (FTA), UNDER THE FEDERAL TRANSIT ACT OF 1964, AS AMENDED, AND IN PART BY THE TAXES OF THE CITIZENS OF LOS ANGELES COUNTY AND OF THE STATE OF CALIFORNIA.	
0	11/15/19
	FINAL CONCEPTUAL DESIGN

DESIGNED BY J. SANCHEZ
DRAWN BY C. CHEUK
CHECKED BY R. LOYA
IN CHARGE N. MAACK
DATE 11/15/2019

M Metro

LOS ANGELES COUNTY METROPOLITAN TRANSPORTATION AUTHORITY

wsp 444 South Flower Street Suite 800 Los Angeles, CA 90071 TEL (213) 362-9470

SUBMITTED _____

APPROVED _____

WEST SANTA ANA BRANCH FREIGHT TRACK TRACK ALIGNMENT SAN PEDRO BRANCH PLAN & PROFILE STA 1045+50 TO STA 1055+50

CONTRACT NO AE5999300
DRAWING NO TF-227
SCALE HOR: 1"=40' VERT: 1"=10'
SHEET NO 59 OF 107

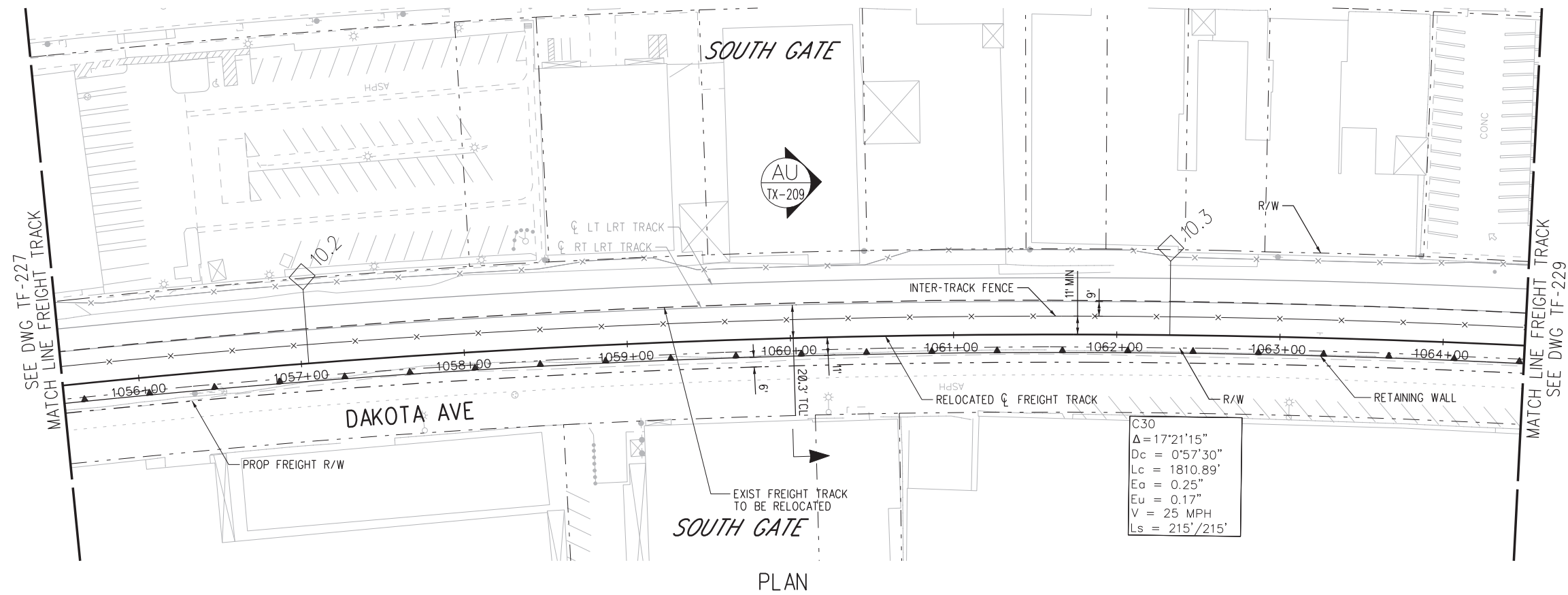

C30
 $\Delta = 17'21'15''$
 $D_c = 0'57'30''$
 $L_c = 1810.89'$
 $E_a = 0.25''$
 $E_u = 0.17''$
 $V = 25 \text{ MPH}$
 $L_s = 215' / 215'$

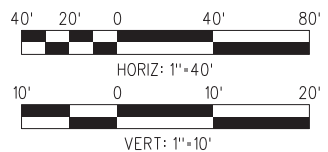
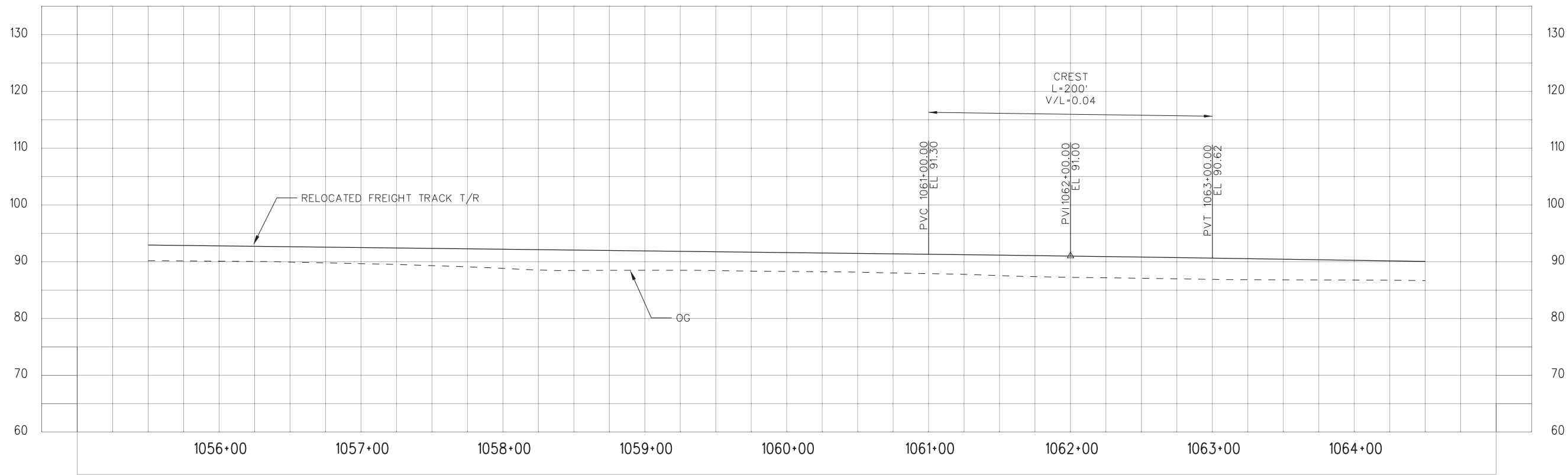

NOT FOR CONSTRUCTION

15-NOV-2019 C-28091ATF 228.plg
 svc-projectwise 22:37

THE PREPARATION OF THIS DRAWING HAS BEEN FINANCED IN PART THROUGH A GRANT FROM THE U.S. DEPARTMENT OF TRANSPORTATION FEDERAL TRANSIT ADMINISTRATION (FTA), UNDER THE FEDERAL TRANSIT ACT OF 1964, AS AMENDED, AND IN PART BY THE TAXES OF THE CITIZENS OF LOS ANGELES COUNTY AND OF THE STATE OF CALIFORNIA.		DESIGNED BY J. SANCHEZ	 LOS ANGELES COUNTY METROPOLITAN TRANSPORTATION AUTHORITY	CONTRACT NO. AE5999300
		DRAWN BY C. CHEUK		DRAWING NO. TF-228
		CHECKED BY R. LOYA		SCALE HOR: 1"=40' VERT: 1"=10'
		IN CHARGE N. MAACK		SHEET NO. 60 OF 107
		DATE 11/15/2019		
	11/15/19	FINAL CONCEPTUAL DESIGN		

444 South Flower Street
 Suite 800
 Los Angeles, CA 90071
 TEL (213) 362-9470

SUBMITTED _____
 APPROVED _____

WEST SANTA ANA BRANCH FREIGHT TRACK
TRACK ALIGNMENT
SAN PEDRO BRANCH
PLAN & PROFILE
STA 1055+50 TO STA 1064+50

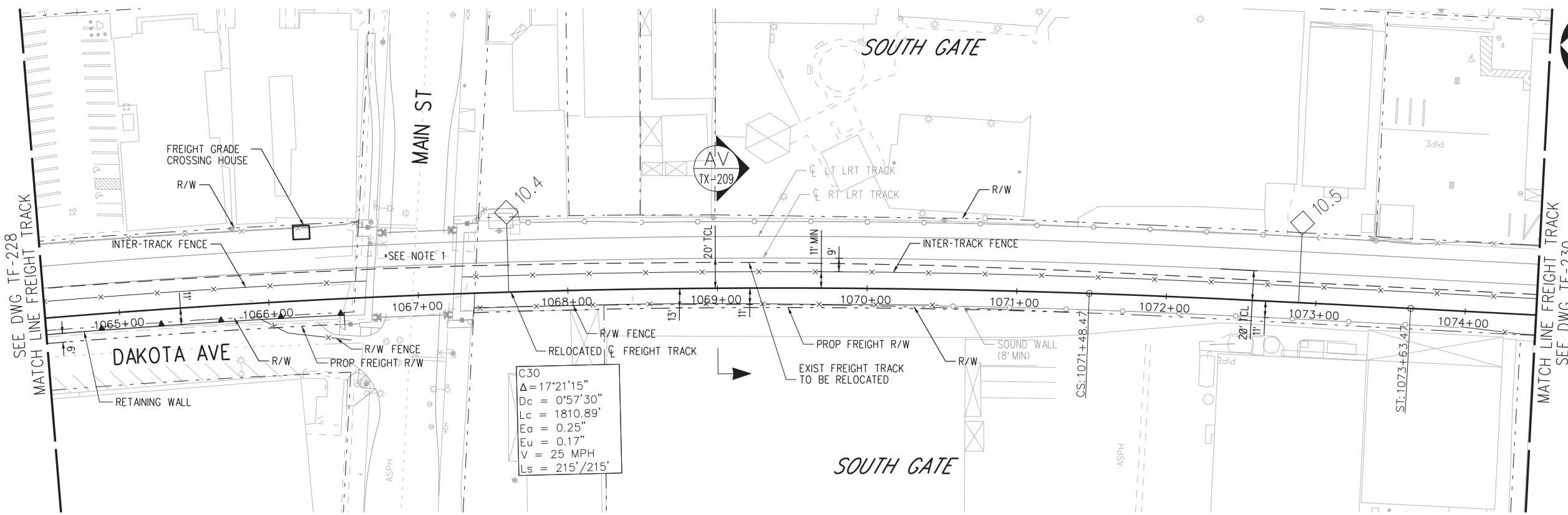

NOTE:
1. REFER TO ADVANCED CONCEPTUAL ENGINEERING GRADE CROSSING PLANS.

C30
 $\Delta = 17^{\circ}21'15''$
 $D_c = 0^{\circ}57'30''$
 $L_c = 1810.89'$
 $E_o = 0.25''$
 $E_u = 0.17''$
 $V = 25 \text{ MPH}$
 $L_s = 215' / 215'$

PLAN

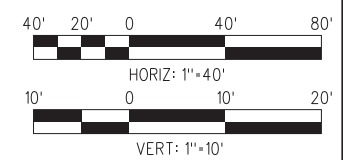
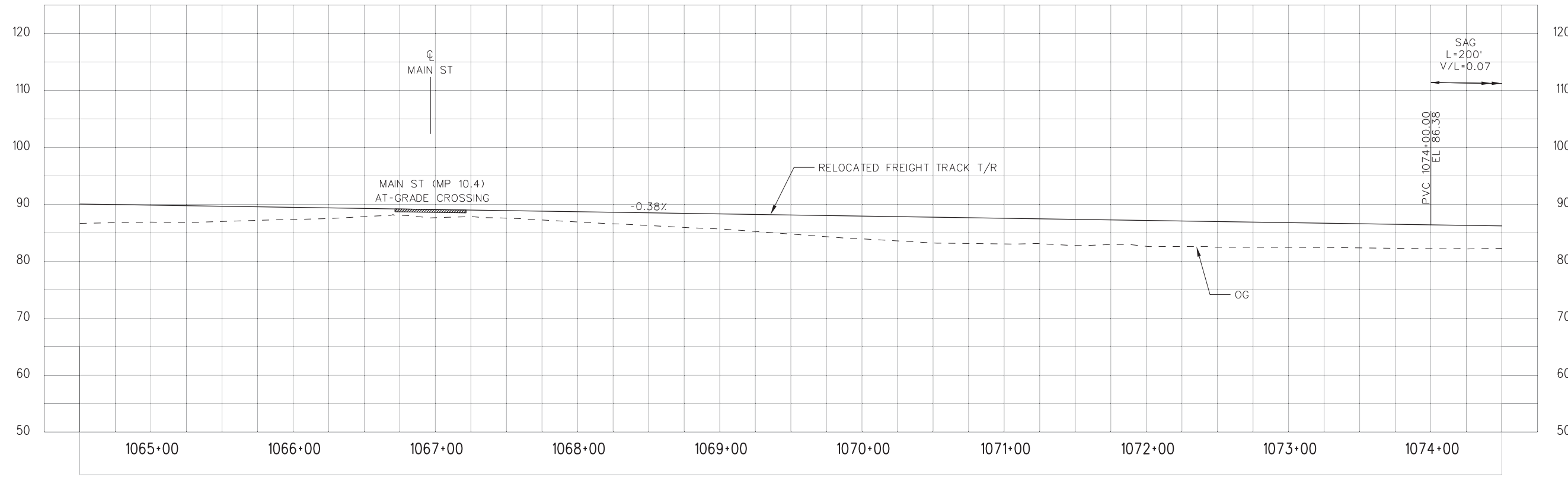

PROFILE

NOT FOR CONSTRUCTION

15-NOV-2019 C-28091ATF 229.plg
 svc-projectwise 22:40

THE PREPARATION OF THIS DRAWING HAS BEEN FINANCED IN PART THROUGH A GRANT FROM THE U.S. DEPARTMENT OF TRANSPORTATION FEDERAL TRANSIT ADMINISTRATION (FTA), UNDER THE FEDERAL TRANSIT ACT OF 1964, AS AMENDED, AND IN PART BY THE TAXES OF THE CITIZENS OF LOS ANGELES COUNTY AND OF THE STATE OF CALIFORNIA.		DESIGNED BY J. SANCHEZ
		DRAWN BY C. CHEUK
		CHECKED BY R. LOYA
		IN CHARGE N. MAACK
		DATE 11/15/2019
0	11/15/19	FINAL CONCEPTUAL DESIGN

LOS ANGELES COUNTY METROPOLITAN TRANSPORTATION AUTHORITY	
444 South Flower Street Suite 800 Los Angeles, CA 90071 TEL (213) 362-9470	SUBMITTED _____ APPROVED _____

WEST SANTA ANA BRANCH FREIGHT TRACK TRACK ALIGNMENT SAN PEDRO BRANCH PLAN & PROFILE STA 1064+50 TO STA 1074+50	
CONTRACT NO. AE5999300	REV
DRAWING NO. TF-229	
SCALE HOR: 1"=40' VERT: 1"=10'	
SHEET NO. 61	OF 107



NOTE:
1. REFER TO ADVANCED CONCEPTUAL ENGINEERING GRADE CROSSING PLANS.

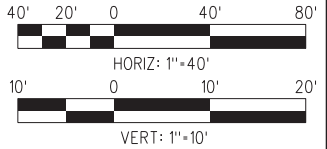
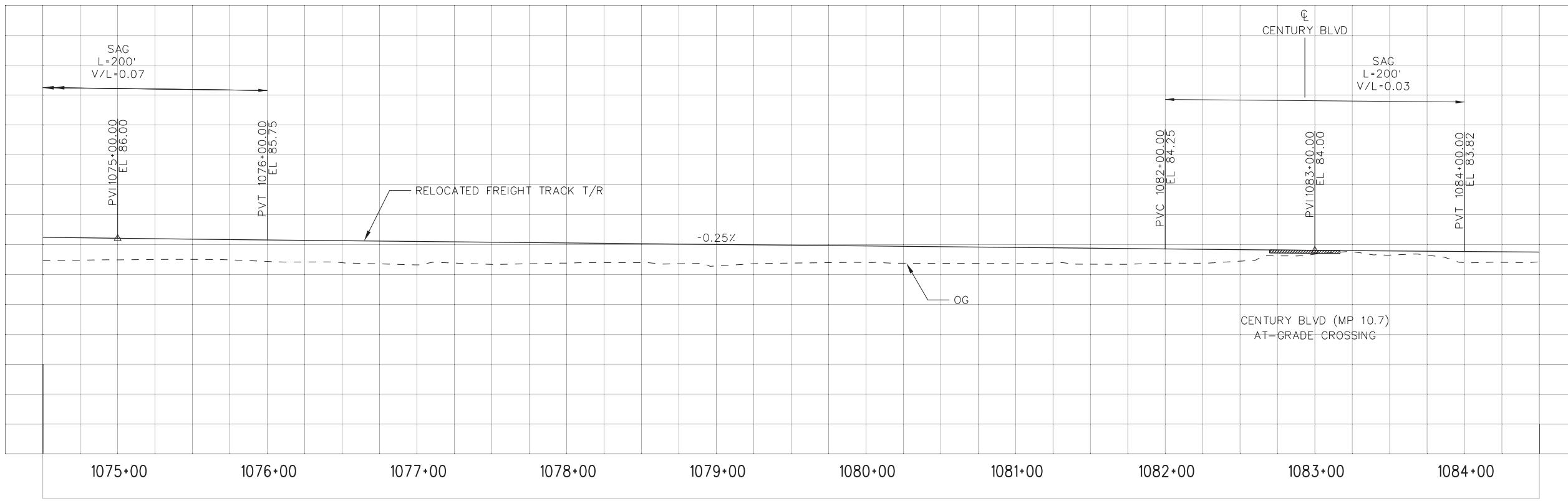
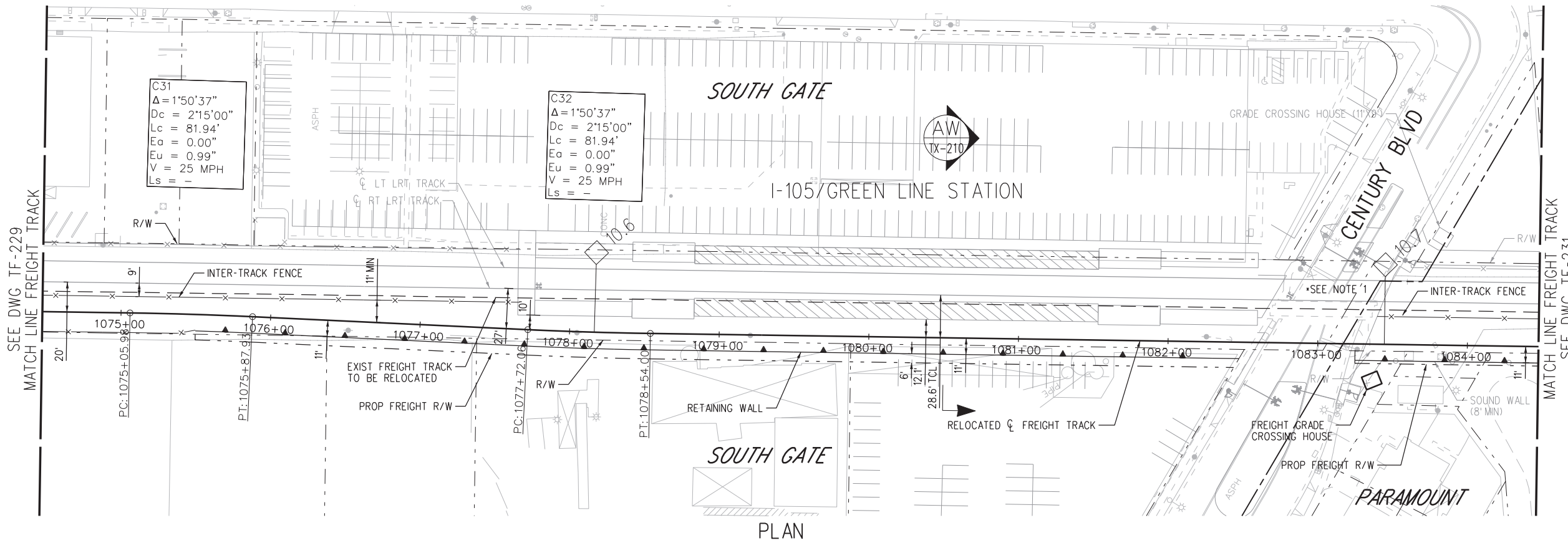

PROFILE

NOT FOR CONSTRUCTION

15-NOV-2019 C-28091ATF 230.plg
svc-projectwise 22:36

THE PREPARATION OF THIS DRAWING HAS BEEN FINANCED IN PART THROUGH A GRANT FROM THE U.S. DEPARTMENT OF TRANSPORTATION FEDERAL TRANSIT ADMINISTRATION (FTA), UNDER THE FEDERAL TRANSIT ACT OF 1964, AS AMENDED, AND IN PART BY THE TAXES OF THE CITIZENS OF LOS ANGELES COUNTY AND OF THE STATE OF CALIFORNIA.	
0	11/15/19
	FINAL CONCEPTUAL DESIGN

DESIGNED BY J. SANCHEZ
DRAWN BY C. CHEUK
CHECKED BY R. LOYA
IN CHARGE N. MAACK
DATE 11/15/2019

M Metro
LOS ANGELES COUNTY METROPOLITAN TRANSPORTATION AUTHORITY

wsp 444 South Flower Street Suite 800 Los Angeles, CA 90071 TEL (213) 362-9470

SUBMITTED _____
APPROVED _____

WEST SANTA ANA BRANCH FREIGHT TRACK
TRACK ALIGNMENT
SAN PEDRO BRANCH
PLAN & PROFILE
STA 1074+50 TO STA 1084+50

CONTRACT NO. AE5999300
DRAWING NO. TF-230
SCALE HORIZ: 1"=40' VERT: 1"=10'
SHEET NO. 62 OF 107

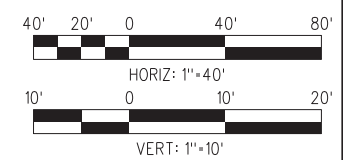
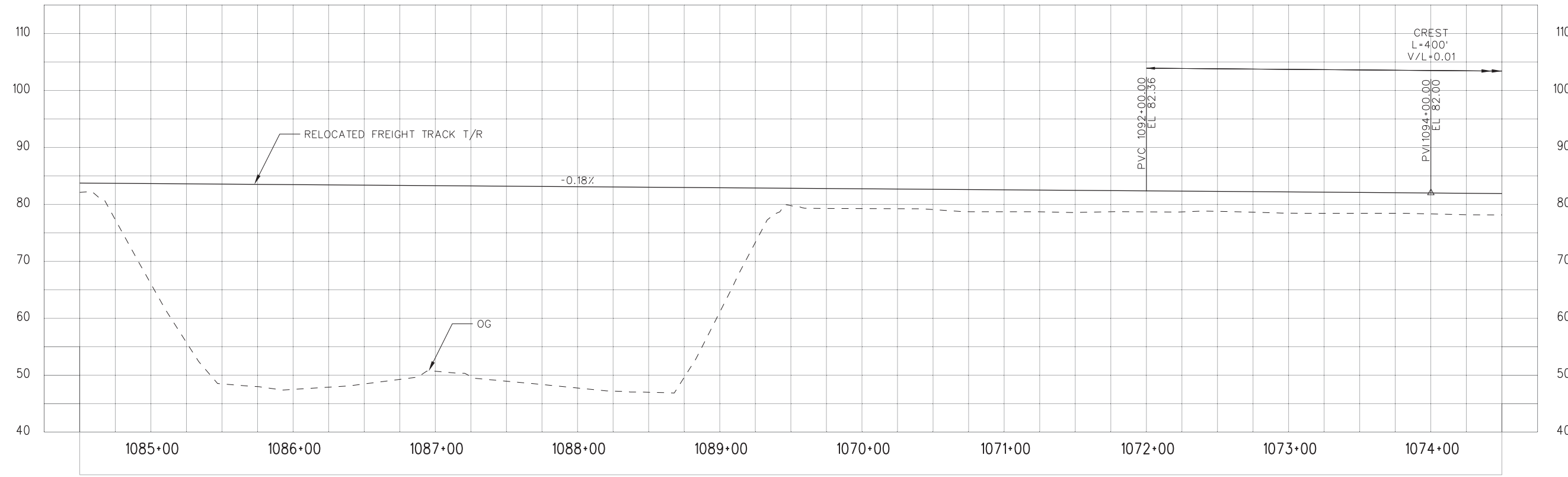
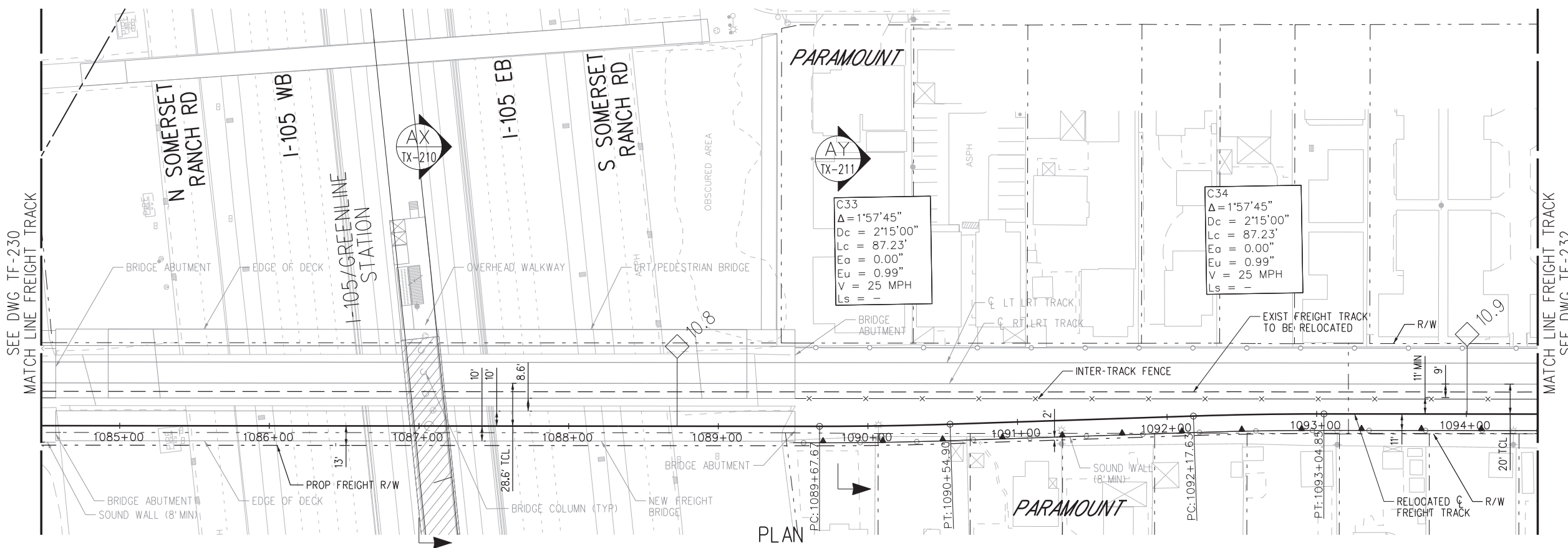

NOT FOR CONSTRUCTION

15-NOV-2019 C-28091ATF 231.plg
 svc-projectwise 22:43

THE PREPARATION OF THIS DRAWING HAS BEEN FINANCED IN PART THROUGH A GRANT FROM THE U.S. DEPARTMENT OF TRANSPORTATION FEDERAL TRANSIT ADMINISTRATION (FTA), UNDER THE FEDERAL TRANSIT ACT OF 1964, AS AMENDED, AND IN PART BY THE TAXES OF THE CITIZENS OF LOS ANGELES COUNTY AND OF THE STATE OF CALIFORNIA.	
0	11/15/19
	FINAL CONCEPTUAL DESIGN

DESIGNED BY J. SANCHEZ
DRAWN BY C. CHEUK
CHECKED BY R. LOYA
IN CHARGE N. MAACK
DATE 11/15/2019

M Metro

wsp 444 South Flower Street Suite 800 Los Angeles, CA 90071 TEL (213) 362-9470

SUBMITTED _____

APPROVED _____

WEST SANTA ANA BRANCH FREIGHT TRACK
TRACK ALIGNMENT
SAN PEDRO BRANCH
PLAN & PROFILE
STA 1084+50 TO STA 1094+50

CONTRACT NO. AE5999300	REV
DRAWING NO. TF-231	
SCALE HOR: 1"=40' VERT: 1"=10'	
SHEET NO. 63	OF 107



NOTE:

- 1. EXISTING TRACK WILL BE LINE AND SURFACE 200' BEYOND THE END OF NEW CONSTRUCTION.

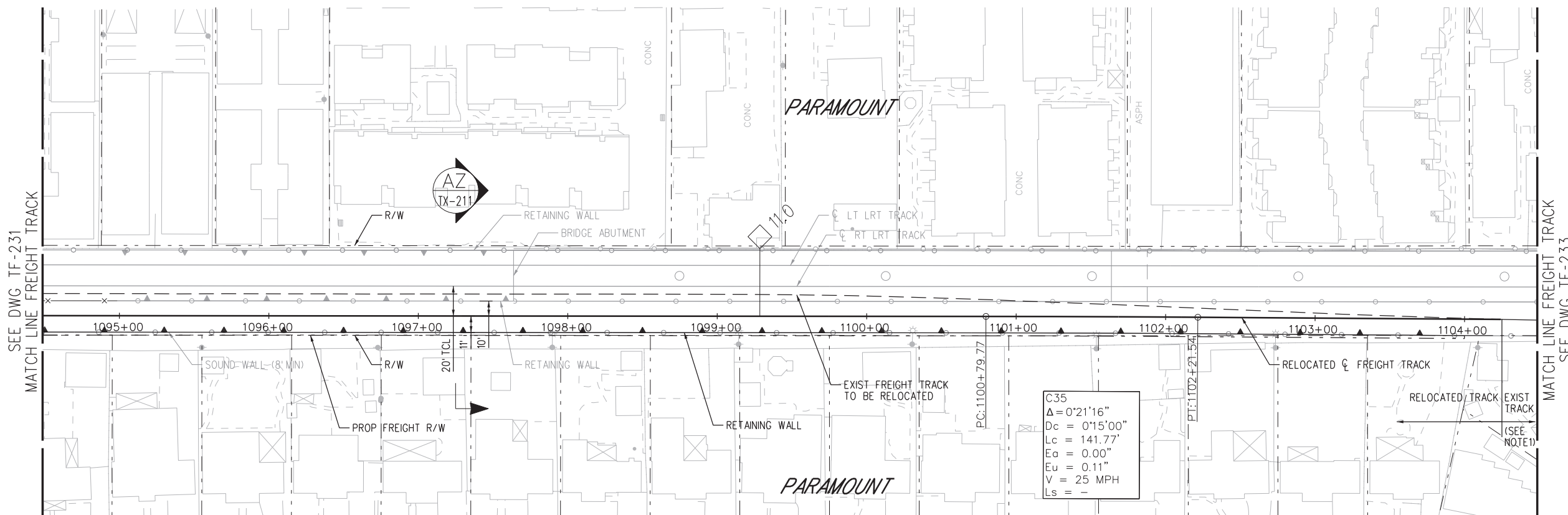

PLAN

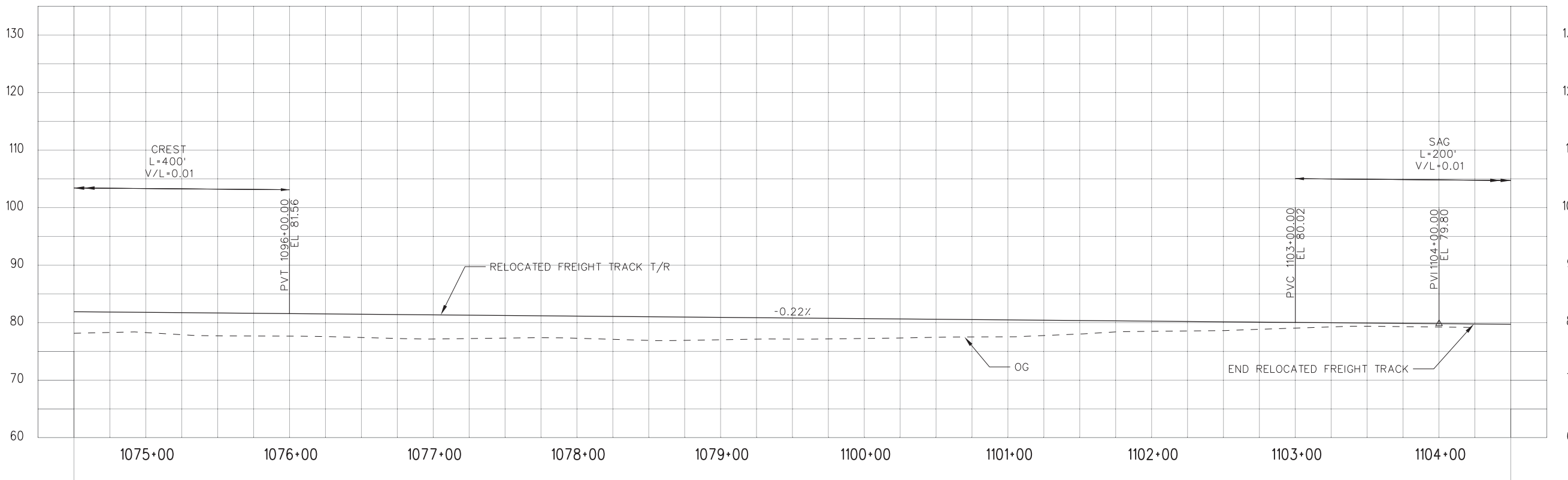

PROFILE

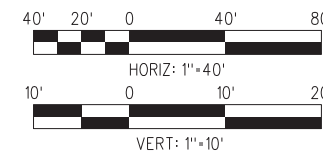

NOT FOR CONSTRUCTION

15-NOV-2019 C-28091ATF 232.plg

svc-projectwise 22:37

THE PREPARATION OF THIS DRAWING HAS BEEN FINANCED IN PART THROUGH A GRANT FROM THE U.S. DEPARTMENT OF TRANSPORTATION FEDERAL TRANSIT ADMINISTRATION (FTA), UNDER THE FEDERAL TRANSIT ACT OF 1964, AS AMENDED, AND IN PART BY THE TAXES OF THE CITIZENS OF LOS ANGELES COUNTY AND OF THE STATE OF CALIFORNIA.		DESIGNED BY J. SANCHEZ
0	11/15/19	DRAWN BY C. CHEUK
		CHECKED BY R. LOYA
		IN CHARGE N. MAACK
		DATE 11/15/2019
		FINAL CONCEPTUAL DESIGN



LOS ANGELES COUNTY METROPOLITAN TRANSPORTATION AUTHORITY



444 South Flower Street Suite 800 Los Angeles, CA 90071 TEL (213) 362-9470

SUBMITTED _____
APPROVED _____

WEST SANTA ANA BRANCH FREIGHT TRACK TRACK ALIGNMENT SAN PEDRO BRANCH PLAN & PROFILE STA 1094+50 TO STA 1104+50

CONTRACT NO AE5999300	REV
DRAWING NO TF-232	
SCALE HORIZ: 1"=40' VERT: 1"=10'	
SHEET NO 64 OF 107	

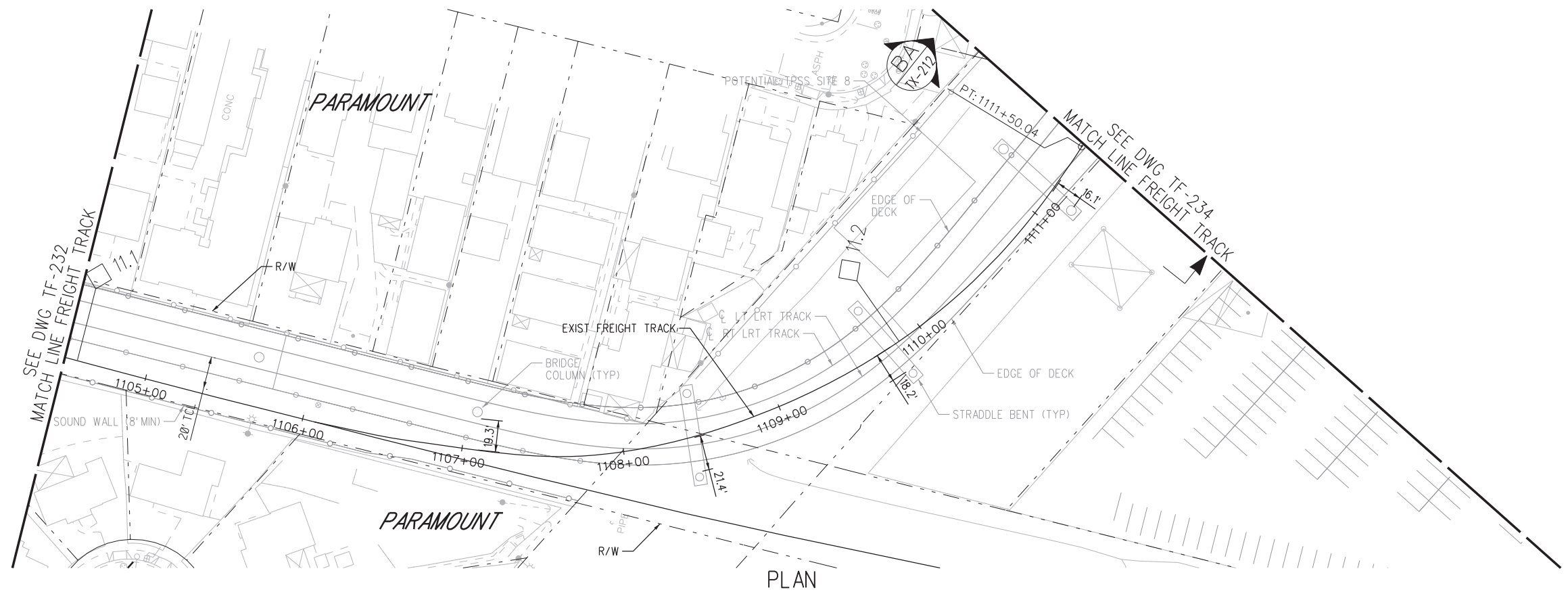

PLAN

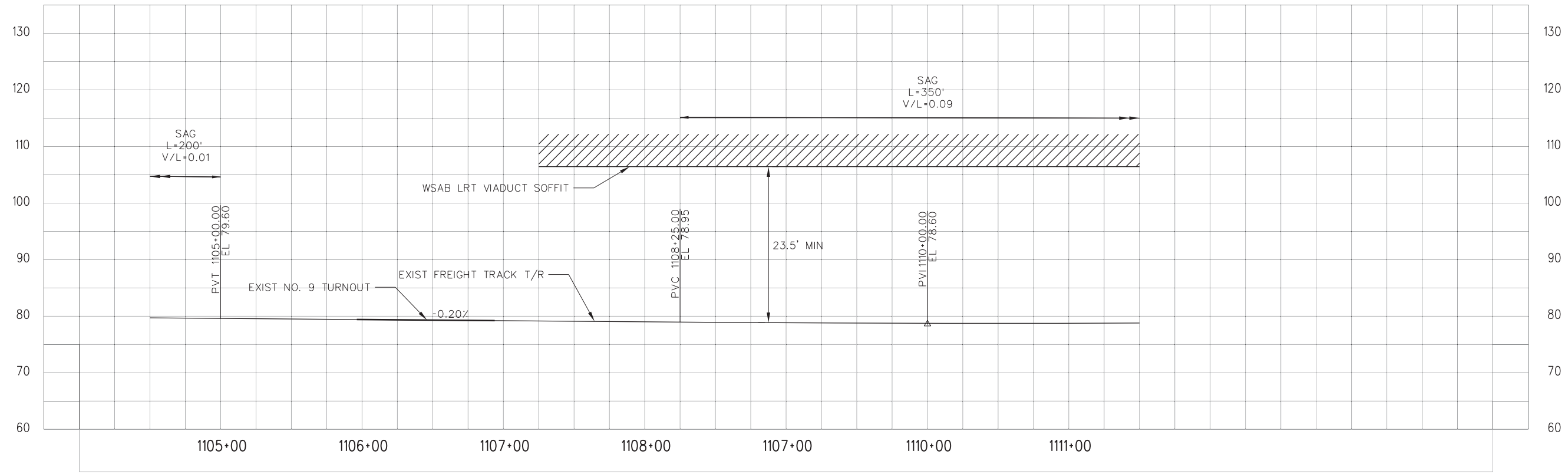

PROFILE

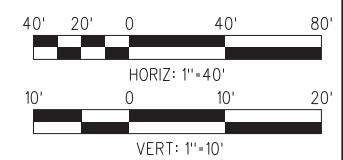

NOT FOR CONSTRUCTION

15-NOV-2019 C-28091ATF 233.plg
svc-projectwise 22:39

THE PREPARATION OF THIS DRAWING HAS BEEN FINANCED IN PART THROUGH A GRANT FROM THE U.S. DEPARTMENT OF TRANSPORTATION FEDERAL TRANSIT ADMINISTRATION (FTA), UNDER THE FEDERAL TRANSIT ACT OF 1964, AS AMENDED, AND IN PART BY THE TAXES OF THE CITIZENS OF LOS ANGELES COUNTY AND OF THE STATE OF CALIFORNIA.	
0	11/15/19
	FINAL CONCEPTUAL DESIGN

DESIGNED BY J. SANCHEZ
DRAWN BY C. CHEUK
CHECKED BY R. LOYA
IN CHARGE N. MAACK
DATE 11/15/2019

M Metro
LOS ANGELES COUNTY METROPOLITAN TRANSPORTATION AUTHORITY

wsp 444 South Flower Street Suite 800 Los Angeles, CA 90071 TEL (213) 362-9470

SUBMITTED _____
APPROVED _____

WEST SANTA ANA BRANCH FREIGHT TRACK		CONTRACT NO. AE5999300
TRACK ALIGNMENT SAN PEDRO BRANCH/PEROW PLAN & PROFILE STA 1104+50 TO STA 1111+50		DRAWING NO. TF-233
		SCALE HOR: 1"=40' VERT: 1"=10'
		SHEET NO. 65 OF 107



NOTE:
 1. EXISTING TRACK WILL BE LINE AND SURFACE 200' BEYOND THE END OF NEW CONSTRUCTION.

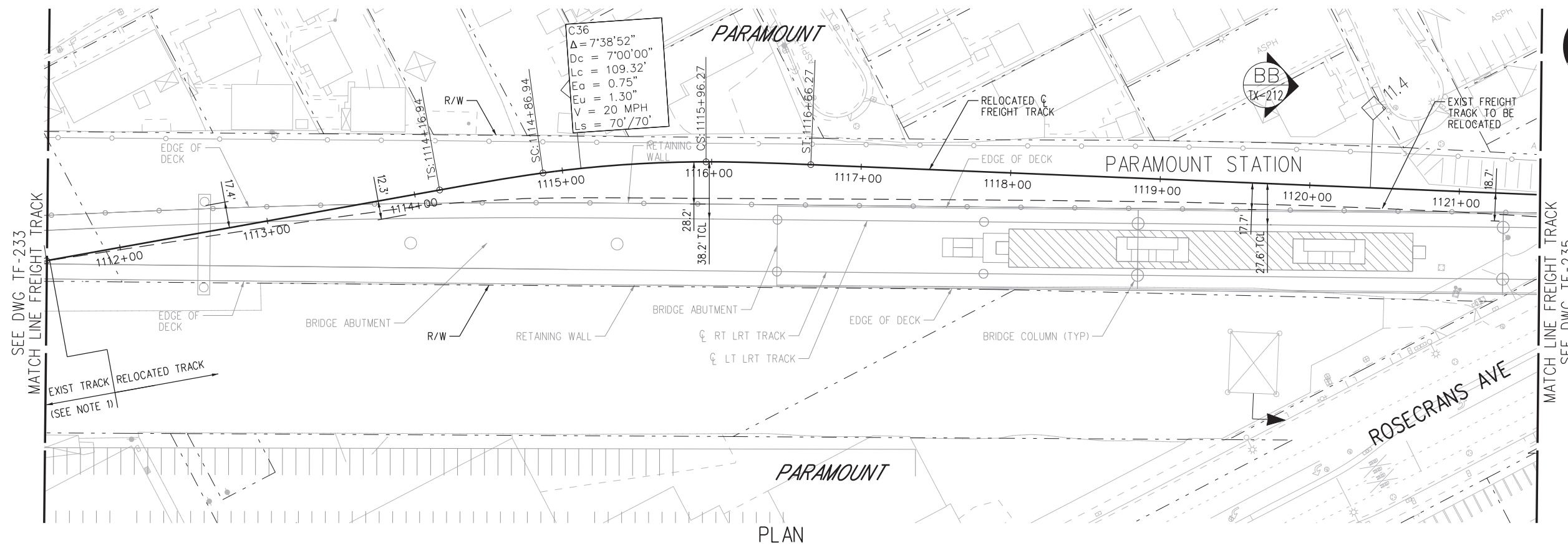

PLAN

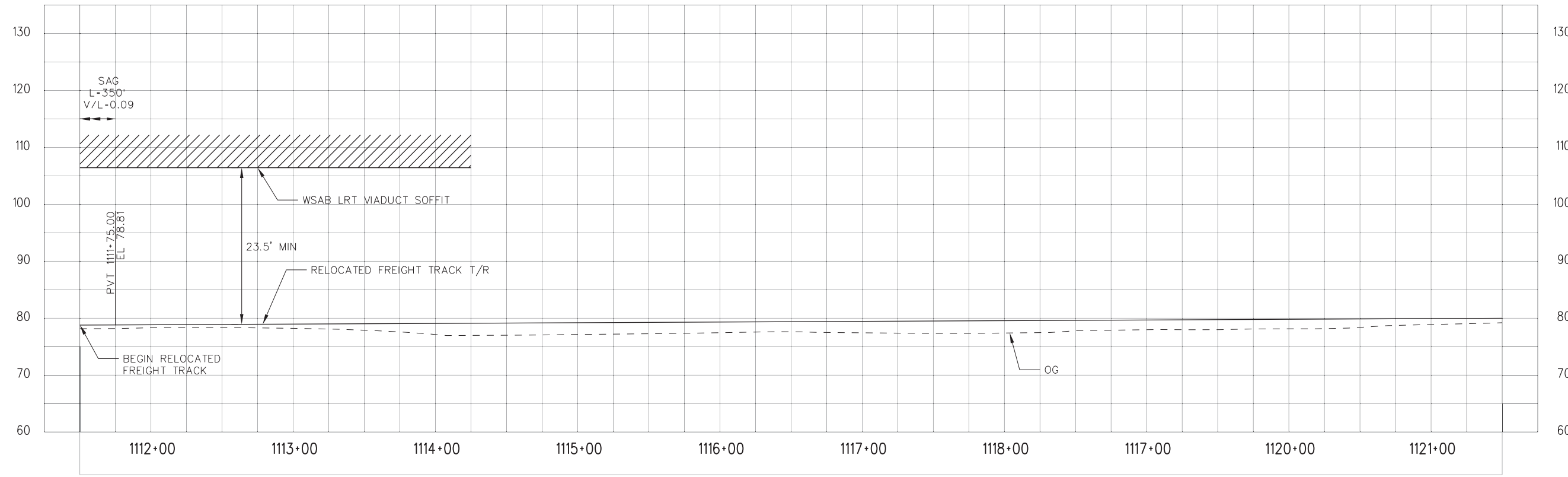

PROFILE

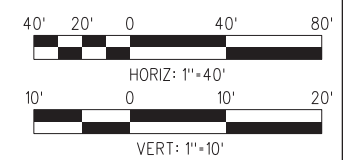

NOT FOR CONSTRUCTION

15-NOV-2019 C-28091ATF 234.plg
 svc-projectwise 22:40

THE PREPARATION OF THIS DRAWING HAS BEEN FINANCED IN PART THROUGH A GRANT FROM THE U.S. DEPARTMENT OF TRANSPORTATION FEDERAL TRANSIT ADMINISTRATION (FTA), UNDER THE FEDERAL TRANSIT ACT OF 1964, AS AMENDED, AND IN PART BY THE TAXES OF THE CITIZENS OF LOS ANGELES COUNTY AND OF THE STATE OF CALIFORNIA.	
0	11/15/19
	FINAL CONCEPTUAL DESIGN

DESIGNED BY J. SANCHEZ
DRAWN BY C. CHEUK
CHECKED BY R. LOYA
IN CHARGE N. MAACK
DATE 11/15/2019

M Metro
LOS ANGELES COUNTY METROPOLITAN TRANSPORTATION AUTHORITY

wsp 444 South Flower Street Suite 800 Los Angeles, CA 90071 TEL (213) 362-9470

SUBMITTED _____
 APPROVED _____

WEST SANTA ANA BRANCH FREIGHT TRACK TRACK ALIGNMENT PEROW PLAN & PROFILE STA 111+50 TO STA 1121+50

CONTRACT NO. AE5999300	REV
DRAWING NO. TF-234	
SCALE HOR: 1"=40' VERT: 1"=10'	
SHEET NO. 66	OF 107

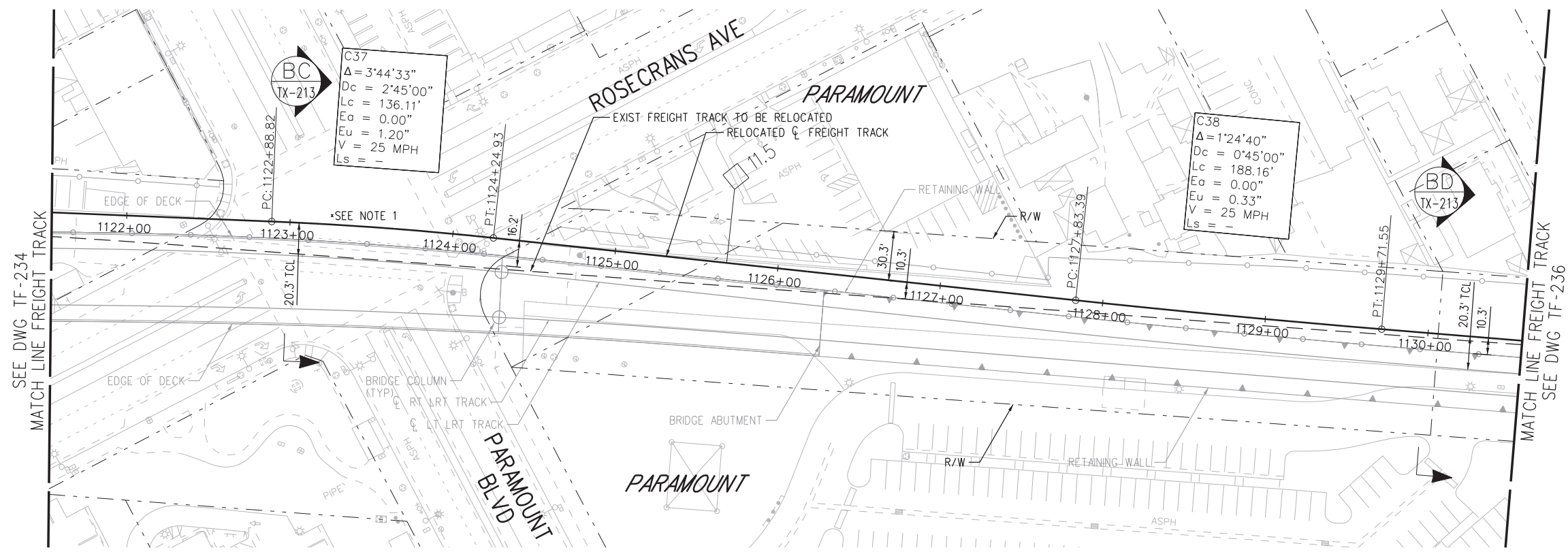

NOTE:
 1. REFER TO ADVANCED CONCEPTUAL ENGINEERING GRADE CROSSING PLANS.

PLAN

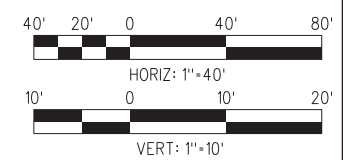
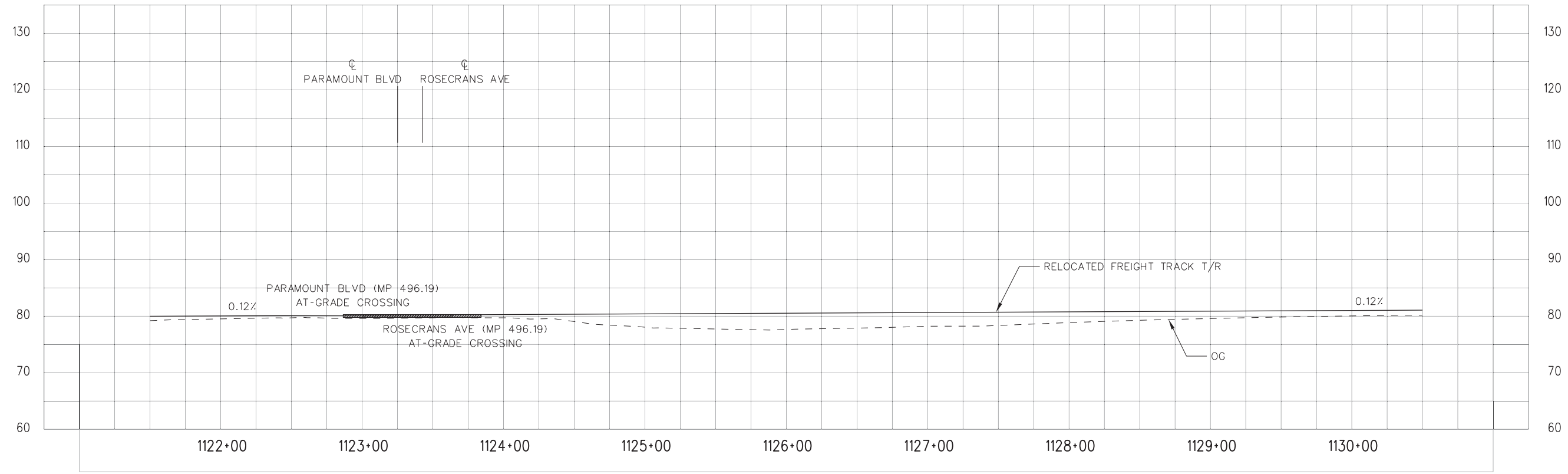

PROFILE

NOT FOR CONSTRUCTION

15-NOV-2019 C-28091ATF 235.plg
 svc-projectwise 22:38

THE PREPARATION OF THIS DRAWING HAS BEEN FINANCED IN PART THROUGH A GRANT FROM THE U.S. DEPARTMENT OF TRANSPORTATION FEDERAL TRANSIT ADMINISTRATION (FTA), UNDER THE FEDERAL TRANSIT ACT OF 1964, AS AMENDED, AND IN PART BY THE TAXES OF THE CITIZENS OF LOS ANGELES COUNTY AND OF THE STATE OF CALIFORNIA.		DESIGNED BY J. SANCHEZ
0	11/15/19	DRAWN BY C. CHEUK
		CHECKED BY R. LOYA
		IN CHARGE N. MAACK
		DATE 11/15/2019
		FINAL CONCEPTUAL DESIGN

M Metro
wsp
444 South Flower Street Suite 800 Los Angeles, CA 90071 TEL (213) 362-9470
SUBMITTED _____
APPROVED _____

LOS ANGELES COUNTY METROPOLITAN TRANSPORTATION AUTHORITY	
WEST SANTA ANA BRANCH FREIGHT TRACK	
TRACK ALIGNMENT	
PEROW	
PLAN & PROFILE	
STA 1121+50 TO STA 1130+50	
CONTRACT NO.	AE5999300
DRAWING NO.	TF-235
SCALE	HOR: 1"=40' VERT: 1"=10'
SHEET NO.	67 OF 107



NOTE:
 1. EXISTING TRACK WILL BE LINE AND SURFACE 200' BEYOND THE END OF NEW CONSTRUCTION.

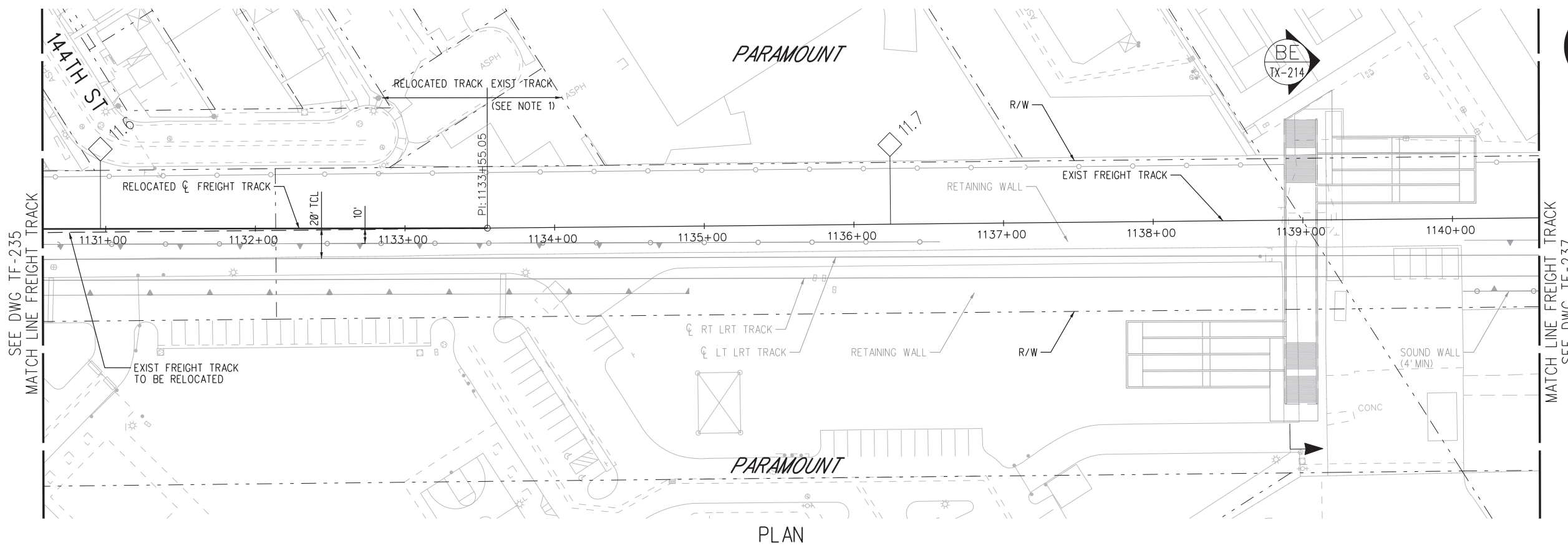

PLAN

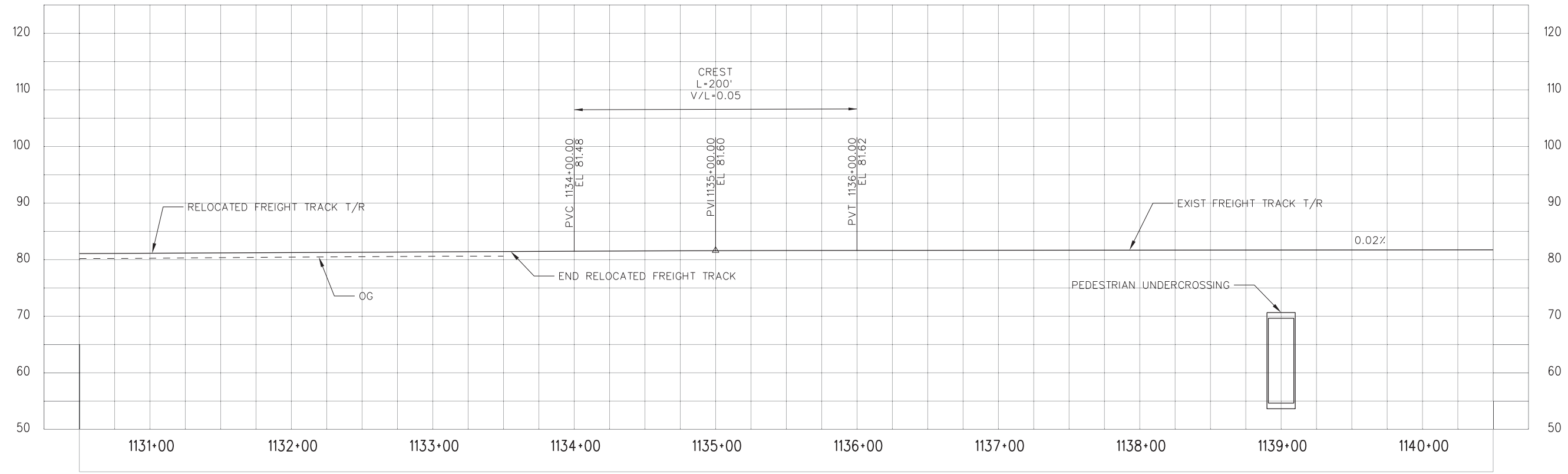

PROFILE

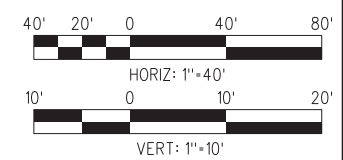

NOT FOR CONSTRUCTION

15-NOV-2019 C-28091ATF 236.plg
 22:41 svc-projectwise

THE PREPARATION OF THIS DRAWING HAS BEEN FINANCED IN PART THROUGH A GRANT FROM THE U.S. DEPARTMENT OF TRANSPORTATION FEDERAL TRANSIT ADMINISTRATION (FTA), UNDER THE FEDERAL TRANSIT ACT OF 1964, AS AMENDED, AND IN PART BY THE TAKES OF THE CITIZENS OF LOS ANGELES COUNTY AND OF THE STATE OF CALIFORNIA.		DESIGNED BY J. SANCHEZ
0	11/15/19	DRAWN BY C. CHEUK
		CHECKED BY R. LOYA
		IN CHARGE N. MAACK
		DATE 11/15/2019
		FINAL CONCEPTUAL DESIGN

M Metro
 444 South Flower Street
 Suite 800
 Los Angeles, CA 90071
 TEL (213) 362-9470

wsp

SUBMITTED _____
 APPROVED _____

**WEST SANTA ANA BRANCH FREIGHT TRACK
 TRACK ALIGNMENT
 PEROW
 PLAN & PROFILE
 STA 1130+50 TO STA 1140+50**

CONTRACT NO. AE5999300	REV
DRAWING NO. TF-236	
SCALE HORIZ: 1"=40' VERT: 1"=10'	
SHEET NO. 68	OF 107

15-NOV-2019 C-28091ATF 237.plg
 svc-projectwise 22:38

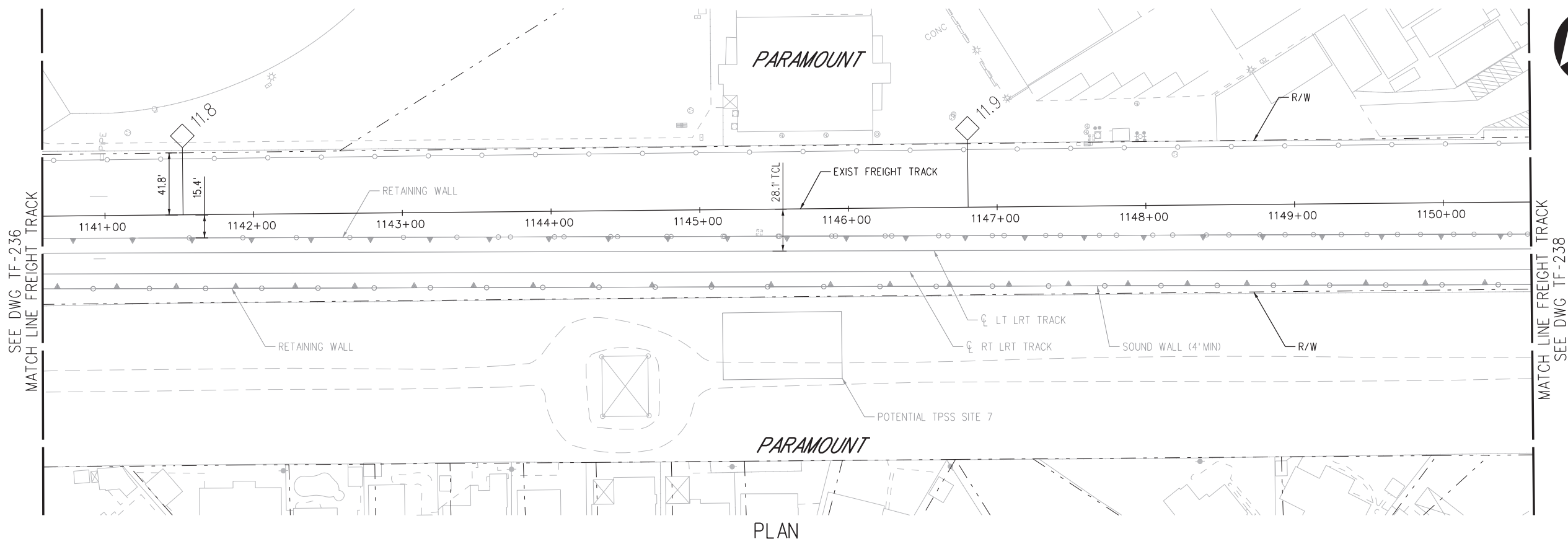

PLAN

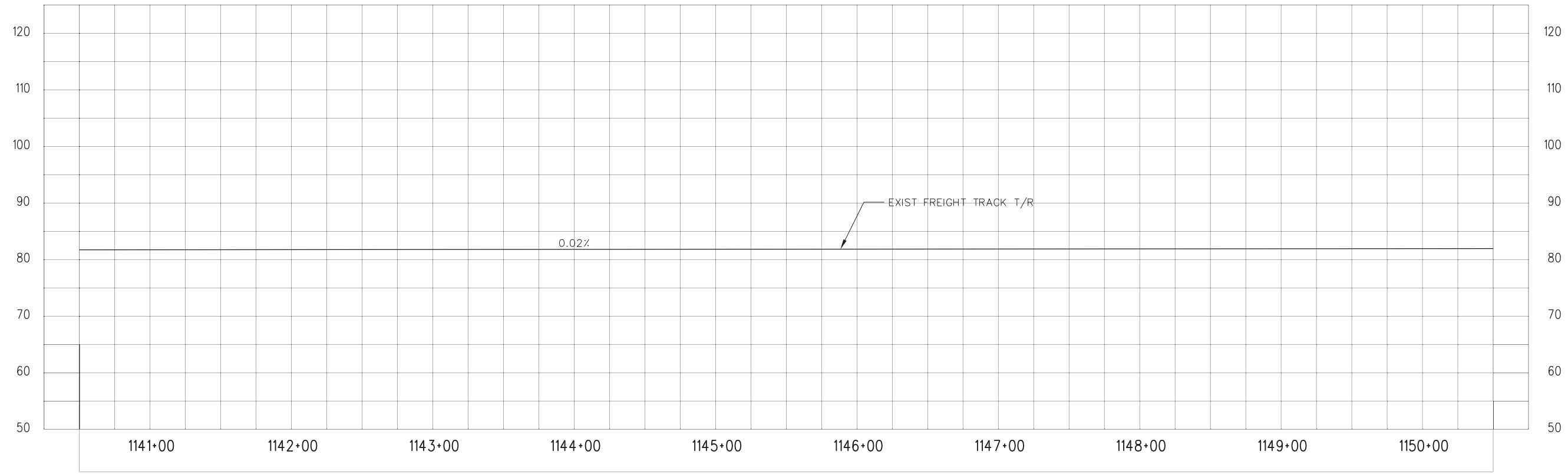

PROFILE

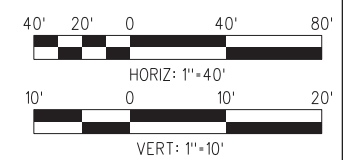

NOT FOR CONSTRUCTION

THE PREPARATION OF THIS DRAWING HAS BEEN FINANCED IN PART THROUGH A GRANT FROM THE U.S. DEPARTMENT OF TRANSPORTATION FEDERAL TRANSIT ADMINISTRATION (FTA), UNDER THE FEDERAL TRANSIT ACT OF 1964, AS AMENDED, AND IN PART BY THE TAXES OF THE CITIZENS OF LOS ANGELES COUNTY AND OF THE STATE OF CALIFORNIA.		DESIGNED BY J. SANCHEZ	 	LOS ANGELES COUNTY METROPOLITAN TRANSPORTATION AUTHORITY	CONTRACT NO. AE5999300	
		DRAWN BY C. CHEUK			DRAWING NO. TF-237	REV
		CHECKED BY R. LOYA			SCALE HOR: 1"=40' VERT: 1"=10'	
0	11/15/19	IN CHARGE N. MAACK			SHEET NO. 69	OF 107
		DATE 11/15/2019				

FINAL CONCEPTUAL DESIGN

444 South Flower Street Suite 800 Los Angeles, CA 90071 TEL (213) 362-9470	SUBMITTED _____ APPROVED _____
---	-----------------------------------

WEST SANTA ANA BRANCH FREIGHT TRACK
 TRACK ALIGNMENT
 PEROW
 PLAN & PROFILE
 STA 1140+50 TO STA 1150+50



NOTES:
 1. EXISTING TRACK WILL BE LINE AND SURFACE 200' BEYOND THE END OF NEW CONSTRUCTION.

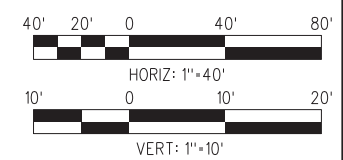
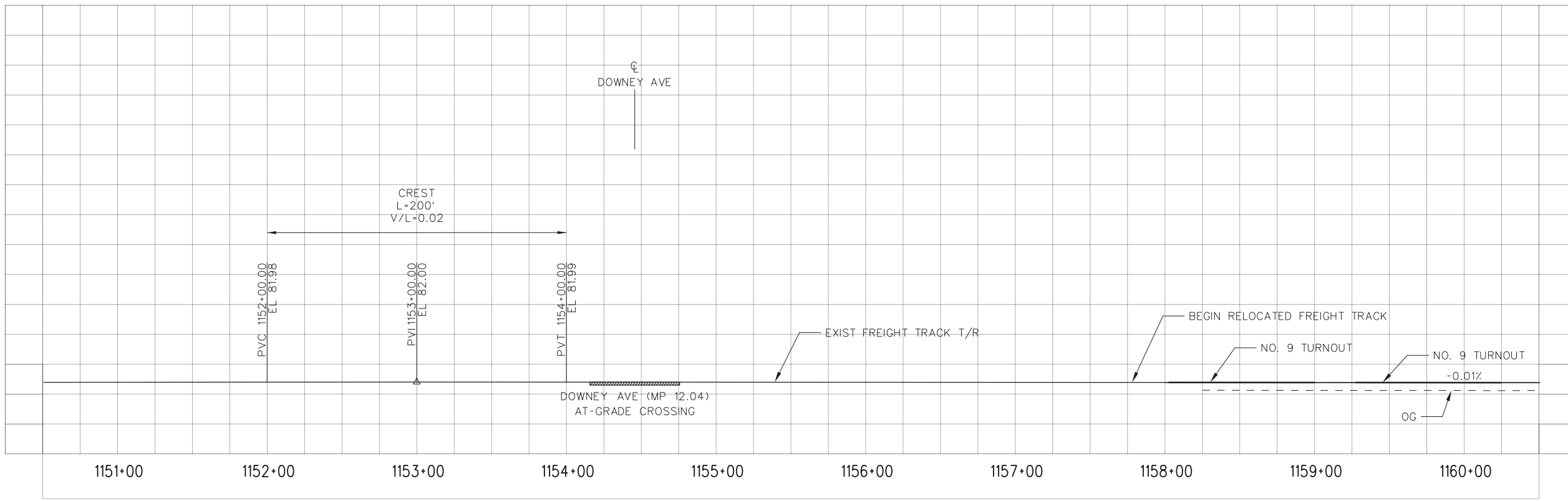
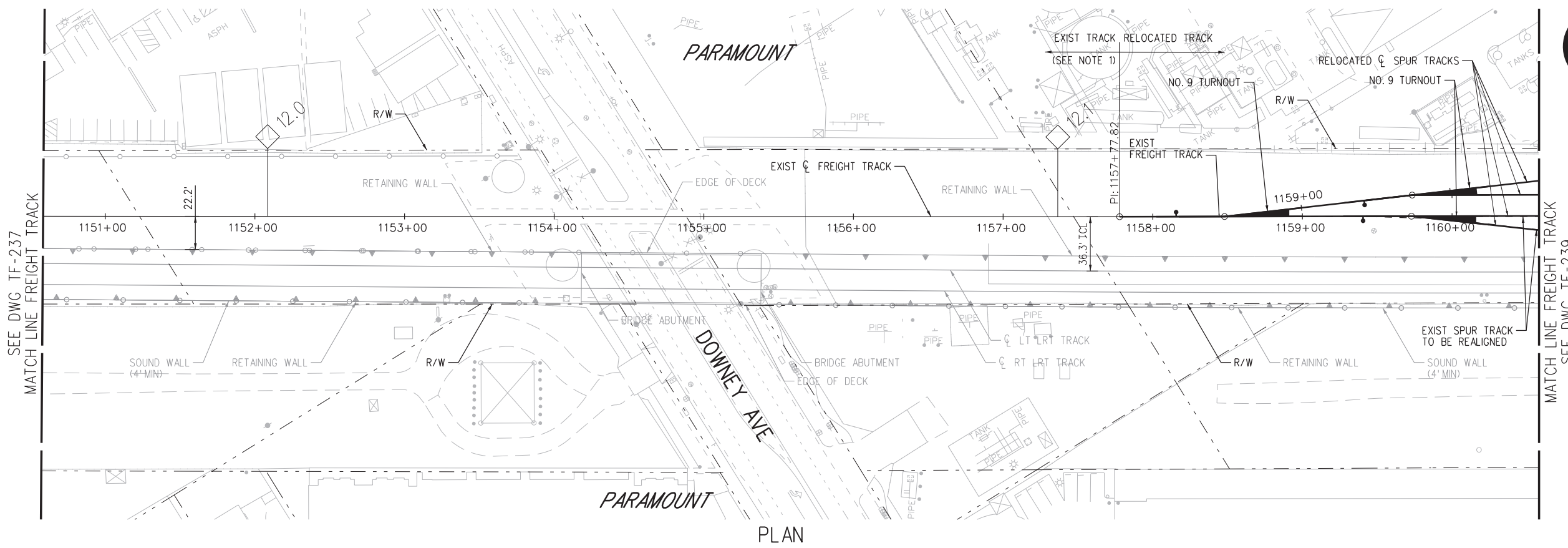

NOT FOR CONSTRUCTION

15-NOV-2019 C-28091ATF 238.plg
 svc-projectwise 22:39

THE PREPARATION OF THIS DRAWING HAS BEEN FINANCED IN PART THROUGH A GRANT FROM THE U.S. DEPARTMENT OF TRANSPORTATION FEDERAL TRANSIT ADMINISTRATION (FTA), UNDER THE FEDERAL TRANSIT ACT OF 1964, AS AMENDED, AND IN PART BY THE TAXES OF THE CITIZENS OF LOS ANGELES COUNTY AND OF THE STATE OF CALIFORNIA.		DESIGNED BY J. SANCHEZ
0	11/15/19	DRAWN BY C. CHEUK
		CHECKED BY R. LOYA
		IN CHARGE N. MAACK
		DATE 11/15/2019
		FINAL CONCEPTUAL DESIGN

Metro
 LOS ANGELES COUNTY METROPOLITAN TRANSPORTATION AUTHORITY

wsp 444 South Flower Street Suite 800 Los Angeles, CA 90071 TEL (213) 362-9470

SUBMITTED _____
 APPROVED _____

WEST SANTA ANA BRANCH FREIGHT TRACK TRACK ALIGNMENT PEROW PLAN & PROFILE STA 1150+50 TO STA 1160+50

CONTRACT NO. AE5999300	REV
DRAWING NO. TF-238	
SCALE HOR: 1"=40' VERT: 1"=10'	
SHEET NO. 70 OF 107	

15-NOV-2019 C-28091ATF 239.plg
 svc-projectwise 22:36

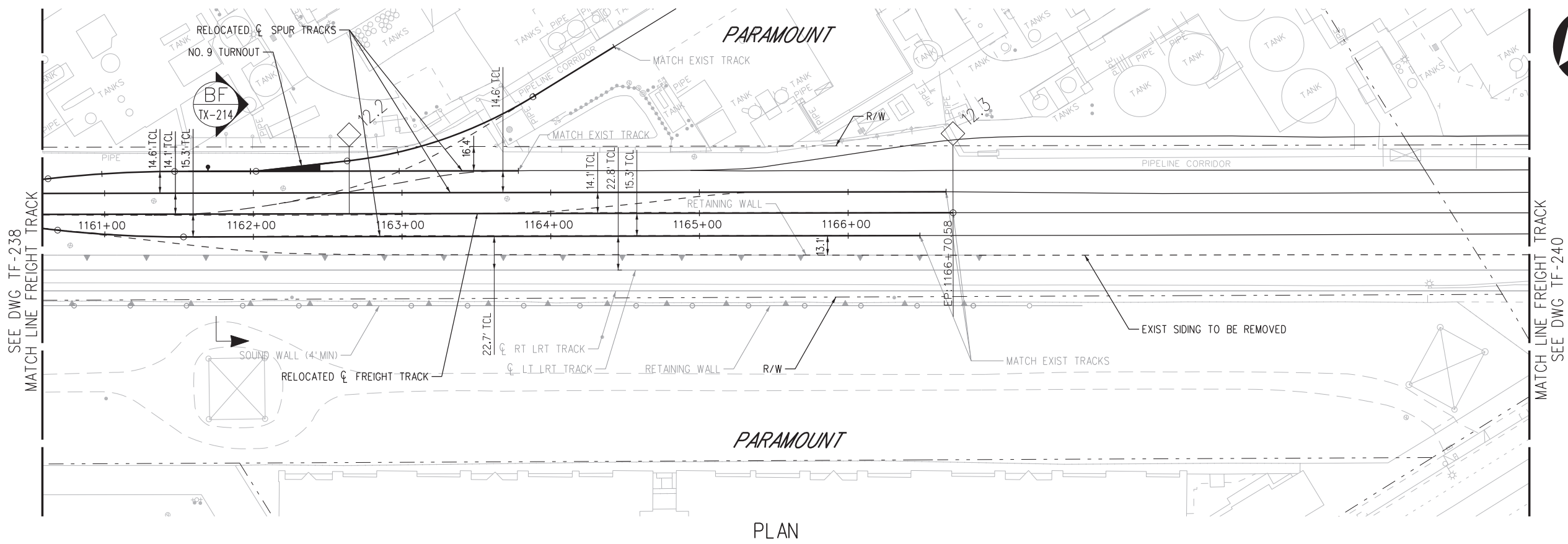

PLAN

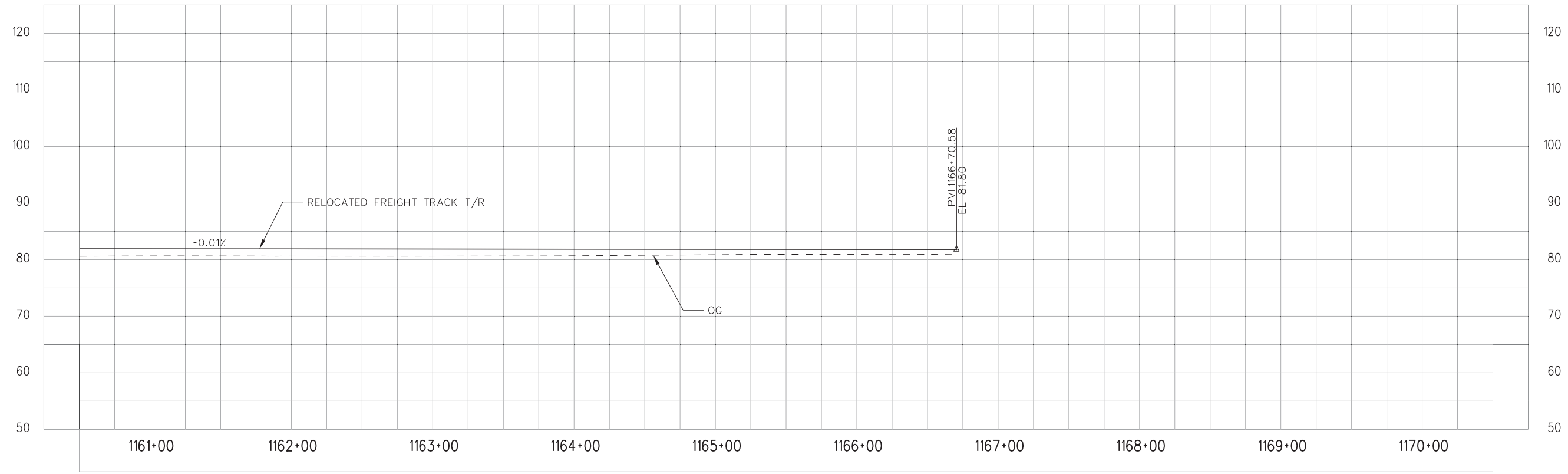

PROFILE

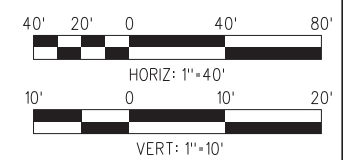

NOT FOR CONSTRUCTION

THE PREPARATION OF THIS DRAWING HAS BEEN FINANCED IN PART THROUGH A GRANT FROM THE U.S. DEPARTMENT OF TRANSPORTATION FEDERAL TRANSIT ADMINISTRATION (FTA), UNDER THE FEDERAL TRANSIT ACT OF 1964, AS AMENDED, AND IN PART BY THE TAXES OF THE CITIZENS OF LOS ANGELES COUNTY AND OF THE STATE OF CALIFORNIA.		DESIGNED BY J. SANCHEZ
0	11/15/19	DRAWN BY C. CHEUK
		CHECKED BY R. LOYA
		IN CHARGE N. MAACK
		DATE 11/15/2019
		FINAL CONCEPTUAL DESIGN

M Metro
 444 South Flower Street
 Suite 800
 Los Angeles, CA 90071
 TEL (213) 362-9470

wsp

SUBMITTED _____
 APPROVED _____

**WEST SANTA ANA BRANCH FREIGHT TRACK
 TRACK ALIGNMENT
 PEROW
 PLAN & PROFILE
 STA 1160+50 TO STA 1170+50**

CONTRACT NO. AE5999300	REV
DRAWING NO. TF-239	
SCALE HOR: 1"=40' VERT: 1"=10'	
SHEET NO. 71 OF 107	

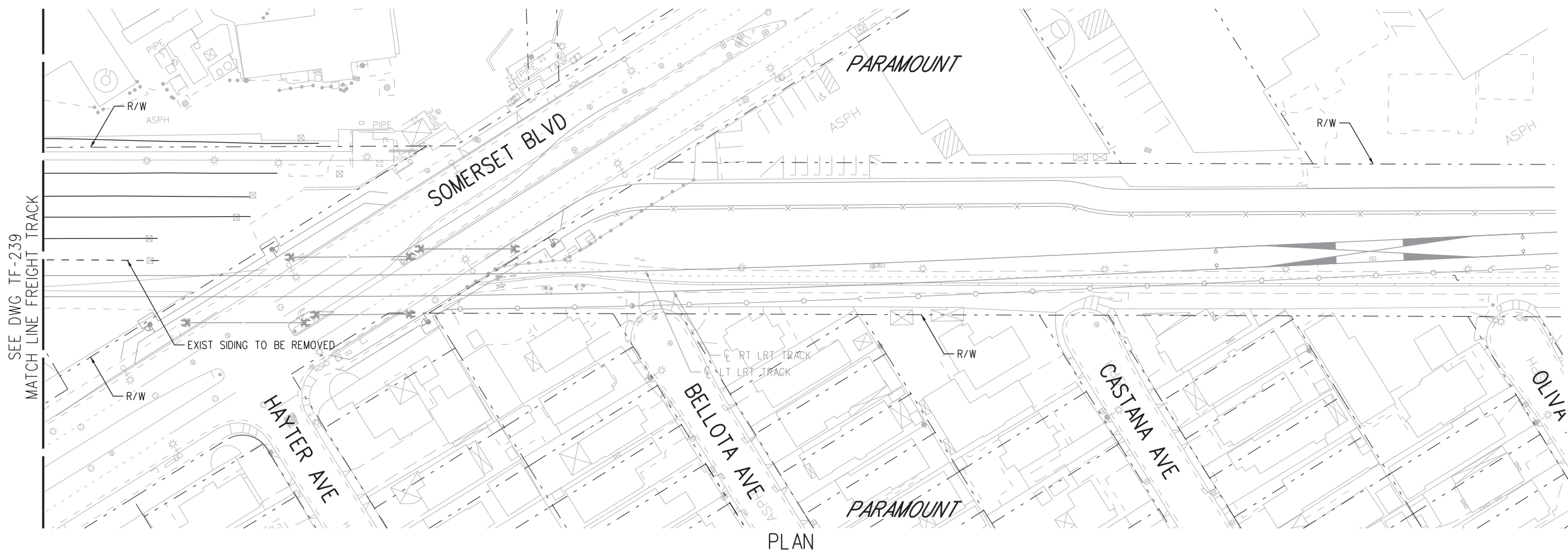

PLAN

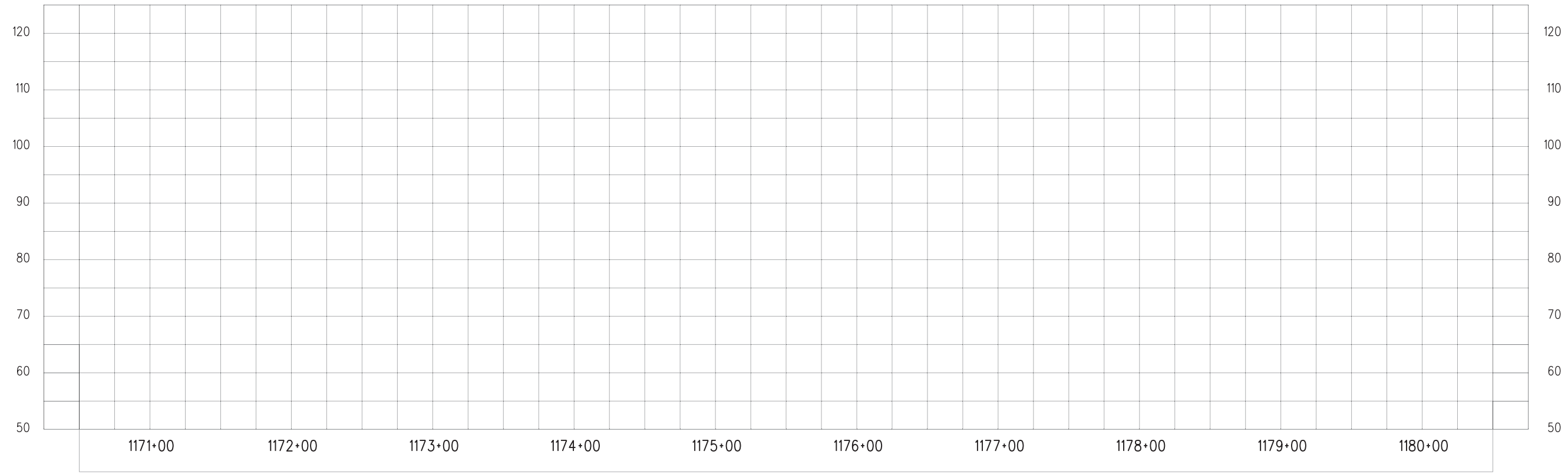

PROFILE

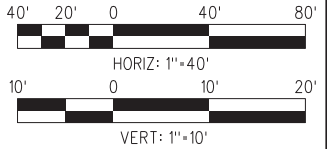

NOT FOR CONSTRUCTION

15-NOV-2019 C-28091ATF240.plg

svc-projectwise 22:40

THE PREPARATION OF THIS DRAWING HAS BEEN FINANCED IN PART THROUGH A GRANT FROM THE U.S. DEPARTMENT OF TRANSPORTATION FEDERAL TRANSIT ADMINISTRATION (FTA), UNDER THE FEDERAL TRANSIT ACT OF 1964, AS AMENDED, AND IN PART BY THE TAXES OF THE CITIZENS OF LOS ANGELES COUNTY AND OF THE STATE OF CALIFORNIA.

DESIGNED BY	J. SANCHEZ
DRAWN BY	C. CHEUK
CHECKED BY	R. LOYA
IN CHARGE	N. MAACK
DATE	11/15/2019
	FINAL CONCEPTUAL DESIGN

0	11/15/19				
---	----------	--	--	--	--



LOS ANGELES COUNTY METROPOLITAN TRANSPORTATION AUTHORITY



444 South Flower Street Suite 800 Los Angeles, CA 90071 TEL (213) 362-9470

SUBMITTED _____
APPROVED _____

WEST SANTA ANA BRANCH FREIGHT TRACK TRACK ALIGNMENT PEROW PLAN & PROFILE STA 1170+50 TO STA 1180+50

CONTRACT NO	AE5999300
DRAWING NO	TF-240
SCALE	HOR: 1"=40' VERT: 1"=10'
SHEET NO	72 OF 107

NOTES:
 1. FOR SOUND WALL AND RETAINING WALL LIMITS, SEE PLAN AND PROFILE SHEETS.

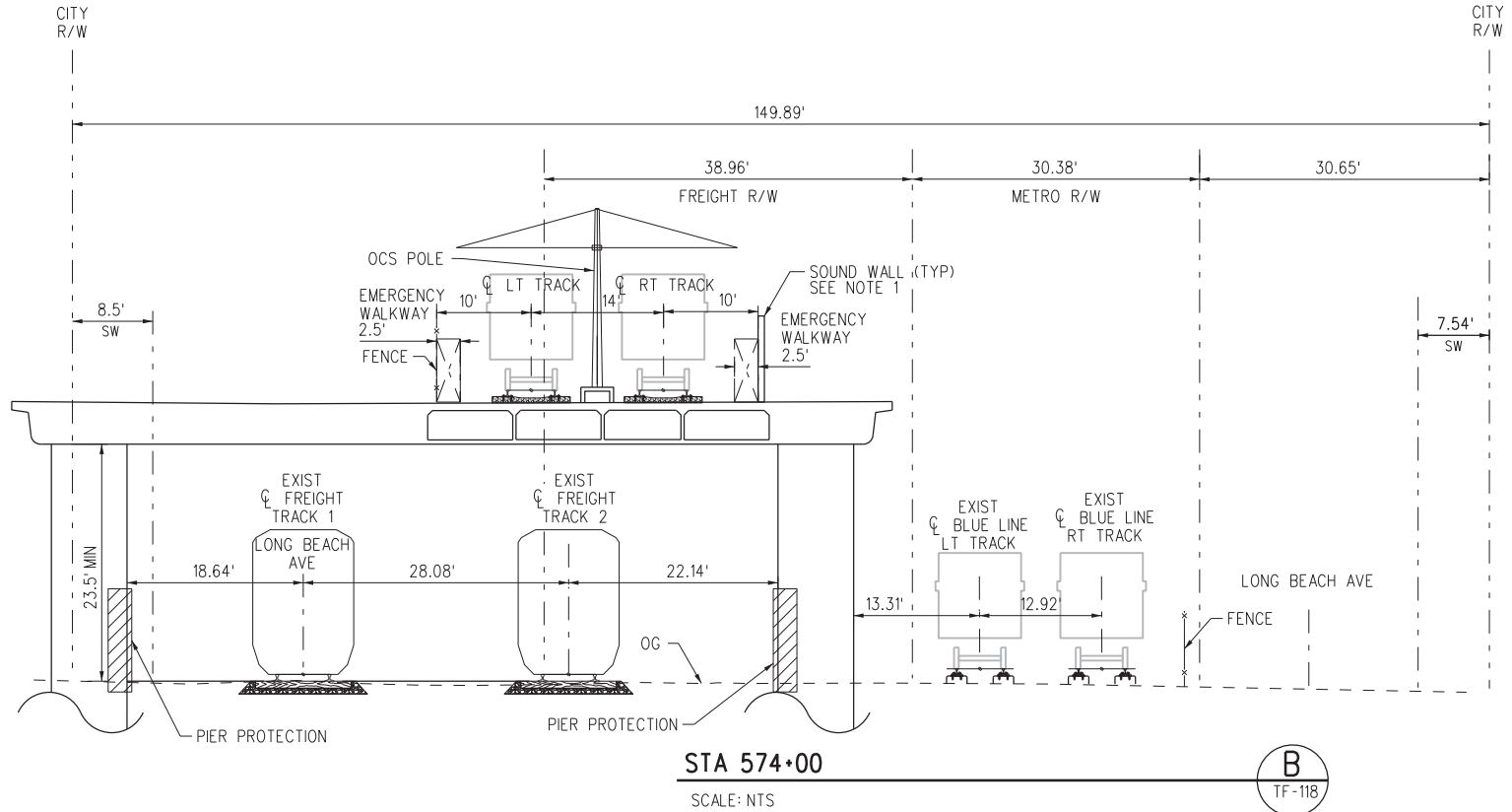
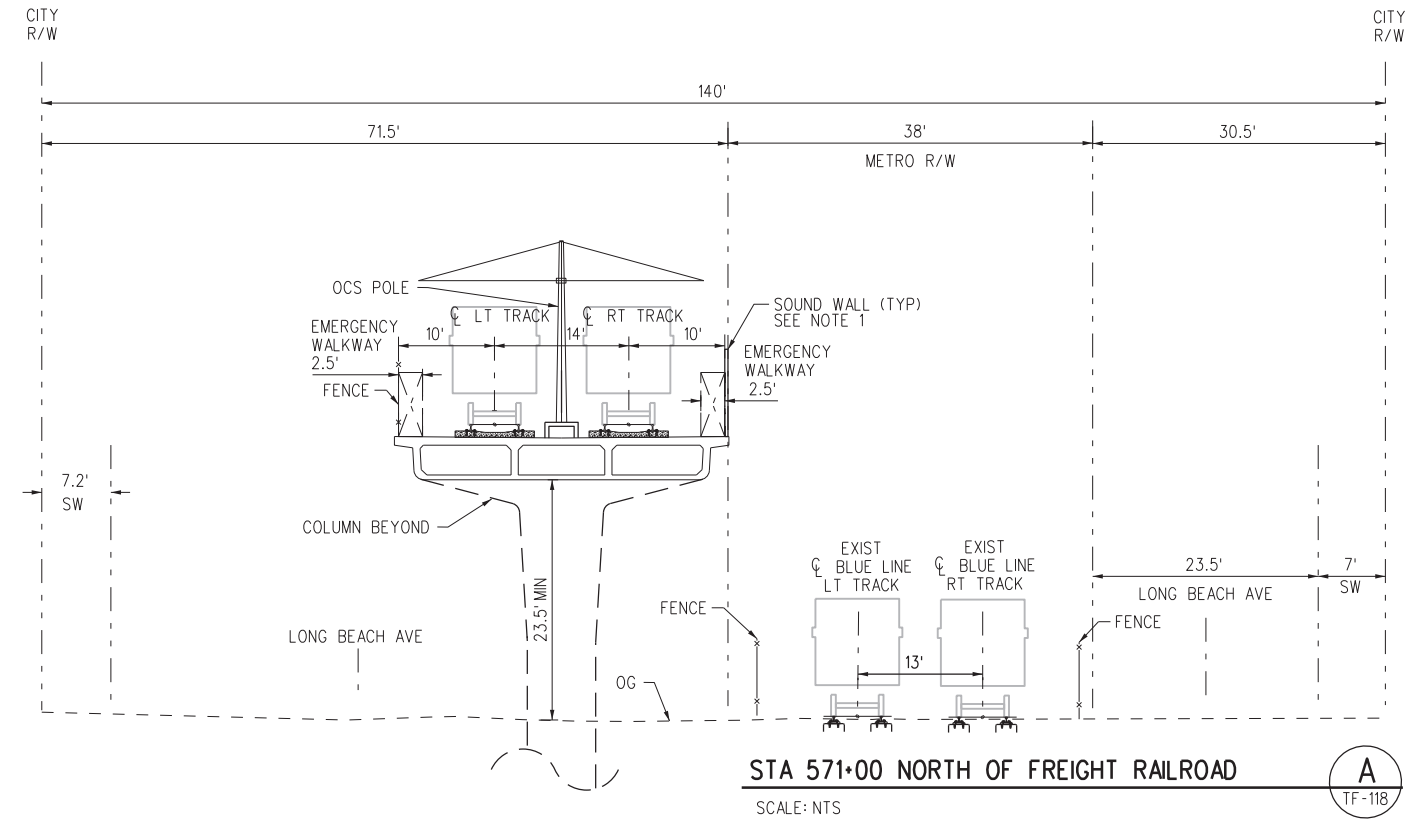

NOT FOR CONSTRUCTION

DESIGNED BY	R. CASAS
DRAWN BY	A. MORALES
CHECKED BY	Y. JIANG
IN CHARGE	N. MAACK
DATE	11/15/2019
FINAL CONCEPTUAL ALIGNMENT	

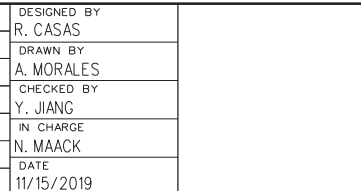

444 South Flower Street
 Suite 800
 Los Angeles, CA 90071
 TEL (213) 362-9470

SUBMITTED _____
 APPROVED _____

WEST SANTA ANA BRANCH FREIGHT TRACK
 CROSS SECTIONS
 NORTHERN ALIGNMENT
 20' OFFSET

CONTRACT NO	AE5999300
DRAWING NO	TX-101
SCALE	NO SCALE
SHEET NO	73 OF 107

15-NOV-2019 C-28091ATX101.plt
 svc-projectwise 23:42

NOTES:
 1. FOR SOUND WALL AND RETAINING WALL LIMITS, SEE PLAN AND PROFILE SHEETS.

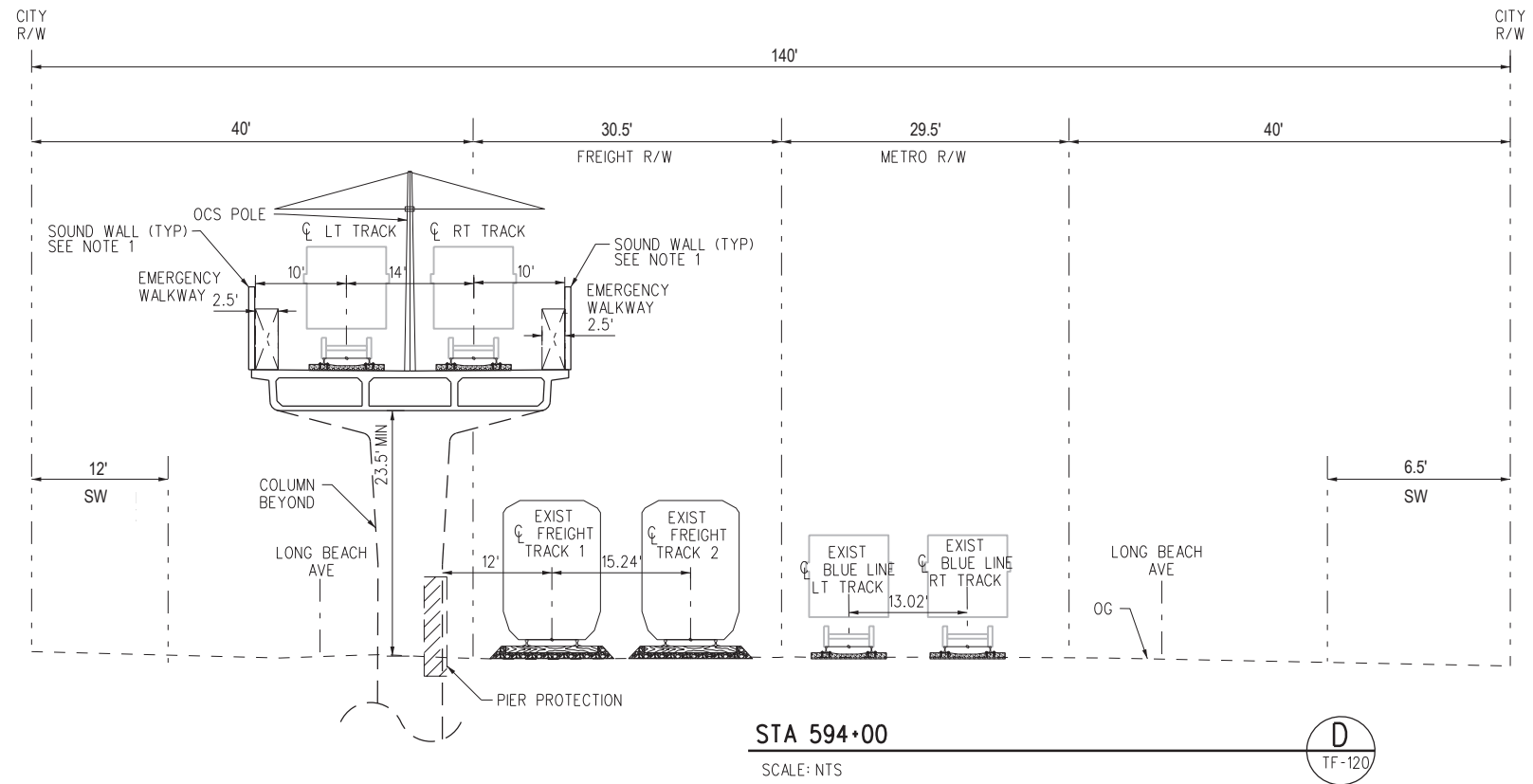
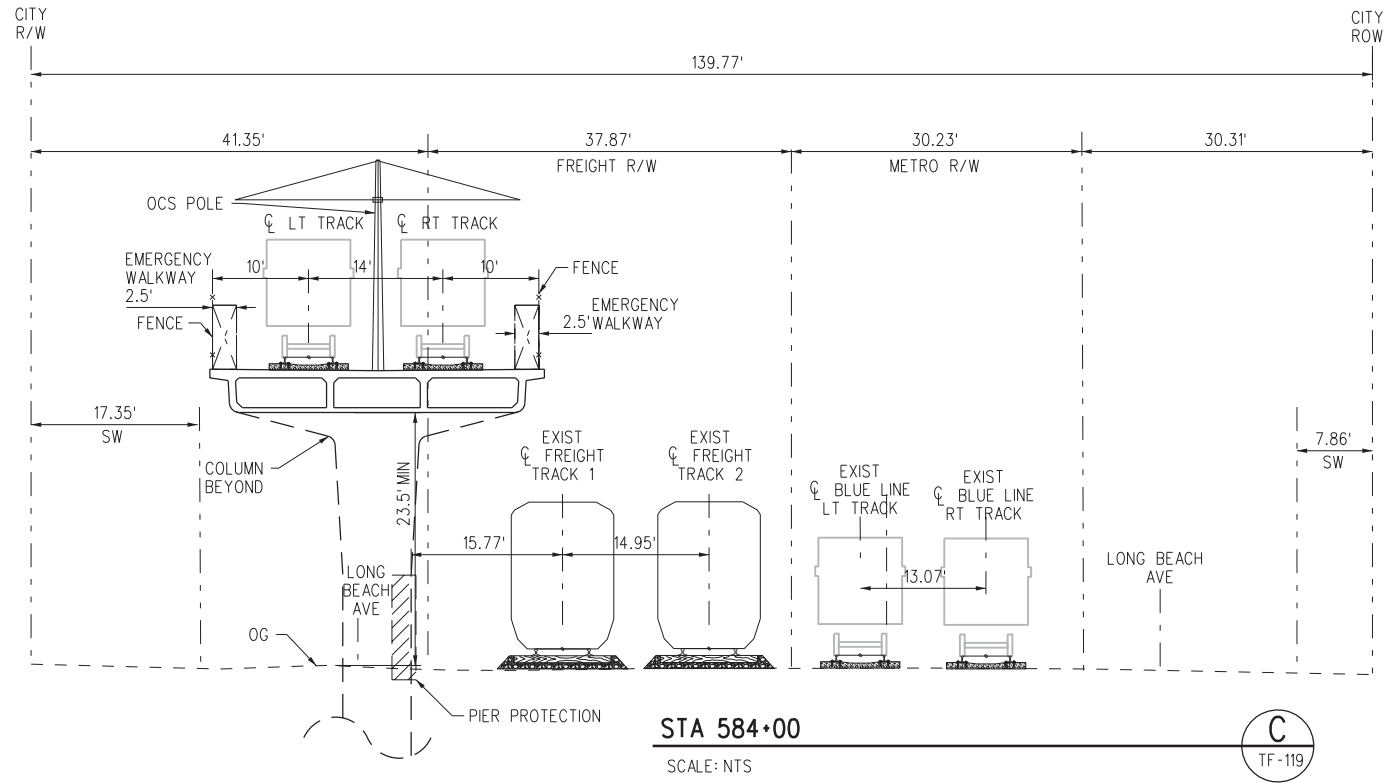

NOT FOR CONSTRUCTION

THE PREPARATION OF THIS DRAWING HAS BEEN FINANCED IN PART THROUGH A GRANT FROM THE U.S. DEPARTMENT OF TRANSPORTATION FEDERAL TRANSIT ADMINISTRATION (FTA), UNDER THE FEDERAL TRANSIT ACT OF 1964, AS AMENDED, AND IN PART BY THE TAXES OF THE CITIZENS OF LOS ANGELES COUNTY AND OF THE STATE OF CALIFORNIA.		DESIGNED BY R. CASAS	 LOS ANGELES COUNTY METROPOLITAN TRANSPORTATION AUTHORITY	CONTRACT NO. AE5999300
0	11/15/19	DRAWN BY A. MORALES		DRAWING NO. TX-102
		CHECKED BY Y. JIANG		SCALE NO SCALE
		IN CHARGE N. MAACK		SHEET NO. 74 OF 107
		DATE 11/15/2019		

FINAL CONCEPTUAL ALIGNMENT

 444 South Flower Street Suite 800 Los Angeles, CA 90071 TEL (213) 362-9470

SUBMITTED _____
 APPROVED _____

WEST SANTA ANA BRANCH FREIGHT TRACK
CROSS SECTIONS
NORTHERN ALIGNMENT
20' OFFSET

NOTES:
 1. FOR SOUND WALL AND RETAINING WALL LIMITS, SEE PLAN AND PROFILE SHEETS.

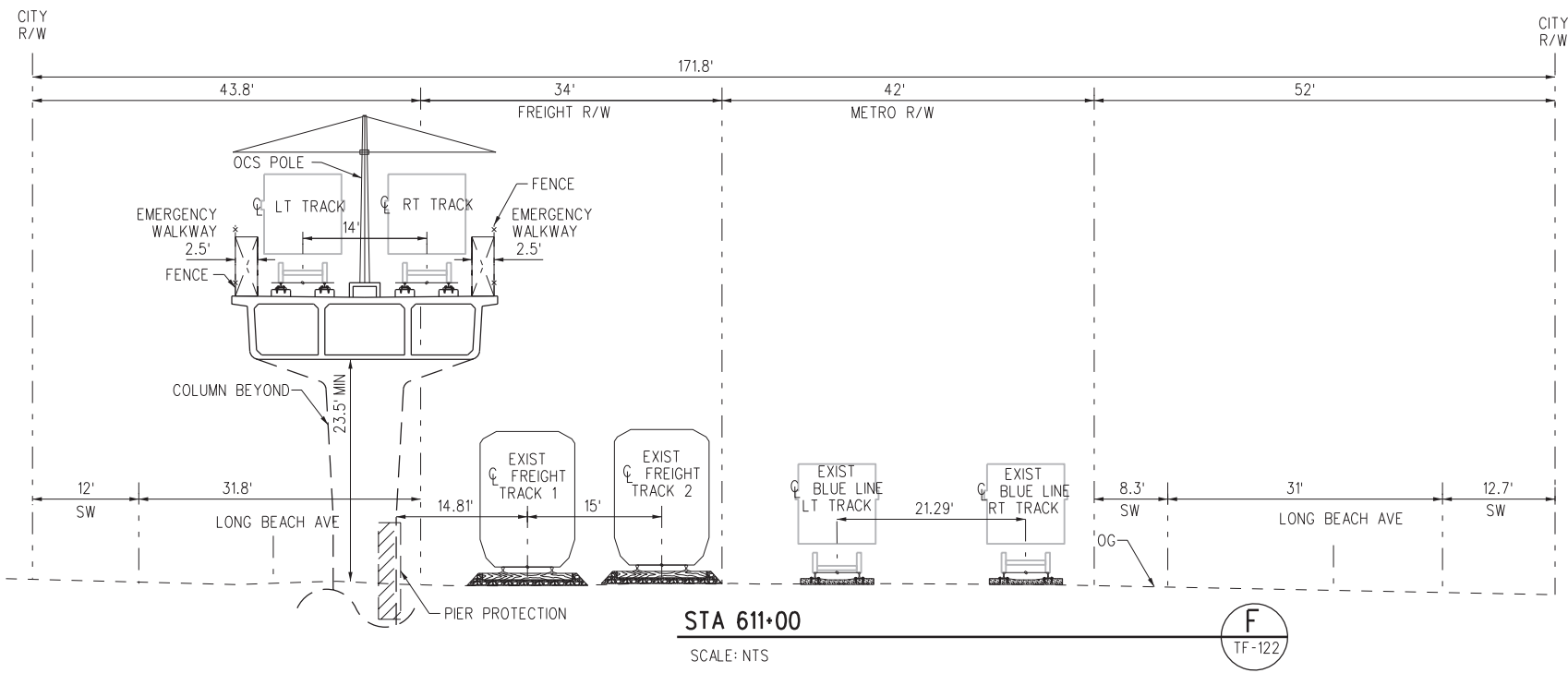
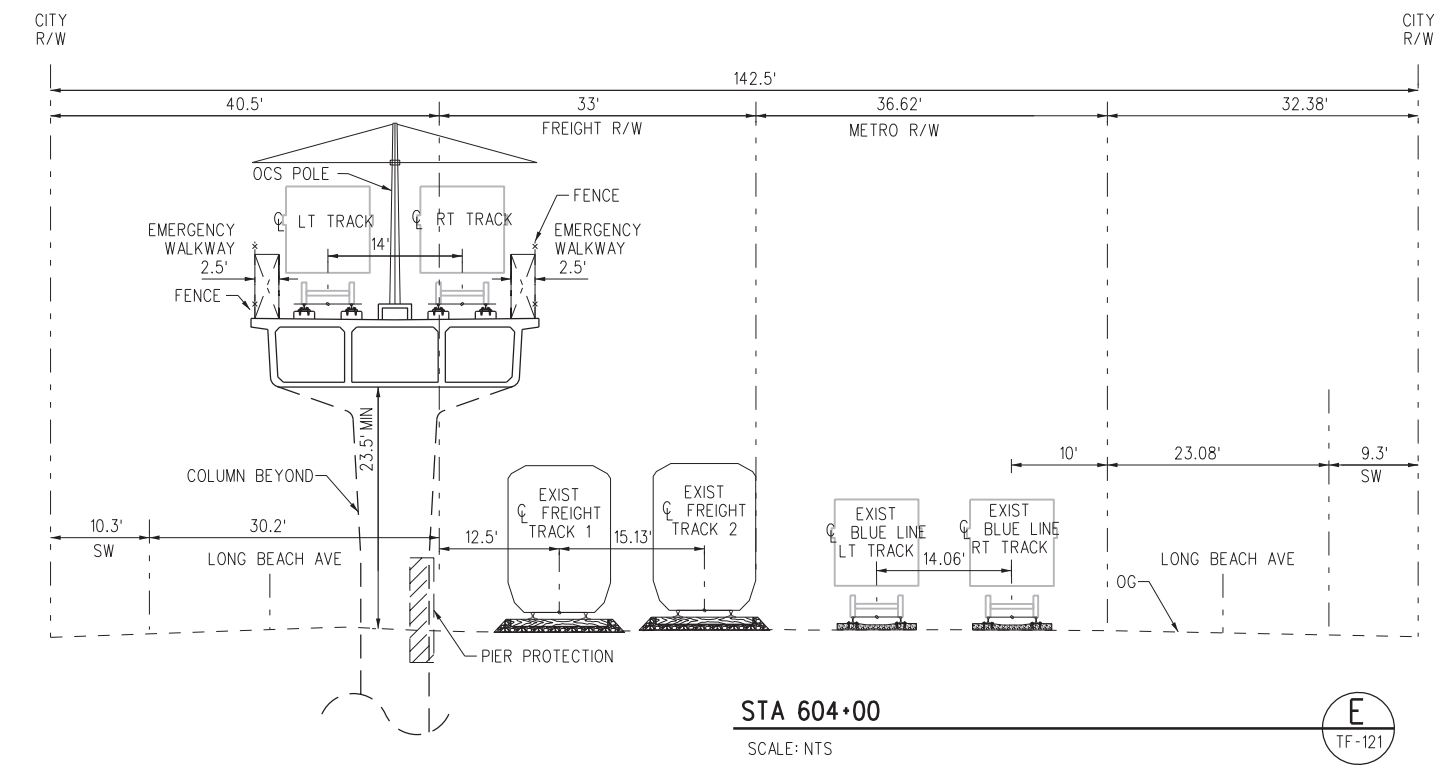

NOT FOR CONSTRUCTION

DESIGNED BY	R. CASAS
DRAWN BY	A. MORALES
CHECKED BY	Y. JIANG
IN CHARGE	N. MAACK
DATE	11/15/2019
DESCRIPTION	FINAL CONCEPTUAL ALIGNMENT

M Metro
 LOS ANGELES COUNTY METROPOLITAN TRANSPORTATION AUTHORITY

wsp 444 South Flower Street Suite 800 Los Angeles, CA 90071 TEL (213) 362-9470

SUBMITTED _____
 APPROVED _____

WEST SANTA ANA BRANCH FREIGHT TRACK
 CROSS SECTIONS
 NORTHERN ALIGNMENT
 20' OFFSET

CONTRACT NO	AE5999300
DRAWING NO	TX-103
SCALE	NO SCALE
SHEET NO	75 OF 107

15-NOV-2019 C-28091ATX103.plg
 svc-projectwise 23:42
 Plot Driver=MTA-half.pen
 Pentable=bw.plt

NOTES:
 1. FOR SOUND WALL AND RETAINING WALL LIMITS, SEE PLAN AND PROFILE SHEETS.

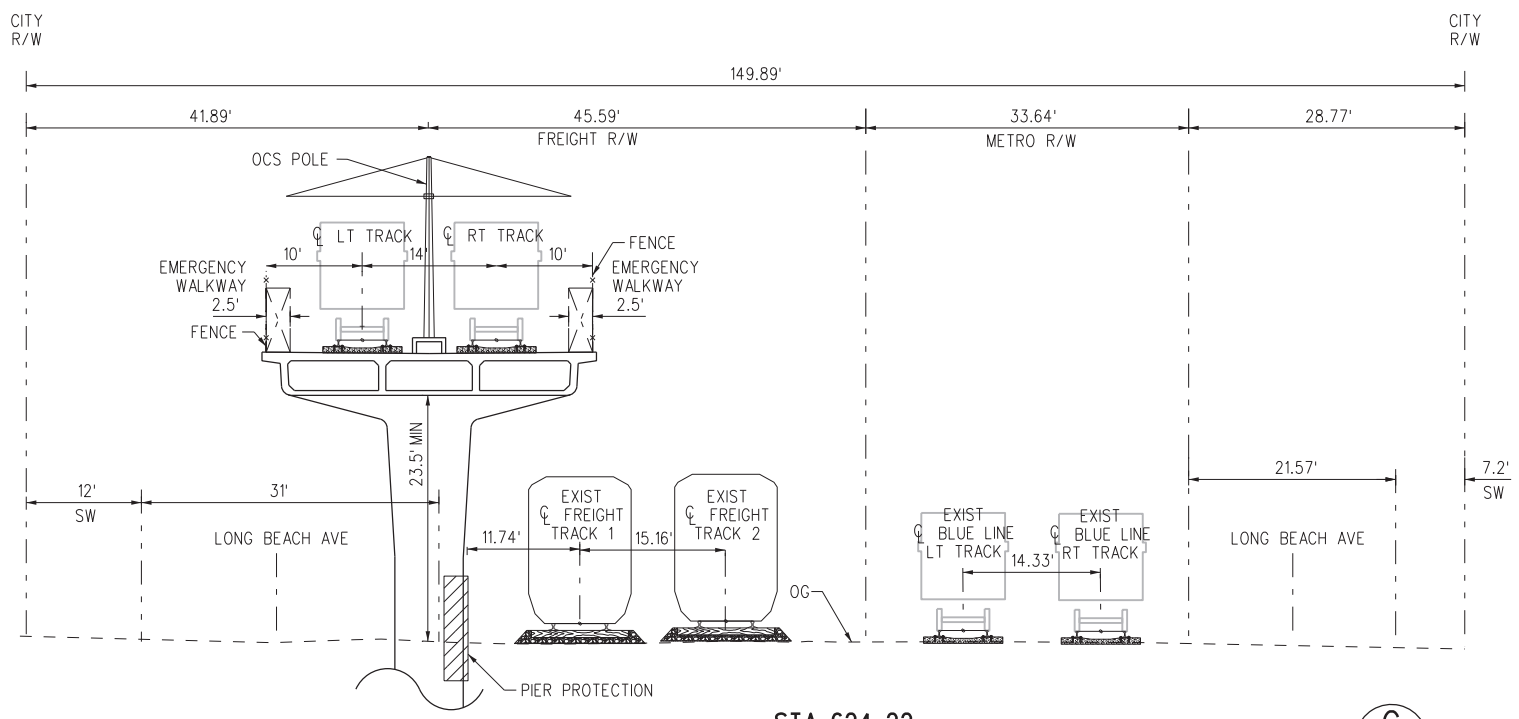

STA 624+22
 SCALE: NTS
 G
 TF-123

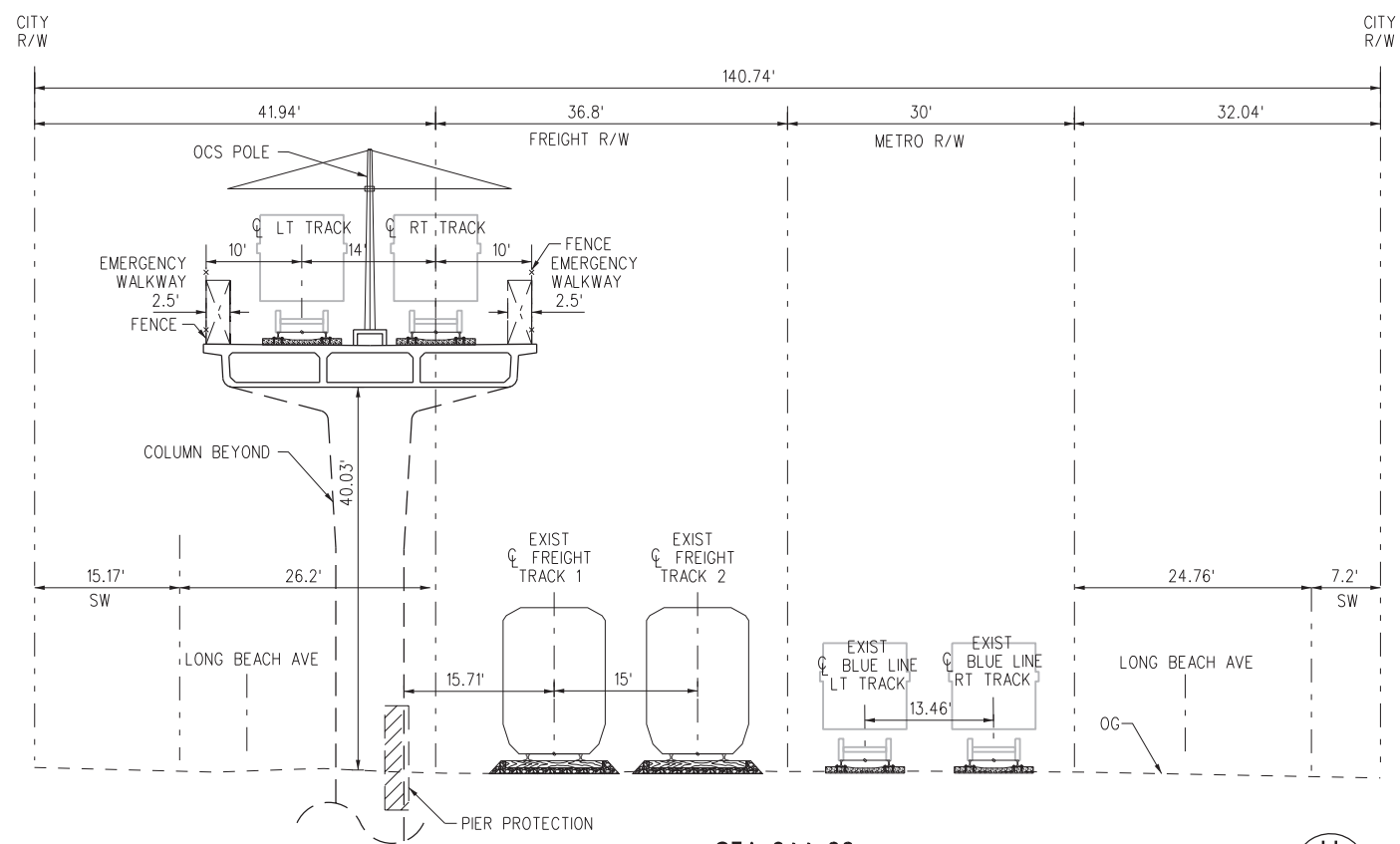

STA 644+00
 SCALE: NTS
 H
 TF-125

NOT FOR CONSTRUCTION

THE PREPARATION OF THIS DRAWING HAS BEEN FINANCED IN PART THROUGH A GRANT FROM THE U.S. DEPARTMENT OF TRANSPORTATION FEDERAL TRANSIT ADMINISTRATION (FTA), UNDER THE FEDERAL TRANSIT ACT OF 1964, AS AMENDED, AND IN PART BY THE TAXES OF THE CITIZENS OF LOS ANGELES COUNTY AND OF THE STATE OF CALIFORNIA.		DESIGNED BY R. CASAS	 LOS ANGELES COUNTY METROPOLITAN TRANSPORTATION AUTHORITY 444 South Flower Street Suite 800 Los Angeles, CA 90071 TEL (213) 362-9470	SUBMITTED _____ APPROVED _____
		DRAWN BY A. MORALES		
		CHECKED BY Y. JIANG		
		IN CHARGE N. MAACK		
		DATE 11/15/2019		
0	11/15/19	FINAL CONCEPTUAL ALIGNMENT		

WEST SANTA ANA BRANCH FREIGHT TRACK		CONTRACT NO AE5999300
CROSS SECTIONS NORTHERN ALIGNMENT 20' OFFSET		DRAWING NO TX-104
		SCALE NO SCALE
		SHEET NO 76 OF 107

15-NOV-2019 C-28091ATX104.plt
 svc-projectwise 23:42
 Plot Driver=MTA-half.pen
 Pentable=bw.plt

NOTES:

1. FOR SOUND WALL AND RETAINING WALL LIMITS, SEE PLAN AND PROFILE SHEETS.
2. CROSS SECTIONS AT SLAUSON STATION MAY REQUIRE REVISION DUE TO CHANGES IN STATION CONFIGURATION. HOWEVER, MINIMUM FREIGHT CLEARANCES TO BE PROVIDED.

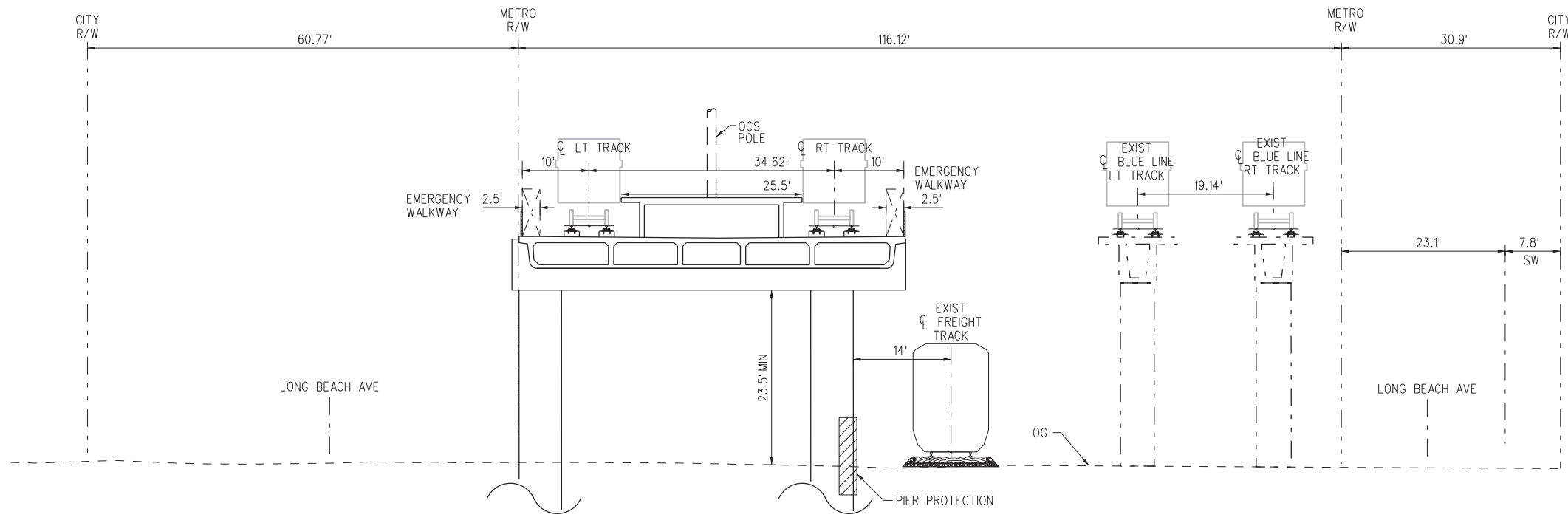

STA 662+50

SCALE: NTS

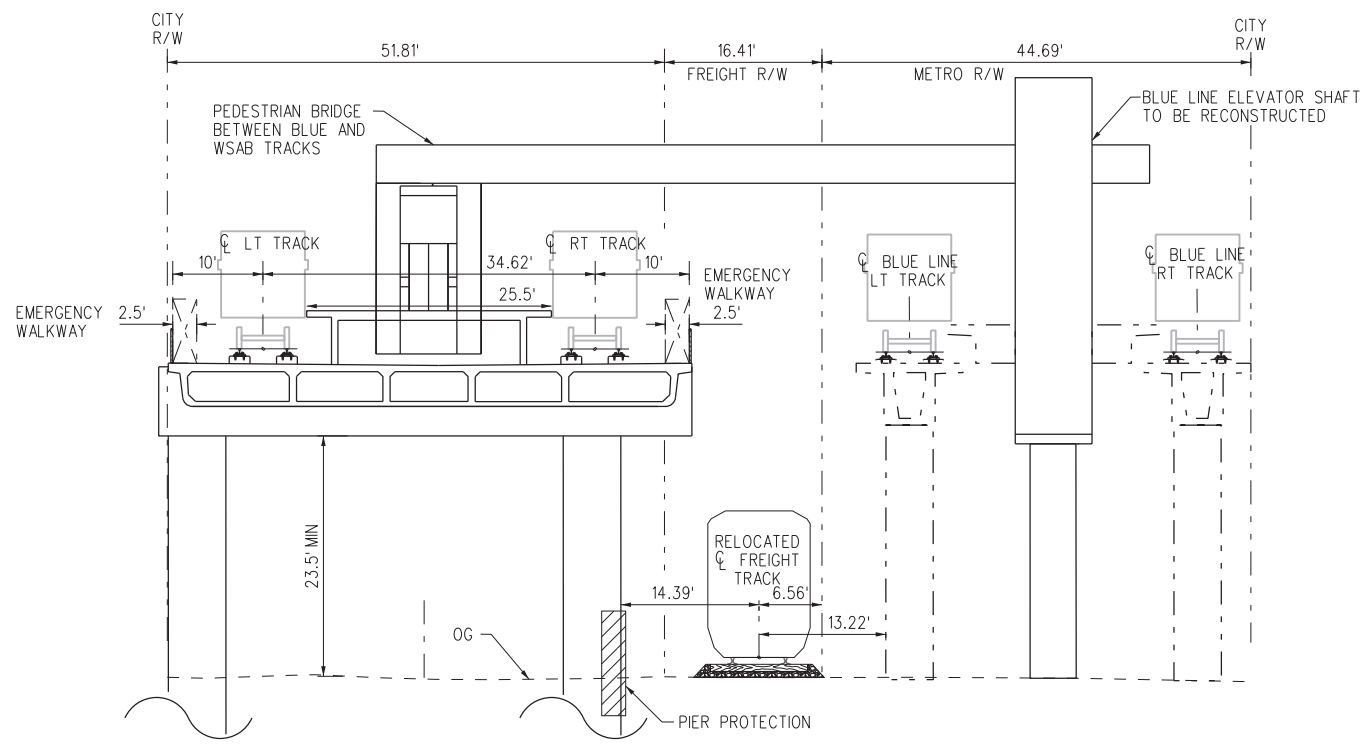

STA 664+34

SCALE: NTS



NOT FOR CONSTRUCTION

THE PREPARATION OF THIS DRAWING HAS BEEN FINANCED IN PART THROUGH A GRANT FROM THE U.S. DEPARTMENT OF TRANSPORTATION FEDERAL TRANSIT ADMINISTRATION (FTA), UNDER THE FEDERAL TRANSIT ACT OF 1964, AS AMENDED, AND IN PART BY THE TAXES OF THE CITIZENS OF LOS ANGELES COUNTY AND OF THE STATE OF CALIFORNIA.		DESIGNED BY R. CASAS	<p>LOS ANGELES COUNTY METROPOLITAN TRANSPORTATION AUTHORITY</p> <p>444 South Flower Street Suite 800 Los Angeles, CA 90071 TEL (213) 362-9470</p>	CONTRACT NO. AE5999300
0	11/15/19	DRAWN BY A. MORALES		DRAWING NO. TX-105
		CHECKED BY Y. JIANG		SCALE NO SCALE
		IN CHARGE N. MAACK		SHEET NO. 77 OF 107
		DATE 11/15/2019		
FINAL CONCEPTUAL ALIGNMENT				

DESIGNED BY R. CASAS
DRAWN BY A. MORALES
CHECKED BY Y. JIANG
IN CHARGE N. MAACK
DATE 11/15/2019

<p>LOS ANGELES COUNTY METROPOLITAN TRANSPORTATION AUTHORITY</p> <p>444 South Flower Street Suite 800 Los Angeles, CA 90071 TEL (213) 362-9470</p>	SUBMITTED _____ APPROVED _____
--	-----------------------------------

WEST SANTA ANA BRANCH FREIGHT TRACK	
CROSS SECTIONS	
NORTHERN ALIGNMENT	
20' OFFSET	

CONTRACT NO. AE5999300	REV
DRAWING NO. TX-105	
SCALE NO SCALE	
SHEET NO. 77 OF 107	

15-NOV-2019 C-28091ATX105.plt

NOTES:

1. FOR SOUND WALL AND RETAINING WALL LIMITS, SEE PLAN AND PROFILE SHEETS.
2. CROSS SECTIONS AT SLAUSON STATION MAY REQUIRE REVISION DUE TO CHANGES IN STATION CONFIGURATION. HOWEVER, MINIMUM FREIGHT CLEARANCES TO BE PROVIDED.

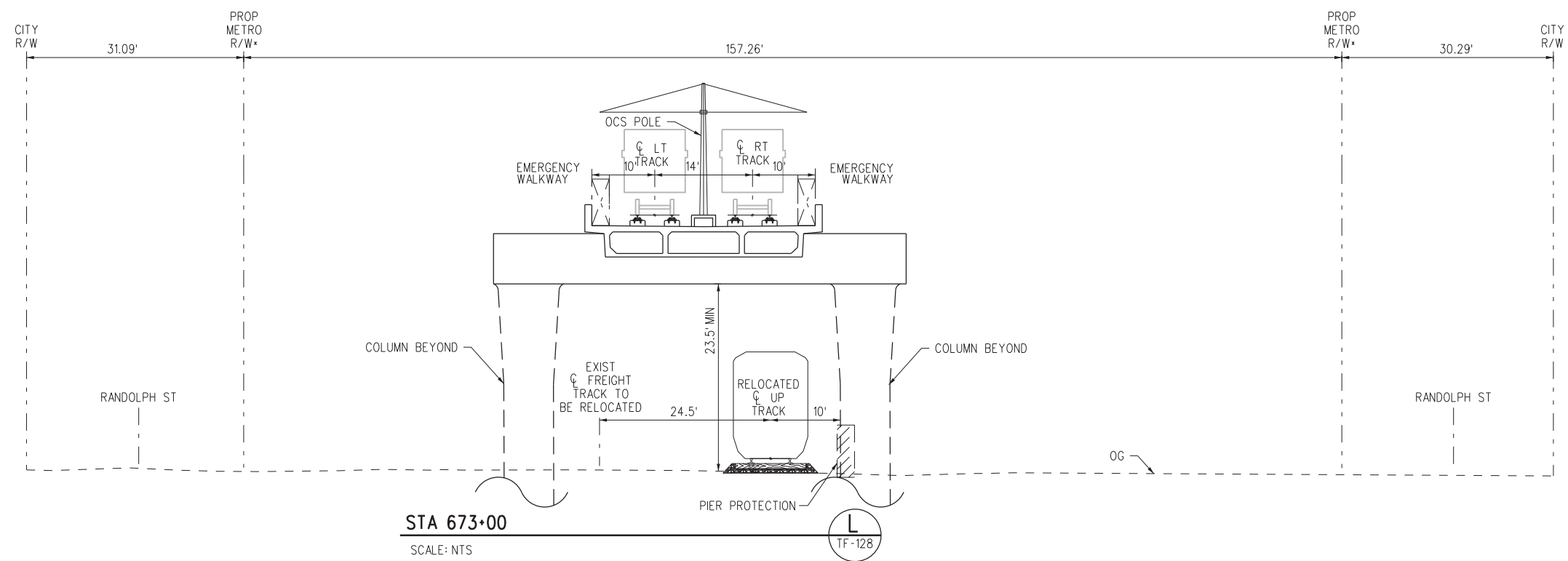
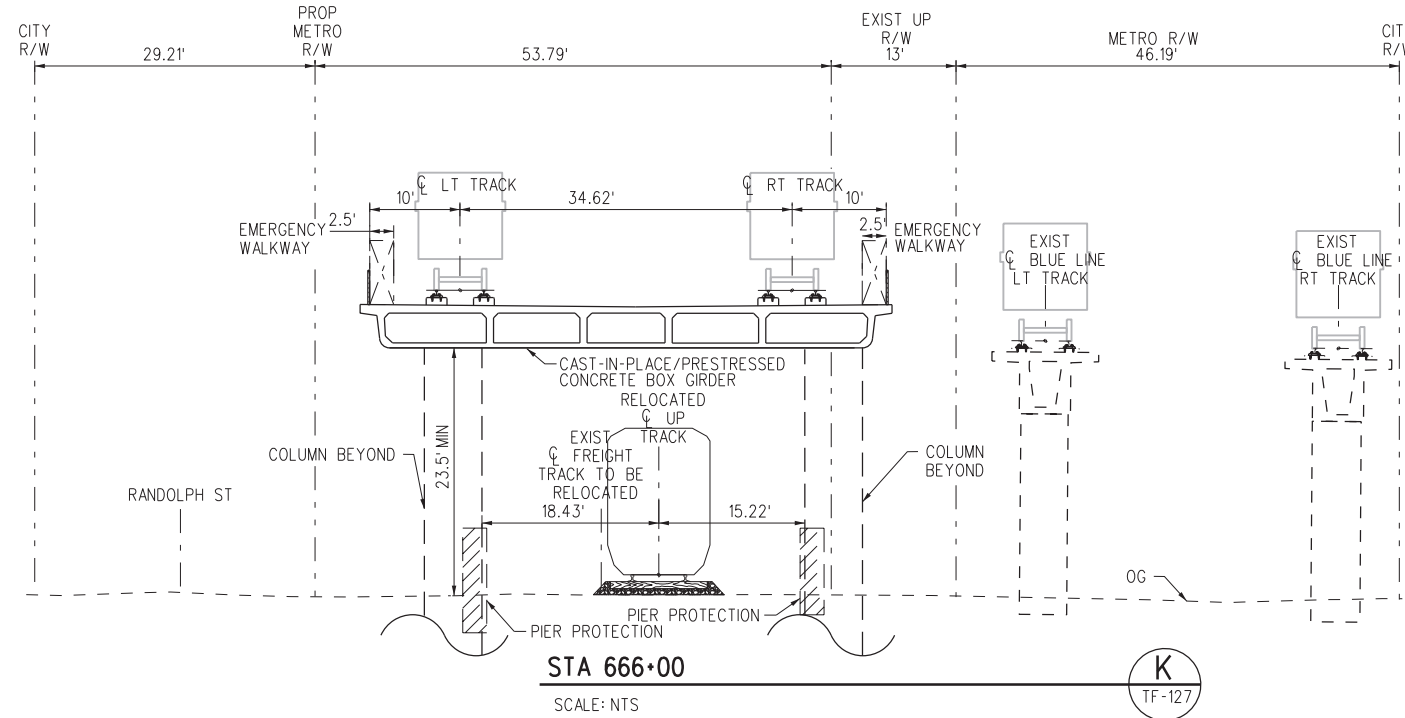

* INCLUDES CONSTRUCTION LAYDOWN AREA

NOT FOR CONSTRUCTION

DESIGNED BY	R. CASAS
DRAWN BY	A. MORALES
CHECKED BY	Y. JIANG
IN CHARGE	N. MAACK
DATE	11/15/2019
	FINAL CONCEPTUAL ALIGNMENT

Metro

LOS ANGELES COUNTY METROPOLITAN TRANSPORTATION AUTHORITY

444 South Flower Street
Suite 800
Los Angeles, CA 90071
TEL (213) 362-9470

SUBMITTED _____

APPROVED _____

CONTRACT NO		AE5999300
DRAWING NO	TX-106	REV
SCALE	NO SCALE	
SHEET NO	78	OF 107

15-NOV-2019 C-28091ATX106.plt

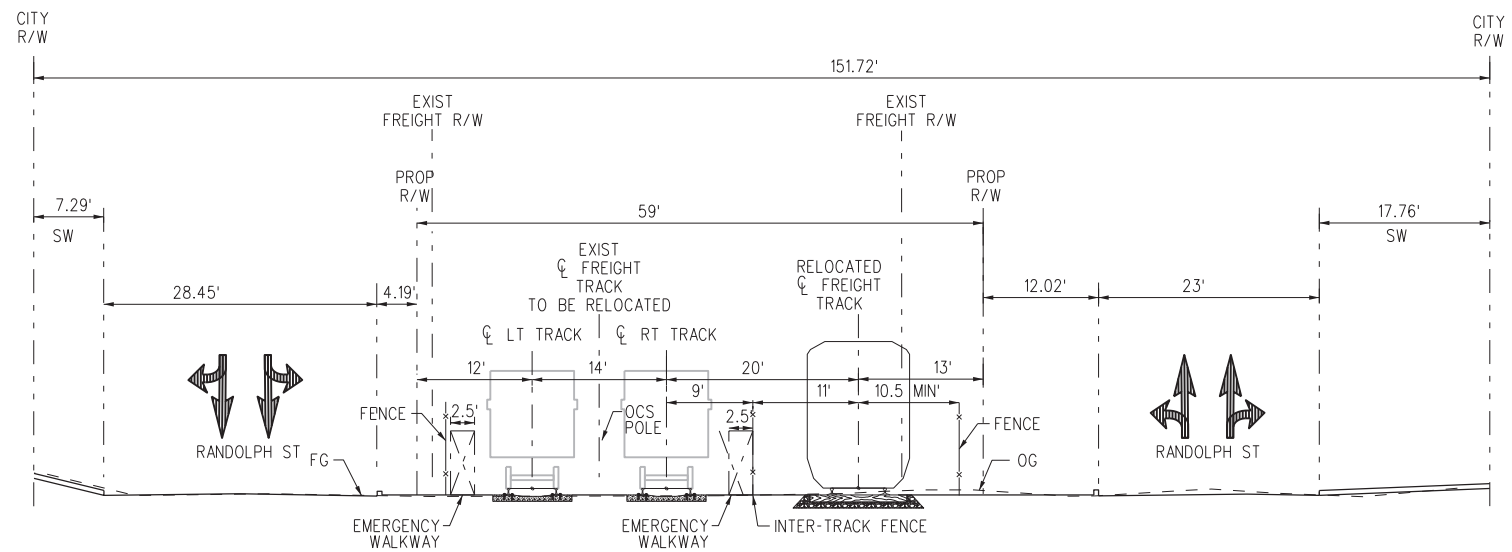

STA 685+00

SCALE: NTS

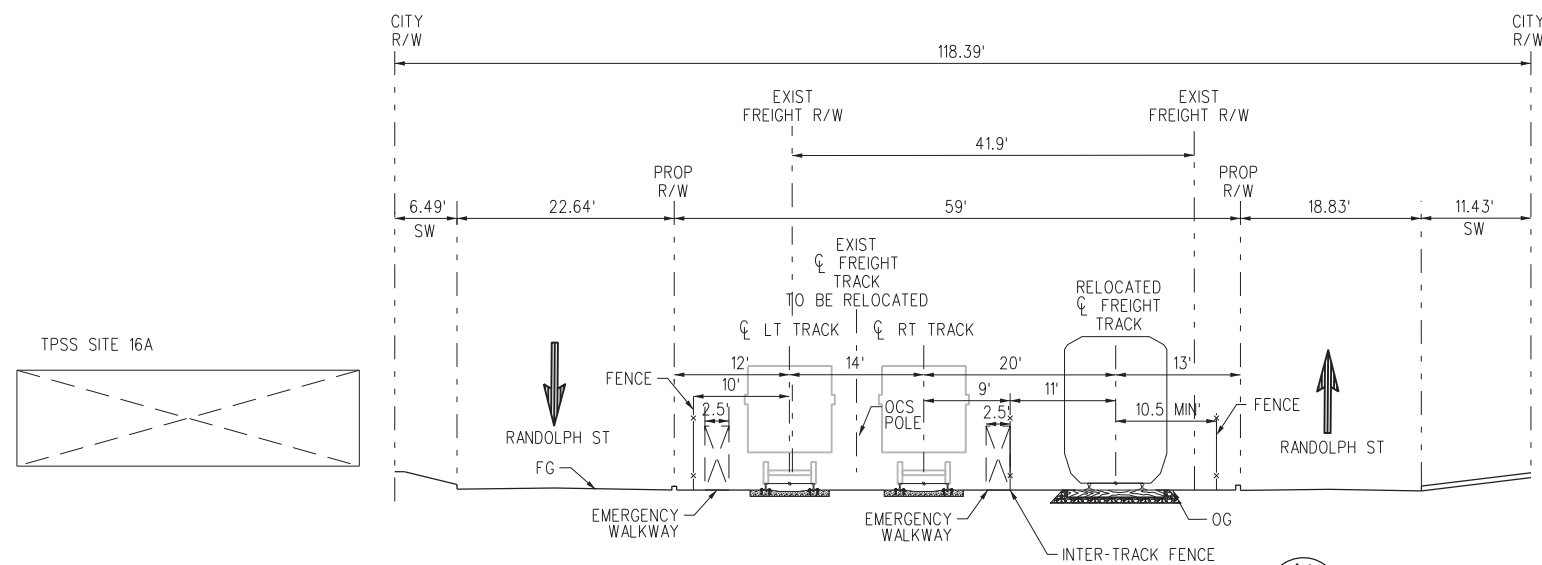

STA 693+00

SCALE: NTS

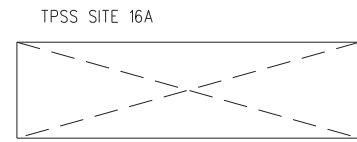

NOT FOR CONSTRUCTION

THE PREPARATION OF THIS DRAWING HAS BEEN FINANCED IN PART THROUGH A GRANT FROM THE U.S. DEPARTMENT OF TRANSPORTATION FEDERAL TRANSIT ADMINISTRATION (FTA), UNDER THE FEDERAL TRANSIT ACT OF 1964, AS AMENDED, AND IN PART BY THE TAXES OF THE CITIZENS OF LOS ANGELES COUNTY AND OF THE STATE OF CALIFORNIA.

DESIGNED BY	R. CASAS
DRAWN BY	A. MORALES
CHECKED BY	Y. JIANG
IN CHARGE	N. MAACK
DATE	11/15/2019
FINAL CONCEPTUAL ALIGNMENT	

0	11/15/19								
---	----------	--	--	--	--	--	--	--	--

M Metro LOS ANGELES COUNTY METROPOLITAN TRANSPORTATION AUTHORITY

wsp 444 South Flower Street Suite 800 Los Angeles, CA 90071 TEL (213) 362-9470

SUBMITTED: _____

APPROVED: _____

WEST SANTA ANA BRANCH FREIGHT TRACK

CROSS SECTIONS NORTHERN ALIGNMENT 20' OFFSET

CONTRACT NO AE5999300

DRAWING NO TX-107 REV

SCALE NO SCALE

SHEET NO 79 OF 107

15-NOV-2019 C-28091ATX107.plt

svc-projectwise 23:44

15-NOV-2019 C-28091ATX108.plt
 svc-projectwise 23:42

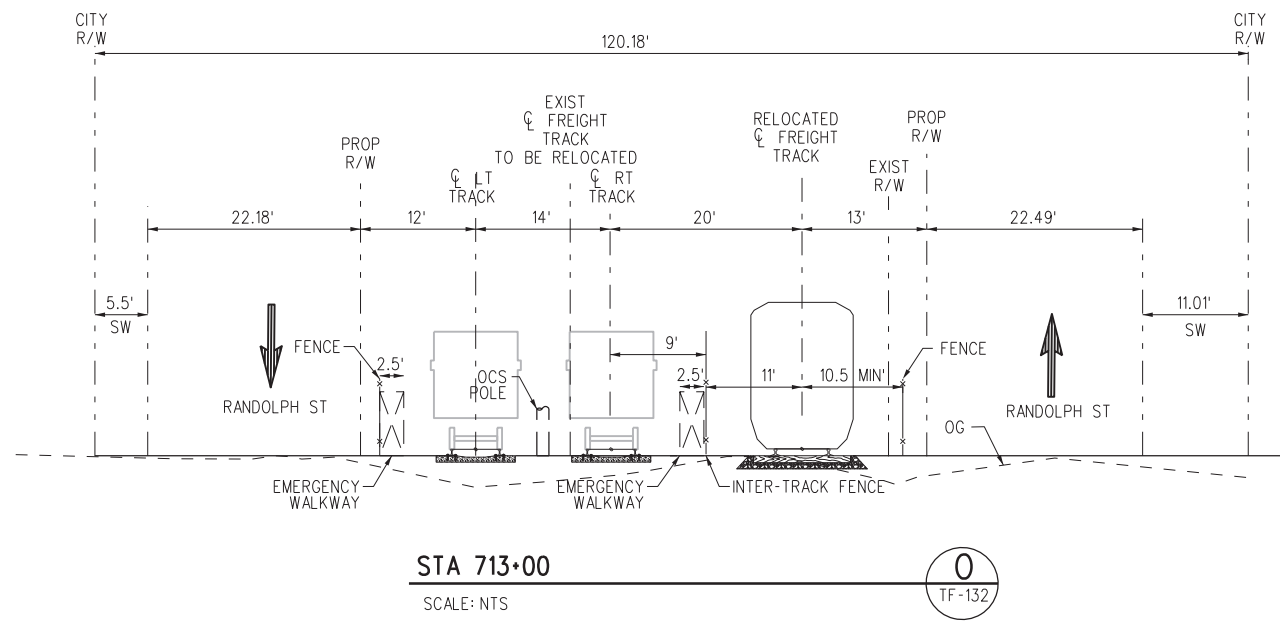

STA 713+00
 SCALE: NTS
 O
 TF-132

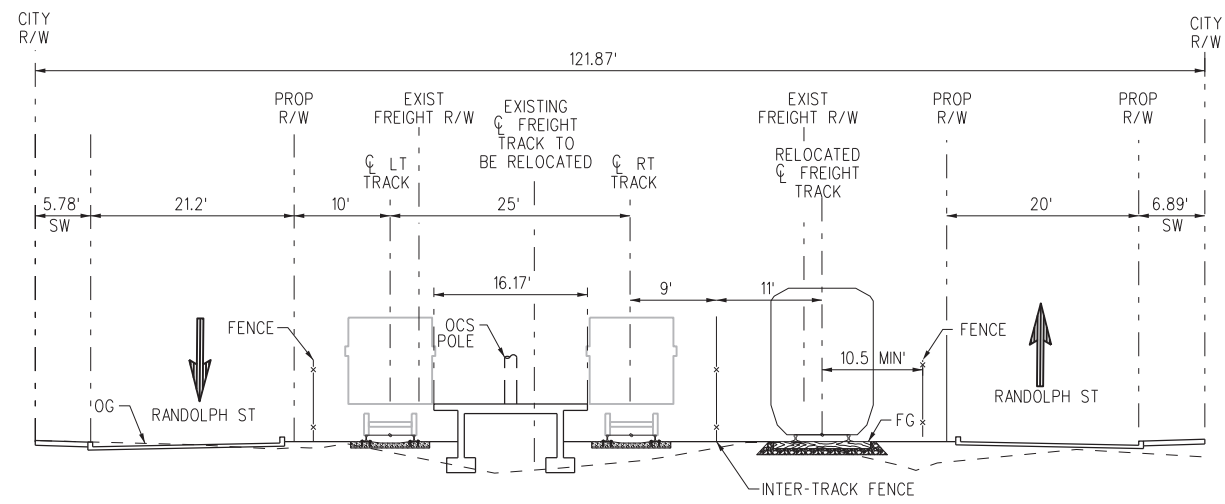

STA 726+00
 SCALE: NTS
 P
 TF-133

NOT FOR CONSTRUCTION

THE PREPARATION OF THIS DRAWING HAS BEEN FINANCED IN PART THROUGH A GRANT FROM THE U.S. DEPARTMENT OF TRANSPORTATION FEDERAL TRANSIT ADMINISTRATION (FTA), UNDER THE FEDERAL TRANSIT ACT OF 1964, AS AMENDED, AND IN PART BY THE TAXES OF THE CITIZENS OF LOS ANGELES COUNTY AND OF THE STATE OF CALIFORNIA.		DESIGNED BY R. CASAS	 LOS ANGELES COUNTY METROPOLITAN TRANSPORTATION AUTHORITY 444 South Flower Street Suite 800 Los Angeles, CA 90071 TEL (213) 362-9470	CONTRACT NO AE5999300
0	11/15/19	DRAWN BY A. MORALES		DRAWING NO TX-108
		CHECKED BY Y. JIANG		SCALE NO SCALE
		IN CHARGE N. MAACK		SHEET NO 80 OF 107
		DATE 11/15/2019		

FINAL CONCEPTUAL ALIGNMENT

Metro

SUBMITTED _____

APPROVED _____

WEST SANTA ANA BRANCH FREIGHT TRACK
 CROSS SECTIONS
 NORTHERN ALIGNMENT
 20' OFFSET

15-NOV-2019 C-28091ATX109.plg
 svc-projectwise 23:43

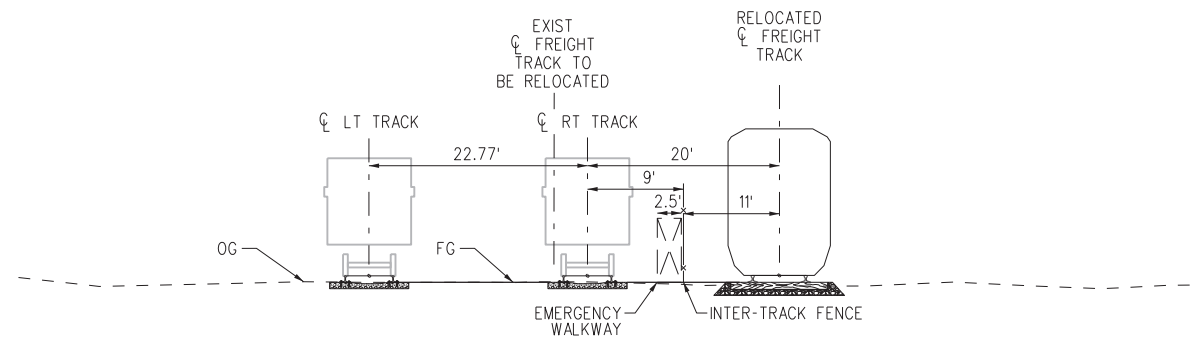

STA 732+00 SEVILLE INTERSECTION

SCALE: NTS

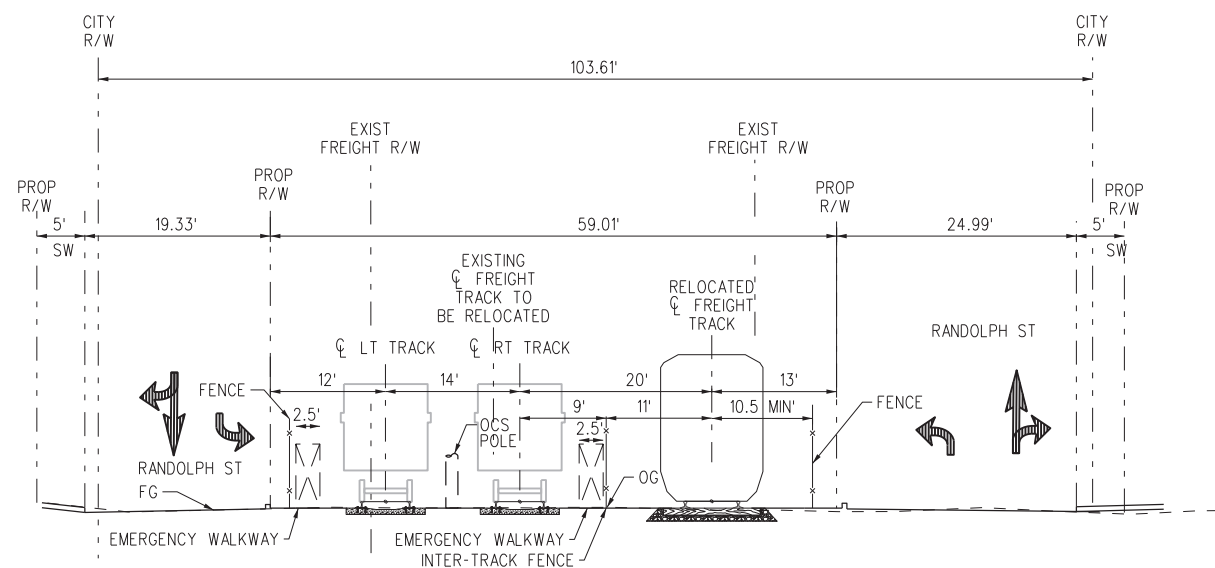



STA 744+00

SCALE: NTS



NOT FOR CONSTRUCTION

THE PREPARATION OF THIS DRAWING HAS BEEN FINANCED IN PART THROUGH A GRANT FROM THE U.S. DEPARTMENT OF TRANSPORTATION FEDERAL TRANSIT ADMINISTRATION (FTA), UNDER THE FEDERAL TRANSIT ACT OF 1964, AS AMENDED, AND IN PART BY THE TAXES OF THE CITIZENS OF LOS ANGELES COUNTY AND OF THE STATE OF CALIFORNIA.		DESIGNED BY R. CASAS	 LOS ANGELES COUNTY METROPOLITAN TRANSPORTATION AUTHORITY	CONTRACT NO AE5999300
		DRAWN BY A. MORALES		DRAWING NO TX-109
		CHECKED BY Y. JIANG		SCALE NO SCALE
		IN CHARGE N. MAACK		SHEET NO 81 OF 107
0	11/15/19	DATE 11/15/2019		
FINAL CONCEPTUAL ALIGNMENT				

 444 South Flower Street Suite 800 Los Angeles, CA 90071 TEL (213) 362-9470	SUBMITTED _____ APPROVED _____
---	-----------------------------------

WEST SANTA ANA BRANCH FREIGHT TRACK CROSS SECTIONS NORTHERN ALIGNMENT 20' OFFSET	
---	--

15-NOV-2019 C-28091ATX110.plt
 svc-projectwise 23:42

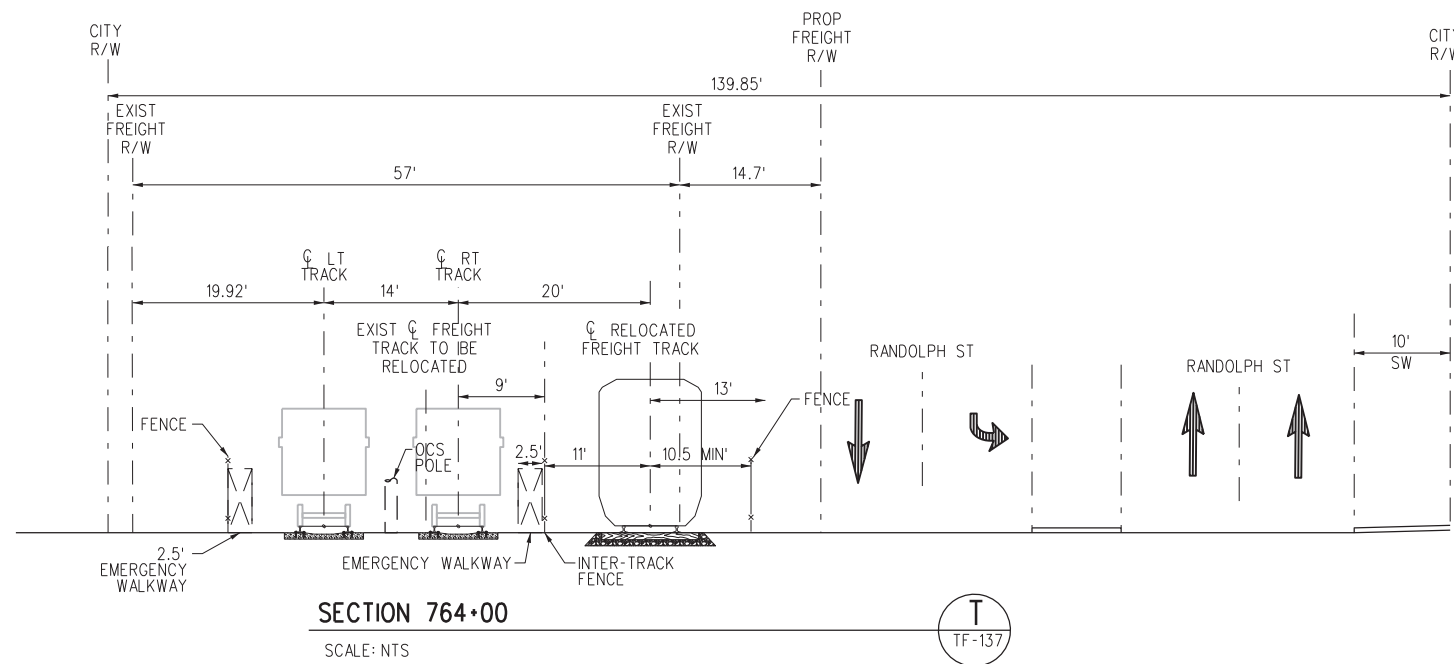
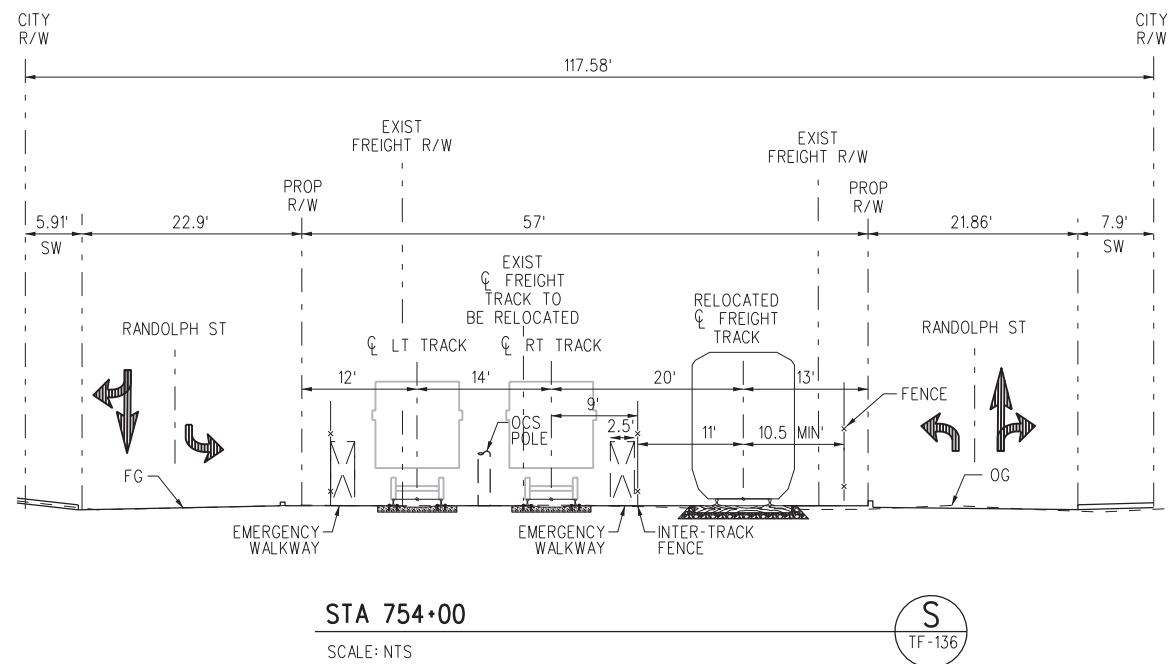

NOT FOR CONSTRUCTION

THE PREPARATION OF THIS DRAWING HAS BEEN FINANCED IN PART THROUGH A GRANT FROM THE U.S. DEPARTMENT OF TRANSPORTATION FEDERAL TRANSIT ADMINISTRATION (FTA), UNDER THE FEDERAL TRANSIT ACT OF 1964, AS AMENDED, AND IN PART BY THE TAXES OF THE CITIZENS OF LOS ANGELES COUNTY AND OF THE STATE OF CALIFORNIA.		DESIGNED BY R. CASAS	 LOS ANGELES COUNTY METROPOLITAN TRANSPORTATION AUTHORITY	CONTRACT NO AE5999300
		DRAWN BY A. MORALES		DRAWING NO TX-110
		CHECKED BY Y. JIANG		SCALE NO SCALE
0	11/15/19	IN CHARGE N. MAACK		SHEET NO 82 OF 107
		DATE 11/15/2019		

FINAL CONCEPTUAL ALIGNMENT

WSP 444 South Flower Street Suite 800 Los Angeles, CA 90071 TEL (213) 362-9470

SUBMITTED _____

APPROVED _____

WEST SANTA ANA BRANCH FREIGHT TRACK
CROSS SECTIONS
NORTHERN ALIGNMENT
20' OFFSET

NOTES:
 1. FOR SOUND WALL AND RETAINING WALL LIMITS, SEE PLAN AND PROFILE SHEETS.

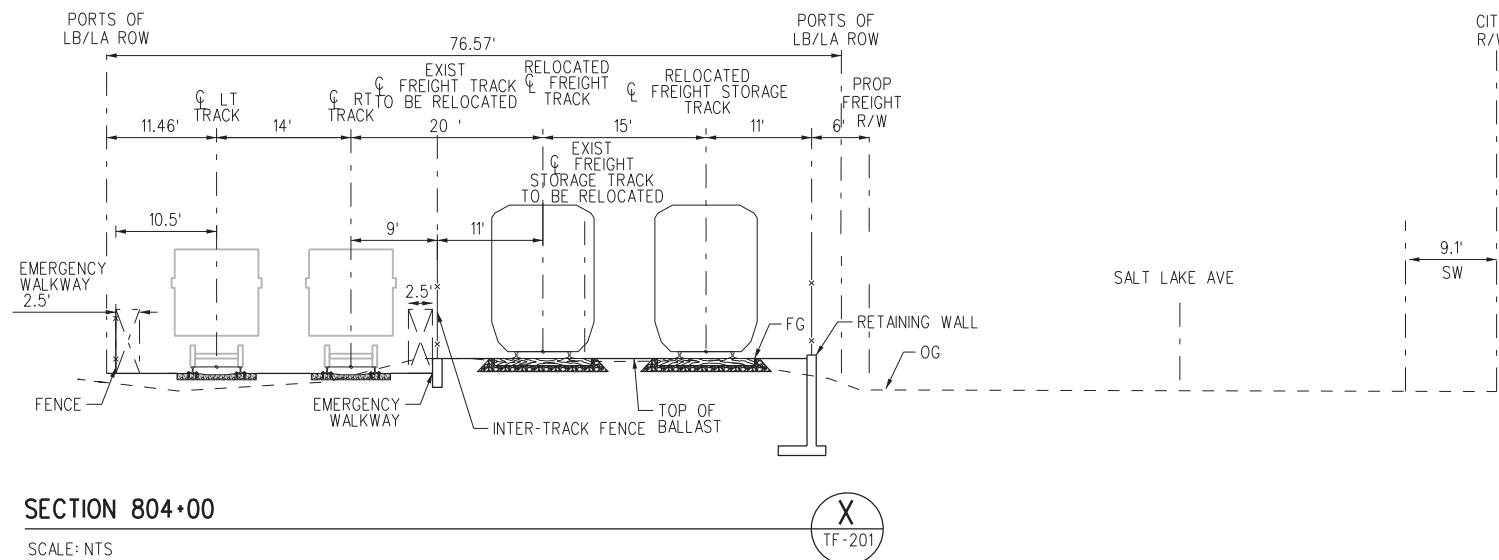
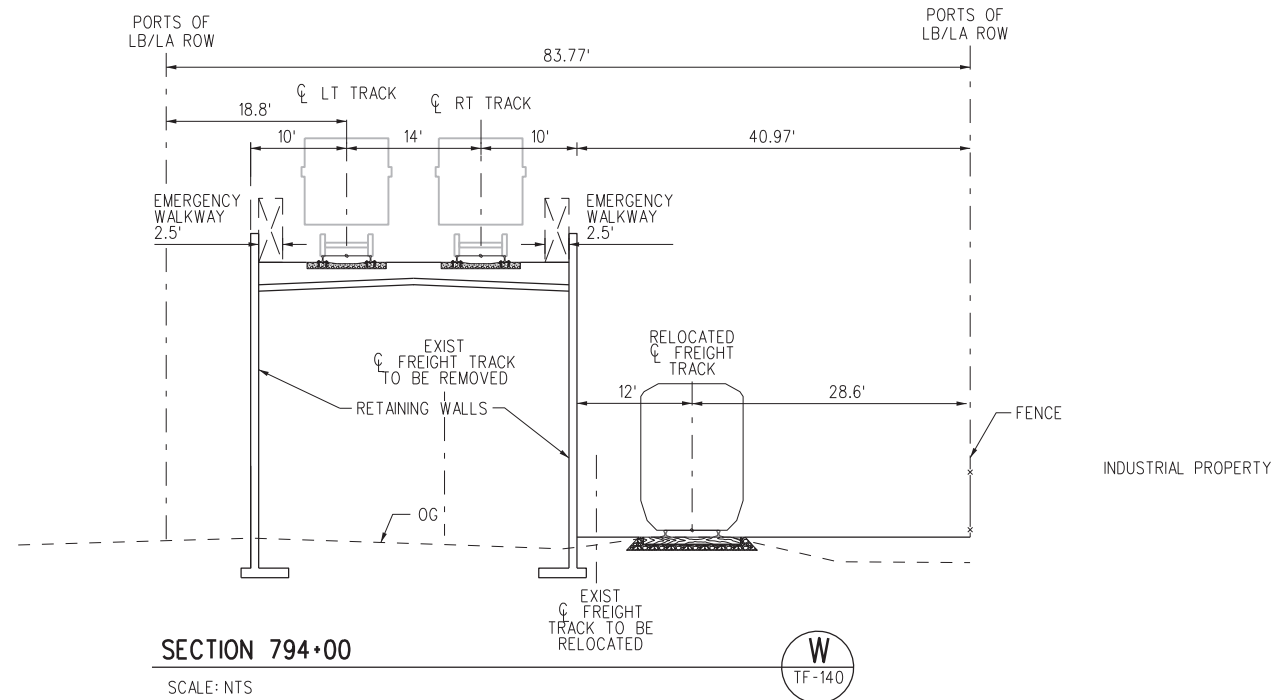

NOT FOR CONSTRUCTION

15-NOV-2019 C-28091ATX112.plg

svc-projectwise 23:42

THE PREPARATION OF THIS DRAWING HAS BEEN FINANCED IN PART THROUGH A GRANT FROM THE U.S. DEPARTMENT OF TRANSPORTATION FEDERAL TRANSIT ADMINISTRATION (FTA), UNDER THE FEDERAL TRANSIT ACT OF 1964, AS AMENDED, AND IN PART BY THE TAXES OF THE CITIZENS OF LOS ANGELES COUNTY AND OF THE STATE OF CALIFORNIA.		DESIGNED BY R. CASAS	 LOS ANGELES COUNTY METROPOLITAN TRANSPORTATION AUTHORITY	WEST SANTA ANA BRANCH FREIGHT TRACK CROSS SECTIONS NORTHERN ALIGNMENT 20' OFFSET	CONTRACT NO AE5999300	
		DRAWN BY A. MORALES			DRAWING NO TX-112	REV
		CHECKED BY Y. JIANG			SCALE NO SCALE	
		IN CHARGE N. MAACK			SHEET NO 84 OF 107	
0	11/15/19	DATE 11/15/2019				

FINAL CONCEPTUAL ALIGNMENT

 444 South Flower Street Suite 800 Los Angeles, CA 90071 TEL (213) 362-9470	SUBMITTED _____ APPROVED _____
---	-----------------------------------

SUBMITTED _____ APPROVED _____

NOTES:
 1. FOR SOUND WALL AND RETAINING WALL LIMITS, SEE PLAN AND PROFILE SHEETS.

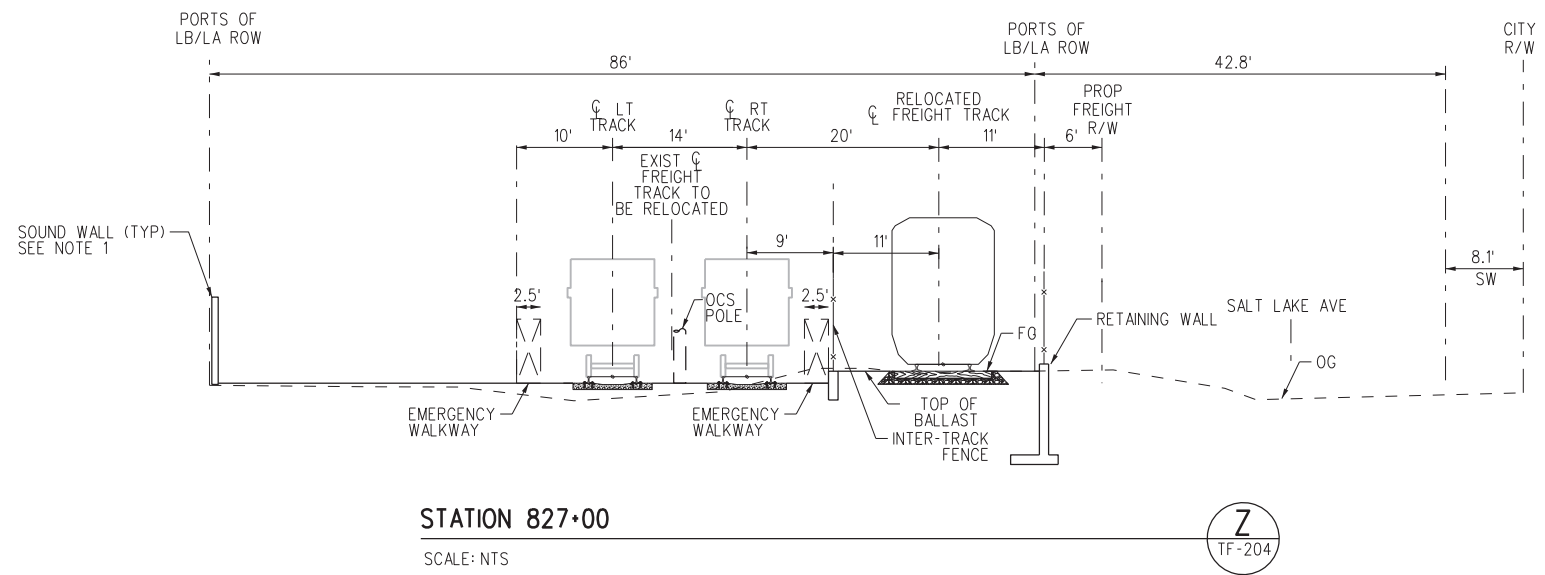
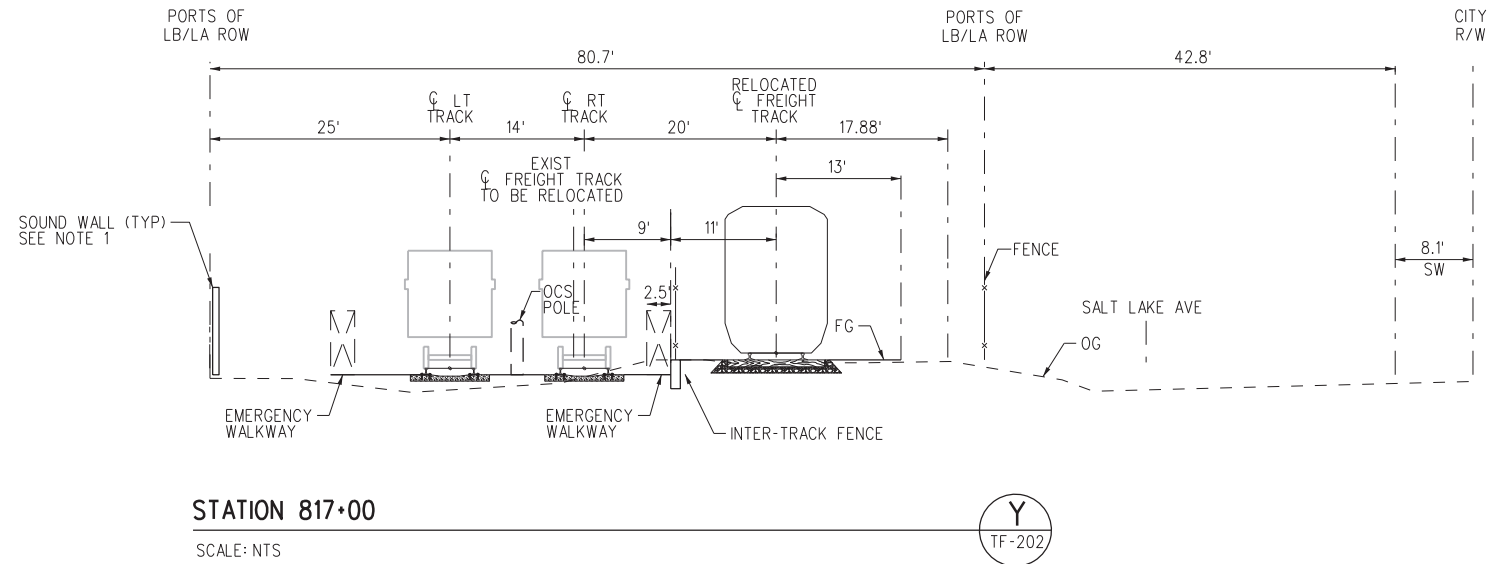

NOT FOR CONSTRUCTION

DESIGNED BY	R. CASAS
DRAWN BY	A. MORALES
CHECKED BY	Y. JIANG
IN CHARGE	N. MAACK
DATE	11/15/2019

0	11/15/19	FINAL CONCEPTUAL ALIGNMENT
---	----------	----------------------------

THE PREPARATION OF THIS DRAWING HAS BEEN FINANCED IN PART THROUGH A GRANT FROM THE U.S. DEPARTMENT OF TRANSPORTATION FEDERAL TRANSIT ADMINISTRATION (FTA), UNDER THE FEDERAL TRANSIT ACT OF 1964, AS AMENDED, AND IN PART BY THE TAXES OF THE CITIZENS OF LOS ANGELES COUNTY AND OF THE STATE OF CALIFORNIA.

M Metro LOS ANGELES COUNTY METROPOLITAN TRANSPORTATION AUTHORITY

wsp 444 South Flower Street Suite 800 Los Angeles, CA 90071 TEL (213) 362-9470

SUBMITTED _____

APPROVED _____

WEST SANTA ANA BRANCH FREIGHT TRACK
 CROSS SECTIONS
 NORTHERN ALIGNMENT
 20' OFFSET

CONTRACT NO	AE5999300
DRAWING NO	TX-113
SCALE	NO SCALE
SHEET NO	85 OF 107

15-NOV-2019 C-28091ATX113.plt

NOTES:
 1. FOR SOUND WALL AND RETAINING WALL LIMITS, SEE PLAN AND PROFILE SHEETS.

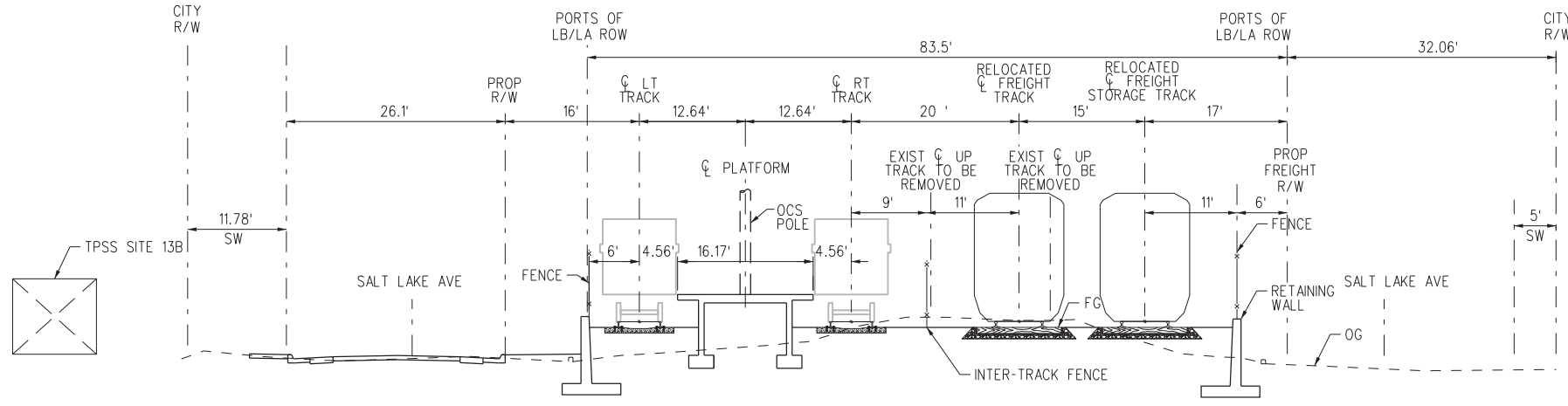

834+00
 FLORENCE/SALT LAKE STATION

SCALE: NTS



NOT FOR CONSTRUCTION

THE PREPARATION OF THIS DRAWING HAS BEEN FINANCED IN PART THROUGH A GRANT FROM THE U.S. DEPARTMENT OF TRANSPORTATION FEDERAL TRANSIT ADMINISTRATION (FTA), UNDER THE FEDERAL TRANSIT ACT OF 1964, AS AMENDED, AND IN PART BY THE TAXES OF THE CITIZENS OF LOS ANGELES COUNTY AND OF THE STATE OF CALIFORNIA.

DESIGNED BY	R. CASAS
DRAWN BY	A. MORALES
CHECKED BY	Y. JIANG
IN CHARGE	N. MAACK
DATE	11/15/2019
	FINAL CONCEPTUAL ALIGNMENT

0	11/15/19								
---	----------	--	--	--	--	--	--	--	--

M Metro LOS ANGELES COUNTY METROPOLITAN TRANSPORTATION AUTHORITY

wsp 444 South Flower Street Suite 800 Los Angeles, CA 90071 TEL (213) 362-9470

SUBMITTED _____

APPROVED _____

WEST SANTA ANA BRANCH FREIGHT TRACK
 CROSS SECTIONS
 NORTHERN ALIGNMENT
 20' OFFSET

CONTRACT NO	AE5999300
DRAWING NO	TX-114
SCALE	NO SCALE
SHEET NO	86 OF 107

15-NOV-2019 C-28091ATX114.plg
 23:43
 svc-projectwise

NOTES:
 1. FOR SOUND WALL AND RETAINING WALL LIMITS, SEE PLAN AND PROFILE SHEETS.

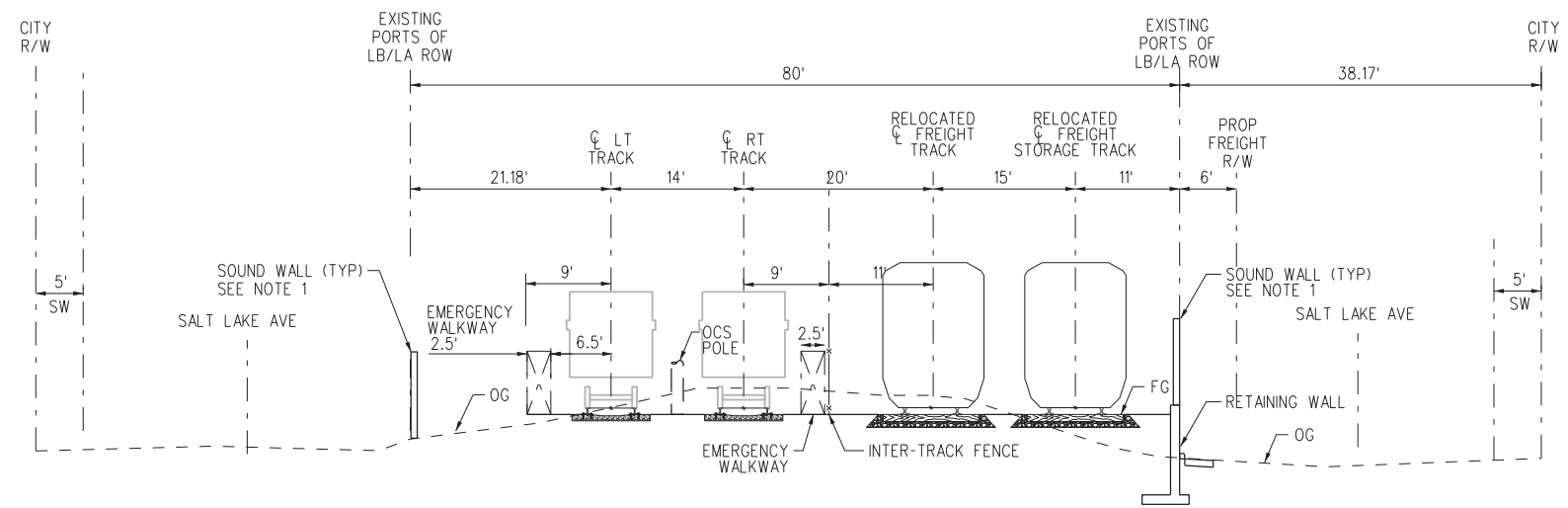
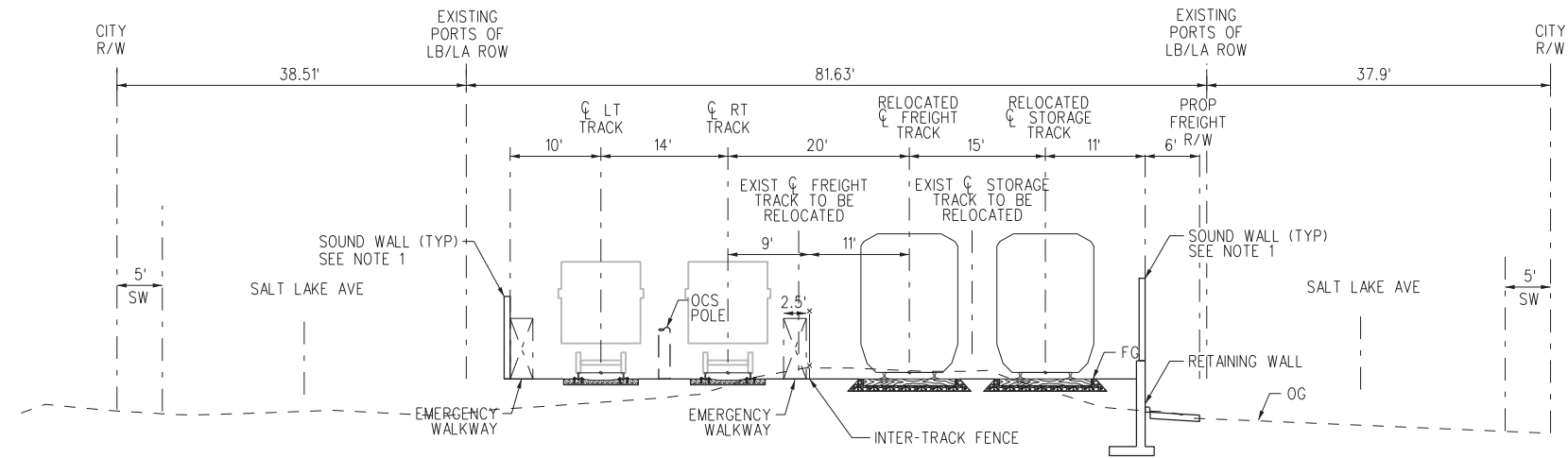

NOT FOR CONSTRUCTION

DESIGNED BY	R. CASAS
DRAWN BY	A. MORALES
CHECKED BY	Y. JIANG
IN CHARGE	N. MAACK
DATE	11/15/2019

0	11/15/19	FINAL CONCEPTUAL ALIGNMENT
---	----------	----------------------------

 Metro 	444 South Flower Street Suite 800 Los Angeles, CA 90071 TEL (213) 362-9470
----------------------	---

LOS ANGELES COUNTY METROPOLITAN TRANSPORTATION AUTHORITY	SUBMITTED _____ APPROVED _____
---	-----------------------------------

WEST SANTA ANA BRANCH FREIGHT TRACK CROSS SECTIONS NORTHERN ALIGNMENT 20' OFFSET	CONTRACT NO AE5999300
	DRAWING NO TX-115
	SCALE NO SCALE
	SHEET NO 87 OF 107

15-NOV-2019 C-28091ATX115.plt
 svc-projectwise 23:43
 Plot Driver=MTA-half.pen
 Pentable=bw.plt

15-NOV-2019 15:43 C:\28091ATX116.plt

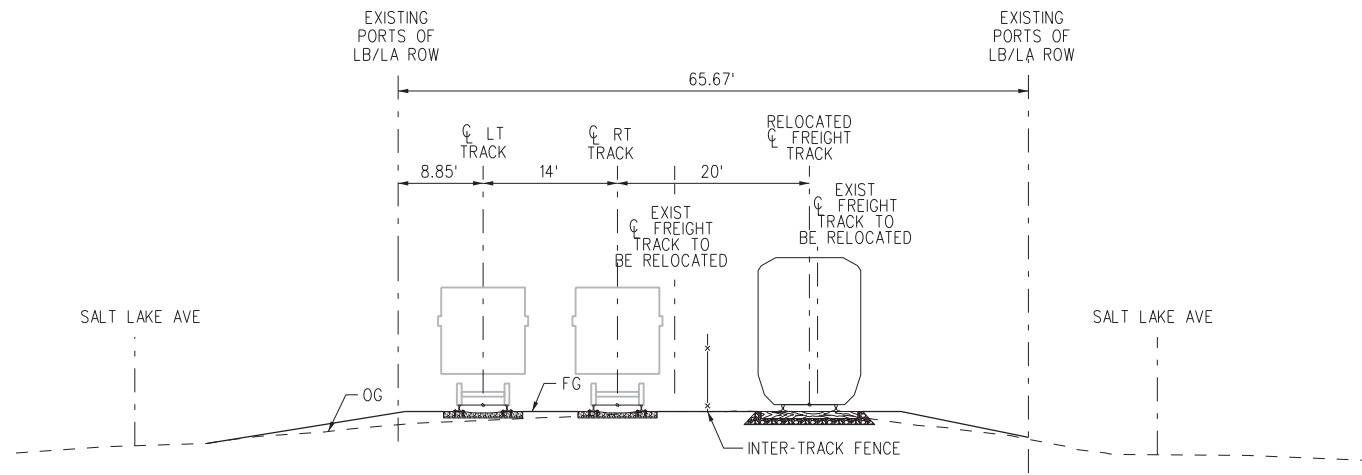

SECTION 869+70 OTIS INTERSECTION

SCALE: NTS



NOT FOR CONSTRUCTION

THE PREPARATION OF THIS DRAWING HAS BEEN FINANCED IN PART THROUGH A GRANT FROM THE U.S. DEPARTMENT OF TRANSPORTATION FEDERAL TRANSIT ADMINISTRATION (FTA), UNDER THE FEDERAL TRANSIT ACT OF 1964, AS AMENDED, AND IN PART BY THE TAXES OF THE CITIZENS OF LOS ANGELES COUNTY AND OF THE STATE OF CALIFORNIA.		DESIGNED BY R. CASAS	<p>LOS ANGELES COUNTY METROPOLITAN TRANSPORTATION AUTHORITY</p>	<p>444 South Flower Street Suite 800 Los Angeles, CA 90071 TEL (213) 362-9470</p>	CONTRACT NO AE5999300	
		DRAWN BY A. MORALES			DRAWING NO TX-116	REV
		CHECKED BY Y. JIANG			SCALE NO SCALE	
0	11/15/19	IN CHARGE N. MAACK			SHEET NO 88	OF 107
		DATE 11/15/2019				

FINAL CONCEPTUAL ALIGNMENT

	SUBMITTED _____ APPROVED _____
--	-----------------------------------

WEST SANTA ANA BRANCH FREIGHT TRACK CROSS SECTIONS NORTHERN ALIGNMENT 20' OFFSET

NOTES:

1. FOR SOUND WALL AND RETAINING WALL LIMITS, SEE PLAN AND PROFILE SHEETS.

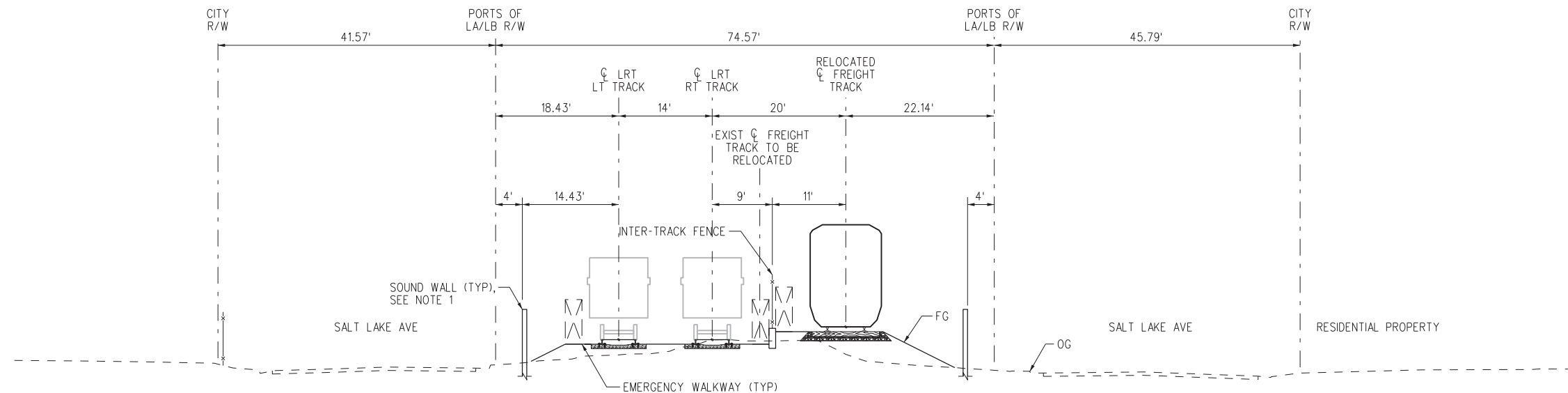

STA 875+00

SCALE: NTS

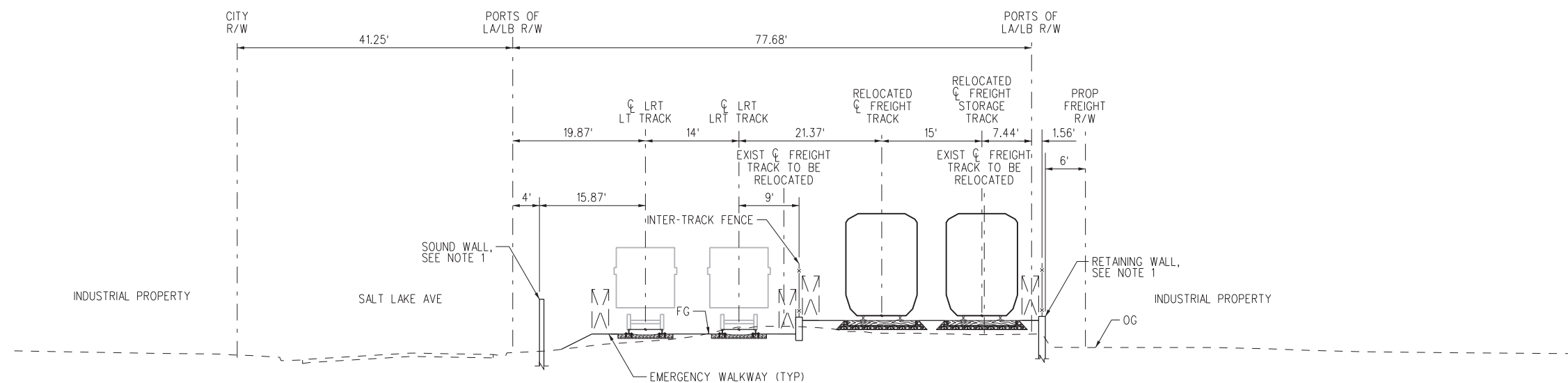

STA 887+00

SCALE: NTS



NOT FOR CONSTRUCTION

THE PREPARATION OF THIS DRAWING HAS BEEN FINANCED IN PART THROUGH A GRANT FROM THE U.S. DEPARTMENT OF TRANSPORTATION FEDERAL TRANSIT ADMINISTRATION (FTA), UNDER THE FEDERAL TRANSIT ACT OF 1964, AS AMENDED, AND IN PART BY THE TAXES OF THE CITIZENS OF LOS ANGELES COUNTY AND OF THE STATE OF CALIFORNIA.

DESIGNED BY	A. TSAO
DRAWN BY	R. MUNOZ
CHECKED BY	R. LOYA
IN CHARGE	N. MAACK
DATE	11/15/2019
0	11/15/19
FINAL CONCEPTUAL ALIGNMENT	



LOS ANGELES COUNTY METROPOLITAN TRANSPORTATION AUTHORITY



444 South Flower Street Suite 800 Los Angeles, CA 90071 TEL (213) 362-9470

SUBMITTED _____
APPROVED _____

WEST SANTA ANA BRANCH FREIGHT TRACK CROSS SECTIONS SOUTHERN ALIGNMENT 20' OFFSET

CONTRACT NO	AE5999300
DRAWING NO	TX-201
SCALE	NO SCALE
SHEET NO	89 OF 107

NOTES:

1. FOR SOUND WALL AND RETAINING WALL LIMITS, SEE PLAN AND PROFILE SHEETS.

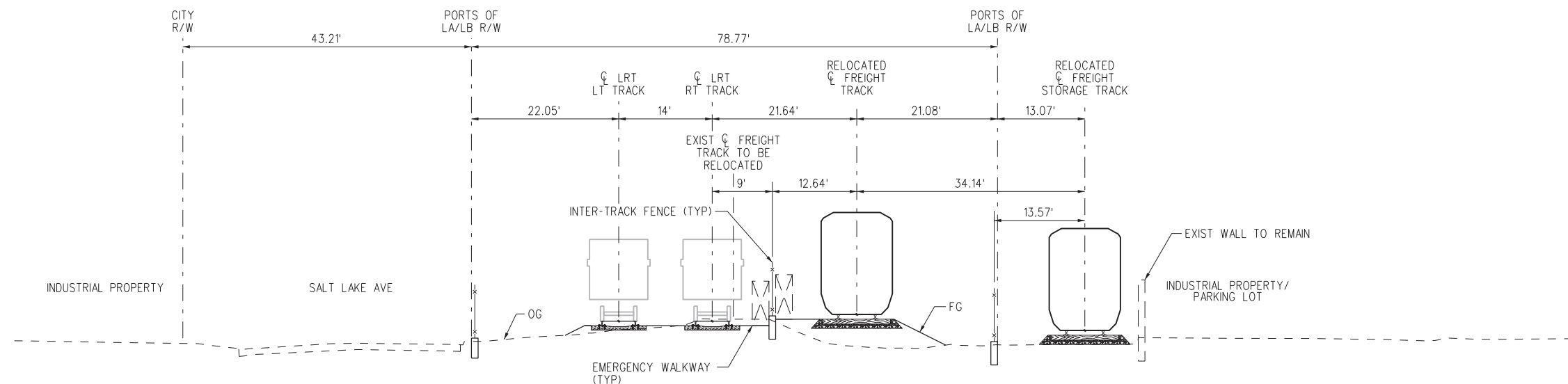

STA 897+00

SCALE: NTS

AG
TF-211

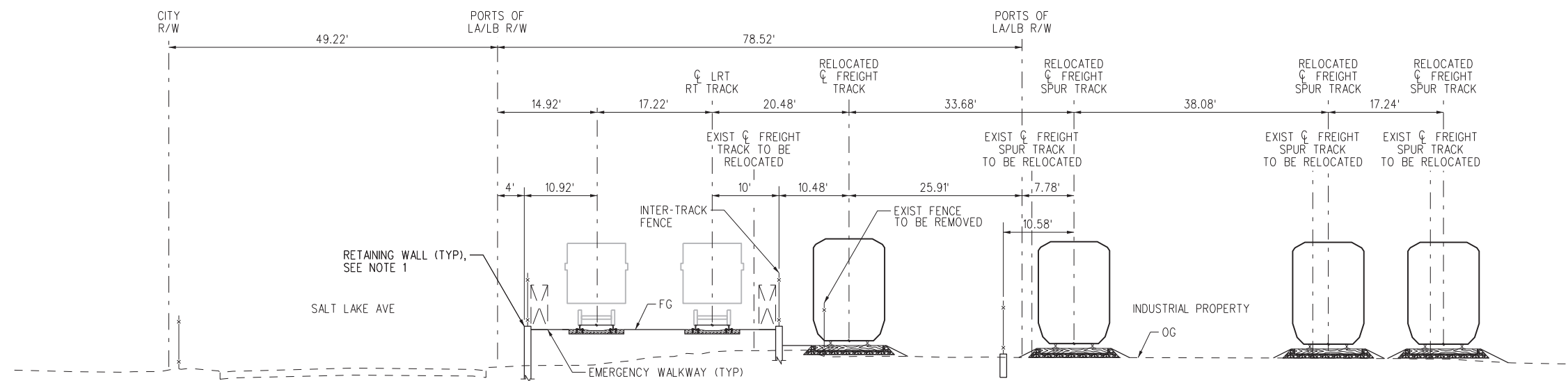

STA 905+00

SCALE: NTS

AH
TF-212

NOT FOR CONSTRUCTION

THE PREPARATION OF THIS DRAWING HAS BEEN FINANCED IN PART THROUGH A GRANT FROM THE U.S. DEPARTMENT OF TRANSPORTATION FEDERAL TRANSIT ADMINISTRATION (FTA), UNDER THE FEDERAL TRANSIT ACT OF 1964, AS AMENDED, AND IN PART BY THE TAKES OF THE CITIZENS OF LOS ANGELES COUNTY AND OF THE STATE OF CALIFORNIA.

DESIGNED BY	A. TSAO
DRAWN BY	R. MUNOZ
CHECKED BY	R. LOYA
IN CHARGE	N. MAACK
DATE	11/15/2019
PROJECT	FINAL CONCEPTUAL ALIGNMENT

M Metro
444 South Flower Street
Suite 800
Los Angeles, CA 90071
TEL (213) 362-9470

WSP

SUBMITTED _____
APPROVED _____

WEST SANTA ANA BRANCH FREIGHT TRACK
CROSS SECTIONS
SOUTHERN ALIGNMENT
20' OFFSET

CONTRACT NO.	AE5999300
DRAWING NO.	TX-202
SCALE	NO SCALE
SHEET NO.	90 OF 107

15-NOV-2019 C-28091ATX202.plg
15:26
svc-projectwise

NOTES:
 1. FOR SOUND WALL AND RETAINING WALL LIMITS, SEE PLAN AND PROFILE SHEETS.

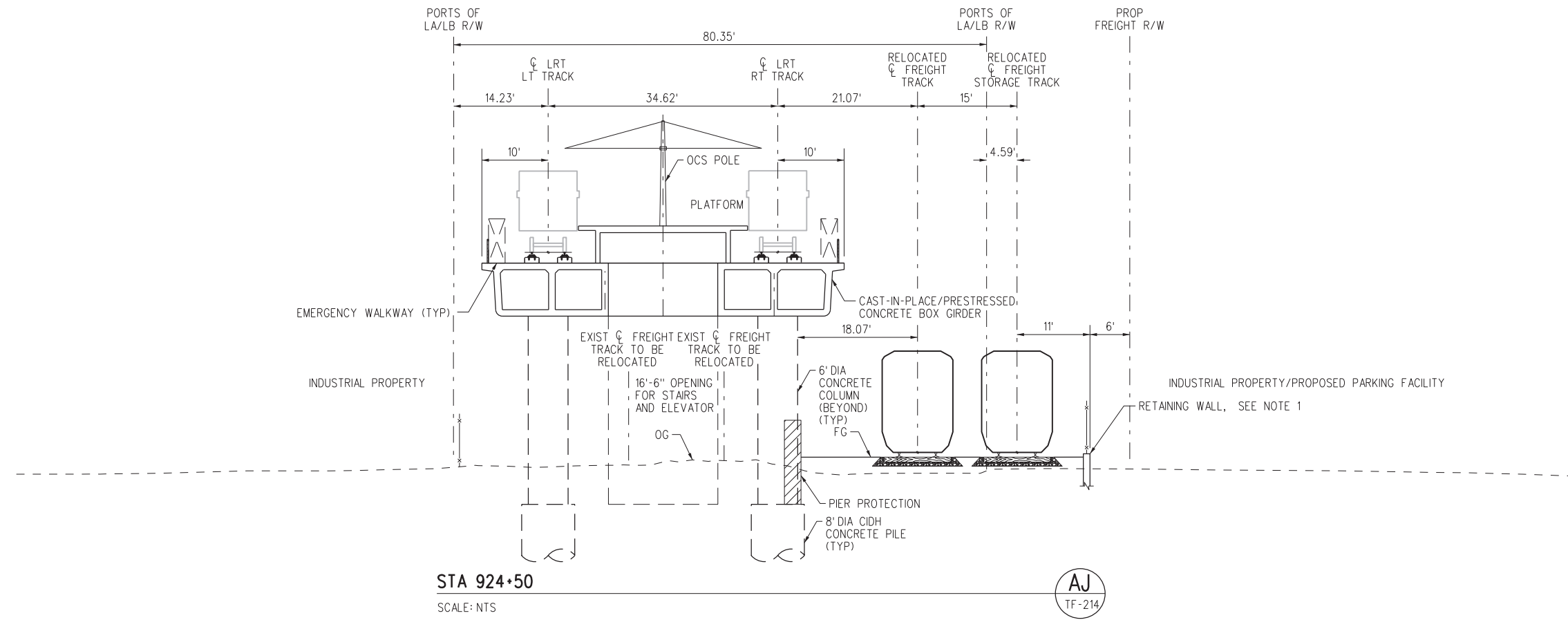
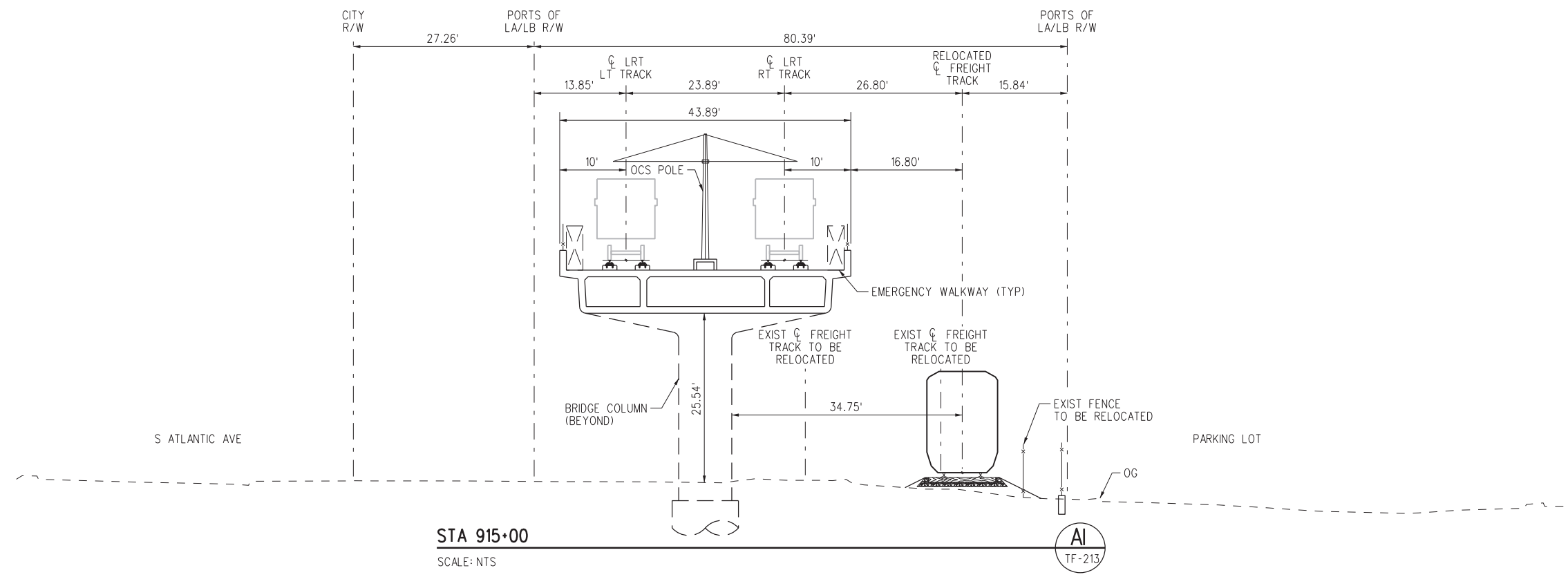

NOT FOR CONSTRUCTION

15-NOV-2019 C-28091ATX203.plg
 15:27
 svc-projectwise

THE PREPARATION OF THIS DRAWING HAS BEEN FINANCED IN PART THROUGH A GRANT FROM THE U.S. DEPARTMENT OF TRANSPORTATION FEDERAL TRANSIT ADMINISTRATION (FTA), UNDER THE FEDERAL TRANSIT ACT OF 1964, AS AMENDED, AND IN PART BY THE TAXES OF THE CITIZENS OF LOS ANGELES COUNTY AND OF THE STATE OF CALIFORNIA.		DESIGNED BY A. TSAO	 LOS ANGELES COUNTY METROPOLITAN TRANSPORTATION AUTHORITY	CONTRACT NO AE5999300
0	11/15/19	DRAWN BY R. MUNOZ		DRAWING NO TX-203
		CHECKED BY R. LOYA		SCALE NO SCALE
		IN CHARGE N. MAACK		SHEET NO 91 OF 107
		DATE 11/15/2019		
		FINAL CONCEPTUAL ALIGNMENT		

DESIGNED BY
A. TSAO
 DRAWN BY
R. MUNOZ
 CHECKED BY
R. LOYA
 IN CHARGE
N. MAACK
 DATE
11/15/2019

444 South Flower Street Suite 800 Los Angeles, CA 90071 TEL (213) 362-9470

SUBMITTED _____
 APPROVED _____

WEST SANTA ANA BRANCH FREIGHT TRACK
CROSS SECTIONS
SOUTHERN ALIGNMENT
20' OFFSET

NOTES:

1. FOR SOUND WALL AND RETAINING WALL LIMITS, SEE PLAN AND PROFILE SHEETS.

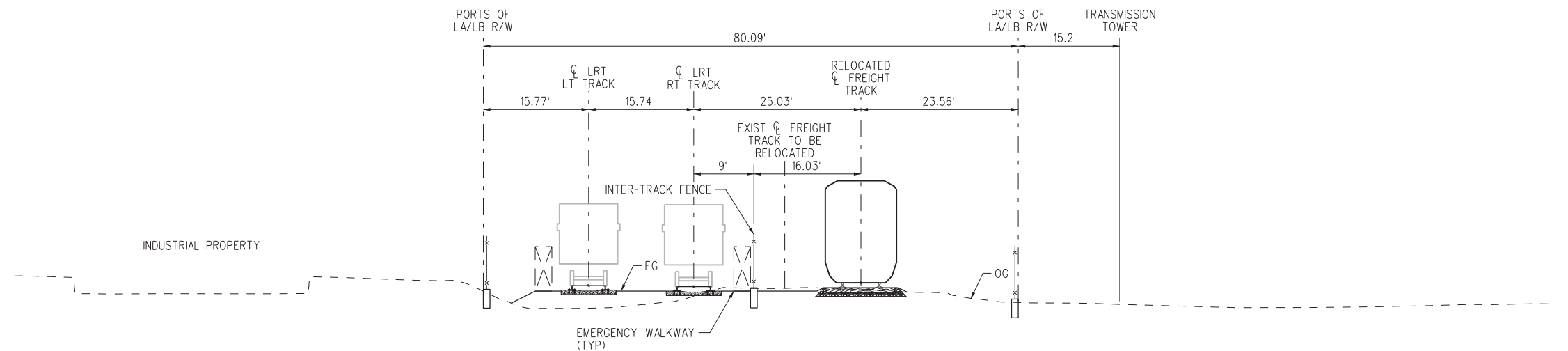

STA 946+50

SCALE: NTS

AK
TF-216

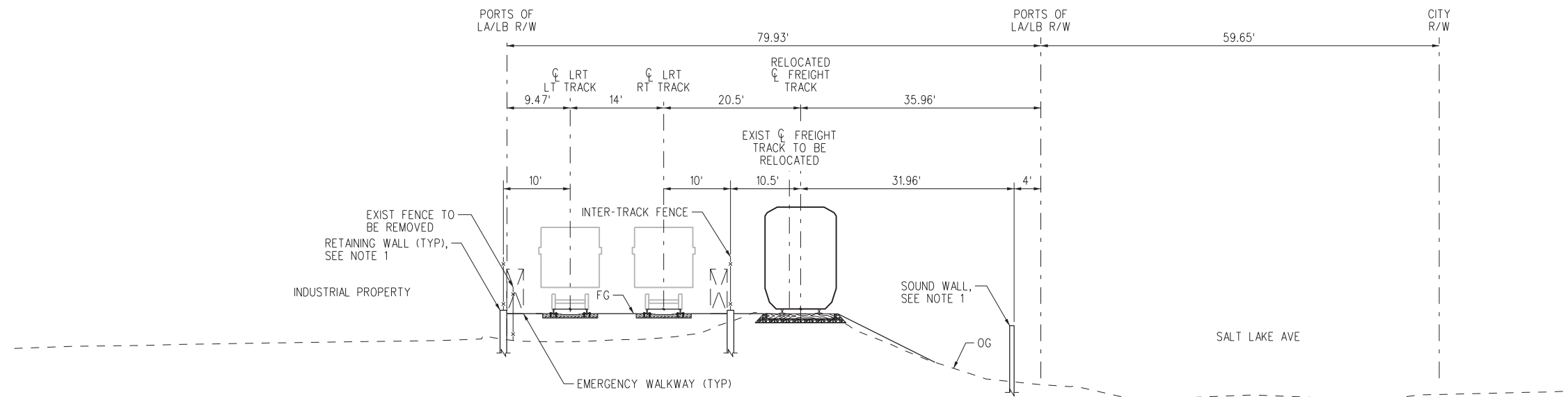

STA 966+50

SCALE: NTS

AL
TF-218

NOT FOR CONSTRUCTION

THE PREPARATION OF THIS DRAWING HAS BEEN FINANCED IN PART THROUGH A GRANT FROM THE U.S. DEPARTMENT OF TRANSPORTATION FEDERAL TRANSIT ADMINISTRATION (FTA), UNDER THE FEDERAL TRANSIT ACT OF 1964, AS AMENDED, AND IN PART BY THE TAXES OF THE CITIZENS OF LOS ANGELES COUNTY AND OF THE STATE OF CALIFORNIA.

DESIGNED BY	A. TSAO
DRAWN BY	R. MUNOZ
CHECKED BY	R. LOYA
IN CHARGE	N. MAACK
DATE	11/15/2019
PROJECT	WEST SANTA ANA BRANCH FREIGHT TRACK
DATE	11/15/19
DESCRIPTION	FINAL CONCEPTUAL ALIGNMENT

M Metro

wsp 444 South Flower Street Suite 800 Los Angeles, CA 90071 TEL (213) 362-9470

LOS ANGELES COUNTY METROPOLITAN TRANSPORTATION AUTHORITY

WEST SANTA ANA BRANCH FREIGHT TRACK

CONTRACT NO AE5999300

DRAWING NO TX-204

SCALE NO SCALE

SHEET NO 92 OF 107

SUBMITTED _____

APPROVED _____

WEST SANTA ANA BRANCH FREIGHT TRACK

CROSS SECTIONS SOUTHERN ALIGNMENT 20' OFFSET

15-NOV-2019 C-28091ATX204.plg

NOTES:

1. FOR SOUND WALL AND RETAINING WALL LIMITS, SEE PLAN AND PROFILE SHEETS.

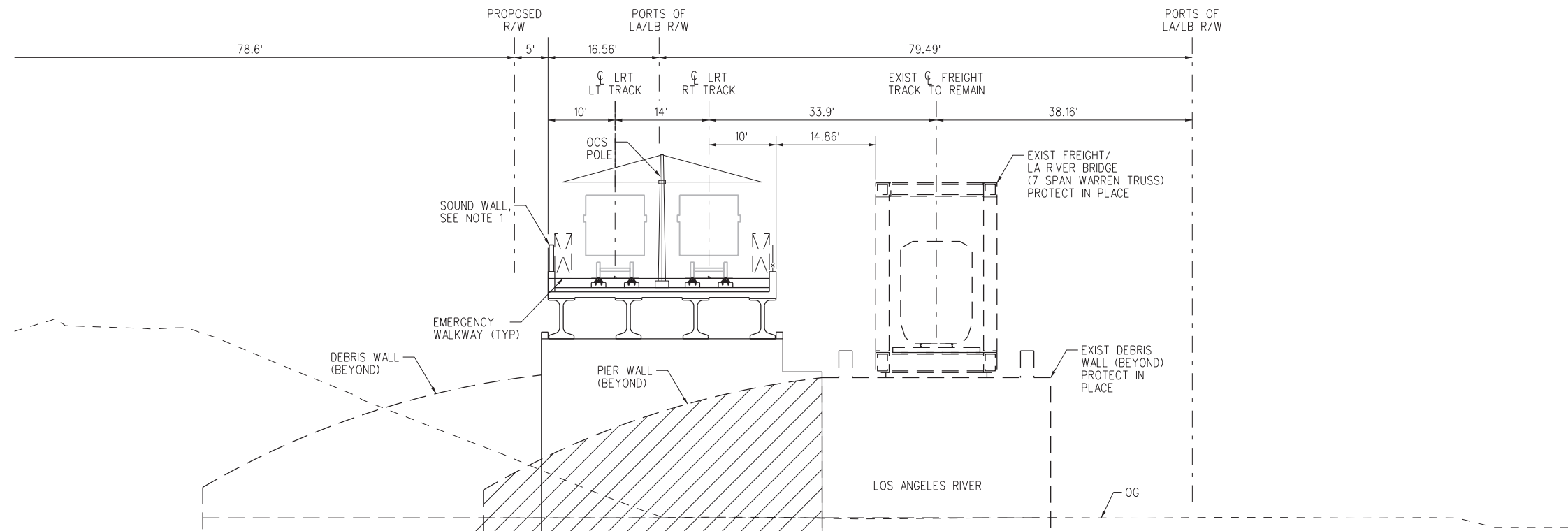

STA 976+50

SCALE: NTS

AM
TF-219

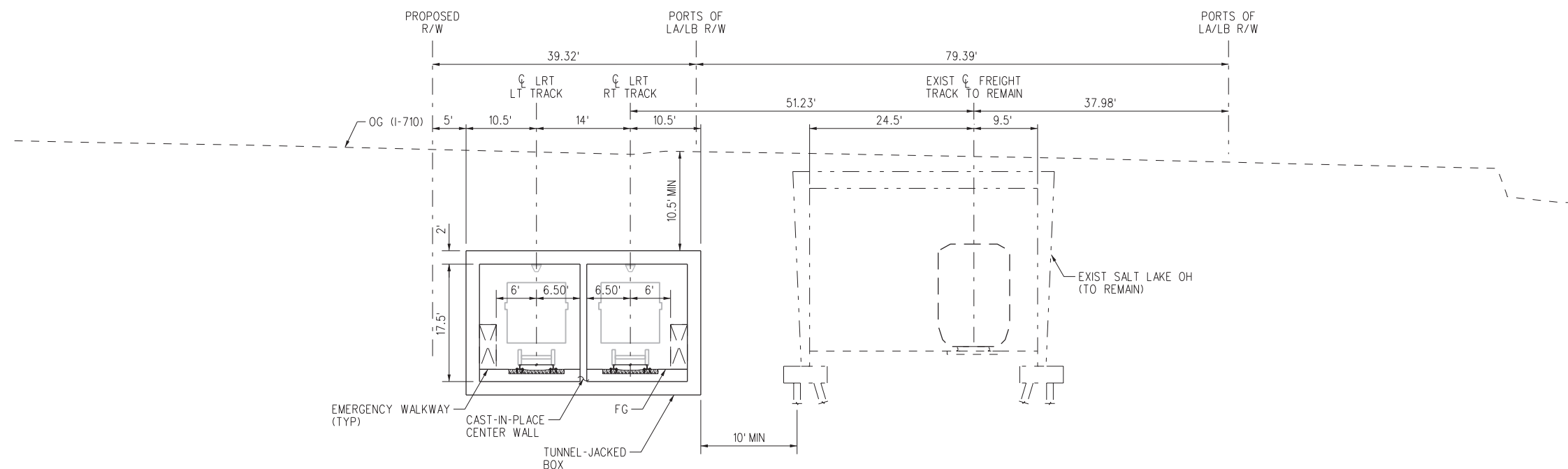

STA 987+50

SCALE: NTS

AN
TF-220

NOT FOR CONSTRUCTION

THE PREPARATION OF THIS DRAWING HAS BEEN FINANCED IN PART THROUGH A GRANT FROM THE U.S. DEPARTMENT OF TRANSPORTATION FEDERAL TRANSIT ADMINISTRATION (FTA), UNDER THE FEDERAL TRANSIT ACT OF 1964, AS AMENDED, AND IN PART BY THE TAKES OF THE CITIZENS OF LOS ANGELES COUNTY AND OF THE STATE OF CALIFORNIA.

DESIGNED BY	A. TSAO
DRAWN BY	R. MUNOZ
CHECKED BY	R. LOYA
IN CHARGE	N. MAACK
DATE	11/15/2019
PROJECT	FINAL CONCEPTUAL ALIGNMENT
DATE	0 11/15/19

DESIGNED BY
A. TSAO

DRAWN BY
R. MUNOZ

CHECKED BY
R. LOYA

IN CHARGE
N. MAACK

DATE
11/15/2019

M Metro

LOS ANGELES COUNTY METROPOLITAN TRANSPORTATION AUTHORITY

wsp 444 South Flower Street Suite 800 Los Angeles, CA 90071 TEL (213) 362-9470

SUBMITTED _____

APPROVED _____

WEST SANTA ANA BRANCH FREIGHT TRACK

CROSS SECTIONS SOUTHERN ALIGNMENT 20' OFFSET

CONTRACT NO. AE5999300

DRAWING NO. TX-205

SCALE NO SCALE

SHEET NO. 93 OF 107

15-NOV-2019 15:27 C-28091ATX205.plg

NOTES:

1. FOR SOUND WALL AND RETAINING WALL LIMITS, SEE PLAN AND PROFILE SHEETS.

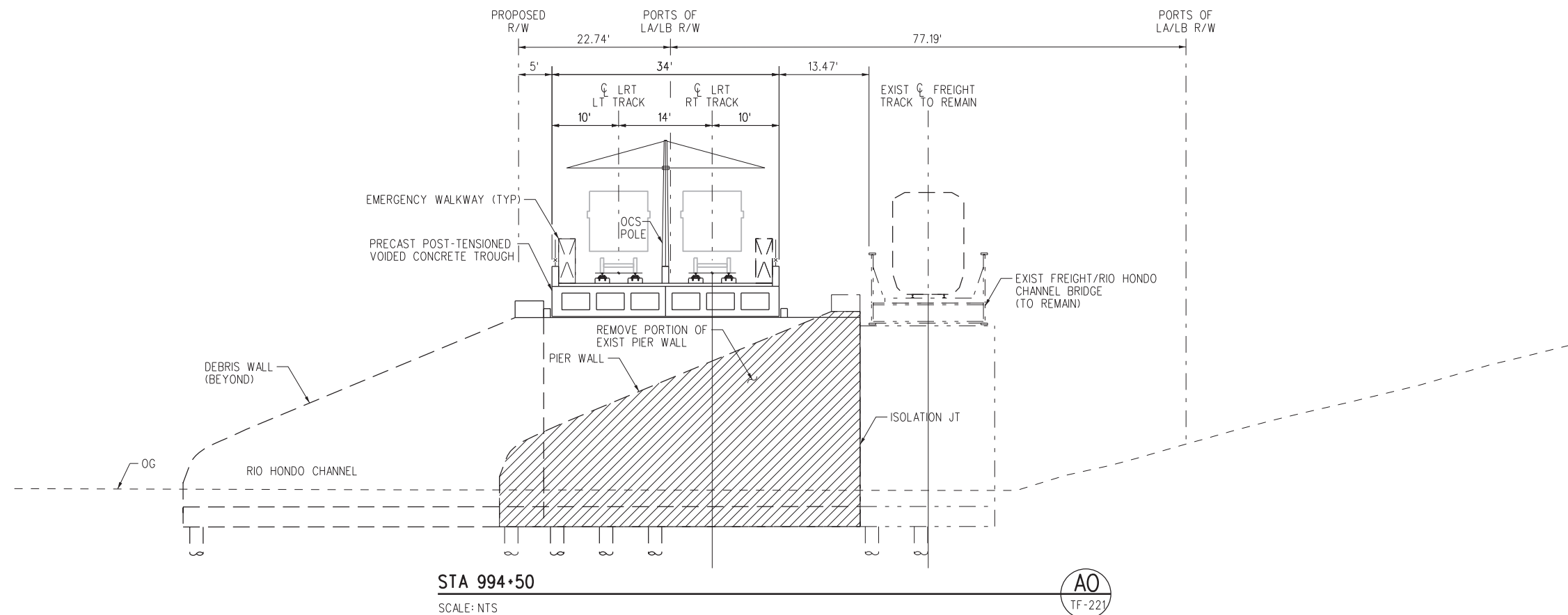

STA 994+50

SCALE: NTS

AO
TF-221

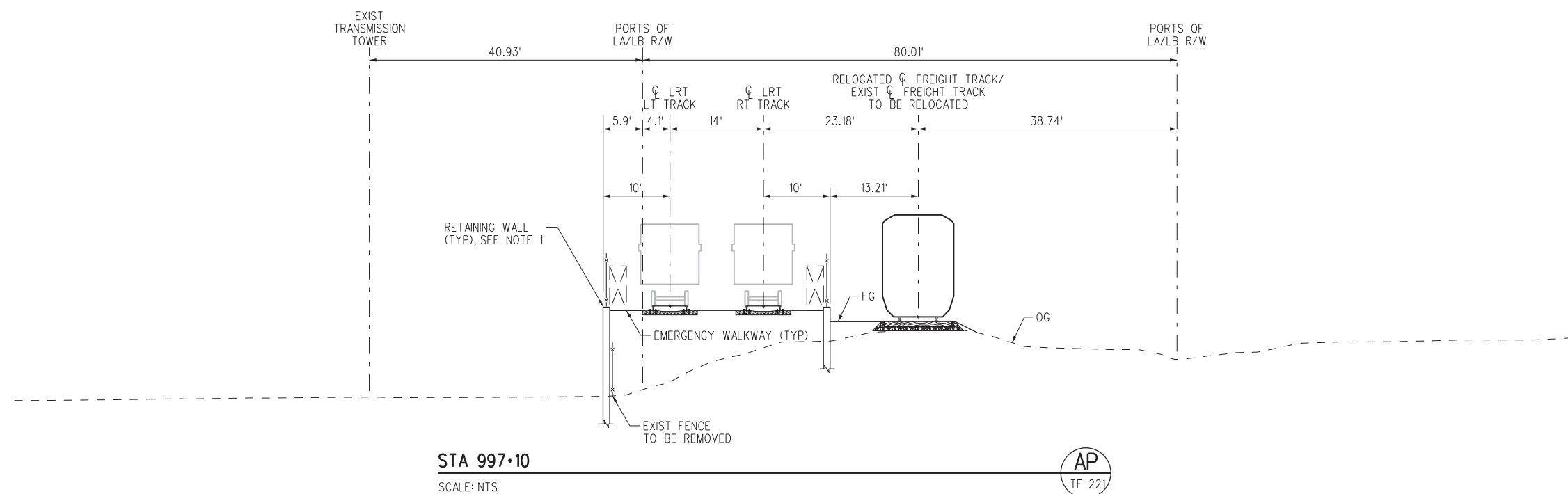

STA 997+10

SCALE: NTS

AP
TF-221

NOT FOR CONSTRUCTION

THE PREPARATION OF THIS DRAWING HAS BEEN FINANCED IN PART THROUGH A GRANT FROM THE U.S. DEPARTMENT OF TRANSPORTATION FEDERAL TRANSIT ADMINISTRATION (FTA), UNDER THE FEDERAL TRANSIT ACT OF 1964, AS AMENDED, AND IN PART BY THE TAKES OF THE CITIZENS OF LOS ANGELES COUNTY AND OF THE STATE OF CALIFORNIA.

DESIGNED BY	A. TSAO
DRAWN BY	R. MUNOZ
CHECKED BY	R. LOYA
IN CHARGE	N. MAACK
DATE	11/15/2019
PROJECT	FINAL CONCEPTUAL ALIGNMENT
DATE	0 11/15/19

DESIGNED BY
A. TSAO

DRAWN BY
R. MUNOZ

CHECKED BY
R. LOYA

IN CHARGE
N. MAACK

DATE
11/15/2019

M Metro LOS ANGELES COUNTY METROPOLITAN TRANSPORTATION AUTHORITY

wsp 444 South Flower Street Suite 800 Los Angeles, CA 90071 TEL (213) 362-9470

SUBMITTED _____

APPROVED _____

WEST SANTA ANA BRANCH FREIGHT TRACK

CROSS SECTIONS SOUTHERN ALIGNMENT 20' OFFSET

CONTRACT NO. AE5999300

DRAWING NO. TX-206

SCALE NO SCALE

SHEET NO. 94 OF 107

15-NOV-2019 C-28091ATX206.plg

NOTES:
 1. FOR SOUND WALL AND RETAINING WALL LIMITS, SEE PLAN AND PROFILE SHEETS.

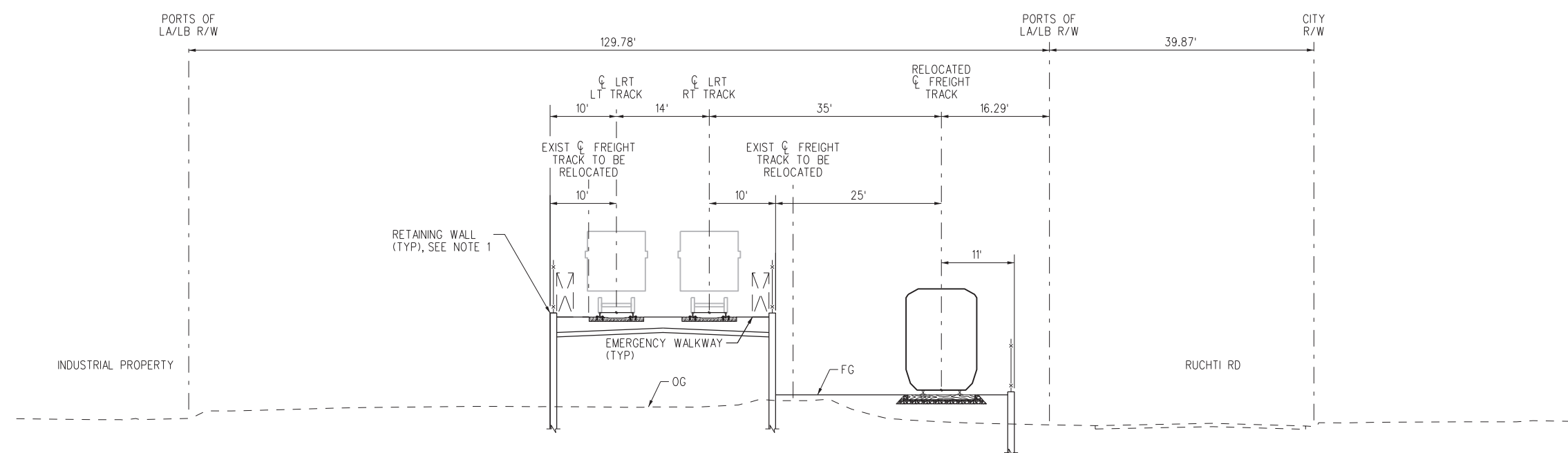

STA 1013+75
 SCALE: NTS

AQ
 TF-223

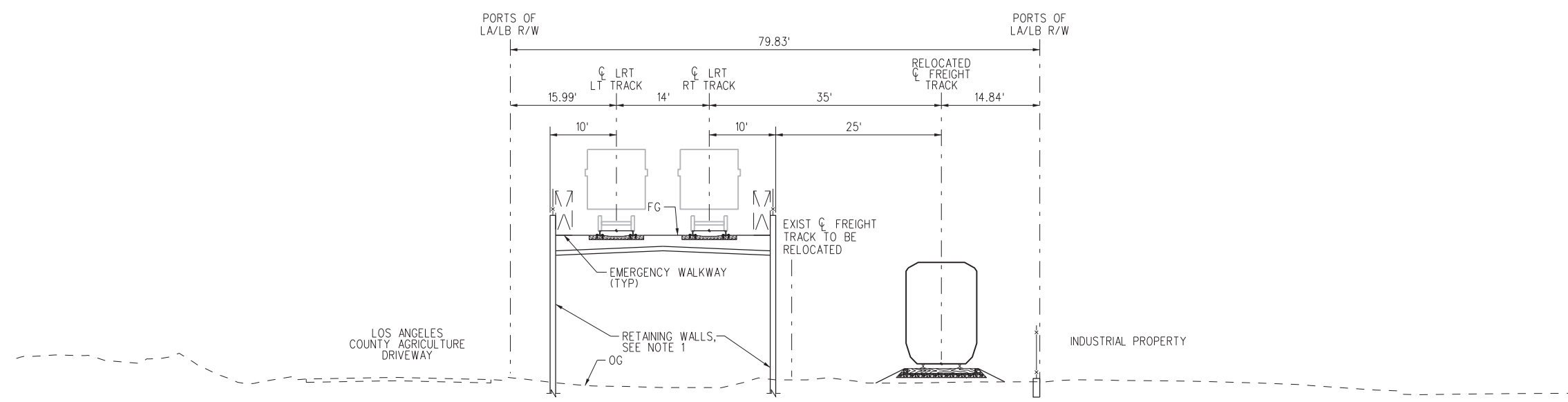

STA 1026+00
 SCALE: NTS

AR
 TF-224

NOT FOR CONSTRUCTION

DESIGNED BY	A. TSAO
DRAWN BY	R. MUNOZ
CHECKED BY	R. LOYA
IN CHARGE	N. MAACK
DATE	11/15/2019

0	11/15/19	FINAL CONCEPTUAL ALIGNMENT
---	----------	----------------------------

THE PREPARATION OF THIS DRAWING HAS BEEN FINANCED IN PART THROUGH A GRANT FROM THE U.S. DEPARTMENT OF TRANSPORTATION FEDERAL TRANSIT ADMINISTRATION (FTA), UNDER THE FEDERAL TRANSIT ACT OF 1964, AS AMENDED, AND IN PART BY THE TAXES OF THE CITIZENS OF LOS ANGELES COUNTY AND OF THE STATE OF CALIFORNIA.

M Metro

LOS ANGELES COUNTY METROPOLITAN TRANSPORTATION AUTHORITY

wsp 444 South Flower Street Suite 800 Los Angeles, CA 90071 TEL (213) 362-9470

SUBMITTED _____

APPROVED _____

CONTRACT NO		AE5999300
DRAWING NO	TX-207	REV
SCALE	NO SCALE	
SHEET NO	95	OF 107

15-NOV-2019 C-28091ATX207.plg
 15:27 svc-projectwise

NOTES:

1. FOR SOUND WALL AND RETAINING WALL LIMITS, SEE PLAN AND PROFILE SHEETS.
- 2.

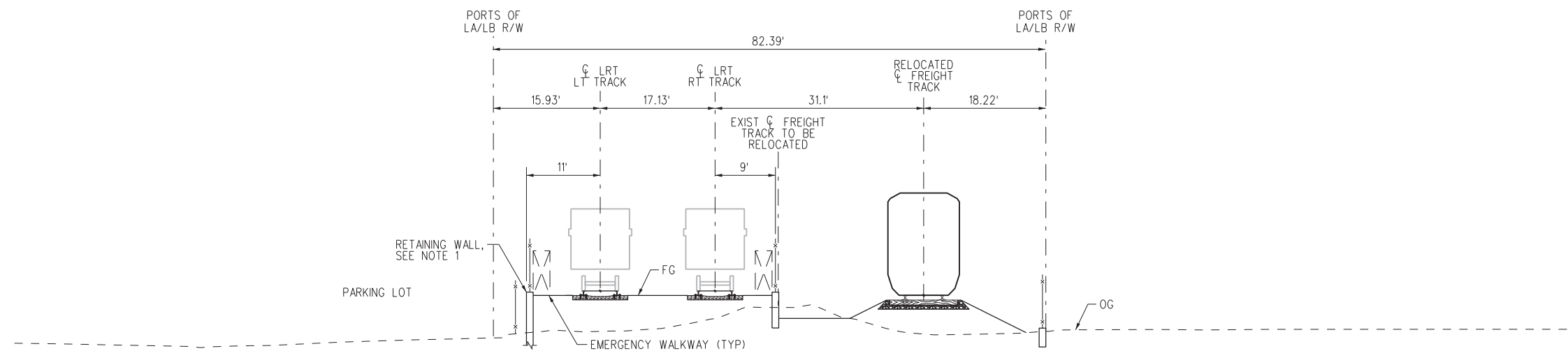

STA 1038+00

SCALE: NTS

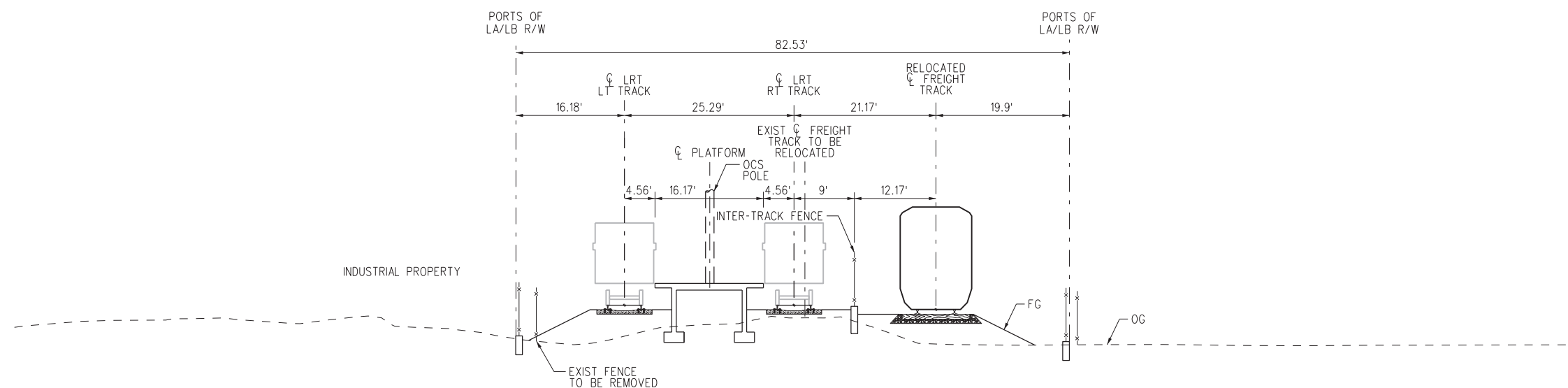

STA 1047+00

SCALE: NTS



NOT FOR CONSTRUCTION

15-NOV-2019 15:27
 C-28091ATX208.plg
 svc-projectwise

DESIGNED BY	A. TSAO
DRAWN BY	R. MUNOZ
CHECKED BY	R. LOYA
IN CHARGE	N. MAACK
DATE	11/15/2019
0	11/15/19
FINAL CONCEPTUAL ALIGNMENT	

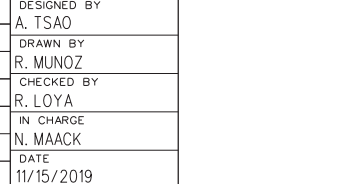

LOS ANGELES COUNTY METROPOLITAN TRANSPORTATION AUTHORITY

SUBMITTED _____

APPROVED _____

WEST SANTA ANA BRANCH FREIGHT TRACK
 CROSS SECTIONS
 SOUTHERN ALIGNMENT
 20' OFFSET

CONTRACT NO.	AE5999300
DRAWING NO.	TX-208
SCALE	NO SCALE
SHEET NO.	96 OF 107

NOTES:

1. FOR SOUND WALL AND RETAINING WALL LIMITS, SEE PLAN AND PROFILE SHEETS.

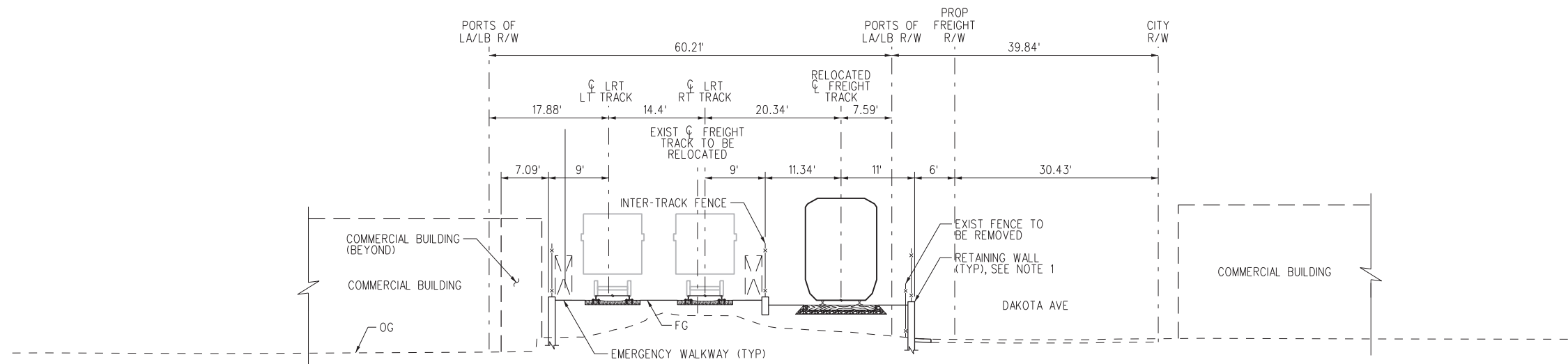

STA 1060+00

SCALE: NTS

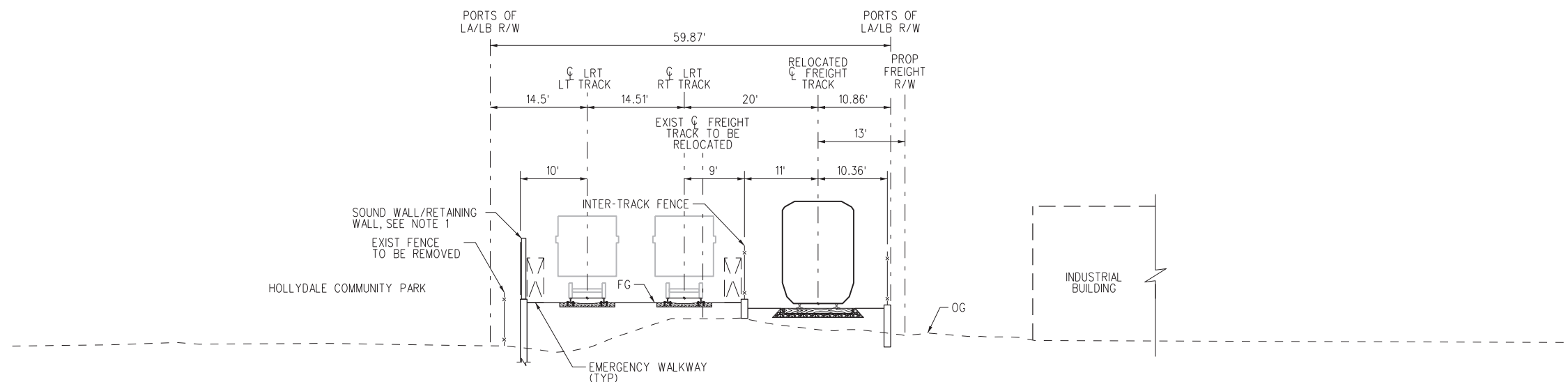

STA 1069+00

SCALE: NTS



NOT FOR CONSTRUCTION

15-NOV-2019 15:27
 C-28091ATX209.plg
 svc-projectwise

Plot Driver=MTA-half.pen Pentable=bw.plt

THE PREPARATION OF THIS DRAWING HAS BEEN FINANCED IN PART THROUGH A GRANT FROM THE U.S. DEPARTMENT OF TRANSPORTATION FEDERAL TRANSIT ADMINISTRATION (FTA), UNDER THE FEDERAL TRANSIT ACT OF 1964, AS AMENDED, AND IN PART BY THE TAXES OF THE CITIZENS OF LOS ANGELES COUNTY AND OF THE STATE OF CALIFORNIA.	DESIGNED BY A. TSAO	 LOS ANGELES COUNTY METROPOLITAN TRANSPORTATION AUTHORITY	CONTRACT NO AE5999300
	DRAWN BY R. MUNOZ		DRAWING NO TX-209
	CHECKED BY R. LOYA		SCALE NO SCALE
	IN CHARGE N. MAACK		SHEET NO 97 OF 107
	DATE 11/15/2019		
0 11/15/19	FINAL CONCEPTUAL ALIGNMENT		

DESIGNED BY A. TSAO
DRAWN BY R. MUNOZ
CHECKED BY R. LOYA
IN CHARGE N. MAACK
DATE 11/15/2019

Metro
 444 South Flower Street
 Suite 800
 Los Angeles, CA 90071
 TEL (213) 362-9470

WSP

SUBMITTED _____
 APPROVED _____

WEST SANTA ANA BRANCH FREIGHT TRACK
CROSS SECTIONS
SOUTHERN ALIGNMENT
20' OFFSET

NOTES:

1. FOR SOUND WALL AND RETAINING WALL LIMITS, SEE PLAN AND PROFILE SHEETS.

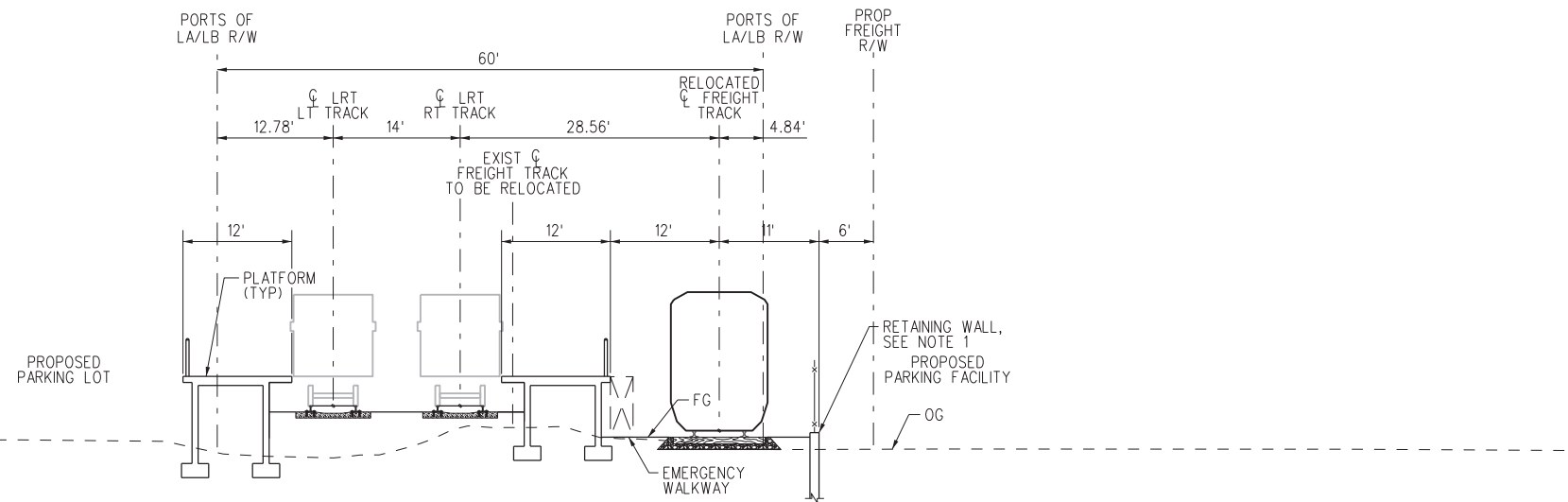

STA 1080+50

SCALE: NTS

AW
TF-230

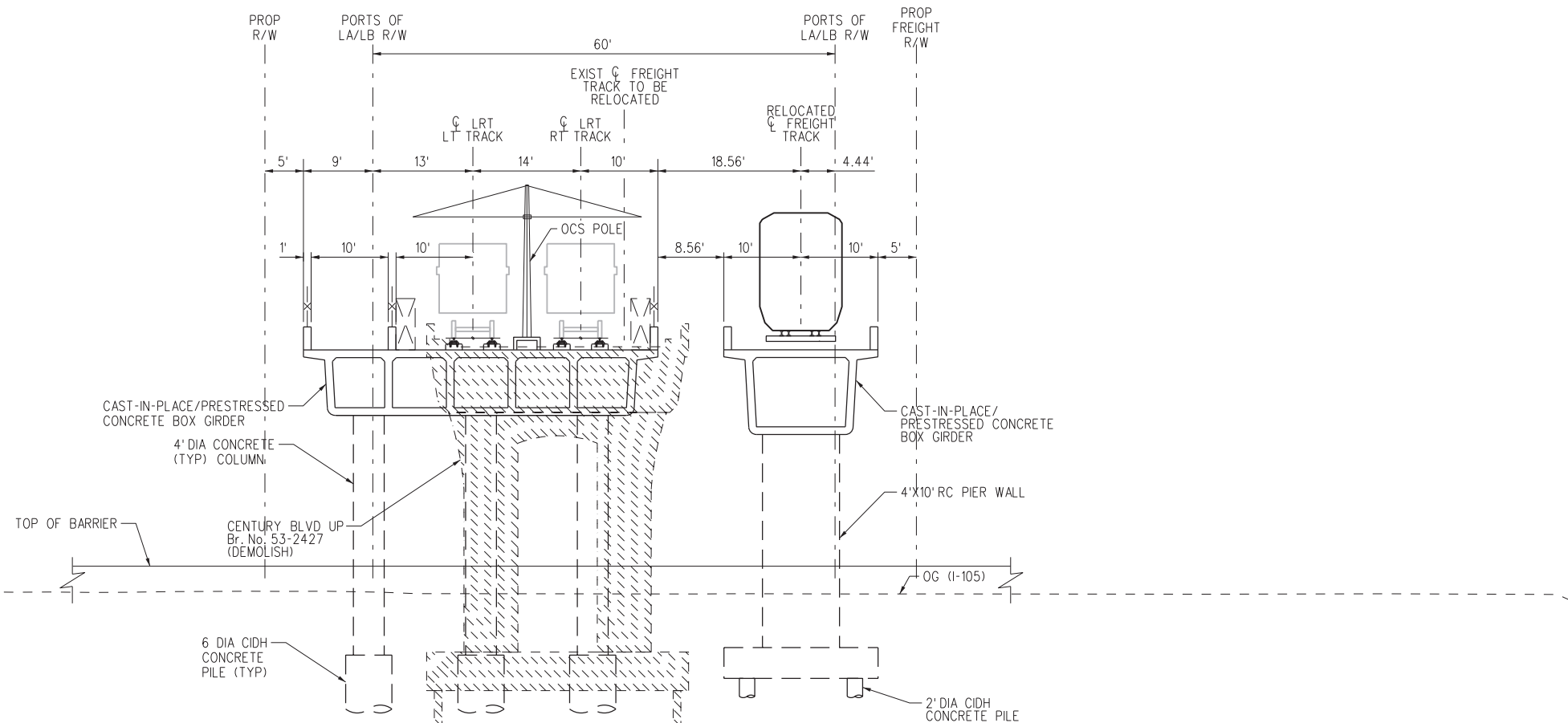

STA 1087+00

SCALE: NTS

AX
TF-231

NOT FOR CONSTRUCTION

THE PREPARATION OF THIS DRAWING HAS BEEN FINANCED IN PART THROUGH A GRANT FROM THE U.S. DEPARTMENT OF TRANSPORTATION FEDERAL TRANSIT ADMINISTRATION (FTA), UNDER THE FEDERAL TRANSIT ACT OF 1964, AS AMENDED, AND IN PART BY THE TAKES OF THE CITIZENS OF LOS ANGELES COUNTY AND OF THE STATE OF CALIFORNIA.		DESIGNED BY A. TSAO	<p>LOS ANGELES COUNTY METROPOLITAN TRANSPORTATION AUTHORITY</p> <p>444 South Flower Street Suite 800 Los Angeles, CA 90071 TEL (213) 362-9470</p>	CONTRACT NO AE5999300	
0	11/15/19	DRAWN BY R. MUNOZ		DRAWING NO TX-210	REV
		CHECKED BY R. LOYA		SCALE NO SCALE	
		IN CHARGE N. MAACK		SHEET NO	
		DATE 11/15/2019		98	OF 107

FINAL CONCEPTUAL ALIGNMENT		SUBMITTED _____ APPROVED _____
----------------------------	--	-----------------------------------

WEST SANTA ANA BRANCH FREIGHT TRACK	
CROSS SECTIONS	
SOUTHERN ALIGNMENT	
20' OFFSET	

15-NOV-2019 C-28091ATX210.plt
15:26
svc-projectwise

NOTES:

1. FOR SOUND WALL AND RETAINING WALL LIMITS, SEE PLAN AND PROFILE SHEETS.

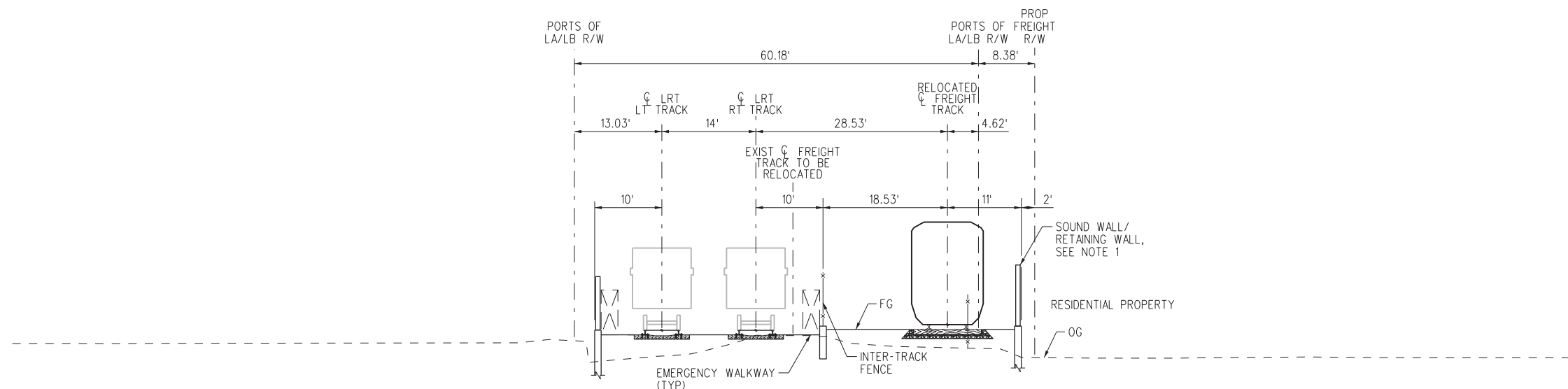

STA 1089+80

SCALE: NTS

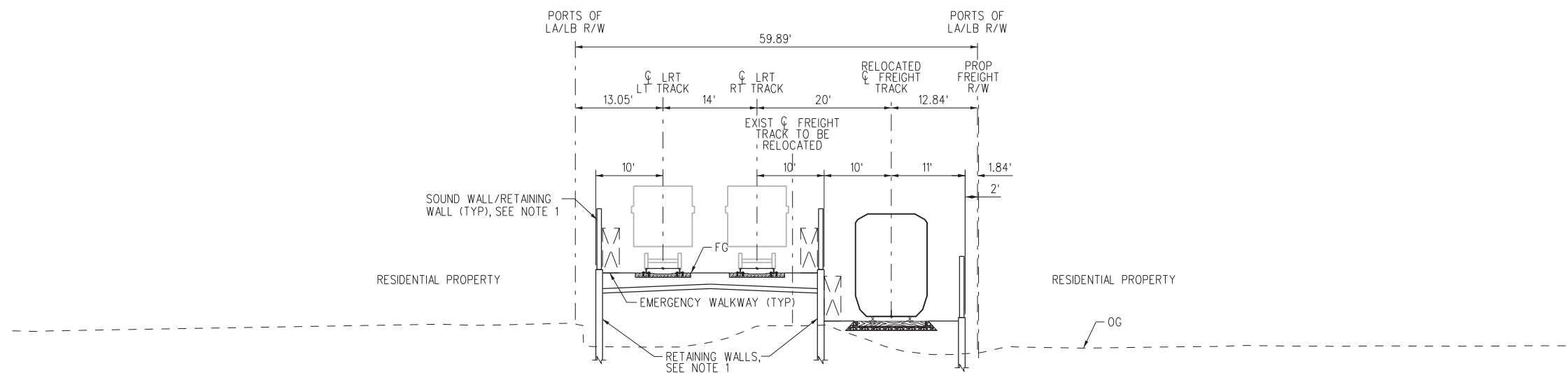

STA 1097+25

SCALE: NTS



NOT FOR CONSTRUCTION

DESIGNED BY	A. TSAO
DRAWN BY	R. MUNOZ
CHECKED BY	R. LOYA
IN CHARGE	N. MAACK
DATE	11/15/2019
FINAL CONCEPTUAL ALIGNMENT	

0	11/15/19								
---	----------	--	--	--	--	--	--	--	--

LOS ANGELES COUNTY METROPOLITAN TRANSPORTATION AUTHORITY

wsp 444 South Flower Street Suite 800 Los Angeles, CA 90071 TEL (213) 362-9470

SUBMITTED _____

APPROVED _____

WEST SANTA ANA BRANCH FREIGHT TRACK
CROSS SECTIONS
SOUTHERN ALIGNMENT
20' OFFSET

CONTRACT NO	AE5999300
DRAWING NO	TX-211
SCALE	NO SCALE
SHEET NO	99 OF 107

15-NOV-2019 C-28091ATX211.plt

NOTES:

1. FOR SOUND WALL AND RETAINING WALL LIMITS, SEE PLAN AND PROFILE SHEETS.

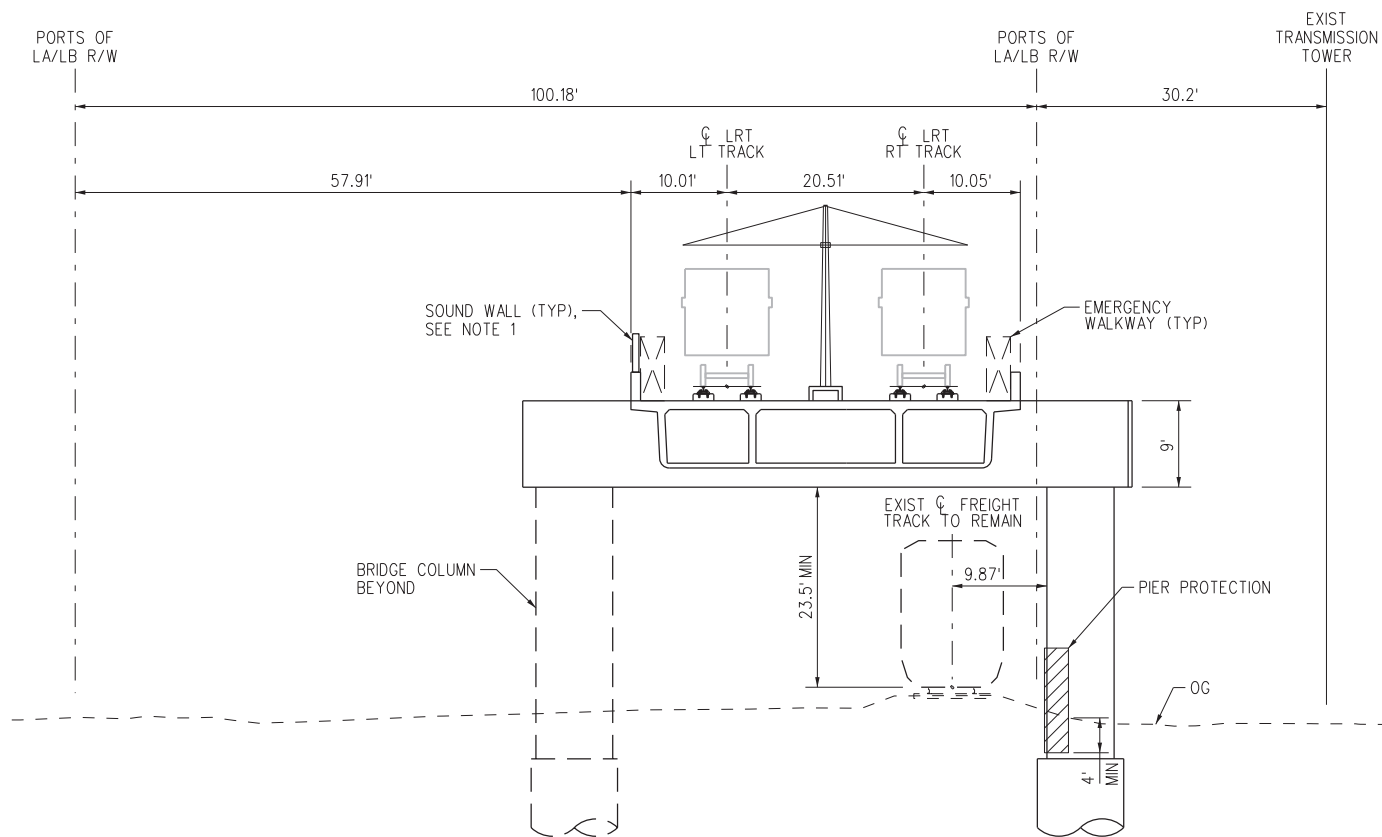

STA 1111+14

SCALE: NTS

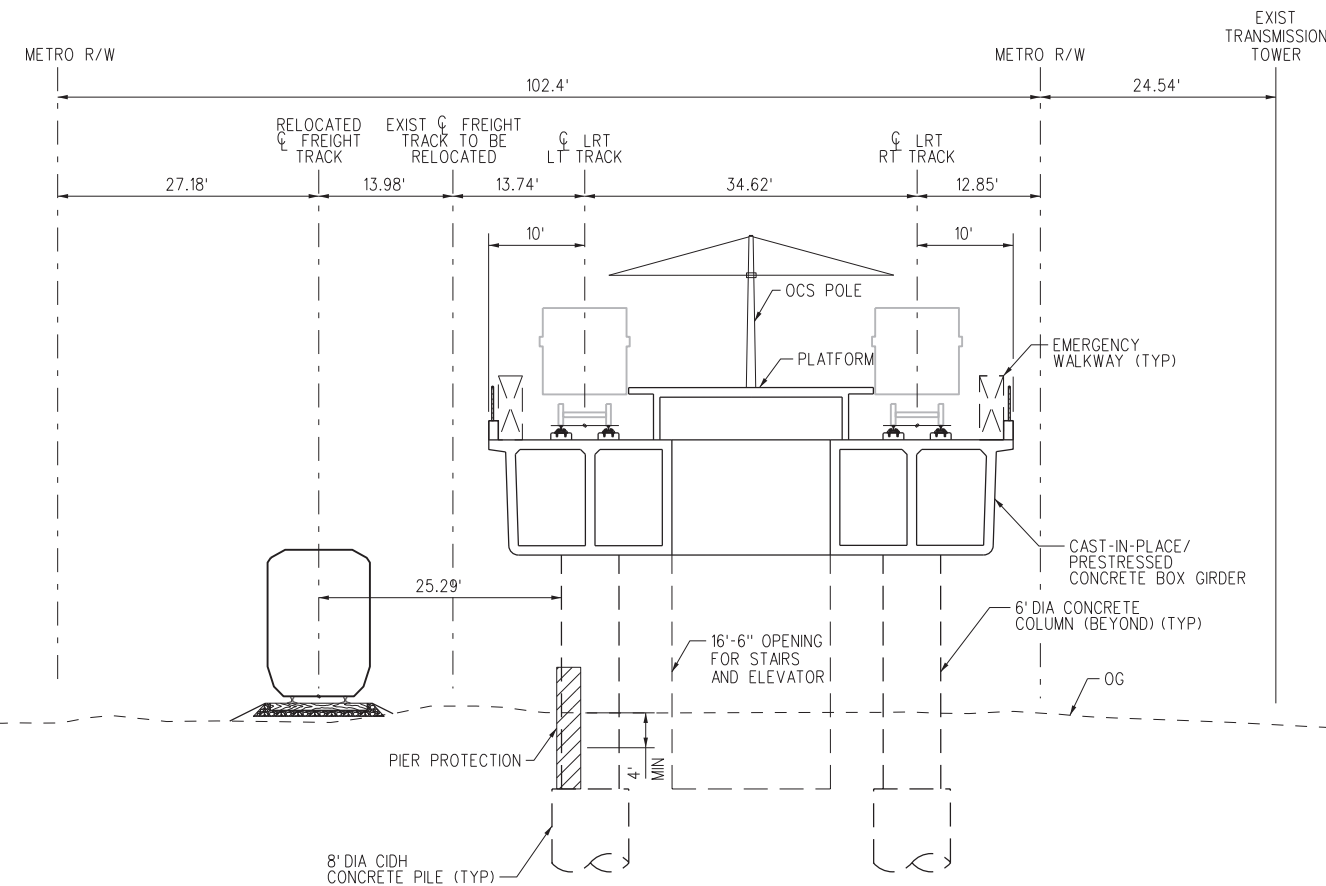

STA 1119+68

SCALE: NTS



NOT FOR CONSTRUCTION

THE PREPARATION OF THIS DRAWING HAS BEEN FINANCED IN PART THROUGH A GRANT FROM THE U.S. DEPARTMENT OF TRANSPORTATION FEDERAL TRANSIT ADMINISTRATION (FTA), UNDER THE FEDERAL TRANSIT ACT OF 1964, AS AMENDED, AND IN PART BY THE TAKES OF THE CITIZENS OF LOS ANGELES COUNTY AND OF THE STATE OF CALIFORNIA.

DESIGNED BY	A. TSAO
DRAWN BY	R. MUNOZ
CHECKED BY	R. LOYA
IN CHARGE	N. MAACK
DATE	11/15/2019
PROJECT	FINAL CONCEPTUAL ALIGNMENT

DATE	11/15/2019
------	------------

M Metro
LOS ANGELES COUNTY METROPOLITAN TRANSPORTATION AUTHORITY

wsp 444 South Flower Street Suite 800 Los Angeles, CA 90071 TEL (213) 362-9470

SUBMITTED: _____
 APPROVED: _____

WEST SANTA ANA BRANCH FREIGHT TRACK
 CROSS SECTIONS
 SOUTHERN ALIGNMENT
 20' OFFSET

CONTRACT NO.	AE5999300
DRAWING NO.	TX-212
SCALE	NO SCALE
SHEET NO.	100 OF 107

15-NOV-2019 C-28091ATX212.plt
 15:27 svc-projectwise

NOTES:

1. FOR SOUND WALL AND RETAINING WALL LIMITS, SEE PLAN AND PROFILE SHEETS.

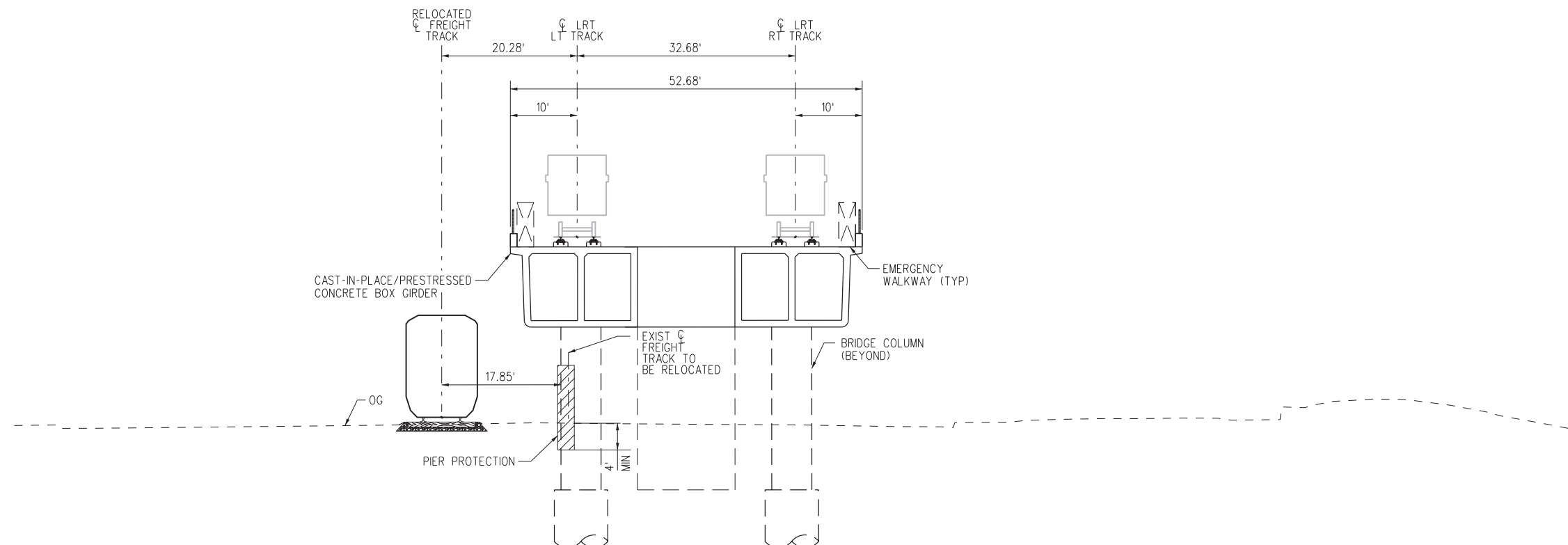

STA 1123+00

SCALE: NTS

BC
TF-235

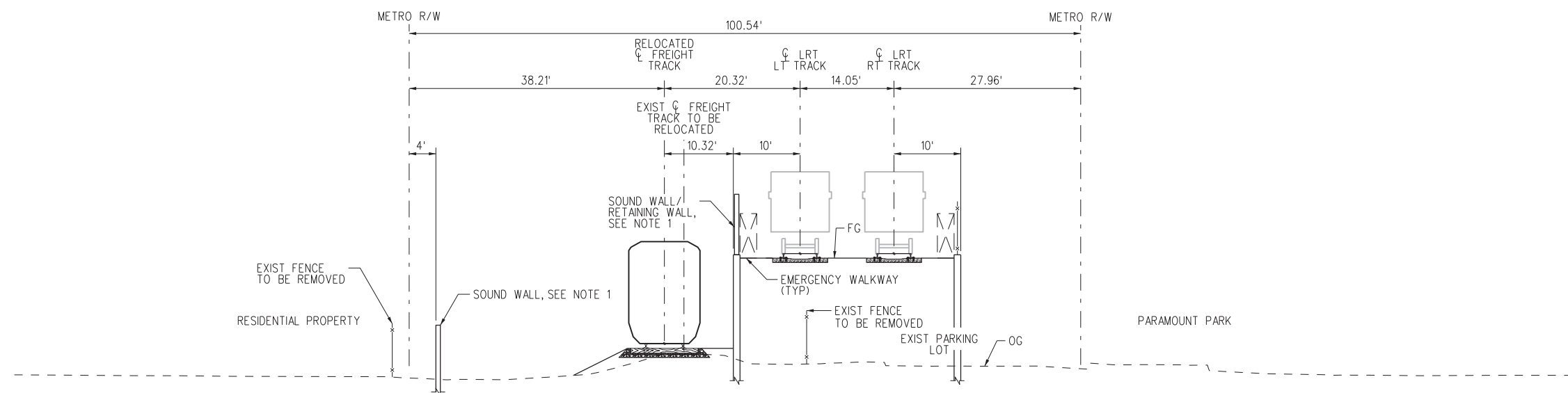



STA 1130+00

SCALE: NTS

BD
TF-235

NOT FOR CONSTRUCTION

DESIGNED BY	A. TSAO
DRAWN BY	R. MUNOZ
CHECKED BY	R. LOYA
IN CHARGE	N. MAACK
DATE	11/15/2019
PROJECT	FINAL CONCEPTUAL ALIGNMENT
DATE	0 11/15/19

LOS ANGELES COUNTY METROPOLITAN TRANSPORTATION AUTHORITY

 444 South Flower Street
 Suite 800
 Los Angeles, CA 90071
 TEL (213) 362-9470

CONTRACT NO	AE5999300
DRAWING NO	TX-213
SCALE	NO SCALE
SHEET NO	101 OF 107
DATE	
APPROVED	

WEST SANTA ANA BRANCH FREIGHT TRACK
CROSS SECTIONS
SOUTHERN ALIGNMENT
20' OFFSET

15-NOV-2019 C-28091ATX213.plt
 15:27
 svc-projectwise

NOTES:

1. FOR SOUND WALL AND RETAINING WALL LIMITS, SEE PLAN AND PROFILE SHEETS.

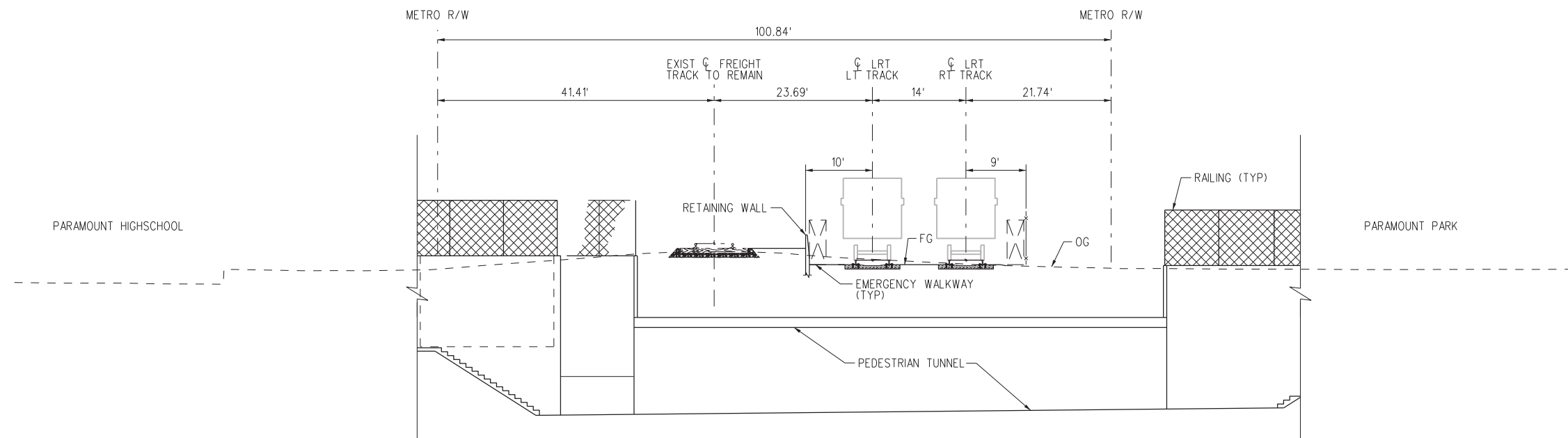

STA 1138+90

SCALE: NTS

BE
TF-236

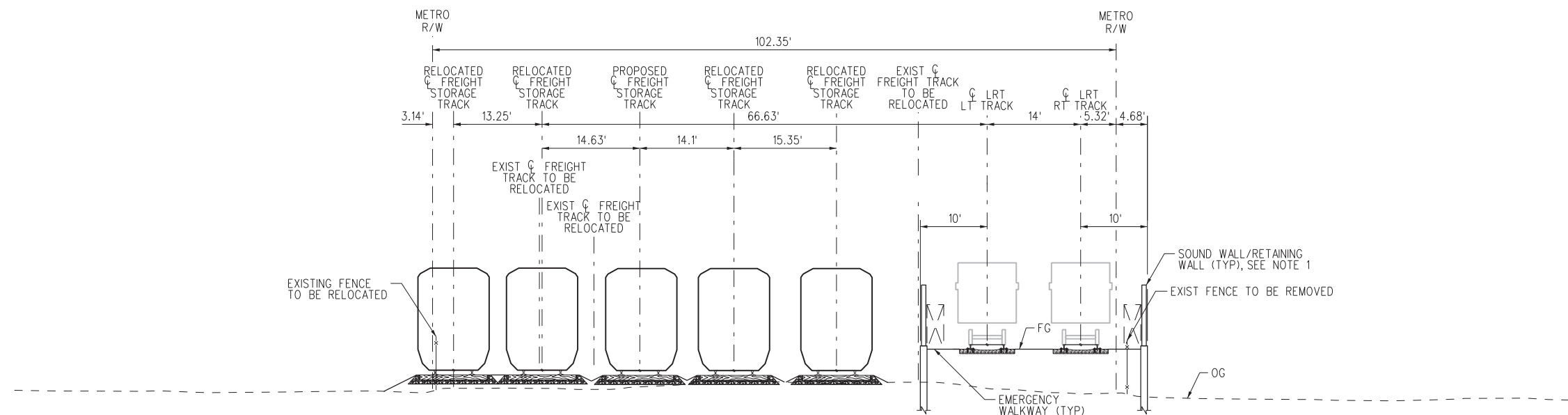

STA 1161+75

SCALE: NTS

BF
TF-239

NOT FOR CONSTRUCTION

THE PREPARATION OF THIS DRAWING HAS BEEN FINANCED IN PART THROUGH A GRANT FROM THE U.S. DEPARTMENT OF TRANSPORTATION FEDERAL TRANSIT ADMINISTRATION (FTA), UNDER THE FEDERAL TRANSIT ACT OF 1964, AS AMENDED, AND IN PART BY THE TAXES OF THE CITIZENS OF LOS ANGELES COUNTY AND OF THE STATE OF CALIFORNIA.

DESIGNED BY	A. TSAO
DRAWN BY	R. MUNOZ
CHECKED BY	R. LOYA
IN CHARGE	N. MAACK
DATE	11/15/2019
0	11/15/19
FINAL CONCEPTUAL ALIGNMENT	

DESIGNED BY
A. TSAO
DRAWN BY
R. MUNOZ
CHECKED BY
R. LOYA
IN CHARGE
N. MAACK
DATE
11/15/2019

M Metro
LOS ANGELES COUNTY METROPOLITAN TRANSPORTATION AUTHORITY

wsp 444 South Flower Street Suite 800 Los Angeles, CA 90071 TEL (213) 362-9470

SUBMITTED _____
APPROVED _____

WEST SANTA ANA BRANCH FREIGHT TRACK		CONTRACT NO	AE5999300
CROSS SECTIONS SOUTHERN ALIGNMENT 20' OFFSET		DRAWING NO	TX-214
		SCALE	NO SCALE
		SHEET NO	102 OF 107

15-NOV-2019 C-28091ATX214.plt
15:27 svc-projectwise

15-NOV-2019 C-28091ACS001R2.plg
 svc-projectwise 22:39

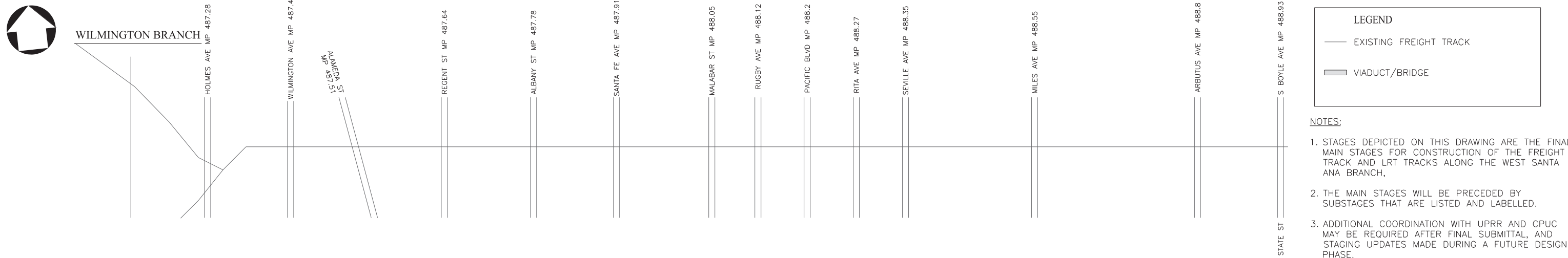

EXISTING CONDITIONS

LEGEND

- EXISTING FREIGHT TRACK
- ▬ VIADUCT/BRIDGE

- NOTES:**
1. STAGES DEPICTED ON THIS DRAWING ARE THE FINAL MAIN STAGES FOR CONSTRUCTION OF THE FREIGHT TRACK AND LRT TRACKS ALONG THE WEST SANTA ANA BRANCH,
 2. THE MAIN STAGES WILL BE PRECEDED BY SUBSTAGES THAT ARE LISTED AND LABELLED.
 3. ADDITIONAL COORDINATION WITH UPRR AND CPUC MAY BE REQUIRED AFTER FINAL SUBMITTAL, AND STAGING UPDATES MADE DURING A FUTURE DESIGN PHASE.

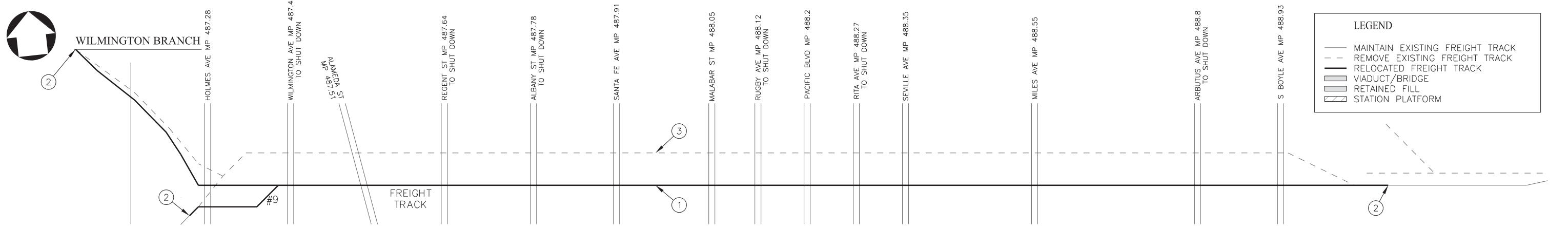

STAGE 1-A - FREIGHT TRACK RELOCATION

LEGEND

- MAINTAIN EXISTING FREIGHT TRACK
- - - REMOVE EXISTING FREIGHT TRACK
- ▬ RELOCATED FREIGHT TRACK
- ▬ VIADUCT/BRIDGE
- ▬ RETAINED FILL
- ▨ STATION PLATFORM

- 1 - CONSTRUCT NEW FREIGHT TRACK. FREIGHT OPERATION REMAINS ON EXISTING TRACKS.
- 2 - DURING WEEKEND WINDOWS, CONNECT NEW FREIGHT TRACKS TO EXISTING TRACKS.
- 3 - REMOVE AND DISPOSE EXISTING TRACKS. FREIGHT OPERATION SWITCHES TO NEW FREIGHT TRACK.

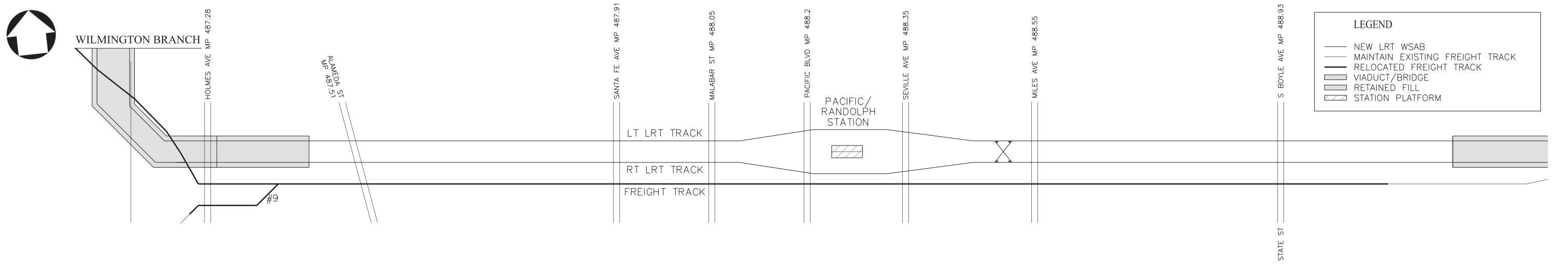

STAGE 2-A - LRT CONSTRUCTION

LEGEND

- NEW LRT WSAB
- MAINTAIN EXISTING FREIGHT TRACK
- ▬ RELOCATED FREIGHT TRACK
- ▬ VIADUCT/BRIDGE
- ▬ RETAINED FILL
- ▨ STATION PLATFORM

NOT FOR CONSTRUCTION

THE PREPARATION OF THIS DRAWING HAS BEEN FINANCED IN PART THROUGH A GRANT FROM THE U.S. DEPARTMENT OF TRANSPORTATION FEDERAL TRANSIT ADMINISTRATION (FTA), UNDER THE FEDERAL TRANSIT ACT OF 1964, AS AMENDED, AND IN PART BY THE TAXES OF THE CITIZENS OF LOS ANGELES COUNTY AND OF THE STATE OF CALIFORNIA.		DESIGNED BY J. SANCHEZ
0	11/15/19	DRAWN BY A. LEE
		CHECKED BY R. LOYA
		IN CHARGE N. MAACK
		DATE 11/15/2019
		FINAL CONCEPTUAL DESIGN

M Metro
LOS ANGELES COUNTY METROPOLITAN TRANSPORTATION AUTHORITY

wsp 444 South Flower Street Suite 800 Los Angeles, CA 90071 TEL (213) 362-9470

SUBMITTED _____
 APPROVED _____

WEST SANTA ANA BRANCH FREIGHT TRACK TRACK ALIGNMENT LA HABRA BRANCH CONSTRUCTION STAGING

CONTRACT NO. **AE5999300**
 DRAWING NO. **CS-001** REV _____
 SCALE **HOR: 1"=400'**
 NTS
 SHEET NO. **103 OF 107**

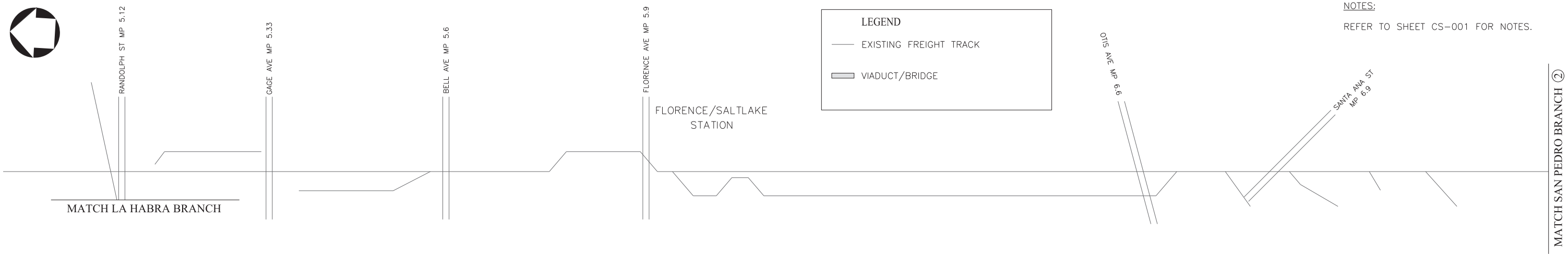

EXISTING CONDITIONS

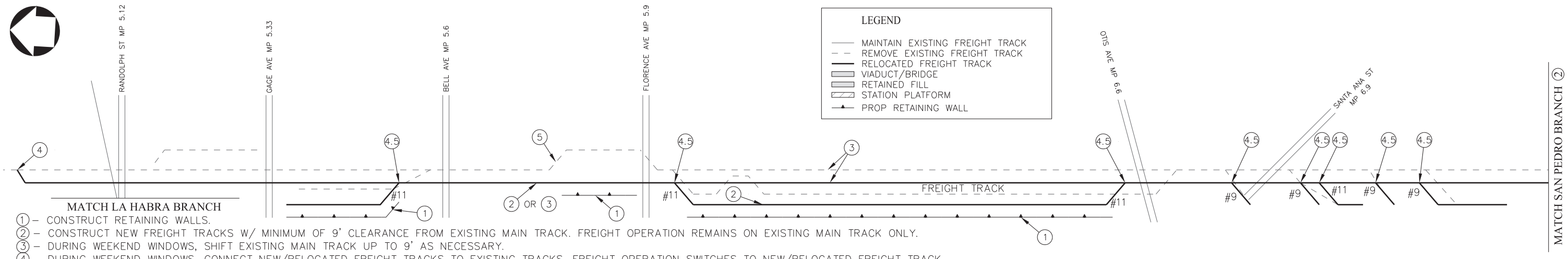

STAGE I-B - FREIGHT TRACK RELOCATION

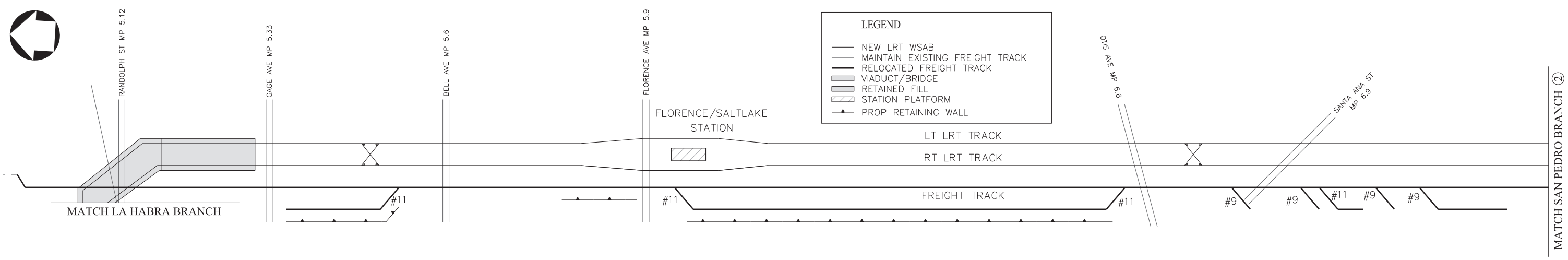

STAGE 2-B - LRT CONSTRUCTION

NOT FOR CONSTRUCTION

15-NOV-2019 C-28091ACS002.plg
svc-projectwise 22:40

THE PREPARATION OF THIS DRAWING HAS BEEN FINANCED IN PART THROUGH A GRANT FROM THE U.S. DEPARTMENT OF TRANSPORTATION FEDERAL TRANSIT ADMINISTRATION (FTA), UNDER THE FEDERAL TRANSIT ACT OF 1964, AS AMENDED, AND IN PART BY THE TAXES OF THE CITIZENS OF LOS ANGELES COUNTY AND OF THE STATE OF CALIFORNIA.		DESIGNED BY J. SANCHEZ
		DRAWN BY A. LEE
		CHECKED BY R. LOYA
		IN CHARGE N. MAACK
		DATE 11/15/2019
0	11/15/19	FINAL CONCEPTUAL DESIGN

LOS ANGELES COUNTY METROPOLITAN TRANSPORTATION AUTHORITY	
444 South Flower Street Suite 800 Los Angeles, CA 90071 TEL (213) 362-9470	SUBMITTED _____ APPROVED _____

WEST SANTA ANA BRANCH FREIGHT TRACK TRACK ALIGNMENT LA HABRA BRANCH CONSTRUCTION STAGING	
CONTRACT NO AE5999300	REV
DRAWING NO CS-002	
SCALE HOR: 1"=400'	NTS
SHEET NO 104	OF 107

15-NOV-2019 C-28091ACS003.plg
 svc-projectwise 22:40

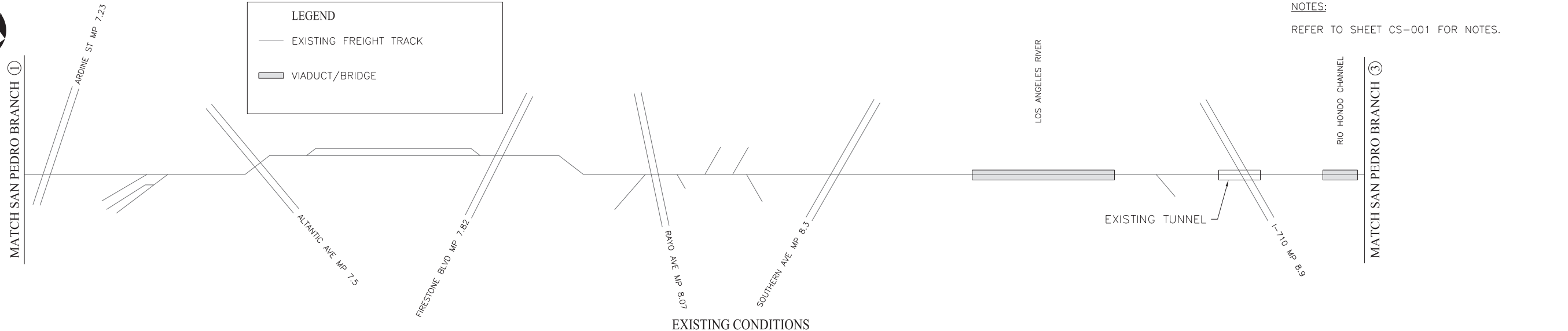

LEGEND

- EXISTING FREIGHT TRACK
- ▬ VIADUCT/BRIDGE

NOTES:
 REFER TO SHEET CS-001 FOR NOTES.

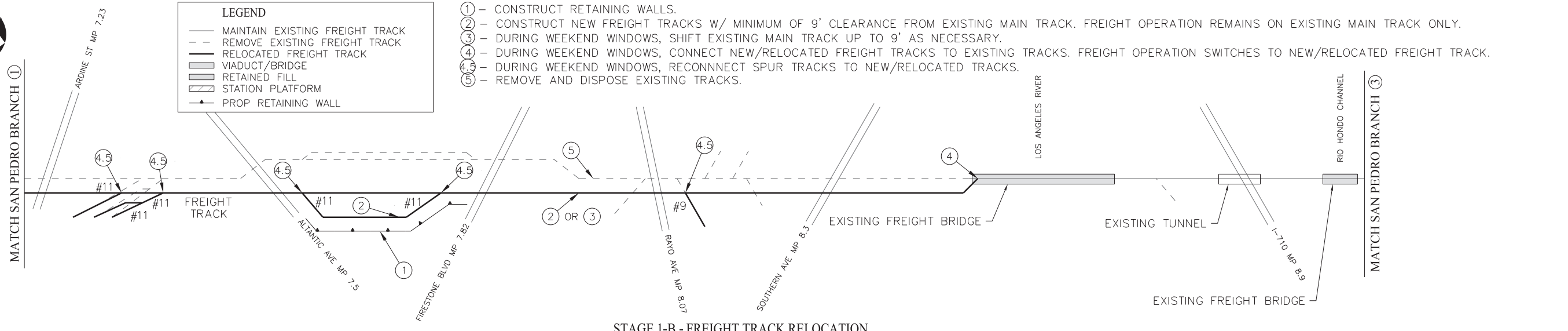

LEGEND

- MAINTAIN EXISTING FREIGHT TRACK
- - - REMOVE EXISTING FREIGHT TRACK
- - - RELOCATED FREIGHT TRACK
- ▬ VIADUCT/BRIDGE
- ▬ RETAINED FILL
- ▨ STATION PLATFORM
- ▲ PROP RETAINING WALL

- ① - CONSTRUCT RETAINING WALLS.
- ② - CONSTRUCT NEW FREIGHT TRACKS W/ MINIMUM OF 9' CLEARANCE FROM EXISTING MAIN TRACK. FREIGHT OPERATION REMAINS ON EXISTING MAIN TRACK ONLY.
- ③ - DURING WEEKEND WINDOWS, SHIFT EXISTING MAIN TRACK UP TO 9' AS NECESSARY.
- ④ - DURING WEEKEND WINDOWS, CONNECT NEW/RELOCATED FREIGHT TRACKS TO EXISTING TRACKS. FREIGHT OPERATION SWITCHES TO NEW/RELOCATED FREIGHT TRACK.
- ④.5 - DURING WEEKEND WINDOWS, RECONNECT SPUR TRACKS TO NEW/RELOCATED TRACKS.
- ⑤ - REMOVE AND DISPOSE EXISTING TRACKS.

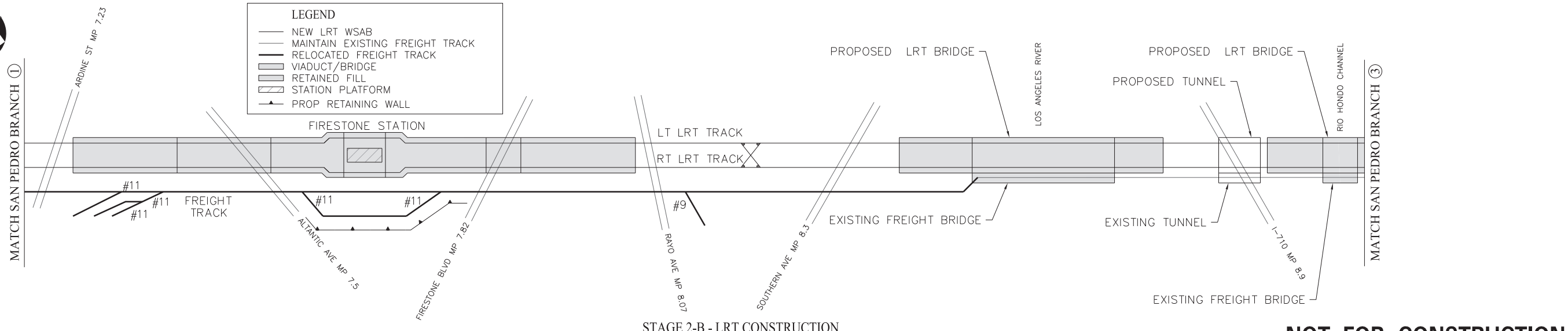

LEGEND

- NEW LRT WSAB
- MAINTAIN EXISTING FREIGHT TRACK
- - - RELOCATED FREIGHT TRACK
- ▬ VIADUCT/BRIDGE
- ▬ RETAINED FILL
- ▨ STATION PLATFORM
- ▲ PROP RETAINING WALL

NOT FOR CONSTRUCTION

THE PREPARATION OF THIS DRAWING HAS BEEN FINANCED IN PART THROUGH A GRANT FROM THE U.S. DEPARTMENT OF TRANSPORTATION FEDERAL TRANSIT ADMINISTRATION (FTA), UNDER THE FEDERAL TRANSIT ACT OF 1964, AS AMENDED, AND IN PART BY THE TAXES OF THE CITIZENS OF LOS ANGELES COUNTY AND OF THE STATE OF CALIFORNIA.		DESIGNED BY J. SANCHEZ	<p>LOS ANGELES COUNTY METROPOLITAN TRANSPORTATION AUTHORITY</p> <p>444 South Flower Street Suite 800 Los Angeles, CA 90071 TEL (213) 362-9470</p>	CONTRACT NO. AE5999300
0	11/15/19	DRAWN BY A. LEE		DRAWING NO. CS-003
		CHECKED BY R. LOYA		SCALE HOR: 1"=400' NTS
		IN CHARGE N. MAACK		SHEET NO. 105 OF 107
		DATE 11/15/2019		

FINAL CONCEPTUAL DESIGN

<p>LOS ANGELES COUNTY METROPOLITAN TRANSPORTATION AUTHORITY</p> <p>444 South Flower Street Suite 800 Los Angeles, CA 90071 TEL (213) 362-9470</p>	SUBMITTED _____ APPROVED _____
---	-----------------------------------

WEST SANTA ANA BRANCH FREIGHT TRACK
 TRACK ALIGNMENT
 SAN PEDRO BRANCH 1
 CONSTRUCTION STAGING



SAN PEDRO BRANCH ②

LEGEND

- EXISTING FREIGHT TRACK
- ▭ VIADUCT/BRIDGE

NOTES:
REFER TO SHEET CS-001 FOR NOTES.

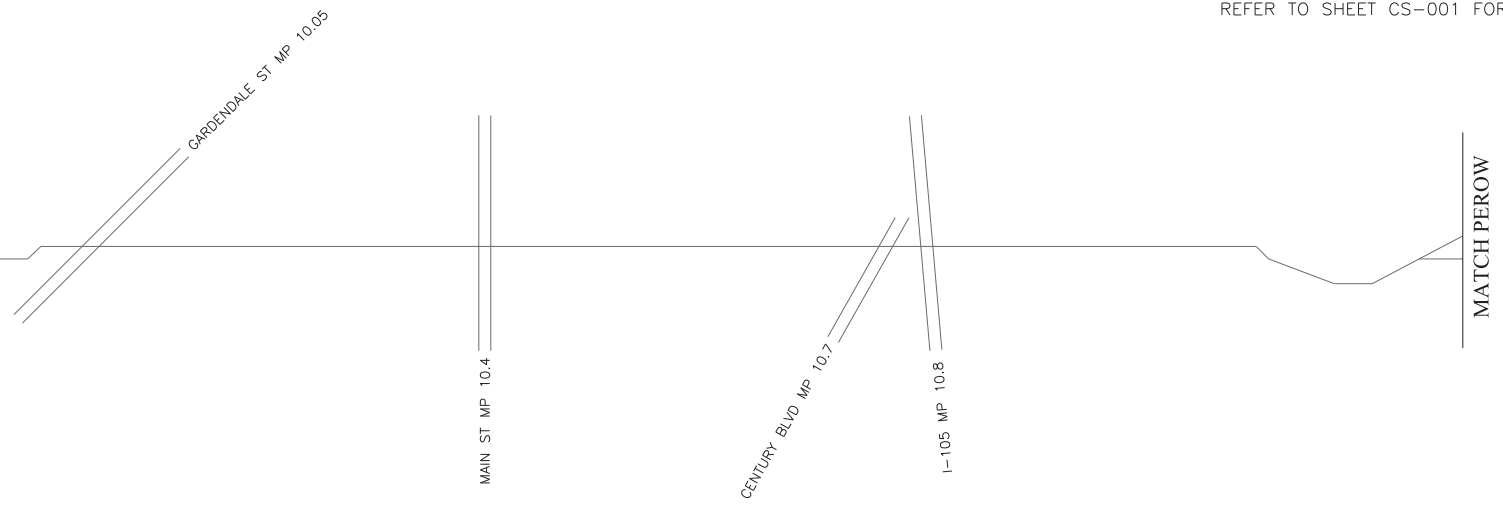

EXISTING CONDITIONS



SAN PEDRO BRANCH ②

LEGEND

- MAINTAIN EXISTING FREIGHT TRACK
- - REMOVE EXISTING FREIGHT TRACK
- RELOCATED FREIGHT TRACK
- ▭ VIADUCT/BRIDGE
- ▨ RETAINED FILL
- ▭ STATION PLATFORM
- ▲ PROP RETAINING WALL

- ① - CONSTRUCT FREIGHT BRIDGE.
- ② - CONSTRUCT RETAINING WALLS.
- ③ - CONSTRUCT NEW FREIGHT TRACKS W/ MINIMUM OF 9' CLEARANCE FROM EXISTING MAIN TRACK. FREIGHT OPERATION REMAINS ON EXISTING MAIN TRACK ONLY.
- ④ - DURING WEEKEND WINDOWS, SHIFT EXISTING MAIN TRACK UP TO 9' AS NECESSARY.
- ⑤ - DURING WEEKEND WINDOWS, CONNECT NEW/RELOCATED FREIGHT TRACKS TO EXISTING TRACKS. FREIGHT OPERATION SWITCHES TO NEW/RELOCATED FREIGHT TRACK.
- ⑥ - DURING WEEKEND WINDOWS, RECONNECT SPUR TRACKS TO NEW/RELOCATED TRACKS.
- ⑦ - REMOVE AND DISPOSE EXISTING TRACKS AND BRIDGE.

STAGE 1-C - FREIGHT TRACK RELOCATION



SAN PEDRO BRANCH ②

LEGEND

- NEW LRT WSAB
- MAINTAIN EXISTING FREIGHT TRACK
- - RELOCATED FREIGHT TRACK
- ▭ VIADUCT/BRIDGE
- ▨ RETAINED FILL
- ▭ STATION PLATFORM
- ▲ PROP RETAINING WALL

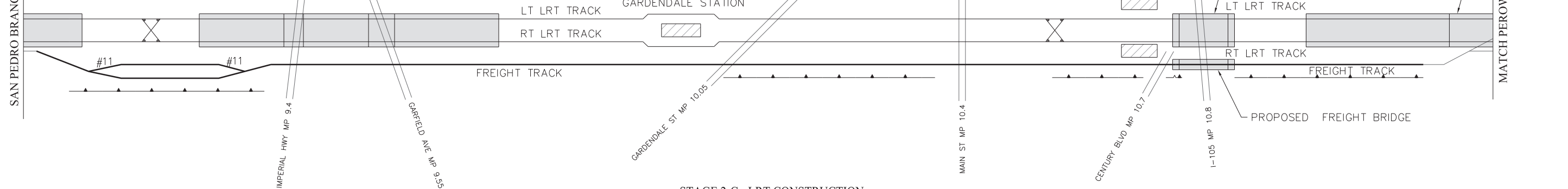

STAGE 2-C - LRT CONSTRUCTION

NOT FOR CONSTRUCTION

15-NOV-2019 C-28091ACS004.plg
svc-projectwise 22:40

THE PREPARATION OF THIS DRAWING HAS BEEN FINANCED IN PART THROUGH A GRANT FROM THE U.S. DEPARTMENT OF TRANSPORTATION FEDERAL TRANSIT ADMINISTRATION (FTA), UNDER THE FEDERAL TRANSIT ACT OF 1964, AS AMENDED, AND IN PART BY THE TAKES OF THE CITIZENS OF LOS ANGELES COUNTY AND OF THE STATE OF CALIFORNIA.		DESIGNED BY J. SANCHEZ
		DRAWN BY A. LEE
		CHECKED BY R. LOYA
		IN CHARGE N. MAACK
		DATE 11/15/2019
0	11/15/19	FINAL CONCEPTUAL DESIGN

LOS ANGELES COUNTY METROPOLITAN TRANSPORTATION AUTHORITY
 444 South Flower Street Suite 800 Los Angeles, CA 90071 TEL (213) 362-9470

SUBMITTED _____
 APPROVED _____

WEST SANTA ANA BRANCH FREIGHT TRACK TRACK ALIGNMENT SAN PEDRO BRANCH 2 CONSTRUCTION STAGING

CONTRACT NO	AE5999300
DRAWING NO	CS-004
SCALE	HOR: 1"=400' NTS
SHEET NO	106 OF 107

15-NOV-2019 22:39
 C-28091ACS005.plg
 svc-projectwise

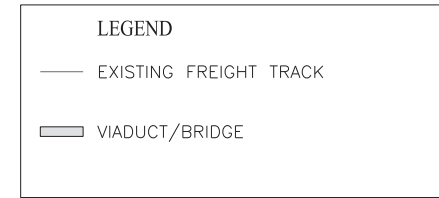
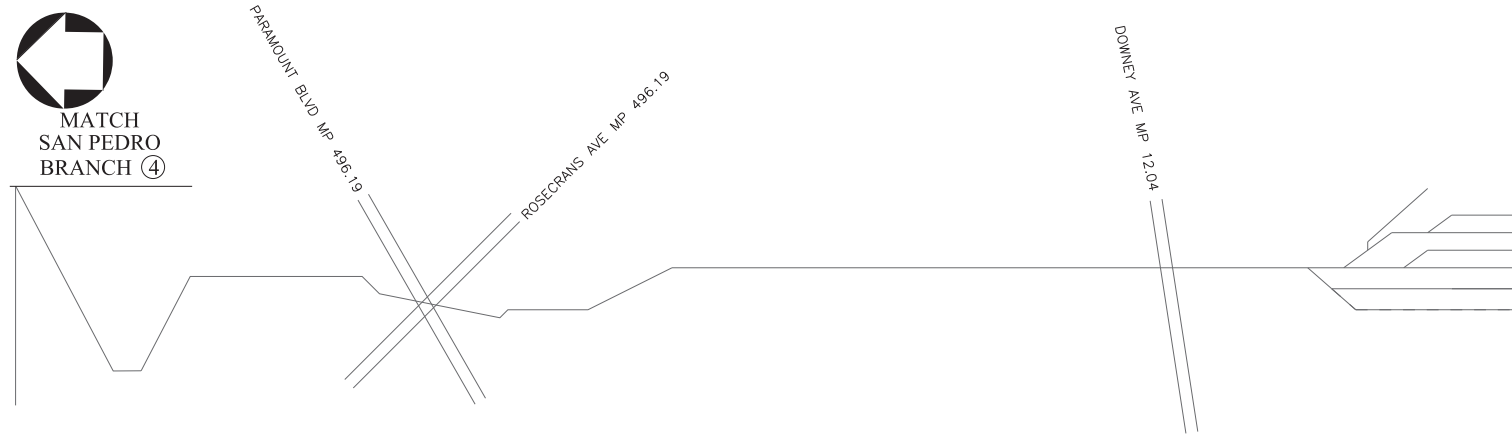

NOTES:
 REFER TO SHEET CS-001 FOR NOTES.

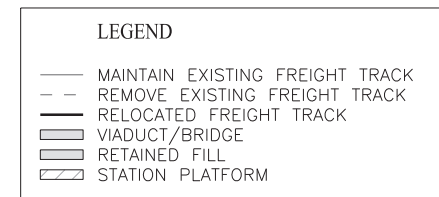
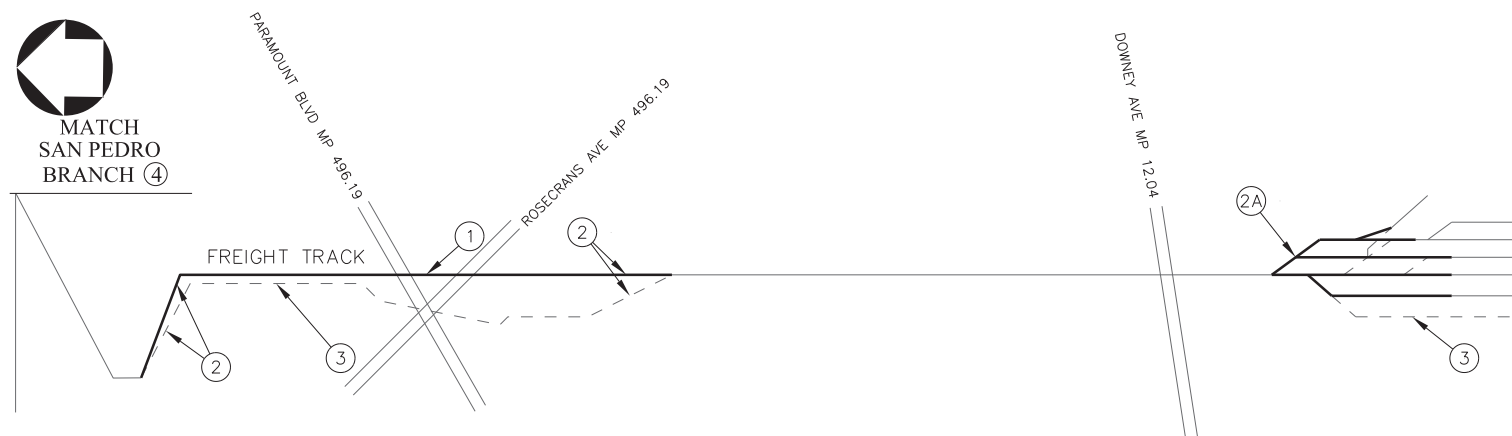

- ① - CONSTRUCT NEW FREIGHT TRACKS W/ MINIMUM OF 9' CLEARANCE FROM EXISTING MAIN TRACK. FREIGHT OPERATION REMAINS ON EXISTING MAIN TRACK ONLY.
- ② - DURING WEEKEND WINDOWS, SHIFT EXISTING TRACKS AND CONNECT BOTH ENDS TO EXISTING TRACKS. FREIGHT OPERATION SWITCHES TO NEW FREIGHT TRACK.
- ②A - RECONSTRUCT STORAGE TRACKS. THIS ACTIVITY REQUIRES CLOSE COORDINATION W/ THE RAILROAD OPERATIONS.
- ③ - REMOVE AND DISPOSE EXISTING TRACKS.

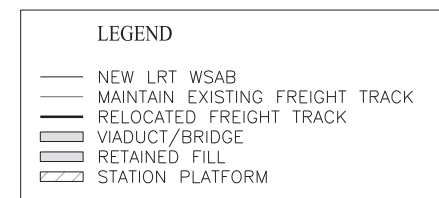
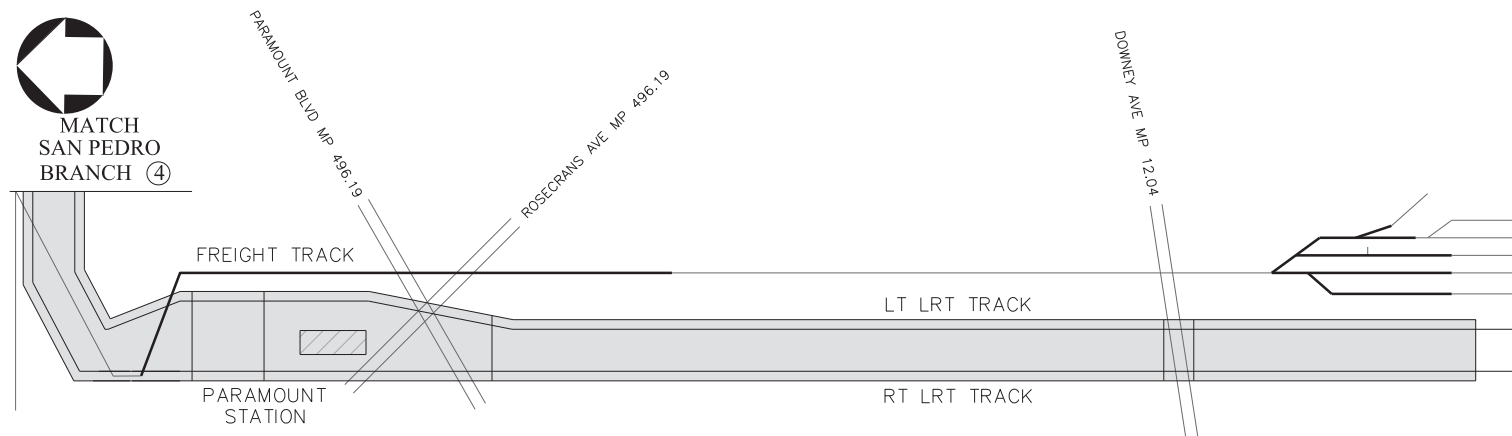

NOT FOR CONSTRUCTION

THE PREPARATION OF THIS DRAWING HAS BEEN FINANCED IN PART THROUGH A GRANT FROM THE U.S. DEPARTMENT OF TRANSPORTATION FEDERAL TRANSIT ADMINISTRATION (FTA), UNDER THE FEDERAL TRANSIT ACT OF 1964, AS AMENDED, AND IN PART BY THE TAXES OF THE CITIZENS OF LOS ANGELES COUNTY AND OF THE STATE OF CALIFORNIA.		DESIGNED BY J. SANCHEZ
0	11/15/19	DRAWN BY A. LEE
		CHECKED BY R. LOYA
		IN CHARGE N. MAACK
		DATE 11/15/2019
		FINAL CONCEPTUAL DESIGN

LOS ANGELES COUNTY METROPOLITAN TRANSPORTATION AUTHORITY	
444 South Flower Street Suite 800 Los Angeles, CA 90071 TEL (213) 362-9470	SUBMITTED _____ APPROVED _____

WEST SANTA ANA BRANCH FREIGHT TRACK TRACK ALIGNMENT SAN PEDRO BRANCH 3 CONSTRUCTION STAGING	
CONTRACT NO. AE5999300	REV
DRAWING NO. CS-005	
SCALE HOR: 1"=400' NTS	
SHEET NO. 107 OF 107	