



## CEQA Referral Initial Study And Notice of Intent to Adopt a Negative Declaration

**Date:** April 24, 2024

**To:** Distribution List (See Attachment A)

**From:** Kristy Doud, Deputy Director  
Planning and Community Development

**Subject:** REZONE APPLICATION NO. PLN2023-0065 – CALOY COMPANY, LP

**Comment Period:** April 24, 2024 – May 28, 2024

**Respond By:** May 28, 2024

**Public Hearing Date:** June 20, 2024

**Time:** 6:00 P.M.

**Location:** Tenth Street Place  
1010 10<sup>th</sup> Street, Modesto, CA 95354  
Chambers – Basement Level

You may have previously received an Early Consultation Notice regarding this project, and your comments, if provided, were incorporated into the Initial Study. Based on all comments received, Stanislaus County anticipates adopting a Mitigated Negative Declaration for this project. This referral provides notice of a 30-day comment period during which Responsible and Trustee Agencies and other interested parties may provide comments to this Department regarding our proposal to adopt the Mitigated Negative Declaration.

All applicable project documents are available for review at: Stanislaus County Department of Planning and Community Development, 1010 10<sup>th</sup> Street, Suite 3400, Modesto, CA 95354. Please provide any additional comments to the above address or call us at (209) 525-6330 if you have any questions. Thank you.

**Applicant:** Caloy Company, LP

**Project Location:** 5425 Montpelier Road, between E Keyes Road and E Monte Vista Avenue, in the Denair area.

**APN:** 019-041-027 and 019-024-050 (portion)

**Williamson Act Contract:** N/A

**General Plan:** Agriculture

**Current Zoning:** General Agriculture (A-2-10) and Planned Development (P-D) (312)

**Project Description:** Request to rezone a 5.65± acre parcel from Planned Development (P-D) (312) to a new P-D, and an 8.99± acre portion of a 266.53± acre parcel from General Agriculture (A-2-40) to P-D, to allow for the expansion of an existing nut oil and cattle feed processing facility. A lot line adjustment between the 266.53± acre and 5.65± acre parcel is included in the request to allow the existing facility and proposed expansion to be contained on one resulting 14.64± acre parcel.



**REZONE APPLICATION NO. PLN2023-0065 – CALOY COMPANY, LP**

Attachment A

Distribution List

X	CA DEPT OF CONSERVATION Land Resources		STAN CO ALUC
X	CA DEPT OF FISH & WILDLIFE		STAN CO ANIMAL SERVICES
	CA DEPT OF FORESTRY (CAL FIRE)	X	STAN CO BUILDING PERMITS DIVISION
X	CA DEPT OF TRANSPORTATION DIST 10	X	STAN CO CEO
X	CA OPR STATE CLEARINGHOUSE		STAN CO CSA
X	CA RWQCB CENTRAL VALLEY REGION	X	STAN CO DER
	CA STATE LANDS COMMISSION		STAN CO ERC
	CEMETERY DISTRICT	X	STAN CO FARM BUREAU
	CENTRAL VALLEY FLOOD PROTECTION	X	STAN CO HAZARDOUS MATERIALS
	CITY OF:		STAN CO PARKS & RECREATION
	COMMUNITY SERVICES DIST:	X	STAN CO PUBLIC WORKS
X	COOPERATIVE EXTENSION	X	STAN CO PUBLIC WORKS SURVEY DIVISION
	COUNTY OF:	X	STAN CO SHERIFF
X	DER GROUNDWATER RESOURCES DIVISION	X	STAN CO SUPERVISOR DIST 2: CHIESA
X	FIRE PROTECTION DIST: DENAIR	X	STAN COUNTY COUNSEL
X	GSA: EAST TURLOCK SUBBASIN	X	StanCOG
	HOSPITAL DIST:	X	STANISLAUS FIRE PREVENTION BUREAU
X	IRRIGATION DIST: EASTSIDE	X	STANISLAUS LAFCO
X	MOSQUITO DIST: TURLOCK	X	STATE OF CA SWRCB DIVISION OF DRINKING WATER DIST. 10
X	STANISLAUS COUNTY EMERGENCY MEDICAL SERVICES		SURROUNDING LAND OWNERS
	MUNICIPAL ADVISORY COUNCIL:		INTERESTED PARTIES
X	PACIFIC GAS & ELECTRIC	X	TELEPHONE COMPANY: AT&T
	POSTMASTER:		TRIBAL CONTACTS (CA Government Code §65352.3)
	RAILROAD:		US ARMY CORPS OF ENGINEERS
X	SAN JOAQUIN VALLEY APCD	X	US FISH & WILDLIFE
X	SCHOOL DIST 1: DENAIR UNIFIED		US MILITARY (SB 1462) (7 agencies)
	SCHOOL DIST 2:	X	USDA NRCS
	WORKFORCE DEVELOPMENT	X	CA DEPT OF FOOD AND AGRICULTURE
X	STAN CO AG COMMISSIONER		
	TUOLUMNE RIVER TRUST		



STANISLAUS COUNTY
CEQA REFERRAL RESPONSE FORM

TO: Stanislaus County Planning & Community Development
1010 10th Street, Suite 3400
Modesto, CA 95354

FROM: \_\_\_\_\_

SUBJECT: REZONE APPLICATION NO. PLN2023-0065 – CALOY COMPANY, LP

Based on this agency's particular field(s) of expertise, it is our position the above described project:

- \_\_\_\_\_ Will not have a significant effect on the environment.
\_\_\_\_\_ May have a significant effect on the environment.
\_\_\_\_\_ No Comments.

Listed below are specific impacts which support our determination (e.g., traffic general, carrying capacity, soil types, air quality, etc.) – (attach additional sheet if necessary)

- 1.
2.
3.
4.

Listed below are possible mitigation measures for the above-listed impacts: PLEASE BE SURE TO INCLUDE WHEN THE MITIGATION OR CONDITION NEEDS TO BE IMPLEMENTED (PRIOR TO RECORDING A MAP, PRIOR TO ISSUANCE OF A BUILDING PERMIT, ETC.):

- 1.
2.
3.
4.

In addition, our agency has the following comments (attach additional sheets if necessary).

\_\_\_\_\_
\_\_\_\_\_

Response prepared by:

Table with 3 columns: Name, Title, Date



**DEPARTMENT OF PLANNING AND COMMUNITY DEVELOPMENT**

1010 10<sup>TH</sup> Street, Suite 3400, Modesto, CA 95354  
Planning Phone: (209) 525-6330 Fax: (209) 525-5911  
Building Phone: (209) 525-6557 Fax: (209) 525-7759

## CEQA INITIAL STUDY

Adapted from CEQA Guidelines APPENDIX G Environmental Checklist Form, Final Text, January 1, 2020

1. **Project title:** Rezone Application No. PLN2023-0065 – Caloy Company, LP
2. **Lead agency name and address:** Stanislaus County  
1010 10<sup>th</sup> Street, Suite 3400  
Modesto, CA 95354
3. **Contact person and phone number:** Kristy Doud, Deputy Director  
(209) 525-6330
4. **Project location:** 5425 Montpelier Road, between E Keyes Road and E Monte Vista Avenue, in the Denair area. (APN: 019-041-027 and a portion of 019-024-050).
5. **Project sponsor's name and address:** Bret Potter, Caloy Company, LP  
P.O. Box 577164, Modesto, CA 95357
6. **General Plan designation:** Agriculture
7. **Zoning:** General Agriculture (A-2-10) and Planned Development (P-D) (312)
8. **Description of project:**

Request to rezone a 5.65± acre parcel from Planned Development (P-D) (312) to a new P-D, and an 8.99± acre portion of a 266.53± acre parcel from General Agriculture (A-2-40) to P-D, to allow for the expansion of an existing nut oil and cattle feed processing facility. A lot line adjustment between the 266.53± acre and 5.65± acre parcel is included in the request to allow the existing facility and proposed expansion to be contained on one resulting 14.64± acre parcel.

The existing facility is 5.65± acres, located on Assessor Parcel Number (APN) 019-041-027, and has a zoning designation of P-D (312), which was approved by the Board of Supervisors on July 24, 2007, under Rezone No. 2006-13, to allow for the conversion of a previous almond storage facility to a nut processing facility which extracts nut oils and produces cattle feed. The facility was then approved by the Planning Commission on August 6, 2009, under Use Permit No. 2009-03, to allow for the facility to have the capacity to filter the nut oils which included the construction of a 24,750 square-foot warehouse and several accessory structures such as silos, a boiler room, and a cooling tower. A Staff Approval Permit was issued in 2011 (SAA 2011-09) to allow for the addition of 14 storage tanks and a and a 70-foot tall steam stripper platform. The unrefined nut oil is stored in tanks until it is transported to Germany for refining; the refined oil is sold directly to cosmetic manufacturers and distributors. The by-product or waste from extracting the nut oils is a cattle feed "cake" that consists of the almond/walnut meat blended with rice hulls.

The existing facility is improved with a 23,267± square-foot processing building, a 16,400 square-foot cooking building, a 4,000 square-foot shed, a 2,700 square-foot office, and multiple storage silos and other accessory equipment. The facility has a parking lot with 20 spaces and lighting consisting of five 21-foot-tall light poles near the eastern property line. Existing fencing consists of a six-foot-tall chain link fence along the side and rear property lines and a five foot 10 inch tall concrete and wrought iron decorative fence which runs along the Montpelier Road frontage. There is a landscaped stormwater drainage basin located on the interior of the decorative fence along the road frontage, approximately 60 feet wide. The existing facility has two driveways from Montpelier Road. Existing signage consists of two freestanding signs on posts, each 32 square feet in size, located at each existing entrance point.

The project request proposes to expand the facility with the construction of a 41,743 square-foot cold storage warehouse, 9,085 square-foot maintenance building, a 48,700 square-foot bottling facility, and a 12,263 square-foot office building. The expansion also includes an additional 105 parking spaces, 16 22-foot-tall light poles, and chain link fencing, six to seven feet in height, around the perimeter of the site. Storm drainage swale and landscaping strips at least 40 feet wide are proposed along the road frontage and northern property line, and a six-foot-wide landscape strip is proposed adjacent to the western property line. Landscaping will consist of drought-resistant shrubs, trees and ground cover. Propose signage includes two new signs on the eastern wall of the proposed buildings, both 32 square feet in size. One new driveway on Montpelier Road and a widening of the existing northeastern driveway is proposed as well as two new driveways fronting an existing access easement (5<sup>th</sup> Street which is a private road) adjacent to the northern property line are proposed.

The existing facility is served by a private well and septic system; the expansion is proposed to be served by either the existing well or a new well, and a new on-site septic system. The facility operates 24 hours a day, seven days a week which is not proposed to change. The facility currently includes a total of 25 employees (15 employees on a maximum shift) which is expected to increase to 35, with 20 employees on a maximum shift. The facility currently has an average of two visitors per-day, which is not proposed to change. There is currently an average of 10 daily truck trips consisting of either the delivery of nuts or picking up finished product, which is anticipated to increase to 20 daily truck trips. Truck traffic is limited to the hours of Monday through Friday from 7:00 a.m. to 5:00 p.m.

The applicant expects construction to begin by June 1, 2025. The facility has multiple building permits that have been issued but not finalized. If approved, all of the existing and proposed structures will be required to be obtained and finalized.

- |   |   |
|---|---|
| <b>9. Surrounding land uses and setting:</b>  | Orchard and row crops surround the site as well as multiple residential lots created by the Town of Montpelier Subdivision. The community of Denair exists 4+ miles west of the site.   |
| <b>10. Other public agencies whose approval is required (e.g., permits, financing approval, or participation agreement.):</b> | Stanislaus County Department of Public Works<br>Stanislaus County Department of Environmental Resources<br>Stanislaus Consolidated Fire District<br>Denair Fire District<br>California Department of Toxic Substances Control |
| <b>11. Attachments:</b>   | <ul style="list-style-type: none"> <li>I. Central California Information Center, Records Search, dated July 12, 2023</li> <li>II. Water Systems Analysis, completed by DF Engineering, Inc, dated January 26, 2024</li> </ul> |

**ENVIRONMENTAL FACTORS POTENTIALLY AFFECTED:**

The environmental factors checked below would be potentially affected by this project, involving at least one impact that is a “Potentially Significant Impact” as indicated by the checklist on the following pages.

- |  |   |   |
|--|---|---|
| <input type="checkbox"/> Aesthetics                  | <input type="checkbox"/> Agriculture & Forestry Resources | <input type="checkbox"/> Air Quality                        |
| <input type="checkbox"/> Biological Resources        | <input type="checkbox"/> Cultural Resources               | <input type="checkbox"/> Energy                             |
| <input type="checkbox"/> Geology / Soils             | <input type="checkbox"/> Greenhouse Gas Emissions         | <input type="checkbox"/> Hazards & Hazardous Materials      |
| <input type="checkbox"/> Hydrology / Water Quality   | <input type="checkbox"/> Land Use / Planning              | <input type="checkbox"/> Mineral Resources                  |
| <input type="checkbox"/> Noise                       | <input type="checkbox"/> Population / Housing             | <input type="checkbox"/> Public Services                    |
| <input type="checkbox"/> Recreation                  | <input type="checkbox"/> Transportation                   | <input type="checkbox"/> Tribal Cultural Resources          |
| <input type="checkbox"/> Utilities / Service Systems | <input type="checkbox"/> Wildfire                         | <input type="checkbox"/> Mandatory Findings of Significance |

**DETERMINATION: (To be completed by the Lead Agency)**

On the basis of this initial evaluation:

- I find that the proposed project **COULD NOT** have a significant effect on the environment, and a **NEGATIVE DECLARATION** will be prepared.
- I find that although the proposed project could have a significant effect on the environment, there will not be a significant effect in this case because revisions in the project have been made by or agreed to by the project proponent. A **MITIGATED NEGATIVE DECLARATION** will be prepared.
- I find that the proposed project **MAY** have a significant effect on the environment, and an **ENVIRONMENTAL IMPACT REPORT** is required.
- I find that the proposed project **MAY** have a “potentially significant impact” or “potentially significant unless mitigated” impact on the environment, but at least one effect 1) has been adequately analyzed in an earlier document pursuant to applicable legal standards, and 2) has been addressed by mitigation measures based on the earlier analysis as described on attached sheets. An **ENVIRONMENTAL IMPACT REPORT** is required, but it must analyze only the effects that remain to be addressed.
- I find that although the proposed project could have a significant effect on the environment, because all potentially significant effects (a) have been analyzed adequately in an earlier EIR or **NEGATIVE DECLARATION** pursuant to applicable standards, and (b) have been avoided or mitigated pursuant to that earlier EIR or **NEGATIVE DECLARATION**, including revisions or mitigation measures that are imposed upon the proposed project, nothing further is required.

Signature on file.  
 Prepared by Kristy Doud, Deputy Director

April 17, 2024  
 Date

**EVALUATION OF ENVIRONMENTAL IMPACTS:**

- 1) A brief explanation is required for all answers except “No Impact” answers that are adequately supported by the information sources a lead agency cites in the parentheses following each question. A “No Impact” answer is adequately supported if the referenced information sources show that the impact simply does not apply to projects like the one involved (e.g., the project falls outside a fault rupture zone). A “No Impact” answer should be explained where it is based on project-specific factors as well as general standards (e.g., the project will not expose sensitive receptors to pollutants, based on a project-specific screening analysis).
- 2) All answers must take account of the whole action involved, including off-site as well as on-site, cumulative as well as project-level, indirect as well as direct, and construction as well as operational impacts.
- 3) Once the lead agency has determined that a particular physical impact may occur, then the checklist answers must indicate whether the impact is potentially significant, less than significant with mitigation, or less than significant. “Potentially Significant Impact” is appropriate if there is substantial evidence that an effect may be significant. If there are one or more “Potentially Significant Impact” entries when the determination is made, an EIR is required.
- 4) “Negative Declaration: Less Than Significant With Mitigation Incorporated” applies where the incorporation of mitigation measures has reduced an effect from “Potentially Significant Impact” to a “Less Than Significant Impact.” The lead agency must describe the mitigation measures, and briefly explain how they reduce the effect to a less than significant level (mitigation measures from Section XVII, “Earlier Analyses,” may be cross-referenced).
- 5) Earlier analyses may be used where, pursuant to the tiering, program EIR, or other CEQA process, an effect has been adequately analyzed in an earlier EIR or negative declaration.

Section 15063(c)(3)(D). In this case, a brief discussion should identify the following:

- a) Earlier Analysis Used. Identify and state where they are available for review.
  - b) Impacts Adequately Addressed. Identify which effects from the above checklist were within the scope of and adequately analyzed in an earlier document pursuant to applicable legal standards, and state whether such effects were addressed by mitigation measures based on the earlier analysis.
  - c) Mitigation Measures. For effects that are “Less than Significant with Mitigation Measures Incorporated,” describe the mitigation measures which were incorporated or refined from the earlier document and the extent to which they address site-specific development standards for the project.
- 6) Lead agencies are encouraged to incorporate into the checklist references to information sources for potential impacts (e.g., general plans, zoning ordinances). References to a previously prepared or outside document should, where appropriate, include a reference to the page or pages where the statement is substantiated.
  - 7) Supporting Information Sources: A source list should be attached, and other sources used or individuals contacted should be cited in the discussion.
  - 8) This is only a suggested form, and lead agencies are free to use different formats; however, lead agencies should normally address the questions from this checklist that are relevant to a project’s environmental effects in whatever format is selected.
  - 9) The explanation of each issue should identify:
    - a) the significant criteria or threshold, if any, used to evaluate each question; and
    - b) the mitigation measure identified, if any, to reduce the impact to less than significant.

**ISSUES**

I. AESTHETICS – Except as provided in Public Resources Code Section 21099, could the project:	Potentially Significant Impact	Less Than Significant With Mitigation Included	Less Than Significant Impact	No Impact
a) Have a substantial adverse effect on a scenic vista?			X	
b) Substantially damage scenic resources, including, but not limited to, trees, rock outcroppings, and historic buildings within a state scenic highway?			X	
c) In non-urbanized areas, substantially degrade the existing visual character or quality of public views of the site and its surroundings? (Public views are those that are experienced from publicly accessible vantage point). If the project is in an urbanized area, would the project conflict with applicable zoning and other regulations governing scenic quality?			X	
d) Create a new source of substantial light or glare which would adversely affect day or nighttime views in the area?			X	

**Discussion:** The existing facility is improved with the following: a 23,267± square-foot processing building; 16,400 square-foot cooking building; 4,000 square-foot shed; 2,700 square-foot office; grain silos and other accessory equipment; parking lot with 20 spaces and lighting consisting of five 21-foot-tall light poles near the eastern property line; fencing consisting of a six-foot-tall chain link fence has been developed along the northern, western, and southern property lines, and a five foot 10 inch tall concrete and wrought iron decorative fence runs along the eastern property line; stormwater drainage basin; and landscaping along the road frontage. Existing signage consists of two four feet by eight feet freestanding signs on posts, one at each existing entrance point. The project request proposes to expand the facility with the construction of a 41,743 square-foot cold storage warehouse, 9,085 square-foot maintenance building, a 48,700 square-foot bottling facility, and a 12,263 square-foot office building. The expansion also includes an additional 105 parking spaces, 16 22-foot-tall light poles, and chain link fencing, six to seven feet in height, around the perimeter of the site. Storm drainage swale and landscaping strips at least 40 feet wide are proposed along the road frontage and northern property line, and a six-foot-wide landscape strip is proposed adjacent to the western property line. Landscaping will consist of drought-resistant shrubs, trees and ground cover. Propose signage includes two new signs on the eastern wall of the proposed buildings, both 32 square feet in size.

The site itself is not considered to be a scenic resource or unique scenic vista. The only scenic designation in the County is along Interstate 5 (I-5) which is not near the project site. The proposed expansion will match the existing development. The project will not degrade the existing visual character or quality of the site or its surroundings. Development will be added to this project to address glare from any on-site lighting. No adverse impacts to the existing visual character of the site or its surroundings are anticipated.

**Mitigation:** None.

**References:** Application information; Stanislaus County Zoning Ordinance; the Stanislaus County General Plan; and Support Documentation<sup>1</sup>.



<b>II. AGRICULTURE AND FOREST RESOURCES:</b> In determining whether impacts to agricultural resources are significant environmental effects, lead agencies may refer to the California Agricultural Land Evaluation and Site Assessment Model (1997) prepared by the California Department of Conservation as an optional model to use in assessing impacts on agriculture and farmland. In determining whether impacts to forest resources, including timberland, are significant environmental effects, lead agencies may refer to information compiled by the California Department of Forestry and Fire Protection regarding the state’s inventory of forest land, including the Forest and Range Assessment Project and the Forest Legacy Assessment project; and forest carbon measurement methodology provided in Forest Protocols adopted by the California Air Resources Board. -- Would the project:	Potentially Significant Impact	Less Than Significant With Mitigation Included	Less Than Significant Impact	No Impact
a) Convert Prime Farmland, Unique Farmland, or Farmland of Statewide Importance (Farmland), as shown on the maps prepared pursuant to the Farmland Mapping and Monitoring Program of the California Resources Agency, to non-agricultural use?			X	
b) Conflict with existing zoning for agricultural use, or a Williamson Act contract?			X	
c) Conflict with existing zoning for, or cause rezoning of, forest land (as defined in Public Resources Code section 12220(g)), timberland (as defined by Public Resources Code section 4526), or timberland zoned Timberland Production (as defined by Government Code section 51104(g))?				X
d) Result in the loss of forest land or conversion of forest land to non-forest use?				X
e) Involve other changes in the existing environment which, due to their location or nature, could result in conversion of Farmland, to non-agricultural use or conversion of forest land to non-forest use?			X	

**Discussion:** The project site is zoned General Agriculture (A-2-40) and Planned Development (312). The parcel is not currently enrolled in a Williamson Act Contract. The project will include the removal of approximately nine acres of an existing almond orchard. The project site is classified as “Unique Farmland” and “Urban and Built-Up Land” by the California Department of Conservation’s Farmland Mapping and Monitoring Program. The California Revised Storie Index is a rating system based on soil properties that dictate the potential for soils to be used for irrigated agricultural production in California. This rating system grades soils with an index rating of 80 and above as excellent. The United States Department of Agriculture Natural Resources Conservation Service (USDA NRCS) Web Soil Survey indicates that the property is comprised of Rocklin sandy loam (ReA), with a Storie Index rating of 43 and Grade Three, which is not considered to be prime soils.

The General Plan of the project site is designated as Agriculture which is proposed to remain unchanged. In accordance with the Land Use Element of the General Plan a Planned Development (PD) zone may be consistent with the Agriculture General Plan designation when it is used for agriculturally-related uses or for uses of a demonstrably unique character, which due to specific agricultural needs or to their transportation needs or to needs that can only be satisfied in the Agriculture designation, may be properly located within areas designated as agricultural on the General Plan. In this case the proposed project is expanding on property adjacent to its current location, which is processing almonds and walnuts, which are produced in the surrounding area.

The County's Agricultural Element's Agricultural Buffer Guidelines states that new or expanding uses approved by discretionary permit in the A-2 zoning district or on a parcel adjoining the A-2 zoning district should incorporate a minimum 150-foot-wide agricultural buffer setback, or 300-foot-wide buffer setback for people-intensive uses, to physically avoid conflicts between agricultural and non-agricultural uses. Public roadways, utilities, drainage facilities, rivers and adjacent riparian areas, landscaping, parking lots, and similar low people-intensive uses are permitted uses within the buffer setback area. The facility currently includes a total of 25 employees (15 employees on a maximum shift) which is expected to increase to 35, with 20 employees on a maximum shift. A proposed increase of 5 employees on-site during a maximum shift is potentially low-people intensive. The project site is adjacent to orchards on the east, west, and north. On the south, the project is adjacent to the existing Caloy operations, and no buffer is required. On the west side, and immediately adjacent to the project site are existing agricultural buildings with no active farming operations. The nearest farmed parcel to the west is located 180 feet from the project site, which exceeds the 150-foot agricultural buffer for low-people intensive uses. On the east, the buildings are set back 80 feet from the existing Montpelier Road, and when adding the 80-foot width of Montpelier Road, the 150-foot buffer is maintained. On the north boundary, the buildings are set back 106 feet from the property line. The 5<sup>th</sup> Street access easement runs north of that and is approximately 30 feet wide, which makes the buffer on the north side approximately 136 feet. Accordingly, a reduced buffer of 136 feet on the northern property line is proposed. Additionally, the entirety of the site will be fenced to prevent trespassing.

The project site is served by the Eastside Irrigation District (EID) for irrigation water. No response was received from EID on the Early Consultation referral; however, the project will include a development standard which will require the developer to follow all EID rules and procedures.

The project will have no impact to forest land or timberland. The project is an agricultural use and does not appear to conflict with any agricultural activities in the area and/or lands enrolled in the Williamson Act. Based on the specific features and design of this project, it does not appear this project will impact the long-term productive agricultural capability of surrounding contracted lands in the A-2 zoning district. There is no indication this project will result in the removal of adjacent contracted land from agricultural use.

**Mitigation:** None.

**References:** Application information; Referral response received from the Agricultural Commissioner's Office, dated December 20, 2023; United States Department of Agriculture NRCS Web Soil Survey; California State Department of Conservation Farmland Mapping and Monitoring Program - Stanislaus County Farmland 2022; Stanislaus County Zoning Ordinance (Title 21); Stanislaus County Williamson Act Uniform Rules; Stanislaus County General Plan and Support Documentation<sup>1</sup>.

<b>III. AIR QUALITY: Where available, the significance criteria established by the applicable air quality management district or air pollution control district may be relied upon to make the following determinations. -- Would the project:</b>	<b>Potentially Significant Impact</b>	<b>Less Than Significant With Mitigation Included</b>	<b>Less Than Significant Impact</b>	<b>No Impact</b>
a) Conflict with or obstruct implementation of the applicable air quality plan?			X	
b) Result in a cumulatively considerable net increase of any criteria pollutant for which the project region is non-attainment under an applicable federal or state ambient air quality standard?			X	
c) Expose sensitive receptors to substantial pollutant concentrations?			X	
d) Result in other emissions (such as those odors adversely affecting a substantial number of people?			X	

**Discussion:** The proposed project is located within the San Joaquin Valley Air Basin (SJVAB) and, therefore, falls under the jurisdiction of the San Joaquin Valley Air Pollution Control District (SJVAPCD). In conjunction with the Stanislaus Council of Governments (StanCOG), the SJVAPCD is responsible for formulating and implementing air pollution control strategies. The SJVAPCD's most recent air quality plans are the 2007 PM10 (respirable particulate matter) Maintenance Plan, the 2008 PM2.5 (fine particulate matter) Plan, and the 2007 Ozone Plan. These plans establish a comprehensive air pollution control program leading to the attainment of state and federal air quality standards in the SJVAB, which has been classified

as “extreme non-attainment” for ozone, “attainment” for respirable particulate matter (PM-10), and “non-attainment” for PM 2.5, as defined by the Federal Clean Air Act.

The existing facility extracts oil from almonds and walnuts and filters some of the extracted oil on-site. The unrefined nut oil is stored in tanks until it is transported to Germany for refining; the refined oil is sold directly to cosmetic manufacturers and distributors. The by-product or waste from extracting the nut oils is a cattle feed “cake” that consists of the almond/walnut meat blended with rice hulls and sold to farming operations. The existing facility is improved with a 23,267± square-foot processing building, a 16,400 square-foot cooking building, a 4,000 square-foot shed, a 2,700 square-foot office, and multiple storage silos and other accessory equipment. The project proposes to expand the existing facility with construction of a 41,743 square-foot cold storage warehouse, 9,085 square-foot maintenance building, a 48,700 square-foot bottling facility, and a 12,263 square-foot office building.

Construction activities associated with the new development can temporarily increase localized PM10, PM2.5, volatile organic compound (VOC), nitrogen oxides (NOX), sulfur oxides (SOX), and carbon monoxide (CO) concentrations within a project’s vicinity. The primary source of construction-related CO, SOX, VOC, and NOX emission is gasoline and diesel-powered, heavy-duty mobile construction equipment. Primary sources of PM10 and PM2.5 emissions are generally clearing and demolition activities, grading operations, construction vehicle traffic on unpaved ground, and wind blowing over exposed surfaces. Any construction will be required to occur in compliance with all SJVAPCD regulations.

The primary source of air pollutants generated by this project would be classified as being generated from “mobile” sources. Mobile sources would generally include dust from roads, farming, and automobile exhausts. Mobile sources are generally regulated by the Air Resources Board of the California EPA which sets emissions for vehicles and acts on issues regarding cleaner burning fuels and alternative fuel technologies. As such, the SJVAPCD has addressed most criteria air pollutants through basin wide programs and policies to prevent cumulative deterioration of air quality within the SJVAB.

The San Joaquin Valley Air Pollution Control District Small Project Analysis Level (SPAL) guidance identifies thresholds of significance for criteria pollutant emissions, which are based on the SJCAPCD’s New Source Review (NSR) offset requirements for stationary sources. The SJVAPCD has pre-qualified emissions and determined a size below, which is reasonable to conclude that a project would not exceed applicable thresholds of significance for criteria pollutants. Any project falling below the thresholds identified by the SJVAPCD are deemed to have a less than significant impact on air quality due to criteria pollutant emissions. The SJCAPCD’s threshold of significance for industrial uses is identified as less than the following number of trips per-day based on vehicle type: 70 one-way heavy duty truck trips and 550 one-way trips for all fleet types not considered to be heavy duty trucks. There is currently an average of 10 daily truck trips consisting of either the delivery of nuts or picking up finished product, which is anticipated to increase to 20 daily truck trips which is below the SJVAPCD’s threshold for heavy duty truck trips.

A referral response received from the San Joaquin Valley Air Pollution Control District stated that the emissions from construction and operation are not expected to exceed any of the significance thresholds as identified in the SJVAPCD’s Guidance for Assessing and Mitigating Air Quality Impacts (GAMAQI). The SJVAPCD’s response stated that in order to determine potential health impacts on surrounding receptors (such as residences, hospitals, day-care facilities, etc.) a Prioritization and/or Health Risk Assessment (HRA) should be performed for the project. The nearest residences are located 160 feet east of the proposed bottling and storage buildings. Potential toxic air contaminants resulting from the project would be caused by mobile emissions created by truck trips and idling. As previously stated, the project will include the addition of 10 truck trips per day. The developer will be required to obtain a Permit to Operate (PTO) from the SJVAPCD prior to issuance of a building permit. As part of the PTO application process HRA information must be provided to and be analyzed by the SJVAPCD. The SJVAPCD requires operators to employ best practices such as implementing truck routes which avoid sensitive receptors or restricting idling times. A development standard will be applied to the project which requires that a PTO be obtained prior to issuance of a building permit and that all best practices and conditions applied to the PTO be met. Additionally, the SJVAPCD’s response stated that The District recommends an Ambient Air Quality Analysis (AAQA) be performed for the project if emissions exceed 100 pounds per day of any pollutant. Based on the SJVAPCD’s District Rule 9510 (Indirect Source Review) because the project square footage is less than 100,000 square feet of industrial space and less than 39,000 square feet of office space, the project is not subject to Rule 9510 and an ISR application is not required.

As required by CEQA Guidelines Section 15064.3, potential impacts regarding Air Quality should be evaluated using Vehicle Miles Traveled (VMT). Stanislaus County has currently not adopted any significance thresholds for VMT, and projects are treated on a case-by-case basis for evaluation under CEQA. However, the State of California - Office of Planning and Research (OPR) has issued guidelines regarding VMT significance under CEQA. The CEQA Guidelines identify vehicle

miles traveled (VMT), which is the amount and distance of automobile travel attributable to a project, as the most appropriate measure of transportation impacts. According to the same technical advisory from OPR, projects that generate or attract fewer than 110 trips per-day generally may be assumed to cause a less-than significant transportation impact. The project proposes an increase of up to 20 vehicle employee trips per day and 10 truck trips per day, which is below the VMT threshold.

The proposed project is considered to be consistent with all applicable air quality plans. The proposed project would not conflict with applicable regional plans or policies adopted by agencies with jurisdiction over the project and would be considered to have a less-than significant impact to air quality.

**Mitigation:** None.

**References:** Application information; San Joaquin Valley Air Pollution Control District - Regulation VIII Fugitive Dust/PM-10 Synopsis; www.valleyair.org; Governor’s Office of Planning and Research Technical Advisory, December 2018; Referral response received from the San Joaquin Valley Air Pollution Control District, dated April 18, 2024; Joaquin Valley Air Pollution Control District’s Small Project Analysis Level (SPAL) Guidance, November 13, 2020; and the Stanislaus County General Plan and Support Documentation<sup>1</sup>.

IV. BIOLOGICAL RESOURCES -- Would the project:	Potentially Significant Impact	Less Than Significant With Mitigation Included	Less Than Significant Impact	No Impact
a) Have a substantial adverse effect, either directly or through habitat modifications, on any species identified as a candidate, sensitive, or special status species in local or regional plans, policies, or regulations, or by the California Department of Fish and Game or U.S. Fish and Wildlife Service?			X	
b) Have a substantial adverse effect on any riparian habitat or other sensitive natural community identified in local or regional plans, policies, regulations, or by the California Department of Fish and Game or U.S. Fish and Wildlife Service?			X	
c) Have a substantial adverse effect on state or federally protected wetlands (including, but not limited to, marsh, vernal pool, coastal, etc.) through direct removal, filling, hydrological interruption, or other means?			X	
d) Interfere substantially with the movement of any native resident or migratory fish or wildlife species or with established native resident or migratory wildlife corridors, or impede the use of native wildlife nursery sites?			X	
e) Conflict with any local policies or ordinances protecting biological resources, such as a tree preservation policy or ordinance?			X	
f) Conflict with the provisions of an adopted Habitat Conservation Plan, Natural Community Conservation Plan, or other approved local, regional, or state habitat conservation plan?			X	

**Discussion:** It does not appear this project will result in impacts to endangered species or habitats, locally designated species, or wildlife dispersal or mitigation corridors. There is no known sensitive or protected species or natural community located on the site. The project is located within the Montpellier Quad of the California Natural Diversity Database. Based on results from the California Natural Diversity Database (CNDDDB) Quad Species List, there are 10 animal species which are state or federally listed as endangered or threatened, or proposed threatened species, that have been recorded to either occur or have occurred within the Montpellier Quad. These species include: the California tiger salamander, western

spadefoot, tricolored blackbird, vernal pool fairy shrimp, vernal pool tadpole shrimp, Hoovers spurge, Coulusa grass, San Joaquin Valley Orcutt grass, hairy Orcutt grass, and Greenes tuctoria.

The project will include the removal of approximately nine acres of an existing almond orchard. However, the site neither contains nor is adjacent to aquatic resources such as vernal pools, rivers, tributaries, creeks, lakes, or wetlands which makes the presence of any of the identified special status fish species unlikely to occur on-site. Due to the site already being improved with an almond orchard, occurrences of the listed plant species are unlikely to occur.

The project will not conflict with a Habitat Conservation Plan, a Natural Community Conservation Plan, or other locally approved conservation plans. Impacts to endangered species or habitats, locally designated species, or wildlife dispersal or mitigation corridors is considered to be less than significant.

An Early Consultation was referred to the California Department of Fish and Wildlife (formerly the Department of Fish and Game) and no response was received.

Impacts to biological resources are considered to be less than significant.

**Mitigation:** None.

**References:** California Department of Fish and Wildlife’s Natural Diversity Database Quad Species List; Stanislaus County General Plan and Support Documentation<sup>1</sup>.

V. CULTURAL RESOURCES -- Would the project:	Potentially Significant Impact	Less Than Significant With Mitigation Included	Less Than Significant Impact	No Impact
a) Cause a substantial adverse change in the significance of a historical resource pursuant to in § 15064.5?			X	
b) Cause a substantial adverse change in the significance of an archaeological resource pursuant to § 15064.5?			X	
c) Disturb any human remains, including those interred outside of formal cemeteries?			X	

**Discussion:** A records search conducted by the Central California Information Center (CCIC) for the project site indicated that there are no historical, cultural, or archeological resources recorded on-site and that the site has a low sensitivity for the discovery of such resources. The report from the CCIC indicated that historic buildings and structure have been recorded within Denair and the surrounding vicinity. It does not appear this project will result in significant impacts to any archaeological or cultural resources. The project will remove an existing almond orchard and will construct a 41,743 square-foot cold storage warehouse, 9,085 square-foot maintenance building, a 48,700 square-foot bottling facility, and a 12,263 square-foot office building. A development standard will be placed on the project, requiring that construction activities shall be halted if any resources are found, until appropriate agencies are contacted, and an archaeological survey is completed.

**Mitigation:** None.

**References:** Application information; Central California Information Center (CCIC) Search, dated July 12, 2023; and Stanislaus County General Plan and Support Documentation<sup>1</sup>.

VI. ENERGY – Would the project:	Potentially Significant Impact	Less Than Significant With Mitigation Included	Less Than Significant Impact	No Impact
a) Result in potentially significant environmental impact due to wasteful, inefficient, or unnecessary consumption of energy resources, during project construction or operation?			X	
b) Conflict with or obstruct a state or local plan for renewable energy or energy efficiency?			X	

**Discussion:** The CEQA Guidelines Appendix F states that energy consuming equipment and processes, which will be used during construction or operation such as: energy requirements of the project by fuel type and end use, energy conservation equipment and design features, energy supplies that would serve the project, total estimated daily vehicle trips to be generated by the project, and the additional energy consumed per trip by mode shall be taken into consideration when evaluating energy impacts. Additionally, the project’s compliance with applicable state or local energy legislation, policies, and standards must be considered.

The existing facility extracts oil from almonds and walnuts and filters some of the extracted oil on-site. The unrefined nut oil is stored in tanks until it is transported to Germany for refining; the refined oil is sold directly to cosmetic manufacturers and distributors. The by-product or waste from extracting the nut oils is a cattle feed “cake” that consists of the almond/walnut meat blended with rice hulls and sold to farming operations. The existing facility is improved with a 23,267± square-foot processing building, a 16,400 square-foot cooking building, a 4,000 square-foot shed, a 2,700 square-foot office, and multiple storage silos and other accessory equipment. The project proposes to expand the existing facility with construction of a 41,743 square-foot cold storage warehouse, 9,085 square-foot maintenance building, a 48,700 square-foot bottling facility, and a 12,263 square-foot office building. The facility operates 24 hours a day, seven days a week which is not proposed to change. The facility currently includes a total of 25 employees (15 employees on a maximum shift) which is expected to increase to 35, with 20 employees on a maximum shift. The facility currently has an average of two visitors per-day, which is not proposed to change. There is currently an average of 10 daily truck trips consisting of either the delivery of nuts or picking up finished product, which is anticipated to increase to 20 daily truck trips. Truck traffic is limited to the hours of Monday through Friday from 7:00 a.m. to 5:00 p.m. A development standard will be placed on the project requiring all construction activities be in compliance with all SJVAPCD regulations and with Title 24, Green Building Code, which includes energy efficiency requirements.

A referral response received from the San Joaquin Valley Air Pollution Control District stated that the emissions from construction and operation are not expected to exceed any of the significance thresholds as identified in the SJVAPCD’s Guidance for Assessing and Mitigating Air Quality Impacts (GAMAQI). The SJVAPCD’s response stated that in order to determine potential health impacts on surrounding receptors (such as residences, hospitals, day-care facilities, etc.) a Prioritization and/or Health Risk Assessment (HRA) should be performed for the project. The nearest residences are located 160 feet east of the proposed bottling and storage buildings. Potential toxic air contaminants resulting from the project would be caused by mobile emissions created by truck trips and idling. As previously stated, the project will include the addition of 10 truck trips per day. The developer will be required to obtain a Permit to Operate (PTO) from the SJVAPCD prior to issuance of a building permit. As part of the PTO application process HRA information must be provided to and be analyzed by the SJVAPCD. The SJVAPCD requires operators to employ best practices such as implementing truck routes which avoid sensitive receptors or restricting idling times. A development standard will be applied to the project which requires that a PTO be obtained prior to issuance of a building permit and that all best practices and conditions applied to the PTO be met. Additionally, the SJVAPCD’s response stated that the SJVACD recommends an Ambient Air Quality Analysis (AAQA) be performed for the project if emissions exceed 100 pounds per day of any pollutant. Based on the SJVAPCD’s District Rule 9510 (Indirect Source Review) because the project square footage is less than 100,000 square feet of industrial space and less than 39,000 square feet of office space, the project is not subject to Rule 9510 and an ISR application is not required.

It does not appear that this project will result in significant impacts to the wasteful, inefficient, or unnecessary consumption of energy resources. Accordingly, the potential impacts to Energy are considered to be less than significant.

**Mitigation:** None.

**References:** Application information; CEQA Guidelines; Title 16 of County Code; CA Building Code; Stanislaus County Zoning Ordinance (Title 21); Stanislaus County 2016 General Plan EIR; Governor’s Office of Planning and Research Technical Advisory, December 2018; Referral response received from the San Joaquin Valley Air Pollution Control District, dated April 18, 2024; Stanislaus County General Plan and Support Documentation<sup>1</sup>.

VII. GEOLOGY AND SOILS -- Would the project:	Potentially Significant Impact	Less Than Significant With Mitigation Included	Less Than Significant Impact	No Impact
a) Directly or indirectly cause potential substantial adverse effects, including the risk of loss, injury, or death involving:			X	
i) Rupture of a known earthquake fault, as delineated on the most recent Alquist-Priolo Earthquake Fault Zoning Map issued by the State Geologist for the area or based on other substantial evidence of a known fault? Refer to Division of Mines and Geology Special Publication 42.			X	
ii) Strong seismic ground shaking?			X	
iii) Seismic-related ground failure, including liquefaction?			X	
iv) Landslides?			X	
b) Result in substantial soil erosion or the loss of topsoil?			X	
c) Be located on a geologic unit or soil that is unstable, or that would become unstable as a result of the project, and potentially result in on- or off-site landslide, lateral spreading, subsidence, liquefaction or collapse?			X	
d) Be located on expansive soil, as defined in Table 18-1-B of the Uniform Building Code (1994), creating substantial direct or indirect risks to life or property?			X	
e) Have soils incapable of adequately supporting the use of septic tanks or alternative waste water disposal systems where sewers are not available for the disposal of waste water?			X	
f) Directly or indirectly destroy a unique paleontological resource or site or unique geologic feature?			X	

**Discussion:** The USDA Natural Resources Conservation Service’s Eastern Stanislaus County Soil Survey indicates that the property is made up of Hanford sandy loam (HdA and HdsA) and Tujunga loamy sand (TuA). As contained in Chapter five of the General Plan and Support Documentation<sup>1</sup>, the areas of the County subject to significant geologic hazard are located in the Diablo Range, west of Interstate 5; however, as per the California Building Code, all of Stanislaus County is located within a geologic hazard zone (Seismic Design Category D, E, or F) and a soils test may be required along with the building permit application. Results from the soils test will determine if unstable or expansive soils are present. If such soils are present, special engineering of the structure will be required to compensate for the soil deficiency.

The project proposes to expand the existing facility with construction of a 41,743 square-foot cold storage warehouse, 9,085 square-foot maintenance building, a 48,700 square-foot bottling facility, and a 12,263 square-foot office building.

The existing facility is served by a private well and septic system; the expansion is proposed to be served by either the existing well or a new well, and a new on-site septic system. A referral response received from Stanislaus County Department of Environmental Resources (DER) indicated that prior to issuance of any grading or building permit, the applicant(s) shall submit a site plan that includes the location, layout and design of all-existing and proposed on-site

wastewater treatment systems (OWTS) that meets all of DER’s standards, including a future 100% expansion (replacement) area, Measure X and LAMP standards and setbacks. Additionally, DER responded that the applicant(s) shall demonstrate and secure any necessary permits for the destruction/relocation of all on-site wastewater treatment systems (OWTS) and/or water wells impacted or proposed by this project, under the direction of DER. These requirements will be added to the project as development standards.

The project was referred to Stanislaus County Public Works (PW), and a referral response was received requesting that a grading and drainage plan be prepared in conformance with PW Standards and Specifications, reviewed, and approved by the PW Department. This requirement will be added to the project as a development standard.

It does not appear that this project will result in significant impacts to any paleontological resources or unique geologic features. Development standards applicable to development of the parcels regarding the discovery of such resources during the construction process will be added to the project. The project site is not located near an active fault or within a high earthquake zone. Landslides are not likely due to the flat terrain of the area. Impacts to Geology and Soils are considered to be less than significant.

**Mitigation:** None.

**References:** Referral response received from the Stanislaus County Department of Environmental Resources, Environmental Health Division, dated December 5, 2023; Referral response from the Stanislaus County Department of Public Works, dated March 29, 2024; Stanislaus County General Plan and Support Documentation<sup>1</sup>.

VIII. GREENHOUSE GAS EMISSIONS -- Would the project:	Potentially Significant Impact	Less Than Significant With Mitigation Included	Less Than Significant Impact	No Impact
a) Generate greenhouse gas emissions, either directly or indirectly, that may have a significant impact on the environment?			X	
b) Conflict with an applicable plan, policy or regulation adopted for the purpose of reducing the emissions of greenhouse gases?			X	

**Discussion:** The principal Greenhouse Gasses (GHGs) are carbon dioxide (CO<sub>2</sub>), methane (CH<sub>4</sub>), nitrous oxide (N<sub>2</sub>O), sulfur hexafluoride (SF<sub>6</sub>), perfluorocarbons (PFCs), hydrofluorocarbons (HFCs), and water vapor (H<sub>2</sub>O). CO<sub>2</sub> is the reference gas for climate change because it is the predominant greenhouse gas emitted. To account for the varying warming potentials of different GHGs, GHG emissions are often quantified and reported as CO<sub>2</sub> equivalents (CO<sub>2</sub>e). In 2006, California passed the California Global Warming Solutions Act of 2006 (Assembly Bill [AB] No. 32), which requires the California Air Resources Board (ARB) design and implement emission limits, regulations, and other measures, such that feasible and cost-effective statewide GHG emissions are reduced to 1990 levels by 2020. Two additional bills, SB 350 and SB32, were passed in 2015 further amending the states Renewables Portfolio Standard (RPS) for electrical generation and amending the reduction targets to 40 percent of 1990 levels by 2030.

The existing facility extracts oil from almonds and walnuts and filters some of the extracted oil on-site. The unrefined nut oil is stored in tanks until it is transported to Germany for refining; the refined oil is sold directly to cosmetic manufacturers and distributors. The by-product or waste from extracting the nut oils is a cattle feed “cake” that consists of the almond/walnut meat blended with rice hulls and sold to farming operations. The existing facility is improved with a 23,267± square-foot processing building, a 16,400 square-foot cooking building, a 4,000 square-foot shed, a 2,700 square-foot office, and multiple storage silos and other accessory equipment. The project proposes to expand the existing facility with construction of a 41,743 square-foot cold storage warehouse, 9,085 square-foot maintenance building, a 48,700 square-foot bottling facility, and a 12,263 square-foot office building. The facility operates 24 hours a day, seven days a week which is not proposed to change. The facility currently includes a total of 25 employees (15 employees on a maximum shift) which is expected to increase to 35, with 20 employees on a maximum shift. The facility currently has an average of two visitors per-day, which is not proposed to change. There is currently an average of 10 daily truck trips consisting of either the delivery of nuts or picking up finished product, which is anticipated to increase to 20 daily truck trips. Truck traffic is limited to the hours of Monday through Friday from 7:00 a.m. to 5:00 p.m.



As required by CEQA Guidelines Section 15064.3, potential impacts regarding Green House Gas Emissions should be evaluated using Vehicle Miles Traveled (VMT). The calculation of VMT is the number of cars/trucks multiplied by the distance traveled by each car/truck. Stanislaus County has currently not adopted any significance thresholds for VMT, and projects are treated on a case-by-case basis for evaluation under CEQA. However, the State of California - Office of Planning and Research (OPR) has issued guidelines regarding VMT significance under CEQA. The CEQA Guidelines identify vehicle miles traveled (VMT), which is the amount and distance of automobile travel attributable to a project, as the most appropriate measure of transportation impacts. According to the same technical advisory from OPR, projects that generate or attract fewer than 110 trips per-day generally may be assumed to cause a less-than significant transportation impact. The project proposes an increase of up to 20 vehicle employee trips per day and 10 truck trips per day, which is below the VMT threshold.

A referral response received from the San Joaquin Valley Air Pollution Control District stated that the emissions from construction and operation are not expected to exceed any of the significance thresholds as identified in the SJVAPCD's Guidance for Assessing and Mitigating Air Quality Impacts (GAMAQI). The SJVAPCD's response stated that in order to determine potential health impacts on surrounding receptors (such as residences, hospitals, day-care facilities, etc.) a Prioritization and/or Health Risk Assessment (HRA) should be performed for the project. The nearest residences are located 160 feet east of the proposed bottling and storage buildings. Potential toxic air contaminants resulting from the project would be caused by mobile emissions created by truck trips and idling. As previously stated, the project will include the addition of 10 truck trips per day. The developer will be required to obtain a Permit to Operate (PTO) from the SJVAPCD prior to issuance of a building permit. As part of the PTO application process HRA information must be provided to and be analyzed by the SJVAPCD. The SJVAPCD requires operators to employ best practices such as implementing truck routes which avoid sensitive receptors or restricting idling times. A development standard will be applied to the project which requires that a PTO be obtained prior to issuance of a building permit and that all best practices and conditions applied to the PTO be met. Additionally, the SJVAPCD's response stated that the SJVACPCD recommends an Ambient Air Quality Analysis (AAQA) be performed for the project if emissions exceed 100 pounds per day of any pollutant. Based on the SJVAPCD's District Rule 9510 (Indirect Source Review) because the project square footage is less than 100,000 square feet of industrial space and less than 39,000 square feet of office space, the project is not subject to Rule 9510 and an ISR application is not required.

A development standard requiring the applicant to comply with all appropriate SJVAPCD rules and regulations and California Green Building Code will be incorporated into the project. Consequently, GHG emissions associated with this project are considered to be less than significant.

**Mitigation:** None.

**References:** Application information; Referral response received from the San Joaquin Valley Air Pollution Control District, dated April 18, 2024; Governor's Office of Planning and Research Technical Advisory, December 2018; Stanislaus County General Plan and Support Documentation<sup>1</sup>.

IX. HAZARDS AND HAZARDOUS MATERIALS -- Would the project:	Potentially Significant Impact	Less Than Significant With Mitigation Included	Less Than Significant Impact	No Impact
a) Create a significant hazard to the public or the environment through the routine transport, use, or disposal of hazardous materials?			X	
b) Create a significant hazard to the public or the environment through reasonably foreseeable upset and accident conditions involving the release of hazardous materials into the environment?			X	
c) Emit hazardous emissions or handle hazardous or acutely hazardous materials, substances, or waste within one-quarter mile of an existing or proposed school?			X	

<p>d) Be located on a site which is included on a list of hazardous materials sites compiled pursuant to Government Code Section 65962.5 and, as a result, would it create a significant hazard to the public or the environment?</p>			<p>X</p>	
<p>e) For a project located within an airport land use plan or, where such a plan has not been adopted, within two miles of a public airport or public use airport, would the project result in a safety hazard or excessive noise for people residing or working in the project area?</p>				<p>X</p>
<p>f) Impair implementation of or physically interfere with an adopted emergency response plan or emergency evacuation plan?</p>			<p>X</p>	
<p>g) Expose people or structures, either directly or indirectly, to a significant risk of loss, injury or death involving wildland fires?</p>			<p>X</p>	

**Discussion:** The existing facility extracts oil from almonds and walnuts and filters some of the extracted oil on-site. The unrefined nut oil is stored in tanks until it is transported to Germany for refining; the refined oil is sold directly to cosmetic manufacturers and distributors. The by-product or waste from extracting the nut oils is a cattle feed “cake” that consists of the almond/walnut meat blended with rice hulls and sold to farming operations. The existing facility is improved with a 23,267± square-foot processing building, a 16,400 square-foot cooking building, a 4,000 square-foot shed, a 2,700 square-foot office, and multiple storage silos and other accessory equipment. The project proposes to expand the existing facility with construction of a 41,743 square-foot cold storage warehouse, 9,085 square-foot maintenance building, a 48,700 square-foot bottling facility, and a 12,263 square-foot office building.

The Stanislaus County Department of Environmental Resources (DER) is responsible for overseeing hazardous materials. A referral response from the Hazardous Materials Division of DER is requiring the applicant to contact DER regarding appropriate permitting requirements for hazardous materials and/or wastes. The applicant is required to use, store, and dispose of any hazardous materials in accordance with all applicable federal, state, and local regulations including any Hazardous Materials Business Plan with the Fire Warden, if applicable. The Hazardous Materials Division and the California Department of Toxic Substances Control (DTSC) both requested that the developer conduct a Phase I or Phase II study prior to the issuance of a grading permit to determine if organic pesticides or metals exist on the project site. DTSC also requested that lead based paint testing occur if any structures are to be demolished and that soil sampling be conducted prior to grading activity. The Hazardous Materials Division requested that they be contacted should any underground storage tanks, buried chemicals, buried refuse, or contaminated soil be discovered during grading or construction. These comments will be reflected through the application of a condition of approval. The proposed use is not recognized as a generator and/or consumer of hazardous materials, therefore, no significant impacts associated with hazards or hazardous materials are anticipated to occur as a result of the proposed project.

Pesticide exposure is a risk in areas located in the vicinity of agriculture. Sources of exposure include contaminated groundwater, which is consumed, and drift from spray applications. Application of sprays is strictly controlled by the Agricultural Commissioner and can only be accomplished after first obtaining permits. A discussion on the project and agricultural buffers is included in Section II – *Agriculture and Forest Resources*. The project was referred to the Stanislaus County Agricultural Commissioner, and a response was received indicating they had no comments on the project.

The project site is not listed on the EnviroStor database managed by the CA Department of Toxic Substances Control or within the vicinity of any airport. The site is located in a Local Responsibility Area (LRA) for fire protection and is served by Denair Fire Protection District (DFPD). The project was referred to the DFPD, and no comments have been received to date.

The project site is not within the vicinity of any airstrip or wildlands.

**Mitigation:** None.

**References:** Application information; Referral response received from the Agricultural Commissioner’s Office, dated December 20, 2023; Referral response received from the Department of Environmental Resources, Hazardous Materials Division, dated November 9, 2023; CA Department of Toxic Substances Control’s data management system (EnviroStar), accessed on September 19, 2023; Stanislaus County Airport Land Use Compatibility Plan; Stanislaus County General Plan and Support Documentation<sup>1</sup>.

X. HYDROLOGY AND WATER QUALITY -- Would the project:	Potentially Significant Impact	Less Than Significant With Mitigation Included	Less Than Significant Impact	No Impact
a) Violate any water quality standards or waste discharge requirements or otherwise substantially degrade surface or ground water quality?			X	
b) Substantially decrease groundwater supplies or interfere substantially with groundwater recharge such that the project may impede sustainable groundwater management of the basin?			X	
c) Substantially alter the existing drainage pattern of the site or area, including through the alteration of the course of a stream or river or through the addition of impervious surfaces, in a manner which would:			X	
i) result in substantial erosion or siltation on- or off-site;			X	
ii) substantially increase the rate of amount of surface runoff in a manner which would result in flooding on- or off-site.			X	
iii) create or contribute runoff water which would exceed the capacity of existing or planned stormwater drainage systems or provide substantial additional sources of polluted runoff; or			X	
iv) impede or redirect flood flows?			X	
d) In flood hazard, tsunami, or seiche zones, risk release of pollutants due to project inundation?			X	
e) Conflict with or obstruct implementation of a water quality control plan or sustainable groundwater management plan?			X	

**Discussion:** Areas subject to flooding have been identified in accordance with the Federal Emergency Management Act (FEMA). The project site is located in FEMA Flood Zone X, which includes areas determined to be outside the 0.2 percent annual chance floodplains. An Early Consultation referral response received from Stanislaus County Department of Public Works (PW) indicated that a grading, drainage, and erosion and sediment control plan for the project will be required, subject to PW review and Standards and Specifications. PW also required that a positive storm drainage (storage, percolation, and treatment) system be installed.

The existing facility extracts oil from almonds and walnuts and filters some of the extracted oil on-site. The unrefined nut oil is stored in tanks until it is transported to Germany for refining; the refined oil is sold directly to cosmetic manufacturers and distributors. The by-product or waste from extracting the nut oils is a cattle feed “cake” that consists of the almond/walnut meat blended with rice hulls and sold to farming operations. The existing facility is improved with a 23,267± square-foot processing building, a 16,400 square-foot cooking building, a 4,000 square-foot shed, a 2,700 square-foot office, and multiple storage silos and other accessory equipment. The project proposes to expand the existing facility with construction of a 41,743 square-foot cold storage warehouse, 9,085 square-foot maintenance building, a 48,700 square-foot bottling facility, and a 12,263 square-foot office building.

The existing facility is served by a private well and septic system; the expansion is proposed to be served by either the existing well or a new well, and a new on-site septic system. A referral response received from Stanislaus County

Department of Environmental Resources (DER) indicated that prior to issuance of any grading or building permit, the applicant(s) shall submit a site plan that includes the location, layout and design of all-existing and proposed on-site wastewater treatment systems (OWTS) and the future 100% Expansion (Replacement) Areas. Any new or modified on-site wastewater treatment system (OWTS) shall meet Measure X requirements, shall be designed according to type and occupancy of the proposed structure to the estimated waste/sewage design flow rate, and shall meet all applicable Local Agency Management Program (LAMP) standards and setbacks. Additionally, DER responded that the applicant(s) shall demonstrate and secure any necessary permits for the destruction/relocation of all on-site wastewater treatment systems (OWTS) and/or water wells impacted or proposed by this project, under the direction of DER.

DER also commented that the proposed project meets the definition of a Public Water System and therefore subject to the requirements of SB1263. The California Safe Drinking Water Act (CA Health and Safety Code Section 116275(h)) defines a Public Water System as a system for the provision of water for human consumption through pipes or other constructed conveyances that has 15 or more service connections or regularly serves at least 25 individuals daily at least 60 days out of the year. A public water system includes the following:

- 1) Any collection, treatment, storage, and distribution facilities under control of the operator of the system that are used primarily in connection with the system.
- 2) Any collection or pretreatment storage facilities not under the control of the operator that are used primarily in connection with the system.
- 3) Any water system that treats water on behalf of one or more public water systems for the purpose of rendering it safe for human consumption.

The water quality of the existing well has yet to be determined. If the existing well does not meet Public Water System standards the applicant may need to either drill a new well or install a water treatment system for the current well. Based on this information, if required to meet current water quality standards, the drilling of a new well would be considered a de minimis extractor, exempt from the County's Groundwater Ordinance and thus not require CEQA-compliance. If the applicant is required to install a water treatment system, it will be required to be approved by the Regional Water Quality Control Board and the Department of Environmental Resources. Regardless of which avenue the applicant takes to meet public water system standards, public water supply permits require on-going testing. Goal Two, Policy Seven, of the Stanislaus County General Plan Conservation/Open Space Element requires that, new development that does not derive domestic water from pre-existing domestic and public water supply systems be required to have a documented water supply that does not adversely impact Stanislaus County water resources. This Policy is implemented by requiring proposals for development that will be served by new water supply systems be referred to appropriate water districts, irrigation districts, community services districts, the State Water Resources Board and any other appropriate agencies for review and comment. Additionally, all development requests shall be reviewed to ensure that sufficient evidence has been provided, to document the existence of a water supply sufficient to meet the short and long-term water needs of the project without adversely impacting the quality and quantity of existing local water resources. Prior to receiving occupancy of any building permit for any later construction, the property owner must obtain concurrence from the State of California Water Resources Control Board (SWRCB), Drinking Water Division, in accordance with CHSC, Section 116527 (SB1263) and apply for a water supply permit if necessary, with the associated technical report to Stanislaus County DER and compliance with CEQA. This will be added as a condition of approval. If the developer utilizes an on-site well as the water source for the project and it does not meet water quality standards, then they may need to install a water treatment system.

The Sustainable Groundwater Management Act (SGMA) was passed in 2014 with the goal of ensuring the long-term sustainable management of California's groundwater resources. SGMA requires agencies throughout California to meet certain requirements including forming Groundwater Sustainability Agencies (GSA), developing Groundwater Sustainability Plans (GSP), and achieving balanced groundwater levels within 20 years. The site is located in the Turlock Subbasin Groundwater Basin Association (TSGBA) GSA, which manages the East and West Turlock Subbasins. A Groundwater Sustainability Plan has been submitted to the California Department of Water Resources (DWR) and is currently going through the review process.

The Central Valley Regional Water Quality Control Board (CVRWQCB) provided an Early Consultation referral response requesting that the applicant coordinate with their agency to determine if any permits or Water Board requirements be obtained/met prior to operation. Development standards will be added to the project requiring the applicant comply with this request prior to issuance of a building permit.

The project site is served by the Eastside Irrigation District (EID) for irrigation water. No response was received from EID on the Early Consultation referral; however, the project will include a development standard which will require the developer to follow all EID rules and procedures.

The project proposes to maintain all stormwater on-site via storm drain basins. A referral response received from Stanislaus County Department of Public Works requested that the on-site storm drain basins be located outside of the County’s road right-of-way.

As a result of the project details, impacts associated with drainage, water quality, and runoff are expected to have a less than significant impact.

**Mitigation:** None.

**References:** Referral response received from Stanislaus County Department of Public Works, dated March 29, 2024; Referral response from Stanislaus County Department of Environmental Resources, Groundwater Resources Division, dated November 3, 2023; Referral Response from Central Valley Regional Water Quality Control Board, dated November 9, 2023; Referral response received from the Department of Environmental Resources, Environmental Health Division, dated December 5, 2023; Stanislaus County General Plan and Support Documentation<sup>1</sup>.

XI. LAND USE AND PLANNING -- Would the project:	Potentially Significant Impact	Less Than Significant With Mitigation Included	Less Than Significant Impact	No Impact
a) Physically divide an established community?			X	
b) Cause a significant environmental impact due to a conflict with any land use plan, policy, or regulation adopted for the purpose of avoiding or mitigating an environmental effect?			X	

**Discussion:** The existing facility extracts oil from almonds and walnuts and filters some of the extracted oil on-site. The unrefined nut oil is stored in tanks until it is transported to Germany for refining; the refined oil is sold directly to cosmetic manufacturers and distributors. The by-product or waste from extracting the nut oils is a cattle feed “cake” that consists of the almond/walnut meat blended with rice hulls and sold to farming operations. The existing facility is improved with a 23,267± square-foot processing building, a 16,400 square-foot cooking building, a 4,000 square-foot shed, a 2,700 square-foot office, and multiple storage silos and other accessory equipment. The project proposes to expand the existing facility with construction of a 41,743 square-foot cold storage warehouse, 9,085 square-foot maintenance building, a 48,700 square-foot bottling facility, and a 12,263 square-foot office building. Approximately nine acres of an existing almond orchard will be removed to accommodate the expansion. However, the soils existing on the project site do not qualify as prime soils.

The General Plan of the project site is designated as Agriculture which is proposed to remain unchanged. In accordance with the Land Use Element of the General Plan a Planned Development (PD) zone may be consistent with the Agriculture General Plan designation when it is used for agriculturally-related uses or for uses of a demonstrably unique character, which due to specific agricultural needs or to their transportation needs or to needs that can only be satisfied in the Agriculture designation, may be properly located within areas designated as agricultural on the General Plan. In this case the proposed project is expanding on property adjacent to its current location which is processing almonds and walnuts, which are produced in the surrounding area.

The County’s Agricultural Element’s Agricultural Buffer Guidelines states that new or expanding uses approved by discretionary permit in the A-2 zoning district or on a parcel adjoining the A-2 zoning district should incorporate a minimum 150-foot-wide agricultural buffer setback, or 300-foot-wide buffer setback for people-intensive uses, to physically avoid conflicts between agricultural and non-agricultural uses. Public roadways, utilities, drainage facilities, rivers and adjacent riparian areas, landscaping, parking lots, and similar low people-intensive uses are permitted uses within the buffer setback area. The facility currently includes a total of 25 employees (15 employees on a maximum shift) which is expected to increase to 35, with 20 employees on a maximum shift. A proposed increase of 5 employees on-site during a maximum shift is potentially low-people intensive. The project site is adjacent to orchards on the east, west, and north. On the south, the project is adjacent to the existing Caloy operations, and no buffer is required. On the west side, and immediately

adjacent to the project site are existing agricultural buildings with no active farming operations. The nearest farmed parcel to the west is located 180 feet from the project site, which exceeds the 150-foot agricultural buffer for low-people intensive uses. On the east, the buildings are set back 80 feet from the existing Montpelier Road, and when adding the 80-foot width of Montpelier Road, the 150-foot buffer is maintained. On the north boundary, the buildings are set back 106 feet from the property line. The 5<sup>th</sup> Street access easement runs north of that and is approximately 30 feet wide, which makes the buffer on the north side approximately 136 feet. Accordingly, a reduced buffer of 136 feet on the northern property line is proposed. Additionally, the entirety of the site will be fenced to prevent trespassing.

The project will not physically divide an established community nor conflict with any habitat conservation plans.

**Mitigation:** None.

**References:** Application materials; Stanislaus County General Plan and Support Documentation<sup>1</sup>.

XII. MINERAL RESOURCES -- Would the project:	Potentially Significant Impact	Less Than Significant With Mitigation Included	Less Than Significant Impact	No Impact
a) Result in the loss of availability of a known mineral resource that would be of value to the region and the residents of the state?			X	
b) Result in the loss of availability of a locally-important mineral resource recovery site delineated on a local general plan, specific plan or other land use plan?			X	

**Discussion:** The location of all commercially viable mineral resources in Stanislaus County has been mapped by the State Division of Mines and Geology in Special Report 173. There are no known significant resources on the site, nor is the project site located in a geological area known to produce resources.

**Mitigation:** None.

**References:** Application materials; and Stanislaus County General Plan and Support Documentation<sup>1</sup>.

XIII. NOISE -- Would the project result in:	Potentially Significant Impact	Less Than Significant With Mitigation Included	Less Than Significant Impact	No Impact
a) Generation of a substantial temporary or permanent increase in ambient noise levels in the vicinity of the project in excess of standards established in the local general plan or noise ordinance, or applicable standards of other agencies?			X	
b) Generation of excessive groundborne vibration or groundborne noise levels?			X	
c) For a project located within the vicinity of a private airstrip or an airport land use plan or, where such a plan has not been adopted, within two miles of a public airport or public use airport, would the project expose people residing or working in the project area to excessive noise levels?			X	

**Discussion:** The proposed project shall comply with the noise standards included in the General Plan and Noise Control Ordinance. The area surrounding the project site consists of scattered single-family dwellings and orchards in all directions. The Stanislaus County General Plan identifies noise levels up to 55 dB Ldn (or CNEL) as the normally acceptable level of noise for residential uses. The site itself is impacted by traffic generated on Montpelier Road, the Monte Vista Farming

Company, an almond hulling and processing facility located adjacent to the existing Caloy facility to the south, and commercial farming occurring on the surrounding almond orchards. The Stanislaus County General Plan identifies noise levels up to 75 dB Ldn (or CNEL) as the normally acceptable level of noise for industrial and agricultural uses. On-site grading and construction resulting from this project may result in a temporary increase in the area’s ambient noise levels; however, noise impacts associated with on-site activities and traffic are not anticipated to exceed the normally acceptable level of noise.

The site is not located within an airport land use plan.

**Mitigation:** None.

**References:** Stanislaus County Noise Control Ordinance (Title 10); Stanislaus County General Plan, Chapter IV – Noise Element, Stanislaus County General Plan and Support Documentation<sup>1</sup>.

<b>XIV. POPULATION AND HOUSING -- Would the project:</b>	<b>Potentially Significant Impact</b>	<b>Less Than Significant With Mitigation Included</b>	<b>Less Than Significant Impact</b>	<b>No Impact</b>
<b>a) Induce substantial unplanned population growth in an area, either directly (for example, by proposing new homes and businesses) or indirectly (for example, through extension of roads or other infrastructure)?</b>			<b>X</b>	
<b>b) Displace substantial numbers of existing people or housing, necessitating the construction of replacement housing elsewhere?</b>			<b>X</b>	

**Discussion:** The site is not included in the vacant sites inventory for the 2016 Stanislaus County Housing Element, which covers the 5<sup>th</sup> cycle or the draft sites inventory for the 6<sup>th</sup> cycle Regional Housing Needs Allocation (RHNA) for the County and will therefore not impact the County’s ability to meet their RHNA. No population growth will be induced, nor will any existing housing be displaced as a result of this project.

**Mitigation:** None.

**References:** Application materials; and Stanislaus County General Plan and Support Documentation<sup>1</sup>.

<b>XV. PUBLIC SERVICES --</b>	<b>Potentially Significant Impact</b>	<b>Less Than Significant With Mitigation Included</b>	<b>Less Than Significant Impact</b>	<b>No Impact</b>
<b>a) Would the project result in the substantial adverse physical impacts associated with the provision of new or physically altered governmental facilities, need for new or physically altered governmental facilities, the construction of which could cause significant environmental impacts, in order to maintain acceptable service ratios, response times or other performance objectives for any of the public services:</b>			<b>X</b>	
<b>Fire protection?</b>			<b>X</b>	
<b>Police protection?</b>			<b>X</b>	
<b>Schools?</b>			<b>X</b>	
<b>Parks?</b>			<b>X</b>	
<b>Other public facilities?</b>			<b>X</b>	

**Discussion:** The County has adopted Public Facilities Fees, as well as Fire Facility Fees on behalf of the appropriate fire district, to address impacts to public services. County adopted Public Facilities Fees, as well as fire and school fees are required to be paid based on the development type prior to issuance of a building permit.

This project site is located within the Denair Union School District, Denair Fire Protection District, Eastside Irrigation District, and is served by the Sherriff for police protection and Stanislaus County Parks and Recreation for parks.

The existing facility is served by a private well and septic system; the expansion is proposed to be served by either the existing well or a new well, and a new on-site septic system. A referral response received from Stanislaus County Department of Environmental Resources (DER) indicated that prior to issuance of any grading or building permit, the applicant(s) shall submit a site plan that includes the location, layout and design of all-existing and proposed on-site wastewater treatment systems (OWTS) that meets all of DER’s standards, including a future 100% expansion (replacement) area, Measure X and LAMP standards and setbacks. Additionally, the project meets the definition of a Public Water System (PWS) and must meet the permitting requirements established by California Regional Water Quality Control Board for a PWS. These requirements will be added to the project as development standards.

The project was referred to Stanislaus County Public Works (PW), and a referral response was received requesting that that the storage depth outside of any gate shall be adequate for trucks coming off the road, which means that entry vehicles will not block any travel lane or shoulder. If the storage depth is inadequate, it may require that the fence be moved further into the property, or a deceleration lane be installed. Additionally, PW is requiring that no parking, loading or unloading of vehicles will be permitted within the County road right-of-way; that an encroachment permit be obtained for any work done in the Stanislaus County road right-of-way; that the developer will be required to install or pay for the installation of any signs and/or markings, if warranted; and that a grading and drainage plan be prepared in conformance with Stanislaus County PW Standards and Specifications and be reviewed and approved by the PW Department. All of Public Works’ comments will be added to the project as development standards.

The project is not anticipated to have any significant adverse impact on County services.

**Mitigation:** None.

**References:** Application information; Referral response received from the Department of Environmental Resources, Environmental Health Division, dated December 5, 2023; Stanislaus County General Plan and Support Documentation<sup>1</sup>.

XVI. RECREATION --	Potentially Significant Impact	Less Than Significant With Mitigation Included	Less Than Significant Impact	No Impact
a) Would the project increase the use of existing neighborhood and regional parks or other recreational facilities such that substantial physical deterioration of the facility would occur or be accelerated?			X	
b) Does the project include recreational facilities or require the construction or expansion of recreational facilities which might have an adverse physical effect on the environment?			X	

**Discussion:** This project will not increase demands for recreational facilities, as such impacts typically are associated with residential development. Public Facility Fees will be required to be paid with any building permit issuance, which includes fees for County Parks and Recreation facilities.

**Mitigation:** None.

**References:** Application materials; and Stanislaus County General Plan and Support Documentation<sup>1</sup>.



XVII. TRANSPORTATION -- Would the project:	Potentially Significant Impact	Less Than Significant With Mitigation Included	Less Than Significant Impact	No Impact
a) Conflict with a program plan, ordinance or policy addressing the circulation system, including transit, roadway, bicycle and pedestrian facilities?			X	
b) Would the project conflict or be inconsistent with CEQA Guidelines section 15064.3, subdivision (b)?			X	
c) Substantially increase hazards due to a geometric design feature (e.g., sharp curves or dangerous intersections) or incompatible uses (e.g., farm equipment)?			X	
d) Result in inadequate emergency access?			X	

**Discussion:** The facility operates 24 hours a day, seven days a week which is not proposed to change. The facility currently includes a total of 25 employees (15 employees on a maximum shift) which is expected to increase to 35, with 20 employees on a maximum shift. The facility currently has an average of two visitors per-day, which is not proposed to change. There is currently an average of 10 daily truck trips consisting of either the delivery of nuts or picking up finished product, which is anticipated to increase to 20 daily truck trips. Truck traffic is limited to the hours of Monday through Friday from 7:00 a.m. to 5:00 p.m.

As required by CEQA Guidelines Section 15064.3, potential impacts to transportation should be evaluated using Vehicle Miles Traveled (VMT). As required by CEQA Guidelines Section 15064.3, potential impacts regarding Air Quality should be evaluated using Vehicle Miles Traveled (VMT). Stanislaus County has currently not adopted any significance thresholds for VMT, and projects are treated on a case-by-case basis for evaluation under CEQA. However, the State of California - Office of Planning and Research (OPR) has issued guidelines regarding VMT significance under CEQA. The CEQA Guidelines identify vehicle miles traveled (VMT), which is the amount and distance of automobile travel attributable to a project, as the most appropriate measure of transportation impacts. According to the same technical advisory from OPR, projects that generate or attract fewer than 110 trips per-day generally may be assumed to cause a less-than significant transportation impact. The project proposes an increase of up to 20 vehicle employee trips per day and 10 truck trips per day, which is below the VMT threshold.

The project site currently has access from Montpellier Road, a County-maintained road identified as 80 foot Major Collector in the Circulation Element. The project was referred to Stanislaus County Public Works (PW), and a referral response was received requesting that that the storage depth outside of any gate shall be adequate for trucks coming off the road, which means that entry vehicles will not block any travel lane or shoulder. If the storage depth is inadequate, it may require that the fence be moved further into the property, or a deceleration lane be installed. Additionally, PW is requiring that no parking, loading or unloading of vehicles will be permitted within the County road right-of-way; that an encroachment permit be obtained for any work done in the Stanislaus County road right-of-way; that the developer will be required to install or pay for the installation of any signs and/or markings, if warranted; that the on-site storm drain basins be located outside of the County road right-of-way; and that a grading and drainage plan be prepared in conformance with Stanislaus County PW Standards and Specifications and be reviewed and approved by the PW Department. All of Public Works' comments will be added to the project as development standards.

The proposed project is not anticipated to conflict with any transportation program, plan, ordinance, or policy.

**Mitigation:** None.

**References:** Referral response from the Stanislaus County Department of Public Works, dated March 29, 2024; Stanislaus County General Plan and Support Documentation<sup>1</sup>.

XVIII. TRIBAL CULTURAL RESOURCES -- Would the project:	Potentially Significant Impact	Less Than Significant With Mitigation Included	Less Than Significant Impact	No Impact
a) Cause a substantial adverse change in the significance of a tribal cultural resource, defined in Public Resources Code section 21074 as either a site, feature, place, cultural landscape that is geographically defined in terms of the size and scope of the landscape, sacred place, or object with cultural value to a California native American tribe, and that is:				
i) Listed or eligible for listing in the California Register of Historical Resources, or in a local register of historical resources as defined in Public Resources Code section 5020.1(k), or			X	
ii) A resource determined by the lead agency, in its discretion and supported by substantial evidence, to be significant pursuant to criteria set for the in subdivision (c) of Public Resource Code section 5024.1. In applying the criteria set forth in subdivision (c) of Public Resource Code section 5024.1, the lead agency shall consider the significance of the resource to a California Native American tribe.			X	

**Discussion:** In accordance with SB 18 and AB 52, this project was not referred to the tribes listed with the Native American Heritage Commission (NAHC) as the project is not a General Plan Amendment and no tribes have requested consultation or project referral noticing. Tribal notification of the project was not referred to any tribes in conjunction with AB 52 requirements, as Stanislaus County has not received any requests for consultation from the tribes listed with the NAHC. A records search conducted by the Central California Information Center (CCIC) for the project site indicated that there are no historical, cultural, or archeological resources recorded on-site and that the site has a low sensitivity for the discovery of such resources. The report from the CCIC indicated that historic buildings and structure have been recorded within Denair and the surrounding vicinity. The project will remove an existing almond orchard and will construct a 41,743 square-foot cold storage warehouse, 9,085 square-foot maintenance building, a 48,700 square-foot bottling facility, and a 12,263 square-foot office building. A development standard will be added to the project which requires if any cultural or tribal resources are discovered during project-related activities, all work is to stop, and the lead agency and a qualified professional are to be consulted to determine the importance and appropriate treatment of the find. It does not appear this project will result in significant impacts to any archaeological or tribal resources.

Tribal Cultural Resources are considered to be less than significant.

**Mitigation:** None.

**References:** Application information; Central California Information Center (CCIC) Search, dated July 12, 2023; and Stanislaus County General Plan and Support Documentation<sup>1</sup>.

XIX. UTILITIES AND SERVICE SYSTEMS -- Would the project:	Potentially Significant Impact	Less Than Significant With Mitigation Included	Less Than Significant Impact	No Impact
a) Require or result in the relocation or construction of new or expanded water, wastewater treatment or storm water drainage, electric power, natural gas, or telecommunications facilities, the construction or relocation of which could cause significant environmental effects?			X	

<p><b>b) Have sufficient water supplies available to serve the project and reasonably foreseeable future development during normal, dry and multiple dry years?</b></p>			<p>X</p>	
<p><b>c) Result in a determination by the wastewater treatment provider which serves or may serve the project that it has adequate capacity to serve the project's projected demand in addition to the provider's existing commitments?</b></p>			<p>X</p>	
<p><b>d) Generate solid waste in excess of State or local standards, or in excess of the capacity of local infrastructure, or otherwise impair the attainment of solid waste reduction goals?</b></p>			<p>X</p>	
<p><b>e) Comply with federal, state, and local management and reduction statutes and regulations related to solid waste?</b></p>			<p>X</p>	

**Discussion:** Limitations on providing services have not been identified. The existing facility extracts oil from almonds and walnuts and filters some of the extracted oil on-site. The unrefined nut oil is stored in tanks until it is transported to Germany for refining; the refined oil is sold directly to cosmetic manufacturers and distributors. The by-product or waste from extracting the nut oils is a cattle feed “cake” that consists of the almond/walnut meat blended with rice hulls and sold to farming operations. The existing facility is improved with a 23,267± square-foot processing building, a 16,400 square-foot cooking building, a 4,000 square-foot shed, a 2,700 square-foot office, and multiple storage silos and other accessory equipment. The project proposes to expand the existing facility with construction of a 41,743 square-foot cold storage warehouse, 9,085 square-foot maintenance building, a 48,700 square-foot bottling facility, and a 12,263 square-foot office building.

The existing facility is served by a private well and septic system; the expansion is proposed to be served by either the existing well or a new well, and a new on-site septic system. A referral response received from Stanislaus County Department of Environmental Resources (DER) indicated that prior to issuance of any grading or building permit, the applicant(s) shall submit a site plan that includes the location, layout and design of all-existing and proposed on-site wastewater treatment systems (OWTS) that meets all of DER’s standards, including a future 100% expansion (replacement) area, Measure X and LAMP standards and setbacks. Additionally, the project meets the definition of a Public Water System (PWS) and must meet the permitting requirements established by California Regional Water Quality Control Board for a PWS. These requirements will be added to the project as development standards.

The project was referred to Stanislaus County Public Works (PW), and a referral response was received requesting that that the storage depth outside of any gate shall be adequate for trucks coming off the road, which means that entry vehicles will not block any travel lane or shoulder. If the storage depth is inadequate, it may require that the fence be moved further into the property, or a deceleration lane be installed. Additionally, PW is requiring that no parking, loading or unloading of vehicles will be permitted within the County road right-of-way; that an encroachment permit be obtained for any work done in the Stanislaus County road right-of-way; that the developer will be required to install or pay for the installation of any signs and/or markings, if warranted; that the on-site storm drain basin be located outside of the County road right-of-way; and that a grading and drainage plan be prepared in conformance with Stanislaus County PW Standards and Specifications and be reviewed and approved by the PW Department. All of Public Works’ comments will be added to the project as development standards.

The Central Valley Regional Water Quality Control Board (CVRWQCB) provided an Early Consultation referral response requesting that the applicant coordinate with their agency to determine if any permits or Water Board requirements be obtained/met prior to operation. Development standards will be added to the project requiring the applicant comply with this request prior to issuance of a building permit.

The project site is served by the Eastside Irrigation District (EID) for irrigation water. No response was received from EID on the Early Consultation referral; however, the project will include a development standard which will require the developer to follow all EID rules and procedures.

No significant impacts related to Utilities and Services Systems have been identified.

**Mitigation:** None.

**References:** Application information; Referral response received from Stanislaus County Department of Environmental Resources, Environmental Health Division, dated December 5, 2023; Referral response from the Stanislaus County Department of Public Works, dated March 29, 2024; Referral response received from Central Valley Regional Water Quality Control Board, dated November 9, 2023; Stanislaus County General Plan and Support Documentation<sup>1</sup>.

XX. WILDFIRE – If located in or near state responsibility areas or lands classified as very high fire hazard severity zones, would the project:	Potentially Significant Impact	Less Than Significant With Mitigation Included	Less Than Significant Impact	No Impact
a) Substantially impair an adopted emergency response plan or emergency evacuation plan?			X	
b) Due to slope, prevailing winds, and other factors, exacerbate wildfire risks, and thereby expose project occupants to, pollutant concentrations from a wildfire or the uncontrolled spread of a wildfire?			X	
c) Require the installation of maintenance of associated infrastructure (such as roads, fuel breaks, emergency water sources, power lines or other utilities) that may exacerbate fire risk or that may result in temporary or ongoing impacts to the environment?			X	
d) Expose people or structures to significant risks, including downslope or downstream flooding or landslides, as a result of runoff, post-fire slope instability, or drainage changes?			X	

**Discussion:** The Stanislaus County Local Hazard Mitigation Plan identifies risks posed by disasters and identifies ways to minimize damage from those disasters. With the Wildfire Hazard Mitigation Activities of this plan in place, impacts to an adopted emergency response plan or emergency evacuation plan are anticipated to be less than significant. The terrain of the site is relatively flat, and the site has access to a County-maintained road. The site is located in a Local Responsibility Area (LRA) for fire protection, the parcel is designated as nonurban and is served by Denair Fire Protection District (DFPD). The project was referred to the DFPD, but no response was received. California Building Code establishes minimum standards for the protection of life and property by increasing the ability of a building to resist intrusion of flame and embers. Building permits will be required for the improvements and will be required to meet fire code, which will be verified through the building permit review process. A grading and drainage plan may be required for the proposed new structures; all fire protection and emergency vehicle access standards met. These requirements will be applied as development standards for the project.

Wildfire risk and risks associated with postfire land changes are considered to be less than significant.

**Mitigation:** None.

**References:** Application information; California Fire Code Title 24, Part 9; California Building Code Title 24, Part 2, Chapter 7; Stanislaus County Local Hazard Mitigation Plan; Referral response from the Stanislaus County Department of Public Works, dated March 29, 2024; Stanislaus County General Plan and Support Documentation<sup>1</sup>.

XXI. MANDATORY FINDINGS OF SIGNIFICANCE --	Potentially Significant Impact	Less Than Significant With Mitigation Included	Less Than Significant Impact	No Impact
a) Does the project have the potential to substantially degrade the quality of the environment, substantially reduce the habitat of a fish or wildlife species, cause a fish or wildlife population to drop below self-sustaining levels, threaten to eliminate a plant or animal community, substantially reduce the number or restrict the range of a rare or endangered plant or animal or eliminate important examples of the major periods of California history or prehistory?			X	
b) Does the project have impacts that are individually limited, but cumulatively considerable? (“Cumulatively considerable” means that the incremental effects of a project are considerable when viewed in connection with the effects of past projects, the effects of other current projects, and the effects of probable future projects.)			X	
c) Does the project have environmental effects which will cause substantial adverse effects on human beings, either directly or indirectly?			X	

**Discussion:** The existing facility extracts oil from almonds and walnuts and filters some of the extracted oil on-site. The unrefined nut oil is stored in tanks until it is transported to Germany for refining; the refined oil is sold directly to cosmetic manufacturers and distributors. The by-product or waste from extracting the nut oils is a cattle feed “cake” that consists of the almond/walnut meat blended with rice hulls and sold to farming operations. The existing facility is improved with a 23,267± square-foot processing building, a 16,400 square-foot cooking building, a 4,000 square-foot shed, a 2,700 square-foot office, and multiple storage silos and other accessory equipment. The project proposes to expand the existing facility with construction of a 41,743 square-foot cold storage warehouse, 9,085 square-foot maintenance building, a 48,700 square-foot bottling facility, and a 12,263 square-foot office building.

The project site is located adjacent to the existing Caloy facility to the south and the Monte Vista Farming Company to the southwest. Approximately 20 single family homes are located east of the project site; developed as part of the antiquated subdivision Town of Montpellier. Underlying lots from this antiquated subdivision are unlikely to develop new single-family dwelling due to the County’s minimum parcel size requirement of one acre to develop with a well and septic system. The rest of the surrounding area is utilized for commercial agricultural and is planted in row crops, orchards, or used as dairies. All of the surrounding land is zoned General Agriculture (A-2)-40) and is subject to meeting the uses allowed under the A-2 zoning district. Any further development would be required to obtain land use entitlements prior to development, which would require additional environmental review, and would most likely not be supported due to being considered leap frog or pre-mature development unless it could be determined it is closely related to agriculture and would not negatively impact the surrounding area.

The project will not conflict with a Habitat Conservation Plan, a Natural Community Conservation Plan, or other locally approved conservation plans. Impacts to endangered species or habitats, locally designated species, or wildlife dispersal or mitigation corridors are considered to be less than significant. The project will not physically divide an established community. Development standards regarding the discovery of cultural resources during any future construction resulting from this request will be added to the project. Review of this project has not indicated any features which might significantly impact the environmental quality of the site and/or the surrounding area.

**Mitigation:** None.

**References:** Initial Study; Stanislaus County General Plan and Support Documentation<sup>1</sup>.





<sup>1</sup> Stanislaus County General Plan and Support Documentation<sup>1</sup> adopted in August 23, 2016, as amended. **Housing Element** adopted on April 5, 2016.

# CALOY COMPANY LP

## REZ PLN2023-0065

### AREA MAP

#### LEGEND

-  Project Site
-  Sphere of Influence
-  City
-  Road
-  River

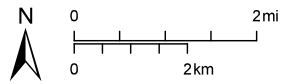

Source: Planning Department GIS

Date: 8/14/2023

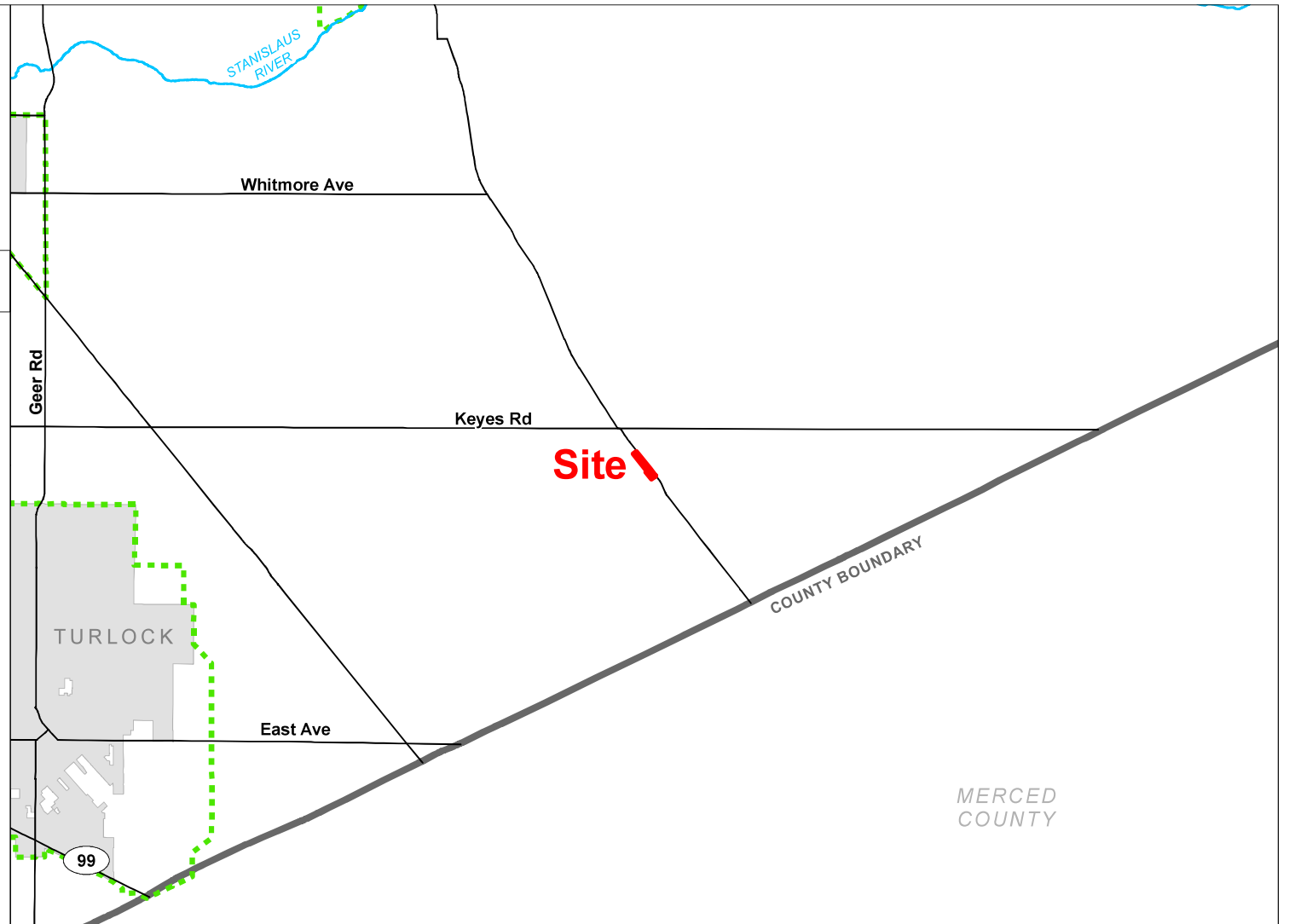

MERCED  
COUNTY

**CALOY  
COMPANY LP**

**REZ  
PLN2023-0065**

*GENERAL PLAN MAP*

LEGEND

-  Project Site
-  Parcel
-  Road
-  Canal
- General Plan**
-  Agriculture

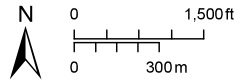

Source: Planning Department GIS

Date: 8/14/2023

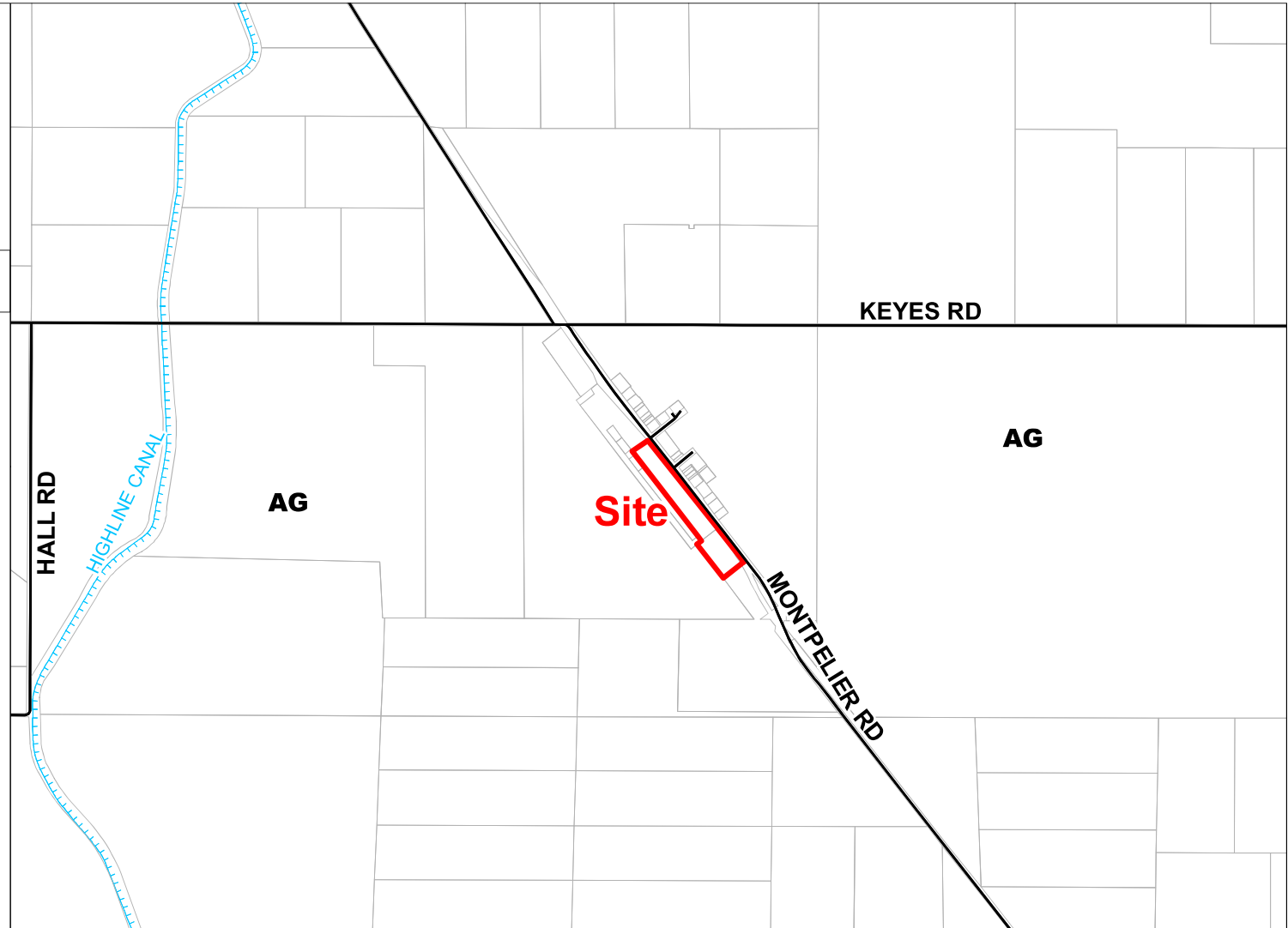







**CALOY  
COMPANY LP**

**REZ  
PLN2023-0065**

*ZONING MAP*

LEGEND

-  Project Site
-  Parcel
-  Road
-  Canal
- Zoning Designation**
-  Planned Development
-  General Agriculture 40 Acre

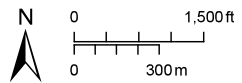

Source: Planning Department GIS

Date: 8/14/2023

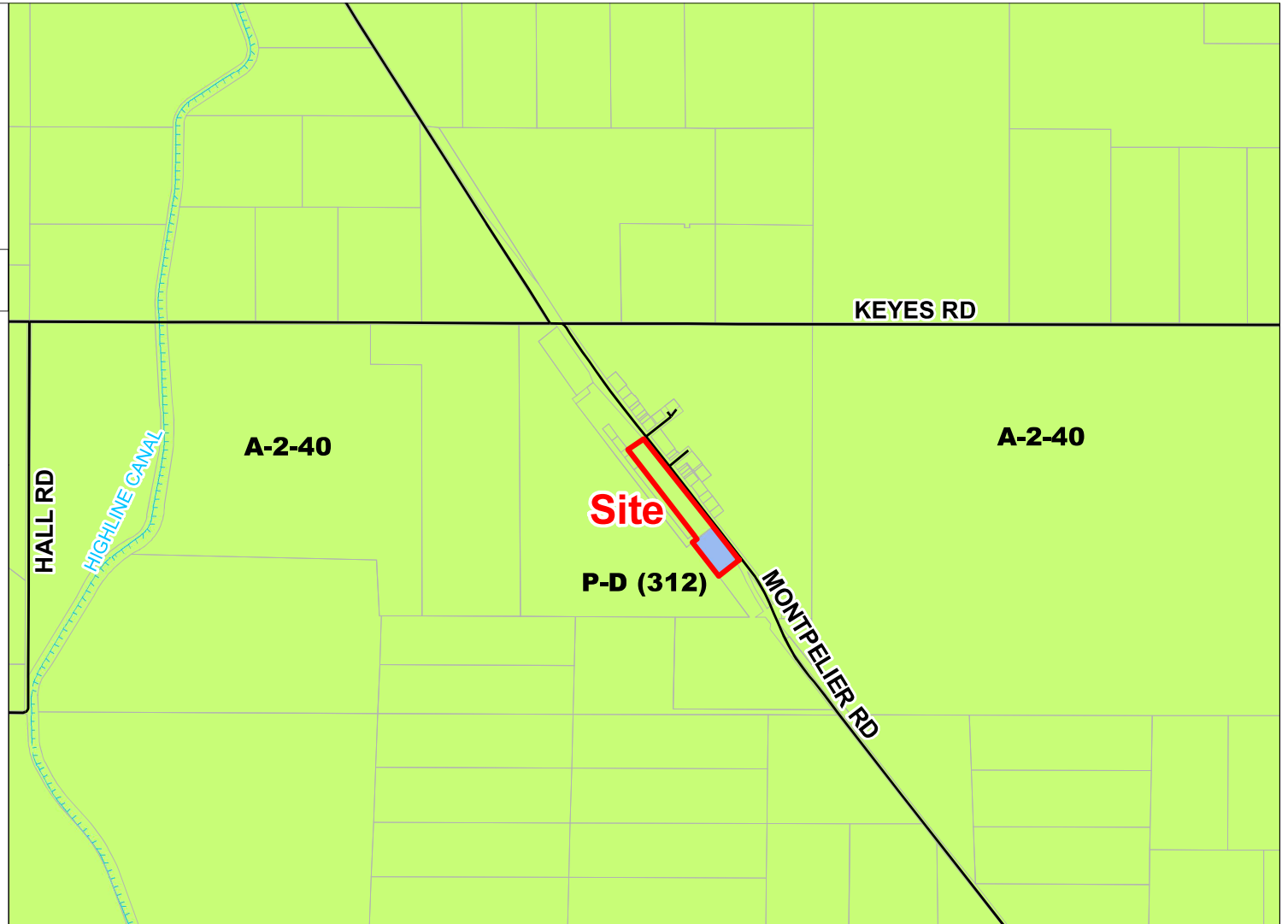





**CALOY  
COMPANY LP**

**REZ  
PLN2023-0065**

2023 AERIAL AREA MAP

LEGEND

-  Project Site
-  Canal
-  Road

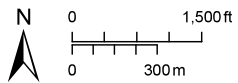

Source: Planning Department GIS

Date: 8/14/2023



Copyright nearmap 2015



**CALOY  
COMPANY LP**

**REZ  
PLN2023-0065**

*2023 AERIAL SITE MAP*

LEGEND

 Project Site

 Road

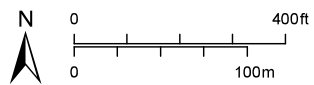

Source: Planning Department GIS

Date: 8/14/2023









# CALOY COMPANY LP

## REZ PLN2023-0065

### ACREAGE MAP

#### LEGEND

-  Project Site
-  Parcel/Acres
-  Road
-  Canal

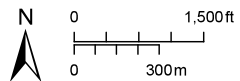

Source: Planning Department GIS

Date: 8/14/2023

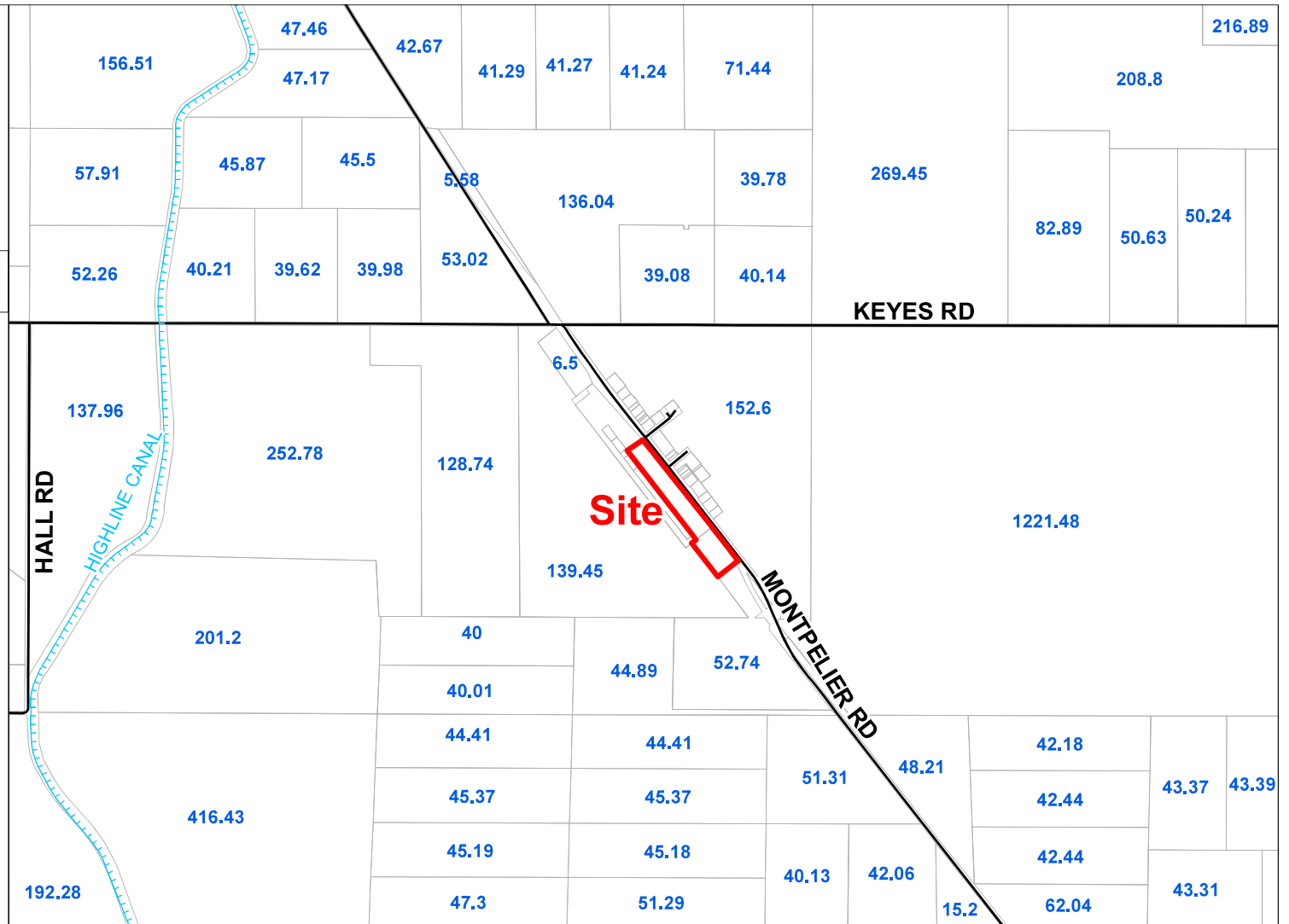

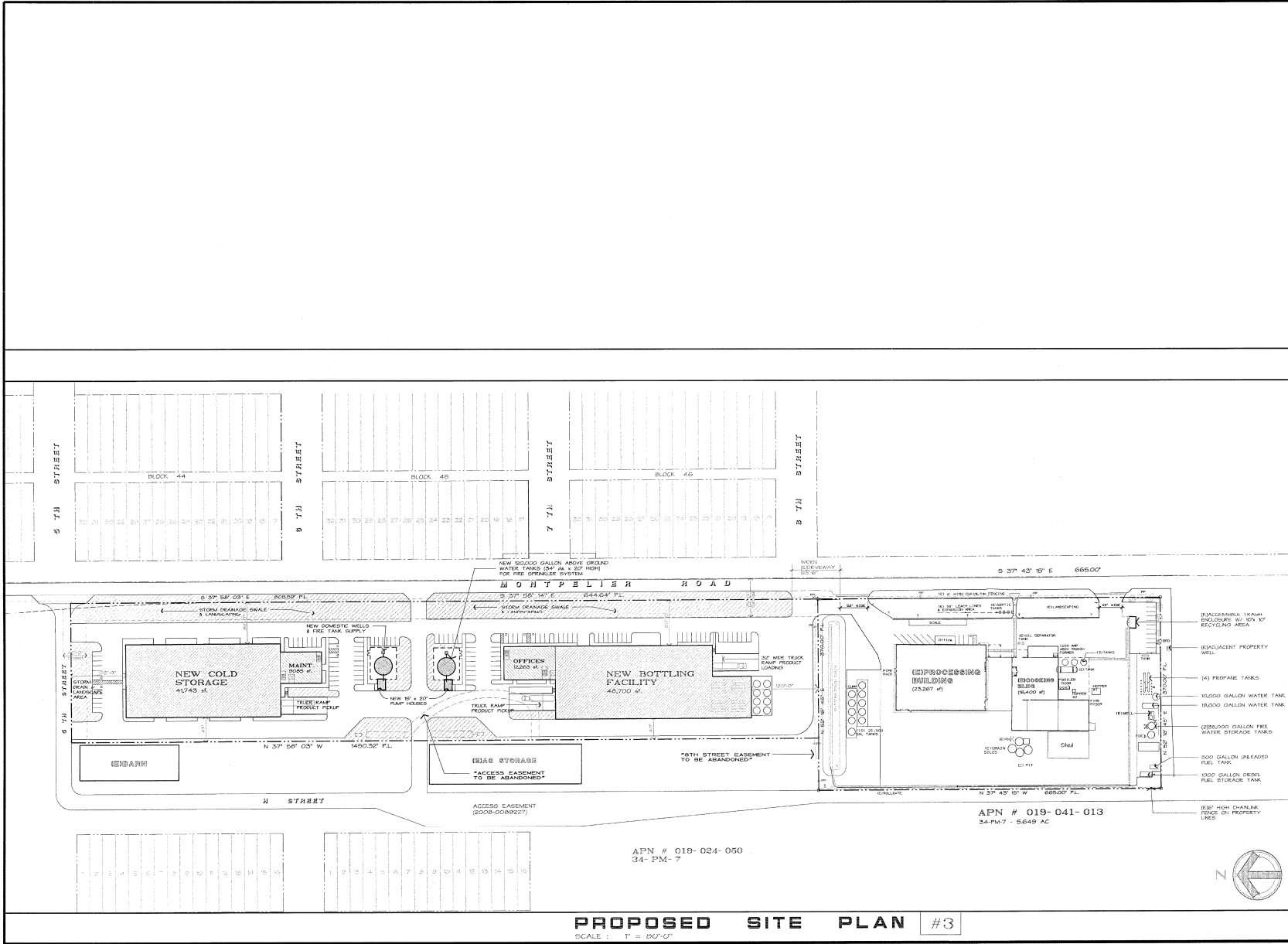

**PROPOSED SITE PLAN #3**  
SCALE: 1" = 80'-0"

PROVISIONS



**FACILITY EXPANSION FOR :**  
**CALOY NATURAL OILS**  
5425 N. MONTEPELLIER ROAD  
DENAIR, CA 95316

**SHEET TITLE:** PROPOSED SITE PLAN #3  
**DATE:** 7/19/23  
**DRAWN BY:** JCS  
**JOB NUMBER:** 2203  
**SIGNATURE:**  
© 2023 YOSHINO-SHAW & ASSOCIATES



**YOSHINO-SHAW & ASSOCIATES**  
= Jim Shaw =  
**ARCHITECT**  
1016 N. GOLDEN STATE BLVD  
TURLOCK, CA 95380

Phone (209) 667-2603  
Fax # (209) 667-2604  
Email: jshaw@fr2zinc.com

**SHEET NO.**  
**A-1.3**

**PROJECT INFO :**

LOT AREA : 391,584 sf.  
 NEW OFFICE / MAINTENANCE AREA : 21,348 sf.  
 NEW BOTTLING AREA : 48,700 sf.  
 NEW COLD STORAGE : 41,743 sf.  
 LOT COVERAGE : 29 %  
 NEW SIGNAGE : NEW SIGNAGE WILL BE PLACED ON EAST FACING WALL OF OFFICE BUILDINGS @ + 20' AFG

**NEW PARKING ANALYSIS :**

TOTAL STALLS PROVIDED = 105  
 # REQUIRED = 89 Stalls  
 OFFICE STALLS (21,348 sf / 300) = 71  
 Accessible Stalls = 7  
 EV Stalls = 36  
 STORAGE STALLS (80,443 sf / 5000) = 18

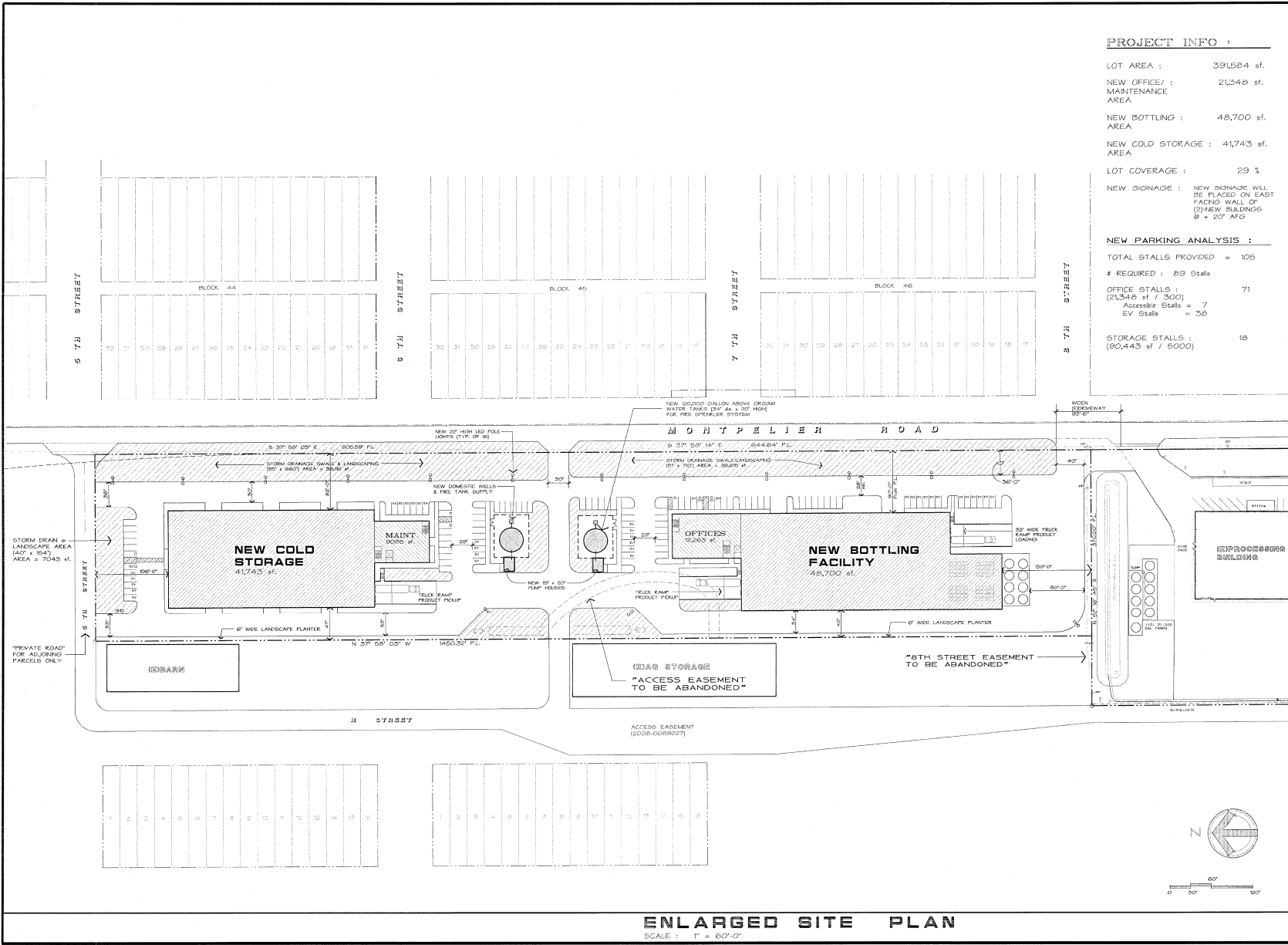

**ENLARGED SITE PLAN**  
 SCALE : 1" = 60'-0"

REVISIONS



**FACILITY EXPANSION FOR :**  
**CALOY NATURAL OILS**  
 5425 N. MONTEPELLIER ROAD  
 DENVER, CA 95016

SHEET TITLE: ENLARGED SITE PLAN #3	DATE: 9/7/23	DRAWN BY: JDS	JOB NUMBER: 2503	SIGNATURE: © 2023 YOSHINO-SHAW & ASSOCIATES
---------------------------------------	-----------------	------------------	---------------------	--



**YOSHINO-SHAW & ASSOCIATES**  
 = Jim Shaw =  
**ARCHITECT**  
 1016 N. GOLDEN STATE BLVD  
 TURLOCK, CA 95380  
 Phone (209) 667-2603  
 Fax # (209) 667-2604  
 Email : jshaw@hr2vr.com

SHEET NO.  
**A-2.0**

NOT FOR RECORDING

NOT FOR RECORDING

**BEFORE LOT LINE ADJUSTMENT**  
**LOT LINE ADJUSTMENT PLN2023-0066**

PARCELS BEFORE LOT LINE ADJUSTMENT OUTLINED IN RED

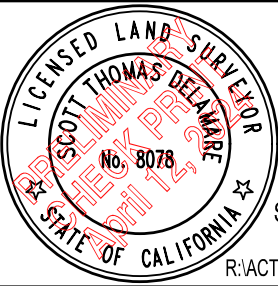
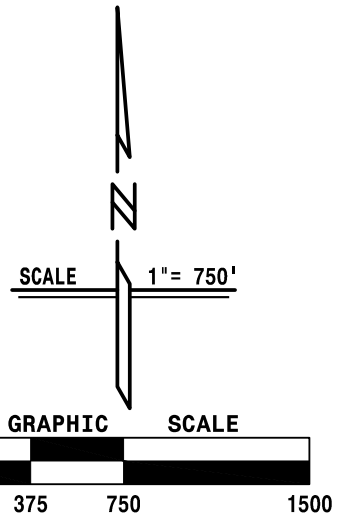
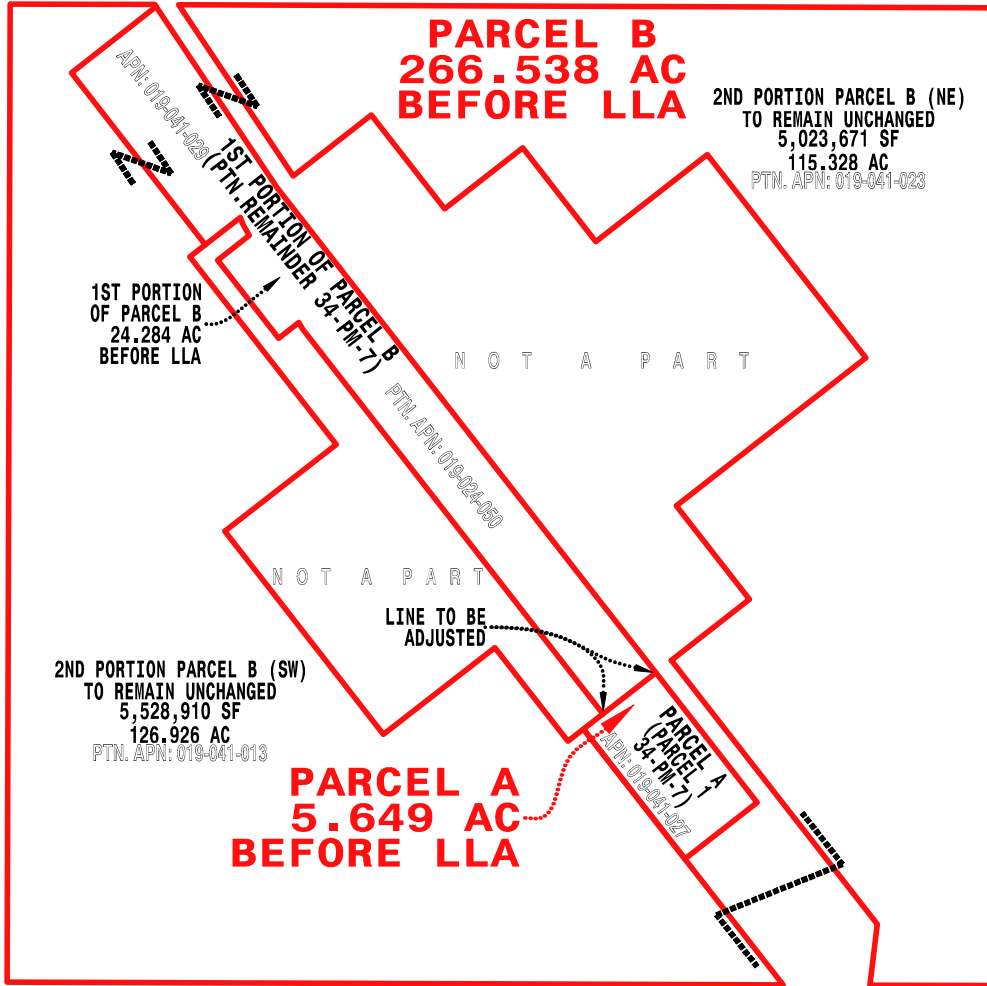

**DF ENGINEERING, INC.**

CIVIL ENGINEERING AND SURVEYING  
3421 TULLY ROAD · SUITE J · MODESTO, CA 95350  
TELEPHONE (209) 529-7450 · EMAIL DFENGINEERING@DFENGINEERING.COM

©COPYRIGHT 2024 DF ENGINEERING, INC.

SIGNED: *Scott Thomas De la Mare*

April 12, 2024

SCOTT THOMAS DELAMARE LS 8078

DATE

R:\ACTIVE PROJ\2022\2207\Dwg\LLA\2207LLA\_ExhibitsABC.dwg, Plat Before Red, Apr 12, 2024, 9:37am, scott

PAGE	<b>1</b>
	OF 1
JOB	2207
AUTHOR	STD
CK. BY	NIP
SCALE	1" = 750'
DATE	Apr., 2024

NOT FOR RECORDING

NOT FOR RECORDING

**AFTER LOT LINE ADJUSTMENT**  
**LOT LINE ADJUSTMENT PLN2023-0066**

PARCELS AFTER LOT LINE ADJUSTMENT OUTLINED IN GREEN

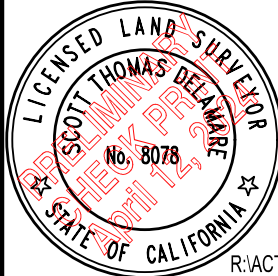
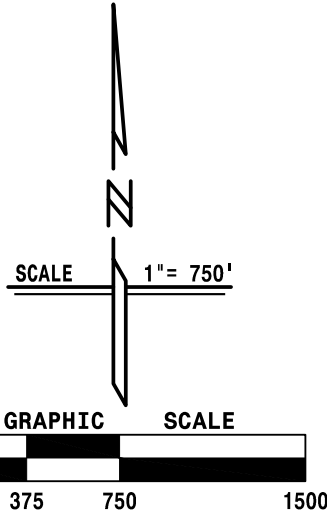
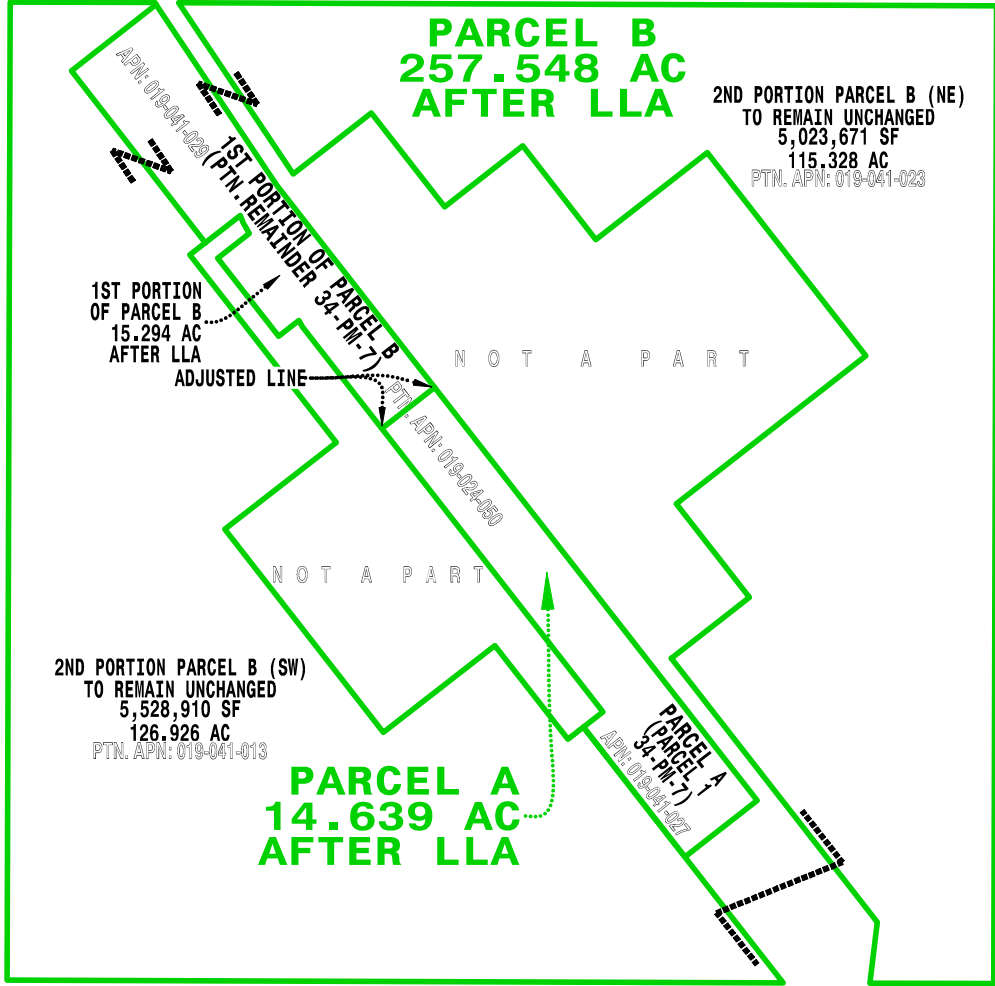

**DF ENGINEERING, INC.**

**CIVIL ENGINEERING AND SURVEYING**  
3421 TULLY ROAD · SUITE J · MODESTO, CA 95350  
TELEPHONE (209) 529-7450 · EMAIL DFENGINEERING@DFENGINEERING.COM  
©COPYRIGHT 2024 DF ENGINEERING, INC.

SIGNED: *Scott Thomas De la Mare* April 12, 2024  
SCOTT THOMAS DELAMARE LS 8078 DATE

PAGE	<b>1</b>
	OF 1
JOB	2207
AUTHOR	STD
CK. BY	NIP
SCALE	1" = 750'
DATE	Apr., 2024

R:\ACTIVE PROJ\2022\2207\Dwg\LLA\2207LLA\_ExhibitsABC.dwg, Plat After Green, Apr 12, 2024, 9:37am, scott

## CENTRAL CALIFORNIA INFORMATION CENTER

*California Historical Resources Information System*

Department of Anthropology – California State University, Stanislaus

One University Circle, Turlock, California 95382

(209) 667-3307



---

*Alpine, Calaveras, Mariposa, Merced, San Joaquin, Stanislaus & Tuolumne Counties*

**Date:** 7/12/2023

**Records Search File #: 12600N**

**Project: Rezone 5425 N. Montpelier Rd.,  
Montpelier, APN 019-024-050**

David. O. Romano  
1034 12<sup>th</sup> Street  
Modesto, CA 95354  
209-521-9521

dave@newman-romano.com

Dear Mr. Romano:

We have conducted a non-confidential extended records search as per your request for the above-referenced project area located on the Montpelier USGS 7.5-minute quadrangle map in Stanislaus County.

Search of our files includes review of our maps for the specific project area and the immediate vicinity of the project area, and review of the following:

National Register of Historic Places (NRHP)  
California Register of Historical Resources (CRHR)  
*California Inventory of Historic Resources (1976)*  
*California Historical Landmarks*  
California Points of Historical Interest listing  
Office of Historic Preservation Built Environment Resource Directory (BERD) and the  
Archaeological Resources Directory (ARD)  
*Survey of Surveys (1989)*  
Caltrans State and Local Bridges Inventory  
General Land Office Plats  
Other pertinent historic data available at the CCaIC for each specific county

The following details the results of the records search:

### **Prehistoric or historic resources within the project area:**

- There are no formally recorded prehistoric or historic archaeological resources or historic buildings or structures within the project area.
- The General Land Office survey plat for T4S R11E (dated 1854) does not show any historic features within Section 36.
- The Official Map of the County of Stanislaus, California (1906) shows the street layout

**ATTACHMENT I**



of Montpelier and the Southern Pacific Railroad alignment. The 1953 edition of the Montpelier USGS quadrangle shows the same historic features.

**Prehistoric or historic resources within the immediate vicinity of the project area:** None other than the Southern Pacific Railroad, portions of which have been recorded elsewhere in Stanislaus County as P-50-000001.

**Resources that are known to have value to local cultural groups:** None has been formally reported to the Information Center.

**Previous investigations within the project area:** None has been formally reported to the Information Center.

### **Recommendations/Comments:**

Please be advised that a historical resource is defined as a building, structure, object, prehistoric or historic archaeological site, or district possessing physical evidence of human activities over 45 years old. Since the project area has not been subject to previous investigations, there may be unidentified features involved in your project that are 45 years or older and considered as historical resources requiring further study and evaluation by a qualified professional of the appropriate discipline.

If the current project does not include ground disturbance, further study for archaeological resources is not recommended at this time. If ground disturbance is considered a part of the current project, we recommend further review for the possibility of identifying prehistoric or historic-era archaeological resources.

If the proposed project contains buildings or structures that meet the minimum age requirement (45 years in age or older) it is recommended that the resource/s be assessed by a professional familiar with architecture and history of the county. Review of the available historic building/structure data has included only those sources listed above and should not be considered comprehensive.

If at any time you might require the services of a qualified professional the Statewide Referral List for Historical Resources Consultants is posted for your use on the internet at <http://chrisinfo.org>

If archaeological resources are encountered during project-related activities, work should be temporarily halted in the vicinity of the discovered materials and workers should avoid altering the materials and their context until a qualified professional archaeologist has evaluated the situation and provided appropriate recommendations. Project personnel should not collect cultural resources.

If human remains are discovered, California Health and Safety Code Section 7050.5 requires you to protect the discovery and notify the county coroner, who will determine if the find is Native

American. If the remains are recognized as Native American, the coroner shall then notify the Native American Heritage Commission (NAHC). California Public Resources Code Section 5097.98 authorizes the NAHC to appoint a Most Likely Descendant (MLD) who will make recommendations for the treatment of the discovery.

Due to processing delays and other factors, not all of the historical resource reports and resource records that have been submitted to the State Office of Historic Preservation are available via this records search. Additional information may be available through the federal, state, and local agencies that produced or paid for historical resource management work in the search area. Additionally, Native American tribes have historical resource information not in the CHRIS Inventory, and you should contact the California Native American Heritage Commission for information on local/regional tribal contacts.

The California Office of Historic Preservation (OHP) contracts with the California Historical Resources Information System's (CHRIS) regional Information Centers (ICs) to maintain information in the CHRIS inventory and make it available to local, state, and federal agencies, cultural resource professionals, Native American tribes, researchers, and the public. Recommendations made by IC coordinators or their staff regarding the interpretation and application of this information are advisory only. Such recommendations do not necessarily represent the evaluation or opinion of the State Historic Preservation Officer in carrying out the OHP's regulatory authority under federal and state law.

We thank you for contacting this office regarding historical resource preservation. Please let us know when we can be of further service. Thank you for sending the signed **Access Agreement Short Form**.

**Note:** Billing will be transmitted separately via email from the Financial Services office (\$150.00), payable within 60 days of receipt of the invoice.

**If you wish to include payment by Credit Card, you must wait to receive the official invoice from Financial Services so that you can reference the CMP # (Invoice Number), and then contact the link below:**

<https://commerce.cashnet.com/ANTHROPOLOGY>

Sincerely,

*E. A. Greathouse*

E. A. Greathouse, Coordinator  
Central California Information Center  
California Historical Resources Information System

\* Invoice Request sent to: ARBilling@csustan.edu, CSU Stanislaus Financial Services



# DF ENGINEERING, INC.

CIVIL ENGINEERING AND SURVEYING  
3421 TULLY ROAD · SUITE J · MODESTO, CA 95350  
TELEPHONE (209) 529-7450 · EMAIL [DFENGINEERING@DFENGINEERING.COM](mailto:DFENGINEERING@DFENGINEERING.COM)  
[www.dfengineering.com](http://www.dfengineering.com)

· SCOTT T. DELAMARE  
LS 8078

· BARBARA J. DELAMARE  
CPA 46482E

· DAVID J. HOBERG  
PE 53311, QSD/QSP

· KEVIN J. ELLIS  
CIVIL TECHNICIAN

## **Project: Facility expansion for Caloy Natural Oils – Water System Analysis**

### **Background/Existing Water System/Distribution:**

The existing production/processing facility is served by a well capable of producing 33 gpm (gallons per minute) or 47,520 gallons per day or 0.05 MGD (million gallons per day).

The processing facility employs 25 staff of which 9 maximum of about 15 employees are present during a twelve-hour shift. There are 5 existing restrooms in this facility.

Existing water consumption per day averages 20 gpm or 28,800 gallons per day or 0.028 MGD.

Existing water consumption is split between process, landscape irrigation and employee use.

There are 2 each 35,000-gallon storage tanks for fire suppression in an emergency.

### **Impact of Facility Expansion/Proposed Water System/Distribution:**

The facility expansion will include a new bottling facility and a cold storage warehouse with 4 additional restrooms. There is no expected water increase for processing operations with the new project expansion.

Staffing will include 10 additional employees.

A new 120,000-gallon water tank will be provided for fire suppression.

The project proposes to build a new well at the north end of the site, which will also be able to pump about 33 gpm. This well is needed, as the existing well can't provide adequate water pressure to move the water all the way to the new northerly buildings. The two wells will be interconnected to provide redundancy in the event problems with one of the wells were to occur.

No significant increase in water consumption is expected to occur with the expansion project as the operational elements of the bottling and cold storage buildings do not include significant water use. A minor increase in average consumption is expected due to the additional employees and landscape irrigation area combined. The resulting overall average consumption is expected to be in the range of 20 – 25 gpm or 28,800 – 36,000 gallons per day or 0.028 – 0.036 MGD.

Prepared by,

DF ENGINEERING, INC.

David J. Hoberg, PE, QSD/QSP  
Senior Project Engineer  
[dave@dfengineering.com](mailto:dave@dfengineering.com)

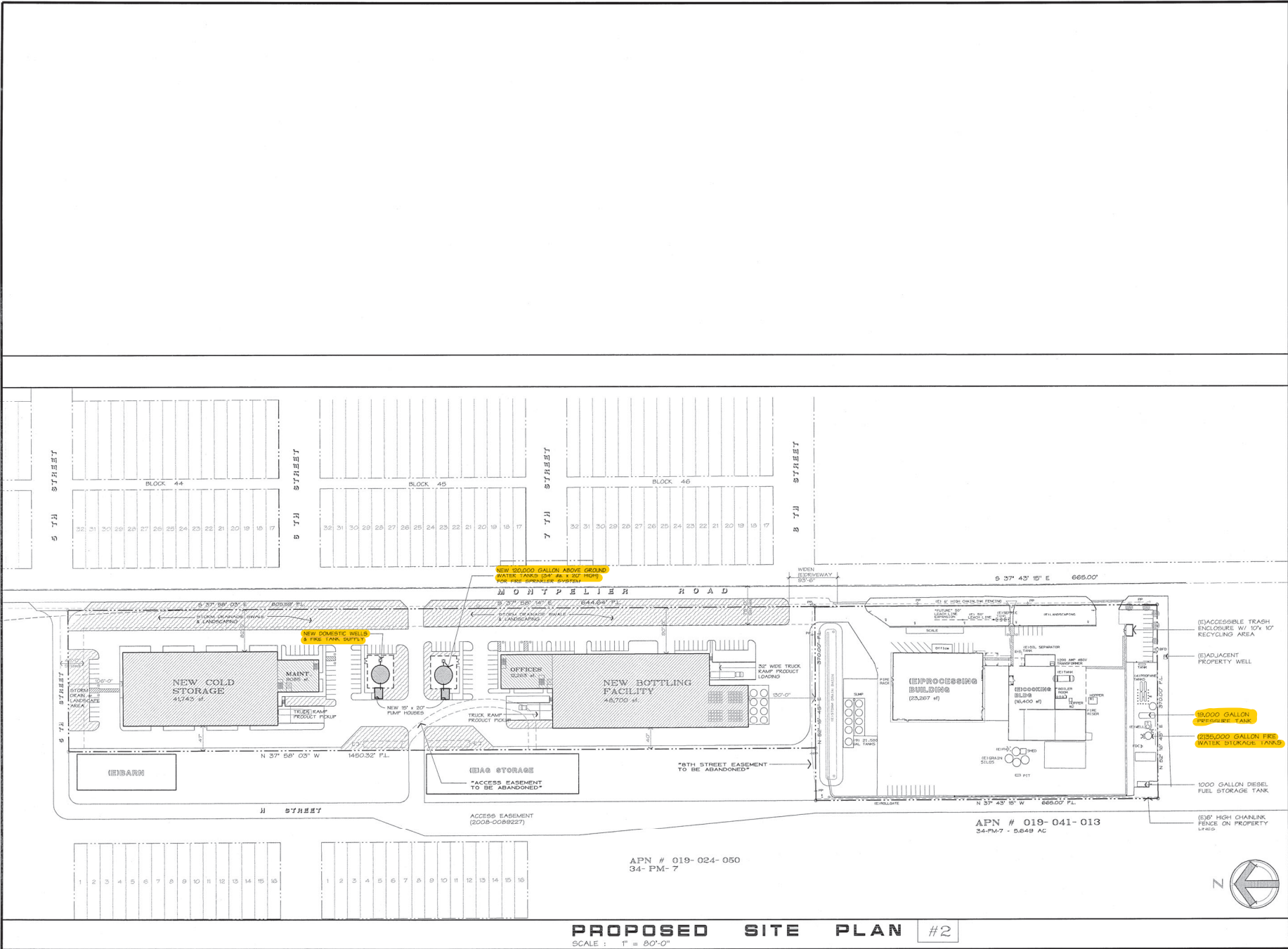

**PROPOSED SITE PLAN #2**  
 SCALE: 1" = 80'-0"

REVISIONS



FACILITY EXPANSION FOR:  
**CALOY NATURAL OILS**  
 5425 N. MONTPELIER ROAD DENVER, CA 95836

PROJECT NAME:  
**CALOY NATURAL OILS**  
 5425 N. MONTPELIER ROAD DENVER, CA 95836

SHEET TITLE:  
 PROPOSED SITE PLAN #2

DATE: 4/20/23  
 DRAWN BY: JPS  
 JOB NUMBER: 2303  
 SIGNATURE: [Signature]



**YOSHINO-SHAW & ASSOCIATES**  
 = Jim Shaw =  
 ARCHITECT

1016 N. GOLDEN STATE BLVD  
 TURLOCK, CA 95380

Phone (209) 667-2603  
 Fax # (209) 667-2604  
 Email: jshaw@frc2wrs.com

SHEET NO.  
**A-1.2**