

Appendix D
Geotechnical Report

**GEOTECHNICAL INVESTIGATION
5201 Patrick Henry Drive
Santa Clara, California**

Prepared For:

**DPR Construction
1510 South Winchester Boulevard
San Jose, California 95128**

Prepared By:

**Langan Engineering and Environmental Services, Inc.
1 Almaden Boulevard, Suite 590
San Jose, California 95113**



**Kelli A. McCurdy, PE #C91646
Project Engineer**



**John Gouchon, GE #2282
Principal/Vice President**

**24 July 2023
731769901**

LANGAN

TABLE OF CONTENTS

1.0	INTRODUCTION.....	1
2.0	SCOPE OF SERVICES	1
3.0	FIELD EXPLORATION AND LABORATORY TESTING	2
3.1	Borings	3
3.2	Cone Penetration Tests (CPTs)	4
3.3	Test Pits.....	5
3.4	Laboratory Testing	5
3.5	Soil Corrosivity Testing	5
4.0	SITE CONDITIONS	6
4.1	Site Conditions.....	6
4.2	Subsurface Conditions	6
5.0	SEISMIC AND GEOLOGIC CONSIDERATIONS	7
5.1	Regional Seismicity	7
5.2	Seismic and Geologic Hazards.....	9
5.2.1	Liquefaction	9
5.2.2	Lateral Spreading	12
5.2.3	Seismic Densification.....	12
5.2.4	Fault Rupture.....	12
5.2.5	Flooding.....	13
5.2.6	Tsunami	13
6.0	DISCUSSION AND CONCLUSIONS.....	13
6.1	Expansive Soil Considerations.....	14
6.2	Foundations and Settlement	14
6.3	Groundwater.....	16
6.4	Corrosion Potential.....	16
6.5	Construction Considerations	16
7.0	RECOMMENDATIONS.....	17
7.1	Earthwork.....	17
7.1.1	Site Preparation.....	17
7.1.2	Lime Treatment.....	19
7.2	Shallow Foundations.....	20
7.3	Floor Slabs.....	21
7.4	Seismic Design.....	22
7.5	Asphalt Pavements.....	24
7.6	Concrete Pavements.....	26
7.7	Utilities	27
7.8	Site Drainage.....	28
7.9	Bioretention Systems.....	28
7.10	Landscaping	29
8.0	ADDITIONAL GEOTECHNICAL SERVICES.....	30
9.0	LIMITATIONS.....	30

REFERENCES

FIGURES

APPENDICES

DISTRIBUTION

731769901.04 Updated Geotechnical Investigation Report_5201 Patrick Henry Drive_Santa Clara

ATTACHMENTS

FIGURES

- Figure 1 Site Location Map
- Figure 2 Site Plan
- Figure 3 Map of Major Faults and Earthquake Epicenters in the San Francisco Bay Area
- Figure 4 Modified Mercalli Intensity Scale
- Figure 5 Regional Seismic Hazard Map
- Figure 6 Pavement Existing Conditions

APPENDICES

- Appendix A Logs of Borings
- Appendix B Cone Penetration Test Results
- Appendix C Logs of Test Pit
- Appendix D Laboratory Test Results
- Appendix E Corrosivity Results
- Appendix F Site-Specific Response Spectra and Time Series

GEOTECHNICAL INVESTIGATION
5201 Patrick Henry Drive
Santa Clara, California

1.0 INTRODUCTION

This report presents the results of a geotechnical investigation performed by Langan Engineering and Environmental Services, Inc. (Langan) for the proposed redevelopment and expansion at 5201 Patrick Henry Drive in Santa Clara, California. We previously performed a preliminary geotechnical study for the project and presented our preliminary findings in a letter report dated 17 August 2022. The location of the site is shown on Figure 1. The property is within assessor's parcel number (APN) 104-50-004 and is bound by Patrick Henry Drive to the west, paved parking lot to the north, Betsy Ross Road to the east, and Bunker Hill Lane to the south, as shown on Figure 2. Currently, the property is occupied by a three-story office building and paved parking lot. Based on a topographic survey of the site (Guida Surveying Inc., 2022), the site is relatively level with ground surface elevations typically ranging from about Elevation 8 to 11 feet¹.

According to our review of preliminary architectural plans², we understand the proposed redevelopment and expansion will consist of demolishing part of the office building with an atrium and constructing a new single-level warehouse and storage area and a $\pm 11,000$ square foot yard. Existing exterior site improvements are expected to be demolished and replaced with new paving and landscaping. We understand 2 to 3½ feet of fill will be placed to raise site grades beneath the proposed expansion. The building loads for the proposed building expansion are currently not available.

2.0 SCOPE OF SERVICES

Our scope of services was outlined in our proposal dated 10 October 2022. The purpose of our geotechnical investigation was to evaluate site-specific subsurface conditions and seismic hazards, including liquefaction potential and lateral spreading, assist the design team in selecting the most appropriate foundation type, and provide recommendations for the foundation and other geotechnical aspects of the development. We used the results of our geotechnical investigations to perform our engineering analysis and develop conclusions and recommendations for the following:

¹ The elevations reference to the North American Vertical Datum of 1988 (NAVD88).

² "DPR Silicon Valley Office, 5201 Patrick Henry, LLC," by SmithGroup (Draft), dated 8 December 2022.

- soil and groundwater conditions at the site
- site seismicity and seismic hazards, including liquefaction and associated seismic and geological hazards
- most appropriate foundation type(s) for the proposed expansion
- design criteria for the recommended foundation type(s), including vertical and lateral capacities and associated estimated settlements
- subgrade preparation for slab-on-grade floors and exterior slabs and flatwork
- 2019 California Building Code (CBC) seismic design criteria, including site classification, mapped values S_s and S_1 , modification factors F_a and F_v and S_{MS} and S_{M1}
- site preparation, grading, drainage, and general earthwork operations, including criteria for fill quality and compaction
- flexible pavement
- soil corrosivity with brief evaluation
- construction considerations, including brief discussion on the reusability of on-site materials (if applicable).

In addition, we performed probabilistic seismic hazard analysis and deterministic analysis to develop site-specific response spectra for the Risk-targeted Maximum Considered Earthquake (MCE_R) and Design Earthquake (DE) per the 2019 CBC and by reference ASCE 7-16. Furthermore, we developed time series for the project.

3.0 FIELD EXPLORATION AND LABORATORY TESTING

As part of our field exploration, we drilled two borings and performed two cone penetration tests (CPTs) at the site. Additionally, we logged one test pit that was excavated by others within the existing building footprint. The approximate locations of the borings, CPTs, and test pit are presented on Figure 2. Prior to performing our field exploration, we obtained a soil boring permit from Valley Water, notified Underground Service Alert (USA), and checked the boring and CPT locations for underground utilities using a private utility locator. Details of each aspect of the field exploration and laboratory testing are discussed in the remainder of this section.

3.1 Borings

Two borings, designated as B-1 and B-2, were drilled at the site as part of this investigation at the approximate locations presented on Figure 2. The borings were drilled on 1 November 2022 by Exploration Geoservices, Inc. (EGI) of San Jose, California, using a truck-mounted drill rig equipped with hollow stem auger drilling equipment. Borings B-1 and B-2 were advanced to a depth of approximately 31½ feet below the existing ground surface (bgs). During drilling, our engineer logged the borings and obtained samples of the material encountered for visual classification and laboratory testing. Logs of the borings are presented in Appendix A as Figures A-1 through A-2. The soil encountered in the boring was classified in accordance with the Classification Chart presented on Figure A-3.

Soil samples were obtained using two different types of samplers. The sampler types are as follows:

- Sprague & Henwood (S&H) split-barrel sampler with a 3.0-inch outside diameter and 2.5-inch inside diameter, lined with steel or brass tubes with an inside diameter of 2.43 inches.
- Shelby Tube (ST) thin-walled piston sampler with a 3-inch outside diameter and a 2.93-inch inside diameter.

The sampler types were chosen on the basis of soil type being sampled and desired sample quality for laboratory testing. In general, the S&H sampler was used to obtain samples in medium stiff to very stiff cohesive soil. The ST sampler was used to obtain relatively undisturbed samples of the soft to medium stiff cohesive soil.

The S&H samplers were driven with 140-pound, downhole wireline hammer falling 30 inches. The samplers were driven up to 18 inches and the hammer blows required to drive the samplers every six inches of penetration were recorded and are presented on the boring logs. A “blow count” is defined as the number of hammer blows per six inches of penetration. The blow counts required to drive the S&H samplers were converted to approximate SPT N-values using the factor of 0.6, to account for sampler type and hammer energy, and are shown on the boring logs. The blow counts used for this conversion were the last two blow counts.

The ST sampler is pushed hydraulically into the soil; the piston pressure required to advance the sampler is shown on the log, measured in pounds per square inch (psi). The pressure required to advance the sampler varies between drill rigs.

Upon completion, the boreholes were backfilled with cement grout in accordance with the requirements of Valley Water, and the pavement surface was patched. The soil cuttings from the borings were collected in 55-gallon drums, which were stored temporarily at the site, tested, and eventually transported off-site for proper disposal.

3.2 Cone Penetration Tests (CPTs)

Two CPTs, designated as CPT-1 and CPT-2, were performed on 1 November 2022 by ConeTec of San Leandro, California, at the approximate locations shown on Figure 2. The CPTs were advanced to approximately 50 and 100 feet bgs.

The CPTs were performed by hydraulically pushing a 1.7-inch-diameter, cone-tipped probe, with a projected area of 15 square centimeters, into the ground. The cone tip measures tip resistance, and the friction sleeve behind the cone tip measures frictional resistance. Electrical strain gauges or load cells within the cone continuously measure the cone tip resistance and frictional resistance during the entire depth of each probing. Accumulated data was processed by computer to provide engineering information, such as the types and approximate strength characteristics of the soil encountered. The CPT logs, showing tip resistance, side friction and friction ratio by depth, as well as interpreted soil classification, are presented in Appendix B. Soil types were estimated using the classification chart shown in Appendix B. Ground surface elevations at each CPT location are provided in Table B-1 in Appendix B.

Pore pressure dissipation tests (PPDTs) were performed during the advancement of each CPT at various depths. The PPDTs were conducted to measure hydrostatic water pressures and to estimate the approximate depth to groundwater. The variation of pore pressure with time is measured behind the tip of the cone and recorded. One PPDT was completed at each CPT location. For this investigation, the duration of the tests ranged from 650 to 820 seconds. The results of the two PPDTs are presented in Appendix B. A summary of interpreted groundwater depths and elevations is included in Table B-1.

While advancing CPT-1, a seismic shear wave velocity survey was performed. The survey consisted of measuring the travel time of shear waves propagating from a seismic energy source on the surface to a detector within the CPT instrument, as the CPT was advanced to various depths. Shear wave velocities were recorded at approximately 3-foot intervals. The shear wave velocity test results are presented in Appendix B.

After completion, the CPTs were backfilled with cement grout in accordance with Valley Water requirements, and the pavement surface was patched.

3.3 Test Pits

One test pit, designated as TP-1, was excavated by others prior to our site visit on 25 October 2022. The approximate location of the test pit is shown on Figure 2. The test pit was excavated to a depth of approximately 3.8 feet below the top of existing floor slab. Our field representative logged the soil and existing foundation type and dimensions, where encountered. Logs of the test pit are included in Appendix C as Figures C-1 and C-2 for Sections A-A' and B-B', respectively. Currently, the test pit has not been backfilled yet.

3.4 Laboratory Testing

The soil samples collected from the field exploration program were reexamined in the office for soil classifications and representative samples were selected for laboratory testing. The laboratory testing program was designed to evaluate engineering properties of the soil at the site. Samples were tested to measure moisture content, dry density, plasticity (Atterberg limits), fines content, shear strength, compressibility, and R-value. Results of the laboratory testing are included on the boring logs and in Appendix D on Figures D-1 through D-5.

3.5 Soil Corrosivity Testing

To evaluate the corrosivity of the soil near the foundation subgrade, we performed corrosivity tests on samples obtained from the upper five feet at boring B-1. The corrosivity of the soil samples was evaluated by CERCO Analytical, Inc. (CERCO), of Concord, California, using the following ASTM Test Methods:

- Redox – ASTM D1498
- pH – ASTM D4972
- Resistivity (100% Saturation) – ASTM G57
- Chloride – ASTM D4327
- Sulfate – ASTM D4327

The laboratory corrosion test results and a brief corrosivity evaluation by CERCO are presented in Appendix E.

4.0 SITE CONDITIONS

The existing site and subsurface conditions observed and encountered at the site, respectively, are discussed in this section.

4.1 Site Conditions

The site is occupied by a three-story office building and paved parking lot. Based on our review of historic aerials (Historic Aerials, 1968 and 1980), construction of the existing building was completed between 1968 and 1980. The site is relatively flat, with the existing ground surface elevations ranging from approximately Elevation 8 to 11 feet (Guida Surveying Inc., 2022).

The surrounding areas are occupied by various commercial businesses, parking structures, and residential neighborhoods. A light rail line for the Santa Clara Valley Transportation Authority (VTA) is present along the center of Tasman Drive, located approximately 1,000 feet south of the site.

4.2 Subsurface Conditions

The surface material encountered consists of approximately 2 to 2½ inches of asphalt concrete (AC) overlying approximately 6 to 8 inches of aggregate base (AB). Beneath the pavement and AB section, the borings and CPTs indicate the site is underlain by recent Holocene deposits that generally consist of moderately compressible alluvial clays interbedded with layers of sand and gravel. The near-surface soil (up to about four to five feet bgs) consists of stiff clay, with a thin layer of clayey gravel at Boring B-1. Atterberg limits tests on the near-surface soil indicate it is highly expansive³ with a plasticity index (PI) of approximately 39 and 40, where tested.

The near-surface clay layer is underlain by medium stiff to very stiff clay and clay with sand layers, interbedded with medium to very dense sand with varying types and amount of fines layers to the maximum depth explored. Based on laboratory test results and CPT data, the undrained shear strength of the clays range from about 1,100 to 5,500 pounds per square foot (psf). Laboratory test results and CPT data indicate the clay has a compression ratios of 0.13 to 0.14, is overconsolidated⁴ with overconsolidated ratios⁵ (OCRs) greater than 3.0.

³ Highly expansive soil undergoes high volume changes with changes in moisture content.

⁴ An overconsolidated clay has experienced a pressure greater than its current load.

⁵ The overconsolidation ratio (OCR) for a soil is defined as the ratio between the maximum sustained pressure the soil has experienced and the present effective vertical pressure.

Groundwater was encountered in the borings at depths between approximately 7 and 8 feet bgs, corresponding to approximately Elevation 1 foot. The groundwater levels were measured at the time of drilling and likely do not represent the stabilized groundwater level. Seasonal fluctuation in rainfall influence groundwater levels and could cause several feet of variation.

The PPDTs conducted at the CPTs were performed at depths between approximately 31.7 and 34.9 feet bgs, in the sand layers. The potentiometric surface of the groundwater was calculated to be approximately 8½ feet bgs, corresponding to approximately Elevation ½ feet. Because the sand layers are confined above and below by clay, the hydrostatic water pressure measured during the PPDTs may not represent static groundwater conditions. A summary of the potentiometric surface levels from the PPDTs is summarized in Table B-1.

Based on the California Geological Survey (CGS) Seismic Hazard Zone Report for the Milpitas Quadrangle (CGS, 2001), the historic high groundwater level in the project vicinity is approximately 5 feet bgs, corresponding to approximate Elevations 3 to 6 feet.

The Foundation Plan by Hill-Adams International Architects & Planners, dated 14 April 1980 show the building is supported on shallow foundations, which was confirmed by test pit TP-1. The test pit indicates the footing is bearing on imported fill material.

5.0 SEISMIC AND GEOLOGIC CONSIDERATIONS

5.1 Regional Seismicity

The major active faults in the area are the Hayward-Rodgers Creek, Monte Vista-Shannon, San Andreas and Calaveras faults. These and other faults of the region are shown on Figure 3. For each of the active faults within 50 kilometers of the site, the distance from the site and estimated mean Moment magnitude⁶ [2014 Working Group on California Earthquake Probabilities (WGCEP) (2015) and Uniform California Earthquake Rupture Forecast Version 3 (UCERF3) as detailed in the United States Geological Survey Open File Report 2013-1165] are summarized in Table 1. The mean Moment magnitude presented on Table 1 was computed assuming full rupture of the segment using the average of the relationships presented in USGS Open-File Report 2013-1165.

⁶ Moment magnitude is an energy-based scale and provides a physically meaningful measure of the size of a faulting event. Moment magnitude is directly related to average slip and fault rupture area.

TABLE 1
Regional Faults and Seismicity

Fault Name	Distance (km)	Direction from Site	Mean Moment Magnitude
Silver Creek	4	East	6.7
Total Hayward-Rodgers Creek Healdsburg	10	Northeast	7.4
Monte Vista - Shannon	12	West	7.0
Mission (connected)	15	Northeast	6.2
Total Calaveras	16	East	7.5
San Andreas 1906 event	18	Southwest	7.9
Pilarcitos	19	West	6.7
Butano	25	Southwest	6.8
Sargent	30	South	6.9
San Gregorio (North)	38	West	7.3
Mount Diablo Thrust	39	Northeast	6.6
Greenville (No)	40	East	6.9
Franklin	49	North	6.7

Note:

1. The table above is a summary and does not include all the fault segmentation, alternate traces and low activity faults included in the UCERF3 model.

Figure 3 also shows the earthquake epicenters for events with magnitude greater than 5.0 from January 1800 through August 2014. Since 1800, four major earthquakes have been recorded on the San Andreas Fault. In 1836 an earthquake with an estimated maximum intensity of VII on the Modified Mercalli (MM) scale (Figure 4) occurred east of Monterey Bay on the San Andreas Fault (Topozada and Borchardt 1998). The estimated Moment magnitude, M_w , for this earthquake is about 6.25. In 1838, an earthquake occurred with an estimated intensity of about VIII-IX (MM), corresponding to an M_w of about 7.5. The San Francisco Earthquake of 1906 caused the most significant damage in the history of the Bay Area in terms of loss of lives and property damage. This earthquake created a surface rupture along the San Andreas Fault from Shelter Cove to San Juan Bautista, approximately 470 kilometers in length. It had a maximum intensity of XI (MM), an M_w of about 7.9, and was felt 560 kilometers away in Oregon, Nevada, and Los Angeles. The Loma Prieta Earthquake occurred on 17 October 1989, in the Santa Cruz Mountains with an M_w of 6.9, approximately 42 km away from the site.

In 1868 an earthquake with an estimated maximum intensity of X on the MM scale occurred on the southern segment (between San Leandro and Fremont) of the Hayward Fault. The estimated M_w for the earthquake is 7.0. In 1861, an earthquake of unknown magnitude (probably an M_w of

about 6.5) was reported on the Calaveras Fault. The most recent significant earthquake on this fault was the 1984 Morgan Hill earthquake ($M_w = 6.2$).

The 2016 U.S. Geologic Survey (USGS) predicted a 72 percent chance of a magnitude 6.7 or greater earthquake occurring in the San Francisco Bay Area in 30 years (Aagaard et al. 2016). More specific estimates of the probabilities for different faults in the Bay Area are presented in Table 2.

TABLE 2
WGCEP (2014) Estimates of 30-Year Probability (2014-2043) of a Magnitude 6.7 or Greater Earthquake

Fault	Probability (percent)
Hayward-Rodgers Creek	33
Calaveras	26
N. San Andreas	22
San Gregorio	16
Greenville	6

5.2 Seismic and Geologic Hazards

During a major earthquake, strong to very strong ground shaking is expected to occur at the project site. Strong ground shaking during an earthquake can result in ground failure such as that associated with soil liquefaction,⁷ lateral spreading,⁸ seismic densification,⁹ or can cause a tsunami. Each of these conditions has been evaluated based on our literature review, field investigation and analysis, and are discussed in this section.

5.2.1 Liquefaction

When saturated soil with little to no cohesion liquefies during a major earthquake, it experiences a temporary loss of shear strength as a result of a transient rise in excess pore water pressure

⁷ Liquefaction is a transformation of soil from a solid to a liquefied state during which saturated soil temporarily loses strength resulting from the buildup of excess pore water pressure, especially during earthquake-induced cyclic loading. Soil susceptible to liquefaction includes loose to medium dense sand and gravel, low-plasticity silt, and some low-plasticity clay deposits.

⁸ Lateral spreading is a phenomenon in which surficial soil displaces along a shear zone that has formed within an underlying liquefied layer. Upon reaching mobilization, the surficial blocks are transported downslope or in the direction of a free face by earthquake and gravitational forces.

⁹ Seismic densification is a phenomenon in which non-saturated, cohesionless soil is densified by earthquake vibrations, causing ground-surface settlement.

generated by strong ground motion. Flow failure, lateral spreading, differential settlement, loss of bearing, ground fissures, and sand boils are evidence of excess pore pressure generation and liquefaction. The site is within a seismic hazard zone, as designated by a map titled *State of California Seismic Hazard Zones, Milpitas Quadrangle* by CGS (2004), as shown on Figure 5. In addition, the property is within a geologic hazard zone for liquefaction, as designated by a map by the County of Santa Clara (County of Santa Clara, 2012).

We performed our liquefaction analysis in accordance with the State of California Special Publication 117A, Guidelines for Evaluation and Mitigation of Seismic Hazards in California and following the procedures in Boulanger and Idriss (2014) to evaluate the liquefaction potential at the site. The Boulanger and Idriss (2014) procedures are updates of the Idriss and Boulanger (2008) procedures and the simplified procedures developed by Seed and Idriss (1971) and later by the 1996 NCEER and the 1998 NCEER/NSF workshops on the Evaluation of Liquefaction Resistance of Soils (Youd and Idriss 2001). To estimate volumetric strain and associated liquefaction-induced settlement, we used the procedure developed by Zhang et al. (2002) for the CPTs.

These methods are used to estimate a factor of safety against liquefaction triggering by taking the ratio of soil strength (resistance of the soil to cyclic shaking) to the seismic demand that can be expected from a design level seismic event. Specifically, two distinct terms are used in the liquefaction triggering analyses:

- Cyclic Resistance Ratio (CRR), which quantifies the soil's resistance to cyclic shaking; a function of soil depth, density, depth of groundwater, earthquake magnitude, and overall soil behavior.
- Cyclic Stress Ratio (CSR), which quantifies the stresses that may develop during cyclic shaking.

The factor of safety (FS) against liquefaction triggering can be expressed as the ratio of CRR over CSR. For our analyses, if the FS for a soil layer is less than 1.3, it is considered possible that the soil layer could liquefy during a large seismic event. For our calculations of estimated liquefaction-induced settlement, we assumed layers with a FS equal to or greater than 1.3 will not experience liquefaction-induced settlement.

The primary design parameters used in our liquefaction triggering calculations are summarized in Table 3.

TABLE 3
Primary Input Parameters Used in Liquefaction Evaluation

Parameter	Value
Depth to historic high groundwater	Approximately 5 feet bgs
Peak Ground Acceleration (PGA _M)*	0.566g
Predominant Earthquake Moment Magnitude (M _w)	8.1
Factor of Safety for Liquefaction Triggering	1.3
CPT conversion factor for tip resistance to SPT N-value	4 to 5

* Values for liquefaction analysis based on our site-specific response spectra per ASCE 7-16 and 2019 California Building Code.

In our analyses, soil that has significant amount of plastic fines, I_p greater than 2.6 were considered too cohesive to liquefy; a corrected cone tip resistance q_{c1N} greater 160 tons per square foot (tsf) were considered too dense to liquefy. Because the predominant earthquake is a moment magnitude 8.1, the cyclic resistance ratio (CRR) has been scaled to a moment magnitude of 7.5 using magnitude scaling factors developed by Boulanger and Idriss (2014).

In our assessment, we considered the approach for soil classification and behavior presented in Robertson (2016). In this approach, CPT data is used to determine dilative and contractive behavior. The soil classification and behavior chart uses the normalized CPT tip resistance and friction ratio to separate material into clayey, sandy, and transitional soil types. The chart further uses another parameter, CD, to divide the dilative and contractive behavior of these soil types. A CD value of 70 or higher separates the soil between contractive and dilative tendencies. To capture transitional and borderline material, we used a CD cut-off value of 80. The CPTs indicate that many of the medium dense sand and low-plasticity silt layers below the groundwater level will likely exhibit dilative behavior and thus not be prone to settlement during earthquake shaking.

We used the results of CPT-1 and CPT-2 to evaluate liquefaction potential; the SPT blow count data from the hollow stem auger borings was judged to be unreliable because of the potential for heave and flow into the augers disturbing the soil below the groundwater table. Layers of loose to medium dense sand with varying amounts of clay and silt, varying in thickness from several inches to 1¼ feet, were encountered below the groundwater level between depths of approximately 10 and 34 feet bgs. Based on our analyses, we conclude several of these layers

could potentially liquefy during a major earthquake and may experience liquefaction-induced settlement.

Using these procedures, we estimate less than one inch of liquefaction-induced settlement could occur at the project site during a major earthquake on a nearby active fault. Differential settlements of up to $\frac{3}{4}$ inch should be expected over a distance of about 30 feet.

5.2.2 Lateral Spreading

Lateral spreading occurs when a continuous layer of soil liquefies at depth and the soil layers above move toward an unsupported face, such as an open slope cut, or in the direction of a regional slope or gradient. The potential for lateral spreading to occur at a site is typically evaluated using an empirical relationship developed by Youd, Hansen, and Bartlett (2002). This relationship incorporates the thickness, fines content, mean grain-size diameter, and relative density of the liquefiable layer, the magnitude and distance of the earthquake from the site, the slope of the ground surface, and boundary conditions (such as a free face or edge of shoreline), to estimate the horizontal ground movement. These empirical relationships indicate that sandy soil layers with $(N_1)_{60}$ values of greater than 15 blows per foot are sufficiently dense to resist the potential for lateral spreading (Youd et al. 2001).

The project site is relatively level and approximately 700 feet east of the Calabazas Creek and 1,500 feet west of the San Tomas Aquino Creek. Our liquefaction analyses indicate there are several layers with $(N_1)_{60}$ values less than 15, however they appear to be discontinuous. Therefore, considering the distance to the nearest free face and the discontinuity of potentially liquefiable layers, we judge the potential for lateral spreading is low.

5.2.3 Seismic Densification

Seismic densification refers to seismically-induced differential compaction of non-saturated granular material (sand and gravel above the groundwater table) caused by earthquake vibrations. The borings and CPTs indicate that the materials above the water table are sufficiently clayey, and therefore the potential for seismic densification is low.

5.2.4 Fault Rupture

Historically, ground surface ruptures closely follow the trace of geologically young faults. The site is not within an Earthquake Fault Zone, as defined by the Alquist-Priolo Earthquake Fault Zoning Act and no known active or potentially active faults exist on the site. Therefore, we conclude the risk of fault offset through the site from a known active fault is low. In a seismically active area,

the remote possibility exists for future faulting in areas where no faults previously existed; however, we conclude that the risk of surficial ground deformation from faulting at the site is low. The property is also not within a geologic hazard zone for fault rupture, as designated by a map titled *Geologic Hazard Zones* by the County of Santa Clara (County of Santa Clara, 2012).

5.2.5 Flooding

The property is located within Federal Emergency Management Agency (FEMA) Flood Zone X, designated as “other flood areas,” which are “area(s) of 0.2% annual chance of flood” (FEMA 2009).

The project civil engineer should further evaluate the future effects of sea level rise and the potential for flooding at the project site. Additionally, the project civil engineer should review the potential impacts to the structures, if flooding were to occur.

5.2.6 Tsunami

The property is not within a potential tsunami flood area as shown on a map prepared jointly by the California Governor’s Office of Emergency Services, the California Geological Survey, Aecom and the University of Southern California (2021).

6.0 DISCUSSION AND CONCLUSIONS

From a geotechnical standpoint, the proposed project is feasible provided the site conditions and geotechnical issues discussed below are properly addressed during the design and construction of the proposed redevelopments. The primary geotechnical issues include:

- the presence of highly expansive near-surface clay
- the presence of shallow groundwater
- presence of moderately compressible clays and potential for settlement under the weight of new building expansion loads
- the potential for liquefaction-induced settlement.

These issues and their impact on the geotechnical aspects of the project are discussed in the following subsections.

6.1 Expansive Soil Considerations

The existing near-surface soil has a high expansion potential. Moisture fluctuations in near-surface expansive soil could cause the soil to expand or contract, resulting in movement and potential damage to improvements that overlie them. Potential causes of moisture fluctuations include drying during construction, subsequent wetting from rain, capillary rise, landscape irrigation, and evapotranspiration from plantings.

For improvements at-grade, the volume changes from expansive soils can cause cracking of foundations, floor slabs and exterior flatwork. Therefore, foundations, slabs and concrete flatwork should be designed and constructed to reduce the effects of the expansive soil. These effects can be mitigated by moisture-conditioning the expansive soil and providing select, non-expansive fill below interior and exterior slabs-on-grade and supporting foundations below the zone of severe moisture change.

An alternative to importing select fill includes lime treatment of the near-surface soil. Lime can reduce the swell potential of the soil and increase its shear strength. Lime stabilization of the at-grade building pads and the subgrade of exterior flatwork can be a cost-effective means of improving on-site soils for use as non-expansive fill. The degree to which lime will react with soil depends on such variables as type of soil, minerals present, quantity of lime, and the length of time the lime-soil mixture is cured. The quantity of lime added generally ranges from 5 to 7 percent by weight and should be determined by laboratory testing. If lime is intended to reduce swelling potential and/or increase the strength of the soil, the contractor should collect a bulk sample of the soil and perform laboratory tests to determine what type of lime will react with the soil and how much lime will be required to reduce the plasticity index to meet the criteria for select fill.

The soil at the site could be wet and difficult to compact during the winter. If required, lime can also be mixed with the on-site soil to aid in compaction.

6.2 Foundations and Settlement

Currently, a site grading plan is not available; however, we understand up to 2 to 3½ feet of fill may be added in the area of the proposed expansion. If new fill is placed to grade the site, we estimate approximately up to ½-inch of consolidation settlement for 2 to 3½ feet of new fill.

The primary considerations related to the selection of the foundation systems are the final building loads, the anticipated building settlements resulting from consolidation of moderately

compressible soil, the potentially liquefiable sand layers and the presence of highly expansive near-surface soil.

The existing structure is supported on shallow foundations, based on the Foundation Plan by Hill-Adams International Architects & Planners, dated 14 April 1980, and has been confirmed by the test pit TP-1. The plans indicate the foundations were designed using an allowable bearing pressure for dead plus live loads of 4,000 psf.

The proposed expansion will be a single-level at-grade structure. Building loads are currently unavailable for the proposed warehouse and storage area expansion. However, based on the proposed height of the structure, we conclude the new structure and ancillary improvements can be supported on a shallow foundation system such as isolated and continuous footings, provided the static and seismically-induced settlement discussed below and in Section 5.2.1 are tolerable.

The proposed structure is susceptible to the following potential sources of settlement:

- consolidation of the underlying alluvial deposits under the weight of new building loads or new fill
- liquefaction-induced settlement.

To evaluate the settlement of the site due to consolidation of the alluvial deposits under the weight of the new building loads, we reviewed the laboratory consolidation tests on relatively undisturbed samples of the clay, as presented in Appendix A and Appendix D. The test results indicate the alluvial clays generally have OCRs greater than 3.0.

Footings designed in accordance with our recommendations in Section 7.2 and for an allowable bearing pressure of 4,000 psf for dead plus live loads, we estimate total static settlement will be up to approximately one inch, with up to ½ inch of differential settlement between columns. We anticipate that about half of this settlement will occur during construction.

As discussed previously, we estimate that less than one inch of liquefaction-induced settlements may occur at the proposed building expansion site; differential settlement between columns may be on the order of ¾ inch during a major earthquake. These settlements are in addition to the predicted total static settlement.

The structural engineer should evaluate the impact of the static and liquefaction-induced settlement to structures supported on spread footing foundations. If the total and differential

settlements are not tolerable, a shallow foundation system over improved ground or deep foundations can be considered.

6.3 Groundwater

During our geotechnical investigations, groundwater was encountered between approximately Elevations ½ and one foot; however, the historic high groundwater is about 5 feet bgs, corresponding to Elevations 3 to 6 feet. Because groundwater levels may fluctuate seasonally, we recommend using a design groundwater level of 5 feet bgs. The contractor should be prepared to dewater excavations deeper than approximately 5 feet bgs.

6.4 Corrosion Potential

Because corrosive soil can adversely affect underground utilities and foundation elements, laboratory testing was performed to evaluate the corrosivity of the near surface soil. CERCO performed tests on soil samples to evaluate corrosion potential to buried metals and concrete. The results of the tests are presented in Table 4 and Appendix E.

TABLE 4
Summary of Corrosivity Test Results

Test Boring	Sample Depth (feet)	pH	Sulfates (mg/kg)	Resistivity (ohms-cm)	Redox (mV)	Chlorides (mg/kg)
B-1	0 to 5	9.23	76	830	270	23

Based upon resistivity measurement, the soil sample tested is classified as “corrosive” to buried iron, steel, cast iron, ductile iron, galvanized steel and dielectric coated steel or iron. The chemical analysis indicates reinforced concrete and cement mortar coated steel should not be affected by the corrosivity of the soil. To protect reinforcing steel from corrosion, adequate coverage should be provided as required by the building code. Corrosivity test results are presented in Appendix E. For more detailed recommendations regarding the corrosion protection of buried metals and concrete, a licensed corrosion consultant should be retained.

6.5 Construction Considerations

The soil at the site consists of materials that can be excavated with conventional earthmoving equipment such as loaders and backhoes, except where concrete foundations and slabs of existing buildings are encountered. Removal of these elements may require the use of jackhammers or hoe-rams. Excavations resulting from the removal of foundations, slabs, and

underground utilities that extend below the bottom of the proposed foundation/floor level will need to be cleaned of any loose soil/debris and backfilled with lean concrete or properly-compacted fill.

The surficial soil is clayey and highly plastic. If earthwork is performed in wet weather conditions, it could be difficult to compact the soil; it might need to be aerated during dry weather. Alternatively, the soil could be lime treated as discussed in Section 6.1. Light grading equipment may be needed to avoid damaging the subgrade.

7.0 RECOMMENDATIONS

From a geotechnical standpoint, the site can be developed as planned, provided the recommendations presented in this section of the report are incorporated into the design and contract documents. Recommendations for foundation design, floor slabs, earthwork, and seismic design are presented in this section of the report.

7.1 Earthwork

The following subsections present recommendations for site preparation and lime treatment, if needed.

7.1.1 Site Preparation

Demolition in areas to be developed should include the removal of existing pavement and underground obstructions, including foundations of previous structures at the site. Any vegetation and organic topsoil should be stripped in areas to receive new site improvements. Stripped organic soil can be stockpiled for later use in landscaped areas, if approved by the owner and architect. Organic topsoil should not be used as compacted fill.

Demolished asphalt and concrete at the site can be crushed to provide recycled construction materials, including sand or Class 2 aggregate base (AB), provided their re-use onsite is acceptable from an environmental standpoint. Where recycled Class 2 AB will be used beneath pavements, it should meet requirements of the Caltrans Standard Specifications. Recycled Class 2 AB that does not meet the Caltrans specifications should not be used beneath City streets, but it is acceptable for use as select fill within building pads and beneath concrete flatwork, provided it meets the requirements for select fill as presented later in this section.

Existing underground utilities beneath areas to receive new improvements should be removed or abandoned in-place by filling them with grout. The procedure for in-place abandonment of

utilities should be evaluated on a case-by-case basis and will depend on location of utilities relative to new improvements. However, in general, existing utilities within four feet of final grades should be removed, and the resulting excavation should be properly backfilled based on the recommendations presented in this section.

To reduce the effects of expansive soil, we recommend at least 24 inches of imported (select) material be placed in the area of the proposed structures constructed at-grade. The select fill should extend at least five feet beyond building footprint. Prior to placement of select fill in building areas, the onsite soil exposed by stripping should be scarified to a depth of at least 12 inches, moisture-conditioned to at least three percent above optimum moisture content and compacted to between 88 and 93 percent relative compaction¹⁰. The soil subgrade should be kept moist until it is covered by select fill. If site grading occurs in late summer or in fall, the surface soil may be dry to depths exceeding 12 inches. Therefore, prior to grading, we should perform moisture content tests on the upper three feet of soil in building areas. Surface soil that has a moisture content of less than 25 percent (the approximate plastic limit of the soil) should be excavated, moisture-conditioned to at least three percent above optimum moisture content, and recompacted to between 88 and 93 percent relative compaction to reduce its expansion potential. Based on our experience in the project area, we judge the maximum depth of required excavation for moisture conditioning will be two feet.

An exception to this general procedure is within any proposed vehicle pavement areas, where the upper six inches of the pavement subgrade should be moisture conditioned to near optimum and compacted to at least 95 percent relative compaction regardless of expansion potential.

The clay exposed at the subgrade will be susceptible to disturbance under construction equipment loads. If the subgrade is disturbed during the rainy season, it may be necessary to scarify, aerate and recompact. However, it may take several weeks of dry weather to dry out sufficiently to obtain proper compaction. Alternatively, a minimum 12-inch-thick working pad consisting of crushed rock could be placed on top of the subgrade or lime treating the upper 12 inches of the subgrade to winterize it. If the subgrade is disturbed, it should be rescarified and recompacted.

Any select fill placed during grading should meet the following criteria:

¹⁰ Relative compaction refers to the in-place dry density of soil expressed as a percentage of the maximum dry density of the same material, as determined by the ASTM D1557-07 laboratory compaction procedure.

- be free of organic matter
- contain no rocks or lumps larger than three inches in greatest dimension
- have a low expansion potential (defined by a liquid limit of less than 40 and plasticity index lower than 12)
- have a low corrosion potential¹¹
- be approved by the geotechnical engineer.

Select fill should be moisture-conditioned to above optimum moisture content, placed in horizontal lifts not exceeding eight inches in loose thickness, and be compacted to at least 90 percent relative compaction, except for fill that is placed within the proposed pavement areas. In these situations, the upper six inches of the soil subgrade and aggregate baserock materials should be compacted to at least 95 percent relative compaction. Where used, sand containing less than 10 percent fines (particles passing the No. 200 sieve), or any fill deeper than five feet, should also be compacted to at least 95 percent relative compaction for its entirety. Samples of on-site and proposed import fill materials should be submitted to the geotechnical engineer for approval at least three business days prior to use at the site.

The near-surface clays do not meet the criteria for reuse as select fill; however, the clay may be used as general site fill below the select fill, provided the soil is moisture-conditioned to at least three percent above optimum moisture content, placed in horizontal lifts not exceeding eight inches in loose thickness, and recompacted to between 88 and 93 percent relative compaction.

7.1.2 Lime Treatment

Lime treatment of fine-grained soils generally includes site preparation, application of lime, mixing, compaction, and curing of the lime treated soil. Field quality control measures should include checking the depth of lime treatment, degree of pulverization, lime spread rate measurement, lime content measurement, and moisture content and density measurements, and mixing efficiency. Quality control may also include laboratory tests for unconfined compressive strength tests or plasticity indices on representative samples.

The lime treatment process should be designed by a contractor specializing in its use and who is experienced in the application of lime in similar soil conditions. Based on our experience with

¹¹ Low corrosion potential is defined as a minimum resistivity of 2,000 ohms-cm and maximum sulfate and chloride concentrations of 250 parts per million.

lime treatment, we judge that the specialty contractor should be able to treat the highly expansive on-site material to produce a non-expansive fill for building subgrade, if needed.

If the lime treatment alternative is selected to mitigate the effects of highly expansive soil, we recommend that the specialty contractor prepare a treatment specification for our review and perform laboratory tests on selected samples of the highly expansive soil to check the type and amount of lime necessary to reduce the PI of the soil to meet the select fill criteria prior to construction. Lime treatment should extend at least two feet beyond the limits of the building pad, if treating expansive soil, etc.

7.2 Shallow Foundations

We concluded that the proposed building expansion and lightweight structures can be supported on a shallow foundation system consisting of spread footings (continuous perimeter footing and isolated interior footings) bearing on native soil, provided the settlement discussed in Section 6.2 are tolerable to the structural design, and the foundations are designed in accordance with our recommendations in this section.

The footings should be at least 18 inches wide for continuous footings and 24 inches wide for isolated spread footings. To reduce the effects of expansive soil, we recommend that perimeter footings be embedded at least 36 inches below the lowest adjacent final soil subgrade, and interior spread footings be embedded at least 30 inches below the lowest adjacent final soil subgrade. If new footings are adjacent to existing footings, they should bottom at the same depth as the existing footing or the previously recommended embedment depths, whichever is deeper. Footings adjacent to utility trenches should bear below an imaginary 1.5:1 (horizontal to vertical) plane projected upward from the bottom edge of the utility trench.

At these bearing depths, we expect the soil will consist of native stiff clay. Shallow foundations bearing on native, undisturbed soil can be designed for an allowable bearing pressure of 4,000 psf for dead plus live loads and may be increased by one third for total design loads, including wind or seismic forces.

Lateral loads on footings can be resisted by a combination of passive resistance acting against the vertical faces of the footings and friction along the bases of the footings. We recommend a passive resistance be calculated using a lateral pressure corresponding to a uniform pressure of 2,000 psf; the upper foot of soil should be ignored unless confined by a concrete slab or pavement. Frictional resistance should be computed using a base friction coefficient of 0.30.

The passive resistance and base friction values include a factor of safety of about 1.5 and may be used in combination without reduction.

The exposed subgrade for the footing should be free of standing water, debris, and disturbed materials prior to constructing the footing. We should check the footing subgrade after cleaning, but prior to placement of reinforcing steel to confirm bearing, moisture condition, and that loose and disturbed material has been removed. If loose or disturbed material is observed in the footing excavation, it should be overexcavated to firm, competent material and replaced with lean concrete or engineered fill. Maintaining proper moisture will likely require wetting the excavations periodically until the concrete is placed; if the soil becomes desiccated and cracks form, it may be necessary to overexcavate to remove the desiccated soil.

7.3 Floor Slabs

Because expansive soil is present near the existing ground surface, the slab on grade should be underlain by 24 inches of select fill (or lime treated soil) and the subgrade should be prepared in accordance with Section 7.1.1. If the subgrade is disturbed during excavation for footings and utilities, it should be re-rolled. Where soft or loose soil is present at the subgrade elevation prior to placing select fill, the weak soil should be removed and replaced with engineered fill or lean concrete.

Moisture is likely to condense on the underside of the ground floor slabs, even though it is above the design groundwater level. Consequently, a moisture barrier should be considered if movement of water vapor through the slabs would be detrimental to its intended use. A typical moisture barrier consists of a capillary moisture break and a water vapor retarder. A moisture barrier is generally not required beneath parking garage slabs, except for areas beneath mechanical, electrical, and storage rooms. If a capillary moisture break is not used below warehouse slabs with vehicular traffic, the slabs should be underlain by at least 6 inches of Class 2 AB.

The capillary moisture break should consist of at least four inches of clean, free-draining gravel or crushed rock. The vapor retarder should meet the requirements for Class C vapor retarders stated in ASTM E1745. The vapor retarder should be placed in accordance with the requirements of ASTM E1643. These requirements include overlapping seams by six inches, taping seams, and sealing penetrations in the vapor retarder. The particle size of the gravel/crushed rock should meet the gradation requirements presented in Table 5.

TABLE 5
Gradation Requirements for Capillary Moisture Break

Sieve Size	Percentage Passing Sieve
<i>Gravel or Crushed Rock</i>	
1 inch	90 – 100
3/4 inch	30 – 100
1/2 inch	5 – 25
3/8 inch	0 – 6

Concrete mixes with high water/cement (w/c) ratios result in excess water in the concrete, which increases the cure time and results in excessive vapor transmission through the slab. Therefore, concrete for the floor slab should have a low w/c ratio - less than 0.45. The slab should be properly cured. Before the floor covering is placed, the contractor should check that the concrete surface and the moisture emission levels (if emission testing is required) meet the manufacturer's requirements.

7.4 Seismic Design

For seismic design in accordance with the provisions of 2019 California Building Code (CBC), a site-specific response analysis is required to be performed for Site Class D, unless the project structural engineer applies the structural exceptions in Section 11.4.8 of ASCE 7-16. If the exceptions are applied, the following parameters may be used:

- Risk-Targeted Maximum Considered Earthquake (MCE_R) S_s and S_1 of 1.500g and 0.600g, respectively.
- Site Class D
- Site Coefficients F_a and F_v of 1.0 and 1.7, respectively, assuming the exemptions of Section 11.4.8 are met.
- MCE_R spectral response acceleration parameters at short periods, S_{MS} , and at one-second period, S_{M1} , of 1.500g and 1.020g, respectively
- Design Earthquake (DE) spectral response acceleration parameters at short period, S_{DS} , and at one-second period, S_{D1} , of 1.000g and 0.680g, respectively
- Peak ground acceleration, PGA_M of 0.612g

We understand the exceptions will likely not be applied; therefore, a site-specific response analysis was requested. We performed probabilistic seismic hazard analysis (PSHA) and deterministic analysis to develop recommended horizontal spectra at the ground surface for the Risk Targeted Maximum Considered Earthquake (MCE_R) and Design Earthquake (DE) consistent with ASCE 7-16 and 2019 CBC.

The recommended spectra are presented on Figure F-8 for 5 percent damping; digitized values of the MCE_R and DE spectra, respectively, for damping ratio of 5 percent are presented in Table 6.

TABLE 6
Recommended MCE_R , and DE Spectra
Spectral Acceleration (g's)

Period (seconds)	MCE_R (5% damping)	DE (5% damping)
0.01	0.673	0.449
0.10	1.058	0.706
0.20	1.485	0.990
0.30	1.694	1.129
0.40	1.732	1.155
0.50	1.680	1.120
0.75	1.393	0.929
1.00	1.214	0.809
1.50	0.889	0.593
2.00	0.685	0.457
3.00	0.481	0.320
4.00	0.363	0.242
5.00	0.278	0.186

Note:

1. DE and MCE_R correspond to the Design Earthquake and Risk-Targeted Maximum Considered Earthquake, respectively, per CBC 2019/ASCE 7-16.

Because site-specific procedure was used to determine the recommended response spectra, the corresponding values of S_{MS} , S_{M1} , S_{DS} and S_{D1} per Section 21.4 of ASCE 7-16 should be used, as shown in Table 7.

Furthermore, we developed time series for the project. Details of our analysis are presented in Appendix F.

TABLE 7
Design Spectral Acceleration Value

Parameter	Spectral Acceleration Value (g's)
S_{MS}	1.559 ¹²
S_{M1}	1.450 ¹³
S_{DS}	1.039 ¹²
S_{D1}	0.967 ¹³

7.5 Asphalt Pavements

Based on our review of the civil as-built plans¹⁴, we understand the existing pavement located on the north side of the building is designated as a “truck driveway” and consists of an asphalt pavement section of 2½ inches of asphaltic concrete (AC) over 6 inches of Class 2 aggregate base (AB) and 9½ inches of Class 2 aggregate subbase. The remaining asphalt pavement areas are designated as “auto driveway & parking” and consist of an asphalt pavement section of 2 inches of AC over 6 inches of AB and 5 inches aggregate subbase. We understand all pavement areas will be used for construction truck traffic during construction. After completion of construction, the existing “truck driveway” aisle will be used as a fire lane, and the existing drive aisle south of the building previously constructed as “auto driveway & parking” will be utilized for truck operations. The proposed fire lane and truck route are presented on Figure 6.

We performed a site visit to assess the condition of pavement under current loading conditions. Our observations are summarized and presented on Figure 6. Where zones are shaded green on Figure 6, the pavement in these areas were recently re-paved and little damage or cracking was observed. The yellow zones indicate the pavement is moderately aged with minor to moderate damage in these areas. We conclude the yellow-zoned pavement likely still has several years of service life remaining before maintenance or re-paving is required. The red zones indicate the pavement is heavily aged, and maintenance or re-paving is recommended in these areas.

¹² S_{MS} and S_{DS} are based on the site-specific response spectra and are based on 90 percent of the maximum spectral acceleration within the period range of 0.2 to 5 seconds; they are governed by 90 percent of the spectral acceleration at a period of 0.4 second.

¹³ S_{M1} and S_{D1} are based on the site-specific response spectra and are the maximum of the product of period, T, and spectral acceleration, S_a , for periods from 1.0 to 5.0 seconds; they are governed by the product of the period and spectral acceleration at a period of 4.0 seconds.

¹⁴ Creegan & D’Angelo Consulting Engineers (1979), “W. F. Batton Office Building for Dysan Corp., 5401 Patrick Henry Drive, Santa Clara, California,” dated 5 December 1979.

For the proposed truck route, we understand the pavement will be replaced. For the areas beyond the proposed truck route (as shown on Figure 6), we understand the existing pavement (including the proposed fire lane section) will remain in place until the pavement conditions require maintenance or replacement. It should be noted that a significant portion of the pavement is moderately aged and may require maintenance or re-paving in the near future in these areas. In addition, the existing pavement within the proposed fire lane area does not meet the recommended standards developed from the State of California flexible pavement design method, as presented in Table 8. However, we conclude it is sufficient to support the imposed load of fire apparatus per AASHTO Guide for Design of Pavement Structures (1993).

For the proposed truck route, the estimated truck traffic includes a 55-foot-long 18-wheeler three times a week and a 3-axle box truck twice a day. Additionally, the proposed fire lane requires the paved surface to support the imposed load of fire apparatus with a gross vehicular weight of 75,000 pounds¹⁵. Based on the anticipated traffic and wheel loads, we conclude a Traffic Index (TI) of 6 is appropriate for both the proposed truck route and fire lane.

The State of California flexible pavement design method was used to develop the recommended asphalt concrete pavement sections. We expect the final soil subgrade in asphalt-paved areas will generally consist of on-site clay. On the basis of the laboratory test results, we selected an R-value of 5 for design.

For the proposed truck route and fire lane, our recommendations for asphalt pavement sections is presented in Table 8.

TABLE 8
Pavement Section Design for Proposed Truck Route and Fire Lane

	TI	Asphalt Concrete (inches)	Class 2 Aggregate Base R = 78 (inches)	Class 2 Aggregate Subbase R = 50 (inches)
Proposed Fire Lane	6	3.5	5	9.5
Proposed Truck Route	6	6.5	6.5	0

¹⁵ Santa Clara Fire Department (2021), "Fire Department Emergency Apparatus Access" dated 24 October 2021.

For recommendations regarding pavement section in other areas, we assumed a Traffic Index (TI) of 4 for automobile parking areas with occasional trucks, and 5 and 6 for driveways and truck-use areas; these TIs should be confirmed by the project civil engineer. Table 9 presents our recommendations for asphalt pavement sections in other areas.

TABLE 9
Pavement Section Design in Other Areas

TI	Asphalt Concrete (inches)	Class 2 Aggregate Base R = 78 (inches)
4	2.5	8
5	3	10
6	3.5	13

Pavement components should conform to the current Caltrans Standard Specifications. The upper six inches of the soil subgrade in pavement areas should be moisture-conditioned to above optimum and compacted to at least 95 percent relative compaction and rolled to provide a smooth non-yielding surface. Aggregate base should be compacted to at least 95 percent relative compaction.

7.6 Concrete Pavements

Differential ground movement due to expansive soil and settlement will tend to distort and crack concrete pavements and rigid exterior improvements such as courtyards and sidewalks. Periodic repairs and replacement of exterior improvements should be expected during the life of the project. Mastic joints or other positive separations should be provided to permit any differential movements between exterior slabs and the buildings.

To reduce the potential for cracking related to expansive soil, we recommend exterior concrete flatwork be underlain by at least 12-inches of select fill, of which the upper four inches should consist of aggregate base compacted to at least 90 percent relative compaction for non-vehicular areas. Lime-treated on-site soil can be used in lieu of select fill. The subgrade should be compacted to at least 90 percent relative compaction, and should provide a smooth, non-yielding surface for support of the concrete slabs. For exterior concrete slabs, we recommend the slab be reinforced with a minimum of No. 3 bars at 18-inch-spacing in both directions. For 4- and 6-inch-thick slabs, we recommend a maximum expansion joint spacing of 15 feet.

Where rigid pavement is required for loading and service areas, we recommend a minimum of six inches of concrete for medium traffic and a minimum of eight inches of concrete for heavy traffic. The concrete should be underlain by at least 12-inches of select fill, of which the upper six inches should consist of aggregate base. Lime-treated on-site soil can be used in lieu of select fill. The upper six inches of subgrade should be compacted to at least 95 percent relative compaction and should provide a smooth, non-yielding surface. All aggregate base material should conform to the current State of California Department of Transportation (Caltrans) Standard Specifications for Class 2 Aggregate Base.

The modulus of rupture of the concrete should be at least 500 psi at 28 days. Contraction joints should be constructed at 15-foot spacing. Where the outer edge of a concrete pavement meets asphalt pavement, the concrete slab should be thickened by 50 percent at a taper not to exceed a slope of 1 in 10. For loading docks, we recommend the slab be reinforced with a minimum of No. 4 bars at 16-inch-spacing in both directions. Recommendations for subgrade preparation and aggregate base compaction for concrete pavement are the same as those we have described for asphalt pavement.

7.7 Utilities

The corrosivity results provided in Appendix E of this report should be reviewed and corrosion protection measures used, if needed. We recommend a corrosion consultant be retained when detailed corrosion protection recommendations are needed.

Utility trenches should be excavated a minimum of four inches below the bottom of pipes or conduits and have clearances of at least four inches on both sides. Where necessary, trench excavations should be shored and braced, in accordance with all safety regulations, to prevent cave-ins. If trenches extend below the groundwater level, it will be necessary to temporarily dewater them to allow for placement of the pipe and/or conduits and backfill.

To provide uniform support, pipes or conduits should be bedded on a minimum of four inches of sand or fine gravel. After pipes and conduits are tested, inspected (if required), and approved, they should be covered to a depth of six inches with sand or fine gravel, which should then be mechanically tamped. Backfill should be placed in lifts of eight inches or less, moisture-conditioned, and compacted to at least 90 percent relative compaction. If fill with less than 10 percent fines is used, the entire depth of the fill should be compacted to at least 95 percent relative compaction. Jetting of trench backfill should not be permitted. Special care should be

taken when backfilling utility trenches in pavement areas. Poor compaction may cause excessive settlements resulting in damage to the pavement section.

Where utility trenches backfilled with sand or gravel enter the building pads, an impermeable plug consisting of low-expansion potential clay or lean concrete, at least five feet in length, should be installed at the building line. Furthermore, where sand- or gravel-backfilled trenches cross planter areas and pass below asphalt or concrete pavements, a similar plug should be placed at the edges of the pavement. The purpose of these plugs is to reduce the potential for water to become trapped in trenches beneath the building or pavements. This trapped water can cause heaving of soils beneath slabs and softening of subgrade soil beneath pavements.

7.8 Site Drainage

Positive surface drainage should be provided around the building to direct surface water away from the existing building foundations. To reduce the potential for water ponding adjacent to the buildings, we recommend the ground surface within a horizontal distance of five feet from the buildings be designed to slope down and away from the buildings with a surface gradient of at least two percent in unpaved areas and one percent in paved areas. In addition, roof downspouts should be discharged into controlled drainage facilities to keep the water away from the foundations.

We recommend bioretention swales be located a minimum of five feet away from building foundations, where shallow foundations are used.

Drainage control design should include provisions for positive surface gradients so that surface runoff is not permitted to pond, particularly adjacent to structures, or on roadways or pavements. Surface runoff should be directed away from foundations to properly designed and installed drop inlets.

7.9 Bioretention Systems

Bioretention areas are landscaping features used to treat stormwater runoff within a development site. They are commonly located in parking lot islands and landscape areas. Surface runoff is directed into shallow, landscaped depressions, which usually include mulch and a prepared soil mix. Typically, the filtered runoff is collected in a perforated underdrain beneath the bioretention system and returned to the storm drain system. For larger storms, runoff will generally overflow the bioretention areas and is diverted to the storm drain system.

The soil within a bioretention system should typically have an infiltration rate sufficient to draw down any pooled water within 48 hours after a storm event. Bioretention soil should be installed in accordance with the Santa Clara County's C.3 stormwater technical guidelines and include an underdrain system with a waterproof liner on the sides and bottom of the bioretention swale.

Underdrains are typically at the invert of the bioretention system to intercept water that does not infiltrate into the surrounding soils. Underdrains consist of a perforated PVC pipe surrounded by two to three inches of Class 2 Permeable material (Caltrans Standard Specifications Section 68-2.02F(3)). The perforated PVC pipe cross-section area should be determined based on the desired hydraulic conductivity of the underdrain. Underdrains should be installed in accordance with the Santa Clara County's C.3 stormwater technical guidelines.

Because of the presence of near surface expansive soil, bioretention systems should be set back a minimum of five feet from building foundations, slabs, concrete flatwork or pavements. Overflow from bioretention areas should be directed to the storm drain system away from building foundations and slabs. If bioretention systems are closer than five feet, passive resistance of foundation elements should be neglected.

Typically, the bottom of the bioretention system is recommended to be a minimum of two feet or more above the groundwater table.

7.10 Landscaping

The use of water-intensive landscaping around the perimeter of the buildings should be avoided to reduce the amount of water introduced to the subgrade. Irrigation of landscaping around the buildings should be limited to drip or bubbler-type systems. Trees with large roots or have high water demand should also be avoided since they can dry out the soil beneath foundations and cause settlement. The purpose of these recommendations is to avoid large differential moisture changes adjacent to the foundations, which have been known to cause significant differential movement over short horizontal distances in expansive soil, resulting in cracking of slabs and architectural damage.

To reduce the potential for irrigation water entering the pavement section, vertical curbs adjacent to landscaped areas should extend through any aggregate base and at least six inches into the underlying soil. In heavily watered areas, such as lawns, it may also be necessary to install a subdrain behind the curb to intercept excess irrigation water.

8.0 ADDITIONAL GEOTECHNICAL SERVICES

Prior to construction, we should review the project plans and specifications to check their conformance with the intent of our recommendations. During construction, we should observe the installation of the shallow foundations and preparation of the building pad subgrade. We should also observe the subgrade preparation and any fill placement and perform field density tests to check that adequate moisture conditioning and fill compaction has been achieved beneath proposed sidewalks and pavement areas. These observations will allow us to compare the actual with the anticipated soil conditions and to check that the contractor's work conforms with the geotechnical aspects of the plans and specifications.

9.0 LIMITATIONS

The conclusions and recommendations presented in this report apply to the site and construction conditions as we have described them and are the result of engineering studies and our interpretations of the existing geotechnical conditions. Actual subsurface conditions may vary. If any variations or undesirable conditions are encountered during construction, or if the proposed construction will differ from that described in this report, Langan should be notified so that supplemental recommendations can be developed. Our scope of services relates solely to the geotechnical aspects of the project and does not address environmental concerns.

REFERENCES

- 2014 Working Group on California Earthquake Probabilities, (2015). "UCERF3: A new earthquake forecast for California's complex fault system," U.S. Geological Survey 2015–3009, 6 p., <http://dx.doi.org/10.3133/fs20153009>.
- Aagaard, B. T., Blair, J. L., Boatwright, J., Garcia, S. H., Harris, R. A., Michael, A. J., Schwartz, D. P., and DiLeo, J.S. (2016). "Earthquake Outlook for the San Francisco Bay Region 2014–2043 (ver. 1.1, August 2016), U.S. Geological Survey Fact Sheet 2016–3020, 6 p. <http://dx.doi.org/10.3133/fs20163020>
- Abrahamson, N. A., Silva, W. J., and Kamai, R. (2014). "Summary of the ASK14 Ground-motion Relation for Active Crustal Regions." *Earthquake Spectra*, Vol. 30, No. 3, p. 1025-1055.
- Abrahamson, N. A. (2000). "Effect of Rupture Directivity on Probabilistic Seismic Hazard Analysis." *Proceedings of Sixth International Conference on Seismic Zonation*, Palm Springs, California, November.
- American Association of State Highway and Transportation Officials (AASHTO) (1993). "Guide for Design of Pavement Structures."
- ASCE/SEI 7-16 (2016). *Minimum Design Loads for Buildings and Other Structures*.
- ASCE 7-16 Supplement No. 1 Proposal Form (2018). ASCE/SEI 7-16 Section 21.2.2 and the commentary to Sections 21.2.2 and 21.3. Revised 9 April.
- Boore, D. M., Stewart, J. P., Seyhan, E., and Atkinson, G. M. (2014). "NGA-West 2 Equations for Predicting PGA, PGV, and 5% Damped PSA for Shallow Crustal Earthquakes." *Earthquake Spectra*, Vol. 30, No. 3, p. 1057-1085.
- Boulanger, R.W. and Idriss, I.M. (2014). "CPT and SPT Based Liquefaction Triggering Procedures." Department of Civil & Environmental Engineering, College of Engineering, University of California at Davis, Center for Geotechnical Modeling, Report No. UCD/CGM-14/01. April.
- Bray, J. D. and Sancio, R. B. (2006). "Assessment of the Liquefaction Susceptibility of Fine-Grained Soils," *Journal of Geotechnical and Geoenvironmental Engineering*, Vol. 132, No. 9, ASCE.
- California Building Standards Commission (2019). *California Building Code*.
- California Division of Mines and Geology (2008). "Guidelines for Evaluating and Mitigating Seismic Hazards in California." Special Publication 117A.

REFERENCES (Continued)

- California Division of Mines and Geology (1996). *Probabilistic Seismic Hazard Assessment for the State of California*, CDMG Open-File Report 96-08. California Geological Survey (2001). *Seismic Hazard Zone Report for the Milpitas 7.5-Minute Quadrangle, Alameda and Santa Clara Counties, California*.
- California Geological Survey (2004). *State of California Seismic Hazard Zones, Milpitas Quadrangle, Official Map*.
- Campbell, K. W., and Bozorgnia, Y. (2014). "NGA-West2 Ground Motion Model for the Average Horizontal Components of PGA, PGV, and 5% Damped Linear Acceleration Response Spectra." *Earthquake Spectra*, Vol. 30, No. 3, p. 1087-1115.
- Cao, T., Bryant, W. A., Rowshandel, B., Branum D. and Wills, C. J. (2003). "The Revised 2002 California Probabilistic Seismic Hazard Maps."
- Cetin, K. O., and Seed, R. B. (2004). "Nonlinear shear mass participation factor (rd) for cyclic shear stress ratio evaluation." *Soil Dynamics and Earthquake Engineering*, Elsevier, 24: 103-113.
- Cetin, K. O., Bilge, H.T., Wu, J., Kammerer, A.M., and R.B. Seed (2009). *Probabilistic Model for the Assessment of Cyclically Induced Reconsolidation (Volumetric) Settlements*. *Journal of Geotechnical and Geoenvironmental Engineering*, Vol. 135, Issue 3 (March 2009).
- Chiou, B. S.-J. and Youngs, R. R. (2014). "Update of the Chiou and Youngs NGA Model for the Average Horizontal Component of Peak Ground Motion and Response Spectra." *Earthquake Spectra*, Vol. 30, No. 3, p. 1117-1153.
- Cornell, C. A. (1968). "Engineering Seismic Risk Analysis." *Bulletin of the Seismological Society of America*, 58(5).
- County of Santa Clara (2012). *Geologic Hazard Zone Map, Sheet 11*.
- Creegan & D'Angelo Consulting Engineers (1979), "W. F. Batton Office Building for Dysan Corp., 5401 Patrick Henry Drive, Santa Clara, California," dated 5 December 1979.
- Division of Occupational Safety and Health (2018). *Cal/OSHA – Title 8 Regulations*.
- Earthquake Solutions (2022). "QuakeManager" Version 2.20 – Advanced.
- Federal Emergency Management Agency (2009). "Flood Insurance Rate Map, Santa Clara County, California, Panel 61 of 830, Map Number 06085C0061H," Effective May 18, 2009.
- Federal Emergency Management Agency (2009). "Flood Insurance Rate Map, Santa Clara County, California, Panel 63 of 830, Map Number 06085C0063H," Effective May 18, 2009.

REFERENCES (Continued)

Field, E.H. et al. (2015). "Long-Term Time-Dependent Probabilities for the Third Uniform California Earthquake Rupture Forecast (UCERF3), *Bulletin of the Seismological Society of America*, Vol 105, No. 2A pp. 511-543.

Field, E. H., Biasi, G. P., Bird, P., Dawson, T. E., Felzer, K. R., Jackson, D. D., Johnson, K. M., Jordan, T. H. Madden, C., Michael, A.J., Milner, K. P., Page, M. T., Parsons, T., Powers, P. M., et al. (2013). "Uniform California earthquake rupture forecast, version 3 (UCERF3) – The time-independent model: U.S. Geological Survey Open-File Report 2013-1165", California Geological Survey Special Report 228, and Southern California Earthquake Center Publication 1792, p. 97, <http://pubs.usgs.gov/of/2013/1165/>.

Gensler (2022). "Site Planning Studies, 5201 Patrick Henry Drive", dated 7 July 2022.

Golesorkhi, R. and Gouchon, J. (2002). "Near-source effects and correlation to recent recorded data." *Proceedings of Seventh US National Conference on Earthquake Engineering*, Boston.

Gregor, N., Al Atik, L., Bozorgnia, Y., and Mazzoni, S. (2018). "Deterministic Analysis Within the UCERF3 Seismic Source Characterization for California." Eleventh U.S. National Conference on Earthquake Engineering.

Guida Surveying Inc. (2022). "Topographic Mapping, 5201 Patrick Henry Drive, City of Santa Clara, State of California", dated 1 December 2022.

Gutenberg, B. and Richter, C. F. (1954). "Seismicity of the Earth and Associated Phenomena."

Historic Aerials. 2022, 5201 Patrick Henry Drive, Santa Clara, California, Historical Aerials for 1968 and 1980, viewed 13 July 2022. <https://www.historicaerials.com/viewer>

Holzer, T.L. et al. (2008). "Liquefaction Hazard Maps for Three Earthquake Scenarios for the Communities of San Jose, Campbell, Cupertino, Los Altos, Los Gatos, Milpitas, Mountain View, Palo Alto, Santa Clara, Saratoga and Sunnyvale, Northern Santa Clara County." USGS Open File Report 2008-1270.

Idriss, I.M. and Boulanger, R.W. (2008). "Soil Liquefaction During Earthquakes." Earthquake Engineering Research Institute. Monograph MNO-12.

Kamai, R., Abrahamson, N.A., and Silva, W.J., 2016, V_{s30} in the NGA GMPEs – Regional Differences and Suggested Practice: Earthquake Spectra, v. 32, p. 2083-2108.

Langan (2022). "Landscaping Planting Plan, DPR Silicon Valley Office Project," dated 19 October 2022.

REFERENCES (Continued)

- Lienkaemper, J.J. (1992). "Map of recently active traces of the Hayward Fault, Alameda and Contra Costa counties, California." Miscellaneous Field Studies Map MF-2196.
- Mazzoni et al. (2023). "The Natural Hazards Risks and Resiliency Research Center (NHR3) Web Portal, Directivity-Based PHSA Interactive Tool for California."
- McGuire, R. K. (1976). "FORTRAN computer program for seismic risk analysis." U.S. Geological Survey, Open-File Report 76-67.
- Pradel, Daniel (1998). "Procedure to Evaluate Earthquake-Induced Settlements in Dry Sand," Journal of Geotechnical and Geoenvironmental Engineering, April, and errata October 1998, pp1048.
- Robertson, P.K. (2016). "Cone Penetration Test (CPT)-Based Soil Behaviour Type (SPT) Classification System – An Update." Canadian Geotechnical Journal 00 1-18, 23 June.
- Santa Clara Fire Department (2021), "Fire Department Emergency Apparatus Access" dated 24 October 2021.
- Seed, H.B. and Idriss, I.M. (1971). "Simplified Procedure for Evaluating Soil Liquefaction during Earthquakes," Journal of Geotechnical Engineering Division, ASCE, 97 (9), 1249-1273.
- Shahi, S. K. and Baker, J. W. (2014). "NGA-West2 Models for Ground Motion Directionality." Earthquake Spectra, Vol. 30, No. 3, p. 1285-1300.
- Singh, J.P. (1985). "Earthquake ground motions: Implications for designing structures and reconciling structural damage." *Earthquake Spectra*, Volume 1, No. 2, pp. 239-270.
- Sitar, N., E.G. Cahill and J.R. Cahill (2012). "Seismically Induced Lateral Earth Pressures on Retaining Structures and Basement Walls."
- SmithGroup (2022). "DPR Silicon Valley Office, 5201 Patrick Henry, LLC," dated 8 December 2022.
- Somerville, P.G., Smith, N. F., Graves, R. W., and Abrahamson, N. A. (1995). "Representation of near-fault directivity effects in design ground motion, and application to Caltrans bridges." *Seismological Research Letter*, 68(1), 199-222.
- Somerville, P.G., Smith, N. F., Graves, R. W., and Abrahamson, N. A. (1997). "Modification of empirical strong ground motion attenuation relations to include amplitude and duration effects of rupture directivity." *Seismological Research Letter*, 68(1), 199-222.
- State of California (2021). *Tsunami Hazard Area Map*, Santa Clara County, produced by the California Geological Survey and the California Governor's Office of Emergency Services.

REFERENCES (Continued)

Topozada, T. R. and Borchardt G. (1998). "Re-Evaluation of the 1836 "Hayward Fault" and the 1838 San Andreas Fault earthquakes," *Bulletin of Seismological Society of America*, 88(1), 140-159.

Townley, S. D. and Allen, M. W. (1939). "Descriptive catalog of earthquakes of the Pacific coast of the United States 1769 to 1928." *Bulletin of the Seismological Society of America*, 29(1).

Tokimatsu, K. and Seed, H.B. (1987). "Evaluation of Settlements in Sand due to Earthquake Shaking." *Journal of Geotechnical Engineering*, Vol. 113, No. 8, pp. 861-878.

Wells, D. L. and Coppersmith, K. J. (1994). "New Empirical Relationships among Magnitude, Rupture Length, Rupture Width, Rupture Area, and Surface Displacement." *Bulletin of the Seismological Society of America*, 84(4), 974-1002.

Wesnousky, S. G. (1986). "Earthquakes, Quaternary Faults, and Seismic Hazards in California." *Journal of Geophysical Research*, 91(1312).

Working Group on California Earthquake Probabilities (WGCEP) (2015). "Earthquake outlook for the San Francisco Bay Region 2014 to 2043." USGS Fact Sheet 2016-3020, Revised August 2016 (ver. 1.1).

Youd, T.L., and Idriss, I.M. (2001). "Liquefaction Resistance of Soils: Summary Report from the 1996 NCEER and 1998 NCEER/NSF Workshops on Evaluation of Liquefaction Resistance of Soils," *Journal of Geotechnical and Geoenvironmental Engineering*, Vol. 127, No. 4.

Youd, T.L., and Garris, C.T. (1995). "Liquefaction-induced ground-surface disruption." *Journal of Geotechnical Engineering*, American Society of Civil Engineers, Vol. 121, 805-809.

Youd, T.L., Hansen, C.M., and Bartlett, S.F., (2002). Revised Multilinear Regression Equations for Prediction of Lateral Spread Displacement, *Journal of Geotechnical and Geoenvironmental Engineering*, December 2002.

Youngs, R. R., and Coppersmith, K. J. (1985). "Implications of fault slip rates and earthquake recurrence models to probabilistic seismic hazard estimates." *Bulletin of the Seismological Society of America*, 75(), 939-964.

FIGURES

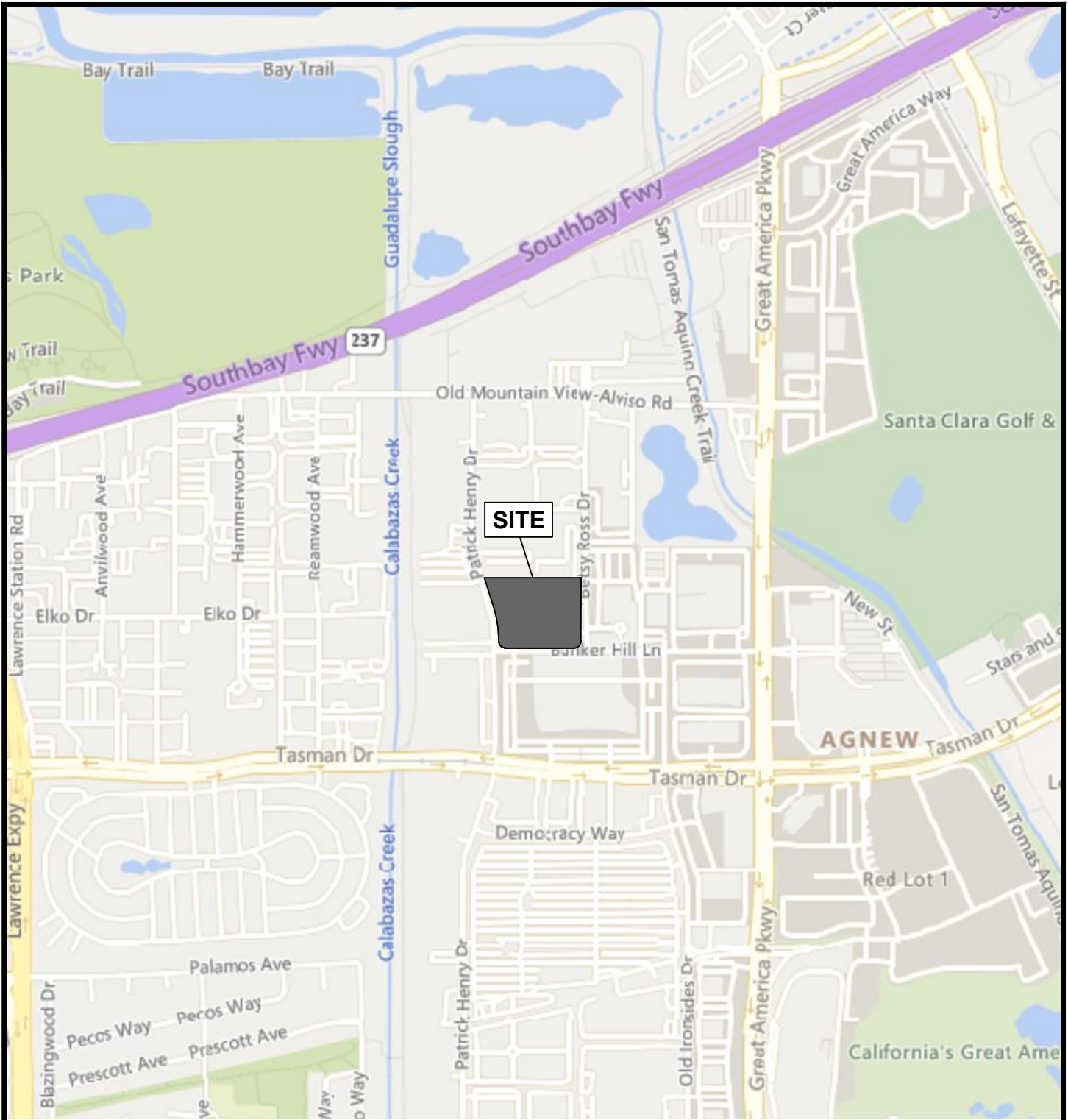



Legend

 Approximate site boundary

Notes:
 1. Topographic base map is provided through AutoCAD's internal map generator by Microsoft Corporation.



0  1,000 Feet
 Approximate scale

 Langan Engineering and Environmental Services, Inc. 135 Main Street, Suite 1500 San Francisco, CA 94105 T: 415.955.5200 F: 415.955.5201 www.langan.com	Project	Figure Title	Project No.	<h1>1</h1>	
	<h2>5201 PATRICK HENRY DRIVE</h2>		Date		
	SANTA CLARA COUNTY CALIFORNIA		<h2>SITE LOCATION MAP</h2>		731769901 11/14/2022
			Drawn By Checked By		JDF KM

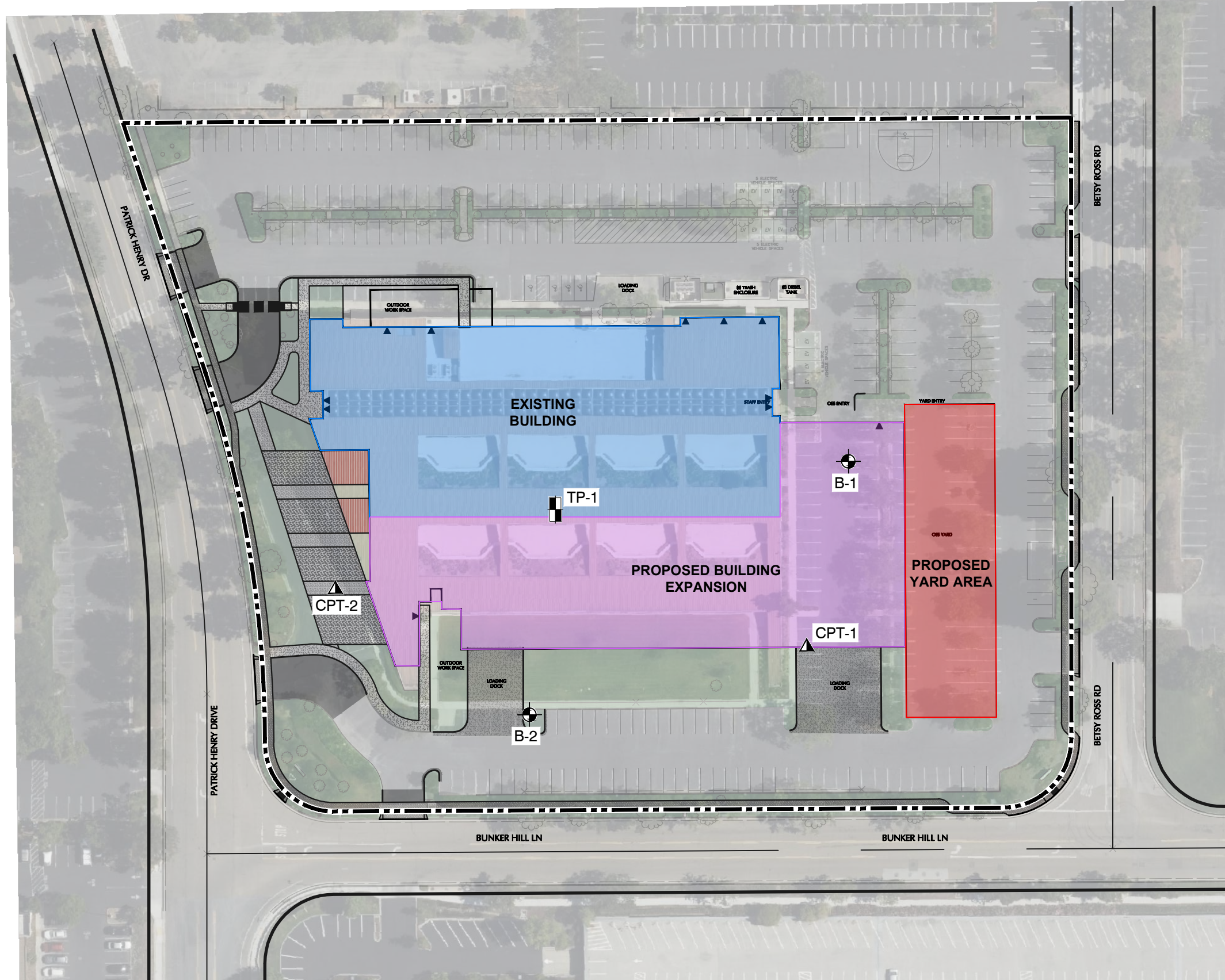

EXPLANATION

	Site boundary
B-1	Approximate location of boring by Langan, November 2022
CPT-1	Approximate location of cone penetration test by Langan, November 2022
TP-1	Approximate location of test pit excavated by others and logged by Langan, October 2022
	Existing building
	Proposed building expansion
	Proposed yard area

- Notes:
- Reference: Landscaping Planting Plan, DPR Silicon Valley Office Project" by Langan, 10/19/2022.
 - All dimensions and locations are approximate.

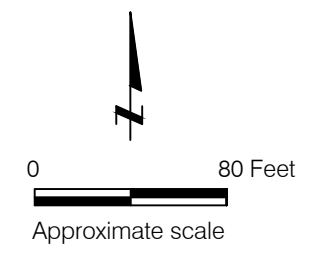

<p>LANGAN Langan Engineering and Environmental Services, Inc. 135 Main Street, Suite 1500 San Francisco, CA 94105 T: 415.955.5200 F: 415.955.5201 www.Langan.com</p>	Project	Figure Title	Project No.	Figure
	5201 PATRICK HENRY DRIVE	SITE PLAN	731769901	2
	SANTA CLARA COUNTY CALIFORNIA		Date	
			12/05/2022	
		Drawn By		
		JDF		
		Checked By		
		KM		

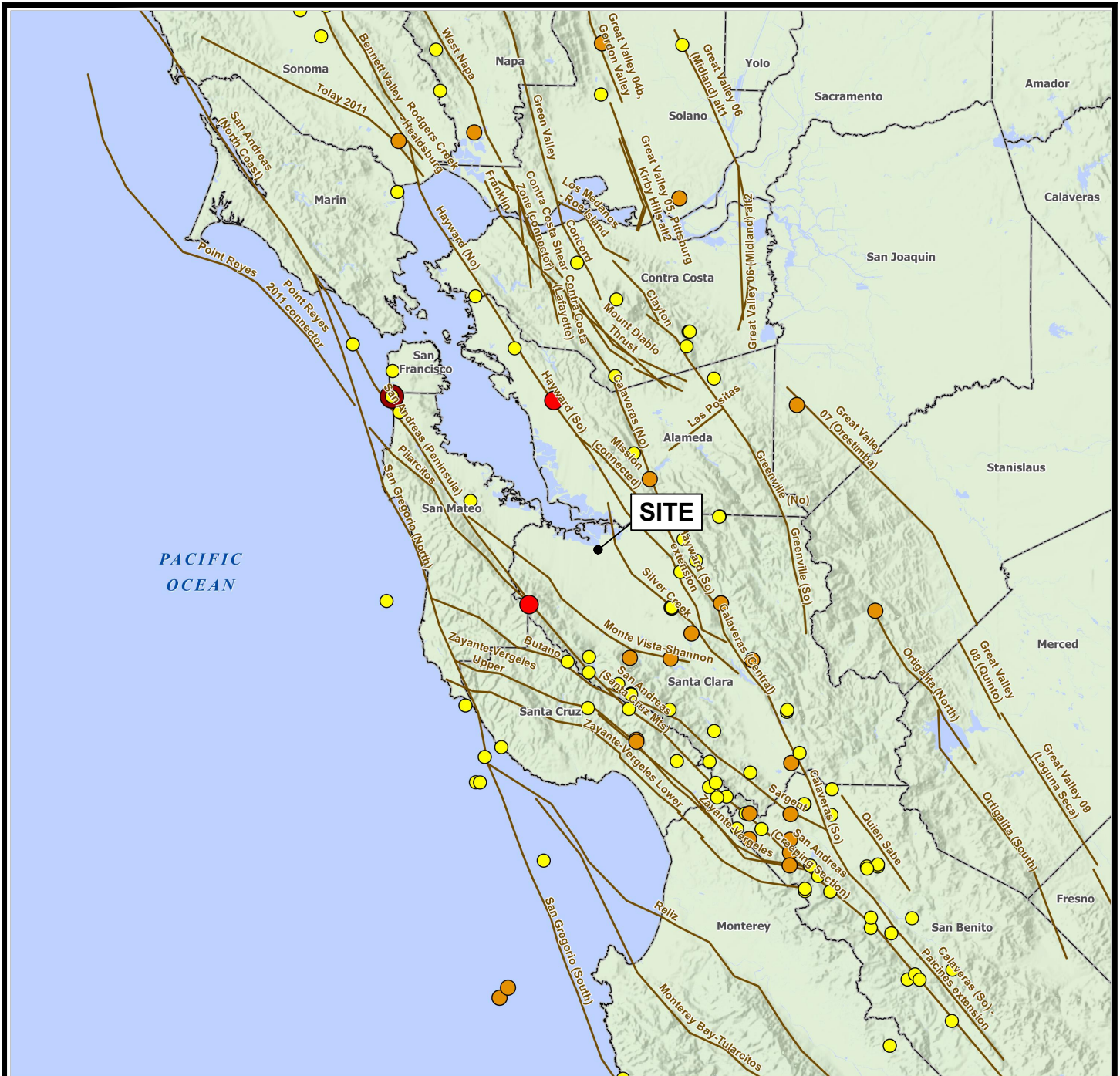

Legend

County Boundary Earthquake Epicenter

Magnitude

- Magnitude 5 to 5.9
- Magnitude 6 to 6.9
- Magnitude 7 to 7.4
- Magnitude 7.5 to 8

Notes:

1. Quaternary fault data displayed are provided by the CGS Map Sheet 48: Fault-based seismic sources used in the Uniform California Earthquake Rupture Forecast, Version (UCERF3).
2. The Earthquake Epicenter (Magnitude) data is provided by the U.S Geological Survey (USGS) and is current through 2015.
3. Basemap hillshade and County boundaries provided by USGS and California Department of Transportation.
4. Map displayed in California State Coordinate System, California (Teale) Albers, North American Datum of 1983 (NAD83), Meters.



LANGAN

Langan Engineering and Environmental Services, Inc.
135 Main Street, Suite 1500
San Francisco, CA 94105

T: 415.955.5200 F: 415.955.5201 www.langan.com

Project

5201 PATRICK HENRY DRIVE

SANTA CLARA

SANTA CLARA COUNTY CALIFORNIA

Figure Title

MAP OF MAJOR FAULTS AND EARTHQUAKE EPICENTERS IN THE SAN FRANCISCO BAY AREA

Project No.
731769901

Date
11/14/2022

Drawn By
JDF

Checked By
KM

Figure

3

I Not felt by people, except under especially favorable circumstances. However, dizziness or nausea may be experienced.

Sometimes birds and animals are uneasy or disturbed. Trees, structures, liquids, bodies of water may sway gently, and doors may swing very slowly.

II Felt indoors by a few people, especially on upper floors of multi-story buildings, and by sensitive or nervous persons.

As in Grade I, birds and animals are disturbed, and trees, structures, liquids and bodies of water may sway. Hanging objects swing, especially if they are delicately suspended.

III Felt indoors by several people, usually as a rapid vibration that may not be recognized as an earthquake at first. Vibration is similar to that of a light, or lightly loaded trucks, or heavy trucks some distance away. Duration may be estimated in some cases.

Movements may be appreciable on upper levels of tall structures. Standing motor cars may rock slightly.

IV Felt indoors by many, outdoors by a few. Awakens a few individuals, particularly light sleepers, but frightens no one except those apprehensive from previous experience. Vibration like that due to passing of heavy, or heavily loaded trucks. Sensation like a heavy body striking building, or the falling of heavy objects inside.

Dishes, windows and doors rattle; glassware and crockery clink and clash. Walls and house frames creak, especially if intensity is in the upper range of this grade. Hanging objects often swing. Liquids in open vessels are disturbed slightly. Stationary automobiles rock noticeably.

V Felt indoors by practically everyone, outdoors by most people. Direction can often be estimated by those outdoors. Awakens many, or most sleepers. Frightens a few people, with slight excitement; some persons run outdoors.

Buildings tremble throughout. Dishes and glassware break to some extent. Windows crack in some cases, but not generally. Vases and small or unstable objects overturn in many instances, and a few fall. Hanging objects and doors swing generally or considerably. Pictures knock against walls, or swing out of place. Doors and shutters open or close abruptly. Pendulum clocks stop, or run fast or slow. Small objects move, and furnishings may shift to a slight extent. Small amounts of liquids spill from well-filled open containers. Trees and bushes shake slightly.

VI Felt by everyone, indoors and outdoors. Awakens all sleepers. Frightens many people; general excitement, and some persons run outdoors.

Persons move unsteadily. Trees and bushes shake slightly to moderately. Liquids are set in strong motion. Small bells in churches and schools ring. Poorly built buildings may be damaged. Plaster falls in small amounts. Other plaster cracks somewhat. Many dishes and glasses, and a few windows break. Knickknacks, books and pictures fall. Furniture overturns in many instances. Heavy furnishings move.

VII Frightens everyone. General alarm, and everyone runs outdoors.

People find it difficult to stand. Persons driving cars notice shaking. Trees and bushes shake moderately to strongly. Waves form on ponds, lakes and streams. Water is muddied. Gravel or sand stream banks cave in. Large church bells ring. Suspended objects quiver. Damage is negligible in buildings of good design and construction; slight to moderate in well-built ordinary buildings; considerable in poorly built or badly designed buildings, adobe houses, old walls (especially where laid up without mortar), spires, etc. Plaster and some stucco fall. Many windows and some furniture break. Loosened brickwork and tiles shake down. Weak chimneys break at the roofline. Cornices fall from towers and high buildings. Bricks and stones are dislodged. Heavy furniture overturns. Concrete irrigation ditches are considerably damaged.

VIII General fright, and alarm approaches panic.

Persons driving cars are disturbed. Trees shake strongly, and branches and trunks break off (especially palm trees). Sand and mud erupts in small amounts. Flow of springs and wells is temporarily and sometimes permanently changed. Dry wells renew flow. Temperatures of spring and well waters varies. Damage slight in brick structures built especially to withstand earthquakes; considerable in ordinary substantial buildings, with some partial collapse; heavy in some wooden houses, with some tumbling down. Panel walls break away in frame structures. Decayed pilings break off. Walls fall. Solid stone walls crack and break seriously. Wet grounds and steep slopes crack to some extent. Chimneys, columns, monuments and factory stacks and towers twist and fall. Very heavy furniture moves conspicuously or overturns.

IX Panic is general.

Ground cracks conspicuously. Damage is considerable in masonry structures built especially to withstand earthquakes; great in other masonry buildings - some collapse in large part. Some wood frame houses built especially to withstand earthquakes are thrown out of plumb, others are shifted wholly off foundations. Reservoirs are seriously damaged and underground pipes sometimes break.

X Panic is general.

Ground, especially when loose and wet, cracks up to widths of several inches; fissures up to a yard in width run parallel to canal and stream banks. Landsliding is considerable from river banks and steep coasts. Sand and mud shifts horizontally on beaches and flat land. Water level changes in wells. Water is thrown on banks of canals, lakes, rivers, etc. Dams, dikes, embankments are seriously damaged. Well-built wooden structures and bridges are severely damaged, and some collapse. Dangerous cracks develop in excellent brick walls. Most masonry and frame structures, and their foundations are destroyed. Railroad rails bend slightly. Pipe lines buried in earth tear apart or are crushed endwise. Open cracks and broad wavy folds open in cement pavements and asphalt road surfaces.

XI Panic is general.

Disturbances in ground are many and widespread, varying with the ground material. Broad fissures, earth slumps, and land slips develop in soft, wet ground. Water charged with sand and mud is ejected in large amounts. Sea waves of significant magnitude may develop. Damage is severe to wood frame structures, especially near shock centers, great to dams, dikes and embankments, even at long distances. Few if any masonry structures remain standing. Supporting piers or pillars of large, well-built bridges are wrecked. Wooden bridges that "give" are less affected. Railroad rails bend greatly and some thrust endwise. Pipe lines buried in earth are put completely out of service.

XII Panic is general.

Damage is total, and practically all works of construction are damaged greatly or destroyed. Disturbances in the ground are great and varied, and numerous shearing cracks develop. Landslides, rock falls, and slumps in river banks are numerous and extensive. Large rock masses are wrenched loose and torn off. Fault slips develop in firm rock, and horizontal and vertical offset displacements are notable. Water channels, both surface and underground, are disturbed and modified greatly. Lakes are dammed, new waterfalls are produced, rivers are deflected, etc. Surface waves are seen on ground surfaces. Lines of sight and level are distorted. Objects are thrown upward into the air.

LANGAN
 Langan Engineering and
 Environmental Services, Inc.
 135 Main Street, Suite 1500
 San Francisco, CA 94105
 T: 415.955.5200 F: 415.955.5201 www.langan.com

Project
**5201 PATRICK
 HENRY DRIVE**
 SANTA CLARA
 SANTA CLARA COUNTY CALIFORNIA

Figure Title
**MODIFIED
 MERCALLI
 INTENSITY SCALE**

Project No.
731769901
 Date
11/14/2022
 Drawn By
JDF
 Checked By
KM

Figure
4

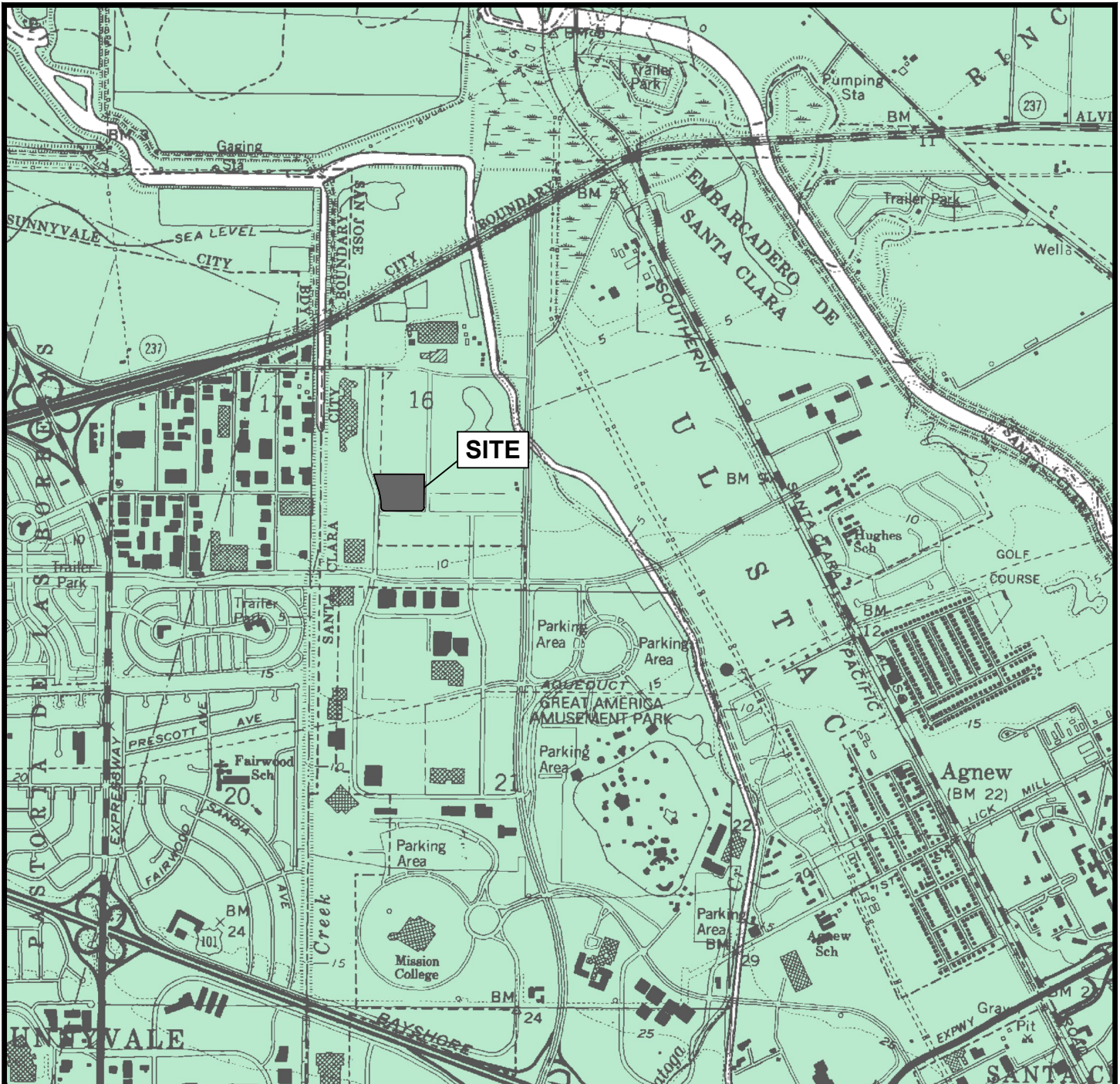

Legend

 Liquefaction; Areas where historical occurrence of liquefaction, or local geological, geotechnical and ground-water conditions indicate a potential for permanent ground displacements such that mitigation as defined in Public Resources Code Section 2693(c) would be required.

0 100 Feet

 Approximate scale



Notes:

1. Reference: Base map is from State of California, Seismic Hazard Zones, Milpitas Quadrangle map by CGS (dated 2004).
2. Liquefaction Susceptibility dataset provided in GIS format by the Association of Bay Area Governments' Resilience Program. This data is preliminary and has not been reviewed for conformity with United States Geological Survey (USGS) editorial standards or with the North American Stratigraphic Code.

LANGAN

Langan Engineering and Environmental Services, Inc.
 135 Main Street, Suite 1500
 San Francisco, CA 94105

T: 415.955.5200 F: 415.955.5201 www.langan.com

Project

5201 PATRICK HENRY DRIVE

SANTA CLARA

SANTA CLARA COUNTY CALIFORNIA

Figure Title

REGIONAL SEISMIC HAZARD MAP

Project No.
731769901

Date
11/14/2022

Drawn By
JDF

Checked By
KM

Figure

5

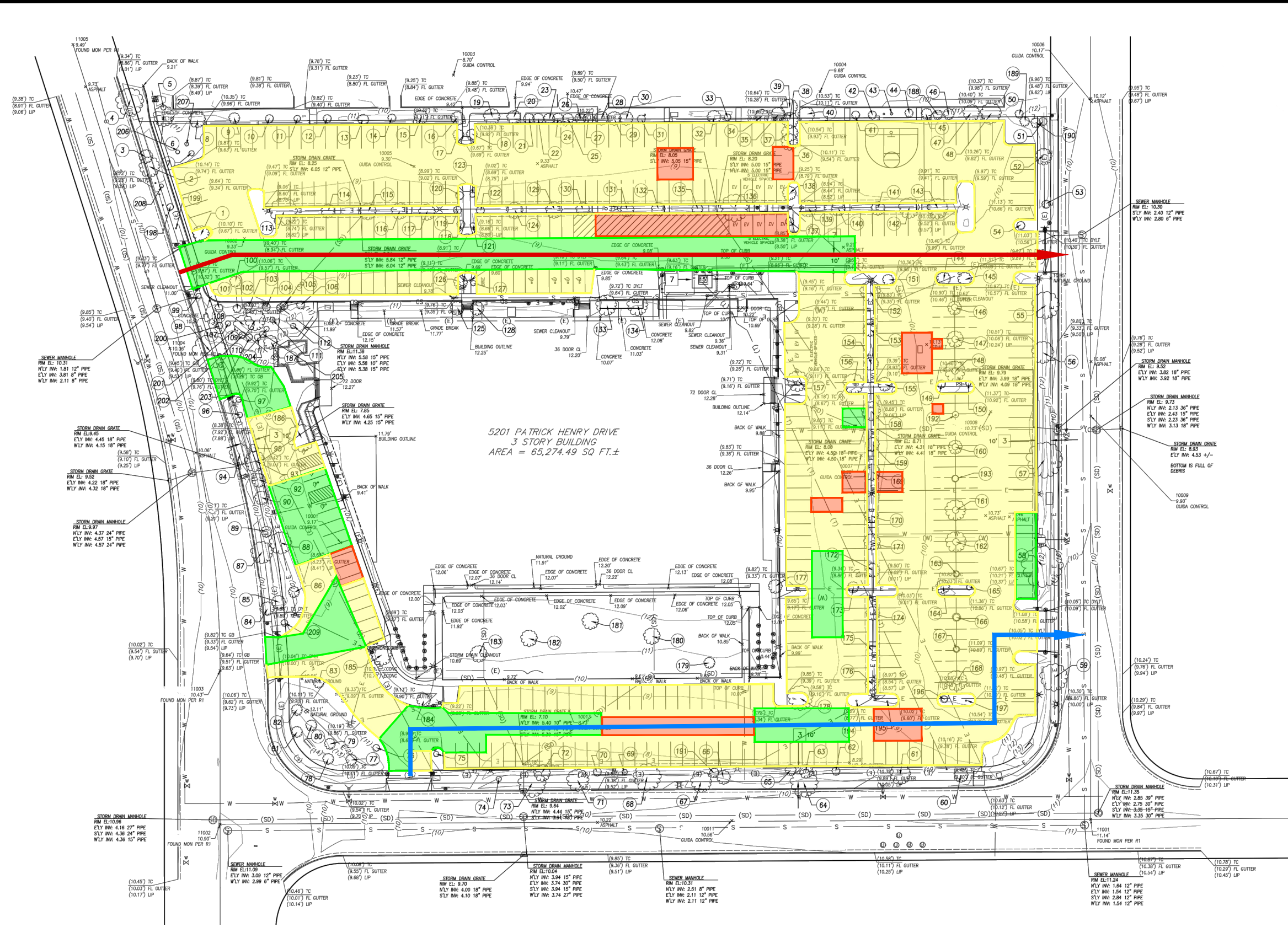

EXPLANATION

- Re-paved area, generally good quality
- Moderately aged pavement (weathering, raveling, block cracking, longitudinal and transverse cracking, etc.)
- Heavily aged pavement (alligator cracking, rutting, potholes, etc.)
- Proposed truck route
- Proposed fire lane

5201 PATRICK HENRY DRIVE
3 STORY BUILDING
AREA = 65,274.49 SQ FT.±

Reference: Drawing provided by Guida Surveying Inc., titled "Topographic Mapping, 5201 Patrick Henry Drive, City of Santa Clara, State of California", Sheet No. 2, dated 12/01/22.

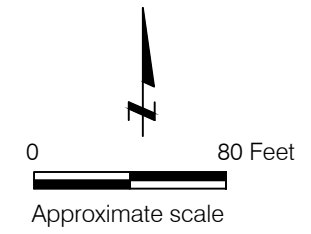

<p>LANGAN Langan Engineering and Environmental Services, Inc. 135 Main Street, Suite 1500 San Francisco, CA 94105 T: 415.955.5200 F: 415.955.5201 www.langan.com</p>	<p>Project 5201 PATRICK HENRY DRIVE SANTA CLARA SANTA CLARA COUNTY CALIFORNIA</p>	<p>Figure Title PAVEMENT EXISTING CONDITIONS</p>	<p>Project No. 731769901</p>	<p>Figure No. 6</p>
				<p>Date 05/15/2023</p>
			<p>Drawn By AG</p>	
			<p>Checked By HL</p>	

APPENDIX A
LOGS OF BORINGS

PROJECT: **5201 PATRICK HENRY DRIVE
Santa Clara, California**

Log of Boring B-1

Boring location: See Site Plan, Figure 2

Logged by: B. Giang
Drilled By: Exploration Geoservices, Inc.

Date started: 11/01/22 Date finished: 11/01/22

Drilling method: Hollow Stem Auger

Hammer weight/drop: 140 lbs./30 inches Hammer type: Safety - Downhole Wireline

LABORATORY TEST DATA

Samplers: Sprague & Henwood (S&H), Shelby Tube (ST)

DEPTH (feet)	SAMPLES				LITHOLOGY	MATERIAL DESCRIPTION	Type of Strength Test	Confining Pressure Lbs/Sq Ft	Shear Strength Lbs/Sq Ft	Fines %	Natural Moisture Content, %	Dry Density Lbs/Cu Ft
	Sampler Type	Sample	Blows/6"	SPT N-value ¹								
Ground Surface Elevation: ~8 feet ²												
1						2.5 inches asphalt concrete (AC)						
						8 inches aggregate base (AB)						
2					GC	CLAYEY GRAVEL (GC) light brown, moist, fine to coarse subangular to subrounded gravel						
3	S&H		5	14	CH	CLAY (CH) gray-brown, stiff, moist LL = 64, PI = 39, see Figure D-1 R-value Test, see Figure D-5 yellow-brown	PP	2,250		28.8	95	
4			8									
5	S&H		8	20		CLAY with SAND (CL) light brown, very stiff, moist, fine sand (11/1/22, 9:49 am)	PP	4,250				
6			16									
7	S&H		6	11	CL	(11/1/22, 8:35 AM) medium stiff, wet	PP	1,750	41.3	24.2	103	
8			9									
9	S&H		6	11	SC	CLAYEY SAND (SC) red-brown, medium dense, wet, fine-grained interbedded with a thin layer of sandy clay at 8.75 feet LL = 28, PI = 10, see Figure D-1	PP	3,250				
10			16									
11	S&H		13	11	SP	SAND with GRAVEL (SP) yellow-brown to gray-brown, medium dense, fine to coarse sand, fine gravel	PP	3,250				
12			5									
13	ST			100 psi		CLAY (CL) red-brown, medium stiff to stiff, wet Consolidation Test, see Figure D-2	PP	1,500		28.6	92	
14												
15						trace coarse sand						
16	S&H		5	8			PP	1,750				
17			5									
18			9									
19												
20												
21	S&H		6	18	CL	stiff to very stiff	PP	4,000				
22			12									
23			18									
24												
25						red brown with light brown mottling, very stiff						
26	S&H		10	21			PP	4,250				
27			15									
28			20									
29												
30												

TEST GEOTECH LOG 731769901_5201 PATRICK HENRY DR.GPJ TEMPLATE_CA-MODIFIED.GDT 12/14/22

LANGAN

Project No.: 731769901

Figure: A-1a

PROJECT:

5201 PATRICK HENRY DRIVE
Santa Clara, California

Log of Boring B-1

DEPTH (feet)	SAMPLES				LITHOLOGY	MATERIAL DESCRIPTION	LABORATORY TEST DATA						
	Sampler Type	Sample	Blows/6"	SPT N-Value ¹			Type of Strength Test	Confining Pressure Lbs/Sq Ft	Shear Strength Lbs/Sq Ft	Fines %	Natural Moisture Content, %	Dry Density Lbs/Cu Ft	
31	S&H		10 18 20	23	CL	CLAY (CL) (continued) stiff to very stiff, trace fine sand	PP		2,500				
32													
33													
34													
35													
36													
37													
38													
39													
40													
41													
42													
43													
44													
45													
46													
47													
48													
49													
50													
51													
52													
53													
54													
55													
56													
57													
58													
59													
60													

TEST GEOTECH LOG 731769901_5201 PATRICK HENRY DR.GPJ_TEMPLATE_CA-MODIFIED.GDT 12/14/22

Boring terminated at a depth of 31.5 feet below ground surface.
Boring backfilled with cement grout.
Groundwater first encountered at 8 feet below ground surface at time of drilling, and was measured at 7 feet below ground surface before grouting.
PP = Pocket penetrometer.

¹ S&H blow counts for the last two increments were converted to SPT N-Values using factor of 0.6 and to account for sampler type and hammer energy.
² Elevations estimated from topographic survey prepared by Guida Surveying Inc. dated 18 October 2022 and reference NAVD88 datum.



PROJECT:

**5201 PATRICK HENRY DRIVE
Santa Clara, California**

Log of Boring B-2

Boring location: See Site Plan, Figure 2

Logged by: B. Giang
Drilled By: Exploration Geoservices, Inc.

Date started: 11/01/22

Date finished: 11/01/22

Drilling method: Hollow Stem Auger

Hammer weight/drop: 140 lbs./30 inches

Hammer type: Safety - Downhole Wireline

LABORATORY TEST DATA

Samplers: Sprague & Henwood (S&H)

DEPTH (feet)	SAMPLES			SPT N-Value ¹	LITHOLOGY	MATERIAL DESCRIPTION	Type of Strength Test	Confining Pressure Lbs/Sq Ft	Shear Strength Lbs/Sq Ft	Fines %	Natural Moisture Content, %	Dry Density Lbs/Cu Ft
	Sampler Type	Sample	Blows/6"									
Ground Surface Elevation: ~9 feet ²												
1						2 inches asphalt concrete (AC)						
						6 inches aggregate base (AB)						
2						CLAY (CH)						
						dark brown, stiff, moist, trace fine gravel						
3	S&H		6	14	CH	LL = 66, PI = 40, see Figure D-1	PP		2,750		26.6	
4			10									
			14									
5	S&H		6	19		CLAY with SAND (CL)						
			12			light brown to gray, very stiff, moist, fine sand						
6			20			very stiff	PP		4,250	76.4	21.5	
7												
8	S&H		7	12		∇ stiff to very stiff, decreased sand content						
			9			(11/1/22, 11:20 am)	PP					
			11		CL	Triaxial Test, see Figure D-4	TxUU	1,000	4,250		25.1	102
9									2,070			
10						light brown with yellow brown mottling, trace coarse						
						subangular gravel						
11	S&H		6	17			PP		3,750			
			12									
			16			∇ (11/1/22, 10:58 AM)						
12												
13												
14						CLAY (CL)						
						light brown with orange and dark brown mottling, stiff,						
						wet						
15	S&H		8	14								
			10									
			14						2,500			
16												
17												
18												
19												
20												
21	S&H		5	12		medium stiff to stiff						
			10			Consolidation Test, see Figure D-3	PP		1,500		27.8	95
			10									
22					CL							
23												
24												
25												
26	S&H		8	17		gray brown with orange mottling, very stiff						
			10									
			18									
27												
28												
29												
30												

TEST GEOTECH LOG 731769901_5201 PATRICK HENRY DR.GPJ TEMPLATE_CA-MODIFIED.GDT 12/14/22

LANGAN

Project No.: 731769901

Figure: A-2a

PROJECT:

5201 PATRICK HENRY DRIVE
Santa Clara, California

Log of Boring B-2

DEPTH (feet)	SAMPLES				LITHOLOGY	MATERIAL DESCRIPTION	LABORATORY TEST DATA						
	Sampler Type	Sample	Blows/6"	SPT N-Value ¹			Type of Strength Test	Confining Pressure Lbs/Sq Ft	Shear Strength Lbs/Sq Ft	Fines %	Natural Moisture Content, %	Dry Density Lbs/Cu Ft	
31	S&H		12 14 24	23	CL	CLAY (CL) (continued) stiff to very stiff	PP		2,750				
32													
33													
34													
35													
36													
37													
38													
39													
40													
41													
42													
43													
44													
45													
46													
47													
48													
49													
50													
51													
52													
53													
54													
55													
56													
57													
58													
59													
60													

TEST GEOTECH LOG 731769901_5201 PATRICK HENRY DR.GPJ_TEMPLATE_CA-MODIFIED.GDT 12/14/22

Boring terminated at a depth of 31.5 feet below ground surface.
Boring backfilled with cement grout.
Groundwater first encountered at 12 feet below ground surface at time of drilling, and was measured at 8 feet below ground surface before grouting.
PP = Pocket penetrometer.

¹ S&H blow counts for the last two increments were converted to SPT N-Values using factor of 0.6 and to account for sampler type and hammer energy.
² Elevations estimated from topographic survey prepared by Guida Surveying Inc. dated 18 October 2022 and reference NAVD88 datum.



Project No.:
731769901

Figure:
A-2b

UNIFIED SOIL CLASSIFICATION SYSTEM

Major Divisions	Symbols	Typical Names
Coarse-Grained Soils <small>(more than half of soil > no. 200 sieve size)</small>	Gravels <small>(More than half of coarse fraction > no. 4 sieve size)</small>	GW Well-graded gravels or gravel-sand mixtures, little or no fines
		GP Poorly-graded gravels or gravel-sand mixtures, little or no fines
		GM Silty gravels, gravel-sand-silt mixtures
		GC Clayey gravels, gravel-sand-clay mixtures
	Sands <small>(More than half of coarse fraction < no. 4 sieve size)</small>	SW Well-graded sands or gravelly sands, little or no fines
		SP Poorly-graded sands or gravelly sands, little or no fines
		SM Silty sands, sand-silt mixtures
		SC Clayey sands, sand-clay mixtures
Fine -Grained Soils <small>(more than half of soil < no. 200 sieve size)</small>	Silts and Clays <small>LL = < 50</small>	ML Inorganic silts and clayey silts of low plasticity, sandy silts, gravelly silts
		CL Inorganic clays of low to medium plasticity, gravelly clays, sandy clays, lean clays
		OL Organic silts and organic silt-clays of low plasticity
	Silts and Clays <small>LL = > 50</small>	MH Inorganic silts of high plasticity
		CH Inorganic clays of high plasticity, fat clays
		OH Organic silts and clays of high plasticity
Highly Organic Soils	PT	Peat and other highly organic soils

SAMPLE DESIGNATIONS/SYMBOLS

GRAIN SIZE CHART		
Classification	Range of Grain Sizes	
	U.S. Standard Sieve Size	Grain Size in Millimeters
Boulders	Above 12"	Above 305
Cobbles	12" to 3"	305 to 76.2
Gravel coarse fine	3" to No. 4 3" to 3/4" 3/4" to No. 4	76.2 to 4.76 76.2 to 19.1 19.1 to 4.76
Sand coarse medium fine	No. 4 to No. 200 No. 4 to No. 10 No. 10 to No. 40 No. 40 to No. 200	4.76 to 0.075 4.76 to 2.00 2.00 to 0.420 0.420 to 0.075
Silt and Clay	Below No. 200	Below 0.075

- Sample taken with Sprague & Henwood split-barrel sampler with a 3.0-inch outside diameter and a 2.43-inch inside diameter. Darkened area indicates soil recovered
- Classification sample taken with Standard Penetration Test sampler
- Undisturbed sample taken with thin-walled tube
- Disturbed sample
- Sampling attempted with no recovery
- Core sample
- Analytical laboratory sample
- Sample taken with Direct Push or Drive sampler
- Sonic

Unstabilized groundwater level

Stabilized groundwater level

PP = Pocket Penetrometer

TV = Torvane

SAMPLER TYPE

C Core barrel

CA California split-barrel sampler with 2.5-inch outside diameter and a 1.93-inch inside diameter

D&M Dames & Moore piston sampler using 2.5-inch outside diameter, thin-walled tube

O Osterberg piston sampler using 3.0-inch outside diameter, thin-walled Shelby tube

PT Pitcher tube sampler using 3.0-inch outside diameter, thin-walled Shelby tube

S&H Sprague & Henwood split-barrel sampler with a 3.0-inch outside diameter and a 2.43-inch inside diameter

SPT Standard Penetration Test (SPT) split-barrel sampler with a 2.0-inch outside diameter and a 1.5-inch inside diameter

ST Shelby Tube (3.0-inch outside diameter, thin-walled tube) advanced with hydraulic pressure

LANGAN
 Langan Engineering and
 Environmental Services, Inc.
 135 Main Street, Suite 1500
 San Francisco, CA 94105

T: 415.955.5200 F: 415.955.5201 www.langan.com

Project
**5201 PATRICK
 HENRY DRIVE**
SANTA CLARA
SANTA CLARA COUNTY CALIFORNIA

Figure Title
SOIL CLASSIFICATION CHART

Project No.
731769901
 Date
11/14/2022
 Drawn By
AG
 Checked By
HL

Figure
A-3

APPENDIX B
CONE PENETRATION TEST RESULTS

TABLE B-1
Cone Penetration Test (CPT) Summary

Location	Approximate Ground Surface Elevation¹ (feet)	Depth of PPDT² (feet)	Interpreted Potentiometric Surface Depth from PPDT (feet)	Interpreted Potentiometric Surface Elevation from PPDT (feet)
CPT-1	9	34.9	8.5	0.5
CPT-2	9	31.7	8.5	0.5

Notes:

1. Elevations are based on a topographic survey provided by Guida Surveying Inc., dated 18 October 2022, and reference North American Vertical Datum of 1988 (NAVD 88).
2. PPDT = pore pressure dissipation test

Cone Penetration Test Summary and Standard Cone Penetration Test Plots

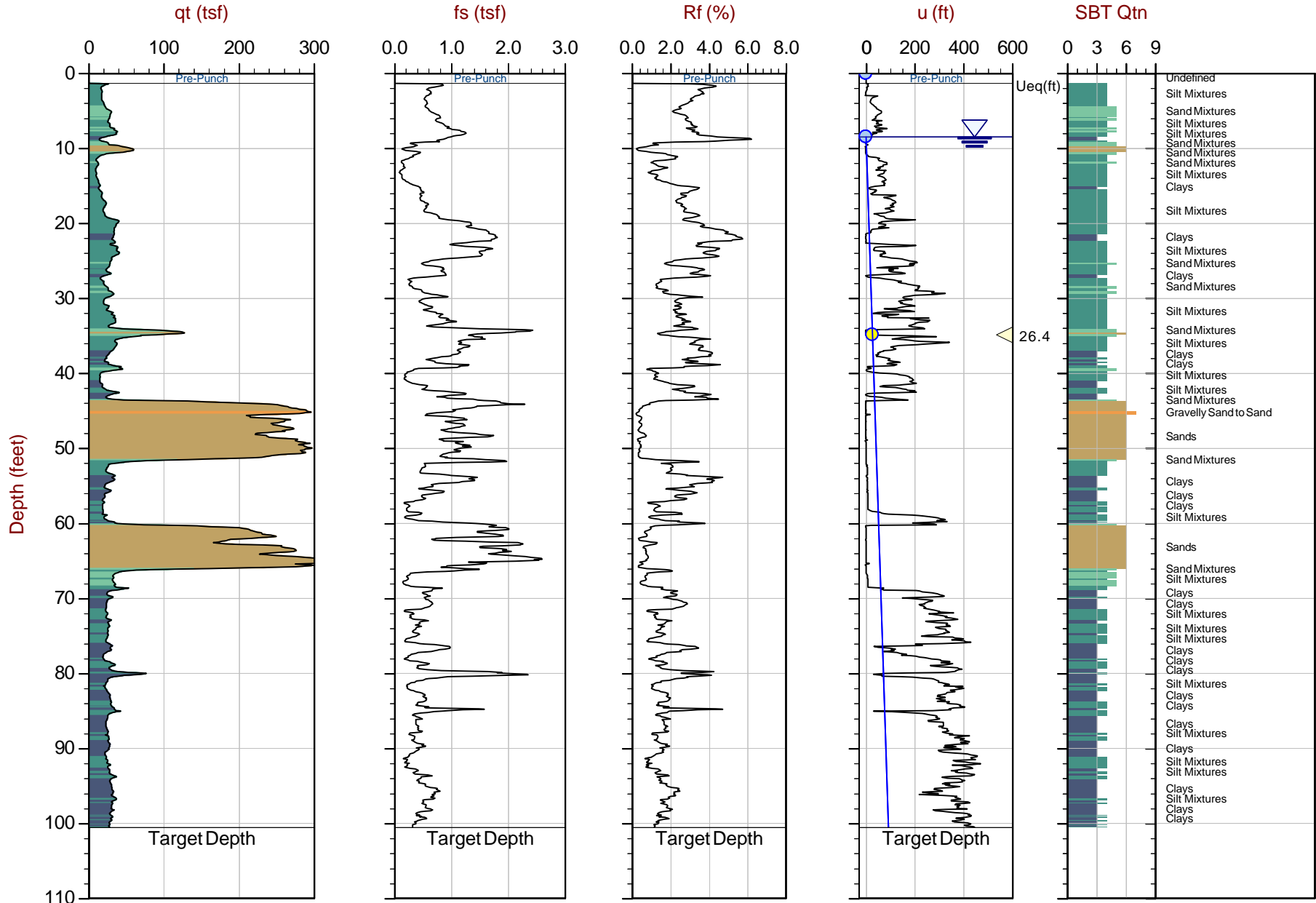

Max Depth: 30.650 m / 100.56 ft
 Depth Inc: 0.025 m / 0.082 ft
 Avg Int: Every Point

File: 22-56-25007_SP01.COR
 Unit Wt: SBTQtn(PKR2009)

SBT: Robertson, 2009 and 2010
 Coords: UTM 10S N: 4140413m E: 590022m

● Equilibrium Pore Pressure (Ueq)
 ● Assumed Ueq
 ◀ Dissipation, Ueq achieved
 ◀ Dissipation, Ueq not achieved
 — Hydrostatic Line

The reported coordinates were acquired from consumer grade GPS equipment and are only approximate locations. The coordinates should not be used for design purposes.

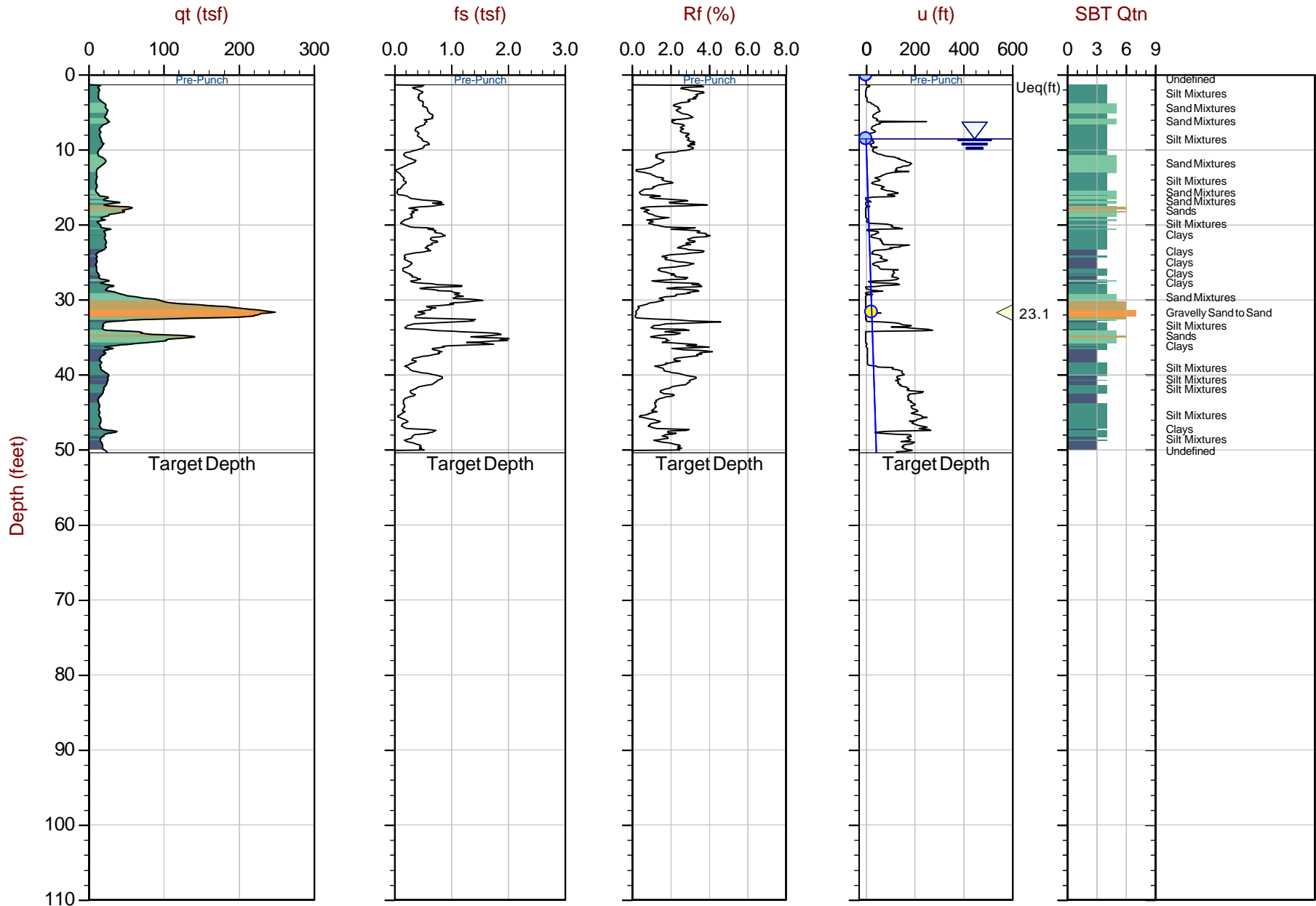

Max Depth: 15.350 m / 50.36 ft
 Depth Inc: 0.025 m / 0.082 ft
 Avg Int: Every Point

File: 22-56-25007_CP02.COR
 Unit Wt: SBTQtn(PKR2009)

SBT: Robertson, 2009 and 2010
 Coords: UTM 10S N: 4140420m E: 589920m

● Equilibrium Pore Pressure (Ueq)
 ● Assumed Ueq
 ◀ Dissipation, Ueq achieved
 ◀ Dissipation, Ueq not achieved
 — Hydrostatic Line

The reported coordinates were acquired from consumer grade GPS equipment and are only approximate locations. The coordinates should not be used for design purposes.

Pore Pressure Dissipation Summary and Pore Pressure Dissipation Plots



Langan Engineering

Job No: 22-56-25007
Date: 11/01/2022 09:01
Site: DPR Construction New Office

Sounding: CPT-1
Cone: 811:T1500F15U35 Area=15 cm²

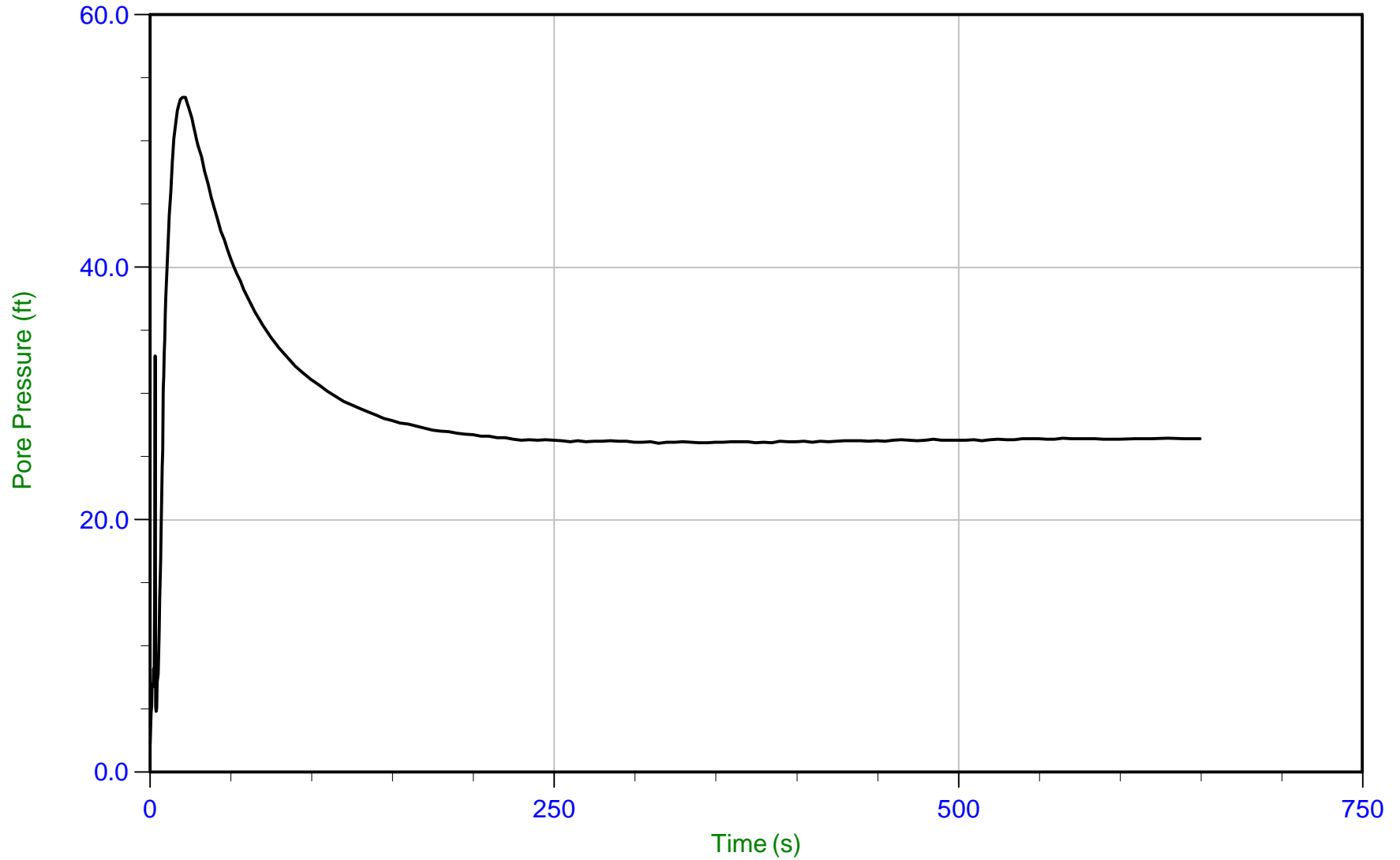

Trace Summary:

Filename: 22-56-25007_SP01.PPD2
Depth: 10.625 m / 34.858 ft
Duration: 649.9 s

u Min: 2.2 ft
u Max: 53.4 ft
u Final: 26.4 ft

WT: 2.576 m / 8.451 ft
Ueq: 26.4 ft



Langan Engineering

Job No: 22-56-25007
Date: 11/01/2022 12:38
Site: DPR Construction New Office

Sounding: CPT-2
Cone: 811:T1500F15U35 Area=15 cm²

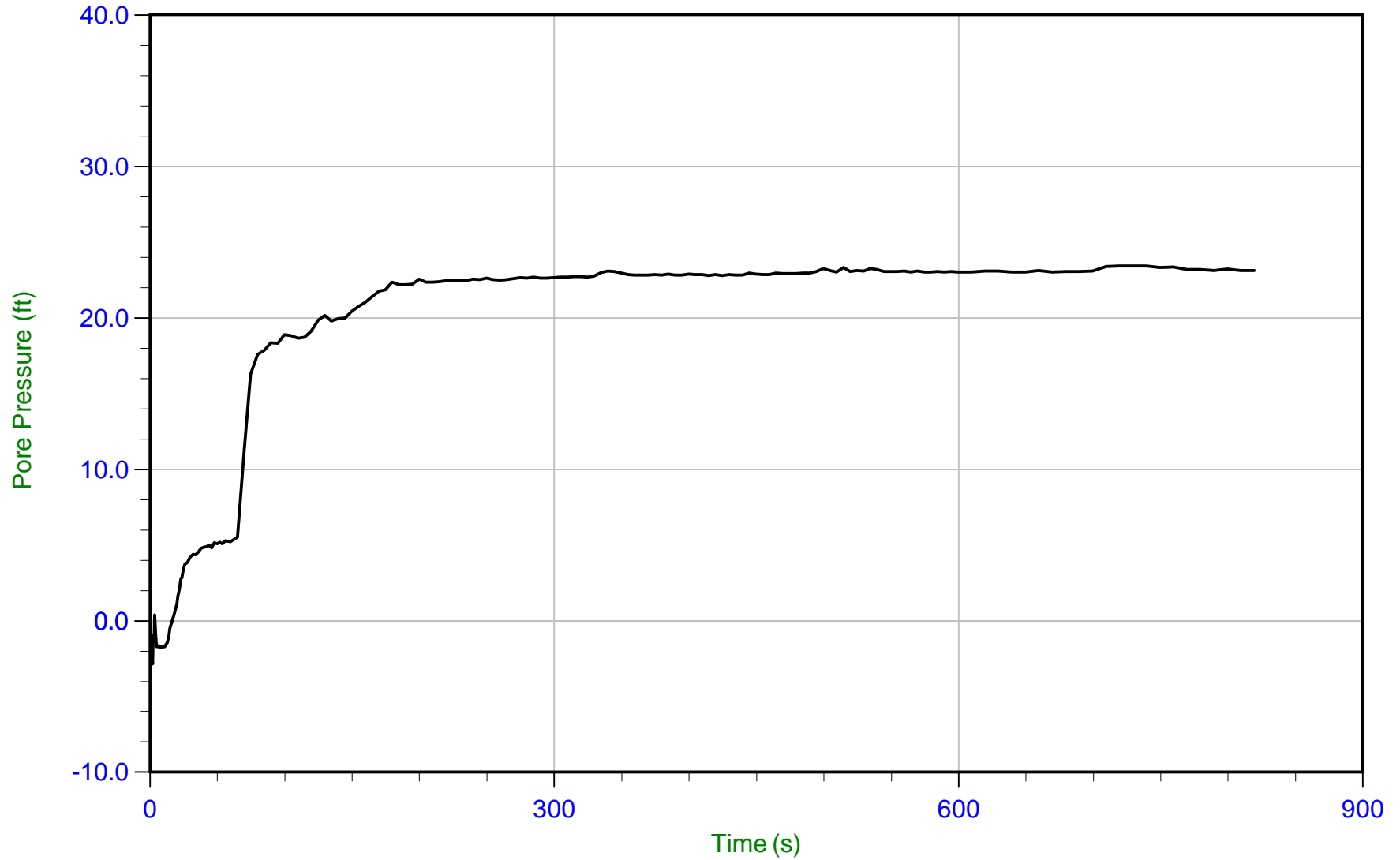

Trace Summary:

Filename: 22-56-25007_CP02.PPD2
Depth: 9.650 m / 31.660 ft
Duration: 819.9 s

u Min: -2.9 ft
u Max: 23.4 ft
u Final: 23.1 ft

WT: 2.595 m / 8.512 ft
Ueq: 23.1 ft

Seismic Cone Penetration Test Tabular Results



Job No: 22-56-25007
Client: Langan Engineering
Project: DPR Construction New Office
Sounding ID: CPT-1
Date: 11:01:22 09:01

Seismic Source: Beam
Seismic Offset (ft): 1.87
Source Depth (ft): 0.00
Geophone Offset (ft): 0.81

SCPT_u SHEAR WAVE VELOCITY TEST RESULTS - V_s

Tip Depth (ft)	Geophone Depth (ft)	Ray Path (ft)	Ray Path Difference (ft)	Travel Time Interval (ms)	Interval Velocity (ft/s)
2.95	2.14	2.84			
6.23	5.42	5.73	2.89	5.51	525
9.51	8.70	8.90	3.17	4.40	720
12.80	11.98	12.13	3.23	5.42	596
16.17	15.36	15.48	3.35	4.52	741
19.46	18.64	18.74	3.26	3.60	906
25.92	25.11	25.18	6.44	7.12	904
29.30	28.49	28.55	3.37	4.22	798
32.58	31.77	31.82	3.28	3.41	960
35.76	34.95	35.00	3.18	3.37	943
39.04	38.23	38.28	3.28	2.75	1190
42.32	41.51	41.55	3.28	4.68	700
45.60	44.79	44.83	3.28	3.74	876
48.88	48.07	48.11	3.28	2.97	1105
52.17	51.35	51.39	3.28	2.75	1191
55.45	54.63	54.67	3.28	3.60	911
58.79	57.98	58.01	3.35	4.50	744
62.07	61.26	61.29	3.28	2.59	1266
65.29	64.48	64.50	3.21	3.41	942
68.57	67.76	67.78	3.28	3.37	973
71.85	71.04	71.06	3.28	3.67	894
75.13	74.32	74.34	3.28	3.71	883
78.41	77.60	77.62	3.28	3.55	924
81.69	80.88	80.90	3.28	3.16	1039
84.97	84.16	84.18	3.28	3.47	946
88.25	87.44	87.46	3.28	3.50	937
91.54	90.72	90.74	3.28	3.55	924
94.82	94.00	94.02	3.28	3.30	995
98.10	97.29	97.30	3.28	3.32	988
100.56	99.75	99.76	2.46	2.44	1007

Seismic Cone Penetration Test Shear Wave (V_s) Traces



Job No: 22-56-25007
Analysis: Shear Wave

Client: Langan Engineering
Date: 11:01:22 09:01

Project: DPR Construction New Office
Cone: 811:T1500F15U35

Filter: BP 0-500 Hz

Sounding: CPT-1

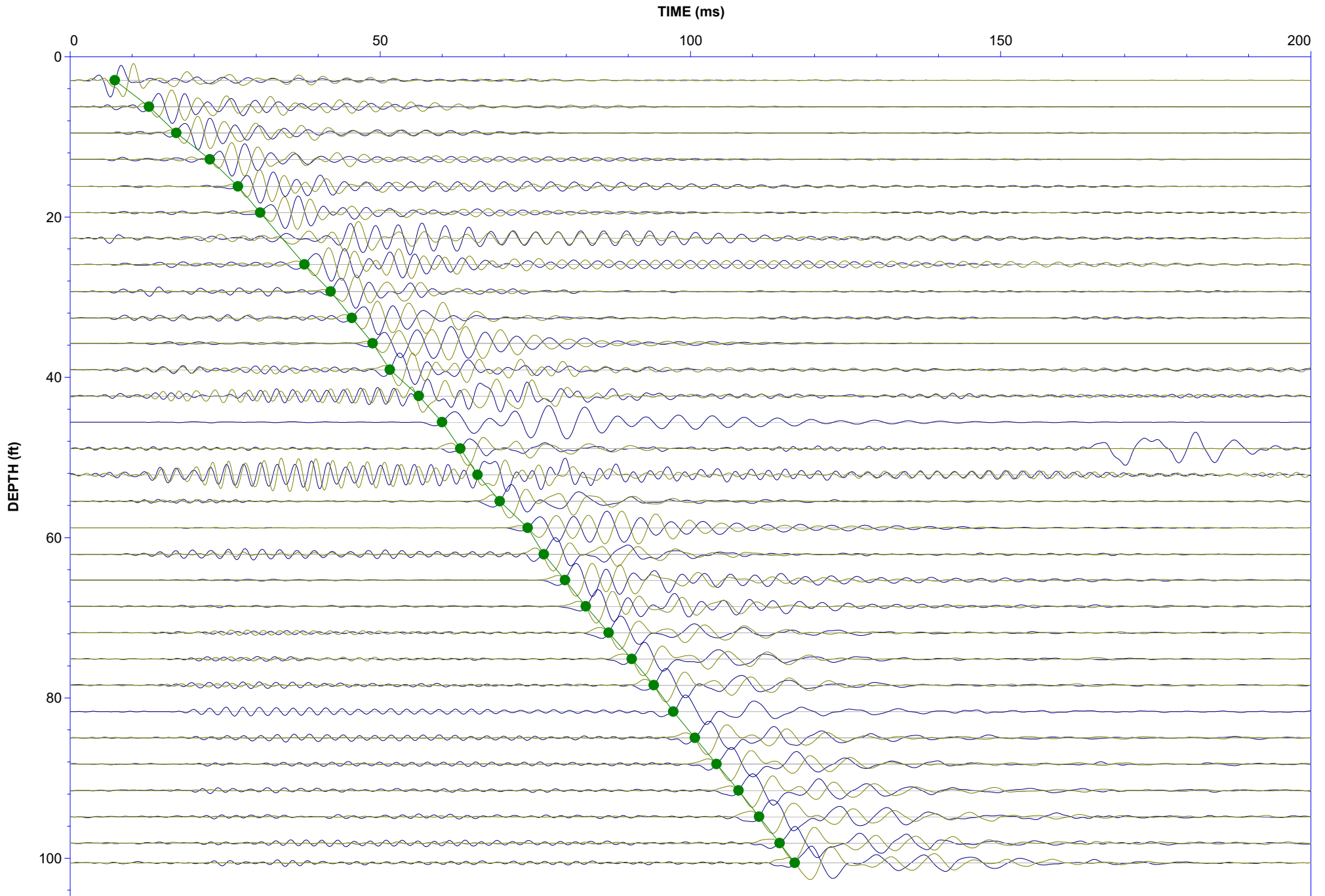

APPENDIX C
LOGS OF TEST PIT

PLAN VIEW

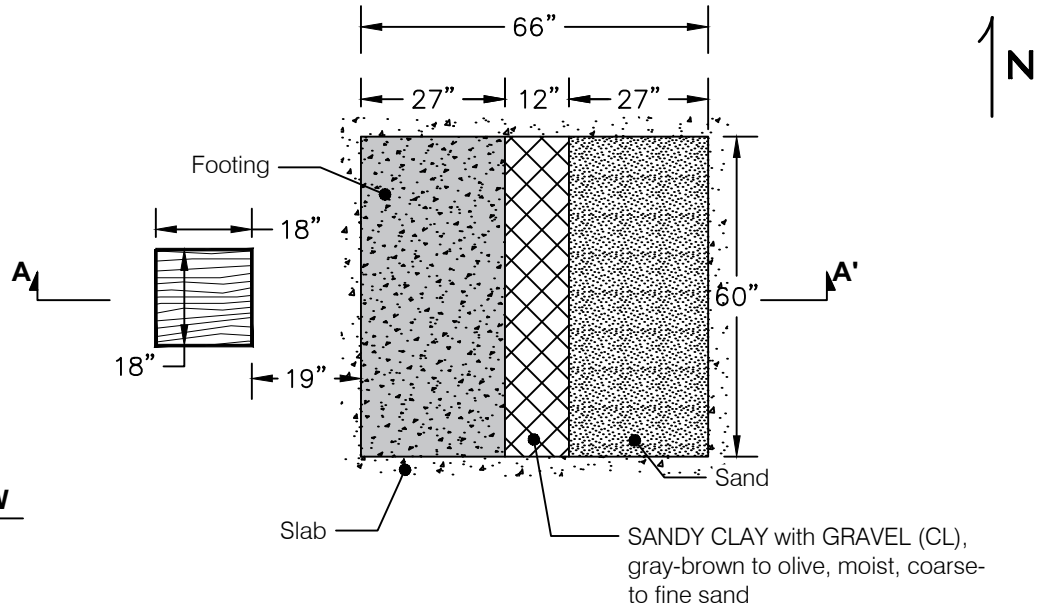

SECTION A-A'

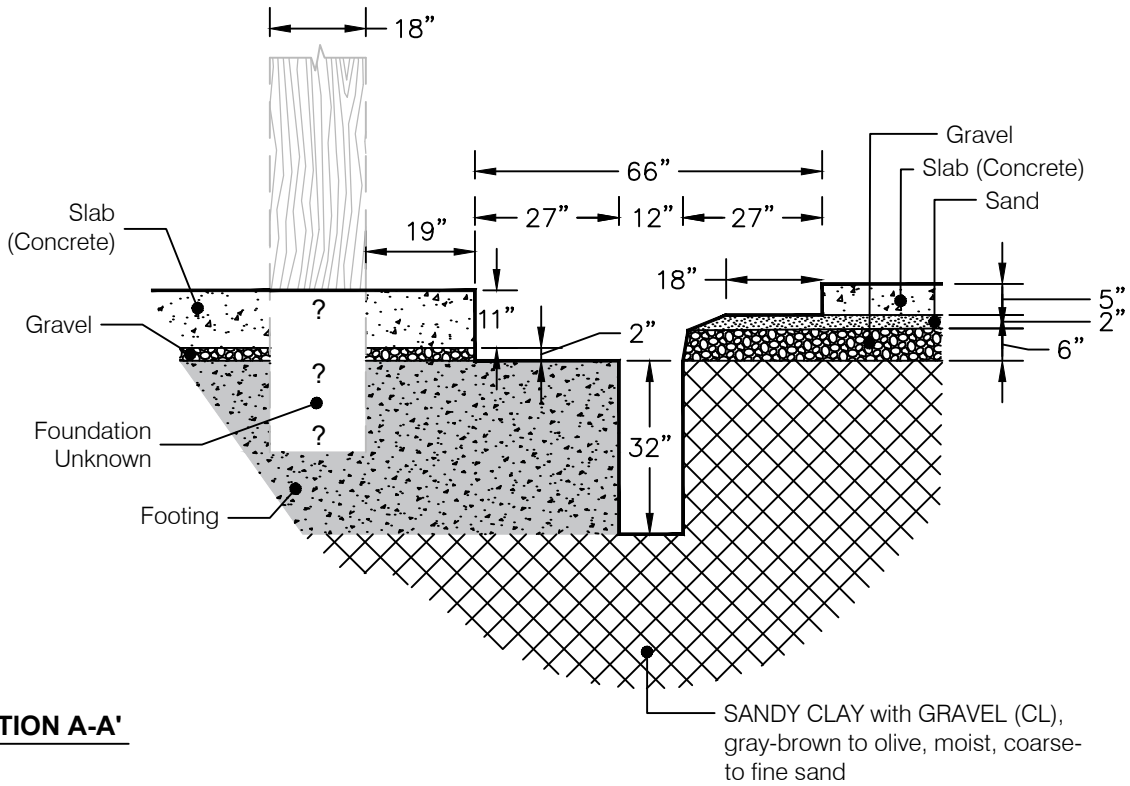

NOT TO SCALE

<p>LANGAN Langan Engineering and Environmental Services, Inc. 135 Main Street, Suite 1500 San Francisco, CA 94105 T: 415.955.5200 F: 415.955.5201 www.langan.com</p>	Project	Figure Title	Project No.	Figure
	5201 PATRICK HENRY DRIVE	TEST PIT LOG TP-1 SECTION A-A'	731769901	
	SANTA CLARA		Date	
	SANTA CLARA COUNTY CALIFORNIA		12/21/2022	
			Drawn By	C-1
			JDF	
			Checked By	
			HL	

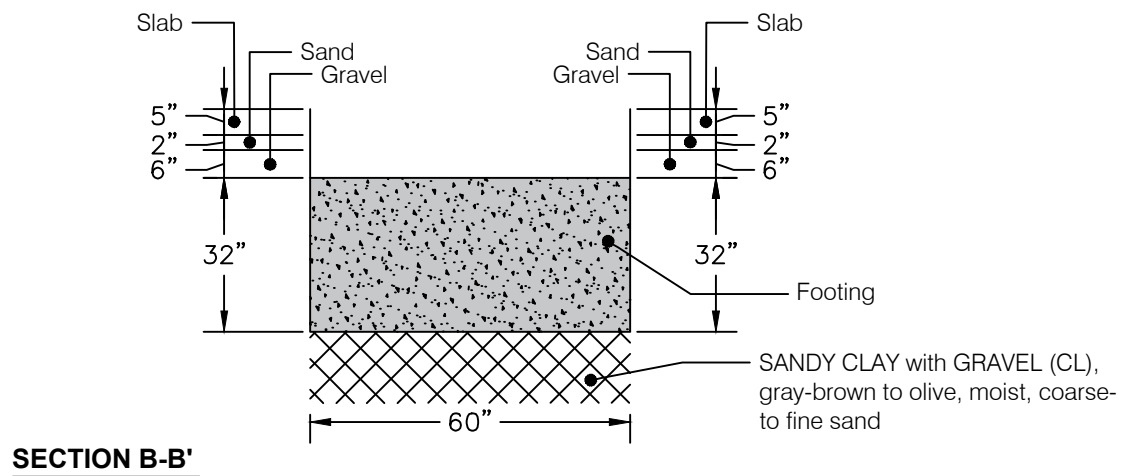
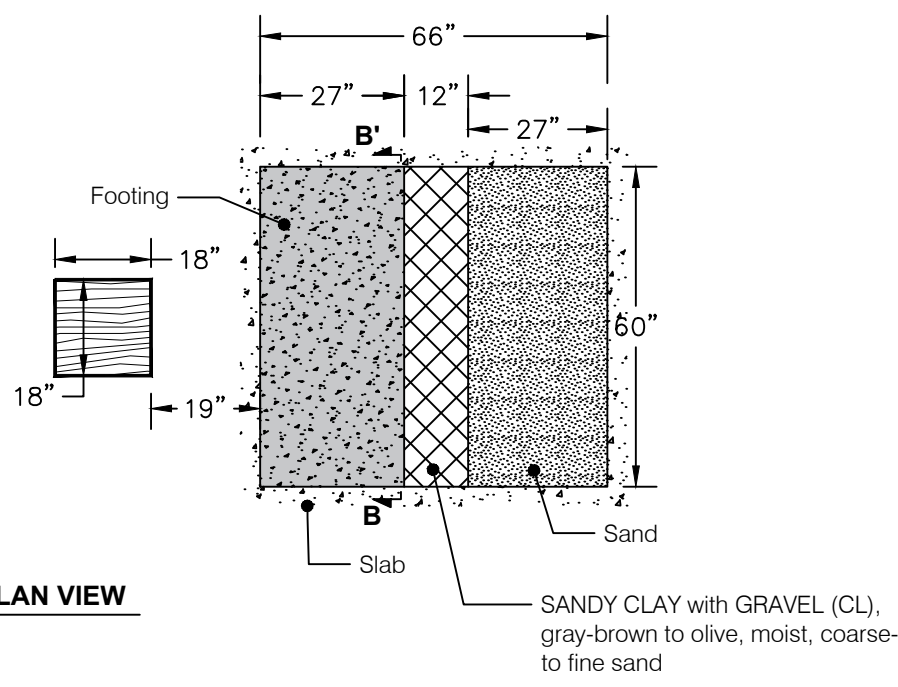

NOT TO SCALE

<p>Langan Engineering and Environmental Services, Inc. 135 Main Street, Suite 1500 San Francisco, CA 94105</p> <p>T: 415.955.5200 F: 415.955.5201 www.langan.com</p>	Project	Figure Title	Project No.	Figure
	5201 PATRICK HENRY DRIVE	TEST PIT LOG TP-1	731769901	
	SANTA CLARA	SECTION B-B'	Date	
	SANTA CLARA COUNTY CALIFORNIA		12/27/2022	
			Drawn By	C-2
			JDF	
			Checked By	
			HL	

APPENDIX D
LABORATORY TEST RESULTS

PLASTICITY CHART

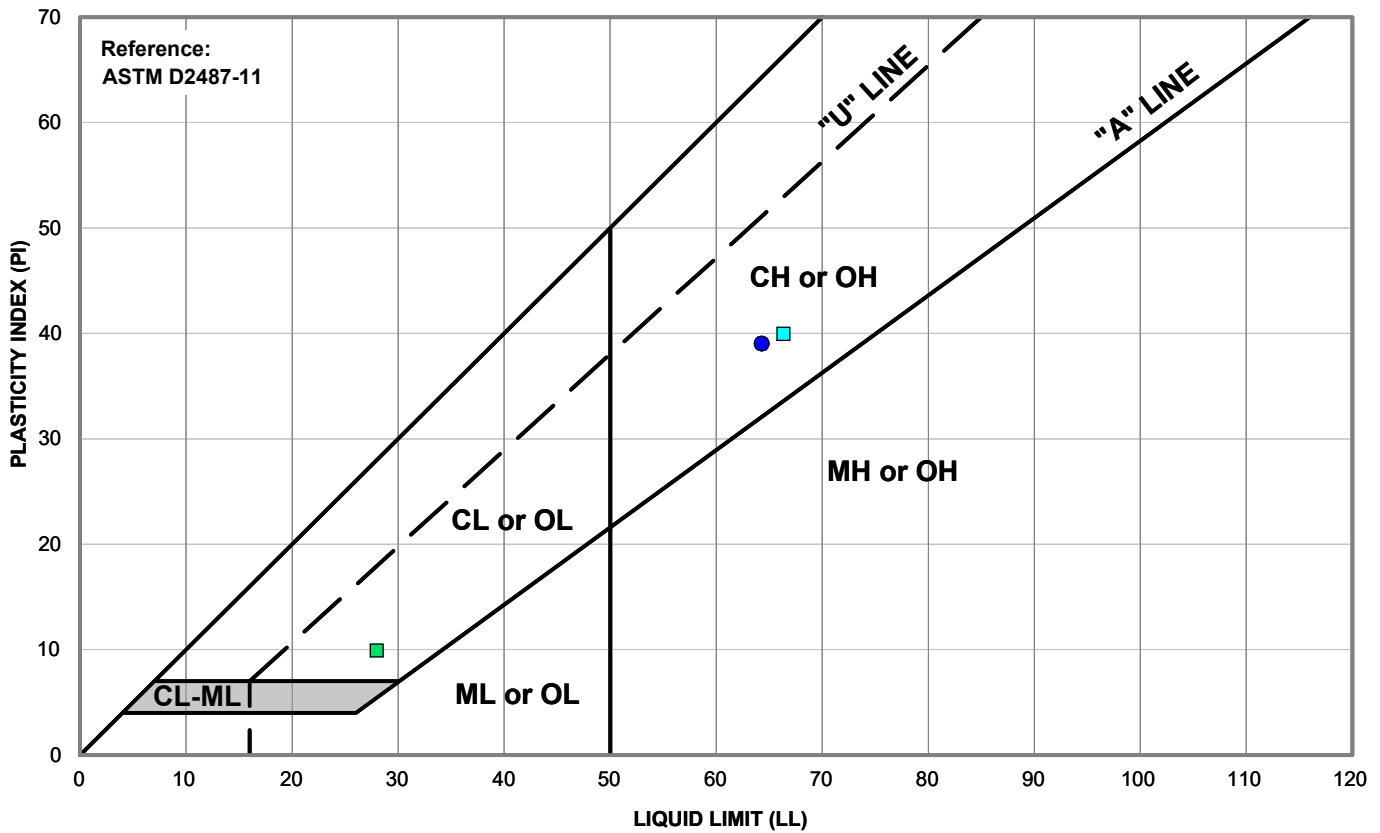

Symbol	Source	Description and Classification	Natural M.C. (%)	Liquid Limit (%)	Plasticity Index (%)	% Passing #200 Sieve
●	B-1 at 3.5 feet	CLAY (CH), gray-brown	28.8	64	39	--
■	B-1 at 8.5 feet	CLAYEY SAND (SC), red-brown	24.2	28	10	41.3
■	B-2 at 3.5 feet	CLAY (CH), dark brown	26.6	66	40	--

LANGAN
 Langan Engineering and Environmental Services, Inc.
 135 Main Street, Suite 1500
 San Francisco, CA 94105
 T: 415.955.5200 F: 415.955.5201 www.langan.com

Project
5201 PATRICK HENRY DRIVE
SANTA CLARA
SANTA CLARA COUNTY CALIFORNIA

Figure Title
PLASTICITY CHART

Project No.
731769901
 Date
11/29/2022
 Drawn By
JDF
 Checked By
HL

Figure
D-1

© 2022 Langan

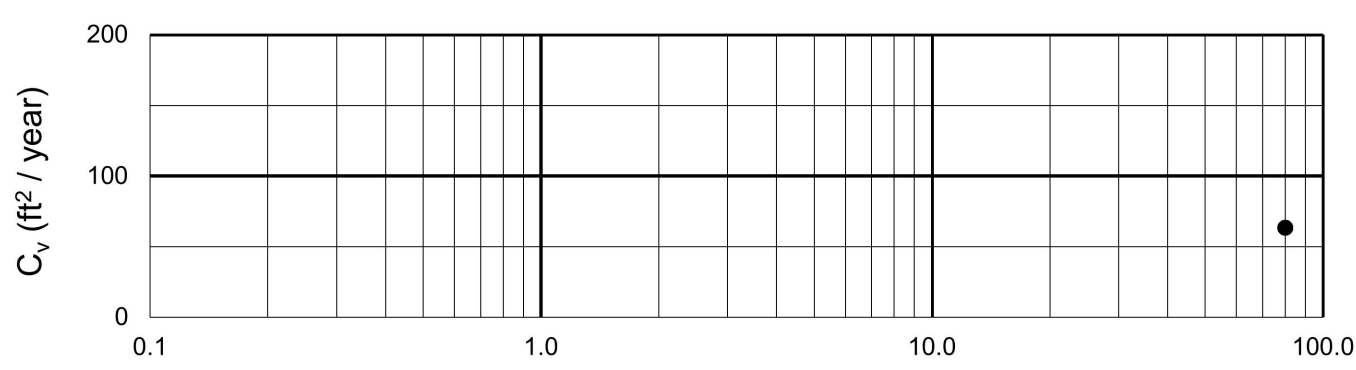
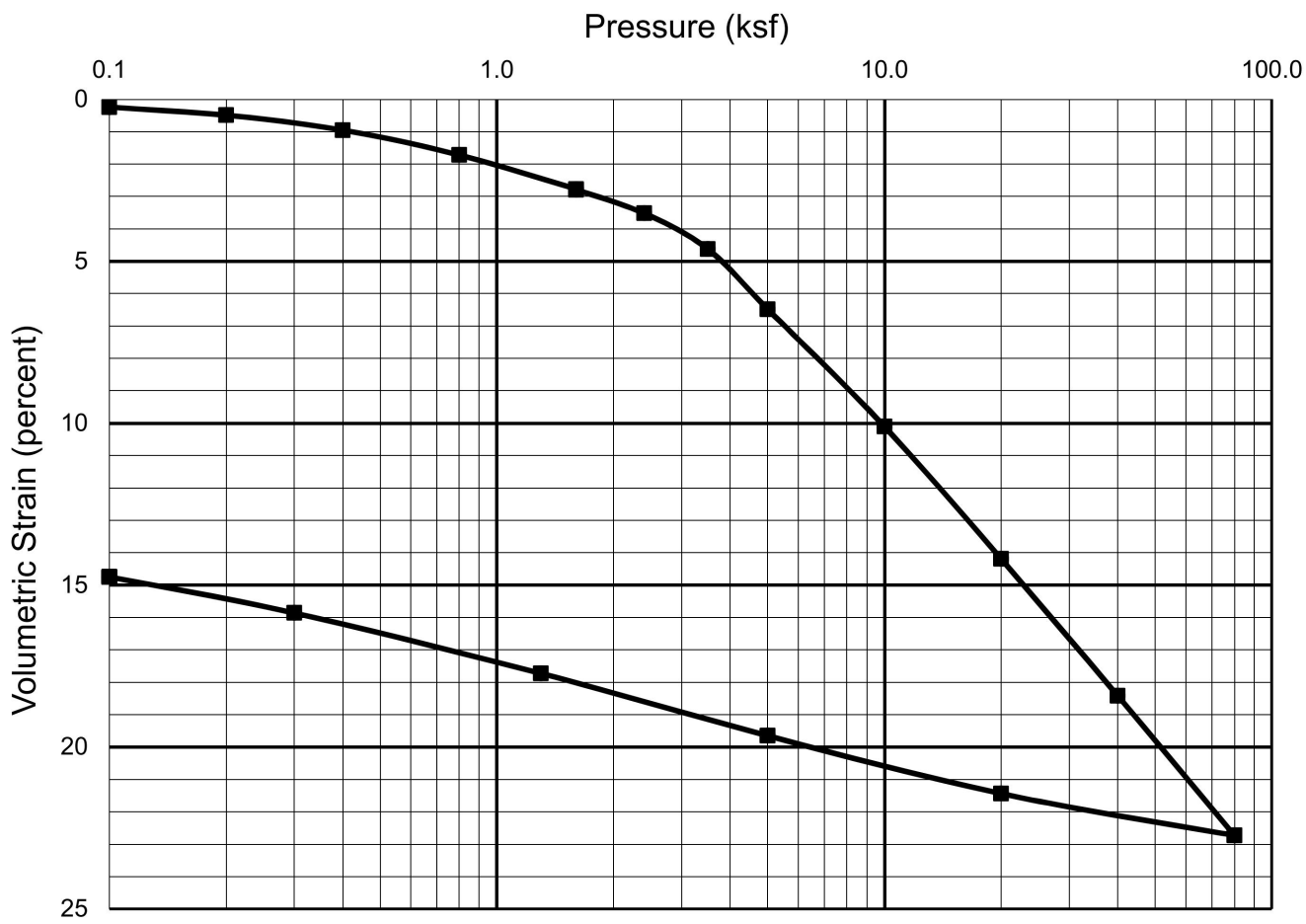

Sampler Type:	Shelby Tube	Condition	Before Test	After Test				
Diameter (in)	2.42	Height (in)	1.00	Water Content	w_o	28.6 %	w_f	20.8 %
Overburden Pressure, p_o	1,170 psf	Void Ratio	e_o	0.83	e_f	0.56		
Preconsol. Pressure, p_c	4,000 psf	Saturation	S_o	93 %	S_f	100 %		
Compression Ratio, C_{ec}	0.14	Dry Density	γ_d	92 pcf	γ_d	108 pcf		
LL	--	PL	--	PI	--	G_s	2.70	(assumed)
Classification	CLAY (CL), red-brown		Source	B-1 at 12 feet				

<p>Langan Engineering and Environmental Services, Inc. 135 Main Street, Suite 1500 San Francisco, CA 94105 T: 415.955.5200 F: 415.955.5201 www.langan.com</p>	Project	5201 PATRICK HENRY DRIVE SANTA CLARA SANTA CLARA COUNTY CALIFORNIA	Figure Title	Project No. 731769901	Figure D-2
	<h1>CONSOLIDATION TEST REPORT</h1>			Date 11/29/2022	
				Drawn By JDF	
				Checked By HL	

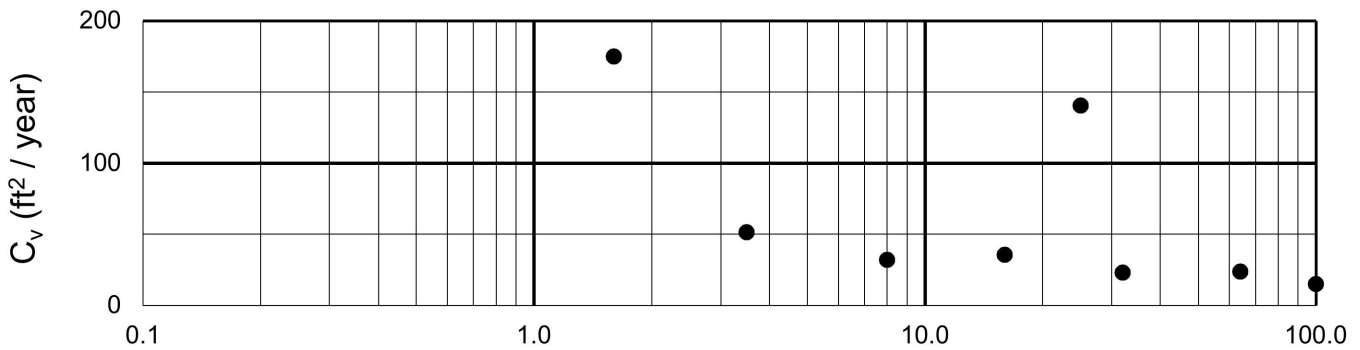
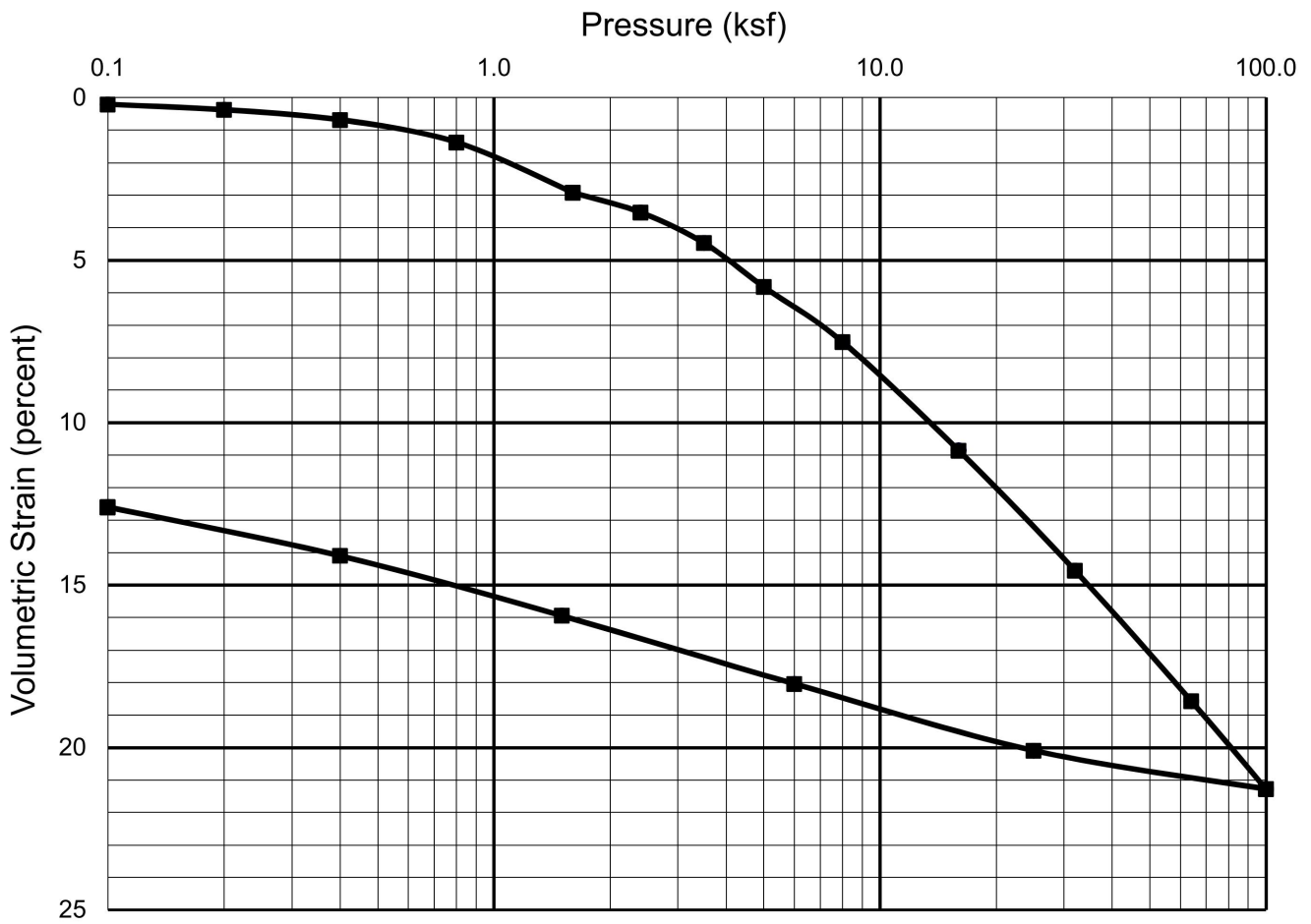

Sampler Type: Sprague & Henwood		Condition		Before Test		After Test	
Diameter (in)	2.42	Height (in)	1.00	Water Content	w _o 27.8 %	w _f	20.4 %
Overburden Pressure, p _o	1,720 psf	Void Ratio		e _o	0.77	e _f	0.55
Preconsol. Pressure, p _c	5,400 psf	Saturation		S _o	97 %	S _f	100 %
Compression Ratio, C _{sc}	0.13	Dry Density		γ _d	95 pcf	γ _d	109 pcf
LL	--	PL	--	PI	--	G _s	2.70 (assumed)
Classification				CLAY (CL), light brown with orange and dark brown mottling		Source	
						B-2 at 21 feet	

<p>Langan Engineering and Environmental Services, Inc. 135 Main Street, Suite 1500 San Francisco, CA 94105 T: 415.955.5200 F: 415.955.5201 www.langan.com</p>	Project	5201 PATRICK HENRY DRIVE SANTA CLARA SANTA CLARA COUNTY CALIFORNIA	Figure Title	CONSOLIDATION TEST REPORT	Project No.	731769901	Figure D-3
	Date	11/29/2022	Checked By	HL			
	Drawn By	JDF					

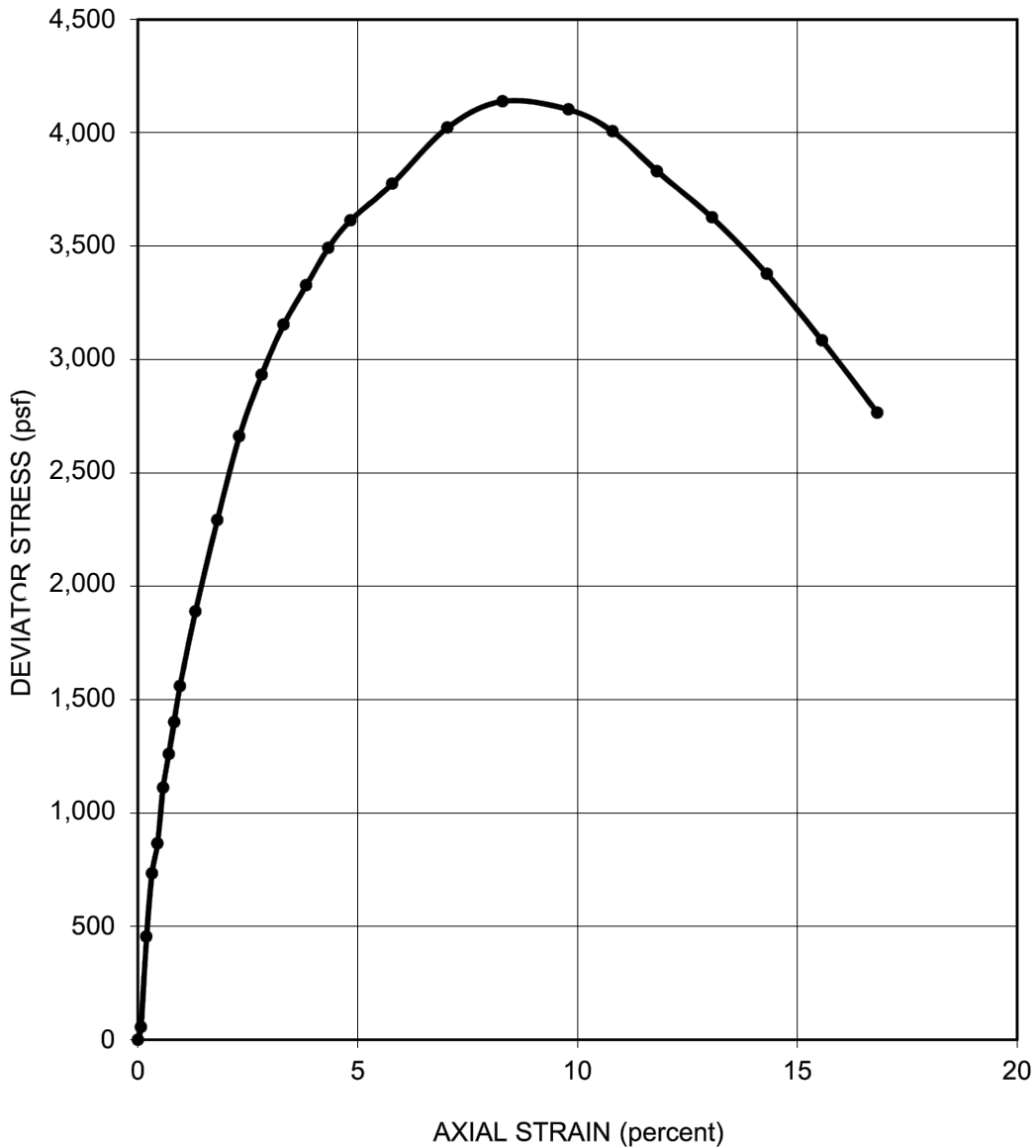

SAMPLER TYPE	Sprague & Henwood		SHEAR STRENGTH	2,070	psf
DIAMETER (in.)	2.38	HEIGHT (in.)	5.65	STRAIN AT FAILURE	8.3 %
MOISTURE CONTENT	25.1 %		CONFINING PRESSURE	1,000	psf
DRY DENSITY	102 pcf		STRAIN RATE	0.75	% / min
DESCRIPTION	CLAY with SAND (CL), light brown to gray			SOURCE	B-2 at 8.5 feet

 Langan Engineering and Environmental Services, Inc. 135 Main Street, Suite 1500 San Francisco, CA 94105 T: 415.955.5200 F: 415.955.5201 www.langan.com	Project	Figure Title	Project No.	Figure
	5201 PATRICK HENRY DRIVE	UNCONSOLIDATED-UNDRAINED TRIAXIAL COMPRESSION TEST	731769901	
	SANTA CLARA		11/29/2022	
	SANTA CLARA COUNTY CALIFORNIA		Drawn By JDF	
			Checked By HL	D-4

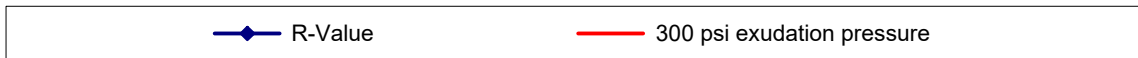
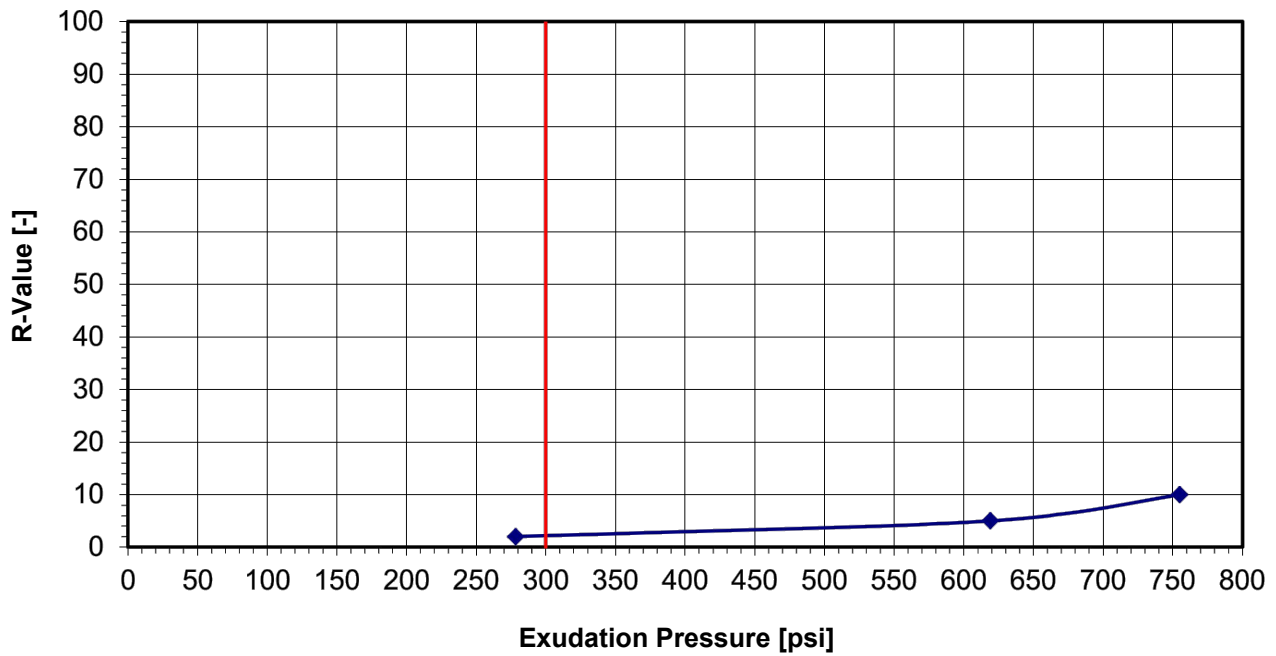

Sample ID	A	B	C	D
Water Content (%)	23.6	20.2	18.0	--
Dry Density (pcf)	101.6	107.7	110.2	--
Exudation Pressure (psi)	278	619	755	--
Expansion Pressure (psf)	0.0	0.0	0.0	--
Resistance Value (R)	2.1	5.3	10.2	--

Sample Source	Sample Description	Sand Equivalent	Expansion Pressure	R-Value
B-1 at 0 to 5 feet	CLAY (CH), gray-brown	--	--	<5

<p>LANGAN Langan Engineering and Environmental Services, Inc. 135 Main Street, Suite 1500 San Francisco, CA 94105 T: 415.955.5200 F: 415.955.5201 www.langan.com</p>	Project 5201 PATRICK HENRY DRIVE SANTA CLARA SANTA CLARA COUNTY CALIFORNIA	Figure Title RESISTANCE VALUE TEST REPORT	Project No. 731769901	Figure D-5
			Date 11/29/2022	
			Drawn By JDF	
			Checked By HL	

APPENDIX E
CORROSIVITY RESULTS



1100 Willow Pass Court, Suite A
Concord, CA 94520-1006
925 462 2771 Fax. 925 462 2775
www.cercoanalytical.com

17 November, 2022

Job No. 2211012
Cust. No. 12242

Mr. Haotian Li
Langan
1 Almaden Blvd., Suite 590
San Jose, CA 95113

Subject: Subject: Project No.: 731769902/700/100.0
Project Name: 5201 Patrick Henry Dr.
Corrosivity Analysis – ASTM Test Methods

Dear Mr. Li:

Pursuant to your request, CERCO Analytical has analyzed the soil sample submitted on November 1, 2022. Based on the analytical results, this brief corrosivity evaluation is enclosed for your consideration.

Based upon the resistivity measurement this sample is classified as “corrosive”. All buried iron, steel, cast iron, ductile iron, galvanized steel and dielectric coated steel or iron should be properly protected against corrosion depending upon the critical nature of the structure. All buried metallic pressure piping such as ductile iron firewater pipelines should be protected against corrosion.

The chloride ion concentration is 23 mg/kg, which is determined to be insufficient to attack steel embedded in a concrete mortar coating.

The sulfate ion concentration is 76 mg/kg and is determined to be insufficient to damage reinforced concrete structures and cement mortar-coated steel at this location.

The pH of the soil is 9.23 which does not present corrosion problems for buried iron, steel, mortar-coated steel and reinforced concrete structures.

The redox potential is 270-mV, which is indicative of potentially “slightly corrosive” soils resulting from anaerobic soil conditions.

This corrosivity evaluation is based on general corrosion engineering standards and is non-specific in nature. For specific long-term corrosion control design recommendations or consultation, please call *JDH Corrosion Consultants, Inc.* at (925) 927-6630.

We appreciate the opportunity of working with you on this project. If you have any questions, or if you require further information, please do not hesitate to contact us.

Very truly yours,
CERCO ANALYTICAL, INC.

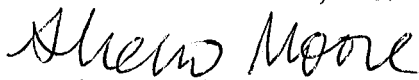
for 
J. Darby Howard, Jr., P.E.
President

JDH/jdl
Enclosure

Client: Langan
 Client's Project No.: 731769902/700/100.0
 Client's Project Name: 5201 Patrick Henry Dr.
 Date Sampled: 1-Nov-22
 Date Received: 9-Nov-22
 Matrix: Soil
 Authorization: Chain of Custody

Date of Report: 17-Nov-2022

Job/Sample No.	Sample I.D.	Redox (mV)	pH	Conductivity (umhos/cm)*	Resistivity (100% Saturation) (ohms-cm)	Sulfide (mg/kg)*	Chloride (mg/kg)*	Sulfate (mg/kg)*
2211012-001	B-1, 0-5'	270	9.23	-	830	-	23	76

Method:	ASTM D1498	ASTM D4972	ASTM D1125M	ASTM G57	ASTM D4658M	ASTM D4327	ASTM D4327
Reporting Limit:	-	-	10	-	50	15	15
Date Analyzed:	15-Nov-2022	15-Nov-2022	-	16-Nov-2022	-	15-Nov-2022	15-Nov-2022

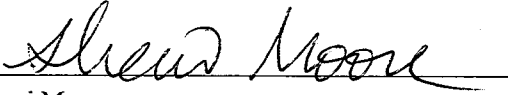
 Sherri Moore
 Chemist

 * Results Reported on "As Received" Basis
 N.D. - None Detected

Chain of Custody

2211012

1100 Willow Pass Court
 Concord, CA 94520-1006
 925 462 2771
 Fax: 925 462 2775



Job No. 731769902/700/100.0	CU# 1224	Client Project I.D. 5201 Patrick Henry Dr	Schedule Analyte	Date Sampled 11/1/22	Date Due
--------------------------------	-------------	--	---------------------	-------------------------	----------

Full Name: Haotian Li, hli@langan.com
 Phone: 341-336-4737 X
 Fax:
 Company and/or Mailing Address: Langan, 1 Almaden Blvd, #590, San Jose, CA 95113
 Cell:
 Sample Source: Bulk Sample

	ANALYSIS					ASTM													
	Redox Potential	pH	Sulfate	Chloride	Resistivity-100% Saturated														
001	X	X	X	X	X														

Lab No.	Sample I.D.	Date	Time	Matrix	Contain.	Size	Preserv.	Qty.
001	B-1, 0 to 5'	11/1/22	8:15am	Soil	Bag			1

MATRIX	DW - Drinking Water	ABBREVIATIONS	HB - Hosebib	SAMPLE RECEIPT	Total No. of Containers	
	GW - Ground Water		PV - Petcock Valve		Rec'd Good Cond/Cold	
	SW - Surface Water		PT - Pressure Tank		Conforms to Record	
	WW - Waste Water		PH - Pump House		Temp. at Lab °C	
Water	RR - Restroom		Temp. at Lab °C			
SL - Sludge	GL - Glass		Temp. at Lab °C			
S - Soil	PL - Plastic		Temp. at Lab °C			
Product	ST - Sterile		Temp. at Lab °C			

Relinquished By: *Haotian Li* Date: 11/8/2022 Time: 8:00 am
 Received By: *Diana Judd* Date: 01/9/22 Time: 1430
 Relinquished By: _____ Date: _____ Time: _____
 Received By: _____ Date: _____ Time: _____
 Relinquished By: _____ Date: _____ Time: _____
 Received By: _____ Date: _____ Time: _____

Comments: THERE IS AN ADDITIONAL CHARGE FOR EXTRUDING SOIL FROM METAL TUBES
 Email Address: hli@langan.com

APPENDIX F
SITE-SPECIFIC RESPONSE SPECTRA AND TIME SERIES

APPENDIX F

SITE-SPECIFIC RESPONSE SPECTRA AND TIME SERIES

This appendix presents the results of our ground motion study for the development of site-specific response spectra and site-specific time series. To develop site-specific response spectra in accordance with 2019 California Building Code (CBC) criteria, and by reference ASCE 7-16, we performed probabilistic seismic hazard analysis (PSHA) and deterministic analysis to develop smooth, site-specific horizontal spectra for two levels of shaking, namely:

- Risk-Targeted Maximum Considered Earthquake (MCE_R), which corresponds to the lesser of the risk-targeted two percent probability of exceedance in 50 years (2,475-year return period) or 84th percentile of the controlling deterministic event both considering the maximum direction as described in ASCE 7-16, with appropriate lower limit checks.
- Design Earthquake (DE), which corresponds to 2/3 of the MCE_R .

We then developed eleven pairs of orthogonal pairs of spectrally scaled horizontal time series for the MCE_R for a total of twenty-two ground motions.

F1.0 PROBABILISTIC SEISMIC HAZARD ANALYSIS

Because the location, recurrence interval, and magnitude of future earthquakes are uncertain, we performed a PSHA, which systematically accounts for these uncertainties. The results of a PSHA define a uniform hazard for a site in terms of a probability that a particular level of shaking will be exceeded during the given life of the structure.

To perform a PSHA, information regarding the seismicity, location, and geometry of each source, along with empirical relationships that describe the rate of attenuation of strong ground motion with increasing distance from the source, are needed. The assumptions necessary to perform the PSHA are that:

- the geology and seismic tectonic history of the region are sufficiently known, such that the rate of occurrence of earthquakes can be modeled by historic or geologic data;
- the level of ground motion at a particular site can be expressed by a ground motion model that is primarily dependent upon earthquake magnitude and distance from the source of the earthquake;
- the earthquake occurrence can be modeled as a Poisson process with a constant mean occurrence rate.

As part of the development of the site-specific spectra, we performed a PSHA to develop a site-specific response spectrum for 2 percent probability of exceedance in 50 years. The ground surface spectrum was developed using the OpenSHA Hazard Spectrum Application 1.5.2. The approach used in PSHA is based on the probabilistic seismic hazard model developed by

Cornell (1968) and McGuire (1976). Our analysis modeled the faults in the Bay Area as linear sources, and earthquake activities were assigned to the faults based on historical and geologic data. The levels of shaking were estimated using ground motion models (GMM) that are primarily dependent upon the magnitude of the earthquake and the distance from the site to the fault, as well as the time-averaged shear wave velocity of the upper 30 meters, V_{s30} .

F1.1 Probabilistic Model

In probabilistic models, the occurrence of earthquake epicenters on a given fault is assumed to be uniformly distributed along the fault. This model considers ground motions arising from the portion of the fault rupture closest to the site rather than from the epicenter. Fault rupture lengths were modeled using fault rupture length-magnitude relationships given by Wells and Coppersmith (1994).

The probability of exceedance, $P_e(Z)$, at a given ground-motion, Z , at the site within a specified time period, T , is given as:

$$P_e(Z) = 1 - e^{-V(z)T}$$

where $V(z)$ is the mean annual rate of exceedance of ground motion level Z . $V(z)$ can be calculated using the total-probability theorem.

$$V(z) = \sum_i v_i \iint P[Z > z | m, r] f_{M_i}(m) f_{R_i|M_i}(r; m) dr dm$$

where:

v_i = the annual rate of earthquakes with magnitudes greater than a threshold M_{oi} in source i

$P[Z > z | m, r]$ = probability that an earthquake of magnitude m at distance r produces ground motion amplitude Z higher than z

$f_{M_i}(m)$ and $f_{R_i|M_i}(r; m)$ = probability density functions for magnitude and distance

Z represents peak ground acceleration, or spectral acceleration values for a given frequency of vibration. The peak accelerations are assumed to be log-normally distributed about the mean with a standard error that is dependent upon the magnitude and GMM used.

F1.2 Source Modeling and Characterization

The segmentation of faults, maximum magnitudes, and recurrence rates were modeled using the data presented in the Uniform California Earthquake Rupture Forecast Version 3 (UCERF3) as detailed in the United States Geological Survey Open File Report 2013-1165. These and other faults of the region are shown on Figure 3. Table F-1 presents the distance and direction from the site to the fault, mean moment magnitude, mean slip rate, and fault length for faults in

UCERF3 source model. The mean moment magnitude presented in Table F-1 was computed assuming full rupture of the segment using the average of the relationships presented in USGS Open-File Report 2013-1165.

TABLE F-1
Source Zone Parameters

Fault Name	Approx. Distance from Fault (km)	Direction from Site	Mean Moment Magnitude¹	Mean Slip Rate (mm/yr)	Fault Length (km)
Silver Creek	4.0	East	6.7	0.1	48
Hayward (So)	10.4	Northeast	6.9	9.8	54
Total Hayward-Rodgers Creek					
Healdsburg	10.4	Northeast	7.4	7.3	213
Monte Vista - Shannon	12.1	West	7.0	0.8	60
Mission (connected)	14.5	Northeast	6.2	0.8	28
Total Calaveras	15.8	East	7.5	8.0	186
Calaveras (Central)	15.8	East	6.8	10.2	52
Calaveras (No)	15.8	East	6.8	4.8	48
Hayward (So) extension	16.1	East	6.1	4.3	23
San Andreas (Peninsula)	18.4	Southwest	7.2	15.1	100
San Andreas 1906 event	18.4	Southwest	7.9	17.2	464
Pilarcitos	19.0	West	6.7	0.7	51
Butano	24.8	Southwest	6.8	0.7	46
San Andreas (Santa Cruz Mts)	25.8	South	7.0	18.6	63
Las Positas	27.0	Northeast	6.3	0.4	15
Sargent	29.9	South	6.9	1.7	57
Zayante-Vergeles 2011 CFM	33.0	Southwest	7.1	0.1	90
Zayante-Vergeles	35.4	South	6.9	0.1	58
San Gregorio (North)	37.6	West	7.3	4.6	129
Mount Diablo Thrust	38.7	Northeast	6.6	1.6	25
Mount Diablo Thrust South	39.4	Northeast	6.1	1.5	11
Greenville (No)	39.8	East	6.9	2.6	51
Greenville (So)	40.6	East	6.5	1.8	29
Mount Diablo Thrust North CFM	41.3	North	6.4	1.8	19
Hayward (No)	45.2	Northwest	6.8	8.3	53
Franklin	49.2	North	6.7	1.1	38
Contra Costa (Lafayette)	50.5	North	6.0	0.8	8
Contra Costa (Larkey)	51.0	North	6.0	0.8	8
Reliz	52.0	Southwest	7.2	0.3	127
Clayton	52.0	North	6.4	0.7	16
Contra Costa (Reliez Valley)	54.1	North	5.9	0.2	6
Great Valley 07 (Orestimba)	54.5	Northeast	6.8	0.5	66
Concord	54.9	North	6.4	3.4	18
Monterey Bay-Tularcitos	55.4	South	7.1	0.6	86
Calaveras (So)	56.8	Southeast	6.4	11.6	26

¹ Mean Moment Magnitude based on entire fault length or segment rupturing using average of the relationships presented in USGS Open-File Report 2013-1165.

Fault Name	Approx. Distance from Fault (km)	Direction from Site	Mean Moment Magnitude ¹	Mean Slip Rate (mm/yr)	Fault Length (km)
Contra Costa Shear Zone (connector)	57.0	North	6.6	0.9	30
Great Valley 06 (Midland) alt1	57.2	Northeast	7.1	0.3	69
Contra Costa (Briones)	59.3	North	6.0	0.4	9
Great Valley 06 Midland alt2	59.6	Northeast	6.7	0.3	33
Contra Costa (Southampton)	60.3	North	6.2	0.1	11
Ortogonalita (North)	61.5	East	6.6	1.8	40
Point Reyes 2011 connector	61.9	West	6.5	0.1	34
San Gregorio (South)	63.2	Southwest	7.1	2.1	90
Los Medanos - Roe Island	63.6	North	6.4	0.2	21
Great Valley 05 Pittsburg Kirby Hills alt2	69.0	North	6.8	1.0	32
Contra Costa (Dillon Point)	69.4	North	6.1	0.7	11
Great Valley 05 Pittsburg - Kirby Hills alt1	70.5	North	6.3	1.0	21
Contra Costa (Ozal - Columbus)	70.5	North	6.0	0.4	9
Green Valley	71.6	North	6.8	3.8	43
Quien Sabe	75.0	Southeast	6.4	0.9	25
Great Valley 08 (Quinto)	80.7	East	6.1	0.3	19
San Andreas (Creeping Section)	80.8	Southeast	7.2	18.7	121
Contra Costa (Vallejo)	80.8	North	5.6	0.6	4
San Andreas (North Coast)	81.2	Northwest	7.4	18.0	171
Contra Costa (Lake Chabot)	81.5	North	5.6	0.7	4
Ortogonalita (South)	81.6	East	6.9	1.2	62
Calaveras (So) - Paicines extension	81.9	Southeast	6.9	7.1	60
West Napa	87.5	North	6.8	1.3	44
Rodgers Creek - Healdsburg	93.7	Northwest	7.1	5.7	82
Great Valley 09 (Laguna Seca)	94.6	East	6.6	1.6	39
Point Reyes	94.6	Northwest	6.8	0.1	63
Great Valley 04b Gordon Valley	98.1	North	6.6	0.9	28

Note: The table above is a summary and does not include all the fault segmentation, alternate traces and low activity faults included in the UCERF3 model.

F1.3 Ground Motion Models

Based on the subsurface conditions, the site is classified as a stiff soil profile, Site Class D. Using the subsurface information available at the site, we estimated the shear wave velocity of the upper 100 feet (30 meters), V_{s30} , is approximately 885 feet per second (270 meters per second). Furthermore, NGAW-2 database indicates that depths Z_1 and $Z_{2.5}$ at close by recording stations are about 500 meters and 0.85 kilometers, respectively. These values were used in the development of site-specific spectra.

The Pacific Earthquake Engineering Research Center (PEER) embarked on the NGA-West 2 project to update the previously developed ground motion prediction equations (ground motion models), which were mostly published in 2014. We used the relationships by Abrahamson et al.

(2014), Boore et al. (2014), Campbell and Bozorgnia (2014) and Chiou and Youngs (2014). These ground motion models include the time-averaged shear wave velocity in the upper 100 feet. Furthermore, these relationships were developed using the same earthquake database, therefore, the mean of the relationships (using equal weights for each ground motion model) is appropriate and was used to develop the recommended spectra.

The NGA relationships database includes the most up-to-date recorded and processed data. They were developed for the “mean” (Rot_{D50}) horizontal components of spectral acceleration.

F1.4 Maximum Direction

ASCE 7-16 specifies the development of MCE_R site-specific response spectra in the maximum direction. Shahi and Baker (2014) provide scaling factors that modify the geometric mean spectra to provide spectral values for the maximum response (maximum direction). Therefore, we used the scaling factors presented on Table 1 of Shahi and Baker (2014) for ratios of $Sa_{RotD100}/Sa_{RotD50}$ to modify the mean PSHA results.

F1.5 Near-Source Effects

The site is in the near-field region (i.e., distances less than about 15 kilometers from a fault) and therefore may experience near-field directivity effects during an earthquake on a nearby fault. It has been recognized that ground motions recorded in the near-field regions show rupture directivity and near-source effects such as velocity and displacements pulses (sometimes referred to as “fling”). In general, such effects tend to increase the long period portion of the acceleration response spectrum when compared to the average spectrum. These effects have been demonstrated by Golesorkhi and Gouchon (2002), Somerville et al. (1995 and 1997), and Singh (1985). Somerville et al. (1997) and Abrahamson (2000) quantified near-source directivity effects and provided scaling factors for modifying the average spectra to capture these effects. The Natural Hazards Risks and Resiliency Research Center (NHR3) developed a directivity-based PSHA interactive tool for California that interpolates the state-wide PSHA results to provide uniform-hazard spectra with and without directivity effects. The tool was developed by Mazzoni et al. (2023). The average directivity factors for the site were estimated using the NHR3 directivity based PSHA tool and were used to develop the average directivity spectrum.

F2.0 PSHA RESULTS

Figure F-1 presents the hazard curve for the mean of the four ground motion models for the peak ground acceleration (PGA), 0.2, 0.5, 1.0, and 1.5 second periods. Figure F-2 presents the Rot_{D50} results of the PSHA for the 2 percent probability of exceedance in 50 years hazard level (2,475-year return period) using the four relationships discussed above as well as the lognormal mean of these relationships and the mean in the maximum direction including average directivity.

Figure F-3 presents the deaggregation plots of the PSHA results for the 2 percent probability of exceedance in 50 years hazard level. Table F-2 presents the mean magnitude, distance, and

epsilon values from the deaggregation results for the 2 percent probability of exceedance in 50 years hazard level. From the examination of these results, it can be seen that the Hayward-Rodgers Creek fault dominates the hazard at the project site at shorter periods. At longer periods, the San Andreas fault dominates the hazard at the project site.

TABLE F-2
Deaggregation Results

Period (seconds)	Mean Magnitude	Mean Distance (km)	Mean Epsilon
0.01	6.9	13.4	2.2
0.20	6.9	14.1	2.3
0.50	7.2	14.2	2.1
1.00	7.3	14.4	2.0
1.50	7.4	14.7	1.9

F3.0 DETERMINISTIC ANALYSIS

We performed a deterministic analysis to develop the MCE_R spectrum at the site. In a deterministic analysis, a given magnitude earthquake occurring at a certain distance from the source is considered as input into an appropriate ground motion model. The same ground motion models, weighting factors, maximum direction factors, and near-source effects as discussed in Section F1.3, F1.4, and F1.5 were used in our deterministic analysis.

On the basis of the deaggregation results we developed deterministic spectra for both scenario earthquakes:

- a Moment Magnitude of 7.3 on the Hayward-Rodgers Creek fault at a distance of 10 kilometers from the site, and;
- a Moment Magnitude of 8.1 on the San Andreas fault at a distance of 18 kilometers from the site.

Figures F-4 and F-5 present the 84th percentile deterministic results for the Hayward-Rodgers Creek and San Andreas scenarios, respectively. The average of the four ground motion models for the Rot_{D50} and the average in the maximum direction, including average directivity for the Hayward-Rodgers Creek scenario, are also presented on those figures.

We conclude the envelope of the two scenarios be used as the deterministic basis for the development of the MCE_R . Figure F-6 presents the average of the 84th percentile deterministic results in the maximum direction for both scenarios as well as the recommended envelope of both scenarios.

F4.0 RECOMMENDED SPECTRA

The MCE_R as defined in ASCE 7-16 is the lesser of the maximum direction PSHA spectrum having a two percent probability of exceedance in 50 years (2,475-year return period) or the maximum direction 84th percentile deterministic spectrum of the governing earthquake scenario and the DE spectrum is defined as 2/3 times the MCE_R spectrum. In addition, the MCE_R spectrum is defined as a Risk-Targeted response spectrum, which corresponds to a targeted collapse probability of one percent in 50 years. The USGS Risk-Targeted Ground Motion calculator was used to determine the risk coefficients for each period of interest for the probabilistic spectrum. We used these risk coefficients to develop the risk targeted PSHA spectrum.

Furthermore, we followed the procedures outlined in Chapter 21 of ASCE 7-16 and Supplement No. 1 to develop the site-specific spectra for MCE_R and DE. Chapter 21 of ASCE 7-16 requires the following checks:

- the largest spectral response acceleration of the resulting 84th percentile deterministic ground motion response spectra shall not be less than $1.5 \times F_a$ where F_a is equal to 1.0.
- the DE spectrum shall not fall below 80 percent of S_a determined in accordance with Section 11.4.6, where F_a is determined using Table 11.4-1 and F_v is taken as 2.5 for $S_1 \geq 0.2$ (Section 21.3 of Chapter 21 ASCE 7-16).
- The site-specific MCE_R spectral response acceleration at any period shall not be taken as less than 150 percent of the site-specific design response spectrum determined in accordance with Section 21.3.

Table F-3 presents digitized values of the site-specific spectra for the mean results of the PSHA 2,475-year return period hazard level and the average results of the 84th percentile deterministic. The average directivity factors, maximum direction factors, and risk coefficients along with the digitized values of the site-specific spectra for the risk-targeted PSHA 2,475-year return period in the maximum direction and the 84th percentile deterministic in the maximum direction, including average directivity, are presented in Table F-3. Table F-4 presents digitized values of the site-specific spectra for the risk-targeted PSHA 2,475-year return period in the maximum direction and the envelope of the 84th percentile deterministic in the maximum direction, including average directivity. The largest spectral response acceleration of the 84th percentile deterministic response spectrum in the maximum direction with average directivity is 1.732g and is greater than $1.5 \times F_a$ (where $F_a = 1.0$ for Site Class D); therefore, no further scaling of the 84th percentile deterministic spectra was needed.

Figure F-7 and Table F-4 present a comparison of the site-specific spectra for the risk-targeted 2,475-year return period PSHA and the 84th percentile deterministic spectra, both in the maximum direction including average directivity. In this case, the 84th percentile deterministic spectrum is less than the risk-targeted PSHA spectrum for a 2 percent probability of exceedance in 50 years (2,475 year return period) for periods less than or equal to 5 seconds, therefore, the basis for the

development of the MCE_R spectrum should be the deterministic spectrum for periods up to 5 seconds. The DE spectrum is defined as 2/3 times the MCE_R ; however, the DE spectrum should not be less than 80 percent of the DE code spectrum as determined using F_a equal to 1.0 and F_v equal to 2.5 (per Section 21.3 of ASCE 7-16). As shown on Figure F-7 and Table F-4, the DE spectrum is greater than or equal to 80 percent of the DE code spectrum for periods up to 5 seconds.

TABLE F-3
Development of Site-Specific Spectra for the Risk-Targeted
2,475-year Return Period PSHA and the 84th Percentile Deterministic Spectra in
Maximum Direction with Average Directivity

Period (sec.)	Sa (g) for 5 percent damping		Average Directivity Factors (NHR3 Directivity -Based PSHA)	Max. Dir. Factors (Shahi and Baker 2014) ¹	Risk Coef. ²	Sa (g) for 5 percent damping	
	Mean PSHA – 2,475-Year Return Period	Average Deterministic 84 th Percentile				Risk-Targeted PSHA – 2,475-Year Return Period Max. Dir. with Average Directivity	Deterministic 84 th Percentile Max. Dir. with Average Directivity
0.01	0.869	0.566	1.00	1.19	1.02	1.055	0.673
0.10	1.516	0.889	1.00	1.19	1.02	1.840	1.058
0.20	1.969	1.227	1.00	1.21	1.03	2.454	1.485
0.30	2.190	1.388	1.00	1.22	1.01	2.698	1.694
0.40	2.201	1.408	1.00	1.23	0.99	2.680	1.732
0.50	2.121	1.359	1.01	1.23	0.98	2.570	1.680
0.75	1.742	1.117	1.01	1.24	0.96	2.087	1.393
1.00	1.457	0.938	1.04	1.24	0.95	1.790	1.214
1.50	1.042	0.684	1.06	1.24	0.94	1.288	0.889
2.00	0.798	0.540	1.08	1.24	0.93	0.992	0.685
3.00	0.525	0.385	1.12	1.25	0.93	0.680	0.481
4.00	0.374	0.288	1.14	1.26	0.92	0.496	0.363
5.00	0.285	0.221	1.18	1.26	0.92	0.389	0.278

Notes:

1. The average directivity factors were applied to the Hayward-Rodgers Creek scenario.
2. The USGS Risk-Targeted Ground Motion calculator was used to determine the risk coefficients for each period of interest for the probabilistic spectrum, <https://earthquake.usgs.gov/designmaps/rtgm/>.

TABLE F-4
Comparison of Site-specific and Code Spectra for Development of
MCE_R Spectrum per ASCE 7-16
Sa (g) for 5 percent damping

Period (sec.)	Risk-Targeted PSHA – 2,475-Year Return Period Max. Dir. with Average Directivity	Deterministic 84 th Percentile Max. Dir. Envelope with Average Directivity	Lesser of PSHA and Deterministic (Initial MCE _R)	2/3 of Initial MCE _R (Initial DE)	ASCE 7-16 - 80% DE per Section 21.3 Site Class D; F _v = 2.50	Recommended Spectra	
						DE	MCE _R
0.01	1.055	0.673	0.673	0.449	0.344	0.449	0.673
0.10	1.840	1.058	1.058	0.706	0.560	0.706	1.058
0.20	2.454	1.485	1.485	0.990	0.800	0.990	1.485
0.30	2.698	1.694	1.694	1.129	0.800	1.129	1.694
0.40	2.680	1.732	1.732	1.155	0.800	1.155	1.732
0.50	2.570	1.680	1.680	1.120	0.800	1.120	1.680
0.75	2.087	1.393	1.393	0.929	0.800	0.929	1.393
1.00	1.790	1.214	1.214	0.809	0.800	0.809	1.214
1.50	1.288	0.889	0.889	0.593	0.533	0.593	0.889
2.00	0.992	0.685	0.685	0.457	0.400	0.457	0.685
3.00	0.680	0.481	0.481	0.320	0.267	0.320	0.481
4.00	0.496	0.363	0.363	0.242	0.200	0.242	0.363
5.00	0.389	0.278	0.278	0.186	0.160	0.186	0.278

The recommended MCE_R and DE spectra are presented in Table F-5 and on Figure F-8.

TABLE F-5
Recommended MCE_R and DE Spectra
 S_a (g) for 5 percent damping

Period (seconds)	MCE_R	DE
0.01	0.673	0.449
0.10	1.058	0.706
0.20	1.485	0.990
0.30	1.694	1.129
0.40	1.732	1.155
0.50	1.680	1.120
0.75	1.393	0.929
1.00	1.214	0.809
1.50	0.889	0.593
2.00	0.685	0.457
3.00	0.481	0.320
4.00	0.363	0.242
5.00	0.278	0.186

Because site-specific procedure was used to determine the recommended response spectra, the corresponding values of S_{MS} , S_{M1} , S_{DS} and S_{D1} per Section 21.4 of ASCE 7-16 should be used as shown in Table F-6.

TABLE F-6
Design Spectral Acceleration Value

Parameter	Spectral Acceleration Value (g's)
S_{MS}^2	1.559
S_{M1}^3	1.450
S_{DS}^2	1.039
S_{D1}^3	0.967

² S_{DS} is based on the site-specific response spectra and is based on 90 percent of the maximum spectral acceleration within the period range of 0.2 to 5 seconds; it is governed by 90 percent of the spectral acceleration at a period of 0.4 seconds.

³ S_{D1} is based on the site-specific response spectra and is the maximum of the product of period, T, and spectral acceleration, S_a , for periods from 1.0 to 5.0 seconds; it is governed by the product of the period and spectral acceleration at a period of 4.0 seconds.

F5.0 SCALED TIME SERIES

The selection of recorded time series is an important step in developing the site-specific ground motions. The intent in this selection process is to choose time series that have a similar magnitude, and distance as that of the recommended MCE_R . We searched for records with the following attributes:

- Moment Magnitude greater than or equal to 6.5 to 8.1
- Rupture distance less 25 km
- V_{S30} less than 450 m/s

In addition, we searched for 4 to 5 records with pulse periods.

We used a single scalar approach to scale each time series. Chapter 16 of ASCE 7-16 requires the average of the maximum direction spectra (ROT_{D100}) from eleven ground motions not fall below 90 percent of the target response spectrum over the period range of interest; for this study, the period range of interest is 0.094 to 1.3 seconds, as provided by GPLA, Inc., the project structural engineer.

We used the computer program QuakeManager version 2.20 (Earthquake Solutions 2022) to select the proposed time series. The algorithm used in QuakeManager calculates the sum of the squared error (SSE) between the target spectrum (MCE_R) and initially scaled ROT_{D100} for each pair of time series in the database. These scaling factors were based on the algorithm used in QuakeManager to reduce the SSE of the suite. The proposed time series were selected generally based on the least SSE; however, we also used our judgment to include time series from a larger earthquake that may not have had the lowest SSE. Table F-7 presents the eleven-time series used for scaling to MCE_R .

The recordings were not rotated in the fault normal and fault parallel direction because the site is approximately 10 km from the Hayward-Rodgers Creek fault. Studies have shown that for sites less than 5 km from a fault that there is strong polarization of the ground motion in the fault normal and fault parallel directions and that the spectral accelerations in fault normal direction are larger than the median value for periods greater than 0.5 second. However, for distances greater than 5 km the direction of maximum response spectra appears random and is not necessarily in the fault normal direction. Therefore, we recommend that the motions be applied randomly to the structure.

Figure F-9 presents a comparison of the initially scaled ROT_{D100} spectra for the suite of time series along with average of the eleven spectra and the target MCE_R .

TABLE F-7
Time Series Used for Scaling¹

NGA Seq. No.	EQ Name	Fault Mech.	Year	Station Name	Mag.	Rrup (km)	Vs30 (m/sec)	Comp.	PGA (g)	PGV (cm/sec)	PGD (cm)	Lowest Useable Freq. (Hz)	T _p Pulse Period ² (sec)	Duration D5-75% (sec)	Duration D5-95% (sec)	Arias Intensity (m/sec)
179	Imperial Valley-06	Strike-slip	1979	El Centro Array #4	6.53	7.1	209	140 230	0.48 0.37	39.6 83.4	25.1 74.2	0.06	4.8	2.7 3.4	6.7 12.3	1.3 1.5
1119	Kobe, Japan	Strike-slip	1995	Takarazuka	6.90	0.3	312	0 90	0.70 0.61	68.4 86.2	26.6 26.8	0	1.8	2.2 2.1	4.6 3.6	3.1 3.9
1176	Kocaeli, Turkey	Strike-slip	1999	Yarimca	7.51	4.8	297	60 150	0.23 0.32	69.7 71.9	62.3 47.3	0.09	5.0	7.0 6.2	15.1 15.1	1.3 1.3
1182	Chi-Chi, Taiwan	Reverse Oblique	1999	CHY006	7.62	9.8	438	N W	0.36 0.36	42.3 62.2	17.0 23.5	0.04	2.6	4.7 5.6	26.7 24.3	1.5 2.0
1504	Chi-Chi, Taiwan	Reverse Oblique	1999	TCU067	7.62	0.6	434	E NO	0.50 0.32	92.0 51.3	101.3 41.9	0.03	-	11.0 7.5	21.7 23.1	3.6 2.6
1602	Duzce, Turkey	Strike-slip	1999	Bolu	7.14	12.0	294	0 90	0.74 0.81	55.9 65.9	25.6 13.1	0.06	0.9	2.7 1.5	8.5 9.5	3.7 2.4
1605	Duzce, Turkey	Strike-slip	1999	Duzce	7.14	6.6	282	180 270	0.40 0.51	71.1 84.2	49.6 48.8	0.07	-	7.3 7.3	11.0 16.9	2.7 2.9
2114	Denali, Alaska	Strike-slip	2002	TAPS Pump Station #10	7.90	2.7	329	47 317	0.33 0.30	115.7 65.9	53.4 36.7	0.13	3.2	4.6 9.1	22.3 29.5	1.9 1.1
5827	El Mayor-Cucapah	Strike-slip	2010	MICHOACAN DE OCAMPO	7.20	15.9	242	0 90	0.54 0.41	61.5 43.5	34.5 29.7	0.04	-	19.8 22.8	32.7 34.5	6.1 4.8
5975	El Mayor-Cucapah	Strike-slip	2010	Calexico Fire Station	7.20	20.5	231	360 90	0.26 0.27	38.3 45.5	26.5 41.4	0.03	-	19.1 18.1	41.9 41.3	1.6 2.4
6911	Darfield, New Zealand	Strike-slip	2010	HORC	7.00	7.3	326	N18E S72E	0.45 0.48	105.9 69.8	52.9 29.7	0.06	9.9	6.4 7.7	7.9 9.5	3.2 3.1

¹ These records and metadata were obtained from the NGA-West2 On-Line Ground-Motion Database Tool

² From the NGA-West2 On-Line Ground-Motion Database Tool; (-) denotes no pulse record

As discussed, the average of the maximum-direction spectra from all the ground motions shall not fall below 90 percent of the target response spectrum for any period within the period range of interest for this study. As noted, before, the period range of interest is 0.094 to 1.3 seconds. We modified the initial scalars developed by QuakeManager version 2.20 to meet this requirement. The scaling factors are presented in Table F-8 for the MCE_R ; because the DE spectrum is 2/3 of the MCE_R spectrum, the scaling factors may be multiplied by 2/3 to obtain the appropriate DE scaling factors, if needed.

TABLE F-8
Scaling Factors for MCE_R Time Series

Time Series	Scaling Factor
Imperial Valley-06 El Centro Array #4	2.01
Kobe, Japan Takarazuka	1.01
Kocaeli, Turkey Yarimca	2.12
Chi-Chi, Taiwan CHY006	1.64
Chi-Chi, Taiwan TCU067	1.59
Duzce, Turkey Bolu	1.14
Duzce, Turkey Duzce	1.27
Denali, Alaska TAPS Pump Station #10	1.06
El Mayor-Cucapah, Mexico Michoacan de Ocampo	1.75
El Mayor-Cucapah, Mexico Calexico Fire Station	2.44
Darfield, New Zealand HORC	1.48

Figure F-10 presents a comparison of the scaled ROT_{D100} spectra for the MCE_R as well as 90 percent of the recommended MCE_R , where the period range of scaling is from 0.094 to 1.3 seconds. Figures F-11 through F-21 present the acceleration, velocity, and displacement of the scaled orthogonal components of time series and comparison between the scaled spectra for each component, ROT_{D100} and the recommended spectra for the MCE_R (target) ground motion level.

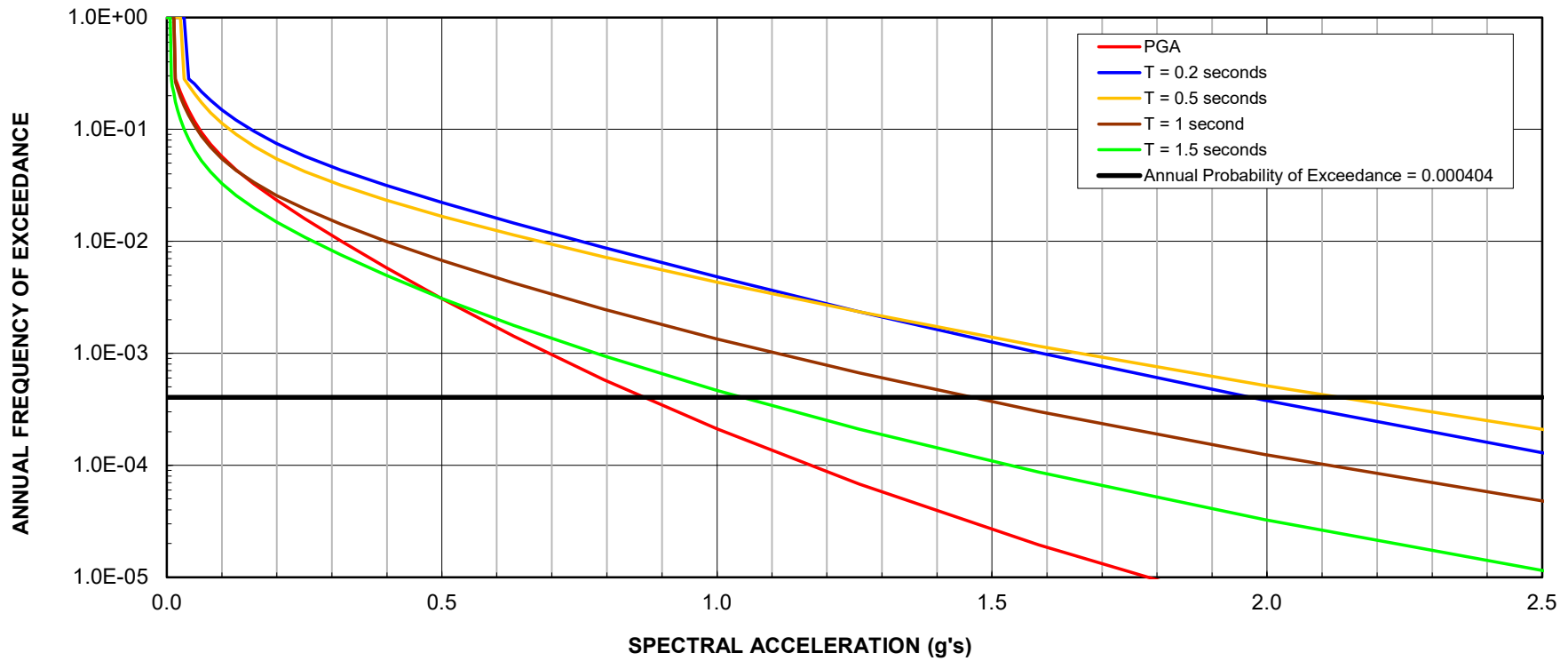

Notes

1. Damping Ratio = 5%
2. Estimated V_{s30} = 270 m/s

LANGAN

135 Main Street, Suite 1500
 San Francisco, California 94105
 T: 415.955.5200 F: 415.955.5201 www.langan.com
 LANGAN ENGINEERING AND ENVIRONMENTAL SERVICES, INC.

Project

5201 Patrick Henry Drive

SANTA CLARA
 SANTA CLARA COUNTY CALIFORNIA

Figure Title

MEAN HAZARD CURVES

Project No.

731769901

Date

7/20/2023

Scale

AS SHOWN

Prepared By:

KM

Figure No.

F-1

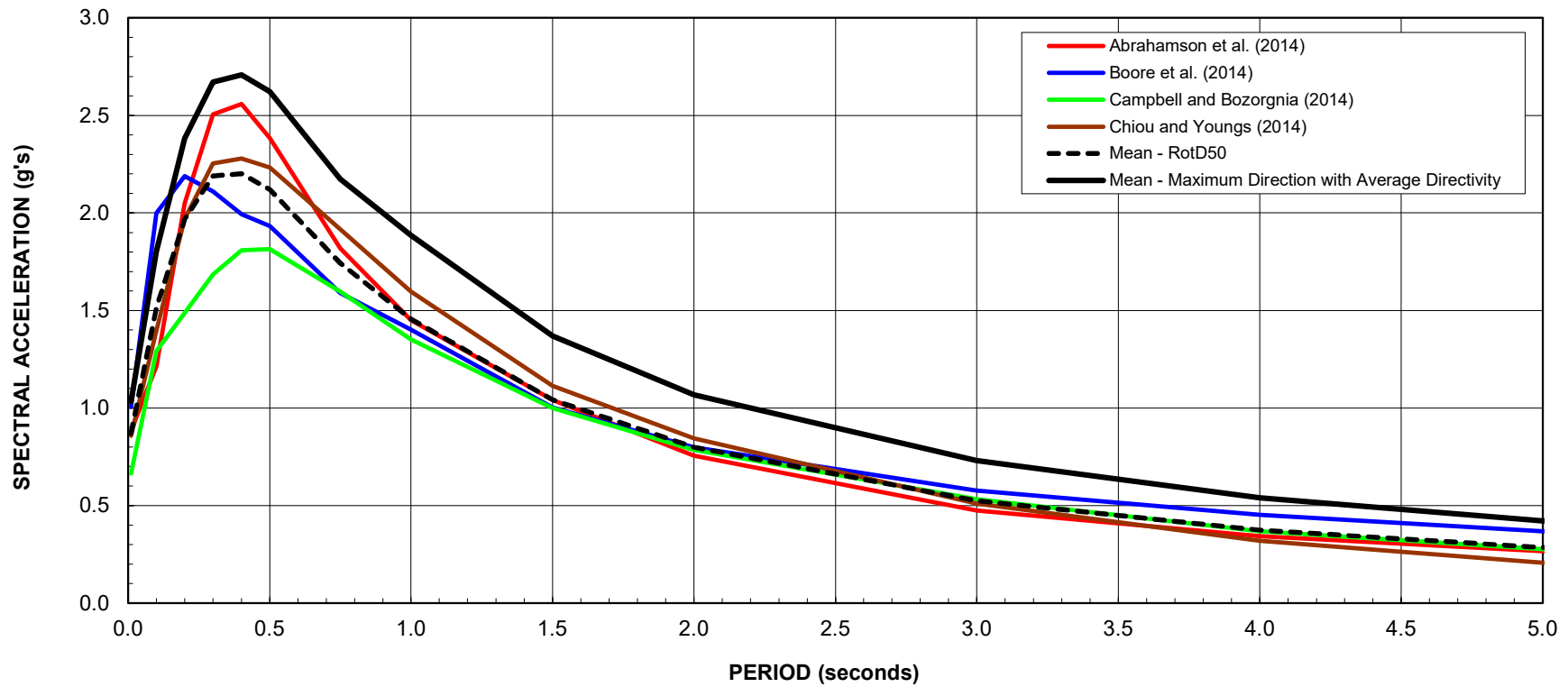

Notes

1. Damping Ratio = 5%
2. Estimated $V_{S30} = 270$ m/s
3. Maximum direction factors from Shahi and Baker (2014).
4. Directivity from NHR3 Directivity-Based PSHA.
5. $Z_1 = 500$ m, $Z_{2.5} = 0.85$ km

 135 Main Street, Suite 1500 San Francisco, California 94105 T: 415.955.5200 F: 415.955.5201 www.langan.com LANGAN ENGINEERING AND ENVIRONMENTAL SERVICES, INC.	Project	Figure Title	Project No.	F-2
	5201 Patrick Henry Drive	RESULTS OF PSHA, 2 PERCENT PROBABILITY OF EXCEEDANCE IN 50 YEARS	731769901	
	SANTA CLARA		Date	
	SANTA CLARA COUNTY CALIFORNIA		7/20/2023	
			Scale	
			AS SHOWN	
			Prepared By:	
			KM	

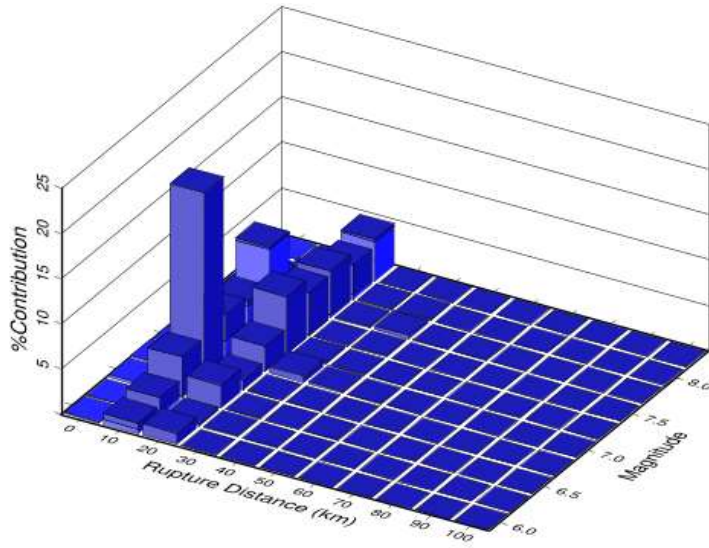

(a) PGA

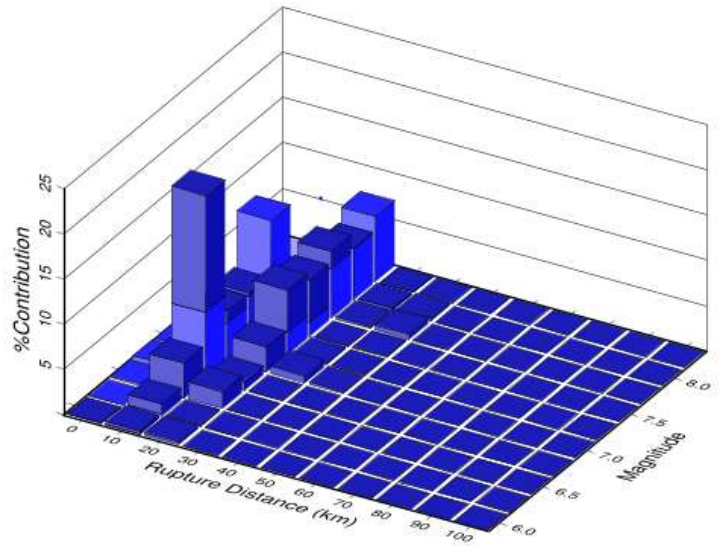

(b) $S_a, T = 1.0$ second

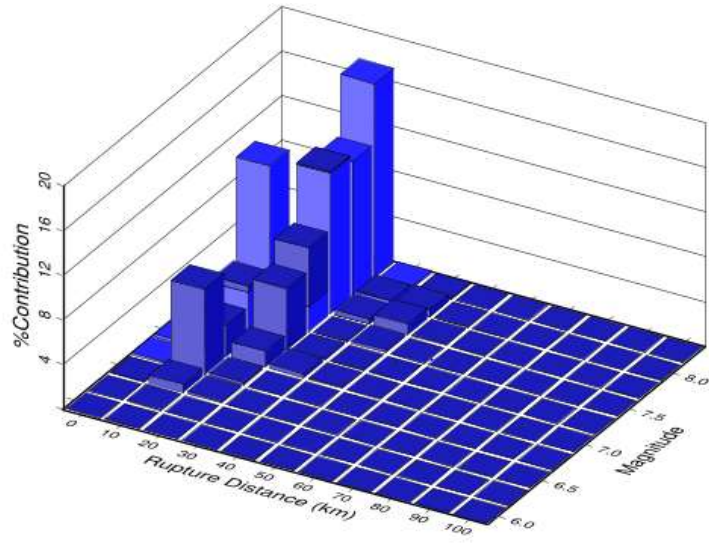

(c) $S_a, T = 4.0$ seconds

LANGAN

135 Main Street, Suite 1500
San Francisco, California 94105

T: 415.955.5200 F: 415.955.5201 www.langan.com

LANGAN ENGINEERING AND ENVIRONMENTAL SERVICES, INC.

Project

5201 Patrick Henry Drive

SANTA CLARA

SANTA CLARA COUNTY CALIFORNIA

Figure Title

2% PROBABILITY OF EXCEEDANCE IN 50 YEARS - MAGNITUDE DISTANCE DEAGGREGATION PLOTS

Project No.

731769901

Date

7/20/2023

Scale

AS SHOWN

Prepared By:

KM

Figure No.

F-3

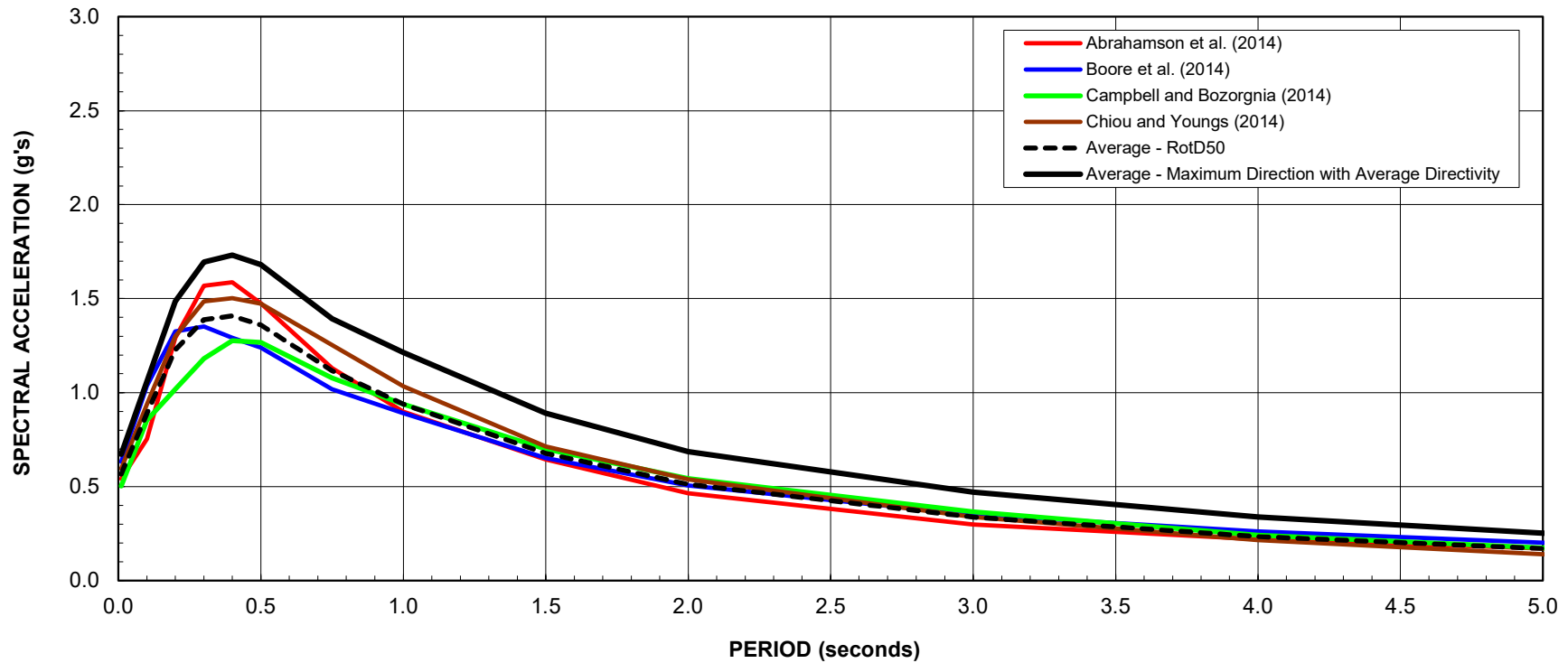

Notes

1. Damping Ratio = 5%
2. Estimated $V_{S30} = 270$ m/s
3. Maximum direction factors from Shahi and Baker (2014).
4. Directivity from NHR3 Directivity-Based PSHA.
5. Deterministic results are for a Moment Magnitude 7.3 occurring on the Hayward-Rodgers Creek fault about 10 km from the site.

 135 Main Street, Suite 1500 San Francisco, California 94105 T: 415.955.5200 F: 415.955.5201 www.langan.com LANGAN ENGINEERING AND ENVIRONMENTAL SERVICES, INC.	Project	Figure Title	Project No.	F-4
	5201 Patrick Henry Drive	RESULTS OF DETERMINISTIC ANALYSIS - 84 th PERCENTILE SPECTRA - HAYWARD-RODGERS CREEK	731769901	
	SANTA CLARA	SANTA CLARA COUNTY CALIFORNIA	Date	
	SANTA CLARA COUNTY CALIFORNIA	SANTA CLARA COUNTY CALIFORNIA	7/20/2023	
			Scale	
			AS SHOWN	
			Prepared By:	
			KM	

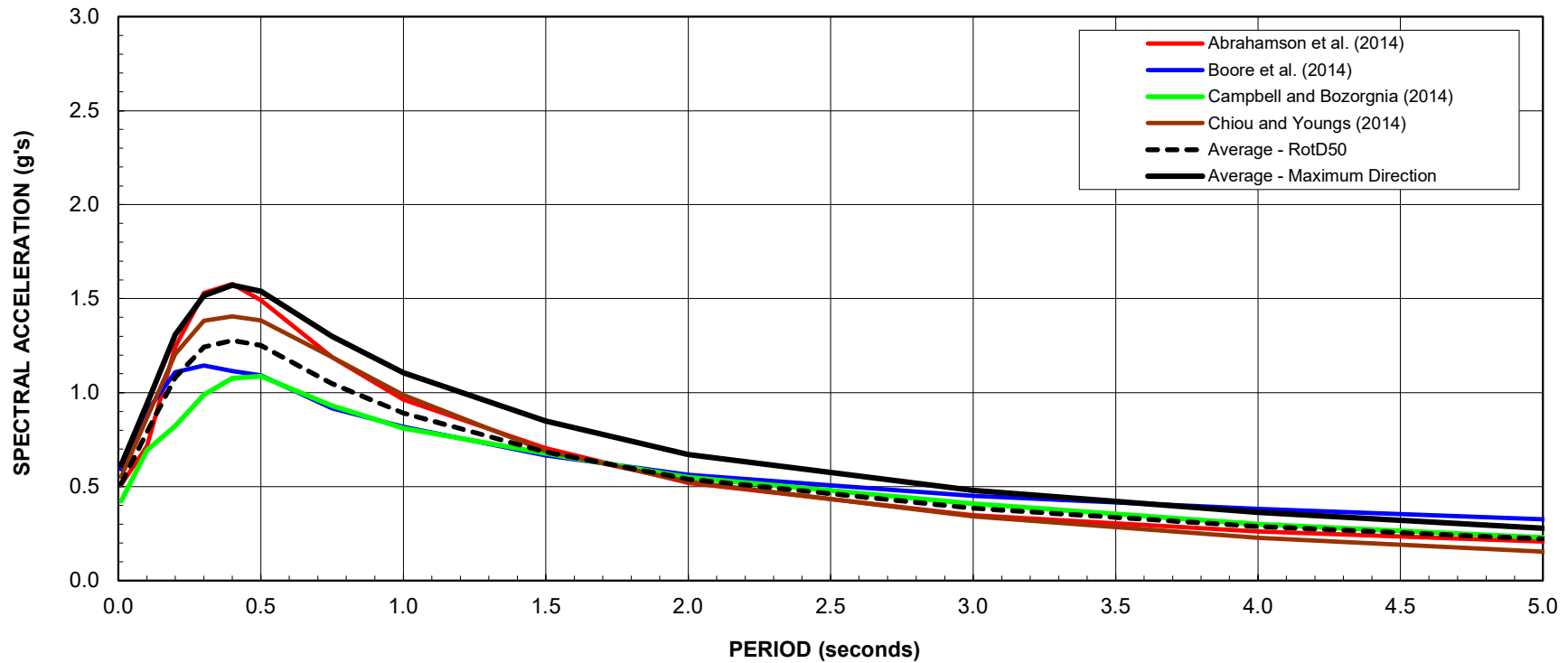

Notes

1. Damping Ratio = 5%
2. Estimated $V_{S30} = 270$ m/s
3. Maximum direction factors from Shahi and Baker (2014).
4. Deterministic results are for a Moment Magnitude 8.1 occurring on the San Andreas fault about 18 km from the site

 135 Main Street, Suite 1500 San Francisco, California 94105 T: 415.955.5200 F: 415.955.5201 www.langan.com LANGAN ENGINEERING AND ENVIRONMENTAL SERVICES, INC.	Project	Figure Title	Project No.	F-5	
	5201 Patrick Henry Drive	RESULTS OF DETERMINISTIC ANALYSIS - 84 th PERCENTILE SPECTRA - SAN ANDREAS	731769901		
	SANTA CLARA	SANTA CLARA COUNTY CALIFORNIA	Date		7/20/2023
	Scale	Prepared By:	AS SHOWN		KM

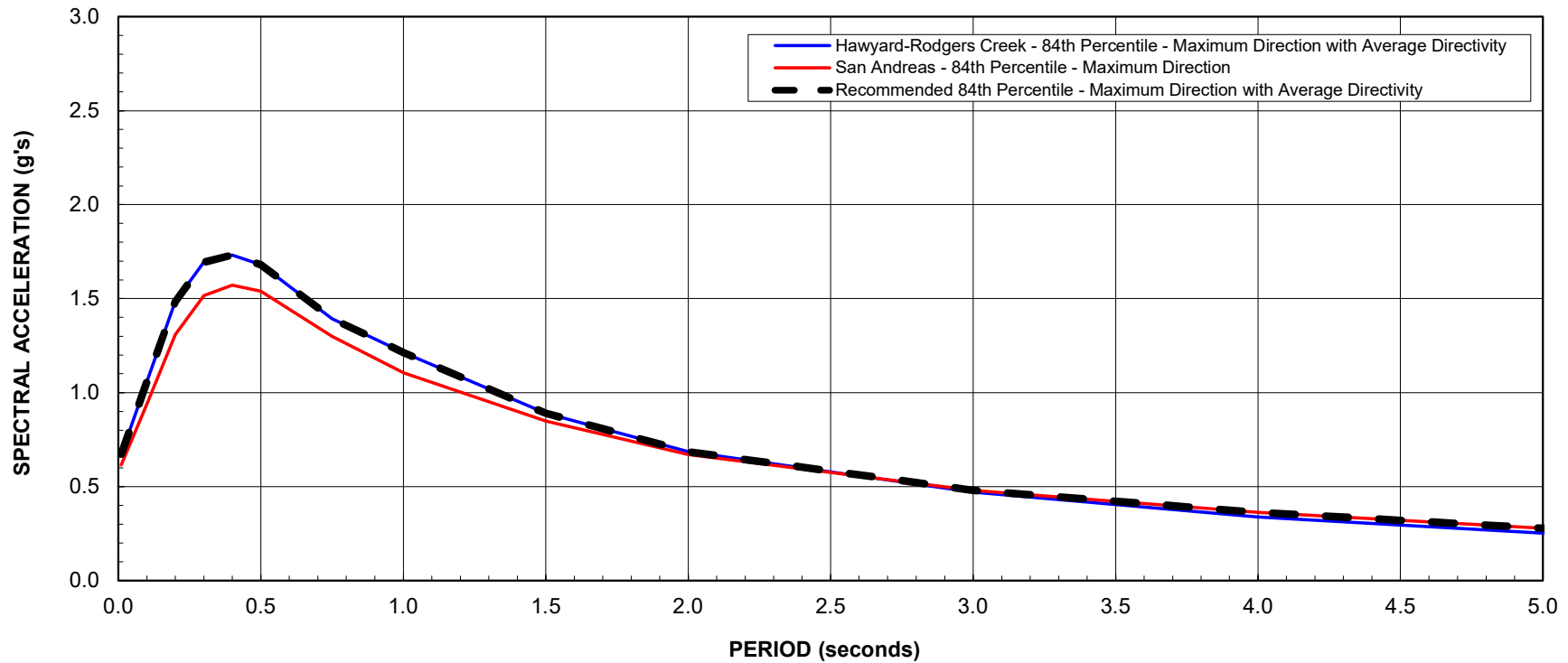

Notes

1. Damping Ratio = 5%
2. Estimated $V_{S30} = 270$ m/s
3. Maximum direction factors from Shahi and Baker (2014).
4. Directivity from NHR3 Directivity-Based PSHA.

 135 Main Street, Suite 1500 San Francisco, California 94105 T: 415.955.5200 F: 415.955.5201 www.langan.com LANGAN ENGINEERING AND ENVIRONMENTAL SERVICES, INC.	Project	Figure Title	Project No.	F-6
	5201 Patrick Henry Drive	COMPARISON OF 84 th PERCENTILE DETERMINISTIC ANALYSIS	731769901	
	SANTA CLARA		Date	
	SANTA CLARA COUNTY CALIFORNIA		7/20/2023	
			Scale	
			AS SHOWN	
			Prepared By:	
			KM	

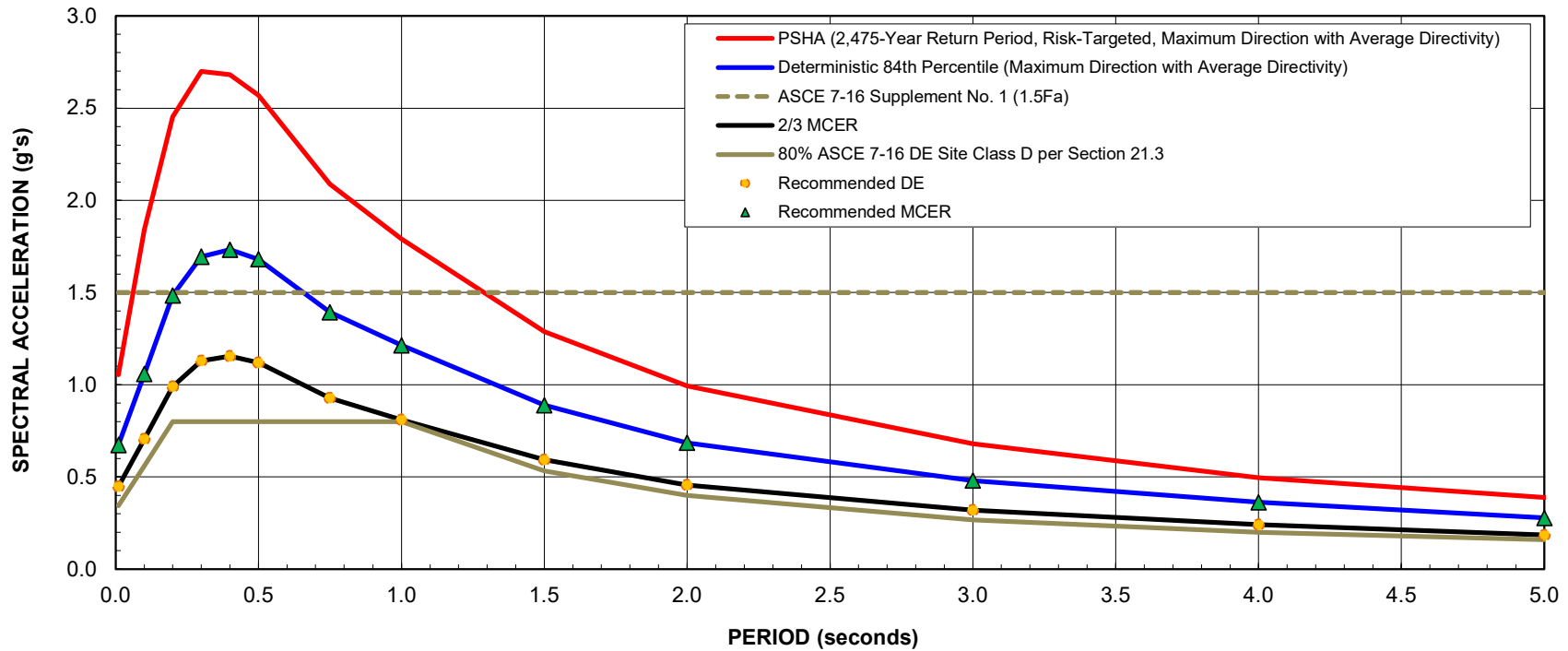

Notes

1. Damping Ratio = 5%
2. Estimated $V_{S30} = 270$ m/s
3. Maximum direction factors from Shahi and Baker (2014).
4. Directivity from NHR3 Directivity-Based PSHA.
5. Deterministic results are the envelope for a Moment Magnitude 7.3 occurring on the Hayward-Rodgers Creek fault about 10 km from the site and a Moment Magnitude of 8.1 occurring on the San Andreas fault about 18 km from the site.

LANGAN

135 Main Street, Suite 1500
San Francisco, California 94105

T: 415.955.5200 F: 415.955.5201 www.langan.com

LANGAN ENGINEERING AND ENVIRONMENTAL SERVICES, INC.

Project

5201 Patrick Henry Drive

SANTA CLARA

SANTA CLARA COUNTY CALIFORNIA

Figure Title

**COMPARISON OF
PROBABILISTIC, DETERMINISTIC
AND DETERMINISTIC LOWER
LIMIT SPECTRA**

Project No.

731769901

Date

7/20/2023

Scale

AS SHOWN

Prepared By:

KM

Figure No.

F-7

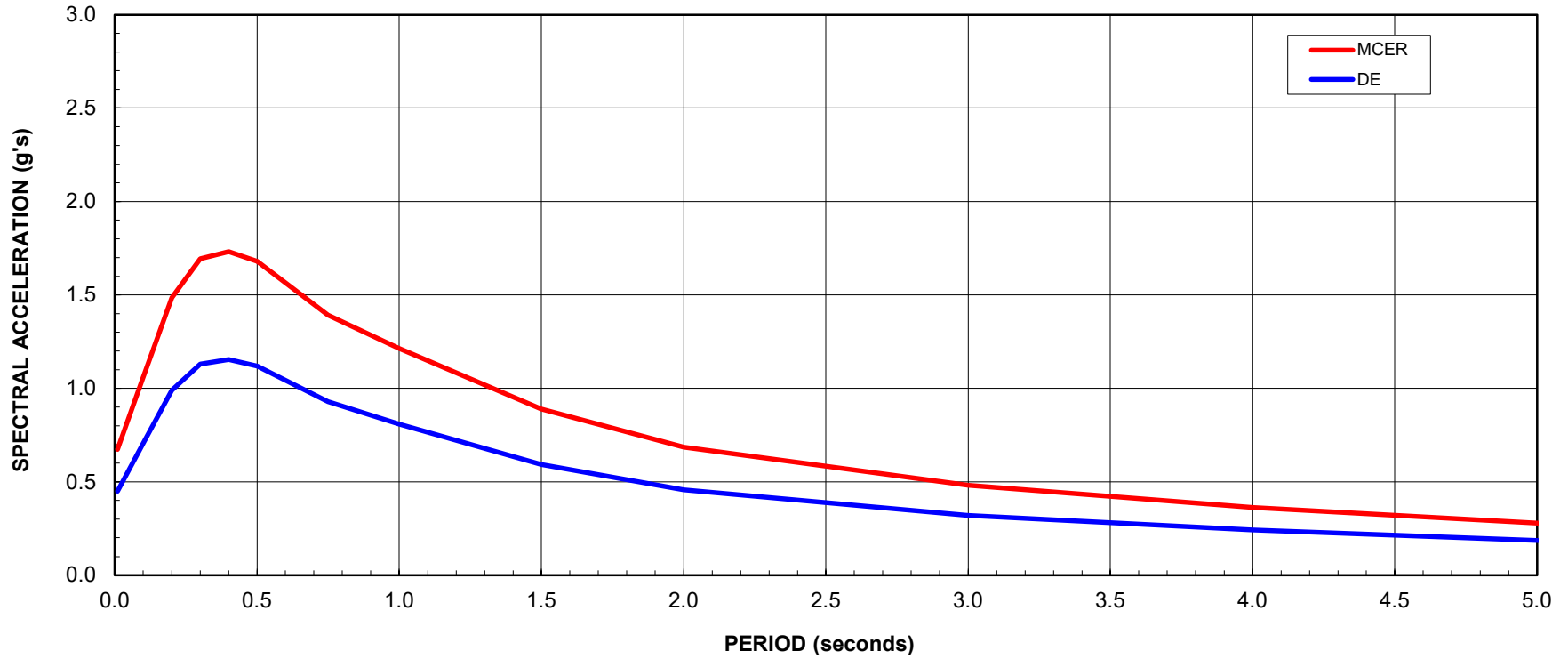

- Notes**
1. Damping Ratio = 5%
 2. Estimated V_{S30} = 270 m/s

LANGAN

135 Main Street, Suite 1500
 San Francisco, California 94105
 T: 415.955.5200 F: 415.955.5201 www.langan.com
 LANGAN ENGINEERING AND ENVIRONMENTAL SERVICES, INC.

Project

**5201 Patrick Henry
 Drive**

SANTA CLARA
 SANTA CLARA COUNTY CALIFORNIA

Figure Title

**RECOMMENDED HORIZONTAL
 SPECTRA**

Project No.

731769901

Date

7/20/2023

Scale

AS SHOWN

Prepared By:

KM

Figure No.

F-8

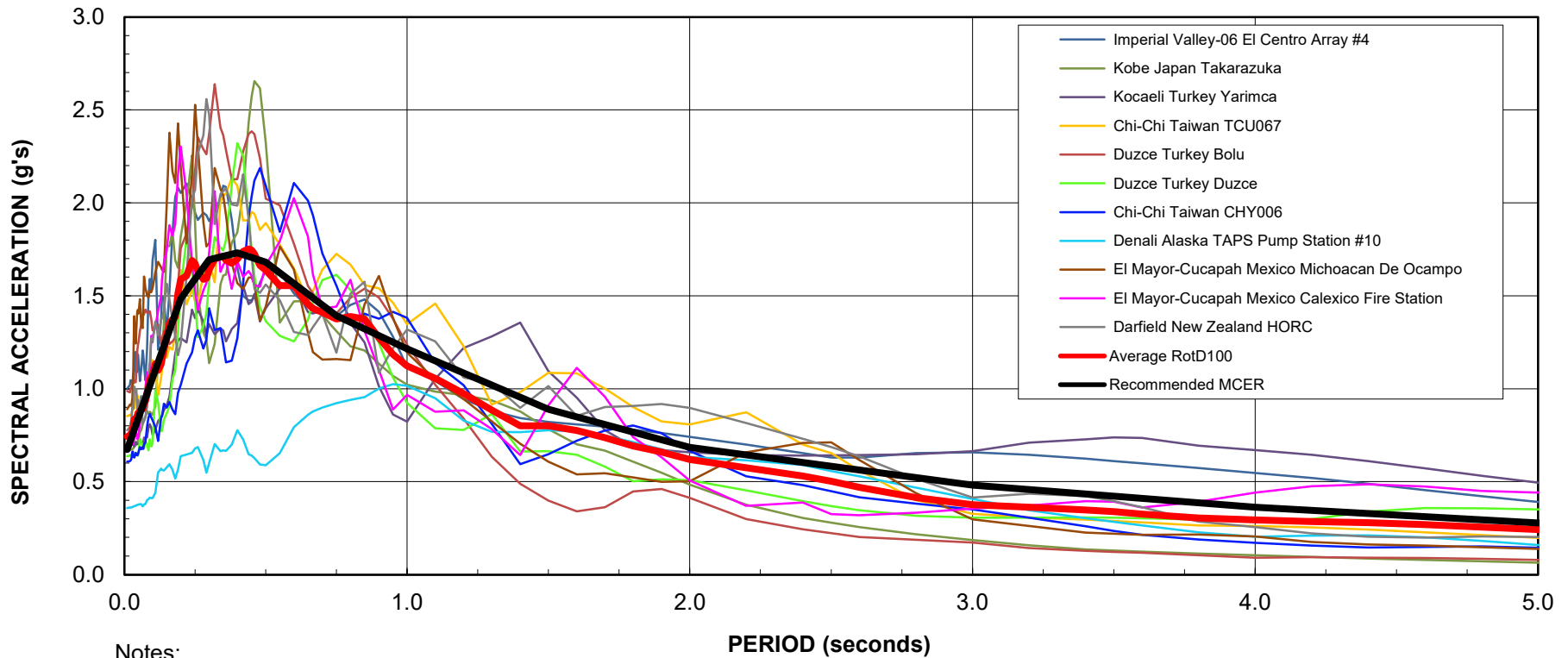

- Notes:
1. Damping Ratio = 5%
 2. Period range of interest is 0.094 to 1.3 seconds

<p>LANGAN</p> <p>LANGAN ENGINEERING & ENVIRONMENTAL SERVICES, INC.</p> <p>135 Main Street, Suite 1500</p> <p>San Francisco, CA 94105</p> <p>T: 415.955.5200 F: 415.955.5201 www.langan.com</p>	Project	Figure Title	Project No.	<p>Figure No.</p> <p>F-9</p>
	5201 Patrick Henry Drive	COMPARISON OF AVERAGE INITIALLY SCALED ROT _{D100} SPECTRA AND HORIZONTAL MCER	731769901	
	SANTA CLARA		Date	
	SANTA CLARA COUNTY, CA		7/21/2023	
			Scale	
			AS SHOWN	
			Prepared By:	
			KM	

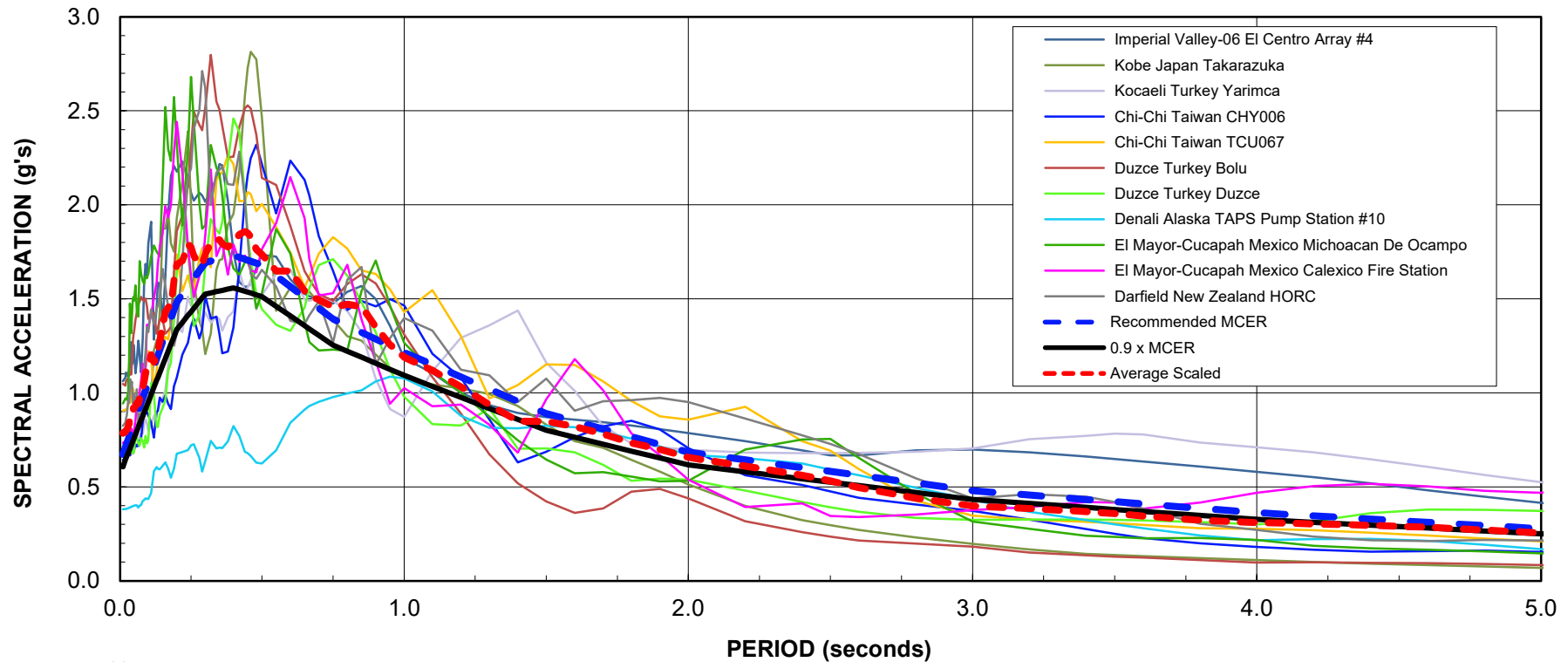

Notes:

1. Damping Ratio = 5%
2. Period range of interest is 0.094 to 1.3 seconds

<p>LANGAN</p> <p>LANGAN ENGINEERING & ENVIRONMENTAL SERVICES, INC.</p> <p>135 Main Street, Suite 1500 San Francisco, CA 94105</p> <p>T: 415.955.5200 F: 415.955.5201 www.langan.com</p>	Project	Figure Title	Project No.	Figure No.	
	<p>5201 Patrick Henry Drive</p> <p>SANTA CLARA</p> <p>SANTA CLARA COUNTY, CA</p>	<p>COMPARISON OF AVERAGE SCALED ROT_{D100} SPECTRA AND HORIZONTAL MCER</p>	731769901	<p>F-10</p>	
			Date		7/21/2023
			Scale		AS SHOWN
Prepared By:	KM				

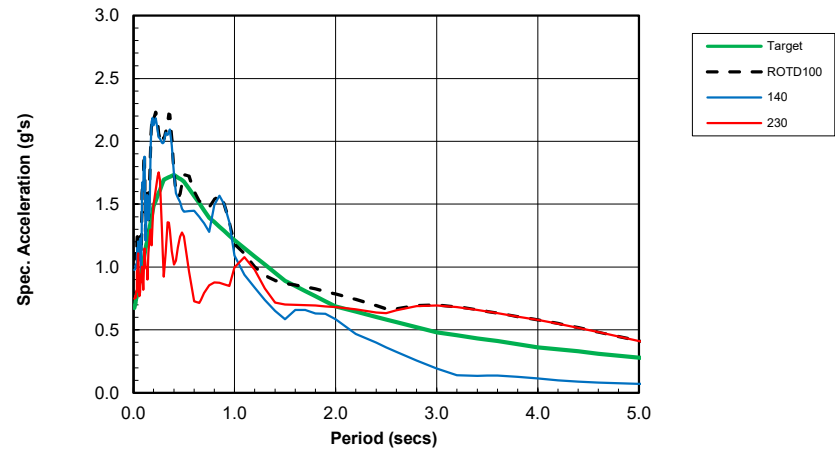
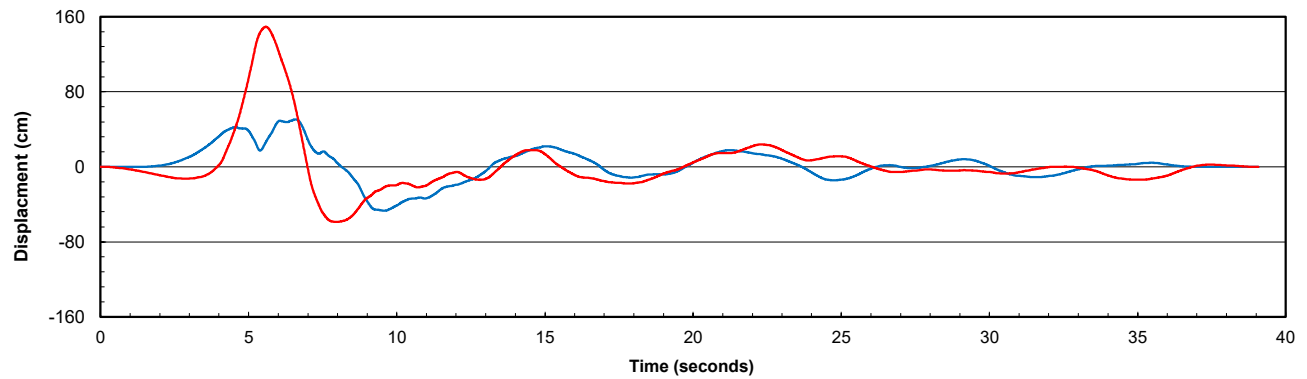
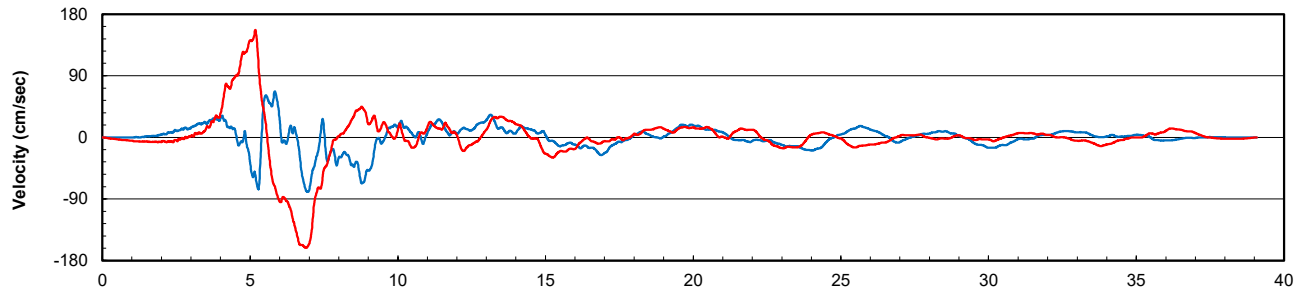
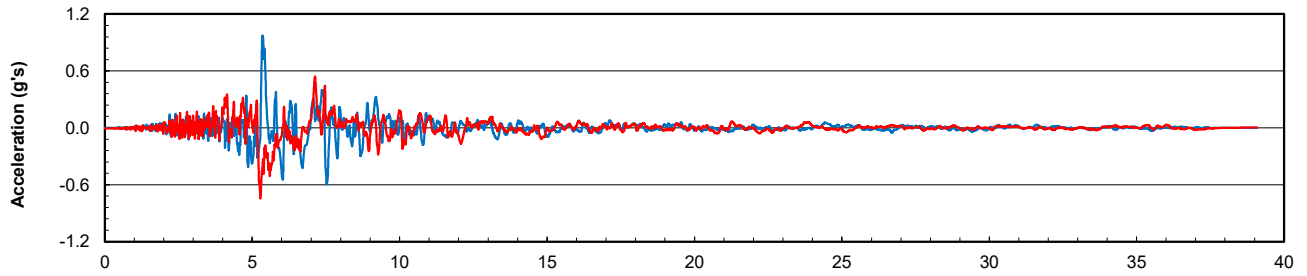

LANGAN
 LANGAN ENGINEERING & ENVIRONMENTAL SERVICES, INC.
 135 Main Street, Suite 1500
 San Francisco, CA 94105
 T: 415.955.5200 F: 415.955.5201 www.langan.com

Project
5201 Patrick Henry Drive

 SANTA CLARA
 SANTA CLARA COUNTY CALIFORNIA

Figure Title
**COMPARISON OF TARGET
 SPECTRA MCER AND SCALED
 TIME SERIES AND SPECTRA
 IMPERIAL VALLEY - 06
 EARTHQUAKE EL CENTRO
 ARRAY #4**

Project No.
 731769901
 Date
 7/21/23
 Scale
 AS SHOWN
 Prepared By:
 KM

Figure No.

F-11

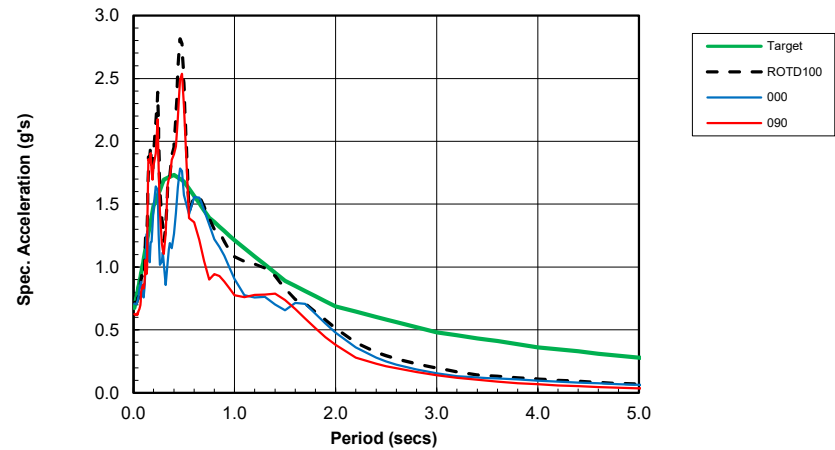
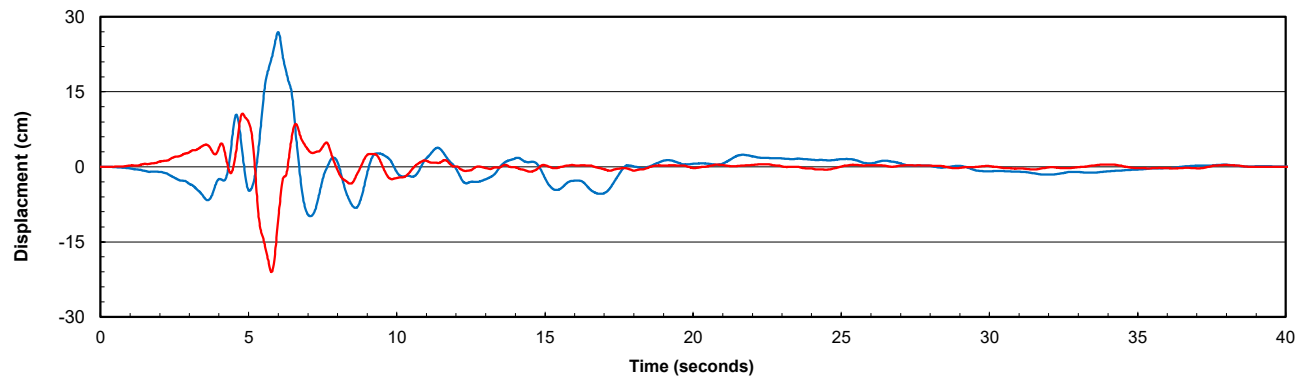
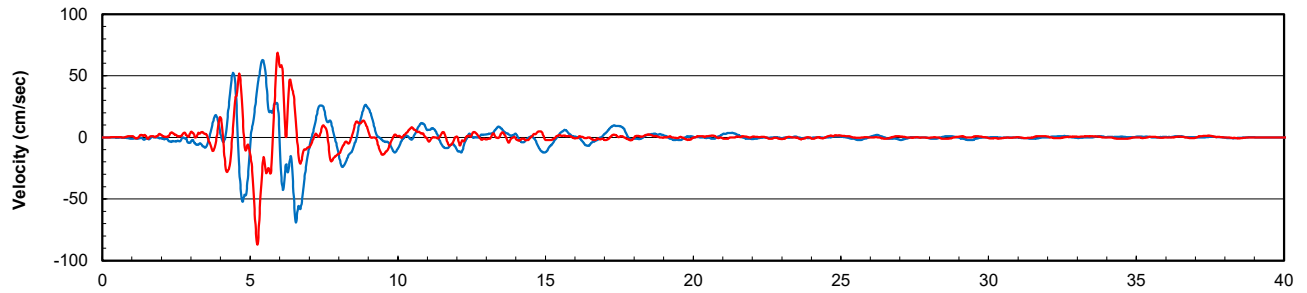
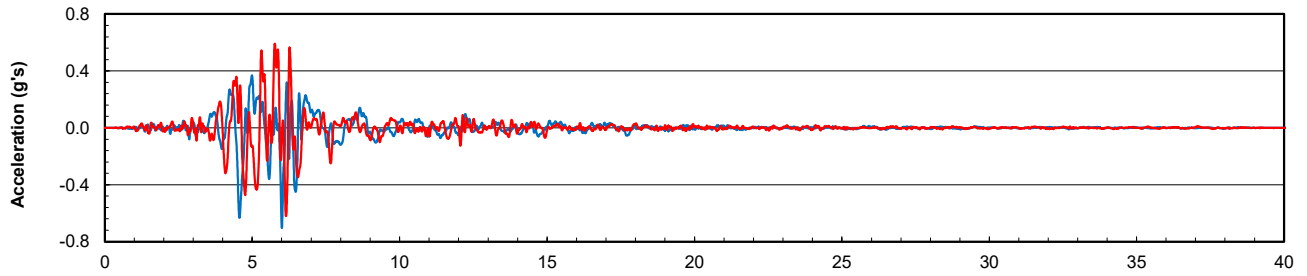

LANGAN

LANGAN ENGINEERING & ENVIRONMENTAL SERVICES, INC.
 135 Main Street, Suite 1500
 San Francisco, CA 94105
 T: 415.955.5200 F: 415.955.5201 www.langan.com

Project
5201 Patrick Henry Drive

 SANTA CLARA
 SANTA CLARA COUNTY CALIFORNIA

Figure Title
**COMPARISON OF TARGET
 SPECTRA MCER AND SCALED
 TIME SERIES AND SPECTRA
 KOBE, JAPAN EARTHQUAKE
 TAKARAZUKA**

Project No.
 731769901
 Date
 7/21/23
 Scale
 AS SHOWN
 Prepared By:
 KM

Figure No.
F-12

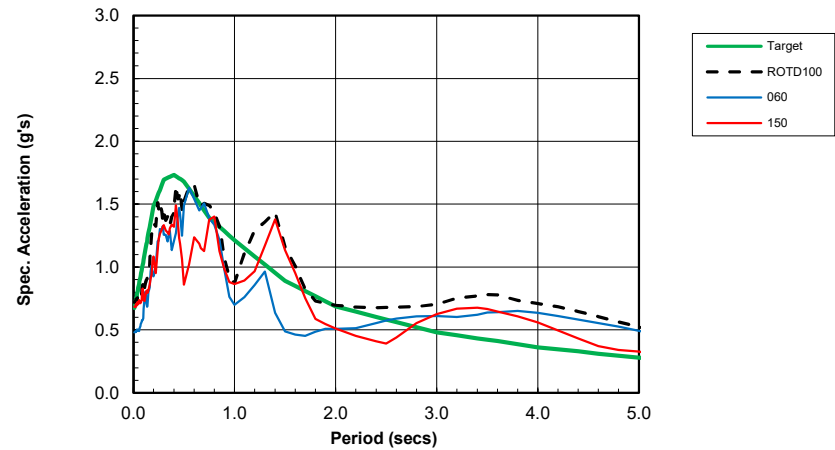
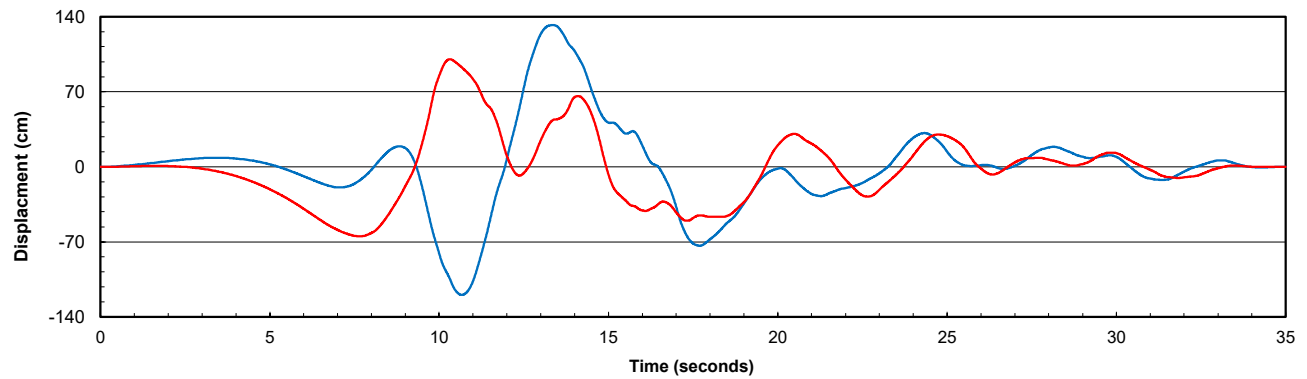
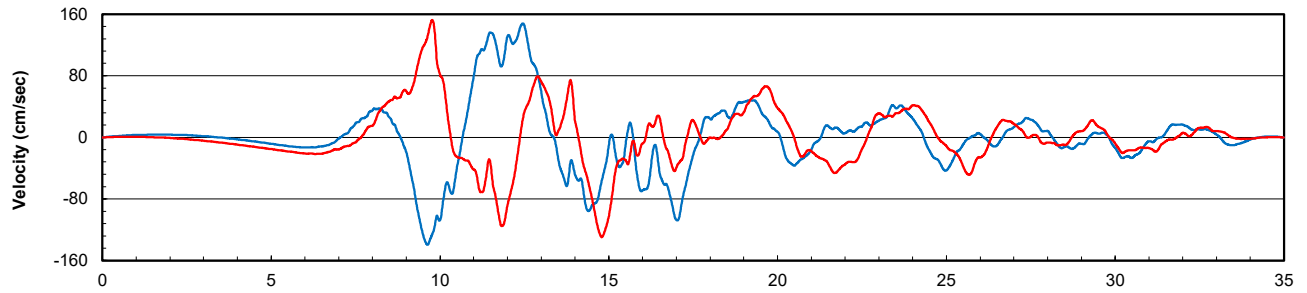
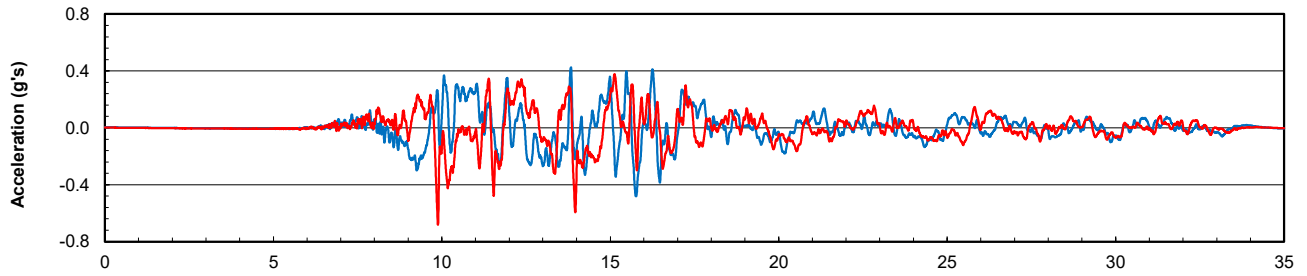

LANGAN
 LANGAN ENGINEERING & ENVIRONMENTAL SERVICES, INC.
 135 Main Street, Suite 1500
 San Francisco, CA 94105
 T: 415.955.5200 F: 415.955.5201 www.langan.com

Project
5201 Patrick Henry Drive

 SANTA CLARA
 SANTA CLARA COUNTY CALIFORNIA

Figure Title
**COMPARISON OF TARGET
 SPECTRA MCER AND SCALED
 TIME SERIES AND SPECTRA
 KOCAELI, TURKEY
 EARTHQUAKE YARIMCA**

Project No.
 731769901
 Date
 7/21/23
 Scale
 AS SHOWN
 Prepared By:
 KM

Figure No.
F-13

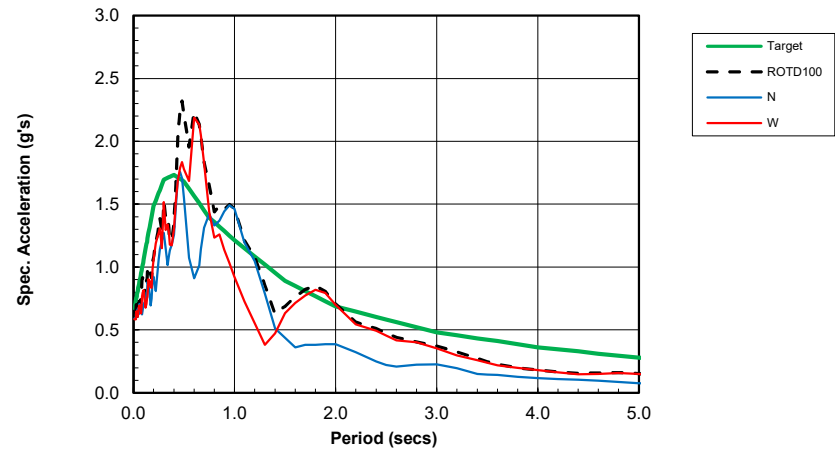
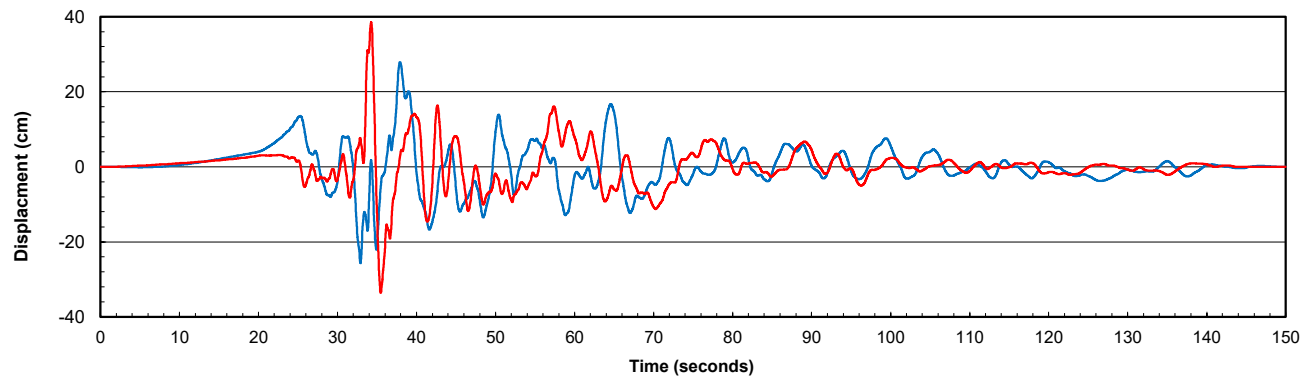
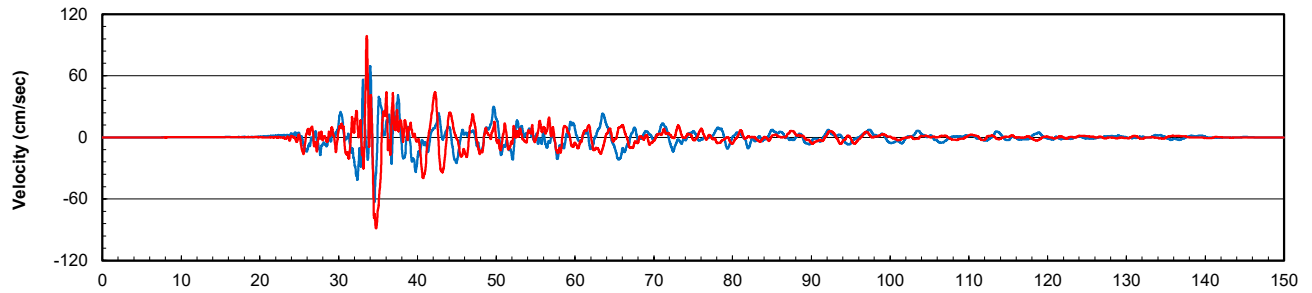
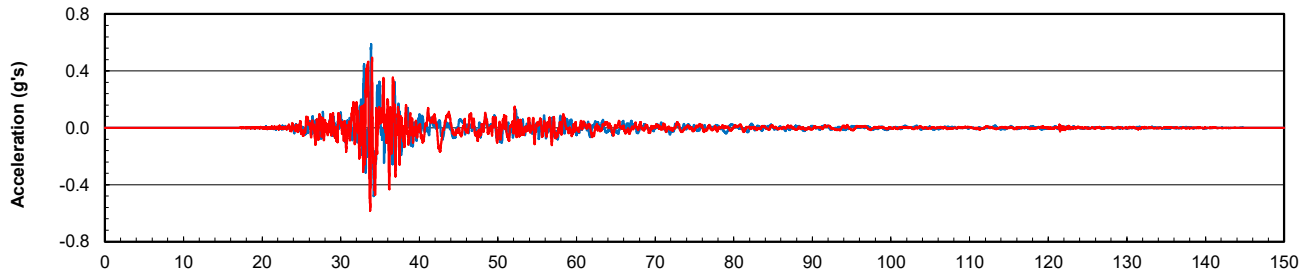

LANGAN
 LANGAN ENGINEERING & ENVIRONMENTAL SERVICES, INC.
 135 Main Street, Suite 1500
 San Francisco, CA 94105
 T: 415.955.5200 F: 415.955.5201 www.langan.com

Project
5201 Patrick Henry Drive

 SANTA CLARA
 SANTA CLARA COUNTY CALIFORNIA

Figure Title
**COMPARISON OF TARGET
 SPECTRA MCER AND SCALED
 TIME SERIES AND SPECTRA
 CHI-CHI, TAIWAN
 EARTHQUAKE CHY006**

Project No.
 731769901
 Date
 7/21/23
 Scale
 AS SHOWN
 Prepared By:
 KM

Figure No.
F-14

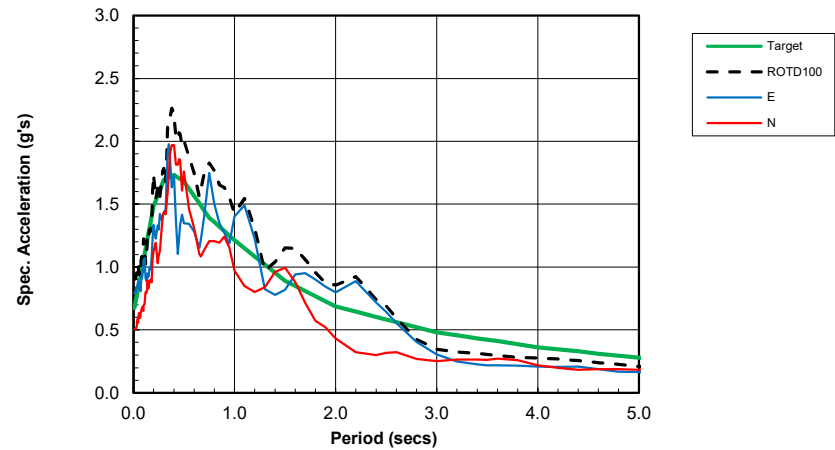
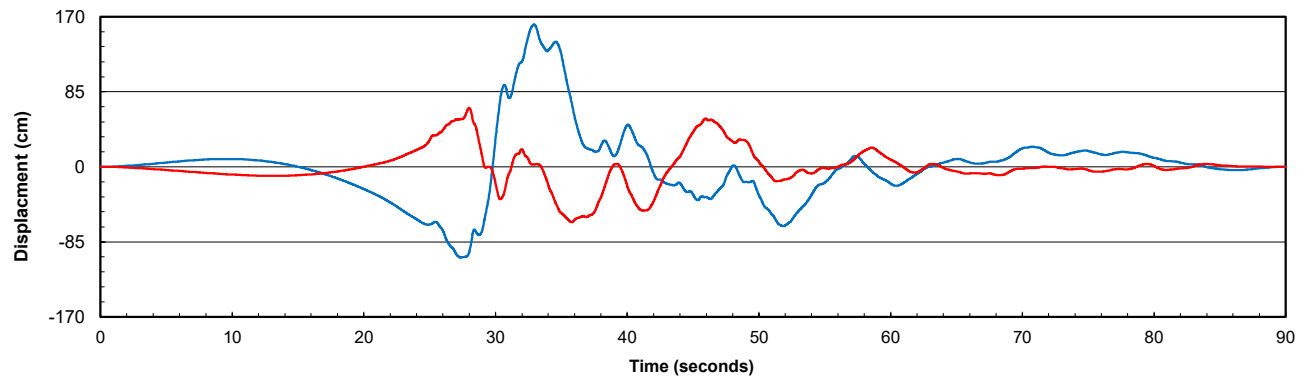
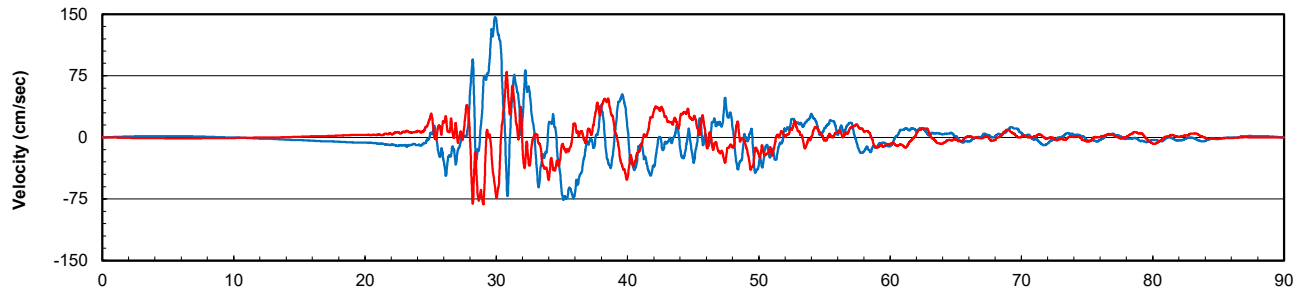
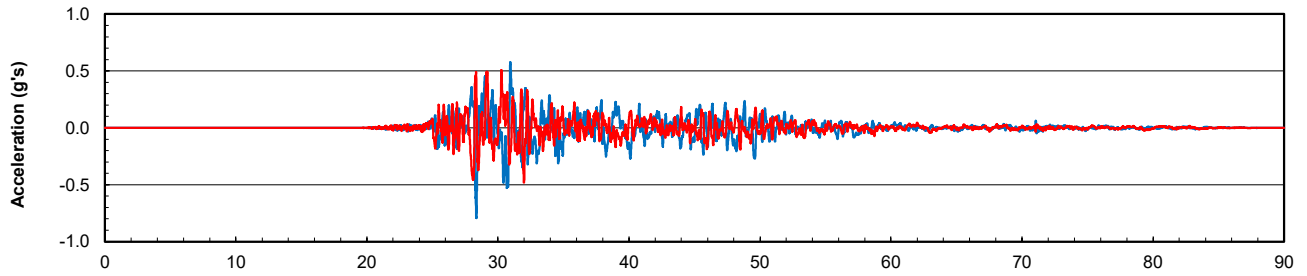

LANGAN

LANGAN ENGINEERING & ENVIRONMENTAL SERVICES, INC.
 135 Main Street, Suite 1500
 San Francisco, CA 94105
 T: 415.955.5200 F: 415.955.5201 www.langan.com

Project
5201 Patrick Henry Drive

 SANTA CLARA
 SANTA CLARA COUNTY CALIFORNIA

Figure Title
**COMPARISON OF TARGET
 SPECTRA MCER AND SCALED
 TIME SERIES AND SPECTRA
 CHI-CHI, TAIWAN
 EARTHQUAKE TCU067**

Project No.
 731769901
 Date
 7/21/23
 Scale
 AS SHOWN
 Prepared By:
 KM

Figure No.
F-15

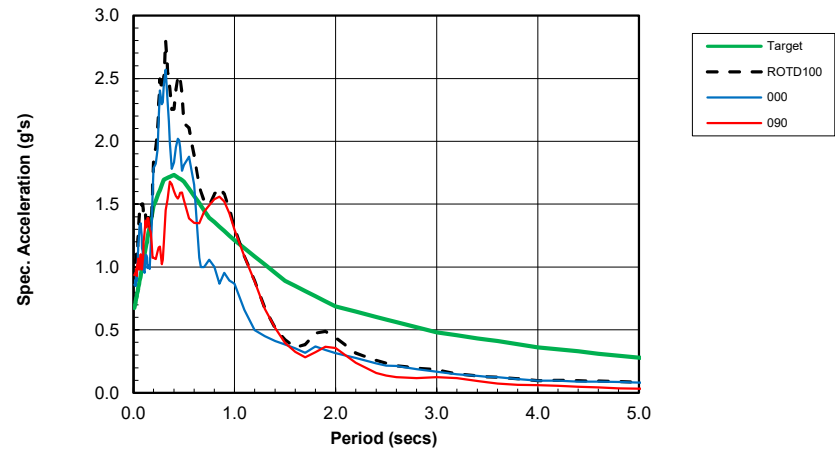
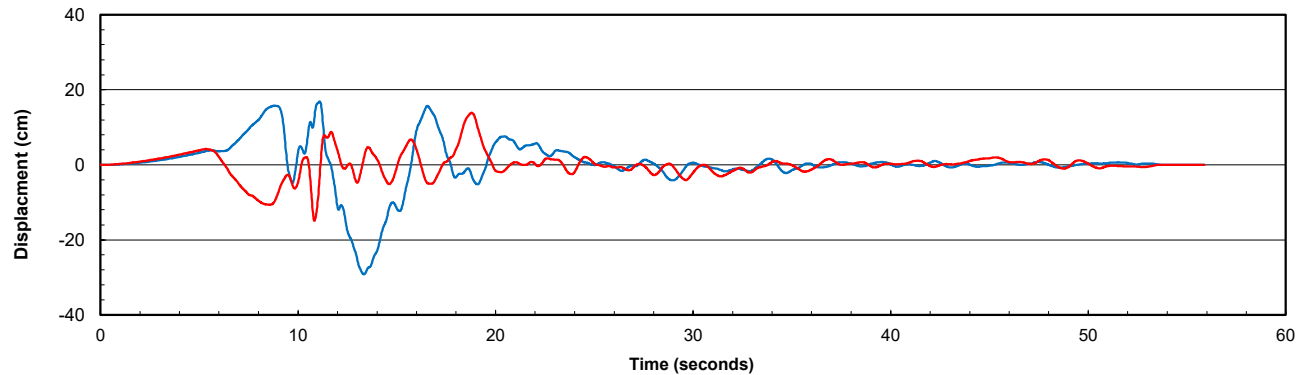
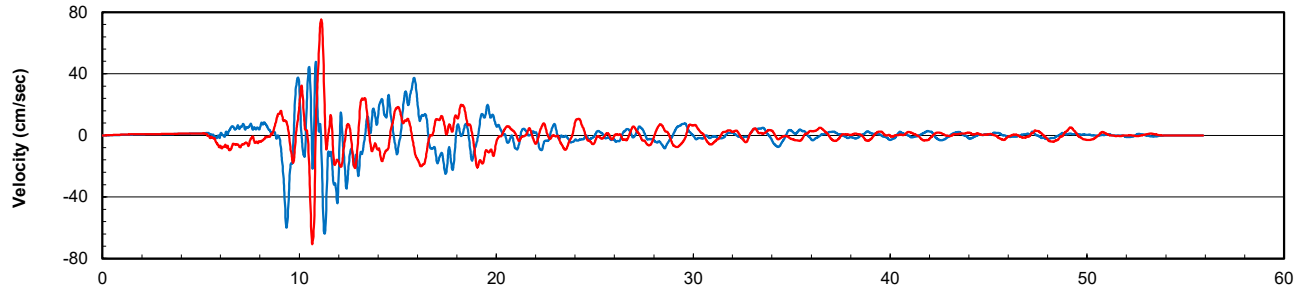
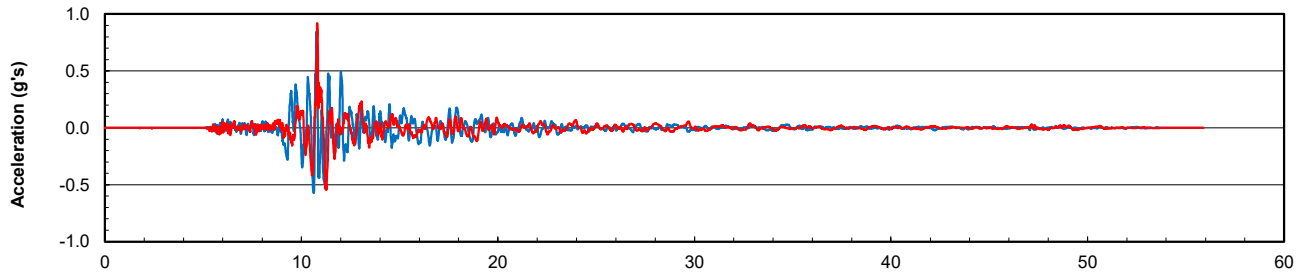

LANGAN
 LANGAN ENGINEERING & ENVIRONMENTAL SERVICES, INC.
 135 Main Street, Suite 1500
 San Francisco, CA 94105
 T: 415.955.5200 F: 415.955.5201 www.langan.com

Project
5201 Patrick Henry Drive

 SANTA CLARA
 SANTA CLARA COUNTY CALIFORNIA

Figure Title
**COMPARISON OF TARGET
 SPECTRA MCER AND SCALED
 TIME SERIES AND SPECTRA
 DUZCE, TURKEY EARTHQUAKE
 BOLU**

Project No.
 731769901
 Date
 7/21/23
 Scale
 AS SHOWN
 Prepared By:
 KM

Figure No.
F-16

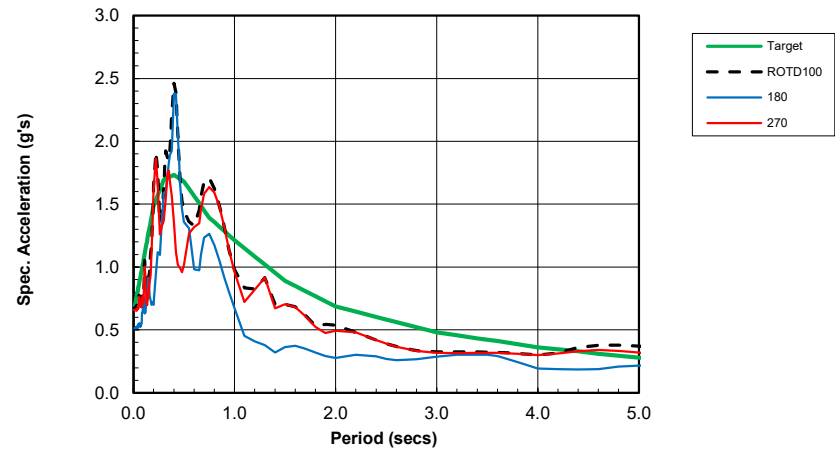
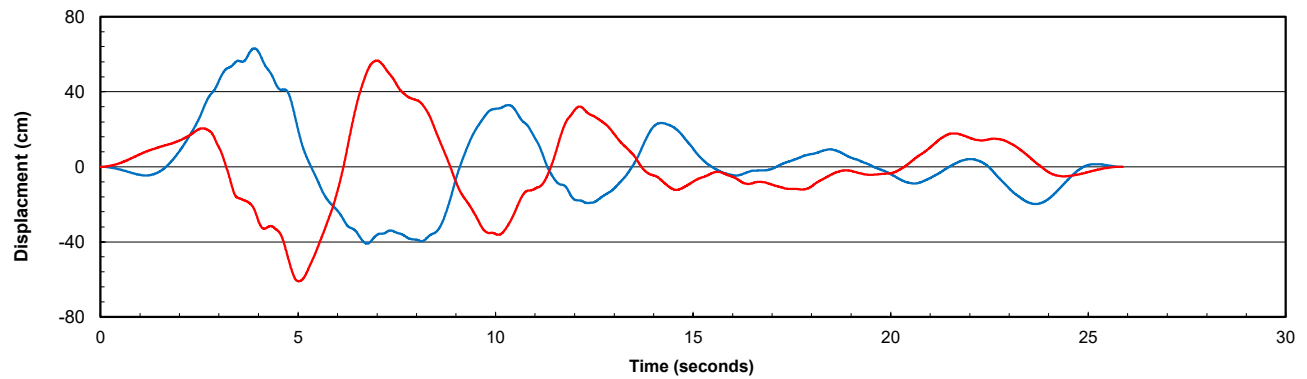
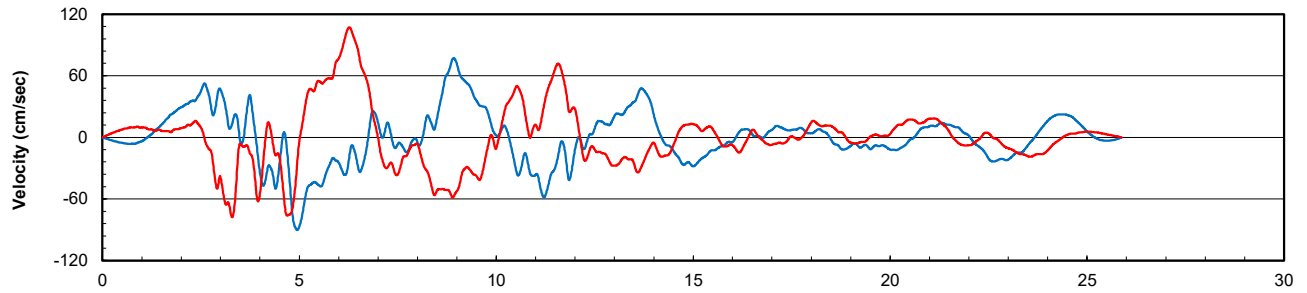
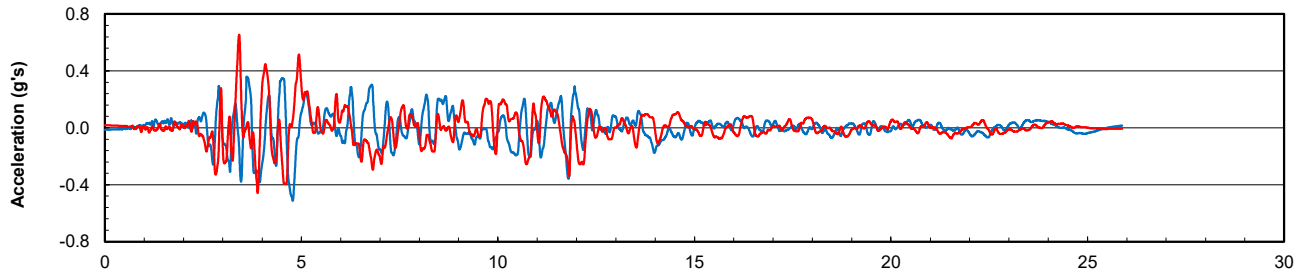

LANGAN

LANGAN ENGINEERING & ENVIRONMENTAL SERVICES, INC.
 135 Main Street, Suite 1500
 San Francisco, CA 94105
 T: 415.955.5200 F: 415.955.5201 www.langan.com

Project
5201 Patrick Henry Drive

 SANTA CLARA
 SANTA CLARA COUNTY CALIFORNIA

Figure Title
**COMPARISON OF TARGET
 SPECTRA MCER AND SCALED
 TIME SERIES AND SPECTRA
 DUZCE, TURKEY EARTHQUAKE
 DUZCE**

Project No.
 731769901
 Date
 7/21/23
 Scale
 AS SHOWN
 Prepared By:
 KM

Figure No.

F-17

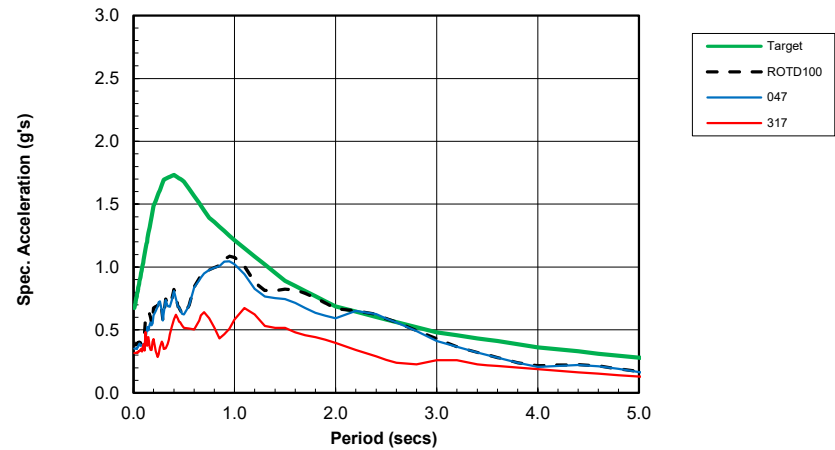
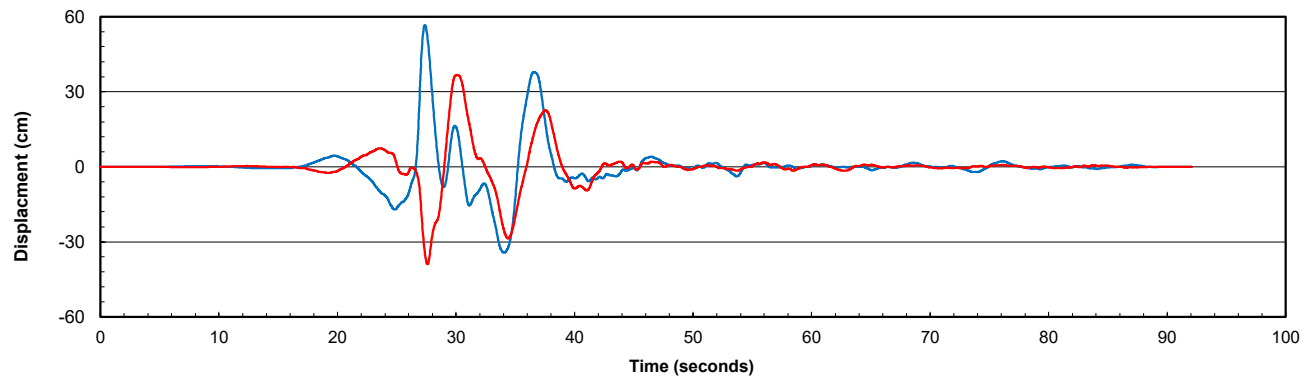
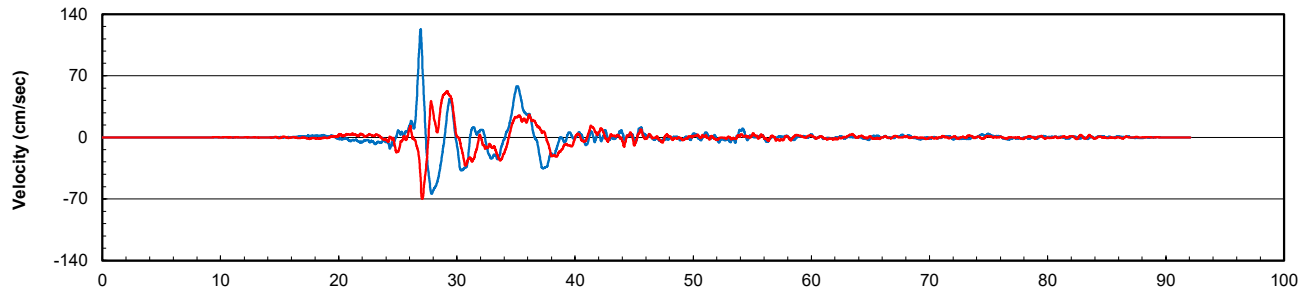
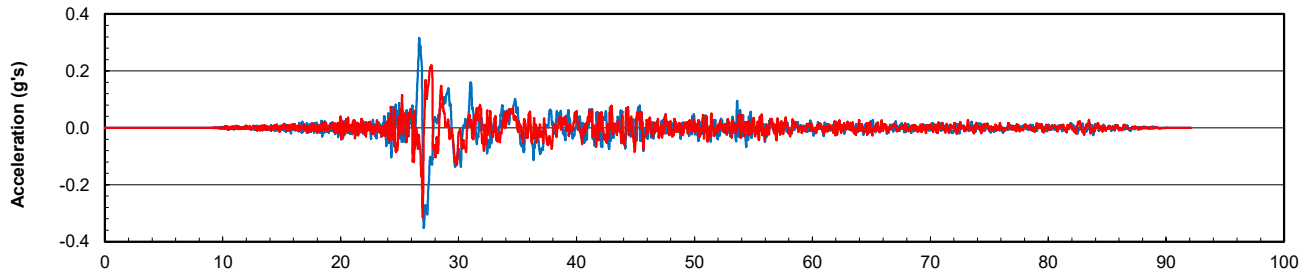

LANGAN
 LANGAN ENGINEERING & ENVIRONMENTAL SERVICES, INC.
 135 Main Street, Suite 1500
 San Francisco, CA 94105
 T: 415.955.5200 F: 415.955.5201 www.langan.com

Project
5201 Patrick Henry Drive

 SANTA CLARA
 SANTA CLARA COUNTY CALIFORNIA

Figure Title
**COMPARISON OF TARGET
 SPECTRA MCER AND SCALED
 TIME SERIES AND SPECTRA
 DENALI, ALASKA
 EARTHQUAKE TAPS PUMP
 STATION #10**

Project No.
 731769901
 Date
 7/21/23
 Scale
 AS SHOWN
 Prepared By:
 KM

Figure No.
F-18

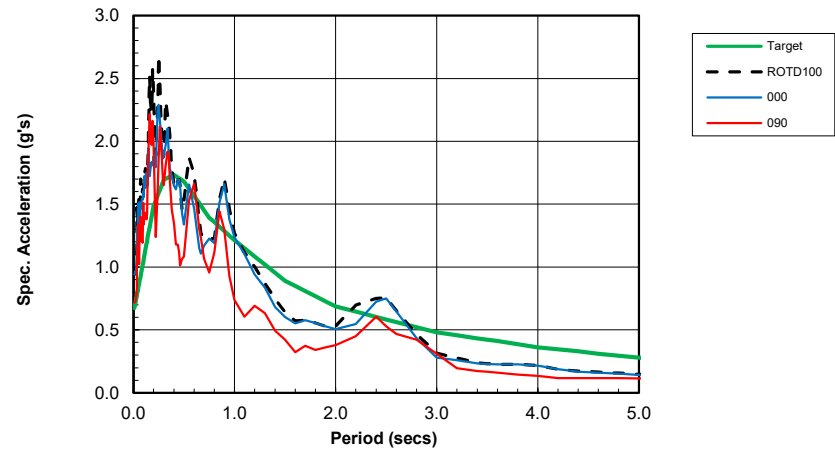
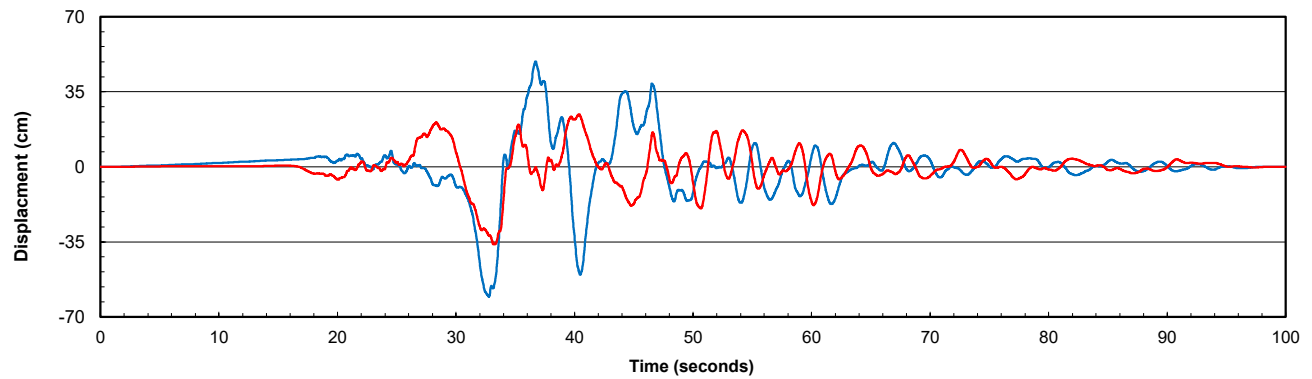
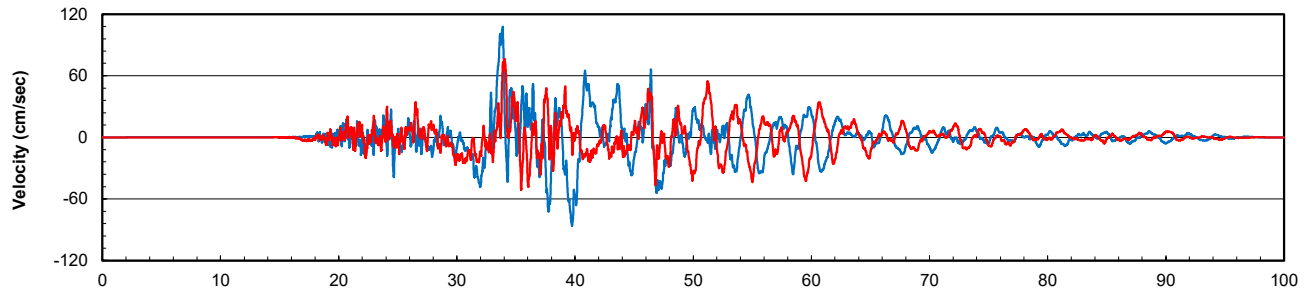
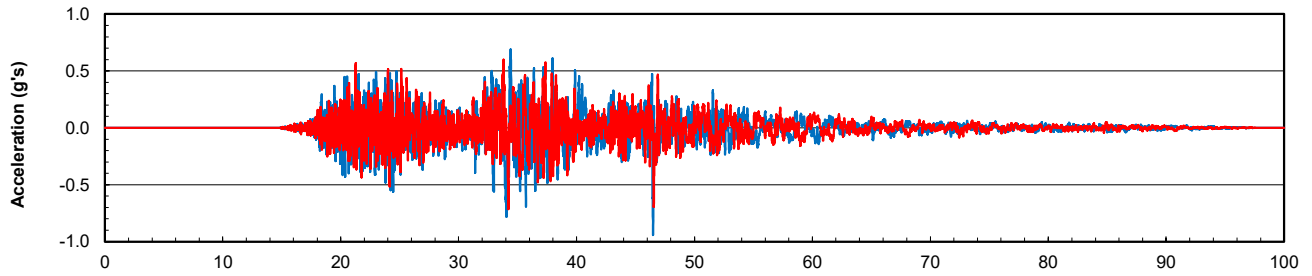

LANGAN
 LANGAN ENGINEERING & ENVIRONMENTAL SERVICES, INC.
 135 Main Street, Suite 1500
 San Francisco, CA 94105
 T: 415.955.5200 F: 415.955.5201 www.langan.com

Project
5201 Patrick Henry Drive

 SANTA CLARA
 SANTA CLARA COUNTY CALIFORNIA

Figure Title
COMPARISON OF TARGET SPECTRA MCER AND SCALED TIME SERIES AND SPECTRA EL MAYOR-CUCAPAH EARTHQUAKE MICHOACAN DE OCAMPO

Project No.
 731769901
 Date
 7/21/23
 Scale
 AS SHOWN
 Prepared By:
 KM

Figure No.
F-19

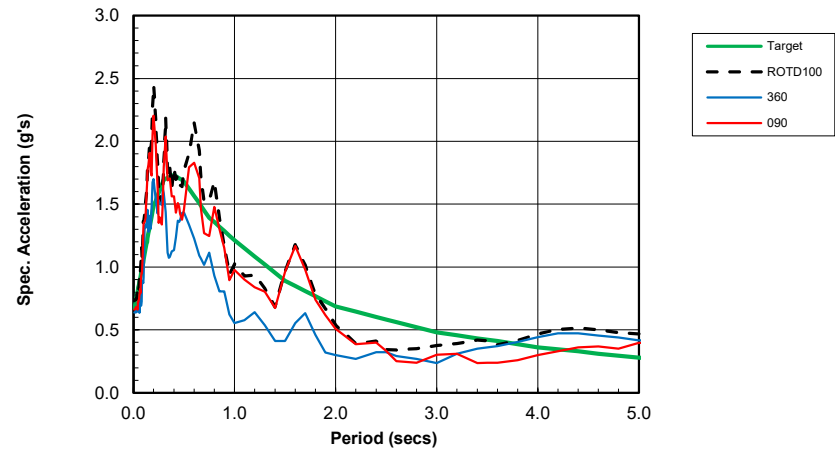
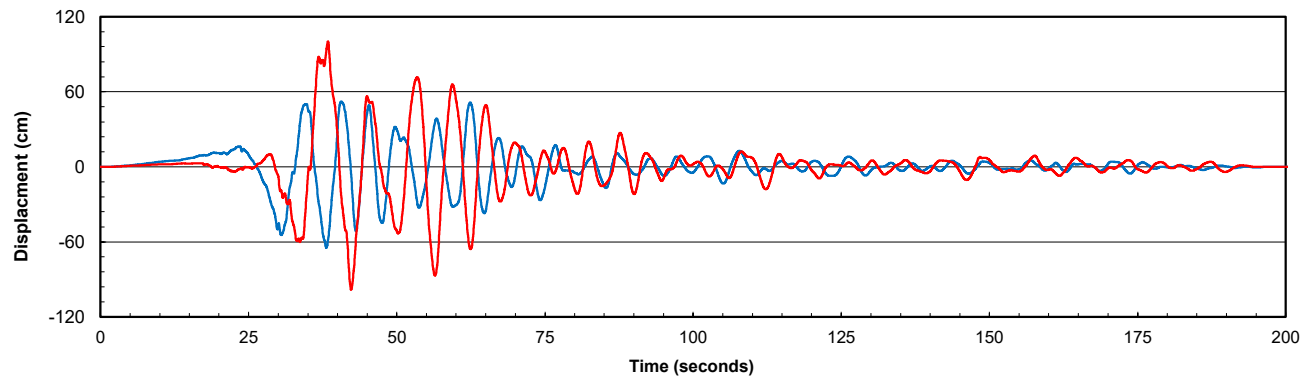
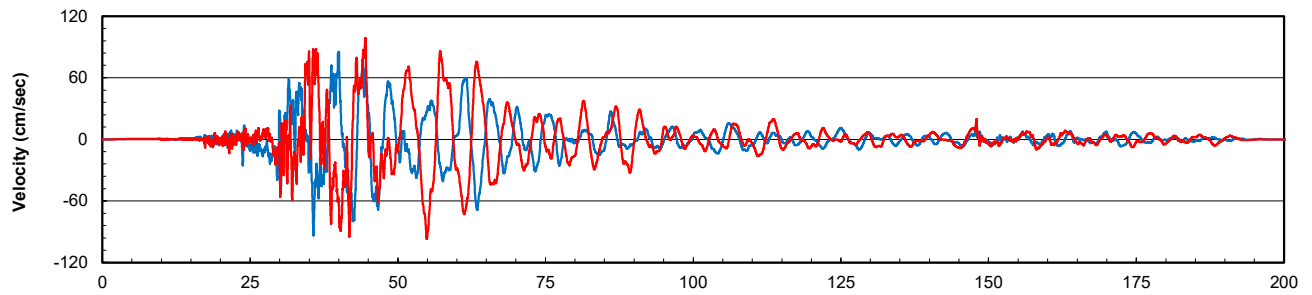
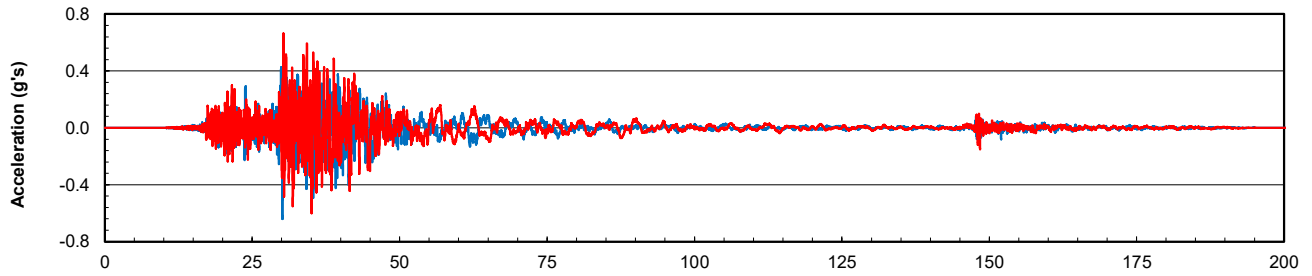

LANGAN

LANGAN ENGINEERING & ENVIRONMENTAL SERVICES, INC.
 135 Main Street, Suite 1500
 San Francisco, CA 94105
 T: 415.955.5200 F: 415.955.5201 www.langan.com

Project
5201 Patrick Henry Drive

 SANTA CLARA
 SANTA CLARA COUNTY CALIFORNIA

Figure Title
**COMPARISON OF TARGET
 SPECTRA MCER AND SCALED
 TIME SERIES AND SPECTRA EL
 MAYOR-CUCAPAH
 EARTHQUAKE CALEXICO FIRE
 STATION**

Project No.
 731769901
 Date
 7/21/23
 Scale
 AS SHOWN
 Prepared By:
 KM

Figure No.
F-20

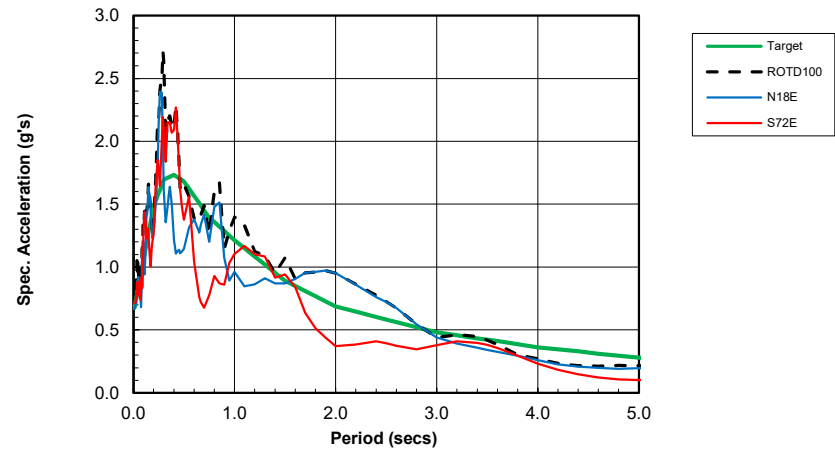
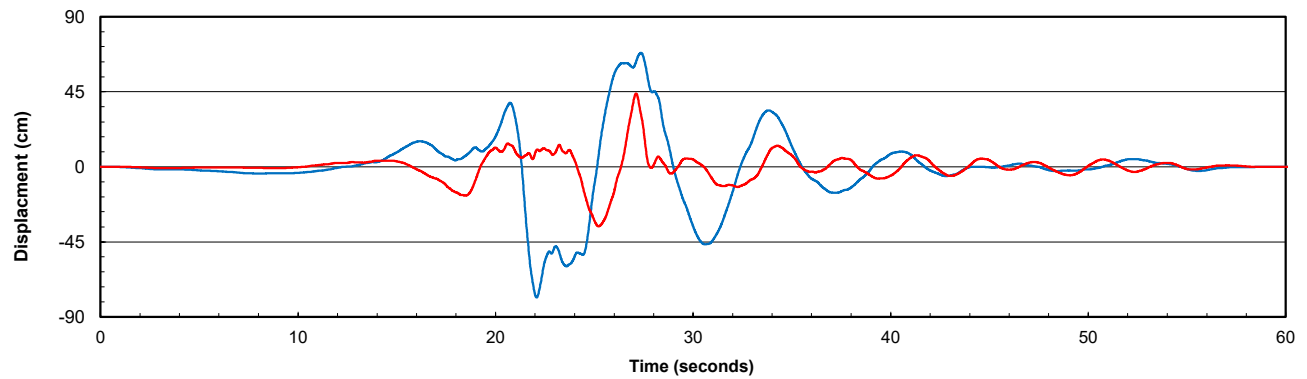
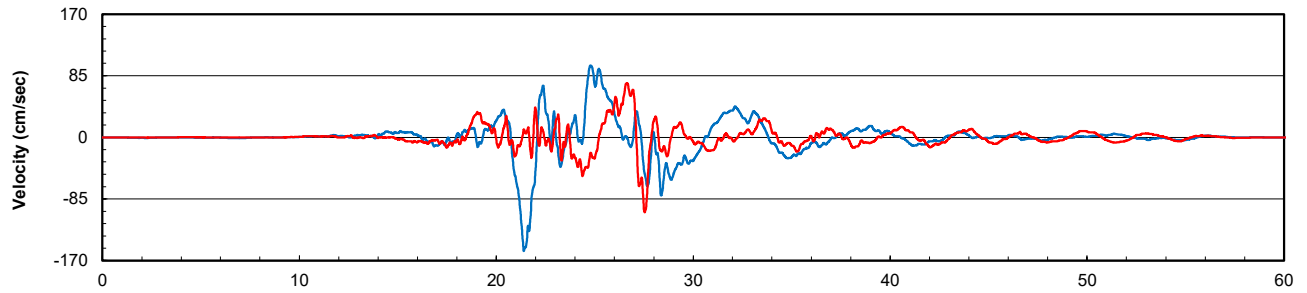
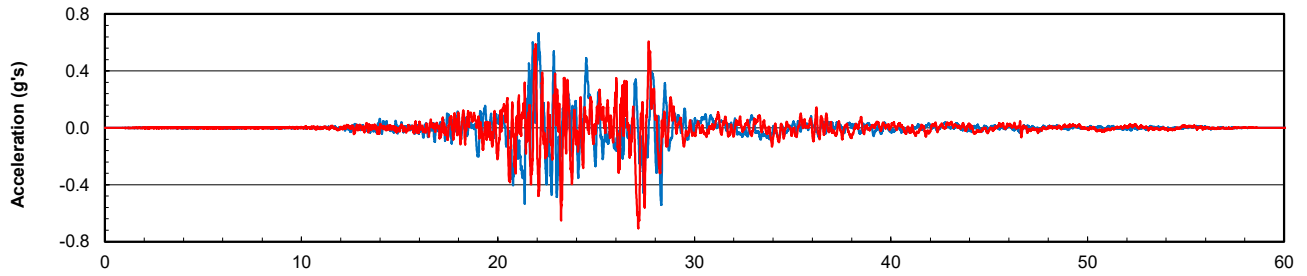

LANGAN

LANGAN ENGINEERING & ENVIRONMENTAL SERVICES, INC.
 135 Main Street, Suite 1500
 San Francisco, CA 94105
 T: 415.955.5200 F: 415.955.5201 www.langan.com

Project
5201 Patrick Henry Drive

 SANTA CLARA
 SANTA CLARA COUNTY CALIFORNIA

Figure Title
**COMPARISON OF TARGET
 SPECTRA MCER AND SCALED
 TIME SERIES AND SPECTRA
 DARFIELD, NEW ZEALAND
 EARTHQUAKE HORC**

Project No.
 731769901
 Date
 7/21/23
 Scale
 AS SHOWN
 Prepared By:
 KM

Figure No.
F-21

DISTRIBUTION

Electronic Copy: Ian Cunningham
DPR Construction
1510 S. Winchester Boulevard
San Jose, California 95128